



## GE Fastrac Program Service

### —Fastrac Fusible Bus Plugs:

Fastrac shipment of fusible plugs 30 through 200 amps for selected Spectra® Series, LowAmp Series, Armor-Clad, FVK, and Plug conversion kits. Shipment leaves the factory next business day after order is entered. Contact your local GE sales office for more details.

### —Fastrac Spectra® series LowAmp Bus:

Ask about Fastrac 2-week shipments for short, simple runs. Maximum of 200 feet of busway. Contact your local GE sales office for more details.

## New from GE!

—**MicroVersaTrip® Plus Trip Units** with 4WGF protection in bus plugs

### —**Joint-Guard Protection System:**

GE invention dynamically indicates proper torque with color. Means easy installation and easy maintenance!

—**Custom Colors** available for unique applications.

—**Style II Outdoor Spectra® Series Design** reduces joint installation time by 50% with improved joint cover spring-latch clamping system. This feature is also standard on splash-proof and drip-proof designs. Ask about the free installation DVD (DEV-066).

—**Weathershield Epoxy Joint Insulators** provided as standard on Style II Spectra® Series Outdoor (NEMA 3R) and Splash-proof designs (IP54 and IP65/66).

Busway Overview .....	11-2
Busway Short-Circuit Ratings .....	11-3
Busway Plug Short-Circuit Ratings.....	11-4
<b>Spectra® Series Busway, Sandwich Bus</b>	
Application and Pricing .....	11-5
Aluminum Conductors .....	11-9
Copper Conductors .....	11-13
Aluminum, Functional Pricing .....	11-21
Plus Bar Sizes .....	11-23
Straight Lengths and Fittings.....	11-25
<b>Spectra® RMS Busway, Sandwich Bus</b>	
Circuit Breaker Busway Plugs .....	11-26
Circuit Breaker with MicroVersaTrip® Plus Trip Units .....	11-31
<b>Spectra® Series Busway, Sandwich Bus</b>	
Plugs, Fusible, Conversion Kits.....	11-35
Plug Options .....	11-39
Reducer Cubicles and Special Adapters .....	11-41
Outlines, Dimensions and Weights.....	11-42
Power Takeoffs .....	11-49
<b>Spectra® Series Busway, Low Amp</b>	
Application and Product Numbers .....	11-53
Aluminum Conductors.....	11-55
Copper Conductors .....	11-59
Circuit Breaker Busway Plugs .....	11-67
Outlines, Dimensions and Weights.....	11-71

<b>Flex-A-Power® Busway</b>	
Aluminum Conductors.....	11-75
Copper Conductors .....	11-77
Type DH Plugs.....	11-79
Dimensions.....	11-82
<b>LW Busway</b>	
Replacement Parts, Application and Pricing.....	11-83
Replacement Parts, Dimensions.....	11-85
Type LTG Plug-in, Application and Pricing.....	11-87
Outlines and Dimensions .....	11-89
<b>Armor-Clad Busway</b>	
Transition Sections and Accessories Pricing.....	11-90
Busway Plugs Pricing .....	11-93
Options and Additions .....	11-98
<b>Flex-A-Power® Busway</b>	
Types FVA, FVK and LVDP, Application and Pricing.....	11-99
Busway Plugs Pricing.....	11-102
Outlines and Dimensions.....	11-105
<b>Type DE Busway</b>	
Plugs for Obsolete DE Busway, Pricing .....	11-106



General Electric is a world leader in busway manufacturing and design, providing a wide range of busway types available from 30 to 5000 amperes and up to 600 Volts ac.

GE busway has many advantages over wire and conduit:

- Lower total installed cost. Busway material costs are often equal or less than wire and conduit, and contractors can install busway in a fraction of the time.
- Lower life cycle cost. Busway components can be added, deleted, or relocated one month or even many years after the initial installation, saving time and money.
- Predictable characteristics. Busway systems conform to common standards. Consultants can use readily published data on busway short-circuit ratings, voltage drop, weights and dimensions in the planning stage of an electrical project.
- Can save considerable space in tight electrical closets and existing buildings.

## Busway Product Lines

- Spectra® Series**...225-5000 amperes
- Spectra® Series LowAmp**...225-800 amperes
- DH**...100 amperes
- LW**...(Replacement parts only)
- LTG**...50 amperes, 300 Volts ac/dc
- Armor-Clad**...(Replacement parts only)
- FVA/FVK**...225-1000 amperes
- LVD/LVDP**...(Replacement parts only)
- DNSP**...(Call GE Energy—Sales Office for information.)

## Usage Considerations

Busway is not designed for use in highly corrosive atmospheres such as battery rooms or in classified hazardous locations where it could be subject to mechanical damage. Busway is not designed to be embedded in the ground or in concrete and should be used only for exposed work. However, most inspection authorities consider the space above ceiling to be accessible, provided the ceiling panels are readily removable.

## Ambient Temperature

GE busway is rated based on a 55° hot spot temperature rise over a maximum ambient of 40°C. The busway should be derated for high ambient temperatures.

## Thermal Expansion

Give consideration to the effects of thermal expansion on busway runs. Compensation for thermal expansion is inherent in DH busway. For other busway types, expansion fittings may be necessary for long straight runs of 150 feet or more, particularly if the busway is not free to move at the ends of the run. The use of an expansion fitting is recommended when the busway run crosses a building expansion joint.

## Standards

There are published standards for all types of low-voltage busway. GE busway conforms to the latest revision of NEMA Standard BU 1, UL standard 857 Federal Specification W-B-811b, CSA. GE busway bears the UL label except where otherwise noted.

## High-Frequency Applications

GE busway can be used at higher than 60-cycle frequency, but in most cases it is necessary to derate the busway. In most busway, the voltage drop increases at higher frequencies.

## Short-Circuit Ratings

All busway with a UL label must be marked with a UL listed short-circuit rating. UL short-circuit ratings apply to “all” busway and associated fittings such as straight lengths, elbows, tees, tap boxes, power takeoffs, and plugs which are necessary for a busway installation. Ratings without a ground bar are established by tests which require the housing and housing joints to provide a satisfactory ground return.

The short-circuit rating of fittings with protective devices which are part of the busway, such as power takeoffs and reducers, is equal to the lower of the short-circuit rating of the protective device or the busway with which the fitting is used. For example, a fusible power takeoff rated with 200,000 amperes with Class J fuses when installed on a busway rated 65,000 amperes would have a rating of 65,000 amperes.

The short-circuit rating of a busway plug is equal to the short-circuit rating of the fuse or circuit breaker used in the plug.

## Busway Publications:

Spectra® Series Busway vs. Wire and Conduit	GEA-12111
Spectra® Series Busway	GET-7005E
Spectra® Series Busway Installation Instructions	DEH-40087C
Spectra® Series LowAmp Busway	GET-8063
Spectra® Series LowAmp Busway Installation Instructions	GEH-6436
Spectra® Series LowAmp Busway vs. Major Competitive Manufacturers	DEC-023
Spectra® Series LowAmp Busway Fact Sheet	DET-103
GE Type DH Plug-In or Feeder Busway	GET-9001A
GE Type DH Busway Installation Instructions	GEH-6437
Spectra® Series Busway—Short Time Heating Limits	GES-9508
Spectra® Series Busway, 600-5000 Amp Bus Bar Sizing	GEZ-7726
Spectra® Series Busway vs. Major Competitor Manufacturers	GEZ-7736
Labor Estimating Manual (Busway)	GEZ-7737
Insulation Integrity	DE-171
Spectra® Series Outdoor Busway	
Installation Video	DEV-051A
Installation DVD	DEV-066
Busway Tool Kit	DEU-060



# Busway Short-Circuit Ratings

## Spectra® Series Busway

### Short-Circuit Ratings Plug-In and Feeder

Amperage	Aluminum (kA) @				Copper (kA) @			
	3 Cycles	6 Cycles	1 Sec.	3* Secs.	3 Cycles	6 Cycles	1 Sec.	3* Secs.
225	50	50	24	14	50	50	36	21
400	85	85	24	14	50	50	36	21
600	85	85	24	14	85	85	36	21
800	100	100	42	24	85	85	36	21
1000	100	100	50	29	100	100	51	29
1200	125	125	62	36	100	100	65	37
1350	150	150	84	49	100	100	76	44
1600	150	150	95	55	125	125	95	55
2000	150	150	121	70	150	150	129	75
2500	200	200	132	76	150	150	162	107
3000	200	200	169*	97	200	200	191*	110
4000	200	200	200*	140	200	200	200*	149
5000	—	—	—	—	200	200	200*	200

\*Ratings based on calculated values

## Spectra® LowAmp Busway

### Plug-In and Feeder Bus

Amp Rating	Aluminum (kA) @			Copper (kA) @		
	3 Cycles	1 Sec.	3 Secs.	3 Cycles	1 Sec.	3 Secs.
225	30	11	6	30	17	10
400	42	17	10	30	17	10
600	50	28	16	42	25	15
800	50	50	29	50	42	24

## Flex-A-Power® Type DH Busway<sup>3</sup>

Type DH Busway has been tested in accordance with NEMA test procedures, to a maximum short-circuit rating of 14,000 rms amperes symmetrical. When properly protected by a maximum 100 ampere UL listed Class K-1, K-5, or J fuses, the DH Busway may be applied to a system with a short-circuit available up to the UL listed short-circuit rating of the fuses.

<sup>3</sup>The adjustable straight length is rated 10 kA.

## Maximum Fuse Sizes for Increased Short-Circuit Protection

Amperage	Max "L" Fuse Sizes For Increased Short-Circuit Rating			
	Aluminum	Copper	@100 kA	@200 kA
225	225	225	1200 <sup>1</sup>	800 <sup>1</sup>
400	400	400	1200 <sup>1</sup>	800 <sup>1</sup>
—	—	600	1200 <sup>1</sup>	800 <sup>1</sup>
600	800	800	2000 <sup>1</sup>	1200 <sup>1</sup>
—	—	1000	—	2000 <sup>1</sup>
800	1200	1200	—	2500 <sup>1</sup>
1000	1350	1350	—	2500 <sup>1</sup>
1200	1600	1600	—	3000 <sup>1</sup>
1350	2000	2000	—	4000 <sup>1</sup>
1600	—	—	—	4000 <sup>1</sup>
2000	2500	2500	—	4000 <sup>1</sup>

<sup>1</sup>Also 600J, 800T or 400R.

## Maximum Fuse Sizes for Increased Short-Circuit Protection

Amperage	Max. Fuse Sizes For Increased Short-Circuit Rating					
	@100 kA			@200 kA		
	Class J	Class T	Class R	Class J	Class T	Class R
Aluminum						
225	600	800	100	400	400	200
400	600	800	400	600	800	400
600	600	800	600	600	800	400
800	600	800	600	600	800	400
Copper						
225	600	800	200	400	400	200
400	600	800	200	400	400	200
600	600	800	400	600	800	400
800	600	800	600	600	800	400



## Fusible Switch Busway Plugs

Fusible switches in all busway fittings (plugs, power takeoffs, and reducers) have the following short-circuit ratings when used with the fuses shown. To qualify for R fuse rating, switches must have R fuse clips which reject other type fuses. The interrupting rating of the fuse must equal or exceed the short-circuit rating of the switch. It is lower than the short-circuit rating of the switch, then the combination has the rating of the fuse.

Switch Type	Switch Ampere Rating	Fuse		Interrupting Rating Amperes rms Symmetrical 240 and 480 Volts
		UL Class	Description	
QMR	30 to 1200	H	One Time	10,000
QMR	30 to 1200	K5	High Interrupting	10,000
QMR	30 to 1200	K1	High Interrupting	10,000
QMR	30 to 1200	J	Current Limiting	200,000
QMR	30 to 1200	R	Current Limiting	200,000
QMR	30 to 1200	L	Current Limiting	200,000

## Spectra® RMS Circuit Breaker IC Ratings (rms sym. kA)

Frame Type	240 V	480 V	600 V
SED	18	14	14
SEH	65	25	18
SEL	100	65	25
SEP	200	100	25
SFH	65	25	18
SFL	100	65	25
SFP	200	100	25
SGH4	65	35	25
SGL4	100	65	65
SGP4	200	100	65
SGH6	65	35	25
SGL6	100	65	65
SGP6	200	100	65
SKH	65	50	25
SKL	100	65	42
SKP	200	100	65

## Circuit Breaker Busway Plugs

Construction	Spectra <sup>1</sup> Frame Type	Trip Range (Amps)	Old Frame Type	Trip Range (Amps)	Spectra® Frame <sup>2</sup> IC Ratings			Old Frame IC Ratings			
					240 V	480 V	600 V	240 V	480 V	600 V	
Standard Frames	-	-	TEB	15-100	-	-	-	10	-	-	
	SED	15-150	TED4	15-100	18	14	14	18	14	-	
	SED	15-150	TED6	15-100	18	14	14	18	14	14	
	SFH	70-250	TFJ	70-225	65	25	18	25	22	18	
	SFH	70-250	TFK	70-225	65	25	18	25	22	18	
	SGH4	125-400	TJJ	125-400	65	35	25	42	30	22	
	SGH4	125-400	TJK4	125-400	65	35	25	42	30	22	
	SGH6	250-600	TJK6	250-600	65	35	25	42	30	22	
	SGH6	250-600	TJ4V	150-600	65	35	25	42	30	22	
	SKH	300-800	TKM8	300-800	65	50	25	42	30	22	
	SKH	300-800	TK4V	800	65	50	25	42	30	22	
	Hi-Break Frames	SEH	15-150	THED	15-100	65	25	18	65	25	18
		SFH	70-250	THFK	70-225	65	25	18	65	25	18
SGH4		125-400	THJK4	125-400	65	35	25	65	35	25	
SGH6		250-600	THJK6	400-600	65	35	25	65	35	25	
SGH6		250-600	THJ4V	150-600	65	35	25	65	35	25	
SGH6		250-600	TJH	150-600	65	35	25	65	35	25	
SKH		300-800	THKM8	300-800	65	60	25	65	35	25	
SKH		300-800	TKH	300-800	65	50	25	65	50	25	
Fuseless Current Limiting		SEP	15-150	THLC1 <sup>3</sup>	15-100	200	100	25	200	150	-
		SFP	70-250	THLC2 <sup>3</sup>	125-225	200	100	25	200	150	-
	SGP4	125-400	THLC4 <sup>3</sup>	225-400	200	100	65	200	150	-	
	SGP6	250-600	-	-	200	100	65	-	-	-	
High Interrupting	SFL	15-150	TEL <sup>3</sup>	15-100	100	65	25	100	65	25	
	SFL	70-250	TFL <sup>3</sup>	125-225	100	65	25	100	65	25	
	SGL4	125-400	TLB4 <sup>3</sup>	250-400	100	65	65	85	50	-	
	SGL6	250-600	TJL4V	150-600	100	65	65	100	65	30	
	SGL6	250-600	TJL	150-600	100	65	65	100	65	30	
	SKL	300-800	TKL4V	400-800	100	65	65	100	65	42	
Tri-Break® Interrupting	-	-	TKL	800	100	65	65	100	65	42	
	-	-	TB1	15-100	-	-	-	200	200	200	
	-	-	TB4	125-400	-	-	-	200	200	200	
	-	-	TB6	300-600	-	-	-	200	200	200	
-	-	TB8	600-800	-	-	-	200	200	200		

<sup>1</sup>Spectra® RMS Circuit Breakers UL listed for Spectra® Series Busway only.

<sup>2</sup>UL listed interrupting ratings in thousand amperes rms symmetrical ac volts.

<sup>3</sup>Discontinued; replaced by Spectra® Frame Type.





**UL Fire-Stop System**

UL listed three-hour fire-stop barrier is now available for use with GE Busway systems. The system is listed in the UL Fire Resistance Directory under section 3L73—Through-Penetration Fire-Stop Systems. In addition to the three-hour test, the system has met the criteria of ASTM E814 (UL1479).

The contractor installs a mineral wool batt (4 PCF Nominal) as shown below, on-site during the busway installation process. For riser applications, the system is used in combination with a standard GE spring hanger and floor flange. For horizontal applications, the system is used in combination with two wall flanges (one per side).

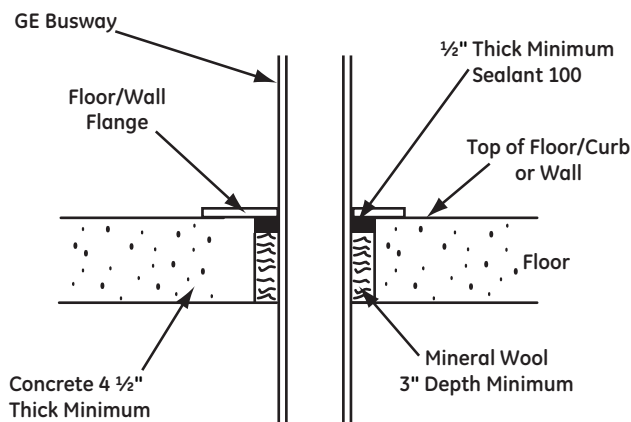

**Note:** The Busway cover plate and sealant is required on both sides for wall installation.

**Cubic Inches Required per Floor and Wall**

Amperage	SEALANT 100 FLOOR		SEALANT 100 WALL	
	Al	Cu	Al	Cu
225-600	17	17	34	34
800	21	17	42	34
1000	22	18	44	42
1200	23	20	46	44
1350	27	22	54	46
1600	28	23	56	54
2000	33	27	66	56
2500	46	33	92	66
3000	53	44	106	92
4000	66	53	132	106
5000		66		132

**List Prices**

Description	Container	Product Number	List Price, GO-126S
Sealant 100	19 cu. in.-Tube	SBFB100	<b>\$110.00</b>

You have two options for ordering the fire-stop material:

1. With initial busway purchase. Use the product numbers listed above and the fire-stop material will be shipped in a specially marked box directly to the job site with the busway.
2. Through 1-800-GE 1-STOP or an authorized GE Silicones Distributor. Recommended for fill-in (if needed) after initial purchase.

This information is provided as a guideline for typical fire-stop systems. If you have an annulus (or opening) greater than 1" beyond the busway enclosure, you will need to determine the proper amount of fire-stop material based on the illustration on this page. Quantities are based on application of recommended amount of material; more may be required if over-application occurs.



**Spectra® Series Busway Seismic Certification Facts Zone 4**

**General**

The complete standard commercial offering of Spectra® Series Busway is certified for ZONE 4 Seismic conditions as witnessed and approved (by the tests performed) at Wyle Laboratories, Huntsville, Alabama.

**Busway Configurations**

Both vertical riser and horizontal sections of Spectra® Series Busway were certified to Zone 4 Seismic conditions. The maximum acceptable parameters are:

Maximum Acceptable Parameters	Vertical Riser Configuration	Horizontal Configuration <sup>1</sup>
Acceptable Orientations		Edgewise & Flatwise
Maximum Ratings	2500A Max Copper 4000A Max Aluminum	5000A Max Copper 4000A Max Aluminum
Maximum Voltage	600 V Max	600 V Max
Service	3- & 4-Wire	3- & 4-Wire
Distribution	Plug-In & Feeder	Plug-In & Feeder
Hangers	Standard Floor Flange Kit with Standard Spring Hanger Assembly	Standard Hanger System using <b>TRAPEZE HANGERS &amp; CLIPS ONLY</b>
Maximum Hanger Spacing	12 feet	10 feet
Full Threaded Drop Rods	Standard 1/2" Rods	Standard 1/2" Rods
Drop Rod Connection <sup>1</sup>	Not Applicable	Must be <b>BOLTED</b> through Ceiling/Floor using standard hardware. <sup>1</sup>
Distribution Equipment Connection (Pbd., Swbd, Swgr, MCC, etc.)	Standard Flanged-End Stub-Special Hardware & Connections NOT required.	Standard Flanged-End Stub-Special Hardware & Connections NOT required.
Bus Plugs	All Types Acceptable	All Types Acceptable
Fittings	All Types Acceptable	All Types Acceptable
Cable Tap Boxes	All Types Acceptable	All Types Acceptable
End Boxes	All Types Acceptable	All Types Acceptable
Acceptable Applications & Constructions	Indoor, Drip-Proof, Splash Proof & Outdoor	Indoor, Drip-Proof, Splash Proof & Outdoor
Proximity To Walls	Standard 1"	Standard 1"

<sup>1</sup> Drop rods "must" be bolted through ceiling/floor and secured on both sides with standard washers and nuts.

**Summary**

These parameters for ZONE 4 seismic conditions are identical to the standard commercial offering of Spectra® Series Busway. **Therefore, Spectra® Series Busway can be used in applications ranging up to ZONE 4 seismic conditions without restrictions, special bracing, connections, or hangers.** Plus, Spectra® Series Busway can connect to equipment (panelboards, switchboards, motor control centers, switchgear, etc.) using standard flanged end stubs, cable tap boxes, and bus plugs.

**Features/Benefits**

**Easy Install:**

**New Joint-Guard protection system**—dynamically indicates proper torque through color! Easy install and maintenance!

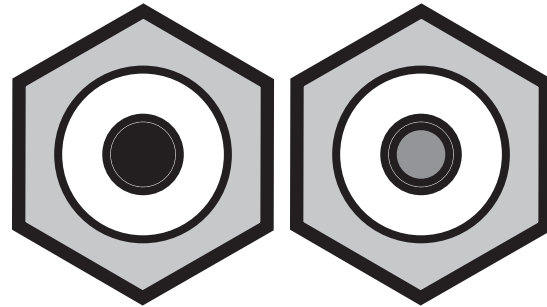

**Tight Joint**

**Loose Joint**

- Lighter Weight**—means it installs faster than other busways and beats wire and conduit for total installed cost.
- Single Drop-Rod Hanger**—per 10-foot section (up to 2500 Al/1600 Cu amps) ensures easy, fast installation.
- Field-Adjustable Isolation Joint**—(± 1/2" per joint) provides on-site flexibility.
- Plug-Assist**—and plug position locator ensure fast, safe, accurate plug installation.
- 5-Day Check Piece Program**—allows you to order busway before you know exact equipment locations. Contact your local Sales Engineer for details.

**Performance/Protection/Maintenance:**

- Exclusive BlueCoat™ epoxy insulation**—(Class B, UL 130°C) provides the industry's best protection (50 years and beyond).
- Earth-Bond Integrated Grounding System**—provides a lower resistance ground path than internal ground bars.
- Highest Short-Circuit Ratings**—mean protection and application flexibility.
- Belleville Spring Washer**—the industry's best, retains over 90% of original contact pressure, offering a maintenance-free joint if torqued properly.

**Applications:**

- Outdoor Design**—exclusively meets the industry's highest outdoor rating. Also meets IP40, IP43, IP54, IP65, IP66. Replaces existing design.
- Std. Outdoor**—with condensation "weep holes" is IP54.
- Outdoor**—is IP65/66.
- Seismic Zone 4 Approved**—with no special requirements.
- Optional UL Listed Fire-Stop**—provides easy code compliance.
- TVSS Bus Plugs**—now available for sensitive applications.

**Available Ratings**

Amperes:	225 to 5000 amperes AC / up to 8000 amperes DC
Voltage:	600 Volts or less
Busing:	Aluminum or Copper
Systems:	3-phase, 3-wire and 3-phase, 4-wire (full neutral)
Enclosures:	Indoor, drip-proof, splash proof and outdoor



**Critical Pricing Notes**

**Pricing Methods**

**Product Number Pricing**—Use product numbers from 11-9 through 11-20, or create product numbers from tables on 11-8 and 11-21 through 11-24.

**Functional Pricing**—For more engineered jobs use pricing per foot (or fraction) on pages 11-21 through 11-24. Prices include material, joint hardware and one std. hanger per 10 feet of bus.

**Price Adders**

**Joint-Guard Protection System**—is a 2% to 4% adder for most ampere ratings. (See pages 11-21 through 11-24 for details.) Standard joint bolt is double headed bolt.

**Custom Colors**—available for 10% adder (bus housing or plug cover only), or 15% adder (complete bus, tap boxes, plugs).

**50% Internal Ground Bar Adder**—for copper and aluminum bus.

**NOTE:** GE's Earth-Bond integrated housing ground system provides a lower resistance ground than internal ground bars!

**Silver Plating**—on copper conductor bars is available for a 15% price adder. (Although not technically beneficial.)

**TVSS**—(Trans voltage surge suppression) plugs are available for sensitive applications. Call GE Industrial Systems Sales Office for pricing and details.

**Elbow Prices**—are for 90° elbows only. **Double the price for angles greater than 90°.** (Angles less than 90° not available.)

**Tap Boxes**—Double price for nonstandard dimensions.

**Special Connections**—Contact factory for pricing. (Including utility company vault connections, special transformer terminations, etc.).

**Fitting Adders**—include the labor of forming and joint hardware only. **Price Busway footage completely through fittings.**

**Transition Pieces**—for Spectra® to Spectra® LowAmp (or Armor-Clad to Spectra®) are priced as bus footage, with an unfused reducer cost for each transition.

**Hangers**—One hanger is included with straight lengths or cable tap boxes at no charge. Product number orders must specify desired hanger product number.

**Reducer Fittings, Crosses, and T's**—are priced based on highest ampacity busway entering the device.

**Cable Tap Boxes**—include mechanical lugs as standard. Compression lugs are an optional price adder.

**Flanged-Ends**—allow connecting busway to non-GE equipment (supplied with or without lugs). When lugs are required, mechanical lugs are standard; compression lugs are optional.

**Switchboard/Switchgear Stub Prices**—include the flange, bus extension, phase collection and other hardware to connect bus to GE equipment. For other GE or non-GE equipment, use flanged ends, or contact your local GE Energy Sales Office.

**Transformer Throat Connection**—includes the necessary rigid connectors, steel enclosure and busway flange to connect to GE transformers. Double the list price for non-GE transformers.

**Vault Connection**—may be priced the same as a transformer throat connection.

**Expansion Sections**—are available in 4-foot lengths only, and allow a movement of 1 or 2 inches.

**Flange Prices**—include flanges on 1 side of a wall or floor only.

**Transformer Taps**—may be used indoors or outdoors. When used outdoors and priced as weatherproof busway, it may be used as a weather head on a service entrance run.

**Custom Packaging**—Add 5%. (Includes export packing.)

**FOB Destination**—Add 2% but not less than \$500 net.



**Spectra® Series Busway Product Numbering System**

For list price calculations, use functional pricing shown on pages 11-21 through 11-24.

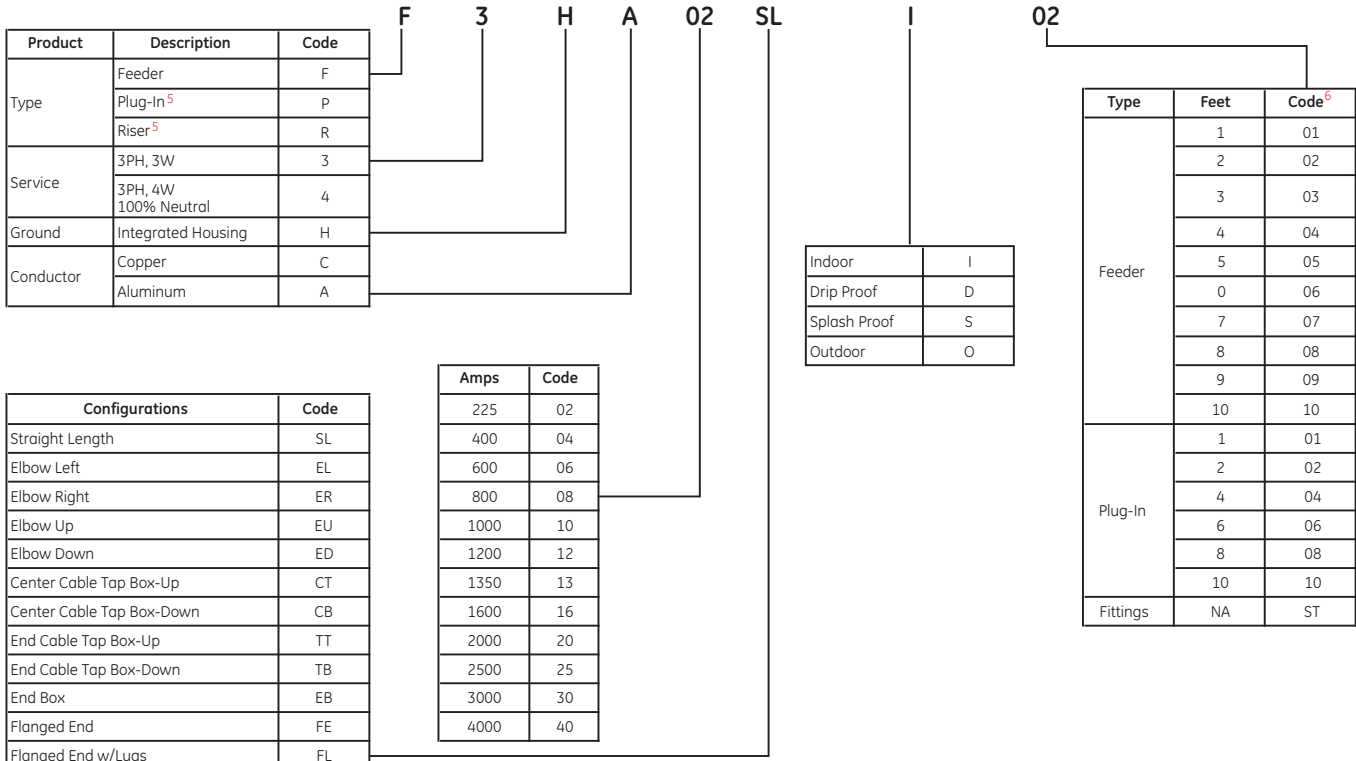

<sup>5</sup> Straight lengths only.

<sup>6</sup> Code 01 suffix for order entry purposes only. Minimum length 2'-0".



**225 Amps Three-Phase, Three-Wire  
 Integrated Housing Ground**

Component	Type	Product Number	List Price GO-126S
Linear Lengths	10-ft. plug-in	P3HA02SLI10	\$1320.00
Linear Lengths	10-ft. feeder	F3HA02SLI10	\$1210.00
Linear Lengths	10-ft. riser	R3HA02SLI10	\$1270.00
Fitting	Elbows; Left	F3HA02ELIST	\$650.00
Fitting	Elbows; Right	F3HA02ERIST	\$650.00
Fitting	Elbows; Up	F3HA02EUIST	\$609.00
Fitting	Elbows; Down	F3HA02EDIST	\$609.00
Accessories	End Cable Tap Box (Up)	F3HA02TTIST	\$1054.00
Accessories	End Cable Tap Box (Dn)	F3HA02TBIST	\$1054.00
Accessories	Center Cable Tap Box (Up)	F3HA02CTIST	\$1098.00
Accessories	Center Cable Tap Box (Dn)	F3HA02CBIST	\$1098.00
Accessories	End Box	F3HA02EBIST	\$128.00
Accessories	Flanged End w/ Lugs	F3HA02FLIST	\$932.00
Accessories	Flanged End	F3HA02FEIST	\$764.00

**800 Amps Three-Phase, Three-Wire  
 Integrated Housing Ground**

Component	Type	Product Number	List Price GO-126S
Linear Lengths	10-ft. plug-in	P3HA08SLI10	\$1540.00
Linear Lengths	10-ft. feeder	F3HA08SLI10	\$1430.00
Linear Lengths	10-ft. riser	R3HA08SLI10	\$1490.00
Fitting	Elbows; Left	F3HA08ELIST	\$694.00
Fitting	Elbows; Right	F3HA08ERIST	\$694.00
Fitting	Elbows; Up	F3HA08EUIST	\$645.00
Fitting	Elbows; Down	F3HA08EDIST	\$645.00
Accessories	End Cable Tap Box (Up)	F3HA08TTIST	\$1150.00
Accessories	End Cable Tap Box (Dn)	F3HA08TBIST	\$1150.00
Accessories	Center Cable Tap Box (Up)	F3HA08CTIST	\$1202.00
Accessories	Center Cable Tap Box (Dn)	F3HA08CBIST	\$1202.00
Accessories	End Box	F3HA08EBIST	\$128.00
Accessories	Flanged End w/ Lugs	F3HA08FLIST	\$1351.00
Accessories	Flanged End	F3HA08FEIST	\$847.00

**400 Amps Three-Phase, Three-Wire  
 Integrated Housing Ground**

Component	Type	Product Number	List Price GO-126S
Linear Lengths	10-ft. plug-in	P3HA04SLI10	\$1320.00
Linear Lengths	10-ft. feeder	F3HA04SLI10	\$1210.00
Linear Lengths	10-ft. riser	R3HA04SLI10	\$1270.00
Fitting	Elbows; Left	F3HA04ELIST	\$650.00
Fitting	Elbows; Right	F3HA04ERIST	\$650.00
Fitting	Elbows; Up	F3HA04EUIST	\$609.00
Fitting	Elbows; Down	F3HA04EDIST	\$609.00
Accessories	End Cable Tap Box (Up)	F3HA04TTIST	\$1054.00
Accessories	End Cable Tap Box (Dn)	F3HA04TBIST	\$1054.00
Accessories	Center Cable Tap Box (Up)	F3HA04CTIST	\$1098.00
Accessories	Center Cable Tap Box (Dn)	F3HA04CBIST	\$1098.00
Accessories	End Box	F3HA04EBIST	\$128.00
Accessories	Flanged End w/ Lugs	F3HA04FLIST	\$1100.00
Accessories	Flanged End	F3HA04FEIST	\$764.00

**1000 Amps Three-Phase, Three-Wire  
 Integrated Housing Ground**

Component	Type	Product Number	List Price GO-126S
Linear Lengths	10-ft. plug-in	P3HA10SLI10	\$1650.00
Linear Lengths	10-ft. feeder	F3HA10SLI10	\$1540.00
Linear Lengths	10-ft. riser	R3HA10SLI10	\$1600.00
Fitting	Elbows; Left	F3HA10ELIST	\$716.00
Fitting	Elbows; Right	F3HA10ERIST	\$716.00
Fitting	Elbows; Up	F3HA10EUIST	\$664.00
Fitting	Elbows; Down	F3HA10EDIST	\$664.00
Accessories	End Cable Tap Box (Up)	F3HA10TTIST	\$1220.00
Accessories	End Cable Tap Box (Dn)	F3HA10TBIST	\$1220.00
Accessories	Center Cable Tap Box (Up)	F3HA10CTIST	\$1275.00
Accessories	Center Cable Tap Box (Dn)	F3HA10CBIST	\$1275.00
Accessories	End Box	F3HA10EBIST	\$128.00
Accessories	Flanged End w/ Lugs	F3HA10FLIST	\$1418.00
Accessories	Flanged End	F3HA10FEIST	\$914.00

**600 Amps Three-Phase, Three-Wire  
 Integrated Housing Ground**

Component	Type	Product Number	List Price GO-126S
Linear Lengths	10-ft. plug-in	P3HA06SLI10	\$1320.00
Linear Lengths	10-ft. feeder	F3HA06SLI10	\$1210.00
Linear Lengths	10-ft. riser	R3HA06SLI10	\$1270.00
Fitting	Elbows; Left	F3HA06ELIST	\$650.00
Fitting	Elbows; Right	F3HA06ERIST	\$650.00
Fitting	Elbows; Up	F3HA06EUIST	\$609.00
Fitting	Elbows; Down	F3HA06EDIST	\$609.00
Accessories	End Cable Tap Box (Up)	F3HA06TTIST	\$1054.00
Accessories	End Cable Tap Box (Dn)	F3HA06TBIST	\$1054.00
Accessories	Center Cable Tap Box (Up)	F3HA06CTIST	\$1098.00
Accessories	Center Cable Tap Box (Dn)	F3HA06CBIST	\$1098.00
Accessories	End Box	F3HA06EBIST	\$128.00
Accessories	Flanged End w/ Lugs	F3HA06FLIST	\$1110.00
Accessories	Flanged End	F3HA06FEIST	\$764.00

**1200 Amps Three-Phase, Three-Wire  
 Integrated Housing Ground**

Component	Type	Product Number	List Price GO-126S
Linear Lengths	10-ft. plug-in	P3HA12SLI10	\$1870.00
Linear Lengths	10-ft. feeder	F3HA12SLI10	\$1760.00
Linear Lengths	10-ft. riser	R3HA12SLI10	\$1820.00
Fitting	Elbows; Left	F3HA12ELIST	\$760.00
Fitting	Elbows; Right	F3HA12ERIST	\$760.00
Fitting	Elbows; Up	F3HA12EUIST	\$700.00
Fitting	Elbows; Down	F3HA12EDIST	\$700.00
Accessories	End Cable Tap Box (Up)	F3HA12TTIST	\$1326.00
Accessories	End Cable Tap Box (Dn)	F3HA12TBIST	\$1326.00
Accessories	Center Cable Tap Box (Up)	F3HA12CTIST	\$1513.00
Accessories	Center Cable Tap Box (Dn)	F3HA12CBIST	\$1513.00
Accessories	End Box	F3HA12EBIST	\$128.00
Accessories	Flanged End w/ Lugs	F3HA12FLIST	\$1693.00
Accessories	Flanged End	F3HA12FEIST	\$1021.00

**Aluminum, Three-Wire, Housing Ground**



# Busway Spectra® Series Busway (continued)

Sandwich Bus  
Aluminum Conductors  
Product Number Pricing

# Section 11

## 1600 Amps Three-Phase, Three-Wire Integrated Housing Ground

Component	Type	Product Number	List Price GO-126S
Linear Lengths	10-ft. plug-in	P3HA16SLI10	\$2530.00
Linear Lengths	10-ft. feeder	F3HA16SLI10	\$2420.00
Linear Lengths	10-ft. riser	R3HA16SLI10	\$2480.00
Fitting	Elbows; Left	F3HA16ELIST	\$1267.00
Fitting	Elbows; Right	F3HA16ERIST	\$1267.00
Fitting	Elbows; Up	F3HA16EUIST	\$943.00
Fitting	Elbows; Down	F3HA16EDIIST	\$943.00
Accessories	End Cable Tap Box (Up)	F3HA16TTIST	\$1647.00
Accessories	End Cable Tap Box (Dn)	F3HA16TBIST	\$1647.00
Accessories	Center Cable Tap Box (Up)	F3HA16CTIST	\$1900.00
Accessories	Center Cable Tap Box (Dn)	F3HA16CBIST	\$1900.00
Accessories	End Box	F3HA16EBIST	\$157.00
Accessories	Flanged End w/ Lugs	F3HA16FLIST	\$2119.00
Accessories	Flanged End	F3HA16FEIST	\$1279.00

## 3000 Amps Three-Phase, Three-Wire Integrated Housing Ground

Component	Type	Product Number	List Price GO-126S
Linear Lengths	10-ft. plug-in	P3HA30SLI10	\$4840.00
Linear Lengths	10-ft. feeder	F3HA30SLI10	\$4730.00
Linear Lengths	10-ft. riser	R3HA30SLI10	\$4790.00
Fitting	Elbows; Left	F3HA30ELIST	\$2056.00
Fitting	Elbows; Right	F3HA30ERIST	\$2056.00
Fitting	Elbows; Up	F3HA30EUIST	\$1422.00
Fitting	Elbows; Down	F3HA30EDIIST	\$1422.00
Accessories	End Cable Tap Box (Up)	F3HA30TTIST	\$2669.00
Accessories	End Cable Tap Box (Dn)	F3HA30TBIST	\$2669.00
Accessories	Center Cable Tap Box (Up)	F3HA30CTIST	\$3597.00
Accessories	Center Cable Tap Box (Dn)	F3HA30CBIST	\$3597.00
Accessories	End Box	F3HA30EBIST	\$190.00
Accessories	Flanged End w/ Lugs	F3HA30FLIST	\$3593.00
Accessories	Flanged End	F3HA30FEIST	\$2081.00

## 2000 Amps Three-Phase, Three-Wire Integrated Housing Ground

Component	Type	Product Number	List Price GO-126S
Linear Lengths	10-ft. plug-in	P3HA20SLI10	\$2970.00
Linear Lengths	10-ft. feeder	F3HA20SLI10	\$2860.00
Linear Lengths	10-ft. riser	R3HA20SLI10	\$2920.00
Fitting	Elbows; Left	F3HA20ELIST	\$1399.00
Fitting	Elbows; Right	F3HA20ERIST	\$1399.00
Fitting	Elbows; Up	F3HA20EUIST	\$1016.00
Fitting	Elbows; Down	F3HA20EDIIST	\$1016.00
Accessories	End Cable Tap Box (Up)	F3HA20TTIST	\$1889.00
Accessories	End Cable Tap Box (Dn)	F3HA20TBIST	\$1889.00
Accessories	Center Cable Tap Box (Up)	F3HA20CTIST	\$2186.00
Accessories	Center Cable Tap Box (Dn)	F3HA20CBIST	\$2186.00
Accessories	End Box	F3HA20EBIST	\$157.00
Accessories	Flanged End w/ Lugs	F3HA20FLIST	\$2468.00
Accessories	Flanged End	F3HA20FEIST	\$1460.00

## 4000 Amps Three-Phase, Three-Wire Integrated Housing Ground

Component	Type	Product Number	List Price GO-126S
Linear Lengths	10-ft. plug-in	P3HA40SLI10	\$5830.00
Linear Lengths	10-ft. feeder	F3HA40SLI10	\$5720.00
Linear Lengths	10-ft. riser	R3HA40SLI10	\$5780.00
Fitting	Elbows; Left	F3HA40ELIST	\$2925.00
Fitting	Elbows; Right	F3HA40ERIST	\$2925.00
Fitting	Elbows; Up	F3HA40EUIST	\$1587.00
Fitting	Elbows; Down	F3HA40EDIIST	\$1587.00
Accessories	End Cable Tap Box (Up)	F3HA40TTIST	\$3161.00
Accessories	End Cable Tap Box (Dn)	F3HA40TBIST	\$3161.00
Accessories	Center Cable Tap Box (Up)	F3HA40CTIST	\$4279.00
Accessories	Center Cable Tap Box (Dn)	F3HA40CBIST	\$4279.00
Accessories	End Box	F3HA40EBIST	\$190.00
Accessories	Flanged End w/ Lugs	F3HA40FLIST	\$4516.00
Accessories	Flanged End	F3HA40FEIST	\$2500.00

## 2500 Amps Three-Phase, Three-Wire Integrated Housing Ground

Component	Type	Product Number	List Price GO-126S
Linear Lengths	10-ft. plug-in	P3HA25SLI10	\$4070.00
Linear Lengths	10-ft. feeder	F3HA25SLI10	\$3960.00
Linear Lengths	10-ft. riser	R3HA25SLI10	\$4020.00
Fitting	Elbows; Left	F3HA25ELIST	\$1729.00
Fitting	Elbows; Right	F3HA25ERIST	\$1729.00
Fitting	Elbows; Up	F3HA25EUIST	\$1198.00
Fitting	Elbows; Down	F3HA25EDIIST	\$1198.00
Accessories	End Cable Tap Box (Up)	F3HA25TTIST	\$2352.00
Accessories	End Cable Tap Box (Dn)	F3HA25TBIST	\$2352.00
Accessories	Center Cable Tap Box (Up)	F3HA25CTIST	\$2894.00
Accessories	Center Cable Tap Box (Dn)	F3HA25CBIST	\$2894.00
Accessories	End Box	F3HA25EBIST	\$157.00
Accessories	Flanged End w/ Lugs	F3HA25FLIST	\$3097.00
Accessories	Flanged End	F3HA25FEIST	\$1753.00

## Aluminum, Three-Wire, Housing Ground



# Busway Spectra® Series Busway (continued)

Sandwich Bus  
Aluminum Conductors  
Product Number Pricing

# Section 11

## 225 Amps Three-Phase, Four-Wire Integrated Housing Ground

Component	Type	Product Number	List Price GO-1265
Linear Lengths	10-ft. plug-in	P4HA02SLI10	\$1430.00
Linear Lengths	10-ft. feeder	F4HA02SLI10	\$1320.00
Linear Lengths	10-ft. riser	R4HA02SLI10	\$1380.00
Fitting	Elbows; Left	F4HA02ELIST	\$756.00
Fitting	Elbows; Right	F4HA02ERIST	\$756.00
Fitting	Elbows; Up	F4HA02EUIST	\$711.00
Fitting	Elbows; Down	F4HA02EDIIST	\$711.00
Accessories	End Cable Tap Box (Up)	F4HA02TTIST	\$1091.00
Accessories	End Cable Tap Box (Dn)	F4HA02TBIST	\$1091.00
Accessories	Center Cable Tap Box (Up)	F4HA02CTIST	\$1138.00
Accessories	Center Cable Tap Box (Dn)	F4HA02CBIST	\$1138.00
Accessories	End Box	F4HA02EBIST	\$128.00
Accessories	Flanged End w/ Lugs	F4HA02FLIST	\$1064.00
Accessories	Flanged End	F4HA02FEIST	\$840.00

## 800 Amps Three-Phase, Four-Wire Integrated Housing Ground

Component	Type	Product Number	List Price GO-1265
Linear Lengths	10-ft. plug-in	P4HA08SLI10	\$1650.00
Linear Lengths	10-ft. feeder	F4HA08SLI10	\$1540.00
Linear Lengths	10-ft. riser	R4HA08SLI10	\$1600.00
Fitting	Elbows; Left	F4HA08ELIST	\$800.00
Fitting	Elbows; Right	F4HA08ERIST	\$800.00
Fitting	Elbows; Up	F4HA08EUIST	\$748.00
Fitting	Elbows; Down	F4HA08EDIIST	\$748.00
Accessories	End Cable Tap Box (Up)	F4HA08TTIST	\$1187.00
Accessories	End Cable Tap Box (Dn)	F4HA08TBIST	\$1187.00
Accessories	Center Cable Tap Box (Up)	F4HA08CTIST	\$1242.00
Accessories	Center Cable Tap Box (Dn)	F4HA08CBIST	\$1242.00
Accessories	End Box	F4HA08EBIST	\$128.00
Accessories	Flanged End w/ Lugs	F4HA08FLIST	\$1618.00
Accessories	Flanged End	F4HA08FEIST	\$946.00

## 400 Amps Three-Phase, Four-Wire Integrated Housing Ground

Component	Type	Product Number	List Price GO-1265
Linear Lengths	10-ft. plug-in	P4HA04SLI10	\$1430.00
Linear Lengths	10-ft. feeder	F4HA04SLI10	\$1320.00
Linear Lengths	10-ft. riser	R4HA04SLI10	\$1380.00
Fitting	Elbows; Left	F4HA04ELIST	\$756.00
Fitting	Elbows; Right	F4HA04ERIST	\$756.00
Fitting	Elbows; Up	F4HA04EUIST	\$711.00
Fitting	Elbows; Down	F4HA04EDIIST	\$711.00
Accessories	End Cable Tap Box (Up)	F4HA04TTIST	\$1091.00
Accessories	End Cable Tap Box (Dn)	F4HA04TBIST	\$1091.00
Accessories	Center Cable Tap Box (Up)	F4HA04CTIST	\$1138.00
Accessories	Center Cable Tap Box (Dn)	F4HA04CBIST	\$1138.00
Accessories	End Box	F4HA04EBIST	\$128.00
Accessories	Flanged End w/ Lugs	F4HA04FLIST	\$1288.00
Accessories	Flanged End	F4HA04FEIST	\$840.00

## 1000 Amps Three-Phase, Four-Wire Integrated Housing Ground

Component	Type	Product Number	List Price GO-1265
Linear Lengths	10-ft. plug-in	P4HA10SLI10	\$1870.00
Linear Lengths	10-ft. feeder	F4HA10SLI10	\$1760.00
Linear Lengths	10-ft. riser	R4HA10SLI10	\$1820.00
Fitting	Elbows; Left	F4HA10ELIST	\$844.00
Fitting	Elbows; Right	F4HA10ERIST	\$844.00
Fitting	Elbows; Up	F4HA10EUIST	\$784.00
Fitting	Elbows; Down	F4HA10EDIIST	\$784.00
Accessories	End Cable Tap Box (Up)	F4HA10TTIST	\$1293.00
Accessories	End Cable Tap Box (Dn)	F4HA10TBIST	\$1293.00
Accessories	Center Cable Tap Box (Up)	F4HA10CTIST	\$1356.00
Accessories	Center Cable Tap Box (Dn)	F4HA10CBIST	\$1356.00
Accessories	End Box	F4HA10EBIST	\$128.00
Accessories	Flanged End w/ Lugs	F4HA10FLIST	\$1723.00
Accessories	Flanged End	F4HA10FEIST	\$1051.00

## 600 Amps Three-Phase, Four-Wire Integrated Housing Ground

Component	Type	Product Number	List Price GO-1265
Linear Lengths	10-ft. plug-in	P4HA06SLI10	\$1430.00
Linear Lengths	10-ft. feeder	F4HA06SLI10	\$1320.00
Linear Lengths	10-ft. riser	R4HA06SLI10	\$1380.00
Fitting	Elbows; Left	F4HA06ELIST	\$756.00
Fitting	Elbows; Right	F4HA06ERIST	\$756.00
Fitting	Elbows; Up	F4HA06EUIST	\$711.00
Fitting	Elbows; Down	F4HA06EDIIST	\$711.00
Accessories	End Cable Tap Box (Up)	F4HA06TTIST	\$1091.00
Accessories	End Cable Tap Box (Dn)	F4HA06TBIST	\$1091.00
Accessories	Center Cable Tap Box (Up)	F4HA06CTIST	\$1138.00
Accessories	Center Cable Tap Box (Dn)	F4HA06CBIST	\$1138.00
Accessories	End Box	F4HA06EBIST	\$128.00
Accessories	Flanged End w/ Lugs	F4HA06FLIST	\$1288.00
Accessories	Flanged End	F4HA06FEIST	\$840.00

## 1200 Amps Three-Phase, Four-Wire Integrated Housing Ground

Component	Type	Product Number	List Price GO-1265
Linear Lengths	10-ft. plug-in	P4HA12SLI10	\$2530.00
Linear Lengths	10-ft. feeder	F4HA12SLI10	\$2420.00
Linear Lengths	10-ft. riser	R4HA12SLI10	\$2480.00
Fitting	Elbows; Left	F4HA12ELIST	\$1025.00
Fitting	Elbows; Right	F4HA12ERIST	\$1025.00
Fitting	Elbows; Up	F4HA12EUIST	\$943.00
Fitting	Elbows; Down	F4HA12EDIIST	\$943.00
Accessories	End Cable Tap Box (Up)	F4HA12TTIST	\$1546.00
Accessories	End Cable Tap Box (Dn)	F4HA12TBIST	\$1546.00
Accessories	Center Cable Tap Box (Up)	F4HA12CTIST	\$1799.00
Accessories	Center Cable Tap Box (Dn)	F4HA12CBIST	\$1799.00
Accessories	End Box	F4HA12EBIST	\$128.00
Accessories	Flanged End w/ Lugs	F4HA12FLIST	\$2175.00
Accessories	Flanged End	F4HA12FEIST	\$1279.00

## Aluminum, Four-Wire, Housing Ground





# Busway Spectra® Series Busway (continued)

Sandwich Bus  
Aluminum Conductors  
Product Number Pricing

# Section 11

## 1600 Amps Three-Phase, Four-Wire Integrated Housing Ground

Component	Type	Product Number	List Price GO-1265
Linear Lengths	10-ft. plug-in	P4HA16SLI10	\$3300.00
Linear Lengths	10-ft. feeder	F4HA16SLI10	\$3190.00
Linear Lengths	10-ft. riser	R4HA16SLI10	\$3200.00
Fitting	Elbows; Left	F4HA16ELIST	\$1627.00
Fitting	Elbows; Right	F4HA16ERIST	\$1627.00
Fitting	Elbows; Up	F4HA16EUIST	\$1200.00
Fitting	Elbows; Down	F4HA16EDIST	\$1200.00
Accessories	End Cable Tap Box (Up)	F4HA16TTIST	\$1904.00
Accessories	End Cable Tap Box (Dn)	F4HA16TBIST	\$1904.00
Accessories	Center Cable Tap Box (Up)	F4HA16CTIST	\$2234.00
Accessories	Center Cable Tap Box (Dn)	F4HA16CBIST	\$2234.00
Accessories	End Box	F4HA16EBIST	\$157.00
Accessories	Flanged End w/ Lugs	F4HA16FLIST	\$2692.00
Accessories	Flanged End	F4HA16FEIST	\$1572.00

## 2000 Amps Three-Phase, Four-Wire Integrated Housing Ground

Component	Type	Product Number	List Price GO-1265
Linear Lengths	10-ft. plug-in	P4HA20SLI10	\$3850.00
Linear Lengths	10-ft. feeder	F4HA20SLI10	\$3740.00
Linear Lengths	10-ft. riser	R4HA20SLI10	\$3800.00
Fitting	Elbows; Left	F4HA20ELIST	\$1792.00
Fitting	Elbows; Right	F4HA20ERIST	\$1792.00
Fitting	Elbows; Up	F4HA20EUIST	\$1291.00
Fitting	Elbows; Down	F4HA20EDIST	\$1291.00
Accessories	End Cable Tap Box (Up)	F4HA20TTIST	\$2182.00
Accessories	End Cable Tap Box (Dn)	F4HA20TBIST	\$2182.00
Accessories	Center Cable Tap Box (Up)	F4HA20CTIST	\$2567.00
Accessories	Center Cable Tap Box (Dn)	F4HA20CBIST	\$2567.00
Accessories	End Box	F4HA20EBIST	\$157.00
Accessories	Flanged End w/ Lugs	F4HA20FLIST	\$3149.00
Accessories	Flanged End	F4HA20FEIST	\$1805.00

## 2500 Amps Three-Phase, Four-Wire Integrated Housing Ground

Component	Type	Product Number	List Price GO-1265
Linear Lengths	10-ft. plug-in	P4HA25SLI10	\$4950.00
Linear Lengths	10-ft. feeder	F4HA25SLI10	\$4840.00
Linear Lengths	10-ft. riser	R4HA25SLI10	\$4900.00
Fitting	Elbows; Left	F4HA25ELIST	\$2122.00
Fitting	Elbows; Right	F4HA25ERIST	\$2122.00
Fitting	Elbows; Up	F4HA25EUIST	\$1473.00
Fitting	Elbows; Down	F4HA25EDIST	\$1473.00
Accessories	End Cable Tap Box (Up)	F4HA25TTIST	\$2645.00
Accessories	End Cable Tap Box (Dn)	F4HA25TBIST	\$2645.00
Accessories	Center Cable Tap Box (Up)	F4HA25CTIST	\$3305.00
Accessories	Center Cable Tap Box (Dn)	F4HA25CBIST	\$3305.00
Accessories	End Box	F4HA25EBIST	\$157.00
Accessories	Flanged End w/ Lugs	F4HA25FLIST	\$3988.00
Accessories	Flanged End	F4HA25FEIST	\$2197.00

## 3000 Amps Three-Phase, Four-Wire Integrated Housing Ground

Component	Type	Product Number	List Price GO-1265
Linear Lengths	10-ft. plug-in	P4HA30SLI10	\$5610.00
Linear Lengths	10-ft. feeder	F4HA30SLI10	\$5500.00
Linear Lengths	10-ft. riser	R4HA30SLI10	\$5560.00
Fitting	Elbows; Left	F4HA30ELIST	\$2454.00
Fitting	Elbows; Right	F4HA30ERIST	\$2454.00
Fitting	Elbows; Up	F4HA30EUIST	\$1717.00
Fitting	Elbows; Down	F4HA30EDIST	\$1717.00
Accessories	End Cable Tap Box (Up)	F4HA30TTIST	\$2926.00
Accessories	End Cable Tap Box (Dn)	F4HA30TBIST	\$2926.00
Accessories	Center Cable Tap Box (Up)	F4HA30CTIST	\$4001.00
Accessories	Center Cable Tap Box (Dn)	F4HA30CBIST	\$4001.00
Accessories	End Box	F4HA30EBIST	\$190.00
Accessories	Flanged End w/ Lugs	F4HA30FLIST	\$4544.00
Accessories	Flanged End	F4HA30FEIST	\$2528.00

## 4000 Amps Three-Phase, Four-Wire Integrated Housing Ground

Component	Type	Product Number	List Price GO-1265
Linear Lengths	10-ft. plug-in	P4HA40SLI10	\$8030.00
Linear Lengths	10-ft. feeder	F4HA40SLI10	\$7920.00
Linear Lengths	10-ft. riser	R4HA40SLI10	\$7980.00
Fitting	Elbows; Left	F4HA40ELIST	\$3972.00
Fitting	Elbows; Right	F4HA40ERIST	\$3972.00
Fitting	Elbows; Up	F4HA40EUIST	\$2119.00
Fitting	Elbows; Down	F4HA40EDIST	\$2119.00
Accessories	End Cable Tap Box (Up)	F4HA40TTIST	\$3894.00
Accessories	End Cable Tap Box (Dn)	F4HA40TBIST	\$3894.00
Accessories	Center Cable Tap Box (Up)	F4HA40CTIST	\$5434.00
Accessories	Center Cable Tap Box (Dn)	F4HA40CBIST	\$5434.00
Accessories	End Box	F4HA40EBIST	\$190.00
Accessories	Flanged End w/ Lugs	F4HA40FLIST	\$5990.00
Accessories	Flanged End	F4HA40FEIST	\$3302.00

## Hangers - Common to all Services

Component	Type	Product Number	List Price GO-1265
225-600 Amps	Flatwise (st.)	SBF16	\$15.00
800 Amps	Flatwise (st.)	SBF28	\$15.00
1000 Amps	Flatwise (st.)	SBF33	\$15.00
1200 Amps	Flatwise (st.)	SBF42	\$15.00
1600 Amps	Flatwise (st.)	SBF65	\$15.00
2000 Amps	Flatwise (st.)	SBF82	\$15.00
2500 Amps	Flatwise (st.)	SBF45	\$15.00
3000 Amps	Flatwise (st.)	SBF57	\$15.00
4000 Amps	Flatwise (st.)	SBF82	\$15.00
Up to 2000 Amps	Edgewise (st.)	SBE45	\$15.00
2500A and above	Edgewise (st.)	SBTE	\$15.00
-	Spring	SBR1	\$67.00

## Aluminum, Four-Wire, Housing Ground



**225 Amps Three-Phase, Three-Wire  
 Integrated Housing Ground**

Component	Type	Product Number	List Price GO-1265
Linear Lengths	10-ft. plug-in	P3HC02SLI10	\$1600.00
Linear Lengths	10-ft. feeder	F3HC02SLI10	\$1400.00
Linear Lengths	10-ft. riser	R3HC02SLI10	\$1500.00
Fitting	Elbows; Left	F3HC02ELIST	\$760.00
Fitting	Elbows; Right	F3HC02ERIST	\$760.00
Fitting	Elbows; Up	F3HC02EUIST	\$713.00
Fitting	Elbows; Down	F3HC02EDIST	\$713.00
Accessories	End Cable Tap Box (Up)	F3HC02TTIST	\$1147.00
Accessories	End Cable Tap Box (Dn)	F3HC02TBIST	\$1147.00
Accessories	Center Cable Tap Box (Up)	F3HC02CTIST	\$1201.00
Accessories	Center Cable Tap Box (Dn)	F3HC02CBIST	\$1201.00
Accessories	End Box	F3HC02EBIST	\$128.00
Accessories	Flanged End w/ Lugs	F3HC02FLIST	\$1021.00
Accessories	Flanged End	F3HC02FEIST	\$853.00

**800 Amps Three-Phase, Three-Wire  
 Integrated Housing Ground**

Component	Type	Product Number	List Price GO-1265
Linear Lengths	10-ft. plug-in	P3HC08SLI10	\$1900.00
Linear Lengths	10-ft. feeder	F3HC08SLI10	\$1700.00
Linear Lengths	10-ft. riser	R3HC08SLI10	\$1800.00
Fitting	Elbows; Left	F3HC08ELIST	\$820.00
Fitting	Elbows; Right	F3HC08ERIST	\$820.00
Fitting	Elbows; Up	F3HC08EUIST	\$763.00
Fitting	Elbows; Down	F3HC08EDIST	\$763.00
Accessories	End Cable Tap Box (Up)	F3HC08TTIST	\$1270.00
Accessories	End Cable Tap Box (Dn)	F3HC08TBIST	\$1270.00
Accessories	Center Cable Tap Box (Up)	F3HC08CTIST	\$1334.00
Accessories	Center Cable Tap Box (Dn)	F3HC08CBIST	\$1334.00
Accessories	End Box	F3HC08EBIST	\$128.00
Accessories	Flanged End w/ Lugs	F3HC08FLIST	\$1463.00
Accessories	Flanged End	F3HC08FEIST	\$959.00

**400 Amps Three-Phase, Three-Wire  
 Integrated Housing Ground**

Component	Type	Product Number	List Price GO-1265
Linear Lengths	10-ft. plug-in	P3HC04SLI10	\$1600.00
Linear Lengths	10-ft. feeder	F3HC04SLI10	\$1400.00
Linear Lengths	10-ft. riser	R3HC04SLI10	\$1500.00
Fitting	Elbows; Left	F3HC04ELIST	\$760.00
Fitting	Elbows; Right	F3HC04ERIST	\$760.00
Fitting	Elbows; Up	F3HC04EUIST	\$713.00
Fitting	Elbows; Down	F3HC04EDIST	\$713.00
Accessories	End Cable Tap Box (Up)	F3HC04TTIST	\$1147.00
Accessories	End Cable Tap Box (Dn)	F3HC04TBIST	\$1147.00
Accessories	Center Cable Tap Box (Up)	F3HC04CTIST	\$1201.00
Accessories	Center Cable Tap Box (Dn)	F3HC04CBIST	\$1201.00
Accessories	End Box	F3HC04EBIST	\$128.00
Accessories	Flanged End w/ Lugs	F3HC04FLIST	\$1189.00
Accessories	Flanged End	F3HC04FEIST	\$853.00

**1000 Amps Three-Phase, Three-Wire  
 Integrated Housing Ground**

Component	Type	Product Number	List Price GO-1265
Linear Lengths	10-ft. plug-in	P3HC10SLI10	\$2100.00
Linear Lengths	10-ft. feeder	F3HC10SLI10	\$1900.00
Linear Lengths	10-ft. riser	R3HC10SLI10	\$2000.00
Fitting	Elbows; Left	F3HC10ELIST	\$860.00
Fitting	Elbows; Right	F3HC10ERIST	\$860.00
Fitting	Elbows; Up	F3HC10EUIST	\$795.00
Fitting	Elbows; Down	F3HC10EDIST	\$795.00
Accessories	End Cable Tap Box (Up)	F3HC10TTIST	\$1370.00
Accessories	End Cable Tap Box (Dn)	F3HC10TBIST	\$1370.00
Accessories	Center Cable Tap Box (Up)	F3HC10CTIST	\$1440.00
Accessories	Center Cable Tap Box (Dn)	F3HC10CBIST	\$1440.00
Accessories	End Box	F3HC10EBIST	\$128.00
Accessories	Flanged End w/ Lugs	F3HC10FLIST	\$1582.00
Accessories	Flanged End	F3HC10FEIST	\$1078.00

**600 Amps Three-Phase, Three-Wire  
 Integrated Housing Ground**

Component	Type	Product Number	List Price GO-1265
Linear Lengths	10-ft. plug-in	P3HC06SLI10	\$1600.00
Linear Lengths	10-ft. feeder	F3HC06SLI10	\$1400.00
Linear Lengths	10-ft. riser	R3HC06SLI10	\$1500.00
Fitting	Elbows; Left	F3HC06ELIST	\$760.00
Fitting	Elbows; Right	F3HC06ERIST	\$760.00
Fitting	Elbows; Up	F3HC06EUIST	\$713.00
Fitting	Elbows; Down	F3HC06EDIST	\$713.00
Accessories	End Cable Tap Box (Up)	F3HC06TTIST	\$1147.00
Accessories	End Cable Tap Box (Dn)	F3HC06TBIST	\$1147.00
Accessories	Center Cable Tap Box (Up)	F3HC06CTIST	\$1201.00
Accessories	Center Cable Tap Box (Dn)	F3HC06CBIST	\$1201.00
Accessories	End Box	F3HC06EBIST	\$128.00
Accessories	Flanged End w/ Lugs	F3HC06FLIST	\$1189.00
Accessories	Flanged End	F3HC06FEIST	\$853.00

**1200 Amps Three-Phase, Three-Wire  
 Integrated Housing Ground**

Component	Type	Product Number	List Price GO-1265
Linear Lengths	10-ft. plug-in	P3HC12SLI10	\$2700.00
Linear Lengths	10-ft. feeder	F3HC12SLI10	\$2500.00
Linear Lengths	10-ft. riser	R3HC12SLI10	\$2600.00
Fitting	Elbows; Left	F3HC12ELIST	\$980.00
Fitting	Elbows; Right	F3HC12ERIST	\$980.00
Fitting	Elbows; Up	F3HC12EUIST	\$895.00
Fitting	Elbows; Down	F3HC12EDIST	\$895.00
Accessories	End Cable Tap Box (Up)	F3HC12TTIST	\$1603.00
Accessories	End Cable Tap Box (Dn)	F3HC12TBIST	\$1603.00
Accessories	Center Cable Tap Box (Up)	F3HC12CTIST	\$1873.00
Accessories	Center Cable Tap Box (Dn)	F3HC12CBIST	\$1873.00
Accessories	End Box	F3HC12EBIST	\$128.00
Accessories	Flanged End w/ Lugs	F3HC12FLIST	\$1913.00
Accessories	Flanged End	F3HC12FEIST	\$1241.00

**Copper, Three-Wire, Housing Ground**



# Busway Spectra® Series Busway (continued)

Sandwich Bus

Copper Conductors

Product Number Pricing

# Section 11

## 1600 Amps Three-Phase, Three-Wire Integrated Housing Ground

Component	Type	Product Number	List Price GO-126S
Linear Lengths	10-ft. plug-in	P3HC16SLI10	\$3400.00
Linear Lengths	10-ft. feeder	F3HC16SLI10	\$3200.00
Linear Lengths	10-ft. riser	R3HC16SLI10	\$3300.00
Fitting	Elbows; Left	F3HC16ELIST	\$1120.00
Fitting	Elbows; Right	F3HC16ERIST	\$1120.00
Fitting	Elbows; Up	F3HC16EUIST	\$1011.00
Fitting	Elbows; Down	F3HC16EDIST	\$1011.00
Accessories	End Cable Tap Box (Up)	F3HC16TTIST	\$1937.00
Accessories	End Cable Tap Box (Dn)	F3HC16TBIST	\$1937.00
Accessories	Center Cable Tap Box (Up)	F3HC16CTIST	\$2277.00
Accessories	Center Cable Tap Box (Dn)	F3HC16CBIST	\$2277.00
Accessories	End Box	F3HC16EBIST	\$128.00
Accessories	Flanged End w/ Lugs	F3HC16FLIST	\$2368.00
Accessories	Flanged End	F3HC16FEIST	\$1528.00

## 2000 Amps Three-Phase, Three-Wire Integrated Housing Ground

Component	Type	Product Number	List Price GO-126S
Linear Lengths	10-ft. plug-in	P3HC20SLI10	\$4300.00
Linear Lengths	10-ft. feeder	F3HC20SLI10	\$4100.00
Linear Lengths	10-ft. riser	R3HC20SLI10	\$4200.00
Fitting	Elbows; Left	F3HC20ELIST	\$1368.00
Fitting	Elbows; Right	F3HC20ERIST	\$1368.00
Fitting	Elbows; Up	F3HC20EUIST	\$1229.00
Fitting	Elbows; Down	F3HC20EDIST	\$1229.00
Accessories	End Cable Tap Box (Up)	F3HC20TTIST	\$2332.00
Accessories	End Cable Tap Box (Dn)	F3HC20TBIST	\$2332.00
Accessories	Center Cable Tap Box (Up)	F3HC20CTIST	\$2762.00
Accessories	Center Cable Tap Box (Dn)	F3HC20CBIST	\$2762.00
Accessories	End Box	F3HC20EBIST	\$157.00
Accessories	Flanged End w/ Lugs	F3HC20FLIST	\$2838.00
Accessories	Flanged End	F3HC20FEIST	\$1830.00

## 2500 Amps Three-Phase, Three-Wire Integrated Housing Ground

Component	Type	Product Number	List Price GO-126S
Linear Lengths	10-ft. plug-in	P3HC25SLI10	\$5300.00
Linear Lengths	10-ft. feeder	F3HC25SLI10	\$5100.00
Linear Lengths	10-ft. riser	R3HC25SLI10	\$5200.00
Fitting	Elbows; Left	F3HC25ELIST	\$2078.00
Fitting	Elbows; Right	F3HC25ERIST	\$2078.00
Fitting	Elbows; Up	F3HC25EUIST	\$1395.00
Fitting	Elbows; Down	F3HC25EDIST	\$1395.00
Accessories	End Cable Tap Box (Up)	F3HC25TTIST	\$2761.00
Accessories	End Cable Tap Box (Dn)	F3HC25TBIST	\$2761.00
Accessories	Center Cable Tap Box (Up)	F3HC25CTIST	\$3469.00
Accessories	Center Cable Tap Box (Dn)	F3HC25CBIST	\$3469.00
Accessories	End Box	F3HC25EBIST	\$157.00
Accessories	Flanged End w/ Lugs	F3HC25FLIST	\$3515.00
Accessories	Flanged End	F3HC25FEIST	\$2171.00

## 3000 Amps Three-Phase, Three-Wire Integrated Housing Ground

Component	Type	Product Number	List Price GO-126S
Linear Lengths	10-ft. plug-in	P3HC30SLI10	\$6400.00
Linear Lengths	10-ft. feeder	F3HC30SLI10	\$6200.00
Linear Lengths	10-ft. riser	R3HC30SLI10	\$6300.00
Fitting	Elbows; Left	F3HC30ELIST	\$2408.00
Fitting	Elbows; Right	F3HC30ERIST	\$2408.00
Fitting	Elbows; Up	F3HC30EUIST	\$1577.00
Fitting	Elbows; Down	F3HC30EDIST	\$1577.00
Accessories	End Cable Tap Box (Up)	F3HC30TTIST	\$3189.00
Accessories	End Cable Tap Box (Dn)	F3HC30TBIST	\$3189.00
Accessories	Center Cable Tap Box (Up)	F3HC30CTIST	\$4416.00
Accessories	Center Cable Tap Box (Dn)	F3HC30CBIST	\$4416.00
Accessories	End Box	F3HC30EBIST	\$157.00
Accessories	Flanged End w/ Lugs	F3HC30FLIST	\$4026.00
Accessories	Flanged End	F3HC30FEIST	\$2514.00

## 4000 Amps Three-Phase, Three-Wire Integrated Housing Ground

Component	Type	Product Number	List Price GO-126S
Linear Lengths	10-ft. plug-in	P3HC40SLI10	\$8400.00
Linear Lengths	10-ft. feeder	F3HC40SLI10	\$8200.00
Linear Lengths	10-ft. riser	R3HC40SLI10	\$8300.00
Fitting	Elbows; Left	F3HC40ELIST	\$3097.00
Fitting	Elbows; Right	F3HC40ERIST	\$3097.00
Fitting	Elbows; Up	F3HC40EUIST	\$1998.00
Fitting	Elbows; Down	F3HC40EDIST	\$1998.00
Accessories	End Cable Tap Box (Up)	F3HC40TTIST	\$4018.00
Accessories	End Cable Tap Box (Dn)	F3HC40TBIST	\$4018.00
Accessories	Center Cable Tap Box (Up)	F3HC40CTIST	\$5628.00
Accessories	Center Cable Tap Box (Dn)	F3HC40CBIST	\$5628.00
Accessories	End Box	F3HC40EBIST	\$190.00
Accessories	Flanged End w/ Lugs	F3HC40FLIST	\$5189.00
Accessories	Flanged End	F3HC40FEIST	\$3173.00

## Copper, Three-Wire, Housing Ground



# Busway Spectra® Series Busway (continued)

Sandwich Bus  
Copper Conductors  
Product Number Pricing

# Section 11

## 225 Amps Three-Phase, Four-Wire Integrated Housing Ground

Component	Type	Product Number	List Price GO-126S
Linear Lengths	10-ft. plug-in	P4HC02SL110	\$2000.00
Linear Lengths	10-ft. feeder	F4HC02SL110	\$1800.00
Linear Lengths	10-ft. riser	R4HC02SL110	\$1900.00
Fitting	Elbows; Left	F4HC02ELIST	\$908.00
Fitting	Elbows; Right	F4HC02ERIST	\$908.00
Fitting	Elbows; Up	F4HC02EUIST	\$847.00
Fitting	Elbows; Down	F4HC02EDIST	\$847.00
Accessories	End Cable Tap Box (Up)	F4HC02TTIST	\$1304.00
Accessories	End Cable Tap Box (Dn)	F4HC02TBIST	\$1304.00
Accessories	Center Cable Tap Box (Up)	F4HC02CTIST	\$1370.00
Accessories	Center Cable Tap Box (Dn)	F4HC02CBIST	\$1370.00
Accessories	End Box	F4HC02EBIST	\$128.00
Accessories	Flanged End w/ Lugs	F4HC02FLIST	\$1221.00
Accessories	Flanged End	F4HC02FEIST	\$997.00

## 800 Amps Three-Phase, Four-Wire Integrated Housing Ground

Component	Type	Product Number	List Price GO-126S
Linear Lengths	10-ft. plug-in	P4HC08SL110	\$2400.00
Linear Lengths	10-ft. feeder	F4HC08SL110	\$2200.00
Linear Lengths	10-ft. riser	R4HC08SL110	\$2300.00
Fitting	Elbows; Left	F4HC08ELIST	\$988.00
Fitting	Elbows; Right	F4HC08ERIST	\$988.00
Fitting	Elbows; Up	F4HC08EUIST	\$913.00
Fitting	Elbows; Down	F4HC08EDIST	\$913.00
Accessories	End Cable Tap Box (Up)	F4HC08TTIST	\$1503.00
Accessories	End Cable Tap Box (Dn)	F4HC08TBIST	\$1503.00
Accessories	Center Cable Tap Box (Up)	F4HC08CTIST	\$1583.00
Accessories	Center Cable Tap Box (Dn)	F4HC08CBIST	\$1583.00
Accessories	End Box	F4HC08EBIST	\$128.00
Accessories	Flanged End w/ Lugs	F4HC08FLIST	\$1856.00
Accessories	Flanged End	F4HC08FEIST	\$1184.00

## 400 Amps Three-Phase, Four-Wire Integrated Housing Ground

Component	Type	Product Number	List Price GO-126S
Linear Lengths	10-ft. plug-in	P4HC04SL110	\$2000.00
Linear Lengths	10-ft. feeder	F4HC04SL110	\$1800.00
Linear Lengths	10-ft. riser	R4HC04SL110	\$1900.00
Fitting	Elbows; Left	F4HC04ELIST	\$908.00
Fitting	Elbows; Right	F4HC04ERIST	\$908.00
Fitting	Elbows; Up	F4HC04EUIST	\$847.00
Fitting	Elbows; Down	F4HC04EDIST	\$847.00
Accessories	End Cable Tap Box (Up)	F4HC04TTIST	\$1304.00
Accessories	End Cable Tap Box (Dn)	F4HC04TBIST	\$1304.00
Accessories	Center Cable Tap Box (Up)	F4HC04CTIST	\$1370.00
Accessories	Center Cable Tap Box (Dn)	F4HC04CBIST	\$1370.00
Accessories	End Box	F4HC04EBIST	\$128.00
Accessories	Flanged End w/ Lugs	F4HC04FLIST	\$1445.00
Accessories	Flanged End	F4HC04FEIST	\$997.00

## 1000 Amps Three-Phase, Four-Wire Integrated Housing Ground

Component	Type	Product Number	List Price GO-126S
Linear Lengths	10-ft. plug-in	P4HC10SL110	\$3000.00
Linear Lengths	10-ft. feeder	F4HC10SL110	\$2800.00
Linear Lengths	10-ft. riser	R4HC10SL110	\$2900.00
Fitting	Elbows; Left	F4HC10ELIST	\$1108.00
Fitting	Elbows; Right	F4HC10ERIST	\$1108.00
Fitting	Elbows; Up	F4HC10EUIST	\$1013.00
Fitting	Elbows; Down	F4HC10EDIST	\$1013.00
Accessories	End Cable Tap Box (Up)	F4HC10TTIST	\$1737.00
Accessories	End Cable Tap Box (Dn)	F4HC10TBIST	\$1737.00
Accessories	Center Cable Tap Box (Up)	F4HC10CTIST	\$1837.00
Accessories	Center Cable Tap Box (Dn)	F4HC10CBIST	\$1837.00
Accessories	End Box	F4HC10EBIST	\$128.00
Accessories	Flanged End w/ Lugs	F4HC10FLIST	\$2029.00
Accessories	Flanged End	F4HC10FEIST	\$1357.00

## 600 Amps Three-Phase, Four-Wire Integrated Housing Ground

Component	Type	Product Number	List Price GO-126S
Linear Lengths	10-ft. plug-in	P4HC06SL110	\$2000.00
Linear Lengths	10-ft. feeder	F4HC06SL110	\$1800.00
Linear Lengths	10-ft. riser	R4HC06SL110	\$1900.00
Fitting	Elbows; Left	F4HC06ELIST	\$908.00
Fitting	Elbows; Right	F4HC06ERIST	\$908.00
Fitting	Elbows; Up	F4HC06EUIST	\$847.00
Fitting	Elbows; Down	F4HC06EDIST	\$847.00
Accessories	End Cable Tap Box (Up)	F4HC06TTIST	\$1304.00
Accessories	End Cable Tap Box (Dn)	F4HC06TBIST	\$1304.00
Accessories	Center Cable Tap Box (Up)	F4HC06CTIST	\$1370.00
Accessories	Center Cable Tap Box (Dn)	F4HC06CBIST	\$1370.00
Accessories	End Box	F4HC06EBIST	\$128.00
Accessories	Flanged End w/ Lugs	F4HC06FLIST	\$1445.00
Accessories	Flanged End	F4HC06FEIST	\$997.00

## 1200 Amps Three-Phase, Four-Wire Integrated Housing Ground

Component	Type	Product Number	List Price GO-126S
Linear Lengths	10-ft. plug-in	P4HC12SL110	\$3600.00
Linear Lengths	10-ft. feeder	F4HC12SL110	\$3400.00
Linear Lengths	10-ft. riser	R4HC12SL110	\$3500.00
Fitting	Elbows; Left	F4HC12ELIST	\$1228.00
Fitting	Elbows; Right	F4HC12ERIST	\$1228.00
Fitting	Elbows; Up	F4HC12EUIST	\$1112.00
Fitting	Elbows; Down	F4HC12EDIST	\$1112.00
Accessories	End Cable Tap Box (Up)	F4HC12TTIST	\$2004.00
Accessories	End Cable Tap Box (Dn)	F4HC12TBIST	\$2004.00
Accessories	Center Cable Tap Box (Up)	F4HC12CTIST	\$2364.00
Accessories	Center Cable Tap Box (Dn)	F4HC12CBIST	\$2364.00
Accessories	End Box	F4HC12EBIST	\$128.00
Accessories	Flanged End w/ Lugs	F4HC12FLIST	\$2457.00
Accessories	Flanged End	F4HC12FEIST	\$1561.00

Copper, Four-Wire, Housing Ground



# Busway Spectra® Series Busway (continued)

Sandwich Bus  
Copper Conductors  
Product Number Pricing

# Section 11

## 1600 Amps Three-Phase, Four-Wire Integrated Housing Ground

Component	Type	Product Number	List Price GO-126S
Linear Lengths	10-ft. plug-in	P4HC16SLI10	\$4600.00
Linear Lengths	10-ft. feeder	F4HC16SLI10	\$4400.00
Linear Lengths	10-ft. riser	R4HC16SLI10	\$4500.00
Fitting	Elbows; Left	F4HC16ELIST	\$1428.00
Fitting	Elbows; Right	F4HC16ERIST	\$1428.00
Fitting	Elbows; Up	F4HC16EUIST	\$1278.00
Fitting	Elbows; Down	F4HC16EDIIST	\$1278.00
Accessories	End Cable Tap Box (Up)	F4HC16TTIST	\$2465.00
Accessories	End Cable Tap Box (Dn)	F4HC16TBIST	\$2465.00
Accessories	Center Cable Tap Box (Up)	F4HC16CTIST	\$2925.00
Accessories	Center Cable Tap Box (Dn)	F4HC16CBIST	\$2925.00
Accessories	End Box	F4HC16EBIST	\$128.00
Accessories	Flanged End w/ Lugs	F4HC16FLIST	\$3068.00
Accessories	Flanged End	F4HC16FEIST	\$1948.00

## 2000 Amps Three-Phase, Four-Wire Integrated Housing Ground

Component	Type	Product Number	List Price GO-126S
Linear Lengths	10-ft. plug-in	P4HC20SLI10	\$5700.00
Linear Lengths	10-ft. feeder	F4HC20SLI10	\$5500.00
Linear Lengths	10-ft. riser	R4HC20SLI10	\$5600.00
Fitting	Elbows; Left	F4HC20ELIST	\$1770.00
Fitting	Elbows; Right	F4HC20ERIST	\$1770.00
Fitting	Elbows; Up	F4HC20EUIST	\$1583.00
Fitting	Elbows; Down	F4HC20EDIIST	\$1583.00
Accessories	End Cable Tap Box (Up)	F4HC20TTIST	\$2922.00
Accessories	End Cable Tap Box (Dn)	F4HC20TBIST	\$2922.00
Accessories	Center Cable Tap Box (Up)	F4HC20CTIST	\$3492.00
Accessories	Center Cable Tap Box (Dn)	F4HC20CBIST	\$3492.00
Accessories	End Box	F4HC20EBIST	\$157.00
Accessories	Flanged End w/ Lugs	F4HC20FLIST	\$3667.00
Accessories	Flanged End	F4HC20FEIST	\$2323.00

## 2500 Amps Three-Phase, Four-Wire Integrated Housing Ground

Component	Type	Product Number	List Price GO-126S
Linear Lengths	10-ft. plug-in	P4HC25SLI10	\$7300.00
Linear Lengths	10-ft. feeder	F4HC25SLI10	\$7100.00
Linear Lengths	10-ft. riser	R4HC25SLI10	\$7200.00
Fitting	Elbows; Left	F4HC25ELIST	\$2800.00
Fitting	Elbows; Right	F4HC25ERIST	\$2800.00
Fitting	Elbows; Up	F4HC25EUIST	\$1849.00
Fitting	Elbows; Down	F4HC25EDIIST	\$1849.00
Accessories	End Cable Tap Box (Up)	F4HC25TTIST	\$3589.00
Accessories	End Cable Tap Box (Dn)	F4HC25TBIST	\$3589.00
Accessories	Center Cable Tap Box (Up)	F4HC25CTIST	\$4563.00
Accessories	Center Cable Tap Box (Dn)	F4HC25CBIST	\$4563.00
Accessories	End Box	F4HC25EBIST	\$157.00
Accessories	Flanged End w/ Lugs	F4HC25FLIST	\$4616.00
Accessories	Flanged End	F4HC25FEIST	\$2824.00

## 3000 Amps Three-Phase, Four-Wire Integrated Housing Ground

Component	Type	Product Number	List Price GO-126S
Linear Lengths	10-ft. plug-in	P4HC30SLI10	\$8800.00
Linear Lengths	10-ft. feeder	F4HC30SLI10	\$8600.00
Linear Lengths	10-ft. riser	R4HC30SLI10	\$8700.00
Fitting	Elbows; Left	F4HC30ELIST	\$3250.00
Fitting	Elbows; Right	F4HC30ERIST	\$3250.00
Fitting	Elbows; Up	F4HC30EUIST	\$2098.00
Fitting	Elbows; Down	F4HC30EDIIST	\$2098.00
Accessories	End Cable Tap Box (Up)	F4HC30TTIST	\$4179.00
Accessories	End Cable Tap Box (Dn)	F4HC30TBIST	\$4179.00
Accessories	Center Cable Tap Box (Up)	F4HC30CTIST	\$5866.00
Accessories	Center Cable Tap Box (Dn)	F4HC30CBIST	\$5866.00
Accessories	End Box	F4HC30EBIST	\$157.00
Accessories	Flanged End w/ Lugs	F4HC30FLIST	\$5288.00
Accessories	Flanged End	F4HC30FEIST	\$3272.00

## 4000 Amps Three-Phase, Four-Wire Integrated Housing Ground

Component	Type	Product Number	List Price GO-126S
Linear Lengths	10-ft. plug-in	P4HC40SLI10	\$11600.00
Linear Lengths	10-ft. feeder	F4HC40SLI10	\$11400.00
Linear Lengths	10-ft. riser	R4HC40SLI10	\$11500.00
Fitting	Elbows; Left	F4HC40ELIST	\$4224.00
Fitting	Elbows; Right	F4HC40ERIST	\$4224.00
Fitting	Elbows; Up	F4HC40EUIST	\$2696.00
Fitting	Elbows; Down	F4HC40EDIIST	\$2696.00
Accessories	End Cable Tap Box (Up)	F4HC40TTIST	\$5402.00
Accessories	End Cable Tap Box (Dn)	F4HC40TBIST	\$5402.00
Accessories	Center Cable Tap Box (Up)	F4HC40CTIST	\$7626.00
Accessories	Center Cable Tap Box (Dn)	F4HC40CBIST	\$7626.00
Accessories	End Box	F4HC40EBIST	\$190.00
Accessories	Flanged End w/ Lugs	F4HC40FLIST	\$6952.00
Accessories	Flanged End	F4HC40FEIST	\$4264.00

## Hangers - Common to All Services

Component	Type	Product Number	List Price GO-126S
225-800 Amps	Flatwise (st.)	SBF16	\$15.00
1000 Amps	Flatwise (st.)	SBF22	\$15.00
1200 Amps	Flatwise (st.)	SBF28	\$15.00
1600 Amps	Flatwise (st.)	SBF42	\$15.00
2000 Amps	Flatwise (st.)	SBTF	\$15.00
2500 Amps	Flatwise (st.)	SBTF	\$15.00
3000 Amps	Flatwise (st.)	SBTG	\$15.00
225-1600 Amps	Edgewise (st.)	SBTH	\$15.00
2000A and above	Edgewise (st.)	SBTE	\$15.00
1200 Amps	Spring	SBR1	\$67.00
4000 Amps	Spring	SBR2	\$67.00

## Copper, Four-Wire, Housing Ground



**Busway**  
**Spectra® Series Busway**  
 Sandwich Bus  
 Copper Conductors  
 Product Number Pricing

**Section 11**

**225 Amps Three-Phase, Three-Wire Internal Ground Bar**

Component	Type	Product Number	List Price GO-126S
Linear Lengths	10-ft. plug-in	P3GC02SLI10	<b>\$1900.00</b>
Linear Lengths	10-ft. feeder	F3GC02SLI10	<b>\$1700.00</b>
Linear Lengths	10-ft. riser	R3GC02SLI10	<b>\$1800.00</b>
Fitting	Elbows; Left	F3GC02ELIST	<b>\$820.00</b>
Fitting	Elbows; Right	F3GC02ERIST	<b>\$820.00</b>
Fitting	Elbows; Up	F3GC02EUIST	<b>\$763.00</b>
Fitting	Elbows; Down	F3GC02EDIST	<b>\$763.00</b>
Accessories	End Cable Tap Box (Up)	F3GC02TTIST	<b>\$1247.00</b>
Accessories	End Cable Tap Box (Dn)	F3GC02TBIST	<b>\$1247.00</b>
Accessories	Center Cable Tap Box (Up)	F3GC02CTIST	<b>\$1311.00</b>
Accessories	Center Cable Tap Box (Dn)	F3GC02CBIST	<b>\$1311.00</b>
Accessories	End Box	F3GC02EBIST	<b>\$128.00</b>
Accessories	Flanged End w/ Lugs	F3GC02FLIST	<b>\$1051.00</b>
Accessories	Flanged End	F3GC02FEIST	<b>\$883.00</b>

**800 Amps Three-Phase, Three-Wire Internal Ground Bar**

Component	Type	Product Number	List Price GO-126S
Linear Lengths	10-ft. plug-in	P3GC08SLI10	<b>\$2250.00</b>
Linear Lengths	10-ft. feeder	F3GC08SLI10	<b>\$2050.00</b>
Linear Lengths	10-ft. riser	R3GC08SLI10	<b>\$2150.00</b>
Fitting	Elbows; Left	F3GC08ELIST	<b>\$890.00</b>
Fitting	Elbows; Right	F3GC08ERIST	<b>\$890.00</b>
Fitting	Elbows; Up	F3GC08EUIST	<b>\$822.00</b>
Fitting	Elbows; Down	F3GC08EDIST	<b>\$822.00</b>
Accessories	End Cable Tap Box (Up)	F3GC08TTIST	<b>\$1387.00</b>
Accessories	End Cable Tap Box (Dn)	F3GC08TBIST	<b>\$1387.00</b>
Accessories	Center Cable Tap Box (Up)	F3GC08CTIST	<b>\$1462.00</b>
Accessories	Center Cable Tap Box (Dn)	F3GC08CBIST	<b>\$1462.00</b>
Accessories	End Box	F3GC08EBIST	<b>\$128.00</b>
Accessories	Flanged End w/ Lugs	F3GC08FLIST	<b>\$1498.00</b>
Accessories	Flanged End	F3GC08FEIST	<b>\$994.00</b>

**400 Amps Three-Phase, Three-Wire Internal Ground Bar**

Component	Type	Product Number	List Price GO-126S
Linear Lengths	10-ft. plug-in	P3GC04SLI10	<b>\$1900.00</b>
Linear Lengths	10-ft. feeder	F3GC04SLI10	<b>\$1700.00</b>
Linear Lengths	10-ft. riser	R3GC04SLI10	<b>\$1800.00</b>
Fitting	Elbows; Left	F3GC04ELIST	<b>\$820.00</b>
Fitting	Elbows; Right	F3GC04ERIST	<b>\$820.00</b>
Fitting	Elbows; Up	F3GC04EUIST	<b>\$763.00</b>
Fitting	Elbows; Down	F3GC04EDIST	<b>\$763.00</b>
Accessories	End Cable Tap Box (Up)	F3GC04TTIST	<b>\$1247.00</b>
Accessories	End Cable Tap Box (Dn)	F3GC04TBIST	<b>\$1247.00</b>
Accessories	Center Cable Tap Box (Up)	F3GC04CTIST	<b>\$1311.00</b>
Accessories	Center Cable Tap Box (Dn)	F3GC04CBIST	<b>\$1311.00</b>
Accessories	End Box	F3GC04EBIST	<b>\$128.00</b>
Accessories	Flanged End w/ Lugs	F3GC04FLIST	<b>\$1219.00</b>
Accessories	Flanged End	F3GC04FEIST	<b>\$883.00</b>

**1000 Amps Three-Phase, Three-Wire Internal Ground Bar**

Component	Type	Product Number	List Price GO-126S
Linear Lengths	10-ft. plug-in	P3GC10SLI10	<b>\$2500.00</b>
Linear Lengths	10-ft. feeder	F3GC10SLI10	<b>\$2300.00</b>
Linear Lengths	10-ft. riser	R3GC10SLI10	<b>\$2400.00</b>
Fitting	Elbows; Left	F3GC10ELIST	<b>\$940.00</b>
Fitting	Elbows; Right	F3GC10ERIST	<b>\$940.00</b>
Fitting	Elbows; Up	F3GC10EUIST	<b>\$863.00</b>
Fitting	Elbows; Down	F3GC10EDIST	<b>\$863.00</b>
Accessories	End Cable Tap Box (Up)	F3GC10TTIST	<b>\$1503.00</b>
Accessories	End Cable Tap Box (Dn)	F3GC10TBIST	<b>\$1503.00</b>
Accessories	Center Cable Tap Box (Up)	F3GC10CTIST	<b>\$1587.00</b>
Accessories	Center Cable Tap Box (Dn)	F3GC10CBIST	<b>\$1587.00</b>
Accessories	End Box	F3GC10EBIST	<b>\$128.00</b>
Accessories	Flanged End w/ Lugs	F3GC10FLIST	<b>\$1622.00</b>
Accessories	Flanged End	F3GC10FEIST	<b>\$1118.00</b>

**600 Amps Three-Phase, Three-Wire Internal Ground Bar**

Component	Type	Product Number	List Price GO-126S
Linear Lengths	10-ft. plug-in	P3GC06SLI10	<b>\$1900.00</b>
Linear Lengths	10-ft. feeder	F3GC06SLI10	<b>\$1700.00</b>
Linear Lengths	10-ft. riser	R3GC06SLI10	<b>\$1800.00</b>
Fitting	Elbows; Left	F3GC06ELIST	<b>\$820.00</b>
Fitting	Elbows; Right	F3GC06ERIST	<b>\$820.00</b>
Fitting	Elbows; Up	F3GC06EUIST	<b>\$763.00</b>
Fitting	Elbows; Down	F3GC06EDIST	<b>\$763.00</b>
Accessories	End Cable Tap Box (Up)	F3GC06TTIST	<b>\$1247.00</b>
Accessories	End Cable Tap Box (Dn)	F3GC06TBIST	<b>\$1247.00</b>
Accessories	Center Cable Tap Box (Up)	F3GC06CTIST	<b>\$1311.00</b>
Accessories	Center Cable Tap Box (Dn)	F3GC06CBIST	<b>\$1311.00</b>
Accessories	End Box	F3GC06EBIST	<b>\$128.00</b>
Accessories	Flanged End w/ Lugs	F3GC06FLIST	<b>\$1219.00</b>
Accessories	Flanged End	F3GC06FEIST	<b>\$883.00</b>

**1200 Amps Three-Phase, Three-Wire Internal Ground Bar**

Component	Type	Product Number	List Price GO-126S
Linear Lengths	10-ft. plug-in	P3GC12SLI10	<b>\$3200.00</b>
Linear Lengths	10-ft. feeder	F3GC12SLI10	<b>\$3000.00</b>
Linear Lengths	10-ft. riser	R3GC12SLI10	<b>\$3100.00</b>
Fitting	Elbows; Left	F3GC12ELIST	<b>\$1080.00</b>
Fitting	Elbows; Right	F3GC12ERIST	<b>\$1080.00</b>
Fitting	Elbows; Up	F3GC12EUIST	<b>\$980.00</b>
Fitting	Elbows; Down	F3GC12EDIST	<b>\$980.00</b>
Accessories	End Cable Tap Box (Up)	F3GC12TTIST	<b>\$1770.00</b>
Accessories	End Cable Tap Box (Dn)	F3GC12TBIST	<b>\$1770.00</b>
Accessories	Center Cable Tap Box (Up)	F3GC12CTIST	<b>\$2090.00</b>
Accessories	Center Cable Tap Box (Dn)	F3GC12CBIST	<b>\$2090.00</b>
Accessories	End Box	F3GC12EBIST	<b>\$128.00</b>
Accessories	Flanged End w/ Lugs	F3GC12FLIST	<b>\$1963.00</b>
Accessories	Flanged End	F3GC12FEIST	<b>\$1291.00</b>

**Copper, Three-Wire, Internal Ground**



# Busway Spectra® Series Busway (continued)

Sandwich Bus

Copper Conductors

Product Number Pricing

# Section 11

## 1600 Amps Three-Phase, Three-Wire Internal Ground Bar

Component	Type	Product Number	List Price GO-126S
Linear Lengths	10-ft. plug-in	P3GC16SLI10	\$4050.00
Linear Lengths	10-ft. feeder	F3GC16SLI10	\$3850.00
Linear Lengths	10-ft. riser	R3GC16SLI10	\$3950.00
Fitting	Elbows; Left	F3GC16ELIST	\$1250.00
Fitting	Elbows; Right	F3GC16ERIST	\$1250.00
Fitting	Elbows; Up	F3GC16EUIST	\$1122.00
Fitting	Elbows; Down	F3GC16EDIST	\$1122.00
Accessories	End Cable Tap Box (Up)	F3GC16TTIST	\$2154.00
Accessories	End Cable Tap Box (Dn)	F3GC16TBIST	\$2154.00
Accessories	Center Cable Tap Box (Up)	F3GC16CTIST	\$2559.00
Accessories	Center Cable Tap Box (Dn)	F3GC16CBIST	\$2559.00
Accessories	End Box	F3GC16EBIST	\$128.00
Accessories	Flanged End w/ Lugs	F3GC16FLIST	\$2433.00
Accessories	Flanged End	F3GC16FEIST	\$1593.00

## 3000 Amps Three-Phase, Three-Wire Internal Ground Bar

Component	Type	Product Number	List Price GO-126S
Linear Lengths	10-ft. plug-in	P3GC30SLI10	\$7650.00
Linear Lengths	10-ft. feeder	F3GC30SLI10	\$7450.00
Linear Lengths	10-ft. riser	R3GC30SLI10	\$7550.00
Fitting	Elbows; Left	F3GC30ELIST	\$2783.00
Fitting	Elbows; Right	F3GC30ERIST	\$2783.00
Fitting	Elbows; Up	F3GC30EUIST	\$1790.00
Fitting	Elbows; Down	F3GC30EDIST	\$1790.00
Accessories	End Cable Tap Box (Up)	F3GC30TTIST	\$3606.00
Accessories	End Cable Tap Box (Dn)	F3GC30TBIST	\$3606.00
Accessories	Center Cable Tap Box (Up)	F3GC30CTIST	\$5072.00
Accessories	Center Cable Tap Box (Dn)	F3GC30CBIST	\$5072.00
Accessories	End Box	F3GC30EBIST	\$157.00
Accessories	Flanged End w/ Lugs	F3GC30FLIST	\$4151.00
Accessories	Flanged End	F3GC30FEIST	\$2639.00

## 2000 Amps Three-Phase, Three-Wire Internal Ground Bar

Component	Type	Product Number	List Price GO-126S
Linear Lengths	10-ft. plug-in	P3GC20SLI10	\$5150.00
Linear Lengths	10-ft. feeder	F3GC20SLI10	\$4950.00
Linear Lengths	10-ft. riser	R3GC20SLI10	\$5050.00
Fitting	Elbows; Left	F3GC20ELIST	\$1538.00
Fitting	Elbows; Right	F3GC20ERIST	\$1538.00
Fitting	Elbows; Up	F3GC20EUIST	\$1373.00
Fitting	Elbows; Down	F3GC20EDIST	\$1373.00
Accessories	End Cable Tap Box (Up)	F3GC20TTIST	\$2615.00
Accessories	End Cable Tap Box (Dn)	F3GC20TBIST	\$2615.00
Accessories	Center Cable Tap Box (Up)	F3GC20CTIST	\$3130.00
Accessories	Center Cable Tap Box (Dn)	F3GC20CBIST	\$3130.00
Accessories	End Box	F3GC20EBIST	\$157.00
Accessories	Flanged End w/ Lugs	F3GC20FLIST	\$2923.00
Accessories	Flanged End	F3GC20FEIST	\$1915.00

## 4000 Amps Three-Phase, Three-Wire Internal Ground Bar

Component	Type	Product Number	List Price GO-126S
Linear Lengths	10-ft. plug-in	P3GC40SLI10	\$10050.00
Linear Lengths	10-ft. feeder	F3GC40SLI10	\$9850.00
Linear Lengths	10-ft. riser	R3GC40SLI10	\$9950.00
Fitting	Elbows; Left	F3GC40ELIST	\$3592.00
Fitting	Elbows; Right	F3GC40ERIST	\$3592.00
Fitting	Elbows; Up	F3GC40EUIST	\$2279.00
Fitting	Elbows; Down	F3GC40EDIST	\$2279.00
Accessories	End Cable Tap Box (Up)	F3GC40TTIST	\$4568.00
Accessories	End Cable Tap Box (Dn)	F3GC40TBIST	\$4568.00
Accessories	Center Cable Tap Box (Up)	F3GC40CTIST	\$6494.00
Accessories	Center Cable Tap Box (Dn)	F3GC40CBIST	\$6494.00
Accessories	End Box	F3GC40EBIST	\$190.00
Accessories	Flanged End w/ Lugs	F3GC40FLIST	\$5334.00
Accessories	Flanged End	F3GC40FEIST	\$3338.00

## 2500 Amps Three-Phase, Three-Wire Internal Ground Bar

Component	Type	Product Number	List Price GO-126S
Linear Lengths	10-ft. plug-in	P3GC25SLI10	\$6350.00
Linear Lengths	10-ft. feeder	F3GC25SLI10	\$6150.00
Linear Lengths	10-ft. riser	R3GC25SLI10	\$6250.00
Fitting	Elbows; Left	F3GC25ELIST	\$2393.00
Fitting	Elbows; Right	F3GC25ERIST	\$2393.00
Fitting	Elbows; Up	F3GC25EUIST	\$1573.00
Fitting	Elbows; Down	F3GC25EDIST	\$1573.00
Accessories	End Cable Tap Box (Up)	F3GC25TTIST	\$3111.00
Accessories	End Cable Tap Box (Dn)	F3GC25TBIST	\$3111.00
Accessories	Center Cable Tap Box (Up)	F3GC25CTIST	\$3959.00
Accessories	Center Cable Tap Box (Dn)	F3GC25CBIST	\$3959.00
Accessories	End Box	F3GC25EBIST	\$157.00
Accessories	Flanged End w/ Lugs	F3GC25FLIST	\$3620.00
Accessories	Flanged End	F3GC25FEIST	\$2276.00

## Copper, Three-Wire, Internal Ground





**Busway**  
**Spectra® Series Busway (continued)**  
 Sandwich Bus  
 Copper Conductors  
 Product Number Pricing

**Section 11**

**225 Amps Three-Phase, Four-Wire Internal Ground Bar**

Component	Type	Product Number	List Price GO-126S
Linear Lengths	10-ft. plug-in	P4GC02SL110	\$2300.00
Linear Lengths	10-ft. feeder	F4GC02SL110	\$2100.00
Linear Lengths	10-ft. riser	R4GC02SL110	\$2200.00
Fitting	Elbows; Left	F4GC02ELIST	\$968.00
Fitting	Elbows; Right	F4GC02ERIST	\$968.00
Fitting	Elbows; Up	F4GC02EUIST	\$898.00
Fitting	Elbows; Down	F4GC02EDIST	\$898.00
Accessories	End Cable Tap Box (Up)	F4GC02TTIST	\$1404.00
Accessories	End Cable Tap Box (Dn)	F4GC02TBIST	\$1404.00
Accessories	Center Cable Tap Box (Up)	F4GC02CTIST	\$1480.00
Accessories	Center Cable Tap Box (Dn)	F4GC02CBIST	\$1480.00
Accessories	End Box	F4GC02EBIST	\$128.00
Accessories	Flanged End w/ Lugs	F4GC02FLIST	\$1251.00
Accessories	Flanged End	F4GC02FEIST	\$1027.00

**800 Amps Three-Phase, Four-Wire Internal Ground Bar**

Component	Type	Product Number	List Price GO-126S
Linear Lengths	10-ft. plug-in	P4GC08SL110	\$2750.00
Linear Lengths	10-ft. feeder	F4GC08SL110	\$2550.00
Linear Lengths	10-ft. riser	R4GC08SL110	\$2650.00
Fitting	Elbows; Left	F4GC08ELIST	\$1058.00
Fitting	Elbows; Right	F4GC08ERIST	\$1058.00
Fitting	Elbows; Up	F4GC08EUIST	\$973.00
Fitting	Elbows; Down	F4GC08EDIST	\$973.00
Accessories	End Cable Tap Box (Up)	F4GC08TTIST	\$1620.00
Accessories	End Cable Tap Box (Dn)	F4GC08TBIST	\$1620.00
Accessories	Center Cable Tap Box (Up)	F4GC08CTIST	\$1711.00
Accessories	Center Cable Tap Box (Dn)	F4GC08CBIST	\$1711.00
Accessories	End Box	F4GC08EBIST	\$128.00
Accessories	Flanged End w/ Lugs	F4GC08FLIST	\$1891.00
Accessories	Flanged End	F4GC08FEIST	\$1219.00

**400 Amps Three-Phase, Four-Wire Internal Ground Bar**

Component	Type	Product Number	List Price GO-126S
Linear Lengths	10-ft. plug-in	P4GC04SL110	\$2300.00
Linear Lengths	10-ft. feeder	F4GC04SL110	\$2100.00
Linear Lengths	10-ft. riser	R4GC04SL110	\$2200.00
Fitting	Elbows; Left	F4GC04ELIST	\$968.00
Fitting	Elbows; Right	F4GC04ERIST	\$968.00
Fitting	Elbows; Up	F4GC04EUIST	\$898.00
Fitting	Elbows; Down	F4GC04EDIST	\$898.00
Accessories	End Cable Tap Box (Up)	F4GC04TTIST	\$1404.00
Accessories	End Cable Tap Box (Dn)	F4GC04TBIST	\$1404.00
Accessories	Center Cable Tap Box (Up)	F4GC04CTIST	\$1480.00
Accessories	Center Cable Tap Box (Dn)	F4GC04CBIST	\$1480.00
Accessories	End Box	F4GC04EBIST	\$128.00
Accessories	Flanged End w/ Lugs	F4GC04FLIST	\$1475.00
Accessories	Flanged End	F4GC04FEIST	\$1027.00

**1000 Amps Three-Phase, Four-Wire Internal Ground Bar**

Component	Type	Product Number	List Price GO-126S
Linear Lengths	10-ft. plug-in	P4GC10SL110	\$3400.00
Linear Lengths	10-ft. feeder	F4GC10SL110	\$3200.00
Linear Lengths	10-ft. riser	R4GC10SL110	\$3300.00
Fitting	Elbows; Left	F4GC10ELIST	\$1188.00
Fitting	Elbows; Right	F4GC10ERIST	\$1188.00
Fitting	Elbows; Up	F4GC10EUIST	\$1081.00
Fitting	Elbows; Down	F4GC10EDIST	\$1081.00
Accessories	End Cable Tap Box (Up)	F4GC10TTIST	\$1870.00
Accessories	End Cable Tap Box (Dn)	F4GC10TBIST	\$1870.00
Accessories	Center Cable Tap Box (Up)	F4GC10CTIST	\$1984.00
Accessories	Center Cable Tap Box (Dn)	F4GC10CBIST	\$1984.00
Accessories	End Box	F4GC10EBIST	\$128.00
Accessories	Flanged End w/ Lugs	F4GC10FLIST	\$2069.00
Accessories	Flanged End	F4GC10FEIST	\$1397.00

**600 Amps Three-Phase, Four-Wire Internal Ground Bar**

Component	Type	Product Number	List Price GO-126S
Linear Lengths	10-ft. plug-in	P4GC06SL110	\$2300.00
Linear Lengths	10-ft. feeder	F4GC06SL110	\$2100.00
Linear Lengths	10-ft. riser	R4GC06SL110	\$2200.00
Fitting	Elbows; Left	F4GC06ELIST	\$968.00
Fitting	Elbows; Right	F4GC06ERIST	\$968.00
Fitting	Elbows; Up	F4GC06EUIST	\$898.00
Fitting	Elbows; Down	F4GC06EDIST	\$898.00
Accessories	End Cable Tap Box (Up)	F4GC06TTIST	\$1404.00
Accessories	End Cable Tap Box (Dn)	F4GC06TBIST	\$1404.00
Accessories	Center Cable Tap Box (Up)	F4GC06CTIST	\$1480.00
Accessories	Center Cable Tap Box (Dn)	F4GC06CBIST	\$1480.00
Accessories	End Box	F4GC06EBIST	\$128.00
Accessories	Flanged End w/ Lugs	F4GC06FLIST	\$1475.00
Accessories	Flanged End	F4GC06FEIST	\$1027.00

**1200 Amps Three-Phase, Four-Wire Internal Ground Bar**

Component	Type	Product Number	List Price GO-126S
Linear Lengths	10-ft. plug-in	P4GC12SL110	\$4100.00
Linear Lengths	10-ft. feeder	F4GC12SL110	\$3900.00
Linear Lengths	10-ft. riser	R4GC12SL110	\$4000.00
Fitting	Elbows; Left	F4GC12ELIST	\$1328.00
Fitting	Elbows; Right	F4GC12ERIST	\$1328.00
Fitting	Elbows; Up	F4GC12EUIST	\$1198.00
Fitting	Elbows; Down	F4GC12EDIST	\$1198.00
Accessories	End Cable Tap Box (Up)	F4GC12TTIST	\$2171.00
Accessories	End Cable Tap Box (Dn)	F4GC12TBIST	\$2171.00
Accessories	Center Cable Tap Box (Up)	F4GC12CTIST	\$2581.00
Accessories	Center Cable Tap Box (Dn)	F4GC12CBIST	\$2581.00
Accessories	End Box	F4GC12EBIST	\$128.00
Accessories	Flanged End w/ Lugs	F4GC12FLIST	\$2507.00
Accessories	Flanged End	F4GC12FEIST	\$1611.00

**Copper, Four-Wire, Internal Ground**



# Busway Spectra® Series Busway (continued)

Sandwich Bus  
Copper Conductors  
Product Number Pricing

# Section 11

## 1600 Amps Three-Phase, Four-Wire Internal Ground Bar

Component	Type	Product Number	List Price GO-1265
Linear Lengths	10-ft. plug-in	P4GC16SLI10	\$5250.00
Linear Lengths	10-ft. feeder	F4GC16SLI10	\$5050.00
Linear Lengths	10-ft. riser	R4GC16SLI10	\$1510.00
Fitting	Elbows; Left	F4GC16ELIST	\$1558.00
Fitting	Elbows; Right	F4GC16ERIST	\$1558.00
Fitting	Elbows; Up	F4GC16EUIST	\$1390.00
Fitting	Elbows; Down	F4GC16EDIST	\$1390.00
Accessories	End Cable Tap Box (Up)	F4GC16TTIST	\$2682.00
Accessories	End Cable Tap Box (Dn)	F4GC16TBIST	\$2682.00
Accessories	Center Cable Tap Box (Up)	F4GC16CTIST	\$3207.00
Accessories	Center Cable Tap Box (Dn)	F4GC16CBIST	\$3207.00
Accessories	End Box	F4GC16EBIST	\$128.00
Accessories	Flanged End w/ Lugs	F4GC16FLIST	\$3133.00
Accessories	Flanged End	F4GC16FEIST	\$2013.00

## 3000 Amps Three-Phase, Four-Wire Internal Ground Bar

Component	Type	Product Number	List Price GO-1265
Linear Lengths	10-ft. plug-in	P4GC30SLI10	\$10050.00
Linear Lengths	10-ft. feeder	F4GC30SLI10	\$9850.00
Linear Lengths	10-ft. riser	R4GC30SLI10	\$9950.00
Fitting	Elbows; Left	F4GC30ELIST	\$3625.00
Fitting	Elbows; Right	F4GC30ERIST	\$3625.00
Fitting	Elbows; Up	F4GC30EUIST	\$2312.00
Fitting	Elbows; Down	F4GC30EDIST	\$2312.00
Accessories	End Cable Tap Box (Up)	F4GC30TTIST	\$4596.00
Accessories	End Cable Tap Box (Dn)	F4GC30TBIST	\$4596.00
Accessories	Center Cable Tap Box (Up)	F4GC30CTIST	\$6522.00
Accessories	Center Cable Tap Box (Dn)	F4GC30CBIST	\$6522.00
Accessories	End Box	F4GC30EBIST	\$157.00
Accessories	Flanged End w/ Lugs	F4GC30FLIST	\$5413.00
Accessories	Flanged End	F4GC30FEIST	\$3397.00

## 2000 Amps Three-Phase, Four-Wire Internal Ground Bar

Component	Type	Product Number	List Price GO-1265
Linear Lengths	10-ft. plug-in	P4GC20SLI10	\$6550.00
Linear Lengths	10-ft. feeder	F4GC20SLI10	\$6350.00
Linear Lengths	10-ft. riser	R4GC20SLI10	\$6450.00
Fitting	Elbows; Left	F4GC20ELIST	\$1940.00
Fitting	Elbows; Right	F4GC20ERIST	\$1940.00
Fitting	Elbows; Up	F4GC20EUIST	\$1728.00
Fitting	Elbows; Down	F4GC20EDIST	\$1728.00
Accessories	End Cable Tap Box (Up)	F4GC20TTIST	\$3205.00
Accessories	End Cable Tap Box (Dn)	F4GC20TBIST	\$3205.00
Accessories	Center Cable Tap Box (Up)	F4GC20CTIST	\$3860.00
Accessories	Center Cable Tap Box (Dn)	F4GC20CBIST	\$3860.00
Accessories	End Box	F4GC20EBIST	\$157.00
Accessories	Flanged End w/ Lugs	F4GC20FLIST	\$3752.00
Accessories	Flanged End	F4GC20FEIST	\$2408.00

## 4000 Amps Three-Phase, Four-Wire Internal Ground Bar

Component	Type	Product Number	List Price GO-1265
Linear Lengths	10-ft. plug-in	P4GC40SLI10	\$13250.00
Linear Lengths	10-ft. feeder	F4GC40SLI10	\$13050.00
Linear Lengths	10-ft. riser	R4GC40SLI10	\$13150.00
Fitting	Elbows; Left	F4GC40ELIST	\$4719.00
Fitting	Elbows; Right	F4GC40ERIST	\$4719.00
Fitting	Elbows; Up	F4GC40EUIST	\$2979.00
Fitting	Elbows; Down	F4GC40EDIST	\$2979.00
Accessories	End Cable Tap Box (Up)	F4GC40TTIST	\$5952.00
Accessories	End Cable Tap Box (Dn)	F4GC40TBIST	\$5952.00
Accessories	Center Cable Tap Box (Up)	F4GC40CTIST	\$8492.00
Accessories	Center Cable Tap Box (Dn)	F4GC40CBIST	\$8492.00
Accessories	End Box	F4GC40EBIST	\$190.00
Accessories	Flanged End w/ Lugs	F4GC40FLIST	\$7117.00
Accessories	Flanged End	F4GC40FEIST	\$4429.00

## 2500 Amps Three-Phase, Four-Wire Internal Ground Bar

Component	Type	Product Number	List Price GO-1265
Linear Lengths	10-ft. plug-in	P4GC25SLI10	\$8350.00
Linear Lengths	10-ft. feeder	F4GC25SLI10	\$8150.00
Linear Lengths	10-ft. riser	R4GC25SLI10	\$8250.00
Fitting	Elbows; Left	F4GC25ELIST	\$3115.00
Fitting	Elbows; Right	F4GC25ERIST	\$3115.00
Fitting	Elbows; Up	F4GC25EUIST	\$2028.00
Fitting	Elbows; Down	F4GC25EDIST	\$2028.00
Accessories	End Cable Tap Box (Up)	F4GC25TTIST	\$3939.00
Accessories	End Cable Tap Box (Dn)	F4GC25TBIST	\$3939.00
Accessories	Center Cable Tap Box (Up)	F4GC25CTIST	\$5053.00
Accessories	Center Cable Tap Box (Dn)	F4GC25CBIST	\$5053.00
Accessories	End Box	F4GC25EBIST	\$157.00
Accessories	Flanged End w/ Lugs	F4GC25FLIST	\$4721.00
Accessories	Flanged End	F4GC25FEIST	\$2929.00

## Hangers - Common to All Services

Component	Type	Product Number	List Price GO-1265
800 Amps	Flatwise (st.)	SBF16	\$15.00
1000 Amps	Flatwise (st.)	SBF22	\$15.00
1200 Amps	Flatwise (st.)	SBF28	\$15.00
1600 Amps	Flatwise (st.)	SBF42	\$15.00
2500 Amps	Flatwise (st.)	SBTF	\$15.00
3000 Amps	Flatwise (st.)	SBTH	\$15.00
4000 Amps	Flatwise (st.)	SBTH	\$15.00
225-1600 Amps	Edgewise (st.)	SBE45	\$15.00
2000-5000 Amps	Edgewise (st.)	SBTE	\$15.00
1200 Amps	Spring	SBR1	\$67.00
4000 Amps	Spring	SBR2	\$67.00

## Copper, Four-Wire, Internal Ground



**Aluminum Conductors Three-Phase, Three-Wire**

Component	Ampere Rating											
	225	400	600	800	1000	1200	1350	1600	2000	2500	3000	4000
List Prices, GO-126S												
Plug-in indoor standard (IP40)	\$132.00	\$132.00	\$132.00	\$154.00	\$165.00	\$187.00	\$220.00	\$253.00	\$297.00	\$407.00	\$484.00	\$583.00
Plug-in drip proof (IP43)	\$152.00	\$152.00	\$152.00	\$177.00	\$190.00	\$216.00	\$253.00	\$292.00	\$342.00	\$469.00	\$557.00	\$671.00
Plug-in splash proof (IP54)	\$165.00	\$165.00	\$165.00	\$193.00	\$206.00	\$234.00	\$275.00	\$316.00	\$371.00	\$509.00	\$605.00	\$729.00
Riser indoor standard (IP40) <sup>3</sup>	\$127.00	\$127.00	\$127.00	\$149.00	\$160.00	\$182.00	\$215.00	\$248.00	\$292.00	\$402.00	\$479.00	\$578.00
Riser drip proof (IP43) <sup>3</sup>	\$146.00	\$146.00	\$146.00	\$172.00	\$185.00	\$198.00	\$251.00	\$291.00	\$343.00	\$475.00	\$568.00	\$686.00
Riser splash proof (IP54) <sup>3</sup>	\$159.00	\$159.00	\$159.00	\$186.00	\$200.00	\$228.00	\$269.00	\$310.00	\$365.00	\$503.00	\$599.00	\$723.00
Joint-Guard™ protection	\$11.00	\$11.00	\$11.00	\$11.00	\$11.00	\$11.00	\$11.00	\$11.00	\$22.00	\$22.00	\$22.00	\$44.00
Feeder indoor standard (IP40)	\$121.00	\$121.00	\$121.00	\$143.00	\$154.00	\$176.00	\$209.00	\$242.00	\$286.00	\$396.00	\$473.00	\$572.00
Feeder drip proof (IP43)	\$140.00	\$140.00	\$140.00	\$165.00	\$177.00	\$202.00	\$241.00	\$278.00	\$329.00	\$456.00	\$545.00	\$658.00
Feeder splash proof (IP54)	\$156.00	\$156.00	\$156.00	\$172.00	\$185.00	\$198.00	\$251.00	\$290.00	\$343.00	\$475.00	\$568.00	\$686.00
Feeder outdoor NEMA 3R (IP65/66)	\$161.00	\$161.00	\$161.00	\$177.00	\$191.00	\$204.00	\$259.00	\$299.00	\$353.00	\$489.00	\$585.00	\$707.00
90° elbow <sup>1</sup>	\$408.00	\$408.00	\$408.00	\$408.00	\$408.00	\$408.00	\$408.00	\$541.00	\$541.00	\$541.00	\$637.00	\$637.00
Tee	\$541.00	\$541.00	\$541.00	\$541.00	\$541.00	\$541.00	\$541.00	\$670.00	\$670.00	\$670.00	\$804.00	\$804.00
End box	\$128.00	\$128.00	\$128.00	\$128.00	\$128.00	\$128.00	\$128.00	\$157.00	\$157.00	\$157.00	\$190.00	\$190.00
Cable tap box <sup>2</sup>	\$1054.00	\$1054.00	\$1054.00	\$1150.00	\$1220.00	\$1325.00	\$1470.00	\$1647.00	\$1889.00	\$2352.00	\$2669.00	\$3161.00
Swbd/swgr stub	\$771.00	\$771.00	\$771.00	\$932.00	\$1028.00	\$1122.00	\$1218.00	\$1346.00	\$1536.00	\$1759.00	\$2049.00	\$2496.00
Flanged end	\$643.00	\$643.00	\$643.00	\$704.00	\$760.00	\$845.00	\$916.00	\$1037.00	\$1174.00	\$1357.00	\$1608.00	\$1928.00
Xfmr throat connection	\$2279.00	\$2279.00	\$2279.00	\$2474.00	\$2664.00	\$2815.00	\$2937.00	\$3228.00	\$3529.00	\$3965.00	\$4412.00	\$5250.00
Xfmr cable tap 3 ph	\$783.00	\$783.00	\$783.00	\$862.00	\$922.00	\$989.00	\$1086.00	\$1187.00	\$1376.00	\$1752.00	\$2068.00	\$2429.00
Xfmr cable tap 3-1 ph	\$2290.00	\$2290.00	\$2290.00	\$2528.00	\$2689.00	\$2910.00	\$3147.00	\$3440.00	\$3927.00	\$4811.00	\$5496.00	\$6537.00
Expansion section	\$832.00	\$832.00	\$832.00	\$995.00	\$1089.00	\$1190.00	\$1285.00	\$1379.00	\$1637.00	\$1893.00	\$2183.00	\$2719.00
Unfused reducer	\$614.00	\$614.00	\$614.00	\$709.00	\$804.00	\$960.00	\$1022.00	\$1156.00	\$1346.00	\$1637.00	\$1893.00	\$2435.00

**Miscellaneous Accessories**

Description	List Price GO-126S
Wall/floor flange	\$129.00
Roof flange	\$637.00
Spring hanger	\$67.00
Extra hanger (1 Std.) <sup>4</sup>	\$15.00

<sup>4</sup>Catalog orders must include hanger product number (see page 11-51).

**Note/Price Adders (see page 11-7 for details and other critical notes)**

**Aluminum, Three-Wire, Housing Ground**



**Busway**  
**Spectra® Series Busway (continued)**  
Sandwich Bus  
Aluminum Conductors  
Functional Pricing

**Section 11**

**Aluminum Conductors Three-Phase, Four-Wire**

Component	Ampere Rating											
	225	400	600	800	1000	1200	1350	1600	2000	2500	3000	4000
	List Prices, GO-126S											
Plug-in indoor standard (IP40)	\$143.00	\$143.00	\$143.00	\$165.00	\$187.00	\$253.00	\$286.00	\$330.00	\$385.00	\$495.00	\$561.00	\$803.00
Plug-in drip proof (IP43)	\$165.00	\$165.00	\$165.00	\$190.00	\$216.00	\$292.00	\$329.00	\$380.00	\$443.00	\$570.00	\$646.00	\$924.00
Plug-in splash proof (IP54)	\$179.00	\$179.00	\$179.00	\$206.00	\$234.00	\$316.00	\$358.00	\$413.00	\$481.00	\$619.00	\$701.00	\$1004.00
Riser indoor standard (IP40) <sup>3</sup>	\$138.00	\$138.00	\$138.00	\$160.00	\$182.00	\$248.00	\$281.00	\$325.00	\$380.00	\$490.00	\$556.00	\$798.00
Riser drip proof (IP43) <sup>3</sup>	\$158.00	\$158.00	\$158.00	\$184.00	\$209.00	\$285.00	\$322.00	\$373.00	\$437.00	\$563.00	\$639.00	\$917.00
Riser splash proof (IP54) <sup>3</sup>	\$173.00	\$173.00	\$173.00	\$200.00	\$228.00	\$310.00	\$351.00	\$406.00	\$475.00	\$613.00	\$695.00	\$998.00
Joint-Guard™ protection	\$11.00	\$11.00	\$11.00	\$11.00	\$11.00	\$11.00	\$11.00	\$11.00	\$22.00	\$22.00	\$22.00	\$44.00
Feeder indoor standard (IP40)	\$132.00	\$132.00	\$132.00	\$154.00	\$176.00	\$242.00	\$275.00	\$319.00	\$374.00	\$484.00	\$550.00	\$792.00
Feeder drip proof (IP43)	\$152.00	\$152.00	\$152.00	\$177.00	\$202.00	\$278.00	\$317.00	\$367.00	\$430.00	\$557.00	\$633.00	\$911.00
Feeder splash proof (IP54)	\$158.00	\$158.00	\$158.00	\$185.00	\$211.00	\$290.00	\$330.00	\$383.00	\$449.00	\$581.00	\$660.00	\$950.00
Feeder outdoor NEMA 3R (IP65/66)	\$163.00	\$163.00	\$163.00	\$191.00	\$217.00	\$299.00	\$340.00	\$394.00	\$462.00	\$598.00	\$680.00	\$979.00
90° elbow <sup>1</sup>	\$492.00	\$492.00	\$492.00	\$492.00	\$492.00	\$541.00	\$541.00	\$670.00	\$670.00	\$670.00	\$804.00	\$804.00
Tee	\$614.00	\$614.00	\$614.00	\$614.00	\$614.00	\$614.00	\$614.00	\$804.00	\$804.00	\$804.00	\$932.00	\$932.00
End box	\$128.00	\$128.00	\$128.00	\$128.00	\$128.00	\$128.00	\$128.00	\$157.00	\$157.00	\$157.00	\$190.00	\$190.00
Cable tap box <sup>2</sup>	\$1091.00	\$1091.00	\$1091.00	\$1187.00	\$1293.00	\$1546.00	\$1690.00	\$1904.00	\$2182.00	\$2645.00	\$2926.00	\$3894.00
Swbd/swgr stub	\$960.00	\$960.00	\$960.00	\$1089.00	\$1218.00	\$1346.00	\$1503.00	\$1670.00	\$1916.00	\$2279.00	\$2658.00	\$3328.00
Flanged end	\$708.00	\$708.00	\$708.00	\$792.00	\$875.00	\$1037.00	\$1092.00	\$1253.00	\$1431.00	\$1713.00	\$1978.00	\$2510.00
Xfmr throat connection	\$2496.00	\$2496.00	\$2496.00	\$2775.00	\$2982.00	\$3228.00	\$3417.00	\$3753.00	\$4189.00	\$4836.00	\$5440.00	\$6668.00
Xfmr cable tap 3 ph	\$840.00	\$840.00	\$840.00	\$945.00	\$1022.00	\$1187.00	\$1321.00	\$1442.00	\$1708.00	\$2057.00	\$2346.00	\$3025.00
Xfmr cable tap 3-1 ph	\$2356.00	\$2356.00	\$2356.00	\$2594.00	\$2815.00	\$3306.00	\$3543.00	\$3902.00	\$4455.00	\$5339.00	\$5964.00	\$7857.00
Expansion section	\$995.00	\$995.00	\$995.00	\$1156.00	\$1285.00	\$1475.00	\$1569.00	\$1916.00	\$2084.00	\$2429.00	\$2820.00	\$3552.00
Unfused reducer	\$737.00	\$737.00	\$737.00	\$899.00	\$1056.00	\$1190.00	\$1307.00	\$1503.00	\$1759.00	\$2183.00	\$2564.00	\$3295.00

<sup>1</sup> Elbows etc. greater than 90° (Double price).

<sup>2</sup> Non-std. tap boxes (Double price).

<sup>3</sup> Plug outlets on one side only.

\* Custom colors (10% to 15% adder).

\* Silver plating on copper (15% adder).

**Miscellaneous Accessories**

Description	List Price GO-126S
Wall/floor flange	\$129.00
Roof flange	\$637.00
Spring hanger	\$67.00
Extra hanger (1 Std.) <sup>4</sup>	\$15.00

<sup>4</sup>Catalog orders must include hanger product number (see page 11-51).

**Note/Price Adders (see page 11-7 for details and other critical notes)**

**Aluminum, Four-Wire, Housing Ground**



**Copper Conductors Three-Phase, Three-Wire**

Component	Ampere Rating													
	225	400	600	800	1000	1200	1350	1600	2000	2500	3000	4000	5000	
List Price, GO-126S														
\$/Ft	Plug-in indoor standard (IP40)	\$160.00	\$160.00	\$160.00	\$190.00	\$210.00	\$270.00	\$300.00	\$340.00	\$430.00	\$530.00	\$640.00	\$840.00	\$1020.00
	Plug-in drip proof (IP43)	\$184.00	\$184.00	\$184.00	\$219.00	\$242.00	\$311.00	\$345.00	\$391.00	\$495.00	\$610.00	\$736.00	\$966.00	\$1173.00
	Plug-in splash proof (IP54)	\$200.00	\$200.00	\$200.00	\$238.00	\$263.00	\$338.00	\$375.00	\$425.00	\$538.00	\$663.00	\$800.00	\$1050.00	\$1275.00
	Riser indoor standard (IP40) <sup>3</sup>	\$150.00	\$150.00	\$150.00	\$180.00	\$200.00	\$260.00	\$290.00	\$330.00	\$420.00	\$520.00	\$630.00	\$830.00	\$1010.00
	Riser drip proof (IP43) <sup>3</sup>	\$173.00	\$173.00	\$173.00	\$207.00	\$230.00	\$299.00	\$334.00	\$380.00	\$483.00	\$598.00	\$725.00	\$955.00	\$1162.00
	Riser splash proof (IP54) <sup>3</sup>	\$188.00	\$188.00	\$188.00	\$225.00	\$250.00	\$325.00	\$363.00	\$413.00	\$525.00	\$650.00	\$788.00	\$1038.00	\$1263.00
	Joint-Guard™ protection	\$11.00	\$11.00	\$11.00	\$11.00	\$11.00	\$11.00	\$11.00	\$11.00	\$11.00	\$22.00	\$22.00	\$22.00	\$44.00
	Feeder-indoor standard (IP40)	\$140.00	\$140.00	\$140.00	\$170.00	\$190.00	\$250.00	\$280.00	\$320.00	\$410.00	\$510.00	\$620.00	\$820.00	\$1000.00
	Feeder drip proof (IP43)	\$161.00	\$161.00	\$161.00	\$196.00	\$219.00	\$288.00	\$322.00	\$368.00	\$472.00	\$587.00	\$713.00	\$943.00	\$1150.00
	Feeder splash proof (IP54)	\$168.00	\$168.00	\$168.00	\$204.00	\$228.00	\$300.00	\$336.00	\$384.00	\$492.00	\$612.00	\$744.00	\$984.00	\$1200.00
	Feeder outdoor NEMA 3R (IP65/66)	\$173.00	\$173.00	\$173.00	\$210.00	\$235.00	\$309.00	\$346.00	\$396.00	\$507.00	\$630.00	\$766.00	\$1014.00	\$1236.00
	Internal ground bus	\$30.00	\$30.00	\$30.00	\$35.00	\$40.00	\$50.00	\$60.00	\$65.00	\$85.00	\$105.00	\$125.00	\$165.00	\$200.00
	\$ Labor Adder	90° elbow <sup>1</sup>	\$480.00	\$480.00	\$480.00	\$480.00	\$480.00	\$480.00	\$480.00	\$480.00	\$548.00	\$548.00	\$548.00	\$637.00
Tee		\$548.00	\$548.00	\$548.00	\$548.00	\$548.00	\$548.00	\$548.00	\$548.00	\$670.00	\$670.00	\$670.00	\$804.00	\$804.00
End box		\$128.00	\$128.00	\$128.00	\$128.00	\$128.00	\$128.00	\$128.00	\$128.00	\$157.00	\$157.00	\$157.00	\$190.00	\$190.00
Cable tap box <sup>2</sup>		\$1147.00	\$1147.00	\$1147.00	\$1270.00	\$1370.00	\$1603.00	\$1737.00	\$1937.00	\$2332.00	\$2761.00	\$3189.00	\$4018.00	\$4841.00
Swbd/swgr stub		\$771.00	\$771.00	\$771.00	\$932.00	\$1089.00	\$1218.00	\$1307.00	\$1536.00	\$1798.00	\$2183.00	\$2496.00	\$3228.00	\$3965.00
Flanged end		\$713.00	\$713.00	\$713.00	\$789.00	\$888.00	\$991.00	\$1062.00	\$1208.00	\$1420.00	\$1661.00	\$1894.00	\$2353.00	\$2976.00
Xfmr throat		\$2368.00	\$2368.00	\$2368.00	\$2630.00	\$2882.00	\$3127.00	\$3328.00	\$3619.00	\$4143.00	\$4770.00	\$5834.00	\$6668.00	\$7897.00
Xfmr cable tap 3 ph		\$828.00	\$828.00	\$828.00	\$916.00	\$994.00	\$1137.00	\$1230.00	\$1343.00	\$1624.00	\$1980.00	\$2368.00	\$2925.00	\$3475.00
Xfmr cable tap 3-1 ph		\$2404.00	\$2404.00	\$2404.00	\$2690.00	\$2899.00	\$3354.00	\$3573.00	\$3908.00	\$4671.00	\$5495.00	\$6378.00	\$8025.00	\$9552.00
Expansion section		\$832.00	\$832.00	\$832.00	\$995.00	\$1089.00	\$1184.00	\$1285.00	\$1385.00	\$1637.00	\$1893.00	\$2183.00	\$2719.00	\$3206.00
Unfused reducer		\$614.00	\$614.00	\$614.00	\$709.00	\$804.00	\$960.00	\$1022.00	\$1155.00	\$1346.00	\$1637.00	\$1893.00	\$2435.00	\$2982.00

**Miscellaneous Accessories**

Description	List Price GO-126S
Wall/floor flange	\$129.00
Roof flange	\$637.00
Spring hanger	\$67.00
Extra hanger (1 Std.) <sup>4</sup>	\$15.00

<sup>4</sup>Catalog orders must include hanger product number (see page 11-51).

**Note/Price Adders (see page 11-7 for details and other critical notes)**

**Copper, Three-Wire, Housing Ground**



**Busway**  
**Spectra® Series Busway (continued)**  
 Sandwich Bus  
 Copper Conductors  
 Functional Pricing

**Section 11**

**Copper Conductors (continued) Three-Phase, Four-Wire**

Component	Ampere Rating												
	225	400	600	800	1000	1200	1350	1600	2000	2500	3000	4000	5000
	List Price, GO-126S												
Plug-in indoor standard (IP40)	\$200.00	\$200.00	\$200.00	\$240.00	\$300.00	\$360.00	\$400.00	\$460.00	\$570.00	\$730.00	\$880.00	\$1160.00	\$1390.00
Plug-in drip proof (IP43)	\$230.00	\$230.00	\$230.00	\$276.00	\$345.00	\$414.00	\$460.00	\$529.00	\$656.00	\$840.00	\$1012.00	\$1334.00	\$1599.00
Plug-in splash proof (IP54)	\$250.00	\$250.00	\$250.00	\$300.00	\$375.00	\$450.00	\$500.00	\$575.00	\$713.00	\$913.00	\$1100.00	\$1450.00	\$1738.00
Riser indoor standard (IP40) <sup>3</sup>	\$190.00	\$190.00	\$190.00	\$230.00	\$290.00	\$350.00	\$390.00	\$450.00	\$560.00	\$720.00	\$870.00	\$1150.00	\$1380.00
Riser drip proof (IP43) <sup>3</sup>	\$219.00	\$219.00	\$219.00	\$265.00	\$334.00	\$403.00	\$449.00	\$518.00	\$644.00	\$828.00	\$1001.00	\$1323.00	\$1587.00
Riser splash proof (IP54) <sup>3</sup>	\$238.00	\$238.00	\$238.00	\$288.00	\$363.00	\$438.00	\$488.00	\$563.00	\$700.00	\$900.00	\$1088.00	\$1438.00	\$1725.00
Joint-Guard™ protection	\$11.00	\$11.00	\$11.00	\$11.00	\$11.00	\$11.00	\$11.00	\$11.00	\$11.00	\$22.00	\$22.00	\$22.00	\$44.00
Feeder-indoor standard (IP40)	\$180.00	\$180.00	\$180.00	\$220.00	\$280.00	\$340.00	\$380.00	\$440.00	\$550.00	\$710.00	\$860.00	\$1140.00	\$1370.00
Feeder drip proof (IP43)	\$207.00	\$207.00	\$207.00	\$253.00	\$322.00	\$391.00	\$437.00	\$506.00	\$633.00	\$817.00	\$989.00	\$1311.00	\$1576.00
Feeder splash proof (IP54)	\$216.00	\$216.00	\$216.00	\$264.00	\$336.00	\$408.00	\$456.00	\$528.00	\$660.00	\$852.00	\$1032.00	\$1368.00	\$1644.00
Feeder outdoor NEMA 3R (IP65/66)	\$222.00	\$222.00	\$222.00	\$272.00	\$346.00	\$420.00	\$470.00	\$544.00	\$680.00	\$878.00	\$1063.00	\$1409.00	\$1693.00
Internal ground bus	\$30.00	\$30.00	\$30.00	\$35.00	\$40.00	\$50.00	\$60.00	\$65.00	\$85.00	\$105.00	\$125.00	\$165.00	\$200.00
90° elbow <sup>1</sup>	\$548.00	\$548.00	\$548.00	\$548.00	\$548.00	\$548.00	\$548.00	\$548.00	\$670.00	\$670.00	\$670.00	\$804.00	\$804.00
Tee	\$614.00	\$614.00	\$614.00	\$614.00	\$614.00	\$614.00	\$614.00	\$614.00	\$804.00	\$804.00	\$804.00	\$932.00	\$932.00
End box	\$128.00	\$128.00	\$128.00	\$128.00	\$128.00	\$128.00	\$128.00	\$128.00	\$157.00	\$157.00	\$157.00	\$190.00	\$190.00
Cable tap box <sup>2</sup>	\$1304.00	\$1304.00	\$1304.00	\$1503.00	\$1737.00	\$2004.00	\$2165.00	\$2465.00	\$2922.00	\$3589.00	\$4179.00	\$5402.00	\$6392.00
Swbd/swgr stub	\$960.00	\$960.00	\$960.00	\$1156.00	\$1346.00	\$1564.00	\$1731.00	\$1955.00	\$2368.00	\$2887.00	\$3373.00	\$4379.00	\$5384.00
Flanged end	\$817.00	\$817.00	\$817.00	\$964.00	\$1077.00	\$1221.00	\$1315.00	\$1508.00	\$1773.00	\$2114.00	\$2412.00	\$3124.00	\$3910.00
Xfmr throat	\$2658.00	\$2658.00	\$2658.00	\$3016.00	\$3373.00	\$3417.00	\$4010.00	\$4407.00	\$5127.00	\$6054.00	\$6892.00	\$8646.00	\$10410.00
Xfmr cable tap 3 ph	\$936.00	\$936.00	\$936.00	\$1077.00	\$1230.00	\$1383.00	\$1531.00	\$1684.00	\$2060.00	\$2509.00	\$2971.00	\$3721.00	\$4438.00
Xfmr cable tap 3-1 ph	\$2644.00	\$2644.00	\$2644.00	\$2990.00	\$3439.00	\$3894.00	\$4173.00	\$4628.00	\$5511.00	\$6695.00	\$7818.00	\$9945.00	\$11770.00
Expansion section	\$995.00	\$995.00	\$995.00	\$1156.00	\$1285.00	\$1475.00	\$1564.00	\$1916.00	\$2084.00	\$2429.00	\$2820.00	\$3552.00	\$4262.00
Unfused reducer	\$737.00	\$737.00	\$737.00	\$899.00	\$1056.00	\$1184.00	\$1307.00	\$1503.00	\$1759.00	\$2183.00	\$2564.00	\$3295.00	\$4066.00

<sup>1</sup> Elbows etc. greater than 90° (Double price).

<sup>2</sup> Non-std. tap boxes (Double price).

<sup>3</sup> Plug outlets on one side only.

\* Custom colors (10% to 15% adder).

\* Silver plating on copper (15% adder).

**Miscellaneous Accessories**

Description	List Price GO-126S
Wall/floor flange	\$129.00
Roof flange	\$637.00
Spring hanger	\$67.00
Extra hanger (1 Std.) <sup>4</sup>	\$15.00

<sup>4</sup> Catalog orders must include hanger product number (see page 11-51).

Note/Price Adders (see page 11-7 for details and other critical notes)

**Copper, Four-Wire, Housing Ground**



**For Optional Larger Bar Sizes Three-Phase, Three-Wire**

		List Prices, GO-1265									
		Aluminum Conductors				Copper Conductors					
<b>Three-Phase, Three-Wire 600 Vac</b>		1600+	2000+	2500+	3000+	1600+	2000+	2500+	3000+	4000+	5000+
\$/Ft	Plug-in indoor <b>standard</b> (IP40)	\$297.00	\$384.00	\$484.00	\$518.00	\$360.00	\$470.00	\$640.00	\$670.00	\$900.00	\$1122.00
	Plug-in drip proof (IP43)	\$342.00	\$443.00	\$557.00	\$596.00	\$414.00	\$541.00	\$736.00	\$771.00	\$1035.00	\$1290.00
	Plug-in splash proof (IP54)	\$371.00	\$480.00	\$605.00	\$648.00	\$450.00	\$588.00	\$800.00	\$838.00	\$1125.00	\$1403.00
	Riser indoor <b>standard</b> (IP40) <sup>1</sup>	\$292.00	\$380.00	\$479.00	\$512.00	\$350.00	\$460.00	\$630.00	\$660.00	\$890.00	\$1112.00
	Riser drip proof (IP43) <sup>1</sup>	\$343.00	\$449.00	\$568.00	\$608.00	\$403.00	\$530.00	\$725.00	\$760.00	\$1024.00	\$1278.00
	Riser splash proof (IP54) <sup>1</sup>	\$365.00	\$475.00	\$599.00	\$640.00	\$438.00	\$575.00	\$788.00	\$825.00	\$1113.00	\$1398.00
	Feeder indoor <b>standard</b> (IP40)	\$286.00	\$374.00	\$473.00	\$506.00	\$340.00	\$450.00	\$620.00	\$650.00	\$880.00	\$1100.00
	Feeder drip proof (IP43)	\$329.00	\$431.00	\$545.00	\$583.00	\$391.00	\$518.00	\$713.00	\$748.00	\$1012.00	\$1265.00
	Feeder splash proof (IP54)	\$343.00	\$449.00	\$568.00	\$608.00	\$408.00	\$540.00	\$744.00	\$780.00	\$1056.00	\$1320.00
	Feeder Outdoor <b>NEMA 3R</b> (IP65/66)	\$353.00	\$462.00	\$585.00	\$626.00	\$421.00	\$556.00	\$766.00	\$803.00	\$1088.00	\$1360.00
	90° elbow <sup>2</sup>	\$541.00	\$541.00	\$637.00	\$637.00	\$548.00	\$548.00	\$548.00	\$637.00	\$637.00	\$700.00
	Tee	\$670.00	\$670.00	\$804.00	\$804.00	\$670.00	\$670.00	\$670.00	\$804.00	\$804.00	\$884.00
	End box	\$157.00	\$157.00	\$190.00	\$190.00	\$157.00	\$157.00	\$157.00	\$190.00	\$190.00	\$209.00
	Cable tap box	\$1889.00	\$2352.00	\$2669.00	\$3161.00	\$2332.00	\$2761.00	\$3189.00	\$4018.00	\$4841.00	\$5325.00
\$ Labor Adder	Swbd/swgr stub	\$1536.00	\$1759.00	\$2049.00	\$2496.00	\$1798.00	\$2183.00	\$2496.00	\$3228.00	\$3965.00	\$4361.00
	Flanged end	\$1174.00	\$1357.00	\$1608.00	\$1928.00	\$1420.00	\$1661.00	\$1894.00	\$2353.00	\$2976.00	\$3274.00
	Xfmr throat	\$3529.00	\$3965.00	\$4412.00	\$5250.00	\$4143.00	\$4770.00	\$5834.00	\$6668.00	\$7897.00	\$8687.00
	Xfmr cable tap 3 ph	\$1376.00	\$1708.00	\$2068.00	\$2297.00	\$1484.00	\$1860.00	\$2368.00	\$2585.00	\$3235.00	\$3822.00
	Xfmr cable tap 3-1 ph	\$3927.00	\$4679.00	\$5496.00	\$6141.00	\$4251.00	\$5135.00	\$6378.00	\$7005.00	\$8832.00	\$10507.00
	Expansion section	\$1637.00	\$1893.00	\$2183.00	\$2719.00	\$1637.00	\$1893.00	\$2183.00	\$2719.00	\$3206.00	\$3526.00
	Unfused reducer	\$1346.00	\$1637.00	\$1893.00	\$2435.00	\$1346.00	\$1637.00	\$1893.00	\$2435.00	\$2982.00	\$3280.00

<sup>1</sup> Plug outlets on one side only.

<sup>2</sup> Double price for elbows other than 90°.

<sup>3</sup> Add "+" sign at the end of the standard catalog.

**Aluminum/Copper, Three-Wire, Housing Ground**

**For Optional Larger Bar Sizes Three-Phase, Four-Wire**

		List Prices, GO-1265									
		Aluminum Conductors				Copper Conductors					
<b>Three-Phase, Four-Wire 600 Vac</b>		1600+	2000+	2500+	3000+	1600+	2000+	2500+	3000+	4000+	5000+
\$/Ft	Plug-in indoor <b>standard</b> (IP40)	\$385.00	\$467.00	\$561.00	\$600.00	\$480.00	\$620.00	\$880.00	\$900.00	\$1280.00	\$1596.00
	Plug-in drip proof (IP43)	\$443.00	\$532.00	\$646.00	\$691.00	\$553.00	\$713.00	\$1012.00	\$1035.00	\$1472.00	\$1835.00
	Plug-in splash proof (IP54)	\$481.00	\$584.00	\$701.00	\$750.00	\$600.00	\$775.00	\$1100.00	\$1125.00	\$1600.00	\$1995.00
	Riser indoor <b>standard</b> (IP40) <sup>1</sup>	\$380.00	\$463.00	\$556.00	\$595.00	\$470.00	\$610.00	\$870.00	\$890.00	\$1270.00	\$1587.00
	Riser drip proof (IP43) <sup>1</sup>	\$437.00	\$532.00	\$639.00	\$684.00	\$542.00	\$702.00	\$1001.00	\$1024.00	\$1461.00	\$1823.00
	Riser splash proof (IP54) <sup>1</sup>	\$475.00	\$579.00	\$695.00	\$744.00	\$588.00	\$763.00	\$1088.00	\$1113.00	\$1588.00	\$1995.00
	Feeder indoor <b>standard</b> (IP40)	\$374.00	\$457.00	\$550.00	\$588.00	\$460.00	\$600.00	\$860.00	\$880.00	\$1260.00	\$1575.00
	Feeder drip proof (IP43)	\$430.00	\$526.00	\$633.00	\$677.00	\$529.00	\$690.00	\$989.00	\$1012.00	\$1449.00	\$1811.00
	Feeder splash proof (IP54)	\$449.00	\$549.00	\$660.00	\$706.00	\$552.00	\$720.00	\$1032.00	\$1056.00	\$1512.00	\$1890.00
	Feeder Outdoor <b>NEMA 3R</b> (IP65/66)	\$462.00	\$565.00	\$680.00	\$727.00	\$569.00	\$742.00	\$1063.00	\$1088.00	\$1557.00	\$1946.00
	90° elbow <sup>2</sup>	\$670.00	\$670.00	\$804.00	\$804.00	\$670.00	\$670.00	\$670.00	\$804.00	\$804.00	\$840.00
	Tee	\$804.00	\$804.00	\$932.00	\$932.00	\$804.00	\$804.00	\$804.00	\$932.00	\$932.00	\$1025.00
	End box	\$157.00	\$157.00	\$190.00	\$190.00	\$157.00	\$157.00	\$157.00	\$190.00	\$190.00	\$209.00
	Cable tap box	\$2182.00	\$2645.00	\$2926.00	\$3894.00	\$2922.00	\$3589.00	\$4179.00	\$5402.00	\$6392.00	\$7031.00
\$ Labor Adder	Swbd/swgr stub	\$1916.00	\$2279.00	\$2658.00	\$3328.00	\$2368.00	\$2887.00	\$3373.00	\$4379.00	\$5384.00	\$5922.00
	Flanged end	\$1431.00	\$1713.00	\$1978.00	\$2510.00	\$1773.00	\$2114.00	\$2412.00	\$3124.00	\$3910.00	\$4301.00
	Xfmr throat	\$4189.00	\$4836.00	\$5440.00	\$6668.00	\$5127.00	\$6054.00	\$6892.00	\$8646.00	\$10410.00	\$11451.00
	Xfmr cable tap 3 ph	\$1708.00	\$2003.00	\$2346.00	\$2617.00	\$1880.00	\$2289.00	\$2971.00	\$3201.00	\$4218.00	\$5018.00
	Xfmr cable tap 3-1 ph	\$4455.00	\$5177.00	\$5964.00	\$6633.00	\$4971.00	\$5435.00	\$7818.00	\$8385.00	\$11112.00	\$13357.00
	Expansion section	\$2084.00	\$2429.00	\$2820.00	\$3552.00	\$2084.00	\$2429.00	\$2820.00	\$3552.00	\$4262.00	\$4688.00
	Unfused reducer	\$1759.00	\$2183.00	\$2564.00	\$3295.00	\$1759.00	\$2183.00	\$2564.00	\$3295.00	\$4066.00	\$4472.00

<sup>1</sup> Plug outlets on one side only.

<sup>2</sup> Double price for elbows other than 90°.

**Aluminum/Copper, Four-Wire, Housing Ground**





**Features and Benefits**

- Rating Plug: simplifies factory floor and equipment changeovers because plug has trip amp interchangeability.
- True Digital rms Sensing: more accurate and reliable trip interruption.
- High Interrupting Rating: satisfies high IC requirements up to 100 kAIC @ 480V.
- UL listed and CSA Certified for heat rise, short-circuit, and ground fault.
- Interlocks and Safety Features: door interlock, plug interlock, ground contact before stab contact, and plug assist<sup>1</sup> for mechanical installation.

**Low-Tier Frames Three-Phase, Three-Wire SEDGA**

Trip Amps	Short Circuit Rating @ 240V (kAIC)	Short Circuit Rating @ 480V (kAIC)	Short Circuit Rating @ 600 V (kAIC)	Product Number	List Price GO-114M
15	18	14	14	SB31SEDG	\$1506.00
20	18	14	14	SB32SEDG	\$1506.00
30	18	14	14	SB33SEDG	\$1506.00
40	18	14	14	SB34SEDG	\$1506.00
50	18	14	14	SB35SEDG	\$1506.00
60	18	14	14	SB36SEDG	\$1506.00
70	18	14	14	SB37SEDG	\$1658.00
80	18	14	14	SB38SEDG	\$1658.00
90	18	14	14	SB39SEDG	\$1658.00
100	18	14	14	SB310SEDG	\$1658.00
110	18	14	14	SB311SEDG	\$3872.00
125	18	14	14	SB312SEDG	\$3872.00
150	18	14	14	SB315SEDG	\$3872.00

**Low-Tier Frames Three-Phase, Three-Wire SEHGA**

Trip Amps	Short Circuit Rating @ 240V (kAIC)	Short Circuit Rating @ 480V (kAIC)	Short Circuit Rating @ 600 V (kAIC)	Product Number	List Price GO-114M
15	65	25	18	SB31SEHG	\$1908.00
20	65	25	18	SB32SEHG	\$1908.00
30	65	25	18	SB33SEHG	\$1908.00
40	65	25	18	SB34SEHG	\$1908.00
50	65	25	18	SB35SEHG	\$1908.00
60	65	25	18	SB36SEHG	\$1908.00
70	65	25	18	SB37SEHG	\$2168.00
80	65	25	18	SB38SEHG	\$2168.00
90	65	25	18	SB39SEHG	\$2168.00
100	65	25	18	SB310SEHG	\$2168.00
110	65	25	18	SB311SEHG	\$4326.00
125	65	25	18	SB312SEHG	\$4326.00
150	65	25	18	SB315SEHG	\$4326.00

<sup>1</sup>Optional for E Frame plugs.

Notes: Breakers must be factory-installed. IC rating in rms symmetrical kA.

**Low-Tier Frames Three-Phase, Three-Wire SFHGA**

Trip Amps	Short Circuit Rating @ 240V (kAIC)	Short Circuit Rating @ 480V (kAIC)	Short Circuit Rating @ 600 V (kAIC)	Product Number	List Price GO-114M
70	65	25	18	SB37SFHG	\$4326.00
90	65	25	18	SB39SFHG	\$4326.00
100	65	25	18	SB310SFHG	\$4326.00
110	65	25	18	SB311SFHG	\$4326.00
125	65	25	18	SB312SFHG	\$4326.00
150	65	25	18	SB315SFHG	\$4326.00
175	65	25	18	SB317SFHG	\$4326.00
200	65	25	18	SB320SFHG	\$4326.00
225	65	25	18	SB322SFHG	\$4326.00
250	65	25	18	SB325SFHG	\$4326.00

**Low-Tier Frames Three-Phase, Three-Wire SGH4GA (400A)**

Trip Amps	Short Circuit Rating @ 240V (kAIC)	Short Circuit Rating @ 480V (kAIC)	Short Circuit Rating @ 600 V (kAIC)	Product Number	List Price GO-114M
125	65	35	25	SB312SGH4G	\$7512.00
150	65	35	25	SB315SGH4G	\$7512.00
175	65	35	25	SB317SGH4G	\$7512.00
200	65	35	25	SB320SGH4G	\$7512.00
225	65	35	25	SB322SGH4G	\$7512.00
250	65	35	25	SB325SGH4G	\$7512.00
300	65	35	25	SB330SGH4G	\$7512.00
350	65	35	25	SB335SGH4G	\$7512.00
400	65	35	25	SB340SGH4G	\$7512.00

**Low-Tier Frames Three-Phase, Three-Wire SGH6GA (600A)**

Trip Amps	Short Circuit Rating @ 240V (kAIC)	Short Circuit Rating @ 480V (kAIC)	Short Circuit Rating @ 600 V (kAIC)	Product Number	List Price GO-114M
250	65	35	25	SB325SGH6G	\$10112.00
300	65	35	25	SB330SGH6G	\$10112.00
350	65	35	25	SB335SGH6G	\$10112.00
400	65	35	25	SB340SGH6G	\$10112.00
450	65	35	25	SB345SGH6G	\$10112.00
500	65	35	25	SB350SGH6G	\$10112.00
600	65	35	25	SB360SGH6G	\$10112.00

**Low-Tier Frames Three-Phase, Three-Wire SKHGA**

Trip Amps	Short Circuit Rating @ 240V (kAIC)	Short Circuit Rating @ 480V (kAIC)	Short Circuit Rating @ 600 V (kAIC)	Product Number	List Price GO-114M
300	65	50	25	SB330SKHG	\$12448.00
400	65	50	25	SB340SKHG	\$12448.00
500	65	50	25	SB350SKHG	\$12448.00
600	65	50	25	SB360SKHG	\$12448.00
700	65	50	25	SB370SKHG	\$12448.00
800	65	50	25	SB380SKHG	\$12448.00



# Busway Spectra® RMS (continued)

Sandwich Bus  
Circuit Breaker Busway Plugs

# Section 11

## Low-Tier Frames Three-Phase, Four-Wire SEDGA

Trip Amps	Short Circuit Rating @ 240V (kAIC)	Short Circuit Rating @ 480V (kAIC)	Short Circuit Rating @ 600 V (kAIC)	Product Number	List Price GO-114M
15	18	14	14	SB41SEDDG	\$1636.00
20	18	14	14	SB42SEDDG	\$1636.00
30	18	14	14	SB43SEDDG	\$1636.00
40	18	14	14	SB44SEDDG	\$1636.00
50	18	14	14	SB45SEDDG	\$1636.00
60	18	14	14	SB46SEDDG	\$1636.00
70	18	14	14	SB47SEDDG	\$1788.00
80	18	14	14	SB48SEDDG	\$1788.00
90	18	14	14	SB49SEDDG	\$1788.00
100	18	14	14	SB410SEDDG	\$1788.00
110	18	14	14	SB411SEDDG	\$4002.00
125	18	14	14	SB412SEDDG	\$4002.00
150	18	14	14	SB415SEDDG	\$4002.00

## Low-Tier Frames Three-Phase, Four-Wire SEHGA

Trip Amps	Short Circuit Rating @ 240V (kAIC)	Short Circuit Rating @ 480V (kAIC)	Short Circuit Rating @ 600 V (kAIC)	Product Number	List Price GO-114M
15	65	25	18	SB41SEHG	\$2038.00
20	65	25	18	SB42SEHG	\$2038.00
30	65	25	18	SB43SEHG	\$2038.00
40	65	25	18	SB44SEHG	\$2038.00
50	65	25	18	SB45SEHG	\$2038.00
60	65	25	18	SB46SEHG	\$2038.00
70	65	25	18	SB47SEHG	\$2194.00
80	65	25	18	SB48SEHG	\$2194.00
90	65	25	18	SB49SEHG	\$2194.00
100	65	25	18	SB410SEHG	\$2194.00
110	65	25	18	SB411SEHG	\$4444.00
125	65	25	18	SB412SEHG	\$4444.00
150	65	25	18	SB415SEHG	\$4444.00

## Low-Tier Frames Three-Phase, Four-Wire SFHGA

Trip Amps	Short Circuit Rating @ 240V (kAIC)	Short Circuit Rating @ 480V (kAIC)	Short Circuit Rating @ 600 V (kAIC)	Product Number	List Price GO-114M
70	65	25	18	SB47SFHG	\$4444.00
90	65	25	18	SB49SFHG	\$4444.00
100	65	25	18	SB410SFHG	\$4444.00
110	65	25	18	SB411SFHG	\$4444.00
125	65	25	18	SB412SFHG	\$4444.00
150	65	25	18	SB415SFHG	\$4444.00
175	65	25	18	SB417SFHG	\$4444.00
200	65	25	18	SB420SFHG	\$4444.00
225	65	25	18	SB422SFHG	\$4444.00
250	65	25	18	SB425SFHG	\$4444.00

## Low-Tier Frames Three-Phase, Four-Wire SGH4GA (400A)

Trip Amps	Short Circuit Rating @ 240V (kAIC)	Short Circuit Rating @ 480V (kAIC)	Short Circuit Rating @ 600 V (kAIC)	Product Number	List Price GO-114M
125	65	35	25	SB412SGH4G	\$8292.00
150	65	35	25	SB415SGH4G	\$8292.00
175	65	35	25	SB417SGH4G	\$8292.00
200	65	35	25	SB420SGH4G	\$8292.00
225	65	35	25	SB422SGH4G	\$8292.00
250	65	35	25	SB425SGH4G	\$8292.00
300	65	35	25	SB430SGH4G	\$8292.00
350	65	35	25	SB435SGH4G	\$8292.00
400	65	35	25	SB440SGH4G	\$8292.00

## Low-Tier Frames Three-Phase, Four-Wire SGH6GA (600A)

Trip Amps	Short Circuit Rating @ 240V (kAIC)	Short Circuit Rating @ 480V (kAIC)	Short Circuit Rating @ 600 V (kAIC)	Product Number	List Price GO-114M
250	65	35	25	SB425SGH6G	\$10632.00
300	65	35	25	SB430SGH6G	\$10632.00
350	65	35	25	SB435SGH6G	\$10632.00
400	65	35	25	SB440SGH6G	\$10632.00
450	65	35	25	SB445SGH6G	\$10632.00
500	65	35	25	SB450SGH6G	\$10632.00
600	65	35	25	SB460SGH6G	\$10632.00

## Low-Tier Frames Three-Phase, Four-Wire SKHGA

Trip Amps	Short Circuit Rating @ 240V (kAIC)	Short Circuit Rating @ 480V (kAIC)	Short Circuit Rating @ 600 V (kAIC)	Product Number	List Price GO-114M
300	65	50	25	SB430SKHG	\$12968.00
400	65	50	25	SB440SKHG	\$12968.00
500	65	50	25	SB450SKHG	\$12968.00
600	65	50	25	SB460SKHG	\$12968.00
700	65	50	25	SB470SKHG	\$12968.00
800	65	50	25	SB480SKHG	\$12968.00

## Mid-Tier Frames Three-Phase, Three-Wire SELGA

Trip Amps	Short Circuit Rating @ 240V (kAIC)	Short Circuit Rating @ 480V (kAIC)	Short Circuit Rating @ 600 V (kAIC)	Product Number	List Price GO-114M
15	100	65	25	SB31SELG	\$2910.00
20	100	65	25	SB32SELG	\$2910.00
30	100	65	25	SB33SELG	\$2910.00
40	100	65	25	SB34SELG	\$2910.00
50	100	65	25	SB35SELG	\$2910.00
60	100	65	25	SB36SELG	\$2910.00
70	100	65	25	SB37SELG	\$3430.00
80	100	65	25	SB38SELG	\$3430.00
90	100	65	25	SB39SELG	\$3430.00
100	100	65	25	SB310SELG	\$3430.00
110	100	65	25	SB311SELG	\$7252.00
125	100	65	25	SB312SELG	\$7252.00
150	100	65	25	SB315SELG	\$7252.00

## Mid-Tier Frames Three-Phase, Three-Wire SFLGA

Trip Amps	Short Circuit Rating @ 240V (kAIC)	Short Circuit Rating @ 480V (kAIC)	Short Circuit Rating @ 600 V (kAIC)	Product Number	List Price GO-114M
70	100	65	25	SB37SFLG	\$7768.00
90	100	65	25	SB39SFLG	\$7768.00
100	100	65	25	SB310SFLG	\$7768.00
110	100	65	25	SB311SFLG	\$7768.00
125	100	65	25	SB312SFLG	\$7768.00
150	100	65	25	SB315SFLG	\$7768.00
175	100	65	25	SB317SFLG	\$7768.00
200	100	65	25	SB320SFLG	\$7768.00
225	100	65	25	SB322SFLG	\$7768.00
250	100	65	25	SB325SFLG	\$7768.00



# Busway Spectra® RMS (continued)

Sandwich Bus  
Circuit Breaker Busway Plugs

# Section 11

## Mid-Tier Frames Three-Phase, Three-Wire SGL4GA

Trip Amps	Short Circuit Rating @ 240V (kAIC)	Short Circuit Rating @ 480V (kAIC)	Short Circuit Rating @ 600 V (kAIC)	Product Number	List Price GO-114M
125	100	65	65	SB312SGL4G	\$11152.00
150	100	65	65	SB315SGL4G	\$11152.00
175	100	65	65	SB317SGL4G	\$11152.00
200	100	65	65	SB320SGL4G	\$11152.00
225	100	65	65	SB322SGL4G	\$11152.00
250	100	65	65	SB325SGL4G	\$11152.00
300	100	65	65	SB330SGL4G	\$11152.00
350	100	65	65	SB335SGL4G	\$11152.00
400	100	65	65	SB340SGL4G	\$11152.00

## Mid-Tier Frames Three-Phase, Four-Wire SFLGA

Trip Amps	Short Circuit Rating @ 240V (kAIC)	Short Circuit Rating @ 480V (kAIC)	Short Circuit Rating @ 600 V (kAIC)	Product Number	List Price GO-114M
70	100	65	25	SB47SFLG	\$8054.00
90	100	65	25	SB49SFLG	\$8054.00
100	100	65	25	SB410SFLG	\$8054.00
110	100	65	25	SB411SFLG	\$8054.00
125	100	65	25	SB412SFLG	\$8054.00
150	100	65	25	SB415SFLG	\$8054.00
175	100	65	25	SB417SFLG	\$8054.00
200	100	65	25	SB420SFLG	\$8054.00
225	100	65	25	SB422SFLG	\$8054.00
250	100	65	25	SB425SFLG	\$8054.00

## Mid-Tier Frames Three-Phase, Three-Wire SGL6GA

Trip Amps	Short Circuit Rating @ 240V (kAIC)	Short Circuit Rating @ 480V (kAIC)	Short Circuit Rating @ 600 V (kAIC)	Product Number	List Price GO-114M
250	100	65	65	SB325SGL6G	\$12838.00
300	100	65	65	SB330SGL6G	\$12838.00
350	100	65	65	SB335SGL6G	\$12838.00
400	100	65	65	SB340SGL6G	\$12838.00
450	100	65	65	SB345SGL6G	\$12838.00
500	100	65	65	SB350SGL6G	\$12838.00
600	100	65	65	SB360SGL6G	\$12838.00

## Mid-Tier Frames Three-Phase, Four-Wire SGL4GA

Trip Amps	Short Circuit Rating @ 240V (kAIC)	Short Circuit Rating @ 480V (kAIC)	Short Circuit Rating @ 600 V (kAIC)	Product Number	List Price GO-114M
125	100	65	65	SB412SGL4G	\$11932.00
150	100	65	65	SB415SGL4G	\$11932.00
175	100	65	65	SB417SGL4G	\$11932.00
200	100	65	65	SB420SGL4G	\$11932.00
225	100	65	65	SB422SGL4G	\$11932.00
250	100	65	65	SB425SGL4G	\$11932.00
300	100	65	65	SB430SGL4G	\$11932.00
350	100	65	65	SB435SGL4G	\$11932.00
400	100	65	65	SB440SGL4G	\$11932.00

## Mid-Tier Frames Three-Phase, Three-Wire SKLGA

Trip Amps	Short Circuit Rating @ 240V (kAIC)	Short Circuit Rating @ 480V (kAIC)	Short Circuit Rating @ 600 V (kAIC)	Product Number	List Price GO-114M
300	100	65	42	SB330SKLG	\$21032.00
400	100	65	42	SB340SKLG	\$21032.00
500	100	65	42	SB350SKLG	\$21032.00
600	100	65	42	SB360SKLG	\$21032.00
700	100	65	42	SB370SKLG	\$21032.00
800	100	65	42	SB380SKLG	\$21032.00

## Mid-Tier Frames Three-Phase, Four-Wire SGL6GA

Trip Amps	Short Circuit Rating @ 240V (kAIC)	Short Circuit Rating @ 480V (kAIC)	Short Circuit Rating @ 600 V (kAIC)	Product Number	List Price GO-114M
250	100	65	65	SB425SGL6G	\$13358.00
300	100	65	65	SB430SGL6G	\$13358.00
350	100	65	65	SB435SGL6G	\$13358.00
400	100	65	65	SB440SGL6G	\$13358.00
450	100	65	65	SB445SGL6G	\$13358.00
500	100	65	65	SB450SGL6G	\$13358.00
600	100	65	65	SB460SGL6G	\$13358.00

## Mid-Tier Frames Three-Phase, Four-Wire SELGA

Trip Amps	Short Circuit Rating @ 240V (kAIC)	Short Circuit Rating @ 480V (kAIC)	Short Circuit Rating @ 600 V (kAIC)	Product Number	List Price GO-114M
15	100	65	25	SB41SELG	\$3170.00
20	100	65	25	SB42SELG	\$3170.00
30	100	65	25	SB43SELG	\$3170.00
40	100	65	25	SB44SELG	\$3170.00
50	100	65	25	SB45SELG	\$3170.00
60	100	65	25	SB46SELG	\$3170.00
70	100	65	25	SB47SELG	\$3690.00
80	100	65	25	SB48SELG	\$3690.00
90	100	65	25	SB49SELG	\$3690.00
100	100	65	25	SB410SELG	\$3690.00
110	100	65	25	SB411SELG	\$7512.00
125	100	65	25	SB412SELG	\$7512.00
150	100	65	25	SB415SELG	\$7512.00

## Mid-Tier Frames Three-Phase, Four-Wire SKLGA

Trip Amps	Short Circuit Rating @ 240V (kAIC)	Short Circuit Rating @ 480V (kAIC)	Short Circuit Rating @ 600 V (kAIC)	Product Number	List Price GO-114M
300	100	65	42	SB430SKLG	\$21812.00
400	100	65	42	SB440SKLG	\$21812.00
500	100	65	42	SB450SKLG	\$21812.00
600	100	65	42	SB460SKLG	\$21812.00
700	100	65	42	SB470SKLG	\$21812.00
800	100	65	42	SB480SKLG	\$21812.00

Notes: Breakers must be factory-installed. IC rating in rms symmetrical kA.



# Busway Spectra® RMS (continued)

Sandwich Bus  
Circuit Breaker Busway Plugs

# Section 11

## Peak-Tier Frames Three-Phase, Three-Wire SEPGA

Trip Amps	Short Circuit Rating @ 240V (kAIC)	Short Circuit Rating @ 480V (kAIC)	Short Circuit Rating @ 600 V (kAIC)	Product Number	List Price GO-114M
15	200	100	25	SB31SEPG	\$4002.00
20	200	100	25	SB32SEPG	\$4002.00
30	200	100	25	SB33SEPG	\$4002.00
40	200	100	25	SB34SEPG	\$4002.00
50	200	100	25	SB35SEPG	\$4002.00
60	200	100	25	SB36SEPG	\$4002.00
70	200	100	25	SB37SEPG	\$4782.00
80	200	100	25	SB38SEPG	\$4782.00
90	200	100	25	SB39SEPG	\$4782.00
100	200	100	25	SB310SEPG	\$4782.00
110	200	100	25	SB311SEPG	\$9982.00
125	200	100	25	SB312SEPG	\$9982.00
150	200	100	25	SB315SEPG	\$9982.00

## Peak-Tier Frames Three-Phase, Three-Wire SFPGA

Trip Amps	Short Circuit Rating @ 240V (kAIC)	Short Circuit Rating @ 480V (kAIC)	Short Circuit Rating @ 600 V (kAIC)	Product Number	List Price GO-114M
70	200	100	25	SB37SFPG	\$10368.00
90	200	100	25	SB39SFPG	\$10368.00
100	200	100	25	SB310SFPG	\$10368.00
110	200	100	25	SB311SFPG	\$10368.00
125	200	100	25	SB312SFPG	\$10368.00
150	200	100	25	SB315SFPG	\$10368.00
175	200	100	25	SB317SFPG	\$10368.00
200	200	100	25	SB320SFPG	\$10368.00
225	200	100	25	SB322SFPG	\$10368.00
250	200	100	25	SB325SFPG	\$10368.00

## Peak-Tier Frames Three-Phase, Three-Wire SGP4GA

Trip Amps	Short Circuit Rating @ 240V (kAIC)	Short Circuit Rating @ 480V (kAIC)	Short Circuit Rating @ 600 V (kAIC)	Product Number	List Price GO-114M
125	200	100	65	SB312SGP4G	\$15438.00
150	200	100	65	SB315SGP4G	\$15438.00
175	200	100	65	SB317SGP4G	\$15438.00
200	200	100	65	SB320SGP4G	\$15438.00
225	200	100	65	SB322SGP4G	\$15438.00
250	200	100	65	SB325SGP4G	\$15438.00
300	200	100	65	SB330SGP4G	\$15438.00
350	200	100	65	SB335SGP4G	\$15438.00
400	200	100	65	SB340SGP4G	\$15438.00

## Peak-Tier Frames Three-Phase, Three-Wire SGP6GA

Trip Amps	Short Circuit Rating @ 240V (kAIC)	Short Circuit Rating @ 480V (kAIC)	Short Circuit Rating @ 600 V (kAIC)	Product Number	List Price GO-114M
250	200	100	65	SB325SGP6G	\$17258.00
350	200	100	65	SB335SGP6G	\$17258.00
400	200	100	65	SB340SGP6G	\$17258.00
450	200	100	65	SB345SGP6G	\$17258.00
500	200	100	65	SB350SGP6G	\$17258.00
600	200	100	65	SB360SGP6G	\$17258.00

Notes: Breakers must be factory-installed. IC rating in rms symmetrical kA.

## Peak-Tier Frames Three-Phase, Three-Wire SKPGA

Trip Amps	Short Circuit Rating @ 240V (kAIC)	Short Circuit Rating @ 480V (kAIC)	Short Circuit Rating @ 600 V (kAIC)	Product Number	List Price GO-114M
300	200	100	25	SB330SKPG	\$24802.00
400	200	100	25	SB340SKPG	\$24802.00
500	200	100	25	SB350SKPG	\$24802.00
600	200	100	25	SB360SKPG	\$24802.00
700	200	100	25	SB370SKPG	\$24802.00
800	200	100	25	SB380SKPG	\$24802.00

## Peak-Tier Frames Three-Phase, Four-Wire SEPGA

Trip Amps	Short Circuit Rating @ 240V (kAIC)	Short Circuit Rating @ 480V (kAIC)	Short Circuit Rating @ 600 V (kAIC)	Product Number	List Price GO-114M
15	200	100	25	SB41SEPG	\$4262.00
20	200	100	25	SB42SEPG	\$4262.00
30	200	100	25	SB43SEPG	\$4262.00
40	200	100	25	SB44SEPG	\$4262.00
50	200	100	25	SB45SEPG	\$4262.00
60	200	100	25	SB46SEPG	\$4262.00
70	200	100	25	SB47SEPG	\$5042.00
80	200	100	25	SB48SEPG	\$5042.00
90	200	100	25	SB49SEPG	\$5042.00
100	200	100	25	SB410SEPG	\$5042.00
110	200	100	25	SB411SEPG	\$10242.00
125	200	100	25	SB412SEPG	\$10242.00
150	200	100	25	SB415SEPG	\$10242.00

## Peak-Tier Frames Three-Phase, Four-Wire SFPGA

Trip Amps	Short Circuit Rating @ 240V (kAIC)	Short Circuit Rating @ 480V (kAIC)	Short Circuit Rating @ 600 V (kAIC)	Product Number	List Price GO-114M
70	200	100	25	SB47SFPG	\$10654.00
90	200	100	25	SB49SFPG	\$10654.00
100	200	100	25	SB410SFPG	\$10654.00
110	200	100	25	SB411SFPG	\$10654.00
125	200	100	25	SB412SFPG	\$10654.00
150	200	100	25	SB415SFPG	\$10654.00
175	200	100	25	SB417SFPG	\$10654.00
200	200	100	25	SB420SFPG	\$10654.00
225	200	100	25	SB422SFPG	\$10654.00
250	200	100	25	SB425SFPG	\$10654.00

## Peak-Tier Frames Three-Phase, Four-Wire SGP4GA

Trip Amps	Short Circuit Rating @ 240V (kAIC)	Short Circuit Rating @ 480V (kAIC)	Short Circuit Rating @ 600 V (kAIC)	Product Number	List Price GO-114M
125	200	100	65	SB412SGP4G	\$15698.00
150	200	100	65	SB415SGP4G	\$15698.00
175	200	100	65	SB417SGP4G	\$15698.00
200	200	100	65	SB420SGP4G	\$15698.00
225	200	100	65	SB422SGP4G	\$15698.00
250	200	100	65	SB425SGP4G	\$15698.00
300	200	100	65	SB430SGP4G	\$15698.00
350	200	100	65	SB435SGP4G	\$15698.00
400	200	100	65	SB440SGP4G	\$15698.00



# Busway Spectra® RMS (continued)

Sandwich Bus

Circuit Breaker Busway Plugs

# Section 11

## Peak-Tier Frames Three-Phase, Four-Wire SGP6GA

Trip Amps	Short Circuit Rating @ 240V (kAIC)	Short Circuit Rating @ 480V (kAIC)	Short Circuit Rating @ 600 V (kAIC)	Product Number	List Price GO-114M
250	200	100	65	SB425SGP6G	<b>\$17778.00</b>
350	200	100	65	SB435SGP6G	<b>\$17778.00</b>
400	200	100	65	SB440SGP6G	<b>\$17778.00</b>
450	200	100	65	SB445SGP6G	<b>\$17778.00</b>
500	200	100	65	SB450SGP6G	<b>\$17778.00</b>
600	200	100	65	SB460SGP6G	<b>\$17778.00</b>

## Peak-Tier Frames Three-Phase, Four-Wire SKPGA

Trip Amps	Short Circuit Rating @ 240V (kAIC)	Short Circuit Rating @ 480V (kAIC)	Short Circuit Rating @ 600 V (kAIC)	Product Number	List Price GO-114M
300	200	100	25	SB430SKPG	<b>\$25582.00</b>
400	200	100	25	SB440SKPG	<b>\$25582.00</b>
500	200	100	25	SB450SKPG	<b>\$25582.00</b>
600	200	100	25	SB460SKPG	<b>\$25582.00</b>
700	200	100	25	SB470SKPG	<b>\$25582.00</b>
800	200	100	25	SB480SKPG	<b>\$25582.00</b>

## Without Rating Plug Three-Phase, Three-Wire

Frame Type	Trip Amps	Product Number	List Price GO-114M
SEDGA	15-30	SB301SEDG	<b>\$1376.00</b>
SEDGA	40-60	SB302SEDG	<b>\$1376.00</b>
SEDGA	70-100	SB303SEDG	<b>\$1528.00</b>
SEDGA	110-150	SB304SEDG	<b>\$3742.00</b>
SEHGA	15-30	SB301SEHG	<b>\$1778.00</b>
SEHGA	40-60	SB302SEHG	<b>\$1778.00</b>
SEHGA	70-100	SB303SEHG	<b>\$1944.00</b>
SEHGA	110-150	SB304SEHG	<b>\$4196.00</b>
SELGA	15-30	SB301SELG	<b>\$2910.00</b>
SELGA	40-60	SB302SELG	<b>\$2910.00</b>
SELGA	70-100	SB303SELG	<b>\$3430.00</b>
SELGA	110-150	SB304SELG	<b>\$7252.00</b>
SEPGA	15-30	SB301SEPG	<b>\$3872.00</b>
SEPGA	40-60	SB302SEPG	<b>\$3872.00</b>
SEPGA	70-100	SB303SEPG	<b>\$4652.00</b>
SEPGA	110-150	SB304SEPG	<b>\$9852.00</b>
SFHGA	70-250	SB300SFHG	<b>\$4196.00</b>
SFLGA	70-250	SB300SFLG	<b>\$7638.00</b>
SFPGA	70-250	SB300SFPG	<b>\$10238.00</b>
SGH4GA	125-400	SB300SGH4G	<b>\$7512.00</b>
SGL4A	125-400	SB300SGL4G	<b>\$11022.00</b>
SGP4GA	125-400	SB300SGP4G	<b>\$14788.00</b>
SGH6GA	250-600	SB300SGH6G	<b>\$9982.00</b>
SGL6GA	250-600	SB300SGL6G	<b>\$12708.00</b>
SGP6GA	250-600	SB300SGP6G	<b>\$17128.00</b>
SKHGA	300-800	SB300SKHG	<b>\$12448.00</b>
SKLGA	300-800	SB300SKLG	<b>\$20902.00</b>
SKPGA	300-800	SB300SKPG	<b>\$24672.00</b>

Notes: Breakers must be factory-installed. IC rating in rms symmetrical kA.

## Without Rating Plug Three-Phase, Four-Wire

Frame Type	Trip Amps	Product Number	List Price GO-114M
SEDGA	15-30	SB401SEDG	<b>\$1506.00</b>
SEDGA	40-60	SB402SEDG	<b>\$1506.00</b>
SEDGA	70-100	SB403SEDG	<b>\$1658.00</b>
SEDGA	110-150	SB404SEDG	<b>\$3872.00</b>
SEHGA	15-30	SB401SEHG	<b>\$2428.00</b>
SEHGA	40-60	SB402SEHG	<b>\$2428.00</b>
SEHGA	70-100	SB403SEHG	<b>\$2594.00</b>
SEHGA	110-150	SB404SEHG	<b>\$4314.00</b>
SELGA	15-30	SB401SELG	<b>\$3170.00</b>
SELGA	40-60	SB402SELG	<b>\$3170.00</b>
SELGA	70-100	SB403SELG	<b>\$7512.00</b>
SELGA	110-150	SB404SELG	<b>\$8054.00</b>
SEPGA	15-30	SB401SEPG	<b>\$4132.00</b>
SEPGA	40-60	SB402SEPG	<b>\$4132.00</b>
SEPGA	70-100	SB403SEPG	<b>\$4912.00</b>
SEPGA	110-150	SB404SEPG	<b>\$10112.00</b>
SFHGA	70-250	SB400SFHG	<b>\$4314.00</b>
SFLGA	70-250	SB400SFLG	<b>\$7924.00</b>
SFPGA	70-250	SB400SFPG	<b>\$10524.00</b>
SGH4GA	125-400	SB400SGH4G	<b>\$8162.00</b>
SGL4A	125-400	SB400SGL4G	<b>\$11802.00</b>
SGP4GA	125-400	SB400SGP4G	<b>\$15568.00</b>
SGH6GA	250-600	SB400SGH6G	<b>\$10502.00</b>
SGL6GA	250-600	SB400SGL6G	<b>\$13228.00</b>
SGP6GA	250-600	SB400SGP6G	<b>\$17648.00</b>
SKHGA	300-800	SB400SKHG	<b>\$12842.00</b>
SKLGA	300-800	SB400SKLG	<b>\$21682.00</b>
SKPGA	300-800	SB400SKPG	<b>\$25452.00</b>

Notes: Breakers must be factory-installed. IC rating in rms symmetrical kA. Order rating plug separately from BuyLog. Breakers must be factory-installed. Plug assist optional for E frame plugs.



### Features and Benefits

#### MicroVersaTrip® Plus Trip Units Standard

- 3-phase Ammeter with +/- accuracy
- Adjustable Long time (L) pickup, 0.5-1.0X, and delay (3-4 bands).
- Adjustable Instantaneous (I) pickup, 1.5-10X.
- Local Overload and Short Circuit Trip Indicators (T) with overload pickup warning.
- Interchangeable trip rating plugs with test set jack for TVRMS test set.
- Digital LCD display with four-button keypad for function selection and set point adjustment and sealable clear Lexan cover for tamper-resistant settings.
- True rms sensing for accurate response to high harmonic content waveforms.
- EMI immunity per ANSI C37.90.

#### Optional

- Adjustable Short Time (S) pickup, 1.0-9.0C, and delay (4 bands) with I<sup>2</sup>t IN/OUT selection.
- Adjustable Ground fault (G) pickup, 0.2-1.0S, and delay (4 bands) with I<sup>2</sup>t IN/OUT selection and trip indicator. The 4 short time and ground fault delay bands provide broader system selectivity

#### MicroVersaTrip® Plus Trip Function

Trip	List Price Adder, GO-114M
LIT	Standard
LSIT	\$5640.00
<b>With Ground Fault Option</b>	
LIGT	Standard
LSIGT	\$5640.00
Shunt Trip	\$1152.00

#### Trip Function Definitions

Long time (L)	Adjustable current setting Adjustable long-time delay
Short Time (S)	Adjustable short-time pick-up Adjustable short-time delay with I <sup>2</sup> t Adjustable short-time delay without I <sup>2</sup> t
Instantaneous (I)	Adjustable pick-up
Ground Fault (G)	Adjustable ground fault pick-up Adjustable ground fault delay with I <sup>2</sup> t Adjustable ground fault delay without I <sup>2</sup> t
Trip Indication Targets	Standard

#### Low Tier Frames (Ground Fault) Three-Phase, Three-Wire

Frame Type	Trip Amps	Product Number	List Price GO-114M
SGHB	60	SB36SGHGF+	\$13398.00
SGHB	80	SB38SGHGF+	\$13398.00
SGHB	100	SB310SGHGF+	\$13398.00
SGHB	125	SB312SGHGF+	\$13398.00
SGHB	150	SB315SGHGF+	\$13398.00
SGH4B	150	SB315SGH4GF+	\$13398.00
SGH4B	200	SB320SGH4GF+	\$13398.00
SGH4B	225	SB322SGH4GF+	\$13398.00
SGH4B	250	SB325SGH4GF+	\$13398.00
SGH4B	300	SB330SGH4GF+	\$13398.00
SGH4B	350	SB335SGH4GF+	\$13398.00
SGH4B	400	SB340SGH4GF+	\$13398.00
SGH6B	300	SB330SGH6GF+	\$15824.00
SGH6B	400	SB340SGH6GF+	\$15824.00
SGH6B	450	SB345SGH6GF+	\$15824.00
SGH6B	500	SB350SGH6GF+	\$15824.00
SGH6B	600	SB360SGH6GF+	\$15824.00
SKHB	300	SB330SKHGF+	\$18442.00
SKHB	400	SB340SKHGF+	\$18442.00
SKHB	500	SB350SKHGF+	\$18442.00
SKHB	600	SB360SKHGF+	\$18442.00
SKHB	700	SB370SKHGF+	\$18442.00
SKHB	800	SB380SKHGF+	\$18442.00

#### Low Tier Frames (Ground Fault) Three-Phase, Four-Wire

Frame Type	Trip Amps	Product Number	List Price GO-114M
SGHB	60	SB46SGHGF+	\$16914.00
SGHB	80	SB48SGHGF+	\$16914.00
SGHB	100	SB410SGHGF+	\$16914.00
SGHB	125	SB412SGHGF+	\$16914.00
SGHB	150	SB415SGHGF+	\$16914.00
SGH4B	150	SB415SGH4GF+	\$16914.00
SGH4B	200	SB420SGH4GF+	\$16914.00
SGH4B	225	SB422SGH4GF+	\$16914.00
SGH4B	250	SB425SGH4GF+	\$16914.00
SGH4B	300	SB430SGH4GF+	\$16914.00
SGH4B	350	SB435SGH4GF+	\$16914.00
SGH4B	400	SB440SGH4GF+	\$16914.00
SGH6B	300	SB430SGH6GF+	\$19182.00
SGH6B	400	SB440SGH6GF+	\$19182.00
SGH6B	450	SB445SGH6GF+	\$19182.00
SGH6B	500	SB450SGH6GF+	\$19182.00
SGH6B	600	SB460SGH6GF+	\$19182.00
SKHB	300	SB430SKHGF+	\$21802.00
SKHB	400	SB440SKHGF+	\$21802.00
SKHB	500	SB450SKHGF+	\$21802.00
SKHB	600	SB460SKHGF+	\$21802.00
SKHB	700	SB470SKHGF+	\$21802.00
SKHB	800	SB480SKHGF+	\$21802.00

LIGT trip function is standard. For LSIGT add \$5640.00 list.





## Low Tier Frames Three-Phase, Three-Wire

Frame Type	Trip Amps	Product Number	List Price GO-114M
SGHB	60	SB36SGHG+	\$8294.00
SGHB	80	SB38SGHG+	\$8294.00
SGHB	100	SB310SGHG+	\$8294.00
SGHB	125	SB312SGHG+	\$8294.00
SGHB	150	SB315SGHG+	\$8294.00
SGH4B	150	SB315SGH4G+	\$8294.00
SGH4B	200	SB320SGH4G+	\$8294.00
SGH4B	225	SB322SGH4G+	\$8294.00
SGH4B	250	SB325SGH4G+	\$8294.00
SGH4B	300	SB330SGH4G+	\$8294.00
SGH4B	350	SB335SGH4G+	\$8294.00
SGH4B	400	SB340SGH4G+	\$8294.00
SGH6B	300	SB330SGH6G+	\$10824.00
SGH6B	400	SB340SGH6G+	\$10824.00
SGH6B	450	SB345SGH6G+	\$10824.00
SGH6B	500	SB350SGH6G+	\$10824.00
SGH6B	600	SB360SGH6G+	\$10824.00
SKHB	300	SB330SKHG+	\$13442.00
SKHB	400	SB340SKHG+	\$13442.00
SKHB	500	SB350SKHG+	\$13442.00
SKHB	600	SB360SKHG+	\$13442.00
SKHB	700	SB370SKHG+	\$13442.00
SKHB	800	SB380SKHG+	\$13442.00

## Low Tier Frames Three-Phase, Four-Wire

Frame Type	Trip Amps	Product Number	List Price GO-114M
SGHB	60	SB46SGHG+	\$9074.00
SGHB	80	SB48SGHG+	\$9074.00
SGHB	100	SB410SGHG+	\$9074.00
SGHB	125	SB412SGHG+	\$9074.00
SGHB	150	SB415SGHG+	\$9074.00
SGH4B	150	SB415SGH4G+	\$9074.00
SGH4B	200	SB420SGH4G+	\$9074.00
SGH4B	225	SB422SGH4G+	\$9074.00
SGH4B	250	SB425SGH4G+	\$9074.00
SGH4B	300	SB430SGH4G+	\$9074.00
SGH4B	350	SB435SGH4G+	\$9074.00
SGH4B	400	SB440SGH4G+	\$9074.00
SGH6B	300	SB430SGH6G+	\$11344.00
SGH6B	400	SB440SGH6G+	\$11344.00
SGH6B	450	SB445SGH6G+	\$11344.00
SGH6B	500	SB450SGH6G+	\$11344.00
SGH6B	600	SB460SGH6G+	\$11344.00
SKHB	300	SB430SKHG+	\$13962.00
SKHB	400	SB440SKHG+	\$13962.00
SKHB	500	SB450SKHG+	\$13962.00
SKHB	600	SB460SKHG+	\$13962.00
SKHB	700	SB470SKHG+	\$13962.00
SKHB	800	SB480SKHG+	\$13962.00

LIT trip function is standard. For LSIT add \$5640.00 list.

## Mid Tier Frames (Ground Fault) Three-Phase, Three-Wire

Frame Type	Trip Amps	Product Number	List Price GO-114M
SGLB	60	SB36SGLGF+	\$17144.00
SGLB	80	SB38SGLGF+	\$17144.00
SGLB	100	SB310SGLGF+	\$17144.00
SGLB	125	SB312SGLGF+	\$17144.00
SGLB	150	SB315SGLGF+	\$17144.00
SGL4B	150	SB315SGL4GF+	\$17144.00
SGL4B	200	SB320SGL4GF+	\$17144.00
SGL4B	225	SB322SGL4GF+	\$17144.00
SGL4B	250	SB325SGL4GF+	\$17144.00
SGL4B	300	SB330SGL4GF+	\$17144.00
SGL4B	350	SB335SGL4GF+	\$17144.00
SGL4B	400	SB340SGL4GF+	\$17144.00
SGL6B	300	SB330SGL6GF+	\$18708.00
SGL6B	400	SB340SGL6GF+	\$18708.00
SGL6B	450	SB345SGL6GF+	\$18708.00
SGL6B	500	SB350SGL6GF+	\$18708.00
SGL6B	600	SB360SGL6GF+	\$18708.00
SKLB	300	SB330SKLGF+	\$26140.00
SKLB	400	SB340SKLGF+	\$26140.00
SKLB	500	SB350SKLGF+	\$26140.00
SKLB	600	SB360SKLGF+	\$26140.00
SKLB	700	SB370SKLGF+	\$26140.00
SKLB	800	SB380SKLGF+	\$26140.00

## Mid Tier Frames (Ground Fault) Three-Phase, Four-Wire

Frame Type	Trip Amps	Product Number	List Price GO-114M
SGLB	60	SB46SGLGF+	\$20764.00
SGLB	80	SB48SGLGF+	\$20764.00
SGLB	100	SB410SGLGF+	\$20764.00
SGLB	125	SB412SGLGF+	\$20764.00
SGLB	150	SB415SGLGF+	\$20764.00
SGL4B	150	SB415SGL4GF+	\$20764.00
SGL4B	200	SB420SGL4GF+	\$20764.00
SGL4B	225	SB422SGL4GF+	\$20764.00
SGL4B	250	SB425SGL4GF+	\$20764.00
SGL4B	300	SB430SGL4GF+	\$20764.00
SGL4B	350	SB435SGL4GF+	\$20764.00
SGL4B	400	SB440SGL4GF+	\$20764.00
SGL6B	300	SB430SGL6GF+	\$22066.00
SGL6B	400	SB440SGL6GF+	\$22066.00
SGL6B	450	SB445SGL6GF+	\$22066.00
SGL6B	500	SB450SGL6GF+	\$22066.00
SGL6B	600	SB460SGL6GF+	\$22066.00
SKLB	300	SB430SKLGF+	\$29760.00
SKLB	400	SB440SKLGF+	\$29760.00
SKLB	500	SB450SKLGF+	\$29760.00
SKLB	600	SB460SKLGF+	\$29760.00
SKLB	700	SB470SKLGF+	\$29760.00
SKLB	800	SB480SKLGF+	\$29760.00

LIGT trip function is standard. For LSIGT add \$5640.00 list.



**Mid Tier Frames Three-Phase, Three-Wire**

Frame Type	Trip Amps	Product Number	List Price GO-114M
SGLB	60	SB36SGLG+	\$12144.00
SGLB	80	SB38SGLG+	\$12144.00
SGLB	100	SB310SGLG+	\$12144.00
SGLB	125	SB312SGLG+	\$12144.00
SGLB	150	SB315SGLG+	\$12144.00
SGL4B	150	SB315SGL4G+	\$12144.00
SGL4B	200	SB320SGL4G+	\$12144.00
SGL4B	225	SB322SGL4G+	\$12144.00
SGL4B	250	SB325SGL4G+	\$12144.00
SGL4B	300	SB330SGL4G+	\$12144.00
SGL4B	350	SB335SGL4G+	\$12144.00
SGL4B	400	SB340SGL4G+	\$12144.00
SGL6B	300	SB330SGL6G+	\$13708.00
SGL6B	400	SB340SGL6G+	\$13708.00
SGL6B	450	SB345SGL6G+	\$13708.00
SGL6B	500	SB350SGL6G+	\$13708.00
SGL6B	600	SB360SGL6G+	\$13708.00
SKLB	300	SB330SKLG+	\$21140.00
SKLB	400	SB340SKLG+	\$21140.00
SKLB	500	SB350SKLG+	\$21140.00
SKLB	600	SB360SKLG+	\$21140.00
SKLB	700	SB370SKLG+	\$21140.00
SKLB	800	SB380SKLG+	\$21140.00

**Peak Tier Frames (Ground Fault) Three-Phase, Three-Wire**

Frame Type	Trip Amps	Product Number	List Price GO-114M
SGPB	60	SB36SGPGF+	\$21490.00
SGPB	80	SB38SGPGF+	\$21490.00
SGPB	100	SB310SGPGF+	\$21490.00
SGPB	125	SB312SGPGF+	\$21490.00
SGPB	150	SB315SGPGF+	\$21490.00
SGP4B	150	SB315SGP4GF+	\$21490.00
SGP4B	200	SB320SGP4GF+	\$21490.00
SGP4B	225	SB322SGP4GF+	\$21490.00
SGP4B	250	SB325SGP4GF+	\$21490.00
SGP4B	300	SB330SGP4GF+	\$21490.00
SGP4B	350	SB335SGP4GF+	\$21490.00
SGP4B	400	SB340SGP4GF+	\$21490.00
SGP6B	300	SB330SGP6GF+	\$23530.00
SGP6B	400	SB340SGP6GF+	\$23530.00
SGP6B	450	SB345SGP6GF+	\$23530.00
SGP6B	500	SB350SGP6GF+	\$23530.00
SGP6B	600	SB360SGP6GF+	\$23530.00
SKPB	300	SB330SKPGF+	\$40792.00
SKPB	400	SB340SKPGF+	\$40792.00
SKPB	500	SB350SKPGF+	\$40792.00
SKPB	600	SB360SKPGF+	\$40792.00
SKPB	700	SB370SKPGF+	\$40792.00
SKPB	800	SB380SKPGF+	\$40792.00

**Mid Tier Frames Three-Phase, Four-Wire**

Frame Type	Trip Amps	Product Number	List Price GO-114M
SGLB	60	SB46SGLG+	\$12924.00
SGLB	80	SB48SGLG+	\$12924.00
SGLB	100	SB410SGLG+	\$12924.00
SGLB	125	SB412SGLG+	\$12924.00
SGLB	150	SB415SGLG+	\$12924.00
SGL4B	150	SB415SGL4G+	\$12924.00
SGL4B	200	SB420SGL4G+	\$12924.00
SGL4B	225	SB422SGL4G+	\$12924.00
SGL4B	250	SB425SGL4G+	\$12924.00
SGL4B	300	SB430SGL4G+	\$12924.00
SGL4B	350	SB435SGL4G+	\$12924.00
SGL4B	400	SB440SGL4G+	\$12924.00
SGL6B	300	SB430SGL6G+	\$14228.00
SGL6B	400	SB440SGL6G+	\$14228.00
SGL6B	450	SB445SGL6G+	\$14228.00
SGL6B	500	SB450SGL6G+	\$14228.00
SGL6B	600	SB460SGL6G+	\$14228.00
SKLB	300	SB430SKLG+	\$21920.00
SKLB	400	SB440SKLG+	\$21920.00
SKLB	500	SB450SKLG+	\$21920.00
SKLB	600	SB460SKLG+	\$21920.00
SKLB	700	SB470SKLG+	\$21920.00
SKLB	800	SB480SKLG+	\$21920.00

**Peak Tier Frames (Ground Fault) Three-Phase, Four-Wire**

Frame Type	Trip Amps	Product Number	List Price GO-114M
SGPB	60	SB46SGPGF+	\$24588.00
SGPB	80	SB48SGPGF+	\$24588.00
SGPB	100	SB410SGPGF+	\$24588.00
SGPB	125	SB412SGPGF+	\$24588.00
SGPB	150	SB415SGPGF+	\$24588.00
SGP4B	150	SB415SGP4GF+	\$24588.00
SGP4B	200	SB420SGP4GF+	\$24588.00
SGP4B	225	SB422SGP4GF+	\$24588.00
SGP4B	250	SB425SGP4GF+	\$24588.00
SGP4B	300	SB430SGP4GF+	\$24588.00
SGP4B	350	SB435SGP4GF+	\$24588.00
SGP4B	400	SB440SGP4GF+	\$24588.00
SGP6B	300	SB430SGP6GF+	\$26890.00
SGP6B	400	SB440SGP6GF+	\$26890.00
SGP6B	450	SB445SGP6GF+	\$26890.00
SGP6B	500	SB450SGP6GF+	\$26890.00
SGP6B	600	SB460SGP6GF+	\$26890.00
SKPB	300	SB430SKPGF+	\$44410.00
SKPB	400	SB440SKPGF+	\$44410.00
SKPB	500	SB450SKPGF+	\$44410.00
SKPB	600	SB460SKPGF+	\$44410.00
SKPB	700	SB470SKPGF+	\$44410.00
SKPB	800	SB480SKPGF+	\$44410.00

LIT trip function is standard. For LSIT add **\$5640.00 list**.

LIGT trip function is standard. For LSIGT add **\$5640.00 list**.





**Busway**  
**Spectra® RMS (continued)**  
 Sandwich Bus  
 Circuit Breaker with MicroVersa Trip Plus Trip Units

**Section 11**

**Peak Tier Frames Three-Phase, Three-Wire**

Frame Type	Trip Amps	Product Number	List Price GO-114M
SGPB	60	SB36SGPG+	\$16490.00
SGPB	80	SB38SGPG+	\$16490.00
SGPB	100	SB310SGPG+	\$16490.00
SGPB	125	SB312SGPG+	\$16490.00
SGPB	150	SB315SGPG+	\$16490.00
SGP4B	150	SB315SGP4G+	\$16490.00
SGP4B	200	SB320SGP4G+	\$16490.00
SGP4B	225	SB322SGP4G+	\$16490.00
SGP4B	250	SB325SGP4G+	\$16490.00
SGP4B	300	SB330SGP4G+	\$16490.00
SGP4B	350	SB335SGP4G+	\$16490.00
SGP4B	400	SB340SGP4G+	\$16490.00
SGP6B	300	SB330SGP6G+	\$18530.00
SGP6B	400	SB340SGP6G+	\$18530.00
SGP6B	450	SB345SGP6G+	\$18530.00
SGP6B	500	SB350SGP6G+	\$18530.00
SGP6B	600	SB360SGP6G+	\$18530.00
SKPB	300	SB330SKPG+	\$35792.00
SKPB	400	SB340SKPG+	\$35792.00
SKPB	500	SB350SKPG+	\$35792.00
SKPB	600	SB360SKPG+	\$35792.00
SKPB	700	SB370SKPG+	\$35792.00
SKPB	800	SB380SKPG+	\$35792.00

**Peak Tier Frames Three-Phase, Four-Wire**

Frame Type	Trip Amps	Product Number	List Price GO-114M
SGPB	60	SB46SGPG+	\$16750.00
SGPB	80	SB48SGPG+	\$16750.00
SGPB	100	SB410SGPG+	\$16750.00
SGPB	125	SB412SGPG+	\$16750.00
SGPB	150	SB415SGPG+	\$16750.00
SGP4B	150	SB415SGP4G+	\$16750.00
SGP4B	200	SB420SGP4G+	\$16750.00
SGP4B	225	SB422SGP4G+	\$16750.00
SGP4B	250	SB425SGP4G+	\$16750.00
SGP4B	300	SB430SGP4G+	\$16750.00
SGP4B	350	SB435SGP4G+	\$16750.00
SGP4B	400	SB440SGP4G+	\$16750.00
SGP6B	300	SB430SGP6G+	\$19050.00
SGP6B	400	SB440SGP6G+	\$19050.00
SGP6B	450	SB445SGP6G+	\$19050.00
SGP6B	500	SB450SGP6G+	\$19050.00
SGP6B	600	SB460SGP6G+	\$19050.00
SKPB	300	SB430SKPG+	\$36572.00
SKPB	400	SB440SKPG+	\$36572.00
SKPB	500	SB450SKPG+	\$36572.00
SKPB	600	SB460SKPG+	\$36572.00
SKPB	700	SB470SKPG+	\$36572.00
SKPB	800	SB480SKPG+	\$36572.00

LIT trip function is standard. For LSIT add \$5640.00 list.



**Features and Benefits**

- Exclusive Plug Assist<sup>1</sup>: for mechanical installation.
- Ground Contact: before stab contact.
- Interlock: to insure that plug is off when engaging bus and when removing plug.
- Door Interlock: plug must be off to open door.

**Standard Frames Three-Phase, Three-Wire TEB**

Voltage	Trip Amps	Product Number	List Price GO-114M
240 Volts Fixed Trip	15	SB31EBG	<b>\$1112.00</b>
240 Volts Fixed Trip	20	SB32EBG	<b>\$1112.00</b>
240 Volts Fixed Trip	30	SB33EBG	<b>\$1112.00</b>
240 Volts Fixed Trip	40	SB34EBG	<b>\$1112.00</b>
240 Volts Fixed Trip	50	SB35EBG	<b>\$1112.00</b>
240 Volts Fixed Trip	60	SB36EBG	<b>\$1112.00</b>
240 Volts Fixed Trip	70	SB37EBG	<b>\$1342.00</b>
240 Volts Fixed Trip	100	SB310EBG	<b>\$1342.00</b>

**Standard Frames Three-Phase, Three-Wire TED4**

Voltage	Trip Amps	Product Number	List Price GO-114M
480 Volts Fixed Trip	15	SB31ED4G	<b>\$1386.00</b>
480 Volts Fixed Trip	20	SB32ED4G	<b>\$1386.00</b>
480 Volts Fixed Trip	30	SB33ED4G	<b>\$1386.00</b>
480 Volts Fixed Trip	40	SB34ED4G	<b>\$1386.00</b>
480 Volts Fixed Trip	50	SB35ED4G	<b>\$1386.00</b>
480 Volts Fixed Trip	60	SB36ED4G	<b>\$1386.00</b>
480 Volts Fixed Trip	70	SB37ED4G	<b>\$1542.00</b>
480 Volts Fixed Trip	100	SB310ED4G	<b>\$1542.00</b>

**Standard Frames Three-Phase, Three-Wire TED6**

Voltage	Trip Amps	Product Number	List Price GO-114M
600 Volts Fixed Trip	15	SB31ED6G	<b>\$1528.00</b>
600 Volts Fixed Trip	20	SB32ED6G	<b>\$1528.00</b>
600 Volts Fixed Trip	30	SB33ED6G	<b>\$1528.00</b>
600 Volts Fixed Trip	40	SB34ED6G	<b>\$1528.00</b>
600 Volts Fixed Trip	50	SB35ED6G	<b>\$1528.00</b>
600 Volts Fixed Trip	60	SB36ED6G	<b>\$1528.00</b>
600 Volts Fixed Trip	70	SB37ED6G	<b>\$1684.00</b>
600 Volts Fixed Trip	100	SB310ED6G	<b>\$1684.00</b>

**Standard Frames Three-Phase, Three-Wire TFJ**

Voltage	Trip Amps	Product Number	List Price GO-114M
600 Volts Fixed Trip	70	SB37FJG	<b>\$3654.00</b>
600 Volts Fixed Trip	100	SB310FJG	<b>\$3654.00</b>
600 Volts Fixed Trip	110	SB311FJG	<b>\$3654.00</b>
600 Volts Fixed Trip	125	SB312FJG	<b>\$3654.00</b>
600 Volts Fixed Trip	150	SB315FJG	<b>\$3654.00</b>
600 Volts Fixed Trip	200	SB320FJG	<b>\$3654.00</b>
600 Volts Fixed Trip	225	SB322FJG	<b>\$3654.00</b>

<sup>1</sup>Optional for E Frame plugs.

**Standard Frames Three-Phase, Three-Wire TFK**

Voltage	Trip Amps	Product Number	List Price GO-114M
600 Volts Inter. Trip	70	SB37FKG	<b>\$4080.00</b>
600 Volts Inter. Trip	100	SB310FKG	<b>\$4080.00</b>
600 Volts Inter. Trip	125	SB312FKG	<b>\$4080.00</b>
600 Volts Inter. Trip	150	SB315FKG	<b>\$4080.00</b>
600 Volts Inter. Trip	200	SB320FKG	<b>\$4080.00</b>
600 Volts Inter. Trip	225	SB322FKG	<b>\$4080.00</b>

**Standard Frames Three-Phase, Three-Wire TJJ**

Voltage	Trip Amps	Product Number	List Price GO-114M
600 Volts Fixed Trip	125	SB312JJG	<b>\$7602.00</b>
600 Volts Fixed Trip	150	SB315JJG	<b>\$7602.00</b>
600 Volts Fixed Trip	200	SB320JJG	<b>\$7602.00</b>
600 Volts Fixed Trip	225	SB322JJG	<b>\$7602.00</b>
600 Volts Fixed Trip	300	SB330JJG	<b>\$7602.00</b>
600 Volts Fixed Trip	400	SB340JJG	<b>\$7602.00</b>

**Standard Frames Three-Phase, Three-Wire TJK4**

Voltage	Trip Amps	Product Number	List Price GO-114M
600 Volts Inter. Trip	125	SB312JK4G	<b>\$7632.00</b>
600 Volts Inter. Trip	150	SB315JK4G	<b>\$7632.00</b>
600 Volts Inter. Trip	175	SB317JK4G	<b>\$7632.00</b>
600 Volts Inter. Trip	200	SB320JK4G	<b>\$7632.00</b>
600 Volts Inter. Trip	225	SB322JK4G	<b>\$7632.00</b>
600 Volts Inter. Trip	300	SB330JK4G	<b>\$7632.00</b>
600 Volts Inter. Trip	400	SB340JK4G	<b>\$7632.00</b>

**Standard Frames Three-Phase, Three-Wire TJK6**

Voltage	Trip Amps	Product Number	List Price GO-114M
600 Volts Inter. Trip	400	SB340JK6G	<b>\$9972.00</b>
600 Volts Inter. Trip	450	SB345JK6G	<b>\$10168.00</b>
600 Volts Inter. Trip	500	SB350JK6G	<b>\$10168.00</b>
600 Volts Inter. Trip	600	SB360JK6G	<b>\$10168.00</b>

**Standard Frames Three-Phase, Three-Wire TKM8**

Voltage	Trip Amps	Product Number	List Price GO-114M
600 Volts Inter. Trip	300	SB330KMG	<b>\$11596.00</b>
600 Volts Inter. Trip	400	SB340KMG	<b>\$11596.00</b>
600 Volts Inter. Trip	500	SB350KMG	<b>\$11596.00</b>
600 Volts Inter. Trip	600	SB360KMG	<b>\$11596.00</b>
600 Volts Inter. Trip	700	SB370KMG	<b>\$12964.00</b>
600 Volts Inter. Trip	800	SB380KMG	<b>\$12964.00</b>

**Standard Frames Three-Phase, Four-Wire TEB**

Voltage	Trip Amps	Product Number	List Price GO-114M
240 Volts Fixed Trip	15	SB41EBG	<b>\$1242.00</b>
240 Volts Fixed Trip	20	SB42EBG	<b>\$1242.00</b>
240 Volts Fixed Trip	30	SB43EBG	<b>\$1242.00</b>
240 Volts Fixed Trip	40	SB44EBG	<b>\$1242.00</b>
240 Volts Fixed Trip	50	SB45EBG	<b>\$1242.00</b>
240 Volts Fixed Trip	60	SB46EBG	<b>\$1242.00</b>
240 Volts Fixed Trip	70	SB47EBG	<b>\$1456.00</b>
240 Volts Fixed Trip	100	SB410EBG	<b>\$1456.00</b>



# Busway Spectra® Series Busway (continued)

Sandwich Bus

Plugs, Fusible, Conversion Kits

# Section 11

## Standard Frames Three-Phase, Four-Wire TED4

Voltage	Trip Amps	Product Number	List Price GO-114M
480 Volts Fixed Trip	15	SB41ED4G	\$1528.00
480 Volts Fixed Trip	20	SB42ED4G	\$1528.00
480 Volts Fixed Trip	30	SB43ED4G	\$1528.00
480 Volts Fixed Trip	40	SB44ED4G	\$1528.00
480 Volts Fixed Trip	50	SB45ED4G	\$1528.00
480 Volts Fixed Trip	60	SB46ED4G	\$1528.00
480 Volts Fixed Trip	70	SB47ED4G	\$1656.00
480 Volts Fixed Trip	100	SB410ED4G	\$1656.00

## Standard Frames Three-Phase, Four-Wire TED6

Voltage	Trip Amps	Product Number	List Price GO-114M
600 Volts Fixed Trip	15	SB41ED6G	\$1640.00
600 Volts Fixed Trip	20	SB42ED6G	\$1640.00
600 Volts Fixed Trip	30	SB43ED6G	\$1640.00
600 Volts Fixed Trip	40	SB44ED6G	\$1640.00
600 Volts Fixed Trip	50	SB45ED6G	\$1640.00
600 Volts Fixed Trip	60	SB46ED6G	\$1640.00
600 Volts Fixed Trip	70	SB47ED6G	\$1812.00
600 Volts Fixed Trip	100	SB410ED6G	\$1812.00

## Standard Frames Three-Phase, Four-Wire TFJ

Voltage	Trip Amps	Product Number	List Price GO-114M
600 Volts Fixed Trip	70	SB47FJG	\$3894.00
600 Volts Fixed Trip	100	SB410FJG	\$3894.00
600 Volts Fixed Trip	110	SB411FJG	\$3894.00
600 Volts Fixed Trip	125	SB412FJG	\$3894.00
600 Volts Fixed Trip	150	SB415FJG	\$3894.00
600 Volts Fixed Trip	200	SB420FJG	\$3894.00
600 Volts Fixed Trip	225	SB422FJG	\$3894.00

## Standard Frames Three-Phase, Four-Wire TFK

Voltage	Trip Amps	Product Number	List Price GO-114M
600 Volts Inter. Trip	70	SB47FKG	\$4296.00
600 Volts Inter. Trip	100	SB410FKG	\$4296.00
600 Volts Inter. Trip	125	SB412FKG	\$4296.00
600 Volts Inter. Trip	150	SB415FKG	\$4296.00
600 Volts Inter. Trip	200	SB420FKG	\$4296.00
600 Volts Inter. Trip	225	SB422FKG	\$4296.00

## Standard Frames Three-Phase, Four-Wire TJJ

Voltage	Trip Amps	Product Number	List Price GO-114M
600 Volts Fixed Trip	125	SB412JJG	\$7974.00
600 Volts Fixed Trip	150	SB415JJG	\$7974.00
600 Volts Fixed Trip	200	SB420JJG	\$7974.00
600 Volts Fixed Trip	225	SB422JJG	\$7974.00
600 Volts Fixed Trip	300	SB430JJG	\$7974.00
600 Volts Fixed Trip	400	SB440JJG	\$7974.00

## Standard Frames Three-Phase, Four-Wire TJK4

Voltage	Trip Amps	Product Number	List Price GO-114M
600 Volts Inter. Trip	125	SB412JK4G	\$8002.00
600 Volts Inter. Trip	150	SB415JK4G	\$8002.00
600 Volts Inter. Trip	175	SB417JK4G	\$8002.00
600 Volts Inter. Trip	200	SB420JK4G	\$8002.00
600 Volts Inter. Trip	225	SB422JK4G	\$8002.00
600 Volts Inter. Trip	300	SB430JK4G	\$8002.00
600 Volts Inter. Trip	400	SB440JK4G	\$8002.00

## Standard Frames Three-Phase, Four-Wire TJK6

Voltage	Trip Amps	Product Number	List Price GO-114M
600 Volts Inter. Trip	400	SB440JK6G	\$10426.00
600 Volts Inter. Trip	450	SB445JK6G	\$10426.00
600 Volts Inter. Trip	500	SB450JK6G	\$10684.00
600 Volts Inter. Trip	600	SB460JK6G	\$10684.00

## Standard Frames Three-Phase, Four-Wire TKM8

Voltage	Trip Amps	Product Number	List Price GO-114M
600 Volts Inter. Trip	300	SB430KMG	\$12108.00
600 Volts Inter. Trip	400	SB440KMG	\$12108.00
600 Volts Inter. Trip	500	SB450KMG	\$12108.00
600 Volts Inter. Trip	600	SB460KMG	\$12108.00
600 Volts Inter. Trip	700	SB470KMG	\$13508.00
600 Volts Inter. Trip	800	SB480KMG	\$13508.00

## Hi-Break Frames Three-Phase, Three-Wire THED

Voltage	Trip Amps	Product Number	List Price GO-114M
600 Volts Fixed Trip	15	SB31HEDG	\$1926.00
600 Volts Fixed Trip	20	SB32HEDG	\$1926.00
600 Volts Fixed Trip	30	SB33HEDG	\$1926.00
600 Volts Fixed Trip	40	SB34HEDG	\$1926.00
600 Volts Fixed Trip	50	SB35HEDG	\$1926.00
600 Volts Fixed Trip	70	SB37HEDG	\$2098.00
600 Volts Fixed Trip	100	SB310HEDG	\$2098.00

## Hi-Break Frames Three-Phase, Three-Wire THFK

Voltage	Trip Amps	Product Number	List Price GO-114M
600 Volts Inter. Trip	70	SB37HFKG	\$6648.00
600 Volts Inter. Trip	100	SB310HFKG	\$6648.00
600 Volts Inter. Trip	125	SB312HFKG	\$6648.00
600 Volts Inter. Trip	150	SB315HFKG	\$6648.00
600 Volts Inter. Trip	200	SB320HFKG	\$6648.00
600 Volts Inter. Trip	225	SB322HFKG	\$6648.00

## Hi-Break Frames Three-Phase, Three-Wire THJK4

Voltage	Trip Amps	Product Number	List Price GO-114M
600 Volts Inter. Trip	125	SB312HJK4G	\$10512.00
600 Volts Inter. Trip	150	SB315HJK4G	\$10512.00
600 Volts Inter. Trip	200	SB320HJK4G	\$10512.00
600 Volts Inter. Trip	225	SB322HJK4G	\$10512.00
600 Volts Inter. Trip	300	SB330HJK4G	\$10512.00
600 Volts Inter. Trip	400	SB340HJK4G	\$10512.00



# Busway Spectra® Series Busway (continued)

Sandwich Bus  
Plugs, Fusible, Conversion Kits

# Section 11

## Hi-Break Frames Three-Phase, Three-Wire THJK6

Voltage	Trip Amps	Product Number	List Price GO-114M
600 Volts Inter. Trip	400	SB340HJK6G	<b>\$10642.00</b>
600 Volts Inter. Trip	450	SB345HJK6G	<b>\$10642.00</b>
600 Volts Inter. Trip	500	SB350HJK6G	<b>\$10642.00</b>
600 Volts Inter. Trip	600	SB360HJK6G	<b>\$10642.00</b>

## Hi-Break Frames Three-Phase, Three-Wire THKM8

Voltage	Trip Amps	Product Number	List Price GO-114M
600 Volts Inter. Trip	300	SB330HKMG	<b>\$12480.00</b>
600 Volts Inter. Trip	400	SB340HKMG	<b>\$12480.00</b>
600 Volts Inter. Trip	500	SB350HKMG	<b>\$12480.00</b>
600 Volts Inter. Trip	600	SB360HKMG	<b>\$12480.00</b>
600 Volts Inter. Trip	700	SB370HKMG	<b>\$14648.00</b>
600 Volts Inter. Trip	800	SB380HKMG	<b>\$14648.00</b>

## Hi-Break Frames Three-Phase, Four-Wire THED

Voltage	Trip Amps	Product Number	List Price GO-114M
600 Volts Fixed Trip	15	SB41HEDG	<b>\$2042.00</b>
600 Volts Fixed Trip	20	SB42HEDG	<b>\$2042.00</b>
600 Volts Fixed Trip	30	SB43HEDG	<b>\$2042.00</b>
600 Volts Fixed Trip	40	SB44HEDG	<b>\$2042.00</b>
600 Volts Fixed Trip	50	SB45HEDG	<b>\$2042.00</b>
600 Volts Fixed Trip	70	SB47HEDG	<b>\$2226.00</b>
600 Volts Fixed Trip	100	SB410HEDG	<b>\$2226.00</b>

## Hi-Break Frames Three-Phase, Four-Wire THFK

Voltage	Trip Amps	Product Number	List Price GO-114M
600 Volts Inter. Trip	70	SB47HFKG	<b>\$6874.00</b>
600 Volts Inter. Trip	100	SB410HFKG	<b>\$6874.00</b>
600 Volts Inter. Trip	125	SB412HFKG	<b>\$6874.00</b>
600 Volts Inter. Trip	150	SB415HFKG	<b>\$6874.00</b>
600 Volts Inter. Trip	200	SB420HFKG	<b>\$6874.00</b>
600 Volts Inter. Trip	225	SB422HFKG	<b>\$6874.00</b>

## Hi-Break Frames Three-Phase, Four-Wire THJK4

Voltage	Trip Amps	Product Number	List Price GO-114M
600 Volts Inter. Trip	125	SB412HJK4G	<b>\$10856.00</b>
600 Volts Inter. Trip	150	SB415HJK4G	<b>\$10856.00</b>
600 Volts Inter. Trip	200	SB420HJK4G	<b>\$10856.00</b>
600 Volts Inter. Trip	225	SB422HJK4G	<b>\$10856.00</b>
600 Volts Inter. Trip	300	SB430HJK4G	<b>\$10856.00</b>
600 Volts Inter. Trip	400	SB440HJK4G	<b>\$10856.00</b>

## Hi-Break Frames Three-Phase, Four-Wire THJK6

Voltage	Trip Amps	Product Number	List Price GO-114M
600 Volts Inter. Trip	400	SB440HJK6G	<b>\$10992.00</b>
600 Volts Inter. Trip	450	SB445HJK6G	<b>\$10992.00</b>
600 Volts Inter. Trip	500	SB450HJK6G	<b>\$10992.00</b>
600 Volts Inter. Trip	600	SB460HJK6G	<b>\$10992.00</b>

## Hi-Break Frames Three-Phase, Four-Wire THKM8

Voltage	Trip Amps	Product Number	List Price GO-114M
600 Volts Inter. Trip	300	SB430HKMG	<b>\$13020.00</b>
600 Volts Inter. Trip	400	SB440HKMG	<b>\$13020.00</b>
600 Volts Inter. Trip	500	SB450HKMG	<b>\$13020.00</b>
600 Volts Inter. Trip	600	SB460HKMG	<b>\$13020.00</b>
600 Volts Inter. Trip	700	SB470HKMG	<b>\$15246.00</b>
600 Volts Inter. Trip	800	SB480HKMG	<b>\$15246.00</b>

## Tri-Break® Frames Three-Phase, Three-Wire TB4

Voltage	Trip Amps	Product Number	List Price GO-114M
600 Volts Inter. Trip	125	SB312B4F14G	<b>\$10512.00</b>
600 Volts Inter. Trip	150	SB315B4F14G	<b>\$10512.00</b>
600 Volts Inter. Trip	200	SB320B4F14G	<b>\$10512.00</b>
600 Volts Inter. Trip	225	SB322B4F14G	<b>\$10512.00</b>
600 Volts Inter. Trip	300	SB330B4F14G	<b>\$12566.00</b>
600 Volts Inter. Trip	400	SB340B4F14G	<b>\$12566.00</b>

## Tri-Break® Frames Three-Phase, Three-Wire TB6

Voltage	Trip Amps	Product Number	List Price GO-114M
600 Volts Inter. Trip	300	SB330B6J14G	<b>\$18868.00</b>
600 Volts Inter. Trip	400	SB340B6J14G	<b>\$18868.00</b>
600 Volts Inter. Trip	500	SB350B6J14G	<b>\$18868.00</b>
600 Volts Inter. Trip	600	SB360B6J14G	<b>\$18868.00</b>

## Tri-Break® Frames Three-Phase, Three-Wire TB8

Voltage	Trip Amps	Product Number	List Price GO-114M
600 Volts Inter. Trip	600	SB360B8K22G	<b>\$21380.00</b>
600 Volts Inter. Trip	700	SB370B8K22G	<b>\$21380.00</b>
600 Volts Inter. Trip	800	SB380B8K22G	<b>\$21380.00</b>

## Tri-Break® Frames Three-Phase, Four-Wire TB4

Voltage	Trip Amps	Product Number	List Price GO-114M
600 Volts Inter. Trip	125	SB412B4F14G	<b>\$10770.00</b>
600 Volts Inter. Trip	150	SB415B4F14G	<b>\$10770.00</b>
600 Volts Inter. Trip	200	SB420B4F14G	<b>\$10770.00</b>
600 Volts Inter. Trip	225	SB422B4F14G	<b>\$10770.00</b>
600 Volts Inter. Trip	300	SB430B4F14G	<b>\$13336.00</b>
600 Volts Inter. Trip	400	SB440B4F14G	<b>\$13336.00</b>

## Tri-Break® Frames Three-Phase, Four-Wire TB6

Voltage	Trip Amps	Product Number	List Price GO-114M
600 Volts Inter. Trip	300	SB430B6J14G	<b>\$19440.00</b>
600 Volts Inter. Trip	400	SB440B6J14G	<b>\$19440.00</b>
600 Volts Inter. Trip	500	SB450B6J14G	<b>\$19440.00</b>
600 Volts Inter. Trip	600	SB460B6J14G	<b>\$19440.00</b>

## Tri-Break® Frames Three-Phase, Four-Wire TB8

Voltage	Trip Amps	Product Number	List Price GO-114M
600 Volts Inter. Trip	600	SB460B8K22G	<b>\$21950.00</b>
600 Volts Inter. Trip	700	SB470B8K22G	<b>\$21950.00</b>
600 Volts Inter. Trip	800	SB480B8K22G	<b>\$21950.00</b>



# Busway Spectra® Series Busway (continued)

Sandwich Bus

Plugs, Fusible, Conversion Kits

## Section 11

### Adapter Kits Convert Spectra® Series plugs to Armor-Clad

Amperage	Product Number	List Price GO-114L
30-100	SBAC1G	\$128.00
150-250	SBAC4G	\$294.00
400-800	SBAC5G	\$442.00

Ground stabs included.

### Adapter Kits

#### Convert Spectra® Series Bus Plugs to Spectra® LowAmp Bus

Amperage	Product Number	List Price GO-114L
30-100	SBSL1G	\$128.00
200-225	SBSL4G	\$294.00
400-600	SBSL5G	\$442.00

(Style 2—shipped after 5/95)

Ground stabs included.

### Switch-Operated Fusible Plugs Three-Phase, Three-Wire

Voltage	Amperage	Product Number	List Price GO-114L
240 VAC	30	SB321RG	\$822.00
240 VAC	60	SB322RG	\$904.00
240 VAC	100	SB323RG	\$1264.00
240 VAC	200	SB324RG	\$2152.00
240 VAC	400	SB325RG	\$5626.00
240 VAC	600	SB326RG	\$7696.00
480 or 600 VAC	30	SB361RG	\$904.00
480 or 600 VAC	60	SB362RG	\$938.00
480 or 600 VAC	100	SB363RG	\$1316.00
480 or 600 VAC	200	SB364RG	\$2252.00
480 or 600 VAC	400	SB365RG	\$5694.00
480 or 600 VAC	600	SB366RG	\$7764.00

With QMR Interrupter Fuses Not Included

### Switch-Operated Fusible Plugs Three-Phase, Four-Wire

Voltage	Amperage	Product Number	List Price GO-114L
240 VAC	30	SB421RG	\$972.00
240 VAC	60	SB422RG	\$1038.00
240 VAC	100	SB423RG	\$1414.00
240 VAC	200	SB424RG	\$2412.00
240 VAC	400	SB425RG	\$6006.00
240 VAC	600	SB426RG	\$8386.00
480 or 600 VAC	30	SB461RG	\$1038.00
480 or 600 VAC	60	SB462RG	\$1072.00
480 or 600 VAC	100	SB463RG	\$1514.00
480 or 600 VAC	200	SB464RG	\$2496.00
480 or 600 VAC	400	SB465RG	\$6078.00
480 or 600 VAC	600	SB466RG	\$8470.00

With QMR Interrupter Fuses Not Included

### Miscellaneous Plug Modifications

—**Plug Assist**—Standard for plugs over 100 amperes. Add suffix “P” to the product number for plugs 100 amperes and below.

**\$94.00, GO-114L or M.**

—**Drip-Proof Plugs**—Includes cover and stab gasketing. Add suffix “I” to product number and **\$156.00 list,**

**GO-114L or M.**

—**Splashproof (IP54) Plugs**—Add suffix “Z” to the product number and add **\$170.00 list** of Drip-Proof. **GO-114L or M.**

—**Spectra® MVT + Option**—Add suffix “+” to the product number. Include note describing type of trip unit. See page 11-31 for **List Price Adders.**



**Busway**  
**Spectra® Series Busway**  
Sandwich Bus  
Plug Options  
Protective Devices and Short-Circuit Ratings

**Section 11**

**Enclosure Three-Phase, Three-Wire Ground Standard**

Frame Type	Trip Amps	Product Number	List Price GO-114M
E	100 max.	SB3100EG	\$728.00
F	225	SB3225FG	\$1196.00

**Enclosure Three-Phase, Four-Wire Ground Standard**

Frame Type	Trip Amps	Product Number	List Price GO-114M
E	100 max.	SB4100EG	\$794.00
F	225	SB4225FG	\$1378.00

(Order circuit breaker from Section 4)

Not for Spectra® breakers. E and F frame enclosures for standard molded case circuit breakers only.

**Contactor Plugs — Add to price of required protective device bus plug**

List Price Adder, GO-114L or M								
Ampere Rating	Electronically Held	Mechanically Held	Pilot Light	Pushbutton Or Selector Switch	Control Transformer	Extra Interlock	Two-Wire Control	Auxiliary Contact
30	\$1756.00	\$2198.00	\$432.00	\$326.00	\$430.00	\$208.00	\$624.00	\$172.00
60	\$2522.00	\$3276.00	\$432.00	\$326.00	\$598.00	\$208.00	\$624.00	\$172.00
100	\$3250.00	\$4212.00	\$432.00	\$326.00	\$832.00	\$208.00	\$624.00	\$172.00

<sup>2</sup>Includes one secondary fuse.

**Options for Fusible Switch Units — Use for Spectra® Series Busway**

List Price, GO-114L							
Description	UL Listed	30 Amps	60 Amps	100 Amps	200 Amps	400 Amps	600 Amps
Factory installed Class R fuse clips							
Add "R" suffix to Product Number	Yes	\$96.00	\$96.00	\$96.00	\$122.00	\$130.00	\$138.00
Factory installed Class J fuse clips							
Add "J" suffix to 600 V plug Product Number	Yes	\$54.00	\$54.00	\$54.00	\$54.00	\$54.00	\$456.00 <sup>3</sup>
QMW in lieu of QMR							
Change "R" in Product Number to "W"	Yes	\$92.00	\$92.00	\$172.00	\$254.00	\$684.00	N/A

<sup>3</sup>UL listed for Spectra® Series and Armor-Clad plug-in busway only.



# Busway Spectra® Series Busway

Sandwich Bus

Plug Options

Protective Devices and Short-Circuit Ratings

## Spectra® Bus Plugs with TRANQUELL® TVSS Protection

Spectra® bus plugs are available with integral TRANQUELL® TVSS devices for a variety of location categories and exposure levels. Indicating lights communicate proper system operation. Ratings and specifications:

- Suitable for medium to high exposure, service entry or branch panel locations
- UL-1449, Second Edition; cUL and UL-1283 Recognized Component
- Maximum surge current ratings of 50kA, 80kA, and 100kA per mode—tested on a complete TVSS unit
- Repetitive surge current tested—ANSI/IEEE C62.41, Category C3: 100kA-5,000 impulses; 80kA-5,000 impulses; 50kA-3,500 impulses
- Noise filtering up to -44dB at 100kHz
- Refer to FES-006 for UL-1449, Second Edition SVR Values
- 65 kAIC

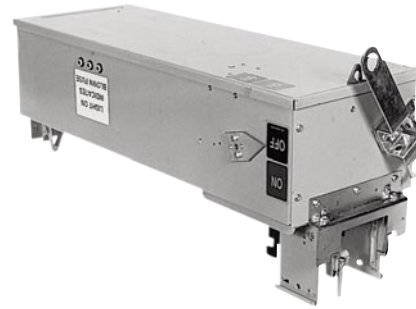

Spectra® TVSS bus plugs

## Spectra® Bus Plugs with TVSS Protection Three-Phase, Three-Wire

Maximum Surge Current Rating	Voltage	Power Type	Ground Fault	TVSS Product Number	Product Number	List Price GO-114L
100kA	240V Delta	Delta	Yes	TME240D100	SB310TVSS240D	\$19500.00
100kA	480V Delta	Delta	Yes	TME480D100	SB310TVSS480D	\$19500.00
100kA	600V Delta	Delta	Yes	TME600D100	SB310TVSS600D	\$19500.00

## Spectra® Bus Plugs with TVSS Protection Three-Phase, Four-Wire

Maximum Surge Current Rating	Voltage	Power Type	Ground Fault	TVSS Product Number	Product Number	List Price GO-114L
100kA	208Y/120V	Wye	Yes	TME120Y100	SB410TVSS208Y	\$20010.00
100kA	240Y/138V	Wye	Yes	TME240Y100	SB410TVSS240Y	\$20010.00
100kA	480Y/277V	Wye	Yes	TME277Y100	SB410TVSS480Y	\$20010.00
100kA	600Y/346V	Wye	Yes	TME347Y100	SB410TVSS600Y	\$20010.00

## Spectra® Bus Plugs with TVSS Protection Three-Phase, Three-Wire

Maximum Surge Current Rating	Voltage	Power Type	Ground Fault	TVSS Product Number	Product Number	List Price GO-114L
80kA	240V Delta	Delta	Yes	TME240D080	SB38TVSS240D	\$12080.00
80kA	480V Delta	Delta	Yes	TME480D080	SB38TVSS480D	\$12080.00
80kA	600V Delta	Delta	Yes	TME600D080	SB38TVSS600D	\$12080.00

## Spectra® Bus Plugs with TVSS Protection Three-Phase, Four-Wire

Maximum Surge Current Rating	Voltage	Power Type	Ground Fault	TVSS Product Number	Product Number	List Price GO-114L
80kA	208Y/120V	Wye	Yes	TME120Y080	SB48TVSS208Y	\$12450.00
80kA	240Y/138V	Wye	Yes	TME240Y080	SB48TVSS240Y	\$12450.00
80kA	480Y/277V	Wye	Yes	TME277Y080	SB48TVSS480Y	\$12450.00
80kA	600Y/346V	Wye	Yes	TME347Y080	SB48TVSS600Y	\$12450.00

## Spectra® Bus Plugs with TVSS Protection Three-Phase, Three-Wire

Maximum Surge Current Rating	Voltage	Power Type	Ground Fault	TVSS Product Number	Product Number	List Price GO-114L
50kA	240V Delta	Delta	Yes	TME240D065	SB35TVSS240D	\$11110.00
50kA	480V Delta	Delta	Yes	TME480D065	SB35TVSS480D	\$11110.00
50kA	600V Delta	Delta	Yes	TME600D065	SB35TVSS600D	\$11110.00

## Spectra® Bus Plugs with TVSS Protection Three-Phase, Four-Wire

Maximum Surge Current Rating	Voltage	Power Type	Ground Fault	TVSS Product Number	Product Number	List Price GO-114L
50kA	208Y/120V	Wye	Yes	TME120Y065	SB45TVSS208Y	\$11370.00
50kA	240Y/138V	Wye	Yes	TME240Y065	SB45TVSS240Y	\$11370.00
50kA	480Y/277V	Wye	Yes	TME277Y065	SB45TVSS480Y	\$11370.00
50kA	600Y/346V	Wye	Yes	TME347Y065	SB45TVSS600Y	\$11370.00





# Busway

## Spectra® Series Busway

Sandwich Bus  
Reducer Cubicles and Special Adapter Cubicles

# Section 11

With Aluminum or Copper Bus Bars—  
Add Footage of Higher Rated Bus through the Cubicle

Device			List Price, GO-126S						
Adapter Type	Frame		3-Pole		3-Phase 4-Wire				
	Construction	Type	Ampere Rating	240 V	600 V	208 V/ 120 V	480 V/ 277 V		
Fusible Switches	High Pressure Contact	QMR (No fuses included)	200	\$2084.00	\$2211.00	\$2211.00	\$2335.00		
			400	\$2558.00	\$2719.00	\$2792.00	\$2949.00		
			600	\$2915.00	\$3228.00	\$3206.00	\$3496.00		
			800	\$4580.00	\$5063.00	\$4635.00	\$4925.00		
			1200	\$4904.00	\$5641.00	\$5417.00	\$6143.00		
	Manually Operated	HPC (No fuses included)	800	\$9150.00	\$9929.00	\$9838.00	\$10375.00		
			1200	\$10488.00	\$11164.00	\$11503.00	\$12109.00		
			1600	\$12109.00	\$12888.00	\$13436.00	\$14134.00		
			2000	\$13640.00	\$14284.00	\$15305.00	\$15986.00		
			2500	\$17925.00	\$18580.00	\$19580.00	\$20648.00		
Standard			3000	\$27924.00	\$28568.00	\$30394.00	\$31039.00		
			4000	\$38342.00	\$39089.00	\$42316.00	\$43067.00		
			TFJ	70-225	\$2826.00		\$2949.00		
			TFK	70-225	\$2982.00		\$3082.00		
			TJJ	125-400	\$3463.00		\$3597.00		
			TJK4	125-400	\$3686.00		\$3843.00		
			TJK6	450-600	\$4970.00		\$5105.00		
			TKM8	700-800	\$5808.00		\$5986.00		
			TKM12	1000	\$6601.00		\$6791.00		
			SSF	1200	\$7976.00		\$8165.00		
Molded-Case Circuit Breakers			600-1600	\$11896.00		\$12063.00			
			2000, 2500, 3000	\$13002.00		\$13225.00			
			List Price, GO-126						
			THFK	70-225	\$3843.00		\$3943.00		
			THJK4	125-400	\$4580.00		\$4747.00		
			Hi-Break®	THKM8	300-600	\$5540.00		\$5663.00	
				THKM8	700-800	\$6377.00		\$6568.00	
				THKM12	1000	\$7182.00		\$7361.00	
			Tri-Break®	THKM12	1200	\$8545.00		\$8746.00	
				TB4	125-225	\$4635.00		\$4747.00	
TB4	250-400	\$5506.00			\$5641.00				
TB6	300-600	\$8332.00			\$8444.00				
TB8	700-800	\$8422.00		\$8813.00					

### Joint-Guard Protection System

Bus Type	Service	Ampere Rating		No. Bolts per Kit	Kit No. (1 per Joint)	List Price	GO Schedule
		Aluminum	Copper				
Spectra	3-Wire	225 to 1350	225 to 2000	1	JGSB1 1	\$110.00	GO-126S
		2000 to 3000	250 to 4000	2	JGSB1 2	\$220.00	GO-126S
		4000	5000	4	JGSB1 4	\$440.00	GO-126S
	3-Wire Grd.	225 to 1350	225 to 2000	1	JGSB2 1	\$110.00	GO-126S
		2000 to 3000	250 to 4000	2	JGSB2 2	\$220.00	GO-126S
		4000	5000	4	JGSB2 4	\$440.00	GO-126S
	4-Wire	225 to 1350	225 to 2000	1	JGSB3 1	\$110.00	GO-126S
		2000 to 3000	250 to 4000	2	JGSB3 2	\$220.00	GO-126S
		4000	5000	4	JGSB3 4	\$440.00	GO-126S
	4-Wire Grd.	225 to 1350	225 to 2000	1	JGSB4 1	\$110.00	GO-126S
		2000 to 3000	250 to 4000	2	JGSB4 2	\$220.00	GO-126S
		4000	5000	4	JGSB4 4	\$440.00	GO-126S
LowAmp	All	All	All	1	JGSB5 1	\$172.00	GO-126L

### Miscellaneous Accessories

#### Hook Sticks

Length (Feet)	Product Number	List Price, GO-114L
8	DFHSE8	\$245.00
12	DFHSE12	\$284.00
16	DFHSE16	\$314.00

#### Compression Lugs

For Tap Boxes, Power Takeoffs and Flanged Ends

Description	List Price, GO-126S
2/0-300 kcmil	\$30.00
500 kcmil	\$40.00
600-750 kcmil	\$58.00
1000 kcmil	\$80.00

#### Flexible Connections

For Transformer Throats

Ampere Rating	List Price, GO-126S	
	3P	4P
0-1600A	\$1662.00	\$2216.00
2000A-3000A	\$3324.00	\$4432.00
4000A	\$4986.00	\$6648.00
5000A	\$6648.00	\$8864.00

Optional joint bolt indicator repeatedly changes colors to indicate proper joint torque.



# Busway Spectra® Series Busway

Sandwich Bus

Plugs

Outlines and Dimensions

## Section 11

### Spectra® RMS Circuit Breaker Busway Plugs Outer Dimensions

Tier	Frame Type	Width (in.)	Length (in.)	Depth (in.)	Handle Height <sup>1</sup>	Weight (Lbs.)	Plug-in Outlets	Figure
Lowest	SED	11	13	8	9.12	25	1	A
Low	SEH	11	13	8	9.12	25	1	A
Low	SFH	11	21.25	9	9.5	41	1	A
Low	SGH	16.75	26.5	12	18	91	2	B
Low	SKH <sup>2</sup>	16.75	36.5	12	18	160	2	B
Mid	SEL	11	13	8	9.12	25	1	A
Mid	SFL	11	21.25	9	9.5	41	1	A
Mid	SGL	16.75	26.5	12	18	91	2	B
Mid	SKL <sup>2</sup>	16.75	36.5	12	18	160	2	B
Peak	SEP	11	13	8	9.12	25	1	A
Peak	SFP	11	21.25	9	9.5	41	1	A
Peak	SGP	16.75	26.5	12	18	91	2	B
Peak	SKP <sup>2</sup>	16.75	36.5	12	18	160	2	B

<sup>1</sup>Maximum distance from enclosure bottom to handle tip.

<sup>2</sup>For ground fault option, increase width dimension by 2.125 inches and length dimension by 6 inches.

### Standard Molded Case Circuit Breaker

Type	Frame Type	Width (in.)	Length (in.)	Depth (in.)	Figure
Standard and Hi-Break	TEB	11	13	8	A
	TED4	11	13	8	A
	THED	11	13	8	A
	TFJ	11	18.5	9.5	A
	TFK	11	18.5	9.5	A
	THFK	11	18.5	9.5	A
	TJJ	16.75	24.5	12	B
	TJK4	16.75	24.5	12	B
	TJK6	16.75	24.5	12	B
	THJK4	16.75	24.5	12	B
THJK6	16.75	24.5	12	B	
TKM8, THKM8, THK, KM	16.75	36.5	12	A	
Tri-Break®	TB1	11.00	18.50	8	A
	TB4	16.75	30.5	12	B
	TB6	16.75	45.25	12	B
	TB8	16.75	45.25	12	B

### Fusible Outer Dimensions

Type	Voltage	Amperage	Weight (Lbs.)	Width (in.)	Length (in.) Standard Gutter	Length (in.) Extended Gutter	Depth (in.)	Figure
QMR	240 and 600 VAC	30	24	11.25	13	18.75	8.75	A
QMR	240 and 600 VAC	60	25	11.25	13	18.75	8.75	A
QMR	240 and 600 VAC	100	28	11.25	18.75	N/A	8.75	A
QMR	240 and 600 VAC	200	46	16	18.75	24.5	8.75	A
QMR	240 and 600 VAC	400	135	20.5	18.75	N/A	18.75	B
QMR	240 and 600 VAC	600	160	20.5	24.5	N/A	18.75	B

NA = Not Available

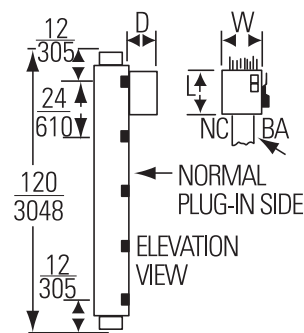

Typical Vertical Application

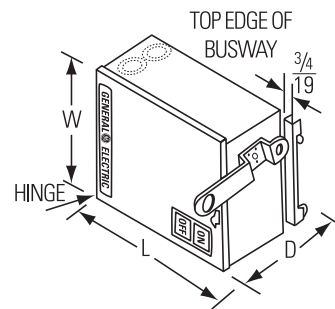

Figure A: Door hinges at left end. All dimensions are shown over largest part of plug.

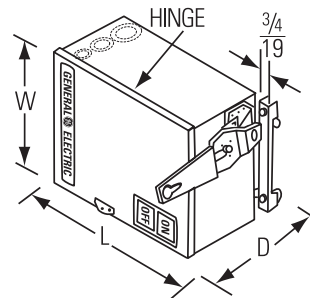

Figure B: Door hinges top. All dimensions are shown over largest part of plug.

Decimal	Fraction
.12	1/8
.38	3/8
.63	5/8
.88	7/8



# Busway Spectra® Series Busway Sandwich Bus Dimensions and Weights

## Section 11

### Aluminum Three-Phase, Three-Wire

Amperage	Figure No.	A width inches (mm)	Bar Sizes Width x Thickness (in.)	DC Ampere Rating	Approx. Weight Lbs./Ft.
225 Amps	1	4.38 (111)	1.63 x .25	600	5
400 Amps	1	4.38 (111)	1.63 x .25	-	5
600 Amps	1	4.38 (111)	1.63 x .25	800/1000	5
800 Amps	1	5.63 (143)	2.88 x .25	1350	6
1000 Amps	1	6.13 (154)	3.38 x .25	1600	7
1200 Amps	1	7.00 (178)	4.25 x .25	-	8
1350 Amps	1	8.50 (216)	5.75 x .25	2500	9
1600 Amps	1	9.25 (235)	6.50 x .25	-	10
2000 Amps	1	11.00 (279)	8.25 x .25	3000	12
2500 Amps	2	15.50 (394)	(2) 4.50 x .25	4000	17
3000 Amps	2	18.00 (457)	(2) 5.75 x .25	-	19
4000 Amps	2	23.00 (584)	(2) 8.25 x .25	6000	25

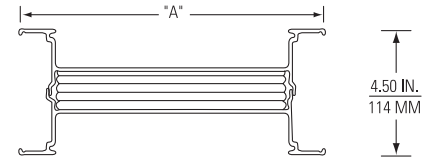

Figure 1: One Bar Per Phase

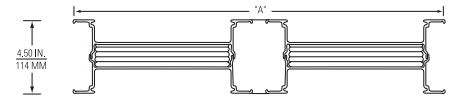
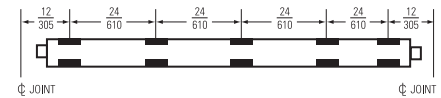

Figure 2: Two Bars Per Phase

### Aluminum Three-Phase, Four-Wire

Amperage	Figure No.	A width inches (mm)	Bar Sizes Width x Thickness (in.)	DC Ampere Rating	Approx. Weight Lbs./Ft.
225 Amps	1	4.38 (111)	1.63 x .25	600	6
400 Amps	1	4.38 (111)	1.63 x .25	-	6
600 Amps	1	4.38 (111)	1.63 x .25	800/1000	6
800 Amps	1	5.63 (143)	2.88 x .25	1350	7
1000 Amps	1	6.13 (154)	3.38 x .25	1600	8
1200 Amps	1	7.00 (178)	4.25 x .25	-	9
1350 Amps	1	8.50 (216)	5.75 x .25	2500	10
1600 Amps	1	9.25 (235)	6.50 x .25	-	12
2000 Amps	1	11.00 (279)	8.25 x .25	3000	15
2500 Amps	2	15.50 (394)	(2) 4.50 x .25	4000	20
3000 Amps	2	18.00 (457)	(2) 5.75 x .25	-	23
4000 Amps	2	23.00 (584)	(2) 8.25 x .25	6000	30



Plug-In Bus; Plug Outlet Locations

### Copper Three-Phase, Three-Wire

Amperage	Figure No.	A width inches (mm)	Bar Sizes Width x Thickness (in.)	DC Ampere Rating	Approx. Weight Lbs./Ft.
225 Amps	1	4.38 (111)	1.63 x .25	800	8
400 Amps	1	4.38 (111)	1.63 x .25	-	8
600 Amps	1	4.38 (111)	1.63 x .25	-	8
800 Amps	1	4.38 (111)	1.63 x .25	1000/1200	8
1000 Amps	1	5.00 (127)	2.25 x .25	1350/1600	10
1200 Amps	1	5.63 (143)	2.88 x .25	-	12
1350 Amps	1	6.13 (156)	3.38 x .25	2000	14
1600 Amps	1	7.00 (178)	4.25 x .25	2500	16
2000 Amps	1	8.50 (216)	5.75 x .25	3000	21
2500 Amps	1	10.25 (260)	7.50 x .25	4000	26
3000 Amps	2	14.50 (368)	(2) 4.00 x .25	5000	32
4000 Amps	2	18.00 (457)	(2) 5.75 x .25	6000	42
5000 Amps	2	21.50 (546)	(2) 7.50 x .25	8000	52

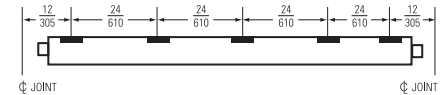

Riser Bus; Plug Outlet Locations

### Copper Three-Phase, Four-Wire

Amperage	Figure No.	A width inches (mm)	Bar Sizes Width x Thickness (in.)	DC Ampere Rating	Approx. Weight Lbs./Ft.
225 Amps	1	4.38 (111)	1.63 x .25	800	9
400 Amps	1	4.38 (111)	1.63 x .25	-	9
600 Amps	1	4.38 (111)	1.63 x .25	-	9
800 Amps	1	4.38 (111)	1.63 x .25	1000/1200	9
1000 Amps	1	5.00 (127)	2.25 x .25	1350/1600	12
1200 Amps	1	5.63 (143)	2.88 x .25	-	15
1350 Amps	1	6.13 (156)	3.38 x .25	2000	17
1600 Amps	1	7.00 (178)	4.25 x .25	2500	20
2000 Amps	1	8.50 (216)	5.75 x .25	3000	26
2500 Amps	1	10.25 (260)	7.50 x .25	4000	33
3000 Amps	2	15.00 (381)	(2) 4.25 x .25	5000	40
4000 Amps	2	18.00 (457)	(2) 5.75 x .25	6000	52
5000 Amps	2	21.50 (546)	(2) 7.50 x .25	8000	66

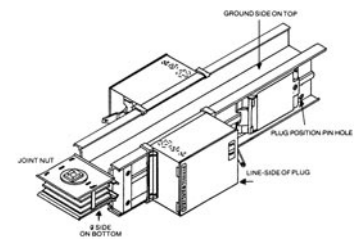

Typical Plug Mounting

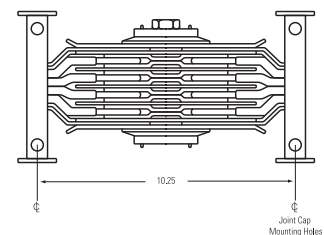

Nominal Position



# Busway Spectra® Series Busway

Sandwich Bus  
Dimensions and Weights

# Section 11

## Turns

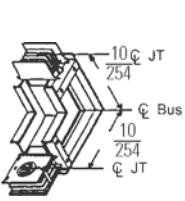

Elbows (Up)

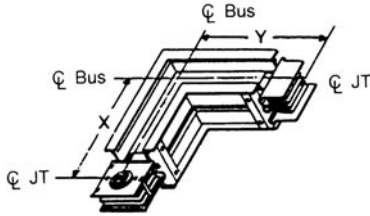

Elbows (Right)

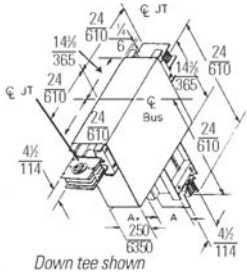

Tees (Down)

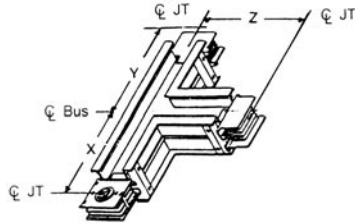

Tees (Right)

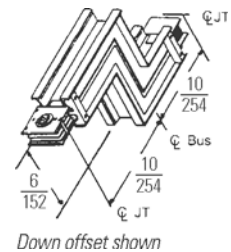

Offsets (Down)

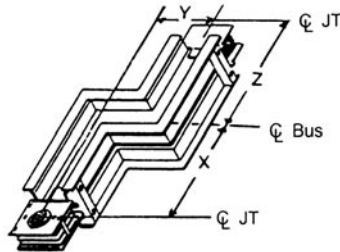

Offsets (Right)

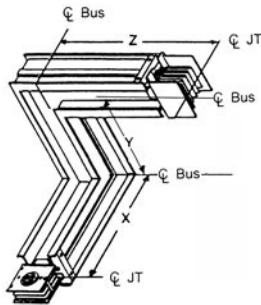

Combination Elbow

## Flat Elbows<sup>1</sup>

		Standard Dimensions (Inches)	
Amp		X	Y
Al	225-1350	12	12
	1600-3000	18	18
	4000	24	24
Cu	225-2000	12	12
	2500-4000	18	18
	5000	24	24

## Flat Tees<sup>1</sup>

		Standard Dimensions (Inches)		
Amps		X	Y	Z
Al	225-1200	12	12	12
	1350-3000	18	18	18
	4000	24	24	24
Cu	225-1600	12	12	12
	2000-4000	18	18	18
	5000	24	24	24

## Flat Offsets<sup>1</sup>

		Standard Dimensions (Inches)		
Amps		X	Y	Z
Al	225-1350	12	5	12
	1600-3000	18	5	18
	4000	24	8	24
Cu	225-2000	12	5	12
	2500-4000	18	5	18
	5000	24	8	24

## Combination Quick Elbows<sup>1</sup>

		Standard Dimensions (Inches)		
Amps		X	Y	Z
Al	225-1350	10	8	12
	1600-2500	10	12	18
	3000-4000	10	16	24
Cu	225-2000	10	8	12
	2500-3000	10	12	18
	4000-5000	10	16	24

<sup>1</sup> All dimensions are to center line.

## Field Check Pieces and Replacement Pieces<sup>1</sup>

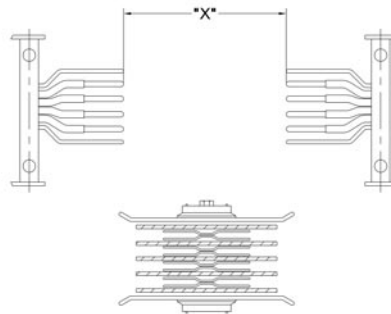

Note: For easier measuring, it may be necessary to remove the joint.

Please remember that when using this dimension, always subtract 1-3/4" from the dimension to get the correct length.

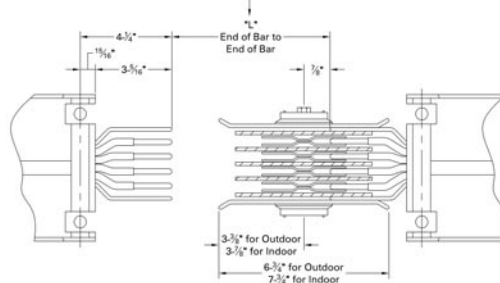

Note: For easier measuring, it may be necessary to remove the joint.

NOTE: For dimensions of flanged-end stubs, refer to GET-7005.



# Busway

## Spectra® Series Busway

Sandwich Bus  
Dimensions and Weights

## Section 11

### Joint Elbows

Configuration	Amperage	Bar Width	Centerline to Centerline Dimensions			
			Flatwise Joint Elbow		Edgewise Joint Elbow	
			Inches	mm	Inches	mm
Single Stack	Al 225-800	1.63-2.88	3	76	6	152
	Cu 225-1200					
	Al 1000-1200	3.38-4.50	4	102	6	152
	Cu 1350-1600					
	Al 1350-2000	5.75-8.25	5	127	6	152
Cu 2000-2500						
Double Stack	Al-2500	4.25-4.5	8	203	6	152
	Cu-3000					
	Al-3000	5.75-6.50	10	254	6	152
	Cu-4000					
	Al-4000	7.5-8.25	12	305	6	152
Cu-5000						

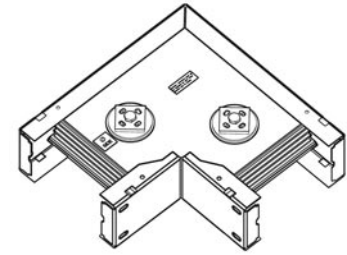

Flatwise joint elbow (indoor only)

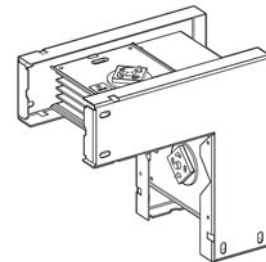

Edgewise joint elbow (indoor only)



# Busway Spectra® Series Busway Sandwich Bus

## Dimensions and Weights

# Section 11

### End Cable Tap Boxes

No. of Stacks	Conductor Material	Amperage	Width (in.)	Height (in.)	"C" Cable Bend Space	No. of #2-600kcmil Lugs/Ø N & GRD
1	Aluminum	225 Amps	17	26	15	1
1	Aluminum	400 Amps	17	26	15	2
1	Aluminum	600 Amps	17	26	15	2
1	Aluminum	800 Amps	17	26	15	3
1	Aluminum	1000 Amps	17	26	15	3
1	Aluminum	1200 Amps	20	29	18	4
1	Aluminum	1350 Amps	20	29	18	4
1	Aluminum	1600 Amps	20	29	18	5
1	Aluminum	2000 Amps	26	29	18	6
2	Aluminum	2500 Amps	26	29	18	8
2	Aluminum	3000 Amps	33	34	23	9
2	Aluminum	4000 Amps	33	34	23	12
1	Copper	225 Amps	17	26	15	1
1	Copper	400 Amps	17	26	15	2
1	Copper	600 Amps	17	26	15	2
1	Copper	800 Amps	17	26	15	3
1	Copper	1000 Amps	17	26	15	3
1	Copper	1200 Amps	20	29	18	4
1	Copper	1350 Amps	20	29	18	4
1	Copper	1600 Amps	20	29	18	5
1	Copper	2000 Amps	26	29	18	6
1	Copper	2500 Amps	26	29	18	8
2	Copper	3000 Amps	33	34	23	9
2	Copper	4000 Amps	33	34	23	12
2	Copper	5000 Amps	39	34	23	15

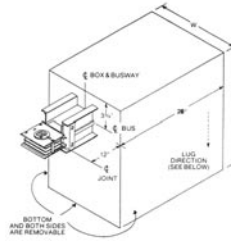

End Tap Box: Feeder or Plug-in

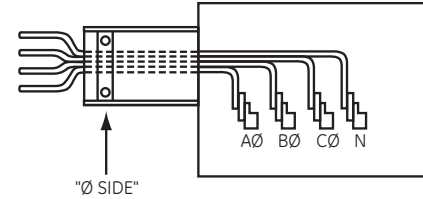

Standard Box Down Position, Side View

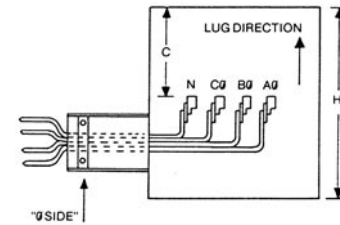

Inverted Box Up Position, Side View

### Center Cable Tap Boxes

No. of Stacks	Conductor Material	Amperage	Width (in.)	E	L	"C" Cable Bend Space	No. of #2-600kcmil Lugs/Ø N & GRD
1	Aluminum	225 Amps	24	4.38	20	15	1
1	Aluminum	400 Amps	24	4.38	20	15	2
1	Aluminum	600 Amps	24	4.38	20	15	2
1	Aluminum	800 Amps	24	4.38	20	15	3
1	Aluminum	1000 Amps	24	4.38	20	15	3
1	Aluminum	1200 Amps	30	6	28	18	4
1	Aluminum	1350 Amps	30	6	28	18	4
1	Aluminum	1600 Amps	30	6	28	18	5
1	Aluminum	2000 Amps	36	9	28	18	6
2	Aluminum	2500 Amps	36	9	32	18	8
2	Aluminum	3000 Amps	48	12.75	39	23	9
2	Aluminum	4000 Amps	48	12.75	39	23	12
1	Copper	225 Amps	24	4.38	20	15	1
1	Copper	400 Amps	24	4.38	20	15	2
1	Copper	600 Amps	24	4.38	20	15	2
1	Copper	800 Amps	24	4.38	20	15	3
1	Copper	1000 Amps	24	4.38	20	15	3
1	Copper	1200 Amps	30	6	28	18	4
1	Copper	1350 Amps	30	6	28	18	4
1	Copper	1600 Amps	30	6	28	18	5
1	Copper	2000 Amps	36	9	28	18	6
1	Copper	2500 Amps	36	9	32	18	8
2	Copper	3000 Amps	48	12.75	39	23	9
2	Copper	4000 Amps	48	12.75	39	23	12
2	Copper	5000 Amps	48	12.75	46	23	15

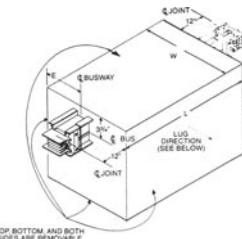

Center Tap Box: Feeder or Plug-in

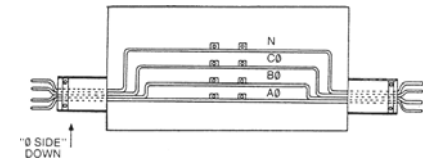

Inverted Box Up Position, Side View

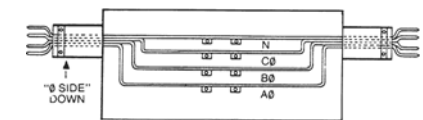

Standard Box Down Position, Side View

### 2000 Amp (Max.) Center Branch Tap Boxes

No. of Stacks	Amperage	Aluminum			Copper			"C" Cable Bend Space	Number of #2-600 kcmil Lugs/ N & Grd
		Width	Dimension "E"	Length	Width	Dimension "E"	Length		
1	2500	—	—	—	36	9	28	18	6
	2500	36	9	28	—	—	—	18	6
2	3000	43	12.75	28	43	12.75	28	18	6
	4000	43	12.75	28	43	12.75	28	18	6
	5000	—	—	—	43	12.75	28	18	6

Mechanical-type (CU-Al wires) lugs standard; Crimp-type optional. Important: Local code requirements can affect the dimensions, number of lugs furnished, etc. In these situations, refer to Company.



**Alternate Cable Tap Boxes**

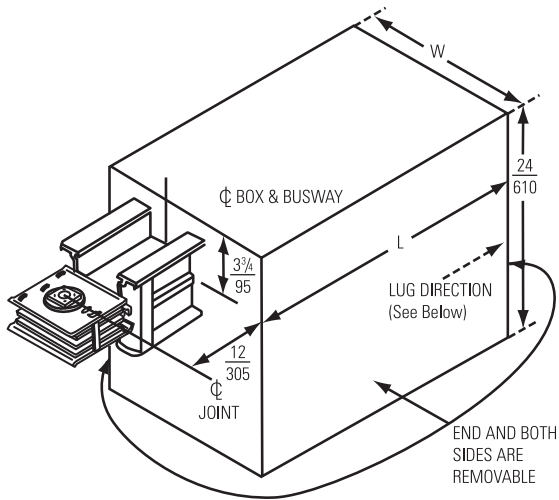

**Alternate End Tap Box: Feeder or Plug-In**

No. of Stacks	Dimensions, Cable Bending Space and Lug Data (Inches)						Number of #2-600 kcmil Lugs Per Phase, N & G
	Amps	Aluminum		Copper		"C" Cable Bend Space	
		W	L	W	L		
1	225	17	26	17	26	15	1
	400	17	26	17	26	15	2
	600	17	26	17	26	15	2
	800	17	26	17	26	15	3
	1000	17	26	17	26	15	3
	1200	20	29	20	29	18	4
	1350	20	29	20	29	18	4
	1600	20	29	20	29	18	5
	2000	26	29	26	29	18	6
	2500	—	—	26	29	18	8
2	2500	26	29	—	—	18	8
	3000	33	34	33	34	23	9
	4000	33	34	33	34	23	12
	5000	—	—	39	34	23	15

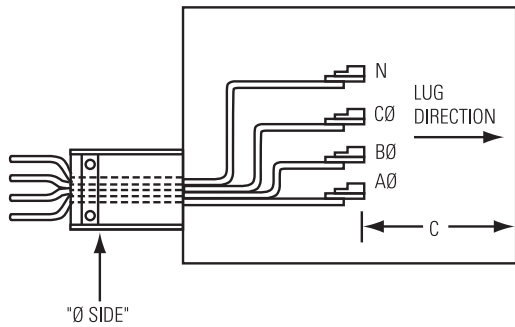

**Inverted Box Up Position, Side View**

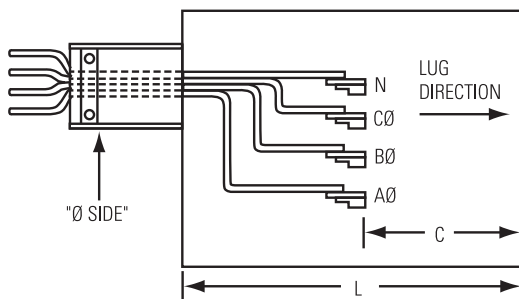

**Box Down Position, Side View**





# Busway Spectra® Series Busway (continued)

Sandwich Bus  
Dimensions and Weights

## Section 11

### Transformer Taps

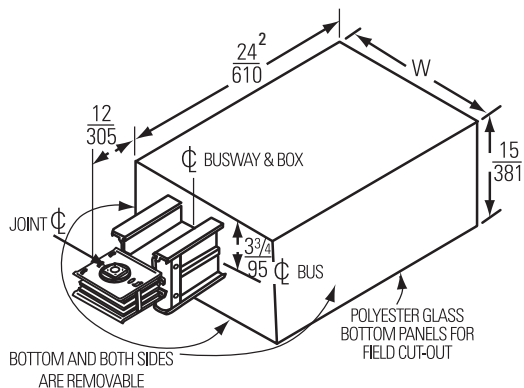

Three-Phase End Tap

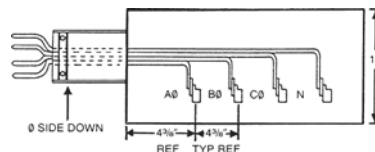

Standard Lug Position

### Single-Phase Transformer Taps

No. of Stacks	Dimensions and Lug Data (Inches)			Number of #2-600 kcmil Lugs Per Phase <sup>1</sup>
	Amps	Aluminum W	Copper W	
1	1000	16	—	2
	1200	16	16	3
	1350	20	16	3
	1600	20	16	3
	2000	20	20	4
2	2500	—	20	5
	2500	24	—	5
	3000	32	24	6
	4000	32	32	8
	5000	—	32	10

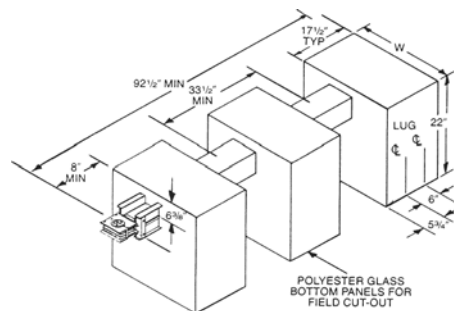

Single-Phase Transformer Taps

<sup>1</sup>Mechanical-type (Cu-Al wire) lugs standard; Crimp-type optional. One ground lug standard through 3000 Amp Cu. Two ground lugs standard for 4000 Amp Al, 5000 Amp Cu. Optional one ground lug per phase lug.

<sup>2</sup>24" dimension changes to 28" for 5000 Amp or when 100% ground lugs are required.

### Three-Phase End Tap

No. of Stacks	Dimensions and Lug Data (Inches)			Number of #2-600 kcmil Lugs Per Phase, N & G
	Amps	Aluminum W	Copper W	
1	600	17	17	2
	800	17	17	2
	1000	17	17	2
	1200	20	20	3
	1350	20	20	3
	1600	20	20	3
	2000	26	26	4
2	2500	—	26	5
	2500	26	—	5
	3000	33	33	6
	4000	33	33	8
	5000	—	39	10



**With Aluminum or Copper Bus Bars, Price Footage through the PTO**

Device				List Price, GO-1265								
Frame			Busway Ampere Rating									
PTO Type <sup>1</sup>	Construction	Type	Ampere Rating	600-1350 Amp with Aluminum Bus Bars 600-1600 Amp with Copper Bus Bars				1600-4000 Amp with Aluminum Bus Bars 2000-5000 Amp with Copper Bus Bars				
				3-Pole		3-Phase, 4-Wire		3-Pole		3-Phase, 4-Wire		
				240 V	600 V	208 V/ 120 V	480 V/ 277 V	240 V	600 V	208 V/ 120 V	480 V/ 277 V	
Fusible Switches (Fig. 2, page 11-52)		QMR (No fuses included)	100	\$703.00	\$715.00	\$832.00	\$838.00	\$737.00	\$743.00	\$866.00	\$871.00	
			200	\$960.00	\$1128.00	\$1089.00	\$1246.00	\$988.00	\$1149.00	\$1117.00	\$1258.00	
			400	\$1698.00	\$2049.00	\$1826.00	\$2183.00	\$1731.00	\$2072.00	\$1853.00	\$2211.00	
			600	\$2496.00	\$2658.00	\$2658.00	\$2915.00	\$2524.00	\$2691.00	\$2747.00	\$2937.00	
			800	\$3943.00	\$3943.00	\$4267.00	\$4267.00	\$4010.00	\$4010.00	\$4311.00	\$4311.00	
			1200	—	—	—	—	\$4143.00	\$4143.00	\$4457.00	\$4457.00	
Bolt-On Cable Tap-off (Fig. 1, page 11-52)		Lugs only	400	\$581.00		\$614.00		\$637.00		\$670.00		
			600	\$614.00		\$637.00		\$670.00		\$696.00		
			800	\$632.00		\$703.00		\$696.00		\$759.00		
			1000	\$670.00		\$737.00		\$731.00		\$793.00		
			1200	\$703.00		\$804.00		\$759.00		\$866.00		
			1350	\$737.00		\$832.00		\$804.00 <sup>2</sup>		\$894.00 <sup>2</sup>		
Molded-Case Circuit Breakers (Fig. 2, page 11-52)	Standard		TFJ 70-225	\$150.00		\$1681.00		\$1731.00		\$1871.00		
			TFK 70-225	\$1748.00		\$1916.00		\$1977.00		\$2117.00		
			TJJ 125-400	\$2803.00		\$3005.00		\$3005.00		\$3206.00		
			TJK4 125-400	\$2982.00		\$3217.00		\$3217.00		\$3407.00		
			TJK6 450-600	\$3798.00		\$3976.00		\$3887.00		\$4066.00		
			TKM8 700-800	\$4859.00		\$5115.00		\$4970.00		\$5218.00		
			TKM12 1000	\$5529.00 <sup>2</sup>		\$5976.00 <sup>3</sup>		\$5719.00		\$6054.00		
			TKM12 1200	\$7037.00 <sup>2</sup>		\$7349.00 <sup>2</sup>		\$7115.00		\$7428.00		
			Hi-Break®			THFK 70-225	\$2608.00		\$2775.00		\$2838.00	
	THJK4 125-400	\$3899.00					\$4155.00		\$4143.00		\$4334.00	
	THKM8 300-600	\$4702.00					\$4948.00		\$4792.00		\$5049.00	
	THKM8 700-800	\$5428.00					\$5696.00		\$5540.00		\$5786.00	
	THKM12 1000	\$6232.00 <sup>2</sup>					\$6568.00 <sup>2</sup>		\$6300.00		\$6623.00	
	THKM12 1200	\$7618.00 <sup>2</sup>					\$7964.00 <sup>2</sup>		\$7684.00		\$8009.00	
	TB4 125-225	\$3899.00					\$4066.00		\$4143.00		\$4278.00	
	TB4 250-400	\$4747.00 <sup>2</sup>					\$4970.00 <sup>2</sup>		\$4981.00		\$5149.00	
	TB6 300-600	\$6847.00					\$7093.00		\$6936.00		\$7194.00	
	TB8 600-800	\$7674.00		\$7941.00		\$7763.00		\$8042.00				
Meter Mod® Metering <sup>4</sup> (Fig. 3, page 11-52)	T-Fuse 240 V	TJ5	400	\$3576.00		\$3732.00		\$3686.00		\$3842.00		
			600	\$3732.00		\$3888.00		\$3786.00		\$3942.00		
			TJK4 125-400	\$3326.00		\$3700.00		\$3700.00		\$3918.00		
	Std. MCCB			TJK6 450-600	\$4368.00		\$4572.00		\$4470.00		\$4676.00	
				TKM8 700-800	\$5588.00		\$5882.00		\$5716.00		\$6001.00	
				TKM12 1000	\$6358.00		\$6872.00		\$6577.00		\$6962.00	
Meter Mod® Metering <sup>5</sup> (Fig. 4, page 11-52)	Spectra RMS™ Circuit Breaker		SGD 125-400A			\$7892.00				\$8142.00		
			SGH 250-600			\$10424.00				\$10674.00		
			SGL 250-600			\$11972.00				\$12222.00		
			SGP 250-600			\$14133.00				\$14383.00		
			SKH 600-1200			\$17914.00				\$18164.00		
			SKL 600-1200			\$19445.00				\$19695.00		
			SKP 600-1200			\$23847.00				\$24097.00		

<sup>1</sup>TMZR mounting Z-rail must be added for the attached Meter Mod.  
<sup>2</sup>Not available on Spectra Series™ Busway with aluminum bus bars.  
<sup>3</sup>800 amp maximum rating.  
<sup>4</sup>Refer to page 11-52 for product numbers to order.  
<sup>5</sup>No fuses included.  
<sup>6</sup>Refer to page 11-52 for dimensions.



**Busway**  
**Spectra® Series Busway (continued)**  
 Sandwich Bus  
 Power Takeoffs

**Section 11**

**With Aluminum or Copper Bus Bars, Price Footage through the PTO**

Device		List Price, GO-126S				
Type	Ampere Rating	3-Pole	3P4W	3-Pole	3P4W	
Bolt-On Tap <sup>6</sup>	KM Breaker	800 A	\$9318.00	\$9568.00	\$9618.00	\$9868.00
		1200 A	\$12804.00	\$13054.00	\$12804.00	\$13354.00
Bolt-On Tap <sup>6</sup>	Power Break II	800 A	\$9666.00	\$9916.00	\$9966.00	\$10216.00
		1600 A	\$11331.00	\$11581.00	\$11631.00	\$11881.00
Bolt-On Tap	QMW	800 A	\$7805.00	\$8055.00	\$8105.00	\$8355.00

<sup>6</sup>Refer to page 11-52 for dimensions.



# Busway Spectra® Series Busway Sandwich Bus Dimensions

## Section 11

### Hangers

#### Vertical Mounting—Spring Hangers (Must be ordered separately)

Spring hangers should be ordered to support the busway at each floor if floor-to-floor span is less than 16 feet. When the floor-to-floor span is over 16 feet, supports and additional spring hangers are required on 16 foot centers maximum. The quantity of springs supplied is based on total weight of busway and devices installed per floor. Simple adjustment procedures are included with installation instructions. Mounting holes align with floor flanges.

Product Number (SBR "X") where "X" = Quantity of springs (1 or 2) on each side of hanger (single spring up to 600 lbs. per floor).

Refer to Installation Instructions DEH-40087 for "A" Dimension.

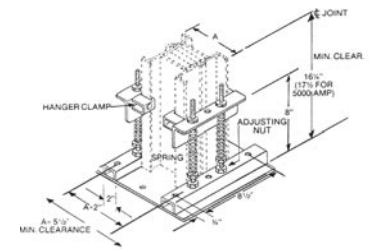

**Product Number SBR "X"**  
**Common to All Services**

**Note:** Floor or wall opening should provide 1/2" clearance all around busway.

#### Horizontal Mounting—One-Stack Clevis Hangers<sup>1</sup>

##### One-Stack Flatwise Hangers

Product Number	Conductor Material	Amperage	Bar Width
SBF16	Aluminum	225-600 Amps	1.63"
	Copper	225-800 Amps	
SBF22	Copper	1000 Amps	2.25"
	Aluminum	800 Amps	
SBF28	Aluminum	800 Amps	2.88"
	Copper	1200 Amps	
SBF33	Aluminum	1000 Amps	3.38"
	Copper	1350 Amps	
SBF42	Aluminum	1200 Amps	4.25"
	Copper	1600 Amps	
SBF57	Aluminum	1350 Amps	5.75"
SBF65	Aluminum	1600 Amps	6.50"
SBF82	Aluminum	2000 Amps	8.25"

<sup>1</sup>Furnished every 10 feet. Requires 0.50 inch diameter drop rods.

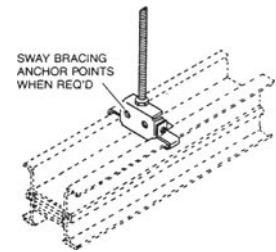

**One-Stack (Standard) Flatwise**  
**Product Number SBF "XX"²**

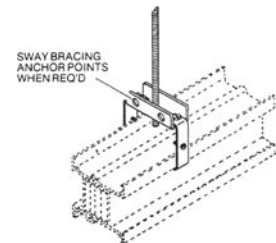

**One-Stack Edgewise Product Number**  
**SBE45 (Up to 2000 Amp Max.)**

#### Horizontal Mounting—Trapeze Hangers<sup>1</sup>

##### One- or Two-Stack Flatwise Trapeze

Product Number	No. of Stacks	Bar Width	Width (in.)
SBTE	1	1.63"-4.25"	10.25
SBTF	1	5.75"-8.25"	14
SBTG	2	4.25"-4.50"	18.5
SBTH	2	5.75"-6.50"	22.5
SBTJ	2	8.25"	26

<sup>1</sup>Furnished every 10 feet. Requires 0.50 inch diameter drop rods.

<sup>2</sup>Available for up to 2000A Al or 1600A Cu Busway.

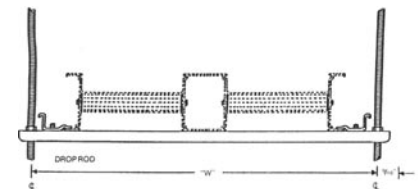

**Horizontal Mounting - Trapeze Hangers.**  
**One Furnished every 10 feet. Requires**  
**(2) 0.50 inch diameter drop rods.**

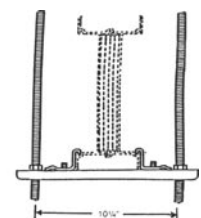

**Edgewise Trapeze Product No. SBTE**



# Busway Spectra® Series Busway

Sandwich Bus  
Power Takeoffs  
Dimensions

# Section 11

## Power Takeoffs (PTO)<sup>1</sup>

Spectra® Series Flex-A-Tap joints accept bolted power takeoff devices up to 1600 amps for many applications. The compact size and flexibility resulting from the modular design allow takeoffs to be mounted at any joint, whether feeder or plug-in. See Fig. 1.

Bolt-On Tap	Amp Rating
Fusible Switches (600A QMW Only)	600
Molded-Case Circuit Breakers (KM & PB Only)	1600A Max
Cable Boxes	1600 Max

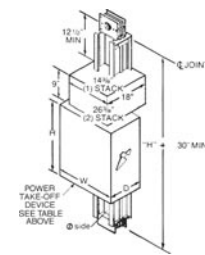
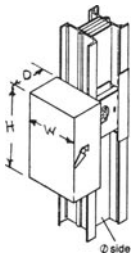

Fig. 1 Bolt on, Flex-A-Tap Fig. 2 Flatwise PTO Section

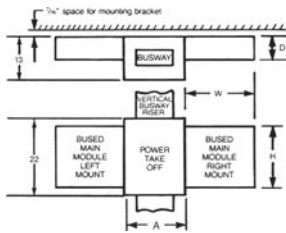

Fig. 3 Meter Mod III PTO Section  
available with no device. Check local codes before ordering

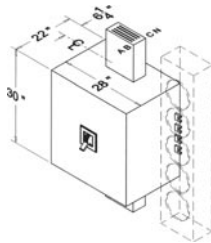

Fig. 4 Meter-mod Metering (in line device)  
Available for G&K Frame Spectra® C/B only

## Flex-A-Tap Device (Fig. 1)

Device	"H"	"W"	"D"
Cable Tap Box	54"	24"	15 1/2"
KM	66"	19 9/32"	15 1/2"
QMW 600A	66"	19 9/32"	15 1/2"
Power Break II	63"	24 9/32"	18"

## Power Takeoff Device Dimensions (Fig. 2)

Rating	Type	"H"	"W"	"D"
100A	QMR	17.75	9.38	6.75
200A	QMR	24.38	15.50	7.25
400A	QMR	18	18.50	17.56
400A	QMW	18	18.50	17.56
600A	QMR	24	18.50	17.56
800A & 1200A	QMR	45.13	36.75	12.75
225A	FJ	17.75	9.75	7.75
400A	JJ	24	15.50	10.75
600A	JK	24	15.50	10.75
600-800A	KM	36	15.50	10.75
1200A	K4V, KL4V, KM, KH, KL With or Without Ground Fault	45.50	15.50	10.75
400A	TB4 Tri-Break®	30	15.50	10.75
600A	TB6 Tri-Break	44.75	15.50	10.75
800A	TB6 Tri-Break	49.75	15.50	10.75
150A	TE & TB1	17.75	9.75	6.75

## Meter Mod III PTO Section (Fig. 3)

Product Number/Frame	Dimensions (Inches)		
	W	H	D
<b>Bused Main Breakers</b>			
TMP3BR4/TJK4	19	18	5.94
TMP3BL6/TJK6	19	18	5.94
TMP3BR6/TJK6	19	18	5.94
TMP3BL8/TKM8	20	18	7.88
TMP3BR8/TKM8	20	18	7.88
TMP3BL10/TKM10	20	18	7.88
TMP3BR10/TKM10	20	18	7.88
TMP3BL12/TKM12	20	18	7.88
TMP3BR12/TKM12	20	18	7.88
<b>Bused Main Switches</b>			
TMP3FL4/TFUSE400	19	18	5.94
TMP3FR4/TFUSE400	19	18	5.94
TMP3FL6/TFUSE600	19	18	5.94
TMP3FR6/TFUSE600	19	18	5.94

Amps	Bar Per Ø	Bar Width (inches)	"A" (inches)
225-1200 Al 225-1600 Cu	1	1.625	16.50
		2.225	
		2.875	
		3.375	
		4.250	
1350-2000 Al 2000-2500 Cu		4.500	20.00
		5.750	
		6.500	
2500 Al 3000 Cu		8.250	24.75
		4.250	
3000-4000 Al 4000-5000 Cu	2	4.500	32.00
		5.750	
		6.500	
		8.250	

Decimal	Fraction
.12	1/8
.38	3/8
.63	5/8
.88	7/8

<sup>1</sup>TMZR mounting Z-rail must be added for the attached Meter Mod.



# Busway Spectra® Series Busway

Low Amp

Application and Product Numbers

## Section 11

### Features/Benefits

---

#### Easy Install:

**New Joint-Guard Protection System**—dynamically indicates proper torque through color! Easy install and maintenance!

**Lighter Weight**—means it installs faster than other busways and beats wire and conduit for total installed cost.

**Single Drop-Rod Hanger**—is furnished with straight lengths for easy, fast installation.

**Field-Adjustable Isolation Joint**—( $\pm 5/8$ " per joint) provides on-site flexibility.

**Adjustable Straight Length**—can eliminate the need for field check pieces! ( $\pm 6$ " from nominal 54").

### Performance/Protection/Maintenance:

---

**Exclusive BlueCoat™ Epoxy Insulation**—(Class B, UL 130°C) provides the industry's best protection (50 years).

**Earth-Bond Integrated Grounding System**—provides a lower resistance ground path than internal ground bars.

**IP4X Plug Outlet**—GE's exclusive plug outlet provides the industry's highest protection. Its "dead front" is fingerproof and screw-driver-proof. (Also meets IP2X and IP3X.)

**Belleville Spring Washer**—the industry's best, retains over 90% of original contact pressure, offering a maintenance-free joint when torqued properly.

### Available Ratings

---

Amperes: 225 to 800 amperes

Voltage: 600 Volts or less

Busing: Aluminum or Copper

Systems: 3-phase, 3-wire and 3-phase, 4-wire (full neutral)

Enclosures: Indoor, drip-proof, (totally enclosed)

---

### Spectra® Series LowAmp Busway Pricing

---

#### Product number pricing

Use the product numbers from tables, or parametric product number generation, on pages 11-54 through 11-66 to price busway components individually. One standard flatwise clevis-type hanger is provided with every straight length. Optional hangers are available and ordered separately.

LowAmp Dripproof Busway – List Price Adder of 18%.



# Busway Spectra® Series Busway (continued)

Low Amp  
Application and Product Numbers

## Section 11

### Spectra® Series LowAmp Busway Product Numbering System

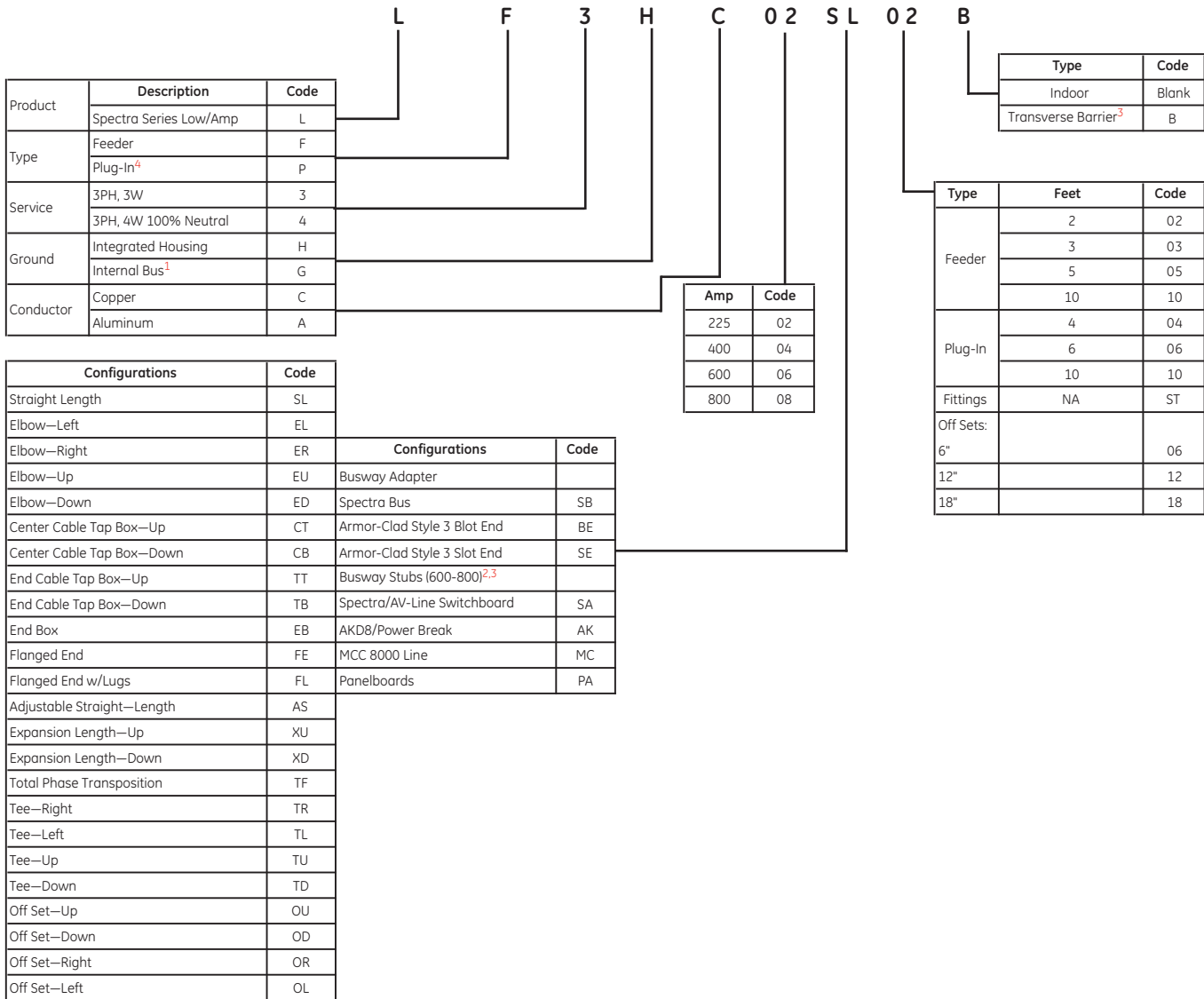

<sup>1</sup>Available w/copper bus bars only.

<sup>2</sup>Requires drawing for layout configuration.

<sup>3</sup>Item available in feeder construction only. (Use with fire barrier and wall/floor flange for 3-hour fire rating)

<sup>4</sup>Straight lengths only.





# Busway Spectra® Series Busway

LowAmp

Aluminum Conductors

Product Number Pricing

# Section 11

## 225 Amps Three-Phase, Three-Wire Integrated Housing Ground

Component	Type	Product Number	List Price GO-126L
Linear Lengths	Plug-In: 10-ft.	LP3HA02SL10	\$1660.00
Linear Lengths	Plug-In: 6-ft.	LP3HA02SL06	\$1142.00
Linear Lengths	Plug-In: 4-ft.	LP3HA02SL04	\$920.00
Linear Lengths	Feeder: 10-ft.	LF3HA02SL10	\$960.00
Linear Lengths	Feeder: 5-ft.	LF3HA02SL05	\$677.00
Linear Lengths	Feeder: 3-ft.	LF3HA02SL03	\$530.00
Linear Lengths	Feeder: 2-ft.	LF3HA02SL02	\$471.00
Linear Lengths	Adjustable Straight Length	LF3HA02ASST	\$1992.00
Fittings	Elbow Left 90°	LF3HA02ELST	\$1064.00
Fittings	Elbow Right 90°	LF3HA02ERST	\$1064.00
Fittings	Elbow Up 90°	LF3HA02EUST	\$897.00
Fittings	Elbow Down 90°	LF3HA02EDST	\$897.00
Accessories	End Cable Tap Box—Up	LF3HA02TTST	\$2218.00
Accessories	End Cable Tap Box—Down	LF3HA02TBST	\$2218.00
Accessories	Center Cable Tap Box—Up	LF3HA02CTST	\$2320.00
Accessories	Center Cable Tap Box—Down	LF3HA02CBST	\$2320.00
Accessories	End Box	LF3HA02EBST	\$200.00
Accessories	Flanged End w/Lugs	LF3HA02FLST	\$785.00
Accessories	Flanged End	LF3HA02FEST	\$526.00
Fittings	Expansion Length—Up	LF3HA02XUST	\$5129.00
Fittings	Expansion Length—Down	LF3HA02XDST	\$5129.00
Fittings	Total Phase Transposition	LF3HA02TFST	\$4152.00
Fittings	Tee—Right	LF3HA02TRST	\$1448.00
Fittings	Tee—Left	LF3HA02TLST	\$1448.00
Fittings	Tee—Up	LF3HA02TUST	\$2576.00
Fittings	Tee—Down	LF3HA02TDST	\$2576.00
Fittings	Off Set—Up (6")	LF3HA02OU06	\$2467.00
Fittings	Off Set—Up (12")	LF3HA02OU12	\$2533.00
Fittings	Off Set—Up (18")	LF3HA02OU18	\$2599.00
Fittings	Off Set—Down (6")	LF3HA02OD06	\$2467.00
Fittings	Off Set—Down (12")	LF3HA02OD12	\$2533.00
Fittings	Off Set—Down (18")	LF3HA02OD18	\$2599.00
Fittings	Off Set—Left (6")	LF3HA02OL06	\$2945.00
Fittings	Off Set—Left (12")	LF3HA02OL12	\$3011.00
Fittings	Off Set—Left (18")	LF3HA02OL18	\$3077.00
Fittings	Off Set—Right (6")	LF3HA02OR06	\$2945.00
Fittings	Off Set—Right (12")	LF3HA02OR12	\$3011.00
Fittings	Off Set—Right (18")	LF3HA02OR18	\$3077.00

## 400 Amps Three-Phase, Three-Wire Integrated Housing Ground

Component	Type	Product Number	List Price GO-126L
Linear Lengths	Plug-In: 10-ft.	LP3HA04SL10	\$1796.00
Linear Lengths	Plug-In: 6-ft.	LP3HA04SL06	\$1233.00
Linear Lengths	Plug-In: 4-ft.	LP3HA04SL04	\$988.00
Linear Lengths	Feeder: 10-ft.	LF3HA04SL10	\$1190.00
Linear Lengths	Feeder: 5-ft.	LF3HA04SL05	\$754.00
Linear Lengths	Feeder: 3-ft.	LF3HA04SL03	\$585.00
Linear Lengths	Feeder: 2-ft.	LF3HA04SL02	\$515.00
Linear Lengths	Adjustable Straight Length	LF3HA04ASST	\$2155.00
Fittings	Elbow Left 90°	LF3HA04ELST	\$1095.00
Fittings	Elbow Right 90°	LF3HA04ERST	\$1095.00
Fittings	Elbow Up 90°	LF3HA04EUST	\$928.00
Fittings	Elbow Down 90°	LF3HA04EDST	\$928.00
Accessories	End Cable Tap Box—Up	LF3HA04TTST	\$2245.00
Accessories	End Cable Tap Box—Down	LF3HA04TBST	\$2245.00
Accessories	Center Cable Tap Box—Up	LF3HA04CTST	\$2348.00
Accessories	Center Cable Tap Box—Down	LF3HA04CBST	\$2348.00
Accessories	End Box	LF3HA04EBST	\$200.00
Accessories	Flanged End w/Lugs	LF3HA04FLST	\$947.00
Accessories	Flanged End	LF3HA04FEST	\$581.00
Fittings	Expansion Length—Up	LF3HA04XUST	\$5189.00
Fittings	Expansion Length—Down	LF3HA04XDST	\$5189.00
Fittings	Total Phase Transposition	LF3HA04TFST	\$4201.00
Fittings	Tee—Right	LF3HA04TRST	\$1506.00
Fittings	Tee—Left	LF3HA04TLST	\$1506.00
Fittings	Tee—Up	LF3HA04TUST	\$2642.00
Fittings	Tee—Down	LF3HA04TDST	\$2642.00
Fittings	Off Set—Up (6")	LF3HA04OU06	\$2539.00
Fittings	Off Set—Up (12")	LF3HA04OU12	\$2611.00
Fittings	Off Set—Up (18")	LF3HA04OU18	\$2682.00
Fittings	Off Set—Down (6")	LF3HA04OD06	\$2539.00
Fittings	Off Set—Down (12")	LF3HA04OD12	\$2611.00
Fittings	Off Set—Down (18")	LF3HA04OD18	\$2682.00
Fittings	Off Set—Left (6")	LF3HA04OL06	\$3017.00
Fittings	Off Set—Left (12")	LF3HA04OL12	\$3089.00
Fittings	Off Set—Left (18")	LF3HA04OL18	\$3160.00
Fittings	Off Set—Right (6")	LF3HA04OR06	\$3017.00
Fittings	Off Set—Right (12")	LF3HA04OR12	\$3089.00
Fittings	Off Set—Right (18")	LF3HA04OR18	\$3160.00

## Hangers - Common to all Service

Amperage	Accessory Type	Product Number	List Price GO-126L
800 Amps	Hanger-Edgewise—Trapeze	SLTE2	\$33.00
800 Amps	Hanger-Flatwise—Trapeze	SLTF2	\$33.00
800 Amps	Hanger-Edgewise—Clevis	SLEC2	\$33.00
225 Amps	Hanger-Flatwise—Clevis	SLFC2 <sup>1</sup>	\$33.00
400 Amps	Hanger-Flatwise—Clevis	SLFC3 <sup>1</sup>	\$33.00
600 Amps	Hanger-Flatwise—Clevis	SLFC4 <sup>1</sup>	\$33.00
800 Amps	Hanger-Flatwise—Clevis	SLFC5 <sup>1</sup>	\$33.00
400 Amps	Hanger-Spring Riser	SLSR2	\$147.00
600 Amps	Hanger-Spring Riser	SLSR4	\$147.00
800 Amps	Hanger-Spring Riser	SLSR5	\$147.00
225 Amps	Hanger-Wall/Floor Flange	SLWF2	\$100.00
400 Amps	Hanger-Wall/Floor Flange	SLWF3	\$100.00
600 Amps	Hanger-Wall/Floor Flange	SLWF4	\$100.00
800 Amps	Hanger-Wall/Floor Flange	SLWF5	\$100.00
800 Amps	Hanger-Outlet Covers	SLOC2	\$14.00

For new Joint-Guard Protection System, add \$110.00 to the list price shown above.

For Drip-Proof Construction, add 18% to the list prices shown above. For

Transverse Barrier, add \$250.00 to list price of feeder straight lengths only. (Use with fire barrier and wall/floor flange for 3-hour fire rating.)

<sup>1</sup>Standard hanger provided unless otherwise specified.



# Busway Spectra® Series Busway (continued)

LowAmp  
Aluminum Conductors  
Product Number Pricing

## 600 Amps Three-Phase, Three-Wire Integrated Housing Ground

Component	Type	Product Number	List Price GO-126L
Linear Lengths	Plug-In: 10-ft.	LP3HA06SL10	\$1931.00
Linear Lengths	Plug-In: 6-ft.	LP3HA06SLO6	\$1321.00
Linear Lengths	Plug-In: 4-ft.	LP3HA06SLO4	\$1052.00
Linear Lengths	Feeder: 10-ft.	LF3HA06SL10	\$1344.00
Linear Lengths	Feeder: 5-ft.	LF3HA06SLO5	\$842.00
Linear Lengths	Feeder: 3-ft.	LF3HA06SLO3	\$646.00
Linear Lengths	Feeder: 2-ft.	LF3HA06SLO2	\$563.00
Linear Lengths	Adjustable Straight Length	LF3HA06ASST	\$2317.00
Fittings	Elbow Left 90°	LF3HA06ELST	\$1147.00
Fittings	Elbow Right 90°	LF3HA06ERST	\$1147.00
Fittings	Elbow Up 90°	LF3HA06EUST	\$980.00
Fittings	Elbow Down 90°	LF3HA06EDST	\$980.00
Accessories	End Cable Tap Box—Up	LF3HA06TTST	\$2291.00
Accessories	End Cable Tap Box—Down	LF3HA06TBST	\$2291.00
Accessories	Center Cable Tap Box—Up	LF3HA06CTST	\$2394.00
Accessories	Center Cable Tap Box—Down	LF3HA06CBST	\$2394.00
Accessories	End Box	LF3HA06EBST	\$200.00
Accessories	Flanged End w/Lugs	LF3HA06FLST	\$999.00
Accessories	Flanged End	LF3HA06FEST	\$632.00
Fittings	Expansion Length—Up	LF3HA06XUST	\$5289.00
Fittings	Expansion Length—Down	LF3HA06XDST	\$5289.00
Fittings	Total Phase Transposition	LF3HA06TFST	\$4282.00
Fittings	Tee—Right	LF3HA06TRST	\$1603.00
Fittings	Tee—Left	LF3HA06TLST	\$1603.00
Fittings	Tee—Up	LF3HA06TUST	\$2753.00
Fittings	Tee—Down	LF3HA06TDST	\$2753.00
Fittings	Off Set—Up (6")	LF3HA06OU06	\$2661.00
Fittings	Off Set—Up (12")	LF3HA06OU12	\$2740.00
Fittings	Off Set—Up (18")	LF3HA06OU18	\$2820.00
Fittings	Off Set—Down (6")	LF3HA06OD06	\$2661.00
Fittings	Off Set—Down (12")	LF3HA06OD12	\$2740.00
Fittings	Off Set—Down (18")	LF3HA06OD18	\$2820.00
Fittings	Off Set—Left (6")	LF3HA06OL06	\$3139.00
Fittings	Off Set—Left (12")	LF3HA06OL12	\$3218.00
Fittings	Off Set—Left (18")	LF3HA06OL18	\$3298.00
Fittings	Off Set—Right (6")	LF3HA06OR06	\$3139.00
Fittings	Off Set—Right (12")	LF3HA06OR12	\$3218.00
Fittings	Off Set—Right (18")	LF3HA06OR18	\$3298.00

# Section 11

## 800 Amps Three-Phase, Three-Wire Integrated Housing Ground

Component	Type	Product Number	List Price GO-126L
Linear Lengths	Plug-In: 10-ft.	LP3HA08SL10	\$2100.00
Linear Lengths	Plug-In: 6-ft.	LP3HA08SLO6	\$1431.00
Linear Lengths	Plug-In: 4-ft.	LP3HA08SLO4	\$1128.00
Linear Lengths	Feeder: 10-ft.	LF3HA08SL10	\$1555.00
Linear Lengths	Feeder: 5-ft.	LF3HA08SLO5	\$961.00
Linear Lengths	Feeder: 3-ft.	LF3HA08SLO3	\$728.00
Linear Lengths	Feeder: 2-ft.	LF3HA08SLO2	\$624.00
Linear Lengths	Adjustable Straight Length	LF3HA08ASST	\$2520.00
Fittings	Elbow Left 90°	LF3HA08ELST	\$1240.00
Fittings	Elbow Right 90°	LF3HA08ERST	\$1240.00
Fittings	Elbow Up 90°	LF3HA08EUST	\$1073.00
Fittings	Elbow Down 90°	LF3HA08EDST	\$1073.00
Accessories	End Cable Tap Box—Up	LF3HA08TTST	\$2460.00
Accessories	End Cable Tap Box—Down	LF3HA08TBST	\$2460.00
Accessories	Center Cable Tap Box—Up	LF3HA08CTST	\$2476.00
Accessories	Center Cable Tap Box—Down	LF3HA08CBST	\$2476.00
Accessories	End Box	LF3HA08EBST	\$200.00
Accessories	Flanged End w/Lugs	LF3HA08FLST	\$1230.00
Accessories	Flanged End	LF3HA08FEST	\$756.00
Fittings	Expansion Length—Up	LF3HA08XUST	\$5593.00
Fittings	Expansion Length—Down	LF3HA08XDST	\$5593.00
Fittings	Total Phase Transposition	LF3HA08TFST	\$4528.00
Fittings	Tee—Right	LF3HA08TRST	\$1777.00
Fittings	Tee—Left	LF3HA08TLST	\$1777.00
Fittings	Tee—Up	LF3HA08TUST	\$2953.00
Fittings	Tee—Down	LF3HA08TDST	\$2953.00
Fittings	Off Set—Up (6")	LF3HA08OU06	\$2879.00
Fittings	Off Set—Up (12")	LF3HA08OU12	\$2973.00
Fittings	Off Set—Up (18")	LF3HA08OU18	\$3067.00
Fittings	Off Set—Down (6")	LF3HA08OD06	\$2879.00
Fittings	Off Set—Down (12")	LF3HA08OD12	\$2973.00
Fittings	Off Set—Down (18")	LF3HA08OD18	\$3067.00
Fittings	Off Set—Left (6")	LF3HA08OL06	\$3357.00
Fittings	Off Set—Left (12")	LF3HA08OL12	\$3451.00
Fittings	Off Set—Left (18")	LF3HA08OL18	\$3545.00
Fittings	Off Set—Right (6")	LF3HA08OR06	\$3357.00
Fittings	Off Set—Right (12")	LF3HA08OR12	\$3451.00
Fittings	Off Set—Right (18")	LF3HA08OR18	\$3545.00

## Hangers - Common to all Services

Amperage	Accessory Type	Product Number	List Price GO-126L
800 Amps	Hanger-Edgewise—Trapeze	SLTE2	\$33.00
800 Amps	Hanger-Flatwise—Trapeze	SLTF2	\$33.00
800 Amps	Hanger-Edgewise—Clevis	SLEC2	\$33.00
225 Amps	Hanger-Flatwise—Clevis	SLFC2 <sup>1</sup>	\$33.00
400 Amps	Hanger-Flatwise—Clevis	SLFC3 <sup>1</sup>	\$33.00
600 Amps	Hanger-Flatwise—Clevis	SLFC4 <sup>1</sup>	\$33.00
800 Amps	Hanger-Flatwise—Clevis	SLFC5 <sup>1</sup>	\$33.00
400 Amps	Hanger-Spring Riser	SLSR2	\$147.00
600 Amps	Hanger-Spring Riser	SLSR4	\$147.00
800 Amps	Hanger-Spring Riser	SLSR5	\$147.00
225 Amps	Hanger-Wall/Floor Flange	SLWF2	\$100.00
400 Amps	Hanger-Wall/Floor Flange	SLWF3	\$100.00
600 Amps	Hanger-Wall/Floor Flange	SLWF4	\$100.00
800 Amps	Hanger-Wall/Floor Flange	SLWF5	\$100.00
800 Amps	Hanger-Outlet Covers	SLOC2	\$14.00

For new Joint-Guard Protection System, add \$110.00 to the list price shown above.

For Drip-Proof Construction, add 18% to the list prices shown above. For

Transverse Barrier, add \$250.00 to list price of feeder straight lengths only. (Use with fire barrier and wall/floor flange for 3-hour fire rating.)

<sup>1</sup>Standard hanger provided unless otherwise specified.



# Busway Spectra® Series Busway

LowAmp  
Aluminum Conductors  
Product Number Pricing

# Section 11

## 225 Amps Three-Phase, Four-Wire Integrated Housing Ground

Component	Type	Product Number	List Price GO-126L
Linear Lengths	Plug-In: 10-ft.	LP4HA02SL10	\$1855.00
Linear Lengths	Plug-In: 6-ft.	LP4HA02SL06	\$1278.00
Linear Lengths	Plug-In: 4-ft.	LP4HA02SL04	\$1032.00
Linear Lengths	Feeder: 10-ft.	LF4HA02SL10	\$1184.00
Linear Lengths	Feeder: 5-ft.	LF4HA02SL05	\$758.00
Linear Lengths	Feeder: 3-ft.	LF4HA02SL03	\$595.00
Linear Lengths	Feeder: 2-ft.	LF4HA02SL02	\$531.00
Linear Lengths	Adjustable Straight Length	LF4HA02ASST	\$2226.00
Fittings	Elbow Left 90°	LF4HA02ELST	\$1104.00
Fittings	Elbow Right 90°	LF4HA02ERST	\$1104.00
Fittings	Elbow Up 90°	LF4HA02EUST	\$936.00
Fittings	Elbow Down 90°	LF4HA02EDST	\$936.00
Accessories	End Cable Tap Box—Up	LF4HA02TTST	\$2249.00
Accessories	End Cable Tap Box—Down	LF4HA02TBST	\$2249.00
Accessories	Center Cable Tap Box—Up	LF4HA02CTST	\$2351.00
Accessories	Center Cable Tap Box—Down	LF4HA02CBST	\$2351.00
Accessories	End Box	LF4HA02EBST	\$200.00
Accessories	Flanged End w/Lugs	LF4HA02FLST	\$804.00
Accessories	Flanged End	LF4HA02FEST	\$545.00
Fittings	Expansion Length—Up	LF4HA02XUST	\$5224.00
Fittings	Expansion Length—Down	LF4HA02XDST	\$5224.00
Fittings	Total Phase Transposition	LF4HA02TFST	\$4229.00
Fittings	Tee—Right	LF4HA02TRST	\$1487.00
Fittings	Tee—Left	LF4HA02TLST	\$1487.00
Fittings	Tee—Up	LF4HA02TUST	\$2618.00
Fittings	Tee—Down	LF4HA02TDST	\$2618.00
Fittings	Off Set—Up (6")	LF4HA02OU06	\$2575.00
Fittings	Off Set—Up (12")	LF4HA02OU12	\$2652.00
Fittings	Off Set—Up (18")	LF4HA02OU18	\$2728.00
Fittings	Off Set—Down (6")	LF4HA02OD06	\$2575.00
Fittings	Off Set—Down (12")	LF4HA02OD12	\$2652.00
Fittings	Off Set—Down (18")	LF4HA02OD18	\$2728.00
Fittings	Off Set—Left (6")	LF4HA02OL06	\$3053.00
Fittings	Off Set—Left (12")	LF4HA02OL12	\$3130.00
Fittings	Off Set—Left (18")	LF4HA02OL18	\$3206.00
Fittings	Off Set—Right (6")	LF4HA02OR06	\$3053.00
Fittings	Off Set—Right (12")	LF4HA02OR12	\$3130.00
Fittings	Off Set—Right (18")	LF4HA02OR18	\$3206.00

## 400 Amps Three-Phase, Four-Wire Integrated Housing Ground

Component	Type	Product Number	List Price GO-126L
Linear Lengths	Plug-In: 10-ft.	LP4HA04SL10	\$2012.00
Linear Lengths	Plug-In: 6-ft.	LP4HA04SL06	\$1381.00
Linear Lengths	Plug-In: 4-ft.	LP4HA04SL04	\$1108.00
Linear Lengths	Feeder: 10-ft.	LF4HA04SL10	\$1335.00
Linear Lengths	Feeder: 5-ft.	LF4HA04SL05	\$845.00
Linear Lengths	Feeder: 3-ft.	LF4HA04SL03	\$656.00
Linear Lengths	Feeder: 2-ft.	LF4HA04SL02	\$579.00
Linear Lengths	Adjustable Straight Length	LF4HA04ASST	\$2414.00
Fittings	Elbow Left 90°	LF4HA04ELST	\$1138.00
Fittings	Elbow Right 90°	LF4HA04ERST	\$1138.00
Fittings	Elbow Up 90°	LF4HA04EUST	\$970.00
Fittings	Elbow Down 90°	LF4HA04EDST	\$970.00
Accessories	End Cable Tap Box—Up	LF4HA04TTST	\$2278.00
Accessories	End Cable Tap Box—Down	LF4HA04TBST	\$2278.00
Accessories	Center Cable Tap Box—Up	LF4HA04CTST	\$2380.00
Accessories	Center Cable Tap Box—Down	LF4HA04CBST	\$2380.00
Accessories	End Box	LF4HA04EBST	\$200.00
Accessories	Flanged End w/Lugs	LF4HA04FLST	\$968.00
Accessories	Flanged End	LF4HA04FEST	\$602.00
Fittings	Expansion Length—Up	LF4HA04XUST	\$5291.00
Fittings	Expansion Length—Down	LF4HA04XDST	\$5291.00
Fittings	Total Phase Transposition	LF4HA04TFST	\$4283.00
Fittings	Tee—Right	LF4HA04TRST	\$1550.00
Fittings	Tee—Left	LF4HA04TLST	\$1550.00
Fittings	Tee—Up	LF4HA04TUST	\$2692.00
Fittings	Tee—Down	LF4HA04TDST	\$2692.00
Fittings	Off Set—Up (6")	LF4HA04OU06	\$2658.00
Fittings	Off Set—Up (12")	LF4HA04OU12	\$2740.00
Fittings	Off Set—Up (18")	LF4HA04OU18	\$2822.00
Fittings	Off Set—Down (6")	LF4HA04OD06	\$2658.00
Fittings	Off Set—Down (12")	LF4HA04OD12	\$2740.00
Fittings	Off Set—Down (18")	LF4HA04OD18	\$2822.00
Fittings	Off Set—Left (6")	LF4HA04OL06	\$3136.00
Fittings	Off Set—Left (12")	LF4HA04OL12	\$3218.00
Fittings	Off Set—Left (18")	LF4HA04OL18	\$3300.00
Fittings	Off Set—Right (6")	LF4HA04OR06	\$3136.00
Fittings	Off Set—Right (12")	LF4HA04OR12	\$3218.00
Fittings	Off Set—Right (18")	LF4HA04OR18	\$3300.00

## Hangers - Common to all Services

Amperage	Accessory Type	Product Number	List Price GO-126L
800 Amps	Hanger-Edgewise—Trapeze	SLTE2	\$33.00
800 Amps	Hanger-Flatwise—Trapeze	SLTF2	\$33.00
800 Amps	Hanger-Edgewise—Clevis	SLEC2	\$33.00
225 Amps	Hanger-Flatwise—Clevis	SLFC2 <sup>1</sup>	\$33.00
400 Amps	Hanger-Flatwise—Clevis	SLFC3 <sup>1</sup>	\$33.00
600 Amps	Hanger-Flatwise—Clevis	SLFC4 <sup>1</sup>	\$33.00
800 Amps	Hanger-Flatwise—Clevis	SLFC5 <sup>1</sup>	\$33.00
400 Amps	Hanger-Spring Riser	SLSR2	\$147.00
600 Amps	Hanger-Spring Riser	SLSR4	\$147.00
800 Amps	Hanger-Spring Riser	SLSR5	\$147.00
225 Amps	Hanger-Wall/Floor Flange	SLWF2	\$100.00
400 Amps	Hanger-Wall/Floor Flange	SLWF3	\$100.00
600 Amps	Hanger-Wall/Floor Flange	SLWF4	\$100.00
800 Amps	Hanger-Wall/Floor Flange	SLWF5	\$100.00
800 Amps	Hanger-Outlet Covers	SLOC2	\$14.00

For new Joint-Guard Protection System, add \$110.00 to the list price shown above.

For Drip-Proof Construction, add 18% to the list prices shown above. For

Transverse Barrier, add \$250.00 to list price of feeder straight lengths only. (Use with fire barrier and wall/floor flange for 3-hour fire rating.)

<sup>1</sup>Standard hanger provided unless otherwise specified.



# Busway Spectra® Series Busway (continued)

LowAmp  
Aluminum Conductors  
Product Number Pricing

# Section 11

## 600 Amps Three-Phase, Four-Wire Integrated Housing Ground

Component	Type	Product Number	List Price GO-126L
Linear Lengths	Plug-In: 10-ft.	LP4HA06SL10	\$2169.00
Linear Lengths	Plug-In: 6-ft.	LP4HA06SLO6	\$1481.00
Linear Lengths	Plug-In: 4-ft.	LP4HA06SLO4	\$1179.00
Linear Lengths	Feeder: 10-ft.	LF4HA06SL10	\$1515.00
Linear Lengths	Feeder: 5-ft.	LF4HA06SLO5	\$945.00
Linear Lengths	Feeder: 3-ft.	LF4HA06SLO3	\$723.00
Linear Lengths	Feeder: 2-ft.	LF4HA06SLO2	\$629.00
Linear Lengths	Adjustable Straight Length	LF4HA06ASST	\$2603.00
Fittings	Elbow Left 90°	LF4HA06ELST	\$1194.00
Fittings	Elbow Right 90°	LF4HA06ERST	\$1194.00
Fittings	Elbow Up 90°	LF4HA06EUST	\$1027.00
Fittings	Elbow Down 90°	LF4HA06EDST	\$1027.00
Accessories	End Cable Tap Box—Up	LF4HA06TTST	\$2326.00
Accessories	End Cable Tap Box—Down	LF4HA06TBST	\$2326.00
Accessories	Center Cable Tap Box—Up	LF4HA06CTST	\$2428.00
Accessories	Center Cable Tap Box—Down	LF4HA06CBST	\$2428.00
Accessories	End Box	LF4HA06EBST	\$200.00
Accessories	Flanged End w/Lugs	LF4HA06FLST	\$1021.00
Accessories	Flanged End	LF4HA06FEST	\$655.00
Fittings	Expansion Length—Up	LF4HA06XUST	\$5403.00
Fittings	Expansion Length—Down	LF4HA06XDST	\$5403.00
Fittings	Total Phase Transposition	LF4HA06TFST	\$4374.00
Fittings	Tee—Right	LF4HA06TRST	\$1655.00
Fittings	Tee—Left	LF4HA06TLST	\$1655.00
Fittings	Tee—Up	LF4HA06TUST	\$2814.00
Fittings	Tee—Down	LF4HA06TDST	\$2814.00
Fittings	Off Set—Up (6")	LF4HA06OU06	\$2795.00
Fittings	Off Set—Up (12")	LF4HA06OU12	\$2887.00
Fittings	Off Set—Up (18")	LF4HA06OU18	\$2979.00
Fittings	Off Set—Down (6")	LF4HA06OD06	\$2795.00
Fittings	Off Set—Down (12")	LF4HA06OD12	\$2887.00
Fittings	Off Set—Down (18")	LF4HA06OD18	\$2979.00
Fittings	Off Set—Left (6")	LF4HA06OL06	\$3273.00
Fittings	Off Set—Left (12")	LF4HA06OL12	\$3365.00
Fittings	Off Set—Left (18")	LF4HA06OL18	\$3457.00
Fittings	Off Set—Right (6")	LF4HA06OR06	\$3273.00
Fittings	Off Set—Right (12")	LF4HA06OR12	\$3365.00
Fittings	Off Set—Right (18")	LF4HA06OR18	\$3457.00

## 800 Amps Three-Phase, Four-Wire Integrated Housing Ground

Component	Type	Product Number	List Price GO-126L
Linear Lengths	Plug-In: 10-ft.	LP4HA08SL10	\$2368.00
Linear Lengths	Plug-In: 6-ft.	LP4HA08SLO6	\$1607.00
Linear Lengths	Plug-In: 4-ft.	LP4HA08SLO4	\$1264.00
Linear Lengths	Feeder: 10-ft.	LF4HA08SL10	\$1763.00
Linear Lengths	Feeder: 5-ft.	LF4HA08SLO5	\$1080.00
Linear Lengths	Feeder: 3-ft.	LF4HA08SLO3	\$812.00
Linear Lengths	Feeder: 2-ft.	LF4HA08SLO2	\$694.00
Linear Lengths	Adjustable Straight Length	LF4HA08ASST	\$2842.00
Fittings	Elbow Left 90°	LF4HA08ELST	\$1296.00
Fittings	Elbow Right 90°	LF4HA08ERST	\$1296.00
Fittings	Elbow Up 90°	LF4HA08EUST	\$1128.00
Fittings	Elbow Down 90°	LF4HA08EDST	\$1128.00
Accessories	End Cable Tap Box—Up	LF4HA08TTST	\$2499.00
Accessories	End Cable Tap Box—Down	LF4HA08TBST	\$2499.00
Accessories	Center Cable Tap Box—Up	LF4HA08CTST	\$2514.00
Accessories	Center Cable Tap Box—Down	LF4HA08CBST	\$2514.00
Accessories	End Box	LF4HA08EBST	\$200.00
Accessories	Flanged End w/Lugs	LF4HA08FLST	\$1257.00
Accessories	Flanged End	LF4HA08FEST	\$783.00
Fittings	Expansion Length—Up	LF4HA08XUST	\$5728.00
Fittings	Expansion Length—Down	LF4HA08XDST	\$5728.00
Fittings	Total Phase Transposition	LF4HA08TFST	\$4637.00
Fittings	Tee—Right	LF4HA08TRST	\$1843.00
Fittings	Tee—Left	LF4HA08TLST	\$1843.00
Fittings	Tee—Up	LF4HA08TUST	\$3033.00
Fittings	Tee—Down	LF4HA08TDST	\$3033.00
Fittings	Off Set—Up (6")	LF4HA08OU06	\$3042.00
Fittings	Off Set—Up (12")	LF4HA08OU12	\$3152.00
Fittings	Off Set—Up (18")	LF4HA08OU18	\$3261.00
Fittings	Off Set—Down (6")	LF4HA08OD06	\$3042.00
Fittings	Off Set—Down (12")	LF4HA08OD12	\$3152.00
Fittings	Off Set—Down (18")	LF4HA08OD18	\$3261.00
Fittings	Off Set—Left (6")	LF4HA08OL06	\$3520.00
Fittings	Off Set—Left (12")	LF4HA08OL12	\$3630.00
Fittings	Off Set—Left (18")	LF4HA08OL18	\$3739.00
Fittings	Off Set—Right (6")	LF4HA08OR06	\$3520.00
Fittings	Off Set—Right (12")	LF4HA08OR12	\$3630.00
Fittings	Off Set—Right (18")	LF4HA08OR18	\$3739.00

## Hangers - Common to all Services

Amperage	Accessory Type	Product Number	List Price GO-126L
800 Amps	Hanger-Edgewise—Trapeze	SLTE2	\$33.00
800 Amps	Hanger-Flatwise—Trapeze	SLTF2	\$33.00
800 Amps	Hanger-Edgewise—Clevis	SLEC2	\$33.00
225 Amps	Hanger-Flatwise—Clevis	SLFC2 <sup>1</sup>	\$33.00
400 Amps	Hanger-Flatwise—Clevis	SLFC3 <sup>1</sup>	\$33.00
600 Amps	Hanger-Flatwise—Clevis	SLFC4 <sup>1</sup>	\$33.00
800 Amps	Hanger-Flatwise—Clevis	SLFC5 <sup>1</sup>	\$33.00
400 Amps	Hanger-Spring Riser	SLSR2	\$147.00
600 Amps	Hanger-Spring Riser	SLSR4	\$147.00
800 Amps	Hanger-Spring Riser	SLSR5	\$147.00
225 Amps	Hanger-Wall/Floor Flange	SLWF2	\$100.00
400 Amps	Hanger-Wall/Floor Flange	SLWF3	\$100.00
600 Amps	Hanger-Wall/Floor Flange	SLWF4	\$100.00
800 Amps	Hanger-Wall/Floor Flange	SLWF5	\$100.00
800 Amps	Hanger-Outlet Covers	SLOC2	\$14.00

For new Joint-Guard Protection System, add \$110.00 to the list price shown above.

For Drip-Proof Construction, add 18% to the list prices shown above. For

Transverse Barrier, add \$250.00 to list price of feeder straight lengths only. (Use with fire barrier and wall/floor flange for 3-hour fire rating.)

<sup>1</sup>Standard hanger provided unless otherwise specified.



# Busway Spectra® Series Busway

LowAmp  
Copper Conductors  
Product Number Pricing

# Section 11

## 225 Amps Three-Phase, Three-Wire Integrated Housing Ground

Component	Type	Product Number	List Price GO-126L
Linear Lengths	Plug-In: 10-ft.	LP3HC02SL10	\$2146.00
Linear Lengths	Plug-In: 6-ft.	LP3HC02SL06	\$1460.00
Linear Lengths	Plug-In: 4-ft.	LP3HC02SL04	\$1160.00
Linear Lengths	Feeder: 10-ft.	LF3HC02SL10	\$1457.00
Linear Lengths	Feeder: 5-ft.	LF3HC02SL05	\$904.00
Linear Lengths	Feeder: 3-ft.	LF3HC02SL03	\$690.00
Linear Lengths	Feeder: 2-ft.	LF3HC02SL02	\$600.00
Linear Lengths	Adjustable Straight Length	LF3HC02ASST	\$2575.00
Fittings	Elbow Left 90°	LF3HC02ELST	\$1208.00
Fittings	Elbow Right 90°	LF3HC02ERST	\$1208.00
Fittings	Elbow Up 90°	LF3HC02EUST	\$1025.00
Fittings	Elbow Down 90°	LF3HC02EDST	\$1025.00
Accessories	End Cable Tap Box—Up	LF3HC02TTST	\$2458.00
Accessories	End Cable Tap Box—Down	LF3HC02TBST	\$2458.00
Accessories	Center Cable Tap Box—Up	LF3HC02CTST	\$2570.00
Accessories	Center Cable Tap Box—Down	LF3HC02CBST	\$2570.00
Accessories	End Box	LF3HC02EBST	\$200.00
Accessories	Flanged End w/Lugs	LF3HC02FLST	\$934.00
Accessories	Flanged End	LF3HC02FEST	\$650.00
Fittings	Expansion Length—Up	LF3HC02XUST	\$5634.00
Fittings	Expansion Length—Down	LF3HC02XDST	\$5634.00
Fittings	Total Phase Transposition	LF3HC02TFST	\$4165.00
Fittings	Tee—Right	LF3HC02TRST	\$1586.00
Fittings	Tee—Left	LF3HC02TLST	\$1586.00
Fittings	Tee—Up	LF3HC02TUST	\$2815.00
Fittings	Tee—Down	LF3HC02TDST	\$2815.00
Fittings	Off Set—Up (6")	LF3HC02OU06	\$2820.00
Fittings	Off Set—Up (12")	LF3HC02OU12	\$2903.00
Fittings	Off Set—Up (18")	LF3HC02OU18	\$2985.00
Fittings	Off Set—Down (6")	LF3HC02OD06	\$2820.00
Fittings	Off Set—Down (12")	LF3HC02OD12	\$2903.00
Fittings	Off Set—Down (18")	LF3HC02OD18	\$2985.00
Fittings	Off Set—Left (6")	LF3HC02OL06	\$3343.00
Fittings	Off Set—Left (12")	LF3HC02OL12	\$3426.00
Fittings	Off Set—Left (18")	LF3HC02OL18	\$3509.00
Fittings	Off Set—Right (6")	LF3HC02OR06	\$3343.00
Fittings	Off Set—Right (12")	LF3HC02OR12	\$3426.00
Fittings	Off Set—Right (18")	LF3HC02OR18	\$3509.00

## 400 Amps Three-Phase, Three-Wire Integrated Housing Ground

Component	Type	Product Number	List Price GO-126L
Linear Lengths	Plug-In: 10-ft.	LP3HC04SL10	\$2146.00
Linear Lengths	Plug-In: 6-ft.	LP3HC04SL06	\$1460.00
Linear Lengths	Plug-In: 4-ft.	LP3HC04SL04	\$1160.00
Linear Lengths	Feeder: 10-ft.	LF3HC04SL10	\$1457.00
Linear Lengths	Feeder: 5-ft.	LF3HC04SL05	\$904.00
Linear Lengths	Feeder: 3-ft.	LF3HC04SL03	\$690.00
Linear Lengths	Feeder: 2-ft.	LF3HC04SL02	\$600.00
Linear Lengths	Adjustable Straight Length	LF3HC04ASST	\$2575.00
Fittings	Elbow Left 90°	LF3HC04ELST	\$1208.00
Fittings	Elbow Right 90°	LF3HC04ERST	\$1208.00
Fittings	Elbow Up 90°	LF3HC04EUST	\$1025.00
Fittings	Elbow Down 90°	LF3HC04EDST	\$1025.00
Accessories	End Cable Tap Box—Up	LF3HC04TTST	\$2458.00
Accessories	End Cable Tap Box—Down	LF3HC04TBST	\$2458.00
Accessories	Center Cable Tap Box—Up	LF3HC04CTST	\$2570.00
Accessories	Center Cable Tap Box—Down	LF3HC04CBST	\$2570.00
Accessories	End Box	LF3HC04EBST	\$200.00
Accessories	Flanged End w/Lugs	LF3HC04FLST	\$1051.00
Accessories	Flanged End	LF3HC04FEST	\$650.00
Fittings	Expansion Length—Up	LF3HC04XUST	\$5634.00
Fittings	Expansion Length—Down	LF3HC04XDST	\$5634.00
Fittings	Total Phase Transposition	LF3HC04TFST	\$4165.00
Fittings	Tee—Right	LF3HC04TRST	\$1586.00
Fittings	Tee—Left	LF3HC04TLST	\$1586.00
Fittings	Tee—Up	LF3HC04TUST	\$2815.00
Fittings	Tee—Down	LF3HC04TDST	\$2815.00
Fittings	Off Set—Up (6")	LF3HC04OU06	\$2820.00
Fittings	Off Set—Up (12")	LF3HC04OU12	\$2903.00
Fittings	Off Set—Up (18")	LF3HC04OU18	\$2985.00
Fittings	Off Set—Down (6")	LF3HC04OD06	\$2820.00
Fittings	Off Set—Down (12")	LF3HC04OD12	\$2903.00
Fittings	Off Set—Down (18")	LF3HC04OD18	\$2985.00
Fittings	Off Set—Left (6")	LF3HC04OL06	\$3343.00
Fittings	Off Set—Left (12")	LF3HC04OL12	\$3426.00
Fittings	Off Set—Left (18")	LF3HC04OL18	\$3509.00
Fittings	Off Set—Right (6")	LF3HC04OR06	\$3343.00
Fittings	Off Set—Right (12")	LF3HC04OR12	\$3426.00
Fittings	Off Set—Right (18")	LF3HC04OR18	\$3509.00

## Hangers - Common to all Services

Amperage	Accessory Type	Product Number	List Price GO-126L
800 Amps	Hanger-Edgewise—Trapeze	SLTE2	\$33.00
800 Amps	Hanger-Flatwise—Trapeze	SLTF2	\$33.00
800 Amps	Hanger-Edgewise—Clevis	SLEC2	\$33.00
225 Amps	Hanger-Flatwise—Clevis	SLFC2 <sup>1</sup>	\$33.00
400 Amps	Hanger-Flatwise—Clevis	SLFC3 <sup>1</sup>	\$33.00
600 Amps	Hanger-Flatwise—Clevis	SLFC4 <sup>1</sup>	\$33.00
800 Amps	Hanger-Flatwise—Clevis	SLFC5 <sup>1</sup>	\$33.00
400 Amps	Hanger-Spring Riser	SLSR2	\$147.00
600 Amps	Hanger-Spring Riser	SLSR4	\$147.00
800 Amps	Hanger-Spring Riser	SLSR5	\$147.00
225 Amps	Hanger-Wall/Floor Flange	SLWF2	\$100.00
400 Amps	Hanger-Wall/Floor Flange	SLWF3	\$100.00
600 Amps	Hanger-Wall/Floor Flange	SLWF4	\$100.00
800 Amps	Hanger-Wall/Floor Flange	SLWF5	\$100.00
800 Amps	Hanger-Outlet Covers	SLOC2	\$14.00

For new Joint-Guard Protection System, add \$110.00 to the list price shown above.

For Drip-Proof Construction, add 18% to the list prices shown above. For

Transverse Barrier, add \$250.00 to list price of feeder straight lengths only. (Use with fire barrier and wall/floor flange for 3-hour fire rating.)

<sup>1</sup>Standard hanger provided unless otherwise specified.



# Busway Spectra® Series Busway (continued)

LowAmp  
Copper Conductors  
Product Number Pricing

# Section 11

## 600 Amps Three-Phase, Three-Wire Integrated Housing Ground

## 800 Amps Three-Phase, Three-Wire Integrated Housing Ground

Component	Type	Product Number	List Price GO-126L
Linear Lengths	Plug-In: 10-ft.	LP3HC06SL10	\$2253.00
Linear Lengths	Plug-In: 6-ft.	LP3HC06SL06	\$1522.00
Linear Lengths	Plug-In: 4-ft.	LP3HC06SL04	\$1195.00
Linear Lengths	Feeder: 10-ft.	LF3HC06SL10	\$1636.00
Linear Lengths	Feeder: 5-ft.	LF3HC06SL05	\$994.00
Linear Lengths	Feeder: 3-ft.	LF3HC06SL03	\$743.00
Linear Lengths	Feeder: 2-ft.	LF3HC06SL02	\$633.00
Linear Lengths	Adjustable Straight Length	LF3HC06ASST	\$2704.00
Fittings	Elbow Left 90°	LF3HC06ELST	\$1272.00
Fittings	Elbow Right 90°	LF3HC06ERST	\$1272.00
Fittings	Elbow Up 90°	LF3HC06EUST	\$1089.00
Fittings	Elbow Down 90°	LF3HC06EDST	\$1089.00
Accessories	End Cable Tap Box—Up	LF3HC06TTST	\$2508.00
Accessories	End Cable Tap Box—Down	LF3HC06TBST	\$2508.00
Accessories	Center Cable Tap Box—Up	LF3HC06CTST	\$2620.00
Accessories	Center Cable Tap Box—Down	LF3HC06CBST	\$2620.00
Accessories	End Box	LF3HC06EBST	\$200.00
Accessories	Flanged End w/Lugs	LF3HC06FLST	\$1106.00
Accessories	Flanged End	LF3HC06FEST	\$705.00
Fittings	Expansion Length—Up	LF3HC06XUST	\$5768.00
Fittings	Expansion Length—Down	LF3HC06XDST	\$5768.00
Fittings	Total Phase Transposition	LF3HC06TFST	\$4264.00
Fittings	Tee—Right	LF3HC06TRST	\$1678.00
Fittings	Tee—Left	LF3HC06TLST	\$1678.00
Fittings	Tee—Up	LF3HC06TUST	\$2922.00
Fittings	Tee—Down	LF3HC06TDST	\$2922.00
Fittings	Off Set—Up (6")	LF3HC06OU06	\$2988.00
Fittings	Off Set—Up (12")	LF3HC06OU12	\$3084.00
Fittings	Off Set—Up (18")	LF3HC06OU18	\$3180.00
Fittings	Off Set—Down (6")	LF3HC06OD06	\$2988.00
Fittings	Off Set—Down (12")	LF3HC06OD12	\$3084.00
Fittings	Off Set—Down (18")	LF3HC06OD18	\$3180.00
Fittings	Off Set—Left (6")	LF3HC06OL06	\$3511.00
Fittings	Off Set—Left (12")	LF3HC06OL12	\$3607.00
Fittings	Off Set—Left (18")	LF3HC06OL18	\$3703.00
Fittings	Off Set—Right (6")	LF3HC06OR06	\$3511.00
Fittings	Off Set—Right (12")	LF3HC06OR12	\$3607.00
Fittings	Off Set—Right (18")	LF3HC06OR18	\$3703.00

Component	Type	Product Number	List Price GO-126L
Linear Lengths	Plug-In: 10-ft.	LP3HC08SL10	\$2529.00
Linear Lengths	Plug-In: 6-ft.	LP3HC08SL06	\$1699.00
Linear Lengths	Plug-In: 4-ft.	LP3HC08SL04	\$1320.00
Linear Lengths	Feeder: 10-ft.	LF3HC08SL10	\$1898.00
Linear Lengths	Feeder: 5-ft.	LF3HC08SL05	\$1141.00
Linear Lengths	Feeder: 3-ft.	LF3HC08SL03	\$844.00
Linear Lengths	Feeder: 2-ft.	LF3HC08SL02	\$710.00
Linear Lengths	Adjustable Straight Length	LF3HC08ASST	\$3035.00
Fittings	Elbow Left 90°	LF3HC08ELST	\$1355.00
Fittings	Elbow Right 90°	LF3HC08ERST	\$1355.00
Fittings	Elbow Up 90°	LF3HC08EUST	\$1172.00
Fittings	Elbow Down 90°	LF3HC08EDST	\$1172.00
Accessories	End Cable Tap Box—Up	LF3HC08TTST	\$2578.00
Accessories	End Cable Tap Box—Down	LF3HC08TBST	\$2578.00
Accessories	Center Cable Tap Box—Up	LF3HC08CTST	\$2690.00
Accessories	Center Cable Tap Box—Down	LF3HC08CBST	\$2690.00
Accessories	End Box	LF3HC08EBST	\$200.00
Accessories	Flanged End w/Lugs	LF3HC08FLST	\$1302.00
Accessories	Flanged End	LF3HC08FEST	\$782.00
Fittings	Expansion Length—Up	LF3HC08XUST	\$5933.00
Fittings	Expansion Length—Down	LF3HC08XDST	\$5933.00
Fittings	Total Phase Transposition	LF3HC08TFST	\$4385.00
Fittings	Tee—Right	LF3HC08TRST	\$1803.00
Fittings	Tee—Left	LF3HC08TLST	\$1803.00
Fittings	Tee—Up	LF3HC08TUST	\$3064.00
Fittings	Tee—Down	LF3HC08TDST	\$3064.00
Fittings	Off Set—Up (6")	LF3HC08OU06	\$3191.00
Fittings	Off Set—Up (12")	LF3HC08OU12	\$3301.00
Fittings	Off Set—Up (18")	LF3HC08OU18	\$3411.00
Fittings	Off Set—Down (6")	LF3HC08OD06	\$3191.00
Fittings	Off Set—Down (12")	LF3HC08OD12	\$3301.00
Fittings	Off Set—Down (18")	LF3HC08OD18	\$3411.00
Fittings	Off Set—Left (6")	LF3HC08OL06	\$3714.00
Fittings	Off Set—Left (12")	LF3HC08OL12	\$3825.00
Fittings	Off Set—Left (18")	LF3HC08OL18	\$3935.00
Fittings	Off Set—Right (6")	LF3HC08OR06	\$3714.00
Fittings	Off Set—Right (12")	LF3HC08OR12	\$3825.00
Fittings	Off Set—Right (18")	LF3HC08OR18	\$3935.00

## Hangers - Common to all Services

Amperage	Accessory Type	Product Number	List Price GO-126L
800 Amps	Hanger-Edgewise—Trapeze	SLTE2	\$33.00
800 Amps	Hanger-Flatwise—Trapeze	SLTF2	\$33.00
800 Amps	Hanger-Edgewise—Clevis	SLEC2	\$33.00
225 Amps	Hanger-Flatwise—Clevis	SLFC2 <sup>1</sup>	\$33.00
400 Amps	Hanger-Flatwise—Clevis	SLFC3 <sup>1</sup>	\$33.00
600 Amps	Hanger-Flatwise—Clevis	SLFC4 <sup>1</sup>	\$33.00
800 Amps	Hanger-Flatwise—Clevis	SLFC5 <sup>1</sup>	\$33.00
400 Amps	Hanger-Spring Riser	SLSR2	\$147.00
600 Amps	Hanger-Spring Riser	SLSR4	\$147.00
800 Amps	Hanger-Spring Riser	SLSR5	\$147.00
225 Amps	Hanger-Wall/Floor Flange	SLWF2	\$100.00
400 Amps	Hanger-Wall/Floor Flange	SLWF3	\$100.00
600 Amps	Hanger-Wall/Floor Flange	SLWF4	\$100.00
800 Amps	Hanger-Wall/Floor Flange	SLWF5	\$100.00
800 Amps	Hanger-Outlet Covers	SLOC2	\$14.00

For new Joint-Guard Protection System, add \$110.00 to the list price shown above.

For Drip-Proof Construction, add 18% to the list prices shown above. For

Transverse Barrier, add \$250.00 to list price of feeder straight lengths only. (Use with fire barrier and wall/floor flange for 3-hour fire rating.)

<sup>1</sup>Standard hanger provided unless otherwise specified.



# Busway Spectra® Series Busway

LowAmp  
Copper Conductors  
Product Number Pricing

# Section 11

## 225 Amps Three-Phase, Four-Wire Integrated Housing Ground

Component	Type	Product Number	List Price GO-126L
Linear Lengths	Plug-In: 10-ft.	LP4HC02SL10	\$2446.00
Linear Lengths	Plug-In: 6-ft.	LP4HC02SL06	\$1664.00
Linear Lengths	Plug-In: 4-ft.	LP4HC02SL04	\$1322.00
Linear Lengths	Feeder: 10-ft.	LF4HC02SL10	\$1681.00
Linear Lengths	Feeder: 5-ft.	LF4HC02SL05	\$1041.00
Linear Lengths	Feeder: 3-ft.	LF4HC02SL03	\$792.00
Linear Lengths	Feeder: 2-ft.	LF4HC02SL02	\$688.00
Linear Lengths	Adjustable Straight Length	LF4HC02ASST	\$2935.00
Fittings	Elbow Left 90°	LF4HC02ELST	\$1265.00
Fittings	Elbow Right 90°	LF4HC02ERST	\$1265.00
Fittings	Elbow Up 90°	LF4HC02EUST	\$1082.00
Fittings	Elbow Down 90°	LF4HC02EDST	\$1082.00
Accessories	End Cable Tap Box—Up	LF4HC02TTST	\$2501.00
Accessories	End Cable Tap Box—Down	LF4HC02TBST	\$2501.00
Accessories	Center Cable Tap Box—Up	LF4HC02CTST	\$2614.00
Accessories	Center Cable Tap Box—Down	LF4HC02CBST	\$2614.00
Accessories	End Box	LF4HC02EBST	\$200.00
Accessories	Flanged End w/Lugs	LF4HC02FLST	\$964.00
Accessories	Flanged End	LF4HC02FEST	\$681.00
Fittings	Expansion Length—Up	LF4HC02XUST	\$5769.00
Fittings	Expansion Length—Down	LF4HC02XDST	\$5769.00
Fittings	Total Phase Transposition	LF4HC02TFST	\$4264.00
Fittings	Tee—Right	LF4HC02TRST	\$1641.00
Fittings	Tee—Left	LF4HC02TLST	\$1641.00
Fittings	Tee—Up	LF4HC02TUST	\$2877.00
Fittings	Tee—Down	LF4HC02TDST	\$2877.00
Fittings	Off Set—Up (6")	LF4HC02OU06	\$2978.00
Fittings	Off Set—Up (12")	LF4HC02OU12	\$3075.00
Fittings	Off Set—Up (18")	LF4HC02OU18	\$3172.00
Fittings	Off Set—Down (6")	LF4HC02OD06	\$2978.00
Fittings	Off Set—Down (12")	LF4HC02OD12	\$3075.00
Fittings	Off Set—Down (18")	LF4HC02OD18	\$3172.00
Fittings	Off Set—Left (6")	LF4HC02OL06	\$3502.00
Fittings	Off Set—Left (12")	LF4HC02OL12	\$3599.00
Fittings	Off Set—Left (18")	LF4HC02OL18	\$3696.00
Fittings	Off Set—Right (6")	LF4HC02OR06	\$3502.00
Fittings	Off Set—Right (12")	LF4HC02OR12	\$3599.00
Fittings	Off Set—Right (18")	LF4HC02OR18	\$3696.00

## 400 Amps Three-Phase, Four-Wire Integrated Housing Ground

Component	Type	Product Number	List Price GO-126L
Linear Lengths	Plug-In: 10-ft.	LP4HC04SL10	\$2446.00
Linear Lengths	Plug-In: 6-ft.	LP4HC04SL06	\$1664.00
Linear Lengths	Plug-In: 4-ft.	LP4HC04SL04	\$1322.00
Linear Lengths	Feeder: 10-ft.	LF4HC04SL10	\$1681.00
Linear Lengths	Feeder: 5-ft.	LF4HC04SL05	\$1041.00
Linear Lengths	Feeder: 3-ft.	LF4HC04SL03	\$792.00
Linear Lengths	Feeder: 2-ft.	LF4HC04SL02	\$688.00
Linear Lengths	Adjustable Straight Length	LF4HC04ASST	\$2935.00
Fittings	Elbow Left 90°	LF4HC04ELST	\$1265.00
Fittings	Elbow Right 90°	LF4HC04ERST	\$1265.00
Fittings	Elbow Up 90°	LF4HC04EUST	\$1082.00
Fittings	Elbow Down 90°	LF4HC04EDST	\$1082.00
Accessories	End Cable Tap Box—Up	LF4HC04TTST	\$2501.00
Accessories	End Cable Tap Box—Down	LF4HC04TBST	\$2501.00
Accessories	Center Cable Tap Box—Up	LF4HC04CTST	\$2614.00
Accessories	Center Cable Tap Box—Down	LF4HC04CBST	\$2614.00
Accessories	End Box	LF4HC04EBST	\$200.00
Accessories	Flanged End w/Lugs	LF4HC04FLST	\$1082.00
Accessories	Flanged End	LF4HC04FEST	\$681.00
Fittings	Expansion Length—Up	LF4HC04XUST	\$5769.00
Fittings	Expansion Length—Down	LF4HC04XDST	\$5769.00
Fittings	Total Phase Transposition	LF4HC04TFST	\$4264.00
Fittings	Tee—Right	LF4HC04TRST	\$1641.00
Fittings	Tee—Left	LF4HC04TLST	\$1641.00
Fittings	Tee—Up	LF4HC04TUST	\$2877.00
Fittings	Tee—Down	LF4HC04TDST	\$2877.00
Fittings	Off Set—Up (6")	LF4HC04OU06	\$2978.00
Fittings	Off Set—Up (12")	LF4HC04OU12	\$3075.00
Fittings	Off Set—Up (18")	LF4HC04OU18	\$3172.00
Fittings	Off Set—Down (6")	LF4HC04OD06	\$2978.00
Fittings	Off Set—Down (12")	LF4HC04OD12	\$3075.00
Fittings	Off Set—Down (18")	LF4HC04OD18	\$3172.00
Fittings	Off Set—Left (6")	LF4HC04OL06	\$3502.00
Fittings	Off Set—Left (12")	LF4HC04OL12	\$3599.00
Fittings	Off Set—Left (18")	LF4HC04OL18	\$3696.00
Fittings	Off Set—Right (6")	LF4HC04OR06	\$3502.00
Fittings	Off Set—Right (12")	LF4HC04OR12	\$3599.00
Fittings	Off Set—Right (18")	LF4HC04OR18	\$3696.00

## Hangers - Common to all Services

Amperage	Accessory Type	Product Number	List Price GO-126L
800 Amps	Hanger-Edgewise—Trapeze	SLTE2	\$33.00
800 Amps	Hanger-Flatwise—Trapeze	SLTF2	\$33.00
800 Amps	Hanger-Edgewise—Clevis	SLEC2	\$33.00
225 Amps	Hanger-Flatwise—Clevis	SLFC2 <sup>1</sup>	\$33.00
400 Amps	Hanger-Flatwise—Clevis	SLFC3 <sup>1</sup>	\$33.00
600 Amps	Hanger-Flatwise—Clevis	SLFC4 <sup>1</sup>	\$33.00
800 Amps	Hanger-Flatwise—Clevis	SLFC5 <sup>1</sup>	\$33.00
400 Amps	Hanger-Spring Riser	SLSR2	\$147.00
600 Amps	Hanger-Spring Riser	SLSR4	\$147.00
800 Amps	Hanger-Spring Riser	SLSR5	\$147.00
225 Amps	Hanger-Wall/Floor Flange	SLWF2	\$100.00
400 Amps	Hanger-Wall/Floor Flange	SLWF3	\$100.00
600 Amps	Hanger-Wall/Floor Flange	SLWF4	\$100.00
800 Amps	Hanger-Wall/Floor Flange	SLWF5	\$100.00
800 Amps	Hanger-Outlet Covers	SLOC2	\$14.00

For new Joint-Guard Protection System, add \$110.00 to the list price shown above.

For Drip-Proof Construction, add 18% to the list prices shown above. For

Transverse Barrier, add \$250.00 to list price of feeder straight lengths only. (Use with fire barrier and wall/floor flange for 3-hour fire rating.)

<sup>1</sup>Standard hanger provided unless otherwise specified.





# Busway Spectra® Series Busway (continued)

LowAmp  
Copper Conductors  
Product Number Pricing

# Section 11

## 600 Amps Three-Phase, Four-Wire Integrated Housing Ground

## 800 Amps Three-Phase, Four-Wire Integrated Housing Ground

Component	Type	Product Number	List Price GO-126L
Linear Lengths	Plug-In: 10-ft.	LP4HC06SL10	\$2551.00
Linear Lengths	Plug-In: 6-ft.	LP4HC06SL06	\$1722.00
Linear Lengths	Plug-In: 4-ft.	LP4HC06SL04	\$1353.00
Linear Lengths	Feeder: 10-ft.	LF4HC06SL10	\$1842.00
Linear Lengths	Feeder: 5-ft.	LF4HC06SL05	\$1119.00
Linear Lengths	Feeder: 3-ft.	LF4HC06SL03	\$838.00
Linear Lengths	Feeder: 2-ft.	LF4HC06SL02	\$715.00
Linear Lengths	Adjustable Straight Length	LF4HC06ASST	\$3061.00
Fittings	Elbow Left 90°	LF4HC06ELST	\$1330.00
Fittings	Elbow Right 90°	LF4HC06ERST	\$1330.00
Fittings	Elbow Up 90°	LF4HC06EUST	\$1147.00
Fittings	Elbow Down 90°	LF4HC06EDST	\$1147.00
Accessories	End Cable Tap Box—Up	LF4HC06TTST	\$2552.00
Accessories	End Cable Tap Box—Down	LF4HC06TBST	\$2552.00
Accessories	Center Cable Tap Box—Up	LF4HC06CTST	\$2664.00
Accessories	Center Cable Tap Box—Down	LF4HC06CBST	\$2664.00
Accessories	End Box	LF4HC06EBST	\$200.00
Accessories	Flanged End w/Lugs	LF4HC06FLST	\$1139.00
Accessories	Flanged End	LF4HC06FEST	\$737.00
Fittings	Expansion Length—Up	LF4HC06XUST	\$5904.00
Fittings	Expansion Length—Down	LF4HC06XDST	\$5904.00
Fittings	Total Phase Transposition	LF4HC06TFST	\$4364.00
Fittings	Tee—Right	LF4HC06TRST	\$1734.00
Fittings	Tee—Left	LF4HC06TLST	\$1734.00
Fittings	Tee—Up	LF4HC06TUST	\$2986.00
Fittings	Tee—Down	LF4HC06TDST	\$2986.00
Fittings	Off Set—Up (6")	LF4HC06OU06	\$3147.00
Fittings	Off Set—Up (12")	LF4HC06OU12	\$3257.00
Fittings	Off Set—Up (18")	LF4HC06OU18	\$3367.00
Fittings	Off Set—Down (6")	LF4HC06OD06	\$3147.00
Fittings	Off Set—Down (12")	LF4HC06OD12	\$3257.00
Fittings	Off Set—Down (18")	LF4HC06OD18	\$3367.00
Fittings	Off Set—Left (6")	LF4HC06OL06	\$3671.00
Fittings	Off Set—Left (12")	LF4HC06OL12	\$3781.00
Fittings	Off Set—Left (18")	LF4HC06OL18	\$3891.00
Fittings	Off Set—Right (6")	LF4HC06OR06	\$3671.00
Fittings	Off Set—Right (12")	LF4HC06OR12	\$3781.00
Fittings	Off Set—Right (18")	LF4HC06OR18	\$3891.00

Component	Type	Product Number	List Price GO-126L
Linear Lengths	Plug-In: 10-ft.	LP4HC08SL10	\$2934.00
Linear Lengths	Plug-In: 6-ft.	LP4HC08SL06	\$1963.00
Linear Lengths	Plug-In: 4-ft.	LP4HC08SL04	\$1521.00
Linear Lengths	Feeder: 10-ft.	LF4HC08SL10	\$2240.00
Linear Lengths	Feeder: 5-ft.	LF4HC08SL05	\$1334.00
Linear Lengths	Feeder: 3-ft.	LF4HC08SL03	\$979.00
Linear Lengths	Feeder: 2-ft.	LF4HC08SL02	\$818.00
Linear Lengths	Adjustable Straight Length	LF4HC08ASST	\$3521.00
Fittings	Elbow Left 90°	LF4HC08ELST	\$1439.00
Fittings	Elbow Right 90°	LF4HC08ERST	\$1439.00
Fittings	Elbow Up 90°	LF4HC08EUST	\$1256.00
Fittings	Elbow Down 90°	LF4HC08EDST	\$1256.00
Accessories	End Cable Tap Box—Up	LF4HC08TTST	\$2637.00
Accessories	End Cable Tap Box—Down	LF4HC08TBST	\$2637.00
Accessories	Center Cable Tap Box—Up	LF4HC08CTST	\$2749.00
Accessories	Center Cable Tap Box—Down	LF4HC08CBST	\$2749.00
Accessories	End Box	LF4HC08EBST	\$200.00
Accessories	Flanged End w/Lugs	LF4HC08FLST	\$1351.00
Accessories	Flanged End	LF4HC08FEST	\$831.00
Fittings	Expansion Length—Up	LF4HC08XUST	\$6128.00
Fittings	Expansion Length—Down	LF4HC08XDST	\$6128.00
Fittings	Total Phase Transposition	LF4HC08TFST	\$4530.00
Fittings	Tee—Right	LF4HC08TRST	\$1891.00
Fittings	Tee—Left	LF4HC08TLST	\$1891.00
Fittings	Tee—Up	LF4HC08TUST	\$3168.00
Fittings	Tee—Down	LF4HC08TDST	\$3168.00
Fittings	Off Set—Up (6")	LF4HC08OU06	\$3429.00
Fittings	Off Set—Up (12")	LF4HC08OU12	\$3561.00
Fittings	Off Set—Up (18")	LF4HC08OU18	\$3692.00
Fittings	Off Set—Down (6")	LF4HC08OD06	\$3429.00
Fittings	Off Set—Down (12")	LF4HC08OD12	\$3561.00
Fittings	Off Set—Down (18")	LF4HC08OD18	\$3692.00
Fittings	Off Set—Left (6")	LF4HC08OL06	\$3952.00
Fittings	Off Set—Left (12")	LF4HC08OL12	\$4084.00
Fittings	Off Set—Left (18")	LF4HC08OL18	\$4216.00
Fittings	Off Set—Right (6")	LF4HC08OR06	\$3952.00
Fittings	Off Set—Right (12")	LF4HC08OR12	\$4084.00
Fittings	Off Set—Right (18")	LF4HC08OR18	\$4216.00

## Hangers - Common to all Services

Amperage	Accessory Type	Product Number	List Price GO-126L
800 Amps	Hanger-Edgewise—Trapeze	SLTE2	\$33.00
800 Amps	Hanger-Flatwise—Trapeze	SLTF2	\$33.00
800 Amps	Hanger-Edgewise—Clevis	SLEC2	\$33.00
225 Amps	Hanger-Flatwise—Clevis	SLFC2 <sup>1</sup>	\$33.00
400 Amps	Hanger-Flatwise—Clevis	SLFC3 <sup>1</sup>	\$33.00
600 Amps	Hanger-Flatwise—Clevis	SLFC4 <sup>1</sup>	\$33.00
800 Amps	Hanger-Flatwise—Clevis	SLFC5 <sup>1</sup>	\$33.00
400 Amps	Hanger-Spring Riser	SLSR2	\$147.00
600 Amps	Hanger-Spring Riser	SLSR4	\$147.00
800 Amps	Hanger-Spring Riser	SLSR5	\$147.00
225 Amps	Hanger-Wall/Floor Flange	SLWF2	\$100.00
400 Amps	Hanger-Wall/Floor Flange	SLWF3	\$100.00
600 Amps	Hanger-Wall/Floor Flange	SLWF4	\$100.00
800 Amps	Hanger-Wall/Floor Flange	SLWF5	\$100.00
800 Amps	Hanger-Outlet Covers	SLOC2	\$14.00

For new Joint-Guard Protection System, add \$110.00 to the list price shown above.

For Drip-Proof Construction, add 18% to the list prices shown above. For

Transverse Barrier, add \$250.00 to list price of feeder straight lengths only. (Use with fire barrier and wall/floor flange for 3-hour fire rating.)

<sup>1</sup>Standard hanger provided unless otherwise specified.



# Busway Spectra® Series Busway

LowAmp

Copper Conductors

Product Number Pricing

# Section 11

## 225 Amps Three-Phase, Three-Wire Internal Copper Ground Bar

Component	Type	Product Number	List Price GO-126L
Linear Lengths	Plug-In: 10-ft.	LP3GC02SL10	\$2175.00
Linear Lengths	Plug-In: 6-ft.	LP3GC02SL06	\$1478.00
Linear Lengths	Plug-In: 4-ft.	LP3GC02SL04	\$1172.00
Linear Lengths	Feeder: 10-ft.	LF3GC02SL10	\$1496.00
Linear Lengths	Feeder: 5-ft.	LF3GC02SL05	\$924.00
Linear Lengths	Feeder: 3-ft.	LF3GC02SL03	\$702.00
Linear Lengths	Feeder: 2-ft.	LF3GC02SL02	\$607.00
Linear Lengths	Adjustable Straight Length	LF3GC02ASST	\$2610.00
Fittings	Elbow Left 90°	LF3GC02ELST	\$1214.00
Fittings	Elbow Right 90°	LF3GC02ERST	\$1214.00
Fittings	Elbow Up 90°	LF3GC02EUST	\$1030.00
Fittings	Elbow Down 90°	LF3GC02EDST	\$1030.00
Accessories	End Cable Tap Box—Up	LF3GC02TTST	\$2461.00
Accessories	End Cable Tap Box—Down	LF3GC02TBST	\$2461.00
Accessories	Center Cable Tap Box—Up	LF3GC02CTST	\$2573.00
Accessories	Center Cable Tap Box—Down	LF3GC02CBST	\$2573.00
Accessories	End Box	LF3GC02EBST	\$200.00
Accessories	Flanged End w/Lugs	LF3GC02FLST	\$936.00
Accessories	Flanged End	LF3GC02FEST	\$653.00
Fittings	Expansion Length—Up	LF3GC02XUST	\$5648.00
Fittings	Expansion Length—Down	LF3GC02XDST	\$5648.00
Fittings	Total Phase Transposition	LF3GC02TFST	\$4175.00
Fittings	Tee—Right	LF3GC02TRST	\$1592.00
Fittings	Tee—Left	LF3GC02TLST	\$1592.00
Fittings	Tee—Up	LF3GC02TUST	\$2823.00
Fittings	Tee—Down	LF3GC02TDST	\$2823.00
Fittings	Off Set—Up (6")	LF3GC02OU06	\$2838.00
Fittings	Off Set—Up (12")	LF3GC02OU12	\$2922.00
Fittings	Off Set—Up (18")	LF3GC02OU18	\$3007.00
Fittings	Off Set—Down (6")	LF3GC02OD06	\$2838.00
Fittings	Off Set—Down (12")	LF3GC02OD12	\$2922.00
Fittings	Off Set—Down (18")	LF3GC02OD18	\$3007.00
Fittings	Off Set—Left (6")	LF3GC02OL06	\$3361.00
Fittings	Off Set—Left (12")	LF3GC02OL12	\$3446.00
Fittings	Off Set—Left (18")	LF3GC02OL18	\$3530.00
Fittings	Off Set—Right (6")	LF3GC02OR06	\$3361.00
Fittings	Off Set—Right (12")	LF3GC02OR12	\$3446.00
Fittings	Off Set—Right (18")	LF3GC02OR18	\$3530.00

## 400 Amps Three-Phase, Three-Wire Internal Copper Ground Bar

Component	Type	Product Number	List Price GO-126L
Linear Lengths	Plug-In: 10-ft.	LP3GC04SL10	\$2175.00
Linear Lengths	Plug-In: 6-ft.	LP3GC04SL06	\$1478.00
Linear Lengths	Plug-In: 4-ft.	LP3GC04SL04	\$1172.00
Linear Lengths	Feeder: 10-ft.	LF3GC04SL10	\$1496.00
Linear Lengths	Feeder: 5-ft.	LF3GC04SL05	\$924.00
Linear Lengths	Feeder: 3-ft.	LF3GC04SL03	\$702.00
Linear Lengths	Feeder: 2-ft.	LF3GC04SL02	\$607.00
Linear Lengths	Adjustable Straight Length	LF3GC04ASST	\$2610.00
Fittings	Elbow Left 90°	LF3GC04ELST	\$1214.00
Fittings	Elbow Right 90°	LF3GC04ERST	\$1214.00
Fittings	Elbow Up 90°	LF3GC04EUST	\$1030.00
Fittings	Elbow Down 90°	LF3GC04EDST	\$1030.00
Accessories	End Cable Tap Box—Up	LF3GC04TTST	\$2461.00
Accessories	End Cable Tap Box—Down	LF3GC04TBST	\$2461.00
Accessories	Center Cable Tap Box—Up	LF3GC04CTST	\$2573.00
Accessories	Center Cable Tap Box—Down	LF3GC04CBST	\$2573.00
Accessories	End Box	LF3GC04EBST	\$200.00
Accessories	Flanged End w/Lugs	LF3GC04FLST	\$1055.00
Accessories	Flanged End	LF3GC04FEST	\$653.00
Fittings	Expansion Length—Up	LF3GC04XUST	\$5648.00
Fittings	Expansion Length—Down	LF3GC04XDST	\$5648.00
Fittings	Total Phase Transposition	LF3GC04TFST	\$4175.00
Fittings	Tee—Right	LF3GC04TRST	\$1592.00
Fittings	Tee—Left	LF3GC04TLST	\$1592.00
Fittings	Tee—Up	LF3GC04TUST	\$2823.00
Fittings	Tee—Down	LF3GC04TDST	\$2823.00
Fittings	Off Set—Up (6")	LF3GC04OU06	\$2838.00
Fittings	Off Set—Up (12")	LF3GC04OU12	\$2922.00
Fittings	Off Set—Up (18")	LF3GC04OU18	\$3007.00
Fittings	Off Set—Down (6")	LF3GC04OD06	\$2838.00
Fittings	Off Set—Down (12")	LF3GC04OD12	\$2922.00
Fittings	Off Set—Down (18")	LF3GC04OD18	\$3007.00
Fittings	Off Set—Left (6")	LF3GC04OL06	\$3361.00
Fittings	Off Set—Left (12")	LF3GC04OL12	\$3446.00
Fittings	Off Set—Left (18")	LF3GC04OL18	\$3530.00
Fittings	Off Set—Right (6")	LF3GC04OR06	\$3361.00
Fittings	Off Set—Right (12")	LF3GC04OR12	\$3446.00
Fittings	Off Set—Right (18")	LF3GC04OR18	\$3530.00

## Hangers - Common to all Services

Amperage	Accessory Type	Product Number	List Price GO-126L
800 Amps	Hanger-Edgewise—Trapeze	SLTE2	\$33.00
800 Amps	Hanger-Flatwise—Trapeze	SLTF2	\$33.00
800 Amps	Hanger-Edgewise—Clevis	SLEC2	\$33.00
225 Amps	Hanger-Flatwise—Clevis	SLFC2 <sup>1</sup>	\$33.00
400 Amps	Hanger-Flatwise—Clevis	SLFC3 <sup>1</sup>	\$33.00
600 Amps	Hanger-Flatwise—Clevis	SLFC4 <sup>1</sup>	\$33.00
800 Amps	Hanger-Flatwise—Clevis	SLFC5 <sup>1</sup>	\$33.00
400 Amps	Hanger-Spring Riser	SLSR2	\$147.00
600 Amps	Hanger-Spring Riser	SLSR4	\$147.00
800 Amps	Hanger-Spring Riser	SLSR5	\$147.00
225 Amps	Hanger-Wall/Floor Flange	SLWF2	\$100.00
400 Amps	Hanger-Wall/Floor Flange	SLWF3	\$100.00
600 Amps	Hanger-Wall/Floor Flange	SLWF4	\$100.00
800 Amps	Hanger-Wall/Floor Flange	SLWF5	\$100.00
800 Amps	Hanger-Outlet Covers	SLOC2	\$14.00

For new Joint-Guard Protection System, add \$110.00 to the list price shown above.

For Drip-Proof Construction, add 18% to the list prices shown above. For

Transverse Barrier, add \$250.00 to list price of feeder straight lengths only. (Use with fire barrier and wall/floor flange for 3-hour fire rating.)

<sup>1</sup>Standard hanger provided unless otherwise specified.



# Busway Spectra® Series Busway (continued)

LowAmp  
Copper Conductors  
Product Number Pricing

## 600 Amps Three-Phase, Three-Wire Internal Copper Ground Bar

Component	Type	Product Number	List Price GO-126L
Linear Lengths	Plug-In: 10-ft.	LP3GC06SL10	\$2253.00
Linear Lengths	Plug-In: 6-ft.	LP3GC06SL06	\$1522.00
Linear Lengths	Plug-In: 4-ft.	LP3GC06SL04	\$1195.00
Linear Lengths	Feeder: 10-ft.	LF3GC06SL10	\$1636.00
Linear Lengths	Feeder: 5-ft.	LF3GC06SL05	\$994.00
Linear Lengths	Feeder: 3-ft.	LF3GC06SL03	\$743.00
Linear Lengths	Feeder: 2-ft.	LF3GC06SL02	\$633.00
Linear Lengths	Adjustable Straight Length	LF3GC06ASST	\$2704.00
Fittings	Elbow Left 90°	LF3GC06ELST	\$1272.00
Fittings	Elbow Right 90°	LF3GC06ERST	\$1272.00
Fittings	Elbow Up 90°	LF3GC06EUST	\$1089.00
Fittings	Elbow Down 90°	LF3GC06EDST	\$1089.00
Accessories	End Cable Tap Box—Up	LF3GC06TTST	\$2508.00
Accessories	End Cable Tap Box—Down	LF3GC06TBST	\$2508.00
Accessories	Center Cable Tap Box—Up	LF3GC06CTST	\$2620.00
Accessories	Center Cable Tap Box—Down	LF3GC06CBST	\$2620.00
Accessories	End Box	LF3GC06EBST	\$200.00
Accessories	Flanged End w/Lugs	LF3GC06FLST	\$1106.00
Accessories	Flanged End	LF3GC06FEST	\$705.00
Fittings	Expansion Length—Up	LF3GC06XUST	\$5768.00
Fittings	Expansion Length—Down	LF3GC06XDST	\$5768.00
Fittings	Total Phase Transposition	LF3GC06TFST	\$4264.00
Fittings	Tee—Right	LF3GC06TRST	\$1678.00
Fittings	Tee—Left	LF3GC06TLST	\$1678.00
Fittings	Tee—Up	LF3GC06TUST	\$2922.00
Fittings	Tee—Down	LF3GC06TDST	\$2922.00
Fittings	Off Set—Up (6")	LF3GC06OU06	\$2988.00
Fittings	Off Set—Up (12")	LF3GC06OU12	\$3084.00
Fittings	Off Set—Up (18")	LF3GC06OU18	\$3180.00
Fittings	Off Set—Down (6")	LF3GC06OD06	\$2988.00
Fittings	Off Set—Down (12")	LF3GC06OD12	\$3084.00
Fittings	Off Set—Down (18")	LF3GC06OD18	\$3180.00
Fittings	Off Set—Left (6")	LF3GC06OL06	\$3511.00
Fittings	Off Set—Left (12")	LF3GC06OL12	\$3607.00
Fittings	Off Set—Left (18")	LF3GC06OL18	\$3703.00
Fittings	Off Set—Right (6")	LF3GC06OR06	\$3511.00
Fittings	Off Set—Right (12")	LF3GC06OR12	\$3607.00
Fittings	Off Set—Right (18")	LF3GC06OR18	\$3703.00

# Section 11

## 800 Amps Three-Phase, Three-Wire Internal Copper Ground Bar

Component	Type	Product Number	List Price GO-126L
Linear Lengths	Plug-In: 10-ft.	LP3GC08SL10	\$2570.00
Linear Lengths	Plug-In: 6-ft.	LP3GC08SL06	\$1723.00
Linear Lengths	Plug-In: 4-ft.	LP3GC08SL04	\$1337.00
Linear Lengths	Feeder: 10-ft.	LF3GC08SL10	\$1982.00
Linear Lengths	Feeder: 5-ft.	LF3GC08SL05	\$1183.00
Linear Lengths	Feeder: 3-ft.	LF3GC08SL03	\$869.00
Linear Lengths	Feeder: 2-ft.	LF3GC08SL02	\$726.00
Linear Lengths	Adjustable Straight Length	LF3GC08ASST	\$3084.00
Fittings	Elbow Left 90°	LF3GC08ELST	\$1369.00
Fittings	Elbow Right 90°	LF3GC08ERST	\$1369.00
Fittings	Elbow Up 90°	LF3GC08EUST	\$1186.00
Fittings	Elbow Down 90°	LF3GC08EDST	\$1186.00
Accessories	End Cable Tap Box—Up	LF3GC08TTST	\$2585.00
Accessories	End Cable Tap Box—Down	LF3GC08TBST	\$2585.00
Accessories	Center Cable Tap Box—Up	LF3GC08CTST	\$2697.00
Accessories	Center Cable Tap Box—Down	LF3GC08CBST	\$2697.00
Accessories	End Box	LF3GC08EBST	\$200.00
Accessories	Flanged End w/Lugs	LF3GC08FLST	\$1310.00
Accessories	Flanged End	LF3GC08FEST	\$791.00
Fittings	Expansion Length—Up	LF3GC08XUST	\$5967.00
Fittings	Expansion Length—Down	LF3GC08XDST	\$5967.00
Fittings	Total Phase Transposition	LF3GC08TFST	\$4410.00
Fittings	Tee—Right	LF3GC08TRST	\$1819.00
Fittings	Tee—Left	LF3GC08TLST	\$1819.00
Fittings	Tee—Up	LF3GC08TUST	\$3086.00
Fittings	Tee—Down	LF3GC08TDST	\$3086.00
Fittings	Off Set—Up (6")	LF3GC08OU06	\$3235.00
Fittings	Off Set—Up (12")	LF3GC08OU12	\$3350.00
Fittings	Off Set—Up (18")	LF3GC08OU18	\$3465.00
Fittings	Off Set—Down (6")	LF3GC08OD06	\$3235.00
Fittings	Off Set—Down (12")	LF3GC08OD12	\$3350.00
Fittings	Off Set—Down (18")	LF3GC08OD18	\$3465.00
Fittings	Off Set—Left (6")	LF3GC08OL06	\$3759.00
Fittings	Off Set—Left (12")	LF3GC08OL12	\$3873.00
Fittings	Off Set—Left (18")	LF3GC08OL18	\$3988.00
Fittings	Off Set—Right (6")	LF3GC08OR06	\$3759.00
Fittings	Off Set—Right (12")	LF3GC08OR12	\$3873.00
Fittings	Off Set—Right (18")	LF3GC08OR18	\$3988.00

## Hangers - Common to all Services

Amperage	Accessory Type	Product Number	List Price GO-126L
800 Amps	Hanger-Edgewise—Trapeze	SLTE2	\$33.00
800 Amps	Hanger-Flatwise—Trapeze	SLTF2	\$33.00
800 Amps	Hanger-Edgewise—Clevis	SLEC2	\$33.00
225 Amps	Hanger-Flatwise—Clevis	SLFC2 <sup>1</sup>	\$33.00
400 Amps	Hanger-Flatwise—Clevis	SLFC3 <sup>1</sup>	\$33.00
600 Amps	Hanger-Flatwise—Clevis	SLFC4 <sup>1</sup>	\$33.00
800 Amps	Hanger-Flatwise—Clevis	SLFC5 <sup>1</sup>	\$33.00
400 Amps	Hanger-Spring Riser	SLSR2	\$147.00
600 Amps	Hanger-Spring Riser	SLSR4	\$147.00
800 Amps	Hanger-Spring Riser	SLSR5	\$147.00
225 Amps	Hanger-Wall/Floor Flange	SLWF2	\$100.00
400 Amps	Hanger-Wall/Floor Flange	SLWF3	\$100.00
600 Amps	Hanger-Wall/Floor Flange	SLWF4	\$100.00
800 Amps	Hanger-Wall/Floor Flange	SLWF5	\$100.00
800 Amps	Hanger-Outlet Covers	SLOC2	\$14.00

For new Joint-Guard Protection System, add \$110.00 to the list price shown above.

For Drip-Proof Construction, add 18% to the list prices shown above. For

Transverse Barrier, add \$250.00 to list price of feeder straight lengths only. (Use with fire barrier and wall/floor flange for 3-hour fire rating.)

<sup>1</sup>Standard hanger provided unless otherwise specified.



# Busway Spectra® Series Busway

LowAmp  
Copper Conductors  
Product Number Pricing

# Section 11

## 225 Amps Three-Phase, Four-Wire Internal Copper Ground Bus

Component	Type	Product Number	List Price GO-126L
Linear Lengths	Plug-In: 10-ft.	LP4GC02SL10	\$2476.00
Linear Lengths	Plug-In: 6-ft.	LP4GC02SL06	\$1682.00
Linear Lengths	Plug-In: 4-ft.	LP4GC02SL04	\$1334.00
Linear Lengths	Feeder: 10-ft.	LF4GC02SL10	\$1723.00
Linear Lengths	Feeder: 5-ft.	LF4GC02SL05	\$1061.00
Linear Lengths	Feeder: 3-ft.	LF4GC02SL03	\$805.00
Linear Lengths	Feeder: 2-ft.	LF4GC02SL02	\$696.00
Linear Lengths	Adjustable Straight Length	LF4GC02ASST	\$2971.00
Fittings	Elbow Left 90°	LF4GC02ELST	\$1271.00
Fittings	Elbow Right 90°	LF4GC02ERST	\$1271.00
Fittings	Elbow Up 90°	LF4GC02EUST	\$1088.00
Fittings	Elbow Down 90°	LF4GC02EDST	\$1088.00
Accessories	End Cable Tap Box—Up	LF4GC02TTST	\$2505.00
Accessories	End Cable Tap Box—Down	LF4GC02TBST	\$2505.00
Accessories	Center Cable Tap Box—Up	LF4GC02CTST	\$2617.00
Accessories	Center Cable Tap Box—Down	LF4GC02CBST	\$2617.00
Accessories	End Box	LF4GC02EBST	\$200.00
Accessories	Flanged End w/Lugs	LF4GC02FLST	\$968.00
Accessories	Flanged End	LF4GC02FEST	\$685.00
Fittings	Expansion Length—Up	LF4GC02XUST	\$5783.00
Fittings	Expansion Length—Down	LF4GC02XDST	\$5783.00
Fittings	Total Phase Transposition	LF4GC02TFST	\$4274.00
Fittings	Tee—Right	LF4GC02TRST	\$1648.00
Fittings	Tee—Left	LF4GC02TLST	\$1648.00
Fittings	Tee—Up	LF4GC02TUST	\$2886.00
Fittings	Tee—Down	LF4GC02TDST	\$2886.00
Fittings	Off Set—Up (6")	LF4GC02OU06	\$2997.00
Fittings	Off Set—Up (12")	LF4GC02OU12	\$3096.00
Fittings	Off Set—Up (18")	LF4GC02OU18	\$3195.00
Fittings	Off Set—Down (6")	LF4GC02OD06	\$2997.00
Fittings	Off Set—Down (12")	LF4GC02OD12	\$3096.00
Fittings	Off Set—Down (18")	LF4GC02OD18	\$3195.00
Fittings	Off Set—Left (6")	LF4GC02OL06	\$3521.00
Fittings	Off Set—Left (12")	LF4GC02OL12	\$3620.00
Fittings	Off Set—Left (18")	LF4GC02OL18	\$3718.00
Fittings	Off Set—Right (6")	LF4GC02OR06	\$3521.00
Fittings	Off Set—Right (12")	LF4GC02OR12	\$3620.00
Fittings	Off Set—Right (18")	LF4GC02OR18	\$3718.00

## 400 Amps Three-Phase, Four-Wire Internal Copper Ground Bus

Component	Type	Product Number	List Price GO-126L
Linear Lengths	Plug-In: 10-ft.	LP4GC04SL10	\$2476.00
Linear Lengths	Plug-In: 6-ft.	LP4GC04SL06	\$1682.00
Linear Lengths	Plug-In: 4-ft.	LP4GC04SL04	\$1334.00
Linear Lengths	Feeder: 10-ft.	LF4GC04SL10	\$1723.00
Linear Lengths	Feeder: 5-ft.	LF4GC04SL05	\$1061.00
Linear Lengths	Feeder: 3-ft.	LF4GC04SL03	\$805.00
Linear Lengths	Feeder: 2-ft.	LF4GC04SL02	\$696.00
Linear Lengths	Adjustable Straight Length	LF4GC04ASST	\$2971.00
Fittings	Elbow Left 90°	LF4GC04ELST	\$1271.00
Fittings	Elbow Right 90°	LF4GC04ERST	\$1271.00
Fittings	Elbow Up 90°	LF4GC04EUST	\$1088.00
Fittings	Elbow Down 90°	LF4GC04EDST	\$1088.00
Accessories	End Cable Tap Box—Up	LF4GC04TTST	\$2505.00
Accessories	End Cable Tap Box—Down	LF4GC04TBST	\$2505.00
Accessories	Center Cable Tap Box—Up	LF4GC04CTST	\$2617.00
Accessories	Center Cable Tap Box—Down	LF4GC04CBST	\$2617.00
Accessories	End Box	LF4GC04EBST	\$200.00
Accessories	Flanged End w/Lugs	LF4GC04FLST	\$1086.00
Accessories	Flanged End	LF4GC04FEST	\$685.00
Fittings	Expansion Length—Up	LF4GC04XUST	\$5783.00
Fittings	Expansion Length—Down	LF4GC04XDST	\$5783.00
Fittings	Total Phase Transposition	LF4GC04TFST	\$4274.00
Fittings	Tee—Right	LF4GC04TRST	\$1648.00
Fittings	Tee—Left	LF4GC04TLST	\$1648.00
Fittings	Tee—Up	LF4GC04TUST	\$2886.00
Fittings	Tee—Down	LF4GC04TDST	\$2886.00
Fittings	Off Set—Up (6")	LF4GC04OU06	\$2997.00
Fittings	Off Set—Up (12")	LF4GC04OU12	\$3096.00
Fittings	Off Set—Up (18")	LF4GC04OU18	\$3195.00
Fittings	Off Set—Down (6")	LF4GC04OD06	\$2997.00
Fittings	Off Set—Down (12")	LF4GC04OD12	\$3096.00
Fittings	Off Set—Down (18")	LF4GC04OD18	\$3195.00
Fittings	Off Set—Left (6")	LF4GC04OL06	\$3521.00
Fittings	Off Set—Left (12")	LF4GC04OL12	\$3620.00
Fittings	Off Set—Left (18")	LF4GC04OL18	\$3718.00
Fittings	Off Set—Right (6")	LF4GC04OR06	\$3521.00
Fittings	Off Set—Right (12")	LF4GC04OR12	\$3620.00
Fittings	Off Set—Right (18")	LF4GC04OR18	\$3718.00

## Hangers - Common to all Services

Amperage	Accessory Type	Product Number	List Price GO-126L
800 Amps	Hanger-Edgewise—Trapeze	SLTE2	\$33.00
800 Amps	Hanger-Flatwise—Trapeze	SLTF2	\$33.00
800 Amps	Hanger-Edgewise—Clevis	SLEC2	\$33.00
225 Amps	Hanger-Flatwise—Clevis	SLFC2 <sup>1</sup>	\$33.00
400 Amps	Hanger-Flatwise—Clevis	SLFC3 <sup>1</sup>	\$33.00
600 Amps	Hanger-Flatwise—Clevis	SLFC4 <sup>1</sup>	\$33.00
800 Amps	Hanger-Flatwise—Clevis	SLFC5 <sup>1</sup>	\$33.00
400 Amps	Hanger-Spring Riser	SLSR2	\$147.00
600 Amps	Hanger-Spring Riser	SLSR4	\$147.00
800 Amps	Hanger-Spring Riser	SLSR5	\$147.00
225 Amps	Hanger-Wall/Floor Flange	SLWF2	\$100.00
400 Amps	Hanger-Wall/Floor Flange	SLWF3	\$100.00
600 Amps	Hanger-Wall/Floor Flange	SLWF4	\$100.00
800 Amps	Hanger-Wall/Floor Flange	SLWF5	\$100.00
800 Amps	Hanger-Outlet Covers	SLOC2	\$14.00

For new Joint-Guard Protection System, add \$110.00 to the list price shown above.

For Drip-Proof Construction, add 18% to the list prices shown above. For

Transverse Barrier, add \$250.00 to list price of feeder straight lengths only. (Use with fire barrier and wall/floor flange for 3-hour fire rating.)

<sup>1</sup>Standard hanger provided unless otherwise specified.



# Busway Spectra® Series Busway (continued)

LowAmp  
Copper Conductors  
Product Number Pricing

# Section 11

## 600 Amps Three-Phase, Four-Wire Internal Copper Ground Bus

## 800 Amps Three-Phase, Four-Wire Internal Copper Ground Bus

Component	Type	Product Number	List Price GO-126L
Linear Lengths	Plug-In: 10-ft.	LP4GC06SL10	\$2589.00
Linear Lengths	Plug-In: 6-ft.	LP4GC06SL06	\$1745.00
Linear Lengths	Plug-In: 4-ft.	LP4GC06SL04	\$1368.00
Linear Lengths	Feeder: 10-ft.	LF4GC06SL10	\$1898.00
Linear Lengths	Feeder: 5-ft.	LF4GC06SL05	\$1148.00
Linear Lengths	Feeder: 3-ft.	LF4GC06SL03	\$855.00
Linear Lengths	Feeder: 2-ft.	LF4GC06SL02	\$726.00
Linear Lengths	Adjustable Straight Length	LF4GC06ASST	\$3107.00
Fittings	Elbow Left 90°	LF4GC06ELST	\$1339.00
Fittings	Elbow Right 90°	LF4GC06ERST	\$1339.00
Fittings	Elbow Up 90°	LF4GC06EUST	\$1156.00
Fittings	Elbow Down 90°	LF4GC06EDST	\$1156.00
Accessories	End Cable Tap Box—Up	LF4GC06TTST	\$2557.00
Accessories	End Cable Tap Box—Down	LF4GC06TBST	\$2557.00
Accessories	Center Cable Tap Box—Up	LF4GC06CTST	\$2669.00
Accessories	Center Cable Tap Box—Down	LF4GC06CBST	\$2669.00
Accessories	End Box	LF4GC06EBST	\$200.00
Accessories	Flanged End w/Lugs	LF4GC06FLST	\$1144.00
Accessories	Flanged End	LF4GC06FEST	\$743.00
Fittings	Expansion Length—Up	LF4GC06XUST	\$5925.00
Fittings	Expansion Length—Down	LF4GC06XDST	\$5925.00
Fittings	Total Phase Transposition	LF4GC06TFST	\$4380.00
Fittings	Tee—Right	LF4GC06TRST	\$1745.00
Fittings	Tee—Left	LF4GC06TLST	\$1745.00
Fittings	Tee—Up	LF4GC06TUST	\$3000.00
Fittings	Tee—Down	LF4GC06TDST	\$3000.00
Fittings	Off Set—Up (6")	LF4GC06OU06	\$3176.00
Fittings	Off Set—Up (12")	LF4GC06OU12	\$3289.00
Fittings	Off Set—Up (18")	LF4GC06OU18	\$3401.00
Fittings	Off Set—Down (6")	LF4GC06OD06	\$3176.00
Fittings	Off Set—Down (12")	LF4GC06OD12	\$3289.00
Fittings	Off Set—Down (18")	LF4GC06OD18	\$3401.00
Fittings	Off Set—Left (6")	LF4GC06OL06	\$3699.00
Fittings	Off Set—Left (12")	LF4GC06OL12	\$3812.00
Fittings	Off Set—Left (18")	LF4GC06OL18	\$3925.00
Fittings	Off Set—Right (6")	LF4GC06OR06	\$3699.00
Fittings	Off Set—Right (12")	LF4GC06OR12	\$3812.00
Fittings	Off Set—Right (18")	LF4GC06OR18	\$3925.00

Component	Type	Product Number	List Price GO-126L
Linear Lengths	Plug-In: 10-ft.	LP4GC08SL10	\$2982.00
Linear Lengths	Plug-In: 6-ft.	LP4GC08SL06	\$1992.00
Linear Lengths	Plug-In: 4-ft.	LP4GC08SL04	\$1540.00
Linear Lengths	Feeder: 10-ft.	LF4GC08SL10	\$2325.00
Linear Lengths	Feeder: 5-ft.	LF4GC08SL05	\$1377.00
Linear Lengths	Feeder: 3-ft.	LF4GC08SL03	\$1004.00
Linear Lengths	Feeder: 2-ft.	LF4GC08SL02	\$835.00
Linear Lengths	Adjustable Straight Length	LF4GC08ASST	\$3587.00
Fittings	Elbow Left 90°	LF4GC08ELST	\$1453.00
Fittings	Elbow Right 90°	LF4GC08ERST	\$1453.00
Fittings	Elbow Up 90°	LF4GC08EUST	\$1270.00
Fittings	Elbow Down 90°	LF4GC08EDST	\$1270.00
Accessories	End Cable Tap Box—Up	LF4GC08TTST	\$2645.00
Accessories	End Cable Tap Box—Down	LF4GC08TBST	\$2645.00
Accessories	Center Cable Tap Box—Up	LF4GC08CTST	\$2757.00
Accessories	Center Cable Tap Box—Down	LF4GC08CBST	\$2757.00
Accessories	End Box	LF4GC08EBST	\$200.00
Accessories	Flanged End w/Lugs	LF4GC08FLST	\$1359.00
Accessories	Flanged End	LF4GC08FEST	\$840.00
Fittings	Expansion Length—Up	LF4GC08XUST	\$6162.00
Fittings	Expansion Length—Down	LF4GC08XDST	\$6162.00
Fittings	Total Phase Transposition	LF4GC08TFST	\$4555.00
Fittings	Tee—Right	LF4GC08TRST	\$1907.00
Fittings	Tee—Left	LF4GC08TLST	\$1907.00
Fittings	Tee—Up	LF4GC08TUST	\$3189.00
Fittings	Tee—Down	LF4GC08TDST	\$3189.00
Fittings	Off Set—Up (6")	LF4GC08OU06	\$3473.00
Fittings	Off Set—Up (12")	LF4GC08OU12	\$3609.00
Fittings	Off Set—Up (18")	LF4GC08OU18	\$3746.00
Fittings	Off Set—Down (6")	LF4GC08OD06	\$3473.00
Fittings	Off Set—Down (12")	LF4GC08OD12	\$3609.00
Fittings	Off Set—Down (18")	LF4GC08OD18	\$3746.00
Fittings	Off Set—Left (6")	LF4GC08OL06	\$3997.00
Fittings	Off Set—Left (12")	LF4GC08OL12	\$4133.00
Fittings	Off Set—Left (18")	LF4GC08OL18	\$4269.00
Fittings	Off Set—Right (6")	LF4GC08OR06	\$3997.00
Fittings	Off Set—Right (12")	LF4GC08OR12	\$4133.00
Fittings	Off Set—Right (18")	LF4GC08OR18	\$4269.00

## Hangers - Common to all Services

Amperage	Accessory Type	Product Number	List Price GO-126L
800 Amps	Hanger-Edgewise—Trapeze	SLTE2	\$33.00
800 Amps	Hanger-Flatwise—Trapeze	SLTF2	\$33.00
800 Amps	Hanger-Edgewise—Clevis	SLEC2	\$33.00
225 Amps	Hanger-Flatwise—Clevis	SLFC2 <sup>1</sup>	\$33.00
400 Amps	Hanger-Flatwise—Clevis	SLFC3 <sup>1</sup>	\$33.00
600 Amps	Hanger-Flatwise—Clevis	SLFC4 <sup>1</sup>	\$33.00
800 Amps	Hanger-Flatwise—Clevis	SLFC5 <sup>1</sup>	\$33.00
400 Amps	Hanger-Spring Riser	SLSR2	\$147.00
600 Amps	Hanger-Spring Riser	SLSR4	\$147.00
800 Amps	Hanger-Spring Riser	SLSR5	\$147.00
225 Amps	Hanger-Wall/Floor Flange	SLWF2	\$100.00
400 Amps	Hanger-Wall/Floor Flange	SLWF3	\$100.00
600 Amps	Hanger-Wall/Floor Flange	SLWF4	\$100.00
800 Amps	Hanger-Wall/Floor Flange	SLWF5	\$100.00
800 Amps	Hanger-Outlet Covers	SLOC2	\$14.00

For new Joint-Guard Protection System, add \$110.00 to the list price shown above.

For Drip-Proof Construction, add 18% to the list prices shown above. For

Transverse Barrier, add \$250.00 to list price of feeder straight lengths only. (Use with fire barrier and wall/floor flange for 3-hour fire rating.)

<sup>1</sup>Standard hanger provided unless otherwise specified.



# Busway Spectra® Series Busway

LowAmp

Circuit Breaker Busway Plugs

# Section 11

## Features and Benefits

- Rating Plug: simplifies factory floor and equipment changeovers because plug has trip/amp interchangeability.
- True Digital rms Sensing: more accurate and reliable trip interruption.
- High Interrupting Rating: satisfies high IC requirements up to 100 kAIC @ 480V.
- UL Listed and CSA Certified: for heat rise, short-circuit, and ground fault.
- Interlocks and Safety Features: door interlock, plug interlock, ground contact before stab contact, and plug assist for mechanical installation.

Breakers must be factory-installed.

## Low-Tier Frames Three-Phase, Three-Wire SEDA

Trip Amps	Short Circuit Rating @ 240V (kAIC)	Short Circuit Rating @ 480V (kAIC)	Short Circuit Rating @ 600V (kAIC)	Product Number	List Price GO-112M
15	18	14	14	SL31SEDDG	\$1506.00
20	18	14	14	SL32SEDDG	\$1506.00
30	18	14	14	SL33SEDDG	\$1506.00
40	18	14	14	SL34SEDDG	\$1506.00
50	18	14	14	SL35SEDDG	\$1506.00
60	18	14	14	SL36SEDDG	\$1506.00
70	18	14	14	SL37SEDDG	\$1658.00
80	18	14	14	SL38SEDDG	\$1658.00
90	18	14	14	SL39SEDDG	\$1658.00
100	18	14	14	SL310SEDDG	\$1658.00
110	18	14	14	SL311SEDDG	\$3872.00
125	18	14	14	SL312SEDDG	\$3872.00
150	18	14	14	SL315SEDDG	\$3872.00

## Low-Tier Frames Three-Phase, Three-Wire SEHA

Trip Amps	Short Circuit Rating @ 240V (kAIC)	Short Circuit Rating @ 480V (kAIC)	Short Circuit Rating @ 600V (kAIC)	Product Number	List Price GO-112M
15	65	25	18	SL31SEHG	\$1908.00
20	65	25	18	SL32SEHG	\$1908.00
30	65	25	18	SL33SEHG	\$1908.00
40	65	25	18	SL34SEHG	\$1908.00
50	65	25	18	SL35SEHG	\$1908.00
60	65	25	18	SL36SEHG	\$1908.00
70	65	25	18	SL37SEHG	\$2168.00
80	65	25	18	SL38SEHG	\$2168.00
90	65	25	18	SL39SEHG	\$2168.00
100	65	25	18	SL310SEHG	\$2168.00
110	65	25	18	SL311SEHG	\$4326.00
125	65	25	18	SL312SEHG	\$4326.00
150	65	25	18	SL315SEHG	\$4326.00

## Low-Tier Frames Three-Phase, Three-Wire SFHA

Trip Amps	Short Circuit Rating @ 240V (kAIC)	Short Circuit Rating @ 480V (kAIC)	Short Circuit Rating @ 600V (kAIC)	Product Number	List Price GO-112M
70	65	25	18	SL37SFHFG	\$4326.00
90	65	25	18	SL39SFHFG	\$4326.00
100	65	25	18	SL310SFHFG	\$4326.00
110	65	25	18	SL311SFHFG	\$4326.00
125	65	25	18	SL312SFHFG	\$4326.00
150	65	25	18	SL315SFHFG	\$4326.00
175	65	25	18	SL317SFHFG	\$4326.00
200	65	25	18	SL320SFHFG	\$4326.00
225	65	25	18	SL322SFHFG	\$4326.00
250	65	25	18	SL325SFHFG	\$4326.00

## Low-Tier Frames Three-Phase, Four-Wire SEDA

Trip Amps	Short Circuit Rating @ 240V (kAIC)	Short Circuit Rating @ 480V (kAIC)	Short Circuit Rating @ 600V (kAIC)	Product Number	List Price GO-112M
15	18	14	14	SL41SEDDG	\$1636.00
20	18	14	14	SL42SEDDG	\$1636.00
30	18	14	14	SL43SEDDG	\$1636.00
40	18	14	14	SL44SEDDG	\$1636.00
50	18	14	14	SL45SEDDG	\$1636.00
60	18	14	14	SL46SEDDG	\$1636.00
70	18	14	14	SL47SEDDG	\$1788.00
80	18	14	14	SL48SEDDG	\$1788.00
90	18	14	14	SL49SEDDG	\$1788.00
100	18	14	14	SL410SEDDG	\$1788.00
110	18	14	14	SL411SEDDG	\$4002.00
125	18	14	14	SL412SEDDG	\$4002.00
150	18	14	14	SL415SEDDG	\$4002.00

## Low-Tier Frames Three-Phase, Four-Wire SEHA

Trip Amps	Short Circuit Rating @ 240V (kAIC)	Short Circuit Rating @ 480V (kAIC)	Short Circuit Rating @ 600V (kAIC)	Product Number	List Price GO-112M
15	65	25	18	SL41SEHG	\$2038.00
20	65	25	18	SL42SEHG	\$2038.00
30	65	25	18	SL43SEHG	\$2038.00
40	65	25	18	SL44SEHG	\$2038.00
50	65	25	18	SL45SEHG	\$2038.00
60	65	25	18	SL46SEHG	\$2038.00
70	65	25	18	SL47SEHG	\$2194.00
80	65	25	18	SL48SEHG	\$2194.00
90	65	25	18	SL49SEHG	\$2194.00
100	65	25	18	SL410SEHG	\$2194.00
110	65	25	18	SL411SEHG	\$4444.00
125	65	25	18	SL412SEHG	\$4444.00
150	65	25	18	SL415SEHG	\$4444.00



# Busway Spectra® Series Busway (continued)

LowAmp  
Circuit Breaker Busway Plugs

## Section 11

### Low-Tier Frames Three-Phase, Four-Wire SFHA

Trip Amps	Short Circuit Rating @ 240V (kAIC)	Short Circuit Rating @ 480V (kAIC)	Short Circuit Rating @ 600V (kAIC)	Product Number	List Price GO-112M
70	65	25	18	SL47SFHG	\$4444.00
90	65	25	18	SL49SFHG	\$4444.00
100	65	25	18	SL410SFHG	\$4444.00
110	65	25	18	SL411SFHG	\$4444.00
125	65	25	18	SL412SFHG	\$4444.00
150	65	25	18	SL415SFHG	\$4444.00
175	65	25	18	SL417SFHG	\$4444.00
200	65	25	18	SL420SFHG	\$4444.00
225	65	25	18	SL422SFHG	\$4444.00
250	65	25	18	SL425SFHG	\$4444.00

### Mid-Tier Frames Three-Phase, Four-Wire SFLA

Trip Amps	Short Circuit Rating @ 240V (kAIC)	Short Circuit Rating @ 480V (kAIC)	Short Circuit Rating @ 600V (kAIC)	Product Number	List Price GO-112M
70	100	65	25	SL47SFLG	\$8054.00
90	100	65	25	SL49SFLG	\$8054.00
100	100	65	25	SL410SFLG	\$8054.00
110	100	65	25	SL411SFLG	\$8054.00
125	100	65	25	SL412SFLG	\$8054.00
150	100	65	25	SL415SFLG	\$8054.00
175	100	65	25	SL417SFLG	\$8054.00
200	100	65	25	SL420SFLG	\$8054.00
225	100	65	25	SL422SFLG	\$8054.00
250	100	65	25	SL425SFLG	\$8054.00

### Mid-Tier Frames Three-Phase, Three-Wire SELA

Trip Amps	Short Circuit Rating @ 240V (kAIC)	Short Circuit Rating @ 480V (kAIC)	Short Circuit Rating @ 600V (kAIC)	Product Number	List Price GO-112M
15	100	65	25	SL31SELG	\$2910.00
20	100	65	25	SL32SELG	\$2910.00
30	100	65	25	SL33SELG	\$2910.00
40	100	65	25	SL34SELG	\$2910.00
50	100	65	25	SL35SELG	\$2910.00
60	100	65	25	SL36SELG	\$2910.00
70	100	65	25	SL37SELG	\$3430.00
80	100	65	25	SL38SELG	\$3430.00
90	100	65	25	SL39SELG	\$3430.00
100	100	65	25	SL310SELG	\$3430.00
110	100	65	25	SL311SELG	\$7252.00
125	100	65	25	SL312SELG	\$7252.00
150	100	65	25	SL315SELG	\$7252.00

### Without Rating Plug Three-Phase, Three-Wire

Frame Type	Trip Amps	Product Number	List Price GO-112M
SEDGA	15-30	SL301SEGDG	\$1376.00
SEDGA	40-60	SL302SEGDG	\$1376.00
SEDGA	70-100	SL303SEGDG	\$1528.00
SEDGA	110-150	SL304SEGDG	\$3742.00
SEHGA	15-30	SL301SEHG	\$1778.00
SEHGA	40-60	SL302SEHG	\$1778.00
SEHGA	70-100	SL303SEHG	\$1944.00
SEHGA	110-150	SL304SEHG	\$4196.00
SFHGA	70-250	SL300SFHG	\$4196.00
SELGA	15-30	SL301SELG	\$2910.00
SELGA	40-60	SL302SELG	\$2910.00
SELGA	70-100	SL303SELG	\$3430.00
SELGA	110-150	SL304SELG	\$7252.00
SFLGA	70-250	SL300SFLG	\$7638.00
SEPGA	15-30	SL301SEPG	\$3872.00
SEPGA	40-60	SL302SEPG	\$3872.00
SEPGA	70-100	SL303SEPG	\$4652.00
SEPGA	110-150	SL304SEPG	\$9852.00

### Mid-Tier Frames Three-Phase, Three-Wire SFLA

Trip Amps	Short Circuit Rating @ 240V (kAIC)	Short Circuit Rating @ 480V (kAIC)	Short Circuit Rating @ 600V (kAIC)	Product Number	List Price GO-112M
70	100	65	25	SL37SFLG	\$7768.00
90	100	65	25	SL39SFLG	\$7768.00
100	100	65	25	SL310SFLG	\$7768.00
110	100	65	25	SL311SFLG	\$7768.00
125	100	65	25	SL312SFLG	\$7768.00
150	100	65	25	SL315SFLG	\$7768.00
175	100	65	25	SL317SFLG	\$7768.00
200	100	65	25	SL320SFLG	\$7768.00
225	100	65	25	SL322SFLG	\$7768.00
250	100	65	25	SL325SFLG	\$7768.00

### Without Rating Plug Three-Phase, Four-Wire

Frame Type	Trip Amps	Product Number	List Price GO-112M
SEDA	15-30	SL401SEDDG	\$1506.00
SEDA	40-60	SL402SEDDG	\$1506.00
SEDA	70-100	SL403SEDDG	\$1658.00
SEDA	110-150	SL404SEDDG	\$3872.00
SEHA	15-30	SL401SEHG	\$2428.00
SEHA	40-60	SL402SEHG	\$2428.00
SEHA	70-100	SL403SEHG	\$2594.00
SEHA	110-150	SL404SEHG	\$4314.00
SFHA	70-250	SL400SFHG	\$4314.00
SELA	15-30	SL401SELG	\$3170.00
SELA	40-60	SL402SELG	\$3170.00
SELA	70-100	SL403SELG	\$7512.00
SELA	110-150	SL404SELG	\$8054.00
SFLA	70-250	SL400SFLG	\$7924.00

### Mid-Tier Frames Three-Phase, Four-Wire SELA

Trip Amps	Short Circuit Rating @ 240V (kAIC)	Short Circuit Rating @ 480V (kAIC)	Short Circuit Rating @ 600V (kAIC)	Product Number	List Price GO-112M
15	100	65	25	SL41SELG	\$3170.00
20	100	65	25	SL42SELG	\$3170.00
30	100	65	25	SL43SELG	\$3170.00
40	100	65	25	SL44SELG	\$3170.00
50	100	65	25	SL45SELG	\$3170.00
60	100	65	25	SL46SELG	\$3170.00
70	100	65	25	SL47SELG	\$3690.00
80	100	65	25	SL48SELG	\$3690.00
90	100	65	25	SL49SELG	\$3690.00
100	100	65	25	SL410SELG	\$3690.00
110	100	65	25	SL411SELG	\$7512.00
125	100	65	25	SL412SELG	\$7512.00
150	100	65	25	SL415SELG	\$7512.00





# Busway Spectra® Series Busway (continued)

LowAmp

Circuit Breaker Busway Plugs

# Section 11

## Circuit Breaker Plugs - Standard Frames Three-Phase, Three-Wire TEB

Trip Amps	Short Circuit Rating @ 240V (kAIC)	Product Number	List Price GO-112M
15	10	SL31EBG	\$1112.00
20	10	SL32EBG	\$1112.00
30	10	SL33EBG	\$1112.00
40	10	SL34EBG	\$1112.00
50	10	SL35EBG	\$1112.00
60	10	SL36EBG	\$1112.00
70	10	SL37EBG	\$1342.00
100	10	SL310EBG	\$1342.00

## Circuit Breaker Plugs - Standard Frames Three-Phase, Four-Wire TED4

Trip Amps	Short Circuit Rating @ 240V (kAIC)	Short Circuit Rating @ 480V (kAIC)	Product Number	List Price GO-112M
15	18	14	SL41ED4G	\$1528.00
20	18	14	SL42ED4G	\$1528.00
30	18	14	SL43ED4G	\$1528.00
40	18	14	SL44ED4G	\$1528.00
50	18	14	SL45ED4G	\$1528.00
60	18	14	SL46ED4G	\$1528.00
70	18	14	SL47ED4G	\$1656.00
100	18	14	SL410ED4G	\$1656.00

## Circuit Breaker Plugs - Standard Frames Three-Phase, Three-Wire TED4

Trip Amps	Short Circuit Rating @ 240V (kAIC)	Short Circuit Rating @ 480V (kAIC)	Product Number	List Price GO-112M
15	18	14	SL31ED4G	\$1386.00
20	18	14	SL32ED4G	\$1386.00
30	18	14	SL33ED4G	\$1386.00
40	18	14	SL34ED4G	\$1386.00
50	18	14	SL35ED4G	\$1386.00
60	18	14	SL36ED4G	\$1386.00
70	18	14	SL37ED4G	\$1542.00
100	18	14	SL310ED4G	\$1542.00

## Circuit Breaker Plugs - Standard Frames Three-Phase, Four-Wire TED6

Trip Amps	Short Circuit Rating @ 240V (kAIC)	Short Circuit Rating @ 480V (kAIC)	Short Circuit Rating @ 600V (kAIC)	Product Number	List Price GO-112M
15	18	14	14	SL41ED6G	\$1640.00
20	18	14	14	SL42ED6G	\$1640.00
30	18	14	14	SL43ED6G	\$1640.00
40	18	14	14	SL44ED6G	\$1640.00
50	18	14	14	SL45ED6G	\$1640.00
60	18	14	14	SL46ED6G	\$1640.00
70	18	14	14	SL47ED6G	\$1812.00
100	18	14	14	SL410ED6G	\$1812.00

## Circuit Breaker Plugs - Standard Frames Three-Phase, Three-Wire TED6

Trip Amps	Short Circuit Rating @ 240V (kAIC)	Short Circuit Rating @ 480V (kAIC)	Short Circuit Rating @ 600V (kAIC)	Product Number	List Price GO-112M
15	18	14	14	SL31ED6G	\$1528.00
20	18	14	14	SL32ED6G	\$1528.00
30	18	14	14	SL33ED6G	\$1528.00
40	18	14	14	SL34ED6G	\$1528.00
50	18	14	14	SL35ED6G	\$1528.00
60	18	14	14	SL36ED6G	\$1528.00
70	18	14	14	SL37ED6G	\$1684.00
100	18	14	14	SL310ED6G	\$1684.00

## Enclosure Only

Service Type	Frame Type	Trip Amps	Product Number	List Price GO-112M
Three-Phase, Three-Wire	E	100 A max.	SL3100EG	\$728.00
Three-Phase, Three-Wire	F	225 A max.	SL3225FG	\$1196.00
Four-Wire	E	100 A max.	SL4100EG	\$794.00
Four-Wire	F	225 A max.	SL4225FG	\$1378.00

(Order circuit breaker from Section 4)

Not for Spectra® breakers. E and F frame enclosures for standard molded case circuit breakers only.

## Circuit Breaker Plugs - Standard Frames Three-Phase, Four-Wire TEB

Trip Amps	Short Circuit Rating @ 240V (kAIC)	Product Number	List Price GO-112M
15	10	SL41EBG	\$1242.00
20	10	SL42EBG	\$1242.00
30	10	SL43EBG	\$1242.00
40	10	SL44EBG	\$1242.00
50	10	SL45EBG	\$1242.00
60	10	SL46EBG	\$1242.00
70	10	SL47EBG	\$1456.00
100	10	SL410EBG	\$1456.00



# Busway Spectra® Series Busway

LowAmp

Busway Plugs, Fusible, Conversion Kits

## Section 11

### Switch-Operated Fusible Plugs Three-Phase, Three-Wire

Voltage	Trip Amps	Product Number	List Price GO-112L
240Vac	30	SL321RG	\$822.00
240Vac	60	SL322RG	\$904.00
240Vac	100	SL323RG	\$1264.00
240Vac	200	SL324RG	\$2152.00
240Vac	400	SL325RG	\$5626.00
480/600Vac	30	SL361RG	\$904.00
480/600Vac	60	SL362RG	\$938.00
480/600Vac	100	SL363RG	\$1316.00
480/600Vac	200	SL364RG	\$2252.00
480/600Vac	400	SL365RG	\$5694.00

With QMR Interrupter Fuses Not Included

### Switch-Operated Fusible Plugs Three-Phase, Four-Wire

Voltage	Trip Amps	Product Number	List Price GO-112L
240	30	SL421RG	\$972.00
240	60	SL422RG	\$1038.00
240	100	SL423RG	\$1414.00
240	200	SL424RG	\$2412.00
240	400	SL425RG	\$6006.00
480/600	30	SL461RG	\$1038.00
480/600	60	SL462RG	\$1072.00
480/600	100	SL463RG	\$1514.00
480/600	200	SL464RG	\$2496.00
480/600	400	SL465RG	\$6078.00

With QMR Interrupter Fuses Not Included

### Adapter Kits

Convert Spectra® Series LowAmp plugs to Spectra® Series Bus. Ground stabs included.

Amperage	Product Number	List Price GO-112L
30-100	SLSB1G	\$128.00
200-250	SLSB4G	\$294.00
400-600	SLSB5G	\$442.00

### Adapter Kits

Convert Spectra® Series Bus Plugs to Spectra® LowAmp Bus. (Style 2—shipped after 5/95.) Ground stabs included.

Amperage	Product Number	List Price GO-114L
30-100	SBSL1G	\$128.00
200-225	SBSL4G	\$294.00
400-600	SBSL5G	\$442.00

### Adapter Kits

Convert Armor-Clad to Spectra® Series LowAmp (Style 8 shipped after 5/95.) Ground stabs included.

Amperage	Product Number	List Price GO-112L
30-100	ACSL1G	\$128.00
200-225	ACSL4G	\$294.00
400	ACSL5G	\$442.00

### Fusible Switch Unit Options

Use for Spectra® Series Busway

Description	UL Listed	List Price, GO-112L				
		30 Amp	60 Amp	100 Amp	200 Amp	400 Amp
Factory-installed Class R fuse clips. Add "R" suffix to Product Number	Yes	\$96.00	\$96.00	\$96.00	\$122.00	\$130.00
Factory-installed Class J fuse clips. Add "J" suffix to (600 V plug) Product Number	Yes	\$54.00	\$54.00	\$54.00	\$54.00	\$54.00
QMW in lieu of QMR. Change "R" in Product Number to "W".	Yes	\$92.00	\$92.00	\$172.00	\$254.00	\$684.00

### Miscellaneous Plug Modifications

- Drip-Resistant Plug: includes cover and stab gasketing. Add suffix "I" to product number and \$156.00 list, GO-114L or M.
- Plug Assist: standard for plugs over 100 amperes. Add suffix "P" to the product number for plugs 100 amperes and below. \$94.00 list, GO-112L or M



# Busway Spectra® Series Busway

LowAmp  
Busway  
Outlines and Dimensions

## Section 11

### Linear Lengths Three-Phase, Three-Wire

Plug-In and Feeder. All Bus are UL listed at 600 Volts.

Conductor Material	Amperage	"A" Width (inches, mm)	Bar Sizes - Width x Thickness (in.)	DC Ampere Rating <sup>1</sup>	Approx. Weight Lbs./Ft.	Approx. Weight Kg/M
Aluminum	225 Amps	3 (76)	.750 x .250	225	5.1	7.6
Aluminum	400 Amps	3 3/8 (86)	1.125 x .250	600	5.8	8.6
Aluminum	600 Amps	4 (102)	1.750 x .250	800	7	10.4
Aluminum	800 Amps	5 (127)	2.875 x .250	1200	9.1	13.5
Copper	225 Amps	3 (76)	.750 x .250	225	6.6	9.8
Copper	400 Amps	3 (76)	.750 x .250	600	6.6	9.8
Copper	600 Amps	3 3/8 (86)	1.125 x .250	800	8.1	12.1
Copper	800 Amps	4 (102)	1.750 x .250	1200	10.5	15.6

<sup>1</sup>DC Bus. is 4-wire with "+ - + -" polarity.

### Linear Lengths Three-Phase, Four-Wire

Plug-In and Feeder. All Bus are UL listed at 600 Volts

Conductor Material	Amperage	"A" Width (inches, mm)	Bar Sizes - Width x Thickness (in.)	DC Ampere Rating	Approx. Weight Lbs./Ft.	Approx. Weight Kg/M
Aluminum	225 Amps	3 (76)	.750 x .250	225	5.4	8
Aluminum	400 Amps	3 3/8 (86)	1.125 x .250	600	6	8.9
Aluminum	600 Amps	4 (102)	1.750 x .250	800	7.5	11.2
Aluminum	800 Amps	5 (127)	2.875 x .250	1200	10	14.9
Copper	225 Amps	3 (76)	.750 x .250	225	7.4	11
Copper	400 Amps	3 (76)	.750 x .250	600	7.4	11
Copper	600 Amps	3 3/8 (86)	1.125 x .250	800	9.2	13.7
Copper	800 Amps	4 (102)	1.750 x .250	1200	12.2	18.2

<sup>1</sup>DC Bus. is 4-wire with "+ - + -" polarity.

### Conversion Chart

Decimal	Fraction
.12	1/8
.63	5/8
.88	7/8

### Hangers - Vertical Mounting

Spring hangers are required to support the busway at each floor. When the floor-to-floor span is over 16 feet, support for the spring hanger should be provided. Simple adjustment procedures are included with installation instructions. Mounting holes align with floor flanges.

### Hangers - Horizontal Mounting

One standard flatwise clevis-type hanger is furnished with each straight length. Edgewise clevis and edgewise/flatwise trapeze hangers are optionally available. Drop rods are not furnished.



Linear Lengths  
Plug-in and Feeder, one bar per phase.

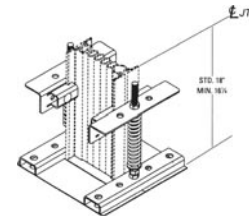

Spring Riser

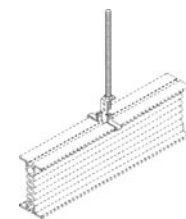

(Standard) Flatwise Hanger  
Shipped with Each Straight Length

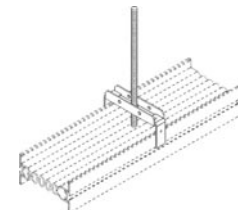

Clevis Hanger for Edgewise Mounting

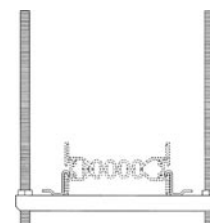

Trapeze Hanger for Edgewise Mounting

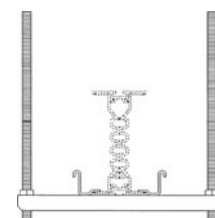

Trapeze Hanger for Flatwise Mounting



# Busway Spectra® Series Busway

LowAmp  
Busway  
Outlines and Dimensions

## Section 11

### End Cable Tap Boxes - Lugs per Phase

Amperage	No. of #2-600kcmil Lugs/Ø N & GRD
225 Amps	1
400 Amps	2
600 Amps	2
800 Amps	3

End Boxes are required to terminate busway runs. No joint assembly is required, and the end surface of the box is even with the joint centerline. See table on page 11-71 for "A" dimension. Box is secured via joint cap bolts.

### Center Cable Tap Boxes - Lugs per Phase

Amperage	No. of #2-600kcmil Lugs/Ø N & GRD
225 Amps	1
400 Amps	2
600 Amps	2
800 Amps	3

### Floor/Wall Flange Cutout and Drilling Detail

Bar Width (mm)	Dimension X (mm)	Dimension Y (mm)
.750	5.000	8.500
1.125	5.375	8.875
1.750	6.000	9.500
2.875	7.125	10.625

Note: Floor or wall opening should provide 1/2" clearance all around the Busway.

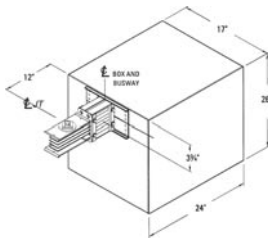

End Cable Tap Box: Feeder or Plug-In

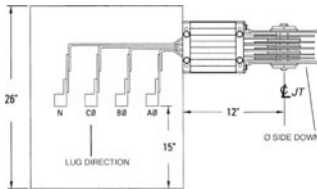

Standard End Cable Tap Box Down Position, Side View

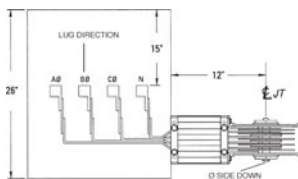

Inverted End Tap Box Up Position, Side View

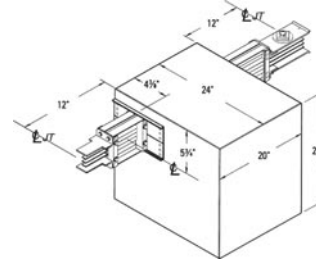

Center Cable Tap Box: Feeder or Plug-In

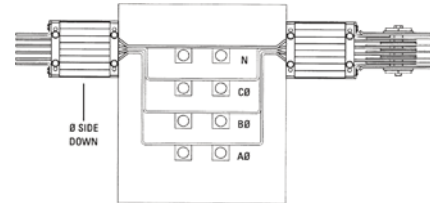

Standard Center Cable Tap Box Down Position, Side View

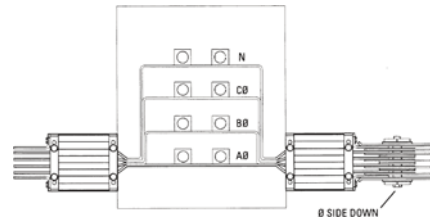

Inverted Center Cable Tap Box Up Position, Side View

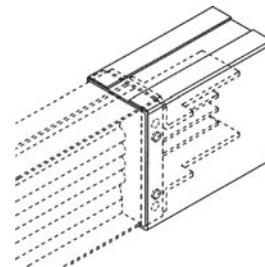

End Box

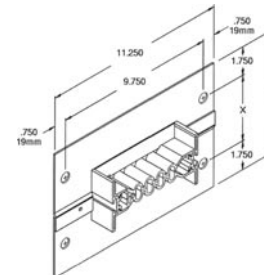

Wall/Floor Flange



# Busway Spectra® Series Busway

LowAmp  
Busway  
Outlines and Dimensions

## Section 11

### Molded-Case Circuit Breakers - Outer Dimensions

Standard and Hi-Break

Frame Type	Trip Amps	Voltage	Width (in.)	Length (in.)	Depth (in.)	Figure No.
TEB	15-100	240	11	13	8	A
TED, THED	15-100	600	11	13	8	A
TED, THED	110-150	600	11	13	8	A

### Molded-Case Circuit Breakers - Outer Dimensions

Low- and Mid-Tier

Frame Type	Trip Amps	Voltage	Width (in.)	Length (in.)	Depth (in.)	Figure No.
SED, SEH, SEL	15-150	480	11	13	8	A
SFHA	70-225	600	11	21.25	9	A

### Fusible Switches Outer Dimensions

Type QMR

Voltage	Amperage	Weight (Lbs.)	Width (in.)	Length (in.) Standard Gutter	Length (in.) Extended Gutter	Depth (in.)	Figure No.
240 and 600	30	24	11.25	13	18.63	8.75	A
240 and 600	60	25	11.25	13	18.63	8.75	A
240 and 600	100	28	11.25	18.75	N/A	8.75	A
240 and 600	200	46	16	18.75	24.5	8.75	A
240 and 600	400	135	20.5	18.75	N/A	18.75	B

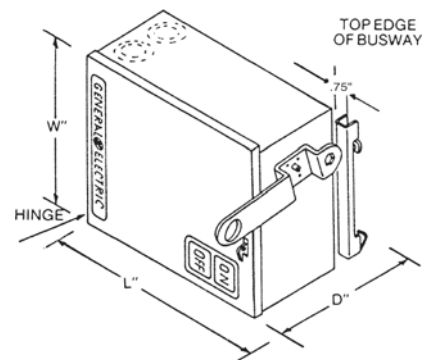

**Figure A**  
Door hinges at left end. All dimensions are shown over largest part of plug.

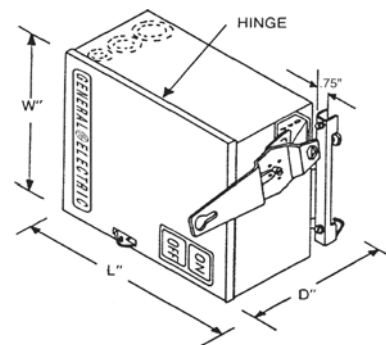

**Figure B**  
Door hinges at top. All dimensions are shown over largest part of plug.



# Busway Spectra® Series Busway

LowAmp  
Busway  
Outlines and Dimensions

## Section 11

### Fittings - Elbows, Tees and Offsets

Spectra® Series LowAmp busway has a complete family of standard catalog fittings to meet virtually all layout requirements using the compact minimum sizes shown.

Nomenclature for completely defining the turn is accomplished by looking into the joint end with phase Ø side facing down on the busway. Using this guideline, a right elbow turns right, an up elbow turns up, etc.

Every piece of busway is labeled to maintain proper phasing. Unless otherwise noted, all turn dimensions are defined from the centerline of the joint end to the centerline of the busway. Figures show dimensions for elbow, tee, and offset fittings.

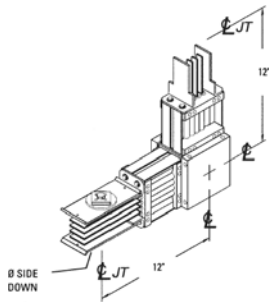

Up 90° Elbow Shown (Down 90° Elbow Reversed)

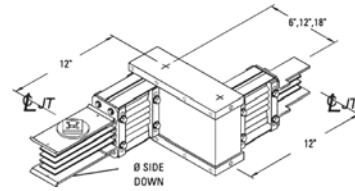

Offset Right Shown (Left Offset Reversed)

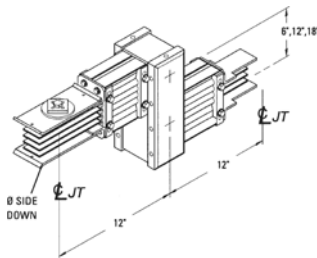

Offset Down Shown (Offset Up Reversed)

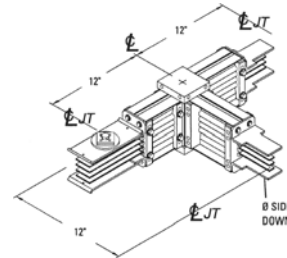

Tee Right Shown (Left Tee Reversed)

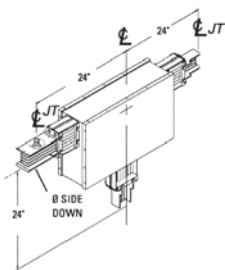

Tee Down Shown (Up Tee Reversed)

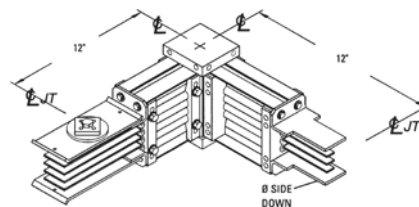

Elbow 90° Right Shown (Left Elbow Reversed)



# Busway Flex-A-Power® Busway

Type DH  
Aluminum Conductors  
Product Number Pricing

## Section 11

### Product Features

Type DH plug-in and feeder busway distributes power through a wide variety of indoor locations where there is a need for small blocks of conveniently available power. Type DH busway has a lower installed cost than wire and conduit, yet has all the advantages and features of plug-in busway. Available Ratings: 100 amperes, 600 volts, indoor enclosures only.

### Applications

Type DH busway provides a ready power source for small machines, portable electric tools, lights, and a variety of other equipment. Type DH busway can serve as either a plug-in or feeder system, with 10 outlets available in every 10-foot length. It may be tapped by circuit breaker, fusible or unfused plugs.

### Single-Phase, Three-Wire AC; Three-Wire DC Standard

Component	Type	Product Number	List Price GO-120
Linear Lengths	10-ft.	DP1HA01SL10	\$240.00
Linear Lengths	6 ft.	DP1HA01SL06	\$145.00
Linear Lengths	2-ft.	DP1HA01SL02	\$52.00
Accessories	End Tap Boxes Straight Bar end	DP1HA01TSST	\$52.00
Accessories	End Tap Boxes Offset Bar End	DP1HA01TOST	\$52.00
Accessories	Center (Joint) Tap Boxes	DP1HA01CCST	\$72.00
Accessories	End (Stub) Straight Bar end	DP1HA01SSST	\$138.00
Fittings	Offset Bar End	DP1HA01SOST	\$138.00

### Single-Phase, Three-Wire AC; Three-Wire DC Internal Ground Bar

Component	Type	Product Number	List Price GO-120
Linear Lengths	10-ft.	DP1GA01SL10	\$270.00
Linear Lengths	6 ft.	DP1GA01SL06	\$160.00
Linear Lengths	2-ft.	DP1GA01SL02	\$62.00
Accessories	End Tap Boxes Straight Bar end	DP1GA01TSST	\$58.00
Accessories	End Tap Boxes Offset Bar End	DP1GA01TOST	\$58.00
Accessories	Center (Joint) Tap Boxes	DP1GA01CCST	\$78.00
Accessories	End (Stub) Straight Bar end	DP1GA01SSST	\$145.00
Fittings	Offset Bar End	DP1GA01SOST	\$145.00

### Three-Phase, Three-Wire, AC Standard

Component	Type	Product Number	List Price GO-120
Linear Lengths	10-ft.	DP3HA01SL10	\$240.00
Linear Lengths	6 ft.	DP3HA01SL06	\$145.00
Linear Lengths	2-ft.	DP3HA01SL02	\$52.00
Accessories	End Tap Boxes Straight Bar end	DP3HA01TSST	\$52.00
Accessories	End Tap Boxes Offset Bar End	DP3HA01TOST	\$52.00
Accessories	Center (Joint) Tap Boxes	DP3HA01CCST	\$72.00
Accessories	End (Stub) Straight Bar end	DP3HA01SSST	\$138.00
Fittings	Offset Bar End	DP3HA01SOST	\$138.00

### Three-Phase, Three-Wire, AC Internal Ground Bar

Component	Type	Product Number	List Price GO-120
Linear Lengths	10-ft.	DP3GA01SL10	\$270.00
Linear Lengths	6 ft.	DP3GA01SL06	\$160.00
Linear Lengths	2-ft.	DP3GA01SL02	\$62.00
Accessories	End Tap Boxes Straight Bar end	DP3GA01TSST	\$58.00
Accessories	End Tap Boxes Offset Bar End	DP3GA01TOST	\$58.00
Accessories	Center (Joint) Tap Boxes	DP3GA01CCST	\$78.00
Accessories	End (Stub) Straight Bar end	DP3GA01SSST	\$145.00
Fittings	Offset Bar End	DP3GA01SOST	\$145.00

### Three-Phase, Four-Wire AC Standard

Component	Type	Product Number	List Price GO-120
Linear Lengths	10-ft.	DP4HA01SL10	\$250.00
Linear Lengths	6 ft.	DP4HA01SL06	\$150.00
Linear Lengths	2-ft.	DP4HA01SL02	\$56.00
Accessories	End Tap Boxes Straight Bar end	DP4HA01TSST	\$56.00
Accessories	End Tap Boxes Offset Bar End	DP4HA01TOST	\$56.00
Accessories	Center (Joint) Tap Boxes	DP4HA01CCST	\$75.00
Accessories	End (Stub) Straight Bar end	DP4HA01SSST	\$135.00
Fittings	Offset Bar End	DP4HA01SOST	\$135.00

### Three-Phase, Four-Wire AC Internal Ground Bar

Component	Type	Product Number	List Price GO-120
Linear Lengths	10-ft.	DP4GA01SL10	\$280.00
Linear Lengths	6 ft.	DP4GA01SL06	\$168.00
Linear Lengths	2-ft.	DP4GA01SL02	\$62.00
Accessories	End Tap Boxes Straight Bar end	DP4GA01TSST	\$60.00
Accessories	End Tap Boxes Offset Bar End	DP4GA01TOST	\$60.00
Accessories	Center (Joint) Tap Boxes	DP4GA01CCST	\$80.00
Accessories	End (Stub) Straight Bar end	DP4GA01SSST	\$140.00
Fittings	Offset Bar End	DP4GA01SOST	\$140.00





# Busway Flex-A-Power® Busway (continued)

# Section 11

Type DH  
Aluminum Conductors  
Product Number Pricing

## Devices Common to All Three- and Four-Wire Systems Standard

Component	Type	Product Number	List Price GO-120
Fittings	Elbows Up	DP4HA01EUST	\$50.00
Fittings	Elbows Down	DP4HA01EDST	\$50.00
Fittings	Elbows Left	DP4HA01ELST	\$50.00
Fittings	Elbows Right	DP4HA01ERST	\$50.00
Fittings	Tees Up	DP4HA01TUST	\$72.00
Fittings	Tees Down	DP4HA01TDST	\$72.00
Fittings	Tees Left	DP4HA01TLST	\$72.00
Fittings	Tees Right	DP4HA01TRST	\$72.00
Fittings	Crosses Up-Down	DP4HA01CDST	\$95.00
Fittings	Crosses Left-Right	DP4HA01CLST	\$95.00
Fittings	Reverse Fittings Straight Bar End	DP4HA01RSST	\$35.00
Fittings	Reverse Fittings Offset Bar End	DP4HA01ROST	\$35.00
Linear Lengths	Adjustable Lengths	DP4HA01ASST	\$275.00
Accessories	End Boxes	DP4HA01EBST	\$10.00
Accessories	Flanges	DH1F	\$8.00
Accessories	Outlet Covers	DH10C	\$10.00
Accessories	Hangers (Edgewise) Single Run	DE1HES	\$6.00
Accessories	Hangers (Edgewise) Single Run (wall/ceiling mtg.)	DH1HU1	\$6.00
Accessories	Hangers (Edgewise) Double Run	DE1HED	\$12.00

## Devices Common to All Three- and Four-Wire Systems Internal Ground Bar

Component	Type	Product Number	List Price GO-120
Fittings	Elbows Up	DP4GA01EUST	\$56.00
Fittings	Elbows Down	DP4GA01EDST	\$56.00
Fittings	Elbows Left	DP4GA01ELST	\$56.00
Fittings	Elbows Right	DP4GA01ERST	\$56.00
Fittings	Tees Up	DP4GA01TUST	\$82.00
Fittings	Tees Down	DP4GA01TDST	\$82.00
Fittings	Tees Left	DP4GA01TLST	\$82.00
Fittings	Tees Right	DP4GA01TRST	\$82.00
Fittings	Crosses Left-Right	DP4GA01CLST	\$110.00
Fittings	Crosses Up-Down	DP4GA01CDST	\$110.00
Fittings	Reverse Fittings Straight Bar End	DP4GA01RSST	\$38.00
Fittings	Reverse Fittings Offset Bar End	DP4GA01ROST	\$38.00
Linear Lengths	Adjustable Lengths	DP4GA01ASST	\$300.00
Accessories	End Boxes	DP4GA01EBST	\$10.00
Accessories	Flanges	DH1F	\$8.00
Accessories	Outlet Covers	DH10C	\$10.00
Accessories	Hangers (Edgewise) Single Run	DE1HES	\$6.00
Accessories	Hangers (Edgewise) Single Run (wall/ceiling mtg.)	DH1HU1	\$6.00
Accessories	Hangers (Edgewise) Double Run	DE1HED	\$12.00



# Busway Flex-A-Power® Busway

Type DH  
Copper Conductors  
Product Number Pricing

## Section 11

### Product Features

Type DH plug-in and feeder busway distributes power through a wide variety of indoor locations where there is a need for small blocks of conveniently available power. Type DH busway has a lower installed cost than wire and conduit, yet has all the advantages and features of plug-in busway. Available Ratings: 100 amperes, 600 volts, indoor enclosures only.

### Applications

Type DH busway provides a ready power source for small machines, portable electric tools, lights, and a variety of other equipment. Type DH busway can serve as either a plug-in or feeder system, with 10 outlets available in every 10-foot length. It may be tapped by circuit breaker, fusible or unfused plugs.

### Single-Phase, Three-Wire AC; Three-Wire DC Standard

Component	Type	Product Number	List Price GO-120
Linear Lengths	10-ft.	DP1HC01SL10	\$275.00
Linear Lengths	6 ft.	DP1HC01SL06	\$165.00
Linear Lengths	2-ft.	DP1HC01SL02	\$65.00
Accessories	End Tap Boxes Straight Bar end	DP1HC01TSST	\$60.00
Accessories	End Tap Boxes Offset Bar End	DP1HC01TOST	\$60.00
Accessories	Center (Joint) Tap Boxes	DP1HC01CCST	\$82.00
Accessories	End (Stub) Straight Bar end	DP1HC01SSST	\$138.00
Fittings	Offset Bar End	DP1HC01SOST	\$138.00

### Single-Phase, Three-Wire AC; Three-Wire DC Internal Ground Bar

Component	Type	Product Number	List Price GO-120
Linear Lengths	10-ft.	DP1GC01SL10	\$325.00
Linear Lengths	6 ft.	DP1GC01SL06	\$200.00
Linear Lengths	2-ft.	DP1GC01SL02	\$70.00
Accessories	End Tap Boxes Straight Bar end	DP1GC01TSST	\$65.00
Accessories	End Tap Boxes Offset Bar End	DP1GC01TOST	\$65.00
Accessories	Center (Joint) Tap Boxes	DP1GC01CCST	\$90.00
Accessories	End (Stub) Straight Bar end	DP1GC01SSST	\$145.00
Fittings	Offset Bar End	DP1GC01SOST	\$145.00

### Three-Phase, Three-Wire, AC Standard

Component	Type	Product Number	List Price GO-120
Linear Lengths	10-ft.	DP3HC01SL10	\$275.00
Linear Lengths	6 ft.	DP3HC01SL06	\$165.00
Linear Lengths	2-ft.	DP3HC01SL02	\$65.00
Accessories	End Tap Boxes Straight Bar end	DP3HC01TSST	\$60.00
Accessories	End Tap Boxes Offset Bar End	DP3HC01TOST	\$60.00
Accessories	Center (Joint) Tap Boxes	DP3HC01CCST	\$82.00
Accessories	End (Stub) Straight Bar end	DP3HC01SSST	\$138.00
Fittings	Offset Bar End	DP3HC01SOST	\$138.00

### Three-Phase, Three-Wire, AC Internal Ground Bar

Component	Type	Product Number	List Price GO-120
Linear Lengths	10-ft.	DP3GC01SL10	\$325.00
Linear Lengths	6 ft.	DP3GC01SL06	\$200.00
Linear Lengths	2-ft.	DP3GC01SL02	\$70.00
Accessories	End Tap Boxes Straight Bar end	DP3GC01TSST	\$65.00
Accessories	End Tap Boxes Offset Bar End	DP3GC01TOST	\$65.00
Accessories	Center (Joint) Tap Boxes	DP3GC01CCST	\$90.00
Accessories	End (Stub) Straight Bar end	DP3GC01SSST	\$145.00
Fittings	Offset Bar End	DP3GC01SOST	\$145.00

### Three-Phase, Four-Wire AC Standard

Component	Type	Product Number	List Price GO-120
Linear Lengths	10-ft.	DP4HC01SL10	\$300.00
Linear Lengths	6 ft.	DP4HC01SL06	\$180.00
Linear Lengths	2-ft.	DP4HC01SL02	\$68.00
Accessories	End Tap Boxes Straight Bar end	DP4HC01TSST	\$62.00
Accessories	End Tap Boxes Offset Bar End	DP4HC01TOST	\$62.00
Accessories	Center (Joint) Tap Boxes	DP4HC01CCST	\$85.00
Accessories	End (Stub) Straight Bar end	DP4HC01SSST	\$145.00
Fittings	Offset Bar End	DP4HC01SOST	\$145.00

### Three-Phase, Four-Wire AC Internal Ground Bar

Component	Type	Product Number	List Price GO-120
Linear Lengths	10-ft.	DP4GC01SL10	\$350.00
Linear Lengths	6 ft.	DP4GC01SL06	\$210.00
Linear Lengths	2-ft.	DP4GC01SL02	\$75.00
Accessories	End Tap Boxes Straight Bar end	DP4GC01TSST	\$70.00
Accessories	End Tap Boxes Offset Bar End	DP4GC01TOST	\$70.00
Accessories	Center (Joint) Tap Boxes	DP4GC01CCST	\$100.00
Accessories	End (Stub) Straight Bar end	DP4GC01SSST	\$150.00
Fittings	Offset Bar End	DP4GC01SOST	\$150.00



# Busway Flex-A-Power® Busway (continued)

# Section 11

Type DH  
Copper Conductors  
Product Number Pricing

## Devices Common to All Three- and Four-Wire Systems Standard

Component	Type	Product Number	List Price GO-120
Fittings	Elbows Up	DP4HC01EUST	\$62.00
Fittings	Elbows Down	DP4HC01EDST	\$62.00
Fittings	Elbows Left	DP4HC01ELST	\$62.00
Fittings	Elbows Right	DP4HC01ERST	\$62.00
Fittings	Tees Up	DP4HC01TUST	\$90.00
Fittings	Tees Down	DP4HC01TDST	\$90.00
Fittings	Tees Left	DP4HC01TLST	\$90.00
Fittings	Tees Right	DP4HC01TRST	\$90.00
Fittings	Crosses Up-Down	DP4HC01CDST	\$115.00
Fittings	Crosses Left-Right	DP4HC01CLST	\$115.00
Fittings	Reverse Fittings Straight Bar End	DP4HC01RSST	\$40.00
Fittings	Reverse Fittings Offset Bar End	DP4HC01ROST	\$40.00
Linear Lengths	Adjustable Lengths	DP4HC01ASST	\$310.00
Accessories	End Boxes	DP4HC01EBST	\$10.00
Accessories	Flanges	DH1F	\$8.00
Accessories	Outlet Covers	DH10C	\$10.00
Accessories	Hangers (Edgewise) Single Run	DE1HES	\$6.00
Accessories	Hangers (Edgewise) Single Run (wall/ceiling mtg.)	DH1HU1	\$6.00
Accessories	Hangers (Edgewise) Double Run	DE1HED	\$12.00

## Devices Common to All Three- and Four-Wire Systems Internal Ground Bar

Component	Type	Product Number	List Price GO-120
Fittings	Elbows Up	DP4GC01EUST	\$68.00
Fittings	Elbows Down	DP4GC01EDST	\$68.00
Fittings	Elbows Left	DP4GC01ELST	\$68.00
Fittings	Elbows Right	DP4GC01ERST	\$68.00
Fittings	Tees Up	DP4GC01TUST	\$100.00
Fittings	Tees Down	DP4GC01TDST	\$100.00
Fittings	Tees Left	DP4GC01TLST	\$100.00
Fittings	Tees Right	DP4GC01TRST	\$100.00
Fittings	Crosses Up-Down	DP4GC01CDST	\$130.00
Fittings	Crosses Left-Right	DP4GC01CLST	\$130.00
Fittings	Reverse Fittings Straight Bar End	DP4GC01RSST	\$45.00
Fittings	Reverse Fittings Offset Bar End	DP4GC01ROST	\$45.00
Linear Lengths	Adjustable Lengths	DP4GC01ASST	\$330.00
Accessories	End Boxes	DP4GC01EBST	\$10.00
Accessories	Flanges	DH1F	\$8.00
Accessories	Outlet Covers	DH10C	\$10.00
Accessories	Hangers (Edgewise) Single Run	DE1HES	\$6.00
Accessories	Hangers (Edgewise) Single Run (wall/ceiling mtg.)	DH1HU1	\$6.00
Accessories	Hangers (Edgewise) Double Run	DE1HED	\$12.00



# Busway Flex-A-Power® Busway

Type DH  
Plugs

## Section 11

### Unfused - Type TB Three-Phase, Four-Wire, Single-Phase, Three-Wire

Amperage	Voltage	Product Number	List Price GO-120
60	600	DHIP4TB2	\$85.00

### Unfused - Type TB Three-Phase, Three-Wire

Amperage	Voltage	Product Number	List Price GO-120
60	600	DHIP3TB2	\$60.00

### Circuit Breaker Plugs - Type TQL Single-Phase, Three-Wire

Amperage	Frame Type	Voltage	Product Number	List Price GO-120
15-50	TQL	240 Max	DFPTQL3N	\$55.00
15-50	TQLX	240 Max	DFPTQLX3N	\$85.00
15-50	TQLR	240 Max	DFPTQLR3N	\$130.00
15-50	TQLRC	240 Max	DFPTQLRC4 <sup>1</sup>	\$160.00

(With Space Only for Three THQL Breaker Poles)

Order breakers separately.

<sup>1</sup>"C" in Product Number indicates screw tightening housing clips.

### Circuit Breaker Plugs - Type TQL Three-Phase, Three-Wire

Amperage	Frame Type	Voltage	Product Number	List Price GO-120
15-50	TQL	240 Max	DFPTQL3	\$60.00
15-50	TQLX	240 Max	DFPTQLX3	\$90.00
15-50	TQLR	240 Max	DFPTQLR3	\$120.00

(With Space Only for Three THQL Breaker Poles)

Order breakers separately.

### Circuit Breaker Plugs - Type TQL Three-Phase, Four-Wire

Amperage	Frame Type	Voltage	Product Number	List Price GO-120
15-50	TQL	240 Max	DFPTQL4	\$70.00
15-50	TQLX	240 Max	DFPTQLX4	\$100.00
15-50	TQLR	240 Max	DFPTQLR4	\$130.00
15-50	TQLC	240 Max	DFPTQLC4 <sup>1</sup>	\$105.00
15-50	TQLRC	240 Max	DFPTQLRC4 <sup>1</sup>	\$160.00

(With Space Only for Three THQL Breaker Poles)

Order breakers separately.

<sup>1</sup>"C" in Product Number indicates screw tightening housing clips.

### Circuit Breaker Plugs - Type TE Single-Phase, Three-Wire

Amperage	Frame Type	Voltage	Product Number	List Price GO-120
15-70	TE	600 Max	DFPTE3N	\$130.00
15-70	TEX	600 Max	DFPTEX3N	\$160.00
15-70	TER	600 Max	DFPTER3N	\$190.00

(With Space Only for Three TEB or TED4 Breaker Poles)

Order breakers separately.

### Circuit Breaker Plugs - Type TE Three-Phase, Three-Wire

Amperage	Frame Type	Voltage	Product Number	List Price GO-120
15-70	TE	600 Max	DFPTE3	\$140.00
15-70	TEX	600 Max	DFPTEX3	\$170.00
15-70	TER	600 Max	DFPTER3	\$200.00

(With Space Only for Three TEB or TED4 Breaker Poles)

Order breakers separately.

### Circuit Breaker Plugs - Type TE Three-Phase, Four-Wire

Amperage	Frame Type	Voltage	Product Number	List Price GO-120
15-70	TE	600 Max	DFPTE4	\$150.00
15-70	TEX	600 Max	DFPTEX4	\$180.00
15-70	TER	600 Max	DFPTER4	\$210.00
15-70	TEC	600 Max	DFPTEC4	\$180.00
15-70	TERC	600 Max	DFPTERC4	\$245.00

(With Space Only for Three TEB or TED4 Breaker Poles)

Order breakers separately.

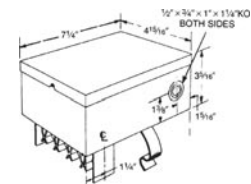

Type TB

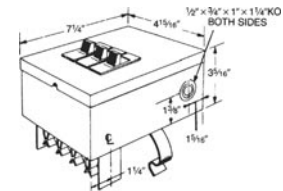

Handle-Operated Type TQL

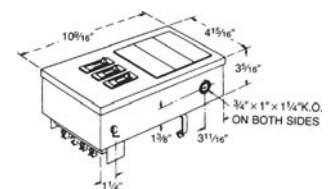

Type TQLR with Receptacle Provision

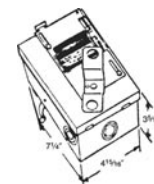

Type TQLX Externally Operated Handle

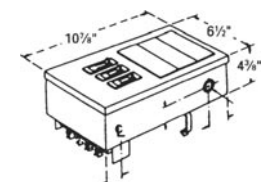

Handle-Operated TE

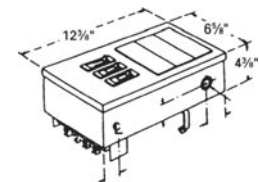

TER with Receptacle Provision

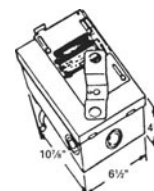

TEX Externally Operated Handle



# Busway Flex-A-Power® Busway

Type DH  
Plugs

## Section 11

### Fusible - Type QMR Single-Phase, Three-Wire

Amperage	Voltage	Product Number	List Price GO-120
30	240	DH421R	\$365.00
60	240	DH422R	\$390.00
100	240	DH423R	\$560.00
30	600	DH461R	\$390.00
60	600	DH462R	\$405.00
100	600	DH463R	\$595.00

With Class H Fuse Clips  
Fuses Not Included

### Fusible - Type QMR Three-Phase, Three-Wire

Amperage	Voltage	Product Number	List Price GO-120
30	240	DH321R	\$305.00
60	240	DH322R	\$340.00
100	240	DH323R	\$495.00
30	600	DH361R	\$340.00
60	600	DH362R	\$360.00
100	600	DH363R	\$510.00

With Class H Fuse Clips  
Fuses Not Included

### Fusible - Type QMR Three-Phase, Four-Wire

Amperage	Voltage	Product Number	List Price GO-120
30	240	DH421R	\$365.00
60	240	DH422R	\$390.00
100	240	DH423R	\$560.00
30	600	DH461R	\$390.00
60	600	DH462R	\$405.00
100	600	DH463R	\$595.00

With Class H Fuse Clips  
Fuses Not Included

### Circuit Breakers Single-Phase, Three-Wire

Amperage	Frame Type	Voltage	Product Number <sup>1</sup>	List Price GO-120
15	TEB	240	DH41EB	\$580.00
20	TEB	240	DH42EB	\$580.00
30	TEB	240	DH43EB	\$580.00
40	TEB	240	DH44EB	\$580.00
50	TEB	240	DH45EB	\$580.00
70	TEB	240	DH47EB	\$690.00
100	TEB	240	DH410EB	\$690.00
15	TED4	480	DH41ED4	\$720.00
20	TED4	480	DH42ED4	\$720.00
30	TED4	480	DH43ED4	\$720.00
40	TED4	480	DH44ED4	\$720.00
50	TED4	480	DH45ED4	\$720.00
70	TED4	480	DH47ED4	\$790.00
100	TED4	480	DH410ED4	\$790.00
15	TED6	600	DH41ED6	\$780.00
20	TED6	600	DH42ED6	\$780.00
30	TED6	600	DH43ED6	\$780.00
40	TED6	600	DH44ED6	\$780.00
50	TED6	600	DH45ED6	\$780.00
70	TED6	600	DH47ED6	\$860.00
100	TED6	600	DH410ED6	\$860.00

Breakers are installed in factory.

<sup>1</sup>These are three-phase, four-wire plugs. The A phase is ignored.

### Circuit Breakers Three-Phase, Three-Wire

Amperage	Frame Type	Voltage	Product Number <sup>1</sup>	List Price GO-120
15	TEB	240	DH31EB	\$510.00
20	TEB	240	DH32EB	\$510.00
30	TEB	240	DH33EB	\$510.00
40	TEB	240	DH34EB	\$510.00
50	TEB	240	DH35EB	\$510.00
70	TEB	240	DH37EB	\$625.00
100	TEB	240	DH310EB	\$625.00
15	TED4	480	DH31ED4	\$650.00
20	TED4	480	DH32ED4	\$650.00
30	TED4	480	DH33ED4	\$650.00
40	TED4	480	DH34ED4	\$650.00
50	TED4	480	DH35ED4	\$650.00
70	TED4	480	DH37ED4	\$725.00
100	TED4	480	DH310ED4	\$725.00
15	TED6	600	DH31ED6	\$720.00
20	TED6	600	DH32ED6	\$720.00
30	TED6	600	DH33ED6	\$720.00
40	TED6	600	DH34ED6	\$720.00
50	TED6	600	DH35ED6	\$720.00
70	TED6	600	DH37ED6	\$800.00
100	TED6	600	DH310ED6	\$800.00

Breakers are installed in factory.

### Circuit Breakers Three-Phase, Four-Wire

Amperage	Frame Type	Voltage	Product Number <sup>1</sup>	List Price GO-120
15	TEB	240	DH41EB	\$580.00
20	TEB	240	DH42EB	\$580.00
30	TEB	240	DH43EB	\$580.00
40	TEB	240	DH44EB	\$580.00
50	TEB	240	DH45EB	\$580.00
70	TEB	240	DH47EB	\$690.00
100	TEB	240	DH410EB	\$690.00
15	TED4	480	DH41ED4	\$720.00
20	TED4	480	DH42ED4	\$720.00
30	TED4	480	DH43ED4	\$720.00
40	TED4	480	DH44ED4	\$720.00
50	TED4	480	DH45ED4	\$720.00
70	TED4	480	DH47ED4	\$790.00
100	TED4	480	DH410ED4	\$790.00
15	TED6	600	DH41ED6	\$780.00
20	TED6	600	DH42ED6	\$780.00
30	TED6	600	DH43ED6	\$780.00
40	TED6	600	DH44ED6	\$780.00
50	TED6	600	DH45ED6	\$780.00
70	TED6	600	DH47ED6	\$860.00
100	TED6	600	DH410ED6	\$860.00

Breakers are installed in factory.

<sup>1</sup>These are three-phase, four-wire plugs. The A phase is ignored.

### Type DH Plug Modifications

—Ground stab - for plugs used with internal ground bus, add \$17.00, GO-120.

—No-fuse switch plugs - price fused switch, then order by description.

—Class R Fuse Clips - add suffix R and price by rating 30 amp, 60 amp add \$40.00, GO-120; 100 amp add \$55.00, GO-120.

—Class J Fuse Clips - add suffix J and \$21.00, GO-120 for ratings 30 through 100 amps.



# Busway Flex-A-Power® Busway

Type DH  
Plugs

### DH—Busway Product Numbering System

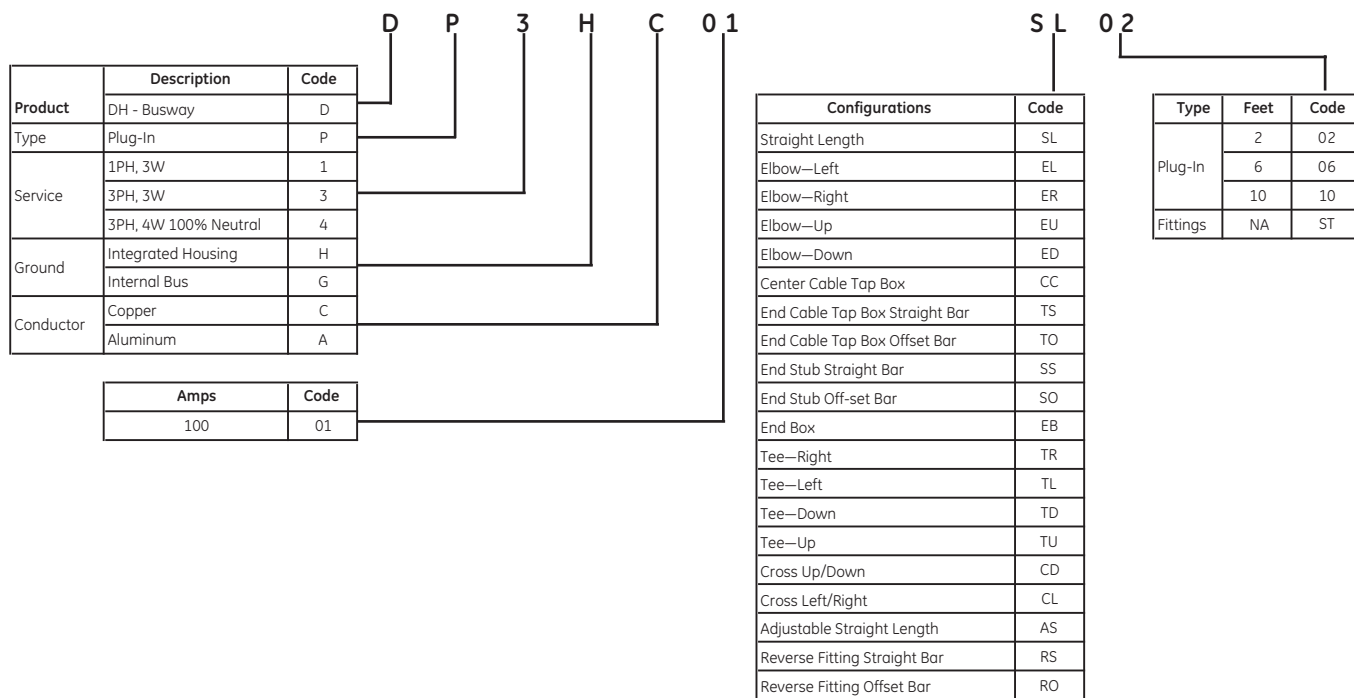

# Busway Flex-A-Power® Busway

Type DH  
Dimensions

## Section 11

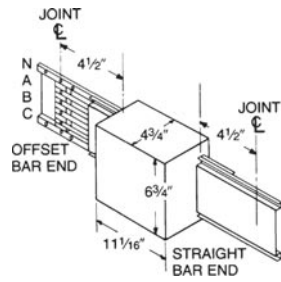
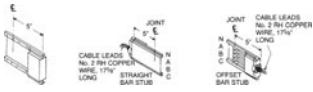

Center Joint Tap Box

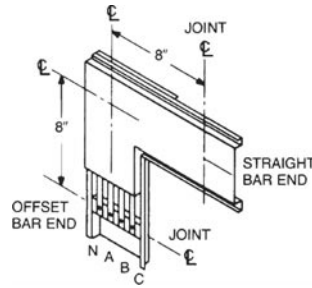

Elbow Down

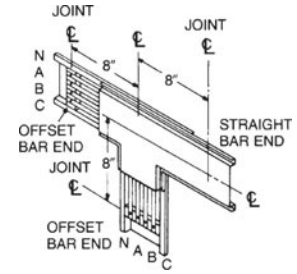

Tee Down

End Stub

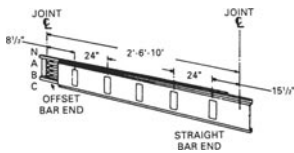

Linear Lengths

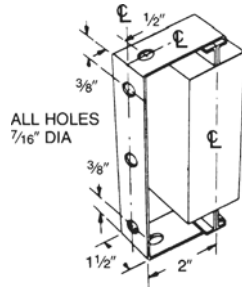

Single Run (wall/ceiling mtg)  
Hanger

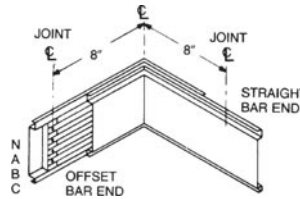

Elbow Left

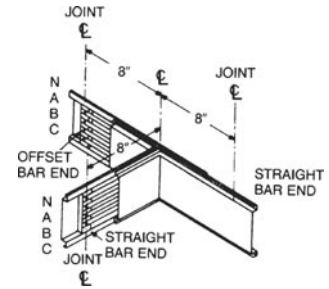

Tee Left

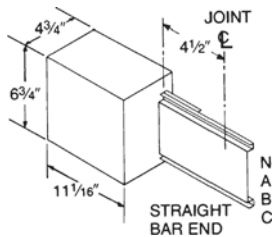

Tap Box-Straight Bar End

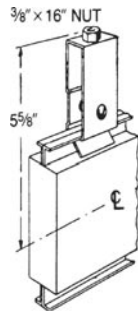

Hanger Edgewise

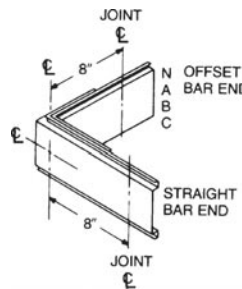

Elbow Right

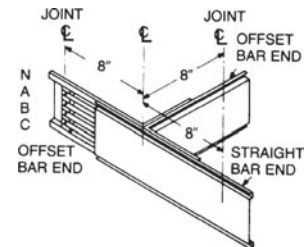

Tee Right

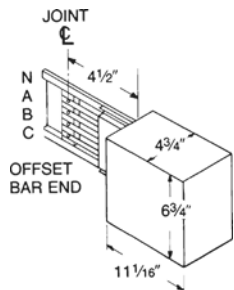

Tap Box-Offset Bar End

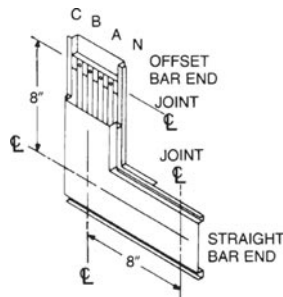

Elbow Up

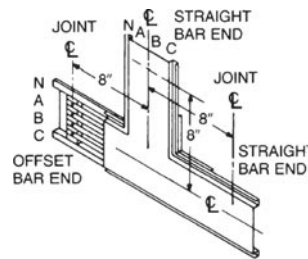

Tee Up





**Product Information**

Type LW plug-in busway replacement parts are available for existing systems.

**Available Ratings**

Amperes: 30 and 60 amperes  
 Voltage: 250 or 300Vac  
 Busing: Copper  
 Systems: Two- and Three-wire  
 Enclosures: Indoor only

**Application**

Type LW busway can be used in a variety of indoor applications, by using the variety of hangers and feed-in boxes available. The 300 Volt, three-wire busway can be used on 480 Y/277 Volt applications because the maximum voltage to ground is less than 300 Volts when using two phases and neutral.

**Feed-In Boxes Three-Phase, Two-Wire**

Type	Amperage	Product Number	List Price GO-119
Feed-In Boxes End Overslung	30	LW23TEA	\$24.00
Feed-In Boxes End Overslung	60	LW26TEA	\$28.50
Feed-In Boxes End Underslung	30	LW23EB	\$24.00
Feed-In Boxes End Underslung	60	LW26EB	\$28.50
Feed-In Boxes End Miniature	30	LW23EM	\$12.00
Feed-In Boxes Center Overslung	30	LW23TCA <sup>1</sup>	\$34.00
Feed-In Boxes Center Overslung	60	LW26TCA <sup>1</sup>	\$41.50
Feed-In Boxes Center Underslung	30	LW23CB	\$34.00
Feed-In Boxes Center Underslung	60	LW26CB	\$41.50

Couplings and connectors included.

<sup>1</sup>Suitable for use in flush installations in T-bar ceilings.

**Feed-In Boxes Three-Phase, Three-Wire**

Type	Amperage	Product Number	List Price GO-119
Feed-In Boxes End Overslung	30	LW33TEA	\$28.50
Feed-In Boxes End Overslung	60	LW36TEA	\$34.00
Feed-In Boxes End Underslung	30	LW33EB	\$28.50
Feed-In Boxes End Underslung	60	LW36EB	\$34.00
Feed-In Boxes End Miniature	30	LW33EM	\$16.25
Feed-In Boxes Center Overslung	30	LW33TCA <sup>1</sup>	\$42.50
Feed-In Boxes Center Overslung	60	LW36TCA <sup>1</sup>	\$46.00
Feed-In Boxes Center Underslung	30	LW33CB	\$42.50
Feed-In Boxes Center Underslung	60	LW36CB	\$46.00

Couplings and connectors included.

Two-phases and neutral from 480 Y/277 Volt system, 300 Volts maximum to ground.

<sup>1</sup>Suitable for use in flush installations in T-bar ceilings.

**Plug-In Tap Boxes**

Accessory Type	Service Type	Amperage	Voltage	Product Number	List Price GO-119
Tap Box	2 or 3-pole	30	300 V	LW3B30	\$27.50
Tap Boxes Single Fuse	2-pole	30	120	LW2F30	\$42.50
Tap Boxes Two Fuses	3-pole	30	120/240 V	LW32F30	\$76.50
Tap Boxes Three Fuses	3-pole	30	250 V	LW3F30	\$101.00
Tap Boxes Single Fuse	2-pole	20	300 V	LW2F320 <sup>2</sup>	\$48.00
Tap Boxes Two Fuses	2-pole	20	480 V	LW22F420 <sup>2</sup>	\$64.50
Tap Boxes Two Fuses	3-pole	20	480/277V	LW32F420 <sup>2,4</sup>	\$78.50
Tap Boxes—Handle through Cover: Single-Pole—THQC	2-pole	15	120 V	LW2C15 <sup>3</sup>	\$70.00
Tap Boxes—Handle through Cover: Single-Pole—THQC	2-pole	20	120 V	LW2C20 <sup>3</sup>	\$70.00
Tap Boxes—Handle through Cover: Single-Pole—THQC	2-pole	30	120	LW2C30 <sup>3</sup>	\$70.00
Tap Boxes—Handle through Cover: Single-Pole—THQC	3-pole	15	120/240 V	LW32C15 <sup>3</sup>	\$86.00
Tap Boxes—Handle through Cover: Two-Pole—THQC	3-pole	20	120/240 V	LW32C20 <sup>3</sup>	\$86.00
Tap Boxes—Handle through Cover: Two-Pole—THQC	3-pole	30	120/240 V	LW32C30 <sup>3</sup>	\$86.00
Tap Boxes—Handle through Cover: Two-Pole—THQC	3-pole	15	240 V	LW3C15 <sup>3</sup>	\$137.00
Tap Boxes—Handle through Cover: Three-Pole—THQC	3-pole	20	240 V	LW3C20 <sup>3</sup>	\$137.00
Tap Boxes—Handle through Cover: Three-Pole—THQC	3-pole	30	240 V	LW3C30 <sup>3</sup>	\$137.00
Tap Boxes—External Operating Handle Single-Pole—THQC	2-pole	15	120 V	LW2C15X <sup>3</sup>	\$90.50
Tap Boxes—External Operating Handle Single-Pole—THQC	2-pole	20	120 V	LW2C20X <sup>3</sup>	\$90.50
Tap Boxes—External Operating Handle Single-Pole—THQC	2-pole	30	120	LW2C30X <sup>3</sup>	\$90.50
Tap Boxes—External Operating Handle Two-Pole—THQC	3-pole	15	120/240 V	LW32C15X <sup>3</sup>	\$108.00
Tap Boxes—External Operating Handle Two-Pole—THQC	3-pole	20	120/240 V	LW32C20X <sup>3</sup>	\$108.00
Tap Boxes—External Operating Handle Two-Pole—THQC	3-pole	30	120/240 V	LW32C30X <sup>3</sup>	\$108.00
Tap Boxes—External Operating Handle Three-Pole—THQC	3-pole	15	240 V	LW3C15X <sup>3</sup>	\$158.00
Tap Boxes—External Operating Handle Three-Pole—THQC	3-pole	20	240 V	LW3C20X <sup>3</sup>	\$158.00
Tap Boxes—External Operating Handle Three-Pole—THQC	3-pole	30	240 V	LW3C30X <sup>3</sup>	\$158.00

(Polarity of single-pole devices can be reversed in the field.)

<sup>2</sup>30 amp fusible tap boxes also available (accepts 25 and 30 amp class G fuses).

Contact your local GE Energy Sales Office.

<sup>3</sup>Includes circuit breaker.

<sup>4</sup>Two-phases and neutral from 480 Y/277 Volt system, 300 Volts maximum to ground.



# Busway LW Busway (continued)

Replacement Parts  
Application and Pricing

## Section 11

### Busway Plugs and Receptacles

Plug Type	Service Type	Amperage	Voltage	Bus Bar Contact	Product Number	List Price GO-119
Terminal Plug only	2-pole	20A	300 V	A-N	LWTPA <sup>1</sup>	<b>\$11.00</b>
Terminal Plug only	2-pole	20A	300 V	A-N	LWTPAG <sup>1,2</sup>	<b>\$13.00</b>
Terminal Plug only	2-pole	20A	300 V	B-N	LWTPB <sup>1</sup>	<b>\$11.00</b>
Terminal Plug only	2-pole	20A	300 V	B-N	LWTPBG <sup>1,2</sup>	<b>\$13.00</b>
Terminal Plug only	2-pole	20A, 5A	300 V, 480 V	A-B	LWTPAB <sup>1</sup>	<b>\$14.25</b>
Terminal Plug only	3-pole	20A, 5A	300 V, 480 V	A-B-N	LW3TP <sup>1</sup>	<b>\$28.50</b>
Receptacle only	2-pole	15A	125 V	A-N	LWRPA <sup>1</sup>	<b>\$9.80</b>
Receptacle only	2-pole	15A	125 V	B-N	LWRPB <sup>1</sup>	<b>\$9.80</b>
Terminal and Receptacle	2-pole	15A	125 V (Receptacle Applications)	A-N	LWTRPA <sup>1</sup>	<b>\$14.25</b>
Terminal and Receptacle	2-pole	20A	300 V (Terminal Applications)	B-N	LWTRPB <sup>1</sup>	<b>\$14.25</b>
Fixture-Plug	2-pole	20A	300 V	AN	LWFPA	<b>\$9.80</b>
Fixture-Plug	2-pole	20A	300 V	BN	LWFPB	<b>\$9.80</b>
Fixture-Plug	3-pole	20A	300 V	A-B-N	LW3FP	<b>\$36.00</b>
Fusible Convenience-Plug with Grounding Pin	2-pole	15A	125 Vac (Polarized)	N/A	DFP21G	<b>\$27.50</b>

**(Polarity of single-pole devices can be reversed in the field.)**

<sup>1</sup>Polarity can be reversed in the field.

<sup>2</sup>Includes ground stab. This plug is designed and polarized for three-wire applications using the "B" conductor of the busway as a continuous ground. Polarity must not be reversed in the field.



**Feed-In Boxes Center Overslung**

Amperage	Dimension A	Dimension B	Dimension C
30	9.63"	4.56"	3.06"
60	11.69"	4.81"	3.81"

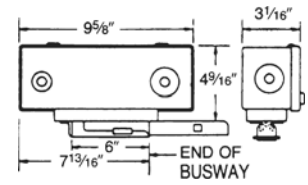

**End Feed Overslung**

**Feed-In Boxes Center Underslung**

Amperage	Dimension A	Dimension B	Dimension C
30	9.63"	4.06"	3.06"
60	11.69"	4.31"	3.81"

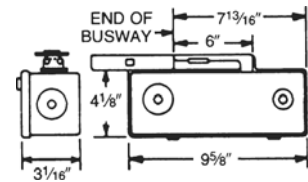

**End Feed Underslung**

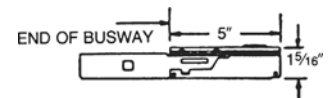

**End Feed Miniature (#12 wire max.)**

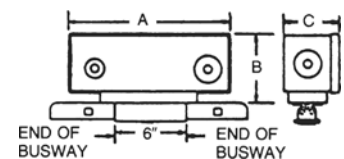

**Center Feed Overslung**

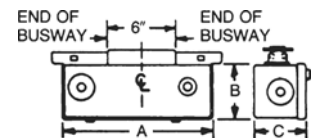

**Center Feed Underslung**



# Busway LW Busway

Replacement Parts

Dimensions

Plug-in Tap Boxes and Plugs

## Section 11

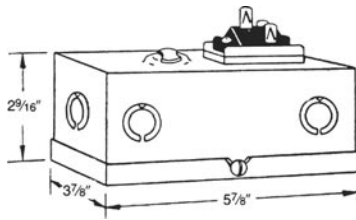

Unfused

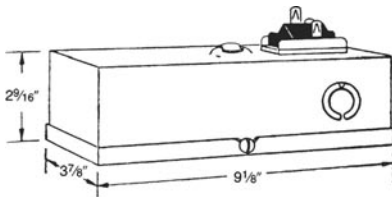

Fusible and Circuit Breaker

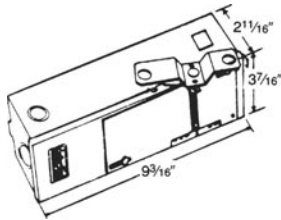

Circuit Breaker, Externally Operated Handle

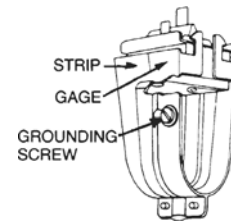

Terminal Plug Cable Clamp Included

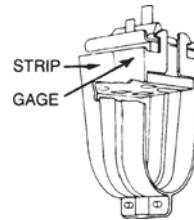

Terminal and Receptacle  
Plug Cable Clamp Included



# Busway Lighting Busway

Type LTG

Plug-in

Application and Pricing

## Section 11

### Type LTG Plug-in Busway

Type LTG plug-in busway is a unique four-wire system designed for convenient distribution of power for lighting or similar light-duty loads.

#### Available Ratings

Amperes: 50 amperes

Voltage: 300 Volts or less, AC or DC

Busing: Copper

Service Type: Three-phase, four-wire

Enclosures: Indoor only

#### Application

Type LTG busway is designed for use on three-phase, four-wire systems that are rated 300 Volts or less. It is available in five- and ten-foot lengths only.

#### Pricing

Type LTG is priced and ordered by product number. Two hangers should be included for each ten feet of busway, and these must be priced separately. Coupling sets are required to connect busway sections, feed-in boxes, or elbows, and these must be priced separately.

#### Linear Lengths and Coupling

Type	Figure No. <sup>1</sup>	Std. Pkg.	Product Number	List Price GO-117
10 feet	1	1	DLTGB422	<b>\$125.00</b>
5 feet	1	1	DLTGB4225	<b>\$109.00</b>
Coupling Set (1 Plate with 4 Connectors)		1	DLTGBCP4	<b>\$20.75</b>
Coupling Plate (only)	2	1	DLTGCP	<b>\$7.60</b>
Bus Connector (only)	3	1	DLTGBC	<b>\$4.40</b>

Order one coupling set for each busway length, feed-in box, and elbow.

<sup>1</sup>See page 11-89.

### Feed-in Boxes

Type	Figure No. <sup>1</sup>	Std. Pkg.	Product Number	List Price GO-117
Feed-In Boxes Surface Mounting End	4	1	DFEB422	<b>\$65.50</b>
Feed-In Boxes Surface Mounting Center	4	1	DFCB422	<b>\$82.00</b>
Feed-In Boxes Suspended Mounting Center	5	1	DAOCBB422	<b>\$75.50</b>
Feed-In Boxes Suspended Mounting Sectionalizing	5	1	DAOCSC422 <sup>2</sup>	<b>\$75.50</b>
Feed-In Boxes Underslung Mounting Center	6	1	DASCB422	<b>\$82.00</b>
Feed-In Boxes Underslung Mounting Sectionalizing	6	1	DASCSB422 <sup>2</sup>	<b>\$82.00</b>

<sup>1</sup>See page 11-89.

<sup>2</sup>Not UL listed.

### Fittings

Type	Figure No. <sup>1</sup>	Std. Pkg.	Product Number	List Price GO-117
Elbows Edgewise, Internal	9	1	DAIEB422	<b>\$120.00</b>
Elbows Edgewise, External	10	1	DAEEB422	<b>\$120.00</b>
Elbows Flat, Internal	8	1	DAIFEB422	<b>\$120.00</b>
Elbows Flat, External	7	1	DAOFEB422	<b>\$120.00</b>

### Hardware

Type	Figure No. <sup>1</sup>	Std. Pkg.	Product Number	List Price GO-117
Hanger Plate (Only with Screws for Surface-Mounting LTG)	11	1	DLTGF	<b>\$3.30</b>
Hanger Plate with Messenger Cable Hook	13	1	DLTGMF1	<b>\$4.40</b>
Combination Rod and Messenger Cable Hanger	12	1	DLTGMF3	<b>\$4.40</b>
End Cap with Screws	14	1	DLTGEC	<b>\$7.60</b>
Fixture Hook	15	1	DLTGFH	<b>\$3.30</b>

Order two hangers for each 10 feet of busway.

<sup>1</sup>See page 11-89.

### Unfused Plugs Terminal (only)

Service Type	Amperage	Voltage	Bus Bar Contact	Std. Pkg.	Product Number	List Price GO-117
4-pole	20	240 AC	A-B	1	DATRP421 <sup>3</sup>	<b>\$54.50</b>

<sup>3</sup>Includes cable clamp and ground terminal.



# Busway Lighting Busway (continued)

Type LTG

Plug-in

Application and Pricing

## Section 11

### Unfused Plugs Terminal and Receptacle

Service Type	Figure No. <sup>1</sup>	Amperage	Voltage	Bus Bar Contact	Std. Pkg.	Product Number	List Price GO-117
2-pole	16	20 (Terminal), 15 (Receptacle)	120Vac (Terminal), 120Vac/ 240Vdc (Receptacle)	A-N	20	DATRP2214AG <sup>2</sup>	<b>\$21.75</b>
2-pole	16	20 (Terminal), 15 (Receptacle)	240Vac (Terminal), 120Vac/ 240Vdc (Receptacle)	B-N	20	DATRP2214BG <sup>2</sup>	<b>\$21.75</b>
2-pole	16	15 (Terminal), 15 (Receptacle)	125Vdc (Terminal), 120Vac/ 240Vdc (Receptacle)	C-N	20	DATRP2214CG <sup>2</sup>	<b>\$21.75</b>

<sup>1</sup>See page 11-89.

<sup>2</sup>Includes cable clamp and ground terminal.

### Unfused Plugs Conduit Box

Service Type	Figure No. <sup>1</sup>	Amperage	Voltage	Bus Bar Contact	Std. Pkg.	Product Number	List Price GO-117
2-pole	17	20	120Vac	A-N	1	DAUC2214A	<b>\$50.00</b>
2-pole	17	20	240Vac	B-N	1	DAUC2214B	<b>\$50.00</b>
2-pole	17	15	125Vdc	C-N	1	DAUC2214C	<b>\$50.00</b>
4-pole	17	20	240Vac	A-B-C-N	1	DAUC421A	<b>\$82.00</b>

<sup>1</sup>See page 11-89.

### Fusible Plugs Single Fuse

Service Type	Figure No. <sup>1</sup>	Amperage	Voltage	Bus Bar Contact	Std. Pkg.	Product Number	List Price GO-117
2-pole	18	20	120Vac/ 125Vdc	A-N	1	DFC2214A	<b>\$120.00</b>
2-pole	18	20	120Vac/ 125Vdc	B-N	1	DFC2214B	<b>\$120.00</b>
2-pole	18	20	120Vac/ 125Vdc	C-N	1	DFC2214C	<b>\$120.00</b>

<sup>1</sup>See page 11-89.

Fuses not included.

### Fusible Plugs 3 Fuses

Service Type	Figure No. <sup>1</sup>	Amperage	Voltage	Bus Bar Contact	Std. Pkg.	Product Number	List Price GO-117
4-pole	18	20	240Vac	A-B-C-N	1	DFC421	<b>\$153.00</b>

<sup>1</sup>See page 11-89.

Fuses not included.

### Circuit Breaker Plugs One Single-Pole Breaker

Service Type	Figure No. <sup>1</sup>	Amperage	Voltage	Bus Bar Contact	Std. Pkg.	Product Number	List Price GO-117
2-pole	19	15	120Vac	A-N	1	DATLB21154A	<b>\$82.00</b>
2-pole	19	15	120Vac	B-N	1	DATLB21154B	<b>\$82.00</b>
2-pole	19	15	120Vac	C-N	1	DATLB21154C	<b>\$82.00</b>
2-pole	19	20	120Vac	A-N	1	DATLB21204A	<b>\$82.00</b>
2-pole	19	20	120Vac	B-N	1	DATLB21204B	<b>\$82.00</b>
2-pole	19	20	120Vac	C-N	1	DATLB21204C	<b>\$82.00</b>
2-pole	19	20	120Vac	A-N	1	DATLB2120 <sup>3</sup>	<b>\$98.00</b>

<sup>1</sup>See page 11-89.

<sup>3</sup>On a three wire system the plug can contact either the A-N or the B-N.

(Includes Type THQL circuit breakers.)



# Busway Lighting Busway

Type LTG  
Plug-in  
Outlines and Dimensions

## Section 11

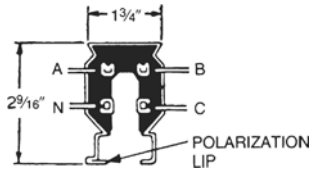

Fig. 1

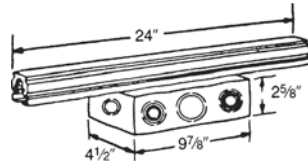

Fig. 6

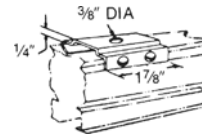

Fig. 11

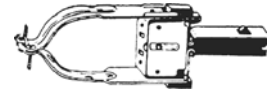

Fig. 16

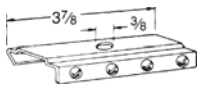

Fig. 2

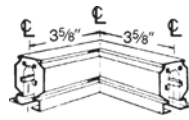

Fig. 7

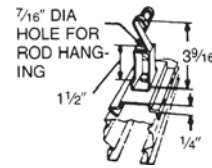

Fig. 12

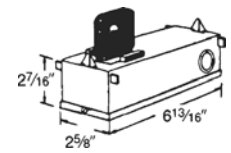

Fig. 17

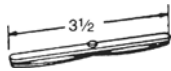

Fig. 3

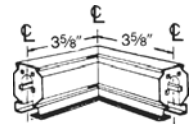

Fig. 8

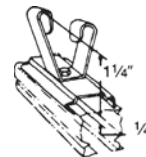

Fig. 13

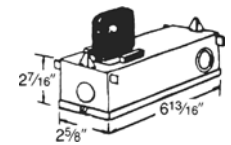

Fig. 18

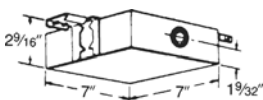

Fig. 4

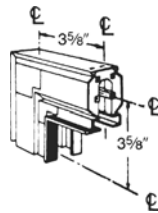

Fig. 9

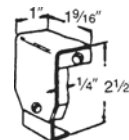

Fig. 14

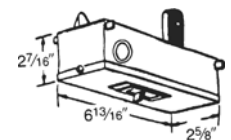

Fig. 19

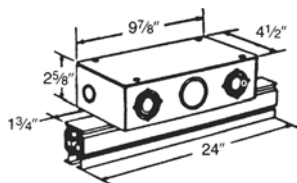

Fig. 5

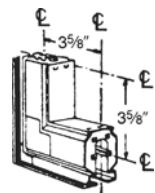

Fig. 10

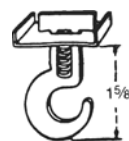

Fig. 15





### General

GE will continue to support your Armor-Clad busway needs with a variety of items allowing you to modify, expand and replace your current system. GE offers transition pieces, bus plugs, switchboard stubs, cable tap boxes, and other items.

### Short-Circuit Ratings

For bus plug short-circuit ratings, see Spectra® ratings on page 11-4.

### Pricing

Prior to ordering transition pieces and accessories from the following page, you will need to obtain the following information to ensure compatibility with your existing Armor-Clad busway system:

- Material: Aluminum or Copper bus bars?
- Ground bar: Optional copper ground bar?
- Service: 3- or 4-wire system?
- Amperes: What ampere is required?
- Phase: What is "A" phase location?
- Joint Type: "Bolt-in" or "Slot-in" joint?

### Plug Dimensions

For bus plug dimensions and weights, see Spectra® plugs on page 11-42.

### Armor-Clad Nomenclature

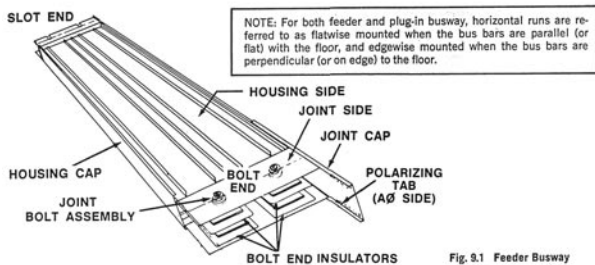

Fig. 9.1 Feeder Busway

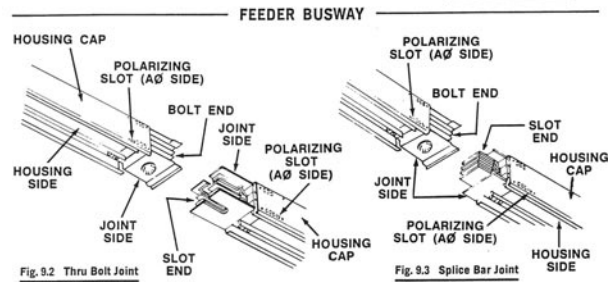

Fig. 9.2 Thru Bolt Joint

Fig. 9.3 Splice Bar Joint

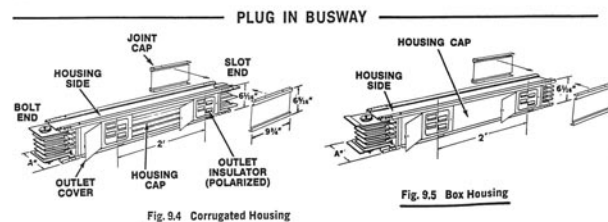
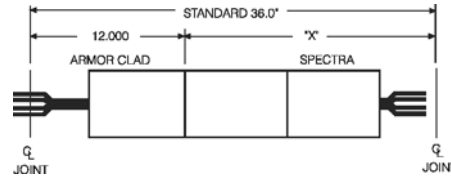

Fig. 9.4 Corrugated Housing

Fig. 9.5 Box Housing

### Transition Section Dimensions

The following shows dimensions for transition sections:  
**Armor-Clad to Spectra®/LowAmp Transition**  
 (Standard 3-foot length; call for custom lengths.)



**Armor-Clad to Spectra® to Armor-Clad Transition**  
 (Standard 5-foot length; call for custom lengths.)

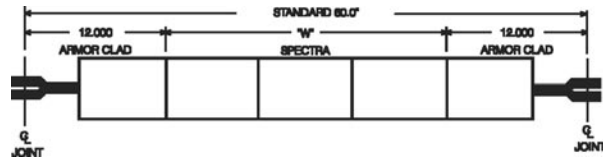

**Aluminum Bus Bars**

		List Prices, GO-126A					
		Ampere Rating					
Component		255	400	600	800	1000	1200
<b>Three-Phase, Three-Wire, AC</b>							
Transition Pieces	3-Ft. Armor-Clad® to Spectra™ to A <sup>1</sup>	—	—	\$1272.00	\$1541.00	\$1755.00	\$2147.00
	5-Ft. Armor-Clad® to Spectra™ to A <sup>1</sup>	—	—	\$2427.00	\$2922.00	\$3327.00	\$4058.00
Accessories	End cable tap box	\$1401.00	\$1548.00	\$1608.00	\$1890.00	\$2081.00	\$2438.00
	Center cable tap box	\$1454.00	\$1643.00	\$1724.00	\$2046.00	\$2261.00	\$2670.00
	Transformer cable tap box 1-3ph	\$845.00	\$879.00	\$929.00	\$1023.00	\$1104.00	\$1191.00
	Switchboard stub	\$1122.00	\$1172.00	\$1274.00	\$1557.00	\$1725.00	\$1919.00
<b>Three-Phase, Four-Wire, AC</b>							
Transition Pieces	3-Ft. Armor-Clad® to Spectra™ to A <sup>1</sup>	—	—	\$1583.00	\$1898.00	\$2291.00	\$2766.00
	5-Ft. Armor-Clad® to Spectra™ to A <sup>1</sup>	—	—	\$3006.00	\$3612.00	\$4346.00	\$5205.00
Accessories	End cable tap box	\$1565.00	\$1739.00	\$1890.00	\$2130.00	\$2489.00	\$3128.00
	Center cable tap box	\$1629.00	\$1856.00	\$2046.00	\$2310.00	\$2721.00	\$3449.00
	Transformer cable tap box 1-3ph	\$921.00	\$971.00	\$1023.00	\$1139.00	\$1241.00	\$1382.00
	Switchboard stub	\$1214.00	\$1365.00	\$1599.00	\$1817.00	\$2063.00	\$2346.00

		List Prices, GO-126A					
		Ampere Rating					
Component		1350	1600	2000	2500	3000	4000
<b>Three-Phase, Three-Wire, AC</b>							
Transition Pieces	3-Ft. Armor-Clad® to Spectra™ to A <sup>1</sup>	\$2334.00	\$2715.00	\$3198.00	\$3887.00	\$4802.00	\$5939.00
	5-Ft. Armor-Clad® to Spectra™ to A <sup>1</sup>	\$4401.00	\$5103.00	\$6003.00	\$7296.00	\$8949.00	\$11115.00
Accessories	End cable tap box	\$2675.00	\$3128.00	\$3657.00	\$4295.00	\$5427.00	\$6305.00
	Center cable tap box	\$2937.00	\$3747.00	\$4403.00	\$5199.00	\$6666.00	\$7749.00
	Transformer cable tap box 1-3ph	\$1272.00	\$1382.00	\$1599.00	\$1917.00	\$2337.00	\$2690.00
	Switchboard stub	\$2091.00	\$2346.00	\$2697.00	\$3116.00	\$3728.00	\$4506.00
<b>Three-Phase, Four-Wire, AC</b>							
Transition Pieces	3-Ft. Armor-Clad® to Spectra™ to A <sup>1</sup>	\$3068.00	\$3560.00	\$4223.00	\$5237.00	\$6209.00	\$8106.00
	5-Ft. Armor-Clad® to Spectra™ to A <sup>1</sup>	\$5766.00	\$6684.00	\$7917.00	\$9819.00	\$11630.00	\$15158.00
Accessories	End cable tap box	\$3416.00	\$3954.00	\$4635.00	\$5577.00	\$6495.00	\$8499.00
	Center cable tap box	\$3779.00	\$4779.00	\$5636.00	\$6816.00	\$7989.00	\$10499.00
	Transformer cable tap box 1-3ph	\$1526.00	\$1641.00	\$1968.00	\$2288.00	\$2657.00	\$3216.00
	Switchboard stub	\$2624.00	\$2940.00	\$3402.00	\$4073.00	\$4775.00	\$6047.00

<sup>1</sup> Call factory for custom lengths of transition pieces.



# Busway Armor-Clad Busway (continued)

Transition Sections and Accessories  
Product Number Pricing

## Section 11

### Copper Bus Bars

Component		List Prices, GO-126C						
		Ampere Rating						
		255	400	600	800	1000	1200	1350
<b>Three-Phase, Three-Wire, AC</b>								
Transition Pieces	3-Ft. Armor-Clad® to Spectra™ to A <sup>1</sup>	—	—	\$1470.00	\$1770.00	\$2061.00	\$2547.00	\$2766.00
	5-Ft. Armor-Clad® to Spectra™ to A <sup>1</sup>	—	—	\$2757.00	\$3305.00	\$3837.00	\$4725.00	\$5121.00
Accessories	End cable tap box	\$1647.00	\$1749.00	\$1997.00	\$2339.00	\$2679.00	\$3222.00	\$3521.00
	Center cable tap box	\$1715.00	\$1845.00	\$2177.00	\$2571.00	\$2960.00	\$3585.00	\$3924.00
	Transformer cable tap box 1-3ph	\$1269.00	\$1311.00	\$1371.00	\$1571.00	\$1776.00	\$2063.00	\$2238.00
	Switchboard stub	\$1554.00	\$1554.00	\$1706.00	\$2105.00	\$2489.00	\$2934.00	\$3194.00
<b>Three-Phase, Four-Wire, AC</b>								
Transition Pieces	3-Ft. Armor-Clad® to Spectra™ to A <sup>1</sup>	\$1913.00	\$2105.00	\$2249.00	\$2738.00	\$3183.00	\$3720.00	\$4056.00
	5-Ft. Armor-Clad® to Spectra™ to A <sup>1</sup>	\$3573.00	\$3957.00	\$4245.00	\$5141.00	\$5948.00	\$6938.00	\$7542.00
Accessories	End cable tap box	\$1956.00	\$2181.00	\$2436.00	\$3020.00	\$3546.00	\$4158.00	\$4598.00
	Center cable tap box	\$2052.00	\$2325.00	\$2684.00	\$3350.00	\$3977.00	\$4653.00	\$5157.00
	Transformer cable tap box 1-3ph	\$1526.00	\$1578.00	\$1620.00	\$1959.00	\$2261.00	\$2562.00	\$2867.00
	Switchboard stub	\$1811.00	\$1962.00	\$2196.00	\$2738.00	\$3275.00	\$3854.00	\$4307.00
<b>Other Items</b>								
Accessories	Wall or floor flange	\$192.00	\$192.00	\$192.00	\$192.00	\$192.00	\$192.00	\$192.00
	Spring Hanger	\$101.00	\$101.00	\$101.00	\$101.00	\$101.00	\$101.00	\$101.00
	Standard trapeze hanger	\$23.00	\$23.00	\$23.00	\$23.00	\$23.00	\$23.00	\$23.00
	Clevis hanger	\$23.00	\$23.00	\$23.00	\$23.00	\$23.00	\$23.00	\$23.00
	Removable joint assembly	—	—	\$407.00	\$428.00	\$465.00	\$486.00	\$515.00
	Joint Isolator	—	—	\$258.00	\$258.00	\$258.00	\$258.00	\$258.00
	Joint tap	—	—	\$452.00	\$476.00	\$516.00	\$540.00	\$572.00

Component		List Prices, GO-126C					
		Ampere Rating					
		1600	2000	2500	3000	4000	5000
<b>Three-Phase, Three-Wire, AC</b>							
Transition Pieces	3-Ft. Armor-Clad® to Spectra™ to A <sup>1</sup>	\$3192.00	\$3855.00	\$4742.00	\$5603.00	\$7271.00	\$9023.00
	5-Ft. Armor-Clad® to Spectra™ to A <sup>1</sup>	\$5898.00	\$7098.00	\$8721.00	\$10284.00	\$13335.00	\$16529.00
Accessories	End cable tap box	\$4062.00	\$4944.00	\$5970.00	\$6995.00	\$8913.00	\$11072.00
	Center cable tap box	\$4539.00	\$6105.00	\$7415.00	\$8756.00	\$11199.00	\$13946.00
	Transformer cable tap box 1-3ph	\$2513.00	\$3042.00	\$3726.00	\$4455.00	\$5546.00	\$6762.00
	Switchboard stub	\$3762.00	\$4533.00	\$5561.00	\$6507.00	\$8460.00	\$10497.00
<b>Three-Phase, Four-Wire, AC</b>							
Transition Pieces	3-Ft. Armor-Clad® to Spectra™ to A <sup>1</sup>	\$4886.00	\$5687.00	\$6870.00	\$8136.00	\$10404.00	\$12431.00
	5-Ft. Armor-Clad® to Spectra™ to A <sup>1</sup>	\$9101.00	\$10520.00	\$12668.00	\$15000.00	\$19116.00	\$22751.00
Accessories	End cable tap box	\$5337.00	\$6548.00	\$8036.00	\$9342.00	\$12245.00	\$15038.00
	Center cable tap box	\$5997.00	\$8166.00	\$10068.00	\$11754.00	\$15453.00	\$19040.00
	Transformer cable tap box 1-3ph	\$3218.00	\$4001.00	\$4851.00	\$5693.00	\$7238.00	\$8879.00
	Switchboard stub	\$4944.00	\$6113.00	\$7548.00	\$8876.00	\$11645.00	\$14408.00
<b>Other Items</b>							
Accessories	Wall or floor flange	\$236.00	\$236.00	\$236.00	\$236.00	\$327.00	\$327.00
	Spring Hanger	\$143.00	\$143.00	\$143.00	\$194.00	\$194.00	\$194.00
	Standard trapeze hanger	\$23.00	\$23.00	\$23.00	\$23.00	\$23.00	\$23.00
	Clevis hanger	\$23.00	\$23.00	\$23.00	\$23.00	\$23.00	\$23.00
	Removable joint assembly	\$927.00	\$993.00	\$1031.00	—	—	—
	Joint Isolator	\$258.00	\$516.00	\$516.00	—	—	—
	Joint tap	\$1031.00	\$1104.00	\$1145.00	—	—	—

<sup>1</sup>Call factory for custom lengths of transition pieces.



# Busway Armor-Clad Busway

Busway Plugs  
Product Number Pricing

# Section 11

## Specification Check

- Exclusive Plug Assist—for mechanical installation on an energized busway run.
- Ground Contact—before stab contact.
- Interlock—to insure that plug is off when engaging bus and when removing plug.
- Door Interlock—plug must be off to open door.

## Standard Frames Three-Phase, Three-Wire TEB

Voltage	Trip Amps	Product Number	List Price GO-114A
240 Volts Fixed Trip	15	AC31EBG	\$642.00
240 Volts Fixed Trip	20	AC32EBG	\$642.00
240 Volts Fixed Trip	30	AC33EBG	\$642.00
240 Volts Fixed Trip	40	AC34EBG	\$642.00
240 Volts Fixed Trip	50	AC35EBG	\$642.00
240 Volts Fixed Trip	70	AC37EBG	\$774.00
240 Volts Fixed Trip	100	AC310EBG	\$774.00

## Standard Frames Three-Phase, Three-Wire TED4

Voltage	Trip Amps	Product Number	List Price GO-114A
480 Volts Fixed Trip	15	AC31ED4G	\$800.00
480 Volts Fixed Trip	20	AC32ED4G	\$800.00
480 Volts Fixed Trip	30	AC33ED4G	\$800.00
480 Volts Fixed Trip	40	AC34ED4G	\$800.00
480 Volts Fixed Trip	50	AC35ED4G	\$800.00
480 Volts Fixed Trip	60	AC36ED4G	\$800.00
480 Volts Fixed Trip	70	AC37ED4G	\$890.00
480 Volts Fixed Trip	100	AC310ED4G	\$890.00

## Standard Frames Three-Phase, Three-Wire TED6

Voltage	Trip Amps	Product Number	List Price GO-114A
600 Volts Fixed Trip	15	AC31ED6G	\$882.00
600 Volts Fixed Trip	20	AC32ED6G	\$882.00
600 Volts Fixed Trip	30	AC33ED6G	\$882.00
600 Volts Fixed Trip	40	AC34ED6G	\$882.00
600 Volts Fixed Trip	50	AC35ED6G	\$882.00
600 Volts Fixed Trip	70	AC37ED6G	\$972.00
600 Volts Fixed Trip	100	AC310ED6G	\$972.00

## Standard Frames Three-Phase, Three-Wire TFJ

Voltage	Trip Amps	Product Number	List Price GO-114A
600 Volts Fixed Trip	70	AC37FJG	\$2108.00
600 Volts Fixed Trip	100	AC310FJG	\$2108.00
600 Volts Fixed Trip	110	AC311FJG	\$2108.00
600 Volts Fixed Trip	125	AC312FJG	\$2108.00
600 Volts Fixed Trip	150	AC315FJG	\$2108.00
600 Volts Fixed Trip	200	AC320FJG	\$2108.00
600 Volts Fixed Trip	225	AC322FJG	\$2108.00

## Standard Frames Three-Phase, Three-Wire TFK

Voltage	Trip Amps	Product Number	List Price GO-114A
600 Volts Inter. Trip	70	AC37FKG	\$2354.00
600 Volts Inter. Trip	100	AC310FKG	\$2354.00
600 Volts Inter. Trip	125	AC312FKG	\$2354.00
600 Volts Inter. Trip	150	AC315FKG	\$2354.00
600 Volts Inter. Trip	200	AC320FKG	\$2354.00
600 Volts Inter. Trip	225	AC322FKG	\$2354.00

## Standard Frames Three-Phase, Three-Wire TJJ

Voltage	Trip Amps	Product Number	List Price GO-114A
600 Volts Fixed Trip	125	AC312JJG	\$4386.00
600 Volts Fixed Trip	150	AC315JJG	\$4386.00
600 Volts Fixed Trip	200	AC320JJG	\$4386.00
600 Volts Fixed Trip	225	AC322JJG	\$4386.00
600 Volts Fixed Trip	300	AC330JJG	\$4386.00
600 Volts Fixed Trip	400	AC340JJG	\$4386.00

## Standard Frames Three-Phase, Three-Wire TJK4

Voltage	Trip Amps	Product Number	List Price GO-114A
600 Volts Inter. Trip	125	AC312JK4G	\$4403.00
600 Volts Inter. Trip	150	AC315JK4G	\$4403.00
600 Volts Inter. Trip	175	AC317JK4G	\$4403.00
600 Volts Inter. Trip	200	AC320JK4G	\$4403.00
600 Volts Inter. Trip	225	AC322JK4G	\$4403.00
600 Volts Inter. Trip	300	AC330JK4G	\$4403.00
600 Volts Inter. Trip	400	AC340JK4G	\$4403.00

## Standard Frames Three-Phase, Three-Wire TJK6

Voltage	Trip Amps	Product Number	List Price GO-114A
600 Volts Inter. Trip	400	AC340JK6G	\$5753.00
600 Volts Inter. Trip	450	AC345JK6G	\$5867.00
600 Volts Inter. Trip	500	AC350JK6G	\$5867.00
600 Volts Inter. Trip	600	AC360JK6G	\$5867.00

## Standard Frames Three-Phase, Three-Wire TKM8

Voltage	Trip Amps	Product Number	List Price GO-114A
600 Volts Inter. Trip	300	AC330KMG	\$6690.00
600 Volts Inter. Trip	400	AC340KMG	\$6690.00
600 Volts Inter. Trip	500	AC350KMG	\$6690.00
600 Volts Inter. Trip	600	AC360KMG	\$6690.00
600 Volts Inter. Trip	700	AC370KMG	\$7479.00
600 Volts Inter. Trip	800	AC380KMG	\$7479.00



# Busway Armor-Clad Busway (continued)

Busway Plugs  
Product Number Pricing

# Section 11

## Standard Frames Three-Phase, Four-Wire TEB

Voltage	Trip Amps	Product Number	List Price GO-114A
240 Volts Fixed Trip	15	AC41EBG	\$717.00
240 Volts Fixed Trip	20	AC42EBG	\$717.00
240 Volts Fixed Trip	30	AC43EBG	\$717.00
240 Volts Fixed Trip	40	AC44EBG	\$717.00
240 Volts Fixed Trip	50	AC45EBG	\$717.00
240 Volts Fixed Trip	70	AC47EBG	\$840.00
240 Volts Fixed Trip	100	AC410EBG	\$840.00

## Standard Frames Three-Phase, Four-Wire TJJ

Voltage	Trip Amps	Product Number	List Price GO-114A
600 Volts Fixed Trip	125	AC412JJG	\$4601.00
600 Volts Fixed Trip	150	AC415JJG	\$4601.00
600 Volts Fixed Trip	200	AC420JJG	\$4601.00
600 Volts Fixed Trip	225	AC422JJG	\$4601.00
600 Volts Fixed Trip	300	AC430JJG	\$4601.00
600 Volts Fixed Trip	400	AC440JJG	\$4601.00

## Standard Frames Three-Phase, Four-Wire TED4

Voltage	Trip Amps	Product Number	List Price GO-114A
480 Volts Fixed Trip	15	AC41ED4G	\$882.00
480 Volts Fixed Trip	20	AC42ED4G	\$882.00
480 Volts Fixed Trip	30	AC43ED4G	\$882.00
480 Volts Fixed Trip	40	AC44ED4G	\$882.00
480 Volts Fixed Trip	50	AC45ED4G	\$882.00
480 Volts Fixed Trip	60	AC46ED4G	\$882.00
480 Volts Fixed Trip	70	AC47ED4G	\$956.00
480 Volts Fixed Trip	100	AC410ED4G	\$956.00

## Standard Frames Three-Phase, Four-Wire TJK4

Voltage	Trip Amps	Product Number	List Price GO-114A
600 Volts Inter. Trip	125	AC412JK4G	\$4617.00
600 Volts Inter. Trip	150	AC415JK4G	\$4617.00
600 Volts Inter. Trip	175	AC417JK4G	\$4617.00
600 Volts Inter. Trip	200	AC420JK4G	\$4617.00
600 Volts Inter. Trip	225	AC422JK4G	\$4617.00
600 Volts Inter. Trip	300	AC430JK4G	\$4617.00
600 Volts Inter. Trip	400	AC440JK4G	\$4617.00

## Standard Frames Three-Phase, Four-Wire TED6

Voltage	Trip Amps	Product Number	List Price GO-114A
600 Volts Fixed Trip	15	AC41ED6G	\$947.00
600 Volts Fixed Trip	20	AC42ED6G	\$947.00
600 Volts Fixed Trip	30	AC43ED6G	\$947.00
600 Volts Fixed Trip	40	AC44ED6G	\$947.00
600 Volts Fixed Trip	50	AC45ED6G	\$947.00
600 Volts Fixed Trip	70	AC47ED6G	\$1046.00
600 Volts Fixed Trip	100	AC410ED6G	\$1046.00

## Standard Frames Three-Phase, Four-Wire TJK6

Voltage	Trip Amps	Product Number	List Price GO-114A
600 Volts Inter. Trip	400	AC440JK6G	\$6015.00
600 Volts Inter. Trip	450	AC445JK6G	\$6015.00
600 Volts Inter. Trip	500	AC450JK6G	\$6164.00
600 Volts Inter. Trip	600	AC460JK6G	\$6164.00

## Standard Frames Three-Phase, Four-Wire TKM8

Voltage	Trip Amps	Product Number	List Price GO-114A
600 Volts Inter. Trip	300	AC430KMG	\$6986.00
600 Volts Inter. Trip	400	AC440KMG	\$6986.00
600 Volts Inter. Trip	500	AC450KMG	\$6986.00
600 Volts Inter. Trip	600	AC460KMG	\$6986.00
600 Volts Inter. Trip	700	AC470KMG	\$7793.00
600 Volts Inter. Trip	800	AC480KMG	\$7793.00

## Standard Frames Three-Phase, Four-Wire TFJ

Voltage	Trip Amps	Product Number	List Price GO-114A
600 Volts Fixed Trip	70	AC47FJG	\$2247.00
600 Volts Fixed Trip	100	AC410FJG	\$2247.00
600 Volts Fixed Trip	110	AC411FJG	\$2247.00
600 Volts Fixed Trip	125	AC412FJG	\$2247.00
600 Volts Fixed Trip	150	AC415FJG	\$2247.00
600 Volts Fixed Trip	200	AC420FJG	\$2247.00
600 Volts Fixed Trip	225	AC422FJG	\$2247.00

## Standard Frames Three-Phase, Four-Wire TFK

Voltage	Trip Amps	Product Number	List Price GO-114A
600 Volts Inter. Trip	70	AC47FKG	\$2478.00
600 Volts Inter. Trip	100	AC410FKG	\$2478.00
600 Volts Inter. Trip	125	AC412FKG	\$2478.00
600 Volts Inter. Trip	150	AC415FKG	\$2478.00
600 Volts Inter. Trip	200	AC420FKG	\$2478.00
600 Volts Inter. Trip	225	AC422FKG	\$2478.00



# Busway Armor-Clad Busway

Busway Plugs  
Product Number Pricing

# Section 11

## Hi-Break Frames Three-Phase, Three-Wire THED

Voltage	Trip Amps	Product Number	List Price GO-114A
600 Volts Fixed Trip	15	AC31HEDG	<b>\$1112.00</b>
600 Volts Fixed Trip	20	AC32HEDG	<b>\$1112.00</b>
600 Volts Fixed Trip	30	AC33HEDG	<b>\$1112.00</b>
600 Volts Fixed Trip	40	AC34HEDG	<b>\$1112.00</b>
600 Volts Fixed Trip	50	AC35HEDG	<b>\$1112.00</b>
600 Volts Fixed Trip	70	AC37HEDG	<b>\$1211.00</b>
600 Volts Fixed Trip	100	AC310HEDG	<b>\$1211.00</b>

## Hi-Break Frames Three-Phase, Four-Wire THED

Voltage	Trip Amps	Product Number	List Price GO-114A
600 Volts Fixed Trip	15	AC41HEDG	<b>\$1178.00</b>
600 Volts Fixed Trip	20	AC42HEDG	<b>\$1178.00</b>
600 Volts Fixed Trip	30	AC43HEDG	<b>\$1178.00</b>
600 Volts Fixed Trip	40	AC44HEDG	<b>\$1178.00</b>
600 Volts Fixed Trip	50	AC45HEDG	<b>\$1178.00</b>
600 Volts Fixed Trip	70	AC47HEDG	<b>\$1284.00</b>
600 Volts Fixed Trip	100	AC410HEDG	<b>\$1284.00</b>

## Hi-Break Frames Three-Phase, Three-Wire THFK

Voltage	Trip Amps	Product Number	List Price GO-114A
600 Volts Inter. Trip	70	AC37HFKG	<b>\$3836.00</b>
600 Volts Inter. Trip	100	AC310HFKG	<b>\$3836.00</b>
600 Volts Inter. Trip	125	AC312HFKG	<b>\$3836.00</b>
600 Volts Inter. Trip	150	AC315HFKG	<b>\$3836.00</b>
600 Volts Inter. Trip	200	AC320HFKG	<b>\$3836.00</b>
600 Volts Inter. Trip	225	AC322HFKG	<b>\$3836.00</b>

## Hi-Break Frames Three-Phase, Four-Wire THFK

Voltage	Trip Amps	Product Number	List Price GO-114A
600 Volts Inter. Trip	70	AC47HFKG	<b>\$3966.00</b>
600 Volts Inter. Trip	100	AC410HFKG	<b>\$3966.00</b>
600 Volts Inter. Trip	125	AC412HFKG	<b>\$3966.00</b>
600 Volts Inter. Trip	150	AC415HFKG	<b>\$3966.00</b>
600 Volts Inter. Trip	200	AC420HFKG	<b>\$3966.00</b>
600 Volts Inter. Trip	225	AC422HFKG	<b>\$3966.00</b>

## Hi-Break Frames Three-Phase, Three-Wire THJK4

Voltage	Trip Amps	Product Number	List Price GO-114A
600 Volts Inter. Trip	125	AC312HJK4G	<b>\$6065.00</b>
600 Volts Inter. Trip	150	AC315HJK4G	<b>\$6065.00</b>
600 Volts Inter. Trip	200	AC320HJK4G	<b>\$6065.00</b>
600 Volts Inter. Trip	225	AC322HJK4G	<b>\$6065.00</b>
600 Volts Inter. Trip	300	AC330HJK4G	<b>\$6065.00</b>
600 Volts Inter. Trip	400	AC340HJK4G	<b>\$6065.00</b>

## Hi-Break Frames Three-Phase, Four-Wire THJK4

Voltage	Trip Amps	Product Number	List Price GO-114A
600 Volts Inter. Trip	125	AC412HJK4G	<b>\$6263.00</b>
600 Volts Inter. Trip	150	AC415HJK4G	<b>\$6263.00</b>
600 Volts Inter. Trip	200	AC420HJK4G	<b>\$6263.00</b>
600 Volts Inter. Trip	225	AC422HJK4G	<b>\$6263.00</b>
600 Volts Inter. Trip	300	AC430HJK4G	<b>\$6263.00</b>
600 Volts Inter. Trip	400	AC440HJK4G	<b>\$6263.00</b>

## Hi-Break Frames Three-Phase, Three-Wire THJK6

Voltage	Trip Amps	Product Number	List Price GO-114A
600 Volts Inter. Trip	400	AC340HJK6G	<b>\$6140.00</b>
600 Volts Inter. Trip	450	AC345HJK6G	<b>\$6140.00</b>
600 Volts Inter. Trip	500	AC350HJK6G	<b>\$6140.00</b>
600 Volts Inter. Trip	600	AC360HJK6G	<b>\$6140.00</b>

## Hi-Break Frames Three-Phase, Four-Wire THJK6

Voltage	Trip Amps	Product Number	List Price GO-114A
600 Volts Inter. Trip	400	AC440HJK6G	<b>\$6342.00</b>
600 Volts Inter. Trip	450	AC445HJK6G	<b>\$6342.00</b>
600 Volts Inter. Trip	500	AC450HJK6G	<b>\$6342.00</b>
600 Volts Inter. Trip	600	AC460HJK6G	<b>\$6342.00</b>

## Hi-Break Frames Three-Phase, Three-Wire THKM8

Voltage	Trip Amps	Product Number	List Price GO-114A
600 Volts Inter. Trip	300	AC330HKMG	<b>\$7200.00</b>
600 Volts Inter. Trip	400	AC340HKMG	<b>\$7200.00</b>
600 Volts Inter. Trip	500	AC350HKMG	<b>\$7200.00</b>
600 Volts Inter. Trip	600	AC360HKMG	<b>\$7200.00</b>
600 Volts Inter. Trip	700	AC370HKMG	<b>\$8451.00</b>
600 Volts Inter. Trip	800	AC380HKMG	<b>\$8451.00</b>

## Hi-Break Frames Three-Phase, Four-Wire THKM8

Voltage	Trip Amps	Product Number	List Price GO-114A
600 Volts Inter. Trip	300	AC430HKMG	<b>\$7512.00</b>
600 Volts Inter. Trip	400	AC440HKMG	<b>\$7512.00</b>
600 Volts Inter. Trip	500	AC450HKMG	<b>\$7512.00</b>
600 Volts Inter. Trip	600	AC460HKMG	<b>\$7512.00</b>
600 Volts Inter. Trip	700	AC470HKMG	<b>\$8796.00</b>
600 Volts Inter. Trip	800	AC480HKMG	<b>\$8796.00</b>



# Busway Armor-Clad Busway

Busway Plugs  
Product Number Pricing

# Section 11

## High Interrupting Spectra® RMS Circuit Breaker Three-Phase, Three-Wire SELA

Short Circuit Rating @ 240V (kAIC)	Short Circuit Rating @ 480V (kAIC)	Short Circuit Rating @ 600V (kAIC)	Trip Amps	Product Number	List Price GO-114A
100	65	25	15	AC31SELG	\$1679.00
100	65	25	20	AC32SELG	\$1679.00
100	65	25	30	AC33SELG	\$1679.00
100	65	25	40	AC34SELG	\$1679.00
100	65	25	50	AC35SELG	\$1679.00
100	65	25	60	AC36SELG	\$1679.00
100	65	25	70	AC37SELG	\$1979.00
100	65	25	80	AC38SELG	\$1979.00
100	65	25	90	AC39SELG	\$1979.00
100	65	25	100	AC310SELG	\$1979.00
100	65	25	110	AC311SELG	\$4184.00
100	65	25	125	AC312SELG	\$4184.00
100	65	25	150	AC315SELG	\$4184.00

IC rating in rms symmetrical kA.

## High Interrupting Spectra® RMS Circuit Breaker Three-Phase, Four-Wire SELA

Short Circuit Rating @ 240V (kAIC)	Short Circuit Rating @ 480V (kAIC)	Short Circuit Rating @ 600V (kAIC)	Trip Amps	Product Number	List Price GO-114A
100	65	25	15	AC41SELG	\$1829.00
100	65	25	20	AC42SELG	\$1829.00
100	65	25	30	AC43SELG	\$1829.00
100	65	25	40	AC44SELG	\$1829.00
100	65	25	50	AC45SELG	\$1829.00
100	65	25	60	AC46SELG	\$1829.00
100	65	25	70	AC47SELG	\$2129.00
100	65	25	80	AC48SELG	\$2129.00
100	65	25	90	AC49SELG	\$2129.00
100	65	25	100	AC410SELG	\$2129.00
100	65	25	110	AC411SELG	\$4334.00
100	65	25	125	AC412SELG	\$4334.00
100	65	25	150	AC415SELG	\$4334.00

IC rating in rms symmetrical kA.

## High Interrupting Spectra® RMS Circuit Breaker Three-Phase, Three-Wire SFLA

Short Circuit Rating @ 240V (kAIC)	Short Circuit Rating @ 480V (kAIC)	Short Circuit Rating @ 600V (kAIC)	Trip Amps	Product Number	List Price GO-114A
100	65	25	70	AC37SFLG	\$4482.00
100	65	25	90	AC39SFLG	\$4482.00
100	65	25	100	AC310SFLG	\$4482.00
100	65	25	110	AC311SFLG	\$4482.00
100	65	25	125	AC312SFLG	\$4482.00
100	65	25	150	AC315SFLG	\$4482.00
100	65	25	175	AC317SFLG	\$4482.00
100	65	25	200	AC320SFLG	\$4482.00
100	65	25	225	AC322SFLG	\$4482.00
100	65	25	250	AC325SFLG	\$4482.00

IC rating in rms symmetrical kA.

## High Interrupting Spectra® RMS Circuit Breaker Three-Phase, Four-Wire SFLA

Short Circuit Rating @ 240V (kAIC)	Short Circuit Rating @ 480V (kAIC)	Short Circuit Rating @ 600V (kAIC)	Trip Amps	Product Number	List Price GO-114A
100	65	25	70	AC47SFLG	\$4647.00
100	65	25	90	AC49SFLG	\$4647.00
100	65	25	100	AC410SFLG	\$4647.00
100	65	25	110	AC411SFLG	\$4647.00
100	65	25	125	AC412SFLG	\$4647.00
100	65	25	150	AC415SFLG	\$4647.00
100	65	25	175	AC417SFLG	\$4647.00
100	65	25	200	AC420SFLG	\$4647.00
100	65	25	225	AC422SFLG	\$4647.00
100	65	25	250	AC425SFLG	\$4647.00

IC rating in rms symmetrical kA.

NOTE: Armor-Clad Busway Plugs have the same dimensions as Spectra®-Series Plugs. Refer to page 11-42.





# Busway Armor-Clad Busway

Busway Plugs  
Product Number Pricing

## Section 11

### Tri-Break® Three-Phase, Three-Wire TB1

Voltage	Trip Amps	Product Number	List Price GO-114A
600 Volts Fixed Trip	15	AC31B1E05G	\$2667.00
600 Volts Fixed Trip	20	AC32B1E05G	\$2667.00
600 Volts Fixed Trip	30	AC33B1E05G	\$2667.00
600 Volts Fixed Trip	40	AC34B1E05G	\$2667.00
600 Volts Fixed Trip	50	AC35B1E09G	\$2667.00
600 Volts Fixed Trip	70	AC37B1E09G	\$2667.00
600 Volts Fixed Trip	100	AC310B1E09G	\$2667.00

### Tri-Break® Three-Phase, Three-Wire TB4

Voltage	Trip Amps	Product Number	List Price GO-114A
600 Volts Inter. Trip	125	AC312B4F14G	\$6065.00
600 Volts Inter. Trip	150	AC315B4F14G	\$6065.00
600 Volts Inter. Trip	200	AC320B4F14G	\$6065.00
600 Volts Inter. Trip	225	AC322B4F14G	\$6065.00
600 Volts Inter. Trip	300	AC330B4F14G	\$7250.00
600 Volts Inter. Trip	400	AC340B4F14G	\$7250.00

### Tri-Break® Three-Phase, Three-Wire TB6

Voltage	Trip Amps	Product Number	List Price GO-114A
600 Volts Inter. Trip	300	AC330B6J14G	\$10886.00
600 Volts Inter. Trip	400	AC340B6J14G	\$10886.00
600 Volts Inter. Trip	500	AC350B6J14G	\$10886.00
600 Volts Inter. Trip	600	AC360B6J14G	\$10886.00

### Tri-Break® Three-Phase, Three-Wire TB8

Voltage	Trip Amps	Product Number	List Price GO-114A
600 Volts Inter. Trip	600	AC360B8K22G	\$12335.00
600 Volts Inter. Trip	700	AC370B8K22G	\$12335.00
600 Volts Inter. Trip	800	AC380B8K22G	\$12335.00

### Tri-Break® Three-Phase, Four-Wire TB1

Voltage	Trip Amps	Product Number	List Price GO-114A
600 Volts Fixed Trip	15	AC41B1E05G	\$2750.00
600 Volts Fixed Trip	20	AC42B1E05G	\$2750.00
600 Volts Fixed Trip	30	AC43B1E05G	\$2750.00
600 Volts Fixed Trip	40	AC44B1E05G	\$2750.00
600 Volts Fixed Trip	50	AC45B1E09G	\$2750.00
600 Volts Fixed Trip	70	AC47B1E09G	\$2750.00
600 Volts Fixed Trip	100	AC410B1E09G	\$2750.00

### Tri-Break® Three-Phase, Four-Wire TB4

Voltage	Trip Amps	Product Number	List Price GO-114A
600 Volts Inter. Trip	125	AC412B4F14G	\$6213.00
600 Volts Inter. Trip	150	AC415B4F14G	\$6213.00
600 Volts Inter. Trip	200	AC420B4F14G	\$6213.00
600 Volts Inter. Trip	225	AC422B4F14G	\$6213.00
600 Volts Inter. Trip	300	AC430B4F14G	\$7694.00
600 Volts Inter. Trip	400	AC440B4F14G	\$7694.00

### Tri-Break® Three-Phase, Four-Wire TB6

Voltage	Trip Amps	Product Number	List Price GO-114A
600 Volts Inter. Trip	300	AC430B6J14G	\$11216.00
600 Volts Inter. Trip	400	AC440B6J14G	\$11216.00
600 Volts Inter. Trip	500	AC450B6J14G	\$11216.00
600 Volts Inter. Trip	600	AC460B6J14G	\$11216.00

### Tri-Break® Three-Phase, Four-Wire TB8

Voltage	Trip Amps	Product Number	List Price GO-114A
600 Volts Inter. Trip	600	AC460B8K22G	\$12663.00
600 Volts Inter. Trip	700	AC470B8K22G	\$12663.00
600 Volts Inter. Trip	800	AC480B8K22G	\$12663.00

### Switch-Operated Fusible Plugs Three-Phase, Three-Wire

Voltage	Trip Amps	Product Number	List Price GO-114B
240	30	AC321RG	\$420.00
240	60	AC322RG	\$462.00
240	100	AC323RG	\$642.00
240	200	AC324RG	\$1088.00
240	400	AC325RG	\$2831.00
240	600	AC326RG	\$3869.00
480 or 600	30	AC361RG	\$462.00
480 or 600	60	AC362RG	\$479.00
480 or 600	100	AC363RG	\$668.00
480 or 600	200	AC364RG	\$1137.00
480 or 600	400	AC365RG	\$2831.00
480 or 600	600	AC366RG	\$3869.00

With QMR Interrupter Fuses Not Included

### Switch-Operated Fusible Plugs Three-Phase, Four-Wire

Voltage	Trip Amps	Product Number	List Price GO-114B
240	30	AC421RG	\$495.00
240	60	AC422RG	\$528.00
240	100	AC423RG	\$717.00
240	200	AC424RG	\$1218.00
240	400	AC425RG	\$3021.00
240	600	AC426RG	\$4214.00
480 or 600	30	AC461RG	\$528.00
480 or 600	60	AC462RG	\$545.00
480 or 600	100	AC463RG	\$767.00
480 or 600	200	AC464RG	\$1260.00
480 or 600	400	AC465RG	\$3021.00
480 or 600	600	AC466RG	\$4221.00

With QMR Interrupter Fuses Not Included

### Shunt Trip Option

List Price GO-114M
List Price Adder
\$1152.00



**Enclosure Only**

**Three-Phase, Three-Wire Ground Standard**

Voltage	Trip Amps	Product Number	List Price GO-114A
E	100 max.	AC3100EG <sup>1</sup>	<b>\$315.00</b>
F	225	AC3225FG <sup>1</sup>	<b>\$690.00</b>

<sup>1</sup>Not for Spectra® breakers. E and F frame enclosures for standard molded case circuit breakers only.  
 (Order circuit breaker from Section 3.)

**Enclosure Only Three-Phase, Four-Wire Ground Standard**

Voltage	Trip Amps	Product Number	List Price GO-114A
E	100 max.	AC4100EG <sup>1</sup>	<b>\$338.00</b>
F	225	AC4225FG <sup>1</sup>	<b>\$795.00</b>

<sup>1</sup>Not for Spectra® breakers. E and F frame enclosures for standard molded case circuit breakers only.  
 (Order circuit breaker from Section 3.)

**Ground Dector Plugs Three-Phase, Three-Wire**

Voltage	Product Number	List Price GO-114B
208-240	AC321N	<b>\$533.00</b>
440-600	AC361N	<b>\$533.00</b>

Not UL Listed

**Adapter Kits**

Voltage	Trip Amps	Product Number	List Price GO-114L
Convert Armor-Clad Plugs to Spectra® Bus	30-100	ACSB1G	<b>\$128.00</b>
Convert Armor-Clad Plugs to Spectra® Bus	200-225	ACSB4G	<b>\$294.00</b>
Convert Armor-Clad Plugs to Spectra® Bus	400-800	ACSB5G	<b>\$442.00</b>

(Style 7 and 8 shipped after 1/91.) Ground stabs included.

**Miscellaneous Modifications**

Plug Assist - Standard for plugs over 100 amperes. Add suffix "P" to the product number for plugs 100 amperes and below, \$54.00 list, GO-114A or B.

**Contactor Plugs—Add to price of required protective device bus plug**

Ampere Rating	Type	List Price Adder GO-114A or B
30	Electrically Held	<b>\$1013.00</b>
60	Electrically Held	<b>\$1455.00</b>
100	Electrically Held	<b>\$1875.00</b>
30	Mechanically Held	<b>\$1268.00</b>
60	Mechanically Held	<b>\$1890.00</b>
100	Mechanically Held	<b>\$2430.00</b>
30	Pilot Light	<b>\$249.00</b>
60	Pilot Light	<b>\$249.00</b>
100	Pilot Light	<b>\$249.00</b>
30	Pushbutton or Selector Switch	<b>\$188.00</b>
60	Pushbutton or Selector Switch	<b>\$188.00</b>
100	Pushbutton or Selector Switch	<b>\$188.00</b>
30	Control Transformer <sup>2</sup>	<b>\$248.00</b>
60	Control Transformer <sup>2</sup>	<b>\$345.00</b>
100	Control Transformer <sup>2</sup>	<b>\$480.00</b>
30	Extra Interlock	<b>\$120.00</b>
60	Extra Interlock	<b>\$120.00</b>
100	Extra Interlock	<b>\$120.00</b>
30	Two-wire Control	<b>\$360.00</b>
60	Two-wire Control	<b>\$360.00</b>
100	Two-wire Control	<b>\$360.00</b>
30	Auxiliary Contact	<b>\$99.00</b>
60	Auxiliary Contact	<b>\$99.00</b>
100	Auxiliary Contact	<b>\$99.00</b>

<sup>2</sup>Includes one secondary fuse.

**Options for Fusible Switch Units— Use for Armor-Clad Busway**

UL Listed Ampere Rating	Description	List Price Adder GO-114A or B
30	Factory installed Class R fuse clips; add suffix "R" to Product Number	<b>\$56.00</b>
60	Factory installed Class R fuse clips; add suffix "R" to Product Number	<b>\$56.00</b>
100	Factory installed Class R fuse clips; add suffix "R" to Product Number	<b>\$56.00</b>
200	Factory installed Class R fuse clips; add suffix "R" to Product Number	<b>\$71.00</b>
400	Factory installed Class R fuse clips; add suffix "R" to Product Number	<b>\$75.00</b>
600	Factory installed Class R fuse clips; add suffix "R" to Product Number	<b>\$80.00</b>
30	Factory installed Class J fuse clips; add suffix "J" to 600 V plug Product Number	<b>\$32.00</b>
60	Factory installed Class J fuse clips; add suffix "J" to 600 V plug Product Number	<b>\$32.00</b>
100	Factory installed Class J fuse clips; add suffix "J" to 600 V plug Product Number	<b>\$32.00</b>
200	Factory installed Class J fuse clips; add suffix "J" to 600 V plug Product Number	<b>\$32.00</b>
400	Factory installed Class J fuse clips; add suffix "J" to 600 V plug Product Number	<b>\$32.00</b>
600	Factory installed Class J fuse clips; add suffix "J" to 600 V plug Product Number	<b>\$263.00</b>
30	QMW in lieu of QMR; change "R" in Product Number to "W"	<b>\$53.00</b>
60	QMW in lieu of QMR; change "R" in Product Number to "W"	<b>\$53.00</b>
100	QMW in lieu of QMR; change "R" in Product Number to "W"	<b>\$99.00</b>
200	QMW in lieu of QMR; change "R" in Product Number to "W"	<b>\$147.00</b>
400	QMW in lieu of QMR; change "R" in Product Number to "W"	<b>\$395.00</b>
600	QMW in lieu of QMR; change "R" in Product Number to "W"	<b>\$2715.00</b>



# Busway Flex-A-Power® Busway

Types FVA, FVK and LVDP

Application and Product Number Pricing

### Types FVA and FVK Busway

Types FVA and FVK Flex-A-Power® busway are obsolete for new manufacture. Only end boxes and cable tap boxes are available.

### Pricing

FVA/FVK busways are priced by product number.

### Aluminum Bus for Type FVA 225 Amps Three-Phase, Three-Wire, or Three-Wire, DC 600 Volts

Component	Type	Product Number	List Price GO-115A
Accessories	End Box	DASKEB34	<b>\$159.00</b>
Accessories	Cable Tap Box	DAACB32 <sup>1</sup>	<b>\$789.00</b>

<sup>1</sup>Center cable tap box. For end cable tap box, price and order this tap box plus an end box.

### Aluminum Bus for Type FVA 400 Amps Three-Phase, Three-Wire, or Three-Wire, DC 600 Volts

Component	Type	Product Number	List Price GO-115A
Accessories	End Box	DASKEB36	<b>\$159.00</b>
Accessories	Cable Tap Box	DAACB34 <sup>1</sup>	<b>\$789.00</b>

<sup>1</sup>Center cable tap box. For end cable tap box, price and order this tap box plus an end box.

### Aluminum Bus for Type FVA 600 Amps Three-Phase, Three-Wire, or Three-Wire, DC 600 Volts

Component	Type	Product Number	List Price GO-115A
Accessories	End Box	DASKEB310	<b>\$159.00</b>
Accessories	Cable Tap Box	DAACB36 <sup>1</sup>	<b>\$789.00</b>

<sup>1</sup>Center cable tap box. For end cable tap box, price and order this tap box plus an end box.

### Aluminum Bus for Type FVA 800 Amps Three-Phase, Three-Wire, or Three-Wire, DC 600 Volts

Component	Type	Product Number	List Price GO-115A
Accessories	End Box	DASKEB310	<b>\$159.00</b>
Accessories	Cable Tap Box	DAACB38 <sup>1</sup>	<b>\$1046.00</b>

<sup>1</sup>Center cable tap box. For end cable tap box, price and order this tap box plus an end box.

### Aluminum Bus for Type FVA 225 Amps Three-Phase, Four-Wire 480 Y/277 or 208 Y/120 Volts, Half Capacity Neutral

Component	Type	Product Number	List Price GO-115A
Accessories	End Box	DASKEBN134A	<b>\$159.00</b>
Accessories	Cable Tap Box	DAACBN132A <sup>1</sup>	<b>\$789.00</b>

<sup>1</sup>Center cable tap box. For end cable tap box, price and order this tap box plus an end box.

### Aluminum Bus for Type FVA 400 Amps Three-Phase, Four-Wire 480 Y/277 or 208 Y/120 Volts, Half Capacity Neutral

Component	Type	Product Number	List Price GO-115A
Accessories	End Box	DASKEBN136A	<b>\$159.00</b>
Accessories	Cable Tap Box	DAACBN134 <sup>1</sup>	<b>\$789.00</b>

<sup>1</sup>Center cable tap box. For end cable tap box, price and order this tap box plus an end box.



# Busway Flex-A-Power® Busway (continued)

Types FVA, FVK and LVDP

Application and Product Number Pricing

## Section 11

### Aluminum Bus for Type FVA 600 Amps Three-Phase, Four-Wire 480 Y/277 or 208 Y/120 Volts, Half Capacity Neutral

Component	Type	Product Number	List Price GO-115A
Accessories	End Box	DASKEBN1310A	<b>\$159.00</b>
Accessories	Cable Tap Box	DAACBN136 <sup>1</sup>	<b>\$951.00</b>

<sup>1</sup>Center cable tap box. For end cable tap box, price and order this tap box plus an end box.

### Aluminum Bus for Type FVA 800 Amps Three-Phase, Four-Wire 480 Y/277 or 208 Y/120 Volts, Half Capacity Neutral

Component	Type	Product Number	List Price GO-115A
Accessories	End Box	DASKEBN1310A	<b>\$159.00</b>
Accessories	Cable Tap Box	DAACBN138 <sup>1</sup>	<b>\$951.00</b>

<sup>1</sup>Center cable tap box. For end cable tap box, price and order this tap box plus an end box.

### Copper Bus for Type FVK 225 Amps Three-Phase, Three-Wire, or Three-Wire, DC 600 Volts

Component	Type	Product Number	List Price GO-115C
Accessories	End Box	DASKEB34 <sup>2</sup>	<b>\$159.00</b>
Accessories	Cable Tap Box	DAKCB32 <sup>1</sup>	<b>\$789.00</b>

<sup>1</sup>Center cable tap box. For end cable tap box, price and order this tap box plus an end box.

<sup>2</sup>GO-115A

### Copper Bus for Type FVK 400 Amps Three-Phase, Three-Wire, or Three-Wire, DC 600 Volts

Component	Type	Product Number	List Price GO-115C
Accessories	End Box	DASKEB34 <sup>2</sup>	<b>\$159.00</b>
Accessories	Cable Tap Box	DAKCB34B <sup>1</sup>	<b>\$789.00</b>

<sup>1</sup>Center cable tap box. For end cable tap box, price and order this tap box plus an end box.

<sup>2</sup>GO-115A

### Copper Bus for Type FVK 600 Amps Three-Phase, Three-Wire, or Three-Wire, DC 600 Volts

Component	Type	Product Number	List Price GO-115C
Accessories	End Box	DASKEB36 <sup>2</sup>	<b>\$159.00</b>
Accessories	Cable Tap Box	DAKCB36 <sup>1</sup>	<b>\$789.00</b>

<sup>1</sup>Center cable tap box. For end cable tap box, price and order this tap box plus an end box.

<sup>2</sup>GO-115A

### Copper Bus for Type FVK 800 Amps Three-Phase, Three-Wire, or Three-Wire, DC 600 Volts

Component	Type	Product Number	List Price GO-115C
Accessories	End Box	DASKEB310 <sup>2</sup>	<b>\$159.00</b>
Accessories	Cable Tap Box	DAKCB310 <sup>1</sup>	<b>\$1046.00</b>

<sup>1</sup>Center cable tap box. For end cable tap box, price and order this tap box plus an end box.

<sup>2</sup>GO-115A

### Copper Bus for Type FVK 1000 Amps Three-Phase, Three-Wire, or Three-Wire, DC 600 Volts

Component	Type	Product Number	List Price GO-115C
Accessories	End Box	DASKEB310 <sup>2</sup>	<b>\$159.00</b>
Accessories	Cable Tap Box	DAKCB310 <sup>1</sup>	<b>\$1046.00</b>

<sup>1</sup>Center cable tap box. For end cable tap box, price and order this tap box plus an end box.

<sup>2</sup>GO-115A



# Busway Flex-A-Power® Busway (continued)

Types FVA, FVK and LVDP

Application and Product Number Pricing

# Section 11

## Copper Bus for Type FVK 225 Amps Three-Phase, Four-Wire 480 Y/277 or 208 Y/120 Volts, Half Capacity Neutral

Component	Type	Product Number	List Price GO-115C
Accessories	End Box	DASKEBN134A <sup>2</sup>	<b>\$159.00</b>
Accessories	Cable Tap Box	DAKCBN132A <sup>1</sup>	<b>\$789.00</b>

<sup>1</sup>Center cable tap box. For end cable tap box, price and order this tap box plus an end box.

<sup>2</sup>GO-115A

## Copper Bus for Type FVK 400 Amps Three-Phase, Four-Wire 480 Y/277 or 208 Y/120 Volts, Half Capacity Neutral

Component	Type	Product Number	List Price GO-115C
Accessories	End Box	DASKEBN134A <sup>2</sup>	<b>\$159.00</b>
Accessories	Cable Tap Box	DAKCBN134A <sup>1</sup>	<b>\$789.00</b>

<sup>1</sup>Center cable tap box. For end cable tap box, price and order this tap box plus an end box.

<sup>2</sup>GO-115A

## Copper Bus for Type FVK 600 Amps Three-Phase, Four-Wire 480 Y/277 or 208 Y/120 Volts, Half Capacity Neutral

Component	Type	Product Number	List Price GO-115C
Accessories	End Box	DASKEBN136A <sup>2</sup>	<b>\$159.00</b>
Accessories	Cable Tap Box	DAKCBN136A <sup>1</sup>	<b>\$789.00</b>

<sup>1</sup>Center cable tap box. For end cable tap box, price and order this tap box plus an end box.

<sup>2</sup>GO-115A

## Copper Bus for Type FVK 800 Amps Three-Phase, Four-Wire 480 Y/277 or 208 Y/120 Volts, Half Capacity Neutral

Component	Type	Product Number	List Price GO-115C
Accessories	End Box	DASKEBN1310A <sup>2</sup>	<b>\$159.00</b>
Accessories	Cable Tap Box	DAKCBN1310A <sup>1</sup>	<b>\$1046.00</b>

<sup>1</sup>Center cable tap box. For end cable tap box, price and order this tap box plus an end box.

<sup>2</sup>GO-115A

## Copper Bus for Type FVK 1000 Amps Three-Phase, Four-Wire 480 Y/277 or 208 Y/120 Volts, Half Capacity Neutral

Component	Type	Product Number	List Price GO-115C
Accessories	End Box	DASKEBN1310A <sup>2</sup>	<b>\$159.00</b>
Accessories	Cable Tap Box	DAKCBN1310A <sup>1</sup>	<b>\$1046.00</b>

<sup>1</sup>Center cable tap box. For end cable tap box, price and order this tap box plus an end box.

<sup>2</sup>GO-115A

## Fusible Plugs—Type QMR Three-Phase, Three-Wire

Component	Voltage	Product Number	List Price GO-114C
30	240	FVK321R	<b>\$390.00</b>
60	240	FVK322R	<b>\$435.00</b>
100	240	FVK323R	<b>\$630.00</b>
200	240	FVK324R	<b>\$1109.00</b>
400	240	FVK325RT <sup>4</sup>	<b>\$2988.00</b>
600	240	FVK326R <sup>3</sup>	<b>\$4104.00</b>
30	600	FVK361R	<b>\$435.00</b>
60	600	FVK362R	<b>\$452.00</b>
100	600	FVK363R	<b>\$656.00</b>
200	600	FVK364R	<b>\$1161.00</b>
400	600	FVK365RT <sup>4</sup>	<b>\$2988.00</b>
600	600	FVK366R <sup>3</sup>	<b>\$4104.00</b>

Externally Operated with Class H Fuse Clips. Fuses Not Included. To add Class R or Class J fuse provisions, see page 11-104.

<sup>3</sup>Special hanger required on LVDP. Furnish nameplate data and see extension panel table. See page 11-104.

<sup>4</sup>T suffix on product number indicates 2(200A) switches used to make up a 400A requirement.

## Fusible Plugs—Type QMR Three-Phase, Four-Wire

Component	Voltage	Product Number	List Price GO-114C
30	240	FVK421R	<b>\$470.00</b>
60	240	FVK422R	<b>\$506.00</b>
100	240	FVK423R	<b>\$710.00</b>
200	240	FVK424R	<b>\$1250.00</b>
400	240	FVK425RT <sup>4</sup>	<b>\$3192.00</b>
600	240	FVK426R <sup>3</sup>	<b>\$4485.00</b>
30	480	FVK461R	<b>\$506.00</b>
60	480	FVK462R	<b>\$524.00</b>
100	480	FVK463R	<b>\$762.00</b>
200	480	FVK464R	<b>\$1295.00</b>
400	480	FVK465RT <sup>4</sup>	<b>\$3192.00</b>
600	480	FVK466R <sup>3</sup>	<b>\$4485.00</b>

Externally Operated with Class H Fuse Clips. Fuses Not Included. To add Class R or Class J fuse provisions, see page 11-104.

<sup>3</sup>Special hanger required on LVDP. Furnish nameplate data and see extension panel table. See page 11-104.

<sup>4</sup>T suffix on product number indicates 2(200A) switches used to make up a 400A requirement.

## Ground Detector Plugs Three-Phase, Three-Wire

Component	Voltage	Product Number	List Price GO-114C
GN	208-240	DAGN32	<b>\$656.00</b>
GN	440-600	DAGN36	<b>\$656.00</b>

(Not UL listed)



# Busway Flex-A-Power® Busway

Types FVA, FVK and LVDP

Busway Plugs

Product Number Pricing

# Section 11

## Circuit Breakers - Standard Frames Three-Phase, Three-Wire TEB

Voltage	Trip Amps	Product Number	List Price GO-114C
240 Volts Fixed Trip	15	FVK31EB	\$630.00
240 Volts Fixed Trip	20	FVK32EB	\$630.00
240 Volts Fixed Trip	30	FVK33EB	\$630.00
240 Volts Fixed Trip	40	FVK34EB	\$630.00
240 Volts Fixed Trip	50	FVK35EB	\$630.00
240 Volts Fixed Trip	70	FVK37EB	\$771.00
240 Volts Fixed Trip	100	FVK310EB	\$771.00

## Circuit Breakers - Standard Frames Three-Phase, Three-Wire TK4V

Voltage	Trip Amps	Product Number	List Price GO-114C
600 Volts	300	FVK330KM	\$7145.00
600 Volts	400	FVK340KM	\$7145.00
600 Volts	500	FVK350KM	\$7145.00
600 Volts	600	FVK360KM	\$7145.00
600 Volts	700	FVK370KM	\$7997.00
600 Volts	800	FVK380KM	\$7997.00

## Circuit Breakers - Standard Frames Three-Phase, Three-Wire TED4

Voltage	Trip Amps	Product Number	List Price GO-114C
480 Volts Fixed Trip	15	FVK31ED4	\$798.00
480 Volts Fixed Trip	20	FVK32ED4	\$798.00
480 Volts Fixed Trip	30	FVK33ED4	\$798.00
480 Volts Fixed Trip	40	FVK34ED4	\$798.00
480 Volts Fixed Trip	50	FVK35ED4	\$798.00
480 Volts Fixed Trip	70	FVK37ED4	\$888.00
480 Volts Fixed Trip	100	FVK310ED4	\$896.00

## Circuit Breakers - Standard Frames Three-Phase, Four-Wire TEB

Voltage	Trip Amps	Product Number	List Price GO-114C
240 Volts Fixed Trip	15	FVK41EB	\$710.00
240 Volts Fixed Trip	20	FVK42EB	\$710.00
240 Volts Fixed Trip	30	FVK43EB	\$710.00
240 Volts Fixed Trip	40	FVK44EB	\$710.00
240 Volts Fixed Trip	50	FVK45EB	\$710.00
240 Volts Fixed Trip	70	FVK47EB	\$842.00
240 Volts Fixed Trip	100	FVK410EB	\$842.00

## Circuit Breakers - Standard Frames Three-Phase, Three-Wire TED6

Voltage	Trip Amps	Product Number	List Price GO-114C
600 Volts Fixed Trip	15	FVK31ED6	\$887.00
600 Volts Fixed Trip	20	FVK32ED6	\$887.00
600 Volts Fixed Trip	30	FVK33ED6	\$887.00
600 Volts Fixed Trip	40	FVK34ED6	\$887.00
600 Volts Fixed Trip	50	FVK35ED6	\$887.00
600 Volts Fixed Trip	70	FVK37ED6	\$984.00
600 Volts Fixed Trip	100	FVK310ED6	\$984.00

## Circuit Breakers - Standard Frames Three-Phase, Four-Wire TED4

Voltage	Trip Amps	Product Number	List Price GO-114C
480 Volts Fixed Trip	15	FVK41ED4	\$887.00
480 Volts Fixed Trip	20	FVK42ED4	\$887.00
480 Volts Fixed Trip	30	FVK43ED4	\$887.00
480 Volts Fixed Trip	40	FVK44ED4	\$887.00
480 Volts Fixed Trip	50	FVK45ED4	\$887.00
480 Volts Fixed Trip	70	FVK47ED4	\$966.00
480 Volts Fixed Trip	100	FVK410ED4	\$966.00

## Circuit Breakers - Standard Frames Three-Phase, Three-Wire TFK

Voltage	Trip Amps	Product Number	List Price GO-114C
600 Volts Inter. Trip	70	FVK37FK	\$2474.00
600 Volts Inter. Trip	100	FVK310FK	\$2474.00
600 Volts Inter. Trip	125	FVK312FK	\$2474.00
600 Volts Inter. Trip	150	FVK315FK	\$2474.00
600 Volts Inter. Trip	200	FVK320FK	\$2474.00
600 Volts Inter. Trip	225	FVK322FK	\$2474.00

## Circuit Breakers - Standard Frames Three-Phase, Four-Wire TED6

Not Available

## Circuit Breakers - Standard Frames Three-Phase, Four-Wire TFK

Voltage	Trip Amps	Product Number	List Price GO-114C
600 Volts Inter. Trip	70	FVK47FK	\$2607.00
600 Volts Inter. Trip	100	FVK410FK	\$2607.00
600 Volts Inter. Trip	125	FVK412FK	\$2607.00
600 Volts Inter. Trip	150	FVK415FK	\$2607.00
600 Volts Inter. Trip	200	FVK420FK	\$2607.00
600 Volts Inter. Trip	225	FVK422FK	\$2607.00

## Circuit Breakers - Standard Frames Three-Phase, Three-Wire TJK4

Voltage	Trip Amps	Product Number	List Price GO-114C
600 Volts Inter. Trip	125	FVK312JK	\$4680.00
600 Volts Inter. Trip	150	FVK315JK	\$4680.00
600 Volts Inter. Trip	200	FVK320JK	\$4680.00
600 Volts Inter. Trip	225	FVK322JK	\$4680.00
600 Volts Inter. Trip	300	FVK330JK	\$4680.00
600 Volts Inter. Trip	400	FVK340JK	\$4680.00



# Busway Flex-A-Power® Busway (continued)

Types FVA, FVK and LVDP

Busway Plugs

Product Number Pricing

# Section 11

## Circuit Breakers—Standard Frames Three-Phase, Four-Wire TJK4

Voltage	Trip Amps	Product Number	List Price GO-114C
600 Volts Inter. Trip	125	FVK412JK	\$4911.00
600 Volts Inter. Trip	150	FVK415JK	\$4911.00
600 Volts Inter. Trip	200	FVK420JK	\$4911.00
600 Volts Inter. Trip	225	FVK422JK	\$4911.00
600 Volts Inter. Trip	300	FVK430JK	\$4911.00
600 Volts Inter. Trip	400	FVK440JK	\$4911.00

## Circuit Breakers—Standard Frames Three-Phase, Four-Wire TK4V

Voltage	Trip Amps	Product Number	List Price GO-114C
600 Volts	300	FVK430KM	\$7464.00
600 Volts	400	FVK440KM	\$7464.00
600 Volts	500	FVK450KM	\$7464.00
600 Volts	600	FVK460KM	\$7464.00
600 Volts	700	FVK470KM	\$8333.00
600 Volts	800	FVK480KM	\$8333.00

## Circuit Breakers—Hi-Break Frames<sup>1</sup> Three-Phase, Three-Wire THED

Voltage	Trip Amps	Product Number	List Price GO-114C
600 Volts Fixed Trip	15	FVK31HED	\$1134.00
600 Volts Fixed Trip	20	FVK32HED	\$1134.00
600 Volts Fixed Trip	30	FVK33HED	\$1134.00
600 Volts Fixed Trip	40	FVK34HED	\$1134.00
600 Volts Fixed Trip	50	FVK35HED	\$1134.00
600 Volts Fixed Trip	70	FVK37HED	\$1241.00
600 Volts Fixed Trip	100	FVK310HED	\$1241.00

## Circuit Breakers—Hi-Break Frames<sup>1</sup> Three-Phase, Three-Wire THFK

Voltage	Trip Amps	Product Number	List Price GO-114C
600 Volts Inter. Trip	70	FVK37HFK	\$4070.00
600 Volts Inter. Trip	100	FVK310HFK	\$4070.00
600 Volts Inter. Trip	125	FVK312HFK	\$4070.00
600 Volts Inter. Trip	150	FVK315HFK	\$4070.00
600 Volts Inter. Trip	200	FVK320HFK	\$4070.00
600 Volts Inter. Trip	225	FVK322HFK	\$4070.00

## Circuit Breakers—Hi-Break Frames<sup>1</sup> Three-Phase, Three-Wire THJK4

Voltage	Trip Amps	Product Number	List Price GO-114C
600 Volts Inter. Trip	125	FVK312HJK	\$6471.00
600 Volts Inter. Trip	150	FVK315HJK	\$6471.00
600 Volts Inter. Trip	200	FVK320HJK	\$6471.00
600 Volts Inter. Trip	225	FVK322HJK	\$6471.00
600 Volts Inter. Trip	300	FVK330HJK	\$6471.00
600 Volts Inter. Trip	400	FVK340HJK	\$6471.00

## Circuit Breakers—Hi-Break Frames<sup>1</sup> Three-Phase, Three-Wire THKM8

Voltage	Trip Amps	Product Number	List Price GO-114C
600 Volts Inter. Trip	300	FVK330HKM	\$7695.00
600 Volts Inter. Trip	400	FVK340HKM	\$7695.00
600 Volts Inter. Trip	500	FVK350HKM	\$7695.00
600 Volts Inter. Trip	600	FVK360HKM	\$7695.00
600 Volts Inter. Trip	700	FVK370HKM	\$9042.00
600 Volts Inter. Trip	800	FVK380HKM	\$9042.00

## Circuit Breakers—Hi-Break Frames<sup>1</sup> Three-Phase, Four-Wire THED

Voltage	Trip Amps	Product Number	List Price GO-114C
600 Volts Fixed Trip	15	FVK41HED	\$1206.00
600 Volts Fixed Trip	20	FVK42HED	\$1206.00
600 Volts Fixed Trip	30	FVK43HED	\$1206.00
600 Volts Fixed Trip	40	FVK44HED	\$1206.00
600 Volts Fixed Trip	50	FVK45HED	\$1206.00
600 Volts Fixed Trip	70	FVK47HED	\$1322.00
600 Volts Fixed Trip	100	FVK410HED	\$1322.00

## Circuit Breakers—Hi-Break Frames<sup>1</sup> Three-Phase, Four-Wire THFK

Voltage	Trip Amps	Product Number	List Price GO-114C
600 Volts Inter. Trip	70	FVK47HFK	\$4211.00
600 Volts Inter. Trip	100	FVK410HFK	\$4211.00
600 Volts Inter. Trip	125	FVK412HFK	\$4211.00
600 Volts Inter. Trip	150	FVK415HFK	\$4211.00
600 Volts Inter. Trip	200	FVK420HFK	\$4211.00
600 Volts Inter. Trip	225	FVK422HFK	\$4211.00

## Circuit Breakers—Hi-Break Frames<sup>1</sup> Three-Phase, Four-Wire THJK4

Voltage	Trip Amps	Product Number	List Price GO-114C
600 Volts Inter. Trip	125	FVK412HJK	\$6684.00
600 Volts Inter. Trip	150	FVK415HJK	\$6684.00
600 Volts Inter. Trip	200	FVK420HJK	\$6684.00
600 Volts Inter. Trip	225	FVK422HJK	\$6684.00
600 Volts Inter. Trip	300	FVK430HJK	\$6684.00
600 Volts Inter. Trip	400	FVK440HJK	\$6684.00

## Circuit Breakers—Hi-Break Frames<sup>1</sup> Three-Phase, Four-Wire THKM8

Voltage	Trip Amps	Product Number	List Price GO-114C
600 Volts Inter. Trip	300	FVK430HKM	\$8031.00
600 Volts Inter. Trip	400	FVK440HKM	\$8031.00
600 Volts Inter. Trip	500	FVK450HKM	\$8031.00
600 Volts Inter. Trip	600	FVK460HKM	\$8031.00
600 Volts Inter. Trip	700	FVK470HKM	\$9414.00
600 Volts Inter. Trip	800	FVK480HKM	\$9414.00

<sup>1</sup>Special hanger required for all plugs except those with TEB, TED4, TED6, and THED frames when mounted on LVDP busway. Furnish complete LVDP busway name-plate data when ordering.





# Busway Flex-A-Power® Busway (continued)

Types FVA, FVK and LVDP

Busway Plugs

Product Number Pricing

## Section 11

### Enclosure Only Three-Phase, Three-Wire

Frame Type	Amperage	Product Number	List Price GO-114C
E	100	FVK3100E	\$339.00
F	225	FVK3225F	\$741.00

Breaker shipped separately for field assembly.

### Enclosure Only Three-Phase, Four-Wire

Frame Type	Amperage	Product Number	List Price GO-114C
E	100	FVK4100E	\$411.00
F	225	FVK4225F	\$854.00

Breaker shipped separately for field assembly.

### Options for Fusible Switch Units – Use for FVK

UL Listed Ampere Rating	Description	List Price Adder GO-114C
30	Factory installed Class R fuse clips; add "R" suffix to Product Number	\$60.00
60	Factory installed Class R fuse clips; add "R" suffix to Product Number	\$60.00
100	Factory installed Class R fuse clips; add "R" suffix to Product Number	\$77.00
200	Factory installed Class R fuse clips; add "R" suffix to Product Number	\$62.00
400	Factory installed Class R fuse clips; add "R" suffix to Product Number	\$83.00
600	Factory installed Class R fuse clips; add "R" suffix to Product Number	\$86.00
30	Factory installed Class J fuse clips; add "J" suffix to 600 V plug Product Number	\$35.00
60	Factory installed Class J fuse clips; add "J" suffix to 600 V plug Product Number	\$35.00
100	Factory installed Class J fuse clips; add "J" suffix to 600 V plug Product Number	\$35.00
200	Factory installed Class J fuse clips; add "J" suffix to 600 V plug Product Number	\$35.00
400	Factory installed Class J fuse clips; add "J" suffix to 600 V plug Product Number	\$35.00
600	Factory installed Class J fuse clips; add "J" suffix to 600 V plug Product Number <sup>1</sup>	\$284.00
30	QMW in lieu of QMR; change "R" in Product Number to "W"	\$57.00
60	QMW in lieu of QMR; change "R" in Product Number to "W"	\$57.00
100	QMW in lieu of QMR; change "R" in Product Number to "W"	\$107.00
200	QMW in lieu of QMR; change "R" in Product Number to "W"	\$161.00
400	QMW in lieu of QMR; change "R" in Product Number to "W"	\$426.00
600	QMW in lieu of QMR; change "R" in Product Number to "W"	N/A

<sup>1</sup>Not UL listed.

### Extension Pans—or LVDP Busway Plugs

Select Busway Plugs then order Extension Pans from table.  
No charge when ordering with plug.

Flex-A-Plug Prefix	Suffix	Ampere Rating	Extension Pan Product Number
TVK	R, RT	30-400	None
TVK	R, RT	600	DF1PPKM
TVK	EB, ED4, ED6, HED	15-150	None
TVK	FJ, FK, HFK	70-225	None
TVK	JJ, JK, HLK	125-400	DF1PPJ
TVK	KM, HKM	125-800	DF1PPKM



# Busway

## Flex-A-Power® Busway

Types FVA, FVK and LVDP  
Outlines and Dimensions

# Section 11

### Hanger Dimensions

With Aluminum Bus Bars

Amperage	Housing Depth (in.)	Hanger Dimension A (in.)	Hanger Dimension B (in.)	Hanger Dimension C (in.)
225 Amps	3.19	4.69	1.88	2.5
400 Amps	4.19	5.19	1.88	2.56
600 Amps	6.19	6.19	1.63	3.81
800 Amps	6.19	6.19	1.63	3.81

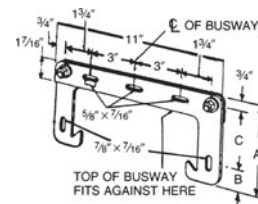

### Hanger Dimensions

With Copper Bus Bars

Amperage	Housing Depth (in.)	Hanger Dimension A (in.)	Hanger Dimension B (in.)	Hanger Dimension C (in.)
225 Amps	3.19	4.69	1.44	2.5
400 Amps	3.19	4.69	1.44	2.5
600 Amps	4.19	5.19	1.88	2.56
800 Amps	6.19	6.19	1.63	3.81
1000 Amps	6.19	6.19	1.63	3.81

### Hanger Dimensions

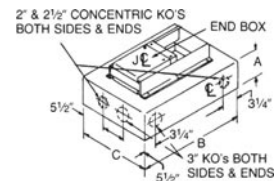

### Cable Tap Boxes - Dimensions

Amperage	Dimension A	Dimension B	Dimension C	No. of #2-600kcmil Lugs/Ø N & GRD
225 Amps	6	32	16	1,1
400 Amps	6	32	16	1,1
600 Amps <sup>1</sup>	6	32	16	1,2
800 Amps <sup>2</sup>	8	52	20	2,3
1000 Amps <sup>2</sup>	8	52	20	2,3

<sup>1</sup>For FVA, use 800 amp dimensions.

<sup>2</sup>No knockouts in this box.

End-of-run cable tap box. For center (joint) cable tap box omit the end box.

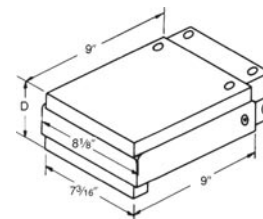

### End Boxes - Dimensions

Amperage	Conductor Material	Dimension D
225 Amps, 400 Amps	Copper	3.19"
600 Amps	Copper	4.19"
800 Amps, 1000 Amps	Copper	6.19"
225 Amps	Aluminum	3.19"
400 Amps	Aluminum	4.19"
600 Amps, 800 Amps	Aluminum	6.19"

End box used to close off end-of-run.

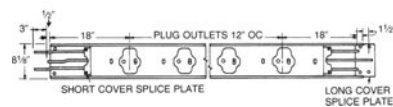
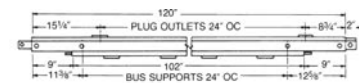

Standard lengths, three-wire systems, 600 volts maximum.

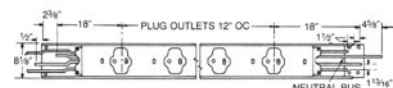
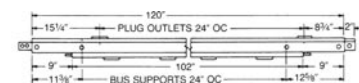

Standard lengths, three-phase, four-wire systems, 480 V/277 Volts



# Busway Type DE Busway

## Distribution Equipment

### Busway Plugs for Obsolete DE Busway

#### Product Number Pricing

A variety of fusible and circuit breaker plugs are available for Type DE busway. Nonfusible operating switch plugs are available at the same price as fusible units. (Not UL Listed) Order by description. For Class R or Class J provisions, see page 11-104.

# Section 11

### Circuit Breakers—Standard Frames Three-Phase, Three-Wire TEB

Voltage	Trip Amps	Product Number	List Price GO-114C
240 V Fixed Trip	15	DE31EB	<b>\$683.00</b>
240 V Fixed Trip	20	DE32EB	<b>\$683.00</b>
240 V Fixed Trip	30	DE33EB	<b>\$683.00</b>
240 V Fixed Trip	40	DE34EB	<b>\$683.00</b>
240 V Fixed Trip	50	DE35EB	<b>\$683.00</b>
240 V Fixed Trip	70	DE37EB	<b>\$834.00</b>
240 V Fixed Trip	100	DE310EB	<b>\$834.00</b>

### Circuit Breakers—Standard Frames Three-Phase, Four-Wire TEB

Voltage	Trip Amps	Product Number	List Price GO-114C
240 V Fixed Trip	15	DE41EB	<b>\$771.00</b>
240 V Fixed Trip	20	DE42EB	<b>\$771.00</b>
240 V Fixed Trip	30	DE43EB	<b>\$771.00</b>
240 V Fixed Trip	40	DE44EB	<b>\$771.00</b>
240 V Fixed Trip	50	DE45EB	<b>\$771.00</b>
240 V Fixed Trip	70	DE47EB	<b>\$905.00</b>
240 V Fixed Trip	100	DE410EB	<b>\$905.00</b>

### Circuit Breakers—Standard Frames Three-Phase, Three-Wire TED4

Voltage	Trip Amps	Product Number	List Price GO-114C
480 V Fixed Trip	15	DE31ED4	<b>\$869.00</b>
480 V Fixed Trip	20	DE32ED4	<b>\$869.00</b>
480 V Fixed Trip	30	DE33ED4	<b>\$869.00</b>
480 V Fixed Trip	40	DE34ED4	<b>\$869.00</b>
480 V Fixed Trip	50	DE35ED4	<b>\$869.00</b>
480 V Fixed Trip	70	DE37ED4	<b>\$966.00</b>
480 V Fixed Trip	100	DE310ED4	<b>\$966.00</b>

### Circuit Breakers—Standard Frames Three-Phase, Four-Wire TED4

Voltage	Trip Amps	Product Number	List Price GO-114C
480 V Fixed Trip	15	DE41ED4	<b>\$957.00</b>
480 V Fixed Trip	20	DE42ED4	<b>\$957.00</b>
480 V Fixed Trip	30	DE43ED4	<b>\$957.00</b>
480 V Fixed Trip	40	DE44ED4	<b>\$957.00</b>
480 V Fixed Trip	50	DE45ED4	<b>\$957.00</b>
480 V Fixed Trip	70	DE47ED4	<b>\$1046.00</b>
480 V Fixed Trip	100	DE410ED4	<b>\$1046.00</b>

### Circuit Breakers—Standard Frames Three-Phase, Three-Wire TED6

Voltage	Trip Amps	Product Number	List Price GO-114C
600 V Fixed Trip	15	DE31ED6	<b>\$957.00</b>
600 V Fixed Trip	20	DE32ED6	<b>\$957.00</b>
600 V Fixed Trip	30	DE33ED6	<b>\$957.00</b>
600 V Fixed Trip	40	DE34ED6	<b>\$957.00</b>
600 V Fixed Trip	50	DE35ED6	<b>\$957.00</b>
600 V Fixed Trip	70	DE37ED6	<b>\$1064.00</b>
600 V Fixed Trip	100	DE310ED6	<b>\$1064.00</b>

### Circuit Breakers—Standard Frames Three-Phase, Four-Wire TED6

Voltage	Trip Amps	Product Number	List Price GO-114C
600 V Fixed Trip	15	DE41ED6	<b>\$1037.00</b>
600 V Fixed Trip	20	DE42ED6	<b>\$1037.00</b>
600 V Fixed Trip	30	DE43ED6	<b>\$1037.00</b>
600 V Fixed Trip	40	DE44ED6	<b>\$1037.00</b>
600 V Fixed Trip	50	DE45ED6	<b>\$1037.00</b>
600 V Fixed Trip	70	DE47ED6	<b>\$1143.00</b>
600 V Fixed Trip	100	DE410ED6	<b>\$1143.00</b>

### Circuit Breakers—Standard Frames Three-Phase, Three-Wire TFK

Voltage	Trip Amps	Product Number	List Price GO-114C
600 V Fixed Trip	70	DE37FK	<b>\$2678.00</b>
600 V Fixed Trip	100	DE310FK	<b>\$2678.00</b>
600 V Fixed Trip	125	DE312FK	<b>\$2678.00</b>
600 V Fixed Trip	150	DE315FK	<b>\$2678.00</b>
600 V Fixed Trip	200	DE320FK	<b>\$2678.00</b>
600 V Fixed Trip	225	DE322FK	<b>\$2678.00</b>

### Circuit Breakers—Standard Frames Three-Phase, Four-Wire TFK

Voltage	Trip Amps	Product Number	List Price GO-114C
600 V Fixed Trip	70	DE47FK	<b>\$2819.00</b>
600 V Fixed Trip	100	DE410FK	<b>\$2819.00</b>
600 V Fixed Trip	125	DE412FK	<b>\$2819.00</b>
600 V Fixed Trip	150	DE415FK	<b>\$2819.00</b>
600 V Fixed Trip	200	DE420FK	<b>\$2819.00</b>
600 V Fixed Trip	225	DE422FK	<b>\$2819.00</b>

### Circuit Breakers—Standard Frames Three-Phase, Three-Wire TJK4

Voltage	Trip Amps	Product Number	List Price GO-114C
600 V Inter. Trip	125	DFPJK1312DE	<b>\$5072.00</b>
600 V Inter. Trip	150	DFPJK1315DE	<b>\$5072.00</b>
600 V Inter. Trip	200	DFPJK1320DE	<b>\$5072.00</b>
600 V Inter. Trip	225	DFPJK1322DE	<b>\$5072.00</b>
600 V Inter. Trip	300	DFPJK1330DE	<b>\$5072.00</b>
600 V Inter. Trip	400	DFPJK1340DE	<b>\$5072.00</b>

### Circuit Breakers—Standard Frames Three-Phase, Four-Wire TJK4

Voltage	Trip Amps	Product Number	List Price GO-114C
600 V Inter. Trip	125	DFPJK1412DE	<b>\$5301.00</b>
600 V Inter. Trip	150	DFPJK1415DE	<b>\$5301.00</b>
600 V Inter. Trip	200	DFPJK1420DE	<b>\$5301.00</b>
600 V Inter. Trip	225	DFPJK1422DE	<b>\$5301.00</b>
600 V Inter. Trip	300	DFPJK1430DE	<b>\$5301.00</b>
600 V Inter. Trip	400	DFPJK1440DE	<b>\$5301.00</b>



# Busway

## Type DE Busway

Distribution Equipment  
Busway Plugs for Obsolete DE Busway  
Product Number Pricing

# Section 11

### Fusible—Operating Switch Type Three-Phase, Three-Wire

Amperage	Voltage	Product Number	List Price GO-114C
30	240	DE321R	\$426.00
60	240	DE322R	\$470.00
100	240	DE323R	\$683.00
200	240	DE324R	\$1197.00
400	240	DE325RT	\$3227.00
600	240	DE326R	\$4433.00
30	600	DE361R	\$470.00
60	600	DE362R	\$488.00
100	600	DE363R	\$710.00
200	600	DE364R	\$1250.00
400	600	DE365R	\$3227.00
600	600	DE366R	\$4433.00

With QMR Interrupter (with Class H fuse clips—fuses not included)

### Fusible—Operating Switch Type Three-Phase, Four-Wire

Amperage	Voltage	Product Number	List Price GO-114C
30	240	DE421R	\$504.00
60	240	DE422R	\$542.00
100	240	DE423R	\$771.00
200	240	DE424R	\$1347.00
400	240	DE425RT	\$4499.00
600	240	DE426R	\$4841.00
30	600	DE461R	\$542.00
60	600	DE462R	\$567.00
100	600	DE463R	\$825.00
200	600	DE464R	\$1392.00
400	600	DE465RT	\$3449.00
600	600	DE466R	\$4841.00

With QMR Interrupter (with Class H fuse clips—fuses not included)

### Circuit Breakers—Hi-Break Frames Three-Phase, Three-Wire THED

Amperage	Voltage	Product Number	List Price GO-114C
600 V Fixed Trip	15	DE31HED	\$1224.00
600 V Fixed Trip	20	DE32HED	\$1224.00
600 V Fixed Trip	30	DE33HED	\$1224.00
600 V Fixed Trip	40	DE34HED	\$1224.00
600 V Fixed Trip	50	DE35HED	\$1224.00
600 V Fixed Trip	70	DE37HED	\$1224.00
600 V Fixed Trip	100	DE310HED	\$1224.00

### Circuit Breakers—Hi-Break Frames Three-Phase, Three-Wire THFK

Amperage	Voltage	Product Number	List Price GO-114C
600 V Inter. Trip	70	DE37HFK	\$4397.00
600 V Inter. Trip	100	DE310HFK	\$4397.00
600 V Inter. Trip	125	DE312HFK	\$4397.00
600 V Inter. Trip	150	DE315HFK	\$4397.00
600 V Inter. Trip	200	DE320HFK	\$4397.00
600 V Inter. Trip	225	DE322HFK	\$4397.00

### Circuit Breakers—Hi-Break Frames Three-Phase, Three-Wire THJK4

Amperage	Voltage	Product Number	List Price GO-114C
600 V Inter. Trip	125	DFPHJK312DE	\$7004.00
600 V Inter. Trip	150	DFPHJK315DE	\$7004.00
600 V Inter. Trip	200	DFPHJK320DE	\$7004.00
600 V Inter. Trip	225	DFPHJK322DE	\$7004.00
600 V Inter. Trip	300	DFPHJK330DE	\$7004.00
600 V Inter. Trip	400	DFPHJK340DE	\$7004.00

### Circuit Breakers—Hi-Break Frames Three-Phase, Four-Wire THED

Amperage	Voltage	Product Number	List Price GO-114C
600 V Fixed Trip	15	DE41HED	\$1304.00
600 V Fixed Trip	20	DE42HED	\$1304.00
600 V Fixed Trip	30	DE43HED	\$1304.00
600 V Fixed Trip	40	DE44HED	\$1304.00
600 V Fixed Trip	50	DE45HED	\$1304.00
600 V Fixed Trip	70	DE47HED	\$1428.00
600 V Fixed Trip	100	DE410HED	\$1428.00

### Circuit Breakers—Hi-Break Frames Three-Phase, Four-Wire THFK

Amperage	Voltage	Product Number	List Price GO-114C
600 V Inter. Trip	70	DE47HFK	\$4539.00
600 V Inter. Trip	100	DE410HFK	\$4539.00
600 V Inter. Trip	125	DE412HFK	\$4539.00
600 V Inter. Trip	150	DE415HFK	\$4539.00
600 V Inter. Trip	200	DE420HFK	\$4539.00
600 V Inter. Trip	225	DE422HFK	\$4539.00

### Circuit Breakers—Hi-Break Frames Three-Phase, Four-Wire THJK4

Amperage	Voltage	Product Number	List Price GO-114C
600 V Inter. Trip	125	DFPHJK412DE	\$7235.00
600 V Inter. Trip	150	DFPHJK415DE	\$7235.00
600 V Inter. Trip	200	DFPHJK420DE	\$7235.00
600 V Inter. Trip	225	DFPHJK422DE	\$7235.00
600 V Inter. Trip	300	DFPHJK430DE	\$7235.00
600 V Inter. Trip	400	DFPHJK440DE	\$7235.00

### Ground Detector Plugs Three-Phase, Three-Wire

Amperage	Voltage	Product Number	List Price GO-114C
GN	208-240	DEGN32R	\$683.00
GN	440-600	DEGN36R	\$683.00

(Not UL Listed)



