

CATALOG

Blackburn®

Overhead connectors



Thomas & Betts is now ABB Installation Products, but our long legacy of quality products and innovation remains the same. From connectors that help wire buildings on Earth to cable ties that help put machines in space, we continue to work every day to make, market, design and sell products that provide a smarter, safer and more reliable flow of electricity, from source to socket.

Table of contents

006–009	Compression pin terminals
010–011	Multi-tap eyebolt connectors
012–013	Storm-Safe® service entrance disconnects
014–015	Service wedges and neutral span clamps
016–024	Aluminum H-tap connectors and covers
025	Copper H-tap connectors
026–030	Stirrup connectors
031–033	Parallel-groove connectors
034	Insulation piercing connectors
035	BolTap™ wedges
036–038	PowerTap™ wedges
039	PowerTap tools and accessories
040–047	Service entrance splices
048	Service entrance connectors
049–059	Full- and semi-tension compression splices
060–062	Automatic splices and deadends
063–064	Hot-line clamps
065–070	Index

SUSTAINABLE DEVELOPMENT

Innovation, operational excellence and sustainable development are central to everything we do, reducing our environmental footprint and improving our communities.



Compression pin terminals

Flood-Seal® insulated compression pin terminals



- Fabricated from pure electrolytic aluminum and softdrawn, tinned copper wire to provide the high strength and conductivity of aluminum and the flexibility of copper
- Flood-Seal covers provided to ensure a watertight seal on the pin as well as around the aluminum cable insertion; also rated up to 600 V
- Oxide inhibitor prevents oxidation
- All pin terminals marked with die references for easy identification

Flood-Seal insulated compression pin terminals

Cat. no.	Conductor size (AWG or kcmil)			Installing dies	P (in.)	B (in.)
	Alum. str.	ACSR	Solid Cu pin			
RU 5 U 4	#4	#4	#4	TU, 52, BG, 243, 5/8, 8A	2	1 ⁵ / ₁₆
RU 5 U 2	#2	#2	#4	TU, 52, BG, 243, 5/8, 8A	2	1 ⁵ / ₁₆
RU 5 U 10	1/0	1/0	#2	TU, 52, BG, 243, 5/8, 8A	2 ¹ / ₂	1 ⁵ / ₁₆
RG 5 U 10	1/0	1/0	#2	5/8-1, 297, 245, TW-TY, 5/8 GOLD	2 ¹ / ₂	1 ³ / ₄
RG 5 U 20	2/0	2/0	1/0	5/8-1, 297, 245, TW-TY, 5/8 GOLD	2 ¹ / ₂	1 ³ / ₄
RX 5 U 30	3/0	3/0	1/0	TX, 76, 249, 840, 11A	3	1 ⁷ / ₈
RX 5 U 40	4/0	4/0	2/0	TX, 76, 249, 840, 11A	3	1 ⁷ / ₈
RX 5 U 336	300-350	336.4 (18/1)	4/0	TX, 76, 249, 840, 11A	4	1 ⁷ / ₈

Diagrams

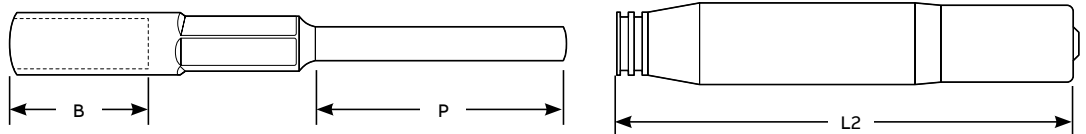

Flood-Seal insulators only

Cat. no.	Conductor size (AWG or kcmil)		L2 (in.)
	Alum. str.	ACSR	
RU 5	#4-1/0	#4-1/0	3 ¹³ / ₁₆
RG 5	1/0 & 2/0	1/0 & 2/0	5 ¹³ / ₁₆
RX 5	3/0-336.4	3/0-336.4	6 ⁷ / ₁₆

Note: For special die requirements, additional pin lengths and offset pin styles, please consult your ABB representative.
For other wire barrel diameters suitable for non-listed dies, please consult your ABB representative.

Compression pin terminals

Aluminum compression pin terminals – Q 5, U 5, X 5 and PT Series

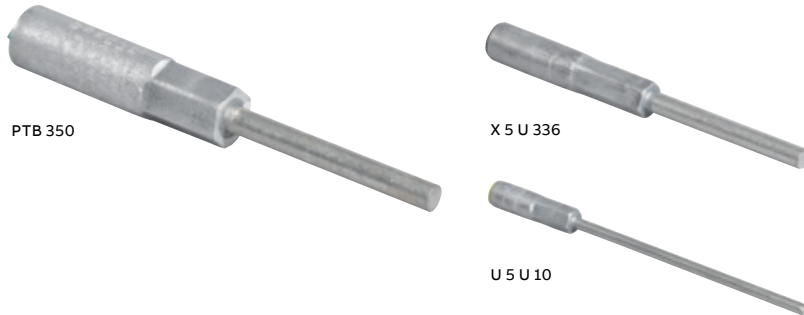

- Connect aluminum and ACSR to copper-alloy equipment clamps, eliminating cold-flow problems of aluminum conductor in copper clamps
- Annealed, tin-plated copper pin ensures high conductivity and bends easily to aid in cable training
- Oxide inhibitor and metal sealant prevent oxidation and protect pin/body from moisture intrusion
- All pin terminals marked with wire size, installing dies and compression locations for easy identification

Q 5, U 5 and X 5 Series

Cat. no.	Conductor size (AWG or kcmil)			Installing dies	Solid Cu pin	P (in.)
	Aluminum		ACSR			
	Sol.	Str.				
Q 5 U 8	#6	#8	–	½, 163, TQ, 6A*	4 (0.204)	2
Q 5 U 6	#4	#5 & #6	#6		4 (0.204)	2
Q 5 U 4	#2	#3 & #4	#4		4 (0.204)	2
Q 5 U 2	–	#1 & #2	#2		4 (0.204)	2
U 5 U 8	#6	#8	–	⅝, 52, BG, TU, 8A*	4 (0.204)	2
U 5 U 6	#4	#5 & #6	#6		4 (0.204)	2
U 5 U 4	#2	#3 & #4	#4		4 (0.204)	2
U 5 U 2	–	#1 & #2	#2		4 (0.204)	2
U 5 U 10	–	1/0	1/0	840, WK840, 249, TX, 11A*	2 (0.257)	2½
X 5 U 10	–	1/0	1/0		2 (0.257)	2½
X 5 U 20	–	2/0	2/0		1/0 (0.325)	2½
X 5 U 30	–	3/0	3/0		1/0 (0.325)	3
X 5 U 40	–	4/0	4/0	2/0 (0.365)	3	
X 5 U 266	–	250–266.8	266.8	3/0 (0.410)	3½	
X 5 U 366	–	300–350	336.4 (18/1)	4/0 (0.460)	4	

Diagram

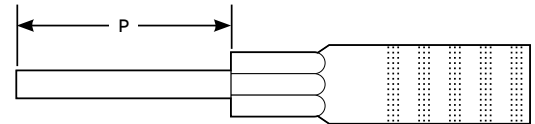

* When using EE1 dies, space compressions ¼" apart.

PT Series

Cat. no.	Conductor size (kcmil)		Installing dies	Solid Cu pin	P (in.)
	Alum. str.	ACSR			
PTB 300	266.8 & 300	266.8 (18/1)	96, 472, 705,	0.460	4
PTB 350	336.4 & 350	266.8 (26/7), 336.4 (18/1)	1-⅛-1	0.460	
PTB 400	397.7 & 400	336.4 (26/7), 397.5 (18/1)		0.460	
PTM 500	447 & 500 & 600 CPT	397.5, 477 (26/7, 18/1)	106A, 300, 426,	0.562	5
PTM 556	500 & 556.5	477 (26/7), 556.5 (18/1)	1⅝, 317	0.562	
PTL 636	600 & 636	556.5, 636 (36/1, 26/7)	140H, 301, 724, 1½	0.562	6
PTL 750	700 & 750	636 (26/7)		0.750	
PTL 800	795 & 800	715.5 (26/7), 795 (36/1)		0.750	
PTL 1000	954 & 1000	795 (26.7), 954 (45/7)		0.875	

Note: For additional pin lengths and offset pin styles, please consult your ABB representative.

Compression pin terminals

Aluminum compression pin terminals – SAPT series



SAPT 4/0-206

For use with high voltage termination kits.

- Made from aluminum for high strength and conductivity
- Annealed, tin-plated copper pin ensures high conductivity and bends easily to aid in cable training
- Oxide inhibitor prevents oxidation
- Metal sealant protects pin/body from moisture intrusion
- All pin terminals marked with wire size, installing dies and compression locations for easy identification

SAPT series

Cat. no.	Conductor size (AWG or kcmil)					Pin dia.	Pin length (in.)	Dies	Barrel insertion (in.)
	ACSR	Str.	Compr.	Compt.	Sol.				
SAPT 6-26	-	#6	-	-	-	2 (0.257)	6	TU, 52, BG, 243, 5/8	1 3/4
SAPT 4-26		#4			#2	2 (0.257)	6	TU, 52, BG, 243, 5/8	1 3/4
SAPT 2-24	#2	#2			1/0	2 (0.257)	4	BG, 5/8, 620H, 9/16	1 3/4
SAPT 2-12	-	#2			-	2 (0.257)	12	TU, 52, BG, 243, 5/8	1 3/4
SAPT 2-26		#1, #2			1/0	2 (0.257)	6	TU, 52, BG, 243, 5/8	1 3/4
SAPT 2-1017		#1, #2			1/0 (0.325)		17	TU, 52, BG, 243, 5/8	1 3/4
SAPT 2-26-840		#1, #2			2 (0.257)		6	TX, 76, 249, 840, 11A	1 3/4
SAPT 1-12E		#1	#1	1/0		2 (0.257)	12	TU, 52, BG, 243, 5/8	1 3/4
SAPT 1S-26		#2		-	-	2 (0.257)	6	TU, 52, BG, 243, 5/8	1 3/4
SAPT 1/0-10		1/0	-			2 (0.257)	10	TU, 52, BG, 243, 5/8	1 3/4
SAPT 1/0-1017 CC	1/0	1/0				1/0 (0.325)	17	TU, 52, BG, 243, 5/8	1 3/4
SAPT 1/0-106		1/0				1/0 (0.325)	6	TU, 52, BG, 243, 5/8	1 3/4
SAPT 1/0-12	-	1/0				2 (0.257)	12	TU, 52, BG, 243, 5/8	1 3/4
SAPT 1/0-26		1/0				2 (0.257)	6	TU, 52, BG, 243, 5/8	1 3/4
SAPT 1/0-26-840		1/0				2 (0.257)	6	TX, 76, 249, 840, 11A	1 3/4
SAPT 3/0-106		3/0				1/0 (0.325)	6	TX, 76, 249, 840, 11A	2 1/4
SAPT 4/0-1018 CC		4/0				1/0 (0.325)	18	TX, 76, 249, 840, 11A	2 1/2
SAPT 4/0-106		4/0				1/0 (0.325)	6	TX, 76, 249, 840, 11A	2 1/2
SAPT 4/0-2012		4/0				2/0 (0.365)	12	TX, 76, 249, 840, 11A	2 1/2
SAPT 4/0-206		4/0				2/0 (0.365)	6	TX, 76, 249, 840, 11A	2 1/2
SAPT 4/0-26		4/0				2 (0.257)	6	TX, 76, 249, 840, 11A	2 1/2
SAPT 350-6	266.8 (26/7), 336.4 (18/1)	336.4-350				(0.562)	6	1 1/8-1, 96, 299, 655, 316, 13A, 321, 94H	2 1/2

Note: For additional pin lengths and offset pin styles, please consult your ABB representative.

Compression pin terminals

Shrouded compression pin terminals – Common die series

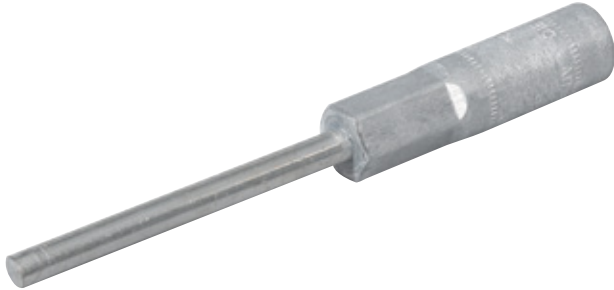

PTSK 4/0

Rainshield protection for insulated cable installed in exposed areas.

- Made from pure electrolytic aluminum for high strength and high conductivity
- Tin-plated copper pin ensures high conductivity and bends easily to aid in cable training
- Prefilled with oxide inhibitor to prevent oxidation
- Metal sealant protects pin/body from moisture intrusion
- All pin terminals marked with die references for easy identification

Shrouded compression pin terminals – Common die series

Cat. no.	Conductor size (AWG or kcmil)		Solid Cu pin	Shroud I.D.	Installing dies	P (in.)	B (in.)	Style
	Alum. Stranded	ACSR						
PTSG 6	#6	#6	0.204	0.400	52, TU, BG, 8A, 5/8, 243	2	1 7/8	2
PTSG 4	#4	#4	0.204	0.450		2	1 7/8	
PTSG 21	#2-#1	#2-#1	0.258	0.604		2	1 7/8	1
PTSG 1/0	1/0	1/0	0.258	0.640		2 1/4	1 7/8	
PTSK 1/0	1/0	1/0	0.258	0.640	840, 11A, 76, TX, 249	4	1 3/4	2
PTSK 2/0	2/0	2/0	0.324	0.750		4	1 3/4	
PTSK 3/0	3/0	3/0	0.324	0.750		4	1 3/4	
PTSK 4/0	4/0	4/0	0.364	0.750		4	1 3/4	
PTSB 350	336.4-350	266.6 (26/7), 366.4 (18/1)	0.460	0.937	1 1/8-1, 299, 655, 96, 13A	4	3 1/8	
PTSL 636	600-636	556.5 (26/7), 636 (36/1)	0.562	1.125	1 1/2, 301, 724, 140H	6	3 3/8	

Diagrams

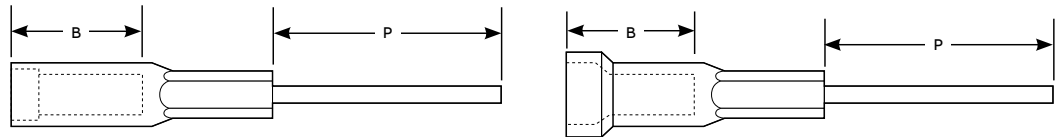

* For special die requirements, please consult your ABB representative.
 Note: For additional pin lengths and offset pin styles, please consult your ABB representative.

Multi-tap eyebolt connectors

Overhead transformer eyebolt multi-tap set-screw connectors



- Designed with factory-mounted 90° angle copper studs for installation in pole-type transformers with secondary eyebolt connections
- Made from high-strength aluminum alloy to maintain constant bolting pressure on conductors
- Screws designed for optimum electrical connection and maximum conductor-contact pressure
- Dual-rated for use with aluminum and copper conductors
- Meets or exceeds ANSI C119.4 specifications

Aluminum overhead transformer eyebolt multi-tap set-screw connectors

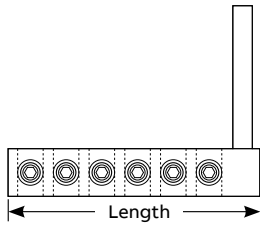
	Cat. no.	No. of outlets	Length (in.)	Stud size (in.)	Cable range (AWG or kcmil)
Diagram 	ABP 240	2	2 ⁵ / ₈	½ x 4	#6–250
	ABP 340	3	3 ³ / ₈		
	ABP 440	4	4 ³ / ₃₂		
	ABP 540	5	4 ⁷ / ₁₆		
	ABP 640	6	5 ³ / ₄		
	ABP 740	7	6 ¹ / ₂		
	ABP 840	8	7 ³ / ₃₂		
	ABP 2350	2	3 ¹ / ₁₆	5/8 x 4	#6–350
	ABP 3350	3	4 ¹ / ₈		
	ABP 4350	4	5		
	ABP 5350	5	5 ¹⁵ / ₁₆		
	ABP 6350	6	6 ¹³ / ₁₆		
	ABP 7350	7	7 ³ / ₄		
	ABP 8350	8	8 ⁵ / ₈		

Note: For special pin lengths and insulating boots, please consult your ABB representative.

Cat. No.	No. of outlets	Length (in.)	Stud size (in.)	Cable range (AWG or kcmil)
ABP 2500	2	3 ³ / ₈	¾ x 4½	#2–500
ABP 3500	3	4 ¹ / ₈		
ABP 4500	4	5 ¹ / ₈		
ABP 5500	5	6 ¹ / ₈		
ABP 6500	6	7 ¹ / ₈		
ABP 7500	7	8 ¹ / ₈		
ABP 8500	8	9 ¹ / ₈		
ABP 2750	2	4 ¹ / ₄	¾ x 4½	1/0–750
ABP 3750	3	5 ¹ / ₈		
ABP 4750	4	6 ¹⁵ / ₁₆		
ABP 5750	5	8 ³ / ₃₂		
ABP 6750	6	9 ⁵ / ₈		
ABP 7750	7	10 ⁶¹ / ₆₄		
ABP 8750	8	12 ⁵ / ₁₆		



- For installing pin sizes slightly different than the norm
- Made from high-strength aluminum alloy to maintain constant bolting pressure on conductors
- Screws designed for optimum electrical connection and maximum conductor-contact pressure
- Dual-rated for use with aluminum and copper conductors

Specialty aluminum overhead transformer eyebolt multi-tap set-screw connector

Cat. no.	No. of outlets	Length (in.)	Stud size (in.)	Cable range (AWG or kcmil)
ABP 3168	4	4 ¹ / ₄	½	#6–250

Multi-tap eyebolt connectors

Overhead transformer eyebolt multi-tap set-screw connectors & adapters



- Made from high-strength aluminum alloy to maintain constant bolting pressure on conductors
- Screws designed for optimum electrical connection and maximum conductor-contact pressure
- Factory-mounted 90° angle copper studs install in pole-type transformers with secondary eyebolt connections
- Flood-Seal® rubber insulation ensures a fully insulated, watertight connection
- Dual-rated for use with aluminum and copper conductors
- Meets or exceeds ANSI C119.4 specifications

Aluminum Flood-Seal overhead transformer eyebolt multi-tap set-screw connectors

Cat. no.	Conductor range (AWG or kcmil)	Outlets	Exposed pin size (in.)
RABP 4350	#12-350	4	½ x 2
RABP 5350		5	
RABP 6350		6	

Note: For oxide-inhibitor option, add "-C" suffix to the catalog number.



CEA 2 50



CEA 4 50



CEA 6 75

- Gain bolting pads for terminal assembly
- Made from tin-plated copper to provide high conductivity and resist corrosion
- Dual-rated to accept copper or aluminum one-hole terminals and two-hole NEMA-drilled terminals

Tin-plated overhead transformer eyebolt adapters

Diagrams	Cat. no.	Fig. No.	Pin diameter (in.)	Exposed pin size (in.)
	CEA 2 50	1	½	2 ⁵ / ₈
	CEA 4 50	2	½	2 ³ / ₄
	CEA 4 75		¾	2 ³ / ₄
	CEA 6 50	3	½	2 ³ / ₄
	CEA 6 75		¾	2 ³ / ₄
	CEA 6 100		1	2 ³ / ₄

Fig. 1 Fig. 2

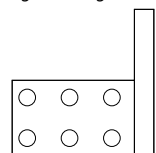

Fig. 3

Note: All bolt holes are 9/16" spaced on 1 3/4" centers. For special pin lengths, please consult your ABB representative.

Storm-Safe® service entrance disconnects

Storm-Safe breakaway service entrance kits – Two and three service



SS 2 K



SS 3 K

Mechanical breakaway link separates service at the pole to prevent damage to utility equipment and customer premises.

- Downed-line safety – separates at the pole, not the weatherhead, so the line always comes down de-energized
- Crew safety – the correction is made well below the high-voltage bushings, making it safer for crews to work during a storm outage
- Quick restoration of power by simply replacing the mechanical breakaway link and re-inserting the contacts
- Disconnect service without pulling the meter
- Internal O-ring prevents moisture ingress into the contact, and external Flood-Seal® insulating rockets seal the entire system from the elements
- Dual-rated for use with aluminum and copper conductors
- Meets ANSI C119.4-2004 specifications

Breakaway service entrance kits

Cat. no.	Contact block	Assembly	Insulating rockets	½-13 Bolts
SS 2 K – Two-service base kit				
SS 2 K	1	(1) U-bolt	(2) Flood-Seal	3
SS 3 K – Three-service base kit				
SS 3 K	1	(1) U-bolt	(2) Flood-Seal	3

Note: SS 2 K requires two SSP pin kits (right). SS 3 K requires three SSP pin kits (right).



SSP 1/0 FN 500 K

Pin kits

Cat. no.	Triplex block (AWG)	Neutral assembly	Breakaway force (lbs.)
SSP 1/0 FN 500 K	1/0, 1/0, 1/0 ACSR	Full neutral	500
SSP 1/0 FN 750 K			750
SSP 1/0 RN 500 K	1/0, 1/0, #2	Reduced neutral	500
SSP 1/0 RN 750 K			750
SSP 2 FN 500 K	#2, #2, #2	Full neutral	500
SSP 2 FN 750 K			750
SSP 2 RN 500 K	#2, #2, #4	Reduced neutral	500
SSP 2 RN 750 K			750
SSP 4 FN 500 K	#4, #4, #4	Full neutral	500
SSP 4 FN 750 K			750
SSP 4 RN 500 K	#4, #4, #6	Reduced neutral	500
SSP 4 RN 750 K			750

Note: Kit consists of two pin terminals, one neutral pin terminal, one SSL Link Kit (breakaway link and bail) and two Flood-Seal® insulating rockets. Three pin kits are required for a three-service base kit and two pin kits are required for a two-service base kit.

Storm-Safe® service entrance disconnects

Storm-Safe breakaway service entrance kits – Single service



SS1 4 FN 750 K

Mechanical breakaway link separates service at the pole to prevent damage to utility equipment and customer premises.

- Downed-line safety – separates at the pole, not the weatherhead, so the line always comes down de-energized
- Crew safety – the correction is made well below the high-voltage bushings, making it safer for crews to work during a storm outage
- Quick restoration of power by simply replacing the mechanical breakaway link and re-inserting the contacts
- Disconnect service without pulling the meter
- Internal O-ring prevents moisture ingress into the contact, and external Flood-Seal® insulating rockets seal the entire system from the elements
- Dual-rated for use with aluminum and copper conductors
- Meets ANSI C119.4-2004 specifications

Breakaway service entrance kits

Cat. no.	Triplex block (AWG)	Neutral assembly	Breakaway force (lbs.)
SS1 1/0 FN 500 K	1/0, 1/0, 1/0 ACSR	Full neutral	500
SS1 1/0 FN 750 K			750
SS1 1/0 RN 500 K	1/0, 1/0, #2	Reduced neutral	500
SS1 1/0 RN 750 K			750
SS1 2 FN 750 K	#2, #2, #2	Full neutral	500
SS1 2 FN 500 K			750
SS1 2 RN 750 K	#2, #2, #4	Reduced neutral	500
SS1 2 RN 500 K			750
SS1 4 FN 500 K	#4, #4, #4	Full neutral	500
SS1 4 FN 750 K			750
SS1 4 RN 500 K	#4, #4, #6	Reduced neutral	500
SS1 4 RN 750 K			750

Note: Kit consists of two sockets, one neutral socket, two pin terminals, one neutral pin terminal, one SSL Link Kit (breakaway link and bail), two Flood-Seal insulating splice covers and one Flood-Seal insulating rocket.



SSL 750 K

SSL – Link kits

Cat. no.	Breakaway force (lbs.)
SSL 500 K	500
SSL 750 K	750

Note: Kit consists of one breakaway link and one bail.

Service wedges and neutral span clamps

W™ aluminum and stainless steel service wedge clamp



Dead-end self-supporting drop wire.

- Drop wire may be cut to exact length for adjustments in drop wire sag
- Can be attached to bare neutral at any point in the span
- Flexible and rigid aluminum bails grip ACSR, AAC and AAAC conductors
- Rigid stainless steel bail grips copper neutral conductors

W aluminum and stainless steel service wedge clamps

Cat. no.	Description	Conductor range (AWG)				Dimensions (in.)		Typical tensile values		
		ACSR	Al	AAAC	Cu	D	L	Conductor	Value (lb.)	Color Code
W62-1	W-1 Series aluminum wedge and slider	#2-#6	#1 str.-#6 sol.	#2-#6	-	2 ³ / ₈	12	26/1 ACSR	1200	Orange
W62-1 FC						flex.	17 ¹ / ₂			
W20-1	W-1 Series aluminum wedge and slider	1/0-#4	2/0 str.-#2 sol.	1/0-4	-	2 ³ / ₈	12 ¹ / ₂	1/06/1 ACSR	1800	Blue
W20-1 FC						flex.	18 ¹ / ₂			
W40-1*	W-1 Series aluminum wedge and slider	4/0-2/0	4/0 str.-2/0 sol.	4/0-2/0	-	2 ³ / ₈	12 ³ / ₄	4/06/1 ACSR	1900	Red
W40-1 FC*						flex.	18 ¹ / ₂			
W62-1 B†	W-1B Series iridite aluminum wedge and slider	2-#6	#1 str.-#6 sol.	#2-#6	-	2 ³ / ₈	12	26/1 ACSR	1200	Orange
W62-1 BFC†						flex.	17 ¹ / ₂			
W20-1 B†	W-1B Series iridite aluminum wedge and slider	1/0-#4	2/0 str.-#2 sol.	1/0-#4	-	2 ³ / ₈	12 ¹ / ₂	1/06/1 ACSR	1800	Blue
W20-1 BFC†						flex.	18 ¹ / ₂			
W40-1 B*†	W-1B Series iridite aluminum wedge and slider	4/0-2/0	4/0 str.-2/0 sol.	4/0-2/0	-	2 ³ / ₈	12 ³ / ₄	4/06/1 ACSR	1900	Red
W40-1 BFC*†						flex.	18 ¹ / ₂			
W62D	W Series stainless steel wedge and slider	-	-	-	#2 str.-#6 sol.	2 ³ / ₈	12	#2-#7 str. AAC	1300	Orange

Diagram

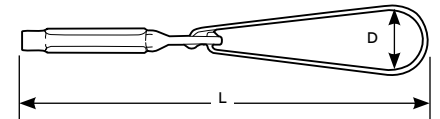

* W40 series clamps rated 850 lb. ultimate tension for 1/0 ACSR, AL or AAAC.

† For extremely corrosive areas.

Note: Catalog numbers with "FC" suffix have a flexible bail.

Service wedges and neutral span clamps

MS neutral span clamp



House not adjacent to a pole?

This is the span clamp you need.

- A combination aerial cable-neutral parallel-groove connector and dead-ending clamp
- Accommodates up to four service drops
- Taps may be installed later, independent of existing connections
- High-strength, one-piece construction
- Castings are of high-strength aluminum alloy
- Hardware is made of galvanized steel

MS neutral span clamp

Cat. no.	Conductor range			
	Main	ACSR Tap	Main	AWG Tap
MS4	4/0-#4	1/0-#6	4/0 str.-#2 sol.	1/0 str.-#6 sol.

Diagram

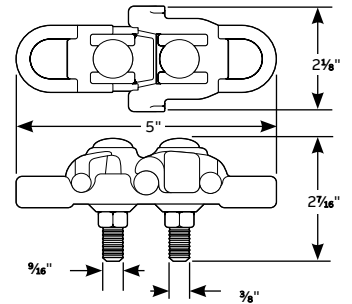

Aluminum H-tap connectors and covers

WR™ wide-range aluminum tap connectors



WR189 or OB101



WR259

For combinations of aluminum-to-aluminum and aluminum-to-copper conductors.

- Made of 1350 aluminum alloy for high strength and high conductivity
- Standard compression tools and dies install all sizes – no special tools needed
- Field-proven ribbed design enables excellent connector/conductor contact without distorting the conductor's shape
- Fold-in tabs provide positive tab interlock as tool closes
- Prefilled with oxide inhibitor held captive in the rib/connection area
- RUS Accepted
- Complies with ANSI C119.4 specifications

WR O and D die seven-connector program

Cat. no.	Connector number	Conductor range (AWG or kcmil)												Connector length (in.)		
		Standard conductor						Diameter (in.)				Connector				
		Main			Tap			Main		Tap						
ACSR	Str.	Sol.	ACSR	Str.	Sol.	ACSR	Str.	ACSR	Str.	Max.	Min.	Max.	Min.			
WR159 OR OB 44 OB 1	1	#2, #4, #6	#1, #2, #3, #4, #6	#2, #4, #6	#2, #4, #6	#1, #2, #3, #4, #6	#2, #4, #6	#1, #2, #3, #4, #6	#1, #2, #3, #4, #6	#1, #2, #3, #4, #6	0.332	0.162	0.332	0.162	1 ¹ / ₁₆ 1 ¹ / ₂	
WR189 OR OB 101 OB 2	2	1/0, #1, #2	2/0, 1/0, #1, #2	3/0, 2/0, 1/0, #1	#2, #4, #6	#1, #2, #3, #4, #6	1/0, #1, #2, #4, #6	2/0, 1/0, #1, #2	2/0, 1/0, #1, #2	#1, #2, #4, #6	#1, #2, #3, #4, #6	0.419	0.266	0.332	0.162	1 ¹³ / ₁₆ 1 ³ / ₄
WR289 OR DB 202 DB 3	3	2/0, 1/0	3/0, 2/0	4/0, 3/0	#2, #4, #6	#1, #2, #3, #4, #6	1/0, #1, #2, #4, #6	2/0, 1/0, #1, #2	2/0, 1/0, #1, #2	#1, #2, #4, #6	#1, #2, #3, #4, #6	0.470	0.398	0.332	0.162	1 ¹³ / ₁₆ 1 ⁷ / ₈
WR279 OR DB 2020	4	2/0, 1/0, #1	3/0, 2/0, 1/0	-	2/0, 1/0, #1	3/0, 2/0, 1/0	-	3/0, 2/0, 1/0	3/0, 2/0, 1/0	3/0, 2/0, 1/0	3/0, 2/0, 1/0	0.470	0.336	0.470	0.336	1 ¹³ / ₁₆
WR379 OR DB 404 DB 5	5	4/0, 3/0	4/0	-	#2, #4, #6	#1, #2, #3, #4, #6	1/0, #1, #2, #4, #6	266 ¹⁸ / ₄ , 250, 4/0	266, 250, 4/0	#1, #2, #4, #6	#1, #2, #3, #4, #6	0.563	0.475	0.332	0.162	1 ¹³ / ₁₆ 1 ⁷ / ₈
WR399 OR DB 4020 DB 6	6	4/0, 3/0	4/0, 3/0	-	2/0, 1/0, #1	2/0, 1/0	3/0, 2/0	266 ¹⁸ / ₄ , 4/0, 3/0	266, 250, 4/0	2/0, 1/0	3/0, 2/0, 1/0	0.563	0.461	0.447	0.338	2 ³ / ₁₆ 2 ¹ / ₂
WR419 OR DB 4040 DB 7	7	4/0, 3/0	4/0, 3/0	-	4/0, 3/0	4/0, 3/0	-	266 ¹⁸ / ₄ , 4/0, 3/0	266, 250, 4/0	266 ¹⁸ / ₄ , 4/0, 3/0	266, 250, 4/0	0.563	0.461	0.563	0.461	2 ⁷ / ₁₆ 2 ¹ / ₂

Note: Connector numbers 1 and 2 use "O" Die; 3-7 use "D" Die.

Aluminum H-tap connectors and covers

WR™ wide-range aluminum tap connectors (continued)

WR O and D die seven-connector program

Cat. no.	Conductor range (AWG or kcmil)														Connector length (in.)
	Standard conductor						Compact conductor				Diameter (in.)				
	Main		Tap		Sol.		Main		Tap		Main		Tap		
ACSR	Str.	ACSR	Str.	ACSR	Str.	ACSR	Str.	ACSR	Str.	Max.	Min.	Max.	Min.		
WR149	#4, #6	#3, #4, #6	#2, #3, #4, #6	#4, #6	#3, #4, #6	#2, #3, #4, #6	#4, #6	#2, #3, #4, #6	#3, #4, #6	#2, #3, #4, #6	0.266	0.162	0.266	0.162	1½
WR179	1/0, #1, #2, #3	1/0, #1, #2	#1	#4, #6	#3, #4, #6	#2, #3, #4, #6	1/0, #1, #2	2/0, #1, #2	#4, #6	#2, #3, #4, #6	0.398	0.266	0.266	0.162	1¾
WR199	1/0, #1, #2, #3	1/0, #1, #2	#1	#2, #3, #4	#1, #2, #3, #4	#1, #2	1/0, #1, #2	2/0, #1, #2	#1, #2, #3, #4	#1, #2	0.398	0.266	0.332	0.232	1¾
WR1010 OR OB 1010	1/0, #1, #2, #3, #4	2/0, 1/0, #1, #2, #3, #4	1/0, #1, #2	1/0, #1, #2, #3, #4	2/0, 1/0, #1, #2, #3, #4	1/0, #1, #2	2/0, 1/0, #1, #2, #3, #4	2/0, 2/0, 1/0, #1, #2, #3, #4	2/0, #1, #2, #3, #4	1/0, #1, #2	0.419	0.232	0.419	0.232	1¾
WR259	1/0, #1	2/0, 1/0	-	1/0, #1	2/0, 1/0	-	2/0, 1/0	2/0, 1/0	2/0, 1/0	2/0, 1/0	0.419	0.326	0.412	0.292	1⅝
WR299	2/0, 1/0	3/0, 2/0	-	#4, #6	#3, #4, #6	#2, #3, #4, #6	3/0, 2/0	3/0	#4, #6	#2, #3, #4, #6	0.470	0.398	0.266	0.162	1½
WR219	1/0, #1	1/0, #1	-	1/0, #1, #2	1/0, #1	-	1/0	2/0, 1/0	1/0	2/0, 1/0	0.398	0.324	0.398	0.316	1⅞
WR239	2/0, 1/0	2/0, 1/0	-	#2, #3, #4	#1, #2, #3	#1, #2	2/0, 1/0	4/0, 3/0	#1, #2, #3, #4	#1, #2	0.447	0.365	0.332	0.236	1⅞
WR229	2/0	3/0, 2/0	-	1/0, #1, #2	1/0, #1	-	3/0, 2/0	3/0	1/0, #1	2/0, 1/0	0.470	0.410	0.398	0.316	1⅞
WR269	2/0	2/0	-	2/0, 1/0	2/0, 1/0	-	2/0	3/0	2/0, 1/0	3/0, 2/0, 1/0	0.447	0.410	0.447	0.336	1⅞

Diagrams

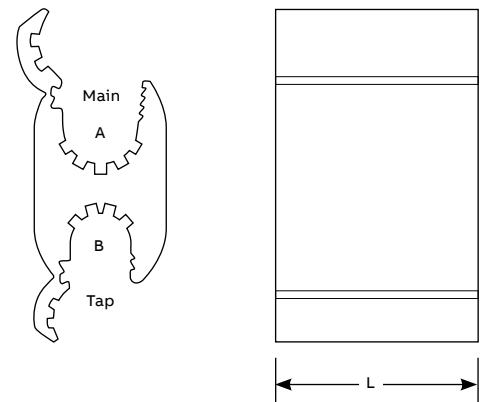

Note: WR149–WR1010 use “O” connector die; all others use “D” connector die.
 WR1010 and WR299 use four indents with a mechanical tool; all others use five indents.
 All die connectors use two indents with a hydraulic tool.

Aluminum H-tap connectors and covers

WR™ wide-range aluminum tap connectors (continued)

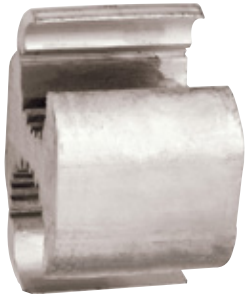

WR Connector

WR supplemental D connectors

Cat. no.	Conductor range (AWG or kcmil)														Connector length (in.)
	Standard conductor*						Compact conductor				Diameter (in.)				
	Main		Tap				Main		Tap		Main		Tap		
ACSR	Str.	Sol.	ACSR	Str.	Sol.	ACSR	Str.	ACSR	Str.	Max.	Min.	Max.	Min.		
WR319	3/0	3/0	-	#2, #3, #4	#1, #2, #3, #4	#1, #2	3/0	4/0	#1, #2, #3, #4	#1, #2	0.502	0.461	0.332	0.299	1 7/8
WR339	3/0	3/0	-	2/0, 1/0, #1	2/0, 1/0	-	3/0	4/0	2/0, 1/0	3/0, 2/0, 1/0	0.502	0.461	0.447	0.336	2 1/8
WR359	4/0, 3/0	4/0, 3/0	-	#4, #6	#3, #4, #6	#2, #3, #4, #6	266, 4/0, 3/0	266, 250, 4/0	1/0, #1, #2	1/0, #1, #2	0.563	0.461	0.266	0.162	1 7/8
WR369	4/0, 3/0	4/0, 3/0	-	#1, #2, #3, #4	1/0, #1, #2, #3	#1	266, 4/0, 3/0	266, 250, 4/0	1/0, #1, #2	1/0, #1, #2	0.563	0.461	0.374	0.266	1 7/8
WR369†	4/0, 3/0, 2/0	4/0, 3/0	-	1/0, #1, #2, #3, #4	1/0, #1, #2, #3, #4	1/0, #1, #2	266, 4/0, 3/0	266, 250, 4/0, 3/0	1/0, #1, #2, #3, #4	1/0, #1, #2	0.563	0.423	0.373	0.232	1 7/8
WR389	4/0, 3/0	4/0, 3/0	-	2/0, 1/0	3/0, 2/0	-	266, 4/0, 3/0	266, 250, 4/0	3/0, 2/0	3/0, 2/0	0.563	0.461	0.470	0.376	2 3/16
WR389†	4/0, 3/0, 2/0	4/0, 3/0	-	2/0, 1/0, #1	3/0, 2/0, 1/0	-	266, 4/0, 3/0	266, 250, 4/0	3/0, 2/0, 1/0	3/0, 2/0, 1/0	0.563	0.423	0.470	0.336	2 3/16

Diagrams

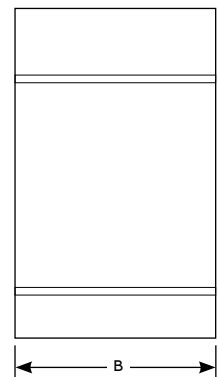
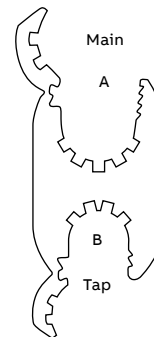

* Will accept conductors of the same wire sizes with a 3% reduction of diameter (compressed). † Conductor range possible only when crimped with a hydraulic tool. Note: WR359 and WR369 use four indents with a mechanical tool; WR319 uses five indents with a mechanical tool; W339 and WR389 use six indents with a mechanical tool. WR369 can also use five indents with a mechanical tool. All die connectors use two indents with a hydraulic tool.

Aluminum H-tap connectors and covers

WR™ wide-range aluminum tap connectors (continued)



WR715

WR N die tap connectors

Cat. no.	Conductor range (AWG or kcmil)														Connector length (in.)
	Standard conductor*					Compact conductor				Diameter (in.)					
	Main		Tap			Main		Tap		Main		Tap			
ACSR	Str.	ACSR	Str.	Sol.	ACSR	Str.	ACSR	Str.	Str.	Max.	Min.	Max.	Min.		
WR715	397 ¹⁸ / ₁ , 336, 266	400, 397, 300, 266, 250	2/0, 1/0, #1, #2, #3, #4, #6	2/0, 1/0, #1, #2, #3, #4, #6	3/0, 2/0, 1/0, #1, #2, #3, #4, #6	477, 397, 336	500, 477, 397, 350	2/0, 1/0, #1, #2, #3, #4, #6	3/0, 2/0, 1/0, #1, #2, #3, #4, #6	0.753	0.502	0.447	0.162	2	
WR775	397 ¹⁸ / ₁ , 336, 266, 4/0	400, 397, 350, 336, 300, 266, 250, 4/0	397 ¹⁸ / ₁ , 336, 266, 4/0	400, 397, 350, 336, 300, 266, 250, 4/0	—	477, 397, 336, 266	500, 477, 397, 350, 336, 300, 266, 250	477, 397, 336, 266	500, 477, 397, 336, 300, 266, 250	0.743	0.502	0.743	0.520	3	
WR815	477 ¹⁸ / ₁ , 397, 336, 266, 4/0	556, 500, 400, 397, 350, 336, 300, 266, 250	2/0, 1/0, #1, #2, #3, #4, #6	2/0, 1/0, #1, #2, #3, #4, #6	3/0, 2/0, 1/0, #1, #2, #3, #4, #6	556, 477, 397, 336, 266	556, 477, 397, 336, 266, 250	2/0, 1/0, #1, #2, #3, #4, #6	3/0, 2/0, 1/0, #1, #2, #3, #4, #6	0.858	0.502	0.447	0.162	2	
WR835 OR NB 50040	477 ¹⁸ / ₁ , 397, 336, 266, 4/0	556, 500, 400, 397, 350, 336, 300, 266, 250	4/0, 3/0, 2/0, 1/0	4/0, 3/0, 2/0, 1/0	4/0, 3/0, 2/0	556, 477, 397, 336, 266	556, 477, 397, 350, 336, 300, 266, 250	266, 4/0, 3/0, 2/0	250, 4/0, 3/0	0.858	0.502	0.563	0.368	2	
WR875 [†]	477 ¹⁸ / ₁ , 397, 336, 266, 4/0	556, 500, 400, 397, 350, 336, 300, 266, 250	477 ¹⁸ / ₁ , 266	350, 336, 300, 266, 250	397, 366	556, 477, 397, 336, 266	556, 477, 397, 350, 336, 300, 336, 300	397, 336, 266	400, 397, 350, 336, 300, 266, 250	0.858	0.502	0.684	0.520	3	
WR885 OR NB 500	477 ¹⁸ / ₁ , 397, 336, 266, 4/0	500, 400, 397, 350, 336, 300, 266, 250, 4/0	477 ¹⁸ / ₁ , 397, 336, 266, 4/0	500, 400, 397, 350, 336, 300, 266, 250, 4/0	—	556, 477, 397, 336, 266	556, 477, 397, 350, 336, 300, 266, 250	556, 477, 397, 336, 266	556, 477, 397, 350, 336, 300, 266, 250	0.814	0.502	0.814	0.520	3	

Diagrams

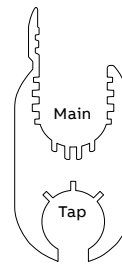

Fig. 1

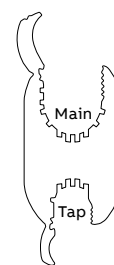
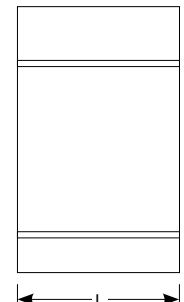

Fig. 2



* Will accept conductors of the same wire sizes with a 3% reduction of diameter (compressed). [†] See Fig. 2. Note: All die connectors can be used with Blackburn JB12A, JB12B, 12A and Y-35 tools. All die connectors are for use with hydraulic tools, 12-ton and greater. WR715, WR815 and WR835 use two indents with a hydraulic tool; all others use three indents.

Aluminum H-tap connectors and covers

WR™ wide-range aluminum tap connectors (continued)



WR699

WR N die tap connectors (continued)

Diagrams	Cat. no.	Conductor range (AWG or kcmil)												Connector length (in.)	
		Standard conductor*						Compact conductor				Diameter (in.)			
		Main		Tap		Sol.	Main		Tap		Max.	Min.	Max.		Min.
ACSR	Str.	ACSR	Str.		ACSR	Str.	ACSR	Str.		Max.	Min.	Max.	Min.		
	WR699	397 ¹⁸ / ₄ , 336, 266	400, 397, 350, 336, 300, 266, 250	#4, #6	#3, #4, #6	#2, #3, #4, #6	477, 397, 336	477, 397, 350, 336, 300	#4, #6	#2, #3, #4, #6	0.743	0.570	0.266	0.162	2
	WR719	397 ¹⁸ / ₄ , 336, 266	400, 397, 350, 336, 300, 266, 250	2/0, 1/0, #1, #2, #3	2/0, 1/0, #1, #2	3/0, 2/0, 1/0, #1	477, 397, 336	477, 397, 350, 336, 300	2/0, 3/0, 1/0, 2/0, #1, #2 1/0, #1		0.743	0.570	0.447	0.289	2
	WR739	397 ¹⁸ / ₄ , 336, 266	400, 397, 350, 336, 300, 266, 250	4/0, 3/0, 2/0, 1/0	4/0, 3/0, 2/0	4/0	477, 397, 336	477, 397, 350, 336, 300	266, 266, 4/0, 250, 3/0 4/0		0.743	0.570	0.563	0.398	2
	WR779	397 ¹⁸ / ₄ , 336, 266	400, 397, 350, 336, 300, 266, 250	397 ¹⁸ / ₄ , 336, 266	400, 397, 350, 336, 266, 250	477, 397	477, 397, 350, 336, 300	477, 477, 397, 397, 336, 336	477, 477, 397, 397, 336, 336		0.743	0.570	0.743	0.570	3
	WR799	477 ¹⁸ / ₄ , 266	500, 250	#4, #6	#3, #4, #6	#2, #3, #4, #6	477 ¹⁸ / ₄ , 266	500, 250	#3, #4, #6	#2, #3, #4, #6	0.814	0.575	0.270	0.160	2
	WR819	477 ¹⁸ / ₄ , 397, 336	556, 500, 477, 450, 400, 397, 350, 336	2/0, 1/0, #1, #2, #3	2/0, 1/0, #1, #2	3/0, 2/0, 1/0, #1	556, 477, 397	556, 477, 397	2/0, 3/0, 1/0, 2/0, #1, #2 1/0, #1		0.858	0.659	0.477	0.289	2
WR839	477 ¹⁸ / ₄ , 397, 336	556, 500, 477, 450, 400, 397, 350, 336	4/0, 3/0, 2/0	4/0, 3/0	4/0	556, 477, 397	556, 477, 397	266, 266, 4/0, 4/0, 3/0 3/0		0.858	0.659	0.563	0.477	2	
WR879 [†]	477 ¹⁸ / ₄ , 397, 336	556, 500, 477, 450, 400, 397, 350, 336	336 ¹⁸ / ₄ , 266	350, 336, 300, 266	397	556, 477, 397	556, 477, 397	397, 3 36	397, 350, 336	0.858	0.659	0.684	0.593	3	
WR889	477 ¹⁸ / ₄ , 397, 336	500, 400, 397, 350, 336	477 ¹⁸ / ₄ , 397, 336	500, 400, 397, 350, 336	-	556, 477, 397, 336	556, 477, 397, 350	556, 556, 477, 477, 397, 397, 336, 336	556, 556, 477, 477, 397, 397, 336, 336	0.814	0.666	0.814	0.666	3	

* Will accept conductors of the same wire sizes with a 3% reduction of diameter (compressed). [†] See Figure 2. Note: All die connectors can be used with Blackburn JB12A, JB12B, WH2, PH2, 12A and Y-35 tools. All die connectors are for use with hydraulic tools, 10-ton and greater. WR779, WR879 and WR889 use three indents with a hydraulic tool; all others use two indents.

Aluminum H-tap connectors and covers

WR™ wide-range aluminum tap connectors (continued)



WR909

WR R die tap connectors

Diagrams	Cat. no.	Conductor range (AWG or kcmil)								Diameter (in.)				Connector length (in.)
		Standard conductor				Compact conductor				Main		Tap		
		Main		Tap		Main		Tap		Max.	Min.	Max.	Min.	
	ACSR	Str.	ACSR	Str.	ACSR	Str.	ACSR	Str.	Max.	Min.	Max.	Min.		
A	WR909	556 ^{18/1}	600, 556,	336 ^{18/1}	350, 336,	636,	700,	397 ^{1/2}	397,	0.893	0.666	0.684	0.398	4 ^{3/4}
		477, 397,	550, 500,	266, 4/0,	266, 250,	556,	636,	336,	350,					
B	WR909	336, 300	477, 450,	3/0, 2/0,	4/0, 3/0,	477,	556,	266,	336,					
			397, 350,	1/0	2/0	397	500,	4/0,	300,					
			336				450,	477,	266,					
							450	2/0	250,					
								4/0,	4/0,					
								3/0	3/0					
	WR929	556 ^{18/1}	600, 556,	556 ^{18/1}	600, 556,	636,	700,	636,	700,	0.893	0.666	0.893	0.666	4 ^{3/4}
		477, 397,	550, 500,	477, 397	550, 477,	556,	636,	556,	636,					
		336, 300	477, 450,	336, 300	450, 400,	477,	556,	477,	556,					
			397, 350,		397, 350,	397	500,	397	477,					
			336		336		477,	450	450					
	WR949	795 ^{29/1}	900, 874,	336 ^{18/1}	350, 336,	954,	1000,	397 ^{18/1}	397,	1.108	0.883	0.684	0.398	4 ^{3/4}
		715, 666,	800, 795,	266, 4/0,	266, 250,	874,	954,	336,	350,					
		636, 605,	750, 715,	3/0, 2/0,	4/0, 3/0,	795	874,	266,	336,					
		556,	700, 636,	1/0	2/0		795,	4/0,	300,					
		477 ^{30/1}	600				750	3/0, 2/0	266,					
									250,					
									4/0,					
									3/0					
	WR969	795 ^{29/1}	900, 874,	556 ^{18/1}	600, 556,	954,	1000,	636,	700,	1.108	0.883	0.893	0.666	4 ^{3/4}
		715, 666,	800, 795,	477, 397,	550, 500,	874,	954,	556,	636,					
		636, 605,	750, 715,	336, 300	477, 450,	795	874,	477,	556,					
		556,	700, 636,		400, 397,		795	397	477,					
		477 ^{30/1}	600		350, 336				450					
	WR989	795 ^{29/1}	900, 874,	795 ^{26/1}	900, 874,	954,	1000,	954,	1000,	1.108	0.883	1.108	0.883	4 ^{3/4}
		715, 666,	800, 795,	715, 666,	800, 795,	874,	954,	874,	954,					
		636, 605,	750, 715,	636, 605,	750, 715,	795	874,	795	874,					
		556,	700, 636,	556,	700, 636,		795,	795,	795,					
		477 ^{30/1}	600	477 ^{30/1}	600		750		750					
	WR999	954 ^{45/1}	1033, 1000,	954 ^{45/1}	1033,	954,	1000,	954,	1000,	1.172	0.997	1.172	0.994	4 ^{3/4}
		900, 874,	900, 800,	900, 874,	1000, 900,	900	900	900,	900					
		795, 715,	795, 750	795, 750,	800, 795,			874						
		666		666	750									

Note: All die connectors can be used with Blackburn JB60A, JB60B, Y60, 60A and PH-3 tools. All die connectors use four indents with a mechanical tool.

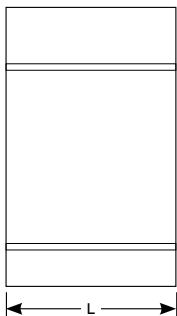
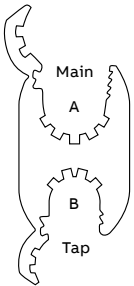

Aluminum H-tap connectors and covers

WR™ wide-range aluminum tap connectors (continued)



WR502



WR9

WR street lighting compression connectors

Cat. no.	Figure no.	Conductor range (AWG or kcmil)								Diameter (in.)						Connector length (in.)
		Standard conductor*														
		Main			Tap A		Tap B			Main		Tap A		Tap B		
ACSR	Str.	Sol.	Str.	Sol.	Str.	Sol.	Str.	Sol.	Max.	Min.	Max.	Min.	Max.	Min.		
WR9	2	#3, #4, #6	#2, #3, #4, #6	#1, #2, #3, #4	#8, #10, #12, #14	#8, #10, #12, #14	-	-	0.292	0.184	0.146	0.064	-	-	1 ³ / ₁₆	
WR139	1	1/0, #1, #2, #3, #4	2/0, 1/0, #1, #2, #3	#1, #2	#8, #10	#6, #8, #10	#12, #14	#12, #14	0.419	0.250	0.162	0.100	0.092	0.064	1 ¹ / ₂	
WR502	1	4/0, 3/0	4/0, 3/0	-	#8, #10	#6, #8, #10	#12, #14	#12, #14	0.563	0.461	0.162	0.100	0.092	0.064	1 ¹ / ₂	
WR502 [†]	1	4/0, 3/0, 2/0, 1/0	4/0, 3/0, 2/0, 1/0	-	#8, #10	#6, #8, #10	#12, #14	#12, #14	0.563	0.365	0.162	0.100	0.092	0.064	1 ¹ / ₂	

Diagrams

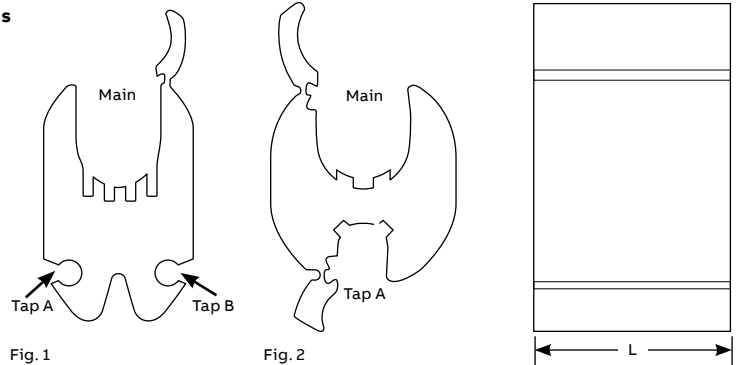

* Will accept conductors of the same wire size with a 3% reduction of diameter (compressed).
[†] This range is possible only when crimped with a hydraulic tool.
 Note: WR9 uses a 5/8" BG connector die; WR139 uses an "O" connector die; WR502 uses a "D" connector die.
 WR9 uses three indents with a mechanical tool; all others use four indents.
 WR139 and WR502 use two indents with a hydraulic tool.

Aluminum H-tap connectors and covers

Aluminum H-type compression connectors

Deadend aluminum, ACSR or aluminum-alloy conductors.

- Prefilled with oxide inhibitor to prevent oxidation and keep out moisture
- Connectors fully marked with installation and compression location information, providing easy identification for easy installation

- Comply with ANSI C119.4 when properly installed on aluminum-to-aluminum or aluminum-to-copper conductors
- RUS accepted

Cat. no.	Style	Standard conductor/ACSR/AAC (AWG or kcmil)											Tap cvr.	
		Main groove, "A" range				Tap groove, "B" range			Side groove, "C" range			L (in.)		Die
		Groove "A" decimal range	ACSR	Str.	Sol.	Groove "B" decimal range	ACSR	Str.	Sol.	Groove "C" decimal range	Str.			
UB 214	5	0.325–0.162	#2 ⁷ / ₁₆ –#6 ⁵ / ₁₆	#2(7)–#6(7)	#1–#6	0.146–0.064	–	#8–#14	#7–#14	–	–	–	¾ ⅝ or BG	CO 20 B
OB 2014	6	0.447–0.292	2/0 ⁶ / ₁₆ –#2 ⁶ / ₁₆	2/0(19)–#2(7)	–	0.146–0.064	–	#8–#14	#7–#14	–	–	–	¾	O
OB 22	4	0.325–0.162	#2 ⁷ / ₁₆ –#6 ⁵ / ₁₆	#2(7)–#6(7)	#2–#6	0.325–0.162	#2 ⁷ / ₁₆ –#6 ⁵ / ₁₆	#2(7)–#6(7)	#2–#6	0.148–0.062	#8–#14	#8–#14	1½	O
OB 103	1	0.398–0.162	1/0 ⁶ / ₁₆ –#6 ⁵ / ₁₆	1/0(19)–#6(7)	#2–#6	0.332–0.162	#2 ⁷ / ₁₆ –#6 ⁵ / ₁₆	#1(19)–#6(7)	#2–#6	–	–	–	1½	O
NB 60020	2	0.915–0.575	556.5 ²⁴ / ₇ –266.8 ¹⁸ / ₁₆	600(61)–250(37)	–	0.419–0.162	1/0 ⁵ / ₁₆ –#6 ⁵ / ₁₆	2/0(.9)–#1(7)	2/0–#6	–	–	–	2½	N
ZB 954	2	1.196–0.586	954 ⁵⁴ / ₇ –266.8 ¹⁸ / ₁₆	1000(61)–266.8(7)	–	1.196–0.586	954 ⁵⁴ / ₇ –266.8 ¹⁸ / ₁₆	1000(61)–266.8(7)	–	–	–	–	6	Z or R
ZB 95440	3	1.140–0.586	795 ³⁰ / ₁₆ –266.8 ¹⁸ / ₁₆	750(61)–266.8(7)	–	0.741–0.522	336.4 ³⁰ / ₇ –4/0 ⁵ / ₁₆	350(37)–4/0(7)	–	0.292–0.162	#2–#6	#2–#6	3	Z or R
ZB 95410	3	1.140–0.586	795 ³⁰ / ₁₆ –266.8 ¹⁸ / ₁₆	750(61)–266.8(7)	–	0.563–0.368	4/0 ⁵ / ₁₆ –1/0 ⁵ / ₁₆	4/0(19)–1/0(7)	–	0.292–0.162	#2–#6	#2–#6	3	Z or R

Diagrams

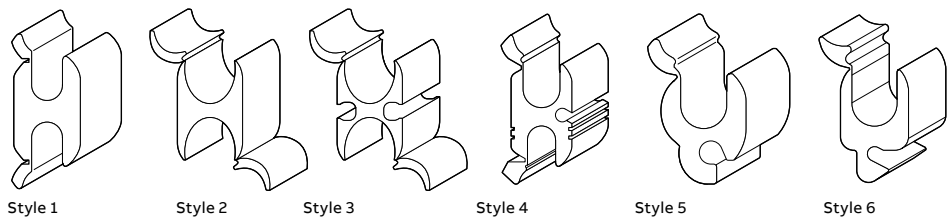

Note: For connector covers, see next page. Install with hydraulic tools only. Use UT 5 tool with "O" and "D" connector dies; use UT 15 tool with "O," "D," "N" or "Z" connector dies. For more information, please consult your ABB representative. For Kearney, use "O" and "D" connector dies with mechanical or hydraulic tools. For Burndy, use "O" and "D-3" connector dies with mechanical or hydraulic tools; use "N," "Z" or "R" connector dies with hydraulic tools.

Aluminum H-tap connectors and covers

H-type connector covers



CO 20 B

CN 600 B

Secure double-locking latches provide a close-fitting top and bottom seal.

- Thin strips of the “grass skirt” mold around the conductors to provide a highly reliable end enclosure
- Tapered drains in both cover halves prevent accumulation of water within the cover, regardless of which half of the cover is down
- Made from black polypropylene to resist the elements, UV sun rays and common contaminants

H-type connector covers

Cat. no.	H (in.)	L (in.)	W (in.)
CO 20 B	2 ¹ / ₄	4 ¹ / ₂	1 ⁵ / ₈
CD 40 B	2 ³ / ₈	5 ⁵ / ₈	1 ³ / ₄
CN 600 B	2 ¹⁵ / ₁₆	6 ⁷ / ₈	2

Type C H-type compression connector covers

Cat. no.	Capacity (before compression)	H (in.)	L (in.)	W (in.)
C2BB	All ⁵ / ₈ " O.D. sleeves 2" long or less	1.10	4.00	1.05
C5BB	All O die taps 1.75" long or less	1.60	3.75	1.25
C7	All D die taps 2.5" long or less	1.80	5.00	1.45
C9	All N and D die taps 2" long or less	2.75	4.25	2.00
C9L	All N and D die taps 5" long or less	2.75	7.25	2.00

Copper H-tap connectors

Copper H-type compression connectors



Efficient design requires less crimping force.

- Made of pure electrolytic copper for high conductivity
- Full-length tab makes installation easy
- Installs with standard compression tools and dies
- RUS accepted

Cat. no.	Fig. No.	Conductor range										Installation information							
		Standard conductor (AWG)*				Diameter (in.)*				H		Connector Length	Mechanical tools†			Hydraulic tools†			
		Main		Tap		Main		Tap		H	H		OD 58	Type O	MD Series	JB12A JB12B series	H series	Y-35	TBM15/Y42/Y46
		Sol.	Str.	Sol.	Str.	Max.	Min.	Max.	Min.			Max.							
CF44-1	1	#4, #6	#6	#4, #6, #8	#6	0.204	0.162	0.204	0.128	0.971	0.729	¹³ / ₁₆	B, T, ⁵ / ₈	B, T, ⁵ / ₈	W-KB, W-BG	BKT	B	BKT, U-BG	BKT, U-B
CFS44-1	2	#4, #6	#6	#4, #6, #8	#8	0.204	0.162	0.204	0.128	0.864	0.743	¹³ / ₁₆	B, T, ⁵ / ₈	B, T, ⁵ / ₈	W-KB, W-BG	BKT	BKT	BKT, U-BG	BKT, U-BG
CF22-1	1	#2, #4	#4	#2, #4	#4	0.258	0.204	0.258	0.204	1.162	0.813	¹³ / ₁₆	K	K	W-KK	-	-	-	BKT
CFS22-1	2	#2, #4	#4	#2, #6	#6	0.258	0.204	0.258	0.162	1.017	0.842	¹³ / ₁₆	K	K	W-KK	W-KK	BKT	BKT	BKT
CF102-1	1	-	1/0, #1, #2	#2, #4	#4	0.373	0.292	0.258	0.162	1.54	1.1	²⁷ / ₃₂	-	-	-	O	O	O	O
CF1010-1	1	-	1/0, #1, #2	-	1/0, #1, #2	0.373	0.292	0.373	0.292	1.61	1.05	²⁷ / ₃₂	-	-	-	O	O	O	O
CF202-1	1	-	2/0, 1/0	-	2/0, 1/0, #1, #2	0.419	0.368	0.258	0.204	1.67	1.269	⁷ / ₈	-	-	-	K-C	C	K-C	K-C
CF2020-1	1	-	2/0, 1/0	-	2/0, 1/0, #1, #2	0.419	0.368	0.414	0.292	1.74	1.22	⁷ / ₈	-	-	-	K-C	C	K-C	K-C
CF402-1	1	-	4/0, 3/0, 2/0	#2, #4	#4	0.528	0.414	0.258	0.204	1.983	1.423	⁷ / ₈	-	-	-	D [∞]	D [∞]	D [∞]	D [∞]
CF4010-1	1	-	4/0, 3/0, 2/0	-	1/0, #1, #2	0.528	0.414	0.373	0.292	1.992	1.423	1 ¹ / ₈	-	-	-	D [∞]	D [∞]	D [∞]	D [∞]
CF4040-1	1	-	4/0, 3/0, 2/0	-	4/0, 3/0, 2/0	0.528	0.414	0.528	0.414	2.252	1.483	1 ¹ / ₈	-	-	-	D [∞]	D [∞]	D [∞]	D [∞]

Diagrams

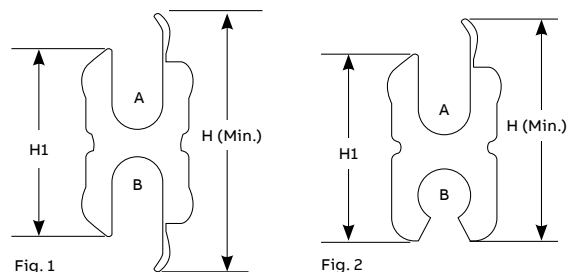

* Decimal dimensions are for conventional conductor, not Copperweld® or Alumoweld®.† Use three indents with mechanical tools and one indent with hydraulic tools. At 15 ton/head, use appropriate die adapters. ∞ Blackburn "D" dies.

Stirrup connectors

WRQ and WRS stirrup connectors



WRS



WRQ

Protect main conductors from arcing damage.

- Guard main conductors against arcs – perfect for when hot line taps are installed
- Utilize standard WR connectors and plated copper bails for high conductivity and corrosion resistance

WRQ and WRS stirrup connectors

Figure 1 Cat. no.	Figure 2 Cat. no.	Conductor range				Copper bail	Installation dies		Dimensions Type WRS (in.)	
		ACSR	AWG or kcmil	Diameter (in.)			Mech.	Hyd.	L	H
WRQ154	WRS154	#2–#6	#1 str.–#6 sol.	0.332	0.162	#4 sol.	O	O	10	7/8
WRQ152	WRS152	#2–#6	#1 str.–#6 sol.	0.332	0.162	#2 sol.	O	O	10	7/8
WRQ172	WRS172	1/0–#3	1/0 str.–#1 sol.	0.398	0.281	#2 sol.	O	O	10	7/8
WRQ232	WRS232	2/0–1/0	2/0 str.–1/0 str.	0.447	0.368	#2 sol.	D	D	10	7/8
WRQ352	WRS352	4/0–3/0	4/0 str.–3/0 str.	0.563	0.46	#2 sol.	D	D	10	7/8
–	WRS719	397 ¹⁸ / ₁ –266	400 str.–250 str.	0.743	0.6	2/0 sol.	–	N	12 ¹ / ₄	3 ³ / ₁₆
–	WRS819	477 ²⁶ / ₁ –266	500 str.–336 str.	0.858	0.666	2/0 sol.	–	N	12 ¹ / ₄	3 ³ / ₁₆
WRQ698	–	477 ²⁶ / ₁ –266	500 str.–250 str.	0.858	0.574	#2 sol.	–	N	12 ¹ / ₄	3 ³ / ₁₆

Diagrams

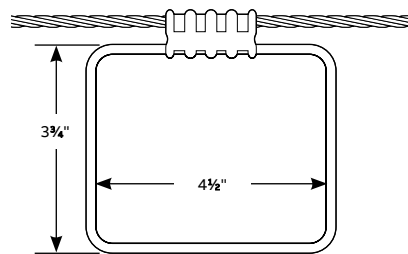

Fig. 1

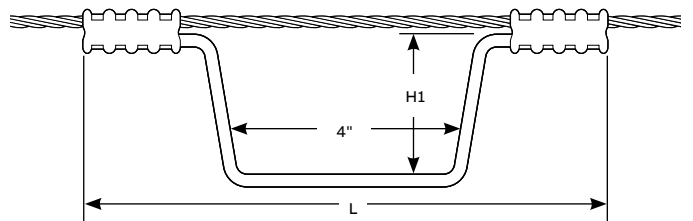

Fig. 2

* Decimal dimensions are for conventional conductor, not Copperweld® or Alumoweld®.

Stirrup connectors

SC and QC stirrup connectors



SCO

Aluminum conductor elements are designed to be preloaded for faster installation into hotstick tools.

- Use standard O, D and N dies – no special compression tools needed
- Prefilled with oxide inhibitor to prevent oxidation and keep out moisture
- Bail made of tin-plated copper wire for high conductivity and corrosion resistance
- Wide range of stirrups fit #6 solid to 500 kcmil wire sizes
- Knurled design resists rotation

SC and QC stirrup connectors

Figure 1 Cat. no.	Figure 2 Cat. no.	ACSR	AWG or kcmil	Conductor range		Bail (tin plated)		Installation dies		Dimensions (in.)	
				in.	mm	Size	Dia. (mm)	Mech.	Hyd.	L	H1
QCO02	SCO02	#2-#6	#2 str.-#6 sol.	0.325-0.162	8.25-0.412	#2 sol.	6.35	O	O	8¾	3½
QCO21	SCO21	2/0-#2	2/0 str.-#2 sol.	0.414-0.292	10.51-7.41	#2 sol.	6.35	O	O	8¾	3½
QCD41	SCD41	4/0-3/0	4/0 str.-3/0 sol.	0.563-0.464	14.29-10.51	#2 sol.	6.35	D	-	8¾	3½
QCN50	SCN50	47718/1-4/0	500-4/0 str.	0.814-0.528	20.66-13.40	1/0 sol.	6.22	-	N	11	3 ¹¹ / ₁₆

Diagrams

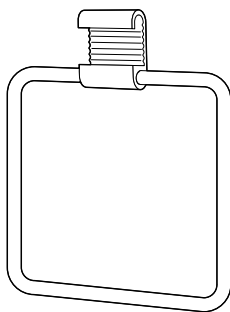

Fig. 1

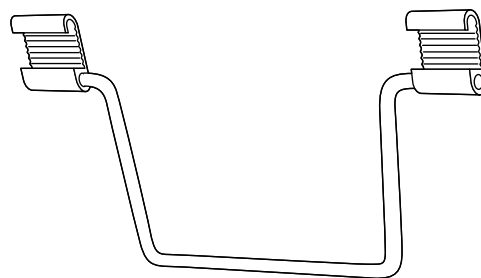

Fig. 2

Stirrup connectors

Anti-rotational hot-line stirrups



NC 60010

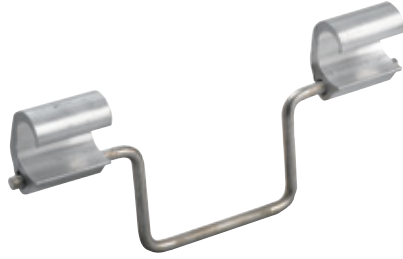

NST 60010

Protect conductors from arc and mechanical damage where hot line clamps are used.

- For aluminum, AAAC and ACSR conductors
- Can be pre-loaded into a hotstick installing tool, hooked over the line and compressed
- Connector is made from aluminum, and factory-installed bail is tin-plated solid copper for high conductivity and corrosion resistance
- Diamond knurling at tap connections and in the hot-line clamping area improve both mechanical and electrical performance
- Connectors prefilled with oxide inhibitor to prevent oxidation and keep out moisture
- All connectors marked with wire size, installation die codes and compression locations, providing easy identification for easy installation

C-type stirrups

Diagram	Cat. no.	Conductor size (AWG or kcmil)			A (in.)	B (in.)	Die
		ACSR	Str.	Sol.			
	OC 42	#4	#4	#6-#4	1 ⁷ / ₈	2	O
	OC 22	#4-#2	#4-#2	#2	1 ⁷ / ₈	2	O
	OC 102	#4-1/0	#2-1/0	-	1 ⁷ / ₈	2	O
	DC 402	3/0-4/0	3/0-4/0	-	2 ³ / ₄	2	D
	NC 40010	266.8 (18/1)- 397.5 (18/1)	250 (37)- 400 (37)	-	2 ¹ / ₈	1/0	N
	NC 60010	397.5 (18/1)- 556.5 (18/1)	477-600	-	2 ¹ / ₈	1/0	N

Crank-type stirrups

Diagram	Cat. no.	Conductor size (AWG or kcmil)			A (in.)	B (in.)	Die
		ACSR	Str.	Sol.			
	OST 42	#4	#6 sol.-#4	10	2	2 ³ / ₄	O
	OST 22	#4-#2	#4-#2	10	2	2 ³ / ₄	O
	OST 102	#4-1/0	#2-1/0	10	2	2 ³ / ₄	O
	OB 103 ST	#6-1/0	#6-1/0	9 ¹ / ₂	2	2 ³ / ₄	O
	DST 402	3/0-4/0	3/0-4/0	10	2	2 ³ / ₄	D
	NST 40010	266.8 (18/1)- 397.5 (18/1)	250 (37)- 400 (37)	12	1/0	2 ⁷ / ₈	N
	NST 60010	397.5 (26/7)- 556.5 (18/1)	477-600	12	1/0	2 ⁷ / ₈	N
	DB 404 ST*	3/0-4/0	3/0-4/0	12	2	2 ³ / ₄	D
	NB 50040 ST*	4/0-477 (18/1)	4/0-500	10	2/0	2 ⁷ / ₈	N

* Designates H-tap style.

Stirrup connectors

Anti-rotational Paltrap™ hot-line stirrups & copper tin-plated bails



Protect aluminum and ACSR main conductors from arc and mechanical damage where hot-line clamps are used.

- For aluminum, 5005, AAAC and ACSR conductors
- Can be pre-loaded into a hotstick installing tool, hooked over the line and compressed
- Paltrap connector is made from aluminum, and factory-installed bail is tin-plated solid copper for high conductivity and corrosion resistance
- Connectors prefilled with oxide inhibitor to prevent oxidation and keep out moisture
- All connectors marked with wire size, installation die codes and compression locations, providing easy identification for easy installation

Anti-rotational Paltrap hot-line stirrups

Diagram	Cat. no.	Main conductor (AWG)			A (in.)	B (in.)	Installing die
		Sol.	Str.	ASCR			
	QH 6 S	#4 and #6	#6	#6	2 ¹ / ₁₆	1	TQ, 12, 1/2,
	QH 4 S	#2	#4	#4	2 ¹ / ₁₆	1	42
	SH 2 S	-	#2	#2	2 ³ / ₈	1 ³ / ₁₆	45, TS, 13, 9/16

Note: Bails may be ordered separately for field assembly of stirrups using Paltrap connectors. Specify catalog number HLB 2 for #2 tinned solid copper bail or catalog number HLB 10 for 1/0 tinned solid copper bail.



S 4425

HLB 2

Designed for distribution service connections with standard hotsticks.

- Choose from seven bail types, all handling either #2 or 1/0 conductor sizes
- Tin plated to resist corrosion

Copper tin-plated bails

Diagrams	Cat. no.	Size (AWG)	Fig.	H (in.)	L (in.)
	HLB 2	#2	1	2 ³ / ₈	4 ¹ / ₄
	HLB 10	1/0	1	2 ³ / ₄	4 ³ / ₈
	S 4425*	#2	2	4	4 ¹ / ₄
	S 4425-1/0	1/0	2	4	4 ¹ / ₄
	OL 4425	#2	3	3 ¹ / ₈	4 ¹ / ₄
	HLCB 2	#2	4	2 ³ / ₄	4 ¹ / ₂

* S 4425 is split in the center and recommended for H-type connector applications.

Stirrup connectors

CCS compression stirrup & LP compression line protector sleeves



CCS compression stirrup

The single-piece stirrup for a large, workhorse conductor.

- Bail made of tin-plated copper wire for high conductivity and corrosion resistance
- Use U or 6024 dies – no special compression tools needed

Cat. no.	kcmil		Conductor range		Copper bail tin plated
	Max.	min.	Diameter (in.)	Max.-min.	
CCS44	800	636 str.	1.032	0.918	2/0 sol.

Diagram

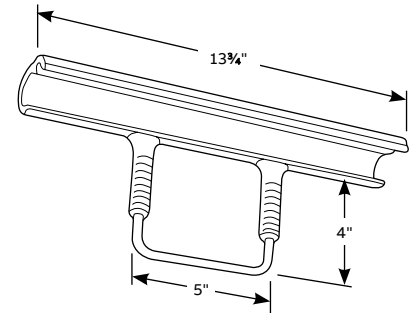

LP10

Covers and protects conductors from arcing when line clamps are attached or disconnected.

- Fit #4, #2 and 1/0 conductors
- Feature a hot-line clamp-bearing surface measuring 1 1/16" diameter by 4" long
- Use 5/8", BG and G dies – no special compression tools needed

LP compression line protector sleeves

Cat. no.	ACSR	AWG	Diameter (in.)		Length (in.)	Installing dies
			Max.	Min.		
LP4	#4	#4	0.257	0.232	8	5/8" Peach, BG, G
LP2	#2	#2	0.316	0.292	8	5/8" Peach, BG, G
LP10	1/0	1/0	0.398	0.373	8	O

Diagram

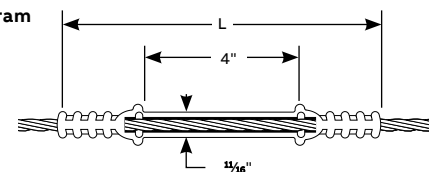

Hot line clamp bearing surface:
1 1/16" dia. x 4" length

Parallel-groove connectors

Aluminum parallel-groove clamps



- Galvanized steel carriage bolt, nut and lockwasher included
- Dual-rated for use on aluminum, ACSR and copper conductors
- Available prefilled with oxide inhibitor to prevent oxidation on copper-to-aluminum connections

PAA one- and two-bolt aluminum parallel-groove clamps

Standard Cat. no.	Prefilled Cat. no.	Conductor range (AWG or kcmil)				Conductor diameter (in.)				Dimensions (in.)				Bolt size
		Main		Tap		Main		Tap		F	H	L	W	
		ACSR	Al/Cu	ACSR	Al/Cu	Max.	Min.	Max.	Min.					
-	PAA29	#2-#6	#2 str.-#6 sol.	#2-#6	#2 str.-#6 sol.	0.316	0.162	0.316	0.162	1/16	1 3/16	1 13/32	1 3/8	5/16
-	PAA339	1/0-#6	1/0 str.-#6 sol.	1/0-#6	1/0 str.-#6 sol.	0.398	0.162	0.398	0.162	1/16	1 9/16	1 1/4	1 1/2	3/8
PAA4	PAA49	1/0-#6	1/0 str.-#6 sol.	1/0-#6	1/0 str.-#6 sol.	0.398	0.162	0.398	0.162	1/16	2 7/32	1 3/16	1 1/2	3/8
PAA5	PAA59	1/0-#8	1/0 str.-#8 sol.	1/0-#8	1/0 str.-#8 sol.	0.398	0.128	0.398	0.128	1/16	2 7/32	1 11/32	1 1/2	3/8
PAA6	PAA69	1/0-#8	2/0 str.-#8 sol.	1/0-#8	2/0 str.-#8 sol.	0.414	0.128	0.414	0.128	1/16	2 7/32	1 3/8	1 5/8	3/8
PAA10*	PAA109	336.4-1/0, 1/0-#6 AR	400-1/0 str., 1/0-#6 AR	1/0-#8	1/0 str.-#8 sol.	0.741	0.368	0.398	0.128	1/16	2 15/32	2	1 3/4	3/8
PAA12	PAA129	4/0-#2	4/0 str.-#2 sol.	4/0-#2	4/0 str.-#2 sol.	0.563	0.258	0.563	0.258	3/4	2 1/4	2	2	1/2
PAA400†	PAA4009†	336.4-1/0, 1/0-#6 AR	400-1/0 str., 1/0-#6 AR	336.4-1/0	400-1/0 str.	0.741	0.368	0.741	0.368	3/4	3 3/4	3 3/4	2 1/2	1/2

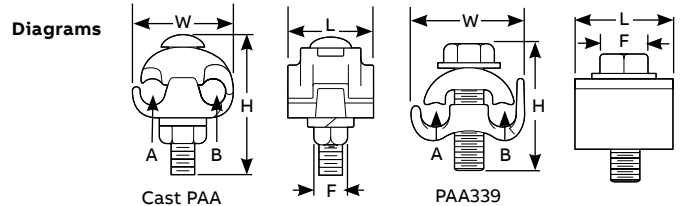

* RUS listed. † PAA400 and PAA4009 are two bolt clamps. AR = Over armor rod. Note: For hex-head bolt option, add "-3" suffix to the catalog number.



- Pressure-cast aluminum body effectively seals out moisture and resists corrosion
- Clamp separates conductors to reduce the possibility of galvanic corrosion

PAC Aluminum parallel-groove clamps with copper liner

Standard Cat. no.	Prefilled Cat. no.	Conductor range (AWG or kcmil)			Conductor diameter (in.)		Dimensions (in.)		
		ACSR	Al	Cu	Main	Tap	H	W	L
PAC345	PAC3459	1/0-#8	1/0 str.-#8 sol.	1/0 str.-#8 sol.	0.398-0.128	0.373-0.128	2 7/32	1 7/32	1 1/4
PAC7*	PAC79	336.4-1/0, 1/0-#6 AR	400-2/0 str., 1/0-#6 AR	1/0 str.-#8 sol.	0.741-0.398	0.373-0.128	2 15/32	1 5/8	1 7/8

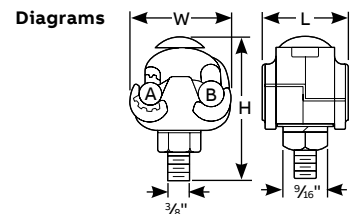

* RUS Listed. Note: For hex-head bolt option, add "-3" suffix to the catalog number.

Parallel-groove connectors

PAE parallel-extruded type groove clamps



- Galvanized steel hardware provides high strength for heavy-duty applications
- Install with live line tools you already have
- Dual-rated for aluminum-to-copper connections
- Prefilled with oxide inhibitor (“-9” suffix in chart) to prevent oxidation on copper-to-aluminum connections

PAE parallel-extruded type groove clamps

Cat. no.	Conductor range (AWG or kcmil)		Conductor diameter				Fig.	Dimensions (in)						Galvanized aluminum	
			Main		Tap			H	W	L	F	B	A	Steel bolt thd. size	Bolt thd. size
			Max.	Min.	Max.	Min.									
PAE-335-79	1/0 str.-#6 sol.	1/0 str.-#6 sol.	0.398	0.162	0.398	0.162	1	1 ¹ / ₁₆	1 ¹ / ₂	1 ¹ / ₄	⁹ / ₁₆	-	-	³ / ₈ -16 UNC	³ / ₈ -16 UNC
PAE-2121-9*	2/0 ACSR-#6 sol., #6 AR	2/0 ACSR-#6 sol., #6 AR	0.447	0.162	0.447	0.162	1	2	1 ⁵ / ₈	1 ³ / ₈	⁹ / ₁₆	⁷ / ₈	-	³ / ₈ -16 UNC	³ / ₈ -16 UNC
PAE-2121X-79	2/0 ACSR-#6 sol., #6 AR	2/0 ACSR-#6 sol., #6 AR	0.447	0.162	0.447	0.162	1	2	1 ⁵ / ₈	1 ³ / ₈	⁹ / ₁₆	⁷ / ₈	-	-	³ / ₈ -16 UNC
PAE-4141-9*	4/0 ACSR-#2 sol., #4-#6 AR	4/0 ACSR-#2 sol., #4-#6 AR	0.563	0.258	0.563	0.258	1	2	2	1 ³ / ₈	⁹ / ₁₆	¹ / ₈	-	³ / ₈ -16 UNC	³ / ₈ -16 UNC
PAE-3921-9-2	397.5 ACSR-3/0 str., 2/0-#6 AR	2/0 str.-#6 sol., #6 AR	0.743	0.464	0.414	0.162	2	2 ¹ / ₁₆	2 ³ / ₄	1 ⁵ / ₈	³ / ₄	1 ¹ / ₈	-	¹ / ₂ -13 UNC	¹ / ₂ -13 UNC
PAE-9941-9	1000-397.5 ACSR, 336.4-2/0 AR	4/0 ACSR-#2 sol., #4-#6 AR	1.152	0.743	0.563	0.258	3	2 ¹³ / ₁₆	25 ³ / ₆₄	2 ¹ / ₄	³ / ₄	-	-	¹ / ₂ -13 UNC	¹ / ₂ -13 UNC
PAE-3931-9-2	397.5 ACSR-3/0 str., 2/0-#6 AR	3/0 ACSR-2 str., #6 AR	0.743	0.464	0.502	0.292	4	2 ¹ / ₁₆	2 ⁵ / ₁₆	3 ³ / ₈	³ / ₄	-	1 ³ / ₄	¹ / ₂ -13 UNC	¹ / ₂ -13 UNC
PAE-3939-9-2	397.5 ACSR-3/0 str., 2/0-#6 AR	397.5 ACSR-3/0 str., 2/0-#6 AR	0.743	0.464	0.743	0.464	5	2 ¹ / ₁₆	2 ¹ / ₁₆	3 ³ / ₈	³ / ₄	-	1 ⁷ / ₈	¹ / ₂ -13 UNC	⁵ / ₈ -11 UNC
PAE-9921-9	1000-397.5 ACSR, 336.4-2/0 AR	2/0 str.-#6 sol., #6 AR	1.152	0.743	0.414	0.162	3	2 ¹³ / ₁₆	2 ³ / ₁₆	2 ¹ / ₄	³ / ₄	-	-	¹ / ₂ -13 UNC	⁵ / ₈ -11 UNC
PAE-9939-9	1000-397.5 ACSR, 336.4-2/0 AR	397.5 ACSR-3/0 str., 2/0-#6 AR	1.152	0.743	0.743	0.464	4	2 ¹³ / ₁₆	3 ⁷ / ₆₄	3 ¹ / ₂	³ / ₄	-	1 ¹ / ₂	¹ / ₂ -13 UNC	⁵ / ₈ -11 UNC
PAE-9999-9	1000-397.5 ACSR, 336.4-2/0 AR	1000-397.5 ACSR, 336.4-2/0 AR	1.152	0.743	1.152	0.743	6	2 ¹³ / ₁₆	3 ¹ / ₂	6	³ / ₄	-	2	¹ / ₂ -13 UNC	⁵ / ₈ -11 UNC

Diagrams

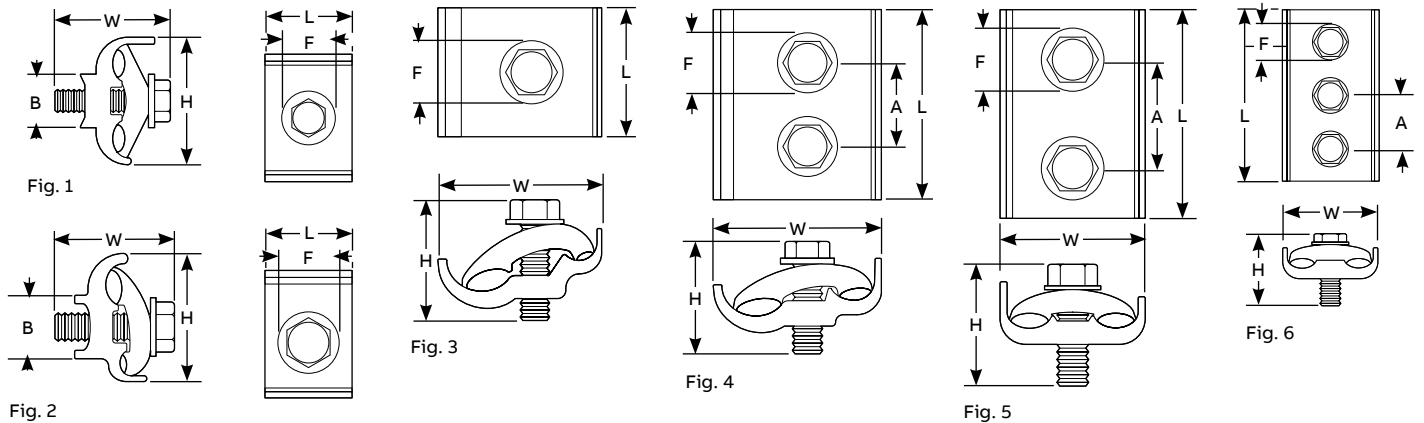

* RUS accepted. AR = Over armor rod.
 Note: For aluminum-hardware option, add “-7” suffix to the catalog number. For tin-plating option, add “-P” suffix to the catalog number.
 For wax-dip option that provides oxide protection for aluminum-to-aluminum connections, add “-6” suffix to the catalog number.

Parallel-groove connectors

K series jumper clamps



These jumper clamps are sized right for #8 solid copper to 1/0 ACSR or 2/0 copper.

- Made of copper alloy for high strength and durability
- Silicon-bronze hex-head washer bolt ensures a super-secure fitting
- Parallel-groove design eliminates the need to remove the bolt for installation
- Available unplated, plated or with plating in one groove – choose the model that works best with your wiring

Jumper clamp

Cat. no.	Plated groove (AWG)		Copper groove (AWG)		Both grooves plated (AWG)		Both grooves unplated (AWG)	
	Max.	Min.	Max.	Min.	Max.	Min.		
With one plated and one copper groove								
K1 ¹	1/0 ACSR, #2 SCG Amerductor, 7/16 galv. strand	#6 ACSR, #12 SCG Amerductor, #8 solid iron	2/0 str. copper, 7/16 Copperweld*, 2A Copperweld	#8 solid copper, #9-12D Copperweld, etc.	-	-	-	
With both grooves plated								
K2 ²	-	-	-	-	1/0 ACSR, #2 SCG Amerductor, 7/16 galvanized steel strand	#6 ACSR, #12 SCG Amerductor, #8 solid iron	-	
With both grooves unplated								
K3 ³	-	-	-	-	-	-	2/0 str. copper, 7/16 Copperweld, 2A Copperweld	#8 solid copper, 9 1/2 D Copperweld, etc.

Diagrams

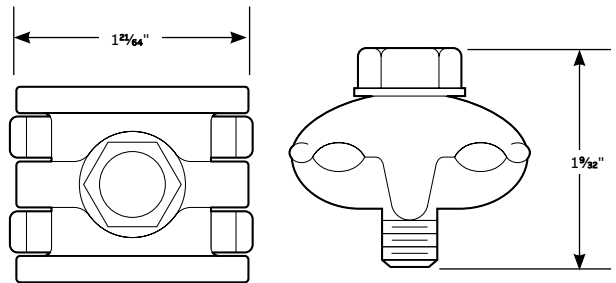

* Trademark of Copperweld.

1) Plated with plating removed from one groove. For use with aluminum, amerductor or galvanized steel strand to copper or copper-bonded steel wires.

2) Clamp is plated. For use with amerductor, aluminum or galvanized steel stranding.

3) Clamp is not plated. For copper-to-copper connections.

Insulation-piercing connectors

Type IPC – Talon insulation piercing connectors



No need to strip conductor insulation or use tape after installation.

- For copper-to-copper, copper-to-aluminum and aluminum-to-aluminum applications (insulated conductor only)
- Performs as splice or tap for non-tension applications up to 600 V, depending on size of connector
- Self insulated for hot line applications
- Six sizes cover range from #10–500 kcmil
- UL® 486B Listed AL9CU (90 °C rated)

Type IPC – Talon insulation piercing connectors



Cat. no.	Al or Cu conductor range AWG/mm ²		No. bolts	Fig.	Dimensions (in.)		
	Main	Tap			W	H	L
IPC1102*	1/0–8	2–8	1	1	$2^{9/16}$	2	$1^{17/32}$
	50–6	35–6					
IPC4111	4/0–1/0	1/0–6	2	2	$2^{1/2}$	3	$1^{19/32}$
	95–50	50–16					
IPC4141	4/0–1/0	4/0–1/0	2	2	$2^{5/8}$	$3^{1/4}$	$1^{29/32}$
	95–50	95–50					
IPC5041*	500–350	4/0–4	1	1	2	$2^{1/2}$	$2^{5/8}$
	240–185	90–25					
IPC3535	350–4/0	350–4/0	2	2	$2^{1/16}$	$2^{1/2}$	$2^{5/8}$
	185–95	185–95					
IPC3541	350–4/0	4/0–10	1	1	$2^{3/4}$	3	$2^{5/8}$
	185–95	95–6					

Diagrams

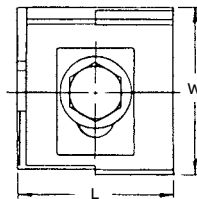

Fig. 1

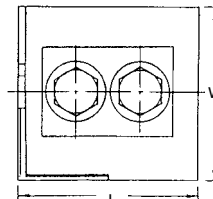
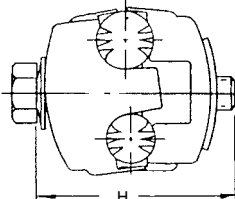
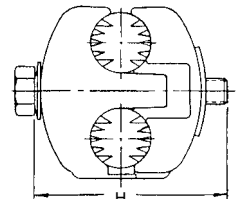
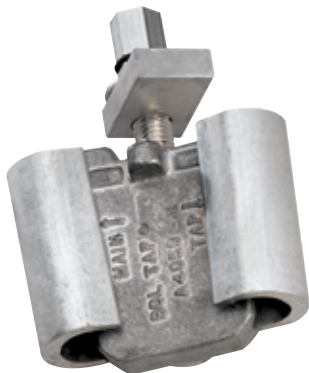

Fig. 2



* 600V Rating (all others 300V).

BolTap™ wedges



A 4055

BolTap wedges

Cat. no.	Conductor combinations (AWG or kcmil)	Cat. no.	Conductor combinations (AWG or kcmil)
A 4025	266.8-#4 or -#6; 336-#4 or -#6; 350-#4 or -#6	A 5045	556-1/0 or -2/0; 605-#2, -1/0, -2/0 or -3/0; 636-#2, -1/0 or -2/0; 653-#2, -1/0, -2/0 or -3/0; 750-1/0 or -2/0; 795-#6, -#4 or -#2; 954-#6
A 4030	266.8-#2 or -1/0; 336-#6, -#4 or -#2; 350-#2; 397-#6 or -#4; 477-#6; 500-#6	A 5050	556-3/0 or -4/0; 605-3/0 or -4/0; 636-1/0, -2/0, -3/0 or -4/0; 653-3/0 or -4/0; 750-3/0 or -4/0; 795-#4, -#2, -1/0 or -2/0; 954-#4
A 4035	266.8-1/0, -2/0, -3/0 or -4/0; 336-#2, -1/0, -2/0 or -3/0; 350-1/0 or -2/0; 397-#4, -#2, -1/0 or -2/0; 477-#6, -#4 or -#2; 500-#4 or -#2; 556-#6, -#5 or -#4	A 5055	336-3/0, -4/0, -250, -266 or -300; 556-250, -266 or -300; 605-4/0 or -250; 653-4/0 or -250; 750-4/0, -250, -266 or -300; 795-1/0, -2/0, -3/0, -4/0 or -250; 954-1/0
A 4040	266.8-3/0, -4/0, -250 or -266; 336-2/0, -3/0, -4/0 or -250; 350-2/0, -3/0, -4/0 or -250; 397-1/0, -2/0, -3/0 or -4/0; 477-#2, -1/0 or -2/0; 500-#2, -1/0 or -2/0; 556-#2 or -1/0	A 5060	556-266, -336 or -350; 605-266, -300, -336 or -350; 636-266, -300, -336 or -350; 653-266, -300, -336 or -350; 750-266, -336, -350 or -397; 795-3/0, -4/0, -250, -266 or -300; 954-2/0, -3/0 or -4/0
A 4045	266.8-266 or -300; 336-4/0, -250, -266 or -300; 350-4/0, -266 or -300; 397-3/0, -4/0, -250 or -266; 477-1/0, -2/0, -3/0 or -4/0; 500-2/0, -3/0 or -4/0; 566-1/0, -2/0 or -3/0	A 5065	336-336, -397, -477 or -500; 556-336, -397, -477 or -500; 605-397, -477 or -500; 653-336, -397, -477 or -500; 750-397, -477 or -500; 795-250, -266, -300, -336 or -350; 954-4/0, -250, -266 or -300
A 4050	336-266, -300, -336 or -350; 350-336 or -350; 397-4/0, -250, -266, -300, -336 or -350; 477-3/0, -4/0, -250, -266 or -300; 500-4/0, -250, -266 or -300; 556-3/0, -4/0, -250 or -266	A 5070	556-477, -556, -636 or -750; 605-477 or -556; 653-477 or -556; 750-477, -556 or -750; 795-266, -336, -397, -477 or -350; 954-266, -336 or -350
A 4055	336-336 or -397; 397-336, -350 or -397; 477-266, -300, -336 or -350; 556-266, -300 or -336	A 5075	556-556; 605-556, -605, -636, -653 or -750; 636-556, -605, -636, -653 or -750; 653-556, -605, -636, -653 or -750; 795-397, -477, -500, -636 or -750; 954-397, -477 or -500
A 4060	397-397 or -500; 477-336, -350, -397, -477 or -500; 500-336, -397 or -500; 556-336, -350, -397 or -500	A 5080	636-636; 795-477, -556, -605, -636, -653, -750 or -795; 954-477, -556, -636 or -750
A 4065	477-397, -477 or -556; 556-397, -477 or -556	A 5085	795-605, -636 or -795; 954-605, -636, -653 or -795
A 5035	556; 653; 750-#6	A 5090	795-795; 954-795 or -954
A 5040	556-#4 or -#2; 605-#6 or -#4; 636-#6, -#4 or -#2; 653-#6 or -#4; 750-#6		

Note: Conductor combinations shown are for reference only. Consult your ABB representative for verification or for conductor combinations not shown. For shear-head option, add "-SH" suffix to the catalog number. For BolTap stirrups, please consult your ABB representative.

Fast and easy installation saves you time and money.

- Only hammer and wrench needed for installation
- Removable and reusable
- Wide conductor range further reduces inventory

PowerTap™ wedges

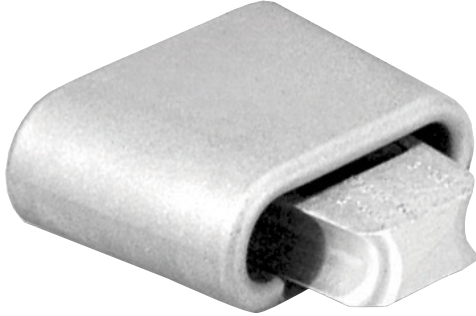

PowerTap wedges

Cat. no.	Wire combinations (AWG or kcmil)
Small taps – Use shell PT-white	
PT 1010	1/0-#2
PT 1011	#2-#2, 1/0-#4
PT 1012	#2-#4, 1/0-#6
PT 1013	#4-#4, #2-#6
PT 1014	#6-#6, #4-#6
PT 1015	#8-#8
Medium taps – Use shell PT-blue	
PT 4001	1/0-1/0, 2/0-#2, 1/0-#2
PT 4002	2/0-2/0, 3/0-1/0, 4/0-#2
PT 4003	3/0-#6, 2/0-#6
PT 4004	2/0-#4, 3/0-#4
PT 4005	2/0-1/0, 3/0-#2
PT 4006	4/0-#4
PT 4007	4/0-#4
PT 4008	3/0-2/0, 4/0-1/0
PT 4009	3/0-3/0, 4/0-2/0
PT 4010	4/0-3/0
PT 4011	4/0-4/0
266 kcmil taps – Use shell PT-blue	
PT 26601	266.8-#6
PT 26602	266.8-#4
PT 26603	266.8-#2
PT 26604	266.8-1/0
PT 26605	266.8-2/0
PT 26606	266.8-3/0
PT 26607	266.8-4/0
PT 26608	-
PT 26609	266.8-266.8

Note: For a kit containing a wedge and PowerTap shell, add “-K” suffix to the catalog number.

Reliable performance in the harshest of environments.

- Low stresses produced at interfaces preclude significant conductor creep and minimize loss of clamping force on connectors
- Contact forces are nearly constant during temperature changes or conductor compaction
- Driving action helps remove oxidation from conductor and lowers contact resistance
- RUS accepted

Cat. no.	Wire combinations (AWG or kcmil)
350 kcmil taps – Use shell PT-blue	
PT 35000	350-#6
PT 35001	350-#4
PT 35002	350-#2
PT 35003	350-1/0
PT 35004	350-2/0
PT 35005	350-3/0
PT 35006	350-4/0
PT 35007	350-350
336-556 kcmil taps – Use shell PT-yellow	
PT 33601	336.4-336.4
PT 33602	336.4-266.8
PT 33603	336.4-4/0
PT 33604	336.4-3/0
PT 33605	336.4-2/0
PT 33606	336.4-1/0
PT 33607	336.4-#2
PT 33608	336.4-#4
PT 33609	336.4-#6
PT 47701	477-#2 or -#3
PT 47702	477-#4 or -#5
PT 47703	477-#6
PT 55601	556.5-477 or -556.5
PT 55602	477-477; 556.5-336.4
PT 55603	477-336.4; 556.5-266.8
PT 55604	477-266.8; 556.4-3/0 or -4/0
PT 55605	477-4/0; 556.5-2/0
PT 55606	477-3/0; 556.5-#1
PT 55607	477-2/0; 556.5-#1
PT 55608	477-1/0; 556.5-#2
PT 55609	556.5-#2 or -#3
PT 55611	556.5-#4 or -#5
PT 55612	556.5-#6

PowerTap™ wedges (continued)

PowerTap wedges

Cat. no.	Wire combinations (AWG or kcmil)
795 kcmil taps – Use shell PT-yellow	
PT 79500	795-795
PT 79501	795-715
PT 79502	795-636
PT 79503	795-556.5
PT 79504	795-477
PT 79505	795-397.5
PT 79506	795-336.4
PT 79507	795-266.4
PT 79508	795-4/0
PT 79509	795-3/0
PT 79510	795-2/0
PT 79511	795-1/0
PT 79512	795-#2
PT 79513	795-#4
PT 79514	795-#6
1033.5 kcmil taps – Use shell PT-yellow	
PT 103300	1033.5-1033.5
PT 103301	1033.5-954
PT 103302	1033.5-795
PT 103303	1033.5-715.5
PT 103304	1033.5-636
PT 103305	1033.5-556.5
PT 103306	1033.5-477
PT 103307	1033.5-397.5
PT 103308	1033.5-336.4
PT 103309	1033.5-266.8
PT 103310	1033.5-4/0
PT 103311	1033.5-3/0
PT 103312	1033.5-2/0
PT 103313	1033.5-1/0
PT 103314	1033.5-#2
PT 103315	1033.5-#4
PT 103316	1033.5-#6

Cat. no.	Wire combinations (AWG or kcmil)
1192 kcmil taps – Use shell PT-yellow	
PT 119200	1192.5-1192.5
PT 119201	1192.5-1033.5
PT 119202	1192.5-954
PT 119203	1192.5-795
PT 119204	1192.5-715.5
PT 119205	1192.5-636
PT 119206	1192.5-556.5
PT 119207	1192.5-477
PT 119208	1192.5-397.5
PT 119209	1192.5-336.4
PT 119210	1192.5-266.8
PT 119211	1192.5-4/0
PT 119212	1192.5-3/0
PT 119213	1192.5-2/0
PT 119214	1192.5-1/0
PT 119215	1192.5-#2
PT 119216	1192.5-#4
PT 119217	1192.5-#6

PowerTap™ wedges

PowerTap stirrups & terminal lugs

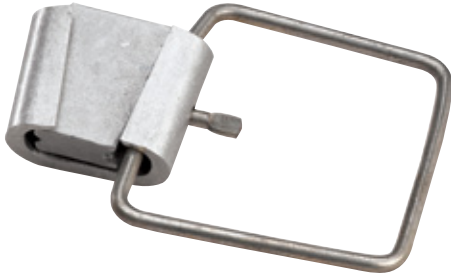

Aluminum stirrup connectors built for strength, conductivity and longevity.

- Bail made of tin-plated copper wire for high conductivity and corrosion resistance
- Wide range of stirrups fit a variety of clamp sizes
- Low stresses produced at interfaces preclude significant conductor creep and minimize loss of clamping force on connectors
- Contact forces remain nearly constant during temperature changes or conductor compaction
- Driving action helps remove oxidation from conductor and lowers contact resistance
- RUS accepted

PowerTap stirrups

Cat. no.	Wire size (AWG or kcmil)	Bail size
Use shell PT-blue		
PT 4020 S 2	#1, 1/0, 2/0	#2
PT 4005 S 10	1/0, 2/0	1/0
PT 4004 S 2	2/0, 3/0	#2
PT 4007 S 2	3/0, 4/0	#2
PT 4007 S 10	3/0, 4/0	1/0
PT 4008 S 20	3/0, 4/0	2/0
PT 26602 S 2	266.8	#2
PT 26603 S 10	266.8	1/0
PT 35002 S 10	350 AAC	1/0
PT 35002 S 2	350 AAC	#2
Use shell PT-white		
PT 1050 S 2	#6	#2
PT 1011 S 2	#5, #4, #2	#2
PT 33606 S 10	336.4	1/0

Cat. no.	Wire size (AWG or kcmil)	Bail size
Use shell PT-yellow		
PT 33605 S 20	336.4	2/0
PT 33604 S 40	336.4	4/0
PT 47701 S 10	397.4, 477	1/0
PT 55607 S 20	397.4, 477	2/0
PT 55606 S 40	397.4, 477	4/0
PT 55608 S 10	556	1/0
PT 55607 S 20	556	2/0
PT 55605 S 40	556	4/0
PT 79511 S 40	636	4/0
PT 79512 S 20	636	2/0
PT 79511 S 20	795	2/0
PT 79509 S 40	795	4/0
PT 103312 S 40	1033.5	4/0



PT 2 N 795

PowerTap terminal lugs

Cat. no.	Wire size (AWG or kcmil)	Tap groove	Spade type
PT 2 N 4/0	#2-#6, 1/0-4/0, 266.8	4/0 str.	2-hole paddle
PT 2 N 336	336.4, 397.5, 477, 556.5	336.4 str.	2-hole paddle
PT 2 N 795	636, 795, 954, 1033.5	795 str.	2-hole paddle
PT 4 N 4/0	#2-#6, 1/0-4/0, 266.8	4/0 str.	4-hole paddle
PT 4 N 336	336.4, 397.5, 477, 556.5	336.4 str.	4-hole paddle
PT 4 N 795	636, 795, 954, 1033.5	795 str.	4-hole paddle
PT 4 N 336 F	336.4, 397.5, 477, 556.5	336.4 str.	4-hole flag
PT 4 N 795 F	636, 795, 954, 1033.5	795 str.	4-hole flag

Strong lugs that withstand corrosion.

- 2-hole paddle, 4-hole paddle and 4-hole flag models available
- Fit a variety of lug sizes

PowerTap™ tools & accessories

PowerTap fire-on tools & accessories



PT-TOOL

On-the-go equipment to make clean moves, adds and changes.

- Long-lasting tool comes with heads of your choice to simplify installation
- Shells, take-off clips and carrying case sold separately to complete your system
- Cleaning tool and cleaning kit also available for maintaining your PowerTap equipment
- Tools and accessories are also compatible with other leading connector manufacturers' products

PowerTap fire-on tools and accessories

Cat. no.	Description
PowerTap tool	
PT-TOOL	(1) Large head, (1) small head, (1) power unit
PT-TOOL S	(1) Small head, (1) power unit
PT-TOOL L	(1) Large head, (1) power unit
PowerTap shells	
PT-RED	Red
PT-WHITE	White
PT-BLUE	Blue
PT-YELLOW	Yellow
PowerTap take-off clips	
PT-CLIP, WHITE/BLUE	White & blue
PT-CLIP, YELLOW	Yellow
PowerTap cleaning tool	
PT-CLEANING TOOL	Cleaning tool
PowerTap cleaning kit	
PT-TOOL CLEANING KIT	See fig. 1
PowerTap carrying case	
PT-CARRYING CASE	Carrying case



Fig. 1

PT-TOOL CLEANING KIT includes:

- Powder solvent x 1
- Gun oil x 1
- Shotgun cleaning rod x 1
- Small shotgun bore brush x 1
- Large shotgun bore brush x 1
- Small shotgun bore swab x 1
- Large shotgun bore swab x 1
- Small brass brush x 1

Service entrance splice

Uninsulated aluminum service entrance compression splices – ½" die series



Q1U54

Basic, uninsulated splices for service entrances.

- Constructed from aluminum for high conductivity
- Solid center barriers and large chamfers for easy cable insertion
- Prefilled with oxide inhibitor to prevent oxidation and keep out moisture
- All splices are color coded and marked with strip lengths, installation die codes and compression locations, providing easy identification for easy installation
- Comply with ANSI C119.4 when properly installed on aluminum-to-aluminum or aluminum-to-copper conductors
- RUS accepted

Uninsulated aluminum service entrance compression splices – ½" die series

Cat. no.	Color	Sol.	Conductor A (AWG)			Color	Sol.	Conductor B (AWG)	
			Str.	ACSR	Str.			ACSR	
Q1U52	Green	#6	#8	-	Green	#6	#8	-	
Q1U53					Brown	#8	#10	-	
Q1U54	Blue	#4	-	#6-6/1	Blue	#4	-	#6-6/1	
Q1U55					Green	#6	#8	-	
Q1U56					Brown	#8	#10	-	
Q1U57	Orange	#2	-	#4-6/1, 7/1	Orange	#2	-	#4-6/1, 7/1	
Q1U58					Blue	#4	-	#6-6/1	
Q1U59					Green	#6	#8	-	
Q1U60					Brown	#8	#10	-	
Q1U65	Red	#1	#1 & #2	#2-6/1, 7/1	Red	#1	#1 & #2	#2-6/1, 7/1	
Q1U67					Orange	#2	-	#4-6/1, 7/1	
Q1U68					Blue	#4	-	#6-6/1	
Q1U69					Green	#6	#8	-	
Q1U70					Brown	#8	#10	-	

Service entrance splices

Aluminum service entrance compression splices – U 1 B™ and CS™ 5/8" die series



U 1 B 1010



CS73

Standard 2" length compression splices.

- Constructed from aluminum for high conductivity
- Solid center barriers and large chamfers for easy cable insertion
- Prefilled with oxide inhibitor to prevent oxidation and keep out moisture
- All splices are color coded and marked with strip lengths, installation die codes and compression locations, providing easy identification for easy installation
- Comply with ANSI C119.4 when properly installed on aluminum-to-aluminum or aluminum-to-copper conductors
- RUS accepted

Aluminum service entrance compression splices – U 1 B and CS 5/8" die series

U 1 B series Cat. no.	CS series Cat. no.	Color	Conductor A (AWG)			Color	Conductor B (AWG)		
			ACSR	Str.	Sol.		ACSR	Str.	Sol.
U 1 B 11	-	Brown	-	#10	#8	Brown	-	#10	#8
U 1 B 88	CS61	Green	-	#8	#6	Green	-	#8	#6
U 1 B 81	-	Brown	-	-	-	Brown	-	#10	#8
U 1 B 66	CS64	Blue	#6 (6/1)	-	#4	Blue	#6 (6/1)	-	#4
U 1 B 68	CS63	Green	-	-	-	Green	-	#8	#6
U 1 B 61	CS62	Brown	-	-	-	Brown	-	#10	#8
U 1 B 612	-	Black	-	6	-	Black	-	#12	#10
U 1 B 44	CS68	Orange	#4 (6/1, 7/1)	-	#2	Orange	#4 (6/1, 7/1)	-	#2
U 1 B 46	CS67	Blue	-	-	-	Blue	#6 (6/1)	-	#4
U 1 B 48	CS66	Green	-	-	-	Green	-	#8	#6
U 1 B 41	CS65	Brown	-	-	-	Brown	-	#10	#8
U 1 B 22	CS73	Red	#2 (6/1, 7/1)	#1 & #2	#1	Red	#2 (6/1, 7/1)	#1 & #2	#1
U 1 B 24	CS72	Orange	-	-	-	Orange	#4 (6/1, 7/1)	-	#2
U 1 B 26	CS71	Blue	-	-	-	Blue	#6 (6/1)	-	#4
U 1 B 28	CS70	Green	-	-	-	Green	-	#8	#6
U 1 B 21	CS69	Brown	-	-	-	Brown	-	#10	#8
U 1 B 1010	CS78	Yellow	1/0 (6/1)	1/0	#1	Yellow	1/0 (6/1)	1/0	-
U 1 B 102	CS77	Red	-	-	-	Red	#2 (6/1, 7/1)	#1 & #2	#1
U 1 B 104	CS76	Orange	-	-	-	Orange	#4 (6/1, 7/1)	-	#2
U 1 B 106	CS75	Blue	-	-	-	Blue	#6 (6/1)	-	#4
U 1 B 108	CS74	Green	-	-	-	Green	-	#8	#6
-	CS84	Gray	-	2/0	-	Yellow	1/0 (6/1)	1/0	-
-	CS85	Gray	-	-	-	Gray	-	2/0	-

Service entrance splices

Insulated aluminum service entrance compression splices – U and ICS 5/8" die series (standard length, 2²⁵/₃₂" long)



URR 22



ICS73-1

For standard conductors.

- Constructed from aluminum for high conductivity
- Solid center barriers and large chamfers for easy cable insertion
- Tough stabilized nylon sleeves resist installing-tool pressure and provide reliable 600 V insulation
- Prefilled with oxide inhibitor to prevent oxidation and keep out moisture
- All splices are color coded and marked with strip lengths, installation die codes and compression locations, providing easy identification for easy installation
- Splices have colored end caps to make identification easy
- Comply with ANSI C119.4 when properly installed on aluminum-to-aluminum or aluminum-to-copper conductors
- RUS accepted

Insulated aluminum service entrance compression splices – U and ICS 5/8" die series (standard length, 2²⁵/₃₂" long)

U series Cat. no.	ICS series Cat. no.	Color	Conductor A (AWG)					Conductor B (AWG)					
			ACSR	Str.	Sol.	Diameter (in.) Max. Min.		Color	ACSR	Str.	Sol.	Diameter (in.) Max. Min.	
UGBR 81	-	Green	-	#8	#6	0.162	0.144	Brown	-	#10	#8	0.128	0.114
UGG 88	ICS61-1	Green	-	#8	#6	0.162	0.144	Green	-	#8	#6	0.162	0.144
UBBR 61	ICS62-1	Blue	#6	#6	#4	0.204	0.184	Brown	-	#10	#8	0.128	0.114
UBG 68	ICS63-1	Green	-	#8	#6	0.162	0.144	Green	-	#8	#6	0.162	0.144
UBB 66	ICS64-1	Blue	#6	#6	#4	0.204	0.184	Blue	#6	#6	#4	0.204	0.184
UOBR 41	ICS65-1	Orange	#4	#4	#2	0.258	0.213	Brown	-	#10	#8	0.128	0.114
UOG 48	ICS66-1	Green	-	#8	#6	0.162	0.144	Green	-	#8	#6	0.162	0.144
UOB 46	ICS67-1	Blue	#6	#6	#4	0.204	0.184	Blue	#6	#6	#4	0.204	0.184
UOO 44	ICS68-1	Orange	#4	#4	#2	0.258	0.213	Orange	#4	#4	#2	0.258	0.213
URBR 21	-	Red	#2	#1 & #2	-	0.328	0.268	Brown	-	#10	#8	0.128	0.114
URG 28	ICS70-1	Green	-	#8	#6	0.162	0.144	Green	-	#8	#6	0.162	0.144
URB 26	ICS71-1	Blue	#6	#6	#4	0.204	0.184	Blue	#6	#6	#4	0.204	0.184
URO 24	ICS72-2	Orange	#4	#4	#2	0.258	0.213	Orange	#4	#4	#2	0.258	0.213
URR 22	ICS73-1	Red	#2	#1 & #2	-	0.328	0.268	Red	#2	#1 & #2	-	0.328	0.268
UYG 08	ICS74-1	Yellow	1/0	1/0	-	0.398	0.368	Green	-	#8	#6	0.162	0.144
UYB 06	ICS75-1	Blue	#6	#6	#4	0.204	0.184	Blue	#6	#6	#4	0.204	0.184
UYO 04	ICS76-1	Orange	#4	#4	#2	0.258	0.213	Orange	#4	#4	#2	0.258	0.213
UYR 02	ICS77-1	Red	#2	#1 & #2	-	0.328	0.268	Red	#2	#1 & #2	-	0.328	0.268
UYU 00	ICS78-1	Yellow	1/0	1/0	-	0.398	0.368	Yellow	1/0	1/0	-	0.398	0.368

Service entrance splices

Insulated aluminum service entrance compression splices – U 1 N 5/8" die series
(longer length, 3 3/4" long)



U 1 N 106

For standard conductors.

- Constructed from aluminum for high conductivity
- Solid center barriers and large chamfers for easy cable insertion
- Prefilled with oxide inhibitor to prevent oxidation and keep out moisture
- All splices are color coded and marked with strip lengths, installation die codes and compression locations, providing easy identification for easy installation
- Comply with ANSI C119.4 when properly installed on aluminum-to-aluminum or aluminum-to-copper conductors
- RUS accepted

Insulated aluminum service entrance compression splices – U 1 N 5/8" die series (longer length, 3 3/4" long)

Cat. no.	Color	Conductor A (AWG)			Color	Conductor B (AWG)		
		Sol.	Str.	ACSR		Sol.	Str.	ACSR
U 1 N 16	Brown	#8	#10	-	Green	#6	#8	-
U 1 N 11					Brown	#8	#10	-
U 1 N 12					Red	#1	#2	#2-6/1, 7/1
U 1 N 88	Green	#6	#8	-	Green	#6	#8	-
U 1 N 81					Brown	#8	#10	-
U 1 N 66	Blue	#4	-	#6-6/1	Blue	#4	-	#6-6/1
U 1 N 68					Green	#6	#8	-
U 1 N 61					Brown	#8	#10	-
U 1 N 44	Orange	#2	-	#4-6/1, 7/1	Orange	#2	-	#4-6/1, 7/1
U 1 N 46					Blue	#4	-	#6-6/1
U 1 N 48					Green	#6	#8	-
U 1 N 41	Red	#1	#1 & #2	#2-6/1, 7/1	Brown	#8	#10	-
U 1 N 22					Red	#1	#1 & #2	#2-6/1, 7/1
U 1 N 24					Orange	#2	#3 & #4	#4-6/1, 7/1
U 1 N 26					Blue	#4	#5 & #6	#6-6/1
U 1 N 28					Green	#6	#8	-
U 1 N 21					Brown	#8	#10	-
U 1 N 1010	Yellow	#1	1/0	1/0-6/1	Yellow	-	1/0	1/0-6/1
U 1 N 102					Red	#1	#1 & #2	#2-6/1
U 1 N 104					Orange	#2	-	#4-6/1
U 1 N 106					Blue	#4	-	#6-6/1
U 1 N 108					Green	#6	#8	-

Service entrance splices

Insulated aluminum service entrance compression splices – U 5/8" die series
(longer length – 3 1/4" long)



For compact conductors.

- Constructed from aluminum for high conductivity
- Solid center barriers and large chamfers for easy cable insertion
- Tough stabilized-nylon sleeves resist installing-tool pressure and provide reliable 600 V insulation
- Prefilled with oxide inhibitor to prevent oxidation and keep out moisture
- All splices are color coded and marked with strip lengths, installation die codes and compression locations, providing easy identification for easy installation
- Comply with ANSI C119.4 when properly installed on aluminum-to-aluminum or aluminum-to-copper conductors
- RUS accepted

Insulated aluminum service entrance compression splices – U 5/8" die series (longer length – 3 1/4" long)

Cat. no.	Color	Conductor A (AWG)			Conductor B (AWG)				
		Str.	Compt.	Comp.	Color	Str.	Compt.	Sol.	Comp.
U 61 BBR	Blue	#6	#6	#6	Brown	#10	–	#8	–
U 68 BG					Green	#8	#8	–	#8
U 66 BB					Blue	#6	#6	–	#6
U 41 OBR	Orange	#4	#4	#4	Brown	#10	–	#8	–
U 48 OG					Green	#8	#8	–	#8
U 46 OB					Blue	#6	#6	–	#6
U 44 OO					Orange	#4	#4	–	#4
U 21 RBR	Red	#2	#2	#2	Brown	#10	–	#8	–
U 28 RG					Green	#8	#8	–	#8
U 26 RB					Blue	#6	#6	–	#6
U 24 RO					Orange	#4	#4	–	#4
U 22 RR					Red	#2	#2	–	#2
U 101 YBR	Yellow	1/0	1/0	1/0	Brown	#10	–	#8	–
U 108 YG					Brown	#8	#8	–	#8
U 106 YB					Blue	#6	#6	–	#6
U 104 YO					Orange	#4	#4	–	#4
U 102 YR					Red	#2	#2	–	#2
U 1010 YY					Yellow	1/0	1/0	–	1/0

Note: Sold in standard carton quantities only.

Service entrance splices

Insulated aluminum service entrance compression splices – 840 die series



X1N 204



IKL47

At 5½" long, these splices are ideal for heavy-duty overhead services.

- Constructed from aluminum for high conductivity
- Solid center barriers and large chamfers for easy cable insertion
- Tough stabilized-nylon sleeves resist installing-tool pressure and provide reliable 600 V insulation
- Prefilled with oxide inhibitor to prevent oxidation and keep out moisture
- All splices are color coded and marked with strip lengths, installation die codes and compression locations, providing easy identification for easy installation
- Comply with ANSI C119.4 when properly installed on aluminum-to-aluminum or aluminum-to-copper conductors
- RUS accepted

Insulated aluminum service entrance compression splices – 840 die series

X 1 N series Cat. no.	IKL series Cat. no.	Color	Conductor A (AWG)				Conductor B (AWG)				
			ACSR	Str.	Compr.	Compt.	Color	ACSR	Str.	Compr.	Compt.
X 1 N 104	IKL34	Yellow	1/0	1/0	1/0	2/0	Orange	#4	#4	#4	-
X 1 N 102	IKL35						Red	#2	#1	#1	1/0
X 1 N 1010	IKL36						Yellow	1/0	1/0	1/0	2/0
X 1 N 204	IKL44	Gray	2/0	2/0	2/0	3/0	Orange	#4	-	-	-
X 1 N 202	IKL45						Red	#2	#1	#1	1/0
X 1 N 2010	IKL46						Yellow	1/0	1/0	1/0	2/0
X 1 N 2020	IKL47						Gray	2/0	2/0	2/0	3/0
X 1 N 304	IKL54	Black	3/0	3/0	3/0	4/0	Orange	#4	-	-	-
X 1 N 302	IKL55						Red	#2	#1	#1	1/0
X 1 N 3010	IKL56						Yellow	1/0	1/0	1/0	2/0
X 1 N 3020	IKL57						Gray	2/0	2/0	2/0	3/0
X 1 N 3030	IKL58						Black	3/0	3/0	3/0	4/0
X 1 N 404	IKL64	Pink	4/0	4/0	4/0	250	Orange	#4	-	-	-
X 1 N 402	IKL65						Red	#2	#1	#1	1/0
X 1 N 4010	IKL66						Yellow	1/0	1/0	1/0	2/0
X 1 N 4020	IKL67						Gray	2/0	2/0	2/0	3/0
X 1 N 4030	IKL68						Black	3/0	3/0	3/0	4/0
X 1 N 4040	IKL69						Pink	4/0	4/0	4/0	250

Service entrance splices

Uninsulated aluminum service entrance compression splices – 840 die series



X 1 U 2020

Ideal for large residential and commercial service drops.

- Constructed from aluminum for high conductivity
- Solid center barriers enable quick wire positioning, proper distribution of inhibitor around the wire and current equalization on stranded conductors
- Prefilled with oxide inhibitor to prevent oxidation and keep out moisture
- Splices marked with strip lengths, die codes and compression locations, providing easy identification for easy installation
- Comply with ANSI C119.4 when properly installed on aluminum-to-aluminum or aluminum-to-copper conductors; also tested and approved for EEI installing dies
- RUS accepted

Uninsulated aluminum service entrance compression splices – 840 die series

Cat. no.	Conductor A (AWG)					Conductor B (AWG)				
	Color	Solid			ASCR	Color	Solid			ASCR
		Al	Cu	Stranded			Al	Cu	Stranded	
X 1 U 44	Orange	#2	#2	–	#4	Orange	#2	#2	–	#4
X 1 U 24	Red	#1	#1	#1 & #2	#2	Orange	#2	#2	–	#4
X 1 U 22						Red	#1	#1	#1 & #2	#2
X 1 U 104	Yellow	1/0, 2/0	–	1/0	1/0	Orange	#2	#2	–	#4
X 1 U 102						Red	#1	#1	#1 & #2	#2
X 1 U 1010						Yellow	1/0 & 2/0	–	1/0	1/0
X 1 U 204	Gray	3/0	–	2/0	2/0	Orange	#2	#2	–	#4
X 1 U 202						Red	#1	#1	#1 & #2	#2
X 1 U 2010						Yellow	1/0 & 2/0	–	1/0	1/0
X 1 U 2020						Gray	3/0	–	2/0	2/0
X 1 U 304	Black	4/0	–	3/0	3/0	Orange	#2	#2	–	#4
X 1 U 302						Red	#1	#1	#1 & #2	#2
X 1 U 3010						Yellow	1/0 & 2/0	–	1/0	1/0
X 1 U 3020						Gray	3/0	–	2/0	2/0
X 1 U 3030						Black	4/0	–	3/0	3/0
X 1 U 404	Pink	–	–	4/0	4/0	Orange	#2	#2	–	#4
X 1 U 402						Red	#1	#1	#1 & #2	#2
X 1 U 4010						Yellow	1/0 & 2/0	–	1/0	1/0
X 1 U 4020						Gray	3/0	–	2/0	2/0
X 1 U 4030						Black	4/0	–	3/0	3/0
X 1 U 4040						Pink	–	–	4/0	4/0

Note: When using EEI 11A die, space compressions $\frac{1}{8}$ " apart.

When installing with UT 5 tool, use H5 (upper) and H6 (lower) dies. When installing with a hydraulic tool, use 76 (2) die.

Service entrance splices

Uninsulated aluminum service entrance compression splices – 840 die series (continued)

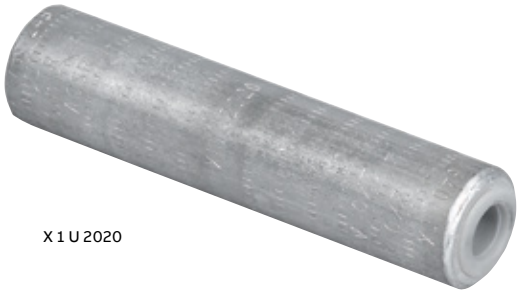

X1U2020

Uninsulated aluminum service entrance compression splices – 840 die series (continued)

Cat. no.	Color	Conductor A (AWG or kcmil)				Conductor B (AWG or kcmil)				
		Solid				Solid				
		Al	Cu	Stranded	ASCR	Al	Cu	Stranded	ASCR	
X 1 U 266	Blue	350	-	250-266.8	266.8	Blue	350	-	250-266.8	266.8
X 1 U 2664						Orange	#2	#2	#3 & #4	#4
X 1 U 2662						Red	#1	#1	#1 & #2	#2
X 1 U 26610						Yellow	1/0 & 2/0	-	1/0	1/0
X 1 U 26620						Gray	3/0	-	2/0	2/0
X 1 U 26630						Black	4/0	-	3/0	3/0
X 1 U 26640						Pink	-	-	4/0	4/0
X 1 U 336	Brown	397.5-400	-	300-350	336.4 (18/1)	Brown	397.5-400	-	300-350	336.4 (18/1)
X 1 U 3364						Orange	#2	#2	#3 & #4	#4
X 1 U 3362						Red	#1	#1	#1 & #2	#2
X 1 U 33610						Yellow	1/0 & 2/0	-	1/0	1/0
X 1 U 33620						Gray	3/0	-	2/0	2/0
X 1 U 33630						Black	4/0	-	3/0	3/0
X 1 U 33640						Pink	-	-	4/0	4/0
X 1 U 33626	Blue	350	-	250-266.8	266.8					

Diagram

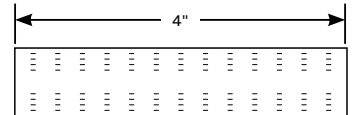

Note: When using EEI 11A die, space compressions $\frac{1}{8}$ " apart.
 When installing with UT 5 tool, use H5 (upper) and H6 (lower) dies. When installing with a hydraulic tool, use 76 (2) die.

Service entrance connectors

N and NPW service entrance connectors



6N

Long-lasting connectors with bodies and screws made of high-strength copper alloy.

- Both types have a slotted hex-head screw for strong, tight connections
- Type NPW is tin plated to resist corrosion
- Type NPW has a tin-plated phosphor bronze washer to protect the conductor and evenly distribute pressure
- Type NPW is dual-rated for use on ACSR and copper conductors

N and NPW service entrance connectors

Cat. no.	Conductor range (AWG)				Dimensions (in.)				Bolt head (in.)
	ACSR		Copper		A	B	C	D	
	Max.	Min.	Max.	Min.					
10N	–	–	#10 str.	#14 sol.	$\frac{3}{8}$	0.337	0.156	0.562	$\frac{9}{32}$
6N	#8	#8	#6 str.	#10 sol.	$\frac{7}{16}$	0.415	0.191	0.656	$\frac{5}{16}$
4N	#6	#8	#4 str.	#6 sol.	$\frac{1}{2}$	0.515	0.243	0.775	$\frac{3}{8}$
–	#4	#8	#2 str.	#6 sol.	$2\frac{1}{32}$	0.643	0.304	0.97	$\frac{1}{8}$
10NPW	–	–	#10 str.	#14 sol.	$\frac{3}{8}$	0.337	0.156	0.562	$\frac{9}{32}$
6NPW	#8	#8	#6 str.	#10 sol.	$\frac{7}{16}$	0.415	0.191	0.656	$\frac{5}{16}$
4NPW	#6	#8	#4 str.	#6 sol.	$\frac{1}{2}$	0.515	0.243	0.775	$\frac{3}{8}$
2NPW	#4	#8	#2 str.	#6 sol.	$2\frac{1}{32}$	0.643	0.304	0.97	$\frac{1}{8}$

Diagrams

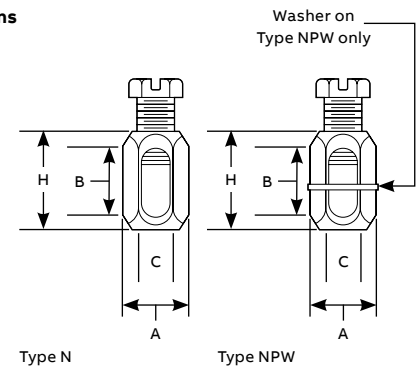

Full- and semi-tension compression splices

Aluminum semi-tension neutral compression splices – Common die series

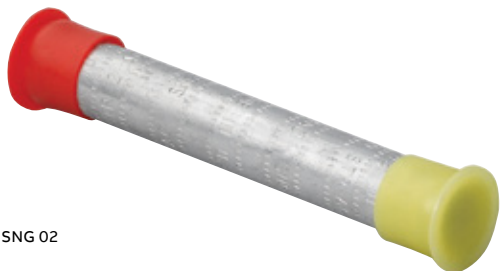

SNG 02

Aluminum construction provides high conductivity.

- Solid center stops ease cable insertion
- Prefilled with oxide inhibitor and topped with color-coded caps to prevent oxidation and keep out moisture
- All splices marked with installation die codes and compression locations, providing easy identification for easy installation
- Designed to develop 40% of the conductor's rated strength
- Meets or exceeds ANSI C119.4 specifications

Aluminum semi-tension neutral compression splices

Cat. no.	Conductor A (AWG)		Conductor B (AWG)		Installing dies
	ACSR	Str.	ACSR	Str.	
SNG 66	#6	#6	#6	#6	TU, 52, 5/8, BG, 243, 8A
SNG 44	#4	#4	#4	#4	
SNG 22	#2	#2	#2	#2	
SNG 00	1/0	1/0	1/0	1/0	
SNG 46	#4	#4	#6	#6	
SNG 24	#2	#2	#4	#4	
SNG 02	1/0	1/0	#2	#2	
SNG 26	#2	#2	#6	#6	
SNG 11	#1	#1	#1	#1	

Diagram

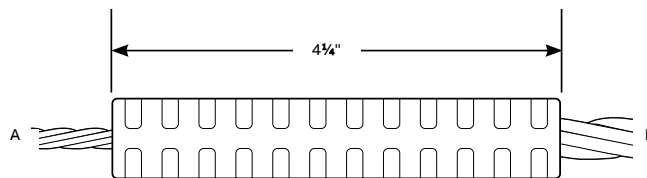

Note: For tin-plating option, add "-TN" suffix to the catalog number.

Full- and semi-tension compression splices

Aluminum loop compression splices



892



872

Designed to develop 25% of the conductor's rated strength.

- Versatile compression splices for ACSR, ACAR, AAAC 5005 and AAC conductors
- Constructed from aluminum for high conductivity
- Prefilled with oxide inhibitor to prevent oxidation and keep out moisture
- All splices marked with wire size, installation die codes and compression locations, providing easy identification for easy installation
- Meets or exceeds ANSI C119.4 specifications

Aluminum loop compression splices

Cat. no.	Wire size (AWG or kcmil)		Length (in.)	EEI* die code	Installing tools and dies (compression per end)	
	ACSR, ACAR [†] , 5005 [†] , AAAC	AAC			Dies – UT5 type	Dies – hydraulic
SNG 00	1/0 (6/1)	1/0	4¼	8A	TU	243, 52, 5/8, BG
Z 1 A 10	2/0 (6/1)	2/0	6¾	–	TZ (6)	58, 60, 245, 9A
Z 1 A 51	–	3/0	4¼	10A	TZ (4)	
866*	3/0 (6/1)	3/0	6¾	10A	TV (9)	
867*	4/0 (6/1)	4/0–250	6¾	11A	TX (9)	249, 76 (3), 76H (6), 840
869	266.8	266–300	7½	11A	TH (6)	87 (3), 87H (6)
H 1 A 33	336.4 (18/1)	336–350	6¾	11A		
872*	336.4	336.4–350	7½	13A	–	96 (3), 96H (6), 472, 655
874*	397.5	397.5–477	7½	14A		106 (3), 106A (6), 719, 327
876*	477	500–556.6	7½	15A		115 (3), 115H (6), 318
879	556.5	600–700	9¾	–		125 (3), 125H (6), 1½/16, 608
883	605–666.6	715.5–800	12¾	–		140 (4), 140H (8)
892	715.5–874.5	874.5–1000	12¾	–		150 (4), 150H (8), 725, 352, 319, 292

Diagram

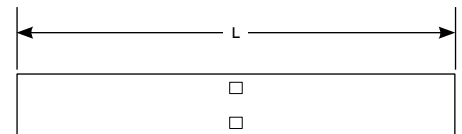

* When using EEI dies, space compressions ½" apart.

† Select diameter equivalent to ACSR.

Full- and semi-tension compression splices

Type ACJ and RCJ aluminum partial-tension jumper sleeves



Type ACJ

Meets the 40% partial tension requirement of ANSI C119.4.

Type ACJ – Aluminum jumper sleeves for all aluminum conductors

Cat. no.	AWG or kcmil wire size (stranding)	Length (in.)	Installing dies*
ACJ20	2/0 (7, 19)	4 ³ / ₄	BY33, C-167, W-247, 737, B39EA, 247, 747
ACJ205	2/0 (7, 19)	4 ³ / ₄	BY41, W-245, 635, B30EA, 245, ⁵ / ₈ -1, 635
ACJ40	4/0 (7, 19)	4 ³ / ₄	BY37, W-249, 840, B49EA, 249
ACJ266	266.8 (7, 19)	5 ³ / ₈	B75AH, 251, 1 ¹ / ₂
ACJ336	336.4 (19, 37)	5 ³ / ₈	B80EA, 321, 1 ¹ / ₈ -1
ACJ350	350 (19)	6 ³ / ₄	B80EA, 490, 547, 1 ¹ / ₈ -1
ACJ397	397.5 (19)	6 ³ / ₄	B80EA, 468, 1 ¹ / ₈ -1
ACJ477	477, 500 (19, 37)	9 ¹ / ₂	B80EA, 317, 426, 1 ¹ / ₈ -1
ACJ556	556.5 (19, 37)	9	B76AH, 318, 1 ¹ / ₈ -1

*OD58 dies are interchangeable with those listed for O-52.



Type RCJ

Type RCJ – Aluminum jumper sleeves for ACSR, AAAC, 5005, AAC conductors

Cat. no.	AWG or kcmil wire size (stranding)	Length (in.)	Installing dies*
RCJ10 [†]	1/0 ACSR (⁶ / ₄) 1/0 AAAC (7) 1/0 5005 (7) 1/0 AAC (7)	6 ¹ / ₂	737, 747, W-C, W-702, B39EA, 167, 247
RCJ20 [†]	2/0 ACSR (⁶ / ₄) 2/0 AAAC (7) 2/0 5005 (7) 2/0 AAC (7)	6 ³ / ₄	781, B74AH, 659, ³ / ₄
RCJ30 [†]	3/0 ACSR (⁶ / ₄) 3/0 AAAC (7) 3/0 5005 (7) 3/0 AAC (7)	6 ¹ / ₄	B49EA, 658, ²⁹ / ₃₂
RCJ40BB [†]	4/0 ACSR (⁶ / ₄) 4/0 AAAC (7) 4/0 5005 (7) 4/0 AAC (7)	6 ³ / ₄	B61EA, 654, 1
RCJ266 [†]	266.8 ACSR (¹⁹ / ₄)	7	B80EA, 655, 1 ¹ / ₈ -1
RCJ336 [†]	336.4 ACSR (¹⁹ / ₄)	7	B80EA, 655, 1 ¹ / ₈ -1
RCJ397	397.5 ACSR (¹⁹ / ₄) 336.4(26-7) 336.4 (30-7)	7 ¹ / ₄	B20AH, 327, 1 ¹ / ₈ -1
RCJ477	477 ACSR (¹⁹ / ₄)	8 ³ / ₄	B20AH, 318, ¹⁵ / ₁₆
RCJ477M	477 ACSR (²⁶ / ₇)	9	B76AH, 318, 1 ¹ / ₈

* OD58 dies are interchangeable with those listed for O-52.

[†] RUS listed.

Full- and semi-tension compression splices

Aluminum full-tension compression splices for aluminum conductors



Q 2 A 7



2190



U 2 A 9

Seamless aluminum tubing provides high conductivity.

- Sleeves have an internal taper that acts as a funnel-like entrance for easy insertion of conductors and provides stress relief on the conductor strands upon compression
- Prefilled with oxide inhibitor to prevent oxidation and keep out moisture
- All splices marked with conductor size and die references, providing easy identification for easy installation
- Designed to develop 95% or more of the conductor's rated strength
- Meets or exceeds ANSI C119.4 specifications

Aluminum full-tension compression splices

Cat. no.	Wire size (AWG or kcmil)	Length (in.)	Installing dies
SNG44	#4 str.	4¼	243, TU, 52, 518, 8A, BG
Q 2 A 7	#2 str.	4½	TQ, 163, 239, ½, 6A
U 2 A 9	1/0	6¼	TU, 52, 243, 19/32, CSA 22, 8A
W 2 A 20	2/0 str.	6½	TW-TY, 245, 635, 9A
Z 2 A 10	2/0 str.	6½	166
Z 2 A 51	3/0 str.	6½	166
2169	3/0 str.	8¼	TV, 66, 694, 702, 781, 10A
2170	4/0–250 str.	8¼	TX, 76, 249, 840, 11A
2174	266–300 str.	10¾	87
2176	336.4–350 str.	10	96H, 655, 1½–1, 321, 13A
2178	397.5–400 str.	10	96H, 655, 1½–1, 13A
2182	450–477 str.	13	106, 14A, 1½/16
2183	556.5 str.	10¾	115H, 318, 1½/16, 15A
2186	636 str.	13¾	125
2187	750–795 str.	13¾	140
2188	795 str.	13¾	140, 1½
2190	874.5–1000 str.	13¾	150

Diagram

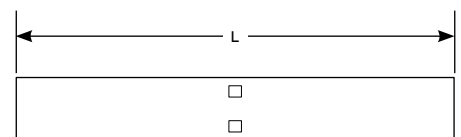

Note: For wire sizes over 1000 kcmil, please consult your ABB representative.

Full- and semi-tension compression splices

Type AC aluminum single-sleeve, full-tension splices for all-aluminum conductor



Type AC

Center stop assures proper conductor positioning.

- External end taper provides conductor stress relief, ease of stringing and corona protection
- Internal end chamfer allows easy conductor insertion and prevents sharp edge contact with conductor
- Fully tested to meet electrical and mechanical requirements of ANSI C119.4; will withstand 95% of conductor rated breaking strength

Type AC – Single-sleeve, full-tension splices for all aluminum conductors

Cat. no.	AWG or kcmil wire size (stranding)	L (in.)	Installing dies*
AC6-TB	6 (7)	3	BY19, W-161, $\frac{5}{16}$, B73SH, 161
AC4-BB	4 (7)	3	BY21, W-162, $\frac{3}{8}$, B71AH, 162, $1\frac{3}{8}$
AC2-TB	2 (7)	$4\frac{1}{8}$	BY23, W-163, $\frac{1}{2}$, B17EA, 163, $2\frac{1}{2}$, 510
AC10-TB	1/0 (7, 19)	$7\frac{1}{4}$	BY31, BGW-243, W-687, $\frac{5}{8}$ -1, B24EA, 243, $\frac{5}{8}$ -1, 635
AC20	2/0 (7, 19)	$9\frac{1}{4}$	BY33, C-167, W-247, 737, B39EA, 247, 747
AC205	2/0 (7, 19)	$9\frac{1}{4}$	BY41, W-245, 635, B30EA, 245
AC30	3/0 (7, 19)	8	BY35, W-247, 781, B74AH, 247
AC40	4/0 (7, 19)	$9\frac{1}{2}$	BY37, W-249, 840, B49EA, 249, 840
AC266	266.8 (7, 19)	$8\frac{5}{8}$	B75AH, 251, 1.00
AC336	336.4 (19, 37)	10	B80EA, 321, $1\frac{1}{8}$ -1
AC350	350 (19)	11	B80EA, 490, 547, $1\frac{1}{8}$ -1
AC397	397.5 (19)	$12\frac{1}{8}$	B80EA, 468, $1\frac{1}{8}$ -1
AC477	477 (19, 37)	$13\frac{1}{2}$	B80EA, 317, 426, $1\frac{1}{8}$ -1
AC556	556 (19, 37)	$13\frac{1}{2}$	B76AH, 318, $1\frac{5}{16}$

* OD58 dies are interchangeable with those listed for O-52.

Full- and semi-tension compression splices

Aluminum full-tension compression splices for ACSR and aluminum-alloy conductors

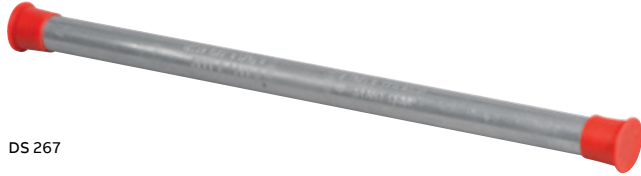

DS 267



BS 467

Simplify hot-line distribution construction and eliminate the separate splicing of ACSR core wires.

- Constructed from seamless aluminum tubing for high conductivity
- Prefilled with oxide inhibitor to prevent oxidation and keep out moisture
- Sleeves have an internal taper that acts as a funnel-like entrance for easy insertion of conductors and provides stress relief on the conductor strands upon compression
- Solid barriers in the center of the sleeves ensure all-around distribution and penetration of the oxide inhibitor to all strands
- All splices marked with conductor size and die references, providing easy identification for easy installation
- Designed to develop 95% or more of the conductor's rated strength
- Meets or exceeds ANSI C119.4 specifications

Aluminum full-tension compression splices

Cat. no.	AWG or kcmil wire size	L (in.)	Installing dies
BS 66	#6 AAC, #6 ACSR (6/1)	6 ⁵ / ₈	TB, 239, 1/2
BS 46	#4 AAC, #4 ACSR (6/1), #4 AAAC	9 ⁷ / ₁₆	TB, 239, 1/2
BS 467	#4 AAC, #4 ACSR (6/1), #4 ACSR (7/1), #4 AAAC	10 ³ / ₈	TB, 239, 1/2
DS 26	#2 AAC, #2 ACSR (6/1)	12 ¹ / ₄	BG, TW-TY
DS 267	#2 AAC, #2 ACSR (6/1), #2 ACSR (7/1), #2 AAAC	11 ¹ / ₄	BG, TW-TY
WS 10	1/0 AAC, 1/0 ACSR (6/1), 1/0 AAAC	12 ³ / ₈	TW-TY, 58, 245
RS 10	1/0 AAC, 1/0 ACSR (6/1), 1/0 AAAC	13	167, 247, 702, 737
MS 20	2/0 AAC, 2/0 ACSR (6/1), 2/0 AAAC	17 ⁷ / ₈	TM, 62, 11 ¹ / ₁₆
16100	3/0 AAC, 3/0 ACSR (6/1), 3/0 AAAC	17 ⁷ / ₈	76H, 658
16101	4/0 AAC, 4/0 ACSR (6/1), 4/0 AAAC	17 ⁷ / ₈	87, 654
16104	336.4 (18/1) ACSR	19	96, 655, 1 ¹ / ₈ -1, 13A
16106	397.5 (18/1) ACSR	28	96
16477	477 (18/1) ACSR	30	115H

Diagram



Note: For wire sizes over 1000 kcmil, please consult your ABB representative.

Full- and semi-tension compression splices

Type RC aluminum single-sleeve full-tension splices for ACSR, AAAC, 5005 and AAC conductors



Type RC

Replaces two-piece splices.

- Center stop assures proper conductor positioning
- External end taper provides conductor stress relief, ease of stringing and corona protection
- Internal end chamfer allows easy conductor insertion and prevents sharp edge contact with conductor
- Tested to meet electrical and mechanical requirements of ANSI C119.4; will withstand 95% of conductor rated breaking strength

Type RC – Single-sleeve, full-tension splices for ACSR, AAAC, 5005, AAC conductors

Cat. no.	AWG or kcmil wire size (stranding)	L (in.)	Installing dies*
RC4BB [†]	4ACSR (6 ¹ / ₄ , 7 ¹ / ₄), 4AAAC (7), 4 5005 (7), 4AAC (7)	12	1/2, W-163, B72AH, 163, 510
RC45 [†]	4ACSR (6 ¹ / ₄ , 7 ¹ / ₄), 4AAAC (7), 4 5005 (7), 4AAC (7)	12	5/8-1, 635, BG, W-BG, W-243, 5/8-1, B24EA, 243, 687
RC2BB [†]	2ACSR (6 ¹ / ₄ , 7 ¹ / ₄), 2AAAC (7), 2 5005 (7), 2AAC (7)	13 5/8	5/8-1, 635, BG, W-245, B24EA, B30EA, 245, 687
RC25 [†]	2ACSR (6 ¹ / ₄ , 7 ¹ / ₄), 2AAAC (7), 2 5005 (7), 2AAC (7)	13 5/8	737, 747, W-C, W-247, W-702, B39EA, 167, 247, 702,
RC10 [†]	1/0 ACSR (6 ¹ / ₄), 1/0 AAAC (7), 1/0 5005 (7), 1/0 AAC (7)	15 1/4	737, 747, W-C, W-702, B39EA, 167, 247, 702
RC205 [†]	2/0 ACSR (6/1)	17	737, 747, W-702, B39EA, 247
RC20 [†]	2/0 ACSR (6 ¹ / ₄), 2/0 AAAC (7), 2/0 5005 (7), 2/0 AAC (7)	16	781, B74AH, 659, 3/4
RC30 [†]	3/0 ACSR (6 ¹ / ₄), 3/0 AAAC (7), 3/0 5005 (7), 3/0 AAC (7)	17	B49EA, 658, 29 3/32
RC40 [†]	4/0 ACSR (6 ¹ / ₄), 4/0 AAAC (7), 4/0 5005 (7), 4/0 AAC (7)	18 1/2	B61EA, 654, 1-2
RC336	336.4 ACSR (18 ¹ / ₄)	19 1/4	B80EA, 655, 1 1/8-1, 1 1/8-2
RC397	397.5 ACSR (18 ¹ / ₄)	21 1/2	B20AH, 327, 1 1/8-1, 1 1/8-2
RC477	477 ACSR (18 ¹ / ₄)	24	B78AH, 788, 15 1/16

*OD58 dies are interchangeable with those listed for O-52.

[†]RUS listed

Full- and semi-tension compression splices

Aluminum multi-range dieless compression splices – Minimum and partial tension



SGAC 500

Compression splices for a wide conductor range, no dies needed.

- Made from aluminum for high strength and high conductivity
- Solid center stop ensures proper cable insertion
- Dual-rated for use with aluminum and copper conductors
- Connector bores coated with oxide inhibitor and capped to prevent oxidation
- All splices marked with conductor sizes for easy identification

Minimum tension

Cat. no.	Conductor size (AWG or kcmil)	Decimal range		Tool	L (in.)
		Min. O.D.	Max. O.D.		
SGAC 1/0	#10 sol. – 1/0 ACSR	0.102	0.398	VC-5/VC-6	2
SNG 00	#10 sol. – 1/0 ACSR	0.102	0.398	VC-5/VC-6	4¼
SGAC 3/0	#8 sol. – 3/0 str.	0.128	0.470	VC-5/VC-6	3
SGAC 250	#4 sol. – 266.8 – 4/0 ACSR	0.204	0.593	VC-5/VC-6	4
SGAC 350	2/0 str. – 350 – 336.4 (18/1)	0.414	0.684	VC-6	5
SGAC 500	4/0 str. – 500 – 477 (18/1)	0.522	0.814	VC-6	5
SGAC 8650	350 str. – 636 (36/1) 400 copper max.	0.681	0.940	VC-8	8⅞
SGAC 8800	397.5 str. – 795 (36/1) 500 copper max.	0.724	1.040	VC-8	10⅞

Diagram

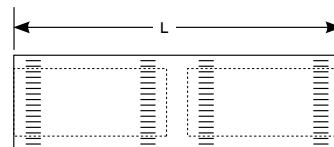

Note: For tin-plating option, add "-TN" suffix to the catalog number.



SKAC 500

Partial tension

Cat. no.	Conductor size (AWG or kcmil)	Decimal range		Tool	B (in.)	L (in.)
		Min. O.D.	Max. O.D.			
SKAC 2/0	#2 str. – 2/0 ACSR	0.292	0.447	VC-5/VC-6	3⅞	6½
SKAC 4/0	1/0 str. – 4/0 ACSR	0.368	0.563	VC-5/VC-6	3⅞	8
SKAC 500	4/0 str. – 477 (18/1) ACSR	0.522	0.814	VC-6	3⅞	8
SKAC 600	300 – 477 (26/7) ACSR	0.629	0.858	VC-6	5⅞	11⅞
SKAC 700	556.5 – 636 (36/1) ACSR	0.858	0.930	VC-8	6⅞	12⅞
SKAC 800	700 – 795 (36/1) ACSR	0.964	1.040	VC-8	6⅞	12⅞

Diagram

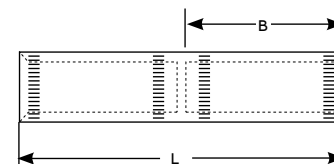

Full- and semi-tension compression splices

Aluminum multi-range dieless compression splices – Full tension



U2A9



AAC 4/0 FT

Aluminum compression splices provide high strength and high conductivity.

- Solid center stop ensures proper cable insertion
- Dual-rated for use with aluminum and copper conductors
- Connector bores coated with oxide inhibitor and capped to prevent oxidation
- All splices marked with conductor size and die references, providing easy identification for easy installation
- Designed to develop 95% or more of the conductor’s rated strength
- Meets or exceeds ANSI C119.4 specifications.

AAC series – Full tension

Cat. no.	Conductor size (AWG or kcmil)	Decimal range		Tool	L (in.)
		Min. O.D.	Max. O.D.		
U2A9	#4 str. – 1/0 str. aluminum	0.232	0.368	VC-5/VC-6	6¼
AAC 4/0 FT	1/0 str. – 4/0 str. aluminum	0.368	0.522		8
AAC 350 FT	4/0 str. – 350 aluminum – 336.4 (18/1)	0.522	0.681	VC-6	9½
AAC 500 FT	336.4 str.–500 aluminum	0.666	0.795		12½

Diagram

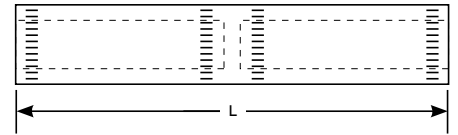

ACSR 397.5 FT

ACSR series – Full tension

Cat. no.	Conductor size (AWG or kcmil)	Decimal range		Tool	B (in.)	L (in.)
		Min. O.D.	Max. O.D.			
U2A9	#4 str.–1/0 str. aluminum	0.232	0.368	VC-5/VC-6	6¼	14¼
ACSR 2 FT	#4 str. – #2 str. aluminum, #4 (6/1)–#2 (7/1) ACSR, #6 sol.–#4 sol. copper, #6 str.–#2 str. copper	0.162	0.325		7	14¼
ACSR 1/0 FT	#2 str.–1/0 (6/1) ACSR	0.292	0.398		8⅜	17
ACSR 2/0 FT	#2 str.–2/0 str. aluminum, #2 (6/1)–2/0 (6/1) ACSR, #2 str.–1/0 str. copper	0.292	0.447		9⅞	18½
ACSR 4/0 FT	1/0 str. – 4/0 str. aluminum 1/0 (6/1)–4/0 (6/1) ACSR, 1/0 str.–3/0 str. copper	0.368	0.563	VC-6	9⅞	20
ACSR 397.5 FT	4/0–397.5 str. aluminum, 4/0 (6/1)–397.5 (18/1) ACSR, 3/0 str.–4/0 str. copper	0.470	0.743		11	23

Diagram

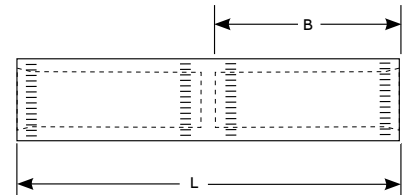

Note: For tin-plating option, add “-TN” suffix to the catalog number.

Full- and semi-tension compression splices

Copper loop compression splices

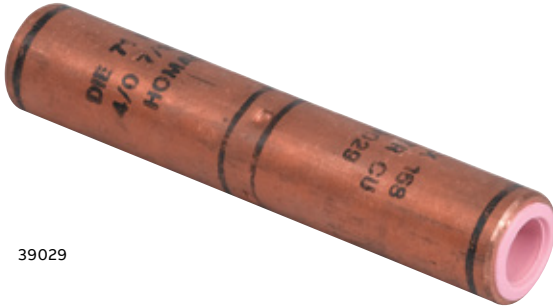

39029

Seamless copper tubing provides high conductivity.

- All splices marked with wire size, installation die codes and compression locations, providing easy identification for easy installation
- Designed to develop 25% or more of the conductor's rated strength
- Meets or exceeds ANSI C119.4 specifications

Copper loop compression splices

Cat. no.	Wire size (AWG)	L (in.)	Installing tools and dies (compressions per end)	
			Dies-UT 5 type	Dies-hydraulic
J 1 C 1	#8 sol. & str.	2 ³ / ₄	TJ (2)	161
J 1 C 3	#6 sol. & str.		TJ (2)	161
L 1 C 5	#4 sol. & str.		TLTN (2)	162
Q 1 C 7	#2 sol. & #2 (7) str.		TQ (2)	-
S 1 C 7	#2 (3) str.	4 ³ / ₄	TS (4)	-
S 1 C 51	#1 sol.		TS (4)	-
S 1 C 8	#1 (7-19) str.		TS (4)	-
S 1 C 52	1/0 sol.		TS (4)	-
U 1 C 9	1/0 (7-19) str.	4 ¹ / ₂	TU (4)	52 (2)
39023	2/0 (7-19) str.		TZ (4)	58 (2)
39026	3/0 (7-19) str.		-	62 (2), 167
39029	4/0 (7-19) str.		-	71 (2), 168

Diagram

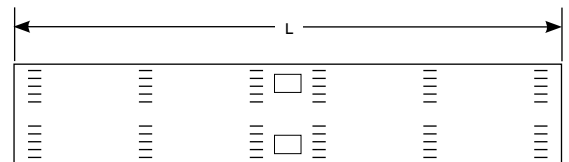

Note: For tin-plating option, add "-TN" suffix to the catalog number.

Full- and semi-tension compression splices

Copper full-tension compression splices



Seamless copper tubing provides high conductivity for full-tension applications.

- All splices marked with wire size, installation die codes and compression locations, providing easy identification for easy installation
- Designed to develop 95% or more of the conductor's rated strength
- Meets or exceeds ANSI C119.4 specifications
- Selected models are RUS accepted

Copper full-tension compression splices

Cat. no.	Wire size (AWG)	L (in.)	Installing dies
Copper conductors			
J 2 C 1	#8 sol. & str.	1 ⁵ / ₁₆	TJ, 161
J 2 C 3*	#6 sol. & str.	2 ¹ / ₄	TJ, 161, J
L 2 C 4	#4 sol.	3 ¹ / ₄	TLTN, 162, ³ / ₈
L 2 C 5*	#4 str.	3 ¹ / ₄	TLTN, 162, ³ / ₈
Q 2 C 6	#2 sol.	4 ³ / ₈	TQ, ¹ / ₂ , 163
Q 2 C 7	#2 (7) str.	4 ³ / ₈	TQ, ¹ / ₂ , 163
S 2 C 7*	#2 (3) str.	4 ¹ / ₄	TS, ⁹ / ₁₆ , 164
S 2 C 52	1/0 str.	4 ¹ / ₄	TS, ⁹ / ₁₆ , 164
U 2 C 9*	1/0 (7-19) str.	5 ¹ / ₄	TU
Z 2 C 1	2/0 (7-19) str.	5 ¹ / ₄	TZ, 166
2723	2/0 (7-19) str.	6 ¹ / ₂	58, 245
2726	3/0 (7-19) str.	6 ¹ / ₂	62, 167
2729	4/0 (7-19) str.	8 ³ / ₈	71, 840, 168
Copperweld[®] copper conductors			
L 2 E 1*	8A	5 ³ / ₁₆	TLTN, 162
L 2 E 3*	6A	5 ³ / ₁₆	TLTN, 162
CFT series			
CFT 8 S-J	#8 sol.	2	J161
CFT 6 S-J	#6 sol.	2 ¹ / ₄	J161
CFT 4 S-P	#4 sol.	2 ³ / ₄	P162
CFT 2 S-X	#2 sol.	3	X163
CFT 8 J	#8 (7) str.	2 ¹ / ₄	J161
CFT 6 J	#6 (7) str.	2 ¹ / ₄	J161
CFT 4 P	#4 (7) str.	2 ³ / ₄	P162
CFT 2 X	#4 (7) str.	3	X163



* RUS accepted
 Note: For tin-plating option, add "-TN" suffix to the catalog number.

Automatic splices and deadends

ATS Autoset® automatic splices



Make quick, dependable overhead tension splices and speed up installation time.

Blackburn® automatic connectors make fast and dependable overhead tension splices that take a bite out of installation time. The conductor simply slips into the color-coded, funnel-shaped end piece and automatically enters the pilot cup with a gentle push. The pilot cup guides the conductor past the unique serrated jaws and into the center of the connector. When the conductor meets the center stop, the pull-back locks it into position as the jaws firmly clamp down. The more pull, the more bite, which provides an instant, positive and automatic connection.

- Color-coded, funnel-shaped end pieces provide instant visual identification of maximum conductor size and swiftly guide conductor into position for insertion

- Pilot caps envelop cable strands and guide the conductors into the center of the splice
- Die-cast precision-made jaws provide optimum contact area for a greater range of conductor sizes
- Compression spring positions the jaw for positive conductor acceptance
- Tubular center stop automatically determines proper insertion length of both conductors
- High-strength aluminum-alloy tubing covers the connection for superior corrosion protection and long-lasting durability
- Color-coded tape enables identification of the minimum conductor size of wide-range connectors – it further eliminates errors and speeds up installations!

ATS Autoset automatic splices

Cat. no.	Conductor range (AWG or kcmil)			Decimal range	Color code	Overall length (in.)
	ACSR	AAAC	AAC			
ATS4-S	#4 ⁵ / ₁₆ , 7 ₁₆	#4	#4	0.232–0.260	4 – Orange	11.50
ATS4	#4 ⁵ / ₁₆ , 7 ₁₆	#4	#4	0.232–0.260	4 – Orange	13.75
ATS42	#4 ⁵ / ₁₆ , 7 ₁₆	#4–#2	#4–#2	0.232–0.332	4 – Orange, 2 – Red	13.75
ATS2	#2 ⁵ / ₁₆ , 7 ₁₆	#2	#2	0.292–0.332	2 – Red	13.75
ATS10	1/0 ⁵ / ₁₆	1/0	1/0	0.368–0.410	1/0 – Yellow	16.25
ATS1020	1/0 ⁵ / ₁₆	1/0–2/0	1/0–2/0	0.368–0.461	1/0 – Yellow, 2/0 – Gray	16.25
ATS20	2/0 ⁷ / ₁₆	2/0	2/0	0.414–0.461	2/0 – Gray	16.25
ATS30	3/0 ⁵ / ₁₆	3/0	3/0	0.461–0.522	3/0 – Black	16.25
ATS3040	3/0 ⁵ / ₁₆	3/0–4/0	3/0–4/0	0.461–0.575	3/0 – Black, 4/0 – Pink	23.50
ATS40	4/0 ⁵ / ₁₆	4/0	4/0	0.475–0.575	4/0 – Pink	23.50
ATS266336	266 ¹⁸ / ₁₆ , 266 ²⁶ / ₁₆ *, 336 ¹⁸ / ₁₆	312.8*	266–336	0.586–0.684	Green	23.50
ATS397477	336 ²⁶ / ₁₆ *, 397 ¹⁸ / ₁₆ , 397 ²⁶ / ₁₆ *, 477 ¹⁸ / ₁₆ *	394.5*	397–477	0.720–0.858	Blue	23.50

* Application limited to maximum 10,000 lb. tensile.

Automatic splices and deadends

ATD-ZB stainless steel bail



This dead-end installs quickly and easily, reducing maintenance costs and inventory.

- Color-coded, funnel-shaped end piece provides instant visual identification of maximum conductor size and swiftly guides conductor into position for insertion
- Pilot cap envelops cable strand and guides the conductor into the center of the splice
- Die-cast precision-made jaws provide optimum contact area for a greater range of conductor sizes
- Compression spring positions the jaw for positive conductor acceptance
- Special microcrystalline-based inhibitor coats the jaws and tube's inner diameter, seals the connection and provides a high-pressure lubricant for long-term, continuous performance

- Factory-installed dust covers repel dirt and debris
- Versatile for deadending ACSR, AAC and AAAC conductors
- Breaking strength exceeds 95% of conductor's rated strength, up to a maximum of 10,000 lbs.
- Galvanized steel clevis pin and stainless steel cotter pin (included) enable the bail to be used with standard deadend suspension insulators
- Color-coded tape enables identification of the minimum conductor size of wide-range connectors – it further eliminates errors and speeds up installations

ATD-ZB stainless steel bail

Cat. no.	Conductor range (AWG or kcmil)			Decimal range	Color code	Approximate dimensions (in.)		
	ACSR	AAAC	AAC			A	B	C
ATD42ZB	#4 ⁶ / ₁ , ⁷ / ₁ ; #2 ⁵ / ₁ , ⁷ / ₁	#4, #2	#4, #2	0.232–0.332	4 – Orange, 2 – Red	12 ¹³ / ₁₆	7 ¹³ / ₁₆	5 ¹ / ₁₆
ATD1020ZB	1/0 ⁶ / ₁ , 2/0 ⁶ / ₁	1/0, 2/0	1/0, 2/0	0.368–0.461	1/0 – Yellow, 2/0 – Gray	14 ¹ / ₂	9	4 ¹⁵ / ₁₆
ATD3040ZB	3/0 ⁶ / ₁ , 4/0 ⁶ / ₁	3/0, 4/0	3/0, 4/0	0.461–0.575	3/0 – Black, 4/0 – Pink	20 ³ / ₄	11 ³ / ₄	8 ¹ / ₂
ATD266336ZB	266 ¹⁸ / ₁ , 336 ¹⁸ / ₁	266, 336	266, 336	0.586–0.684	Green	20 ³ / ₄	11 ³ / ₄	8 ¹ / ₂
ATD397477ZB	397 ¹⁸ / ₁ , 477 ¹⁸ / ₁	397, 477	397, 477	0.720–0.858	Blue	20 ³ / ₄	11 ³ / ₄	8 ¹ / ₂

Diagrams

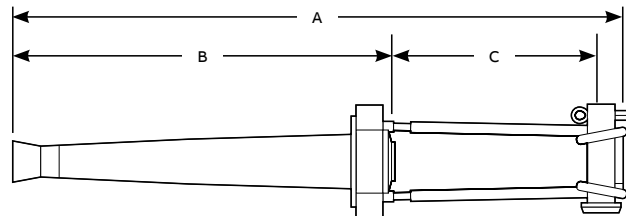

Type ZB

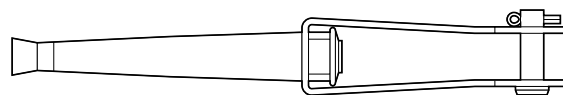

Automatic splices and deadends

ATD-CB clevis bracket & ATD-FB flexible bail

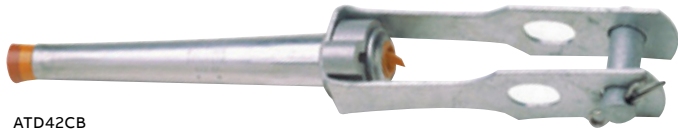

ATD42CB

Grab and go – slots are provided for use with standard pulling hooks.

- Versatile for dead-ending ACSR, AAC and AAAC conductors
- Breaking strength exceeds 95% of conductor's rated strength, up to a maximum of 10,000 lbs.
- Galvanized steel clevis pin and stainless steel cotter pin (included) enable the bail to be used with standard deadend suspension insulators

ATD-CB clevis bracket

Cat. no.	Conductor range (AWG or kcmil)				Approximate dimensions (in.)			
	ACSR	AAAC	AAC	Decimal range	Color code	A	B	C
ATD42CB	#4 ⁶ / ₁ , 7 ¹ / ₁ ; #2 ⁶ / ₁ , 7 ¹ / ₁	#4, #2	#4, #2	0.232–0.332	4 – Orange, 2 – Red	12 ³ / ₁₆	7 ³ / ₁₆	5 ¹ / ₁₆
ATD1020CB	1/0 ⁶ / ₁ , 2/0 ⁶ / ₁	1/0, 2/0	1/0, 2/0	0.368–0.461	1/0 – Yellow, 2/0 – Gray	15 ¹ / ₄	9	5 ³ / ₈
ATD3040CB	3/0 ⁶ / ₁ , 4/0 ⁶ / ₁	3/0, 4/0	3/0, 4/0	0.461–0.575	3/0 – Black, 4/0 – Pink	20 ³ / ₄	11 ³ / ₄	6 ¹ / ₂
ATD266336CB	266 ¹⁸ / ₁ , 336 ¹⁸ / ₁	266, 336	266, 336	0.586–0.684	Green	19 ³ / ₁₆	11 ³ / ₄	6 ¹ / ₂
ATD397477CB	397 ¹⁸ / ₁ , 477 ¹⁸ / ₁	397, 477	397, 477	0.720–0.858	Blue	19 ³ / ₁₆	11 ³ / ₄	6 ¹ / ₂

Diagram

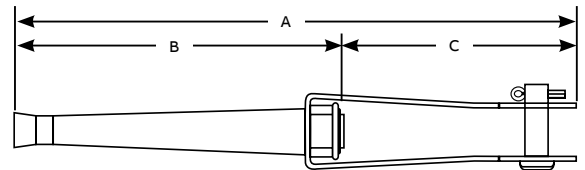

ATD42FB

Use with spool-type and other insulators when flexibility is a must.

- Versatile for dead-ending ACSR, AAC and AAAC conductors
- Breaking strength exceeds 95% of conductor's rated strength

ATD-FB flexible bail

Cat. no.	Conductor range (AWG or kcmil)				Approximate dimensions (in.)		
	ACSR	AAAC	AAC	Decimal range	Color code	A	B
ATD42FB	#4 ⁶ / ₁ , 7 ¹ / ₁ ; #2 ⁶ / ₁ , 7 ¹ / ₁	#4, #2	#4, #2	0.232–0.332	4 – Orange, 2 – Red	14 ³ / ₁₆	7 ³ / ₁₆
ATD1020FB	1/0 ⁶ / ₁ , 2/0 ⁶ / ₁	1/0, 2/0	1/0, 2/0	0.368–0.461	1/0 – Yellow, 2/0 – Gray	18 ⁷ / ₈	9

Diagram

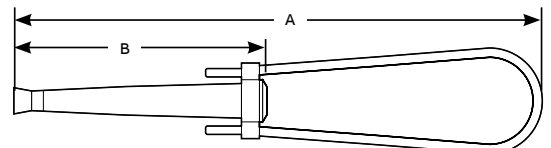

Hot-line clamps

HLC™ hot-line clamps (protected thread)



Hot-line clamps built for all seasons.

- Eyebolt coated with grease to ensure easy turning in all weather conditions
- Built for general/copper applications and available for a wide conductor range

HLC hot-line clamps (protected thread)



Cat. no.	Body	For wire combination	Conductor range			
			Main		Tap	
			ACSR	AWG or kcmil	ACSR	AWG
HLC2108*	Bronze	Copper to copper	-	2/0-#8	-	2/0
HLC2108P	Plated bronze	General purpose	2/0-#6	2/0-#8	2/0-#6	2/0-#8
HLC2108AP9	Plated aluminum	General purpose	2/0-#6	2/0-#8	2/0-#6	2/0-#8
HLC3974	Bronze	Copper to copper	-	400-#6 sol.	-	4/0-#6 sol.
HLC3974P	Plated bronze	General purpose	-	400-#6 sol.	3/0-#6	4/0-#6 sol.
HLC3974AP	Plated aluminum	General purpose	397.5-#6	400-#6 sol.	3/0-#6	4/0-#6 sol.

* RUS accepted.

Note: For oxide-inhibitor option, add "-9" suffix to the catalog number.

Hot-line clamps

PGH™ center-bolt parallel-groove hot-tap clamps



Reliable performance for years to come.

- Tight, secure fittings to positively secure main and tap wires
- Catalog numbers ending with 9 are prefilled with oxide inhibitor to prevent oxidation and keep out moisture

PGH center-bolt parallel-groove hot-tap clamps

Std. Cat. no.	Prefilled Cat. no.	Conductor range				Conductor diameter (in.)				Center bolts			Dimensions (in.)		
		Main		Tap		Main		Tap		No.	Dia.	Fig.	W	H	L
		ACSR	AWG or kcmil	ACSR	AWG	Max.	Min.	Max.	Min.						
-	PGH29	2/0-#8	2/0 str.-#8 sol.	1/0-#8	1/0 str.-#8 sol.	0.447	0.128	0.398	0.128	1	1/2	1	2 3/8	5 3/4	2 3/8
PGH4	PGH49	397.5-#6, 2/0-#6	450-#4 sol.	3/0-#6	4/0 str.-#6 sol.	0.781	0.198	0.528	0.162	1		1	3 5/16	6 5/16	2 7/16
-	PGH69	397.5 ¹⁸ / ₁₆ -#2 AR	1000-4/0 str.	266-#6	300-#6 sol.	1.152	0.522	0.657	0.162	2		2	4	6 3/4	4 1/4
-	PGH6129*	874-4/0, 397.5 ¹⁸ / ₁₆ -#2 AR	1000-4/0 str.	266-#6	300-#6 sol.	1.152	0.522	0.657	0.162	1		3	3 5/8	6 3/4	3 1/16
Copper clamps															
PGH3	PGH39	-	2/0 str.-#8 sol.	-	2/0 Str.-#8 sol.	0.419	0.419	0.128	0.128	1	7/16	1	2 3/8	5 1/4	1 1/4

Diagrams

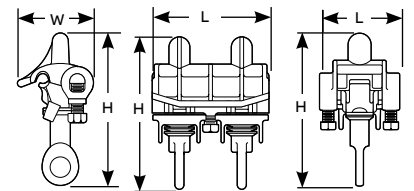

Fig. 1

Fig. 2

Fig. 3

* PGH6129 has two hex-head bolt and pressure pad tap conductor retainers. AR – with armor rod.
Note: Copper clamps are for use on copper conductors only.

Appendix

Part number index

Cat. no.	Page	Cat. no.	Page	Cat. no.	Page
10N	48	A 5050	35	AC40	53
10NPW	48	A 5055	35	AC477	53
16100	54	A 5060	35	AC4-BB	53
16101	54	A 5065	35	AC556	53
16104	54	A 5070	35	AC6-TB	53
16106	54	A 5075	35	ACJ20	51
16477	54	A 5080	35	ACJ205	51
2169	52	A 5085	35	ACJ266	51
2170	52	A 5090	35	ACJ336	51
2174	52	AAC 350 FT	57	ACJ350	51
2176	52	AAC 4/0 FT	57	ACJ397	51
2178	52	AAC 500 FT	57	ACJ40	51
2182	52	ABP 2350	10	ACJ477	51
2183	52	ABP 240	10	ACJ556	51
2186	52	ABP 2500	10	ACSR 1/0 FT	57
2187	52	ABP 2750	10	ACSR 2 FT	57
2188	52	ABP 3168	10	ACSR 2/0 FT	57
2190	52	ABP 3350	10	ACSR 397.5 FT	57
2723	59	ABP 340	10	ACSR 4/0 FT	57
2726	59	ABP 3500	10	ATD1020CB	62
2729	59	ABP 3750	10	ATD1020FB	62
2NPW	48	ABP 4350	10	ATD1020ZB	61
39023	58	ABP 440	10	ATD266336CB	62
39026	58	ABP 4500	10	ATD266336ZB	61
39029	58	ABP 4750	10	ATD3040CB	62
4N	48	ABP 5350	10	ATD3040ZB	61
4NPW	48	ABP 540	10	ATD397477CB	62
6N	48	ABP 5500	10	ATD397477ZB	61
6NPW	48	ABP 5750	10	ATD42CB	62
866	50	ABP 6350	10	ATD42FB	62
867	50	ABP 640	10	ATD42ZB	61
869	50	ABP 6500	10	ATS10	60
872	50	ABP 6750	10	ATS1020	60
874	50	ABP 7350	10	ATS2	60
876	50	ABP 740	10	ATS20	60
879	50	ABP 7500	10	ATS266336	60
883	50	ABP 7750	10	ATS30	60
892	50	ABP 8350	10	ATS3040	60
A 4025	35	ABP 840	10	ATS397477	60
A 4030	35	ABP 8500	10	ATS4	60
A 4035	35	ABP 8750	10	ATS40	60
A 4040	35	AC10-TB	53	ATS42	60
A 4045	35	AC20	53	ATS4-S	60
A 4050	35	AC205	53	BS 46	54
A 4055	35	AC266	53	BS 467	54
A 4060	35	AC2-TB	53	BS 66	54
A 4065	35	AC30	53	C F T 2 S-X	59
A 5035	35	AC336	53	C F T 2 X	59
A 5040	35	AC350	53	C F T 4 P	59
A 5045	35	AC397	53	C F T 4 S-P	59

Appendix

Part number index

Cat. no.	Page	Cat. no.	Page	Cat. no.	Page
C FT 6 J	59	DB 2020	16	IKL58	45
C FT 6 S-J	59	DB 3	16	IKL64	45
C FT 8 J	59	DB 4020	16	IKL65	45
C FT 8 S-J	59	DB 404	16	IKL66	45
C2BB	24	DB 404 ST	28	IKL67	45
C5BB	24	DB 4040	16	IKL68	45
C7	24	DB 5	16	IKL69	45
C9	24	DB 6	16	IPC1102	34
C9L	24	DB 7	16	IPC3535	34
CCS44	30	DC 402	28	IPC3541	34
CD 40 B	24	DS 26	54	IPC4111	34
CEA 2 50	11	DS 267	54	IPC4141	34
CEA 4 50	11	DST 402	28	IPC5041	34
CEA 4 75	11	H 1 A 33	50	J 1 C 1	58
CEA 6 100	11	HLB 10	29	J 1 C 3	58
CEA 6 50	11	HLB 2	29	J 2 C 1	59
CEA 6 75	11	HLC2108	63	J 2 C 3	59
CF1010-1	25	HLC2108AP9	63	K1	33
CF102-1	25	HLC2108P	63	K2	33
CF2020-1	25	HLC3974	63	K3	33
CF202-1	25	HLC3974AP	63	L 1 C 5	58
CF22-1	25	HLC3974P	63	L 2 C 4	59
CF4010-1	25	HLCB 2	29	L 2 C 5	59
CF402-1	25	ICS61-1	42	L 2 E 1	59
CF4040-1	25	ICS62-1	42	L 2 E 3	59
CF44-1	25	ICS63-1	42	LP10	30
CFS22-1	25	ICS64-1	42	LP2	30
CFS44-1	25	ICS65-1	42	LP4	30
CN 600 B	24	ICS66-1	42	MS 20	54
CO 20 B	24	ICS67-1	42	MS4	15
CS61	41	ICS68-1	42	NB 500	19
CS62	41	ICS70-1	42	NB 50040	19
CS63	41	ICS71-1	42	NB 50040 ST	28
CS64	41	ICS72-2	42	NB 60020	23
CS65	41	ICS73-1	42	NC 40010	28
CS66	41	ICS74-1	42	NC 60010	28
CS67	41	ICS75-1	42	NST 40010	28
CS68	41	ICS76-1	42	NST 60010	28
CS69	41	ICS77-1	42	OB 1	16
CS70	41	ICS78-1	42	OB 101	16
CS71	41	IKL34	45	OB 1010	17
CS72	41	IKL35	45	OB 103	23
CS73	41	IKL36	45	OB 103 ST	28
CS74	41	IKL44	45	OB 2	16
CS75	41	IKL45	45	OB 2014	23
CS76	41	IKL46	45	OB 22	23
CS77	41	IKL47	45	OB 44	16
CS78	41	IKL54	45	OC 102	28
CS84	41	IKL55	45	OC 22	28
CS85	41	IKL56	45	OC 42	28
DB 202	16	IKL57	45	OL 4425	29

Appendix

Part number index

Cat. no.	Page	Cat. no.	Page	Cat. no.	Page
OR	17	PT 103304	37	PT 33604 S 40	38
OST 102	28	PT 103305	37	PT 33605	36
OST 22	28	PT 103306	37	PT 33605 S 20	38
OST 42	28	PT 103307	37	PT 33606	36
PAA10	31	PT 103308	37	PT 33606 S 10	38
PAA109	31	PT 103309	37	PT 33607	36
PAA12	31	PT 103310	37	PT 33608	36
PAA129	31	PT 103311	37	PT 33609	36
PAA29	31	PT 103312	37	PT 35000	36
PAA339	31	PT 103312 S 40	38	PT 35001	36
PAA4	31	PT 103313	37	PT 35002	36
PAA400	31	PT 103314	37	PT 35002 S 10	38
PAA4009	31	PT 103315	37	PT 35002 S 2	38
PAA49	31	PT 103316	37	PT 35003	36
PAA5	31	PT 1050 S 2	38	PT 35004	36
PAA59	31	PT 119200	37	PT 35005	36
PAA6	31	PT 119201	37	PT 35006	36
PAA69	31	PT 119202	37	PT 35007	36
PAC345	31	PT 119203	37	PT 4 N 336	38
PAC3459	31	PT 119204	37	PT 4 N 336 F	38
PAC7	31	PT 119205	37	PT 4 N 4/0	38
PAC79	31	PT 119206	37	PT 4 N 795	38
PAE-2121-9	32	PT 119207	37	PT 4 N 795 F	38
PAE-2121X-79	32	PT 119208	37	PT 4001	36
PAE-335-79	32	PT 119209	37	PT 4002	36
PAE-3921-9-2	32	PT 119210	37	PT 4003	36
PAE-3931-9-2	32	PT 119211	37	PT 4004	36
PAE-3939-9-2	32	PT 119212	37	PT 4004 S 2	38
PAE-4141-9	32	PT 119213	37	PT 4005	36
PAE-9921-9	32	PT 119214	37	PT 4005 S 10	38
PAE-9939-9	32	PT 119215	37	PT 4006	36
PAE-9941-9	32	PT 119216	37	PT 4007	36
PAE-9999-9	32	PT 119217	37	PT 4007 S 10	38
PGH29	64	PT 2 N 336	38	PT 4007 S 2	38
PGH3	64	PT 2 N 4/0	38	PT 4008	36
PGH39	64	PT 2 N 795	38	PT 4008 S 20	38
PGH4	64	PT 26601	36	PT 4009	36
PGH49	64	PT 26602	36	PT 4010	36
PGH6129	64	PT 26602 S 2	38	PT 4011	36
PGH69	64	PT 26603	36	PT 4020 S 2	38
PT 1010	36	PT 26603 S 10	38	PT 47701	36
PT 1011	36	PT 26604	36	PT 47701 S 10	38
PT 1011 S 2	38	PT 26605	36	PT 47702	36
PT 1012	36	PT 26606	36	PT 47703	36
PT 1013	36	PT 26607	36	PT 55601	36
PT 1014	36	PT 26608	36	PT 55602	36
PT 1015	36	PT 26609	36	PT 55603	36
PT 103300	37	PT 33601	36	PT 55604	36
PT 103301	37	PT 33602	36	PT 55605	36
PT 103302	37	PT 33603	36	PT 55605 S 40	38
PT 103303	37	PT 33604	36	PT 55606	36

Appendix

Part number index

Cat. no.	Page	Cat. no.	Page	Cat. no.	Page
PT 55606 S 40	38	PTSL 636	9	RCJ20	51
PT 55607	36	PT-TOOL	39	RCJ266	51
PT 55607 S 20	38	PT-Tool Cleaning Kit	39	RCJ30	51
PT 55608	36	PT-TOOL L	39	RCJ336	51
PT 55608 S 10	38	PT-TOOL S	39	RCJ397	51
PT 55609	36	PT-WHITE	39	RCJ40BB	51
PT 55611	36	PT-YELLOW	39	RCJ477	51
PT 55612	36	Q 1 C 7	58	RCJ477M	51
PT 79500	37	Q 1 U 52	40	RG 5	6
PT 79501	37	Q 1 U 53	40	RG 5 U 10	6
PT 79502	37	Q 1 U 54	40	RG 5 U 20	6
PT 79503	37	Q 1 U 55	40	RS 10	54
PT 79504	37	Q 1 U 56	40	RU 5	6
PT 79505	37	Q 1 U 57	40	RU 5 U 10	6
PT 79506	37	Q 1 U 58	40	RU 5 U 2	6
PT 79507	37	Q 1 U 59	40	RU 5 U 4	6
PT 79508	37	Q 1 U 60	40	RX 5	6
PT 79509	37	Q 1 U 65	40	RX 5 U 30	6
PT 79509 S 40	38	Q 1 U 67	40	RX 5 U 336	6
PT 79510	37	Q 1 U 68	40	RX 5 U 40	6
PT 79511	37	Q 1 U 69	40	S 1 C 51	58
PT 79511 S 20	38	Q 1 U 70	40	S 1 C 52	58
PT 79511 S 40	38	Q 2 A 7	52	S 1 C 7	58
PT 79512	37	Q 2 C 6	59	S 1 C 8	58
PT 79512 S 20	38	Q 2 C 7	59	S 2 C 52	59
PT 79513	37	Q 5 U 2	7	S 2 C 7	59
PT 79514	37	Q 5 U 4	7	S 4425	29
PTB 300	7	Q 5 U 6	7	S 4425-1/0	29
PTB 350	7	Q 5 U 8	7	SAPT 1/0-10	8
PTB 400	7	QCD41	27	SAPT 1/0-1017 CC	8
PT-BLUE	39	QCN50	27	SAPT 1/0-106	8
PT-Carrying Case	39	QCO02	27	SAPT 1/0-12	8
PT-CLEANING TOOL	39	QCO21	27	SAPT 1/0-26	8
PT-CLIP, WHITE/BLUE	39	QH 4 S	29	SAPT 1/0-26-840	8
PT-CLIP, YELLOW	39	QH 6 S	29	SAPT 1-12E	8
PTL 1000	7	RABP 4350	11	SAPT 1S-26	8
PTL 636	7	RABP 5350	11	SAPT 2-1017	8
PTL 750	7	RABP 6350	11	SAPT 2-12	8
PTL 800	7	RC10	55	SAPT 2-24	8
PTM 500	7	RC20	55	SAPT 2-26	8
PTM 556	7	RC205	55	SAPT 2-26-840	8
PT-RED	39	RC25	55	SAPT 3/0-106	8
PTSB 350	9	RC2BB	55	SAPT 350-6	8
PTSG 1/0	9	RC30	55	SAPT 4/0-1018 CC	8
PTSG 21	9	RC336	55	SAPT 4/0-106	8
PTSG 4	9	RC397	55	SAPT 4/0-2012	8
PTSG 6	9	RC40	55	SAPT 4/0-206	8
PTSK 1/0	9	RC45	55	SAPT 4/0-26	8
PTSK 2/0	9	RC477	55	SAPT 4-26	8
PTSK 3/0	9	RC4BB	55	SAPT 6-26	8
PTSK 4/0	9	RCJ10	51	SCD41	27

Appendix

Part number index

Cat. no.	Page	Cat. no.	Page	Cat. no.	Page
SCN50	27	SSP 4 FN 500 K	12	U 104 YO	44
SCO02	27	SSP 4 FN 750 K	12	U 106 YB	44
SCO21	27	SSP 4 RN 500 K	12	U 108 YG	44
SGAC 1/0	56	SSP 4 RN 750 K	12	U 2 A 9	52, 57
SGAC 250	56	U 1 B 1010	41	U 2 C 9	59
SGAC 3/0	56	U 1 B 102	41	U 21 RBR	44
SGAC 350	56	U 1 B 104	41	U 22 RR	44
SGAC 500	56	U 1 B 106	41	U 24 RO	44
SGAC 8650	56	U 1 B 108	41	U 26 RB	44
SGAC 8800	56	U 1 B 11	41	U 28 RG	44
SH 2 S	29	U 1 B 21	41	U 41 OBR	44
SKAC 2/0	56	U 1 B 22	41	U 44 OO	44
SKAC 4/0	56	U 1 B 24	41	U 46 OB	44
SKAC 500	56	U 1 B 26	41	U 48 OG	44
SKAC 600	56	U 1 B 28	41	U 5 U 10	7
SKAC 700	56	U 1 B 41	41	U 5 U 2	7
SKAC 800	56	U 1 B 44	41	U 5 U 4	7
SNG 00	49–50, 56	U 1 B 46	41	U 5 U 6	7
SNG 02	49	U 1 B 48	41	U 5 U 8	7
SNG 11	49	U 1 B 61	41	U 61 BBR	44
SNG 22	49	U 1 B 612	41	U 66 BB	44
SNG 24	49	U 1 B 66	41	U 68 BG	44
SNG 26	49	U 1 B 68	41	U2A9	57
SNG 44	49	U 1 B 81	41	UB 214	23
SNG 46	49	U 1 B 88	41	UBB 66	42
SNG 66	49	U 1 C 9	58	UBBR 61	42
SNG44	52	U 1 N 1010	43	UBG 68	42
SS 2 K	12	U 1 N 102	43	UGBR 81	42
SS 3 K	12	U 1 N 104	43	UGG 88	42
SS1 1/0 FN 500 K	13	U 1 N 106	43	UOB 46	42
SS1 1/0 FN 750 K	13	U 1 N 108	43	UOBR 41	42
SS1 1/0 RN 500 K	13	U 1 N 11	43	UOG 48	42
SS1 1/0 RN 750 K	13	U 1 N 12	43	UOO 44	42
SS1 2 FN 500 K	13	U 1 N 16	43	URB 26	42
SS1 2 FN 750 K	13	U 1 N 21	43	URBR 21	42
SS1 2 RN 500 K	13	U 1 N 22	43	URG 28	42
SS1 2 RN 750 K	13	U 1 N 24	43	URO 24	42
SS1 4 FN 500 K	13	U 1 N 26	43	URR 22	42
SS1 4 FN 750 K	13	U 1 N 28	43	UYB 06	42
SS1 4 RN 500 K	13	U 1 N 41	43	UYG 08	42
SS1 4 RN 750 K	13	U 1 N 44	43	UYO 04	42
SSL 500 K	13	U 1 N 46	43	UYR 02	42
SSL 750 K	13	U 1 N 48	43	UYU 00	42
SSP 1/0 FN 500 K	12	U 1 N 61	43	W 2 A 20	52
SSP 1/0 FN 750 K	12	U 1 N 66	43	W20–1	14
SSP 1/0 RN 500 K	12	U 1 N 68	43	W20–1 B	14
SSP 1/0 RN 750 K	12	U 1 N 81	43	W20–1 BFC	14
SSP 2 FN 500 K	12	U 1 N 88	43	W20–1 FC	14
SSP 2 FN 750 K	12	U 101 YBR	44	W40–1	14
SSP 2 RN 500 K	12	U 1010 YY	44	W40–1 B	14
SSP 2 RN 750 K	12	U 102 YR	44	W40–1 BFC	14

Appendix

Part number index

Cat. no.	Page	Cat. no.	Page	Cat. no.	Page
W40-1 FC	14	WR999	21	X 1 U 3030	46
W62-1	14	WRQ152	26	X 1 U 304	46
W62-1 B	14	WRQ154	26	X 1 U 336	47
W62-1 BFC	14	WRQ172	26	X 1 U 33610	47
W62-1 FC	14	WRQ232	26	X 1 U 3362	47
W62D	14	WRQ352	26	X 1 U 33620	47
WR1010	17	WRQ698	26	X 1 U 33626	47
WR139	22	WRS152	26	X 1 U 33630	47
WR149	17	WRS154	26	X 1 U 3364	47
WR159	16	WRS172	26	X 1 U 33640	47
WR179	17	WRS232	26	X 1 U 4010	46
WR189	16	WRS352	26	X 1 U 402	46
WR199	17	WRS719	26	X 1 U 4020	46
WR219	17	WRS819	26	X 1 U 4030	46
WR229	17	WS 10	54	X 1 U 404	46
WR239	17	X 1 N 1010	45	X 1 U 4040	46
WR259	17	X 1 N 102	45	X 1 U 44	46
WR269	17	X 1 N 104	45	X 1 U102	46
WR279	16	X 1 N 2010	45	X 5 U 10	7
WR289	16	X 1 N 202	45	X 5 U 20	7
WR299	17	X 1 N 2020	45	X 5 U 266	7
WR319	18	X 1 N 204	45	X 5 U 30	7
WR339	18	X 1 N 3010	45	X 5 U 366	7
WR359	18	X 1 N 302	45	X 5 U 40	7
WR369	18	X 1 N 3020	45	Z 1 A 10	50
WR379	16	X 1 N 3030	45	Z 1 A 51	50
WR389	18	X 1 N 304	45	Z 2 A 10	52
WR399	16	X 1 N 4010	45	Z 2 A 51	52
WR419	16	X 1 N 402	45	Z 2 C 1	59
WR502	22	X 1 N 4020	45	ZB 954	23
WR699	20	X 1 N 4030	45	ZB 95410	23
WR715	19	X 1 N 404	45	ZB 95440	23
WR719	20	X 1 N 4040	45		
WR739	20	X 1 U 1010	46		
WR775	19	X 1 U 104	46		
WR779	20	X 1 U 2010	46		
WR799	20	X 1 U 202	46		
WR815	19	X 1 U 2020	46		
WR819	20	X 1 U 204	46		
WR835	19	X 1 U 22	46		
WR839	20	X 1 U 24	46		
WR875	19	X 1 U 266	47		
WR879	20	X 1 U 26610	47		
WR885	19	X 1 U 2662	47		
WR889	20	X 1 U 26620	47		
WR9	22	X 1 U 26630	47		
WR909	21	X 1 U 2664	47		
WR929	21	X 1 U 26640	47		
WR949	21	X 1 U 3010	46		
WR969	21	X 1 U 302	46		
WR989	21	X 1 U 3020	46		

Additional information

We reserve the right to make technical changes or modify the contents of this document without prior notice. With regard to purchase orders, the agreed particulars shall prevail. ABB AG does not accept any responsibility whatsoever for potential errors or possible lack of information in this document.

We reserve all rights in this document and in the subject matter and illustrations contained therein. Any reproduction, disclosure to third parties or utilization of its contents – in whole or in parts – is forbidden without prior written consent of ABB AG.



—
US

ABB Installation Products
Electrification Products division
860 Ridge Lake Blvd.
Memphis, TN 38120
+1 901-252-5000

tnb.abb.com