

GE Fastrac Program Service

—Fastrac A-Series® Panelboards:

Fastrac shipment of A-Series® Panelboards 125A – 800A is available for select main and branch breaker types. Shipments leave the factory as quickly as 24 hours after the order is placed. Contact your local GE sales office for more details.

—Fastrac Spectra® Series Panelboards:

Fastrac shipment of Spectra® Series Panelboards 250A – 1200A is available for select main and branch breaker types. Shipments leave the factory as quickly as 24 hours after the order is placed. Contact your local GE sales office for more details.

New from GE!

—Spectra® Series Integrated Submetering Panelboard: This new product integrates multi-tenant metering into a reliable Spectra® Series Powerpanel to reduce space and installation cost and time.

—FG as a Branch Device in Spectra® Series Panelboards: Our latest breaker technology now available as a branch device in our Spectra® Series Panelboard.

—A-Series® Lighting Control Panelboard Software: New software to make programming A-Series Lighting Control Panelboards easier and more user friendly.

A-Series® Panelboards

Applications.....9-3
 Types9-4
 Equipment Ratings9-5
 Circuit Breaker Interrupting Ratings.....9-6
 Fusible Switches Load and Interrupting Ratings9-8
 Merchandisable Kits and Sizing Information9-10
 Terminal Lugs9-11
 Pricing and Ordering.....9-13
 Sizing and Pricing9-14
 Product Options9-15
 Type AL (Plug-in).....9-17
 Type AQ (Bolt-on)9-26
 Type AE (Bolt-on).....9-35
 Type AL, AQ, AE – Main Molded Case Switch Interiors9-43
 Type AL, AQ, AE – Main Lighting Contactor Interiors.....9-44
 Type AL, AQ, AE – Main Molded Case Switch and Lighting Contactor Panel9-45
 Type AD9-48
 Accessories.....9-53
 Lighting Control Panel—Remote Operated
 Circuit Breakers9-55
 Pro-Stock Panelboards – Unassembled9-60
 Column – Type ALC (Plug-in).....9-66
 Column – Type AQC (Bolt-on)9-71
 Column – Type AEC (Bolt-on).....9-74
 Column – Type ALC, AQC, AEC – Main Molded Case Switch Interiors9-77
 Column – Type ALC, AQC, AEC – Main Molded Case Switch Panels9-78
 Column – Field Installed Kits/Replacement Parts/Enclosures.....9-79

Spectra® Series Panelboards

Factory Assembled Build-Up Pricing9-81
 PCU Selection.....9-91
 Circuit Breaker Options.....9-92
 Interior, Enclosure Options9-94
 Spectra® Series Integrated Submetering Panelboard.....9-96
 How to Size Boxes9-97
 Sizing Information.....9-98
 Replacement Boxes and Fronts.....9-99
 Accessories.....9-101
 Renewal Parts Modular Concept.....9-102
 Renewal Parts Circuit Breaker Sizing9-103
 Renewal Parts Product Number Structure9-104
 Renewal Parts – Mounting Hardware.....9-107
 Renewal Parts – Main Lug Modules;
 Neutral and Ground Kits.....9-112
 Renewal Parts – Accessories.....9-113
 Renewal Parts – Interiors, Boxes and Fronts.....9-114
 Renewal Parts – Type SCP Panelboards9-115
 Renewal Parts – Type CCB and QMR Panelboards.....9-116
Available Publications9-119



Publications and Reference: See Section 22 for a complete list of additional product-related publications

This page left blank intentionally.



Panelboards

A-Series® Panelboards

Applications

Standards

All GE panelboards meet the latest revision of the following standards.

- National Electrical Code-Ref. Article 384.
- UL67 panelboards: UL50 cabinets and boxes. UL943 GFCI.
- UL489 molded case circuit breakers. UL98 fusible switches.
- CSA or C-uL listing for Spectra® Series Power Panelboards.
- C-uL Listing for A-Series® non-service entrance panelboards
- International Building Code Seismic Zone 3 and 4.
- California Building Code Seismic Zone 4.

NOTE—only panelboards containing all UL Listed devices can be UL labeled.

- NEMA PB1.
- Federal Specifications
 - Panelboards, W-P-115c.
 - Type 1—Circuit breaker equipped
 - Class 1—Panelboards
 - Class 2—Load centers
 - Molded case circuit breakers, WC-375B/GEN.
 - Fusible switches, W-S-865c.

Application

The following classifications and limitations of panelboards have been established by the Underwriters Laboratories and the National Electrical Code. Note— “an overcurrent protective device is a circuit breaker pole or single fuse”. Panelboards have no fire wall ratings. All 50/60 Hz rated.

Panelboards

There is no limitation as to the number and rating of branch circuits, except as determined by available enclosures.

Service Entrance Equipment

- Must be located near the point of entrance of building supply conductors.
- Lighting and appliance panels must have one but not more than two main disconnects with a current rating equal to or less than panelboard rating.
- Distribution panels may have up to six operating handles to entirely disconnect panelboard from the source.
- Must include connector for bonding and grounding neutral conductor.
- A service entrance-type UL label will be factory installed or in kit form, when specified.

Interrupting Ratings—Circuit Breakers

Panelboards have integrated short circuit ratings. When fully rated, the rating is that of the lowest rated device in the panelboard. When series connected rated, the rating is that of the main device in panel (or remote line side protected device) and branch-tested/UL Listed combination. See table on page 9-6 for fully rated breakers. See DEH-40007 for Series Rated Breakers.

Short-Circuit Ratings—Fusible Switch Units

The interrupting rating of the fuse must equal or exceed the short-circuit rating of the switch. If it is lower, then the interrupting rating of the switch is the same as the fuse. Switches have no short-circuit rating if renewable fuses are used.

Seismic Ratings

All A-Series® Lighting Panels and Spectra® Power Panels have been tested and certified to meet the International Building Code (IBC) Zone 3 and Zone 4 as well as the California Building Code (CBC) Zone 4.



Panelboards

A-Series® Panelboards

Types

Section 9

Panelboard Types

Item	A-Series					Column Type Panels			Distribution Panels
	AL Pg. 9-17	AQ Pg. 9-26	AE Pg. 9-35	AD/AD Plus Pg. 9-48	Lighting Control Panel Pg. 9-55	ALC Pg. 9-66	AQC Pg. 9-70	AEC Pg. 9-74	Spectra Pg. 9-81
Max. Voltage	240Vac	240Vac	480V/277Vac ¹ 125/250Vdc	600Vac	480V/277Vac	240Vac	240Vac	480/277Vac 125/250Vdc	600Vac 250Vdc
Max. Main Lug Amperes	800A	800A	800A	800A	400A	225A	225A	225A	1200A
Max. Main Breaker or Switch Amperes	800A	800A	800A	800A	400A	225A	225A	225A	1200A
Main Devices	THQB, THHQB, TQD, THQD, TEY, TJD, TFJ		TEY, TFJ, TJJ	THED, TFJ, TJJ	TEY, SE, TFJ, SF, TJJ, SG	THQB, THHQB, TQD, THQD, TEY, TFJ, SE, SF		TEY, TFJ, SE, SF	SF, SG, SK, ADS Switches, FB, FC, FE, FG
Branches Max. Amps	100A	100A	100A	100A-1 ph, 2ph 150A-3 ph	100A	100A	100A	80A-8 1/2 Box 80A-7 1/2 Box	1200A
Branch Devices	THQL, THHQL	THQB, THHQB, TXQB (Bolt-on)	TEY	FB, TED, THED, SE	TEYRC, TEY, THQBGF	THQL, THHQL	THQB, THHQB, TXQB (Bolt on)	TEY	TED, SE, SF, SG, SK, THQB, THHQB, TEY, TQD, ADS Switches, FB, FC, FE, FG
Subfeeds Max. Amps (100% Rated)	225	225	225	225	225	150	150	150	—
Subfeed Breaker Types	TQD, THQD	TQD, THQD	TED, TFJ, SE, SF	TED, TFJ, SE, SF	TED, TFJ, SE, SF	TQD, THQD	TQD, THQD	TED	—

A-Series® Standard Main Breaker Types and Ratings

IC Ratings	Voltage	Panel Type																
		AQ/AL			AE / Lighting Control Panel						AD / AD Plus							
		100A	225A	400A ³	600A ³	800A ³	150A	225A	400A	600A	800A	150A	225A	400A	600A	800A		
10	240	THQB	TQD/TFJ	SKHAB														
22	240	THHQB	THQD	TJD	SGHA6													
65	240	TEY	SFHA	SGHA4	SGHA6	SFHA ⁴		SGHA4 ⁴	SGHA6									
100	240	SEL	SFL	SGL	SGL6													
200	240	SEP	SFP	SGPA4														
14 ²	480V/277						TEY ⁴	TFJ ⁴	SGHA/TJJ ⁴	SGHA6	SKHAB	TED	TFJ	TJJ				
35	480V/277											SEHA	SFHA	SGHA4	SGHA6			
18																	SKHAB	
25							SEHA ⁴	SFHA ⁴										
65	480V/277						SELA ⁴	SFLA ⁴	SGLA4	SGLA6								
100	480V/277						SEPA ⁴	SFPA										
14 ²	480											TED	TFJ	TJJ	SGHA6			
65	480											SELA	SFLA	SGLA4	SGLA6			
100	480											SEPA	SFPA	SGPA4	SGLA6			
18 ²	600											THED	TFJ	TJJ	SGHA6	SKHAB		
25	600											SELA	SFLA	SGHA4	SGHA6			
35k ²	600V/347											SEPA	SFPA	SGPA4	SGPA6			

¹AE Panels are suitable for use on 3-PH, 3W applications when derived from 3PH, 4W 480V/277 service where the neutral is not connected to the panel. For 3ph-Delta use AD Panels.

²Not series rated.

³Not available in column panelboards.

⁴Light Control Panel ratings.



Panelboards

A-Series® Panelboards

Equipment Ratings

A-Series® Panels—For Expanded Ratings

Panel Type	System Voltage (Maximum)	UL Series ¹ Connected Rating rms Symmetrical Amps (in Thousands)		Type	Branch		Fully Rated ² Equipment Rating rms Symmetrical Amps (in Thousands)
		SEP, SFP, SGP Main 400A Max.	SEL, SFL, SGL 600A Max.		No. Poles	Ampere Rating	
AL	120/240Vac	200	85	THQL/THHQL-GF	1,2	15-30	10/22
				THQL/THHQL	1,2	15-100	10/22
				TXQL	1,2	15-30	65
	240Vac			THQL/THHQL	2,3	15-100	10/22
				TXQL	3	15-30	65
				TQD/THQD	2,3	125-225	10/22
AQ	120/240Vac	200	85	THQB/THHQB-GF	1,2	15-30	10/22
				THQB/THHQB	1,2	15-100	10/22
				TXQB	1,2	15-30	65
	240Vac			THQB/THHQB	2,3	15-100	10/22
				TXQB	3	15-30	65
				TQD/THQD	2,3	125-225	10/22
AE	240Vac	200	85	TEY	1,2,3	15-100	65
				THED	2,3	15-30	65
				SF	2,3	125-225	65
	480Y/277Vac			TEY	1,2,3	15-100	14/25
				TED	2,3	110-150	14
				TFJ	2,3	125-225	14
AD/AD Plus	480Vac	100	65	TED/FB/SE/SF	1,2,3	15-225	65
	600/377Vac	35	35	TED/FB/SE/SF	1,2,3	15-225	35

Column Type A-Series® Panels

Panel Type	System Voltage (Maximum)	UL Series ¹ Connected Rating rms Symmetrical Amps (in Thousands)		Type	Branch		Fully Rated ² Equipment Rating rms Symmetrical Amps (in Thousands)
		SEL, SFL 225A Max.			No. Poles	Ampere Rating	
ALC	120/240Vac	85		THQL/THHQL	1,2	15-30	10/22
				THQL/THHQL	1,2	15-100	10/22
				TXQL	1,2	15-30	65
	240Vac			THQL/THHQL	2,3	15-100	10/22
				TXQL	3	15-30	65
				TQD/THQD	2,3	125-150	10/22
AQC	120/240Vac	85		THQB/THHQB-GF	1,2	15-30	10/22
				THQB/THHQB	1,2	15-100	10/22
				TXQB	1,2	15-30	65
	240Vac			THQB/THHQB	2,3	15-100	10/22
				TXQB	3	15-30	65
				TQD/THQD	2,3	125-150	10/22
AEC	480Y/277Vac	65		TEY	1,2,3	15-80 ³	14
				TED	2,3	110-150	14

¹Applicable to panelboards with either local or remote main circuit breaker(s) - 400A maximum standard A-Series; 225A maximum Column Type. See DET-008 for complete Series Ratings listings.

²Fully rated equipment rating is equal to the lowest interrupting rating of any circuit breaker installed.

³80A max. with #3-60°C wire max.



Publications and Reference: See Section 22 for a complete list of additional product-related publications

Panelboards

A-Series® Panelboards

Circuit Breaker Interrupting Ratings

Fully Rated

Section 9

Molded Case Circuit Breakers Interrupting Ratings

Molded Case Circuit Breakers						UL Listed Interrupting Ratings in Thousand Amps rms Symmetrical												
Construction	Frame	Trip Range (Amps)	No. Poles	Rated Volts		Federal Specs C/B Class W-C-375B	ac Volts								dc volts			
				ac	dc		120	120/240	240	277	347	480Y/277	480	600Y/347	600	125	250	
HQ Frames	THQB, THQL	15-70	1	120/240	—	12a	10	10	—	—	—	—	—	—	—	—	—	
		15-125	2	120/240	—	12a	—	10	—	—	—	—	—	—	—	—	—	
		15-100	2, 3	240	—	12b	—	—	10	—	—	—	—	—	—	—	—	
HHQ Frames	THHQL, THHQB	15-70	1	120/240	—	14a	22	22	—	—	—	—	—	—	—	—	—	
		15-125	2	120/240	—	14a	—	22	—	—	—	—	—	—	—	—	—	
		15-100	2, 3	240	—	14b	—	—	22	—	—	—	—	—	—	—	—	
XQ Frames	TXQL, TXQB	15-30	1, 2	120/240	—	15a	—	65	—	—	—	—	—	—	—	—	—	
		15-30	3	240	—	15b	—	—	65	—	—	—	—	—	—	—	—	
Standard Frames	TEY	15-100	1	277	125	—	—	—	65	14	—	—	—	—	—	10	—	
		15-100	2, 3	480Y/277	250	—	—	—	65	—	14	—	—	—	—	—	10	
	TEB	15-100	1	120	125	12a	10	10	—	—	—	—	—	—	—	—	5	—
		15-100	2	240	250	12b	—	—	10	—	—	—	—	—	—	—	—	5
	TEB	15-100	3	240	—	12b	—	—	10	—	—	—	—	—	—	—	—	—
		15-100	3	240	—	12b	—	—	10	—	—	—	—	—	—	—	—	—
	TED ¹	15-100	1	277, 347	125	13a	—	—	—	14	10	—	1	—	—	10	—	
	TED4	15-100	2	480	250	13b	—	—	18	—	—	—	18	—	—	—	10	
	TED4	15-150	3	480	—	13b	—	—	18	—	—	—	18	—	—	—	—	
	TED6	15-100	3	600	—	18a	—	—	18	—	—	—	18	—	14	—	—	
	TED6	110-150	3	600	—	N/A	—	—	18	—	—	—	18	—	14	—	—	
	SEH	15-150	2, 3	600	—	—	—	—	65	—	—	—	25	—	18	—	—	
	TQD	125-225	2, 3	240	—	12b	—	—	10	—	—	—	—	—	—	—	—	
	TFJ	70-225	2	480	250	20a	—	—	25	—	—	—	22	—	—	—	10	
	TFK	70-225	2	480	250	20a	—	—	25	—	—	—	22	—	—	—	10	
	TFJ	70-225	3	600	—	20a	—	—	25	—	—	—	22	—	18	—	—	
	TFK	70-225	3	600	—	20a	—	—	25	—	—	—	22	—	18	—	—	
	SFH	70-250	3	600	—	20a, 22a	—	—	65	—	—	—	35	—	18	—	—	
	TJD	250-400	2, 3	240	250 ²	14b	—	—	22	—	—	—	—	—	—	—	—	10
	SGH4	125-400	2, 3	600	—	21a	—	—	65	—	—	—	35	—	25	—	—	
SGH6	250-600	2, 3	600	—	—	—	—	65	—	—	—	35	—	25	—	—		
SKH8	300-800	3	600	—	21a, 23a	—	—	65	—	—	—	35	—	25	—	—		
SKH12	600-1200	3	600	—	21a, 23a	—	—	65	—	—	—	35	—	25	—	—		
Hi-Break Frames	THED ¹	15-30	1	347	125	13a	—	—	—	65	18	—	—	—	—	20 ³	—	
		15-100	2	480	250	22a	—	—	65	—	—	—	25	—	—	—	20 ³	
	THED4	110-150	3	480	—	—	—	—	42	—	—	—	25	—	—	—		
	THED6	15-100	3	600	—	22a	—	—	65	—	—	—	25	—	18	—	—	
	THED6	110-150	3	600	—	N/A	—	—	42	—	—	—	25	—	18	—	—	
	THQD	125-225	2, 3	240	—	N/A	—	—	22	—	—	—	—	—	—	—	—	
	THFK	70-225	2, 3	600	250 ²	20a	—	—	65	—	—	—	25	—	18	—	20 ³	
	THJK4	125-400	2, 3	600	250 ²	23a	—	—	65	—	—	—	35	—	25	—	20 ³	
	THJK6	250-600	2, 3	600	250 ²	23a	—	—	65	—	—	—	35	—	25	—	20 ³	
	THKM8	300-800	2, 3	600	250 ²	23a	—	—	65	—	—	—	35	—	25	—	20 ³	
THKM12	600-1200	2, 3	600	—	23a	—	—	65	—	—	—	35	—	25	—	—		

¹TED/THED, IP-347V-30A Max., device is suitable for 10kAIC at 480 Vac, but not labeled or listed.

²3-pole devices are not dc rated.

³DC ratings above 10,000 AIC are not UL Listed.



Panelboards

A-Series® Panelboards

Circuit Breaker Interrupting Ratings

Fully Rated

Molded Case Circuit Breakers Interrupting Ratings (Continued)

Molded Case Circuit Breakers							UL Listed Interrupting Ratings in Thousand Amps rms Symmetrical										
Construction	Frame	Trip Range (Amps)	No. Poles	Rated Volts		Federal Specs C/B Class W-C-375B	ac Volts						dc volts				
				ac	dc		120	120/240	240	277	347	480Y/277	480	600Y/347	600	125	250
Current Limiting Circuit Breakers	FBV6	15-100	1	347	—	13a,13b, 14a	35	—	—	35	22	—	—	—	—	—	—
	FBN6	15-100	1	347	—	13a,13b, 14a	65	—	—	65	25	—	—	—	—	—	—
	FBH6	15-100	1	347	—	13a,13b, 14a	100	—	—	100	35	—	—	—	—	—	—
	FBL6	15-100	1	347	—	13a,13b, 14a	100	—	—	100	42	—	—	—	—	—	—
	FBV6	15-100	2,3	600	250	21a, 22a	—	—	65	—	—	—	35	22	—	—	25 ¹
	FBN6	15-100	2,3	600	250	21a, 22a, 23a	—	—	150	—	—	—	65	25	—	—	30 ¹
	FBH6	15-100	2,3	600	250	21a, 22a, 23a	—	—	200	—	—	—	100	35	—	—	42 ¹
	FBL6	15-100	2,3	600	250	21a, 22a, 23a	—	—	200	—	—	—	150	42	—	—	65 ¹
	FCS6	15-100	2,3	600	250	20a	—	—	42	—	—	—	25	18	—	—	22 ¹
	FCV6	15-100	2,3	600	250	21a, 22a	—	—	65	—	—	—	35	22	—	—	25 ¹
	FCN6	15-100	2,3	600	250	21a, 22a, 23a	—	—	150	—	—	—	65	25	—	—	30 ¹
	FCH6	15-100	2,3	600	250	21a, 22a, 23a	—	—	200	—	—	—	100	35	—	—	42 ¹
	FCL6	15-100	2,3	600	250	21a, 22a, 23a	—	—	200	—	—	—	150	42	—	—	65 ¹
	SEL	15-150	2,3	600	—	—	—	—	100	—	—	—	65	—	25	—	—
	SEP	15-150	2,3	600	—	—	—	—	200	—	—	—	100	—	25	—	—
	SFL	70-250	2,3	600	—	—	—	—	100	—	—	—	65	—	25	—	—
	SFP	70-250	2,3	600	—	—	—	—	200	—	—	—	100	—	25	—	—
	SGL	250-600	2,3	600	—	—	—	—	100	—	—	—	65	—	65	—	—
	SGP	250-600	2,3	600	—	—	—	—	200	—	—	—	100	—	65	—	—
	FGV2	125-250	2,3	600	250	21a, 22a	—	—	65	—	—	—	35	—	22	—	—
	FGN2	125-250	2,3	600	250	23a	—	—	150	—	—	—	65	—	35	—	—
	FGH2	125-250	2,3	600	250	24a	—	—	200	—	—	—	100	—	42	—	—
	FGL2	125-250	2,3	600	250	25a	—	—	200	—	—	—	150	—	65	—	—
	FGP2	125-250	2,3	600	250	25a	—	—	200	—	—	—	200	—	65	—	—
	FGV4	250-400	2,3	600	250	21a, 22a	—	—	65	—	—	—	35	—	22	—	—
	FGN4	250-400	2,3	600	250	23a	—	—	150	—	—	—	65	—	35	—	—
	FGH4	250-400	2,3	600	250	24a	—	—	200	—	—	—	100	—	42	—	—
	FGL4	250-400	2,3	600	250	25a	—	—	200	—	—	—	150	—	65	—	—
	FGP4	250-400	2,3	600	250	25a	—	—	200	—	—	—	200	—	65	—	—
	FGV6	375-600	2,3	600	250	21a, 22a	—	—	65	—	—	—	35	—	22	—	—
	FGN6	375-600	2,3	600	250	23a	—	—	150	—	—	—	65	—	35	—	—
	FGH6	375-600	2,3	600	250	24a	—	—	200	—	—	—	100	—	42	—	—
FGL6	375-600	2,3	600	250	25a	—	—	200	—	—	—	150	—	65	—	—	
FGP6	375-600	2,3	600	250	25a	—	—	200	—	—	—	200	—	65	—	—	
SKL	300-1200	3	600	—	—	—	—	100	—	—	—	65	—	42	—	—	
SKP	300-1200	3	600	—	—	—	—	200	—	—	—	100	—	65	—	—	
Fused Current Limiting Frames	TB4	125-400	2,3	600	—	26a	—	—	200 ²	—	—	—	200 ²	—	200 ²	—	—
	TB6	300-600	3	600	—	26a	—	—	200 ²	—	—	—	200 ²	—	200 ²	—	—
	TB8	600-800	3	600	—	26a	—	—	200 ²	—	—	—	200 ²	—	200 ²	—	—

¹Utilizing 2 poles in series on one leg

²UL Listed for only 100,000 AIC when internally mounted accessories are used.



Panelboards

A-Series® Panelboards

Fusible Switches Load and Interrupting Ratings

Short Circuit Ratings—Fusible Switch Units (Plug-In Only)

UL Class	Available Amp Rating	Maximum Short-Circuit Rating in Sym. rms Amps	Max. Voltage	Application
H	30-600	10,000	250/600	One-time general purpose
J	30-600	200,000	600	Fast-acting rejection sizing mains & feeders, current limiting
K	30-600	50,000	250/600	Dual element no rejection means, motor starting current limiting
		100,000		
		200,000		
L	800-1200	200,000	600	Rejection means available in two forms
				Fast-acting mains & feeders
R	30-600	100,000	250/600	Time-delay motor starting current limiting
		200,000		Dual element rejection means, motor starting current limiting
T	100-600	200,000	250/600	Fast-acting small physical size mains & feeders, current limiting

Panelboard Terminal Lugs - Main Lugs² and Neutral Incoming Lugs

Lighting Panels (A-Series®)

Panelboard		Terminal Lugs (Cu-Al)		
Types	Max. Main Bus Rating in Amps	No. Per	Wire (Cu-Al)	
			No. Per Lug	Range
AL AQ AE AD	125	1	1	#14-2/0
	225	1	1	#6-350kcmil
	400	1	1	#4-600kcmil or 1/0-250kcmil
	600	1	2	2/0-500 mcm
	800	2	2	3/0-500 mcm

²Additional lug sizes available using oversize items.

200% Neutral Lugs

125A - (2) - #14-2/0

225A - (2) - #6-250 MCM

400A - (2) - #4-600 MCM

600A - (4) - #4-600 MCM

Branch Neutral Lugs

Small Holes #14-#4

Large Holes #14-2/0

Column Type Panels

Panelboard		Terminal Lugs (Cu-Al)		
Types	Max. Main Bus Rating in Amps	No. Per	Wire (Cu-Al)	
			No. Per Lug	Range
ALC	100	1	1	#6-2/0
AQC AEC	225	1	1	#6-350kcmil

Maximum Horsepower Ratings¹ ADS Fusible Switch

Rating in Amps ¹	Volts, ac						Volts, dc		
	2-Pole			3-Pole			2-Pole	2-Pole	
	120	240	480	600	240	480	600	125	250
With Standard Fuses									
30	1/2	1 1/2	3	3	3	5	7 1/2	2	5
60	1 1/2	3	5	10	7 1/2	15	15	5	10
100	—	7 1/2	10	15	15	25	30	—	20
200	—	15	25	30	25	50	60	—	40
400	—	—	—	—	50	100	125	—	50
600	—	—	—	—	75	150	200	—	50
With "Time-delay" Fuses									
30	2	3	7 1/2	10	7 1/2	15	20	3	—
60	3	10	20	25	15	30	50	—	—
100	—	15	30	40	30	60	75	—	—
200	—	15	50	50	60	125	150	—	—
400	—	—	—	—	125	250	350	—	—
600	—	—	—	—	200	400	500	—	—

¹Ratings are based on latest revision of the National Electrical Code Article 430. Horsepower ratings for switches with Standard Class H fuses are based on one-time fuses having minimum time-delay. When time-delay fuses are used, the horsepower ratings are maximum for the switches.

Spectra® Optional Main Lug Terminations

	# Wires Per Lug	Max. # Lugs Per Phase		
		250-600A	800A 1200A 21"	800A 1200A 27"
CU/AL Mechanical				
#6-350 kcmil	1	2	2	4
#2-500 kcmil	2	2	2	4
#2-600 kcmil	2	2	2	4
3/0 750 kcmil	2	2	2	4
CU/AL Compression ³				
1/0	1	4	4	8
2/0	1	4	4	8
3/0	1	4	4	8
4/0	1	4	4	8
250 kcmil	1	4	4	8
300 kcmil	1	4	4	8
350 kcmil	1	4	4	8
400 kcmil	1	4	4	8
500 kcmil	1	4	4	8
600 kcmil	1	4	4	8
750 kcmil	1	4	4	8

³Not available on 19" main lug module.



Panelboards

A-Series® Panelboards

Fusible Switches Load and Interrupting Ratings

Spectra® Series Neutral Kits

- Includes mechanical lugs and bonding strap.
- 250 to 600A neutral kits can be converted to dual main version by doubling the main lug quantity using lug kits (see Accessories).
- Main lug on neutral kit can be converted to compression main using AMKP lug kit.

Amps	Standard Neutral (Single Main Lug) ⁴				Dual Main Neutral ⁵			
	Product Number	List Price, GO-103C	Accepts Wire Qty.	Accepts Wire Size (Cu/Al)	Product Number	List Price, GO-103C	Accepts Wire Qty.	Accepts Wire Size (Cu/Al)
250	ANKN400	\$237.00	2 (Main)	#2 - 600kcmil	ANKN400	\$237.00	2 (Main)	#2 - 600kcmil
			16	#14 - 2/0			16	#14 - 2/0
			5	#6 - 300kcmil			5	#6 - 300kcmil
			24	#14 - #4			24	#14 - #4
400	ANKN400	\$237.00	2 (Main)	#2 - 600kcmil	ANKN120	\$555.00	8 (Main)	#2 - 600kcmil
			16	#14 - 2/0			9	#14 - 2/0
			5	#6 - 300kcmil			10	#6 - 300kcmil
			24	#14 - #4			10	#14 - #4
600	ANKN120	\$555.00	8 (Main)	#2 - 600kcmil	ANKN120	\$555.00	8 (Main)	#2 - 600kcmil
			9	#14 - 2/0			9	#14 - 2/0
			10	#6 - 300kcmil			10	#6 - 300kcmil
			10	#14 - #4			10	#14 - #4
800	ANKN120	\$555.00	8 (Main)	#2 - 600kcmil	ANK800D	\$664.00	8 (Main)	#2 - 500kcmil
			9	#14 - 2/0			8	#14 - 2/0
			10	#6 - 300kcmil			10	#6 - 300kcmil
			10	#14 - #4			4	#2 - 500kcmil
1200	ANKN120	\$555.00	8 (Main)	#2 - 600kcmil	ANK120D	\$757.00	8 (Main)	#2 - 500kcmil
			9	#14 - 2/0			8	#14 - 2/0
			10	#6 - 300kcmil			10	#6 - 300kcmil
			10	#14 - #4			4	#2 - 500kcmil

⁴For 3ph, 4W single-section panelboards, use a standard neutral.

⁵For 3ph, 4W multi-section panelboards, use a standard neutral on the last section, and a dual main neutral on the first and middle sections.



Panelboards

A-Series® Panelboards

Merchandisable Kits and Sizing Information

Section 9

Spectra® Series Type ANKN/ANK/ANKT Neutral Kits

Amps (N = Neutral, GF = Ground Fault)	Box Width	Main	Lug Type	Ground Fault	Product Number
250A Single & Dual	27-36"	Single/Dual	Mechanical	No	ANKN400 ¹
	27-36"	Single	Mechanical	No	ANK250 ²
	27-36"	Dual	Mechanical	No	ANK250D ²
	36"	Single	Crimp Main & Feeders	No	ANK250C
	36"	Dual	Crimp Main & Feeders	No	ANK250DC
250A 200%N	36"	Single/Dual	Mechanical	No	ANKN120 ¹
	36"	Single	Mechanical	No	ANKT36250 ²
	36"	Dual	Mechanical	No	ANKT36250D ²
400A Single & Dual	27-44"	Single	Mechanical	No	ANKN400 ¹
	27-44"	Single	Mechanical	No	ANK400 ²
	27-44"	Single	Mechanical	No	ANKCU400 ⁴
	27-44"	Dual	Mechanical	No	ANKN120 ¹
	27-44"	Dual	Mechanical	No	ANK400D ²
	36-44"	Single	Crimp Main & Feeders	No	ANK400C
	36-44"	Dual	Crimp Main & Feeders	No	ANK400DC
400A GF	27-44"	Single	Mechanical	Yes	ANK400GF
	36-44"	Single	Crimp Main, Mech. Feeders	Yes	ANK400GFCM
400A 200%N	36-44"	Single/Dual	Mechanical	No	ANKN120 ¹
	36"	Single	Mechanical	No	ANKT36400 ²
	40"	Single	Mechanical	No	ANKT40400 ²
	44"	Single	Mechanical	No	ANKT44400 ²
	36"	Dual	Mechanical	No	ANKT36400D ²
	40"	Dual	Mechanical	No	ANKT40400D ²
	44"	Dual	Mechanical	No	ANKT44400D ²
600A Single & Dual	27-44"	Single/Dual	Mechanical	No	ANKN120 ¹
	27-44"	Single	Mechanical	No	ANK600 ²
	27-44"	Dual	Mechanical	No	ANK600D ²
	36-44"	Single	Crimp Main & Feeders	No	ANK600C
	36-44"	Dual	Crimp Main & Feeders	No	ANK600DC
600A GF	27-44"	Single	Mechanical	Yes	ANK600GF
	36-44"	Single	Mechanical	No	ANKN120 ¹
600A 200%N	36"	Single	Mechanical	No	ANKT36600 ²
	40"	Single	Mechanical	No	ANK40600 ²
	44"	Single	Mechanical	No	ANK44600 ²
	36"	Dual	Mechanical	No	ANKT36600D
	40"	Dual	Mechanical	No	ANKT40600D
	44"	Dual	Mechanical	No	ANKT44600D
	800A Single & Dual	31-44"	Single	Mechanical	No
31-44"		Single	Mechanical	No	ANK800 ²
31-44"		Dual	Mechanical	No	ANK800D ³
36-44"		Single	Crimp Main & Feeders	No	ANK800C
36-44"		Dual	Crimp Main & Feeders	No	ANK800DC ³
31-44"		Single	Mechanical	Yes	ANK800GF ³
36-44"		Single	Crimp Main & Feeders	Yes	ANK800GFC ³
800A GF	36"	Single	Mechanical	No	ANKT36800 ³
	40"	Single	Mechanical	No	ANKT40800 ³
	44"	Single	Mechanical	No	ANKT44800 ³
	36"	Dual	Mechanical	No	ANKT36800D ³
	40"	Dual	Mechanical	No	ANKT40800D ³
1000A GF	44"	Dual	Mechanical	No	ANKT44800D ³
	31-44"	Single	Mechanical	Yes	ANK100GF ³
	36-44"	Single	Crimp Main & Feeders	Yes	ANK100GFC ³
1200A Single & Dual	31-44"	Single	Mechanical	No	ANKN120 ¹
	31-44"	Single	Mechanical	No	ANKNCU120 ⁴
	31-44"	Single	Mechanical	No	ANK120 ²
	31-44"	Dual	Mechanical	No	ANK120D ³
	31-44"	Dual	Mechanical	No	ANKNCU120D ⁴
	36-44"	Single	Crimp Main & Feeders	No	ANK120C
	36-44"	Dual	Crimp Main & Feeders	No	ANK120DC ³
1200A GF	31-44"	Single	Mechanical	Yes	ANK120GF ³
	36-44"	Single	Crimp Main & Feeders	Yes	ANK120GFC ³
1200A 200%N	36"	Single	Mechanical	No	ANKT36120 ³
	40"	Single	Mechanical	No	ANKT40120 ³
	44"	Single	Mechanical	No	ANKT44120 ³
	36"	Dual	Mechanical	No	ANKT36120D ³
	40"	Dual	Mechanical	No	ANKT40120D ³
	44"	Dual	Mechanical	No	ANKT44120D ³

¹Wire range #2AWG through 600 kcmil.

²Wire range above 600 kcmil.

³These neutrals require the 29 inch "A" gutters in the 75" and 96" high enclosures (75 High-23X or 96 High-38X)

⁴Material = Copper main lugs, copper feeder.



Panelboards

A-Series® Panelboards

Terminal Lugs

Spectra® Series Main Lugs Top or Bottom Feed 240 Vac and 600 Vac, 200-1200 Amperes

Main Lug Kits (Factory Installed and/or Merchandise Panelboards)

- Kit bolts directly to interior bus bars (either APN Plug-In Style or APNB Bolt-On Style).
- Can be used for feed-through lug application by replacing standard cover plate with AFL feed-through cover plate kit (See Accessories).
- F suffix indicates all AFPML cover plates are included to fit applicable box widths. If cover plates are not necessary, remove the F suffix.
- For 2 pole applications, replace the third digit or numeral “3” in the product number with the number “2”.
- Aluminum mechanical lugs can be converted to copper by replacing the first from last digit from an A to a C.

Standard Main Lug Kit (Mechanical Lugs)

Main Amps	Single or Dual Configuration	Module "X" Height	Product Number	List Price, GO-103C	Lugs Incl. Per Phase	Wires Per Lug	Wire Range (Cu/Al ¹)	Cover Plate Kit Included Product Number	List Price, GO-148F	Min. Box Width
250	Single & Dual	4X	AMB3600MAF	\$1261.00	1	2	8-500kcmil(1) 2/0-600kcmil(1)	AFPML4X	\$137.00	27"
400	Single	4X	AMB3600MAF	\$1261.00	1	2	8-500kcmil(1) 2/0-600kcmil(1)	AFPML4X	\$137.00	27"
	Dual	4X	AMB3120MAF	\$2092.00	1	4	2/0-600kcmil(4)	AFPML4X	\$137.00	27"
600	Single	4X	AMB3600MAF	\$1261.00	1	2	8-500kcmil(1) 2/0-600kcmil(1)	AFPML4X	\$137.00	27"
	Dual	4X	AMB3120MAF	\$2092.00	1	4	2/0-600kcmil(4)	AFPML4X	\$137.00	27"
800	Single	4X	AMB3120MAF	\$2092.00	1	4	2/0-600kcmil(4)	AFPML4X	\$137.00	31"
	Dual	4X	AMB3120DMAF	\$2450.00	1	8	2/0-600kcmil(8)	AFPML4X	\$137.00	36"
1200	Single	4X	AMB3120MAF	\$2092.00	1	4	2/0-600kcmil(4)	AFPML4X	\$137.00	31"
	Dual	4X	AMB3120DMAF	\$2450.00	1	8	2/0-600kcmil(8)	AFPML4X	\$137.00	36"

¹Copper lugs can only be used with copper wire

Compression Main Lug Kit

Main Amps	Single or Dual Configuration	Module "X" Height	Product Number	List Price, GO-103C	Lugs Incl. Per Phase	Wires Per Lug	Wire Range (Cu/Al)	Cover Plate Kit Included Product Number	List Price, GO-148F	Min. Box Width
250	Single	6X	AMB3250CAF	\$729.00	1	2	350 kcmil	AFPML6X	\$137.00	36"
	Dual	6X	AMB3250DCAF	\$908.00	2	1	350 kcmil	AFPML6X	\$137.00	36"
400	Single	6X	AMB3600CAF	\$1261.00	2	1	500 kcmil	AFPML6X	\$137.00	36"
	Dual	6X	AMB3600DCAF	\$1067.00	4	1	500 kcmil	AFPML6X	\$137.00	36"
600	Single	6X	AMB3600CAF	\$1261.00	1	2	500 kcmil	AFPML6X	\$137.00	36"
	Dual	6X	AMB3600DCAF	\$1067.00	4	1	500 kcmil	AFPML6X	\$137.00	36"
800	Single	6X	AMB3800CAF	\$1531.00	3	1	500 kcmil	AFPML6X	\$137.00	36"
	Dual	6X	AMB3800DCAF	\$1889.00	6	1	500 kcmil	AFPML6XW	\$137.00	36"
1200	Single	6X	AMB3120CAF	\$2092.00	4	1	500 kcmil	AFPML6X	\$137.00	36"
	Dual	6X	AMB3120DCAF	\$2450.00	8	1	500 kcmil	AFPML6XW	\$137.00	36"

Provisional Main Lug Kit

Main Amps	Single or Dual Configuration	Module "X" Height	Product Number	List Price, GO-103C	Max. Wires Per Phase	Cover Plate Kit Included Product Number	List Price, GO-103C	Min. Box Width
250	Single	6X	AMB3120NF	\$2092.00	4	AFPML6X	\$137.00	36"
	Dual	6X	AMB3120NF	\$2092.00	4	AFPML6X	\$137.00	36"
400	Single	6X	AMB3120NF	\$2092.00	4	AFPML6X	\$137.00	36"
	Dual	6X	AMB3120NF	\$2092.00	4	AFPML6X	\$137.00	36"
600	Single	6X	AMB3120NF	\$2092.00	4	AFPML6X	\$137.00	36"
	Dual	6X	AMB3120NF	\$2092.00	4	AFPML6X	\$137.00	36"
800	Single	6X	AMB3120NF	\$2092.00	4	AFPML6X	\$137.00	36"
	Dual	6X	AMB3120DNF	\$2450.00	8	AFPML6XW	\$137.00	36"
1200	Single	6X	AMB3120NF	\$2092.00	4	AFPML6X	\$137.00	36"
	Dual	6X	AMB3120DNF	\$2450.00	8	AFPML6XW	\$137.00	36"



Publications and Reference: See Section 22 for a complete list of additional product-related publications

Panelboards A-Series® Panelboards Terminal Lugs

Section 9

Molded Case Circuit Breakers

Circuit Breaker Frame					Terminal Lugs (Cu-Al)				
Standard	Hi-Break	Tri-Break®	Current Limiting	High Interrupting	Poles	No. Per Pole	Product Number	Wire—Cu-Al (Unless otherwise noted)	
								Per Lug	Range
THQL	TXQL, THHQL	—	—	—	1,2,3	1	Fixed to Breaker Terminal	1	(15-30A) #14-4 Cu or #12-4 Al (35-100A) #14-1/0 Cu or #12-1/0 Al
THQB	TXQB, THHQB	—	—	—	1,2,3			1	(15-25A) #14-#12 Cu or #12-#10 Al (30-60A) #10-#6 Cu or #8-#4 Al (70-100A) #4-#1 Cu or #2-1/0 Al
TEY	—	—	—	—	1,2,3			1	(15-20A) #14-#12 Cu or #10-#12 Al (35-60A) #10-#6 Cu or #8-#4 Al (70-100A) #4-#1 Cu or #2-1/0 Al
TEB	—	—	—	—	1,2,3	1	TCAL14	1	(15-30A, TCAL14)-#14-8
TED	THED ¹	—	—	—	1			TCAL12	(30-60A, TCAL12)-#14-3 Cu, #12-1 Al
TED4	—	—	—	—	2-3			TCAL12A	(70-90A, TCAL12A)-#6-2/0 Cu, #4-2/0 Al
TED6	THED	—	—	—	2-3			TCAL15	(100-150A, TCAL15)-#3-3/0
—	—	—	FVB FBN FBH FBL	—	1,2,3	1	FCAL12 FCAL13 FCAL14	1	(15-20A) #14-#12 Cu or #10-#12 Al (35-60A) #10-#6 Cu or #8-#4 Al (70-100A) #4-#1 Cu or #2-1/0 Al
—	—	—	FCS FCV FCN FCH FCL	—	2,3			1	FCALK12 FCALK13 FCALK14
SEDA	SEHA	—	SELA SEPA	—	2-3	1	TCAL18	1	#12-3/0 Cu, #12-3/0 Al
—	—	—	FES1T FEV1T FEN1T FEH1T FEL1T	—	2-3	1	FCALK15	1	#12-3/0 Cu, #14-1/0 Al
—	—	—	FES1E FEV1E FEN1E FEH1E FEL1E	—	2-3	1	FCALK15	1	#12-3/0 Cu, #14-1/0 Al
TQD	THQD	—	—	—	2-3	1	TCAL25	1	#1-300kcmil
SFHA	—	—	SFLA SFPA	—	2-3	1	TCAL29	1	#8-350kcmil
TFJ, TFK	THFK	—	—	—	2-3	1	TCAL24, 26	1	#4-300kcmil
—	—	—	FES2T FEV2T FEN2T FEH2T FEL2T	—	2-3	1	FCALK16	1	#8-250kcmil Cu, #8-250kcmil
—	—	—	FES2E FEV2E FEN2E FEH2E FEL2E	—	2-3	1	FCALK16	1	#8-250kcmil Cu, #8-250kcmil
SGDA	—	—	SGL	—	2	1	TCLK265 ²	—	2/2/0-400kcmil Cu) or 2/2/0-500kcmil Al) or #6-600kcmil
SGHA	—	—	SGP	—	3	1	TCLK365 ²	—	2/2/0-400kcmil Cu) or 2/2/0-500kcmil Al) or #6-600kcmil
—	—	—	FGV2	—	2-3	1	FCALK318H	—	Top hole #8-400kcmil Cu or #6-500kcmil Al Bottom hole #2/0-600kcmil Cu & Al
—	—	—	FGN2 FGH2 FGL2 FGP2	—	2-3	1	FCALK318H	—	Top hole #8-400kcmil Cu or #6-500kcmil Al Bottom hole #2/0-600kcmil Cu & Al
—	—	—	FGV4	—	2-3	1	FCALK318H	—	Top hole #8-400kcmil Cu or #6-500kcmil Al Bottom hole #2/0-600kcmil Cu & Al
—	—	—	FGN4 FGH4 FGL4 FGP4	—	2-3	1	FCALK318H	—	Top hole #8-400kcmil Cu or #6-500kcmil Al Bottom hole #2/0-600kcmil Cu & Al
—	—	—	FGV6	—	2-3	1	FCALK318H	—	Top hole #8-400kcmil Cu or #6-500kcmil Al Bottom hole #2/0-600kcmil Cu & Al
—	—	—	FGN6 FGH6 FGL6 FGP6	—	2-3	1	FCALK318H	—	Top hole #8-400kcmil Cu or #6-500kcmil Al Bottom hole #2/0-600kcmil Cu & Al
TJJ, TJK4	THJK4	TB4	—	—	2-3	1	TCAL43	1	#6-600kcmil or 2-/2/0-250kcmil
TJD	—	—	—	—	2-3	1	TCAL43	1	#6-600kcmil or 2-/2/0-250kcmil
TJK6	THJK6, THJ4V	—	—	—	2-3	1	TCAL43	1	#6-600kcmil or 2-/2/0-250kcmil
—	—	TB6	—	—	3	1	TCAL63	2	250-350kcmil, Cu, or 350-500kcmil, Al
—	—	—	—	—	3	1	TCAL61	2	2/0-500kcmil
SKHA8	THKM8	—	—	SKLA8	2-3	1	TCAL41	1	#4-600kcmil or 2-1/0-250kcmil
TKM8 ⁴	—	—	—	SKPA8	—	—	TCAL61	2	2/0-500kcmil
—	—	—	—	Load End	—	1	TCAL81	3	3/0-500kcmil
—	—	—	—	Load End	—	1	TCAL91	3	3/0-500kcmil
—	—	TB8	—	—	3	1	TCAL81	3	3/0-500kcmil
SKHA12,	THKM12	—	—	SKLA12,	2-3	1	TCAL81	3	3/0-500kcmil
TKM12 ⁴	—	—	—	SKPA12	—	—	TCAL121	4	250-350kcmil Cu or 350-500kcmil Al
—	—	—	—	Load End	2-3	1	TCAL131	4	250-350kcmil Cu or 350-500kcmil Al
—	—	TB1	THLC1	—	3	1	TCAL12	1	(15-60A, TCAL12)#14-#3 Cu or #12-#1 Al (70-100A, TCAL12A)#6-2/0 Cu or #4-2/0 Al (100-150A, TCAL15)#3-3/0 Cu or #1-3/0 Al
—	—	—	THLC2	—	3	1	TCAL15	1	(15-60A, TCAL12)#14-#3 Cu or #12-#1 Al (70-100A, TCAL12A)#6-2/0 Cu or #4-2/0 Al (100-150A, TCAL15)#3-3/0 Cu or #1-3/0 Al
—	—	—	THLC4	—	3	1	TCAL27	1	(125-225A, TCAL27)#4-300kcmil
—	—	—	THLC4	TLB4 ⁴	3	1	TCLK43 ³	—	3/0-500kcmil or 2-(3/0-250kcmil)

¹One-pole THED frame available only in 15-30 amp trip.

²Lug kit—includes line or load end cover.

³Three-pole lug assembly suitable for line or load end.

⁴For replacement use only.

ADS Fusible Switch Module Terminations (CU/AL Mechanical)⁵

Amp Rating	Voltage	Wire Size (CU/AL)	# Wires Per Lug	# Lugs Per Phase
30	240/600	#2-#14	1	1
60	240	#2-#14	1	1
60	600	#14-1/0	1	1
100	240/600	#14-1/0	1	1
200	240/600	#6-250kcmil	1	1
400	240/600	1/0-250kcmil or #2-600kcmil	2 or 1	1
600	240/600	1/0-250kcmil or #2-600kcmil	2 or 1	1
800	600	1/0-250kcmil or #2-600kcmil	2 or 1	1
1200	600	1/0-250kcmil or #2-600kcmil	2 or 1	1

⁵For optional mechanical or compression lugs refer to GET-7006.



Panelboards

A-Series® Panelboards

Pricing and Ordering

Information Required to Price and Order a Panelboard

- Short-circuit Rating (10kA, 18kA, etc.)
- Service Entrance Label (Yes) or (No)
- Mark(s) (LPA, MDP, RPC, etc.)
- Service (3-ph, 4-w 208Y/120; 3-ph, 3-w 480 volts, etc.)
- Entrance of Incoming Line (Top) or (Bottom).
(Bottom Supplied as Standard)
- Trim (Surface) or (Flush)
- Incoming Wire Size (500kcmil, 250kcmil, etc.)
- Incoming Number of Wires per phase (1, 2, 3, etc.)
- Wire Material (Copper or Aluminum)
- Main Type (Main Lugs Only, Circuit Breaker, Fusible Switch, etc.)
- Amperage of Main Bus
- Frame of Main Circuit Breaker (SG, SK, TJK, etc.) (if applicable)
- Options to Mains (Shunt Trip, Lighting Contactor, etc.)
- Equipment Ground (Optional)
- Branches
 - Amp Rating (20, 30, 50, etc.)
 - Poles (1, 2, or 3)
 - Frame (THQB, TED, etc.)
 - Quantity (1, 10, 15, etc.)
- Options:
 - Interior (Copper bus, 200% rated neutral, etc.)
 - Box (Painted, Increased Gutter, etc.)
 - Front (Door in Door, etc.)
 - Ground Fault Protection (Yes) or (No)
- Type of Panel (AQ, AE, Spectra® Bolt-on, etc.)

How to Price Factory Assembled Panelboards

Main Price (or Interior Price for A-Series®) + Branch Circuits + Options = Total List of Panelboard. The sum of these list prices is the total list for the complete panelboard including box and front.

How to Lay Out Factory Assembled Panelboards

- Refer to build-up pricing page for the type of panelboard required.
- Multi-section panels must have a main circuit breaker or main lugs in each section. Double (dual) main lugs or thru-feed lugs must be added as required in all but the last section.
- Once panel is selected, refer to How to Size Boxes page for type of panel selected and follow Steps 1 through 5.

How to price a Pro-Stock, unassembled panelboard

Total the following components:

- Interior
- Box (add ground bars as required)
- Front
- Main breaker or lug kit
- Subfeed breaker or feed thru lug kit (if required)
- Branch Breakers (from Section 3)
- Accessories (200% neutral, service entrance etc.)
= Total List Price

Please consult your local distributor for net pricing and current stock levels.

How to Order GE Fastrac Program Panelboards

Select and price items required that are indicated in red. Clearly indicate on the order that GE Fastrac Program service is required.



Sizing and Pricing Example

PANELBOARD DESCRIPTION:

3-Phase, 4-Wire, 208Y/120Vac, bottom feed 225 amp main breaker, 10 kAIC rating, surface mounted with options:

- Copper bus
- Feed thru lugs
- Wide box—30 inch

Product numbers are *not* required to enter orders, but when pricing/sizing, listing product numbers is an excellent means to assure accuracy.

STEP 1: SIZE AND PRICE BRANCH BREAKERS

Each breaker *pole* requires *one* panelboard space

No. Breakers Required	Breaker Type	Breaker Amps	No. of Poles Each	Pole Space Required	Price Each	Price
2	THQB-GF	20	1	2	\$111.00	\$222.00
18	THQB	20	1	18	\$15.00	\$270.00
1	THQB	30	3	3	\$100.00	\$100.00
21 Total				23 Total		\$592.00

STEP 2: DETERMINE PRICE, SIZE AND INTERIOR PRODUCT NO. FROM TYPE AQ PANELBOARD 3-PHASE, 4-WIRE, MAIN LUG TABLE, PAGE 9-29

For 225A max panel amps with 23 total breaker poles, select 19-24 available branch space interior, rated 10 kAIC.

Basic Product Number	Height Required Inches	List Price
AQF3242AB	40.5 in.	\$1596.00 ¹

STEP 3: Select panelboard "interior" options from Page 9-31. Determine list price, the product number and *additional panel height* where required for:

- Copper bus
- Feed thru lugs

STEP 3A: To indicate that options are required add suffix letter "X" to the interior product number (listed above in Step 2).

AQF3242ABX

STEP 3B: Determine any increased panel height and list price adder from the "Interior Options" table on Page 9-31. Develop an options product number for *each* option.

List interior option product number prefix:

- Feed thru lugs
- Copper bus

Interior option summary:

Interior Option Product Number	Additional Panel Height Inch	List Price Adder
AX		
T1	3	\$164.00
B7	0	\$103.00
AXT1B7	3 in.	\$267.00

STEP 4: Determine *total* panel height required for use in selecting box and front. Add Step 2 and 3B to obtain the *total* panel height in inches.

43.5 in.

STEP 5: Select box and front options, from enclosure tables, pg. 9-34. Price enclosure *options* only and list option product number suffix.

STEP 5A: List standard box product number

Option: Wide box

STEP 5B: List standard 43.5 in. surface front product number

Option: Wide front

Total enclosure option list price adder, add Step 5A and 5B.

Box Product Number	Front Product Number	List Price Adder
AB43		
W		\$83.00
	AF43S	
	W	\$82.00
		\$165.00

STEP 6: CALCULATE TOTAL PANELBOARD LIST PRICE

Price includes breakers, interior, box, front and all options. Add Steps 1, 2, 3B and 5B

\$2620.00

ORDER SUMMARY

Interior (price includes standard box and front)

Interior options: Feed thru lugs and copper bus

Box with wide option added:

Surface front with wide option added:

2-20A 1P THQB-GF:

18-20A 1P THQB:

1-30A-3P THQB:

Product Number	List Price
AQF3242ABX	\$1596.00
AXT1B7	\$267.00
AB43W	\$83.00
AF43SW	\$82.00
<hr/>	
	\$222.00
<hr/>	
	\$270.00
<hr/>	
	\$100.00
<hr/>	
Total List Price:	\$2620.00

¹ List price includes standard box and front.

PRODUCT NUMBERS ARE NOT REQUIRED TO ENTER ORDERS



Panelboards

A-Series® Panelboards

Product Options

Enclosure Options

Box Options

Description	Product Number Suffix ¹	List Price GO-101
Blank Endwalls	B	2
Painted Box	P	\$200.00
30" Wide ³	W	\$250.00
NEMA 3R/12	3	\$950.00
NEMA 4X (Stainless Steel)	4S	\$4950.00
NEMA 4X (Painted Galvaneal)	4	\$2800.00
16 7/8" wide	5	-\$40.00
Endwall w/Knockouts	K	2

¹Add to base box Product Number

²No charge if included on original order. Price kit from page 9-54 if field conversion is required.

³Includes field installable gutter barrier.

TVSS⁶ Transient Voltage Surge Suppression

Maximum Surge Current Per Mode	Maximum Surge Current Per Phase	Description	List Price GO-101 A Series Panelboards ^{4,5}
65kA	130kA	TVSS, UL1449, UL1283	\$6350.00
80kA	160kA	TVSS, UL1449, UL1283	\$7000.00
100kA	200kA	TVSS, UL1449, UL1283	\$8500.00
100kA		TVSS, no Count or UL1283	\$2875.00
100kA		TVSS, no UL1283	\$3575.00

⁴Price applies to any A-Series® panel furnished in a standard 20" wide enclosure, types AL, AQ, AE, or AD.

⁵See Section 15 for product numbers.

⁶Factory installed TVSS units. Installed in 10" module, add interior Suffix T6 + 10" to box height.

Front Options—NEMA 1 Only

Description	Product Number Suffix ⁷	List Price GO-101
Screw Cover	C	\$61.00
Front Hinged to Box	D	\$110.00
Optional Locks:		
Yale 511S w/Rosette	Y	\$300.00
Corbin 15767	L	\$146.00
Nameplate	N	\$27.00
Door within a Door ⁸	P	\$238.00
Stainless Steel ⁹	S	\$1467.00
30" Wide	W	\$250.00
Screw-on nameplates	U	\$74.00
Metal Directory Card	M	\$50.00

⁷Add to base front Product Number.

⁸Consists of two lockable doors—one over panel interior and one over box wiring gutters. Yale locks not available.

⁹Flush only. Available with C and N options.



Door within Door



Front Hinged to Box



Standard Door



Yale Lock



Corbin Lock



Publications and Reference: See Section 22 for a complete list of additional product-related publications

Panelboards

A-Series® Panelboards

Product Options

Enclosure Options

BOX EXTENSIONS—For additional end gutter space or conduit skirt applications—price from page 9-54.

Equipment Grounds—Factory Supplied with Panelboard

Description	Product Number	List Price Adder GO-101
Field installed kits		
Standard bonded to box—for each 12 branch positions	TGL2	\$15.00
Copper bonded to box—for each 12 branch positions	TGC2	\$94.00
Standard-isolated/insulated—for each 12 branch positions	EGS12	\$99.00
Copper-isolated/insulated—for each 12 branch positions	EGC12	\$132.00
Main lug for above terminal kits	TGL20	\$25.00

Optional Equipment Grounds

Description	Product Number	List Price GO-134B
Aluminum Extruded Bonded	AEBG	\$75.00
Copper Extruded Bonded	AEBGC	\$140.00
Aluminum Extruded Isolated	AEIG	\$115.00
Copper Extruded Isolated	AEIGC	\$150.00
Copper Isolated/Bonded	ASPGIBC	\$452.00 ¹⁸

¹⁸GO-101

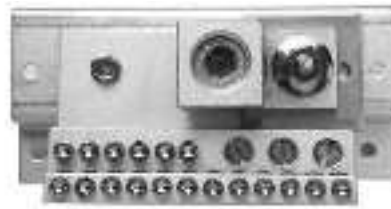

AEBG



AEBGC



AEIG



AEIGC



ASPGIBC



Panelboards

A-Series® Panelboards

Type AL

240 Vac Plug-in

Factory Assembled

Single-Phase, 3-Wire Pricing

Service Information:

- 1-ph, 3-w
- 240/120 volts ac max.

Plug-in Branch Breakers:

- 15-100 amps, 1, 2, 3-poles
- Types THQL, THHQL, TXQL

Service Entrance Label will be factory installed only when specified. Please see page 9-3 for UL Standards on service entrance. Service Entrance Labels are available for field installation. Please contact a GE Consumer & Industrial Sales Office for ordering instructions.

Mains:

- 100A-THQB, THHQB, TEY, SE
- 225A-TQD, THQD, SF
- 400A-TJD, SG
- 600A-SG
- 800A-SK
- 125-800 Amp main lug

NOTE: Sizing dimensions to be used only for enclosure selection, not to determine interior length.

Main Lug Interiors^{1,2}

Use THQL Plug In Breakers		Single Main Lugs			Subfeed Main Lugs		
Panel Amps Max.	Branch Space Required	Interior Product Number	List Price, ³ GO-101	Sizing Dim. (Inches)	Interior Product Number	List Price, ³ GO-101	Sizing Dim. (Inches)
125	0-12	ALF1121MB	\$445.00	22.5	ALF1121SB	\$494.00	22.5
	13-18	ALF1181MB	\$481.00	25.5	ALF1181SB	\$528.00	25.5
	19-24	ALF1241MB	\$541.00	28.5	ALF1241SB	\$589.00	28.5
	25-30	ALF1301MB	\$601.00	31.5	ALF1301SB	\$649.00	31.5
	31-36	ALF1361MB	\$661.00	34.5	ALF1361SB	\$709.00	34.5
	37-42	ALF1421MB	\$721.00	37.5	ALF1421SB	\$769.00	37.5
225	0-12	ALF1122MB	\$494.00	28.5	ALF1122SB	\$542.00	28.5
	13-18	ALF1182MB	\$528.00	31.5	ALF1182SB	\$578.00	31.5
	19-24	ALF1242MB	\$589.00	34.5	ALF1242SB	\$637.00	34.5
	25-30	ALF1302MB	\$649.00	37.5	ALF1302SB	\$697.00	37.5
	31-36	ALF1362MB	\$709.00	40.5	ALF1362SB	\$758.00	40.5
	37-42	ALF1422MB	\$769.00	43.5	ALF1422SB	\$818.00	43.5
400	0-12	ALF1124MB	\$663.00	37.5	ALF1124SB	\$810.00	43.5
	0-24	ALF1244MB	\$771.00	40.5	ALF1244SB	\$920.00	46.5
	13-18	ALF1184MB	\$715.00	43.5	ALF1184SB	\$863.00	49.5
	25-30	ALF1304MB	\$832.00	46.5	ALF1304SB	\$981.00	52.5
	31-36	ALF1364MB	\$892.00	49.5	ALF1364SB	\$1041.00	55.5
	37-42	ALF1424MB	\$951.00	52.5	ALF1424SB	\$1101.00	58.5
600	0-12	ALF1126MB	\$838.00	43.5	—	—	—
	0-24	ALF1246MB	\$947.00	46.5	—	—	—
	13-18	ALF1186MB	\$891.00	49.5	—	—	—
	25-30	ALF1306MB	\$1007.00	52.5	—	—	—
	31-36	ALF1366MB	\$1067.00	55.5	—	—	—
	37-42	ALF1426MB	\$1128.00	58.5	—	—	—
800 ⁴	0-12	ALF1128MB	\$1130.00	43.5	—	—	—
	13-18	ALF1188MB	\$1256.00	46.5	—	—	—
	19-24	ALF1248MB	\$1373.00	49.5	—	—	—
	25-30	ALF1308MB	\$1494.00	52.5	—	—	—
	31-36	ALF1368MB	\$1650.00	55.5	—	—	—
	37-42	ALF1428MB	\$1755.00	58.5	—	—	—

¹Bottom feed furnished as standard—change last character in Product Number from B to T for top feed.

²Single section interior available up to 84 circuits. Consult Speedi or sales office for details.

³Includes standard panelboard interior, box and front. Add price for options when required.

⁴Box is 30" wide x 7.81" deep.

SPLIT BUS—Refer to publication DE-81 or consult your local sales office.



Publications and Reference: See Section 22 for a complete list of additional product-related publications

Panelboards

A-Series® Panelboards

Type AL

Section 9

Enclosures

Sizing Dim. (Inches)	Box Product Number	Inside Box Dim. (Inches)			Front Product Number
		Length	Width	Depth	
0-25.5	AB25	25.5	20	5.81	AF25F,S
28.5-31.5	AB31	31.5	20	5.81	AF31F,S
34.5-37.5	AB37	37.5	20	5.81	AF37F,S
40.5-43.5	AB43	43.5	20	5.81	AF43F,S
46.5-49.5	AB49	49.5	20	5.81	AF49F,S
52.5-55.5	AB55	55.5	20	5.81	AF55F,S
57.5-64.5	AB64	64.5	20	5.81	AF64F,S
67.5-76.5	AB76	76.5	20	5.81	AF76F,S

Flush fronts are 1 1/2 inches larger than box. Surface fronts are 1/4 inch larger than box.

Main Breaker Interiors^{1,2}

Panel Amps Max.	Branch Space Required	Interrupting Rating					
		10kA			22kA		
		Interior Product Number	List Price, ³ GO-101	Sizing Dim. (Inches)	Interior Product Number	List Price, ³ GO-101	Sizing Dim. (Inches)
100	0-12	ALF1121AB	\$629.00	22.5	ALF1121CB	\$646.00	22.5
	13-18	ALF1181AB	\$665.00	25.5	ALF1181CB	\$682.00	25.5
	19-24	ALF1241AB	\$725.00	28.5	ALF1241CB	\$741.00	28.5
	25-30	ALF1301AB	\$784.00	31.5	ALF1301CB	\$801.00	31.5
	31-36	ALF1361AB	\$842.00	34.5	ALF1361CB	\$861.00	34.5
	37-42	ALF1421AB	\$903.00	37.5	ALF1421CB	\$922.00	37.5
225	0-12	ALF1122AB	\$1323.00	28.5	ALF1122CB	\$1452.00	28.5
	13-18	ALF1182AB	\$1358.00	31.5	ALF1182CB	\$1487.00	31.5
	19-24	ALF1242AB	\$1418.00	34.5	ALF1242CB	\$1547.00	34.5
	25-30	ALF1302AB	\$1479.00	37.5	ALF1302CB	\$1607.00	37.5
	31-36	ALF1362AB	\$1538.00	40.5	ALF1362CB	\$1668.00	40.5
	37-42	ALF1422AB	\$1598.00	43.5	ALF1422CB	\$1727.00	43.5
400	0-12	—	—	—	ALF1124CB	\$2032.00	46.5
	13-18	—	—	—	ALF1184CB	\$2089.00	49.5
	19-24	—	—	—	ALF1244CB	\$2147.00	52.5
	25-30	—	—	—	ALF1304CB	\$2207.00	55.5
	31-36	—	—	—	ALF1364CB	\$2267.00	58.5
	37-42	—	—	—	ALF1424CB	\$2327.00	61.5
600	0-12	—	—	—	ALF1126CB	\$3395.00	46.5
	13-18	—	—	—	ALF1186CB	\$3453.00	49.5
	19-24	—	—	—	ALF1246CB	\$3512.00	52.5
	25-30	—	—	—	ALF1306CB	\$3572.00	55.5
	31-36	—	—	—	ALF1366CB	\$3632.00	58.5
	37-42	—	—	—	ALF1426CB	\$3692.00	61.5

¹Bottom feed furnished as standard—change last character in Product Number from B to T for top feed.

²Single section interior available up to 84 circuits. Consult Speedi or sales office for details.

³Includes standard panelboard interior, box and front. Add price for options when required.



Panelboards

A-Series® Panelboards

Type AL

Main Breaker Interiors^{1,2} (Continued)

Panel Amps Max.	Branch Space Required	Interrupting Rating								
		65kA			100kA			200kA		
		Interior Product Number	List Price, ³ GO-101	Sizing Dim. (Inches)	Interior Product Number	List Price, ³ GO-101	Sizing Dim. (Inches)	Interior Product Number	List Price, ³ GO-101	Sizing Dim. (Inches)
100	0-12	ALF1121EB	\$1009.00	22.5	ALF1121FB	\$1402.00	22.5	ALF1121HB	\$1895.00	22.5
	13-18	ALF1181EB	\$1045.00	25.5	ALF1181FB	\$1438.00	25.5	ALF1181HB	\$1931.00	25.5
	19-24	ALF1241EB	\$1105.00	28.5	ALF1241FB	\$1498.00	28.5	ALF1241HB	\$1991.00	28.5
	25-30	ALF1301EB	\$1166.00	31.5	ALF1301FB	\$1558.00	31.5	ALF1301HB	\$2051.00	31.5
	31-36	ALF1361EB	\$1225.00	34.5	ALF1361FB	\$1618.00	34.5	ALF1361HB	\$2112.00	34.5
	37-42	ALF1421EB	\$1285.00	37.5	ALF1421FB	\$1678.00	37.5	ALF1421HB	\$2172.00	37.5
225	0-12	ALF1122JB	\$2072.00	28.5	ALF1122FB	\$2745.00	40.5	ALF1122HB	\$2956.00	40.5
	13-18	ALF1182JB	\$2107.00	31.5	ALF1182FB	\$2779.00	43.5	ALF1182HB	\$2993.00	43.5
	19-24	ALF1242JB	\$2167.00	34.5	ALF1242FB	\$2839.00	46.5	ALF1242HB	\$3050.00	46.5
	25-30	ALF1302JB	\$2227.00	37.5	ALF1302FB	\$2899.00	49.5	ALF1302HB	\$3111.00	49.5
	31-36	ALF1362JB	\$2288.00	40.5	ALF1362FB	\$2959.00	52.5	ALF1362HB	\$3172.00	52.5
	37-42	ALF1422JB	\$2347.00	43.5	ALF1422FB	\$3020.00	55.5	ALF1422HB	\$3232.00	55.5
400	0-12	ALF1124JB	\$2777.00	46.5	ALF1124FB	\$3581.00	46.5	ALF1124HB	\$3945.00	46.5
	13-18	ALF1184JB	\$2834.00	49.5	ALF1184FB	\$3640.00	49.5	ALF1184HB	\$4002.00	49.5
	19-24	ALF1244JB	\$2892.00	52.5	ALF1244FB	\$3700.00	52.5	ALF1244HB	\$4060.00	52.5
	25-30	ALF1304JB	\$2952.00	55.5	ALF1304FB	\$3761.00	55.5	ALF1304HB	\$4119.00	55.5
	31-36	ALF1364JB	\$3012.00	58.5	ALF1364FB	\$3821.00	58.5	ALF1364HB	\$4180.00	58.5
	37-42	ALF1424JB	\$3072.00	61.5	ALF1424FB	\$3881.00	61.5	ALF1424HB	\$4240.00	61.5
600	0-12	ALF1126JB	\$4130.00	46.5	ALF1126FB	\$4944.00	46.5	—	—	—
	13-18	ALF1186JB	\$4198.00	49.5	ALF1186FB	\$5004.00	49.5	—	—	—
	19-24	ALF1246JB	\$4257.00	52.5	ALF1246FB	\$5065.00	52.5	—	—	—
	25-30	ALF1306JB	\$4317.00	55.5	ALF1306FB	\$5126.00	55.5	—	—	—
	31-36	ALF1366JB	\$4377.00	58.5	ALF1366FB	\$5186.00	58.5	—	—	—
	37-42	ALF1426JB	\$4437.00	61.5	ALF1426FB	\$5246.00	61.5	—	—	—
800 ⁴	0-12	ALF1128JB	\$4843.00	55.5	—	—	—	—	—	—
	13-18	ALF1188JB	\$5026.00	58.5	—	—	—	—	—	—
	19-24	ALF1248JB	\$5200.00	61.5	—	—	—	—	—	—
	25-30	ALF1308JB	\$5385.00	64.5	—	—	—	—	—	—
	31-36	ALF1368JB	\$5560.00	67.5	—	—	—	—	—	—
	37-42	ALF1428JB	\$5740.00	70.5	—	—	—	—	—	—

¹Bottom feed furnished as standard—change last character in Product Number from B to T for top feed.

²Single section interior available up to 84 circuits. Consult Speedi or sales office for details.

³Includes standard panelboard interior, box and front. Add price for options when required.

⁴Box is 30" wide x 7.81" deep.



Panelboards

A-Series® Panelboards

Section 9

Type AL

240 Vac Plug-in

Factory Assembled

Three-Phase, 3-Wire/4-Wire Pricing¹

Service Information:

3-ph, 3-w; 3-ph, 4-w;
240 Vac max.

Plug-in Branch Breakers:

15-100 amps, 1, 2, 3-poles
Types THQL, THHQL,
TXQL.

Service Entrance Label will be factory installed only when specified. Please see page 9-3 for UL Standards on service entrance. Service Entrance Labels are available for field installation. Please contact a GE Consumer & Industrial Sales Office for ordering instructions.

Mains:

100A-THQB, THHQB, TEY, SE
225A-TQD, THQD, SF
400A-TJD, SG
600A-SG
800-SK
125-800 amps main lug

NOTE: Sizing dimensions to be used only for enclosure selection, not to determine interior length.

¹For 3-ph, 3-wire applications, no neutral supplied.

Main Lug Interiors^{2,3}

Use THQL Plug-in Breakers		Single Main Lugs			Subfeed Main Lugs		
Panel Amps Max.	Branch Space Required	Interior Product Number	List Price, ⁴ GO-101	Sizing Dim. (Inches)	Interior Product Number	List Price, ⁴ GO-101	Sizing Dim. (Inches)
125	0-12	ALF3121MB	\$487.00	22.5	ALF3121SB	\$548.00	22.5
	13-18	ALF3181MB	\$523.00	25.5	ALF3181SB	\$584.00	25.5
	19-24	ALF3241MB	\$583.00	28.5	ALF3241SB	\$645.00	28.5
	25-30	ALF3301MB	\$644.00	31.5	ALF3301SB	\$705.00	31.5
	31-36	ALF3361MB	\$704.00	34.5	ALF3361SB	\$765.00	34.5
	37-42	ALF3421MB	\$763.00	37.5	ALF3421SB	\$824.00	37.5
225	0-12	ALF3122MB	\$529.00	28.5	ALF3122SB	\$591.00	28.5
	13-18	ALF3182MB	\$565.00	31.5	ALF3182SB	\$627.00	31.5
	19-24	ALF3242MB	\$626.00	34.5	ALF3242SB	\$687.00	34.5
	25-30	ALF3302MB	\$686.00	37.5	ALF3302SB	\$747.00	37.5
	31-36	ALF3362MB	\$746.00	40.5	ALF3362SB	\$807.00	40.5
	37-42	ALF3422MB	\$805.00	43.5	ALF3422SB	\$867.00	43.5
400	0-12	ALF3124MB	\$745.00	37.5	ALF3124SB	\$913.00	43.5
	0-24	ALF3244MB	\$851.00	40.5	ALF3244SB	\$1023.00	46.5
	13-18	ALF3184MB	\$796.00	43.5	ALF3184SB	\$966.00	49.5
	25-30	ALF3304MB	\$910.00	46.5	ALF3304SB	\$1083.00	52.5
	31-36	ALF3364MB	\$970.00	49.5	ALF3364SB	\$1143.00	55.5
	37-42	ALF3424MB	\$1030.00	52.5	ALF3424SB	\$1203.00	58.5
600	0-12	ALF3126MB	\$904.00	43.5	—	—	—
	0-24	ALF3246MB	\$1114.00	46.5	—	—	—
	13-18	ALF3186MB	\$957.00	49.5	—	—	—
	25-30	ALF3306MB	\$1074.00	52.5	—	—	—
	31-36	ALF3366MB	\$1134.00	55.5	—	—	—
	37-42	ALF3426MB	\$1194.00	58.5	—	—	—
800 ⁵	0-12	ALF3128MB	\$1190.00	43.5	—	—	—
	13-18	ALF3188MB	\$1316.00	46.5	—	—	—
	19-24	ALF3248MB	\$1433.00	49.5	—	—	—
	25-30	ALF3308MB	\$1554.00	52.5	—	—	—
	31-36	ALF3368MB	\$1710.00	55.5	—	—	—
	37-42	ALF3428MB	\$1815.00	58.5	—	—	—

¹For 3-ph, 3-wire applications, no neutral supplied.

²Bottom feed supplied as standard—change last character in Product Number from B to T for top feed.

³Single section interior available up to 84 circuits. Consult Speedi or sales office for details.

⁴Includes standard panelboard interior, box and front. Add price for options when required.

⁵Box is 30" wide x 7.81" deep.

SPLIT BUS—Refer to publication DE-81 or consult your local sales office.



Product Number Selection Instructions: See page 9-13

Panelboards

A-Series® Panelboards

Type AL

240 Vac Plug-in

Factory Assembled

Three-Phase, 3-Wire/4-Wire Pricing¹

Enclosures

Panel Sizing Dim. (Inches)	Box Product Number	Inside Box Dim. (Inches)			Front Product Number
		Length	Width	Depth	
0-25.5	AB25	25.5	20	5.81	AF25F,S
28.5-31.5	AB31	31.5	20	5.81	AF31F,S
34.5-37.5	AB37	37.5	20	5.81	AF37F,S
40.5-43.5	AB43	43.5	20	5.81	AF43F,S
46.5-49.5	AB49	49.5	20	5.81	AF49F,S
52.5-55.5	AB55	55.5	20	5.81	AF55F,S
57.5-64.5	AB64	64.5	20	5.81	AF64F,S
67.5-76.5	AB76	76.5	20	5.81	AF76F,S

Flush fronts are 1 1/2 inch larger than box. Surface fronts are 1/4 inch larger than box.

Main Breaker Interiors^{2,3}

Panel Amps Max.	Branch Space Required	Interrupting Rating					
		10kA			22kA		
		Interior Product Number	List Price, ⁴ GO-101	Sizing Dim. (Inches)	Interior Product Number	List Price, ⁴ GO-101	Sizing Dim. (Inches)
100	0-12	ALF3121AB	\$736.00	22.5	ALF3121CB	\$845.00	22.5
	13-18	ALF3181AB	\$770.00	25.5	ALF3181CB	\$880.00	25.5
	19-24	ALF3241AB	\$831.00	28.5	ALF3241CB	\$941.00	28.5
	25-30	ALF3301AB	\$891.00	31.5	ALF3301CB	\$1001.00	31.5
	31-36	ALF3361AB	\$950.00	34.5	ALF3361CB	\$1061.00	34.5
	37-42	ALF3421AB	\$1010.00	37.5	ALF3421CB	\$1120.00	37.5
225	0-12	ALF3122AB	\$1540.00	28.5	ALF3122CB	\$1671.00	28.5
	13-18	ALF3182AB	\$1576.00	31.5	ALF3182CB	\$1706.00	31.5
	19-24	ALF3242AB	\$1636.00	34.5	ALF3242CB	\$1766.00	34.5
	25-30	ALF3302AB	\$1696.00	37.5	ALF3302CB	\$1826.00	37.5
	31-36	ALF3362AB	\$1757.00	40.5	ALF3362CB	\$1887.00	40.5
	37-42	ALF3422AB	\$1817.00	43.5	ALF3422CB	\$1947.00	43.5
400	0-12	—	—	—	ALF3124CB	\$2360.00	46.5
	13-18	—	—	—	ALF3184CB	\$2418.00	49.5
	19-24	—	—	—	ALF3244CB	\$2478.00	52.5
	25-30	—	—	—	ALF3304CB	\$2539.00	55.5
	31-36	—	—	—	ALF3364CB	\$2599.00	58.5
	37-42	—	—	—	ALF3424CB	\$2659.00	61.5
600	0-12	—	—	—	ALF3126CB	\$3934.00	46.5
	13-18	—	—	—	ALF3186CB	\$3993.00	49.5
	19-24	—	—	—	ALF3246CB	\$4053.00	52.5
	25-30	—	—	—	ALF3306CB	\$4114.00	55.5
	31-36	—	—	—	ALF3366CB	\$4174.00	58.5
	37-42	—	—	—	ALF3426CB	\$4234.00	61.5

¹For 3-ph, 3-wire applications, no neutral supplied.

²Bottom feed supplied as standard—change last character in Product Number from B to T for top feed.

³Single section interior available up to 84 circuits. Consult Speedi or sales office for details.

⁴Includes standard panelboard interior, box and front. Add price for options when required.



Publications and Reference: See Section 22 for a complete list of additional product-related publications

Panelboards

A-Series® Panelboards

Section 9

Type AL

240 Vac Plug-in

Factory Assembled

Three-Phase, 3-Wire/4-Wire Pricing¹

Main Breaker Interiors^{2,3} (Continued)

Panel Amps Max.	Branch Space Required	Interrupting Rating								
		65kA			100kA			200kA		
		Interior Product Number	List Price, ³ GO-101	Sizing Dim. (Inches)	Interior Product Number	List Price, ⁴ GO-101	Sizing Dim. (Inches)	Interior Product Number	List Price, ⁴ GO-101	Sizing Dim. (Inches)
100	0-12	ALF3121EB	\$1136.00	22.5	ALF3121FB	\$1487.00	22.5	ALF3121HB	\$1975.00	22.5
	13-18	ALF3181EB	\$1172.00	25.5	ALF3181FB	\$1523.00	25.5	ALF3181HB	\$2012.00	25.5
	19-24	ALF3241EB	\$1232.00	28.5	ALF3241FB	\$1582.00	28.5	ALF3241HB	\$2073.00	28.5
	25-30	ALF3301EB	\$1293.00	31.5	ALF3301FB	\$1642.00	31.5	ALF3301HB	\$2133.00	31.5
	31-36	ALF3361EB	\$1353.00	34.5	ALF3361FB	\$1703.00	34.5	ALF3361HB	\$2193.00	34.5
	37-42	ALF3421EB	\$1412.00	37.5	ALF3421FB	\$1763.00	37.5	ALF3421HB	\$2252.00	37.5
225	0-12	ALF3122JB	\$2361.00	28.5	ALF3122FB	\$3114.00	40.5	ALF3122HB	\$3356.00	40.5
	13-18	ALF3182JB	\$2396.00	31.5	ALF3182FB	\$3150.00	43.5	ALF3182HB	\$3392.00	43.5
	19-24	ALF3242JB	\$2456.00	34.5	ALF3242FB	\$3210.00	46.5	ALF3242HB	\$3451.00	46.5
	25-30	ALF3302JB	\$2516.00	37.5	ALF3302FB	\$3270.00	49.5	ALF3302HB	\$3511.00	49.5
	31-36	ALF3362JB	\$2577.00	40.5	ALF3362FB	\$3330.00	52.5	ALF3362HB	\$3571.00	52.5
	37-42	ALF3422JB	\$2637.00	43.5	ALF3422FB	\$3391.00	55.5	ALF3422HB	\$3632.00	55.5
400	0-12	ALF3124JB	\$3160.00	46.5	ALF3124FB	\$4026.00	46.5	ALF3124HB	\$4284.00	46.5
	13-18	ALF3184JB	\$3218.00	49.5	ALF3184FB	\$4084.00	49.5	ALF3184HB	\$4342.00	49.5
	19-24	ALF3244JB	\$3278.00	52.5	ALF3244FB	\$4143.00	52.5	ALF3244HB	\$4400.00	52.5
	25-30	ALF3304JB	\$3339.00	55.5	ALF3304FB	\$4203.00	55.5	ALF3304HB	\$4459.00	55.5
	31-36	ALF3364JB	\$3399.00	58.5	ALF3364FB	\$4264.00	58.5	ALF3364HB	\$4520.00	58.5
	37-42	ALF3424JB	\$3459.00	61.5	ALF3424FB	\$4324.00	61.5	ALF3424HB	\$4580.00	61.5
600	0-12	ALF3126JB	\$4734.00	46.5	ALF3126FB	\$5600.00	46.5	—	—	—
	13-18	ALF3186JB	\$4793.00	49.5	ALF3246FB	\$5718.00	49.5	—	—	—
	19-24	ALF3246JB	\$4853.00	52.5	ALF3186FB	\$5659.00	52.5	—	—	—
	25-30	ALF3306JB	\$4914.00	55.5	ALF3306FB	\$5778.00	55.5	—	—	—
	31-36	ALF3366JB	\$4974.00	58.5	ALF3366FB	\$5839.00	58.5	—	—	—
	37-42	ALF3426JB	\$5034.00	61.5	ALF3426FB	\$5899.00	61.5	—	—	—
800 ⁵	0-12	ALF3128JB	\$4943.00	55.5	—	—	—	—	—	—
	13-18	ALF3188JB	\$5126.00	58.5	—	—	—	—	—	—
	19-24	ALF3248JB	\$5300.00	61.5	—	—	—	—	—	—
	25-30	ALF3308JB	\$5485.00	64.5	—	—	—	—	—	—
	31-36	ALF3368JB	\$5660.00	67.5	—	—	—	—	—	—
	37-42	ALF3428JB	\$5840.00	70.5	—	—	—	—	—	—

¹ For 3-ph, 3-wire applications, no neutral supplied.

² Bottom feed supplied as standard—change last character in Product Number from B to T for top feed.

³ Single section interior available up to 84 circuits. Consult Speedi or sales office for details.

⁴ Includes standard panelboard interior, box and front. Add price for options when required.

⁵ Box is 30" wide x 7.81" deep.



Product Number Selection Instructions: See page 9-13

Panelboards

A-Series® Panelboards

Type AL

240 Vac Plug-In
Factory Assembled Pricing

Branch Breakers THQL Circuit Breakers, Plug-In Mounting

Molded Case Circuit Breakers				List Price, GO-101			
Branch Breaker Mounting	Type	Plug-In Frames	Trip Range In Amps	1-Pole 120V	2-Pole 120/240V	2-Pole ² 240V	3-Pole 240V
				No. Spaces Required			
				1	2	2	3
Double Branch	THQL (10,000 AIC)	THQL	15-60 ²	\$12.00	\$27.00	\$74.00	\$98.00
			70	\$23.00	\$54.00	\$87.00	\$119.00
			80-100 ³	—	\$80.00	\$126.00	\$138.00
	THHQL (22,000 AIC)	THQL-HID	15-30	\$16.00	\$28.00	—	—
			15-20 ²	\$22.00	\$54.00	\$119.00	\$125.00
		THHQL	25-60	\$29.50	\$54.00	\$119.00	\$125.00
			70	\$39.00	\$87.00	\$151.00	\$170.00
			80-100 ³	—	\$126.00	\$172.00	\$187.00
		THHQL-HID	15-30	\$28.00	\$82.00	—	—
			TXQL (65,000 AIC)	TXQL	15-30	\$43.00	\$101.00
Subfeed Breakers ⁴ (Bolt-On) Single Branch	Standard High Break	TQD	—	—	\$531.00	\$623.00	
		THQD	—	—	\$764.00	\$800.00	

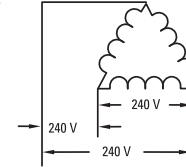

FIG. 1

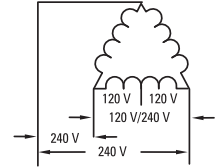

FIG. 2

¹2-pole, 120/240-volt, Q-line circuit breakers can be connected line-to-line on 3-phase, 4-wire, 120/208-volt or single-phase, 120/240-volt systems. 2-pole, 240-volt, Q-line circuit breakers must be used when connected to 3-phase, 3-wire 240-volt delta systems (Fig. 1), or to the high leg of a midpoint delta ground system (Fig. 2).

²15 and 20 amp devices are SWD rated.

³The sum of double branch breaker ratings mounted opposite each other cannot exceed 180 amperes.

⁴Create appropriate option Product Number and determine size requirements from options table page 9-24. Specify breaker type, poles and ampacity in addition to option Product Number when ordering.

Main, Branch, And Subfeed Breaker Accessories⁵

Circuit Breaker Frame	Shunt Trip	List Prices, GO-101			
		Auxiliary Contacts 2- and 3-Pole Only		Padlocking Devices	Handle Locking Devices
		No. of AB Switch Elements	For 240 VAC		
THQL, THHQL TXQL	\$98.00 ⁶	1	\$89.00 ⁶	\$10.00	\$6.00
TEY	\$392.00	1	\$200.00 ⁶	\$11.00	\$6.00
SE	\$392.00	1	\$200.00	\$14.00	—
		2	\$360.00	\$14.00	—
TQD	\$447.00	—	—	\$14.00	—
SF	\$447.00	2	\$447.00	\$14.00	\$10.00
SG, TJD	\$447.00	1	\$243.00	\$20.00	—
		2	\$447.00		
SK	\$447.00	2	\$447.00	\$20.00	—

⁵Internal accessories must be factory installed.

⁶Takes up one branch space in sizing for both main and branch applications.



Publications and Reference: See Section 22 for a complete list of additional product-related publications

Panelboards

A-Series® Panelboards

Section 9

Type AL

240 Vac Plug-In

Factory Assembled Pricing

Panelboard Options

NOTE: Sizing dimensions to be used only for enclosure selection, not to determine interior length. Use Speedi-Win or call your GE sales engineer for exact box height needed.

Interior Options

Option	Description	Product ¹ Number Option Suffix	100/125 Amps		225 Amps		400 Amps		600 Amps		800A		
			Panel Sizing Adder	List Price Adder, GO-101	Panel Sizing Adder ⁹	List Price Adder, GO-101	Panel Sizing Adder ⁹	List Price Adder, GO-101	Panel Sizing Adder ⁹	List Price Adder, GO-101	Panel Sizing Adder ⁹	List Price Adder, GO-101	Panel Sizing Adder
Optional Lugs ²	Compression Alum	L1	—	\$30.00	—	\$50.00	—	\$130.00	—	\$175.00			
	Pressure Copper	L2	—	\$49.00	—	\$49.00	—	\$92.00	—	\$114.00	N/A	—	
	Comp. Alum. Oversize	L3	—	\$152.00	—	\$152.00	—	\$461.00	—	\$461.00			
	Pressure Alum. Oversize	L4	—	\$54.00	—	\$54.50	—	\$330.00	—	\$330.00			
Subfeed Breakers And Contactors (Select Only One)	2 Poles TQD ³	Q2	N/A		6		6		6				
	3 Poles TQD ³	Q3	N/A		6		6		6				
	4 Poles TQD ³	Q4	N/A		9		9		9				
	5 Poles TQD ³	Q5	N/A		9		9		9				
	6 Poles TQD	Q6	N/A		9		9		9				
	7 Poles TQD	Q7	N/A		12		12		12		12		
	8 Poles TQD	Q8	N/A		12		12		12		12		
	9 Poles TQD	Q9	N/A	Price From Panel or Contactor Sections by Device	15	Price From Panel or Contactor Sections by Device	15	Price From Panel Section	15	Price From Panel Section	15	15	
	11 Poles TQD	QB	N/A		N/A		18		18		18		
	12 Poles TQD	Q1	N/A		N/A		18		18		18		
	13 Poles TQD	QC	N/A		N/A		21		21		21		
	14 Poles TQD	QD	N/A		N/A		21		21		21		
	15 Poles TQD	QE	N/A		N/A		24		24		24		
	16 Poles TQD	QF	N/A		N/A		24		24		24		
17 Poles TQD	QG	N/A		N/A		27		27		27			
18 Poles TQD	QH	N/A		N/A		27		27		27			
	2 or 3 Pole Contactor ⁴	C1	15		18		N/A		N/A				
Feed Thru	Feed Thru Lugs ⁵	T1	3	\$164.00	3	\$164.00	3	\$286.00	6	\$286.00	6	\$451.00	
Busbar ⁶	600 APSI Alum.	B1	—	\$595.00	—	\$595.00	—	\$759.00	—	N/A	—	N/A	
	750 APSI Alum.	B2	—	\$135.00	—	\$135.00	—	Std.	—	Std.	—	N/A	
	800 APSI Copper	B3	—	\$610.00	—	\$610.00	—	\$904.00	—	N/A	—	N/A	
	1000 APSI Copper	B4	—	\$210.00	—	\$210.00	—	\$323.00	—	\$387.00	—	\$559.00 ⁸	
	Standard Copper	B7	—	\$103.00	—	\$103.00	—	\$182.00	—	\$246.00	—	N/A	
200% Rated ⁷	2 Standard Lugs	N2	—	\$60.00	—	\$100.00	9	\$140.00	9	\$280.00 ⁷	N/A	N/A	

¹Option Product Number prefix is "AX".

²Oversize lugs available on single main lug panels only.

³For TQD main breaker panels, adder is 3 inches less than value shown.

⁴For contactor subfeeds with contactor mains, add another 3 inches.

⁵Feed thru lugs not available on subfeed or oversized main lug panels.

⁶For silver or tin plating 1000 APSI cu only add **\$100.00 List, GO-101**.

⁷200% rated neutrals in 600A panels require 30"W box. See page 9-8 for wire sizes.

⁸800A bus must be silver plated.

⁹Add 7" for two or more subfeed breakers.

PERMANENT CIRCUIT NUMBERS—Numbers 1-48. Field Installed. See page 9-54.



Product Number Selection Instructions: See page 9-13

Panelboards

A-Series® Panelboards

Type AL

Enclosure Options

Box Options

Description	Product Number Suffix ¹	List Price GO-101
Blank Endwalls	B	2
Painted Box	P	\$200.00
30" Wide ³	W	\$250.00
NEMA 3R/12	3	\$950.00
NEMA 4X (Stainless Steel)	4S	\$4950.00
NEMA 4X (Painted Galvaneal)	4	\$2800.00
16 7/8" wide	5	-\$40.00
Endwall w/Knockouts	K	2

¹ Add to base box Product Number

² No charge if included on original order. Price kit from page 9-54 if field conversion is required.

³ Includes field installable gutter barrier.

TVSS¹⁴ Transient Voltage Surge Suppression

Maximum Surge Current Per Mode	Maximum Surge Current Per Phase	Description	List Price GO-101 A Series Panelboards ^{4,5}
65kA	130kA	TVSS, UL1449, UL1283	\$6350.00
80kA	160kA	TVSS, UL1449, UL1283	\$7000.00
100kA	200kA	TVSS, UL1449, UL1283	\$8500.00
100kA		TVSS, no Count or UL1283	\$2875.00
100kA		TVSS, no UL1283	\$3575.00

⁴ Price applies to any A-Series® panel furnished in a standard 20" wide enclosure, types AL, AQ, AE, or AD.

⁵ See Section 15 for product numbers.

⁶ Factory installed TVSS units. Installed in 10" module, add interior Suffix T6 + 10" to box height.

Front Options—NEMA 1 Only

Description	Product Number Suffix ⁷	List Price GO-101
Screw Cover	C	\$61.00
Front Hinged to Box	D	\$110.00
Optional Locks:		
Yale 511S w/Rosette	Y	\$300.00
Corbin 15767	L	\$146.00
Nameplate	N	\$27.00
Door within a Door ⁸	P	\$238.00
Stainless Steel ⁹	S	\$1467.00
30" Wide	W	\$250.00
Screw-on nameplates	U	\$74.00
Metal Directory Card	M	\$50.00

⁷ Add to base front Product Number.

⁸ Consists of two lockable doors—one over panel interior and one over box wiring gutters. Yale locks not available.

⁹ Flush only. Available with C and N options.

BOX EXTENSIONS—For additional end gutter space or conduit skirt applications—price from page 9-54.

Equipment Grounds—Factory Supplied with Panelboard

Description	Product Number	List Price Adder GO-101
Field installed kits		
Standard bonded to box—for each 12 branch positions	TGL2	\$15.00
Copper bonded to box—for each 12 branch positions	TGC2	\$94.00
Standard-isolated/insulated—for each 12 branch positions	EGS12	\$99.00
Copper-isolated/insulated—for each 12 branch positions	EGC12	\$132.00
Main lug for above terminal kits	TGL20	\$25.00

Optional Equipment Grounds

Description	Product Number	List Price GO-134B
Aluminum Extruded Bonded	AEBG	\$75.00
Copper Extruded Bonded	AEBGC	\$140.00
Aluminum Extruded Isolated	AEIG	\$115.00
Copper Extruded Isolated	AEIGC	\$150.00
Copper Isolated/Bonded	ASPGIBC	\$452.00 ¹⁸

¹⁸GO-101



Publications and Reference: See Section 22 for a complete list of additional product-related publications

Panelboards

A-Series® Panelboards

Type AQ

240 Vac Bolt-On

Factory Assembled

Single-Phase, 3-Wire Pricing

GE Fastrac Program items are indicated in red.

Service Information:

1-ph, 3-w
240/120 Vac max.

Bolt-On Branch Breakers:

15-100 amps, 1, 2, 3-poles
Types THQB, THHQB, TXQB

Service Entrance Label will be factory installed only when specified. Please see page 9-3 for UL Standards on service entrance. Service Entrance Labels are available for field installation. Please contact a GE Consumer & Industrial Sales Office for ordering instructions.

Mains:

100-THQB, THHQB, TEY, SE
225-TQD, THQD, SF
400-TJD, SG
600-SG
800-SK
125-800 amp main lug

NOTE: Sizing Dimensions to be used only for enclosure selection, not to determine interior length.

Main Lug Interiors^{1,2}

Use THQB Bolt-on Breakers		Single Main Lugs			Subfeed Main Lugs		
Panel Amps Max.	Branch Space Required	Interior Product Number	List Price, ³ GO-101	Sizing Dim. (in.)	Interior Product Number	List Price, ³ GO-101	Sizing Dim. (in.)
125	0-12	AQF1121MB	\$445.00	22.5	AQF1121SB	\$494.00	22.5
	13-18	AQF1181MB	\$481.00	25.5	AQF1181SB	\$518.00	25.5
	19-24	AQF1241MB	\$541.00	28.5	AQF1241SB	\$589.00	28.5
	25-30	AQF1301MB	\$601.00	31.5	AQF1301SB	\$649.00	31.5
	31-36	AQF1361MB	\$661.00	34.5	AQF1361SB	\$709.00	34.5
	37-42	AQF1421MB	\$721.00	37.5	AQF1421SB	\$769.00	37.5
225	0-12	AQF1122MB	\$494.00	28.5	AQF1122SB	\$542.00	28.5
	13-18	AQF1182MB	\$528.00	31.5	AQF1182SB	\$578.00	31.5
	19-24	AQF1242MB	\$589.00	34.5	AQF1242SB	\$637.00	34.5
	25-30	AQF1302MB	\$649.00	37.5	AQF1302SB	\$697.00	37.5
	31-36	AQF1362MB	\$709.00	40.5	AQF1362SB	\$758.00	40.5
	37-42	AQF1422MB	\$769.00	43.5	AQF1422SB	\$818.00	43.5
400	0-12	AQF1124MB	\$663.00	37.5	AQF1124SB	\$810.00	43.5
	0-24	AQF1244MB	\$771.00	40.5	AQF1244SB	\$920.00	46.5
	13-18	AQF1184MB	\$715.00	43.5	AQF1184SB	\$863.00	49.5
	25-30	AQF1304MB	\$832.00	46.5	AQF1304SB	\$981.00	52.5
	31-36	AQF1364MB	\$892.00	49.5	AQF1364SB	\$1041.00	55.5
	37-42	AQF1424MB	\$951.00	52.5	AQF1424SB	\$1101.00	58.5
600	0-12	AQF1126MB	\$838.00	43.5	—	—	—
	0-24	AQF1246MB	\$947.00	46.5	—	—	—
	13-18	AQF1186MB	\$891.00	49.5	—	—	—
	25-30	AQF1306MB	\$1007.00	52.5	—	—	—
	31-36	AQF1366MB	\$1067.00	55.5	—	—	—
	37-42	AQF1426MB	\$1128.00	58.5	—	—	—
800 ⁴	0-12	AQF1128MB	\$1130.00	43.5	—	—	—
	13-18	AQF1188MB	\$1256.00	46.5	—	—	—
	19-24	AQF1248MB	\$1373.00	49.5	—	—	—
	25-30	AQF1308MB	\$1494.00	52.5	—	—	—
	31-36	AQF1368MB	\$1650.00	55.5	—	—	—
	37-42	AQF1428MB	\$1755.00	58.5	—	—	—

¹Bottom feed furnished as standard-change last character in Product No. from B to T for Top Feed.

²Single section interiors available up to 84 circuits. Consult Speedi or sales office for details.

³Includes standard panelboard interior, box and front. Add price for options when required.

⁴Box is 30" wide x 7.81" deep.

SPLIT BUS—Refer to publication DE-81 or consult your local sales office



Product Number Selection Instructions: See page 9-13

Panelboards

A-Series® Panelboards

Type AQ

Enclosures

Sizing Dim. (inches)	Box Product ¹ Number	Inside Box Dim. (inches)			Front Product Number
		Length	Width	Depth	
0-25.5	AB25*	25.5	20	5.81	AF25F,S
28.5-31.5	AB31*	31.5	20	5.81	AF31F,S
34.5-37.5	AB37*	37.5	20	5.81	AF37F,S
40.5-43.5	AB43*	43.5	20	5.81	AF43F,S
46.5-49.5	AB49*	49.5	20	5.81	AF49F,S
52.5-55.5	AB55*	55.5	20	5.81	AF55F,S
57.5-64.5	AB64*	64.5	20	5.81	AF64F,S
67.5-76.5	AB76*	76.5	20	5.81	AF76F,S

Flush fronts are 1 1/2 inches larger than box. Surface fronts are 1/4 inch larger than box.

¹ "*" Add appropriate suffix.

Main Breaker Interiors^{1,2}

Panel Amps Max.	Branch Space Required	Interrupting Rating					
		10kA			22kA		
		Interior Product Number	List Price, ³ GO-101	Sizing Dim. (in.)	Interior Product Number	List Price, ³ GO-101	Sizing Dim. (in.)
100	0-12	AQF1121AB	\$629.00	22.5	AQF1121CB	\$646.00	22.5
	13-18	AQF1181AB	\$665.00	25.5	AQF1181CB	\$682.00	25.5
	19-24	AQF1241AB	\$725.00	28.5	AQF1241CB	\$741.00	28.5
	25-30	AQF1301AB	\$784.00	31.5	AQF1301CB	\$801.00	31.5
	31-36	AQF1361AB	\$842.00	34.5	AQF1361CB	\$861.00	34.5
	37-42	AQF1421AB	\$903.00	37.5	AQF1421CB	\$922.00	37.5
225	0-12	AQF1122AB	\$1323.00	28.5	AQF1122CB	\$1452.00	28.5
	13-18	AQF1182AB	\$1358.00	31.5	AQF1182CB	\$1487.00	31.5
	19-24	AQF1242AB	\$1418.00	34.5	AQF1242CB	\$1547.55	34.5
	25-30	AQF1302AB	\$1479.00	37.5	AQF1302CB	\$1607.00	37.5
	31-36	AQF1362AB	\$1538.00	40.5	AQF1362CB	\$1668.00	40.5
	37-42	AQF1422AB	\$1598.00	43.5	AQF1422CB	\$1727.00	43.5
400	0-12	—	—	—	AQF1124CB	\$2032.00	46.5
	13-18	—	—	—	AQF1184CB	\$2089.00	49.5
	19-24	—	—	—	AQF1244CB	\$2147.00	52.5
	25-30	—	—	—	AQF1304CB	\$2207.00	55.5
	31-36	—	—	—	AQF1364CB	\$2267.00	58.5
	37-42	—	—	—	AQF1424CB	\$2327.00	61.5
600	0-12	—	—	—	AQF1126CB	\$3395.00	46.5
	13-18	—	—	—	AQF1186CB	\$3453.00	49.5
	19-24	—	—	—	AQF1246CB	\$3512.00	52.5
	25-30	—	—	—	AQF1306CB	\$4317.00	55.5
	31-36	—	—	—	AQF1366CB	\$3632.00	58.5
	37-42	—	—	—	AQF1426CB	\$3692.00	61.5

¹Bottom feed furnished as standard-change last character in Product No. from B to T for Top Feed.

²Single section interiors available up to 84 circuits. Consult Speedi or sales office for details.

³Includes standard panelboard interior, box and front. Add price for options when required.



Publications and Reference: See Section 22 for a complete list of additional product-related publications

Panelboards

A-Series® Panelboards

Type AQ

Section 9

Main Breaker Interiors^{1,2} (Continued)

Panel Amps Max.	Branch Space Required	Interrupting Rating								
		65kA			100kA			200kA		
		Interior Product Number	List Price, ³ GO-101	Sizing Dim. (in.)	Interior Product Number	List Price, ³ GO-101	Sizing Dim. (in.)	Interior Product Number ⁴	List Price, ³ GO-101	Sizing Dim. (in.)
100	0-12	AQF1121EB	\$1009.00	22.5	AQF1121FB	\$1402.00	22.5	AQF1121HT	\$1895.00	22.5
	13-18	AQF1181EB	\$1045.00	25.5	AQF1181FB	\$1438.00	25.5	AQF1181HT	\$1931.00	25.5
	19-24	AQF1241EB	\$1105.00	28.5	AQF1241FB	\$1498.00	28.5	AQF1241HT	\$1991.00	28.5
	25-30	AQF1301EB	\$1166.00	31.5	AQF1301FB	\$1558.00	31.5	AQF1301HT	\$2051.00	31.5
	31-36	AQF1361EB	\$1225.00	34.5	AQF1361FB	\$1618.00	34.5	AQF1361HT	\$2112.00	34.5
	37-42	AQF1421EB	\$1285.00	37.5	AQF1421FB	\$1678.00	37.5	AQF1421HT	\$2172.00	37.5
225	0-12	AQF1122JB	\$2072.00	28.5	AQF1122FB	\$2745.00	40.5	AQF1122HB	\$2956.00	40.5
	13-18	AQF1182JB	\$2107.00	31.5	AQF1182FB	\$2779.00	43.5	AQF1182HB	\$2993.00	43.5
	19-24	AQF1242JB	\$2167.00	34.5	AQF1242FB	\$2839.00	46.5	AQF1242HB	\$3050.00	46.5
	25-30	AQF1302JB	\$2227.00	37.5	AQF1302FB	\$2899.00	49.5	AQF1302HB	\$3111.00	49.5
	31-36	AQF1362JB	\$2288.00	40.5	AQF1362FB	\$2959.00	52.5	AQF1362HB	\$3172.00	52.5
	37-42	AQF1422JB	\$2347.00	43.5	AQF1422FB	\$3020.00	55.5	AQF1422HB	\$3232.00	55.5
400	0-12	AQF1124JB	\$2777.00	46.5	AQF1124FB	\$3581.00	46.5	AQF1124HB	\$3945.00	46.5
	13-18	AQF1184JB	\$2834.00	49.5	AQF1184FB	\$3640.00	49.5	AQF1184HB	\$4002.00	49.5
	19-24	AQF1244JB	\$2892.00	52.5	AQF1244FB	\$3700.00	52.5	AQF1244HB	\$4060.00	52.5
	25-30	AQF1304JB	\$2952.00	55.5	AQF1304FB	\$3761.00	55.5	AQF1304HB	\$4119.00	55.5
	31-36	AQF1364JB	\$3012.00	58.5	AQF1364FB	\$3821.00	58.5	AQF1364HB	\$4180.00	58.5
	37-42	AQF1424JB	\$3072.00	61.5	AQF1424FB	\$3881.00	61.5	AQF1424HB	\$4240.00	61.5
600	0-12	AQF1126JB	\$4140.00	46.5	AQF1126FB	\$4944.00	46.5	—	—	—
	13-18	AQF1186JB	\$4198.00	49.5	AQF1186FB	\$5004.00	49.5	—	—	—
	19-24	AQF1246JB	\$4257.00	52.5	AQF1246FB	\$5065.00	52.5	—	—	—
	25-30	AQF1306JB	\$4317.00	46.5	AQF1306FB	\$5126.00	55.5	—	—	—
	31-36	AQF1366JB	\$4377.00	58.5	AQF1366FB	\$5186.00	58.5	—	—	—
	37-42	AQF1426JB	\$4437.00	61.5	AQF1426FB	\$5246.00	61.5	—	—	—
800 ⁵	0-12	AQF1128JB	\$4843.00	55.5	—	—	—	—	—	—
	13-18	AQF1188JB	\$5026.00	58.5	—	—	—	—	—	—
	19-24	AQF1248JB	\$5200.00	61.5	—	—	—	—	—	—
	25-30	AQF1308JB	\$5385.00	64.5	—	—	—	—	—	—
	31-36	AQF1368JB	\$5560.00	67.5	—	—	—	—	—	—
	37-42	AQF1428JB	\$5740.00	70.5	—	—	—	—	—	—

¹Bottom feed furnished as standard-change last character in Product No. from B to T for Top Feed.

²Single section interiors available up to 84 circuits. Consult Speedi or sales office for details.

³Includes standard panelboard interior, box and front. Add price for options when required.

⁴100A main breaker UL Listed for top feed only.

⁵Box is 30" wide x 7.81" deep.



Panelboards

A-Series® Panelboards

Type AQ

240 Vac Bolt-On

Factory Assembled

Three-Phase, 3-Wire/4-Wire Pricing¹

GE Fastrac Program items are indicated in red²

Service Information:

3-ph, 3-w, 3-ph, 4-w;
240 Vac Max.

Bolt-On Branch Breakers:

15-100 amps, 1, 2, 3-poles
types THQB, THHQB, TXQB.

Service Entrance Equipment:

Service entrance rating is standard on all main breaker panels and 12 and 18 circuit, 225 amp max MLO devices. No need to specify on order.

Mains:

100-THQB, THHQB, TEY, SE
225-TQD, THQD, SF
400-TJD, SG
600-SG
800-SK
125-800 amp main lug

NOTE: Sizing dimensions to be used only for enclosure selection, not to determine interior length.

Main Lug Interiors^{3,4}

Use THQB Bolt-on Breakers		Single Main Lugs			Subfeed Main Lugs		
Panel Amps Max.	Branch Space Required	Interior Product Number	List Price, ⁵ GO-101	Sizing Dim. (in.)	Interior Product Number	List Price, ⁵ GO-101	Sizing Dim. (in.)
125	0-12	AQF3121MB	\$487.00	22.5	AQF3121SB	\$548.00	22.5
	13-18	AQF3181MB	\$523.00	25.5	AQF3181SB	\$584.00	25.5
	19-24	AQF3241MB	\$583.00	28.5	AQF3241SB	\$645.00	28.5
	25-30	AQF3301MB	\$644.00	31.5	AQF3301SB	\$705.00	31.5
	31-36	AQF3361MB	\$704.00	34.5	AQF3361SB	\$765.00	34.5
	37-42	AQF3421MB	\$763.00	37.5	AQF3421SB	\$824.00	37.5
225	0-12	AQF3122MB	\$529.00	28.5	AQF3122SB	\$591.00	28.5
	13-18	AQF3182MB	\$565.00	31.5	AQF3182SB	\$627.00	31.5
	19-24	AQF3242MB	\$626.00	34.5	AQF3242SB	\$687.00	34.5
	25-30	AQF3302MB	\$686.00	37.5	AQF3302SB	\$747.00	37.5
	31-36	AQF3362MB	\$746.00	40.5	AQF3362SB	\$807.00	40.5
	37-42	AQF3422MB	\$805.00	43.5	AQF3422SB	\$867.00	43.5
400	0-12	AQF3124MB	\$745.00	37.5	AQF3124SB	\$913.00	43.5
	13-18	AQF3184MB	\$796.00	43.5	AQF3184SB	\$966.00	49.5
	19-24	AQF3244MB	\$851.00	40.5	AQF3244SB	\$1023.00	46.5
	25-30	AQF3304MB	\$910.00	46.5	AQF3304SB	\$1083.00	52.5
	31-36	AQF3364MB	\$970.00	49.5	AQF3364SB	\$1143.00	55.5
	37-42	AQF3424MB	\$1030.00	52.5	AQF3424SB	\$1203.00	58.5
600	0-12	AQF3126MB	\$886.00	43.5	—	—	—
	13-18	AQF3186MB	\$957.00	49.5	—	—	—
	19-24	AQF3246MB	\$1014.00	46.5	—	—	—
	25-30	AQF3306MB	\$1074.00	52.5	—	—	—
	31-36	AQF3366MB	\$1134.00	55.5	—	—	—
	37-42	AQF3426MB	\$1194.00	58.5	—	—	—
800 ⁶	0-12	AQF3128MB	\$1190.00	43.5	—	—	—
	13-18	AQF3188MB	\$1316.00	46.5	—	—	—
	19-24	AQF3248MB	\$1433.00	49.5	—	—	—
	25-30	AQF3308MB	\$1554.00	52.5	—	—	—
	31-36	AQF3368MB	\$1710.00	55.5	—	—	—
	36-42	AQF3428MB	\$1815.00	58.5	—	—	—

¹For 3-ph, 3-wire applications, no neutral supplied.

²3-ph, 4-wire 240/120Vac Hi-leg Delta panels not available as GE Fastrac™ Program.

³Bottom feed furnished as standard-change last character in Product Number from B to T for Top Feed.

⁴Single section interiors available up to 84 circuits. Consult Speedi or sales office for details.

⁵Includes standard panelbox interior, box and front. Add price for options when required.

⁶Box is 30" wide x 7.81" deep.

SPLIT BUS—Refer to publication DE-81 or consult your local sales office



Publications and Reference: See Section 22 for a complete list of additional product-related publications

Panelboards

A-Series® Panelboards

Type AQ

Section 9

Enclosures

Sizing Dim. (inches)	Box Product ¹ Number	Inside Box Dim. (inches)			Front Product Number
		Length	Width	Depth	
0-25.5	AB25*	25.5	20	5.81	AF25F,S
28.5-31.5	AB31*	31.5	20	5.81	AF31F,S
34.5-37.5	AB37*	37.5	20	5.81	AF37F,S
40.5-43.5	AB43*	43.5	20	5.81	AF43F,S
46.5-49.5	AB49*	49.5	20	5.81	AF49F,S
52.5-55.5	AB55*	55.5	20	5.81	AF55F,S
57.5-64.5	AB64*	64.5	20	5.81	AF64F,S
67.5-76.5	AB76*	76.5	20	5.81	AF76F,S

Flush fronts are 1 1/2 inches larger than box. Surface fronts are 1/4 inch larger than box.

¹*Add appropriate suffix.

Main Breaker Interiors^{2,3}

Panel Amps Max.	Branch Space Required	Interrupting Rating					
		10kA			22kA		
		Interior Product Number	List Price, ⁴ GO-101	Sizing Dim. (in.)	Interior Product Number	List Price, ⁴ GO-101	Sizing Dim. (in.)
100	0-12	AQF3121AB	\$736.00	22.5	AQF3121CB	\$845.00	22.5
	13-18	AQF3181AB	\$770.00	25.5	AQF3181CB	\$880.00	25.5
	19-24	AQF3241AB	\$831.00	28.5	AQF3241CB	\$941.00	28.5
	25-30	AQF3301AB	\$891.00	31.5	AQF3301CB	\$1001.00	31.5
	31-36	AQF3361AB	\$950.00	34.5	AQF3361CB	\$1061.00	34.5
	37-42	AQF3421AB	\$1010.00	37.5	AQF3421CB	\$1120.00	37.5
225	0-12	AQF3122AB	\$1540.00	28.5	AQF3122CB	\$1671.00	28.5
	13-18	AQF3182AB	\$1576.00	31.5	AQF3182CB	\$1706.00	31.5
	19-24	AQF3242AB	\$1636.00	34.5	AQF3242CB	\$1766.00	34.5
	25-30	AQF3302AB	\$1696.00	37.5	AQF3302CB	\$1826.00	37.5
	31-36	AQF3362AB	\$1757.00	40.5	AQF3362CB	\$1887.00	40.5
	37-42	AQF3422AB	\$1817.00	43.5	AQF3422CB	\$1947.00	43.5
400	0-12	—	—	—	AQF3124CB	\$2360.00	46.5
	13-18	—	—	—	AQF3184CB	\$2418.00	49.5
	19-24	—	—	—	AQF3244CB	\$2478.00	52.5
	25-30	—	—	—	AQF3304CB	\$2539.00	55.5
	31-36	—	—	—	AQF3364CB	\$2599.00	58.5
	37-42	—	—	—	AQF3424CB	\$2659.00	61.5
600	0-12	—	—	—	AQF3126CB	\$3934.00	46.5
	13-18	—	—	—	AQF3186CB	\$3993.00	49.5
	19-24	—	—	—	AQF3246CB	\$4053.00	52.5
	25-30	—	—	—	AQF3306CB	\$4114.00	55.5
	31-36	—	—	—	AQF3366CB	\$4174.00	58.5
	37-42	—	—	—	AQF3426CB	\$4234.00	61.5

²Bottom feed furnished as standard-change last character in Product Number from B to T for Top Feed.

³Single section interiors available up to 84 circuits. Consult Speedi or sales office for details.

⁴Includes standard panelbox interior, box and front. Add price for options when required.



Product Number Selection Instructions: See page 9-13

Panelboards

A-Series® Panelboards

Type AQ

Main Breaker Interiors^{1,2} (Continued)

Panel Amps Max.	Branch Space Required	Interrupting Rating								
		65kA			100kA			200kA		
		Interior Product Number	List Price, ³ GO-101	Sizing Dim. (in.)	Interior Product Number	List Price, ³ GO-101	Sizing Dim. (in.)	Interior Product Number	List Price, ³ GO-101	Sizing Dim. (in.)
100	0-12	AQF3121EB	\$1136.00	22.5	AQF3121FB	\$1487.00	22.5	AQF3121HB	\$1975.00	22.5
	13-18	AQF3181EB	\$1172.00	25.5	AQF3181FB	\$1523.00	25.5	AQF3181HB	\$2012.00	25.5
	19-24	AQF3241EB	\$1232.00	28.5	AQF3241FB	\$1582.00	28.5	AQF3241HB	\$2073.00	28.5
	25-30	AQF3301EB	\$1293.00	31.5	AQF3301FB	\$1642.00	31.5	AQF3301HB	\$2133.00	31.5
	31-36	AQF3361EB	\$1353.00	34.5	AQF3361FB	\$1703.00	34.5	AQF3361HB	\$2193.00	34.5
	37-42	AQF3421EB	\$1412.00	37.5	AQF3421FB	\$1763.00	37.5	AQF3421HB	\$2252.00	37.5
225	0-12	AQF3122JB	\$2361.00	28.5	AQF3122FB	\$3114.00	40.5	AQF3122HB	\$3356.00	40.5
	13-18	AQF3182JB	\$2396.00	31.5	AQF3182FB	\$3150.00	43.5	AQF3182HB	\$3392.00	43.5
	19-24	AQF3242JB	\$2456.00	34.5	AQF3242FB	\$3210.00	46.5	AQF3242HB	\$3451.00	46.5
	25-30	AQF3302JB	\$2516.00	37.5	AQF3302FB	\$3270.00	49.5	AQF3302HB	\$3511.00	49.5
	31-36	AQF3362JB	\$2577.00	40.5	AQF3362FB	\$3330.00	52.5	AQF3362HB	\$3571.00	52.5
	37-42	AQF3422JB	\$2637.00	43.5	AQF3422FB	\$3391.00	55.5	AQF3422HB	\$3632.00	55.5
400	0-12	AQF3124JB	\$3160.00	46.5	AQF3124FB	\$4026.00	46.5	AQF3124HB	\$4284.00	46.5
	13-18	AQF3184JB	\$3218.00	49.5	AQF3184FB	\$4084.00	49.5	AQF3184HB	\$4342.00	49.5
	19-24	AQF3244JB	\$3278.00	52.5	AQF3244FB	\$4143.00	52.5	AQF3244HB	\$4400.00	52.5
	25-30	AQF3304JB	\$3339.00	55.5	AQF3304FB	\$4203.00	55.5	AQF3304HB	\$4459.00	55.5
	31-36	AQF3364JB	\$3399.00	58.5	AQF3364FB	\$4264.00	58.5	AQF3364HB	\$4520.00	58.5
	37-42	AQF3424JB	\$3459.00	61.5	AQF3424FB	\$4324.00	61.5	AQF3424HB	\$4580.00	61.5
600	0-12	AQF3126JB	\$4734.00	46.5	AQF3126FB	\$5600.00	46.5	—	—	—
	13-18	AQF3186JB	\$4793.00	49.5	AQF3186FB	\$5659.00	49.5	—	—	—
	19-24	AQF3246JB	\$4853.00	52.5	AQF3246FB	\$5718.00	52.5	—	—	—
	25-30	AQF3306JB	\$4914.00	55.5	AQF3306FB	\$5778.00	55.5	—	—	—
	31-36	AQF3366JB	\$4974.00	58.5	AQF3366FB	\$5839.00	58.5	—	—	—
	37-42	AQF3426JB	\$4924.00	61.5	AQF3426FB	\$5899.00	61.5	—	—	—
800 ⁴	0-12	AQF3128JB	\$4943.00	55.5	—	—	—	—	—	—
	13-18	AQF3188JB	\$5126.00	58.5	—	—	—	—	—	—
	19-24	AQF3248JB	\$5300.00	61.5	—	—	—	—	—	—
	25-30	AQF3308JB	\$5485.00	64.5	—	—	—	—	—	—
	31-36	AQF3368JB	\$5660.00	67.5	—	—	—	—	—	—
	37-42	AQF3428JB	\$5840.00	70.5	—	—	—	—	—	—
	43-48	AQF3488JB	\$6029.00	70.4	—	—	—	—	—	—

¹Bottom feed furnished as standard-change last character in Product Number from B to T for Top Feed.

²Single section interiors available up to 84 circuits. Consult Speedi or sales office for details.

³Includes standard panelbox interior, box and front. Add price for options when required.

⁴Box is 30" wide x 7.81" deep.



Panelboards

A-Series® Panelboards

Section 9

Type AQ

240 Vac Bolt-On

Factory Assembled Pricing

GE Fastrac Program items are indicated in red

THQB Circuit Breakers–Bolt-on

Molded Case Circuit Breakers				List Price, GO-101			
Branch Breaker Mounting	Type	Bolt On Frames	Trip Range (Amps)	1-Pole 120 V	2-Pole 120/240 V	2-Pole 240 V ¹	3-Pole 240 V
Space Required	—	—	—	1	2	2	3
			15-60 ²	\$15.00	\$33.00	\$87.00	\$100.00
		THQB ³	70	\$31.00	\$60.00	\$87.00	\$119.00
			80-100 ⁴	—	\$87.00	\$126.00	\$138.00
	THQB	THQB-GF	15 20 25 30	\$111.00	\$185.00	—	—
		THQB-GFEP	15-30 ³	\$211.00	\$485.00	—	—
	(10,000 AIC)	THQB-HID	15-30	\$19.00	\$41.00	—	—
Double Branch			15-20 ²	\$23.00	\$61.00	\$139.00	\$145.00
			25-60 ³	\$32.50	\$61.00	\$139.00	\$145.00
		THHQB ³	70	\$46.00	\$92.50	\$151.00	\$191.00
			80-100 ⁴	—	\$133.00	\$185.00	\$214.00
	THHQB (22,000 AIC)	THHQB-GF	15 20 25 30	\$216.00	—	—	—
		THHQB-HID	15-30	\$33.00	\$107.00	—	—
	TXQB (65,000 AIC)	TXQB	15-30	\$43.00	\$119.00	—	\$236.00
Subfeed Breakers ⁵ (Single Branch)	Standard High Break	TQD	—	—	—	\$531.00	\$623.00
		THQD	—	—	—	\$764.00	\$800.00

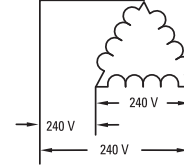

FIG. 1

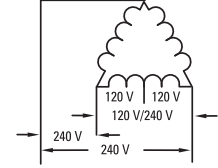

FIG. 2

¹2-pole, 120/240-volt, Q-line circuit breakers can be connected line-to-line on 3-phase, 4-wire, 120/208-volt or single-phase, 120/240-volt systems. 2-pole, 240-volt, Q-line circuit breakers must be used when connected to 3-phase, 3-wire 240-volt delta systems (Fig. 1), or to the high leg of a midpoint delta grounded system (Fig. 2).

²15 and 20 amp devices are SWD rated.

³25, 35, and 45 amp ratings are not available as GE Fastrac™ Program.

⁴The sum of double branch breaker ratings mounted opposite each other cannot exceed 180 amperes.

⁵Create appropriate option Product Number and determine size requirements from options table page 9-35. Specify breaker type, poles and ampacity in addition to option Product Number when ordering.

Main, Branch And Subfeed Breaker Accessories⁶

List Prices, GO-101					
Circuit Breaker Frame	Shunt Trip	Auxiliary Contacts 2 and 3-Pole Only		Padlocking Devices	Handle Locking Devices
		No. of AB Switch Elements	For 240VAC		
THQB, THHQB, TXQB	\$98.00 ⁷	1	\$89.00 ⁷	\$10.00	\$6.00
TEY	\$392.00 ⁷	1	\$200.00 ⁷	\$11.00	\$6.00
		1	\$200.00	—	—
SE	\$392.00	2	\$360.00	—	—
TQD	\$447.00	—	—	\$14.00	—
SF, TFL	\$447.00	2	\$447.00	\$14.00	\$10.00
		1	\$243.00	—	—
SG, TJD	\$447.00	2	\$447.00	\$20.00	—
SK	\$447.00	2	\$447.00	\$20.00	—

⁶Internal accessories must be factory installed.

⁷Takes up one branch space in sizing for both main and branch applications.



Product Number Selection Instructions: See page 9-13

Panelboards

A-Series® Panelboards

Type AQ

240 Vac Bolt-On

Factory Assembled Pricing

Panelboard Options

GE Fastrac Program items are indicated in red

NOTE: Sizing dimensions to be used only for enclosure selection, not to determine interior length. Use Speedi-Win or call your GE sales engineer for exact box height needed.

Interior Options

Option	Description	Product ¹ Number Option Suffix	100/125 Amps		225 Amps		400 Amps		600 Amps		800 Amps	
			Panel Sizing Adder	List Price Adder, GO-101	Panel Sizing Adder ⁹	List Price Adder, GO-101	Panel Sizing Adder ⁹	List Price Adder, GO-101	Panel Sizing Adder ⁹	List Price Adder, GO-101	Panel Sizing Adder ⁹	List Price Adder, GO-101
Optional Lugs ²	Compression Alum.	L1	—	\$30.00	—	\$50.00	—	\$130.00	—	\$175.00		
	Pressure Copper	L2	—	\$49.00	—	\$49.00	—	\$92.00	—	\$114.00		
	Comp. Alum. Oversize	L3	—	\$152.00	—	\$152.00	—	\$461.00	—	\$461.00	N/A	—
	Pressure Alum. Oversize	L4	—	\$54.00	—	\$54.00	—	\$330.00	—	\$330.00		
Subfeed Breakers And Contactors (Select Only One)	2 Poles TQD ³	Q2	N/A		6		6		6			
	3 Poles TQD ³	Q3	N/A		6		6		6			
	4 Poles TQD ³	Q4	N/A		9		9		9			
	5 Poles TQD ³	Q5	N/A		9		9		9			
	6 Poles TQD	Q6	N/A		9		9		9			
	7 Poles TQD	Q7	N/A		12		12		12		12	
	8 Poles TQD	Q8	N/A		12		12		12		12	
	9 Poles TQD	Q9	N/A	Price From Panel or Contactor Sections by Device	15	Price From Panel or Contactor Sections by Device	15	Price From Panel Section	15	Price From Panel Section	15	
	11 Poles TQD	QB	N/A		N/A		18		18		18	
	12 Poles TQD	Q1	N/A		N/A		18		18		18	
	13 Poles TQD	QC	N/A		N/A		21		21		21	
	14 Poles TQD	QD	N/A		N/A		21		21		21	
	15 Poles TQD	QE	N/A		N/A		24		24		24	
	16 Poles TQD	QF	N/A		N/A		24		24		24	
17 Poles TQD	QG	N/A		N/A		27		27		27		
18 Poles TQD	QH	N/A		N/A		27		27		27		
	2 or 3 Pole Contactor ⁴	C1	15		18		N/A		N/A			
Feed Thru	Feed Thru Lugs ⁵	T1	3	\$164.00	3	\$164.00	3	\$286.00	6	\$286.00	6	\$451.00
Busbar ⁶	600 APSI Alum.	B1	—	\$595.00	—	\$595.00	—	\$759.00	—	N/A	—	N/A
	750 APSI Alum.	B2	—	\$135.00	—	\$135.00	—	Std.	—	Std.	—	N/A
	800 APSI Copper	B3	—	\$610.00	—	\$610.00	—	\$904.00	—	N/A	—	N/A
	1000 APSI Copper	B4	—	\$210.00	—	\$210.00	—	\$323.00	—	\$387.00	—	\$559.00 ⁸
	Standard Copper	B7	—	\$103.00	—	\$103.00	—	\$182.00	—	\$246.00	—	N/A
200% Rated ⁷ Neutrals	2 Standard Lugs	N2	—	\$60.00	—	\$100.00	9	\$140.00	9	\$280.00 ⁷	N/A	N/A

¹Option Product Number prefix is "AX".

²Oversize lugs available on single main lug panels only.

³For TQD main panels, adder is 3 inches less than value shown.

⁴For contactor subfeeds with contactor mains, add another 3 inches.

⁵Feed thru lugs not available on subfeed or oversized main lug panels.

⁶For silver or tin plating 1000 APSI Cu only add \$100.00 List, GO-101.

⁷200% rated neutrals in 600 panels require 30"W box. See page 9-8 for wire sizes.

⁸800A bus must be silver plated.

⁹Add 7" for 2 or more subfeed breakers.



Publications and Reference: See Section 22 for a complete list of additional product-related publications

Panelboards

A-Series® Panelboards

Type AQ

Section 9

Enclosure Options

Box Options

Description	Product Number Suffix ¹⁰	List Price GO-101
Blank Endwalls	B	11
Painted Box	P	\$200.00
30" Wide ¹²	W	\$250.00
NEMA 3R/12	3	\$950.00
Endwall w/Knockouts	K	11
NEMA 4X (Stainless Steel)	4S	\$4950.00
NEMA 4X (Painted Galvaneal)	4	\$2800.00
16 7/8" Wide	5	-\$40.00

¹⁰Add to base box Product Number.

¹¹No charge if included on original order. Price kit from page 9-54 if field conversion is required.

¹²Includes field installable gutter barrier.

TVSS¹⁵ Transient Voltage Surge Suppression

Maximum Surge Current Per Mode	Maximum Surge Current Per Phase	Description	List Price, GO-101 A Series Panelboards ^{13,14}
65kA	130kA	TVSS, UL1449, UL1283	\$6350.00
80kA	160kA	TVSS, UL1449, UL1283	\$7000.00
100kA	200kA	TVSS, UL1449, UL1283	\$8500.00
100kA		TVSS, no Count or UL1283	\$2875.00
100kA		TVSS, no UL1283	\$3575.00

¹³Price applies to any A Series® panel furnished in a standard 20" wide enclosure, types AL, AQ, AE, or AD.

¹⁴See Section 15 for product numbers.

¹⁵Factory Installed TVSS units. Installed in 10" module, add interior Suffix T6 + 10" to box height.

Front Options—NEMA 1 Only

Description	Product Number Suffix ¹⁶	List Price GO-101
Screw Cover	C	\$61.00
Front Hinged to Box	D	\$110.00
Optional Locks:		
Yale 511S w/Rosette	Y	\$300.00
Corbin 15767	L	\$146.00
Nameplate	N	\$27.00
Door within a Door ¹⁷	P	\$238.00
Stainless Steel ¹⁸	S	\$1467.00
30" Wide	W	\$250.00
Screw-on nameplates	U	\$74.00
Metal Directory Card	M	\$50.00

¹⁶Add to base front Product Number.

¹⁷Consists of two lockable doors—one over panel interior and one over box wiring gutters. Yale locks not available.

¹⁸Flush only. Available with C and N options.

BOX EXTENSIONS—For additional end gutter space or conduit skirt applications—price from page 9-54.

Equipment Grounds—Factory Supplied with Panelboard

Description	Product Number	List Price Adder GO-101
Field installed kits		
Standard bonded to box—for each 12 branch positions	TGL2	\$15.00
Copper bonded to box—for each 12 branch positions	TGC2	\$94.00
Standard-isolated/insulated—for each 12 branch positions	EGS12	\$99.00
Copper-isolated/insulated—for each 12 branch positions	EGC12	\$132.00
Main lug for above terminal kits	TGL20	\$25.00

Optional Equipment Grounds

Description	Product Number	List Price GO-134B
Aluminum Extruded Bonded	AEBG	\$75.00
Copper Extruded Bonded	AEBGC	\$140.00
Aluminum Extruded Isolated	AEIG	\$115.00
Copper Extruded Isolated	AEIGC	\$150.00
Copper Isolated/Bonded	ASPGIBC	\$452.00 ¹⁹

¹⁹GO-101



Product Number Selection Instructions: See page 9-13

Panelboards

A-Series® Panelboards

Type AE

480Y/277 Vac

Bolt-On Factory Assembled

Three-Phase, 4-Wire Pricing

GE Fastrac Program items are indicated in red

Service Information:

3-ph, 4-w

480Y/277 Vac or 208Y/120 Vac

Bolt On Branch Breakers:

15-100 amps, 1, 2, 3-poles

Type TEY

Service Entrance Label will be factory installed only when specified.

Please see page 9-3 for UL Standards on service entrance. Service

Entrance Labels are available for field installation. Please contact a

GE Consumer & Industrial Sales Office for ordering instructions.

Mains:

100A-TEY, SE

225A-TFJ, SF

400A-TJJ, SG

600A-SG

800A-SK

125-800 amp main lug

NOTE: Sizing dimensions to be used only for enclosure selection, not to determine interior length.

Main Lug Interiors^{2,4}

Use TEY Bolt-on Breakers		Single Main Lugs			Subfeed Main Lugs		
Panel Amps Max.	Branch Space Required	Interior Product Number ²	List Price, ¹ GO-101	Sizing Dim. (ln.)	Interior Product Number ²	List Price, ¹ GO-101	Sizing Dim. (ln.)
125	0-12	AEF3121MB	\$605.00	22.5	AEF3121SB	\$641.00	22.5
	13-18	AEF3181MB	\$658.00	25.5	AEF3181SB	\$694.00	25.5
	19-24	AEF3241MB	\$750.00	28.5	AEF3241SB	\$786.00	28.5
	25-30	AEF3301MB	\$841.00	31.5	AEF3301SB	\$877.00	31.5
	31-36	AEF3361MB	\$933.00	34.5	AEF3361SB	\$968.00	34.5
	37-42	AEF3421MB	\$1024.00	37.5	AEF3421SB	\$1060.00	37.5
225	0-12	AEF3122MB	\$672.00	28.5	AEF3122SB	\$712.00	28.5
	13-18	AEF3182MB	\$726.00	31.5	AEF3182SB	\$765.00	31.5
	19-24	AEF3242MB	\$817.00	34.5	AEF3242SB	\$856.00	34.5
	25-30	AEF3302MB	\$908.00	37.5	AEF3302SB	\$947.00	37.5
	31-36	AEF3362MB	\$1000.00	40.5	AEF3362SB	\$1039.00	40.5
	37-42	AEF3422MB	\$1091.00	43.5	AEF3422SB	\$1130.00	43.5
400	0-12	AEF3124MB	\$832.00	37.5	AEF3124SB	\$924.00	43.5
	13-18	AEF3184MB	\$908.00	40.5	AEF3184SB	\$1001.00	46.5
	19-24	AEF3244MB	\$992.00	43.5	AEF3244SB	\$1085.00	49.5
	25-30	AEF3304MB	\$1084.00	46.5	AEF3304SB	\$1176.00	52.5
	31-36	AEF3364MB	\$1175.00	49.5	AEF3364SB	\$1267.00	55.5
	37-42	AEF3424MB	\$1265.00	52.5	AEF3424SB	\$1358.00	58.5
600	0-12	AEF3126MB	\$971.00	43.5	—	—	—
	13-18	AEF3186MB	\$1049.00	46.5	—	—	—
	19-24	AEF3246MB	\$1133.00	49.5	—	—	—
	25-30	AEF3306MB	\$1224.00	52.5	—	—	—
	31-36	AEF3366MB	\$1316.00	55.5	—	—	—
	37-42	AEF3426MB	\$1407.00	58.5	—	—	—
800 ³	0-12	AEF3128MB	\$1218.00	55.5	—	—	—
	13-18	AEF3188MB	\$1338.00	55.5	—	—	—
	19-24	AEF3248MB	\$1458.00	55.5	—	—	—
	25-30	AEF3308MB	\$1578.00	55.5	—	—	—
	31-36	AEF3368MB	\$1730.00	55.5	—	—	—
	36-42	AEF3428MB	\$1840.00	58.5	—	—	—

¹Includes standard panelboard interior box and front. Add price for options when required.

²Bottom feed supplied as standard-change last character in Product Number from B to T for Top Feed.

³Box is 30" wide x 7.81" deep.

⁴Single section interiors available up to 84 circuits. Consult Speedi or sales office for details.

SPLIT BUS—Refer to publication DE-81 or consult your local sales office



Publications and Reference: See Section 22 for a complete list of additional product-related publications

Panelboards

A-Series® Panelboards

Type AE

Section 9

Enclosures

Sizing Dim. (Inches)	Box Product Number	Inside Box Dim. (Inches)			Front Product Number
		Length	Width	Depth	
0-25.5	AB25	25.5	20	5.81	AF25F,S
28.5-31.5	AB31	31.5	20	5.81	AF31F,S
34.5-37.5	AB37	37.5	20	5.81	AF37F,S
40.5-43.5	AB43	43.5	20	5.81	AF43F,S
46.5-49.5	AB49	49.5	20	5.81	AF49F,S
52.5-55.5	AB55	55.5	20	5.81	AF55F,S
57.5-64.5	AB64	64.5	20	5.81	AF64F,S
67.5-76.5	AB76	76.5	20	5.81	AF76F,S

Flush fronts are 1 1/2 inches larger than box. Surface fronts are 1/4 inch larger than box.

Main Breaker Interiors^{1,2}

Interrupting Rating													
Panel Amps Max.	Branch Space Required	14kA 480Y/277 Vac ³			25kA 480Y/277 Vac			65kA 480Y/277 Vac 100kA 240 Vac Max			100kA 480Y/277 Vac 200kA 240 Vac Max		
		Interior Product Number	List Price, ⁴ GO-101	Sizing Dim. (In.)	Interior Product Number	List Price, ⁴ GO-101	Sizing Dim. (In.)	Interior Product Number	List Price, ⁴ GO-101	Sizing Dim. (In.)	Interior Product Number	List Price, ⁴ GO-101	Sizing Dim. (In.)
100	0-12	AEF3121BB	\$990.00	22.5	AEF3121KB	\$1285.00	22.5	AEF3121DB	\$1606.00	22.5	AEF3121GB	\$2097.00	22.5
	13-18	AEF3181BB	\$1043.00	25.5	AEF3181KB	\$1338.00	25.5	AEF3181DB	\$1659.00	25.5	AEF3181GB	\$2151.00	25.5
	19-24	AEF3241BB	\$1134.00	28.5	AEF3241KB	\$1429.00	28.5	AEF3241DB	\$1750.00	28.5	AEF3241GB	\$2242.00	28.5
	25-30	AEF3301BB	\$1225.00	31.5	AEF3301KB	\$1520.00	31.5	AEF3301DB	\$1842.00	31.5	AEF3301GB	\$2333.00	31.5
	31-36	AEF3361BB	\$1317.00	34.5	AEF3361KB	\$1612.00	34.5	AEF3361DB	\$1933.00	34.5	AEF3361GB	\$2425.00	34.5
	37-42	AEF3421BB	\$1406.00	37.5	AEF3421KB	\$1701.00	37.5	AEF3421DB	\$2025.00	37.5	AEF3421GB	\$2516.00	37.5
225	0-12	AEF3122BB	\$1711.00	40.5	AEF3122KB	\$2006.00	28.5	AEF3122DB	\$3224.00	40.5	AEF3122GB	\$3478.00	40.5
	13-18	AEF3182BB	\$1764.00	43.5	AEF3182KB	\$2059.00	31.5	AEF3182DB	\$3276.00	43.5	AEF3182GB	\$3530.00	43.5
	19-24	AEF3242BB	\$1854.00	46.5	AEF3242KB	\$2149.00	34.5	AEF3242DB	\$3367.00	46.5	AEF3242GB	\$3622.00	46.5
	25-30	AEF3302BB	\$1946.00	49.5	AEF3302KB	\$2241.00	37.5	AEF3302DB	\$3459.00	49.5	AEF3302GB	\$3713.00	49.5
	31-36	AEF3362BB	\$2037.00	52.5	AEF3362KB	\$2332.00	40.5	AEF3362DB	\$3550.00	52.5	AEF3362GB	\$3804.00	52.5
	37-42	AEF3422BB	\$2128.00	55.5	AEF3422KB	\$2423.00	43.5	AEF3422DB	\$3642.00	55.5	AEF3422GB	\$3896.00	55.5
400	0-12	AEF3124BB	\$2556.00	46.5	—	—	AEF3124DB	\$4139.00	46.5	AEF3124GB	\$4418.00	46.5	
	13-18	AEF3184BB	\$2642.00	49.5	—	—	AEF3184DB	\$4226.00	49.5	AEF3184GB	\$4506.00	49.5	
	19-24	AEF3244BB	\$2731.00	52.5	—	—	AEF3244DB	\$4315.00	52.5	AEF3244GB	\$4595.00	52.5	
	25-30	AEF3304BB	\$2823.00	55.5	—	—	AEF3304DB	\$4406.00	55.5	AEF3304GB	\$4686.00	55.5	
	31-36	AEF3364BB	\$2914.00	58.5	—	—	AEF3364DB	\$4497.00	58.5	AEF3364GB	\$4778.00	58.5	
	37-42	AEF3424BB	\$3004.00	61.5	—	—	AEF3424DB	\$4588.00	61.5	AEF3424GB	\$4869.00	61.5	
600	0-12	AEF3126BB	\$4484.00	46.5	—	—	AEF3126DB	\$6067.00	46.5	—	—	—	
	13-18	AEF3186BB	\$4573.00	49.5	—	—	AEF3186DB	\$6157.00	49.5	—	—	—	
	19-24	AEF3246BB	\$4663.00	52.5	—	—	AEF3246DB	\$6247.00	52.5	—	—	—	
	25-30	AEF3306BB	\$4755.00	55.5	—	—	AEF3306DB	\$6338.00	55.5	—	—	—	
	31-36	AEF3366BB	\$4846.00	58.5	—	—	AEF3366DB	\$6429.00	58.5	—	—	—	
	37-42	AEF3426BB	\$4936.00	61.5	—	—	AEF3426DB	\$6520.00	61.5	—	—	—	
800 ⁵	0-12	AEF3128BB	\$5246.00	55.5	—	—	—	—	—	—	—	—	
	13-18	AEF3188BB	\$5355.00	58.5	—	—	—	—	—	—	—	—	
	19-24	AEF3248BB	\$5442.00	61.5	—	—	—	—	—	—	—	—	
	25-30	AEF3308BB	\$5702.00	64.5	—	—	—	—	—	—	—	—	
	31-36	AEF3368BB	\$5941.00	67.5	—	—	—	—	—	—	—	—	
	37-42	AEF3428BB	\$6181.00	70.5	—	—	—	—	—	—	—	—	

¹Bottom feed supplied as standard-change last character in Product Number from B to T for Top Feed.

²Single section interiors available up to 84 circuits. Consult Speedi or sales office for details.

³Ratings at 240 Vac are:

100 Amp-65kA

225 Amp-25kA

400 Amp-42kA

600 Amp-42kA

⁴Includes standard panelboard interior box and front. Add price for options when required.

⁵Box is 30" wide x 7.81" deep.

Product Number Selection Instructions: See page 9-13



Panelboards

A-Series® Panelboards

Type AE

480Y/277 Vac Bolt-On

Factory Assembled Pricing

GE Fastrac Program items are indicated in red

Branch Breakers, TEY Circuit Breakers—Bolt-On

Branch Breaker Mounting	Type	Bolt-On Frames	Trip Range (Amps)	List Price, GO-101		
				1-Pole 277 Vac	2-Pole 480/277 Vac	3-Pole 480/277 Vac
				No. Spaces Required		
			1	2	3	
Double Branch	TEY (14,000AIC)	TEY	15-60 ³	\$53.00	\$130.00	\$230.00
			70-100 ⁴	\$116.00	\$274.00	\$326.00
Subfeed ¹ Breakers (Single Branch)	Standard ² Frames	TED4	125-150	—	—	\$1002.00
		SF/TJJ (3P Max)	110-225	—	\$846.00	\$1057.00

¹Create appropriate option product number and determine size requirements from options table on page 9-38. Specify breaker type, poles and ampacity in addition to option product number when ordering.

²**NOTE:** TED and SF subfeeds horizontally mounted. Subfeed breaker types cannot be combined in the same panel.

³15 and 20 ampere TEY breakers are SWD rated for fluorescent lighting applications.

⁴The sum of double branch breakers mounted opposite each other cannot exceed 180 amperes.

Main, Branch, And Subfeed Breaker Accessories⁵

Circuit Breaker Frame	UVR or Shunt Trip	List Price, GO-101			
		Auxiliary Contacts 2 and 3-Pole Only		Padlocking Devices	Handle Locking Devices
		No. of AB Switch Elements	For 240 Vac		
TEY ^{5,6}	\$392.00 ⁷	1	\$200.00 ⁷	\$11.00	\$6.00
TED	\$392.00	1	\$200.00	\$11.00	\$6.00
		2	\$360.00		
SE	\$392.00	1	\$200.00	\$14.00	—
		2	\$360.00		
SF, TFJ	\$447.00	2	\$447.00	\$14.00	\$10.00
		4	\$485.00		
SG, TJJ	\$447.00	1	\$243.00	\$20.00	—
		2	\$447.00		
SK	\$447.00	2	\$447.00	\$20.00	—

⁵Internal accessories must be factory installed.

⁶Internal accessories only available on 2 and 3-pole.

⁷Takes up one branch space in sizing for both main and branch applications.



Publications and Reference: See Section 22 for a complete list of additional product-related publications

Panelboards

A-Series® Panelboards

Section 9

Type AE

480Y/277 Vac Bolt-On

Factory Assembled Pricing

Panelboard Options

GE Fastrac Program items are indicated in red

NOTE: Sizing dimensions to be used only for enclosure selection, not to determine interior length.

Interior Options

Option	Description	Product ¹ Number Option Suffix	100/125 Amps		225 Amps		400 Amps		600 Amps		800 Amps	
			Panel Sizing Adder	List Price Adder, GO-101	Panel Sizing ³ Adder	List Price Adder, GO-101	Panel Sizing ³ Adder	List Price Adder, GO-101	Panel Sizing ³ Adder	List Price Adder, GO-101	Panel Sizing ³ Adder	List Price Adder, GO-101
Optional Lugs ²	Compression Alum.	L1	—	\$30.00	—	\$50.00	—	\$130.00	—	\$175.00		
	Pressure Copper	L2	—	\$49.00	—	\$49.00	—	\$92.00	—	\$114.00		
	Comp. Alum. Oversize	L3	—	\$152.00	—	\$152.00	—	\$461.00	—	\$461.00	N/A	—
	Pressure Alum. Oversize	L4	—	\$54.00	—	\$54.00	—	\$330.00	—	\$330.00		
Subfeed Breakers And Contactors (Select Only One)	3 Poles TED	F3	N/A		6		6		6			
	6 Poles TED	F6	N/A		9		9		9			
	9 Poles TED	F9	N/A	Price From Panel or Contactor Sections by Device	15	Price From Panel or Contactor Sections by Device	15	Price From Panel Section	15	Price From Panel Section	15	15
	12 Poles TED	F1	N/A		N/A		18		18		18	
	15 Poles TED	FE	N/A		N/A		24		24		24	
	18 Poles TED	FH	N/A		N/A		27		27		27	
	2 or 3 Poles SF	F1	N/A		12		18		18			
2 or 3 Pole Contactor ⁴	C1	15	18		N/A		N/A					
Feed Thru	Feed Thru Lugs ⁵	T1	3		\$164.00		3		\$164.00		3	\$286.00
Busbar ⁶	600 APSI Alum.	B1	—	\$595.00	—	\$595.00	—	\$759.00	—	N/A	—	N/A
	750 APSI Alum.	B2	—	\$135.00	—	\$135.00	—	Std.	—	Std.	—	N/A
	800 APSI Copper	B3	—	\$610.00	—	\$610.00	—	\$904.00	—	N/A	—	N/A
	1000 APSI Copper	B4	—	\$210.00	—	\$210.00	—	\$323.00	—	\$387.00	—	\$559.00 ⁸
	Standard Copper	B7	—	\$103.00	—	\$103.00	—	\$182.00	—	\$246.00	—	N/A
200% Rated ⁷ Neutrals	2 Standard Lugs	N2	—	\$60.00	—	\$100.00	9	\$140.00	9	\$280.00 ⁷	N/A	N/A

¹Option Product Number prefix is "AX".

²Oversize lugs available on single main lug panels only.

³Add 7" for 2 or more subfeed breakers.

⁴For contactor subfeeds with contactor mains, add another 3 inches.

⁵Feed thru lugs not available on subfeed or oversized main lug panels.

⁶For silver or tin plating 1000 APSI Cu only add \$100 List, GO-101.

⁷200% rated neutrals in 600A panels require 30"W box. See page 9-8 for wire sizes.

⁸800A bus must be silver plated.

PERMANENT CIRCUIT NUMBERS—Numbers 1-48. Field Installed. See page 9-54.



Product Number Selection Instructions: See page 9-13

Panelboards

A-Series® Panelboards

Type AE

Enclosure Options

Box Options

Description	Product Number Suffix ¹	List Price, GO-101
Blank Endwalls	B	²
Painted Box	P	\$200.00
30" Wide ³	W	\$250.00
NEMA 3R/12	3	\$950.00
Endwall w/Knockouts	K	²
NEMA 4X (Stainless Steel)	4S	\$4950.00
NEMA 4X (Painted Galvaneal)	4	\$2800.00
16 7/8" Wide	5	-\$40.00

¹ Add to base box Product Number.

² No charge if included on original order. Price kit from page 9-54 if field conversion is required.

³ Includes field installable gutter barrier.

TVSS⁴ Transient Voltage Surge Suppression

Maximum Surge Current Per Mode	Maximum Surge Current Per Phase	Description	List Price, GO-101 A Series Panelboards ^{5,6}
65kA	130kA	TVSS, UL1449, UL1283	\$6350.00
80kA	160kA	TVSS, UL1449, UL1283	\$7000.00
100kA	200kA	TVSS, UL1449, UL1283	\$8500.00
100kA		TVSS, no Count or UL1283	\$2875.00
100kA		TVSS, no UL1283	\$3575.00

⁴ Factory Installed TVSS units. Installed in 10" module, add interior Suffix T6 + 10" to box height.

⁵ Price applies to any A Series® panel furnished in a standard 20" wide enclosure, types AL, AQ, AE, or AD.

⁶ See Section 15 for product numbers.

Front Options—NEMA 1 Only

Description	Product Number Suffix ⁷	List Price, GO-101
Screw Cover	C	\$61.00
Front Hinged to Box	D	\$110.00
Optional Locks:		
Yale 511S w/Rosette	Y	\$300.00
Corbin 15767	L	\$146.00
Nameplate	N	\$27.00
Door within a Door ⁸	P	\$238.00
Stainless Steel ⁹	S	\$1467.00
30" Wide	W	\$250.00
Screw-on nameplates	U	\$74.00
Metal Directory Card	M	\$50.00

⁷ Add to base front Product Number.

⁸ Consists of two lockable doors—one over panel interior and one over box wiring gutters. Yale locks not available.

⁹ Flush only. Available with C and N options.

BOX EXTENSIONS—For additional end gutter space or conduit skirt applications—price from page 9-54.

Equipment Grounds—Factory Supplied with Panelboard

Description	Product Number	List Price, Adder, GO-101
Field installed kits		
Standard bonded to box—for each 12 branch positions	TGL2	\$15.00
Copper bonded to box—for each 12 branch positions	TGC2	\$94.00
Standard-isolated/insulated—for each 12 branch positions	EGS12	\$99.00
Copper-isolated/insulated—for each 12 branch positions	EGC12	\$132.00
Main lug for above terminal kits	TGL20	\$25.00

Optional Equipment Grounds

Description	Product Number	List Price GO-134B
Aluminum Extruded Bonded	AEBG	\$75.00
Copper Extruded Bonded	AEBGC	\$140.00
Aluminum Extruded Isolated	AEIG	\$115.00
Copper Extruded Isolated	AEIGC	\$150.00
Copper Isolated/Bonded	ASPGIBC	\$452.00 ¹⁰

¹⁰GO-101



Publications and Reference: See Section 22 for a complete list of additional product-related publications

Panelboards

A-Series® Panelboards

Section 9

Type AE

125/250 Vdc Max. Bolt-On or 120/240 Vac

Factory Assembled

Single-Phase, 3-Wire Pricing

Service Information:

1-ph, 3w

125/250 Vdc Max. or 120/240 Vac

Bolt On Branch Breakers:

15-100 amps, 1, 2, 3-poles

Type TEY

Service Entrance Label will be factory installed only when specified.

Please see page 9-3 for UL Standards on service entrance. Service Entrance Labels are available for field installation. Please contact a GE Consumer & Industrial Sales Office for ordering instructions.

DC Mains:

100A-TEY, SE

225A-TFJ, SF

400A-TJJ, SG

125-600 amp main lug

AC Mains:

100A-TEY, SE

225A-TFJ, SF

400A-TJJ, SG

600A-SG

800A-SK

125-800 amp main lug

NOTE: Sizing dimensions to be used only for enclosure selection, not to determine interior length.

Main Lug Interiors¹

Use TEY Bolt-on Breakers		Single Main Lugs			Subfeed Main Lugs		
Panel Amps Max.	Branch Space Required	Interior Product Number ¹	List Price, ² GO-101	Sizing Dim. (in.)	Interior Product Number ¹	List Price, ² GO-101	Sizing Dim. (in.)
125	0-12	AEF1121MB	\$605.00	22.5	AEF1121SB	\$641.00	22.5
	13-18	AEF1181MB	\$658.00	25.5	AEF1181SB	\$694.00	25.5
	19-24	AEF1241MB	\$750.00	28.5	AEF1241SB	\$786.00	28.5
	25-30	AEF1301MB	\$841.00	31.5	AEF1301SB	\$877.00	31.5
	31-36	AEF1361MB	\$933.00	34.5	AEF1361SB	\$968.00	34.5
	37-42	AEF1421MB	\$1024.00	37.5	AEF1421SB	\$1060.00	37.5
225	0-12	AEF1122MB	\$672.00	28.5	AEF1122SB	\$712.00	28.5
	13-18	AEF1182MB	\$726.00	31.5	AEF1182SB	\$765.00	31.5
	19-24	AEF1242MB	\$817.00	34.5	AEF1242SB	\$856.00	34.5
	25-30	AEF1302MB	\$908.00	37.5	AEF1302SB	\$947.00	37.5
	31-36	AEF1362MB	\$1000.00	40.5	AEF1362SB	\$1039.00	40.5
	37-42	AEF1422MB	\$1091.00	43.5	AEF1422SB	\$1130.00	43.5
400	0-12	AEF1124MB	\$832.00	37.5	AEF1124SB	\$924.00	43.5
	13-18	AEF1184MB	\$908.00	40.5	AEF1184SB	\$1001.00	46.5
	19-24	AEF1244MB	\$992.00	43.5	AEF1244SB	\$1085.00	49.5
	25-30	AEF1304MB	\$1084.00	46.5	AEF1304SB	\$1176.00	52.5
	31-36	AEF1364MB	\$1175.00	49.5	AEF1364SB	\$1267.00	55.5
	37-42	AEF1424MB	\$1265.00	52.5	AEF1424SB	\$1358.00	58.5
600	0-12	AEF1126MB	\$971.00	43.5	—	—	—
	13-18	AEF1186MB	\$1049.00	46.5	—	—	—
	19-24	AEF1246MB	\$1133.00	49.5	—	—	—
	25-30	AEF1306MB	\$1224.00	52.5	—	—	—
	31-36	AEF1366MB	\$1316.00	55.5	—	—	—
	37-42	AEF1426MB	\$1407.00	58.5	—	—	—

¹Bottom feed supplied as standard-change last character in Product Number from B to T for Top Feed.

²Includes standard panelboard interior box and front. Add price for options when required.

SPLIT BUS—Refer to publication DE-81 or consult your local sales office



Product Number Selection Instructions: See page 9-13

Panelboards

A-Series® Panelboards

Type AE

125/250 Vdc Max. Bolt-On or 120/240 Vac
Factory Assembled Pricing

Main Breaker Interiors¹

Panel Amps Max.	Branch Space Required	Interrupting Rating		
		10kA 125/250Vdc Max.		
		Interior Product Number	List Price, GO-101	Sizing Dim. (In.)
100	0-12	AEF1121BB	\$990.00	22.5
	13-18	AEF1181BB	\$1043.00	25.5
	19-24	AEF1241BB	\$1134.00	28.5
	25-30	AEF1301BB	\$1225.00	31.5
	31-36	AEF1361BB	\$1317.00	34.5
	37-42	AEF1421BB	\$1406.00	37.5
225	0-12	AEF1122BB	\$1711.00	40.5
	13-18	AEF1182BB	\$1764.00	43.5
	19-24	AEF1242BB	\$1854.00	46.5
	25-30	AEF1302BB	\$1956.00	49.5
	31-36	AEF1362BB	\$2037.00	52.5
	37-42	AEF1422BB	\$2118.00	55.5
400	0-12	AEF1124BB	\$2556.00	52.5
	13-18	AEF1184BB	\$2642.00	49.5
	19-24	AEF1244BB	\$2731.00	52.5
	25-30	AEF1304BB	\$2823.00	55.5
	31-36	AEF1364BB	\$2914.00	58.5
	37-42	AEF1424BB	\$3004.00	61.5

¹Bottom feed supplied as standard-change last character in Product Number from B to T for Top Feed.

²Includes standard panelboard interior box and front. Add price for options when required.

Enclosures

Sizing Dim. (Inches)	Box Product Number	Inside Box Dim. (Inches)			Front Product Number
		Length	Width	Depth	
0-25.5	AB25	25.5	20	5.81	AF25F,S
28.5-31.5	AB31	31.5	20	5.81	AF31F,S
34.5-37.5	AB37	37.5	20	5.81	AF37F,S
40.5-43.5	AB43	43.5	20	5.81	AF43F,S
46.5-49.5	AB49	49.5	20	5.81	AF49F,S
52.5-55.5	AB55	55.5	20	5.81	AF55F,S
57.5-64.5	AB64	64.5	20	5.81	AF64F,S
67.5-76.5	AB76	76.5	20	5.81	AF76F,S

Flush fronts are 1 1/2 inches larger than box. Surface fronts are 1/4 inch larger than box.

Branch Breakers, TEY Circuit Breakers—Bolt-On

Branch Breaker Mounting	Type	Bolt-On Frames	Trip Range (Amps)	List Price, GO-101	
				1-Pole	2-Pole
				No. Spaces Required	
				1	2
Double Branch	TEY (14,000AIC)	TEY	15-60	\$53.00	\$130.00
			70-100 ³	\$116.00	\$274.00

³The sum of double branch breakers mounted opposite each other cannot exceed 180 amperes.

Main, Branch, And Subfeed Breaker Accessories⁴

Circuit Breaker Frame	Shunt Trip	List Price, GO-101			
		Auxiliary Contacts 2 and 3-Pole Only		Padlocking Devices	Handle Locking Devices
		No. of AB Switch Elements	For 240 Vac		
TEY ^{4,5}	\$392.00 ⁴	1	\$200.00 ⁶	\$11.00	\$6.00
SF ⁷	\$447.00	2	\$447.00	\$14.00	\$10.00
		4	\$485.00		
TJJ	\$447.00	1	\$243.00	\$20.00	—
		2	\$447.00		

⁴Internal accessories must be factory installed.

⁵Internal accessories only available on 2-pole.

⁶Takes up one branch space in sizing for both main and branch applications.

⁷120/240 Vac only.



Publications and Reference: See Section 22 for a complete list of additional product-related publications

Panelboards

A-Series® Panelboards

Section 9

Type AE

125/250 Vdc Max. Bolt-On

Factory Assembled Pricing

Panelboard Options

NOTE: Sizing dimensions to be used only for enclosure selection, not to determine interior length.

Interior Options

Option	Description	Product Number Option Suffix	100/125 Amps		225 Amps		400 Amps		600 Amps	
			Panel Sizing Adder	List Price Adder, GO-101	Panel Sizing Adder	List Price Adder, GO-101	Panel Sizing Adder	List Price Adder, GO-101	Panel Sizing Adder	List Price Adder, GO-101
Optional Lugs ²	Compression Alum.	L1	—	\$30.00	—	\$50.00	—	\$130.00	—	\$175.00
	Pressure Copper	L2	—	\$49.00	—	\$49.00	—	\$92.00	—	\$114.00
	Comp. Alum. Oversize	L3	—	\$152.00	—	\$152.00	—	\$461.00	—	\$461.00
	Pressure Alum. Oversize	L4	—	\$54.00	—	\$54.00	—	\$330.00	—	\$330.00
Feed Thru	Feed Thru Lugs ³	T1	3	\$164.00	3	\$164.00	3	\$286.00	3	\$246.00
Busbar ⁴	600 APSI Alum.	B1	—	\$595.00	—	\$595.00	—	\$759.00	—	N/A
	750 APSI Alum.	B2	—	\$135.00	—	\$135.00	—	Std.	—	Std.
	800 APSI Copper	B3	—	\$476.00	—	\$476.00	—	\$625.00	—	N/A
	1000 APSI Copper ⁴	B4	—	\$103.00	—	\$103.00	—	\$182.00	—	\$246.00
200% Rated ⁵ Neutrals	2 Standard Lugs	N2	—	\$960.00	—	\$100.00	9	\$140.00	9	\$280.00

¹Option Product Number prefix is "AX".

²Oversize lugs available on single main lug panels only.

³Feed thru lugs not available on subfeed or oversized main lug panels.

⁴For silver or tin plating 1000 APSI Cu only add **\$100 List, GO-101**.

⁵200% rated neutrals in 600A panels require 30"W box. See page 9-8 for wire sizes.

SPLIT BUS—Refer to publication DE-81 or consult your local sales office
PERMANENT CIRCUIT NUMBERS—Numbers 1-48. Field Installed. See page 9-54.

Enclosure Options

Box Options

Description	Product Number Suffix ⁶	List Price, GO-101
Blank Endwalls	B	⁷
Painted Box	P	\$200.00
30" Wide ⁸	W	\$250.00
NEMA 3R/12	3	\$950.00
NEMA 4X (Stainless Steel)	4S	\$4950.00

⁶Add to base box Product Number.

⁷No charge if included on original order. Price kit from page 9-54 if field conversion is required.

⁸Includes field installable gutter barrier.

BOX EXTENSIONS—For additional end gutter space or conduit skirt applications—price from page 9-54.

Equipment Grounds – Factory Supplied with Panelboard

Description	Product Number	List Price Adder, GO-101
Field installed kits		
Standard bonded to box—for each 12 branch positions	TGL2	\$15.00
Copper bonded to box—for each 12 branch positions	TGC2	\$94.00
Standard-isolated/insulated—for each 12 branch positions	EGS12	\$99.00
Copper-isolated/insulated—for each 12 branch positions	EGC12	\$132.00
Main lug for above terminal kits	TGL20	\$25.00

Front Options – NEMA 1 Only

Description	Product Number Suffix ⁹	List Price, GO-101
Screw Cover	C	\$61.00
Front Hinged to Box	D	\$110.00
Optional Locks:		
Yale 511S w/Rosette	Y	\$300.00
Corbin 15767	L	\$146.00
Nameplate	N	\$27.00
Door within a Door ¹⁰	P	\$238.00
Stainless Steel ¹¹	S	\$1467.00
30" Wide	W	\$250.00
Screw-on nameplate	U	\$74.00
Metal directory Card	M	\$50.00

⁹Add to base front Product Number.

¹⁰Consists of two lockable doors—one over panel interior and one over box wiring gutters.

¹¹Flush only. Available with C, G, and N options.

Main, Branch, and Subfeed Breaker Accessories: price from page 9-41.



Product Number Selection Instructions: See page 9-13

Panelboards

A-Series® Panelboards

Types AL, AQ, AE

Main Molded Case Switch Interiors Factory Assembled Pricing¹

NOTE: Sizing dimensions to be used only for enclosure selection, not to determine interior length.

Type AL 240 Vac Max.²

Panel Amps Max.	Branch Space Required	Interior Product Number 1-Phase, 3-Wire	List Price, ³ GO-101	Interior Product Number 3-Phase, 4-Wire	List Price, ³ GO-101	Sizing Dim. (Inches)	UL Listed Short Circuit Withstand Rating	
							240Vac Max.	480/277Vac Max.
100	0-12	ALF1121YB	\$548.00	ALF3121YB	\$664.00	25.5	10,000 Amps max, when protected by line side THQB circuit breaker	
	13-18	ALF1181YB	\$592.00	ALF3181YB	\$697.00	28.5		
	19-24	ALF1241YB	\$652.00	ALF3241YB	\$758.00	31.5		
	25-30	ALF1301YB	\$712.00	ALF3301YB	\$818.00	34.5		
	31-36	ALF1361YB	\$770.00	ALF3361YB	\$878.00	37.5		
	37-42	ALF1421YB	\$831.00	ALF3421YB	\$938.00	40.5		
225	0-12	ALF1122YB	\$1187.00	ALF3122YB	\$1374.00	34.5	10,000 Amps max, when protected by line side TQD circuit breaker	
	13-18	ALF1182YB	\$1222.00	ALF3182YB	\$1420.00	37.5		
	19-24	ALF1242YB	\$1282.00	ALF3242YB	\$1481.00	40.5		
	25-30	ALF1302YB	\$1342.00	ALF3302YB	\$1540.00	43.5		
	31-36	ALF1362YB	\$1402.00	ALF3362YB	\$1600.00	46.5		
	37-42	ALF1422YB	\$1463.00	ALF3422YB	\$1660.00	49.5		
400	19-24	ALF1244YB	\$1901.00	ALF3244YB	\$2242.00	61.5	22,000 Amps max, when protected by line side TJD circuit breaker	
	25-30	ALF1304YB	\$1933.00	ALF3304YB	\$2274.00	64.5		
	31-36	ALF1364YB	\$1966.00	ALF3364YB	\$2308.00	67.5		
	37-42	ALF1424YB	\$1998.00	ALF3424YB	\$2341.00	70.5		

Pricing Information:
Price branch breakers from corresponding panel sections.

Type AQ 240 Vac Max.²

Panel Amps Max.	Branch Space Required	Interior Product Number 1-Phase, 3-Wire	List Price, ³ GO-101	Interior Product Number 3-Phase, 4-Wire	List Price, ³ GO-101	Sizing Dim. (Inches)	UL Listed Short Circuit Withstand Rating	
							240Vac Max.	480/277Vac Max.
100	0-12	AQF1121YB	\$548.00	AQF3121YB	\$664.00	25.5	10,000 Amps max, when protected by line side THQB circuit breaker	
	13-18	AQF1181YB	\$592.00	AQF3181YB	\$697.00	28.5		
	19-24	AQF1241YB	\$652.00	AQF3241YB	\$758.00	31.5		
	25-30	AQF1301YB	\$712.00	AQF3301YB	\$818.00	34.5		
	31-36	AQF1361YB	\$770.00	AQF3361YB	\$878.00	37.5		
	37-42	AQF1421YB	\$831.00	AQF3421YB	\$938.00	40.5		
225	0-12	AQF1122YB	\$1187.00	AQF3122YB	\$1384.00	34.5	10,000 Amps max, when protected by line side TQD circuit breaker	
	13-18	AQF1182YB	\$1222.00	AQF3182YB	\$1420.00	37.5		
	19-24	AQF1242YB	\$1282.00	AQF3242YB	\$1481.00	40.5		
	25-30	AQF1302YB	\$1342.00	AQF3302YB	\$1540.00	43.5		
	31-36	AQF1362YB	\$1402.00	AQF3362YB	\$1600.00	46.5		
	37-42	AQF1422YB	\$1463.00	AQF3422YB	\$1660.00	49.5		
400	19-24	AQF1244YB	\$1959.00	AQF3244YB	\$2291.00	61.5	22,000 Amps max, when protected by line side TJD circuit breaker	
	25-30	AQF1304YB	\$2020.00	AQF3304YB	\$2352.00	64.5		
	31-36	AQF1364YB	\$2080.00	AQF3364YB	\$2412.00	67.5		
	37-42	AQF1424YB	\$2140.00	AQF3424YB	\$2472.00	70.5		

Type AE 480Y/277 Vac Max.²

Panel Amps Max.	Branch Space Required	Interior Product Number 3-Phase, 4-Wire	List Price, ³ GO-101	Sizing Dim. (Inches)	UL Listed Short Circuit Withstand Rating	
					240Vac Max.	480/277Vac Max.
225	0-12	AEF3122YB	\$1558.00	40.5	14,000 Amps max, when protected by line side TFJ circuit breaker	
	13-18	AEF3182YB	\$1612.00	43.5		
	19-24	AEF3242YB	\$1703.00	46.5		
	25-30	AEF3302YB	\$1794.00	49.5		
	31-36	AEF3362YB	\$1885.00	52.5		
	37-42	AEF3422YB	\$1976.00	55.5		
400	19-24	AEF3244YB	\$2527.00	61.5	14,000 Amps max, when protected by line side TJJ circuit breaker	
	25-30	AEF3304YB	\$2619.00	64.5		
	31-36	AEF3364YB	\$2710.00	67.5		
	37-42	AEF3424YB	\$2802.00	70.5		

¹Molded case switches cannot be used as subfeed or branch breakers as they do not meet UL wire protection requirements.

²Bottom feed supplied as standard. Change last character in Product Number from B to T for Top Feed.

³Includes standard panelboard interior box and front. Add price for options when required.



Publications and Reference: See Section 22 for a complete list of additional product-related publications

Panelboards

A-Series® Panelboards

Types AL, AQ, AE
Main Lighting Contactor Interiors
Factory Assembled Pricing

Type AL 240 Vac Max.¹

Panel Amps Max.	Branch Space Required	Interior Product Number 1-Phase, 3-Wire	List Price, ² GO-101	Interior Product Number 3-Phase, 4-Wire	List Price, ² GO-101	Sizing Dim. (Inches)
100	0-12	ALF1121LB	\$445.00	ALF3121LB	\$487.00	40.5
	13-18	ALF1181LB	\$481.00	ALF3181LB	\$523.00	43.5
	19-24	ALF1241LB	\$541.00	ALF3241LB	\$583.00	46.5
	25-30	ALF1301LB	\$601.00	ALF3301LB	\$644.00	49.5
	31-36	ALF1361LB	\$661.00	ALF3361LB	\$704.00	52.5
	37-42	ALF1421LB	\$721.00	ALF3421LB	\$763.00	55.5
225	0-12	ALF1122LB	\$494.00	ALF3122LB	\$529.00	52.5
	13-18	ALF1182LB	\$528.00	ALF3182LB	\$565.00	55.5
	19-24	ALF1242LB	\$589.00	ALF3242LB	\$626.00	58.5
	25-30	ALF1302LB	\$649.00	ALF3302LB	\$686.00	61.5
	31-36	ALF1362LB	\$709.00	ALF3362LB	\$746.00	64.5
	37-42	ALF1422LB	\$769.00	ALF3422LB	\$805.00	67.5

Pricing Information:

Select desired type of lighting contactor main from the table page 9-45. Specify type and add contactor List Price to the basic panel price when ordering.

Type AQ 240 Vac Max.¹

Panel Amps Max.	Branch Space Required	Interior Product Number 1-Phase, 3-Wire	List Price, ² GO-101	Interior Product Number 3-Phase, 4-Wire	List Price, ² GO-101	Sizing Dim. (Inches)
100	0-12	AQF1121LB	\$445.00	AQF3121LB	\$487.00	40.5
	13-18	AQF1181LB	\$481.00	AQF3181LB	\$523.00	43.5
	19-24	AQF1241LB	\$541.00	AQF3241LB	\$583.00	46.5
	25-30	AQF1301LB	\$601.00	AQF3301LB	\$644.00	49.5
	31-36	AQF1361LB	\$661.00	AQF3361LB	\$704.00	52.5
	37-42	AQF1421LB	\$721.00	AQF3421LB	\$763.00	55.5
225	0-12	AQF1122LB	\$494.00	AQF3122LB	\$529.00	52.5
	13-18	AQF1182LB	\$528.00	AQF3182LB	\$565.00	55.5
	19-24	AQF1242LB	\$589.00	AQF3242LB	\$626.00	58.5
	25-30	AQF1302LB	\$649.00	AQF3302LB	\$686.00	61.5
	31-36	AQF1362LB	\$709.00	AQF3362LB	\$746.00	64.5
	37-42	AQF1422LB	\$769.00	AQF3422LB	\$805.00	67.5

Type AE 480Y/277 Vac Max.¹

Panel Amps Max.	Branch Space Required	Interior Product Number 3-Phase, 4-Wire	List Price, ² GO-101	Sizing Dim. (Inches)
100	0-12	AEF3121LB	\$605.00	40.5
	13-18	AEF3181LB	\$658.00	43.5
	19-24	AEF3241LB	\$750.00	46.5
	25-30	AEF3301LB	\$841.00	49.5
	31-36	AEF3361LB	\$933.00	52.5
	37-42	AEF3421LB	\$1024.00	55.5
225	0-12	AEF3122LB	\$672.00	52.5
	13-18	AEF3182LB	\$726.00	55.5
	19-24	AEF3242LB	\$817.00	58.5
	25-30	AEF3302LB	\$908.00	61.5
	31-36	AEF3362LB	\$1000.00	64.5
	37-42	AEF3422LB	\$1091.00	67.5

¹Bottom feed supplied as standard. Change last character in Product Number from B to T for Top Feed.

²Includes standard panelboard interior box and front. Add price for options when required.



Product Number Selection Instructions: See page 9-13

Panelboards

A-Series® Panelboards

Types AL, AQ, AE

Main Molded Case Switch and Lighting Contactor Panel
Factory Assembled Pricing

Main and Subfeed Contactors

Ampere Rating	Poles	List Price, GO-101			
		GE Type CR160MC Mechanically Held		ASCO Type 920 Mechanically Held	
		120V Coil	277V Coil	120V Coil	277V Coil
30	2-Pole	\$1341.00	—	\$2368.00	—
	3-Pole	\$1408.00	\$1408.00	\$2668.00	\$2668.00
60	2-Pole	\$1671.00	—	\$2491.00	—
	3-Pole	\$1873.00	\$1873.00	\$2857.00	\$2857.00
75	2-Pole	\$1671.00	—	\$2491.00	—
	3-Pole	\$1873.00	\$1873.00	\$2857.00	\$2857.00
100	2-Pole	\$1916.00	—	\$2819.00	—
	3-Pole	\$2230.00	\$2230.00	\$3308.00	\$3308.00
150	2-Pole	\$2432.00	—	\$3509.00	—
	3-Pole	\$3066.00	\$3066.00	\$4507.00	\$4507.00
200	2-Pole	\$2961.00	—	\$3948.00	—
	3-Pole	\$3421.00	\$3421.00	\$4996.00	\$4996.00
225	2-Pole	\$3267.00	—	\$4341.00	—
	3-Pole	\$3982.00	\$3982.00	\$5514.00	\$5514.00

Enclosure Information

Panel Size	Box Product Number	Box Size Inches	Front Product Number ¹
0-25.5	AB25	25.5x20x5.81	AF25F,S
28.5-31.5	AB31	31.5x20x5.81	AF31F,S
34.5-37.5	AB37	37.5x20x5.81	AF37F,S
40.5-43.5	AB43	43.5x20x5.81	AF43F,S
46.5-49.5	AB49	49.5x20x5.81	AF49F,S
52.5-55.5	AB55	55.5x20x5.81	AF55F,S
57.5-64.5	AB64	64.5x20x5.81	AF64F,S
67.5-76.5	AB76	76.5x20x5.81	AF76F,S

¹Flush fronts are 1 1/2" larger than box. Surface fronts are 1/4" larger.

Enclosure Options

Box Options

Description	Product Number Suffix ³	List Price, GO-101
Blank Endwalls	B	⁴
Increased Gage	G	\$200.00
Painted Box	P	\$200.00
30" Wide ²	W	\$250.00
NEMA 3R/12	3	\$950.00

²Includes field installable gutter barrier.

³Add to base box Product Number.

⁴No charge if included on original order.

Front Options – NEMA 1 Only

Description	Product Number Suffix ⁷	List Price, GO-101
Screw Cover	C	\$61.00
Front Hinged to Box	D	\$110.00
Increased Gage	G	\$200.00
Optional Locks:		
Yale 511S w/Rosette	Y	\$300.00
Corbin 15767	L	\$146.00
Nameplate	N	\$27.50
Door within a Door ⁵	P	\$238.00
Stainless Steel ⁶	S	\$1467.00
30" Wide	W	\$250.00

⁵Consists of two lockable doors—one over panel interior and one over box wiring gutters.

⁶Flush only. Available with C, G, and N options.

⁷Add to base front Product Number.

BOX EXTENSIONS—For additional end gutter space or conduit skirt applications—price from page 9-54.



Publications and Reference: See Section 22 for a complete list of additional product-related publications

Panelboards

A-Series® Panelboards

Section 9

Types AL, AQ, AE

Main Molded Case Switch And Lighting Contactor Panels

Factory Assembled Pricing

Panelboard Options

NOTE: Sizing dimensions to be used only for enclosure selection, not to determine interior length.

Interior Options

Option	Description	Product Number Option Suffix	100/125 Amps		225 Amps		400 Amps		600 Amps	
			Panel Sizing Adder	List Price Adder, GO-101	Panel Sizing Adder ⁶	List Price Adder, GO-101	Panel Sizing Adder ⁶	List Price Adder, GO-101	Panel Sizing Adder ⁶	List Price Adder, GO-101
Subfeed Breakers and Contactors (Select Only One)	2 Poles TQD ²	Q2	N/A		6		6		6	
	3 Poles TQD ²	Q3	N/A		6		6		6	
	4 Poles TQD ²	Q4	N/A		9		9		9	
	5 Poles TQD ²	Q5	N/A	Price From Panel or Contactor Sections By Device	9	Price From Panel or Contactor Sections By Device	9	Price From Panel Sections	9	Price From Panel Sections
	6 Poles TQD	Q6	N/A		9		9		9	
	3 Poles TED	E3	N/A		6		6		6	
	6 Poles TED	E6	N/A		9		9		9	
	2 or 3 Poles SF	F1	N/A		8.5		9		9	
2 or 3 Pole Contactor ³	C1	15		18		N/A		N/A		
Feed Thru	Feed Thru Lugs	T1	3	\$164.00	3	\$164.00	3	\$286.00	3	\$286.00
Busbar Silver Tin ⁴	600 APSI Alum.	B1	—	\$595.00	—	\$595.00	—	\$759.00	—	
	750 APSI Alum.	B2	—	\$135.00	—	\$135.00	—	Std.	—	
	800 APSI Copper	B3	—	\$610.00	—	\$610.00	—	\$904.00	—	N/A
	1000 APSI Copper	B4	—	\$210.00	—	\$210.00	—	\$323.00	—	\$387.00
	Standard Copper	B7	—	\$103.00	—	\$103.00	—	\$182.00	—	\$246.00
200% ⁵ Rated Neutrals	2 Standard Lugs	N2	—	\$60.00	—	\$100.00	9	\$140.00	9	\$280.00

¹Option Product Number prefix is "AX".

²For TQD main-switch panels, adder is 3 inches less than value shown.

³For contactor subfeeds with contactor mains, add another 3 inches.

⁴For silver or tin plating 1000 APSI Cu only add **\$100 List, GO-101**.

⁵200% rated neutrals are not available in 600A panels. See page 9-8 for wire sizes.

⁶Add 7" for 2 or more subfeed breakers.

PERMANENT CIRCUIT-NUMBERS 1-48. Field Installed.



Product Number Selection Instructions: See page 9-13

Panelboards

A-Series® Panelboards

Types AL, AQ, AE

Contactor Control Options⁷

Description	List Price, GO-101	Panel Sizing Adder (Inches)
2-Wire Control Relay, 115Vac Coil	\$286.00	
Fuse Block	\$118.00	
Tork Time Clock, 120Vac, 24 Hr.	\$772.00	
Tork Time Clock, 120Vac, Astronomical Dial ⁸	\$932.00	15 (when used singly or in combination with all other control options except control power transformer).
Tork Time Clock, 120Vac, 7 Day Dial ⁸	\$772.00	
Tork Time Clock, 120Vac, 24Hr. with Reserve Power ⁸	\$1019.00	
Tork Time Clock, 120Vac, 7 Day with Reserve Power ⁸	\$1019.00	
Two Position Selector Switch, On-Off	\$137.00	
Three Position Selector Switch, Off-Auto-On	\$137.00	
Pilot Lights (1) Red Labeled "Off" & (1) Green Labeled "On"	\$274.00	
15" Option Space With Provisions For All Options Except Control Power Transformer	\$392.00	
15" Option Section With Provision For Two Time Clocks	\$465.00	15
21" Option Section With Provision For All Options	\$518.00	
Control Power Transformer 480/240 Primary, 120V Sec.	\$551.00	21 ⁹

⁷For more detailed information on the A SERIES® contactor control sections refer to DE-85.

⁸A maximum of two time clocks can be factory installed. Only options available with two clocks are pilot lights and selector switches.

⁹Includes space for use in combination with other control options.

Field Installed 2-Wire Control Relay Kit, 115Vac Coil	
ASP2WRELAY ¹⁰	List Price, GO-101
	\$286.00

¹⁰Requires no additional space.

TVSS13 Transient Voltage Surge Suppression

Maximum Surge Current Per Mode	Maximum Surge Current Per Phase	Description	List Price, GO-101 A Series Panelboards ^{11,12}
65kA	130kA	TVSS, UL1449, UL1283	\$6350.00
80kA	160kA	TVSS, UL1449, UL1283	\$7000.00
100kA	200kA	TVSS, UL1449, UL1283	\$8500.00
100kA		TVSS, no Count or UL1283	\$2875.00
100kA		TVSS, no UL1283	\$3575.00

¹¹Price applies to any A Series® panel furnished in a standard 20" wide enclosure, types AL, AQ, AE, or AD.

¹²See Section 15 for product numbers.

¹³Factory Installed Transient Voltage Surge Suppression (TVSS) Units. Installed in 10" module, add Suffix T6 + 10" to box height.

Equipment Grounds – Factory Supplied with Panelboard

Description	Product Number	List Price, Adder, GO-101
Field installed kits		
Standard bonded to box-for each 12 branch positions	TGL2	\$15.00
Copper bonded to box-for each 12 branch positions	TGC2	\$94.00
Standard-isolated/insulated-for each 12 branch positions	EGS12	\$99.00
Copper-isolated/insulated-for each 12 branch positions	EGC12	\$132.00
Main lug for above terminal kits	TGL20	\$25.00

Optional Equipment Grounds

Description	Product Number	List Price GO-134B
Aluminum Extruded Bonded	AEBG	\$75.00
Copper Extruded Bonded	AEBGC	\$140.00
Aluminum Extruded Isolated	AEIG	\$115.00
Copper Extruded Isolated	AEIGC	\$150.00
Copper Isolated/Bonded	ASPGIBC	\$452.00 ¹⁴

¹⁴GO-101

Branch and Subfeed Breaker Accessories: Price from appropriate panel sections.



Publications and Reference: See Section 22 for a complete list of additional product-related publications

Panelboards

A-Series® Panelboards

Section 9

Type AD

600 Vac

Factory Assembled

Three-Phase, 3-Wire/4-Wire Pricing

Service Information:

- 3-ph, 4w 120/208 Vac
- 3-ph, 3w 480 Vac
- 3-ph, 4w 480Y/277 Vac
- 3-ph, 3w 600 Vac
- 3-ph, 4w 600Y/347 Vac
- UL Listed
- CSA Certified

Branch Breakers:

- 15-100A 1P, 2P; 15-150A 3P
- 220A Max. double branch

Mains:

- 150A-THED, SE
- 225A-TFJ, SF
- 400A-TJJ, SG
- 600A-SG
- 800A-SK
- 150-800A MLO

Main Lug Interiors^{1,4}

Use E150 Line Bolt-on Branch Breakers		Single Main Lugs			Subfeed Main Lugs		
Panel Amps Max	Branch Space Required	Interior Product Number	List Price, GO-101	Sizing Dim's (In's)	Interior Product Number	List Price, GO-101	Sizing Dim's (In's)
125	0-12	ADF3121MB	\$619.00	25.5	ADF3121SB	\$656.00	28.5
	13-18	ADF3181MB	\$673.00	28.5	ADF3181SB	\$710.00	34.5
	19-24	ADF3241MB	\$768.00	31.5	ADF3241SB	\$804.00	37.5
	25-30	ADF3301MB	\$861.00	34.5	ADF3301SB	\$898.00	40.5
	31-36	ADF3361MB	\$955.00	37.5	ADF3361SB	\$991.00	46.5
	37-42	ADF3421MB	\$1049.00	40.5	ADF3421SB	\$1086.00	49.5
225	0-12	ADF3122MB	\$688.00	31.5	ADF3122SB	\$729.00	31.5
	13-18	ADF3182MB	\$743.00	37.5	ADF3182SB	\$783.00	37.5
	19-24	ADF3242MB	\$836.00	40.5	ADF3242SB	\$876.00	40.5
	25-30	ADF3302MB	\$930.00	43.5	ADF3302SB	\$970.00	43.5
	31-36	ADF3362MB	\$1024.00	49.5	ADF3362SB	\$1064.00	49.5
	37-42	ADF3422MB	\$1117.00	52.5	ADF3422SB	\$1157.00	52.5
400	0-12	ADF3124MB	\$852.00	40.5	ADF3124SB	\$947.00	46.5
	13-18	ADF3184MB	\$930.00	46.5	ADF3184SB	\$1025.00	49.5
	19-24	ADF3244MB	\$1016.00	49.5	ADF3244SB	\$1111.00	52.5
	25-30	ADF3304MB	\$1110.00	52.5	ADF3304SB	\$1204.00	58.5
	31-36	ADF3364MB	\$1203.00	58.5	ADF3364SB	\$1298.00	61.5
	37-42	ADF3424MB	\$1296.00	61.5	ADF3424SB	\$1391.00	64.5
600	0-12	ADF3126MB	\$993.00	46.5	—	—	—
	13-18	ADF3186MB	\$1073.00	49.5	—	—	—
	19-24	ADF3246MB	\$1160.00	52.5	—	—	—
	25-30	ADF3306MB	\$1254.00	58.5	—	—	—
	31-36	ADF3366MB	\$1348.00	61.5	—	—	—
	37-42	ADF3426MB	\$1441.00	64.5	—	—	—
800 ²	0-12	ADF3128MB	\$1390.00	55.5	—	—	—
	13-18	ADF3188MB	\$1585.00	55.5	—	—	—
	19-24	ADF3248MB	\$1780.00	55.5	—	—	—
	25-30	ADF3308MB	\$1975.00	55.5	—	—	—
	31-36	ADF3368MB	\$2170.00	61.5	—	—	—
	37-42	ADF3428MB	\$2365.00	64.5	—	—	—

¹Bottom feed supplied as standard. Change last character in Product Number from B to T for top feed.

²Box is 30" wide x 7.81" deep.

³TFJ main rated 22,000AIC max.

⁴Single section interiors available up to 78 circuits. Consult Speedi or your local field office for details.



Product Number Selection Instructions: See page 9-13

Panelboards

A-Series® Panelboards

Type AD

Enclosures

Sizing Dimensions (Inches)	Box Product Number	Inside Box Dim. (Inches)			Front Product Number
		Length	Width	Depth	
28.5-31.5	AB31	31.5	20	5.81	AF31F,S
34.5-37.5	AB37	37.5	20	5.81	AF37F,S
40.5-43.5	AB43	43.5	20	5.81	AF43F,S
46.5-49.5	AB49	49.5	20	5.81	AF49F,S
52.5-55.5	AB55	55.5	20	5.81	AF55F,S
57.5-64.5	AB64	64.5	20	5.81	AF64F,S
67.5-76.5	AB76	76.5	20	5.81	AF76F,S

Flush fronts are 1.5 inches larger than box. Surface fronts are .25 inches larger than box.

Main Breaker Interiors^{1,4}

Use E150 Line Bolt-on Branch Breakers		Interrupting Rating					
		25kA 480Vac ³			35kA 480Vac		
Panel Amps Max.	Branch Space Required	Interior Product Number	List Price, GO-101	Sizing Dim's (In's)	Interior Product Number	List Price, GO-101	Sizing Dim's (In's)
150	0-12	ADF3121TB	\$1114.00	31.5	ADF3121KB	\$1214.00	31.5
	13-18	ADF3181TB	\$1068.00	37.5	ADF3181KB	\$1268.00	37.5
	19-24	ADF3241TB	\$1161.00	40.5	ADF3241KB	\$1361.00	40.5
	25-30	ADF3301TB	\$1255.00	43.5	ADF3301KB	\$1455.00	43.5
	31-36	ADF3361TB	\$1349.00	49.5	ADF3361KB	\$1549.00	49.5
	37-42	ADF3421TB	\$1440.00	52.5	ADF3421KB	\$1640.00	52.5
225	0-12	ADF3122TB	\$1753.00	43.5	ADF3122KB	\$2340.00	43.5
	13-18	ADF3182TB	\$1807.00	49.5	ADF3182KB	\$2435.00	49.5
	19-24	ADF3242TB	\$1899.00	52.5	ADF3242KB	\$2533.00	52.5
	25-30	ADF3302TB	\$1994.00	55.5	ADF3302KB	\$2630.00	55.5
	31-36	ADF3362TB	\$2087.00	61.5	ADF3362KB	\$2727.00	61.5
	37-42	ADF3422TB	\$2180.00	64.5	ADF3422KB	\$2825.00	64.5
400	0-12	ADF3124TB	\$2617.00	49.5	ADF3124KB	\$3450.00	49.5
	0-18	ADF3184TB	\$2706.00	55.5	ADF3184KB	\$3539.00	55.5
	19-24	ADF3244TB	\$2798.00	58.5	ADF3244KB	\$3631.00	58.5
	25-30	ADF3304TB	\$2893.00	61.5	ADF3304KB	\$3726.00	61.5
	31-36	ADF3364TB	\$2986.00	67.5	ADF3364KB	\$3819.00	67.5
	37-42	ADF3424TB	\$3078.00	70.5	ADF3424KB	\$3911.00	70.5
600	0-12	—	—	—	ADF3126KB	\$5429.00	49.5
	0-18	—	—	—	ADF3186KB	\$5520.00	55.5
	19-24	—	—	—	ADF3246KB	\$5612.00	58.5
	25-30	—	—	—	ADF3306KB	\$5706.00	61.5
	31-36	—	—	—	ADF3366KB	\$5799.00	67.5
	37-42	—	—	—	ADF3426KB	\$5891.00	70.5
800 ²	0-12	—	—	—	—	—	—
	13-18	—	—	—	—	—	—
	19-24	—	—	—	—	—	—
	25-30	—	—	—	—	—	—
	31-36	—	—	—	—	—	—

¹Bottom feed supplied as standard. Change last character in Product Number from B to T for top feed.

²Box is 30" wide x 7.81" deep.

³TFJ main rated 22,000AIC max.

⁴Single section interiors available up to 78 circuits. Consult Speedi or your local field office for details.



Publications and Reference: See Section 22 for a complete list of additional product-related publications

Panelboards

A-Series® Panelboards

Type AD

Section 9

Main Breaker Interiors^{1,4} (Continued)

Use E150 Line Bolt-on Branch Breakers		Interrupting Rating								
		65kA 480Vac			100kA 480Vac			18kA 600Vac		
Panel Amps Max.	Branch Space Required	Interior Product Number	List Price, GO-101	Sizing Dim's (In's)	Interior Product Number	List Price, GO-101	Sizing Dim's (In's)	Interior Product Number	List Price, GO-101	Sizing Dim's (In's)
150	0-12	ADF3121DB	\$1684.00	28.5	ADF3121GB	\$2200.00	28.5	ADF3121UB	\$1014.00	28.5
	13-18	ADF3181DB	\$1740.00	31.5	ADF3181GB	\$2257.00	31.5	ADF3181UB	\$1068.00	31.5
	19-24	ADF3241DB	\$1836.00	34.5	ADF3241GB	\$2352.00	34.5	ADF3241UB	\$1161.00	34.5
	25-30	ADF3301DB	\$1932.00	37.5	ADF3301GB	\$2448.00	37.5	ADF3301UB	\$1255.00	37.5
	31-36	ADF3361DB	\$2028.00	40.5	ADF3361GB	\$2544.00	40.5	ADF3361UB	\$1349.00	40.5
	37-42	ADF3421DB	\$2124.00	43.5	ADF3421GB	\$2640.00	43.5	ADF3421UB	\$1440.00	43.5
225	0-12	ADF3122DB	\$3383.00	43.5	ADF3122GB	\$3650.00	43.5	ADF3122UB	\$1753.00	43.5
	13-18	ADF3182DB	\$3438.00	49.5	ADF3182GB	\$3704.00	49.5	ADF3182UB	\$1807.00	49.5
	19-24	ADF3242DB	\$3533.00	52.5	ADF3242GB	\$3801.00	52.5	ADF3242UB	\$1899.00	52.5
	25-30	ADF3302DB	\$3630.00	55.5	ADF3302GB	\$3897.00	55.5	ADF3302UB	\$1994.00	55.5
	31-36	ADF3362DB	\$3725.00	61.5	ADF3362GB	\$3992.00	61.5	ADF3362UB	\$2087.00	61.5
	37-42	ADF3422DB	\$3782.00	64.5	ADF3422GB	\$4089.00	64.5	ADF3422UB	\$2180.00	64.5
400	0-12	ADF3124DB	\$4345.00	49.5	ADF3124GB	\$4639.00	49.5	ADF3124UB	\$2617.00	49.5
	0-18	ADF3184DB	\$4436.00	55.5	ADF3184GB	\$4730.00	55.5	ADF3184UB	\$2706.00	52.5
	19-24	ADF3244DB	\$4529.00	58.5	ADF3244GB	\$4823.00	58.5	ADF3244UB	\$2798.00	55.5
	25-30	ADF3304DB	\$4624.00	61.5	ADF3304GB	\$4918.00	61.5	ADF3304UB	\$2893.00	61.5
	31-36	ADF3364DB	\$4720.00	67.5	ADF3364GB	\$5015.00	67.5	ADF3364UB	\$2986.00	67.5
	37-42	ADF3424DB	\$4815.00	70.5	ADF3424GB	\$5110.00	70.5	ADF3424UB	\$3078.00	70.5
600	0-12	ADF3126DB	\$6324.00	49.5	—	—	—	ADF3126UB	\$4596.00	49.5
	0-18	ADF3186DB	\$6415.00	55.5	—	—	—	ADF3186UB	\$4687.00	52.5
	19-24	ADF3246DB	\$6507.00	58.5	—	—	—	ADF3246UB	\$4779.00	55.5
	25-30	ADF3306DB	\$6601.00	61.5	—	—	—	ADF3306UB	\$4873.00	61.5
	31-36	ADF3366DB	\$6694.00	67.5	—	—	—	ADF3366UB	\$4966.00	64.5
	37-42	ADF3426DB	\$6788.00	70.5	—	—	—	ADF3426UB	\$5058.00	70.5
800 ²	0-12	—	—	—	—	—	—	ADF3128KB	\$6353.00	58.5
	13-18	—	—	—	—	—	—	ADF3188KB	\$6468.00	64.5
	19-24	—	—	—	—	—	—	ADF3248KB	\$6559.00	67.5
	25-30	—	—	—	—	—	—	ADF3308KB	\$6839.00	70.5
	31-36	—	—	—	—	—	—	ADF3368KB	\$7085.00	76.5

¹Bottom feed supplied as standard. Change last character in Product Number from B to T for top feed.

²Box is 30" wide x 7.81" deep.

³TFJ main rated 22,000AIC max.

⁴Single section interiors available up to 78 circuits. Consult Speedi or your local field office for details.



Panelboards

A-Series® Panelboards

Type AD

600 Vac

Factory Assembled

Branch Breakers

E150-Line, Bolt-on

Max. Volts	Frame ^{1,2}	Trip	List Price Each, GO-101								
			Per Circuit			Frame	Trip	Per Circuit			
			1 pole	2 pole	3 pole			1 pole	2 pole ³	3 pole	
277V	TED	15-60	\$76.00	—	—	THED	15-30	\$200.00	—	—	
		70-100	\$175.00	—	—			—	—	—	
480V	TED4	15-60	—	\$205.00	\$270.00	THED4	15-60	—	\$263.00	—	
		70-110	—	\$284.00	\$338.00			70-110	—	\$344.00	—
		125-150	—	—	\$476.00			125-150	—	—	\$765.00
	SEHA ⁴	15-60	—	\$642.00	\$747.00	SELA ⁴	15-60	—	\$661.00	\$868.00	
		70-100	—	\$746.00	\$849.00			70-100	—	\$856.00	\$1010.00
		110-150	—	\$1539.00	\$1930.00			110-150	—	\$1920.00	\$2280.00
600V	TED6	15-60	—	\$263.00	\$302.00	THED6	15-60	—	—	\$397.00	
		70-110	—	—	\$379.00			70-110	—	—	\$447.00
		125-150	—	—	\$650.00			125-150	—	—	\$765.00
600V	FBV	15-60	\$156.18	\$218.12	\$357.27						
		70-100	\$256.88	\$302.18	\$448.36						
600V	FBN	15-60	\$181.78	\$254.00	\$415.85						
		70-100	\$299.00	\$351.88	\$521.88						
600V	FBH	15-60	\$281.66	\$383.15	\$626.95						
		70-100	\$463.25	\$530.80	\$786.80						
600V	FBL	15-60	\$366.40	\$511.89	\$838.05						
		70-100	\$602.63	\$709.15	\$1051.73						

¹220A Double branch maximum (90/130A).

²Mounting of branch breaker in future space requires hardware kit ASPTED3P, \$83.50 List Price, GO-134B. Provides hardware sufficient to mount 3, 1-pole or 1, 3-pole breaker.

³Requires 3 poles of branch space.

⁴Spectra branch breakers require barrier ASP25AD65KA (See page 9-54).

Interior Options

Note: Sizing dimensions to be used only for estimating enclosure selection, not to determine interior length.

Options	Description	Product Number Option Suffix	125/150A		225A		400A		600A		800A	
			Sizing Adder	List Price Adder, GO-101	Sizing Adder	List Price Adder, GO-101	Sizing Adder	List Price Adder, GO-101	Sizing Adder	List Price Adder, GO-101	Sizing Adder	List Price Adder, GO-101
Optional Lugs ⁵	Compression AL	L1	—	\$30.00	—	\$50.00	—	\$130.00	—	\$175.00	—	—
	Pressure CU	L2	—	\$49.00	—	\$49.00	—	\$92.00	—	\$114.00	—	—
	Comp. AL Oversize	L3	—	\$152.00	9"	\$152.00	—	\$461.00	—	\$461.00	—	—
	Press. AL Oversize	L4	—	\$54.00	9"	\$54.00	—	\$330.00	—	\$330.00	—	—
Subfeed Breaker	2 or 3 Pole SF	F1	N/A	—	12"	Price by Device	18"	Price by Device	18"	Price by Device	—	—
Feed Thru	Feed Thru Lugs ⁶	T1	9"	\$164.00	9"	\$164.00	3"	\$286.00	6"	\$286.00	6"	\$451.00
Busbar Silver ⁷ Tin Heat Rise	600 APSI AL	B1	—	\$595.00	—	\$595.00	—	\$759.00	—	—	—	N/A
	750 APSI AL	B2	—	\$135.00	—	\$135.00	—	Std.	—	Std.	—	Std.
	800 APSI CU	B3	—	\$476.00	—	\$476.00	—	\$625.00	—	—	—	N/A
	1000 APSI CU ⁷	B4	—	\$103.00	—	\$103.00	—	\$182.00	—	\$246.00	—	\$459.00
200% Rated Neutrals ⁸	—	N2	—	\$60.00	—	\$100.00	—	\$140.00	—	\$280.00	N/A	N/A

⁵Oversize lugs available on single main lug panels only.

⁶Feed thru lugs not available on subfeed or oversized main lug panels.

⁷For silver or tin plating 1000 APSI Cu only add \$100 List, GO-101.

⁸200% rated neutrals in 600A panels require 30"W box. See page 9-8 for wire sizes.

Subfeed Breakers—3 pole maximum

Max. Volts	Frame	Trip	List Price, GO-101	
			2 pole	3 pole
600 V	SFHA	70-250	\$1256.00	\$1571.00



Publications and Reference: See Section 22 for a complete list of additional product-related publications

Panelboards

A-Series® Panelboards

Type AD

Section 9

Enclosure Options

Box Options

Description	Box Product Number Suffix	List Price GO-101
Blank Endwalls	B	1
Painted Box	P	\$160.00
30" Wide	W	\$250.00
NEMA 3R/12	3	\$950.00
Knockout	K	1
NEMA 4X (Stainless Steel)	4S	\$4950.00
NEMA 4X (Painted Galvaneal)	4	\$2800.00
16 7/8" Wide	5	-\$40.00
NEMA 3R/12 with additional vertical padlock hasp	L	\$500.00

¹No charge if included on original order.

Front Options

Description	Front Product Number Suffix	List Price GO-101
Screw Cover	C/H	\$61.00
Hinged Door-in-Door	D	\$110.00
Optional Locks:		
Yale 511S	Y	\$300.00
Corbin 15767	L & J	\$146.00
Nameplate	N	\$27.00
Door within Door ²	P	\$238.00
Stainless Steel ³	S	\$1467.00
30" Wide	W	\$250.00
Screw-on nameplates	U	\$74.00
Metal directory card holder	M	\$50.00

²Consists of two lockable doors—one over panel interior and one over box wiring gutters. Yale locks not available.

³Flush only. Available with C and N options.

TVSS⁶ Transient Voltage Surge Suppression

Maximum Surge Current Per Mode	Maximum Surge Current Per Phase	Description	List Price, GO-101 A Series Panelboards ^{4,5}
65kA	130kA	TVSS, UL1449, UL1283	\$6350.00
80kA	160kA	TVSS, UL1449, UL1283	\$7000.00
100kA	200kA	TVSS, UL1449, UL1283	\$8500.00
100kA		TVSS, no Count or UL1283	\$2875.00
100kA		TVSS, no UL1283	\$3575.00

⁴Price applies to any A Series® panel furnished in a standard 20" wide enclosure, types AL, AQ, AE, or AD.

⁵See Section 15 for product numbers.

⁶Factory Installed Transient Voltage Surge Suppression (TVSS) Units. Installed in 10" module, add Suffix T6 + 10" to box height.

Optional Equipment Grounds

Description	Product Number	List Price GO-134B
Aluminum Extruded Bonded	AEBG	\$75.00
Copper Extruded Bonded	AEBGC	\$140.00
Aluminum Extruded Isolated	AEIG	\$115.00
Copper Extruded Isolated	AEIGC	\$150.00
Copper Isolated/Bonded	ASPGIBC	\$452.00 ⁷

⁷GO-101

FRONT FILLER PLATES TEDFP1 - Field installed, List Price \$1.00 ea., GO-101, standard pack = 50.

BOX EXTENSIONS - For additional end gutter space or conduit skirt applications - price from BuyLog page 9-54.

Main, Branch, and Subfeed Breaker Accessories from BuyLog page 9-37.



Panelboards

A-Series® Panelboards

Accessories
Field Installed Kits/Replacement Parts
Order By Product Number from Factory

Enclosures¹

Panel Size	Box Product Number	Box Size Inches ²	List Price, ³ GO-134B	Front Product Number ⁴	List Price, ³ GO-134B
0-25.5	AB25B	25.5	\$166.00	AF25F,S	\$170.00
28.5-31.5	AB31B	31.5	\$170.00	AF31F,S	\$174.00
34.5-37.5	AB37B	37.5	\$182.00	AF37F,S	\$191.00
40.5-43.5	AB43B	43.5	\$204.00	AF43F,S	\$218.00
46.5-49.5	AB49B	49.5	\$233.00	AF49F,S	\$257.00
52.5-55.5	AB55B	55.5	\$261.00	AF55F,S	\$299.00
57.5-64.5	AB64B	64.5	\$286.00	AF64F,S	\$326.00
67.5-76.5	AB76B	76.5	\$324.00	AF76F,S	\$367.00

¹"B" suffix provides blank end walls. Order "K" suffix for endwalls with knockouts.

²Standard boxes are 20" wide by 5.81 inches deep.

³Use when ordering items separately for replacement. Do not deduct from panel list price to obtain interior only pricing.

⁴Flush fronts are 1 1/2" larger than box. Surface fronts are 1/4" larger.

Box Options

Description	Product Number Suffix ⁵	List Price, GO-101
Painted Box	P	\$200.00
30" wide ⁶	W	\$250.00
NEMA 3R/12/4S/4X	3	\$950.00
NEMA 4X (Stainless Steel)	4S	\$4950.00

⁵Add to base box product number.

⁶Includes field installable gutter barrier.

Front Options

Description	Product Number Suffix ⁷	List Price, GO-101
Screw cover	C	\$61.00
Front hinged to box	D	\$110.00
Optional Locks:		
Yale 5116 w/Rosette	Y	\$300.00
Corbin 15767	L	\$146.00
GE 75 Key Lock	E	\$80.00
Corbin 60 Key Lock	J	\$80.00
Door within a door ⁸	P	\$238.00
Stainless steel ⁹	S	\$1467.00
30" wide	W	\$82.00
Nameplate	N	\$27.00
Screw on nameplate	U	\$74.00
Metal directory	M	\$50.00

⁷Add to base front product number.

⁸Consists of two lockable doors—one over panel interior and one over box wiring gutters. Yale locks not available.

⁹Flush only. Available with C and N options.

THQB/THHQB/THQL/THHQL/TEY Filler Plates

Product Number	List Price GO-137A
TQLFP1	\$2.50

TQD/THQD/TED4/SE/FB Filler Plates

Product Number	List Price GO-101
TEDFP1	\$1.00

Breaker Mounting¹⁰ Hardware Kits

Product Number	List Price GO-134B
ASPTED3P (Breaker type TED/THED4/SE)	\$83.50
ASPTQD3P (Breaker type TQD/THQD)	\$83.50
ASPFB12P (Breaker type FB)	\$20.00¹¹

¹⁰Use to mount breaker in existing space.

¹¹GO-101.

Stainless Steel Enclosures for GE Lighting Panels

Dimensions (inches)			Product Number ¹²		List Price Each GO-134B
H	W	D	UL Standard	CSA Labeled	
25.5	20	6	AB254S	AB254AS	\$1245.00
25.5	30	8	AB254DWS	AB254DWAS	\$1305.00
31.5	20	6	AB314S	AB314AS	\$1475.00
31.5	30	8	AB314DWS	AB314DWAS	\$1550.00
37.5	20	6	AB374S	AB374AS	\$1730.00
37.5	30	8	AB374DWS	AB374DWAS	\$1815.00
43.5	20	6	AB434S	AB434AS	\$1955.00
43.5	30	8	AB434DWS	AB434DWAS	\$2055.00
49.5	20	6	AB494S	AB494AS	\$2185.00
49.5	30	8	AB494DWS	AB494DWAS	\$2295.00
55.5	20	6	AB554S	AB554AS	\$2245.00
55.5	30	8	AB554DWS	AB554DWAS	\$2570.00
64.5	20	6	AB644S	AB644AS	\$2785.00
64.5	30	8	AB644DWS	AB644DWAS	\$2925.00
76.5	20	6	AB764S	AB764AS	\$3265.00
76.5	30	8	AB764DWS	AB764DWAS	\$3430.00

¹²DW in product number indicates enclosure is 30" wide and 8" deep.



Publications and Reference: See Section 22 for a complete list of additional product-related publications

Panelboards

A-Series® Panelboards

Section 9

Accessories
Field Installed Kits/Replacement Parts
Order By Product Number from Factory

Endwall Kits

Field installed. For standard 20"w x 5.81"d boxes.

Product Number	Description	Qty.	List Price GO-134B
ABEW2	Blank	1	\$31.00
AKEW2	Knockout	1	\$21.00

Panelboards Parts

Description	Product Number	List Price, GO-101
Directory Card	139C5612P3	\$2.00
Replacement Lock with Std. Key	569B737P1	\$22.00
Replacement Lock with GE75 Key	569B737P2	\$22.00
Additional Keys for Above Lock	569B737P5	\$2.00
Circuit Numbering Strips-		
1-48	569B806G1	\$4.00
49-84	569B806G2	\$4.00
85-126	569B806G3	\$4.00
Adhesive Backed Lamicoid Nameplate 3/4 in. x 3 in.	315A7190P1	\$27.00
Metal Directory Card Holder	139C5491G1	\$50.00
Directory Card Holder	139C5491P4	\$10.00
Delta Hi-leg Conversion Kit, to Add B-Phase		
Plug on AL Panels	APHBL	\$60.00
Bolt on AE/AQ Panels	APHBQ	\$60.00
NEMA 3R/12 Tamper Proof Tork Screw Kit	NEMATRX	\$30.00
2P to 3P TQD Conv. Kit	ASP2PTQD3P	\$100.00
2P to 3P SF Conv. Kit for horizontal subfeed	ASP2PTFJ3P	\$100.00
AD 25 to 65 kAIC Barrier kit	ASP25AD65KA ¹	\$100.00
Service Entrance Kit	ASPERENT	\$50.00
2 wire Relay Kit	ASP2WRelay	\$286.00
Yale Lock Kit	ASPYALE47	\$120.00
Corbin Lock Kit	ASPCORBNTU1	\$120.00
2-3 pole TQD Mechanical Interlock	TQDFM1	\$120.00
AQ/AL/AE Rail Bracket	ASPAQLEBKT	\$20.00
Front Flush Adjust Kit	ASPFLUSHADJ	\$20.00
AE Front Mounting Kit	139C5720G3	\$30.00
AQ/AL Front Mounting Kit	139C5720G6	\$30.00
AD Front Mounting Kit	139C5728G9	\$30.00
Front Hinge to Box Mounting Kit	139C5700G6	\$20.00
Front Extension Mounting Kit	139C5700G11	\$20.00

¹Included in factory assembled panels—AD panels with Spectra® branch breakers.

Permanent Circuit Number Kits

Product Number		Description	List Price, GO-134B
AQ, AL, AE	AD		
APN48	APN48AD	No's 1-48	\$116.00
APN84	APN84AD	No's 43-84	\$116.00
APN126	APN126AD	No's 85-126	\$116.00



Replacement Lock with Standard Key



Replacement Lock with GE75 Key

Box Extensions

Bolts to A-SERIES® box with or without box endwall in place. Extensions can be combined to obtain lengths greater than 18 and 24 inches.

Box Width and Depth	Box Mounting	Box Extension Length (Inches)	Box Extension Product Number	List Price, GO-101
20 x 5.81	Flush	9	ABX2509F	\$145.00
		18	ABX2518F	\$167.00
		24	ABX2524F	\$194.00
		9	ABX2509S	\$145.00
		18	ABX2518S	\$167.00
		24	ABX2524S	\$194.00
	Surface	31	ABX2531S	\$220.00
		37	ABX2537S	\$240.00
		43	ABX2543S	\$271.00
		49	ABX2549S	\$311.00
		55	ABX2555S	\$358.00
		64	ABX2564S	\$353.00
30 x 5.81	Flush	76	ABX2576S	\$440.00
		18	ABX3518F	\$194.00
		24	ABX3524F	\$223.00
	Surface	18	ABX3518S	\$194.00
		24	ABX3524S	\$223.00
		30 x 7.81	Flush	18
24	ABX3724F			\$250.00
Surface	18		ABX3718S	\$223.00
		24	ABX3724S	\$250.00

Box Extensions Covers Only

10 covers per kit.

Description	Product Number	List Price, GO-101
9" Covers Surface	ASPABX09S	\$145.00
9" Covers Flush	ASPABX09F	\$155.00
18" Covers Surface	ASPABX18S	\$285.00
18" Covers Flush	ASPABX18F	\$300.00
64" to 76" Covers Surface	ASPABX20S	\$300.00
64" to 76" Covers Flush	ASPABX20F	\$300.00



Panelboards

A-Series® Panelboards

Lighting Control Panel

480Y/277 Vac/120/208 Vac

Remote Operated Circuit Breakers

Bolt-On Factory Assembled

Three-Phase, 4-Wire Pricing

Service Information:

3-ph, 4-w/480Y/277 Vac

3-ph, 4-w/208Y/120 Vac

1-ph, 3-w/120/240 Vac

Bolt On Branch Breakers:

15-30 amps, TEYRC 1, 2 pole

15-100 amps, TEY³ 1, 2, 3 poles

Please contact a GE Consumer & Industrial Sales Office for ordering instructions.

Mains:

100A-TEY, SE

225A-TFJ, SF

400A-TJJ, SG

125-400 amp main lug



NOTE: Sizing dimensions to be used only for enclosure selection, not to determine interior length.

Main Lug Interiors¹

Use TEY Bolt-on Breakers		Single Main Lugs			Subfeed Main Lugs		
Panel Amps Max.	Branch Space Required	Interior Product Number	List Price, ² GO-101	Sizing Dim. (in.)	Interior Product Number	List Price, ² GO-101	Sizing Dim. (in.)
125	0-12	AEF3121MB	\$605.00	22.5	AEF3121SB	\$641.00	22.5
	13-18	AEF3181MB	\$658.00	25.5	AEF3181SB	\$694.00	25.5
	19-24	AEF3241MB	\$750.00	28.5	AEF3241SB	\$786.00	28.5
	25-30	AEF3301MB	\$841.00	31.5	AEF3301SB	\$877.00	31.5
	31-36	AEF3361MB	\$933.00	34.5	AEF3361SB	\$968.00	34.5
	37-42	AEF3421MB	\$1024.00	37.5	AEF3421SB	\$1060.00	37.5
225	0-12	AEF3122MB	\$672.00	28.5	AEF3122SB	\$712.00	28.5
	13-18	AEF3182MB	\$726.00	31.5	AEF3182SB	\$765.00	31.5
	19-24	AEF3242MB	\$817.00	34.5	AEF3242SB	\$856.00	34.5
	25-30	AEF3302MB	\$908.00	37.5	AEF3302SB	\$947.00	37.5
	31-36	AEF3362MB	\$1000.00	40.5	AEF3362SB	\$1039.00	40.5
	37-42	AEF3422MB	\$1091.00	43.5	AEF3422SB	\$1130.00	43.5
400	0-12	AEF3124MB	\$832.00	37.5	AEF3124SB	\$924.00	43.5
	13-18	AEF3184MB	\$908.00	40.5	AEF3184SB	\$1001.00	46.5
	19-24	AEF3244MB	\$992.00	43.5	AEF3244SB	\$1085.00	49.5
	25-30	AEF3304MB	\$1084.00	46.5	AEF3304SB	\$1176.00	52.5
	31-36	AEF3364MB	\$1175.00	49.5	AEF3364SB	\$1267.00	55.5
	37-42	AEF3424MB	\$1265.00	52.5	AEF3424SB	\$1358.00	58.5

¹Bottom feed supplied as standard. Change last character in Product Number from B to T for Top Feed.

²Includes standard panelboard interior box and front. Add price for options when required.

³ TEYKIT required for TEY Breakers. Good up to 10 poles.



Panelboards

A-Series® Panelboards

Lighting Control Panel

480Y/277 Vac/120/208 Vac
Remote Operated Circuit Breakers

Section 9

Enclosures

Sizing Dim. (Inches)	Box Product Number	Inside Box Dim. (Inches)			Front Product Number
		Length	Width	Depth	
0-25.5	AB25	25.5	20	5.81	AF25F,S
28.5-31.5	AB31	31.5	20	5.81	AF31F,S
34.5-37.5	AB37	37.5	20	5.81	AF37F,S
40.5-43.5	AB43	43.5	20	5.81	AF43F,S
46.5-49.5	AB49	49.5	20	5.81	AF49F,S
52.5-55.5	AB55	55.5	20	5.81	AF55F,S
57.5-64.5	AB64	64.5	20	5.81	AF64F,S
67.5-76.5	AB76	76.5	20	5.81	AF76F,S

Flush fronts are 1 1/2 inches larger than box. Surface fronts are 1/4 inch larger than box.

Main Breaker Interiors¹

Panel Amps Max.	Branch Space Required	Interrupting Rating								
		14kA 480Y/277Vac ³			25kA 480Y/277Vac			65kA 480Y/277Vac 85kA 240 Vac Max		
		Interior Product Number	List Price, ² GO-101	Sizing Dim. (In.)	Interior Product Number	List Price, ² GO-101	Sizing Dim. (In.)	Interior Product Number	List Price, ² GO-101	Sizing Dim. (In.)
100	0-12	AEF3121BB	\$990.00	25.5	AEF3121KB	\$1295.00	25.5	AEF3121DB	\$1606.00	25.5
	13-18	AEF3181BB	\$1043.00	28.5	AEF3181KB	\$1338.00	28.5	AEF3181DB	\$1659.00	28.5
	19-24	AEF3241BB	\$1134.00	31.5	AEF3241KB	\$1429.00	31.5	AEF3241DB	\$1750.00	31.5
	25-30	AEF3301BB	\$1225.00	34.5	AEF3301KB	\$1520.00	34.5	AEF3301DB	\$1842.00	34.5
	31-36	AEF3361BB	\$1317.00	37.5	AEF3361KB	\$1612.00	37.5	AEF3361DB	\$1933.00	37.5
	37-42	AEF3421BB	\$1406.00	40.5	AEF3421KB	\$1701.00	40.5	AEF3421DB	\$2025.00	40.5
225	0-12	AEF3122BB	\$1711.00	40.5	AEF3122KB	\$2006.00	40.5	AEF3122DB	\$3224.00	40.5
	13-18	AEF3182BB	\$1764.00	43.5	AEF3182KB	\$2059.00	43.5	AEF3182DB	\$3276.00	43.5
	19-24	AEF3242BB	\$1854.00	46.5	AEF3242KB	\$2149.00	46.5	AEF3242DB	\$3367.00	46.5
	25-30	AEF3302BB	\$1946.00	49.5	AEF3302KB	\$2241.00	49.5	AEF3302DB	\$3459.00	49.5
	31-36	AEF3362BB	\$2037.00	52.5	AEF3362KB	\$2332.00	52.5	AEF3362DB	\$3550.00	52.5
	37-42	AEF3422BB	\$2128.00	55.5	AEF3422KB	\$2423.00	55.5	AEF3422DB	\$3642.00	55.5
400	0-12	AEF3124BB	\$2556.00	46.5	—	—	—	—	—	—
	13-18	AEF3184BB	\$2642.00	49.5	—	—	—	—	—	—
	19-24	AEF3244BB	\$2731.00	52.5	—	—	—	—	—	—
	25-30	AEF3304BB	\$2823.00	55.5	—	—	—	—	—	—
	31-36	AEF3364BB	\$2914.00	58.5	—	—	—	—	—	—
	37-42	AEF3424BB	\$3004.00	61.5	—	—	—	—	—	—

¹Bottom feed supplied as standard. Change last character in Product Number from B to T for Top Feed.

²Includes standard panelboard interior box and front. Add price for options when required.

³Ratings at 120/240 Vac are:

100 Amp-65kA
225 Amp-25kA
400 Amp-42kA



Product Number Selection Instructions: See page 9-13

Panelboards

A-Series® Panelboards

Lighting Control Panel

480Y/277 Vac/120/208 Vac
Remote Operated Circuit Breakers

Branch Breakers, Bolt-On

Branch Breaker Mounting	Type	Bolt-on Frame	Trip Range (Amps)	List Price, GO-101		
				1-Pole (277 Vac)	2-Pole (480/277 Vac)	3-Pole (480/277 Vac)
Double Branch	TEYRC (14KAIC)	TEYRC	15-30 ⁵	\$248.00	\$550.00	—
Double Branch	TEY (14KAIC)	TEY	15-60 ³	\$53.00	\$130.00	\$230.00
			70-100 ⁴	\$116.00	\$274.00	\$326.00
Double Branch	THQB (10KAIC)	THQBGF	15-30 ⁶	\$122.00	\$203.00	—
		THQBGFEP	15-30 ⁶	\$232.00	\$533.00	—
Subfeed Breakers ^{1,2}	TED4 (14KAIC)	TED4	125-150	—	—	\$1002.00
	SEH (25KAIC)	SEH	125-150	—	—	\$1930.00
	SEL (65KAIC)	SEL	125-150	—	—	\$2280.00
	SFH (25KAIC)	SFH	125-225	—	\$1256.00	\$1571.00
	SFL (65KAIC)	SFL	125-225	—	\$2297.00	\$2761.00



TEYRC Remote Operated Circuit Breakers

- ¹Create appropriate option product number and determine size requirements from options table on page 9-58. Specify breaker type, poles and ampacity in addition to option product number when ordering.
- ²Subfeed horizontally mounted. Subfeed breaker types cannot be combined in the same panel.
- ³15 and 20 ampere breakers are SWD rated for fluorescent lighting applications.
- ⁴The sum of double branch breakers mounted opposite each other cannot exceed 150 amperes.
- ⁵HID, HACR and SWD rated.
- ⁶120/240 Vac, factory installed only.

Main, Branch, and Subfeed Breaker Accessories⁸

Circuit Breaker Frame	Shunt Trip	List Price, GO-101			
		Auxiliary Contacts 2 and 3-Pole Only		Padlocking Devices	Handle Locking Devices
		No. of AB Switch Elements	For 240 Vac		
TEY ^{7,8}	\$392.00 ⁶	1	\$200.00 ⁶	\$11.00	\$6.00
TED	\$392.00	1	\$200.00	\$11.00	\$6.00
		2	\$360.00		
SE	\$392.00	1	\$200.00	\$14.00	—
		2	\$360.00		
SF	\$447.00	2	\$447.00	\$14.00	\$10.00
		4	\$485.00		

- ⁶Takes up one branch space in sizing for both main and branch applications.
- ⁷Internal accessories only available on 2 and 3-pole.
- ⁸Internal accessories must be factory installed.

Controller

Description	Product Number Option Suffix	Panel Sizing Adder	List Price Adder GO-101
Internal controller	MR	9	\$4751.00
Internal controller with ethernet option	MR	9	\$5418.00
External controller	MX ⁹		\$4751.00
External controller with ethernet option	MX ⁹		\$5418.00
External controller connection cable - 5 feet			\$139.00
External controller connection cable - 10 feet			\$209.00
External controller connection cable - 15 feet			\$290.00
External controller connection cable - 20 feet			\$342.00
External controller connection cable - 25 feet			\$402.00



Controller

- ⁹External controller requires external controller connection cable.



Publications and Reference: See Section 22 for a complete list of additional product-related publications

Panelboards

A-Series® Panelboards

Lighting Control Panel

480Y/277 Vac/120/208 Vac
Remote Operated Circuit Breaker

Section 9

Interior Options

Option	Description	Product ¹ Number Option Suffix	100/125 Amps		225 Amps		400 Amps	
			Panel Sizing Adder	List Price Adder, GO-101	Panel Sizing Adder	List Price Adder, GO-101	Panel Sizing Adder	List Price Adder, GO-101
Optional Lugs ²	Compression Alum.	L1	—	\$30.00	—	\$50.00	—	\$130.00
	Pressure Copper	L2	—	\$49.00	—	\$49.00	—	\$92.00
	Comp. Alum. Oversize	L3	—	\$152.00	—	\$152.00	—	\$461.00
	Pressure Alum. Oversize	L4	—	\$54.00	—	\$54.00	—	\$330.00
Subfeed Breakers (Select Only One)	3 Poles TED, SE	E3	N/A	Price From Panel Sections	6	Price From Panel Sections	6	Price From Panel Sections
	2 or 3 Poles SF	F1	N/A		12		18	
Feed Thru	Feed Thru Lugs ³	T1	3	\$164.00	3	\$164.00	3	\$286.00
	600 APSI Alum.	B1	—	\$595.00	—	\$595.00	—	\$759.00
Busbar	750 APSI Alum.	B2	—	\$135.00	—	\$135.00	—	Std.
	1000 APSI Copper	B4	—	\$210.00	—	\$210.00	—	\$323.00
200% Rated Neutrals	2 Standard Lugs	N2	—	\$60.00	—	\$100.00	9	\$140.00

¹Option Product Number prefix is "AX".

²Oversize lugs available on single main lug panels only.

³Feed thru lugs not available on subfeed or oversized main lug panels.

PERMANENT CIRCUIT NUMBERS—Numbers 1-48. Field Installed. See page 9-54.

Enclosure Options

Box Options

Description	Product Number Suffix ⁵	List Price, GO-101
Blank Endwalls	B	⁶
Painted Box	P	\$200.00
30" Wide ⁷	W	\$250.00
NEMA 3R/12	3	\$950.00
NEMA 4X (Stainless Steel)	4S	\$4950.00
Endwall w/Knockouts	K	⁶

⁵Add to base box Product Number.

⁶No charge if included on original order. Price kit from page 9-54 if field conversion is required.

⁷Includes field installable gutter barrier.

TVSS¹⁰ Transient Voltage Surge Suppression

Maximum Surge Current Per Mode	Maximum Surge Current Per Phase	Description	List Price, GO-101 A Series Panelboards ^{8,9}
65kA	130kA	TVSS, UL1449, UL1283	\$6350.00
80kA	160kA	TVSS, UL1449, UL1283	\$7000.00
100kA	200kA	TVSS, UL1449, UL1283	\$8500.00
100kA	200kA	TVSS, UL1449 no Count	\$2875.00
100kA	200kA	TVSS, UL1449	\$3575.00

⁸Price applies to any A Series® panel furnished in a standard 20" wide enclosure, types AL, AQ, AE, or AD.

⁹See Section 15 for product numbers.

¹⁰Factory Installed TVSS units. Installed in 10" module, add interior Suffix T6 + 10" to box height.

Front Options—NEMA 1 Only

Description	Product Number Suffix ¹¹	List Price, GO-101
Screw Cover	C	\$61.00
Front Hinged to Box	D	\$110.00
Optional Locks:		
Yale 511S w/Rosette	Y	\$300.00
Corbin 15767	L	\$146.00
Nameplate	N	\$27.00
Door within a Door ¹²	P	\$238.00
Stainless Steel ¹³	S	\$1467.00
30" Wide	W	\$250.00
Screw-on nameplates	U	\$74.00
Metal Directory Card	M	\$50.00

¹¹Add to base front Product Number.

¹²Consists of two lockable doors—one over panel interior and one over box wiring gutters. Yale locks not available.

¹³Flush only. Available with C and N options.

BOX EXTENSIONS—For additional end gutter space or conduit skirt applications—price from page 9-54.

Equipment Grounds—Factory Supplied with Panelboard

Description	Product Number	List Price, Adder, GO-101
Field installed kits		
Standard bonded to box—for each 12 branch positions	TGL2	\$15.00
Copper bonded to box—for each 12 branch positions	TGC2	\$94.00
Standard-isolated/insulated—for each 12 branch positions	EGS12	\$99.00
Copper-isolated/insulated—for each 12 branch positions	EGC12	\$132.00
Main lug for above terminal kits	TGL20	\$25.00



Product Number Selection Instructions: See page 9-13

Panelboards

A-Series® Panelboards

Lighting Control Panel

480Y/277 Vac/120/208 Vac
Remote Operated Circuit Breaker

Accessories

Description	Product Number	List Price GO-134B
Programming Software PC-based start up software	ASROCBPRGM	\$3000.00
Handheld Programmer Customer interface with LCD screen	ASRGLCHPK	\$1680.00
Daylight Optimization Module Performs sunlight harvesting by measuring the amount of light and provides a control signal to a dimming mechanism to maintain a preset lighting level.	ASRGLCDOK	\$2000.00
Remote Switch Expansion Module Provides additional 16 digital input signals to the controller for each module	ASRGLCDSK	\$1238.00
Control Wiring Insulation Tubing Requirement per UL67 and NEC725.55, that low voltage class 2 and 3 control wiring be separated with tubing having an insulation rating equal to branch load wiring.	ASRGLCCWT	\$25.00



Programming Software



Hand-Held Programmer



Dimming Module



Remote Switch Module



Publications and Reference: See Section 22 for a complete list of additional product-related publications

Panelboards

A-Series® Panelboards

Pro-Stock, Unassembled Lighting Panels

100-600A

240 Vac 1 or 3 Phase or 480Y/277 Vac 3 Phase

Order by Product Number from the Customer Service Center

1 Select Interior

Select the interior by bus type, panel rating and number of circuits. Identify the box/front height for use in Steps 2 and 3.

Copper Bus

Voltage	Rating (Amps)	No. of Circuits	Feed-thru		Non Feed-thru		List Price GO-101P	TGL2 Ground Bars ^{2,3}	
			Product Number ¹	Box/Front Height	Product Number ¹	Box/Front Height			
240 Vac, 1 Phase	100-225	18	AQU1182RCXAXT1B4	37.5"	AQU1182RCXAXB4	31.5"	\$235.00	2	
		30	AQU1302RCXAXT1B4	43.5"	AQU1302RCXAXB4	37.5"	\$258.00	3	
		42	AQU1422RCXAXT1B4	49.5"	AQU1422RCXAXB4	43.5"	\$306.00	4	
	400	18	AQU1184RCXAXT1B4	64.5"	-	-	\$352.00	2	
		42	AQU1424RCXAXT1B4	76.5"	AQU1424RCXAXB4	64.5"	\$392.00	4	
		600	18	AQU1186RCXAXT1B4	64.5"	-	-	\$495.00	2
208/120 Vac, 3 Phase	100-225	42	AQU1426RCXAXT1B4	76.5"	AQU1426RCXAXB4	64.5"	\$530.00	4	
		18	AQU3182RCXAXT1B4	37.5"	AQU3182RCXAXB4	31.5"	\$235.00	2	
		30	AQU3302RCXAXT1B4	43.5"	AQU3302RCXAXB4	37.5"	\$258.00	3	
	400	42	AQU3422RCXAXT1B4	49.5"	AQU3422RCXAXB4	43.5"	\$306.00	4	
		18	AQU3184RCXAXT1B4	64.5"	-	-	\$352.00	2	
		42	AQU3424RCXAXT1B4	76.5"	AQU3424RCXAXB4	64.5"	\$392.00	4	
	600	18	AQU3186RCXAXT1B4	64.5"	-	-	\$495.00	2	
		42	AQU3426RCXAXT1B4	76.5"	AQU3426RCXAXB4	64.5"	\$530.00	4	
		18	AEU3182RCXAXT1B4	37.5"	AEU3182RCXAXB4	31.5"	\$235.00	2	
	480/277 Vac, 3 Phase	100-225	30	AEU3302RCXAXT1B4	43.5"	AEU3302RCXAXB4	37.5"	\$258.00	3
			42	AEU3422RCXAXT1B4	49.5"	AEU3422RCXAXB4	43.5"	\$306.00	4
			18	AEU3184RCXAXT1B4	64.5"	-	-	\$352.00	2
400		42	AEU3424RCXAXT1B4	76.5"	AEU3424RCXAXB4	64.5"	\$392.00	4	
		18	AEU3186RCXAXT1B4	64.5"	-	-	\$495.00	2	
		42	AEU3426RCXAXT1B4	76.5"	AEU3426RCXAXB4	64.5"	\$530.00	4	

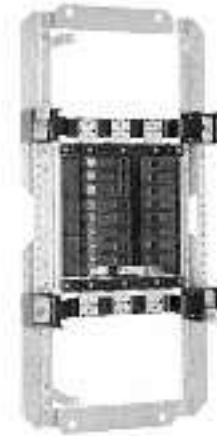

Aluminum Bus

Voltage	Rating (Amps)	No. of Circuits	Feed-thru Product Number ¹	Box/Front Height	List Price GO-101P	TGL2 Ground Bars ^{2,3}
240 Vac, 1 Phase	100-225	18	AQU1182RCXAXT1	37.5"	\$164.00	2
		30	AQU1302RCXAXT1	43.5"	\$190.00	3
		42	AQU1422RCXAXT1	49.5"	\$230.00	4
208/120 Vac, 3 Phase	100-225	18	AQU3182RCXAXT1	37.5"	\$164.00	2
		30	AQU3302RCXAXT1	43.5"	\$190.00	3
		42	AQU3422RCXAXT1	49.5"	\$230.00	4
480/277 Vac, 3 Phase	100-225	18	AEU3182RCXAXT1	37.5"	\$164.00	2
		30	AEU3302RCXAXT1	43.5"	\$190.00	3
		42	AEU3422RCXAXT1	49.5"	\$230.00	4

TGL20 Ground Lug Quantities

Interior Type	No. of TGL20s Required by Panel Rating		
	100A-225A	400A	600A
Main Lug Only	1	1	2
Main Lug and Feed-thru	2	2	4
Main Breaker Only	1	1	1
Main Breaker and Sub-feed	1	1	1
Main Breaker and Feed-thru	2	2	3

¹For CSA label, add "M8" suffix to product number.

²For TGL20 ground lug quantities, see TGL20 Ground Lug Quantities table above.

³For isolated ground, use EGS12. When using the EGS12, 3, 5 and 7 ground lugs (TGL20s) are required for 18, 30 and 42 circuits respectively.



Panelboards

A-Series® Panelboards

Pro-Stock, Unassembled Lighting Panels

2 Select Box

Select a box of the correct height (see Step 1). Boxes come with blank endwalls. If endwalls with knockouts are required, also order knockout endwall kit AKEW2, List Price \$21.00, GO-134B.

Box Height	NEMA 1				NEMA 3R/12	
	20" Wide		30" Wide		20" Wide	
	Product Number ¹	List Price GO-134B	Product Number ¹	List Price GO-134B	Product Number ¹	List Price GO-134B
31.5"	AB31B	\$170.00	AB31BW	\$420.00	AB313	\$1283.00
37.5"	AB37B	\$182.00	AB37BW	\$432.00	AB373	\$1295.00
43.5"	AB43B	\$204.00	AB43BW	\$454.00	AB433	\$1317.00
49.5"	AB49B	\$233.00	AB49BW	\$483.00	AB493	\$1344.00
64.5"	AB64B	\$286.00	AB64BW	\$536.00	AB643	\$1399.00
76.5"	AB76B	\$324.00	AB76BW	\$574.00	AB763	\$2441.00

¹For CSA label, add "A" suffix to product number.



NEMA 1



NEMA 3R/12

3 Select Front

Select a front of the correct height (see Step 1).

Front Height	Standard (20" wide)			Door Within Door (20" wide)			Front Hinged To Box (20" wide)			Standard (30" Wide)		
	Flush ¹	Surface ¹	List Price GO-134B	Flush ¹	Surface ¹	List Price GO-134B	Flush ¹	Surface ¹	List Price GO-134B	Flush ¹	Surface ¹	List Price GO-134B
31.5"	AF31F	AF31S	\$174.00	AF31FP	AF31SP	\$412.00	AF31FD	AF31SD	\$284.00	AF31FW	AF31SW	\$424.00
37.5"	AF37F	AF37S	\$191.00	AF37FP	AF37SP	\$429.00	AF37FD	AF37SD	\$301.00	AF37FW	AF37SW	\$441.00
43.5"	AF43F	AF43S	\$218.00	AF43FP	AF43SP	\$456.00	AF43FD	AF43SD	\$328.00	AF43FW	AF43SW	\$468.00
49.5"	AF49F	AF49S	\$257.00	AF49FP	AF49SP	\$495.00	AF49FD	AF49SD	\$367.00	AF49FW	AF49SW	\$507.00
64.5"	AF64F	AF64S	\$326.00	AF64FP	AF64SP	\$564.00	AF64FD	AF64SD	\$436.00	AF64FW	AF64SW	\$576.00
76.5"	AF76F	AF76S	\$367.00	AF76FP	AF76SP	\$605.00	AF76FD	AF76SD	\$477.00	AF76FW	AF76SW	\$617.00

¹For CSA label, add "A" suffix to product number.



Door Within Door



Standard



Front Hinged to Box



Publications and Reference: See Section 22 for a complete list of additional product-related publications

Panelboards

A-Series® Panelboards

Pro-Stock, Unassembled Lighting Panels

4 Select Main and/or Sub-feed Breaker Kit

Select main breaker kit appropriate for your interior type (see Step 1), amp rating and kAIC rating. If a sub-feed breaker is required, repeat the selection process.

Note: 400A and 600A breaker kits cannot be used for sub-feed applications in Pro-Stock panelboards.

For additional details and pricing, see Section 4 of the BuyLog.

Interior Type	Product Number ¹	List Price GO-101P	Rating Amps	No. of Poles	Breaker Rating (kAIC)						
					10	14	22	25	65	100	200
AQU1: 240 VAC 1 Phase	MB612	\$35.00	100	2	THQB		THHQB				
	MB614	\$80.00	100	4	(2) THQB		(2) THHQB				
	MB512	\$118.00	225	2	TQD		THQD				
	MB332	\$145.00	400	2					SGHA	SGLA	SGPA
	MB332	\$145.00	600	2					SGHA	SGLA	SGPA
	MB332WB	\$4225.00	600	2					SGHA+Kit		
AQU3: 208/120 VAC, 3 Phase	MB613	\$35.00	100	3	THQB		THHQB				
	MB616	\$90.00	100	6	(2) THQB		(2) THHQB				
	MB513	\$92.00	225	3	TQD		THQD				
	MB516	\$210.00	400	6	(2) TQD		(2) THQD				
	MB233	\$125.00	225	3					SFHA	SFLA	SFPA
	MB233WB	\$1325.00	225	3					SFHA+Kit		
	MB2332 ⁵	\$125.00	400	6 ⁵					2nd SFHA		
	MB2332WB ⁵	\$1500.00	400	6 ⁵					2nd SFHA+Kit		
	MB333	\$160.00	400	3					SGHA	SGLA	SGPA
	MB333	\$160.00	600	3					SGHA	SGLA	SGPA
	MB333WB	\$5100.00	600	3					SGHA+Kit		
AEU3: 480/277 Vac, 3 Phase	MB423	\$35.00	100	3		TEY					
	MB426	\$90.00	100	6		(2) TEY					
	MB133	\$52.00	150	3		TED ²		THED			
	MB133	\$52.00	150	3				SEHA	SELA	SEPA	
	MB133WB	\$1000.00	150	3				SEHA+Kit			
	MB233	\$125.00	225	3				SFHA ⁴	SFLA	SFPA	
	MB233WB	\$1325.00	225	3				SFHA+Kit ⁴			
	MB2332 ⁵	\$125.00	400	6 ⁵				2nd SFHA ⁴			
	MB2332WB ⁵	\$1500.00	400	6 ⁵				2nd SFHA+Kit ⁴			
	MB333	\$160.00	400	3				SGHA ⁴	SGLA	SGPA	
MB333	\$160.00	600	3				SGHA ⁴	SGLA	SGPA		
MB333WB	\$5100.00	600	3				SGHA+Kit ⁴				

¹Breaker not included except for "WB" kits (where product number ends in "WB"). "WB" kits include a breaker, mounting kit and load-side lugs. Rating plugs must be ordered separately.

²Actual breaker rating is 18kAIC.

³Actual breaker rating is 30kAIC.

⁴Actual breaker rating is 35kAIC.

⁵To achieve 6 poles of subfeed, the MB233WB or MB233 kit is also required. 6 poles of subfeed only work with 400A and 600A interiors.

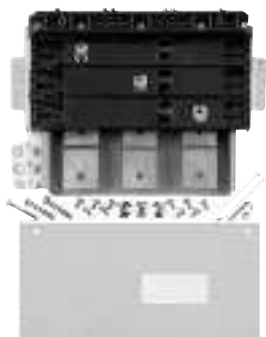

MB513 Breaker Kit

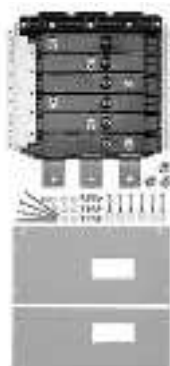

MB516 6-Pole Breaker Kit

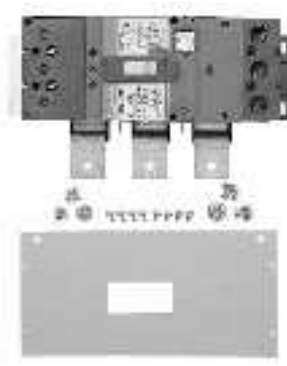

MB233WB "WB" Breaker Kit



Panelboards

A-Series® Panelboards

Pro-Stock, Unassembled Lighting Panels

5 Typical Main Breakers

- Skip Step 5 if you selected a main breaker kit ending in “WB” — no breaker is required.
- To correlate breaker types with the kAIC rating in specific panelboards, see the table for Step 4. For more rating details, see A-Series® Lighting Panels Rating Series Labels (DEH-40007).

- All TQD and Spectra® main breakers require line-side lugs.
- For TEY and THQB main breakers, see branch breakers tables in Step 7.

Digital, Solid State Spectra® RMS Breakers (3-pole) For use with appropriate main breaker kit (see Step 4).

Poles	Breaker			Rating Plug ¹			Terminal Lugs for Front Connection ²								
	Current Sensor	Product Number	List Price GO-135S	Amp Rating	Product Number	List Price GO-135S	Product Number	List Price GO-135S	Wire Range (Cu/Al)						
3	100	SEDA36AT0100	\$492.00	100	SRPE100A100	\$106.00	TCAL18	\$3.00	#12-3/0						
		SEHA36AT0100	\$734.00												
		SELA36AT0100	\$895.00												
		SEPA36AT0100	\$1482.00												
	150	SEDA36AT0150	\$1253.00	110	SRPE150A110	\$106.00									
		SELA36AT0150	\$2165.00	125	SRPE150A125	\$106.00									
		SEPA36AT0150	\$3477.00	150	SRPE150A150	\$106.00									
			70	SRPF250A70	\$106.00										
	250	SFLA36AT0250 SFPA36AT0250	\$2631.00 \$3490.00	90	SRPF250A90	\$106.00				TCAL29	\$8.00	#8-350 MCM			
				100	SRPF250A100	\$106.00									
				110	SRPF250A110	\$106.00									
				125	SRPF250A125	\$106.00									
150				SRPF250A150	\$106.00										
175				SRPF250A175	\$106.00										
200				SRPF250A200	\$106.00										
225				SRPF250A225	\$106.00										
3				400	SGHA36AT0400 SGLA36AT0400 SGPA36AT0400	\$2383.00 \$3487.00 \$4653.00	125	SRPG400A125	\$106.00				TCLK365	\$42.00	Al: (2) 2/0-500 MCM or (1) #6-600 MCM Cu: (2) 2/0-400 MCM or (1) #8-600 MCM
							150	SRPG400A150	\$106.00						
	175	SRPG400A175	\$106.00												
	200	SRPG400A200	\$106.00												
2	400	SGHA26AT0400 SGLA26AT0400 SGPA26AT0400	\$1959.00 \$2926.00 \$3856.00	225	SRPG400A225	\$106.00	TCLK265	\$28.00							
				250	SRPG400A250	\$106.00									
				300	SRPG400A300	\$106.00									
				350	SRPG400A350	\$106.00									
3	600	SGLA36AT0600 SGPA36AT0600	\$4270.00 \$5548.00	400	SRPG400A400	\$106.00	TCLK365	\$42.00							
				250	SRPG600A250	\$106.00									
				300	SRPG600A300	\$106.00									
				350	SRPG600A350	\$106.00									
2	600	SGLA26AT0600 SGPA26AT0600	\$3545.00 \$4607.00	400	SRPG600A400	\$106.00	TCLK265	\$28.00							
				500	SRPG600A500	\$106.00									
				600	SRPG600A600	\$106.00									

¹Any rating plug within a given current sensor group may be paired with any breaker in that group.

²Except for “WB” kits, lugs must be ordered separately for Spectra® breakers. All Spectra® breakers also require an appropriate rating plug.

Main or subfeed breakers for use with AQ panels (208/120 Vac 3-phase or 240 Vac single phase). See Step 4.

Amp Rating	2-pole				3-pole			
	10kAIC		22kAIC		10kAIC		22kAIC	
	Product ³ Number	List Price GO-135F	Product Number	List Price GO-135F	Product ³ Number	List Price GO-135F	Product Number	List Price GO-135F
100	TQD22100X2	\$233.00	THQD22100X2	\$552.00	TQD32100X2	\$617.00	THQD32100X2	\$883.00
125	TQD22125X2	\$233.00	THQD22125X2	\$552.00	TQD32125X2	\$617.00	THQD32125X2	\$883.00
150	TQD22150X2	\$233.00	THQD22150X2	\$552.00	TQD32150X2	\$617.00	THQD32150X2	\$883.00
175	TQD22175X2	\$233.00	THQD22175X2	\$552.00	TQD32175X2	\$617.00	THQD32175X2	\$883.00
200	TQD22200X2	\$233.00	THQD22200X2	\$552.00	TQD32200X2	\$617.00	THQD32200X2	\$883.00
225	TQD22225X2	\$233.00	THQD22225X2	\$552.00	TQD32225X2	\$617.00	THQD32225X2	\$883.00
250	-	-	TJD422250L2	\$1466.00	-	-	TJD432250L3	\$1760.00
300	-	-	TJD422300L2	\$1466.00	-	-	TJD432300L3	\$1760.00
350	-	-	TJD422350L2	\$1466.00	-	-	TJD432350L3	\$1760.00
400	-	-	TJD422400L2	\$1466.00	-	-	TJD432400L3	\$1760.00

Main or subfeed breakers for use with AE panels (480/277 Vac 3-phase). See Step 4.

Amp Rating	3-pole					
	18kAIC		22kAIC		30kAIC	
	Product Number	List Price, GO-135B	Product Number	List Price, GO-135B	Product Number	List Price, GO-135B
110	TED134110WL	\$1198.00	THED134110WL	\$1683.00	MB233WB	
125	TED134125WL	\$1198.00	THED134125WL	\$1683.00	MB233WB	
150	TED134150WL	\$1198.00	THED134150WL	\$1683.00	MB233WB	
175	-	-	-	-	MB233WB	
200	-	-	-	-	MB233WB	
225	-	-	-	-	MB233WB	
250	-	-	-	-	TJJ436250L3	\$2531.00
300	-	-	-	-	TJJ436300L3	\$2531.00
350	-	-	-	-	TJJ436350L3	\$2531.00
400	-	-	-	-	TJJ436400L3	\$2531.00

³Any load-side lugs on TQD breakers must be removed before assembly. TQD breakers with X2 product number suffix feature line-side lugs only.

⁴See Step 4 table for List Price (GO-101P) for MB233WB.



Publications and Reference: See Section 22 for a complete list of additional product-related publications

Panelboards

A-Series® Panelboards

Pro-Stock, Unassembled Lighting Panels

6 Select Main Lug Kit and Accessories

Select lug kit(s) for main lug and/or feed-thru applications, if required. (All lugs are suitable for interiors with either copper or aluminum bus.) Also select any accessories required.



Main Lug Kits

Lug Type	Amp Rating	Standard			Oversized			200% Neutral	
		Product Number	List Price GO-101P	Wire Range	Product Number	List Price GO-101P	Wire Range	Product Number	List Price GO-101P
Pressure	225	MLA1	\$30.00	6-350 MCM	MLA2	\$52.00	1-600 MCM or (2) 1/0-250 MCM	NKA	\$25.00
	400	MLA41	\$60.00	2-600 MCM or (2) 1/0-250 MCM	MLA62	\$100.00	3/0-800 MCM	NKA4 ²	\$50.00
	600	MLA61	\$90.00	(2) 2/0-500 MCM	MLA62	\$100.00	3/0-800 MCM	-	-
Copper	225	MLR1	\$65.00	4-350 MCM	MLR2	\$105.00	1-600 MCM	NKR	\$43.00
	400	MLR41	\$120.00	1-600 MCM	MLR61	\$175.00	(2) 2/0-500 MCM	NKR4	\$80.00
	600	MLR61	\$175.00	(2) 2/0-500 MCM	-	-	-	-	-
Compression	225	MLT1	\$65.00	2/0-300 MCM	MLT2	\$105.00	4/0-500 MCM	NKT	\$43.00
	400	MLT42	\$120.00	250-600 MCM	MLT41	\$120.00	500-750 MCM ¹	NKT4	\$80.00
Dual	225	MLA2	\$52.00	1-600 MCM or (2) 1/0-250 MCM	-	-	-	-	-
Main	400	MLA61	\$90.00	(2) 2/0-500 MCM	-	-	-	-	-

¹500 MCM Cu, 750 MCM Al.

²For 200% neutral feed-thru, order NKA4FT, List Price \$85.00 (GO-101P). Wire range (2) 2/0 - 600 MCM or (4) 4-250 MCM.

Accessories

Service Entrance ³			ProCare Kit ⁴		
Amp Rating	Product Number	List Price, GO-101P	Description	Product Number	List Price, GO-101P
225A	BNDKT	\$15.00	ProCare Kit for Pro-Stock panelboard installation and maintenance	PROCARE	\$100.00
400A	BNDKT6	\$30.00			
600A	BNDKT6	\$30.00			

³Service entrance kit includes a bonding strap with hardware and a service entrance label.

⁴ProCare Kit includes: (5) filler plate hardware kits, (9) bus stud nuts, (5) MLA1 filler plates, (2) 225A phase barriers, (2) feed-thru barriers, (1) 400/600A phase barrier, (50) directory cards/rating books, (50) circuit number strips (1-48), (50) circuit number strips (43-84), (5) standard locks and keys, (50) deadfront screws, (10) AQ/AE front hardware kits, (10) AD front hardware kits, (50) service disconnect labels, (50) main labels.

7 Typical Bolt-On Branch Breakers

These tables show typical branch breakers, but do not include all branch breakers that can be used with Pro-Stock panelboards.

Branch circuit breakers for use with AQ panels (208/120 Vac 3-phase or 240 Vac single phase)

Amp Rating	10kAIC						22kAIC					
	1-pole		2-pole		3-pole		1-pole		2-pole		3-pole	
	Product Number	List Price GO-135B	Product Number	List Price GO-135B	Product Number	List Price GO-135B	Product Number	List Price GO-135B	Product Number	List Price GO-135B	Product Number	List Price GO-135B
15	THQB1115	\$19.75	THQB2115	\$43.50	THQB32015	\$139.00	THQB1115	\$35.00	THQB2115	\$82.50	THQB32015	\$212.00
20	THQB1120	\$19.75	THQB2120	\$43.50	THQB32020	\$139.00	THQB1120	\$35.00	THQB2120	\$82.50	THQB32020	\$212.00
25	THQB1125	\$19.75	THQB2125	\$43.50	THQB32025	\$139.00	THQB1125	\$39.00	THQB2125	\$82.50	THQB32025	\$212.00
30	THQB1130	\$19.75	THQB2130	\$43.50	THQB32030	\$139.00	THQB1130	\$39.00	THQB2130	\$82.50	THQB32030	\$212.00
35	THQB1135	\$19.75	THQB2135	\$43.50	THQB32035	\$139.00	THQB1135	\$39.00	THQB2135	\$82.50	THQB32035	\$212.00
40	THQB1140	\$19.75	THQB2140	\$43.50	THQB32040	\$139.00	THQB1140	\$39.00	THQB2140	\$82.50	THQB32040	\$212.00
45	THQB1145	\$19.75	THQB2145	\$43.50	THQB32045	\$139.00	THQB1145	\$39.00	THQB2145	\$82.50	THQB32045	\$212.00
50	THQB1150	\$19.75	THQB2150	\$43.50	THQB32050	\$139.00	THQB1150	\$39.00	THQB2150	\$82.50	THQB32050	\$212.00
60	THQB1160	\$19.75	THQB2160	\$43.50	THQB32060	\$139.00	THQB1160	\$39.00	THQB2160	\$82.50	THQB32060	\$212.00
70	THQB1170	\$38.00	THQB2170	\$82.50	THQB32070	\$175.00	THQB1170	\$51.00	THQB2170	\$126.00	THQB32070	\$263.00
80	-	-	THQB2180	\$113.00	THQB32080	\$199.00	-	-	THQB2180	\$183.00	THQB32080	\$307.00
90	-	-	THQB2190	\$113.00	THQB32090	\$199.00	-	-	THQB2190	\$183.00	THQB32090	\$307.00
100	-	-	THQB21100	\$113.00	THQB32100	\$199.00	-	-	THQB21100	\$183.00	THQB32100	\$307.00

Branch circuit breakers for use with AE panels (480/277 Vac 3-phase)

Amp Rating	14kAIC					
	1-pole		2-pole		3-pole	
	Product Number	List Price GO-135B	Product Number	List Price GO-135B	Product Number	List Price GO-135B
15	TEY115	\$72.00	TEY215	\$216.00	TEY315	\$316.00
20	TEY120	\$72.00	TEY220	\$216.00	TEY320	\$316.00
30	TEY130	\$72.00	TEY230	\$216.00	TEY330	\$316.00
40	TEY140	\$72.00	TEY240	\$216.00	TEY340	\$316.00
50	TEY150	\$72.00	TEY250	\$216.00	TEY350	\$316.00
60	TEY160	\$72.00	TEY260	\$216.00	TEY360	\$316.00
70	TEY170	\$142.00	TEY270	\$352.00	TEY370	\$424.00
80	TEY180	\$142.00	TEY280	\$352.00	TEY380	\$424.00
90	TEY190	\$142.00	TEY290	\$352.00	TEY390	\$424.00
100	TEY1100	\$142.00	TEY2100	\$352.00	TEY3100	\$424.00



Panelboards

A-Series® Panelboards

Pro-Stock, Unassembled Lighting Panels

8 Integrated Tranquell® ME TVSS

Select appropriate transient voltage surge suppressor – 65k symmetrical fault withstand.

Maximum Surge Current	Configuration	Product No. (Replace xxxx with selected nominal voltage from table below)	List Price GO-AC11
65kA per mode / 130kA per phase	Lights, Alarm, Surge Counter, Form C Contacts	TPMExxxx06PS	\$1500.00
80kA per mode / 160kA per phase	Lights, Alarm, Surge Counter, Form C Contacts	TPMExxxx08PS	\$1700.00
100kA per mode / 200kA per phase	Lights, Alarm, Surge Counter, Form C Contacts	TPMExxxx10PS	\$2200.00
100kA per mode / 200kA per phase	Lights, Alarm, Contacts, No Surge Counter, No Filter	TPMExxxx10PSNC	\$1000.00
100kA per mode / 200kA per phase	Lights, Alarm, Surge Counter, Contacts, No Filter	TPMExxxx10PSNF	\$1200.00

Nominal Voltage (Volts RMS)	Configuration	Suppressed Voltage Rating UL 1449 2nd Edition L-N / L-G / N-G	Max. Continuing Operating Voltage	Product No. Digits (Replace xxxx in table above)
120/240	1 Phase, 3 Wire + Ground	500 / 500 / 500	125%	120S
120Y/208	3 Phase, 4 Wire + Ground	500 / 500 / 500	125%	120Y
240 Delta	3 Phase, 3 Wire + Ground	- / 800 / -	115%	240D
120/240	Delta HL 3 Phase, 4 Wire + Ground	500/700 / 500/700 / 500	115%	240H
277Y/480	3 Phase, 4 Wire + Ground	800 / 800 / 800	115%	277Y

Pro-Stock Interiors Product Number Structure

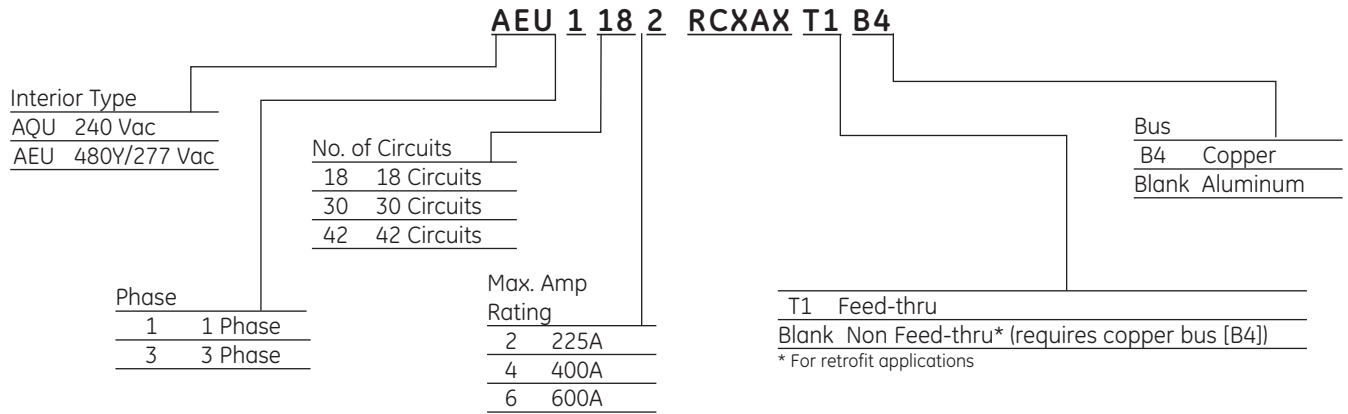

Publications and Reference: See Section 22 for a complete list of additional product-related publications

Panelboards

A-Series® Panelboards

Column—Type ALC

240 Vac Plug-In
Factory Assembled
Single-Phase, 3-Wire Pricing

Service Information:

1-ph, 3-w
240/120 volts ac max.

Plug-In Branch Breakers:

15-100 amps, 1, 2, 3-poles
Types THQL, THQL, TXQL

Mains:

100A-THQB, THQB, TEY, SE
225-TQD, THQD, SF
125-225 Amp main lug

NOTE: Sizing dimensions to be used only for enclosure selection, not to determine interior length.

Service Entrance Label will be factory installed only when specified. Please see page 9-3 for UL Standards on service entrance. Service Entrance Labels are available for field installation. Please contact a GE Consumer & Industrial Sales Office for ordering instructions.

Main Lug Interiors¹

Use THQL Plug In-Breakers		Single Main Lugs		
Panel Amps Max.	Branch Space Required	Interior Product Number	List Price, ² GO-101	Sizing Dim. (Inches)
125	0-12	ALC1121MT	\$491.00	37.5
	13-18	ALC1181MT	\$534.00	43.5
	19-24	ALC1241MT	\$606.00	49.5
	25-30	ALC1301MT	\$679.00	55.5
	31-36	ALC1361MT	\$751.00	64.5
	37-42	ALC1421MT	\$824.00	64.5
225	0-12	ALC1122MT	\$549.00	43.5
	13-18	ALC1182MT	\$591.00	49.5
	19-24	ALC1242MT	\$664.00	55.5
	25-30	ALC1302MT	\$737.00	64.5
	31-36	ALC1362MT	\$810.00	64.5
	37-42	ALC1422MT	\$882.00	76.5

¹Top feed furnished as standard—change last character in Product Number from T to B for bottom feed.

²Includes standard panelboard interior, box and front. Add price for options when required.

Enclosures

Sizing Dim. (Inches)	Box Product Number	Outside Box Dim. (Inches)			Front Product Number
		Length	Width	Depth	
37.5	AB378	37.5	8.62	5.81	AF37F8,S8
43.5	AB438	43.5	8.62	5.81	AF43F8,S8
49.5	AB498	49.5	8.62	5.81	AF49F8,S8
55.5	AB558	55.5	8.62	5.81	AF55F8,S8
64.5	AB648	64.5	8.62	5.81	AF64F8,S8
76.5	AB768	76.5	8.62	5.81	AF76F8,S8

Flush fronts are 1 1/2 inches larger than box. Surface fronts are 1/4 inch larger than box.

Main Breaker Interiors¹

Panel Amps Max.	Branch Space Required	Interrupting Rating											
		10kA			22kA			65kA			85kA		
		Interior Product Number	List Price, ² GO-101	Sizing Dim. (Inches)	Interior Product Number	List Price, ² GO-101	Sizing Dim. (Inches)	Interior Product Number	List Price, ² GO-101	Sizing Dim. (Inches)	Interior Product Number	List Price, ² GO-101	Sizing Dim. (Inches)
100	0-12	ALC1121AT	\$710.00	37.5	ALC1121CT	\$734.00	37.5	ALC1121ET	\$1173.00	37.5	ALC1121FT	\$1648.00	37.5
	13-18	ALC1181AT	\$757.00	43.5	ALC1181CT	\$777.00	43.5	ALC1181ET	\$1217.00	43.5	ALC1181FT	\$1692.00	43.5
	19-24	ALC1241AT	\$829.00	49.5	ALC1241CT	\$848.00	49.5	ALC1241ET	\$1289.00	49.5	ALC1241FT	\$1764.00	49.5
	25-30	ALC1301AT	\$900.00	55.5	ALC1301CT	\$921.00	55.5	ALC1301ET	\$1363.00	55.5	ALC1301FT	\$1837.00	55.5
	31-36	ALC1361AT	\$970.00	64.5	ALC1361CT	\$993.00	64.5	ALC1361ET	\$1434.00	64.5	ALC1361FT	\$1910.00	64.5
	37-42	ALC1421AT	\$1044.00	76.5	ALC1421CT	\$1067.00	76.5	ALC1421ET	\$1507.00	64.5	ALC1421FT	\$1982.00	64.5
225	0-12	ALC1122AT	\$1552.00	43.5	ALC1122CT	\$1708.00	43.5	—	—	—	ALC1122FT	\$3274.00	43.5
	13-18	ALC1182AT	\$1595.00	49.5	ALC1182CT	\$1751.00	49.5	—	—	—	ALC1182FT	\$3314.00	49.5
	19-24	ALC1242AT	\$1668.00	55.5	ALC1242CT	\$1824.00	55.5	—	—	—	ALC1242FT	\$3387.00	55.5
	25-30	ALC1302AT	\$1741.00	64.5	ALC1302CT	\$1896.00	64.5	—	—	—	ALC1302FT	\$3460.00	64.5
	31-36	ALC1362AT	\$1813.00	64.5	ALC1362CT	\$1970.00	64.5	—	—	—	ALC1362FT	\$3532.00	76.5
	37-42	ALC1422AT	\$1885.00	76.5	ALC1422CT	\$2042.00	76.5	—	—	—	ALC1422FT	\$3606.00	76.5

¹Top feed furnished as standard—change last character in Product Number from T to B for bottom feed.

²Includes standard panelboard interior, box and front. Add price for options when required.

³For 3-ph, 3-wire applications, panel is constructed as a 3-ph, 4-wire but is labeled to indicate that the neutral is not terminated during installation.



Product Number Selection Instructions: See page 9-13

Panelboards

A-Series® Panelboards

Column—Type ALC

240 Vac Plug-In

Factory Assembled

Three-Phase, 3-Wire/4-Wire Pricing³

Service Information:

- 3-ph, 3-w; 3-ph, 4-w;
- 240 Vac max.

Plug-in Branch Breakers:

- 15-100 amps, 1, 2, 3-poles
- Types THQL, THHQL, TXQL

Mains:

- 100A—THQB, THHQB, TEY, SE
- 225A—TQD, THQD, SF
- 125-225 amp main lug

NOTE: Sizing dimensions to be used only for enclosure selection, not to determine interior length.

Service Entrance Label will be factory installed only when specified. Please see page 9-3 for UL Standards on service entrance. Service Entrance Labels are available for field installation. Please contact a GE Consumer & Industrial Sales Office for ordering instructions.

Main Lug Interiors¹

Use THQL Plug-in Breakers		Single Main Lugs		
Panel Amps Max.	Branch Space Required	Interior Product Number	List Price, ² GO-101	Sizing Dim. (Inches)
125	0-12	ALC3121MT	\$541.00	37.5
	13-18	ALC3181MT	\$584.00	43.5
	19-24	ALC3241MT	\$657.00	49.5
	25-30	ALC3301MT	\$730.00	55.5
	31-36	ALC3361MT	\$803.00	64.5
	37-42	ALC3421MT	\$875.00	64.5
225	0-12	ALC3122MT	\$592.00	43.5
	13-18	ALC3182MT	\$636.00	49.5
	19-24	ALC3242MT	\$710.00	55.5
	25-30	ALC3302MT	\$782.00	64.5
	31-36	ALC3362MT	\$855.00	64.5
	37-42	ALC3422MT	\$926.00	76.5

¹Top feed supplied as standard—change last character in Product Number from T to B for bottom feed.

²Includes standard panelboard interior, box and front. Add price for options when required.

Enclosures

Sizing Dim. (Inches)	Box Product Number	Outside Box Dim. (Inches)			Front Product Number
		Length	Width	Depth	
37.5	AB378	37.5	8.62	5.81	AF37F8,S8
43.5	AB438	43.5	8.62	5.81	AF43F8,S8
49.5	AB498	49.5	8.62	5.81	AF49F8,S8
55.5	AB558	55.5	8.62	5.81	AF55F8,S8
64.5	AB648	64.5	8.62	5.81	AF64F8,S8
76.5	AB768	76.5	8.62	5.81	AF76F8,S8

Flush fronts are 1 1/2 inches larger than box. Surface fronts are 1/4 inch larger than box.

Main Breaker Interiors¹

Panel Amps Max.	Branch Space Required	Interrupting Rating											
		10kA			22kA			65kA			100kA		
		Interior Product Number	List Price, ² GO-101	Sizing Dim. (Inches)	Interior Product Number	List Price, ² GO-101	Sizing Dim. (Inches)	Interior Product Number	List Price, ² GO-101	Sizing Dim. (Inches)	Interior Product Number	List Price, ² GO-101	Sizing Dim. (Inches)
100	0-12	ALC3121AT	\$843.00	37.5	ALC3121CT	\$975.00	37.5	ALC3121ET	\$1327.00	37.5	ALC3121FT	\$1751.00	37.5
	13-18	ALC3181AT	\$883.00	43.5	ALC3181CT	\$1016.00	43.5	ALC3181ET	\$1370.00	43.5	ALC3181FT	\$1794.00	43.5
	19-24	ALC3241AT	\$957.00	49.5	ALC3241CT	\$1090.00	49.5	ALC3241ET	\$1442.00	49.5	ALC3241FT	\$1866.00	49.5
	25-30	ALC3301AT	\$1030.00	55.5	ALC3301CT	\$1162.00	55.5	ALC3301ET	\$1516.00	55.5	ALC3301FT	\$1938.00	55.5
	31-36	ALC3361AT	\$1101.00	64.5	ALC3361CT	\$1235.00	64.5	ALC3361ET	\$1588.00	64.5	ALC3361FT	\$2012.00	64.5
	37-42	ALC3421AT	\$1174.00	76.5	ALC3421CT	\$1307.00	76.5	ALC3421ET	\$1660.00	64.5	ALC3421FT	\$2085.00	64.5
225	0-12	ALC3122AT	\$1851.00	43.5	ALC3122CT	\$1973.00	43.5	—	—	—	ALC3122FT	\$3719.00	43.5
	13-18	ALC3182AT	\$1859.00	49.5	ALC3182CT	\$2016.00	49.5	—	—	—	ALC3182FT	\$3763.00	49.5
	19-24	ALC3242AT	\$1932.00	55.5	ALC3242CT	\$2089.00	55.5	—	—	—	ALC3242FT	\$3836.00	55.5
	25-30	ALC3302AT	\$2004.00	64.5	ALC3302CT	\$2165.00	64.5	—	—	—	ALC3302FT	\$3908.00	64.5
	31-36	ALC3362AT	\$2078.00	64.5	ALC3362CT	\$2235.00	64.5	—	—	—	ALC3362FT	\$3981.00	76.5
	37-42	ALC3422AT	\$2151.00	76.5	ALC3422CT	\$3209.00	76.5	—	—	—	ALC3422FT	\$4055.00	76.5

¹Top feed supplied as standard—change last character in Product Number from T to B for bottom feed.

²Includes standard panelboard interior, box and front. Add price for options when required.

³For 3-ph, 3-wire applications, panel is constructed as a 3-ph, 4-wire but is labeled to indicate that the neutral is not terminated during installation.



Publications and Reference: See Section 22 for a complete list of additional product-related publications

Panelboards

A-Series® Panelboards

Column—Type ALC

240 Vac Plug-In
Factory Assembled Pricing

Section 9

Branch Breakers THQL Circuit Breakers, Plug-In Mounting

Molded Case Circuit Breakers				List Price, GO-101			
Branch Breaker Mounting	Type	Plug-In Frames	Trip ¹ Range in Amps	1-Pole 120V	2-Pole 120/240V	2-Pole ² 240V	3-Pole 240V
				Number of Spaces Required			
				1	2	2	3
Single Branch	THQL (10,000 AIC)	THQL	15-60 ³	\$12.00	\$27.00	\$74.00	\$98.00
			70	\$23.00	\$54.00	\$87.00	\$119.00
			80-100	—	\$80.00	\$126.00	\$138.00
		THQL-HID	15-30	\$111.00	\$185.00	—	—
			15-30	\$16.00	\$28.00	—	—
			15-20 ³	\$22.00	\$54.00	\$119.00	\$125.00
Single Branch	THHQL (22,000 AIC)	THHQL	25-60	\$29.50	\$54.00	\$119.00	\$125.00
			70	\$39.00	\$87.00	\$151.00	\$170.00
			80-100	—	\$126.00	\$172.00	\$187.00
		THHQL-HID	15-30	\$28.00	\$82.00	—	—
			15-30	\$43.00	\$101.00	—	\$223.00
Single Branch	TXQL (65,000 AIC)	TXQL	15-30	\$43.00	\$101.00	—	\$223.00
Subfeed Breakers ⁴ (Bolt-On) Single Branch	Standard High Break	TQD THQD (3 poles max.) ⁵	—	—	—	\$531.00	\$623.00
Single Branch	Standard High Break	TQD THQD (3 poles max.) ⁵	—	—	—	\$764.00	\$800.00

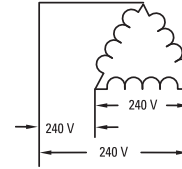

FIG. 1

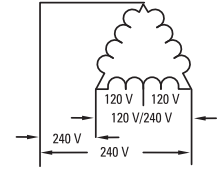

FIG. 2

¹Use #1 AWG maximum, 75° C wire for 90A and 100A branch breakers.

²2-pole, 120/240-volt, Q-line circuit breakers can be connected line-to-line on 3-phase, 4-wire, 120/208-volt or single-phase, 120/240-volt systems, 2-pole, 240-volt, Q-line circuit breakers must be used when connected to 3-phase, 3-wire 240-volt delta systems (Fig. 1), or to the high leg of a midpoint delta grounded system (Fig. 2).

³15 and 20 amp devices are SWD rated.

⁴Create appropriate option Product Number and determine size requirements from options table page 9-65. Specify breaker type, poles and ampacity in addition to option Product Number when ordering.

⁵3-pole maximum, Type ALC column panels.

Main, Branch, And Subfeed Breaker Accessories⁶

Circuit Breaker Frame	Shunt Trip	List Prices, GO-101			
		Auxiliary Contacts 2- and 3-Pole Only		Padlocking Devices	Handle Locking Devices
		No. of AB Switch Elements	For 240Vac		
THQL, THHQL, TXQL	\$98.00 ⁷	1	\$89.00 ⁷	\$10.00	\$6.00
TEY	\$392.00	1	\$200.00 ⁷	\$11.00	\$6.00
TEL	\$392.00	1	\$200.00	\$11.00	\$6.00
		2	\$360.00		
TQD	\$447.00	—	—	\$14.00	—
TFL	\$447.00	2	\$447.00	\$14.00	\$10.00

⁶Internal accessories must be factory installed.

⁷Takes up one branch space in sizing for both main and branch applications.



Product Number Selection Instructions: See page 9-13

Panelboards

A-Series® Panelboards

Column—Type ALC

240 Vac Plug-In

Factory Assembled Pricing

Panelboard Options

NOTE: Sizing dimensions to be used only for enclosure selection, not to determine interior length.

Interior Options

Option	Description	Product ² Number Option Suffix	100/125 Amps		225 Amps	
			Panel Sizing Adder ³	List Price Adder, GO-101	Panel Sizing Adder ³	List Price Adder, GO-101
Optional Lugs ¹	Compression Alum Pressure Copper	L1	—	—	—	—
		L2	—	\$49.00	—	\$49.00
Subfeed Breakers	2 Poles TQD	Q2	—	Price From Panel or Contactor Sections by Device	—	Price From Panel or Contactor Sections by Device
	3 Poles TQD	Q3	—	—	—	—
Feed Thru	Feed Thru Lugs	T1	—	\$164.00	—	\$164.00
Busbar	1000 APSI Copper	B4	—	\$210.00	—	\$210.00

¹Oversize lugs not available on Column panels.

²Option Product Number prefix is "AX".

³Contact GE sales office for sizing.

PERMANENT CIRCUIT NUMBERS—Numbers 1-48. Field Installed. See page 9-54.

Enclosure Options

Box Options

Description	Product Number Suffix ⁴	List Price Adder, GO-101
Painted Box	P	\$200.00
6 5/8" Wide	6	\$250.00
7 5/8" Wide	7	\$250.00

⁴Add to base box Product Number.

Front Options—NEMA 1 Only

Description	Product Number Suffix ⁵	List Price Adder, GO-101
Front Hinged to Box	D	\$110.00
Optional Locks:		
Yale 511S w/Rosette	Y	\$300.00
Corbin 15767	L	\$146.00
GE75	E	\$146.00
Nameplate	N	\$27.00
7 5/8" Wide	7	\$82.00
Gasketing—NEMA 1	K	\$120.00

⁵Add to base front Product Number.

Equipment Grounds – Factory Supplied with Panelboard

Description	Product Number	List Price Adder, GO-101
Field installed kits		
Standard bonded to box—for each 12 branch positions	TGL2 ⁶	\$15.00
Copper bonded to box—for each 12 branch positions	TGC2 ⁶	\$94.00
Standard-isolated/insulated—for each 12 branch positions	EGS12 ⁶	\$99.00
Copper-isolated/insulated—for each 12 branch positions	EGC12 ⁶	\$132.00
Main lug for above terminal kits	TGL20	\$25.00

⁶Not required for pull box.

Main, Branch, and Subfeed Breaker Accessories: price from page 9-68.



Publications and Reference: See Section 22 for a complete list of additional product-related publications

Panelboards

A-Series® Panelboards

Column—Type AQC

240 Vac Bolt-On

Factory Assembled

Single-Phase, 3-Wire Pricing

Service Information:

- 1-ph, 3-w
- 240/120 volts ac max.

Bolt-On Branch Breakers:

- 15-100 amps, 1, 2, 3-poles
- Types THQB, THQB, TXQB

Mains:

- 100-THQB, THQB, TEY, SE
- 225-TQD, THQD, SF
- 125-225 amp main lug

NOTE: Sizing dimensions to be used only for enclosure selection, not to determine interior length.

Service Entrance Label will be factory installed only when specified. Please see page 9-3 for UL Standards on service entrance. Service Entrance Labels are available for field installation. Please contact a GE Consumer & Industrial Sales Office for ordering instructions.

Main Lug Interiors¹

Use THQB Bolt-On Breakers		Single Main Lugs		
Panel Amps Max.	Branch Space Required	Interior Product Number	List Price, ² GO-101	Sizing Dim. (Inches)
125	0-12	AQC1121MT	\$491.00	37.5
	13-18	AQC1181MT	\$534.00	43.5
	19-24	AQC1241MT	\$606.00	49.5
	25-30	AQC1301MT	\$679.00	55.5
	31-36	AQC1361MT	\$751.00	64.5
	37-42	AQC1421MT	\$824.00	64.5
225	0-12	AQC1122MT	\$549.00	43.5
	13-18	AQC1182MT	\$591.00	49.5
	19-24	AQC1242MT	\$664.00	55.5
	25-30	AQC1302MT	\$737.00	64.5
	31-36	AQC1362MT	\$810.00	64.5
	37-42	AQC1422MT	\$882.00	76.5

Enclosures

Sizing Dim. (Inches)	Box Product Number	Outside Box Dim. (Inches)			Front Product Number
		Length	Width	Depth	
37.5	AB378	37.5	8.62	5.81	AF37F8,S8
43.5	AB438	43.5	8.62	5.81	AF43F8,S8
49.5	AB498	49.5	8.62	5.81	AF49F8,S8
55.5	AB558	55.5	8.62	5.81	AF55F8,S8
64.5	AB648	64.5	8.62	5.81	AF64F8,S8
76.5	AB768	76.5	8.62	5.81	AF76F8,S8

Flush fronts are 1 1/2 inches larger than box. Surface fronts are 1/4 inch larger than box.

¹Top feed furnished as standard—change last character in Product Number from T to B for bottom feed.

²Includes standard panelboard interior, box and front. Add price for options when required.

Main Breaker Interiors¹

Panel Amps Max.	Branch Space Required	Interrupting Rating											
		10kA			22kA			65kA			100kA		
		Interior Product Number	List Price, ² GO-101	Sizing Dim. (Inches)	Interior Product Number	List Price, ² GO-101	Sizing Dim. (Inches)	Interior Product Number	List Price, ² GO-101	Sizing Dim. (Inches)	Interior Product Number	List Price, ² GO-101	Sizing Dim. (Inches)
100	0-12	AQC1121AT	\$710.00	37.5	AQC1121CT	\$734.00	37.5	AQC1121ET	\$1173.00	37.5	AQC1121FT	\$1648.00	37.5
	13-18	AQC1181AT	\$757.00	43.5	AQC1181CT	\$777.00	43.5	AQC1181ET	\$1217.00	43.5	AQC1181FT	\$1692.00	43.5
	19-24	AQC1241AT	\$829.00	49.5	AQC1241CT	\$848.00	49.5	AQC1241ET	\$1289.00	49.5	AQC1241FT	\$1764.00	49.5
	25-30	AQC1301AT	\$900.00	55.5	AQC1301CT	\$921.00	55.5	AQC1301ET	\$1363.00	55.5	AQC1301FT	\$1837.00	55.5
	31-36	AQC1361AT	\$970.00	64.5	AQC1361CT	\$933.00	64.5	AQC1361ET	\$1434.00	64.5	AQC1361FT	\$1910.00	64.5
	37-42	AQC1421AT	\$1044.00	76.5	AQC1421CT	\$1067.00	76.5	AQC1421ET	\$1507.00	64.5	AQC1421FT	\$1982.00	64.5
225	0-12	AQC1122AT	\$1552.00	43.5	AQC1122CT	\$1708.00	43.5	—	—	—	AQC1122FT	\$3274.00	43.5
	13-18	AQC1182AT	\$1595.00	49.5	AQC1182CT	\$1751.00	49.5	—	—	—	AQC1182FT	\$3314.00	49.5
	19-24	AQC1242AT	\$1668.00	55.5	AQC1242CT	\$1824.00	55.5	—	—	—	AQC1242FT	\$3387.00	55.5
	25-30	AQC1302AT	\$1741.00	64.5	AQC1302CT	\$1896.00	64.5	—	—	—	AQC1302FT	\$3460.00	64.5
	31-36	AQC1362AT	\$1813.00	64.5	AQC1362CT	\$1970.00	64.5	—	—	—	AQC1362FT	\$3532.00	76.5
	37-42	AQC1422AT	\$1885.00	76.5	AQC1422CT	\$2042.00	76.5	—	—	—	AQC1422FT	\$3606.00	76.5

¹Top feed furnished as standard—change last character in Product Number from T to B for bottom feed.

²Includes standard panelboard interior, box and front. Add price for options when required.



Product Number Selection Instructions: See page 9-13

Panelboards

A-Series® Panelboards

Column—Type AQC

240 Vac Bolt-On

Factory Assembled

Three-Phase, 3-Wire/4-Wire Pricing³

Service Information:

3-ph, 3-w; 3-ph, 4-w;
240 Vac max.

Bolt-On Branch Breakers:

15-100 amps, 1, 2, 3-poles types
THQB, THHQB, TXQB.

Mains:

100—THQB, THHQB, TEY, SE
225—TQD, THQD, SF
125-225 amp main lug

NOTE: Sizing dimensions to be used only for enclosure selection, not to determine interior length.

Service Entrance Label will be factory installed only when specified. Please see page 9-3 for UL Standards on service entrance. Service Entrance Labels are available for field installation. Please contact a GE Consumer & Industrial Sales Office for ordering instructions.

Main Lug Interiors¹

Use THQL Bolt-On Breakers		Single Main Lugs		
Panel Amps Max.	Branch Space Required	Interior Product Number	List Price, ² GO-101	Sizing Dim. (Inches)
125	0-12	AQC3121MT	\$541.00	37.5
	13-18	AQC3181MT	\$584.00	43.5
	19-24	AQC3241MT	\$657.00	49.5
	25-30	AQC3301MT	\$730.00	55.5
	31-36	AQC3361MT	\$803.00	64.5
	37-42	AQC3421MT	\$875.00	64.5
225	0-12	AQC3122MT	\$592.00	43.5
	13-18	AQC3182MT	\$636.00	49.5
	19-24	AQC3242MT	\$710.00	55.5
	25-30	AQC3302MT	\$782.00	64.5
	31-36	AQC3362MT	\$855.00	64.5
	37-42	AQC3422MT	\$926.00	76.5

Enclosures

Sizing Dim. (Inches)	Box Product Number	Outside Box Dim. (Inches)			Front Product Number
		Length	Width	Depth	
37.5	AB378	37.5	8.62	5.81	AF37F8,S8
43.5	AB438	43.5	8.62	5.81	AF43F8,S8
49.5	AB498	49.5	8.62	5.81	AF49F8,S8
55.5	AB558	55.5	8.62	5.81	AF55F8,S8
64.5	AB648	64.5	8.62	5.81	AF64F8,S8
76.5	AB768	76.5	8.62	5.81	AF76F8,S8

Flush fronts are 1 1/2 inches larger than box. Surface fronts are 1/4 inch larger than box.

Main Breaker Interiors¹

Panel Amps Max.	Branch Space Required	Interrupting Rating											
		10kA			22kA			65kA			100kA		
		Interior Product Number ¹	List Price, ² GO-101	Sizing Dim. (Inches)	Interior Product Number ¹	List Price, ² GO-101	Sizing Dim. (Inches)	Interior Product Number ¹	List Price, ² GO-101	Sizing Dim. (Inches)	Interior Product Number ¹	List Price, ² GO-101	Sizing Dim. (Inches)
100	0-12	AQC3121AT	\$843.00	37.5	AQC3121CT	\$975.00	37.5	AQC3121ET	\$1327.00	37.5	AQC3121FT	\$1751.00	37.5
	13-18	AQC3181AT	\$883.00	43.5	AQC3181CT	\$1016.00	43.5	AQC3181ET	\$1370.00	43.5	AQC3181FT	\$1794.00	43.5
	19-24	AQC3241AT	\$957.00	49.5	AQC3241CT	\$1090.00	49.5	AQC3241ET	\$1442.00	49.5	AQC3241FT	\$1866.00	49.5
	25-30	AQC3301AT	\$1030.00	55.5	AQC3301CT	\$1163.00	55.5	AQC3301ET	\$1516.00	55.5	AQC3301FT	\$1938.00	55.5
	31-36	AQC3361AT	\$1101.00	64.5	AQC3361CT	\$1235.00	64.5	AQC3361ET	\$1588.00	64.5	AQC3361FT	\$2012.00	64.5
	37-42	AQC3421AT	\$1174.00	76.5	AQC3421CT	\$1307.00	76.5	AQC3421ET	\$1660.00	64.5	AQC3421FT	\$2085.00	64.5
225	0-12	AQC3122AT	\$1815.00	43.5	AQC3122CT	\$1973.00	43.5	—	—	—	AQC3122FT	\$3719.00	43.5
	13-18	AQC3182AT	\$1859.00	49.5	AQC3182CT	\$2016.00	49.5	—	—	—	AQC3182FT	\$3763.00	49.5
	19-24	AQC3242AT	\$1932.00	55.5	AQC3242CT	\$2089.00	55.5	—	—	—	AQC3242FT	\$3836.00	55.5
	25-30	AQC3302AT	\$2004.00	64.5	AQC3302CT	\$2162.00	64.5	—	—	—	AQC3302FT	\$3908.00	64.5
	31-36	AQC3362AT	\$2078.00	64.5	AQC3362CT	\$2235.00	64.5	—	—	—	AQC3362FT	\$3981.00	76.5
	37-42	AQC3422AT	\$2151.00	76.5	AQC3422CT	\$2308.00	76.5	—	—	—	AQC3422FT	\$4055.00	76.5

¹Top feed supplied as standard—change last character in Product Number from T to B for bottom feed.

²Includes standard panelboard interior, box and front. Add price for options when required.

³For 3-ph, 3-wire applications, panel is constructed as a 3-ph, 4-wire but is labeled to indicate that the neutral is not terminated during installation.



Publications and Reference: See Section 22 for a complete list of additional product-related publications

Panelboards

A-Series® Panelboards

Column—Type AQC

240 Vac Bolt-On
Factory Assembled Pricing

Section 9

THQB Circuit Breakers—Bolt-on

Molded Case Circuit Breakers				List Price, GO-101			
Branch Breaker Mounting	Type	Plug-In Frames	Trip ¹ Range In Amps	1-Pole 120V	2-Pole 120/240V	2-Pole ² 240V	3-Pole 240V
				Number of Spaces Required			
				1	2	2	3
Single Branch	—	THQB	15-60 ³	\$15.00	\$33.00	\$87.00	\$100.00
			70	\$31.00	\$60.00	\$87.00	\$119.00
			80-100	—	\$87.00	\$126.00	\$138.00
Single Branch	THQB (10,000 AIC)	THQB-GF	15-30	\$111.00	\$185.00	—	—
		THQB-HID	15-30	\$19.00	\$41.00	—	—
	THHQB (22,000 AIC)	—	15-20 ³	\$23.00	\$61.00	\$139.00	\$145.00
		—	25-60	\$32.50	\$61.00	\$139.00	\$145.00
		—	70	\$46.00	\$92.50	\$151.00	\$191.00
		—	80-100	—	\$133.00	\$185.00	\$214.00
—	THHQB-GF	15-30	\$216.00	—	—	—	
—	THHQB-HID	15-30	\$33.00	\$107.00	—	—	
Single Branch	TXQB (65,000 AIC)	TXQB	15-30	\$43.00	\$119.00	—	\$236.00
Subfeed Breakers ^{4,5} (Single Branch)	Standard High Break	TQD, THQD (3 poles max.)	—	—	—	\$531.00	\$623.00
—	—	—	—	—	—	\$764.00	\$800.00

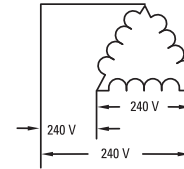

FIG. 1

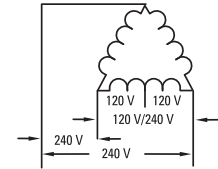

FIG. 2

¹Use #1 AWG maximum, 75° C wire for 90A and 100A branch breakers.

²2-pole, 120/240-volt, Q-line circuit breakers can be connected line-to-line on 3-phase, 4-wire, 120/208-volt or single-phase, 120/240-volt systems. 2-pole, 240-volt, Q-line circuit breakers must be used when connected to 3-phase, 3-wire 240-volt delta systems (Fig. 1), or to the high leg of a midpoint delta grounded system (Fig. 2).

³15 and 20 amp devices are SWD rated.

⁴Create appropriate option Product Number and determine size requirements from options table page 9-69. Specify breaker type, poles and ampacity in addition to option Product Number when ordering.

⁵3 poles maximum.

Main, Branch And Subfeed Breaker Accessories⁶

Circuit Breaker Frame	Shunt Trip	List Prices, GO-101		
		Auxiliary Contacts 2 and 3-Pole Only	Padlocking Devices	Handle Locking Devices
		No. of AB Switch Elements	For 240Vac	
THQB, THHQB, TXQB	\$98.00 ⁷	1	\$89.00 ⁷	\$6.00
TEY	\$392.00 ⁷	1	\$200.00 ⁷	\$6.00
SE, TEL	\$392.00	1	\$200.00	\$6.00
		2	\$360.00	\$6.00
TQD	\$447.00	—	—	—
SF, TFL, TFJ	\$447.00	2	\$447.00	\$10.00

⁶Internal accessories must be factory installed.

⁷Takes up one branch space in sizing for both main and branch applications.



Product Number Selection Instructions: See page 9-13

Panelboards

A-Series® Panelboards

Column—Type AQC

240 Vac Bolt-On

Factory Assembled Pricing

Panelboard Options

NOTE: Sizing dimensions to be used only for enclosure selection, not to determine interior length.

Interior Options

Option	Description	Product ² Number Option Suffix	100/125 Amps		225 Amps	
			Panel Sizing Adder ³	List Price Adder, GO-101	Panel Sizing Adder ³	List Price Adder, GO-101
Optional Lugs ¹	Compression Alum. Pressure Copper	L1	—	—	—	—
		L2	—	\$49.00	—	\$49.00
Subfeed Breakers	2 Poles TQD	Q2	—	Price From Panel or Contactor Sections by Device	—	Price From Panel or Contactor Sections by Device
	3 Poles TQD	Q3	—	—	—	—
Feed Thru	Feed Thru Lugs	T1	—	\$164.00	—	\$164.00
Busbar	1000 APSI Copper	B4	—	\$210.00	—	\$210.00

¹Oversize lugs not available on Column panels.

²Option Product Number prefix is "AX".

³Contact GE sales office for sizing.

PERMANENT CIRCUIT NUMBERS—Numbers 1-48. Field Installed. See page 9-54.

Enclosure Options

Box Options

Description	Product Number Suffix ⁴	List Price Adder GO-101
Painted Box	P	\$200.00
6 5/8" Wide	6	\$250.00
7 5/8" Wide	7	\$250.00

⁴Add to base box Product Number.

Front Options—NEMA 1 Only

Description	Product Number Suffix ⁵	List Price Adder, GO-101
Front Hinged to Box	D	\$110.00
Optional Locks:		
Yale 511S w/Rosette	Y	\$300.00
Corbin 15767	L	\$146.00
GE75	E	\$146.00
Nameplate	N	\$27.00
7 5/8" Wide	7	\$82.00
Gasketing—NEMA 1	K	\$120.00

⁵Add to base front Product Number.

BOX EXTENSIONS – For additional end gutter space or conduit skirt applications – price from page 9-80.

Equipment Grounds – Factory Supplied with Panelboard

Description	Product Number	List Price Adder, GO-101
Field installed kits		
Standard bonded to box-for each 12 branch positions	TGL2 ⁶	\$15.00
Copper bonded to box-for each 12 branch positions	TGC2 ⁶	\$94.00
Standard-isolated/insulated-for each 12 branch positions	EGS12 ⁶	\$99.00
Copper-isolated/insulated-for each 12 branch positions	EGC12 ⁶	\$132.00
Main lug for above terminal kits	TGL20	\$25.00

⁶Not required for pull box.

Main, Branch, and Subfeed Breaker Accessories: price from page 9-72.



Publications and Reference: See Section 22 for a complete list of additional product-related publications

Panelboards

A-Series® Panelboards

Column—Type AEC

480Y/277 Vac Bolt-On

Factory Assembled

Three-Phase, 4-Wire Pricing¹

Service Information:

3-ph, 4-w

480Y/277 Vac¹

Bolt On Branch Breakers:

15-80 amps, 1, 2, 3-poles

Type TEY

Service Entrance Label will be factory installed only when specified. Please see page 9-3 for UL Standards on service entrance. Service Entrance Labels are available for field installation. Please contact a GE Consumer & Industrial Sales Office for ordering instructions.

Mains:

100A-TEY, SE

225A-TFJ, SF

125-225 amp main lug

NOTE: Sizing dimensions to be used only for enclosure selection, not to determine interior length.

¹AE panels are suitable for use on 3-ph, 3-w applications when derived from a 3-ph, 4-w 480Y/277 Vac service where the neutral is not brought to the panelboard.

Enclosures

Sizing Dim. (Inches)	Box Product Number	Outside Box Dim. (Inches)			Front Product Number
		Length	Width	Depth	
37.5	AB378	37.5	8.62	5.81	AF37F8,S8
43.5	AB438	43.5	8.62	5.81	AF43F8,S8
49.5	AB498	49.5	8.62	5.81	AF49F8,S8
55.5	AB558	55.5	8.62	5.81	AF55F8,S8
64.5	AB648	64.5	8.62	5.81	AF64F8,S8
76.5	AB768	76.5	8.62	5.81	AF76F8,S8

Flush fronts are 1 1/2 inches larger than box. Surface fronts are 1/4 inch larger than box.

Main Lug Interiors²

Use TEY Bolt-on Breakers		Single Main Lugs		
Panel Amps Max.	Branch Space Required	Interior Product Number ²	List Price, ³ GO-101	Sizing Dim. (Inches)
125	0-12	AEC3121MT	\$684.00	37.5
	13-18	AEC3181MT	\$748.00	43.5
	19-24	AEC3241MT	\$859.00	49.5
	25-30	AEC3301MT	\$969.00	55.5
	31-36	AEC3361MT	\$1080.00	64.5
	37-42	AEC3421MT	\$1190.00	64.5
225	0-12	AEC3122MT	\$765.00	43.5
	13-18	AEC3182MT	\$831.00	49.5
	19-24	AEC3242MT	\$941.00	55.5
	25-30	AEC3302MT	\$1051.00	64.5
	31-36	AEC3362MT	\$1162.00	64.5
	37-42	AEC3422MT	\$1272.00	76.5

²Top feed supplied as standard—change last character in Product Number from T to B for bottom feed.

³Includes standard panelboard interior box and front. Add price for options when required.

Main Breaker Interiors²

Panel Amps Max.	Branch Space Required	Interrupting Rating					
		14KA 480Y/277Vac ⁴			65KA 480Y/277Vac 100KA 240Vac Max		
		Interior Product Number	List Price, ³ GO-101	Sizing Dim. (Inches)	Interior Product Number	List Price, ³ GO-101	Sizing Dim. (Inches)
100	0-12	AEC3121BT	\$1150.00	37.5	AEC3121DT	\$1895.00	37.5
	13-18	AEC3181BT	\$1213.00	43.5	AEC3181DT	\$1959.00	43.5
	19-24	AEC3241BT	\$1323.00	49.5	AEC3241DT	\$2069.00	49.5
	25-30	AEC3301BT	\$1433.00	55.5	AEC3301DT	\$2180.00	55.5
	31-36	AEC3361BT	\$1546.00	64.5	AEC3361DT	\$2290.00	64.5
	37-42	AEC3421BT	\$1652.00	76.5	AEC3421DT	\$2402.00	64.5
225	0-12	AEC3122BT	\$2022.00	37.5	AEC3122DT	\$3852.00	37.5
	13-18	AEC3182BT	\$2086.00	43.5	AEC3182DT	\$3916.00	43.5
	19-24	AEC3242BT	\$2195.00	49.5	AEC3242DT	\$4026.00	49.5
	25-30	AEC3302BT	\$2307.00	55.5	AEC3302DT	\$4137.00	55.5
	31-36	AEC3362BT	\$2417.00	64.5	AEC3362DT	\$4247.00	64.5
	37-42	AEC3422BT	\$2527.00	76.5	AEC3422DT	\$4358.00	76.5

²Top feed supplied as standard—change last character in Product Number from T to B for bottom feed.

³Includes standard panelboard interior box and front. Add price for options when required.

⁴Ratings at 240 Vac are: 100 Amp-65kA 225 Amp-25kA.



Product Number Selection Instructions: See page 9-13

Panelboards

A-Series® Panelboards

Column—Type AEC

480Y/277 Vac Bolt-On
Factory Assembled Pricing

Branch Breakers, TEY Circuit Breakers—Bolt-On

Branch Breaker Mounting	Type	Bolt-On Frames	Trip ¹ Range (Amps)	List Price, GO-101		
				1-Pole 277Vac	2-Pole 480/277Vac	3-Pole 480/277Vac
				No. Spaces Required		
				1	2	3
Single Branch	TEY (14,000AIC)	TEY	15-60 ³	\$53.00	\$130.00	\$230.00
			70-80	\$116.00	\$274.00	\$326.00
Subfeed ² Breakers (Single Branch)	TED4	TED4 (3P Max)	125-150	—	—	\$1002.00

¹80 Amp. Max. must use #3 AWG-60°C copper wire only.

²Create appropriate option Product Number and determine size requirements from options table on page 9-76. Specify breaker type, poles and ampacity in addition to option Product Number when ordering.

³15 and 20 ampere TEY breakers are SWD rated for fluorescent lighting applications.

Main, Branch, And Subfeed Breaker Accessories⁴

Circuit Breaker Frame	Shunt Trip	Auxiliary Contacts 2 and 3-Pole Only		Padlocking Devices	Handle Locking Devices
		No. of AB Switch Elements	For 240Vac		
TEY ⁵	\$392.00 ⁶	1	\$200.00 ⁶	\$11.00	\$6.00
TED ⁷	\$392.00	1	\$200.00	\$11.00	\$6.00
		2	\$360.00		
SE	\$392.00	1	\$200.00	\$11.00	—
		2	\$360.00		
SF, TFJ	\$447.00	2	\$447.00	\$14.00	\$10.00
		4 ⁸	\$485.00		

⁴Internal accessories must be factory installed.

⁵Internal accessories only available on 2 and 3-pole.

⁶Takes up one branch space in sizing for both main and branch applications.

⁷**NOTE:** TED subfeed vertically mounted.

⁸4 switch element not available on TFL.



Panelboards

A-Series® Panelboards

Column—Type AEC

480Y/277 Vac Bolt-On

Factory Assembled Pricing

Panelboard Options

NOTE: Sizing dimensions to be used only for enclosure selection, not to determine interior length.

Interior Options

Option	Description	Product ² Number Option Suffix	100/125 Amps		225 Amps	
			Panel Sizing Adder ³	List Price Adder, GO-101	Panel Sizing Adder ³	List Price Adder, GO-101
Optional Lugs ¹	Compression Alum. Pressure Copper	L1	—	—	—	—
		L2	—	\$49.00	—	\$49.00
Subfeed	2 Pole TED4	E2	—	Price From Panel or Contactor Sections by Device	—	Price From Panel or Contactor Sections by Device
Breakers	3 Poles TED4	E3	—	—	—	—
Feed Thru	Feed Thru Lugs	T1	—	\$164.00	—	\$164.00
Busbar	1000 APSI Copper	B4	—	\$210.00	—	\$210.00

¹Oversize lugs not available on Column panels.

²Option Product Number prefix is "AX".

³Contact GE sales office for sizing.

PERMANENT CIRCUIT NUMBERS—Numbers 1-48. Field installed. See page 9-54.

Enclosure Options

Box Options

Description	Product Number Suffix ⁴	List Price Adder, GO-101
Painted Box	P	\$200.00
6 5/8" Wide	6	\$250.00
7 5/8" Wide	7	\$250.00

⁴Add to base box Product Number.

Front Options—NEMA 1 Only

Description	Product Number Suffix ⁵	List Price Adder, GO-101
Front Hinged to Box	D	\$110.00
Optional Locks:		
Yale 511S w/Rosette	Y	\$300.00
Corbin 15767	L	\$146.00
GE75	E	\$146.00
Nameplate	N	\$27.00
7 5/8" Wide	7	\$82.00
Gasketing—NEMA 1	K	\$120.00

⁵Add to base front Product Number.

BOX EXTENSIONS – For additional end gutter space or conduit skirt applications – price from page 9-80.

Equipment Grounds – Factory Supplied with Panelboard

Description	Product Number	List Price Adder, GO-101
Field installed kits		
Standard bonded to box-for each 12 branch positions	TGL2 ⁶	\$15.00
Copper bonded to box-for each 12 branch positions	TGC2 ⁶	\$94.00
Standard-isolated/insulated-for each 12 branch positions	EGS12 ⁶	\$99.00
Copper-isolated/insulated-for each 12 branch positions	EGC12 ⁶	\$132.00
Main lug for above terminal kits	TGL20	\$25.00

⁶Not required for pull box.

Main, Branch, and Subfeed Breaker Accessories: price from page 9-75.



Product Number Selection Instructions: See page 9-13

Panelboards

A-Series® Panelboards

Column—Types ALC, AQC, AEC

Main Molded Case Switch Interiors

Factory Assembled Pricing

NOTE: Sizing dimensions to be used only for enclosure selection, not to determine interior length.

Type AL 240 Vac Max.¹

Panel Amps Max.	Branch Space Required	Interior Product Number 1-Phase, 3-Wire	List Price, ² GO-101	Interior Product Number 3-Phase, 4-Wire	List Price, ² GO-101	Sizing Dim. (Inches)	UL Listed Short Circuit Withstand Rating	
							240Vac Max.	480/277Vac Max.
100	0-12	ALC1121YT	\$615.00	ALC3121YT	\$755.00	37.5	10,000 Amps max, when protected by line side THQB circuit breaker	
	13-18	ALC1181YT	\$668.00	ALC3181YT	\$795.00	43.5		
	19-24	ALC1241YT	\$740.00	ALC3241YT	\$869.00	49.5		
	25-30	ALC1301YT	\$807.00	ALC3301YT	\$942.00	55.5		
	31-36	ALC1361YT	\$883.00	ALC3361YT	\$1014.00	64.5		
	37-42	ALC1421YT	\$957.00	ALC3421YT	\$1087.00	76.5		
225	0-12	ALC1122YT	\$1388.00	ALC3122YT	\$1626.00	43.5	10,000 Amps max, when protected by line side TQD circuit breaker	
	13-18	ALC1182YT	\$1430.00	ALC3182YT	\$1670.00	49.5		
	19-24	ALC1242YT	\$1503.00	ALC3242YT	\$1744.00	55.5		
	25-30	ALC1302YT	\$1575.00	ALC3302YT	\$1815.00	64.5		
	31-36	ALC1362YT	\$1648.00	ALC3362YT	\$1888.00	64.5		
	37-42	ALC1422YT	\$1722.00	ALC3422YT	\$1960.00	76.5		

Pricing Information:

Price branch breakers from corresponding panel sections.

Price modifications from options table, page 9-80.

Type AQ 240 Vac Max.¹

Panel Amps Max.	Branch Space Required	Interior Product Number 1-Phase, 3-Wire	List Price, ² GO-101	Interior Product Number 3-Phase, 4-Wire	List Price, ² GO-101	Sizing Dim. (Inches)	UL Listed Short Circuit Withstand Rating	
							240Vac Max.	480/277Vac Max.
100	0-12	AQC1121YT	\$615.00	AQC3121YT	\$755.00	37.5	10,000 Amps max, when protected by line side THQB circuit breaker	
	13-18	AQC1181YT	\$668.00	AQC3181YT	\$795.00	43.5		
	19-24	AQC1241YT	\$740.00	AQC3241YT	\$869.00	49.5		
	25-30	AQC1301YT	\$807.00	AQC3301YT	\$942.00	55.5		
	31-36	AQC1361YT	\$883.00	AQC3361YT	\$1014.00	64.5		
	37-42	AQC1421YT	\$957.00	AQC3421YT	\$1087.00	76.5		
225	0-12	AQC1122YT	\$1388.00	AQC3122YT	\$1626.00	43.5	10,000 Amps max, when protected by line side TQD circuit breaker	
	13-18	AQC1182YT	\$1430.00	AQC3182YT	\$1670.00	49.5		
	19-24	AQC1242YT	\$1503.00	AQC3242YT	\$1744.00	55.5		
	25-30	AQC1302YT	\$1575.00	AQC3302YT	\$1815.00	64.5		
	31-36	AQC1362YT	\$1648.00	AQC3362YT	\$1888.00	64.5		
	37-42	AQC1422YT	\$1722.00	AQC3422YT	\$1960.00	76.5		

Type AE 480Y/277 Vac Max.¹

Panel Amps Max.	Branch Space Required	Interior Product Number 3-Phase, 4-Wire	List Price, ² GO-101	Sizing Dim. (Inches)	UL Listed Short Circuit Withstand Rating	
					240Vac Max.	480/277Vac Max.
225	0-12	AEC3122YT	\$1837.00	37.5	14,000 Amps max. when protected by line side TFJ circuit breaker	
	13-18	AEC3182YT	\$1902.00	43.5		
	19-24	AEC3242YT	\$1967.00	49.5		
	25-30	AEC3302YT	\$2122.00	55.5		
	31-36	AEC3362YT	\$2233.00	64.5		
	37-42	AEC3422YT	\$1334.00	76.5		

¹Top feed supplied as standard. Change last character in Product Number from T to B for bottom feed.

²Includes standard panelboard interior box and front. Add price for options when required.



Publications and Reference: See Section 22 for a complete list of additional product-related publications

Panelboards

A-Series® Panelboards

Column—Types AQC, ALC, AEC

Factory Assembled Pricing

Panelboard Options—Main Molded Case Switch Panels

NOTE: Sizing dimensions to be used only for enclosure selection, not to determine interior length.

Interior Options

Option	Description ¹	Product ² Number Option Suffix	100/125 Amps		225 Amps	
			Panel Height Adder ³	List Price Adder, GO-101	Panel Height Adder ³	List Price Adder, GO-101
Subfeed Breakers	2 Poles TQD	Q2		Price From Panel or Contactor Sections By Device		Price From Panel or Contactor Sections By Device
	3 Poles TQD	Q3	—		—	
	2 Poles TED4	E2	—		—	
	3 Poles TED4	E3				
Feed Thru	Feed Thru Lugs	T1	—	\$164.00	—	\$164.00
Busbar	1000 APSI Copper	B4	—	\$210.00	—	\$210.00

¹TQD—AL/AQ TED—AE

²Option Product Number prefix is "AX".

³Contact GE Sales office for sizing.

PERMANENT CIRCUIT-NUMBERS 1-48. Field Installed. See page 9-54.

Equipment Grounds – Factory Supplied with Panelboard

Description	Product Number	List Price Adder, GO-101
Field installed kits		
Standard bonded to box-for each 12 branch positions	TGL2 ⁴	\$15.00
Copper bonded to box-for each 12 branch positions	TGC2 ⁴	\$94.00
Standard-isolated/insulated-for each 12 branch positions	EGS12 ⁴	\$99.00
Copper-isolated/insulated-for each 12 branch positions	ECC12 ⁴	\$132.00
Main lug for above terminal kits	TGL20	\$25.00

⁴Not required for Pull Box.

Branch and Subfeed Breaker Accessories: Price from appropriate panel sections.



Panelboards

A-Series® Panelboards

Column

Field Installed Kits/Replacement Parts

Miscellaneous Kits

Order by Product Number from the National Service Center

Description	Product Number	List Price	GO Sched.
Equipment Grounds:			
Standard Terminal Strip With Provision for (1) 14-8 Cu or 12-8 Al (3) 14-4 Cu or 6-4 Al	TGL2	\$6.75	137A
Above terminal with Copper Strap	TGC2	\$94.00	134B
Main Lug 6-2/0 Cu/Al	TGL20	\$11.50	137A
Standard Isolated Insulated (1) 14-8 Cu or 12-8 Al (3) 14-4 Cu or 6-4 Al	EGS12	\$39.00	134B
Above terminal with Copper Strap	EGC12	\$132.00	134B
Handle Locking Devices:			
THQL, THHQL THQB, THHQB	THL103	\$6.50	137A
TEY	TEYLD1	\$5.00	135B
TED	TLD3	\$5.00	135B
TFJ, TFL, TLB4	TFKLD1	\$6.00	135B
Padlocking Devices:			
THQL, THHQL, TXQL THQB, THHQB, TXQB	THP100	\$6.50	137A
TEY	TEYPLD1	\$9.00	135B
TED, TEL	TEFPLD1	\$8.00	135B
TQD	TQDPLD1	\$20.75	137A
TFJ, TFL	TFKPLD1	\$4.00	135B
Filler Plate for Q Line and TEY Breakers	TQLFP1	\$2.50	137A
Gasketing Kit	AGSK	\$50.00	101
Safety Catch for Trough Covers ¹	ACHK	\$50.00	101

¹Standard on pull box.

Panelboards Parts

Order from Factory

Description	Product Number	List Price, GO-101
Directory Card	139C5612P2	\$2.00
Circuit Numbering		
Strips - 1-48	569B806G1	\$4.00
43-84	569B806G2	\$4.00
Directory Card Holder	139C5491P4	\$10.00

Permanent Circuit Number Kits

Order from Factory

Product Number	Description	List Price GO-134B
APN48	No's 1-48	\$116.00
APN84	No's 43-84	\$116.00



Publications and Reference: See Section 22 for a complete list of additional product-related publications

Panelboards

A-Series® Panelboards

Column

Enclosures—Boxes, Fronts, Extension Troughs
and Pull Boxes for Replacement
Order By Product Number from the Factory

Front Options—NEMA 1 Only

Description	Product Number Suffix ⁵	List Price, GO-101
Hinged door in door	D	\$110.00
Optional Locks:		
Yale 5116 w/ Rosette	Y	\$300.00
Corbin 15767	L	\$146.00
GE75	E	\$146.00
Nameplate	N	\$27.50
7 5/8" Wide	7	\$82.00
Gasketing—NEMA 1	K	\$120.00

⁵Add to base front product number.

Box Options

Description	Product Number Suffix ⁴	List Price GO-101
Painted Box	P	\$160.00
7 5/8" Wide	7	\$82.00

⁴Add to base box product number.

Enclosures

Panel Size	Box Product Number	Box Size Inches ²	List Price, ¹ GO-101	Front Product Number ³	List Price, ¹ GO-101
37.5	AB378	37.5	\$100.00	AF37F8,S8	\$191.00
43.5	AB438	43.5	\$100.00	AF43F8,S8	\$218.00
49.5	AB498	49.5	\$100.00	AF49F8,S8	\$257.00
55.5	AB558	55.5	\$100.00	AF55F8,S8	\$299.00
64.5	AB648	64.5	\$100.00	AF64F8,S8	\$326.00
76.5	AB768	76.5	\$100.00	AF76F8,S8	\$367.00

¹Use when ordering items separately for replacement. Do not deduct from panel list price to obtain interior only pricing.

²Standard boxes are 8.62 inches wide by 5.81 inches deep.

³Flush fronts are 1 1/2" larger than box. Surface fronts are 1/4" larger. Flush fronts are available on 8 1/2" box only.

Extension Troughs (Surface only) With Covers and Barrier

Height (in feet)	8 5/8" Wide (Standard)	7 5/8" Wide	6 5/8" Wide	List Price GO-101
1	AT18	AT17	AT16	\$74.00
2	AT28	AT27	AT26	\$93.00
3	AT38	AT37	AT36	\$149.00
4	AT48	AT47	AT46	\$168.00
5	AT58	AT57	AT56	\$192.00
6	AT68	AT67	AT66	\$216.00

Pull Box with Cover (Surface Only) 1 Foot Height

Description	List Price GO-101
AP18 For 8 5/8" Wide Trough	\$137.00
AP17 For 7 5/8" Wide Trough	\$137.00
AP16 For 6 5/8" Wide Trough	\$137.00

Extension Trough and Pull Box Options

Description	Product Number Suffix	List Price, GO-101	
		Troughs	Pull Box
Gasketing	K	\$27.00/ft.	\$80.00
Painted	P	\$27.00/ft.	\$80.00
Hinge Cover ⁶	D	\$27.00/ft.	\$80.00
200% Neutral (Pull box)	C2 (125A)	—	\$60.00
	C3 (125A)	—	\$60.00
	C2 (225A)	—	\$100.00
	C3 (225A)	—	\$100.00
Copper Neutral (Pull box)	C (225A)	—	\$60.00

No safety catch.



Panelboards

Spectra® Series Panelboards

MCCB and Fusible Mains and Feeders
Factory Assembled Build-Up Pricing
 GE Fastrac Program items indicated in red

Service Information:

600 Vac maximum
 250 Vdc maximum
 1ph-3w, 3ph-3w/4w

Mains:

1200 amps maximum main lugs, circuit breaker, or fusible switch

Branches:

15-1200 1P, 2P, 3P Circuit Breakers
 30-1200 2P or 3P Fusible Switch

Fuses:

Not Included

Fuse Provisions:

30-600 Amp Units: Class R¹
 800-1200 amp units: Class L²

Service Entrance Equipment:

Spectra® Power Panel includes standard label certifying SE Rating if conditions are met. No need to specify on order.

Step 1. Specify Panel Type, Service and Mounting

(Flush or Surface)

Step 2. Specify Main Location and Price³

For Mech. Lug Only up to 600 kcmil

2a. Factory Installed Main Lugs (Bolt-on)

Main Amp Rating	List Price Each, GO-101			Single Main Lug X Height ⁴	Fits Box Widths
	3PH-4W	3PH-3W	1PH-3W		
250	\$591.00	\$464.00	\$591.00	4X	27", 31", 36"
400	\$825.00	\$657.00	\$825.00	4X	27", 31", 36", 40", 44"
600	\$1101.00	\$866.00	\$1101.00	4X	27", 31", 36", 40", 44"
800	\$1395.00	\$1068.00	\$1395.00	4X	31", 36", 40", 44"
1200	\$1866.00	\$1476.00	\$1866.00	4X	31", 36", 40", 44"

Dual Main Lugs and Thru-Feed Lugs

Main Amp Rating	List Price Each, GO-101						Main Lug X Height	Fits Box Width
	Double (Dual) Main Lugs			Thru-Feed Lugs				
	3PH-4W	3PH-3W	1PH-3W	3PH-4W	3PH-3W	1PH-3W		
250	\$741.00	\$614.00	\$591.00	\$899.00	\$772.00	\$851.00	4X	27", 31", 36"
400	\$1075.00	\$907.00	\$825.00	\$1203.00	\$1035.00	\$1134.00	4X	27", 31", 36", 40", 44"
600	\$1551.00	\$1316.00	\$1101.00	\$1511.00	\$1276.00	\$1479.00	4X	27", 31", 36", 40", 44"
800	\$1995.00	\$1668.00	\$1395.00	\$1980.00 ⁵	\$1653.00 ⁵	\$1932.00	4X	31", 36", 40", 44" ⁷
1200	\$2616.00	\$2226.00	\$1866.00	\$2562.00 ⁵	\$2172.00 ⁵	\$2468.00	4X	31", 36", 40", 44" ⁷

¹R Fuse clips standard through 600 amp; L Fuse clips standard on 800 and 1200 amp. Optional fuse clips (See page 9-100) are available at no additional charge when specified at time of order.

²Class L Fuses are not dc rated.

³For multi-section panels include main price for each section and dual or feed-thru lugs in all except last section.

⁴Compression main lugs require 6X height & minimum 36" box width.

⁵Requires additional 6X panel space (4X for lug, 6X for wire bending space).

⁶Reg. Additional 3X space for wire bending space.

⁷Dual main lugs 800 & 1200 amp require minimum 36" box width.



Publications and Reference: See Section 22 for a complete list of additional product-related publications

Panelboards Spectra® Series Panelboards

Section 9

GE Fastrac Program items are indicated in red

Step 2. Specify Main Location and Price³ (Continued)

2b. Main Circuit Breakers 80% Rated

Main Amp Rating	Interrupting Rating			Breaker Frame	List Price Each, GO-101						X-Height	Fits Box Width
	240V	480V	600V		Standard Frames			Plug-in per Circuit				
					Bolt-on per Circuit			Plug-in per Circuit				
				3P-4W	3P-3W	1P-3W	3P-4W	3P-3W	1P-3W			
250	65	35	18	SFHA	\$1785.00	\$1660.00	\$1545.00	\$1981.00	\$1843.00	\$1493.00	3X	
	100	65	25	SFLA	\$2805.00	\$2692.00	\$2388.00	\$3114.00	\$2988.00	\$2651.00	3X	27", 31", 36", 40", 44"
	200	100	25	SFPA	\$3500.00	\$3387.00	\$2900.00	\$3885.00	\$3760.00	\$3219.00	3X	
	65	35	22	FGV2	\$2727.00	\$2587.00	\$2351.00	\$3027.00	\$2872.00	\$2610.00	3X	
	150	65	35	FGN2	\$4002.00	\$3845.00	\$3421.00	\$4442.00	\$4268.00	\$3797.00	3X	
	200	100	42	FGH2	\$4012.00	\$3855.00	\$3431.00	\$4452.00	\$4278.00	\$3807.00	3X	27", 31", 36", 40", 44"
	200	150	50	FGL2	\$5819.00	\$5405.00	\$4549.00	\$6057.00	\$5826.00	\$5049.00	3X	
400	200	200	65	FGP2	\$6325.00	\$5875.00	\$4944.00	\$6584.00	\$6333.00	\$5488.00	3X	
	65	—	—	SGDA4 ⁸	\$2610.00	\$2491.00	\$2470.00	\$2897.00	\$2765.00	\$2470.00	3X	36", 40", 44"
	65	35	25	SGHA4	\$2727.00	\$2587.00	\$2351.00	\$3027.00	\$2872.00	\$2610.00	4X	27", 31", 36", 40", 44"
	65	35	25	SGHB4 ⁹	\$3808.00	\$3651.00	—	\$4227.00	\$4053.00	—	4X	
	100	65	65	SGLA4	\$4002.00	\$3845.00	\$3421.00	\$4442.00	\$4268.00	\$3797.00	4X	
	100	65	65	SGLB4	\$4745.00	\$4564.00	—	\$5617.00	\$5217.00	—	4X	27", 31", 36", 40", 44"
	200	100	65	SGPA4	\$5060.00	\$4700.00	\$3955.00	\$5267.00	\$5066.00	\$4390.00	4X	
	200	100	65	SGPB4 ⁹	\$5450.00	\$5151.00	—	\$6050.00	\$5717.00	—	4X	27", 31", 36", 40", 44"
	65	35	22	FGV4	\$2727.00	\$2587.00	\$2351.00	\$3027.00	\$2872.00	\$2610.00	4X	
	150	65	35	FGN4	\$4002.00	\$3845.00	\$3421.00	\$4442.00	\$4268.00	\$3797.00	4X	
	200	100	42	FGH4	\$4012.00	\$3855.00	\$3431.00	\$4452.00	\$4278.00	\$3807.00	4X	27", 31", 36", 40", 44"
600	200	150	50	FGL4	\$5819.00	\$5405.00	\$4549.00	\$6057.00	\$5826.00	\$5049.00	4X	
	200	200	65	FGP4	\$6325.00	\$5875.00	\$4944.00	\$6584.00	\$6333.00	\$5488.00	4X	
	65	35	25	SGHA6	\$4303.00	\$4110.00	\$3603.00	\$4776.00	\$4562.00	\$3999.00	4X	27", 31", 36", 40", 44"
	65	35	25	SGHB6 ⁹	\$4545.00	\$4389.00	—	\$5045.00	\$4872.00	—	4X	
	100	65	25	SGLA6	\$4969.00	\$4779.00	\$4280.00	\$5516.00	\$5305.00	\$4751.00	4X	
	100	65	25	SGLB6 ⁹	\$6316.00	\$5984.00	—	\$7011.00	\$6642.00	—	4X	27", 31", 36", 40", 44"
	200	100	65	SGPA6	\$6720.00	\$6530.00	\$6180.00	\$7459.00	\$7248.00	\$6860.00	4X	
	200	100	65	SGPB6 ⁹	\$7240.00	\$7070.00	—	\$8036.00	\$7848.00	—	4X	27", 31", 36", 40", 44"
	65	35	22	FGV6	\$4303.00	\$4110.00	\$3603.00	\$4776.00	\$4562.00	\$3999.00	4X	
	150	65	35	FGN6	\$4969.00	\$4779.00	\$4280.00	\$5516.00	\$5305.00	\$4751.00	4X	
	200	100	42	FGH6	\$4979.00	\$4789.00	\$4290.00	\$5526.00	\$5315.00	\$4761.00	4X	27", 31", 36", 40", 44"
800	200	150	50	FGL6	\$7728.00	\$7510.00	\$7107.00	\$8578.00	\$8336.00	\$7889.00	4X	
	200	200	65	FGP6	\$8400.00	\$8163.00	\$7725.00	\$9324.00	\$9060.00	\$8575.00	4X	
	65	35	25	SKHA8	\$5669.00	\$5379.00	\$4715.00	\$6293.00	\$5971.00	\$5234.00	6X	40", 44"
	65	35	25	SKHB8 ⁹	\$5912.00	\$5622.00	—	\$6562.00	\$6240.00	—	6X	
	100	65	42	SKLA8	\$6552.00	\$6262.00	\$5896.00	\$7273.00	\$6951.00	\$6545.00	6X	40", 44"
	100	65	42	SKLB8 ⁹	\$6689.00	\$6311.00	—	\$7425.00	\$7005.00	—	6X	
	200	100	65	SKPA8	\$7840.00	\$7550.00	\$6990.00	\$8702.00	\$8381.00	\$7759.00	6X	44"
	200	100	65	SKPB8 ⁹	\$7990.00	\$7660.00	—	\$8869.00	\$8503.00	—	6X	
	65	35	25	SKHA12	\$7168.00	\$6843.00	\$6311.00	\$7956.00	\$7596.00	\$7005.00	6X	40", 44"
	100	65	42	SKLA12	\$8076.00	\$7751.00	\$7374.00	\$8964.00	\$8604.00	\$8185.00	6X	40", 44"
	1000	200	100	65	SKPA12	\$9400.00	\$9075.00	\$8350.00	\$10434.00	\$10073.00	\$9269.00	6X
65		35	25	SKHB12 ⁹	\$7460.00	\$7173.00	—	\$8281.00	\$7962.00	—	6X	40", 44"
100		65	42	SKLB12 ⁹	\$8226.00	\$7915.00	—	\$9131.00	\$8786.00	—	6X	40", 44"
200		100	65	SKPB12 ⁹	\$9556.00	\$9248.00	—	\$10607.00	\$10265.00	—	6X	44"
65		35	25	SKHA12	\$9212.00	\$8885.00	\$8317.00	\$10225.00	\$9862.00	\$9232.00	6X	40", 44"
1200	100	65	42	SKLA12	\$10010.00	\$9683.00	\$8837.00	\$11111.00	\$10748.00	\$9809.00	6X	40", 44"
	200	100	65	SKPA12	\$11700.00	\$11375.00	\$10330.00	\$12987.00	\$12626.00	\$11466.00	6X	44"
	65	35	25	SKHB12 ⁹	\$9635.00	\$9308.00	—	\$10695.00	\$10332.00	—	6X	40", 44"
	100	65	42	SKLB12 ⁹	\$10314.00	\$9974.00	—	\$11446.00	\$11071.00	—	6X	40", 44"
	200	100	65	SKPB12 ⁹	\$11950.00	\$11670.00	—	\$13265.00	\$12954.00	—	6X	44"

⁸240Vac maximum.

⁹This is a Spectra® MVT Plus™ circuit breaker. Refer to page 9-93 for options. Main amp rating is 225A.

Note: Options for molded case circuit breakers see page 9-92.



GE Fastrac Program items are indicated in red

Step 2. Specify Main Location and Price¹ (Continued)

2c. Main Circuit Breakers — 100% Rated¹

Main Amp Rating	List Price Each, GO-101											
	Standard Frames											
	Interrupting Rating			Breaker Frame	Bolt-on per Circuit			Plug-in per Circuit			X-Height	Fits Box Widths
	240V	480V	600V		3P-4W	3P-3W	1P-3W	3P-4W	3P-3W	1P-3W		
400	65	35	25	SGHHA4	\$3271.00	\$3130.00	\$2868.00	\$3631.00	\$3474.00	\$3183.00	4X	27", 31", 36", 40", 44"
	65	35	25	SGHHB4 ²	\$4455.00	\$4308.00	—	\$4945.00	\$4782.00	—	4X	
	100	65	65	SGLLA4	\$4802.00	\$4614.00	\$4105.00	\$5330.00	\$5122.00	\$4557.00	4X	
	100	65	65	SGLLB4 ²	\$5599.00	\$5385.00	—	\$6215.00	\$5977.00	—	4X	
	200	100	65	SGPPA4	\$6021.00	\$5593.00	\$4706.00	\$6683.00	\$6208.00	\$5224.00	4X	
	200	100	65	SGPPB4 ²	\$6421.00	\$6077.00	—	\$7127.00	\$6745.00	—	4X	
800	65	35	25	SKHHA8	\$8386.00	\$8075.00	\$7447.00	\$9308.00	\$8963.00	\$8266.00	6X	40", 44"
	65	35	25	SKHHB8 ²	\$8877.00	\$8464.00	—	\$9853.00	\$9395.00	—	6X	
	100	65	42	SKLLA8	\$7731.00	\$7448.00	\$7070.00	\$8581.00	\$8267.00	\$7848.00	6X	
	100	65	42	SKLLB8 ²	\$8026.00	\$7573.00	—	\$8909.00	\$8406.00	—	6X	
	200	100	65	SKPPA8	\$9330.00	\$8984.00	\$8318.00	\$10356.00	\$9972.00	\$9233.00	6X	
	200	100	65	SKPPB8 ²	\$9508.00	\$9115.00	—	\$10554.00	\$10118.00	—	6X	
1000	65	35	25	SKHHA10	\$10686.00	\$10395.00	\$9731.00	\$11861.00	\$11538.00	\$10801.00	6X	40", 44"
	100	65	42	SKLLA10	\$11612.00	\$11232.00	\$10339.00	\$12889.00	\$12468.00	\$11476.00	6X	
	200	100	65	SKPPA10	\$13572.00	\$13195.00	\$11983.00	\$15065.00	\$14646.00	\$13301.00	6X	
	65	35	25	SKHHB10 ²	\$11562.00	\$11466.00	—	\$12834.00	\$12727.00	—	6X	
	100	65	42	SKLLB10 ²	\$11961.00	\$11696.00	—	\$13277.00	\$12983.00	—	6X	
	200	100	65	SKPPB10 ²	\$13981.00	\$13537.00	—	\$15519.00	\$15026.00	—	6X	
1200	65	35	25	SKHHA12	\$10686.00	\$10395.00	\$9731.00	\$11861.00	\$11538.00	\$10801.00	6X	40", 44"
	100	65	42	SKLLA12	\$11612.00	\$11232.00	\$10339.00	\$12889.00	\$12468.00	\$11476.00	6X	
	200	100	65	SKPPA12	\$13572.00	\$13195.00	\$11983.00	\$15065.00	\$14646.00	\$13301.00	6X	
	65	35	25	SKHHB12 ²	\$11562.00	\$11466.00	—	\$12834.00	\$12727.00	—	6X	
	100	65	42	SKLLB12 ²	\$11961.00	\$11696.00	—	\$13277.00	\$12983.00	—	6X	
	200	100	65	SKPPB12 ²	\$13981.00	\$13537.00	—	\$15519.00	\$15026.00	—	6X	

¹For multi-section panels include main price for each section and dual or feed-thru lugs in all except last section.

²This is a Spectra® MVT Plus circuit breaker. See page 9-93 for trip unit functions.

Note: Options for molded case circuit breakers see page 9-92.

2d. Main Fusible Switch — ADS Type

Main Amp Rating	List Price Each, GO-101						
	Standard Frames						
	250 Volt			600 Volt			
	3P-4W	3P-3W	1P-3W	3P-4W	3P-3W	X-Height	Fits Box Widths
200	\$1414.00	\$1281.00	\$1138.00	\$1644.00	\$1508.00	7X	36", 44"
400	\$2809.00	\$2636.00	\$2238.00	\$3303.00	\$3145.00	10X	36" ³ , 44"
600	\$3921.00	\$3677.00	\$3313.00	\$4135.00	\$3921.00	10X	36" ³ , 44"
800	\$6095.00	\$5759.00	\$5016.00	\$6095.00	\$5759.00	19X	44"
1200	\$7834.00	\$7401.00	\$6448.00	\$7834.00	\$7401.00	19X	44"

³Only J & T 400 & 600 Amp fit 36".



Panelboards Spectra® Series Panelboards

GE Fastrac Program items indicated in red

Section 9

Step 3. Molded Case Circuit Breaker Feeders

(Specify quantity, ampacity, poles, frame and price)

3a. Group Mounted Circuit Breakers - 80% Rated—Bolt-on Per Circuit

*See Note Below for Space Only Pricing.

Branch Mounting	Interrupting Rating						Breaker Frame	Trip Range	List Price, GO-101					X-Height	Fits Box Width	
	120V	240V	277V	480V	347V	600Y/ 347V			600V	Standard Frames—Bolt-on Per Circuit						
	3P	2P	1P	Space	Hdwr											
NA**	—	10	—	—	—	—	—	THQB	15-60	\$891.00	\$791.00	\$280.00	\$75.00	\$294.00		
Twin	—	10	—	—	—	—	—	THQB	70	\$956.00	\$868.00	\$332.00	\$75.00	\$294.00		
	—	10	—	—	—	—	—	THQB	80-100	\$1065.00	\$989.00	\$407.00	\$75.00	\$294.00		
Twin	—	22	—	—	—	—	—	THHQB	15-60	\$1183.00	\$1065.00	\$527.00	\$75.00	\$294.00		
	—	22	—	—	—	—	—	THHQB	70	\$1736.00	\$1562.00	\$703.00	\$75.00	\$294.00		
	—	22	—	—	—	—	—	THHQB	80-100	\$1938.00	\$1736.00	\$887.00	\$75.00	\$294.00	3X	27", 31", 36", 40" 44"
Twin	—	65	—	14	—	—	—	TEY	15-60	\$310.00	\$230.00	\$211.00	\$75.00	\$294.00		
	—	65	—	14	—	—	—	TEY	70-100	\$380.00	\$320.00	\$190.00	\$75.00	\$294.00		
Twin	—	10	—	—	—	—	—	TEB	15-60	\$305.00	\$260.00	\$145.00	\$75.00	\$294.00		
	—	10	—	—	—	—	—	TEB	70-100	\$341.00	\$260.00	\$145.00	\$75.00	\$294.00		
Twin	—	10	—	—	—	—	—	TQD	125-225	\$634.00	\$534.00	—	\$75.00	\$294.00	3X (2X-2Pole)	
Twin	—	22	—	—	—	—	—	THQD	125-225	\$845.00	\$783.00	—	\$75.00	\$294.00	3X	
Twin	—	65	—	—	—	—	—	SGDA	250-400	\$1673.00	\$1356.00	—	\$100.00	\$1377.00	4X	40", 44"
	—	18	—	18	—	—	—	TED4	15-60	\$392.00	\$305.00	\$205.00	\$75.00	\$294.00		
Twin	—	18	—	18	—	—	—	TED4	70-100	\$448.00	\$392.00	—	\$75.00	\$294.00	3X (2X-2Pole)	
	—	18	—	18	—	—	—	TED4	110-150	\$1092.00	—	—	\$75.00	\$294.00		
Twin	—	65	—	25	—	—	—	THED4	15-60	—	\$573.00	\$205.00	\$75.00	\$294.00	3X	
	—	65	—	25	—	—	—	THED4	70-100	—	\$648.00	—	\$75.00	\$294.00		
Twin	—	18	—	18	—	14	—	TED6	15-60	\$439.00	—	—	\$75.00	\$294.00		
	—	18	—	18	—	14	—	TED6	70-100	\$521.00	—	—	\$75.00	\$294.00	3X (2X-2Pole)	
Twin	—	18	—	18	—	14	—	TED6	110-150	\$1092.00	—	—	\$75.00	\$294.00		
	—	42	—	25	—	18	—	FCS6	15-60	\$601.00	\$543.00	—	\$75.00	\$294.00		
Twin	—	42	—	25	—	18	—	FCS6	70-100	\$667.00	\$603.00	—	\$75.00	\$294.00		
	—	65	—	25	—	18	—	THED6	15-60	\$713.00	—	—	\$75.00	\$294.00		
Twin	—	65	—	25	—	18	—	THED6	70-100	\$792.00	—	—	\$75.00	\$294.00		
	—	42	—	25	—	18	—	THED6	110-150	\$1474.00	—	—	\$75.00	\$294.00		
Twin	—	18	—	18	—	—	—	SEDA	15-60	\$632.00	\$583.00	—	\$75.00	\$294.00		
	—	18	—	18	—	—	—	SEDA	70-100	\$709.00	\$627.00	—	\$75.00	\$294.00		
Twin	—	18	—	18	—	—	—	SEDA	110-150	\$1256.00	\$1100.00	—	\$75.00	\$294.00		
	65 ¹	65	35 ¹	35	22 ¹	22	—	FBV6	15-60							
Twin	65 ¹	65	35 ¹	35	22 ¹	22	—	FBV6	70-100							
	—	65	—	25	—	—	18	SEHA	15-60	\$821.00	\$741.00	—	\$75.00	\$294.00		27", 31", 36", 40", 44"
Twin	—	65	—	25	—	—	18	SEHA	70-100	\$911.00	\$840.00	—	\$75.00	\$294.00		
	—	65	—	25	—	—	18	SEHA	110-150	\$1695.00	\$1562.00	—	\$75.00	\$294.00		
Twin	150 ¹	150	65 ¹	65	25 ¹	25	—	FBN6	15-60							
	150 ¹	150	65 ¹	65	25 ¹	25	—	FBN6	70-100							
Twin	—	100	—	65	—	—	25	SELA	15-60	\$1332.00	\$1237.00	—	\$75.00	\$294.00		
	—	100	—	65	—	—	25	SELA	70-100	\$1480.00	\$1332.00	—	\$75.00	\$294.00		
Twin	—	100	—	65	—	—	25	SELA	110-150	\$2347.00	\$2112.00	—	\$75.00	\$294.00		
	200 ¹	200	100 ¹	100	35 ¹	35	—	FBH6	15-60							
Twin	200 ¹	200	100 ¹	100	35 ¹	35	—	FBH6	70-100							
	—	200	—	100	—	—	25	SEPA	15-60	\$2171.00	\$1953.00	—	\$75.00	\$294.00		
Twin	—	200	—	100	—	—	25	SEPA	70-100	\$2423.00	\$2171.00	—	\$75.00	\$294.00		
	—	200	—	100	—	—	25	SEPA	110-150	\$3070.00	\$2763.00	—	\$75.00	\$294.00		
Twin	200 ¹	200	150 ¹	150	42 ¹	42	—	FBL6	15-60							
	200 ¹	200	150 ¹	150	42 ¹	42	—	FBL6	70-100							

*NOTE: Pricing for Space Only for Bolt-on panels for 3X height is \$25 for 1-pole, \$50 2-pole, and \$75 for 3-pole; 4X height is \$100 for 2- or 3-pole; 6X height is \$150 for 2- or 3-pole.

**Not available shipped in power panel. Must order separate product number from OneStop.

Circuit breaker 1" per pole, but requires switchboard spacing of full "X" height.

¹kAIC ratings for 1 pole breaker.

Note: Options for molded case circuit breakers see page 9-92.



Panelboards Spectra® Series Panelboards

GE Fastrac Program items indicated in red

Step 3. Molded Case Circuit Breaker Feeders (Continued)

(Specify quantity, ampacity, poles, frame and price)

3a. Group Mounted Circuit Breakers - 80% Rated—Bolt-on Per Circuit (Continued)

*See Note Below for Space Only Pricing.

Branch Mounting	Interrupting Rating			Breaker Frame	Trip Range	List Price, GO-101					X-Height	Fits Box Width
	120V	480V	600V			Standard Frames—Bolt-on Per Circuit						
						3P	2P	1P	Space	Hdwr		
Single or Twin	65	35	18	SFHA	20-225	\$1224.00	\$1116.00	—	\$75.00	\$725.00	3X	27 ¹ , 31 ¹ , 36 ¹ , 40 ¹ , 44 ¹
	65	35	18	SFHA	250	\$1495.00	\$1224.00	—	\$75.00	\$725.00		
Single or Twin	100	65	25	SFLA	20-225	\$2722.00	\$1897.00	—	\$75.00	\$725.00		
	100	65	25	SFLA	250	\$2850.00	\$2340.00	—	\$75.00	\$725.00		
Single or Twin	200	100	25	SFPA	20-225	\$3217.00	\$2600.00	—	\$75.00	\$725.00		
	200	100	25	SFPA	250	\$3860.00	\$3120.00	—	\$75.00	\$725.00		
Single or Twin	65	35	22	FGV2	125-250	\$1878.00	\$1511.00	—	\$100.00	\$1377.00		
	150	65	35	FGN2		\$3085.00	\$2532.00	—	\$100.00	\$1377.00		
	200	100	42	FGH2		\$4275.00	\$3510.00	—	\$100.00	\$1377.00		
	200	150	65	FGL2		\$4905.00	\$4025.00	—	\$100.00	\$1377.00		
	200	200	65	FGP2		\$5331.00	\$4375.00	—	\$100.00	\$1377.00		
Single or Twin	65	35	25	SGHA4	125-400	\$1878.00	\$1511.00	—	\$100.00	\$1377.00		
	65	35	25	SGHB4 ²	60-400	\$2715.00	—	—	\$100.00	\$1377.00		
Single or Twin	100	65	42	SGLA4	125-400	\$3085.00	\$2532.00	—	\$100.00	\$1377.00		
	100	65	42	SGLB4 ²	60-400	\$4351.00	—	—	\$100.00	\$1377.00		
Single or Twin	200	100	65	SGPA4	125-400	\$4265.00	\$3500.00	—	\$100.00	\$1377.00		
	200	100	65	SGPB4 ²	60-400	\$4950.00	—	—	\$100.00	\$1377.00		
Single or Twin	65	35	22	FGV4	125-250	\$1878.00	\$1511.00	—	\$100.00	\$1377.00		
	150	65	35	FGN4		\$3085.00	\$2532.00	—	\$100.00	\$1377.00		
	200	100	42	FGH4		\$4275.00	\$3510.00	—	\$100.00	\$1377.00		
	200	150	65	FGL4		\$4905.00	\$4025.00	—	\$100.00	\$1377.00		
	200	200	65	FGP4		\$5331.00	\$4375.00	—	\$100.00	\$1377.00		
Single or Twin	65	35	25	SGHA6	250-600	\$3091.00	\$2519.00	—	\$100.00	\$1377.00		
	65	35	25	SGHB6 ²		\$3679.00	—	—	\$100.00	\$1377.00		
	100	65	42	SGLA6		\$3893.00	\$3172.00	—	\$100.00	\$1377.00		
	100	65	42	SGLB6 ²		\$5397.00	—	—	\$100.00	\$1377.00		
	200	100	65	SGPA6		\$5735.00	\$4620.00	—	\$100.00	\$1377.00		
Single or Twin	200	100	65	SGPB6 ²	—	\$8581.00	—	—	\$100.00	\$1377.00		
	65	35	22	FGV6	125-250	\$3091.00	\$2519.00	—	\$100.00	\$1377.00		
	150	65	35	FGN6		\$3893.00	\$3172.00	—	\$100.00	\$1377.00		
	200	100	42	FGH6		\$3903.00	\$3182.00	—	\$100.00	\$1377.00		
	200	150	65	FGL6		\$6295.00	\$5313.00	—	\$100.00	\$1377.00		
	200	200	65	FGP6		\$7169.00	\$4851.00	—	\$100.00	\$1377.00		

*NOTE: Pricing for Space Only for Bolt-on panels for 3X height is \$25 for 1-pole, \$50 2-pole, and \$75 for 3-pole; 4X height is \$100 for 2- or 3-pole; 6X height is \$150 for 2- or 3-pole.

Circuit breaker 1" per pole, but requires switchboard spacing of full "X" height.

¹Single mount only.

²This is a Spectra® MVT Plus circuit breaker. Refer to page 9-93 for options.

Note: Options for molded case circuit breakers see page 9-92.



Publications and Reference: See Section 22 for a complete list of additional product-related publications

Panelboards

Spectra® Series Panelboards

Section 9

GE Fastrac Program items indicated in red

Step 3. Molded Case Circuit Breaker Feeders (Continued)

(Specify quantity, ampacity, poles, frame and price)

3a. Group Mounted Circuit Breakers - 80% Rated—Bolt-on Per Circuit (Continued)

*See Note Below for Space Only Pricing.

Branch Mounting	Interrupting Rating			Breaker Frame	Trip Range	List Price, GO-101					X-Height	Fits Box Width
	120V	480V	600V			Standard Frames—Bolt-on Per Circuit						
						3P	2P	1P	Space	Hdwr		
Single	65	35	25	SKHA8	300-800	\$4193.00	\$3321.00	—	\$150.00	\$1724.00	6X	40", 44"
	65	35	25	SKHB8 ¹		\$4727.00	—	—	—	—		
	100	65	42	SKLA8		\$4969.00	\$4092.00	—	\$150.00	\$1724.00		
Single	100	65	42	SKLB8 ¹	300-800	\$5532.00	—	—	—	—	6X	44"
	200	100	65	SKPA8		\$6800.00	\$5430.00	—	\$150.00	\$1724.00		
Single	200	100	65	SKPB8 ¹	300-800	\$7560.00	—	—	—	—	6X	44"
	65	35	25	SKHA12		1000	\$5560.00	\$4652.00	—	\$150.00		
Single	65	35	25	SKHA12	1200	\$7712.00	\$6032.00	—	\$150.00	\$1724.00	6X	40", 44"
	65	35	25	SHKB12 ¹	1000-1200	\$8345.00	—	—	—	—		
Single	100	65	42	SKLA12	1000	\$6345.00	\$5474.00	—	\$150.00	\$1724.00	6X	40", 44"
	100	65	42	SKLA12	1200	\$8848.00	\$6756.00	—	\$150.00	\$1724.00		
Single	100	65	42	SKLB12 ¹	1000-1200	\$10135.00	—	—	—	—	6X	44"
	200	100	65	SKPA12	1000	\$7465.00	\$6730.00	—	\$150.00	\$1724.00		
Single	200	100	65	SKPA12	1200	\$10240.00	\$9220.00	—	\$150.00	\$1724.00	6X	44"
	200	100	65	SKPB12 ¹	1000-1200	\$11015.00	—	—	—	—		

*NOTE: Pricing for Space Only for Bolt-on panels for 3X height is \$25 for 1-pole, \$50 2-pole, and \$75 for 3-pole; 4X height is \$100 for 2- or 3-pole; 6X height is \$150 for 2- or 3-pole.

FCV/FCS/FCN/FCL Series 2P breaker supplied in 3P envelope ONLY

Circuit breaker 1" per pole, but requires switchboard spacing of full "X" height.

¹This is a Spectra® MVT Plus circuit breaker. Refer to page 9-93 for trip unit functions.

Note: Options for molded case circuit breakers see page 9-92.



Panelboards Spectra® Series Panelboards

GE Fastrac Program items indicated in red

Step 3. Molded Case Circuit Breaker Feeders

(Specify quantity, ampacity, poles, frame and price)

3a. Group Mounted Circuit Breakers - 80% Rated—Plug-in Per Circuit

*See Note Below for Space Only Pricing.

Branch Mounting	Interrupting Rating							Breaker Frame	Trip Range	List Price, GO-101					X-Height	Fits Box Width
	120V	240V	277V	480V	347V	600V/347V	600V			Standard Frames—Plug-in Per Circuit						
	3P	2P	1P	Space	Hdwr											
NA**	—	10	—	—	—	—	—	THQB	15-60	\$891.00	\$791.00	\$280.00	\$75.00	\$294.00		
Twin	—	10	—	—	—	—	—	THQB	70	\$956.00	\$868.00	\$332.00	\$75.00	\$294.00		
	—	10	—	—	—	—	—	THQB	80-100	\$1065.00	\$989.00	\$407.00	\$75.00	\$294.00		
	—	22	—	—	—	—	—	THQB	15-60	\$1183.00	\$1065.00	\$527.00	\$75.00	\$294.00		
Twin	—	22	—	—	—	—	—	THQB	70	\$1736.00	\$1562.00	\$703.00	\$75.00	\$294.00		
	—	22	—	—	—	—	—	THQB	80-100	\$1938.00	\$1736.00	\$887.00	\$75.00	\$294.00		
Twin	—	65	—	14	—	—	—	TEY	15-60	\$344.00	\$255.00	\$211.00	\$83.00	NA**		27", 31", 36", 40" 44"
	—	65	—	14	—	—	—	TEY	70-100	\$422.00	\$355.00	\$211.00	\$83.00	NA**		
Twin	—	10	—	—	—	—	—	TEB	15-60	\$339.00	\$289.00	\$161.00	\$83.00	NA**		
	—	10	—	—	—	—	—	TEB	70-100	\$379.00	\$289.00	\$161.00	\$83.00	NA**		
Twin	—	10	—	—	—	—	—	TQD	125-225	\$704.00	\$593.00	—	\$83.00	NA**		3X (2X - 2Pole)
	—	22	—	—	—	—	—	THQD	125-225	\$938.00	\$869.00	—	\$83.00	NA**		3X
Twin	—	65	—	—	—	—	—	SGDA	250-400	\$1857.00	\$1505.00	—	\$111.00	NA**		4X
	—	18	—	18	—	—	—	TED4	15-60	\$436.00	\$339.00	\$228.00	\$83.00	NA**		
Twin	—	18	—	18	—	—	—	TED4	70-100	\$497.00	\$436.00	—	\$83.00	NA**		3X (2X - 2Pole)
	—	18	—	18	—	—	—	TED4	110-150	\$1212.00	—	—	\$83.00	NA**		
Twin	—	65	—	25	—	—	—	THED4	15-60	—	\$573.00	\$228.00	\$83.00	NA**		3X
	—	65	—	25	—	—	—	THED4	70-100	—	\$648.00	—	\$83.00	NA**		
Twin	—	18	—	18	—	14	—	TED6	15-60	\$487.00	—	—	\$83.00	NA**		
	—	18	—	18	—	14	—	TED6	70-100	\$579.00	—	—	\$83.00	NA**		3X (2X - 2Pole)
	—	18	—	18	—	14	—	TED6	110-150	\$1212.00	—	—	\$83.00	NA**		
Twin	—	42	—	25	—	18	—	FCS6	15-60	\$667.00	\$603.00	—	\$83.00	NA**		
	—	42	—	25	—	18	—	FCS6	70-100	\$741.00	\$670.00	—	\$83.00	NA**		
Twin	—	65	—	25	—	18	—	THED6	15-60	\$792.00	—	—	\$83.00	NA**		
	—	65	—	25	—	18	—	THED6	70-100	\$880.00	—	—	\$83.00	NA**		
	—	42	—	25	—	18	—	THED6	110-150	\$1636.00	—	—	\$83.00	NA**		
Twin	—	18	—	18	—	—	—	SEDA	15-60	\$702.00	\$647.00	—	\$83.00	NA**		
	—	18	—	18	—	—	—	SEDA	70-100	\$787.00	\$695.00	—	\$83.00	NA**		
	—	18	—	18	—	—	—	SEDA	110-150	\$1394.00	\$1221.00	—	\$83.00	NA**		
Twin	65 ¹	65	35 ¹	35	22 ¹	22	—	FBV6	15-60							
	65 ¹	65	35 ¹	35	22 ¹	22	—	FBV6	70-100							
Twin	—	65	—	35	—	22	—	FCV6	15-60	\$767.00	\$692.00	—	\$83.00	NA**		
	—	65	—	35	—	22	—	FCV6	70-100	\$851.00	\$785.00	—	\$83.00	NA**		
Twin	—	65	—	25	—	18	—	SEHA	15-60	\$911.00	\$822.00	—	\$83.00	NA**		27", 31", 36", 40", 44"
	—	65	—	25	—	18	—	SEHA	70-100	\$1011.00	\$932.00	—	\$83.00	NA**		
	—	65	—	25	—	18	—	SEHA	110-150	\$1881.00	\$1734.00	—	\$83.00	NA**		
Twin	150 ¹	150	65 ¹	65	25 ¹	25	—	FBN6	15-60							
	150 ¹	150	65 ¹	65	25 ¹	25	—	FBN6	70-100							
Twin	—	150	—	65	—	25	—	FCN6	15-60	\$1245.00	\$1156.00	—	\$83.00	NA**		
	—	150	—	65	—	25	—	FCN6	70-100	\$1383.00	\$1245.00	—	\$83.00	NA**		
Twin	—	100	—	65	—	25	—	SELA	15-60	\$1478.00	\$1373.00	—	\$83.00	NA**		
	—	100	—	65	—	25	—	SELA	70-100	\$1642.00	\$1478.00	—	\$83.00	NA**		
	—	100	—	65	—	25	—	SELA	110-150	\$2605.00	\$2344.00	—	\$83.00	NA**		
Twin	200 ¹	200	100 ¹	100	35 ¹	35	—	FBH6	15-60							
	200 ¹	200	100 ¹	100	35 ¹	35	—	FBH6	70-100							
Twin	—	200	—	100	—	35	—	FCH6	15-60	\$2029.00	\$1826.00	—	\$83.00	NA**		
	—	200	—	100	—	35	—	FCH6	70-100	\$2265.00	\$2029.00	—	\$83.00	NA**		
Twin	—	200	—	100	—	25	—	SEPA	15-60	\$2410.00	\$2168.00	—	\$83.00	NA**		
	—	200	—	100	—	25	—	SEPA	70-100	\$2690.00	\$2410.00	—	\$83.00	NA**		
	—	200	—	100	—	25	—	SEPA	110-150	\$3408.00	\$3067.00	—	\$83.00	NA**		
Twin	200 ¹	200	150 ¹	150	42 ¹	42	—	FBL6	15-60							
	200 ¹	200	150 ¹	150	42 ¹	42	—	FBL6	70-100							
Twin	—	200	—	150	—	42	—	FCL6	15-60	\$1927.00	\$1734.00	—	\$83.00	NA**		
	—	200	—	150	—	42	—	FCL6	70-100	\$2151.00	\$2120.00	—	\$83.00	NA**		

*NOTE: Pricing for Space Only for Plug-in panels for 3X height is \$28 for 1-pole, \$56 for 2-pole, and \$83 for 3-pole; 4X height is \$111 for 2- or 3-pole; 6X height is \$167 for 2- or 3-pole.

**Not available shipped in power panel. Must order separate product number from OneStop.

FCV/FCS/FCN/FCL Series 2P breaker supplied in 3P envelope ONLY

Circuit breaker 1" per pole, but requires switchboard spacing of full "X" height.

¹kAIC ratings for 1 pole breaker.

Note: Options for molded case circuit breakers see page 9-92.



Publications and Reference: See Section 22 for a complete list of additional product-related publications

Panelboards

Spectra® Series Panelboards

GE Fastrac Program items indicated in red

Section 9

Step 3. Molded Case Circuit Breaker Feeders

(Specify quantity, ampacity, poles, frame and price)

3a. Group Mounted Circuit Breakers - 80% Rated—Plug-in Per Circuit

*See Note Below for Space Only Pricing.

Branch Mounting	Interrupting Rating			Breaker Frame	Trip Range	List Price, GO-101					X-Height	Fits Box Width
	120V	480V	600V			Standard Frames—Plug-in Per Circuit				Hdwr		
						3P	2P	1P	Space			
Single or Twin	65	35	18	SFHA	20-225	\$1358.00	\$1239.00	—	—	NA**	3X	27"¹, 31", 36", 40", 44"
	65	35	18	SFHA	250	\$1659.00	\$1358.00	—	—	NA**		
Single or Twin	100	65	25	SFLA	20-225	\$3021.00	\$2106.00	—	\$83.00	NA**		
	100	65	25	SFLA	250	\$3164.00	\$2597.00	—	\$83.00	NA**		
Single or Twin	200	100	25	SFPA	20-225	\$3571.00	\$2886.00	—	\$83.00	NA**		
	200	100	25	SFPA	250	\$4285.00	\$3463.00	—	\$83.00	NA**		
Single or Twin	65	35	22	FGV2	125-250	\$2085.00	\$1677.00	—	\$111.00	NA**		
	150	65	35	FGN2		\$3424.00	\$2811.00	—	\$111.00	NA**		
	200	100	42	FGH2		\$4744.00	\$3895.00	—	\$111.00	NA**		
	200	150	65	FGL2		\$5444.00	\$4468.00	—	\$111.00	NA**		
	200	200	65	FGP2		\$5918.00	\$4856.00	—	\$111.00	NA**		
Single or Twin	65	35	25	SGHA4	125-400	\$2085.00	\$1677.00	—	\$111.00	NA**		
	65	35	25	SGHB4²	60-400	\$3014.00	—	—	\$111.00	NA**		
Single or Twin	100	65	42	SGLA4	125-400	\$3424.00	\$2811.00	—	\$111.00	NA**		
	100	65	42	SGLB4²	60-400	\$4830.00	—	—	\$111.00	NA**		
Single or Twin	200	100	65	SGPA4	125-400	\$4734.00	\$3885.00	—	\$111.00	NA**		
	200	100	65	SGPB4²	60-400	\$5495.00	—	—	\$111.00	NA**		
Single or Twin	65	35	22	FGV4	125-250	\$2085.00	\$1677.00	—	\$111.00	NA**		
	150	65	35	FGN4		\$3424.00	\$2811.00	—	\$111.00	NA**		
	200	100	42	FGH4		\$4744.00	\$3895.00	—	\$111.00	NA**		
	200	150	65	FGL4		\$5444.00	\$4468.00	—	\$111.00	NA**		
	200	200	65	FGP4		\$5918.00	\$4856.00	—	\$111.00	NA**		
Single or Twin	65	35	25	SGHA6	250-600	\$3431.00	\$2796.00	—	\$111.00	NA**		
	65	35	25	SGHB6²		\$4084.00	—	—	\$111.00	NA**		
	100	65	42	SGLA6		\$4321.00	\$3521.00	—	\$111.00	NA**		
	100	65	42	SGLB6²		\$5991.00	—	—	\$111.00	NA**		
	200	100	65	SGPA6		\$6366.00	\$5128.00	—	\$111.00	NA**		
	200	100	65	SGPB6²		\$9525.00	—	—	\$111.00	NA**		
Single or Twin	65	35	22	FGV6	125-250	\$3431.00	\$2796.00	—	\$111.00	NA**		
	150	65	35	FGN6		\$4321.00	\$3521.00	—	\$111.00	NA**		
	200	100	42	FGH6		\$4331.00	\$5138.00	—	\$111.00	NA**		
	200	150	65	FGL6		\$7320.00	\$5897.00	—	\$111.00	NA**		
	200	200	65	FGP6		\$7957.00	\$6416.00	—	\$111.00	NA**		

*NOTE: Pricing for Space Only for Plug-in panels for 3X height is \$28 for 1-pole, \$56 for 2-pole, and \$83 for 3-pole; 4X height is \$111 for 2- or 3-pole; 6X height is \$167 for 2- or 3-pole.

FCV/FCS/FCN/FCL Series 2P breaker supplied in 3P envelope ONLY

Circuit breaker 1" per pole, but requires switchboard spacing of full "X" height.

**Not available shipped in power panel. Must order separate product number from OneStop.

¹Single mount only.

²This is a Spectra® MVT Plus circuit breaker. Refer to page 9-93 for trip unit functions.

Note: Options for molded case circuit breakers see page 9-92.



Panelboards

Spectra® Series Panelboards

GE Fastrac Program items indicated in red

Step 3. Molded Case Circuit Breaker Feeders

(Specify quantity, ampacity, poles, frame and price)

3a. Group Mounted Circuit Breakers - 80% Rated—Plug-in Per Circuit

*See Note Below for Space Only Pricing.

Branch Mounting	Interrupting Rating			Breaker Frame	Trip Range	List Price, GO-101				X-Height	Fits Box Width	
	120V	480V	600V			Standard Frames—Plug-in Per Circuit						
						3P	2P	1P	Space			Hdwr
Single	65	35	25	SKHA8	300-800	\$4654.00	\$3686.00	—	\$167.00	NA**	6X	40", 44"
	65	35	25	SKHB8 ¹		\$5247.00	—	—	\$167.00	NA**		
	100	65	42	SKLA8		\$5516.00	\$4542.00	—	\$167.00	NA**		
	100	65	42	SKLB8 ¹		\$6141.00	—	—	\$167.00	NA**		
Single	200	100	65	SKPA8	300-800	\$7548.00	\$6027.00	—	\$167.00	NA**	6X	44"
	200	100	65	SKPB8 ¹		\$8392.00	—	—	\$167.00	NA**		
Single	65	35	25	SKHA12	1000	\$6172.00	\$5164.00	—	\$167.00	NA**	6X	40", 44"
	65	35	25	SKHA12	1200	\$8560.00	\$6696.00	—	\$167.00	NA**		
Single	65	35	25	SHKB12 ¹	1000-1200	\$9263.00	—	—	\$167.00	NA**	6X	40", 44"
	100	65	42	SKLA12	1000	\$7043.00	\$6076.00	—	\$167.00	NA**		
Single	100	65	42	SKLA12	1200	\$9821.00	\$7499.00	—	\$167.00	NA**	6X	44"
	100	65	42	SKLB12 ¹	1000-1200	\$10135.00	—	—	\$167.00	NA**		
Single	200	100	65	SKPA12	1000	\$8286.00	\$7470.00	—	\$167.00	NA**	6X	44"
	200	100	65	SKPA12	1200	\$11366.00	\$10234.00	—	\$167.00	NA**		
Single	200	100	65	SKPB12 ¹	1000-1200	\$12227.00	—	—	\$167.00	NA**		

*NOTE: Pricing for Space Only for Plug-in panels for 3X height is \$28 for 1-pole, \$56 for 2-pole, and \$83 for 3-pole; 4X height is \$111 for 2- or 3-pole; 6X height is \$167 for 2- or 3-pole.

FCV/FCS/FCN/FCL Series 2P breaker supplied in 3P envelope ONLY

Circuit breaker 1" per pole, but requires switchboard spacing of full "X" height.

**Not available shipped in power panel. Must order separate product number from OneStop.

¹This is a Spectra® MVT Plus circuit breaker. Refer to page 9-93 for trip unit functions.

Note: Options for molded case circuit breakers see page 9-92.



Publications and Reference: See Section 22 for a complete list of additional product-related publications

GE Fastrac Program items indicated in red

Step 3. Molded Case Circuit Breaker Feeders (Continued)

3b. Branch Circuit Breakers — 100% Rated

Branch Mounting	Main Amp Rating	Interrupting Rating		Breaker Frame	List Price Each, GO-101				X-Height	Fits Box Widths	
					Standard Frames						
					Bolt-on per Circuit		Plug-in per Circuit				
					240V	480V	600V	3 Pole			2 Pole
Single or Twin	400	65	35	25	SGHHA4	\$2254.00	\$1813.00	\$2502.00	\$2012.00	4X	27", 31", 36", 40", 44"
		65	35	25	SGHHB4 ²	\$3176.00	—	\$3525.00	—	4X	
		100	65	65	SGLLA4	\$3702.00	\$3038.00	\$4109.00	\$3372.00	4X	
		100	65	65	SGLLB4 ²	\$5178.00	—	\$5748.00	—	4X	
		200	100	65	SGPPA4 ²	\$5099.00	\$4165.00	\$5660.00	\$4623.00	4X	
		200	100	65	SGPPB4 ²	\$5890.00	—	\$6538.00	—	4X	
Single	800	65	35	25	SKHHA8	\$4948.00	\$3919.00	\$5492.00	\$4350.00	6X	27", 31", 36", 40", 44"
		65	35	25	SKHHB8 ²	\$5531.00	—	\$6139.00	—	6X	40", 44"
		100	65	42	SKLLA8	\$5913.00	\$4869.00	\$6563.00	\$5405.00	6X	27", 31", 36", 40", 44"
		100	65	42	SKLLB8 ²	\$6583.00	—	\$7307.00	—	6X	40", 44"
		200	100	65	SKPPA8	\$7956.00	\$6407.00	\$8831.00	\$7112.00	6X	27", 31", 36", 40", 44"
		200	100	65	SKPPB8 ²	\$8845.00	—	\$9818.00	—	6X	44"
Single	1000	65	35	25	SKHHA10	\$6561.00	\$5489.00	\$7283.00	\$6093.00	6X	40", 44"
		100	65	42	SKLLA10	\$7423.00	\$6405.00	\$8240.00	\$7110.00	6X	40", 44"
		200	100	65	SKPPA10	\$8734.00	\$7874.00	\$9695.00	\$8740.00	6X	44"
		65	36	25	SKHHB10 ²	\$9747.00	—	\$10819.00	—	6X	40", 44"
		100	65	42	SKLLB10 ²	\$10683.00	—	\$11858.00	—	6X	40", 44"
		200	100	65	SKPPB1 ²	\$12777.00	—	\$14182.00	—	6X	44"
Single	1200	65	36	25	SKHHB1 ²	\$9747.00	—	\$10819.00	—	6X	40", 44"
		100	65	42	SKLLB12 ²	\$10683.00	—	\$11858.00	—	6X	40", 44"
		200	100	65	SKPPB12 ²	\$12777.00	—	\$14182.00	—	6X	44"

¹3P THQB, TAHQS w/shunt trip = 5X.

²This is Spectra® MVT Plus circuit breaker, 3ph, 4w ground fault is not available on a branch device. See page 9-93 for other available trip functions.

3c. ADS Fusible Switches (Available in Plug-in Only)

Unit Type	Ampere Rating	List Price Each, GO-101					
		250 Volts		600 Volts		Space only CU/AL	
		3-pole	2-pole	3-pole	2-pole	2 & 3 pole	"X" Height
Double Branch ^{3,4}	30/30	\$543.00	\$440.00	\$705.00	\$609.00	\$111.00	4
	30/Blank	\$272.00	\$220.00	\$352.00	\$304.00	\$111.00	4
	60/60	\$543.00	\$440.00	\$705.00	\$609.00	\$139.00	4 or 5 ⁵
	60/Blank	\$272.00	\$220.00	\$352.00	\$304.00	\$139.00	4 or 5 ⁵
	100/100	\$735.00	\$617.00	\$1063.00	\$855.00	\$139.00	5
	100/Blank	\$367.00	\$309.00	\$532.00	\$427.00	\$139.00	5
Single Branch ³	200/200	\$1727.00	\$1270.00	\$2187.00	\$1687.00	\$194.00	7
	200	\$864.00	\$635.00	\$1093.00	\$844.00	\$194.00	7
	400	\$1967.00	\$1380.00	\$2492.00	\$1854.00	\$278.00	10
	600	\$2692.00	\$2075.00	\$2948.00	\$2343.00	\$278.00	10
	800 ⁶	\$4878.00	\$3741.00	\$4877.00	\$3741.00	\$527.00	19
	1200 ⁶	\$5224.00	\$4030.00	\$5224.00	\$4030.00	\$527.00	19

³R Fuse clips standard through 600 amp; L Fuse clips standard on 800 and 1200 amp. Optional fuse clips (page 9-100) available at no extra charge when specified at time of order.

⁴List price is per pair of circuits of the same number of poles. When circuits of a double branch unit are of different amp ratings, such as a 100 amp—60 amp of 100 amp—30 amp, price and layout as a 100 amp—100 amp unit. Also, when a two-pole circuit is desired, opposite a three-pole circuit, price as a three-pole double-branch unit.

⁵250 volt 60 amp units are 4X, 600 volt 60 amp units are 5X.

⁶ADS not available in N12 or N3R construction.

Note: Options for molded case circuit breakers see page 9-92.



Panelboards

Spectra® Series Panelboards

PCU Selection
 Order from the Customer Service Center
 Available in Spectra® Plug-in Only

Spectra® Series PCU Selection Guide

(Ref DET-104) Specify Overload Relay Amps
 (Included w/PCU)

Description: 15hp max, 22A, 600V max

Configuration: 3PH, 3W, & ground; all units are 4X height, 120V control.

Pilot Device	Mount	Product Number ¹	List Price GO-101
Yes	Double	APCU151FNDPD**	\$4477.00
Yes	Single	APCU151FNDPSX*	\$2239.00
No	Double	APCU151FNDND**	\$4218.00
No	Single	APCU151FNDNSX*	\$2109.00

¹Replace * with required overload range from table.

Spectra® PCU Control Power Transformer Kits

One kit required per panel unless an external, 120VAC is brought into the panel.

Continuous kVA	Primary Voltage ²	Capacity	Product Number	List Price, GO-101
.200	600	Standard	APCUCKA200	\$913.00
.300	600	Extra	APCUCKA300	\$1002.00
.200	480/240	Standard	APCUCKB200	\$914.00
.300	480/240	Extra	APCUCKB300	\$907.00
.200	208	Standard	APCUCKC200	\$938.00
.300	208	Extra	APCUCKC300	\$938.00

²Secondary voltage is 120VAC.

PCU Overload Selection

*	Overload Range
B	0.16-0.26A
C	0.25-0.41A
D	0.40-0.65A
F	0.65-1.1A
G	1.0-1.5A
H	1.3-1.9A
J	1.8-2.7A
K	2.5-4.1A
L	4.0-6.3A
M	5.5-8.5A
N	8.0-12.0A
P	10.0-16.0A
S	14.5-18.0A
T	17.5-22.0A
X	BLANK

Spectra® PCU Kits

Description	Product Number	List Price, GO-101
Spectra PCU Pilot Light Option (Kit includes red and green pilot lights)	APCUKPLT	\$143.00
Spectra PCU Wiring Kit (Optional kit for remote wiring)	APCUWK	\$14.00
Spectra PCU Expansion Kit to expand or rebuild PCU units)	APCUEKAF (left side)	\$2007.00
	APCURKAF (right side)	\$2007.00
Spectra PCU Blank Cans (Provides space for future PCU starters, other devices)	4X APCUDCAN4X	\$600.00
	7X APCUDCAN7X	\$700.00



Publications and Reference: See Section 22 for a complete list of additional product-related publications

Panelboards

Spectra® Series Panelboards

Section 9

Circuit Breaker Options

GE Fastrac Program items indicated in red

Options for Molded Case Circuit Breakers³

List Price Each, GO-101							
Circuit Breaker Frame	Bell Alarm	Shunt Trip	Under Voltage Release	Auxiliary Contacts For Molded Case Circuit Breakers 2 and 3-pole Only			
				No. of AB Switch Elements	For 240 Vac	For 600 Vac	Kirk Lock
Q-Line ⁴	—	\$98.00	—	1 ⁵	\$89.00	—	—
TEY ^{6,8}	—	\$392.00	—	1	\$200.00	\$249.00	—
FC	\$261.00	\$392.00	\$392.00	2	\$261.00	\$261.00	—
SE, TE	\$261.00	\$392.00 ⁷	\$392.00	1	\$200.00	\$261.00	—
				2	\$360.00	\$479.00	—
FE ⁸	Breaker not available at time of printing						—
SF, TQD, THLC4	\$261.00	\$447.00	\$447.00	1	—	\$261.00	—
				2	\$447.00	—	—
				4	\$485.00	—	—
SG	\$261.00	\$447.00	\$447.00	1	\$243.00	\$261.00	\$821.00
				2	\$447.00	\$479.00	—
FG ⁸	\$261.00	\$392.00	\$392.00	2	\$261.00	\$261.00	\$821.00
SK	\$261.00	\$447.00	\$447.00	1	\$230.00	\$249.00	—
				2	\$416.00	\$474.00	\$821.00
				4	\$740.00	\$764.00	—

³Must be factory-installed.

⁴Allow 1X of space for option when sizing panelboard.

⁵Switch is SPST. Operates like "A" side of an "AB" contact and is rated six amps at 120 volts ac and three amps at 24 volts ac.

⁶Internal accessories available on 2 and 3-pole only.

⁷Not available in 1-pole.

⁸Bell alarm has two (2) versions, bell alarm trip and bell alarm mechanism.



Panelboards

Spectra® Series Panelboards

Circuit Breaker Options

GE Fastrac Program items indicated in red

MicroVersaTrip® Plus⁸ Trip Unit Functions with Ammeter For SG and SK Spectra® RMS Molded-Case Circuit Breakers

MicroVersaTrip® Plus protective trip unit characteristics are determined by choosing a set of functions from a group of conventional combinations. Trip units are not suitable for dc applications.

Trip Unit Suffix	List Price, ⁸ GO-108A	Longtime (L)	Shorttime (S)	Adj. Instantaneous (I)	4-Wire Ground Fault (G) ^{9,10}	OL/SC Targets ¹¹	OL/SC/GF Targets ¹¹
LI	No Price Adder	X		X		X	
LSI	\$1880.00	X	X	X		X	
LIG	\$3222.00	X		X	X	X	X
LSIG	\$4342.00	X	X	X	X	X	X

X = Function included

⁸Basic Trip Unit includes Long Time and Adjustable Instantaneous overcurrent trip functions, three phase Ammeter and OL/SC trip indicators. When optional functions are required, specify suffix and price. MicroVersaTrip® Plus Trip Units with optional control power require a Voltage Module; refer to Engineered Products Catalog, Section 3, for sizing and pricing.

⁹Trip Units with suffix "G" include neutral sensor for 3Φ-4W applications. For 3Φ-3W grounded wye applications **deduct \$1000.00** list from the trip units list price.

¹⁰3Φ-4W ground fault available only on main devices.

¹¹Trip indication targets are standard.

(Formerly non-automatic circuit breakers) Not available in Hi-Break construction

Make deductions from prices of conventional main breakers of same rating

Molded Case Switch Mains¹²

Type	Circuit Breaker Rating		List Price Deduction Each, GO-101	
	Volts ac	Max. Amps	2-pole	3-pole
Standard Frames				
SG4	600	440	\$187.00	\$187.00
SK8	600	800	\$1481.00	\$1481.00
SK10	600	1000	\$2986.00	\$2986.00

¹²These switches have UL Listed series rated short-circuit interrupting capacity when protected by the proper upstream main breaker.



Publications and Reference: See Section 22 for a complete list of additional product-related publications

Panelboards Spectra® Series Panelboards

Section 9

Interior, Enclosure Options

GE Fastrac Program items indicated in red

Bus Bars

Description	List Price Adder Per Panel, GO-101				
	Main Bus Rating in Amps				
	225 or less	400	600	800	1200
Copper 1000 Amp/sq-in. Main Vertical Bus					
Silver plated copper in lieu of silver plated aluminum	\$255.00	\$373.00	\$504.00	\$659.00	\$995.00
Aluminum 600 Amp/sq-in. Main Bus Density					
Reduces current density from 750 amps/sq-in. to 600 amps/sq-in.	\$764.00	\$1021.00	\$1294.00	\$1729.00	—
Copper 800 Amp/sq-in. Main Bus Density					
Reduces current density from 1000 amps/sq-in. to 800 amps/sq-in.	\$1138.00	\$1524.00	\$1953.00	\$2725.00	—

Locking Devices

Frame Style	Description	Product Number	List Price Each	GO-Sched.
Padlocking Device (single padlock)				
Q ¹	THQB, THHQB	THP100	\$6.50	137A
E	TEY	TEYPLD1	—	135B
FC	FCS, FCV, FCN, FCH, FCL, FCPE	FCPLD	\$8.00	135S
SE, E	TEB, TED, THED	TEFPLD1	\$8.00	135B
		TLC1PLD1	\$17.00	135B
	SED, SEH, SEL, SEP	SEPLD	\$8.70	135S
FE	FES, FEV, FEN, FEH, FEL, FEPE	Breaker not available at time of printing		
QD	TQD, THQD	TQDPLD1	\$20.75	137A
SF, F		TLC4PLD1	\$22.00	135B
	SFH, SFL, SFP	SEPLD	\$8.70	135S
SG	SGD, SGH, SGL, SGP	SGPLD	\$15.00	135S
FG	FGV, FGN, FGH, FGL, FGP, FGPE	FGPLD	\$8.00	135S
SK, K	SKH, SKL, SKP	SKPLD	\$28.50	135S
Handle Locking (nonpadlocking)				
Q ¹	THQB, THHQB	THL103	\$6.50	137A
E	TEB, TED, THED	TLD3	\$5.00	135B

¹Not available for ground fault breakers.

Locking Devices EUSERC Approved—Factory Installed Only

Breaker Type	Product Number	List Price, GO-135B
TQD	TQDPLD2	\$32.00
FC	FCS, FCV, FCN, FCH, FCL, FCPE	\$32.00
E150	TEDPLD2	\$32.00
SE150, SF250 ²	SEFPLD2	\$32.00 ³
FE	FES, FEV, FEN, FEH, FEL, FEPE	Breaker not available at time of printing
SG600	SGPLD2	\$48.00 ³
FG	FGV, FGN, FGH, FGL, FGP, FGPE	\$48.00
J600	TJKPLD2	\$48.00
SK1200	SKPLD2	\$60.00 ³

²Field installable

³GO-135S.

Equipment Ground Bars

Spectra® grounding kits are sized according to the number of panel circuits (one per circuit or space).

Description	List Price Addition GO-101
Bondable to box—includes bonding strap and main terminal	\$135.00
Insulated/isolated—includes main terminal	\$210.00

Enclosures (Box)

Description	List Price Each, GO-101
Painted/Increased Gage	
One option provides 12 gage box painted ANSI 61 gray (not available separately)	\$650.00
NEMA 3R	\$1550.00
NEMA 12	\$1550.00
NEMA 4X Stainless Steel	\$14000.00
Wide Box (increased gutter space)	
To increase to 31" from 27" box	\$250.00
To increase to 36" from 31" box	\$250.00
To increase to 44" from 40" box	\$250.00
To increase to 44" from 36" box	\$250.00
Narrow Box ⁴	
To decrease to 27" from 36" box (circuit breakers only)	No Charge
To decrease to 36" from 44" box	No Charge
Box skirt — 12" high	\$218.00 per 12" section
Touch-up Paint	
ANSI 61 gray, 12 oz. can	\$29.00

⁴Narrow box option limited to panels with maximum 600-amp circuit breaker feeders and 400-amp fusible feeders with T or J fuse clips. This option single branches some double branched devices and may result in additional sections. See page 9-99 and 9-100 for sizing information.

Fronts

Standard Arrangement	List Price Each, GO-101				
	27"	31"	36"	40"	44"
	4 piece surface only (no door)				
Optional regular door (27W, surface only)	\$238.00	—	—	—	—
Optional door ^{5,6} within a door front	—	\$750.00	\$750.00	\$750.00	\$750.00
Optional front hinged to box surface only	\$238.00	\$238.00	\$238.00	\$238.00	\$238.00

⁵Specify surface or flush.

⁶Not available in 27" wide.

Front Modifications

(Add to price of front)

Description	Each, GO-101
Lexan Cardholder for fronts with doors	Standard
Lamicaid Nameplate (1 per panel)	\$46.00
Yale 511S Spring Bolt Lock with Rosette Sleeve	\$300.00
Corbin 15767 Latch Bolt	\$146.00
3 pt Catch and Vault Handle	\$118.00
Permanent Number Tabs #1-49	\$79.00
Permanent Number Tabs #1-99	\$158.00



TVSS (Transient Voltage Surge Suppression)

Product Number	System Voltage	Panel Width	X Height	Panel Type	Surge Current Capability (per model)	List Price Each, GO-101
ATME	120/208V, 240V Delta, 120/240V Delta, 120/240V Delta, 277/480V, 480V Delta	27" - 44"	7X	Plug-in/ Bolt-on	65ka	\$7325.00
					80ka	\$7970.00
ATHE	120/208V, 240V Delta, 120/240V Delta, 120/240V Delta, 277/480V, 480V Delta	27" - 44"	7X	Plug-in/ Bolt-on	100ka	\$10235.00
					150ka	\$21070.00
					200ka	\$24750.00

*Field installable kits are available for adding to existing boards.

*Kits include: TVSS unit, 3 cover sizes, cover mounting brackets and cable.

*Add a "K" to the end of the full Product Number for the kit number.

Energy Management Meters

Product Number	System Voltage	Phase/ Wire	List Price GO-101	Ship Cycle
EPM6000	600/347V	3P 4W/3P 3W	\$13250.00	N
	480V	3P 4W/3P 3W		
	208/120V	3P 4W		
PQM Meter Module	600/347V	3P 4W/3P 3W	\$19800.00	N
	480V	3P 4W/3P 3W		
	240V	3P 3W		
	240/120V HI-Leg	3P 4W		
	208/120V	3P 4W		

7X required for panel distribution section mounting

Fits in 27", 31", 36", 40" and 44" wide sections

List Price includes CT & CPT's (Control Power Transformer)



Panelboards

Spectra® Series Panelboards

Spectra® Series Integrated Submetering Panelboard

Submetering lets you measure and bill energy use (electrical, water, gas) in master-metered commercial and/or residential buildings. Suitable for either new construction or retrofit, the Spectra® Series Integrated Submetering Panelboard combines the benefits of a multi-tenant digital meter with a reliable GE Spectra® Series panelboard.

Save Valuable Real Estate

GE's fully-integrated solution maximizes valuable real estate by combining meters, current transformers, communications and overload protection into a single UL Listed, factory-assembled panel. It requires only a fraction of the space needed for traditional modular metering.

Lower Construction Costs

Because this panelboard requires no special communications wiring, you'll reduce wire, conduit and installation costs. Individual branch circuit readings communicate through power line communication. All in all, it's lighter, more flexible, faster and easier to install than conventional utility metering.

Save Time

Fully assembled and wired in the factory.

Features and benefits

- Factory assembled/wired internal meters minimize installation labor
- Factory installed/wired CTs eliminate lengthy wiring runs and wiring errors
- Small footprint takes up less wall space than separate panels and meters
- UL Listed
- Communication:
 - Power line communication standard on all meters
 - Optional Modbus RS-485 communication
 - Up to 48 pulse inputs to capture energy data from other pulse-type energy devices (water, gas, steam meters)
- IEC optical front panel interface for programming
- Real-time, per-phase viewing of voltage, current, power factor, phase angle, watts, VARs, VA and frequency
- Event reporting with time and date stamps
 - Local LCD display
 - Push-button scroll
 - 32-digit liquid crystal display (16 digit x 2 rows)
 - Programmable display scroll and decimal place display
- Meets ANSI C12.1 and C12.16 revenue certifiable accuracy specifications and Canada (AE-1148)
- Data can be accessed and collected through third party read-bill-collect service or, with Modbus option, the internal EPM 4000 platform utilizes GE's Energy Aggregator billing software, an ideal web-based solution for tracking and monitoring energy consumption. Energy Aggregator allows for the creation of utility rate structures and automatic billing generation.



Specifications

Panel Type	Spectra Bolt-On (SBO)
Certifications	UL, cUL
Services	1P3W, 3P3W, 3P4W
Voltages	120/240V, 120/208V, 480/277V
Main Amps	250, 400, 600, 800, 1200
Main Types	SF, SG, SK
Busing	Cu
Feeder Types	TED, TQD, THQD, SE, SF
Feeder Amps	15-250A
Max Fully Rated AIC Ratings	65kAIC
Branch Devices	24-2 pole max.; 18-3 pole max.
No. of Meter Points/Panel	6, 9, 12, 15, 18, 21, 24
Series Ratings	65kAIC
Meter Specifications	Per EPM 4000 Brochure

Typical Dimensions

Tenants	Panel Dimensions (inches)
6	65H x 40W x 11.5D
12	76H x 40W x 11.5D
18/24	89H x 44W x 11.5D

Example of 6-unit Wiring Diagram

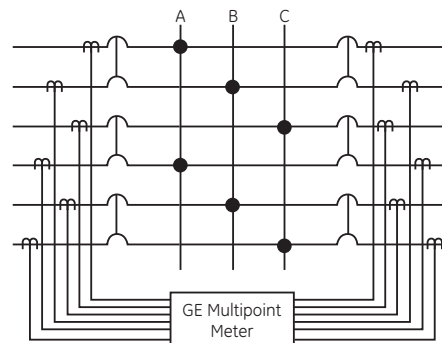

Panelboards

Spectra® Series Panelboards

How to Size Boxes

Step 1.

Select the narrowest width that accommodates all devices and ratings required for the specific panelboard.

		Panelboard Width		
		27" Wide	31"/36" Wide	40"/44" Wide
Mains	Main Lugs	250-600A	250-1200A ²	400-1200A
	Main Fusible Switch ¹	—	200-600A	400-1200A
	Main Breaker	225-600A	225-600A	400-1200A
Branch Fusible Switches ¹	Double Branched Switches	—	30-100A Class H/R/K	30-200A Class H/R/K
		—	200A Class T	200A Class T
	Single Branched Switches	—	30-200A Class H/R/K	30-600A Class H/R/K
		—	400-600A Class T	400-600A Class T
		—	—	800-1200A Class L
Branch Circuit Breakers	Double Branched Breakers	15-150A (480V) 15-225A (240V)	15-250A	15-600A
	Single Branched Breakers	15-600A	15-600A	225-1200A
Interiors		18-38X	18-48X	18-48X

¹Fusible switches not available in 31" and 40" wide.

²800-1200A dual main lugs not available in 31" wide.

Step 2.

Find the unit "X" heights of the main and branch devices.

Main Lugs:

4X simple main lugs, 250A-1200A.

4X dual main lugs, 250A-600A.

6X dual main lugs, 800A-1200A.

Breakers: See table to right

Switches: See page 9-101

Add to get total required "X" height

Main and Branch Circuit Breakers

Mounting Type	Breaker Max. Amps	Breaker Frames	Unit "X" Height		Fits Box Widths	
			3-Pole Modules	2-Pole Modules		
Double Branch	100	THQB or THHQB	3X	3X	27", 36", 44"	
		TEY	3X	3X		
	150	TEB or TED	3X	3X		2X
		THED				
	225	SEDA ³ or SEHA ³ or SELA ³ or SEPA ³	3X	3X		2X
		FC (FE Future), FCS, FCV, FCN, FCH, FCL (Future FES, FEV, FEN, FEH, FEL)				
	250	TQD or THQD	3X	2X		2X
	400	SFHA ³ or SFLA ³ or SFPA ³	4X	4X		4X
		SGDA				
	600	SGHA or SGLA or SGPA	4X	4X		4X
Double Branch Adjacent to Switch	150	SEDA or SEHA or SELA or SEPA	4X	4X	36", 44"	
	250	SFHA or SFLA or SFPA	4X	4X		
Single or Main	250	SFHA or SFLA or SFPA	3X	3X		
	400	SGD	4X	4X	27", 31", 36", 40", 44"	
	600	SGH or SGL or SGP	4X	4X		
	1200	SKH or SKL or SKP	6X	6X	40" ⁴ , 44"	
Single or Main Adjacent to Switch	250	SFH or SFL or SFP	4X	4X	36", 44"	
	1200	SKP	7X	7X	44"	

³SE and SF breakers located adjacent to a fusible switch require mounting modules suitable for mounting "Adjacent to Switch".

⁴SKP not available in 40".

Step 3.

Select equal or next largest panel "X" height shown on page 9-98, which gives you the corresponding box height.



Publications and Reference: See Section 22 for a complete list of additional product-related publications

Panelboards Spectra® Series Panelboards

Sizing Information

Section 9

Panel Interiors—Basic Sizing Logic

Amp	Main Type ¹	Neutral Type ²	X-Hgt	Interior Product Number ³	Box Hgt	Basic Front Product Number	Available Box	
							NEMA 1	NEMA 3R, 12
250A	CB, SW, Single/Dual MLO	Single/Dual/None	18X	APN(B)1802	65	APF6518N	27-36"	27-36"
			23X	APN(B)2302	65	APF6523N	27-36"	27-36"
			28X	APN(B)2802	65	APF6528N	27-36"	27-36"
			38X	APN(B)3802	89	APF8938N	27-36"	27-36"
			48X	APN(B)4802	96	APF9648N	31-36"	N/A
250A	CB, SW, Single/Dual MLO	200% Single or Dual	18X	APN(B)1802	65	APF6518N	36"	36"
			23X	APN(B)2302	65	APF6523N	36"	36"
			28X	APN(B)2802	65	APF6528N	36"	36"
			38X	APN(B)3802	89	APF8938N	36"	36"
			48X	APN(B)4802	96	APF9648N	36"	N/A
400A	CB, SW, Single/Dual MLO	Single/Dual/GF/None	18X	APN(B)1804	65	APF6518	27-44"	27-44"
			23X	APN(B)2304	65	APF6523	27-44"	27-44"
			28X	APN(B)2804	75	APF7528	27-44"	27-44"
			33X	APN(B)3304	89	APF8933	27-44"	27-36"
			38X	APN(B)3304	89	APF8938	27-44"	27-36"
400A	CB, SW, Single/Dual MLO	200% Single or Dual	18X	APN(B)1804	65	APF6518	36-44"	36-44"
			23X	APN(B)2304	65	APF6523	36-44"	36-44"
			28X	APN(B)2804	75	APF7528	36-44"	36-44"
			33X	APN(B)3304	89	APF8933	36-44"	36"
			38X	APN(B)3804	89	APF8938	36-44"	36"
600A	CB, SW, Single/Dual MLO	Single/Dual/GF/None	18X	APN(B)1806	65	APF6523	27-44"	27-44"
			28X	APN(B)2806	75	APF7528	27-44"	27-44"
			33X	APN(B)3306	89	APF8933	27-44"	27-36"
			38X	APN(B)3806	89	APF8938	27-44"	27-36"
			43X	APN(B)4306	96	APF9643	31-44"	N/A
600A	CB, SW, Single/Dual MLO	200% Single or Dual	18X	APN(B)1806	65	APF6523	36-44"	36-44"
			28X	APN(B)2806	75	APF7528	36-44"	36-44"
			33X	APN(B)3306	89	APF8933	36-44"	36"
			38X	APN(B)3806	89	APF8938	36-44"	36"
			43X	APN(B)4306	96	APF9643	36-44"	N/A
800A	CB, SW, Single MLO	Single/None	23X	APN(B)2308	75	APF7523E	31-44"	31-44"
			GF CB	GF/None	23X	APN(B)2308	75	APF7523E
	CB, SW, Dual MLO	Dual/None	23X	APN(B)2308	75	APF7523E	36-44"	36-44"
			28X	APN(B)2808	75	APF7528	31-44"	31-44"
	CB, SW, Single MLO	Single/None	33X	APN(B)3308	89	APF8933	31-44"	31-36"
			38X	APN(B)3808	89	APF8938	31-44"	31-36"
	CB, SW, Single MLO	Single/None	38X	APN(B)3808	96	APF9638E	31-44"	N/A
			GF CB	GF/None	38X	APN(B)3808	96	APF9638E
	CB, SW, Dual MLO	Dual/None	38X	APN(B)3808	96	APF9638E	36-44"	N/A
			43X	APN(B)4308	96	APF9643	31-44"	N/A
800A	CB, SW, Single MLO	200% Single or Dual	23X	APN(B)2308	75	APF7523E	36-44"	36-44"
			38X	APN(B)3808	96	APF9638E	36-44"	N/A
1200A	CB, SW, Single MLO	Single/None	23X	APN(B)2312	75	APF7523E	36-44"	31-44"
			GF CB	GF/None	23X	APN(B)2312	75	APF7523E
	CB, SW, Dual MLO	Dual/None	23X	APN(B)2312	75	APF7523E	36-44"	36-44"
			28X	APN(B)2812	75	APF7528	31-44"	31-44"
	CB, SW, Single MLO	Single/None	33X	APN(B)3312	89	APF8933	31-44"	31-36"
			38X	APN(B)3812	89	APF8938	31-44"	31-36"
	CB, SW, Single MLO	Single/None	38X	APN(B)3812	96	APF9638E	31-44"	N/A
			GF CB	GF/None	38X	APN(B)3812	96	APF9638E
	CB, SW, Dual MLO	Dual/None	38X	APN(B)3812	96	APF9638E	36-44"	N/A
			43X	APN(B)4312	96	APF9643	31-44"	N/A
1200A	CB, SW, Single/Dual MLO	200% Single or Dual	23X	APN(B)2312	75	APF7523E	36-44"	36-44"
			38X	APN(B)3812	96	APF9638E	36-44"	N/A

¹CB = Circuit Breaker, SW = Fusible Switch, MLO = Main Lugs Only, GF = Ground Fault

²Dual neutral is also required for feed thru lugs 1PH3W or 3PH4W.

³Interior Product Number APN is for Plug-In Style and APNB is for Bolt-On Style. Interior Catalog Number Suffixes are:

ASM Type: F = Factory, U = Merchandised (200KAIC with AML Main Lugs), Removed M for AMS MLO

Bus Material: Blank - 750APSI Al, B2 - 600APSI Al (Factory Only), B3 - 800APSI Cu (Factory Only), B4 - 1000APSI Cu,

H1 - Aluminum Bus Heat Rated, H2 - Copper Bus Heat Rated, P1 - Single Phase or DC Rated for APN (Factory Only, No B2 or B3 Option), P - Single Phase or DC Rated for APNB (Factory Only, No B2 or B3 Option)

Bracing: Blank - 200KAIC (Plug In Only), A - 42KAIC, B - 100KAIC

Note: Interior pricing included in price of the panel.



Panelboards Spectra® Series Panelboards

Replacement Boxes and Fronts
Order from the Customer Service Center

Type APB NEMA 1 Enclosure

Width	Height	Interior X-Height	Modification	Product Number	
27"	65"	18X	11.50"D, Std Gauge	APB2765AS	
			11.50"D, Painted/Heavy Gauge	APB2765ASP	
			14.25"D, Std Gauge	APB2765A	
		23X	14.25"D, Painted/Heavy Gauge	APB2765AP	
			11.50"D, Std Gauge	APB2765BS	
			11.50"D, Painted/Heavy Gauge	APB2765BSP	
	75"	28X	14.25"D, Std Gauge	APB2765B	
			14.25"D, Painted/Heavy Gauge	APB2765BP	
			11.50"D, Std Gauge	APB2765CS	
		33X, 38X	11.50"D, Painted/Heavy Gauge	APB2765CSP	
			14.25"D, Std Gauge	APB2765C	
			14.25"D, Painted/Heavy Gauge	APB2765CP	
	31"	65"	18X	11.50"D, Std Gauge	APB2775S
				11.50"D, Painted/Heavy Gauge	APB2775SP
				14.25"D, Std Gauge	APB2775
			23X	14.25"D, Painted/Heavy Gauge	APB2775P
				11.50"D, Std Gauge	APB2789S
				11.50"D, Painted/Heavy Gauge	APB2789SP
		75"	28X	14.25"D, Std Gauge	APB2789
				14.25"D, Painted/Heavy Gauge	APB2789P
				11.50"D, Std Gauge	APB3165A
			33X, 38X	11.50"D, Painted/Heavy Gauge	APB3165AP
				14.25"D, Std Gauge	APB3165AD
				14.25"D, Painted/Heavy Gauge	APB3165ADP
36"	65"	23X	11.50"D, Std Gauge	APB3165B	
			11.50"D, Painted/Heavy Gauge	APB3165BP	
			14.25"D, Std Gauge	APB3165BD	
		28X	14.25"D, Painted/Heavy Gauge	APB3165BDP	
			11.50"D, Std Gauge	APB3165C	
			11.50"D, Painted/Heavy Gauge	APB3165CP	
	75"	28X	14.25"D, Std Gauge	APB3165CD	
			14.25"D, Painted/Heavy Gauge	APB3165CDP	
			11.50"D, Std Gauge	APB3175	
		33X, 38X	11.50"D, Painted/Heavy Gauge	APB3175P	
			14.25"D, Std Gauge	APB3175D	
			14.25"D, Painted/Heavy Gauge	APB3175DP	
40"	65"	23X, 28X	11.50"D, Std Gauge	APB3189	
			11.50"D, Painted/Heavy Gauge	APB3189P	
			14.25"D, Std Gauge	APB3189D	
		33X, 38X	14.25"D, Painted/Heavy Gauge	APB3189DP	
			11.50"D, Std Gauge	APB3196A	
			11.50"D, Painted/Heavy Gauge	APB3196AP	
	75"	38X, 43X	14.25"D, Std Gauge	APB3196AD	
			14.25"D, Painted/Heavy Gauge	APB3196ADP	
			11.50"D, Std Gauge	APB3196B	
		48X	11.50"D, Painted/Heavy Gauge	APB3196BP	
			14.25"D, Std Gauge	APB3196BD	
			14.25"D, Painted/Heavy Gauge	APB3196BDP	

Type APB NEMA 1 Enclosure (Continued)

Width	Height	Interior X-Height	Modification	Product Number	
36"	65"	18X, 23X, 28X	11.50"D, Std Gauge	APB3665	
			11.50"D, Painted/Heavy Gauge	APB3665P	
			16.25"D, Std Gauge	APB3665D	
		23X, 28X	16.25"D, Painted/Heavy Gauge	APB3665DP	
			11.50"D, Std Gauge	APB3675	
			11.50"D, Painted/Heavy Gauge	APB3675P	
	75"	33X, 38X	16.25"D, Std Gauge	APB3675D	
			16.25"D, Painted/Heavy Gauge	APB3675DP	
			11.50"D, Std Gauge	APB3689	
		38X, 43X, 48X	11.50"D, Painted/Heavy Gauge	APB3689P	
			16.25"D, Std Gauge	APB3689D	
			16.25"D, Painted/Heavy Gauge	APB3689DP	
	40"	65"	18X, 23X	11.50"D, Std Gauge	APB3696
				11.50"D, Painted/Heavy Gauge	APB3696P
				16.25"D, Std Gauge	APB3696D
			23X, 28X	16.25"D, Painted/Heavy Gauge	APB3696DP
				11.50"D, Std Gauge	APB4065
				11.50"D, Painted/Heavy Gauge	APB4065P
		75"	33X, 38X	14.25"D, Std Gauge	APB4065D
				14.25"D, Painted/Heavy Gauge	APB4065DP
				11.50"D, Std Gauge	APB4075
			38X, 43X, 48X	11.50"D, Painted/Heavy Gauge	APB4075P
				14.25"D, Std Gauge	APB4075D
				14.25"D, Painted/Heavy Gauge	APB4075DP
44"	65"	18X, 23X	11.50"D, Std Gauge	APB4089	
			11.50"D, Painted/Heavy Gauge	APB4089P	
			14.25"D, Std Gauge	APB4089D	
		23X, 28X	14.25"D, Painted/Heavy Gauge	APB4089DP	
			11.50"D, Std Gauge	APB4096	
			11.50"D, Painted/Heavy Gauge	APB4096P	
	75"	33X, 38X	14.25"D, Std Gauge	APB4096D	
			14.25"D, Painted/Heavy Gauge	APB4096DP	
			11.50"D, Std Gauge	APB4465	
		38X, 43X, 48X	11.50"D, Painted/Heavy Gauge	APB4465P	
			16.25"D, Std Gauge	APB4465D	
			16.25"D, Painted/Heavy Gauge	APB4465DP	
48"	65"	23X, 28X	11.50"D, Std Gauge	APB4475	
			11.50"D, Painted/Heavy Gauge	APB4475P	
			16.25"D, Std Gauge	APB4475D	
		33X, 38X	16.25"D, Painted/Heavy Gauge	APB4475DP	
			11.50"D, Std Gauge	APB4489	
			11.50"D, Painted/Heavy Gauge	APB4489P	
	75"	38X, 43X, 48X	16.25"D, Std Gauge	APB4489D	
			16.25"D, Painted/Heavy Gauge	APB4489DP	
			11.50"D, Std Gauge	APB4496	
		48X	11.50"D, Painted/Heavy Gauge	APB4496P	
			16.25"D, Std Gauge	APB4496D	
			16.25"D, Painted/Heavy Gauge	APB4496DP	



Publications and Reference: See Section 22 for a complete list of additional product-related publications

Panelboards

Spectra® Series Panelboards

Replacement Boxes and Fronts
Order from the Customer Service Center

Type APB NEMA 3R and 12 Enclosures

Width	Depth	Height	Interior X-Height ¹	Product Number ²
27"	14.25"	65"	18X	APB(D,R)276518(B,T)
			23X	APB(D,R)276523(B,T)
			28X	APB(D,R)276528(B,T)
		75"	28X	APB(D,R)277528(B,T)
			33X	APB(D,R)278933(B,T)
			38X	APB(D,R)278938(B,T)
31"	14.25"	65"	18X	APB(D,R)316518(B,T)
			23X	APB(D,R)316523(B,T)
			28X	APB(D,R)316528(B,T)
		75"	23X	APB(D,R)317523E(B,T)
			23X GF	APB(D,R)317523E(B,T)
			28X	APB(D,R)317528(B,T)
89"	33X	APB(D,R)318933(B,T)		
	38X	APB(D,R)318938(B,T)		
	36"	16.25"	65"	18X
23X				APB(D,R)366523E(B,T)
28X				APB(D,R)366528(B,T)
75"			23X	APB(D,R)367523E(B,T)
			23X DM	APB(D,R)367523E(B,T)
			28X	APB(D,R)367528(B,T)
89"	33X	APB(D,R)368933(B,T)		
	38X	APB(D,R)368938(B,T)		
	40"	14.25"	65"	18X
23X				APB(D,R)406523(B,T)
23X				APB(D,R)407523E(B,T)
75"			23X DM	APB(D,R)407523E(B,T)
			28X	APB(D,R)407528(B,T)
			44"	16.25"
23X	APB(D,R)446523(B,T)			
23X	APB(D,R)447523(B,T)			
75"	23X DM	APB(D,R)447523E(B,T)		
	28X	APB(D,R)447528(B,T)		

¹GF = Ground Fault
DM = Dual Main, Ground Fault, 200% Neutral
²(D,R) D = NEMA 12
R = NEMA 3R
(B,T) B = Bottom Feed
T = Top Feed

200% Neutral

Provides second neutral assembly of equal amperage rating.

List Price Each, GO-101

250A	400A	600A	800A	1200A
\$865.00	\$965.00	\$1195.00	\$1527.00	\$1820.00

Compression Lugs

Main Lugs, Neutral Lugs and Fusible Switches

The standard sizes and number of mechanical lugs are shown on page 9-11. List price addition per lug:

Description	List Price Each GO-101	Description	List Price Each GO-101
#12 1/0	\$20.00	500 kcmil	\$59.00
2/0-300 kcmil	\$39.00	600-750 kcmil	\$81.00



Accessories

Optional Fuse Clips

UL Class	Amp Rating	Availability
H	30-600	No Charge-Specify on order
J	30-600	No Charge-Specify on order
K	30-600	No Charge-Specify on order

ADS Fusible Switches (Available in Plug-in only)

Remove Dual and Feed-thru Lugs (added to main lugs) Adder for space only

X-height	List Price Adder GO-101
1	\$28.00
2	\$56.00
3	\$83.00
4	\$111.00
5	\$139.00
6	\$167.00
7	\$194.00
8	\$223.00
10	\$278.00
19	\$527.00

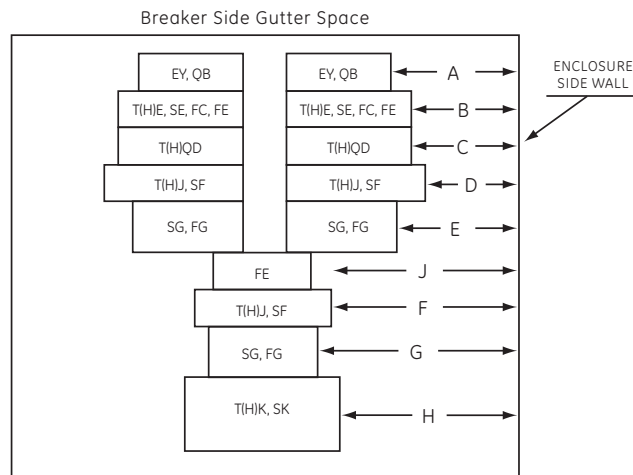

Letter Reference	Enclosure Width				
	27	31	36	40	44
A	7.88	9.88	12.38	14.38	16.38
B	5.75	7.75	10.25	12.25	14.25
C	5.63	7.63	10.13	12.13	14.13
D	N/A	5.50	8	10	12
E	N/A	N/A	6.38	8.38	10.38
F	8.88	10.88	13.38	15.38	17.38
G	8.13	10.13	12.63	14.63	16.63
H	N/A	N/A	N/A	12.63	14.63
J	Breaker not available at time of printing				

ALL DIMENSIONS ARE FROM FACE OF LUG, SHOWN IN INCHES AND ± .250 Single mounted devices as branch or main

Breakers are arranged, as a standard and if not specified, with largest and highest amperage closest to main incoming and the smallest, lowest amperage furthest from the main incoming. The spaces, if any, will follow after the breakers. All main breakers are mounted horizontally and incoming lugs are, as a standard and if not specified, always oriented to the left gutter regardless if top or bottom feed. If 2 or more large branch breakers (SK, SG single mounted) are supplied with the board then the factory will start the first breaker with the lugs to the right and the second breaker with lugs to left and will continue staggering them until all have been installed. If any further clarification is needed, please contact your local GE representative.



Publications and Reference: See Section 22 for a complete list of additional product-related publications

Panelboards

Spectra® Series Panelboards

Renewal Parts

Modular Concept

Order all components from Customer Service Center

Fig. 1.1 is a front view of a typical Spectra® Series fusible panelboard.

Fig. 1.2 is also a front view, but with the front (4 pc trim), all fusible switches, and all filler plates removed.

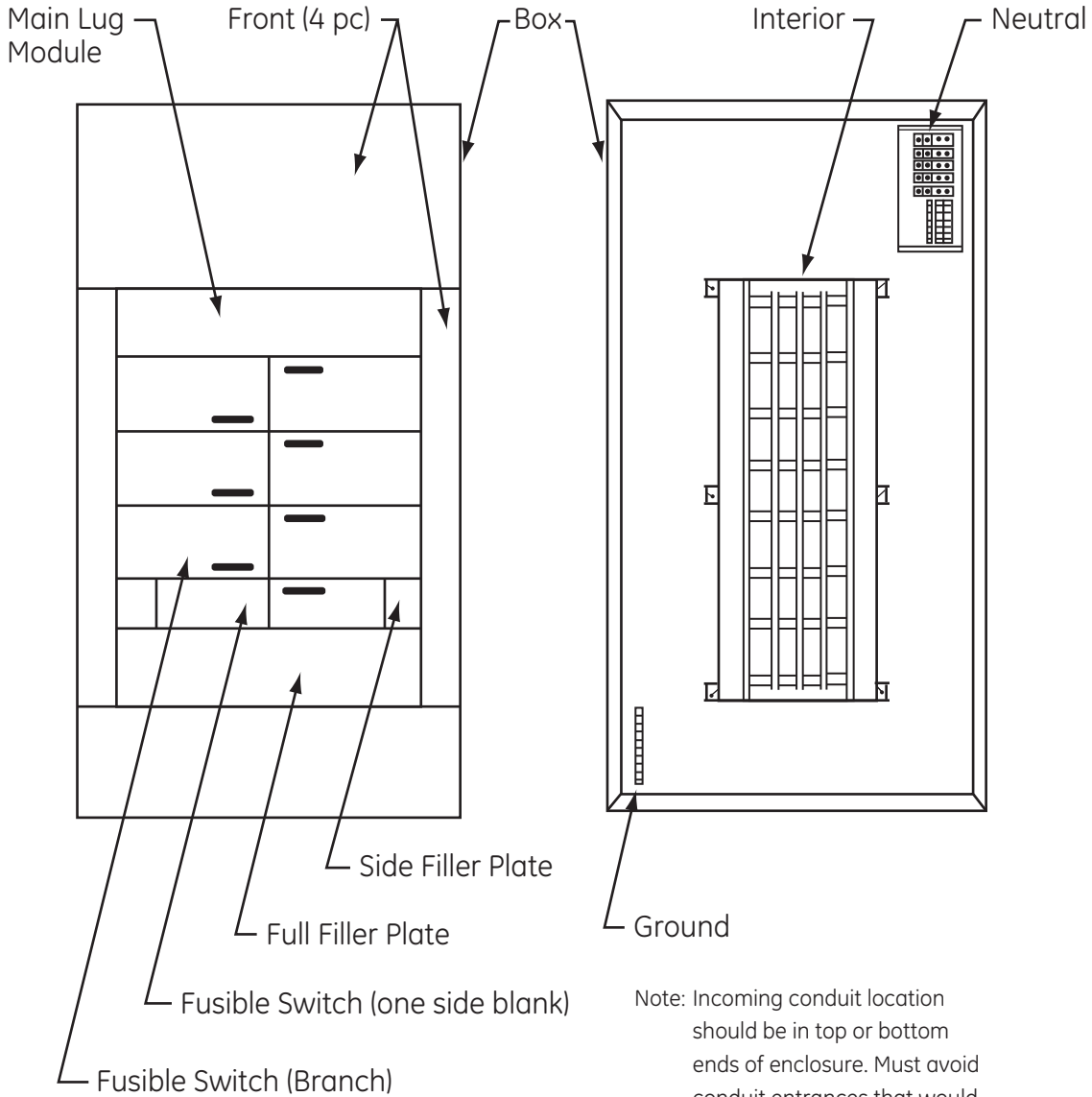

Fig. 1.1

Fig. 1.2



Panelboards

Spectra® Series Panelboards

Renewal Parts

Circuit Breaker Sizing

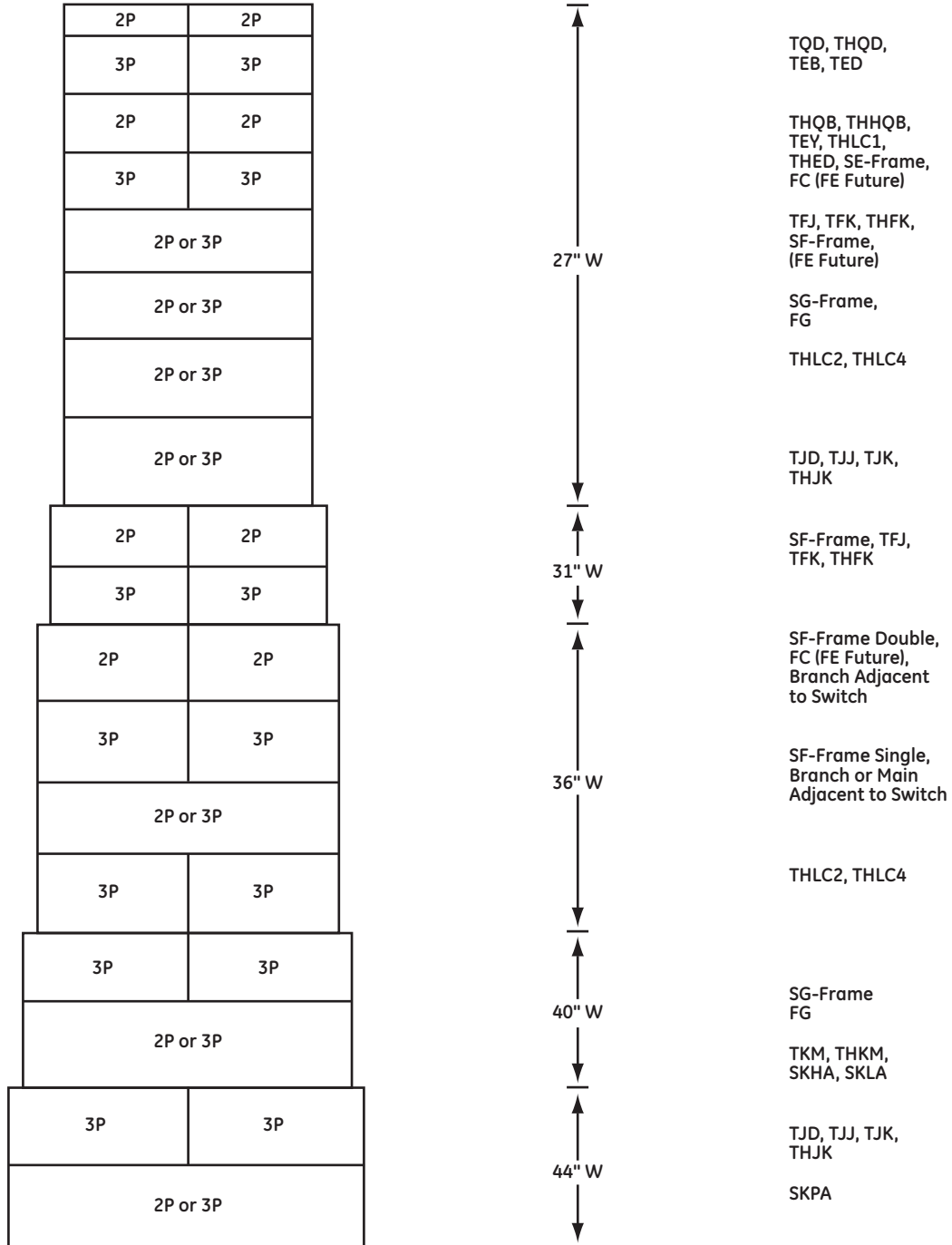

Publications and Reference: See Section 22 for a complete list of additional product-related publications

Panelboard Interior – Type APN

Example:	APN	38	06	U	B4
		"X" Hgt of Interior	Ampere Rating	Interior Type	Modification Code
		18 = 18X 23 = 23X 28 = 28X 33 = 33X 38 = 38X 43 = 43X 48 = 48X 53 = 53X	02 = 200A 04 = 400A 06 = 600A 08 = 800A 12 = 1200A	U = Unassembled	Blank = Standard (Aluminum Bus) B4 = Copper Bus (100A/sq in.)

Panelboard Interior – Type APNB

Example:	APNB	38	06	U	B4
		"X" Hgt of Interior	Ampere Rating	Interior Type	Modification Code
		18 = 18X 23 = 23X 28 = 28X 33 = 33X 38 = 38X 43 = 43X 48 = 48X 53 = 53X	02 = 200A 04 = 400A 06 = 600A 08 = 800A 12 = 1200A	U = Unassembled	Blank = Standard (Aluminum Bus) B4 = Copper Bus (100A/sq in.)

Panelboard Box – Type APB

Example:	APB	36	89	
		Box Width	Box Height	Modification Code
		27 = 27" 36 = 36" 44 = 44"	65 = 65" 75 = 75" 89 = 89" 96 = 96"	Blank = Any box except APB2765 A = For APB2765 with 18X interior B = For APB2765 with 23X interior C = For APB2765 with 28X interior

Panelboard Front – Type APF

Example:	APF	89	38	
		Box Height	"X" Hgt of Interior	Modification Code
		65 = 65" 75 = 75" 89 = 89" 96 = 96"	18 = 18X 23 = 23X 28 = 28X 33 = 33X 38 = 38X 43 = 43X 48 = 48X 53 = 53X	Blank = For Std Box (36" wide) S = For Slim Box (27" wide) W = For Wide Box (44" wide) E = Extra Line Gutter Space for Dual Main Neutral N = Nonvented Front (for 250A only)



Panelboards

Spectra® Series Panelboards

Renewal Parts

Product Number Structure (Continued)

Main Lug Module – Type AMB

Example:	AMB	3	600	S	FP
		No. of Poles	Ampere Rating	Modification Code	Accessory Code
		3 = 3 poles	250 = 200A 400 = 400A 600 = 600A 800 = 800A 120 = 1200A	Blank = 6X Module with Mech Lugs S = 4X Module with Mech Lugs C = 6X Module with Compression Lugs D = Dual Main Lug	FP = With Filler Plate Kit (cover plates) MA = Mechanical Al/Cu Rated

Disconnect Switches – Type ADS

Example:	ADS	3	6	200	H	D	FP
		No. of Poles	Voltage Rating	Ampere Rating	Fuse Type	Unit Type	Accessory Code
		2 = 2 poles 3 = 3 poles	2 = 240V 6 = 600V	030 = 30A 060 = 60A 100 = 100A 200 = 200A 400 = 400A 600 = 600A 800 = 800A 120 = 1200A	H = Class H, R, or K T = Class T J = Class J L = Class L	D = Double Unit with 2 switches S = Single Switch in a Double Unit B = Single Branch Unit M = Main Switch K = Expansion Kit (switch only . . . no module)	FP = With Filler Plate Kit (side fillers)

Circuit Breaker Mounting Modules – Type AMC

Example:	AMC	6	EB	S	FP
		No. of Total CB Poles on Module	Breaker Frames	Unit Type	Accessory Code
		6 = 6 poles (3-pole breakers, double branched) 4 = 4 poles (2-pole breakers, double branched) 3 = 3 poles (3-pole breakers, single branched) 2 = 2 poles (2-pole breakers, single branched)	QB = THQB, THHQB EY = TEY EB = TEB, TED, THED, SED, SEH, SEL, SEP FDB = FC FEB = FE Future FJ = TFJ, TFK, THFK, TFL, SFH, SFL, SFP JK = TJD, TJJ, TJK, THJK, TJ4V, TJL4V LB = TLB4, THLC2, THLC4 GB or GM = SGD, SGH, SGL, SGP FGB = FG KM = TKM, THKM, TK4V, TKL4V, SKH, SKL, SKP FB = FB	Blank = Std. S = Special Type to allow TFL, SE and SF to be mounted adjacent to a switch	FP = With Filler Plate Kit (full width plates with cutouts for handles, etc.)



Publications and Reference: See Section 22 for a complete list of additional product-related publications

Panelboards

Spectra® Series Panelboards

Renewal Parts

Product Number Structure (Continued)

Section 9

Bolt-on Strap Kits – Type AMCB

Example:	AMCB	6	EB	B	FP
		<u>Poles</u>	<u>C/B Frame</u>	<u>Mounting</u>	<u>Accessory Code</u>
		2	EB = SE, TEB, T(H)ED	Blank = Main or Branch	FP = With Filler
		3	EY = TEY	B = Branch Only	Plate Kit
		4	FDB = FC	M = Main Only	(full width
		6	FE = FEB Future		plates with
			FJ = SF		cutouts for
			G = SG		handles, etc)
			FG = FGB		
			K = SK, T(H)KM		
			LB = THLC2,4		
			QD = T(H)QD		
			SE = SE, THED		

Neutral Kits – Type ANK

Example:	ANK	800	D
		<u>Ampere Rating</u>	<u>Modification Code</u>
		250 = 250A	Blank = Std (single main)
		400 = 400A	D = Dual Main
		600 = 600A	GF = Ground Fault Only
		800 = 800A	
		100 = 1000A	
		120 = 1200A	

Equipment Ground Kits – Type AEG

Example:	AEG	21	S
		<u>No. of Circuits</u>	<u>Modification Code</u>
		10	Blank = Std (bonded)
		21	S = Insulated/Isolated
		31	

NEMA 1 Box Extensions - Type APB¹

Example:	APB	27	E
		<u>Width</u>	<u>Extension Depth</u>
		27	E = 12H, 11.5D, 31/36/40/44W
		31	12H, 14.25D, 27W
		36	ED = 12H, 14.25D, 31/40W
		40	12H, 16.25D, 36/44W
		44	ES = 12H, 11.5D, 27W

¹Note: Available in SPEEDI under "EXT" code on modifications screen. Also available by product number through ONE STOP.



Panelboards

Spectra® Series Panelboards

Renewal Parts

Mounting Hardware
Order from the Customer Service Center

Product Features

- Use to mount main or branch circuit breakers into panelboard. Breakers bolt on to the mounting modules.
- FP suffix indicates that all AFP filler plates, with cutouts for handles, are included to fit all applicable box widths. On double branch modules, filler plates to cover any unused breaker poles are also included.
- Circuit breakers not included in module price.
- Includes all necessary hardware.

Circuit Breaker Mounting Modules Plug-In Spectra® 3-pole

Mounting Arrangement	Maximum Breaker Amperage	Breaker Frame	X Height	Filler Plate Kit Product Number	Box Width Range	Product Number	List Price GO-139C
Double Branch	100	THQB or THHQB	3X	AFP3QBD	27", 31", 36" 40", 44"	AMC6QBFP	\$263.00
Double Branch	100	TEY	3X	AFP3EYD	27", 31", 36" 40", 44"	AMC6EYFP	\$263.00
Double Branch	100	FCS, FCV, FCN, FCH or FCL	3X	AFP3FDD	27", 31", 36", 40", 44"	AMC6FDBFP	\$263.00
Double Branch	150	TEB, TED, THED, SEDA, SEHA, SELA or SEPA	3X	AFP3SED	27", 31", 36" 40", 44"	AMC6EBFP	\$263.00
Double Branch	225	TQD or THQD	3X	AFP3QDD	27", 31", 36" 40", 44"	AMC6QDFP	\$263.00
Double Branch	225	TFJ or TFK or THFK	3X	AFP3TFD	31", 36", 40", 44"	AMC6FJFPTF	\$649.00
Double Branch	250	SFHA or SFLA or SFPA	3X	AFP3SFD	31", 36", 40" 44"	AMC6FJFP1	\$649.00
Double Branch	400	TJD or TJJ	6X	AFP6TJD	44"	AMC6JKFP	\$1234.00
Double Branch	600	TJK or THJK	6X	AFP6TJD	44"	AMC6JKFP	\$1234.00
Double Branch	600	FGL, FGN, FGH or FGP	4X	AFP4FGD	40", 44"	AMC6FGBFP	\$1234.00
Double Branch	600	SGDA or SGHA or SGLA or SGPA	4X	AFP4SGD	40", 44"	AMC6GBFP2	\$1234.00
Double Branch Adjacent to Switch	100	FCS, FCV, FCN, FCH or FCL	4X	AFP4FDD	36", 44"	AMC6FDSFP	\$263.00
Double Branch Adjacent to Switch	150	SEDA or SEHA or SELA or SEPA	4X	AFP4SED	36", 44"	AMC6EBSFP	\$263.00
Double Branch Adjacent to Switch	250	SFHA or SFLA or SFPA	4X	AFP4SFD	36", 44"	AMC6FLSFP	\$772.00
Single Branch or Main	225	TFJ or TFK or THFK	3X	AFP3TFS	27", 31", 36", 40", 44"	AMC3FJFPTF	\$649.00
Single Branch or Main	250	SFHA or SFLA or SFPA	3X	AFP3SFS	27", 31", 36", 40", 44"	AMC3FJFP1	\$649.00
Single Branch or Main	400	TJD or TJJ	6X	AFP6TJS	27", 31", 36", 40", 44"	AMC3JKFP	\$1234.00
Single Branch or Main	600	TJK or THJK	6X	AFP6TJS	27", 31", 36", 40", 44"	AMC3JKFP	\$1234.00
Single Branch or Main	600	FGV, FGN, FGH or FGP	4X	AFP4FGS	27", 31", 36", 40", 44"	AMC3FGMFP	\$1234.00
Single Branch or Main	600	SGDA or SGHA or SGLA or SGPA	4X	AFP4SGS	27", 31", 36", 40", 44"	AMC3GMFP	\$1234.00
Single Branch or Main	1200	TKM or THKM or SKHA or SKLA	6X	AFP6SKS	40", 44"	AMC3KMFP	\$1545.00
Single Branch or Main	1200	SKPA	6X	AFP6SKS	44"	AMC3KMFP	\$1545.00
Single Branch or Main Adjacent to Switch	250	SFHA or SFLA or SFPA	4X	AFP4SFS	36", 44"	AMC3FLSFP	\$772.00

Circuit Breaker Mounting Modules Plug-In Spectra® 2-pole

Mounting Arrangement	Maximum Breaker Amperage	Breaker Frame	X Height	Filler Plate Kit Product Number	Box Width Range	Product Number	List Price GO-139C
Double Branch	100	THQB or THHQB	3X	AFP3QBD	27", 31", 36" 40", 44"	AMC6QBFP	\$263.00
Double Branch	100	TEY	3X	AFP3EYD	27", 31", 36" 40", 44"	AMC6EYFP	\$263.00
Double Branch	100	FCS, FCV, FCN, FCH or FCL	3X	AFP3FDD	27", 31", 36", 40", 44"	AMC4FDBFP	\$263.00
Double Branch	150	TEB or TED	3X	AFP2TED	27", 31", 36" 40", 44"	AMC4EBFP	\$263.00
Double Branch	150	SEDA or SEHA or SELA or SEPA, THED	3X	AFP3SED	27", 31", 36" 40", 44"	AMC4SEFP	\$263.00
Double Branch	225	TQD or THQD	2X	AFP2QDD	27", 31", 36" 40", 44"	AMC4QDFP	\$263.00
Double Branch	225	TFJ or TFK or THFK	3X	AFP3TFD	31", 36", 40", 44"	AMC4FJFPTF	\$649.00
Double Branch	250	SFHA or SFLA or SFPA	3X	AFP3SFD	31", 36", 40" 44"	AMC4FJFP1	\$649.00
Double Branch	400	TJD or TJJ	6X	AFP6TJD	44"	AMC4JKFP	\$1234.00
Double Branch	600	TJK or THJK	6X	AFP6TJD	44"	AMC4JKFP	\$1234.00
Double Branch	600	FGV, FGN, FGH or FGP	4X	AFP4FGD	40", 44"	AMC4FGBFP	\$1234.00
Double Branch	600	SGDA or SGHA or SGLA or SGPA	4X	AFP4SGD	40", 44"	AMC4GBFP2	\$1234.00
Double Branch Adjacent to Switch	100	FCS, FCV, FCN, FCH or FCL	4X	AFP4FDD	36", 44"	AMC4FDSFP	\$263.00
Double Branch Adjacent to Switch	150	SEDA or SEHA or SELA or SEPA	4X	AFP4SED	36", 44"	AMC4EBSFP	\$263.00
Double Branch Adjacent to Switch	250	SFHA or SFLA or SFPA	4X	AFP4SFD	36", 44"	AMC4FLSFP	\$772.00
Single Branch or Main	225	TFJ or TFK or THFK	3X	AFP3TFS	27", 31", 36", 40", 44"	AMC2FJFPTF	\$649.00
Single Branch or Main	250	SFHA or SFLA or SFPA	3X	AFP3SFS	27", 31", 36", 40", 44"	AMC2FJFP1	\$649.00
Single Branch or Main	400	TJD or TJJ	6X	AFP6TJS	27", 31", 36", 40", 44"	AMC2JKFP	\$1254.90
Single Branch or Main	600	TJK or THJK	6X	AFP6TJS	27", 31", 36", 40", 44"	AMC2JKFP	\$1254.90
Single Branch or Main	600	FGV, FGN, FGH or FGP	4X	AFP4FGS	27", 31", 36", 40", 44"	AMC2FGMFP	\$1234.00
Single Branch or Main	600	SGDA or SGHA or SGLA or SGPA	4X	AFP4SGS	27", 31", 36", 40", 44"	AMC2GMFP	\$1234.00
Single Branch or Main	1200	TKM or THKM or SKHA or SKLA	6X	AFP6SKS	40", 44"	AMC2KMFP	\$1545.00
Single Branch or Main	1200	SKPA	6X	AFP6SKS	44"	AMC2KMFP	\$1545.00
Single Branch or Main Adjacent to Switch	250	SFHA or SFLA or SFPA	4X	AFP4SFS	36", 44"	AMC2FLSFP	\$772.00

¹SE and SF breakers located adjacent to a fusible switch, PCU or TVSS require mounting modules suitable for mounting "Adjacent to Switch."

SGDA circuit breaker rated 400 amps maximum.

²THLC 1/2/4 breaker no longer available.

Note: 1X = 1 3/8" vertical panel space.



Publications and Reference: See Section 22 for a complete list of additional product-related publications

Panelboards

Spectra® Series Panelboards

Renewal Parts

Mounting Hardware

Order from the Customer Service Center

Product Features

- Module includes fusible switch and panelboard mounting connectors. Fuses not included.
- Class R Fuse Clip Kit (for field installation) included with all switches that accept Class R Fuses.
- FP suffix indicates that all AFP filler plates are included to fit applicable box widths.

Branch Switch Modules Plug-In Spectra® 240 Volts 3-pole

Mounting Arrangement	Fuse Type	Switch Amperes	X Height	Side Filler Plate Kit Part Number	Box Width Range	Product Number	List Price GO-139B
Double Branch-2 switches	H, R, or K	30	4X	AFP4X	36", 44"	ADS32030HDFP	\$572.00
Double Branch-2 switches	H, R, or K	60	4X	AFP4X	36", 44"	ADS32060HDFP	\$572.00
Double Branch-2 switches	H, R, or K	100	5X	AFP5X	36", 44"	ADS32100HDFP	\$772.00
Double Branch-2 switches	T	100	7X	AFP7T	36", 44"	ADS32100TDFP	\$729.00
Double Branch-2 switches	H, R, or K	200	7X	AFP7X2	44"	ADS32200HDFP	\$1832.00
Double Branch-2 switches	T	200	7X	AFP7T	36", 44"	ADS32200TDFP	\$1832.00
Double Branch-switch plus space	H, R, or K	30	4X	AFP4X	36", 44"	ADS32030HSFP	\$286.00
Double Branch-switch plus space	H, R, or K	60	4X	AFP4X	36", 44"	ADS32060HSFP	\$286.00
Double Branch-switch plus space	H, R, or K	100	5X	AFP5X	36", 44"	ADS32100HSFP	\$386.00
Single Branch	H, R, or K	200	7X	AFP7X	36", 44"	ADS32200HBFP	\$916.00
Single Branch	H, R, or K	400	10X	AFP10X	44"	ADS32400HBFP	\$2035.00
Single Branch	T	400	10X	AFP10T	36", 44"	ADS32400TBFP	\$2084.00
Single Branch	H, R, or K	600	10X	AFP10X	44"	ADS32600HBFP	\$2841.00
Single Branch	T	600	10X	AFP10T	36", 44"	ADS32600TBFP	\$2854.00

Branch Switch Modules Plug-In Spectra® 240 Volts 2-pole

Mounting Arrangement	Fuse Type	Switch Amperes	X Height	Side Filler Plate Kit Part Number	Box Width Range	Product Number	List Price GO-139B
Double Branch-2 switches	H, R, or K	30	4X	AFP4X	36", 44"	ADS22030HDFP	\$462.00
Double Branch-2 switches	H, R, or K	60	4X	AFP4X	36", 44"	ADS22060HDFP	\$462.00
Double Branch-2 switches	T	100	7X	AFP7T	36", 44"	ADS32100TDFP	\$729.00
Double Branch-2 switches	H, R, or K	100	5X	AFP5X	36", 44"	ADS22100HDFP	\$649.00
Double Branch-2 switches	H, R, or K	200	7X	AFP7X2	44"	ADS22200HDFP	\$1414.00
Double Branch-2 switches	T	200	7X	AFP7T	36", 44"	ADS22200TD	\$1365.00
Double Branch-switch plus space	H, R, or K	30	4X	AFP4X	36", 44"	ADS22030HSFP	\$231.00
Double Branch-switch plus space	H, R, or K	60	4X	AFP4X	36", 44"	ADS22060HSFP	\$202.00
Double Branch-switch plus space	H, R, or K	100	5X	AFP5X	36", 44"	ADS22100HSFP	\$324.00
Single Branch	H, R, or K	200	7X	AFP7X	36", 44"	ADS22200HBFP	\$683.00
Single Branch	T	200	7X	AFP7X	36", 44"	ADS22200TS	\$683.00
Single Branch	H, R, or K	400	10X	AFP10X	44"	ADS22400HBFP	\$1427.00
Single Branch	T	400	10X	AFP10T	36", 44"	ADS22400TBFP	\$1433.00
Single Branch	H, R, or K	600	10X	AFP10X	44"	ADS22600HBFP	\$2355.00
Single Branch	T	600	10X	AFP10T	36", 44"	ADS22600TBFP	\$2201.00

Note: 1X = 1 3/8" vertical panel space



Panelboards

Spectra® Series Panelboards

Renewal Parts

Mounting Hardware
Order from the Customer Service Center

Product Features

- Module includes fusible switch and panelboard mounting connectors. Fuses not included.
- Class R Fuse Clip Kit (for field installation) included with all switches that accept Class R Fuses.
- FP suffix indicates that all AFP filler plates are included to fit applicable box widths.

Branch Switch Modules Plug-In Spectra® 600 Volts 3-pole

Mounting Arrangement	Fuse Type	Switch Amperes	X Height	Side Filler Plate Kit Part Number	Box Width Range	Product Number	List Price GO-1398
Double Branch-2 switches	H, R, J, or K	30	4X	AFP4X	36", 44"	ADS36030HDFP	\$738.00
Double Branch-2 switches	H, R, J, or K	60	5X	AFP5X	36", 44"	ADS36060HDFP	\$738.00
Double Branch-2 switches	H, R, J, or K	100	5X	AFP5X	36", 44"	ADS36100HDFP	\$1111.00
Double Branch-2 switches	H, R, or K	200	7X	AFP7X2	44"	ADS36200HDFP	\$2319.00
Double Branch-2 switches	J	200	7X	AFP7T	36", 44"	ADS36200JDFP	\$2319.00
Double Branch-switch plus space	H, R, J, or K	30	4X	AFP4X	36", 44"	ADS36030HSFP	\$369.00
Double Branch-switch plus space	H, R, J, or K	60	5X	AFP5X	36", 44"	ADS36060HSFP	\$369.00
Double Branch-switch plus space	H, R, J, or K	100	5X	AFP5X	36", 44"	ADS36100HSFP	\$555.00
Single Branch	H, R, or K	200	7X	AFP7X	36", 44"	ADS36200HBFP	\$1160.00
Single Branch	H, R, or K	400	10X	AFP10X	44"	ADS36400HBFP	\$2639.00
Single Branch	J	400	10X	AFP10T	36", 44"	ADS36400JBFP	\$2639.00
Single Branch	T	400	10X	AFP10T	36", 44"	ADS36400TBFP	\$2639.00
Single Branch	H, R, or K	600	10X	AFP10X	44"	ADS36600HBFP	\$3112.00
Single Branch	J	600	10X	AFP10T	36", 44"	ADS36600JBFP	\$3125.00
Single Branch	T	600	10X	AFP10T	36", 44"	ADS36600TBFP	\$3125.00
Single Branch	L	800	19X	AFP19X	44"	ADS36800LBFP	\$5149.00
Single Branch	L	1200	19X	AFP19X	44"	ADS36120LBFP	\$5514.00

Branch Switch Modules Plug-In Spectra® 600 Volts 2-pole

Mounting Arrangement	Fuse Type	Switch Amperes	X Height	Side Filler Plate Kit Part Number	Box Width Range	Product Number	List Price GO-1398
Double Branch-2 switches	H, R, J, or K	30	4X	AFP4X	36", 44"	ADS26030HDFP	\$636.00
Double Branch-2 switches	H, R, J, or K	60	5X	AFP5X	36", 44"	ADS26060HDFP	\$636.00
Double Branch-2 switches	H, R, J, or K	100	5X	AFP5X	36", 44"	ADS26100HDFP	\$895.00
Double Branch-2 switches	T	100	7X		N/A	ADS26100TDFP	\$871.00
Double Branch-2 switches	H, R, or K	200	7X	AFP7X2	44"	ADS26200HDFP	\$1950.00
Double Branch-2 switches	J	200	7X	AFP7T	36", 44"	ADS26200JDFP	\$2319.00
Double Branch-switch plus space	H, R, J, or K	30	4X	AFP4X	36", 44"	ADS26030HSFP	\$318.00
Double Branch-switch plus space	H, R, J, or K	60	5X	AFP5X	36", 44"	ADS26060HSFP	\$318.00
Double Branch-switch plus space	H, R, J, or K	100	5X	AFP5X	36", 44"	ADS26100HSFP	\$447.00
Single Branch	H, R, or K	200	7X	AFP7X	36", 44"	ADS26200HBFP	\$895.00
Single Branch	J	200	7X	AFP7X	36"	ADS26200JSFP	\$1789.00
Single Branch	H, R, or K	400	10X	AFP10X	44"	ADS26400HBFP	\$2025.00
Single Branch	J	400	10X	AFP10T	36", 44"	ADS26400JBFP	\$1963.00
Single Branch	T	400	10X	AFP10T	36", 44"	ADS26400TBFP	\$1963.00
Single Branch	H, R, or K	600	10X	AFP10X	44"	ADS26600HBFP	\$2701.00
Single Branch	J	600	10X	AFP10T	36", 44"	ADS26600JBFP	\$2483.00
Single Branch	T	600	10X	AFP10T	36", 44"	ADS26600TBFP	\$2483.00
Single Branch	L	800	19X	AFP19X	44"	ADS26800LBFP	\$4217.00
Single Branch	L	1200	19X	AFP19X	44"	ADS26120LBFP	\$4590.00

Note: 1X = 1 3/8" vertical space



Publications and Reference: See Section 22 for a complete list of additional product-related publications

Panelboards

Spectra® Series Panelboards

Renewal Parts

Mounting Hardware

Order from the Customer Service Center

Mounting Hardware With Filler Plate, Straps and Brackets Bolt-On Spectra®

Mounting kit with filler plate includes hardware straps, brackets and filler plate.

Filler plate kit includes filler plate and associated hardware only.

Mounting Arrangement	Breaker Frame	Number of Poles	Box Width Range	X Height	Product Number	List Price GO-134B
Dual Mounted	TEB, TED	2-pole	27"-44"	2X	AMCB4EBFP	\$263.00
Dual Mounted	TEY	2-pole	27"-44"	3X	AMCB4EYFP	\$263.00
Dual Mounted	FCS, FCV, FCN, FCH or FCL	2-pole	27", 31", 36", 40", 44"	3X	AMCB4FDBFP	\$263.00
Dual Mounted	TQD, THQD	2-pole	27"-44"	2X	AMCB4QDFP	\$263.00
Dual Mounted	THED, SED, SEH, SEL, SEP	2-pole	27"-44"	3X	AMCB4SEFP	\$263.00
Dual Mounted	TEB, TED, THED, SED, SEH, SEL, SEP	3-pole	27"-44"	3X	AMCB6EBFP	\$263.00
Dual Mounted	TEY	3-pole	27"-44"	3X	AMCB6EYFP	\$263.00
Dual Mounted	FCS, FCV, FCN, FCH or FCL	3-pole	27", 31", 36", 40", 44"	3X	AMCB6FDBFP	\$263.00
Dual Mounted	TQD, THQD	3-pole	27"-44"	3X	AMCB6QDFP	\$263.00
Dual Mounted	SFH, SFL, SFP	2-pole	31"-44"	3X	AMCB4FJFP	\$649.00
Dual Mounted	SFH, SFL, SFP	3-pole	31"-44"	3X	AMCB6FJFP	\$649.00
Dual Mounted	TFJ, TFK, THFK	2-pole	36"-44"	2X	AMCB4FJFPTF	\$649.00
Dual Mounted	TFJ, TFK, THFK	3-pole	36"-44"	3X	AMCB6FJFPTF	\$649.00
Dual Mounted	FGV, FGN, FGH or FGP	2-pole	40", 44"	4X	AMCB4FGBFP	\$1234.00
Dual Mounted	SGH, SGL, SGP	2-pole	40"-44"	4X	AMCB4GGBFP	\$1234.00
Dual Mounted	FGV, FGN, FGH or FGP	3-pole	40", 44"	4X	AMCB6FGBFP	\$1234.00
Dual Mounted	SGH, SGL, SGP	3-pole	40"-44"	4X	AMCB6GGBFP	\$1234.00
Single Mounted	SFH, SFL, SFP	2-pole	27"-44"	3X	AMCB2FJFP	\$649.00
Single Mounted	TFJ, TFK, THFK	2-pole	27"-44"	3X	AMCB2FJFPTF	\$649.00
Single Mounted	FGV, FGN, FGH or FGP	2-pole	27", 31", 36", 40", 44"	4X	AMCB2FGMFP	\$1234.00
Single Mounted	SGH, SGL, SGP	2-pole	27"-44"	4X	AMCB2GMFP	\$1234.00
Single Mounted	SFH, SFL, SFP	3-pole	27"-44"	3X	AMCB3FJFP	\$649.00
Single Mounted	TFJ, TFK, THFK	3-pole	27"-44"	3X	AMCB3FJFPTF	\$649.00
Single Mounted	FGV, FGN, FGH or FGP	3-pole	27", 31", 36", 40", 44"	4X	AMCB3FGMFP	\$1234.00
Single Mounted	SGH, SGL, SGP	3-pole	27"-44"	4X	AMCB3GMFP	\$1234.00
Single Mounted	SKP	2-pole	27"-44"	6X	AMCB3LBFP	\$772.00
Single Mounted	SKH, SKL, SKP, TKM, THKM	2-pole	40"-44"	6X	AMCB2KMFP	\$1545.00
Single Mounted	SKH, SKL, SKP, TKM, THKM	3-pole	40"-44"	6X	AMCB3KMFP	\$1545.00

Filler Plates Bolt-On Spectra®

Filler plate kit includes filler plate and associated hardware only.

Mounting Arrangement	Breaker Frame	Number of Poles	Box Width Range	X Height	Product Number	List Price GO-139C
Dual Mounted	TQD, THQD	2-pole	27"-44"	2X	AFP2QDD	\$55.00
Dual Mounted	TEB, TED	2-pole	27"-44"	2X	AFP2TED	\$55.00
Dual Mounted	TEY	2-, 3-pole	27"-44"	3X	AFP3EYD	\$55.00
Dual Mounted	TQD, THQD	3-pole	27"-44"	3X	AFP3QDD	\$55.00
Dual Mounted	TEB, TED, THED, SED, SEH, SEL, SEP	2-, 3-pole	27"-44"	3X	AFP3SED	\$55.00
Dual Mounted	SFH, SFL, SFP	2-, 3-pole	31"-44"	3X	AFP3SFD	\$55.00
Dual Mounted	TFJ, TFK, THFK	2-, 3-pole	36"-44"	2X, 3X	AFP3TFD	\$55.00
Dual Mounted	FGV, FGN, FGH or FGP	3-pole	40", 44"	4X	AFP4FGD	\$55.00
Dual Mounted	SGH, SGL, SGP	2-, 3-pole	40"-44"	4X	AFP4SGD	\$55.00
Single Mounted	SFH, SFL, SFP	2-, 3-pole	27"-44"	3X	AFP3SFS	\$55.00
Single Mounted	TFJ, TFK, THFK	2-, 3-pole	27"-44"	3X	AFP3TFS	\$55.00
Single Mounted	FGV, FGN, FGH or FGP	2-, 3-pole	27", 31", 36", 40", 44"	4X	AFP4FGS	\$55.00
Single Mounted	SGH, SGL, SGP	2-, 3-pole	27"-44"	4X	AFP4SGS	\$55.00
Single Mounted	SKP	2-pole	27"-44"	6X	AFP5LCS	\$55.00
Single Mounted	SKP, SKH, SKL, TKM, THKM	3-pole	44"-44"	6X	AFP6SKS	\$55.00

Notes: 1X = 1 3/8" vertical space. THLC 1/2/4 breaker no longer available.



Panelboards

Spectra® Series Panelboards

Renewal Parts

Order from the Customer Service Center

Filler Plates Plug-In or Bolt-On Spectra®

Use to cover unused spaces.
Includes filler plate support brackets and hardware.

Space X Height ¹	Box Width Range	Switchboard Section Widths	Product Number	List Price GO-103C
1X	27", 31"	35	APP1S	\$61.50
2X	27", 31"	35	APP2S	\$61.50
3X	27", 31"	35	APP3S	\$61.50
4X	27", 31"	35	APP4S	\$61.50
5X	27", 31"	35	APP5S	\$61.50
6X	27", 31"	35	APP6S	\$61.50
1X	36", 40"	40	APP1	\$61.50
2X	36", 40"	40	APP2	\$61.50
3X	36", 40"	40	APP3	\$61.50
4X	36", 40"	40	APP4	\$61.50
5X	36", 40"	40	APP5	\$61.50
6X	36", 40"	40	APP6	\$61.50
1X	44"	45	APP1W	\$61.50
2X	44"	45	APP2W	\$61.50
3X	44"	45	APP3W	\$61.50
4X	44"	45	APP4W	\$61.50
5X	44"	45	APP5W	\$61.50
6X	44"	45	APP6W	\$61.50

¹ X-height: 1X = 1 3/8"

Mounting Hardware Plug-In or Bolt-On Spectra® ADS Switch Replacement Load Base Kits

Includes load base, clips and lugs.

Replacement for Load Base Part Number	Load Base Ampere Rating	Load Base - No. of Poles	Load Base Voltage	Product Number	List Price GO-139B
ADS22030HD	-	-	-	331A1519G1	\$67.00
ADS32030HD	-	-	-	331A1519G2	\$92.00
ADS322060HD	-	-	-	331A1519G3	\$65.00
ADS32060HD	-	-	-	331A1519G4	\$92.00
ADS26030HD	-	-	-	331A1519G5	\$65.00
ADS36030HD	-	-	-	331A1519G6	\$92.00
ADS26060HD	-	-	-	331A1519G7	\$101.00
ADS36060HD	-	-	-	331A1519G8	\$223.00
ADS36200JD	-	-	-	331A1519G12	\$398.00
ADS26200JD	-	-	-	331A1519G16	\$271.00
ADS36200JM	-	-	-	331A1519G20	\$396.00
ADS26200JM	-	-	-	331A1519G22	\$271.00
-	100A	2-pole	240V & 600V	331A1519G9	\$83.00
-	100A	3-pole	240V & 600V	331A1519G10	\$196.00
-	100A	3-pole	240V & 600V	331A1519G14	\$101.00
-	100A	2-pole	240V & 600V	331A1519G18	\$74.00
-	200A	3-pole	240V & 600V	331A1519G11	\$112.00
-	200A	2-pole	240V & 600V	331A1519G13	\$105.00
-	200A	2-pole	240V & 600V	331A1519G15	\$80.50
-	200A	2-pole	240V & 600V	331A1519G17	\$76.00
-	200A	3-pole	240V & 600V	331A1519G19	\$112.00
-	200A	2-pole	240V & 600V	331A1519G21	\$80.50
-	400A	2-pole	240V & 600V	331A1545G1	\$227.00
-	400A	3-pole	240V & 600V	331A1545G3	\$366.00
-	400A	2-pole	240V & 600V	331A1545G5	\$569.00
-	400A	3-pole	240V & 600V	331A1545G7	\$569.00
-	600A	2-pole	240V & 600V	331A1545G2	\$229.00
-	600A	3-pole	240V & 600V	331A1545G4	\$370.00
-	600A	2-pole	240V & 600V	331A1545G6	\$850.00
-	600A	3-pole	240V & 600V	331A1545G8	\$850.00
-	400-1200A	-	-	331A1543G1	\$103.00

Mounting Hardware Single Breaker Plug-In Spectra®

Included when ordering AMC module. Only required when mounting breaker on existing module.
Kit contains screws and washers to mount one circuit breaker on AMC circuit breaker mounting module.

Circuit Breaker Mounting Module Part Number	Product Number	List Price GO-139C
AMC6EB	AHKE1	\$3.00
AMC4SE		
AMC4EB		
AMC6EBS		
AMC6EL	AHKEL1	\$3.00
AMC2FLS	AHKF1	\$3.00
AMC6FJ		
AMC4FJ		
AMC3FJ		
AMC2FJ		
AMC6FLS		
AMC3FLS		
AMC4FLS		
AMC2GM	AHKG1	\$8.00
AMC6GB		
AMC4GB		
AMC3GM		
AMC2JK	AHKJ1	\$8.00
AMC6JK		
AMC4JK		
AMC3JK		
AMC3LB	AHKL1	\$4.00
AMC6LB		
AMC4QD	AHKQ1	\$3.00
AMC6QD		
FCS, FCV, FCN, FCH or FCL	AHKFD1	\$3.00
FGV, FGN, FGH or FGP	AHKFG1	\$8.00

Mounting Hardware—Hardware only; no brackets or straps Bolt-On Spectra®

Breaker Frame	Product Number	List Price GO-134B
SE	AHKBE1	\$38.00
SF	AHKBF1	\$38.00
SG	AHKBG1	\$38.00
THQD	AHKBQ1	\$38.00
FCS, FCV, FCN, FCH or FCL	AHKBFD1	\$38.00
FGV, FGN, FGH or FGP	AHKBFG1	\$38.00



Publications and Reference: See Section 22 for a complete list of additional product-related publications

Panelboards

Spectra® Series Panelboards

Renewal Parts

Main Lug Modules; Neutral and Ground Kits
Plug-In or Bolt-On

Lug Kits and Modules Plug-In Spectra®

- FP suffix indicates all AFPML cover plates included to fit applicable box widths.
- Can be converted to dual main lug version by adding lug kits (see Accessories).
- Mechanical lug modules can be converted to compression lug modules by replacing standard lugs with AMKP compression lug kit (see Accessories)
- Can be used for feed-thru lugs application by replacing standard cover plate with AFL feed-thru lug cover plate kit (see Accessories).

Lug Ampere Rating	Lug Type	X Height	Lugs Per Phase	Wires per Lug	Wire Range (Cu/Al)	Included Cover Plate	Box Width Range	Product Number	List Price GO-103C
250	Mechanical	4X	1	1	#6-350kcmil	AFPML4X	27",36"	AML3250SFP ¹	\$657.00
250	Mechanical	6X	1	1	#6-350kcmil	AFPML6X	36"	AML3250FP	\$657.00
400	Mechanical	4X	1	2	#2-500kcmil	AFPML4X	27",36",44"	AML3400SFP ¹	\$933.00
400	Mechanical	6X	1	2	#2-500kcmil	AFPML6X	36",44"	AML3400FP	\$933.00
600	Mechanical	4X	1	2	#2-500kcmil	AFPML4X	27",36",44"	AML3600SFP ¹	\$1227.00
600	Mechanical	6X	1	2	#2-500kcmil	AFPML6X	36",44"	AML3600FP	\$1227.00
800	Mechanical	6X	2	2	#2-500kcmil	AFPML6XW	36",44"	AML3800FP	\$1514.00
1200	Mechanical	6X	2	2	#2-500kcmil	AFPML6XW	36",44"	AML3120FP	\$2092.00
250	Compression	6X	2	1	350kcmil	AFPML6X	36"	AML3250CFP	\$657.00
400	Compression	6X	2	1	500kcmil	AFPML6X	36",44"	AML3400CFP	\$933.00
600	Compression	6X	2	1	500kcmil	AFPML6X	36",44"	AML3600CFP	\$1227.00
800	Compression	6X	4	1	500kcmil	AFPML6XW	36",44"	AML3800CFP	\$1514.00
1200	Compression	6X	4	1	500kcmil	AFPML6XW	36",44"	AML3120CFP	\$2092.00

¹4X modules cannot be converted to compression lug version.

Lug Kits and Modules Plug-In or Bolt-On Spectra®—Neutral

- Includes mechanical lugs and bonding strap.
- 250 to 600A neutral kits can be converted to dual main version by doubling the main lug quantity using lug kits (see Accessories).
- Main lug on neutral kit can be converted to compression main using AMKP lug kit.

Lug Amp Rating	No. of Main Lugs	No. of Wires	Wire Range (Cu/Al)	Product Number	List Price GO-103C
Bolt-On 250/400	Single/Dual	2 (MAIN)	#2 - 600kcmil	ANKN400	\$237.00
		16	#14 - 2/0		
		5	#6 - 300kcmil		
		24	#14 - #4		
600/800/1200	Single/Dual	8 (MAIN)	#2 - 600kcmil	ANKN120	\$555.00
		9	#14 - 2/0		
		10	#6 - 300kcmil		
		10	#14 - #4		
Plug-In 800	Dual	8 (MAIN)	#2 - 500kcmil	ANK800D	\$664.00
		8	#14 - 2/0		
		10	#6 - 300kcmil		
		4	#2 - 500kcmil		
1200	Dual	8 (MAIN)	#2 - 500kcmil	ANK120D	\$757.00
		8	#14 - 2/0		
		10	#6 - 300kcmil		
		4	#2 - 500kcmil		

For 3ph, 4W single-section panelboards, use a standard neutral.

For 3ph, 4W multi-section panelboards, use a standard neutral on the last section, and a dual main neutral on the first and middle sections.

Lug Kits and Modules Plug-In or Bolt-On Spectra®—Ground

- AEG10 and AEG21 should be ordered in multiples of 10 due to 10 kits per carton bulk-packaging.
- AEG21S and AEG31S are packaged as quantity 1 kit per carton.

Bonding Type	Total Circuits	No. of Wires	Wire Range (Cu/Al)	Product Number	List Price GO-103C
Bonded	10	10	#6-2/0 Cu/Al	AEG10	\$172.00
Bonded	21	9	Solid: #14-#8 Cu or #12-#8 Al or Stranded: #12-#8 Cu or #12-#8 Al or Stranded: #10-#4 Cu or #10-#4 Al	AEG21	\$92.00
Insulated/isolated	21	9	Solid: #14-#8 Cu or #12-#8 Al or Stranded: #12-#8 Cu or #12-#8 Al or Stranded: #10-#4 Cu or #10-#4 Al	AEG21S	\$331.00
Insulated/isolated	31	10	#6-2/0 Cu/Al	AEG31S	\$331.00



Panelboards

Spectra® Series Panelboards

Merchandise

Renewal Parts
Accessories

Feed Thru Lug Cover Plate Kits

- Use to convert AML main lug module to feed thru lug module
- Kit includes barrier and oversized cover plates.
(Discard original cover plates.)

Lug Amp Rating	X Height	Box Width Range	Product Number	List Price GO-103C
250/400/600	9X	27", 36", 44"	AFL600	\$507.00
800/1200	12X	36", 44"	AFL120	\$863.00

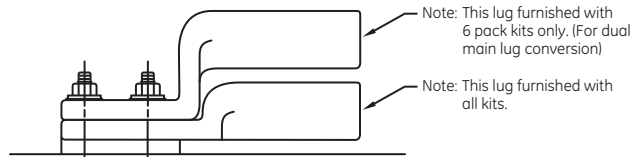

Crimp Lugs

Mechanical Lug Kits and Modules

- Use to convert AML main mechanical lug modules or ANK neutral modules to dual main lug version.
- Can be used to replace standard lugs with oversized lugs.

Wire Range (Cu/Al)	Lugs Per Kit	Wires per Lug	Product Number	List Price GO-139C
#6-350kcmil	3	1	AMK350	\$116.00
#2-500kcmil	3	2	AMK500	\$179.00
#2-600kcmil	3	2	AMK600	\$179.00
3/0-750kcmil	3	2	AMK750	\$208.00

Compression Lug Kits

- Use to replace standard load-side mechanical lugs on ADS branch switches.
- Each kit includes 3 lugs.

Wire Range	Lugs Per Phase	For Switch Amperes	Product Number	List Price GO-139B
#8-1/0 Cu/Al	1	30, 60, or 100	KLP101	\$135.00
#4-300kcmil Cu/Al	1	200	KLP300	\$225.00
2/0-500kcmil Cu/Al	2, 4	800 or 1200	KLP500	\$435.00
400-600kcmil Cu/Al or 400-500kcmil Cu	2, 4	800 or 1200	KLP600	\$564.00
500-750kcmil Al or 750kcmil Cu	2, 4	800 or 1200	KLP750	\$564.00

Compression Lug Kits and Modules

Use to convert AML main mechanical lug modules to compression lug version.

Wire Size	Package Type	Crimp Tool Die Cat. No. Homac	Crimp Tool Die Cat. No. Burndy	Crimp Tool Die Cat. No. T&B	Product Number	List Price GO-139C
1/0	3 PACK	15CA52	296	50	AMKP101	\$71.00
1/0	6 PACK	15CA52	296	50	AMKP2101	\$143.00
2/0	3 PACK	15CA52	297	54H	AMKP202	\$71.00
2/0	6 PACK	15CA52	297	54H	AMKP2202	\$143.00
3/0	3 PACK	15CA66	467	60	AMKP303	\$71.00
3/0	6 PACK	15CA66	467	60	AMKP2303	\$143.00
4/0	3 PACK	15CA71H	298	66	AMKP404	\$71.00
4/0	6 PACK	15CA71H	298	66	AMKP2404	\$143.00
250kcmil	3 PACK	15CA76	324	71H	AMKP250	\$88.00
250kcmil	6 PACK	15CA76	324	71H	AMKP2250	\$176.00
300kcmil	3 PACK	15CA87H 15C87	470	76	AMKP300	\$103.00
300kcmil	6 PACK	15CA87H 15C87	470	76	AMKP2300	\$206.00
350kcmil	3 PACK	15CA96H 15C96H	299	87H	AMKP350	\$116.00
350kcmil	6 PACK	15CA96H 15C96H	299	87H	AMKP2350	\$232.00
400kcmil	3 PACK	15CA96H 15C96H	472	94H	AMKP400	\$116.00
400kcmil	6 PACK	15CA96H 15C96H	472	94H	AMKP2400	\$232.00
500kcmil	3 PACK	15CA106A 15C106R	300	99H	AMKP500	\$179.00
500kcmil	6 PACK	15CA106A 15C106R	300	99H	AMKP2500	\$358.00
600kcmil	3 PACK	15CA115H 15C115H	473	106H	AMKP600	\$179.00
600kcmil	6 PACK	15CA115H 15C115H	473	106H	AMKP2600	\$358.00
700/750 kcmil	3 PACK	15C125H	936	115H	AMKP750	\$208.00
700/750 kcmil	6 PACK	15C125H	936	115H	AMKP2750	\$416.00

Notes: For dual main applications, double the kit quantity.

Permanent Circuit Number Tabs

For Circuit Numbers	Product Number	List Price GO-139C
1-49	APN49	\$111.00
1-99	APN99	\$222.00



Publications and Reference: See Section 22 for a complete list of additional product-related publications

Panelboards

Spectra® Series Panelboards

Merchandise

Renewal Parts
 Interiors, Boxes and Fronts
 Order from Customer Service Center

Product Features

- In selecting an interior X-height, add up all required main and branch module X-heights, plus any required spaces for future.
- UL Service Entrance label is included on all interiors.

Boxes

Panel Current Rating (amperes)	Space X Height	Box Width/Depth	Box Height (inches)	Product Number	List Price GO-103B
250, 400	18	27" W x 14.5" D	64.63	APB2765A	\$112.00
250	28	27" W x 14.5" D	64.63	APB2765C	\$112.00
250, 400, 600	38	27" W x 14.5" D	89.25	APB2789	\$152.00
400	28	27" W x 14.5" D	75.5	APB2775	\$130.00
600	23	27" W x 14.5" D	64.63	APB2765B	\$112.00
250, 400, 600	18, 28	36" W x 11.5" D	64.63	APB3665	\$165.00
400, 800, 1200	28	36" W x 11.5" D	75.5	APB3675	\$180.00
250, 400, 600, 800, 1200	38	36" W x 11.5" D	89.25	APB3689	\$204.00
250, 400, 600, 800, 1200	43, 48	36" W x 11.5" D	96.13	APB3696	\$215.00
400, 600	18, 23	44" W x 11.5" D	64.63	APB4465	\$183.00
400, 800, 1200	23, 28	44" W x 11.5" D	75.5	APB4475	\$204.00
400, 600, 800, 1200	38	44" W x 11.5" D	89.25	APB4489	\$227.00
400, 600, 800, 1200	43, 48	44" W x 11.5" D	96.13	APB4496	\$241.00

Front w/Door

Panel Current Rating (amperes)	Space X Height	Box Width/Depth	Box Height (inches)	Product Number	List Price GO-103B
250	18	27" W x 14.5" D	64.63	APF6518NS	\$197.00
250	28	27" W x 14.5" D	64.63	APF6528NS	\$197.00
250	38	27" W x 14.5" D	89.25	APF8938NS	\$316.00
400	18	27" W x 14.5" D	64.63	APF6518S	\$197.00
400	28	27" W x 14.5" D	75.5	APF7528S	\$278.00
600	23	27" W x 14.5" D	64.63	APF6523S	\$197.00
600	38	27" W x 14.5" D	89.25	APF8938S	\$316.00

4-pc Fronts

Panel Current Rating (amperes)	Space X Height	Box Width/Depth	Box Height (inches)	Product Number	List Price GO-103B
250	18	36" W x 11.5" D	64.63	APF6518N	\$237.00
250	28	36" W x 11.5" D	64.63	APF6528N	\$237.00
250	38	36" W x 11.5" D	89.25	APF8938N	\$447.00
250	53	36" W x 11.5" D	96.13	APF9653N	\$481.00
400	18	36" W x 11.5" D	64.63	APF6518	\$237.00
400, 800, 1200	28	36" W x 11.5" D	75.5	APF7528	\$329.00
400, 600, 800, 1200	38	36" W x 11.5" D	89.25	APF8938	\$447.00
600	23	36" W x 11.5" D	64.63	APF6523	\$237.00
400, 600, 800, 1200	48	36" W x 11.5" D	96.13	APF9648	\$481.00
800	23	36" W x 11.5" D	75.5	APF7523	\$329.00
800, 1200	43	36" W x 11.5" D	96.13	APF9643	\$481.00
400	18	44" W x 11.5" D	64.63	APF6518W	\$371.00
600	23	44" W x 11.5" D	64.63	APF6523W	\$371.00
800	23	44" W x 11.5" D	75.5	APF7523W	\$428.00
400, 1200	28	44" W x 11.5" D	75.5	APF7528W	\$428.00
400, 600, 800, 1200	38	44" W x 11.5" D	89.25	APF8938W	\$522.00
800, 1200	43	44" W x 11.5" D	96.13	APF9643W	\$564.00
400, 600	48	44" W x 11.5" D	96.13	APF9648W	\$564.00

Interior Aluminum

Panel Current Rating (amperes)	Space X Height	Product Number	List Price GO-103B
250	18	APN1802U	\$481.00
250	28	APN2802U	\$750.00
250	38	APN3802U	\$1018.00
250	53	APN5302U	\$1420.00
400	18	APN1804U	\$536.00
400	28	APN2804U	\$840.00
400	38	APN3804U	\$1136.00
400	48	APN4804U	\$1437.00
600	23	APN2306U	\$761.00
600	38	APN3806U	\$1259.00
600	48	APN4806U	\$1588.00
800	23	APN2308U	\$835.00
800	38	APN3808U	\$1439.00
800	43	APN4308U	\$1556.00
1200	28	APN2812U	\$1105.00
1200	38	APN3812U	\$1499.00
1200	43	APN4312U	\$1694.00

Interior Copper

Panel Current Rating (amperes)	Space X Height	Product Number	List Price GO-103B
250	18	APN1802UB4	\$835.00
250	28	APN2802UB4	\$1105.00
250	38	APN3802UB4	\$1370.00
250	53	APN5302UB4	\$1774.00
400	18	APN1804UB4	\$1126.00
400	28	APN2804UB4	\$1425.00
400	38	APN3804UB4	\$1724.00
400	48	APN4804UB4	\$2025.00
600	23	APN2306UB4	\$1554.00
600	38	APN3806UB4	\$2052.00
600	48	APN4806UB4	\$2383.00
800	23	APN2308UB4	\$1872.00
800	38	APN3808UB4	\$2415.00
800	43	APN4308UB4	\$2476.00
1200	28	APN2812UB4	\$2671.00
1200	38	APN3812UB4	\$3063.00
1200	43	APN4312UB4	\$3258.00



Panelboards

Spectra® Series Panelboards

Type SCP Plus

Renewal Parts

Enclosure Options, Mounting Hardware and Spare Parts

Order through the Customer Service Center unless stated otherwise below.

GE Fastrac Program items are indicated in red

Boxes

Box Width/Depth	X Height	Box Height (inches)	Product Number	List Price GO-101
31"W x 11.5"D	15	49.375	ACB311149	\$454.00
31"W x 11.5"D	18	53.5	ACB311153	\$489.00
31"W x 11.5"D	21	57.625	ACB311157	\$539.00
31"W x 11.5"D	24	61.75	ACB311161	\$700.00
31"W x 11.5"D	27	65.875	ACB311165	\$780.00
31"W x 11.5"D	30	70	ACB311170	\$846.00
31"W x 11.5"D	33	74.125	ACB311174	\$890.00
31"W x 11.5"D	36	78.25	ACB311178	\$942.00
31"W x 11.5"D	39	82.275	ACB311182	\$992.00
31"W x 11.5"D	42	86.5	ACB311186	\$1051.00
40"W x 11.5"D	15	49.375	ACB401149	\$466.00
40"W x 11.5"D	18	53.5	ACB401153	\$490.00
40"W x 11.5"D	21	57.625	ACB401157	\$700.00
40"W x 11.5"D	24	61.75	ACB401161	\$746.00
40"W x 11.5"D	27	65.875	ACB401165	\$785.00
40"W x 11.5"D	30	70	ACB401170	\$824.00
40"W x 11.5"D	33	74.125	ACB401174	\$886.00
40"W x 11.5"D	36	78.25	ACB401178	\$934.00
40"W x 11.5"D	39	82.275	ACB401182	\$965.00
40"W x 11.5"D	42	86.5	ACB401186	\$1003.00

Box dimensions are inside dimensions. Add 1/4-inch for outside dimensions.
Boxes furnished with no knockouts.

Fronts

Box Width/Depth	X Height	Box Height (inches)	Product Number	List Price GO-101
31"W x 11.5"D	15	49.375	ACF3149S	\$298.00
31"W x 11.5"D	18	53.5	ACF3153S	\$336.00
31"W x 11.5"D	21	57.625	ACF3157S	\$360.00
31"W x 11.5"D	24	61.75	ACF3161S	\$466.00
31"W x 11.5"D	27	65.875	ACF3165S	\$509.00
31"W x 11.5"D	30	70	ACF3170S	\$553.00
31"W x 11.5"D	33	74.125	ACF3174S	\$597.00
31"W x 11.5"D	36	78.25	ACF3178S	\$634.00
31"W x 11.5"D	39	82.275	ACF3182S	\$666.00
31"W x 11.5"D	42	86.5	ACF3186S	\$709.00
40"W x 11.5"D	15	49.375	ACF4049S	\$336.00
40"W x 11.5"D	18	53.5	ACF4053S	\$373.00
40"W x 11.5"D	21	57.625	ACF4057S	\$416.00
40"W x 11.5"D	24	61.75	ACF4061S	\$529.00
40"W x 11.5"D	27	65.875	ACF4065S	\$628.00
40"W x 11.5"D	30	70	ACF4070S	\$647.00
40"W x 11.5"D	33	74.125	ACF4074S	\$678.00
40"W x 11.5"D	36	78.25	ACF4078S	\$734.00
40"W x 11.5"D	39	82.275	ACF4082S	\$760.00
40"W x 11.5"D	42	86.5	ACF4086S	\$802.00

Flush fronts (F) are 2 inches larger than box. Surface fronts (S) are 1/4-inch larger than box.

Note: If filler plates for SCP+ panels are required, please contact Houston equipment plant.

Note: THLC 1/2/4 breaker no longer available.

Mounting Hardware—Hardware Kit and Straps

Mounting Arrangement	Breaker Frame	Maximum Breaker Amperage	Breaker Number of Poles	Product Number	List Price GO-134B
Dual Mounted	SHE, SEL, SED, SEP	150A		ACTMKSE	\$663.00
Dual Mounted	TEB, TED, THED	150A	single-pole	ACTMKEB1P	\$330.00
Dual Mounted	TEB, TED, THED	150A	two-pole	ACTMKEB2P	\$663.00
Dual Mounted	TEB, TED, THED	150A	three-pole	ACTMKEB3P	\$663.00
Dual Mounted	TFK, SFH, SFL, SFP	250A		ACTMKSF	\$1270.00
Dual Mounted	TQD, THQD	225A	two-pole	ACTMKQD2P	\$1041.00
Dual Mounted	TQD, THQD	225A	three-pole	ACTMKQD3P	\$1041.00
Dual Mounted	TJD, TJJ, TJK	400A		ACTMKJD	\$1815.00
Dual Mounted	SGD, SGH, SGL, SGP	400A, 600A		ACTMKSG	\$2170.00
Single Mounted	SGD, SGH, SGL, SGP	400A, 800A		ACSMKSG	\$2170.00
Single Mounted	SKH, SKL	800A, 1200A		ACSMKSK	\$4286.00
Single Mounted	TB4	400A		ACSMKTB4	\$4246.00
Single Mounted	TB6	600A		ACSMKTB6	\$3391.00
Single Mounted	TB8	800A		ACSMKTB8	\$4946.00

Mounting Hardware—Filler Plate and Filler Hardware

Mounting Arrangement	Breaker Frame	Maximum Breaker Amperage	Breaker Number of Poles	Product Number	List Price GO-134B
Dual Mounted	SHE, SEL, SED, SEP	150A		ACTFPKSE	\$143.00
Dual Mounted	TEB, TED, THED	150A	single-pole	ACTFPKEB1P	\$143.00
Dual Mounted	TEB, TED, THED	150A	two-pole	ACTFPKEB2P	\$143.00
Dual Mounted	TEB, TED, THED	150A	three-pole	ACTFPKEB3P	\$143.00
Dual Mounted	TFK, SFH, SFL, SFP	250A		ACTFPKSF	\$143.00
Dual Mounted	TQD, THQD	225A	two-pole	ACTFPKQD2P	\$143.00
Dual Mounted	TQD, THQD	225A	three-pole	ACTFPKQD3P	\$143.00
Dual Mounted	TJD, TJJ, TJK	400A		ACTFPKJD	\$143.00
Dual Mounted	SGD, SGH, SGL, SGP	400A, 600A		ACTFPKSG	\$143.00
Single Mounted	SGD, SGH, SGL, SGP	400A, 800A		ACSFPKSG	\$143.00
Single Mounted	SKH, SKL	800A, 1200A		ACSFPKSK	\$143.00
Single Mounted	TB4	400A		ACSFPKTB4	\$143.00

Mounting Hardware—Hardware to Mount One Breaker

Mounting Arrangement	Breaker Frame	Maximum Breaker Amperage	Breaker Number of Poles	Product Number	List Price GO-134B
Dual Mounted	SHE, SEL, SED, SEP	150A		ACTHKSE	\$84.00
Dual Mounted	TEB, TED, THED	150A	single-pole	ACTHKEB1P	\$84.00
Dual Mounted	TEB, TED, THED	150A	two-pole	ACTHKEB2P	\$84.00
Dual Mounted	TEB, TED, THED	150A	three-pole	ACTHKEB3P	\$84.00
Dual Mounted	TFK, SFH, SFL, SFP	250A		ACTHKSF	\$84.00
Dual Mounted	TQD, THQD	225A	two-pole	ACTHKQD2P	\$84.00
Dual Mounted	TQD, THQD	225A	three-pole	ACTHKQD3P	\$84.00
Dual Mounted	TJD, TJJ, TJK	400A		ACTHKJD	\$84.00
Dual Mounted	SGD, SGH, SGL, SGP	400A, 600A		ACTHKSG	\$84.00
Single Mounted	SGD, SGH, SGL, SGP	400A, 800A		ACSHKSG	\$84.00
Single Mounted	SKH, SKL	800A, 1200A		ACSHKSK	\$84.00
Single Mounted	TB4	400A		ACSHKTB4	\$84.00



Publications and Reference: See Section 22 for a complete list of additional product-related publications

Panelboards

Spectra® Series Panelboards

Power

Section 9

Renewal Parts

Type CCB and QMR Panelboards

Order through the Customer Service Center unless stated otherwise below.

GE Fastrac Program items are indicated in red

Mounting Hardware—Copper Straps for Use on Cu or Al Main Bus Dual Mounted

Breaker Frame	Kit Ampere Rating	Product Number	List Price GO-134B
TEB/TED	150A	TED1DPK	\$663.00
TFJ/TFK/TFL	225A	TF2DPK	\$1270.00
TQD	225A	TQ2DPK	\$1041.00
TJD/TJJ/TJK	400A	TJ4DPK	\$1815.00
TJK	600A	TJ6DPK	\$2170.00
THJ4V/TJL4V	600A	THJV6DPK	\$5080.00
TLB1/THLC1	150A	THLC1DPK	\$2075.00
TEL	150A	TEL1DPK	\$1917.00
TB1	150A	TB1DPK	\$1747.00
SFH/SFL	225A	SF2DPK1.2	\$1070.00

¹If mounting hardware exists – must order SFCARE @ \$30.00 List Price, GO-148F for additional insulators.

²225A Maximum

Mounting Hardware—Copper Straps for Use on Cu or Al Main Bus Single Mounted

Breaker Frame	Kit Ampere Rating	Product Number	List Price GO-134B
TKM8/THKM8	800A	TK8SPK ³	\$3028.00
TK4V/THK4V/TKL4V	1200A	TKL12SPK ⁴	\$5685.00
TB1	100A	TB1SPK ³	\$1747.00
TB4	400A	TB4SPK	\$2926.00
TB6	600A	TB6SPK ³	\$3391.00
TB8	800A	TB8SPK ³	\$4946.00
TKM12/THKM12	1200A	TK12SPK ^{3,4}	\$5093.00
TJL1-6,S/TJH1-6S	600A	TJ9SPK	\$5080.00
TKL8, 12S/TKH8, 12,S	1200A	TK9SPK	\$5685.00
TLB1	150A	THLC1SPK	\$2075.00
TLB4	400A	THLC4SPK	\$3014.00
SKH8	800A	SK8SPK ³	\$4286.00
SKH12	1200A	SK12SPK ³	\$5685.00

³Deep mounted interior is required.

⁴Requires 7x of space if mounted at extreme end (top or bottom) of interior or 8x if mounted in center of interior.

Replacement Panelboard CCB Box⁵

Box Width/Depth	X Height	Box Height (inches)	Product Number	List Price GO-101
31" Wide x 9 1/2"	15X	49	DASW3121	\$359.00
Deep Box (No Knockouts)				
31" Wide x 9 1/2"	21X	57 5/8	DASW3127	\$436.00
Deep Box (No Knockouts)				
31" Wide x 9 1/2"	24X	61 3/4	DASW3130	\$480.00
Deep Box (No Knockouts)				
31" Wide x 9 1/2"	27X	65 7/8	DASW3133	\$659.00
Deep Box (No Knockouts)				
31" Wide x 9 1/2"	30X	70	DASW3136	\$667.00
Deep Box (No Knockouts)				
31" Wide x 9 1/2"	36X	78 1/4	DASW3142	\$787.00
Deep Box (No Knockouts)				
35" Wide x 11 1/2"	33X	74 1/8	DACB3539	\$890.00
Deep Box (No Knockouts)				
35" Wide x 11 1/2"	39X	82 3/8	DACB3545	\$992.00
Deep Box (No Knockouts)				
40" Wide x 11 1/2"	21X	57 5/8	DACB4027	\$770.00
Deep Box (No Knockouts)				
40" Wide x 11 1/2"	24X	61 3/4	DACB4030	\$821.00
Deep Box (No Knockouts)				
40" Wide x 11 1/2"	27X	65 7/8	DACB4033	\$864.00
Deep Box (No Knockouts)				
40" Wide x 11 1/2"	30X	70	DACB4036	\$907.00
Deep Box (No Knockouts)				
40" Wide x 11 1/2"	33X	74 1/8	DACB4039	\$975.00
Deep Box (No Knockouts)				
40" Wide x 11 1/2"	36X	78 1/4	DACB4042	\$1028.00
Deep Box (No Knockouts)				
40" Wide x 11 1/2"	39X	82 3/8	DACB4045	\$1062.00
Deep Box (No Knockouts)				
40" Wide x 11 1/2"	42X	86 1/2	DACB4048	\$1103.00
Deep Box (No Knockouts)				

⁵Use List Price when enclosure is ordered separately. Enclosure prices cannot be deducted from factory assembled list prices to obtain interior only pricing. Note: Box dimensions are inside dimensions. Add 1/4-inch for outside dimensions. Boxes furnished without knockouts as standard.



Panelboards

Spectra® Series Panelboards

Power

Renewal Parts

Type [CCB](#) and [QMR](#) Panelboards

Order through the Customer Service Center unless stated otherwise below.

GE Fastrac Program items are indicated in red

Replacement Panelboard CCB Front¹ (Flush or Surface)

Box Width/Depth	X Height	Box Height (inches)	Product Number ²	List Price GO-101
31" Wide x 9 1/2"	15X	49	CBA3121S,F	\$359.00
Deep Box (No Knockouts)				
31" Wide x 9 1/2"	18X	53 1/2	CBA3124S,F	\$410.00
Deep Box (No Knockouts)				
31" Wide x 9 1/2"	21X	57 5/8	CBA3127S,F	\$436.00
Deep Box (No Knockouts)				
31" Wide x 9 1/2"	24X	61 3/4	CBA3130S,F	\$489.00
Deep Box (No Knockouts)				
31" Wide x 9 1/2"	30X	70	CBA3136S,F	\$677.00
Deep Box (No Knockouts)				
31" Wide x 9 1/2"	42X	86 1/2	CBA3148S,F	\$735.00
Deep Box (No Knockouts)				
35" Wide x 11 1/2"	36X	78 1/4	CBA3542S,F	\$872.00
Deep Box (No Knockouts)				
40" Wide x 11 1/2"	21X	57 5/8	CBA4027S,F	\$572.00
Deep Box (No Knockouts)				
40" Wide x 11 1/2"	24X	61 3/4	CBA4030S,F	\$728.00
Deep Box (No Knockouts)				
40" Wide x 11 1/2"	30X	70	CBA4036S,F	\$890.00
Deep Box (No Knockouts)				
40" Wide x 11 1/2"	33X	74 1/8	CBA4039S,F	\$933.00
Deep Box (No Knockouts)				
40" Wide x 11 1/2"	36X	78 1/4	CBA4042S,F	\$1010.00
Deep Box (No Knockouts)				
40" Wide x 11 1/2"	39X	82 3/8	CBA4045S,F	\$1045.00
Deep Box (No Knockouts)				

¹Use List Price when enclosure is ordered separately. Enclosure prices cannot be deducted from factory assembled list prices to obtain interior only pricing.

²Flush fronts (F) are 2 inches larger than box. Surface fronts (S) are 1/4-inch larger than box.

QMR Mounting Hardware Kits Are Copper for Use with Cu or Al Main Bus Dual Mounted

Breaker Frame	Kit Ampere Rating	Voltage	Product Number	List Price GO-143
THFP	30-60A	240 & 600V	THFP62DPK	\$480.00
THFP	100A	600V	THFP63DPKJ	\$436.00
THFP	100A	240 & 600V	THFP63DPK	\$480.00
THFP	100-30/60	600V	THFP63DPKC	\$480.00

Note: QMR Power Panelboards 600V, 100A double branch units require a minimum width of 40". 600V, 30A and 60A double branch, and 240V, 30A, 60A and 100A single and double branch units can be built in a 35" wide enclosure.

QMR Mounting Hardware Kits Are Copper for Use with Cu or Al Main Bus Single Mounted

Breaker Frame	Kit Ampere Rating	Voltage	Product Number	List Price GO-143
THFP	30/60A	240V	THFP22SPK	\$302.00
THFP	30/60/100A	240V & 600V	THFP62SPK	\$480.00
THFP	100A	600V	THFP63SPK	\$480.00
THFP	200A	240 & 600V	THFP64SPK	\$988.00
THFP	400A	240 & 600V	THFP65SPK	\$1516.00
THFP	600A	240 & 600V	THFP66SPK	\$1624.00
THFP	1200A	240 & 600V	THFP67SPK	\$2728.00

Note: QMR Power Panelboards 600V, 100A double branch units require a minimum width of 40". 600V, 30A and 60A double branch, and 240V, 30A, 60A and 100A single and double branch units can be built in a 35" wide enclosure.

Filler Plates

Panel Type	X Height	Product Number	List Price GO-143
QMR	1X	QMRFP1	\$74.00
QMR	2X	QMRFP2	\$93.00
QMR	5X	QMRFP5	\$225.00
QMR	3X	75C145005G703	\$77.00
CCB	1X	CCBFP1	\$74.00
CCB	3X	CCBFP3	\$113.00
CCB	5X	CCBFP5	\$225.00
CCB	2X	75C145005G711	\$58.00
CCB	6X	75C145005G715	\$152.00
SCP+	1X	SCPPFP1	\$74.00
SCP+	2X	SCPPFP2	\$93.00
SCP+	3X	SCPPFP3	\$225.00
SCP+	5X	SCPPFP5	\$77.00

(Order from Local Sales Office or Equipment Plant)



Publications and Reference: See Section 22 for a complete list of additional product-related publications

Panelboards Spectra® Series Panelboards Power

Renewal Parts

Type CCB and QMR Panelboards

Order through the Customer Service Center unless stated otherwise below.

GE Fastrac Program items are indicated in red

QMR Fusible Switch 240V

Select Mounting Hardware¹ or Order as Complete Hole Filler Kit

Switch Amps	Number of Poles	Style	Product Number	List Price GO-143
30	2	3X Unit - Old Style	THFP221X	\$572.00
30	2	3X Left Hand Unit - Old Style	THFP221XL	\$572.00
30	3	Old Style	THFP321	\$693.00
30	3	Left Hand Unit - Old Style	THFP321L	\$693.00
30	3	3X Unit - Old Style	THFP321X	\$658.00
30	3	3X Left Hand Unit - Old Style	THFP321XL	\$658.00
60	2	3X Unit - Old Style	THFP222X	\$572.00
60	2	3X Left Hand Unit - Old Style	THFP222XL	\$572.00
60	3	Old Style	THFP322	\$649.00
100	2	Old Style	THFP223	\$674.00
100	2	Left Hand Unit - Old Style	THFP223L	\$674.00
100	2	3X Unit - Old Style	THFP223X	\$658.00
100	2	3X Left Hand Unit - Old Style	THFP223XL	\$658.00
100	3	Old Style	THFP323	\$722.00
200	2	Old Style	THFP224	\$1263.00
200	3	Old Style	THFP324	\$1582.00
400	2	Old Style	THFP225	\$3122.00
400	3	Old Style	THFP325	\$3551.00
600	2	Old Style	THFP226	\$3505.00
600	3	Old Style	THFP326	\$3945.00

¹Mounting Hardware is found on page 9-116.

QMR Fusible Switch 600V

Select Mounting Hardware¹ or Order as Complete Hole Filler Kit

Switch Amps	Number of Poles	Style	Product Number	List Price GO-143
30	2	Old Style	THFP261	\$775.00
30	2	Left Hand Unit - Old Style	THFP261L	\$775.00
30	3	Old Style	THFP361	\$795.00
30	3	Left Hand Unit - Old Style	THFP361L	\$795.00
60	2	Old Style	THFP262	\$693.00
60	2	Left Hand Unit - Old Style	THFP262L	\$775.00
60	3	Old Style	THFP362	\$795.00
60	3	Left Hand Unit - Old Style	THFP362L	\$795.00
100	2	Old Style	THFP263	\$964.00
100	2	Old Style	THFP263L	\$964.00
100	3	Old Style	THFP363	\$1008.00
100	3	Old Style	THFP363L	\$1008.00
200	3	Old Style	THFP364	\$1976.00
400	3	Old Style	THFP365	\$4777.00
600	3	Old Style	THFP366	\$4928.00
800	3	Old Style	THFP367	\$11350.00
1200	3	Old Style	THFP368	\$11810.00

¹Mounting Hardware is found on page 9-116.

Complete Hole Filler Kits

Ordering is easy for applications requiring both an overcurrent device and the associated mounting hardware. To order the device plus hardware, simply select the appropriate suffix from the table below and add it to the device product number.

For example, a requirement for a 100A 3-pole TED breaker and hardware for a CCB panel should be ordered as TED134100DPK:

Breaker/TED134100 + Suffix/DPK = Complete Unit Shipped/(1) TED134100 Circuit Breaker, (1) TED1DPK Hardware Kit

Device and Hardware Suffix Selection

Panelboard Lighting Type	Device Type		
	Twin (Double) Mount	Single Mount	TQD, TED, Panel Subfeed
CCB/QMR	DPK	SPK	—
Switchboards	DPK	SPK	—

To ensure a unit shipment, you must order using the device product number plus suffix; orders for the device and kit as separate items will ship as separate items.

Maximum Horsepower Ratings QMR Fusible Switch

Rating in Amperes ¹	Vac						Vdc		
	2-Pole		3-Pole		2-Pole		3-Pole		
	120	240	480	600	240	480	600	125	250
With Standard and Fuses (Class H)									
30	1/2	1 1/2	3	3	3	5	7 1/2	2	5
60	1 1/2	3	5	10	7 1/2	15	15	5	10
100	—	7 1/2	10	15	15	25	30	—	20
200	—	15	25	30	25	50	60	—	40
400	—	—	—	—	50	100	125	—	—
600	—	—	—	—	75	150	200	—	—
With "Time-delay" Fuses (Class H)									
30	2	5	10	15	10	20	20	3	—
60	3	10	20	25	20	40	50	5	—
100	—	15	30	40	30	60	75	—	—
200	—	30	50	50	60	125	150	—	—
400	—	—	—	—	125	250	350	—	—
600	—	—	—	—	200	400	500	—	—

¹Ratings are based on latest revision of the National Electric Code Article 430.

Horsepower ratings for switches with standard class H fuses are based on one-time fuses having minimum time-delay.

When time-delay fuses are used the horsepower ratings are maximum for the switches.

QMR Fusible Switch Terminations²

Switch Amperes	Voltage	Wire Range (Cu/Al)	Wires per Lug	Lugs per Phase
30	250/600	#14-10	1	1
60	250/600	#14-2	1	1
100	250/600	#10-1/0	1	1
200	250/600	#6-250kcmil or 2(1/0-250kcmil)	1	1
400	250/600	#6-250kcmil or 2(1/0-250kcmil)	1	1
600	250/600	250-350kcmil Cu or 350-500kcmil Al	2	2
800	250/600	#4-600kcmil	1	4
1000	250/600	#4-600kcmil	1	4

²For optional lugs refer to GEH-460B



Available Publications

Spectra® Series Power Panels Plug-In and Bolt-On

Circuit Breaker Mounting Instructions (Modules)	
TKM, THKM, TK4V, TKL4V, SKHA, SKLA, SKPA	GEH-5623
TJK, TJD, TJJ, THJK, TJ4V, THJ4V, TJL4V	GEH-5624
TEB, TED, THED, TEL, SEDA, SEHA, SELA, SEPA	GEH-5625
TFJ, TFK, THFK, TFL, SFHA, SFLA, SEPA	GEH-5626
TQD, THQD	GEH-5643
THLC1	GEH-5644
SGDA, SGHA, SGLA, SGPA (3 pole)	GEH-5673
SGDA, SGHA, SGLA, SGPA (2 pole)	GEH-5674
THLC2, THLC4, TLB4 (3 pole)	GEH-5675
THLC2, THLC4, TLB4 (2 pole)	GEH-5676
TEY, THQB, THHQB	GEH-5677
Circuit Breaker Mounting Hardware Kits	
TQD, THQD, SE TEB, TED, THED, THLC1, SF, TFJ, TFK, THFK, SG, TJK, THJK, TJD, TJJ, THLC2, THLC4	GEH-5913
Installing Lugs	
Type AML Main Lug Kits	GEH-5588
Type AML Feed Thru Main Lug Kits	GEH-5630
Installing Fusible Switches	
Fuse Pullers	DEH-034
Class R Fuse Rejector Kit	GEH-4616
R Fuse Rejection Pin, 400-600 Ampere Switch Units	GEH-5577
Lug Kits into GE Type ADS Switches	GEH-5944
Alternate Lugs, 30-1200 Ampere Fusible Switch Units	GEJ-3050
Installing Fusible Switch Expansion Kits	
30/60 Ampere Expansion Kit	GEH-5547
60A, 100A Expansion Kits for Type ADS Fusible Switch Units	GEH-5581
200 Ampere Expansion Kit (J, T Fuses)	GEH-5582
200 Ampere Expansion Kit (H, K, R Fuses)	GEH-5889
Handle and Load Base Replacements on Fusible Switches	
Handle Replacement: 400-1200 Ampere Switches	GEH-5553
Load Base Replacement for Type ADS 400-600 Ampere Switches	GEH-5576
Miscellaneous	
Typical - Fusible Mains and Feeders	DE-166
Technical Data, Spectra Series Panelboards - Pressure Locked Connectors	DE-168

Spectra® Series Plug-In (Only)

Circuit Breaker Mounting Instructions (Modules)	
TKM, THKM, TK4V, TKL4V, SKHA, SKLA, SKPA	GEH-5623
TJK, TJD, TJJ, THJK, TJ4V, THJ4V, TJL4V	GEH-5624
TEB, TED, THED, TEL, SEDA, SEHA, SELA, SEPA	GEH-5625
TFJ, TFK, THFK, TFL, SFHA, SFLA, SEPA	GEH-5626
TQD, THQD	GEH-5643
SGDA, SGHA, SGLA, SGPA (3 pole)	GEH-5673
SGDA, SGHA, SGLA, SGPA (2 pole)	GEH-5674
THLC2, THLC4, TLB4 (3 pole)	GEH-5675
Circuit Breaker Mounting Hardware Kits	
TQD, THQD, SE TEB, TED, THED, THLC1, SF, TFJ, TFK, THFK, SG, TJK, THJK, TJD, TJJ, THLC2, THLC4	GEH-5913
Installing Lugs	
Type AML Main Lug Kits	GEH-5588
Type AML Feed Thru Main Lug Kits	GEH-5630

Spectra® Series Plug-In (Only) (continued)

Installing Fusible Switches	
Fuse Pullers	DEH-034
Class R Fuse Rejector Kit	GEH-4616
R Fuse Rejection Pin, 400-600 Ampere Switch Units	GEH-5577
Lug Kits into GE Type ADS Switches	GEH-5944
Alternate Lugs, 30-1200 Ampere Fusible Switch Units	GEJ-3050
Installing Fusible Switch Expansion Kits	
30/60 Ampere Expansion Kit	GEH-5547
60A, 100A Expansion Kits for Type ADS Fusible Switch Units	GEH-5581
200 Ampere Expansion Kit (J, T Fuses)	GEH-5582
200 Ampere Expansion Kit (H, K, R Fuses)	GEH-5889
Handle and Load Base Replacements on Fusible Switches	
Handle Replacement: 400-1200 Ampere Switches	GEH-5553
Load Base Replacement for Type ADS 400-600 Ampere Switches	GEH-5576
Miscellaneous	
Typical - Fusible Mains and Feeders	DE-166
Technical Data, Spectra Series Panelboards - Pressure Locked Connectors	DE-168

Spectra® Series Bolt-On (Only)

Circuit Breaker Mounting Instructions (Straps)	
TEB, TED, THED, SED, SEH, SEL, SEP	DEH-047
SGH, SFL, SFP	DEH-059
SGH, SGL, SGP	DEH-060
SKH, SKL, SKP, TKM, THKM	DEH-061
TEY	DEH-062
TQD, THQD	DEH-065

A-Series® Panelboards

Lighting Panel Rating Labels	DEH-40007
GE Panelboards	DEA-185
Stainless Steel Enclosures	DET-386
AD Plus Lighting Panelboards	DEP-131
UL Recognized Series Connected Ratings	DET-008

A-Series® Lighting Control Panel

Lighting Control Panel Catalog/Selection Guide	DEA-388
Fact Sheet	DET-398

Pro-Stock Panelboard

Selection and Pricing Guide	DEP-104A
Fact Sheet	DET-233
Product Summary	DEE-240
Initial Stock Order Form	DEZ-176
Branch Breaker Recommended Stock List	DEE-241
Pro-Stock Literature Order Form	DEZ-178
Sell Sheet	DEA-232
New Product Commercialization Summary	DEE-240
Q & A	DEQ-068



Publications and Reference: See Section 22 for a complete list of additional product-related publications

