

Recessed Floor Boxes for Concrete & Wood Floors

Resource RFB® Series of Floor Boxes are versatile recessed activation solutions that provide power, communication and/or audio/video services to open space areas, or directly to workstations. Resource RFB Series Floor Boxes are available in two- to six-gang models with a variety of aesthetic cover options including colors and profiles available.

Resource RFB Series Floor Boxes have many applications, including schools, financial institutions, commercial office buildings, hospitality and residences.



Protection from water, dirt, and debris.

RFB4 Series Floor Box with the new FloorPort Activation Cover.

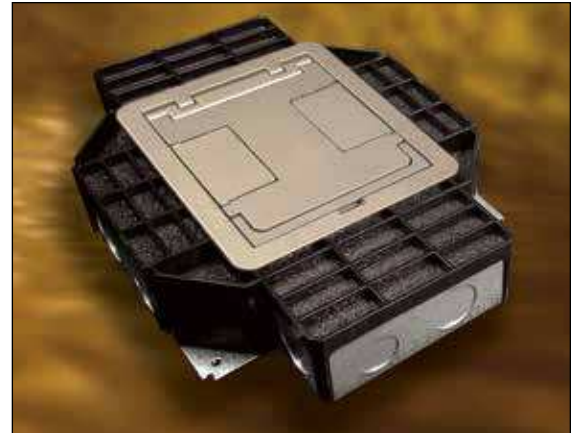

FEATURES & BENEFITS

- **RFB6 & RFB6E have independent wiring compartments that allow capacity for up to six duplex receptacles and/or communication services.** Reduces overall cost by providing for most cabling requirements.
- **The RFB4 has three versions for various applications.** A cast iron version to meet on grade requirements, a steel version to reduce installation cost on above grade floors, and a shallow steel version that provides flexibility with varying concrete depths.
- **Fully adjustable before and after the concrete pour.** Labor savings by adapting to various pour depths and conditions.
- **Range of conduit sizes.** Allows for most conduit schemes, even feed through capability, which saves time and money during installation. KOs range from 1/2" to 2" trade size.
- **Triple service boxes.** Accommodate power, communication and/or audio/video devices which reduces the need for multiple boxes.
- **Accepts round Evolution™ Series Covers.** RFB4E Series Floor Box accept the round 6" Evolution™ Series Covers while RFB6E Series Floor Box accepts the round 8" Evolution™ Series Covers increasing the ability to match aesthetics throughout the building.
- **RFB2 & RFB4 shallow versions allow pass-around tunneling.** Flexibility in design to have adjacent compartments wired together.
- **Redesigned FloorPort Activation Covers.** Provides TopGuard protection from water, dirt and debris plus added strength and durability. Now available in brushed aluminum and five decorative powder coat finishes: Black, Brass, Nickel, Gray and Bronze.
- **Wide variety of mounting brackets.** Can adapt to most power and communication needs. Reduces overall life cycle cost.
- **RFB4E and RFB6E Series Floor Boxes available for bare concrete and terrazzo floors.** By using RFB4E-CTR or RFB6E-CTR Rings (sold separately) these boxes can be installed into bare concrete or terrazzo floors with a clean, aesthetic finish.
- **Datacom connectivity options.** Accepts industry standard and proprietary devices from a wide range of manufacturers to provide a seamless and aesthetically pleasing interface for voice, data, audio, and video applications at the point-of-use. A wide selection of data and adapter options are available for use with Ortronics® TracJack™ and Series II devices.
- **2" Conduit Hub.** By using 2HUB with the RFB4E Series Floor Box (sold separately) a greater capacity of pre-terminated cables can be brought in the a shallower box. Increasing the functionality and reducing concrete pours.
- **Installs in both concrete and wood floors.** Provides the first recessed wood floor box for both commercial and residential applications. Available for RFB2, RFB6 and RFB6E Series Floor Boxes.
- **Lightweight "slab-on-grade" version.** Special fusion-bonded epoxy corrosion resistant paint finish allows for slab-on-grade use without the weight of cast iron material. Available in RFB2, RFB4E, RFB6 and RFB6E Series Floor Boxes.
- **Accepts Floorport™ Activation Covers.** Allows a consistent aesthetic finish for the RFB2, RFB4 & RFB6 Series Recessed Floor Boxes.
- **Buy America Act/NAFTA versions.** FloorPort Service Fittings are now available in versions that meet the Buy America Act/NAFTA requirements.
- **UL Listed to U.S. and Canadian safety standards for tile, terrazzo, carpet and wood floors.**



Download this product's PEP ecopassport environmental product declaration at www.legrand.us/resources-and-downloads. This declaration conforms with ISO 14025 and 14040 and is in alignment with EN 15804.

Resource RFB Series Floor Box Selection Guide

Box Model	Install Floor Type:		Box Type:	Box Capacity:	Depth Behind Plates:	A/V Compatibility	Trade Size Conduit Feed:	Cover Style	Country of Origin	Adjustability
	Concrete	Wood								
RFB2	Yes	Yes	Above Grade	2 Gangs	3" [76mm]	Legrand AVIP, Altinex Intera, Extron AAP, MAAP & Decorator, Ortronics Series II	1/2" - 1 1/4"	FloorPort	Mexico	Fully Adjustable
RFB2-SS	Yes	Yes	Above Grade	2 Gangs	3" [76mm]		1/2" - 3/4"	FloorPort	Mexico	
RFB2-OG	Yes	Yes	On-Grade	2 Gangs	3" [76mm]		1/2" - 1 1/4"	FloorPort	Mexico	
RFB4	Yes	No	Above Grade	4 Gangs	2" [51mm]		1/2" - 1 1/4"	FloorPort	Mexico	
RFB4-4DB	Yes	No	Above Grade	4 Gangs	2" [51mm]		1/2" - 1 1/4"	FloorPort	Mexico	
RFB4-SS	Yes	No	Above Grade	4 Gangs	2" [51mm]		1/2" - 1"	FloorPort	Mexico	
RFB4-CI-1	Yes	No	On-Grade	4 Gangs	2" [51mm]		1" - 1 1/4"	FloorPort	China	
RFB4-CI-1-NA	Yes	No	On-Grade	4 Gangs	2" [51mm]		1" - 1 1/4"	FloorPort	USA	
RFB4E	Yes	No	Above Grade	4 Gangs	3 1/2" [89mm]		3/4" - 2"	Evolution 6CT2, 6CTC2 & 6CFFTC Series	Mexico	
RFB4E-OG	Yes	No	On-Grade	4 Gangs	3 1/2" [89mm]		3/4" - 2"		Mexico	
RFB6	Yes	Yes	Above Grade	6 Gangs	3 1/4" [83mm]		3/4" - 1 1/4"	FloorPort	Mexico	
RFB6-OG	Yes	Yes	On-Grade	6 Gangs	3 1/4" [83mm]		3/4" - 1 1/4"	FloorPort	Mexico	
RFB6E	Yes	Yes	Above Grade	6 Gangs	3 1/4" [83mm]		3/4" - 1 1/4"	Evolution 8CT2 & 8CTC2 Series	Mexico	
RFB6E-OG	Yes	Yes	On-Grade	6 Gangs	3 1/4" [83mm]		3/4" - 1 1/4"		Mexico	

NOTE: Pricing may vary depending on country of origin. Consult your local sales representative for more information.

RFB2 Series Floor Boxes Compartment Capacities/Knockout Locations & Sizes

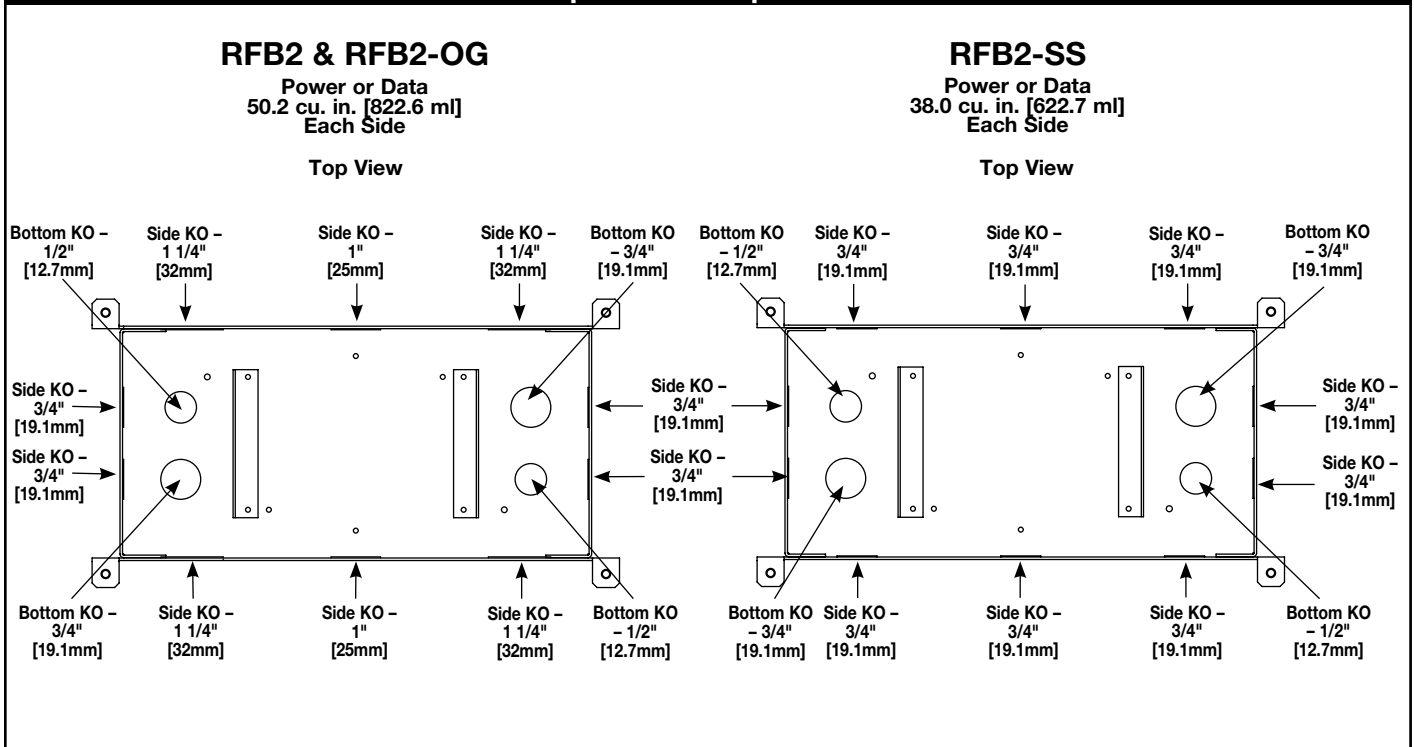

RFB2 Series Multiservice Steel Recessed Floor Box Ordering Information

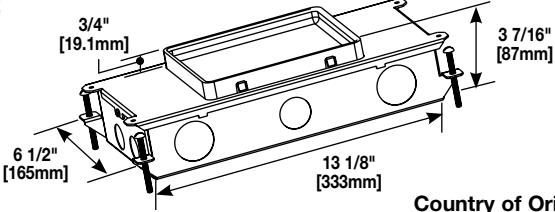
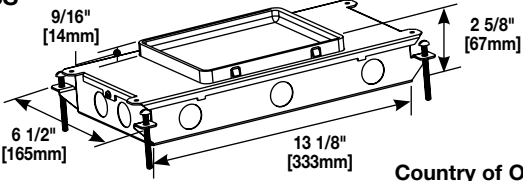
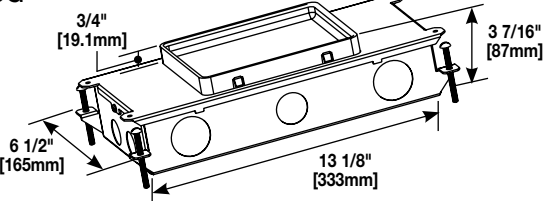
Catalog No./Item	Description/Specifications
<p>RFB2</p>  <p style="text-align: right;">Country of Origin: Mexico</p>	<p>Two-Compartment Box – For use in either concrete or wood floors. Fully adjustable with tunnel compartment. Supplied with one (1) duplex receptacle mounting plate, and one (1) communication mounting plate (RFB22AB). Other device plates sold separately.</p>
<p>RFB2-SS</p>  <p style="text-align: right;">Country of Origin: Mexico</p>	<p>Two-Compartment Shallow Stamped Steel Floor Box – For use in either concrete or wood floors. Fully adjustable with tunnel compartment. Supplied with one (1) duplex receptacle mounting plate, and one (1) communication mounting plate (RFB22AB). Other device plates sold separately.</p>
<p>RFB2-OG</p>  <p style="text-align: right;">Country of Origin: Mexico</p>	<p>Two-Compartment Box – For use On Grade. Fully adjustable with tunnel compartment. Supplied with one (1) duplex receptacle mounting plate, and one (1) communication mounting plate (RFB22AB). Other device plates sold separately.</p> <p>NOTE: RFB2-OG for on-grade applications is painted with a fusion-bonded epoxy designed for use on metal reinforcement bar and related accessories before encapsulating in concrete.</p>

RFB2 Series Multiservice Steel Recessed Floor Box Accessories

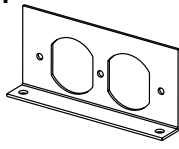
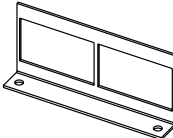
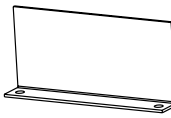
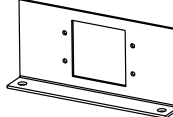
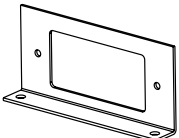
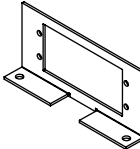
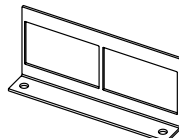
Catalog No./Item	Description/Specifications	Catalog No./Item	Description/Specifications
<p>RFB2DP</p>  <p>Internal Duplex Receptacle Bracket – Accepts standard 15 Amp & 20 Amp Duplex Receptacles. Country of Origin: Mexico</p> <p>NOTE: For RFB2 Series Floor Boxes only.</p>	<p>RFB2RT</p>  <p>Internal Communication Bracket – Includes Two (2) adapters to accept Ortronics® TracJack devices, and Two (2) adapters to accept Ortronics® Series II devices (sold separately). Country of Origin: Mexico</p> <p>NOTE: For RFB2 Series Floor Boxes only.</p>		
<p>RFB2B</p>  <p>Internal Blank Bracket – Plate used to close off unused gangs. Country of Origin: Mexico</p> <p>NOTE: For RFB2 Series Floor Boxes only.</p>	<p>RFB2EXT</p>  <p>Internal Audio/Video Bracket – Accepts two (2) Legrand AVIP or Extron® Electronics MAAP Series devices (sold separately). Country of Origin: Mexico</p> <p>NOTE: For RFB2 Series Floor Boxes only.</p>		
<p>RFB2GFI</p>  <p>Internal GFI or Decorator Style Receptacle Bracket – Accepts standard GFCI or Decorator Style Receptacles, Communication or Audio/Video Devices. Country of Origin: Mexico</p> <p>NOTE: For RFB2 Series Floor Boxes only.</p>	<p>RFB2-AAP</p>  <p>Internal Audio/Video Bracket – Accepts Two (2) Extron® Electronics AAP Series devices (sold separately). Country of Origin: Mexico</p> <p>NOTE: For RFB2 Series Floor Boxes only.</p>		
<p>RFB22AB</p>  <p>Internal Communication Bracket – Includes two (2) adapters to accept Wiremold CM2 Series Open System communication inserts (sold separately). Country of Origin: Mexico</p> <p>NOTE: For RFB2 Series Floor Boxes only.</p>			

RFB2 Series Multiservice Steel Recessed Floor Box Accessories

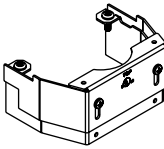
Catalog No./Item	Description/Specifications
<p>RFBKIT</p> 	<p>Barrier Kit – Barrier kit used to separate power and communication wires in partition feed covers. Supplied with base and three extensions to adjust to cover height. Kit should be used on RFB2, RFB2-OG, RFB2-SS, RFB4 and RFB4-SS Floor Boxes. Kits are sold separately.</p> <p>Country of Origin: USA</p>

<p>FP-CTR</p> 	<p>Bare Concrete & Terrazzo Ring – Nonmetallic ring for use on bare polished concrete and terrazzo floor applications.</p> <p>Country of Origin: USA</p>
--	--

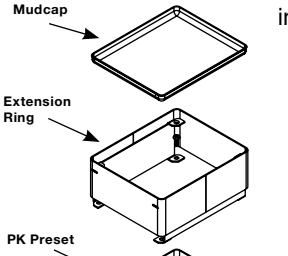
Catalog No./Item	Description/Specifications												
<p>PKER</p> 	<p>Extensions – Attaches to preset to add height to preset. Can be field installed.</p> <table border="1" style="width: 100%; border-collapse: collapse;"> <thead> <tr> <th>Extension</th> <th>Height Above Preset "A"</th> </tr> </thead> <tbody> <tr> <td>PKER-10</td> <td>1" [25mm]</td> </tr> <tr> <td>PKER-15</td> <td>1 1/2" [38mm]</td> </tr> <tr> <td>PKER-20</td> <td>2" [51mm]</td> </tr> <tr> <td>PKER-25</td> <td>2 1/2" [64mm]</td> </tr> <tr> <td>PKER-30</td> <td>3" [76mm]</td> </tr> </tbody> </table> <p>Country of Origin: USA</p>	Extension	Height Above Preset "A"	PKER-10	1" [25mm]	PKER-15	1 1/2" [38mm]	PKER-20	2" [51mm]	PKER-25	2 1/2" [64mm]	PKER-30	3" [76mm]
Extension	Height Above Preset "A"												
PKER-10	1" [25mm]												
PKER-15	1 1/2" [38mm]												
PKER-20	2" [51mm]												
PKER-25	2 1/2" [64mm]												
PKER-30	3" [76mm]												

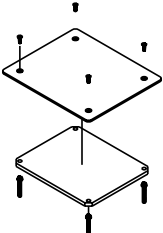
<p>S3AXB</p> 	<p>Blanking Plate – Aluminum top plate with steel support plate and four (4) adjusting screws.</p> <p>Country of Origin: USA</p>
--	--

FloorPort Series Cover Assemblies for RFB2 Series Floor Boxes

FLOORPORT PART NUMBER CONFIGURATOR

FP	B	TC	NK
FloorPort Cover	Blank Top Cutout Top Furniture Feed	B C FF	Tile (Flangeless) Tile/Carpet (Flanged)
		T TC	Nickel Brass Black Bronze Gray Brushed Aluminum
			NK BS BK BZ GY AL

FloorPort Series Flanged Cover Assemblies Ordering Information

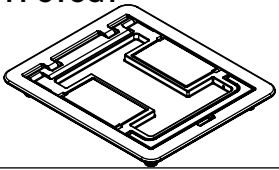
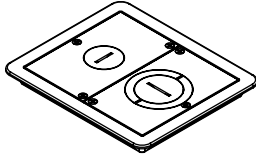
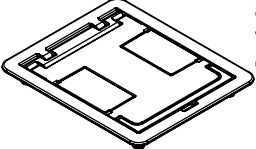
Catalog No./Item	Description/Specifications	Catalog No./Item	Description/Specifications
FPCTCBK FPCTCBZ FPCTCBS FPCTCNK FPCTCAL FPCTCGY 	Cutout Cover Assembly – Flanged cover for use in tile or carpet installation. Die-cast aluminum assembly available in black (BK), bronze (BZ), brass (BS), nickel (NK), gray (GY), or brushed aluminum (AL). Insert in lid allows for carpet or tile cutouts to match finished floor.	FPFFTCBK FPFFTCBZ FPFFTCBS FPFFTCNK FPFFTCAL FPFFTCGY 	Furniture Feed Cover Assembly – Flanged cover for use in tile or carpet installation. Die-cast aluminum assembly available in black (BK), bronze (BZ), brass (BS), nickel (NK), gray (GY), or brushed aluminum (AL). Provided with one 1" trade size screw plug for power or communication type cabling and one combination 1 1/4" and 2" trade size screw plug for communication type cabling. Allows for feeding both power and communication cabling.
FPBTCBK FPBTCBZ FPBTCBS FPBTCNK FPBTCAL FPBTCGY 	Blank Cover Assembly – Flanged cover for use in tile or carpet installation. Die-cast aluminum assembly available in black (BK), bronze (BZ), brass (BS), nickel (NK), gray (GY), or brushed aluminum (AL). Lid area is flush with the finished floor, no cutouts provided.		Country of Origin: USA
	Country of Origin: India		Country of Origin: USA

FloorPort Series Flangeless Cover Assemblies Ordering Information

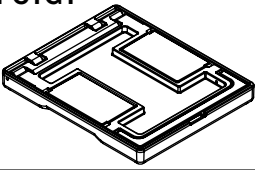
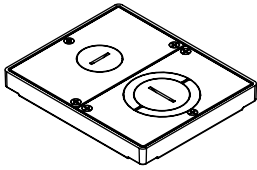
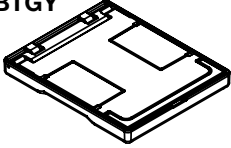
Catalog No./Item	Description/Specifications	Catalog No./Item	Description/Specifications
FPCTBK FPCTBZ FPCTBS FPCTNK FPCTAL FPCTGY 	Cutout Cover Assembly – Flangeless cover for use in tile installations. Die-cast aluminum assembly available in black (BK), bronze (BZ), brass (BS), nickel (NK), gray (GY), or brushed aluminum (AL). Insert in lid allows for tile cutouts to match finished floor.	FPFFTBK FPFFTBZ FPFFTBBS FPFFTNK FPFFTAL FPFFTGY 	Furniture Feed Cover Assembly – Flangeless cover for use in tile installations. Die-cast aluminum assembly available in black (BK), bronze (BZ), brass (BS), nickel (NK), gray (GY), or brushed aluminum (AL). Provided with one 1" trade size screw plug for power or communication type cabling and one combination 1 1/4" and 2" trade size screw plug for communication type cabling. Allows for feeding both power and communication cabling.
FPBTBK FPBTBZ FPBTBS FPBTNK FPBTAL FPBTGY 	Blank Cover Assembly – Flangeless cover for use in tile installations. Die-cast aluminum assembly available in black (BK), bronze (BZ), brass (BS), nickel (NK), gray (GY), or brushed aluminum (AL). Lid area is flush with the finished floor, no cutouts provided.		Country of Origin: USA
	Country of Origin: India		Country of Origin: USA

NOTE: Pricing varies depending on country of origin. Consult your local sales representative for more information.

North American Made FloorPort Series Cover Assemblies for RFB2 Series Floor Boxes

NORTH AMERICAN MADE FLOORPORT PART NUMBER CONFIGURATOR

FP	B	TC	NK	NA
FloorPort Cover	Blank Top Cutout Top Furniture Feed	B C FF Tile (Flangeless) Tile/Carpet (Flanged)	T TC Nickel Brass Black Bronze Gray Brushed Aluminum	NK BS BK BZ GY AL North American Made

North American Made FloorPort Series Flanged Cover Assemblies Ordering Information

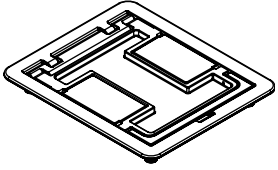
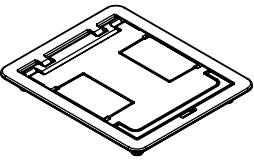
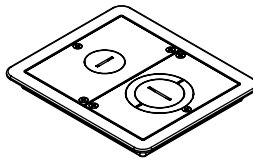
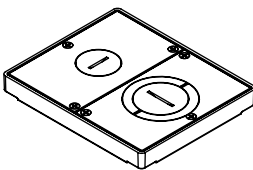
Catalog No./Item	Description/Specifications
<p>FPCTCBK-NA FPCTCBZ-NA FPCTCBS-NA FPCTCNK-NA FPCTCGY-NA</p>  <p style="text-align: center;">Country of Origin: USA</p>	<p>Cutout Cover Assembly – Flanged cover for use in tile or carpet installation. Die-cast aluminum assembly available in black (BK), bronze (BZ), brass (BS), nickel (NK), or gray (GY). Insert in lid allows for carpet or tile cutouts to match finished floor.</p>
<p>FPBTCBK-NA FPBTCBZ-NA FPBTCBS-NA FPBTCNK-NA FPBTCTGY-NA</p>  <p style="text-align: center;">Country of Origin: USA</p>	<p>Blank Cover Assembly – Flanged cover for use in tile or carpet installation. Die-cast aluminum assembly available in black (BK), bronze (BZ), brass (BS), nickel (NK), or gray (GY). Lid area is flush with the finished floor, no cutouts provided.</p>
<p>FPFFTCBK FPFFTCBZ FPFFTCBS FPFFTCNK FPFFTCAL FPFFTCGY</p>  <p style="text-align: center;">Country of Origin: USA</p>	<p>Furniture Feed Cover Assembly – Flanged cover for use in tile or carpet installation. Die-cast aluminum assembly available in black (BK), bronze (BZ), brass (BS), nickel (NK), gray (GY), or brushed aluminum (AL). Provided with one 1" trade size screw plug for power or communication type cabling and one combination 1 1/4" and 2" trade size screw plug for communication type cabling. Allows for feeding both power and communication cabling.</p>
<p>FPFFTBK FPFFTBZ FPFFTBS FPFFTNK FPFFTAL FPFFTGY</p>  <p style="text-align: center;">Country of Origin: USA</p>	<p>Furniture Feed Cover Assembly – Flangeless cover for use in tile installations. Die-cast aluminum assembly available in black (BK), bronze (BZ), brass (BS), nickel (NK), gray (GY), or brushed aluminum (AL). Provided with one 1" trade size screw plug for power or communication type cabling and one combination 1 1/4" and 2" trade size screw plug for communication type cabling. Allows for feeding both power and communication cabling.</p>

NOTE: Pricing varies depending on country of origin. Consult your local sales representative for more information.

LOAD CAPACITIES FOR FLOORPORT COVER ASSEMBLIES	
CATALOG NUMBERS	MAXIMUM LOAD IN POUNDS
FPCTC	1000
FPBTC	750
FPFFTC	1000
FPCT	1000
FPBT	750
FPFFT	1000

NOTE: Load applied through a 2" [51mm] mandrel in center of service fitting. Loads above are static loads only and do not pertain to rolling loads.

RFB4 & RFB4-4DB Series Multiservice Steel Recessed Floor Box Ordering Information

Catalog No./Item

Description/Specifications

RFB4

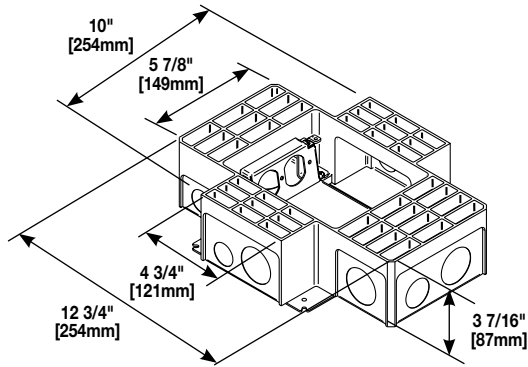

Four-Compartment Combination Box – 12 3/4" L x 10" W x 3 7/16" D [324mm x 254mm x 87mm]. Fully adjustable with tunnel compartment and two receptacle brackets. **Tunneling from end power compartment to end power compartment only.** Communication brackets not included. See "Accessories".

NOTE: Only for use in concrete floors.

Country of Origin: Assembled in Mexico from components made in the USA

RFB4-4DB

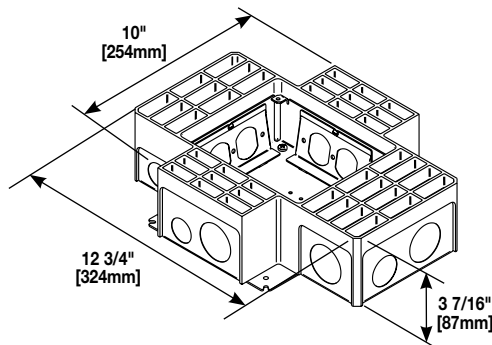

Four-Compartment Box – Includes four duplex receptacle brackets. 12 3/4" L x 10" W x 3 7/16" D [324mm x 254mm x 87mm]. Fully adjustable. **Tunneling from adjacent or opposite compartments only, (not cross compartments).** Tunneling can be set to feed all four compartments from one conduit in a single-service application.

NOTE: Only for use in concrete floors.

Country of Origin: Assembled in Mexico from components made in the USA

NOTE: All boxes and activations are sold separately.

RFB4 & RFB4-4DB Series Compartment Capacities and Knockout Locations and Sizes

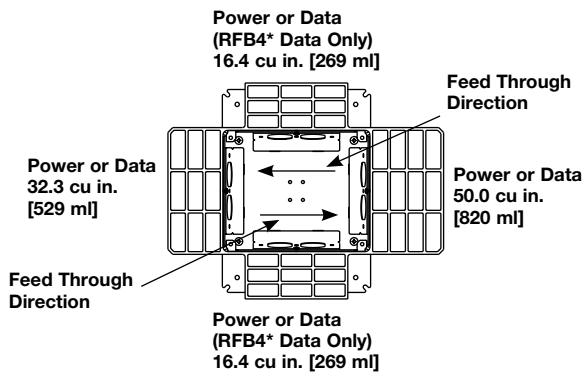

FOR RFB4

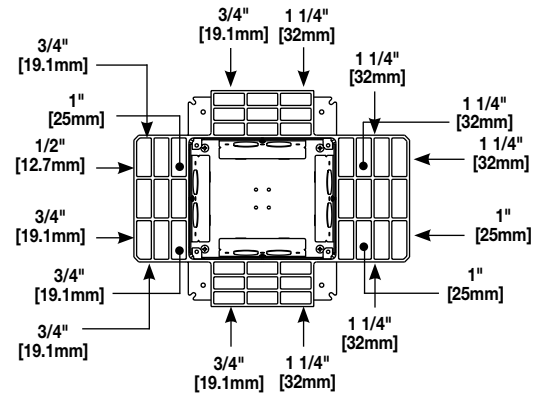

Indicates Bottom KO.

*No feed through to opposite data compartment on RFB4.



RFB4 Series Floor Box with FloorPort Activation Cover.

RFB4 & RFB4-4DB Series Multiservice Steel Recessed Floor Box Accessories

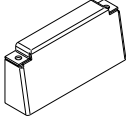
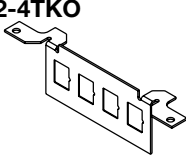
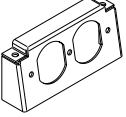
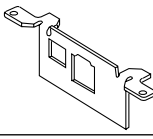
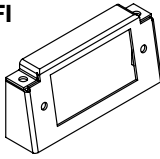
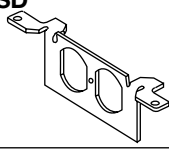
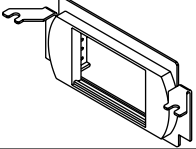
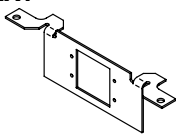
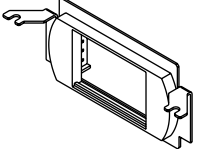
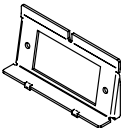
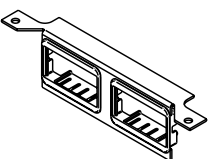
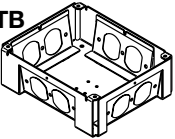
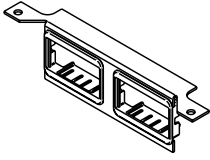
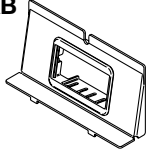
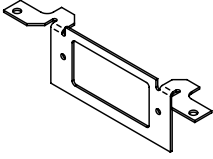
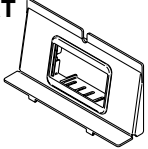
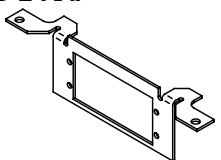
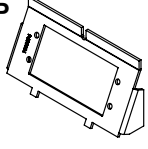
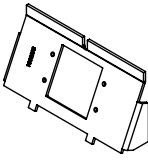
Catalog No./Item	Description/Specifications	Catalog No./Item	Description/Specifications
RFB-B 	Internal Blank Bracket – Power compartments only. Used to close off unused gangs. NOTE: For RFB4 only. Country of Origin: USA	DTB-2-4TKO 	Communication Bracket – Four (4) RJ keystone opening knockouts. Use as blank plate or for up to four (4) RJ openings. NOTE: For RFB4 only. Opening dimension is 9/16" x 3/4" [14.3mm x 19.1mm]. Country of Origin: USA
RFB-DR 	Internal Duplex Bracket – Accepts standard 15 Amp & 20 Amp Duplex Receptacles. NOTE: For RFB4 only. Country of Origin: USA	DTB-2-DT 	Communication Bracket – With one IBM Type II opening and one keystone opening (devices not included). NOTE: For RFB4 only. Country of Origin: Mexico
RFB-GFI 	Internal GFI Bracket – Accepts standard GFCI or Decorator Style Receptacles, Communication or Audio/Video Devices. NOTE: For RFB4 only. Country of Origin: USA	DTB-2-SD 	Communication Bracket – With duplex opening for use with 106 Adapter (sold separately) (devices not included). NOTE: For RFB4 only. Country of Origin: Mexico
RFB4-LPB 	Communication Bracket – Activate™ low profile adapter included. Wiremold CM Series Open System inserts sold separately. NOTE: For RFB4 only. Country of Origin: Mexico	DTB-EXT 	Internal Audio/Video Bracket – Accepts two (2) Legrand AVIP or Extron® Electronics MAAP devices (sold separately). NOTE: For RFB4 only. Country of Origin: Mexico
RFB4-LPBS2 	Communication Bracket – Ortronics® Series II Low profile adapter included. NOTE: For RFB4 only. Country of Origin: Mexico	RFB-GFI-4DB 	Internal GFCI Bracket – Accepts standard GFCI or Decorator style receptacles, communications or A/V devices. NOTE: For RFB4-4DB only. Country of Origin: USA
DTB-2-2AB 	Communication Bracket – Two (2) 2A size adapters included. Wiremold CM2 Series Open System inserts, sold separately. NOTE: For RFB4 only. Country of Origin: Mexico	RFB-WTB 	Conversion Kit – To convert the RFB4 Box to a RFB4-4DB Box. NOTE: For RFB4 & RFB4-4DB. Country of Origin: Mexico
DTB-2-2RT 	Communication Bracket – Ortronics® AB2TJ TracJack and ABS2 Series II adapters included. NOTE: For RFB4 only. Country of Origin: Mexico	WTB-2-AB 	Communication Bracket – One 2A adapter included. Wiremold CM2 Series Open System inserts sold separately. NOTE: For RFB4-4DB only. Country of Origin: Mexico
DTB-2-DECORA 	Communication Bracket – Decorator style opening for decorator style 106 Adapter. Country of Origin: Mexico	WTB-2-RT 	Communication Bracket – Ortronics® AB2TJ TracJack and ABS2 Series II adapters included. NOTE: For RFB4-4DB only. Country of Origin: Mexico
DTB-2-AAP 	Internal Audio/Video Bracket – Accepts two (2) Extron® Electronics AAP devices (sold separately). NOTE: For RFB4 only. Country of Origin: Mexico	WTB-AAP 	Internal Audio/Video Bracket – Accepts two (2) Extron® Electronics AAP Series Devices (sold separately). NOTE: For RFB4-4DB only. Country of Origin: Mexico
		WTB-MAAP 	Internal Audio/Video Bracket – Accepts two (2) Legrand AVIP or Extron® Electronics MAAP Series Devices (sold separately). NOTE: For RFB4-4DB only. Country of Origin: Mexico

Additional configurations available. Please consult your local Sales Representative for more information.

RFB4 & RFB4-4DB Series Multiservice Steel Recessed Floor Box Accessories (continued)

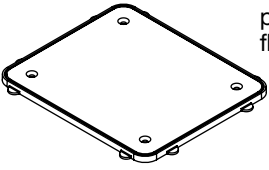
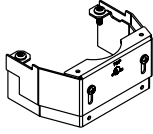
Catalog No./Item	Description/Specifications
<p>FP-CTR</p>  <p style="text-align: right;">Country of Origin: USA</p>	<p>RFBKIT</p>  <p>Barrier Kit – Barrier kit used to separate power and communication wires in partition feed covers. Supplied with base and three extensions to adjust to cover height. Kit should be used on RFB2, RFB2-OG, RFB2-SS, RFB4 and RFB4-SS Floor Boxes. Kits are sold separately.</p> <p style="text-align: right;">Country of Origin: USA</p>

RFB4-CI-1 Series Multiservice Cast Iron Recessed Floor Box Ordering Information

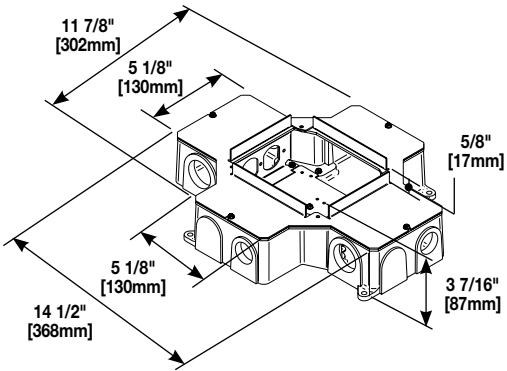
Catalog No./Item	Description/Specifications
<p>RFB4-CI-1</p> 	<p>Four-Compartment Cast Iron Box – 14 1/2" L x 11 7/8" W x 3 7/16" D [368mm x 302mm x 87mm]. Fully adjustable with tunnel compartment and two receptacle brackets. Feed through from adjacent or opposite compartments only, (not cross compartments). Communication brackets not included. See "Accessories".</p> <p>NOTE: Only for use in concrete floors. All boxes and activations are sold separately.</p> <p style="text-align: right;">Country of Origin: China</p>

North American Made RFB4-CI-NA Series Multiservice Cast Iron Recessed Floor Box Ordering Information

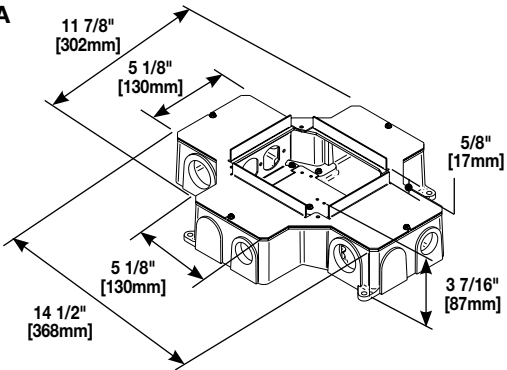
Catalog No./Item	Description/Specifications
<p>RFB4-CI-NA</p> 	<p>Four-Compartment Cast Iron Box – 14 1/2" L x 11 7/8" W x 3 7/16" D [368mm x 302mm x 87mm]. Fully adjustable with tunnel compartment and two receptacle brackets. Feed through from adjacent or opposite compartments only, (not cross compartments). Communication brackets not included. See "Accessories".</p> <p>NOTE: Only for use in concrete floors. All boxes and activations are sold separately.</p> <p style="text-align: right;">Country of Origin: USA</p>

RFB4-CI-1 & RFB4-CI-NA Series Compartment Capacities and Knockout Locations and Sizes

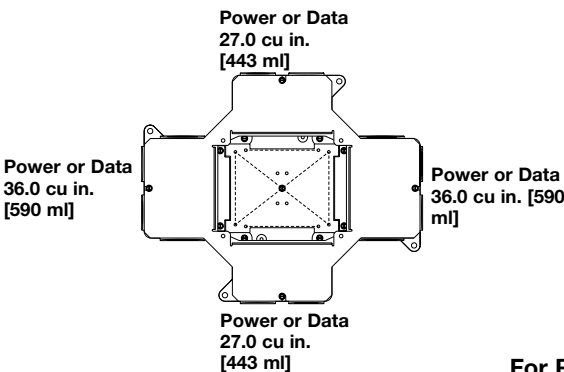
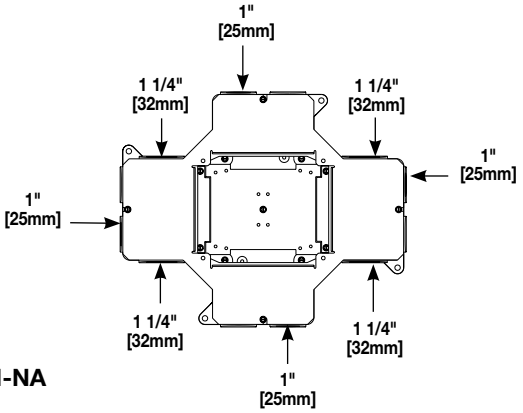
 <p style="text-align: center;">For RFB4-CI-1 & RFB4-CI-NA</p>	
--	--

NOTE: Pricing varies depending on country of origin. Consult your local sales representative for more information.

RFB4-CI-1 Series Multiservice Cast Iron Floor Box Accessories

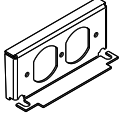
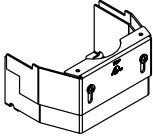
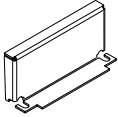
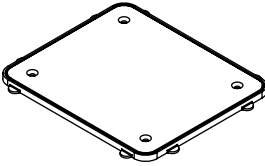
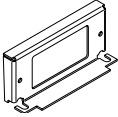
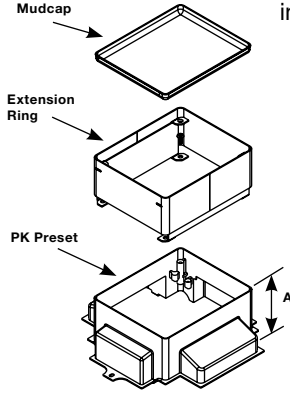
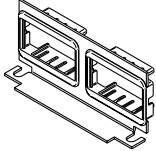
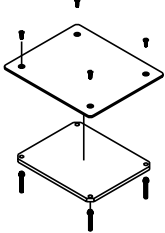
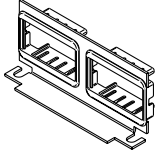
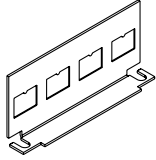
Catalog No./Item	Description/Specifications	Catalog No./Item		Description/Specifications											
CIHT-D	 <p>Internal Duplex Receptacle Bracket – Accepts standard 15 Amp & 20 Amp Duplex Receptacles. Country of Origin: USA</p>	RFBCIKIT	 <p>Barrier Kit – Barrier kit used with RFB4-CI Floor Boxes. Kits are sold separately. Country of Origin: USA</p>												
CIH/LT-B	 <p>Internal Blank Bracket – Used to close off unused gangs. Country of Origin: USA</p>	FP-CTR	 <p>Bare Concrete & Terrazzo Ring – Nonmetallic ring for use on bare polished concrete and terrazzo floor applications. Country of Origin: USA</p>												
CIHT-GFI	 <p>Internal GFI Device Bracket – Accepts standard GFCI or Decorator Style Receptacles, Communication or Audio/Video Devices. Country of Origin: USA</p>	PKER	<p>Extensions – Attaches to preset to add height to preset. Can be field installed.</p>  <table border="1" style="margin-left: auto; margin-right: auto;"> <thead> <tr> <th>Extension</th> <th>Height Above Preset "A"</th> </tr> </thead> <tbody> <tr> <td>PKER-10</td> <td>1" [25mm]</td> </tr> <tr> <td>PKER-15</td> <td>1 1/2" [38mm]</td> </tr> <tr> <td>PKER-20</td> <td>2" [51mm]</td> </tr> <tr> <td>PKER-25</td> <td>2 1/2" [64mm]</td> </tr> <tr> <td>PKER-30</td> <td>3" [76mm]</td> </tr> </tbody> </table> <p>Country of Origin: USA</p>	Extension	Height Above Preset "A"	PKER-10	1" [25mm]	PKER-15	1 1/2" [38mm]	PKER-20	2" [51mm]	PKER-25	2 1/2" [64mm]	PKER-30	3" [76mm]
Extension	Height Above Preset "A"														
PKER-10	1" [25mm]														
PKER-15	1 1/2" [38mm]														
PKER-20	2" [51mm]														
PKER-25	2 1/2" [64mm]														
PKER-30	3" [76mm]														
CILT-2AB	 <p>Communication Bracket – Communication bracket with two 2A size Activate adapters included. Accepts Wiremold CM2 Series Open System communication modules (sold separately). Country of Origin: Mexico</p>	S3AXB	 <p>Blanking Plate – Aluminum top plate with steel support plate and four (4) adjusting screws. Country of Origin: USA</p>												
CILT-2-RT	 <p>Communication Bracket – Communication bracket with Ortronics® AB2TJ TracJack and ABS2 Series II adapters included. Accepts Ortronics® workstation connectivity outlets and modular inserts. Country of Origin: Mexico</p>														
CILT-4TKO	 <p>Communication Bracket – Communication bracket with four (4) RJ opening knockouts. Use as blank plate or for up to four RJ openings. Country of Origin: USA</p> <p>NOTE: Opening dimension is 9/16" x 3/4" [14.3mm x 19.1mm].</p>														

Additional configurations available. Please consult your local Sales Representative for more information.

RFB4-SS Series Multiservice Shallow Steel Recessed Floor Box Ordering Information

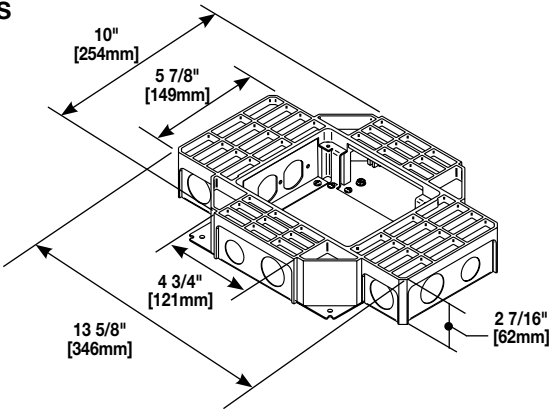
Catalog No./Item	Description/Specifications
<p>RFB4-SS</p>  <p>Dimensions: Total Length: 10" [254mm] Tunnel Length: 5 7/8" [149mm] Depth: 4 3/4" [121mm] Total Width: 13 5/8" [346mm] Height: 2 7/16" [62mm]</p>	<p>Four-Compartment Shallow Stamped Steel Box – 13 5/8" L x 10" W x 2 7/16" D [346mm x 254mm x 62mm]. Fully adjustable with tunnel compartment and two receptacle brackets.</p> <p>Feed through tunneling to adjacent compartments only. Tunneling can be set to feed all four compartments from one conduit in a single-service application. Communication brackets not included. See "Accessories".</p> <p>NOTE: Only for use in concrete floors. All boxes and activations are sold separately.</p> <p>Country of Origin: Assembled in Mexico from components made in the USA</p>

RFB4-SS Series Compartment Capacities/Knockout Locations & Sizes

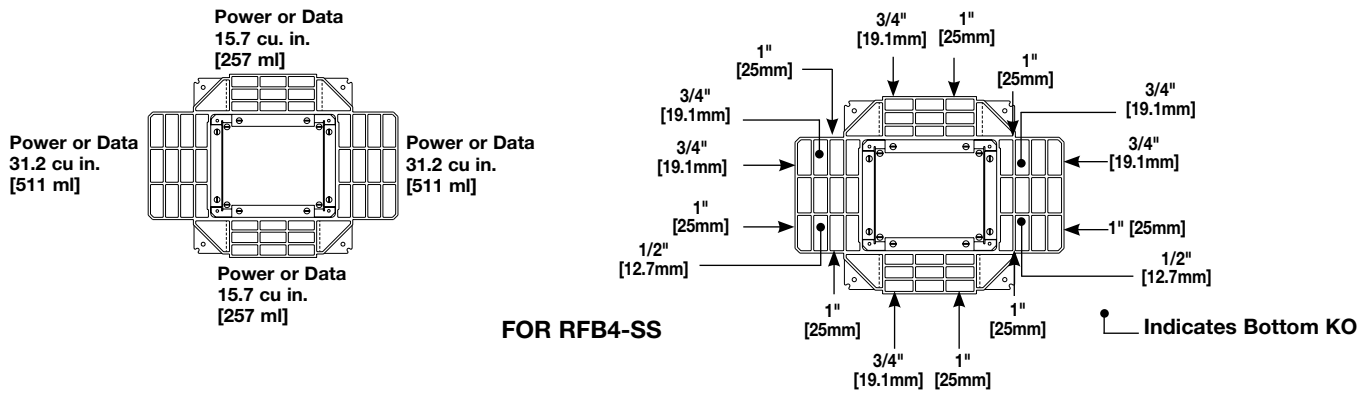

RFB4-SS Series Multiservice Shallow Steel Floor Box Accessories

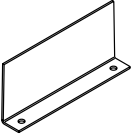
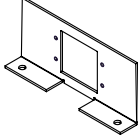
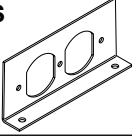
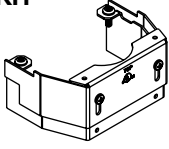
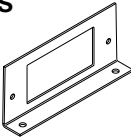
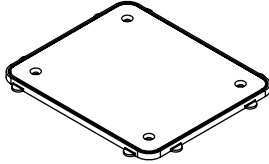
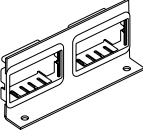
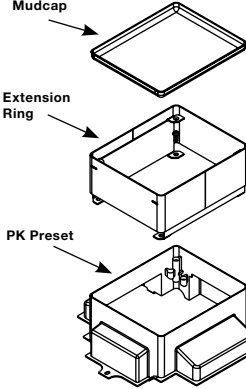
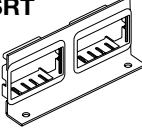
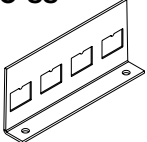
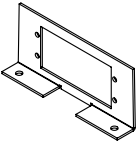
Catalog No./Item	Description/Specifications	Catalog No./Item	Description/Specifications												
RFB-B-SS 	Internal Blank Bracket – Used to close off unused gangs. Country of Origin: Mexico	RFB4-SS-MAAP 	Internal Audio/Video Bracket – Accepts two Extron® Electronics MAAP Series Devices. (Sold separately) Country of Origin: Mexico NOTE: For RFB4-SS Series Floor Boxes only.												
RFB-RB-SS 	Internal Duplex Receptacle Bracket – Accepts standard 15 Amp & 20 Amp Duplex Receptacles. Country of Origin: Mexico	RFBKIT 	Barrier Kit – Barrier kit used to separate power and communication wires in partition feed covers. Supplied with base and three extensions to adjust to cover height. Kit should be used on RFB2, RFB2-OG, RFB2-SS, RFB4 and RFB4-SS Floor Boxes. Kits are sold separately. Country of Origin: USA												
RFB-GFI-SS 	Internal GFI Receptacle Bracket – Accepts standard GFCI & Decorator style Receptacles Communication or Audio/Video Devices. Country of Origin: Mexico	FP-CTR 	Bare Concrete & Terrazzo Ring – Nonmetallic ring for use on bare polished concrete and terrazzo floor applications. Country of Origin: USA												
RFB-2AB-SS 	Internal Bracket – Two Pass & Seymour® Activate adapters included. Wiremold CM Series Open System inserts sold separately. Country of Origin: Mexico	PKER 	Extensions – Attaches to preset to add height to preset. Can be field installed. <table border="1" style="margin-left: auto; margin-right: auto;"><thead> <tr> <th>Extension</th> <th>Height Above Preset "A"</th> </tr> </thead> <tbody> <tr> <td>PKER-10</td> <td>1" [25mm]</td> </tr> <tr> <td>PKER-15</td> <td>1 1/2" [38mm]</td> </tr> <tr> <td>PKER-20</td> <td>2" [51mm]</td> </tr> <tr> <td>PKER-25</td> <td>2 1/2" [64mm]</td> </tr> <tr> <td>PKER-30</td> <td>3" [76mm]</td> </tr> </tbody> </table> Country of Origin: USA	Extension	Height Above Preset "A"	PKER-10	1" [25mm]	PKER-15	1 1/2" [38mm]	PKER-20	2" [51mm]	PKER-25	2 1/2" [64mm]	PKER-30	3" [76mm]
Extension	Height Above Preset "A"														
PKER-10	1" [25mm]														
PKER-15	1 1/2" [38mm]														
PKER-20	2" [51mm]														
PKER-25	2 1/2" [64mm]														
PKER-30	3" [76mm]														
RFB-2-SSRT 	Communication Bracket – Ortronics® AB2TJ TracJack and ABS2 Series II adapters included. Country of Origin: Mexico														
RFB-4TKO-SS 	Internal Bracket – Four RJ Keystone opening knockouts. Use as blank plate or for up to four RJ openings. Country of Origin: Mexico NOTE: Opening dimension is 9/16" x 3/4" [14.3mm x 19.1mm].														
RFB4-SS-AAP 	Internal Audio/Video Bracket – Accepts two (2) Extron® Electronics AAP Series Devices. (Sold separately) Country of Origin: Mexico NOTE: For RFB4-SS Series Floor Boxes only.														

Additional configurations available. Please consult your local Sales Representative for more information.

RFB4-SS Series Multiservice Shallow Steel Floor Box Accessories

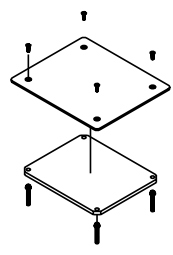
Catalog No./Item	Description/Specifications
<p data-bbox="131 189 243 220">S3AXB</p>  <p>The diagram illustrates the Blanking Plate assembly. It consists of two main components: an aluminum top plate and a steel support plate. The top plate is shown with four adjusting screws, one at each corner, which are used to adjust the height of the plate. The steel support plate is shown below the top plate, with four screws that pass through the top plate and into the support plate to secure it. The entire assembly is designed to be mounted on a floor box.</p>	<p data-bbox="406 189 810 283">Blanking Plate – Aluminum top plate with steel support plate and four (4) adjusting screws.</p>

FloorPort Series Cover Assemblies for RFB4 Series Floor Boxes

FLOORPORT PART NUMBER CONFIGURATOR

FP	B	TC	NK
FloorPort Cover	Blank Top Cutout Top Furniture Feed	B C FF	Tile (Flangeless) Tile/Carpet (Flanged)
		T TC	Nickel Brass Black Bronze Gray Brushed Aluminum
			NK BS BK BZ GY AL

FloorPort Series Flanged Cover Assemblies Ordering Information

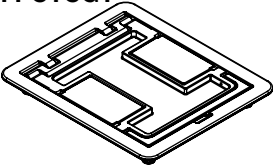
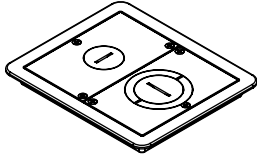
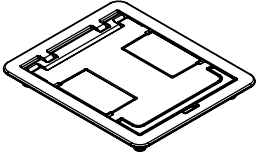
Catalog No./Item	Description/Specifications	Catalog No./Item	Description/Specifications
FPCTCBK FPCTCBZ FPCTCBS FPCTCNK FPCTCAL FPCTCGY 	Cutout Cover Assembly – Flanged cover for use in tile or carpet installation. Die-cast aluminum assembly available in black (BK), bronze (BZ), brass (BS), nickel (NK), gray (GY), or brushed aluminum (AL). Insert in lid allows for carpet or tile cutouts to match finished floor.	FPFFTCBK FPFFTCBZ FPFFTCBS FPFFTCNK FPFFTCAL FPFFTCGY 	Furniture Feed Cover Assembly – Flanged cover for use in tile or carpet installation. Die-cast aluminum assembly available in black (BK), bronze (BZ), brass (BS), nickel (NK), gray (GY), or brushed aluminum (AL). Provided with one 1" trade size screw plug for power or communication type cabling and one combination 1 1/4" and 2" trade size screw plug for communication type cabling. Allows for feeding both power and communication cabling.
FPBTCBK FPBTCBZ FPBTCBS FPBTCNK FPBTCAL FPBTCGY 	Blank Cover Assembly – Flanged cover for use in tile or carpet installation. Die-cast aluminum assembly available in black (BK), bronze (BZ), brass (BS), nickel (NK), gray (GY), or brushed aluminum (AL). Lid area is flush with the finished floor, no cutouts provided.		Country of Origin: USA
	Country of Origin: India		Country of Origin: USA

FloorPort Series Flangeless Cover Assemblies Ordering Information

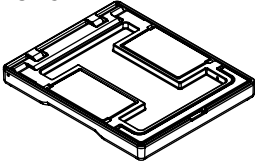
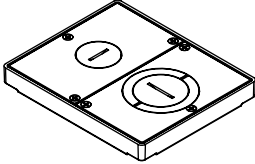
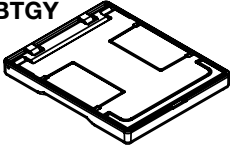
Catalog No./Item	Description/Specifications	Catalog No./Item	Description/Specifications
FPCTBK FPCTBZ FPCTBS FPCTNK FPCTAL FPCTGY 	Cutout Cover Assembly – Flangeless cover for use in tile installations. Die-cast aluminum assembly available in black (BK), bronze (BZ), brass (BS), nickel (NK), gray (GY), or brushed aluminum (AL). Insert in lid allows for tile cutouts to match finished floor.	FPFFTBK FPFFTBZ FPFFTBBS FPFFTNK FPFFTAL FPFFTGY 	Furniture Feed Cover Assembly – Flangeless cover for use in tile installations. Die-cast aluminum assembly available in black (BK), bronze (BZ), brass (BS), nickel (NK), gray (GY), or brushed aluminum (AL). Provided with one 1" trade size screw plug for power or communication type cabling and one combination 1 1/4" and 2" trade size screw plug for communication type cabling. Allows for feeding both power and communication cabling.
FPBTBK FPBTBZ FPBTBS FPBTNK FPBTAL FPBTGY 	Blank Cover Assembly – Flangeless cover for use in tile installations. Die-cast aluminum assembly available in black (BK), bronze (BZ), brass (BS), nickel (NK), gray (GY), or brushed aluminum (AL). Lid area is flush with the finished floor, no cutouts provided.		Country of Origin: USA
	Country of Origin: India		Country of Origin: USA

NOTE: Pricing varies depending on country of origin. Consult your local sales representative for more information.

North American Made FloorPort Series Cover Assemblies for RFB4 Series Floor Boxes

NORTH AMERICAN MADE FLOORPORT PART NUMBER CONFIGURATOR

FP	B	TC	NK	NA
FloorPort Cover	Blank Top Cutout Top Furniture Feed	B C FF	Tile (Flangeless) Tile/Carpet (Flanged)	T TC
			Nickel Brass Black Bronze Gray Brushed Aluminum	NK BS BK BZ GY AL
				North American Made
				NA

North American Made FloorPort Series Flanged Cover Assemblies Ordering Information

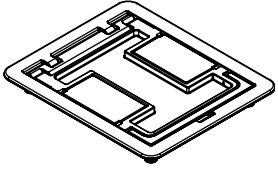
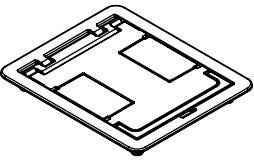
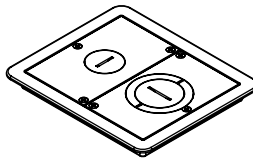
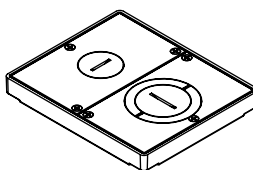
Catalog No./Item	Description/Specifications
<p>FPCTCBK-NA FPCTCBZ-NA FPCTCBS-NA FPCTCNK-NA FPCTCGY-NA</p>  <p style="text-align: center;">Country of Origin: USA</p>	<p>Cutout Cover Assembly – Flanged cover for use in tile or carpet installation. Die-cast aluminum assembly available in black (BK), bronze (BZ), brass (BS), nickel (NK), or gray (GY). Insert in lid allows for carpet or tile cutouts to match finished floor.</p>
<p>FPBTCBK-NA FPBTCBZ-NA FPBTCBS-NA FPBTCNK-NA FPBTCTGY-NA</p>  <p style="text-align: center;">Country of Origin: USA</p>	<p>Blank Cover Assembly – Flanged cover for use in tile or carpet installation. Die-cast aluminum assembly available in black (BK), bronze (BZ), brass (BS), nickel (NK), or gray (GY). Lid area is flush with the finished floor, no cutouts provided.</p>
<p>FPFFTCBK FPFFTCBZ FPFFTCBS FPFFTCNK FPFFTCAL FPFFTCGY</p>  <p style="text-align: center;">Country of Origin: USA</p>	<p>Furniture Feed Cover Assembly – Flanged cover for use in tile or carpet installation. Die-cast aluminum assembly available in black (BK), bronze (BZ), brass (BS), nickel (NK), gray (GY), or brushed aluminum (AL). Provided with one 1" trade size screw plug for power or communication type cabling and one combination 1 1/4" and 2" trade size screw plug for communication type cabling. Allows for feeding both power and communication cabling.</p>
<p>FPFFTBK FPFFTBZ FPFFTBS FPFFTNK FPFFTAL FPFFTGY</p>  <p style="text-align: center;">Country of Origin: USA</p>	<p>Furniture Feed Cover Assembly – Flangeless cover for use in tile installations. Die-cast aluminum assembly available in black (BK), bronze (BZ), brass (BS), nickel (NK), gray (GY), or brushed aluminum (AL). Provided with one 1" trade size screw plug for power or communication type cabling and one combination 1 1/4" and 2" trade size screw plug for communication type cabling. Allows for feeding both power and communication cabling.</p>

NOTE: Pricing varies depending on country of origin. Consult your local sales representative for more information.

LOAD CAPACITIES FOR FLOORPORT COVER ASSEMBLIES	
CATALOG NUMBERS	MAXIMUM LOAD IN POUNDS
FPCTC	1000
FPBTC	750
FPFFTC	1000
FPCT	1000
FPBT	750
FPFFT	1000

NOTE: Load applied through a 2" [51mm] mandrel in center of service fitting. Loads above are static loads only and do not pertain to rolling loads.

RFB4E Series Multiservice Steel Recessed Floor Box Ordering Information

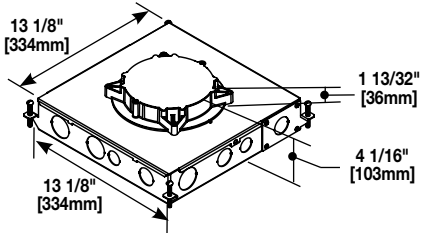
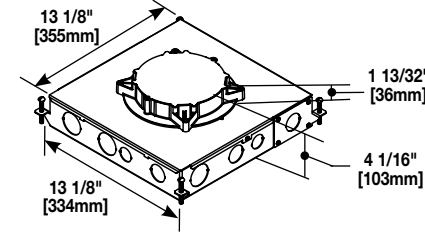
Catalog No./Item	Description/Specifications
<p>RFB4E</p>  <p>13 1/8" [334mm] 13 1/8" [334mm] 1 13/32" [36mm] 4 1/16" [103mm]</p>	<p>Four-Compartment Box – For use in concrete floors. For use with the round Evolution cover. Fully adjustable with tunnel compartments. Device Plates sold separately.</p> <p>Country of Origin: Mexico</p>
<p>RFB4E-OG</p>  <p>13 1/8" [355mm] 13 1/8" [334mm] 1 13/32" [36mm] 4 1/16" [103mm]</p>	<p>Four-Compartment On-Grade Box – For use in concrete floors. For use with the round Evolution cover. Fully adjustable with tunnel compartments. Device Plates sold separately.</p> <p>Country of Origin: Mexico</p>

RFB4E Series Compartment Knockout Locations & Sizes

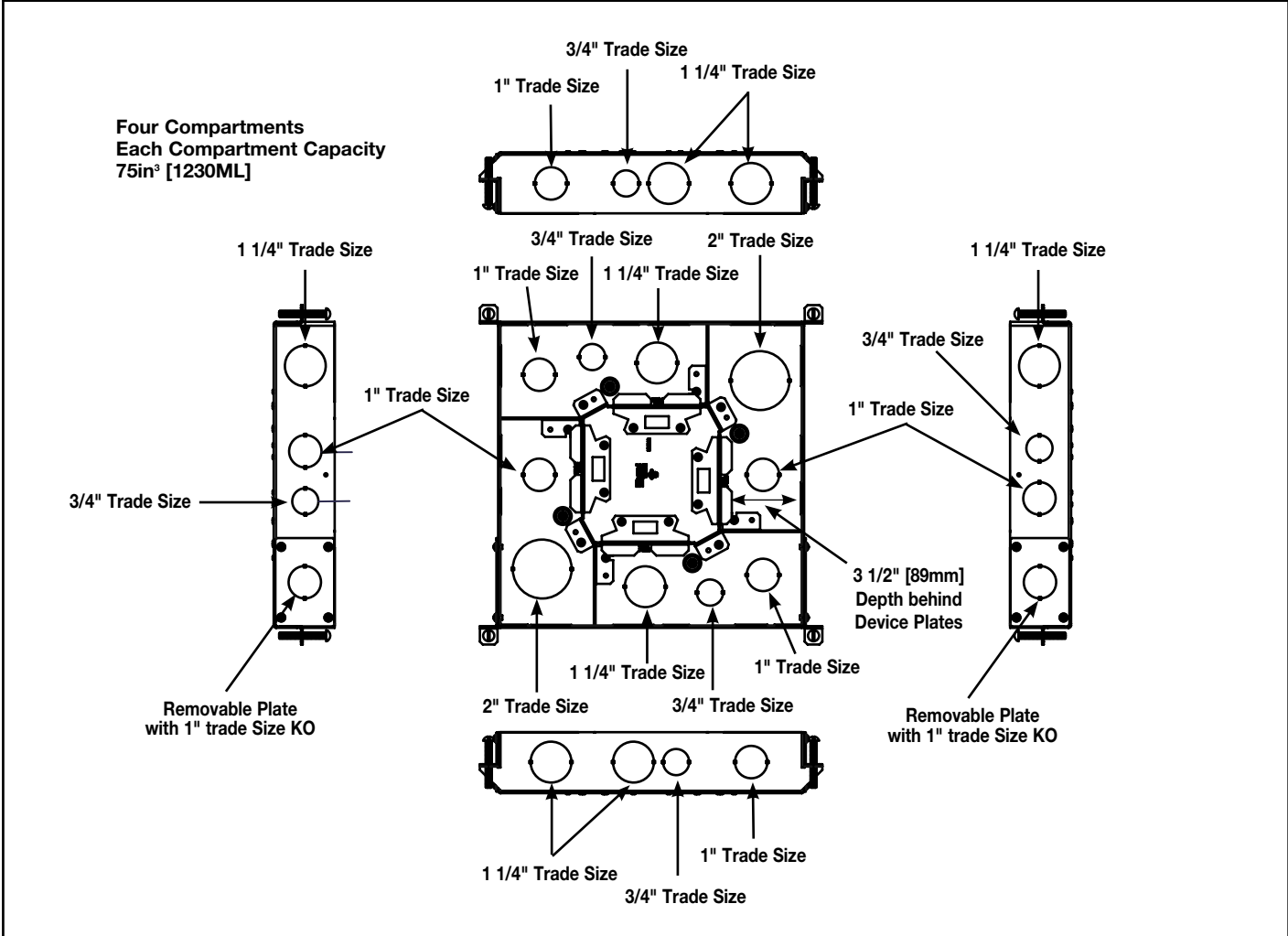

RFB4E, RFB6 & RFB6E Series Multiservice Steel Recessed Floor Box Accessories

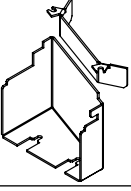
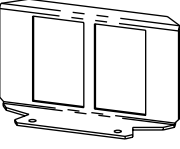
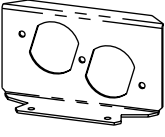
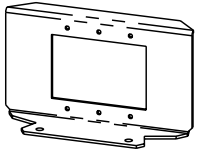
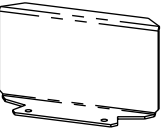
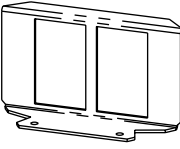
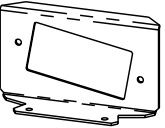
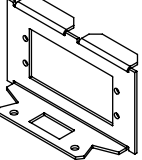
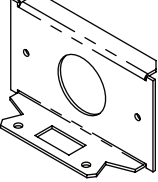
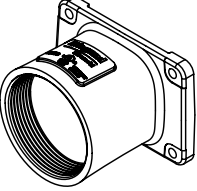
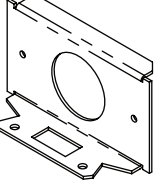
Catalog No./Item	Description/Specifications	Catalog No./Item	Description/Specifications
RFB4EKIT 	Barrier Kit – Barrier kit used to separate power and communication services in combination with a 6CFFTC Furniture Feed Cover. (sold separately). Country of Origin: Mexico	RFB6RT 	Internal Communication Bracket – Includes one (1) adapter to accept Ortronics® TracJack devices, and one (1) adapter to accept Ortronics® Series II devices (sold separately). Country of Origin: USA NOTE: For use with RFB4E, RFB6 and RFB6E Series Floor Boxes.
RFB6DP 	Internal Duplex Receptacle Bracket – Accepts standard 15 & 20 Amp Duplex Receptacles. Country of Origin: USA NOTE: For use with RFB4E, RFB6 and RFB6E Series Floor Boxes.	RFB6EXT 	Internal Audio/Video Bracket – Accepts three (3) Legrand AVIP or Extron® Electronics MAAP Series devices (sold separately). Country of Origin: USA NOTE: For use with RFB4E, RFB6 and RFB6E Series Floor Boxes.
RFB6B 	Internal Blank Bracket – Closes off unused gangs. Country of Origin: USA NOTE: For use with RFB4E, RFB6 and RFB6E Series Floor Boxes.	RFB62A 	Internal Communication Bracket – Includes two (2) adapters to accept Wiremold CM2 Series Open System communication inserts (sold separately). Country of Origin: USA NOTE: For use with RFB4E, RFB6 and RFB6E Series Floor Boxes.
RFB6GFI 	Internal GFI or Decorator Style Receptacle Bracket – Accepts standard GFCI & Decorator Style Receptacles, Communication or Audio/Video Devices. Country of Origin: USA NOTE: For use with RFB4E, RFB6 and RFB6E Series Floor Boxes.	RFB6-AAP 	Internal Audio/Video Bracket – Accepts two (2) Extron® Electronics AAP Series Devices (sold separately). Country of Origin: USA NOTE: For use with RFB4E, RFB6 and RFB6E Series Floor Boxes.
RFB6S1 	Internal Single Receptacle Bracket – Receptacle opening 1 3/8" [35mm]. Country of Origin: USA NOTE: For use with RFB4E, RFB6 and RFB6E Series Floor Boxes.	2HUB 	2" Conduit Transition Hub – Trade size 2" die cast zinc conduit fitting allows for 2" conduit to transition into a shallow box design. Includes: die cast fitting, gasket, and mounting screws. Country of Origin: USA
RFB6S2 	Internal Single Receptacle Bracket – Receptacle opening 1 9/16" [40mm]. Country of Origin: USA NOTE: For use with RFB4E, RFB6 and RFB6E Series Floor Boxes.		

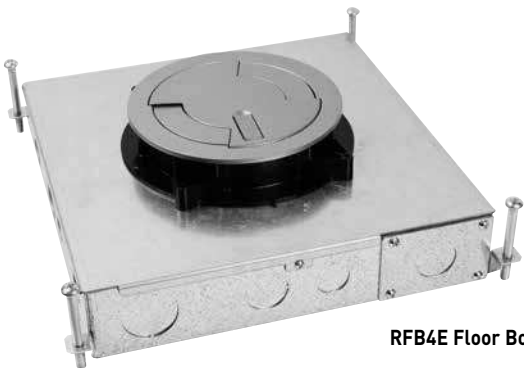

RFB4E Floor Box with Evolution Series Cover.

Evolution Series Cover Assemblies for RFB4E & RFB4E-OG Floor Boxes

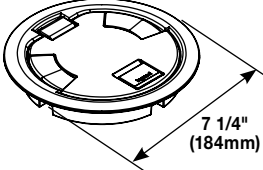
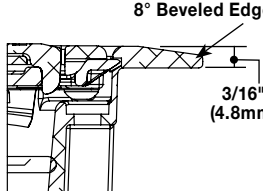
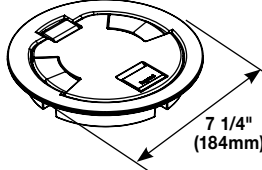
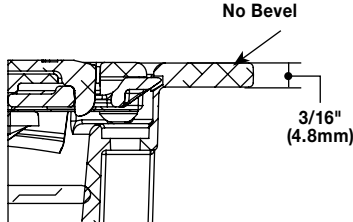
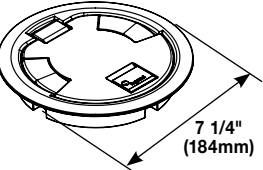
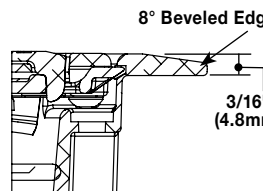
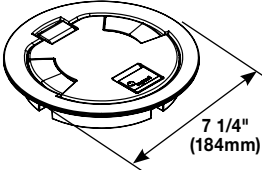
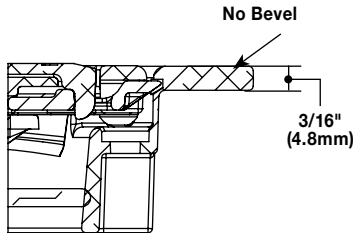
Catalog No./Item	Description/Specifications	Catalog No./Item	Description/Specifications
<p>6CTC2BK 6CTC2BS 6CTC2GY 6CTC2NK 6CTC2BZ 6CTC2AL</p>  <p style="text-align: center;">7 1/4" (184mm)</p>  <p style="text-align: center;">8° Beveled Edge 3/16" (4.8mm)</p>	<p>Surface Style Cover Assembly – Low profile cover. Each cover is made from die-cast aluminum materials and equipped with a durable hinge which allows the cover to rotate open 180°, two (2) slide egress doors that lock in the open position and auto close around the cables when the covers are closed, an 8° beveled edge that meets ADA guidelines and reduces tripping hazards. These covers are designed to sit on top of the finished floor surface such as: carpet, tile, wood, polished concrete and terrazzo. Available in six (6) aesthetic powder-coated finishes: Black (BK), Brass (BS), Gray (GY), Nickel (NK), Bronze (BZ), and Aluminum (AL).</p> <p style="text-align: right;">Country of Origin: USA</p>	<p>6CT2BK 6CT2BS 6CT2GY 6CT2NK 6CT2BZ 6CT2AL</p>  <p style="text-align: center;">7 1/4" (184mm)</p> <p>NOTE: Includes 6TS Tile Shim.</p>  <p style="text-align: center;">No Bevel 3/16" (4.8mm)</p>	<p>Flush-Style Cover Assembly – Low profile covers. Each cover is made from die-cast aluminum materials and equipped with a durable hinge which allows the cover to rotate open 180°, two (2) slide egress doors that lock in the open position and auto close around the cables when the covers are closed. These covers are designed to sit flush with the finished floor surface such as: carpet, tile, and wood. Available in six (6) aesthetic powder-coated finishes: Black (BK), Brass (BS), Gray (GY), Nickel (NK), Bronze (BZ), and Aluminum (AL).</p> <p style="text-align: right;">Country of Origin: USA</p>
<p>6CTC2BKTR 6CTC2BSTR 6CTC2GYTR 6CTC2NKTR 6CTC2BZTR 6CTC2ALTR</p>  <p style="text-align: center;">7 1/4" (184mm)</p>  <p style="text-align: center;">8° Beveled Edge 3/16" (4.8mm)</p>	<p>Tamper-Resistant Surface Style Cover Assembly – Low profile cover. Each cover is made from die-cast aluminum materials and equipped with a tamper-resistant screw to keep out unauthorized personnel, a durable hinge which allows the cover to rotate open 180°, two (2) slide egress doors that lock in the open position and auto close around the cables when the covers are closed, an 8° beveled edge that meets ADA guidelines and reduces tripping hazards. These covers are designed to sit on top of the finished floor surface such as: carpet, tile, wood, polished concrete and terrazzo. Available in six (6) aesthetic powder-coated finishes: Black (BK), Brass (BS), Gray (GY), Nickel (NK), Bronze (BZ), and Aluminum (AL).</p> <p style="text-align: right;">Country of Origin: USA</p>	<p>6CT2BKTR 6CT2BSTR 6CT2GYTR 6CT2NKTR 6CT2BZTR 6CT2GYTR</p>  <p style="text-align: center;">7 1/4" (184mm)</p> <p>NOTE: Includes 6TS Tile Shim.</p>  <p style="text-align: center;">No Bevel 3/16" (4.8mm)</p>	<p>Tamper-Resistant Flush-Style Cover Assembly – Low profile covers. Each cover is made from die-cast aluminum materials and equipped with a tamper-resistant screw to keep out unauthorized personnel, a durable hinge which allows the cover to rotate open 180°, two (2) slide egress doors that lock in the open position and auto close around the cables when the covers are closed. These covers are designed to sit flush with the finished floor surface such as: carpet, tile, and wood. Available in six (6) aesthetic powder-coated finishes: Black (BK), Brass (BS), Gray (GY), Nickel (NK), Bronze (BZ), and Aluminum (AL).</p> <p style="text-align: right;">Country of Origin: USA</p>

NOTE: All surface-style poke-thru devices come with a transition angle to aid in the change in floor elevation.

Evolution Series Cover Assemblies for RFB4E & RFB4E-OG Floor Boxes

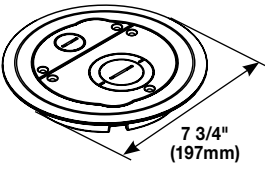
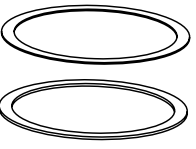
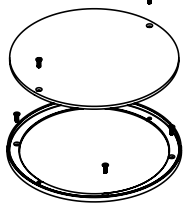
Catalog No./Item	Description/Specifications
<p>6CFFTCBK 6CFFTCBS 6CFFTCGY 6CFFTCNK 6CFFTCBZ</p>  <p style="text-align: right;">7 3/4" (197mm)</p>	<p>Furniture Feed Cover Assembly – Surface style, die-cast aluminum cover assembly, with one (1) 3/4" trade size screw plug opening and one (1) concentric 2"-1 1/4" trade size screw plug opening. Includes one (1) 3/4" and one (1) 2" trade size conduit fittings.</p> <p style="text-align: right;">Country of Origin: USA</p>
<p>6TS</p> 	<p>Tile Shim – Used for floor coverings greater than 5/16" (7.9mm). The 6TS will allow the top surface of the cover to be flush with the finished floor. Includes: six (6) 1/16" (1.6mm) thick shims. Up to a total of 3/8" (9.5mm) of adjustment.</p>
<p>RFB4E-CTR</p> 	<p>Bare Concrete & Terrazzo Ring – Nonmetallic ring for use with bare concrete and terrazzo floor applications.</p> <p style="text-align: right;">Country of Origin: USA</p>

RFB6 & RFB6E Series Multiservice Steel Recessed Floor Box Ordering Information

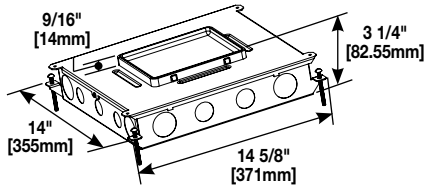
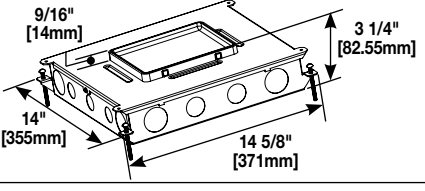
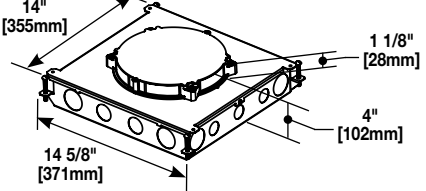
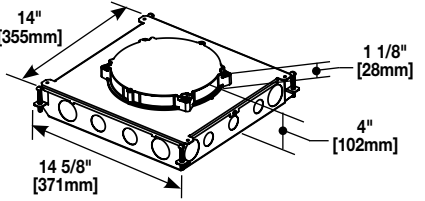
Catalog No./Item	Description/Specifications
<p>RFB6</p> 	<p>Six-Compartment Box – For use in either concrete or wood floors. Fully adjustable with tunnel compartment. Supplied with two (2) duplex mounting plates, two (2) communication mounting plates (RFB62A), and (2) blank mounting plates. Other plates sold separately.</p> <p style="text-align: right;">Country of Origin: Mexico</p>
<p>RFB6-OG</p> 	<p>Six-Compartment On-Grade Box – For use in either concrete or wood floors. Fully adjustable with tunnel compartment. Supplied with two (2) duplex mounting plates, two (2) communication mounting plates (RFB62A), and (2) blank mounting plates. Other plates sold separately.</p> <p style="text-align: right;">Country of Origin: Mexico</p>
<p>RFB6E</p> 	<p>Six-Compartment Box – For use in concrete floors. For use with the round Evolution cover. Fully adjustable with tunnel compartments. Supplied with two (2) duplex mounting plates. Other plates sold separately.</p> <p style="text-align: right;">Country of Origin: Mexico</p>
<p>RFB6E-OG</p> 	<p>Six-Compartment On-Grade Box – For use in concrete floors. For use with the round Evolution cover. Fully adjustable with tunnel compartments. Supplied with two (2) duplex mounting plates. Other plates sold separately.</p> <p style="text-align: right;">Country of Origin: Mexico</p>

RFB6 Series Compartment Capacities/Knockout Locations & Sizes

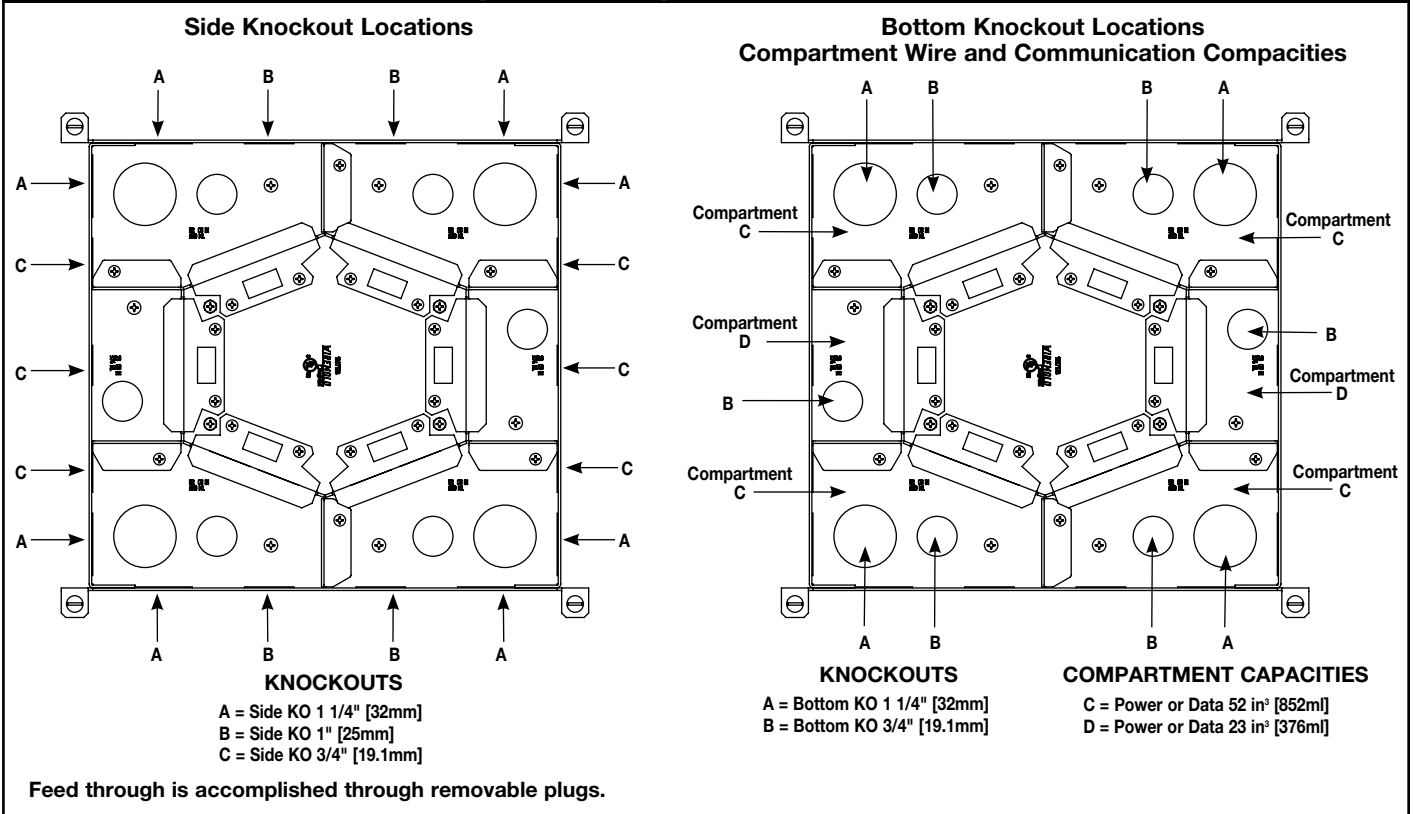

RFB6 & RFB6E Series Multiservice Steel Recessed Floor Box Accessories

Catalog No./Item	Description/Specifications	Catalog No./Item	Description/Specifications
RFB6DP 	Internal Duplex Receptacle Bracket – Accepts standard 15 & 20 Amp Duplex Receptacles. Country of Origin: USA NOTE: For use with RFB4E, RFB6 and RFB6E Series Floor Boxes.	RFB6S1 	Internal Single Receptacle Bracket – Receptacle opening 1 3/8" [35mm]. Country of Origin: USA NOTE: For use with RFB4E, RFB6 and RFB6E Series Floor Boxes.
RFB6B 	Internal Blank Bracket – Closes off unused gangs. Country of Origin: USA NOTE: For use with RFB4E, RFB6 and RFB6E Series Floor Boxes.	RFB6S2 	Internal Single Receptacle Bracket – Receptacle opening 1 9/16" [40mm]. Country of Origin: USA NOTE: For use with RFB4E, RFB6 and RFB6E Series Floor Boxes.
RFB6GFI 	Internal GFI or Decorator Style Receptacle Bracket – Accepts standard GFCI & Decorator Style Receptacles, Communication or Audio/Video Devices. Country of Origin: USA NOTE: For use with RFB4E, RFB6 and RFB6E Series Floor Boxes.	RFB6RT 	Internal Communication Bracket – Includes one (1) adapter to accept Ortronics® TracJack devices, and one (1) adapter to accept Ortronics® Series II devices (sold separately). Country of Origin: USA NOTE: For use with RFB4E, RFB6 and RFB6E Series Floor Boxes.

RFB6 & RFB6E Series Multiservice Steel Recessed Floor Box Accessories

Catalog No./Item **Description/Specifications**

RFB6EXT

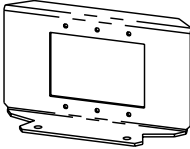

Internal Audio/Video Bracket – Accepts three (3) Legrand AVIP or Extron® Electronics MAAP Series devices (sold separately).

Country of Origin: USA

NOTE: For use with RFB4E, RFB6 and RFB6E Series Floor Boxes.

RFB62A

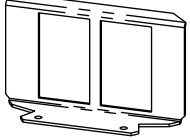

Internal Communication Bracket – Includes two (2) adapters to accept Wiremold CM2 Series Open System communication inserts (sold separately).

Country of Origin: USA

NOTE: For use with RFB4E, RFB6 and RFB6E Series Floor Boxes.

RFB6-AAP

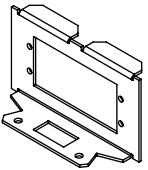

Internal Audio/Video Bracket – Accepts two (2) Extron® Electronics AAP Series Devices (sold separately).

Country of Origin: USA

NOTE: For use with RFB4E, RFB6 and RFB6E Series Floor Boxes.

FP-CTR

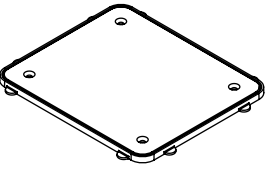

Bare Concrete & Terrazzo Ring – Nonmetallic ring for use on bare polished concrete and terrazzo floor applications.

Country of Origin: USA

NOTE: For use with RFB6 Series Floor Boxes.

Catalog No./Item **Description/Specifications**

PKER

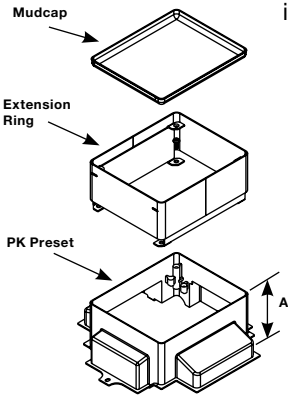

Extensions – Attaches to preset to add height to preset. Can be field installed.

Extension	Height Above Preset "A"
PKER-10	1" [25mm]
PKER-15	1 1/2" [38mm]
PKER-20	2" [51mm]
PKER-25	2 1/2" [64mm]
PKER-30	3" [76mm]

Country of Origin: USA

S3AXBP

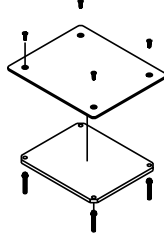

Blanking Plate – Aluminum top plate with steel support plate and four (4) adjusting screws.

Country of Origin: USA

RFB6KIT

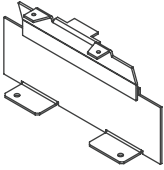

Barrier Kit – Used to separate power and communication services. Used in combination with FloorPort Furniture Feed Covers (FPFFTC Series). Covers sold separately.

Evolution Series Cover Assemblies for RFB6E & RFB6E-OG Floor Boxes

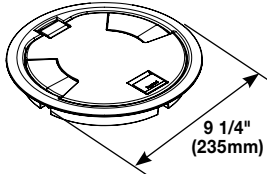
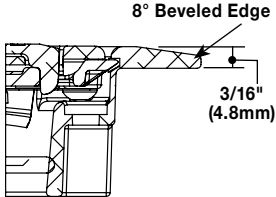
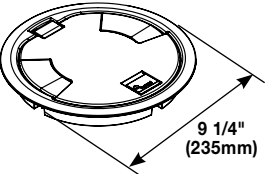
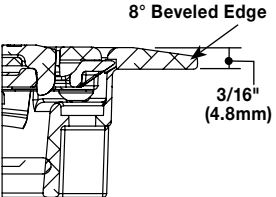
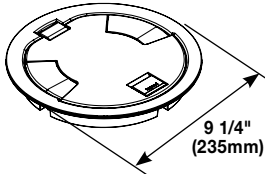
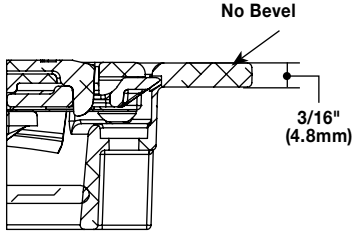
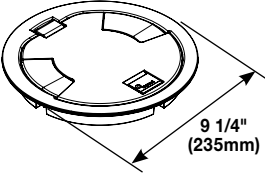
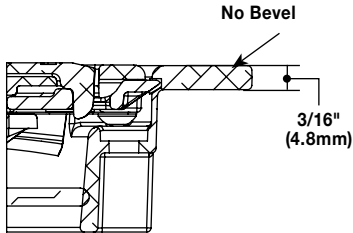
Catalog No./Item	Description/Specifications
<p> 8CTC2BK 8CTC2BS 8CTC2GY 8CTC2NK 8CTC2BZ 8CTC2AL </p>  <p style="text-align: center;">9 1/4" (235mm)</p>  <p style="text-align: center;">8° Beveled Edge 3/16" (4.8mm)</p> <p style="text-align: right;">Country of Origin: USA</p>	<p> Surface Style Cover Assembly – Low profile cover designed to attach to the 8STC and 8STCP Poke-Thru Stem Assemblies. Each cover is made from die-cast aluminum materials and equipped with a durable hinge which allows the cover to rotate open 180°, two (2) slide egress doors that lock in the open position and auto close around the cables when the covers are closed, an 8° beveled edge that meet ADA guidelines and reduces tripping hazards. These covers are designed to sit on top of the finished floor surfaces such as: carpet, tile, wood, polished concrete and terrazzo. Available in six (6) aesthetic powder-coated finishes: Black (BK), Brass (BS), Gray (GY), Nickel (NK), Bronze (BZ) and Aluminum (AL). </p>
<p> 8CTC2BKTR 8CTC2BSTR 8CTC2GYTR 8CTC2NKTR 8CTC2BZTR 8CTC2ALTR </p>  <p style="text-align: center;">9 1/4" (235mm)</p>  <p style="text-align: center;">8° Beveled Edge 3/16" (4.8mm)</p> <p style="text-align: right;">Country of Origin: USA</p>	<p> Tamper-Resistant Surface Style Cover Assembly – Low profile cover designed to attach to the 8STC and 8STCP Poke-Thru Stem Assemblies. Each cover is made from die-cast aluminum materials and equipped with a tamper-resistant screw to keep out unauthorized personnel, a durable hinge which allows the cover to rotate open 180°, two (2) slide egress doors that lock in the open position and auto close around the cables when the covers are closed, an 8° beveled edge that meet ADA guidelines and reduces tripping hazards. These covers are designed to sit on top of the finished floor surface such as: carpet, tile, wood, polished concrete and terrazzo. Available in six (6) aesthetic powder-coated finishes: Black (BK), Brass (BS), Gray (GY), Nickel (NK), Bronze (BZ) and Aluminum (AL). </p>
<p> 8CT2BK 8CT2BS 8CT2GY 8CT2NK 8CT2BZ 8CT2AL </p>  <p style="text-align: center;">9 1/4" (235mm)</p> <p>NOTE: Includes 8TS Tile Shim.</p>  <p style="text-align: center;">No Bevel 3/16" (4.8mm)</p> <p style="text-align: right;">Country of Origin: USA</p>	<p> Flush-Style Cover Assembly – Low profile covers that are designed to attach to the 8STC and 8STCP Poke-Thru Stem Assemblies. Each cover is made from die-cast aluminum materials and equipped with a durable hinge which allows the cover to rotate open 180°, two (2) slide egress doors that lock in the open position and auto close around the cables when the covers are closed. These covers are designed to sit flush with the finished floor surfaces such as: carpet, tile and wood. Available in six (6) powder-coated finishes: Black (BK), Brass (BS), Gray (GY), Nickel (NK), Bronze (BZ) and Aluminum (AL). </p>
<p> 8CT2BKTR 8CT2BSTR 8CT2GYTR 8CT2NKTR 8CT2BZTR 8CT2ALTR </p>  <p style="text-align: center;">9 1/4" (235mm)</p> <p>NOTE: Includes 8TS Tile Shim.</p>  <p style="text-align: center;">No Bevel 3/16" (4.8mm)</p> <p style="text-align: right;">Country of Origin: USA</p>	<p> Tamper-Resistant Flush-Style Cover Assembly – Low profile covers that are designed to attach to the 8STC and 8STCP Poke-Thru Stem Assemblies. Each cover is made from die-cast aluminum materials and equipped with a tamper-resistant screw to keep out unauthorized personnel, a durable hinge which allows the cover to rotate open 180°, two (2) slide egress doors that lock in the open position and auto close around the cables when the covers are closed. These covers are designed to sit flush with the finished floor surfaces such as: carpet, tile and wood. Available in six (6) powder-coated finishes: Black (BK), Brass (BS), Gray (GY), Nickel (NK), Bronze (BZ) and Aluminum (AL). </p>

NOTE: All surface-style poke-thru devices come with a transition angle to aid in the change in floor elevation.

Evolution Series Cover Assemblies for RFB4E & RFB4E-OG Floor Boxes

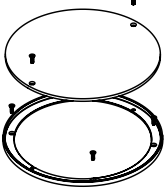
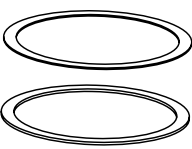
Catalog No./Item	Description/Specifications
<p>RFB6E-CTR</p> 	<p>Bare Concrete & Terrazzo Ring – Nonmetallic ring for use with bare concrete and terrazzo floor applications.</p> <p>Country of Origin: USA</p> <p>NOTE: Only for use on RFB6E and RFB6E-OG Floor Boxes.</p> <p>NOTE: Designed to work with 8CTC & 8CT Series Covers only.</p>
<p>8TS</p> 	<p>Tile Shim – Used for floor coverings greater than 5/16" (7.9mm). The 8TS will allow the top surface of the cover to be flush with the finished floor. Includes: two (2) 1/8" (3.2mm) and two (2) 1/16" (1.6mm) thick shims. Up to a total of 3/8" (9.5mm) of adjustment.</p> <p>Country of Origin: USA</p>

FloorPort Series Cover Assemblies for RFB2, RFB4 & RFB6 Series Floor Boxes

FLOORPORT PART NUMBER CONFIGURATOR

FP	B	TC	NK
FloorPort Cover	Blank Top Cutout Top Furniture Feed	B C FF	Tile (Flangeless) Tile/Carpet (Flanged)
		T TC	Nickel Brass Black Bronze Gray Brushed Aluminum
			NK BS BK BZ GY AL

FloorPort Series Flanged Cover Assemblies Ordering Information

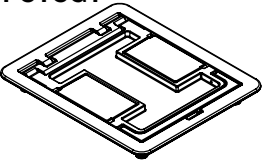
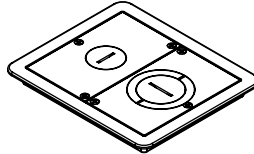
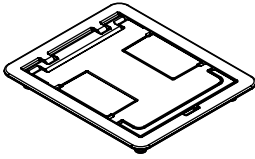
Catalog No./Item	Description/Specifications	Catalog No./Item	Description/Specifications
FPCTCBK FPCTCBZ FPCTCBS FPCTCNK FPCTCAL FPCTCGY 	Cutout Cover Assembly – Flanged cover for use in tile or carpet installation. Die-cast aluminum assembly available in black (BK), bronze (BZ), brass (BS), nickel (NK), gray (GY), or brushed aluminum (AL). Insert in lid allows for carpet or tile cutouts to match finished floor.	FPFFTCBK FPFFTCBZ FPFFTCBS FPFFTCNK FPFFTCAL FPFFTCGY 	Furniture Feed Cover Assembly – Flanged cover for use in tile or carpet installation. Die-cast aluminum assembly available in black (BK), bronze (BZ), brass (BS), nickel (NK), gray (GY), or brushed aluminum (AL). Provided with one 1" trade size screw plug for power or communication type cabling and one combination 1 1/4" and 2" trade size screw plug for communication type cabling. Allows for feeding both power and communication cabling.
FPBTCBK FPBTCBZ FPBTCBS FPBTCNK FPBTCAL FPBTCGY 	Blank Cover Assembly – Flanged cover for use in tile or carpet installation. Die-cast aluminum assembly available in black (BK), bronze (BZ), brass (BS), nickel (NK), gray (GY), or brushed aluminum (AL). Lid area is flush with the finished floor, no cutouts provided.		Country of Origin: USA
	Country of Origin: India		Country of Origin: USA

FloorPort Series Flangeless Cover Assemblies Ordering Information

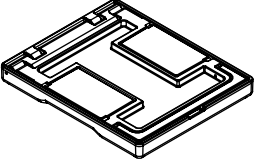
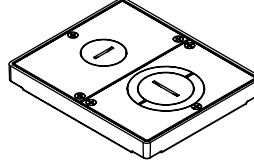
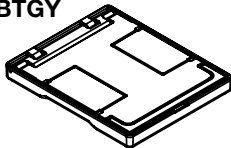
Catalog No./Item	Description/Specifications	Catalog No./Item	Description/Specifications
FPCTBK FPCTBZ FPCTBS FPCTNK FPCTAL FPCTGY 	Cutout Cover Assembly – Flangeless cover for use in tile installations. Die-cast aluminum assembly available in black (BK), bronze (BZ), brass (BS), nickel (NK), gray (GY), or brushed aluminum (AL). Insert in lid allows for tile cutouts to match finished floor.	FPFFTBK FPFFTBZ FPFFTBS FPFFTNK FPFFTAL FPFFTGY 	Furniture Feed Cover Assembly – Flangeless cover for use in tile installations. Die-cast aluminum assembly available in black (BK), bronze (BZ), brass (BS), nickel (NK), gray (GY), or brushed aluminum (AL). Provided with one 1" trade size screw plug for power or communication type cabling and one combination 1 1/4" and 2" trade size screw plug for communication type cabling. Allows for feeding both power and communication cabling.
FPBTBK FPBTBZ FPBTBS FPBTNK FPBTAL FPBTGY 	Blank Cover Assembly – Flangeless cover for use in tile installations. Die-cast aluminum assembly available in black (BK), bronze (BZ), brass (BS), nickel (NK), gray (GY), or brushed aluminum (AL). Lid area is flush with the finished floor, no cutouts provided.		Country of Origin: USA
	Country of Origin: India		Country of Origin: USA

NOTE: Pricing varies depending on country of origin. Consult your local sales representative for more information.

North American Made FloorPort Series Cover Assemblies for RFB2, RFB4 & RFB6 Series Floor Boxes

NORTH AMERICAN MADE FLOORPORT PART NUMBER CONFIGURATOR

<u>FP</u>	<u>B</u>	<u>TC</u>	<u>NK</u>	<u>NA</u>
FloorPort Cover	Blank Top Cutout Top Furniture Feed	B C FF Tile (Flangeless) Tile/Carpet (Flanged) T TC	Nickel Brass Black Bronze Gray Brushed Aluminum	NK BS BK BZ GY AL North American Made NA

North American Made FloorPort Series Flanged Cover Assemblies Ordering Information

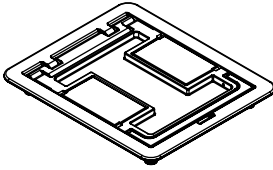
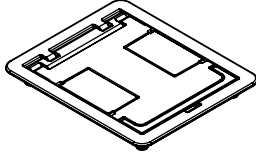
Catalog No./Item	Description/Specifications
FPCTCBK-NA FPCTCBZ-NA FPCTCBS-NA FPCTCNK-NA FPCTCGY-NA 	Cutout Cover Assembly – Flanged cover for use in tile or carpet installation. Die-cast aluminum assembly available in black (BK), bronze (BZ), brass (BS), nickel (NK), or gray (GY). Insert in lid allows for carpet or tile cutouts to match finished floor.
	Country of Origin: USA
FPBTCBK-NA FPBTCBZ-NA FPBTCBS-NA FPBTCNK-NA FPBTCGY-NA 	Blank Cover Assembly – Flanged cover for use in tile or carpet installation. Die-cast aluminum assembly available in black (BK), bronze (BZ), brass (BS), nickel (NK), or gray (GY). Lid area is flush with the finished floor, no cutouts provided.
	Country of Origin: USA

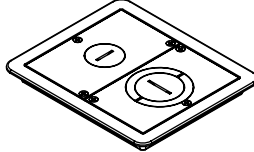
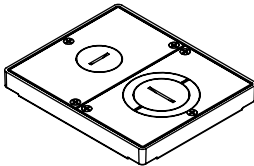
Catalog No./Item	Description/Specifications
FPFFTCBK FPFFTCBZ FPFFTCBS FPFFTCNK FPFFTCAL FPFFTCGY 	Furniture Feed Cover Assembly – Flanged cover for use in tile or carpet installation. Die-cast aluminum assembly available in black (BK), bronze (BZ), brass (BS), nickel (NK), gray (GY), or brushed aluminum (AL). Provided with one 1" trade size screw plug for power or communication type cabling and one combination 1 1/4" and 2" trade size screw plug for communication type cabling. Allows for feeding both power and communication cabling.
	Country of Origin: USA
FPFFTBK FPFFTBZ FPFFTBS FPFFTNK FPFFTAL FPFFTGY 	Furniture Feed Cover Assembly – Flangeless cover for use in tile installations. Die-cast aluminum assembly available in black (BK), bronze (BZ), brass (BS), nickel (NK), gray (GY), or brushed aluminum (AL). Provided with one 1" trade size screw plug for power or communication type cabling and one combination 1 1/4" and 2" trade size screw plug for communication type cabling. Allows for feeding both power and communication cabling.
	Country of Origin: USA

NOTE: Pricing varies depending on country of origin. Consult your local sales representative for more information.

NOTE: Load applied through a 2" [51mm] mandrel in center of service fitting. Loads above are static loads only and do not pertain to rolling loads.

LOAD CAPACITIES FOR FLOORPORT COVER ASSEMBLIES

CATALOG NUMBERS	MAXIMUM LOAD IN POUNDS
FPCTC	1000
FPBTC	750
FPFFTC	1000
FPCT	1000
FPBT	750
FPFFT	1000

NOTE: All brand and product names referenced in this document are registered trademarks or trademarks of their respective holders.



NOTE: The paper used to print this document is an environmentally responsible paper with 10% post consumer waste, with FSC and SFI Chain of Custody certifications, Lacey Act complaint. 100% of the electricity used to manufacture Flo sheets is generated with Green-e certified renewable energy.



Electrical Wiring Systems

60 Woodlawn Street
West Hartford, CT 06110
Phone: 1.877.BY.LEGRAND (295-3472)
www.legrand.us

570 Applewood Crescent
Vaughan, Ontario L4K 4B4
Phone: 905.738.9195
www.legrand.ca

