

the **adorne**[®] collection
www.adornemyhome.com

designed to be better.™



Legrand, North America

60 Woodlawn Street
West Hartford, CT 06110
1.877.BY.LEGRAND (295.3472)
www.legrand.us

9024 Keele St.
Concord, ON, L4K 2N2, Canada
905.738.9195
www.legrand.ca

©20176 Legrand. All Rights Reserved. PN C11797R2 70K - KP - 12/17

the **adorne**[®] collection
2018 CATALOG



**SWITCHES, DIMMERS, OUTLETS,
& ACCESSORIES**

DECORATIVE WALL PLATES

**UNDER-CABINET LIGHTING &
POWER SYSTEM**

**WI-FI LIGHTING SYSTEMS FOR
THE HOME**



designed to be better.™

IT'S JUST A
LIGHT SWITCH.
LIKE PARIS
IS JUST A CITY.



TABLE OF CONTENTS



02 INTRO TO THE ADORNE COLLECTION

- Design Inspiration
- Product Overview



06 SWITCHES, DIMMERS, OUTLETS, & ACCESSORIES

- Overview
- Switches & Dimmers
- Outlets
- Illumination Accessories
- Connectivity



30 WALL PLATES

- Overview
- Hubbardton Forge®
- Cast Metals
- Real Materials
- Plastics



46 UNDER-CABINET LIGHTING & POWER SYSTEM

- Overview
- Modular Tracks
- Control Boxes
- Lighting
- Accessories



56 WI-FI LIGHTING SYSTEM FOR THE HOME

- Wi-Fi Lighting System
- Wi-Fi Ready Switches and Dimmers
- Accessories



64 MORE INFORMATION

- Customer Tools and Support
- Index

IT'S TIME FOR A BEAUTIFUL SWITCH

The adorne collection makes life simply beautiful. It starts with stylishly smart switches, dimmers, outlets, and wall plates that merge an awe-inspiring array of styles and finishes with a high tech wow factor that's easy to get used to. You'll soon discover why adorne makes it a delight to hit the lights.



 adorne's under-cabinet system seamlessly blends lighting, power, and music into a simple recipe for a state of the art, clutter-free kitchen. See how to keep every modern convenience (like our innovative iPad and iPhone USB chargers) close at hand but ingeniously tucked away. Bluetooth connectivity, hidden power outlets, and a plug and play music system are just a few of the key ingredients for your infinitely flexible kitchen.

Finally, the adorne collection brings Wi-Fi control to music and lighting with its range of home system solutions. It's the kind of innovation that at first seems luxurious, but soon makes you wonder how you ever lived without.



Simply put, the adorne collection brings a new world of convenience — and a stylish finishing touch — to any space.





TRADITIONAL

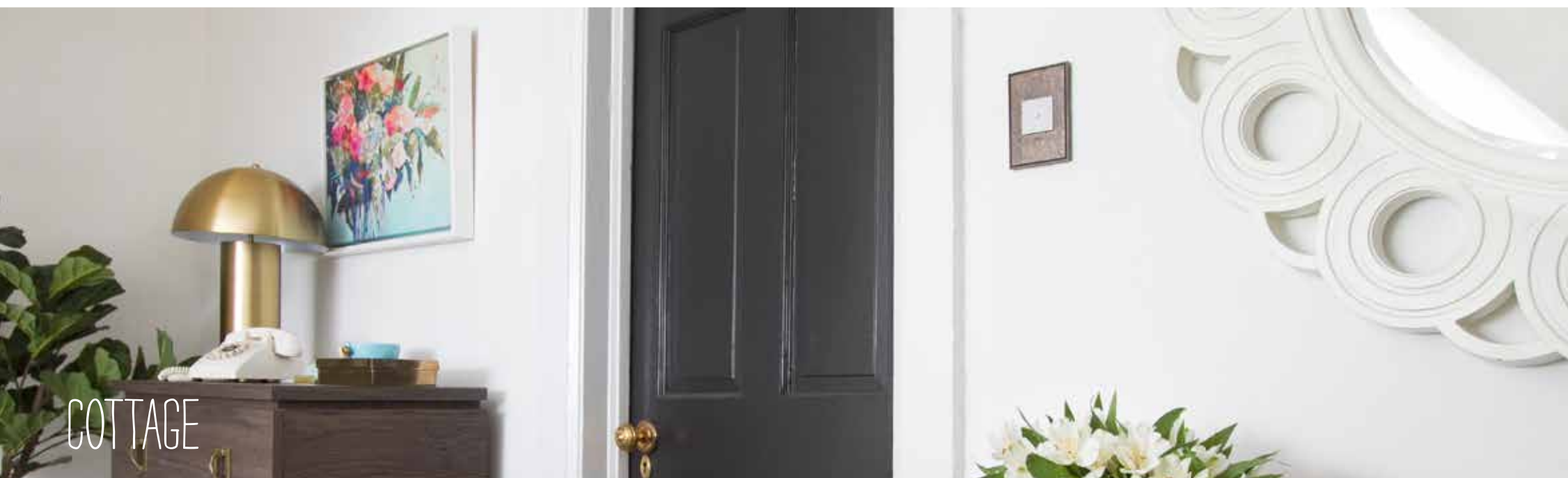

COTTAGE



CONTEMPORARY

TURN ON YOUR STYLE

The adorne collection offers solutions to match any taste — finishes to fit any personality. Whether you favor the clean lines of modern design, or cozy, cottage-style comfort, or even the classic elegance of a more traditional style, adorne is built to fit.

Take your pick of white or magnesium switches, dimmers, and outlets, and match them with a wide array of wall plate options. You'll find everything from lush natural woods, metals, and leather to a brilliant spectrum of colorful solids. Watch these usually forgotten finishing touches transform your walls from blah to breathtaking, letting the personality of your design shine through.

And how about the kitchen? Striking the right balance between practicality and style is always a challenge—whether traditional, contemporary, cottage, or otherwise. By tucking modular power outlets, lighting options, and music under the cabinets, adorne keeps counters and backsplashes uncluttered and puts the kitchen of your dreams in the most flattering light.

The adorne collection's range of high tech, high style solutions combines accessible, flexible, and smart designs to inspire creativity and enliven your living spaces to a whole new level.

PLUG IN TO
YOUR
CREATIVE
OUTLET



SWITCHES, DIMMERS,
OUTLETS, & ACCESSORIES



8 Overview

16 Switches & Dimmers

22 Outlets

26 Nightlights & Illumination

28 Connectivity

PADDLE™ SWITCHES AND DIMMERS

The Paddle design features a simple up-and-down motion, allowing you to turn lights on and off with ease. Dimmers include a slider for dimming or brightening lights. Pair with a Locator Status Light to add illumination to your Paddle switch or dimmer. See page 27.



PICASSO
65 GRAVURES
BERGGRUEN
10 RUE DE L'UNIVERSITÉ - PARIS-VII - 75006



PADDLE SWITCHES

ASPD1532W4
ASPD1532M4
ASPD2032W4
ASPD2032M4
ASPD1532W277
ASPD1532M277
ASPD2042W4
ASPD2042M4
ASPD1542W277
ASPD1542M277
ASPD1531W4
ASPD1531M4
ASPD1531W277
ASPD1531M277

PADDLE DIMMERS

ADPD453LW2
ADPD453LM2
ADPD703HW4
ADPD703HM4
ADPD1103HW4
ADPD1103HM2
ADPD4FBL3P2W4 (0-10V)
ADPD4FBL3P2M4 (0-10V)

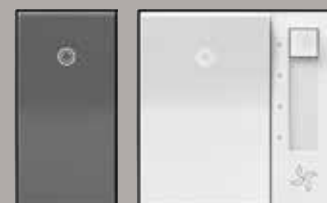

HALF-SIZE PADDLE SWITCHES

ASPD1531W4
ASPD1531M4
ASPD1531W277
ASPD1531M277

PADDLE FAN SPEED CONTROLS

AAFN4S16AW4
AAFN4S16AM4

WHISPER™ SWITCHES AND DIMMERS

The Whisper design features an innovative cross between a traditional toggle and paddle switch. Whisper dimmers include a slide for dimming or brightening lights. Pair with a Locator Status Light to add illumination to your Whisper switch or dimmer. See page 27.

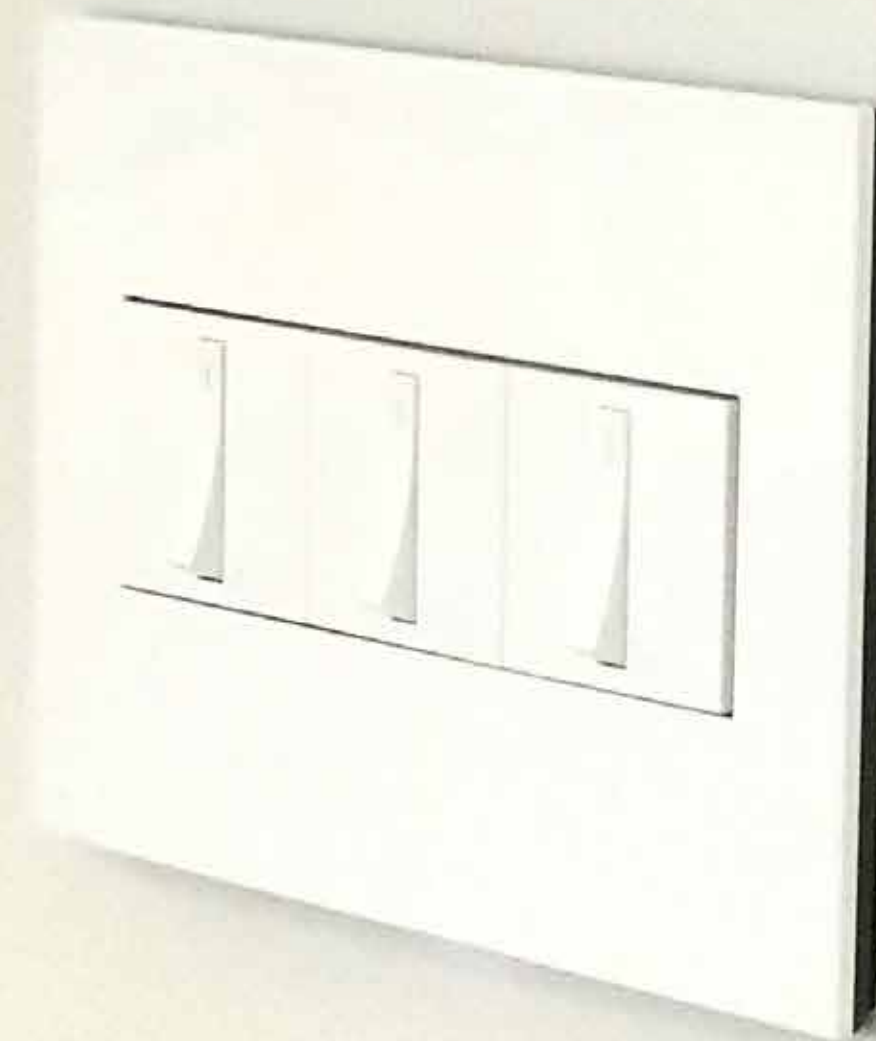

WHISPER SWITCHES

ASWR1532W4
ASWR1532M4

WHISPER DIMMERS

ADWR703HW4
ADWR703HM4
ADWR1103HW4
ADWR1103HM4



WHISPER WI-FI READY SWITCHES

ASWRRRM1
ASWRRRW1
ASWR155RMM1
ASWR155RMW1

WHISPER WI-FI READY DIMMERS

ADWR600RMHW1
ADWR600RMHM1
ADWR700RMTUW1
ADWR700RMTUM1
ADWRRRW1
ADWRRRM1

SOFTAP™ SWITCHES AND DIMMERS

The softTap design features an innovative micro-movement that turns lights on and off with just a soft “tap” of the finger. Dimmers include a unique paddle to adjust light levels.

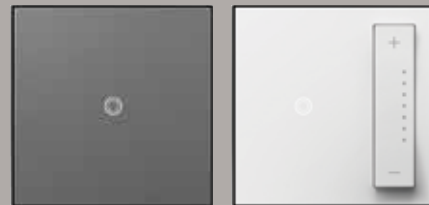

SOFTAP SWITCHES

ASTP1532W4
ASTP1532M4

SOFTAP DIMMERS

ADTP703TUW4
ADTP703TUM4
ADTP703HW2
ADTP703HM2
ADTP1103HW4
ADTP1103HM4
ADTP4FBL3PW4
ADTP4FBL3PM4



SOFTAP WI-FI READY SWITCHES

ASTP155RMW1
ASTP155RMM1
ASTPRRW1
ASTPRRM1

SOFTAP WI-FI READY DIMMERS

ADTP700RMTUW1
ADTP700RMTUM1
ADTP600RMHW1
ADTP600RMHM1
ADTPRRW1
ADTPRRM1

TOUCH™ SWITCHES AND DIMMERS

The Touch design features a stunning translucent face and operates just like an iPhone® - simply touch your finger on the circle to turn lights on and off, or use the arrows on the right to dim them (Touch dimmer only).



TOUCH SWITCHES

ASTH1532W2
ASTH1532M2

TOUCH DIMMERS

ADTH4FBL3PW4 (0-10V)
ADTH4FBL3PM4 (0-10V)



TOUCH WI-FI READY SWITCHES

ASTH155RMW1
ASTH155RMM1
ASTHRRW1
ASTHRRM1

TOUCH WI-FI READY DIMMERS

























ADTP700RMTUW1
ADTP700RMTUM1
ADTP600RMHW1
ADTP600RMHM1
ADTPRRW1
ADTPRRM1

SWITCHES

Paddle™

The Paddle design features a simple up-and-down motion, allowing you to turn lights on and off with ease. Dimmers include a slider for dimming or brightening lights.















Pair with a Locator Status Light to add illumination to your Paddle switch or dimmer. See page 27.

NAME	SPECIFICATIONS	RATING	COMPATIBLE LOADS	COMPLIANCE	FINISH OPTIONS	PART NUMBER
	Single-Pole/3-Way 	15A, 120 VAC	All Loads		White Magnesium	ASPD1532W4 ASPD1532M4
		20A, 120 VAC	All Loads		White Magnesium	ASPD2032W4 ASPD2032M4
	4-Way (Must be paired with two 3-way switches.) 	15A, 277 VAC	All Loads		White Magnesium	ASPD1532W277 ASPD1532M277
		20A, 120 VAC	All Loads		White Magnesium	ASPD2042W4 ASPD2042M4
		15A, 277 VAC	All Loads		White Magnesium	ASPD1542W277 ASPD1542M277
		20A, 120 VAC	All Loads		White Magnesium	ASPD2042W4 ASPD2042M4
	Single-Pole/3-Way 	450W	CFL, LED		White Magnesium	ADPD453LW2 ADPD453LM2
	Single-Pole/3-Way 2-Wire 	25W - 700W	Incandescent, Halogen 		White Magnesium	ADPD703HW4 ADPD703HM4
	Single-Pole/3-Way 4-Wire 	25W - 1100W	Incandescent, Halogen 		White Magnesium	ADPD1103HW4 ADPD1103HM2
		0-10V	0-10V Light Fixtures		White Magnesium	ADPD4FBL3P2W4 ADPD4FBL3P2M4
	Single-Pole/3-Way 	15A, 120 VAC	All Loads		White Magnesium	ASPD1531W4 ASPD1531M4
		15A, 277 VAC	All Loads		White Magnesium	ASPD1531W277 ASPD1531M277
	4-Speed De-hummer 	1.6A, 120 VAC	Paddle-Type Ceiling Fan		White Magnesium	AAFN4S16AW4 AAFN4S16AM4

Whisper™

The Whisper design features classic, elegant lines and a fluid motion. Whisper dimmers include a slide for dimming or brightening lights.



Pair with a Locator Status Light to add illumination to your Whisper switch or dimmer. See page 27.

NAME	SPECIFICATIONS	RATING	COMPATIBLE LOADS	COMPLIANCE	FINISH OPTIONS	PART NUMBER
	Single-Pole/3-Way 	15A, 120 VAC	All Loads		White Magnesium	ASWR1532W4 ASWR1532M4
	Single-Pole/3-Way 2-Wire 	25W - 700W	Incandescent, Halogen 		White Magnesium	ADWR703HW4 ADWR703HM4
	Single-Pole/3-Way 2-Wire 	25W - 1100W	Incandescent, Halogen 		White Magnesium	ADWR1103HW4 ADWR1103HM4
	Wi-Fi Ready Dimmer, Tru-Universal , 700W, 3-Wire 	6W - 700W	Incandescent, Halogen, MLV, Fluorescent, ELV, CFL, LED 		White Magnesium	ADWR700RMTUW1 ADWR700RMTUM1

Push™

The Push Switch allows you to turn lights on and off with a simple push-button motion.

Pair with a Locator Status Light to add illumination to your Push switch. See page 27.

NAME	SPECIFICATIONS	RATING	COMPATIBLE LOADS	COMPLIANCE	FINISH OPTIONS	PART NUMBER
	Single-Pole/3-Way	15A, 120 VAC	All Loads		White Magnesium	ASPU1532W4 ASPU1532M4

sofTap™















The sofTap design features an innovative micro-movement that turns lights on and off with just a soft “tap” of the finger. Dimmers include a unique paddle to adjust light levels.

2015 LIGHTING tomorrow Award Winner

Tru-Universal - 2015 Lighting for Tomorrow Winner!

Our Tru-Universal technology enables a dimmer to control all load types. Dimmers marked as Tru-Universal, such as the sofTap Dimmer below, automatically adapt to any load or combination of loads attached to them - Incandescent/Halogen, Magnetic Low Voltage, Electronic Low Voltage in Forward or Reverse Phase, CFL/LED bulbs, etc. They eliminate the flickering, early dropout, or “pop-on” deficiencies which can plague other non-adaptive dimmers.

The adorne Tru-Universal dimmer is the ultimate solution to dimming difficult loads. Simply pair it with any fixture and you're done!











NAME	SPECIFICATIONS	RATING	COMPATIBLE LOADS	COMPLIANCE	FINISH OPTIONS	PART NUMBER
sofTap Switch 	Single-Pole/3-Way 	15A, 120 VAC, 1/2 Hp	All Loads		White Magnesium	ASTP1532W4 ASTP1532M4
sofTap Dimmer 	Wi-Fi Ready Master (3-Wire)  Tru-Universal 2015 Lighting For Tomorrow Winner	6W - 700W	Incandescent, Halogen, MLV, Fluorescent, ELV, CFL, LED 		White Magnesium	ADTP703TJW4 ADTP703TJM4
	Single-Pole/3-Way 2-Wire 	700W	Incandescent, Halogen 		White Magnesium	ADTP703HW2 ADTP703HM2
	Single-Pole/3-Way 2-Wire 	700W	Incandescent, Halogen 		White Magnesium	ADTP1103HW4 ADTP1103HM4
	Single-Pole/3-Way 	0-10V	0-10V Light Fixtures		White Magnesium	ADTP4FBL3PW4 ADTP4FBL3PM4

2015 LIGHTING tomorrow Award Winner

Touch™

The Touch design features a stunning translucent face and operates just like an iPhone® - simply touch your finger on the circle to turn lights on and off, or use the arrows on the right to dim them (Touch dimmer only).

The white Touch interface is created using a unique translucent material. In multi-gang installations, we recommend pairing white Touch switches and dimmers for optimal consistency.

NAME	SPECIFICATIONS	RATING	COMPATIBLE LOADS	COMPLIANCE	FINISH OPTIONS	PART NUMBER
Touch Switch 	Single-Pole/3-Way 	15A, 120 VAC, 1/2 Hp	All Loads		White Magnesium	ASTH1532W2 ASTH1532M2
Touch Dimmer 	Single-Pole/3-Way 	0-10V	0-10V Light Fixtures		White Magnesium	ADTH4FBL3PW4 ADTH4FBL3PM4
Touch Wi-Fi Ready Dimmer 	Wi-Fi Ready Master (3-Wire)  Tru-Universal	6W - 700W	Incandescent, Halogen, MLV, Fluorescent, ELV, CFL, LED 		White Magnesium	ADTH700RMTUW1 ADTH700RMTUM1



iPhone® is a registered trademark of Apple, Inc.

SensaSwitch™ + SensaDimmer™



SensaSwitches include passive infrared (PIR) sensor technology, automatically turning lights on or off when you enter or leave a room. The design features an innovative micro-movement that allows you to also manually turn on lights with a soft touch of the finger. SensaSwitches are available in three models:





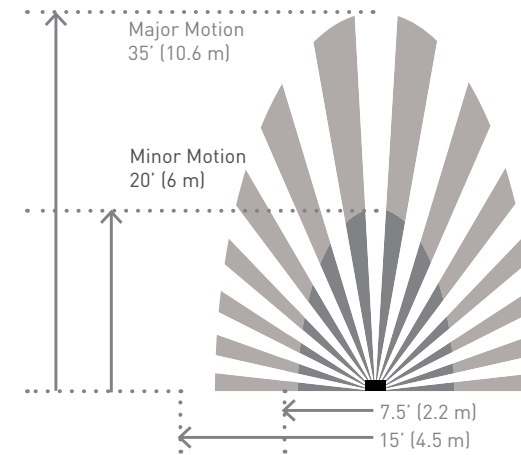









- Auto-ON/Auto-OFF: Automatically turns lights on when you enter a room and off when you leave. (Occupancy Sensor)
- Manual-ON/Auto-OFF: Allows you to turn lights on when you enter a room and automatically turns them off when you leave. (Vacancy Sensor)
- Manual-ON/Timer-OFF: Allows you to turn lights on when you enter a room and select a time for lights to turn off (options include 10, 20, 30, and 60 minutes). (Timer)

SensaSwitches are perfect for kitchens, bathrooms, garages, and pantries. The SensaDimmer turns lights on when you enter a room and off when you leave, but can be adjusted to become Manual-ON/Auto-OFF if desired. The chart to the right provides an overview of the sensor coverage area.



SensaSwitch™ + SensaDimmer™ Coverage Area

The Occupancy Sensor, Vacancy Sensor, and SensaDimmer each have a maximum coverage range of 180 degrees and a coverage area of 600 sq. ft. The sensor must have a clear and unobstructed view of the coverage area. Objects blocking the sensor's lens may prevent detection thereby causing the light to turn off even though someone is in the area. Windows, glass doors, and other transparent barriers will obstruct the sensor's view and prevent detection.

NAME	SPECIFICATIONS	RATING	COMPATIBLE LOADS	TIME DELAY	COMPLIANCE	FINISH OPTIONS	PART NUMBER
SensaSwitch, Auto-ON/Auto-OFF 	Single-Pole/3-Way  Occupancy Sensor (Must be paired with another SensaSwitch or SensaDimmer in 3-way applications)	600W, 120VAC, 60 Hz, 1/6 Hp	All Loads	5 minutes – 30 minutes		White Magnesium	ASOS32W4 ASOS32M4
SensaSwitch, Manual-ON/Auto-OFF 	Single-Pole/3-Way  Vacancy Sensor (Must be paired with another SensaSwitch or SensaDimmer in 3-way applications)	600W, 120VAC, 60 Hz, 1/6 Hp	All Loads	5 minutes – 30 minutes	 CA Title 24	White Magnesium	ASVS12W4 ASVS12M4
SensaSwitch, Manual-ON/Timer-OFF 	Single-Pole/3-Way  Timer (Must be paired with another SensaSwitch or SensaDimmer)	600W, 120VAC, 60 Hz, 1/6 Hp	All Loads	Options include 60, 30, 20, or 10 minutes		White Magnesium	ASTM2W2 ASTM2M2
SensaDimmer, Auto-ON/Auto-OFF 	Single-Pole/3-Way  Dimming Occupancy Sensor 3-Wire (Must be paired with another SensaSwitch or SensaDimmer)	25W - 700W 25W - 450W	Incandescent,  Halogen, 	5 minutes – 30 minutes		White Magnesium	ADSM703HW2 ADSM703HM2





Wave™

The Wave switch features innovative technology combined with sleek, contemporary design. Simply wave your hand in front of the switch to turn lights on and off.

With its touch-free motion, the Wave is ideal for countertop areas in kitchens and bathrooms. It has a preset sensor distance of approximately 4". However, this can be easily adjusted to sense movement from 1" to 6" in front of switch.



















NAME	SPECIFICATIONS	RATING	COMPATIBLE LOADS	COMPLIANCE	FINISH OPTIONS	PART NUMBER
Wave Switch 	Single-Pole/3-Way 	15A, 120 VAC, 1/2 Hp	All Loads		White Magnesium	ASWV1532W2 ASWV1532M2



















Outlets (Receptacles)

All adorne outlets include a tamper-resistant design featuring a patented shutter system, keeping children safe by preventing them from pushing small objects into the outlet. The shutters are molded a dark color so that they fade into the background while keeping users safe. Outlets and GFCIs are available in full- and plus-size versions.

All adorne 15A outlets have a 20A feed or pass-through allowing them to be installed on 20A circuits, such as in kitchens, bathrooms, etc.





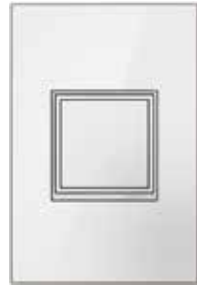

NAME	DESCRIPTION	RATINGS	NEMA CONFIGURATION	COMPLIANCE	FINISH OPTIONS	PART NUMBER
 Tamper-Resistant Outlet	Pair with a Half-Size Nightlight, Paddle Switch, or USB Outlet for greater functionality in a 1-Gang+ Wall Plate. 15A provides 20A pass-through.	15A, 125V 	5-15R		White Magnesium	ARTR152W4 ARTR152M4
		20A, 125V 	5-20R		White Magnesium	ARTR202W4 ARTR202M4
 Plus-Size Tamper-Resistant Outlet	Compatible with 1-Gang+ Wall Plates only. Cannot be used in multi-gang installations. 15A provides 20A pass-through.	15A, 125V 	5-15R		White Magnesium	ARTR153W4 ARTR153M4
 Tamper-Resistant GFCI	GFCIs protect against serious injury due to electric shock. They are required by National Electrical Code in kitchens and bathrooms. All adorne GFCIs are self testing to meet the latest NEC requirement. 15A provides 20A pass-through.	15A, 125V 	5-15R		White Magnesium	AGFTR2152W4 AGFTR2152M4
		20A, 125V 	5-20R		White Magnesium	AGFTR2202W4 AGFTR2202M4
 Plus-Size Tamper-Resistant GFCI	GFCIs protect against serious injury due to electric shock. They are required in kitchens and bathrooms. All adorne GFCIs are self testing to meet the latest NEC requirement. 15A provides 20A pass-through. Compatible with 1-Gang+ Wall Plates only. Cannot be used in multi-gang installations.	15A, 125V 	5-15R		White Magnesium	AGFTR2153W4 AGFTR2153M4
 Energy-Saving ON/OFF Outlet	On/off switch allows you to save energy and stop the flow of power without unplugging your device. Perfect for kitchens, bathrooms, and computer rooms. Provides 20A pass-through.	15A, 125V 	5-15R		White Magnesium	ARPS152W4 ARPS152M4

NAME	DESCRIPTION	RATINGS	NEMA CONFIGURATION	COMPLIANCE	FINISH OPTIONS	PART NUMBER
 Wi-Fi Ready ON/OFF Outlet	Lets you control a plug load from a new location without running additional wires when paired with adorne Wi-Fi Ready Remote Switches (page 60). On/off switch also allows you to save energy and stop the flow of power to the outlet without unplugging your device. Provides 20A pass-through.	15A, 125V 	5-15R		White Magnesium	ARPS15RF2W4 ARPS15RF2M4
 Tamper-Resistant Dual Controlled Outlet	This Plug Load outlet controls both receptacles, which will turn off for energy efficiency and cost savings. They are code-required, meet standards, and include permanent power markings. 15A provides 20A pass-through.	15A, 125V 	5-15R		White Magnesium	ARCD152W10 ARCD152M10
		20A, 125V 	5-20R		White Magnesium	ARCD202W10 ARCD202M10
 Tamper-Resistant Half Controlled Outlet	This Plug Load outlet controls half the receptacle, featuring a factory-broken split-circuit tab, allowing half of the receptacle to turn off for energy efficiency and cost savings. They are code-required, meet standards, and include permanent power markings. Provides 20A pass-through.	15A, 125V 	5-15R		White Magnesium	ARCH152W10 ARCH152M10
 Half-Size USB Outlet	Perfect for charging mobile devices such as phones and tablets. Pair with a switch or outlet in a 1-Gang+ plate for more functionality in one box. Provides 20A pass-through.	2.1A, 5VDC, 11W 			White Magnesium	ARUSBW4 ARUSBM4
 Dual USB Plus-Size Outlet Combo	Perfect for charging multiple mobile devices such as phones and tablets.	3.1A, 5V DC, 15A, 125V 			White Magnesium	ARTRUSB153M4 ARTRUSB153W4



Pop-Out™ Outlet (Receptacle)

Pop-Out Outlets require a special frame (included in package) and are not compatible with those used with adorne wall plates. **They require a deep box, such as Pass & Seymour S122R, for installation or in a location that has a thick material like a kitchen backsplash, in a standard box.** Each outlet includes capacity for three plugs.



NAME	DESCRIPTION	RATINGS	NEMA CONFIGURATION	COMPLIANCE	FINISH OPTIONS	PART NUMBER
Pop-Out Outlet, 1-Gang 	Includes 1-gang frame for installation. Cannot be paired with other switches, dimmers, outlets, or accessories. 15A version provides 3 receptacles. 20A version provides 2 receptacles. Cannot be used in multi-gang installations.	15A 	5-15R		White Magnesium	ARPTR151GW2 ARPTR151GM2
		20A	5-20R		White Magnesium	ARPTR201GW2 ARPTR201GM2
Pop-Out Outlet, 2-Gang 	Includes one Pop-Out Outlet and 2-gang frame for installation. Select this option to pair your Pop-Out Outlet with another adorne switch, dimmer, outlet, or accessory.	15A 	5-15R		White Magnesium	ARPTR152GW2 ARPTR152GM2



deQuorum™ Flip-Up Table Boxes

deQuorum Flip-Up Table Boxes provide flexibility in decor, communication connectivity options, and installation to meet specific functional and aesthetic needs. Flip-Up Table Boxes bring the modules above the work surface when in use for easy access. Available in a black powder coat or brushed stainless steel finish.

*For additional configurations reach contact your local rep.

NAME	DESCRIPTION	RATINGS	NEMA CONFIGURATION	COMPLIANCE	FINISH OPTIONS	PART NUMBER
Field Wired Dequorum™ Single Flip Up Unit with USB 	Unit includes one (1) 15A tamper resistant duplex receptacle with two (2) USB ports that provide 3.1A.	15A, 125V	5-15R		Black Stainless	DQFF15UBK DQFF15UST
Cord Ended Dequorum™ Single Flip Up Unit with USB 	Unit includes one (1) 15A black tamper-resistant duplex receptacle with two (2) USB ports that provide 3.1A. Unit comes with a 6' (1.83m) cord. Comes with a black powder coat finish.	15A, 125V	5-15R		Black Stainless	DQFP15UBK DQFP15UST
Cord Ended Dequorum™ Single Flip Up Unit 	Unit includes one (1) 15A black tamper-resistant duplex receptacle. Unit comes with a 6' (1.83m) cord. Comes with a black powder coat finish.	15A, 125V	5-15R		Black Stainless	DQFP15BK DQFP15ST



Furniture Power Centers

Furniture Power Centers offer endless design possibilities for providing power that's built-into furniture that have never been available before. Fueled by the beauty and diversity of adorne devices and wall plates, Furniture Power Centers are designed to blend seamlessly with or provide a beautiful accent to your furniture and design of your space. Add charging, switching and dimming directly into the headboard, night stand or lobby seating- just plug and play.

NAME	DESCRIPTION	RATINGS	NEMA CONFIGURATION	COMPLIANCE	FINISH OPTIONS	PART NUMBER
Furniture Power, Outlet and USB Port 	Easily add power and charging to furniture. 1 tamper-resistant outlet and 1 USB charging port in a magnesium finish. Wall plate sold separately. Comes standard with 8 foot cord with right angle plug.	Receptacles: 15A 120Vac USB charging ports: 2.4A, 5Vdc each			White Magnesium	AD1-RU-W AD1-RU-M
Furniture Power, Outlet and 2 USB Ports 	Easily add power and charging to furniture. 1 tamper-resistant outlet and 2 USB charging ports in a magnesium finish. Wall plate sold separately. Comes standard with 8 foot cord with right angle plug.	Receptacles: 15A 120Vac USB charging ports: 2.4A, 5Vdc each			White Magnesium	AD2-Z-W AD2-Z-M
Furniture Power, 2 Outlets and 2 USB Ports 	Easily add power and charging to furniture. 2 tamper-resistant outlets and 2 USB charging ports in a magnesium finish. Wall plate sold separately. Comes standard with 8 foot cord with right angle plug.	Receptacles: 15A 120Vac USB charging ports: 2.4A, 5Vdc each			White Magnesium	AD3-ZR-W AD3-ZR-M

Illumination Accessories

You've never seen a nightlight that hides itself so cleverly, yet responds so elegantly to a simple touch. Or one that can be lifted from its home on your wall to double as a carry-around flashlight. When it comes to brilliant solutions, adorne really shines.

All nightlights include ambient light level sensors. Each features a range of settings, including: Always Off, Low, Medium, and High. If set to Low, Medium, or High, the nightlight's LED will only be visible when the ambient room is dark. To change the selected setting, simply push on the square in the upper right-hand corner of the nightlight.

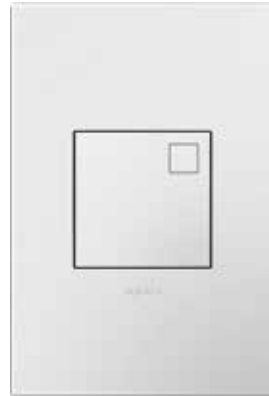

NAME	DESCRIPTION	COMPLIANCE	PART NUMBER
Half-size Nightlight	Features a soft, glowing LED light. Pair with a switch or outlet in a 1-Gang, 3-Module Plate for added flexibility. Light levels include: Always Off Low Medium High		AANLM14
Nightlight	Features a soft, glowing LED light. Light levels include: Always Off Low Medium High		AANLM24
Portable Nightlight/ Flashlight	Simply push on this innovative nightlight to remove it from the wall and use it as a flashlight. Device recharges while mounted in wall and operates for up to 10 hours during a power failure. Includes light level options listed above, as well as Flashlight Mode, which is activated only when device is removed from wall.		AARNL2



In-wall nightlight function



Press on nightlight to remove from wall



Portable flashlight function

Accent Nightlight

The Accent Nightlight is a stunning addition to any adorne product and is compatible with any* 1- through 4-Gang wall plate. The device is invisible once installed, but can be activated by placing a finger under the wall plate. This will cause the light to cycle through several light level options, as depicted in the chart below.

NAME	COMPLIANCE	PART NUMBER
Accent Nightlight, 1-Gang		AAAL1G4
Accent Nightlight, 2-Gang		AAAL2G2
Accent Nightlight, 3-Gang		AAAL3G2
Accent Nightlight, 4-Gang		AAAL4G2



*Please note, the Accent Nightlight will not work with the Pop-Out Outlet.

Light Level Settings

The Accent Nightlight will cycle through these options, allowing you to select the setting you prefer. Auto-OFF indicates that the light will automatically turn on when the room is dark and off when the room is light.

DAYTIME	NIGHT TIME
Auto-OFF (1)	High
Always ON (2)	Medium
	Low
	Ultra-Low
	OFF (3)

1. Light turns off automatically when room is light.
2. Light remains on when room is light.
3. Light remains off when room is dark.

Locator Status Light: Find Us in the Dark

NAME	DESCRIPTION	COMPLIANCE	PART NUMBER
Locator Status Light	Add a stylish, small locator light to your Paddle, Whisper, or Push switch or dimmer and you'll never again have to slide your hand across the wall trying to find that switch. The locator light is a standard feature of all other switches and dimmers. It can be disabled if desired. Locator light is on when the load is off and off when the load is on.		AALSL6 AALSL277 (277 VAC)

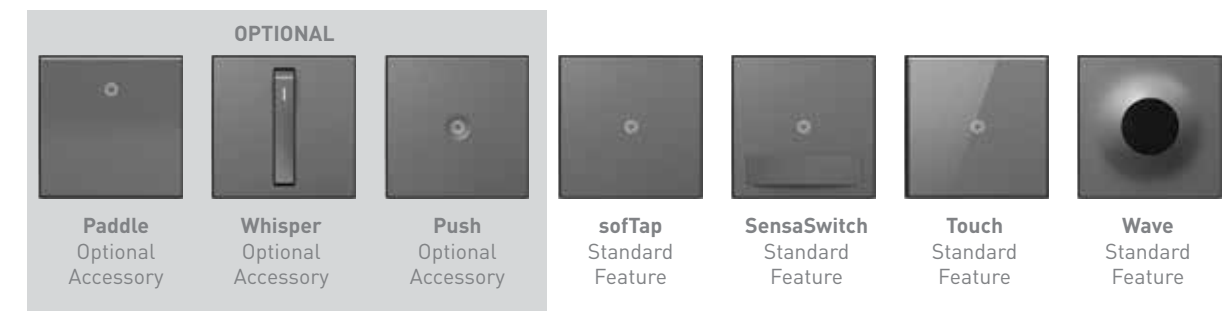

CONNECTIVITY

Accessories: Blank Module

Use this blank insert to give your project a complete, finished look. Pair it with other half-size devices, like the Nightlight, Paddle Switch, or USB, in a 1-gang wall plate.

NAME	FINISH OPTIONS	PART NUMBER
Half-Size Blank	White Magnesium	AABK1W4 AABK1M4



Accessories: Mounting Frames

NAME	FINISH OPTIONS	PART NUMBER
1-Gang Mounting Frame		AF1G
2-Gang Mounting Frame		AF2G
3-Gang Mounting Frame		AF3G
4-Gang Mounting Frame		AF4G
5-Gang Mounting Frame		AF5G
6-Gang Mounting Frame		AF6G



Keystone Frames

For a consistent look throughout the project, select an adorne keystone frame to enable audio, video, and data connectivity in an adorne wall plate. Simply pair a 1-port, 2-port, or 4-port frame with any keystone inserts shown on the next page and then mount in an adorne wall plate for a complete installation.

NAME	FINISH OPTIONS	PART NUMBER
1-Port Frame	White Magnesium	AC1PFW1 AC1PFM1
2-Port Frame	White Magnesium	AC2PFW1 AC2PFM1
4-Port Frame	White Magnesium	AC4PFW1 AC4PFM1
In-Wall Cable Access Port	White Magnesium	ACBRSTPW1 ACBRSTPM1



1-Port Frame

2-Port Frame



4-Port Frame

In-Wall Cable Access Port

Keystone Inserts

NAME	FINISH OPTIONS	PART NUMBER
Cat 5e RJ45 Data/Phone Insert	White Magnesium	AC5ERJ45W1 AC5ERJ45M1
Cat 5e RJ45 Data Coupler Insert	White Magnesium	AC5ERJ45CW1 AC5ERJ45CM1
Cat 6 RJ45 Data Insert	White Magnesium	AC6RJ45W1 AC6RJ45M1
RJ25 Phone Jack	White Magnesium	ACRJ25W1 ACRJ25M1
Component Video RCA to F Kit	White Magnesium	ACRGBRCAFW1 ACRGBRCAFM1
Composite Video RCA to F-Connector	White Magnesium	ACYRCAFW1 ACYRCAFM1

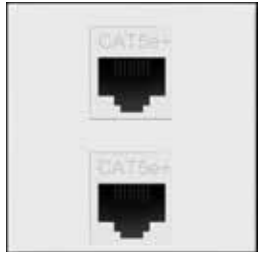

NAME	FINISH OPTIONS	PART NUMBER
HDMI Keystone Coupler	White Magnesium	ACHDMIW1 ACHDMIM1
Single Keystone Speaker Connector	White Magnesium	ACSSIW1 ACSSIM1
Speaker Binding Posts	White Magnesium	ACABPW1 ACABPM1
Subwoofer RCA to F-Connector	White Magnesium	ACPRCAFW1 ACPRCAFM1
Video F-Connector	White Magnesium	ACNRFCW1 ACNRFCM1
Blank Keystone Insert (4-Pack)	White Magnesium	ACBLKW4 ACBLKM4



CHOOSE A STYLE
AS INTERESTING
AS YOURS

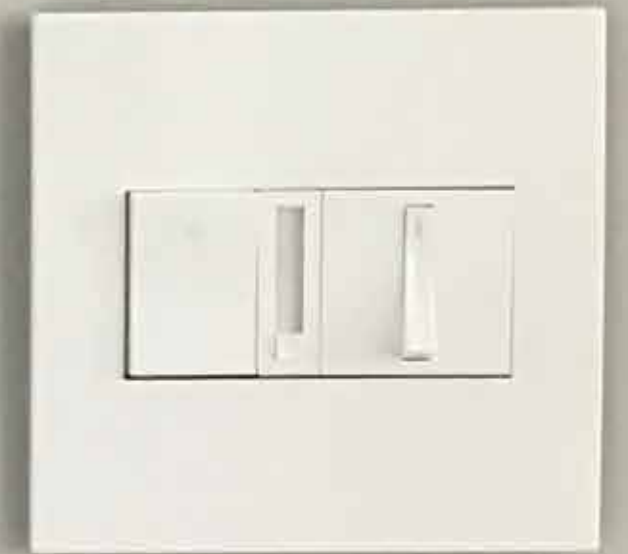

WALL PLATES







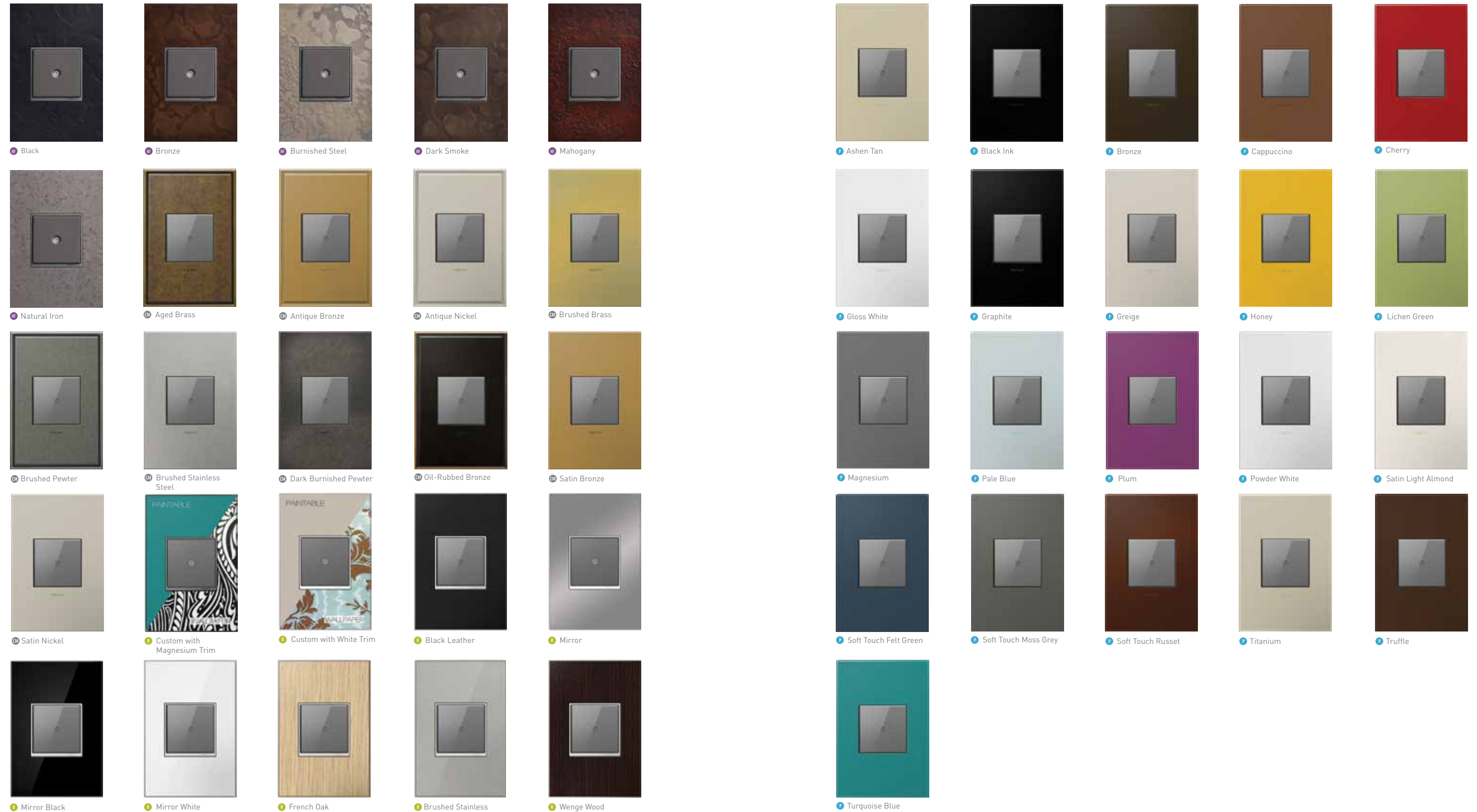









32	Overview
34	The Hubbardton Forge® Line
36	Cast Metals
37	Real Materials
38	Plastics

HF HUBBARDTTON FORGE®
 CM CAST METALS
 R REAL MATERIALS
 P PLASTIC



The Hubbardton Forge® Line

What happens when you combine a 6,000 year-old art with leading edge, touch-sensitive technology? Introducing the Hubbardton Forge line by Legrand, as part of the adorne® collection. Six lustrous metal plates, forged by fire to make adorne's simply elegant switches and outlets a perfect match with Hubbardton Forge's rich array of metal textures and finishes. It's a partnership forged in the fires of creativity and passion.

NAME	GANGS	PART NUMBER	NAME	GANGS	PART NUMBER
Black   	1-Gang 2-Gang 3-Gang 4-Gang 1-Gang+	AWM1G2HF BK4 AWM2GHFBK1 AWM3GHFBK1 AWM4GHFBK1 AWM1G3HF BK1	Dark Smoke   	1-Gang 2-Gang 3-Gang 4-Gang 1-Gang+	AWM1G2HFDS4 AWM2GHFDS1 AWM3GHFDS1 AWM4GHFDS1 AWM1G3HFDS1
Bronze   	1-Gang 2-Gang 3-Gang 4-Gang 1-Gang+	AWM1G2HFBR4 AWM2GHFBR1 AWM3GHFBR1 AWM4GHFBR1 AWM1G3HFBR1	Mahogany   	1-Gang 2-Gang 3-Gang 4-Gang 1-Gang+	AWM1G2HFMMH4 AWM2GHFMMH1 AWM3GHFMMH1 AWM4GHFMMH1 AWM1G3HFMMH1
Burnished Steel   	1-Gang 2-Gang 3-Gang 4-Gang 1-Gang+	AWM1G2HFBS4 AWM2GHFBS1 AWM3GHFBS1 AWM4GHFBS1 AWM1G3HFBS1	Natural Iron   	1-Gang 2-Gang 3-Gang 4-Gang 1-Gang+	AWM1G2HFIFE4 AWM2GHFIFE1 AWM3GHFIFE1 AWM4GHFIFE1 AWM1G3HFIFE1



DARK SMOKE | AWM2GHFDS1





















Variations in finish appearance are a normal and desired result of the process rendering each piece an individual and unique work of art.



BRUSHED BRASS | AWC1G2BB4

Cast Metals

adorne Cast Metal wall plates are hand-crafted by artisans, making them unique and distinctive. These slight variations in finish and color add to the rich beauty of the adorne Cast Metal offering.



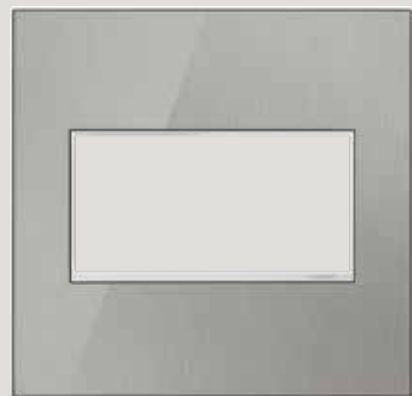





NAME	GANGS	PART NUMBER	NAME	GANGS	PART NUMBER
 Aged Brass 	1-Gang 2-Gang 3-Gang 4-Gang 1-Gang+	AWC1G2AB4 AWC2GAB4 AWC3GAB4 AWC4GAB4 AWC1G3AB4	 Brushed Stainless Steel 	1-Gang 2-Gang 3-Gang 4-Gang 1-Gang+	AWC1G2BS4 AWC2GBS4 AWC3GBS4 AWC4GBS4 AWC1G3BS4
 Antique Bronze 	1-Gang 2-Gang 3-Gang 4-Gang 1-Gang+	AWC1G2NB4 AWC2GNB4 AWC3GNB4 AWC4GNB4 AWC1G3NB4	 Dark Burnished Pewter 	1-Gang 2-Gang 3-Gang 4-Gang 1-Gang+	AWC1G2DP4 AWC2GDP4 AWC3GDP4 AWC4GDP4 AWC1G3DP4
 Antique Nickel 	1-Gang 2-Gang 3-Gang 4-Gang 1-Gang+	AWC1G2AN4 AWC2GAN4 AWC3GAN4 AWC4GAN4 AWC1G3AN4	 Oil-Rubbed Bronze 	1-Gang 2-Gang 3-Gang 4-Gang 1-Gang+	AWC1G2OB4 AWC2GOB4 AWC3GOB4 AWC4GOB4 AWC1G3OB4
 Brushed Brass 	1-Gang 2-Gang 3-Gang 4-Gang 1-Gang+	AWC1G2BB4 AWC2GBB4 AWC3GBB4 AWC4GBB4 AWC1G3BB4	 Satin Bronze 	1-Gang 2-Gang 3-Gang 4-Gang 1-Gang+	AWC1G2SB4 AWC2GSB4 AWC3GSB4 AWC4GSB4 AWC1G3SB4
 Brushed Pewter 	1-Gang 2-Gang 3-Gang 4-Gang 1-Gang+	AWC1G2BP4 AWC2GBP4 AWC3GBP4 AWC4GBP4 AWC1G3BP4	 Satin Nickel 	1-Gang 2-Gang 3-Gang 4-Gang 1-Gang+	AWC1G2SN4 AWC2GSN4 AWC3GSN4 AWC4GSN4 AWC1G3SN4

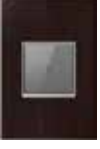

BRUSHED STAINLESS | AWM2GMS4

Real Materials

adorne Real Material wall plates are created with natural materials such as leather and wood. Each wall plate is hand-crafted by artisans and no two are exactly alike. These slight variations in finish and color add to the unique beauty of the adorne Real Material line.

NAME	GANGS	PART NUMBER	NAME	GANGS	PART NUMBER
Black Leather 	1-Gang 2-Gang 3-Gang 4-Gang 1-Gang+	AWM1G2LE4 AWM2GLE4 AWM3GLE4 AWM4GLE4 AWM1G3LE4	Mirror White 	1-Gang 2-Gang 3-Gang 4-Gang 1-Gang+	AWM1G2MW4 AWM2GMW4 AWM3GMW4 AWM4GMW4 AWM1G3MW4
Brushed Stainless 	1-Gang 2-Gang 3-Gang 4-Gang 1-Gang+	AWM1G2MS4 AWM2GMS4 AWM3GMS4 AWM4GMS4 AWM1G3MS4	Wenge Wood 	1-Gang 2-Gang 3-Gang 4-Gang 1-Gang+	AWM1G2WE4 AWM2GWE4 AWM3GWE4 AWM4GWE4 AWM1G3WE4
French Oak 	1-Gang 2-Gang 3-Gang 4-Gang 1-Gang+	AWM1G2FH4 AWM2GFH4 AWM3GFH4 AWM4GFH4 AWM1G3FH4	Custom with Magnesium Trim 	1-Gang 2-Gang 3-Gang 4-Gang 1-Gang+	AWM1G2M4 AWM2GM4 AWM3GM4 AWM4GM4 AWM1G3M4
Mirror 	1-Gang 2-Gang 3-Gang 4-Gang 1-Gang+	AWM1G2MR4 AWM2GMR4 AWM3GMR4 AWM4GMR4 AWM1G3MR4	Custom with White Trim 	1-Gang 2-Gang 3-Gang 4-Gang 1-Gang+	AWM1G2W4 AWM2GW4 AWM3GW4 AWM4GW4 AWM1G3W4
Mirror Black 	1-Gang 2-Gang 3-Gang 4-Gang 1-Gang+	AWM1G2MB4 AWM2GMB4 AWM3GMB4 AWM4GMB4 AWM1G3MB4	Mirror White, White-on-White 	1-Gang 2-Gang 3-Gang 4-Gang 1-Gang+	AWM1G2MWW4 AWM2GMWW4 AWM3GMWW4 AWM4GMWW4 AWM1G3MWW4



GRAPHITE | AWP3GGR4







Plastics







Available in a variety of classic and contemporary colors, adorne Plastic wall plates provide the perfect finishing touch to any installation.

NAME	GANGS	PART NUMBER
Ashen Tan	1-Gang 2-Gang 3-Gang 4-Gang 1-Gang+ 5-Gang 6-Gang	AWP1G2AT4 AWP2GAT4 AWP3GAT4 AWP4GAT4 AWP1G3AT4 AWP5GAT1 AWP6GAT1
Black Ink	1-Gang 2-Gang 3-Gang 4-Gang 1-Gang+ 5-Gang 6-Gang	AWP1G2NK4 AWP2GNK4 AWP3GNK4 AWP4GNK4 AWP1G3NK4 AWP5GNK1 AWP6GNK1
Bronze	1-Gang 2-Gang 3-Gang 4-Gang 1-Gang+ 5-Gang 6-Gang	AWP1G2BR6 AWP2GBR4 AWP3GBR4 AWP4GBR4 AWP1G3BR4 AWP5GBR1 AWP6GBR1
Cappuccino	1-Gang 2-Gang 3-Gang 4-Gang 1-Gang+ 5-Gang 6-Gang	AWP1G2CP4 AWP2GCP4 AWP3GCP4 AWP4GCP4 AWP1G3CP4 AWP5GCP1 AWP6GCP1
Cherry	1-Gang 2-Gang 3-Gang 4-Gang 1-Gang+ 5-Gang 6-Gang	AWP1G2CH4 AWP2GCH4 AWP3GCH4 AWP4GCH4 AWP1G3CH4 AWP5GCH1 AWP6GCH1

NAME	GANGS	PART NUMBER
Gloss White	1-Gang 2-Gang 3-Gang 4-Gang 1-Gang+ 5-Gang 6-Gang	AWP1G2WH6 AWP2GWH4 AWP3GWH4 AWP4GWH4 AWP1G3WH4 AWP5GWH1 AWP6GWH1
Gloss White, White-on-White	1-Gang 2-Gang 3-Gang 4-Gang 1-Gang+ 5-Gang 6-Gang	AWP1G2WHW10 AWP2GWHW10 AWP3GWHW4 AWP4GWHW4 AWP1G3WHW4 AWP5GWHW1 AWP6GWHW1
Graphite	1-Gang 2-Gang 3-Gang 4-Gang 1-Gang+ 5-Gang 6-Gang	AWP1G2GR6 AWP2GGR4 AWP3GGR4 AWP4GGR4 AWP1G3GR4 AWP5GGR1 AWP6GGR1
Greige	1-Gang 2-Gang 3-Gang 4-Gang 1-Gang+ 5-Gang 6-Gang	AWP1G2GG4 AWP2GGG4 AWP3GGG4 AWP4GGG4 AWP1G3GG4 AWP5GGG1 AWP6GGG1
Honey	1-Gang 2-Gang 3-Gang 4-Gang 1-Gang+ 5-Gang 6-Gang	AWP1G2HY6 AWP2GHY4 AWP3GHY4 AWP4GHY4 AWP1G3HY4 AWP5GHY1 AWP6GHY1

Plastics

NAME	GANGS	PART NUMBER
Lichen Green 	1-Gang 2-Gang 3-Gang 4-Gang 1-Gang+ 5-Gang 6-Gang	AWP1G2LG6 AWP2GLG4 AWP3GLG4 AWP4GLG4 AWP1G3LG4 AWP5GLG1 AWP6GLG1
Magnesium 	1-Gang 2-Gang 3-Gang 4-Gang 1-Gang+ 5-Gang 6-Gang	AWP1G2MG6 AWP2GMG4 AWP3GMG4 AWP4GMG4 AWP1G3MG4 AWP5GMG1 AWP6GMG1
Pale Blue 	1-Gang 2-Gang 3-Gang 4-Gang 1-Gang+ 5-Gang 6-Gang	AWP1G2BL6 AWP2GBL4 AWP3GBL4 AWP4GBL4 AWP1G3BL4 AWP5GBL1 AWP6GBL1
Plum 	1-Gang 2-Gang 3-Gang 4-Gang 1-Gang+ 5-Gang 6-Gang	AWP1G2PL4 AWP2GPL4 AWP3GPL4 AWP4GPL4 AWP1G3PL4 AWP5GPL1 AWP6GPL1
Powder White 	1-Gang 2-Gang 3-Gang 4-Gang 1-Gang+ 5-Gang 6-Gang	AWP1G2PW4 AWP2GPW4 AWP3GPW4 AWP4GPW4 AWP1G3PW4 AWP5GPW1 AWP6GPW1
Satin Light Almond 	1-Gang 2-Gang 3-Gang 4-Gang 1-Gang+	AWP1G2LA6 AWP2GLA4 AWP3GLA4 AWP4GLA4 AWP1G3LA4

NAME	GANGS	PART NUMBER
Soft Touch Felt Green 	1-Gang 2-Gang 3-Gang 4-Gang 1-Gang+ 5-Gang 6-Gang	AWP1G2FG6 AWP2FG4 AWP3FG4 AWP4FG4 AWP1G3FG4 AWP5FG1 AWP6FG1
Soft Touch Moss Grey 	1-Gang 2-Gang 3-Gang 4-Gang 1-Gang+ 5-Gang 6-Gang	AWP1G2M06 AWP2GM04 AWP3GM04 AWP4GM04 AWP1G3M04 AWP5GM01 AWP6GM01
Soft Touch Russet 	1-Gang 2-Gang 3-Gang 4-Gang 1-Gang+ 5-Gang 6-Gang	AWP1G2RS6 AWP2GRS4 AWP3GRS4 AWP4GRS4 AWP1G3RS4 AWP5GRS1 AWP6GRS1
Titanium 	1-Gang 2-Gang 3-Gang 4-Gang 1-Gang+ 5-Gang 6-Gang	AWP1G2TM6 AWP2TM4 AWP3TM4 AWP4TM4 AWP1G3TM4 AWP5TM1 AWP6TM1
Truffle 	1-Gang 2-Gang 3-Gang 4-Gang 1-Gang+ 5-Gang 6-Gang	AWP1G2TF4 AWP2TF4 AWP3TF4 AWP4TF4 AWP1G3TF4 AWP5GTF1 AWP6GTF1
Turquoise 	1-Gang 2-Gang 3-Gang 4-Gang 1-Gang+ 5-Gang 6-Gang	AWP1G2TB4 AWP2GTB4 AWP3GTB4 AWP4GTB4 AWP1G3TB4 AWP5GTB1 AWP6GTB1



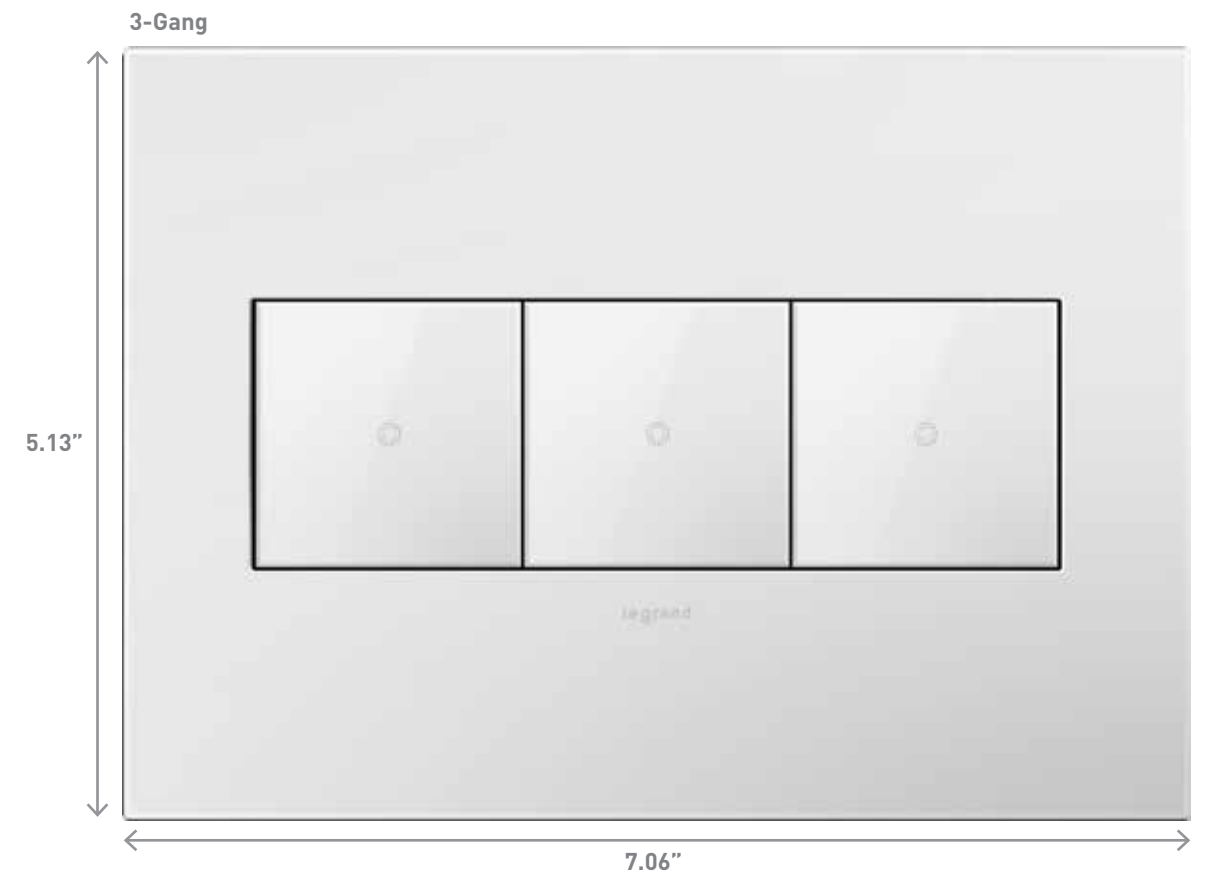
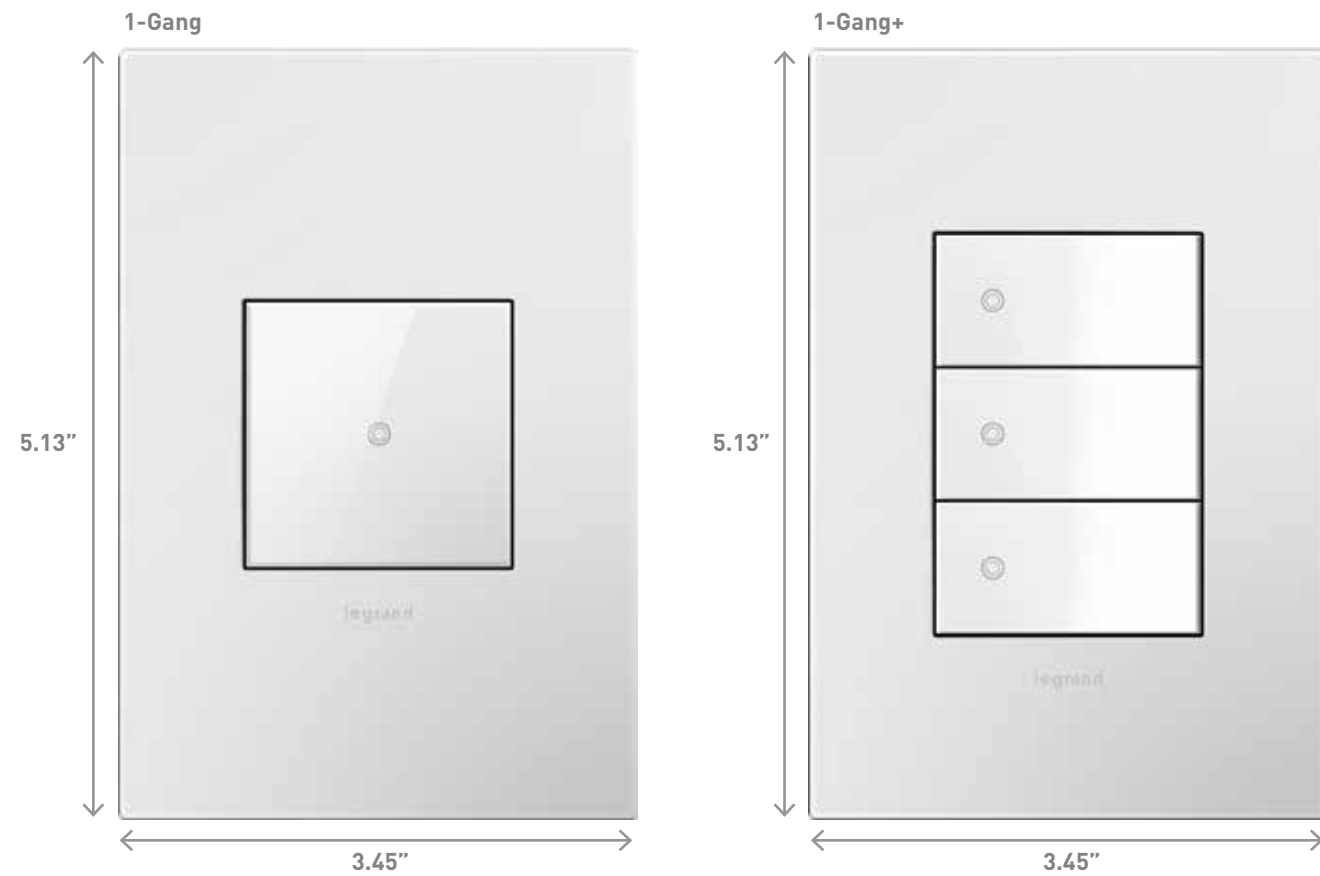

Wall Plates

Available in six gang sizes, adorne wall plates provide the perfect complement to adorne switches, dimmers, outlets, and accessories. The collection includes a variety of finishes, from cast metals like Satin Nickel and Oil-Rubbed Bronze to real materials such as Leather and Wood. In addition, the collection includes a full offering of plastic plates in contemporary and classic colors, as well as three innovative Soft Touch finishes.

Each wall plate is packaged with a mounting frame to enable easy installation when paired with a device. All plates are screwless and simply snap onto the included metal frame. See page 64 for more information on the adorne frame system.

All adorne wall plates are UL and ETL-approved. 5- and 6-Gang wall plates are not available in all colors.

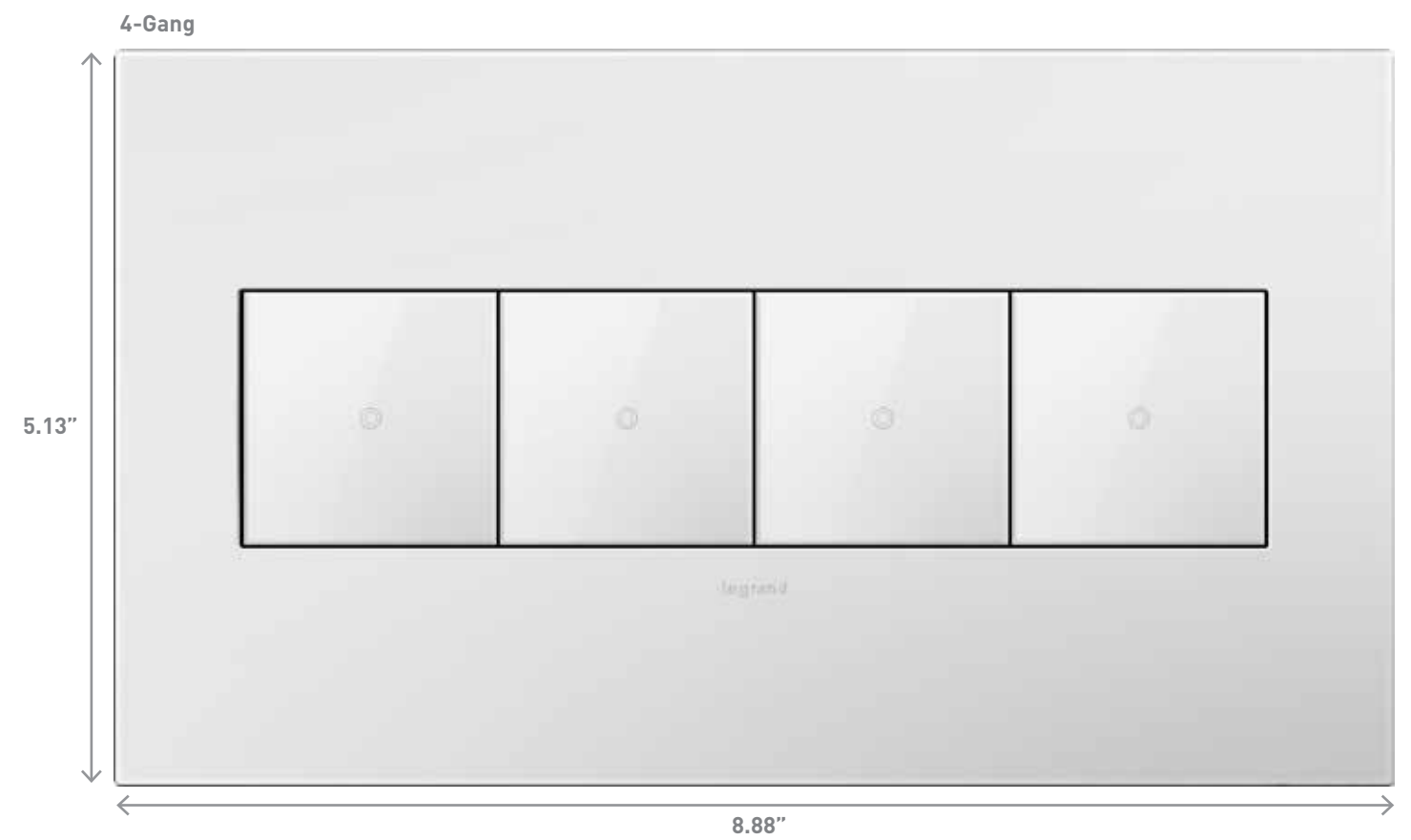
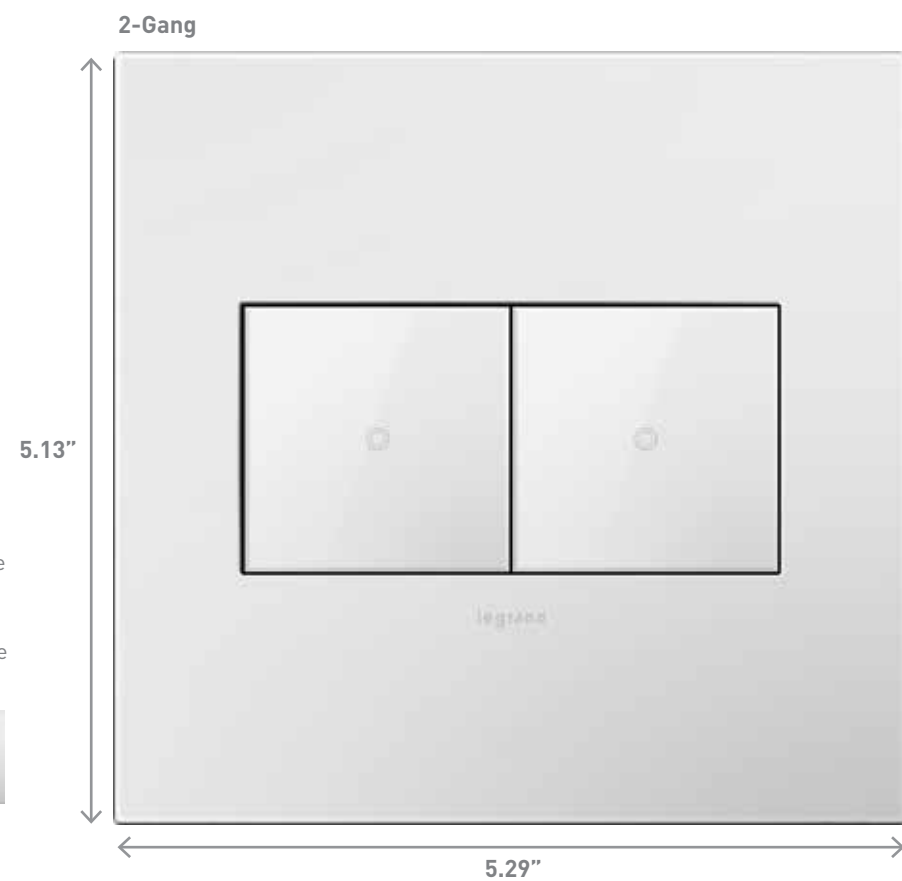



A FRESH
IDEA
FOR COOKING LIGHT

UNDER-CABINET LIGHTING & POWER SYSTEM

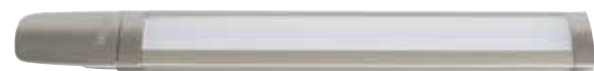

48	Overview
52	Modular Tracks
53	Control Boxes
54	Lighting
55	Modules and Accessories

A RECIPE FOR KITCHEN MAGIC.

The adorne Under-Cabinet Lighting System brings an array of modular components that swap out so easily, you'll want to reconfigure whenever the mood strikes. From speakers and smart phone docks to lighting and outlets, there's a world of possibilities to choose from with these high-tech, highly convenient building blocks.

UNDER CABINET LIGHTING



USB Module:
A handy outlet to power today's devices.



Tamper-Resistant Outlet Module:
Convenient power snaps in where you need it.



LED Slimline Light: A low-profile, continuous lighting option.



Linear Lights: For a consistent, continuous light.



Tablet Cradle:
Puts apps and the internet where you need them.



Mobile Cradle:
Because recharging doesn't have to look sloppy.



Music System:
Plug and play your favorites—wirelessly.



Modular Tracks: The nerve center that tucks away out of sight. Available in four sizes and two colors.



LOOKING UP A view from below reveals how the adorne collection tucks neatly away, offering tons of convenience while hiding underneath your cabinets.

How to Specify the System

The adorne Under-Cabinet Lighting System is a fully customizable and modular solution for eliminating kitchen clutter. It is compatible with any kitchen layout, such as a galley, L-shaped, or U-shaped, as well as with any home wiring. In order to ensure you have specified the correct products for your system, we recommend you follow the steps outlined below.

1. Planning Your System Layout

First, determine where you want to install the system. Then measure your cabinets to determine the length of Modular Track required:

- Measure each cabinet length at back of cabinet.
- For installations with a corner, allow 3" on each side for Corner Connector.
- When totaling up the length of required Modular Track, be sure to include the length of the desired Control Box or Direct Wire Connector. For a 1-gang box, allow 5". For a 2-gang box, allow 5.25". For Direct Wire Connector, allow 6". For more detail on Control Box options, see page 53.
- If your selection of Modular Tracks does not match the exact length of your cabinets, you can use a Modular Track Extender to complete the track. This piece can be cut down to 6". Standard 12", 18", and 27" Modular Tracks cannot be shortened.



9" Modular Track



12" Modular Track



18" Modular Track



27" Modular Track



18" Modular Track Extender



Modular Track Corner Connector

Visit www.adornemyhome.com to watch planning and installation videos.

Sample Installation: Length of cabinets is equal to combined length of standard Modular Tracks

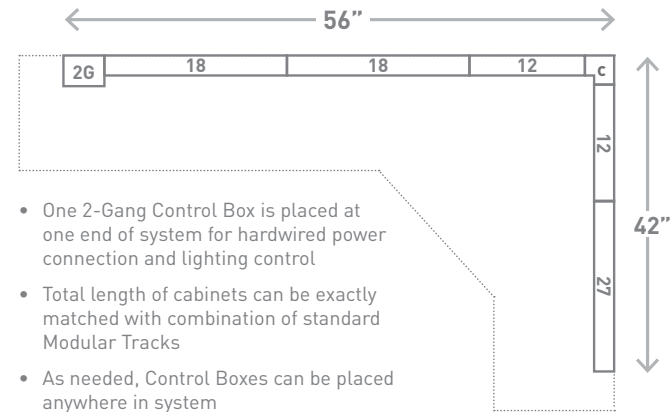

Sample Installation: Length of cabinets is greater than combined length of standard Modular Tracks

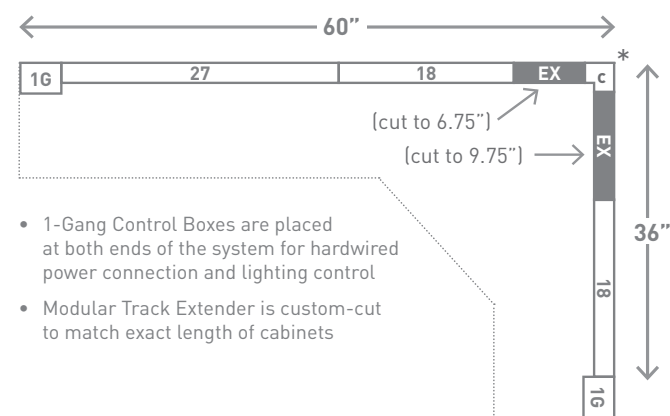

Sample Installation: Direct wire with system controls in a remote location

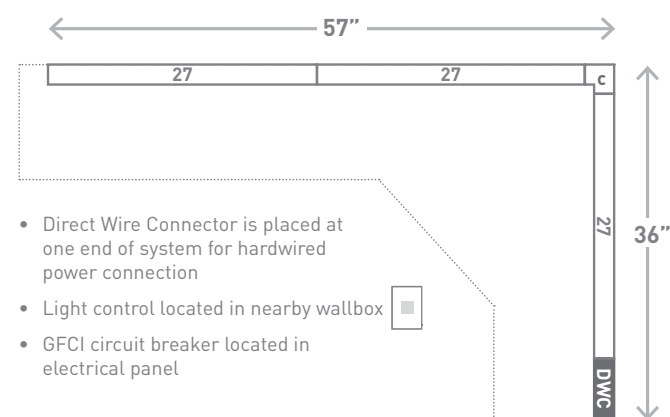

2. Selecting the Control Box and Power Options

Next, select the type of lighting and power connection you'd like to include. For a simple install, the Plug-In Control Box provides the easiest solution. For a hardwired installation, there are five options to choose from which enable expanded lighting control options such as dimming:

- Control Box with Paddle Dimmer
- Control Box with Paddle Dimmer and GFCI protection
- Control Box, 1-Gang (No Devices)
- Control Box, 2-Gang (No Devices)
- Direct Wire Connector

For hardwired installations, there must be three separate circuits from the electrical panel:

- Receptacle Circuit: 20 Amps; GFCI-protected; Use #12 wire
- Lighting Circuit: 15 Amps; Use #12 or #14 wire
- Accessory Circuit: 15 Amps; Use #12 or #14 wire

Hardwired Control Boxes



Compatible with all adorne 2-module devices. The CFL/LED Paddle Dimmer (ADPD453LM2) is recommended for use with the adorne system.

3. Selecting the LED Lights

The adorne Under-Cabinet Lighting System is only compatible with adorne LED lights. Recommended placement for lights is every 18" along Modular Track.

You can select any combination of Linear lights to complete your system. In addition, if you are mounting a light under the cabinet and wish to move it further to the front of the counter, you can use the LED Light Extender. This enables you to increase the length of any light from the Modular Track from a standard 11" to up to 22". This is especially useful in corner installations.



4. Choosing Accessories to Complete the System

The final step is to select the accessories to perfectly complement your system. adorne offers a range of options, including USB charging ports, mobile and tablet cradles, and a Digital Music Kit. Each of these accessories provides flexibility in that it can be added or removed at any time – simply swap it with an existing outlet or blank module to increase your system capabilities.

We're here to help!

We have a dedicated project services team on staff to help you plan your projects, including supplying a full takeoff with a wiring diagram based on your floor plans.

Give us a call at 315.468.8413 or email us your project info at adornemyproject@legrand.us.

Modular Tracks



















The adorne system is a flexible and modular solution designed to eliminate kitchen clutter. Fully customizable, you can select from several types of modules and modify your system in minutes. Simply pop out an existing module and replace it with a new module at any time.

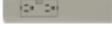

The Modular Tracks listed below simply plug together to create a full system custom-designed for any kitchen. They form the base of the system, housing all of the wiring that connects the modules.

Each system must include a Control Box or Direct Wire Connector that is hardwired to existing wiring or plugged into an outlet on the backsplash.

NAME	COMPLIANCE	SPECIFICATIONS	PART NUMBER
 12" Modular Track	 	Includes one Tamper-Resistant Outlet Module and one Blank Module. Can support up to two LED lights. Provides 120V power via 15A outlet modules and 20A pass-through. Module openings are 6" on-center.	APMT12TM2 APMT12W2
 18" Modular Track	 	Includes one Tamper-Resistant Outlet Module and one Blank Module. Can support up to two LED lights. Provides 120V power via 15A outlet modules and 20A pass-through. Module openings are 9" on-center.	APMT18TM4 APMT18W4
 27" Modular Track	 	Includes two Tamper-Resistant Outlet Modules and one Blank Module. Can support up to three LED lights. Provides 120V power via 15A outlet modules and 20A pass-through. Module openings are 9" on-center.	APMT27TM2 APMT27W2
 18" Modular Track Extender		Enables a perfect fit for any kitchen. Simply cut to length (minimum of 6") and attach to end of Modular Track. Does not include any module openings.	APME18TM2 APME18W2
 Modular Track Corner Connector		Use with installations that include a right-angle corner to connect two Modular Tracks. Allow 3" on each side for installations with Corner Connectors.	APCCTM4 APDWCW1
 Short Modular Track	 	Includes one Tamper-Resistant Outlet Module. Intended for use on short cabinet sections. 10" in length but can be cut to 8". Enables direct wire connection to wiring behind the wall. Cannot be combined with any other track section.	APST9TM1 APST9W1
 Pro Kit		Includes the adorne control box with the paddle dimmer, 18" Track, 12" Track, an additional tamper-resistant outlet, and a tablet cradle.	APMTPROTM1

We're here to help!

We have a dedicated project services team on staff to help you plan your projects, including supplying a full takeoff based on your floor plans.

Give us a call at 315.468.8413 or email us your project info at adornemyproject@legrand.us.

Control Boxes

Every Under-Cabinet Lighting System must include one of the below Control Boxes or Direct Wire Connector. These boxes connect to existing in-wall wiring or plug into an outlet on the backsplash to provide system power.

Control Boxes include system end caps, ensuring a clean finish on the left and right edges of the installed system.



Hardwired installations require three circuits from the electrical panel.

NAME	COMPLIANCE	SPECIFICATIONS	PART NUMBER
 Control Box with Paddle Dimmer	450W 	Connects to existing in-wall wiring. Fits onto end of Modular Track, adding 5" onto system length. Includes adorne 450W CFL/LED Paddle Dimmer (ADPD453LM2). GFCI protection must be provided at the electrical panel.	APCB1TM4 APCB1W4
 Control Box with Paddle Dimmer and 15A GFCI	450W 15A 	Connects to existing in-wall wiring. Fits onto end of Modular Track, adding 5.25" onto system length. Includes adorne 450W CFL/LED Paddle Dimmer (ADPD453LM2) and 15A Tamper-Resistant GFCI Outlet (AGFTR152M4).	APCB6TM2 APCB6W2
 Plug-In Control Box		Snaps into any module opening on the track and plugs into an existing outlet to provide system power. Cord length of 24" can easily be shortened to match the distance from outlet to Modular Track.	APCB3TM4
 Control Box, No Devices, 1-Gang		Connects to existing in-wall wiring. Fits onto end of Modular Track, adding 5" onto system length. Customize with your preference of adorne dimmers, switches, or outlets.	APCB4TM1 APCB4W1
 Control Box, No Devices, 2-Gang		Connects to existing in-wall wiring. Fits onto end of Modular Track, adding 5.25" onto system length. Customize with your preference of adorne dimmers, switches, or outlets.	APCB5TM1 APCB5W1
 Direct Wire Connector		Enables direct wire feed of power from in-wall wiring, eliminating need for a Control Box. Connector is 6" in length.	APDWCTM1 APDWCTW1

Lighting

adorne Linear LED Lights are designed for use with the adorne system only. They can be paired with the adorne SofTap Tru-Universal Dimmer (ADTP703TUV4) to enable dimming.

Lights easily plug into a connection port on any system module. Optimal positioning is one light for every 18" of Modular Track. Lights can be added or removed as needed.

NAME	COMPLIANCE	SPECIFICATIONS	PART NUMBER
LED Linear Light		<ul style="list-style-type: none"> • 8W • 280 lumens • correlated color temperature: 3000K color rendering index: 95 	ALLNLEDTM4
6" LED SlimlineLight		<ul style="list-style-type: none"> • 2.38 Watts • 158 lumens • coorelated color temperature: 3000K, color rendering index 93 	ALSLED6W4 ALSLED6TM4
12" LED Slimline Light		<ul style="list-style-type: none"> • 4.83 Watts • 328 lumens • coorelated color temperature: 3000K, color rendering index 93 	ALSLED12W4 ALSLED12W4
Light Extender		Enables adorne LED lights to be mounted up to 22" from backsplash by extending cord length beyond default 11". Ideal for corner cabinet installations.	ALEXTLEDTM4
LED Dimmable Driver		The 30 Watt LED dimmable drive powers up to 6 feet of adorne expandable light strips.	ALSDDR30W1 ALSDDR30TM1
LED Dimmable Driver		The 60 Watt LED dimmable drive powers up to 10 feet of adorne expandable light strips.	ALSDDR60TM1 ALSDDR60W1

The adorne system is optimized to provide a premium under-cabinet lighting solution by utilizing the latest innovations in lighting research and LED technologies.

System specifications:

- OSRAM OSOLON® Color Champ LED
- Nominal 3000K Correlated Color Temperature (CCT) warm light output
- Color Rendering Index (CRI) of 95
- Excellent range of color differentiation and rendering of the important red color (think red meat and apples) and skin tones
- A bright lumen light output (Puck = 240 lumens/Linear = 280 lumens) provides optimized lighting for the under-cabinet environment
- Efficient driver design integrated in each fixture results in:
 - Reliable and smooth dimming
 - ENERGY STAR certification
 - Rated for 40,000 hours of high performance
- LED quality control uses a "fine bin system" based on a three-step MacAdams ellipse to ensure color consistency

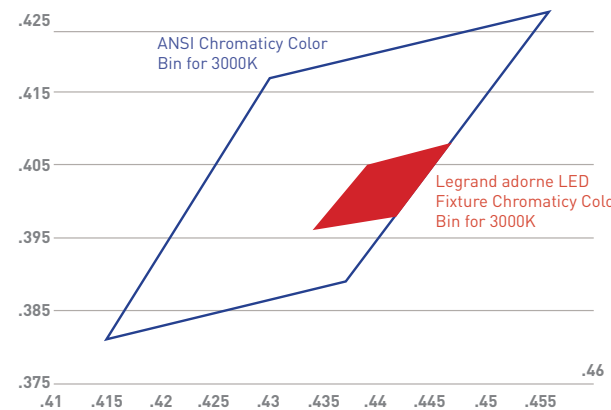

adorne individual LEDs are specifically selected to ensure fixture output CCT uniformity within a range of less than 100. This tight manufacturing assurance process ensures that variations inherent in the LED chip manufacturing process do not compromise reliable light quality.



Digital Music Kit

The Digital Music Kit adds high performance sound to your adorne Under-Cabinet Lighting System. It includes two speakers and a detachable dock for smart phones or MP3 players. Simply fit the main speaker into one module opening and then place the second speaker in any other module location. Speakers can be easily removed and relocated at any time by simply pushing on the sides of the modules and popping them out of the track.

The system features BLUETOOTH® wireless technology to enable streaming of music from your devices. It also includes a 3.5mm cable to manually connect devices.

NAME	COMPLIANCE	SPECIFICATIONS	PART NUMBER
Digital Music Kit		2" (50mm) full range drivers Digital signal processing for full, rich sound BLUETOOTH wireless technology is A2DP compatible Includes USB charging capability	AUDMTM1

Bluetooth® is a registered trademark of Bluetooth SIG, Inc. The Bluetooth word mark and logos are owned by the Bluetooth SIG, Inc. and any use of such marks (licensee name) is under license. Other trademarks and trade names are those of their respective owners.

Modules and Accessories

adorne system modules are designed to fit in any module opening, and can be easily added or removed by using the included module tool. Simply fit the tool into either end of the module and pop it out of the track.

Cradles do not occupy a module opening. Instead, they save space by resting on the back edge of the track.



NAME	COMPLIANCE	SPECIFICATIONS	PART NUMBER
15A Outlet Module	15A, 120V 	Provides two power outlets by snapping into any module opening. Tamper-resistant outlet is designed with a patented shutter system. Included with short, 12", 18", and 27" Modular Tracks.	APTR15TM4 APTR15W4
USB Outlet Module	3.1A, 5V 	Provides two USB charging ports for devices such as mobile phones and tablets by snapping into any module opening. Charging cable not included.	APUSB3TM4 APUSB3W4
Mobile Phone Cradle		Attaches anywhere along track to hold a mobile phone. Perfect for use with USB Outlet Module while charging devices.	AAPCTM4 AAPCW4
Tablet Cradle		Attaches anywhere along track to hold a tablet. Perfect for use with USB Outlet Module while charging devices.	AATCTM4 AATCTW4



BEAUTY & BRAINS

WI-FI LIGHTING SYSTEM



58 Wi-Fi Lighting System

60 Wi-Fi Ready Switches and Dimmers

62 Accessories

WI-FI LIGHTING SYSTEM

APP-BASED LIGHTING CONTROL FOR THE HOME



HOW IT WORKS

1. Replace any standard light switch with a Wi-Fi ready switch or dimmer.
2. Plug the Hub into your home network.
3. Download the free Legrand Lighting Control app.
4. Easily set up your custom lighting settings.
5. Enjoy voice control by integrating with Amazon Alexa or the Google Assistant



1. ADD SECURITY

Wherever you are, your home can look like you never left. Set up timed lighting sequences for when you're away.

2. REST EASY IN VACATION MODE

Vacation mode automatically remembers your last week of lighting activity. Set it for your house to replay on its own while you're on vacation.



3. SAVE ENERGY

Ever wonder if all the lights are off for the night? Use the app to ensure the electricity goes to bed when you do.

4. SET YOUR RULES

Imagine setting your lights to wake up in the morning and greet you at home after a day away. You determine your rules, easily set it up in the app, and just like that your life is a little brighter. With countless options, you can set your lights to your liking while you're home or away. The app is free in the App Store.

GETTING STARTED IS EASY!

The Wi-Fi Ready Starter Kit (KTWIFI1) has everything you need to add app-based lighting control to your home.





The App

The right lighting doesn't just transform a room, it changes the way you live in it. The Lighting Control app delivers simple, Wi-Fi control of compatible Legrand dimmers, switches, and other devices allowing you to adjust your lighting with effortless precision. Free download in the app store.



The Hub™

The adorne hub allows you to program and select home lighting scenes from your smart phone or tablet. In addition, it allows you to schedule lighting events based on time-of-day, such as turning on the exterior lights at sunset.

NAME	PART NUMBER
The Hub	LC7001

Wi-Fi Ready Switches, Dimmers, & Outlets

The adorne Wi-Fi lighting system provides unrivaled convenience, security, and energy-savings for both remodel projects and new construction. The ability to set scenes allows you to create the perfect lighting environment in multiple rooms or the entire house, all at the touch of a single button.

Whisper™

NAME	SPECIFICATIONS	RATING	COMPATIBLE LOADS	COMPLIANCE	FINISH OPTIONS	PART NUMBER
Whisper Wi-Fi Ready Switch	Wi-Fi Ready Master		All Loads	UL LISTED	White Magnesium	ASWR155RMW1 ASWR155RMM1
	Wi-Fi Ready Remote				White Magnesium	ASWRRRW1 ASWRRRM1
Whisper Wi-Fi Ready Dimmer	Wi-Fi Ready Dimmer, Tru-Universal, 700W, 3-Wire	6W - 700W	Incandescent, Halogen, MLV, Fluorescent, ELV, CFL, LED	UL LISTED	White Magnesium	ADWR700RMTUW1 ADWR700RMTUM1
	Wi-Fi Ready Master Dimmer, 2-wire	60W - 600W	Incandescent, Halogen		White Magnesium	ADWR600RMHW1 ADWR600RMHM1
	Wi-Fi Ready Remote Dimmer			UL LISTED	White Magnesium	ADWRRRW1 ADWRRRM1





sofTap™

NAME	SPECIFICATIONS	RATING	COMPATIBLE LOADS	COMPLIANCE	FINISH OPTIONS	PART NUMBER
sofTap Wi-Fi Ready Switch	Wi-Fi Ready Master		All Loads	UL LISTED	White Magnesium	ASTP155RMW1 ASTP155RMM1
	Wi-Fi Ready Remote				White Magnesium	ASTPRRW1 ASTPRRM1
sofTap Wi-Fi Ready Dimmer	Wi-Fi Ready Master (3-Wire) Tru-Universal	6W - 700W	Incandescent, Halogen, MLV, Fluorescent, ELV, CFL, LED	UL LISTED	White Magnesium	ADTP700RMTUW1 ADTP700RMTUM1
	Wi-Fi Ready Master (2-Wire)	60W - 700W	Incandescent, Halogen		White Magnesium	ADTP600RMHW1 ADTP600RMHM1
	Wi-Fi Ready Remote			UL LISTED	White Magnesium	ADTPRRW1 ADTPRRM1



Touch™

NAME	SPECIFICATIONS	RATING	COMPATIBLE LOADS	COMPLIANCE	FINISH OPTIONS	PART NUMBER
Touch Wi-Fi Ready Switch	Wi-Fi Ready Master		All Loads	UL LISTED	White Magnesium	ASTH155RMW1 ASTH155RMM1
	Wi-Fi Ready Remote				White Magnesium	ASTHRRW1 ASTHRRM1
Touch Wi-Fi Ready Dimmer	Wi-Fi Ready Master (3-Wire) Tru-Universal	6W - 700W	Incandescent, Halogen, MLV, Fluorescent, ELV, CFL, LED	UL LISTED	White Magnesium	ADTH700RMTUW1 ADTH700RMTUM1
	Wi-Fi Ready Master (2-Wire)	60W - 600W	Incandescent, Halogen		White Magnesium	ADTH600RMHW1 ADTH600RMHM1
	Wi-Fi Ready Remote			UL LISTED	White Magnesium	ADTHRRW1 ADTHRRM1
WiFi Lighting Starter Kit	Kit Includes: 1 Wi-Fi Ready Whisper Dimmer, 1 Wi-Fi Ready Whisper Switch, 2 Gloss White Wall Plates, and 1 Hub	60W - 700W	Incandescent, Halogen, ELV, MLV, Fluorescent	UL LISTED	White	KTWIF1

Wi-Fi Ready Scene Controllers

NAME	SPECIFICATIONS	RATING	COMPATIBLE LOADS	COMPLIANCE	FINISH OPTIONS	PART NUMBER
sofTap In-Wall Scene Controller 	Wi-Fi Ready In-Wall Scene Controller binds to Wi-Fi Ready Master(s) to provide four custom scenes. Requires The Hub and free Legrand Lighting Control App.	120VAC			White Magnesium	ADTPRIWHCW1 ADTPRIWHCM1
Touch In-Wall Scene Controller 	Wi-Fi Ready In-Wall Scene Controller binds to Wi-Fi Ready Master(s) to provide four custom scenes. Requires The Hub and free Legrand Lighting Control App.	120VAC			White Magnesium	ADTHRIWHCW1 ADTHRIWHCM1

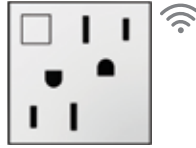
Wi-Fi Ready Outlet

NAME	DESCRIPTION	RATINGS	NEMA CONFIGURATION	COMPLIANCE	FINISH OPTIONS	PART NUMBER
Wi-Fi Ready ON/OFF Outlet 	Lets you control a plug load from a new location without running additional wires when paired with adorne Wi-Fi Ready Remote Switches (page 60). On/off switch also allows you to save energy and stop the flow of power to the outlet without unplugging your device. Provides 20A pass-through.	15A, 125V 	5-15R		White Magnesium	ARPS15RF2W4 ARPS15RF2M4

Accessories

NAME	COLOR	SPECIFICATIONS	PART NUMBER
Lighting Remote Control 	White	This unique remote allows you to control your wi-fi ready switches and dimmers from anywhere in the home as well as create lighting scenes. The remote is easy to program and is compatible with adorne Wi-Fi Ready lighting controls. It allows up to four lighting scenes, as well as one-touch dimming or brightening of your lights. Remote includes a magnetic wall-mount cradle for easy storage.	ADWHRM4
Tru-Universal Plug-In Lamp Adapter 	White	Allows remote control of table or floor lamps up to 300W when used with the adorne Wi-Fi Lighting System. Simply plug the module into any grounded, 120V outlet and then plug the lamp into the module.	LC2150
Plug-In Small Appliance Module 	White	Allows remote control of small appliances such as coffeemakers, radios, and TVS when used with the adorne Wi-Fi Lighting System. Simply plug the module into any grounded, 120V outlet and then plug the appliance into the module.	MRP7-W
RS232 to RF Interface 	Black	Enables integration of a third party control system with the adorne Whole-House Lighting System. Features a two-wire interface from other control systems and two operating modes (maintained or momentary type inputs). Includes power supply.	MR232-G
Repeater & Away Emulator 	Black	Provides extra security when you're on vacation. Records the normal usage of lights throughout a 24-hour period and then plays them back when you're not at home. Also expands the range of the wireless system from 100' to 300'. A repeater is needed with all Wi-Fi systems.	MRR2-G
In-Wall 2000W Box Dimmer 	Black	Supports the addition of large lighting loads to the adorne Wi-Fi Lighting System.	MR2000
Interior Intercom Unit 	NA	Additional interior intercom units can be added to the system and connected wirelessly to existing units.	AI6000M1

The adorne Frame System

The frame is the foundation upon which the adorne modular system is built. It is manufactured with high-strength galvanized metal and includes a ground wire.

Frames include plastic spacers. The spacers remain in place for devices with full size backbodies. They must be removed for devices with plus size backbodies, such as dimmers and GFCI outlets.

The frame completes the enclosure, providing a safe installation during the construction phase and allowing the wall plate to be installed at the end of the project.

Each frame includes a leaded ground that supports the full adorne system. Most switches, outlets, and wall plates (including cast metals) are automatically grounded to the frame, saving time and ensuring a safe and reliable ground path.



1-Gang, Full Size with Spacers



1-Gang, Plus Size without Spacers



2-Gang with Spacers



3-Gang with Spacers



4-Gang with Spacers



5-Gang with Spacers



6-Gang with Spacers

The adorne Modular System

Complete versatility and unmatched flexibility

adorne fits in all existing NEMA-approved wallboxes.*

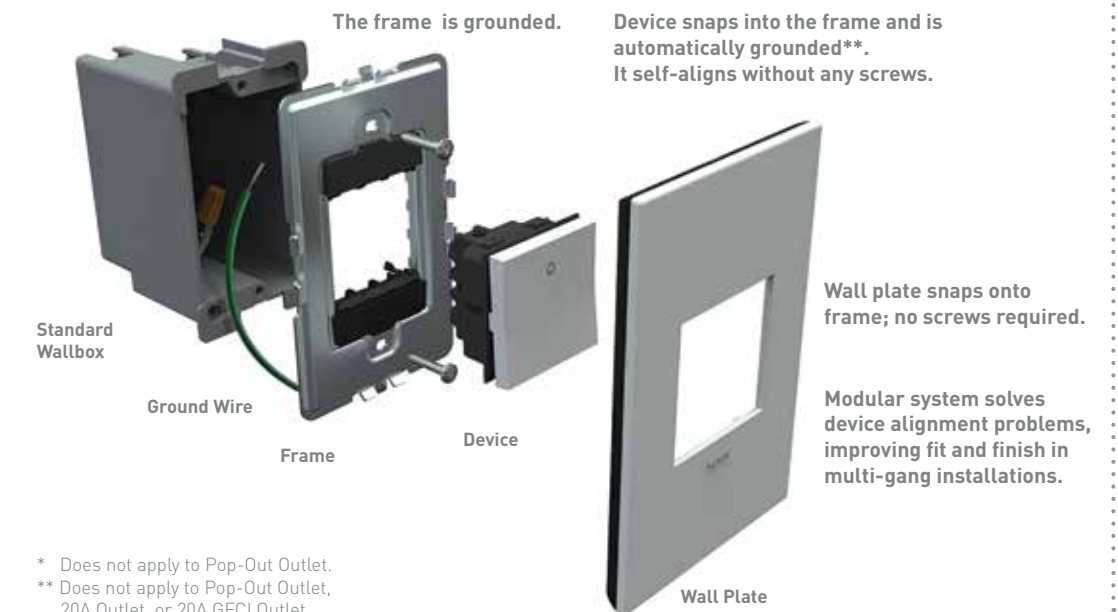

* Does not apply to Pop-Out Outlet.
** Does not apply to Pop-Out Outlet, 20A Outlet, or 20A GFCI Outlet.

Devices simply snap into the frame from the front. During installation, screw the frame to the box, then pull the wires through the frame and wire the device. Then, simply snap the device into the frame.



The adorne Collection features an intelligent part numbering structure to aid in product selection. Each character in the part number represents a specific product feature. All adorne part numbers begin with the letter A to indicate that they are part of the adorne collection.

Example for: Switches and Dimmers

Paddle Switch, 2-Module, 15A, Magnesium

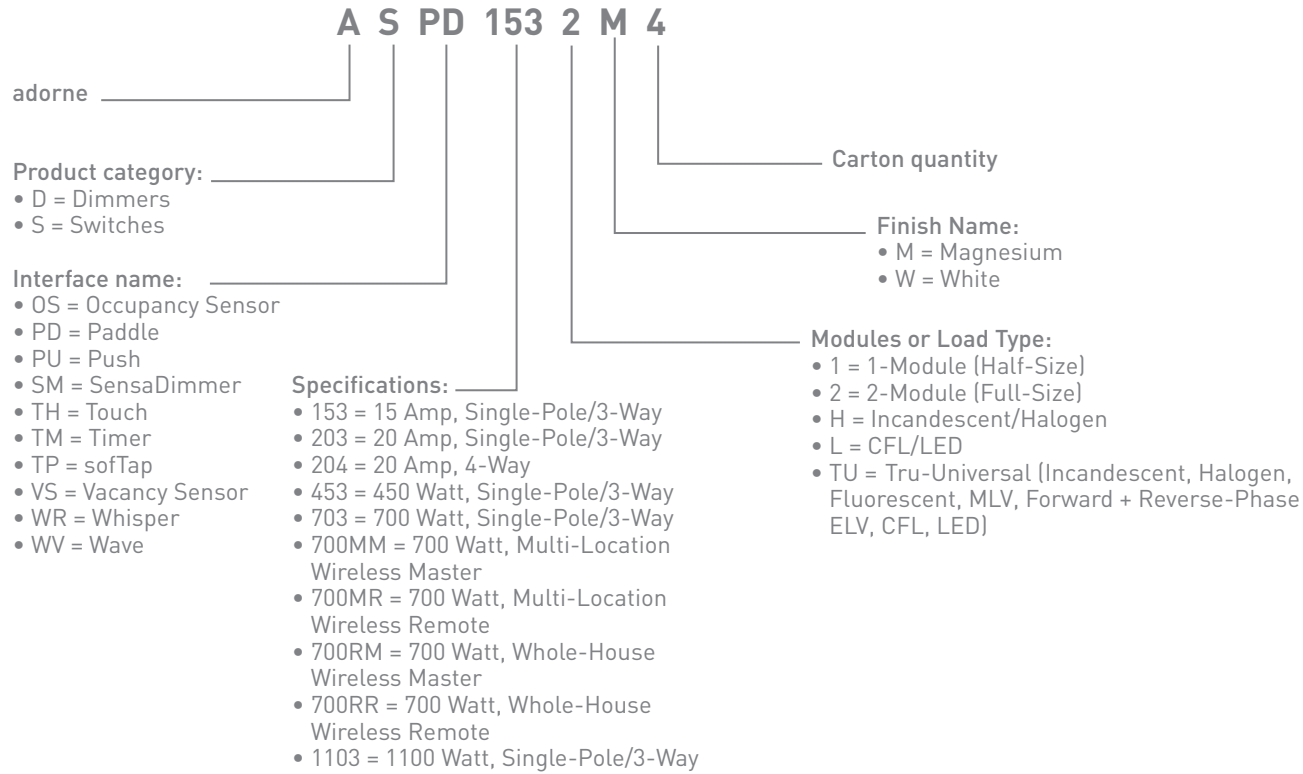

Example for: Wall Plates

Satin Nickel 1-Gang, 2-Module Wall Plate

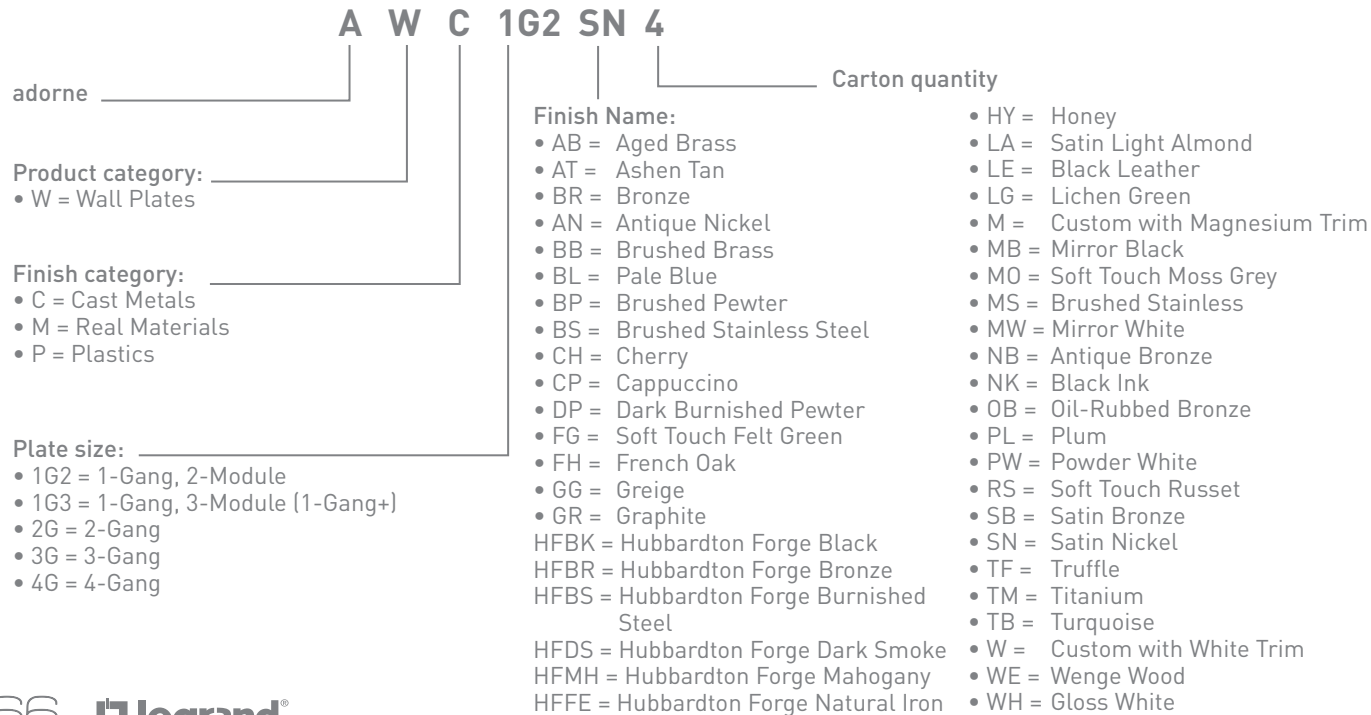

Example for: Outlets and Accessories

Tamper-Resistant Outlet, 15A, 2-Module

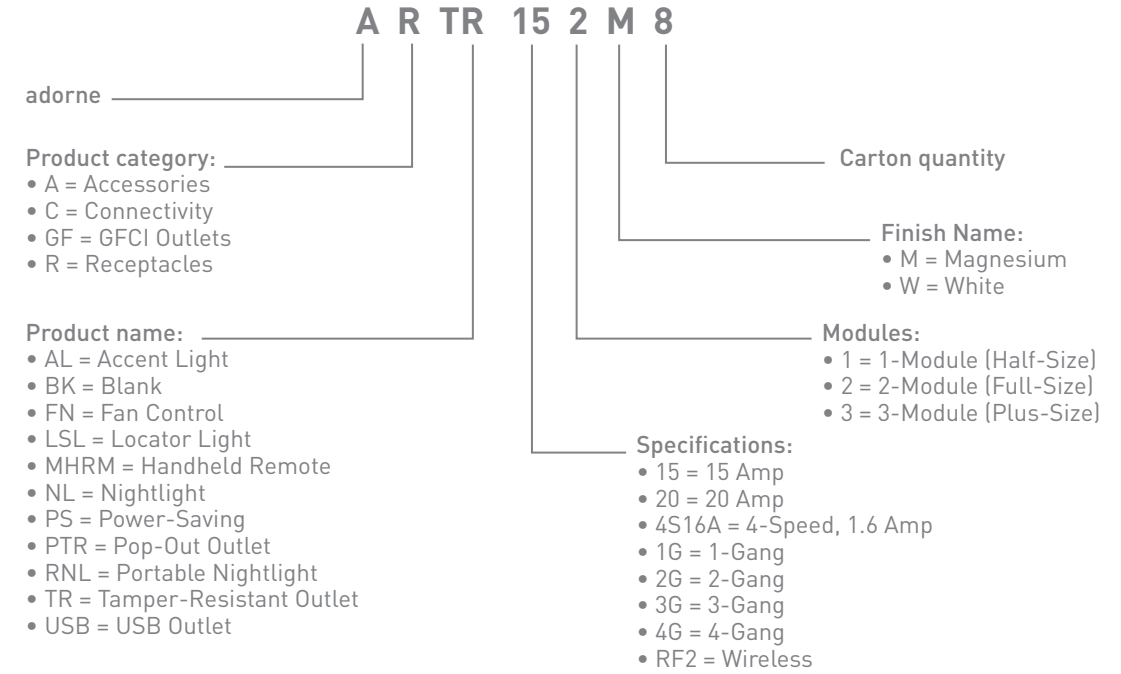

Example for: Under-Cabinet Lighting System & Wireless Systems for the Home

18" Modular Track

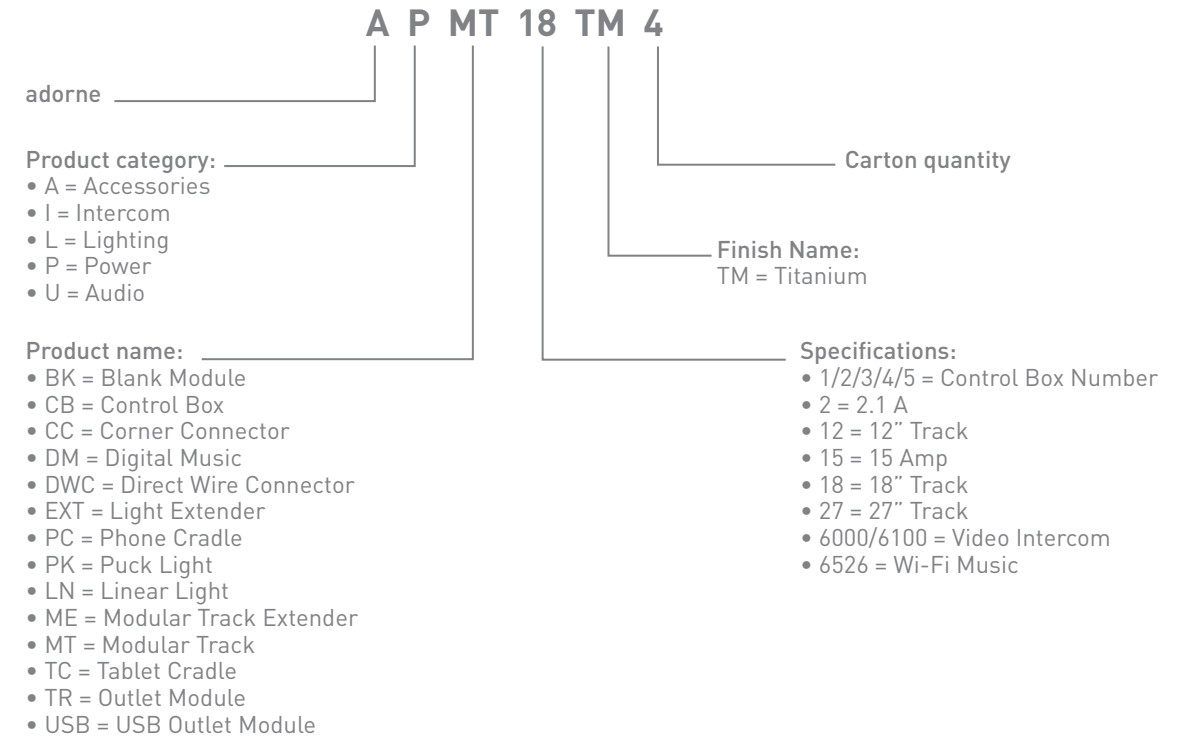

Modular Unit Dimensions

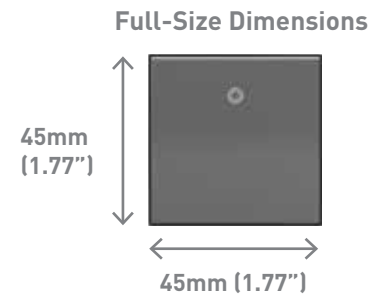
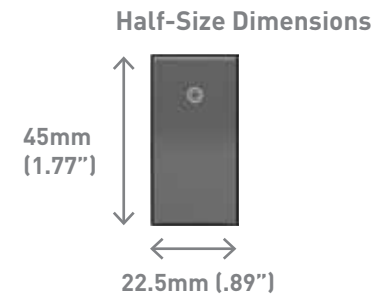

- The basic building block of the system is a half-size unit (45mm x 22.5mm).
- All devices have either half-size or full-size front faces.
- Devices also have either half-size, full-size, or plus-size backbodies.
- Most switches, dimmers, and outlets are in the full-size format (45mm x 45 mm). This is the standard adorne proprietary "45" opening.

Front Face and Backbody Modular Sizes

NAME	FRONT FACE SIZE	BACKBODY SIZE
SWITCHES		
Paddle Switch, 2-Module	Full-Size	Full-Size
Paddle Switch, 1-Module	Half-Size	Half-Size
Whisper Switch	Full-Size	Full-Size
Push Switch	Full-Size	Full-Size
sofTap Switch	Full-Size	Plus-Size
SensaSwitch	Full-Size	Plus-Size
Touch	Full-Size	Plus-Size
Wave	Full-Size	Plus-Size
DIMMERS		
Paddle	Full-Size	Plus-Size
Whisper	Full-Size	Plus-Size
sofTap	Full-Size	Plus-Size
SensaDimmer	Full-Size	Plus-Size
Touch	Full-Size	Plus-Size
Paddle Fan Speed Control	Full-Size	Plus-Size

NAME	FRONT FACE SIZE	BACKBODY SIZE
OUTLETS		
Tamper-Resistant Outlet, Full-Size	Full-Size	Full-Size
Tamper-Resistant Outlet, Plus-Size	Plus-Size	Plus-Size
GFCI Outlet, Full-Size	Full-Size	Plus-Size
GFCI Outlet, Plus-Size	Plus-Size	Plus-Size
Energy-Saving ON/OFF Outlet	Full-Size	Full-Size
USB Outlet	Half-Size	Half-Size
ILLUMINATION		
Nightlight, Half-Size	Half-Size	Half-Size
Nightlight, Full-Size	Full-Size	Full-Size
Portable Nightlight/Flashlight	Full-Size	Plus-Size

Optional Configurations

1-Gang



1-Gang



1-Gang+



2-Gang



3-Gang

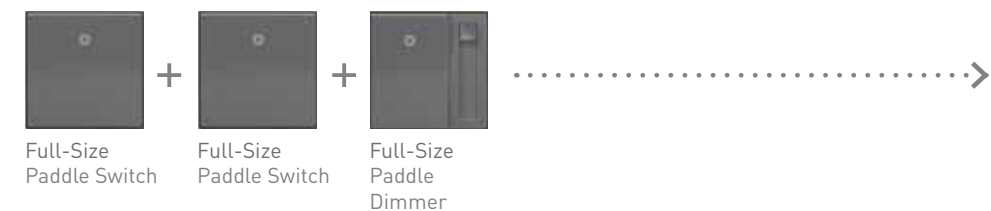

4-Gang



Dimensions

NAME	PART NUMBER	DIMENSIONS (H x W x D)	
Paddle Switch	ASPD1531W4	1.77" x 1.77" x 1.5"	
	ASPD1532M4		
	ASPD2032W4	1.77" x 1.77" x 1.59"	
	ASPD2032M4		
	ASPD2042W4	1.77" x 1.77" x 1.72"	
Paddle Dimmer	ADPD703HW4	4.20" x 1.77" x 1.62"	
	ADPD703HM4		
	ADPD1103HW4	4.20" x 2.51" x 1.62"	
	ADPD1103HM2		
	ADPD453LW2	4.20" x 1.77" x 1.62"	
Paddle Switch, Half-Size	ASPD1531W4	1.77" x 0.89" x 1.5"	
	ASPD1531M4		
Paddle Fan Speed Control	AAFN4S16AW4	2.66" x 1.77" x 1.85"	
Whisper Switch	ASWR1532W4	1.77" X 1.77" x 1.63"	
	ASWR1532M4		
Whisper Wi-Fi Ready Switch	ASWRRR1	1.77" X 1.77" x 1.63"	
	ASWRRRW1		
	ASWR155RMM1	1.77" X 1.77" x 1.63"	
	ASWR155RMW1		
Whisper Dimmer	ADWR703HW4	4.20" x 1.77" x 1.77"	
	ADWR703HM4		
	ADWR1103HW4	4.20" x 2.51" x 1.77"	
	ADWR1103HM4		
Whisper Wi-Fi Ready Dimmer	ADWR600RMHW1	4.20" x 1.77" x 1.79"	
	ADWR600RMHM1		
	ADWR700RMTUW1	4.20" x 1.77" x 1.79"	
	ADWR700RMTUM1		
sofTap Switch	ASTP1532W4	2.66" x 1.77" x 1.63"	
	ASTP1532M4		
	sofTap Dimmer	ADTP703HW2	4.20" x 1.77" x 1.79"
		ADTP703HM2	
ADTP1103HW4		4.20" x 2.51" x 1.79"	
ADTP1103HM4			
sofTap Wi-Fi Ready Switch	ADTP703UW2	4.20" x 1.77" x 1.79"	
	ADTP703UM2		
	sofTap Wi-Fi Ready Dimmer	ASTPRF2W2	2.66" x 1.77" x 1.63"
		ASTPRF2M2	
ASTPRFR2W2		2.66" x 1.77" x 1.63"	
ASTPRFR2M2			
sofTap Wi-Fi Ready Switch	ASTP155RMW1	2.66" x 1.77" x 1.63"	
	ASTP155RMM1		
	ASTPRRW1	2.66" x 1.77" x 1.63"	
	ASTPRRM1		
sofTap Wi-Fi Ready Dimmer	ADTP700MMUW2	4.20" x 1.77" x 1.79"	
	ADTP700MMUM2		
	ADTP700MMHW2	4.20" x 1.77" x 1.79"	
	ADTP700MMHM2		
	ADTPMRUW2	4.20" x 1.77" x 1.79"	
sofTap Wi-Fi Ready Dimmer	ADTPMRUM2		
	ADTP700RMHW1	4.20" x 1.77" x 1.79"	
	ADTP700RMHM1		
	ADTP700RMUW1	4.20" x 1.77" x 1.79"	
	ADTP700RMUM1		
sofTap Wi-Fi Ready Dimmer	ADTPRRW1	4.20" x 1.77" x 1.79"	
	ADTPRRM1		

NAME	PART NUMBER	DIMENSIONS (H x W x D)
Push Switch	ASPU1532W4	1.77" X 1.77" x 1.82"
	ASPU1532M4	
SensaSwitch, Auto-ON/Auto-OFF	ASOS32W4	2.66" x 1.77" x 1.85"
	ASOS32M4	
SensaSwitch, Manual-ON/Auto-OFF	ASVS12W4	2.66" x 1.77" x 1.85"
	ASVS12M4	
SensaSwitch, Manual-ON/Timed-OFF	ASTM2W2	2.66" x 1.77" x 1.85"
	ASTM2M2	
SensaDimmer, Auto-ON/Auto-OFF	ADSM703HW2	4.20" x 1.77" x 1.85"
	ADSM703HM2	
Wave Switch	ASWV1532W2	2.66" x 1.77" x 1.71"
	ASWV1532M2	
Touch Switch	ASTH1532W2	2.66" x 1.77" x 1.63"
	ASTH1532M2	
Touch Wi-Fi Ready Switch	ASTH155RMW1	2.66" x 1.77" x 1.63"
	ASTH155RMM1	
	ASTHRRW1	2.66" x 1.77" x 1.63"
	ASTHRRM1	
Touch Wi-Fi Ready Dimmer	ADTH700MMUW2	4.20" x 1.77" x 1.79"
	ADTH700MMUM2	
	ADTHMRUW2	4.20" x 1.77" x 1.79"
	ADTHMRUM2	
	ADTH700RMHW1	4.20" x 1.77" x 1.79"
	ADTH700RMHM1	
	ADTH700RMUW1	
ADTH700RMUM1		
Blank, Half-Size	AABK1W4	1.77" X 0.89" x 0.96"
	AABK1M4	
Tamper-Resistant Outlet	ARTR152W4	2.12" x 1.77" x 1.73"
	ARTR152M4	
	ARTR202W4	2.12" x 1.77" x 1.73"
	ARTR202M4	
Tamper Resistant Outlet, Plus-Size	ARTR153W4	3" x 1.77" x 1.48"
	ARTR153M4	
Tamper-Resistant GFCI	AGFTR152W4	2.66" x 1.77" x 1.82"
	AGFTR152M4	
	AGFTR202W4	2.66" x 1.77" x 1.82"
	AGFTR202M4	
Tamper-Resistant GFCI, Plus-Size	AGFTR153W4	3.00" x 1.76" x 1.82"
	AGFTR153M4	
Energy-Saving ON/OFF Outlet	ARPS152W4	2.66" x 1.77" x 1.73"
	ARPS152M4	
Wi-Fi Ready Outlet	ARPS15RF2W4	2.66" x 1.76" x 1.82"
	ARPS15RF2M4	
USB Outlet, Half-Size	ARUSBW4	1.77" X 0.89" x 1.81"
	ARUSBM4	

PART NO.	PAGE NO.	PART NO.	PAGE NO.	PART NO.	PAGE NO.
	A	ADPD453LW2	8, 16	ALLNLEDTM4	54
		ADPD453LM2	8, 16	ALSLDR30TM1	54
AAAL1G4	27	ADPD703HM4	8, 16, 70	ALSLDR30W1	54
AAAL2G2	27	ADPD703HW4	8, 16, 70	ALSLDR60TM1	54
AAAL3G2	27	ADPD1103HM2	8, 16, 70	ALSLDR60W1	54
AAAL4G2	27	ADPD1103HW4	8	ALSILLED6TM4	54
AABK1M4	28, 70	ADSM703HM2	20, 70	ALSILLED6W4	54
AABK1W4	28, 70	ADSM703HW2	20, 70	ALSILLED12W4	54
AAFN4S16AM4	9, 16, 70	ADTH4FBL3PM4	14, 19	APCB1TM4	53
AAFN4S16AW4	9, 16, 70	ADTH4FBL3PW4	14, 19	APCB1W4	53
AALSL6	27	ADTH600RMHM1	61	APCB3TM4	53
AALSL277	27	ADTH600RMHW1	61	APCB4TM1	53
AANLM14	26	ADTH700RMTUM1	19, 61	APCB4W1	53
AANLM24	26	ADTH700RMTUW1	19, 61	APCB5TM1	53
AAPCTM4	55	ADTHRIWHCM1	62	APCB5W1	53
AAPCW4	55	ADTHRIWHCW1	62	APCB6TM2	53
AARNL2	26	ADTHRRM1	61	APCB6W2	53
AATCTM4	55	ADTHRRW1	61	APCCTM4	52
AATCTW4	55	ADTP4FBL3PM4	12, 18	APDWCTM1	53
AC1PFM1	28	ADTP4FBL3PW4	12, 18	APDWCTW1	53
AC1PFW1	28	ADTP600RMHM1	13, 15, 61	APDWCW1	52
AC2PFM1	28	ADTP600RMHMW1	13, 15, 61	APME18TM2	52
AC2PFW1	28	ADTP700RMTUM1	13, 15, 61	APME18W2	52
AC4PFM1	28	ADTP700RMTUW1	13, 15, 61	APMT12TM2	52
AC4PFW1	28	ADTP703HM2	12, 18, 70	APMT12W2	52
AC5ERJ45CM1	29	ADTP703HW2	12, 18, 70	APMT18TM4	52
AC5ERJ45CW1	29	ADTP703TUM4	12, 18	APMT18W4	52
AC5ERJ45M1	29	ADTP703TUW4	12, 18, 54	APMT27TM2	52
AC5ERJ45W1	29	ADTP1103HM4	12, 18, 70	APMT27W2	52
AC6RJ45M1	29	ADTP1103HW4	12, 18, 70	APMTPROTUM1	52
AC6RJ45W1	29	ADTPRIWHCM1	62	APST9TM1	52
ACABPM1	29	ADTPRIWHCW1	62	APST9W1	52
ACABPW1	29	ADTPRRM1	13, 15, 61, 70	APTR15TM4	55
ACBLKM4	29	ADTPRRW1	13, 15, 61, 70	APTR15W4	55
ACBLKW4	29	ADWHRM4	63	APUSB3TM4	55
ACBRSTPM1	28	ADWR600RMHM1	11, 60, 70	APUSB3W4	55
ACBRSTPW1	28	ADWR600RMHW1	11, 60, 70	ARCD152M10	23
AChDMIM1	29	ADWR700RMTUM1	11, 17, 60, 70	ARCD152W10	23
AChDMIW1	29	ADWR700RMTUW1	11, 17, 60, 70	ARCD202M10	23
ACNRFCM1	29	ADWR703HM4	10, 17, 70	ARCD202W10	23
ACNRFCW1	29	ADWR703HW4	10, 17, 70	ARCH152M10	23
ACPRCAFM1	29	ADWR1103HM4	10, 17, 70	ARCH152W10	23
ACPRCAFW1	29	ADWR1103HW4	10, 17, 70	ARPS15RF2M4	23, 62, 70
ACRGRBCAFM1	29	ADWRRR1	11, 60, 70	ARPS15RF2W4	23, 62, 70
ACRGRBCAFW1	29	ADWRRRW1	11, 60, 70	ARPS152M4	22, 70
ACRJ25M1	29	AF1G	28	ARPS152W4	22, 70
ACRJ25W1	29	AF2G	28	ARPTR151GM2	24
ACSSIM1	29	AF3G	28	ARPTR151GW2	24
ACSSIW1	29	AF4G	28	ARPTR152GM2	24
ACYRCAFM1	29	AF5G	28	ARPTR152GW2	24
ACYRCAFW1	29	AF6G	28	ARPTR201GM2	24
AD1-RU-M	25	AGFTR2152M4	22	ARPTR201GW2	24
AD1-RU-W	25	AGFTR2152W4	22	ARTR152M4	22, 70
AD2-Z-M	25	AGFTR2153M4	22	ARTR152W4	22, 70
AD2-Z-W	25	AGFTR2153W4	22	ARTR153M4	22, 70
AD3-ZR-M	25	AGFTR2202M4	22	ARTR153W4	22, 70
AD3-ZR-W	25	AGFTR2202W4	22	ARTR202M4	22, 70
ADPD4FBL3P2M4	8, 16	AI6000M1	63	ARTR202W4	22, 70
ADPD4FBL3P2W4	8, 16	ALEXTLEDTM4	54	ARTRUSB153M4	23

INDEX BY PART NUMBER

INDEX BY PART NUMBER

PART NO.	PAGE NO.	PART NO.	PAGE NO.	PART NO.	PAGE NO.	PART NO.	PAGE NO.	PART NO.	PAGE NO.	PART NO.	PAGE NO.
ARTRUSB153W4	23	AWC1G3BP4	37	AWM1G3HFMH1	35	AWP1G2BR6	41	AWP2GRS4	42	AWP5GLG1	42
ARUSBM4	23, 70	AWC1G3BS4	37	AWM1G3LE4	39	AWP1G2CH4	41	AWP2GTB4	42	AWP5GMG1	42
ARUSBW4	23, 70	AWC1G3DP4	37	AWM1G3M4	39	AWP1G2CP4	41	AWP2GTF4	42	AWP5GMO1	42
ASOS32M4	20, 70	AWC1G3NB4	37	AWM1G3MB4	39	AWP1G2FG6	42	AWP2GTM4	42	AWP5GNK1	41
ASOS32W4	20, 70	AWC1G3OB4	37	AWM1G3MS4	39	AWP1G2GG4	41	AWP2GWH4	41	AWP5GPL1	42
ASPD1531M4	8, 9, 16, 70	AWC1G3SB4	37	AWM1G3MW4	39	AWP1G2GR6	41	AWP2GWHW10	41	AWP5GPW1	42
ASPD1531M277	8, 9, 16	AWC1G3SN4	37	AWM1G3MWW4	39	AWP1G2HY6	41	AWP3GAT4	41	AWP5GRS1	42
ASPD1531W4	8, 9, 16, 70	AWC2GAB4	37	AWM1G3W4	39	AWP1G2LA6	42	AWP3GBL4	42	AWP5GTB1	42
ASPD1531W277	8, 9, 16	AWC2GAN4	37	AWM1G3WE4	39	AWP1G2LG6	42	AWP3GBR4	41	AWP5GTF1	42
ASPD1532M4	8, 16, 70	AWC2GBB4	37	AWM2GFH4	39	AWP1G2MG6	42	AWP3GCH4	41	AWP5GTM1	42
ASPD1532M277	8, 16	AWC2GBP4	37	AWM2GHFBK1	35	AWP1G2MO6	42	AWP3GCP4	41	AWP5GWH1	41
ASPD1532W4	8, 16	AWC2GBS4	37	AWM2GHFBR1	35	AWP1G2NK4	41	AWP3GFG4	42	AWP5GWHW1	41
ASPD1532W277	8, 16	AWC2GDP4	37	AWM2GHFBS1	35	AWP1G2PL4	42	AWP3GGG4	41	AWP6GAT1	41
ASPD1542M277	8, 16	AWC2GNB4	37	AWM2GHFDS1	34, 35	AWP1G2PW4	42	AWP3GGR4	40, 41	AWP6GBL1	42
ASPD1542W277	8, 16	AWC2GOB4	37	AWM2GHFFE1	35	AWP1G2RS6	42	AWP3GHY4	41	AWP6GBR1	41
ASPD2032M4	8, 16, 70	AWC2GSB4	37	AWM2GHFMH1	35	AWP1G2TB4	42	AWP3GLA4	42	AWP6GCH1	41
ASPD2032W4	8, 16, 70	AWC2GSN4	37	AWM2GLE4	39	AWP1G2TF4	42	AWP3GLG4	42	AWP6GCP1	41
ASPD2042M4	8, 16, 70	AWC3GAB4	37	AWM2GM4	39	AWP1G2TM6	42	AWP3GMG4	42	AWP6GFG1	42
ASPD2042W4	8, 16, 70	AWC3GAN4	37	AWM2GMB4	39	AWP1G2WH6	41	AWP3GMO4	42	AWP6GGG1	41
ASPU1532M4	17, 70	AWC3GBB4	37	AWM2GMR4	39	AWP1G2WHW10	41	AWP3GNK4	41	AWP6GGR1	41
ASPU1532W4	17, 70	AWC3GBP4	37	AWM2GMS4	38, 39	AWP1G3AT4	41	AWP3GPL4	42	AWP6GHY1	41
ASTH155RMM1	15, 61, 70	AWC3GBS4	37	AWM2GMW4	39	AWP1G3BL4	42	AWP3GPW4	42	AWP6GLG1	42
ASTH155RMW1	15, 61, 70	AWC3GDP4	37	AWM2GMWW4	39	AWP1G3BR4	41	AWP3GRS4	42	AWP6GMG1	42
ASTH1532M2	14, 19, 70	AWC3GNB4	37	AWM2GW4	39	AWP1G3CH4	41	AWP3GTB4	42	AWP6GMO1	42
ASTH1532W2	14, 19, 70	AWC3GOB4	37	AWM2GWE4	39	AWP1G3CP4	41	AWP3GTF4	42	AWP6GNK1	41
ASTHRRM1	15, 61, 70	AWC3GSB4	37	AWM3GFH4	39	AWP1G3FG4	42	AWP3GTM4	42	AWP6GPL1	42
ASTHRRW1	15, 61, 70	AWC3GSN4	37	AWM3GHFBK1	35	AWP1G3GG4	41	AWP3GWH4	41	AWP6GPW1	42
ASTM2M2	20, 70	AWC4GAB4	37	AWM3GHFBR1	35	AWP1G3GR4	41	AWP3GWHW4	41	AWP6GRS1	42
ASTM2W2	20, 70	AWC4GAN4	37	AWM3GHFBS1	35	AWP1G3HY4	41	AWP4GAT4	41	AWP6GTB1	42
ASTP155RMM1	13, 61, 70	AWC4GBB4	37	AWM3GHFDS1	35	AWP1G3LA4	42	AWP4GBL4	42	AWP6GTF1	42
ASTP155RMW1	13, 61, 70	AWC4GBP4	37	AWM3GHFFE1	35	AWP1G3LG4	42	AWP4GBR4	41	AWP6GTM1	42
ASTP1532M4	12, 18, 70	AWC4GBS4	37	AWM3GHFMH1	35	AWP1G3MG4	42	AWP4GCH4	41	AWP6GWH1	41
ASTP1532W4	12, 18, 70	AWC4GDP4	37	AWM3GLE4	39	AWP1G3MO4	42	AWP4GCP4	41	AWP6GWHW1	41
ASTPRRM1	13, 61, 70	AWC4GNB4	37	AWM3GM4	39	AWM1G3MR4	39	AWP4GFG4	42		
ASTPRRW1	13, 61, 70	AWC4GOB4	37	AWM3GMB4	39	AWP1G3NK4	41	AWP4GGG4	41		D
ASVS12M4	20, 70	AWC4GSB4	37	AWM3GMR4	39	AWP1G3PL4	42	AWP4GGR4	41		
ASVS12W4	20, 70	AWC4GSN4	37	AWM3GMS4	39	AWP1G3PW4	42	AWP4GHY4	41	DQFF15UBK	24
ASWR155RMM1	11, 60, 70	AWM1G2FH4	39	AWM3GMW4	39	AWP1G3RS4	42	AWP4GLA4	42	DQFF15UST	24
ASWR155RMW1	11, 60, 70	AWM1G2HFBK4	35	AWM3GMWW4	39	AWP1G3TB4	42	AWP4GLG4	42	DQFP15BK	24
ASWR1532M4	10, 17, 70	AWM1G2HFBR4	35	AWM3GW4	39	AWP1G3TF4	42	AWP4GMG4	42	DQFP15ST	24
ASWR1532W4	10, 17, 70	AWM1G2HFBS4	35	AWM3GWE4	39	AWP1G3TM4	42	AWP4GMO4	42	DQFP15UBK	24
ASWRRRM1	11, 60, 70	AWM1G2HFDS4	35	AWM4GFH4	39	AWP1G3WH4	41	AWP4GNK4	41	DQFP15UST	24
ASWRRRW1	11, 60, 70	AWM1G2HFFE4	35	AWM4GHFBK1	35	AWP1G3WHW4	41	AWP4GPL4	42		
ASWV1532M2	21, 70	AWM1G2HFMH4	35	AWM4GHFBR1	35	AWP2GAT4	41	AWP4GPW4	42		K
ASWV1532W2	21, 70	AWM1G2LE4	39	AWM4GHFBS1	35	AWP2GBL4	42	AWP4GRS4	42		
AUDMTM1	55	AWM1G2M4	39	AWM4GHFDS1	35	AWP2GBR4	41	AWP4GTB4	42	KTWIF1	61
AWC1G2AB4	37	AWM1G2MB4	39	AWM4GHFFE1	35	AWP2GCH4	41	AWP4GTF4	42		
AWC1G2AN4	37	AWM1G2MR4	39	AWM4GHFMH1	35	AWP2GCP4	41	AWP4GTM4	42		L
AWC1G2BB4	36, 37	AWM1G2MS4	39	AWM4GLE4	39	AWP2GFG4	42	AWP4GWH4	41		
AWC1G2BP4	37	AWM1G2MW4	39	AWM4GM4	39	AWP2GGG4	41	AWP4GWHW4	41	LC2150	63
AWC1G2BS4	37	AWM1G2MWW4	39	AWM4GMB4	39	AWP2GGR4	41	AWP5GAT1	41	LC7001	60
AWC1G2DP4	37	AWM1G2W4	39	AWM4GMR4	39	AWP2GHY4	41	AWP5GBL1	42		
AWC1G2NB4	37	AWM1G2WE4	39	AWM4GMS4	39	AWP2GLA4	42	AWP5GBR1	41		M
AWC1G2OB4	37	AWM1G3FH4	39	AWM4GMW4	39	AWP2GLG4	42	AWP5GCH1	41		
AWC1G2SB4	37	AWM1G3HFBK1	35	AWM4GMWW4	39	AWP2GMG4	42	AWP5GCP1	41	MR232-G	63
AWC1G2SN4	37	AWM1G3HFBR1	35	AWM4GW4	39	AWP2GMO4	42	AWP5GFG1	42	MR2000	63
AWC1G3AB4	37	AWM1G3HFBS1	35	AWM4GWE4	39	AWP2GNK4	41	AWP5GGG1	41	MRP7-W	63
AWC1G3AN4	37	AWM1G3HFDS1	35	AWP1G2AT4	41	AWP2GPL4	42	AWP5GGR1	41	MRR2-G	63
AWC1G3BB4	37	AWM1G3HFFE1	35	AWP1G2BL6	42	AWP2GPW4	42	AWP5GHY1	41		