



CONNECT AND PROTECT

Grounding, Bonding and nVent ERICO Cadweld

Solutions Guide

nVent

ERICO



Introduction

nVent Engineered Electrical & Fastening Solutions is a leading global manufacturer and marketer of superior engineered products for niche electrical, mechanical and concrete applications. These nVent products are sold globally under a variety of market-leading brands: nVent ERICO welded electrical connections, facility electrical protection, and rail and industrial products; nVent CADDY fixing, fastening and support products; nVent ERIFLEX low voltage power and grounding connections; and nVent LENTON engineered systems for concrete reinforcement.

For more information please visit nVent.com/ERICO.

WARNING

nVent products shall be installed and used only as indicated in nVent's product instruction sheets and training materials. Instruction sheets are available at nVent.com/ERICO and from your nVent customer service representative. Improper installation, misuse, misapplication or other failure to completely follow nVent's instructions and warnings may cause product malfunction, property damage, serious bodily injury and death and/or void your warranty.

Directory

SOLUTION RESOURCES

Facility Electrical Protection	5-6
Grounding Principles	7-13
Ground System Components	14-15
nVent ERICO Hammerlock	16-17
nVent ERICO Ground Enhancement Material (GEM)	18-20
nVent ERICO Cu-Bond Composite Cable	21
nVent ERICO Cu-Bond Round Conductor	22-23
Grounding Stainless Steel Braids	24-25
nVent ERICO Cadweld	26-38
Datacom	40-41
Power Generation, Transmission & Distribution	42-43
Substation/Earthing Grounding	44-45
Solar Products	46-47
Wind Products	48-49
Telecom	50-51
Lightning Protection	52-53

CONNECTORS AND POSITIONERS

Ground Rod Connectors	56-65
Structural Connectors	66-71
Conductor to Conductor Connectors	72-80
Pipe, Fence and Gate Connectors	81-91
Rebar Connectors	92-94
Pedestal Connectors	95-96
Positioners and Attachments	97-99

CONDUCTORS

Cu-Bond Round Conductors	102-105
Cu-Bond Composite Cable	106
Non-Insulated Round Conductors	106-107
Braids and Power Shunts	108-109
Copper Tape	110-111

GROUNDING AND BONDING

Ground Rods	114-121
Ground Enhancement Material (GEM)	122

Inspection Housings.....	123-125
Ground Mats and Mesh	126-128
Signal Reference Grid.....	129
Ground Plates.....	130-134
Ground Points for Concrete	135-138
Aircraft and Static Grounding.....	139-143
GROUNDING BUSBARS	
Grounding Busbars and Supports.....	146-157
Intersystem Bonding Termination Bar.....	158
GROUNDING TOOLS	
Ground Rod Driving Tools.....	160-163
Ground Resistance Testers.....	164-169
CADWELD MOLDS	
Grounding Connection Specifications.....	172-183
Cable to Cable Molds	174-184
Cable to Ground Rod Splice Molds.....	184-185
Cable to Ground Rod or Other Rounds Molds.....	185-196
Cable to Cable to Ground Rod or Other Rounds Molds	197-200
Cable to Steel Molds.....	200-210
Cable to Lug or Busbar Molds	211-216
Busbar to Busbar Molds	217-219
Lug to Busbar or Steel Molds	220-221
Cable to Rebar Molds	221-229
Cable to Ground Receptacle or Ground Plate Molds.....	229-231
Copper or Steel Stud to Steel Surface Molds	232
Additional Molds.....	233-236
CADWELD WELDING MATERIAL, TOOLS AND ACCESSORIES	
Welding Materials.....	238-239
Cadweld One Shot.....	240-242
Lugs.....	242-247
Clamping and Clamping Tools	248-254
Disks, Sleeves, Shims and Batting.....	255-260
Tools & Accessories	261
Hammer Die	262
Ignition Systems.....	263-265
Cleaning Tools	266-267
Hand Tools.....	268-269
Safety Equipment.....	270-271
TECHNICAL CHARTS	
Technical Charts.....	274-276
INDEX	
Index.....	277-287

Facility Electrical Protection for the 21st Century

Lightning strikes and the dangerous over-voltage surges caused by lightning and man-made events represent a direct threat to people, buildings and sensitive electronic equipment.

Today, the consequences of an unexpected lightning strike or power surge can be catastrophic for a company. Proper protection can save thousands of dollars in damage, operational downtime and lost business opportunities.

TOTAL FACILITY PROTECTION

The consequences of an unexpected lightning strike or power surge can be catastrophic for a facility:

- Personnel are at risk.
- Critical equipment may be damaged or destroyed.
- Data can be corrupted.
- The costs of operational downtime and lost revenue can be very substantial.

As industries become more dependent on increasingly sensitive equipment, proper protection from lightning and dangerous over-voltage transients is necessary.

With over 60 years of research, testing and product development, nVent ERICO has acknowledged that no single technology can totally eliminate vulnerability to lightning and surges.

The nVent ERICO Six Point Plan of Protection is designed to provide total facility protection by integrating several concepts. The Six Point Plan will minimize the risk of damage to facilities through:

- Direct Strike Protection
- Grounding and Bonding
- Surge and Over-voltage Transient Protection

THE SIX POINT PLAN OF PROTECTION

- 1 Capture the lightning strike.**
Capture the lightning strike to a known and preferred attachment point using a purpose-designed air terminal system.
- 2 Convey this energy to ground.**
Conduct the energy to the ground via a purpose-designed downconductor.
- 3 Dissipate energy into the grounding system.**
Dissipate energy into a low impedance grounding system.
- 4 Bond all ground points together.**
Bond all ground points to eliminate ground loops and create an equipotential plane.
- 5 Protect incoming AC power feeders.**
Protect equipment from surges and transients on incoming power lines to prevent equipment damage and costly operational downtime.
- 6 Protect low voltage data/telecommunications circuits.**
Protect equipment from surges and transients on incoming telecommunications and signal lines to prevent equipment damage and costly operational downtime.

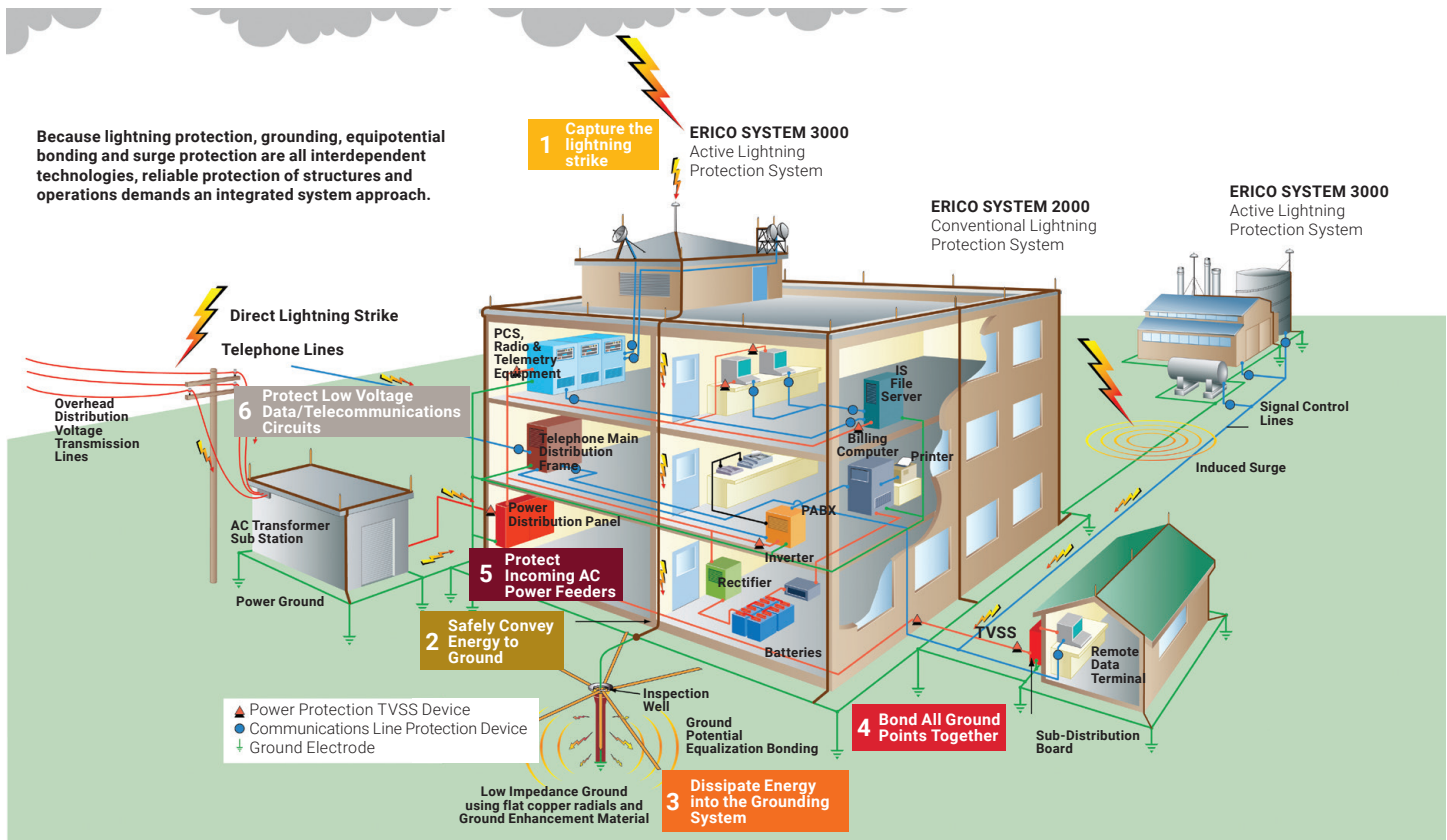

nVent ERICO is a leading global designer, manufacturer and marketer of precision-engineered specialty metal products serving niche markets in a diverse range of electrical, construction, utility and rail applications. The company is headquartered in Solon, Ohio, USA with a network of sales locations serving more than 25 countries and with manufacturing and distribution facilities

worldwide. nVent ERICO's well-known brand names include: nVent CADDY electrical and mechanical fixings, fasteners and supports; Cadweld welded electrical connections; surge protection devices; rail and industrial products; ERIFLEX low voltage power distribution; facility electrical protection; and nVent LENTON concrete products. Visit nVent ERICO online at nVent.com/ERICO.

Facility Electrical Protection for the 21st Century

DIRECT STRIKE PROTECTION

nVent ERICO's innovative technology provides two systems for capturing lightning energy. The nVent ERICO System 2000 provides conventional air terminal technology to meet traditional needs.

An alternative approach to lightning protection is the nVent ERICO System 3000, which utilizes the collection volume principle to determine the effective placement of lightning protection to ensure the safe conveyance and dissipation of the lightning energy into the ground.

Over 7000 facilities, including some of the tallest and most vulnerable buildings in the world, are protected by System 3000.

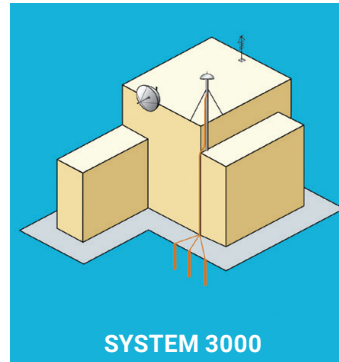
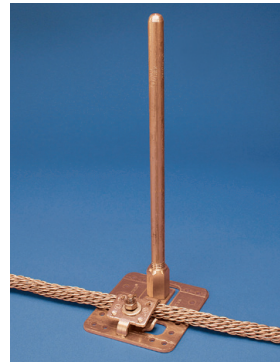
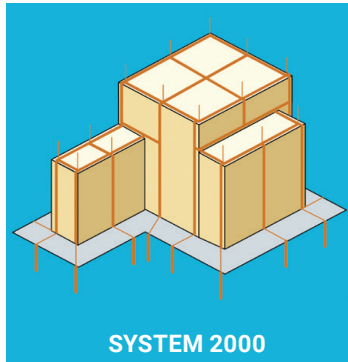

- Well known technology of passive rods or air terminals, familiar to installers
- Air terminals available in aluminum, copper and stainless
- IEC®, B.S., and U.S. Standard Compliant
- Precision manufacturing helps ensure easy assembly and installation
- Computer-aided design to IEC62305, NFPA®-780, AS/NZS1768

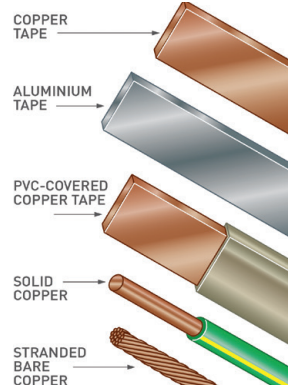

- Advanced lightning protection system based on latest lightning research and technology
- Enhanced area of protection, fewer air terminals needed
- Economical and easy to install
- Fewer downconductors are required
- Designed to protect all types of structures and "open areas"
- Computer-aided design using Collection Volume method

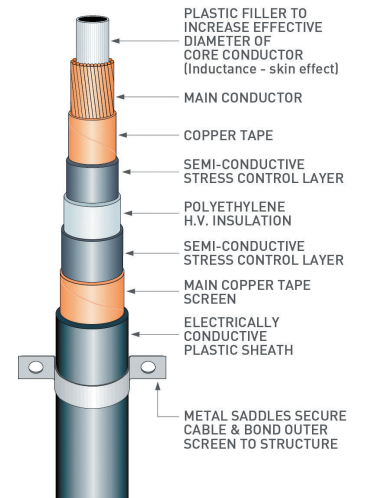

GROUNDING AND BONDING

For the efficient performance of a lightning protection system, it is essential that a low impedance ground be provided to facilitate the dissipation of the lightning energy into the earth mass.

Because soil conditions and seasonal patterns vary from site to site, the methods of grounding need to be considered on an individual basis.

As a grounding specialist, nVent ERICO provides a range of grounding systems to suit any application.



NVENT ERICO CADWELD PLUS

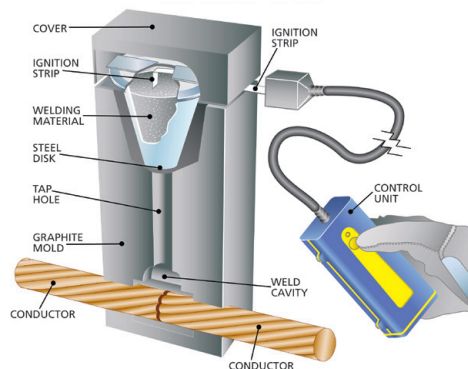

Connections are often the most critical element of grounding systems, so the preferred method of connection is the Cadweld exothermic welding process.

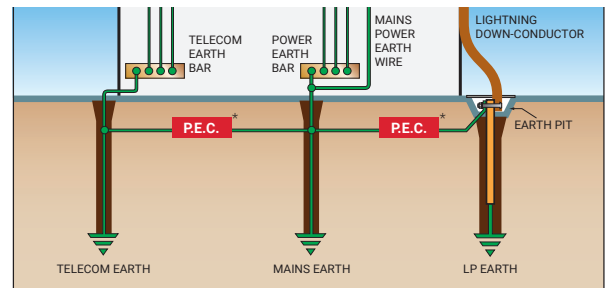

nVent ERICO offers a variety of products, such as ground bars, signal reference grids, ground plates and potential equalization clamps, which are designed to create an equipotential plane and help protect personnel and valuable equipment. Cadweld copper-bonded or stainless steel earth rods and GEM facilitate the transfer of surges and fault currents into the earth, and provide a very long service life due to superior construction and quality.

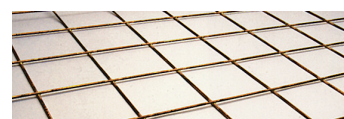
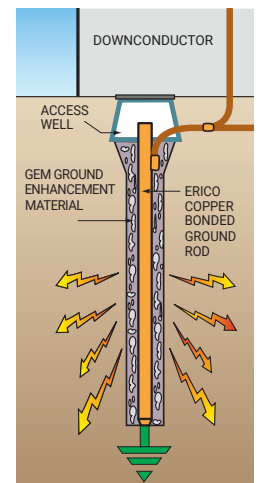

Grounding Principles



INTRODUCTION

Grounding and bonding are an integral part of any modern electrical protection system design. An effective, low-impedance ground system is a key element of this system.

It is crucial to help provide personnel safety, as well as reliable protection for vital equipment and to minimize interruptions of service and costly downtime.

With over a century of experience in the design and manufacture of bonding and grounding products, nVent ERICO, a single source provider, offers what we believe is the best range of long lasting and cost-effective grounding products available.

Soil conditions and seasonal patterns vary from site to site, the methods of grounding need to be considered on an individual basis.

BASIC DEFINITIONS

Ground: A conducting connection, whether intentional or accidental, between an electrical circuit or equipment and the earth, or to some conducting body that serves in place of the earth.

Earth: The conductive mass of the earth, whose electric potential at any point is conventionally taken as equal to zero. (In some countries the term "ground" is used instead of "earth.")

Bonding: The permanent joining of metallic parts to form an electrically conductive path that will ensure electrical continuity and the capacity to conduct any current likely to be imposed.

THE NEED TO GROUND!

There are important reasons why a grounding system should be installed.

1. The most important reason is to help protect people!
2. To help provide protection of structures and equipment from unintentional contact with live conductors.
3. To help support maximum safety from electrical system faults and lightning.

It is a fundamental fact that electricity ALWAYS flows to the point of lowest potential. The task is to help ensure that electricity, including faults, lightning and electronic noise, flows to this point with maximum safety to people, while maintaining the reliability of equipment. Therefore we must help ensure the safe, controlled flow of electricity with minimum voltage drop to earth in all cases.

GROUNDING CODES AND STANDARDS

Grounding needs vary according to function. The grounding requirements of a power system will vary from those of electrical equipment, lightning protection or for the proper function of electronic equipment.

Proper installation of appropriate grounding systems requires knowledge of the needs and layout of the facility. Soil characteristics, grounding conductor materials grounding connections and terminations, are significant factors determining the design of a grounding system. Applicable standards and codes must be applied.

While many codes and standards contain minimum grounding and bonding requirements, the design and installation of electrical grounding systems is one of the most important aspects of any electrical distribution system. However, codes and standards are often misunderstood and grounding systems subsequently installed improperly.

Grounding Principles

WHY IS GOOD GROUNDING IMPORTANT?

The transient nature of lightning with its associated fast rise times and large magnitude currents mean that special consideration needs to be given to grounding, for lightning protection to be effective. Many factors such as soil resistivity variations, installation accessibility, layout and existing physical features are all site specific and tend to affect decisions on grounding methods employed. The primary aim of a direct strike grounding system is to:

- Efficiently dissipate lightning energy into the ground
- Help protect equipment and personnel

GROUNDING PRINCIPLES

Low impedance is the key to lightning protection. All grounding connections should be as short and direct as possible to minimize inductance and reduce peak voltages induced in the connections. The ground electrode system must efficiently couple lightning surges into the ground by maximizing capacitive coupling to the soil. The resistance of the ground itself to lightning currents must also be minimized. Only when all these factors are taken into account will maximum lightning protection be achieved.

GROUND IMPEDANCE

Soil resistivity is an important design consideration. It varies markedly for different soil types, moisture content and temperatures and gives rise to variations in ground impedances.

SHORT, DIRECT GROUND CONNECTIONS

The voltage generated by a lightning discharge depends primarily on the risetime of the current and the impedance (primarily inductance) of the path to ground. Extremely fast rise times result in significant voltage rises due to any series inductance resulting from long, indirect paths, or sharp bends in the routing of ground conductors. This is why short, direct ground connections are important.

COUPLING FROM THE ELECTRODE SYSTEM TO THE GROUND

The efficiency of a ground electrode system in coupling a lightning current to ground is dependent on a number of factors, including the geometry of the ground electrode system, the shape of the conductors and the effective coupling into the soil.

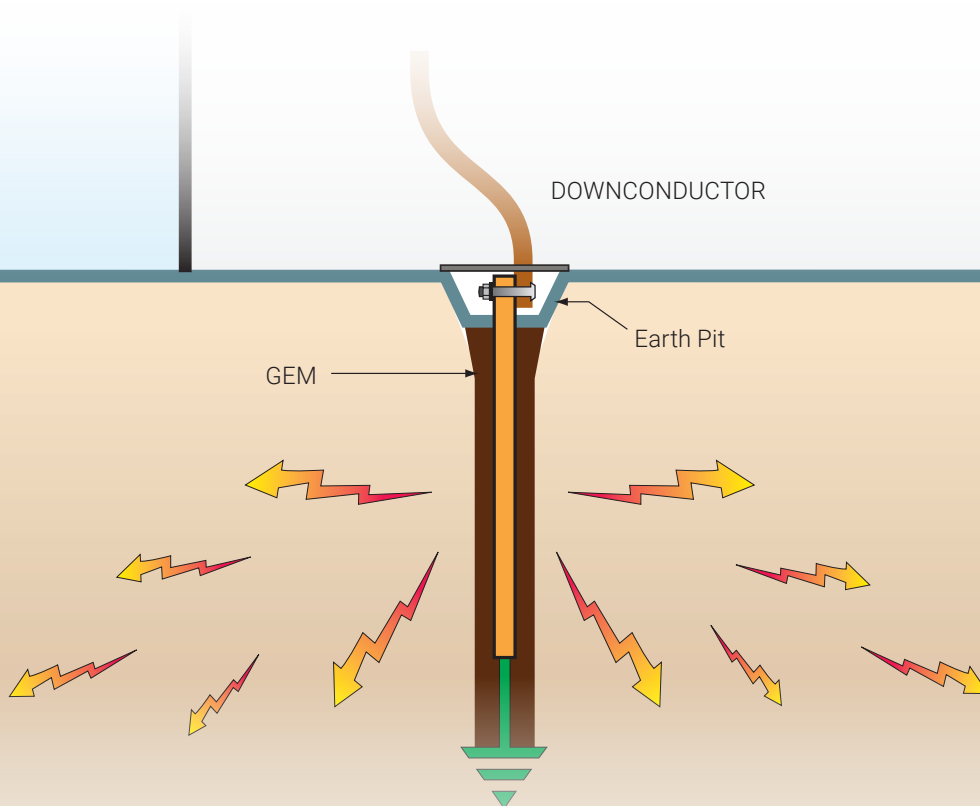

A typical grounding system.

Grounding Principles

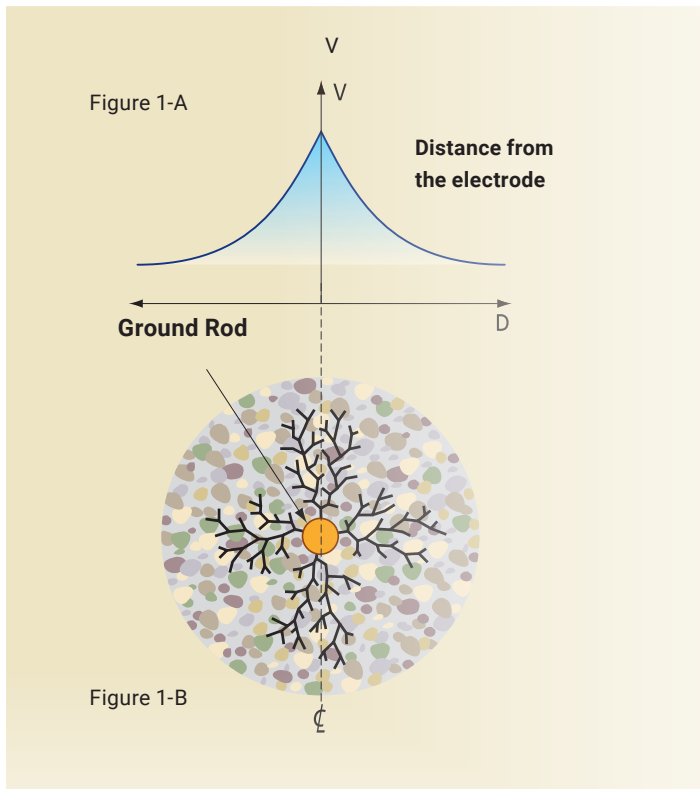

Figure 1-B illustrates current flow from the injection point of a single ground electrode. As current flows out from the central injection point, a voltage gradient on the ground surface around the electrode is produced. This gradient levels off to a plateau at some distance from the electrode, as seen in Figure 1-A. The impedance seen by the current is determined by the soil particles in direct contact with the surface of the rod, and by the general impedance of the soil.

- **Good electrical conductivity**
- **Conductors capable of withstanding available electrical fault currents**
- **Long life — at least 40 years**
- **Low ground resistance and impedance**

The basic philosophy of any grounding installation should be an attempt to maximize the surface area of electrodes or conductors with the surrounding soil. Not only does this help to lower the earth resistance of the grounding system, but it also greatly improves the impedance of the grounding system under lightning surge conditions.

• Equipotential bonding

Equipotential bonding helps ensure that hazardous potential differences do not occur between different incoming conductors such as metallic water services, power systems, telecommunication systems and the local ground, and also minimizes step and touch potentials.

• Good corrosion resistance

The ground electrode system should be corrosion resistant, and compatible with other conductors that are buried and bonded to the ground system. Copper is by far the most common material used for grounding conductors. In general, some form of maintenance or inspection procedure should be adopted to ensure the long-term effectiveness of a grounding system.

• Electrically and mechanically robust and reliable

Mechanical coupling can be used to join ground conductors, but suffers from corrosion effects when dissimilar metals are involved. As well as mechanical strength, Cadweld connections provide excellent low impedance, long life electrical connections with excellent corrosion resistance.

Ground Resistance

When current flows from a ground electrode into the surrounding soil, it is often described as flowing through a series of concentric shells of increasing diameter.

Each successive shell has a greater area for current flow and consequently, lower resistance. At some point distant from the earth conductor the current dissipation becomes so large and current density so small, that the resistance is negligible.

In theory, the ground resistance may be derived from the general formula:

$$R = P \frac{L}{A} \text{ Resistance} = \text{Resistivity} \times \frac{\text{Length}}{\text{Area}}$$

This formula illustrates why the shells of concentric earth decrease in resistance the farther they are from the ground rod:

$$R = \text{Resistivity of Soil} \times \frac{\text{Thickness of Shell}}{\text{Area}}$$

In the case of ground resistance, uniform earth (or soil) resistivity throughout the volume is assumed, although this is seldom the case in nature. The equations for systems of electrodes are very complex and often expressed only as approximations. The most commonly used formula for single ground electrode systems, developed by Professor H.R. Dwight of the Massachusetts Institute of Technology, is the following:

$$R = P \frac{\rho}{2\pi L} \left\{ (\ln \frac{4L}{r}) - 1 \right\}$$

R = resistance in ohms of the ground rod to the earth (or soil)

L = grounding electrode length

r = grounding electrode radius

ρ = average resistivity in ohms-cm.

Grounding Principles

CONDITIONS INFLUENCING SOIL RESISTIVITY

The resistance of the earth itself (soil resistivity) can significantly impact the overall impedance of the grounding system. Several factors, such as soil composition, moisture content, mineral content, contaminants, etc., determine the overall resistivity of the earth.

SOIL TYPE	Resistivity ohm-cm		
	Average	Min.	Max.
Fills – ashes, cinders, brine wastes	2,370	590	7,000
Clay, shale, gumbo, loam	4,060	340	16,300
Clay, shale, gumbo, loam with varying proportions of sand and gravel	15,800	1,020	135,000
Gravel, sand, stones, with little clay or loam	94,000	59,000	458,000

U.S. Bureau of Standards Technical Report 108

SOIL RESISTIVITY TESTING

To properly design a grounding system, it is essential to test soil resistivity. Several methods can be used to measure earth resistivity: the four-point method, the variation in-depth method (three-point method) and the two-point method. The most accurate method and the one that nVent ERICO recommends is the four-point method.

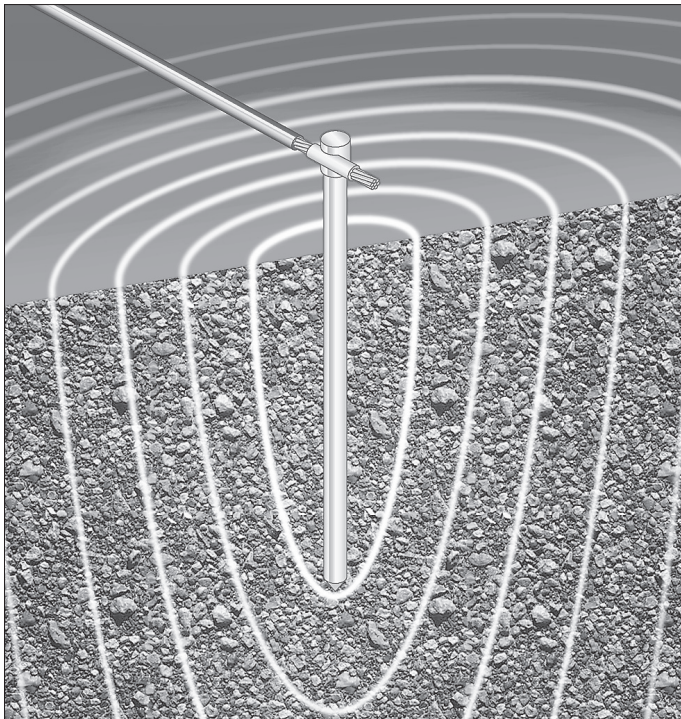

Sphere of Influence - electrical current flows from the ground rod into surrounding soil and progressively dissipates in waves of increasing diameter.

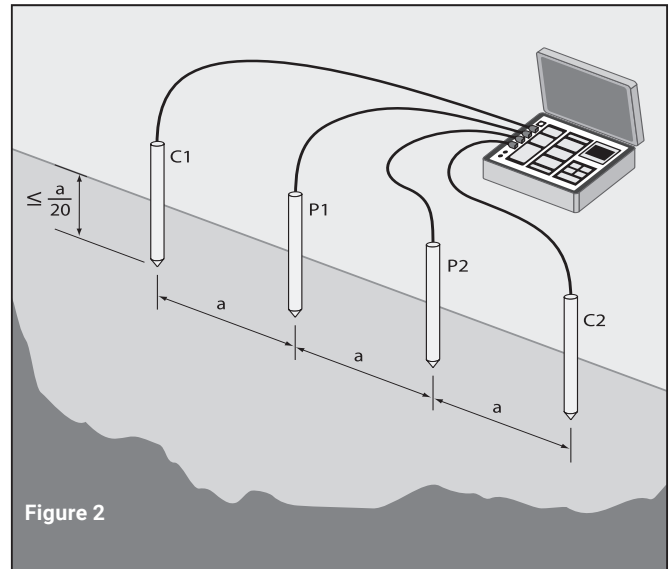

THE FOUR-POINT METHOD

1. Four test stakes are positioned in a straight line an equal distance apart and are hammered into the ground to be surveyed to a depth of not more than 1/20 the distance between the adjacent stakes.
2. An earth resistance tester is connected to these four stakes as shown in Figure 2.
3. The DC test option on the tester is then selected and performed, and the resistance figure "R" recorded.
4. The soil resistivity level "r" (in ohms/cm) is then calculated using the formula: $r = 2\rho aR$ where:

R = the resistance figure, in ohms

a = the separation of the test stakes, in meters.

$$\rho = \frac{4\pi AR}{\frac{1 + 2A}{\sqrt{A^2 + 4B^2}} - \frac{2A}{\sqrt{A^2 + 4B^2}}}$$

Where:

A = distance between the electrodes in centimeters

B = electrode depth in centimeters

If $A > 20 B$, the formula becomes:

$$\rho = 2\pi AR \text{ (with A in cm)}$$

$$\rho = 191.5 AR \text{ (with A in feet)}$$

$$\rho = \text{Soil resistivity (ohm-cm)}$$

This value is average resistivity of the ground at a depth equivalent to the distance "A" between two electrodes.

Grounding Principles



Avoid hazardous Step and Touch Potentials (shock) or even death by low impedance grounding and bonding between metallic equipment, chassis, piping, and other conductive objects so that currents, due to faults or lightning, do not result in hazardous voltage rise.

STEP AND TOUCH POTENTIAL

Step Potential

Step Potential is the voltage difference between a person's feet caused by the dissipation gradient of a fault entering the earth.

Touch Potential

Touch Potential is similar to "Step Potential" except that the fault current passes through the person's arm and torso on the way to the ground.

Another function of the grounding system is to provide a reference for circuit conductors to stabilize their voltage to ground during normal operation. The earth itself is not essential to provide a reference function; another suitable inductive body may be used instead.

The function of a grounding electrode system and a ground terminal is to provide a system of conductors, which ensures electrical contact with the earth.

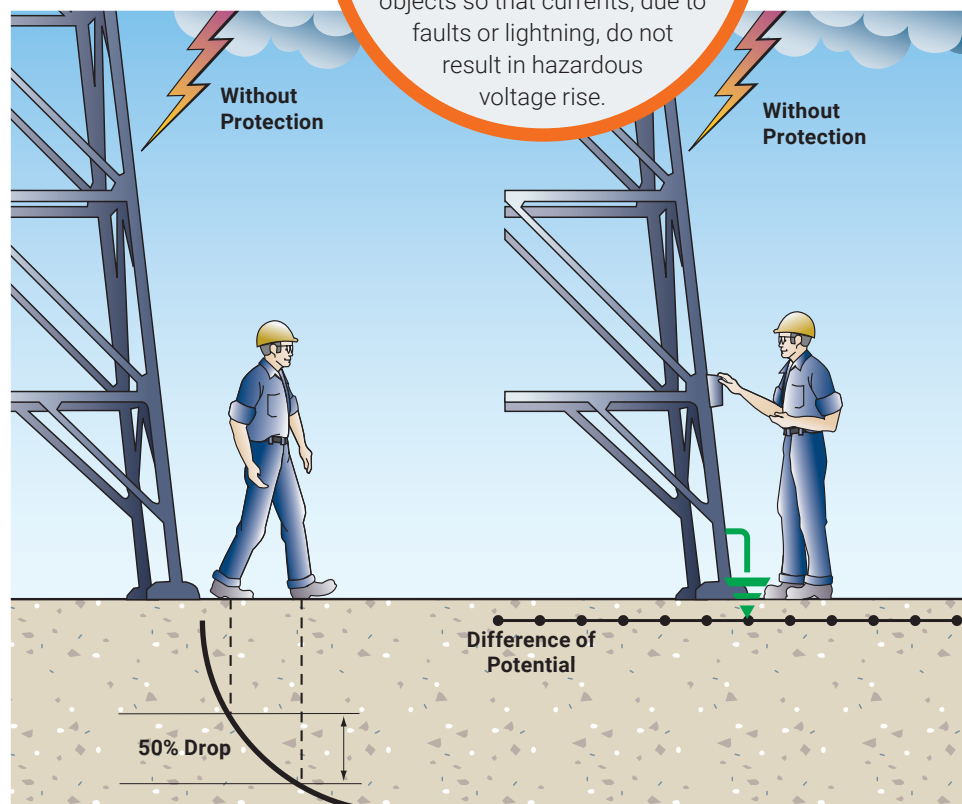

Grounding Principles

GROUNDING / EARTHING SYSTEM DESIGN

Grounding systems are important. It is not expensive to build an appropriate ground system during initial construction of a facility, but it can be very expensive to add to it, enhance it, or replace it after the facility is complete. Care should be taken to design a system that is appropriate both for clearing ground faults and dissipating lightning energy. The system must have a long performance life, meet applicable codes / standards for safety, and have sufficient bonding points to make it easy to add new equipment / facility grounding to it easily.

Design considerations include:

- Purpose of facility
- Design life of facility
- Soil resistivity at 3 depths
- Corrosive nature of soil
- Shape and available area of facility site
- Existing structures and their grounding systems
- Seasonal variations in moisture and temperature for facility site
- Public access & personnel use
- Adjacent facilities and electrical systems
- Future uses, additions, equipment for facility

For proper operation of overcurrent devices, it is important to have a low DC ohmic resistance to remote earth. In many instances, this is best achieved by installing a deep ground electrode on site. It should be driven deep enough to reach the permanent water table.

For dissipation of direct or indirect lightning currents, it is better to have many horizontal ground conductors in the soil, preferably in a radial array. This provides a low impedance path of dissipation to the high frequency component of the lightning energy.

For personnel, particularly where people congregate or where equipment operators will be located, it is important to have a grid system or other equipotential plane to reduce "step potential" and have equipment and metal structures bonded to the ground system to reduce "touch potential".

A proper facility grounding system incorporates these necessities in the most cost-effective manner that will last for the design life of the facility.

nVent ERICO is a manufacturer and marketer of grounding, bonding, lightning protection and surge protection products and systems. nVent ERICO has many knowledgeable and experienced engineers on staff with the training and the tools (including some of the latest design software) to design appropriate grounding systems. These engineers can assist facility owners, engineers and contractors in designing the most appropriate system for the facility in question.

Grounding Chain

1. Grounding Electrode Conductor
2. Grounding Connections
3. Grounding Electrode
4. Electrode to Soil Resistance
5. Soil

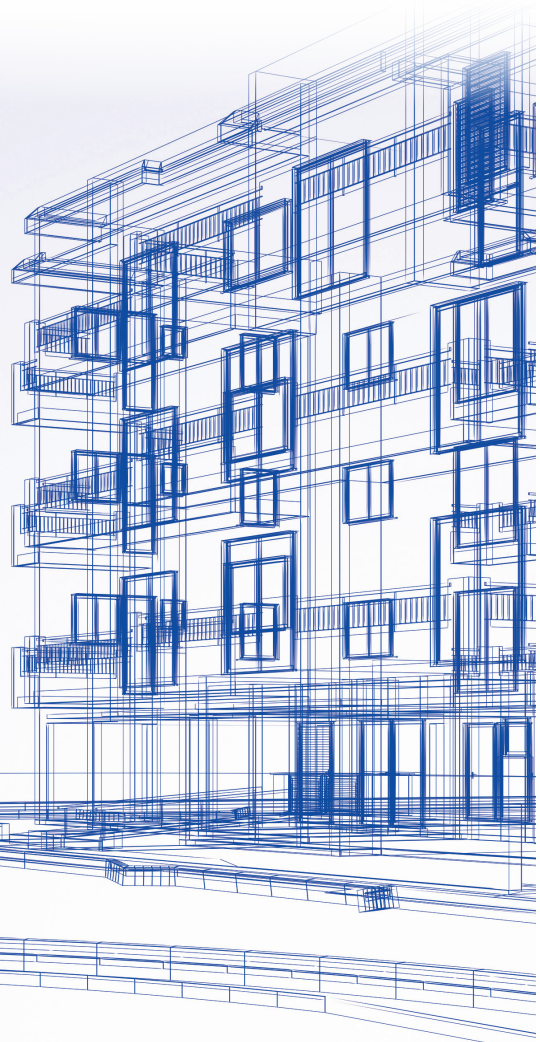

Grounding Principles

THE GROUNDING CHAIN

The performance of the grounding system is determined by the quality of the following five components all of which are of equal importance.

1. **The Grounding Electrode Conductor.** Typically made from copper or copper-bonded steel, the grounding electrode conductor must be large enough to withstand the maximum available fault current over the maximum clearing time.
2. **The Grounding Connections.** Often overlooked, the grounding connections are used to tie the elements of the electrode system together. Exothermically welded connections provide a molecular bond that will never loosen or corrode. Mechanical connectors, such as crimp, bolted, and wedge type, rely on physical point-to-point surface contact to maintain the integrity of the electrical connection. IEEE® Standard 837-2014 provides detailed information on the application and testing of permanent grounding connections. nVent ERICO can provide an independent, third-party test report evaluating the performance of these connectors in accordance with the testing procedures set forth in IEEE Standard 837-2014 Standard for Qualifying Permanent Substation Grounding Connections.
3. **The Grounding Electrode.** The grounding electrode provides the physical connection to the earth and is the instrument used to dissipate current into it. There are two main types of electrodes. "Natural" electrodes are intrinsic to the facility and include metal underground water pipe, the metal frame of the building (if effectively grounded), and reinforcing bar in concrete foundations. "Made" electrodes are installed specifically to improve the performance of the ground system and include wire meshes, metallic plates, buried copper conductor and rods or pipes driven into the ground. The ground rod is the most widely used electrode.
4. **Electrode to Soil Resistance.** Amount of rod surface and rod replacement are the controlling factors. Doubling diameter reduces resistance by only 10% and is not cost effective. Doubling rod length, however, theoretically reduces resistance by 40%. The most common solution is proper placement of multiple rods that are driven to the required depths.
5. **The Soil.** The soil resistivity, measured in ohm-centimeters or ohm-meters, plays a significant role in determining the overall performance of the grounding system and must be known before a proper grounding system can be engineered. Measuring soil resistivity allows the design engineer to locate an area with the most conductive soil and to determine the depth of the conductive soil so that electrodes can be placed accordingly.



The grounding system will carry little or no current for long periods of time until a fault occurs or a lightning strike or other transient requires dissipation. At that point, the grounding system components will be expected to perform like new while conducting large amounts of current. Most of the grounding system is concealed below grade, making inspection of the grounding components difficult or impossible. The underground environment is a harsh one. The initial selection of the components used in the grounding system is of critical importance to its long-term effectiveness.

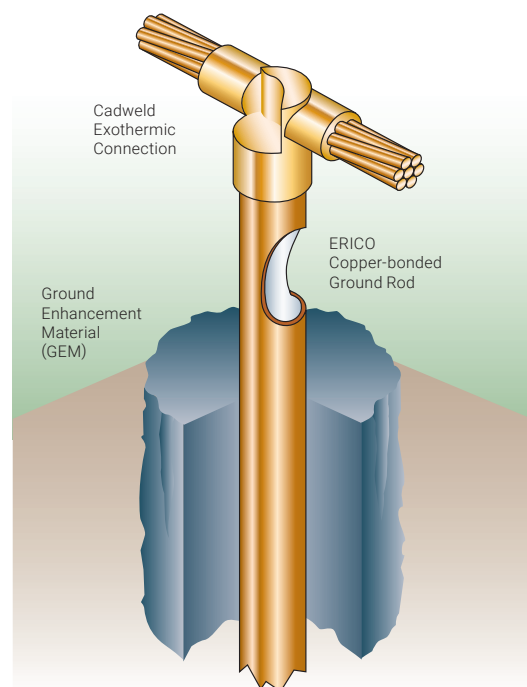

Ground System Components

GROUND ELECTRODES

The ground electrode is a critical component of the grounding system. Many different types of electrodes are available, some "natural" and some "made". The natural types include metal underground water pipe, the metal frame of a building (if effectively grounded), a copper wire or reinforcing bar in a concrete foundation or underground structures or systems. Consideration should be given to bonding of natural earths to ensure electrical continuity with a facility's other "earths".

"Made" electrodes are specifically installed to improve the system grounding or earthing. These earth electrodes must ideally penetrate into the moisture level below the ground level to reduce resistance. They must also consist of metal conductors (or a combination of metal conductor types), which do not corrode excessively for the period of time they are expected to serve. Made electrodes include rods or pipes driven into the earth, metallic plates buried in the earth or a copper wire ring encircling the structure. Underground gas piping or aluminum electrodes are NOT permitted for use as ground electrodes.

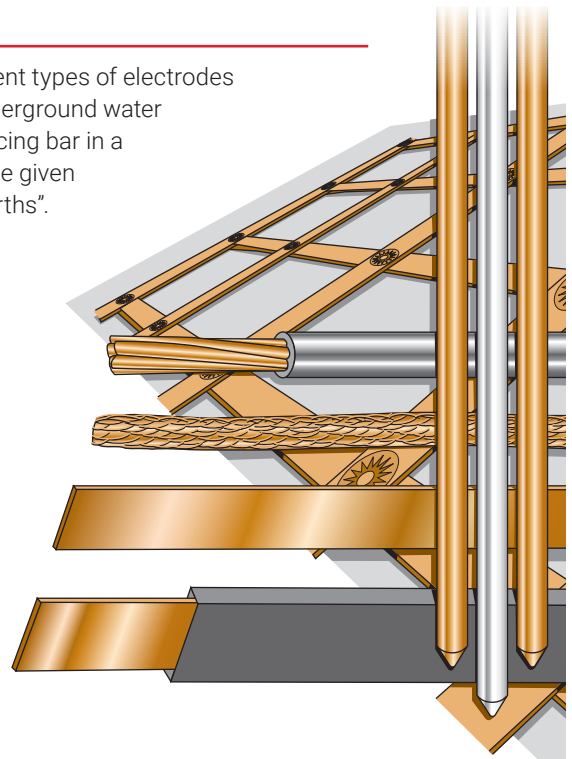

GROUND RODS - WHICH GROUND ROD SHOULD BE USED?

Ground rods are often selected on the basis of their resistance to corrosion. The other major factor is cost. All too often, the cost of a product is seen as the initial up front price, but the real cost is determined by the serviceable life of the ground rod.

Galvanized steel rods are one of the cheapest electrodes available. However, they are not the most cost effective since they have a relatively short service life. Solid copper and stainless steel rods have a long service life. However, they are considerably more expensive than galvanized steel rods. In addition to this, solid copper rods are not suited to deep driving or even driving short lengths into hard ground, without bending.

Ask for the nVent ERICO White Paper on Ground Rods – Copper-bonded vs. Galvanized.



The photo shows two ground rods subjected to the same pressure load test. The nVent ERICO copper-bonded ground rod, shown on the left, will bend without tears, cracks or folds, to the outer sheath. The inferior copperclad rod shown on the right, has developed cracks and creases to the outer sheath, which will significantly reduce its serviceable life and put the integrity of the entire electrode at risk.

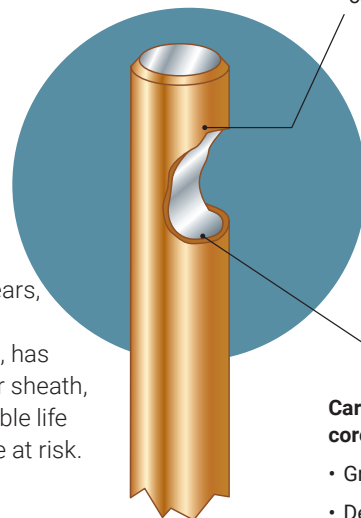

Copper-Bonded Ground Rod	Galvanized Ground Rod
--------------------------	-----------------------

• **Cost-effective long service life**

Copper-bonded coating:

- Permanent molecular bond
- Low resistance performance
- High fault current capacity (IEEE® Std 80)
 - Will not slip or tear when driven
 - Will not crack if rod is bent
- Copper coating may vary to meet required standards
 - 10 mil (254 micron) minimum coating on rods listed to UL® 467

Carbon Steel core and tip*:

- Greater tensile strength
- Deep driving capability

• **Lower purchase price – not as cost-effective over the expected life as Copper-bonded**

Galvanized coating:

- Relatively short service life
- May crack if rod is bent

3.9 mil (99 micron) minimum coating per ASTM® 123

* ERICO copper-bonded and galvanized rods

Ground System Components

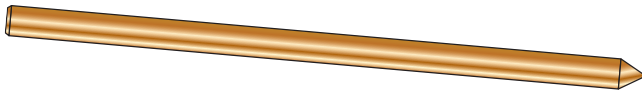

COPPER-BONDED GROUND ROD

The copper-bonded ground rod has an electrolytic coating of copper deposited over a layer of nickel. This process ensures a long lasting, molecular bond between the copper layer and the steel core. nVent ERICO recommends copper-bonded ground rods because the copper coating will not slip or tear when driven, nor will it crack if the rod is bent. The tough, carbon steel core has good characteristics for deep driving. Copper-bonded ground rods have a high resistance to corrosion and provide a low resistance path to ground.

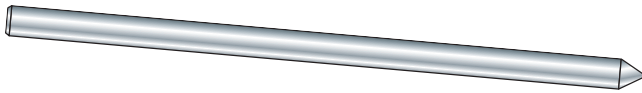

THE STAINLESS STEEL GROUND ROD OPTION

It is important to note that certain soils and land fill areas may not be compatible with copper. In these situations, stainless steel is a better proposition. Stainless steel may also be an alternative, where structures or components, such as steel towers, poles or lead sheathed cables are in close proximity to an array of ground electrodes. In these circumstances, consideration must be given to the consequence of galvanic corrosion. The high cost of stainless steel rods prohibits their widespread use.

NEGRP

The photo on the left shows two ground rods that were driven into the soil vertically at the Pecos testing site in Las Vegas, NV in December of 1992. The top ground rod is galvanized steel, 3/4" x 10'. Bottom ground rod is copper-bonded, 5/8" x 8'. Both ground rods were exhumed from the site in April of 2004. The loss of zinc resulted in excessive corrosion of the steel. The copper-bonded steel ground rods showed minimal corrosion.



Excavated after 12 years.



Excavated after 11 years.

The photo on the right shows a galvanized steel ground rod driven vertically into the ground at the Pawnee testing site in Las Vegas, NV. One area is reduced from a 3/4" diameter to approximately a 1/4" diameter due to extensive corrosion. The eventual failure would result in a potentially catastrophic loss of ground.

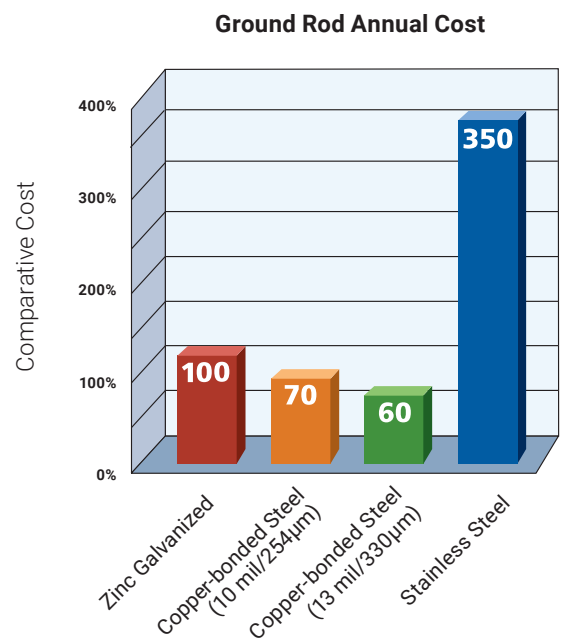
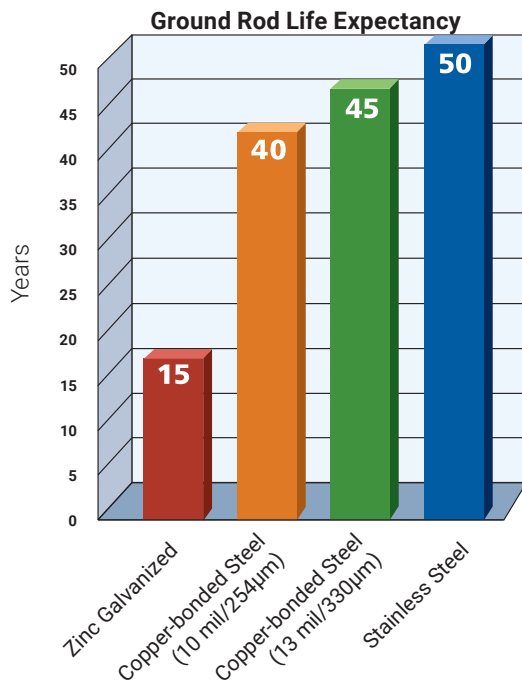

nVent ERICO Hammerlock



Hammerlock is machined from highly conductive copper.



It is easy to see why acorn clamps are more susceptible to corrosion than any other type of grounding connection.

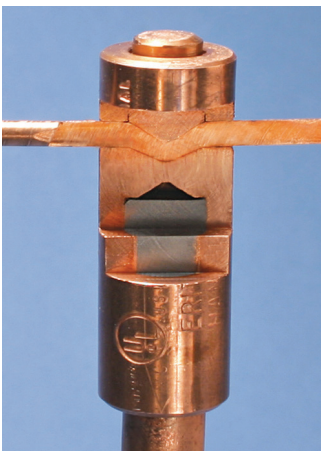

Hammerlock cutaway.

HIGH QUALITY CONNECTIONS

The patented nVent ERICO Hammerlock grounding connector from nVent ERICO connects the grounding conductor to the ground rod. Machined from highly conductive copper, the state-of-the-art Hammerlock provides a low-resistance connection designed to withstand ground fault currents and lightning transients. The Hammerlock connector's mechanically rugged design will help ensure that the highest level of performance is maintained for many years after the connection has been buried in the harsh underground environment. The Hammerlock is one of the quickest and easiest grounding connectors to install and requires no special tools or training. It has been engineered to be user-friendly, cost-effective, and provides a high level of protection for people and expensive equipment.

Features Include:

- Machined from 100% high-conductivity copper
- Excellent mechanical strength
- Irreversible connection
- Fast and simple installation requires only a hammer
- No training required
- Provides a visual indication of completed connection
- Allows for "T" or pass-through connections
- UL® Listed (#2, 4 and 6 solid to 5/8" copper or galvanized rod)

The Importance of Grounding Connections

Electrical utilities and other industries are discovering significant cost benefits when high-quality electrical grounding systems are installed. Many are specifying low-resistance grounds along their transmission and distribution networks. These low-resistance electrodes limit neutral-to-ground voltage, improve safety and provide better protection against lightning damage. In fact, the savings realized from reduced equipment damage and the decrease in service interruptions have prompted many utilities to undertake large-scale grounding improvement programs.

The three main components of the grounding system are the grounding connector, grounding conductor and ground rod. They are all equally important to the performance of the system. A loose or corroded connection will render the grounding system ineffective. While acorn clamps are still the connector of choice, many installers recognize the serious deficiency in their performance and the risks associated with poor-quality connections. Many acorn clamps are loose the day they are installed.

In order to install an acorn clamp effectively, it is necessary to know the proper torque level for the bolt. Since acorn clamps don't come with instructions and most crews don't have or wouldn't use a torque wrench, many are broken or installed incorrectly. The cost of replacing damaged equipment, and the labor associated with doing so, quickly puts the cost of using inferior connectors into perspective.

Installation Costs

The actual cost of the grounding connector represents only a small fraction of the total installed expense when the labor rate of the installation crew, equipment overhead costs, ground rod and conductor costs are considered. Installation costs increase significantly when deep-driven rods are used—a common practice in grounding improvement programs.

Therefore, investing in the best-performing, longest-lasting grounding connector is a wise choice. Initially paying more for a quality connector will actually save money in the long run, by reducing downtime and eliminating the need for crews to return to the site for repairs.

nVent ERICO Hammerlock

Hammerlock Is The Answer!

Acorn clamps are utilized because they are inexpensive. They were developed before the proliferation of expensive electronics, at a time when the demand for electric power was lower and before power quality was a serious consideration. The Hammerlock, on the other hand, was designed to meet the needs of today's modern grounding programs. Therefore, an upgraded or perhaps more aptly stated, updated, grounding program specification should require a quality connector and exclude the acorn clamp.

How the Hammerlock works

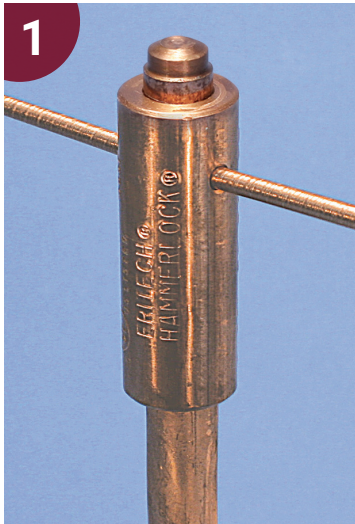

The ground wire is placed through the connector body and then the body is placed on the top of the ground rod. As the connector is struck with a hammer, Hammerlock is connected to the ground rod using the same compression technology used in the nVent ERICO threadless couplers that connect deep-driven rods together.

At the same time, the ground wire is locked in place as the connector plug enters the body.

Ease of Installation

Installing the Hammerlock is as easy as swinging a hammer. Its intuitive design requires no special tools or training. When the large diameter on the Hammerlock plug is flush or below the round body, the connection is complete and irreversible. The Hammerlock can be installed three to five times faster than an acorn clamp and is easier to install in a trench.

The Hammerlock provides a high-quality grounding connection that is easy to use and cost-effective – withstanding 100% of the current carrying capacity of the conductor. Given the important function of today's grounding system, the Hammerlock provides excellent connector value.

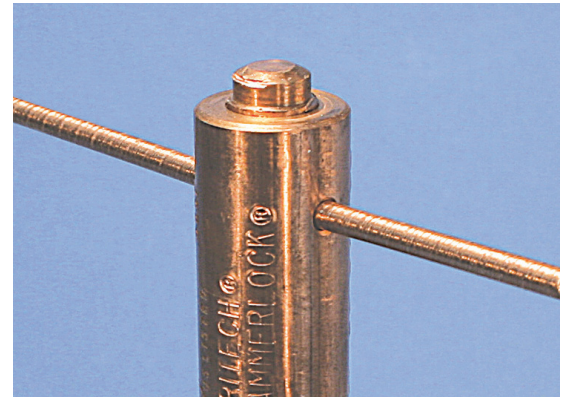

Hammerlock Specification

Cable to ground rod connectors shall be made from a round, high conductivity copper alloy bar stock, with a minimum of 90% IACS. The connector shall provide a high quality, irreversible, compression connection area for the conductor and a taper fit compression connection area for the ground rod. The connector shall be able to withstand 100% of the current carrying capacity of the conductor. The connector shall not rely on bolts or screws to maintain the integrity of the connection. Each connector shall be clearly marked with the catalog number and clear description of the conductor and ground rod to be connected and packaged with installation instructions.

A hammer shall be required for the connector installation. The connector shall provide a positive visual means of verifying a successfully completed connection. The connector shall be the Hammerlock as manufactured by nVent ERICO or approved equal. Silicon bronze connectors are not acceptable.

nVent ERICO Ground Enhancement Material (GEM)

nVent ERICO Ground Enhancement Material (GEM) is the effective, maintenance free, permanent, easy to use, and environmentally sensitive solution to your toughest grounding problems.

GEM is a low-resistance, non-corrosive, carbon-based superior conductive material that improves grounding effectiveness, especially in areas of poor conductivity such as rocky ground, mountain tops and sandy soil. GEM is also the answer in situations where ground rods can't be driven or where limited land area makes adequate grounding difficult with conventional methods.

GEM contains portland cement, which sets within 3 days and fully cures within 28 days, to become a highly conductive concrete that performs in all soil conditions irrespective of the presence of water. GEM maintains a constant level of superior performance once cured that will not diminish over the life of the grounding system.

GEM comes in easy to use 25 lb (11.3 kg) bags or buckets that one person can install. GEM is maintenance-free and will never leach or wash away. A Material Safety Data Sheet (MSDS) is available on request.

GEM is effective

- Dramatically reduces earth resistance and impedance measurements
- Maintains constant resistance for the life of the system once in its set form
- Performs in all soil conditions even during dry spells
- May reduce the size of the grounding system where conventional methods are unsatisfactory

GEM is maintenance free

- Does not require periodic charging treatments or placement
- Does not require the continuous presence of water to maintain its conductivity

GEM is permanent

- Fully sets within 3 days, fully cures within 28 days.
- Does not dissolve, decompose or leach out with time
- Non-corrosive
- Reduces vandalism and theft since conductors are hard to remove from concrete

GEM is easy to use

- Easy-to-handle 25 lb (11.3 kg) bags or buckets
- Requires one person to install

GEM is environmentally sensitive

- Exceeds IEC® 62561-7 which sets the benchmark for corrosion, leaching, sulfur content, and other environmental regulations
- MSDS sheet available upon request

GEM
Ground Enhancement Material
Conforms to IEC 62561-7

FAST AND EASY ORDERING

For more information, contact your local ERICO sales representative for a quote. You can reference the GEM part numbers.

Part Number	Description
GEM25A	25-lb. (11.3 kg) bag with handles
GEM25ABKT	25-lb. (11.3 kg) plastic bucket with locking lid



nVent ERICO Ground Enhancement Material (GEM)

DESIGN AND ESTIMATING SOFTWARE

Design software estimates the quantity of GEM needed and calculates the anticipated ground resistance on any installation. GEM software is available at nVent.com/ERICO/products/GEM.asp.

Parameter	Recommended Values	Test Method
Standards Compliance		Full compliance to IEC 62561-7 EPA Toxicity Characteristic Leaching Procedure (TCLP), test method 1311
Leaching	Arsenic < 1.5 mg/L, Barium < 60 mg/L, Cadmium < 0.15 mg/L, Chromium < 3.0 mg/L, Lead < 1.5 mg/L, Mercury < 0.06 mg/L, Elenium < 1.0 mg/L	EC 62561-7 EN 12457-2
Sulfur Content	< 2%	ISO 14869-1
Resistivity	<2 Ω-cm for powder <20 Ω-cm for mixed and cured material	Compressed powder according to ASTM G187-12 Mixed and cured per ASTM D991-89
Corrosion Performance	For copper-plated earth electrodes, the polarization resistance shall be > 8 Ω x m2 for aggressive environments For galvanized earth electrodes, the polarization resistance shall be > 7.6Ω x m2 for aggressive environments	IEC 62561-7, Sec 5.5, aggressive environment.
Flexural Strength	300-450 psi [2070-3100 kPa]	ASTM C293
Compressive Strength	100-200 psi [690-1390 kPa] after 672 hours curing time	ASTM C109

INSTALLATION INSTRUCTIONS

Trench Installation:

- Mix GEM into a slurry form by using a standard cement mixer or mix in a bucket, mixing box, wheelbarrow, etc. Use 1.5 to 2 gallons (5.7 to 7.6 liters) of clean-potable water per bag or bucket of GEM. Do not mix GEM with salt water.
- Spread out enough GEM to uniformly cover bottom of trench –about 2 in (5 cm) deep. (See Table). Let the GEM harden to prevent the conductor from sinking to the bottom of the trench.
- Place conductor on top of GEM. (See Note 1)
- Spread more GEM on top of conductor to completely cover conductor – about 2 in (5 cm) deep. Allow GEM to harden. Wait 30 minutes to one hour before filling the trench with soil backfill.
- Carefully cover the GEM with soil making sure not to expose the conductor.

Note 1: Wait for the GEM to harden, about 15 to 20 minutes, before placing the conductor on top of the GEM. You must apply 4 inches (10 cm) of insulating material to the conductors and ground rods exiting the GEM, starting 2 inches (5 cm) inside the GEM.

Note 2: Excess standing water must be removed from trench.

Estimated linear feet of ground conductor covering with each bag of GEM.

Trench Width		Total Thickness of GEM					
		in	cm	in	cm	in	cm
Inches	Centimeters	4	10.2	5	12.7	6	15.2
4	10.0	3.5	1.0m	2.8	0.8m	2.3	0.7m
6	15.2	9.3	0.7m	1.8	0.5m	1.5	0.4m
8	20.3	7.0	0.5m	1.4	0.4m	1.1	0.3m
10	25.4	5.6	0.4m	1.1	0.3m	0.9	0.3m
12	30.5	4.7	0.3m	0.9	0.3m	0.7	0.2m

A 25 lb. bag of GEM will cover 3.5 linear feet (1.0 m) of conductor length for a 4" wide (10.2 cm), 4" thick (10.2 cm) covering [2" (5.1 cm) below and 2" (5.1 cm) above conductor], based on 63.5 lb/cu ft (1017 kg/m³)

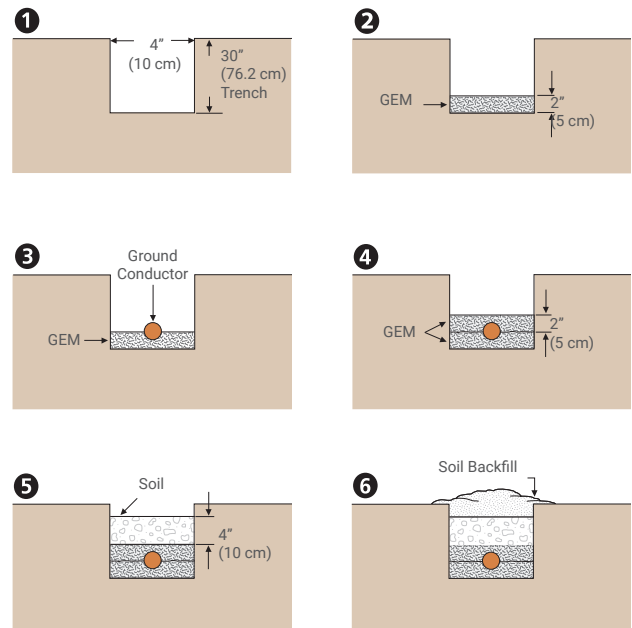

nVent ERICO Ground Enhancement Material (GEM)

Ground Rod Backfill Installation:

1. Auger a 3-inch (7.5 cm) or larger diameter hole to a depth of 6 inches (15 cm) shorter than the length of the ground rod.
2. Place ground rod into augered hole and drive 1 foot (30 cm) (if possible) into bottom of the hole. The top of the ground rod will be approximately 6 inches (15 cm) below grade. At this time, make any connections to ground rod using Cadweld connections. (See Note 1)
3. Premix GEM into a slurry form. Use 1.5 to 2 gallons (5.7 to 7.6 liters) of clean-potable water per bag or bucket of GEM. The installation of GEM in a dry state is acceptable for vertical ground rod applications.
4. Pour the appropriate amount of GEM (see table) around the ground rod. To ensure the GEM material completely fills the hole, tamp around the ground rod with a pole. Wait 30 minutes to 1 hour before filling the hole with soil backfill.
5. Fill remainder of augered hole with soil removed during augering.
For various augered-hole diameters and depths, see the table below:

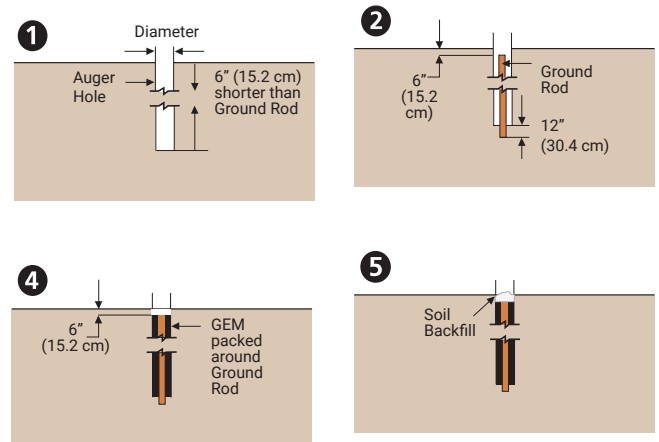

Note 1: 4 inches (10 cm) of insulating material must be applied to the conductors and ground rods exiting the GEM, starting 2 inches (5 cm) inside the GEM.

Note 2: Excess standing water must be removed from the hole.

Estimated bags of GEM for backfilling around ground rods to a density of 63.5 lb/ft³

Diameter of Hole		Depth of Hole*											
		ft		m		ft		m		ft		m	
Inches	Centimeters	5	1.5	6	1.8	8	2.4	10	3.0	15	4.6	20	6.1
4	10.2	2		2		2		3		4		5	
6	15.2	3		3		4		5		8		10	
8	20.3	5		6		8		9		14		18	
10	25.4	7		9		12		14		21		28	
12	30.5	10		12		16		20		30		40	

*8' (2.4 m) minimum rod length required to be in contact with the soil (or GEM). Per NEC® 250-52

Note: To mix GEM into a slurry form, use a standard cement mixer or mix in a mixing box, wheelbarrow, etc. Use 1.5 to 2 gallons (5.7 to 7.6 liters) of clean-potable water per bag of GEM. Do not mix GEM with salt water. For storage and safety precautions, see product packaging.

Customer Support

Support representatives are available to answer any product or application questions you may have; visit nVent.com/ERICO to find a phone number for your nearest customer support representative.

nVent ERICO Cu-Bond Composite Cable



nVent ERICO Cu-Bond is a bare concentric stranded conductor that consists of peripheral tinned copper plated steel which protects and conceals the internal copper stranding.

This conductor is ideal for exposed electrical grounding applications where copper theft may occur. The conductor is difficult to cut with hand tools and the outer stranding is magnetic, which further deters thieves looking for copper.

The CC5A05CB (19 strand) is electrically equivalent to a 4 AWG (25mm²), the CC5A20CB is electrically equivalent to a 2/0 AWG (70mm²) and the CC5A40CB is electrically equivalent to a 4/0 AWG (120mm²).

These conductors are ideal for transmission tower, distribution pole and a wide range of above and below grade grounding applications.

FEATURES

- Outer strands comprised of tinned copper bonded steel for corrosion resistance and theft deterrence
- Inner copper stranding is tinned for superior corrosion resistance
- Copper stranding inside of conductor provides increased conductivity and conductor flexibility
- Copper strands are hidden by outer tinned copper bonded steel strands
- Available in three sizes / configurations with electrical equivalency to 4, 2/0 and 4/0 AWG copper
- Suitable for direct burial applications
- More flexible and easier to work with than copper clad steel conductors

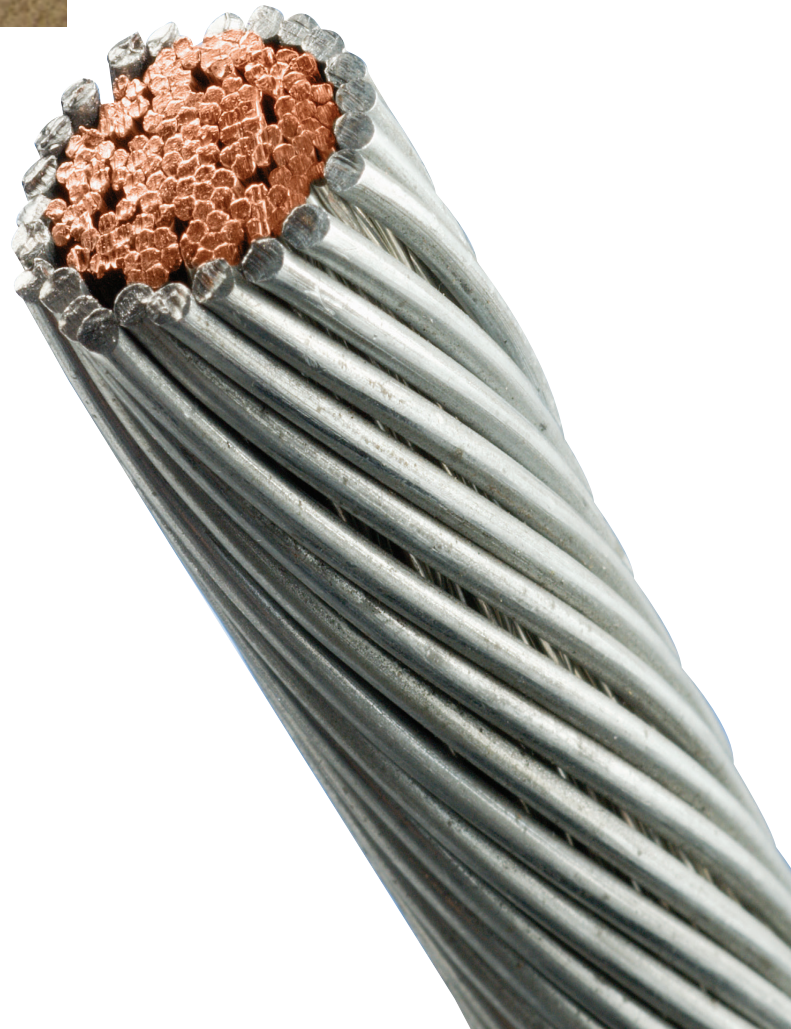

nVent ERICO Cu-Bond Round Conductor



Substation earthing riser

For decades, nVent ERICO has provided the market with high quality copper-bonded ground rods.

nVent ERICO has taken that same concept in ground rods and made this into a revolutionary new grounding conductor. The nVent ERICO Cu-Bond Round Conductor is comprised of an electro-plated coating of copper deposited over a layer of nickel surrounding a steel core. This process helps ensure a long-lasting molecular bond between the copper layer and the steel.

The conductor core consists of a low-carbon steel grade for improved flexibility in the field. The copper surface of the conductor provides high conductivity and corrosion-resistance properties.

FEATURES

- Copper-bonded coating will not crack or tear when the conductor is bent
- High resistance to corrosion and provides a low resistance path to Earth
- Available in standard packaging lengths of 100 meters, 50 meters, and 25 meters
- Minimum copper plating thickness of 254 microns
- Available in nominal diameters of 8, 10, 13, 14, 16, and 18 mm
- Meets the requirements of IEC® 62305-3 Edition 2 and IEC/EN 62561-2 for lightning protection applications
- Cu-Bond Round conductors are UL certified to IEC® 62561-2



BENEFITS AS AN ALTERNATIVE TO COPPER CONDUCTOR

- **Theft deterrent:** Copper theft is a problem everywhere. Cu-Bond Round Conductor is hard to cut with hand tools due to its steel core. They are also magnetic, notifying potential thieves that the materials within are of little scrap value.
- **Cost-effective:** Because the copper is bonded to a steel core, the cost of the conductor is minimized by reducing the total amount of copper in the cable.

BENEFITS AS AN ALTERNATIVE TO GALVANIZED STEEL CONDUCTOR

- **Superior corrosion resistance:** In comparison to other steel-based products, Cu-Bond Round Conductor provides excellent application life of typically 30-40 years in most soil conditions.



Equipotential grounding conductor

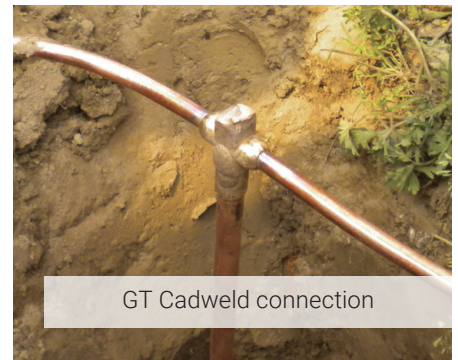

GT Cadweld connection

nVent ERICO Cu-Bond Round Conductor

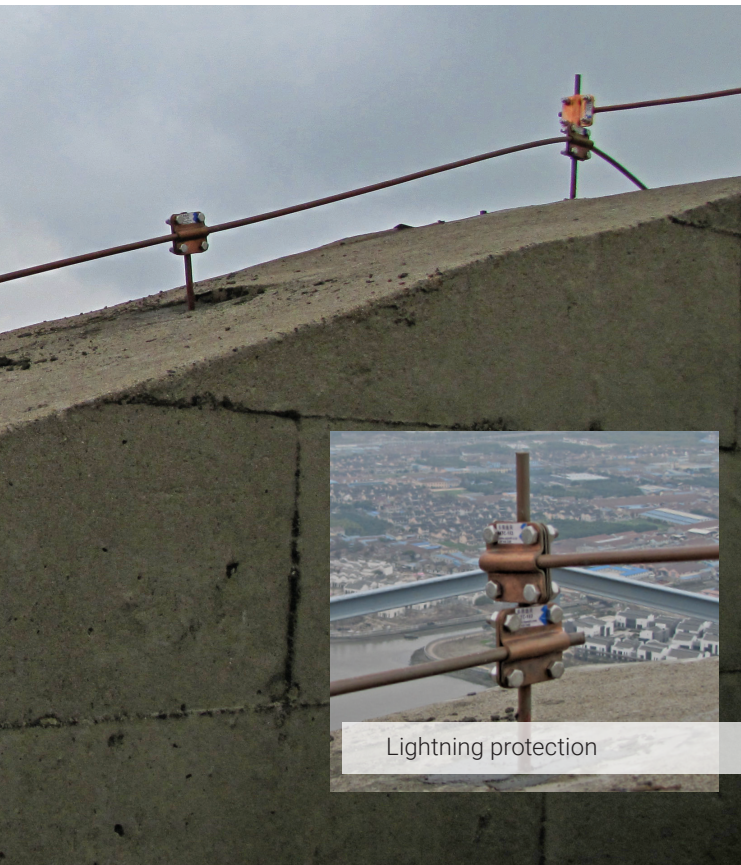

ABOVE GRADE APPLICATIONS

The unique properties of Cu-Bond Round Conductor make it ideal for both horizontal and vertical placement. Above grade, the conductor is well-suited as a lightning-protection conductor when applied in accordance with the IEC 62305-3 Edition 2.0 standard.

• Utility

- Distribution down-lead conductor and assemblies
- Bonding kits for substation fence or equipment ground risers back to the grid

• Commercial and Industrial

- Alternative conductors to solid copper rod and tapes in grounding and lightning protection

• Telecom

- Conductor for connecting equipment ground to ground grid, and riser (down-lead) conductors for tower
- Grounding conductor for datacenter mesh bonding

• Rail

- Trackside bonding conductor and stray current conductor
- Grounding kits for trackside equipment, electrical traction power
- Substation, wayside shelters, communication antenna equipment



BELOW GRADE APPLICATIONS

Copper-bonded steel conductors are ideal as earthing and bonding conductors where copper theft on-site may occur. Cu-Bond is ideal for use in a variety of applications including power distribution earthing and bonding; substation earthing; commercial, industrial, and railway earthing.

• Buried ground grid conductors and electrodes:

- Wireless telecom tower earthing
- Utility substation earthing; power distribution and transmission earthing
- Large scale ground mount solar farm earthing
- Industrial facility earthing, for example, petro-chemical and mining infrastructure
- Railway earthing

• Interconnecting grounding conductor between wind towers or grounding grid at base of wind tower



Cu-Bond Round Conductor is stamped with compliance markings directly on the product to ensure genuine product and high quality standards. Beware of imitations.

Ground Stainless Steel Braids (CPI + CPIW)



Stainless Steel Braids Technical Characteristics

- 316L stainless steel braid ready to use
- Full application range: 16 to 70 mm² section with 150 to 1100 mm length
- High-quality 316L stainless steel: superior abrasion, corrosion, chemical, and UV resistance for outdoor applications
- Time savings: Quick and easy to install. Ready to use. No additional cutting, stripping, crimping and punching needed. Less labor time for installation
- Material savings: No additional lugs or terminals needed
- Durable in outdoor, salt and corrosive environments
- Non-magnetic material
- UL® Listed to UL467 - grounding and bonding equipment for US and Canada
- Great for expansion joints where constant movement requires a flexible and indestructible covering



READY-TO-USE STAINLESS STEEL BRAIDS FOR MULTIPLE APPLICATIONS

nVent ERICO developed and manufactures a range of ground stainless steel braids. These high-quality 316L stainless steel braids can be installed in extremely corrosive environments, like offshore applications or coastal applications. The CPI braid is ideal for applications using stainless steel pipe or tanks, like the food and beverage industry, building industry, transportation, oil and chemical industry.

nVent ERICO offers 316L stainless steel, one of the highest resistant stainless steel options on the market. nVent ERICO has mastered the process of manufacturing stainless steel for braiding, crimping, cutting or punching and offers a full range of ready-to-use stainless steel braids.

In addition, the CPIW offered by nVent ERICO allows for more connections to larger bolts than any other 50 mm² or 70 mm² braid.

WHERE STAINLESS BRAIDS CAN BE USED:

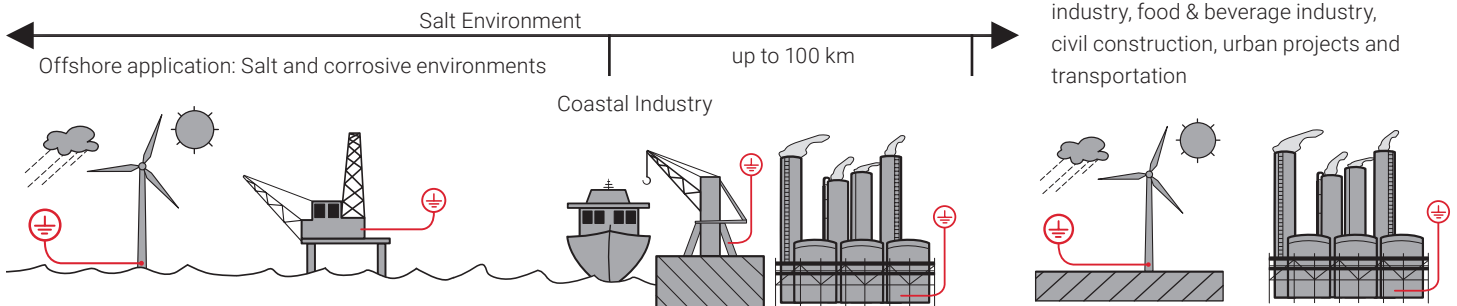

Ground Copper Braids (MBJ & BJ)

Tinned Copper Ground Braids Technical Characteristics

With integral palm

- A complete range of ground flexible connections from 6 to 100 mm² section and from 100 to 500 mm length
- Resistant to vibration and fatigue, reducing maintenance
- Reliable: No extra contact due to the lugs crimped at the ends of the cable
- Provides weight savings, material savings and lower impedance when compared to similar lugged cables with insulation
- Integral palm, without tin or crimped lugs for superior electrical contact and tensile strength resistance
- Quick and easy to install: Ready to use. No cutting, stripping, crimping or punching. Less labor time for installation
- Material savings: No lugs or terminals
- GOST compliant
- RoHS compliant



INNOVATIVE, STATE-OF-THE-ART MANUFACTURING PROCESS

nVent ERICO manufacturing directly massivates the palms of the MBJ tinned-plated braids. This manufacturing process provides an effective electrical contact, due to the integral palms, without the addition of tin or crimped lugs.

This process welds the flexible braid and brings back a solid tinned or red copper block as a palm. Unlike the traditional press-welded palms process, nVent ERICO's process is suitable for red copper, but also for tin plated copper. The electrical contact between each wire is optimized.

This nVent ERICO process also helps eliminate moisture issues in the palms. By using crimped lugs in a severe environment, moisture can enter in the lug (often by capillarity) and create corrosion between each wire. After several years, the electrical contact between each wire can deteriorate and alter the electrical conductivity of the equipment. The corrosion in the palm is impossible to remove without changing the element.

This process produces RoHS products; no additional substances are added to the tinned-plated wires during the manufacturing process.

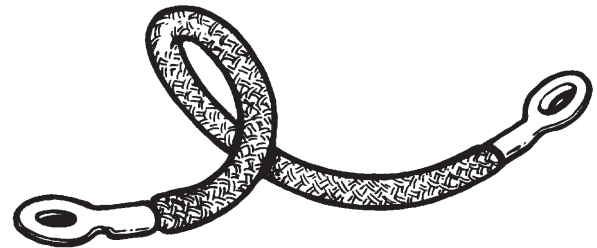

BJ

Round braids with crimped lugs

Part No.	Description	Cross Section	L in	Ø D in	Intensity A	
556900	BJ 6-150 S	11.84 kcmil	5.91	0.006	45	10
556910	BJ 6-200 S	11.84 kcmil	7.87	0.006	45	10
556920	BJ 10-300 S	19.74 kcmil	11.81	0.006	75	10

nVent ERICO Cadweld Plus

nVent ERICO Cadweld Plus connections offer all the benefits of conventional Cadweld connections:

- Current carrying capacity equal to or greater than that of the conductor
- Withstand repeated fault currents without failing during operation
- Permanent, molecular bond that will not loosen or corrode, resulting in a connection with a lifetime equal to that of the installation
- Join copper to copper, copper to galvanized or plain steel, copper to copper clad steel, copper to bronze/brass/stainless steel, steel to steel, etc.
- No external power or heat source required
- Quality Assurance Inspection is easy and visual
- Minimal installation training required
- Exceed requirements of "IEEE Std. 837-2014 -Std. for Qualifying Permanent Connections Used In Substation Grounding"

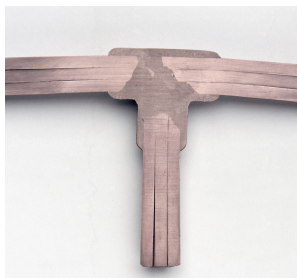
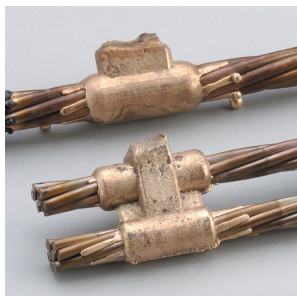

The Cadweld molecular bond will last the lifetime of the conductors.

CADWELD PLUS

The ultimate welded connection that will never loosen, corrode or increase in resistance.

nVent ERICO is dedicated to continuous product improvement to meet its customers' needs and maintain the highest level of satisfaction. The introduction of Cadweld electrical connections in 1938 enabled them to be quickly recognized as the ultimate connection for rail, cathodic, power and grounding applications.

Continuing the tradition of technical leadership, Cadweld Plus was developed as a simplified method of performing exothermically welded electrical connections. This trusted system now features a new Cadweld Plus cup design for the integrated welding material package which has streamlined the installation process by eliminating ignition materials.

The tamper proof, integrated welding material package consists of a steel cup containing Cadweld patented welding material alloys and an ignition source. This newly shaped welding material package is designed for use in all standard Cadweld molds, including Cadweld Multi. Once placed in the Cadweld mold, the welding material is electronically ignited using a simple battery-powered control unit with a six-foot lead.

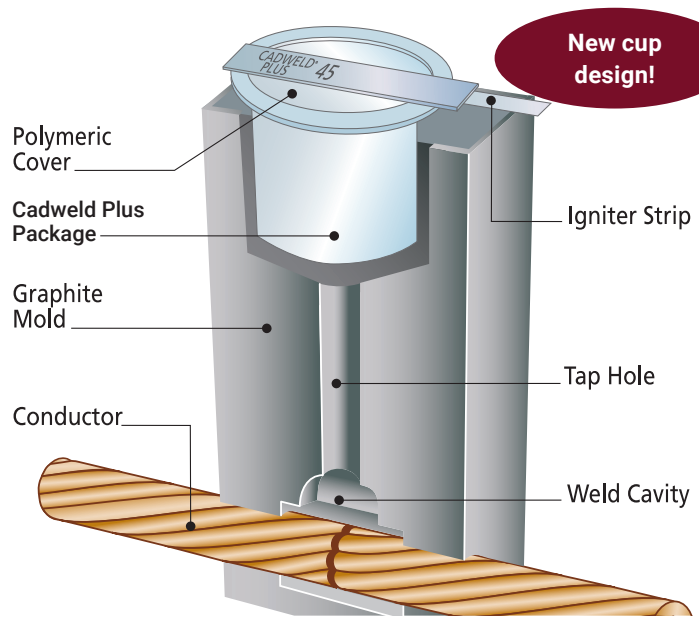

Feature	Benefits
Integrated Welding Material Package	<ul style="list-style-type: none"> • Simplifies training and set up • Saves labor • Simplifies cleaning
Color Coded Welding Material	<ul style="list-style-type: none"> • Helps reduce risk of misapplication • Simple visual verification of correct welding material size
Electronic Control Unit	<ul style="list-style-type: none"> • No starting material required • Easy ignition
Replaceable Six or Fifteen Foot Control Unit Lead	<ul style="list-style-type: none"> • Increased flexibility in hard to reach areas

nVent ERICO Cadweld Plus

- Consists of a tamper proof, disposable, moisture-resistant welding material cup. The welding material, disk and ignition source are incorporated into the self-contained package
- Long shelf life
- Completes welds at distances of up to 6 ft/1.8 meters (up to 15 ft/4.6 meters with optional lead)
- Requires minimum components – no starting material, no disks, no flint igniters
- Easy to handle, store and transport – by air, land or sea in unlimited quantities
- Reduces installation time by 20%
- Has color-coded welding material containers – by size and alloy type – for easy identification
- Has electronic ignition with a CE/UL battery powered controller box that is designed for 600 connections with one set of 8 standard AA batteries (included) – requiring no special batteries or chargers
- Designed for use in standard Cadweld molds including Cadweld Multi

Installation Is Easy! 4 Simple Steps For Permanently Welded Electrical Connections



Self contained welding material package



1 Insert Cadweld Plus cup into mold (may require use of a cover/baffle)



2 Attach control unit termination clip to ignition strip



3 Press and hold control unit switch and wait for the ignition



4 Open the mold and remove the expended steel cup – no special disposal required

Cadweld Plus Control Unit initiates the reaction of the metal crucible. The standard unit includes a 6-foot (1.8 meter) high temperature control unit lead. The lead attaches to the ignition strip using a custom made, purpose-designed termination clip.

After the termination clip is installed on the ignition strip, the installer pushes and holds the ignition button to start a charging and discharging sequence. Within a few seconds the control unit sends a predetermined voltage to the ignition strip and the reaction is initiated.

Cadweld Multi



CADWELD MULTI

The complete welding system for improving grounding system performance, reliability, and installation convenience.

Cadweld Multi simplifies the exothermic welding process. Make over 30 separate connection types with a single, universal mold, which now enables you to make connections to a ground rod.

Welding material sold separately.

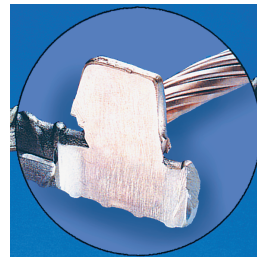

EXOTHERMIC WELDED CONNECTIONS

Exothermic welded connections are immune to thermal conditions which can cause mechanical and compression joints to become loose or corrode. They are recognized for their durability and longevity.

Cadweld Multi offers enhanced user benefits:

- Performs welds to ground rods
- Versatile mold produces an unlimited variety of connections
- Compact compression structure enables easy alignment of conductors
- Language-free instruction guide
- Lightweight kit for easy transportation
- Easy-to-use system completes weld in seconds
- Video available on nVent.com/ERICO

CADWELD CONNECTION

The ERICO CADWELD PLUS exothermic welding process fuses conductors together to form a molecular bond with a current-carrying capacity equal to that of the conductor. Grounding systems incorporating this type of connection therefore operate as a continuous conductor with lower resistivity.

Standard Compliance

Cadweld Multi satisfies the requirements of:

- BS 6651
- BS 7430
- NFC 15-100
- IEEE® 837-2014
- IEEE 80-2000
- IEC 1025-1 (ENV 61024-1)

Cadweld Multi

4 EASY STEPS FOR MULTIPLE, PERMANENTLY WELDED, ELECTRICAL CONNECTIONS

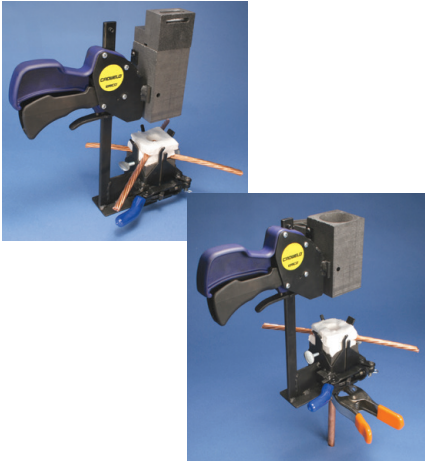

Step 1: Layer batting and variable conductor sizes to be welded into dry mold.



Step 2: Add Cadweld Plus welding material.

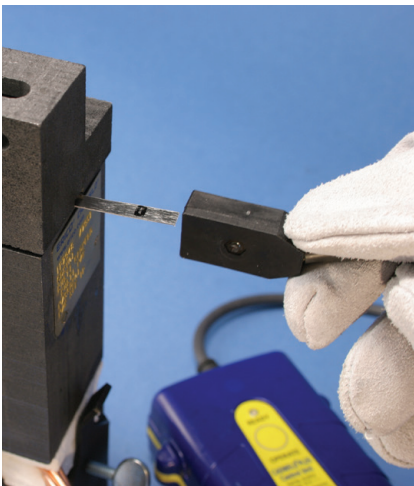

Step 3: Close cover and connect Cadweld Plus control unit.



Step 4: Press and hold operate button. Open mold after 10 seconds.

HOW DOES IT WORK?

Cadweld Multi combines a versatile mold block and a range of gaskets (batting) to allow numerous different welded connections to be produced without the need to change the mold for each connection type



The process is similar to the Cadweld with one distinct difference...

there is no need to change the mold for different connection types.

The whole process is complete in about one minute. Page 31 details the gasket quantities required for each weld.

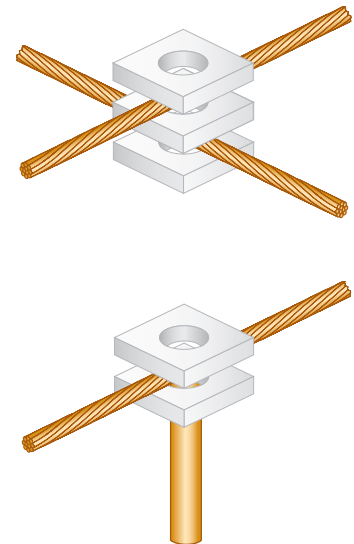

Cadweld Multi

Cadweld Multi offers all of the benefits of Cadweld connections:

- Current-carrying capacity equal to that of the conductor
- Permanent molecular bond that will not loosen or corrode
- Works with Cadweld traditional welding material
- Works with Cadweld Plus welding material
- Will withstand repeated fault currents
- No external power or heat required
- Ground rod capabilities
- Visual inspection possible
- Requires minimal training

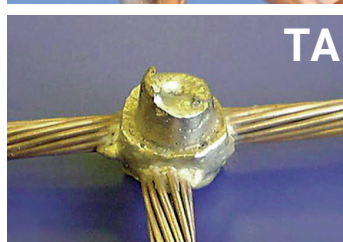
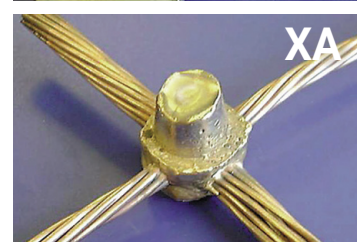
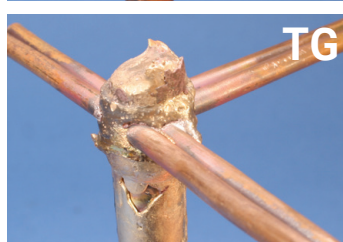
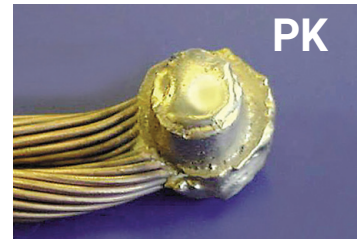

Cadweld Multi

CADWELD MULTI CONNECTION CAPABILITIES

Copper Cable/Solid to Copper Cable/Solid

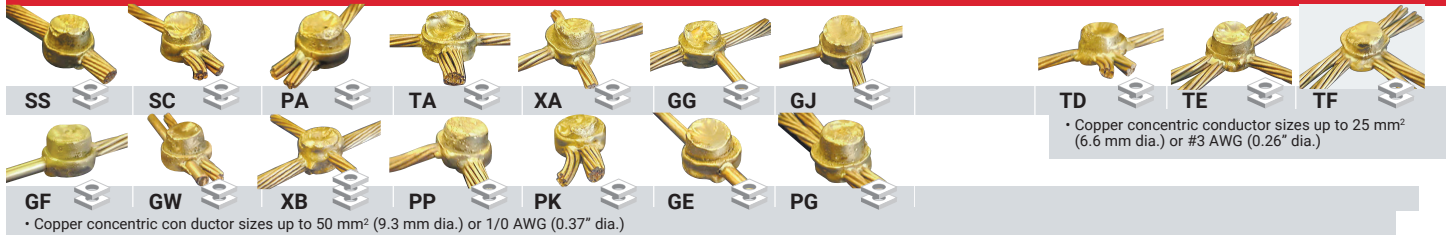

Copper Cable/Solid Strip to Rebar

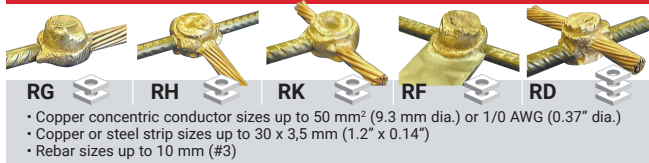

Copper Strip to Copper Strip



Copper Cable/Solid to Copper or Steel Strip/Lug



Galvanized Steel Strip to Galvanized Steel Strip



Ground Rod Connections

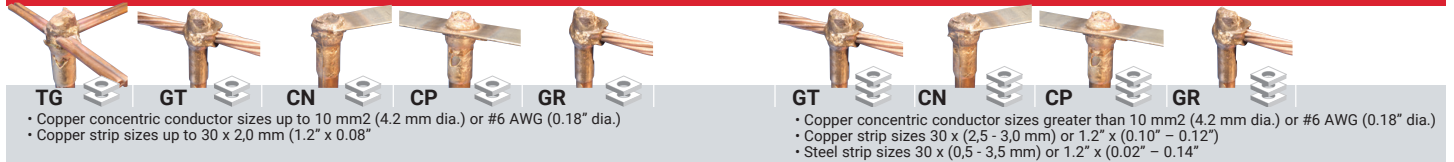

Cadweld Multi Available Items

Part Nr	Article Nr	Description		Weight (kg)
KITCDMV01	167782	Cadweld Multi Kit	1	25.000
The CADWELD MULTI kit (KITCDMV01) contains the following list of items:				
FMCDMV01	120883	Handle Clamp	1	1.800
CDMV01H	240399	Mold for H welds	1	1.200
CDMV0112	240398	Mold for welds on 1/2 rods	1	1.200
CDMV0158	240397	Mold for welds on 5/8 rods	1	1.200
CDMV0134	240396	Mold for welds on 3/4 rods*	1	1.200
SCDM01	120886	Set of 33 batting/gaskets	2	0.200
B399P	162070	SKK1 clamp	1	0.500
TSCSTP	197295	Toolset	1	2.000
B136B	182030	Slag Removal Spade	1	0.144
		Language free instruction sheet	1	
The following items can be used with the Cadweld Multi Kit (KITCDMV01). They are sold separately.				
T320	165000	Flint Ignitor T320	1	0.090
90	163040	Cadweld Traditional welding material	10	0.090
115	163050	Cadweld Traditional welding material	10	0.115
PLUSCU	165745	Control Unit	1	1.088
PLUS#90F20	165705	Cadweld Plus welding material	10	0.158

Symbol denotes number of batting (gaskets) required for each connection.



Requires 2 batting layers for weld



Requires 3 batting layers for weld

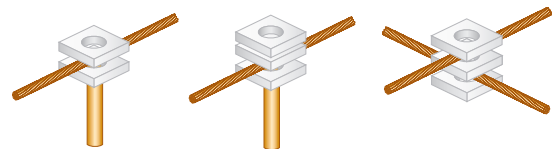

NOTES:

- *For connections using a 3/4" ground rod, it is necessary to use #115 / 115PLUSF20 weld material (sold separately).
- For all other connection types, use #90 or 90PLUSF20.
- For connections using galvanized material, remove galvanizing before welding, for a better connection.

Cadweld One Shot



PERMANENT EXOTHERMIC CONNECTIONS WITHOUT THE MOLD

Cadweld One Shot produces a permanent exothermic connection to a ground rod that will not loosen, corrode or increase in resistance for the life of the installation. The convenient single-use package makes the connection to the ground rod without a mold or starting material.

Thanks to the electronic Cadweld One Shot Control Unit, welds can now be completed up to 6 ft. (1.8 m) away, increasing weld flexibility in hard-to reach areas. The refractory ceramic body on the Cadweld One Shot is more durable than conventional ceramic and resists breaking.

INSTALLATION IS EASY!



1. After preparing the ground rod and wire, position the Cadweld One Shot and attach the lead to the control unit.



2. Ignite the Cadweld One Shot with the electronic Cadweld Plus Control Unit.



3. After one minute, break off the ceramic crucible. It can also be left in place, if desired.

FEATURES:

- Easy-to-use electronic ignition. No starting material needed
- Extremely durable disposable ceramic outer body eliminates the graphite mold and frame
- Produces a permanent connection that will not loosen or corrode
- Fits both plain and threaded copper-bonded and full-size steel and stainless steel ground rods
- NEC® compliant
- cULus® Listed

HOW TO ORDER CADWELD PRODUCTS

This catalog lists the most popular Cadweld connections using solid or concentric stranded copper conductor, insulated or bare. Look in the index for the connection you need. To save time and money, avoid non-catalog items or specials whenever possible.

If you cannot find the connection you need, contact nVent ERICO or your local distributor or agent. We have designed over 45,000 connections, and "specials" are designed every day.

1. What connection do you want?

We strongly recommend that wherever possible you use molds listed in this catalog. After selecting the connection, turn to the appropriate page and select the mold, weld metal and tools you need.

2. Only the most popular Cadweld connections are listed in this catalog.

For a complete listing of Cadweld Exolon connections, please refer to nVent.com/ERICO or your local nVent ERICO representative.

3. What are the conductor sizes?

This catalog covers connections between solid or concentric stranded copper conductors to each other, to lugs, to ground rods, to rebar, to rail and to special grounding accessories. For sizes not listed, contact your local Cadweld distributor, agent, or nVent ERICO.

Note: Other publications describe connections to conductors of copperclad, high voltage copper, aluminum, busbar, lightning protection cable, steel cable, etc.

4. You must have the following to make a weld:

- 4.1 Mold to fit your conductors
- 4.2 Weld metal required by your mold
- 4.3 Handle clamps on frame
- 4.4 Flint ignitor (included with handle clamps and frames)
- 4.5 If using Cadweld Exolon, you need a Relia-Start™ battery instead of a flint ignitor.
- 4.6 Lugs, sleeves, packing material listed on the page with the mold.

Cadweld Exolon

CADWELD EXOLON REDUCED-EMISSION MOLDS

Developed in 1988, Cadweld Exolon connections represented a significant advancement in welded electrical connections for sensitive indoor applications like data centers, hospitals, and other clean room environments. The virtual elimination of smoke and a unique electronic starting system makes this an ideal solution for sensitive applications. Each Cadweld Exolon package contains ceramic filters that produce an extremely low emission connection.



How to order Cadweld Exolon:

1. To order Cadweld Exolon products, just specify molds and weld metal from the catalog and add an "XL" prefix.

Example: TAC2Q2Q becomes XLTAC2Q2Q, and 150 becomes XL150.

2. If the weld metal shown in the catalog shows more than one tube required such as 2-#200, you must specify #XL400 to get the correct size filters.

Example: XLTAD-4L3Q: XL400

3. The following molds require a price key change:

- "C" price key molds using 2-#150 weld metals change to XLD price key.
- "E" price key molds using 2-#150 weld metals change to XLJ price key.
- "H" price key molds using 2-#150 weld metals, contact nVent ERICO.
- "M" price key molds using 2-#150 weld metals change to XLV price key.
- "R" price key molds using 2-#150 weld metals change to XLF price key.
- "T" price key molds, ALL change to XLP price key.

Example: TAC3Q3Q using 2-#150 weld metals change to XLTAD3Q3Q using #XL300 weld metal

4. Filters and ignitors are included with the weld metal. XL filters and ignitors are not sold separately.

5. The ignitor can be used only once and then must be discarded. Filters will last as specified in the instructions supplied with each mold.

6. A Relia-Start electric starter, part number XLB971A1 (battery, charger, carrying case and connecting cable), is required for XL weld metal. There is no starting material in the XL weld metal tube. Batteries operate about 200 starts before recharging from 120 VAC is required. The charger, all electrical connections and instructions are included in the battery case.

7. Baffle with cover is required for larger molds. Estimated life of the baffle is 500 welds.

- XLB972A1 Baffle is required for molds using XL200 and XL250 weld metals.
- XLB973A1 Baffle is required for molds using XL300 to XL750 weld metals.

8. For EZ Change Handles, add XL prefix. (Flint ignitor not included.)

9. Welding Tray, part number XLB974B2, is used under the mold to protect cables and equipment from hot materials.

Cadweld

OTHER INFORMATION

Certain tools may be required for various connections. If required, these tools are listed on the same pages as the connection and in Section A. Some tools in section A can save you a lot of time. Also refer to A9E, Contractor Tips, to make your job easier, and learn about labor saving ideas.

For complete pricing information, please visit nVent.com/ERICO or contact an ERICO Representative
For Cadweld literature, guides, instructional videos, and more, visit nVent.com/ERICO.

For all your connection needs – we're only a phone call away.

Phone: 800-677-9089

Fax: 800-677-8131

or call your local Cadweld distributor, agent, or Cadweld regional sales manager

Required tools summary:

Required tools are listed with each mold. For your reference, handle clamps and/or frame are summarized below.

Mold	Required
A*	Includes frame with handle
C, Q & R	Requires L160
D, F & Z	Requires L159
E*	Includes frame but also requires L160
J*	Includes frame but also requires L159
K*, M* & V*	Includes frame with handles

* To order mold only – without handles or frame – add suffix "M" to mold part number.

Heavy Duty Electrical Connections for Stranded Concentric Copper Conductors

Heavy Duty connections were developed to be used on reclaimed cable. Heavy Duty connections use a larger size connection cavity in the mold and a larger size weld metal than the equivalent standard connections.

The larger size weld metal supplies extra BTU's (but not a higher temperature) to melt the heavy oxide coating on the conductor and to overcome severe field conditions.

Heavy Duty connections offer the following advantages:

- Eliminates cutting the run conductor on certain types of connections.
- Reduces cable cleaning requirements for old or reclaimed cable.
- Increases reliability under adverse field conditions.

Cadweld

GROUNDING CONNECTION SPECIFICATION

This specification covers the Cadweld exothermic welding system for use in making electrical connections. The Cadweld system supplied under this specification shall include welding material, molds, tools and accessories as required.

Unless otherwise specified, Cadweld exothermic welding system shall be used for all electrical grounding connections of copper to copper and copper to steel conductors. Cadweld connections shall be suitable for exposure to the elements of direct burial in earth or concrete without degradation over the lifetime of the grounding system.

The Cadweld exothermic welding system furnished under this specification shall meet the applicable requirements of IEEE Standard 80 "IEEE Guide for Safety in AC Substation Grounding" and IEEE Standard 837 IEEE "Standard for Qualifying Permanent Connections Used in Substation Grounding". Independent test data showing conformance to IEEE Std. 837 shall be readily available.

The Cadweld Mold Numbering System

The Cadweld mold part number gives, in code, the complete information about the mold.

Type of connection, mold price key, and conductor size(s)

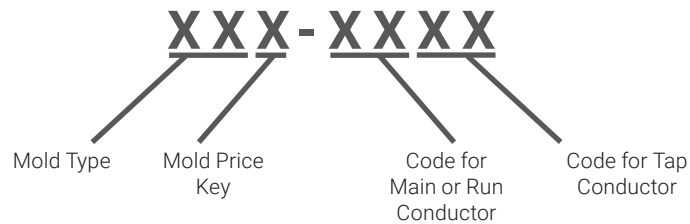

Examples:

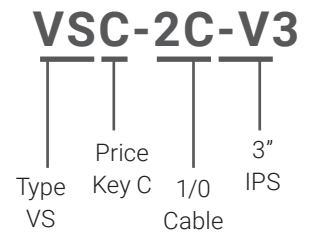
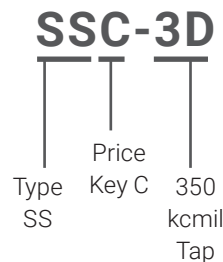
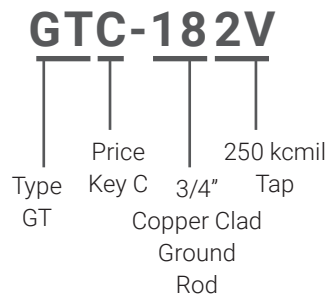
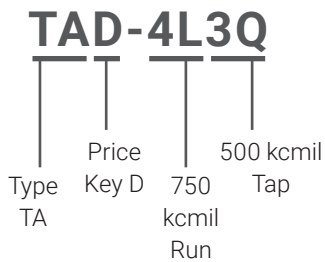

Cadweld

A graphite mold is used for making most Cadweld connections. Cadweld molds will generally last an average of 50 or more connections under normal usage.

Price Key and Handle Clamp and/or Frames

Handle clamps are required for most molds. Specialized frames with handles are used on some molds. Flint igniters are included with handle clamps. The following handle clamps are most widely used.

L160 for all molds having a "C", "E", "R" and "Q" mold price key (3" wide molds)

L159 for all molds having a "D", "F", "J" and "Z" mold price key (4" wide molds)

Handle Clamps with an "XL" prefix are for use with the Cadweld Exolon system and do not come with a flint igniter.
Mini E-Z Change Clamps for use with mini-welders.

Pictured below are the molds and handle clamps / and or frames and handles for the various price key molds:



"A" Price Key Mold
Includes Hold Down Frame



"C", "D", "F", "R", "Q" and "Z" Price Key
Mold L160 or L159
Handle Clamp Required

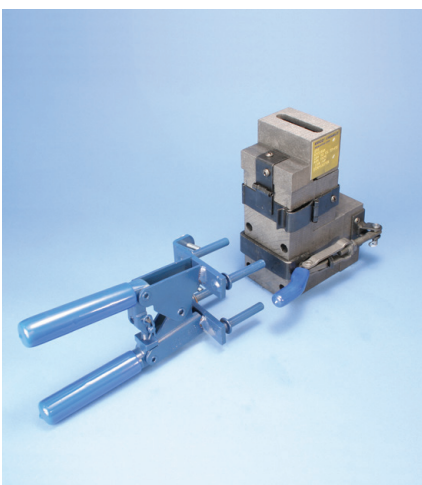

"E" and "J" Price Key Mold
L160 or L159 Handle Clamp Required

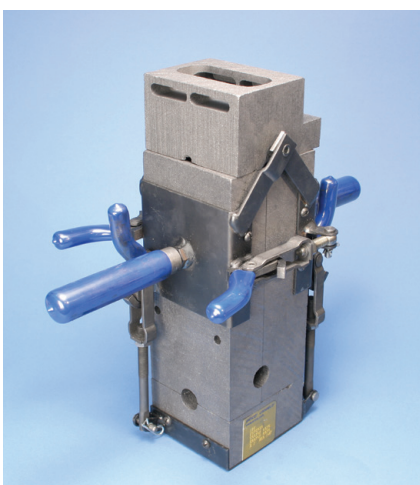

"M" and "V" Price Key Mold
Includes Frame with Handles

Cadweld



"H" Price Key Mold Includes Hold Down Frame with Handles



"G", "K", and "L" Price Key Mold Includes Frame with Handles

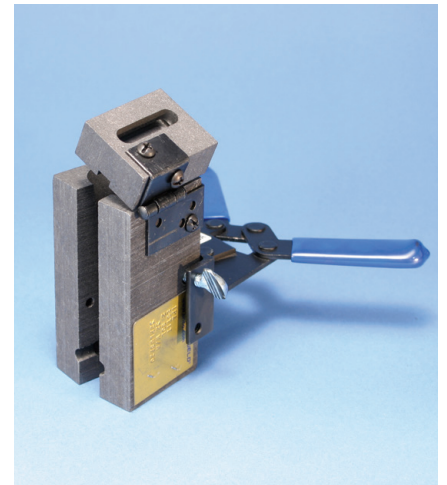

"T", "P" and "N" Price Key Mold Includes Mini-EZ Handle Clamp

To order mold only, add an "M" suffix to the part number (for example, SST1TM)

MOLD OPTIONS



Split Crucible Molds

Molds made with a horizontal opening and solid crucible section may be specified as a split crucible type. The advantage of the split crucible mold is easier cleaning.

To order a mold with a split crucible, add an "L" suffix to the mold part number (for example, TAC2G2GL).

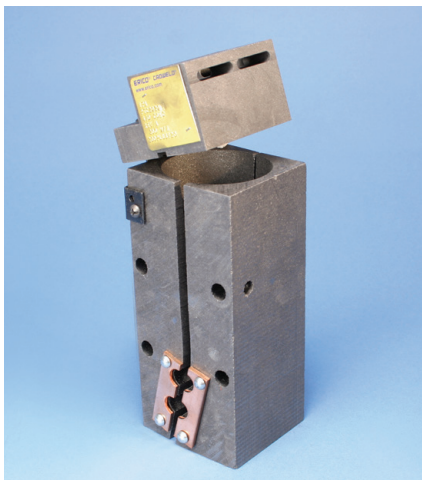

WEAR PLATES

Wear Plates reduce mechanical abrasion of molds at cable entry points and help prevent leakage of molten metal (particularly on larger 7 strand conductor). These features prolong mold life.

To order a mold with wear plates, add a "W" suffix to the mold part number (for example, PTC2G2GW).

SUPERIOR SOLUTIONS

Over a century of industry experience

Representatives across the US and Globe

Complimentary design and engineering services

Complete facility electrical protection solutions

And more



ERICO AND NVENT

Customized solutions for modern industry

Since 1903, ERICO has been a partner in building global industry and infrastructure. Today, we continue that tradition by offering industry leading products in addition to value-added solutions.

As of 2015, ERICO is now a nVent company in an effort to continue serving our customers as effectively as possible.

Visit our website below for more information.

nVent.com/ERICO

Grounding, Bonding & Connectivity Products

nVent ERICO Facility Electrical Protection

nVent ERICO offers a full range of grounding, bonding and connectivity products for data centers and other datacom applications worldwide. nVent ERICO's product offerings include grounding and bonding accessories, surge protection and lightning protection products, and welded electrical connections.

Grounding and Bonding

nVent ERICO offers an extensive line of grounding and bonding products, which includes ground rods and accessories, signal reference grids, chemical ground rods, GEM ground enhancement material, couplers, clamps, inspection wells, grounding and perimeter bus bars and ground test instruments.

Surge Protection

nVent ERICO surge protection products are designed to protect against damaging electrical surges on power and communications lines caused by lightning, building systems and other switching events.

Lightning Protection

Direct and indirect lightning strikes can pose many risks to businesses, including damaging buildings and critical equipment. nVent ERICO lightning protection products offer a variety of solutions to help protect valuable equipment and personnel and to avoid disruption and downtime.

Welded Electrical Connections

Cadweld welded electrical connections are used to connect the grounding and bonding conductors to each other and to the ground electrode system, including ground rod electrodes, building steel and rebar. Cadweld connections provide a permanent, low-resistance connection needed to create a long-lasting, reliable bonding network. Cadweld connections will not deteriorate, cannot loosen and are made with inexpensive, lightweight and portable equipment. Cadweld Exolon is a filtered, smokeless connection system designed for making connections indoors.

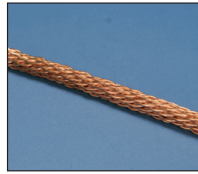

Lightning Protection Cable

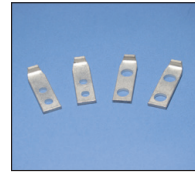

Cadweld Lugs

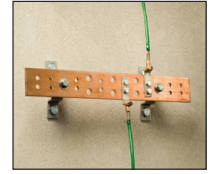

Telecommunications Ground Bar (TGB) and Cadweld Lugs



Lightning Air Terminals



Cable Runway Ground Strap (CRGS6)

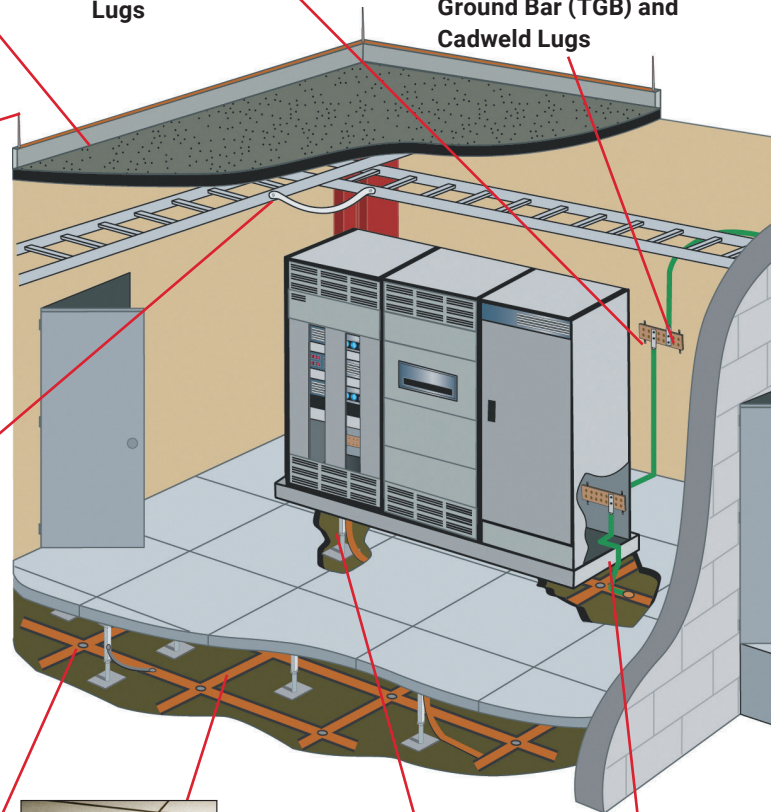

Signal Reference Grid (SRG)

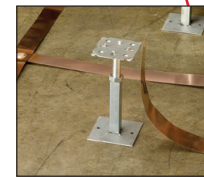





Low Impedance Riser (LIR)

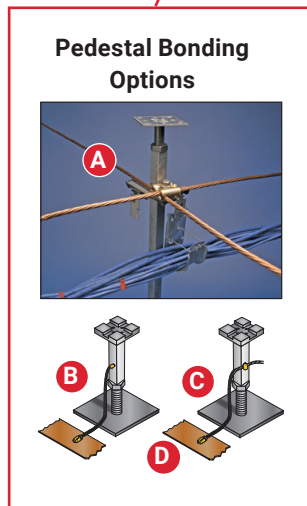

Common Bonding Network Jumper (CBNJ09)



Pedestal Bonding Options

- A**  Universal Pedestal Clamp (MBNUPCJ82, MBNUPCJ240)
- B**  Cadweld Connection to Pedestal (VS)
- C**  Cadweld Through Connection to Pedestal (VG)
- D**  Cadweld Connection to SRG (HA)

For Datacom Applications

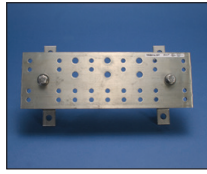

Telecommunications Main Ground Bar (TMGB) and Cadweld Lugs



Power Surge Protection



Water/Gas Pipe Clamp

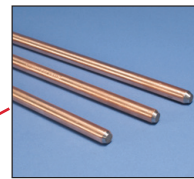

Ground Rods

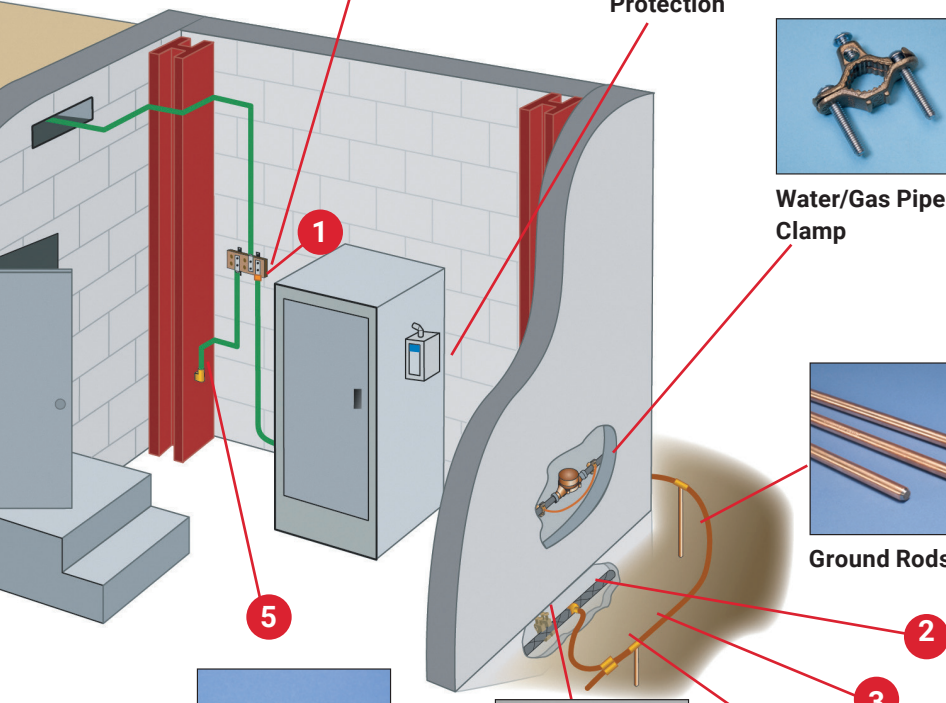

CAT 6 Network Surge Protector



Coaxial Surge Protector



Subscriber/High Speed Line Surge Protector



Rebar Clamps

ERICO CADWELD CONNECTIONS

- 1 Cable-to-Lug (GL)
- 2 Cable-to-Rebar (RH)
- 3 Cable-to-Ground Rod (GT)
- 4 Cable-to-Cable (PT)
- 5 Cable-to-Steel (VF)

Prefabricated Signal Reference Grid (SRG)

The SRG is an integrated high-frequency, low-impedance signal reference grid structure, which consists of a network of flat copper strips welded at the crossovers in accordance with recommendations found in IEEE® 1100 "IEEE Recommended Practice for Powering and Grounding Electronic Equipment." The SRG is also referred to as a "Supplementary Bonding Grid" (SBG) per TIA® 607.

The SRG lies directly on the sub-floor under the raised-floor structure and is used to interconnect metal frames, racks, enclosures, common terminals for signal level power and the electrical distribution grounding system. The SRG is used as a ground reference system for IT equipment by creating an equipotential ground reference plane over a large range of frequencies from DC through the Megahertz range. At high frequencies, flat strip conductors have considerably lower inductive reactance than concentric stranded or solid conductors and the configuration of the SRG results in a lower impedance system, which limits potential differences between data systems and other systems during voltage transients or other power system disturbances. The following graph from IEEE 1100 shows the impedance of an SRG system versus a wire-only grounding system.

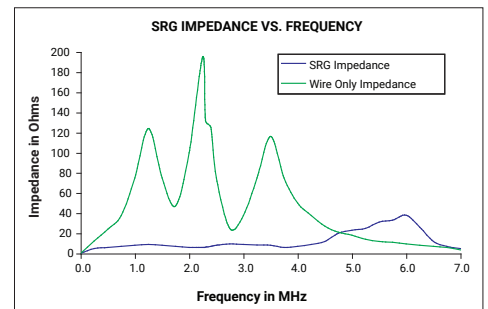

SRG Features and Benefits

- Economical and maintenance-free
- Recommended in IEEE® 1100
- Reduces common-mode noise
- Increases noise immunity to electric fields
- Reduces capacitive coupled interference
- Compliant with Information Technology Industry Council Information Letter "Guidelines For Grounding Information Technology Equipment (ITE)" and the National Electrical Code.

IEEE is a registered trademark of The Institute of Electrical and Electronics Engineers, Incorporated.

TIA is a copyright of Telecommunications Industry Association

NOTE: Cadweld connections shown are typical. Connections for any configuration and conductor are available to meet specific application requirements.

Power Generation

Power Generation Facilities

Traditional power generation facilities have either been coal-fired, gas-fired, nuclear, diesel or hydro-powered. Modern alternative power generation facilities can include geothermal, bio-gas, wind or solar. nVent ERICO brand of lightning protection systems have been used to provide lightning protection to the whole host of facilities in a unique manner. nVent ERICO grounding and bonding solutions can provide a complete system for the grounding and bonding of any of these facilities.

Power Generation Plant

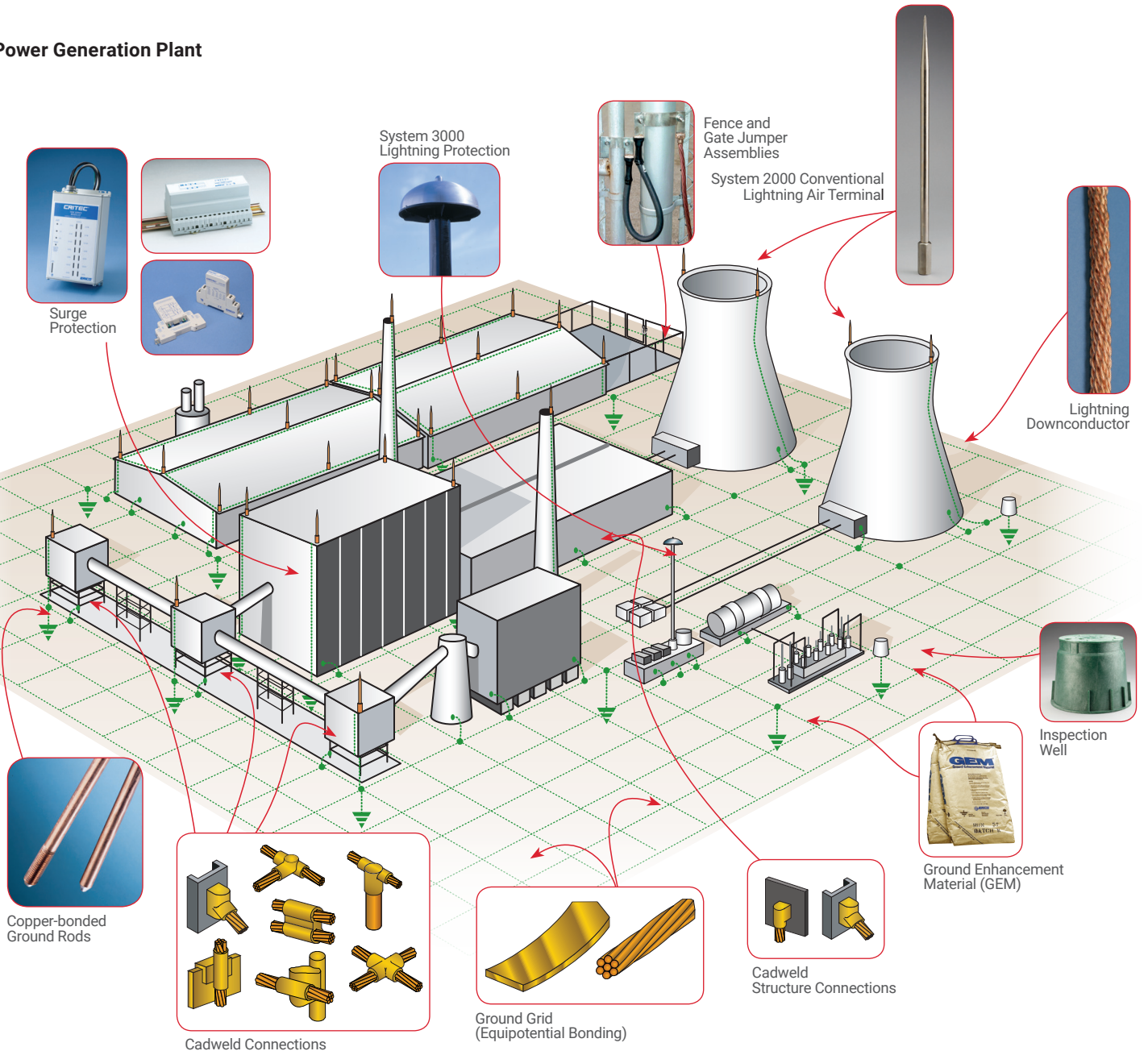

Power Transmission and Distribution

Distribution Pole

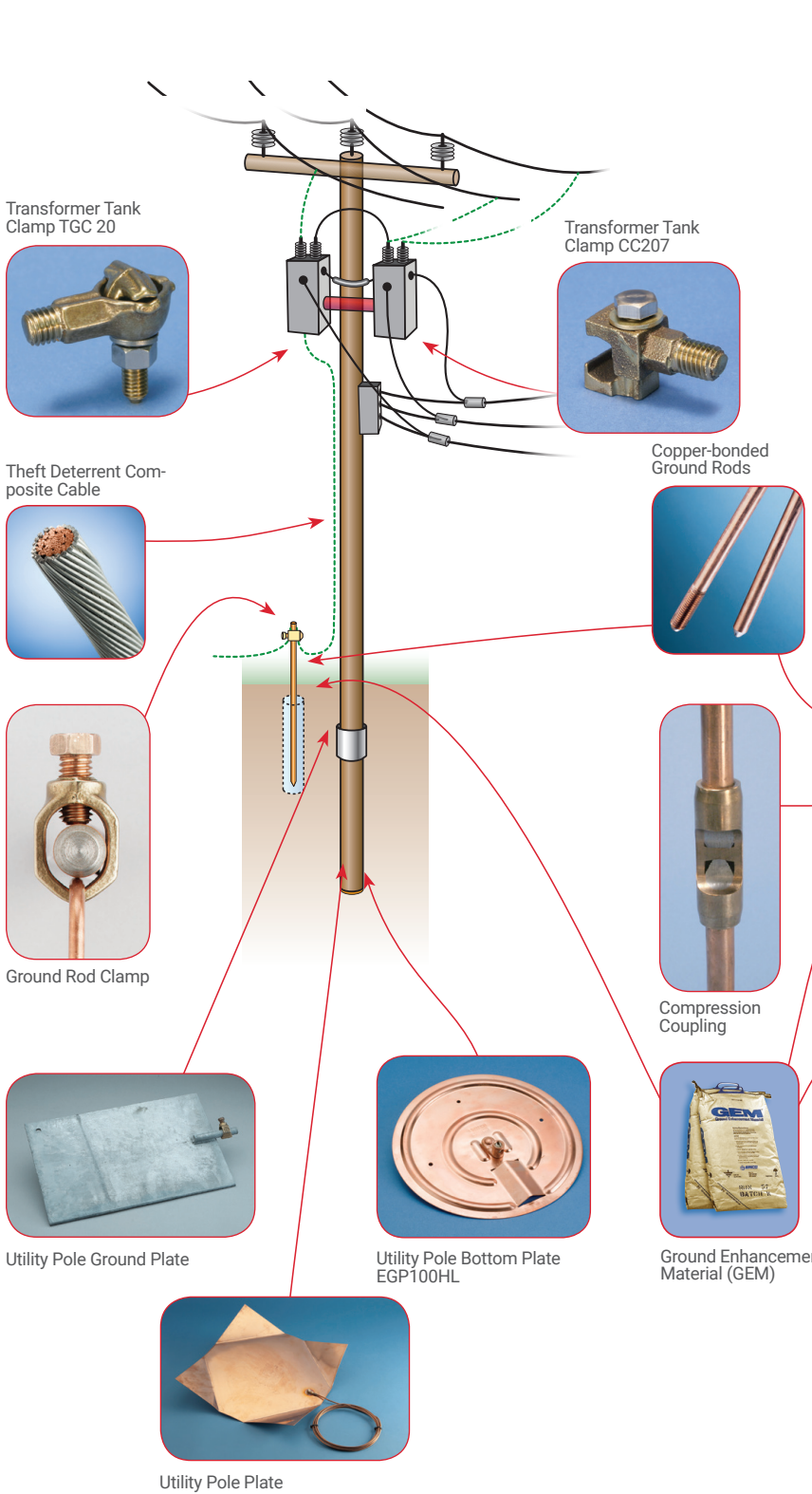

Transmission Tower

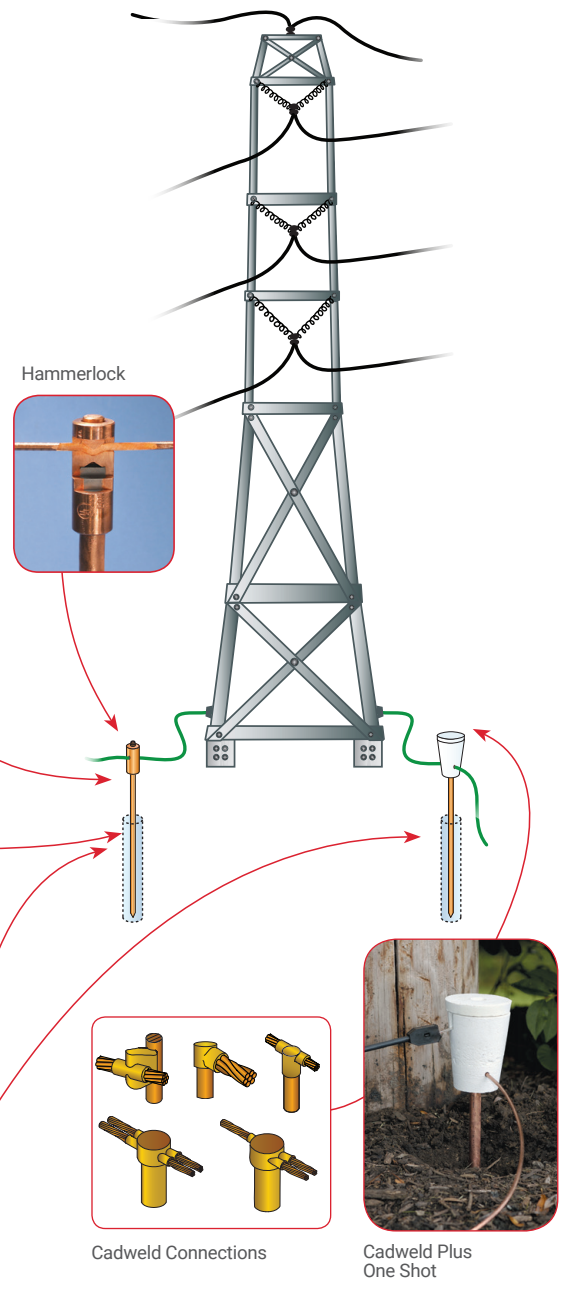

Substation Earthing/Grounding and Lightning Protection

The conceptual design of a ground grid at a substation is summarized by the points below and depicted on pages 4 and 5.

- a) A continuous loop conductor should surround the perimeter to enclose as much area as practical. Under Standard IEEE® 80, this loop conductor is placed 3 ft (or 1 meter) outside the fence line. This measure helps to avoid high current concentration and high gradients both in the grid area and near the projecting cable ends. Enclosing more area also reduces the resistance of the grounding grid.
- b) Within the substation, conductors are typically laid in a parallel grid and, where practical, along the structures or rows of equipment to provide for short ground connections.
- c) A typical grid system for a substation may include bare copper conductors buried 18" (0.5 m) below grade, spaced 9 ft to 21 ft (3 m to 7 m) apart, in a grid pattern. At cross-connections, the conductors would be securely bonded together. Ground rods may be at the grid corners and at junction points along the perimeter.
- d) This grid system would be extended over the entire substation switchyard and beyond the fence line.

Earth/Ground Rods

nVent ERICO offers a range of ground rods to suit the needs and preferences of the utilities. The most common of these are copper-bonded steel rods, due to their versatility in varied soil conditions and compatibility with various common metals used underground. The copper-bonded ground rod has an electrolytic coating of copper deposited over a layer of nickel. This process helps ensure a long-lasting molecular bond between the copper layer and the steel core. nVent ERICO recommends nVent ERICO brand of copper-bonded ground rods because the copper coating will not slip or tear when driven, nor will it crack if the rod is bent. The tough, carbon steel core has good characteristics for deep driving. Copper-bonded ground rods have a high resistance to corrosion and provide a low-resistance path to ground.

It is important to note that certain soils and landfill areas may not be compatible with copper. In these situations, stainless steel is a better choice. The nVent ERICO brand of copper-bonded ground rods comply with UL® 467, BS:7430 & EN50164, Standards.



Surge Protection

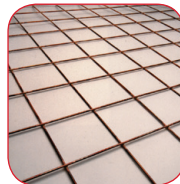

Prefabricated Wire Mesh



Copper-bonded Rods



Ground Enhancement Material (GEM)

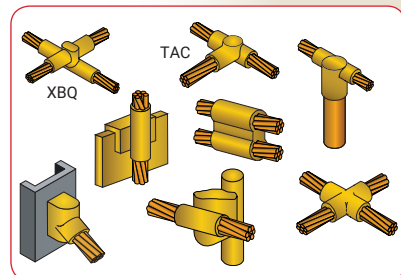

Cadweld Connections

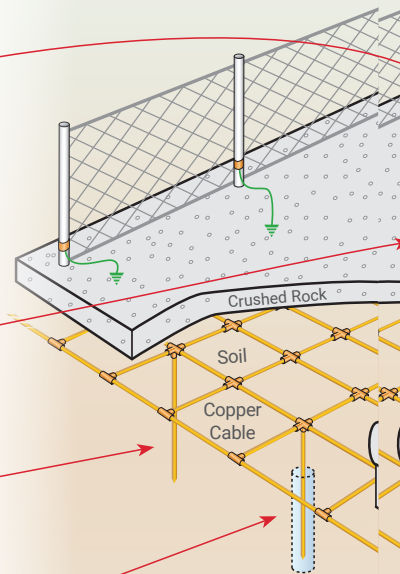

Substation Earthing/Grounding and Lightning Protection

Surge Protection for SCADA-controlled Equipment

Electronic equipment operating within a substation environment is particularly subject to electrical disturbances such as switching, electrical noise, ground potential rise and occasional induced or direct lightning impulse. Surge protection is an extremely cost-effective investment for electronic substation equipment, because:

- Each site's operation is critical to the quality supply of electrical power
- Downtime costs are significant

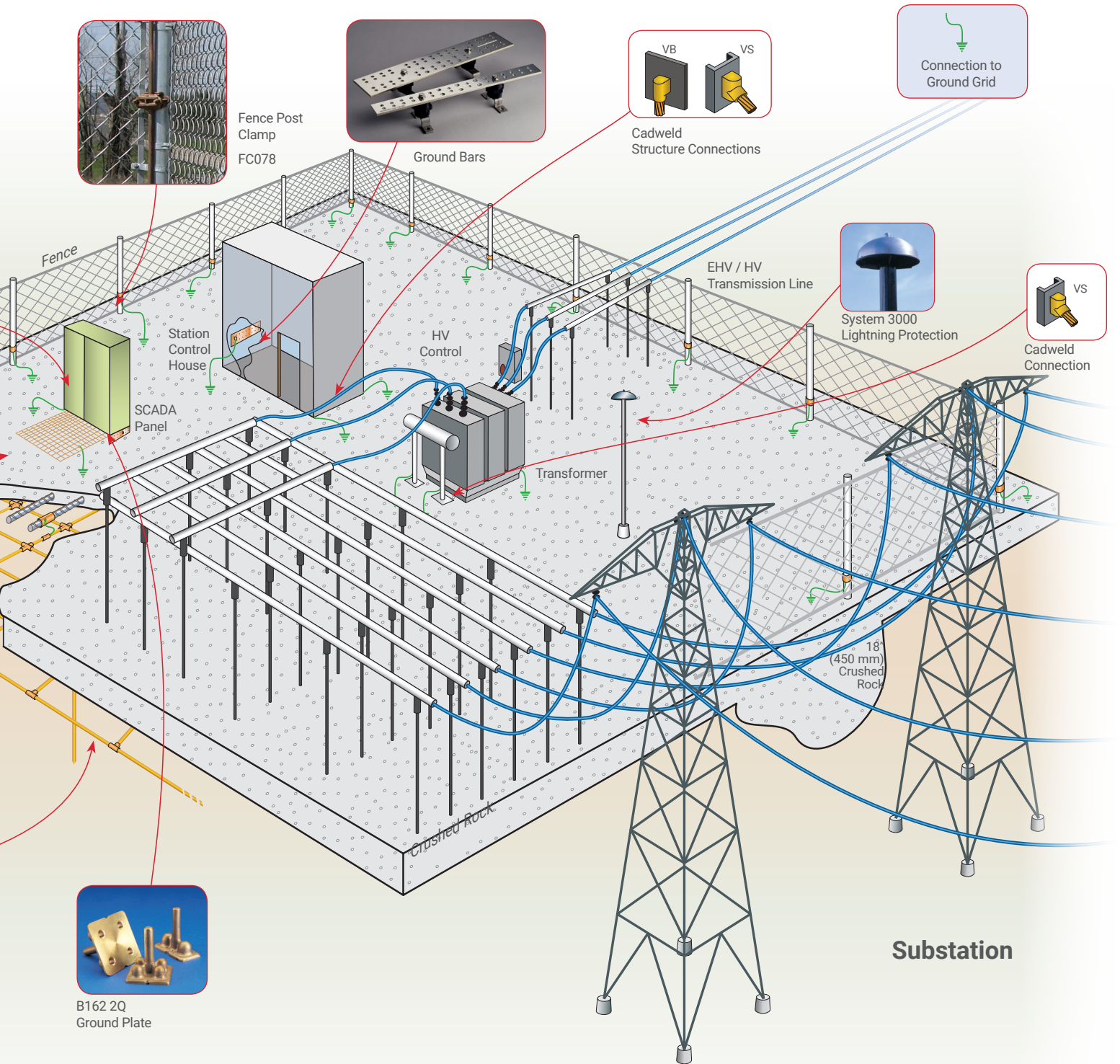

Solar Products

nVent ERICO offers a wide range of products for the solar market. In addition to an extensive product offering, nVent ERICO engineers and designers can provide design assistance for many solar installation aspects of your facilities worldwide.

The megawatts of solar energy produced continues to increase globally. More countries have focused resources on this valuable endeavor. Solar photovoltaic power systems include modules, inverters, rack mounting components, monitoring systems for off-grid systems, batteries and charge controllers. Solar power systems are designed to be in service for periods of 30 years or more, therefore it is imperative to construct the systems with products that are designed to help provide efficient operation for the lifetime of the installation. nVent ERICO is uniquely positioned to provide the necessary products, components and services for solar programs worldwide.

Years of experience in the fields of grounding and bonding, lightning protection, low-voltage power distribution, fastening and support and reinforced concrete construction, combined with global manufacturing capabilities, allow nVent ERICO to provide comprehensive solutions for the solar market. Four of our product lines have joined together to offer a full range of solutions: nVent ERICO facility electrical protection products, nVent ERIFLEX low-voltage power distribution products, nVent LENTON concrete reinforcement products and nVent CADDY fixings, fasteners and supports.

nVent ERICO's products are technically superior, meet or exceed international and industry code requirements and help prolong service life. As a global organization, nVent ERICO is experienced with regional codes, standards and practices, including OEM specs.

Grounding, Lightning Protection, Electrical Connection and Cable Management Solutions for the Solar Power Industry



Lightning Protection Systems

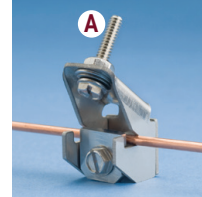

Solar Bonding Lugs

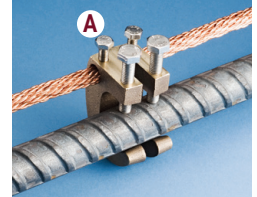

Grounding Accessories



RIGD and SK Series Strut Clamps



MBJ Grounding Braids



Copper-bonded Ground Rods

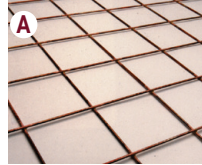

Equipotential Ground Mesh



Intersystem Bonding Termination (IBTB)



SCH Series Strut Clamps



nVent LENTON Terminator

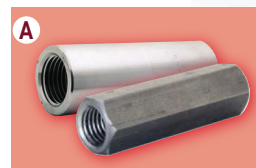

Bolt Couplers

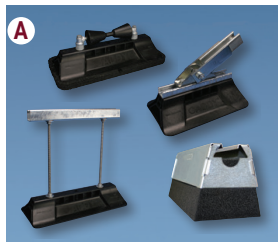

nVent CADDY Pyramid



Cadweld Exothermically Welded Connections



Ground Enhancement Material

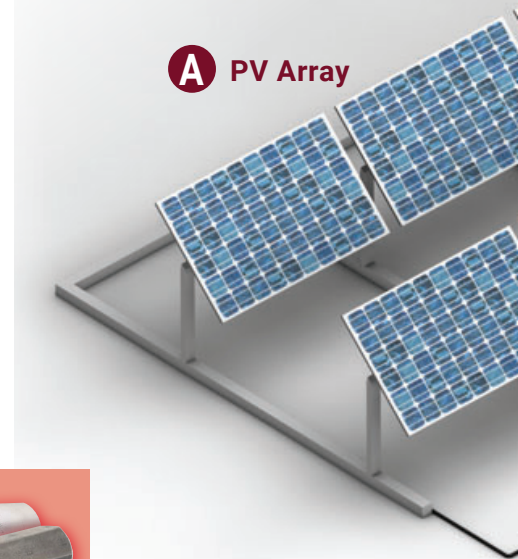

PV Array

Solar Products



nVent ERIFLEX Flexibar

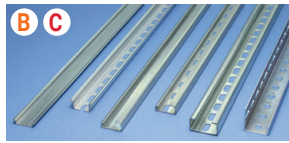

DIN Rail Profiles



Low Voltage Insulators

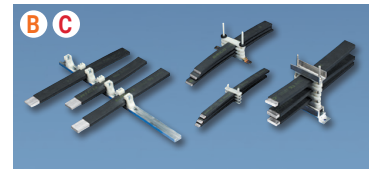

nVent ERIFLEX Flexibar Supports

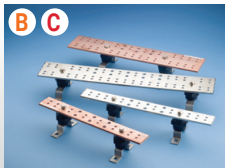

Equipment Grounding Bus Bars



TDS50 DC Surge Protection Devices

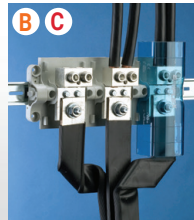

Power Terminals



Power Blocks/Splice Blocks



Distribution Blocks

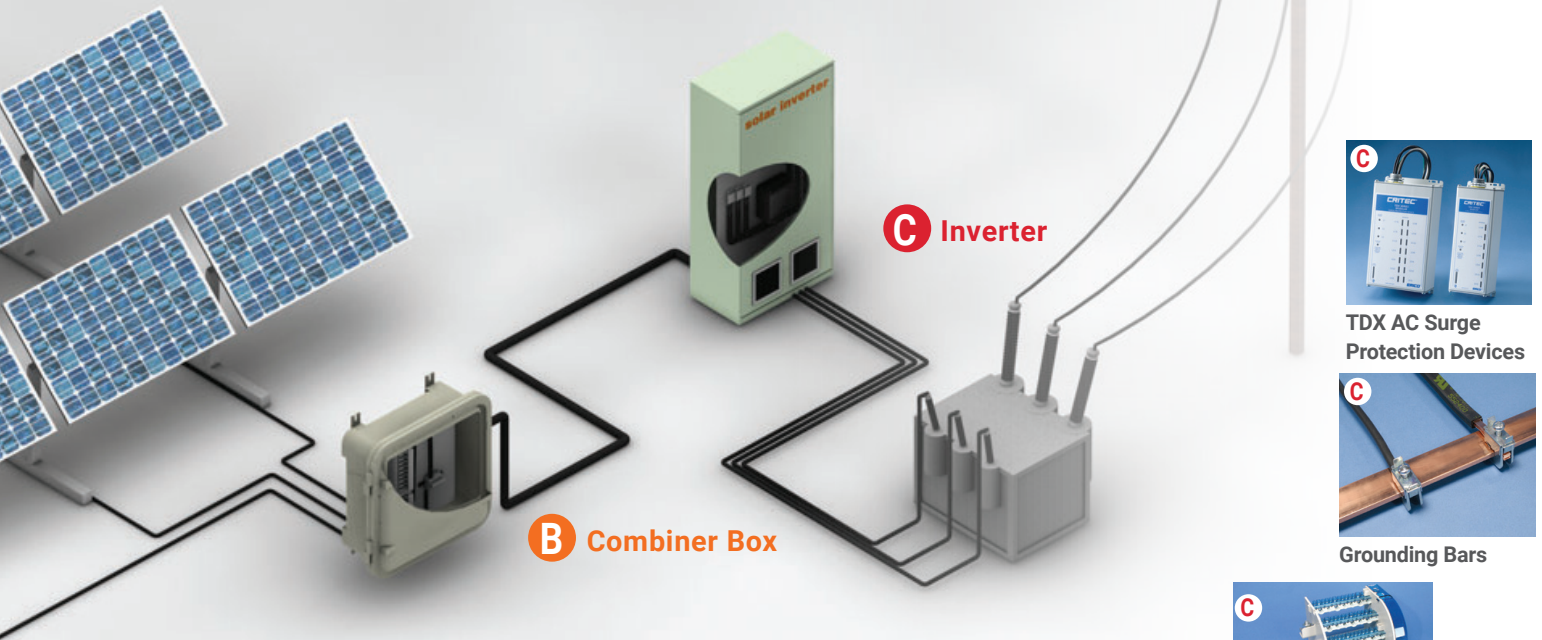

TDX AC Surge Protection Devices

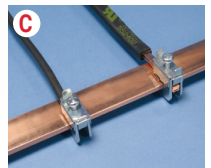

Grounding Bars



Terminal Strip



Two and Four Pole Distribution Blocks

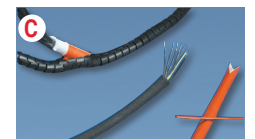

Cabling Sleeves



Insulated Braided Shunt



Splice Blocks

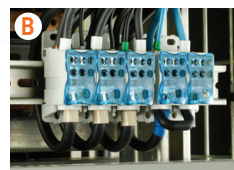

Distribution Blocks

Wind Products

Foundation Grounding and Construction, Bonding, Power Connections, Surge Protection, and Lightning Protection

nVent ERICO offers a complete range of foundation grounding and construction, bonding, power connections, surge protection, and lightning protection products for the wind energy industry. In addition to our extensive product offering, our engineers and designers are ready to provide design assistance for your facilities worldwide.

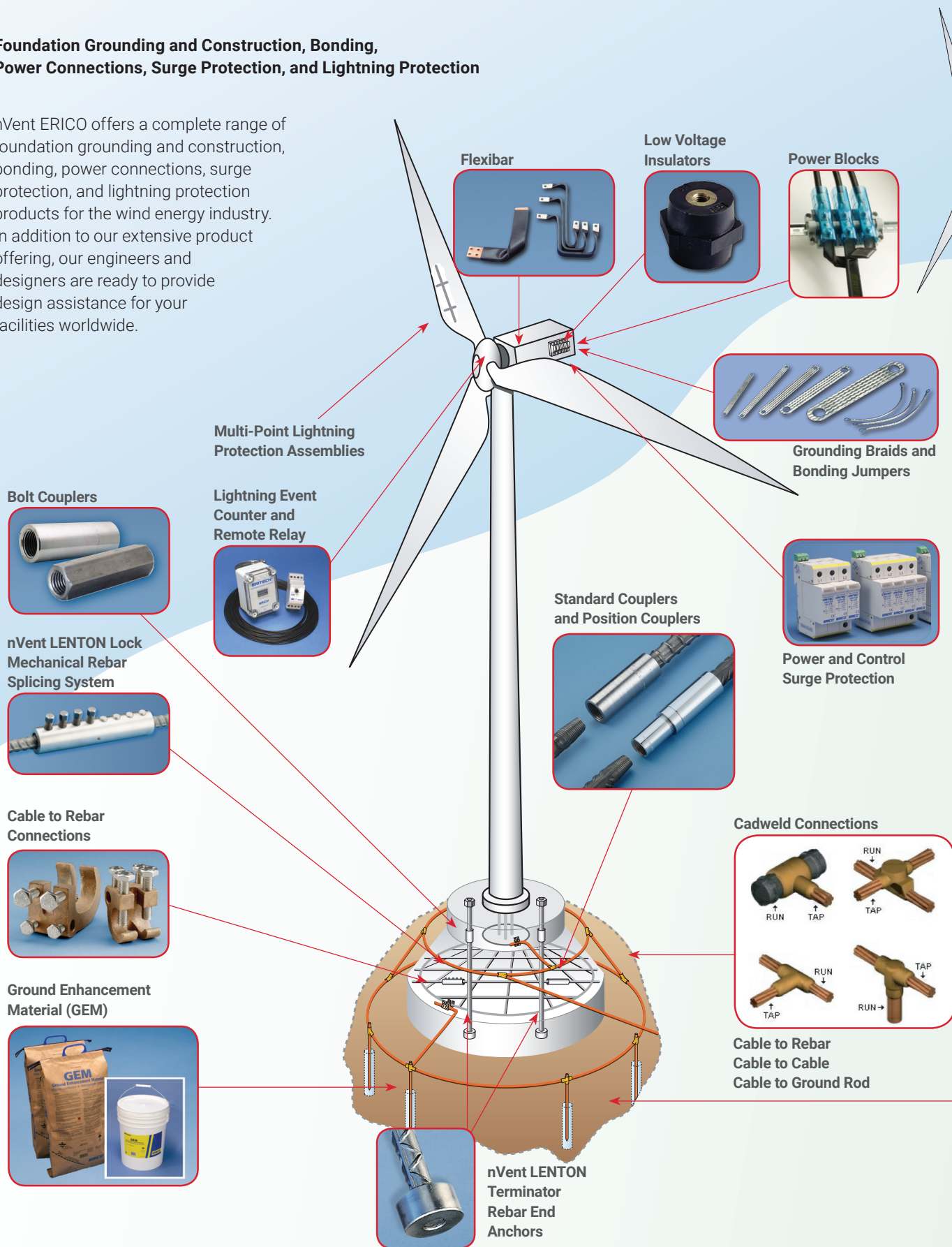

Wind Products

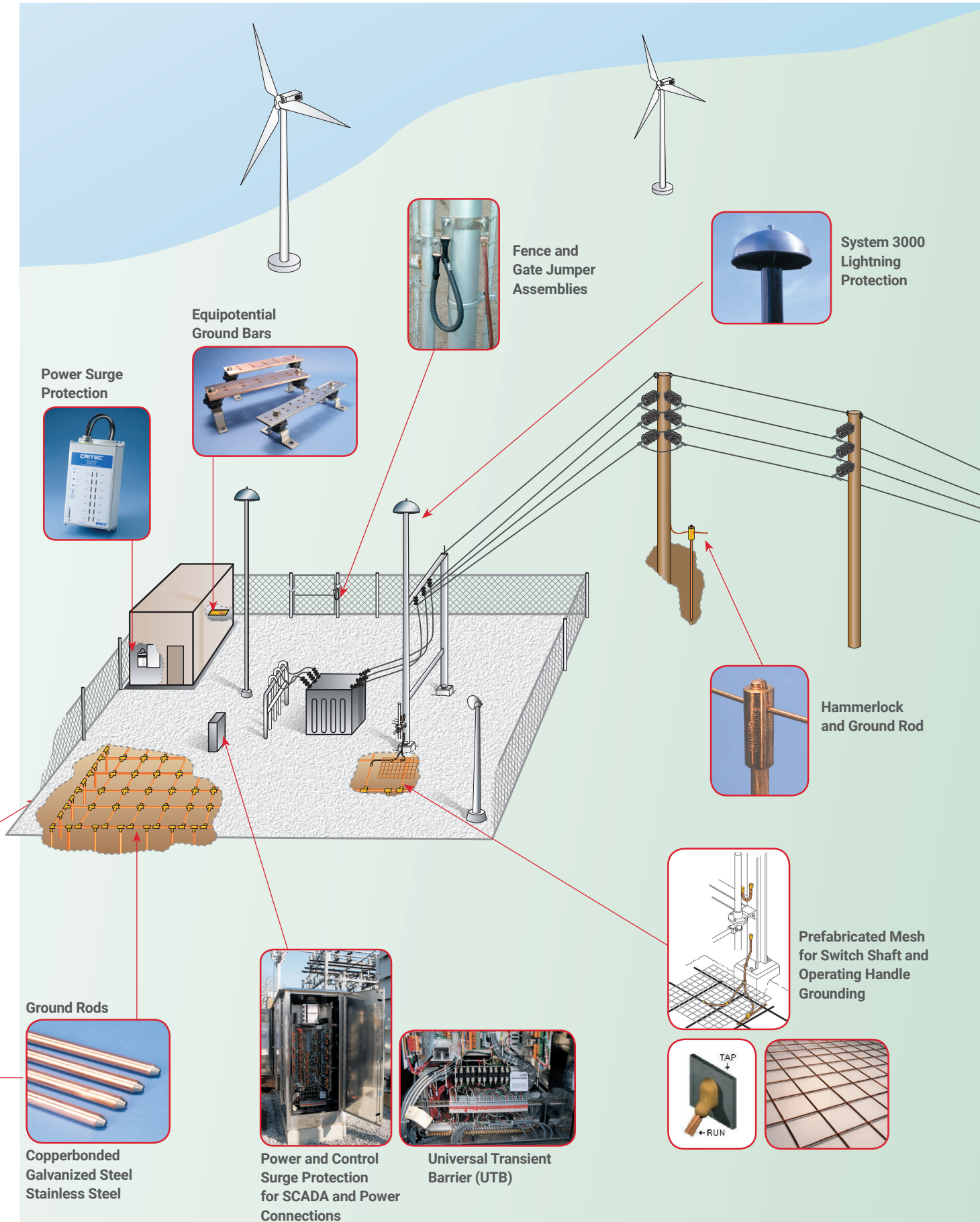

Telecom

Grounding/earthing, lightning protection and surge protection are critical parts of a telecommunications facility installation. nVent ERICO has complete telecommunications applications solutions to help protect the facility against electrical noise, lightning induced surges and transients caused by switching components in the power systems.

nVent ERICO solutions include ground rods, ground mats, ground enhancing material (GEM), ground bars, Cadweld connections, lightning protection systems and MDF, co-axial and power surge protectors.

To make the application of these products simpler, the grounding, lightning protection and surge protection system at a telecommunications facility is divided into 5 components.

1. Indoor Bonding Arrangement
2. Outdoor Grounding Arrangement
3. Surge Protection for Power Lines
4. Surge Protection for Telephone Lines
5. Direct Strike Lightning Protection

nVent ERICO ground bars can be used to achieve the ideal indoor grounding arrangement as required at the telecommunications facility.

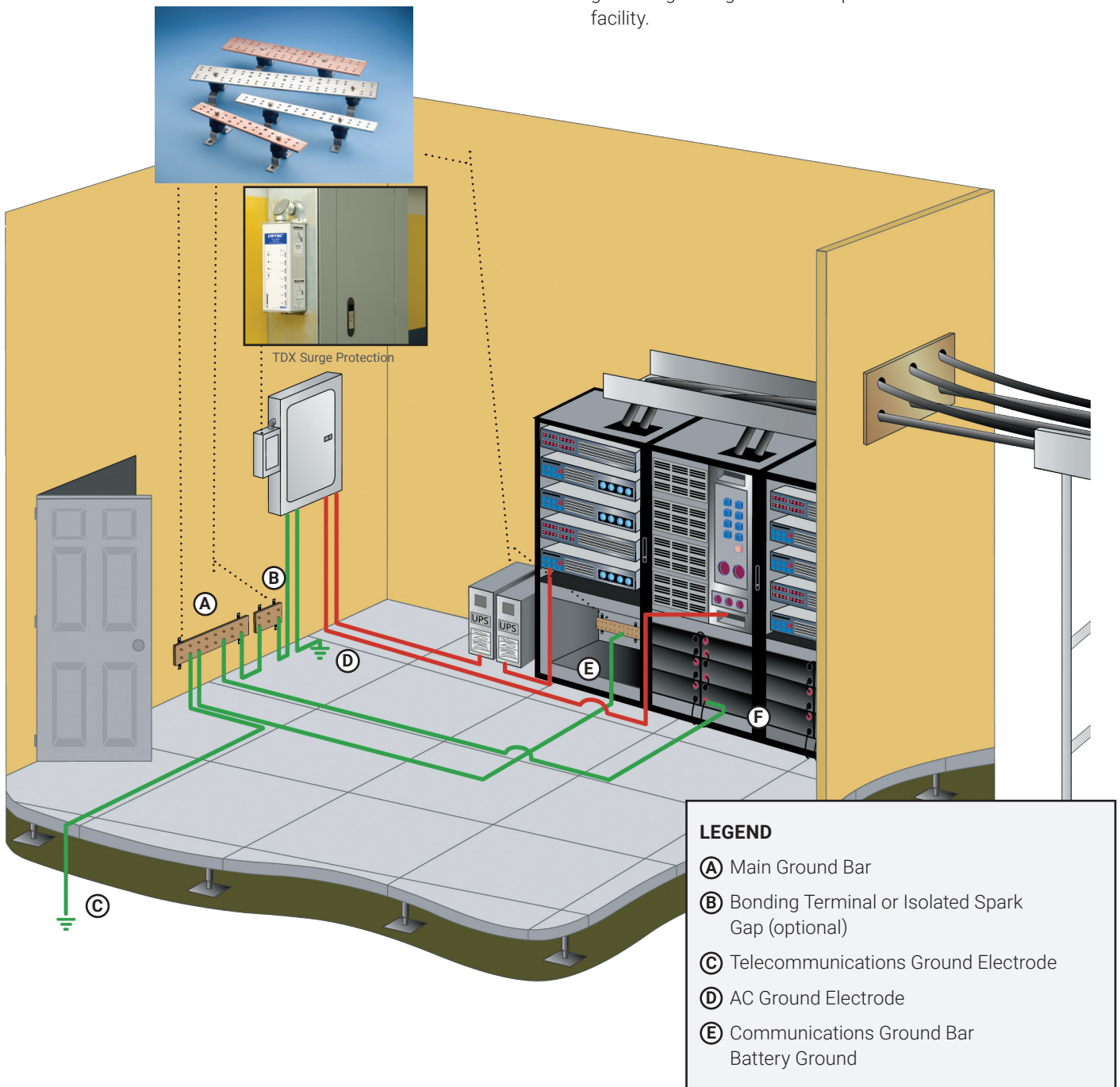

Telecom

The outdoor arrangement of a grounding system at a telecommunications facility is depicted here. This arrangement is not always possible due to certain constraints at the site. Where the telecommunication equipment is installed in a large multi functional building or several floors above the ground floor this layout may not be possible.

Alternative outdoor ground electrode system needs to be considered on a case by case basis if the suggested layout below is not possible to implement.

nVent ERICO offers a full range of products to form the outdoor grounding system at a telecommunications facility.

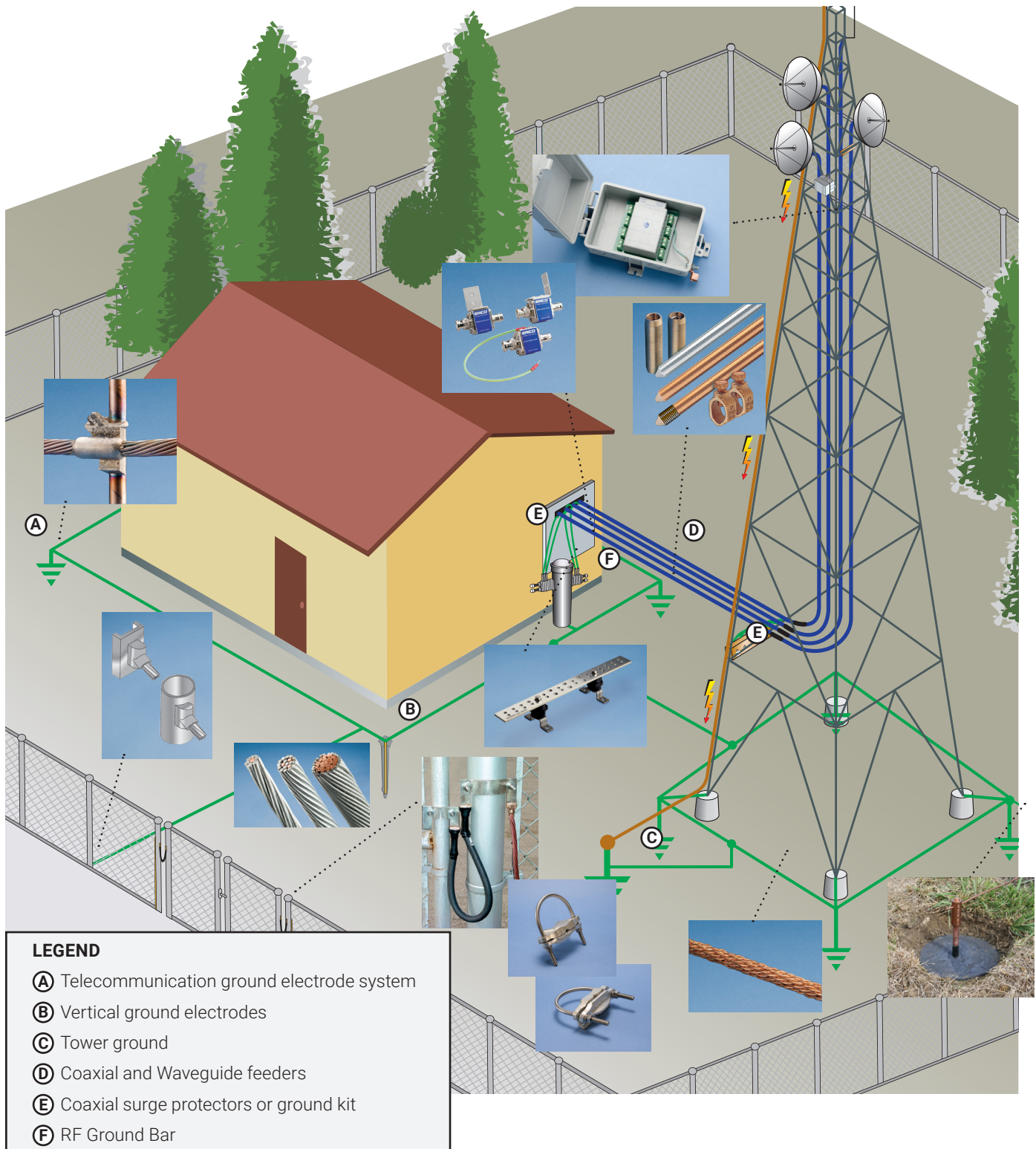

LEGEND

- Ⓐ Telecommunication ground electrode system
- Ⓑ Vertical ground electrodes
- Ⓒ Tower ground
- Ⓓ Coaxial and Waveguide feeders
- Ⓔ Coaxial surge protectors or ground kit
- Ⓕ RF Ground Bar

Lightning Protection for Telecommunications Towers

Direct lightning strikes to telecommunications towers are a reasonably regular occurrence, more so on mountain tops and in certain parts of the world. The traditional approach to lightning protection on towers is to have a lightning rod on the top of the tower and a dedicated down conductor comprised of bare cable or tape that is installed on the tower to connect the lightning rod to the ground.

A modern method is to use an optimal air terminal design, the nVent ERICO Dynasphere mounted on top of the telecommunications mast on a 3-4 metres long fibreglass reinforced pole, FRP. The FRP provides isolation between the air terminal and the tower and helps ensure that the lightning

does not flash over and electrify the mast or the antenna. A special purpose downconductor, called the nVent ERICO Ericore is routed in the core of the FRP and connects to the bottom of the Dynasphere via a high voltage, impulse rated termination. The Ericore runs along a leg of the tower away from the routes of feeders, down to the tower grounding system. Ericore cable is designed to minimize the voltage between itself and the tower so that the bulk of the lightning energy is contained within the cable, thereby protecting the tower and feeders from conducted lightning currents and having much less reliance on bonding practices which sometimes are overlooked or completed incorrectly.

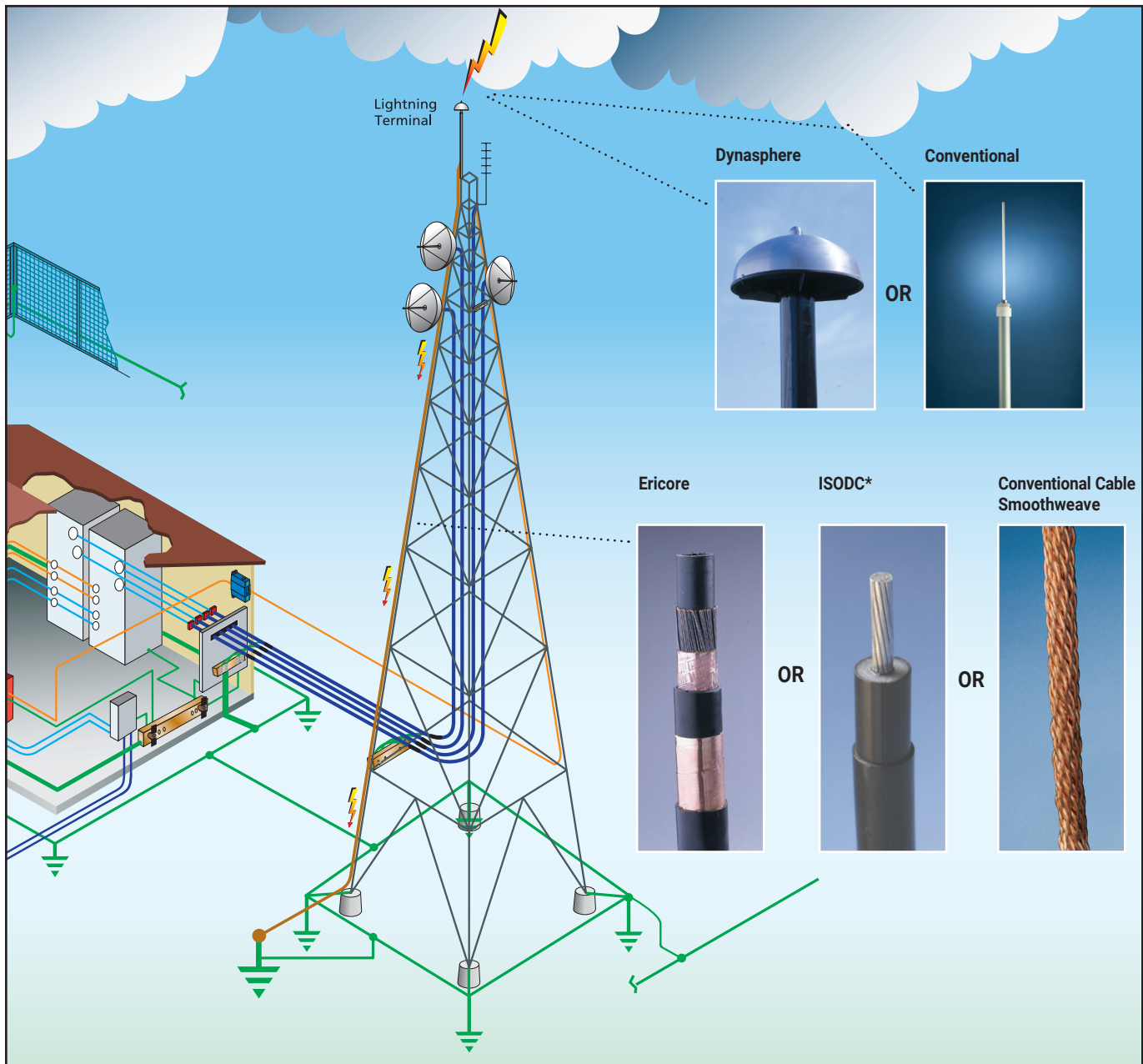

* ISODC - is an isolated lightning protection cable system based around IEC62305. It is designed to isolate the lightning current from sensitive equipment, eliminating the need for separation distances required with conventional cable. Contact nVent ERICO for further information.

Lightning Protection for Roof Mounted Installations

Traditionally, some rooftop installation have been protected by the use of air terminals (Franklin Lightning Rods), often connected to the building lightning protection system. However, the traditional building lightning protection techniques are not well suited to protect these roof top installations. Hence many telecommunications companies have opted not to provide any form of air terminal. Instead they do extensive bonding of all their roof mounted equipment.

The Isolated Downconductor System provides a modern approach to lightning protection for rooftop installations. The nVent ERICO brand of isolated systems provide a traditional air terminal fitted to an isolated fiberglass reinforced plastic (FRP) mast. The isolated downconductor internally connects to the air terminal inside the FRP. The FRP mast has natural isolation properties, high strength for windy sites and low weight to minimize mast loading.

The advantage is that this downconductor can be mounted directly on the mast or structure to be protected – without electrification of mounted equipment under lightning conditions.

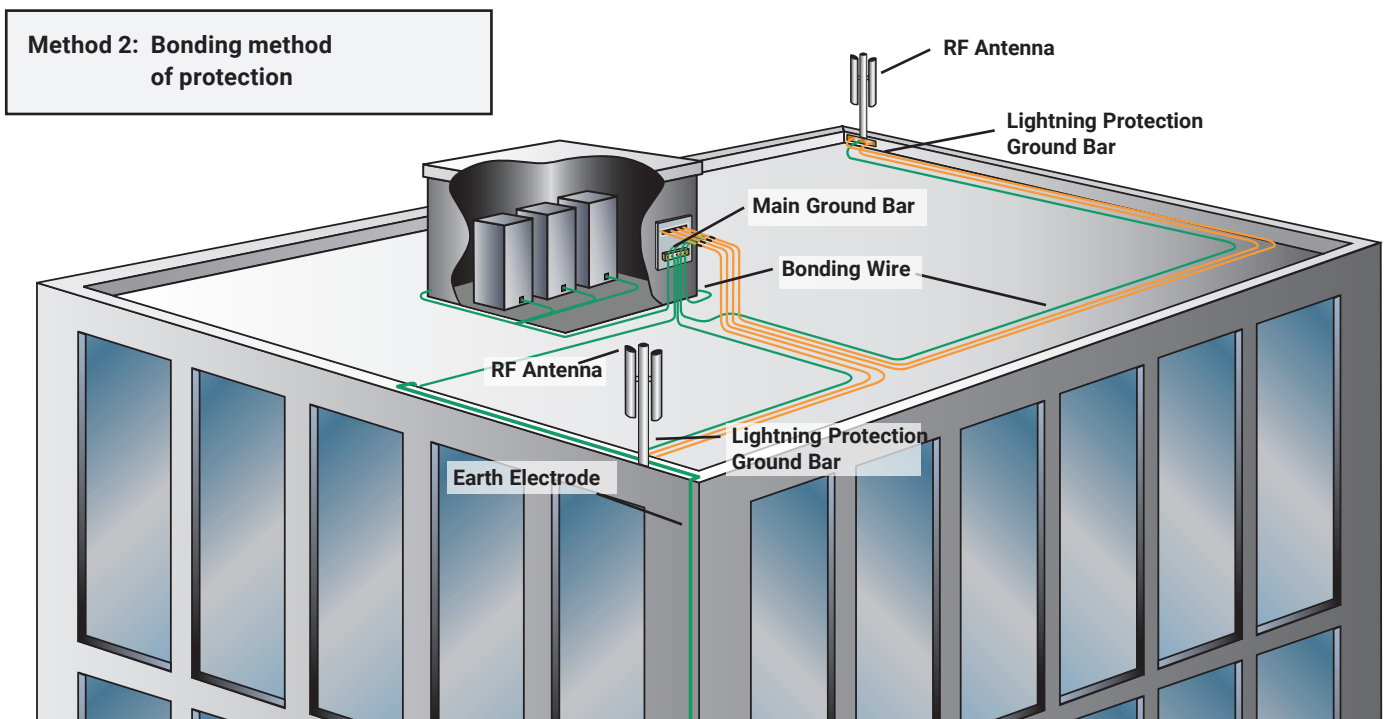
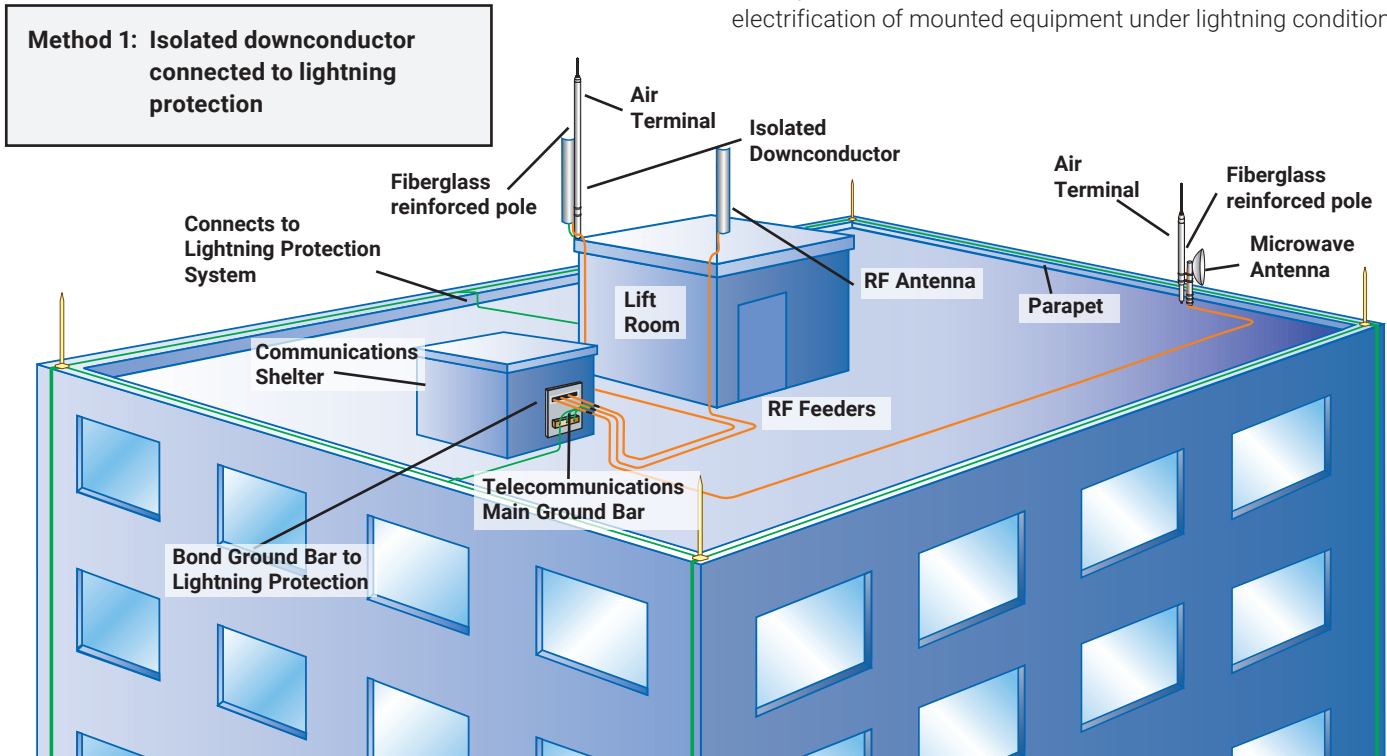

Connectors & Positioners

HAMMERLOCK GROUND CLAMP

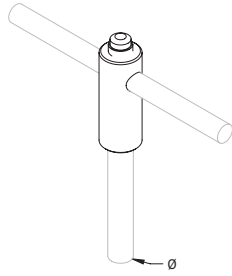

FEATURED HIGHLIGHTS

- Irreversible connection with excellent mechanical strength
- Fast and simple installation requires only a hammer
- No special training required
- Low resistance connection
- Provides a visual indication of completed connection
- Allows for "T" or pass-through connections

The patented Hammerlock irreversible grounding connector mechanically connects the grounding conductor to the ground rod. Machined from highly conductive copper, the state-of-the-art Hammerlock provides a low resistance connection designed to withstand ground fault currents and lightning transients. The connector's mechanically rugged design will help ensure that the highest level of performance is maintained for many years after the connection has been buried in the harsh underground environment.

Material: Copper



Part Number	Ground Rod Diameter, Nominal	Ground Rod Diameter, Actual	Conductor Size	Number of Conductors	Certifications
Ground Rod Type: Copper-bonded					
EHL12FC1K	1/2"	0.50"	#6 Solid - #4 Solid, 16 mm ² Stranded	1	cULus
EHL12FC1K1K	1/2"	0.50"	#6 Solid - #4 Solid, 16 mm ² Stranded	2	cULus
EHL12FC1V	1/2"	0.50"	#4 Stranded - #2 Stranded, 25 mm ² Stranded	1	cULus
EHL12FC2G	1/2"	0.50"	1/0 Stranded - 2/0 Stranded	1	cULus
EHL34C1K	3/4"	0.68"	#6 Solid - #4 Solid, 16 mm ² Stranded	1	cULus
EHL34C1V	3/4"	0.68"	#4 Stranded - #2 Stranded, 25 mm ² Stranded	1	cULus
EHL34C2G	3/4"	0.68"	1/0 Stranded - 2/0 Stranded	1	cULus
EHL58C1K	5/8"	0.56"	#6 Solid - #4 Solid, 16 mm ² Stranded	1	cULus
EHL58C1K1K	5/8"	0.56"	#6 Solid - #4 Solid, 16 mm ² Stranded	2	cULus
EHL58C1V	5/8"	0.56"	#4 Stranded - #2 Stranded, 25 mm ² Stranded	1	cULus
EHL58C2G	5/8"	0.56"	1/0 Stranded - 2/0 Stranded	1	cULus
Ground Rod Type: Galvanized					
EHL34G1K	3/4"	0.73"	#6 Solid - #4 Solid, 16 mm ² Stranded	1	cULus
EHL34G1V	3/4"	0.73"	#4 Stranded - #2 Stranded, 25 mm ² Stranded	1	cULus
EHL34SG1K	3/4"	0.73"	#6 Solid - #4 Solid, 16 mm ² Stranded	1	cULus
EHL34SG1V	3/4"	0.73"	#4 Stranded - #2 Stranded, 25 mm ² Stranded	1	cULus
EHL58G1K	5/8"	0.63"	#6 Solid - #4 Solid, 16 mm ² Stranded	1	cULus
EHL58G1K1K	5/8"	0.63"	#6 Solid - #4 Solid, 16 mm ² Stranded	2	cULus
EHL58G1V	5/8"	0.63"	#4 Stranded - #2 Stranded, 25 mm ² Stranded	1	cULus
EHL58G2G	5/8"	0.63"	1/0 Stranded - 2/0 Stranded	1	cULus

GROUND ROD CLAMP, ROD TO CONDUCTOR, STAINLESS STEEL

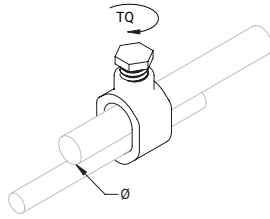

FEATURED HIGHLIGHTS

- For use with copper-bonded ground rods
- Parts that are UL Listed are suitable for direct burial in earth or concrete

Material: Silicon Bronze



Part Number	Ground Rod Diameter, Nominal	Ground Rod Diameter, Actual	Conductor Size	Wrench Size	Certifications
Torque: 150 – 300 in lb					
CP34	1/2" – 3/4"	0.50" – 0.68"	#10 Solid - 1/0 Stranded, 6 mm ² Solid - 50 mm ² Stranded	1/2"	CSA, cULus
CP38	3/8"	0.38"	#10 Solid - #2 Stranded, 6 mm ² Solid - 25 mm ² Stranded	3/8"	cULus
CP58	1/2" – 5/8"	0.50" – 0.56"	#10 Solid - #2 Stranded, 6 mm ² Solid - 25 mm ² Stranded	1/2"	CSA, cULus
Torque: 150 – 450 in lb					
HDC1	1"	1.00"	#8 Solid - 4/0 Stranded, 10 mm ² Solid - 95 mm ² Stranded	9/16"	cULus
HDC12	1/2"	0.50"	#10 Solid - #2 Stranded, 6 mm ² Solid - 25 mm ² Stranded	1/2"	CSA, cULus
HDC34	3/4"	0.68"	#8 Solid - 1/0 Stranded, 10 mm ² Solid - 50 mm ² Stranded	9/16"	CSA, cULus
HDC34SP	3/4"	0.68"	#8 Solid - 3/0 Stranded, 10 mm ² Solid - 70 mm ² Stranded	9/16"	CSA
HDC58	5/8"	0.56"	#8 Solid - 1/0 Stranded, 10 mm ² Solid - 50 mm ² Stranded	9/16"	CSA, cULus
HDC58R	5/8"	0.56"	#8 Solid - 1/0 Stranded, 10 mm ² Solid - 50 mm ² Stranded	1/2"	CSA, cULus

GROUND ROD CLAMP, ROD TO CONDUCTOR, STAINLESS STEEL

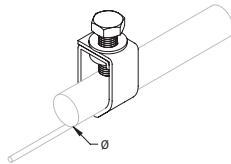

FEATURED HIGHLIGHTS

- Unique stamped body design will not crack from excessive torque
- Provides a greater surface area contact to allow improved performance of the connector
- Compatible with copper, copper bonded, galvanized, stainless steel, rebar and plain steel ground rods and electrodes

Material: Stainless Steel 304 (EN 1.4301)

Torque: 150 – 300 in lb



Part Number	Ground Rod Diameter, Nominal	Ground Rod Diameter, Actual	Conductor Size	Wrench Size
Torque: 150 – 300 in lb				
SP58	1/2" – 5/8"	0.500" – 0.625"	#10 Solid - #2 Stranded, 6 mm ² Solid - 25 mm ² Stranded	1/2"
SP58B916	1/2" – 5/8"	0.500" – 0.625"	#10 Solid - #2 Stranded, 6 mm ² Solid - 25 mm ² Stranded	9/16"

GROUND ROD CLAMP, U-BOLT, TINNED, ONE CONDUCTOR

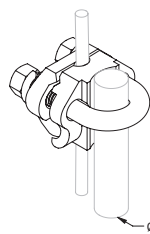
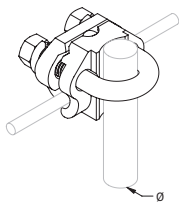

FEATURED HIGHLIGHTS

- Tinned finish provides a theft-deterrent appearance
- Accepts conductors in both parallel and perpendicular orientations

Material: Bronze, Stainless Steel 304 (EN 1.4301)
Finish: Tinned



Part Number	Ground Rod Diameter, Nominal	Conductor Size, UL
GC064	5/8" - 3/4"	#4 Sol - 2/0 Str, 16 mm ² Str - 50 mm ² Str
GC065	5/8" - 3/4"	2/0 Sol - 250 kcmil Str, 70 mm ² Str - 120 mm ² Str

Conductor Orientation (Parallel or Perpendicular)

GC064	Conductor Size					
	Nominal Ground Rod Diameter	#4 Sol	#4 Str	#2 Sol	#2 Str	1/0 Sol 3/0 Sol
5/8" copper-bonded ground rod	Par.	Par.	Par.	Par.	Both	Perp.
5/8" galvanized/stainless steel ground rod	Par.	Par.	Par.	-	Perp.	Perp.
3/4" copper-bonded ground rod	Par.	-	-	-	Perp.	Perp.
3/4" galvanized/stainless steel ground rod	-	-	-	-	Perp.	-

GC065	Conductor Size				
	Nominal Ground Rod Diameter	#4 Sol-#4 Str	#2 Sol-4/0 Sol	4/0 Str	250 kcmil Str
5/8" copper-bonded ground rod	Par.	Both	Both	Par.	
5/8" galvanized/stainless steel ground rod	Par.	Both	Both	Par.	
3/4" copper-bonded ground rod	Par.	Both	Both	-	
3/4" galvanized/stainless steel ground rod	Par.	Both	-	-	

GROUND ROD CLAMP, U-BOLT, TINNED, ONE CONDUCTOR

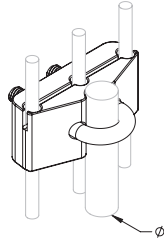

FEATURED HIGHLIGHTS

- Ground rod clamp that allows up to three separate conductors to be connected to a ground rod
- Bronze material is a copper alloy with high copper content
- Tinned bronze has theft-deterrent appearance

Material: Bronze
Finish: Tinned

Part Number	Ground Rod Diameter, Nominal	Ground Rod Diameter, Actual	Conductor Size
GC065TH	5/8" - 3/4"	0.625" - 0.750"	2/0 Solid - 250 kcmil Stranded, 70 mm ² Stranded - 120 mm ² Stranded

GROUND ROD CLAMP, U-BOLT SADDLE, ONE CONDUCTOR

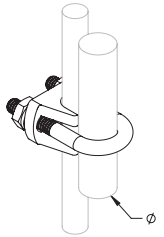

FEATURED HIGHLIGHTS

- Clamp that allows a conductor to be connected to a ground rod

Material: Copper Alloy

Part Number	Ground Rod Diameter, Nominal	Ground Rod Diameter, Actual	Conductor Size
REP16120L	3/4"	0.68"	#4 Solid - 4/0 Stranded, 16 mm ² Stranded - 120 mm ² Stranded

GROUND ROD CLAMP, U-BOLT, BARE, ONE CONDUCTOR

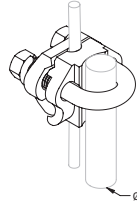
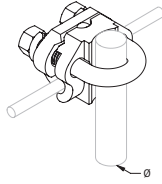
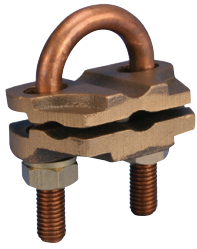

FEATURED HIGHLIGHTS

- Accepts conductors in both parallel and perpendicular orientations
- For use with copper-bonded ground rods

Material: Copper, Bronze, Brass

Part Number	Ground Rod Diameter, Nominal	Ground Rod Diameter, Actual	Conductor Size
GUV16070	5/8" - 1"	0.560" - 0.914"	#4 Solid - 2/0 Stranded, 16 mm ² Stranded - 70 mm ² Stranded
GUV70185	5/8" - 1"	0.560" - 0.914"	#4 Solid - 300 kcmil Stranded, 16 mm ² Stranded - 185 mm ² Stranded

Conductor Orientation (Parallel or Perpendicular)

Nominal Ground Rod Diameter	#4 Sol - 4/0 Sol	4/0 Str	250 kcmil Str	300 kcmil Str
5/8" copper-bonded ground rod	Both	Both	Both	Both
3/4" copper-bonded ground rod	Both	Both	Both	Both
1" copper-bonded ground rod	Both	Both	Both	-

GROUND ROD CLAMP WITH PREFABRICATED PIGTAIL

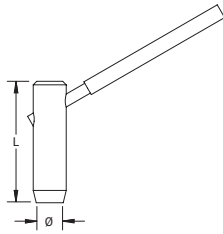
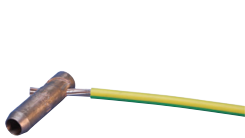

FEATURED HIGHLIGHTS

- Prefabricated assembly including grounding clamp with pigtail
- Fast and simple installation requires only a hammer

Material: Copper

Insulation: Green and Yellow Insulated Cable

Part Number	Ground Rod Diameter, Nominal	Length	Pigtail Length	Conductor Size	Unit Weight
EPT1225300	1/2"	2.8"	11.8'	25 mm ² Stranded	1.1 lb
EPT1425350	5/8"	3.0"	13.8'	25 mm ² Stranded	1.1 lb
EPT1435350	5/8"	3.0"	13.8'	35 mm ² Stranded	1.1 lb
EPT1450350	5/8"	3.0"	13.8'	50 mm ² Stranded	1.1 lb

GROUND ROD SPLIT CLAMP, ROD TO TAPE

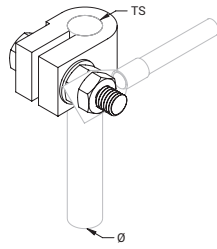
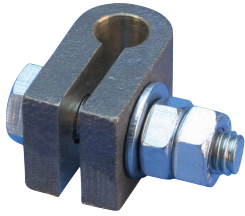

FEATURED HIGHLIGHTS

- Used to connect a ground rod to a lug or to tape with a punched hole

Material: Gunmetal

Part Number	Ground Rod Diameter, Actual	Thread Size
RCC16	0.56" Max	M10
SRC15	0.58" Max	M10

U-BOLT GROUND ROD CLAMP

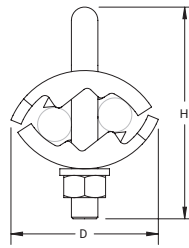
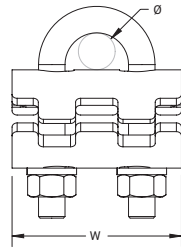

FEATURED HIGHLIGHTS

- Connects conductors to ground rods
- Listed to UL® 96

Material: Brass

Part Number	Conductor Size, UL	Ground Rod Diameter, Nominal	Ground Rod Diameter, Actual	Depth	Height	Width	Unit Weight
LPC795	Class 1 - Class 2 (4/0 Max)	1/2" - 3/4"	0.504" - 0.681"	1.66"	2 1/2"	2"	0.242 lb



GROUND ROD CLAMP

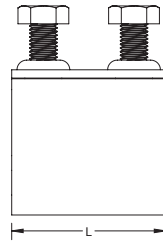
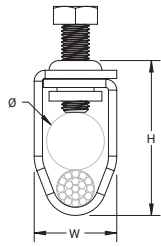

FEATURED HIGHLIGHTS

- Unique stamped body design will not crack as mechanical forces are increased
- Stainless steel threads will not strip if over-tightened
- Unique internal profile offers pull-out load in excess of four times the UL® 96 requirement
- Listed to UL® 96



Material: Copper

Part Number	Conductor Size, UL	Ground Rod Diameter, Nominal	Ground Rod Diameter, Actual	Height	Length	Width	Unit Weight
LPC790	Class 1 - Class 2 (4/0 Max)	1/2" - 3/4"	0.504" - 0.681"	1.65"	1 3/4"	0.94"	0.336 lb

COMPRESSION COUPLER FOR COPPER-BONDED GROUND ROD, POINTED

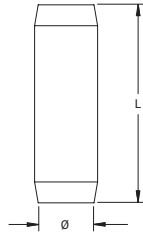

FEATURED HIGHLIGHTS

- Threadless compression coupler for use with pointed copper-bonded ground rods
- Inside of coupler is tapered so ground rod compresses during installation to form an irreversible conductive connection

Material: Steel
Finish: Electrogalvanized



Part Number	Ground Rod Diameter, Nominal	Length	Unit Weight	Complies With
CC12F	1/2"	2 3/4"	0.29 lb	
CC34	3/4"	2 3/4"	0.44 lb	IEC® EN 62561-2
CC58	5/8"	2 3/4"	0.32 lb	IEC® EN 62561-2

IEC® EN 62561-2 supercedes EN 50164-2.

COMPRESSION COUPLER FOR GALVANIZED GROUND ROD, POINTED

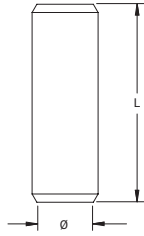

Material: Steel
Finish: Electrogalvanized

FEATURED HIGHLIGHTS

- Threadless compression coupler for use with galvanized steel ground rods
- Inside of coupler is tapered so ground rod compresses during installation to form an irreversible conductive connection

Part Number	Ground Rod Diameter, Nominal	Length	Unit Weight
GCC34	3/4"	3 1/2"	0.36 lb
GCC58F	5/8"	3"	0.31 lb

COMPRESSION COUPLER FOR STAINLESS STEEL GROUND ROD, POINTED

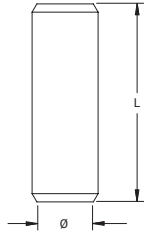
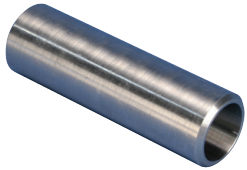

Material: Stainless Steel 304 (EN 1.4301)



FEATURED HIGHLIGHTS

- Threadless compression coupler for use with pointed stainless steel ground rods in corrosive soils
- Inside of coupler is tapered so ground rod compresses during installation to form an irreversible conductive connection

Part Number	Ground Rod Diameter, Nominal	Length	Unit Weight	Certifications
CC34SS	3/4"	3 1/4"	0.34 lb	cULus
CC58SS	5/8"	3"	0.25 lb	cULus
CCSS14	14 mm	2 3/4"	0.10 lb	

THREADED COUPLER FOR COPPER-BONDED GROUND ROD, SECTIONAL

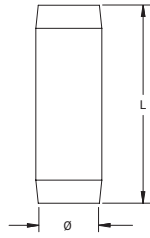

FEATURED HIGHLIGHTS

- High-strength couplings are threaded and chamfered at both ends for easy driving
- Corrosion-resistant couplings ensure permanent, low resistance copper-to-copper connections



Part Number	Ground Rod Diameter, Nominal	Length	Thread Size	Unit Weight	Certifications
Material: Bronze					
CR12S	9/16"	2.5"	9/16 UNC	0.16 lb	CSA, cULus
CR34	3/4"	3.0"	3/4 UNC	0.34 lb	CSA, cULus
CR58	5/8"	2.4"	5/8 UNC	0.23 lb	CSA, cULus
Material: Silicon Bronze					
CR100	1"	3.9"	1 UNC	0.78 lb	cULus

THREADED COUPLER FOR STAINLESS STEEL GROUND ROD, SECTIONAL

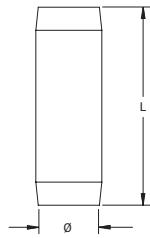

FEATURED HIGHLIGHTS

- Corrosion-resistant couplings ensure permanent, low-resistance connections between ground rods



Material: Stainless Steel 304 (EN 1.4301)

Part Number	Ground Rod Diameter, Nominal	Length	Thread Size	Unit Weight	Certifications
CR34SS	3/4"	3.06"	3/4 UNC	0.40 lb	cULus
CR58C E	5/8"	2.75"	5/8 UNC	0.26 lb	
CR58SS	5/8"	3.06"	5/8 UNC	0.27 lb	cULus

GROUNDING BUSBAR CONNECTOR, SOLID ROUND CONDUCTOR

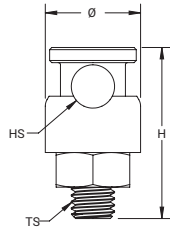

FEATURED HIGHLIGHTS

- Used to connect Cu-Bond Round Conductor to grounding busbars

Material: Copper Alloy, Stainless Steel 18-8 (EN 1.4305)
Finish: Tinned

Part Number	Height	Diameter	Hole Size	Thread Size	ERICO CU-BOND Conductor	Complies With
BCR8T	1.56"	0.79"	0.37"	M10	CBSC8	IEC® 62561-1

IEC compliance is valid only for ERICO CU-BOND Conductors listed.

STAMPED BONDING PLATE

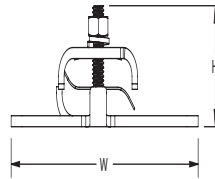
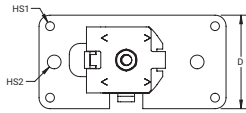
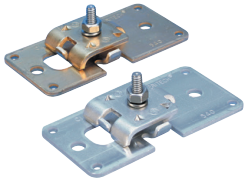

FEATURED HIGHLIGHTS

- Stamped bonding plate suitable for structural steel applications
- Listed to UL® 96

Conductor Size, UL: Class 1 - Class 2 (4/0 Max)



Part Number	Contact Area	Depth	Height	Width	Hole Size 1	Hole Size 2	Unit Weight
Material: Copper – Finish: Bare							
LPC540	8 in ² Min	2 1/8"	1 1/4"	4 1/4"	0.2"	0.311"	0.560 lb
Material: Copper – Finish: Tinned							
LPC540L	8 in ² Min	2 1/8"	1 1/4"	4 1/4"	0.2"	0.311"	0.560 lb
Material: Copper, Aluminum, Stainless Steel 304 (EN 1.4301) – Finish: Bare							
LPC540A	8 in ² Min	2 1/8"	1 1/4"	4 1/4"	0.2"	0.311"	0.230 lb

Stainless steel separator included with LPC540A for bi-metallic applications.

BONDING PLATE

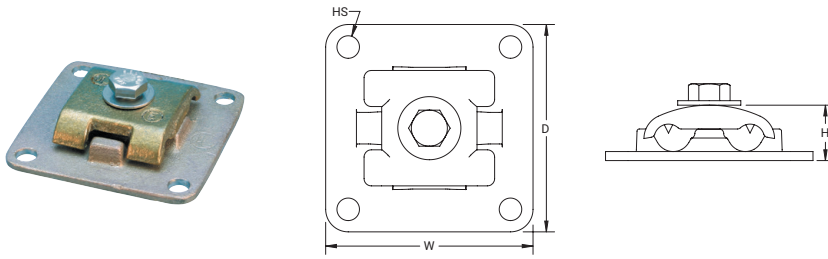

FEATURED HIGHLIGHTS

- Cast bonding plate for structural steel applications
- Listed to UL® 96

Conductor Size, UL: Class 1 - Class 2 (4/0 Max)



Part Number	Contact Area	Depth	Height	Width	Hole Size	Unit Weight
Material: Brass						
LPC532	8 in ² Min	2 7/8"	0.66"	2 7/8"	5/16"	0.640 lb
Material: Brass – Finish: Tinned						
LPC532L	8 in ² Min	2 7/8"	0.66"	2 7/8"	5/16"	0.640 lb

CAST BEAM BONDING CLAMP

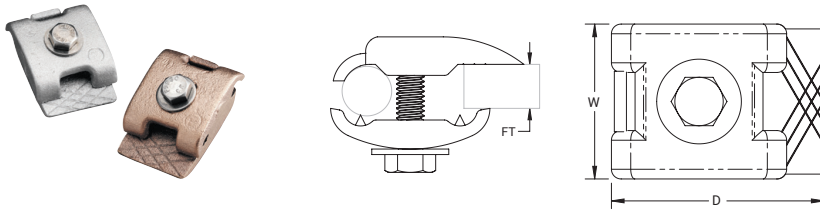

FEATURED HIGHLIGHTS

- Clamp for bonding cable to flat metal objects such as I-beams, angle irons and channel irons
- Listed to UL® 96

Conductor Size, UL: Class 1 - Class 2 (4/0 Max)



Part Number	Flange Thickness	Depth	Width	Unit Weight
Material: Copper – Finish: Bare				
LPC559	1/4" Max	2 1/4"	1.6"	0.385 lb
Material: Copper – Finish: Tinned				
LPC559L	1/4" Max	2 1/4"	1.6"	0.385 lb

CAST TWO BOLT BEAM BONDING CLAMP

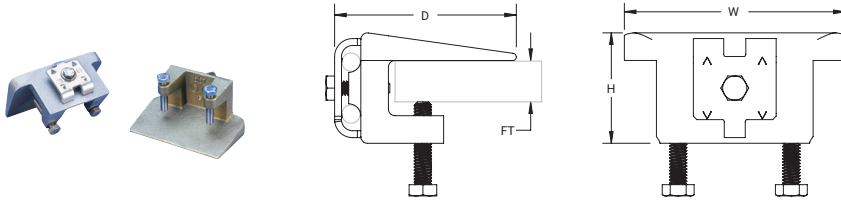

FEATURED HIGHLIGHTS

- Clamp for bonding cable to flat metal objects such as I-beams, angle irons and channel irons
- Listed to UL® 96

Conductor Size, UL: Class 1 - Class 2 (4/0 Max)



Part Number	Flange Thickness	Depth	Height	Width	Contact Area	Unit Weight
Material: Copper						
LPC557	1" Max	2 3/4"	2"	4"	8 in ² Min	2.055 lb
Material: Copper — Finish: Tinned						
LPC557L	1" Max	2 3/4"	2"	4"	8 in ² Min	2.055 lb

BEAM CLAMP FOR SOLID ROUND CONDUCTOR

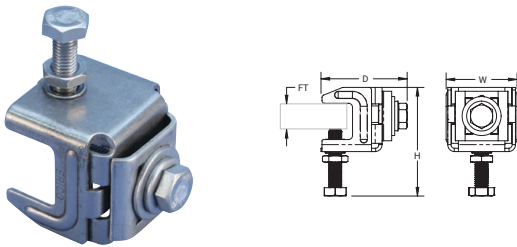

FEATURED HIGHLIGHTS

- Clamp for attaching solid round conductor such as Cu-Bond Round Conductor to flat metal objects such as I-beams, angle irons and channel irons
- For use with copper-bonded, copper, or stainless steel solid conductors

Material: Stainless Steel 316 (EN 1.4401)

Part Number	Width	Height	Depth	Flange Thickness	ERICO CU-BOND Conductor	Unit Weight	Complies With
SBCS0810	2.17"	3.35"	2.76"	1/4" – 1"	CBSC8, CBSC10	0.61 lb	IEC® 62561-4
SBCS1314	2.17"	3.54"	2.76"	1/4" – 1"	CBSC13, CBSC14	0.61 lb	IEC® 62561-4

IEC compliance is valid only for Cu-Bond Conductors listed.

PREFABRICATED LUG BOND



FEATURED HIGHLIGHTS

- Made with bare annealed copper cable
- Tinned copper NEMA® lugs welded to the cable with Cadweld connections

Prefabricated lug bonds are custom made to specifications. Common usage includes cable tray bonding and grounding, structure bonds, surge arrester leads and power jumpers.

B21-2-1L-12

B21	Lug Bond Assembly	
2	Lug Configuration	2 = Double-Lug Bond, 1-Hole each on Straight Lugs 3 = Double-Lug Bond, 2-Holes each on Straight Lugs 6 = Single-Lug Bond Stub, 1-Hole on Straight Lug 7 = Single-Lug Bond Stub, 2-Holes on Straight Lug 8 = Single-Lug Bond Stub, 1-Hole on 45° Lug 9 = Single-Lug Bond Stub, 2-Holes on 45° Lug
1L	Cable Code	1L = #4 Stranded 1V = #2 Stranded 2C = 1/0 Stranded 2G = 2/0 Stranded 2Q = 4/0 Stranded 2Q = 4/0 Stranded 2V = 250 MCM Stranded
12	Bond Length in inches (from outer-most hole center)	

Part Number	Conductor Size	Number of Wires	Length 1	Length 2	Width	Thickness	Hole Size	Angle
Lug Configuration: B212								
B2121L8	#4 Stranded	7	8"	1.47"	1"	0.19"	9/16"	-
B2121V12	#2 Stranded	7	12"	1.47"	1"	0.19"	9/16"	-
B2122G16	2/0 Stranded	7	16"	1.47"	1"	0.19"	9/16"	-
B2122Q00318	4/0 Stranded	7	318"	1.47"	1"	0.19"	9/16"	-
B2122Q20	4/0 Stranded	7	20"	1.47"	1"	0.19"	9/16"	-
B2122Q24	4/0 Stranded	7	24"	1.47"	1"	0.19"	9/16"	-
Lug Configuration: B213								
B2131L15	#4 Stranded	7	15"	3.25"	1"	0.19"	9/16"	-
B2131L20	#4 Stranded	7	20"	3.25"	1"	0.19"	9/16"	-
B2131L22	#4 Stranded	7	22"	3.25"	1"	0.19"	9/16"	-
B2131L24	#4 Stranded	7	24"	3.25"	1"	0.19"	9/16"	-
B2131L28	#4 Stranded	7	28"	3.25"	1"	0.19"	9/16"	-
B2131L32	#4 Stranded	7	32"	3.25"	1"	0.19"	9/16"	-
B2131L35	#4 Stranded	7	35"	3.25"	1"	0.19"	9/16"	-
B2131L38	#4 Stranded	7	38"	3.25"	1"	0.19"	9/16"	-
B2131L42	#4 Stranded	7	42"	3.25"	1"	0.19"	9/16"	-
B2131L44	#4 Stranded	7	44"	3.25"	1"	0.19"	9/16"	-
B2131V18	#2 Stranded	7	18"	3.25"	1"	0.19"	9/16"	-
B2131V36	#2 Stranded	7	36"	3.25"	1"	0.19"	9/16"	-
B2132G11	2/0 Stranded	7	11"	3.25"	1"	0.19"	9/16"	-
B2132G14	2/0 Stranded	7	14"	3.25"	1"	0.19"	9/16"	-
B2132Q18	4/0 Stranded	7	18"	3.25"	1"	0.19"	9/16"	-
B2132Q36	4/0 Stranded	7	36"	3.25"	1"	0.19"	9/16"	-

Part Number	Conductor Size	Number of Wires	Length 1	Length 2	Width	Thickness	Hole Size	Angle
B2132Q48	4/0 Stranded	7	48"	3.25"	1"	0.19"	9/16"	-
B2132Q54	4/0 Stranded	7	54"	3.25"	1"	0.19"	9/16"	-
B2132Q60	4/0 Stranded	7	60"	3.25"	1"	0.19"	9/16"	-
B2132V18	250 kcmil Stranded	19	18"	3.25"	1"	0.19"	9/16"	-
Lug Configuration: B216								
B2162C72	1/0 Stranded	7	72"	1.47"	1"	0.19"	9/16"	-
B2162C96	1/0 Stranded	7	96"	1.47"	1"	0.19"	9/16"	-
B2162Q24	4/0 Stranded	7	24"	1.47"	1"	0.19"	9/16"	-
B2162Q8	4/0 Stranded	7	8"	1.47"	1"	0.19"	9/16"	-
Lug Configuration: B217								
B2171L24	#4 Stranded	7	24"	3.25"	1"	0.19"	9/16"	-
B2172C12	1/0 Stranded	7	12"	3.25"	1"	0.19"	9/16"	-
B2172G24	2/0 Stranded	7	24"	3.25"	1"	0.19"	9/16"	-
B2172Q00196	4/0 Stranded	7	196"	3.25"	1"	0.19"	9/16"	-
B2172Q12	4/0 Stranded	7	12"	3.25"	1"	0.19"	9/16"	-
B2172Q24	4/0 Stranded	7	24"	3.25"	1"	0.19"	9/16"	-
Lug Configuration: B218								
B2182Q30	4/0 Stranded	7	30"	1.47"	1"	0.19"	9/16"	45°
Lug Configuration: B219								
B2192C12	1/0 Stranded	7	12"	3.25"	1"	0.19"	9/16"	45°
B2192Q08	4/0 Stranded	7	8"	3.25"	1"	0.19"	9/16"	45°
B2192Q12	4/0 Stranded	7	12"	3.25"	1"	0.19"	9/16"	45°

LAY-IN LUG

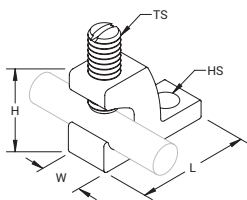
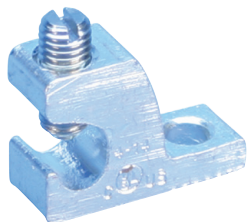

FEATURED HIGHLIGHTS

- Often used in solar bonding lug applications
- Lay-in features allows for easy positioning
- Set screw hardware made of 304 stainless steel

Material: Copper, Stainless Steel 304 (EN 1.4301)
Finish: Tinned



Part Number	Length	Width	Height	Hole Size	Thread Size	Conductor Size
EL6CADB	1.04"	0.39"	0.76"	0.22"	1/4 NF	#14 Solid - #4 Stranded, 2.5 mm ² Stranded - 16 mm ² Stranded

SOLAR BONDING LUG

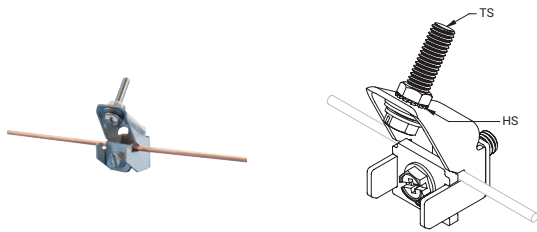

FEATURED HIGHLIGHTS

- Bonds the frames and mounting structures of solar photo voltaic systems in accordance with NEC® requirements
- Copper alloy is corrosion resistant and galvanically compatible with copper grounding conductors and aluminum photovoltaic module frames
- Lay-in feature allows for easy positioning along multiple frames

Material: Bronze, Stainless Steel 18-8 (EN 1.4305)
Finish: Tinned



Part Number	Direct Burial	Conductor Size	Hole Size	Screw Included	Thread Size
EL6CS	No	#14 Solid - #6 Stranded	0.221"	Yes	10 UNS
EL6CS8	No	#14 Solid - #6 Stranded	0.221"	Yes	8 UNS
EL6CSDB	Yes	#14 Solid - #6 Stranded	0.221"	Yes	10 UNS
EL6CSDB8	Yes	#14 Solid - #6 Stranded	0.221"	Yes	8 UNS
EL6CSDBNH	Yes	#14 Solid - #6 Stranded	0.221"	No	
EL6CSNH	No	#14 Solid - #6 Stranded	0.221"	No	

TRANSFORMER TANK GROUNDING CONNECTOR WITH ROTATING EYE BOLT

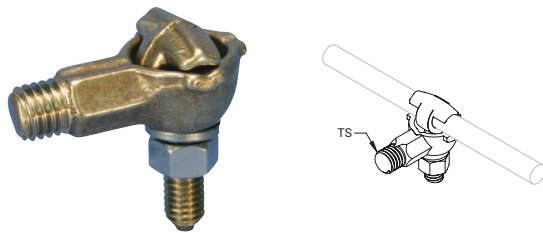

FEATURED HIGHLIGHTS

- Rotating eye bolt accommodates cable either vertically or horizontally
- Fits all EEI®-NEMA® distribution transformers
- No special tools required; use regular lineman's wrench

Material: Bronze, Stainless Steel 302 (EN 1.4324), Stainless Steel 304 (EN 1.4301)

Part Number	Conductor Size	Thread Size
TGC2/0	#10 Solid - 2/0 Stranded	1/2 UNC

TRANSFORMER TANK GROUNDING CONNECTOR, EXTERNAL THREAD

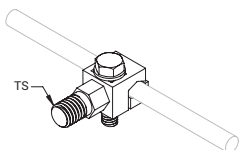
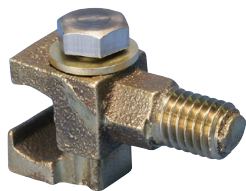

FEATURED HIGHLIGHTS

- Fits all EEI®-NEMA® distribution transformers
- No special tools required; use regular lineman's wrench

Material: Bronze

Part Number	Conductor Size	Thread Size
Finish: Tinned		
CC207	#6 Solid - 1/0 Stranded	1/2 UNC

TRANSFORMER TANK GROUNDING CONNECTOR, INTERNAL THREAD

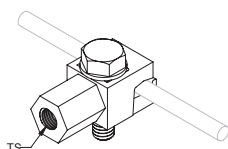
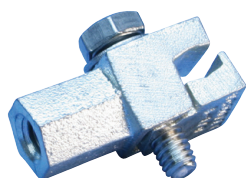

FEATURED HIGHLIGHTS

- Fits all EEI®-NEMA® distribution transformers
- No special tools required; use regular lineman's wrench

Material: Bronze, Stainless Steel 304 (EN 1.4301)

Part Number	Conductor Size	Thread Size
VC207IT	#6 Solid - 1/0 Stranded	3/8 UNC

EARTH BOSS

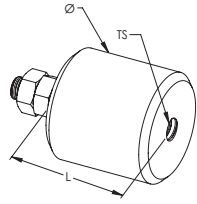
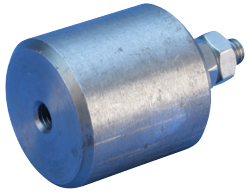

FEATURED HIGHLIGHTS

- Provides preferential equipotential bonding connection point

Material: Stainless Steel 316 (EN 1.4401), Steel

Part Number	Length	Diameter	Thread Size
50010EBOSS	1.97"	1.97"	M10

The surface of the earth boss needs to be cleaned before welding. Welding procedures vary, depending on the type of steel used.

516 PARALLEL CABLE CONNECTOR

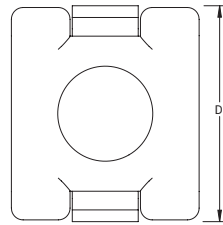
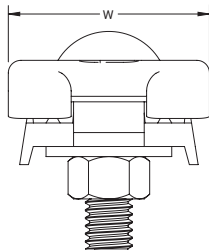

FEATURED HIGHLIGHTS

- Cable splice with positive single bolt tension grip on cable or wire
- For use with all full size cables on Class I/II structures
- Listed to UL® 96

Conductor Size, UL: Class 1 - Class 2 (4/0 Max)



Part Number	Depth	Width	Unit Weight
Material: Copper – Finish: Bare			
LPC516	1.84"	1 1/2"	0.40 lb
Material: Copper – Finish: Tinned			
LPC516L	1.84"	1 1/2"	0.40 lb
Material: Copper, Aluminum, Stainless Steel 18-8 (EN 1.4305) – Finish: Bare			
LPC516A	1.84"	1 1/2"	0.26 lb

517 PARALLEL CABLE CONNECTOR

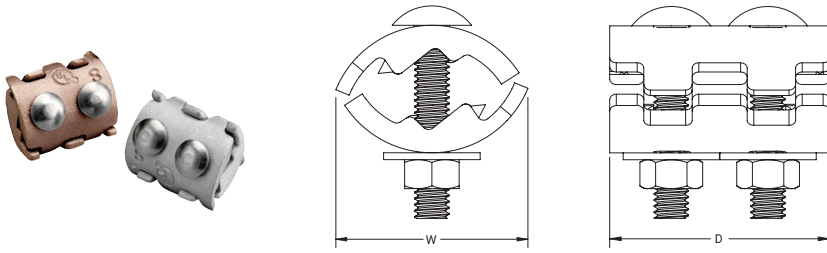

FEATURED HIGHLIGHTS

- Cable splice with positive two bolt tension grip on cable or wire
- For use with all full size cables on Class I/II structures
- Listed to UL® 96

Conductor Size, UL: Class 1 - Class 2 (4/0 Max)



Part Number	Depth	Width	Unit Weight
Material: Copper			
LPC517	1.91"	1.66"	0.514 lb
Material: Copper – Finish: Tinned			
LPC517L	1.91"	1.66"	0.514 lb

CABLE CLAMP

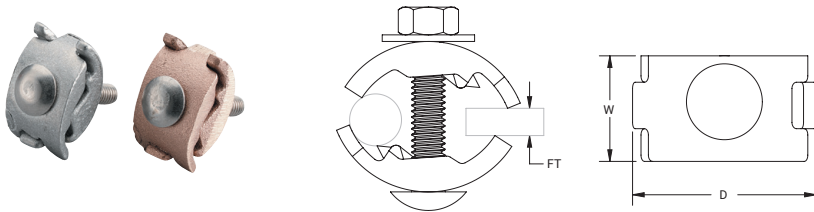

FEATURED HIGHLIGHTS

- Clamps to flat metal objects such as I-beams, angle irons and channel irons
- Can be used as a parallel conductor clamp
- Positive bolt tension draws tight on steel member to UL® 96
- Listed to UL® 96

Conductor Size, UL: Class 1 - Class 2 (4/0 Max), Secondary



Part Number	Flange Thickness	Depth	Width	Unit Weight
Material: Brass				
LPC858	1/2" Max	1.66"	0.89"	0.240 lb
Material: Brass – Finish: Tinned				
LPC858L	1/2" Max	1.66"	0.89"	0.240 lb

Flange thickness will impact the maximum cable holding capability.

STAMPED BOLTED PARALLEL CABLE CONNECTOR

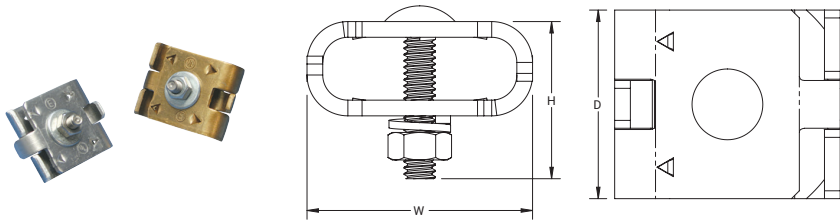

FEATURED HIGHLIGHTS

- For positive bolt tension cable clamping
- Listed to UL® 96

Conductor Size, UL: Class 1 - Class 2 (4/0 Max)



Part Number	Depth	Height	Width	Unit Weight
Material: Copper				
LPC502	1 1/2"	1 1/2"	1.78"	0.215 lb
Material: Copper — Finish: Tinned				
LPC502L	1 1/2"	1 1/2"	1.78"	0.215 lb
Material: Copper, Aluminum, Stainless Steel 304 (EN 1.4301)				
LPC502A	1 1/2"	1 1/2"	1.78"	0.194 lb

Stainless steel separator included with LPC502A for bi-metallic applications.

JUMPER CLAMP FOR TELECOM

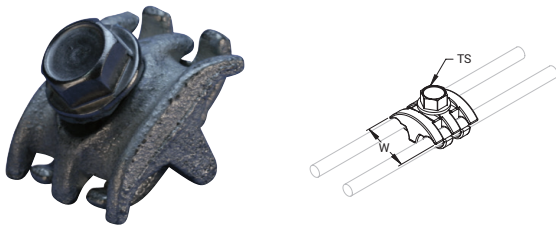

FEATURED HIGHLIGHTS

- For use in telecom applications

Material: Bronze
Finish: Tinned



Part Number	Width	Thread Size	Conductor Size
KUL	1.4"	5/16 UNC	#6 Solid

Although a #6 Solid conductor is similar in size to a metric 16 mm² Solid conductor, the UL listing is currently only for #6 Solid.

CROSS-RUN CABLE CONNECTORS, SOLID ROUND CONDUCTOR

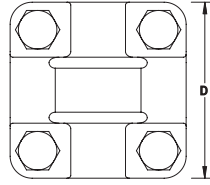
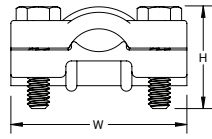

FEATURED HIGHLIGHTS

- Can be used as a cross-run cable connector
- Four bolts for positive bolt tension grip on cables
- For use with Cu-Bond Round Conductors

Material: Brass

Part Number	Depth	Height	Width	ERICO CU-BOND Conductor	Unit Weight	Complies With
LPC595NB	2"	1"	2"	CBSC8, CBSC10	0.62 lb	IEC® 62561-1

IEC compliance is valid only for Cu-Bond Conductors listed.

T-CONNECTOR

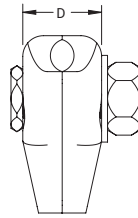
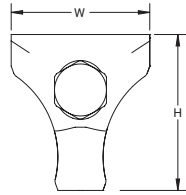

FEATURED HIGHLIGHTS

- For 90° conductor connections

Part Number	Conductor Size	Depth	Height	Width	ERICO CU-BOND Conductor	Unit Weight	Complies With
Material: Brass							
CTR8CU	8 mm Solid, 10 mm Solid	0.83"	1.81"	1.58"	CBSC10	0.37 lb	IEC® 62561-1
Material: Zinc Alloy							
CTR10	8 mm Solid, 10 mm Solid	0.80"	1.92"	1.04"		0.26 lb	

IEC compliance is valid only for Cu-Bond Conductors listed.

IN-LINE CABLE CONNECTOR

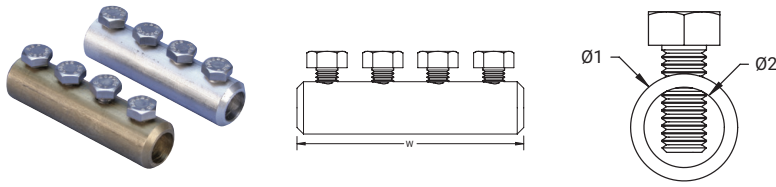

FEATURED HIGHLIGHTS

- Cable splicer with four bolts for pressure on each cable
- LPC513 is compatible with Cu-Bond Round Conductors

Conductor Size, UL: Class 1 - Class 2 (4/0 Max)



Part Number	Diameter 1	Diameter 2	Width	Cu-Bond Conductor	Unit Weight	Complies With
Material: Copper						
LPC513	3/4"	0.563"	3 1/4"	CBSC8, CBSC10, CBSC13	0.37 lb	IEC® 62561-1
Material: Copper – Finish: Tinned						
LPC513L	3/4"	0.563"	3 1/4"		0.37 lb	

IEC compliance is valid only for ERICO CU-BOND Conductors listed.

MESH BONDING NETWORK CONNECTOR, MBNC240

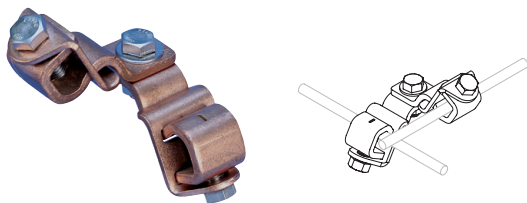

FEATURED HIGHLIGHTS

- Allows for fast, simple and economical field connection of grounding and bonding wires
- Heavy duty clamps with stainless steel hardware are suitable for direct burial
- Can accommodate additional pigtails that can be used to connect to building steel and equipment
- Can be combined with Universal Pedestal Clamp for bonding to various pedestal sizes for mesh bonding networks

For complete pedestal clamp assembly, reference part MBNUPCJ240

Material: Copper, Stainless Steel 304 (EN 1.4301)



Part Number	Conductor Size	Cu-Bond Conductor	Complies With	Standard Packaging Quantity
MBNC240	#2 Solid - 4/0 Stranded, 35 mm ² - 100 mm ²	CBSC8, CBSC10, CBSC13	IEC® 62561-1	25 pc

IEC compliance is valid only for Cu-Bond Conductors listed.

MESH BONDING NETWORK CONNECTOR, MBNC240A

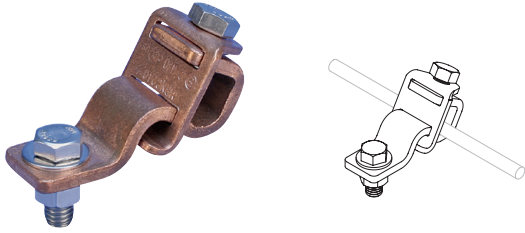

For complete pedestal clamp assembly, reference part number MBNUPCJ240

FEATURED HIGHLIGHTS

- Allows for fast, simple and economical field connection of grounding and bonding wires
- Heavy duty clamps with stainless steel hardware are suitable for direct burial
- Can be combined with Universal Pedestal Clamp for bonding to various pedestal sizes for mesh bonding networks

Material: Copper, Stainless Steel 304 (EN 1.4301)



Part Number	Conductor Size	Standard Packaging Quantity
MBNC240A	#2 Solid - 4/0 Stranded, 35 mm ² - 100 mm ²	25 pc

MESH BONDING NETWORK CONNECTOR, MBNC82

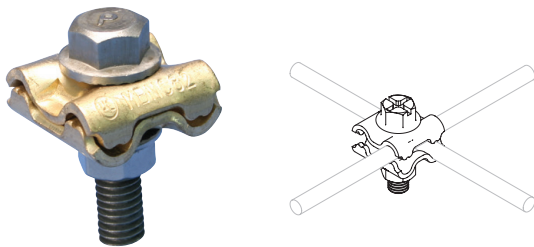

For complete pedestal clamp assembly, reference part number MBNUPJ82

FEATURED HIGHLIGHTS

- Allows for fast, simple and economical field connection of grounding and bonding wires
- Heavy duty clamps with stainless steel hardware are suitable for direct burial
- Can accommodate additional pigtails that can be used to connect to building steel and equipment
- Can be combined with Universal Pedestal Clamp for bonding to various pedestal sizes for mesh bonding networks

Material: Bronze, Stainless Steel 304 (EN 1.4301)



Part Number	Conductor Size	Standard Packaging Quantity
MBNC82	#8 Solid - #2 Stranded, 10 mm ² Solid - 35 mm ² Stranded	25 pc

SRG CONNECTOR

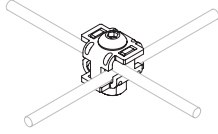

FEATURED HIGHLIGHTS

- Allows for fast, simple and economical field connection of grounding and bonding wires
- Heavy duty clamps with stainless steel hardware are suitable for direct burial
- Can accommodate additional pigtails that can be used to connect to building steel and equipment
- Can be combined with Universal Pedestal Clamp for bonding to various pedestal sizes for mesh bonding networks

Material: Bronze, Stainless Steel 304 (EN 1.4301)



Part Number	Conductor Size
SRGC46	#6 Solid - #4 Stranded, 16 mm ² Stranded

SPLIT BOLT CONNECTOR

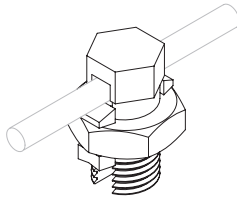

FEATURED HIGHLIGHTS

- Unplated high-strength silicon bronze accommodates copper to copper connections
- Tin plated, high-strength copper alloy split bolt with spacer separates dissimilar conductors and accommodates copper-to-copper, copper-to-aluminum and aluminum-to-aluminum connections

Material: Silicon Bronze



Part Number	Conductor Size	Certifications
Tin Plating: No		
ESB2	#6 Solid - #2 Stranded, 16 mm ² Stranded - 25 mm ² Stranded	cULus
ESB2/0	#2 Solid - 2/0 Stranded, 35 mm ² Stranded - 50 mm ² Stranded	UL
ESB4	#8 Solid - #4 Solid, 10 mm ² Stranded - 16 mm ² Stranded	cULus
ESB4/0	1/0 Solid - 250 kcmil Stranded, 70 mm ² Stranded - 120 mm ² Stranded	
ESB6	#10 Solid - #6 Stranded, 6 mm ² Stranded - 10 mm ² Stranded	cULus
ESB8	#16 Stranded - #8 Stranded, 1.5 mm ² Stranded - 6 mm ² Stranded	cULus
Tin Plating: Yes		
ESBP1/0	#6 Solid - 1/0 Stranded, 16 mm ² Stranded - 50 mm ² Stranded	UL
ESBP2	#8 Solid - #2 Stranded, 10 mm ² Stranded - 25 mm ² Stranded	UL
ESBP2/0	#8 Solid - 2/0 Stranded, 10 mm ² Stranded - 50 mm ² Stranded	UL
ESBP350	3/0 Stranded - 350 kcmil Stranded, 95 mm ² Stranded - 150 mm ² Stranded	
ESBP4	#8 Solid - #3 Stranded, 10 mm ² Stranded - 25 mm ² Stranded	UL
ESBP4/0	#4 Stranded - 250 kcmil Stranded, 25 mm ² Stranded - 120 mm ² Stranded	
ESBP6	#10 Stranded - #6 Stranded, 6 mm ² Stranded - 10 mm ² Stranded	UL
ESBP8	#14 Stranded - #8 Stranded, 2.5 mm ² Stranded - 6 mm ² Stranded	UL

WISE CLAMP

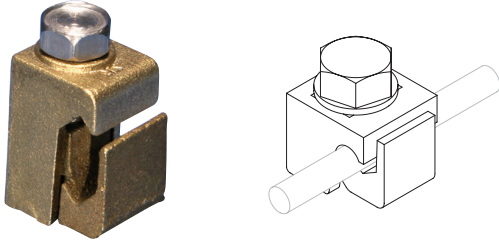

FEATURED HIGHLIGHTS

- Used to splice two conductors together

Material: Bronze

Part Number	Conductor Size
VC62	#6 Solid - #2 Solid, 16 mm ² Solid - 25 mm ² Solid

WISE CLAMP FOR TELECOM

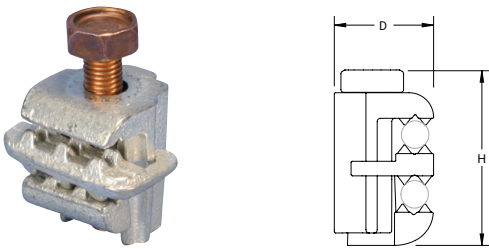

FEATURED HIGHLIGHTS

- Used to bond messenger wire to ground tap conductors
- When clamp is tightened, the piercing teeth puncture the insulation on the messenger wire, forming a positive ground connection without stripping the cable

Material: Copper Alloy, Stainless Steel 304 (EN 1.4301)
 Finish: Tinned

Part Number	Height	Width	Depth	Diameter	Thread Size	Unit Weight
EVC167P	1 5/8"	1 1/4"	1"	0.146" – 0.312"	5/16 UNC	0.21 lb

MULTI-PURPOSE GROUNDING CLAMP, STAINLESS STEEL

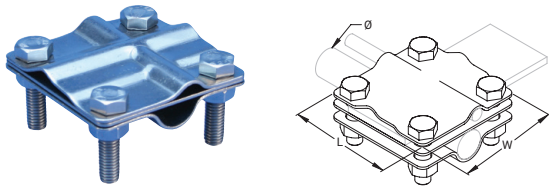

FEATURED HIGHLIGHTS

- Convenient multi-purpose clamp designed to accommodate round conductors, flat conductors, ground rods and rebar
- Stainless steel material with inner plate allows compatibility between most dissimilar metals

Material: Stainless Steel 304 (EN 1.4301)

Conductor Size: 35 mm² Stranded - 50 mm² Stranded, #2 Stranded - 1/0 Solid

Tape Size: 40 x 4 mm Max

Part Number	Ground Rod Diameter, Nominal	Ground Rod Diameter, Actual	Rebar Size, Metric	Rebar Size, US	Rebar Size, Canada	Length	Width
MPSC404SS	5/8" – 3/4"	0.561" – 0.750"	16 – 20 mm	#5 – #6	15M – 20M	2.6"	2.6"

UNIVERSAL CLAMP, SOLID ROUND CONDUCTOR

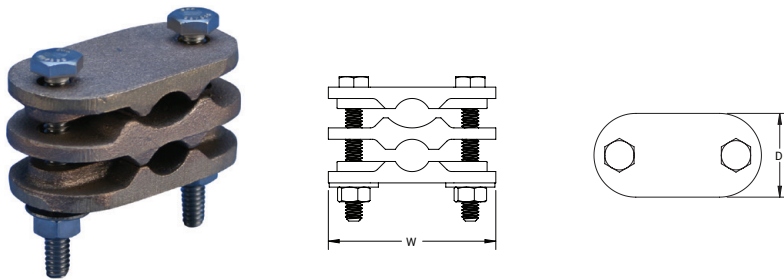

FEATURED HIGHLIGHTS

- For parallel connections of Cu-Bond Round Conductor

Material: Brass

Part Number	Depth	Width	ERICO CU-BOND Conductor	Unit Weight	Complies With
LPC466B	1 1/4"	2 1/2"	CBSC10, CBSC13	0.615 lb	IEC® 62561-1

IEC compliance is valid only for ERICO CU-BOND Conductors listed.

WATER PIPE GROUND CLAMP

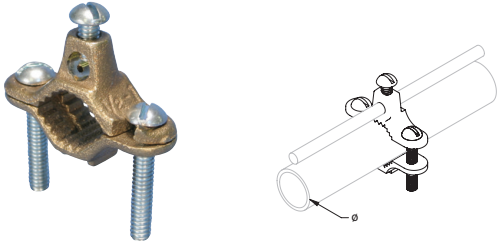

FEATURED HIGHLIGHTS

- High-strength silicone bronze
- Used for connecting copper conductors to metallic water pipe or ground rods



Part Number	Pipe Size, Nominal	Conductor Size	Certifications
Material: Silicon Bronze			
CWP1JJ	1/2" – 1"	#10 Solid - #4 Stranded, 6 mm ² Stranded - 16 mm ² Stranded	
CWP1JU	1/2" – 1"	#10 Solid - #2 Stranded, 6 mm ² Stranded - 25 mm ² Stranded	CSA, cULus
CWP2JU	1 1/4" – 2"	#10 Solid - #2 Stranded, 6 mm ² Stranded - 25 mm ² Stranded	CSA, cULus
CWP4J	2 1/2" – 4"	#10 Solid - #4 Stranded, 6 mm ² Stranded - 16 mm ² Stranded	CSA, cULus
CWP6J	4 1/2" – 6"	#10 Solid - #4 Stranded, 6 mm ² Stranded - 16 mm ² Stranded	CSA
Material: Zinc Alloy			
ZWP1J	1/2" – 1"	#10 Solid - #6 Solid, 6 mm ² Stranded - 10 mm ² Stranded	cULus

Optional copper screw for use in direct burial applications.

WATER/GAS PIPE GROUND CLAMP

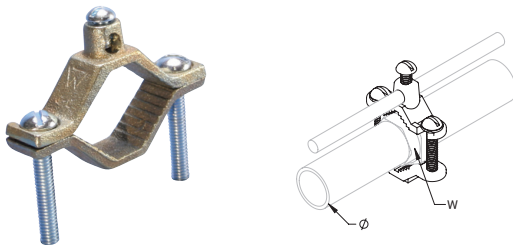

FEATURED HIGHLIGHTS

- High-strength silicone bronze
- Used for connecting copper conductors to metallic water pipe, ground rods, or flexible gas pipe (CSST) with brass hex fittings
- Conform to the requirements of the 2009 edition of NFPA[®] 54, NFGC[®] (National Fuel Gas Code) and NEC[®] (National Electric Code) for bonding corrugated stainless steel tubing (CSST) gas piping systems to the grounding conductor of the building's electrical system
- SH version for outdoor applications



Material: Silicon Bronze

Part Number	Pipe Size, Nominal	Hex Width	Conductor Size	Certifications
For Outdoor Use: No				
CWP1J	1/2" – 1"	1" – 1 1/4"	#10 Solid - #2 Solid, 6 mm ² Solid - 25 mm ² Stranded	CSA, cULus
CWP2J	1 1/4" – 2"	1 1/2" – 2 1/8"	#10 Solid - #2 Stranded, 6 mm ² Stranded - 25 mm ² Stranded	CSA, cULus
CWP3J	2 1/2" – 4"	2 1/2" – 3 1/8"	#10 Solid - #4 Stranded, 6 mm ² Stranded - 16 mm ² Stranded	cULus
For Outdoor Use: Yes				
CWP1JSH	1/2" – 1"	1" – 1 1/4"	#10 Solid - #2 Stranded, 6 mm ² Stranded - 25 mm ² Stranded	cULus
CWP2JSH	1 1/4" – 2"	1 1/2" – 2 1/8"	#10 Solid - #2 Stranded, 6 mm ² Solid - 25 mm ² Stranded	cULus
CWP3JSH	2 1/2" – 4"	2 1/2" – 3 1/8"	#10 Solid - #4 Stranded, 6 mm ² Stranded - 16 mm ² Stranded	cULus

CAST PIPE CLAMP

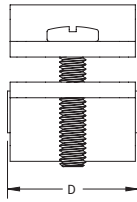
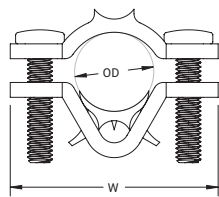

FEATURED HIGHLIGHTS

- Clamp for bonding horizontal or vertical pipes to the lightning protection system
- Listed to UL® 96

Conductor Size, UL: Class 1 - Class 2 (4/0 Max), Secondary



Part Number	Outer Diameter	Depth	Width	Unit Weight
Material: Brass – Finish: Bare				
LPC580	0.75" – 1.32"	1 1/2"	2 3/4"	0.59 lb
Material: Brass – Finish: Tinned				
LPC580L	0.75" – 1.32"	1 1/2"	2 3/4"	0.59 lb

CAST U-BOLT PIPE CLAMP

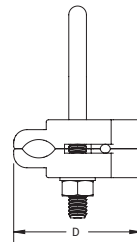
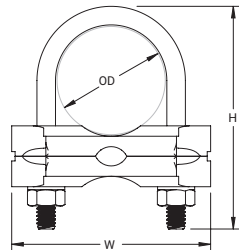
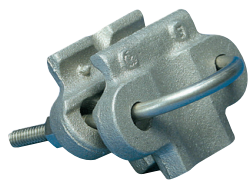

FEATURED HIGHLIGHTS

- Clamp for bonding conductor to handrails, pipes and rebar to lightning protection system
- Listed to UL® 96

Conductor Size, UL: Class 1 - Class 2 (4/0 Max), Secondary



Part Number	Outer Diameter	Depth	Height	Width	Unit Weight
Material: Brass – Finish: Bare					
LPC570	0.68" – 1.50"	1.8"	3"	2.67"	0.715 lb
Material: Brass – Finish: Tinned					
LPC570L	0.68" – 1.50"	1.8"	3"	2.67"	0.715 lb

NOTCHED CAST U-BOLT PIPE CLAMP

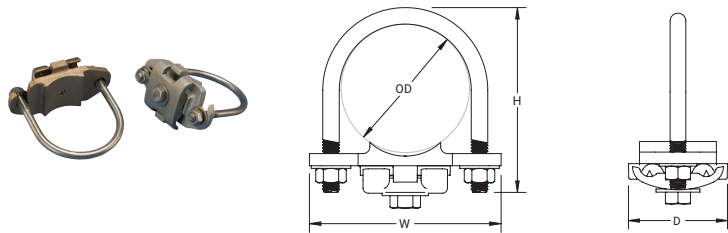

FEATURED HIGHLIGHTS

- Clamp for bonding of handrails and pipes to the lightning protection system
- Notched hole makes assembly easy and eliminates loose hardware
- Listed to UL® 96

Conductor Size, UL: Class 1 - Class 2 (4/0 Max)



Part Number	Outer Diameter	Depth	Height	Width	Unit Weight
Material: Aluminum – Finish: Bare					
LPA571	2" – 2 1/2"	1.96"	3 1/2"	3.63"	0.400 lb
Material: Brass – Finish: Bare					
LPC571	2" – 2 1/2"	1.96"	3 1/2"	3.63"	0.835 lb
Material: Brass – Finish: Tinned					
LPC571L	2" – 2 1/2"	1.96"	3 1/2"	3.63"	0.835 lb

PIPE TO RIGID CONDUIT GROUND CLAMP

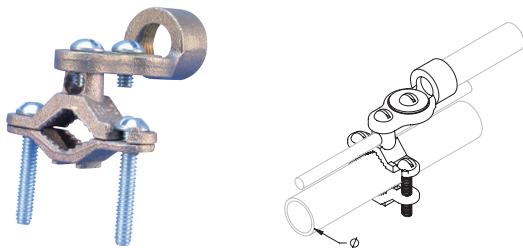

FEATURED HIGHLIGHTS

- For use in grounding rigid conduit systems to metallic water pipe

Material: Bronze

Part Number	Water Pipe Size	Rigid Conduit Size	Conductor Size
CWP1JH12	1/2" – 1"	1/2"	#10 Solid - #6 Solid
CWP1JH34	1/2" – 1"	3/4"	#10 Solid - 2/0 Stranded
CWP2JH34	1 1/4" – 2"	3/4"	#10 Solid - 2/0 Stranded
CWP2JH44	1 1/4" – 2"	1"	#10 Solid - 3/0 Stranded
CWP4JH34	2 1/2" – 4"	3/4"	#10 Solid - 2/0 Stranded

STAMPED U-BOLT PIPE CLAMP

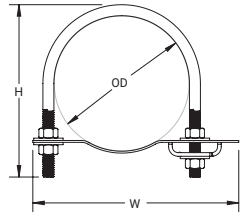
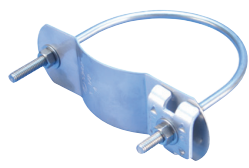

FEATURED HIGHLIGHTS

- Clamp for bonding of pipes and exhaust stacks to the lightning protection system
- Listed to UL® 96



Part Number	Outer Diameter	Depth	Height	Width	Unit Weight
Material: Copper, Stainless Steel 304 (EN 1.4301)					
LPC5964	3.900" – 4.625"	2"	5 13/16"	6.250"	0.885 lb
LPC5966	0.438" – 6.858"	2"	8 13/16"	8.313"	0.820 lb

STAMPED U-BOLT PIPE CLAMP, 90°

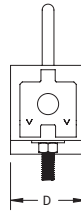
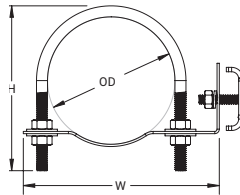

FEATURED HIGHLIGHTS

- Clamp for bonding of pipes, handrails and exhaust stacks to the lightning protection system
- Listed to UL® 96



Conductor Size, UL: Class 1 - Class 2 (4/0 Max)

Part Number	Outer Diameter	Depth	Height	Width	Unit Weight
Material: Copper, Stainless Steel 304 (EN 1.4301)					
LPC5962	1.900" – 2.625"	2"	3.625"	4.675"	0.515 lb
LPC5963	2.630" – 3.630"	2"	4.693"	5.500"	0.763 lb

THIN WALL PIPE GROUND CLAMP ASSEMBLY

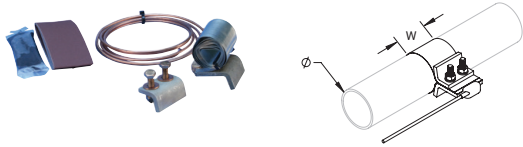

FEATURED HIGHLIGHTS

- Tinned copper strap draws tightly around pipe
- All hardware is included
- Includes emery cloth and anti-oxidant compound
- Conductor stub is easily spliced to ground conductor
- Cadweld connection of conductor to strap eliminates a mechanical interface

Material: Copper, Silicon Bronze
Finish: Tinned

Part Number	Width	Water Pipe Size	Conductor Size	Cable Length
B852A12C1G96	2"	3" – 12"	#6 Solid	96'
B852A12C2Q60	2"	3" – 12"	4/0 Concentric	60'
B852A8C1G48	2"	3" – 8"	#6 Solid	48'
B852A8C1G96	2"	3" – 8"	#6 Solid	96'

CABLE/POINT PIPE SUPPORT

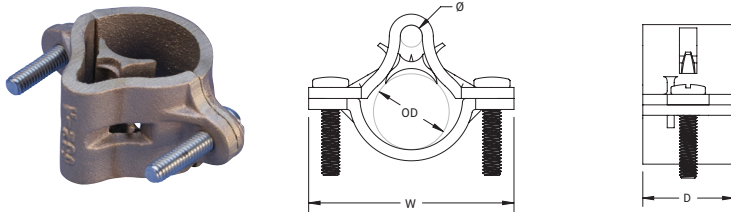

FEATURED HIGHLIGHTS

- Clamp for bonding horizontal or vertical pipes to the lightning protection system
- May be used as a vertical support for air terminals
- Listed to UL® 96

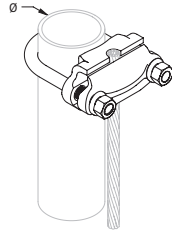

Part Number	Diameter	Outer Diameter	Depth	Width	Unit Weight
Material: Brass – Finish: Bare					
LPC330	3/8"	1.40" – 1.75"	1 5/8"	3.5"	0.790 lb
LPC331	3/8"	1.85" – 2.75"	1 5/8"	3.9"	0.835 lb
Material: Brass – Finish: Tinned					
LPC330L	3/8"	1.40" – 1.75"	1 5/8"	3.5"	0.790 lb
LPC331L	3/8"	1.85" – 2.75"	1 5/8"	3.9"	0.835 lb

FENCE CLAMP, ONE CONDUCTOR**FEATURED HIGHLIGHTS**

- Theft-deterrent appearance
- Stainless steel hardware included
- Tin plating minimizes the risk of corrosion
- The clamp accepts the conductor either in parallel or at right angles to the pipe

Material: Bronze, Stainless Steel 304 (EN 1.4301)

Finish: Tinned



Part Number	Fence Post Size, Nominal	Fence Post Outside Diameter, Actual	Conductor Size	Cu-Bond Conductor	Complies With	Certifications
FC073	1 1/2"	1.90"	#4 Solid - 2/0 Stranded, 16 mm ² Stranded - 70 mm ² Stranded			
FC074	1 1/2"	1.90"	2/0 Solid - 250 kcmil Stranded, 50 mm ² Stranded - 120 mm ² Stranded			
FC075	2"	2.38"	#4 Solid - 2/0 Stranded, 16 mm ² Stranded - 70 mm ² Stranded	CBSC8	IEC® 62561-1	cULus
FC076	2"	2.38"	2/0 Solid - 250 kcmil Stranded, 50 mm ² Stranded - 120 mm ² Stranded	CBSC10, CBSC13	IEC® 62561-1	
FC078	2 1/2"	2.88"	2/0 Solid - 250 kcmil Stranded, 16 mm ² Stranded - 120 mm ² Stranded			
FC079	3"	3.50"	#4 Solid - 2/0 Stranded, 16 mm ² Stranded - 70 mm ² Stranded			
FC080	3"	3.50"	2/0 Solid - 250 kcmil Stranded, 50 mm ² Stranded - 120 mm ² Stranded			
FC082	3 1/2"	4.00"	#4 Solid - 2/0 Stranded, 16 mm ² Stranded - 120 mm ² Stranded			

IEC compliance is valid only for Cu-Bond Conductors listed.

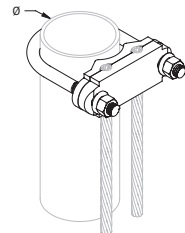
FENCE CLAMP, TWO CONDUCTORS**FEATURED HIGHLIGHTS**

- Theft-deterrent appearance
- Stainless steel hardware included
- Tin plating minimizes the risk of corrosion

Material: Copper Alloy, Stainless Steel 304 (EN 1.4301)

Finish: Tinned



Part Number	Fence Post Size, Nominal	Fence Post Outside Diameter, Actual	Conductor Size
FC076DH	2"	2.38"	2/0 Solid - 250 kcmil Stranded, 50 mm ² Stranded - 120 mm ² Stranded
FC078DH	2 1/2"	2.88"	2/0 Solid - 250 kcmil Stranded, 16 mm ² Stranded - 120 mm ² Stranded
FC082DH	3 1/2"	4.00"	#4 Solid - 2/0 Stranded, 16 mm ² Stranded - 120 mm ² Stranded

FENCE CLAMP FOR FIELD-WELDED CONNECTIONS

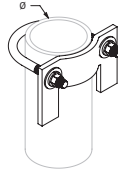

FEATURED HIGHLIGHTS

- Ideal for when Cadweld connections cannot be made to aluminum pipe or thin-wall steel tube
- Stainless steel hardware included
- Can be used when field-welding conductors

Material: Electrolytic Copper
Finish: Tinned

Part Number	Fence Post Size, Nominal	Fence Post Outside Diameter, Actual
B522B	1 1/4"	1.66"
B522C	1 1/2"	1.90"
B522D	2"	2.38"
B522E	2 1/2"	2.88"
B522F	3"	3.50"
B522G	3 1/2"	4.00"
B522H	4"	4.50"
B522K	6"	6.63"

FLEXIBLE JUMPER FOR FENCE AND GATE GROUNDING

FEATURED HIGHLIGHTS

- Used to bond gates, switch operating handles and any other item where movement or vibration requires a flexible grounding jumper
- Multi-stranded insulated ropelay conductor provides flexibility and strand protection
- Swaged ends of jumper allow larger conductor to fit in the same mold as concentric conductor
- Connections are made with Cadweld exothermic connections using the same mold required for other fence post connections



Part Number	Article Number	Color Code Ring
FJ	Flexible Jumper	
2Q	Cable Code	#2 Solid = 1T 2/0 Stranded = 2G 4/0 Stranded = 2Q
24	Length of Jumper (inches)	

Material: Copper, Polyethylene Rubber

Part Number	Cable Code	Conductor Size	Cable Length
FJ1T18	1T	#2 Solid	18"
FJ1T24	1T	#2 Solid	24"
FJ1T240	1T	#2 Solid	240"
FJ1T42	1T	#2 Solid	42"
FJ1T96	1T	#2 Solid	96"
FJ2G12	2G	2/0 Stranded	12"
FJ2G120	2G	2/0 Stranded	120"
FJ2G132	2G	2/0 Stranded	132"
FJ2G144	2G	2/0 Stranded	144"
FJ2G16	2G	2/0 Stranded	16"
FJ2G168	2G	2/0 Stranded	168"
FJ2G18	2G	2/0 Stranded	18"

Part Number	Cable Code	Conductor Size	Cable Length
FJ2G180	2G	2/0 Stranded	180"
FJ2G228	2G	2/0 Stranded	228"
FJ2G24	2G	2/0 Stranded	24"
FJ2G30	2G	2/0 Stranded	30"
FJ2G36	2G	2/0 Stranded	36"
FJ2G360	2G	2/0 Stranded	360"
FJ2G72	2G	2/0 Stranded	72"
FJ2G84	2G	2/0 Stranded	84"
FJ2G96	2G	2/0 Stranded	96"
FJ2Q120	2Q	4/0 Stranded	120"
FJ2Q156	2Q	4/0 Stranded	156"
FJ2Q16	2Q	4/0 Stranded	16"
FJ2Q168	2Q	4/0 Stranded	168"
FJ2Q18	2Q	4/0 Stranded	18"
FJ2Q180	2Q	4/0 Stranded	180"
FJ2Q216	2Q	4/0 Stranded	216"
FJ2Q24	2Q	4/0 Stranded	24"
FJ2Q240	2Q	4/0 Stranded	240"
FJ2Q252	2Q	4/0 Stranded	252"
FJ2Q36	2Q	4/0 Stranded	36"
FJ2Q384	2Q	4/0 Stranded	384"
FJ2Q48	2Q	4/0 Stranded	48"
FJ2Q600	2Q	4/0 Stranded	600"
FJ2QA24	2Q	4/0 Stranded	24"

PREFABRICATED FENCE CLAMP ASSEMBLY WITH SINGLE GROUND LEAD



FEATURED HIGHLIGHTS

- Ideal for when Cadweld connections cannot be made to aluminum pipe or thin-wall steel tube
- Stainless steel hardware included
- Available in either left or right-hand orientation

Material: Copper, Polyethylene Rubber

A235-D-2G-2-RH

A235	Series	
D	Nominal Pipe Size (inches)	B = 1 1/4" C = 1 1/2" D = 2" E = 2 1/2" F = 3" G = 3-1/2" H = 4"
2G	Ground Lead Cable Code (AWG)	2C = 1/0 Stranded 2G = 2/0 Stranded 2Q = 4/0 Stranded
2	Ground Lead Length (feet)	
RH	Ground Lead Side	LH = Left Hand RH = Right Hand

Material: Copper, Stainless Steel 18-8 (EN 1.4305), Stainless Steel 304 (EN 1.4301)
Finish: Tinned

Part Number	Fence Post Size, Nominal	Fence Post Outside Diameter, Actual	Ground Lead Conductor Size	Ground Lead Length
Orientation: Left Hand				
A235C2C1LH	1 1/2"	1.90"	1/0 Str	1'
A235D2G4LH	2"	2.38"	2/0 Str	4'
A235D2Q4LH	2"	2.38"	4/0 Str	4'
A235D2Q5LH	2"	2.38"	4/0 Str	5'
A235E2G4LH	2 1/2"	2.88"	2/0 Str	4'
A235E2Q4LH	2 1/2"	2.88"	4/0 Str	4'
A235E2Q5LH	2 1/2"	2.88"	4/0 Str	5'
A235F2C2LH	3"	3.50"	1/0 Str	2'
Orientation: Right Hand				
A235D2G2RH	2"	2.38"	2/0 Str	2'
A235D2Q4RH	2"	2.38"	4/0 Str	4'
A235D2Q5RH	2"	2.38"	4/0 Str	5'
A235E2Q2RH	2 1/2"	2.88"	4/0 Str	2'
A235E2Q5RH	2 1/2"	2.88"	4/0 Str	5'
A235G2Q2RH	3 1/2"	4.00"	4/0 Str	2'
A235H2C10RH	4"	4.50"	1/0 Str	10'

Right hand orientation shown in diagram.

PREFABRICATED GATE JUMPER ASSEMBLY

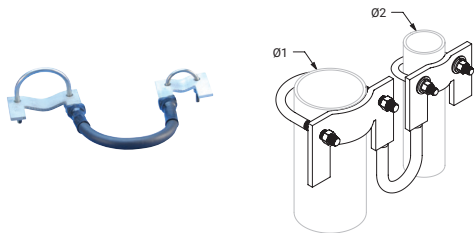

FEATURED HIGHLIGHTS

- Ideal for when Cadweld connections cannot be made to aluminum pipe or thin-wall steel tube
- Jumper conductor is insulated
- Stainless steel hardware included
- Available in either left or right-hand orientation

A238-EB-2S-12-LH

A238	Series	
EB	Clamp Code	EB = 2 1/2" Gate, 1 1/4" Post EC = 2 1/2" Gate, 1 1/2" Post FB = 3" Gate, 1 1/4" Post FC = 3" Gate, 1 1/2" Post GB = 3 1/2" Gate, 1 1/4" Post GC = 3 1/2" Gate, 1 1/2" Post HB = 4" Gate, 1 1/4" Post HC = 4" Gate, 1 1/2" Post
2S	4/0 AWG Flexible Jumper Designation	
12	Jumper Length (inches)	
LH	Jumper Side	LH = Left Hand RH = Right Hand

Material: Copper, Stainless Steel 18-8 (EN 1.4305), Stainless Steel 304 (EN 1.4301)
Finish: Tinned

Part Number	Fixed Gate Diameter, Nominal	Fixed Gate Diameter, Actual	Post Frame Diameter, Nominal	Post Frame Diameter, Actual	Jumper Conductor Size	Jumper Length
Orientation: Left Hand						
A238EB2S12LH	2 1/2"	2.88"	1 1/4"	1.66"	4/0 Str	12"
A238EC2S12LH	2 1/2"	2.88"	1 1/2"	1.90"	4/0 Str	12"
A238EC2S24LH	2 1/2"	2.88"	1 1/2"	1.90"	4/0 Str	24"
A238FC2S12LH	3"	3.50"	1 1/2"	1.90"	4/0 Str	12"
A238FC2S16LH	3"	3.50"	1 1/2"	1.90"	4/0 Str	16"
A238FC2S18LH	3"	3.50"	1 1/2"	1.90"	4/0 Str	18"
A238FC2S24LH	3"	3.50"	1 1/2"	1.90"	4/0 Str	24"
A238FD2S18LH	3"	3.50"	2"	2.38"	4/0 Str	18"
A238GC2S12LH	3 1/2"	4.00"	1 1/2"	1.90"	4/0 Str	12"
A238GC2S18LH	3 1/2"	4.00"	1 1/2"	1.90"	4/0 Str	18"
A238GC2S24LH	3 1/2"	4.00"	1 1/2"	1.90"	4/0 Str	24"
A238HB2S18LH	4"	4.50"	1 1/4"	1.66"	4/0 Str	18"
A238HC2S24LH	4"	4.50"	1 1/2"	1.90"	4/0 Str	24"
A238KC2S24LH	6"	6.63"	1 1/2"	1.90"	4/0 Str	24"
Orientation: Right Hand						
A238EC2S12RH	2 1/2"	2.88"	1 1/2"	1.90"	4/0 Str	12"
A238EC2S24RH	2 1/2"	2.88"	1 1/2"	1.90"	4/0 Str	24"
A238FC2S12RH	3"	3.50"	1 1/2"	1.90"	4/0 Str	12"
A238FC2S16RH	3"	3.50"	1 1/2"	1.90"	4/0 Str	16"
A238FC2S18RH	3"	3.50"	1 1/2"	1.90"	4/0 Str	18"
A238FC2S24RH	3"	3.50"	1 1/2"	1.90"	4/0 Str	24"
A238FD2S18RH	3"	3.50"	2"	2.38"	4/0 Str	18"
A238FF2S12RH	3"	3.50"	3"	3.50"	4/0 Str	12"
A238GC2S12RH	3 1/2"	4.00"	1 1/2"	1.90"	4/0 Str	12"
A238GC2S18RH	3 1/2"	4.00"	1 1/2"	1.90"	4/0 Str	18"
A238GC2S24RH	3 1/2"	4.00"	1 1/2"	1.90"	4/0 Str	24"

Part Number	Fixed Gate Diameter, Nominal	Fixed Gate Diameter, Actual	Post Frame Diameter, Nominal	Post Frame Diameter, Actual	Jumper Conductor Size	Jumper Length
A238GD2S24RH	3 1/2"	4.00"	2"	2.38"	4/0 Str	24"
A238HB2S18RH	4"	4.50"	1 1/4"	1.66"	4/0 Str	18"
A238HD2S24RH	4"	4.50"	2"	2.38"	4/0 Str	24"
A238KC2S24RH	6"	6.63"	1 1/2"	1.90"	4/0 Str	24"
A238KD2S24RH	6"	6.63"	2"	2.38"	4/0 Str	24"

"Fixed gate" refers to the pipe on the fence itself, while "post frame" refers to the post on the swinging door. Left hand orientation shown in diagram.

PREFABRICATED GATE JUMPER ASSEMBLY WITH GROUND LEADS

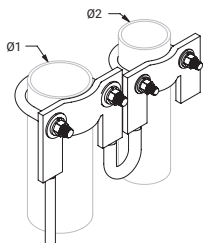

FEATURES

- Ideal for when Cadweld connections cannot be made to aluminum pipe or thin-wall steel tube
- Jumper conductor is insulated
- Stainless steel hardware included
- Available in either left or right-hand orientation

A239-EB-2S-24-2Q-4-RH		
A239	Series	
EB	Clamp Code	EB = 2 1/2" Gate, 1 1/4" Post EC = 2 1/2" Gate, 1 1/2" Post FB = 3" Gate, 1 1/4" Post FC = 3" Gate, 1 1/2" Post GB = 3 1/2" Gate, 1 1/4" Post GC = 3 1/2" Gate, 1 1/2" Post HB = 4" Gate, 1 1/4" Post HC = 4" Gate, 1 1/2" Post
2S	4/0 AWG Flexible Jumper Designation	
24	Jumper Length (inches)	
2Q	Ground Lead Cable Code (AWG)	2C = 1/0 Stranded 2G = 2/0 Stranded 2Q = 4/0 Stranded 9F = Copper-Clad Steel #9, 19-Strand
4	Ground Lead Length (feet)	
RH	Ground Lead Side	LH = Left Hand RH = Right Hand

Material: Copper, Stainless Steel 18-8 (EN 1.4305), Stainless Steel 304 (EN 1.4301)

Finish: Tinned

Part Number	Fixed Gate Diameter, Nominal	Fixed Gate Diameter, Actual	Post Frame Diameter, Nominal	Post Frame Diameter, Actual	Jumper Conductor Size	Jumper Length	Ground Lead Conductor Size	Ground Lead Length
Orientation: Left Hand								
A239DC2S242C4LH	2"	2.38"	1 1/2"	1.9"	4/0 Str	24"	1/0 Str	4'
A239EC2S182Q6LH	2 1/2"	2.88"	1 1/2"	1.9"	4/0 Str	18"	4/0 Str	6'
A239EC2S242C4LH	2 1/2"	2.88"	1 1/2"	1.9"	4/0 Str	24"	1/0 Str	4'
A239EC2S242G8LH	2 1/2"	2.88"	1 1/2"	1.9"	4/0 Str	24"	2/0 Str	8'
A239EC2S242Q4LH	2 1/2"	2.88"	1 1/2"	1.9"	4/0 Str	24"	4/0 Str	4'
A239FC2S242C2LH	3"	3.50"	1 1/2"	1.9"	4/0 Str	24"	1/0 Str	2'
A239FC2S242G4LH	3"	3.50"	1 1/2"	1.9"	4/0 Str	24"	2/0 Str	4'
A239FC2S242G5LH	3"	3.50"	1 1/2"	1.9"	4/0 Str	24"	2/0 Str	5'
A239FC2S242Q10L	3"	3.50"	1 1/2"	1.9"	4/0 Str	24"	4/0 Str	10'
A239FC2S242Q2LH	3"	3.50"	1 1/2"	1.9"	4/0 Str	24"	4/0 Str	2'
A239FC2S242Q4LH	3"	3.50"	1 1/2"	1.9"	4/0 Str	24"	4/0 Str	4'
A239FC2S242Q8LH	3"	3.50"	1 1/2"	1.9"	4/0 Str	24"	4/0 Str	8'

Part Number	Fixed Gate Diameter, Nominal	Fixed Gate Diameter, Actual	Post Frame Diameter, Nominal	Post Frame Diameter, Actual	Jumper Conductor Size	Jumper Length	Ground Lead Conductor Size	Ground Lead Length
A239FD2S241V1LH	3"	3.50"	2"	2.4"	4/0 Str	24"	#2 Str	1'
A239FD2S242G4LH	3"	3.50"	2"	2.4"	4/0 Str	24"	2/0 Str	4'
A239GC2S242Q4LH	3 1/2"	4.00"	1 1/2"	1.9"	4/0 Str	24"	4/0 Str	4'
A239HC2S182C5LH	4"	4.50"	1 1/2"	1.9"	4/0 Str	18"	1/0 Str	5'
A239HC2S182Q6LH	4"	4.50"	1 1/2"	1.9"	4/0 Str	18"	4/0 Str	6'
A239HC2S242C10L	4"	4.50"	1 1/2"	1.9"	4/0 Str	24"	1/0 Str	10'
A239HC2S242C4LH	4"	4.50"	1 1/2"	1.9"	4/0 Str	24"	1/0 Str	4'
A239HC2S242G30L	4"	4.50"	1 1/2"	1.9"	4/0 Str	24"	2/0 Str	30'
A239HC2S242G4LH	4"	4.50"	1 1/2"	1.9"	4/0 Str	24"	2/0 Str	4'
A239HC2S242G5LH	4"	4.50"	1 1/2"	1.9"	4/0 Str	24"	2/0 Str	5'
A239HC2S242Q2LH	4"	4.50"	1 1/2"	1.9"	4/0 Str	24"	4/0 Str	2'
A239HD2S242Q2LH	4"	4.50"	2"	2.4"	4/0 Str	24"	4/0 Str	2'
A239HD2S242Q5LH	4"	4.50"	2"	2.4"	4/0 Str	24"	4/0 Str	5'
Orientation: Right Hand								
A239EB2S242Q4RH	2 1/2"	2.88"	1 1/4"	1.7"	4/0 Str	24"	4/0 Str	4'
A239EC2S242C4RH	2 1/2"	2.88"	1 1/2"	1.9"	4/0 Str	24"	1/0 Str	4'
A239EC2S242Q4RH	2 1/2"	2.88"	1 1/2"	1.9"	4/0 Str	24"	4/0 Str	4'
A239FC2S122G24R	3"	3.50"	1 1/2"	1.9"	4/0 Str	12"	2/0 Str	24'
A239FC2S242C2RH	3"	3.50"	1 1/2"	1.9"	4/0 Str	24"	1/0 Str	2'
A239FC2S242G4RH	3"	3.50"	1 1/2"	1.9"	4/0 Str	24"	2/0 Str	4'
A239FC2S242G5RH	3"	3.50"	1 1/2"	1.9"	4/0 Str	24"	2/0 Str	5'
A239FC2S242Q4RH	3"	3.50"	1 1/2"	1.9"	4/0 Str	24"	4/0 Str	4'
A239FD2S242G4RH	3"	3.50"	2"	2.4"	4/0 Str	24"	2/0 Str	4'
A239GC2S242Q4RH	3 1/2"	4.00"	1 1/2"	1.9"	4/0 Str	24"	4/0 Str	4'
A239HB2S242Q1RH	4"	4.50"	1 1/4"	1.7"	4/0 Str	24"	4/0 Str	1'
A239HC2S182C5RH	4"	4.50"	1 1/2"	1.9"	4/0 Str	18"	1/0 Str	5'
A239HC2S242C10R	4"	4.50"	1 1/2"	1.9"	4/0 Str	24"	1/0 Str	10'
A239HC2S242C4RH	4"	4.50"	1 1/2"	1.9"	4/0 Str	24"	1/0 Str	4'
A239HC2S242G30R	4"	4.50"	1 1/2"	1.9"	4/0 Str	24"	2/0 Str	30'
A239HC2S242G5RH	4"	4.50"	1 1/2"	1.9"	4/0 Str	24"	2/0 Str	5'
A239HC2S242Q2RH	4"	4.50"	1 1/2"	1.9"	4/0 Str	24"	4/0 Str	2'
A239HD2S242Q2RH	4"	4.50"	2"	2.4"	4/0 Str	24"	4/0 Str	2'
A239HD2S242Q5RH	4"	4.50"	2"	2.4"	4/0 Str	24"	4/0 Str	5'
A239KD2S242Q4RH	6"	4.50"	2"	2.4"	4/0 Str	24"	4/0 Str	4'

"Fixed gate" refers to the pipe on the fence itself, while "post frame" refers to the post on the swinging door. Left hand orientation shown in diagram.

REBAR GROUNDING CLAMP, PARALLEL

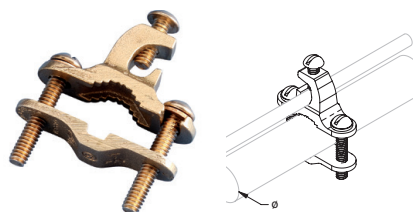

FEATURED HIGHLIGHTS

- Universal use for rebar, rods or pipes
- Lay-in feature cuts installation time
- Bronze alloy construction with Stainless Steel 304 screws
- Approved for direct burial in earth and concrete

Material: Bronze, Stainless Steel 304 (EN 1.4301)

Connection Type: Parallel

Conductor Size:



Part Number	Ground Rod Diameter, Actual	Water Pipe Size	Rebar Size, Metric	Rebar Size, US	Rebar Size, Canada
EK16	0.5" – 1.0"	1/2" – 1"	12 – 25 mm	#4 – #8	10M – 25M

REBAR GROUNDING CLAMP, PERPENDICULAR

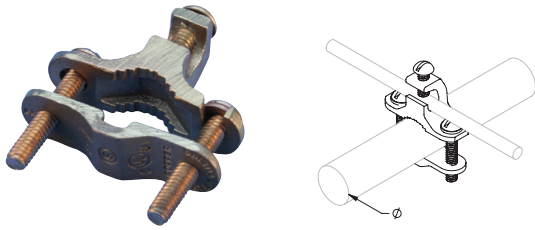

Material: Bronze, Stainless Steel 304 (EN 1.4301)
 Connection Type: Perpendicular
 Conductor Size:

FEATURED HIGHLIGHTS

- Universal use for rebar, rods or pipes
- Lay-in feature cuts installation time
- Bronze alloy construction with Stainless Steel 304 screws
- Approved for direct burial in earth and concrete



Part Number	Ground Rod Diameter, Actual	Water Pipe Size	Rebar Size, Metric	Rebar Size, US	Rebar Size, Canada
EK17	0.5" – 1.0"	1/2" – 1"	12 – 25 mm	#4 – #8	10M – 25M

REBAR GROUNDING CLAMP, HEAVY DUTY

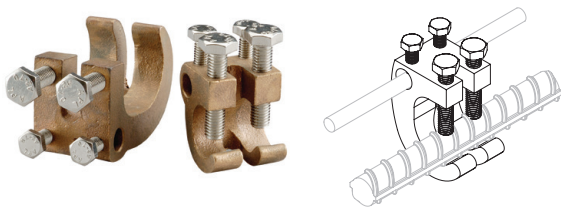

FEATURED HIGHLIGHTS

- Provides two connection points to concrete encased electrodes (rebar) for states where the Authority Having Jurisdiction (AHJ) requires it
- Meets 2005 NEC® standard requirement for bonding to rebar into the grounding system
- Has high-strength bronze alloy construction
- Easy to install



Part Number	Rebar Size, Metric	Rebar Size, US	Rebar Size, Canada
Conductor Size: #8 Solid - 2/0 Stranded, 10 mm² Stranded - 70 mm² Stranded			
RC70	8 – 18 mm	#3 – #6	10M – 20M
Conductor Size: #8 Solid - 4/0 Stranded, 10 mm² Stranded - 100 mm² Stranded			
RC100	18 – 36 mm	#6 – #11	20M – 35M

REBAR BONDING CLAMP

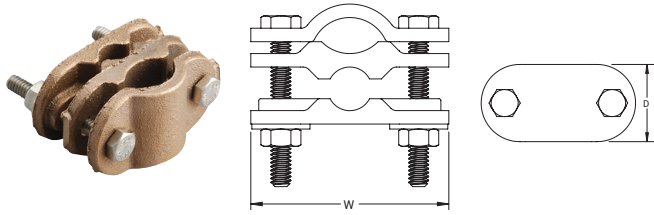

Material: Brass

Conductor Size, UL: Class 2 (4/0 Max)



FEATURED HIGHLIGHTS

- Provides bond from lightning protection system to rebar

Part Number	Rebar Size, Canada	Rebar Size, Metric	Rebar Size, US	Depth	Width	Unit Weight
LPC466	10M Max	29 mm Max	#9 Max	1 1/4"	2 1/2"	0.615 lb

ARC WELDABLE BOND

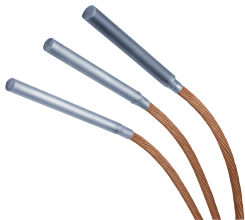

Material: Copper, Steel

FEATURED HIGHLIGHTS

- 19-strand concentric cable flash-welded to steel rod for a bonding connection to structural steel and to rebar
- Economical alternative to exothermic welding when only a few connections need to be made and an arc welder is available on site
- Rod is sized to match the ampacity of the cable for fault currents

Part Number	Conductor Size	Cable Length	Rod Size	Rod Length
EWB2G9164	2/0 Stranded	4'	9/16"	8"
EWB2L584	3/0 Stranded	4'	5/8"	8"
EWB2Q344	4/0 Stranded	4'	3/4"	8"
EWBCS701	70 mm ² Stranded	3'	1/2"	8"

UNIVERSAL PEDESTAL CLAMP WITH CABLE MANAGEMENT, MBNUPCJ240

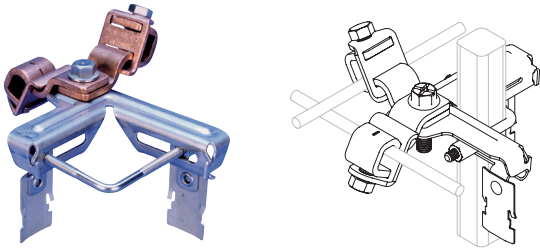

For individual connector, reference part number MBNC240A

Material: Copper, Steel, Stainless Steel 304 (EN 1.4301)
Finish: nVent CADDY Armour, Electrogalvanized



Part Number	Conductor Size	Pedestal Size	Standard Packaging Quantity
MBNUPCJ240	#2 Solid - 4/0 Stranded, 35 mm ² - 100 mm ²	7/8" - 2" Round or Square	25 pc

FEATURED HIGHLIGHTS

- Only one attachment required for both mesh bonding and cable management
- Eliminates the need for separate mounting brackets for different pedestal types or sizes
- Stainless steel construction of bracket and hardware reduces potential for galvanic corrosion
- Mesh bonding conductors do not have to bend around each pedestal to conform to grid pattern
- Suitable for round or square pedestals

UNIVERSAL PEDESTAL CLAMP WITH CABLE MANAGEMENT, MBNUPCJ82

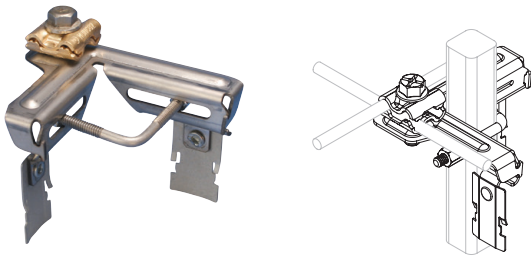

For individual connector, reference part number MBNC82

Material: Copper, Steel, Stainless Steel 304 (EN 1.4301)
Finish: nVent CADDY Armour, Electrogalvanized



Part Number	Conductor Size	Pedestal Size	Standard Packaging Quantity
MBNUPCJ82	#8 Solid - #2 Stranded, 10 mm ² Solid - 35 mm ² Stranded	7/8" - 2" Round or Square	25 pc

FEATURED HIGHLIGHTS

- Only one attachment required for both mesh bonding and cable management
- Eliminates the need for separate mounting brackets for different pedestal types or sizes
- Stainless steel construction of bracket and hardware reduces potential for galvanic corrosion
- Mesh bonding conductors do not have to bend around each pedestal to conform to grid pattern
- Suitable for round or square pedestals

SRG CONNECTOR PEDESTAL MOUNTING BRACKET

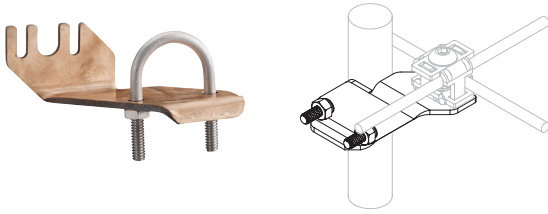

FEATURED HIGHLIGHTS

- Only one attachment required for both mesh bonding and cable management
- Eliminates the need for separate mounting brackets for different pedestal types or sizes
- Stainless steel construction of bracket and hardware reduces potential for galvanic corrosion
- Mesh bonding conductors do not have to bend around each pedestal to conform to grid pattern
- Suitable for round or square pedestals

Material: Stainless Steel 304 (EN 1.4301), Bronze



Part Number	Pedestal Size	Standard Packaging Quantity
SRGC46BR	7/8" Square; 1" Round	10 pc

COMMON BONDING NETWORK JUMPER

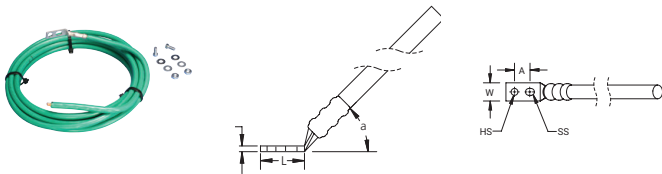

FEATURED HIGHLIGHTS

- Helps to achieve a secure electrical connection in telecommunications
- Stranded wire allows for small radius bends
- Tinned copper lug and hardware included

Material: Steel, Copper
 Finish: Electrogalvanized, Tinned
 Number of Wires: 7
 Insulation: Green Insulated Conductor

Part Number	Length	Width	A	Thickness	Hole Size	Slot Size	Angle	Conductor Size	Cable Length	Standard Packaging Quantity
CBNJ09	1.27"	0.48"	0.57"	0.08"	0.27"	0.27" x 0.40"	45°	#6 Stranded	9'	25 pc
CBNJ09P10	1.27"	0.48"	0.57"	0.08"	0.27"	0.27" x 0.40"	45°	#6 Stranded	9'	5 x 10 pc

COPPER LUG MECHANICAL CONNECTOR

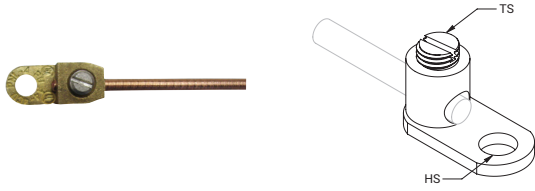

FEATURED HIGHLIGHTS

- Simple to use and install
- Suitable for telecom and equipotential bonding applications

Material: Copper



Part Number	Conductor Size	Thread Size	Hole Size
EL4	#14 Solid - #4 Stranded, 2.5 mm ² Stranded - 16 mm ² Stranded	5/16 UNF	0.3"

FLUSH MOUNT POSITIONER, SOLID ROUND CONDUCTOR

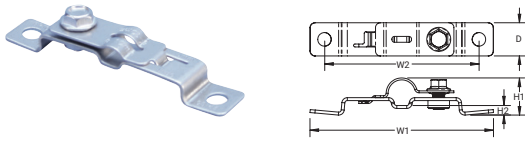

FEATURED HIGHLIGHTS

- Flush-mount positioning clamps for use with solid round conductors, including Cu-Bond Round Conductor
- For use with copper-bonded, copper, or stainless steel solid conductors

Material: Stainless Steel 18-8 (EN 1.4305), Stainless Steel 316 (EN 1.4401)

Part Number	Width 1	Width 2	Height 1	Height 2	Depth	Cu-Bond Conductor	Unit Weight	Complies With
CSS0810000	3.74"	3.15"	0.79"	0.2"	0.67"	CBSC8, CBSC10	0.2 kg	IEC® 62561-4
CSS1314000	3.74"	3.15"	0.79"	0.2"	0.67"	CBSC13, CBSC14	0.2 kg	IEC® 62561-4
CSS1618000	3.74"	3.15"	0.98"	0.2"	0.67"	CBSC16, CBSC18	0.2 kg	IEC® 62561-4

IEC compliance is valid only for Cu-Bond Conductors listed.

50 MM OFFSET POSITIONER, SOLID ROUND CONDUCTOR

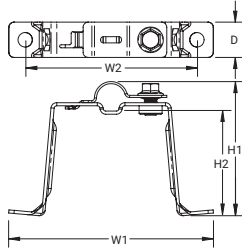

FEATURED HIGHLIGHTS

- Positioning clamps with 50 mm (1.97") offset for use with solid round conductors, including Cu-Bond Round Conductor
- For use with copper-bonded, copper, or stainless steel solid conductors

Material: Stainless Steel 18-8 (EN 1.4305), Stainless Steel 316 (EN 1.4401)

Part Number	Width 1	Width 2	Height 1	Height 2	Depth	Cu-Bond Conductor	Unit Weight	Complies With
CSS0810050	3.94"	3.15"	2.56"	1.97"	0.67"	CBSC8, CBSC10	0.24 lb	IEC® 62561-4
CSS1314050	3.94"	3.15"	2.56"	1.97"	0.67"	CBSC13, CBSC14	0.24 lb	IEC® 62561-4
CSS1618050	3.94"	3.15"	2.75"	1.97"	0.67"	CBSC16, CBSC18	0.24 lb	IEC® 62561-4

IEC compliance is valid only for Cu-Bond Conductors listed.

150 MM OFFSET POSITIONER, SOLID ROUND CONDUCTOR

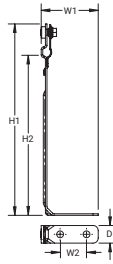

FEATURED HIGHLIGHTS

- Positioning clamps with 150 mm (5.9") offset for use with solid round conductors, including Cu-Bond Round Conductor
- For use with copper-bonded, copper, or stainless steel solid conductors
- Ideal for use in positioning solid round conductor in a horizontal orientation, such as on a roof or parapet

Material: Stainless Steel 18-8 (EN 1.4305), Stainless Steel 316 (EN 1.4401)

Part Number	Width 1	Width 2	Height 1	Height 2	Depth	Cu-Bond Conductor	Unit Weight	Complies With
CSS0810150	2.17"	1"	7.28"	5.9"	0.67"	CBSC8, CBSC10	0.29 kg	IEC® 62561-4
CSS1314150	2.17"	1"	7.28"	5.9"	0.67"	CBSC13, CBSC14	0.29 kg	IEC® 62561-4

IEC compliance is valid only for Cu-Bond Conductors listed.

THEFT DETERRENT COMPOSITE CABLE CLIP

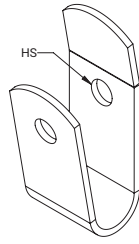

FEATURED HIGHLIGHTS

- For use with CC5A04 Theft Deterrent Composite Cable

Material: Aluminum

Part Number	Conductor Size	Hole Size
CCL04A	#14 Solid - 2/0 Solid, 2.5 mm ² Stranded - 10 mm ² Stranded	0.2"

Conductors

CU-BOND ROUND CONDUCTOR

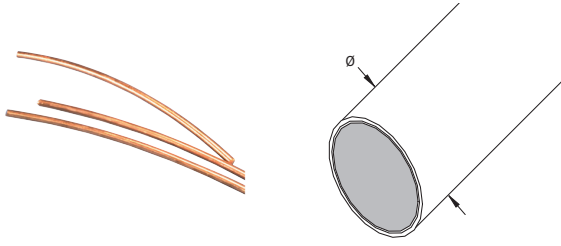

For decades, nVent ERICO has provided the market with high quality copper-bonded ground rods. nVent ERICO has taken that same concept in ground rods and made this into a revolutionary new grounding conductor. The core of the nVent ERICO Cu-Bond Round Conductor is a low carbon steel grade for improved flexibility in the field. The steel core is plated with nickel then electro-plated with a coating of copper. This electro-plating process helps ensure a long-lasting molecular bond between the copper layer and the steel.

Material: Copper-Bonded Steel
 Plating Thickness: 10 mil
 Complies With: IEC® 62305-3 Edition 2; IEC® 62561-2; EN 62561-2



FEATURED HIGHLIGHTS

- Theft-deterrent; steel core is hard to cut with hand tools
- Cost-effective; copper bonded to a steel core minimizes the amount of copper in the cable
- Superior corrosion resistance; application life of typically 30-40 years in most soil conditions
- Copper-bonded coating will not crack or tear when the conductor is bent
- High resistance to corrosion and provides a low-resistance path to ground
- Cu-Bond Round Conductor is marked every meter (3.28') for easy measurement in the field
- Meets the requirements of IEC® 62305-3 Edition 2 and IEC/EN 62561-2 for lightning protection applications
- Cu-Bond Round Conductors are UL certified to IEC® 62561-2

Part Number	Diameter	Length	Fusing Capacity Equivalency	Cadweld Conductor Code	Unit Weight
CBSC10	0.39"	328'	#2	T2	139.4 lb
CBSC10A	0.39"	82'	#2	T2	34.9 lb
CBSC10B	0.39"	164'	#2	T2	69.7 lb
CBSC13	0.52"	328'	1/0	T3	239.0 lb
CBSC13A	0.52"	82'	1/0	T3	59.8 lb
CBSC13B	0.52"	164'	1/0	T3	119.5 lb
CBSC14	0.56"	328'	2/0	T4	277.7 lb
CBSC14A	0.56"	82'	2/0	T4	69.4 lb
CBSC14B	0.56"	164'	2/0	T4	138.9 lb
CBSC16	0.62"	328'	3/0	T5	332.5 lb
CBSC16A	0.62"	82'	3/0	T5	83.1 lb
CBSC16B	0.62"	164'	3/0	T5	166.3 lb
CBSC18	0.70"	328'	4/0	T6	427.0 lb
CBSC18A	0.70"	82'	4/0	T6	106.8 lb
CBSC18B	0.70"	164'	4/0	T6	213.5 lb
CBSC8	0.31"	328'	#4	T1	86.6 lb
CBSC8A	0.31"	82'	#4	T1	21.7 lb
CBSC8B	0.31"	164'	#4	T1	43.3 lb

Resistance per unit length measurements made in mΩ/m, CBSC compared with respect to AWG/Metric. The IEEE® 837 standard (Annex C) provides a method of calculating the fusing current for conductors. This chart is a reference of the calculations for copper-bonded steel conductor according to the IEEE 837 standard. This information is for reference only.

CONDUCTOR PHYSICAL SIZE COMPARISON

Conductor Size	Approximate Diameter	Approximate Diameter	Cross Section	Cross Section
#4 AWG	0.235"	5.97 mm	-	-
25 mm ²	0.266"	6.76 mm	-	-
#2 AWG	0.292"	7.42 mm	-	-
35 mm ²	0.301"	7.65 mm	-	-
CBSC8	0.315"	8 mm	0.08 in ²	50.27 mm ²
50 mm ²	0.35"	8.89 mm	-	-
1/0 AWG	0.373"	9.47 mm	-	-
CBSC10	0.394"	10 mm	0.12 in ²	78.52 mm ²
2/0 AWG	0.419"	10.64 mm	-	-
70 mm ²	0.421"	10.69 mm	-	-
3/0 AWG	0.41"	10.4 mm	-	-
95 mm ²	0.49"	12.47 mm	-	-
CBSC13	0.52"	13.2 mm	0.21 in ²	138.07 mm ²
4/0 AWG	0.528"	13.41 mm	-	-
CBSC14	0.56"	14.2 mm	0.25 in ²	158.90 mm ²
120 mm ²	0.56"	14.22 mm	-	-
250 MCM	0.575"	14.61 mm	-	-
CBSC16	0.618"	15.7 mm	0.31 in ²	199.84 mm ²
150 mm ²	0.62"	15.75 mm	-	-
300 MCM	0.629"	15.98 mm	-	-
185 mm ²	0.695"	17.65 mm	-	-
CBSC18	0.697"	17.7 mm	0.38 in ²	243.27 mm ²

CONDUCTIVITY COMPARISON

Part Number	AWG (Ω /km)	CBSC Resistance per Length Comparison	mm ² (Ω /km)	CBSC Resistance per Length Comparison
CBSC18	1/0 AWG	118.52%	50 mm ²	110.82%
	2 AWG	74.54%	35 mm ²	77.57%
CBSC16	2 AWG	102.20%	35 mm ²	106.36%
	4 AWG	64.27%	25 mm ²	75.97%
CBSC14	2 AWG	137.78%	25 mm ²	102.42%
	4 AWG	86.65%	16 mm ²	65.55%
CBSC13	2 AWG	134.46%	25 mm ²	99.95%
	4 AWG	84.56%	16 mm ²	63.97%
CBSC10	4 AWG	132.25%	16 mm ²	100.05%
	6 AWG	83.17%	10 mm ²	62.53%
CBSC8	6 AWG	107.85%	16 mm ²	129.73%
	8 AWG	67.83%	10 mm ²	81.08%

Fusing Current I_{rms} (kA) - IEEE® 837 Annex C

Conductor Type Copper-bonded, Steel Core, Rod a		CBSC8	CBSC10	CBSC13	CBSC14	CBSC16	CBSC18
Conductor Cross Section in mm ²	A	50.265	78.52	138.07	158.903	199.84	243.27
Initial Conductor Temperature in °C	T _a	40	40	40	40	40	40
Time of Current Flow in Seconds	t _c	2	2	2	2	2	2
Maximum Allowable Temperature in °C	T _m	1084	1084	1084	1084	1084	1084
Thermal Coefficient of Resistivity at							
Reference Temperature T _r	a _r	0.00378	0.00378	0.00378	0.00378	0.00378	0.00378
Resistivity of the Ground Conductor at							
Reference Temperature T _r in m&-cm	r _r	8.621	8.621	8.621	8.621	8.621	8.621
1/a ₀ or (1/a _r)–T _r in °C	K ₀	245	245	245	245	245	245
Thermal Capacity Factor in Joules/cm ³ /°C	TCAP	3.846	3.846	3.846	3.846	3.846	3.846
Material Conductivity (%)	%	24.5	20.4	18.8	15.9	16.3	17.7
Fusing Current Calculation	β	84.73	84.73	84.73	84.73	84.73	84.73
	I	4.79	7.48	13.16	15.15	19.05	23.19
	I _{90%}	4.31	6.74	11.84	13.63	17.14	20.87
	I _{80%}	3.83	5.99	10.53	12.12	15.24	18.55

CU-BOND ROUND CONDUCTOR MANUAL STRAIGHTENING TOOL



FEATURED HIGHLIGHTS

- Hand tool used to reduce curvature in Cu-Bond Round Conductor
- Can be used with Cu-Bond Round Conductors CBSC8, CBSC10, and CBSC13

Part Number	Length
EGRA15	53 1/2"

CU-BOND ROUND CONDUCTOR POWERED STRAIGHTENING TOOL

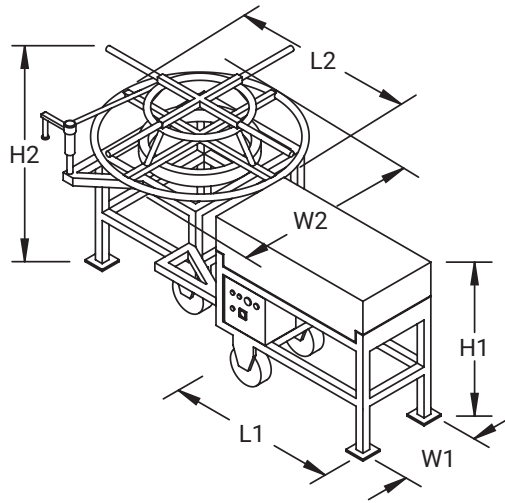

FEATURED HIGHLIGHTS

- Operates on 220/240V (single phase) or 110/120V with step-up transformer included on CBSCSSMT
- Two operating modes: Automatic with speed control and manual forward/reverse
- Interchangeable rollers allow the machine to straighten CBSC8, CBSC10, and CBSC13
- Manual straightening bar straightens the first few sections of Cu-Bond Round Conductor prior to feeding it into the machine
- Enclosure covers moving internal parts
- Safety switch for emergency shutoff
- Includes control rod to calibrate setup of the straightening machine
- Designed to be able to be moved on site by a forklift
- Wheels and collapsible handles allow for easy movement on the jobsite
- Add-on uncoiler holds Cu-Bond Round Conductor coils and provides a method of feeding material into the machine and gives repeatable and precise straightness results



Part Number	Length 1	Length 2	Width 1	Width 2	Height 1	Height 2	Operating Voltage	Unit Weight
CBSCSSM	43 1/4"	44 1/2"	20"	44 1/2"	39 1/4"	40"	220/240V	507 lb
CBSCSSMT	43 1/4"	44 1/2"	20"	44 1/2"	39 1/4"	40"	110/120V - 220/240V	507 lb

Spare parts are available for order. Contact your nVent ERICO representative for more information.

CU-BOND COMPOSITE CABLE



Cu-Bond is a bare concentric stranded conductor that consists of peripheral tinned copper plated steel which protects and conceals the internal copper stranding.

Material: Copper, Copper-Bonded Steel
Finish: Tinned
Insulated: No

FEATURED HIGHLIGHTS

- Outer strands comprised of tinned copper-bonded steel for theft deterrence and improved corrosion resistance
- Inner copper stranding is tinned for superior corrosion resistance
- Copper stranding inside of conductor increases conductivity and conductor flexibility
- Copper strands are hidden by outer galvanized steel strands
- Available in three sizes/configurations with electrical equivalency to 4, 2/0 and 4/0 AWG copper
- Suitable for direct burial applications
- More flexible and easier to work with than copper clad steel conductors

Part Number	Stranding	Resistance	Fusing Capacity Equivalency	Cable Diameter	Cable Length	Conductor Code	Hammerlock	Unit Weight
CC5A05CB	(19) Strands: (3) Tinned Copper, (16) Tin Plated Copper-Bonded Steel	0.374 Ω/1000'	#4	0.320"	250'	S1	EHL58C2G, EHL34C2G	61 lb
CC5A20CB	(154) Strands: (133) Tinned Copper, (21) Tin Plated Copper-Bonded Steel	0.087 Ω/1000'	2/0	0.524"	200'	S5		113 lb
CC5A40CB	(161) Strands: (133) Tinned Copper, (27) Tinned Copper- Bonded Steel	0.056 Ω/1000'	4/0	0.651"	200'	S7		174 lb

Weight does not include reel.

INSULATED COPPER CONDUCTOR

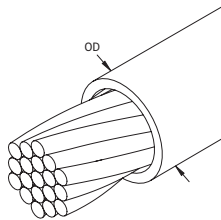

FEATURED HIGHLIGHTS

- Insulated copper conductor is compacted, so the diameter is smaller than conventional insulated copper conductor
- Green and yellow insulation protects the strands of the conductor

Material: Copper, Polyvinylchloride

Part Number	Conductor Size	Number of Wires	Wire Diameter	Cable Diameter	Outer Diameter	Cable Length	Insulation Thickness	Unit Weight
Conductor Type: Concentric, Compacted								
ICECH120C	120 mm ² Stranded	24	0.11"	0.508"	0.63"	1,640'	0.04"	1,279 lb
ICECH150C	150 mm ² Stranded	30	0.11"	0.557"	0.70"	1,640'	0.04"	1,698 lb
ICECH185C	185 mm ² Stranded	37	0.11"	0.624"	0.78"	1,640'	0.04"	2,315 lb
ICECH240C	240 mm ² Stranded	37	0.11"	0.719"	0.89"	1,640'	0.04"	3,009 lb

Part Number	Conductor Size	Number of Wires	Wire Diameter	Cable Diameter	Outer Diameter	Cable Length	Insulation Thickness	Unit Weight
ICECH50C	50 mm ² Stranded	10	0.11"	0.321"	0.43"	164'	0.04"	57 lb
ICECH70C	70 mm ² Stranded	14	0.11"	0.380"	0.49"	1,640'	0.04"	794 lb
ICECH95C	95 mm ² Stranded	19	0.11"	0.447"	0.57"	1,640'	0.04"	1,080 lb
Conductor Type: Concentric, Non-Compacted								
ICECH25	25 mm ² Stranded	7	0.90"	0.230"	0.33"	164'	0.04"	29 lb

Outer diameter dimensions are approximate.

NON-INSULATED SOLID CONDUCTOR

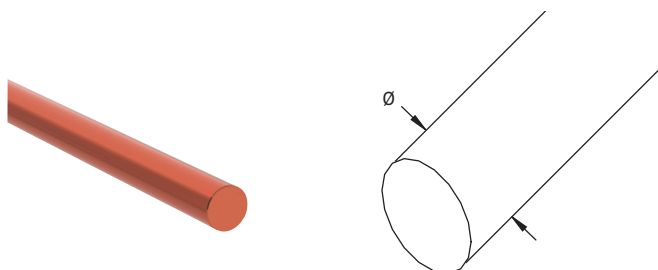

FEATURED HIGHLIGHTS

- Solid cable for a variety of applications
- Available in smaller pool sizes for convenience
- LPA and LPC parts are used for lightning protection system downconductor or grounding applications



Part Number	Length	Cross Section	Conductor Size	Diameter	Unit Weight	Certifications
Material: Copper — Finish: Bare						
A809A06F100	100'	41.70 kcmil	#4 Solid	0.204"	0.038 lb	
LPC151250	250'	26.24 kcmil	#6 Solid	0.161"	0.024 lb	UL
LPC151CTO		26.24 kcmil	#6 Solid	0.161"	0.024 lb	UL
LPC154CTO		66.36 kcmil	#2 Solid	0.325"	0.062 lb	UL
RCEC6	328'	55.80 kcmil	6 mm ² Solid	0.236"	0.050 lb	
Material: Copper — Finish: Tinned						
LPC154LCTO		66.36 kcmil	#2 Solid	0.325"	0.062 lb	UL

Unit weight is per foot (0.3048 m). Cut-to-order (CTO) lengths are available for an additional charge.

NON-INSULATED STRANDED CONDUCTOR

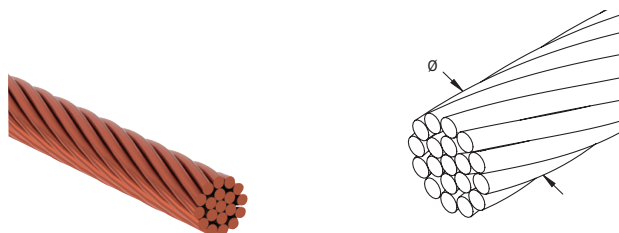

FEATURED HIGHLIGHTS

- Stranded pure electrolytic copper cable conductors for a variety of applications
- Stranded grounded conductor cut into standard lengths for easy field installation

Material: Copper
Conductor Type: Concentric

Part Number	Number of Wires	Wire Diameter	Diameter	Length	Cross Section	Conductor Size	Unit Weight
A800A09F100	19	0.084"	0.500"	100'	133.0 kcmil	2/0 Stranded	41.1 lb
A800A09F65	19	0.084"	0.500"	65'	133.0 kcmil	2/0 Stranded	26.7 lb
A800A22F100	19	0.106"	0.528"	100'	211.6 kcmil	4/0 Stranded	65.0 lb
SCEC120	37	0.079"	0.560"	1,640'	236.8 kcmil	120 mm ² Stranded	1,135.0 lb

Part Number	Number of Wires	Wire Diameter	Diameter	Length	Cross Section	Conductor Size	Unit Weight
SCEC150	37	0.089"	0.620"	1,640'	296.0 kcmil	150 mm ² Stranded	1,466.0 lb
SCEC185	37	0.099"	0.695"	1,640'	365.1 kcmil	185 mm ² Stranded	1,843.0 lb
SCEC25	7	0.084"	0.253"	164'	49.3 kcmil	25 mm ² Stranded	25.0 lb
SCEC35	7	0.099"	0.301"	164'	69.1 kcmil	35 mm ² Stranded	25.0 lb
SCEC50	19	0.070"	0.350"	164'	98.7 kcmil	50 mm ² Stranded	51.0 lb
SCEC95	19	0.099"	0.496"	1,640'	187.5 kcmil	95 mm ² Stranded	936.0 lb

Outer diameter dimensions are approximate.

CPI GROUNDING AND BONDING BRAID, STAINLESS STEEL

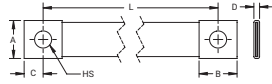

High-quality CPI stainless steel grounding and bonding braids can be installed in extremely corrosive environments, like offshore applications or coastal applications. The full range of CPI braids are ideal for applications using stainless steel pipe or tanks, like the food and beverage industry, building industry, transportation, oil and chemical industry.

FEATURED HIGHLIGHTS

- Superior abrasion, corrosion, chemical and UV resistance make CPI braids ideal for outdoor applications
- Great for expansion joints where constant movement requires a flexible and durable solution
- Ready to use out of the box, eliminates the need for cutting, stripping, crimping and punching
- Quick and easy to install
- Resistant to vibration and fatigue, reducing maintenance
- Will not rust or discolor, so the appearance will never fade or change
- Excellent electrical contact
- No additional lugs or terminals needed
- Non-magnetic material
- Recommended by the EMC/EMI directives
- GOST compliant
- RoHS compliant

Material: Stainless Steel 316L (EN 1.4404)
 Certification Details: UL® 467
 Complies With:



Part Number	Article Number	Cross Section	Length	Hole Size	A	B	C	D	Unit Weight
CPI16-150-8	554277	31.57 kcmil	5.906"	0.335"	0.689"	0.787"	0.394"	0.118"	0.068 lb
CPI16-200-8	554278	31.57 kcmil	7.874"	0.335"	0.689"	0.787"	0.394"	0.118"	0.082 lb
CPI16-250-8	554279	31.57 kcmil	9.843"	0.335"	0.689"	0.787"	0.394"	0.118"	0.095 lb
CPI16-300-8	554280	31.57 kcmil	11.811"	0.335"	0.689"	0.787"	0.394"	0.118"	0.110 lb
CPI16-400-8	554282	31.57 kcmil	15.748"	0.335"	0.689"	0.787"	0.394"	0.118"	0.137 lb
CPI16-600-8	554286	31.57 kcmil	23.622"	0.335"	0.689"	0.787"	0.394"	0.118"	0.192 lb
CPI25-150-10	554299	49.34 kcmil	5.906"	0.413"	1.043"	1.181"	0.591"	0.138"	0.128 lb
CPI25-200-10	554300	49.34 kcmil	7.874"	0.413"	1.043"	1.181"	0.591"	0.138"	0.150 lb
CPI25-250-10	554301	49.34 kcmil	9.843"	0.413"	1.043"	1.181"	0.591"	0.138"	0.172 lb
CPI25-300-10	554302	49.34 kcmil	11.811"	0.413"	1.043"	1.181"	0.591"	0.138"	0.194 lb
CPI25-400-10	554304	49.34 kcmil	15.748"	0.413"	1.043"	1.181"	0.591"	0.138"	0.238 lb
CPI25-600-10	554308	49.34 kcmil	23.622"	0.413"	1.043"	1.181"	0.591"	0.138"	0.324 lb
CPI35-150-12	554321	69.07 kcmil	5.906"	0.512"	1.043"	1.181"	0.591"	0.157"	0.157 lb
CPI35-200-12	554322	69.07 kcmil	7.874"	0.512"	1.043"	1.181"	0.591"	0.157"	0.187 lb
CPI35-250-12	554323	69.07 kcmil	9.843"	0.512"	1.043"	1.181"	0.591"	0.157"	0.218 lb
CPI35-300-12	554324	69.07 kcmil	11.811"	0.512"	1.043"	1.181"	0.591"	0.157"	0.247 lb
CPI35-400-12	554326	69.07 kcmil	15.748"	0.512"	1.043"	1.181"	0.591"	0.157"	0.309 lb
CPI35-600-12	554330	69.07 kcmil	23.622"	0.512"	1.043"	1.181"	0.591"	0.157"	0.430 lb
CPI50-150-12	554343	98.68 kcmil	5.906"	0.512"	1.181"	1.181"	0.591"	0.197"	0.245 lb
CPI50-200-12	554344	98.68 kcmil	7.874"	0.512"	1.181"	1.181"	0.591"	0.197"	0.287 lb
CPI50-250-12	554345	98.68 kcmil	9.843"	0.512"	1.181"	1.181"	0.591"	0.197"	0.331 lb
CPI50-300-12	554346	98.68 kcmil	11.811"	0.512"	1.181"	1.181"	0.591"	0.197"	0.375 lb
CPI50-400-12	554348	98.68 kcmil	15.748"	0.512"	1.181"	1.181"	0.591"	0.197"	0.461 lb
CPI50-600-12	554352	98.68 kcmil	23.622"	0.512"	1.181"	1.181"	0.591"	0.197"	0.635 lb
CPI70-1100-12	554384	138.15 kcmil	43.307"	0.512"	1.181"	1.181"	0.591"	0.228"	1.464 lb
CPI70-150-12	554365	138.15 kcmil	5.906"	0.512"	1.181"	1.181"	0.591"	0.228"	0.306 lb

Part Number	Article Number	Cross Section	Length	Hole Size	A	B	C	D	Unit Weight
CPI70-200-12	554366	138.15 kcmil	7.874"	0.512"	1.181"	1.181"	0.591"	0.228"	0.368 lb
CPI70-250-12	554367	138.15 kcmil	9.843"	0.512"	1.181"	1.181"	0.591"	0.228"	0.428 lb
CPI70-300-12	554368	138.15 kcmil	11.811"	0.512"	1.181"	1.181"	0.591"	0.228"	0.489 lb
CPI70-400-12	554370	138.15 kcmil	15.748"	0.512"	1.181"	1.181"	0.591"	0.228"	0.611 lb
CPI70-600-12	554374	138.15 kcmil	23.622"	0.512"	1.181"	1.181"	0.591"	0.228"	0.855 lb
CPI70-800-12	554378	138.15 kcmil	31.496"	0.512"	1.181"	1.181"	0.591"	0.228"	1.098 lb

MBJ GROUNDING AND BONDING BRAID, TINNED COPPER

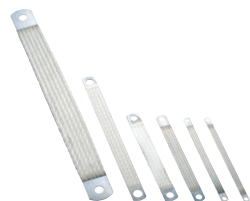

MBJ Grounding and Bonding Braids are a reliable and convenient grounding solution for applications that require flexibility and durability. The tinned copper ground braids with massivated palms come ready to install without any additional cutting, stripping, crimping or punching and do not require the addition of tin or crimped lugs. The proprietary manufacturing process optimizes the electrical contact between each wire and helps eliminate moisture issues in the palms, preventing corrosion and lengthening the useful life of the braid.

Material: Copper
 Finish: Tinned
 Working Temperature: 221 °F Max
 Complies With:

FEATURED HIGHLIGHTS

- Complete range of earth/ground flexible connections from 6 - 100 mm² (11.84 - 197.35 kcmil) cross section and from 100 - 500 mm (3.937" - 19.685") length
- Integral palm, without tin or crimped lugs for superior electrical contact and tensile strength resistance
- Resistant to vibration and fatigue, reducing maintenance
- Provides weight savings, material savings and lower impedance when compared to similar lugged cables with insulation
- Ready to use out of the box, eliminates the need for cutting, stripping, crimping and punching
- Quick and easy to install
- Recommended by the EMC/EMI directives and less impedance than cables
- GOST compliant
- RoHS compliant



Part Number	Article Number	Intensity	Thickness	Cross Section	Length	Hole Size	A	B	Unit Weight
MBJ100-250-16	563500	349 A	0.157"	197.35 kcmil	9.843"	0.650"	1.969"	2.165"	0.559 lb
MBJ100-250-30	563510	349 A	0.157"	197.35 kcmil	9.843"	1.201"	1.969"	2.165"	0.559 lb
MBJ100-500-16	563520	349 A	0.157"	197.35 kcmil	19.685"	0.650"	1.969"	2.165"	1.118 lb
MBJ100-500-30	563530	349 A	0.157"	197.35 kcmil	19.685"	1.201"	1.969"	2.165"	1.118 lb
MBJ10-200-6	556930	75 A	0.043"	19.74 kcmil	7.874"	0.256"	0.433"	0.709"	0.048 lb
MBJ10-300-6	556610	75 A	0.043"	19.74 kcmil	11.811"	0.256"	0.433"	0.709"	0.073 lb
MBJ16-100-6	563540	120 A	0.059"	31.57 kcmil	3.937"	0.256"	0.591"	0.787"	0.040 lb
MBJ16-100-8	556620	120 A	0.059"	31.57 kcmil	3.937"	0.335"	0.591"	0.787"	0.040 lb
MBJ16-150-6	563550	120 A	0.059"	31.57 kcmil	5.906"	0.256"	0.591"	0.787"	0.077 lb
MBJ16-150-8	556630	120 A	0.059"	31.57 kcmil	5.906"	0.335"	0.591"	0.787"	0.077 lb
MBJ16-200-6	563300	120 A	0.059"	31.57 kcmil	7.874"	0.256"	0.591"	0.787"	0.073 lb
MBJ16-200-8	556640	120 A	0.059"	31.57 kcmil	7.874"	0.335"	0.591"	0.787"	0.073 lb
MBJ16-250-8	556650	120 A	0.059"	31.57 kcmil	9.843"	0.335"	0.591"	0.787"	0.088 lb
MBJ16-300-6	563320	120 A	0.059"	31.57 kcmil	11.811"	0.256"	0.591"	0.787"	0.110 lb
MBJ16-300-8	556660	120 A	0.059"	31.57 kcmil	11.811"	0.335"	0.591"	0.787"	0.110 lb
MBJ16-500-8	556940	120 A	0.059"	31.57 kcmil	19.685"	0.335"	0.591"	0.787"	0.180 lb
MBJ25-100-10	556670	150 A	0.059"	49.34 kcmil	3.937"	0.413"	0.866"	1.102"	0.059 lb
MBJ25-150-10	556680	150 A	0.059"	49.34 kcmil	5.906"	0.413"	0.866"	1.102"	0.086 lb
MBJ25-200-10	556690	150 A	0.059"	49.34 kcmil	7.874"	0.413"	0.866"	1.102"	0.114 lb
MBJ25-200-12	563430	150 A	0.059"	49.34 kcmil	7.874"	0.492"	0.866"	1.102"	0.114 lb
MBJ25-200-6	563340	150 A	0.059"	49.34 kcmil	7.874"	0.256"	0.866"	1.102"	0.114 lb
MBJ25-250-10	556700	150 A	0.059"	49.34 kcmil	9.843"	0.413"	0.866"	1.102"	0.141 lb
MBJ25-300-10	556710	150 A	0.059"	49.34 kcmil	11.811"	0.413"	0.866"	1.102"	0.169 lb
MBJ25-500-10	556950	150 A	0.059"	49.34 kcmil	19.685"	0.413"	0.866"	1.102"	0.286 lb

Part Number	Article Number	Intensity	Thickness	Cross Section	Length	Hole Size	A	B	Unit Weight
MBJ30-100-10	556720	180 A	0.079"	59.20 kcmil	3.937"	0.413"	0.866"	1.102"	0.070 lb
MBJ30-150-10	556730	180 A	0.079"	59.20 kcmil	5.906"	0.413"	0.866"	1.102"	0.103 lb
MBJ30-200-10	556740	180 A	0.079"	59.20 kcmil	7.874"	0.413"	0.866"	1.102"	0.136 lb
MBJ30-250-10	556750	180 A	0.079"	59.20 kcmil	9.843"	0.413"	0.866"	1.102"	0.165 lb
MBJ30-300-10	556760	180 A	0.079"	59.20 kcmil	11.811"	0.413"	0.866"	1.102"	0.202 lb
MBJ30-500-10	556960	180 A	0.079"	59.20 kcmil	19.685"	0.413"	0.866"	1.102"	0.341 lb
MBJ35-100-10	556770	197 A	0.083"	69.07 kcmil	3.937"	0.413"	0.866"	1.102"	0.081 lb
MBJ35-150-10	556780	197 A	0.083"	69.07 kcmil	5.906"	0.413"	0.866"	1.102"	0.119 lb
MBJ35-200-10	556790	197 A	0.083"	69.07 kcmil	7.874"	0.413"	0.866"	1.102"	0.158 lb
MBJ35-250-10	556800	197 A	0.083"	69.07 kcmil	9.843"	0.413"	0.866"	1.102"	0.196 lb
MBJ35-250-25	565000	197 A	0.059"	69.07 kcmil	9.843"	1.004"	1.575"	1.772"	0.196 lb
MBJ35-300-10	556810	197 A	0.083"	69.07 kcmil	11.811"	0.413"	0.866"	1.102"	0.242 lb
MBJ35-500-10	556970	197 A	0.083"	69.07 kcmil	19.685"	0.413"	0.866"	1.102"	0.396 lb
MBJ50-100-10	556820	250 A	0.098"	98.68 kcmil	3.937"	0.413"	1.102"	1.300"	0.114 lb
MBJ50-150-10	556830	250 A	0.098"	98.68 kcmil	5.906"	0.413"	1.102"	1.300"	0.169 lb
MBJ50-200-10	556840	250 A	0.098"	98.68 kcmil	7.874"	0.413"	1.102"	1.300"	0.264 lb
MBJ50-200-12	563440	250 A	0.098"	98.68 kcmil	7.874"	0.492"	1.102"	1.300"	0.264 lb
MBJ50-200-16	563360	250 A	0.098"	98.68 kcmil	7.874"	0.650"	1.102"	1.300"	0.242 lb
MBJ50-200-18	563370	250 A	0.098"	98.68 kcmil	7.874"	0.728"	1.102"	1.300"	0.242 lb
MBJ50-200-6	563350	250 A	0.098"	98.68 kcmil	7.874"	0.256"	1.102"	1.300"	0.264 lb
MBJ50-250-10	556850	250 A	0.098"	98.68 kcmil	9.843"	0.413"	1.102"	1.300"	0.279 lb
MBJ50-300-10	556860	250 A	0.098"	98.68 kcmil	11.811"	0.413"	1.102"	1.300"	0.337 lb
MBJ50-300-16	563390	250 A	0.098"	98.68 kcmil	11.811"	0.650"	1.102"	1.300"	0.330 lb
MBJ50-300-18	563400	250 A	0.098"	98.68 kcmil	11.811"	0.728"	1.102"	1.300"	0.308 lb
MBJ50-300-6	563380	250 A	0.098"	98.68 kcmil	11.811"	0.256"	1.102"	1.300"	0.330 lb
MBJ50-500-10	556980	250 A	0.098"	98.68 kcmil	19.685"	0.413"	1.102"	1.300"	0.561 lb
MBJ50-500-12	563560	250 A	0.098"	98.68 kcmil	19.685"	0.492"	1.102"	1.300"	0.561 lb
MBJ6-150-6	556600	40 A	0.043"	11.84 kcmil	5.906"	0.256"	0.433"	0.709"	0.022 lb
MBJ6-200-6	563410	40 A	0.043"	11.84 kcmil	7.874"	0.256"	0.433"	0.709"	0.037 lb
MBJ70-300-10	563460	290 A	0.133"	138.15 kcmil	11.811"	0.413"	1.102"	1.300"	0.462 lb
MBJ70-300-12	563420	290 A	0.133"	138.15 kcmil	11.811"	0.492"	1.102"	1.300"	0.462 lb
MBJ70-300-16	563470	290 A	0.133"	138.15 kcmil	11.811"	0.650"	1.102"	1.300"	0.440 lb
MBJ70-300-22	563480	290 A	0.110"	138.15 kcmil	11.811"	0.886"	1.575"	1.772"	0.440 lb
MBJ70-300-6	563450	290 A	0.133"	138.15 kcmil	11.811"	0.256"	1.102"	1.300"	0.462 lb
MBJ70-500-10	563490	290 A	0.133"	138.15 kcmil	19.685"	0.413"	1.102"	1.300"	0.748 lb

TAPE CONDUCTOR

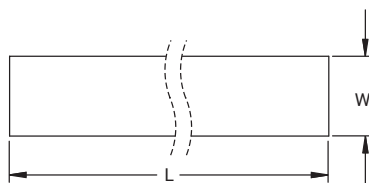
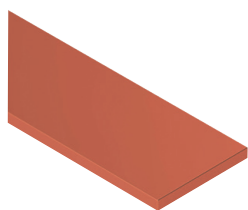

FEATURED HIGHLIGHTS

- Lower impedance than equivalent sized round conductor
- Used for lightning protection system downconductor or grounding applications

Material: Copper
Finish: Bare

Part Number	Length	Width	Thickness	Unit Weight
A811A26F50	50'	2"	26 GA	0.152 lb
A811A26F500	500'	2"	26 GA	0.152 lb
A811A26W4F500	500'	4"	26 GA	0.231 lb
A811C20F100	100'	3"	20 GA	0.410 lb

Part Number	Length	Width	Thickness	Unit Weight
A811C20F20	20'	3"	20 GA	0.410 lb
LPC172CTO		3/4"	8 GA	0.110 lb

Cut-to-order (CTO) lengths are available for an additional charge. Unit weight is per meter (3.28').

LOW IMPEDANCE RISER

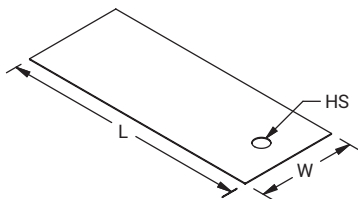
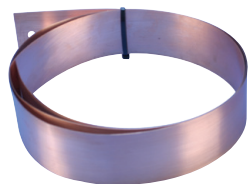

FEATURED HIGHLIGHTS

- Used to connect the signal reference grid to equipment
- Welded to the SRG using Cadweld mold type TW
- Has a lower impedance than a 4/0 AWG copper conductor

Material: Copper

Part Number	Length	Width	Thickness	Hole Size
B802D01A12	12"	2"	26 GA	5/16"
B802D01A120	120"	2"	26 GA	5/16"
B802D01A24	24"	2"	26 GA	5/16"
B802D01A36	36"	2"	26 GA	5/16"
B802D01A48	48"	2"	26 GA	5/16"
B802D01A5	5"	2"	26 GA	5/16"

Grounding & Bonding

COPPER-BONDED GROUND ROD, POINTED

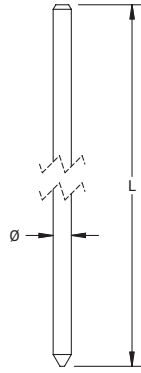

FEATURED HIGHLIGHTS

- 99.9% pure electrolytic copper coating
- Molecular bond to nickel-sealed high strength steel core
- Rods have a high carbon steel core and tip that provide superior strength when driving
- Copper coating will not crack when bent or tear when driven
- Minimum copper coating of 10 mils on rods listed to UL® 467
- nVent ERICO name, length, diameter and part number is roll-stamped within 12" (304,8 mm) of chamfered end
- UL logo and control number where applicable stamped on each rod for easy inspection after installation

Material: Copper-Bonded Steel
Tensile Strength: 80,000 psi Min



Part Number	Ground Rod Diameter, Nominal	Ground Rod Diameter, Actual	Length	Plating Thickness	Unit Weight	UPC Label	Complies With	Certifications
611300	1/2"	0.504"	10.0'	10 mil	6.9 lb	No	ANSI®/NEMA® GR1	CSA, cULus
611300UPC	1/2"	0.504"	10.0'	10 mil	6.9 lb	Yes	ANSI®/NEMA® GR1	cULus
611303	1/2"	0.505"	10.0'	13 mil	7.4 lb	No	ANSI®/NEMA® GR1	cULus
611330	1/2"	0.504"	3.0'	10 mil	2.2 lb	No		
611340	1/2"	0.504"	4.0'	10 mil	2.8 lb	No		
611350	1/2"	0.504"	5.0'	10 mil	3.5 lb	No		
611353	1/2"	0.505"	5.0'	13 mil	3.7 lb	No		
611360	1/2"	0.504"	6.0'	10 mil	4.4 lb	No		
611360UPC	1/2"	0.504"	6.0'	10 mil	4.4 lb	Yes		
611380	1/2"	0.504"	8.0'	10 mil	5.5 lb	No	ANSI®/NEMA® GR1	UL
611380UPC	1/2"	0.504"	8.0'	10 mil	5.5 lb	Yes	ANSI®/NEMA® GR1	UL
613400	3/4"	0.681"	10.0'	10 mil	12.6 lb	No	IEC® EN 62561-2, ANSI®/NEMA® GR1	CSA, cULus
613400UPC	3/4"	0.681"	10.0'	10 mil	12.6 lb	Yes	IEC® EN 62561-2, ANSI®/NEMA® GR1	cULus
613403	3/4"	0.681"	10.0'	13 mil	12.4 lb	No	IEC® EN 62561-2, ANSI®/NEMA® GR1	cULus
613412	3/4"	0.681"	12.0'	10 mil	14.9 lb	No	IEC® EN 62561-2, ANSI®/NEMA® GR1	cULus
613415	3/4"	0.681"	15.0'	10 mil	18.5 lb	No	IEC® EN 62561-2, ANSI®/NEMA® GR1	cULus
613440	3/4"	0.681"	4.0'	10 mil	5.6 lb	No	IEC® EN 62561-2	
613450	3/4"	0.681"	5.0'	10 mil	6.2 lb	No	IEC® EN 62561-2	
613460	3/4"	0.681"	6.0'	10 mil	7.5 lb	No	IEC® EN 62561-2	
613480	3/4"	0.681"	8.0'	10 mil	10.1 lb	No	IEC® EN 62561-2, ANSI®/NEMA® GR1	UL
613483	3/4"	0.681"	8.0'	13 mil	10.0 lb	No	IEC® EN 62561-2, ANSI®/NEMA® GR1	cULus
613840	3/8"	0.358"	4.0'	10 mil	1.3 lb	No		
613840UPC	3/8"	0.358"	4.0'	10 mil	1.3 lb	Yes		
613850	3/8"	0.358"	5.0'	10 mil	1.6 lb	No		
613860	3/8"	0.358"	6.0'	10 mil	2.0 lb	No		
613880	3/8"	0.358"	8.0'	10 mil	2.7 lb	No		
614400	1"	0.914"	10.0'	10 mil	22.0 lb	No	ANSI®/NEMA® GR1	CSA, cULus
615800	5/8"	0.560"	10.0'	10 mil	8.5 lb	No	IEC® EN 62561-2, ANSI®/NEMA® GR1	CSA, cULus
615800UPC	5/8"	0.560"	10.0'	10 mil	8.4 lb	Yes	IEC® EN 62561-2, ANSI®/NEMA® GR1	cULus
615803	5/8"	0.561"	10.0'	13 mil	8.4 lb	No	IEC® EN 62561-2, ANSI®/NEMA® GR1	cULus
615812	5/8"	0.560"	12.0'	10 mil	10.0 lb	No	IEC® EN 62561-2, ANSI®/NEMA® GR1	cULus
615815	5/8"	0.560"	15.0'	10 mil	12.8 lb	No	IEC® EN 62561-2, ANSI®/NEMA® GR1	cULus

Part Number	Ground Rod Diameter, Nominal	Ground Rod Diameter, Actual	Length	Plating Thickness	Unit Weight	UPC Label	Complies With	Certifications
615823	5/8"	0.560"	1.9'	10 mil	1.8 lb	No	IEC® EN 62561-2	
615830	5/8"	0.560"	3.0'	10 mil	2.5 lb	No	IEC® EN 62561-2	
615840	5/8"	0.560"	4.0'	10 mil	3.4 lb	No	IEC® EN 62561-2	
615840UPC	5/8"	0.560"	4.0'	10 mil	3.4 lb	Yes	IEC® EN 62561-2	
615843	5/8"	0.561"	4.0'	13 mil	3.4 lb	No	IEC® EN 62561-2	
615850	5/8"	0.560"	5.0'	10 mil	4.2 lb	No	IEC® EN 62561-2	
615853	5/8"	0.561"	5.0'	13 mil	4.5 lb	No	IEC® EN 62561-2	
615860	5/8"	0.560"	6.0'	10 mil	5.1 lb	No	IEC® EN 62561-2	
615860UPC	5/8"	0.560"	6.0'	10 mil	5.1 lb	Yes	IEC® EN 62561-2	
615863	5/8"	0.561"	6.0'	13 mil	5.4 lb	No	IEC® EN 62561-2	
615880	5/8"	0.560"	8.0'	10 mil	6.8 lb	No	IEC® EN 62561-2, ANSI®/NEMA® GR1	UL
615880UPC	5/8"	0.560"	8.0'	10 mil	6.8 lb	Yes	IEC® EN 62561-2, ANSI®/NEMA® GR1	UL
615883	5/8"	0.561"	8.0'	13 mil	6.8 lb	No	IEC® EN 62561-2, ANSI®/NEMA® GR1	UL
615883UPC	5/8"	0.561"	8.0'	13 mil	6.8 lb	Yes	IEC® EN 62561-2, ANSI®/NEMA® GR1	UL

For rods to be listed to UL® 467, they must be at least 8' (2.43 m) in length. IEC® EN 62561-2 supercedes EN 50164-2. Additional lengths available.

COPPER-BONDED GROUND ROD, SECTIONAL

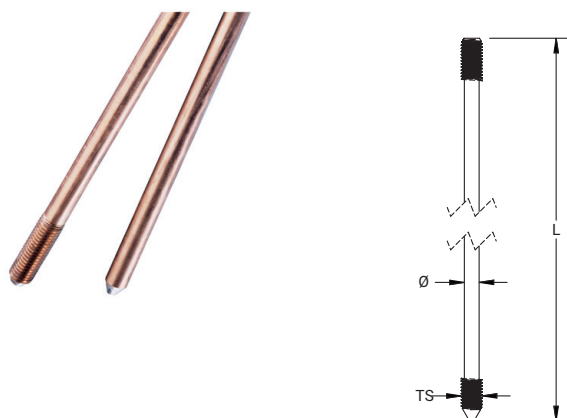

FEATURED HIGHLIGHTS

- Cold-rolled threads with continuous, unbroken grain flows preserve copper coating and are stronger than cut threads
- 99.9% pure electrolytic copper coating
- Molecular bond to nickel-sealed high strength steel core
- Rods have a high carbon steel core and tip that provide superior strength when driving
- Copper coating will not crack when bent or tear when driven
- Minimum copper coating of 10 mils on rods listed to UL® 467
- nVent ERICO name, length, diameter and part number is roll-stamped within 12" (304,8 mm) of chamfered end
- UL logo and control number where applicable stamped on each rod for easy inspection after installation

Material: Copper-Bonded Steel
Tensile Strength: 80,000 psi Min



Part Number	Ground Rod Diameter, Nominal	Ground Rod Diameter, Actual	Thread Size	Length	Plating Thickness	Unit Weight	Complies With	Certifications
Thread Location: Chamfered (Non-Pointed) End Only								
625850	5/8"	0.560"	5/8 UNC	5'	10 mil	4.2 lb	IEC® EN 62561-2	
Thread Location: Pointed and Chamfered Ends								
631300	1/2"	0.504"	9/16 UNC	10'	10 mil	6.9 lb	ANSI®/NEMA® GR1	CSA, cULus
631303	1/2"	0.505"	9/16 UNC	10'	13 mil	7.0 lb	ANSI®/NEMA® GR1	cULus
631340	1/2"	0.504"	9/16 UNC	4'	10 mil	2.7 lb		
631350	1/2"	0.504"	9/16 UNC	5'	10 mil	3.5 lb		
631360	1/2"	0.504"	9/16 UNC	6'	10 mil	4.2 lb		
631380	1/2"	0.504"	9/16 UNC	8'	10 mil	5.4 lb	ANSI®/NEMA® GR1	UL
633400	3/4"	0.680"	3/4 UNC	10'	10 mil	12.5 lb	ANSI®/NEMA® GR1, IEC® EN 62561-2	CSA, cULus
633403	3/4"	0.681"	3/4 UNC	10'	13 mil	12.5 lb	ANSI®/NEMA® GR1, IEC® EN 62561-2	cULus
633415	3/4"	0.680"	3/4 UNC	15'	10 mil	18.8 lb	ANSI®/NEMA® GR1, IEC® EN 62561-2	cULus

Part Number	Ground Rod Diameter, Nominal	Ground Rod Diameter, Actual	Thread Size	Length	Plating Thickness	Unit Weight	Complies With	Certifications
633430	3/4"	0.680"	3/4 UNC	3'	10 mil	3.8 lb	IEC® EN 62561-2	
633440	3/4"	0.680"	3/4 UNC	4'	10 mil	4.9 lb	IEC® EN 62561-2	
633450	3/4"	0.680"	3/4 UNC	5'	10 mil	6.2 lb	IEC® EN 62561-2	
633460	3/4"	0.680"	3/4 UNC	6'	10 mil	7.1 lb	IEC® EN 62561-2	
633463	3/4"	0.681"	3/4 UNC	6'	13 mil	7.1 lb	IEC® EN 62561-2	
633470	3/4"	0.680"	3/4 UNC	7'	10 mil	8.5 lb	IEC® EN 62561-2	
633480	3/4"	0.680"	3/4 UNC	8'	10 mil	9.6 lb	ANSI®/NEMA® GR1, IEC® EN 62561-2	UL
634400	1"	1.000"	1 UNC	10'	10 mil	22.1 lb	ANSI®/NEMA® GR1	CSA, cULus
635800	5/8"	0.560"	5/8 UNC	10'	10 mil	8.4 lb	ANSI®/NEMA® GR1, IEC® EN 62561-2	CSA, cULus
635803	5/8"	0.561"	5/8 UNC	10'	13 mil	8.5 lb	ANSI®/NEMA® GR1, IEC® EN 62561-2	cULus
635830	5/8"	0.560"	5/8 UNC	3'	10 mil	2.6 lb	IEC® EN 62561-2	
635840	5/8"	0.560"	5/8 UNC	4'	10 mil	3.4 lb	IEC® EN 62561-2	
635843	5/8"	0.561"	5/8 UNC	4'	13 mil	3.4 lb	IEC® EN 62561-2	
635850	5/8"	0.560"	5/8 UNC	5'	10 mil	4.2 lb	IEC® EN 62561-2	
635860	5/8"	0.560"	5/8 UNC	6'	10 mil	5.0 lb	IEC® EN 62561-2	
635870	5/8"	0.560"	5/8 UNC	7'	10 mil	6.4 lb	IEC® EN 62561-2	
635880	5/8"	0.560"	5/8 UNC	8'	10 mil	6.7 lb	ANSI®/NEMA® GR1, IEC® EN 62561-2	UL
635883	5/8"	0.561"	5/8 UNC	8'	13 mil	6.7 lb	ANSI®/NEMA® GR1, IEC® EN 62561-2	UL

For rods to be listed to UL® 467, they must be at least 8' (2.43 m) in length. IEC® EN 62561-2 supercedes EN 50164-2.

CONVENIENT GROUND ELECTRODE KIT

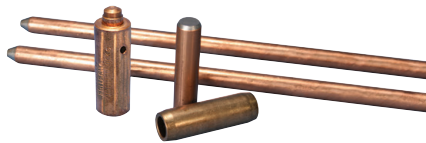

FEATURED HIGHLIGHTS

- Kit includes two ground rods, ground clamp, compression coupler and drive sleeve
- UL®-Listed and NEC®-Compliant
- Allows for installation from ground level
- Two 4' (1.2 m) ground rods with coupler provide more convenient storage and transportation than one 8' (2.4 m) ground rod



Part Number	Ground Rods	Clamp	Hammerlock	Drive Sleeve	Conductor Size
Material: Copper-Bonded Steel, Bronze					
CGE5CP	615840	CP58		EDS58	#8 Solid - #2 Stranded, 10 mm² Solid - 35 mm² Stranded
Material: Copper-Bonded Steel, Copper					
CGE51K	615840		EHL58C1K	EDS58	#4 Solid - #6 Solid, 10 mm² Stranded - 16 mm² Stranded

PORTABLE GROUND ROD KIT



FEATURED HIGHLIGHTS

- Segmented portable ground rod kit specified by the United States military
- Each of the three ground rod sections is 3' (0.91 m) long, thus creating a total depth of 9' (2.74 m) of earth grounding
- All accessories are provided in the kit to assemble the portable ground
- 6' (1.83 m) of copper grounding cable connected to the rod, makes for an easy connection to a vehicle or other item requiring a ground

Part Number

635837

Kit Includes: 3 sectional copper-bonded ground rods - 5/8" x 3" (190.5 mm x 0.91 m), 3 threaded couplers, 1 drive stud, 1 heavy duty ground rod clamp, Tang and collar lugs, and 6' (1.83 m) of #6 copper wire.

STAINLESS STEEL GROUND ROD, POINTED

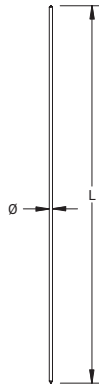
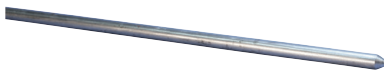

FEATURED HIGHLIGHTS

- For use in highly-corrosive soils

Material: Stainless Steel 302 (EN 1.4324), Stainless Steel 304 (EN 1.4301)
Tensile Strength: 85,000 psi Min



Part Number	Ground Rod Diameter, Nominal	Ground Rod Diameter, Actual	Length	Unit Weight	UPC Label	Certifications
681300	1/2"	0.500"	10'	6.6 lb	No	
683400	3/4"	0.750"	10'	15.0 lb	No	cULus
683412	3/4"	0.750"	12'	19.0 lb	No	
683450	3/4"	0.750"	5'	6.9 lb	No	
683480	3/4"	0.750"	8'	10.1 lb	No	UL
684400	1"	1.000"	10'	26.8 lb	No	
684415	1"	1.000"	15'	30.0 lb	No	
685800	5/8"	0.625"	10'	10.4 lb	No	cULus
685880	5/8"	0.625"	8'	8.3 lb	No	UL
685880UPC	5/8"	0.625"	8'	8.3 lb	Yes	UL

STAINLESS STEEL GROUND ROD, SECTIONAL

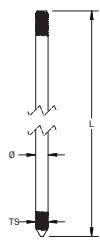
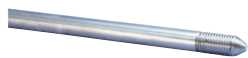

FEATURED HIGHLIGHTS

- Utilizes a cut thread for highly corrosive soil

Tensile Strength: 70,000 psi Min



Part Number	Ground Rod Diameter, Nominal	Ground Rod Diameter, Actual	Thread Size	Length	Unit Weight	Certifications
Material: Stainless Steel 302 (EN 1.4324), Stainless Steel 304 (EN 1.4301)						
681300S	1/2"	0.500"	1/2 UNC	10'	6.6 lb	
683450S	3/4"	0.750"	3/4 UNC	5'	6.9 lb	
684400S	1"	1.000"	1 UNC	10'	26.8 lb	
685800S	5/8"	0.625"	5/8 UNC	10'	10.4 lb	cULus
685880S	5/8"	0.625"	5/8 UNC	8'	7.8 lb	UL
Material: Stainless Steel 316 (EN 1.4401)						
683400S316	3/4"	0.750"	3/4 UNC	10'	13.8 lb	cULus

CHEMICAL GROUND ELECTRODE

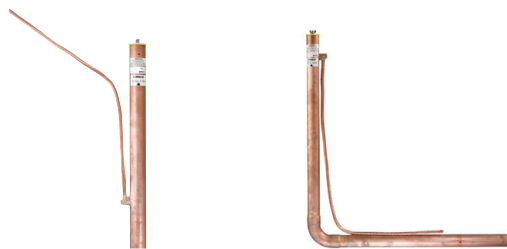

Chemical ground electrodes provide a low impedance ground in locations of high soil resistivity and dry soil conditions. Used in conjunction with a Bentonite backfill and nVent ERICO's unique GEM material, the nVent ERICO chemical ground rod electrode systems provide a method to improve soil resistivity directly surrounding the electrode, and can replace multiple conventional ground rods. It maintains a low ground resistance, maintenance-free installation that dissipates lightning energy and other dangerous electrical fault currents, even in sandy or rocky soil conditions.

FEATURED HIGHLIGHTS

- Contains natural electrolytic salts, which permeate into the surrounding soil to condition the soil and increase its conductivity
- Easy connection to ground electrode conductor using the factory provided pigtail (up or down orientation)
- Provides decades of reliable services due to rugged construction and high-quality metals with a 30-year minimum service life
- 2-1/8" (54 mm) outside diameter copper pipe with 0.083" (2.1 mm) wall
- Available in continuous sections up to 10' (3.05 m) in length; longer rods can be field assembled using 5' (1.52 m) or 10' (3.05 m) extensions
- Optional factory-attached radial strips are available to reduce impedance to high-frequency lightning energy and to control the direction of the dissipation
- L-shaped rods are available for horizontal installation applications where it is impractical to auger deep vertical holes
- Access segment on horizontal (L-shaped) chemical ground electrodes is 32" (813 mm) deep

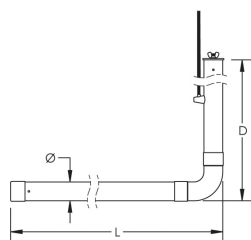

Horizontal with Pigtail Up

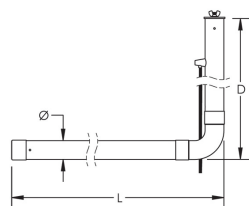

Horizontal with Pigtail Down

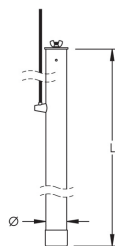

Vertical with Pigtail Up

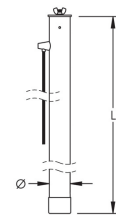

Vertical with Pigtail Down

ECR-V-10-2Q-4-U-B

ECR	nVent ERICO Chemical Ground Electrode System	
V	Installation	H: Horizontal HE: Horizontal Extended V: Vertical E: Vertical Extended
10	Electrode Length (')	
2Q	Cable Size	1G: #6 Sol, 1L: #4 Str, 1T: #2 Sol, 1V: #2 Str 2C: 1/0 Str, 2G: 2/0 Str, 2K: 3/0 Sol, 2L: 3/0 Str, 2Q: 4/0 Str 2V: 250 kcmil Str, 3D: 350 kcmil Str, 3Q: 500 kcmil Str, 4L: 750 kcmil Str
4	Pigtail Length (')	
U	Pigtail Orientation	U: Up, D: Down
B*	Rod assembly only	Add "B" for rod assembly only. Leave blank for kit.

Material: Copper



Global Part Number	Electrode Length	Pigtail Length	Depth	Conductor Size	Kit
ECRE152Q4U	15'	4.0'		4/0 Stranded	Yes
ECRE201T4U	20'	4.0'		#2 Solid	Yes
ECRE202G4U	20'	4.0'		2/0 Stranded	Yes
ECRE202Q4U	20'	4.0'		4/0 Stranded	Yes
ECRE401T4D	40'	4.0'		#2 Solid	Yes
ECRE402Q4U	40'	4.0'		4/0 Stranded	Yes
ECRH081T4D	8'	4.0'	32"	#2 Solid	Yes
ECRH081T4U	8'	4.0'	32"	#2 Solid	Yes
ECRH081T4UB	8'	4.0'	32"	#2 Solid	No
ECRH082C4U	8'	4.0'	32"	1/0 Stranded	Yes
ECRH101T4D	10'	4.0'	32"	#2 Solid	Yes
ECRH101T4U	10'	4.0'	32"	#2 Solid	Yes
ECRH102G4U	10'	4.0'	32"	2/0 Stranded	Yes
ECRH102Q4D	10'	4.0'	32"	4/0 Stranded	Yes
ECRH102Q4U	10'	4.0'	32"	4/0 Stranded	Yes
ECRHE151G4U	15'	4.0'	32"	#6 Solid	Yes
ECRHE152Q4U	15'	4.0'	32"	4/0 Stranded	Yes
ECRV082Q4D	8'	4.0'		4/0 Stranded	Yes
ECRV082Q4U	8'	4.0'		4/0 Stranded	Yes
ECRV101V4U	10'	4.0'		#2 Stranded	Yes
ECRV102C4U	10'	4.0'		1/0 Stranded	Yes
ECRV102G4U	10'	4.0'		2/0 Stranded	Yes
ECRV102L4U	10'	4.0'		3/0 Stranded	Yes
ECRV102Q10U	10'	10.0'		4/0 Stranded	Yes
ECRV102Q4D	10'	4.0'		4/0 Stranded	Yes
ECRV102Q4U	10'	4.0'		4/0 Stranded	Yes
ECRV102Q4UB	10'	4.0'		4/0 Stranded	No
ECRV102V4U	10'	4.0'		250 kcmil Stranded	Yes
ECRV103Q4D	10'	4.0'		500 kcmil Stranded	Yes
ECRV121T4U	12'	4.0'		#2 Solid	Yes
ECRV122V4D	12'	4.0'		250 kcmil Stranded	Yes
ECRV123Q4D	12'	4.0'		500 kcmil Stranded	Yes

CHEMICAL GROUND ELECTRODE SALT MIX



FEATURED HIGHLIGHTS

- Individual packages of salt mix are available for sale separately from the chemical ground rod assembly

Part Number	Unit Weight
ECRCHM15LB	15 lb

SOLID COPPER GROUND ROD, POINTED

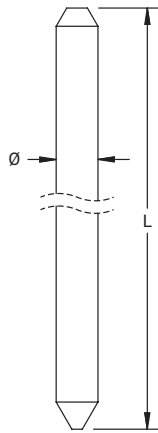
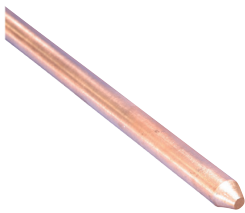

FEATURED HIGHLIGHTS

- Solid copper ground rods made of high conductive hard drawn bare copper

Material: Copper
Tensile Strength: 42,000 psi Min



Part Number	Ground Rod Diameter, Nominal	Ground Rod Diameter, Actual	Length	Unit Weight	Certifications
LPC700	1/2"	0.500"	8'	6.1 lb	UL
LPC702	1/2"	0.500"	10'	7.6 lb	cULus
LPC704	5/8"	0.625"	8'	9.5 lb	UL
LPC706	5/8"	0.625"	10'	11.8 lb	cULus
LPC711	3/4"	0.750"	10'	17.0 lb	cULus

Due to the inherent softness of the copper material, special consideration should be given when driving this product into the soil.

GALVANIZED GROUND ROD, POINTED

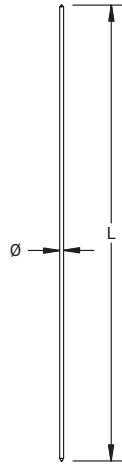
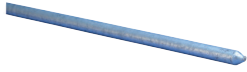

FEATURED HIGHLIGHTS

- Meets ANSI®/NEMA® GR1
- Zinc-coated exteriors are hot-dip galvanized for solid protection against corrosion, in accordance with ASTM® specification A153-78
- Surfaces are rigidly inspected to eliminate seams, slivers and other defects

Material: Steel

Finish: Hot-Dip Galvanized

Tensile Strength: 80,000 psi Min



Part Number	Ground Rod Diameter, Nominal	Ground Rod Diameter, Actual	Length	Unit Weight	UPC Label	Certifications
811260UPC	1/2"	0.507"	6'	4.1 lb	Yes	
811280UPC	1/2"	0.507"	8'	5.4 lb	Yes	
811350	1/2"	0.507"	5'	3.4 lb	No	
811360	1/2"	0.507"	6'	4.1 lb	No	
811380	1/2"	0.507"	8'	5.4 lb	No	
813400	3/4"	0.732"	10'	14.0 lb	No	CSA
813400UPC	3/4"	0.732"	10'	14.3 lb	Yes	
813480	3/4"	0.732"	8'	11.2 lb	No	
814400	1"	1.011"	10'	27.2 lb	No	CSA
815800	5/8"	0.631"	10'	10.6 lb	No	CSA
815800UPC	5/8"	0.631"	10'	10.6 lb	Yes	
815840	5/8"	0.631"	4'	4.2 lb	No	
815850	5/8"	0.631"	5'	5.3 lb	No	
815860	5/8"	0.631"	6'	6.4 lb	No	
815860UPC	5/8"	0.631"	6'	6.4 lb	Yes	
815880	5/8"	0.631"	8'	8.5 lb	No	
815880UPC	5/8"	0.631"	8'	8.4 lb	Yes	

VENT ERICO GROUND ENHANCEMENT MATERIAL (GEM)



nVent ERICO Ground Enhancement Material (GEM) is a superior conductive material that solves your toughest grounding problems. It is the ideal material to use in areas of poor conductivity, such as rocky ground, mountain tops and sandy soil. GEM dramatically reduces earth resistance and impedance measurements. Furthermore, GEM may reduce the size of the grounding system where conventional methods are unsatisfactory. Once installed, GEM is maintenance-free, not requiring periodic charging or the presence of water to maintain its conductivity.

To learn more about GEM, please see pages 18-20.

Unit Weight: 25 lb

Part Number	Packaging
GEM25A	Bag with handles
GEM25ABKT	Plastic bucket with locking lid

FEATURED HIGHLIGHTS

- Maintains constant resistance for the life of the system once in its set form
- Performs in all soil conditions even during dry spells
- Does not require periodic charging treatments or placement
- Does not require the continuous presence of water to maintain its conductivity
- Fully sets within 3 days, fully cures within 28 days
- Does not dissolve, decompose, or leach out with time
- Non-corrosive
- Reduces vandalism and theft since conductors are hard to remove from concrete
- Easy-to-handle 25 lb (11.3kg) bags or buckets
- Requires only one person to install
- Exceeds IEC® 62561-7 which sets the benchmark for corrosion, leaching, sulfur content, and other environmental regulations
- Complies to the United States Environmental Protection Agency (EPA) Toxicity Characteristic Leaching Procedure (TCLP), EPA test method 1311
- Can be installed using trench or ground rod backfill methods

INSPECTION HOUSING, HIGH DENSITY POLYETHYLENE (HDPE)

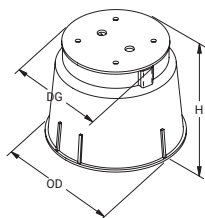

FEATURED HIGHLIGHTS

- Pedestrian load rating
- Suitable for lighter load rating applications in turf
- Chemical, UV and corrosion resistant
- 3/8" x 1 3/4" (44 mm) stainless steel lock bolt included
- Boxes and covers nest in 3 1/4" (83 mm) increments
- Two 3 1/2" x 1 1/2" (89 x 38 mm) knockouts per box
- T416BH includes four additional holes in the cover to allow water to enter the inspection well, typically for use with chemical ground rods

Material: High Density Polyethylene (HDPE)
Color: Green
Load Rating: 300 psf

Part Number	Diameter, Grade Level	Outer Diameter	Height	Unit Weight
T416B	10 1/4"	13.1"	10"	4.5 lb
T416BH	10 1/4"	13.1"	10"	4.5 lb

INSPECTION HOUSING WITH CONDUIT CUTOUT, HIGH DENSITY POLYETHYLENE (HDPE)

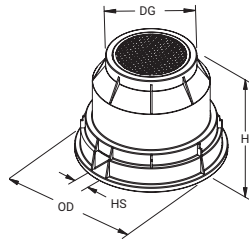

FEATURED HIGHLIGHTS

- Suitable for lighter load rating applications in turf
- Chemical, UV and corrosion resistant

Material: High Density Polyethylene (HDPE)
 Color: Black
 Load Rating: 300 psf

Part Number	Diameter, Grade Level	Outer Diameter	Height	Hole Size	Unit Weight
T416C	14 1/4"	24.38"	18 1/4"	2 3/4"	16.2 lb

KEY FOR T416C INSPECTION HOUSING



FEATURED HIGHLIGHTS

- Replacement key for the T416C Inspection Housing
- Useful for maintenance crews or inspectors in the field

Part Number	Unit Weight
T416CKEY	0.65 lb

INSPECTION HOUSING, LIGHTWEIGHT POLYMER CONCRETE



FEATURED HIGHLIGHTS

- Tier 15 Design Load of 15,000 lbs (6,804 kg) with a test load of 22,500 lbs (10,206 kg)
- Non-slip cover suitable for non-deliberate, incidental traffic
- Cuts with a standard hole saw, no concrete tools required

Material: Polymer Concrete

Part Number	Height	Length	Width	Unit Weight
T416A	18"	25.1"	16.2"	75 lb
T416D	12"	15.4"	15.4"	31 lb
T416E	18"	15.4"	15.4"	35 lb
T416F	23"	15.4"	15.4"	47 lb

Product specifications subject to change without notice.

INSPECTION HOUSING, HIGH-IMPACT POLYPROPYLENE

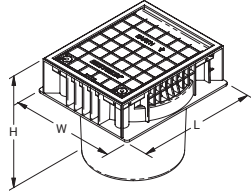
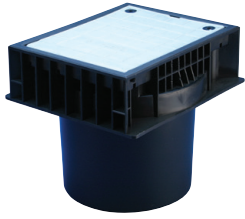

FEATURED HIGHLIGHTS

- Offers a high level of protection for critical grounding terminations through the use of its lockable lid
- Easy-locking lid only opened with security key
- Ease of ground termination maintenance due to large working aperture
- Lightweight design allows easy handling, storage and transportation
- Suitable for both paving and hot tar applications
- UV-stabilized against degradation by sunlight
- Non-brittle to prevent cold weather damage
- Base designed to accommodate Grounding Busbar for Inspection Housing (545135)

Material: High-Impact Polypropylene

Part Number	Height	Length	Width	Unit Weight
PIT03	8.5"	9.5"	8.2"	2.8 lb

INSPECTION HOUSING, CONCRETE

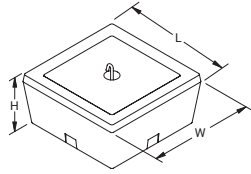

FEATURED HIGHLIGHTS

- Concrete design for higher load rating
- Available with a central lifting hook
- Flush-fitting lid with plain surface minimizes slipping
- Suitable for most grounding and lightning protection installations
- Base designed to accept 545140 Grounding Busbar for Inspection Housings
- Square shape

Material: Concrete
Color: Gray

Part Number	Height	Length	Width	Unit Weight
IP900C	6"	13"	13"	57.2 lb

INSPECTION HOUSING, SEAL KIT

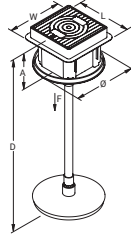

FEATURED HIGHLIGHTS

- Prevents the ingress of ground water into and surrounding the inspection housing
- Waterproofing is achieved by enclosing an upper section of copper-bonded ground rod within a plastic pipe with seals located on both sides of the concrete pour
- The two plate-style flange serves to reduce pressure, which may occur from the capillary effect of water on the outside of the seal and inspection housing
- The flanges are intended to prevent water pressure from “popping” the inspection pit out of the concrete
- Delivered as a kit, including a 3.9 foot (1.2 meter) PVC pipe, to be adjusted to site conditions

Material: Thermoplastic

Part Number	Length (L)	Width (W)	Depth (D)	A	Diameter	Water Pressure	Working Load (F)	Unit Weight
WGRS200	9.7"	9.7"	4.6'	8.2"	13.8"	80 psi Max	13,227 lb	9.5 lb

GROUNDING BUSBAR FOR INSPECTION HOUSING

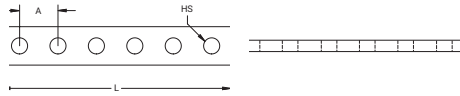
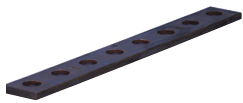

FEATURED HIGHLIGHTS

- Grounding busbar for use in conjunction with ground rod inspection housings

Material: Copper

Part Number	Length	Width	Thickness	A	Hole Size	Number of Holes	Inspection Housing	Unit Weight
545135	7.87"	0.98"	0.02"	0.98"	0.41"	8	PIT03	0.49 lb
545140	11.81"	0.98"	0.02"	0.98"	0.41"	12	IP-900-C	0.73 lb
545530	5.90"	0.98"	0.02"	0.98"	0.41"	6	103470, 103480	0.37 lb

GROUND MAT

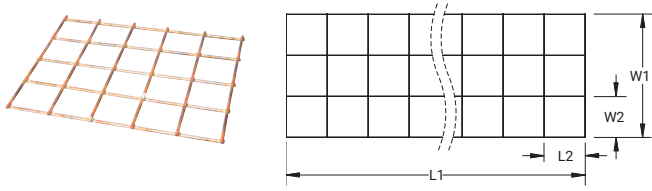

Prefabricated ground mats, made of wire mesh, are ideal for systems designed for safety purposes to protect operators against "touch potentials" at manually operated disconnect switches.

Material: Copper, Copper-Bonded Steel

FEATURED HIGHLIGHTS

- Silver brazed joints (35% silver alloy brazing material) provide strength to resist separation during installation and bear the traffic of heavy vehicles
- Conductor spacing available in standard configurations
- Option to add center wire into the mat configuration is available
- Ground mats are laid flat onto pallets for shipping

Part Number	MAT
Length 1 (L1)	96" Max
Width 1 (W1)	72" Max
Grid Spacing (L2 x W2)	2" x 2"
	4" x 4"
	6" x 6"
	8" x 8"
	10" x 10"
	12" x 12"
Conductor Size	#4 Solid Copper
	#6 Solid Copper
	#6 Copper-Clad Steel (30% or 40% Conductivity)
	#8 Solid Copper
Center Wire Conductor Size	#8 Copper-Clad Steel (30% or 40% Conductivity)
	1/0 Solid or Stranded
	2/0 Solid or Stranded
	4/0 Solid or Stranded
	250 kcmil Stranded
	300 kcmil Stranded
Overhang	350 kcmil Stranded
	500 kcmil Stranded
	Standard: Half Conductor Spacing + 2" (51 mm)
	With Center Wire
	With Overhanging Center Wire

W2 and L2 available in listed Grid Spacing only.

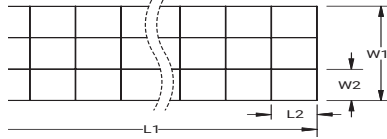
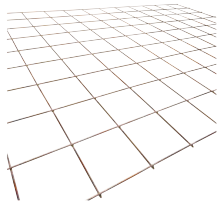

FEATURED HIGHLIGHTS

- Prefabricated ground mesh wound into a roll format for shipping
- Silver brazed joints (35% silver alloy brazing material) provide strength to resist separation during installation and bear the traffic of heavy vehicles
- Conductor spacing in many rectangular configurations up to 24" x 48" (610 mm x 1219 mm) in 2" (51 mm) increments
- Normally supplied in sections with standard overhang for interconnecting half conductor spacing + 2" (51 mm)

Prefabricated ground mesh from nVent ERICO is a convenient, efficient and economical means of improving grounding systems at facilities with high voltage installations and wherever large area grounds are required. Equipotential mesh reduces step potentials at power plants and substations, and effectively minimizes ground plane fluctuations at communications antenna sites. Wire mesh is also an excellent ground screen, reflector and electronic shield for large facilities.

Material: Copper, Copper-Bonded Steel

Part Number	MESH
Length 2 (L2)	2" – 24"
Width 1 (W1)	20' Max
Width 2 (W2)	2" – 48"
Conductor Size	#6 Solid Copper #6 Copper-Clad Steel (30% or 40% Conductivity) #8 Solid Copper #8 Copper-Clad Steel (30% or 40% Conductivity) #10 Solid Copper
Overhang	Standard: Half Conductor Spacing + 2" (51 mm) None Half Conductor Spacing
Unit Weight	500 lb Max

Net Weight (lbs) per 1,000 Square Feet							
Conductor Spacing (W2 x L2)	Copper-clad Steel Conductor (AWG)			Solid Copper Conductor (AWG)			
	#6	#8	#10	#6	#8	#10	
2" x 2"	888 lbs	558 lbs	351 lbs	974 lbs	609 lbs	383 lbs	
4" x 4"	443 lbs	279 lbs	175 lbs	487 lbs	305 lbs	192 lbs	
6" x 6"	295 lbs	186 lbs	117 lbs	325 lbs	203 lbs	128 lbs	
8" x 8"	222 lbs	139 lbs	88 lbs	243 lbs	153 lbs	96 lbs	
12" x 12"	148 lbs	93 lbs	59 lbs	163 lbs	102 lbs	64 lbs	
24" x 24"	74 lbs	47 lbs	29 lbs	91 lbs	51 lbs	32 lbs	

Add 75 lbs per roll for approximate shipping weight.

Length 1 (L1) is unlimited, up to 500 lbs. (227 kg) maximum. Length 2 (L2) and Width 2 (W2) are available in 2" (51 mm) increments only.

EXPANDED COPPER MESH

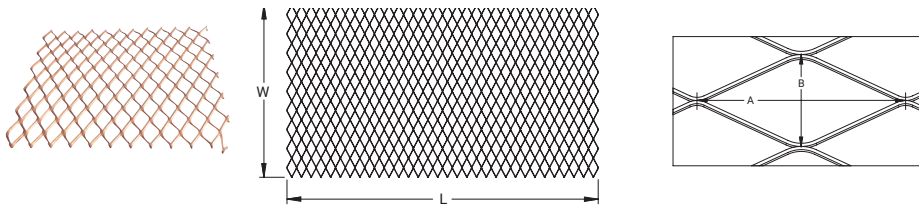

FEATURED HIGHLIGHTS

- Produced from copper plate and contains no welds or joints

Material: Copper

Part Number	Length	Width	Thickness	A	B
EMMCU080X36X96A	96"	36"	0.08"	0.9"	2"

POOL MESH

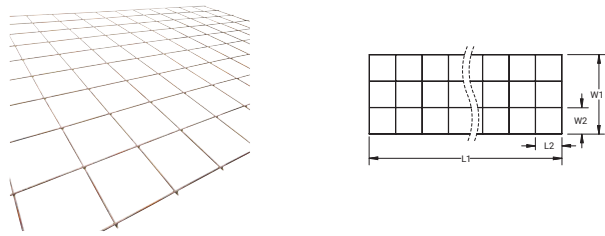

FEATURED HIGHLIGHTS

- Convenient, efficient and economical solution for equipotential bonding grids for swimming pool applications

The requirements for bonding and grounding permanently installed indoor and outdoor swimming pools are provided in Article 680 "Swimming Pools, Fountains and Similar Installations" of the 2005 Edition of the National Electrical Code (NEC®). All of the bonded parts in or around swimming pools must be attached to an equipotential bonding grid. This grid must extend 3' (0.91 m) beyond the inside surface of the pool under concrete, stone or other paved walking surfaces.

Material: Copper

Part Number	Length 1	Width 1	Grid Spacing	Conductor Size
POOLMESH2100	100'	2'	12" x 12"	#8 Solid
POOLMESH250	50'	2'	12" x 12"	#8 Solid
POOLMESH3100	100'	3'	12" x 12"	#8 Solid
POOLMESH350	50'	3'	12" x 12"	#8 Solid

Net Weight (lbs) per Standard Mat										
Grid Spacing										
Conductor Size										
Standard Mat Size (square feet)										
	2" x 2"		4" x 4"		6" x 6"		8" x 8"		12" x 12"	
	4' x 4'		4' x 6'		4' x 4'		4' x 6'		4' x 4'	
#6 Copper-Clad Steel Wire	14.6 lbs	21.7 lbs	7.6 lbs	11.2 lbs	5.3 lbs	7.7 lbs	4.1 lbs	6 lbs	2.9 lbs	4.2 lbs
#8 Copper-Clad Steel Wire	9.2 lbs	13.7 lbs	4.8 lbs	7.1 lbs	3.3 lbs	4.9 lbs	2.6 lbs	3.8 lbs	1.9 lbs	2.7 lbs

Weights are for copper-clad steel wire. Add 10% for approximate weight of solid copper wire.
Mats are palletized for shipment. Add 50 lbs per pallet for gross weight. Maximum of 100 mats per pallet.

SIGNAL REFERENCE GRID

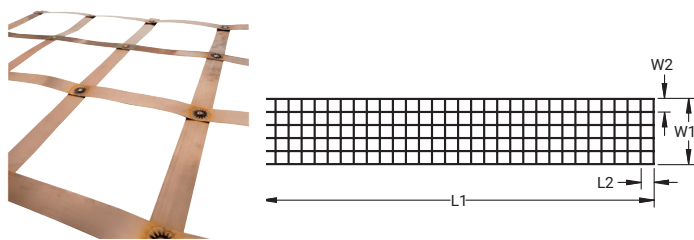

FEATURED HIGHLIGHTS

- Provides a low impedance equipotential plane to protect sensitive electronic equipment from transient noise
- Pre-engineered welded grid of 26 gauge copper strips reduces voltage differences between interconnected electronic equipment
- Welded connections do not deteriorate, corrode or loosen with time
- Can be easily field-welded to suit any size computer room
- Complies with IEEE® Standard 1100-1992

Material: Copper



Part Number	Length 1	Width 1	Grid Spacing	Thickness	Strip Width
SRGBD100	100'	10'	24" x 24"	0.016"	2"
SRGBE100	100'	12'	24" x 24"	0.016"	2"
SRGBG100	100'	16'	24" x 24"	0.016"	2"

Custom sizes available upon request. Contact your nVent ERICO representative for more information.

COPPER GROUND PLATE

FEATURED HIGHLIGHTS

- Provides a large surface area to dissipate current into the ground
- Available in a variety of sizes and pigtail configurations



GPE-C-E-A-H-024-1L-024-(T)

GPE	Ground Plate Electrode	
C	Material	A: Steel (HRS M1020) B: Stainless Steel (SS304) C: Copper (C11000) D: Galvanized Steel
E	Pigtail Connection Type	C: Continuous (2 x "L J" nVent ERICO Cadweld Connection) E: End ("L J" Cadweld Connection Style) N: No Pigtail
A	Plate Thickness Code (Stock Tolerance)	A: 1/32" (Min. for Lightning – Cu) B: 1/16" (Min. for Power – Cu) C: 3/32" D: 1/8" E: 1/4" (Min. for Power – Stl.) F: 3/8" G: 1/2" H: 1/64" (26 Gauge) J: 3/16"
H	Plate Width Code	A: 1" · B: 2" · C: 3" · D: 4" · E: 5" · F: 6" · G: 9" · H: 12" · J: 18" K: 24" · L: 30" · M: 36" · N: 42" · P: 48" · Q: 17" · R: 10"
024	Plate Length Code (inches) (3 digits required)	
1L*	Pigtail Cable Type (nVent ERICO Cable Code)	
024*	Pigtail Length (inches)	
(T)*	Tinned	

Pigtail Connection

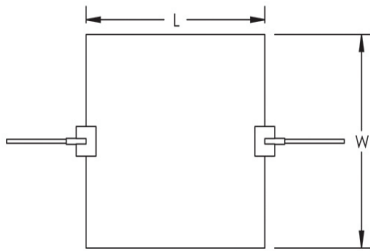

Continuous

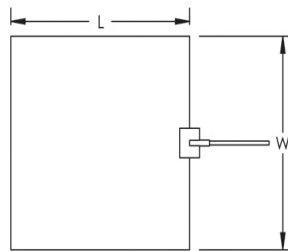

End

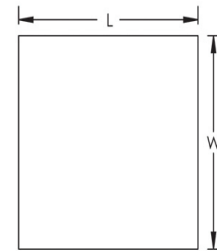

None

Material: Copper

Part Number	Width	Length	Pigtail Connection	Pigtail Length	Conductor Size	Thickness
GPECCAM036	36"	36"	None			1/32"
GPECCAM0361H024	36"	36"	Continuous	24"	#6 Stranded	1/32"
GPECCBJ0181T024	18"	18"	Continuous	24"	#2 Solid	1/16"
GPECCBJ0181T060	18"	18"	Continuous	60"	#2 Solid	1/16"
GPECCBJ181T108S	18"	18"	Continuous	108"	#2 Solid	1/16"
GPECCDK0241L024	24"	24"	Continuous	24"	#4 Stranded	1/8"
GPECCCK0242C036	24"	24"	Continuous	36"	1/0 Stranded	1/4"
GPECEAJ0181G024	18"	18"	End	24"	#6 Solid	1/32"
GPECEAJ0241G024	18"	24"	End	24"	#6 Solid	1/32"
GPECEAK0241G024	24"	24"	End	24"	#6 Solid	1/32"
GPECEAK0241H024	24"	24"	End	24"	#6 Stranded	1/32"
GPECEAK0242V024	24"	24"	End	24"	250 kcmil Stranded	1/32"
GPECEAM0361H024	36"	36"	End	24"	#6 Stranded	1/32"
GPECEAM0362V012	36"	36"	End	12"	250 kcmil Stranded	1/32"
GPECEAP0481H024	48"	48"	End	24"	#6 Stranded	1/32"
GPECEBH0121V024	12"	12"	End	24"	#2 Stranded	1/16"
GPECEBH0241K024	12"	24"	End	24"	#4 Solid	1/16"
GPECEBQ0171G120	17"	17"	End	120"	#6 Solid	1/16"
GPECEDK0241L024	24"	24"	End	24"	#4 Stranded	1/8"
GPECEDK0242Q036	24"	24"	End	36"	4/0 Stranded	1/8"
GPECEEK0241T024	24"	24"	End	24"	#2 Solid	1/4"
GPECEEK0242Q008	24"	24"	End	8"	4/0 Stranded	1/4"
GPECEEK0242Q060	24"	24"	End	60"	4/0 Stranded	1/4"
GPECEEK0242Q120	24"	24"	End	120"	4/0 Stranded	1/4"
GPECEEK0242Q180	24"	24"	End	180"	4/0 Stranded	1/4"
GPECEEK0361T024	24"	36"	End	24"	#2 Solid	1/4"
GPECNAJ018	18"	18"	None			1/32"
GPECNAK024	24"	24"	None			1/32"
GPECNBH012	12"	12"	None			1/16"
GPECNBH024	12"	24"	None			1/16"
GPECNDF006	6"	6"	None			1/8"
GPECNDH024	12"	24"	None			1/8"
GPECNEB024	2"	24"	None			1/4"
GPECNED004	4"	4"	None			1/4"
GPECNED012	4"	12"	None			1/4"
GPECNED014	4"	14"	None			1/4"
GPECNED096	4"	96"	None			1/4"
GPECNEG024	9"	24"	None			1/4"
GPECNEH016	12"	16"	None			1/4"
GPECNEK024	24"	24"	None			1/4"
GPECNEM040	36"	40"	None			1/4"
GPECNEN040	42"	40"	None			1/4"
GPECNFH033	12"	33"	None			3/8"
GPECNFK024	24"	24"	None			3/8"
GPECNGF012	6"	12"	None			1/2"
GPECNGK024	24"	24"	None			1/2"
GPECNHM096	36"	96"	None			1/64"
Finish: Tinned						
GPECCDM0361T10T	36"	36"	Continuous	10"	#2 Solid	1/8"
GPECEJK0361T24T	24"	36"	End	24"	#2 Solid	3/16"
GPECNDK024T	24"	24"	None			1/8"
GPECNDM036T	36"	36"	None			1/8"

COPPER GROUND PLATE WITH BENT CORNERS

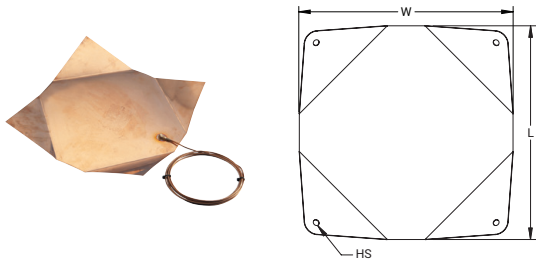

FEATURED HIGHLIGHTS

- Used to ground utility poles
- The corners of the ground plate are nailed into the base of the pole

Material: Copper

Part Number	Length	Width	Thickness	Hole Size	Conductor Size	Pigtail Included	Pigtail Length
Finish: Bare – Type: Ground Plate, No Holes							
GPECEHX1	17"	17"	0.064"		#6 Solid	Yes	12'
GPECEHX3	17"	17"	0.064"		#2 Stranded	Yes	12'
Finish: Tinned – Type: Ground Plate With Holes							
GPECEHX1T	17"	17"	0.064"	1/2"	#6 Solid	Yes	12'

The pigtail for GPECEHX1T is tinned, but the plate itself is bare copper.

COPPER GROUND PLATE WITH CABLE ATTACHMENTS

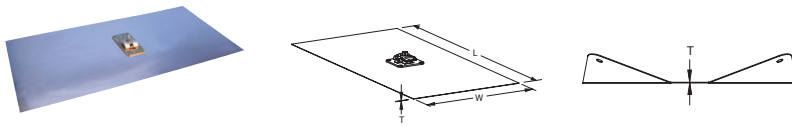

FEATURED HIGHLIGHTS

- Bonding plates provide mechanical attachment points to ground plate
- Listed to UL® 96

Material: Copper



Part Number	Width	Length	Thickness
Number of Cable Attachments: 1			
LPC753	12"	24"	20 GA
LPC754	18"	18"	20 GA
LPC755	36"	36"	20 GA
Number of Cable Attachments: 2			
LPC750	12"	24"	20 GA
LPC751	18"	18"	20 GA
LPC752	36"	36"	20 GA
LPC756	24"	24"	20 GA

COPPER UTILITY GROUND PLATE

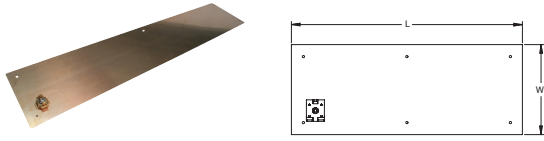

FEATURED HIGHLIGHTS

- Provides a large surface area to dissipate current into the ground
- Wrap around the bottom of a utility pole to install

Part Number	Connector	Length	Width	Thickness	Standard Packaging Quantity
UGP719	SRGC46	19 1/4"	7 1/2"	1/16"	1 pc
UGP719BP5	SRGC46	19 1/4"	7 1/2"	1/16"	5 pc
UGP719SBP5	ESB2 Split Bolt	19 1/4"	7 1/2"	1/16"	5 pc
UGP738	SRGC46	38 1/2"	7 1/2"	1/16"	1 pc
UGP738P10	SRGC46	38 1/2"	7 1/2"	1/16"	10 pc
UGP738P5	SRGC46	38 1/2"	7 1/2"	1/16"	5 pc
UGP738SBP5	ESB2 Split Bolt	38 1/2"	7 1/2"	1/16"	5 pc

COPPER UTILITY POLE BOTTOM PLATE

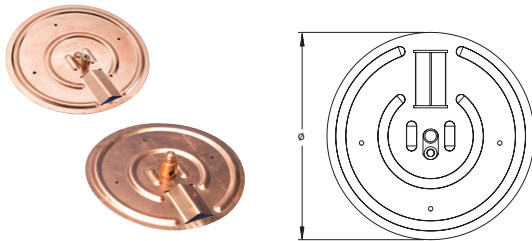

FEATURED HIGHLIGHTS

- Integrated connector provides a convenient method for terminating the grounding conductor
- Quick and easy installation
- Cost-effective ground electrode solution
- Manufactured of corrosion-resistant electrolytic copper
- Construction meets the requirements of the NESC®
- Fix cable and nail to base before raising pole

Material: Copper

Part Number	Connector	Conductor Size	Diameter	Thickness
EGP100	Lug	#14 Solid - #4 Stranded, 2.5 mm ² Stranded - 16 mm ² Stranded	7 1/2"	0.025"
EGP100HL	Hammerlock	#14 Solid - #4 Stranded, 2.5 mm ² Stranded - 16 mm ² Stranded	7 1/2"	0.025"

STEEL GROUND PLATE

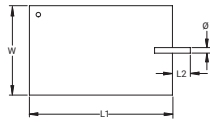
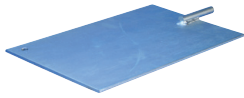

FEATURED HIGHLIGHTS

- Provides a large surface area to dissipate current into the ground
- Includes a welded steel rod pigtail

Material: Steel



Part Number	Connector	Length 1	Length 2	Width	Thickness	Diameter	Certifications
Finish: ElectroGalvanized							
EGGP	None	16"	2"	10"	1/4"	5/8"	C-CSA-US
EGGPC	HDC58	16"	2"	10"	1/4"	5/8"	C-CSA-US
Finish: Plain							
EBGP	None	16"	2"	10"	1/4"	5/8"	

B162 EARTHPOINT, TWO STUD

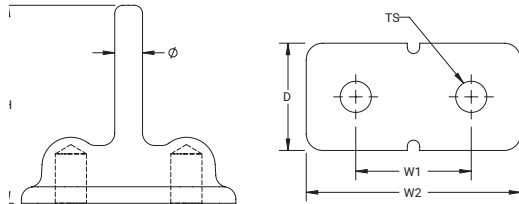

FEATURED HIGHLIGHTS

- Long-lasting design
- Low ground resistance and impedance
- Superior electrical conductivity and resistance to corrosion
- Electrically and mechanically robust and reliable
- Easy to install as a Prefabricated Earthbridge once Cadweld welded to a piece of conductor

Material: Brass

Part Number	Width 1	Width 2	Depth	Height	Diameter	Thread Size
B1622Q	1 3/4"	3 1/4"	1 5/8"	3"	0.53"	1/2 UNC

Assemblies require conductors and Cadweld connections, which must be ordered separately.

B161/B164 EARTHPOINT, FOUR STUD

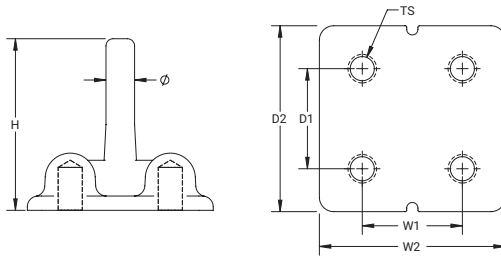

FEATURED HIGHLIGHTS

- Long-lasting design
- Low ground resistance and impedance
- Superior electrical conductivity and resistance to corrosion
- Electrically and mechanically robust and reliable
- Easy to install as a Prefabricated Earthbridge once Cadweld welded to a piece of conductor

Material: Brass

Part Number	Width 1	Width 2	Depth 1	Depth 2	Height	Diameter	Thread Size
B1612Q	1 1/4"	2 1/2"	1"	2 1/4"	3"	0.530"	3/8 UNC
B1613Q	1 1/4"	2 1/2"	1"	2 1/4"	3"	0.825"	3/8 UNC
B1642Q	1 3/4"	3 1/4"	1 3/4"	3 1/4"	3"	0.530"	1/2 UNC
B1643Q	1 3/4"	3 1/4"	1 3/4"	3 1/4"	3"	0.825"	1/2 UNC

Assemblies require conductors and Cadweld connections, which must be ordered separately.

GROUND POINT

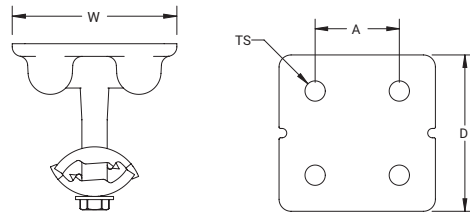

FEATURED HIGHLIGHTS

- Cast grounding plate for equipment, machinery, or structure grounding points
- May be installed flush in concrete floor or wall
- Cable connection under bolt tension

Material: Brass

Part Number	Conductor Size, UL	Thread Size	Depth	Width	A	Unit Weight
LPC682	Class 1 - Class 2 (4/0 Max)	1/2 UNC	3 1/4"	3 1/4"	1 3/4"	1.535 lb

REBAR BONDING KIT, SINGLE CONNECTION

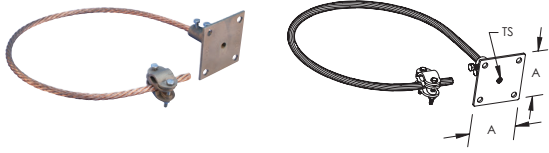

FEATURED HIGHLIGHTS

- Kit includes Rebar Bonding Plate, Rebar Bonding Clamp and conductor
- Provides ground system connection points in concrete structures
- Used for equipment, machinery and structure grounding

Material: Brass, Copper



Part Number	Conductor Type	Cable Length	Thread Size	A	Unit Weight
LPC46740X1	LPC404	3'	1/2 UNC	4"	3.218 lb
LPC467X1	LPC401	3'	1/2 UNC	4"	2.400 lb

REBAR BONDING KIT, DUAL CONNECTION

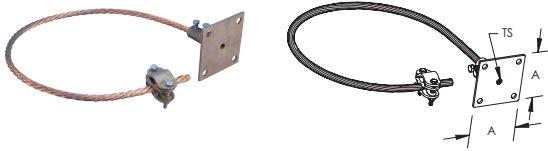

FEATURED HIGHLIGHTS

- Kit includes Rebar Bonding Plate, two Rebar Bonding Clamps and two conductors
- Provides ground system connection points in concrete structures
- Used for equipment, machinery and structure grounding

Material: Brass, Copper



Part Number	Conductor Type	Cable Length	Thread Size	A	Unit Weight
LPC46740X2	LPC404	3'	1/2 UNC	4"	5.792 lb
LPC467X2	LPC401	3'	1/2 UNC	4"	4.154 lb

Cable Length represents the length of a single conductor.

REBAR BONDING PLATE

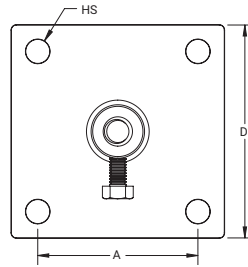
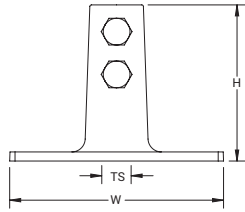

FEATURED HIGHLIGHTS

- Provides ground system connection points in concrete structures
- Used for equipment, machinery and structure grounding

Material: Brass



Part Number	Conductor Size	Thread Size	Depth	Height	Width	A	Hole Size	Unit Weight
LPC467	2/0 Stranded - 4/0 Stranded	1/2 UNC	4"	2.92"	4"	3"	0.45"	0.644 lb

GROUND POINT ASSEMBLY



FEATURED HIGHLIGHTS

- Convenient ground system connection points in concrete structures
- Used for equipment, machinery and structure grounding
- Results in maximum current-carrying capacity equal to the cross-sectional area of the conductor or stud
- The Cadweld connection between the stud and pigtail will not loosen or corrode

Ground Plate Configuration

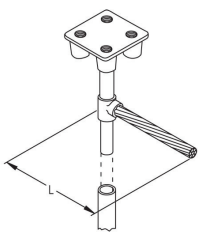

RA

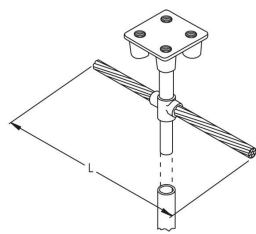

RB

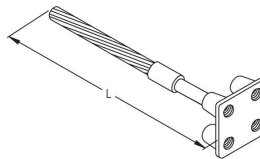

SS

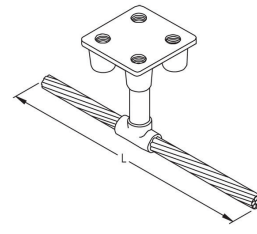

TA

Ground Plate Configuration

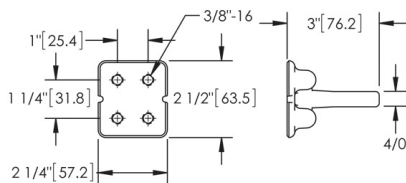

B1612Q

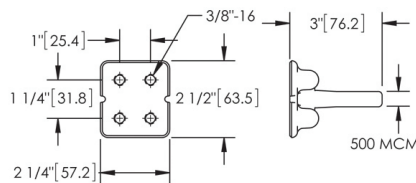

B1613Q

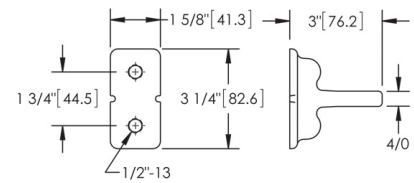

B1622Q

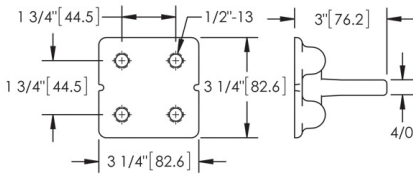

B1642Q

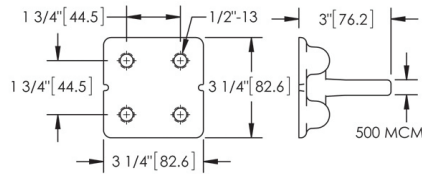

B1643Q

B530-A-2Q-72

B530	Ground Plate Configuration	B530 = RA B531 = RB B532 = SS B533 = TA
A	Ground Plate Part Number	A = B1612Q B = B1613Q C = B1622Q D = B1642Q E = B1643Q
2Q	Cable Code	1G = #6 Solid 1L = #4 Stranded 1V = #2 Stranded 2C = 1/0 Stranded 2G = 2/0 Stranded 2Q = 4/0 Stranded 2V = 250 MCM Stranded 3D = 350 MCM Stranded 3Q = 500 MCM Stranded
72	Cable Length (inches)	

Material: Copper Alloy

Part Number	Ground Plate Configuration	Ground Plate Part Number	Conductor Size	Cable Length
B530A1L12	RA	B1612Q	#4 Stranded	12"
B530A1V12	RA	B1612Q	#2 Stranded	12"
B530A2Q48	RA	B1612Q	4/0 Stranded	48"
B530A2Q72	RA	B1612Q	4/0 Stranded	72"
B530B2G24	RA	B1613Q	2/0 Stranded	24"
B530C1L048	RA	B1622Q	#4 Stranded	48"
B530C2C24	RA	B1622Q	1/0 Stranded	24"
B530C2G48	RA	B1622Q	2/0 Stranded	48"
B530C2Q36	RA	B1622Q	4/0 Stranded	36"
B530C2Q48	RA	B1622Q	4/0 Stranded	48"
B530C2Q96	RA	B1622Q	4/0 Stranded	96"
B530D2C48	RA	B1642Q	1/0 Stranded	48"
B530D2G18	RA	B1642Q	2/0 Stranded	18"
B530D2G180	RA	B1642Q	2/0 Stranded	180"
B530D2G24	RA	B1642Q	2/0 Stranded	24"
B530D2G48	RA	B1642Q	2/0 Stranded	48"
B530D2Q12	RA	B1642Q	4/0 Stranded	12"
B530D2Q120	RA	B1642Q	4/0 Stranded	120"
B530D2Q144	RA	B1642Q	4/0 Stranded	144"
B530D2Q180	RA	B1642Q	4/0 Stranded	180"
B530D2Q24	RA	B1642Q	4/0 Stranded	24"
B530D2Q32	RA	B1642Q	4/0 Stranded	32"
B530D2Q36	RA	B1642Q	4/0 Stranded	36"
B530D2Q48	RA	B1642Q	4/0 Stranded	48"
B530D2Q72	RA	B1642Q	4/0 Stranded	72"
B530D2Q96	RA	B1642Q	4/0 Stranded	96"
B531A2Q36	RB	B1612Q	4/0 Stranded	36"
B531D2G24	RB	B1642Q	2/0 Stranded	24"
B531D2Q12	RB	B1642Q	4/0 Stranded	12"
B531D2Q120	RB	B1642Q	4/0 Stranded	120"
B531D2Q144	RB	B1642Q	4/0 Stranded	144"
B531D2Q24	RB	B1642Q	4/0 Stranded	24"
B531D2Q48	RB	B1642Q	4/0 Stranded	48"
B531D2Q6	RB	B1642Q	4/0 Stranded	6"
B531D2Q72	RB	B1642Q	4/0 Stranded	72"

Part Number	Ground Plate Configuration	Ground Plate Part Number	Conductor Size	Cable Length
B531D2Q96	RB	B1642Q	4/0 Stranded	96"
B532A2Q48	SS	B1612Q	4/0 Stranded	48"
B532C2G24	SS	B1622Q	2/0 Stranded	24"
B532C2G60	SS	B1622Q	2/0 Stranded	60"
B532C2Q240	SS	B1622Q	4/0 Stranded	240"
B532C2Q48	SS	B1622Q	4/0 Stranded	48"
B532C2V48	SS	B1622Q	250 kcmil Stranded	48"
B532C3Q48	SS	B1622Q	500 kcmil Stranded	48"
B532D1L48	SS	B1642Q	#4 Stranded	48"
B532D1V36	SS	B1642Q	#2 Stranded	36"
B532D2C24	SS	B1642Q	1/0 Stranded	24"
B532D2C36	SS	B1642Q	1/0 Stranded	36"
B532D2G12	SS	B1642Q	2/0 Stranded	12"
B532D2G48	SS	B1642Q	2/0 Stranded	48"
B532D2Q36	SS	B1642Q	4/0 Stranded	36"
B532D2Q40	SS	B1642Q	4/0 Stranded	40"
B532D2Q48	SS	B1642Q	4/0 Stranded	48"
B532D2Q50	SS	B1642Q	4/0 Stranded	50"
B532D2Q72	SS	B1642Q	4/0 Stranded	72"
B532E3D96	SS	B1643Q	350 kcmil Stranded	96"
B532E3Q48	SS	B1643Q	500 kcmil Stranded	48"
B532E3Q96	SS	B1643Q	500 kcmil Stranded	96"
B533A2G48	TA	B1612Q	2/0 Stranded	48"
B533A2Q24	TA	B1612Q	4/0 Stranded	24"
B533C2Q48	TA	B1622Q	4/0 Stranded	48"
B533D2Q12	TA	B1642Q	4/0 Stranded	12"
B533D2Q24	TA	B1642Q	4/0 Stranded	24"
B533D2Q48	TA	B1642Q	4/0 Stranded	48"

Custom lengths available. Please contact nVent ERICO for details.

AIRCRAFT GROUNDING RECEPTACLE WITH BAR ATTACHMENT POINT

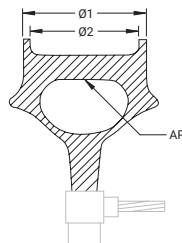
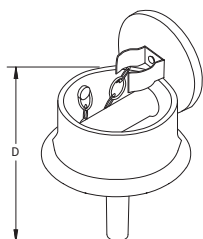

FEATURED HIGHLIGHTS

- Castings for use in static grounding systems of refueling areas
- Suitable as a combination tie down and static ground point
- Easily connected to grounding system conductor and/or ground rods
- Designed for simple installation with flush paved surfaces
- Compatible with Cadweld connections

Material: Phosphor Bronze

Part Number	Diameter 1	Diameter 2	Depth	Attachment Point	Pipe Size	Connection Type
B166	3 7/8"	3 5/8"	6 1/4"	3/4" Diameter Bar	1/2"	RA, RB
B167	4 3/4"	4 13/32"	7 1/4"	1 1/2" Diameter Bar	1/2"	RA, RB

AIRCRAFT GROUNDING RECEPTACLE WITH BALL STUD

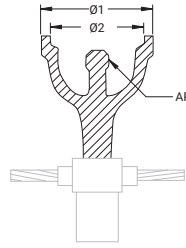
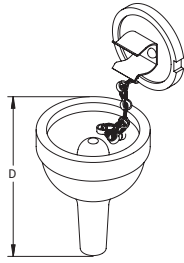

FEATURED HIGHLIGHTS

- Castings for use in static grounding systems of refueling areas
- Easily connected to grounding system conductor and/or ground rods
- Designed for simple installation with flush paved surfaces
- Compatible with Cadweld connections

Material: Phosphor Bronze

Part Number	Diameter 1	Diameter 2	Depth	Attachment Point	Pipe Size	Connection Type
B165	2 3/4"	2 3/16"	4 1/2"	Permanent 5/8" Ball Stud	1/2"	RA, RB
B165R	2 3/4"	2 3/16"	4 1/2"	Removable 5/8" Ball Stud	1/2"	RA, RB

AIRCRAFT GROUNDING RECEPTACLE REPLACEMENT BALL STUD



FEATURED HIGHLIGHTS

- Replacement ball stud for B165R Aircraft Grounding Receptacle

Material: Phosphor Bronze

Part Number

B165RS

AIRCRAFT GROUNDING RECEPTACLE REPLACEMENT COVER

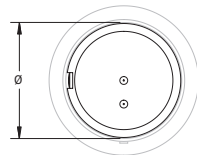

FEATURED HIGHLIGHTS

- Replacement covers available for Aircraft Grounding Receptacles
- Includes cover only, without chain or spring clip

Material: Phosphor Bronze

Part Number	For Use With	Diameter
B165B	B165 and B165R	2 3/16"
B166B	B166	3 5/8"
B167B	B167	4 13/32"

AIRCRAFT GROUNDING RECEPTACLE FOR SECTIONALGROUND RODS

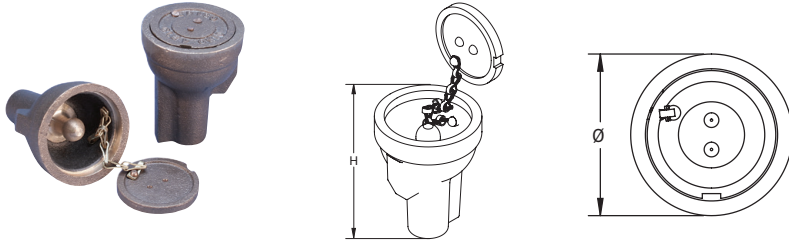

FEATURED HIGHLIGHTS

- Castings for use in static grounding systems of refueling areas
- Designed for simple installation with flush paved surfaces
- Standard pin connection
- Chain-retained cover plate
- Couple directly to 3/4" (nominal) sectional or extension rod
- LPC681 includes spring clip to secure the cover plate
- Listed to UL® 96

Material: Bronze

Part Number	Diameter	Height	Attachment Point	Spring Clip Included
LPC680	2 3/4"	3 1/2"	Permanent 3/4" Ball Stud	No
LPC681	2 3/4"	3 1/2"	Permanent 3/4" Ball Stud	Yes

AIRCRAFT GROUNDING TIE DOWN



FEATURED HIGHLIGHTS

- Used as an attachment point for static grounding

Material: Copper-Bonded Steel, Bronze

Part Number	Diameter	Length	Thread Size	A	B
663400	2"	10'	3/4 UNC	5"	1"

AIRCRAFT GROUNDING TIE DOWN MOLD

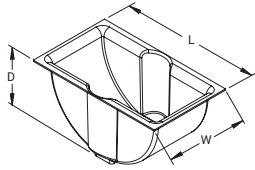

FEATURED HIGHLIGHTS

- Plastic mold for making depression in concrete pour around loop in Aircraft Grounding Tie Down

Material: High-Impact Polystyrene

Part Number	Length	Width	Depth
DM5834	6"	3"	2.9"

AIRCRAFT GROUNDING CLAMP

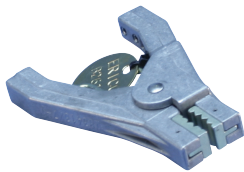

FEATURED HIGHLIGHTS

- Fits ground rods up to 3/4" nominal and nVent ERICO Aircraft Grounding Receptacles B165 and B166
- Cast aluminum construction with plated steel jaws
- Aviation industry standard for bonding and grounding aircraft and refueling vehicles
- Ideal for attaching to landing gear, posts, ground balls, ground rods and other curved unpainted surfaces
- Complies with Mil Spec M83413/7-1

Material: Aluminum, Steel

Part Number	Jaw Opening	Throat Depth	Harness Included
B2617A	3/4" Max	3/4"	No

STATIC GROUNDING CLAMP FOR DRUMS



FEATURED HIGHLIGHTS

- Designed specifically for grounding or bonding small containers, drums, totes, machinery or personnel in areas containing flammable liquids or dust
- Plier-type clamp has a die cast aluminum body with two stainless steel points and a hefty 55 pound (25 kg) spring compression
- Design allows the clamp to penetrate multiple layers of paint or corrosion build-up so that proper contact is made to bare metal

Material: Aluminum, Stainless Steel 416 (EN 1.4005)



Part Number	Jaw Opening	Throat Depth	Harness Included
B2610A	1" Max	1"	No

FM is a registered certification mark of FM Approvals LLC, LTD.

STATIC GROUNDING CABLE REEL, BARE CABLE

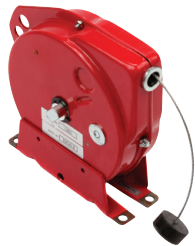

FEATURED HIGHLIGHTS

- Includes a stop at the end of the retractable cable
- Typically used with B2610A Static Grounding Clamp For Drums (sold separately)

Material: Steel
Finish: Electrogalvanized

Part Number	Product	Diameter	Length
B2618A	Cable for grounding flammable drums and totes	3/32"	20'
B2618B	Cable for grounding tanker trucks and rail cars	3/32"	50'

Containers with flammable liquid should remain closed until bonding and grounding is complete, because an initial spark may occur during the connection of grounding equipment which could ignite vapors or gases.

Grounding Busbars

GROUNDING BUSBAR - ELECTRICAL BUSBAR

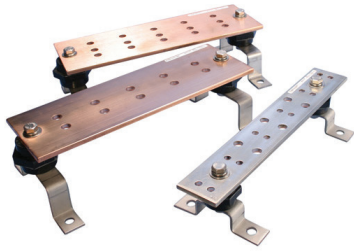

FEATURED HIGHLIGHTS

- Provides a convenient, single-point grounding and bonding location
- Conductors are welded to the bar using a Cadweld exothermic connection or are mechanically fastened by using lugs
- Custom bars can be designed and manufactured to customer specifications

E G B A 1 4 4 1 2 C C

nVent ERICO Ground Bar Designation

Configuration

A = Insul & Brkt C = None (Bar only)
B = Brkt only D = Insul only

Thickness

18 = 1/8" 58 = 5/8" 12 = 1/2"
38 = 3/8" 14 = 1/4" 34 = 3/4"

Width

1 = 1" 4 = 4" 7 = 7"
2 = 2" 5 = 5" 8 = 8"
3 = 3" 6 = 6" 9 = 9"

Pig Tail Length Ft. (Empty if none)

A = 1 E = 5 J = 9 N = 16 S = 24 W = 32
B = 2 F = 6 K = 10 O = 17 T = 25 X = 34
C = 3 G = 7 L = 11 P = 18 U = 26 Y = 36
D = 4 H = 8 M = 12 Q = 19 V = 27 Z = 38

nVent ERICO Cable Code (Empty if none)

1K = #4 Sol Tin 2C = 1/0 2V = 250 KCM
1T = #2 Sol Tin SG = 2/0 3D = 350 KCM
2L = 3/0 3Q = 500 KCM
2Q = 4/0 4L = 750 KCM

Tin Plating (Empty if none)
T = Tinned

Hole Pattern

Length (rounded to the nearest inch, up to 96 inch max.)

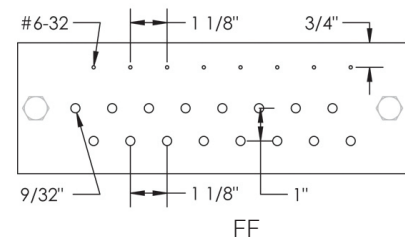
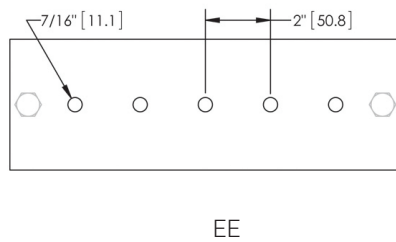
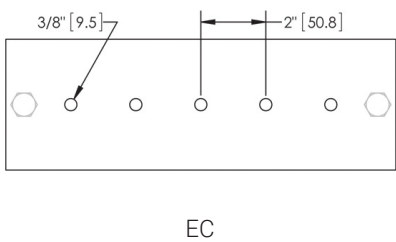
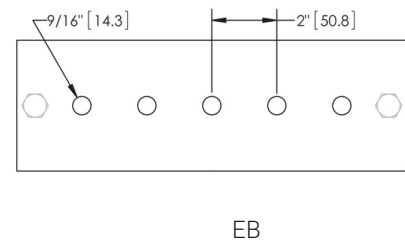
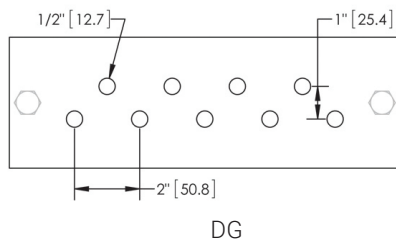
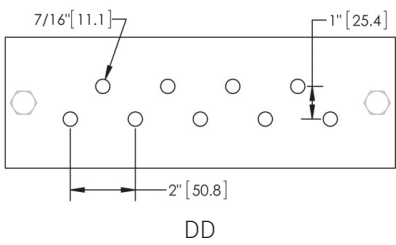
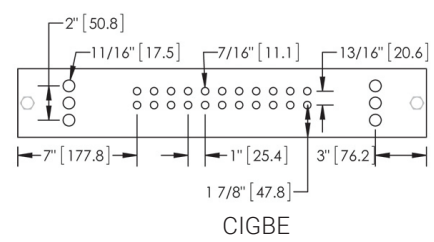
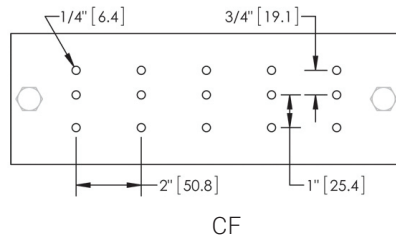
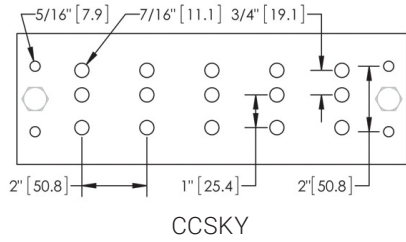
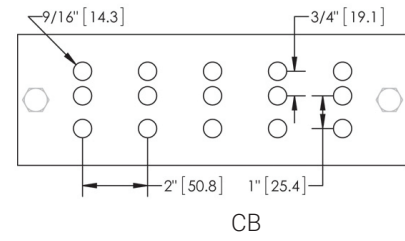
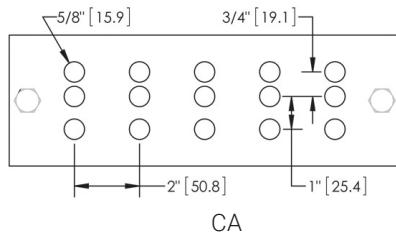
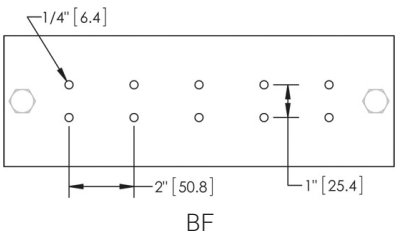
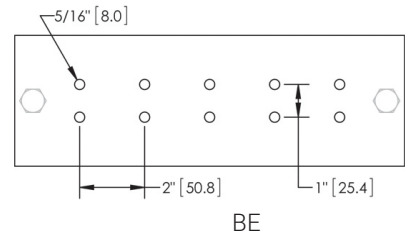
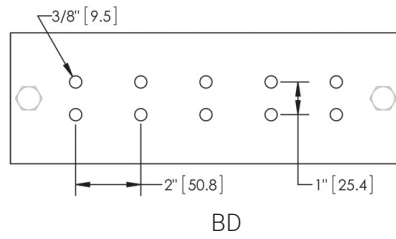
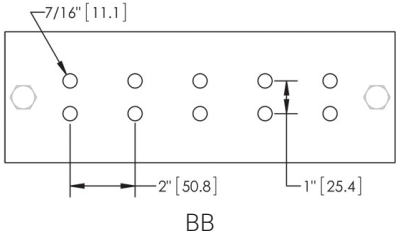
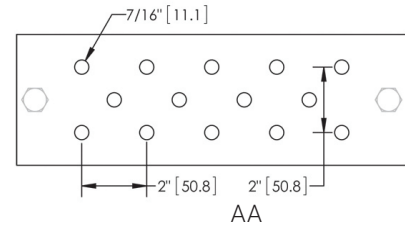
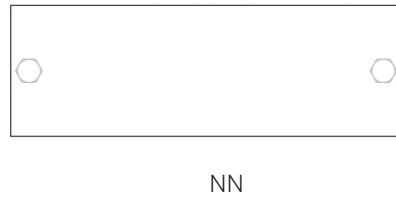
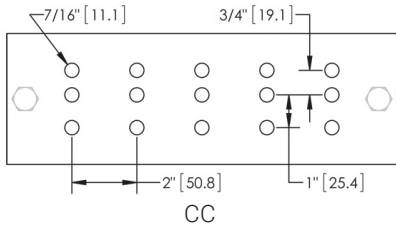

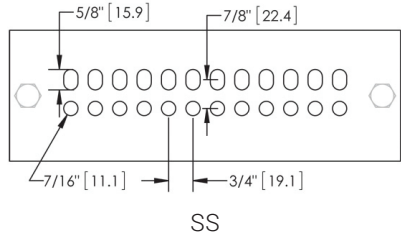
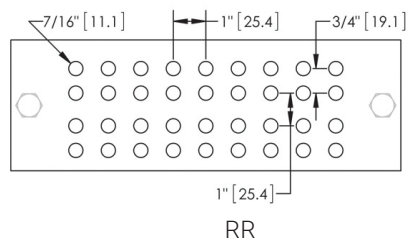
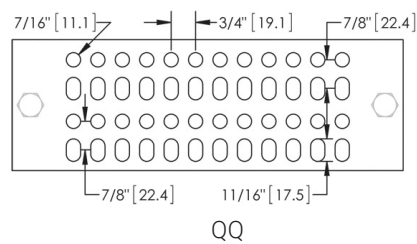
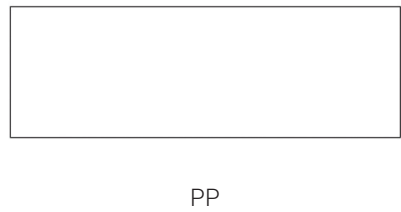
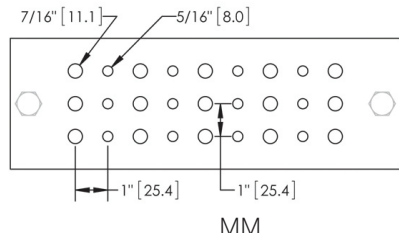
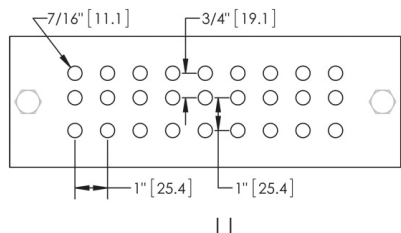
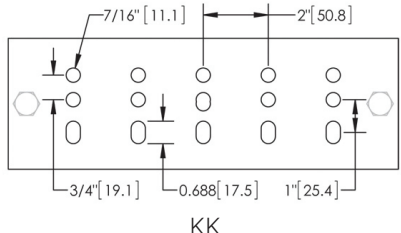
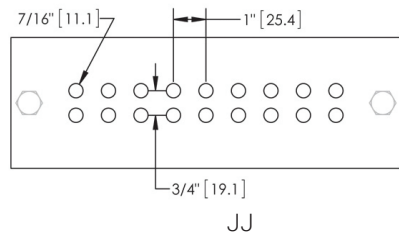
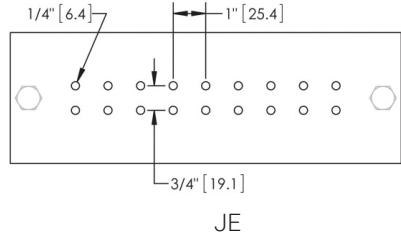
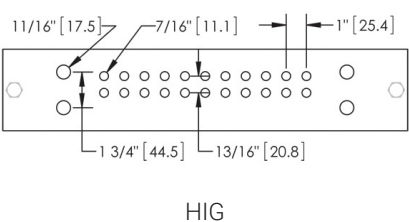
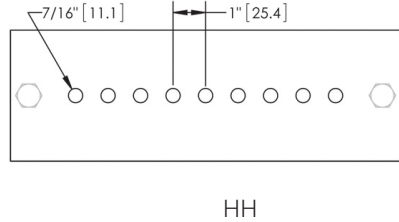
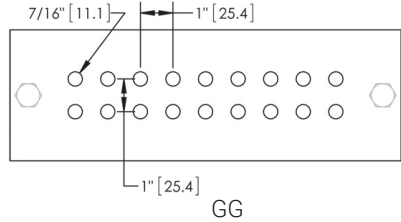
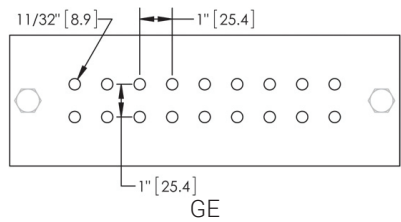

Global Part Number	Hole Pattern	Mounting Hole Size	Length	Width	Thickness	Tin Plating	Pigtail Included
EGBA14112EE	EE	0.438"	12"	1"	1/4"	No	No
EGBA14212BB	BB	0.438"	12"	2"	1/4"	No	No
EGBA14212EE	EE	0.438"	12"	2"	1/4"	No	No
EGBA14212HH	HH	0.438"	12"	2"	1/4"	No	No
EGBA14212NN	NN	0.438"	12"	2"	1/4"	No	No
EGBA14212TES	TES	0.438"	12"	2"	1/4"	No	No
EGBA14215JJ	JJ	0.438"	15"	2"	1/4"	No	No
EGBA14215TES	TES	0.438"	15"	2"	1/4"	No	No
EGBA14224NN	NN	0.438"	24"	2"	1/4"	No	No
EGBA14406CC	CC	0.438"	6"	4"	1/4"	No	No
EGBA14410FF	FF	0.438"	10"	4"	1/4"	No	No
EGBA14412AA	AA	0.438"	12"	4"	1/4"	No	No
EGBA14412BB	BB	0.438"	12"	4"	1/4"	No	No
EGBA14412CC	CC	0.438"	12"	4"	1/4"	No	No
EGBA14412GG	GG	0.438"	12"	4"	1/4"	No	No
EGBA14412LL	LL	0.438"	12"	4"	1/4"	No	No
EGBA14412MM	MM	0.438"	12"	4"	1/4"	No	No
EGBA14412NN	NN	0.438"	12"	4"	1/4"	No	No
EGBA14420CC	CC	0.438"	20"	4"	1/4"	No	No
EGBA14420CCT	CC	0.438"	20"	4"	1/4"	Yes	No
EGBA14420NN	NN	0.438"	20"	4"	1/4"	No	No
EGBA14424CC	CC	0.438"	24"	4"	1/4"	No	No
EGBA14424GG	GG	0.438"	24"	4"	1/4"	No	No
EGBA14424LL	LL	0.438"	24"	4"	1/4"	No	No
EGBA14424MM	MM	0.438"	24"	4"	1/4"	No	No
EGBA14424NN	NN	0.438"	24"	4"	1/4"	No	No
EGBA14436CC	CC	0.438"	36"	4"	1/4"	No	No

TELECOM GROUNDING BUSBAR

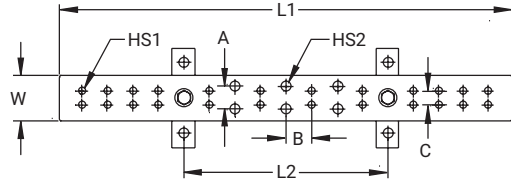
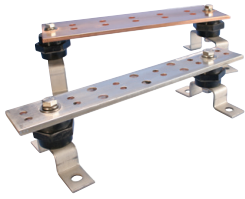

Material: Copper
Width: 2"
Thickness: 1/4"



FEATURED HIGHLIGHTS

- Meets TIA-607-C and conforms to BICSI® recommendations
- Complies with NEMA® standards
- Accepts two hole lugs with 5/16" or 7/16" bolt holes (hardware not included)
- Telecom grounding busbar splice kits are available to extend the length of the busbar

Part Number	Length 1	Length 2	Hole Size 1	Hole Size 1 Number of Pairs	Hole Size 2	Hole Size 2 Number of Pairs	A	B	C
Tin Plating: No									
TGBA12L06P	12"	9"	5/16"	6	7/16"	3	1"	1 1/8"	5/8"
TGBA16L08P	15 1/2"	9"	5/16"	8	7/16"	3	1"	1 1/8"	5/8"
TGBA18L10P	17 3/4"	9"	5/16"	10	7/16"	3	1"	1 1/8"	5/8"
TGBA20L12P	20"	9"	5/16"	12	7/16"	3	1"	1 1/8"	5/8"
TGBA24L14P	24"	18"	5/16"	14	7/16"	5	1"	1 1/8"	5/8"
TGBA29L18P	29"	18"	5/16"	18	7/16"	5	1"	1 1/8"	5/8"
Tin Plating: Yes									
TGBA12L06PT	12"	9"	5/16"	6	7/16"	3	1"	1 1/8"	5/8"
TGBA16L08PT	15 1/2"	9"	5/16"	8	7/16"	3	1"	1 1/8"	5/8"
TGBA18L10PT	17 3/4"	9"	5/16"	10	7/16"	3	1"	1 1/8"	5/8"
TGBA20L12PT	20"	9"	5/16"	12	7/16"	3	1"	1 1/8"	5/8"
TGBA24L14PT	24"	18"	5/16"	14	7/16"	5	1"	1 1/8"	5/8"
TGBA29L18PT	29"	18"	5/16"	18	7/16"	5	1"	1 1/8"	5/8"

TELECOM MAIN GROUNDING BUSBAR

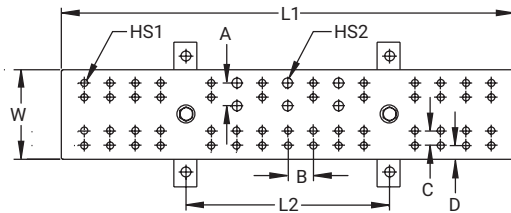

Material: Copper
Width: 4"
Thickness: 1/4"



FEATURED HIGHLIGHTS

- Meets TIA-607-C and conforms to BICSI® recommendations
- Complies with NEMA® standards
- Accepts two hole lugs with 5/16" or 7/16" bolt holes (hardware not included)
- Telecom grounding busbar splice kits are available to extend the length of the busbar

Part Number	Length 1	Length 2	Hole Size 1	Hole Size 1 Number of Pairs	Hole Size 2	Hole Size 2 Number of Pairs	A	B	C	D
Tin Plating: No										
TMGBA12L15P	12"	9"	5/16"	15	7/16"	3	1"	1 1/8"	5/8"	5/8"
TMGBA16L19P	15 1/2"	9"	5/16"	19	7/16"	3	1"	1 1/8"	5/8"	5/8"
TMGBA18L23P	17 3/4"	9"	5/16"	23	7/16"	3	1"	1 1/8"	5/8"	5/8"

Part Number	Length 1	Length 2	Hole Size 1	Hole Size 1 Number of Pairs	Hole Size 2	Hole Size 2 Number of Pairs	A	B	C	D
TMGBA20L27P	20"	9"	5/16"	27	7/16"	3	1"	1 1/8"	5/8"	5/8"
TMGBA24L33P	24"	18"	5/16"	33	7/16"	5	1"	1 1/8"	5/8"	5/8"
TMGBA29L41P	29"	18"	5/16"	41	7/16"	5	1"	1 1/8"	5/8"	5/8"
Tin Plating: Yes										
TMGBA12L15PT	12"	9"	5/16"	15	7/16"	3	1"	1 1/8"	5/8"	5/8"
TMGBA16L19PT	15 1/2"	9"	5/16"	19	7/16"	3	1"	1 1/8"	5/8"	5/8"
TMGBA18L23PT	17 3/4"	9"	5/16"	23	7/16"	3	1"	1 1/8"	5/8"	5/8"
TMGBA20L27PT	20"	9"	5/16"	27	7/16"	3	1"	1 1/8"	5/8"	5/8"
TMGBA24L33PT	24"	18"	5/16"	33	7/16"	5	1"	1 1/8"	5/8"	5/8"
TMGBA29L41PT	29"	18"	5/16"	41	7/16"	5	1"	1 1/8"	5/8"	5/8"

TELECOM GROUNDING BUSBAR SPLICE KIT

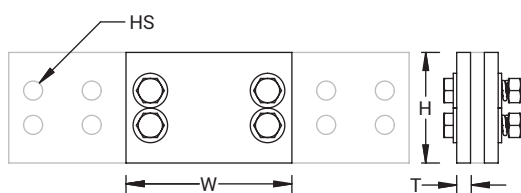

FEATURED HIGHLIGHTS

- For use with telecom grounding busbars
- Includes two tinned copper splice plates and 1/4" stainless steel fasteners

Material: Copper
Finish: Tinned



Part Number	For Use With	Height	Width	Thickness	Hole Size
TGBSPLICEKIT	TGB Series	2"	3"	1/4"	11/32"
TMGBSPLICEKIT	TMGB Series	4"	3 1/2"	1/4"	11/32"

PERIMETER GROUNDING BUSBAR FOR CORNERS

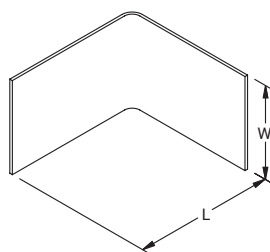
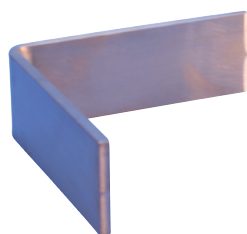

FEATURED HIGHLIGHTS

- For use in installing perimeter grounding busbar system to fit within or around 90° corners

Material: Copper



Part Number	Length	Width	Thickness
EPGC1416X6	6"	1"	1/4"
EPGC1426X6	6"	2"	1/4"
EPGC1428X8	8"	2"	1/4"
EPGC1436X6	6"	3"	1/4"

Part Number	Length	Width	Thickness
EPGC1446X6	6"	4"	1/4"
EPGC1816X6	6"	1"	1/8"
EPGC1826X6	6"	2"	1/8"
EPGC1846X6	6"	4"	1/8"
Finish: Tinned			
EPGC1446X6T	6"	4"	1/4"

PERIMETER GROUNDING BUSBAR FOR DOORS

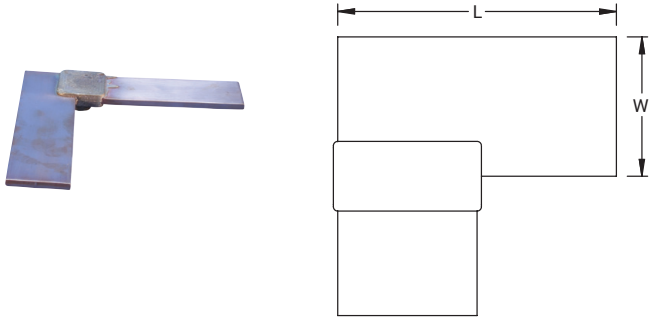

FEATURED HIGHLIGHTS

- For use in installing perimeter grounding busbar system to fit around doors

Material: Copper



Part Number	Length	Width	Thickness	Certifications
EPGC1418X8FL	8"	1"	1/4"	
EPGC1818X8FL	8"	1"	1/8"	cULus
EPGC1828X8FL	8"	2"	1/8"	cULus
EPGC1848X8FL	8"	4"	1/8"	cULus

PERIMETER GROUNDING BUSBAR FOR WALLS

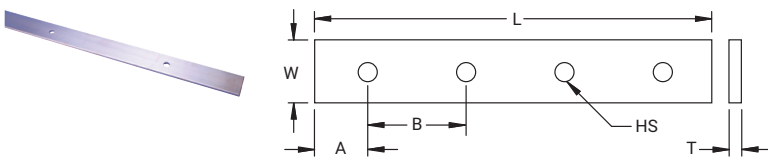

FEATURED HIGHLIGHTS

- Perimeter grounding busbars are used to terminate ground wires and cables from equipment and other devices
- For busbars that include insulators and brackets, eight individual brackets and insulators are provided



Part Number	Length	Width	Thickness	A	B	Hole Size
Material: Copper – Busbar Configuration: Busbar Only						
EPGC141120	120"	1"	1/4"	15"	30"	7/16"
EPGC142120	120"	2"	1/4"	15"	30"	7/16"
EPGC142144	144"	2"	1/4"	15"	30"	7/16"
EPGC143120	120"	3"	1/4"	15"	30"	7/16"
EPGC144120	120"	4"	1/4"	15"	30"	7/16"
EPGC182120	120"	2"	1/8"	15"	30"	7/16"

Part Number	Length	Width	Thickness	A	B	Hole Size
EPGC183144	144"	3"	1/8"	15"	30"	7/16"
EPGC184120	120"	4"	1/8"	15"	30"	7/16"
Material: Copper, Polyamide, Stainless Steel 304 (EN 1.4301) – Busbar Configuration: Busbar, Insulators and Brackets						
EPGA142120	120"	2"	1/4"	15"	30"	7/16"
EPGA144120	120"	4"	1/4"	15"	30"	7/16"

GROUNDING BUSBAR MOUNTING KIT

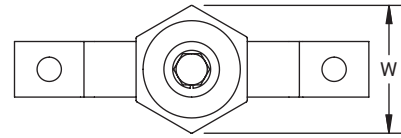
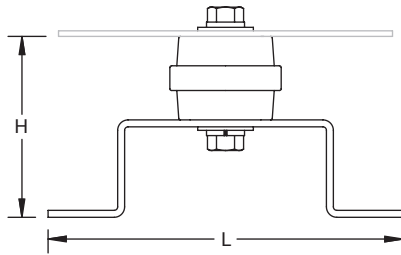

FEATURED HIGHLIGHTS

- Includes hardware, fasteners, insulators and brackets

Material: Polyamide, Stainless Steel 304 (EN 1.4301)
Finish: Bare

Part Number	Busbar Width	Height	Length	Width
B548A41	1" – 2"	2 5/8"	4 1/4"	2"
B548A42	3" – 4"	3 3/8"	6 5/16"	2"

GROUNDING BUSBAR MOUNTING KIT WITH BEAM CLAMP

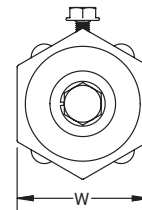
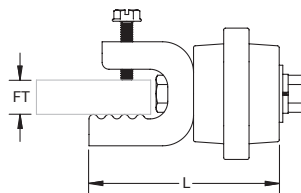
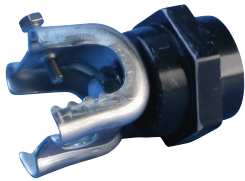

FEATURED HIGHLIGHTS

- Mounting kit for grounding busbars to steel beam
- Includes stainless steel hardware, fasteners, insulators and brackets

Material: Polyamide, Stainless Steel 304 (EN 1.4301)

Part Number	Flange Thickness	Length	Width
B548A39	7/8" Max	3 3/8"	2"

THEFT-DETERRENT GROUNDING BUSBAR, FLANGE MOUNT ASSEMBLY

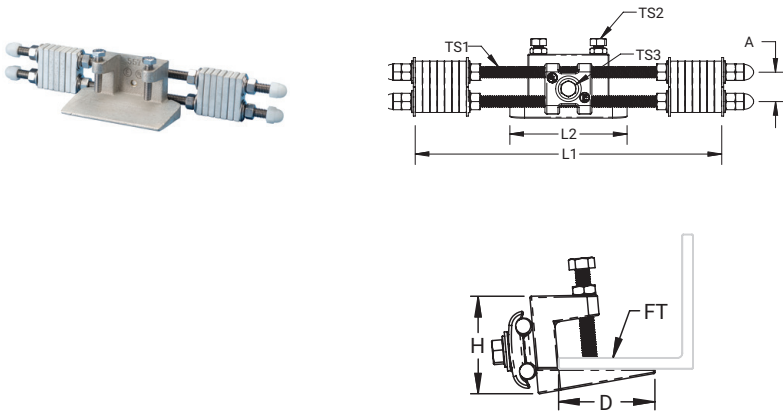

FEATURED HIGHLIGHTS

- Mounts to a typical structural beam flange on a telecom tower without cutting or drilling the flange
- Accepts standard telecommunication grounding lugs (lugs not included)
- Includes 14 Standard Spacers (TDSGAS)

Material: Copper, Stainless Steel 18-8 (EN 1.4305), Nylon
 Finish: Tinned
 Spacer Thickness: 1/4"



Part Number	Length 1	Length 2	Depth	Height	A	Flange Thickness	Thread Size 1	Thread Size 2	Thread Size 3
TDSGABC14	10 1/2"	4"	2.13"	2.7"	1"	1/4" – 1"	3/8 UNC	5/16 UNC	5/16 UNC

THEFT-DETERRENT GROUNDING BUSBAR, POLE MOUNT ASSEMBLY

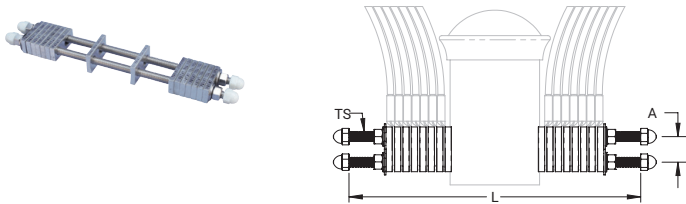

FEATURED HIGHLIGHTS

- Mounts on a standard Schedule 40 ice bridge pole (3.5" or 88.9 mm nominal outer diameter) and provides a path to the buried ground ring via a connection to the post
- This assembly eliminates the need for a solid copper busbar and down lead
- The connection to the ground ring is concealed below grade
- Accepts standard telecommunication grounding lugs (lugs not included)
- Includes 14 Standard Spacers (TDSGAS) and 2 Pole Mount Spacers (TDSGAP)
- Pole itself is not included in the assembly

Material: Copper, Stainless Steel 304 (EN 1.4301), Stainless Steel 18-8 (EN 1.4305)
 Finish: Tinned
 Spacer Thickness: 1/4"



Part Number	Length	A	Thread Size
TDSGAPA14	10 1/2"	1"	3/8 UNC

THEFT-DETERRENT GROUNDING BUSBAR, POST MOUNT ASSEMBLY

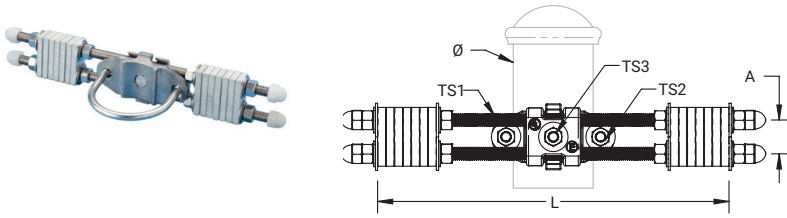

FEATURED HIGHLIGHTS

- Mounts to a Schedule 40 pipe or post without cutting or drilling the pipe
- Accepts standard telecommunication grounding lugs (lugs not included)
- Includes 14 Standard Spacers (TDSGAS)

Material: Copper, Stainless Steel 304 (EN 1.4301), Stainless Steel 18-8 (EN 1.4305)
 Finish: Tinned
 Spacer Thickness: 1/4"



Part Number	Length	A	Fence Post Size, Nominal	Fence Post Outside Diameter, Actual	Thread Size 1	Thread Size 2	Thread Size 3
TDSGAPC14	10 1/2"	1"	1 1/2" – 2"	1.9" – 2.5"	3/8 UNC	5/16 UNC	5/16 UNC

THEFT-DETERRENT GROUNDING BUSBAR, WALL MOUNT ASSEMBLY

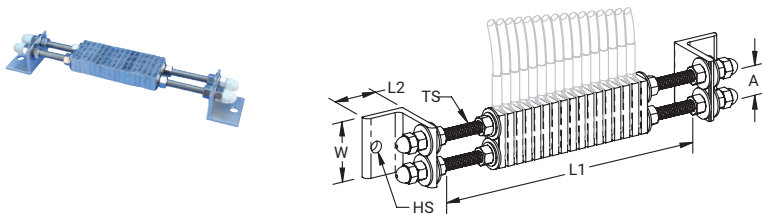

FEATURED HIGHLIGHTS

- Utilizes a utility or telecom tower's or other mounting structure's connection to a ground ring to provide equipotential bonding and a low-impedance path to ground
- Can be used for any mounting application and in any configuration
- Accepts standard telecommunication grounding lugs (lugs not included)
- Includes 17 Standard Spacers (TDSGAS)

Material: Copper, Aluminum, Stainless Steel 304 (EN 1.4301)
 Finish: Tinned
 Spacer Thickness: 1/4"



Part Number	Length 1	Length 2	Width	Height	A	Hole Size	Thread Size
TDSGAWB17	9 1/4"	1 1/2"	2"	2"	1"	0.39"	3/8 UNC

THEFT-DETERRENT GROUNDING BUSBAR, WALL MOUNTING BRACKET

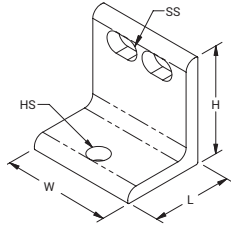
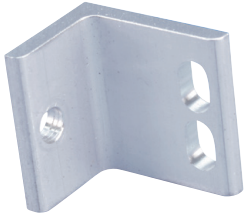

FEATURED HIGHLIGHTS

- Replacement wall bracket for wall mount assembly

Material: Aluminum

Part Number	Length	Width	Height	Hole Size	Slot Size	Unit Weight
TDSGAWB	2"	1 1/2"	2"	0.39"	0.64" x 0.39"	0.14 lb

SPACER FOR THEFT-DETERRENT GROUNDING BUSBAR

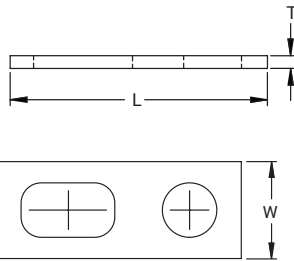

FEATURED HIGHLIGHTS

- Extra spacers available for additional conductor connections
- Additional standard spacers for use with all Theft-Deterrent Grounding Busbar assemblies
- Pole mount spacers are curved to fit next to the mounting pole

Material: Copper
Finish: Tinned

Part Number	Type	Length	Width	A	B	Thickness	Hole Size	Slot Size
TDSGAP	Pole Mount	1 3/4"	1"	3/8"	7/8"	1/4"	0.39"	0.64" x 0.39"
TDSGAS	Standard	1 3/4"	3/4"	3/8"	7/8"	1/4"	0.39"	0.64" x 0.39"

GROUNDING STANDOFF FOR TELECOM TOWERS

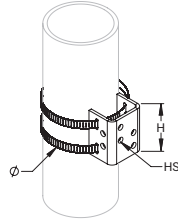
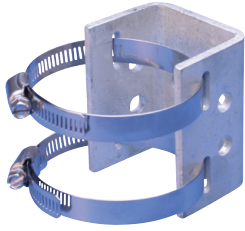

FEATURED HIGHLIGHTS

- Provides a direct, low-impedance electrical ground connection to the tower
- Offers a quick installation process
- Compact design fits in tight and confined locations
- Available in tinned copper to reduce dissimilar metal issues
- 6 TIA double-hole lug attachment points

Most equipment on a telecommunication tower is grounded by connecting a copper conductor to a ground bar mounted to the tower itself. The lead length of the conductor is often extensive, which can add resistance to the grounding system.

Material: Copper, Stainless Steel 301 (EN 1.4310)
Finish: Tinned

Part Number	Diameter	Height	Hole Size
ETMAGS	5" Max	3"	3/8"

EARTH BLOCK

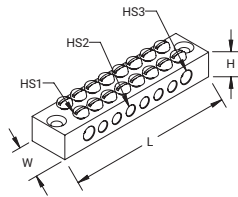
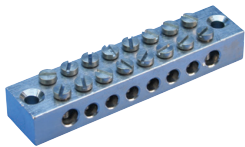

FEATURED HIGHLIGHTS

- Used to connect multiple earthing cables to a single point which then connects to the earthing system
- Two holes available (countersink M5) for installation of the earth block

Material: Brass
Finish: Tinned

Part Number	Length	Width	Height	Hole Size 1	Hole Size 2	Hole Size 3
EBL08	3.465"	0.787"	0.512"	0.157"	0.204"	0.256"

INTERSYSTEM BONDING TERMINATION BAR

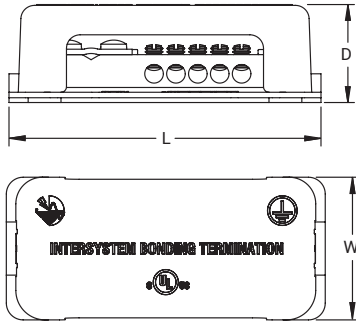

FEATURED HIGHLIGHTS

- Interconnects and terminates grounding conductors from telephone, CATV, radio and TV antennas
- Ideal for residential and small commercial applications
- Meets requirements of 2008 NEC® Article 250.94
- Accommodates five connectors for conductor sizes #14 Solid – #6 Stranded (1,5 – 25 mm²)
- Accommodates one connector for conductor sizes #6 Solid – #2 Stranded (16 – 35 mm²)
- Integral mounting base enables easy installation
- Includes mounting hardware
- Connects to grounding electrode conductor – does not rely on meter base enclosure bonding connection

The Intersystem Bonding Termination (IBTB), part of the nVent ERICO line of Facility Electrical Protection products, is designed to meet the requirements of the 2008 NEC® Article 250.94 "Bonding for Other Systems." The IBTB is mounted adjacent to the meter base or service entrance equipment and is a convenient way to interconnect and terminate grounding conductors from telephone, CATV or radio and television antennas. The IBTB includes corrosion-resistant, stainless steel mounting hardware and is easily accessible for connection and inspection. The lay-in connection clamp (#6- #2 AWG, or 16-35 mm²) allows easy installation of the grounding electrode conductor in one continuous length, where possible. The polymeric base and housing is impact-resistant, UV-stabilized and meets UL® requirements for weatherability performance.



Part Number	Depth	Length	Width
IBTB	1.41"	4.5"	2.01"

Grounding Tools

GROUND ROD DRIVER

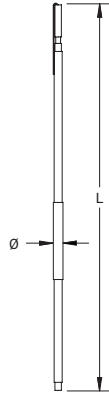

FEATURED HIGHLIGHTS

- Usable on all types of round ground rods: copper-bonded, galvanized, and stainless steel
- Inserts are interchangeable with standard ground rod driver body
- The driver will not deform the end of the rod, making connection of the ground conductor quick and easy

Part Number	Ground Rod Diameter, Nominal	Ground Rod Diameter, Actual	Length	Unit Weight
EGRD34	3/4" Max	0.68" Max	5'	23 lb
EGRD58	5/8" Max	0.56" Max	5'	23 lb

GROUND ROD DRIVER REPLACEMENT INSERT

FEATURED HIGHLIGHTS

- For use with the EGRD Ground Rod Driver
- Inserts are interchangeable with standard ground rod driver body



Part Number	Ground Rod Diameter, Nominal	Ground Rod Diameter, Actual	Unit Weight
EGRD34I	3/4"	0.68" Max	6 lb
EGRD58I	5/8"	0.56" Max	6 lb

GROUND ROD DRIVING HEAD FOR POWER TOOLS

FEATURED HIGHLIGHTS

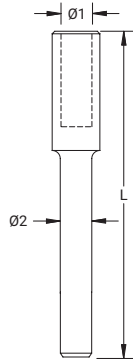
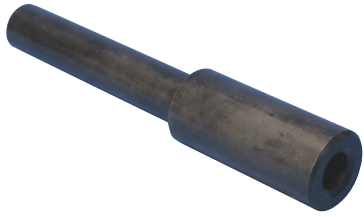

Material: Steel
Ground Rod Type: Copper-bonded, Galvanized

Part Number	Ground Rod Diameter, Nominal	Diameter 1	Diameter 2	Length
DH34	3/4"	0.78"	0.85"	7"
DH58	5/8"	0.58"	0.85"	7"

GROUND ROD DRIVING HEAD FOR ROTARY HAMMER

FEATURED HIGHLIGHTS

- Ground rod driving head for use with a rotary hammer

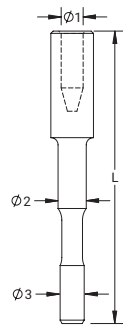

Material: Steel
Ground Rod Type: Copper-bonded, Galvanized

Part Number	Ground Rod Diameter, Nominal	Diameter 1	Diameter 2	Diameter 3	Length
B13716RH15	5/8"	0.58"	0.74"	0.64"	7.7"

GROUND ROD DRIVING STUD FOR ROTARY HAMMER WITH COUPLER

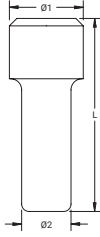

FEATURED HIGHLIGHTS

- Used in conjunction with a CC58 ground rod coupler to drive a pointed ground rod
- DSCC58 driving stud fits inside CC58 coupler, then the assembly is placed on top of the ground rod
- Hammering is then carried out on the DSCC58

Material: Steel
Ground Rod Type: Copper-bonded

Part Number	Ground Rod Diameter, Nominal	Diameter 1	Diameter 2	Length
DSCC58	5/8"	0.78"	0.52"	2"

GROUND ROD DRIVE SLEEVE FOR POINTED GROUND RODS

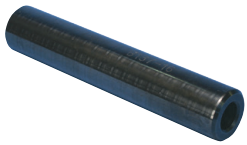

FEATURED HIGHLIGHTS

- For use with unthreaded ground rods
- Slides on top of ground rod to prevent mushrooming while driving into ground

Material: Steel
Ground Rod Type: Copper-bonded, Galvanized

Part Number	Ground Rod Diameter, Nominal	Diameter	Length
158380	5/8"	0.63"	2.6"
B13714	1/2"	0.52"	6.0"
B13716	5/8"	0.58"	6.0"
B13718	3/4"	0.70"	6.0"
B13722	1"	0.94"	6.0"
B13731	5/8"	0.64"	6.0"
B13733	3/4"	0.77"	6.0"
B13737	1"	1.02"	6.0"
DH12M	1/2"	0.53"	3.9"
DH34M	3/4"	0.79"	3.9"
DH58M	5/8"	0.63"	3.9"
EDS12	1/2"	0.53"	2.5"
EDS58	5/8"	0.58"	2.5"

GROUND ROD DRIVING STUD FOR SECTIONAL GROUND RODS

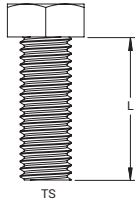

FEATURED HIGHLIGHTS

- Used in conjunction with threaded couplers while driving sectional ground rods

Material: Steel

Part Number	Ground Rod Diameter, Nominal	Thread Size	Length
158100	5/8"	5/8 UNC	1.25"
158110	3/4"	3/4 UNC	1.50"
710090	3/8"	M10	0.71"
710100	3/8"	M10	0.83"
DS1	1"	1 UNC	2.50"
DS12	1/2"	1/2 UNC	1.50"
DS12S	1/2"	9/16 UNC	1.75"
DS34	3/4"	3/4 UNC	2.00"
DS58	5/8"	5/8 UNC	1.75"
DS58C	5/8"	5/8 UNC	1.44"

GROUND ROD DRIVING POINT FOR SECTIONAL GROUND RODS

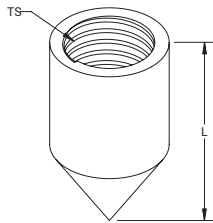

FEATURED HIGHLIGHTS

- Threaded ground rod driving tip to assist in driving sectional ground rods into the earth

Material: Steel

Part Number	Ground Rod Diameter, Nominal	Thread Size	Length
SDT34	3/4"	3/4 UNC	1.7"
SDT58	5/8"	5/8 UNC	1.7"

2- AND 3-POINT GROUND RESISTANCE TESTER KIT



FEATURED HIGHLIGHTS

- Measures ground resistance (2- and 3-Point) Fall-of-Potential method
- Provides high-breaking fuse protection capacity, 0.1A, >250V
- Auto-ranging: automatically selects the optimum range
- Color-coded terminals and lead identification
- Extremely simple to operate: connect – press – hold – read
- Designed to reject high levels of noise and interference
- Large LCD digital display
- Rugged dustproof and rainproof field case
- Battery-powered, with low battery indication
- Includes eight 1.5V AA batteries to power approximately 1800 15-second measurements



Part Number	EST3640
Soil Resistivity Test	No
Measurement Range	0 – 2,000 Ω
Resolution	10 mΩ – 1 Ω
Test Current	10.0 – 0.1 mA
Open Voltage	42 V Max
Operating Frequency	128 Hz square wave
Accuracy	3% of Reading +/- 3ct 5% of Reading +/- 3ct
Unit Weight	35 lb

Kit includes: Two 300' (91.4 m) color-coded leads on spools (red and blue), two 5' (1.5 m) color-coded leads (red and blue), two 100' (30.5 m) color-coded leads (green and black), four 14.5" (368 mm) T-shaped auxiliary ground electrodes, one set of five-spaded lugs, one 100' (30.5 m) tape measure, and one carrying bag.

2-, 3- AND 4-POINT GROUND RESISTANCE TESTER KIT



FEATURED HIGHLIGHTS

- Measures ground resistance (2- and 3-Point) Fall-of-Potential method and soil resistivity (4-Point)
- Fuse protection of 0.1A, >250V, 0.25 x 1.25" with 30kA Interrupt Capacity
- Both models will perform over 2,000 measurements of the 15-second tests between recharging or battery replacement
- Provides a response time of approximately four to eight seconds for a stabilized measurement
- Step voltage tests and touch potential measurements
- Auto-ranging: automatically selects the optimum resistance range and test current
- Designed to reject high levels of noise and interference
- Extremely simple to operate: connect – press – hold – read
- May also be used for continuity tests on bonding
- Large easy-to-read backlit display
- LED on faceplate informs operator of high input noise, high auxiliary rod resistance and fault connections
- Rugged dustproof and rainproof field case
- Color-coded terminals
- Low battery indication



Part Number	Soil Resistivity Test	Measurement Range	Resolution	Open Voltage	Test Current	Operating Frequency	Accuracy	Auxiliary Electrode Influence	Withstanding Voltage	Unit Weight
EST4620	Yes	0 – 2,000 Ω	10 mΩ – 1 Ω	42 V Max	10.0 – 0.1 mA	128 Hz square wave	2% of Reading +/- 1ct, 5% of Reading +/- 3ct	3 – 50 kΩ	250 VAC, 100 VDC	35 lb
EST4630	Yes	0 – 2,000 Ω	10 mΩ – 1 Ω	42 V Max	10.0 – 0.1 mA	128 Hz square wave	2% of Reading +/- 1ct, 5% of Reading +/- 3ct	3 – 50 kΩ	250 VAC, 100 VDC	35 lb

Kit includes: Two 300' (91.4 m) color-coded leads on spools (red and blue), two 5' (1.5 m) color-coded leads (red and blue), two 100' (30.5 m) color-coded leads (green and black), four 14.5" (368 mm) T-shaped auxiliary ground electrodes, one set of five-spaded lugs, one 100' (30.5 m) tape measure, and one carrying bag.

2-, 3- AND 4-POINT GROUND RESISTANCE TESTER KIT WITH DATAVIEW® SOFTWARE



FEATURED HIGHLIGHTS

- Measures Ground Impedance at frequencies up to 5kHz to test lightning strike protection
- Ground Resistance testing using the 2 clamp method (no auxiliary rods needed) using optional current probes
- Includes DataView® software for data storage, real-time display, analysis, report generation and system configuration
- 3-Point Fall-of-Potential measurement with manual or automatic frequency selection
- Used under difficult conditions such as the presence of high-stray currents that normally affect accuracy
- Automatic report generation including the fall of potential plot
- 4-Point soil resistivity measurement with automatic calculation of Rho and user selection of Wenner or Schlumberger test method
- 3-Point earth coupling measurement
- Manual and automatic frequency scan from 41 to 5,078Hz for optimum test accuracy in electrically-noisy environments
- Selectable test voltage of 16 or 32V up to 250mA of test current
- 2- and 4-Wire Bond Resistance/Continuity Measurement (DC Resistance) with automatic polarity reversal
- Stores up to 512 complete test results in internal memory
- Optically isolated USB communication included
- Display with automatic backlight when entering a function
- Rugged dustproof and rainproof field case - IP53 rated in closed position
- AC-powered with rechargeable NiMH batteries from wall charger or vehicle power
- Auto-off power management



Part Number

EST6472

Kit includes: Two 300' (91.4 m) color-coded leads on spools (red and blue), two 5' (1.5 m) color-coded leads (red and blue), two 100' (30.5 m) color-coded leads (green and black), four 14.5" (368 mm) T-shaped auxiliary ground electrodes, one set of five-spaded lugs, one 100' (30.5 m) tape measure, and one carrying bag. Ground Resistance Tester Clamp-On Probe is not included and must be ordered separately.

Ground Resistance Tester Information

3-Point Measurement	
Range (Auto-Ranging)	0.09Ω to 99.9kΩ
Resolution	0.01Ω to 100Ω
Test Voltage	Nominal 16 or 32Vrms user selectable
Operating Frequency	41 to 5078Hz automatic or user selectable
Test Current	Up to 250mA
Accuracy	±2% of Reading + 1ct @ 128Hz
2-Clamp Measurement	
Range	0.1 to 500Ω
Resolution	0.01 to 1Ω

Ground Resistance Tester Information

Operating Frequency	Auto: 1367Hz; Manual: 128Hz-1367Hz-1611Hz-1758Hz
Soil Resistivity 4-Point Measurement	
Test Method	Wenner or Schlumberger selectable with automatic calculation of test results in Ω -meters
Range (Auto-Ranging)	0.01 to 99.99k Ω ; ρ max: 999k Ω m
Resolution	0.01 to 100 Ω
Test Voltage	16 or 32V user selectable
Operating Frequency	From 41 to 128Hz selectable
External Voltage Measurement	
Range (Auto-Ranging)	0.1 to 65.0VAC/DC – DC to 440Hz
Accuracy	$\pm 2\%$ of Reading + 1ct
Resistance Measurement (Bond Testing)	
Measurement Type	2-Pole (with lead resistance compensation) or 4-Pole (Kelvin sensing) user selectable
Range (Auto-Ranging)	2-Pole 0.02 Ω to 99.99k Ω ; 4-Pole 0.02 Ω to 99.99k Ω
Accuracy	$\pm 2\%$ of Reading + 2cts
Test Voltage	16VDC (+, - or auto polarity)
Test Current	Up to 250mA max
Data Storage	
Memory Capacity	512 test results (64KB)
Power	
Power Source	9.6V rechargeable battery pack (included)
Recharging Source	110/220 50/60Hz external charger with 18Vdc, 1.9A output

Kit includes: Two 300' (91.4 m) color-coded leads on spools (red and blue), two 5' (1.5 m) color-coded leads (red and blue), two 100' (30.5 m) color-coded leads (green and black), four 14.5" (368 mm) T-shaped auxiliary ground electrodes, one set of five-spaded lugs, one 100' (30.5 m) tape measure, and one carrying bag.

Ground Resistance Tester Clamp-On Probe is not included and must be ordered separately.

nVent, CADDY, CADWELD, CRITEC, ERICO, ERIFLEX and LENTON are owned by nVent or its global affiliates. All other trademarks are the property of their respective owners. nVent reserves the right to change specifications without prior notice.

HANDHELD CLAMP-ON GROUND RESISTANCE TESTER



FEATURED HIGHLIGHTS

- Measures earth resistance without need to disconnect from the electrical system or need for auxillary ground electrodes or reels
- Ground Resistance is auto-ranging from 1 to 199Ω
- Current Measurement is auto-ranging from 1mA to 40A
- Ground voltage indication - warns of unsafe conditions
- Clamping diameter of 1.4" (35 mm) with large jaw design
- Stores up to 300 measurements
- Includes a hard carrying case, calibration loop, four 1.5V AA batteries and a user manual



Part Number	Ground Resistance Measurement Range	Ground Resistance Resolution	Ground Resistance Accuracy	Current Measurement Range	Current Measurement Resolution	Current Measurement Accuracy	Current Measurement Frequency	Operating Frequency	Loop Impedance Measurement
EST401	0.01 – 1,500.00 Ω	0.001 – 50.000 Ω	Approx. 1.5% - 25%	0.20 mA – 39.99 A	1 μA – 10 mA	+/- 2%	47 – 800 Hz	2,083 Hz	10 to 100μH; 100 to 500μH

GROUND RESISTANCE TESTER CLAMP-ON PROBE



FEATURED HIGHLIGHTS

- AC Clamp-on probe for use with EST6472
- Extends use of EST6472 to be used as a clamp-on ground resistance tester



Part Number	Unit Weight
ESR182	3 lb

GROUND RESISTANCE TESTER CABLE REEL



FEATURED HIGHLIGHTS

- Includes two reels of silicone rubber insulated wire—one reel is red and the other reel is blue—for easy stake identification
- The far end of test lead remains attached to the reel base, which eliminates tangling and speeds up the process of test stake deployment
- Each reel includes 500 feet (152.4 m) of cable, a screwdriver and a lead that connects the reel to the test meter

Part Number	Cable Length	Unit Weight
ESTREELKIT500	500'	17 lb

nVent ERICO Cadweld Molds

GROUNDING CONNECTION SPECIFICATION

This specification covers the nVent ERICO Cadweld exothermic welding system for use in making electrical connections. The Cadweld system supplied under this specification shall include welding material, molds, tools and accessories as required.

Unless otherwise specified, Cadweld exothermic welding system shall be used for all electrical grounding connections of copper to copper and copper to steel conductors. Cadweld connections shall be suitable for exposure to the elements of direct burial in earth or concrete without degradation over the lifetime of the grounding system.

The Cadweld exothermic welding system furnished under this specification shall meet the applicable requirements of IEEE Standard 80 "IEEE Guide for Safety in AC Substation Grounding" and IEEE Standard 837 IEEE "Standard for Qualifying Permanent Connections Used in Substation Grounding". Independent test data showing conformance to IEEE Std. 837 shall be readily available.

The Cadweld Mold Numbering System

The Cadweld mold part number gives, in code, the complete information about the mold. Type of connection, mold price key, and conductor size(s)

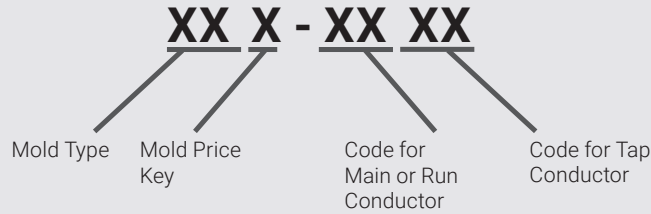

Examples:

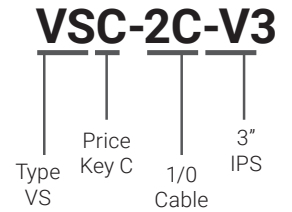
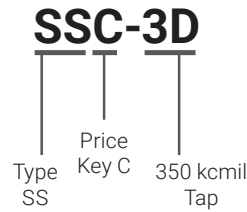
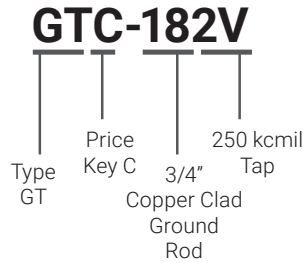
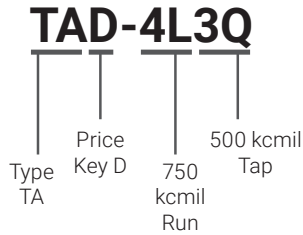

CONNECTIONS USED FOR GROUNDING REINFORCING BARS

Cadweld provides efficient and permanent connections for both grounding and attaching lightning protection conductors to rebar. When making Cadweld connections to rebar, the normal materials required are: mold, handle and weld metal. In addition, packing material is also required. These materials act as a seal between the mold and rebar to prevent leaks. One unit of packing material must be ordered for each weld.

CONNECTIONS TO STRUCTURAL REINFORCING BAR AND ANCHOR BOLTS

Welding of ground conductors to reinforcing bars (rebar) by the Cadweld process should not be harmful if stresses in the rebar are below yield. As design stresses are normally only about 50% to 60% of the nominal yield strength of the rebar, welding by the Cadweld process should not be detrimental under design stresses.

As the ACI Building Code (ACI318-14 Commentary, 25.5.2.1) advises, "splice requirements encourage splicing bars at points of minimum stress ... encourage the location of splices away from regions of high tensile stress." The same advice should apply to locations of Cadweld connections of a ground conductor to rebar. Where possible, locate the weld area away from areas of maximum tensile stress, e.g., near the free end of the bar in a lap splice, on the hook extension for a hooked bar, etc. The same considerations apply to Cadweld connections to anchor bolts.

NOTE:

For lightning protection applications where the main lightning protection conductor is connected to the rebar, nVent ERICO recommends a 2/0 AWG copper conductor for structures over 75 feet in height and a #2 AWG copper conductor for structures under 75 feet. For a bonding conductor, a #6 AWG copper may be used. These sizes meet NFPA78 Code requirement. Anchor bolts are connected in the same way.

All welds to rebar requiring larger than a #150 weld metal will be sold only after review by nVent ERICO.

CABLE TO CABLE

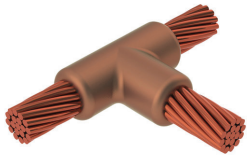

- Forms a permanent, low resistance connection
- Provides a molecular bond
- Cadweld Exothermic Connections are rated with the same current capacity as the conductor
- Portable installation equipment with no external source of power required
- Installers can be easily trained to make Cadweld Exothermic Connections
- Connections are visually inspected

SS MOLDS

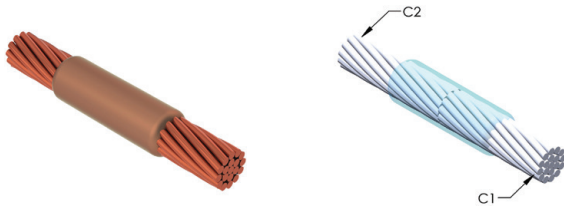

Global Part Number	Mold Family	Price Key	Conductor 1	Conductor 2	Welding Material	Ease of Use	Handle Clamp (Sold separately unless noted)
SSC1D	SS	C	#8 Solid	#8 Solid	25 or 25PLUSF20	Preferred	L160
SSC1G	SS	C	#6 Solid	#6 Solid	25 or 25PLUSF20	Preferred	L160
SSC1H	SS	C	#6 Concentric	#6 Concentric	25 or 25PLUSF20	Preferred	L160
SSC1K	SS	C	#4 Solid	#4 Solid	45 or 45PLUSF20	Preferred	L160
SSC1L	SS	C	#4 Concentric	#4 Concentric	25 or 25PLUSF20	Preferred	L160
SSC1T	SS	C	#2 Solid	#2 Solid	32 or 32PLUSF20	Preferred	L160
SSC1V	SS	C	#2 Concentric	#2 Concentric	32 or 32PLUSF20	Preferred	L160
SSC1Y	SS	C	#1 Concentric	#1 Concentric	32 or 32PLUSF20	Preferred	L160
SSC2C	SS	C	1/0 Concentric	1/0 Concentric	45 or 45PLUSF20	Preferred	L160
SSC2G	SS	C	2/0 Concentric	2/0 Concentric	65 or 65PLUSF20	Preferred	L160
SSC2Q	SS	C	4/0 Concentric	4/0 Concentric	90 or 90PLUSF20	Preferred	L160
SSC2V	SS	C	250 kcmil Concentric	250 kcmil Concentric	115 or 115PLUSF20	Preferred	L160
SSC3A	SS	C	300 kcmil Concentric	300 kcmil Concentric	115 or 115PLUSF20	Preferred	L160
SSC3D	SS	C	350 kcmil Concentric	350 kcmil Concentric	150 or 150PLUSF20	Preferred	L160
SSC3H	SS	C	400 kcmil Concentric	400 kcmil Concentric	150 or 150PLUSF20	Preferred	L160
SSC3Q	SS	C	500 kcmil Concentric	500 kcmil Concentric	200 or 200PLUSF20	Preferred	L160
SSC4L	SS	C	750 kcmil Concentric	750 kcmil Concentric	150 x 2 or 300PLUSF20	Preferred	L160
SSD4Y	SS	D	1000 kcmil Concentric	1000 kcmil Concentric	200 x 2 or 400PLUSF20	Preferred	L159
SST1G	SS	T	#6 Solid	#6 Solid	25 or 25PLUSF20	Preferred	Clamp Included
SST1K	SS	T	#4 Solid	#4 Solid	25 or 25PLUSF20	Preferred	Clamp Included
SST1L	SS	T	#4 Concentric	#4 Concentric	25 or 25PLUSF20	Preferred	Clamp Included
SST1T	SS	T	#2 Solid	#2 Solid	32 or 32PLUSF20	Preferred	Clamp Included
SST1V	SS	T	#2 Concentric	#2 Concentric	32 or 32PLUSF20	Preferred	Clamp Included

PC MOLDS

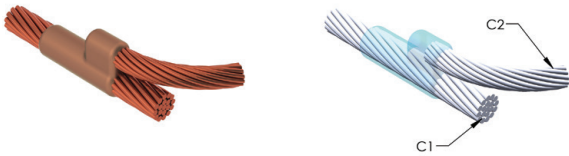

Global Part Number	Mold Family	Price Key	Conductor 1	Conductor 2	Welding Material	Ease of Use	Handle Clamp (Sold separately unless noted)
PCC1G1G	PC	C	#6 Solid	#6 Solid	25 or 25PLUSF20	Preferred	L160
PCC1G1H	PC	C	#6 Solid	#6 Concentric	25 or 25PLUSF20	Preferred	L160
PCC1H1H	PC	C	#6 Concentric	#6 Concentric	25 or 25PLUSF20	Preferred	L160
PCC1K1G	PC	C	#4 Solid	#6 Solid	32 or 32PLUSF20	Preferred	L160
PCC1K1K	PC	C	#4 Solid	#4 Solid	32 or 32PLUSF20	Preferred	L160
PCC1L1G	PC	C	#4 Concentric	#6 Solid	32 or 32PLUSF20	Preferred	L160
PCC1L1H	PC	C	#4 Concentric	#6 Concentric	32 or 32PLUSF20	Preferred	L160
PCC1L1L	PC	C	#4 Concentric	#4 Concentric	32 or 32PLUSF20	Preferred	L160
PCC1T1G	PC	C	#2 Solid	#6 Solid	32 or 32PLUSF20	Preferred	L160
PCC1T1H	PC	C	#2 Solid	#6 Concentric	32 or 32PLUSF20	Preferred	L160
PCC1T1T	PC	C	#2 Solid	#2 Solid	65 or 65PLUSF20	Preferred	L160
PCC1T1V	PC	C	#2 Solid	#2 Concentric	65 or 65PLUSF20	Preferred	L160
PCC1V1G	PC	C	#2 Concentric	#6 Solid	32 or 32PLUSF20	Preferred	L160
PCC1V1H	PC	C	#2 Concentric	#6 Concentric	32 or 32PLUSF20	Preferred	L160
PCC1V1L	PC	C	#2 Concentric	#4 Concentric	45 or 45PLUSF20	Preferred	L160
PCC1V1T	PC	C	#2 Concentric	#2 Solid	65 or 65PLUSF20	Preferred	L160
PCC1V1V	PC	C	#2 Concentric	#2 Concentric	65 or 65PLUSF20	Preferred	L160
PCC1Y1G	PC	C	#1 Concentric	#6 Solid	45 or 45PLUSF20	Preferred	L160
PCC1Y1H	PC	C	#1 Concentric	#6 Concentric	45 or 45PLUSF20	Preferred	L160
PCC1Y1V	PC	C	#1 Concentric	#2 Concentric	65 or 65PLUSF20	Preferred	L160
PCC1Y1Y	PC	C	#1 Concentric	#1 Concentric	65 or 65PLUSF20	Preferred	L160
PCC2C1G	PC	C	1/0 Concentric	#6 Solid	45 or 45PLUSF20	Preferred	L160
PCC2C1H	PC	C	1/0 Concentric	#6 Concentric	45 or 45PLUSF20	Preferred	L160
PCC2C1K	PC	C	1/0 Concentric	#4 Solid	65 or 65PLUSF20	Preferred	L160
PCC2C1L	PC	C	1/0 Concentric	#4 Concentric	65 or 65PLUSF20	Preferred	L160
PCC2C1T	PC	C	1/0 Concentric	#2 Solid	65 or 65PLUSF20	Preferred	L160
PCC2C1V	PC	C	1/0 Concentric	#2 Concentric	65 or 65PLUSF20	Preferred	L160
PCC2C2C	PC	C	1/0 Concentric	1/0 Concentric	90 or 90PLUSF20	Preferred	L160
PCC2G1G	PC	C	2/0 Concentric	#6 Solid	65 or 65PLUSF20	Preferred	L160
PCC2G1H	PC	C	2/0 Concentric	#6 Concentric	65 or 65PLUSF20	Preferred	L160
PCC2G1L	PC	C	2/0 Concentric	#4 Concentric	65 or 65PLUSF20	Preferred	L160
PCC2G1T	PC	C	2/0 Concentric	#2 Solid	90 or 90PLUSF20	Preferred	L160
PCC2G1V	PC	C	2/0 Concentric	#2 Concentric	90 or 90PLUSF20	Preferred	L160
PCC2G1Y	PC	C	2/0 Concentric	#1 Concentric	115 or 115PLUSF20	Preferred	L160
PCC2G2G	PC	C	2/0 Concentric	2/0 Concentric	115 or 115PLUSF20	Preferred	L160
PCC2Q1G	PC	C	4/0 Concentric	#6 Solid	90 or 90PLUSF20	Preferred	L160
PCC2Q1H	PC	C	4/0 Concentric	#6 Concentric	90 or 90PLUSF20	Preferred	L160
PCC2Q1K	PC	C	4/0 Concentric	#4 Solid	90 or 90PLUSF20	Preferred	L160
PCC2Q1L	PC	C	4/0 Concentric	#4 Concentric	90 or 90PLUSF20	Preferred	L160
PCC2Q1T	PC	C	4/0 Concentric	#2 Solid	115 or 115PLUSF20	Preferred	L160

Global Part Number	Mold Family	Price Key	Conductor 1	Conductor 2	Welding Material	Ease of Use	Handle Clamp (Sold separately unless noted)
PCC2Q1V	PC	C	4/0 Concentric	#2 Concentric	115 or 115PLUSF20	Preferred	L160
PCC2Q1Y	PC	C	4/0 Concentric	#1 Concentric	115 or 115PLUSF20	Preferred	L160
PCC2Q2C	PC	C	4/0 Concentric	1/0 Concentric	115 or 115PLUSF20	Preferred	L160
PCC2Q2G	PC	C	4/0 Concentric	2/0 Concentric	115 or 115PLUSF20	Preferred	L160
PCC2Q2Q	PC	C	4/0 Concentric	4/0 Concentric	150 or 150PLUSF20	Preferred	L160
PCC2V2G	PC	C	250 kcmil Concentric	2/0 Concentric	150 or 150PLUSF20	Preferred	L160
PCC2V2Q	PC	C	250 kcmil Concentric	4/0 Concentric	200 or 200PLUSF20	Preferred	L160
PCC2V2V	PC	C	250 kcmil Concentric	250 kcmil Concentric	200 or 200PLUSF20	Preferred	L160
PCC3Q2Q	PC	C	500 kcmil Concentric	4/0 Concentric	200 or 200PLUSF20	Preferred	L160
PCC3Q3Q	PC	C	500 kcmil Concentric	500 kcmil Concentric	150 x 2 or 300PLUSF20	Preferred	L160
PCD4L4L	PC	D	750 kcmil Concentric	750 kcmil Concentric	200 x 3 or 600PLUSF20	Preferred	L159
PCT1H1H	PC	T	#6 Concentric	#6 Concentric	25 or 25PLUSF20	Preferred	Clamp Included
PCT1L1D	PC	T	#4 Concentric	#8 Solid	32 or 32PLUSF20	Preferred	Clamp Included
PCT1L1G	PC	T	#4 Concentric	#6 Solid	32 or 32PLUSF20	Preferred	Clamp Included
PCT1L1H	PC	T	#4 Concentric	#6 Concentric	32 or 32PLUSF20	Preferred	Clamp Included
PCT1T1G	PC	T	#2 Solid	#6 Solid	32 or 32PLUSF20	Preferred	Clamp Included
PCT1T1H	PC	T	#2 Solid	#6 Concentric	32 or 32PLUSF20	Preferred	Clamp Included
PCT1V1D	PC	T	#2 Concentric	#8 Solid	32 or 32PLUSF20	Preferred	Clamp Included
PCT1V1G	PC	T	#2 Concentric	#6 Solid	32 or 32PLUSF20	Preferred	Clamp Included
PCT1V1H	PC	T	#2 Concentric	#6 Concentric	32 or 32PLUSF20	Preferred	Clamp Included

TA MOLDS

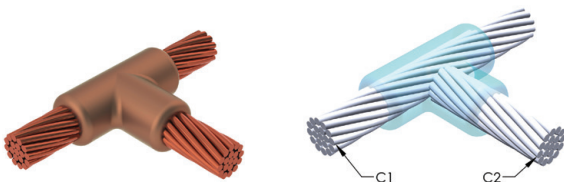

Global Part Number	Mold Family	Price Key	Conductor 1	Conductor 2	Welding Material	Ease of Use	Handle Clamp (Sold separately unless noted)
TAC1D1D	TA	C	#8 Solid	#8 Solid	32 or 32PLUSF20	Preferred	L160
TAC1G1G	TA	C	#6 Solid	#6 Solid	32 or 32PLUSF20	Preferred	L160
TAC1G1H	TA	C	#6 Solid	#6 Concentric	32 or 32PLUSF20	Preferred	L160
TAC1H1H	TA	C	#6 Concentric	#6 Concentric	32 or 32PLUSF20	Preferred	L160
TAC1K1K	TA	C	#4 Solid	#4 Solid	32 or 32PLUSF20	Preferred	L160
TAC1K1L	TA	C	#4 Solid	#4 Concentric	32 or 32PLUSF20	Preferred	L160
TAC1L1H	TA	C	#4 Concentric	#6 Concentric	32 or 32PLUSF20	Preferred	L160
TAC1L1L	TA	C	#4 Concentric	#4 Concentric	32 or 32PLUSF20	Preferred	L160
TAC1T1G	TA	C	#2 Solid	#6 Solid	45 or 45PLUSF20	Preferred	L160
TAC1T1H	TA	C	#2 Solid	#6 Concentric	45 or 45PLUSF20	Preferred	L160
TAC1T1K	TA	C	#2 Solid	#4 Solid	45 or 45PLUSF20	Preferred	L160
TAC1T1L	TA	C	#2 Solid	#4 Concentric	45 or 45PLUSF20	Preferred	L160

Global Part Number	Mold Family	Price Key	Conductor 1	Conductor 2	Welding Material	Ease of Use	Handle Clamp (Sold separately unless noted)
TAC1T1T	TA	C	#2 Solid	#2 Solid	45 or 45PLUSF20	Preferred	L160
TAC1T1V	TA	C	#2 Solid	#2 Concentric	45 or 45PLUSF20	Preferred	L160
TAC1V1G	TA	C	#2 Concentric	#6 Solid	45 or 45PLUSF20	Preferred	L160
TAC1V1H	TA	C	#2 Concentric	#6 Concentric	45 or 45PLUSF20	Preferred	L160
TAC1V1K	TA	C	#2 Concentric	#4 Solid	45 or 45PLUSF20	Preferred	L160
TAC1V1L	TA	C	#2 Concentric	#4 Concentric	45 or 45PLUSF20	Preferred	L160
TAC1V1T	TA	C	#2 Concentric	#2 Solid	45 or 45PLUSF20	Preferred	L160
TAC1V1V	TA	C	#2 Concentric	#2 Concentric	45 or 45PLUSF20	Preferred	L160
TAC1V1Y	TA	C	#2 Concentric	#1 Concentric	45 or 45PLUSF20	Preferred	L160
TAC1Y1L	TA	C	#1 Concentric	#4 Concentric	45 or 45PLUSF20	Preferred	L160
TAC1Y1T	TA	C	#1 Concentric	#2 Solid	45 or 45PLUSF20	Preferred	L160
TAC2C1G	TA	C	1/0 Concentric	#6 Solid	45 or 45PLUSF20	Preferred	L160
TAC2C1H	TA	C	1/0 Concentric	#6 Concentric	45 or 45PLUSF20	Preferred	L160
TAC2C1K	TA	C	1/0 Concentric	#4 Solid	45 or 45PLUSF20	Preferred	L160
TAC2C1L	TA	C	1/0 Concentric	#4 Concentric	45 or 45PLUSF20	Preferred	L160
TAC2C1T	TA	C	1/0 Concentric	#2 Solid	45 or 45PLUSF20	Preferred	L160
TAC2C1V	TA	C	1/0 Concentric	#2 Concentric	45 or 45PLUSF20	Preferred	L160
TAC2C1Y	TA	C	1/0 Concentric	#1 Concentric	45 or 45PLUSF20	Preferred	L160
TAC2C2C	TA	C	1/0 Concentric	1/0 Concentric	90 or 90PLUSF20	Preferred	L160
TAC2G1G	TA	C	2/0 Concentric	#6 Solid	45 or 45PLUSF20	Preferred	L160
TAC2G1H	TA	C	2/0 Concentric	#6 Concentric	45 or 45PLUSF20	Preferred	L160
TAC2G1K	TA	C	2/0 Concentric	#4 Solid	45 or 45PLUSF20	Preferred	L160
TAC2G1L	TA	C	2/0 Concentric	#4 Concentric	45 or 45PLUSF20	Preferred	L160
TAC2G1T	TA	C	2/0 Concentric	#2 Solid	45 or 45PLUSF20	Preferred	L160
TAC2G1V	TA	C	2/0 Concentric	#2 Concentric	45 or 45PLUSF20	Preferred	L160
TAC2G1Y	TA	C	2/0 Concentric	#1 Concentric	45 or 45PLUSF20	Preferred	L160
TAC2G2C	TA	C	2/0 Concentric	1/0 Concentric	90 or 90PLUSF20	Preferred	L160
TAC2G2G	TA	C	2/0 Concentric	2/0 Concentric	90 or 90PLUSF20	Preferred	L160
TAC2Q1G	TA	C	4/0 Concentric	#6 Solid	90 or 90PLUSF20	Preferred	L160
TAC2Q1H	TA	C	4/0 Concentric	#6 Concentric	90 or 90PLUSF20	Preferred	L160
TAC2Q1K	TA	C	4/0 Concentric	#4 Solid	90 or 90PLUSF20	Preferred	L160
TAC2Q1L	TA	C	4/0 Concentric	#4 Concentric	90 or 90PLUSF20	Preferred	L160
TAC2Q1T	TA	C	4/0 Concentric	#2 Solid	90 or 90PLUSF20	Preferred	L160
TAC2Q1V	TA	C	4/0 Concentric	#2 Concentric	90 or 90PLUSF20	Preferred	L160
TAC2Q1Y	TA	C	4/0 Concentric	#1 Concentric	90 or 90PLUSF20	Preferred	L160
TAC2Q2C	TA	C	4/0 Concentric	1/0 Concentric	90 or 90PLUSF20	Preferred	L160
TAC2Q2G	TA	C	4/0 Concentric	2/0 Concentric	90 or 90PLUSF20	Preferred	L160
TAC2Q2Q	TA	C	4/0 Concentric	4/0 Concentric	150 or 150PLUSF20	Preferred	L160
TAC2V1T	TA	C	250 kcmil Concentric	#2 Solid	90 or 90PLUSF20	Preferred	L160
TAC2V1V	TA	C	250 kcmil Concentric	#2 Concentric	90 or 90PLUSF20	Preferred	L160
TAC2V1Y	TA	C	250 kcmil Concentric	#1 Concentric	90 or 90PLUSF20	Preferred	L160
TAC2V2C	TA	C	250 kcmil Concentric	1/0 Concentric	90 or 90PLUSF20	Preferred	L160
TAC2V2G	TA	C	250 kcmil Concentric	2/0 Concentric	90 or 90PLUSF20	Preferred	L160
TAC2V2Q	TA	C	250 kcmil Concentric	4/0 Concentric	150 or 150PLUSF20	Preferred	L160
TAC2V2V	TA	C	250 kcmil Concentric	250 kcmil Concentric	150 or 150PLUSF20	Preferred	L160
TAC3A1T	TA	C	300 kcmil Concentric	#2 Solid	90 or 90PLUSF20	Preferred	L160
TAC3A1V	TA	C	300 kcmil Concentric	#2 Concentric	90 or 90PLUSF20	Preferred	L160
TAC3A2C	TA	C	300 kcmil Concentric	1/0 Concentric	90 or 90PLUSF20	Preferred	L160
TAC3A2G	TA	C	300 kcmil Concentric	2/0 Concentric	90 or 90PLUSF20	Preferred	L160
TAC3A2Q	TA	C	300 kcmil Concentric	4/0 Concentric	150 or 150PLUSF20	Preferred	L160
TAC3A2V	TA	C	300 kcmil Concentric	250 kcmil Concentric	200 or 200PLUSF20	Preferred	L160
TAC3A3A	TA	C	300 kcmil Concentric	300 kcmil Concentric	200 or 200PLUSF20	Preferred	L160
TAC3D1V	TA	C	350 kcmil Concentric	#2 Concentric	90 or 90PLUSF20	Preferred	L160
TAC3D1Y	TA	C	350 kcmil Concentric	#1 Concentric	90 or 90PLUSF20	Preferred	L160
TAC3D2C	TA	C	350 kcmil Concentric	1/0 Concentric	90 or 90PLUSF20	Preferred	L160
TAC3D2G	TA	C	350 kcmil Concentric	2/0 Concentric	150 or 150PLUSF20	Preferred	L160
TAC3D2Q	TA	C	350 kcmil Concentric	4/0 Concentric	150 or 150PLUSF20	Preferred	L160
TAC3D2V	TA	C	350 kcmil Concentric	250 kcmil Concentric	200 or 200PLUSF20	Preferred	L160

Global Part Number	Mold Family	Price Key	Conductor 1	Conductor 2	Welding Material	Ease of Use	Handle Clamp (Sold separately unless noted)
TAC3D3A	TA	C	350 kcmil Concentric	300 kcmil Concentric	200 or 200PLUSF20	Preferred	L160
TAC3D3D	TA	C	350 kcmil Concentric	350 kcmil Concentric	200 or 200PLUSF20	Preferred	L160
TAC3H2C	TA	C	400 kcmil Concentric	1/0 Concentric	90 or 90PLUSF20	Preferred	L160
TAC3H2G	TA	C	400 kcmil Concentric	2/0 Concentric	90 or 90PLUSF20	Preferred	L160
TAC3H2Q	TA	C	400 kcmil Concentric	4/0 Concentric	150 or 150PLUSF20	Preferred	L160
TAC3H2V	TA	C	400 kcmil Concentric	250 kcmil Concentric	200 or 200PLUSF20	Preferred	L160
TAC3H3A	TA	C	400 kcmil Concentric	300 kcmil Concentric	200 or 200PLUSF20	Preferred	L160
TAC3H3D	TA	C	400 kcmil Concentric	350 kcmil Concentric	200 or 200PLUSF20	Preferred	L160
TAC3H3H	TA	C	400 kcmil Concentric	400 kcmil Concentric	250 or 250PLUSF20	Preferred	L160
TAC3Q2C	TA	C	500 kcmil Concentric	1/0 Concentric	90 or 90PLUSF20	Preferred	L160
TAC3Q2G	TA	C	500 kcmil Concentric	2/0 Concentric	90 or 90PLUSF20	Preferred	L160
TAC3Q2Q	TA	C	500 kcmil Concentric	4/0 Concentric	150 or 150PLUSF20	Preferred	L160
TAC3Q2V	TA	C	500 kcmil Concentric	250 kcmil Concentric	200 or 200PLUSF20	Preferred	L160
TAC3Q3A	TA	C	500 kcmil Concentric	300 kcmil Concentric	200 or 200PLUSF20	Preferred	L160
TAC3Q3D	TA	C	500 kcmil Concentric	350 kcmil Concentric	200 or 200PLUSF20	Preferred	L160
TAC3Q3Q	TA	C	500 kcmil Concentric	500 kcmil Concentric	150 x 2 or 300PLUSF20	Preferred	L160
TAC4L2G	TA	C	750 kcmil Concentric	2/0 Concentric	150 or 150PLUSF20	Preferred	L160
TAC4L2Q	TA	C	750 kcmil Concentric	4/0 Concentric	150 or 150PLUSF20	Preferred	L160
TAC4L2V	TA	C	750 kcmil Concentric	250 kcmil Concentric	200 or 200PLUSF20	Preferred	L160
TAC4L3D	TA	C	750 kcmil Concentric	350 kcmil Concentric	250 or 250PLUSF20	Preferred	L160
TAC4Y2G	TA	C	1000 kcmil Concentric	2/0 Concentric	150 or 150PLUSF20	Preferred	L160
TAC4Y2Q	TA	C	1000 kcmil Concentric	4/0 Concentric	150 or 150PLUSF20	Preferred	L160
TAC4Y3D	TA	C	1000 kcmil Concentric	350 kcmil Concentric	250 or 250PLUSF20	Preferred	L160
TAD3Q4L	TA	D	500 kcmil Concentric	750 kcmil Concentric	200 x 2 or 400PLUSF20	Preferred	L159
TAD3X3X	TA	D	600 kcmil Concentric	600 kcmil Concentric	200 x 2 or 400PLUSF20	Preferred	L159
TAD4L3H	TA	D	750 kcmil Concentric	400 kcmil Concentric	200 x 2 or 400PLUSF20	Preferred	L159
TAD4L3Q	TA	D	750 kcmil Concentric	500 kcmil Concentric	200 x 2 or 400PLUSF20	Preferred	L159
TAD4L4L	TA	D	750 kcmil Concentric	750 kcmil Concentric	500 or 500PLUSF20	Preferred	L159
TAD4Y2V	TA	D	1000 kcmil Concentric	250 kcmil Concentric	200 x 2 or 400PLUSF20	Preferred	L159
TAD4Y3Q	TA	D	1000 kcmil Concentric	500 kcmil Concentric	200 x 2 or 400PLUSF20	Preferred	L159
TAD4Y4L	TA	D	1000 kcmil Concentric	750 kcmil Concentric	500 or 500PLUSF20	Preferred	L159
TAD4Y4Y	TA	D	1000 kcmil Concentric	1000 kcmil Concentric	500 or 500PLUSF20	Preferred	L159

XA MOLDS

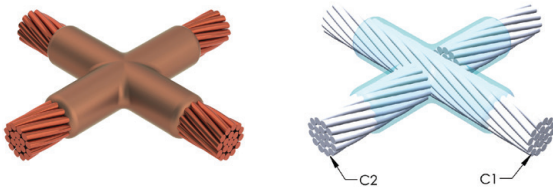

Global Part Number	Mold Family	Price Key	Conductor 1	Conductor 2	Welding Material	Ease of Use	Handle Clamp (Sold separately unless noted)
XAC1G1G	XA	C	#6 Solid	#6 Solid	45 or 45PLUSF20	Preferred	L160
XAC1H1H	XA	C	#6 Concentric	#6 Concentric	45 or 45PLUSF20	Preferred	L160
XAC1K1K	XA	C	#4 Solid	#4 Solid	45 or 45PLUSF20	Preferred	L160
XAC1L1L	XA	C	#4 Concentric	#4 Concentric	45 or 45PLUSF20	Preferred	L160
XAC1T1T	XA	C	#2 Solid	#2 Solid	65 or 65PLUSF20	Preferred	L160
XAC1V1H	XA	C	#2 Concentric	#6 Concentric	65 or 65PLUSF20	Preferred	L160
XAC1V1L	XA	C	#2 Concentric	#4 Concentric	65 or 65PLUSF20	Preferred	L160
XAC1V1T	XA	C	#2 Concentric	#2 Solid	65 or 65PLUSF20	Preferred	L160

Global Part Number	Mold Family	Price Key	Conductor 1	Conductor 2	Welding Material	Ease of Use	Handle Clamp (Sold separately unless noted)
XAC1V1V	XA	C	#2 Concentric	#2 Concentric	65 or 65PLUSF20	Preferred	L160
XAC1Y1Y	XA	C	#1 Concentric	#1 Concentric	65 or 65PLUSF20	Preferred	L160
XAC2C1V	XA	C	1/0 Concentric	#2 Concentric	90 or 90PLUSF20	Preferred	L160
XAC2C2C	XA	C	1/0 Concentric	1/0 Concentric	90 or 90PLUSF20	Preferred	L160
XAC2G1T	XA	C	2/0 Concentric	#2 Solid	115 or 115PLUSF20	Preferred	L160
XAC2G1V	XA	C	2/0 Concentric	#2 Concentric	115 or 115PLUSF20	Preferred	L160
XAC2G2C	XA	C	2/0 Concentric	1/0 Concentric	115 or 115PLUSF20	Preferred	L160
XAC2G2G	XA	C	2/0 Concentric	2/0 Concentric	115 or 115PLUSF20	Preferred	L160
XAC2Q1V	XA	C	4/0 Concentric	#2 Concentric	115 or 115PLUSF20	Preferred	L160
XAC2Q1Y	XA	C	4/0 Concentric	#1 Concentric	150 or 150PLUSF20	Preferred	L160
XAC2Q2C	XA	C	4/0 Concentric	1/0 Concentric	150 or 150PLUSF20	Preferred	L160
XAC2Q2G	XA	C	4/0 Concentric	2/0 Concentric	150 or 150PLUSF20	Preferred	L160
XAC2Q2Q	XA	C	4/0 Concentric	4/0 Concentric	200 or 200PLUSF20	Preferred	L160
XAC2V1V	XA	C	250 kcmil Concentric	#2 Concentric	115 or 115PLUSF20	Preferred	L160
XAC2V2C	XA	C	250 kcmil Concentric	1/0 Concentric	150 or 150PLUSF20	Preferred	L160
XAC2V2G	XA	C	250 kcmil Concentric	2/0 Concentric	150 or 150PLUSF20	Preferred	L160
XAC2V2Q	XA	C	250 kcmil Concentric	4/0 Concentric	200 or 200PLUSF20	Preferred	L160
XAC2V2V	XA	C	250 kcmil Concentric	250 kcmil Concentric	200 or 200PLUSF20	Preferred	L160
XAC3A2G	XA	C	300 kcmil Concentric	2/0 Concentric	150 or 150PLUSF20	Preferred	L160
XAC3A2Q	XA	C	300 kcmil Concentric	4/0 Concentric	200 or 200PLUSF20	Preferred	L160
XAC3A2V	XA	C	300 kcmil Concentric	250 kcmil Concentric	250 or 250PLUSF20	Preferred	L160
XAC3A3A	XA	C	300 kcmil Concentric	300 kcmil Concentric	200 or 200PLUSF20	Preferred	L160
XAC3D2C	XA	C	350 kcmil Concentric	1/0 Concentric	200 or 200PLUSF20	Preferred	L160
XAC3D2G	XA	C	350 kcmil Concentric	2/0 Concentric	200 or 200PLUSF20	Preferred	L160
XAC3D2Q	XA	C	350 kcmil Concentric	4/0 Concentric	200 or 200PLUSF20	Preferred	L160
XAC3D2V	XA	C	350 kcmil Concentric	250 kcmil Concentric	250 or 250PLUSF20	Preferred	L160
XAC3D3D	XA	C	350 kcmil Concentric	350 kcmil Concentric	250 or 250PLUSF20	Preferred	L160
XAC3H3H	XA	C	400 kcmil Concentric	400 kcmil Concentric	150 x 2 or 300PLUSF20	Preferred	L160
XAC3Q2G	XA	C	500 kcmil Concentric	2/0 Concentric	250 or 250PLUSF20	Preferred	L160
XAC3Q2Q	XA	C	500 kcmil Concentric	4/0 Concentric	150 x 2 or 300PLUSF20	Preferred	L160
XAD3Q3Q	XA	D	500 kcmil Concentric	500 kcmil Concentric	500 or 500PLUSF20	Preferred	L159
XAD3X3X	XA	D	600 kcmil Concentric	600 kcmil Concentric	500 or 500PLUSF20	Preferred	L159
XAD4L2Q	XA	D	750 kcmil Concentric	4/0 Concentric	500 or 500PLUSF20	Preferred	L159
XAD4Y2Q	XA	D	1000 kcmil Concentric	4/0 Concentric	500 or 500PLUSF20	Preferred	L159

XB MOLDS

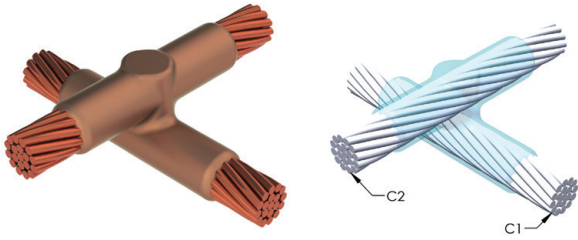

Global Part Number	Mold Family	Price Key	Conductor 1	Conductor 2	Welding Material	Ease of Use	Handle Clamp (Sold separately unless noted)
XB32C2C	XB	3	1/0 Concentric	1/0 Concentric	150 or 150PLUSF20	Easy	L163
XB32G2G	XB	3	2/0 Concentric	2/0 Concentric	200 or 200PLUSF20	Easy	L163
XB32L2L	XB	3	3/0 Concentric	3/0 Concentric	250 or 250PLUSF20	Easy	L163
XB32Q2Q	XB	3	4/0 Concentric	4/0 Concentric	250 or 250PLUSF20	Easy	L163
XB32V2V	XB	3	250 kcmil Concentric	250 kcmil Concentric	150 x 2 or 300PLUSF20	Easy	L163
XB43D3D	XB	4	350 kcmil Concentric	350 kcmil Concentric	500 or 500PLUSF20	Easy	L164
XBC1K1K	XB	C	#4 Solid	#4 Solid	65 or 65PLUSF20	Easy	L160
XBC1L1L	XB	C	#4 Concentric	#4 Concentric	65 or 65PLUSF20	Easy	L160
XBC1T1T	XB	C	#2 Solid	#2 Solid	90 or 90PLUSF20	Easy	L160
XBC1V1L	XB	C	#2 Concentric	#4 Concentric	65 or 65PLUSF20	Easy	L160
XBC1V1V	XB	C	#2 Concentric	#2 Concentric	90 or 90PLUSF20	Easy	L160
XBC1Y1Y	XB	C	#1 Concentric	#1 Concentric	115 or 115PLUSF20	Easy	L160
XBC2C1V	XB	C	1/0 Concentric	#2 Concentric	115 or 115PLUSF20	Easy	L160
XBK3X3X	XB	K	600 kcmil Concentric	600 kcmil Concentric	500 x 2 or 1000PLUSF20	Easy	Includes Frame w/ Handles
XBK4L3Q	XB	K	750 kcmil Concentric	500 kcmil Concentric	500 x 2 or 1000PLUSF20	Easy	Includes Frame w/ Handles
XBK4L4L	XB	K	750 kcmil Concentric	750 kcmil Concentric	250 x 5 or 1250PLUSF20	Easy	Includes Frame w/ Handles
XBK4Y3Q	XB	K	1000 kcmil Concentric	500 kcmil Concentric	500 x 2 or 1000PLUSF20	Easy	Includes Frame w/ Handles
XBK4Y4Y	XB	K	1000 kcmil Concentric	1000 kcmil Concentric	500 x 3 or 1500PLUSF20	Easy	Includes Frame w/ Handles
XBM2C2C	XB	M	1/0 Concentric	1/0 Concentric	150 or 150PLUSF20	Easy	Includes Frame w/ Handles
XBM2G2G	XB	M	2/0 Concentric	2/0 Concentric	200 or 200PLUSF20	Easy	Includes Frame w/ Handles
XBM2L2L	XB	M	3/0 Concentric	3/0 Concentric	250 or 250PLUSF20	Easy	Includes Frame w/ Handles
XBM2Q2Q	XB	M	4/0 Concentric	4/0 Concentric	250 or 250PLUSF20	Easy	Includes Frame w/ Handles
XBM2V2V	XB	M	250 kcmil Concentric	250 kcmil Concentric	150 x 2 or 300PLUSF20	Easy	Includes Frame w/ Handles
XBP1G1G	XB	P	#6 Solid	#6 Solid	32 or 32PLUSF20	Easy	Clamp Included
XBP1H1H	XB	P	#6 Concentric	#6 Concentric	45 or 45PLUSF20	Easy	Clamp Included
XBQ2C2C	XB	Q	1/0 Concentric	1/0 Concentric	150 or 150PLUSF20	Easy	L160
XBQ2G1V	XB	Q	2/0 Concentric	#2 Concentric	150 or 150PLUSF20	Easy	L160
XBQ2G2C	XB	Q	2/0 Concentric	1/0 Concentric	200 or 200PLUSF20	Easy	L160
XBQ2G2G	XB	Q	2/0 Concentric	2/0 Concentric	200 or 200PLUSF20	Easy	L160
XBQ2Q2C	XB	Q	4/0 Concentric	1/0 Concentric	200 or 200PLUSF20	Easy	L160
XBQ2Q2G	XB	Q	4/0 Concentric	2/0 Concentric	200 or 200PLUSF20	Easy	L160

Global Part Number	Mold Family	Price Key	Conductor 1	Conductor 2	Welding Material	Ease of Use	Handle Clamp (Sold separately unless noted)
XBQ2Q2Q	XB	Q	4/0 Concentric	4/0 Concentric	250 or 250PLUSF20	Easy	L160
XBQ2V2G	XB	Q	250 kcmil Concentric	2/0 Concentric	250 or 250PLUSF20	Easy	L160
XBQ2V2Q	XB	Q	250 kcmil Concentric	4/0 Concentric	150 x 2 or 300PLUSF20	Easy	L160
XBQ2V2V	XB	Q	250 kcmil Concentric	250 kcmil Concentric	150 x 2 or 300PLUSF20	Easy	L160
XBV3A3A	XB	V	300 kcmil Concentric	300 kcmil Concentric	200 x 2 or 400PLUSF20	Easy	Includes Frame w/ Handles
XBV3D3D	XB	V	350 kcmil Concentric	350 kcmil Concentric	500 or 500PLUSF20	Easy	Includes Frame w/ Handles
XBV3H3H	XB	V	400 kcmil Concentric	400 kcmil Concentric	200 x 3 or 600PLUSF20	Easy	Includes Frame w/ Handles
XBV3Q3Q	XB	V	500 kcmil Concentric	500 kcmil Concentric	200 x 3 or 600PLUSF20	Easy	Includes Frame w/ Handles

PG MOLDS

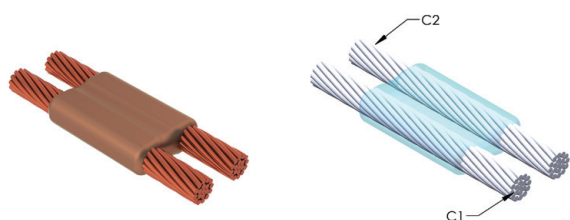

Global Part Number	Mold Family	Price Key	Conductor 1	Conductor 2	Welding Material	Ease of Use	Handle Clamp (Sold separately unless noted)
PGT08CU	PG	T	#8 Solid	#8 Solid	15 or 15PLUSF20	Easy	Clamp Included
PGT10CU	PG	T	#10 Solid	#10 Solid	15 or 15PLUSF20	Easy	Clamp Included
PGT1D1D	PG	T	#8 Solid	#8 Solid	15 or 15PLUSF20	Easy	Clamp Included
PGT1G1G	PG	T	#6 Solid	#6 Solid	25 or 25PLUSF20	Easy	Clamp Included
PGT1G1H	PG	T	#6 Solid	#6 Concentric	25 or 25PLUSF20	Easy	Clamp Included
PGT1H1H	PG	T	#6 Concentric	#6 Concentric	25 or 25PLUSF20	Easy	Clamp Included
PGT1K1K	PG	T	#4 Solid	#4 Solid	32 or 32PLUSF20	Easy	Clamp Included

PT MOLDS

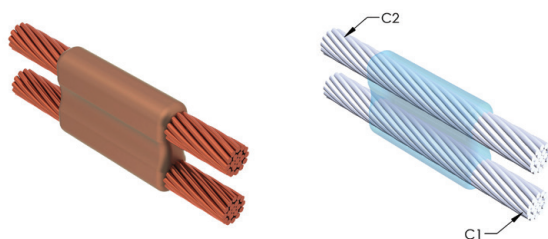

Global Part Number	Mold Family	Price Key	Conductor 1	Conductor 2	Welding Material	Ease of Use	Handle Clamp (Sold separately unless noted)
PTC1D1D	PT	C	#8 Solid	#8 Solid	25 or 25PLUSF20	Preferred	L160
PTC1G1G	PT	C	#6 Solid	#6 Solid	32 or 32PLUSF20	Preferred	L160
PTC1H1H	PT	C	#6 Concentric	#6 Concentric	32 or 32PLUSF20	Preferred	L160
PTC1K1K	PT	C	#4 Solid	#4 Solid	32 or 32PLUSF20	Preferred	L160

Global Part Number	Mold Family	Price Key	Conductor 1	Conductor 2	Welding Material	Ease of Use	Handle Clamp (Sold separately unless noted)
PTC1L1D	PT	C	#4 Concentric	#8 Solid	32 or 32PLUSF20	Preferred	L160
PTC1L1G	PT	C	#4 Concentric	#6 Solid	32 or 32PLUSF20	Preferred	L160
PTC1L1H	PT	C	#4 Concentric	#6 Concentric	32 or 32PLUSF20	Preferred	L160
PTC1L1L	PT	C	#4 Concentric	#4 Concentric	32 or 32PLUSF20	Preferred	L160
PTC1T1D	PT	C	#2 Solid	#8 Solid	45 or 45PLUSF20	Preferred	L160
PTC1T1G	PT	C	#2 Solid	#6 Solid	45 or 45PLUSF20	Preferred	L160
PTC1T1H	PT	C	#2 Solid	#6 Concentric	45 or 45PLUSF20	Preferred	L160
PTC1T1K	PT	C	#2 Solid	#4 Solid	65 or 65PLUSF20	Preferred	L160
PTC1T1L	PT	C	#2 Solid	#4 Concentric	65 or 65PLUSF20	Preferred	L160
PTC1T1T	PT	C	#2 Solid	#2 Solid	65 or 65PLUSF20	Preferred	L160
PTC1T1V	PT	C	#2 Solid	#2 Concentric	65 or 65PLUSF20	Preferred	L160
PTC1V1D	PT	C	#2 Concentric	#8 Solid	45 or 45PLUSF20	Preferred	L160
PTC1V1G	PT	C	#2 Concentric	#6 Solid	45 or 45PLUSF20	Preferred	L160
PTC1V1H	PT	C	#2 Concentric	#6 Concentric	45 or 45PLUSF20	Preferred	L160
PTC1V1K	PT	C	#2 Concentric	#4 Solid	65 or 65PLUSF20	Preferred	L160
PTC1V1L	PT	C	#2 Concentric	#4 Concentric	65 or 65PLUSF20	Preferred	L160
PTC1V1T	PT	C	#2 Concentric	#2 Solid	65 or 65PLUSF20	Preferred	L160
PTC1V1V	PT	C	#2 Concentric	#2 Concentric	65 or 65PLUSF20	Preferred	L160
PTC1Y1G	PT	C	#1 Concentric	#6 Solid	65 or 65PLUSF20	Preferred	L160
PTC1Y1T	PT	C	#1 Concentric	#2 Solid	65 or 65PLUSF20	Preferred	L160
PTC1Y1Y	PT	C	#1 Concentric	#1 Concentric	65 or 65PLUSF20	Preferred	L160
PTC2C1D	PT	C	1/0 Concentric	#8 Solid	65 or 65PLUSF20	Preferred	L160
PTC2C1G	PT	C	1/0 Concentric	#6 Solid	65 or 65PLUSF20	Preferred	L160
PTC2C1H	PT	C	1/0 Concentric	#6 Concentric	65 or 65PLUSF20	Preferred	L160
PTC2C1L	PT	C	1/0 Concentric	#4 Concentric	65 or 65PLUSF20	Preferred	L160
PTC2C1T	PT	C	1/0 Concentric	#2 Solid	65 or 65PLUSF20	Preferred	L160
PTC2C1V	PT	C	1/0 Concentric	#2 Concentric	65 or 65PLUSF20	Preferred	L160
PTC2C1Y	PT	C	1/0 Concentric	#1 Concentric	65 or 65PLUSF20	Preferred	L160
PTC2C2C	PT	C	1/0 Concentric	1/0 Concentric	90 or 90PLUSF20	Preferred	L160
PTC2G1D	PT	C	2/0 Concentric	#8 Solid	90 or 90PLUSF20	Preferred	L160
PTC2G1G	PT	C	2/0 Concentric	#6 Solid	90 or 90PLUSF20	Preferred	L160
PTC2G1H	PT	C	2/0 Concentric	#6 Concentric	90 or 90PLUSF20	Preferred	L160
PTC2G1K	PT	C	2/0 Concentric	#4 Solid	65 or 65PLUSF20	Preferred	L160
PTC2G1L	PT	C	2/0 Concentric	#4 Concentric	90 or 90PLUSF20	Preferred	L160
PTC2G1T	PT	C	2/0 Concentric	#2 Solid	90 or 90PLUSF20	Preferred	L160
PTC2G1V	PT	C	2/0 Concentric	#2 Concentric	90 or 90PLUSF20	Preferred	L160
PTC2G2C	PT	C	2/0 Concentric	1/0 Concentric	115 or 115PLUSF20	Preferred	L160
PTC2G2G	PT	C	2/0 Concentric	2/0 Concentric	115 or 115PLUSF20	Preferred	L160
PTC2Q1D	PT	C	4/0 Concentric	#8 Solid	90 or 90PLUSF20	Preferred	L160
PTC2Q1G	PT	C	4/0 Concentric	#6 Solid	90 or 90PLUSF20	Preferred	L160
PTC2Q1H	PT	C	4/0 Concentric	#6 Concentric	90 or 90PLUSF20	Preferred	L160
PTC2Q1K	PT	C	4/0 Concentric	#4 Solid	150 or 150PLUSF20	Preferred	L160
PTC2Q1L	PT	C	4/0 Concentric	#4 Concentric	150 or 150PLUSF20	Preferred	L160
PTC2Q1T	PT	C	4/0 Concentric	#2 Solid	150 or 150PLUSF20	Preferred	L160
PTC2Q1V	PT	C	4/0 Concentric	#2 Concentric	150 or 150PLUSF20	Preferred	L160
PTC2Q1Y	PT	C	4/0 Concentric	#1 Concentric	150 or 150PLUSF20	Preferred	L160
PTC2Q2C	PT	C	4/0 Concentric	1/0 Concentric	150 or 150PLUSF20	Preferred	L160
PTC2Q2G	PT	C	4/0 Concentric	2/0 Concentric	150 or 150PLUSF20	Preferred	L160
PTC2Q2Q	PT	C	4/0 Concentric	4/0 Concentric	200 or 200PLUSF20	Preferred	L160
PTC2V1T	PT	C	250 kcmil Concentric	#2 Solid	150 or 150PLUSF20	Preferred	L160
PTC2V1V	PT	C	250 kcmil Concentric	#2 Concentric	150 or 150PLUSF20	Preferred	L160
PTC2V2C	PT	C	250 kcmil Concentric	1/0 Concentric	150 or 150PLUSF20	Preferred	L160
PTC2V2G	PT	C	250 kcmil Concentric	2/0 Concentric	150 or 150PLUSF20	Preferred	L160
PTC2V2Q	PT	C	250 kcmil Concentric	4/0 Concentric	200 or 200PLUSF20	Preferred	L160
PTC2V2V	PT	C	250 kcmil Concentric	250 kcmil Concentric	250 or 250PLUSF20	Preferred	L160
PTC3A2Q	PT	C	300 kcmil Concentric	4/0 Concentric	200 or 200PLUSF20	Preferred	L160
PTC3A3A	PT	C	300 kcmil Concentric	300 kcmil Concentric	150 x 2 or 300PLUSF20	Preferred	L160
PTC3D2Q	PT	C	350 kcmil Concentric	4/0 Concentric	200 or 200PLUSF20	Preferred	L160

Global Part Number	Mold Family	Price Key	Conductor 1	Conductor 2	Welding Material	Ease of Use	Handle Clamp (Sold separately unless noted)
PTC3D2V	PT	C	350 kcmil Concentric	250 kcmil Concentric	250 or 250PLUSF20	Preferred	L160
PTC3D3D	PT	C	350 kcmil Concentric	350 kcmil Concentric	150 x 2 or 300PLUSF20	Preferred	L160
PTC3H2Q	PT	C	400 kcmil Concentric	4/0 Concentric	200 or 200PLUSF20	Preferred	L160
PTC3Q2G	PT	C	500 kcmil Concentric	2/0 Concentric	150 or 150PLUSF20	Preferred	L160
PTC3Q2Q	PT	C	500 kcmil Concentric	4/0 Concentric	200 or 200PLUSF20	Preferred	L160
PTC3Q2V	PT	C	500 kcmil Concentric	250 kcmil Concentric	250 or 250PLUSF20	Preferred	L160
PTC3Q3A	PT	C	500 kcmil Concentric	300 kcmil Concentric	150 x 2 or 300PLUSF20	Preferred	L160
PTC3Q3D	PT	C	500 kcmil Concentric	350 kcmil Concentric	150 x 2 or 300PLUSF20	Preferred	L160
PTC4L2Q	PT	C	750 kcmil Concentric	4/0 Concentric	250 or 250PLUSF20	Preferred	L160
PTC4Y2Q	PT	C	1000 kcmil Concentric	4/0 Concentric	150 x 2 or 300PLUSF20	Preferred	L160
PTD2Q2Q	PT	D	4/0 Concentric	4/0 Concentric	200 or 200PLUSF20	Preferred	L159
PTD3H3H	PT	D	400 kcmil Concentric	400 kcmil Concentric	200 x 2 or 400PLUSF20	Preferred	L159
PTD3Q3Q	PT	D	500 kcmil Concentric	500 kcmil Concentric	200 x 2 or 400PLUSF20	Preferred	L159
PTF4L4L	PT	F	750 kcmil Concentric	750 kcmil Concentric	250 x 3 or 750PLUSF20	Preferred	L159
PTF4Y4Y	PT	F	1000 kcmil Concentric	1000 kcmil Concentric	500 x 2 or 1000PLUSF20	Preferred	L159

PH MOLDS

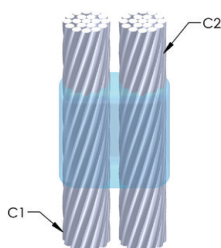
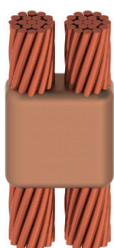

Global Part Number	Mold Family	Price Key	Conductor 1	Conductor 2	Welding Material	Ease of Use	Handle Clamp (Sold separately unless noted)
PHJ2Q2Q	PH	J	4/0 Concentric	4/0 Concentric	200 x 2 or 400PLUSF20	Difficult	Include Frame & Requires L159
PHJ2V2Q	PH	J	250 kcmil Concentric	4/0 Concentric	200 x 2 or 400PLUSF20	Difficult	Include Frame & Requires L159
PHJ2V2V	PH	J	250 kcmil Concentric	250 kcmil Concentric	200 x 2 or 400PLUSF20	Difficult	Include Frame & Requires L159
PHJ3A3A	PH	J	300 kcmil Concentric	300 kcmil Concentric	200 x 2 or 400PLUSF20	Difficult	Include Frame & Requires L159
PHJ3D2Q	PH	J	350 kcmil Concentric	4/0 Concentric	200 x 2 or 400PLUSF20	Difficult	Include Frame & Requires L159
PHJ3D2V	PH	J	350 kcmil Concentric	250 kcmil Concentric	200 x 2 or 400PLUSF20	Difficult	Include Frame & Requires L159
PHJ3Q2Q	PH	J	500 kcmil Concentric	4/0 Concentric	500 or 500PLUSF20	Difficult	Include Frame & Requires L159
PHJ3Q3Q	PH	J	500 kcmil Concentric	500 kcmil Concentric	250 x 3 or 750PLUSF20	Difficult	Include Frame & Requires L159
PHR1K1K	PH	R	#4 Solid	#4 Solid	65 or 65PLUSF20	Difficult	L160
PHR1L1L	PH	R	#4 Concentric	#4 Concentric	65 or 65PLUSF20	Difficult	L160
PHR1T1T	PH	R	#2 Solid	#2 Solid	115 or 115PLUSF20	Difficult	L160
PHR1V1L	PH	R	#2 Concentric	#4 Concentric	90 or 90PLUSF20	Difficult	L160
PHR1V1T	PH	R	#2 Concentric	#2 Solid	115 or 115PLUSF20	Difficult	L160
PHR1V1V	PH	R	#2 Concentric	#2 Concentric	115 or 115PLUSF20	Difficult	L160
PHR2C1T	PH	R	1/0 Concentric	#2 Solid	115 or 115PLUSF20	Difficult	L160
PHR2C1V	PH	R	1/0 Concentric	#2 Concentric	115 or 115PLUSF20	Difficult	L160
PHR2C2C	PH	R	1/0 Concentric	1/0 Concentric	150 or 150PLUSF20	Difficult	L160
PHR2G1L	PH	R	2/0 Concentric	#4 Concentric	115 or 115PLUSF20	Difficult	L160

Global Part Number	Mold Family	Price Key	Conductor 1	Conductor 2	Welding Material	Ease of Use	Handle Clamp (Sold separately unless noted)
PHR2G1T	PH	R	2/0 Concentric	#2 Solid	150 or 150PLUSF20	Difficult	L160
PHR2G1V	PH	R	2/0 Concentric	#2 Concentric	150 or 150PLUSF20	Difficult	L160
PHR2G2C	PH	R	2/0 Concentric	1/0 Concentric	150 or 150PLUSF20	Difficult	L160
PHR2G2G	PH	R	2/0 Concentric	2/0 Concentric	150 or 150PLUSF20	Difficult	L160
PHR2Q1T	PH	R	4/0 Concentric	#2 Solid	200 or 200PLUSF20	Difficult	L160
PHR2Q1V	PH	R	4/0 Concentric	#2 Concentric	200 or 200PLUSF20	Difficult	L160
PHR2Q2C	PH	R	4/0 Concentric	1/0 Concentric	250 or 250PLUSF20	Difficult	L160
PHR2Q2G	PH	R	4/0 Concentric	2/0 Concentric	250 or 250PLUSF20	Difficult	L160
PHT1D1D	PH	T	#8 Solid	#8 Solid	25 or 25PLUSF20	Difficult	Clamp Included

CABLE TO GROUND ROD SPLICE



- Forms a permanent, low resistance connection
- Provides a molecular bond
- Cadweld Exothermic Connections are rated with the same current capacity as the conductor
- Portable installation equipment with no external source of power required
- Installers can be easily trained to make Cadweld Exothermic Connections
- Connections are visually inspected

GB MOLDS

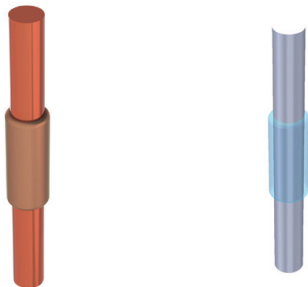

Global Part Number	Mold Family	Price Key	Ground Rod Diameter (Nominal)	Ground Rod Diameter (Actual)	Ground Rod Type	Welding Material Required	Ease of Use	Handle Clamp Required	Other Accessories Required
HDGBR12	GB	R	3/8"	0.375"	Steel	250 or 250PLUSF20	Preferred	L160	B120
HDGBC14S	GB	C	1/2"	0.505"	Steel	200 or 200PLUSF20	Preferred	L160	B120
HDGBD16	GB	D	5/8"	0.563"	Copper-bonded	150 x 2 or 300PLUSF20	Preferred	L159	B120
HDGBD31	GB	D	5/8"	0.625"	Steel	150 x 2 or 300PLUSF20	Preferred	L159	B120
HDGBF18	GB	F	3/4"	0.682"	Copper-bonded	200 x 2 or 400PLUSF20	Preferred	L159	B120
HDGBF22	GB	F	1"	0.914"	Copper-bonded	250 x 3 or 750PLUSF20	Preferred	L159	B120
HDGBF33	GB	F	3/4"	0.750"	Steel	200 x 2 or 400PLUSF20	Preferred	L159	B120
HDGBF37	GB	F	1"	1.000"	Steel	250 x 3 or 750PLUSF20	Preferred	L159	B120
HDGBR15	GB	R	1/2"	0.475"	Copper-bonded	250 or 250PLUSF20	Preferred	L160	B120

GE MOLDS

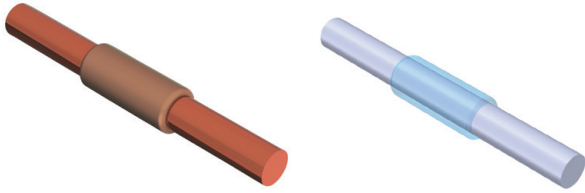

Global Part Number	Mold Family	Price Key	Ground Rod Diameter (Nominal)	Ground Rod Diameter (Actual)	Ground Rod Type	Welding Material Required	Ease of Use	Handle Clamp Required
GEC18	GE	C	3/4"	0.682"	Copper-bonded	200 or 200PLUSF20	Preferred	L160
GEC14	GE	C	1/2"	0.505"	Steel	150 or 150PLUSF20	Preferred	L160
GEC16	GE	C	5/8"	0.563"	Copper-bonded	115 or 115PLUSF20	Preferred	L160
GEC31	GE	C	5/8"	0.625"	Steel	200 or 200PLUSF20	Preferred	L160

CABLE TO GROUND ROD OR OTHER ROUNDS

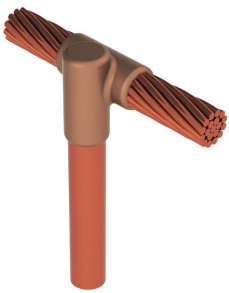

- Forms a permanent, low resistance connection
- Provides a molecular bond
- Cadweld Exothermic Connections are rated with the same current capacity as the conductor
- Portable installation equipment with no external source of power required
- Installers can be easily trained to make Cadweld Exothermic Connections
- Connections are visually inspected

GR MOLDS

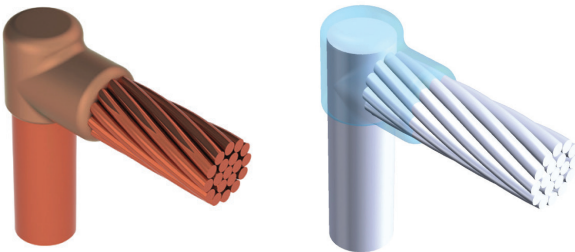

Global Part Number	Mold Family	Price Key	Ground Rod Type	Ground Rod Diameter, Nominal	Ground Rod Diameter, Actual	Conductor Size	Welding Material	Ease of Use	Handle Clamp	Other Accessories Required
GRC141V	GR	C	Steel	1/2"	0.505"	#2 Concentric	65 or 65PLUSF20	Preferred	L160	
GRC141Y	GR	C	Steel	1/2"	0.505"	#1 Concentric	65 or 65PLUSF20	Preferred	L160	
GRC142C	GR	C	Steel	1/2"	0.505"	1/0 Concentric	90 or 90PLUSF20	Preferred	L160	
GRC142G	GR	C	Steel	1/2"	0.505"	2/0 Concentric	90 or 90PLUSF20	Preferred	L160	
GRC142Q	GR	C	Steel	1/2"	0.505"	4/0 Concentric	90 or 90PLUSF20	Preferred	L160	
GRC142V	GR	C	Steel	1/2"	0.505"	250 kcmil Concentric	90 or 90PLUSF20	Preferred	L160	
GRC161E	GR	C	Copper-bonded	5/8"	0.563"	#8 Concentric	65 or 65PLUSF20	Preferred	L160	B1331L
GRC161G	GR	C	Copper-bonded	5/8"	0.563"	#6 Solid	65 or 65PLUSF20	Preferred	L160	B1331L

Global Part Number	Mold Family	Price Key	Ground Rod Type	Ground Rod Diameter, Nominal	Ground Rod Diameter, Actual	Conductor Size	Welding Material	Ease of Use	Handle Clamp	Other Accessories Required
GRC161H	GR	C	Copper-bonded	5/8"	0.563"	#6 Concentric	65 or 65PLUSF20	Preferred	L160	B112
GRC161K	GR	C	Copper-bonded	5/8"	0.563"	#4 Solid	65 or 65PLUSF20	Preferred	L160	
GRC161L	GR	C	Copper-bonded	5/8"	0.563"	#4 Concentric	65 or 65PLUSF20	Preferred	L160	
GRC161T	GR	C	Copper-bonded	5/8"	0.563"	#2 Solid	65 or 65PLUSF20	Preferred	L160	
GRC161V	GR	C	Copper-bonded	5/8"	0.563"	#2 Concentric	65 or 65PLUSF20	Preferred	L160	
GRC161Y	GR	C	Copper-bonded	5/8"	0.563"	#1 Concentric	65 or 65PLUSF20	Preferred	L160	
GRC162C	GR	C	Copper-bonded	5/8"	0.563"	1/0 Concentric	90 or 90PLUSF20	Preferred	L160	
GRC162G	GR	C	Copper-bonded	5/8"	0.563"	2/0 Concentric	90 or 90PLUSF20	Preferred	L160	
GRC162Q	GR	C	Copper-bonded	5/8"	0.563"	4/0 Concentric	90 or 90PLUSF20	Preferred	L160	
GRC162V	GR	C	Copper-bonded	5/8"	0.563"	250 kcmil Concentric	90 or 90PLUSF20	Preferred	L160	
GRC163A	GR	C	Copper-bonded	5/8"	0.563"	300 kcmil Concentric	115 or 115PLUSF20	Preferred	L160	
GRC163D	GR	C	Copper-bonded	5/8"	0.563"	350 kcmil Concentric	115 or 115PLUSF20	Preferred	L160	
GRC163H	GR	C	Copper-bonded	5/8"	0.563"	400 kcmil Concentric	150 or 150PLUSF20	Preferred	L160	
GRC163Q	GR	C	Copper-bonded	5/8"	0.563"	500 kcmil Concentric	150 or 150PLUSF20	Preferred	L160	
GRC181G	GR	C	Copper-bonded	3/4"	0.682"	#6 Solid	90 or 90PLUSF20	Preferred	L160	B1331L
GRC181H	GR	C	Copper-bonded	3/4"	0.682"	#6 Concentric	90 or 90PLUSF20	Preferred	L160	B112
GRC181K	GR	C	Copper-bonded	3/4"	0.682"	#4 Solid	90 or 90PLUSF20	Preferred	L160	
GRC181L	GR	C	Copper-bonded	3/4"	0.682"	#4 Concentric	90 or 90PLUSF20	Preferred	L160	
GRC181T	GR	C	Copper-bonded	3/4"	0.682"	#2 Solid	90 or 90PLUSF20	Preferred	L160	
GRC181V	GR	C	Copper-bonded	3/4"	0.682"	#2 Concentric	90 or 90PLUSF20	Preferred	L160	
GRC181Y	GR	C	Copper-bonded	3/4"	0.682"	#1 Concentric	90 or 90PLUSF20	Preferred	L160	
GRC182C	GR	C	Copper-bonded	3/4"	0.682"	1/0 Concentric	90 or 90PLUSF20	Preferred	L160	
GRC182G	GR	C	Copper-bonded	3/4"	0.682"	2/0 Concentric	90 or 90PLUSF20	Preferred	L160	
GRC182Q	GR	C	Copper-bonded	3/4"	0.682"	4/0 Concentric	90 or 90PLUSF20	Preferred	L160	
GRC182V	GR	C	Copper-bonded	3/4"	0.682"	250 kcmil Concentric	90 or 90PLUSF20	Preferred	L160	
GRC183A	GR	C	Copper-bonded	3/4"	0.682"	300 kcmil Concentric	115 or 115PLUSF20	Preferred	L160	
GRC183D	GR	C	Copper-bonded	3/4"	0.682"	350 kcmil Concentric	115 or 115PLUSF20	Preferred	L160	
GRC183H	GR	C	Copper-bonded	3/4"	0.682"	400 kcmil Concentric	150 or 150PLUSF20	Preferred	L160	
GRC183Q	GR	C	Copper-bonded	3/4"	0.682"	500 kcmil Concentric	150 or 150PLUSF20	Preferred	L160	
GRC184L	GR	C	Copper-bonded	3/4"	0.682"	750 kcmil Concentric	250 or 250PLUSF20	Preferred	L160	
GRC221T	GR	C	Copper-bonded	1"	0.914"	#2 Solid	150 or 150PLUSF20	Preferred	L160	
GRC221V	GR	C	Copper-bonded	1"	0.914"	#2 Concentric	150 or 150PLUSF20	Preferred	L160	
GRC222C	GR	C	Copper-bonded	1"	0.914"	1/0 Concentric	150 or 150PLUSF20	Preferred	L160	
GRC222G	GR	C	Copper-bonded	1"	0.914"	2/0 Concentric	150 or 150PLUSF20	Preferred	L160	
GRC222Q	GR	C	Copper-bonded	1"	0.914"	4/0 Concentric	150 or 150PLUSF20	Preferred	L160	
GRC222V	GR	C	Copper-bonded	1"	0.914"	250 kcmil Concentric	150 or 150PLUSF20	Preferred	L160	

Global Part Number	Mold Family	Price Key	Ground Rod Type	Ground Rod Diameter, Nominal	Ground Rod Diameter, Actual	Conductor Size	Welding Material	Ease of Use	Handle Clamp	Other Accessories Required
GRC223D	GR	C	Copper-bonded	1"	0.914"	350 kcmil Concentric	200 or 200PLUSF20	Preferred	L160	
GRC223Q	GR	C	Copper-bonded	1"	0.914"	500 kcmil Concentric	200 or 200PLUSF20	Preferred	L160	
GRC224L	GR	C	Copper-bonded	1"	0.914"	750 kcmil Concentric	150 x 2 or 300PLUSF20	Preferred	L160	
GRC311L	GR	C	Steel	5/8"	0.625"	#4 Concentric	65 or 65PLUSF20	Preferred	L160	
GRC311T	GR	C	Steel	5/8"	0.625"	#2 Solid	65 or 65PLUSF20	Preferred	L160	
GRC311V	GR	C	Steel	5/8"	0.625"	#2 Concentric	65 or 65PLUSF20	Preferred	L160	
GRC312C	GR	C	Steel	5/8"	0.625"	1/0 Concentric	90 or 90PLUSF20	Preferred	L160	
GRC312G	GR	C	Steel	5/8"	0.625"	2/0 Concentric	90 or 90PLUSF20	Preferred	L160	
GRC312Q	GR	C	Steel	5/8"	0.625"	4/0 Concentric	90 or 90PLUSF20	Preferred	L160	
GRC312V	GR	C	Steel	5/8"	0.625"	250 kcmil Concentric	90 or 90PLUSF20	Preferred	L160	
GRC313Q	GR	C	Steel	5/8"	0.625"	500 kcmil Concentric	150 or 150PLUSF20	Preferred	L160	
GRC331H	GR	C	Steel	3/4"	0.750"	#6 Concentric	90 or 90PLUSF20	Preferred	L160	B112
GRC331L	GR	C	Steel	3/4"	0.750"	#4 Concentric	90 or 90PLUSF20	Preferred	L160	
GRC331T	GR	C	Steel	3/4"	0.750"	#2 Solid	90 or 90PLUSF20	Preferred	L160	
GRC331V	GR	C	Steel	3/4"	0.750"	#2 Concentric	90 or 90PLUSF20	Preferred	L160	
GRC332C	GR	C	Steel	3/4"	0.750"	1/0 Concentric	90 or 90PLUSF20	Preferred	L160	
GRC332G	GR	C	Steel	3/4"	0.750"	2/0 Concentric	90 or 90PLUSF20	Preferred	L160	
GRC332Q	GR	C	Steel	3/4"	0.750"	4/0 Concentric	90 or 90PLUSF20	Preferred	L160	
GRC332V	GR	C	Steel	3/4"	0.750"	250 kcmil Concentric	90 or 90PLUSF20	Preferred	L160	
GRC333Q	GR	C	Steel	3/4"	0.750"	500 kcmil Concentric	150 or 150PLUSF20	Preferred	L160	
GRC372C	GR	C	Steel	1"	1.000"	1/0 Concentric	150 or 150PLUSF20	Preferred	L160	
GRC372G	GR	C	Steel	1"	1.000"	2/0 Concentric	150 or 150PLUSF20	Preferred	L160	
GRC372Q	GR	C	Steel	1"	1.000"	4/0 Concentric	150 or 150PLUSF20	Preferred	L160	
GRD224Y	GR	D	Copper-bonded	1"	0.914"	1000 kcmil Concentric	200 x 2 or 400PLUSF20	Preferred	L159	
GRP141G	GR	P	Steel	1/2"	0.505"	#6 Solid	25 or 25PLUSF20	Preferred		B399B Mini EZ Attached
GRP161V	GR	P	Copper-bonded	5/8"	0.563"	#2 Concentric	45 or 45PLUSF20	Preferred		B399B Mini EZ Attached
GRP181K	GR	P	Copper-bonded	3/4"	0.682"	#4 Solid	45 or 45PLUSF20	Preferred		B399B Mini EZ Attached
GRP181L	GR	P	Copper-bonded	3/4"	0.682"	#4 Concentric	45 or 45PLUSF20	Preferred		B399B Mini EZ Attached
GRP181V	GR	P	Copper-bonded	3/4"	0.682"	#2 Concentric	45 or 45PLUSF20	Preferred		B399B Mini EZ Attached
GRP331K	GR	P	Steel	3/4"	0.750"	#4 Solid	45 or 45PLUSF20	Preferred		B399B Mini EZ Attached

Global Part Number	Mold Family	Price Key	Ground Rod Type	Ground Rod Diameter, Nominal	Ground Rod Diameter, Actual	Conductor Size	Welding Material	Ease of Use	Handle Clamp	Other Accessories Required
GRP331L	GR	P	Steel	3/4"	0.750"	#4 Concentric	45 or 45PLUSF20	Preferred	B399B Mini EZ Attached	
GRP371K	GR	P	Steel	1"	1.000"	#4 Solid	65 or 65PLUSF20	Preferred	B399B Mini EZ Attached	
GRP371L	GR	P	Steel	1"	1.000"	#4 Concentric	65 or 65PLUSF20	Preferred	B399B Mini EZ Attached	
GRT14A1G	GR	T	Steel	1/2"	0.505"	#6 Solid	25 or 25PLUSF20	Preferred	B399A Mini EZ Attached	
GRT14A1H	GR	T	Steel	1/2"	0.505"	#6 Concentric	25 or 25PLUSF20	Preferred	B399A Mini EZ Attached	
GRT14A1K	GR	T	Steel	1/2"	0.505"	#4 Solid	25 or 25PLUSF20	Preferred	B399A Mini EZ Attached	
GRT14A1L	GR	T	Steel	1/2"	0.505"	#4 Concentric	25 or 25PLUSF20	Preferred	B399A Mini EZ Attached	
GRT14A1T	GR	T	Steel	1/2"	0.505"	#2 Solid	32 or 32PLUSF20	Preferred	B399A Mini EZ Attached	
GRT14A1V	GR	T	Steel	1/2"	0.505"	#2 Concentric	32 or 32PLUSF20	Preferred	B399A Mini EZ Attached	
GRT14B1G	GR	T	Copper-bonded	1/2"	0.562"	#6 Solid	25 or 25PLUSF20	Preferred	B399A Mini EZ Attached	
GRT14B1H	GR	T	Copper-bonded	1/2"	0.562"	#6 Concentric	25 or 25PLUSF20	Preferred	B399A Mini EZ Attached	
GRT14C1G	GR	T	Steel	1/2"	0.505"	#6 Solid	25 or 25PLUSF20	Preferred	B399A Mini EZ Attached	
GRT14C1H	GR	T	Steel	1/2"	0.505"	#6 Concentric	25 or 25PLUSF20	Preferred	B399A Mini EZ Attached	
GRT14C1K	GR	T	Steel	1/2"	0.505"	#4 Solid	25 or 25PLUSF20	Preferred	B399A Mini EZ Attached	
GRT14C1L	GR	T	Steel	1/2"	0.505"	#4 Concentric	25 or 25PLUSF20	Preferred	B399A Mini EZ Attached	
GRT14C1T	GR	T	Steel	1/2"	0.505"	#2 Solid	32 or 32PLUSF20	Preferred	B399A Mini EZ Attached	
GRT14C1V	GR	T	Steel	1/2"	0.500"	#2 Concentric	32 or 32PLUSF20	Preferred	B399A Mini EZ Attached	

GT MOLDS

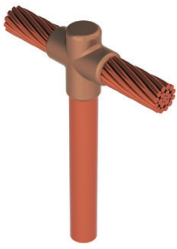

Global Part Number	Mold Family	Price Key	Ground Rod Type	Ground Rod Diameter, Nominal	Ground Rod Diameter, Actual	Conductor Size	Welding Material	Ease of Use	Handle Clamp	Other Accessories Required
GTC141G	GT	C	Steel	1/2"	0.505"	#6 Solid	90 or 90PLUSF20	Preferred	L160	B1331L x 2
GTC141T	GT	C	Steel	1/2"	0.505"	#2 Solid	90 or 90PLUSF20	Preferred	L160	
GTC141V	GT	C	Steel	1/2"	0.505"	#2 Concentric	90 or 90PLUSF20	Preferred	L160	
GTC142C	GT	C	Steel	1/2"	0.505"	1/0 Concentric	90 or 90PLUSF20	Preferred	L160	
GTC142G	GT	C	Steel	1/2"	0.505"	2/0 Concentric	90 or 90PLUSF20	Preferred	L160	
GTC142Q	GT	C	Steel	1/2"	0.505"	4/0 Concentric	115 or 115PLUSF20	Preferred	L160	
GTC142V	GT	C	Steel	1/2"	0.505"	250 kcmil Concentric	150 or 150PLUSF20	Preferred	L160	
GTC143Q	GT	C	Steel	1/2"	0.505"	500 kcmil Concentric	250 or 250PLUSF20	Preferred	L160	
GTC181K	GT	C	Copper-bonded	3/4"	0.682"	#4 Solid	90 or 90PLUSF20	Preferred	L160	
GTC181L	GT	C	Copper-bonded	3/4"	0.682"	#4 Concentric	90 or 90PLUSF20	Preferred	L160	
GTC181T	GT	C	Copper-bonded	3/4"	0.682"	#2 Solid	90 or 90PLUSF20	Preferred	L160	
GTC181V	GT	C	Copper-bonded	3/4"	0.682"	#2 Concentric	90 or 90PLUSF20	Preferred	L160	
GTC181Y	GT	C	Copper-bonded	3/4"	0.682"	#1 Concentric	90 or 90PLUSF20	Preferred	L160	
GTC182C	GT	C	Copper-bonded	3/4"	0.682"	1/0 Concentric	115 or 115PLUSF20	Preferred	L160	
GTC182G	GT	C	Copper-bonded	3/4"	0.682"	2/0 Concentric	115 or 115PLUSF20	Preferred	L160	
GTC182Q	GT	C	Copper-bonded	3/4"	0.682"	4/0 Concentric	115 or 115PLUSF20	Preferred	L160	
GTC182V	GT	C	Copper-bonded	3/4"	0.682"	250 kcmil Concentric	150 or 150PLUSF20	Preferred	L160	
GTC183A	GT	C	Copper-bonded	3/4"	0.682"	300 kcmil Concentric	200 or 200PLUSF20	Preferred	L160	
GTC183D	GT	C	Copper-bonded	3/4"	0.682"	350 kcmil Concentric	200 or 200PLUSF20	Preferred	L160	
GTC183H	GT	C	Copper-bonded	3/4"	0.682"	400 kcmil Concentric	250 or 250PLUSF20	Preferred	L160	
GTC183Q	GT	C	Copper-bonded	3/4"	0.682"	500 kcmil Concentric	250 or 250PLUSF20	Preferred	L160	
GTC221K	GT	C	Copper-bonded	1"	0.914"	#4 Solid	150 or 150PLUSF20	Preferred	L160	
GTC221L	GT	C	Copper-bonded	1"	0.914"	#4 Concentric	150 or 150PLUSF20	Preferred	L160	
GTC221T	GT	C	Copper-bonded	1"	0.914"	#2 Solid	150 or 150PLUSF20	Preferred	L160	
GTC221V	GT	C	Copper-bonded	1"	0.914"	#2 Concentric	150 or 150PLUSF20	Preferred	L160	
GTC221Y	GT	C	Copper-bonded	1"	0.914"	#1 Concentric	150 or 150PLUSF20	Preferred	L160	
GTC222C	GT	C	Copper-bonded	1"	0.914"	1/0 Concentric	150 or 150PLUSF20	Preferred	L160	
GTC222G	GT	C	Copper-bonded	1"	0.914"	2/0 Concentric	150 or 150PLUSF20	Preferred	L160	
GTC222Q	GT	C	Copper-bonded	1"	0.914"	4/0 Concentric	150 or 150PLUSF20	Preferred	L160	
GTC222V	GT	C	Copper-bonded	1"	0.914"	250 kcmil Concentric	200 or 200PLUSF20	Preferred	L160	
GTC223D	GT	C	Copper-bonded	1"	0.914"	350 kcmil Concentric	200 or 200PLUSF20	Preferred	L160	
GTC223H	GT	C	Copper-bonded	1"	0.914"	400 kcmil Concentric	200 or 200PLUSF20	Preferred	L160	

Global Part Number	Mold Family	Price Key	Ground Rod Type	Ground Rod Diameter, Nominal	Ground Rod Diameter, Actual	Conductor Size	Welding Material	Ease of Use	Handle Clamp	Other Accessories Required
GTC223Q	GT	C	Copper-bonded	1"	0.914"	500 kcmil Concentric	250 or 250PLUSF20	Preferred	L160	
GTC311L	GT	C	Steel	5/8"	0.625"	#4 Concentric	90 or 90PLUSF20	Preferred	L160	
GTC311T	GT	C	Steel	5/8"	0.625"	#2 Solid	90 or 90PLUSF20	Preferred	L160	
GTC311V	GT	C	Steel	5/8"	0.625"	#2 Concentric	90 or 90PLUSF20	Preferred	L160	
GTC311Y	GT	C	Steel	5/8"	0.625"	#1 Concentric	90 or 90PLUSF20	Preferred	L160	
GTC312C	GT	C	Steel	5/8"	0.625"	1/0 Concentric	90 or 90PLUSF20	Preferred	L160	
GTC312G	GT	C	Steel	5/8"	0.625"	2/0 Concentric	115 or 115PLUSF20	Preferred	L160	
GTC312Q	GT	C	Steel	5/8"	0.625"	4/0 Concentric	115 or 115PLUSF20	Preferred	L160	
GTC312V	GT	C	Steel	5/8"	0.625"	250 kcmil Concentric	150 or 150PLUSF20	Preferred	L160	
GTC313A	GT	C	Steel	5/8"	0.625"	300 kcmil Concentric	200 or 200PLUSF20	Preferred	L160	
GTC313D	GT	C	Steel	5/8"	0.625"	350 kcmil Concentric	200 or 200PLUSF20	Preferred	L160	
GTC313H	GT	C	Steel	5/8"	0.625"	400 kcmil Concentric	250 or 250PLUSF20	Preferred	L160	
GTC313Q	GT	C	Steel	5/8"	0.625"	500 kcmil Concentric	250 or 250PLUSF20	Preferred	L160	
GTC331T	GT	C	Steel	3/4"	0.750"	#2 Solid	90 or 90PLUSF20	Preferred	L160	
GTC331Y	GT	C	Steel	3/4"	0.750"	#1 Concentric	90 or 90PLUSF20	Preferred	L160	
GTC333H	GT	C	Steel	3/4"	0.750"	400 kcmil Concentric	250 or 250PLUSF20	Preferred	L160	
GTC331V	GT	C	Steel	3/4"	0.750"	#2 Concentric	90 or 90PLUSF20	Preferred	L160	
GTC332C	GT	C	Steel	3/4"	0.750"	1/0 Concentric	115 or 115PLUSF20	Preferred	L160	
GTC332G	GT	C	Steel	3/4"	0.750"	2/0 Concentric	115 or 115PLUSF20	Preferred	L160	
GTC332Q	GT	C	Steel	3/4"	0.750"	4/0 Concentric	115 or 115PLUSF20	Preferred	L160	
GTC332V	GT	C	Steel	3/4"	0.750"	250 kcmil Concentric	150 or 150PLUSF20	Preferred	L160	
GTC333A	GT	C	Steel	3/4"	0.750"	300 kcmil Concentric	200 or 200PLUSF20	Preferred	L160	
GTC333D	GT	C	Steel	3/4"	0.750"	350 kcmil Concentric	200 or 200PLUSF20	Preferred	L160	
GTC333Q	GT	C	Steel	3/4"	0.750"	500 kcmil Concentric	250 or 250PLUSF20	Preferred	L160	
GTC371L	GT	C	Steel	1"	1.000"	#4 Concentric	150 or 150PLUSF20	Preferred	L160	
GTC371V	GT	C	Steel	1"	1.000"	#2 Concentric	150 or 150PLUSF20	Preferred	L160	
GTC372C	GT	C	Steel	1"	1.000"	1/0 Concentric	150 or 150PLUSF20	Preferred	L160	
GTC372G	GT	C	Steel	1"	1.000"	2/0 Concentric	150 or 150PLUSF20	Preferred	L160	
GTC372Q	GT	C	Steel	1"	1.000"	4/0 Concentric	150 or 150PLUSF20	Preferred	L160	
GTC372V	GT	C	Steel	1"	1.000"	250 kcmil Concentric	200 or 200PLUSF20	Preferred	L160	
GTC373Q	GT	C	Steel	1"	1.000"	500 kcmil Concentric	250 or 250PLUSF20	Preferred	L160	
GTD164L	GT	D	Copper-bonded	5/8"	0.563"	750 kcmil Concentric	200 x 2 or 400PLUSF20	Preferred	L159	
GTD184L	GT	D	Copper-bonded	3/4"	0.682"	750 kcmil Concentric	200 x 2 or 400PLUSF20	Preferred	L159	
GTD184Y	GT	D	Copper-bonded	3/4"	0.682"	1000 kcmil Concentric	500 or 500PLUSF20	Preferred	L159	

Global Part Number	Mold Family	Price Key	Ground Rod Type	Ground Rod Diameter, Nominal	Ground Rod Diameter, Actual	Conductor Size	Welding Material	Ease of Use	Handle Clamp	Other Accessories Required
GTD224L	GT	D	Copper-bonded	1"	0.914"	750 kcmil Concentric	500 or 500PLUSF20	Preferred	L159	
GTD224Y	GT	D	Copper-bonded	1"	0.914"	1000 kcmil Concentric	500 or 500PLUSF20	Preferred	L159	
GTD374Y	GT	D	Steel	1"	1.000"	1000 kcmil Concentric	500 or 500PLUSF20	Preferred	L159	
GTP161T	GT	P	Copper-bonded	5/8"	0.563"	#2 Solid	45 or 45PLUSF20	Preferred		B399B Mini EZ Attached
GTP161V	GT	P	Copper-bonded	5/8"	0.563"	#2 Concentric	65 or 65PLUSF20	Preferred		B399B Mini EZ Attached
GTP181G	GT	P	Copper-bonded	3/4"	0.682"	#6 Solid	45 or 45PLUSF20	Preferred		B399B Mini EZ Attached
GTP181H	GT	P	Copper-bonded	3/4"	0.682"	#6 Concentric	45 or 45PLUSF20	Preferred		B399B Mini EZ Attached
GTP181K	GT	P	Copper-bonded	3/4"	0.682"	#4 Solid	65 or 65PLUSF20	Preferred		B399B Mini EZ Attached
GTP181L	GT	P	Copper-bonded	3/4"	0.682"	#4 Concentric	65 or 65PLUSF20	Preferred		B399B Mini EZ Attached
GTP181T	GT	P	Copper-bonded	3/4"	0.682"	#2 Solid	65 or 65PLUSF20	Preferred		B399B Mini EZ Attached
GTP181V	GT	P	Copper-bonded	3/4"	0.682"	#2 Concentric	65 or 65PLUSF20	Preferred		B399B Mini EZ Attached
GTP331G	GT	P	Steel	3/4"	0.750"	#6 Solid	45 or 45PLUSF20	Preferred		B399B Mini EZ Attached
GTP331H	GT	P	Steel	3/4"	0.750"	#6 Concentric	45 or 45PLUSF20	Preferred		B399B Mini EZ Attached
GTP331K	GT	P	Steel	3/4"	0.750"	#4 Solid	65 or 65PLUSF20	Preferred		B399B Mini EZ Attached
GTP331L	GT	P	Steel	3/4"	0.750"	#4 Concentric	65 or 65PLUSF20	Preferred		B399B Mini EZ Attached
GTT14A1A	GT	T	Steel	1/2"	0.505"	#10 Solid	32 or 32PLUSF20	Preferred		B399A Mini EZ Attached
GTT14A1G	GT	T	Steel	1/2"	0.505"	#6 Solid	32 or 32PLUSF20	Preferred		B399A Mini EZ Attached
GTT14A1H	GT	T	Steel	1/2"	0.505"	#6 Concentric	32 or 32PLUSF20	Preferred		B399A Mini EZ Attached
GTT14A1K	GT	T	Steel	1/2"	0.505"	#4 Solid	32 or 32PLUSF20	Preferred		B399A Mini EZ Attached
GTT14A1L	GT	T	Steel	1/2"	0.505"	#4 Concentric	32 or 32PLUSF20	Preferred		B399A Mini EZ Attached

Global Part Number	Mold Family	Price Key	Ground Rod Type	Ground Rod Diameter, Nominal	Ground Rod Diameter, Actual	Conductor Size	Welding Material	Ease of Use	Handle Clamp	Other Accessories Required
GTT14B1H	GT	T	Copper-bonded	1/2"	0.562"	#6 Concentric	32 or 32PLUSF20	Preferred	B399A Mini EZ Attached	
GTT14C1G	GT	T	Steel	1/2"	0.505"	#6 Solid	32 or 32PLUSF20	Preferred	B399A Mini EZ Attached	
GTT14C1H	GT	T	Steel	1/2"	0.505"	#6 Concentric	32 or 32PLUSF20	Preferred	B399A Mini EZ Attached	
GTT14C1K	GT	T	Steel	1/2"	0.505"	#4 Solid	32 or 32PLUSF20	Preferred	B399A Mini EZ Attached	
GTT14C1L	GT	T	Steel	1/2"	0.505"	#4 Concentric	32 or 32PLUSF20	Preferred	B399A Mini EZ Attached	
GTT161G	GT	T	Copper-bonded	5/8"	0.563"	#6 Solid	32 or 32PLUSF20	Preferred	B399A Mini EZ Attached	
GTT161H	GT	T	Copper-bonded	5/8"	0.563"	#6 Concentric	32 or 32PLUSF20	Preferred	B399A Mini EZ Attached	
GTT161K	GT	T	Copper-bonded	5/8"	0.563"	#4 Solid	32 or 32PLUSF20	Preferred	B399A Mini EZ Attached	
GTT161L	GT	T	Copper-bonded	5/8"	0.563"	#4 Concentric	32 or 32PLUSF20	Preferred	B399A Mini EZ Attached	
GTT311G	GT	T	Steel	5/8"	0.625"	#6 Solid	32 or 32PLUSF20	Preferred	B399A Mini EZ Attached	
GTT311H	GT	T	Steel	5/8"	0.625"	#6 Concentric	32 or 32PLUSF20	Preferred	B399A Mini EZ Attached	
GTT311K	GT	T	Steel	5/8"	0.625"	#4 Solid	32 or 32PLUSF20	Preferred	B399A Mini EZ Attached	
GTT311L	GT	T	Steel	5/8"	0.625"	#4 Concentric	32 or 32PLUSF20	Preferred	B399A Mini EZ Attached	

GY MOLDS

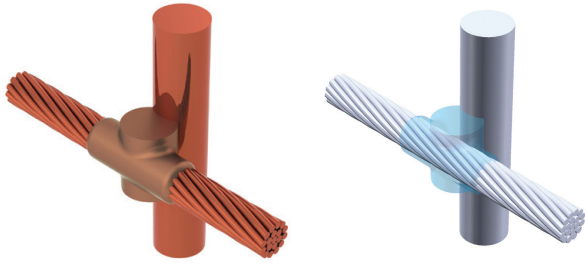

Global Part Number	Mold Family	Price Key	Ground Rod Type	Ground Rod Diameter, Nominal	Ground Rod Diameter, Actual	Conductor Size	Welding Material	Ease of Use	Handle Clamp	Other Accessories Required
GYE141V	GY	E	Steel	1/2"	0.505"	#2 Concentric	90 or 90PLUSF20	Preferred	L160	
GYE142C	GY	E	Steel	1/2"	0.505"	1/0 Concentric	115 or 115PLUSF20	Preferred	L160	
GYE142G	GY	E	Steel	1/2"	0.505"	2/0 Concentric	115 or 115PLUSF20	Preferred	L160	
GYE142L	GY	E	Steel	1/2"	0.505"	3/0 Concentric	150 or 150PLUSF20	Preferred	L160	
GYE142Q	GY	E	Steel	1/2"	0.505"	4/0 Concentric	150 or 150PLUSF20	Preferred	L160	
GYE142V	GY	E	Steel	1/2"	0.505"	250 kcmil Concentric	150 or 150PLUSF20	Preferred	L160	
GYE161G	GY	E	Copper-bonded	5/8"	0.563"	#6 Solid	90 or 90PLUSF20	Preferred	L160	B1331L x 2
GYE161H	GY	E	Copper-bonded	5/8"	0.563"	#6 Concentric	90 or 90PLUSF20	Preferred	L160	B112 x 2
GYE161K	GY	E	Copper-bonded	5/8"	0.563"	#4 Solid	90 or 90PLUSF20	Preferred	L160	
GYE161L	GY	E	Copper-bonded	5/8"	0.563"	#4 Concentric	90 or 90PLUSF20	Preferred	L160	
GYE161Q	GY	E	Copper-bonded	5/8"	0.563"	#3 Concentric	90 or 90PLUSF20	Preferred	L160	
GYE161T	GY	E	Copper-bonded	5/8"	0.563"	#2 Solid	90 or 90PLUSF20	Preferred	L160	
GYE161V	GY	E	Copper-bonded	5/8"	0.563"	#2 Concentric	90 or 90PLUSF20	Preferred	L160	
GYE162C	GY	E	Copper-bonded	5/8"	0.563"	1/0 Concentric	115 or 115PLUSF20	Preferred	L160	
GYE162G	GY	E	Copper-bonded	5/8"	0.563"	2/0 Concentric	115 or 115PLUSF20	Preferred	L160	
GYE162Q	GY	E	Copper-bonded	5/8"	0.563"	4/0 Concentric	150 or 150PLUSF20	Preferred	L160	
GYE162V	GY	E	Copper-bonded	5/8"	0.563"	250 kcmil Concentric	150 or 150PLUSF20	Preferred	L160	
GYE163A	GY	E	Copper-bonded	5/8"	0.563"	300 kcmil Concentric	200 or 200PLUSF20	Preferred	L160	
GYE163D	GY	E	Copper-bonded	5/8"	0.563"	350 kcmil Concentric	250 or 250PLUSF20	Preferred	L160	
GYE181G	GY	E	Copper-bonded	3/4"	0.682"	#6 Solid	90 or 90PLUSF20	Preferred	L160	B1331L x 2
GYE181H	GY	E	Copper-bonded	3/4"	0.682"	#6 Concentric	90 or 90PLUSF20	Preferred	L160	B112 x 2
GYE181K	GY	E	Copper-bonded	3/4"	0.682"	#4 Solid	90 or 90PLUSF20	Preferred	L160	
GYE181L	GY	E	Copper-bonded	3/4"	0.682"	#4 Concentric	90 or 90PLUSF20	Preferred	L160	
GYE181T	GY	E	Copper-bonded	3/4"	0.682"	#2 Solid	90 or 90PLUSF20	Preferred	L160	
GYE181V	GY	E	Copper-bonded	3/4"	0.682"	#2 Concentric	90 or 90PLUSF20	Preferred	L160	
GYE181Y	GY	E	Copper-bonded	3/4"	0.682"	#1 Concentric	115 or 115PLUSF20	Preferred	L160	
GYE182C	GY	E	Copper-bonded	3/4"	0.682"	1/0 Concentric	115 or 115PLUSF20	Preferred	L160	
GYE182G	GY	E	Copper-bonded	3/4"	0.682"	2/0 Concentric	115 or 115PLUSF20	Preferred	L160	
GYE332V	GY	E	Steel	3/4"	0.750"	250 kcmil Concentric	200 or 200PLUSF20	Preferred	L160	
GYE372G	GY	E	Steel	1"	1.000"	2/0 Concentric	115 or 115PLUSF20	Preferred	L160	
GYE372Q	GY	E	Steel	1"	1.000"	4/0 Concentric	150 or 150PLUSF20	Preferred	L160	
GYE372V	GY	E	Steel	1"	1.000"	250 kcmil Concentric	200 or 200PLUSF20	Preferred	L160	

Global Part Number	Mold Family	Price Key	Ground Rod Type	Ground Rod Diameter, Nominal	Ground Rod Diameter, Actual	Conductor Size	Welding Material	Ease of Use	Handle Clamp	Other Accessories Required
GYF163Q	GY	F	Copper-bonded	5/8"	0.563"	500 kcmil Concentric	200 x 2 or 400PLUSF20	Preferred	L159	
GYF183Q	GY	F	Copper-bonded	3/4"	0.682"	500 kcmil Concentric	500 or 500PLUSF20	Preferred	L159	
GYF313H	GY	F	Steel	5/8"	0.625"	400 kcmil Concentric	200 x 2 or 400PLUSF20	Preferred	L159	
GYF313Q	GY	F	Steel	5/8"	0.625"	500 kcmil Concentric	200 x 2 or 400PLUSF20	Preferred	L159	
GYF333Q	GY	F	Steel	3/4"	0.750"	500 kcmil Concentric	500 or 500PLUSF20	Preferred	L159	
GYJ163H	GY	J	Copper-bonded	5/8"	0.563"	400 kcmil Concentric	150 x 2 or 300PLUSF20	Preferred	L159	
GYJ163Q	GY	J	Copper-bonded	5/8"	0.563"	500 kcmil Concentric	200 x 2 or 400PLUSF20	Preferred	L159	
GYJ164L	GY	J	Copper-bonded	5/8"	0.563"	750 kcmil Concentric	500 or 500PLUSF20	Preferred	L159	
GYJ183D	GY	J	Copper-bonded	3/4"	0.682"	350 kcmil Concentric	150 x 2 or 300PLUSF20	Preferred	L159	
GYJ183H	GY	J	Copper-bonded	3/4"	0.682"	400 kcmil Concentric	500 or 500PLUSF20	Preferred	L159	
GYJ183Q	GY	J	Copper-bonded	3/4"	0.682"	500 kcmil Concentric	500 or 500PLUSF20	Preferred	L159	
GYJ184L	GY	J	Copper-bonded	3/4"	0.682"	750 kcmil Concentric	500 or 500PLUSF20	Preferred	L159	
GYJ223D	GY	J	Copper-bonded	1"	0.914"	350 kcmil Concentric	150 x 2 or 300PLUSF20	Preferred	L159	
GYJ223Q	GY	J	Copper-bonded	1"	0.914"	500 kcmil Concentric	500 or 500PLUSF20	Preferred	L159	
GYE182Q	GY	E	Copper-bonded	3/4"	0.682"	4/0 Concentric	150 or 150PLUSF20	Preferred	L160	
GYE182V	GY	E	Copper-bonded	3/4"	0.682"	250 kcmil Concentric	200 or 200PLUSF20	Preferred	L160	
GYE189B	GY	E	Copper-bonded	3/4"	0.682"	7/#8 Copperweld	115 or 115PLUSF20	Preferred	L160	
GYE222C	GY	E	Copper-bonded	1"	0.914"	1/0 Concentric	115 or 115PLUSF20	Preferred	L160	
GYE222G	GY	E	Copper-bonded	1"	0.914"	2/0 Concentric	115 or 115PLUSF20	Preferred	L160	
GYE222Q	GY	E	Copper-bonded	1"	0.914"	4/0 Concentric	150 or 150PLUSF20	Preferred	L160	
GYE222V	GY	E	Copper-bonded	1"	0.914"	250 kcmil Concentric	200 or 200PLUSF20	Preferred	L160	
GYE223D	GY	E	Copper-bonded	1"	0.914"	350 kcmil Concentric	150 x 2 or 300PLUSF20	Preferred	L160	
GYE311T	GY	E	Steel	5/8"	0.625"	#2 Solid	90 or 90PLUSF20	Preferred	L160	
GYE311V	GY	E	Steel	5/8"	0.625"	#2 Concentric	90 or 90PLUSF20	Preferred	L160	
GYE312C	GY	E	Steel	5/8"	0.625"	1/0 Concentric	115 or 115PLUSF20	Preferred	L160	
GYE312G	GY	E	Steel	5/8"	0.625"	2/0 Concentric	115 or 115PLUSF20	Preferred	L160	
GYE312Q	GY	E	Steel	5/8"	0.625"	4/0 Concentric	150 or 150PLUSF20	Preferred	L160	
GYE312V	GY	E	Steel	5/8"	0.625"	250 kcmil Concentric	150 or 150PLUSF20	Preferred	L160	
GYE331T	GY	E	Steel	3/4"	0.750"	#2 Solid	90 or 90PLUSF20	Preferred	L160	
GYE331V	GY	E	Steel	3/4"	0.750"	#2 Concentric	90 or 90PLUSF20	Preferred	L160	
GYE332C	GY	E	Steel	3/4"	0.750"	1/0 Concentric	115 or 115PLUSF20	Preferred	L160	
GYE332G	GY	E	Steel	3/4"	0.750"	2/0 Concentric	115 or 115PLUSF20	Preferred	L160	
GYE332Q	GY	E	Steel	3/4"	0.750"	4/0 Concentric	150 or 150PLUSF20	Preferred	L160	
GYJ224L	GY	J	Copper-bonded	1"	0.914"	750 kcmil Concentric	500 or 500PLUSF20	Preferred	L159	
GYJ313Q	GY	J	Steel	5/8"	0.625"	500 kcmil Concentric	200 x 2 or 400PLUSF20	Preferred	L159	
GYJ333D	GY	J	Steel	3/4"	0.750"	350 kcmil Concentric	150 x 2 or 300PLUSF20	Preferred	L159	

Global Part Number	Mold Family	Price Key	Ground Rod Type	Ground Rod Diameter, Nominal	Ground Rod Diameter, Actual	Conductor Size	Welding Material	Ease of Use	Handle Clamp	Other Accessories Required
GYJ333Q	GY	J	Steel	3/4"	0.750"	500 kcmil Concentric	500 or 500PLUSF20	Preferred	L159	
GYJ373Q	GY	J	Steel	1"	1.000"	500 kcmil Concentric	500 or 500PLUSF20	Preferred	L159	
GYR142C	GY	R	Steel	1/2"	0.505"	1/0 Concentric	115 or 115PLUSF20	Preferred	L160	
GYR142G	GY	R	Steel	1/2"	0.505"	2/0 Concentric	115 or 115PLUSF20	Preferred	L160	
GYR142Q	GY	R	Steel	1/2"	0.505"	4/0 Concentric	150 or 150PLUSF20	Preferred	L160	
GYR161G	GY	R	Copper-bonded	5/8"	0.563"	#6 Solid	90 or 90PLUSF20	Preferred	L160	B1331L x 2
GYR161H	GY	R	Copper-bonded	5/8"	0.563"	#6 Concentric	90 or 90PLUSF20	Preferred	L160	B112 x 2
GYR161L	GY	R	Copper-bonded	5/8"	0.563"	#4 Concentric	90 or 90PLUSF20	Preferred	L160	
GYR161T	GY	R	Copper-bonded	5/8"	0.563"	#2 Solid	90 or 90PLUSF20	Preferred	L160	
GYR161V	GY	R	Copper-bonded	5/8"	0.563"	#2 Concentric	90 or 90PLUSF20	Preferred	L160	
GYR162C	GY	R	Copper-bonded	5/8"	0.563"	1/0 Concentric	115 or 115PLUSF20	Preferred	L160	
GYR162G	GY	R	Copper-bonded	5/8"	0.563"	2/0 Concentric	115 or 115PLUSF20	Preferred	L160	
GYR162Q	GY	R	Copper-bonded	5/8"	0.563"	4/0 Concentric	150 or 150PLUSF20	Preferred	L160	
GYR162V	GY	R	Copper-bonded	5/8"	0.563"	250 kcmil Concentric	150 or 150PLUSF20	Preferred	L160	
GYR163A	GY	R	Copper-bonded	5/8"	0.563"	300 kcmil Concentric	200 or 200PLUSF20	Preferred	L160	
GYR163D	GY	R	Copper-bonded	5/8"	0.563"	350 kcmil Concentric	250 or 250PLUSF20	Preferred	L160	
GYR181G	GY	R	Copper-bonded	3/4"	0.682"	#6 Solid	90 or 90PLUSF20	Preferred	L160	B1331L x 2
GYR181H	GY	R	Copper-bonded	3/4"	0.682"	#6 Concentric	90 or 90PLUSF20	Preferred	L160	B112 x 2
GYR181T	GY	R	Copper-bonded	3/4"	0.682"	#2 Solid	90 or 90PLUSF20	Preferred	L160	
GYR181V	GY	R	Copper-bonded	3/4"	0.682"	#2 Concentric	90 or 90PLUSF20	Preferred	L160	
GYR182C	GY	R	Copper-bonded	3/4"	0.682"	1/0 Concentric	115 or 115PLUSF20	Preferred	L160	
GYR182G	GY	R	Copper-bonded	3/4"	0.682"	2/0 Concentric	115 or 115PLUSF20	Preferred	L160	
GYR182Q	GY	R	Copper-bonded	3/4"	0.682"	4/0 Concentric	150 or 150PLUSF20	Preferred	L160	
GYR182V	GY	R	Copper-bonded	3/4"	0.682"	250 kcmil Concentric	200 or 200PLUSF20	Preferred	L160	
GYR183D	GY	R	Copper-bonded	3/4"	0.682"	350 kcmil Concentric	150 x 2 or 300PLUSF20	Preferred	L160	
GYR312G	GY	R	Steel	5/8"	0.625"	2/0 Concentric	115 or 115PLUSF20	Preferred	L160	
GYR331H	GY	R	Steel	3/4"	0.750"	#6 Concentric	90 or 90PLUSF20	Preferred	L160	B112 x 2
GYR331V	GY	R	Steel	3/4"	0.750"	#2 Concentric	90 or 90PLUSF20	Preferred	L160	
GYR332G	GY	R	Steel	3/4"	0.750"	2/0 Concentric	115 or 115PLUSF20	Preferred	L160	
GYR332Q	GY	R	Steel	3/4"	0.750"	4/0 Concentric	150 or 150PLUSF20	Preferred	L160	
GYR332V	GY	R	Steel	3/4"	0.750"	250 kcmil Concentric	200 or 200PLUSF20	Preferred	L160	

GN MOLDS

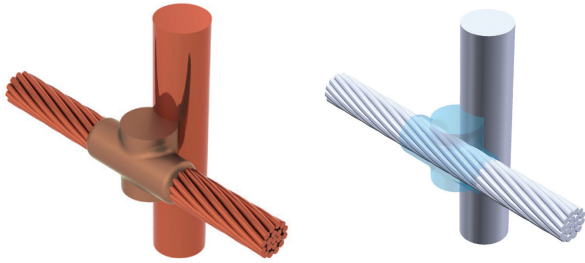

Global Part Number	Mold Family	Price Key	Ground Rod Type	Ground Rod Diameter, Nominal	Ground Rod Diameter, Actual	Conductor Size	Welding Material Required	Ease of Use	Handle Clamp Required
GNR161H	GN	R	Copper-bonded	5/8"	0.563"	#6 Concentric	90 or 90PLUSF20	Easy	L160
GNR161T	GN	R	Copper-bonded	5/8"	0.563"	#2 Solid	90 or 90PLUSF20	Easy	L160
GNR161V	GN	R	Copper-bonded	5/8"	0.563"	#2 Concentric	90 or 90PLUSF20	Easy	L160
GNR162C	GN	R	Copper-bonded	5/8"	0.563"	1/0 Concentric	115 or 115PLUSF20	Easy	L160
GNR181H	GN	R	Copper-bonded	3/4"	0.682"	#6 Concentric	90 or 90PLUSF20	Easy	L160
GNR181T	GN	R	Copper-bonded	3/4"	0.682"	#2 Solid	90 or 90PLUSF20	Easy	L160

GN MOLD KIT

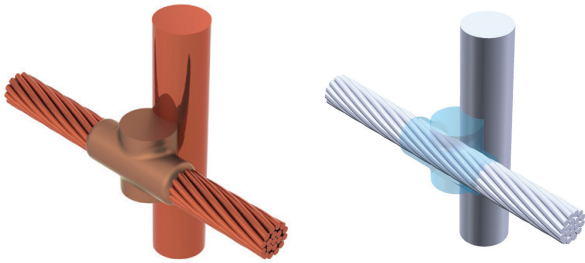

Global Part Number	Mold Family	Price Key	Ground Rod Type	Ground Rod Diameter, Nominal	Ground Rod Diameter, Actual	Conductor Size	Welding Material Required	Ease of Use	Handle Clamp Required
K217	GN	See Kit Pricing	Copper-bonded	5/8"	0.560"	#6 Solid	25, Included in Kit	Easy	B399DS, Included in Kit
K217R	GN	See Kit Pricing	Copper-bonded	5/8"	0.560"	#6 Solid	25, Included in Kit	Easy	B399DS, Included in Kit
K218	GN	See Kit Pricing	Copper-bonded	5/8"	0.560"	#4 Solid	25, Included in Kit	Easy	B399DS, Included in Kit
K218R	GN	See Kit Pricing	Copper-bonded	5/8"	0.560"	#4 Solid	25, Included in Kit	Easy	B399DS, Included in Kit
K220	GN	See Kit Pricing	Copper-bonded	1/2"	0.504"	#6 Solid	25, Included in Kit	Easy	B399DS, Included in Kit
K220R	GN	See Kit Pricing	Copper-bonded	1/2"	0.504"	#6 Solid	25, Included in Kit	Easy	B399DS, Included in Kit
K221	GN	See Kit Pricing	Copper-bonded	1/2"	0.504"	#4 Solid	25, Included in Kit	Easy	B399DS, Included in Kit
K221R	GN	See Kit Pricing	Copper-bonded	1/2"	0.504"	#4 Solid	25, Included in Kit	Easy	B399DS, Included in Kit
K222	GN	See Kit Pricing	Copper-bonded	3/4"	0.681"	#6 Solid	25, Included in Kit	Easy	B399DS, Included in Kit
K222R	GN	See Kit Pricing	Copper-bonded	3/4"	0.681"	#6 Solid	25, Included in Kit	Easy	B399DS, Included in Kit
K223	GN	See Kit Pricing	Copper-bonded	3/4"	0.681"	#4 Solid	25, Included in Kit	Easy	B399DS, Included in Kit
K223R	GN	See Kit Pricing	Copper-bonded	3/4"	0.681"	#4 Solid	25, Included in Kit	Easy	B399DS, Included in Kit

CABLE TO CABLE TO GROUND ROD OR OTHER ROUNDS

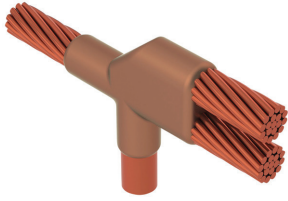

- Forms a permanent, low resistance connection
- Provides a molecular bond
- Cadweld Exothermic Connections are rated with the same current capacity as the conductor
- Portable installation equipment with no external source of power required
- Installers can be easily trained to make Cadweld Exothermic Connections
- Connections are visually inspected

NC MOLDS

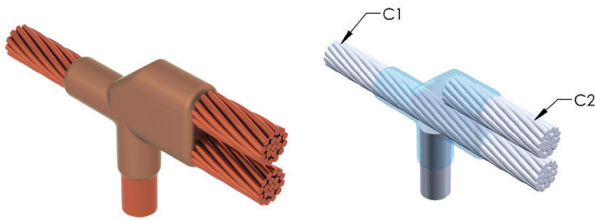

Global Part Number	Mold family	Price Key	Conductor 1	Conductor 2	Ground Rod Size, Nominal	Ground Rod Size Actual	Ground Rod Type	Welding Material Required	Ease of Use	Handle Clamp
NCF222V	NC	F	250 kcmil Concentric	250 kcmil Concentric	1"	0.914"	Copper-bonded	200 x 2 or 400PLUSF20	Preferred	L159, Sold Separately
NCF223D	NC	F	350 kcmil Concentric	350 kcmil Concentric	1"	0.914"	Copper-bonded	200 x 2 or 400PLUSF20	Preferred	L159, Sold Separately
NCF223Q	NC	F	500 kcmil Concentric	500 kcmil Concentric	1"	0.914"	Copper-bonded	250 x 3 or 750PLUSF20	Preferred	L159, Sold Separately
NCF313Q	NC	F	500 kcmil Concentric	500 kcmil Concentric	5/8"	0.625"	Steel	200 x 3 or 600PLUSF20	Preferred	L159
NCF333Q	NC	F	500 kcmil Concentric	500 kcmil Concentric	3/4"	0.750"	Steel	200 x 3 or 600PLUSF20	Preferred	L159
NCR142C	NC	R	1/0 Concentric	1/0 Concentric	1/2"	0.505"	Steel	115 or 115PLUSF20	Preferred	L160
NCR142G	NC	R	2/0 Concentric	2/0 Concentric	1/2"	0.505"	Steel	150 or 150PLUSF20	Preferred	L160
NCR142Q	NC	R	4/0 Concentric	4/0 Concentric	1/2"	0.505"	Steel	200 or 200PLUSF20	Preferred	L160
NCR161T	NC	R	#2 Solid	#2 Solid	5/8"	0.563"	Copper-bonded	115 or 115PLUSF20	Preferred	L160
NCR161T1G	NC	R	#2 Solid	#6 Solid	5/8"	0.563"	Copper-bonded	115 or 115PLUSF20	Preferred	L160
NCR161V	NC	R	#2 Concentric	#2 Concentric	5/8"	0.563"	Copper-bonded	115 or 115PLUSF20	Preferred	L160
NCR161Y	NC	R	#1 Concentric	#1 Concentric	5/8"	0.563"	Copper-bonded	115 or 115PLUSF20	Preferred	L160
NCR162C	NC	R	1/0 Concentric	1/0 Concentric	5/8"	0.563"	Copper-bonded	150 or 150PLUSF20	Preferred	L160
NCR162G	NC	R	2/0 Concentric	2/0 Concentric	5/8"	0.563"	Copper-bonded	200 or 200PLUSF20	Preferred	L160
NCR162G2Q	NC	R	2/0 Concentric	4/0 Concentric	5/8"	0.563"	Copper-bonded	250 or 250PLUSF20	Preferred	L160
NCR162Q	NC	R	4/0 Concentric	4/0 Concentric	5/8"	0.563"	Copper-bonded	250 or 250PLUSF20	Preferred	L160

Global Part Number	Mold family	Price Key	Conductor 1	Conductor 2	Ground Rod Size, Nominal	Ground Rod Size Actual	Ground Rod Type	Welding Material Required	Ease of Use	Handle Clamp
NCR162V	NC	R	250 kcmil Concentric	250 kcmil Concentric	5/8"	0.563"	Copper-bonded	150 x 2 or 300PLUSF20	Preferred	L160
NCR181T	NC	R	#2 Solid	#2 Solid	3/4"	0.682"	Copper-bonded	115 or 115PLUSF20	Preferred	L160
NCR181V	NC	R	#2 Concentric	#2 Concentric	3/4"	0.682"	Copper-bonded	115 or 115PLUSF20	Preferred	L160
NCR181Y	NC	R	#1 Concentric	#1 Concentric	3/4"	0.682"	Copper-bonded	115 or 115PLUSF20	Preferred	L160
NCR182C	NC	R	1/0 Concentric	1/0 Concentric	3/4"	0.682"	Copper-bonded	150 or 150PLUSF20	Preferred	L160
NCR182G	NC	R	2/0 Concentric	2/0 Concentric	3/4"	0.682"	Copper-bonded	200 or 200PLUSF20	Preferred	L160
NCR182Q	NC	R	4/0 Concentric	4/0 Concentric	3/4"	0.682"	Copper-bonded	250 or 250PLUSF20	Preferred	L160
NCR182V	NC	R	250 kcmil Concentric	250 kcmil Concentric	3/4"	0.682"	Copper-bonded	150 x 2 or 300PLUSF20	Preferred	L160
NCR221T	NC	R	#2 Solid	#2 Solid	1"	0.914"	Copper-bonded	150 or 150PLUSF20	Preferred	L160
NCR221V	NC	R	#2 Concentric	#2 Concentric	1"	0.914"	Copper-bonded	150 or 150PLUSF20	Preferred	L160
NCR221Y	NC	R	#1 Concentric	#1 Concentric	1"	0.914"	Copper-bonded	200 or 200PLUSF20	Preferred	L160
NCR222C	NC	R	1/0 Concentric	1/0 Concentric	1"	0.914"	Copper-bonded	200 or 200PLUSF20	Preferred	L160
NCR222G	NC	R	2/0 Concentric	2/0 Concentric	1"	0.914"	Copper-bonded	250 or 250PLUSF20	Preferred	L160
NCR222Q	NC	R	4/0 Concentric	4/0 Concentric	1"	0.914"	Copper-bonded	150 x 2 or 300PLUSF20	Preferred	L160
NCR311V	NC	R	#2 Concentric	#2 Concentric	5/8"	0.625"	Steel	115 or 115PLUSF20	Preferred	L160
NCR312C	NC	R	1/0 Concentric	1/0 Concentric	5/8"	0.625"	Steel	150 or 150PLUSF20	Preferred	L160
NCR312G	NC	R	2/0 Concentric	2/0 Concentric	5/8"	0.625"	Steel	200 or 200PLUSF20	Preferred	L160
NCR312Q	NC	R	4/0 Concentric	4/0 Concentric	5/8"	0.625"	Steel	250 or 250PLUSF20	Preferred	L160
NCR332C	NC	R	1/0 Concentric	1/0 Concentric	3/4"	0.750"	Steel	150 or 150PLUSF20	Preferred	L160
NCR332G	NC	R	2/0 Concentric	2/0 Concentric	3/4"	0.750"	Steel	200 or 200PLUSF20	Preferred	L160
NCR332Q	NC	R	4/0 Concentric	4/0 Concentric	3/4"	0.750"	Steel	250 or 250PLUSF20	Preferred	L160
NCR372Q	NC	R	4/0 Concentric	4/0 Concentric	1"	1.000"	Steel	150 x 2 or 300PLUSF20	Preferred	L160

ND MOLDS

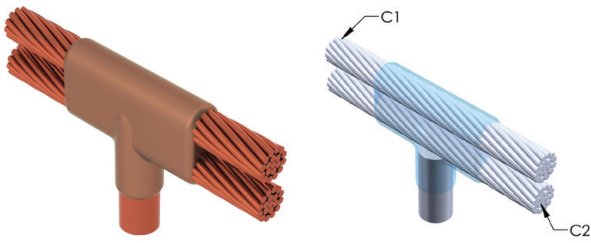

Global Part Number	Mold family	Price Key	Conductor 1	Conductor 2	Ground Rod Size, Nominal	Ground Rod Size Actual	Ground Rod Type	Welding Material Required	Ease of Use	Handle Clamp
NDF162Q	ND	F	4/0 Concentric	4/0 Concentric	5/8"	0.563"	Copper-bonded	150 x 2 or 300PLUSF20	Preferred	L159
NDF162V	ND	F	250 kcmil Concentric	250 kcmil Concentric	5/8"	0.563"	Copper-bonded	200 x 2 or 400PLUSF20	Preferred	L159
NDF182Q	ND	F	4/0 Concentric	4/0 Concentric	3/4"	0.682"	Copper-bonded	150 x 2 or 300PLUSF20	Preferred	L159
NDF182V	ND	F	250 kcmil Concentric	250 kcmil Concentric	3/4"	0.682"	Copper-bonded	200 x 2 or 400PLUSF20	Preferred	L159
NDF183D	ND	F	350 kcmil Concentric	350 kcmil Concentric	3/4"	0.682"	Copper-bonded	500 or 500PLUSF20	Preferred	L159
NDF183Q	ND	F	500 kcmil Concentric	500 kcmil Concentric	3/4"	0.682"	Copper-bonded	250 x 3 or 750PLUSF20	Preferred	L159
NDF222G	ND	F	2/0 Concentric	2/0 Concentric	1"	0.914"	Copper-bonded	150 x 2 or 300PLUSF20	Preferred	L159
NDF222Q	ND	F	4/0 Concentric	4/0 Concentric	1"	0.914"	Copper-bonded	200 x 2 or 400PLUSF20	Preferred	L159
NDF223Q	ND	F	500 kcmil Concentric	500 kcmil Concentric	1"	0.914"	Copper-bonded	500 x 2 or 1000PLUSF20	Preferred	L159
NDF312Q	ND	F	4/0 Concentric	4/0 Concentric	5/8"	0.625"	Steel	150 x 2 or 300PLUSF20	Preferred	L159
NDF313Q	ND	F	500 kcmil Concentric	500 kcmil Concentric	5/8"	0.625"	Steel	250 x 3 or 750PLUSF20	Preferred	L159
NDF332Q	ND	F	4/0 Concentric	4/0 Concentric	3/4"	0.750"	Steel	150 x 2 or 300PLUSF20	Preferred	L159
NDF372Q	ND	F	4/0 Concentric	4/0 Concentric	1"	1.000"	Steel	200 x 2 or 400PLUSF20	Preferred	L159
NDR141L	ND	R	#4 Concentric	#4 Concentric	1/2"	0.505"	Steel	115 or 115PLUSF20	Preferred	L160
NDR142C	ND	R	1/0 Concentric	1/0 Concentric	1/2"	0.505"	Steel	150 or 150PLUSF20	Preferred	L160
NDR142G	ND	R	2/0 Concentric	2/0 Concentric	1/2"	0.505"	Steel	200 or 200PLUSF20	Preferred	L160
NDR142Q	ND	R	4/0 Concentric	4/0 Concentric	1/2"	0.505"	Steel	250 or 250PLUSF20	Preferred	L160
NDR161G	ND	R	#6 Solid	#6 Solid	5/8"	0.563"	Copper-bonded	115 or 115PLUSF20	Preferred	L160
NDR161L	ND	R	#4 Concentric	#4 Concentric	5/8"	0.563"	Copper-bonded	115 or 115PLUSF20	Preferred	L160
NDR161T	ND	R	#2 Solid	#2 Solid	5/8"	0.563"	Copper-bonded	150 or 150PLUSF20	Preferred	L160
NDR161V	ND	R	#2 Concentric	#2 Concentric	5/8"	0.563"	Copper-bonded	150 or 150PLUSF20	Preferred	L160
NDR161Y	ND	R	#1 Concentric	#1 Concentric	5/8"	0.563"	Copper-bonded	150 or 150PLUSF20	Preferred	L160
NDR162C	ND	R	1/0 Concentric	1/0 Concentric	5/8"	0.563"	Copper-bonded	200 or 200PLUSF20	Preferred	L160
NDR162G	ND	R	2/0 Concentric	2/0 Concentric	5/8"	0.563"	Copper-bonded	250 or 250PLUSF20	Preferred	L160
NDR181H	ND	R	#6 Concentric	#6 Concentric	3/4"	0.682"	Copper-bonded	115 or 115PLUSF20	Preferred	L160
NDR181L	ND	R	#4 Concentric	#4 Concentric	3/4"	0.682"	Copper-bonded	115 or 115PLUSF20	Preferred	L160
NDR181T	ND	R	#2 Solid	#2 Solid	3/4"	0.682"	Copper-bonded	150 or 150PLUSF20	Preferred	L160
NDR181V	ND	R	#2 Concentric	#2 Concentric	3/4"	0.682"	Copper-bonded	150 or 150PLUSF20	Preferred	L160

Global Part Number	Mold family	Price Key	Conductor 1	Conductor 2	Ground Rod Size, Nominal	Ground Rod Size Actual	Ground Rod Type	Welding Material Required	Ease of Use	Handle Clamp
NDR181Y	ND	R	#1 Concentric	#1 Concentric	3/4"	0.682"	Copper-bonded	150 or 150PLUSF20	Preferred	L160
NDR182C	ND	R	1/0 Concentric	1/0 Concentric	3/4"	0.682"	Copper-bonded	200 or 200PLUSF20	Preferred	L160
NDR182G	ND	R	2/0 Concentric	2/0 Concentric	3/4"	0.682"	Copper-bonded	250 or 250PLUSF20	Preferred	L160
NDR182Q	ND	R	4/0 Concentric	4/0 Concentric	3/4"	0.682"	Copper-bonded	150 x 2 or 300PLUSF20	Preferred	L160
NDR221V	ND	R	#2 Concentric	#2 Concentric	1"	0.914"	Copper-bonded	250 or 250PLUSF20	Preferred	L160
NDR311V	ND	R	#2 Concentric	#2 Concentric	5/8"	0.625"	Steel	150 or 150PLUSF20	Preferred	L160
NDR312C	ND	R	1/0 Concentric	1/0 Concentric	5/8"	0.625"	Steel	200 or 200PLUSF20	Preferred	L160
NDR312G	ND	R	2/0 Concentric	2/0 Concentric	5/8"	0.625"	Steel	250 or 250PLUSF20	Preferred	L160
NDR332G	ND	R	2/0 Concentric	2/0 Concentric	3/4"	0.750"	Steel	150 x 2 or 300PLUSF20	Preferred	L160

CABLE TO STEEL

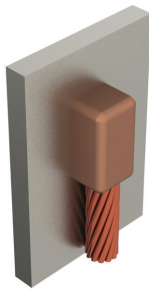

- Forms a permanent, low resistance connection
- Provides a molecular bond
- Cadweld Exothermic Connections are rated with the same current capacity as the conductor
- Portable installation equipment with no external source of power required
- Installers can be easily trained to make Cadweld Exothermic Connections
- Connections are visually inspected

HA MOLDS

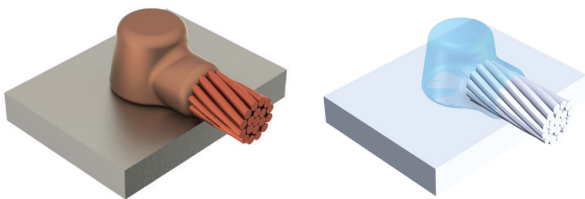

Global Part Number	Mold Family	Price Key	Conductor Size	Connects To	Pipe Diameter	Welding Material Required	Ease of Use	Handle Clamp Required	Conductor Sleeve
HAA1G	HA	A	#6 Solid	Flat Surface or Steel Pipe	14" and Larger	45 or 45PLUSF20	Preferred	Included with Mold	B1331L
HAA1G162C	HA	A	#6 Solid	Steel Pipe	1 1/4" to 2"	45 or 45PLUSF20	Preferred	Included with Mold	B1331L
HAA1G350C	HA	A	#6 Solid	Steel Pipe	3" to 4"	45 or 45PLUSF20	Preferred	Included with Mold	B1331L
HAA1H	HA	A	#6 Concentric	Flat Surface or Steel Pipe	14" and Larger	45 or 45PLUSF20	Preferred	Included with Mold	B112
HAA1H11C	HA	A	#6 Concentric	Steel Pipe	10" to 12"	45 or 45PLUSF20	Preferred	Included with Mold	B112
HAA1H162C	HA	A	#6 Concentric	Steel Pipe	1 1/4" to 2"	45 or 45PLUSF20	Preferred	Included with Mold	B112
HAA1H350C	HA	A	#6 Concentric	Steel Pipe	3" to 4"	45 or 45PLUSF20	Preferred	Included with Mold	B112
HAA1H7C	HA	A	#6 Concentric	Steel Pipe	6" to 8"	45 or 45PLUSF20	Preferred	Included with Mold	B112

Global Part Number	Mold Family	Price Key	Conductor Size	Connects To	Pipe Diameter	Welding Material Required	Ease of Use	Handle Clamp Required	Conductor Sleeve
HAA1K	HA	A	#4 Solid	Flat Surface or Steel Pipe	14" and Larger	45 or 45PLUSF20	Preferred	Included with Mold	
HAA1K162C	HA	A	#4 Solid	Steel Pipe	1 1/4" to 2"	45 or 45PLUSF20	Preferred	Included with Mold	
HAA1L	HA	A	#4 Concentric	Flat Surface or Steel Pipe	14" and Larger	45 or 45PLUSF20	Preferred	Included with Mold	
HAA1L11C	HA	A	#4 Concentric	Steel Pipe	10" to 12"	45 or 45PLUSF20	Preferred	Included with Mold	
HAA1L162C	HA	A	#4 Concentric	Steel Pipe	1 1/4" to 2"	45 or 45PLUSF20	Preferred	Included with Mold	
HAA1L350C	HA	A	#4 Concentric	Steel Pipe	3" to 4"	45 or 45PLUSF20	Preferred	Included with Mold	
HAA1L7C	HA	A	#4 Concentric	Steel Pipe	6" to 8"	45 or 45PLUSF20	Preferred	Included with Mold	
HAA1T	HA	A	#2 Solid	Flat Surface or Steel Pipe	14" and Larger	45 or 45PLUSF20	Preferred	Included with Mold	
HAA1T162C	HA	A	#2 Solid	Steel Pipe	1 1/4" to 2"	45 or 45PLUSF20	Preferred	Included with Mold	
HAA1T350C	HA	A	#2 Solid	Steel Pipe	3" to 4"	45 or 45PLUSF20	Preferred	Included with Mold	
HAA1T7C	HA	A	#2 Solid	Steel Pipe	6" to 8"	45 or 45PLUSF20	Preferred	Included with Mold	
HAA1V	HA	A	#2 Concentric	Flat Surface or Steel Pipe	14" and Larger	45 or 45PLUSF20	Preferred	Included with Mold	
HAA1V11C	HA	A	#2 Concentric	Steel Pipe	10" to 12"	45 or 45PLUSF20	Preferred	Included with Mold	
HAA1V162C	HA	A	#2 Concentric	Steel Pipe	1 1/4" to 2"	45 or 45PLUSF20	Preferred	Included with Mold	
HAA1V350C	HA	A	#2 Concentric	Steel Pipe	3" to 4"	45 or 45PLUSF20	Preferred	Included with Mold	
HAA1V7C	HA	A	#2 Concentric	Steel Pipe	6" to 8"	45 or 45PLUSF20	Preferred	Included with Mold	
HAA1Y	HA	A	#1 Concentric	Flat Surface or Steel Pipe	14" and Larger	65 or 65PLUSF20	Preferred	Included with Mold	
HAA1Y11C	HA	A	#1 Concentric	Steel Pipe	10" to 12"	65 or 65PLUSF20	Preferred	Included with Mold	
HAA1Y325C	HA	A	#1 Concentric	Steel Pipe	2 1/2" to 4"	65 or 65PLUSF20	Preferred	Included with Mold	
HAH2C20C	HA	H	1/0 Concentric	Steel Pipe	12" to 28"	90 or 90PLUSF20	Preferred	Included with Mold	
HAH2C350C	HA	H	1/0 Concentric	Steel Pipe	3" to 4"	90 or 90PLUSF20	Preferred	Included with Mold	
HAH2C8C	HA	H	1/0 Concentric	Steel Pipe	6" to 10"	90 or 90PLUSF20	Preferred	Included with Mold	
HAH2G20C	HA	H	2/0 Concentric	Steel Pipe	12" to 28"	90 or 90PLUSF20	Preferred	Included with Mold	
HAH2G350C	HA	H	2/0 Concentric	Steel Pipe	3" to 4"	90 or 90PLUSF20	Preferred	Included with Mold	
HAH2G8C	HA	H	2/0 Concentric	Steel Pipe	6" to 10"	90 or 90PLUSF20	Preferred	Included with Mold	
HAH2Q20C	HA	H	4/0 Concentric	Steel Pipe	12" to 28"	115 or 115PLUSF20	Preferred	Included with Mold	
HAH2Q350C	HA	H	4/0 Concentric	Steel Pipe	3" to 4"	115 or 115PLUSF20	Preferred	Included with Mold	
HAH2Q3C	HA	H	4/0 Concentric	Steel Pipe	2" to 4"	115 or 115PLUSF20	Preferred	Included with Mold	
HAH2Q8C	HA	H	4/0 Concentric	Steel Pipe	6" to 10"	115 or 115PLUSF20	Preferred	Included with Mold	
HAH9D350C	HA	H	7/#6 Copperweld	Steel Pipe	3" to 4"	115 or 115PLUSF20	Preferred	Included with Mold	

HS MOLDS

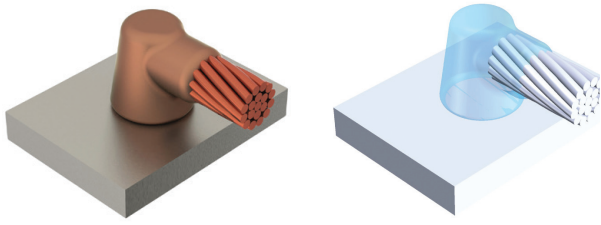

Global Part Number	Mold Family	Price Key	Conductor Size	Connects To	Pipe Diameter	Welding Material Required	Ease of Use	Handle Clamp Required	Conductor Sleeve
HSC1G	HS	C	#6 Solid	Flat Surface or Steel Pipe	14" and Larger	65 or 65PLUSF20	Preferred	L160	B1331L
HSC1H	HS	C	#6 Concentric	Flat Surface or Steel Pipe	14" and Larger	65 or 65PLUSF20	Preferred	L160	B112
HSC1L	HS	C	#4 Concentric	Flat Surface or Steel Pipe	14" and Larger	65 or 65PLUSF20	Preferred	L160	
HSC1T	HS	C	#2 Solid	Flat Surface or Steel Pipe	14" and Larger	65 or 65PLUSF20	Preferred	L160	
HSC1V	HS	C	#2 Concentric	Flat Surface or Steel Pipe	14" and Larger	65 or 65PLUSF20	Preferred	L160	
HSC2C	HS	C	1/0 Concentric	Flat Surface or Steel Pipe	30" and Larger	90 or 90PLUSF20	Preferred	L160	
HSC2G	HS	C	2/0 Concentric	Flat Surface or Steel Pipe	30" and Larger	90 or 90PLUSF20	Preferred	L160	
HSC2Q	HS	C	4/0 Concentric	Flat Surface or Steel Pipe	30" and Larger	115 or 115PLUSF20	Preferred	L160	
HSC2V	HS	C	250 kcmil Concentric	Flat Surface or Steel Pipe	30" and Larger	115 or 115PLUSF20	Preferred	L160	

HC MOLDS

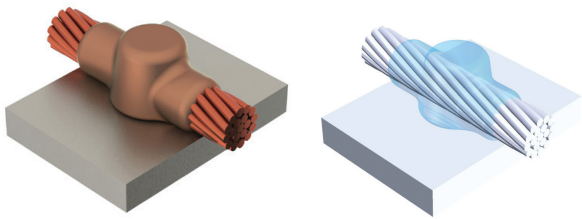

Global Part Number	Mold Family	Price Key	Conductor Size	Connects To	Pipe Diameter	Welding Material Required	Ease of Use	Handle Clamp Required	Conductor Sleeve
HCA1G	HC	A	#6 Solid	Flat Surface or Steel Pipe	14" and Larger	45 or 45PLUSF20	Preferred	Included with Mold	B1331L x 2
HCA1H	HC	A	#6 Concentric	Flat Surface or Steel Pipe	14" and Larger	45 or 45PLUSF20	Preferred	Included with Mold	B112 x 2
HCA1K	HC	A	#4 Solid	Flat Surface or Steel Pipe	14" and Larger	45 or 45PLUSF20	Preferred	Included with Mold	
HCA1L	HC	A	#4 Concentric	Flat Surface or Steel Pipe	14" and Larger	45 or 45PLUSF20	Preferred	Included with Mold	
HCA1T	HC	A	#2 Solid	Flat Surface or Steel Pipe	14" and Larger	45 or 45PLUSF20	Preferred	Included with Mold	
HCA1V	HC	A	#2 Concentric	Flat Surface or Steel Pipe	14" and Larger	45 or 45PLUSF20	Preferred	Included with Mold	
HCA1Y	HC	A	#1 Concentric	Flat Surface or Steel Pipe	14" and Larger	65 or 65PLUSF20	Preferred	Included with Mold	

HT MOLDS

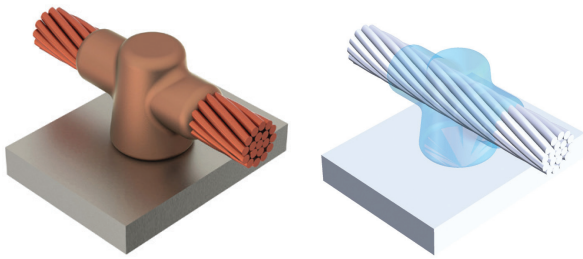

Global Part Number	Mold Family	Price Key	Conductor Size	Connects To	Pipe Diameter	Welding Material Required	Ease of Use	Handle Clamp Required
HTC1T	HT	C	#2 Solid	Flat Surface or Steel Pipe	14" and Larger	65 or 65PLUSF20	Preferred	L160
HTC1V	HT	C	#2 Concentric	Flat Surface or Steel Pipe	14" and Larger	65 or 65PLUSF20	Preferred	L160
HTC2C	HT	C	1/0 Concentric	Flat Surface or Steel Pipe	30" and Larger	90 or 90PLUSF20	Preferred	L160
HTC2G	HT	C	2/0 Concentric	Flat Surface or Steel Pipe	30" and Larger	115 or 115PLUSF20	Preferred	L160
HTC2Q	HT	C	4/0 Concentric	Flat Surface or Steel Pipe	30" and Larger	150 or 150PLUSF20	Preferred	L160
HTC2V	HT	C	250 kcmil Concentric	Flat Surface or Steel Pipe	30" and Larger	150 or 150PLUSF20	Preferred	L160

VS MOLDS

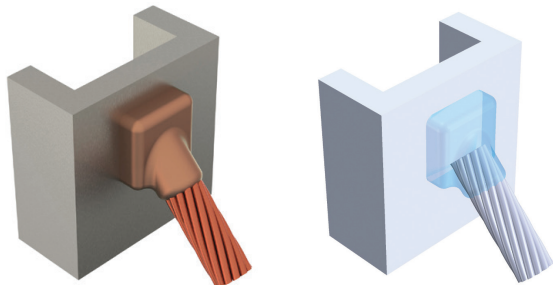

Global Part Number	Mold Family	Price Key	Conductor Size	Connects To	Pipe Diameter	Welding Material Required	Ease of Use	Handle Clamp Required	Conductor Sleeve
VSC1G	VS	C	#6 Solid	Flat Surface or Steel Pipe	32" and Larger	45 or 45PLUSF20	Preferred	L160 or B396	B1331L
VSC1GV3C	VS	C	#6 Solid	Steel Pipe	1-1/2" to 4"	45 or 45PLUSF20	Preferred	L160 or B160V	B1331L
VSC1GV5C	VS	C	#6 Solid	Steel Pipe	4" to 6"	45 or 45PLUSF20	Preferred	L160, B160V or B158	B1331L
VSC1GV8C	VS	C	#6 Solid	Steel Pipe	6" to 10"	45 or 45PLUSF20	Preferred	L160, B160V or B158	B1331L
VSC1H	VS	C	#6 Concentric	Flat Surface or Steel Pipe	32" and Larger	45 or 45PLUSF20	Preferred	L160 or B396	B112
VSC1HV21C	VS	C	#6 Concentric	Steel Pipe	12" to 30"	45 or 45PLUSF20	Preferred	L160	B112
VSC1HV3C	VS	C	#6 Concentric	Steel Pipe	1-1/2" to 4"	45 or 45PLUSF20	Preferred	L160 or B160V	B112
VSC1HV8C	VS	C	#6 Concentric	Steel Pipe	6" to 10"	45 or 45PLUSF20	Preferred	L160, B160V or B158	B112
VSC1K	VS	C	#4 Solid	Flat Surface or Steel Pipe	32" and Larger	45 or 45PLUSF20	Preferred	L160 or B396	
VSC1KV3C	VS	C	#4 Solid	Steel Pipe	1-1/2" to 4"	45 or 45PLUSF20	Preferred	L160 or B160V	
VSC1KV5C	VS	C	#4 Solid	Steel Pipe	4" to 6"	45 or 45PLUSF20	Preferred	L160, B160V or B158	
VSC1KV8C	VS	C	#4 Solid	Steel Pipe	6" to 10"	45 or 45PLUSF20	Preferred	L160, B160V or B158	
VSC1L	VS	C	#4 Concentric	Flat Surface or Steel Pipe	32" and Larger	45 or 45PLUSF20	Preferred	L160 or B396	
VSC1LV21C	VS	C	#4 Concentric	Steel Pipe	12" to 30"	45 or 45PLUSF20	Preferred	L160	
VSC1LV3C	VS	C	#4 Concentric	Steel Pipe	1-1/2" to 4"	45 or 45PLUSF20	Preferred	L160 or B160V	
VSC1LV5C	VS	C	#4 Concentric	Steel Pipe	4" to 6"	45 or 45PLUSF20	Preferred	L160, B160V or B158	
VSC1LV8C	VS	C	#4 Concentric	Steel Pipe	6" to 10"	45 or 45PLUSF20	Preferred	L160, B160V or B158	
VSC1PV3C	VS	C	#3 Solid	Steel Pipe	1-1/2" to 4"	45 or 45PLUSF20	Preferred	L160 or B160V	

Global Part Number	Mold Family	Price Key	Conductor Size	Connects To	Pipe Diameter	Welding Material Required	Ease of Use	Handle Clamp Required	Conductor Sleeve
VSC1T	VS	C	#2 Solid	Flat Surface or Steel Pipe	32" and Larger	45 or 45PLUSF20	Preferred	L160 or B396	
VSC1TV21C	VS	C	#2 Solid	Steel Pipe	12" to 30"	45 or 45PLUSF20	Preferred	L160	
VSC1TV3C	VS	C	#2 Solid	Steel Pipe	1-1/2" to 4"	45 or 45PLUSF20	Preferred	L160 or B160V	
VSC1TV5C	VS	C	#2 Solid	Steel Pipe	4" to 6"	45 or 45PLUSF20	Preferred	L160, B160V or B158	
VSC1TV8C	VS	C	#2 Solid	Steel Pipe	6" to 10"	45 or 45PLUSF20	Preferred	L160, B160V or B158	
VSC1V	VS	C	#2 Concentric	Flat Surface or Steel Pipe	32" and Larger	45 or 45PLUSF20	Preferred	L160 or B396	
VSC1VV21C	VS	C	#2 Concentric	Steel Pipe	12" to 30"	45 or 45PLUSF20	Preferred	L160	
VSC1VV3C	VS	C	#2 Concentric	Steel Pipe	1-1/2" to 4"	45 or 45PLUSF20	Preferred	L160 or B160V	
VSC1VV5C	VS	C	#2 Concentric	Steel Pipe	4" to 6"	45 or 45PLUSF20	Preferred	L160, B160V or B158	
VSC1VV8C	VS	C	#2 Concentric	Steel Pipe	6" to 10"	45 or 45PLUSF20	Preferred	L160, B160V or B158	
VSC1Y	VS	C	#1 Concentric	Flat Surface or Steel Pipe	32" and Larger	65 or 65PLUSF20	Preferred	L160 or B396	
VSC1YV21C	VS	C	#1 Concentric	Steel Pipe	12" to 30"	65 or 65PLUSF20	Preferred	L160	
VSC1YV3C	VS	C	#1 Concentric	Steel Pipe	1-1/2" to 4"	65 or 65PLUSF20	Preferred	L160 or B160V	
VSC1YV5C	VS	C	#1 Concentric	Steel Pipe	4" to 6"	65 or 65PLUSF20	Preferred	L160, B160V or B158	
VSC1YV8C	VS	C	#1 Concentric	Steel Pipe	6" to 10"	65 or 65PLUSF20	Preferred	L160, B160V or B158	
VSC2C	VS	C	1/0 Concentric	Flat Surface or Steel Pipe	32" and Larger	90 or 90PLUSF20	Preferred	L160 or B396	
VSC2CV21C	VS	C	1/0 Concentric	Steel Pipe	12" to 30"	90 or 90PLUSF20	Preferred	L160	
VSC2CV3C	VS	C	1/0 Concentric	Steel Pipe	2" to 4"	90 or 90PLUSF20	Preferred	L160 or B160V	
VSC2CV5C	VS	C	1/0 Concentric	Steel Pipe	4" to 6"	90 or 90PLUSF20	Preferred	L160, B160V or B158	
VSC2CV8C	VS	C	1/0 Concentric	Steel Pipe	6" to 10"	90 or 90PLUSF20	Preferred	L160, B160V or B158	
VSC2G	VS	C	2/0 Concentric	Flat Surface or Steel Pipe	32" and Larger	90 or 90PLUSF20	Preferred	L160 or B396	
VSC2GV21C	VS	C	2/0 Concentric	Steel Pipe	12" to 30"	90 or 90PLUSF20	Preferred	L160	
VSC2GV3C	VS	C	2/0 Concentric	Steel Pipe	2" to 4"	90 or 90PLUSF20	Preferred	L160 or B160V	
VSC2GV5C	VS	C	2/0 Concentric	Steel Pipe	4" to 6"	90 or 90PLUSF20	Preferred	L160, B160V or B158	
VSC2GV8C	VS	C	2/0 Concentric	Steel Pipe	6" to 10"	90 or 90PLUSF20	Preferred	L160, B160V or B158	
VSC2Q	VS	C	4/0 Concentric	Flat Surface or Steel Pipe	32" and Larger	115 or 115PLUSF20	Preferred	L160 or B396	
VSC2QV21C	VS	C	4/0 Concentric	Steel Pipe	12" to 30"	115 or 115PLUSF20	Preferred	L160	
VSC2QV3C	VS	C	4/0 Concentric	Steel Pipe	2" to 4"	115 or 115PLUSF20	Preferred	L160 or B160V	
VSC2QV5C	VS	C	4/0 Concentric	Steel Pipe	4" to 6"	115 or 115PLUSF20	Preferred	L160, B160V or B158	
VSC2QV8C	VS	C	4/0 Concentric	Steel Pipe	6" to 10"	115 or 115PLUSF20	Preferred	L160, B160V or B158	
VSC2V	VS	C	250 kcmil Concentric	Flat Surface or Steel Pipe	32" and Larger	115 or 115PLUSF20	Preferred	L160 or B396	
VSC3A	VS	C	300 kcmil Concentric	Flat Surface or Steel Pipe	32" and Larger	150 or 150PLUSF20	Preferred	L160 or B396	
VSC3D	VS	C	350 kcmil Concentric	Flat Surface or Steel Pipe	32" and Larger	200 or 200PLUSF20	Preferred	L160 or B396	
VSC3H	VS	C	400 kcmil Concentric	Flat Surface or Steel Pipe	32" and Larger	200 or 200PLUSF20	Preferred	L160 or B396	
VSC3Q	VS	C	500 kcmil Concentric	Flat Surface or Steel Pipe	32" and Larger	200 or 200PLUSF20	Preferred	L160 or B396	
VSP1K	VS	P	#4 Solid	Flat Surface or Steel Pipe	32" and Larger	45 or 45PLUSF20	Preferred	Mini EZ Attached or B399BM	
VSP1T	VS	P	#2 Solid	Flat Surface or Steel Pipe	32" and Larger	45 or 45PLUSF20	Preferred	Mini EZ Attached or B399BM	
VST1G	VS	T	#6 Solid	Flat Surface or Steel Pipe	32" and Larger	25 or 25PLUSF20	Preferred	Mini EZ Attached or B399AM	
VST1H	VS	T	#6 Concentric	Flat Surface or Steel Pipe	32" and Larger	25 or 25PLUSF20	Preferred	Mini EZ Attached or B399AM	
VST1L	VS	T	#4 Concentric	Flat Surface or Steel Pipe	32" and Larger	25 or 25PLUSF20	Preferred	Mini EZ Attached or B399AM	

VB MOLDS

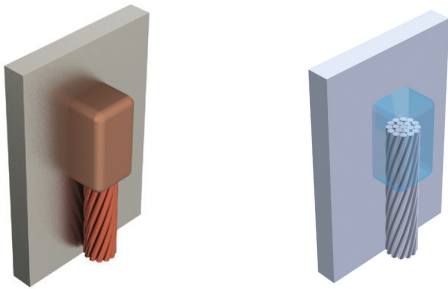

Global Part Number	Mold Family	Price Key	Conductor Size	Connects To	Pipe Diameter	Welding Material Required	ColuEase of Use	Handle Clamp Required	Conductor Sleeve
VBC1G	VB	C	#6 Solid	Flat Surface or Steel Pipe	32" and Larger	65 or 65PLUSF20	Easy	L160 or B396	B1331L
VBC1H	VB	C	#6 Concentric	Flat Surface or Steel Pipe	32" and Larger	65 or 65PLUSF20	Easy	L160 or B396	B112
VBC1HV3C	VB	C	#6 Concentric	Steel Pipe	2" to 4"	65 or 65PLUSF20	Easy	L160 and B160V	B112
VBC1K	VB	C	#4 Solid	Flat Surface or Steel Pipe	32" and Larger	65 or 65PLUSF20	Easy	L160 or B396	
VBC1KV3C	VB	C	#4 Solid	Steel Pipe	2" to 4"	65 or 65PLUSF20	Easy	L160 and B160V	
VBC1L	VB	C	#4 Concentric	Flat Surface or Steel Pipe	32" and Larger	65 or 65PLUSF20	Easy	L160 or B396	
VBC1LV21C	VB	C	#4 Concentric	Steel Pipe	12" to 30"	65 or 65PLUSF20	Easy	L160	
VBC1LV3C	VB	C	#4 Concentric	Steel Pipe	2" to 4"	65 or 65PLUSF20	Easy	L160 and B160V	
VBC1LV5C	VB	C	#4 Concentric	Steel Pipe	4" to 6"	65 or 65PLUSF20	Easy	L160, B160V or B158	
VBC1LV8C	VB	C	#4 Concentric	Steel Pipe	6" to 10"	65 or 65PLUSF20	Easy	L160, B160V or B158	
VBC1T	VB	C	#2 Solid	Flat Surface or Steel Pipe	32" and Larger	65 or 65PLUSF20	Easy	L160 or B396	
VBC1TV21C	VB	C	#2 Solid	Steel Pipe	12" to 30"	65 or 65PLUSF20	Easy	L160	
VBC1TV3C	VB	C	#2 Solid	Steel Pipe	2" to 4"	65 or 65PLUSF20	Easy	L160 or B160V	
VBC1TV5C	VB	C	#2 Solid	Steel Pipe	4" to 6"	65 or 65PLUSF20	Easy	L160, B160V or B158	
VBC1TV8C	VB	C	#2 Solid	Steel Pipe	6" to 10"	65 or 65PLUSF20	Easy	L160, B160V or B158	
VBC1V	VB	C	#2 Concentric	Flat Surface or Steel Pipe	32" and Larger	65 or 65PLUSF20	Easy	L160 or B396	
VBC1VV21C	VB	C	#2 Concentric	Steel Pipe	12" to 30"	65 or 65PLUSF20	Easy	L160	
VBC1VV3C	VB	C	#2 Concentric	Steel Pipe	2" to 4"	65 or 65PLUSF20	Easy	L160 or B160V	
VBC1VV5C	VB	C	#2 Concentric	Steel Pipe	4" to 6"	65 or 65PLUSF20	Easy	L160, B160V or B158	
VBC1VV8C	VB	C	#2 Concentric	Steel Pipe	6" to 10"	65 or 65PLUSF20	Easy	L160, B160V or B158	
VBC1Y	VB	C	#1 Concentric	Flat Surface or Steel Pipe	32" and Larger	90 or 90PLUSF20	Easy	L160 or B396	
VBC1YV3C	VB	C	#1 Concentric	Steel Pipe	2" to 4"	90 or 90PLUSF20	Easy	L160 or B160V	
VBC2C	VB	C	1/0 Concentric	Flat Surface or Steel Pipe	32" and Larger	115 or 115PLUSF20	Easy	L160 or B396	
VBC2CV21C	VB	C	1/0 Concentric	Steel Pipe	12" to 30"	115 or 115PLUSF20	Easy	L160	
VBC2CV3C	VB	C	1/0 Concentric	Steel Pipe	2" to 4"	115 or 115PLUSF20	Easy	L160 or B160V	
VBC2CV5C	VB	C	1/0 Concentric	Steel Pipe	4" to 6"	115 or 115PLUSF20	Easy	L160, B160V or B158	
VBC2CV8C	VB	C	1/0 Concentric	Steel Pipe	6" to 10"	115 or 115PLUSF20	Easy	L160, B160V or B158	
VBC2G	VB	C	2/0 Concentric	Flat Surface or Steel Pipe	32" and Larger	115 or 115PLUSF20	Easy	L160 or B396	

Global Part Number	Mold Family	Price Key	Conductor Size	Connects To	Pipe Diameter	Welding Material Required	ColuEase of Use	Handle Clamp Required	Conductor Sleeve
VBC2GV21C	VB	C	2/0 Concentric	Steel Pipe	12" to 30"	115 or 115PLUSF20	Easy	L160	
VBC2GV3C	VB	C	2/0 Concentric	Steel Pipe	2" to 4"	115 or 115PLUSF20	Easy	L160 or B160V	
VBC2GV5C	VB	C	2/0 Concentric	Steel Pipe	4" to 6"	115 or 115PLUSF20	Easy	L160, B160V or B158	
VBC2GV8C	VB	C	2/0 Concentric	Steel Pipe	6" to 10"	115 or 115PLUSF20	Easy	L160, B160V or B158	
VBC2Q	VB	C	4/0 Concentric	Flat Surface or Steel Pipe	32" and Larger	150 or 150PLUSF20	Easy	L160 or B396	
VBC2QV21C	VB	C	4/0 Concentric	Steel Pipe	12" to 30"	150 or 150PLUSF20	Easy	L160	
VBC2QV3C	VB	C	4/0 Concentric	Steel Pipe	1-1/2" to 4"	150 or 150PLUSF20	Easy	L160 or B160V	
VBC2QV5C	VB	C	4/0 Concentric	Steel Pipe	4" to 6"	150 or 150PLUSF20	Easy	L160, B160V or B158	
VBC2QV8C	VB	C	4/0 Concentric	Steel Pipe	6" to 10"	150 or 150PLUSF20	Easy	L160, B160V or B158	
VBC2V	VB	C	250 kcmil Concentric	Flat Surface or Steel Pipe	32" and Larger	200 or 200PLUSF20	Easy	L160 or B396	
VBC2VV5C	VB	C	250 kcmil Concentric	Steel Pipe	4" to 6"	200 or 200PLUSF20	Easy	L160, B160V or B158	
VBC3A	VB	C	300 kcmil Concentric	Flat Surface or Steel Pipe	32" and Larger	200 or 200PLUSF20	Easy	L160 or B396	
VBC3H	VB	C	400 kcmil Concentric	Flat Surface or Steel Pipe	32" and Larger	250 or 250PLUSF20	Easy	L160 or B396	
VBR3Q	VB	R	500 kcmil Concentric	Flat Surface or Steel Pipe	32" and Larger	150 x 2 or 300PLUSF20	Easy	L160 or B396	

VF MOLDS

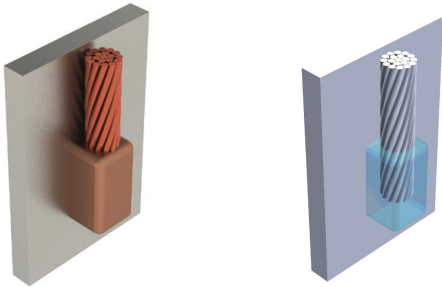

Global Part Number	Mold Family	Price Key	Conductor Size	Connects To	Pipe Diameter	Welding Material Required	Ease of Use	Handle Clamp Required	Conductor Sleeve
VFC1G	VF	C	#6 Solid	Flat Surface or Steel Pipe	32" and Larger	65 or 65PLUSF20	Preferred	L160 or B396	B1331L
VFC1GV3C	VF	C	#6 Solid	Steel Pipe	2" to 4"	65 or 65PLUSF20	Preferred	L160 or B160V	B1331L
VFC1H	VF	C	#6 Concentric	Flat Surface or Steel Pipe	32" and Larger	65 or 65PLUSF20	Preferred	L160 or B396	B112
VFC1HV3C	VF	C	#6 Concentric	Steel Pipe	2" to 4"	65 or 65PLUSF20	Preferred	L160 or B160V	B112
VFC1K	VF	C	#4 Solid	Flat Surface or Steel Pipe	32" and Larger	65 or 65PLUSF20	Preferred	L160 or B396	
VFC1KV3C	VF	C	#4 Solid	Steel Pipe	2" to 4"	65 or 65PLUSF20	Preferred	L160 or B160V	
VFC1L	VF	C	#4 Concentric	Flat Surface or Steel Pipe	32" and Larger	65 or 65PLUSF20	Preferred	L160 or B396	
VFC1LV21C	VF	C	#4 Concentric	Steel Pipe	12" to 30"	65 or 65PLUSF20	Preferred	L160	
VFC1LV3C	VF	C	#4 Concentric	Steel Pipe	2" to 4"	65 or 65PLUSF20	Preferred	L160 or B160V	
VFC1LV8C	VF	C	#4 Concentric	Steel Pipe	6" to 10"	65 or 65PLUSF20	Preferred	L160, B160V or B158	

Global Part Number	Mold Family	Price Key	Conductor Size	Connects To	Pipe Diameter	Welding Material Required	Ease of Use	Handle Clamp Required	Conductor Sleeve
VFC1T	VF	C	#2 Solid	Flat Surface or Steel Pipe	32" and Larger	65 or 65PLUSF20	Preferred	L160 or B396	
VFC1TV21C	VF	C	#2 Solid	Steel Pipe	12" to 30"	65 or 65PLUSF20	Preferred	L160	
VFC1TV3C	VF	C	#2 Solid	Steel Pipe	2" to 4"	65 or 65PLUSF20	Preferred	L160 or B160V	
VFC1TV5C	VF	C	#2 Solid	Steel Pipe	4" to 6"	65 or 65PLUSF20	Preferred	L160, B160V or B158	
VFC1V	VF	C	#2 Concentric	Flat Surface or Steel Pipe	32" and Larger	65 or 65PLUSF20	Preferred	L160 or B396	
VFC1VV3C	VF	C	#2 Concentric	Steel Pipe	2" to 4"	65 or 65PLUSF20	Preferred	L160 or B160V	
VFC1VV5C	VF	C	#2 Concentric	Steel Pipe	4" to 6"	65 or 65PLUSF20	Preferred	L160, B160V or B158	
VFC1VV8C	VF	C	#2 Concentric	Steel Pipe	6" to 10"	65 or 65PLUSF20	Preferred	L160, B160V or B158	
VFC1Y	VF	C	#1 Concentric	Flat Surface or Steel Pipe	32" and Larger	90 or 90PLUSF20	Preferred	L160 or B396	
VFC2C	VF	C	1/0 Concentric	Flat Surface or Steel Pipe	32" and Larger	150 or 150PLUSF20	Preferred	L160 or B396	
VFC2CV3C	VF	C	1/0 Concentric	Steel Pipe	2" to 4"	150 or 150PLUSF20	Preferred	L160 or B160V	
VFC2CV8C	VF	C	1/0 Concentric	Steel Pipe	6" to 10"	150 or 150PLUSF20	Preferred	L160, B160V or B158	
VFC2G	VF	C	2/0 Concentric	Flat Surface or Steel Pipe	32" and Larger	150 or 150PLUSF20	Preferred	L160 or B396	
VFC2GV3C	VF	C	2/0 Concentric	Steel Pipe	2" to 4"	150 or 150PLUSF20	Preferred	L160 or B160V	
VFC2GV5C	VF	C	2/0 Concentric	Steel Pipe	4" to 6"	150 or 150PLUSF20	Preferred	L160, B160V or B158	
VFC2GV8C	VF	C	2/0 Concentric	Steel Pipe	6" to 10"	150 or 150PLUSF20	Preferred	L160, B160V or B158	
VFF3Q	VF	F	500 kcmil Concentric	Flat Surface or Steel Pipe	32" and Larger	200 x 2 or 400PLUSF20	Preferred	L159 and B159M	
VFR2Q	VF	R	4/0 Concentric	Flat Surface or Steel Pipe	32" and Larger	200 or 200PLUSF20	Preferred	L160 or B396	
VFR2QV21C	VF	R	4/0 Concentric	Steel Pipe	12" to 30"	200 or 200PLUSF20	Preferred	L160	
VFR2QV3C	VF	R	4/0 Concentric	Steel Pipe	2" to 4"	200 or 200PLUSF20	Preferred	L160 or B160V	
VFR2QV5C	VF	R	4/0 Concentric	Steel Pipe	4" to 6"	200 or 200PLUSF20	Preferred	L160, B160V or B158	
VFR2QV8C	VF	R	4/0 Concentric	Steel Pipe	6" to 10"	200 or 200PLUSF20	Preferred	L160, B160V or B158	
VFR2V	VF	R	250 kcmil Concentric	Flat Surface or Steel Pipe	32" and Larger	200 or 200PLUSF20	Preferred	L160 or B396	
VFR3A	VF	R	300 kcmil Concentric	Flat Surface or Steel Pipe	32" and Larger	250 or 250PLUSF20	Preferred	L160 or B396	
VFR3D	VF	R	350 kcmil Concentric	Flat Surface or Steel Pipe	32" and Larger	150 x 2 or 300PLUSF20	Preferred	L160 or B396	
VFR3H	VF	R	400 kcmil Concentric	Flat Surface or Steel Pipe	32" and Larger	150 x 2 or 300PLUSF20	Preferred	L160 or B396	

VG MOLDS

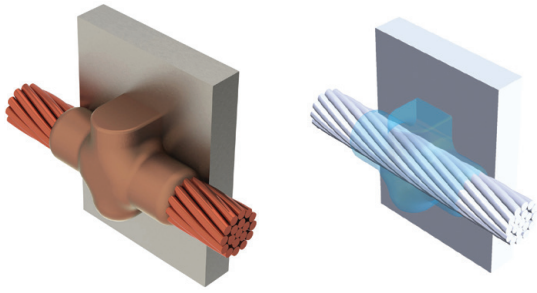

Global Part Number	Mold Family	Price Key	Conductor Size	Connects To	Pipe Diameter	Welding Material Required	Ease of Use	Handle Clamp Required	Conductor Sleeve
VGC1G	VG	C	#6 Solid	Flat Surface or Steel Pipe	32" and Larger	45 or 45PLUSF20	Preferred	L160	B1331L x 2
VGC1H	VG	C	#6 Concentric	Flat Surface or Steel Pipe	32" and Larger	45 or 45PLUSF20	Preferred	L160	B112 x 2
VGC1L	VG	C	#4 Concentric	Flat Surface or Steel Pipe	32" and Larger	45 or 45PLUSF20	Preferred	L160	
VGC1T	VG	C	#2 Solid	Flat Surface or Steel Pipe	32" and Larger	45 or 45PLUSF20	Preferred	L160	
VGC1V	VG	C	#2 Concentric	Flat Surface or Steel Pipe	32" and Larger	45 or 45PLUSF20	Preferred	L160	
VGC1Y	VG	C	#1 Concentric	Flat Surface or Steel Pipe	32" and Larger	65 or 65PLUSF20	Preferred	L160	
VGC2C	VG	C	1/0 Concentric	Flat Surface or Steel Pipe	32" and Larger	115 or 115PLUSF20	Preferred	L160	
VGC2G	VG	C	2/0 Concentric	Flat Surface or Steel Pipe	32" and Larger	115 or 115PLUSF20	Preferred	L160	

VT MOLDS

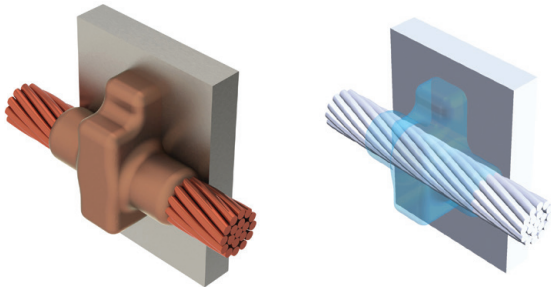

Global Part Number	Mold Family	Price Key	Conductor Size	Connects To	Pipe Diameter	Welding Material Required	Ease of Use	Handle Clamp Required	Conductor Sleeve
VTC1G	VT	C	#6 Solid	Flat Surface or Steel Pipe	32" and Larger	65 or 65PLUSF20	Preferred	L160	B1331L x 2
VTC1H	VT	C	#6 Concentric	Flat Surface or Steel Pipe	32" and Larger	65 or 65PLUSF20	Preferred	L160	B112 x 2
VTC1K	VT	C	#4 Solid	Flat Surface or Steel Pipe	32" and Larger	65 or 65PLUSF20	Preferred	L160	
VTC1L	VT	C	#4 Concentric	Flat Surface or Steel Pipe	32" and Larger	65 or 65PLUSF20	Preferred	L160	
VTC1LV3C	VT	C	#4 Concentric	Steel Pipe	2" to 4"	65 or 65PLUSF20	Preferred	L160 or B160VT	
VTC1LV5C	VT	C	#4 Concentric	Steel Pipe	4" to 6"	65 or 65PLUSF20	Preferred	L160, B160VT or B158	
VTC1T	VT	C	#2 Solid	Flat Surface or Steel Pipe	32" and Larger	65 or 65PLUSF20	Preferred	L160	
VTC1TV3C	VT	C	#2 Solid	Steel Pipe	2" to 4"	65 or 65PLUSF20	Preferred	L160 or B160VT	
VTC1TV5C	VT	C	#2 Solid	Steel Pipe	4" to 6"	65 or 65PLUSF20	Preferred	L160, B160VT or B158	
VTC1TV8C	VT	C	#2 Solid	Steel Pipe	6" to 10"	65 or 65PLUSF20	Preferred	L160, B160VT or B158	

Global Part Number	Mold Family	Price Key	Conductor Size	Connects To	Pipe Diameter	Welding Material Required	Ease of Use	Handle Clamp Required	Conductor Sleeve
VTC1V	VT	C	#2 Concentric	Flat Surface or Steel Pipe	32" and Larger	65 or 65PLUSF20	Preferred	L160	
VTC1VV3C	VT	C	#2 Concentric	Steel Pipe	2" to 4"	65 or 65PLUSF20	Preferred	L160 or B160VT	
VTC2C	VT	C	1/0 Concentric	Flat Surface or Steel Pipe	32" and Larger	115 or 115PLUSF20	Preferred	L160	
VTC2CV3C	VT	C	1/0 Concentric	Steel Pipe	2" to 4"	115 or 115PLUSF20	Preferred	L160 or B160VT	
VTC2G	VT	C	2/0 Concentric	Flat Surface or Steel Pipe	32" and Larger	115 or 115PLUSF20	Preferred	L160	
VTC2GV3C	VT	C	2/0 Concentric	Steel Pipe	2" to 4"	115 or 115PLUSF20	Preferred	L160 or B160VT	
VTC2Q	VT	C	4/0 Concentric	Flat Surface or Steel Pipe	32" and Larger	150 or 150PLUSF20	Preferred	L160	
VTC2QV21C	VT	C	4/0 Concentric	Steel Pipe	12" to 30"	150 or 150PLUSF20	Preferred	L160	
VTC2QV3C	VT	C	4/0 Concentric	Steel Pipe	2" to 4"	150 or 150PLUSF20	Preferred	L160 or B160VT	
VTC2QV5C	VT	C	4/0 Concentric	Steel Pipe	4" to 6"	150 or 150PLUSF20	Preferred	L160, B160VT or B158	
VTC2V	VT	C	250 kcmil Concentric	Flat Surface or Steel Pipe	32" and Larger	150 or 150PLUSF20	Preferred	L160	
VTD3Q	VT	D	500 kcmil Concentric	Flat Surface or Steel Pipe	32" and Larger	500 or 500PLUSF20	Preferred	L159	

VV MOLDS

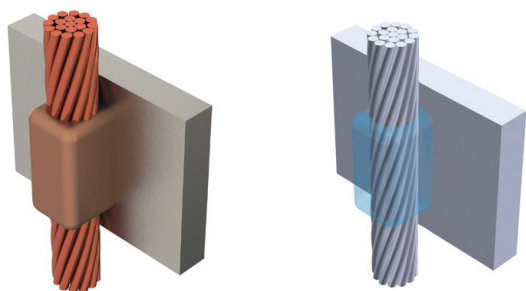

Global Part Number	Mold Family	Price Key	Conductor Size	Connects To	Pipe Diameter	Welding Material Required	Ease of Use	Handle Clamp Required	Conductor Sleeve
VVC1G	VV	C	#6 Solid	Flat Surface or Steel Pipe	32" and Larger	90 or 90PLUSF20	Preferred	L160 or B396	B1331L x 2
VVC1GV3C	VV	C	#6 Solid	Steel Pipe	1-1/2" to 4"	90 or 90PLUSF20	Preferred	L160 or B160V	B1331L x 2
VVC1H	VV	C	#6 Concentric	Flat Surface or Steel Pipe	32" and Larger	90 or 90PLUSF20	Preferred	L160 or B396	B112 x 2
VVC1K	VV	C	#4 Solid	Flat Surface or Steel Pipe	32" and Larger	90 or 90PLUSF20	Preferred	L160 or B396	
VVC1L	VV	C	#4 Concentric	Flat Surface or Steel Pipe	32" and Larger	90 or 90PLUSF20	Preferred	L160 or B396	
VVC1LV3C	VV	C	#4 Concentric	Steel Pipe	1-1/2" to 4"	90 or 90PLUSF20	Preferred	L160 or B160V	
VVC1T	VV	C	#2 Solid	Flat Surface or Steel Pipe	32" and Larger	115 or 115PLUSF20	Preferred	L160 or B396	
VVC1TV3C	VV	C	#2 Solid	Steel Pipe	1-1/2" to 4"	115 or 115PLUSF20	Preferred	L160 or B160V	
VVC1V	VV	C	#2 Concentric	Flat Surface or Steel Pipe	32" and Larger	115 or 115PLUSF20	Preferred	L160 or B396	
VVC1VV21C	VV	C	#2 Concentric	Steel Pipe	12" to 30"	115 or 115PLUSF20	Preferred	L160	
VVC1VV3C	VV	C	#2 Concentric	Steel Pipe	1-1/2" to 4"	115 or 115PLUSF20	Preferred	L160 or B160V	
VVC1Y	VV	C	#1 Concentric	Flat Surface or Steel Pipe	32" and Larger	115 or 115PLUSF20	Preferred	L160 or B396	

Global Part Number	Mold Family	Price Key	Conductor Size	Connects To	Pipe Diameter	Welding Material Required	Ease of Use	Handle Clamp Required	Conductor Sleeve
VVR2C	VV	R	1/0 Concentric	Flat Surface or Steel Pipe	32" and Larger	200 or 200PLUSF20	Preferred	L160 or B396	
VVR2CV3C	VV	R	1/0 Concentric	Steel Pipe	2" to 4"	200 or 200PLUSF20	Preferred	L160 or B160V	
VVR2G	VV	R	2/0 Concentric	Flat Surface or Steel Pipe	32" and Larger	200 or 200PLUSF20	Preferred	L160 or B396	
VVR2GV21C	VV	R	2/0 Concentric	Steel Pipe	12" to 30"	200 or 200PLUSF20	Preferred	L160	
VVR2GV3C	VV	R	2/0 Concentric	Steel Pipe	2" to 4"	200 or 200PLUSF20	Preferred	L160 or B160V	
VVR2GV5C	VV	R	2/0 Concentric	Steel Pipe	4" to 6"	200 or 200PLUSF20	Preferred	L160, B160V or B158	
VVR2Q	VV	R	4/0 Concentric	Flat Surface or Steel Pipe	32" and Larger	250 or 250PLUSF20	Preferred	L160 or B396	
VVR2QV21C	VV	R	4/0 Concentric	Steel Pipe	12" to 30"	250 or 250PLUSF20	Preferred	L160	
VVR2QV3C	VV	R	4/0 Concentric	Steel Pipe	2" to 4"	250 or 250PLUSF20	Preferred	L160 or B160V	
VVR2QV8C	VV	R	4/0 Concentric	Steel Pipe	6" to 10"	250 or 250PLUSF20	Preferred	L160, B160V or B158	
VVR2V	VV	R	250 kcmil Concentric	Flat Surface or Steel Pipe	32" and Larger	250 or 250PLUSF20	Preferred	L160 or B396	

VN MOLDS

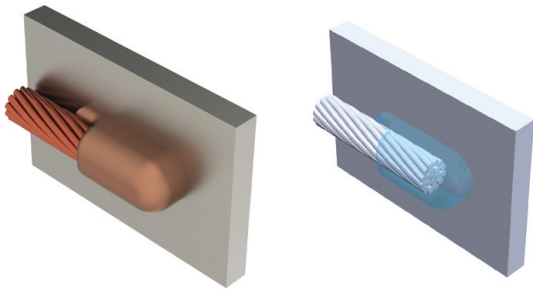

Global Part Number	Mold Family	Price Key	Conductor Size	Connects To	Welding Material Required	Ease of Use	Handle Clamp Required	Conductor Sleeve
VNC1GLH	VN	C	#6 Solid	Flat Surface	45 or 45PLUSF20	Preferred	L160	B1331L
VNC1HLH	VN	C	#6 Concentric	Flat Surface	45 or 45PLUSF20	Preferred	L160	B112
VNC1HRH	VN	C	#6 Concentric	Flat Surface	45 or 45PLUSF20	Preferred	L160	B112
VNC1LLH	VN	C	#4 Concentric	Flat Surface	45 or 45PLUSF20	Preferred	L160	
VNC1LRH	VN	C	#4 Concentric	Flat Surface	45 or 45PLUSF20	Preferred	L160	
VNC1TLH	VN	C	#2 Solid	Flat Surface	45 or 45PLUSF20	Preferred	L160	
VNC1TRH	VN	C	#2 Solid	Flat Surface	45 or 45PLUSF20	Preferred	L160	
VNC1VLH	VN	C	#2 Concentric	Flat Surface	45 or 45PLUSF20	Preferred	L160	
VNC1VRH	VN	C	#2 Concentric	Flat Surface	45 or 45PLUSF20	Preferred	L160	
VNC2CLH	VN	C	1/0 Concentric	Flat Surface	90 or 90PLUSF20	Preferred	L160	
VNC2CRH	VN	C	1/0 Concentric	Flat Surface	90 or 90PLUSF20	Preferred	L160	
VNC2GLH	VN	C	2/0 Concentric	Flat Surface	90 or 90PLUSF20	Preferred	L160	
VNC2GRH	VN	C	2/0 Concentric	Flat Surface	90 or 90PLUSF20	Preferred	L160	
VNC2LLH	VN	C	3/0 Concentric	Flat Surface	115 or 115PLUSF20	Preferred	L160	
VNC2LRH	VN	C	3/0 Concentric	Flat Surface	115 or 115PLUSF20	Preferred	L160	
VNC2QLH	VN	C	4/0 Concentric	Flat Surface	115 or 115PLUSF20	Preferred	L160	
VNC2QRH	VN	C	4/0 Concentric	Flat Surface	115 or 115PLUSF20	Preferred	L160	
VNC2VLH	VN	C	250 kcmil Concentric	Flat Surface	115 or 115PLUSF20	Preferred	L160	
VNC2VRH	VN	C	250 kcmil Concentric	Flat Surface	115 or 115PLUSF20	Preferred	L160	

CABLE TO LUG OR BUSBAR

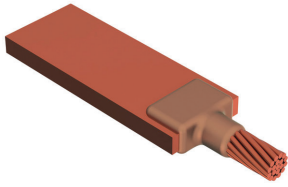

- Forms a permanent, low resistance connection
- Provides a molecular bond
- Cadweld Exothermic Connections are rated with the same current capacity as the conductor
- Portable installation equipment with no external source of power required
- Installers can be easily trained to make Cadweld Exothermic Connections
- Connections are visually inspected

GL MOLDS

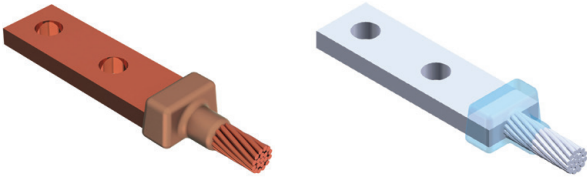

Global Part Number	Mold Family	Price Key	Conductor Size	Lug / Busbar Size	Welding Material Required	Ease of Use	Handle Clamp required	Conductor Sleeve
GLCCE1G	GL	C	#6 Solid	1/8" x 1"	32 or 32PLUSF20	Preferred	L160	B1331L
GLCCE1H	GL	C	#6 Concentric	1/8" x 1"	32 or 32PLUSF20	Preferred	L160	B112
GLCCE1K	GL	C	#4 Solid	1/8" x 1"	32 or 32PLUSF20	Preferred	L160	
GLCCE1L	GL	C	#4 Concentric	1/8" x 1"	32 or 32PLUSF20	Preferred	L160	
GLCCE1T	GL	C	#2 Solid	1/8" x 1"	32 or 32PLUSF20	Preferred	L160	
GLCCE1V	GL	C	#2 Concentric	1/8" x 1"	32 or 32PLUSF20	Preferred	L160	
GLCCE1Y	GL	C	#1 Concentric	1/8" x 1"	32 or 32PLUSF20	Preferred	L160	
GLCCE2C	GL	C	1/0 Concentric	1/8" x 1"	45 or 45PLUSF20	Preferred	L160	
GLCCE2G	GL	C	2/0 Concentric	1/8" x 1"	45 or 45PLUSF20	Preferred	L160	
GLCCE2Q	GL	C	4/0 Concentric	1/8" x 1"	65 or 65PLUSF20	Preferred	L160	
GLCDE1H	GL	C	#6 Concentric	3/16" x 1"	45 or 45PLUSF20	Preferred	L160	B112
GLCDE2C	GL	C	1/0 Concentric	3/16" x 1"	45 or 45PLUSF20	Preferred	L160	
GLCDE2G	GL	C	2/0 Concentric	3/16" x 1"	65 or 65PLUSF20	Preferred	L160	
GLCDE2Q	GL	C	4/0 Concentric	3/16" x 1"	65 or 65PLUSF20	Preferred	L160	
GLCDE2V	GL	C	250 kcmil Concentric	3/16" x 1"	65 or 65PLUSF20	Preferred	L160	
GLCEE2Q	GL	C	4/0 Concentric	1/4" x 1"	65 or 65PLUSF20	Preferred	L160	
GLCEE2V	GL	C	250 kcmil Concentric	1/4" x 1"	90 or 90PLUSF20	Preferred	L160	
GLCEE3A	GL	C	300 kcmil Concentric	1/4" x 1"	90 or 90PLUSF20	Preferred	L160	
GLCEE3D	GL	C	350 kcmil Concentric	1/4" x 1"	90 or 90PLUSF20	Preferred	L160	
GLCEG1V	GL	C	#2 Concentric	1/4" x 1 1/2"	90 or 90PLUSF20	Preferred	L160	
GLCEG2C	GL	C	1/0 Concentric	1/4" x 1 1/2"	115 or 115PLUSF20	Preferred	L160	
GLCEG2G	GL	C	2/0 Concentric	1/4" x 1 1/2"	115 or 115PLUSF20	Preferred	L160	
GLCEG2Q	GL	C	4/0 Concentric	1/4" x 1 1/2"	115 or 115PLUSF20	Preferred	L160	
GLCEG2V	GL	C	250 kcmil Concentric	1/4" x 1 1/2"	115 or 115PLUSF20	Preferred	L160	
GLCEG3H	GL	C	400 kcmil Concentric	1/4" x 1 1/2"	150 or 150PLUSF20	Preferred	L160	
GLCEG3Q	GL	C	500 kcmil Concentric	1/4" x 1 1/2"	150 or 150PLUSF20	Preferred	L160	
GLPCC1T	GL	P	#2 Solid	1/8" x 5/8"	25 or 25PLUSF20	Preferred	B399B Mini EZ Attached	

LA MOLDS

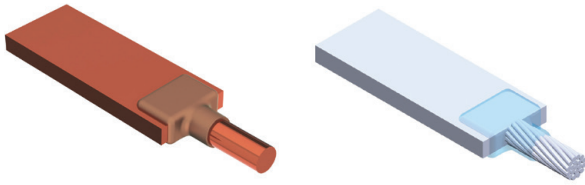

Global Part Number	Mold Family	Price Key	Conductor Size	Lug / Busbar Size	Welding Material Required	Ease of Use	Handle Clamp required	Conductor Sleeve
LAC1GCE	LA	C	#6 Solid	1/8" x 1"	45 or 45PLUSF20	Preferred	L160	B1331L
LAC1GEE	LA	C	#6 Solid	1/4" x 1"	65 or 65PLUSF20	Preferred	L160	B1331L
LAC1HCE	LA	C	#6 Concentric	1/8" x 1"	45 or 45PLUSF20	Preferred	L160	B112
LAC1HEE	LA	C	#6 Concentric	1/4" x 1"	65 or 65PLUSF20	Preferred	L160	B112
LAC1HEG	LA	C	#6 Concentric	1/4" x 1 1/2"	65 or 65PLUSF20	Preferred	L160	B112
LAC1KCE	LA	C	#4 Solid	1/8" x 1"	45 or 45PLUSF20	Preferred	L160	
LAC1KEE	LA	C	#4 Solid	1/4" x 1"	45 or 45PLUSF20	Preferred	L160	
LAC1LCE	LA	C	#4 Concentric	1/8" x 1"	45 or 45PLUSF20	Preferred	L160	
LAC1LEE	LA	C	#4 Concentric	1/4" x 1"	45 or 45PLUSF20	Preferred	L160	
LAC1LEG	LA	C	#4 Concentric	1/4" x 1 1/2"	45 or 45PLUSF20	Preferred	L160	
LAC1TCE	LA	C	#2 Solid	1/8" x 1"	45 or 45PLUSF20	Preferred	L160	
LAC1TDE	LA	C	#2 Solid	3/16" x 1"	45 or 45PLUSF20	Preferred	L160	
LAC1TEE	LA	C	#2 Solid	1/4" x 1"	65 or 65PLUSF20	Preferred	L160	
LAC1TEG	LA	C	#2 Solid	1/4" x 1 1/2"	65 or 65PLUSF20	Preferred	L160	
LAC1TEK	LA	C	#2 Solid	1/4" x 3" and wider	65 or 65PLUSF20	Preferred	L160	
LAC1VCE	LA	C	#2 Concentric	1/8" x 1"	45 or 45PLUSF20	Preferred	L160	
LAC1VDE	LA	C	#2 Concentric	3/16" x 1"	45 or 45PLUSF20	Preferred	L160	
LAC1VEE	LA	C	#2 Concentric	1/4" x 1"	65 or 65PLUSF20	Preferred	L160	
LAC1VEG	LA	C	#2 Concentric	1/4" x 1 1/2"	65 or 65PLUSF20	Preferred	L160	
LAC1YCE	LA	C	#1 Concentric	1/8" x 1"	45 or 45PLUSF20	Preferred	L160	
LAC2C002	LA	C	1/0 Concentric	1/4" x 1"	65 or 65PLUSF20	Preferred	L160	
LAC2CCE	LA	C	1/0 Concentric	1/8" x 1"	45 or 45PLUSF20	Preferred	L160	
LAC2CDE	LA	C	1/0 Concentric	3/16" x 1"	65 or 65PLUSF20	Preferred	L160	
LAC2CEE	LA	C	1/0 Concentric	1/4" x 1"	65 or 65PLUSF20	Preferred	L160	
LAC2CEG	LA	C	1/0 Concentric	1/4" x 1 1/2"	65 or 65PLUSF20	Preferred	L160	
LAC2CEK	LA	C	1/0 Concentric	1/4" x 3" and wider	65 or 65PLUSF20	Preferred	L160	
LAC2G002	LA	C	2/0 Concentric	1/4" x 1"	65 or 65PLUSF20	Preferred	L160	
LAC2GCE	LA	C	2/0 Concentric	1/8" x 1"	65 or 65PLUSF20	Preferred	L160	
LAC2GCEW	LA	C	2/0 Concentric	1/8" x 1"	65 or 65PLUSF20	Preferred	L160	
LAC2GDE	LA	C	2/0 Concentric	3/16" x 1"	65 or 65PLUSF20	Preferred	L160	
LAC2GEE	LA	C	2/0 Concentric	1/4" x 1"	65 or 65PLUSF20	Preferred	L160	
LAC2GEEW	LA	C	2/0 Concentric	1/4" x 1"	65 or 65PLUSF20	Preferred	L160	
LAC2GEG	LA	C	2/0 Concentric	1/4" x 1 1/2"	65 or 65PLUSF20	Preferred	L160	
LAC2Q002	LA	C	4/0 Concentric	1/4" x 1"	90 or 90PLUSF20	Preferred	L160	
LAC2QCE	LA	C	4/0 Concentric	1/8" x 1"	65 or 65PLUSF20	Preferred	L160	
LAC2QCEW	LA	C	4/0 Concentric	1/8" x 1"	65 or 65PLUSF20	Preferred	L160	
LAC2QDE	LA	C	4/0 Concentric	3/16" x 1"	90 or 90PLUSF20	Preferred	L160	
LAC2QEE	LA	C	4/0 Concentric	1/4" x 1"	90 or 90PLUSF20	Preferred	L160	

Global Part Number	Mold Family	Price Key	Conductor Size	Lug / Busbar Size	Welding Material Required	Ease of Use	Handle Clamp required	Conductor Sleeve
LAC2QEEW	LA	C	4/0 Concentric	1/4" x 1"	90 or 90PLUSF20	Preferred	L160	
LAC2QEG	LA	C	4/0 Concentric	1/4" x 1 1/2"	90 or 90PLUSF20	Preferred	L160	
LAC2QEGW	LA	C	4/0 Concentric	1/4" x 1 1/2"	90 or 90PLUSF20	Preferred	L160	
LAC2QEH	LA	C	4/0 Concentric	1/4" x 2"	90 or 90PLUSF20	Preferred	L160	
LAC2QEHW	LA	C	4/0 Concentric	1/4" x 2"	90 or 90PLUSF20	Preferred	L160	
LAC2QEK	LA	C	4/0 Concentric	1/4" x 3" and wider	90 or 90PLUSF20	Preferred	L160	
LAC2QGG	LA	C	4/0 Concentric	3/8" x 1 1/2"	115 or 115PLUSF20	Preferred	L160	
LAC2QGH	LA	C	4/0 Concentric	3/8" x 2"	115 or 115PLUSF20	Preferred	L160	
LAC2QGHW	LA	C	4/0 Concentric	3/8" x 2"	115 or 115PLUSF20	Preferred	L160	
LAC2QGK	LA	C	4/0 Concentric	3/8" x 3" and wider	115 or 115PLUSF20	Preferred	L160	
LAC2QJK	LA	C	4/0 Concentric	1/2" x 3" and wider	115 or 115PLUSF20	Preferred	L160	
LAC2VDE	LA	C	250 kcmil Concentric	3/16" x 1"	90 or 90PLUSF20	Preferred	L160	
LAC2VEE	LA	C	250 kcmil Concentric	1/4" x 1"	90 or 90PLUSF20	Preferred	L160	
LAC2VEG	LA	C	250 kcmil Concentric	1/4" x 1 1/2"	90 or 90PLUSF20	Preferred	L160	
LAC2VEH	LA	C	250 kcmil Concentric	1/4" x 2"	90 or 90PLUSF20	Preferred	L160	
LAC2VEK	LA	C	250 kcmil Concentric	1/4" x 3" and wider	90 or 90PLUSF20	Preferred	L160	
LAC3AEE	LA	C	300 kcmil Concentric	1/4" x 1"	90 or 90PLUSF20	Preferred	L160	
LAC3AEEW	LA	C	300 kcmil Concentric	1/4" x 1"	90 or 90PLUSF20	Preferred	L160	
LAC3AEG	LA	C	300 kcmil Concentric	1/4" x 1 1/2"	90 or 90PLUSF20	Preferred	L160	
LAC3AEGW	LA	C	300 kcmil Concentric	1/4" x 1 1/2"	90 or 90PLUSF20	Preferred	L160	
LAC3AEH	LA	C	300 kcmil Concentric	1/4" x 2"	90 or 90PLUSF20	Preferred	L160	
LAC3AEK	LA	C	300 kcmil Concentric	1/4" x 3" and wider	90 or 90PLUSF20	Preferred	L160	
LAC3AJKW	LA	C	300 kcmil Concentric	1/2" x 3" and wider	250 or 250PLUSF20	Preferred	L160	
LAC3DEE	LA	C	350 kcmil Concentric	1/4" x 1"	115 or 115PLUSF20	Preferred	L160	
LAC3DEEW	LA	C	350 kcmil Concentric	1/4" x 1"	115 or 115PLUSF20	Preferred	L160	
LAC3DEG	LA	C	350 kcmil Concentric	1/4" x 1 1/2"	115 or 115PLUSF20	Preferred	L160	
LAC3DEH	LA	C	350 kcmil Concentric	1/4" x 2"	115 or 115PLUSF20	Preferred	L160	
LAC3DEK	LA	C	350 kcmil Concentric	1/4" x 3" and wider	115 or 115PLUSF20	Preferred	L160	
LAC3HEE	LA	C	400 kcmil Concentric	1/4" x 1"	115 or 115PLUSF20	Preferred	L160	
LAC3QEE	LA	C	500 kcmil Concentric	1/4" x 1"	150 or 150PLUSF20	Preferred	L160	
LAC3QEEW	LA	C	500 kcmil Concentric	1/4" x 1"	150 or 150PLUSF20	Preferred	L160	
LAC3QEG	LA	C	500 kcmil Concentric	1/4" x 1 1/2"	200 or 200PLUSF20	Preferred	L160	
LAC3QEGW	LA	C	500 kcmil Concentric	1/4" x 1 1/2"	200 or 200PLUSF20	Preferred	L160	
LAC3QEH	LA	C	500 kcmil Concentric	1/4" x 2"	200 or 200PLUSF20	Preferred	L160	
LAC3QEK	LA	C	500 kcmil Concentric	1/4" x 3" and wider	200 or 200PLUSF20	Preferred	L160	
LAC3QEKW	LA	C	500 kcmil Concentric	1/4" x 3" and wider	200 or 200PLUSF20	Preferred	L160	
LAC3QGG	LA	C	500 kcmil Concentric	3/8" x 1 1/2"	200 or 200PLUSF20	Preferred	L160	
LAC3QJH	LA	C	500 kcmil Concentric	1/2" x 2"	250 or 250PLUSF20	Preferred	L160	
LAC4LGG	LA	C	750 kcmil Concentric	3/8" x 1 1/2"	150 x 2 or 300PLUSF20	Preferred	L160	
LAD4LJK	LA	D	750 kcmil Concentric	1/2" x 3"	200 x 2 or 400PLUSF20	Preferred	L159	
LAD4YJK	LA	D	1000 kcmil Concentric	1/2" x 3"	500 or 500PLUSF20	Preferred	L159	
LAT1HAA	LA	T	#6 Concentric	1/16" x 1/2"	25 or 25PLUSF20	Preferred	B399A Mini EZ Attached	B112
LAT1LAA	LA	T	#4 Concentric	1/16" x 1/2"	25 or 25PLUSF20	Preferred	B399A Mini EZ Attached	

LJ MOLDS

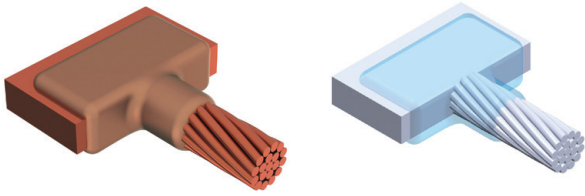

Global Part Number	Mold Family	Price Key	Conductor Size	Lug / Busbar Size	Welding Material Required	Ease of Use	Handle Clamp required	Conductor Sleeve
LJCAG1G	LJ	C	#6 Solid	1/16" x 1 1/2" and wider	45 or 45PLUSF20	Preferred	L160	B1331L
LJCAG1H	LJ	C	#6 Concentric	1/16" x 1 1/2" and wider	45 or 45PLUSF20	Preferred	L160	B112
LJCAG1K	LJ	C	#4 Solid	1/16" x 1 1/2" and wider	45 or 45PLUSF20	Preferred	L160	
LJCAG1T	LJ	C	#2 Solid	1/16" x 1 1/2" and wider	45 or 45PLUSF20	Preferred	L160	
LJCAG1V	LJ	C	#2 Concentric	1/16" x 1 1/2" and wider	45 or 45PLUSF20	Preferred	L160	
LJCAG1Y	LJ	C	#1 Concentric	1/16" x 1 1/2" and wider	45 or 45PLUSF20	Preferred	L160	
LJCAG2C	LJ	C	1/0 Concentric	1/16" x 1 1/2" and wider	45 or 45PLUSF20	Preferred	L160	
LJCAG2G	LJ	C	2/0 Concentric	1/16" x 1 1/2" and wider	65 or 65PLUSF20	Preferred	L160	
LJCAG2Q	LJ	C	4/0 Concentric	1/16" x 1 1/2" and wider	90 or 90PLUSF20	Preferred	L160	
LJCE1G	LJ	C	#6 Solid	1/8" x 1"	45 or 45PLUSF20	Preferred	L160	B1331L
LJCE1T	LJ	C	#2 Solid	1/8" x 1"	45 or 45PLUSF20	Preferred	L160	
LJCE1V	LJ	C	#2 Concentric	1/8" x 1"	45 or 45PLUSF20	Preferred	L160	
LJCE2C	LJ	C	1/0 Concentric	1/8" x 1"	90 or 90PLUSF20	Preferred	L160	
LJCE2G	LJ	C	2/0 Concentric	1/8" x 1"	90 or 90PLUSF20	Preferred	L160	
LJCE2Q	LJ	C	4/0 Concentric	1/8" x 1"	90 or 90PLUSF20	Preferred	L160	
LJCCG1G	LJ	C	#6 Solid	1/8" x 1 1/2" and wider	45 or 45PLUSF20	Preferred	L160	B1331L
LJCCG1H	LJ	C	#6 Concentric	1/8" x 1 1/2" and wider	45 or 45PLUSF20	Preferred	L160	B112
LJCCG1L	LJ	C	#4 Concentric	1/8" x 1 1/2" and wider	45 or 45PLUSF20	Preferred	L160	
LJCCG1T	LJ	C	#2 Solid	1/8" x 1 1/2" and wider	45 or 45PLUSF20	Preferred	L160	
LJCCG1V	LJ	C	#2 Concentric	1/8" x 1 1/2" and wider	45 or 45PLUSF20	Preferred	L160	
LJCCG2C	LJ	C	1/0 Concentric	1/8" x 1 1/2" and wider	90 or 90PLUSF20	Preferred	L160	
LJCCG2G	LJ	C	2/0 Concentric	1/8" x 1 1/2" and wider	90 or 90PLUSF20	Preferred	L160	
LJCCG2Q	LJ	C	4/0 Concentric	1/8" x 1 1/2" and wider	90 or 90PLUSF20	Preferred	L160	
LJCDG1T	LJ	C	#2 Solid	3/16" x 1 1/2" and wider	65 or 65PLUSF20	Preferred	L160	
LJCED2G	LJ	C	2/0 Concentric	1/4" x 3/4"	90 or 90PLUSF20	Preferred	L160	
LJCEE1T	LJ	C	#2 Solid	1/4" x 1"	65 or 65PLUSF20	Preferred	L160	
LJCEE1V	LJ	C	#2 Concentric	1/4" x 1"	65 or 65PLUSF20	Preferred	L160	
LJCEE2Q	LJ	C	4/0 Concentric	1/4" x 1"	90 or 90PLUSF20	Preferred	L160	
LJCEE3Q	LJ	C	500 kcmil Concentric	1/4" x 1"	200 or 200PLUSF20	Preferred	L160	
LJCEF2Q	LJ	C	4/0 Concentric	1/4" x 1 1/4" and wider	90 or 90PLUSF20	Preferred	L160	
LJCEG1G	LJ	C	#6 Solid	1/4" x 1 1/2" and wider	65 or 65PLUSF20	Preferred	L160	B1331L
LJCEG1H	LJ	C	#6 Concentric	1/4" x 1 1/2" and wider	65 or 65PLUSF20	Preferred	L160	B112
LJCEG1K	LJ	C	#4 Solid	1/4" x 1 1/2" and wider	65 or 65PLUSF20	Preferred	L160	
LJCEG1L	LJ	C	#4 Concentric	1/4" x 1 1/2" and wider	65 or 65PLUSF20	Preferred	L160	
LJCEG1T	LJ	C	#2 Solid	1/4" x 1 1/2" and wider	65 or 65PLUSF20	Preferred	L160	
LJCEG1TL	LJ	C	#2 Solid	1/4" x 1 1/2" and wider	65 or 65PLUSF20	Preferred	L160	
LJCEG1V	LJ	C	#2 Concentric	1/4" x 1 1/2" and wider	65 or 65PLUSF20	Preferred	L160	
LJCEG1X	LJ	C	#1 Solid	1/4" x 1 1/2" and wider	90 or 90PLUSF20	Preferred	L160	

Global Part Number	Mold Family	Price Key	Conductor Size	Lug / Busbar Size	Welding Material Required	Ease of Use	Handle Clamp required	Conductor Sleeve
LJCEG1Y	LJ	C	#1 Concentric	1/4" x 1 1/2" and wider	90 or 90PLUSF20	Preferred	L160	
LJCEG2C	LJ	C	1/0 Concentric	1/4" x 1 1/2" and wider	90 or 90PLUSF20	Preferred	L160	
LJCEG2G	LJ	C	2/0 Concentric	1/4" x 1 1/2" and wider	90 or 90PLUSF20	Preferred	L160	
LJCEG2Q	LJ	C	4/0 Concentric	1/4" x 1 1/2" and wider	90 or 90PLUSF20	Preferred	L160	
LJCEG2V	LJ	C	250 kcmil Concentric	1/4" x 1 1/2" and wider	115 or 115PLUSF20	Preferred	L160	
LJCEG3A	LJ	C	300 kcmil Concentric	1/4" x 1 1/2" and wider	115 or 115PLUSF20	Preferred	L160	
LJCEG3D	LJ	C	350 kcmil Concentric	1/4" x 1 1/2" and wider	150 or 150PLUSF20	Preferred	L160	
LJCEG3Q	LJ	C	500 kcmil Concentric	1/4" x 1 1/2" and wider	200 or 200PLUSF20	Preferred	L160	
LJCEG3X	LJ	C	600 kcmil Concentric	1/4" x 1 1/2" and wider	250 or 250PLUSF20	Preferred	L160	
LJCEG4L	LJ	C	750 kcmil Concentric	1/4" x 1 1/2" and wider	150 x 2 or 300PLUSF20	Preferred	L160	
LJCGG1L	LJ	C	#4 Concentric	3/8" x 1 1/2" and wider	90 or 90PLUSF20	Preferred	L160	
LJCGG1T	LJ	C	#2 Solid	3/8" x 1 1/2" and wider	90 or 90PLUSF20	Preferred	L160	
LJCGG1V	LJ	C	#2 Concentric	3/8" x 1 1/2" and wider	90 or 90PLUSF20	Preferred	L160	
LJCGG2C	LJ	C	1/0 Concentric	3/8" x 1 1/2" and wider	90 or 90PLUSF20	Preferred	L160	
LJCGG2G	LJ	C	2/0 Concentric	3/8" x 1 1/2" and wider	90 or 90PLUSF20	Preferred	L160	
LJCGG2Q	LJ	C	4/0 Concentric	3/8" x 1 1/2" and wider	115 or 115PLUSF20	Preferred	L160	
LJCGG2V	LJ	C	250 kcmil Concentric	3/8" x 1 1/2" and wider	150 or 150PLUSF20	Preferred	L160	
LJCGG3D	LJ	C	350 kcmil Concentric	3/8" x 1 1/2" and wider	200 or 200PLUSF20	Preferred	L160	
LJCGG3Q	LJ	C	500 kcmil Concentric	3/8" x 1 1/2" and wider	250 or 250PLUSF20	Preferred	L160	
LJCGG4L	LJ	C	750 kcmil Concentric	3/8" x 1 1/2" and wider	150 x 2 or 300PLUSF20	Preferred	L160	
LJCJG1T	LJ	C	#2 Solid	1/2" x 1 1/2" and wider	115 or 115PLUSF20	Preferred	L160	
LJCJG1V	LJ	C	#2 Concentric	1/2" x 1 1/2" and wider	115 or 115PLUSF20	Preferred	L160	
LJCJG2C	LJ	C	1/0 Concentric	1/2" x 1 1/2" and wider	115 or 115PLUSF20	Preferred	L160	
LJCJG2G	LJ	C	2/0 Concentric	1/2" x 1 1/2" and wider	115 or 115PLUSF20	Preferred	L160	
LJCJG2Q	LJ	C	4/0 Concentric	1/2" x 1 1/2" and wider	150 or 150PLUSF20	Preferred	L160	
LJCJG2V	LJ	C	250 kcmil Concentric	1/2" x 1 1/2" and wider	200 or 200PLUSF20	Preferred	L160	
LJCJG3A	LJ	C	300 kcmil Concentric	1/2" x 1 1/2" and wider	200 or 200PLUSF20	Preferred	L160	
LJCJG3Q	LJ	C	500 kcmil Concentric	1/2" x 1 1/2" and wider	150 x 2 or 300PLUSF20	Preferred	L160	
LJCLG2Q	LJ	C	4/0 Concentric	3/4" x 1 1/2" and wider	200 or 200PLUSF20	Preferred	L160	

LQ MOLDS

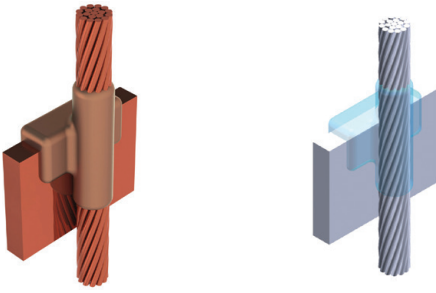

Global Part Number	Mold Family	Price Key	Conductor Size	Lug / Busbar Size	Welding Material Required	Ease of Use	Handle Clamp required
LQEEH1T	LQ	E	#2 Solid	1/4" x 2" and wider	250 or 250PLUSF20	Easy	L160
LQEEH1V	LQ	E	#2 Concentric	1/4" x 2" and wider	250 or 250PLUSF20	Easy	L160
LQEGH1V	LQ	E	#2 Concentric	3/8" x 2" and wider	250 or 250PLUSF20	Easy	L160
LQJEH2C	LQ	J	1/0 Concentric	1/4" x 2" and wider	200 x 2 or 400PLUSF20	Easy	L159
LQJEH2CM	LQ	J	1/0 Concentric	1/4" x 2" and wider	200 x 2 or 400PLUSF20	Easy	L160
LQJEH2G	LQ	J	2/0 Concentric	1/4" x 2" and wider	200 x 2 or 400PLUSF20	Easy	L159
LQJEH2Q	LQ	J	4/0 Concentric	1/4" x 2" and wider	500 or 500PLUSF20	Easy	L159
LQJEH2QM	LQ	J	4/0 Concentric	1/4" x 2" and wider	500 or 500PLUSF20	Easy	L160
LQJEH2V	LQ	J	250 kcmil Concentric	1/4" x 2" and wider	500 or 500PLUSF20	Easy	L159
LQJEH2VM	LQ	J	250 kcmil Concentric	1/4" x 2" and wider	500 or 500PLUSF20	Easy	L160
LQJEH3A	LQ	J	300 kcmil Concentric	1/4" x 2" and wider	500 or 500PLUSF20	Easy	L159
LQJEH3D	LQ	J	350 kcmil Concentric	1/4" x 2" and wider	500 or 500PLUSF20	Easy	L159
LQJEH3Q	LQ	J	500 kcmil Concentric	1/4" x 2" and wider	500 or 500PLUSF20	Easy	L159
LQJEH3QM	LQ	J	500 kcmil Concentric	1/4" x 2" and wider	500 or 500PLUSF20	Easy	L160
LQJEH3X	LQ	J	600 kcmil Concentric	1/4" x 2" and wider	200 x 3 or 600PLUSF20	Easy	L159
LQJEH4L	LQ	J	750 kcmil Concentric	1/4" x 2" and wider	200 x 3 or 600PLUSF20	Easy	L159
LQJGH2C	LQ	J	1/0 Concentric	3/8" x 2" and wider	200 x 2 or 400PLUSF20	Easy	L159
LQJGH2G	LQ	J	2/0 Concentric	3/8" x 2" and wider	200 x 2 or 400PLUSF20	Easy	L159
LQJGH2Q	LQ	J	4/0 Concentric	3/8" x 2" and wider	500 or 500PLUSF20	Easy	L159
LQJGH2QM	LQ	J	4/0 Concentric	3/8" x 2" and wider	500 or 500PLUSF20	Easy	L160
LQJGH2V	LQ	J	250 kcmil Concentric	3/8" x 2" and wider	500 or 500PLUSF20	Easy	L159
LQJGH3Q	LQ	J	500 kcmil Concentric	3/8" x 2" and wider	500 or 500PLUSF20	Easy	L159
LQJGH4L	LQ	J	750 kcmil Concentric	3/8" x 2" and wider	200 x 3 or 600PLUSF20	Easy	L159
LQJH2G	LQ	J	2/0 Concentric	1/2" x 2" and wider	500 or 500PLUSF20	Easy	L159
LQJH2Q	LQ	J	4/0 Concentric	1/2" x 2" and wider	200 x 3 or 600PLUSF20	Easy	L159
LQJH2V	LQ	J	250 kcmil Concentric	1/2" x 2" and wider	200 x 3 or 600PLUSF20	Easy	L159

BUSBAR TO BUSBAR

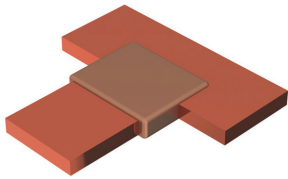

- Forms a permanent, low resistance connection
- Provides a molecular bond
- Cadweld Exothermic Connections are rated with the same current capacity as the conductor
- Portable installation equipment with no external source of power required
- Installers can be easily trained to make Cadweld Exothermic Connections
- Connections are visually inspected

BA MOLDS

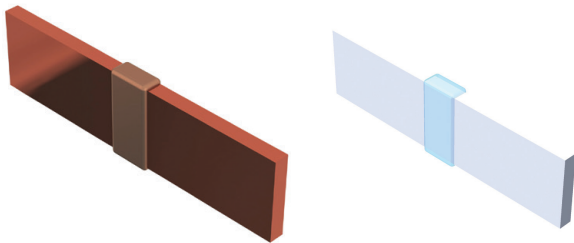

Global Part Number	Mold Family	Price Key	Busbar Size 1	Busbar Size 2	Welding Material Required	Ease of Use	Handle Clamp Required
BACCA	BA	C	1/8" x 1/2"	1/8" x 1/2"	45 or 45PLUSF20	Preferred	L160
BACCE	BA	C	1/8" x 1"	1/8" x 1"	45 or 45PLUSF20	Preferred	L160
BACDE	BA	C	3/16" x 1"	3/16" x 1"	65 or 65PLUSF20	Preferred	L160
BACEE	BA	C	1/4" x 1"	1/4" x 1"	90 or 90PLUSF20	Preferred	L160
BACEH	BA	C	1/4" x 2"	1/4" x 2"	200 or 200PLUSF20	Preferred	L160
BADEK	BA	D	1/4" x 3"	1/4" x 3"	200 x 2 or 400PLUSF20	Preferred	L159
BADEM	BA	D	1/4" x 4"	1/4" x 4"	500 or 500PLUSF20	Preferred	L159
BADGK	BA	D	3/8" x 3"	3/8" x 3"	500 or 500PLUSF20	Preferred	L159

BB MOLDS

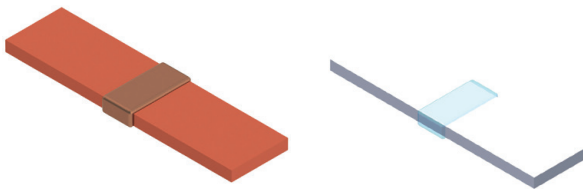

Global Part Number	Mold Family	Price Key	Busbar Size 1	Busbar Size 2	Welding Material Required	Ease of Use	Handle Clamp Required
BBCCE	BB	C	1/8" x 1"	1/8" x 1"	90 or 90PLUSF20	Easy	L160
BBCEF	BB	C	1/4" x 1 1/4"	1/4" x 1 1/4"	150 or 150PLUSF20	Easy	L160
BBCEG	BB	C	1/4" x 1 1/2"	1/4" x 1 1/2"	150 or 150PLUSF20	Easy	L160
BBDEHEH	BB	D	1/4" x 2"	1/4" x 2"	250 or 250PLUSF20	Easy	L159
BBFEK	BB	F	1/4" x 3"	1/4" x 3"	200 x 2 or 400PLUSF20	Easy	L159

BM MOLDS

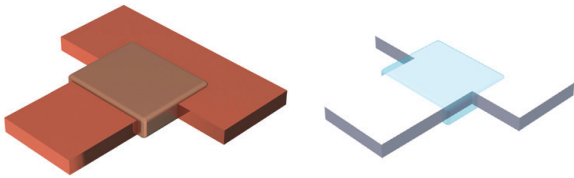

Global Part Number	Mold Family	Price Key	Busbar Size 1	Busbar Size 2	Welding Material Required	Ease of Use	Handle Clamp Required
BMCCECE	BM	C	1/8" x 1"	1/8" x 1"	90 or 90PLUSF20	Easy	L160
BMCCGCG	BM	C	1/8" x 1/2"	1/8" x 1/2"	90 or 90PLUSF20	Easy	L160
BMCEDEDE	BM	C	3/16" x 1"	3/16" x 1"	90 or 90PLUSF20	Easy	L160
BMDCHCH	BM	D	1/8" x 2"	1/8" x 2"	250 or 250PLUSF20	Easy	L159
BMDEKEK	BM	D	1/4" x 3" and wider	1/4" x 3"	200 x 2 or 400PLUSF20	Easy	L159
BMKEMEM	BM	K	1/4" x 4" and wider	1/4" x 4"	200 x 3 or 600PLUSF20	Easy	Frame Included

BQ MOLDS

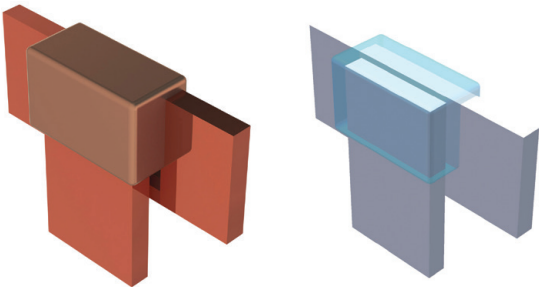

Global Part Number	Mold Family	Price Key	Busbar Size 1	Busbar Size 2	Welding Material Required	Ease of Use	Handle Clamp Required
BQDEHEH	BQ	D	1/4" x 2" and wider	1/4" x 2"	200 x 2 or 400PLUSF20	Preferred	L159
BQDEKEK	BQ	D	1/4" x 3"	1/4" x 3"	200 x 2 or 400PLUSF20	Preferred	L159

EP MOLDS

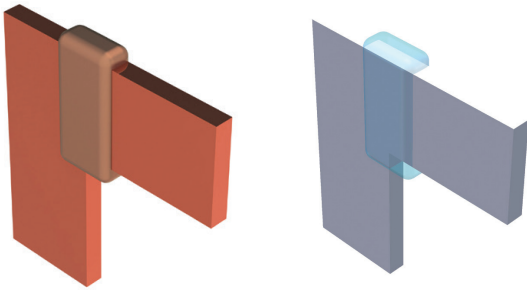

Global Part Number	Mold Family	Price Key	Busbar Size 1	Busbar Size 2	Welding Material Required	Ease of Use	Handle Clamp Required
EPCCCE	EP	C	1/8" x 1"	1/8" x 1"	45 or 45PLUSF20	Preferred	L160
EPCCCH	EP	C	1/8" x 2"	1/8" x 2" and wider	90 or 90PLUSF20	Preferred	L160
EPCCCK	EP	C	1/8" x 3"	1/8" x 3" and wider	200 or 200PLUSF20	Preferred	L160
EPCCCE	EP	C	1/4" x 1"	1/4" x 1"	90 or 90PLUSF20	Preferred	L160
EPCCCH	EP	C	1/4" x 2"	1/4" x 2" and wider	200 or 200PLUSF20	Preferred	L160
EPDCM	EP	D	1/8" x 4"	1/8" x 4" and wider	150 x 2 or 300PLUSF20	Preferred	L159
EPDEM	EP	D	1/4" x 4"	1/4" x 4" and wider	500 or 500PLUSF20	Preferred	L159
EPDGM	EP	D	3/8" x 4"	3/8" x 4" and wider	200 x 3 or 600PLUSF20	Preferred	L159

LUG TO BUSBAR OR STEEL

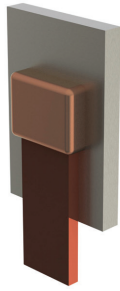

- Forms a permanent, low resistance connection
- Provides a molecular bond
- Cadweld Exothermic Connections are rated with the same current capacity as the conductor
- Portable installation equipment with no external source of power required
- Installers can be easily trained to make Cadweld Exothermic Connections
- Connections are visually inspected

BW MOLDS

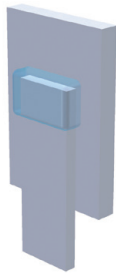
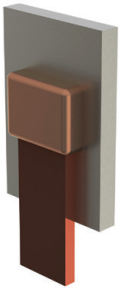

Global Part Number	Mold family	Price Key	Lug/Busbar Size	Connects To	Welding Material Required	Ease of Use	Handle Clamp Required
BWCCG	BW	C	1/8" x 1 1/2"	Steel Surface	150 or 150PLUSF20	Preferred	L160
BWCDE	BW	C	3/16" x 1"	Steel Surface	90 or 90PLUSF20	Preferred	L160
BWCDG	BW	C	3/16" x 1/2"	Steel Surface	150 or 150PLUSF20	Preferred	L160
BWCEF	BW	C	1/4" x 1 1/4"	Steel Surface	200 or 200PLUSF20	Preferred	L160
BWDJH	BW	D	1/2" x 2"	Steel Surface	500 or 500PLUSF20	Preferred	L160

CC MOLDS

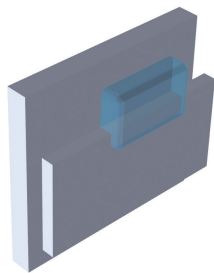
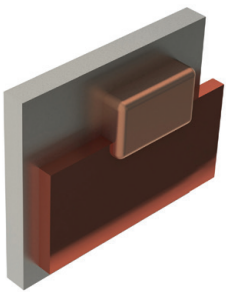

Global Part Number	Mold family	Price Key	Lug/Busbar Size	Connects To	Welding Material Required	Ease of Use	Handle Clamp Required
CCCEH	CC	C	1/4" x 2" and wider	Steel Surface	150 x 2 or 300PLUSF20	Preferred	L160

CF MOLDS

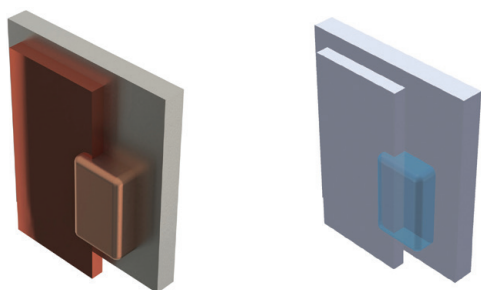

Global Part Number	Mold family	Price Key	Lug/Busbar Size	Connects To	Welding Material Required	Ease of Use	Handle Clamp Required
CFCDELH	CF	C	3/16" x 1"	Steel Surface	150 or 150PLUSF20	Easy	L160
CFDEHRH	CF	D	1/4" x 2" and wider	Steel Surface	150 x 2 or 300PLUSF20	Easy	L160

CABLE TO REBAR

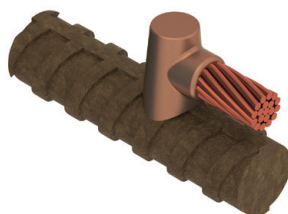

- Forms a permanent, low resistance connection
- Provides a molecular bond
- Cadweld Exothermic Connections are rated with the same current capacity as the conductor
- Portable installation equipment with no external source of power required
- Installers can be easily trained to make Cadweld Exothermic Connections
- Connections are visually inspected

RR MOLDS

Global Part Number	Mold Family	Price Key	Rebar Size, US	Conductor Size	Welding Material Required	Shim / Batching Required	Ease of Use	Handle Clamp Required	Conductor Sleeve
RRA521H	RR	A	#4	#6 Concentric	25 or 25PLUSF20	B143B	Preferred		B112
RRA521K	RR	A	#4	#4 Solid	32 or 32PLUSF20	B143B	Preferred		
RRA521L	RR	A	#4	#4 Concentric	32 or 32PLUSF20	B143B	Preferred		
RRA521T	RR	A	#4	#2 Solid	45 or 45PLUSF20	B143A	Preferred		
RRA521V	RR	A	#4	#2 Concentric	45 or 45PLUSF20	B143A	Preferred		
RRA521Y	RR	A	#4	#1 Concentric	65 or 65PLUSF20	B143A	Preferred		
RRA531D	RR	A	#5	#8 Solid	25 or 25PLUSF20	B143B	Preferred		B1331K
RRA531G	RR	A	#5	#6 Solid	25 or 25PLUSF20	B143B	Preferred		B1331L
RRA531H	RR	A	#5	#6 Concentric	25 or 25PLUSF20	B143B	Preferred		B112
RRA531K	RR	A	#5	#4 Solid	32 or 32PLUSF20	B143B	Preferred		
RRA531L	RR	A	#5	#4 Concentric	32 or 32PLUSF20	B143B	Preferred		
RRA531T	RR	A	#5	#2 Solid	45 or 45PLUSF20	B143A	Preferred		
RRA531V	RR	A	#5	#2 Concentric	45 or 45PLUSF20	B143A	Preferred		
RRA531Y	RR	A	#5	#1 Concentric	65 or 65PLUSF20	B143A	Preferred		
RRA541G	RR	A	#6	#6 Solid	25 or 25PLUSF20	B143B	Preferred		B1331L
RRA541H	RR	A	#6	#6 Concentric	25 or 25PLUSF20	B143B	Preferred		B112
RRA541L	RR	A	#6	#4 Concentric	32 or 32PLUSF20	B143B	Preferred		
RRA541T	RR	A	#6	#2 Solid	45 or 45PLUSF20	B143B	Preferred		

Global Part Number	Mold Family	Price Key	Rebar Size, US	Conductor Size	Welding Material Required	Shim / Batching Required	Ease of Use	Handle Clamp Required	Conductor Sleeve
RRA541V	RR	A	#6	#2 Concentric	45 or 45PLUSF20	B143B	Preferred		
RRA541Y	RR	A	#6	#1 Concentric	65 or 65PLUSF20	B143B	Preferred		
RRA551L	RR	A	#7	#4 Concentric	32 or 32PLUSF20	B143B	Preferred		
RRA551T	RR	A	#7	#2 Solid	45 or 45PLUSF20	B143B	Preferred		
RRA551V	RR	A	#7	#2 Concentric	45 or 45PLUSF20	B143B	Preferred		
RRA561L	RR	A	#8	#4 Concentric	32 or 32PLUSF20	B143B	Preferred		
RRA561T	RR	A	#8	#2 Solid	45 or 45PLUSF20	B143B	Preferred		
RRA561V	RR	A	#8	#2 Concentric	45 or 45PLUSF20	B143B	Preferred		
RRA561Y	RR	A	#8	#1 Concentric	65 or 65PLUSF20	B143B	Preferred		
RRA571T	RR	A	#9	#2 Solid	45 or 45PLUSF20	B143B	Preferred		
RRA571V	RR	A	#9	#2 Concentric	45 or 45PLUSF20	B143B	Preferred		
RRH562C	RR	H	#8	1/0 Concentric	90 or 90PLUSF20	B144C	Preferred		
RRH562G	RR	H	#8	2/0 Concentric	90 or 90PLUSF20	B144C	Preferred		
RRH562L	RR	H	#8	3/0 Concentric	115 or 115PLUSF20	B144C	Preferred		
RRH562Q	RR	H	#8	4/0 Concentric	115 or 115PLUSF20	B144C	Preferred		
RRH562V	RR	H	#8	250 kcmil Concentric	150 or 150PLUSF20	B144C	Preferred		
RRH572C	RR	H	#9	1/0 Concentric	90 or 90PLUSF20	B144C	Preferred		
RRH572G	RR	H	#9	2/0 Concentric	90 or 90PLUSF20	B144C	Preferred		
RRH572L	RR	H	#9	3/0 Concentric	115 or 115PLUSF20	B144C	Preferred		
RRH572Q	RR	H	#9	4/0 Concentric	115 or 115PLUSF20	B144C	Preferred		
RRH572V	RR	H	#9	250 kcmil Concentric	150 or 150PLUSF20	B144C	Preferred		
RRH582C	RR	H	#10	1/0 Concentric	90 or 90PLUSF20	B144C	Preferred		
RRH582G	RR	H	#10	2/0 Concentric	90 or 90PLUSF20	B144C	Preferred		
RRH582L	RR	H	#10	3/0 Concentric	115 or 115PLUSF20	B144C	Preferred		
RRH582Q	RR	H	#10	4/0 Concentric	115 or 115PLUSF20	B144C	Preferred		
RRH582V	RR	H	#10	250 kcmil Concentric	150 or 150PLUSF20	B144C	Preferred		
RRH592C	RR	H	#11	1/0 Concentric	90 or 90PLUSF20	B144C	Preferred		
RRH592G	RR	H	#11	2/0 Concentric	90 or 90PLUSF20	B144C	Preferred		
RRH592L	RR	H	#11	3/0 Concentric	115 or 115PLUSF20	B144C	Preferred		
RRH592Q	RR	H	#11	4/0 Concentric	115 or 115PLUSF20	B144C	Preferred		
RRH592V	RR	H	#11	250 kcmil Concentric	150 or 150PLUSF20	B144C	Preferred		
RRA581H	RR	A	#10	#6 Concentric	25 or 25PLUSF20	B143B	Preferred		B112
RRA581T	RR	A	#10	#2 Solid	45 or 45PLUSF20	B143B	Preferred		
RRA581V	RR	A	#10	#2 Concentric	45 or 45PLUSF20	B143B	Preferred		
RRA591H	RR	A	#11	#6 Concentric	25 or 25PLUSF20	B143B	Preferred		B112
RRA591L	RR	A	#11	#4 Concentric	32 or 32PLUSF20	B143B	Preferred		
RRA591T	RR	A	#11	#2 Solid	45 or 45PLUSF20	B143B	Preferred		
RRA591V	RR	A	#11	#2 Concentric	45 or 45PLUSF20	B143B	Preferred		
RRC511H	RR	C	#3	#6 Concentric	25 or 25PLUSF20		Preferred	L160	
RRC511L	RR	C	#3	#4 Concentric	32 or 32PLUSF20		Preferred	L160	
RRC511T	RR	C	#3	#2 Solid	45 or 45PLUSF20		Preferred	L160	
RRC511V	RR	C	#3	#2 Concentric	45 or 45PLUSF20		Preferred	L160	
RRC512C	RR	C	#3	1/0 Concentric	90 or 90PLUSF20		Preferred	L160	
RRC512G	RR	C	#3	2/0 Concentric	90 or 90PLUSF20		Preferred	L160	
RRC512L	RR	C	#3	3/0 Concentric	115 or 115PLUSF20		Preferred	L160	
RRC512Q	RR	C	#3	4/0 Concentric	115 or 115PLUSF20		Preferred	L160	

Global Part Number	Mold Family	Price Key	Rebar Size, US	Conductor Size	Welding Material Required	Shim / Batching Required	Ease of Use	Handle Clamp Required	Conductor Sleeve
RRC512V	RR	C	#3	250 kcmil Concentric	150 or 150PLUSF20		Preferred	L160	
RRC522C	RR	C	#4	1/0 Concentric	90 or 90PLUSF20	B141A	Preferred	L160	
RRC522G	RR	C	#4	2/0 Concentric	90 or 90PLUSF20	B141A	Preferred	L160	
RRC522L	RR	C	#4	3/0 Concentric	115 or 115PLUSF20	B141A	Preferred	L160	
RRC522Q	RR	C	#4	4/0 Concentric	115 or 115PLUSF20	B141A	Preferred	L160	
RRC522V	RR	C	#4	250 kcmil Concentric	150 or 150PLUSF20	B141A	Preferred	L160	
RRC532C	RR	C	#5	1/0 Concentric	90 or 90PLUSF20	B141A	Preferred	L160	
RRC532G	RR	C	#5	2/0 Concentric	90 or 90PLUSF20	B141A	Preferred	L160	
RRC532L	RR	C	#5	3/0 Concentric	115 or 115PLUSF20	B141A	Preferred	L160	
RRC532Q	RR	C	#5	4/0 Concentric	115 or 115PLUSF20	B141A	Preferred	L160	
RRC532V	RR	C	#5	250 kcmil Concentric	150 or 150PLUSF20	B141A	Preferred	L160	
RRH542G	RR	H	#6	2/0 Concentric	90 or 90PLUSF20	B144C	Preferred		
RRH542L	RR	H	#6	3/0 Concentric	115 or 115PLUSF20	B144C	Preferred		
RRH542Q	RR	H	#6	4/0 Concentric	115 or 115PLUSF20	B144C	Preferred		
RRH542V	RR	H	#6	250 kcmil Concentric	150 or 150PLUSF20	B144C	Preferred		
RRH552C	RR	H	#7	1/0 Concentric	90 or 90PLUSF20	B144C	Preferred		
RRH552G	RR	H	#7	2/0 Concentric	90 or 90PLUSF20	B144C	Preferred		
RRH552L	RR	H	#7	3/0 Concentric	115 or 115PLUSF20	B144C	Preferred		
RRH552Q	RR	H	#7	4/0 Concentric	115 or 115PLUSF20	B144C	Preferred		
RRH552V	RR	H	#7	250 kcmil Concentric	150 or 150PLUSF20	B144C	Preferred		
RRH602L	RR	H	#14	3/0 Concentric	115 or 115PLUSF20	B144C	Preferred		
RRH602Q	RR	H	#14	4/0 Concentric	115 or 115PLUSF20	B144C	Preferred		
RRH612C	RR	H	#18	1/0 Concentric	90 or 90PLUSF20	B144C	Preferred		
RRH612L	RR	H	#18	3/0 Concentric	115 or 115PLUSF20	B144C	Preferred		
RRH612Q	RR	H	#18	4/0 Concentric	115 or 115PLUSF20	B144C	Preferred		

RD MOLDS



Global Part Number	Mold Family	Price Key	Rebar Size, US	Conductor Size	Welding Material Required	Shim / Batching Required	Ease of Use	Handle Clamp Required	Conductor Sleeve
RDC511G	RD	C	#3	#6 Solid	65 or 65PLUSF20	B141A	Preferred	L160	B1331L
RDC511H	RD	C	#3	#6 Concentric	65 or 65PLUSF20	B141A	Preferred	L160	B112
RDC511K	RD	C	#3	#4 Solid	65 or 65PLUSF20	B141A	Preferred	L160	
RDC511L	RD	C	#3	#4 Concentric	65 or 65PLUSF20	B141A	Preferred	L160	
RDC511T	RD	C	#3	#2 Solid	65 or 65PLUSF20	B141A	Preferred	L160	
RDC521G	RD	C	#4	#6 Solid	65 or 65PLUSF20	B141A	Preferred	L160	B1331L
RDC521H	RD	C	#4	#6 Concentric	65 or 65PLUSF20	B141A	Preferred	L160	B112
RDC521K	RD	C	#4	#4 Solid	65 or 65PLUSF20	B141A	Preferred	L160	
RDC521L	RD	C	#4	#4 Concentric	65 or 65PLUSF20	B141A	Preferred	L160	
RDC521T	RD	C	#4	#2 Solid	65 or 65PLUSF20	B141A	Preferred	L160	
RDC521V	RD	C	#4	#2 Concentric	90 or 90PLUSF20	B141A	Preferred	L160	
RDC531G	RD	C	#5	#6 Solid	65 or 65PLUSF20	B141A	Preferred	L160	B1331L

Global Part Number	Mold Family	Price Key	Rebar Size, US	Conductor Size	Welding Material Required	Shim / Barring Required	Ease of Use	Handle Clamp Required	Conductor Sleeve
RDC531H	RD	C	#5	#6 Concentric	65 or 65PLUSF20	B141A	Preferred	L160	B112
RDC531K	RD	C	#5	#4 Solid	65 or 65PLUSF20	B141A	Preferred	L160	
RDC531L	RD	C	#5	#4 Concentric	65 or 65PLUSF20	B141A	Preferred	L160	
RDC531T	RD	C	#5	#2 Solid	90 or 90PLUSF20	B141A	Preferred	L160	
RDC531V	RD	C	#5	#2 Concentric	90 or 90PLUSF20	B141A	Preferred	L160	
RDH541H	RD	H	#6	#6 Concentric	65 or 65PLUSF20	B144C	Preferred		B112
RDH541L	RD	H	#6	#4 Concentric	65 or 65PLUSF20	B144C	Preferred		
RDH541T	RD	H	#6	#2 Solid	90 or 90PLUSF20	B144C	Preferred		
RDH541V	RD	H	#6	#2 Concentric	90 or 90PLUSF20	B144C	Preferred		
RDH542C	RD	H	#6	1/0 Concentric	115 or 115PLUSF20	B144C	Preferred		
RDH542G	RD	H	#6	2/0 Concentric	115 or 115PLUSF20	B144C	Preferred		
RDH542Q	RD	H	#6	4/0 Concentric	150 or 150PLUSF20	B144C	Preferred		
RDH542V	RD	H	#6	250 kcmil Concentric	150 or 150PLUSF20	B144C	Preferred		
RDH551G	RD	H	#7	#6 Solid	65 or 65PLUSF20	B144C	Preferred		B1331L
RDH551H	RD	H	#7	#6 Concentric	65 or 65PLUSF20	B144C	Preferred		B112
RDH551L	RD	H	#7	#4 Concentric	65 or 65PLUSF20	B144C	Preferred		
RDH551T	RD	H	#7	#2 Solid	90 or 90PLUSF20	B144C	Preferred		
RDH551V	RD	H	#7	#2 Concentric	90 or 90PLUSF20	B144C	Preferred		
RDH552C	RD	H	#7	1/0 Concentric	115 or 115PLUSF20	B144C	Preferred		
RDH552G	RD	H	#7	2/0 Concentric	115 or 115PLUSF20	B144C	Preferred		
RDH552Q	RD	H	#7	4/0 Concentric	150 or 150PLUSF20	B144C	Preferred		
RDH552V	RD	H	#7	250 kcmil Concentric	150 or 150PLUSF20	B144C	Preferred		
RDH561L	RD	H	#8	#4 Concentric	65 or 65PLUSF20	B144C	Preferred		
RDH561T	RD	H	#8	#2 Solid	90 or 90PLUSF20	B144C	Preferred		
RDH561V	RD	H	#8	#2 Concentric	90 or 90PLUSF20	B144C	Preferred		
RDH561Y	RD	H	#8	#1 Concentric	90 or 90PLUSF20	B144C	Preferred		
RDH562C	RD	H	#8	1/0 Concentric	115 or 115PLUSF20	B144C	Preferred		
RDH562G	RD	H	#8	2/0 Concentric	115 or 115PLUSF20	B144C	Preferred		
RDH562Q	RD	H	#8	4/0 Concentric	150 or 150PLUSF20	B144C	Preferred		
RDH562V	RD	H	#8	250 kcmil Concentric	150 or 150PLUSF20	B144C	Preferred		
RDH571T	RD	H	#9	#2 Solid	90 or 90PLUSF20	B144C	Preferred		
RDH571V	RD	H	#9	#2 Concentric	90 or 90PLUSF20	B144C	Preferred		
RDH572C	RD	H	#9	1/0 Concentric	115 or 115PLUSF20	B144C	Preferred		
RDH572G	RD	H	#9	2/0 Concentric	115 or 115PLUSF20	B144C	Preferred		
RDH572Q	RD	H	#9	4/0 Concentric	150 or 150PLUSF20	B144C	Preferred		
RDH572V	RD	H	#9	250 kcmil Concentric	150 or 150PLUSF20	B144C	Preferred		
RDH581T	RD	H	#10	#2 Solid	90 or 90PLUSF20	B144C	Preferred		
RDH581V	RD	H	#10	#2 Concentric	90 or 90PLUSF20	B144C	Preferred		
RDH582C	RD	H	#10	1/0 Concentric	115 or 115PLUSF20	B144C	Preferred		
RDH582G	RD	H	#10	2/0 Concentric	115 or 115PLUSF20	B144C	Preferred		
RDH582Q	RD	H	#10	4/0 Concentric	150 or 150PLUSF20	B144C	Preferred		
RDH582V	RD	H	#10	250 kcmil Concentric	150 or 150PLUSF20	B144C	Preferred		
RDH591V	RD	H	#11	#2 Concentric	90 or 90PLUSF20	B144C	Preferred		
RDH591Y	RD	H	#11	#1 Concentric	90 or 90PLUSF20	B144C	Preferred		

Global Part Number	Mold Family	Price Key	Rebar Size, US	Conductor Size	Welding Material Required	Shim / Barring Required	Ease of Use	Handle Clamp Required	Conductor Sleeve
RDH592C	RD	H	#11	1/0 Concentric	115 or 115PLUSF20	B144C	Preferred		
RDH592G	RD	H	#11	2/0 Concentric	115 or 115PLUSF20	B144C	Preferred		
RDH592Q	RD	H	#11	4/0 Concentric	150 or 150PLUSF20	B144C	Preferred		
RDH592V	RD	H	#11	250 kcmil Concentric	150 or 150PLUSF20	B144C	Preferred		
RDH602G	RD	H	#14	2/0 Concentric	115 or 115PLUSF20	B144C	Preferred		
RDH602Q	RD	H	#14	4/0 Concentric	150 or 150PLUSF20	B144C	Preferred		
RDH612G	RD	H	#18	2/0 Concentric	115 or 115PLUSF20	B144C	Preferred		
RDH612Q	RD	H	#18	4/0 Concentric	150 or 150PLUSF20	B144C	Preferred		
RDM512G	RD	M	#3	2/0 Concentric	115 or 115PLUSF20	B141A	Preferred		
RDM512Q	RD	M	#3	4/0 Concentric	150 or 150PLUSF20	B141A	Preferred		
RDM522C	RD	M	#4	1/0 Concentric	115 or 115PLUSF20	B141A	Preferred		
RDM522G	RD	M	#4	2/0 Concentric	115 or 115PLUSF20	B141A	Preferred		
RDM522Q	RD	M	#4	4/0 Concentric	150 or 150PLUSF20	B141A	Preferred		
RDM522V	RD	M	#4	250 kcmil Concentric	150 or 150PLUSF20	B141A	Preferred		
RDM532C	RD	M	#5	1/0 Concentric	115 or 115PLUSF20	B141A	Preferred		
RDM532G	RD	M	#5	2/0 Concentric	115 or 115PLUSF20	B141A	Preferred		
RDM532Q	RD	M	#5	4/0 Concentric	150 or 150PLUSF20	B141A	Preferred		
RDM532V	RD	M	#5	250 kcmil Concentric	150 or 150PLUSF20	B141A	Preferred		

RC MOLDS

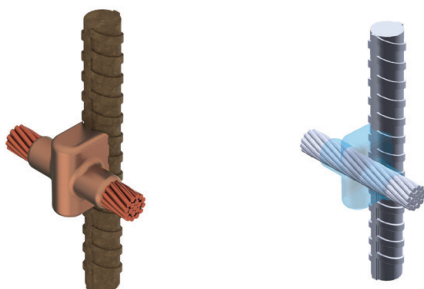

Global Part Number	Mold Family	Price Key	Rebar Size, US	Conductor Size	Welding Material Required	Shim / Barring Required	Ease of Use	Handle Clamp Required	Conductor Sleeve
RCE511H	RC	E	#3	#6 Concentric	90 or 90PLUSF20	B140A	Preferred	L160	B112
RCE511L	RC	E	#3	#4 Concentric	90 or 90PLUSF20	B140A	Preferred	L160	
RCE511T	RC	E	#3	#2 Solid	90 or 90PLUSF20	B140A	Preferred	L160	
RCE511V	RC	E	#3	#2 Concentric	90 or 90PLUSF20	B140A	Preferred	L160	
RCE512C	RC	E	#3	1/0 Concentric	115 or 115PLUSF20	B140A	Preferred	L160	
RCE512G	RC	E	#3	2/0 Concentric	115 or 115PLUSF20	B140A	Preferred	L160	
RCE512Q	RC	E	#3	4/0 Concentric	150 or 150PLUSF20	B140A	Preferred	L160	
RCE521G	RC	E	#4	#6 Solid	90 or 90PLUSF20	B140A	Preferred	L160	B1331L
RCE521H	RC	E	#4	#6 Concentric	90 or 90PLUSF20	B140A	Preferred	L160	B112
RCE521L	RC	E	#4	#4 Concentric	90 or 90PLUSF20	B140A	Preferred	L160	
RCE521T	RC	E	#4	#2 Solid	90 or 90PLUSF20	B140A	Preferred	L160	
RCE521V	RC	E	#4	#2 Concentric	90 or 90PLUSF20	B140A	Preferred	L160	
RCE521Y	RC	E	#4	#1 Concentric	115 or 115PLUSF20	B140A	Preferred	L160	
RCE522C	RC	E	#4	1/0 Concentric	115 or 115PLUSF20	B140A	Preferred	L160	

Global Part Number	Mold Family	Price Key	Rebar Size, US	Conductor Size	Welding Material Required	Shim / Batting Required	Ease of Use	Handle Clamp Required	Conductor Sleeve
RCE522G	RC	E	#4	2/0 Concentric	115 or 115PLUSF20	B140A	Preferred	L160	
RCE522Q	RC	E	#4	4/0 Concentric	150 or 150PLUSF20	B140A	Preferred	L160	
RCE522V	RC	E	#4	250 kcmil Concentric	150 or 150PLUSF20	B140A	Preferred	L160	
RCE531G	RC	E	#5	#6 Solid	90 or 90PLUSF20	B140A	Preferred	L160	B1331L
RCE531H	RC	E	#5	#6 Concentric	90 or 90PLUSF20	B140A	Preferred	L160	B112
RCE531L	RC	E	#5	#4 Concentric	90 or 90PLUSF20	B140A	Preferred	L160	
RCE531T	RC	E	#5	#2 Solid	90 or 90PLUSF20	B140A	Preferred	L160	
RCE531V	RC	E	#5	#2 Concentric	90 or 90PLUSF20	B140A	Preferred	L160	
RCE532C	RC	E	#5	1/0 Concentric	115 or 115PLUSF20	B140A	Preferred	L160	
RCE532G	RC	E	#5	2/0 Concentric	115 or 115PLUSF20	B140A	Preferred	L160	
RCE532Q	RC	E	#5	4/0 Concentric	150 or 150PLUSF20	B140A	Preferred	L160	
RCE532V	RC	E	#5	250 kcmil Concentric	150 or 150PLUSF20	B140A	Preferred	L160	
RCE541H	RC	E	#6	#6 Concentric	90 or 90PLUSF20	B144B	Preferred	L160	B112
RCE541L	RC	E	#6	#4 Concentric	90 or 90PLUSF20	B144B	Preferred	L160	
RCE541T	RC	E	#6	#2 Solid	90 or 90PLUSF20	B144B	Preferred	L160	
RCE541V	RC	E	#6	#2 Concentric	90 or 90PLUSF20	B144B	Preferred	L160	
RCE542C	RC	E	#6	1/0 Concentric	115 or 115PLUSF20	B144B	Preferred	L160	
RCE542G	RC	E	#6	2/0 Concentric	115 or 115PLUSF20	B144B	Preferred	L160	
RCE542Q	RC	E	#6	4/0 Concentric	150 or 150PLUSF20	B144B	Preferred	L160	
RCE551H	RC	E	#7	#6 Concentric	90 or 90PLUSF20	B144B	Preferred	L160	B112
RCE551L	RC	E	#7	#4 Concentric	90 or 90PLUSF20	B144B	Preferred	L160	
RCE551T	RC	E	#7	#2 Solid	90 or 90PLUSF20	B144B	Preferred	L160	
RCE551V	RC	E	#7	#2 Concentric	90 or 90PLUSF20	B144B	Preferred	L160	
RCE552C	RC	E	#7	1/0 Concentric	115 or 115PLUSF20	B144B	Preferred	L160	
RCE552G	RC	E	#7	2/0 Concentric	115 or 115PLUSF20	B144B	Preferred	L160	
RCE552Q	RC	E	#7	4/0 Concentric	150 or 150PLUSF20	B144B	Preferred	L160	
RCE561H	RC	E	#8	#6 Concentric	90 or 90PLUSF20	B144B	Preferred	L160	B112
RCE561K	RC	E	#8	#4 Solid	90 or 90PLUSF20	B144B	Preferred	L160	
RCE561T	RC	E	#8	#2 Solid	90 or 90PLUSF20	B144B	Preferred	L160	
RCE561V	RC	E	#8	#2 Concentric	90 or 90PLUSF20	B144B	Preferred	L160	
RCE562C	RC	E	#8	1/0 Concentric	115 or 115PLUSF20	B144B	Preferred	L160	
RCE562G	RC	E	#8	2/0 Concentric	115 or 115PLUSF20	B144B	Preferred	L160	
RCE562Q	RC	E	#8	4/0 Concentric	150 or 150PLUSF20	B144B	Preferred	L160	
RCE571T	RC	E	#9	#2 Solid	90 or 90PLUSF20	B144B	Preferred	L160	
RCE571V	RC	E	#9	#2 Concentric	90 or 90PLUSF20	B144B	Preferred	L160	
RCE572C	RC	E	#9	1/0 Concentric	115 or 115PLUSF20	B144B	Preferred	L160	
RCE572G	RC	E	#9	2/0 Concentric	115 or 115PLUSF20	B144B	Preferred	L160	
RCE572Q	RC	E	#9	4/0 Concentric	150 or 150PLUSF20	B144B	Preferred	L160	
RCE581V	RC	E	#10	#2 Concentric	90 or 90PLUSF20	B144B	Preferred	L160	
RCE582C	RC	E	#10	1/0 Concentric	115 or 115PLUSF20	B144B	Preferred	L160	
RCE582G	RC	E	#10	2/0 Concentric	115 or 115PLUSF20	B144B	Preferred	L160	
RCE582Q	RC	E	#10	4/0 Concentric	150 or 150PLUSF20	B144B	Preferred	L160	
RCE591G	RC	E	#11	#6 Solid	90 or 90PLUSF20	B144B	Preferred	L160	B1331L
RCE591V	RC	E	#11	#2 Concentric	90 or 90PLUSF20	B144B	Preferred	L160	
RCE591Y	RC	E	#11	#1 Concentric	115 or 115PLUSF20	B144B	Preferred	L160	
RCE592C	RC	E	#11	1/0 Concentric	115 or 115PLUSF20	B144B	Preferred	L160	

Global Part Number	Mold Family	Price Key	Rebar Size, US	Conductor Size	Welding Material Required	Shim / Batching Required	Ease of Use	Handle Clamp Required	Conductor Sleeve
RCE592G	RC	E	#11	2/0 Concentric	115 or 115PLUSF20	B144B	Preferred	L160	
RCE592Q	RC	E	#11	4/0 Concentric	150 or 150PLUSF20	B144B	Preferred	L160	
RCE602G	RC	E	#14	2/0 Concentric	115 or 115PLUSF20	B144B	Preferred	L160	
RCE602Q	RC	E	#14	4/0 Concentric	150 or 150PLUSF20	B144B	Preferred	L160	
RCE612G	RC	E	#18	2/0 Concentric	115 or 115PLUSF20	B144B	Preferred	L160	

RH MOLDS

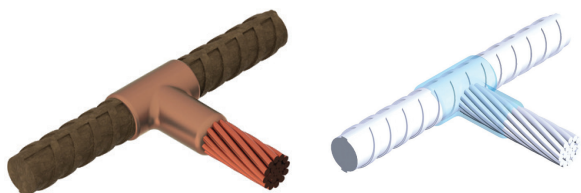

Global Part Number	Mold Family	Price Key	Rebar Size, US	Conductor Size	Welding Material Required	Shim / Batching Required	Ease of Use	Handle Clamp Required	Conductor Sleeve
RHC512C	RH	C	#3	1/0 Concentric	90 or 90PLUSF20	B141A	Preferred	L160	
RHC512Q	RH	C	#3	4/0 Concentric	115 or 115PLUSF20	B141A	Preferred	L160	
RHC521H	RH	C	#4	#6 Concentric	65 or 65PLUSF20	B141A	Preferred	L160	B112
RHC521L	RH	C	#4	#4 Concentric	65 or 65PLUSF20	B141A	Preferred	L160	
RHC521V	RH	C	#4	#2 Concentric	65 or 65PLUSF20	B141A	Preferred	L160	
RHC522C	RH	C	#4	1/0 Concentric	90 or 90PLUSF20	B141A	Preferred	L160	
RHC522G	RH	C	#4	2/0 Concentric	90 or 90PLUSF20	B141A	Preferred	L160	
RHC522Q	RH	C	#4	4/0 Concentric	115 or 115PLUSF20	B141A	Preferred	L160	
RHC531H	RH	C	#5	#6 Concentric	90 or 90PLUSF20	B141A	Preferred	L160	B112
RHC531L	RH	C	#5	#4 Concentric	90 or 90PLUSF20	B141A	Preferred	L160	
RHC531T	RH	C	#5	#2 Solid	90 or 90PLUSF20	B141A	Preferred	L160	
RHC531V	RH	C	#5	#2 Concentric	90 or 90PLUSF20	B141A	Preferred	L160	
RHC532C	RH	C	#5	1/0 Concentric	115 or 115PLUSF20	B141A	Preferred	L160	
RHC532G	RH	C	#5	2/0 Concentric	115 or 115PLUSF20	B141A	Preferred	L160	
RHC532Q	RH	C	#5	4/0 Concentric	150 or 150PLUSF20	B141A	Preferred	L160	
RHC541L	RH	C	#6	#4 Concentric	90 or 90PLUSF20	B141A	Preferred	L160	
RHC541V	RH	C	#6	#2 Concentric	90 or 90PLUSF20	B141A	Preferred	L160	
RHC542C	RH	C	#6	1/0 Concentric	115 or 115PLUSF20	B141A	Preferred	L160	
RHC542G	RH	C	#6	2/0 Concentric	115 or 115PLUSF20	B141A	Preferred	L160	
RHC542Q	RH	C	#6	4/0 Concentric	150 or 150PLUSF20	B141A	Preferred	L160	

RJ MOLDS

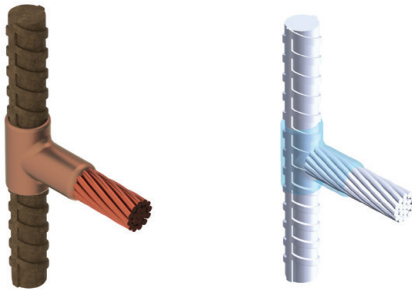

Global Part Number	Mold Family	Price Key	Rebar Size, US	Conductor Size	Welding Material Required	Shim / Batting Required	Ease of Use	Handle Clamp Required	Conductor Sleeve
RJC522C	RJ	C	#4	1/0 Concentric	115 or 115PLUSF20	B140A	Preferred	L160	
RJC522G	RJ	C	#4	2/0 Concentric	115 or 115PLUSF20	B140A	Preferred	L160	
RJC522Q	RJ	C	#4	4/0 Concentric	150 or 150PLUSF20	B140A	Preferred	L160	
RJC522V	RJ	C	#4	250 kcmil Concentric	150 or 150PLUSF20	B140A	Preferred	L160	
RJC531H	RJ	C	#5	#6 Concentric	45 or 45PLUSF20	B140A	Preferred	L160	B112
RJC531K	RJ	C	#5	#4 Solid	65 or 65PLUSF20	B140A	Preferred	L160	
RJC531L	RJ	C	#5	#4 Concentric	65 or 65PLUSF20	B140A	Preferred	L160	
RJC531T	RJ	C	#5	#2 Solid	65 or 65PLUSF20	B140A	Preferred	L160	
RJC531V	RJ	C	#5	#2 Concentric	65 or 65PLUSF20	B140A	Preferred	L160	
RJC531Y	RJ	C	#5	#1 Concentric	90 or 90PLUSF20	B140A	Preferred	L160	
RJC532C	RJ	C	#5	1/0 Concentric	115 or 115PLUSF20	B140A	Preferred	L160	
RJC532G	RJ	C	#5	2/0 Concentric	115 or 115PLUSF20	B140A	Preferred	L160	
RJC532Q	RJ	C	#5	4/0 Concentric	150 or 150PLUSF20	B140A	Preferred	L160	
RJC532V	RJ	C	#5	250 kcmil Concentric	150 or 150PLUSF20	B140A	Preferred	L160	
RJC541H	RJ	C	#6	#6 Concentric	45 or 45PLUSF20	B140A	Preferred	L160	B112
RJC541L	RJ	C	#6	#4 Concentric	65 or 65PLUSF20	B140A	Preferred	L160	
RJC541T	RJ	C	#6	#2 Solid	65 or 65PLUSF20	B140A	Preferred	L160	
RJC541V	RJ	C	#6	#2 Concentric	65 or 65PLUSF20	B140A	Preferred	L160	
RJC542C	RJ	C	#6	1/0 Concentric	115 or 115PLUSF20	B140A	Preferred	L160	
RJC542G	RJ	C	#6	2/0 Concentric	115 or 115PLUSF20	B140A	Preferred	L160	
RJC542Q	RJ	C	#6	4/0 Concentric	150 or 150PLUSF20	B140A	Preferred	L160	
RJC542V	RJ	C	#6	250 kcmil Concentric	150 or 150PLUSF20	B140A	Preferred	L160	
RJE551L	RJ	E	#7	#4 Concentric	65 or 65PLUSF20	B144A	Preferred	L160	
RJE551T	RJ	E	#7	#2 Solid	65 or 65PLUSF20	B144A	Preferred	L160	
RJE551V	RJ	E	#7	#2 Concentric	65 or 65PLUSF20	B144A	Preferred	L160	
RJE552C	RJ	E	#7	1/0 Concentric	115 or 115PLUSF20	B144B	Preferred	L160	
RJE552G	RJ	E	#7	2/0 Concentric	115 or 115PLUSF20	B144B	Preferred	L160	
RJE552Q	RJ	E	#7	4/0 Concentric	150 or 150PLUSF20	B144B	Preferred	L160	
RJE561L	RJ	E	#8	#4 Concentric	65 or 65PLUSF20	B144A	Preferred	L160	
RJE561T	RJ	E	#8	#2 Solid	65 or 65PLUSF20	B144A	Preferred	L160	
RJE561V	RJ	E	#8	#2 Concentric	65 or 65PLUSF20	B144A	Preferred	L160	
RJE562C	RJ	E	#8	1/0 Concentric	115 or 115PLUSF20	B144B	Preferred	L160	
RJE562Q	RJ	E	#8	4/0 Concentric	150 or 150PLUSF20	B144B	Preferred	L160	
RJE562V	RJ	E	#8	250 kcmil Concentric	150 or 150PLUSF20	B144B	Preferred	L160	
RJE571L	RJ	E	#9	#4 Concentric	65 or 65PLUSF20	B144A	Preferred	L160	

Global Part Number	Mold Family	Price Key	Rebar Size, US	Conductor Size	Welding Material Required	Shim / Batting Required	Ease of Use	Handle Clamp Required	Conductor Sleeve
RJE571T	RJ	E	#9	#2 Solid	65 or 65PLUSF20	B144A	Preferred	L160	
RJE571V	RJ	E	#9	#2 Concentric	65 or 65PLUSF20	B144A	Preferred	L160	
RJE572C	RJ	E	#9	1/0 Concentric	115 or 115PLUSF20	B144B	Preferred	L160	
RJE572G	RJ	E	#9	2/0 Concentric	115 or 115PLUSF20	B144B	Preferred	L160	
RJE572Q	RJ	E	#9	4/0 Concentric	150 or 150PLUSF20	B144B	Preferred	L160	
RJE572V	RJ	E	#9	250 kcmil Concentric	150 or 150PLUSF20	B144B	Preferred	L160	
RJE581T	RJ	E	#10	#2 Solid	65 or 65PLUSF20	B144A	Preferred	L160	
RJE581V	RJ	E	#10	#2 Concentric	65 or 65PLUSF20	B144A	Preferred	L160	
RJE582C	RJ	E	#10	1/0 Concentric	115 or 115PLUSF20	B144B	Preferred	L160	
RJE582G	RJ	E	#10	2/0 Concentric	115 or 115PLUSF20	B144B	Preferred	L160	
RJE582Q	RJ	E	#10	4/0 Concentric	150 or 150PLUSF20	B144B	Preferred	L160	
RJE582V	RJ	E	#10	250 kcmil Concentric	150 or 150PLUSF20	B144B	Preferred	L160	
RJE591V	RJ	E	#11	#2 Concentric	65 or 65PLUSF20	B144A	Preferred	L160	
RJE592C	RJ	E	#11	1/0 Concentric	115 or 115PLUSF20	B144B	Preferred	L160	
RJE592G	RJ	E	#11	2/0 Concentric	115 or 115PLUSF20	B144B	Preferred	L160	
RJE592Q	RJ	E	#11	4/0 Concentric	150 or 150PLUSF20	B144B	Preferred	L160	
RJE592V	RJ	E	#11	250 kcmil Concentric	150 or 150PLUSF20	B144B	Preferred	L160	
RJE602C	RJ	E	#14	1/0 Concentric	115 or 115PLUSF20	B144B	Preferred	L160	

CABLE TO GROUND RECEPTACLE OR GROUND PLATE



- Forms a permanent, low resistance connection
- Provides a molecular bond
- Cadweld Exothermic Connections are rated with the same current capacity as the conductor
- Portable installation equipment with no external source of power required
- Installers can be easily trained to make Cadweld Exothermic Connections
- Connections are visually inspected

RA MOLDS

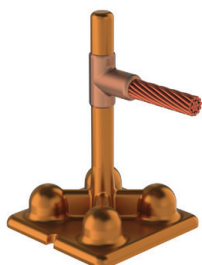

Global Part Number	Mold Family	Price Key	Conductor Size	Ground Receptacle	Welding Material Required	Ease of Use	Handle Clamp
RAC2C	RA	C	1/0 Concentric	B165 Grounding Receptacle	150 or 150PLUSF20	Preferred	L160
RAC2G	RA	C	2/0 Concentric	B165 Grounding Receptacle	150 or 150PLUSF20	Preferred	L160
RAC2Q	RA	C	4/0 Concentric	B165 Grounding Receptacle	150 or 150PLUSF20	Preferred	L160

RB MOLDS



Global Part Number	Mold Family	Price Key	Conductor Size	Ground Receptacle	Welding Material Required	Ease of Use	Handle Clamp
RBC2G	RB	C	2/0 Concentric	B165 Grounding Receptacle	150 or 150PLUSF20	Preferred	L160
RBC2Q	RB	C	4/0 Concentric	B165 Grounding Receptacle	200 or 200PLUSF20	Preferred	L160

GB/GR MOLDS



Global Part Number	Mold Family	Price Key	Conductor Size	Ground Plate/ Grounding Receptacle	Ground Rod Diameter, Nominal	Ground Rod Diameter, Actual	Ground Rod Type	Welding Material Required	Ease of Use	Handle Clamp
GBJGR 162CR2	GB/GR	J	1/0 Concentric	B166 Grounding Receptacle	5/8"	0.563"	Copper-bonded	200 x 2 or 200PLUSF20	Preferred	L159
GBJGR 162QR1	GB/GR	J	4/0 Concentric	B165 Grounding Receptacle	5/8"	0.563"	Copper-bonded	200 x 2 or 200PLUSF20	Preferred	L159
GBJGR 182CR1	GB/GR	J	1/0 Concentric	B165 Grounding Receptacle	3/4"	0.682"	Copper-bonded	200 x 2 or 200PLUSF20	Preferred	L159
GBJGR 182CR2	GB/GR	J	1/0 Concentric	B166 Grounding Receptacle	3/4"	0.682"	Copper-bonded	200 x 2 or 200PLUSF20	Preferred	L159
GBJGR 182GR1	GB/GR	J	2/0 Concentric	B165 Grounding Receptacle	3/4"	0.682"	Copper-bonded	200 x 2 or 200PLUSF20	Preferred	L159
GBJGR 182GR2	GB/GR	J	2/0 Concentric	B166 Grounding Receptacle	3/4"	0.682"	Copper-bonded	200 x 2 or 200PLUSF20	Preferred	L159
GBJGR 182QR1	GB/GR	J	4/0 Concentric	B165 Grounding Receptacle	3/4"	0.682"	Copper-bonded	200 x 2 or 200PLUSF20	Preferred	L159
GBJGR 332GR1	GB/GR	J	2/0 Concentric	B165 Grounding Receptacle	3/4"	0.750"	Steel	200 x 2 or 200PLUSF20	Preferred	L159

GB/GT MOLDS

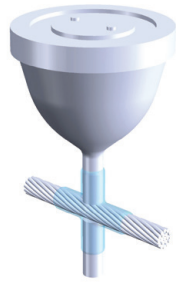

Global Part Number	Mold Family	Price Key	Conductor Size	Ground Plate/ Grounding Receptacle	Ground Rod Diameter, Nominal	Ground Rod Diameter, Actual	Ground Rod Type	Welding Material Required	Ease of Use	Handle Clamp
GBJGT 162GR1	GB/GT	J	2/0 Concentric	B165 Grounding Receptacle	5/8"	0.563"	Copper-bonded	200 x 2 or 200PLUSF20	Preferred	L159
GBJGT 182CR1	GB/GT	J	1/0 Concentric	B165 Grounding Receptacle	3/4"	0.682"	Copper-bonded	200 x 2 or 200PLUSF20	Preferred	L159
GBJGT 182CR3	GB/GT	J	1/0 Concentric	B167 Grounding Receptacle	3/4"	0.682"	Copper-bonded	200 x 2 or 200PLUSF20	Preferred	L159
GBJGT 182GR1	GB/GT	J	2/0 Concentric	B165 Grounding Receptacle	3/4"	0.682"	Copper-bonded	200 x 2 or 200PLUSF20	Preferred	L159
GBJGT 182QR1	GB/GT	J	4/0 Concentric	B165 Grounding Receptacle	3/4"	0.682"	Copper-bonded	200 x 2 or 200PLUSF20	Preferred	L159
GBJGT 332GR1	GB/GT	J	2/0 Concentric	B165 Grounding Receptacle	3/4"	0.750"	Steel	200 x 2 or 200PLUSF20	Preferred	L159

COPPER OR STEEL STUD TO STEEL SURFACE

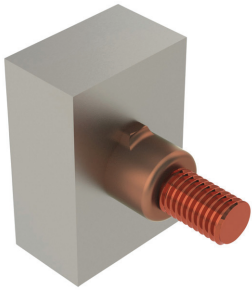

- Forms a permanent, low resistance connection
- Provides a molecular bond
- Cadweld Exothermic Connections are rated with the same current capacity as the conductor
- Portable installation equipment with no external source of power required
- Installers can be easily trained to make Cadweld Exothermic Connections
- Connections are visually inspected

HV MOLDS

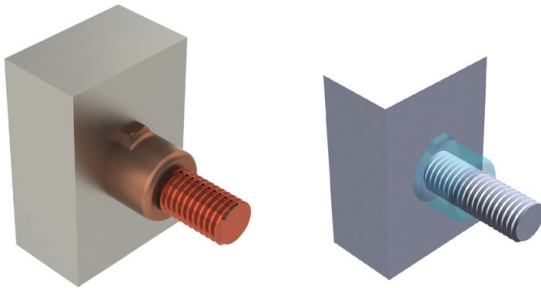

Global Part Number	Mold Family	Price Key	Stud Type	Connects To	Welding Material Required	Ease of Use	Handle Clamp required
HVC12	HV	C	3/8" Steel Stud	Steel Surface	45 or 45PLUSF20	Easy	L160
HVC12CU	HV	C	3/8" Copper Stud	Steel Surface	90 or 90PLUSF20	Easy	L160
HVC14CU	HV	C	1/2" Copper Stud	Steel Surface	115 or 115PLUSF20	Easy	L160
HVC18	HV	C	3/4" Steel Stud	Steel Surface	150 or 150PLUSF20	Easy	L160
HVC31CU	HV	C	5/8" Copper Stud	Steel Surface	150 or 150PLUSF20	Easy	L160
HVD37CU	HV	D	1" Copper Stud	Steel Surface	200 x 2 or 400PLUSF20	Easy	L159

HX MOLDS

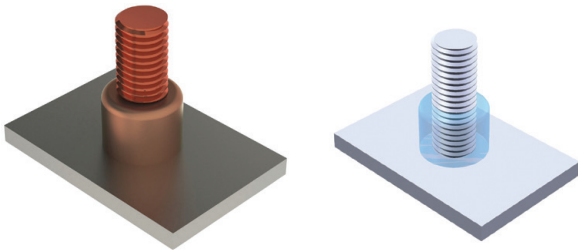

Global Part Number	Mold Family	Price Key	Stud Type	Connects To	Welding Material Required	Ease of Use	Handle Clamp required
HXC10	HX	C	1/4" Steel Stud	Steel Surface	25 or 25PLUSF20	Easy	L160
HXC12	HX	C	3/8" Steel Stud	Steel Surface	45 or 45PLUSF20	Easy	L160
HXC14	HX	C	1/2" Steel Stud	Steel Surface	65 or 65PLUSF20	Easy	L160
HXC14CU	HX	C	1/2" Copper Stud	Steel Surface	115 or 115PLUSF20	Easy	L160
HXC16	HX	C	5/8" Steel Stud	Steel Surface	90 or 90PLUSF20	Easy	L160
HXC22	HX	C	1" Steel Stud	Steel Surface	150 x 2 or 300PLUSF20	Easy	L160

Additional Molds

The Cadweld connection styles presented in the additional mold section are “non-catalog” offerings. These connection styles and others are available when standard connections do not meet the installation requirements. Connections are identified with an ease of use and a mold split identifier. Ease of use categories include: preferred, easy, difficult and most difficult.

If possible, efforts should be made to use preferred or easy to use connection styles. Mold split identifies molds that have a vertically split crucible (V). Those without a designation do not have a vertically split crucible. For additional information and/or assistance in ordering non-catalog connection styles, please contact your nVent ERICO representative.

CABLE TO CABLE



SV
Ease of Use: DIFFICULT
Mold Split: V

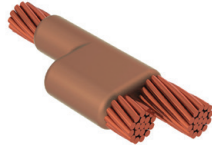

SC
Ease of Use: PREFERRED
Mold Split: -



SE
Ease of Use: DIFFICULT
Mold Split: V

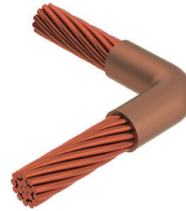

PP
Ease of Use: PREFERRED
Mold Split: -

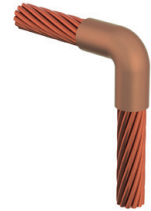

PR
Ease of Use: EASY
Mold Split: V

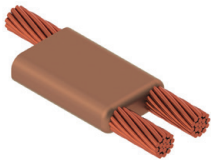

PA
Ease of Use: EASY
Mold Split: -



PB
Ease of Use: DIFFICULT
Mold Split: V



PD
Ease of Use: DIFFICULT
Mold Split: V

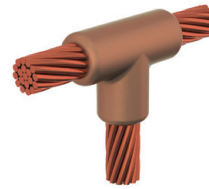

TV
Ease of Use: DIFFICULT
Mold Split: V



TL
Ease of Use: DIFFICULT
Mold Split: V



TC
Ease of Use: DIFFICULT
Mold Split: V

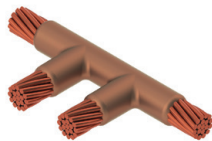

TD
Ease of Use: DIFFICULT
Mold Split: -

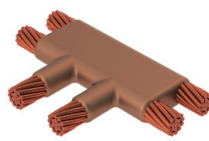

TF
Ease of Use: DIFFICULT
Mold Split: V

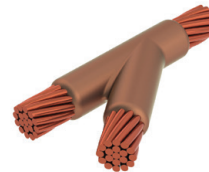

YR
Ease of Use: EASY
Mold Split: H

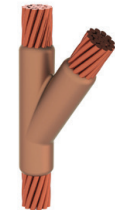

YC
Ease of Use: DIFFICULT
Mold Split: V

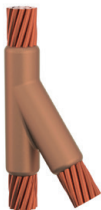

YD
Ease of Use: DIFFICULT
Mold Split: V

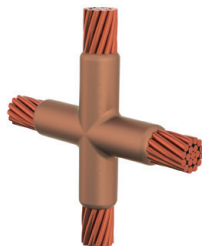

XC
Ease of Use: DIFFICULT
Mold Split: V

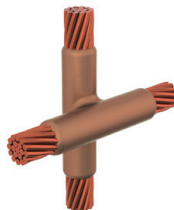

XG
Ease of Use: DIFFICULT
Mold Split: -

CABLE TO GROUND RODS

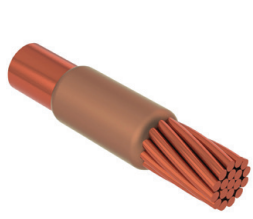

GF
Ease of Use: PREFERRED
Mold Split: V

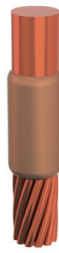

GD
Ease of Use: DIFFICULT
Mold Split: V



GC
Ease of Use: DIFFICULT
Mold Split: V

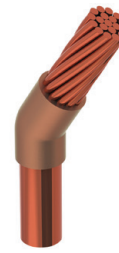

GV
Ease of Use: PREFERRED
Mold Split: V

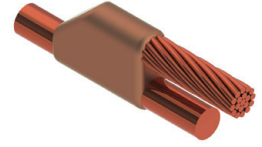

GS
Ease of Use: PREFERRED
Mold Split: V

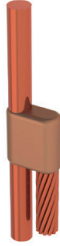

GQ
Ease of Use: EASY
Mold Split: V

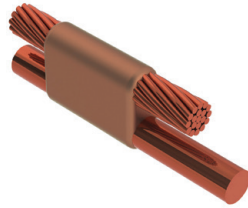

DQ
Ease of Use: PREFERRED
Mold Split: V

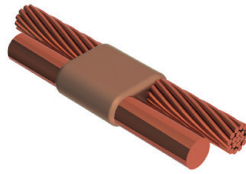

GW
Ease of Use: EASY
Mold Split: V

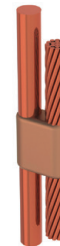

GP
Ease of Use: DIFFICULT
Mold Split: V

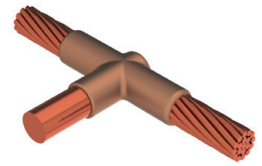

GG
Ease of Use: PREFERRED
Mold Split: -

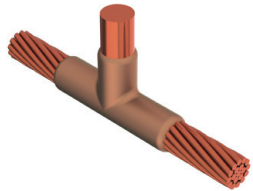

GH
Ease of Use: DIFFICULT
Mold Split: V

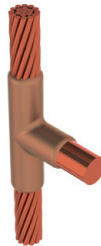

GX
Ease of Use: DIFFICULT
Mold Split: V

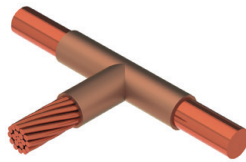

GJ
Ease of Use: PREFERRED
Mold Split: -

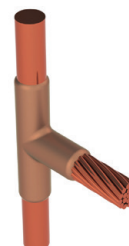

GM
Ease of Use: EASY
Mold Split: V

CABLE TO STEEL

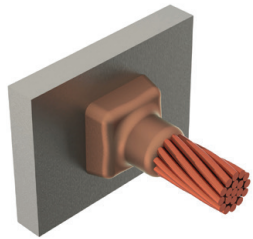

VA
Ease of Use: PREFERRED
Mold Split: V

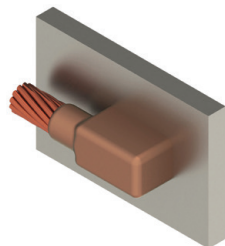

VL
Ease of Use: PREFERRED
Mold Split: V

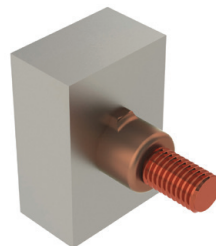

HV
Ease of Use: PREFERRED
Mold Split: V

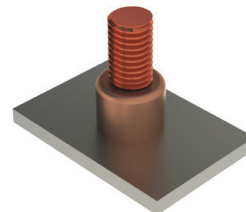

HX
Ease of Use: PREFERRED
Mold Split: V

STUDS TO STEEL SURFACE

CABLE TO REBAR

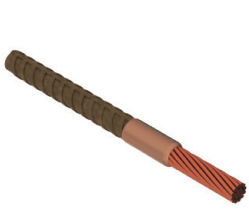

RG
Ease of Use: PREFERRED
Mold Split: V



RE
Ease of Use: EASY
Mold Split: V



RF
Ease of Use: EASY
Mold Split: V



RV
Ease of Use: EASY
Mold Split: V



DR
Ease of Use: EASY
Mold Split: V

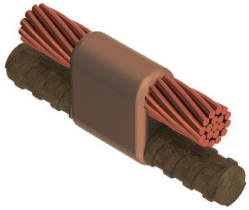

RT
Ease of Use: EASY
Mold Split: V



RW
Ease of Use: EASY
Mold Split: V

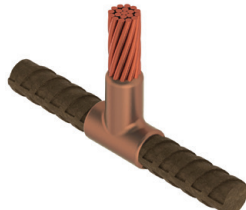

RM
Ease of Use: EASY
Mold Split: V

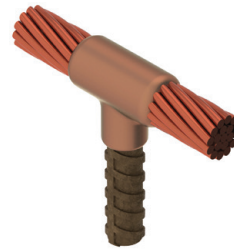

RQ
Ease of Use: EASY
Mold Split: V

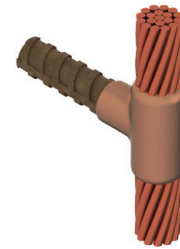

RL
Ease of Use: EASY
Mold Split: V

CABLE TO LUG OR BUSBAR

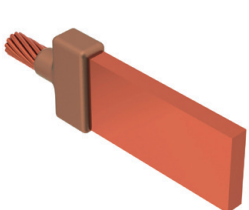

LB
Ease of Use: PREFERRED
Mold Split: V

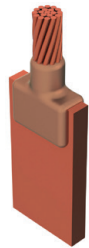

LD
Ease of Use: DIFFICULT
Mold Split: -

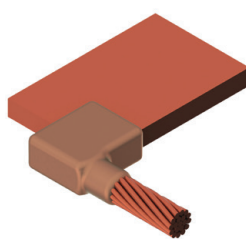

LX
Ease of Use: EASY
Mold Split: V

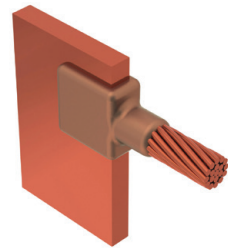

MG
Ease of Use: EASY
Mold Split: -

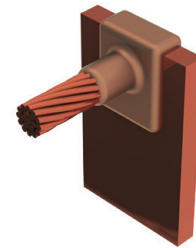

ME
Ease of Use: EASY
Mold Split: V

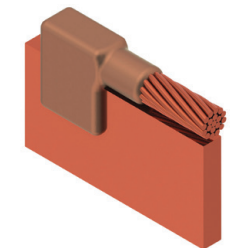

LV
Ease of Use: PREFERRED
Mold Split: V

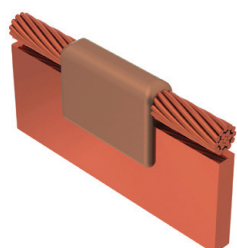

LW
Ease of Use: PREFERRED
Mold Split: -

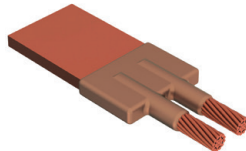

LS
Ease of Use: EASY
Mold Split: V

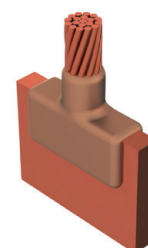

LM
Ease of Use: PREFERRED
Mold Split: -

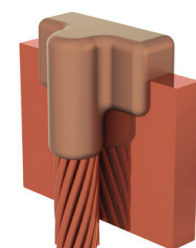

LL
Ease of Use: PREFERRED
Mold Split: V

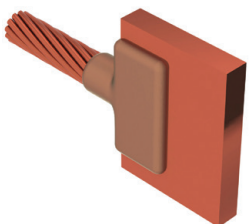

LK
Ease of Use: EASY
Mold Split: -

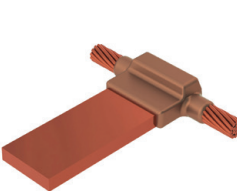

LE
Ease of Use: EASY
Mold Split: V

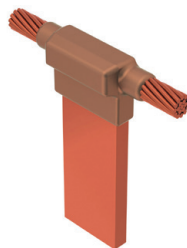

LG
Ease of Use: DIFFICULT
Mold Split: -

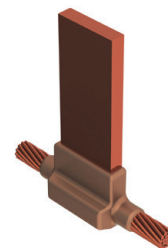

LF
Ease of Use: DIFFICULT
Mold Split: V

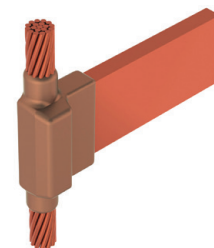

LH
Ease of Use: DIFFICULT
Mold Split: -

BUSBAR TO BUSBAR

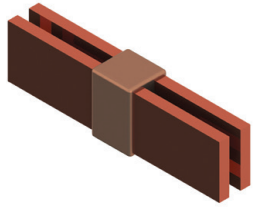

BF
Ease of Use: EASY
Mold Split: -

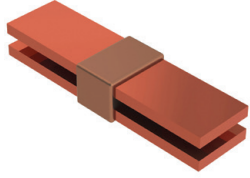

BG
Ease of Use: EASY
Mold Split: -



BH
Ease of Use: MOST
DIFFICULT
Mold Split: V

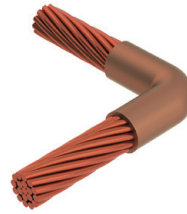

BJ
Ease of Use: EASY
Mold Split: V

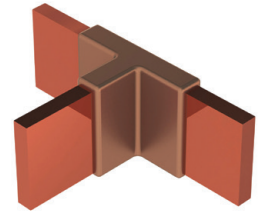

BK
Ease of Use: EASY
Mold Split: -

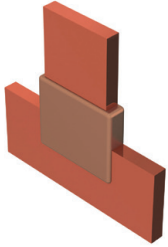

DE
Ease of Use: DIFFICULT
Mold Split: V

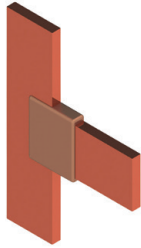

EE
Ease of Use: DIFFICULT
Mold Split: V

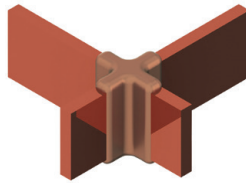

EC
Ease of Use: MOST
DIFFICULT
Mold Split: V

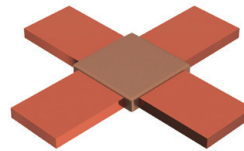

EA
Ease of Use: MOST
DIFFICULT
Mold Split: V

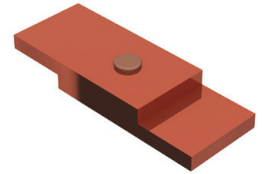

TW
Ease of Use: PREFERRED
Mold Split: -

LUG OR BUSBAR TO STEEL

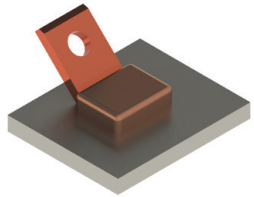

HL
Ease of Use: PREFERRED
Mold Split: V

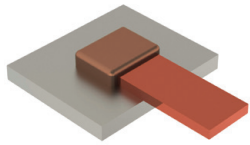

CG
Ease of Use: PREFERRED
Mold Split: -

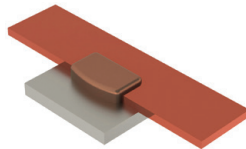

CH
Ease of Use: PREFERRED
Mold Split: -

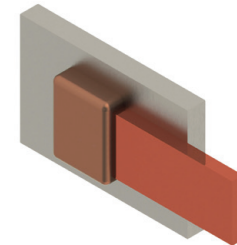

DF
Ease of Use: EASY
Mold Split: V

Busbar to Ground Rod

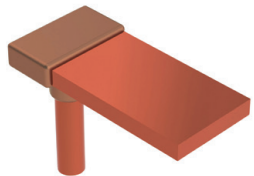

CN
Ease of Use: PREFERRED
Mold Split: V

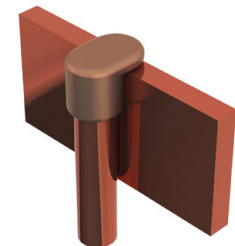

CR
Ease of Use: PREFERRED
Mold Split: V

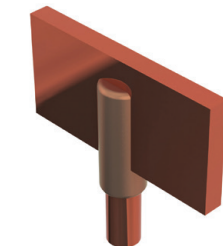

CM
Ease of Use: DIFFICULT
Mold Split: V

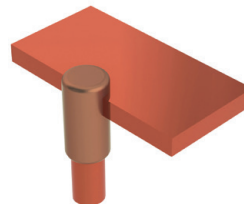

CP
Ease of Use: EASY
Mold Split: V

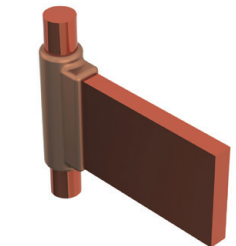

CQ
Ease of Use: DIFFICULT
Mold Split: V

ERICO Cadweld Welding Material, Tools + Accessories

CADWELD WELDING MATERIAL, F20

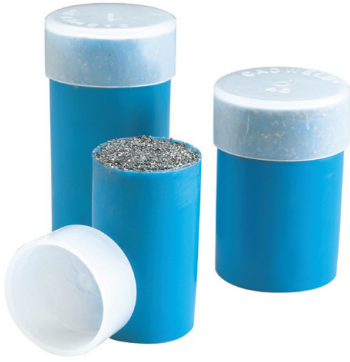

FEATURED HIGHLIGHTS

- Mixture consists mainly of copper oxide and aluminum
- Primarily used in grounding and bonding applications
- Welding material is in the top of the tube and starting material is in the bottom of the tube
- Packaged by size in plastic tubes with clear caps
- Tubes packaged in plastic boxes along with metal disks
- Each welded connection uses a single disk
- Non-explosive
- Not subject to spontaneous ignition
- See specific Cadweld connection details to determine welding material requirements



Part Number	Standard Packaging Quantity
115	10 pc
15	20 pc
150	10 pc
200	10 pc
25	20 pc
250	10 pc
32	20 pc
45	20 pc
500	10 pc
65	20 pc
90	10 pc

CADWELD PLUS WELDING MATERIAL, F20



FEATURED HIGHLIGHTS

- Mixture consists mainly of copper oxide and aluminum
- Primarily used in grounding and bonding applications
- Integrated welding material package
- Color coding by size for easy identification
- Electronic ignition
- No starting material required
- Non-explosive
- Not subject to spontaneous ignition
- See specific Cadweld connection details to determine welding material requirements



Part Number	Color Code Ring	Certifications	Standard Packaging Quantity
115PLUSF20	Orange	cULus	10 pc
1250PLUSF20	None		5 pc
150PLUSF20	Dark Blue	cULus	10 pc
15PLUSF20	Black	cULus	20 pc

Part Number	Color Code Ring	Certifications	Standard Packaging Quantity
200PLUSF20	Yellow	cULus	10 pc
250PLUSF20	Purple	cULus	10 pc
25PLUSF20	Red	cULus	20 pc
300PLUSF20	Light Green	cULus	10 pc
32PLUSF20	White	cULus	20 pc
400PLUSF20	Brown		10 pc
45PLUSF20	Light Blue	cULus	20 pc
500PLUSF20	Light Brown		10 pc
600PLUSF20	White		5 pc
65PLUSF20	Dark Green	cULus	20 pc
750PLUSF20	White		5 pc
90PLUSF20	Gray	cULus	10 pc

CADWELD EXOLON WELDING MATERIAL, F20



FEATURED HIGHLIGHTS

- Mixture consists mainly of copper oxide and aluminum
- Primarily used in grounding and bonding applications
- Designed for applications where low smoke emission is required
- Welding material packaged in tubes without starting material
- Tubes packaged with filters and igniters
- Electronic ignition
- Each weld uses one igniter
- Not subject to spontaneous ignition
- See specific Cadweld connection details to determine welding material requirements



Part Number	Certifications
XL115	cULus
XL15	cULus
XL150	cULus
XL200	cULus
XL25	cULus
XL250	cULus
XL300	cULus
XL32	cULus
XL400	cULus
XL45	cULus
XL500	cULus
XL600	
XL65	cULus
XL750	
XL90	cULus

CADWELD ONE SHOT, CABLE TO GROUND ROD



FEATURED HIGHLIGHTS

- Single use ceramic mold which eliminates the need for a graphite mold and handle clamp/frame
- Produces a permanent connection that will not loosen or corrode
- Fits plain copper-bonded, threaded copper-bonded, full-size galvanized and stainless steel ground rods
- NEC® compliant



Part Number	Mold Family	Ground Rod Diameter, Nominal	Ground Rod Diameter, Actual	Connection, Solid	Connection, Stranded
Welding Material Type: Cadweld Plus					
GR1141GPLUS	GR	1/2"	0.440" – 0.507"	#8, #6	#8
GR1141LPLUS	GR	1/2"	0.440" – 0.507"	#4, #3	#6, #4
GR1141VPLUS	GR	1/2"	0.440" – 0.507"	#2, #1	#3, #2
GR1161GPLUS	GR	5/8"	0.555" – 0.635"	#8, #6	#8
GR1161LPLUS	GR	5/8"	0.555" – 0.635"	#4, #3	#6, #4
GR1161VPLUS	GR	5/8"	0.555" – 0.635"	#2, #1	#3, #2
GR1162CPLUS	GR	5/8"	0.555" – 0.635"	2/0, 1/0	#1, 1/0
GR1162GPLUS	GR	5/8"	0.555" – 0.635"		2/0
GR1162QPLUS	GR	5/8"	0.555" – 0.635"		4/0
GR1181GPLUS	GR	3/4"	0.673" – 0.765"	#8, #6	#8
GR1181LPLUS	GR	3/4"	0.673" – 0.765"	#4, #3	#6, #4
GR1181VPLUS	GR	3/4"	0.673" – 0.765"	#2, #1	#3, #2
GR1182CPLUS	GR	3/4"	0.673" – 0.765"	2/0, 1/0	#1, 1/0
GR1182GPLUS	GR	3/4"	0.673" – 0.765"		2/0
GR1182QPLUS	GR	3/4"	0.673" – 0.765"		4/0
GT1141GPLUS	GT	1/2"	0.440" – 0.507"	#8, #6	#8
GT1141LPLUS	GT	1/2"	0.440" – 0.507"	#4, #3	#6, #4
GT1141VPLUS	GT	1/2"	0.440" – 0.507"	#2, #1	#3, #2
GT1142GPLUS	GT	1/2"	0.440" – 0.507"		2/0
GT1161GPLUS	GT	5/8"	0.555" – 0.635"	#8, #6	#8
GT1161LPLUS	GT	5/8"	0.555" – 0.635"	#4, #3	#6, #4
GT1161VPLUS	GT	5/8"	0.555" – 0.635"	#2, #1	#3, #2
GT1162CPLUS	GT	5/8"	0.555" – 0.635"	2/0, 1/0	#1, 1/0
GT1162GPLUS	GT	5/8"	0.555" – 0.635"		2/0
GT1181GPLUS	GT	3/4"	0.673" – 0.765"	#8, #6	#8
GT1181LPLUS	GT	3/4"	0.673" – 0.765"	#4, #3	#6, #4
GT1181VPLUS	GT	3/4"	0.673" – 0.765"	#2, #1	#3, #2
GT1182CPLUS	GT	3/4"	0.673" – 0.765"	2/0, 1/0	#1, 1/0
GT1182GPLUS	GT	3/4"	0.673" – 0.765"		2/0
NT1141GPLUS	NT	1/2"	0.440" – 0.507"	#8, #6	#8
NT1141LPLUS	NT	1/2"	0.440" – 0.507"	#4, #3	#6, #4
NT1141VPLUS	NT	1/2"	0.440" – 0.507"	#2, #1	#3, #2
NT1161G1TPLUS	NT	5/8"	0.555" – 0.635"	#8, #6, #2	#8
NT1161GPLUS	NT	5/8"	0.555" – 0.635"	#8, #6	#8
NT1161LPLUS	NT	5/8"	0.555" – 0.635"	#4, #3	#6, #4
NT1161VPLUS	NT	5/8"	0.555" – 0.635"	#2, #1	#3, #2
NT1181GPLUS	NT	3/4"	0.673" – 0.765"	#8, #6	#8
NT1181LPLUS	NT	3/4"	0.673" – 0.765"	#4, #3	#6, #4
NT1181VPLUS	NT	3/4"	0.673" – 0.765"	#2, #1	#3, #2
NX1141GPLUS	NX	1/2"	0.440" – 0.507"	#8, #6	#8
NX1141LPLUS	NX	1/2"	0.440" – 0.507"	#4, #3	#6, #4
NX1161G1TPLUS	NX	5/8"	0.555" – 0.635"	#8, #6, #2	#8

Part Number	Mold Family	Ground Rod Diameter, Nominal	Ground Rod Diameter, Actual	Connection, Solid	Connection, Stranded
NX1161GPLUS	NX	5/8"	0.555" – 0.635"	#8, #6	#8
NX1161LPLUS	NX	5/8"	0.555" – 0.635"	#4, #3	#6, #4
NX1161VPLUS	NX	5/8"	0.555" – 0.635"	#2, #1	#3, #2
NX1181GPLUS	NX	3/4"	0.673" – 0.765"	#8, #6	#8
NX1181LPLUS	NX	3/4"	0.673" – 0.765"	#4, #3	#6, #4
NX1181VPLUS	NX	3/4"	0.673" – 0.765"	#2, #1	#3, #2
Welding Material Type: Traditional					
GR1141G	GR	1/2"	0.440" – 0.507"	#8, #6	#8
GR1141L	GR	1/2"	0.440" – 0.507"	#4, #3	#6, #4
GR1141V	GR	1/2"	0.440" – 0.507"	#2, #1	#3, #2
GR1161G	GR	5/8"	0.555" – 0.635"	#8, #6	#8
GR1161GF	GR	5/8"	0.555" – 0.635"	#8, #6	#8
GR1161L	GR	5/8"	0.555" – 0.635"	#4, #3	#6, #4
GR1161V	GR	5/8"	0.555" – 0.635"	#2, #1	#3, #2
GR1162C	GR	5/8"	0.555" – 0.635"	1/0, 2/0	#1, 1/0
GR1162G	GR	5/8"	0.555" – 0.635"		2/0
GR1162Q	GR	5/8"	0.555" – 0.635"		4/0
GR1181G	GR	3/4"	0.673" – 0.765"	#8, #6	#8
GR1181L	GR	3/4"	0.673" – 0.765"	#4, #3	#6, #4
GR1181V	GR	3/4"	0.673" – 0.765"	#2, #1	#3, #2
GR1182C	GR	3/4"	0.673" – 0.765"	1/0, 2/0	#1, 1/0
GR1182G	GR	3/4"	0.673" – 0.765"		2/0
GR1182Q	GR	3/4"	0.673" – 0.765"		4/0
GT1141G	GT	1/2"	0.440" – 0.507"	#8, #6	#8
GT1141L	GT	1/2"	0.440" – 0.507"	#4, #3	#6, #4
GT1141V	GT	1/2"	0.440" – 0.507"	#2, #1	#3, #2
GT1161G	GT	5/8"	0.555" – 0.635"	#8, #6	#8
GT1161L	GT	5/8"	0.555" – 0.635"	#4, #3	#6, #4
GT1161LF	GT	5/8"	0.555" – 0.635"	#4, #3	#6, #4
GT1161V	GT	5/8"	0.555" – 0.635"	#2, #1	#3, #2
GT1161VF	GT	5/8"	0.615" – 0.635"	#2, #1	#3, #2
GT1162C	GT	5/8"	0.555" – 0.635"	1/0, 2/0	#1, 1/0
GT1162G	GT	5/8"	0.555" – 0.635"		2/0
GT1181G	GT	3/4"	0.673" – 0.765"	#8, #6	#8
GT1181L	GT	3/4"	0.673" – 0.765"	#4, #3	#6, #4
GT1181V	GT	3/4"	0.673" – 0.765"	#2, #1	#3, #2
GT1182C	GT	3/4"	0.673" – 0.765"	1/0, 2/0	#1, 1/0
GT1182G	GT	3/4"	0.673" – 0.765"		2/0
NT1141G	NT	1/2"	0.440" – 0.507"	#8, #6	#8
NT1141L	NT	1/2"	0.440" – 0.507"	#4, #3	#6, #4
NT1141V	NT	1/2"	0.440" – 0.507"	#2, #1	#3, #2
NT1161G	NT	5/8"	0.555" – 0.635"	#8, #6	#8
NT1161L	NT	5/8"	0.555" – 0.635"	#4, #3	#6, #4
NT1161V	NT	5/8"	0.555" – 0.635"	#2, #1	#3, #2
NT1181G	NT	3/4"	0.673" – 0.765"	#8, #6	#8
NT1181L	NT	3/4"	0.673" – 0.765"	#4, #3	#6, #4
NT1181V	NT	3/4"	0.673" – 0.765"	#2, #1	#3, #2
NX1141G	NX	1/2"	0.440" – 0.507"	#8, #6	#8
NX1141L	NX	1/2"	0.440" – 0.507"	#4, #3	#6, #4
NX1161G	NX	5/8"	0.555" – 0.635"	#8, #6	#8
NX1161G1T	NX	5/8"	0.555" – 0.635"	#8, #6, #2	#8
NX1161L	NX	5/8"	0.555" – 0.635"	#4, #3	#6, #4
NX1161V	NX	5/8"	0.555" – 0.635"	#2, #1	#3, #2
NX1181G	NX	3/4"	0.673" – 0.765"	#8, #6	#8
NX1181L	NX	3/4"	0.673" – 0.765"	#4, #3	#6, #4
NX1181V	NX	3/4"	0.673" – 0.765"	#2, #1	#3, #2

A gap between conductors may be required. See mold tag for more information.

CADWELD ONE SHOT, CABLE TO CABLE

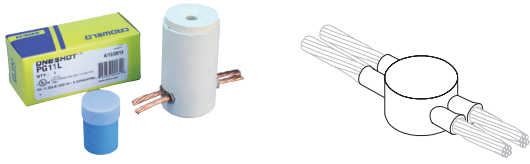

FEATURED HIGHLIGHTS

- Single use ceramic mold which eliminates the need for a graphite mold and handle clamp/frame
- Produces a permanent connection that will not loosen or corrode
- NEC® compliant



Part Number	Mold Family	Connection, Solid	Connection, Stranded
Welding Material Type: Cadweld Plus			
PG11LPLUS	PG	#4, #3	#6, #4
Welding Material Type: Traditional			
PG11L	PG	#3, #4	#6, #4
PG11V	PG	#2, #1	#3, #2

1 HOLE LUG

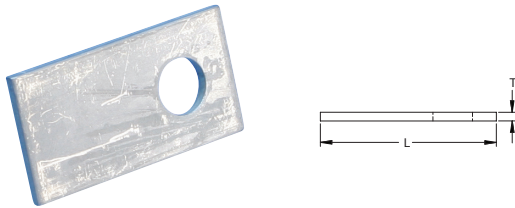

FEATURED HIGHLIGHTS

- Provides an efficient bolting surface for grounding and power applications
- Electrolytic grade copper

Material: Copper
Finish: Tinned
Type: NEMA®

Part Number	Length	Width	Thickness	A	Hole Size	Equivalent Conductor Size
B101AA	1.250"	0.500"	0.062"	0.310"	0.281"	39 kcmil
B101CE	1.940"	1.000"	0.125"	0.500"	0.438"	159 kcmil
B101DE	1.940"	1.000"	0.188"	0.563"	0.563"	239 kcmil
B101EE	2.190"	1.000"	0.250"	0.625"	0.563"	318 kcmil
B101EG	2.500"	1.500"	0.250"	0.750"	0.688"	477 kcmil
B101GG	2.750"	1.500"	0.375"	0.750"	0.688"	716 kcmil
B101GH	3.380"	2.000"	0.375"	1.000"	0.688"	955 kcmil
B101JH	3.380"	2.000"	0.500"	1.000"	0.563"	1,273 kcmil
B101QQ	1.941"	1.000"	0.125"	0.470"	0.410"	159 kcmil
PBB101EG	2.500"	1.500"	0.250"	0.750"	0.688"	477 kcmil
PBB101GH	3.380"	2.000"	0.375"	1.000"	0.688"	955 kcmil

For sizes not listed, contact nVent ERICO.

2 HOLE LUG

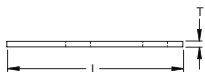

FEATURED HIGHLIGHTS

- Provides an efficient bolting surface for grounding and power applications
- Electrolytic grade copper
- For use with Cadweld type LA connections only

Material: Copper
Finish: Tinned
Type: NEMA®

Part Number	Length	Width	Thickness	A	B	Hole Size	Equivalent Conductor Size
B102CE	4.000"	1.0"	0.125"	0.625"	1.75"	0.563"	159 kcmil
B102DE	4.000"	1.0"	0.188"	0.625"	1.75"	0.563"	239 kcmil
B102EE	4.125"	1.0"	0.250"	0.625"	1.75"	0.563"	318 kcmil
B102EG	4.125"	1.5"	0.250"	0.625"	1.75"	0.563"	477 kcmil
B102EH	4.125"	2.0"	0.250"	0.625"	1.75"	0.563"	637 kcmil
B102GG	4.750"	1.5"	0.375"	0.625"	1.75"	0.563"	716 kcmil
B102GH	4.750"	2.0"	0.375"	0.625"	1.75"	0.563"	955 kcmil
B102JH	5.250"	2.0"	0.500"	0.625"	1.75"	0.563"	1,273 kcmil

For sizes not listed, contact nVent ERICO.

4 HOLE LUG

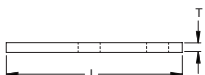

FEATURED HIGHLIGHTS

- Provides an efficient bolting surface for grounding and power applications
- Electrolytic grade copper
- For use with Cadweld type LA connections only

Material: Copper
Finish: Tinned
Type: NEMA®

Part Number	Length	Width	Thickness	A	B	Hole Size	Equivalent Conductor Size
B104EK	4.50"	3"	0.250"	0.625"	1.75"	0.563"	955 kcmil
B104GK	4.75"	3"	0.375"	0.625"	1.75"	0.563"	1,432 kcmil
B104JK	4.75"	3"	0.500"	0.625"	1.75"	0.563"	1,910 kcmil

For sizes not listed, contact nVent ERICO.

1 HOLE OFFSET LUG

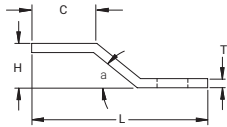
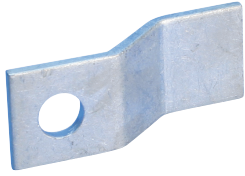

FEATURED HIGHLIGHTS

- Provides an efficient bolting surface for grounding and power applications
- Electrolytic grade copper
- For use with Cadweld type LA connections only

Part Number	H	L	W	T	A	B	C	HS	a
Material: Copper – Finish: Tinned Type – NEMA®:									
B101CEOL	0.63	2.500	1.000	0.125	0.500	1.00	0.875	0.438	45
B101DEOL	0.69	2.690	1.000	0.188	0.563	1.13	0.875	0.563	45
B101EEOL	0.75	3.000	1.000	0.250	0.625	1.28	1.060	0.563	45
B101EGOL	0.75	3.250	1.500	0.250	0.750	1.50	1.060	0.688	45
B101GGOL	1.25	4.250	1.500	0.375	0.750	1.75	1.500	0.688	45
B101GHOL	1.25	5.000	2.000	0.375	1.000	2.38	1.500	0.688	45
B101QQOL	0.62	2.520	1.000	0.125	0.470	0.87	0.750	0.440	45
B101SQOL	0.56	2.677	1.000	0.187	0.550	1.10	0.810	0.560	45
Material: Copper – Finish: Tinned Type – Non-NEMA®:									
B305TC	0.79	3.600	1.180	0.200	0.590	1.33	1.570	0.669	45
Material: Stainless Steel 304 (EN 1.4301) – Type: Non-NEMA®									
B305SS	0.79	3.600	1.180	0.200	0.590	1.33	1.570	0.669	45

For sizes not listed, contact nVent ERICO.

2 HOLE OFFSET LUG

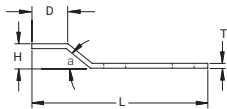

FEATURED HIGHLIGHTS

- Provides an efficient bolting surface for grounding and power applications
- Electrolytic grade copper
- For use with Cadweld type LA connections only

Material: Copper
Finish: Tinned

Part Number	H	L	W	T	A	B	C	D	HS
Type: NEMA®									
B102CEOL	0.63	4.500	1.000	0.125	0.625	1.75	3.000	0.875	0.563
B102DEOL	0.69	4.500	1.000	0.188	0.625	1.75	3.000	0.875	0.563
B102EEOL	0.75	4.750	1.000	0.250	0.625	1.75	3.000	1.060	0.563
B102EFOL	0.75	4.750	1.250	0.250	0.625	1.75	3.000	1.060	0.563
B102EGOL	0.75	4.750	1.500	0.250	0.625	1.75	3.000	1.060	0.563
B102EHOL	0.75	5.000	2.000	0.250	0.625	1.75	3.000	1.250	0.563
B102GGOL	1.25	5.875	1.500	0.375	0.625	1.75	3.250	1.500	0.563
B102GHOL	1.25	5.875	2.000	0.375	0.625	1.75	3.250	1.500	0.563
B102JHOL	1.38	5.875	2.000	0.500	0.625	1.75	3.250	2.000	0.563
B102QQOL	0.62	4.488	1.000	0.125	0.620	1.75	2.990	1.000	0.559
Type: Non-NEMA®									
B103DEOL	1.07	4.500	1.000	0.188	0.625	1.00	1.930	0.875	0.438

For sizes not listed, contact nVent ERICO.

4 HOLE OFFSET LUG

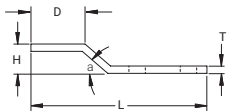
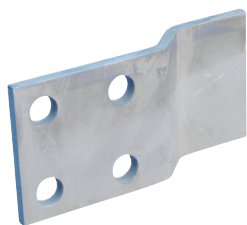

FEATURED HIGHLIGHTS

- Provides an efficient bolting surface for grounding and power applications
- Electrolytic grade copper
- For use with Cadweld type LA connections only

Material: Copper
Finish: Tinned
Type: NEMA®

Part Number	H	L	W	T	A	B	C	D	HS
B104EKOL	1.56	6.00	3	0.250	0.625	1.75	3.375	1.75	0.563
B104GKOL	1.56	6.25	3	0.375	0.625	1.75	3.625	1.75	0.563
B104JKOL	1.56	6.25	3	0.500	0.625	1.75	3.625	1.75	0.563

For sizes not listed, contact nVent ERICO.

1 HOLE LUG, GL STYLE

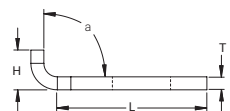

FEATURED HIGHLIGHTS

- Provides an efficient bolting surface for grounding and power applications
- Electrolytic grade copper
- For use with Cadweld type LA connections only

Material: Copper
Finish: Tinned
Type: NEMA®

Part Number	Height	Length	Width	Thickness	A	Hole Size	Angle	Equivalent Conductor Size
B121CE	0.44"	1.440"	1.000"	0.125"	0.625"	0.563"	90°	159 kcmil
B121DE	0.44"	1.470"	1.000"	0.188"	0.625"	0.563"	105°	239 kcmil
B121EE	0.44"	1.500"	1.000"	0.250"	0.625"	0.563"	135°	318 kcmil
B121EG	0.44"	1.500"	1.500"	0.250"	0.625"	0.563"	135°	477 kcmil
B121QQ	0.43"	1.516"	1.000"	0.126"	0.630"	0.560"	90°	159 kcmil
B121SQ	0.43"	1.437"	1.000"	0.187"	0.630"	0.550"	90°	239 kcmil

For sizes not listed, contact nVent ERICO.

2 HOLE LUG, GL STYLE

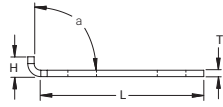

FEATURED HIGHLIGHTS

- Provides an efficient bolting surface for grounding and power applications
- Electrolytic grade copper
- For use with Cadweld type LA connections only

Material: Copper
Finish: Tinned

Part Number	H	L	W	T	A	B	HS	a	Equivalent Conductor Size
Type: NEMA®									
B122CE	0.44	3.19	1.00	0.125	0.625	1.75	0.563	90	159
B122DE	0.44	3.25	1.00	0.188	0.625	1.75	0.563	90	239
B122EE	0.44	3.25	1.00	0.250	0.625	1.75	0.563	90	318
B122EG	0.44	3.25	1.50	0.250	0.625	1.75	0.563	90	477
Type: Non-NEMA®									
B123CE03	0.44	2.47	1.00	0.125	0.625	1.00	0.438	90	159
B123EG03	0.44	3.25	1.50	0.250	0.625	1.00	0.438	90	477

For sizes not listed, contact nVent ERICO.

2 HOLE TELECOM LUG

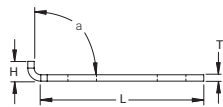

FEATURED HIGHLIGHTS

- Provides an efficient bolting surface for grounding and power applications
- Electrolytic grade copper
- Hole spacing for telecom ground bars
- For use with Cadweld mold GLPCC001TC only

Material: Copper
Finish: Tinned

Part Number	Height	Length	Width	Thickness	A	B	Hole Size	Angle	Equivalent Conductor Size
B922CC14A	0.31"	1.875"	0.625"	0.125"	0.375"	0.625"	0.281"	90°	99 kcmil
B922CC14B	0.31"	1.875"	0.625"	0.125"	0.375"	0.750"	0.281"	90°	99 kcmil
B922CC14C	0.31"	1.875"	0.625"	0.125"	0.375"	1.000"	0.281"	90°	99 kcmil
B922CC38B	0.31"	1.875"	0.625"	0.125"	0.375"	0.750"	0.281"	90°	99 kcmil
B922CC38C	0.31"	1.875"	0.625"	0.125"	0.375"	1.000"	0.281"	90°	99 kcmil
B922CE716B	0.44"	1.875"	1.000"	0.125"	0.625"	0.750"	0.281"	90°	159 kcmil

For sizes not listed, contact nVent ERICO.

PREFABRICATED LUG BOND



Prefabricated lug bonds are custom made to specifications. Common usage includes cable tray bonding and grounding, structure bonds, surge arrester leads and power jumpers.

Material: Copper
Finish: Tinned

FEATURED HIGHLIGHTS

- Made with bare annealed copper cable
- Tinned copper NEMA® lugs welded to the cable with Cadweld connections

Part Number	Conductor Size	Number of Wires	Length 1	Length 2	Width	Thickness	Hole Size	Angle
Lug Configuration: B212								
B2121L8	#4 Stranded	7	8"	1.47"	1"	0.19"	9/16"	
B2121V12	#2 Stranded	7	12"	1.47"	1"	0.19"	9/16"	
B2122G16	2/0 Stranded	7	16"	1.47"	1"	0.19"	9/16"	
B2122Q20	4/0 Stranded	7	20"	1.47"	1"	0.19"	9/16"	
B2122Q24	4/0 Stranded	7	24"	1.47"	1"	0.19"	9/16"	
Lug Configuration: B213								
B2131L15	#4 Stranded	7	15"	3.25"	1"	0.19"	9/16"	
B2131L20	#4 Stranded	7	20"	3.25"	1"	0.19"	9/16"	
B2131L22	#4 Stranded	7	22"	3.25"	1"	0.19"	9/16"	
B2131L24	#4 Stranded	7	24"	3.25"	1"	0.19"	9/16"	
B2131L28	#4 Stranded	7	28"	3.25"	1"	0.19"	9/16"	
B2131L32	#4 Stranded	7	32"	3.25"	1"	0.19"	9/16"	
B2131L35	#4 Stranded	7	35"	3.25"	1"	0.19"	9/16"	
B2131L38	#4 Stranded	7	38"	3.25"	1"	0.19"	9/16"	
B2131L42	#4 Stranded	7	42"	3.25"	1"	0.19"	9/16"	
B2131L44	#4 Stranded	7	44"	3.25"	1"	0.19"	9/16"	
B2131V18	#2 Stranded	7	18"	3.25"	1"	0.19"	9/16"	
B2131V36	#2 Stranded	7	36"	3.25"	1"	0.19"	9/16"	
B2132G11	2/0 Stranded	7	11"	3.25"	1"	0.19"	9/16"	
B2132G14	2/0 Stranded	7	14"	3.25"	1"	0.19"	9/16"	
B2132Q18	4/0 Stranded	7	18"	3.25"	1"	0.19"	9/16"	
B2132Q36	4/0 Stranded	7	36"	3.25"	1"	0.19"	9/16"	
B2132Q48	4/0 Stranded	7	48"	3.25"	1"	0.19"	9/16"	
B2132Q54	4/0 Stranded	7	54"	3.25"	1"	0.19"	9/16"	
B2132Q60	4/0 Stranded	7	60"	3.25"	1"	0.19"	9/16"	
B2132V18	250 kcmil Stranded	19	18"	3.25"	1"	0.19"	9/16"	
Lug Configuration: B216								
B2162C72	1/0 Stranded	7	72"	1.47"	1"	0.19"	9/16"	
B2162C96	1/0 Stranded	7	96"	1.47"	1"	0.19"	9/16"	
B2162Q24	4/0 Stranded	7	24"	1.47"	1"	0.19"	9/16"	
B2162Q8	4/0 Stranded	7	8"	1.47"	1"	0.19"	9/16"	
Lug Configuration: B217								
B2171L24	#4 Stranded	7	24"	3.25"	1"	0.19"	9/16"	
B2172C12	1/0 Stranded	7	12"	3.25"	1"	0.19"	9/16"	
B2172G24	2/0 Stranded	7	24"	3.25"	1"	0.19"	9/16"	
B2172Q12	4/0 Stranded	7	12"	3.25"	1"	0.19"	9/16"	
B2172Q24	4/0 Stranded	7	24"	3.25"	1"	0.19"	9/16"	
Lug Configuration: B218								
B2182Q30	4/0 Stranded	7	30"	1.47"	1"	0.19"	9/16"	45°
Lug Configuration: B219								
B2192C12	1/0 Stranded	7	12"	3.25"	1"	0.19"	9/16"	45°
B2192Q08	4/0 Stranded	7	8"	3.25"	1"	0.19"	9/16"	45°
B2192Q12	4/0 Stranded	7	12"	3.25"	1"	0.19"	9/16"	45°

HANDLE CLAMP

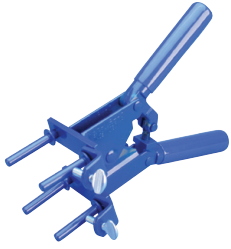

FEATURED HIGHLIGHTS

- Used to securely close the mold around the conductors
- Handle clamps are required for most molds
- Specialized frames and handles are required for some molds
- L160SM has off-set handles to ease the installation of connections in a ditch
- See specific Cadweld mold requirements

Part Number	Fits Mold Price Key
L159	D, F, J, Z
L160	C, E, Q, R
L160SM	C, E, Q, R

HANDLE CLAMP FOR THREE-PIECE VERTICAL SPLIT MOLDS

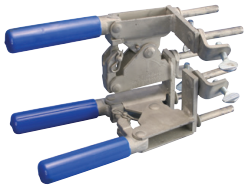

FEATURED HIGHLIGHTS

- Opens the mold in two directions
- Provides more convenience and further simplifies the installation process

Part Number	Fits Mold Price Key
L163	3
L164	4

HANDLE CLAMP, MAGNETIC



FEATURED HIGHLIGHTS

- Designed to securely hold an Cadweld mold to a large flat or slightly curved vertical steel surface
- Used on vertically split molds

Part Number	Fits Mold Price Key
B159M	D, F
B396	C, R

HANDLE CLAMP WITH CHAIN SUPPORT



FEATURED HIGHLIGHTS

- Securely holds the Cadweld mold to a pipe
- See specific Cadweld mold requirements

Part Number	Fits Mold Price Key	For Connection Type
Pipe Orientation: Horizontal		
B159H	D, F	HA, HC, HS, HT
B160B	C, R	Vertical Split Molds
B160H	C, R	HA, HC, HS, HT
Pipe Orientation: Vertical		
B159V	D, F	VS, VF, VB, VV
B159VT	D, F	VT
B160V	C, R	VS, VF, VB, VV
B160VT	C, R	VT
L160VG	C, R	VG

HANDLE CLAMP CHAIN



FEATURED HIGHLIGHTS

- Handle clamp accessory used on specific clamps to securely hold the Cadweld mold to a pipe
- See specific Cadweld mold requirements

Part Number	For Connection Type	Handle Clamp	Chain Length	Pipe Orientation	Pipe Size
B158	HA, HC, HS, HT, VB	B159V, B160V, B159VT, B160VT, B159H, and B160H	20"	Horizontal, Vertical	4" – 10"

MAGNETIC ASSEMBLY

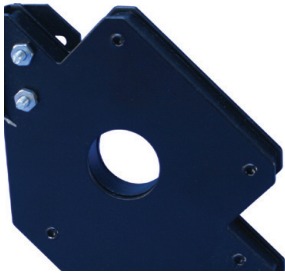

FEATURED HIGHLIGHTS

- Powerful welding magnet securely positions the mold during the connection process to a flat steel surface or steel pipe
- Helps with mold stability to reduce the chance of welding material leakage
- Quickly and easily attaches to hold down "A" Price Key molds (new or retrofit)
- Assembly is adjustable
- Ideal when used with Cadweld PLUS to allow for use of full extension of control unit lead

Part Number

B323N2

PIPE CLAMP CHAIN



FEATURED HIGHLIGHTS

- Handle clamp accessory
- Used on specific clamps to hold the Cadweld mold to a particular surface
- See specific Cadweld mold requirements

Part Number	Fits Mold Price Key	Pipe Size	Pipe Orientation
B319	CAN, CAP, CAT	6" Max	Vertical
B320	CAA	6" Max	Horizontal

SUPPORT CLAMP FOR VERTICAL FLAT STEEL SURFACE

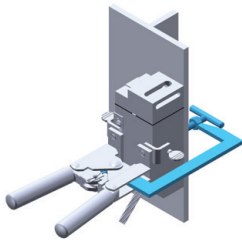

FEATURED HIGHLIGHTS

- Securely supports an Cadweld mold to a vertical "H" column or angle
- Easily attaches to an L160 or L159 handle clamp
- For use with type VF molds for up to 3/4" (19.1 mm) thick steel
- For use with type VB, VG, VN, and VS molds for up to 1" (25.4 mm) thick steel

Part Number	For Use With Handle Clamp
B134	L160, Sold Separately
B135	L159, Sold Separately

FENCE FABRIC ATTACHMENT ASSEMBLY

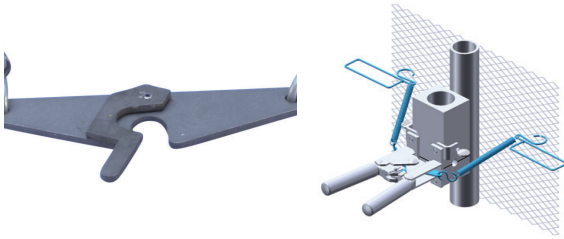

FEATURED HIGHLIGHTS

- Fastens to an L160 or L159 handle clamp
- Firmly holds the mold to the fence post after the fence fabric is in place
- Ideal for retrofit jobs

Part Number	For Connection Type
B827A	VS, VF, VB, VV

HANDLE CLAMP, MINI EZ

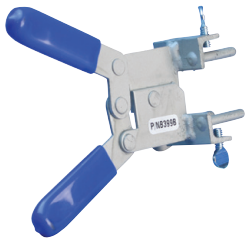

FEATURED HIGHLIGHTS

- Mini EZ Handle Clamps are typically included with the mold
- See specific Cadweld mold or Cadweld kit requirements to determine the handle clamp requirements

Part Number	Fits Mold Price Key
B399A	N, P, T
B399B	N, P, T
B399C	N, P, T
B399Q	N, P, T
L161	N, P, T

HANDLE CLAMP, MINI EZ WITH CHAIN SUPPORT

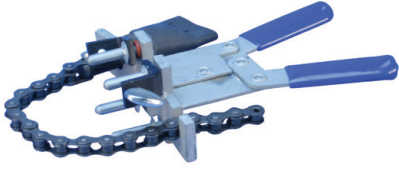

FEATURED HIGHLIGHTS

- Securely holds the Cadweld mold to a rod or rebar in a vertical position

Part Number	Fits Mold Price Key	Connection Type
L161A	P	GYP, GY35 Compact kit, RC35 and GY35 Maxikit

HANDLE CLAMP, MINI EZ WITH SPRING CLAMP



FEATURED HIGHLIGHTS

- Mini EZ Handle Clamps with Spring Clamp are typically included with the mold
- Ideal for connections to ground rods and rebar
- See specific Cadweld mold or Cadweld kit requirements to determine the handle clamp requirements

Part Number	Fits Mold Price Key
B399AS	N, P, T
B399BS	N, P, T
B399CS	N, P, T
B399DS	N, P, T
B399ES	N, P, T

HANDLE CLAMP, MINI EZ, MAGNETIC

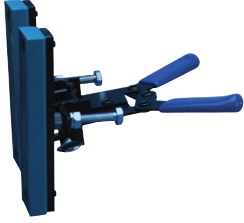

FEATURED HIGHLIGHTS

- Designed to securely hold an Cadweld mold to a large flat or slightly curved vertical steel surface
- Allows for simple placement of the Cadweld mold in the desired connection location
- See specific Cadweld mold or Cadweld kit requirements to determine the handle clamp requirements

Part Number	Fits Mold Price Key
B399AM	N, P, T
B399BM	N, P, T

CABLE CLAMP ASSEMBLY



FEATURED HIGHLIGHTS

- Designed for use with hard-drawn copper cable, copper-bonded conductors or any cable under tension
- Use of the clamp aids in preventing cable movement and prolongs mold life

Part Number
B265

GROUND ROD CLAMPING TOOL

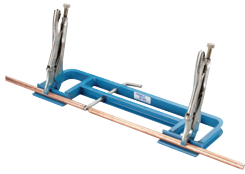

Part Number

B120

FEATURED HIGHLIGHTS

- Must be used to provide the correct positioning of ground rods and mold while splicing the rods with Cadweld for HDGB and GB type connections

DISK

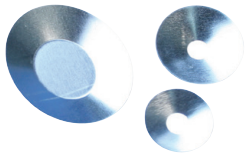

FEATURED HIGHLIGHTS

- Required each time a traditional Cadweld connection is made
- Placed at the bottom of the crucible, holding the welding material until the reaction takes place

Material: Steel

Part Number	Welding Material	Diameter
B117A	15 - 32, Sold Separately	3/4"
B117B	45 - 115, Sold Separately	1"
B117C	150 - 500, Sold Separately	1 1/2"

DISK KIT



FEATURED HIGHLIGHTS

- Contains three disk sizes for common Cadweld connection applications
- Convenience item for replacing lost or damaged disks

Part Number	Material
T328D	Steel

DISK CONTAINER



FEATURED HIGHLIGHTS

- Metal container for holding disks and small Cadweld accessories

Part Number	Diameter	Height
T328	3"	1"

CONDUCTOR SLEEVE

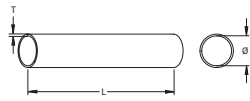

FEATURED HIGHLIGHTS

- Used to adapt a limited range of smaller size cables to a larger size Cadweld Mold
- Provides strength and stability on finely-stranded copper conductors

Part Number	Length	Thickness	Diameter
Material: Copper — Finish: Tinned Type — Chamfered:			
S01	1.000"	0.031"	0.561"
S07	1.000"	0.031"	0.671"
SBS09C	1.000"	0.031"	0.328"
SBS11C	0.813"	0.031"	0.212"
SBS12C	1.063"	0.031"	0.212"
SBS13C	1.500"	0.031"	0.212"
Material: Copper — Finish: Tinned Type — Flared:			
180380	0.984"	0.094"	0.209"
H102F	1.024"	0.041"	0.169"
H106AF	1.378"	0.039"	0.591"
H106F	1.024"	0.039"	0.591"
H113F	1.024"	0.039"	0.315"
H11F	1.024"	0.039"	0.512"
PBS24F	1.500"	0.031"	0.795"
S01F	1.000"	0.031"	0.561"
S02F	1.000"	0.031"	0.611"
S03F	1.000"	0.031"	0.455"
S05F	1.000"	0.031"	0.391"
S06F	1.000"	0.031"	0.480"
S07F	1.000"	0.031"	0.671"
S09F	1.000"	0.031"	0.328"
S17F	1.000"	0.031"	0.344"
S20F	1.000"	0.031"	0.240"
S429F1C12	0.750"	0.015"	0.134"
S429F1F	0.375"	0.015"	0.168"
S429F1J	0.375"	0.015"	0.212"
S429F1N	0.438"	0.015"	0.268"
S429F1N12	0.750"	0.015"	0.268"
S429F1S	0.438"	0.015"	0.300"
S429F1W	0.438"	0.015"	0.336"
S429F1W12	0.750"	0.015"	0.336"
S429F2A	0.500"	0.015"	0.380"
S429F2A12	0.750"	0.015"	0.380"
S429F2E	0.500"	0.015"	0.428"
S429F2E16	1.000"	0.015"	0.428"
S429F2J	0.500"	0.020"	0.480"
S429F2J16	1.000"	0.020"	0.480"
S429F2N	0.563"	0.020"	0.540"
S429F2N16	1.000"	0.020"	0.540"
S429F2S	0.563"	0.020"	0.605"
S429F2S16	1.000"	0.020"	0.605"

Part Number	Length	Thickness	Diameter
S429F2W16	1.000"	0.020"	0.658"
S429F3B16	1.000"	0.020"	0.722"
S429F3F	0.688"	0.020"	0.780"
S429F3F16	1.000"	0.020"	0.780"
S429F3K16	1.000"	0.025"	0.832"
S429F3M12	0.750"	0.015"	0.242"
S429F3N16	1.000"	0.025"	0.882"
S429F3S20	1.250"	0.025"	0.930"
S429F4C16	1.000"	0.020"	0.466"
S429F4K16	1.000"	0.020"	0.666"
S429F4M16	1.000"	0.020"	0.749"
S429F4N24	1.500"	0.035"	1.155"
S429F4P16	1.000"	0.020"	0.799"
S429F4T20	1.250"	0.025"	0.982"
S429F4X24	1.500"	0.035"	1.074"
S429F5A24	1.500"	0.035"	1.332"
S429F5B24	1.500"	0.035"	1.134"
S429F5E24	1.500"	0.035"	1.224"
S429F5F24	1.500"	0.035"	1.375"
S429FY922	1.375"	0.078"	0.833"
Material: Copper — Finish: Tinned Type — Straight:			
B112	1.063"	0.031"	0.212"
B1331H	1.000"	0.025"	0.106"
B1331K	1.000"	0.031"	0.140"
B1331L	1.000"	0.031"	0.170"
B1331V	1.000"	0.031"	0.240"
B1331Y	1.000"	0.031"	0.265"
B1332C	1.000"	0.031"	0.312"
B1332G	1.000"	0.031"	0.344"
B1332L	1.000"	0.031"	0.391"
B1332Q	1.000"	0.031"	0.430"
H101	1.024"	0.039"	0.236"
H102	0.984"	0.041"	0.169"
H103	0.984"	0.047"	0.209"
H105	0.925"	0.039"	0.118"
H117	0.984"	0.039"	0.276"
S4291F	0.375"	0.015"	0.168"
S4291J	0.375"	0.015"	0.212"
S4291N12	0.750"	0.015"	0.268"
S4291W	0.438"	0.015"	0.336"
S4291W12	0.750"	0.015"	0.336"
S4292A	0.500"	0.015"	0.380"
S4292E	0.500"	0.015"	0.428"
S4292J	0.500"	0.020"	0.480"
S4292J16	1.000"	0.020"	0.480"
S4292N	0.563"	0.020"	0.540"
S4292S	0.563"	0.020"	0.605"
S4293F	0.688"	0.020"	0.780"
Material: Steel — Finish: Copper Plated Type — Flared:			
KH118003532	2.000"	0.035"	1.180"

SLEEVE KIT



FEATURED HIGHLIGHTS

- Contains a variety of adapter sleeves that allow a buildup of smaller conductors to fit the opening of larger sized conductors in a Cadweld mold
- Includes shim stock for wrapping around a conductor, increasing the diameter to fit larger conductor openings in a Cadweld mold
- Contains extra disks for all sizes of traditional welding material
- Includes extra flints for Cadweld Flint Igniters

Part
Number

T427

COPPER SHIM

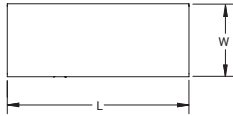
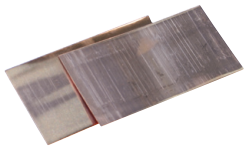

FEATURED HIGHLIGHTS

- Wrapped around the cable until the diameter is about the same as the cable opening in the mold

Material: Copper

Part Number	Length	Width	Thickness
B140A	1.5"	3.0"	0.013"
B140B	2.5"	3.0"	0.013"
B140K	4.5"	1.5"	0.013"
B140L	5.5"	1.5"	0.013"
B140N	3.0"	1.5"	0.013"
B141A	1.5"	3.0"	0.013"
B141C	2.5"	3.0"	0.013"

CADWELD REPLACEMENT PART KIT



FEATURED HIGHLIGHTS

- Miscellaneous handle clamp and Cadweld connection accessories
- Kit includes: (1) disk container, (2) handle clamp thumb screws, (1) handle clamp clevis pin, (1) handle clamp hitch pin, (1) handle clamp adjustment screw, (10) replacement flints, (4) B140A copper shims, (5) B1331L tinned copper sleeves, and (5) B1332Q tinned copper sleeves

Part Number

K158A

BATTING/PACKING MATERIAL



FEATURED HIGHLIGHTS

- Preformed ceramic packing material
- Seals mold conductor openings
- Prevents welding material leakage
- See Cadweld mold requirements for specific batting part number

Part Number

ACB4000H1

ACC4005H2

ACC4007H3

ACC4035H8

ACC4035H9

ACC4061H1

ACC4061H2

ACC4061H3

ACC4061H4

ACC4062H1

B142A

B142B

B143A

B143B

B144A

B144B

B144C

B144D

B144E

B144M

B144Q

B145A

GALVANIZING BAR

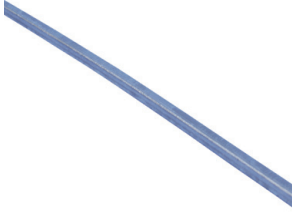

FEATURED HIGHLIGHTS

- Used to repair a galvanized surface that has been damaged by welding or drilling
- Low-temperature self-fluxing material
- The bar may be melted using the heat produced after making a Cadweld connection, or a small torch may be used

Part Number	Material
T319	Zinc Alloy

GALVANIZING SPRAY



FEATURED HIGHLIGHTS

- Easy-to-use galvanizing paint in a spray can
- Used to touch up heat affected areas on galvanized steel surfaces after welding

Part Number	Unit Weight
T372A	1 lb

HAMMER DIE



FEATURED HIGHLIGHTS

- Hardened steel die
- Used to form the end of a field-made bond
- Formed end designed to fit specific Cadweld mold

Material: Steel

Part Number	Conductor Size	nVent ERICO Sleeve
Type: Grounding		
JD01	4/0 Concentric	S01F
JD02	4/0 Ropelay	S02F
JD03	2/0 Concentric	S03F
JD05	1/0 Concentric	S05F
JD06	2/0 Ropelay	S06F
JD07	250 kcmil Ropelay	S07F
JD09	#2 Concentric	S09F
JD11	#4 Concentric	S20F
Type: Power		
WD80	1/0 Concentric	S05F
WD82	95 mm ² Concentric, 4/0 Concentric	S01F
WD83	4/0 Ropelay	S02F
WD84	2/0 Concentric, 1/0 Ropelay	S03F
WD85	2/0 Ropelay	S06F
WD87	150 mm ² Ropelay	S24F
WD88	4/0 Welding cable	S429F3N16
WD94	35 mm ² Concentric	S17F
Type: Signal		
SBD50	3/16" Bondstrand	SBS12C
SBD51	5/16" Bondstrand	SBS09C
SBD55	35 mm ² Concentric	S17F

MOLD SEALER



FEATURED HIGHLIGHTS

- Ideal for sealing hot or cold molds to retard leakage from large stranded conductors
- Prolongs useful mold life when the cable opening becomes worn
- Required on certain Cadweld molds such as Types HA, HB, HC, VG and VN

Part Number	Unit Weight
T403	2 lb

FLINT IGNITOR



FEATURED HIGHLIGHTS

- Used to ignite the starting material when making a traditional Cadweld connection or a nVent LENTON Cadweld rebar connection

Part Number
T320

REPLACEMENT FLINT



FEATURED HIGHLIGHTS

- Replacement flints for T320 Flint Ignitor

Part Number	Standard Packaging Quantity
T320A	10 pc

FLINT IGNITOR EXTENSION



FEATURED HIGHLIGHTS

- Attaches to T320 Flint Ignitor and allows the installer to be approximately 30" (762 mm) away from the mold
- Ideal for applications such as making a mold in a narrow trench while the installer is at ground level

Part Number
B32130

CADWELD PLUS CONTROL UNIT



FEATURED HIGHLIGHTS

- Battery-powered controller box designed for 600 connections with one set of batteries
- Requires no special batteries or charger
- Comes standard with high temperature lead
- Connects to the welding material ignition strip with a custom made, purpose-designed termination clip
- Sends a predetermined voltage to the ignition strip and initiates the reaction
- PBPLUSCU meets AREMA® C&S Manual Recommendations; Part 8.1.34, 2013



Part Number	Cable Length	Batteries	Working Temperature	Certifications
Type: Controller Box with Leads				
PBPLUSCU	6'	8 Lithium AA Batteries	-40 to 140 °F	cURus
PLUSCU	6'	8 Standard AA Batteries	0 – 130 °F	cURus, NOM
PLUSCU15L	15'	8 Standard AA Batteries	0 – 130 °F	cURus
Type: Replacement Leads Only				
PLUSCULD15QC	15'			
PLUSCULDQC	6'			

BATTERY PACK



FEATURED HIGHLIGHTS

- Battery, charger, and carrying case required for the ignition of Cadweld Exolon welding material
- Battery operates approximately 200 connections before requiring a recharge
- Charger, all electrical connections and instructions are included in the battery case

Part Number

XLB971A1

CARD CLOTH BRUSH



FEATURED HIGHLIGHTS

- Aids in removing oxides from conductor surfaces
- Made of short, stiff bristles
- Generally preferred for cleaning concentric conductors and busbars which are not heavily oxidized

Part Number

T313

WIRE BRUSH



FEATURED HIGHLIGHTS

- Aids in removing oxides from conductor surfaces
- Useful for cleaning coarse or very dirty conductors

Part Number

Product

T314	Brush with Replaceable Brush Heads
T314A	Replacement Brush Heads
T336	Standard Brush

MOLD CLEANING BRUSH



FEATURED HIGHLIGHTS

- Ideal for cleaning Cadweld molds
- Soft bristles minimize wear of graphite during the cleaning process
- Removes slag and particles from mold cavity, tap hole, crucible and cover

Part Number	Type
T302A	Wide
T394	Narrow

MOLD CLEANER



FEATURED HIGHLIGHTS

- Used to remove the slag from the crucible area of the mold after making a Cadweld connection

Part Number	Mold Type
B136A	Most Cadweld molds using #65 welding material and smaller
B136B	Most Cadweld molds using #90 welding material and larger
B136D	Most Cadweld rail bond molds
B136E	Specific Cadweld molds only (See mold requirements to determine need)
B136F	Specific Cadweld molds only (See mold requirements to determine need)

CADWELD TOOL KIT



FEATURED HIGHLIGHTS

- Convenient tool kits for Cadweld connection installations

Part Number	Product
T315	Standard Kit
T315A	Complete Kit
T343	Heavy-Duty Kit
T343R	Heavy-Duty Kit with Rasp

TORCH HEAD



FEATURED HIGHLIGHTS

- Self-igniting propane torch head
- Squeezing the control knob produces an instant flame; releasing it extinguishes the flame
- No flame adjusting
- Burn tip remains cool during normal use
- Operates on its side or upside down
- Can withstand 60 MPH (96 KPH) winds without flareout
- Fits all standard 14.1 and 16.4 ounce (400 and 465 gram) propane cylinders

Part Number
T111

TOOL BOX



FEATURED HIGHLIGHTS

- Metal box with removable tote tray
- Recommended for carrying tools, molds, welding material and propane torch used to make Cadweld connections

Part Number	Length	Width	Height
T396	19"	7"	7 1/2"

TOOL TRAY

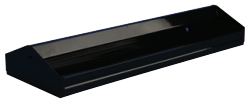

FEATURED HIGHLIGHTS

- Ideal for carrying one or two molds, welding material, propane torch and tools

Part Number

T331

RASP



FEATURED HIGHLIGHTS

- Used to remove rust from steel surfaces or to remove galvanizing from hot dipped galvanized steel to expose the bare steel for welding
- Curved blade makes it an efficient tool for flat surfaces

Part Number

Product

T321

Rasp

T321A

Replacement Blade

WELDING TRAY



FEATURED HIGHLIGHTS

- Recommended when using Cadweld overhead or over expensive equipment
- Designed to contain a potential spill of molten weld metal

Part Number	Height	Length	Width
XLB974B2	3 1/4"	13 1/4"	7"

CERAMIC BLANKET



FEATURED HIGHLIGHTS

- Woven ceramic blanket that can be used to hold a hot mold or keep the work surface free of slag when cleaning the mold

Part Number
T306

SAFETY GLASSES



Material: Polycarbonate

**Part
Number**

T393

As with all tasks, nVent ERICO recommends users consider safety first when making Cadweld connections and wear appropriate safety equipment.

FEATURED HIGHLIGHTS

- Provides protection against moderate impact hazards
- May be worn separately or over prescription glasses

CANVAS GLOVE WITH LEATHER PALM



**Part
Number**

T378L

As with all tasks, nVent ERICO recommends users consider safety first when making Cadweld connections and wear appropriate safety equipment.

FEATURED HIGHLIGHTS

- Heavy canvas gloves with leather palms

Technical Charts

CONCENTRIC STRANDED CONDUCTOR SIZES

Size (AWG/MCM/mm ²)	Circular Mils	Stranding	Nominal O.D. of Strand	Approx. O.D. (inches)	Approx. O.D. (mm)	Weight (lbs/mft)	Cadweld Cable Code
8 AWG	16,510	Solid	–	0.1285	3.26	50.0	1D
8 AWG	16,510	7/.0486"	0.0486	0.1460	3.71	50.1	1E
6 AWG	26,240	Solid	–	0.1620	4.11	79.5	1G
6 AWG	26,240	7/.0612"	0.0612	0.1840	4.67	81.1	1H
16 mm ²	31,600	7/1.17	0.0461	0.2010	5.11	96.1	W3
4 AWG	41,740	Solid	–	0.2043	5.19	126.3	1K
4 AWG	41,740	7/.0772"	0.0772	0.2320	5.89	129.0	1L
4 AWG	41,740	19/.0469"	0.0469	0.2350	5.97	129.0	1L
25 mm ²	49,300	7/2.14 mm	0.0843	0.2530	6.43	152.5	Y1
25 mm ²	49,300	19/1.35	0.0531	0.2660	6.76	152.5	Y1
2 AWG	66,360	Solid	–	0.2576	6.54	200.9	1T
2 AWG	66,360	7/.0974"	0.0974	0.2920	7.42	204.9	1V
2 AWG	66,360	19/.0591"	0.0591	0.2920	7.42	205.0	1V
35 mm ²	66,360	19/1.53 mm	0.0602	0.3010	7.65	211.0	Y2
50 mm ²	98,500	19/1.78 mm	0.0701	0.3500	8.89	287.6	Y3
1/0 AWG	105,600	Solid	–	0.3249	8.25	319.5	2B
1/0 AWG	105,600	7/.1228"	0.1228	0.3690	9.37	326.0	2C
1/0 AWG	105,600	19/.0745"	0.0745	0.3730	9.47	326.0	2C
2/0 AWG	133,100	Solid	–	0.3648	9.27	402.8	2F
2/0 AWG	133,100	7/.1379"	0.1379	0.4140	10.52	410.9	2G
2/0 AWG	133,100	19/.0837"	0.0837	0.4190	10.64	410.9	2G
70 mm ²	138,000	19/2.14 mm	0.0843	0.4210	10.69	415.3	Y4
3/0 AWG	167,800	Solid	–	0.4096	10.40	507.8	2K
3/0 AWG	167,800	7/.1548"	0.1548	0.4650	11.81	518.0	2L
3/0 AWG	167,800	19/.0940"	0.0940	0.4700	11.94	518.0	2L
95 mm ²	187,000	37/1.78 mm	0.0700	0.4910	12.47	576.5	Y5
95 mm ²	187,000	19/2.52	0.0992	0.4960	12.60	576.5	Y5
4/0 AWG	211,600	Solid	–	0.4600	11.68	610.5	2P
4/0 AWG	211,600	7/.1739"	0.1739	0.5220	13.26	653.0	2Q
4/0 AWG	211,600	19/.1055"	0.1055	0.5280	13.41	653.0	2Q
120 mm ²	237,000	37/2.03 mm	0.0799	0.5600	14.22	737.1	Y6
250 MCM	250,000	19/.1147"	0.1147	0.5750	14.61	771.0	2V
250 MCM	250,000	37/.0822"	0.0822	0.5750	14.61	771.0	2V
150 mm ²	296,000	37/2.25 mm	0.0886	0.6200	15.75	896.4	Y7
300 MCM	300,000	19/.1257"	0.1257	0.6290	15.98	926.9	3A
300 MCM	300,000	37/.0900"	0.0900	0.6290	15.98	926.9	3A
185 mm ²	365,000	27/2.52 mm	0.0992	0.6950	17.65	1124.1	Y8
400 MCM	400,000	37/.1040	0.1040	0.7200	18.29	1235.2	3H
240 mm ²	474,000	61/2.25 mm	0.0886	0.7970	20.24	1478.2	Y9
500 MCM	500,000	19/.1622"	0.1622	0.8130	20.65	1544.0	3Q
500 MCM	500,000	37/.1162"	0.1162	0.8130	20.65	1544.0	3Q
750 MCM	750,000	61/.1109"	0.1109	0.9980	25.35	2316.0	4L
500 mm ²	987,000	61/3.20 mm	0.1260	1.1340	28.80	2990.8	W1
1000 MCM	1,000,000	61/.1280"	0.1280	1.1520	29.26	3088.0	4Y

DSA COPPER-BONDED CONDUCTOR

Cable Stranding	Nominal Diameter	kcmil	Equivalent Copper Size*	Cadweld Cable Code
7/#10	.306	72.7	3 AWG	9A
7/#8	.385	115.6	1	9B
7/#7	.433	145.7	1/0	9C
7/#6	.486	183.8	2/0	9D
7/#5	.546	231.7	3/0	9E
19/#9	.572	248.8	3/0	9F
7/#4	.613	292.2	4/0	9L
19/#8	.642	313.7	4/0	9G
19/#7	.721	395.5	250 Kcmil	9H
37/#9	.801	484.4	300	7W
19/#6	.810	498.8	350	9J
37/#8	.899	610.9	400	7V
19/#5	.910	628.9	450	9K
37/#7	1.010	770.3	500	9M

*Approximate based on fusing current calculations

RECTANGULAR COPPER BUSBAR

Thickness (inches)	Width (inches)	Circular Mil Size	Weight (lbs per foot)	Cadweld Busbar Code
1/8	1	159,200	.484	CE
	1-1/2	238,700	.726	CG
	2	318,300	.969	CH
3/16	1	238,700	.727	DE
	2	477,500	1.45	DH
	1-1/2	477,500	1.45	EG
1/4	2	636,600	1.94	EH
	3	954,900	2.91	EK
	4	1,273,000	3.88	EM
	1	477,500	1.45	GE
3/8	1-1/2	716,200	2.18	GG
	2	954,900	2.91	GH
	3	1,432,000	4.36	GK
	4	1,910,000	5.81	GM
1/2	2	1,273,000	3.88	JH
	3	1,910,000	5.81	JK
	4	2,546,000	7.75	JM

BARE COPPER-BONDED CONDUCTOR

Nominal Size	Material	Type	Thread Size	Body Dia.	Cadweld Ground Rod Code
1/2"	Copper-bonded	Sectional	9/16"	.505	14
	Steel*	Plain		.500	14
	Copper-bonded	Plain		.475	15
	Copper-bonded	Sectional	1/2"	.447	13
	Copper-bonded	Sectional	5/8"	.563	16
Steel*	Plain	.625		31	
Copper-bonded	Plain	.563		16	
5/8"	Copper-bonded	Sectional	3/4"	.682	18
	Steel*	Plain		.750	33
	Copper-bonded	Plain		.682	18
3/4"	Copper-bonded	Sectional	1"	.914	22
	Steel*	Plain		1.000	37
1"	Copper-bonded	Plain		.914	22

*Plain steel, stainless steel, stainless clad rods or galvanized steel.

REINFORCING BARS

Nominal Dimensions				
Rebar Sizes	Dia. (inches)	Cross-Sectional Area (Sq. inches)	Equivalent Copper Sizes*	Cadweld Rebar Code
3	.375	.11	9 AWG	51
4	.500	.20	7	52
5	.625	.31	5	53
6	.750	.44	3	54
7	.875	.60	2	55
8	1.000	.79	1	56
9	1.128	1.00	1/0	57
10	1.270	1.27	2/0	58
11	1.410	1.56	3/0	59
14	1.693	2.25	250 kcmil	60
18	2.257	4.00	450	61

*Based on 8% IACS, rounded to the next higher commercial copper size.

Useful Conversions

Area

Square Inches x 1273 = kcmil
 Square Millimeters x 1.974 = kcmil
 kcmil x 0.5067 = Square Millimeters

Density

Copper: 0.323 lb/in³
 Steel: 0.283 lb/in³

STEEL PIPE SIZES

Standard Weight ASTM® A53-90-B
 (Schedule 40) ANSI®/ASME® B36.10M-1985

Nominal Size (inches)	O.D. (inches)	OD (mm)	Wall Thickness (inches)	Cadweld Mold Code
1	1.315	33.4	.133	1
1-1/4	1.660	42.1	.140	1.25
1-1/2	1.900	48.2	.145	1.50
2	2.375	60.3	.154	2
2-1/2	2.875	73.0	.203	2.50
3	3.500	88.9	.216	3
3-1/2	4.000	101.6	.226	3.50
4	4.500	114.3	.237	4
5	5.563	141.3	.258	5
6	6.625	168.2	.280	6
8	8.625	219.0	.322	8
10	10.750	273.0	.365	10

OTHER STANDARD SECTIONS USED FOR FENCE POSTS

Section	Cadweld Mold Code
1-1/2" square	PS15
2" square	PS20
2-1/2" square	PS25
3" square	PS30*
1.875 x 1.625 x .133 "H"	PH1
2.25 x 1.95 .143 "H"	PH2

*For D or F mold price only.

Index

Part	Page	Part	Page	Part	Page	Part	Page	Part	Page
15	236	613480	114	635880	116	A238EC2S12LH	90	A239HB2S242Q1RH	92
15PLUSF20	236	613483	114	635883	116	A238EC2S12RH	90	A239HC2S182C5LH	92
25	236	613840	114	663400	141	A238EC2S24LH	90	A239HC2S182C5RH	92
25PLUSF20	236	613840UPC	114	681300	117	A238EC2S24RH	90	A239HC2S182Q6LH	92
32	236	613850	114	681300S	118	A238FC2S12LH	90	A239HC2S242C4LH	92
32PLUSF20	237	613860	114	683400	117	A238FC2S12RH	90	A239HC2S242C4RH	92
45	236	613880	114	683400S316	118	A238FC2S16LH	90	A239HC2S242C10L	92
45PLUSF20	237	614400	114	683412	117	A238FC2S16RH	90	A239HC2S242C10R	92
65	236	615800	114	683450	117	A238FC2S18LH	90	A239HC2S242G4LH	92
65PLUSF20	237	615800UPC	114	683450S	118	A238FC2S18RH	90	A239HC2S242G5LH	92
90	236	615803	114	683480	117	A238FC2S24LH	90	A239HC2S242G5RH	92
90PLUSF20	237	615812	114	684400	117	A238FC2S24RH	90	A239HC2S242G30L	92
115	236	615815	114	684400S	118	A238FD2S18LH	90	A239HC2S242G30R	92
115PLUSF20	236	615823	114	684415	117	A238FD2S18RH	90	A239HC2S242Q2LH	92
150	236	615830	114	685800	117	A238FF2S12RH	90	A239HC2S242Q2RH	92
150PLUSF20	236	615840	114	685800S	118	A238GC2S12LH	90	A239HD2S242Q2LH	92
200	236	615840UPC	114	685880	117	A238GC2S12RH	90	A239HD2S242Q2RH	92
200PLUSF20	236	615843	115	685880S	118	A238GC2S18LH	90	A239HD2S242Q5LH	92
250	236	615850	115	685880UPC	117	A238GC2S18RH	90	A239HD2S242Q5RH	92
250PLUSF20	236	615853	115	710090	163	A238GC2S24LH	90	A239KD2S242Q4RH	92
300PLUSF20	237	615860	115	710100	163	A238GC2S24RH	90	A800A09F65	107
400PLUSF20	237	615860UPC	115	811260UPC	121	A238GD2S24RH	90	A800A09F100	107
500	236	615863	115	811280UPC	121	A238HB2S18LH	90	A800A22F100	107
500PLUSF20	237	615880	115	811350	121	A238HB2S18RH	91	A809A06F100	107
600PLUSF20	237	615880UPC	115	811360	121	A238HC2S24LH	90	A811A26F50	110
750PLUSF20	237	615883	115	811380	121	A238HD2S24RH	91	A811A26F500	110
1250PLUSF20	236	615883UPC	115	813400	121	A238KC2S24LH	90	A811A26W4F500	110
50010EBOSS	72	625850	115	813400UPC	121	A238KC2S24RH	91	A811C20F20	110
158100	163	631300	115	813480	121	A238KD2S24RH	91	A811C20F100	110
158110	163	631303	115	814400	121	A239DC2S242C4LH	91	ACB4000H1	258
158380	162	631340	115	815800	121	A239EB2S242Q4RH	92	ACC4005H2	258
180380	255	631350	115	815800UPC	121	A239EC2S182Q6LH	91	ACC4007H3	258
545135	125	631360	115	815840	121	A239EC2S242C4LH	91	ACC4035H8	258
545140	125	631380	115	815850	121	A239EC2S242C4RH	92	ACC4035H9	258
545530	125	633400	115	815860	121	A239EC2S242G8LH	91	ACC4061H1	258
611300	114	633403	115	815860UPC	121	A239EC2S242Q4LH	91	ACC4061H2	258
611300UPC	114	633415	115	815880	121	A239EC2S242Q4RH	92	ACC4061H3	258
611303	114	633430	115	815880UPC	121	A239FC2S122G24R	92	ACC4061H4	258
611330	114	633440	115	A235C2C1LH	89	A239FC2S242C2LH	91	ACC4062H1	258
611340	114	633450	115	A235D2G2RH	89	A239FC2S242C2RH	92	B101AA	240
611350	114	633460	115	A235D2G4LH	89	A239FC2S242G4LH	91	B101CE	240
611353	114	633463	115	A235D2Q4LH	89	A239FC2S242G4RH	92	B101CEOL	242
611360	114	633470	115	A235D2Q4RH	89	A239FC2S242G5LH	91	B101DE	240
611360UPC	114	633480	115	A235D2Q5LH	89	A239FC2S242G5RH	92	B101DEOL	242
611380	114	634400	116	A235D2Q5RH	89	A239FC2S242Q2LH	92	B101EE	240
611380UPC	114	635800	116	A235E2G4LH	89	A239FC2S242Q4LH	92	B101EEOL	242
613400	114	635803	116	A235E2Q2RH	89	A239FC2S242Q4RH	92	B101EG	240
613400UPC	114	635830	116	A235E2Q4LH	89	A239FC2S242Q8LH	92	B101EGOL	242
613403	114	635837	117	A235E2Q5LH	89	A239FC2S242Q10L	91	B101GG	240
613412	114	635840	116	A235E2Q5RH	89	A239FD2S241V1LH	92	B101GGOL	242
613415	114	635843	116	A235F2C2LH	89	A239FD2S242G4LH	92	B101GH	240
613440	114	635850	116	A235G2Q2RH	89	A239FD2S242G4RH	92	B101GHOL	242
613450	114	635860	116	A235H2C10RH	89	A239GC2S242Q4LH	92	B101JH	240
613460	114	635870	116	A238EB2S12LH	90	A239GC2S242Q4RH	92	B101QQ	240

Part	Page	Part	Page	Part	Page	Part	Page	Part	Page
B101QQOL	242	B141A	257	B522K	87	B532E3Q48	139	B2131L44	245
B101SQOL	242	B141C	257	B530A1L12	138	B532E3Q96	139	B2131V18	245
B102CE	241	B142A	258	B530A1V12	138	B533A2G48	139	B2131V36	245
B102CEOL	242	B142B	258	B530A2Q48	138	B533A2Q24	139	B2132G11	245
B102DE	241	B143A	258	B530A2Q72	138	B533C2Q48	139	B2132G14	245
B102DEOL	242	B143B	258	B530B2G24	138	B533D2Q12	139	B2132Q18	245
B102EE	241	B144A	258	B530C1L048	138	B533D2Q24	139	B2132Q36	245
B102EEOL	242	B144B	258	B530C2C24	138	B533D2Q48	139	B2132Q48	245
B102EFOL	242	B144C	258	B530C2G48	138	B548A39	153	B2132Q54	245
B102EG	241	B144D	258	B530C2Q36	138	B548A41	153	B2132Q60	245
B102EGOL	242	B144E	258	B530C2Q48	138	B548A42	153	B2132V18	245
B102EH	241	B144M	258	B530C2Q96	138	B802D01A5	111	B2162C72	245
B102EHOL	242	B144Q	258	B530D2C48	138	B802D01A12	111	B2162C96	245
B102GG	241	B145A	259	B530D2G18	138	B802D01A24	111	B2162Q8	245
B102GGOL	242	B158	248	B530D2G24	138	B802D01A36	111	B2162Q24	245
B102GH	241	B159H	247	B530D2G48	138	B802D01A48	111	B2171L24	245
B102GHOL	242	B159M	247	B530D2G180	138	B802D01A120	111	B2172C12	245
B102JH	241	B159V	247	B530D2Q12	138	B827A	250	B2172G24	245
B102JHOL	242	B159VT	247	B530D2Q24	138	B852A8C1G48	85	B2172Q12	245
B102QQOL	242	B160B	247	B530D2Q32	138	B852A8C1G96	85	B2172Q24	245
B103DEOL	243	B160H	247	B530D2Q36	138	B852A12C1G96	85	B2182Q30	245
B104EK	241	B160V	247	B530D2Q48	138	B852A12C2Q60	85	B2192C12	245
B104EKOL	243	B160VT	247	B530D2Q72	138	B922CC14A	244	B2192Q08	246
B104GK	241	B165	140	B530D2Q96	138	B922CC14B	244	B2192Q12	246
B104GKOL	243	B165B	140	B530D2Q120	138	B922CC14C	244	B2610A	143
B104JK	241	B165R	140	B530D2Q144	138	B922CC38B	244	B2617A	142
B104JKOL	243	B165RS	140	B530D2Q180	138	B922CC38C	244	B2618A	143
B112	256	B166	139	B531A2Q36	138	B922CE716B	244	B2618B	143
B117A	253	B166B	141	B531D2G24	138	B1331H	256	B13714	162
B117B	253	B167	139	B531D2Q6	139	B1331K	256	B13716	162
B117C	253	B167B	141	B531D2Q12	139	B1331L	256	B13716RH15	161
B120	253	B265	252	B531D2Q24	139	B1331V	256	B13718	162
B121CE	243	B305SS	242	B531D2Q48	139	B1331Y	256	B13722	162
B121DE	243	B305TC	242	B531D2Q72	139	B1332C	256	B13731	162
B121EE	243	B319	249	B531D2Q96	139	B1332G	256	B13733	162
B121EG	243	B320	249	B531D2Q120	139	B1332L	256	B13737	162
B121QQ	243	B323N2	248	B531D2Q144	139	B1332Q	256	B32130	262
B121SQ	243	B396	247	B532A2Q48	139	B1612Q	135	BACCA	215
B122CE	244	B399A	250	B532C2G24	139	B1613Q	135	BACCE	215
B122DE	244	B399AM	252	B532C2G60	139	B1622Q	134	BACDE	215
B122EE	244	B399AS	251	B532C2Q48	139	B1642Q	135	BACEE	215
B122EG	244	B399B	250	B532C2Q240	139	B1643Q	135	BACEH	215
B123CE03	244	B399BM	252	B532C2V48	139	B2121L8	245	BADEK	215
B123EG03	244	B399BS	251	B532C3Q48	139	B2121V12	245	BADEM	215
B134	249	B399C	250	B532D1L48	139	B2122G16	245	BADGK	215
B135	249	B399CS	251	B532D1V36	139	B2122Q20	245	BBCCE	215
B136A	265	B399DS	251	B532D2C24	139	B2122Q24	245	BBCEF	215
B136B	265	B399ES	251	B532D2C36	139	B2131L15	245	BBCEG	215
B136D	265	B399Q	250	B532D2G12	139	B2131L20	245	BBDEHEH	215
B136E	265	B522B	87	B532D2G48	139	B2131L22	245	BBFEK	215
B136F	265	B522C	87	B532D2Q36	139	B2131L24	245	BCR8T	65
B140A	257	B522D	87	B532D2Q40	139	B2131L28	245	BMCCECE	216
B140B	257	B522E	87	B532D2Q48	139	B2131L32	245	BMCCGCG	216
B140K	257	B522F	87	B532D2Q50	139	B2131L35	245	BMCDEDE	216
B140L	257	B522G	87	B532D2Q72	139	B2131L38	245	BMDCHCH	216
B140N	257	B522H	87	B532E3D96	139	B2131L42	245	BMDEKEK	216

Part	Page	Part	Page	Part	Page	Part	Page	Part	Page
BMKEMEM	216	CPI25-200-10	108	CWP4JH34	83	EHL12FC1K	56	EPGC143120	152
BQDEHEH	216	CPI25-250-10	108	CWP6J	81	EHL12FC1K1K	56	EPGC144120	152
BQDEKEK	216	CPI25-300-10	108	DH12M	162	EHL12FC1V	56	EPGC182120	153
BWCCG	218	CPI25-400-10	108	DH34	161	EHL12FC2G	56	EPGC183144	153
BWCDE	218	CPI25-600-10	108	DH34M	162	EHL34C1K	56	EPGC184120	153
BWCDG	218	CPI35-150-12	108	DH58	161	EHL34C1V	56	EPT1225300	60
BWCEF	218	CPI35-200-12	108	DH58M	162	EHL34C2G	56	EPT1425350	60
BWDJH	218	CPI35-250-12	108	DM5834	142	EHL34G1K	56	EPT1435350	60
CBNJ09	96	CPI35-300-12	108	DS1	163	EHL34G1V	56	EPT1450350	60
CBNJ09P10	96	CPI35-400-12	108	DS12	163	EHL34SG1K	56	ESB2	78
CBSC8	102	CPI35-600-12	108	DS12S	163	EHL34SG1V	56	ESB2/0	78
CBSC8A	102	CPI50-150-12	108	DS34	163	EHL58C1K	56	ESB4	78
CBSC8B	102	CPI50-200-12	108	DS58	163	EHL58C1K1K	56	ESB4/0	78
CBSC10	102	CPI50-250-12	108	DS58C	163	EHL58C1V	56	ESB6	78
CBSC10A	102	CPI50-300-12	108	DSCC58	162	EHL58C2G	56	ESB8	78
CBSC10B	102	CPI50-400-12	108	EBGP	134	EHL58G1K	56	ESBP1/0	78
CBSC13	102	CPI50-600-12	108	EBL08	157	EHL58G1K1K	56	ESBP2	78
CBSC13A	102	CPI70-150-12	108	ECRCHM15LB	120	EHL58G1V	56	ESBP2/0	78
CBSC13B	102	CPI70-200-12	109	EDS12	162	EHL58G2G	56	ESBP4	78
CBSC14	102	CPI70-250-12	109	EDS58	162	EK16	92	ESBP4/0	78
CBSC14A	102	CPI70-300-12	109	EGBA14112EE	149	EK17	93	ESBP6	78
CBSC14B	102	CPI70-400-12	109	EGBA14212BB	149	EL4	97	ESBP8	78
CBSC16	102	CPI70-600-12	109	EGBA14212EE	149	EL6CADB	69	ESBP350	78
CBSC16A	102	CPI70-800-12	109	EGBA14212HH	149	EL6CS	70	ESR182	168
CBSC16B	102	CPI70-1100-12	108	EGBA14212NN	149	EL6CS8	70	EST401	168
CBSC18	102	CR12S	64	EGBA14212TES	149	EL6CSDB	70	EST4620	165
CBSC18A	102	CR34	64	EGBA14215JJ	149	EL6CSDB8	70	EST4630	165
CBSC18B	102	CR34SS	64	EGBA14215TES	149	EL6CSDBNH	70	EST6472	166
CBSCSSM	105	CR58	64	EGBA14224NN	149	EL6CSNH	70	ESTREELKIT500	169
CBSCSSMT	105	CR58CE	64	EGBA14406CC	149	EMMCU080X36X96A	128	ETMAGS	157
CC5A05CB	106	CR58SS	64	EGBA14410FF	149	EPCCE	217	EVC167P	79
CC5A20CB	106	CR100	64	EGBA14412AA	149	EPCCCH	217	EWB2G9164	94
CC5A40CB	106	CSS0810000	97	EGBA14412BB	149	EPCK	217	EWB2L584	94
CC12F	62	CSS0810050	98	EGBA14412CC	149	EPCEE	217	EWB2Q344	94
CC34	62	CSS0810150	98	EGBA14412GG	149	EPCEH	217	EWBCS701	94
CC34SS	63	CSS1314000	97	EGBA14412LL	149	EPDCM	217	FC073	86
CC58	62	CSS1314050	98	EGBA14412MM	149	EPDEM	217	FC074	86
CC58SS	63	CSS1314150	98	EGBA14412NN	149	EPDGM	217	FC075	86
CC207	71	CSS1618000	97	EGBA14420CC	149	EPGA142120	153	FC076	86
CCCEH	218	CSS1618050	98	EGBA14420CCT	149	EPGA144120	153	FC076DH	86
CCL04A	99	CTR8CU	75	EGBA14420NN	149	EPGC1416X6	151	FC078	86
CCSS14	63	CTR10	75	EGBA14424CC	149	EPGC1418X8FL	152	FC078DH	86
CFCDELH	219	CWP1J	81	EGBA14424GG	149	EPGC1426X6	151	FC079	86
CFDEHRH	219	CWP1JH12	83	EGBA14424LL	149	EPGC1428X8	151	FC080	86
CGE5CP	116	CWP1JH34	83	EGBA14424MM	149	EPGC1436X6	151	FC082	86
CGE51K	116	CWP1JJ	81	EGBA14424NN	149	EPGC1446X6	151	FC082DH	86
CP34	57	CWP1JSH	81	EGBA14436CC	149	EPGC1446X6T	152	FJ1T18	87
CP38	57	CWP1JU	81	EGGP	134	EPGC1816X6	152	FJ1T24	87
CP58	57	CWP2J	81	EGGPC	134	EPGC1818X8FL	152	FJ1T42	87
CPI16-150-8	108	CWP2JH34	83	EGP100	133	EPGC1826X6	152	FJ1T96	87
CPI16-200-8	108	CWP2JH44	83	EGP100HL	133	EPGC1828X8FL	152	FJ1T240	87
CPI16-250-8	108	CWP2JSH	81	EGRA15	104	EPGC1846X6	152	FJ2G12	88
CPI16-300-8	108	CWP2JU	81	EGRD34	160	EPGC1848X8FL	152	FJ2G16	88
CPI16-400-8	108	CWP3J	81	EGRD34I	160	EPGC141120	152	FJ2G18	88
CPI16-600-8	108	CWP3JSH	81	EGRD58	160	EPGC142120	152	FJ2G24	88
CPI25-150-10	108	CWP4J	81	EGRD58I	160	EPGC142144	152	FJ2G30	88

Part	Page	Part	Page	Part	Page	Part	Page	Part	Page
FJ2G36	88	GLCEG1V	209	GPECNED014	131	GRC161Y	184	GRP161V	185
FJ2G72	88	GLCEG2C	209	GPECNED096	131	GRC162C	184	GRP181K	185
FJ2G84	88	GLCEG2G	209	GPECNEG024	131	GRC162G	184	GRP181L	185
FJ2G96	88	GLCEG2Q	209	GPECNEH016	131	GRC162Q	184	GRP181V	185
FJ2G120	88	GLCEG2V	209	GPECNEK024	131	GRC162V	184	GRP331K	185
FJ2G132	88	GLCEG3H	209	GPECNEM040	131	GRC163A	184	GRP331L	185
FJ2G144	88	GLCEG3Q	209	GPECNEN040	131	GRC163D	184	GRP371K	185
FJ2G168	88	GLPCC1T	209	GPECNFH033	131	GRC163H	184	GRP371L	186
FJ2G180	88	GNR161H	194	GPECNFK024	131	GRC163Q	184	GRT14A1G	186
FJ2G228	88	GNR161T	194	GPECNGF012	131	GRC181G	184	GRT14A1H	186
FJ2G360	88	GNR161V	194	GPECNGK024	131	GRC181H	184	GRT14A1K	186
FJ2Q16	88	GNR162C	194	GPECNHM096	131	GRC181K	184	GRT14A1L	186
FJ2Q18	88	GNR181H	194	GR1141G	239	GRC181L	184	GRT14A1T	186
FJ2Q24	88	GNR181T	194	GR1141GPLUS	238	GRC181T	184	GRT14A1V	186
FJ2Q36	88	GPECCAM036	131	GR1141L	239	GRC181V	184	GRT14B1G	186
FJ2Q48	88	GPECCAM0361H024	131	GR1141LPLUS	238	GRC181Y	184	GRT14B1H	186
FJ2Q120	88	GPECCBJ0181T024	131	GR1141V	239	GRC182C	184	GRT14C1G	186
FJ2Q156	88	GPECCBJ0181T060	131	GR1141VPLUS	238	GRC182G	184	GRT14C1H	186
FJ2Q168	88	GPECCBJ181T108S	131	GR1161G	239	GRC182Q	184	GRT14C1K	186
FJ2Q180	88	GPECCDK0241L024	131	GR1161GF	239	GRC182V	184	GRT14C1L	186
FJ2Q216	88	GPECCDM0361T10T	131	GR1161GPLUS	238	GRC183A	184	GRT14C1T	186
FJ2Q240	88	GPECCCK0242C036	131	GR1161L	239	GRC183D	184	GRT14C1V	186
FJ2Q252	88	GPECEAJ0181G024	131	GR1161LPLUS	238	GRC183H	184	GT1141G	239
FJ2Q384	88	GPECEAJ0241G024	131	GR1161V	239	GRC183Q	184	GT1141GPLUS	238
FJ2Q600	88	GPECEAK0241G024	131	GR1161VPLUS	238	GRC184L	184	GT1141L	239
FJ2QA24	88	GPECEAK0241H024	131	GR1162C	239	GRC221T	184	GT1141LPLUS	238
GC064	58	GPECEAK0242V024	131	GR1162CPLUS	238	GRC221V	184	GT1141V	239
GC065	58	GPECEAM0361H024	131	GR1162G	239	GRC222C	184	GT1141VPLUS	238
GC065TH	59	GPECEAM0362V012	131	GR1162GPLUS	238	GRC222G	184	GT1142GPLUS	238
GCC34	63	GPECEAP0481H024	131	GR1162Q	239	GRC222Q	184	GT1161G	239
GCC58F	63	GPECEBH0121V024	131	GR1162QPLUS	238	GRC222V	184	GT1161GPLUS	238
GEC14	183	GPECEBH0241K024	131	GR1181G	239	GRC223D	184	GT1161L	239
GEC16	183	GPECEBQ0171G120	131	GR1181GPLUS	238	GRC223Q	184	GT1161LF	239
GEC18	183	GPECEDK0241L024	131	GR1181L	239	GRC224L	184	GT1161LPLUS	238
GEC31	183	GPECEDK0242Q036	131	GR1181LPLUS	238	GRC311L	185	GT1161V	239
GEM25A	122	GPECEEK0241T024	131	GR1181V	239	GRC311T	185	GT1161VF	239
GEM25ABKT	122	GPECEEK0242Q008	131	GR1181VPLUS	238	GRC311V	185	GT1161VPLUS	238
GLCCE1G	209	GPECEEK0242Q060	131	GR1182C	239	GRC312C	185	GT1162C	239
GLCCE1H	209	GPECEEK0242Q120	131	GR1182CPLUS	238	GRC312G	185	GT1162CPLUS	238
GLCCE1K	209	GPECEEK0242Q180	131	GR1182G	239	GRC312Q	185	GT1162G	239
GLCCE1L	209	GPECEEK0361T024	131	GR1182GPLUS	238	GRC312V	185	GT1162GPLUS	238
GLCCE1T	209	GPECEHX1	132	GR1182Q	239	GRC313Q	185	GT1181G	239
GLCCE1V	209	GPECEHX1T	132	GR1182QPLUS	238	GRC331H	185	GT1181GPLUS	238
GLCCE1Y	209	GPECEHX3	132	GRC141V	183	GRC331L	185	GT1181L	239
GLCCE2C	209	GPECEJK0361T24T	131	GRC141Y	183	GRC331T	185	GT1181LPLUS	238
GLCCE2G	209	GPECNAJ018	131	GRC142C	183	GRC331V	185	GT1181V	239
GLCCE2Q	209	GPECNAK024	131	GRC142G	183	GRC332C	185	GT1181VPLUS	238
GLCDE1H	209	GPECNBH012	131	GRC142Q	183	GRC332G	185	GT1182C	239
GLCDE2C	209	GPECNBH024	131	GRC142V	183	GRC332Q	185	GT1182CPLUS	238
GLCDE2G	209	GPECNDF006	131	GRC161E	183	GRC332V	185	GT1182G	239
GLCDE2Q	209	GPECNDH024	131	GRC161G	183	GRC333Q	185	GT1182GPLUS	238
GLCDE2V	209	GPECNDK024T	131	GRC161H	184	GRC372C	185	GTC141G	187
GLCEE2Q	209	GPECNDM036T	131	GRC161K	184	GRC372G	185	GTC141T	187
GLCEE2V	209	GPECNEB024	131	GRC161L	184	GRC372Q	185	GTC141V	187
GLCEE3A	209	GPECNED004	131	GRC161T	184	GRD224Y	185	GTC142C	187
GLCEE3D	209	GPECNED012	131	GRC161V	184	GRP141G	185	GTC142G	187

Part	Page	Part	Page	Part	Page	Part	Page	Part	Page
GTC142Q	187	GTC372V	188	GYE162V	191	GYR142Q	193	HAA1V	199
GTC142V	187	GTC373Q	189	GYE163A	191	GYR161G	193	HAA1V7C	199
GTC143Q	187	GTD164L	189	GYE163D	191	GYR161H	193	HAA1V11C	199
GTC181K	187	GTD184L	189	GYE181G	191	GYR161L	193	HAA1V162C	199
GTC181L	187	GTD184Y	189	GYE181H	191	GYR161T	193	HAA1V350C	199
GTC181T	187	GTD224L	189	GYE181K	191	GYR161V	193	HAA1Y	199
GTC181V	187	GTD224Y	189	GYE181L	191	GYR162C	193	HAA1Y11C	199
GTC181Y	187	GTD374Y	189	GYE181T	191	GYR162G	193	HAA1Y325C	199
GTC182C	187	GTP161T	189	GYE181V	191	GYR162Q	193	HAH2C8C	199
GTC182G	187	GTP161V	189	GYE181Y	191	GYR162V	193	HAH2C20C	199
GTC182Q	187	GTP181G	189	GYE182C	191	GYR163A	193	HAH2C350C	199
GTC182V	187	GTP181H	189	GYE182G	191	GYR163D	193	HAH2G8C	199
GTC183A	187	GTP181K	189	GYE182Q	192	GYR181G	193	HAH2G20C	199
GTC183D	187	GTP181L	189	GYE182V	192	GYR181H	193	HAH2G350C	199
GTC183H	187	GTP181T	189	GYE189B	192	GYR181T	193	HAH2Q3C	199
GTC183Q	187	GTP181V	189	GYE222C	192	GYR181V	193	HAH2Q8C	199
GTC221K	187	GTP331G	189	GYE222G	192	GYR182C	193	HAH2Q20C	199
GTC221L	187	GTP331H	189	GYE222Q	192	GYR182G	193	HAH2Q350C	199
GTC221T	187	GTP331K	189	GYE222V	192	GYR182Q	193	HAH9D350C	199
GTC221V	187	GTP331L	189	GYE223D	192	GYR182V	193	HCA1G	200
GTC221Y	187	GTT14A1A	189	GYE311T	192	GYR183D	193	HCA1H	200
GTC222C	187	GTT14A1G	189	GYE311V	192	GYR312G	193	HCA1K	200
GTC222G	187	GTT14A1H	189	GYE312C	192	GYR331H	193	HCA1L	200
GTC222Q	188	GTT14A1K	189	GYE312G	192	GYR331V	193	HCA1T	200
GTC222V	188	GTT14A1L	189	GYE312Q	192	GYR332G	193	HCA1V	200
GTC223D	188	GTT14B1H	190	GYE312V	192	GYR332Q	193	HCA1Y	200
GTC223H	188	GTT14C1G	190	GYE331T	192	GYR332V	193	HDC1	57
GTC223Q	188	GTT14C1H	190	GYE331V	192	H11F	255	HDC12	57
GTC311L	188	GTT14C1K	190	GYE332C	192	H101	256	HDC34	57
GTC311T	188	GTT14C1L	190	GYE332G	193	H102	256	HDC34SP	57
GTC311V	188	GTT161G	190	GYE332Q	193	H102F	255	HDC58	57
GTC311Y	188	GTT161H	190	GYE332V	191	H103	256	HDC58R	57
GTC312C	188	GTT161K	190	GYE372G	191	H105	256	HDGBC14S	182
GTC312G	188	GTT161L	190	GYE372Q	192	H106AF	255	HDGBD16	182
GTC312Q	188	GTT311G	190	GYE372V	192	H106F	255	HDGBD31	182
GTC312V	188	GTT311H	190	GYF163Q	192	H113F	255	HDGBF18	182
GTC313A	188	GTT311K	190	GYF183Q	192	H117	256	HDGBF22	182
GTC313D	188	GTT311L	190	GYF313H	192	HAA1G	198	HDGBF33	182
GTC313H	188	GUV16070	60	GYF313Q	192	HAA1G162C	198	HDGBF37	182
GTC313Q	188	GUV70185	60	GYF333Q	192	HAA1G350C	198	HDGBR12	182
GTC331T	188	GYE141V	191	GYJ163H	192	HAA1H	198	HDGBR15	182
GTC331V	188	GYE142C	191	GYJ163Q	192	HAA1H7C	199	HSC1G	200
GTC331Y	188	GYE142G	191	GYJ164L	192	HAA1H11C	198	HSC1H	200
GTC332C	188	GYE142L	191	GYJ183D	192	HAA1H162C	199	HSC1L	200
GTC332G	188	GYE142Q	191	GYJ183H	192	HAA1H350C	199	HSC1T	200
GTC332Q	188	GYE142V	191	GYJ183Q	192	HAA1K	199	HSC1V	200
GTC332V	188	GYE161G	191	GYJ184L	192	HAA1K162C	199	HSC2C	200
GTC333A	188	GYE161H	191	GYJ223D	192	HAA1L	199	HSC2G	200
GTC333D	188	GYE161K	191	GYJ223Q	192	HAA1L7C	199	HSC2Q	200
GTC333H	188	GYE161L	191	GYJ224L	193	HAA1L11C	199	HSC2V	200
GTC333Q	188	GYE161Q	191	GYJ313Q	193	HAA1L162C	199	HTC1T	201
GTC371L	188	GYE161T	191	GYJ333D	193	HAA1L350C	199	HTC1V	201
GTC371V	188	GYE161V	191	GYJ333Q	193	HAA1T	199	HTC2C	201
GTC372C	188	GYE162C	191	GYJ373Q	193	HAA1T7C	199	HTC2G	201
GTC372G	188	GYE162G	191	GYR142C	193	HAA1T162C	199	HTC2Q	201
GTC372Q	188	GYE162Q	191	GYR142G	193	HAA1T350C	199	HTC2V	201

Part	Page	Part	Page	Part	Page	Part	Page	Part	Page
IBTB	158	LAC1VCE	210	LAC3QEH	211	LJCEG3X	213	LPC571	83
ICECH25	107	LAC1VDE	210	LAC3QEK	211	LJCEG4L	213	LPC571L	83
ICECH50C	107	LAC1VEE	210	LAC3QEKW	211	LJCGG1L	213	LPC580	82
ICECH70C	107	LAC1VEG	210	LAC3QGG	211	LJCGG1T	213	LPC580L	82
ICECH95C	107	LAC1YCE	210	LAC3QJH	211	LJCGG1V	213	LPC595NB	75
ICECH120C	106	LAC2C002	210	LAC4LGG	211	LJCGG2C	213	LPC595NB13	75
ICECH150C	106	LAC2CCE	210	LAD4LJK	211	LJCGG2G	213	LPC680	141
ICECH185C	106	LAC2CDE	210	LAD4YJK	211	LJCGG2Q	213	LPC681	141
ICECH240C	107	LAC2CEE	210	LAT1HAA	211	LJCGG2V	213	LPC682	135
IP900C	124	LAC2CEG	210	LAT1LAA	211	LJCGG3D	213	LPC700	120
JD01	260	LAC2CEK	210	LJCAG1G	212	LJCGG3Q	213	LPC702	120
JD02	260	LAC2G002	210	LJCAG1H	212	LJCGG4L	213	LPC704	120
JD03	260	LAC2GCE	210	LJCAG1K	212	LJCJG1T	213	LPC706	120
JD05	260	LAC2GCEW	210	LJCAG1T	212	LJCJG1V	213	LPC711	120
JD06	260	LAC2GDE	210	LJCAG1V	212	LJCJG2C	213	LPC750	132
JD07	260	LAC2GEE	210	LJCAG1Y	212	LJCJG2G	214	LPC751	132
JD09	260	LAC2GEEW	210	LJCAG2C	212	LJCJG2Q	214	LPC752	132
JD11	260	LAC2GEG	210	LJCAG2G	212	LJCJG2V	214	LPC753	132
K158A	258	LAC2Q002	210	LJCAG2Q	212	LJCJG3A	214	LPC754	132
K217	194	LAC2QCE	210	LJCCE1G	212	LJCJG3Q	214	LPC755	132
K217R	194	LAC2QCEW	210	LJCCE1T	212	LJCLG2Q	214	LPC756	132
K218	194	LAC2QDE	210	LJCCE1V	212	LPA571	83	LPC790	62
K218R	194	LAC2QEE	210	LJCCE2C	212	LPC151CTO	107	LPC795	61
K220	194	LAC2QEEW	210	LJCCE2G	212	LPC154CTO	107	LPC858	73
K220R	194	LAC2QEG	210	LJCCE2Q	212	LPC154LCTO	107	LPC858L	73
K221	194	LAC2QEGW	210	LJCCG1G	212	LPC172CTO	111	LPC5962	84
K221R	194	LAC2QEH	211	LJCCG1H	212	LPC330	85	LPC5963	84
K222	194	LAC2QEHW	211	LJCCG1L	212	LPC330L	85	LPC5964	84
K222R	194	LAC2QEK	211	LJCCG1T	212	LPC331	85	LPC5966	84
K223	194	LAC2QGG	211	LJCCG1V	212	LPC331L	85	LPC46740X1	136
K223R	194	LAC2QGH	211	LJCCG2C	212	LPC466	94	LPC46740X2	136
KH118003532	256	LAC2QGHW	211	LJCCG2G	212	LPC466B	80	LPC151250	107
KUL	74	LAC2QGK	211	LJCCG2Q	212	LPC467	137	LQEEH1T	214
L159	246	LAC2QJK	211	LJCDG1T	212	LPC467X1	136	LQEEH1V	214
L160	246	LAC2VDE	211	LJCED2G	212	LPC467X2	136	LQEGH1V	214
L160SM	246	LAC2VEE	211	LJCEE1T	212	LPC502	74	LQJEH2C	214
L160VG	247	LAC2VEG	211	LJCEE1V	212	LPC502A	74	LQJEH2CM	214
L161	250	LAC2VEH	211	LJCEE2Q	212	LPC502L	74	LQJEH2G	214
L161A	251	LAC2VEK	211	LJCEE3Q	212	LPC513	76	LQJEH2Q	214
L163	246	LAC3AEE	211	LJCEF2Q	213	LPC513L	76	LQJEH2QM	214
L164	246	LAC3AEEW	211	LJCEG1G	213	LPC516	72	LQJEH2V	214
LAC1GCE	210	LAC3AEG	211	LJCEG1H	213	LPC516A	72	LQJEH2VM	214
LAC1GEE	210	LAC3AEGW	211	LJCEG1K	213	LPC516L	72	LQJEH3A	214
LAC1HCE	210	LAC3AEH	211	LJCEG1L	213	LPC517	73	LQJEH3D	214
LAC1HEE	210	LAC3AEK	211	LJCEG1T	213	LPC517L	73	LQJEH3Q	214
LAC1HEG	210	LAC3AJKW	211	LJCEG1TL	213	LPC532	66	LQJEH3QM	214
LAC1KCE	210	LAC3DEE	211	LJCEG1V	213	LPC532L	66	LQJEH3X	214
LAC1KEE	210	LAC3DEEW	211	LJCEG1X	213	LPC540	65	LQJEH4L	214
LAC1LCE	210	LAC3DEG	211	LJCEG1Y	213	LPC540A	65	LQJGH2C	214
LAC1LEE	210	LAC3DEH	211	LJCEG2C	213	LPC540L	65	LQJGH2G	214
LAC1LEG	210	LAC3DEK	211	LJCEG2G	213	LPC557	67	LQJGH2Q	214
LAC1TCE	210	LAC3HEE	211	LJCEG2Q	213	LPC557L	67	LQJGH2QM	214
LAC1TDE	210	LAC3QEE	211	LJCEG2V	213	LPC559	66	LQJGH2V	214
LAC1TEE	210	LAC3QEEW	211	LJCEG3A	213	LPC559L	66	LQJGH3Q	214
LAC1TEG	210	LAC3QEG	211	LJCEG3D	213	LPC570	82	LQJGH4L	214
LAC1TEK	210	LAC3QEGW	211	LJCEG3Q	213	LPC570L	82	LQJH2G	214

Part	Page	Part	Page	Part	Page	Part	Page	Part	Page
LQJH2Q	214	MBJ70-500-10	110	NDF222Q	197	NX1161GPLUS	239	PCC2Q1Y	174
LQJH2V	214	MBJ100-250-16	109	NDF223Q	197	NX1161L	239	PCC2Q2C	174
MBJ6-150-6	110	MBJ100-250-30	109	NDF312Q	197	NX1161LPLUS	239	PCC2Q2G	174
MBJ6-200-6	110	MBJ100-500-16	109	NDF313Q	197	NX1161V	239	PCC2Q2Q	174
MBJ10-200-6	109	MBJ100-500-30	109	NDF332Q	197	NX1161VPLUS	239	PCC2V2G	174
MBJ10-300-6	109	MBNC82	77	NDF372Q	197	NX1181G	239	PCC2V2Q	174
MBJ16-100-6	109	MBNC240	76	NDR141L	197	NX1181GPLUS	239	PCC2V2V	174
MBJ16-100-8	109	MBNC240A	77	NDR142C	197	NX1181L	239	PCC3Q2Q	174
MBJ16-150-6	109	MBNUPCJ82	95	NDR142G	197	NX1181LPLUS	239	PCC3Q3Q	174
MBJ16-150-8	109	MBNUPCJ240	95	NDR142Q	197	NX1181V	239	PCD4L4L	174
MBJ16-200-6	109	MPSC404SS	80	NDR161G	197	NX1181VPLUS	239	PCT1H1H	174
MBJ16-200-8	109	NCF222V	195	NDR161L	197	PBB101EG	240	PCT1L1D	174
MBJ16-250-8	109	NCF223D	195	NDR161T	197	PBB101GH	240	PCT1L1G	174
MBJ16-300-6	109	NCF223Q	195	NDR161V	197	PBPLUSCU	263	PCT1L1H	174
MBJ16-300-8	109	NCF313Q	195	NDR161Y	197	PBS24F	255	PCT1T1G	174
MBJ16-500-8	109	NCF333Q	195	NDR162C	197	PCC1G1G	173	PCT1T1H	174
MBJ25-100-10	109	NCR142C	195	NDR162G	197	PCC1G1H	173	PCT1V1D	174
MBJ25-150-10	109	NCR142G	195	NDR181H	197	PCC1H1H	173	PCT1V1G	174
MBJ25-200-6	109	NCR142Q	195	NDR181L	197	PCC1K1G	173	PCT1V1H	174
MBJ25-200-10	109	NCR161T	195	NDR181T	198	PCC1K1K	173	PG11L	240
MBJ25-200-12	109	NCR161T1G	195	NDR181V	198	PCC1L1G	173	PG11LPLUS	240
MBJ25-250-10	109	NCR161V	195	NDR181Y	198	PCC1L1H	173	PG11V	240
MBJ25-300-10	109	NCR161Y	195	NDR182C	198	PCC1L1L	173	PGT1D1D	179
MBJ25-500-10	109	NCR162C	195	NDR182G	198	PCC1T1G	173	PGT1G1G	179
MBJ30-100-10	110	NCR162G	195	NDR182Q	198	PCC1T1H	173	PGT1G1H	179
MBJ30-150-10	110	NCR162G2Q	195	NDR221V	198	PCC1T1T	173	PGT1H1H	179
MBJ30-200-10	110	NCR162Q	195	NDR311V	198	PCC1T1V	173	PGT1K1K	179
MBJ30-250-10	110	NCR162V	195	NDR312C	198	PCC1V1G	173	PGT08CU	179
MBJ30-300-10	110	NCR181T	196	NDR312G	198	PCC1V1H	173	PGT10CU	179
MBJ30-500-10	110	NCR181V	196	NDR332G	198	PCC1V1L	173	PHJ2Q2Q	181
MBJ35-100-10	110	NCR181Y	196	NT1141G	239	PCC1V1T	173	PHJ2V2Q	181
MBJ35-150-10	110	NCR182C	196	NT1141GPLUS	238	PCC1V1V	173	PHJ2V2V	181
MBJ35-200-10	110	NCR182G	196	NT1141L	239	PCC1Y1G	173	PHJ3A3A	181
MBJ35-250-10	110	NCR182Q	196	NT1141LPLUS	238	PCC1Y1H	173	PHJ3D2Q	181
MBJ35-250-25	110	NCR182V	196	NT1141V	239	PCC1Y1V	173	PHJ3D2V	181
MBJ35-300-10	110	NCR221T	196	NT1141VPLUS	238	PCC1Y1Y	173	PHJ3Q2Q	181
MBJ35-500-10	110	NCR221V	196	NT1161G	239	PCC2C1G	173	PHJ3Q3Q	181
MBJ50-100-10	110	NCR221Y	196	NT1161G1TPLUS	238	PCC2C1H	173	PHR1K1K	181
MBJ50-150-10	110	NCR222C	196	NT1161GPLUS	238	PCC2C1K	173	PHR1L1L	181
MBJ50-200-6	110	NCR222G	196	NT1161L	239	PCC2C1L	173	PHR1T1T	181
MBJ50-200-10	110	NCR222Q	196	NT1161LPLUS	238	PCC2C1T	173	PHR1V1L	181
MBJ50-200-12	110	NCR311V	196	NT1161V	239	PCC2C1V	173	PHR1V1T	181
MBJ50-200-16	110	NCR312C	196	NT1161VPLUS	238	PCC2C2C	173	PHR1V1V	181
MBJ50-200-18	110	NCR312G	196	NT1181G	239	PCC2G1G	173	PHR2C1T	181
MBJ50-250-10	110	NCR312Q	196	NT1181GPLUS	238	PCC2G1H	173	PHR2C1V	181
MBJ50-300-6	110	NCR332C	196	NT1181L	239	PCC2G1L	173	PHR2C2C	182
MBJ50-300-10	110	NCR332G	196	NT1181LPLUS	238	PCC2G1T	173	PHR2G1L	182
MBJ50-300-16	110	NCR332Q	196	NT1181V	239	PCC2G1V	173	PHR2G1T	182
MBJ50-300-18	110	NCR372Q	196	NT1181VPLUS	238	PCC2G1Y	173	PHR2G1V	182
MBJ50-500-10	110	NDF162Q	197	NX1141G	239	PCC2G2G	173	PHR2G2C	182
MBJ50-500-12	110	NDF162V	197	NX1141GPLUS	238	PCC2Q1G	173	PHR2G2G	182
MBJ70-300-6	110	NDF182Q	197	NX1141L	239	PCC2Q1H	173	PHR2Q1T	182
MBJ70-300-10	110	NDF182V	197	NX1141LPLUS	238	PCC2Q1K	173	PHR2Q1V	182
MBJ70-300-12	110	NDF183D	197	NX1161G	239	PCC2Q1L	173	PHR2Q2C	182
MBJ70-300-16	110	NDF183Q	197	NX1161G1T	239	PCC2Q1T	173	PHR2Q2G	182
MBJ70-300-22	110	NDF222G	197	NX1161G1TPLUS	238	PCC2Q1V	174	PHT1D1D	182

Part	Page	Part	Page	Part	Page	Part	Page	Part	Page
PIT03	124	PTC2Q1T	180	RCE531T	224	RDC521V	222	RDM522C	223
PLUSCU	263	PTC2Q1V	180	RCE531V	224	RDC531G	222	RDM522G	223
PLUSCU15L	263	PTC2Q1Y	180	RCE532C	224	RDC531H	222	RDM522Q	223
PLUSCULD15QC	263	PTC2Q2C	180	RCE532G	224	RDC531K	222	RDM522V	223
PLUSCULDQC	263	PTC2Q2G	180	RCE532Q	224	RDC531L	222	RDM532C	223
POOLMESH250	128	PTC2Q2Q	180	RCE532V	224	RDC531T	222	RDM532G	223
POOLMESH350	128	PTC2Q2Q	181	RCE541H	224	RDC531V	222	RDM532Q	223
POOLMESH2100	128	PTC2V1T	180	RCE541L	224	RDH541H	222	RDM532V	223
POOLMESH3100	128	PTC2V1V	180	RCE541T	224	RDH541L	222	REP16120L	59
PTC1D1D	179	PTC2V2C	180	RCE541V	224	RDH541T	222	RHC512C	225
PTC1G1G	179	PTC2V2G	180	RCE542C	224	RDH541V	222	RHC512Q	225
PTC1H1H	179	PTC2V2Q	180	RCE542G	224	RDH542C	222	RHC521H	225
PTC1K1K	179	PTC2V2V	180	RCE542Q	224	RDH542G	222	RHC521L	225
PTC1L1D	179	PTC3A2Q	180	RCE551H	224	RDH542Q	222	RHC521V	225
PTC1L1G	179	PTC3A3A	180	RCE551L	224	RDH542V	222	RHC522C	225
PTC1L1H	179	PTC3D2Q	180	RCE551T	224	RDH551G	222	RHC522G	225
PTC1L1L	179	PTC3D2V	181	RCE551V	224	RDH551H	222	RHC522Q	225
PTC1T1D	179	PTC3D3D	181	RCE552C	224	RDH551L	222	RHC531H	225
PTC1T1G	179	PTC3H2Q	181	RCE552G	224	RDH551T	222	RHC531L	225
PTC1T1H	179	PTC3Q2G	181	RCE552Q	224	RDH551V	222	RHC531T	225
PTC1T1K	180	PTC3Q2Q	181	RCE561H	224	RDH552C	222	RHC531V	225
PTC1T1L	180	PTC3Q2V	181	RCE561K	224	RDH552G	222	RHC532C	225
PTC1T1T	180	PTC3Q3A	181	RCE561T	224	RDH552Q	222	RHC532G	225
PTC1T1V	180	PTC3Q3D	181	RCE561V	224	RDH552V	222	RHC532Q	225
PTC1V1D	180	PTC4L2Q	181	RCE562C	224	RDH561L	222	RHC541L	225
PTC1V1G	180	PTC4Y2Q	181	RCE562G	224	RDH561T	222	RHC541V	225
PTC1V1H	180	PTD3H3H	181	RCE562Q	224	RDH561V	222	RHC542C	225
PTC1V1K	180	PTD3Q3Q	181	RCE571T	224	RDH561Y	222	RHC542G	225
PTC1V1L	180	PTF4L4L	181	RCE571V	224	RDH562C	222	RHC542Q	225
PTC1V1T	180	PTF4Y4Y	181	RCE572C	224	RDH562G	222	RJC522C	226
PTC1V1V	180	RAC2C	227	RCE572G	224	RDH562Q	222	RJC522G	226
PTC1Y1G	180	RAC2G	227	RCE572Q	224	RDH562V	222	RJC522Q	226
PTC1Y1T	180	RAC2Q	227	RCE581V	224	RDH571T	222	RJC522V	226
PTC1Y1Y	180	RC70	93	RCE582C	224	RDH571V	222	RJC531H	226
PTC2C1D	180	RC100	93	RCE582G	224	RDH572C	222	RJC531K	226
PTC2C1G	180	RCC16	61	RCE582Q	224	RDH572G	222	RJC531L	226
PTC2C1H	180	RCE511H	223	RCE591G	224	RDH572Q	222	RJC531T	226
PTC2C1L	180	RCE511L	223	RCE591V	224	RDH572V	222	RJC531V	226
PTC2C1T	180	RCE511T	223	RCE591Y	224	RDH581T	222	RJC531Y	226
PTC2C1V	180	RCE511V	223	RCE592C	224	RDH581V	222	RJC532C	226
PTC2C1Y	180	RCE512C	223	RCE592G	224	RDH582C	222	RJC532G	226
PTC2C2C	180	RCE512G	223	RCE592Q	224	RDH582G	222	RJC532Q	226
PTC2G1D	180	RCE512Q	223	RCE602G	224	RDH582Q	223	RJC532V	226
PTC2G1G	180	RCE521G	223	RCE602Q	225	RDH582V	223	RJC541H	226
PTC2G1H	180	RCE521H	223	RCE612G	225	RDH591V	223	RJC541L	226
PTC2G1K	180	RCE521L	223	RCEC6	107	RDH591Y	223	RJC541T	226
PTC2G1L	180	RCE521T	223	RDC511G	221	RDH592C	223	RJC541V	226
PTC2G1T	180	RCE521V	223	RDC511H	221	RDH592G	223	RJC542C	226
PTC2G1V	180	RCE521Y	224	RDC511K	221	RDH592Q	223	RJC542G	226
PTC2G2C	180	RCE522C	224	RDC511L	221	RDH592V	223	RJC542Q	226
PTC2G2G	180	RCE522G	224	RDC511T	221	RDH602G	223	RJC542V	226
PTC2Q1D	180	RCE522Q	224	RDC521G	222	RDH602Q	223	RJE551L	226
PTC2Q1G	180	RCE522V	224	RDC521H	222	RDH612G	223	RJE551T	226
PTC2Q1H	180	RCE531G	224	RDC521K	222	RDH612Q	223	RJE551V	226
PTC2Q1K	180	RCE531H	224	RDC521L	222	RDM512G	223	RJE552C	226
PTC2Q1L	180	RCE531L	224	RDC521T	222	RDM512Q	223	RJE552G	226

Part	Page	Part	Page	Part	Page	Part	Page	Part	Page
RJE552Q	226	RRA581T	220	RRH612C	221	S4291W12	256	SST1V	172
RJE561L	226	RRA581V	220	RRH612L	221	S4292A	256	T111	266
RJE561T	226	RRA591H	220	RRH612Q	221	S4292E	256	T302A	265
RJE561V	226	RRA591L	220	S01	255	S4292J	256	T306	268
RJE562C	226	RRA591T	220	S01F	255	S4292J16	256	T313	264
RJE562Q	226	RRA591V	220	S02F	255	S4292N	256	T314	264
RJE562V	226	RRC511H	220	S03F	255	S4292S	256	T314A	264
RJE571L	226	RRC511L	220	S05F	255	S4293F	256	T315	266
RJE571T	226	RRC511T	220	S06F	255	SBCS0810	67	T315A	266
RJE571V	226	RRC511V	221	S07	255	SBCS1314	67	T319	259
RJE572C	226	RRC512C	221	S07F	255	SBD50	260	T320	261
RJE572G	227	RRC512G	221	S09F	255	SBD51	260	T320A	262
RJE572Q	227	RRC512L	221	S17F	255	SBD55	260	T321	267
RJE572V	227	RRC512Q	221	S20F	255	SBS09C	255	T321A	267
RJE581T	227	RRC512V	221	S429F1C12	255	SBS11C	255	T328	254
RJE581V	227	RRC522C	221	S429F1F	255	SBS12C	255	T328D	254
RJE582C	227	RRC522G	221	S429F1J	255	SBS13C	255	T331	267
RJE582G	227	RRC522L	221	S429F1N	255	SCEC25	108	T336	264
RJE582Q	227	RRC522Q	221	S429F1N12	255	SCEC35	108	T343	266
RJE582V	227	RRC522V	221	S429F1S	255	SCEC50	108	T343R	266
RJE591V	227	RRC532C	221	S429F1W	255	SCEC95	108	T372A	259
RJE592C	227	RRC532G	221	S429F1W12	255	SCEC120	108	T378L	269
RJE592G	227	RRC532L	221	S429F2A	255	SCEC150	108	T393	269
RJE592Q	227	RRC532Q	221	S429F2A12	255	SCEC185	108	T394	265
RJE592V	227	RRC532V	221	S429F2E	255	SDT34	163	T396	267
RJE602C	227	RRH542G	221	S429F2E16	255	SDT58	163	T403	261
RRA521H	219	RRH542L	221	S429F2J	255	SP58	57	T416A	123
RRA521K	219	RRH542Q	221	S429F2J16	255	SP58B916	57	T416B	122
RRA521L	219	RRH542V	221	S429F2N	255	SRC15	61	T416BH	122
RRA521T	219	RRH552C	221	S429F2N16	255	SRGBD100	129	T416C	123
RRA521V	219	RRH552G	221	S429F2S	255	SRGBE100	129	T416CKEY	123
RRA521Y	219	RRH552L	221	S429F2S16	255	SRGBG100	129	T416D	124
RRA531D	219	RRH552Q	221	S429F2W16	255	SRGC46	78	T416E	124
RRA531G	219	RRH552V	221	S429F3B16	255	SRGC46BR	96	T416F	124
RRA531H	219	RRH562C	220	S429F3F	255	SSC1D	172	T427	257
RRA531K	219	RRH562G	220	S429F3F16	256	SSC1G	172	TAC1D1D	174
RRA531L	220	RRH562L	220	S429F3K16	256	SSC1H	172	TAC1G1G	174
RRA531T	220	RRH562Q	220	S429F3M12	256	SSC1K	172	TAC1G1H	174
RRA531V	220	RRH562V	220	S429F3N16	256	SSC1L	172	TAC1H1H	174
RRA531Y	220	RRH572C	220	S429F3S20	256	SSC1T	172	TAC1K1K	174
RRA541G	220	RRH572G	220	S429F4C16	256	SSC1V	172	TAC1K1L	174
RRA541H	220	RRH572L	220	S429F4K16	256	SSC1Y	172	TAC1L1H	174
RRA541L	220	RRH572Q	220	S429F4M16	256	SSC2C	172	TAC1L1L	174
RRA541T	220	RRH572V	220	S429F4N24	256	SSC2G	172	TAC1T1G	174
RRA541V	220	RRH582C	220	S429F4P16	256	SSC2Q	172	TAC1T1H	174
RRA541Y	220	RRH582G	220	S429F4T20	256	SSC2V	172	TAC1T1K	174
RRA551L	220	RRH582L	220	S429F4X24	256	SSC3A	172	TAC1T1L	174
RRA551T	220	RRH582Q	220	S429F5A24	256	SSC3D	172	TAC1T1T	174
RRA551V	220	RRH582V	220	S429F5B24	256	SSC3H	172	TAC1T1V	174
RRA561L	220	RRH592C	220	S429F5E24	256	SSC3Q	172	TAC1V1G	174
RRA561T	220	RRH592G	220	S429F5F24	256	SSC4L	172	TAC1V1H	174
RRA561V	220	RRH592L	220	S429FY922	256	SSD4Y	172	TAC1V1K	174
RRA561Y	220	RRH592Q	220	S4291F	256	SST1G	172	TAC1V1L	174
RRA571T	220	RRH592V	220	S4291J	256	SST1K	172	TAC1V1T	174
RRA571V	220	RRH602L	221	S4291N12	256	SST1L	172	TAC1V1V	175
RRA581H	220	RRH602Q	221	S4291W	256	SST1T	172	TAC1V1Y	175

Part	Page	Part	Page	Part	Page	Part	Page	Part	Page
TAC1Y1L	175	TAC3H3D	176	TMGBA29L41P	151	VFC1H	204	VNC2LRH	208
TAC1Y1T	175	TAC3H3H	176	TMGBA29L41PT	151	VFC1HV3C	204	VNC2QLH	208
TAC2C1G	175	TAC3Q2C	176	TMGBSPLICEKIT	151	VFC1K	204	VNC2QRH	208
TAC2C1H	175	TAC3Q2G	176	UGP719	133	VFC1KV3C	204	VNC2VLH	208
TAC2C1K	175	TAC3Q2Q	176	UGP719BP5	133	VFC1L	204	VNC2VRH	208
TAC2C1L	175	TAC3Q2V	176	UGP719SBP5	133	VFC1LV3C	204	VSC1G	201
TAC2C1T	175	TAC3Q3A	176	UGP738	133	VFC1LV8C	204	VSC1GV3C	201
TAC2C1V	175	TAC3Q3D	176	UGP738P5	133	VFC1LV21C	204	VSC1GV5C	201
TAC2C1Y	175	TAC3Q3Q	176	UGP738P10	133	VFC1T	204	VSC1GV8C	201
TAC2C2C	175	TAC4L2G	176	UGP738SBP5	133	VFC1TV3C	205	VSC1H	201
TAC2G1G	175	TAC4L2Q	176	VBC1G	203	VFC1TV5C	205	VSC1HV3C	201
TAC2G1H	175	TAC4L2V	176	VBC1H	203	VFC1TV21C	205	VSC1HV8C	201
TAC2G1K	175	TAC4L3D	176	VBC1HV3C	203	VFC1V	205	VSC1HV21C	201
TAC2G1L	175	TAC4Y2G	176	VBC1K	203	VFC1VV3C	205	VSC1K	201
TAC2G1T	175	TAC4Y2Q	176	VBC1KV3C	203	VFC1VV5C	205	VSC1KV3C	201
TAC2G1V	175	TAC4Y3D	176	VBC1L	203	VFC1VV8C	205	VSC1KV5C	201
TAC2G1Y	175	TAD3Q4L	176	VBC1LV3C	203	VFC1Y	205	VSC1KV8C	201
TAC2G2C	175	TAD3X3X	176	VBC1LV5C	203	VFC2C	205	VSC1L	201
TAC2G2G	175	TAD4L3H	176	VBC1LV8C	203	VFC2CV3C	205	VSC1LV3C	201
TAC2Q1G	175	TAD4L3Q	176	VBC1LV21C	203	VFC2CV8C	205	VSC1LV5C	201
TAC2Q1H	175	TAD4L4L	176	VBC1T	203	VFC2G	205	VSC1LV8C	201
TAC2Q1K	175	TAD4Y2V	176	VBC1TV3C	203	VFC2GV3C	205	VSC1LV21C	201
TAC2Q1L	175	TAD4Y3Q	176	VBC1TV5C	203	VFC2GV5C	205	VSC1PV3C	202
TAC2Q1T	175	TAD4Y4L	176	VBC1TV8C	203	VFC2GV8C	205	VSC1T	202
TAC2Q1V	175	TAD4Y4Y	176	VBC1TV21C	203	VFF3Q	205	VSC1TV3C	202
TAC2Q1Y	175	TDSGABC14	154	VBC1V	203	VFR2Q	205	VSC1TV5C	202
TAC2Q2C	175	TDSGAP	156	VBC1VV3C	203	VFR2QV3C	205	VSC1TV8C	202
TAC2Q2G	175	TDSGAPA14	154	VBC1VV5C	203	VFR2QV5C	205	VSC1TV21C	202
TAC2Q2Q	175	TDSGAPC14	155	VBC1VV8C	203	VFR2QV8C	205	VSC1V	202
TAC2V1T	175	TDSGAS	156	VBC1VV21C	203	VFR2QV21C	205	VSC1VV3C	202
TAC2V1V	175	TDSGAWB	156	VBC1Y	203	VFR2V	205	VSC1VV5C	202
TAC2V1Y	175	TDSGAWB17	155	VBC1YV3C	203	VFR3A	205	VSC1VV8C	202
TAC2V2C	175	TGBA12L06P	150	VBC2C	203	VFR3D	205	VSC1VV21C	202
TAC2V2G	175	TGBA12L06PT	150	VBC2CV3C	203	VFR3H	205	VSC1Y	202
TAC2V2Q	175	TGBA16L08P	150	VBC2CV5C	203	VGC1G	206	VSC1YV3C	202
TAC2V2V	175	TGBA16L08PT	150	VBC2CV8C	203	VGC1H	206	VSC1YV5C	202
TAC3A1T	175	TGBA18L10P	150	VBC2CV21C	203	VGC1L	206	VSC1YV8C	202
TAC3A1V	175	TGBA18L10PT	150	VBC2G	203	VGC1T	206	VSC1YV21C	202
TAC3A2C	175	TGBA20L12P	150	VBC2GV3C	204	VGC1V	206	VSC2C	202
TAC3A2G	175	TGBA20L12PT	150	VBC2GV5C	204	VGC1Y	206	VSC2CV3C	202
TAC3A2Q	175	TGBA24L14P	150	VBC2GV8C	204	VGC2C	206	VSC2CV5C	202
TAC3A2V	175	TGBA24L14PT	150	VBC2GV21C	204	VGC2G	206	VSC2CV8C	202
TAC3A3A	175	TGBA29L18P	150	VBC2Q	204	VNC1GLH	208	VSC2CV21C	202
TAC3D1V	175	TGBA29L18PT	150	VBC2QV3C	204	VNC1HLH	208	VSC2G	202
TAC3D1Y	175	TGBSPLICEKIT	151	VBC2QV5C	204	VNC1HRH	208	VSC2GV3C	202
TAC3D2C	175	TGC2/0	70	VBC2QV8C	204	VNC1LLH	208	VSC2GV5C	202
TAC3D2G	175	TMGBA12L15P	150	VBC2QV21C	204	VNC1LRH	208	VSC2GV8C	202
TAC3D2Q	175	TMGBA12L15PT	151	VBC2V	204	VNC1TLH	208	VSC2GV21C	202
TAC3D2V	175	TMGBA16L19P	150	VBC2VV5C	204	VNC1TRH	208	VSC2Q	202
TAC3D3A	175	TMGBA16L19PT	151	VBC3A	204	VNC1VLH	208	VSC2QV3C	202
TAC3D3D	175	TMGBA18L23P	150	VBC3H	204	VNC1VRH	208	VSC2QV5C	202
TAC3H2C	176	TMGBA18L23PT	151	VBR3Q	204	VNC2CLH	208	VSC2QV8C	202
TAC3H2G	176	TMGBA20L27P	150	VC62	79	VNC2CRH	208	VSC2QV21C	202
TAC3H2Q	176	TMGBA20L27PT	151	VC207IT	71	VNC2GLH	208	VSC2V	202
TAC3H2V	176	TMGBA24L33P	151	VFC1G	204	VNC2GRH	208	VSC3A	202
TAC3H3A	176	TMGBA24L33PT	151	VFC1GV3C	204	VNC2LLH	208	VSC3D	202

Part	Page	Part	Page	Part	Page
VSC3H	202	WD85	260	XBC1V1L	178
VSC3Q	202	WD87	260	XBC1V1V	178
VSP1K	202	WD88	260	XBC1Y1Y	178
VSP1T	202	WD94	260	XBC2C1V	178
VST1G	202	WGRS200	125	XBK3X3X	178
VST1H	202	XAC1G1G	176	XBK4L3Q	178
VST1L	203	XAC1H1H	176	XBK4L4L	178
VTC1G	206	XAC1K1K	176	XBK4Y3Q	178
VTC1H	206	XAC1L1L	176	XBK4Y4Y	178
VTC1K	206	XAC1T1T	176	XBM2C2C	178
VTC1L	206	XAC1V1H	176	XBM2G2G	178
VTC1LV3C	206	XAC1V1L	176	XBM2L2L	178
VTC1LV5C	206	XAC1V1T	176	XBM2Q2Q	178
VTC1T	206	XAC1V1V	177	XBM2V2V	178
VTC1TV3C	206	XAC1Y1Y	177	XBP1G1G	178
VTC1TV5C	206	XAC2C1V	177	XBP1H1H	178
VTC1TV8C	207	XAC2C2C	177	XBQ2C2C	178
VTC1V	207	XAC2G1T	177	XBQ2G1V	178
VTC1VV3C	207	XAC2G1V	177	XBQ2G2C	178
VTC2C	207	XAC2G2C	177	XBQ2G2G	178
VTC2CV3C	207	XAC2G2G	177	XBQ2Q2C	178
VTC2G	207	XAC2Q1V	177	XBQ2Q2G	178
VTC2GV3C	207	XAC2Q1Y	177	XBQ2Q2Q	178
VTC2Q	207	XAC2Q2C	177	XBQ2V2G	178
VTC2QV3C	207	XAC2Q2G	177	XBQ2V2Q	178
VTC2QV5C	207	XAC2Q2Q	177	XBQ2V2V	179
VTC2QV21C	207	XAC2V1V	177	XBV3A3A	179
VTC2V	207	XAC2V2C	177	XBV3D3D	179
VTD3Q	207	XAC2V2G	177	XBV3H3H	179
VVC1G	207	XAC2V2Q	177	XBV3Q3Q	179
VVC1GV3C	207	XAC2V2V	177	XL15	237
VVC1H	207	XAC3A2G	177	XL25	237
VVC1K	207	XAC3A2Q	177	XL32	237
VVC1L	207	XAC3A2V	177	XL45	237
VVC1LV3C	207	XAC3A3A	177	XL65	237
VVC1T	207	XAC3D2C	177	XL90	237
VVC1TV3C	207	XAC3D2G	177	XL115	237
VVC1V	207	XAC3D2Q	177	XL150	237
VVC1VV3C	207	XAC3D2V	177	XL200	237
VVC1VV21C	207	XAC3D3D	177	XL250	237
VVC1Y	208	XAC3H3H	177	XL300	237
VVR2C	208	XAC3Q2G	177	XL400	237
VVR2CV3C	208	XAC3Q2Q	177	XL500	237
VVR2G	208	XAD3Q3Q	177	XL600	237
VVR2GV3C	208	XAD3X3X	177	XL750	237
VVR2GV5C	208	XAD4L2Q	177	XLB971A1	263
VVR2GV21C	208	XAD4Y2Q	177	XLB974B2	268
VVR2Q	208	XB32C2C	178	ZWP1J	81
VVR2QV3C	208	XB32G2G	178		
VVR2QV8C	208	XB32L2L	178		
VVR2QV21C	208	XB32Q2Q	178		
VVR2V	208	XB32V2V	178		
WD80	260	XB43D3D	178		
WD82	260	XBC1K1K	178		
WD83	260	XBC1L1L	178		
WD84	260	XBC1T1T	178		

Our powerful portfolio of brands:

CADDY ERICO HOFFMAN RAYCHEM SCHROFF TRACER



[nVent.com/ERICO](https://www.nvent.com/ERICO)

nVent products shall be installed and used only as indicated in nVent's product instruction sheets and training materials. Instruction sheets are available at [nVent.com/ERICO](https://www.nvent.com/ERICO) and from your nVent customer service representative. Improper installation, misuse, misapplication or other failure to completely follow nVent's instructions and warnings may cause product malfunction, property damage, serious bodily injury and death and/or void your warranty.

©2018 nVent. All nVent marks and logos are owned or licensed by nVent Services GmbH or its affiliates. All other trademarks are the property of their respective owners. nVent reserves the right to change specifications without notice.

ERICO-CAT-E1243C-E534LT15NAEN-EN-1805