





HOW TO BUY TECH LIGHTING

Lighting Professional

Tech Lighting products can be purchased through a network of helpful and knowledgeable sales representatives located Internationally. To find the representative nearest you, visit www.techlighting.com, or call us at 847.410.4400.

Consumer

Tech Lighting products are available in select lighting showrooms throughout North America. To find the showroom nearest you, visit www.techlighting.com.

FOR MORE INFORMATION

Our Full Line Catalog is very extensive, however, more information is available. For detailed specification sheets, product instructions, bill of material reference guides and much more, visit www.techlighting.com.

FOR 25 YEARS, TECH LIGHTING HAS BEEN THE INDUSTRY LEADER IN LOW-VOLTAGE LIGHTING SYSTEMS AND CONTEMPORARY DECORATIVE FIXTURES. SINCE INCEPTION, WE HAVE EXPANDED WELL BEYOND OUR ROOTS, AND TODAY OUR PORTFOLIO TRANSCENDS SPECIFIC AESTHETIC AND CATEGORICAL DEFINITIONS AND INSTEAD IS ROOTED IN INNOVATIVE, ORIGINAL DESIGN AND UNCOMPROMISING QUALITY.

IN RECENT YEARS WE HAVE GAINED BROAD RECOGNITION ON THE ARCHITECTURAL SIDE OF OUR BUSINESS FOR BALANCING AN ABSOLUTE PASSION FOR EVERY DESIGN DETAIL WITH A DEEP CONCERN FOR THE WAY OUR FIXTURES ILLUMINATE A SPACE; AND WE NEVER LOSE SITE OF THE INDIVIDUALS THAT ACTUALLY USE OUR PRODUCTS. WE CARE ABOUT WHAT THEY CARE ABOUT.

VISIT TECHLIGHTING.COM TO SEE THE FULL BREADTH OF OUR OFFERING.

TABLE OF CONTENTS

To help you choose the type of fixtures best suited for your project, we have color-coded the sections of this catalog. Each section describes a product category in detail, including step-by-step instructions on how to configure our architectural grade lighting systems, the most common components for each system, or how to use one of our system kits to make basic installations as easy as possible.

LOW-VOLTAGE PENDANTS	52-153
LOW-VOLTAGE HEADS	154-193
LINE-VOLTAGE HEADS	194-213
LINE-VOLTAGE PENDANTS / SUSPENSION	214-313
MULTI-PORT CHANDELIERS	314-321
LINEAR SUSPENSION	322-339
FLUSH & SEMI-FLUSH MOUNT	340-355
WALL COLLECTION	356-411
BATH COLLECTION	412-433
UNILUME LED UNDERCABINET	434-443
FREEJACK	444-455
MONORAIL	456-479
TWO-CIRCUIT MONORAIL	480-497
WALL MONORAIL	498-513
KABLE LITE	514-533
T-TRAK	534-553
DISPLAY & EXHIBIT	554-565
ACCESSORIES & OPTICAL CONTROLS	566-579
LEDs, LAMPS & TRANSFORMERS	580-593

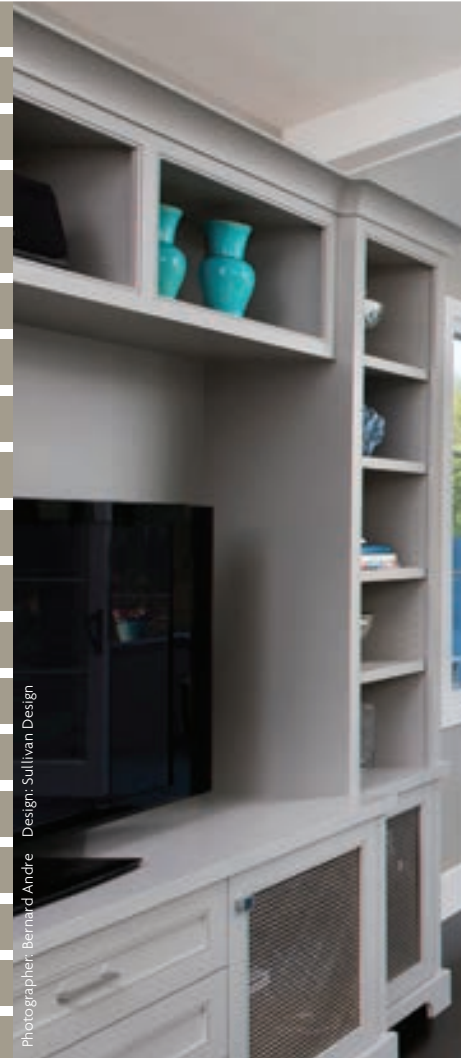

Photographer: Bernard Andre Design, Sullivan Design

This catalog also features item number grids for ease of ordering. For example, below is the item number grid for an Ecran pendant. Select from the bolded codes to build your item number of choice: 700MOECNCGLS-LED means you have selected the MonoRail option for the Ecran pendant in clear / polished gold lattice with a satin nickel finish and led lamp type.

700	SYSTEM MOECN	COLOR CG	PATTERN L	FINISH S	VOLTAGE -LED
FJ	FREEJACK	CG	L	Z	12 VOLT HALOGEN
MP	MONOPOINT*	CLEAR / POLISHED GOLD	LATTICE	ANTIQUE BRONZE	24 VOLT HALOGEN
KL	KABLE LITE	CN	M	C	-24
MO	MONORAIL	CLEAR / POLISHED NICKEL	MOROCCAN	CHROME	24 VOLT HALOGEN
MO2	TWO-CIRCUIT MONORAIL		PLAID	S	-LED
				SATIN NICKEL	12 VOLT LED 3000K

MonoRail p. 456 with John head p. 166



PRODUCT OVERVIEW

Given the vast selection of Tech Lighting products, we have included this quick visual reference guide. We hope that you find this to be a valuable tool and an easy way to get an effective overview of the entire catalog. The guide includes a thumbnail for every fixture and accessory listed alphabetically by category. Most fixtures come in multiple color, finish and lamping options which are detailed on the product pages themselves. Please note, the visual guide does not reference our systems hardware which can be found on pp. 444-553.

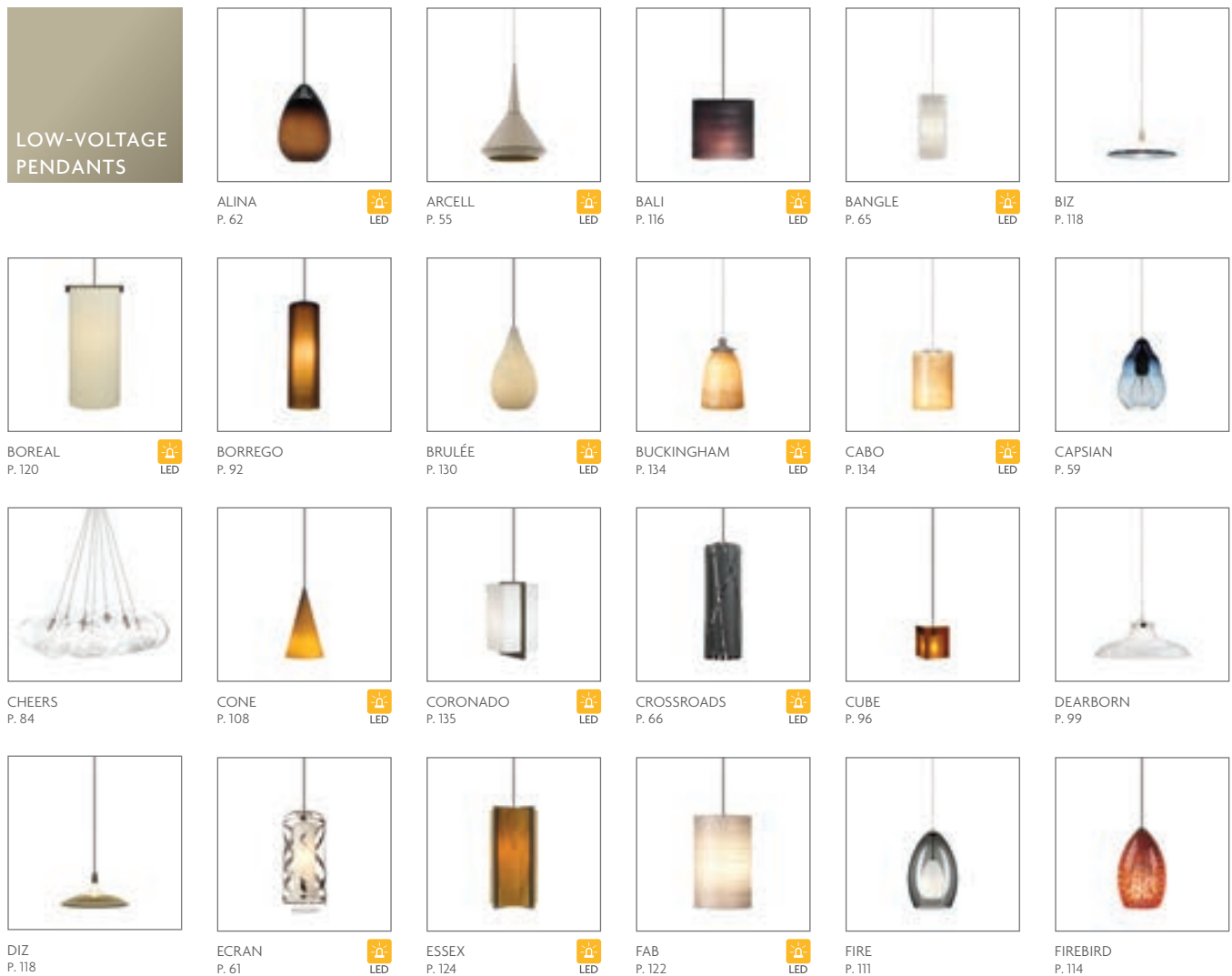

ICONOGRAPHY

Throughout this catalog you will find these icons which represent special features of our products. By making a few, key features easier to find, these icons will help you in selecting the best products for your specific application.



Indicates which fixtures have a **Fluorescent** option. Most fluorescent fixtures include an Instant Start ballast. Consult factory when using occupancy sensors. Program Start ballast options may be available custom.



Indicates which fixtures are **Wet Listed**



Indicates which fixtures are **Energy Star**



Indicates which fixtures have an **LED** option. When a letter and page number are indicated below the LED icon, more detail can be found for that particular LED solution (LED Specifications on p. 580).



Indicates which fixtures are **ADA Compliant**



FIREFRIT
P. 114



FIREFROST
P. 112



HANGING WOK
P. 152



INNER FIRE
P. 112



KIEV
P. 65



LIZA
P. 61



MANCHON
P. 94



MELROSE
P. 140



MELT
P. 146



METEOR FRIT
P. 146



MINI ADMIRAL
CLASSIC
P. 69



MINI ARTIC
P. 55



MINI BENTON
P. 102



MINI BRIDGEPORT
P. 102



MINI CARGO SOLID
P. 69



MINI CLYBOURN
P. 70



MINI DELAWARE
P. 104



MINI DILLON
P. 80



MINI ECHO
P. 86



MINI HALSTED
P. 70



MINI HUDSON
P. 107



MINI LARSPUR
P. 126



MINI MELROSE
P. 140



MINI MISSON
P. 136





MINI MULBERRY
P. 122



MINI OVATION
P. 142



MINI STARRY NIGHT
P. 142



MINI TAVERN
P. 104



MINI TAZA
P. 144



NEBBIA
P. 107



NIKO
P. 144



OAK PARK
P. 136



OTTO
P. 116



PARFUM
P. 59



PELÉ
P. 100



PEYTON
P. 90



PINNACLE
P. 78



PIPER
P. 72



PLAYA
P. 88



PROJEKT
P. 57



PYRAMID
P. 96



RAINDROP
P. 152



REVEL
P. 57



RIVER ROCK
OBLONG OVAL
P. 132



RIVER ROCK
SOFT ROUND
P. 132



RIVER ROCK WEDGE
P. 132



SARA
P. 94



SAVOY
P. 148



SCAVO
P. 128



SELINA
P. 62



SILVA
P. 135



SILVER GLAZE
P. 130



SKY
P. 72



SMALL NEST
P. 138



SOLEIL
P. 111



SOLITUDE
P. 96



SPIRE
P. 82



SUGAR
P. 138



SUMMIT
P. 74



SYDNEY
P. 92



TETRA
P. 100



TIBOR
P. 95



TOPO
P. 80



TORPEDO*
P. 150



VAN BUREN
P. 99



VEIL
P. 90



* SHOWN ACCESSORIZED. SEE PP. 566-579 FOR ACCESSORIES AND OPTICAL CONTROLS



VENTANA
P. 66



WESTON
P. 81



ZENITH
P. 76



ADLER*
P. 181



AERO*
P. 169



CAM
P. 172



ELTON
P. 166



ENVISION
P. 165



HELIOS*
P. 160



IBISS
P. 158



ISO
P. 157



JOHN
P. 166



K-BYE-BYE
P. 184



K-GIRO*
P. 188



K-HELLO
P. 182



K-JANE
P. 186



K-JOHNNY*
P. 186



K-PIVOT
P. 184



K-TELESCOPE*
P. 188



MINI OM*
P. 163



MO-PIVOT*
P. 174



POD
P. 176



SCANIA
P. 163



SPORTSTER
P. 171



SPOT
P. 171



SPROCKET*
P. 172



SULLIVAN*
P. 181



SWIVEL*
P. 174



T156
P. 176



TELE*
P. 178



TELLIUM
P. 165



TILT*
P. 169



VERYON
P. 157



WALL ARCHIE*
P. 190



WALL GEORGI
P. 190



WALL TELESCOPE*
P. 191



WALLY LITE*
P. 191

* SHOWN ACCESSORIZED. SEE PP. 566-579 FOR ACCESSORIES AND OPTICAL CONTROLS

FUNCTIONAL ART



BUGS
P. 192



DRAGONFLY
P. 192



KABLE LITE 4" ROUND
MONOPOINT CANOPY
P. 193



METAL MAN
P. 193

LINE-VOLTAGE HEADS



BREEZE CERAMIC METAL
HALIDE PAR
P. 211



BREEZE CERAMIC METAL
HALIDE T4
P. 212



BREEZE INCANDESCENT
PAR
P. 210



ENVISION
P. 196



OM CERAMIC METAL
HALIDE MR16 / PAR
P. 199



OM CERAMIC METAL
HALIDE T4
P. 200



OM INCANDESCENT PAR
P. 198



SPORTSTER CERAMIC
METAL HALIDE MR16 / PAR
P. 203



SPORTSTER
INCANDESCENT PAR
P. 202



SPOT CERAMIC METAL
HALIDE PAR
P. 206



SPOT INCANDESCENT PAR
P. 204



TWEAK CERAMIC METAL
HALIDE MR16 / PAR
P. 209



TWEAK INCANDESCENT
PAR
P. 208

LINE-VOLTAGE PENDANTS / SUSPENSION



ARTIC
P. 222



ARTIC GRANDE
P. 220



BEACON
P. 256



BENTON
P. 288



BRIDGEPORT
P. 288



CABO GRANDE
P. 296



CARGO SOLID
P. 282



CAPSIAN GRANDE
P. 235



CLARK
P. 258



CLEO
P. 250



CRESCENDO
P. 304



DELANCEY
P. 294



DILLON
P. 232



ECHO
P. 252



ECHO GRANDE
P. 254



EMERGE
P. 302



FINO LARGE
P. 267





FINO SMALL
P. 268



FIRE GRANDE
P. 243



FIRE ONYX
P. 296



HUDSON
P. 264



INNER WORLD
P. 240



JAYDEN GRANDE
P. 262



KIEV LARGE
P. 226



LARKSPUR
P. 274



LARKSPUR
SUSPENSION
P. 311



LEXINGTON
P. 290



LIZA GRANDE
P. 260



MALI
P. 235



MARSHALL
P. 224



MEEKA
P. 251



MELROSE
P. 300



MINI CRESCENDO
P. 305



MOIRÉ
P. 230



MONROE
P. 284



MULBERRY
P. 292



OVATION
P. 303



PARFUM GRANDE
P. 236



PEYTON GRANDE
P. 272



PIPER GRANDE
P. 248



PLAYA
P. 270



POWELL STREET
P. 244



PULLMAN
P. 276



RHAPSODY
P. 307



RIVER ROCK CHANDELIER
P. 310



SARA GRANDE
P. 262



SMALL NEST
P. 298



SOCO
PP. 216-219



SODA
P. 303



SOLEIL GRANDE
P. 242



SPIRE CHANDELIER
P. 308



STACCATO
P. 306



TAVERN
P. 286



TAZA
P. 302



TOPO SUSPENSION
P. 228



TRACE
SUSPENSION
P. 309



UNION LARGE
P. 278



UNION SMALL
P. 280



VAN BUREN MEDIUM
P. 280





VEIL GRANDE
P. 273



VENTANA GRANDE
P. 249



WORLD
P. 238



WRIGHTWOOD
P. 280



ZHANE TRIO
P. 246



MULTI-PORT
CHANDELIERS



PP. 314-321

LINEAR
SUSPENSION



BIZA
P. 324



CROSSROADS
P. 332



JORN
P. 326



KNOX
P. 334



MERCER SUSPENSION
P. 338



REVEL
P. 330

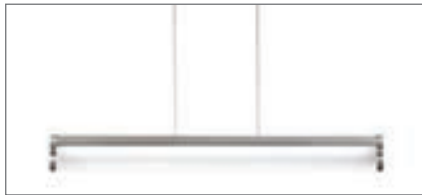

UNISON
P. 336



ZHANE
P. 328



FLUSH & SEMI-
FLUSH MOUNT



90
P. 345



360
P. 345



BAXTER
P. 348



BOXIE
P. 342



CHAMBERS CEILING
P. 346



CIRQUE
P. 342



CLARK CEILING
P. 355



FLUID ROUND
P. 344



FLUID SQUARE
P. 344



MONROE CEILING
P. 354



MULBERRY CEILING
P. 346





PROVINCIA
P. 349



TAVERN CEILING
P. 354



TOPO FLUSH
P. 350



TRACE
SEMI-FLUSH MOUNT
P. 352



WALL
COLLECTION



ADMIRAL CLASSIC
P. 408



ADMIRAL SIMPLE
P. 408



BOREAL
P. 400



BRIDGEPORT
P. 402



CABO
P. 390



CABO GRANDE
P. 390



CHELSEA
P. 396



CORBEL
P. 388



CORBEL CLASSIC
P. 388



CORONADO
P. 390



CORVA
P. 406



COSMO
P. 374



CROSSROADS
P. 366



CUBE
P. 392



DRAKE
P. 398



DRAKE SIMPLE
P. 398



ECHO
P. 378



EMBER
P. 370



ENSU
P. 358



ESSEX
P. 382



FIRE
P. 394



FIREBIRD
P. 394



HUDSON
P. 404



JAXON
P. 368



JAYDEN
P. 372



KATANA
P. 360



KINZE
P. 367



KIDON
P. 404



LARKSPUR
P. 384



LASALLE
P. 376



LEXINGTON
P. 371



LINDEN
P. 376



MINI
LARKSPUR
P. 384



MURA
P. 361



NEBBIA
P. 386





OVATION
P. 386



PLAYA
P. 380



PLAYA
FLUSH
P. 380



PULL LARGE
P. 363



PULL SMALL
P. 362



REVEL
P. 364



REVEL
LINEAR
P. 364



RUE
P. 392



SABLE
P. 396



SARA
P. 372



VAN BUREN
P. 409



VEIL
P. 383



VENTANA
P. 406



WEBSTER
P. 402



WRIGHTWOOD
P. 409



BATH
COLLECTION



CORVA BATH
P. 426



KINZE
P. 414



KISDON
P. 426



LINDEN
P. 418



LUNA
P. 426



LYNN BATH
P. 424

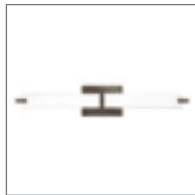

METRO
P. 420

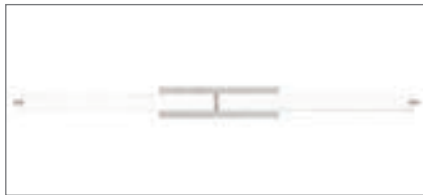

METRO LONG
P. 422



REFLECTION
MIRROR
P. 429



SARA DOUBLE
P. 416



SIBER MIRROR
P. 428



SOLACE
P. 424



TIGRIS MIRROR
OVAL
P. 432



TIGRIS MIRROR
ROUND
P. 430



ZONE
P. 415



UNILUME LED
UNDERCABINET



UNILUME LED
UNDERCABINET
PP. 434-443



DISPLAY
& EXHIBIT



CP SCREW-ON*
P. 560



CPI CLAMP-ON LIGHT*
P. 560



DJ-ARCHIE
P. 563



DJ-GEORGI
P. 563



DJ-TELESCOPE
P. 563



DJ-WALLY LITE
P. 563



JOSHUA 2" CANOPY*
P. 564



JOSHUA 4" ROUND
FLUSH CANOPY
P. 564



JOSHUA AND MEG
PICTURE LIGHTS
P. 565



LC-ARCHIE*
P. 561



LC-GEORGI
P. 561



LC-WALLY LITE
P. 561



LIL BIG WONDER
P. 565



LIL WONDER
P. 565

ACCESSORIES



AERO WOOD HANDLE
ACCESSORY
P. 568



BACKLIGHT SHIELD
P. 576



BELL
P. 575



BELLADONNA
P. 574



CONE GLASS SHIELD
P. 569



CONE ONYX SHIELD
P. 569



CUSTOMIZABLE GOBO
TEMPLATE
PP. 176, 578



DICHROIC GLASS SHIELD
P. 571



FIREBIRD GLASS SHIELD
P. 570



FLIGHT PAPER
P. 575



FLUTE GLASS SHIELD
P. 573



GOBO HOLDER
PP. 176, 578



GOBO MAGNIFYING LENS
PP. 176, 578



HURRICANE
GLASS SHIELD
P. 573



INDUSTRIAL HANG
STRAIGHT
P. 568



IRON WRAP ACCESSORY
P. 568



LIL EGYPT
P. 572



LIL WOK
P. 575



MARTINI GLASS SHIELD
P. 572



MISSION GLASS SHIELD
P. 573



PRISM GLASS SHIELD
P. 572



ROUND GLASS SHIELD
P. 569



SCAVO GLASS SHADE
P. 570

* SHOWN ACCESSORIZED. SEE PP. 566-579 FOR ACCESSORIES AND OPTICAL CONTROLS



SODA GLASS SHADE
P. 570



SPROCKET
SPY ACCESSORY
P. 577



SUGAR ACCESSORY
P. 571



SWAG HOOK
P. 568



TAZA ACCESSORY
P. 571



TINKERBELL
P. 574



TINKERBELL WITH
INTEGRATED LENS HOLDER
P. 574



OPTICAL
CONTROLS

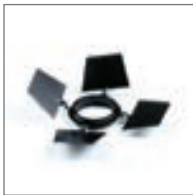

BARNDOORS
P. 577



COLOR & DICHOIC LENS
P. 579

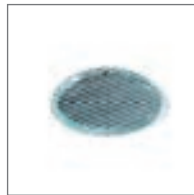

DIFFUSER, SPREAD & SOFT
FOCUS LENS
P. 579



EGGCRATE LOUVER
P. 579



LOUVER LENS HOLDER
P. 576



MR16 SNOUT
P. 577



SNAP LOUVER LENS
HOLDER
P. 576



UV FILTERS
P. 578



Zenith pendant p. 76





Cheers pendant p. 84



Photographer: Raul J. Garcia

LOW-VOLTAGE PENDANTS 52-153

Typically smaller than their line-voltage counterparts, our low-voltage pendants are as versatile as they are beautiful. The minimalist cord virtually disappears while the halogen lamps produce beautiful white light. The halogen source is more energy efficient than a typical incandescent light bulb, and many of the pendants are also offered with our state-of-the-art, incredibly energy efficient LED module.

Kiev pendant p. 65



MonoRail p. 456 with Tilt head p. 169



Photographer: Matthew Millman BCCI Construction Company



Photographer: Judy Davis/Hoachlander Davis Photography

LOW-VOLTAGE HEADS 154-193

Smaller than typical line-voltage track heads, our low-voltage heads are not the track heads we all grew up with! Thoughtful design and precision engineering marry up with high performing MR16 lamps and LED modules to offer incredible choice for virtually any task application. Myriad styles help fit any décor while a wide selection of accessories extend the possibilities.

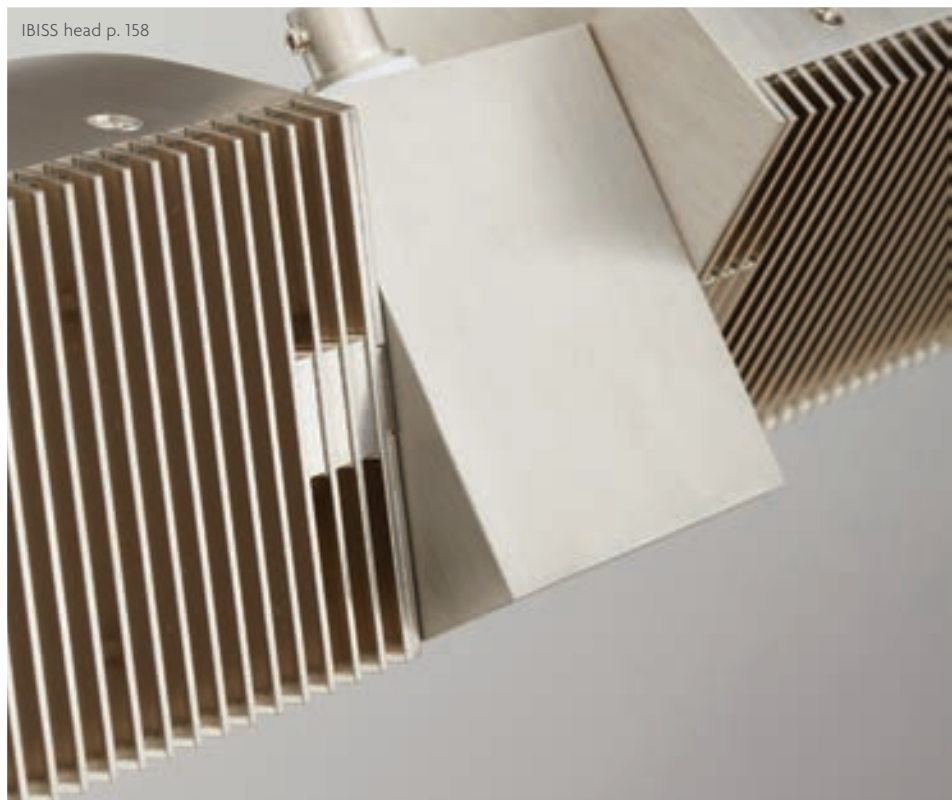

T-TRAK p. 534 with Sportster head p. 202



Photographer: Paul Rivera, Arch Photo, Inc.



T-TRAK p. 534 with Sportster head p. 202

Photographer: Burnett Studios, Jim Burnett Jr.

LINE-VOLTAGE HEADS 194-213

Offered in numerous lamping options, our 120 volt track heads are engineered to perform in a wide variety of residential and commercial applications, while their beautiful design and precision lines help elevate them above typical line-voltage track solutions.

Om head p. 198



Capsian Grande pendant p. 235





Echo pendant p. 252



LINE-VOLTAGE PENDANTS / 214-313 SUSPENSION

The only common thread is that this versatile group of fixtures mounts to the ceiling. Beyond that, there is incredible breadth of scale, style and color. Our large scale pendants, contemporary chandeliers and suspension fixtures easily take the place of traditional chandeliers and make a powerful statement in any space.

Liza Grande pendant p. 260



Line-Voltage 7-port canopy p. 319 with Beacon pendant p. 256





Line-Low 7-port canopy p. 319 with Sara pendant p. 94 and Sara Grande pendant p. 262

MULTI-PORT CHANDELIERS 314-321

Creativity takes off when multi-port canopies are used to create elegant custom chandeliers. Offered in Low-Voltage, line-voltage and a combination of low- line-voltage as well as in several shapes, sizes and finishes, the possibilities are limitless.



11-Port Round canopy p. 319

Zhane linear suspension p. 328





Revel linear suspension p. 330

LINEAR SUSPENSION 322-339

These fixtures each take a unique spin on the linear suspension fixture. Perfect for a distinct look over a kitchen island, above a dining room table, illuminating a conference room or welcoming guests into a lobby, our ever-expanding offering follows the design mandate of balancing beautiful form with true function.

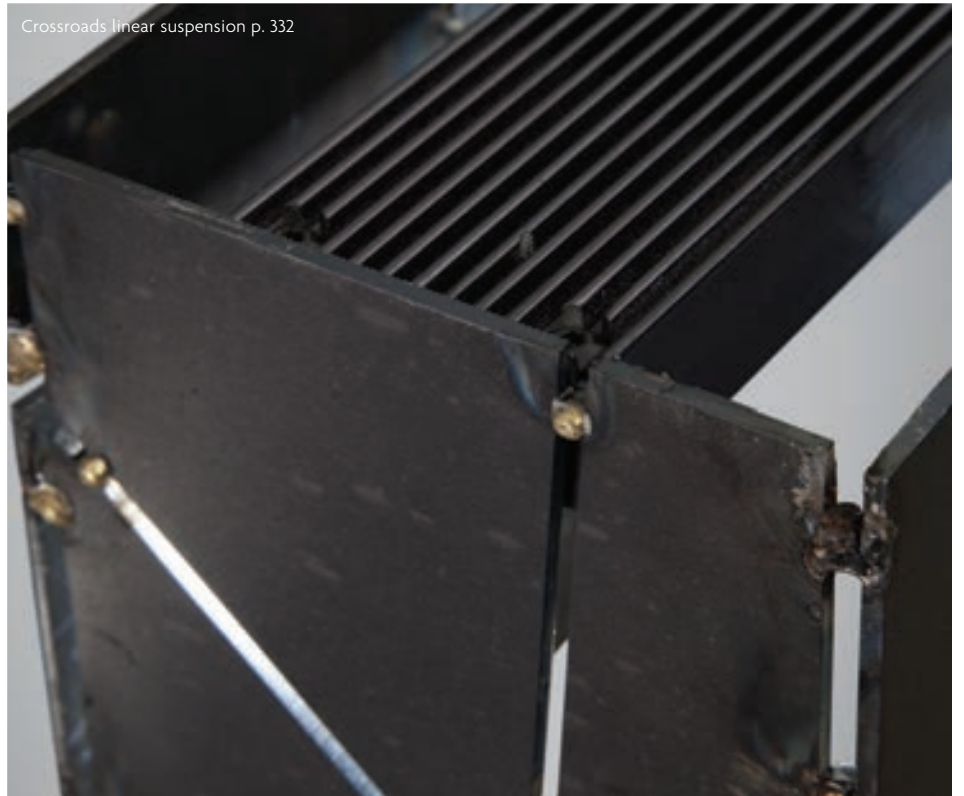

Crossroads linear suspension p. 332

Mulberry Ceiling flush mount p. 346



Photographer: Steve Henke



Cirque flush mount p. 342



FLUSH & SEMI-FLUSH MOUNT 340-355

Given their versatility and universal appeal, flush & semi-flush mount fixtures are ideal for entries, hallways, closets, stairwells and virtually any space with a lower ceiling clearance. Thoughtful designs in a variety of materials will invariably help not only illuminate, but elevate these spaces.

Fluid Square flush mount p. 344



Playa Flush wall p. 380





Coronado wall p. 390

WALL COLLECTION 356-411

Wall sconces highlight and frame architectural features like no other type of fixture. Whether flanking a mirror, mantle, bed, desk, sitting area or providing soft, ambient light down a long hallway, wall fixtures truly serve a highly visible, central role in a room's décor. Many of these sconces work equally well in a bathroom setting to illuminate a vanity area.



Ventana wall p. 406

Metro p. 420



Photographer: Lars Frazer Interior Design: Miller Greene Design Studio



BATH COLLECTION 412-433

Adequate light is imperative in the bathroom, and today's bathrooms deserve a solution that is as pleasing to the eye as it is functional. From the simple and clean to the truly magnificent, our bath fixtures and lit mirrors will not only help you get ready in the morning, but will help you relax, recharge and serve you for years to come. Many of the bath bars may also be mounted vertically flanking the mirror which is ideal for casting an even light across the face.







UNILUME LED UNDERCABINET 434-443

Unilume is the latest innovation in LED Undercabinet. By using tightly clustered LEDs, a 98% reflective mixing chamber and a remote phosphor lens, we are able to achieve incredibly high efficacy and even illumination in a minimal housing while eliminating hot spots and distracting multiple shadows that result from traditional point source LEDs.



FreeJack canopy p. 452 with Fire pendant p. 111





FreeJack canopy p. 452 with Peyton pendant p. 90

FREEJACK 444-455

Single- and multi-port canopies in myriad shapes and styles along with several different system adapters make it simple to install our low-voltage pendants and heads in countless configurations.



FreeJack canopy p. 452 with Sprocket head p. 172

MonoRail p. 456 with Spot head p. 171 and Piper pendant p. 72



Photographer: Matthew Millman Design: Aidlin Darling Design



MonoRail p. 456 with Aero head p. 169



Trends Publishing International · Photographer: John Umberger · Designer: Stainback-Hess Studio

MONORAIL 456-479

MonoRail is a low-voltage rail system which serves as the infrastructure on which limitless lighting designs can be achieved with low-voltage pendants and directional heads. MonoRail is a sleek, versatile and contemporary alternative to traditional track and can be customized for large or small spaces with a wide variety of angular configurations or bent into soft curves for more fluid designs.

Pass-Through Transformer p. 470



Two-Circuit MonoRail p. 480 with Sprocket head p. 172



Photographer: Jeff Millies, Hedrich Blessing Design: Michael Waechter, AIA

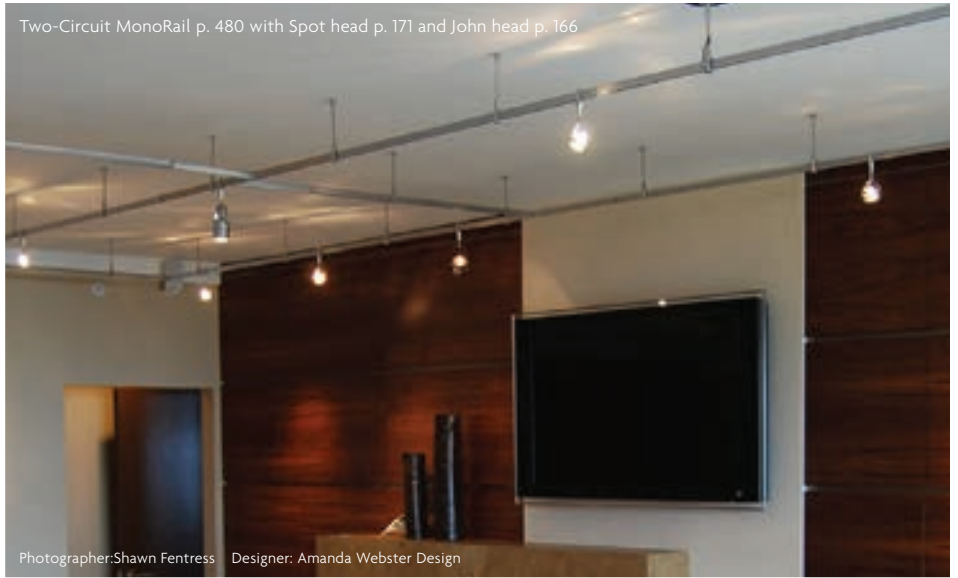

Two-Circuit MonoRail p. 480 with Spot head p. 171 and John head p. 166

Photographer: Shawn Fentress Designer: Amanda Webster Design



TWO-CIRCUIT MONORAIL 480-497

Independent switching of two separate circuits means you can combine a series of pendants and directional heads on the same expanse of rail, and still control them independently. This is ideal when layers of light are desired to create both ambient and directional or task lighting in one specific area.



Two-Circuit MonoRail p. 480 with Tilt head p. 169

Photographer: © Galina Coadu Lighting: Yaacov Golan

Wall MonoRail p. 498 with Wall Georgj head p. 190



Photographer: © Galina Coadă



Photographer: www.peterrymwid.com

WALL MONORAIL 498-513

Whether the design challenge is highlighting wall art or signage or avoiding interference of special ceiling features such as tin ceilings, murals, or tray ceilings, wall monorail is a versatile solution for installing a series of low-voltage directional heads along a wall.

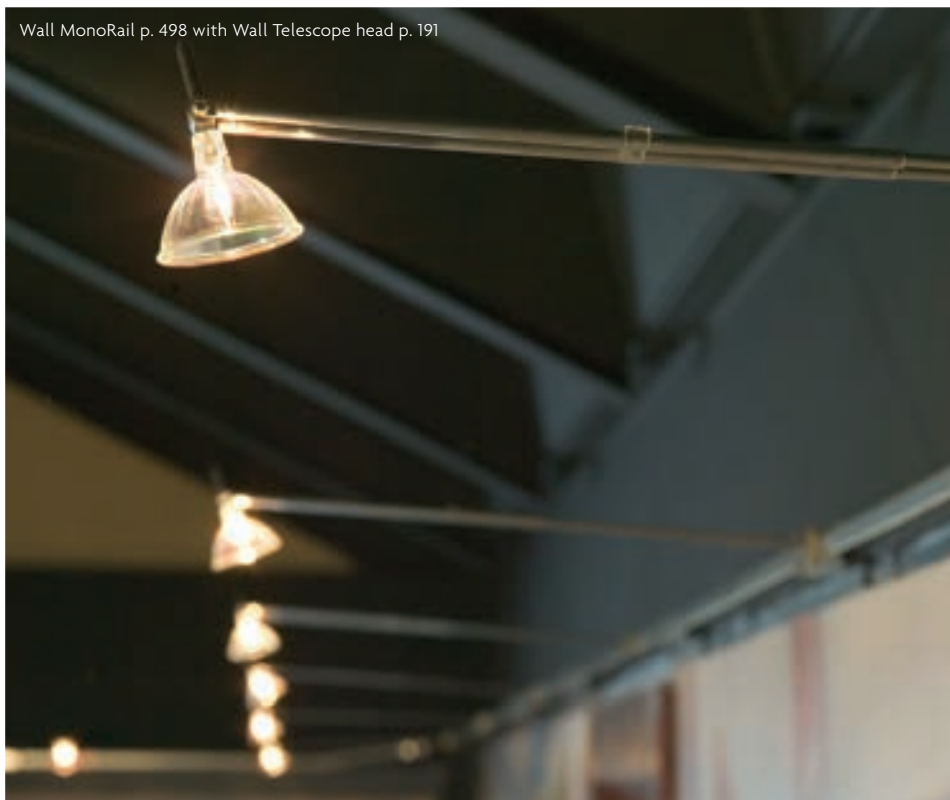

Kable Lite p. 514 with K-Pivot head p. 184 and Piper pendant p. 72



Photographer: Lars Frazer Interior Design: Miller Greene Design Studio



Kable Lite p. 514 with K-Bye-Bye head p. 184



Trends Publishing International Photographer: Tim Maloney Design: Fu Tung Cheng, Cheng Design (Berkeley, Ca.)

KABLE LITE 514-533

Low-voltage heads or pendants are suspended from two parallel cables that virtually disappear while the fixtures appear to almost float in the space. Kable Lite is a flexible solution particularly suited for high ceilings making the fixtures themselves take center stage.

Kable Lite p. 514 with K-Bye-Bye head p. 184

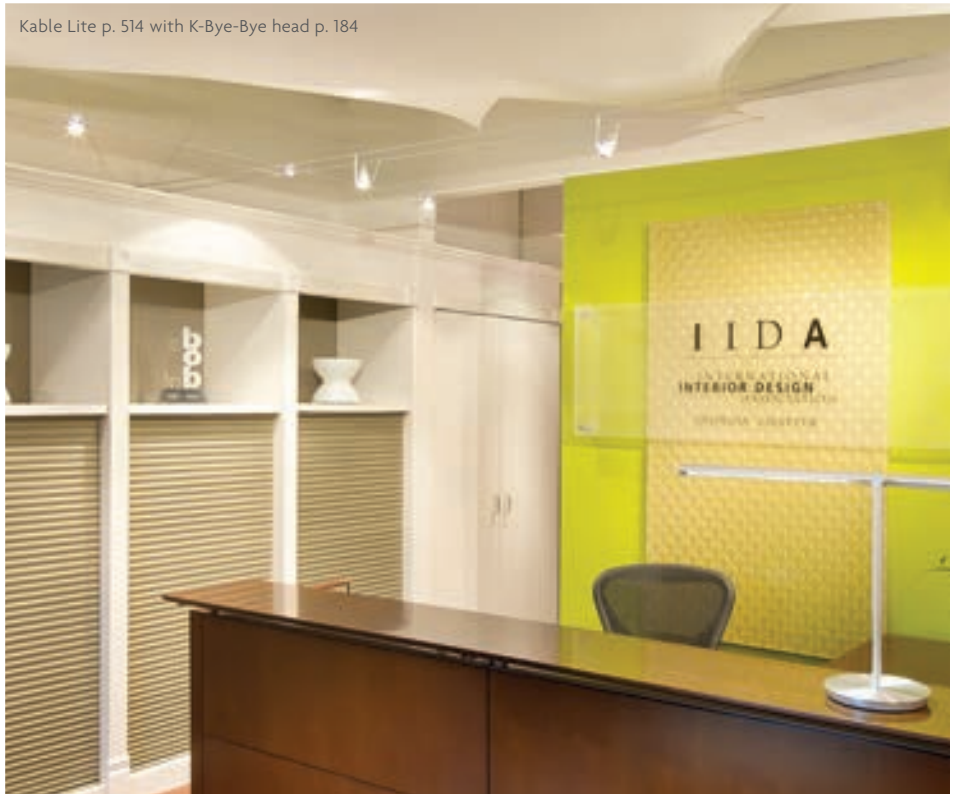

Photographer: John Clemmer Photography

T-TRAK p. 534 with Sportster head p. 202



Design: Aidlin Darling Design



T-TRAK p. 534 with Om head p.198

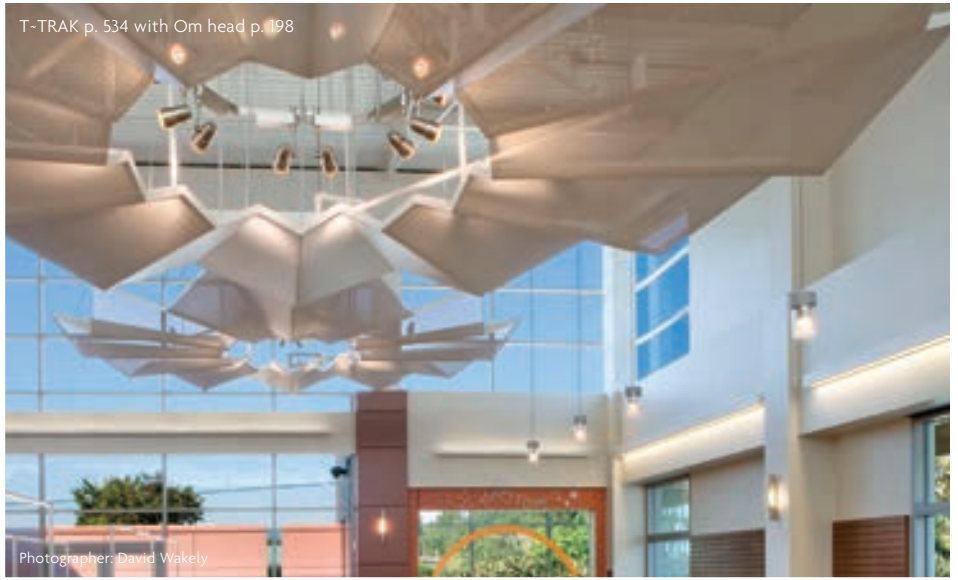

Photographer: David Wakely



T~TRAK 534-553

T-TRAK is our award winning, architectural, hand-bendable 120 volt track system. Available as single-circuit or two-circuit which allows for two independent layers of light off the same system. T-TRAK also includes our Power Jack Monopoint canopies. Offered for use with a wide selection of line-voltage heads and pendants or even our low-voltage products using the appropriate adapter along with multiple lamping options to meet the needs of virtually any application.

Om head p. 198





Display Jack canopy p. 562 with DJ-Wally Lite head p. 563 and MonoRail p. 456 with Piper pendant p. 72



Display Jack canopy p. 562 with DJ-Georgi head p. 563



Trends Publishing International Photographer: John Umberger Architect: Altus Architecture

DISPLAY & EXHIBIT 554-565

Lightweight, adjustable and unobtrusive, our selection of display and exhibit solutions directs light exactly where it is needed while allowing the artwork, signage or merchandise to take center stage.



Joshua Picture Light p. 565





Modified Jaxon wall p. 368

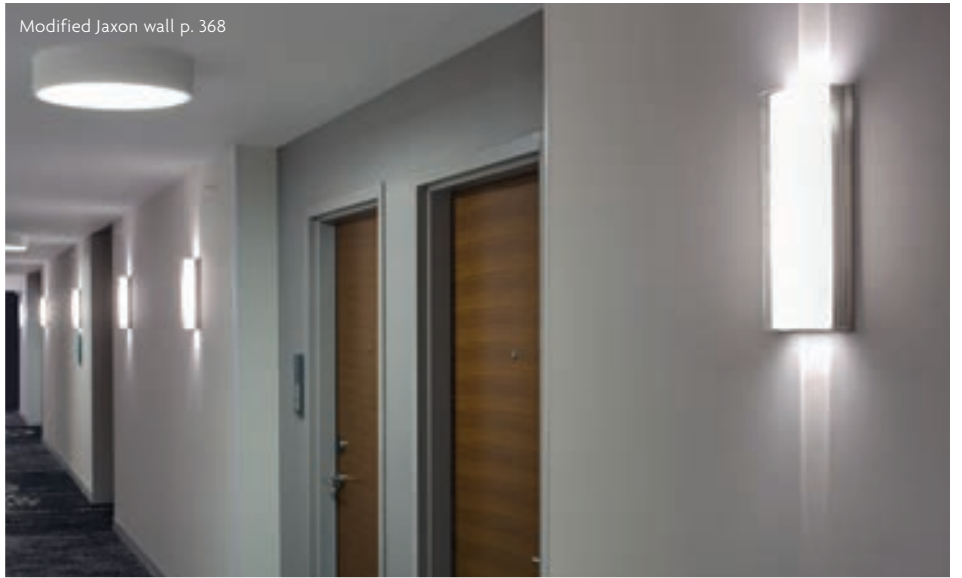

CUSTOM CAPABILITIES

We want to fulfill your vision – whether minor modifications to existing products or creating unique products specific to your design criteria. By working collaboratively and keeping you informed every step of the way, we are committed to delivering the best product possible on time and on budget.

Contact our Quotations Department at 847.410.4400 for assistance with any custom requests.

Modified T-TRAK p. 534 with Spot head p. 202



Photographer: Cesar Rubio



LOW-VOLTAGE PENDANTS



LOW-VOLTAGE PENDANTS





MINI ARTIC



A
P. 580

A sculptural metal frame whose arms elegantly represent the path the light is taking is surrounded by a modern, high-gloss, semi-translucent shade which allows light to playfully bounce around the fixture and enables just a hint of the light source itself to shine through. Includes low-voltage, 50 watt halogen MR16 lamp or 6 watt replaceable LED module and six feet of field-cutttable suspension cable.

700	SYSTEM	MATC	OUTER / INNER COLOR	CAGE FINISH	FINISH	VOLTAGE
FJ	FREEJACK	BG	GLOSS BLACK-GOLD	S SATIN NICKEL	S SATIN NICKEL	12 VOLT HALOGEN
MP	MONOPOINT*	BS	GLOSS BLACK-SILVER			-24 24 VOLT HALOGEN
KL	KABLE LITE	WG	GLOSS WHITE-GOLD			-LED 12 VOLT HALOGEN
MO	MONORAIL	WS	GLOSS WHITE-SILVER			-LED 12 VOLT LED 3000K
MO2	TWO-CIRCUIT MONORAIL					

PRODUCT DIMENSIONS

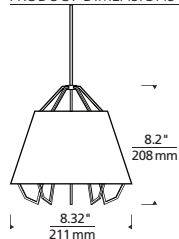

COMPLEMENTARY PRODUCT
LINE-VOLTAGE PENDANTS P. 220, 222



ARCELL



A
P. 580

Inspired by mid-century modern design, the minimalist yet playful lines create a silhouette which loosely suggests that of shop lights. Includes low-voltage, 35 watt halogen MR16 lamp or 6 watt field-replaceable LED module and six feet of field-cutttable suspension cable.

700	SYSTEM	ACL	COLOR	FINISH	VOLTAGE
FJ	FREEJACK	N	BRONZE BROWN	Z ANTIQUE BRONZE**	12 VOLT HALOGEN
MP	MONOPOINT*	H	CASHMERE	S SATIN NICKEL	-24 24 VOLT HALOGEN
KL	KABLE LITE	D	DUNE		-LED 12 VOLT LED 3000K
MO	MONORAIL	S	STONE		
MO2	TWO-CIRCUIT MONORAIL				

PRODUCT DIMENSIONS

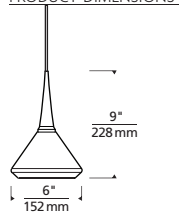

* INCLUDES 4" ROUND FLUSH CANOPY

** ANTIQUE BRONZE IS NOT AVAILABLE FOR KABLE LITE





REVEL



A
P. 580

Captures light in motion. The sleek metal surface is laser-cut with several horizontal cutouts which allow light to shine through the inner white case glass diffuser. Includes low-voltage, 50 watt halogen bi-pin lamp or 6 watt replaceable LED module and six feet of field-cutttable suspension cable.

700	SYSTEM	RVL	COLOR	FINISH	VOLTAGE
FJ	FREEJACK	Z	ANTIQU BRONZE	Z ANTIQUE BRONZE S SATIN NICKEL	12 VOLT HALOGEN
MP	MONOPOINT*	B	GLOSS BLACK		-24 24 VOLT HALOGEN
MO	MONORAIL	W	GLOSS WHITE		-LED 12 VOLT LED 3000K
MO2	TWO-CIRCUIT MONORAIL	S	SATIN NICKEL		

PRODUCT DIMENSIONS

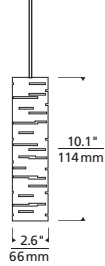

COMPLEMENTARY PRODUCT
LINEAR SUSPENSION P. 330 / WALL P. 364



PROJEKT



A
P. 580

Sculptural and unexpected, this is a very modern take on the traditional finial. The LED light source shines brightly on the decorative finial perched inside the metal and glass exterior. The finish on the outer metal frame contrasts nicely making the polished finial inside the true focal point of the design. Includes 6 watt replaceable LED module and six feet of field-cutttable suspension cable.

700	SYSTEM	PJT	COLOR	FINISH	VOLTAGE
FJ	FREEJACK	N	BROWN	Z ANTIQUE BRONZE S SATIN NICKEL	-LED 12 VOLT LED 3000K
MP	MONOPOINT*	C	CLEAR		
MO	MONORAIL	K	SMOKE		
MO2	TWO-CIRCUIT MONORAIL				

PRODUCT DIMENSIONS

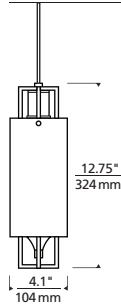

* INCLUDES 4" ROUND FLUSH CANOPY





CAPSIAN

Delicate Moroccan inspired silhouette of Italian hand-blown, transparent glass surrounds a unique low-voltage Classic Edison style lamp. Adds warm beauty to any space. Includes low-voltage, 60 watt medium base A19 lamp and six feet of field-cutttable suspension cable. Because the lamp is underdriven, it only consumes 30 watts for the purposes of transformer and energy calculations. Ships with an additional lamp to make it easier upon relamping.

700	SYSTEM	CPS	COLOR	FINISH	VOLTAGE
FJ	FREEJACK	K	SMOKE	Z	ANTIQU BRONZE**
MP	MONOPOINT*	U	STEEL BLUE	S	SATIN NICKEL
KL	KABLE LITE				
MO	MONORAIL				
MO2	TWO-CIRCUIT MONORAIL				

PRODUCT DIMENSIONS

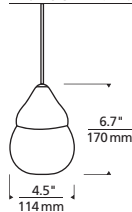

COMPLEMENTARY PRODUCT
LINE-VOLTAGE PENDANT P. 235



PARFUM

With a modern take on vintage French perfume bottles, the silhouette is sleek and clean while still warm and elegant. A metal band separates the top and bottom hand-blown glass pieces, and the bottom glass features a beautiful clear draw adding richness and depth to the design. Includes low-voltage, 35 watt halogen bi-pin lamp (opaque bottom glass) or 20 watt halogen bi-pin lamp (transparent bottom glass) and six feet of field-cutttable suspension cable.

700	SYSTEM	PFM	COLOR (TOP / BOTTOM)	FINISH	VOLTAGE
FJ	FREEJACK	CLCL	CLEAR / CLEAR	Z	ANTIQU BRONZE
MP	MONOPOINT*	CLWH	CLEAR / WHITE	S	SATIN NICKEL
MO	MONORAIL	TKSM	TRANSPARENT SMOKE / SMOKE		-24
MO2	TWO-CIRCUIT MONORAIL	TKTK	TRANSPARENT SMOKE / TRANSPARENT SMOKE		
		TKWH	TRANSPARENT SMOKE / WHITE		
		WHWH	WHITE / WHITE		

PRODUCT DIMENSIONS

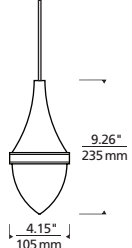

COMPLEMENTARY PRODUCT
LINE-VOLTAGE PENDANT P. 236

* INCLUDES 4" ROUND FLUSH CANOPY
** ANTIQU BRONZE IS NOT AVAILABLE FOR KABLE LITE

LOW-VOLTAGE PENDANTS





ECRAN



A
P. 580

Named after the French word for “screen,” the pill-shaped outer glass is adorned with one of three distinctly elegant patterns – all created with real platinum and gold. The glass is hand-blown in Italy and then shipped to EGIZIA, an Italian company known the world over for its incredible silk-screening techniques, so the precious metals can be meticulously silk-screened onto glass. The beautiful patterns are brought to life as the light shines through them from an additional hand-blown inner white glass diffuser. Each pendant ships with disposable polishing cloths to ensure the metals retain their luster over time. Includes low-voltage, 50 watt halogen bi-pin lamp or 6 watt replaceable LED module and six feet of field-cutttable suspension cable.

700	SYSTEM	ECN	COLOR	PATTERN	FINISH	VOLTAGE
FJ	FREEJACK	CG	CLEAR / POLISHED GOLD	L LATTICE	Z ANTIQUE BRONZE**	12 VOLT HALOGEN
MP	MONOPOINT*	CP	CLEAR / POLISHED PLATINUM	M MOROCCAN	C CHROME	-24 24 VOLT HALOGEN
KL	KABLE LITE			P PLAID	S SATIN NICKEL	-LED 12 VOLT LED 3000K
MO	MONORAIL					
MO2	TWO-CIRCUIT MONORAIL					

EGIZIA

Luxury design handmade in Italy

PRODUCT DIMENSIONS

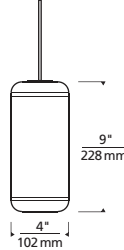

LIZA

Classically modern. Clear, flame-worked borosilicate glass—commercially known as Pyrex®—is formed into a dramatic cylinder with a flowing diagonal pattern of open glass which creates visual depth against an inner white glass diffuser. Includes low-voltage, 50 watt halogen bi-pin lamp and six feet of field-cutttable suspension cable.

700	SYSTEM	LIZ	COLOR	FINISH	VOLTAGE
FJ	FREEJACK	B	BLACK	Z ANTIQUE BRONZE	12 VOLT HALOGEN
MP	MONOPOINT*	C	CLEAR	C CHROME	-24 24 VOLT HALOGEN
MO	MONORAIL	K	SMOKE	S SATIN NICKEL	
MO2	TWO-CIRCUIT MONORAIL				

PRODUCT DIMENSIONS

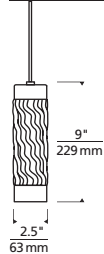

COMPLEMENTARY PRODUCT
LINE-VOLTAGE PENDANT P. 260

* INCLUDES 4" ROUND FLUSH CANOPY

** ANTIQUE BRONZE IS NOT AVAILABLE FOR KABLE LITE





BROWN

SMOKE



STEEL BLUE

WHITE

ALINA



A
P. 580

Hand-blown Venetian teardrop shaped glass with beautiful clear draw. Includes low-voltage, 50 watt halogen bi-pin lamp or 6 watt replaceable LED module and six feet of field-cutttable suspension cable.

700	SYSTEM	ALI	COLOR	FINISH	VOLTAGE	
FJ	FREEJACK	N	BROWN	Z	ANTIQU BRONZE	12 VOLT HALOGEN
MP	MONOPOINT*	K	SMOKE	C	CHROME	-24 24 VOLT HALOGEN
MO	MONORAIL	U	STEEL BLUE	S	SATIN NICKEL	-LED 12 VOLT LED 3000K
MO2	TWO-CIRCUIT MONORAIL	W	WHITE			

PRODUCT DIMENSIONS

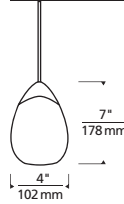

BROWN

SMOKE



STEEL BLUE

WHITE

SELINA



A
P. 580

Hand-blown Venetian cone-shaped glass with rich, opaque color at the base which transitions into a beautiful clear draw at the top. Includes low-voltage, 50 watt halogen bi-pin lamp or 6 watt replaceable LED module and six feet of field-cutttable suspension cable.

700	SYSTEM	SLN	COLOR	FINISH	VOLTAGE	
FJ	FREEJACK	N	BROWN	Z	ANTIQU BRONZE	12 VOLT HALOGEN
MP	MONOPOINT*	K	SMOKE	C	CHROME	-24 24 VOLT HALOGEN
MO	MONORAIL	U	STEEL BLUE	S	SATIN NICKEL	-LED 12 VOLT LED 3000K
MO2	TWO-CIRCUIT MONORAIL	W	WHITE			

PRODUCT DIMENSIONS

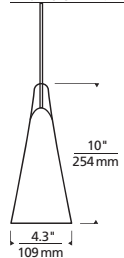

* INCLUDES 4" ROUND FLUSH CANOPY



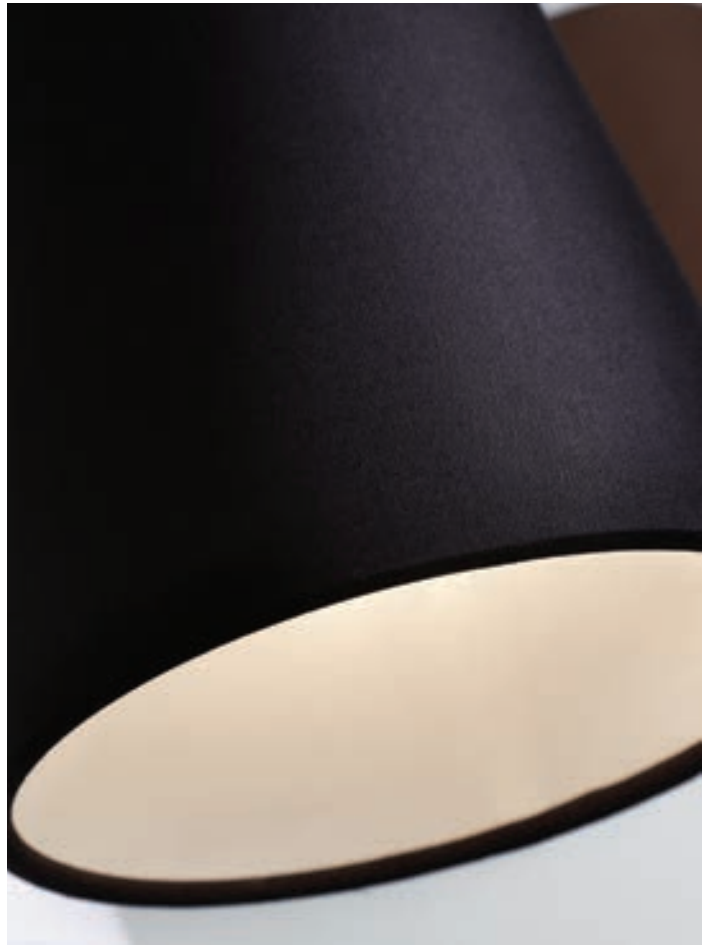



KIEV



A
P. 580

Antique meets modern with a turned ornate glass fount and simple tapered fabric shade with rolled edges. Includes low-voltage, 50 watt halogen bi-pin lamp or 6 watt replaceable LED module and six feet of field-cutttable suspension cable.

700	SYSTEM	KIE	COLOR	FOUNT COLOR	FINISH	VOLTAGE
FJ	FREEJACK	B	BLACK	C	Z	12 VOLT HALOGEN
MP	MONOPOINT*	N	BROWN	F	ANTIQUE BRONZE**	24 VOLT HALOGEN
KL	KABLE LITE	W	WHITE	K	CHROME	-LED 12 VOLT LED 3000K
MO	MONORAIL			S	SATIN NICKEL	
MO2	TWO-CIRCUIT MONORAIL					

PRODUCT DIMENSIONS

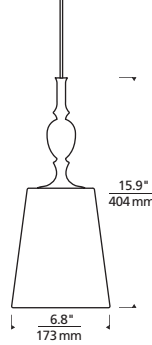

COMPLEMENTARY PRODUCT
LINE-VOLTAGE PENDANT P. 226



BANGLE



A
P. 580

Five crystal bangles surround an inner glass diffuser. Hundreds of facets are precisely hand-cut into each bracelet to create the elegant details that truly set this design apart. Bangles can be mixed and matched. Contact factory for custom color combinations. Includes low-voltage, 50 watt halogen bi-pin lamp or 6 watt replaceable LED module and six feet of field-cutttable suspension cable.

700	SYSTEM	BNGL	COLOR	FINISH	VOLTAGE
FJ	FREEJACK	A	AMBER	Z	12 VOLT HALOGEN
MP	MONOPOINT*	C	CLEAR	CHROME	24 VOLT HALOGEN
KL	KABLE LITE	K	SMOKE	S	-LED 12 VOLT LED 3000K
MO	MONORAIL				
MO2	TWO-CIRCUIT MONORAIL				

PRODUCT DIMENSIONS

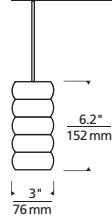

* INCLUDES 4" ROUND FLUSH CANOPY

** ANTIQUE BRONZE IS NOT AVAILABLE FOR KABLE LITE

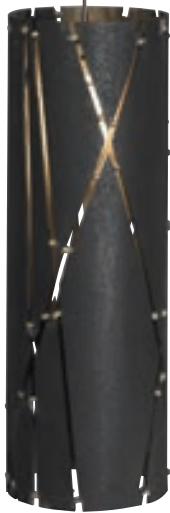

CROSSROADS



A
P. 580

Inspired by the sheen of big city streets and intersections illuminated at night. Composed of raw sheet steel protected with a clear lacquer coat and accented by brass spot welding at the joints, it has a purposefully imperfect, rugged, industrial design. Includes low-voltage, 50 watt halogen bi-pin lamp or 6 watt field-replaceable LED module and six feet of field-cutttable suspension cable.

700	SYSTEM	CRS	PENDANT FINISH / HARDWARE FINISH	VOLTAGE
	FJ	FREEJACK	AB STEEL / ANTIQUE BRONZE	12 VOLT HALOGEN
	MP	MONOPOINT*	S STEEL / SATIN NICKEL	-24 24 VOLT HALOGEN
	MO	MONORAIL		-LED 12 VOLT LED 3000K
	MO2	TWO-CIRCUIT MONORAIL		

PRODUCT DIMENSIONS

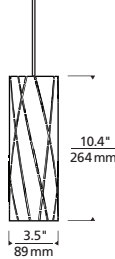

PRODUCT DETAILS



COMPLEMENTARY PRODUCT
LINEAR SUSPENSION P. 332 / WALL P. 366



ANTIQUÉ BRONZE

VENTANA



A
P. 580

Graceful metal dome with intricate, asymmetric cutouts. The elliptical inner white case glass softens the light shining through this dramatic piece. Includes low-voltage, 50 watt halogen bi-pin lamp or 6 watt replaceable LED module and six feet of field-cutttable suspension cable.

700	SYSTEM	VNT	FINISH	VOLTAGE
	FJ	FREEJACK	Z ANTIQUÉ BRONZE	12 VOLT HALOGEN
	MP	MONOPOINT*	S SATIN NICKEL	-24 24 VOLT HALOGEN
	MO	MONORAIL		-LED 12 VOLT LED 3000K
	MO2	TWO-CIRCUIT MONORAIL		

PRODUCT DIMENSIONS

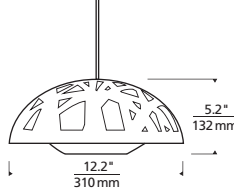

SATIN NICKEL

COMPLEMENTARY PRODUCT
LINE-VOLTAGE PENDANT P. 249 / WALL P. 406

* INCLUDES 4" ROUND FLUSH CANOPY



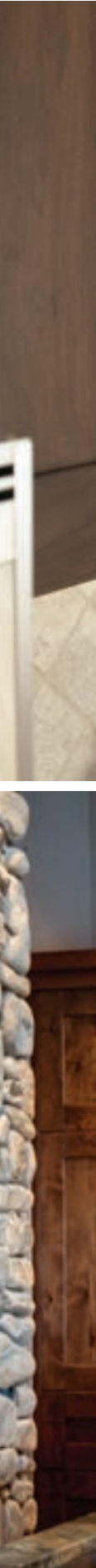



MINI ADMIRAL CLASSIC



Nautical-inspired mariner light with white glass diffuser, classic cage and rain guard detail. Includes low-voltage, 50 watt halogen bi-pin lamp or 6 watt replaceable LED module and six feet of field-cutttable suspension cable.

600	SYSTEM	MADMC	COLOR	FINISH	VOLTAGE
FJ	FREEJACK		W WHITE	Z ANTIQUE BRONZE	12 VOLT HALOGEN
MP	MONOPOINT*			S SATIN NICKEL	24 VOLT HALOGEN
MO	MONORAIL				-LED 12 VOLT LED 3000K
MO2	TWO-CIRCUIT MONORAIL				

PRODUCT DIMENSIONS

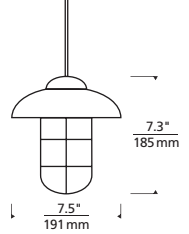

COMPLEMENTARY PRODUCT
WALL P. 408



MINI CARGO SOLID

Industrial-inspired dome-shaped metal shade. Includes low-voltage, 50 watt MR16 flood lamp and six feet of field-cutttable suspension cable.

600	SYSTEM	MCRGS	FINISH	VOLTAGE
FJ	FREEJACK		Z ANTIQUE BRONZE**	12 VOLT HALOGEN
MP	MONOPOINT*		S SATIN NICKEL	-24 24 VOLT HALOGEN
KL	KABLE LITE			
MO	MONORAIL			
MO2	TWO-CIRCUIT MONORAIL			

PRODUCT DIMENSIONS

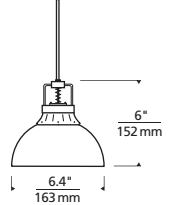

COMPLEMENTARY PRODUCT
SUSPENSION P. 282

SEE P. 514 FOR ADDITIONAL APPLICATION PHOTO

* INCLUDES 4" ROUND FLUSH CANOPY

** ANTIQUE BRONZE IS NOT AVAILABLE FOR KABLE LITE



CLEAR PRISMATIC WITH SATIN NICKEL



FROST WITH ANTIQUE BRONZE

MINI CLYBOURN



A P. 580

A true replica of historic street light designed with working metal clips to hold a fully enclosed glass diffuser in place. Includes low-voltage, 50 watt halogen bi-pin lamp or 6 watt replaceable LED module and six feet of field-cutttable suspension cable.

600	SYSTEM	MCLYB	COLOR	FINISH	VOLTAGE
FJ	FREEJACK		C CLEAR PRISMATIC	Z ANTIQUE BRONZE	12 VOLT HALOGEN
MP	MONOPOINT*		F FROST	S SATIN NICKEL	-24 24 VOLT HALOGEN
MO	MONORAIL				-LED 12 VOLT LED 3000K
MO2	TWO-CIRCUIT MONORAIL				

PRODUCT DIMENSIONS

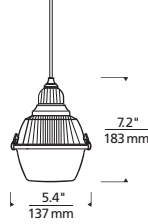

PRODUCT DETAILS



CLEAR PRISMATIC WITH SATIN NICKEL



FROST WITH ANTIQUE BRONZE

MINI HALSTED



A P. 580

A true replica of historic street light designed with functional metal clips to hold a fully enclosed acorn-shaped glass diffuser in place. Includes low-voltage, 50 watt halogen bi-pin lamp or 6 watt replaceable LED module and six feet of field-cutttable suspension cable.

600	SYSTEM	MHALS	COLOR	FINISH	VOLTAGE
FJ	FREEJACK		C CLEAR PRISMATIC	Z ANTIQUE BRONZE	12 VOLT HALOGEN
MP	MONOPOINT*		F FROST	S SATIN NICKEL	-24 24 VOLT HALOGEN
MO	MONORAIL				-LED 12 VOLT LED 3000K
MO2	TWO-CIRCUIT MONORAIL				

PRODUCT DIMENSIONS

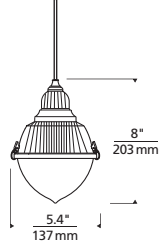

* INCLUDES 4" ROUND FLUSH CANOPY



LOW-VOLTAGE PENDANTS

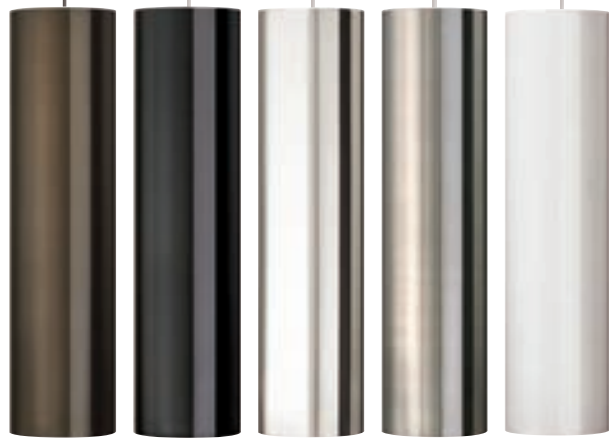

ANTIQUÉ BRONZE BLACK CHROME SATIN NICKEL WHITE



A
P. 580

PIPER

Sleek cylinder shaped metal shade provides crisp down light. Includes low-voltage, 50 watt MR16 flood lamp or 6 watt replaceable LED module and six feet of field-cutttable suspension cable.

700	SYSTEM	PPR	COLOR / FINISH	VOLTAGE
FJ	FREEJACK	ZZ	ANTIQUÉ BRONZE / ANTIQUÉ BRONZE	12 VOLT HALOGEN
MP	MONOPOINT*	BS	BLACK / SATIN NICKEL	-24 24 VOLT HALOGEN
MO	MONORAIL	CC	CHROME / CHROME	-LED 12 VOLT LED 3000K
MO2	TWO-CIRCUIT MONORAIL	SS	SATIN NICKEL / SATIN NICKEL	
		WS	WHITE / SATIN NICKEL	

PRODUCT DIMENSIONS

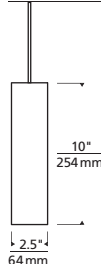

COMPLEMENTARY PRODUCT
LINE-VOLTAGE PENDANT P. 248

SEE PP. 38, 44, 321, 556 FOR ADDITIONAL APPLICATION PHOTOS



COPPER



SATIN NICKEL



A
P. 580

SKY

Lightweight anodized metal pendant. Available in 8" or 12" diameter. Includes low-voltage, 50 watt MR16 flood lamp or 6 watt replaceable LED module and six feet of field-cutttable suspension cable.

700	SYSTEM	SKY	SIZE	COLOR	FINISH	VOLTAGE
FJ	FREEJACK	08	8" DIAMETER	CP COPPER	Z ANTIQUÉ BRONZE**	12 VOLT HALOGEN
MP	MONOPOINT*	12	12" DIAMETER	SN SATIN NICKEL	C CHROME	-24 24 VOLT HALOGEN
K	KABLE LITE				S SATIN NICKEL	-LED 12 VOLT LED 3000K
MO	MONORAIL					
MO2	TWO-CIRCUIT MONORAIL					

PRODUCT DIMENSIONS

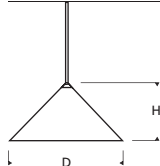

SIZE	D	H
SKY 8"	8" (203 MM)	4" (102 MM)
SKY 12"	12" (305 MM)	6" (152 MM)

* INCLUDES 4" ROUND FLUSH CANOPY

** ANTIQUÉ BRONZE IS NOT AVAILABLE FOR KABLE LITE



Photographer: Matthew Millman Design: Aidlin Darling Design

LOW-VOLTAGE PENDANTS

SUMMIT



A
P. 580

Sleek satin nickel metal cone, available in large and small versions. Includes low-voltage, 35 watt MR16 flood lamp or 6 watt replaceable LED module and six feet of field-cutttable suspension cable.

700	SYSTEM	SUM	SIZE	FINISH	VOLTAGE
FJ	FREEJACK		S SMALL	S SATIN NICKEL	12 VOLT HALOGEN
MP	MONOPOINT*		L LARGE		-24 24 VOLT HALOGEN
MO	MONORAIL				-LED 12 VOLT LED 3000K
MO2	TWO-CIRCUIT MONORAIL				

PRODUCT DIMENSIONS

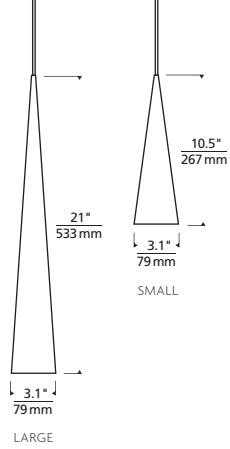

SEE PP. 52, 215 FOR ADDITIONAL APPLICATION PHOTOS



LARGE



SMALL

* INCLUDES 4" ROUND FLUSH CANOPY





SMOKE, LARGE

SMOKE, SMALL

STEEL BLUE, LARGE

STEEL BLUE, SMALL

WHITE, LARGE

WHITE, SMALL

ZENITH



A
P. 580

Slender, organic-shaped glass with vertical stringers to add depth and dimension. Includes low-voltage, 50 watt halogen bi-pin lamp or 6 watt replaceable LED module and six feet of field-cutttable suspension cable.

700	SYSTEM	ZEN	SIZE	COLOR	FINISH	VOLTAGE
FJ	FREEJACK	S	SMALL	K SMOKE	Z ANTIQUE BRONZE	12 VOLT HALOGEN
MP	MONOPOINT*	L	LARGE	U STEEL BLUE	C CHROME	-24 24 VOLT HALOGEN
MO	MONORAIL			W WHITE	S SATIN NICKEL	-LED 12 VOLT LED 3000K
MO2	TWO-CIRCUIT MONORAIL					

PRODUCT DIMENSIONS

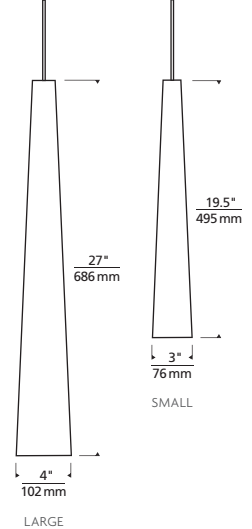

* INCLUDES 4" ROUND FLUSH CANOPY

Zenith, Large



LOW-VOLTAGE PENDANTS



BLACK, LARGE

BLACK, SMALL

BROWN, LARGE

BROWN, SMALL

LATTE, LARGE

LATTE, SMALL

WHITE, LARGE

WHITE, SMALL

PINNACLE



P. 580

Sleek glass cone, available in large and small versions. Black includes low-voltage, 35 watt MR16 flood lamp or 6 watt replaceable LED module. Brown, latte and white include low-voltage, 50 watt halogen bi-pin lamp or 6 watt replaceable LED module. Each include six feet of field-cutable suspension cable.

700	SYSTEM	PIN	SIZE	COLOR	FINISH	VOLTAGE
FJ	FREEJACK		S SMALL	B BLACK	Z ANTIQUE BRONZE**	12 VOLT HALOGEN
MP	MONOPOINT*		L LARGE	N BROWN	C CHROME	-24 24 VOLT HALOGEN
KL	KABLE LITE (SMALL ONLY)			L LATTE	S SATIN NICKEL	-LED 12 VOLT LED 3000K
MO	MONORAIL			W WHITE		
MO2	TWO-CIRCUIT MONORAIL					

PRODUCT DIMENSIONS

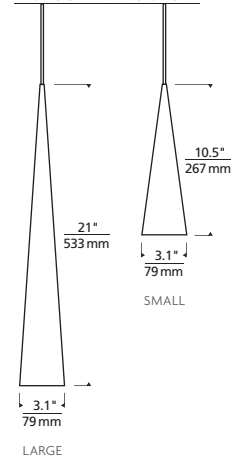

* INCLUDES 4" ROUND FLUSH CANOPY

** ANTIQUE BRONZE IS NOT AVAILABLE FOR KABLE LITE

Pinnacle, Large



Photographer: © Galina Coadu

LOW-VOLTAGE PENDANTS



HEATHER GRAY
WITH WALNUT TRIM

WHITE
WITH MAPLE TRIM

TOPO



P. 580

This modern cylinder shade is elevated to a richer, warmer dimension with a sophisticated combination of fabric and wood. The bands of wood trim are spline-joined around the circumference of the shade – a delicate feat of quality craftsmanship. Includes low-voltage, 50 watt halogen bi-pin lamp or 6 watt replaceable LED module and six feet of field-cutttable suspension cable.

700	SYSTEM	TPO	COLOR	TRIM	FINISH	VOLTAGE
FJ	FREEJACK	Y	HEATHER GRAY	M MAPLE	Z ANTIQUE BRONZE**	12 VOLT HALOGEN
MP	MONOPOINT*			W WALNUT	C CHROME	-24 24 VOLT HALOGEN
KL	KABLE LITE	W	WHITE		S SATIN NICKEL	-LED 12 VOLT LED 3000K
MO	MONORAIL					
MO2	TWO-CIRCUIT MONORAIL					

PRODUCT DIMENSIONS

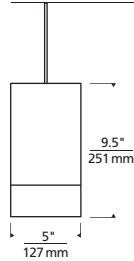

PRODUCT DETAILS



COMPLEMENTARY PRODUCT
SUSPENSION P. 228 / FLUSH MOUNT P. 350
SEE P. 359 FOR ADDITIONAL APPLICATION PHOTO



BROWN



WHITE

MINI DILLON



P. 580

Translucent organza drum with inner glass cylinder to provide a soft wash of light. Includes low-voltage, 50 watt halogen bi-pin lamp or 6 watt replaceable LED module and six feet of field-cutttable suspension cable.

700	SYSTEM	MDLNW	COLOR	FINISH	VOLTAGE
FJ	FREEJACK	N	BROWN	Z ANTIQUE BRONZE	12 VOLT HALOGEN
MP	MONOPOINT*	W	WHITE	C CHROME	-24 24 VOLT HALOGEN
MO	MONORAIL			S SATIN NICKEL	-LED 12 VOLT LED 3000K
MO2	TWO-CIRCUIT MONORAIL				

PRODUCT DIMENSIONS

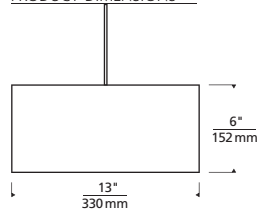

COMPLEMENTARY PRODUCT
LINE-VOLTAGE PENDANT P. 232

* INCLUDES 4" ROUND FLUSH CANOPY
** ANTIQUE BRONZE IS NOT AVAILABLE FOR KABLE LITE



FOG / WEATHERED OAK

SAND / WEATHERED OAK

WESTON



A
P. 580

Classic and modern with just a touch of rustic charm. The clean, contemporary Belgian linen shade is complemented with weathered oak detailing adding a warmth to the design and making it perfect for a broad range of applications. The solid wood finial is created using furniture-making techniques, turning the wood into the baluster shape. Includes low-voltage, 50 watt halogen bi-pin lamp or 6 watt replaceable LED module and six feet of field-cutttable suspension cable.

700	SYSTEM	WST	COLOR	FINISH	VOLTAGE
FJ	FREEJACK	FW	FOG / WEATHERED OAK	Z ANTIQUE BRONZE**	12 VOLT HALOGEN
MP	MONOPOINT*	SW	SAND / WEATHERED OAK	S SATIN NICKEL	-24 24 VOLT HALOGEN
KL	KABLE LITE				-LED 12 VOLT LED 3000K
MO	MONORAIL				
MO2	TWO-CIRCUIT MONORAIL				

PRODUCT DETAILS



* INCLUDES 4" ROUND FLUSH CANOPY

** ANTIQUE BRONZE IS NOT AVAILABLE FOR KABLE LITE

PRODUCT DIMENSIONS

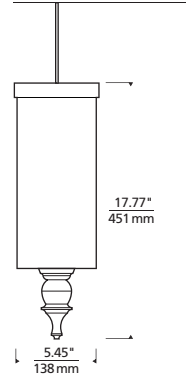



LARGE



MEDIUM



SMALL

SPIRE

Sophisticated tapered felt pendant in a modern color palette. Available in three sizes. Includes low-voltage, 50 watt halogen bi-pin lamp and six feet of field-cuttable suspension cable.

700	SYSTEM	SPR	SIZE	COLOR	FINISH	VOLTAGE
FJ	FREEJACK	S	SMALL	O CHARCOAL GRAY	Z ANTIQUE BRONZE**	12 VOLT HALOGEN
MP	MONOPOINT*	M	MEDIUM		S SATIN NICKEL	-24 24 VOLT HALOGEN
KL	KABLE LITE	L	LARGE			
MO	MONORAIL					
MO2	TWO-CIRCUIT MONORAIL					

COMPLEMENTARY PRODUCT
SUSPENSION P. 308

PRODUCT DIMENSIONS

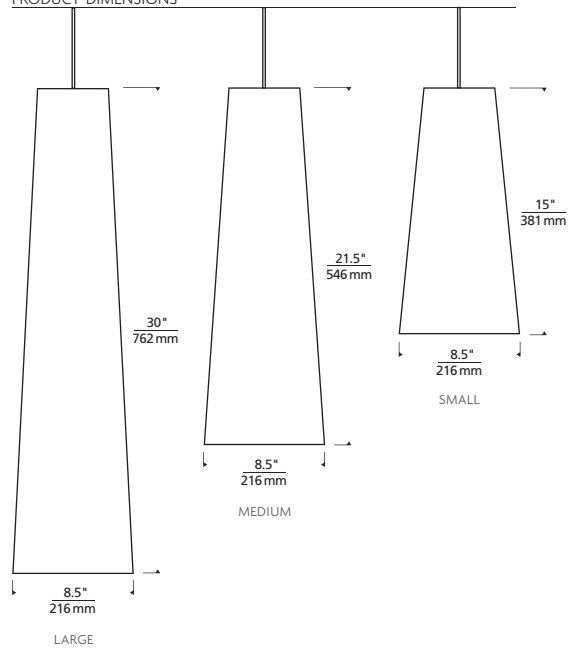

* INCLUDES 4" ROUND FLUSH CANOPY

** ANTIQUE BRONZE IS NOT AVAILABLE FOR KABLE LITE

Spire, Small



LOW-VOLTAGE PENDANTS



1 CHEER



7 CHEERS

CHEERS

Cheer with single fused globe includes one low-voltage, 10 watt xenon bi-pin lamp. Cheers with seven clear glass globes with fused center tubes suspended from one central hub. Cheers includes seven low-voltage, 10 watt xenon bi-pin lamps. Each include six feet of field-cutable suspension cable.

700	SYSTEM	CHR	TYPE	FINISH	VOLTAGE
FJ	FREEJACK	1	CHEER	Z ANTIQUE BRONZE	12 VOLT HALOGEN
MP	MONOPOINT*	7	CHEERS	C CHROME	-24 24 VOLT HALOGEN
KL	KABLE LITE (CHEER 1 LIGHT ONLY)			S SATIN NICKEL	
MO	MONORAIL				
MO2	TWO-CIRCUIT MONORAIL				

SEE P. 17 FOR ADDITIONAL APPLICATION PHOTO

PRODUCT DIMENSIONS

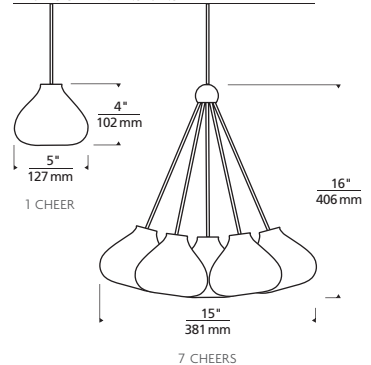

* INCLUDES 4" ROUND FLUSH CANOPY



Photographer: Greg Premru



AMBER



AQUAMARINE



CLEAR



HAVANA BROWN



SMOKE



STEEL BLUE

MINI ECHO



A
P. 580

Translucent cylinder over a white case glass cylinder, highlighted with three metal details. Includes low-voltage, 50 watt halogen bi-pin lamp or 6 watt replaceable LED module and six feet of field-cutable suspension cable.

700 SYSTEM	ECP	COLOR	FINISH	VOLTAGE
FJ	FREEJACK	A AMBER	Z ANTIQUE BRONZE	12 VOLT HALOGEN
MP	MONOPOINT*	Q AQUAMARINE	C CHROME	-24 24 VOLT HALOGEN
MO	MONORAIL	C CLEAR	S SATIN NICKEL	-LED 12 VOLT LED 3000K
MO2	TWO-CIRCUIT MONORAIL	B HAVANA BROWN		
		S SMOKE		
		U STEEL BLUE		

COMPLEMENTARY PRODUCT
LINE-VOLTAGE PENDANTS P. 252, 254 / WALL P. 378

SEE P. 320 FOR ADDITIONAL APPLICATION PHOTO

PRODUCT DIMENSIONS

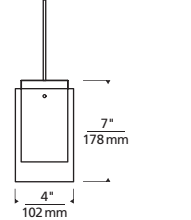

* INCLUDES 4" ROUND FLUSH CANOPY



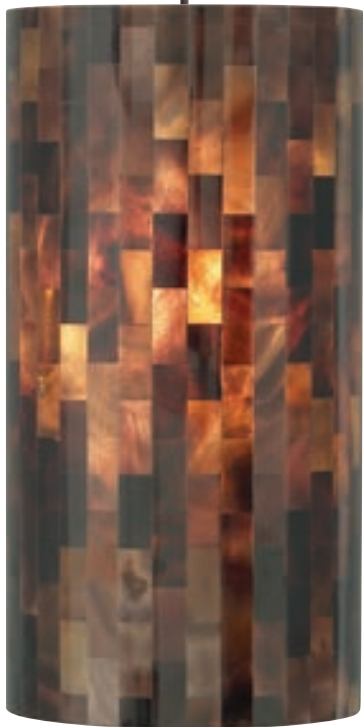

BROWN

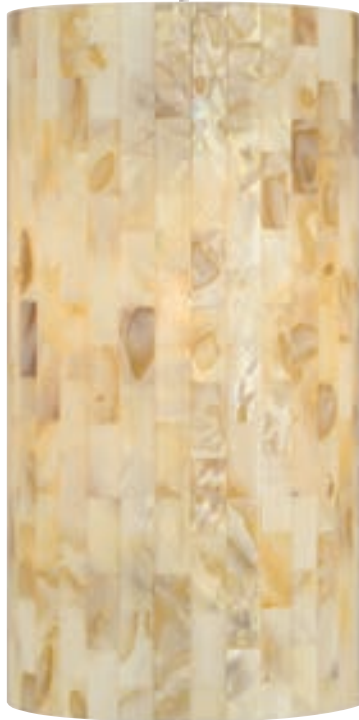

NATURAL



WHITE

PLAYA



P. 580

Elegant multi-toned cylindrical shade comprised of natural shell panels. The shells are burnished to remove rough edges, meticulously polished, cut to size, and carefully adhered by hand to an inner glass cylinder. Includes low-voltage, 50 watt halogen bi-pin lamp or 6 watt replaceable LED module and six feet of field-cutable suspension cable.

700	SYSTEM	PLA	COLOR	FINISH	VOLTAGE
FJ	FREEJACK	B	BROWN	Z	12 VOLT HALOGEN
MP	MONOPOINT*	N	NATURAL	C	24 VOLT HALOGEN
KL	KABLE LITE	W	WHITE	S	12 VOLT LED 3000K
MO	MONORAIL				
MO2	TWO-CIRCUIT MONORAIL				

PRODUCT DIMENSIONS

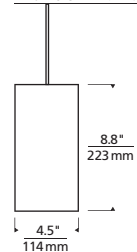

COMPLEMENTARY PRODUCT
LINE-VOLTAGE PENDANT P. 270 / WALL P. 380, 382

* INCLUDES 4" ROUND FLUSH CANOPY

** ANTIQUE BRONZE IS NOT AVAILABLE FOR KABLE LITE



LOW-VOLTAGE PENDANTS



BROWN / GOLD

LATTE / GOLD

WHITE / SILVER

VEIL



P. 580

Cylindrical shade with crushed glass texture accented with inner layer of gold or silver. Includes low-voltage, 50 watt halogen bi-pin lamp or 6 watt replaceable LED module and six feet of field-cutttable suspension cable.

700	SYSTEM	VEI	OUTER / INNER	FINISH	VOLTAGE	
FJ	FREEJACK	N	BROWN / GOLD	Z	ANTIQUE BRONZE	12 VOLT HALOGEN
MP	MONOPOINT*	L	LATTE / GOLD	C	CHROME	-24 24 VOLT HALOGEN
MO	MONORAIL	W	WHITE / SILVER	S	SATIN NICKEL	-LED 12 VOLT LED 3000K
MO2	TWO-CIRCUIT MONORAIL					

PRODUCT DIMENSIONS

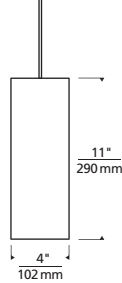

PRODUCT DETAILS



COMPLEMENTARY PRODUCT
LINE-VOLTAGE PENDANT P. 273 / WALL P. 383



BROWN

WHITE

PEYTON



P. 580

Cylindrical shade composed of glass mosaic tiles and inner frost glass diffuser. Includes low-voltage, 50 watt halogen bi-pin lamp or 6 watt replaceable LED module and six feet of field-cutttable suspension cable.

700	SYSTEM	PEY	COLOR	FINISH	VOLTAGE	
FJ	FREEJACK	N	BROWN	Z	ANTIQUE BRONZE	12 VOLT HALOGEN
MP	MONOPOINT*	W	WHITE	C	CHROME	-24 24 VOLT HALOGEN
MO	MONORAIL	S		S	SATIN NICKEL	-LED 12 VOLT LED 3000K
MO2	TWO-CIRCUIT MONORAIL					

PRODUCT DIMENSIONS

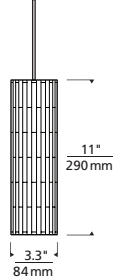

PRODUCT DETAILS



COMPLEMENTARY PRODUCT
LINE-VOLTAGE PENDANT P. 272

SEE P. 37 FOR ADDITIONAL APPLICATION PHOTO

* INCLUDES 4" ROUND FLUSH CANOPY





AMBER

SMOKE

WHITE

BORREGO

The outer glass cylinder is meticulously etched and finished by hand in a four hour process. It surrounds an inner blown white glass diffuser which adds great visual depth and helps to showcase the carvings. Includes low-voltage, 50 watt halogen bi-pin lamp and six feet of field-cutttable suspension cable.

700	SYSTEM	BRG	COLOR	FINISH	VOLTAGE
FJ	FREEJACK	A	AMBER	Z ANTIQUE BRONZE**	12 VOLT HALOGEN
MP	MONOPOINT*	K	SMOKE	C CHROME	-24 24 VOLT HALOGEN
KL	KABLE LITE	W	WHITE	S SATIN NICKEL	
MO	MONORAIL				
MO2	TWO-CIRCUIT MONORAIL				

PRODUCT DIMENSIONS



PRODUCT DETAILS



AMBER

WHITE

SYDNEY

Inspired by the world-famous Sydney Opera House, three concentric glass shades form the structure of this glass pendant. Includes low-voltage, 50 watt halogen bi-pin lamp and six feet of field-cutttable suspension cable.

700	SYSTEM	SYD	COLOR	FINISH	VOLTAGE
FJ	FREEJACK	A	AMBER	Z ANTIQUE BRONZE	12 VOLT HALOGEN
MP	MONOPOINT*	W	WHITE	C CHROME	-24 24 VOLT HALOGEN
MO	MONORAIL			S SATIN NICKEL	
MO2	TWO-CIRCUIT MONORAIL				

PRODUCT DIMENSIONS

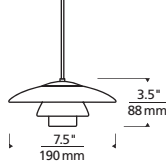

* INCLUDES 4" ROUND FLUSH CANOPY

** ANTIQUE BRONZE IS NOT AVAILABLE FOR KABLE LITE



LOW-VOLTAGE PENDANTS



MANCHON

Cut crystal cylinder is draped with Le Labo® chain maille from Paris to create a dramatic and unique pendant. Hand-blown inner glass helps diffuse the light. Includes low-voltage, 50 watt halogen bi-pin lamp and six feet of field-cutttable suspension cable.

700	SYSTEM	MCNC	FINISH	VOLTAGE
	FJ	FREEJACK	C CHROME	12 VOLT HALOGEN
	MP	MONOPOINT*	S SATIN NICKEL	-24 24 VOLT HALOGEN
	MO	MONORAIL		
	MO2	TWO-CIRCUIT MONORAIL		

PRODUCT DIMENSIONS

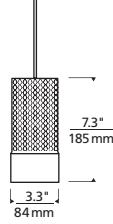

PRODUCT DETAILS



SEE P. 317 FOR ADDITIONAL APPLICATION PHOTO



SARA

Crisp, pressed crystal pendant with hand-blown inner white glass diffuser. Includes low-voltage, 35 watt halogen bi-pin lamp and six feet of field-cutttable suspension cable.

700	SYSTEM	SAR	COLOR	FINISH	VOLTAGE
	FJ	FREEJACK	C CLEAR	Z ANTIQUE BRONZE	12 VOLT HALOGEN
	MP	MONOPOINT*		C CHROME	-24 24 VOLT HALOGEN
	MO	MONORAIL		S SATIN NICKEL	
	MO2	TWO-CIRCUIT MONORAIL			

PRODUCT DIMENSIONS

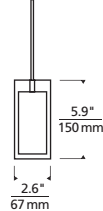

COMPLEMENTARY PRODUCT
LINE-VOLTAGE PENDANT P. 262 / WALL P. 372 / BATH P. 416

* INCLUDES 4" ROUND FLUSH CANOPY



BLACK

SATIN NICKEL

WHITE

TIBOR



A
P. 580

The LED source is hidden inside the upper metal cap and shines brightly through the extravagant, hand-faceted solid crystal for a strikingly dramatic effect inspired by the clean lines of ice formations. Includes 6 watt replaceable LED module and six feet of field-cutttable suspension cable.

700	SYSTEM	TBRC	FINISH**	VOLTAGE
	FJ	FREEJACK	B BLACK	-LED 12 VOLT LED 3000K
	MP	MONOPOINT*	S SATIN NICKEL	
	MO	MONORAIL	W WHITE	
	MO2	TWO-CIRCUIT MONORAIL		

PRODUCT DIMENSIONS

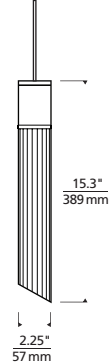

PRODUCT DETAILS

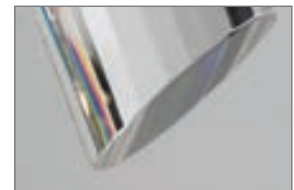

* INCLUDES 4" ROUND FLUSH CANOPY

** ALL FINISHES INCLUDE SATIN NICKEL CABLE AND SYSTEM CONNECTOR



AMBER



FROST

SOLITUDE



A
P. 580

Rectangular pressed glass shade. Includes low-voltage, 35 watt halogen bi-pin lamp or 6 watt replaceable LED module and six feet of field-cutttable suspension cable.

700	SYSTEM	SLD	COLOR	FINISH	VOLTAGE		
	FJ	FREEJACK	A	AMBER	Z	ANTIQU BRONZE	12 VOLT HALOGEN
	MP	MONOPOINT*	F	FROST	C	CHROME	-24 24 VOLT HALOGEN
	MO	MONORAIL			S	SATIN NICKEL	-LED 12 VOLT LED 3000K
	MO2	TWO-CIRCUIT MONORAIL					

PRODUCT DIMENSIONS

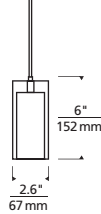

COMPLEMENTARY PRODUCT
WALL P. 392



AMBER



COBALT



FROST

CUBE

Classic geometric cube shape made of pressed glass. Includes low-voltage, 35 watt halogen bi-pin lamp and six feet of field-cutttable suspension cable.

700	SYSTEM	CUB	COLOR	FINISH	VOLTAGE		
	FJ	FREEJACK	A	AMBER	Z	ANTIQU BRONZE**	12 VOLT HALOGEN
	MP	MONOPOINT*	C	COBALT	C	CHROME	-24 24 VOLT HALOGEN
	KL	KABLE LITE	F	FROST	S	SATIN NICKEL	
	MO	MONORAIL					
	MO2	TWO-CIRCUIT MONORAIL					

PRODUCT DIMENSIONS

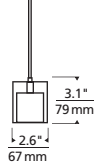

COMPLEMENTARY PRODUCT
WALL P. 392

SEE P. 444 FOR ADDITIONAL APPLICATION PHOTO

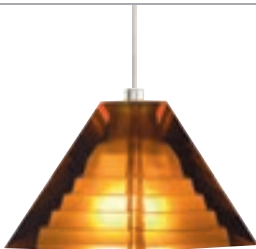

AMBER



COBALT

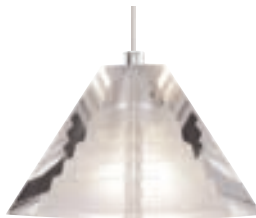

FROST

PYRAMID

Classic pyramid shape enhanced with a subtle step pattern inside. Made of pressed glass. Includes low-voltage, 35 watt halogen bi-pin lamp and six feet of field-cutttable suspension cable.

700	SYSTEM	PYR	COLOR	FINISH	VOLTAGE		
	FJ	FREEJACK	A	AMBER	Z	ANTIQU BRONZE**	12 VOLT HALOGEN
	MP	MONOPOINT*	P	COBALT	C	CHROME	-24 24 VOLT HALOGEN
	K	KABLE LITE	F	FROST	S	SATIN NICKEL	
	MO	MONORAIL					
	MO2	TWO-CIRCUIT MONORAIL					

PRODUCT DIMENSIONS

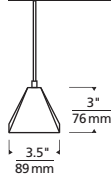

* INCLUDES 4" ROUND FLUSH CANOPY

** ANTIQU BRONZE IS NOT AVAILABLE FOR KABLE LITE



Photographer: Greg Premru

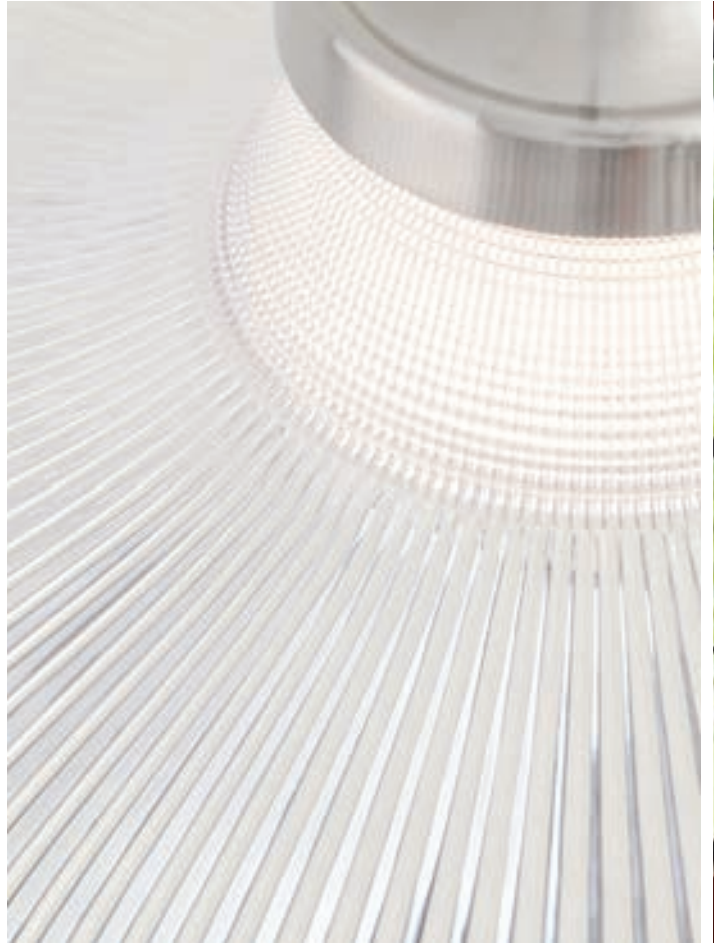



DEARBORN [CIRCA 1920]

Flared Holophane® prismatic glass diffuses light throughout the pendant to reduce glare and enhance visual comfort. Specifically designed for proximity to the task area, directs the majority of the light downward. Includes low-voltage, 50 watt halogen bi-pin lamp and six feet of field-cutttable suspension cable.

600	SYSTEM	DBNC	FINISH	VOLTAGE
FJ	FREEJACK	Z	ANTIQUE BRONZE**	12 VOLT HALOGEN
MP	MONOPOINT*	S	SATIN NICKEL	-24 24 VOLT HALOGEN
KL	KABLE LITE			
MO	MONORAIL			
MO2	TWO-CIRCUIT MONORAIL			

PRODUCT DIMENSIONS

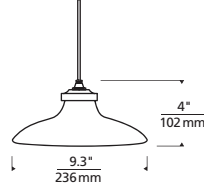

VAN BUREN [CIRCA 1930]



A

P. 580

Acorn-shaped Holophane® prismatic glass diffuses light throughout the pendant to reduce glare and enhance visual comfort. Directs majority of light downward. Also allows specifically controlled amount of light to pass through sides, increasing light levels in the space and reducing contrast between task and general lighting. Includes low-voltage, 50 watt halogen bi-pin lamp or 6 watt replaceable LED module and six feet of field-cutttable suspension cable.

600	SYSTEM	VBNC	FINISH	VOLTAGE
FJ	FREEJACK	Z	ANTIQUE BRONZE**	12 VOLT HALOGEN
MP	MONOPOINT*	S	SATIN NICKEL	-24 24 VOLT HALOGEN
KL	KABLE LITE			-LED 12 VOLT LED 3000K
MO	MONORAIL			
MO2	TWO-CIRCUIT MONORAIL			

PRODUCT DIMENSIONS

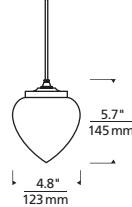

COMPLEMENTARY PRODUCT
LINE-VOLTAGE PENDANT P. 280 / WALL P. 409

* INCLUDES 4" ROUND FLUSH CANOPY

** ANTIQUE BRONZE IS NOT AVAILABLE FOR KABLE LITE



ANTIQUE BRONZE

SATIN NICKEL

PELÉ



A
P. 580

Modern glass sphere topped with glass detail. Includes low-voltage, 50 watt frosted halogen bi-pin lamp or 6 watt replaceable LED module and six feet of field-cutttable suspension cable.

700	SYSTEM	PEL	COLOR	FINISH	VOLTAGE		
	FJ	FREEJACK	W	WHITE	Z	ANTIQUE BRONZE**	12 VOLT HALOGEN
	MP	MONOPOINT*			C	CHROME	-24 24 VOLT HALOGEN
	KL	KABLE LITE			S	SATIN NICKEL	-LED 12 VOLT LED 3000K
	MO	MONORAIL					
	MO2	TWO-CIRCUIT MONORAIL					

PRODUCT DIMENSIONS

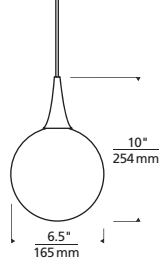

ANTIQUE BRONZE

SATIN NICKEL

TETRA



A
P. 580

Tall rectilinear glass in frost white accented with four metal beads. Includes low-voltage, 50 watt halogen bi-pin lamp or 6 watt replaceable LED module and six feet of field-cutttable suspension cable.

700	SYSTEM	TETW	FINISH	VOLTAGE	
	FJ	FREEJACK	Z	ANTIQUE BRONZE	12 VOLT HALOGEN
	MP	MONOPOINT*	C	CHROME	-24 24 VOLT HALOGEN
	MO	MONORAIL	S	SATIN NICKEL	-LED 12 VOLT LED 3000K
	MO2	TWO-CIRCUIT MONORAIL			

PRODUCT DIMENSIONS

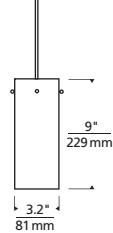

* INCLUDES 4" ROUND FLUSH CANOPY

** ANTIQUE BRONZE IS NOT AVAILABLE FOR KABLE LITE



Photographer: Doug Thompson Photography Architecture and Interior Design: www.K2design.com



MINI BENTON



P. 580

Carriage light inspired hand-welded metal cap with tapered glass shade and metal ring detail. Includes low-voltage, 50 watt halogen bi-pin lamp or 6 watt replaceable LED module and six feet of field-cutttable suspension cable.

600	SYSTEM	MBEN	COLOR	FINISH	VOLTAGE
	FJ	FREEJACK	W WHITE	Z ANTIQUE BRONZE**	12 VOLT HALOGEN
	MP	MONOPOINT*		5 SATIN NICKEL	-24 24 VOLT HALOGEN
	KL	KABLE LITE			-LED 12 VOLT LED 3000K
	MO	MONORAIL			
	MO2	TWO-CIRCUIT MONORAIL			

PRODUCT DIMENSIONS

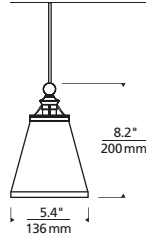

COMPLEMENTARY PRODUCT
LINE-VOLTAGE PENDANT P. 288



ANTIQU BRONZE

SATIN NICKEL

MINI BRIDGEPORT



P. 580

Carriage light inspired hand-welded metal cap with cylindrical glass shade and metal ring detail. Includes low-voltage, 50 watt halogen bi-pin lamp or 6 watt replaceable LED module and six feet of field-cutttable suspension cable.

600	SYSTEM	MBRG	COLOR	FINISH	VOLTAGE
	FJ	FREEJACK	W WHITE	Z ANTIQUE BRONZE**	12 VOLT HALOGEN
	MP	MONOPOINT*		5 SATIN NICKEL	-24 24 VOLT HALOGEN
	KL	KABLE LITE			-LED 12 VOLT LED 3000K
	MO	MONORAIL			
	MO2	TWO-CIRCUIT MONORAIL			

PRODUCT DIMENSIONS

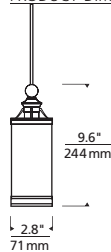

COMPLEMENTARY PRODUCT
LINE-VOLTAGE PENDANT P. 288 / WALL P. 402

* INCLUDES 4" ROUND FLUSH CANOPY

** ANTIQUE BRONZE IS NOT AVAILABLE FOR KABLE LITE



LOW-VOLTAGE PENDANTS



WHITE WITH SATIN NICKEL WITH DETAIL

WHITE WITH SATIN NICKEL WITHOUT DETAIL



AMBER WITH ANTIQUE BRONZE WITH DETAIL

AMBER WITH ANTIQUE BRONZE WITHOUT DETAIL

MINI DELAWARE



A
P. 580

Octagonal flared glass shade ships with optional decorative metal detail (included). Includes low-voltage, 50 watt halogen bi-pin lamp or 6 watt replaceable LED module and six feet of field-cutttable suspension cable.

600	SYSTEM	MDLW	COLOR	FINISH	VOLTAGE
FJ	FREEJACK		A AMBER	Z ANTIQUE BRONZE**	12 VOLT HALOGEN
MP	MONOPOINT*		W WHITE	S SATIN NICKEL	-24 24 VOLT HALOGEN
KL	KABLE LITE				-LED 12 VOLT LED 3000K
MO	MONORAIL				
MO2	TWO-CIRCUIT MONORAIL				

PRODUCT DIMENSIONS

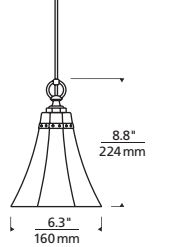

MINI TAVERN



A
P. 580

Traditional schoolhouse-shaped glass shade with engraved ornate cap. Includes low-voltage, 50 watt halogen bi-pin lamp or 6 watt replaceable LED module and six feet of field-cutttable suspension cable.



ANTIQUÉ BRONZE

SATIN NICKEL

600	SYSTEM	MTVRW	FINISH	VOLTAGE
FJ	FREEJACK		Z ANTIQUÉ BRONZE**	12 VOLT HALOGEN
MP	MONOPOINT*		S SATIN NICKEL	-24 24 VOLT HALOGEN
KL	KABLE LITE			-LED 12 VOLT LED 3000K
MO	MONORAIL			
MO2	TWO-CIRCUIT MONORAIL			

PRODUCT DIMENSIONS

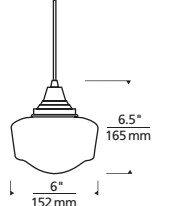

PRODUCT DETAILS



COMPLEMENTARY PRODUCT
SUSPENSION P. 286 / SEMI-FLUSH MOUNT P. 354

* INCLUDES 4" ROUND FLUSH CANOPY

** ANTIQUÉ BRONZE IS NOT AVAILABLE FOR KABLE LITE



LOW-VOLTAGE PENDANTS

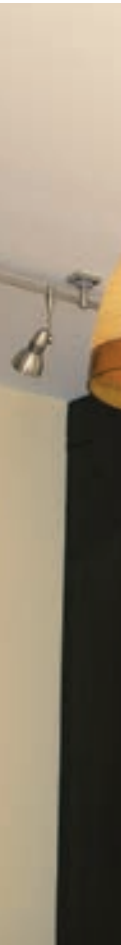



NEBBIA



Hand-blown glass with an elegant fused swirl topped with metal detail. Includes low-voltage, 50 watt halogen bi-pin lamp or 6 watt replaceable LED module and six feet of field-cutttable cable.

700	SYSTEM	NEBL	COLOR	FINISH	VOLTAGE	
FJ	FREEJACK	A	AMBER	Z	ANTIQU BRONZE	12 VOLT HALOGEN
MP	MONOPOINT*	N	BROWN	S	SATIN NICKEL	-24 24 VOLT HALOGEN
MO	MONORAIL	W	WHITE			-LED 12 VOLT LED 3000K
MO2	TWO-CIRCUIT MONORAIL					

PRODUCT DIMENSIONS

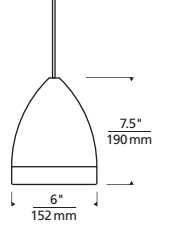

COMPLEMENTARY PRODUCT
WALL P. 386

Mini Om p. 163



MINI HUDSON



Clean, modern cylindrical glass shade topped with a simple metal cap detail. Includes low-voltage, 50 watt halogen bi-pin lamp or 6 watt replaceable LED module and six feet of field-cutttable suspension cable.

700	SYSTEM	MHUD	COLOR	FINISH	VOLTAGE	
FJ	FREEJACK	N	BROWN	Z	ANTIQU BRONZE**	12 VOLT HALOGEN
MP	MONOPOINT*	L	LATTE	C	CHROME	-24 24 VOLT HALOGEN
KL	KABLE LITE	W	WHITE	S	SATIN NICKEL	-LED 12 VOLT LED 3000K
MO	MONORAIL					
MO2	TWO-CIRCUIT MONORAIL					

PRODUCT DIMENSIONS

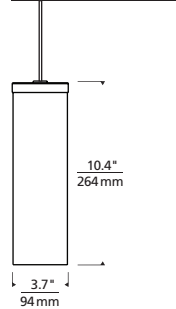

COMPLEMENTARY PRODUCT
LINE-VOLTAGE PENDANT P. 264 / WALL P. 404
SEE P. 321 FOR ADDITIONAL APPLICATION PHOTO

* INCLUDES 4" ROUND FLUSH CANOPY

** ANTIQU BRONZE IS NOT AVAILABLE FOR KABLE LITE



CONE



A
P. 580

Case glass cone with reflective white interior or transparent glass cone. Case glass Includes low-voltage, 50 watt halogen bi-pin lamp or 6 watt replaceable LED module. Transparent glass includes low-voltage, 50 watt MR16 flood lamp. Each include six feet of field-cutttable suspension cable.

700	SYSTEM	CON	COLOR	FINISH	VOLTAGE
FJ	FREEJACK	A	AMBER	Z ANTIQUE BRONZE***	12 VOLT HALOGEN
MP	MONOPOINT*	C	CLEAR**	C CHROME	-24 24 VOLT HALOGEN
K	KABLE LITE	P	COBALT	S SATIN NICKEL	-LED 12 VOLT HALOGEN
MO	MONORAIL	R	RED		
MO2	TWO-CIRCUIT MONORAIL	W	WHITE		

PRODUCT DIMENSIONS

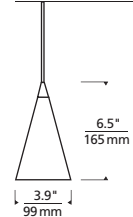

COMPLEMENTARY PRODUCT
ACCESSORY P. 569

SEE P. 446 FOR ADDITIONAL APPLICATION PHOTO

* INCLUDES 4" ROUND FLUSH CANOPY

** CLEAR NOT AVAILABLE IN LED

*** ANTIQUE BRONZE IS NOT AVAILABLE FOR KABLE LITE



Photographer: Josh Kuchinsky Design: Siemasko + Verbridge





Photographer: Ed Rorer Architect: Steve Forster Designer: Home Systems, Lafayette, Ca

SOLEIL

Teardrop-shaped transparent colored glass that gently fades to clear. Amber, havana brown, and olive green are diffused by a matching colored inner glass. Smoke is diffused by white inner glass. Includes low-voltage, 35 watt halogen bi-pin lamp and six feet of field-cutttable suspension cable.

700	SYSTEM	SOL	COLOR	FINISH	VOLTAGE
FJ	FREEJACK	A	AMBER	Z	ANTIQU BRONZE 12 VOLT HALOGEN
MP	MONOPOINT*	N	HAVANA BROWN	C	CHROME -24 24 VOLT HALOGEN
MO	MONORAIL	V	OLIVE GREEN	S	SATIN NICKEL
MO2	TWO-CIRCUIT MONORAIL	K	SMOKE		

PRODUCT DIMENSIONS

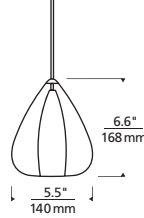

COMPLEMENTARY PRODUCT
LINE-VOLTAGE PENDANT P. 242



Photographer: Eric Roth Design: Siemasko + Verbruggen

FIRE

Rich, translucent Murano glass surrounds a small frost raindrop glass. Includes low-voltage, 35 watt halogen bi-pin lamp and six feet of field-cutttable suspension cable.

700	SYSTEM	FIR	COLOR	FINISH	VOLTAGE
FJ	FREEJACK	A	AMBER	Z	ANTIQU BRONZE 12 VOLT HALOGEN
MP	MONOPOINT*	B	COBALT	C	CHROME -24 24 VOLT HALOGEN
MO	MONORAIL	N	HAVANA BROWN	S	SATIN NICKEL
MO2	TWO-CIRCUIT MONORAIL	R	RED		
		K	SMOKE		
		U	STEEL BLUE		

PRODUCT DIMENSIONS

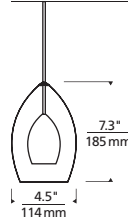

COMPLEMENTARY PRODUCT
LINE-VOLTAGE PENDANT P. 243 / WALL P. 394

SEE P. 36, 316, 318 FOR ADDITIONAL APPLICATION PHOTOS

* INCLUDES 4" ROUND FLUSH CANOPY



AMBER

COBALT



FROST

RED

INNER FIRE

Clear glass surrounds a small raindrop glass in frost or a color. Includes low-voltage, 35 watt halogen bi-pin lamp and six feet of field-cutttable suspension cable.

700	SYSTEM	FIRC	COLOR	FINISH	VOLTAGE		
	FJ	FREEJACK	M	AMBER	Z	ANTIQU BRONZE	12 VOLT HALOGEN
	MP	MONOPOINT*	B	COBALT	C	CHROME	-24 24 VOLT HALOGEN
	MO	MONORAIL	F	FROST	S	SATIN NICKEL	
	MO2	TWO-CIRCUIT MONORAIL	R	RED			

PRODUCT DIMENSIONS

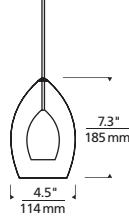

AMBER

CHARTREUSE

COBALT

FIREFROST



A
P. 580

Murano glass with frosted or case glass interior. Includes low-voltage, 50 watt halogen bi-pin lamp or 6 watt replaceable LED module and six feet of field-cutttable suspension cable.

700	SYSTEM	FIRF	COLOR	FINISH	VOLTAGE		
	FJ	FREEJACK	A	AMBER	Z	ANTIQU BRONZE**	12 VOLT HALOGEN
	MP	MONOPOINT*	H	CHARTREUSE	C	CHROME	-24 24 VOLT HALOGEN
	KL	KABLE LITE	B	COBALT	S	SATIN NICKEL	-LED 12 VOLT LED 3000K
	MO	MONORAIL	R	RED			
	MO2	TWO-CIRCUIT MONORAIL	W	WHITE			

PRODUCT DIMENSIONS

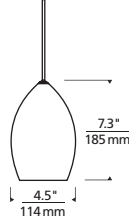

RED

WHITE

* INCLUDES 4" ROUND FLUSH CANOPY

** ANTIQU BRONZE IS NOT AVAILABLE FOR KABLE LITE



Trends Publishing International | Photographer: Eric Plasecki | Architect: Sean O'Kane, AIA, Architect PC



BLUEBIRD



CARDINAL



OWL

FIREBIRD

Patterned Murano glass surrounds a small frost raindrop glass. Includes low-voltage, 35 watt halogen bi-pin lamp and six feet of field-cutttable suspension cable.

700	SYSTEM	FIR	COLOR	FINISH	VOLTAGE	
FJ	FREEJACK	L	BLUEBIRD	Z	ANTIQUÉ BRONZE	12 VOLT HALOGEN
MP	MONOPOINT*	D	CARDINAL	C	CHROME	-24 24 VOLT HALOGEN
MO	MONORAIL	O	OWL	S	SATIN NICKEL	
MO2	TWO-CIRCUIT MONORAIL	T	PARROT			
		P	PEACOCK			
		S	SWAN			



PARROT



PEACOCK



SWAN

PRODUCT DIMENSIONS

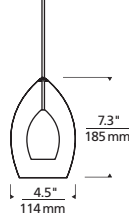

COMPLEMENTARY PRODUCT
WALL P. 394

SEE P. 483 FOR ADDITIONAL APPLICATION PHOTO



FERRARI RED



TAHOE PINE AMBER

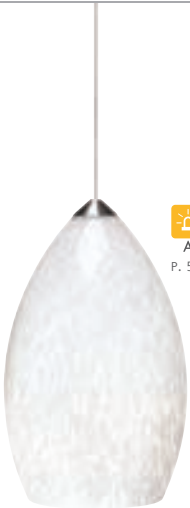

WHITE FRIT

FIREFRIT



A
P. 580

A colorful twist on our popular Fire pendant with brilliant frit glass. Includes low-voltage, 50 watt halogen bi-pin lamp or 6 watt replaceable LED module and six feet of field-cutttable suspension cable.

700	SYSTEM	FIRY	COLOR	FINISH	VOLTAGE	
FJ	FREEJACK	R	FERRARI RED	Z	ANTIQUÉ BRONZE**	12 VOLT HALOGEN
MP	MONOPOINT*	A	TAHOE PINE AMBER	C	CHROME	-24 24 VOLT HALOGEN
KL	KABLE LITE	W	WHITE	S	SATIN NICKEL	-LED 12 VOLT LED 3000K
MO	MONORAIL					
MO2	TWO-CIRCUIT MONORAIL					

PRODUCT DIMENSIONS

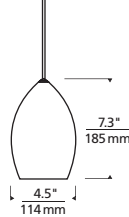

* INCLUDES 4" ROUND FLUSH CANOPY

** ANTIQUÉ BRONZE IS NOT AVAILABLE FOR KABLE LITE



Interior Design: Drury Design Kitchen & Bath Studio, Glen Ellyn, IL

LOW-VOLTAGE PENDANTS



AMETHYST



CRYSTAL



DARK BROWN



SMOKE

BALI



A
P. 580

Hand-carved, blown-glass cylinder with inner glass diffuser. Includes low-voltage, 50 watt halogen bi-pin lamp or 6 watt replaceable LED module and six feet of field-cutttable suspension cable.

700	SYSTEM	BAL	COLOR	FINISH	VOLTAGE
FJ	FREEJACK	M	AMETHYST	Z ANTIQUE BRONZE	12 VOLT HALOGEN
MP	MONOPOINT*	C	CRYSTAL	C CHROME	-24 24 VOLT HALOGEN
MO	MONORAIL	N	DARK BROWN	S SATIN NICKEL	-LED 12 VOLT LED 3000K
MO2	TWO-CIRCUIT MONORAIL	K	SMOKE		

PRODUCT DIMENSIONS

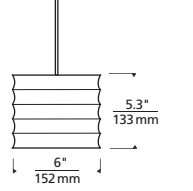

AMETHYST



BROWN



CLEAR



SMOKE



STEEL BLUE

OTTO

Stunning hand-etched, mouth blown outer transparent glass shade with inner glass diffuser. Includes low-voltage, 50 watt halogen bi-pin lamp and six feet of field-cutttable suspension cable.

700	SYSTEM	OTO	COLOR	FINISH	VOLTAGE
FJ	FREEJACK	M	AMETHYST	Z ANTIQUE BRONZE	12 VOLT HALOGEN
MP	MONOPOINT*	N	BROWN	C CHROME	-24 24 VOLT HALOGEN
MO	MONORAIL	C	CLEAR	S SATIN NICKEL	
MO2	TWO-CIRCUIT MONORAIL	K	SMOKE		
		U	STEEL BLUE		

PRODUCT DIMENSIONS

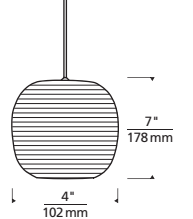

* INCLUDES 4" ROUND FLUSH CANOPY



LOW-VOLTAGE PENDANTS



CLEAR



HAVANA BROWN



OLIVE GREEN



STEEL BLUE (MOUNTED UP)

DIZ

Transparent slumped glass plate floats around the exposed, secured MR16. May be mounted up or down. Includes low-voltage, 50 watt MR16 flood lamp and six feet of field-cutttable suspension cable.

700	SYSTEM	DIZ	COLOR	FINISH	VOLTAGE		
	FJ	FREEJACK	C	CLEAR	Z	ANTIQUÉ BRONZE**	12 VOLT HALOGEN
	MP	MONOPOINT*	N	HAVANA BROWN	C	CHROME	-24 24 VOLT HALOGEN
	KL	KABLE LITE	V	OLIVE GREEN	S	SATIN NICKEL	
	MO	MONORAIL	U	STEEL BLUE			
	MO2	TWO-CIRCUIT MONORAIL					

PRODUCT DIMENSIONS

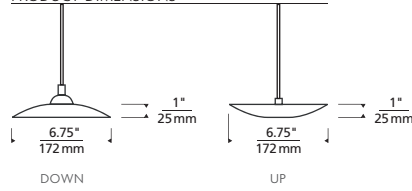

CLEAR



HAVANA BROWN



STEEL BLUE

BIZ

Transparent glass disk floats around the exposed, secured MR16. Includes low-voltage, 50 watt MR16 flood lamp and six feet of field-cutttable suspension cable.

700	SYSTEM	BIZ	COLOR	FINISH	VOLTAGE		
	FJ	FREEJACK	C	CLEAR	Z	ANTIQUÉ BRONZE**	12 VOLT HALOGEN
	MP	MONOPOINT*	N	HAVANA BROWN	C	CHROME	-24 24 VOLT HALOGEN
	KL	KABLE LITE	U	STEEL BLUE	S	SATIN NICKEL	
	MO	MONORAIL					
	MO2	TWO-CIRCUIT MONORAIL					

PRODUCT DIMENSIONS

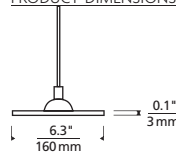

* INCLUDES 4" ROUND FLUSH CANOPY

** ANTIQUÉ BRONZE IS NOT AVAILABLE FOR KABLE LITE





BOREAL



A
P. 580



Natural hemp fabric shade with recycled paper backing topped with recycled sand-cast bronze metal work. The fabric shade and recycled bronze are both sourced locally within 20 miles of our facility. The product also ships in environmentally-friendly recycled packaging. Includes low-voltage, 50 watt halogen bi-pin lamp or 6 watt replaceable LED module and six feet of field-cuttable suspension cable.

700	SYSTEM	BORI	FINISH***	VOLTAGE
FJ	FREEJACK	Z	ANTIQUE BRONZE**	12 VOLT HALOGEN
MP	MONOPOINT*	S	WHITE BRONZE	-24 24 VOLT HALOGEN
KL	KABLE LITE			-LED 12 VOLT LED 3000K
MO	MONORAIL			
MO2	TWO-CIRCUIT MONORAIL			

PRODUCT DIMENSIONS

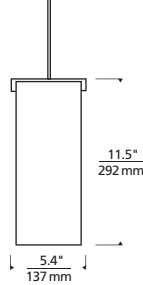

PRODUCT DETAILS



COMPLEMENTARY PRODUCT
WALL P. 400

BOREAL FREEJACK 4" ROUND FLUSH CANOPY



ANTIQUE BRONZE



WHITE BRONZE

700FJ4RB	FINISH	VOLTAGE
Z	ANTIQUE BRONZE	120V IN / 12V OUT
S	WHITE BRONZE	024 120V IN / 24V OUT
		277 277V IN / 12V OUT
		-LED 120V IN / 12V OUT LED
		-LED277 277V IN / 12V OUT

PRODUCT DETAILS



TIP: 120V FreeJack canopies are dimmable with a standard incandescent dimmer. 120V LED FreeJack canopies are dimmable with a low-voltage electronic dimmer. 277V FreeJack canopies are dimmable with 277V incandescent dimmer. 277V LED canopies are dimmable with 277V low-voltage electronic dimmer.

* INCLUDES 4" ROUND FLUSH CANOPY

** ANTIQUE BRONZE IS NOT AVAILABLE FOR KABLE LITE

*** WHILE WE FEEL THEY LOOK VERY NICE TOGETHER, THE BOREAL FINISHES WILL NOT BE AN EXACT MATCH TO EXISTING SATIN NICKEL AND ANTIQUE BRONZE HARDWARE





DESERT CLAY BOTTOM GLASS DIFFUSER



RED



WHITE

MINI MULBERRY

Modern simple round fabric shade with glass diffuser provides a glare free wash of light; highlighted with metal detail. Includes two low-voltage, 35 watt halogen bi-pin lamps and six feet of field-cutttable suspension cable.

700	SYSTEM	MUL	COLOR	FINISH	VOLTAGE
FJ	FREEJACK	C	DESERT CLAY	Z	ANTIQU BRONZE 12 VOLT HALOGEN
MP	MONOPOINT*	R	RED	C	CHROME -24 24 VOLT HALOGEN
MO	MONORAIL	W	WHITE	S	SATIN NICKEL
MO2	TWO-CIRCUIT MONORAIL				

PRODUCT DIMENSIONS

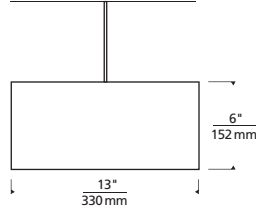

COMPLEMENTARY PRODUCT
LINE-VOLTAGE PENDANT P. 292 / FLUSH MOUNT P. 346



ALMOND



RED



WHITE

FAB



Cylinder shaped shade, constructed of Indian silk with hand-rolled edges. Includes low-voltage, 50 watt halogen bi-pin lamp or 6 watt replaceable LED module and six feet of field-cutttable suspension cable.

700	SYSTEM	FAB	COLOR	FINISH	VOLTAGE
FJ	FREEJACK	A	ALMOND	Z	ANTIQU BRONZE** 12 VOLT HALOGEN
MP	MONOPOINT*	R	RED	C	CHROME -24 24 VOLT HALOGEN
KL	KABLE LITE	W	WHITE	S	SATIN NICKEL -LED 12 VOLT LED 3000K
MO	MONORAIL				
MO2	TWO-CIRCUIT MONORAIL				

PRODUCT DIMENSIONS

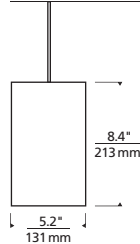

* INCLUDES 4" ROUND FLUSH CANOPY

** ANTIQU BRONZE IS NOT AVAILABLE FOR KABLE LITE



Designed + Built by Harrell Remodeling

LOW-VOLTAGE PENDANTS



BEACH AMBER

SAND

SURF WHITE

ESSEX



P. 580

Individually slumped glass panels joined with a metal frame. Includes low-voltage, 50 watt halogen bi-pin lamp or 6 watt replaceable LED module and six feet of field-cutttable suspension cable.

700	SYSTEM	ESX	COLOR	FINISH	VOLTAGE
FJ	FREEJACK	A	BEACH AMBER	Z ANTIQUE BRONZE	12 VOLT HALOGEN
MP	MONOPOINT*	S	SAND	S SATIN NICKEL	-24 24 VOLT HALOGEN
MO	MONORAIL	W	SURF WHITE		-LED 12 VOLT LED 3000K
MO2	TWO-CIRCUIT MONORAIL				

COMPLEMENTARY PRODUCT
WALL P. 382

PRODUCT DIMENSIONS

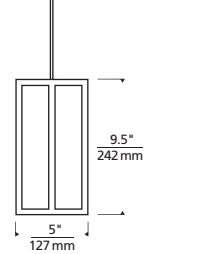

* INCLUDES 4" ROUND FLUSH CANOPY



Photographer: Bernard Andre

LOW-VOLTAGE PENDANTS



SAND



SURF WHITE

BOTTOM GLASS DIFFUSER



BEACH AMBER

MINI LARKSPUR

Fused and slumped plate glass shade, warm with color and pattern, highlighted with metal details. Glass disc diffuser provides glare free light. Includes two low-voltage, 35 watt halogen bi-pin lamps and six feet of field-cuttable suspension cable.

700	SYSTEM	LRK	COLOR	FINISH	VOLTAGE
FJ	FREEJACK	A	BEACH AMBER	Z	12 VOLT HALOGEN
MP	MONOPOINT*	S	SAND	C	24 VOLT HALOGEN
MO	MONORAIL	W	SURF WHITE	S	
MO2	TWO-CIRCUIT MONORAIL				

PRODUCT DIMENSIONS

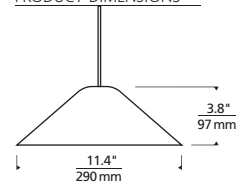

COMPLEMENTARY PRODUCT
 LINE-VOLTAGE PENDANT P. 274 / SUSPENSION P. 311 / WALL P. 384
 SEE P. 448 FOR ADDITIONAL APPLICATION PHOTO

* INCLUDES 4" ROUND FLUSH CANOPY



Photographer: © Tim Lee Photography



AMBER



AMETHYST



FROST



GREEN

SCAVO



A
P. 580

Named for the technique in which it's made. Scavo is mouth blown and undergoes a finishing process that provides a frosted outer surface. Includes low-voltage, 50 watt halogen bi-pin lamp or 6 watt replaceable LED module and six feet of field-cuttable suspension cable.

PRODUCT DIMENSIONS

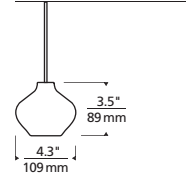

700	SYSTEM	SCA	COLOR	FINISH	VOLTAGE
	FJ	FREEJACK	A AMBER	Z ANTIQUE BRONZE**	12 VOLT HALOGEN
	MP	MONOPOINT*	M AMETHYST	C CHROME	-24 24 VOLT HALOGEN
	KL	KABLE LITE	F FROST	S SATIN NICKEL	-LED 12 VOLT LED 3000K
	MO	MONORAIL	G GREEN		
	MO2	TWO-CIRCUIT MONORAIL			

 COMPLEMENTARY PRODUCT ACCESSORY P. 570

* INCLUDES 4" ROUND FLUSH CANOPY

** ANTIQUE BRONZE IS NOT AVAILABLE FOR KABLE LITE



Photographer: Mark O'Tyson



AMBER



BROWN



GRAY



WHITE

BRULÉE



A
P. 580

Teardrop shaped glass with caramelized exterior finish. Includes low-voltage, 50 watt halogen bi-pin lamp or 6 watt replaceable LED module and six feet of field-cutttable suspension cable.

700	SYSTEM	BRU	COLOR	FINISH	VOLTAGE
	FJ	FREEJACK	A AMBER	Z ANTIQUE BRONZE**	12 VOLT HALOGEN
	MP	MONOPOINT*	N BROWN	C CHROME	-24 24 VOLT HALOGEN
	KL	KABLE LITE	Y GRAY	S SATIN NICKEL	-LED 12 VOLT LED 3000K
	MO	MONORAIL	W WHITE		
	MO2	TWO-CIRCUIT MONORAIL			

PRODUCT DIMENSIONS

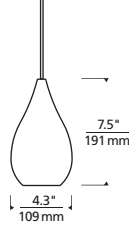

SILVER GLAZE



A
P. 580

Hand-blown transparent glass highlighted with a ceramic powder glaze. Height of transparent band may vary as a result of the hand-blown glass process. Includes low-voltage, 50 watt halogen bi-pin lamp or 6 watt replaceable LED module and six feet of field-cutttable suspension cable.

700	SYSTEM	SGZ	COLOR	FINISH	VOLTAGE
	FJ	FREEJACK	Q AQUA / CLEAR	Z ANTIQUE BRONZE	12 VOLT HALOGEN
	MP	MONOPOINT*	N BROWN	S SATIN NICKEL	-24 24 VOLT HALOGEN
	MO	MONORAIL			-LED 12 VOLT LED 3000K
	MO2	TWO-CIRCUIT MONORAIL			

PRODUCT DIMENSIONS

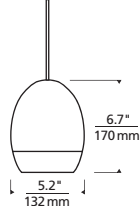

AQUA / CLEAR



BROWN

* INCLUDES 4" ROUND FLUSH CANOPY

** ANTIQUE BRONZE IS NOT AVAILABLE FOR KABLE LITE



LOW-VOLTAGE PENDANTS



NOT ILLUMINATED



ILLUMINATED

RIVER ROCK OBLONG OVAL

Inspired by rocks along a river bed and captured through a hand-blown glass process. Please note: the bottoms of the pendants will not hang parallel to the floor. This is by design and part of the natural look and feel we are going after with pieces inspired by the natural world. Includes low-voltage, 35 watt halogen bi-pin lamp and six feet of field-cutable suspension cable.

700	SYSTEM	RIVO	COLOR	FINISH	VOLTAGE	
FJ	FREEJACK	B	BLUE SLATE	Z	ANTIQU BRONZE**	12 VOLT HALOGEN
MP	MONOPOINT*			C	CHROME	-24 24 VOLT HALOGEN
KL	KABLE LITE			S	SATIN NICKEL	
MO	MONORAIL					
MO2	TWO-CIRCUIT MONORAIL					

PRODUCT DIMENSIONS

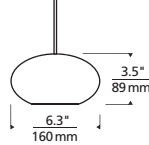

COMPLEMENTARY PRODUCT
SUSPENSION P. 310



NOT ILLUMINATED



ILLUMINATED

RIVER ROCK SOFT ROUND

Inspired by rocks along a river bed and captured through a hand-blown glass process. Please note: the bottoms of the pendants will not hang parallel to the floor. This is by design and part of the natural look and feel we are going after with pieces inspired by the natural world. Includes low-voltage, 35 watt halogen bi-pin lamp and six feet of field-cutable suspension cable.

700	SYSTEM	RIVR	COLOR	FINISH	VOLTAGE	
FJ	FREEJACK	S	SAND	Z	ANTIQU BRONZE**	12 VOLT HALOGEN
MP	MONOPOINT*			C	CHROME	-24 24 VOLT HALOGEN
KL	KABLE LITE			S	SATIN NICKEL	
MO	MONORAIL					
MO2	TWO-CIRCUIT MONORAIL					

PRODUCT DIMENSIONS

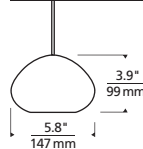

COMPLEMENTARY PRODUCT
SUSPENSION P. 310



GREEN SLATE
NOT ILLUMINATED



GREEN SLATE
ILLUMINATED

RIVER ROCK WEDGE

Inspired by rocks along a river bed and captured through a hand-blown glass process. Please note: the bottoms of the pendants will not hang parallel to the floor. This is by design and part of the natural look and feel we are going after with pieces inspired by the natural world. Includes low-voltage, 35 watt halogen bi-pin lamp and six feet of field-cutable suspension cable.

700	SYSTEM	RIVW	COLOR	FINISH	VOLTAGE	
FJ	FREEJACK	G	GREEN SLATE	Z	ANTIQU BRONZE**	12 VOLT HALOGEN
MP	MONOPOINT*	N	PEBBLE BROWN	C	CHROME	-24 24 VOLT HALOGEN
KL	KABLE LITE			S	SATIN NICKEL	
MO	MONORAIL					
MO2	TWO-CIRCUIT MONORAIL					

PRODUCT DIMENSIONS

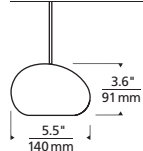

COMPLEMENTARY PRODUCT
SUSPENSION P. 310



PEBBLE BROWN
NOT ILLUMINATED



PEBBLE BROWN
ILLUMINATED

* INCLUDES 4" ROUND FLUSH CANOPY

** ANTIQU BRONZE IS NOT AVAILABLE FOR KABLE LITE



LOW-VOLTAGE PENDANTS



CABO



A
P. 580

Onyx cylinder provides a warm textured look. Includes low-voltage, 50 watt halogen bi-pin lamp or 6 watt replaceable LED module and six feet of field-cutttable suspension cable.

700	SYSTEM	CBO	FINISH	VOLTAGE	
	FJ	FREEJACK	Z	ANTIQU BRONZE	12 VOLT HALOGEN
	MP	MONOPOINT*	C	CHROME	-24 24 VOLT HALOGEN
	MO	MONORAIL	S	SATIN NICKEL	-LED 12 VOLT LED 3000K
	MO2	TWO-CIRCUIT MONORAIL			

PRODUCT DIMENSIONS

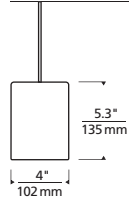

COMPLEMENTARY PRODUCT
LINE-VOLTAGE PENDANT P. 296 / WALL P. 390



BUCKINGHAM



A
P. 580

Elegant natural onyx shade that offers a warm glow with ornate solid brass detail. Includes low-voltage, 50 watt halogen bi-pin lamp or 6 watt replaceable LED module and six feet of field-cutttable suspension cable.

600	SYSTEM	BKMO	FINISH	VOLTAGE	
	FJ	FREEJACK	Z	ANTIQU BRONZE	12 VOLT HALOGEN
	MP	MONOPOINT*	S	SATIN NICKEL	-24 24 VOLT HALOGEN
	MO	MONORAIL			-LED 12 VOLT LED 3000K
	MO2	TWO-CIRCUIT MONORAIL			

PRODUCT DIMENSIONS

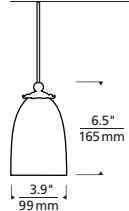

* INCLUDES 4" ROUND FLUSH CANOPY



WHITE GLASS
WITH ANTIQUE BRONZE

HONEY ONYX
WITH SATIN NICKEL

CORONADO



Rectangular onyx shade with metal frame. Includes low-voltage, 35 watt halogen bi-pin lamp or 6 watt replaceable LED module and six feet of field-cutttable suspension cable.

700	SYSTEM	COR	COLOR	FINISH	VOLTAGE	
FJ	FREEJACK	H	HONEY ONYX	Z	ANTIQU BRONZE	12 VOLT HALOGEN
MP	MONOPOINT*	W	WHITE GLASS	S	SATIN NICKEL	-24 24 VOLT HALOGEN
MO	MONORAIL					-LED 12 VOLT LED 3000K
MO2	TWO-CIRCUIT MONORAIL					

PRODUCT DIMENSIONS

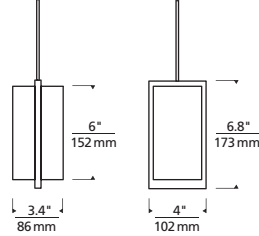

COMPLEMENTARY PRODUCT
WALL P. 390



SILVA



Blown glass cylinder with unique organic pattern. Includes low-voltage, 50 watt halogen bi-pin lamp or 6 watt replaceable LED module and six feet of field-cutttable suspension cable.

700	SYSTEM	SLVAC	FINISH	VOLTAGE
FJ	FREEJACK	Z	ANTIQU BRONZE**	12 VOLT HALOGEN
MP	MONOPOINT*	C	CHROME	-24 24 VOLT HALOGEN
KL	KABLE LITE	S	SATIN NICKEL	-LED 12 VOLT LED 3000K
MO	MONORAIL			
MO2	TWO-CIRCUIT MONORAIL			

PRODUCT DIMENSIONS

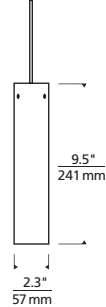

SEE P. 449 FOR ADDITIONAL APPLICATION PHOTO

* INCLUDES 4" ROUND FLUSH CANOPY

** ANTIQU BRONZE IS NOT AVAILABLE FOR KABLE LITE



AMBER WITH ANTIQUE BRONZE



HAVANA BROWN WITH SATIN NICKEL



CLEAR WITH ANTIQUE BRONZE

OAK PARK

Craftsman-style four-sided seeded glass shade with black metal frame. White inner shade diffuses lamp. Includes low-voltage, 50 watt halogen bi-pin lamp and six feet of field-cutttable suspension cable.

700	SYSTEM	OAKB	COLOR	FINISH	VOLTAGE
FJ	FREEJACK	A	AMBER	Z ANTIQUE BRONZE**	12 VOLT HALOGEN
MP	MONOPOINT*	N	HAVANA BROWN	C CHROME	-24 24 VOLT HALOGEN
K	KABLE LITE	W	CLEAR	S SATIN NICKEL	
MO	MONORAIL				
MO2	TWO-CIRCUIT MONORAIL				

PRODUCT DIMENSIONS

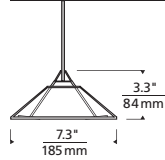

PRODUCT DETAILS



AMBER WITH ANTIQUE BRONZE



FROST WITH SATIN NICKEL

MINI MISSION



A
P. 580

Mission-inspired pressed glass shade. Includes low-voltage, 35 watt halogen bi-pin lamp or 6 watt replaceable LED module and six feet of field-cutttable suspension cable.

600	SYSTEM	MMSN	COLOR	FINISH	VOLTAGE
FJ	FREEJACK	A	AMBER	Z ANTIQUE BRONZE**	12 VOLT HALOGEN
KL	KABLE LITE	F	FROST	S SATIN NICKEL	-LED 12 VOLT LED 3000K
MP	MONOPOINT*				
MO	MONORAIL				
MO2	TWO-CIRCUIT MONORAIL				

PRODUCT DIMENSIONS

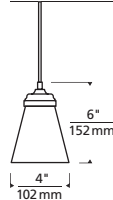

COMPLEMENTARY PRODUCT
ACCESSORY P. 573

* INCLUDES 4" ROUND FLUSH CANOPY

** ANTIQUE BRONZE IS NOT AVAILABLE FOR KABLE LITE



Designed + Built by Harrell Remodeling



AMBER

COBALT BLUE



FROST WHITE

SMALL NEST



A
P. 580

Glass shade with clear glass wrap and metal detail. Includes low-voltage, 50 watt halogen bi-pin lamp or 6 watt replaceable LED module and six feet of field-cutttable suspension cable.

700	SYSTEM	NSP	COLOR	FINISH	VOLTAGE
	FJ	FREEJACK	A AMBER	Z ANTIQUE BRONZE	12 VOLT HALOGEN
	MP	MONOPOINT*	B COBALT BLUE	C CHROME	-24 24 VOLT HALOGEN
	MO	MONORAIL	W FROST WHITE	S SATIN NICKEL	-LED 12 VOLT LED 3000K
	MO2	TWO-CIRCUIT MONORAIL			

PRODUCT DIMENSIONS

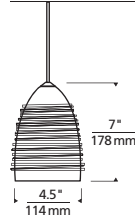

PRODUCT DETAILS



COMPLEMENTARY PRODUCT
LINE-VOLTAGE PENDANT P. 298



AMBER

AQUA



VIOLET

WHITE

SUGAR



A
P. 580

Streams of glass piping formed into a graceful glass shade. Includes low-voltage, 50 watt halogen bi-pin lamp or 6 watt replaceable LED module and six feet of field-cutttable suspension cable.

700	SYSTEM	SUG	COLOR	FINISH	VOLTAGE
	FJ	FREEJACK	A AMBER	Z ANTIQUE BRONZE**	12 VOLT HALOGEN
	MP	MONOPOINT*	Q AQUA	C CHROME	-24 24 VOLT HALOGEN
	KL	KABLE LITE	V VIOLET	S SATIN NICKEL	-LED 12 VOLT LED 3000K
	MO	MONORAIL	W WHITE		
	MO2	TWO-CIRCUIT MONORAIL			

PRODUCT DIMENSIONS

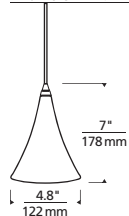

PRODUCT DETAILS

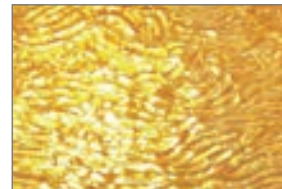

COMPLEMENTARY PRODUCT
ACCESSORY P. 571

SEE P. 138 FOR ADDITIONAL APPLICATION PHOTO

* INCLUDES 4" ROUND FLUSH CANOPY

** ANTIQUE BRONZE IS NOT AVAILABLE FOR KABLE LITE



Photographer: Eric Roth



BLUE-VIOLET

FERRARI RED

MELROSE



A
P. 580

Gracefully shaped glass shade, richly layered in brilliant frit, with machined top detail. Includes low-voltage, 50 watt halogen bi-pin lamp or 6 watt replaceable LED module and six feet of field-cutttable suspension cable.

700	SYSTEM	MLP	COLOR	FINISH	VOLTAGE
FJ	FREEJACK		B BLUE-VIOLET	Z ANTIQUE BRONZE	12 VOLT HALOGEN
MP	MONOPOINT*		R FERRARI RED	C CHROME	-24 24 VOLT HALOGEN
MO	MONORAIL		A TAHOE PINE AMBER	S SATIN NICKEL	-LED 12 VOLT LED 3000K
MO2	TWO-CIRCUIT MONORAIL		W WHITE FRIT		

PRODUCT DIMENSIONS

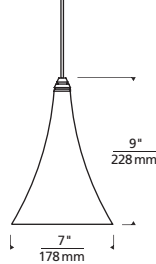

PRODUCT DETAILS



COMPLEMENTARY PRODUCT
LINE-VOLTAGE PENDANT P. 300



TAHOE PINE AMBER

WHITE FRIT



BLUE-VIOLET

FERRARI RED

MINI MELROSE



A
P. 580

Gracefully shaped glass shade, richly layered in brilliant frit, with machined top detail. Includes low-voltage, 50 watt halogen bi-pin lamp or 6 watt replaceable LED module and six feet of field-cutttable suspension cable.

700	SYSTEM	MML	COLOR	FINISH	VOLTAGE
FJ	FREEJACK		B BLUE-VIOLET	Z ANTIQUE BRONZE**	12 VOLT HALOGEN
MP	MONOPOINT*		R FERRARI RED	C CHROME	-24 24 VOLT HALOGEN
KL	KABLE LITE		A TAHOE PINE AMBER	S SATIN NICKEL	-LED 12 VOLT LED 3000K
MO	MONORAIL		W WHITE FRIT		
MO2	TWO-CIRCUIT MONORAIL				

PRODUCT DIMENSIONS

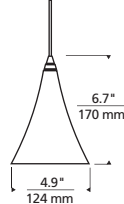

COMPLEMENTARY PRODUCT
LINE-VOLTAGE PENDANT P. 300

SEE P. 447 FOR ADDITIONAL APPLICATION PHOTO

* INCLUDES 4" ROUND FLUSH CANOPY

** ANTIQUE BRONZE IS NOT AVAILABLE FOR KABLE LITE



TAHOE PINE AMBER

WHITE FRIT



LOW-VOLTAGE PENDANTS



TAHOE AMBER PINE



TORTOISE SHELL
WITH IRON WRAP ACCESSORY



WHITE FRIT
WITH RED GLASS BALL



OPTIONAL
IRON WRAP ACCESSORY
P. 568

MINI OVATION



A
P. 580

Hand pulled glass shade, richly layered in brilliant color, with machined top or glass ball detail. Handmade wrought Iron Wrap Accessory sold separately. Includes low-voltage, 50 watt halogen bi-pin lamp or 6 watt replaceable LED module and six feet of field-cutttable suspension cable.

700	SYSTEM	MOV	COLOR	GLASS BALL	FINISH	VOLTAGE
FJ	FREEJACK	A	TAHOE PINE AMBER	N NO BALL	Z ANTIQUE BRONZE**	12 VOLT HALOGEN
MP	MONOPOINT*	A	AMBER	A AMBER	C CHROME	-24 24 VOLT HALOGEN
KL	KABLE LITE	T	TORTOISE SHELL	R RED	S SATIN NICKEL	-LED 12 VOLT LED 3000K
MO	MONORAIL	W	WHITE FRIT			
MO2	TWO-CIRCUIT MONORAIL					

PRODUCT DIMENSIONS

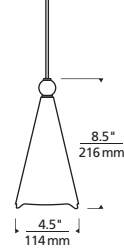

PRODUCT DETAILS



COMPLEMENTARY PRODUCT
LINE-VOLTAGE PENDANT P. 303 / WALL P. 386
SEE P. 387 FOR ADDITIONAL APPLICATION PHOTO



CARAMEL



DARK AMBER

MINI STARRY NIGHT



A
P. 580

Cone shaped glass shade richly layered in hand twisted colors with reflective white interior. Includes low-voltage, 50 watt halogen bi-pin lamp or 6 watt replaceable LED module and six feet of field-cutttable suspension cable.

700	SYSTEM	STR	COLOR	FINISH	VOLTAGE
FJ	FREEJACK	C	CARAMEL	Z ANTIQUE BRONZE**	12 VOLT HALOGEN
MP	MONOPOINT*	A	DARK AMBER	C CHROME	-24 24 VOLT HALOGEN
KL	KABLE LITE	S		S SATIN NICKEL	-LED 12 VOLT LED 3000K
MO	MONORAIL				
MO2	TWO-CIRCUIT MONORAIL				

PRODUCT DIMENSIONS

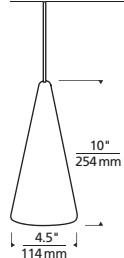

PRODUCT DETAILS



* INCLUDES 4" ROUND FLUSH CANOPY
** ANTIQUE BRONZE IS NOT AVAILABLE FOR KABLE LITE



Photographer: www.peterrymid.com Design: Ulrich Kitchens

LOW-VOLTAGE PENDANTS



AMBER



BLUE-GREEN



BROWN



A
P. 580

MINI TAZA

Blown glass shade with intensely twisted rich glass color. Includes low-voltage, 50 watt halogen bi-pin lamp or 6 watt replaceable LED module and six feet of field-cutttable suspension cable.

700	SYSTEM	TAZ	COLOR	FINISH	VOLTAGE	
FJ	FREEJACK	A	AMBER	Z	ANTIQUE BRONZE**	12 VOLT HALOGEN
MP	MONOPOINT*	B	BLUE-GREEN	C	CHROME	-24 24 VOLT HALOGEN
KL	KABLE LITE	N	BROWN	S	SATIN NICKEL	-LED 12 VOLT LED 3000K
MO	MONORAIL	C	CREAM			
MO2	TWO-CIRCUIT MONORAIL	R	RED			

PRODUCT DIMENSIONS

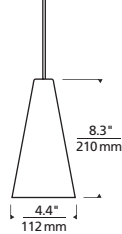

COMPLEMENTARY PRODUCT
LINE-VOLTAGE PENDANT P. 302 / ACCESSORY P. 571



CREAM



RED



AMETHYST



FROST



GREEN



A
P. 580

NIKO

Cone shaped glass shade embedded with large murini and canes of glass. Includes low-voltage, 50 watt halogen bi-pin lamp or 6 watt replaceable LED module and six feet of field-cutttable suspension cable.

700	SYSTEM	NKO	COLOR	FINISH	VOLTAGE	
FJ	FREEJACK	M	AMETHYST	Z	ANTIQUE BRONZE**	12 VOLT HALOGEN
MP	MONOPOINT*	F	FROST	C	CHROME	-24 24 VOLT HALOGEN
KL	KABLE LITE	G	GREEN	S	SATIN NICKEL	-LED 12 VOLT LED 3000K
MO	MONORAIL					
MO2	TWO-CIRCUIT MONORAIL					

PRODUCT DIMENSIONS

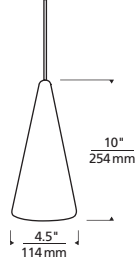

* INCLUDES 4" ROUND FLUSH CANOPY
** ANTIQUE BRONZE IS NOT AVAILABLE FOR KABLE LITE



LOW-VOLTAGE PENDANTS



AMBER FRIT

WHITE FRIT

MELT



A
P. 580

Inverted teardrop shaped, richly colored frit glass accented with a clear glass draw at the bottom and three metal beads at the top. Includes low-voltage, 50 watt halogen bi-pin lamp or 6 watt replaceable LED module and six feet of field-cutttable suspension cable.

700	SYSTEM	MLT	COLOR	FINISH	VOLTAGE
	FJ	FREEJACK	A AMBER FRIT	Z ANTIQUE BRONZE**	12 VOLT HALOGEN
	MP	MONOPOINT*	C WHITE FRIT	C CHROME	-24 24 VOLT HALOGEN
	KL	KABLE LITE		S SATIN NICKEL	-LED 12 VOLT LED 3000K
	MO	MONORAIL			
	MO2	TWO-CIRCUIT MONORAIL			

PRODUCT DIMENSIONS

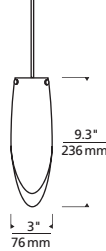

AMBER FRIT

RED FRIT

METEOR FRIT

Dome shaped glass shade, richly layered in brilliant frit. Includes low-voltage, 50 watt halogen bi-pin lamp and six feet of field-cutttable suspension cable.

700	SYSTEM	ME	COLOR	FINISH	VOLTAGE
	FJ	FREEJACK	AF AMBER FRIT	Z ANTIQUE BRONZE**	12 VOLT HALOGEN
	MP	MONOPOINT*	RF RED FRIT	C CHROME	-24 24 VOLT HALOGEN
	KL	KABLE LITE	WF WHITE FRIT	S SATIN NICKEL	
	MO	MONORAIL			
	MO2	TWO-CIRCUIT MONORAIL			

PRODUCT DIMENSIONS

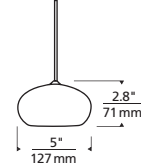

WHITE FRIT

* INCLUDES 4" ROUND FLUSH CANOPY

** ANTIQUE BRONZE IS NOT AVAILABLE FOR KABLE LITE



LOW-VOLTAGE PENDANTS



AMBER

RED

WHITE

SAVOY



A
P. 580

Delicately shaped glass shade, layered in vibrant colors. Includes low-voltage, 35 watt halogen bi-pin lamp or 6 watt replaceable LED module and six feet of field-cutttable suspension cable.

700	SYSTEM	SAV	COLOR	FINISH	VOLTAGE
FJ	FREEJACK	A	AMBER	Z ANTIQUE BRONZE**	12 VOLT HALOGEN
MP	MONOPOINT*	R	RED	C CHROME	-24 24 VOLT HALOGEN
KL	KABLE LITE	W	WHITE	S SATIN NICKEL	-LED 12 VOLT HALOGEN
MO	MONORAIL				
MO2	TWO-CIRCUIT MONORAIL				

SEE P. 497 FOR ADDITIONAL APPLICATION PHOTO

PRODUCT DIMENSIONS

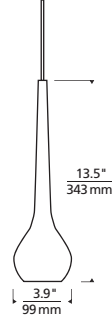

* INCLUDES 4" ROUND FLUSH CANOPY

** ANTIQUE BRONZE IS NOT AVAILABLE FOR KABLE LITE



Photographer: Burnett Studios, Jim Burnett Jr.



TORPEDO PENDANT
WITH FIREBIRD GLASS SHIELD

TORPEDO PENDANT

Stylish pendant to customize with Round, Cone, Cone Onyx, Soda, Dichroic, Firebird, Flute, Hurricane, Martini, Mission or Prism Glass Shield, Belladonna, Bell, Tinkerbell, Lil Egypt, Meteorite, Sugar, Scavo or Taza accessory. Accessory required; sold separately (pp. 566-579). Low-voltage, MR16 of up to 50 watts (not included). Includes six feet of field-cutttable suspension cable.

700	SYSTEM	TRPN	FINISH
FJ	FREEJACK		Z ANTIQUE BRONZE**
MP	MONOPOINT*		C CHROME
K	KABLE LITE		S SATIN NICKEL
MO	MONORAIL		
MO2	TWO-CIRCUIT MONORAIL		

PRODUCT DIMENSIONS

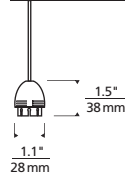

COMPLEMENTARY PRODUCT
HEAD P. 169

ANTIQUE BRONZE



TORPEDO PENDANT
WITH BELL



TORPEDO PENDANT
WITH ROUND GLASS SHIELD



TORPEDO PENDANT
WITH BELLADONNA

CHROME



TORPEDO PENDANT
WITH TINKERBELL



TORPEDO PENDANT
WITH PRISM GLASS SHIELD



TORPEDO PENDANT
WITH LIL EGYPT

SATIN NICKEL



TORPEDO PENDANT
WITH DICHRIC GLASS SHIELD



TORPEDO PENDANT
WITH CONE GLASS SHIELD



TORPEDO PENDANT
WITH CONE ONYX

* INCLUDES 4" ROUND FLUSH CANOPY

** ANTIQUE BRONZE IS NOT AVAILABLE FOR KABLE LITE



Photographer: Gazston



AMBER

CLEAR

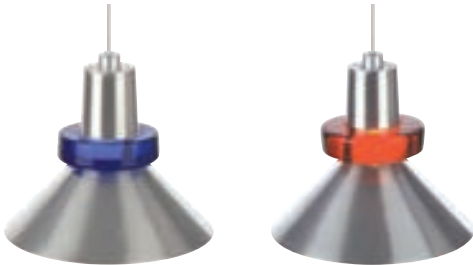

COBALT

RED

HANGING WOK

Wok-shaped metal shade with clear or colored glass disk that glows from within. Includes low-voltage, 50 watt MR16 flood lamp and six feet of field-cutttable suspension cable.

700	SYSTEM	WKS	COLOR	FINISH	VOLTAGE
FJ	FREEJACK	A	AMBER	Z ANTIQUE BRONZE**	12 VOLT HALOGEN
MP	MONOPOINT*	W	CLEAR	C CHROME	-24 24 VOLT HALOGEN
K	KABLE LITE	C	COBALT	S SATIN NICKEL	
MO	MONORAIL	R	RED		
MO2	TWO-CIRCUIT MONORAIL				

PRODUCT DIMENSIONS

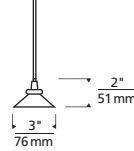

COMPLEMENTARY PRODUCT ACCESSORY P. 575

SEE P. 182 FOR ADDITIONAL APPLICATION PHOTO



AMBER

COBALT



RED

WHITE

RAINDROP

Opaque white or colored raindrop shaped glass. Includes low-voltage, 50 watt halogen bi-pin lamp and six feet of field-cutttable suspension cable.

700	SYSTEM	RD	COLOR	FINISH	VOLTAGE
FJ	FREEJACK	M	AMBER	Z ANTIQUE BRONZE**	12 VOLT HALOGEN
MP	MONOPOINT*	B	COBALT	C CHROME	-24 24 VOLT HALOGEN
KL	KABLE LITE	R	RED	S SATIN NICKEL	
MO	MONORAIL	W	WHITE		
MO2	TWO-CIRCUIT MONORAIL				

PRODUCT DIMENSIONS

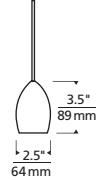

* INCLUDES 4" ROUND FLUSH CANOPY

** ANTIQUE BRONZE IS NOT AVAILABLE FOR KABLE LITE



Trends Publishing International US Kitchen Trends 17/5 P138 Photographer: Tom Maloney Designer: Arteriors Architecture

MonoRail p. 456 with Sportster head p. 171



LOW-VOLTAGE HEADS



LOW-VOLTAGE HEADS





ISO



P. 580

16 watt, 850+ lumen directional LED head. The precision lines of the heat sink peak through the sleek outer housing creating a look that speaks to the functional performance of the luminaire. The LED is easily field-replaceable and upgradeable due to the solderless connector. The heat sink remains with the fixture minimizing any waste at the end of the lamp module's life. The head rotates 360° and pivots 90° to direct the beam. Integrated lens holder accommodates one lens or louver (sold separately). Dimmable to 10% with low-voltage electronic or magnetic dimmer (based on the transformer).

700	SYSTEM	ISO	LAMP	BEAM SPREAD	LENGTH (A)	FINISH	-LED
FJ	FREEJACK	827	80 CRI 2700K LED	20 20°	03 3"	S SATIN NICKEL	
MP	MONOPOINT*			30 30°	06 6"		
MO	MONORAIL	830	80 CRI 3000K LED	50 50°	12 12"	W WHITE	
MOZ	TWO-CIRCUIT MONORAIL	930	90 CRI 3000K LED		18 18***		

PRODUCT DIMENSIONS

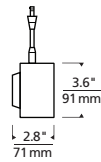

SPECIFICATIONS

Power Consumption: 13 watts (LED),
3 watts (Integrated Driver)

Color Temperature: 3000° K

Output: 800+ lms

Efficiency: 50+ lms / watt

CRi: 80+

Beam Spreads: 20°, 30°, 50°

Life: 50,000 hours to L70

Dimming: 10%

Warranty: 5 years

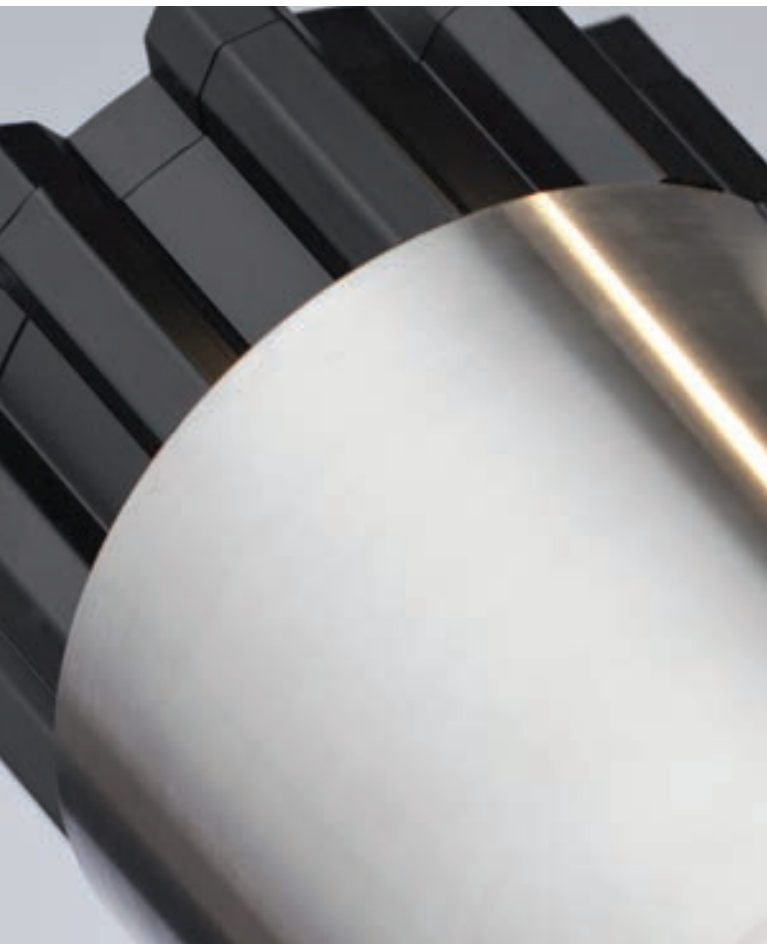

VERYON



P. 580

16 watt, 850+ lumen directional LED head made of machined aluminum housing and extruded aluminum heat sink. The LED is easily field replaceable and upgradeable due to the solderless connector. The heat sink remains with the fixture minimizing any waste at the end of the lamp module's life. The two-tone finish adds a modern industrial aesthetic. The head rotates 360° and pivots 90° to direct the beam. Integrated lens holder accommodates one lens or louver (sold separately). Dimmable to 10% with low-voltage electronic or magnetic dimmer (based on the transformer).

700	SYSTEM	VRN	LAMP	BEAM SPREAD	LENGTH (A)	FINISH
FJ	FREEJACK	82	80 CRI 2700K LED	16 16°	03 3"	BS BLACK / SATIN NICKEL
MP	MONOPOINT*			28 28°	06 6"	
MO	MONORAIL	83	80 CRI 3000K LED	45 45°	12 12"	SS SATIN NICKEL / SATIN NICKEL
MOZ	TWO-CIRCUIT MONORAIL	93	90 CRI 3000K LED		18 18°	

PRODUCT DIMENSIONS

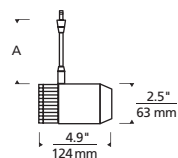

SPECIFICATIONS

Power Consumption: 13 watts (LED),
3 watts (Integrated Driver)

Color Temperature: 3000° K

Output: 850+ lms

Efficiency: 50+ lms / watt

CRi: 80+

Beam Spreads: 16°, 28°, 45°

Life: 50,000 hours to L70

Dimming: 10%

Warranty: 5 years

* INCLUDES 4" ROUND FLUSH CANOPY

** IT IS NOT RECOMMENDED TO TILT THE 18" ISO MORE THAN 45°



SINGLE FLOOD EDGE LIT



SINGLE WALL WASH



DOUBLE WALL WASH



DOUBLE FLOOD EDGE LIT

IBISS LIGHTFAIR INNOVATION AWARDS* DESIGN EXCELLENCE WINNER

IBISS
E
P. 580

Constructed of die cast aluminum, the IBISS heads are designed to celebrate what's achievable with LED resulting in a form that would never be possible with traditional lamping. Going beyond simply incorporating LED, the IBISS heads are beautiful in their minimalist simplicity and deliver ultimate performance. Pivots vertically 330°, rotates horizontally 360°. Available in a 10 watt single or 20 watt double version. Each LED module pivots independently on the double version. Available as FLOOD or Asymmetric WALL WASH. An embedded lens helps diffuse glare and minimize shadowing while maintaining a high degree of efficiency. Dimmable to 10% with low-voltage electronic or magnetic dimmer (based on the transformer).

700 SYSTEM	IBIS FORM	STYLE	LAMP	LENGTH (A)	FINISH
FJ FREEJACK	FE FLOOD	S SINGLE (10W)	L2 LED 2700K	03 3"	Z ANTIQUE BRONZE
MP MONOPOINT*	FE FLOOD	D DOUBLE (20W)	L3 LED 3000K	06 6"	5 SATIN NICKEL
MO MONORAIL	FS FLOOD			12 12"	
WMO WALL MONORAIL**	WW WALL WASH			18 18"	

PRODUCT DIMENSIONS

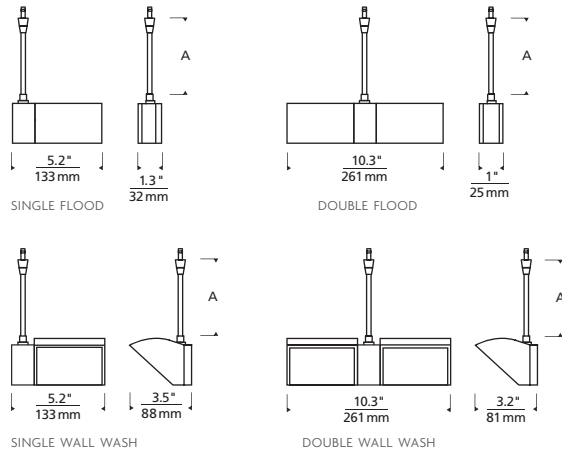

PRODUCT DETAILS

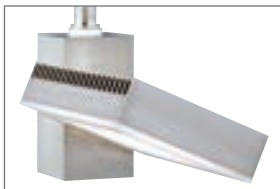

SINGLE FLOOD EDGE LIT

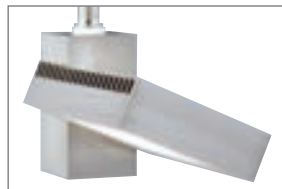

SINGLE FLOOD SOLID

SPECIFICATIONS

	Single	Double
Power Consumption:	10 watts	20 watts
Color Temperature:	2700° K, 3000° K	2700° K, 3000° K
Output:	700 lms	1400 lms
Efficiency:	70 lms / watt	70 lms / watt
CRI:	80	80
Life:	50,000 hours to L70	50,000 hours to L70
Dimming:	10%	10%
Warranty:	5 years	5 years

* INCLUDES 4" ROUND FLUSH CANOPY

** FOR SINGLE HEAD, USE UP TO 12" MAXIMUM LENGTH, AND FOR DOUBLE HEAD USE UP TO 6" MAXIMUM LENGTH. NOT RECOMMENDED FOR SINGLE WALL WASH.



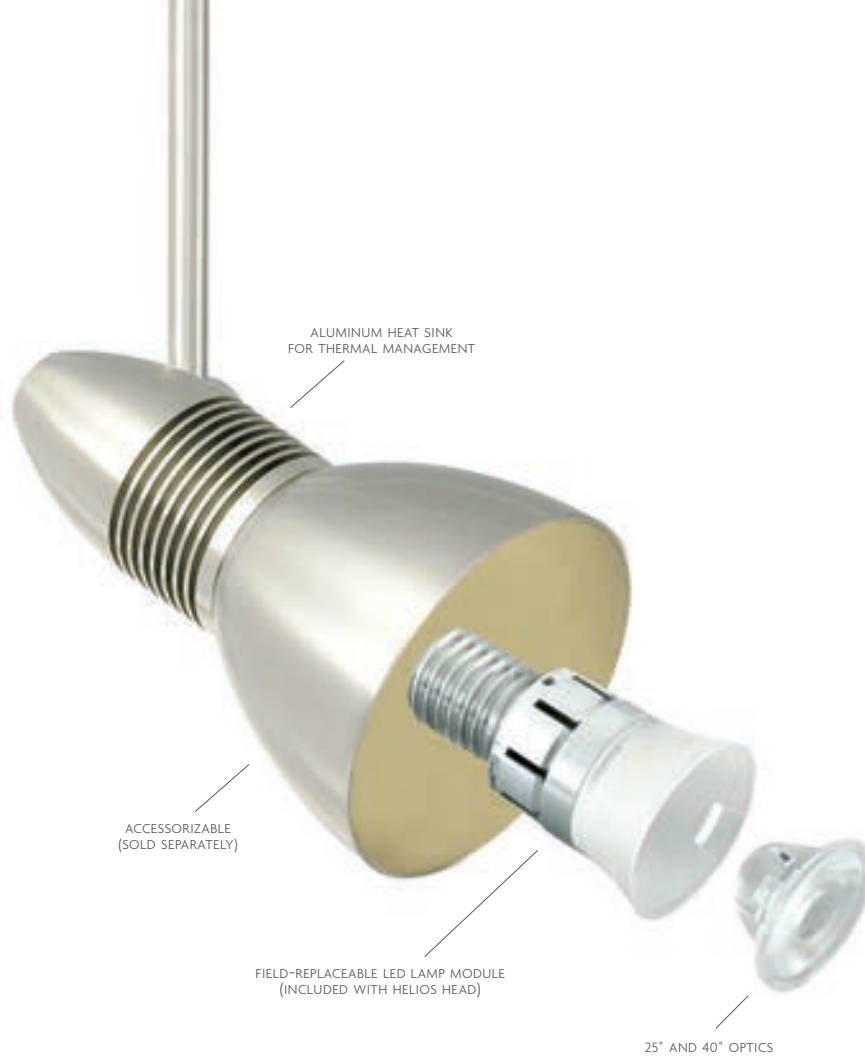

HELIOS



P. 580

6 watt directional LED head. LED module is easily field-replaceable with the screw-in base specifically designed for our head. The heat sink remains with the fixture minimizing any waste at the end of the lamp module life. Head rotates 360° and pivots 260° to direct the beam. Accessories in myriad styles and colors allow you to create the ideal custom LED fixture (accessories required; sold separately). Lenses and louvers may only be used with Round Glass Shield and Tinkerbell with Integral Lens Holder Accessory. Dimmable to 10% with low-voltage electronic or magnetic dimmer (based on the transformer).

PRODUCT DIMENSIONS

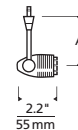

700	SYSTEM	HEL	BEAM SPREAD	LENGTH (A)	FINISH	-LED
FJ	FREEJACK		25 25°	03 3"	Z ANTIQUE BRONZE	
MP	MONOPOINT*		40 40°	06 6"	S SATIN NICKEL	
MO	MONORAIL			12 12"		
WMO	WALL MONORAIL			18 18"		
				24 24"		

SPECIFICATIONS

Power Consumption: Initial 6 watts
 Color Temperature: 3000° K
 Lumens: 350 net lumens
 Lumens / Watt: 55 lms / watt
 Color Rendering Index: >85 CRI
 Rated Average Life: >30,000 hours to L70
 Center Beam
 Candle Power: 25° - 748; 40° - 550
 Dimming: 10%
 Warranty: 5 years

ACCESSORY REQUIRED

Cone, Cone Onyx, Dichroic, Firebird, Flute, Hurricane, Martini, Mission, Prism, Round or Soda Glass Shield; Bell, Belladonna, Lil Egypt, Scavo, Sugar, Taza or Tinkerbell (sold separately pp. 566-579)

* INCLUDES 4" ROUND FLUSH CANOPY







SCANIA

Clean modern European-inspired head with a plated or matte painted finish. Head rotates 360°, pivots 180° to direct the beam. Includes Snap Louver Lens Holder. Can hold a single lens or louver (sold separately). Low-voltage, MR16 lamp of up to 50 watts (not included).

700	SYSTEM	SCAN	LENGTH (A)	BODY COLOR	FINISH
	FJ	FREEJACK	03 3"	B BLACK	S SATIN NICKEL
	MP	MONOPOINT*	06 6"	R BURNT SIENNA	
	MO	MONORAIL	12 12"	L LINEN	
	MO2	TWO-CIRCUIT MONORAIL		M METAL	

PRODUCT DIMENSIONS

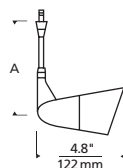

COMPATIBLE OPTICAL CONTROLS

Glass Lens or Eggcrate Louver
(sold separately pp. 566-579)



MINI OM

Flexible, clean head rotates 360°; pivots 260° to direct the beam. Low-voltage, MR16 lamp of up to 50 watts (not included). Accessory required; sold separately.

700	SYSTEM	OM	LENGTH (A)	FINISH
	FJ	FREEJACK	03 3"	Z ANTIQUE BRONZE
	MP	MONOPOINT*	06 6"	S SATIN NICKEL
	MO	MONORAIL	12 12"	
	MO2	TWO-CIRCUIT MONORAIL	18 18"	
	WMO	WALL MONORAIL		

PRODUCT DIMENSIONS

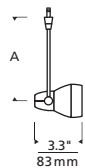

COMPATIBLE OPTICAL CONTROLS

Glass Lens or Eggcrate Louver
(sold separately pp. 566-579)

SEE P. 107 FOR ADDITIONAL APPLICATION PHOTO

MINI OM ACCESSORY

Metal backlight shield with built in colored glass, onyx, or solid metal ring. Includes Snap Louver Lens Holder. Can hold a single lens or louver. MR16 lamp of up to 50 watts (not included).

700MR16OM	COLOR	FINISH
CC	CLEAR	Z ANTIQUE BRONZE
F	FROST	S SATIN NICKEL
O	ONYX	
S	SOLID METAL	

* INCLUDES 4" ROUND FLUSH CANOPY





WITH EGGCRATE LOUVER





ENVISION

Specification grade head with precision internal gearing mechanisms that allow for hot aiming and are self-locking. Rotates 360° and pivots 0° to 90°. Up to two lenses or louvers (sold separately) are held captive inside the lamp cartridge which includes an integral glare reducing snoot. Lamp cartridge and lens orientation adjust 180°. Lamp cartridge is keyed to maintain accurate focus during relamping. All functionality can be fine-tuned using a phillips or flat head screwdriver and with the guide of accompanying markings. Low-voltage, MR16 lamp of up to 50 watts (not included).

700	SYSTEM	ENV	LENGTH (A)	FINISH
	FJ	FREEJACK	03 3.5"	5 SATIN NICKEL
	MP	MONOPOINT*	07 7.5"	
	MO	MONORAIL		
	MO2	TWO-CIRCUIT MONORAIL		

PRODUCT DIMENSIONS

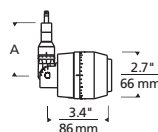

COMPATIBLE OPTICAL CONTROLS

Glass Lens or Eggcrate Louver
(sold separately pp. 566-579)

TELLIUM

Simple, industrial-inspired head puts light where you need it. Machined aluminum and brass housings create crisp edges. Head rotates 360°; pivots 90° to direct the beam. Integrated lens holder accommodates up to two lenses or louvers (sold separately). Accepts low-voltage, MR16 lamp of up to 50 watts (not included).

700	SYSTEM	TLM	LENGTH (A)	FINISH
	FJ	FREEJACK	03 3"	Z ANTIQUE BRONZE
	MP	MONOPOINT*	06 6"	S SATIN NICKEL
	MO	MONORAIL	12 12"	
	MO2	TWO-CIRCUIT MONORAIL	18 18"	

PRODUCT DIMENSIONS

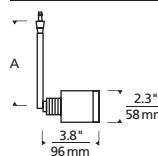

COMPATIBLE OPTICAL CONTROLS

Glass Lens or Eggcrate Louver
(sold separately pp. 566-579)



See p. 581 for LED MR16 lamping options

* INCLUDES 4" ROUND FLUSH CANOPY



WITH EGGRATE LOUVER

JOHN

Adjustable head tilts and rotates infinitely. Integral louver lens holder can hold a single glass lens (sold separately) or an eggcrate louver (included). Low-voltage, MR16 lamp of up to 50 watts (not included).

700	SYSTEM	JON	LENGTH (A)	FINISH
FJ	FREEJACK		03 3"	Z ANTIQUE BRONZE
MP	MONOPOINT*		06 6"	C CHROME
MO	MONORAIL		12 12"	S SATIN NICKEL
MO2	TWO-CIRCUIT MONORAIL		18 18"	
			24 24"	
WMO	WALL MONORAIL			

PRODUCT DIMENSIONS



COMPATIBLE OPTICAL CONTROLS

Glass Lens or Eggcrate Louver (sold separately pp. 566-579)

SEE PP. 41, 485, 503 FOR APPLICATION PHOTOS



See p. 581 for LED MR16 lamping options



WITH EGGRATE LOUVER

ELTON

Adjustable double head tilts and rotates infinitely. Integral louver lens holders can hold a single glass lens (sold separately) or an eggcrate louver (two included). Two low-voltage, MR16 lamps of up to 35 watts each (not included).

700	SYSTEM	ELT	LENGTH (A)	FINISH
FJ	FREEJACK		03 3"	Z ANTIQUE BRONZE
MP	MONOPOINT*		06 6"	C CHROME
MO	MONORAIL		12 12"	S SATIN NICKEL
MO2	TWO-CIRCUIT MONORAIL		18 18"	
			24 24"	
WMO	WALL MONORAIL			

PRODUCT DIMENSIONS

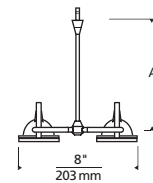

COMPATIBLE OPTICAL CONTROLS

Glass Lens or Eggcrate Louver (sold separately pp. 566-579)



See p. 581 for LED MR16 lamping options

* INCLUDES 4" ROUND FLUSH CANOPY



Photographer: Patricia Parinejad





Trends Publishing International | Photographer: John Lumbarger | Designer: Kimberley Warren

AERO

Dozens of design possibilities. Accessories in myriad styles and colors allow you to create the ideal custom element (accessory required; sold separately). Aero's head rotates 360°, pivots 260° to direct the beam. Removable glass handle. Low-voltage, MR16 lamp of up to 50 watts (not included).

700	SYSTEM	AE	LENGTH (A)	FINISH
FJ	FREEJACK		3 3"	Z ANTIQUE BRONZE
MP	MONOPOINT*		6 6"	C CHROME
MO	MONORAIL		12 12"	S SATIN NICKEL
MO2	TWO-CIRCUIT MONORAIL		18 18"	
WMO	WALL MONORAIL		24 24"	

PRODUCT DIMENSIONS

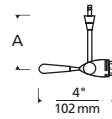

ACCESSORY REQUIRED

Cone, Cone Onyx, Dichroic, Firebird, Flute, Hurricane, Martini, Mission, Prism, Round or Soda Glass Shield; Bell, Belladonna, Lil Egypt, Scavo, Sugar, Taza, or Tinkerbell (sold separately pp. 566-579)

SEE PP. 39, 87, 141, 456, 459, 461, 483, 491, 497, 566 FOR ADDITIONAL APPLICATION PHOTOS



See p. 581 for LED MR16 lamping options



Photographer: Matthew Millman | BCCI Construction Company

TILT

Flexible minimalist head with multiple accessory options; rotates 360°, pivots 90°. Low-voltage, MR16 lamp of up to 50 watts (not included).

700	SYSTEM	TLT	LENGTH (A)	FINISH
FJ	FREEJACK		2"	Z ANTIQUE BRONZE
MP	MONOPOINT*		06 6"	C CHROME
MO	MONORAIL		12 12"	S SATIN NICKEL
MO2	TWO-CIRCUIT MONORAIL		18 18"	
WMO	WALL MONORAIL			

PRODUCT DIMENSIONS

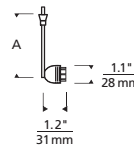

ACCESSORY REQUIRED

Cone, Cone Onyx, Dichroic, Firebird, Flute, Hurricane, Martini, Mission, Prism, Round or Soda Glass Shield; Bell, Belladonna, Lil Egypt, Scavo, Sugar, Taza, or Tinkerbell (sold separately pp. 566-579)

SEE PP. 18, 19, 484 FOR ADDITIONAL APPLICATION PHOTOS



See p. 581 for LED MR16 lamping options

* INCLUDES 4" ROUND FLUSH CANOPY



WITH EGGRATE LOUVER



WITH EGGRATE LOUVER





Photographer: Matthew Millman Design: Aidlin Darling Design

SPOT

Classic head rotates 360° around stem, pivots 290°. Can hold one lens or louver (sold separately). Low-voltage, MR16 lamp of up to 50 watts (not included).

700	SYSTEM	SPT6	LENGTH (A)	FINISH
FJ	FREEJACK		04 4.5"	C CHROME
MP	MONOPOINT*		06 6"	S SATIN NICKEL
MO	MONORAIL		12 12"	
MO2	TWO-CIRCUIT MONORAIL		18 18"	
WMO	WALL MONORAIL			

PRODUCT DIMENSIONS

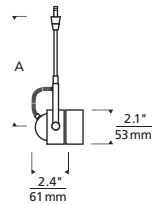

COMPATIBLE OPTICAL CONTROLS

Glass Lens or Eggcrate Louver (sold separately pp. 566-579)

SEE PP. 38, 41, 458 FOR ADDITIONAL APPLICATION PHOTOS



See p. 581 for LED MR16 lamping options



Photographer: Claudio Santini

SPORTSTER

Minimal stylish head rotates 360° and pivots 180°. Eggcrate louver included. Low-voltage, MR16 lamp of up to 75 watts (not included).

700	SYSTEM	SS6	LENGTH (A)	FINISH
FJ	FREEJACK		04 4.5"	C CHROME
MP	MONOPOINT*		06 6"	S SATIN NICKEL
MO	MONORAIL		12 12"	
MO2	TWO-CIRCUIT MONORAIL		18 18"	
WMO	WALL MONORAIL		24 24"	

PRODUCT DIMENSIONS

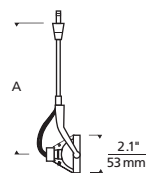

COMPATIBLE OPTICAL CONTROLS

Glass Lens or Eggcrate Louver (sold separately pp. 566-579)

SEE P. 155 FOR ADDITIONAL APPLICATION PHOTO



See p. 581 for LED MR16 lamping options

* INCLUDES 4" ROUND FLUSH CANOPY



WITH SPY ACCESSORY
(SOLD SEPARATELY)



WITH BACKLIGHT SHIELD
(SOLD SEPARATELY)



SPROCKET

Sleek Sprocket, with its removable handle, has many accessory options. Head rotates 360° and pivots 260° on vertical axis. Low-voltage, MR16 lamp of up to 75 watts (not included).

700	SYSTEM	SP	LENGTH (A)	FINISH
FJ	FREEJACK	1	1.2"	Z ANTIQUE BRONZE
MP	MONOPOINT*	3	3"	C CHROME
MO	MONORAIL	6	6"	S SATIN NICKEL
MO2	TWO-CIRCUIT MONORAIL	12	12"	
		18	18"	
WMO	WALL MONORAIL	24	24"	

PRODUCT DIMENSIONS

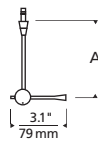

COMPATIBLE ACCESSORIES & OPTICAL CONTROLS

Backlight Shield, Barndoors, Eggcrate Louver, Flight Paper, Glass Lens, Louver Lens Holder, MR16 Snout, Snap Louver Lens Holder, or Spy Accessory (sold separately pp. 566-579)

SEE PP. 40, 460, 467, 480, 517, 536 FOR ADDITIONAL APPLICATION PHOTOS



LED See p. 581 for LED MR16 lamping options



CAM

Clean-lined head rotates 360° around stem; pivots 340°. Low-voltage, MR16 lamp of up to 75 watts (not included).

700	SYSTEM	CAM	LENGTH (A)	FINISH
FJ	FREEJACK	03	3"	C CHROME
MP	MONOPOINT*	06	6"	S SATIN NICKEL
MO	MONORAIL	12	12"	
MO2	TWO-CIRCUIT MONORAIL			
WMO	WALL MONORAIL			

PRODUCT DIMENSIONS

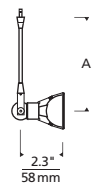

LED See p. 581 for LED MR16 lamping options

* INCLUDES 4" ROUND FLUSH CANOPY



Photographer: Christopher Barrett, Hecrich Blessing Design: OWP&P, Chicago, IL



MO-PIVOT BARE



MO-PIVOT WITH BACKLIGHT SHIELD (SOLD SEPARATELY)



MO-PIVOT WITH LIL EGYPT SHIELD (SOLD SEPARATELY)



MO-PIVOT WITH ROUND GLASS SHIELD (SOLD SEPARATELY)

MO-PIVOT

Directs the beam right where you want it. Head swivels 220°, pivots on vertical and horizontal axes. Specify for low-voltage, MR16 of up to 75 watts (not included). For MonoRail system only.

700MOPIV	FINISH
Z	ANTIQUE BRONZE
C	CHROME
S	SATIN NICKEL

PRODUCT DIMENSIONS

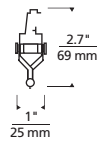

COMPATIBLE ACCESSORIES & OPTICAL CONTROLS

Backlight Shield, Barndoors, Cone Glass Shield, Eggcrate Louver, Flight Paper, Glass Lens, Lil Egypt, Lil Wok, Louver Lens Holder, MR16 Snout, Round Glass Shield, Snap Louver Lens Holder, or Taza Accessory (sold separately pp. 566-579)



See p. 581 for LED MR16 lamping options



SWIVEL BARE



SWIVEL WITH MESH BACKLIGHT SHIELD (SOLD SEPARATELY)

SWIVEL

A highly adjustable, minimal head rotates 360° around stem, swivels 240° at “elbow”; lamp pivots 240°. Customize with any of dozens of available accessories (sold separately). Low-voltage, MR16 lamp of up to 75 watts (not included).

700	SYSTEM	SW	LENGTH (A)	FINISH
FJ	FREEJACK	03	3"	C CHROME
MP	MONOPOINT*	06	6"	S SATIN NICKEL
MO	MONORAIL	12	12"	
MO2	TWO-CIRCUIT MONORAIL	18	18"	
WMO	WALL MONORAIL			

PRODUCT DIMENSIONS

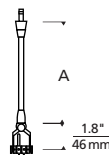

COMPATIBLE ACCESSORIES & OPTICAL CONTROLS

Backlight Shield, Barndoors, Cone Glass Shield, Eggcrate Louver, Flight Paper, Glass Lens, Lil Egypt, Lil Wok, Louver Lens Holder, MR16 Snout, Round Glass Shield, Snap Louver Lens Holder, or Taza Accessory (sold separately pp. 566-579)

SEE PP. 15, 482 FOR APPLICATION PHOTOS



See p. 581 for LED MR16 lamping options

* INCLUDES 4" ROUND FLUSH CANOPY



SWIVEL WITH ROUND GLASS SHIELD (SOLD SEPARATELY)



SWIVEL WITH LIL EGYPT SHIELD (SOLD SEPARATELY)



Photographer: Lars Frazer



T156

High-tech head swivels 360°; head tilts in yoke. Low-voltage, MR16 lamp of up to 75 watts (not included). May be accessorized with Gobo Holder (see below).

700	SYSTEM	156	LENGTH (A)	FINISH
FJ	FREEJACK		45 3"	C CHROME
MP	MONOPOINT*		06 6"	S SATIN NICKEL
MO	MONORAIL		12 12"	
MO2	TWO-CIRCUIT MONORAIL		18 18"	

PRODUCT DIMENSIONS

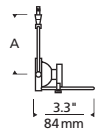

PRODUCT DETAILS



PROJECT YOUR CUSTOMIZED IMAGE

COMPATIBLE ACCESSORIES & OPTICAL CONTROLS

Eggcrate Louver, Glass Lens, MR16 Snout, plus Gobo Holder (below) (sold separately pp. 566-579)



See p. 581 for LED MR16 lamping options

GOBO HOLDER

Add this magnifying lens, gobo holder and a gobo template (sold separately) to the T156 and project a pattern or logo onto any surface. Includes MR16 snout.

700AC156	FINISH
	C CHROME
	S SATIN NICKEL



GOBO MAGNIFYING LENS

Add this optional lens to the gobo holder to increase the size of the projected image.

700MAGGL	FINISH
	C CHROME
	S SATIN NICKEL



GOBO CUSTOMIZABLE TEMPLATE

Gobos are available in standard and custom patterns. For additional information on standard and custom gobos, please call 847.410.4400



AMBER

AMETHYST

POD

Modern head surrounded by a translucent glass orb. Head rotates 360°, pivots 260° to direct the beam. MR16 lamp of up to 50 watts (not included).

700	SYSTEM	POD	LENGTH (A)	COLOR	FINISH
FJ	FREEJACK		03 4"	A AMBER	C CHROME
MP	MONOPOINT*		06 6"	M AMETHYST	S SATIN NICKEL
MO	MONORAIL		12 12"	C CLEAR	
MO2	TWO-CIRCUIT MONORAIL		18 18"		
	WMO WALL MONORAIL				

PRODUCT DIMENSIONS

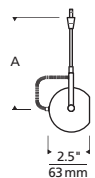

See p. 581 for LED MR16 lamping options



CLEAR

* INCLUDES 4" ROUND FLUSH CANOPY



Photographer: Greg Premru



TELE WITH ROUND GLASS SHIELD
(SOLD SEPARATELY)



TELE
(SHOWN BARE)

TELE

Tele telescopes from 9" to 25" to bring the light right where you need it. Head rotates 360°, swivels 130° at the bracket, and the lamp rotates 290°. Low-voltage, MR16 lamp of up to 75 watts (not included).

700	SYSTEM	TEL	FINISH
FJ	FREEJACK		Z ANTIQUE BRONZE
MP	MONOPOINT*		C CHROME
MO	MONORAIL		S SATIN NICKEL
MO2	TWO-CIRCUIT MONORAIL		
WMO	WALL MONORAIL		

PRODUCT DIMENSIONS

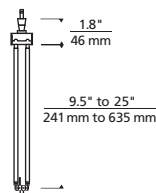

COMPATIBLE ACCESSORIES & OPTICAL CONTROLS

Backlight Shield, Barndoors, Cone Glass Shield, Eggcrate Louver, Flight Paper, Glass Lens, Lil Egypt, Lil Wok, Louver Lens Holder, MR16 Snout, Round Glass Shield, Snap, Louver Lens Holder, or Taza Accessory (sold separately pp. 566-579)

SEE P. 444 FOR ADDITIONAL APPLICATION PHOTO



See p. 581 for LED MR16 lamping options

* INCLUDES 4" ROUND FLUSH CANOPY



Photographer: Claudio Santini





ADLER

Warehouse-inspired adjustable head that can be customized with multiple accessory options (required, sold separately); rotates 360°; pivots 90°. Low-voltage, MR16 lamp up to 50 watts (not included).

600	SYSTEM	ADL	LENGTH (A)	FINISH
	FJ	FREEJACK	03 3"	Z ANTIQUE BRONZE
	MP	MONOPOINT*	06 6"	S SATIN NICKEL
	MO	MONORAIL	12 12"	
	MO2	TWO-CIRCUIT MONORAIL	18 18"	

PRODUCT DIMENSIONS

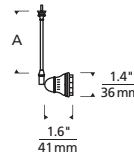

COMPATIBLE ACCESSORIES

Cone, Cone Onyx, Dichroic, Firebird, Flute, Hurricane, Martini, Mission, Prism, Round or Soda Glass Shield; Bell, Belladonna, Lil Egypt, Scavo, Sugar, Taza, or Tinkerbell (sold separately pp. 566-579)



LED See p. 581 for LED MR16 lamping options



SULLIVAN

Adjustable Mission-inspired head to customize with multiple accessory options (required, sold separately); rotates 360°; pivots 90°. Low-voltage, MR16 lamp up to 50 watts (not included).

600	SYSTEM	SVN	LENGTH (A)	FINISH
	FJ	FREEJACK	03 3"	Z ANTIQUE BRONZE
	MP	MONOPOINT*	06 6"	S SATIN NICKEL
	MO	MONORAIL	12 12"	
	MO2	TWO-CIRCUIT MONORAIL	18 18"	

PRODUCT DIMENSIONS

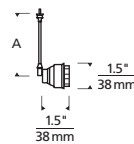

COMPATIBLE ACCESSORIES

Cone, Cone Onyx, Dichroic, Firebird, Flute, Hurricane, Martini, Mission, Prism, Round or Soda Glass Shield; Bell, Belladonna, Lil Egypt, Scavo, Sugar, Taza, or Tinkerbell (sold separately pp. 566-579)



LED See p. 581 for LED MR16 lamping options

* INCLUDES 4" ROUND FLUSH CANOPY

K-HELLO

Highly adjustable head tilts between cables and rotates 140° within its ring. Integral louver lens holder can hold glass lens (sold separately) or eggcrate louver (included). Satin aluminum finish. Specify low-voltage, MR16 lamp of up to 50 watts or AR111 lamp of up to 75 watts (not included). For Kable Lite system only.

700KHELLO	TYPE / CABLE SEPARATION (A)
3	MR16 / 3.5"
5	MR16 / 5.5"
6	MR16 / 6.6"

PRODUCT DIMENSIONS



COMPATIBLE OPTICAL CONTROLS

Glass Lens or MR16 Snout (sold separately pp. 566-579)

SEE PP. 503, 514, 517, 518 FOR ADDITIONAL APPLICATION PHOTOS



LED

See p. 581 for LED MR16 lamping options

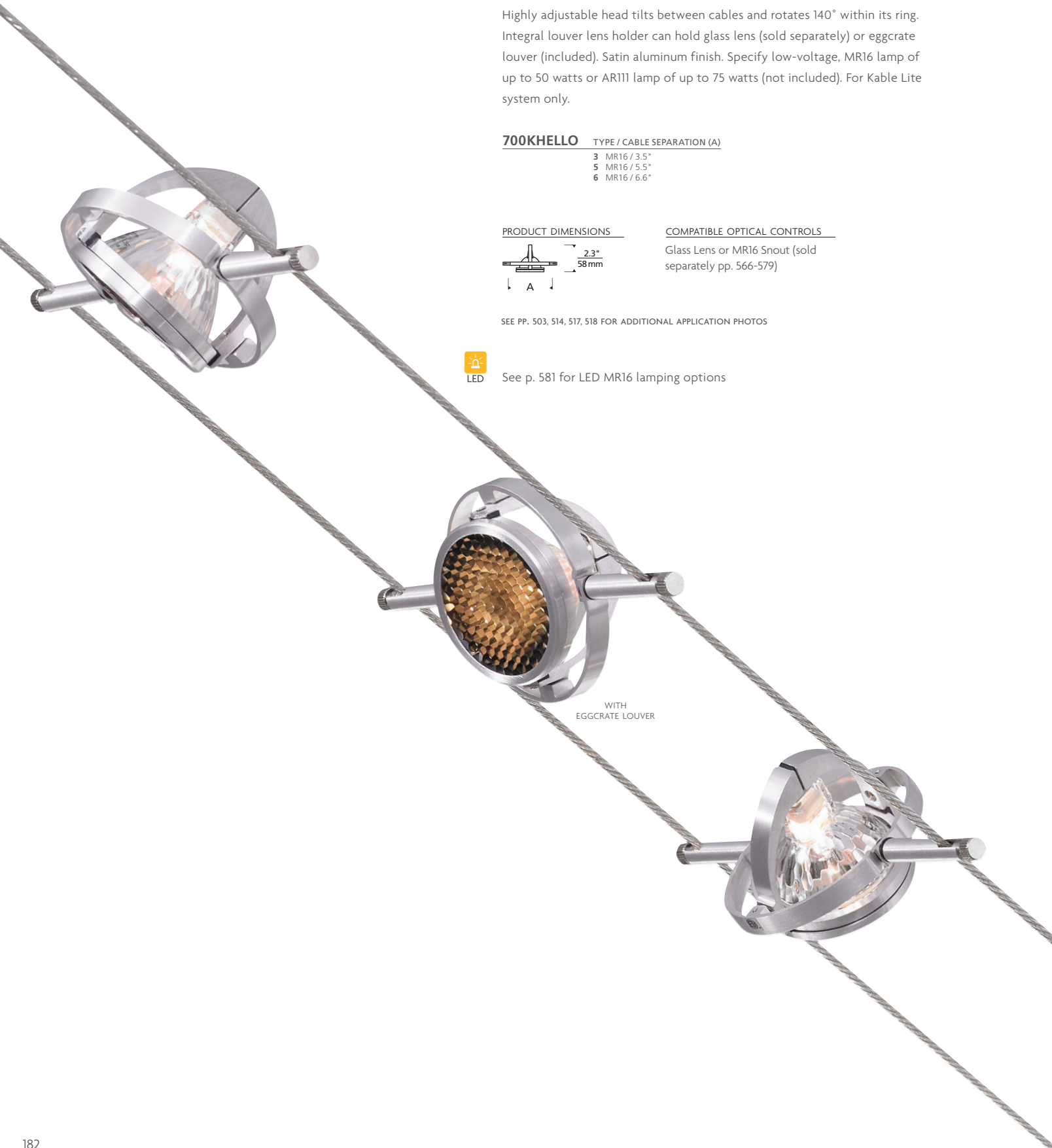

WITH
EGGCRATE LOUVER



Photographer: Greg Premru



WITH LIL WOK
(SOLD SEPARATELY)

K-PIVOT

Head swivels 220°. 2" to 8" versions pivot on horizontal axis, 1" version pivots on vertical axis only. Low-voltage, MR16 lamp of up to 75 watts (not included). For Kable Lite system only.

700KPIV	CABLE SEPARATION (A)	FINISH
01	1"	C CHROME
02	2"	S SATIN NICKEL
03	3.5"	
05	5.5"	
08	8"	

PRODUCT DIMENSIONS

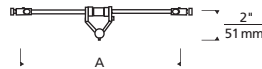

COMPATIBLE ACCESSORIES & OPTICAL CONTROLS

Backlight Shield, Barndoors, Cone Glass Shield, Eggcrate Louver, Flight Paper, Glass Lens, Lil Egypt, Lil Wok, Louver Lens Holder, MR16 Snout, Round Glass Shield, Snap Louver Lens Holder, or Taza Accessory (sold separately pp. 566-579)

SEE PP. 44, 519 FOR ADDITIONAL APPLICATION PHOTOS



See p. 581 for LED MR16 lamping options



K-BYE-BYE

Adjustable arms rotate individually. For cable separations of 3.5" to 8". Lamp rotates 360°. Satin aluminum finish. Low-voltage, MR16 lamp of up to 75 watts (not included). For Kable Lite system only.

700KBYENC

PRODUCT DIMENSIONS

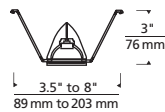

COMPATIBLE ACCESSORIES & OPTICAL CONTROLS

Louver Lens Holder or Round Glass Shield (sold separately pp. 566-579)

SEE P. 45 FOR APPLICATION PHOTO



See p. 581 for LED MR16 lamping options



Photographer: Lars Frazer Interior Design: Miller Greene Design Studio



WITH MESH BACKLIGHT SHIELD
(SOLD SEPARATELY)

K-JANE

K-Jane drops below the cables; head pivots 220° on two axes. For cable separations of up to twice the length. Field-cutttable. Low-voltage, MR16 lamp of up to 75 watts (not included). For Kable Lite system only.

700KJAN	LENGTH (A)	FINISH
	05 5"	C CHROME
	12 12"	S SATIN NICKEL
	24 24"	
	36 36"	

PRODUCT DIMENSIONS

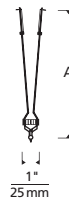

COMPATIBLE ACCESSORIES & OPTICAL CONTROLS

Backlight Shield, Barndoors, Cone Glass Shield, Eggcrate Louver, Flight Paper, Glass Lens, Lil Egypt, Lil Wok, Louver Lens Holder, MR16 Snout, Round Glass Shield, Snap Louver Lens Holder, or Taza Accessory (sold separately pp. 566-579)



See p. 581 for LED MR16 lamping options



K-JOHNNY

Versatile, field-cutttable, with a pivoting head to direct the beam. Low-voltage, MR16 lamp of up to 75 watts (not included). For Kable Lite system only.

700KJOH	CABLE SEPARATION (A)	FINISH
	05 UP TO 5"	C CHROME
	12 UP TO 12"	S SATIN NICKEL
	18 UP TO 18"	
	24 UP TO 24"	
	48 UP TO 48"	
	144 UP TO 144"	

PRODUCT DIMENSIONS

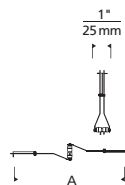

COMPATIBLE ACCESSORIES & OPTICAL CONTROLS

Backlight Shield, Barndoors, Cone Glass Shield, Eggcrate Louver, Flight Paper, Glass Lens, Lil Egypt, Lil Wok, Louver Lens Holder, MR16 Snout, Round Glass Shield, Snap Louver Lens Holder, or Taza Accessory (sold separately pp. 566-579)

SEE P. 516 FOR ADDITIONAL APPLICATION PHOTOS



See p. 581 for LED MR16 lamping options



Photographer: Bob Narod Designer: Jennifer Gilmer, CKD at Jennifer Gilmer Kitchen & Bath Ltd.



K-GIRO

Direct the beam right where you want it: Giro rotates 350° between parallel cables; lamp rotates 360°. Low-voltage, MR16 lamp of up to 75 watts (not included). For Kable Lite system only.

700KGIR	CABLE SEPARATION (A)	FINISH
	05 5.5"	C CHROME
	08 8"	S SATIN NICKEL

PRODUCT DIMENSIONS



COMPATIBLE ACCESSORIES & OPTICAL CONTROLS

Backlight Shield, Barndoors, Cone Glass Shield, Eggcrate Louver, Flight Paper, Glass Lens, Lil Egypt, Lil Wok, Louver Lens Holder, MR16 Snout, Round Glass Shield, Snap Louver Lens Holder, or Taza Accessory (sold separately pp. 566-579)



LED

See p. 581 for LED MR16 lamping options



K-TELESCOPE

Arms telescope individually from 12-42", creating unlimited angles. For cable separations of 1" to 48". Head rotates 330° and has swivel and pivot action to direct the beam. Low-voltage, MR16 lamp of up to 75 watts, (not included). For Kable Lite system only.

700KTEL16	FINISH
	C CHROME
	S SATIN NICKEL

PRODUCT DIMENSIONS

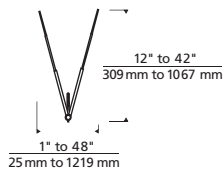

COMPATIBLE ACCESSORIES & OPTICAL CONTROLS

Backlight Shield, Barndoors, Cone Glass Shield, Eggcrate Louver, Flight Paper, Glass Lens, Lil Egypt, Lil Wok, Louver Lens Holder, MR16 Snout, Round Glass Shield, Snap Louver Lens Holder, or Taza Accessory (sold separately pp. 566-579)



LED

See p. 581 for LED MR16 lamping options

WITH LIL WOK
(SOLD SEPARATELY)



Photographer: Jim Brady



WALL ARCHIE

Clamps to Wall MonoRail. 17" long with a 11" high swooping curve. Pivots at head to direct beam. Low-voltage, MR16 lamp of up to 75 watts (not included). For Wall MonoRail system only.

700WMARCH FINISH
 Z ANTIQUE BRONZE
 C CHROME
 S SATIN NICKEL

PRODUCT DIMENSIONS

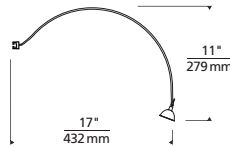

COMPATIBLE ACCESSORIES & OPTICAL CONTROLS

Backlight Shield, Barndoors, Cone Glass Shield, Eggcrate Louver, Flight Paper, Glass Lens, Lil Egypt, Lil Wok, Louver Lens Holder, MR16 Snout, Round Glass Shield, Snap Louver Lens Holder, or Taza Accessory (sold separately pp. 566-579)



See p. 581 for LED MR16 lamping options



WALL GEORGI

Clamps to Wall MonoRail. 18" long with 3" high gentle curve. Pivots at head to direct beam. Low-voltage, MR16 lamp of up to 75 watts (not included). For Wall MonoRail system only.

700WMGRG FINISH
 Z ANTIQUE BRONZE
 C CHROME
 S SATIN NICKEL

PRODUCT DIMENSIONS

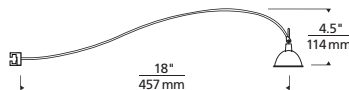

COMPATIBLE ACCESSORIES & OPTICAL CONTROLS

Backlight Shield, Barndoors, Cone Glass Shield, Eggcrate Louver, Flight Paper, Glass Lens, Lil Egypt, Lil Wok, Louver Lens Holder, MR16 Snout, Round Glass Shield, Snap Louver Lens Holder, or Taza Accessory (sold separately pp. 566-579)

SEE PP. 42, 43, 500, 501, 517 FOR APPLICATION PHOTOS



See p. 581 for LED MR16 lamping options



WITH MESH BACKLIGHT SHIELD
(SOLD SEPARATELY)

WALL TELESCOPE

Clamps to Wall MonoRail. Telescopes from 9" to 25". Pivots at head to direct beam. Low-voltage, MR16 lamp of up to 75 watts (not included). For Wall MonoRail system only.

700WMTEL	FINISH
Z	ANTIQUe BRONZE
C	CHROME
S	SATIN NICKEL

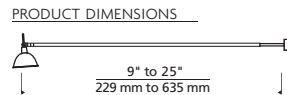

COMPATIBLE ACCESSORIES & OPTICAL CONTROLS
Backlight Shield, Barndoors, Cone Glass Shield, Eggcrate Louver, Flight Paper, Glass Lens, Lil Egypt, Lil Wok, Louver Lens Holder, MR16 Snout, Round Glass Shield, Snap Louver Lens Holder, or Taza Accessory (sold separately pp. 566-579)

SEE PP. 502, 512, 513 FOR APPLICATION PHOTOS



See p. 581 for LED MR16 lamping options



WITH ROUND GLASS SHIELD
(SOLD SEPARATELY)

WALLY LITE

Clamps to Wall MonoRail. Available in two lengths. Pivots at head to direct beam. Low-voltage, MR16 lamp of up to 75 watts (not included). For Wall MonoRail system only.

700WMWAL	LENGTH (A)	FINISH
	12 12"	Z ANTIQUe BRONZE
	24 24"	C CHROME
		S SATIN NICKEL

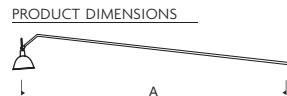

COMPATIBLE ACCESSORIES & OPTICAL CONTROLS
Backlight Shield, Barndoors, Cone Glass Shield, Eggcrate Louver, Flight Paper, Glass Lens, Lil Egypt, Lil Wok, Louver Lens Holder, MR16 Snout, Round Glass Shield, Snap Louver Lens Holder, or Taza Accessory (sold separately pp. 566-579)

SEE P. 498 FOR APPLICATION PHOTO



See p. 581 for LED MR16 lamping options



BLUE

DRAGONFLY

Aluminum wings; glass body in white or blue. Two 18" hand-bendable, field-cutttable wire leads. Includes low-voltage, 20 watt halogen bi-pin lamp.

700	SYSTEM	BUGDF	GLASS	VOLTAGE
K	KABEL-LITE	B	BLUE	12 VOLT HALOGEN
MO	MONORAIL	W	WHITE	-24 24 VOLT HALOGEN

PRODUCT DIMENSIONS

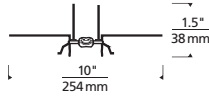

WHITE

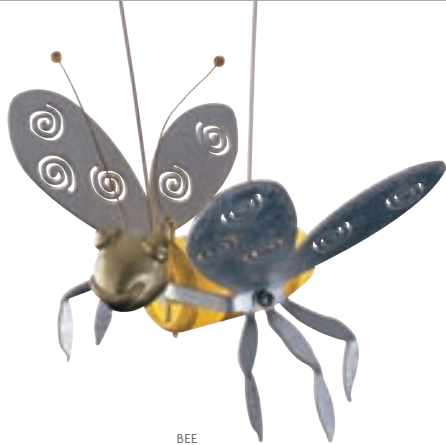

BEE

BUGS

Aluminum wings and legs; glass body. Two 18" hand-bendable, field-cutttable wire leads. Includes low-voltage, 20 watt halogen bi-pin lamp.

700	SYSTEM	BUG	GLASS	VOLTAGE
K	KABEL-LITE	B	BEE (YELLOW)	12 VOLT HALOGEN
MO	MONORAIL	L	LADY BUG (RED)	-24 24 VOLT HALOGEN

PRODUCT DIMENSIONS

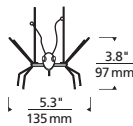

LADYBUG



4" METAL MAN POINT
(SHOWN ON MOUNTING BRACKET)



METAL MAN
HANG



METAL MAN
STRETCH

METAL MAN

Whimsical art fixture of a metal man holding a positionable low-voltage, MR16 lamp of up to 75 watts (not included). Ground aluminum finish. Two sizes, three styles. System mounting bracket or Kable Lite mounting feet included.

700	SYSTEM	MM	SIZE	STYLE	FINISH		
FJ	FREEJACK	5	5.5" X 8"	HA	HANG	C	CHROME
KL	KABLE LITE	8	8" X 12"	PO	POINT	S	SATIN NICKEL
MO	MONORAIL			ST	STRETCH		
MO2	TWO-CIRCUIT MONORAIL						

PRODUCT DIMENSIONS

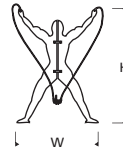

COMPATIBLE ACCESSORIES & OPTICAL CONTROLS

Backlight Shield, Barndoors, Eggcrate Louver, Flight Paper, Glass Lens, Lil Egypt, Lil Wok, Louver Lens Holder, MR16 Snout, Snap Louver Lens Holder, or Taza Accessory (sold separately pp. 566-579)

KABLE LITE 4" ROUND MONOPOINT CANOPY

4" round flush canopy mounts to a standard 4" junction box with round plaster ring (provided by electrician). Allows for monopoint mounting of any Kable Lite head. 12 volt, 75 watt electronic transformer (included) fits inside junction box. Two 24" long, field-cuttable and bendable wire leads.



4" ROUND CANOPY
(SHOWN WITH METAL MAN POINT,
SOLD SEPARATELY)

700KC4R	FINISH
CH	CHROME
SN	SATIN NICKEL



LINE-VOLTAGE HEADS



LINE-VOLTAGE HEADS



ENVISION



P. 580

Die cast aluminum LED head, pivots vertically 90°; rotates horizontally 360°. Features horizontal locking mechanisms. LED module and optics are modular for ease of replacement. Front air intake design allows airflow past internal heat sink fins to rear exit vents while conserving a clean, thoughtful and seamless form. 19 watt isolated power supply sits within head to avoid further visual impact on track; dimmable digital logic controller operated in constant current mode. Field-replaceable proprietary 19 watt LED module. Three interchangeable optics: 15°, 25° and 40°. Holds up to two PAR16 / MR16 lenses or louvers, sold separately.

PRODUCT DIMENSIONS

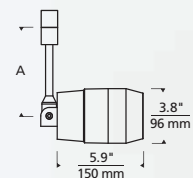

700 SYSTEM	ENVL	TYPE	BEAM SPREAD	LENGTH (A)	FINISH	
PJ	POWERJACK	L2	LED 2700K	1 15°	06 6"	S SATIN NICKEL
TT	SINGLE-CIRCUIT T-TRAK	L3	LED 3000K	2 25°	12 12"	W WHITE
TT2	TWO-CIRCUIT T-TRAK	L5	LED 3500K	4 40°	18 18"	

To mount this head on Halo, Juno or Lightlier Track, see p. 552

SEE P. 194 FOR ADDITIONAL APPLICATION PHOTO

HOLDS UP TO TWO ACCESSORIES, SOLD SEPARATELY: EGGCRATE LOUVER, GLASS LENS, OR UV FILTER (PP. 578-579)



Photographer: Matthew Millman BCCI Construction Company



OM INCANDESCENT PAR

Versatile die cast aluminum head, pivots vertically 180°, rotates horizontally 350°. Features vertical and horizontal locking mechanisms and decorative lens ring. 120 volt incandescent PAR16 lamp with GU10 base, up to 50 watts; 120 volt incandescent PAR20 lamp with E26 medium base, up to 50 watts; PAR30 Long or PAR30 Short lamp with E26 medium base, up to 75 watts (lamp not included). Holds up to two lenses or louvers, sold separately.

700 SYSTEM	OM	TYPE	LENGTH (A)	LENS RING	FINISH
PJ POWERJACK	16	PAR16	03 3"	F FROST	S SATIN NICKEL
TT SINGLE-CIRCUIT T-TRAK	20	PAR20	06 6"	S SOLID	W WHITE
TT2 TWO-CIRCUIT T-TRAK	30L	PAR30 LONG	12 12"		
	30S	PAR30 SHORT			

To mount this head on Halo, Juno or Lightolier Track, see p. 552

SEE PP. 47, 539 FOR APPLICATION PHOTOS

LENS RING OPTIONS



FROST LENS RING

SOLID LENS RING

PRODUCT DIMENSIONS

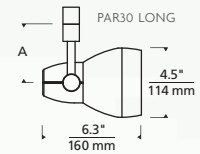
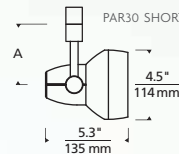
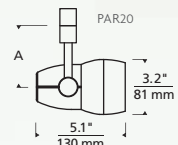
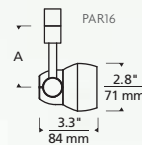

HOLDS UP TO TWO ACCESSORIES, SOLD SEPARATELY: EGGCRATE LOUVER, GLASS LENS, OR UV FILTER (PP. 578-579)



OM CERAMIC METAL HALIDE MR16 / PAR

Versatile die cast aluminum head, pivots vertically 180°, rotates horizontally 350°. Features vertical and horizontal locking mechanisms and decorative lens ring. Includes energy-saving electronic ballast in slim aluminum die cast housing. Input voltage 120v 50/60 hertz, THD <10%. Power Jack version is compatible with Power Jack Canopy with Ballast (sold separately). Ceramic metal halide MR16 with GX10 base, up to 39 watts; ceramic metal halide PAR20 lamp with E26 medium base, up to 39 watts; PAR30 long lamp up to 70 watts (lamp not included). Holds up to two lenses or louvers, sold separately.

PRODUCT DIMENSIONS

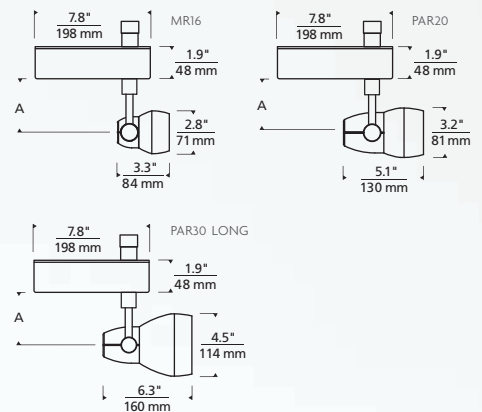

700 SYSTEM	OMC	TYPE	WATTAGE	LENGTH (A)	LENS RING	FINISH
PJ	POWERJACK	16 PAR16	2 20 WATT	06 5.1"	F FROST	S SATIN NICKEL
TT	SINGLE-CIRCUIT T-TRAK	20 PAR20	3 39 WATT	12 11.1"	S SOLID	W WHITE
TT2	TWO-CIRCUIT T-TRAK	30L PAR30 LONG	7 70 WATT (PAR30 ONLY)			

To mount this head on Halo, Juno or Lightlier Track, see p. 552

SEE P. 549 FOR APPLICATION PHOTO

LENS RING OPTIONS



HOLDS UP TO TWO ACCESSORIES, SOLD SEPARATELY: EGGCRATE LOUVER, GLASS LENS, OR UV FILTER (PP. 578-579)



OM CERAMIC METAL HALIDE T4

Versatile die cast aluminum head, pivots vertically 180°, rotates horizontally 350°. Features vertical and horizontal locking mechanisms and decorative lens ring. Four beam spread options with specular reflector and UV filtering glass lens. Includes energy-saving electronic ballast in slim aluminum die cast housing. Input voltage 120v 50/60 hertz, THD <10%. Power Jack version is compatible with Power Jack Canopy with Ballast (sold separately). Ceramic metal halide T4.5 lamp with G8.5 base, up to 70 watts (lamp not included). Holds up to two PAR30 lenses or louvers.

PRODUCT DIMENSIONS

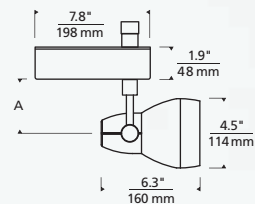

700 SYSTEM	OMT4	REFLECTOR	WATTAGE	LENGTH (A)	LENS RING	FINISH
PJ	POWERJACK	1 15 DEGREE	2 20 WATT	06 5.1"	F FROST	S SATIN NICKEL
TT	SINGLE-CIRCUIT T-TRAK	3 30 DEGREE	3 39 WATT	12 11.1"	S SOLID	W WHITE
TT2	TWO-CIRCUIT T-TRAK	4 45 DEGREE	7 70 WATT			
		6 60 DEGREE				

To mount this head on Halo, Juno or Lightolier Track, see p. 552

LENS RING OPTIONS



HOLDS UP TO TWO ACCESSORIES, SOLD SEPARATELY: EGGCRATE LOUVER, GLASS LENS, OR UV FILTER (PP. 578-579)

PHOTOMETRIC DATA

LUMINAIRE:

Fabricated metal housing, formed multi-faceted metal reflector with premium specular finish, clear flat glass lens in semi-specular metal trim ring

BALLAST:

120 volt 50/60 hertz, THD < 10%

COLOR RENDERING INDEX:

>80

INITIAL LUMENS:

3,400

RATED AVERAGE LIFE:

9,000 hours

LAMP:

One 39 watt clear T4.5 ceramic metal halide

COLOR TEMPERATURE:

3000K

15° REFLECTOR, 39 WATT LAMP

VERTICAL ANGLE	HORIZONTAL ANGLE 0°
0°	20212
5°	13360
15°	1253
25°	316
35°	262
45°	212
55°	70
65°	0
75°	6
85°	5
90°	1

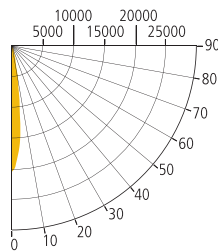

AXIALLY SYMMETRIC

30° REFLECTOR, 39 WATT LAMP

VERTICAL ANGLE	HORIZONTAL ANGLE 0°
0°	6662
5°	6742
15°	3545
25°	310
35°	330
45°	212
55°	61
65°	0
75°	6
85°	4
90°	1

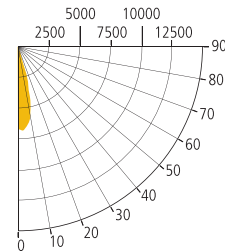

AXIALLY SYMMETRIC

ZONAL LUMEN SUMMARY

ZONE	LUMENS	% LAMP	% FIXT
0°-30°	1529.3	46.3	79.3
0°-40°	1693.0	51.3	87.8
0°-60°	1917.2	58.1	99.4
60°-90°	11.2	0.3	0.6
0°-90°	1928.4	58.4	100.0
90°-180°	0.0	0.0	0.0
0°-180°	1928.4	58.4	100.0

ZONAL LUMEN SUMMARY

ZONE	LUMENS	% LAMP	% FIXT
0°-30°	1748.8	53.0	80.2
0°-40°	1948.2	59.0	89.4
0°-60°	2167.9	65.7	99.5
60°-90°	11.9	0.4	0.5
0°-90°	2179.8	66.1	100.0
90°-180°	0.0	0.0	0.0
0°-180°	2179.8	66.1	100.0

45° REFLECTOR, 39 WATT LAMP

VERTICAL ANGLE	HORIZONTAL ANGLE 0°
0°	2840
5°	2544
15°	1827
25°	1250
35°	809
45°	550
55°	163
65°	61
75°	19
85°	1
90°	0

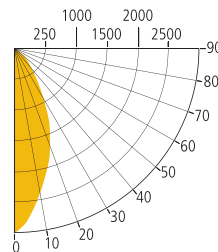

AXIALLY SYMMETRIC

60° REFLECTOR, 39 WATT LAMP

VERTICAL ANGLE	HORIZONTAL ANGLE 0°
0°	1228
5°	1195
15°	1221
25°	1300
35°	1102
45°	663
55°	221
65°	10
75°	12
85°	8
90°	2

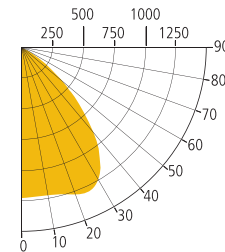

AXIALLY SYMMETRIC

ZONAL LUMEN SUMMARY

ZONE	LUMENS	% LAMP	% FIXT
0°-30°	1312.3	39.2	53.0
0°-40°	1824.0	54.5	73.6
0°-60°	2390.3	71.4	96.4
60°-90°	88.0	2.6	3.6
0°-90°	2478.3	74.1	100.0
90°-180°	0.0	0.0	0.0
0°-180°	2478.3	74.1	100.0

ZONAL LUMEN SUMMARY

ZONE	LUMENS	% LAMP	% FIXT
0°-30°	1057.3	32.0	42.5
0°-40°	1738.3	52.7	69.9
0°-60°	2450.5	74.3	98.5
60°-90°	38.1	1.2	1.5
0°-90°	2488.7	75.4	100.0
90°-180°	0.0	0.0	0.0
0°-180°	2488.7	75.4	100.0



SPORTSTER INCANDESCENT PAR

Minimal, stylish head, pivots vertically 180°, rotates horizontally 350°. Features vertical and horizontal locking mechanisms. 120 volt incandescent PAR16 lamp with GU10 base up to 50 watts; PAR20 lamp with E26 medium base up to 50 watts; PAR30 lamp with E26 medium base up to 75 watts; PAR38 lamp with E26 medium base up to 120 watts (lamp not included).

700	SYSTEM	SS	TYPE	LENGTH (A)	FINISH	
	PJ	POWERJACK	16	PAR16	08 SEE RIGHT	S SATIN NICKEL
	TT	SINGLE-CIRCUIT T-TRAK	20	PAR20	12 11.1"	W WHITE
	TT2	TWO-CIRCUIT T-TRAK	30	PAR30		
			38	PAR38		

To mount this head on Halo, Juno or Lightolier Track, see p. 552

SEE PP. 20, 21, 46, 149, 538 FOR APPLICATION PHOTOS

PRODUCT DIMENSIONS

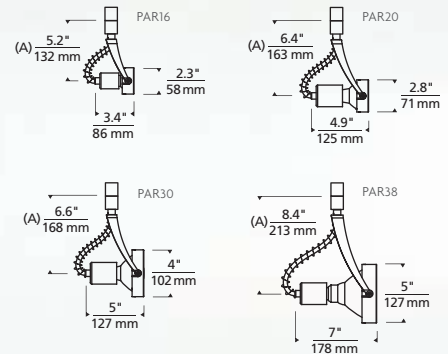

HOLDS UP TO TWO ACCESSORIES, SOLD SEPARATELY: EGGGRATE LOUVER, GLASS LENS, OR UV FILTER (PP. 578-579)



SPORTSTER CERAMIC METAL HALIDE MR16 / PAR

Minimal, stylish head, pivots vertically 180°; rotates horizontally 350°. Features vertical and horizontal locking mechanisms. Includes energy-saving electronic ballast in slim aluminum die-cast housing. Input voltage 120v 50/60 hertz, THD <10%. Power Jack version is compatible with Power Jack Canopy with CMH Ballast (sold separately). Ceramic metal halide MR16 lamp with GX10 base up to 39 watts; ceramic metal halide lamp with PAR20 E26 medium base up to 39 watts; PAR30 Long lamp with E26 medium base up to 70 watts (lamp not included).

700 SYSTEM	SSC	TYPE	WATTAGE	LENGTH (A)	FINISH	
PJ	POWERJACK	16	CMH MR16	2 20 WATT	08 SEE RIGHT	5 SATIN NICKEL
TT	SINGLE-CIRCUIT T-TRAK	20	PAR20	3 39 WATT	12 11.1"	W WHITE
TT2	TWO-CIRCUIT T-TRAK	30L	PAR30 LONG	7 70 WATT (PAR30 ONLY)		

To mount this head on Halo, Juno or Lightolier Track, see p. 552

PRODUCT DIMENSIONS

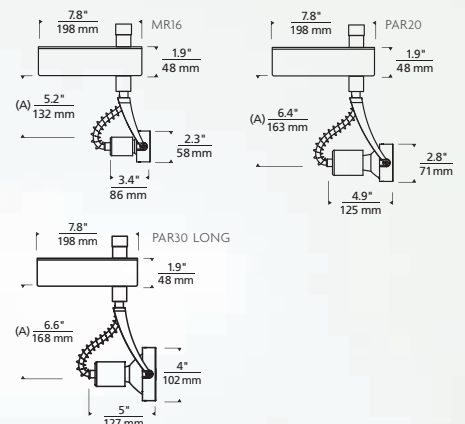

HOLDS UP TO TWO ACCESSORIES, SOLD SEPARATELY: EGGCRATE LOUVER, GLASS LENS, OR UV FILTER (PP. 578-579)



SPOT INCANDESCENT PAR

Classic die cast aluminum head, pivots vertically 180°; rotates horizontally 350°. Features vertical and horizontal locking mechanisms. 120 volt incandescent PAR20 lamp with E26 medium base up to 50 watts; PAR30 Short lamp with E26 medium base up to 75 watts (lamp not included). Holds up to two lenses or louvers, sold separately.

700 SYSTEM	SPT	TYPE	LENGTH (A)	FINISH
PJ POWERJACK	20	PAR20	08 SEE RIGHT	S SATIN NICKEL
TT SINGLE-CIRCUIT T-TRAK	30S	PAR30 SHORT	12 11.1"	W WHITE
TT2 TWO-CIRCUIT T-TRAK				

PRODUCT DIMENSIONS

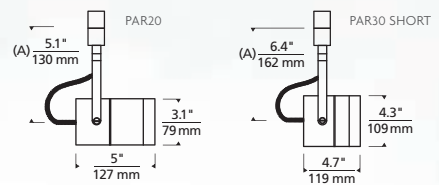

SEE PP. 51, 535, 537 FOR ADDITIONAL APPLICATION PHOTOS

HOLDS UP TO TWO ACCESSORIES, SOLD SEPARATELY: EGGCRATE LOUVER, GLASS LENS, OR UV FILTER (PP. 578-579)



Photographer: Paul Rivera, Arch Photo, Inc.



SPOT CERAMIC METAL HALIDE PAR

Classic die cast aluminum head, pivots vertically 180°, rotates horizontally 350°. Features vertical and horizontal locking mechanisms. Includes energy-saving electronic ballast in slim aluminum die-cast housing. Input voltage 120v 50/60 hertz, THD <10%. Power Jack version is compatible with Power Jack Canopy with Ballast (sold separately). Ceramic metal halide PAR20 lamp with E26 medium base up to 39 watts (lamp not included). Holds up to two lenses or louvers, sold separately.

700	SYSTEM	SPTC	TYPE	WATTAGE	LENGTH (A)	FINISH
	PJ POWERJACK	20	PAR20	2 20 WATT	08 5.6"	S SATIN NICKEL
	TT SINGLE-CIRCUIT T-TRAK			3 39 WATT	12 11.1"	W WHITE
	TT2 TWO-CIRCUIT T-TRAK					

PRODUCT DIMENSIONS

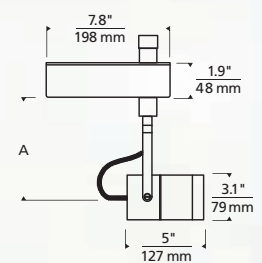

HOLDS UP TO TWO ACCESSORIES, SOLD SEPARATELY: EGGCRATE LOUVER, GLASS LENS, OR UV FILTER (PP. 578-579)



Photographer: Peter Aaron / Esto Architect: Ronnette Riley



TWEAK INCANDESCENT PAR

Minimal head pivots vertically 180°; rotates horizontally 350°. Features horizontal locking mechanism. Dimmable with a standard incandescent dimmer. 120 volt incandescent PAR16 lamp with GU10 base up to 50 watts; PAR20 lamp with E26 medium base up to 50 watts; PAR30 lamp with E26 medium base up to 75 watts; PAR38 lamp with E26 medium base up to 120 watts (lamp not included). May be accessorized with PAR Louver Lens Holder (sold separately).

PRODUCT DIMENSIONS

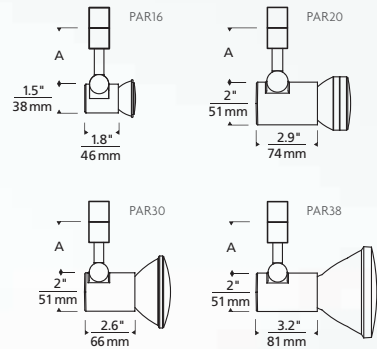

700 SYSTEM	TWS	TYPE	LENGTH (A)	FINISH
PJ	POWERJACK	16 PAR16	03 2.5"	S SATIN NICKEL
TT	SINGLE-CIRCUIT T-TRAK	20 PAR20	06 6"	W WHITE
TT2	TWO-CIRCUIT T-TRAK	30 PAR30	12 12"	
		38 PAR38		

PAR LOUVER LENS HOLDER

PAR16 size hold one lens or louver; PAR20, PAR30, PAR38 sizes hold up to two lenses or louvers (pp. 578-579). Order separately.



700PARLL	TYPE	FINISH
16	PAR16	S SATIN NICKEL
20	PAR20	W WHITE
30	PAR30	
38	PAR38	

HOLDS UP TO TWO ACCESSORIES, SOLD SEPARATELY: EGGCRATE LOUVER, GLASS LENS, OR UV FILTER (PP. 578-579)



TWEAK CERAMIC METAL HALIDE MR16 / PAR

Minimal head pivots vertically 180°; rotates horizontally 350°. Features horizontal locking mechanisms. Includes energy-saving electronic ballast in slim aluminum die cast housing. Input voltage 120v 50/60 hertz; THD <10%. Power Jack version is compatible with Power Jack Canopy with CMH Ballast (sold separately). Ceramic metal halide MR16 lamp with GX10 base up to 39 watts; ceramic metal halide PAR20 lamp with E26 medium base up to 39 watts; PAR30 long lamp with E26 medium base up to 70 watts (lamp not included). May be accessorized with PAR Louver Lens Holder (sold separately).

700 SYSTEM	TWSC	TYPE	WATTAGE	LENGTH (A)	FINISH
PJ	POWERJACK	16 CMH MR16	2 20 WATT	06 6"	S SATIN NICKEL
TT	SINGLE-CIRCUIT T-TRAK	20 PAR20	3 39 WATT	12 12"	W WHITE
TT2	TWO-CIRCUIT T-TRAK	30L PAR30 LONG	7 70 WATT (PAR30 ONLY)		

PAR LOUVER LENS HOLDER

PAR16 size hold one lens or louver; PAR20 and PAR30 Long, sizes hold up to two lenses or louvers (pp. 578-579). Order separately.



700PARLL	TYPE	FINISH
16	CMH MR16	S SATIN NICKEL
20	PAR20	W WHITE
30	PAR30 LONG	

HOLDS UP TO TWO ACCESSORIES, SOLD SEPARATELY: EGGCRATE LOUVER, GLASS LENS, OR UV FILTER (PP. 578-579)

PRODUCT DIMENSIONS

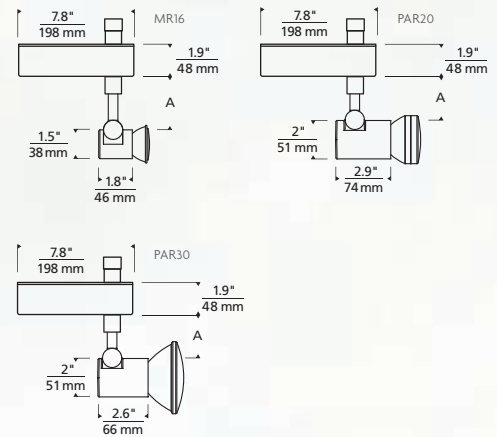



BREEZE INCANDESCENT PAR

Organic shaped die cast aluminum head, pivots vertically 180°, rotates horizontally 350°. Features vertical and horizontal locking mechanisms and decorative lens ring. 120 volt incandescent PAR30 Short or PAR30 Long lamp with E26 medium base up to 75 watts (not included). Holds up to two lenses or louvers, sold separately.

700 SYSTEM	BZ TYPE	LENS RING	FINISH
PJ POWERJACK	30L PAR30 LONG	A AMBER	S SATIN NICKEL
TT SINGLE-CIRCUIT T-TRAK	30S PAR30 SHORT	B COBALT	W WHITE
TT2 TWO-CIRCUIT T-TRAK		F FROST	
		S SOLID	

PRODUCT DIMENSIONS

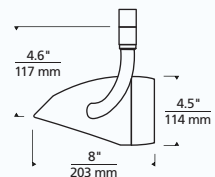

LENS RING OPTIONS



HOLDS UP TO TWO ACCESSORIES, SOLD SEPARATELY: EGGCRATE LOUVER, GLASS LENS, OR UV FILTER (PP. 578-579)



BREEZE CERAMIC METAL HALIDE PAR

Organic shaped die cast aluminum head, pivots vertically 180°; rotates horizontally 350°. Features vertical and horizontal locking mechanisms and decorative lens ring. Includes energy-saving electronic ballast in slim aluminum die cast housing. Input voltage 120v 50/60 hertz, THD <10%. Power Jack version is compatible with Power Jack Canopy with Ballast (sold separately). Ceramic metal halide PAR30 Long lamp with E26 medium base up to 70 watts (lamp not included). Holds up to two lenses or louvers, sold separately.

PRODUCT DIMENSIONS

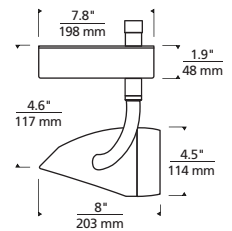

700 SYSTEM	BZC	TYPE	WATTAGE	LENS RING	FINISH
PJ	POWERJACK	30L PAR30 LONG	2 20 WATT	A AMBER	S SATIN NICKEL
TT	SINGLE-CIRCUIT T-TRAK		3 39 WATT	B COBALT	W WHITE
TT2	TWO-CIRCUIT T-TRAK		7 70 WATT	F FROST	
				S SOLID	

LENS RING OPTIONS



HOLDS UP TO TWO ACCESSORIES, SOLD SEPARATELY: EGGRATE LOUVER, GLASS LENS, OR UV FILTER (PP. 578-579)



BREEZE CERAMIC METAL HALIDE T4

Organic shaped die cast aluminum head, pivots vertically 180°, rotates horizontally 350°. Features vertical and horizontal locking mechanisms and decorative lens ring. Four beam spread options with specular reflector and UV filtering glass lens. Includes energy-saving electronic ballast in slim aluminum die cast housing. Input voltage 120v 50/60 hertz, THD <10%. Power Jack version is compatible with Power Jack Canopy with ballast (sold separately). Ceramic metal halide T4.5 lamp with G8.5 base up to 70 watts (lamp not included). Holds up to two PAR30 size lenses or louvers, sold separately.

PRODUCT DIMENSIONS

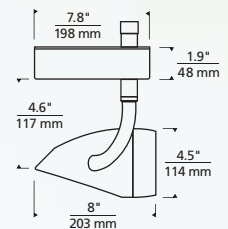

700 SYSTEM	BZT4	REFLECTOR	WATTAGE	LENS RING	FINISH
PJ	POWERJACK	1 15 DEGREE	2 20 WATT	A AMBER	S SATIN NICKEL
TT	SINGLE-CIRCUIT T-TRAK	3 30 DEGREE	3 39 WATT	B COBALT	W WHITE
TT2	TWO-CIRCUIT T-TRAK	4 45 DEGREE	7 70 WATT	F FROST	
		6 60 DEGREE		S SOLID	

LENS RING OPTIONS



HOLDS UP TO TWO ACCESSORIES, SOLD SEPARATELY: EGGCRATE LOUVER, GLASS LENS, OR UV FILTER (PP. 578-579)

PHOTOMETRIC DATA

LUMINAIRE:

Fabricated metal housing, formed multi-faceted metal reflector with premium specular finish, clear flat glass lens in semi-specular metal trim ring

BALLAST:

120 volt 50/60 hertz, THD < 10%

COLOR RENDERING INDEX:

>80

INITIAL LUMENS:

3,400

RATED AVERAGE LIFE:

9,000 hours

LAMP:

One 39 watt clear T4.5 ceramic metal halide

COLOR TEMPERATURE:

3000K

15° REFLECTOR, 39 WATT LAMP

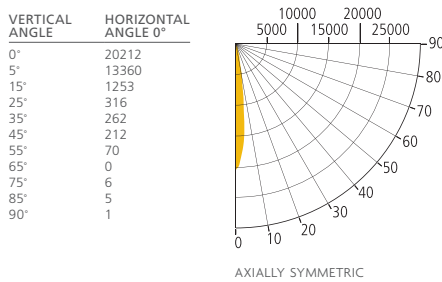

30° REFLECTOR, 39 WATT LAMP

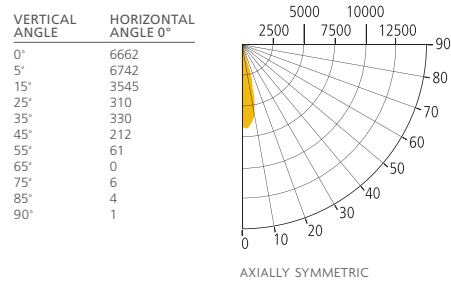

ZONAL LUMEN SUMMARY

ZONE	LUMENS	% LAMP	% FIXT
0°-30°	1529.3	46.3	79.3
0°-40°	1693.0	51.3	87.8
0°-60°	1917.2	58.1	99.4
60°-90°	11.2	0.3	0.6
0°-90°	1928.4	58.4	100.0
90°-180°	0.0	0.0	0.0
0°-180°	1928.4	58.4	100.0

ZONAL LUMEN SUMMARY

ZONE	LUMENS	% LAMP	% FIXT
0°-30°	1748.8	53.0	80.2
0°-40°	1948.2	59.0	89.4
0°-60°	2167.9	65.7	99.5
60°-90°	11.9	0.4	0.5
0°-90°	2179.8	66.1	100.0
90°-180°	0.0	0.0	0.0
0°-180°	2179.8	66.1	100.0

45° REFLECTOR, 39 WATT LAMP

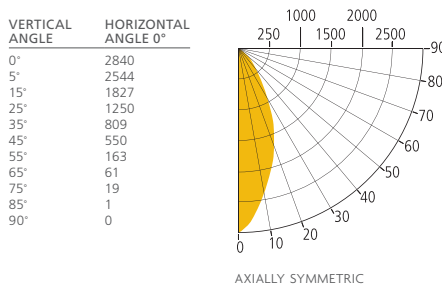

60° REFLECTOR, 39 WATT LAMP

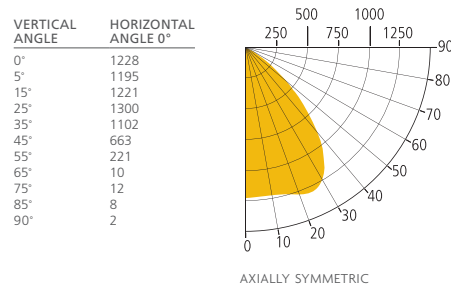

ZONAL LUMEN SUMMARY

ZONE	LUMENS	% LAMP	% FIXT
0°-30°	1312.3	39.2	53.0
0°-40°	1824.0	54.5	73.6
0°-60°	2390.3	71.4	96.4
60°-90°	88.0	2.6	3.6
0°-90°	2478.3	74.1	100.0
90°-180°	0.0	0.0	0.0
0°-180°	2478.3	74.1	100.0

ZONAL LUMEN SUMMARY

ZONE	LUMENS	% LAMP	% FIXT
0°-30°	1057.3	32.0	42.5
0°-40°	1738.3	52.7	69.9
0°-60°	2450.5	74.3	98.5
60°-90°	38.1	1.2	1.5
0°-90°	2488.7	75.4	100.0
90°-180°	0.0	0.0	0.0
0°-180°	2488.7	75.4	100.0

Inner World pendant p. 240 and Summit pendant p. 74



LINE-VOLTAGE PENDANTS / SUSPENSION



LINE-VOLTAGE PENDANTS /
SUSPENSION





SoCo LINE-VOLTAGE PENDANTS,

Tech Lighting's SoCo system of Socket & Cords delivers choice, flexibility and the power of custom design. We know bare lamps can be beautiful, and we make it easy to create your own unique look. Mix, match and cluster to create a truly unique light sculpture or just install a few at a time to put light exactly where you need it. Need help laying out a design? We can help. Perfect for residential and commercial applications.





1 CHOOSE YOUR FABRIC CORD COLOR AND LENGTH.

While we showcase eight standard colors options and three standard cord lengths, the possibilities are almost limitless. Contact us for alternate colors and custom lengths or let us cut your cords to size so you save time during installation.

2 CHOOSE YOUR SOCKET AND FINISH.

Select between the modern or the vintage socket in your ideal finish – both are perfect for a wide array of design aesthetics. A four inch flush canopy in the matching metal finish ships standard with every pendant. Due to the diameter of the cord, SoCo pendants do not currently work with our T-TRAK system or our multi-port canopies. For compatible mini canopies see p. 219.

3 CHOOSE YOUR LAMP TO COMPLETE THE LOOK.

Don't forget your lamps. The SoCo sockets accommodate virtually any medium base lamps up to 150 watts. We have made it easy to order some of the most popular lamps including several energy efficient LED and compact fluorescent options. Don't see what you are looking for here? Contact us for our full lamp offering.

4 MAKE YOUR SELECTION WITH THE ORDERING GRID.

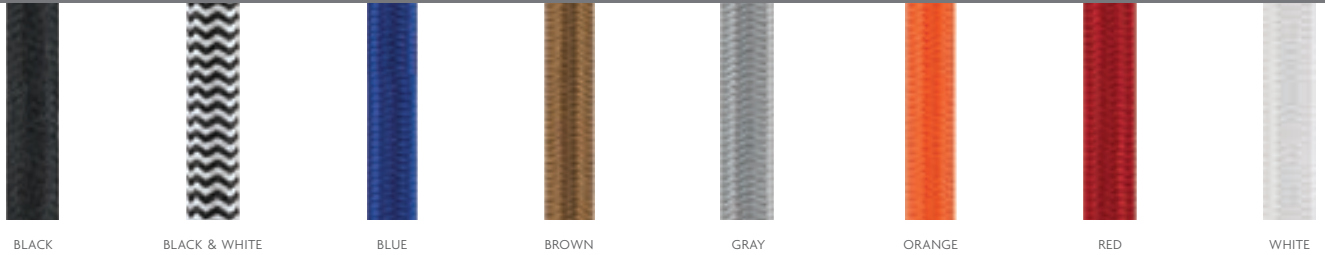

BLACK BLACK & WHITE BLUE BROWN GRAY ORANGE RED WHITE

CUSTOM CORD COLORS AVAILABLE, CONSULT FACTORY.



ANTIQUE BRONZE BLACK SATIN NICKEL WHITE

MODERN

ANTIQUE BRONZE SATIN NICKEL

VINTAGE



#300BHV396 INCANDESCENT CLEAR A19 60W #300BHV389 INCANDESCENT CLASSIC EDISON 40W #300BHV480 INCANDESCENT SQUIRREL CAGE 60W #300BHV485 INCANDESCENT HALF-CHROME 60W #300BHV477 LED A19 12.5W REMOTE PHOSPHOR #300BHV483 LED A19 8W #300BHV484 LED PAR30 LONG THROW #300BHV479 COMPACT FLUORESCENT PLUMEN T1W

SOCKET & CORD

700TDSOCOP	SOCKET	CORD LENGTH**	CORD COLOR***	FINISH****
M	MODERN	08 8'	B BLACK	Z ANTIQUE BRONZE
V	VINTAGE*	16 16'	I BLACK & WHITE	B BLACK
		24 24'	U BLUE	S SATIN NICKEL
			N BROWN	W WHITE
			Y GRAY	
			O ORANGE	
			R RED	
			W WHITE	

SWAG HOOK

Use as a creative tool to gracefully change a pendant's point of suspension from the mounting canopy to any point on the ceiling. Order one for each pendant.

700TDSWG	FINISH
Z	ANTIQU BRONZE
B	BLACK
S	SATIN NICKEL
W	WHITE

* VINTAGE SOCKET ONLY AVAILABLE IN ANTIQUE BRONZE AND SATIN NICKEL FINISHES
 ** CUSTOM CORD LENGTHS AVAILABLE, CONSULT FACTORY
 *** CUSTOM CORD COLORS AVAILABLE, CONSULT FACTORY
 **** SHIPS WITH MATCHING CANOPY

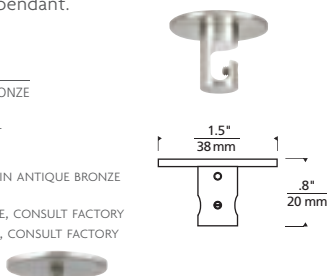

SOCO MINI CANOPIES

Mount to a standard 4" junction box with round plaster ring (provided by electrician).

700TDMRD	SIZE	FINISH
3	3-PORT	Z ANTIQUE BRONZE
7	7-PORT	B BLACK
11	11-PORT	S SATIN NICKEL
		W WHITE

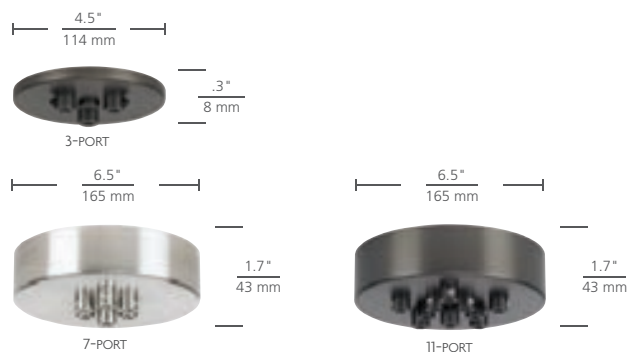

ARTIC GRANDE



The scale of this piece will truly transform a space. A sculptural metal frame whose arms elegantly represent the path the light is taking is surrounded by a modern, high-gloss, semi-translucent shade which allows light to playfully bounce around the fixture and enables just a hint of the light source itself to shine through. Ships with satin nickel canopy, 21 feet of field-cutttable cloth cord and twelve feet of aircraft cable. Includes three 120 volt, 60 watt or equivalent medium base S21 Squirrel Cage lamps, one 11 watt medium base LED 3000K PAR 30 long lamp or one 75 watt or equivalent medium base Halogen PAR 30 long lamp. Dimmable with standard incandescent dimmer.

700TDATCGP	OUTER / INNER COLOR	CORD COLOR	CAGE FINISH	CANOPY	VOLTAGE
BG	GLOSS BLACK / GOLD	B BLACK Y GRAY	S SATIN NICKEL	S SATIN NICKEL	-INC INCANDESCENT SQUIRREL CAGE 120V
BS	GLOSS BLACK / SILVER				-PAR HALOGEN PAR30L 120V
WG	GLOSS WHITE / GOLD				-LED LED PAR30L 3000K 120V
WS	GLOSS WHITE / SILVER				

PRODUCT DETAILS



GLOSS BLACK / SILVER
WITH GRAY CORD

PRODUCT DIMENSIONS

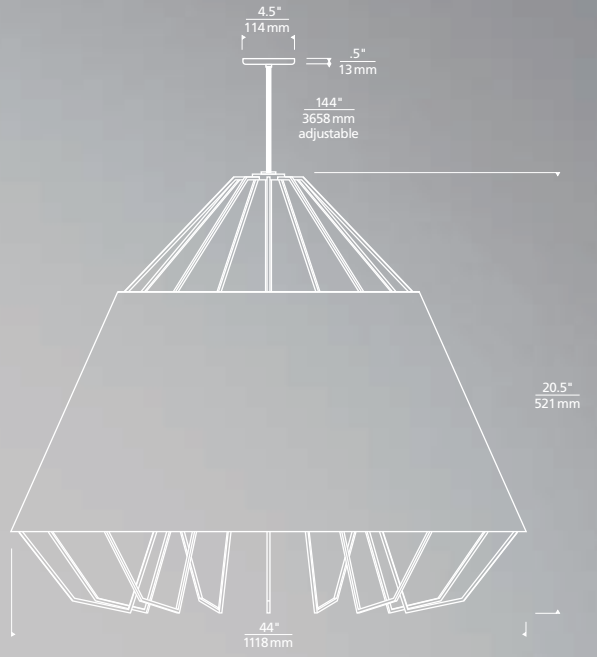

GLOSS WHITE / SILVER
WITH BLACK CORD

ALSO AVAILABLE IN GLOSS BLACK/SILVER AND GLOSS WHITE/GOLD.



GLOSS BLACK / SILVER
WITH BLACK CORD

GLOSS WHITE / GOLD
WITH GRAY CORD

ARTIC



A sculptural metal frame whose arms elegantly represent the path the light is taking is surrounded by a modern, high-gloss, semi-translucent shade which allows light to playfully bounce around the fixture and enables just a hint of the light source itself to shine through. Black, satin nickel, and white finish options ship with satin nickel shade hardware. Includes one 120 volt, 50 watt or equivalent medium base Halogen PAR 20 lamp, one 120 volt, 60 watt or equivalent medium base S21 Squirrel Cage lamp, or one 120 volt, 7 watt medium base 3000K LED PAR 20 lamp. Fixture provided with six feet of field-cuttable cloth cord. Dimmable with standard incandescent dimmer.

PRODUCT DIMENSIONS

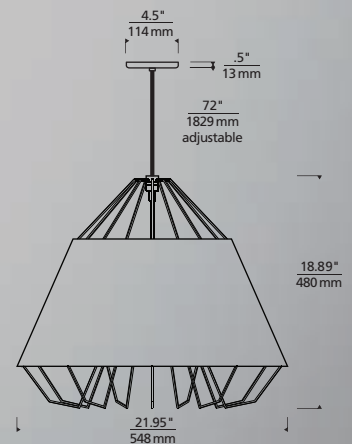

700TDATCP	OUTER / INNER COLOR	CORD COLOR	CAGE FINISH	CANOPY	LAMP
BG	GLOSS BLACK / GOLD	B BLACK	S SATIN NICKEL	B BLACK	-INC INCANDESCENT SQUIRREL CAGE 120V
BS	GLOSS BLACK / SILVER	Y GRAY		S SATIN NICKEL	-PAR HALOGEN PAR20 120V
WG	GLOSS WHITE / GOLD			W WHITE	-LED LED PAR20 3000K 120V
WS	GLOSS WHITE / SILVER				

COMPLEMENTARY PRODUCT
LOW-VOLTAGE PENDANT P. 55 / LINE-VOLTAGE PENDANT P. 220

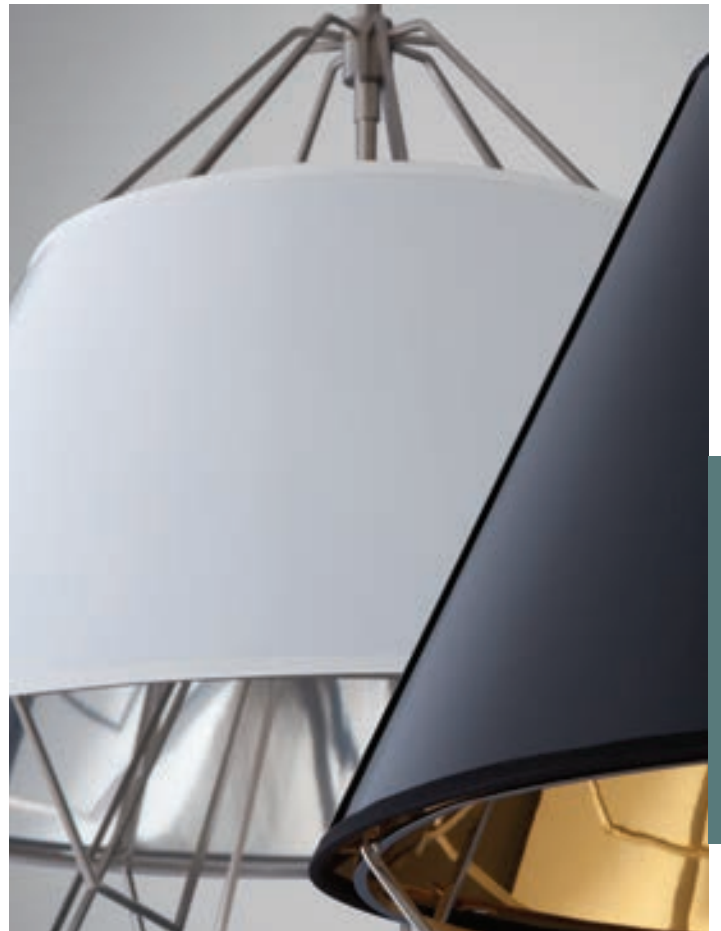



POLISHED NICKEL FINIAL WITH GRAY CORD

GUNMETAL FINIAL

MARSHALL



An elegant, tailored herring bone, men's suit fabric shade is made truly spectacular with the addition of two bold and classic solid metal finials. The fabric cord plays beautifully with the other design details making this piece both fashionable and handsome yet also timeless. Includes two 120 volt, 75 watt or equivalent medium base A19 lamps or two 120 volt, 27 watt GU24 base self-ballasted compact fluorescent lamps. May also be lamped with two 100 watt or equivalent medium base A19 lamps (not included). Fixture provided with six feet of field-cuttable cloth cord. Incandescent version dimmable with standard incandescent dimmer.

700TDMARP	SHADE COLOR / FINIAL FINISH	CORD COLOR	CANOPY	LAMP
YM	HERRING BONE / GUNMETAL	B BLACK Y GRAY	B BLACK N POLISHED NICKEL W WHITE	INCANDESCENT 120V -CF COMPACT FLUORESCENT 120V
YN	HERRING BONE / POLISHED NICKEL			

PRODUCT DIMENSIONS

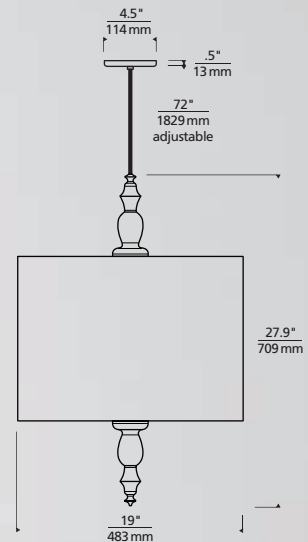





BLACK
WITH FROST FOUNT

BLACK
WITH SMOKE FOUNT

WHITE
WITH CLEAR FOUNT

KIEV LARGE



Antique meets modern with a turned ornate glass fount and simple tapered fabric shade with rolled edges. Black, satin nickel, and white finish options include a satin nickel detail and clear cable; antique bronze finish includes antique bronze detail and brown cable. Includes 120 volt, 75 watt or equivalent A19 medium base lamp or GX24Q-3 base 32 watt triple tube compact fluorescent lamp (electronic ballast included). Fixture provided with six feet of field-cuttable cable. Incandescent version dimmable with standard incandescent dimmer.

700	SYSTEM	KIPL	SHADE COLOR	FOUNT COLOR	FINISH	LAMP
TD	MONOPOINT*	B	BLACK	C	Z	INCANDESCENT 120V
TT	SINGLE-CIRCUIT T-TRAK	W	WHITE	F	B	COMPACT FLUORESCENT 120V
TT2	TWO-CIRCUIT T-TRAK			K	S	COMPACT FLUORESCENT 277V***

COMPLEMENTARY PRODUCT
LOW-VOLTAGE PENDANT P. 65

* INCLUDES 4.5" ROUND CANOPY

** ANTIQUE BRONZE AND BLACK FINISH ONLY AVAILABLE ON TD

*** CF277 LAMP ONLY AVAILABLE ON TD

PRODUCT DIMENSIONS

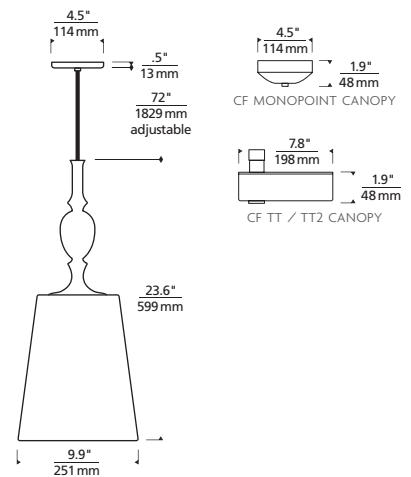



LINE-VOLTAGE PENDANTS /
SUSPENSION



TOPO SUSPENSION



This modern drum shade is elevated to a richer, warmer dimension with a sophisticated combination of fabric and wood. The bands of wood trim are spline-joined around the circumference of the shade – a delicate feat of quality craftsmanship. The rigid stem is available in antique bronze, polished nickel or satin nickel and completes the look. Includes four 120 volt, 75 watt or equivalent A19 medium base lamps or four 26 watt GX24Q-3 base triple tube compact fluorescent lamps (electronic ballast included). May also be lamped with GX24Q-3 base 32 watt triple tube compact fluorescent lamps (not included). Incandescent version dimmable with standard incandescent dimmer.

PRODUCT DIMENSIONS

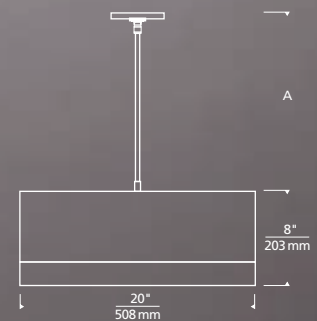

700TPO	LENGTH (A)	SHADE COLOR	TRIM	FINISH	LAMP
	24 24"	Y HEATHER GRAY	M MAPLE	Z ANTIQUE BRONZE	INCANDESCENT 120V
	36 36"	W WHITE	W WALNUT	N POLISHED NICKEL	-CF COMPACT FLUORESCENT 120V
	48 48"			S SATIN NICKEL	-CF277 COMPACT FLUORESCENT 277V

COMPLEMENTARY PRODUCT
LOW-VOLTAGE PENDANT P. 80 / FLUSH MOUNT P. 350





GRAY / GRAY



BLACK / BLACK



WHITE / WHITE

MOIRÉ



The design of this oversized modern drum shade is elevated as two layers of synthetic fiber create a 'moiré' pattern with visual interest and depth that seems to alter as the viewing angle changes. A matching fabric cord and painted ceiling canopy tie the look together. Includes three 120 volt, 60 watt or equivalent medium base G40 globe lamps or three 120v, 11 watt or medium base self-ballasted compact fluorescent Plumen lamps. Fixture provided with 21 feet of field-cuttable cloth cord and twelve feet of aircraft cable. Incandescent version dimmable with standard incandescent dimmer.

PRODUCT DIMENSIONS

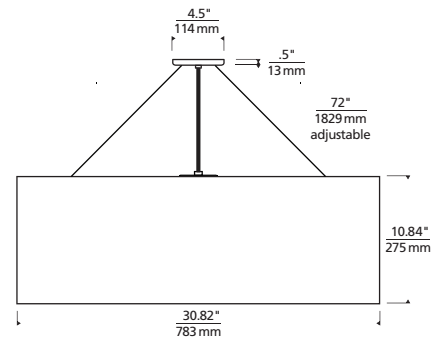

700TDMREP	SHADE COLOR / CANOPY FINISH	LAMP
BB	BLACK / BLACK	INCANDESCENT 120V
YY	GRAY / GRAY	-CF COMPACT FLUORESCENT 120V
WW	WHITE / WHITE	

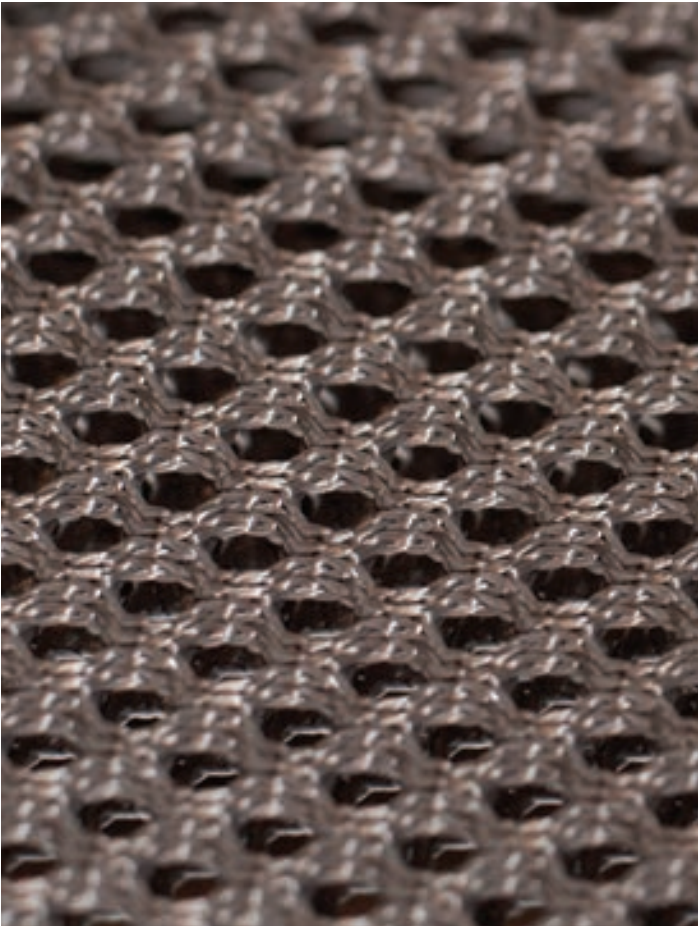



BROWN



WHITE

DILLON



Translucent organza drum with inner glass cylinder to provide a soft wash of light. Black, satin nickel, and white finish options include clear cable; antique bronze finish includes brown cable. Includes 120 volt, 75 watt or equivalent medium base A19 lamp or GX24Q-3 base 32 watt triple tube compact fluorescent lamp (electronic ballast included). Fixture provided with six feet of field-cuttable cable. Incandescent version dimmable with standard incandescent dimmer.

700 SYSTEM	DLNPW	COLOR	FINISH	LAMP
TD	MONOPOINT*	N BROWN	Z ANTIQUE BRONZE**	INCANDESCENT 120V
TT	SINGLE-CIRCUIT T-TRAK	W WHITE	B BLACK**	-CF COMPACT FLUORESCENT 120V
TT2	TWO-CIRCUIT T-TRAK		S SATIN NICKEL	-CF277 COMPACT FLUORESCENT 277V***
			W WHITE	

COMPLEMENTARY PRODUCT
LOW-VOLTAGE PENDANT P. 80

PRODUCT DIMENSIONS

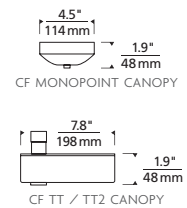
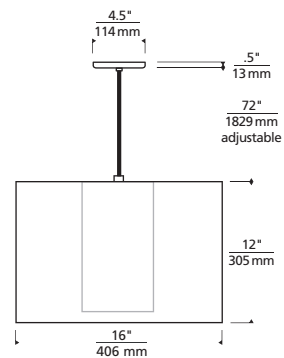

* INCLUDES 4.5" ROUND CANOPY

** ANTIQUE BRONZE AND BLACK FINISH ONLY AVAILABLE ON TD

*** CF277 LAMP ONLY AVAILABLE ON TD



Photographer: JohnClemmer.net





CAPSIAN GRANDE



Hand-blown by Italian artisans, the Moroccan-inspired shape of this large-scale, transparent glass pendant provides a dramatic backdrop for its unique lamping options. The Capsian Grande makes a grand statement in any space, individually or clustered together. Black, satin nickel, and white finish options include satin detail and clear cable; antique bronze finish includes antique bronze detail and brown cable. Includes 120 volt, 60 watt or equivalent medium base S21 Squirrel Cage lamp or 120v, 11 watt medium base self-ballasted compact fluorescent Plumen lamp. Fixture is provided with twelve feet of field-cutable cable. Incandescent version dimmable with standard incandescent dimmer.

700TDCPSGP	COLOR	FINISH	LAMP
	K SMOKE	Z ANTIQUE BRONZE	INCANDESCENT 120V
	U STEEL BLUE	B BLACK	-CF COMPACT FLUORESCENT 120V
		S SATIN NICKEL	
		W WHITE	

PRODUCT DIMENSIONS

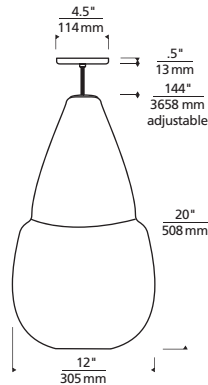

COMPLEMENTARY PRODUCT
LOW-VOLTAGE PENDANT P. 59

SEE P. 22 FOR ADDITIONAL APPLICATION PHOTO



MALI



Hand-blown by Italian artisans, the Moroccan-inspired shape of this large-scale, transparent glass pendant provides a dramatic backdrop for its unique lamping options. The Mali Pendant makes a grand statement in any space – individually or clustered together. Black, satin nickel, and white finish options include satin detail and clear cable; antique bronze finish includes antique bronze detail and brown cable. Includes 120 volt, 60 watt or equivalent medium base A19 Classic Edison lamp or 120v, 11 watt medium base self-ballasted compact fluorescent Plumen lamp. Fixture is provided with twelve feet of field-cutable cable. Incandescent version dimmable with standard incandescent dimmer.

700TDMALP	COLOR	FINISH	LAMP
	A AMBER	Z ANTIQUE BRONZE	INCANDESCENT 120V
	K SMOKE	B BLACK	-CF COMPACT FLUORESCENT 120V
		S SATIN NICKEL	
		W WHITE	

PRODUCT DIMENSIONS

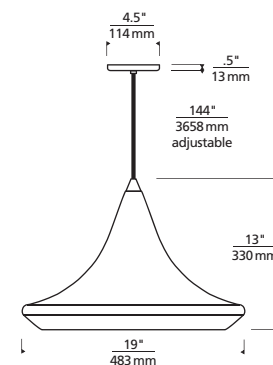



WHITE / WHITE

TRANSPARENT SMOKE /
TRANSPARENT SMOKE

CLEAR / WHITE

CLEAR / CLEAR

TRANSPARENT SMOKE / SMOKE

TRANSPARENT
SMOKE / WHITE

PARFUM GRANDE



With a modern take on vintage French perfume bottles, the silhouette is sleek and clean while still warm and elegant. A metal band separates the top and bottom hand-blown glass pieces, and the bottom glass features a beautiful clear draw adding richness and depth to the design. Black, satin nickel, and white finish include satin nickel metal details and clear cable; antique bronze finish includes antique bronze metal details and brown cable. Clear and Transparent Smoke bottom includes 120 volt, 60 watt or equivalent S21 Squirrel Cage Lamp or 120 volt, 9 watt medium base self-ballasted compact fluorescent Baby Plumen lamp. Smoke and White bottom includes 120 volt, 60 watt or equivalent BT15 medium base halogen lamp or 26 watt GX24Q-3 base triple tube compact fluorescent lamp (electronic ballast included). Fixture provided with six feet of field-cuttable cable. Incandescent version dimmable with standard incandescent dimmer.

PRODUCT DIMENSIONS

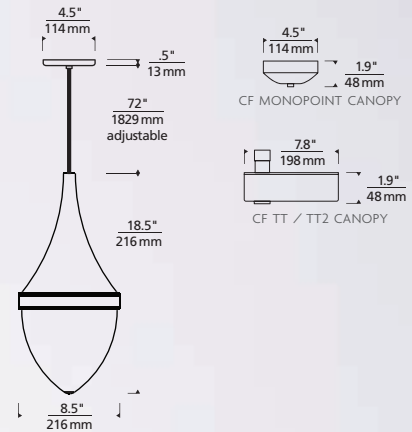

700TDPFMGP

COLOR (TOP / BOTTOM)	FINISH	VOLTAGE
CLCL CLEAR / CLEAR	Z ANTIQUE BRONZE	INCANDESCENT 120V
CLWH CLEAR / WHITE	B BLACK	-CF COMPACT FLUORESCENT 120V
TKSM TRANSPARENT SMOKE / SMOKE	S SATIN NICKEL	
TKTK TRANSPARENT SMOKE / TRANSPARENT SMOKE	W WHITE	
TKWH TRANSPARENT SMOKE / WHITE		
WHWH WHITE / WHITE		

COMPLEMENTARY PRODUCT
LOW-VOLTAGE PENDANT P. 59

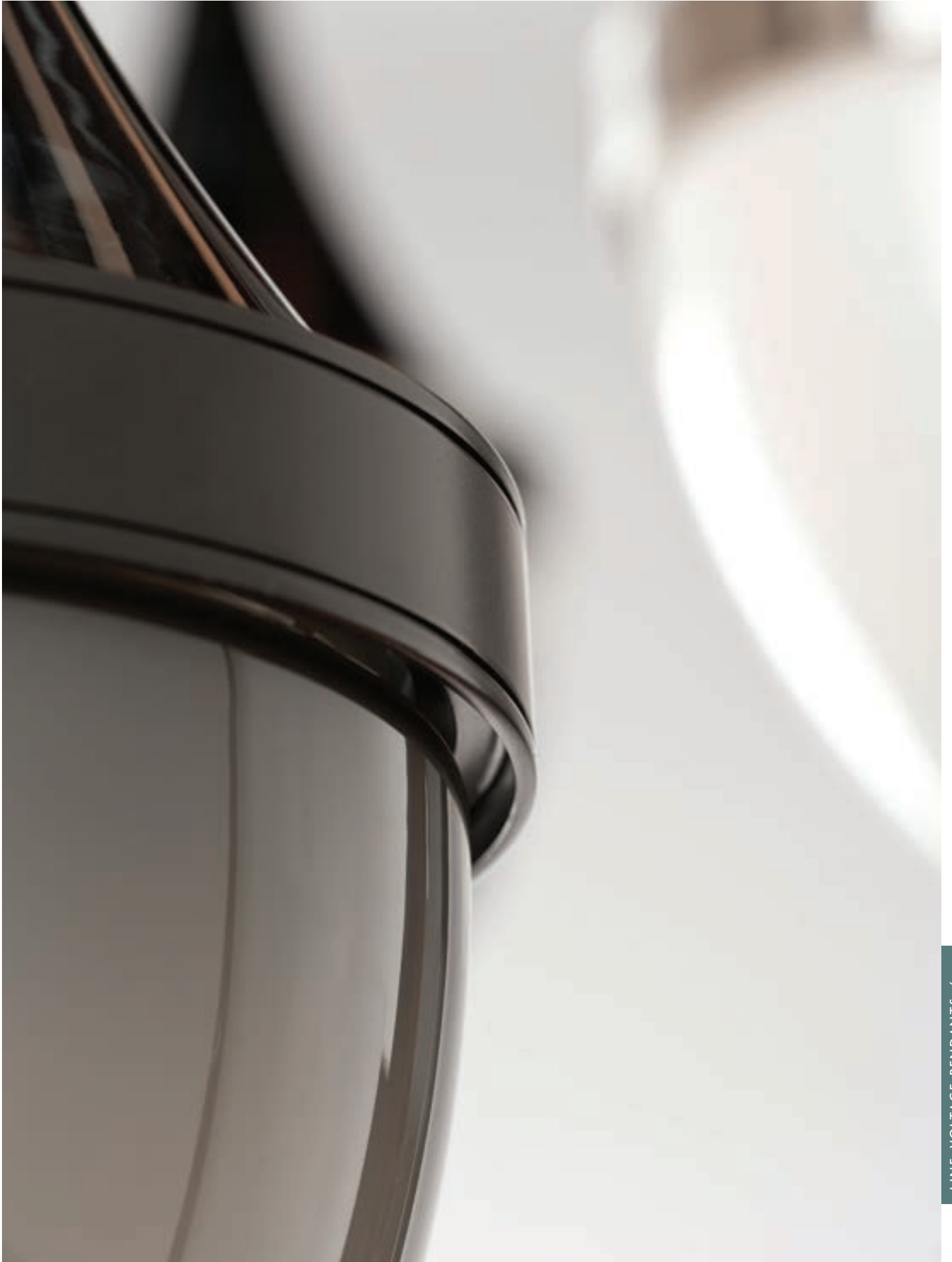



SMOKE

AMBER

WORLD

20 inches in diameter, this hand-blown Murano glass is truly a work of art. Classic Edison lamps and clean, modern hardware complete the look. Black, satin nickel, and white finish options come with a satin nickel cap and clear cable; antique bronze finish with an antique bronze cap and brown cable. Includes three 120 volt, 60 watt or equivalent E26 medium base Classic Edison lamps. Fixture is provided with twelve feet of field-cuttable cable. Dimmable with standard incandescent dimmer.

700TDWOP	COLOR	FINISH
A	AMBER	Z ANTIQUE BRONZE
K	SMOKE	B BLACK
		S SATIN NICKEL
		W WHITE

PRODUCT DIMENSIONS

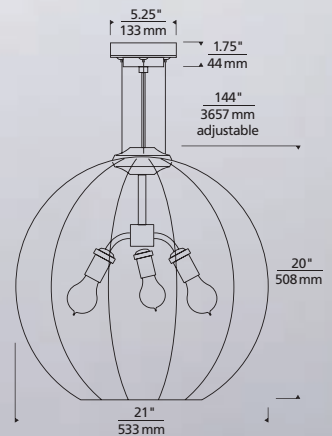





AMBER

SMOKE

INNER WORLD



20 inches in diameter, this hand-blown Murano glass is truly a work of art. Inner white case glass helps diffuse the light. Black, satin nickel, and white finish options come with a satin nickel cap and clear cable; antique bronze finish with an antique bronze cap and brown cable. Includes 120 volt, 100 watt or equivalent medium base A19 lamp or 32 watt GX24Q-3 base triple tube compact fluorescent lamp (electronic ballast included). May also be lamped with GX24Q-3 base 26 watt triple tube compact fluorescent lamp (not included). Fixture is provided with twelve feet of field-cuttable cable. Incandescent version dimmable with standard incandescent dimmer.

PRODUCT DIMENSIONS

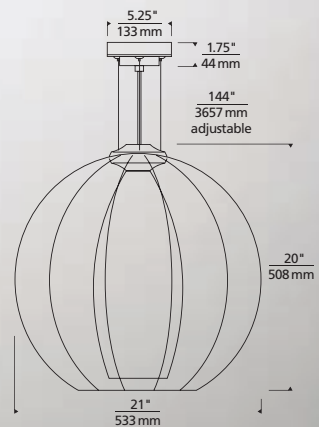

700TDIWOP

COLOR	FINISH	LAMP
A AMBER	Z ANTIQUE BRONZE	INCANDESCENT 120V
K SMOKE	B BLACK	-CF COMPACT FLUORESCENT 120V
	S SATIN NICKEL	-CF277 COMPACT FLUORESCENT 277V
	W WHITE	

SEE P. 214 FOR ADDITIONAL APPLICATION PHOTO





BROWN

CLEAR

SMOKE

SOLEIL GRANDE



Venetian, teardrop-shaped transparent glass. Inner white case glass helps diffuse the light. Black, satin nickel, and white finish options come with a satin nickel cap and clear cable; antique bronze finish with an antique bronze cap and brown cable. Includes 120 volt, 75 watt or equivalent medium base A19 lamp or 32 watt GX24Q-3 base triple tube compact fluorescent lamp (electronic ballast included). May also be lamped with GX24Q-3 base 26 watt triple tube compact fluorescent lamp (not included). Fixture is provided with twelve feet of field-cuttable cable. Incandescent version dimmable with standard incandescent dimmer.

PRODUCT DIMENSIONS

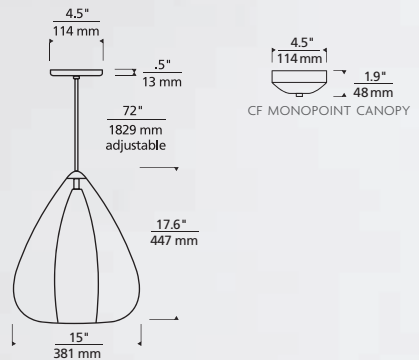

700TDSOLGP

COLOR	FINISH	LAMP
N BROWN	Z ANTIQUE BRONZE	INCANDESCENT 120V
C CLEAR	B BLACK	-CF COMPACT FLUORESCENT 120V
K SMOKE	S SATIN NICKEL	-CF277 COMPACT FLUORESCENT 277V
	W WHITE	

COMPLEMENTARY PRODUCT
LOW-VOLTAGE PENDANT P. 111



AMBER



CLEAR



HAVANA BROWN



SMOKE



STEEL BLUE

FIRE GRANDE



CF

Rich translucent glass surrounds a frost glass diffuser. Black, satin nickel, and white finish options include a satin nickel detail and clear cable; antique bronze finish includes antique bronze detail and brown cable. Includes 120 volt, 40 watt G9 base halogen lamp or 120 volt GU24 base 27 watt self-ballasted compact fluorescent lamp. Fixture provided with six feet of field-cuttable cable. Incandescent version dimmable with standard incandescent dimmer.

700	SYSTEM	FIRGP	COLOR	FINISH	LAMP
TD	MONOPOINT*		A AMBER	Z ANTIQUE BRONZE**	INCANDESCENT 120V
TT	SINGLE-CIRCUIT		C CLEAR	B BLACK**	-CF COMPACT FLUORESCENT 120V
	T-TRAK		N HAVANA BROWN	S SATIN NICKEL	
TT2	TWO-CIRCUIT		K SMOKE	W WHITE	
	T-TRAK		U STEEL BLUE		

COMPLEMENTARY PRODUCT
LOW-VOLTAGE PENDANT P. 111 / WALL P. 394

SEE PP. 316, 318 FOR ADDITIONAL APPLICATION PHOTOS

* INCLUDES 4.5" ROUND CANOPY

** ANTIQUE BRONZE AND BLACK FINISH ONLY AVAILABLE ON TD

PRODUCT DIMENSIONS

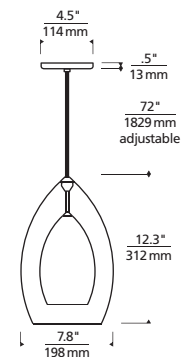



HIGH GLOSS BLACK / WHITE

HIGH GLOSS BLACK / SUNRISE ORANGE

POWELL STREET



Spun metal shade available in two styles: High Gloss features an exterior coated in a luxurious high gloss black or white paint paired with a matte white interior; Satin Nickel exterior is paired with Sunrise Orange or Matte White interior. Includes 120 volt, 150 watt or equivalent medium base G40 globe lamp or 32 watt GX24Q-3 triple tube compact fluorescent lamp surrounded by a blown white glass globe diffuser. Fixture is provided with six feet of field-cutttable cable. Incandescent version dimmable with standard incandescent dimmer.

PRODUCT DIMENSIONS

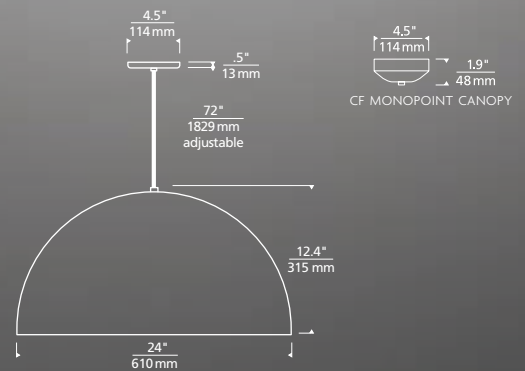

700	SYSTEM	PSP24	OUTER / INNER COLOR	FINISH	LAMP
TD	MONOPOINT*	BW	HIGH GLOSS BLACK / WHITE	B BLACK**	INCANDESCENT 120V
TT	SINGLE-CIRCUIT T-TRAK	WW	HIGH GLOSS WHITE / WHITE	S SATIN NICKEL	-CF COMPACT FLUORESCENT 120V
TT2	TWO-CIRCUIT T-TRAK	SO	SATIN NICKEL / SUNRISE ORANGE	W WHITE	-CF277 COMPACT FLUORESCENT 277V***
		SW	SATIN NICKEL / WHITE		

* INCLUDES 4.5" ROUND CANOPY
 ** BLACK FINISH ONLY AVAILABLE ON TD
 *** CF277 LAMP ONLY AVAILABLE ON TD



SATIN NICKEL / WHITE



HIGH GLOSS WHITE / WHITE



Photographer: Eric Roth



SATIN NICKEL

BLACK

ZHANE TRIO



The ultra-modern Zhane Trio suspension has three straight, softly sculpted, tapered extensions that diverge from the middle in opposite directions. Sleek and elegant, this piece features a bottom acrylic diffuser which provides a glare-free wash of light from the LED light source in each of the three arms. Includes three 10 watt, 2600 lumen, 3000K field-replaceable LED modules. Fixture provided with 21 feet of field-cuttable cloth cord and twelve feet of aircraft cable. Dimmable with low-voltage electronic dimmer.

PRODUCT DIMENSIONS

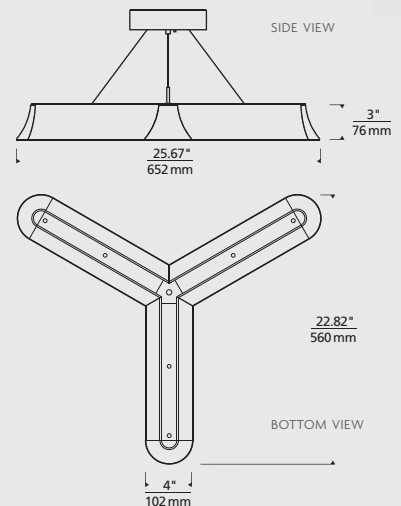

700ZHNT	FINISH	LAMP
B	BLACK (RUBBERIZED)	-LED LED 3000K 120V
S	SATIN NICKEL	-LED277 LED 3000K 277V

COMPLEMENTARY PRODUCT
LINEAR SUSPENSION P. 328





GLOSS BLACK

GLOSS WHITE

SATIN NICKEL

PIPER GRANDE



D
P. 580

A large, sleek cylindrical, metal shade provides crisp down light. Includes 120 volt, 50 watt or equivalent medium base PAR 20 lamp or 18 watt, 850+ lumen field replaceable LED module. Fixture is provided with six feet of field-cuttable cable. Incandescent and LED versions are dimmable with standard incandescent dimmer.

PRODUCT DIMENSIONS

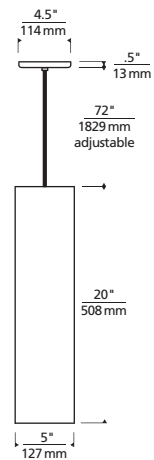

700	SYSTEM	PPRGP	COLOR	FINISH	LAMP	
TD	MONOPOINT*	B	GLOSS BLACK	B	BLACK**	INCANDESCENT 120V
TT	SINGLE-CIRCUIT T-TRAK	W	GLOSS WHITE	S	SATIN NICKEL	-LED2 LED 2700K 120V
TT2	TWO-CIRCUIT T-TRAK	S	SATIN NICKEL	W	WHITE	-LED3 LED 3000K 120V

COMPLEMENTARY PRODUCT
LOW-VOLTAGE PENDANT P. 72

* INCLUDES 4.5" ROUND CANOPY
** BLACK FINISH ONLY AVAILABLE ON TD



ANTIQUE BRONZE



SATIN NICKEL

VENTANA GRANDE



A graceful metal dome with intricate, asymmetric cutouts. The elliptical inner white case glass softens the light shining through this dramatic piece. The outer metal dome is available in satin nickel and antique bronze. Includes 120 volt, 60 watt or equivalent medium base BT15 lamp or 26 watt GX24Q-3 base triple tube compact fluorescent lamp (electronic ballast included). May also be lamped with GX24Q-3 base 32 watt triple tube compact fluorescent lamp (not included). Fixture is provided with six feet of field-cutttable cable. Incandescent version dimmable with standard incandescent dimmer.

PRODUCT DIMENSIONS

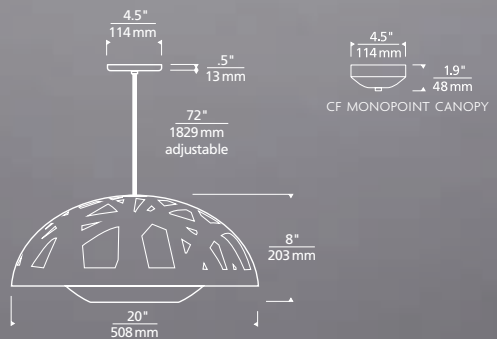

700TDVNTGP

FINISH	LAMP
Z ANTIQUE BRONZE	INCANDESCENT 120V
S SATIN NICKEL	COMPACT FLUORESCENT 120V
	-CF277 COMPACT FLUORESCENT 277V

COMPLEMENTARY PRODUCT
LOW-VOLTAGE PENDANT P. 66 / WALL P. 406



CLEO GRANDE
WITH ORANGE CORD



CLEO MEDIUM
WITH RED CORD



CLEO MEDIUM
WITH GRAY CORD

CLEO



Modern simplicity. A large white orb of hand-blown glass is suspended from colorful cloth cord for a dramatic statement. The Grande includes a 120 volt, 150 watt or equivalent medium base G40 lamp or 32 watt GX24Q-3 base triple tube compact fluorescent lamp (electronic ballast included) and is provided with 21 feet of field-cuttable cloth cord and twelve feet of aircraft field-cuttable cable. The Medium includes a 120 volt, 75 watt or equivalent medium base A19 lamp or 32 watt GX24Q-3 base triple tube compact fluorescent lamp (electronic ballast included) and is provided with six feet of field-cuttable cloth cord. Incandescent versions are dimmable with standard incandescent dimmer.

700TDCLOP	SIZE	COLOR	CORD	FINISH	LAMP	
G	GRANDE	W WHITE	Y GRAY	Z ANTIQUE BRONZE	-CF	INCANDESCENT 120V
M	MEDIUM	O ORANGE	R RED	B BLACK	-CF277	COMPACT FLUORESCENT 120V
				S SATIN NICKEL		COMPACT FLUORESCENT 277V
				W WHITE		

PRODUCT DETAILS

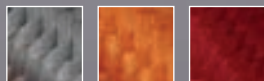

GRAY
CORD

ORANGE
CORD

RED
CORD

PRODUCT DIMENSIONS

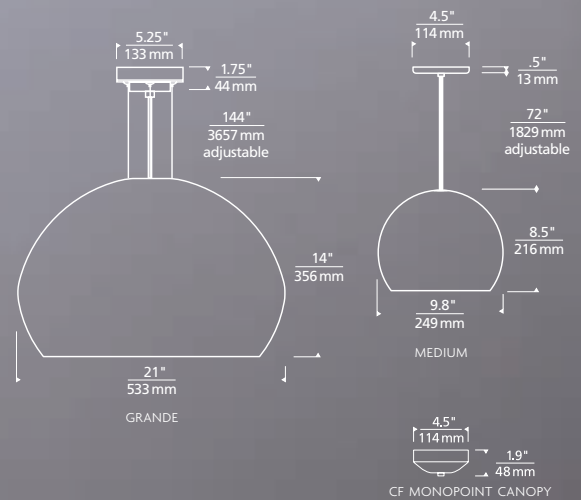



MEEKA



In a unique combination of materials, the large-scale, internationally-inspired blown glass shade is dramatically draped with Le Labo® chain maille from Paris to create a statement piece. Black, satin nickel, and white finish options include satin detail and clear cable. Includes 120 volt, 75 watt or equivalent medium base A19 lamp or 32 watt GX24Q-3 base triple tube compact fluorescent lamp (electronic ballast included). Fixture is provided with twelve feet of field-cutttable cable. Incandescent version dimmable with standard incandescent dimmer.

700TDMKAP	COLOR	FINISH	LAMP
	W WHITE	B BLACK	INCANDESCENT 120V
		S SATIN NICKEL	-CF COMPACT FLUORESCENT 120V
		W WHITE	-CF277 COMPACT FLUORESCENT 277V

PRODUCT DETAILS



PRODUCT DIMENSIONS

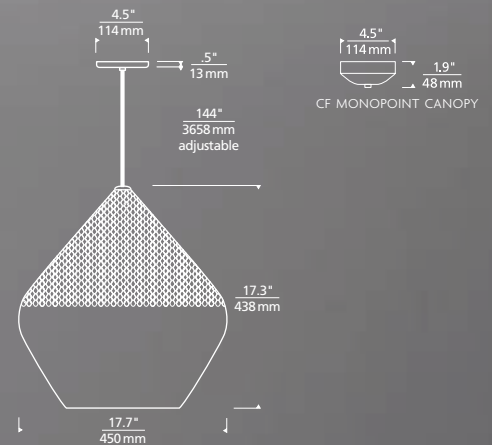



AMBER

AQUAMARINE

CLEAR

HAVANA BROWN

SMOKE

STEEL BLUE

ECHO



Transparent cylinder shade over a white case glass cylinder. Black satin nickel, and white finish options include three satin nickel cylinder details and clear cable; antique bronze finish includes three antique bronze cylinder details and brown cable. Available in two sizes: large and small. Large includes 120 volt, 75 watt or equivalent A19 medium base lamp or 18 watt GX24Q-2 base triple tube compact fluorescent lamp (electronic ballast included). Small includes 120 volt, 60 watt mini candelabra base lamp. Fixture is provided with six feet of field-cuttable cable. Incandescent version dimmable with standard incandescent dimmer.

700	SYSTEM	ECP	SIZE	COLOR	FINISH	LAMP
TD	MONOPOINT*		LARGE	A AMBER	Z ANTIQUE BRONZE**	INCANDESCENT 120V
TT	SINGLE-CIRCUIT T-TRAK	S SMALL		Q AQUAMARINE	B BLACK**	COMPACT FLUORESCENT 120V (LARGE ONLY)
TT2	TWO-CIRCUIT T-TRAK			C CLEAR	S SATIN NICKEL	COMPACT FLUORESCENT 277V (LARGE ONLY)***
				B HAVANA BROWN	W WHITE	
				S SMOKE		
				U STEEL BLUE		

PRODUCT DIMENSIONS

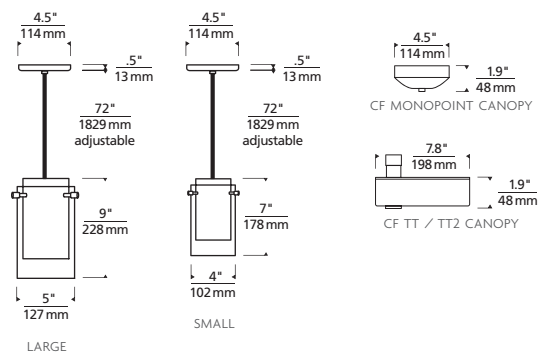

COMPLEMENTARY PRODUCT
 LOW-VOLTAGE PENDANT P. 86 / LINE-VOLTAGE PENDANT P. 254 / WALL P. 378

SEE P. 23 FOR ADDITIONAL APPLICATION PHOTO

* INCLUDES 4.5" ROUND CANOPY

** ANTIQUE BRONZE AND BLACK FINISH ONLY AVAILABLE ON TD

*** CF277 LAMP ONLY AVAILABLE ON TD



LINE-VOLTAGE PENDANTS /
SUSPENSION



AMBER

AQUAMARINE

CLEAR

ECHO GRANDE



Transparent cylinder shade over a white case glass cylinder. Black, satin nickel, and white finish options include three satin nickel cylinder details and clear cable; antique bronze finish includes three antique bronze cylinder details and brown cable. Includes 120 volt, 75 watt or equivalent medium base A19 lamp or 32 watt GX24Q-3 base triple tube compact fluorescent lamp (electronic ballast included). May also be lamped with GX24Q-3 base 26 watt triple tube compact fluorescent lamp (not included). Fixture is provided with six feet of field-cuttable cable. Incandescent version dimmable with standard incandescent dimmer.

700	SYSTEM	ECGP	COLOR	FINISH	LAMP	
TD	MONOPOINT*	A	AMBER	Z	ANTIQUE BRONZE**	INCANDESCENT 120V
TT	SINGLE-CIRCUIT	Q	AQUAMARINE	B	BLACK**	-CF COMPACT FLUORESCENT 120V
	T-TRAK	C	CLEAR	S	SATIN NICKEL	-CF277 COMPACT FLUORESCENT 277V***
TT2	TWO-CIRCUIT	B	HAVANA BROWN	W	WHITE	
	T-TRAK	K	SMOKE			
		U	STEEL BLUE			

PRODUCT DIMENSIONS

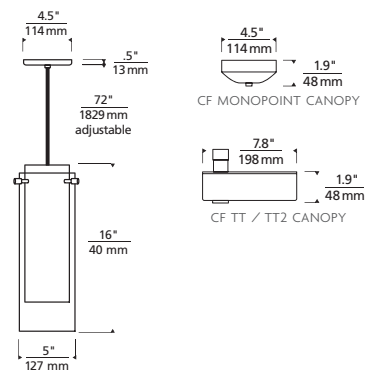

COMPLEMENTARY PRODUCT
 LOW-VOLTAGE PENDANT P. 86 / LINE-VOLTAGE PENDANT P. 252 / WALL P. 378

* INCLUDES 4.5" ROUND CANOPY

** ANTIQUE BRONZE AND BLACK FINISH ONLY AVAILABLE ON TD

*** CF277 LAMP ONLY AVAILABLE ON TD



HAVANA BROWN



SMOKE



STEEL BLUE



AMBER

AQUAMARINE

CLEAR

BEACON



Transparent cylinder shade. Black, satin nickel, and white finish options include three satin nickel cylinder details and clear cable; antique bronze finish includes three antique bronze cylinder details and brown cable. Includes 120 volt, 30 watt or equivalent medium base T9 Classic Edison lamp or 120 volt, 9 watt medium base self-ballasted compact fluorescent Baby Plumen lamp. Fixture is provided with six feet of field-cuttable cable. Incandescent version dimmable with standard incandescent dimmer.

PRODUCT DIMENSIONS

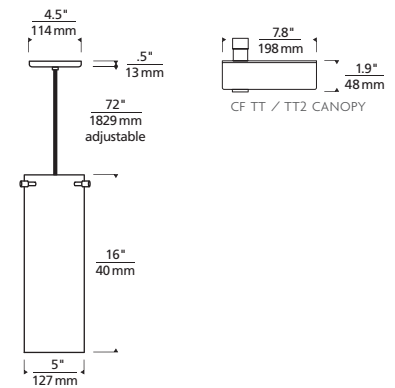

700	SYSTEM	BCNP	COLOR	FINISH	LAMP	
TD	MONOPOINT*	A	AMBER	Z	ANTIQUE BRONZE**	INCANDESCENT 120V
TT	SINGLE-CIRCUIT	Q	AQUAMARINE	B	BLACK**	-CF COMPACT FLUORESCENT 120V
	T-TRAK	C	CLEAR	S	SATIN NICKEL	
TT2	TWO-CIRCUIT	B	HAVANA BROWN	W	WHITE	
	T-TRAK	K	SMOKE			
		U	STEEL BLUE			

SEE P. 24 FOR ADDITIONAL APPLICATION PHOTO

* INCLUDES 4.5" ROUND CANOPY

** ANTIQUE BRONZE AND BLACK FINISH ONLY AVAILABLE ON TD



HAVANA BROWN



SMOKE



STEEL BLUE
WITH PLUMEN



ON / OFF SWITCH



HAVANA BROWN
WITH POLISHED NICKEL



WHITE
WITH SATIN NICKEL



CLEAR
WITH ANTIQUE BRONZE

CLARK



Inspired by a vintage lamp socket and includes an integral on / off switch. Incandescent includes 120 volt 40 watt or equivalent medium base, Classic Edison lamp. Compact fluorescent includes 18 watt GX24Q-2 base, triple tube lamp (electronic ballast included). Both options include six feet of field-cuttable cable. Incandescent version dimmable with standard incandescent dimmer.

600CLKP

COLOR	FINISH	LAMP
C CLEAR	Z ANTIQUE BRONZE	INCANDESCENT
B HAVANA BROWN	N POLISHED NICKEL	-CF COMPACT FLUORESCENT 120V
W WHITE	S SATIN NICKEL	(WHITE OPTION ONLY)

COMPLEMENTARY PRODUCT
FLUSH MOUNT P. 355

PRODUCT DIMENSIONS

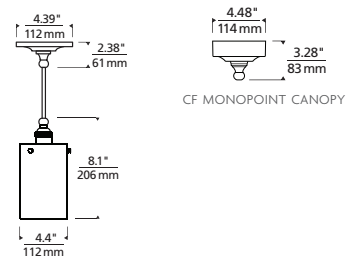



LINE-VOLTAGE PENDANTS /
SUSPENSION



SMOKE

BLACK

CLEAR

LIZA GRANDE



Classically modern. Clear, flame-worked borosilicate glass – commercially known as Pyrex® – is formed into a large, dramatic cylinder with a flowing diagonal pattern of open glass which creates visual depth against an inner white glass diffuser. Black, satin nickel, and white finish options include satin detail and clear cable; antique bronze finish includes antique bronze detail and brown cable. Includes 120 volt, 60 watt or equivalent BT15 medium base lamp or 26 watt GX24Q-3 base triple tube compact fluorescent lamp (electronic ballast included). May also be lamped with GX24Q-3 base 32 watt triple tube compact fluorescent lamp (not included). Fixture is provided with six feet of field-cuttable cable. Incandescent version dimmable with standard incandescent dimmer.

PRODUCT DIMENSIONS

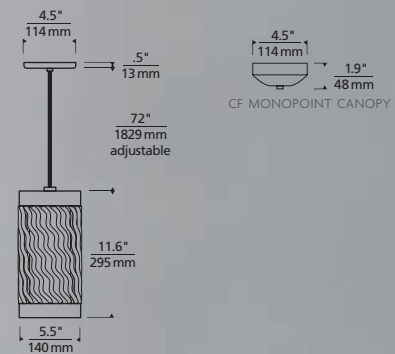

700	SYSTEM	LIZGP	COLOR	FINISH	LAMP
TD	MONOPOINT*	B	BLACK	Z	ANTIQUE BRONZE**
TT	SINGLE-CIRCUIT T-TRAK	C	CLEAR	B	BLACK**
		S	SMOKE	S	SATIN NICKEL
TT2	TWO-CIRCUIT T-TRAK	W	WHITE		
					-CF INCANDESCENT 120V -CF277 COMPACT FLUORESCENT 120V COMPACT FLUORESCENT 277V***

* INCLUDES 4.5" ROUND CANOPY

** ANTIQUE BRONZE AND BLACK FINISH ONLY AVAILABLE ON TD

*** CF277 LAMP ONLY AVAILABLE ON TD

COMPLEMENTARY PRODUCT
LOW-VOLTAGE PENDANT P. 61



LINE-VOLTAGE PENDANTS /
SUSPENSION



JAYDEN GRANDE



Pure indulgence, the Jayden Grande is cut from a solid block of crystal and formed into an elegant rectangular prism which surrounds a hand-blown inner white glass diffuser. Instantly elevates any space. Black, satin nickel, and white finish options include satin detail and clear cable; antique bronze finish includes antique bronze detail and brown cable. Includes 120 volt, 60 watt or equivalent medium base BT15 lamp or 26 watt GX24Q-3 base triple tube compact fluorescent lamp (electronic ballast included). May also be lamped with GX24Q-3 base 32 watt triple tube compact fluorescent lamp (not included). Fixture is provided with six feet of field-cutable cable. Incandescent version dimmable with standard incandescent dimmer.

700TDJDNPG	COLOR	FINISH	LAMP
C	CLEAR	Z ANTIQUE BRONZE	INCANDESCENT 120V
B	BLACK		-CF COMPACT FLUORESCENT 120V
S	SATIN NICKEL		-CF277 COMPACT FLUORESCENT 277V
W	WHITE		

PRODUCT DIMENSIONS

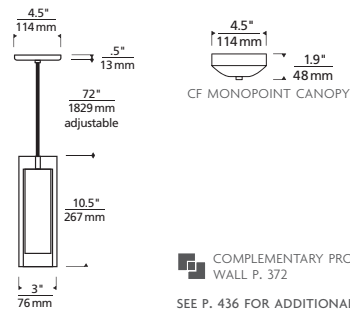

SARA GRANDE



Pure indulgence, the Sara Grande is cut from a solid block of crystal and formed into an elegant cylinder which surrounds a hand-blown inner white glass diffuser. Instantly elevates any space. Black, satin nickel, and white finish options include satin detail and clear cable; antique bronze finish includes antique bronze detail and brown cable. Includes 120 volt, 60 watt or equivalent medium base BT15 lamp or 26 watt GX24Q-3 base triple tube compact fluorescent lamp (electronic ballast included). May also be lamped with GX24Q-3 base 32 watt triple tube compact fluorescent lamp (not included). Fixture is provided with six feet of field-cutable cable. Incandescent version dimmable with standard incandescent dimmer.

700TDSARGP	COLOR	FINISH	LAMP
C	CLEAR	Z ANTIQUE BRONZE	INCANDESCENT 120V
B	BLACK		-CF COMPACT FLUORESCENT 120V
S	SATIN NICKEL		-CF277 COMPACT FLUORESCENT 277V
W	WHITE		

PRODUCT DIMENSIONS

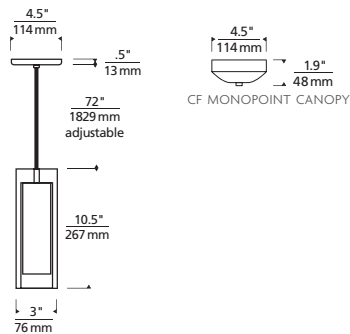



LINE-VOLTAGE PENDANTS /
SUSPENSION



LATTE

RED

WHITE

HUDSON



Clean pure style with presence. A long cylindrical glass shade topped with a simple metal cap detail, suspended from a round canopy. Choose from a selection of rich glass colors with a gloss finish. Black, satin nickel, and white finish options come standard with a satin nickel cap and clear cable; antique bronze finish with an antique bronze cap and brown cable. Includes 120 volt, 75 watt or equivalent A19 medium base lamp or 32 watt GX24Q-3 base triple tube compact fluorescent lamp (electronic ballast included). May also be lamped with GX24Q-3 Base 26 watt triple tube fluorescent lamp (not included). Fixture is provided with six feet of field-cuttable cable. Incandescent version dimmable with standard incandescent dimmer.

700	SYSTEM	HUDP	COLOR	FINISH	LAMP	
TD	MONOPOINT*	L	LATTE	Z	ANTIQUE BRONZE**	INCANDESCENT 120V
TT	SINGLE-CIRCUIT T-TRAK	R	RED	B	BLACK**	-CF COMPACT FLUORESCENT 120V
TT2	TWO-CIRCUIT T-TRAK	W	WHITE	S	SATIN NICKEL	-CF277 COMPACT FLUORESCENT 277V***
				W	WHITE	

COMPLEMENTARY PRODUCT
LOW-VOLTAGE PENDANT P. 107 / WALL P. 404

* INCLUDES 4.5" ROUND CANOPY
** ANTIQUE BRONZE AND BLACK FINISH ONLY AVAILABLE ON TD
*** CF277 LAMP ONLY AVAILABLE ON TD

PRODUCT DIMENSIONS

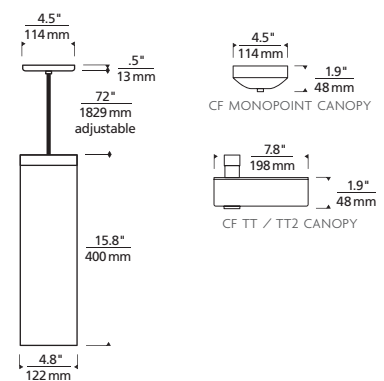







AMBER

LATTE

WHITE

FINO LARGE



Dramatic case glass shade topped with metal detail. Black, satin nickel, and white finish options include a satin nickel detail and clear cable; antique bronze finish includes antique bronze detail and brown cable. Includes 2G11 base 36 watt twin tube compact fluorescent lamp (electronic ballast included). Fixture provided with twelve feet of field-cutttable cable. Not dimmable.

700	SYSTEM	FINPL	COLOR	FINISH	LAMP	
TD	MONOPOINT*	A	AMBER	Z	ANTIQUE BRONZE**	CF
TT	SINGLE-CIRCUIT T-TRAK	L	LATTE	B	BLACK**	COMPACT FLUORESCENT 120V
TT2	TWO-CIRCUIT T-TRAK	W	WHITE	S	SATIN NICKEL	-CF277 COMPACT FLUORESCENT 277V***
				W	WHITE	

COMPLEMENTARY PRODUCT
LINE-VOLTAGE PENDANT P. 268

PRODUCT DIMENSIONS

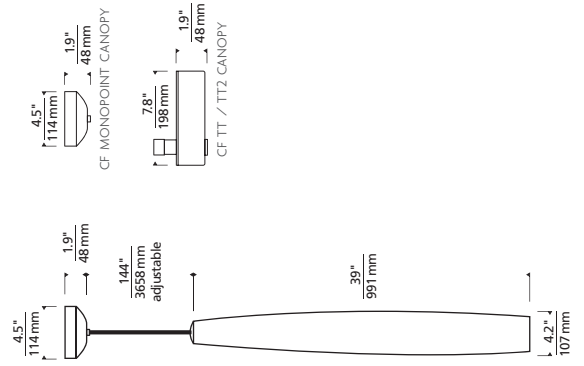

* INCLUDES 4.5" ROUND CANOPY
** ANTIQUE BRONZE AND BLACK FINISH ONLY AVAILABLE ON TD
*** CF277 LAMP ONLY AVAILABLE ON TD



AMBER

LATTE

WHITE

FINO SMALL



Slender case glass shade topped with metal detail. Black, satin nickel, and white finish options include a satin nickel detail and clear cable; antique bronze finish includes antique bronze detail and brown cable. Includes 120 volt, 75 watt or equivalent medium base A19 lamp or G24Q-3 base 26 watt quad tube compact fluorescent lamp (electronic ballast included). Fixture provided with six feet of field-cuttable cable. Incandescent version dimmable with standard incandescent dimmer.

700	SYSTEM	FINPS	COLOR	FINISH	LAMP
TD	MONOPOINT*	A	AMBER	Z ANTIQUE BRONZE**	INCANDESCENT 120V
TT	SINGLE-CIRCUIT T-TRAK	L	LATTE	B BLACK**	-CF COMPACT FLUORESCENT 120V
TT2	TWO-CIRCUIT T-TRAK	W	WHITE	S SATIN NICKEL W WHITE	-CF277 COMPACT FLUORESCENT 277V***

COMPLEMENTARY PRODUCT
LINE-VOLTAGE PENDANT P. 266

* INCLUDES 4.5" ROUND CANOPY
** ANTIQUE BRONZE AND BLACK FINISH ONLY AVAILABLE ON TD
*** CF277 LAMP ONLY AVAILABLE ON TD

PRODUCT DIMENSIONS

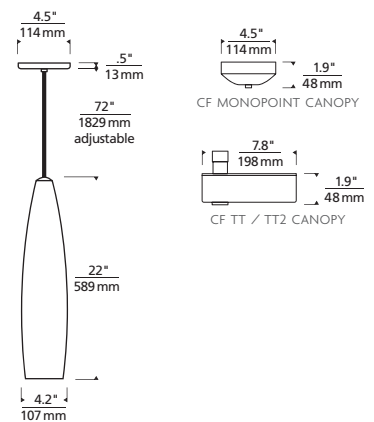



Photographer: Jim Bartsch Architect: Melissa Livingston Lighting Designer: 186 Lighting Design Group

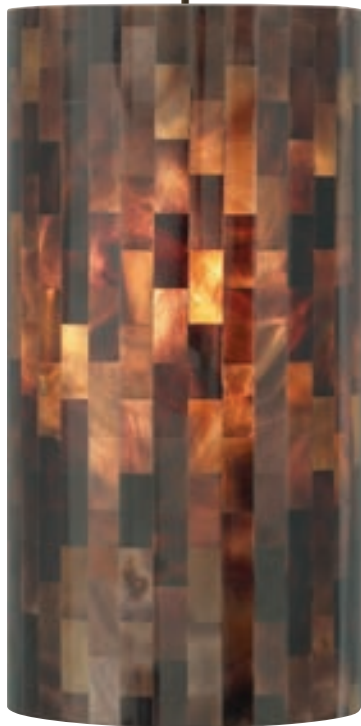

BROWN



NATURAL



WHITE

PLAYA



Elegant multi-toned shade comprised of natural shell panels. The shells are burnished to remove rough edges, meticulously polished, cut to size, and carefully adhered by hand to an inner glass cylinder; suspended from a round canopy. Black, satin nickel, and white canopy options include clear cable; antique bronze includes brown cable. Includes 120 volt 60 watt or equivalent medium base A19 lamp or GX24Q-3 base 26 watt triple tube compact fluorescent lamp (electronic ballast included). Fixture is provided with six feet of field-cuttable cable. Incandescent version dimmable with standard incandescent dimmer.

700	SYSTEM	PLAP	COLOR	FINISH	LAMP
TD	MONOPOINT*	B	BROWN	Z ANTIQUE BRONZE**	INCANDESCENT 120V
TT	SINGLE-CIRCUIT	N	NATURAL	B BLACK**	-CF COMPACT FLUORESCENT 120V
TT2	TWO-CIRCUIT	W	WHITE	S SATIN NICKEL	-CF277 COMPACT FLUORESCENT 277V***
				W WHITE	

PRODUCT DIMENSIONS

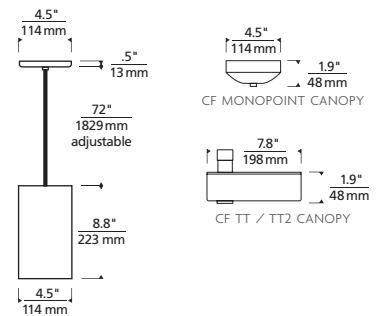

COMPLEMENTARY PRODUCT
LINE-VOLTAGE PENDANT P. 88 / WALL P. 380, 382

* INCLUDES 4.5" ROUND CANOPY

** ANTIQUE BRONZE AND BLACK FINISH ONLY AVAILABLE ON TD

*** CF277 LAMP ONLY AVAILABLE ON TD



LINE-VOLTAGE PENDANTS /
SUSPENSION



BROWN

WHITE

PEYTON GRANDE



A large cylindrical shade composed of glass mosaic tiles and inner frost glass diffuser. Black, satin nickel, and white finish options include satin detail and clear cable; antique bronze finish includes antique bronze detail and brown cable. Includes 120 volt, 60 watt or equivalent medium base BT15 or 26 watt GX24Q-3 base triple tube compact fluorescent lamp (electronic ballast included). May also be lamped with 32 watt GX24Q-3 base triple tube compact fluorescent lamp (not included). Fixture is provided with six feet of field-cuttable cable. Incandescent version dimmable with standard incandescent dimmer.

700	SYSTEM	PEYGP	COLOR	FINISH	LAMP
TD	MONOPOINT*	N	BROWN	Z ANTIQUE BRONZE**	INCANDESCENT 120V
TT	SINGLE-CIRCUIT T-TRAK	W	WHITE	B BLACK**	-CF COMPACT FLUORESCENT 120V
TT2	TWO-CIRCUIT T-TRAK			S SATIN NICKEL W WHITE	-CF277 COMPACT FLUORESCENT 277V***

COMPLEMENTARY PRODUCT
LOW-VOLTAGE PENDANT P. 90

* INCLUDES 4.5" ROUND CANOPY

** ANTIQUE BRONZE AND BLACK FINISH ONLY AVAILABLE ON TD

*** CF277 LAMP ONLY AVAILABLE ON TD

PRODUCT DIMENSIONS

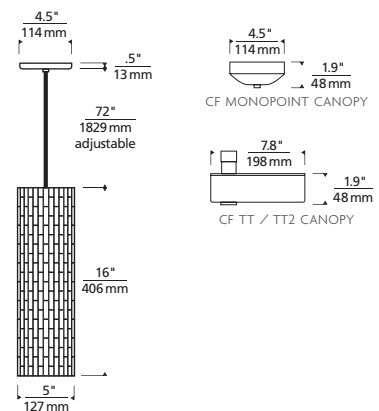



BROWN / GOLD



LATTE / GOLD



WHITE / SILVER

VEIL GRANDE



A large, cylindrical shade with crushed glass texture accented with an inner layer of gold or silver. Black, satin nickel, and white finish options include satin detail and clear cable; antique bronze finish includes antique bronze detail and brown cable. Includes 120 volt, 75 watt or equivalent medium base A19 lamp or 26 watt GX24Q-3 base triple tube compact fluorescent lamp (electronic ballast included). May also be lamped with GX24Q-3 base 32 watt triple tube compact fluorescent lamp (not included). Fixture is provided with six feet of field-cuttable cable. Incandescent version dimmable with standard incandescent dimmer.

700	SYSTEM	VEIGP	OUTER / INNER	FINISH	LAMP
TD	MONOPOINT*	N	BROWN / GOLD	Z ANTIQUE BRONZE**	INCANDESCENT 120V
TT	SINGLE-CIRCUIT T-TRAK	L	LATTE / GOLD	B BLACK**	COMPACT FLUORESCENT 120V
TT2	TWO-CIRCUIT T-TRAK	W	WHITE / SILVER	S SATIN NICKEL	COMPACT FLUORESCENT 277V***
				W WHITE	

COMPLEMENTARY PRODUCT
LOW-VOLTAGE PENDANT P. 90 / WALL P. 383

* INCLUDES 4.5" ROUND CANOPY
** ANTIQUE BRONZE AND BLACK FINISH ONLY AVAILABLE ON TD
*** CF277 LAMP ONLY AVAILABLE ON TD

PRODUCT DIMENSIONS

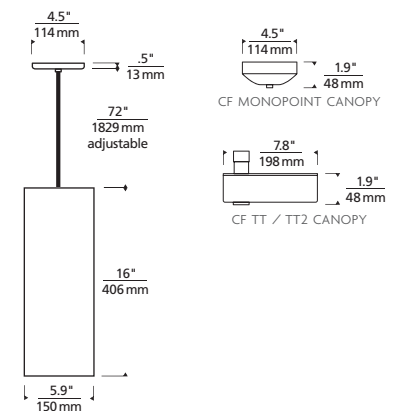



SAND



SURF WHITE



BEACH AMBER

LARKSPUR



Fused and slumped plate glass shade, warm with color and pattern, highlighted with metal detail and suspended from a round canopy. Glass diffuser provides a glare free wash of light. Black, satin nickel and white finish options include satin nickel detail and clear cable; antique bronze includes antique bronze detail and brown cable. Includes 120 volt, 100 watt or equivalent A19 medium base lamp or 18 watt GX24Q-2 base triple tube compact fluorescent lamp (electronic ballast included). Fixture is provided with six feet of field-cuttable cable. Incandescent version dimmable with standard incandescent dimmer.

700TDLRKP

COLOR	FINISH	LAMP
A BEACH AMBER	Z ANTIQUE BRONZE	INCANDESCENT 120V
S SAND	B BLACK	-CF COMPACT FLUORESCENT 120V
W SURF WHITE	S SATIN NICKEL	-CF277 COMPACT FLUORESCENT 277V
	W WHITE	

PRODUCT DIMENSIONS

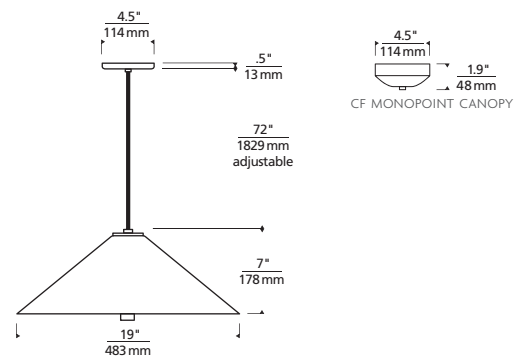

COMPLEMENTARY PRODUCT
 LOW-VOLTAGE PENDANT P. 126 / SUSPENSION P. 311 / WALL P. 384





PULLMAN [CIRCA 1930]



Vintage Holophane® prismatic glass with rich oak leaf details diffuses light to reduce glare and enhance visual comfort. General area light designed to evenly illuminate ceilings, walls, and floors. Incandescent includes 120 volt 100 watt mini-candelabra base lamp; fluorescent includes 32 watt GX24Q-3 base, triple tube lamp and electronic ballast. Fluorescent may also be lamped with 26 watt GX24Q-3 base, triple tube lamp. Incandescent version dimmable with standard incandescent dimmer.

600PMNS	LENGTH (A)	COLOR	FINISH	LAMP
	24 24"	F FROST	Z ANTIQUE BRONZE	INCANDESCENT 120V
	36 36"		N POLISHED NICKEL	-CF COMPACT FLUORESCENT 120V
	48 48"		S SATIN NICKEL	

PRODUCT DETAILS



PRODUCT DIMENSIONS

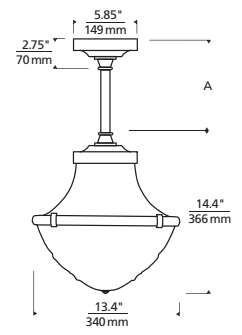

COMPATIBLE WITH INDUSTRIAL HANG STRAIGHT P. 568



LINE-VOLTAGE PENDANTS /
SUSPENSION



UNION LARGE [CIRCA 1930]



Dome-shaped three-part Holophane® prismatic glass diffuses light to reduce glare and enhance visual comfort. Provides general area light designed to evenly illuminate ceilings, walls, and floors. Incandescent includes 120 volt 100 watt or equivalent medium base, A19 lamp; fluorescent includes 32 watt GX24Q-3 base, triple tube lamp and electronic ballast. Fluorescent may also be lamped with 26 watt GX24Q-3 base, triple tube lamp. Incandescent version dimmable with standard incandescent dimmer.

600UNLS	LENGTH (A)	COLOR	FINISH	LAMP
	24 24"	F FROST	Z ANTIQUE BRONZE	INCANDESCENT 120V
	36 36"		N POLISHED NICKEL	-CF COMPACT FLUORESCENT 120V
	48 48"		S SATIN NICKEL	

PRODUCT DIMENSIONS

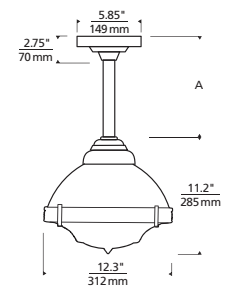

COMPLEMENTARY PRODUCT
LINE-VOLTAGE PENDANT P. 280



COMPATIBLE WITH INDUSTRIAL
HANG STRAIGHT
P. 568



Interior Designer: Jennifer Frentzel



VAN BUREN MEDIUM [CIRCA 1920]



Acorn-shaped Holophane® prismatic glass diffuses light throughout the shade to reduce glare and enhance visual comfort; solid brass cap. Incandescent includes 120 volt 75 watt or equivalent clear medium base, A19 lamp; compact fluorescent includes 18 watt GX24Q-2 base triple tube lamp and electronic ballast. Each includes six feet of field-cutable cable. Incandescent version dimmable with standard incandescent dimmer.

600VBNMPC	FINISH	LAMP
Z	ANTIQUE BRONZE	INCANDESCENT 120V
N	POLISHED NICKEL	-CF COMPACT FLUORESCENT 120V
S	SATIN NICKEL	

COMPLEMENTARY PRODUCT
LOW-VOLTAGE PENDANT P. 99 / WALL P. 409

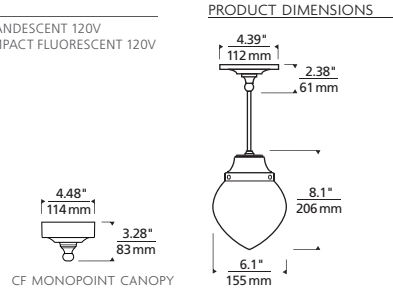

WRIGHTWOOD [CIRCA 1920]



Globe-shaped prismatic glass diffuses light throughout the shade to reduce glare and enhance visual comfort; solid brass cap. Incandescent includes 120 volt 75 watt or equivalent medium base, A19 clear lamp; compact fluorescent includes 18 watt GX24Q-2 base triple tube lamp and electronic ballast. Each includes six feet of field-cutable cable. Incandescent version dimmable with standard incandescent dimmer.

600WRIPC	FINISH	LAMP
Z	ANTIQUE BRONZE	INCANDESCENT 120V
N	POLISHED NICKEL	-CF COMPACT FLUORESCENT 120V
S	SATIN NICKEL	

COMPLEMENTARY PRODUCT
WALL P. 409

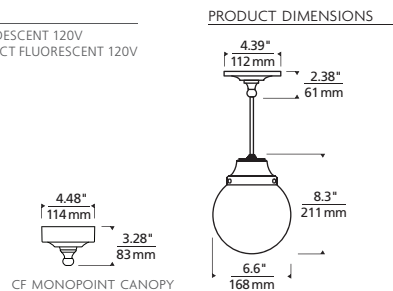

UNION SMALL [CIRCA 1930]



Dome-shaped two-part Holophane® prismatic glass diffuses light to reduce glare and enhance visual comfort. Provides general area light designed to evenly illuminate ceilings, walls, and floors. Incandescent includes 120 volt 60 watt mini-candelabra base lamp; fluorescent includes 13 watt GX24Q-1 base triple tube lamp and electronic ballast. Each includes six feet of field-cutable cable. Incandescent version dimmable with standard incandescent dimmer.

600UNSPF	FINISH	LAMP
Z	ANTIQUE BRONZE	INCANDESCENT 120V
N	POLISHED NICKEL	-CF COMPACT FLUORESCENT 120V
S	SATIN NICKEL	

COMPLEMENTARY PRODUCT
LINE-VOLTAGE PENDANT P. 278

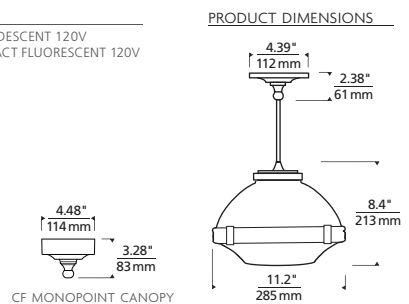





FIXED-LENGTH



TELESCOPING

CARGO SOLID



Industrial-inspired dome-shaped metal shade with frosted, tempered glass diffuser. Incandescent includes 120 volt 100 watt or equivalent medium base, A19 lamp; fluorescent includes 18 watt GX24Q-2 base, triple tube lamp and electronic ballast. Each includes a fixed-length or telescoping stem. Incandescent version dimmable with standard incandescent dimmer.

600CRGSS	LENGTH (A)	FINISH	LAMP
18	18"	B ANTIQUE BRASS	INCANDESCENT 120V
24	24"	N POLISHED NICKEL	-CF COMPACT FLUORESCENT 120V
36	36"		
48	48"		
T1	18"-23" (TELESCOPING)		
T2	25"-37" (TELESCOPING)		

COMPLEMENTARY PRODUCT
LOW-VOLTAGE PENDANT P. 69

PRODUCT DIMENSIONS

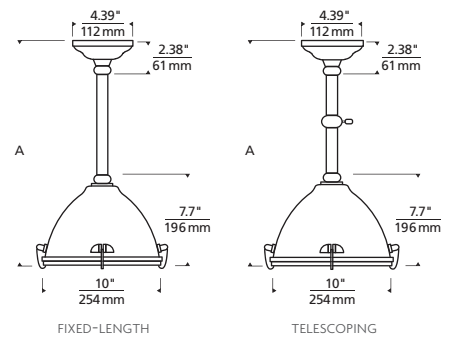

COMPATIBLE WITH INDUSTRIAL
HANG STRAIGHT
P. 568

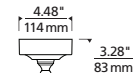

CF MONOPOINT CANOPY



LINE-VOLTAGE PENDANTS /
SUSPENSION



FIXED-LENGTH



TELESCOPING

MONROE



CF

Dome-shaped schoolhouse glass shade. Incandescent includes 120 volt 100 watt or equivalent medium base, A19 lamp; fluorescent includes 26 watt GX24Q-3 base, triple tube lamp and electronic ballast. Fluorescent may also be lamped with 32 watt GX24Q-3 base, triple tube lamp. Each includes a fixed-length or telescoping stem. Incandescent version dimmable with standard incandescent dimmer.

600MNRS	LENGTH (A)	COLOR	FINISH	LAMP
24	24"	W WHITE	Z ANTIQUE BRONZE	INCANDESCENT 120V
36	36"		N POLISHED NICKEL	-CF COMPACT FLUORESCENT 120V
48	48"		S SATIN NICKEL	
T1	18"-24" (TELESCOPING)			
T2	25"-38" (TELESCOPING)			

COMPLEMENTARY PRODUCT
FLUSH MOUNT P. 354

PRODUCT DIMENSIONS

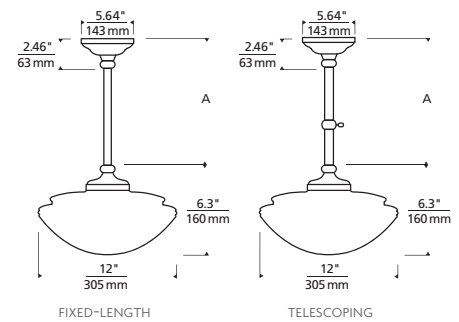

COMPATIBLE WITH INDUSTRIAL
HANG STRAIGHT
P. 568



LINE-VOLTAGE PENDANTS /
SUSPENSION



FIXED-LENGTH



TELESCOPING

TAVERN



Traditional schoolhouse-style glass shade. Incandescent includes 120 volt 100 watt or equivalent medium base, A19 lamp; fluorescent includes 26 watt GX24Q-3 base, triple tube lamp and electronic ballast. Fluorescent may also be lamped with 32 watt GX24Q-3 base, triple tube lamp. Each includes a fixed-length or telescoping stem. Incandescent version dimmable with standard incandescent dimmer.

600TVRS	LENGTH (A)	COLOR	FINISH	LAMP
24	24"	W WHITE	Z ANTIQUE BRONZE	INCANDESCENT 120V
36	36"		N POLISHED NICKEL	-CF COMPACT FLUORESCENT 120V
48	48"		S SATIN NICKEL	
T1	21"-27" (TELESCOPING)			
T2	28"-40" (TELESCOPING)			

COMPLEMENTARY PRODUCT
 LOW-VOLTAGE PENDANT P. 104 / SEMI-FLUSH MOUNT P. 354

PRODUCT DIMENSIONS

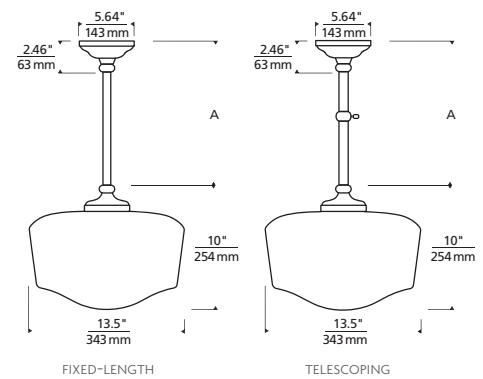

COMPATIBLE WITH INDUSTRIAL
 HANG STRAIGHT
 P. 568





BENTON



Carriage light inspired hand-welded metal cap with tapered glass shade and metal ring detail. Incandescent includes 120 volt 60 watt G9 base, halogen lamp; compact fluorescent includes 18 watt GX24Q-2 base triple tube lamp and electronic ballast. Each includes six feet of field-cuttable cable. Incandescent version dimmable with standard incandescent dimmer.

600BENP	COLOR	FINISH	LAMP
	W WHITE	Z ANTIQUE BRONZE N POLISHED NICKEL S SATIN NICKEL	INCANDESCENT 120V -CF COMPACT FLUORESCENT 120V

PRODUCT DIMENSIONS

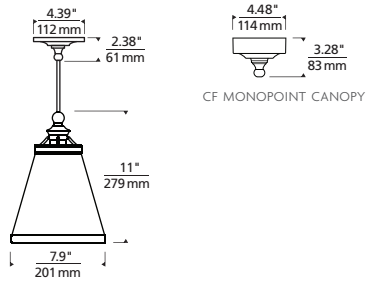

COMPLEMENTARY PRODUCT
LOW-VOLTAGE PENDANT P. 102



ANTIQUÉ BRONZE

SATIN NICKEL

BRIDGEPORT



Carriage light inspired hand-welded metal cap with cylindrical glass shade and metal ring detail. Incandescent includes 120 volt 60 watt G9 base, halogen lamp; compact fluorescent includes 18 watt GX24Q-2 base triple tube lamp and electronic ballast. Each includes six feet of field-cuttable cable. Incandescent version dimmable with standard incandescent dimmer.

600BRGP	COLOR	FINISH	LAMP
	W WHITE	Z ANTIQUÉ BRONZE N POLISHED NICKEL S SATIN NICKEL	INCANDESCENT 120V -CF COMPACT FLUORESCENT 120V

PRODUCT DIMENSIONS

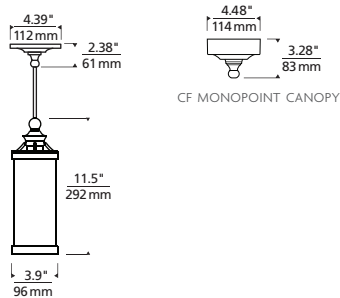

COMPLEMENTARY PRODUCT
LOW-VOLTAGE PENDANT P. 102 / WALL P. 402



LINE-VOLTAGE PENDANTS /
SUSPENSION



BLACK

DESERT CLAY

RED

WASHABLE IVORY

WHITE

LEXINGTON



Large fabric drum shade suspended from a round canopy. Glass diffuser provides a glare free wash of light. Black, satin nickel, and white finish options include satin nickel detail and clear cable; antique bronze includes antique bronze detail and brown cable. Available in two lamp configurations: incandescent and fluorescent. Incandescent version includes four 100 watt or equivalent A19 medium base lamps. Fluorescent version includes electronic ballasts hidden inside the shade and can be lamped with either four 26 watt or 32 watt GX24Q-3 base triple tube lamps (sold separately). Fixture is provided with six feet of field-cuttable cable. Incandescent version dimmable with standard incandescent dimmer. Dimmable fluorescent ships standard with two wire Advance Mark X dimming ballast. Dimmers supplied by others. Dimmer and ballast compatibility to be field verified. Consult factory for custom ballast availability and pricing.

PRODUCT DIMENSIONS

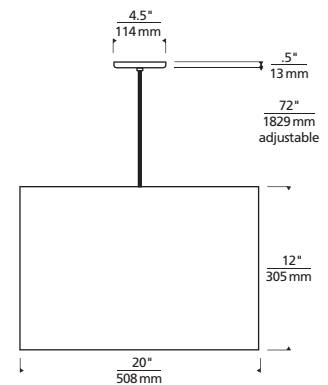

700	SYSTEM	LEXP	COLOR	FINISH	LAMP
TD	MONOPOINT*	B	BLACK	Z	INCANDESCENT 120V
TT	SINGLE-CIRCUIT T-TRAK	C	DESERT CLAY	B	BLACK**
		R	RED	S	SATIN NICKEL
TT2	TWO-CIRCUIT T-TRAK	WI	WASHABLE IVORY	W	WHITE
		W	WHITE		
					-CF COMPACT FLUORESCENT 120V***
					-CF277 COMPACT FLUORESCENT 277V***
					-CFD COMPACT FLUORESCENT 120V DIMMABLE***

COMPLEMENTARY PRODUCT
WALL P. 371

* INCLUDES 4.5" ROUND CANOPY

** ANTIQUE BRONZE AND BLACK FINISH ONLY AVAILABLE ON TD

*** TD ONLY





DESERT CLAY



WHITE

MULBERRY



CF



Short fabric drum shade suspended from a round canopy. Glass diffuser provides a glare free wash of light. Black, satin nickel, and white finish options include satin nickel detail and clear glass; antique bronze includes antique bronze detail and brown detail. Available in two lamp configurations: incandescent and fluorescent. Incandescent version includes four 75 watt or equivalent A19 medium base lamps. Fluorescent version includes four 18 watt GU24 base self-ballasted compact fluorescent lamps. Fixture is provided with six feet of field-cuttable cable. Incandescent version dimmable with standard incandescent dimmer.

PRODUCT DIMENSIONS

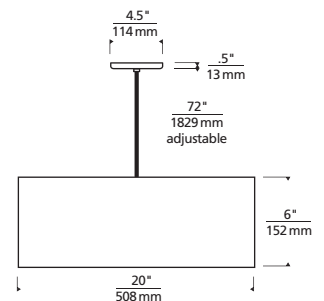

700	SYSTEM	MULP	COLOR	FINISH	LAMP
TD	MONOPOINT*	C	DESERT CLAY	Z	INCANDESCENT 120V
TT	SINGLE-CIRCUIT T-TRAK	W	WHITE	B	COMPACT FLUORESCENT 120V
TT2	TWO-CIRCUIT T-TRAK			S	
				W	



COMPLEMENTARY PRODUCT
LOW-VOLTAGE PENDANT P. 122 / SEMI-FLUSH MOUNT P. 346

* INCLUDES 4.5" ROUND CANOPY

** ANTIQUE BRONZE AND BLACK FINISH ONLY AVAILABLE ON TD



LINE-VOLTAGE PENDANTS /
SUSPENSION



DESERT CLAY



RED



WHITE

DELANCEY



Large cylindrical shaped fabric shade suspended from a round canopy. Glass diffuser provides a glare free wash of light. Black, satin nickel, and white finish options include satin nickel detail and clear cable; antique bronze includes antique bronze detail and brown cable. Available in two lamp configurations: incandescent and fluorescent. Incandescent version includes four 100 watt or equivalent A19 medium base lamps. Fluorescent version includes electronic ballasts hidden inside the shade and can be lamped with either four 26 watt or 32 watt GX24Q-3 base triple tube lamps (sold separately). Fixture is provided with six feet of field-cutttable cable. Incandescent version dimmable with standard incandescent dimmer. Dimmable fluorescent ships standard with two wire Advance Mark X dimming ballast. Dimmers supplied by others. Dimmer and ballast compatibility to be field verified. Consult factory for custom ballast availability and pricing.

PRODUCT DIMENSIONS

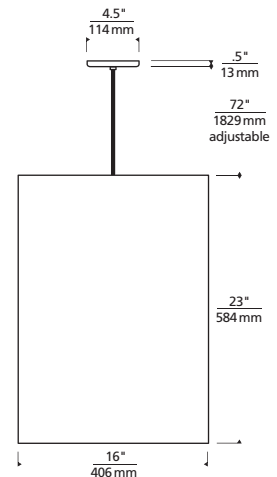

700	SYSTEM	DELP	COLOR	FINISH	LAMP	
TD	MONOPOINT*	C	DESERT CLAY	Z	ANTIQUE BRONZE**	INCANDESCENT 120V
TT	SINGLE-CIRCUIT T-TRAK	R	RED	B	BLACK**	-CF COMPACT FLUORESCENT 120V****
		W	WHITE	S	SATIN NICKEL	-CF277 COMPACT FLUORESCENT 277V****
TT2	TWO-CIRCUIT T-TRAK			W	WHITE	-CFD FLUORESCENT 120V DIMMABLE****

* INCLUDES 4.5" ROUND CANOPY

** ANTIQUE BRONZE AND BLACK FINISH ONLY AVAILABLE ON TD

*** TD ONLY



LINE-VOLTAGE PENDANTS /
SUSPENSION



CABO GRANDE



Onyx cylinder provides a warm textured look. Finished with minimal top detail and suspended from a round canopy. Black, satin nickel, and white canopy options include satin nickel top detail and clear cable; antique bronze includes antique bronze detail and brown cable. Includes 120 volt 75w or equivalent A19 medium base lamp or GX24Q-3 base 32w triple tube compact fluorescent lamp (electronic ballast included). Fixture is provided with six feet of field-cutable cable. Incandescent version dimmable with standard incandescent dimmer.

700	SYSTEM	CBOGPH	FINISH	LAMP
TD	MONOPOINT*	Z	ANTIQUE BRONZE**	INCANDESCENT 120V
TT	SINGLE-CIRCUIT T-TRAK	B	BLACK**	-CF COMPACT FLUORESCENT 120V
TT2	TWO-CIRCUIT T-TRAK	S	SATIN NICKEL	-CF277 COMPACT FLUORESCENT 277V***
		W	WHITE	

PRODUCT DIMENSIONS

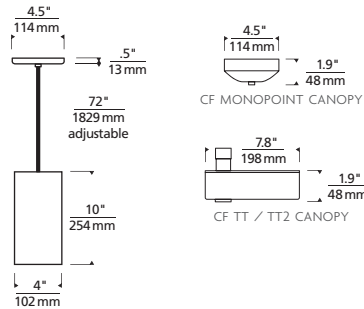

COMPLEMENTARY PRODUCT
LOW-VOLTAGE PENDANT P. 134 / WALL P. 390



FIRE ONYX



Warm onyx in an elegant teardrop shape. Black, satin nickel, and white finish options include a satin nickel detail and clear cable; antique bronze finish includes antique bronze detail and brown cable. Includes 120 volt, 60 watt or equivalent BT15 medium base halogen lamp or GX24Q-1 base 13 watt triple tube compact fluorescent lamp (electronic ballast included). Fixture is provided with six feet of field-cutable cable. Incandescent version dimmable with standard incandescent dimmer.

700	SYSTEM	FIRXH	FINISH	LAMP
TD	MONOPOINT*	Z	ANTIQUE BRONZE**	INCANDESCENT 120V
TT	SINGLE-CIRCUIT T-TRAK	B	BLACK**	-CF COMPACT FLUORESCENT 120V
TT2	TWO-CIRCUIT T-TRAK	S	SATIN NICKEL	-CF277 COMPACT FLUORESCENT 277V***
		W	WHITE	

PRODUCT DIMENSIONS

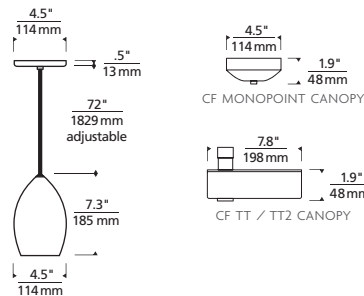

* INCLUDES 4.5" ROUND CANOPY

** ANTIQUE BRONZE AND BLACK FINISH ONLY AVAILABLE ON TD

*** CF277 LAMP ONLY AVAILABLE ON TD



LINE-VOLTAGE PENDANTS /
SUSPENSION



AMBER

COBALT BLUE

FROST WHITE

SMALL NEST

Glass shade with clear glass wrap, suspended from a round canopy. Black, satin nickel, and white canopy options include satin nickel ball detail and clear cable; antique bronze includes antique bronze detail and brown cable. Includes 120 volt 60 watt mini-candelabra base lamp. Fixture is provided with six feet of field-cutable cable.

700	SYSTEM	NSP	COLOR	FINISH
TD	MONOPOINT*	A	AMBER	Z ANTIQUE BRONZE**
TT	SINGLE-CIRCUIT T-TRAK	B	COBALT BLUE	B BLACK**
TT2	TWO-CIRCUIT T-TRAK	W	FROST WHITE	S SATIN NICKEL W WHITE

 COMPLEMENTARY PRODUCT
LOW-VOLTAGE PENDANT P. 138

PRODUCT DIMENSIONS

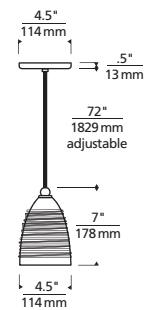

* INCLUDES 4.5" ROUND CANOPY

** ANTIQUE BRONZE AND BLACK FINISH ONLY AVAILABLE ON TD



Photographer: Eric Tadsen Design: Bouril Design Studio



BLUE-VIOLET



FERRARI RED



TAHOE PINE AMBER



WHITE FRIT

MELROSE



Gracefully shaped glass shade, richly layered in brilliant color, with machined top detail suspended from either a modern canopy or a round canopy. Black, satin nickel, and white canopy options include satin nickel top detail and clear cable; antique bronze includes antique bronze detail and brown cable. Includes 120 volt, 60 watt mini-candelabra base lamp or 18 watt GX24Q-2 base triple tube compact fluorescent lamp (electronic ballast included). Fixture is provided with six feet of field-cuttable cable. Incandescent version dimmable with standard incandescent dimmer.

PRODUCT DIMENSIONS

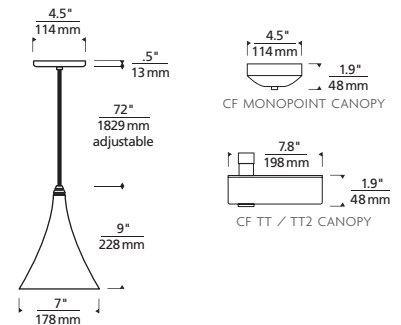

700	SYSTEM	MLP	COLOR	FINISH	LAMP
TD	MONOPOINT*	B	BLUE-VIOLET	Z	INCANDESCENT 120V
TT	SINGLE-CIRCUIT T-TRAK	R	FERRARI RED	B	BLACK**
		A	TAHOE PINE AMBER	S	SATIN NICKEL
TT2	TWO-CIRCUIT T-TRAK	W	WHITE FRIT	W	WHITE
					-CF COMPACT FLUORESCENT 120V
					-CF277 COMPACT FLUORESCENT 277V***

COMPLEMENTARY PRODUCT
LOW-VOLTAGE PENDANT P. 140

* INCLUDES 4.5" ROUND CANOPY

** ANTIQUE BRONZE AND BLACK FINISH ONLY AVAILABLE ON TD

*** CF277 LAMP ONLY AVAILABLE ON TD



Photographer: www.peterrymwid.com

LINE-VOLTAGE PENDANTS /
SUSPENSION



FROST WHITE

LIME GREEN



TAHOE PINE AMBER

WHITE FRIT

EMERGE



Conical shaped glass shade, richly layered in brilliant color, suspended from a round canopy. Black, satin nickel, and white canopy options include satin nickel detail and clear cable; antique bronze includes antique bronze detail and brown cable. Includes 120 volt, 75 watt or equivalent A19 medium base lamp or 18 watt GX24Q-2 base triple tube compact fluorescent lamp (electronic ballast included). Fixture is provided with six feet of field-cuttable cable. Incandescent version dimmable with standard incandescent dimmer.

700	SYSTEM	EMP	COLOR	FINISH	LAMP
TD	MONOPOINT*	F	FROST WHITE	Z	INCANDESCENT 120V
TT	SINGLE-CIRCUIT T-TRAK	G	LIME GREEN	ANTIQUE BRONZE**	COMPACT FLUORESCENT 120V
TT2	TWO-CIRCUIT T-TRAK	A	TAHOE PINE AMBER	B	BLACK**
		S	SATIN NICKEL	-CF277	COMPACT FLUORESCENT 277V***
		W	WHITE FRIT	W	WHITE

PRODUCT DIMENSIONS

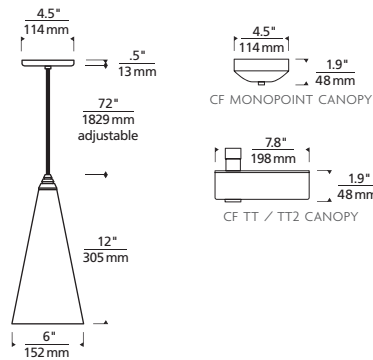

TAZA



Blown glass shade with intense color twists suspended from a round canopy. Black, satin nickel, and white canopy options include clear cable; antique bronze includes brown cable. Includes 120 volt, 75 watt or equivalent A19 medium base lamp or 18 watt GX24Q-2 base triple tube compact fluorescent lamp (electronic ballast included). Fixture is provided with six feet of field-cuttable cable. Incandescent version dimmable with standard incandescent dimmer.

700	SYSTEM	TAZP	COLOR	FINISH	LAMP
TD	MONOPOINT*	A	AMBER	Z	INCANDESCENT 120V
TT	SINGLE-CIRCUIT T-TRAK	B	BLUE / GREEN	ANTIQUE BRONZE**	COMPACT FLUORESCENT 120V
TT2	TWO-CIRCUIT T-TRAK	N	BROWN	B	BLACK**
		C	CREAM	S	SATIN NICKEL
				W	WHITE

PRODUCT DIMENSIONS

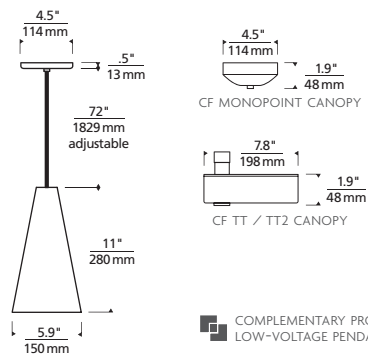

COMPLEMENTARY PRODUCT
LOW-VOLTAGE PENDANT P. 144 / ACCESSORY P. 571

* INCLUDES 4.5" ROUND CANOPY

** ANTIQUE BRONZE AND BLACK FINISH ONLY AVAILABLE ON TD

*** CF277 LAMP ONLY AVAILABLE ON TD



AMBER

BLUE / GREEN



BROWN

CREAM



TAHOE PINE AMBER
WITH SATIN NICKEL
IRON WRAP ACCESSORY



TORTOISE SHELL
WITH AMBER GLASS BALL
AND BLACK IRON WRAP
ACCESSORY



WHITE FRIT



OPTIONAL
IRON WRAP ACCESSORY
P. 568

OVATION



Hand pulled glass shade, richly layered in brilliant color, with machined top or glass ball detail suspended from a round canopy. Black, satin nickel, and white canopy options include satin nickel top detail and clear cable; antique bronze includes antique bronze detail and brown cable. Handmade wrought Iron Wrap Accessory sold separately. Includes 120 volt, 75 watt or equivalent A19 medium base lamp or 18 watt GX24Q-2 base triple tube compact fluorescent lamp (electronic ballast included). Fixture is provided with six feet of field-cutttable cable. Incandescent version dimmable with standard incandescent dimmer.

700	SYSTEM	OVP	COLOR	GLASS BALL	FINISH	LAMP
TD	MONOPOINT*		A TAHOE PINE AMBER	NN NO BALL	Z ANTIQUE BRONZE**	INCANDESCENT 120V
TT	SINGLE-CIRCUIT T-TRAK		T TORTOISE SHELL	AN AMBER	B BLACK**	COMPACT FLUORESCENT 120V
TT2	TWO-CIRCUIT T-TRAK		W WHITE FRIT	RN RED	S SATIN NICKEL	COMPACT FLUORESCENT 277V***
					W WHITE	-CF277

PRODUCT DIMENSIONS

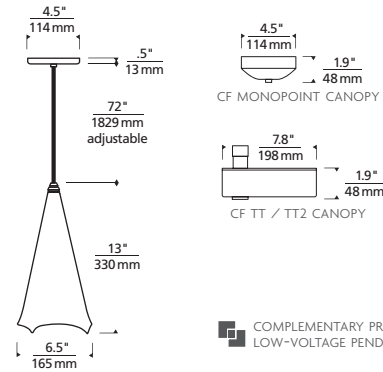

COMPLEMENTARY PRODUCT
LOW-VOLTAGE PENDANT P. 142 / WALL P. 386



AMBER



FROST

SODA



Sleek glass shade infused with bubbles, suspended from a round canopy. Black, satin nickel, and white canopy options include clear cable; antique bronze includes brown cable. Includes 120 volt, 75 watt or equivalent A19 medium base lamp or 32 watt GX24Q-3 base triple tube compact fluorescent lamp (electronic ballast included). Fixture is provided with six feet of field-cutttable cable. Incandescent version dimmable with standard incandescent dimmer.

700	SYSTEM	SDALP	COLOR	FINISH	LAMP
TD	MONOPOINT*		A AMBER	Z ANTIQUE BRONZ**	INCANDESCENT 120V
TT	SINGLE-CIRCUIT T-TRAK		F FROST	B BLACK**	COMPACT FLUORESCENT 120V
TT2	TWO-CIRCUIT T-TRAK		S SATIN NICKEL	W WHITE	COMPACT FLUORESCENT 277V***
					-CF277

PRODUCT DIMENSIONS

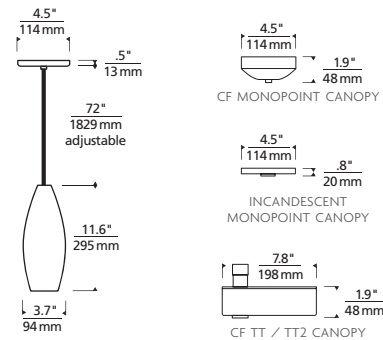

COMPLEMENTARY PRODUCT
ACCESSORY P. 570

* INCLUDES 4.5" ROUND CANOPY

** ANTIQUE BRONZE AND BLACK FINISH ONLY AVAILABLE ON TD

*** CF277 LAMP ONLY AVAILABLE ON TD



CRESCENDO

Seven free-floating arms suspended by aerial cable, each tipped on both ends with frosted lamps and white flight paper. 9" diameter round canopy houses a 300 watt electronic transformer with short circuit protection. Includes fourteen 12 volt, 20 watt Frostline™ MR16 lamps. Dimmable with a low-voltage electronic dimmer.

700CRES

WIDTH (W)	LENGTH (L)	FINISH
36 36"	STANDARD	C CHROME
48 48"	L LONG	S SATIN NICKEL

(W) WIDTH	(L) STANDARD	(L) LONG
36 (914 mm)	6' (1829 mm)	14' (4267 mm)
48 (1219 mm)	8' (2438 mm)	14' (4267 mm)

PRODUCT DIMENSIONS

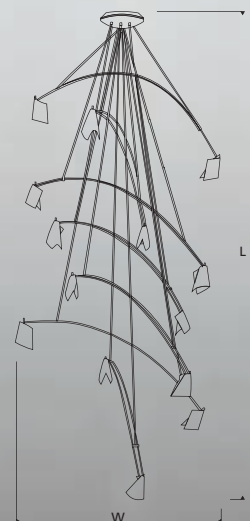



MINI CRESCENDO

Three free-floating arms suspended by aerial cable, each tipped on both ends with frosted lamps and white flight paper. 6.5" diameter round canopy houses a 150 watt transformer with short circuit protection. 36" width and 40" length. Includes six 12 volt, 20 watt Frostline™ MR16 lamps. Dimmable with a low-voltage electronic dimmer.

700CRES36S FINISH
 C CHROME
 S SATIN NICKEL

PRODUCT DETAILS

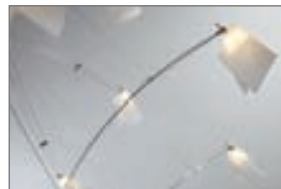
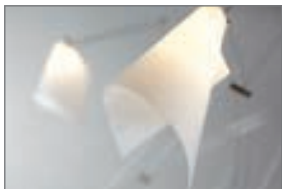

PRODUCT DIMENSIONS

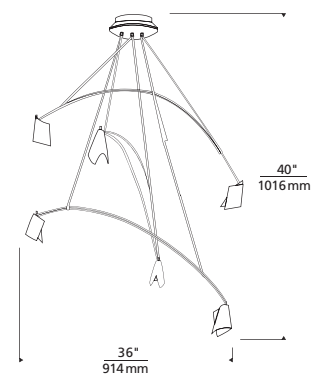

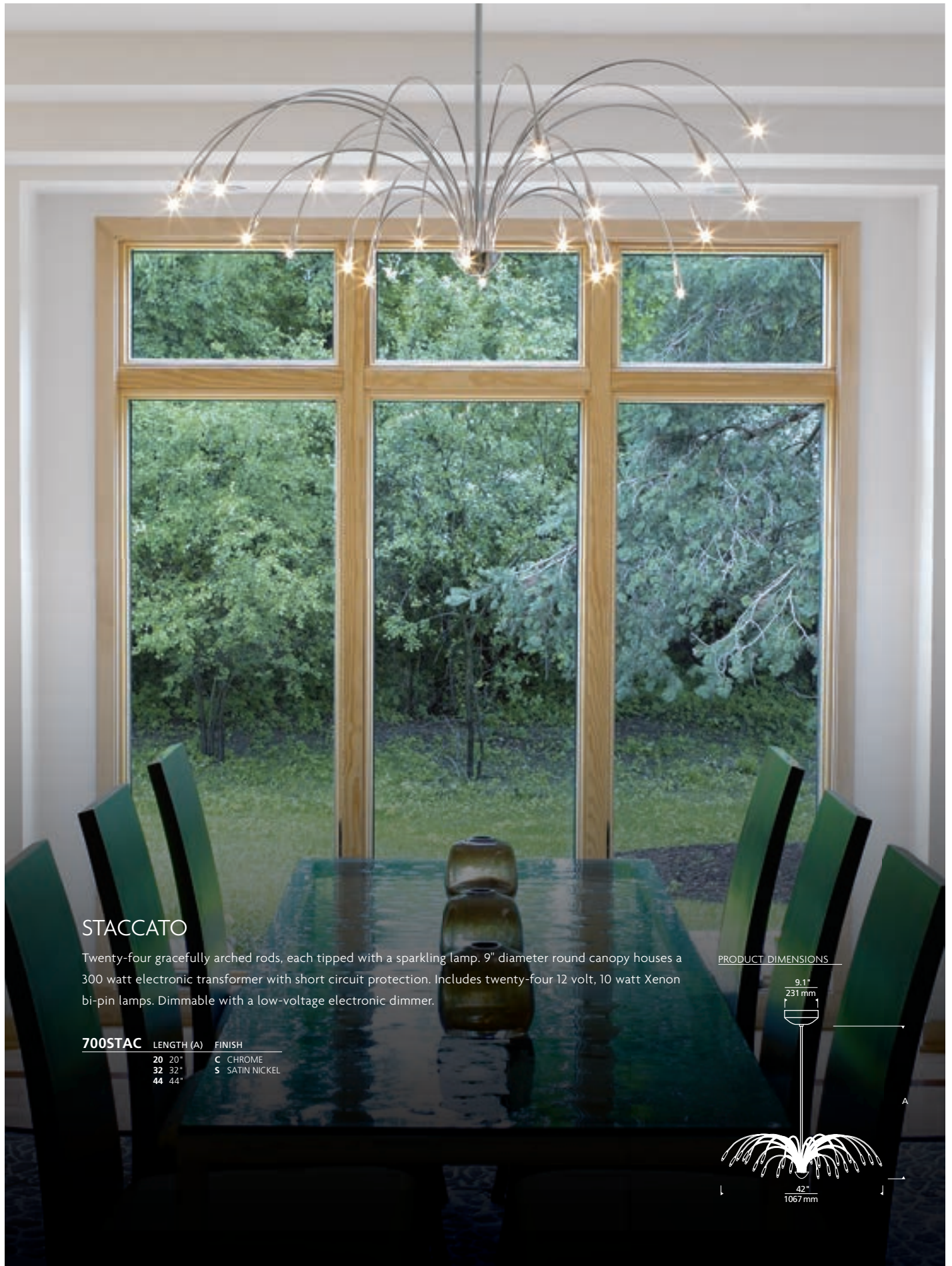

STACCATO

Twenty-four gracefully arched rods, each tipped with a sparkling lamp. 9" diameter round canopy houses a 300 watt electronic transformer with short circuit protection. Includes twenty-four 12 volt, 10 watt Xenon bi-pin lamps. Dimmable with a low-voltage electronic dimmer.

PRODUCT DIMENSIONS

9.1"
231 mm

9.1"
231 mm

9.1"
231 mm

9.1"
231 mm

9.1"
231 mm

9.1"
231 mm

9.1"
231 mm

9.1"
231 mm

9.1"
231 mm

9.1"
231 mm

9.1"
231 mm

9.1"
231 mm

9.1"
231 mm

9.1"
231 mm

9.1"
231 mm

9.1"
231 mm

9.1"
231 mm

9.1"
231 mm

9.1"
231 mm

9.1"
231 mm

700STAC	LENGTH (A)	FINISH
20	20"	C CHROME
32	32"	S SATIN NICKEL
44	44"	





RHAPSODY

Fifteen whimsical arms wrapped from a central core, each tipped with a frosted lamp and white flight paper. 9" diameter round canopy houses a 300 watt electronic transformer with short circuit protection. Includes fifteen 12 volt, 20 watt Frostline™ MR16 lamps. Dimmable with a low-voltage electronic dimmer.

700RHAP	LENGTH (A)	FINISH
32	32"	C CHROME
44	44"	S SATIN NICKEL
56	56"	
68	68"	

PRODUCT DIMENSIONS

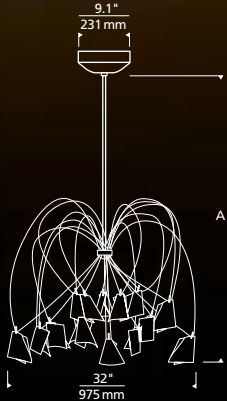



SPIRE CHANDELIER

Sophisticated tapered felt pendants combine to create an elegant yet casual chandelier. Pre-Cut option is pictured. Includes 2 small, 2 medium, and 1 large pendant. Standard option includes eight feet of field-cuttable cable for each pendant. Includes five low-voltage, 50 watt halogen bi-pin lamps and low-voltage electronic transformer. Dimmable with low-voltage electronic dimmer.

700CHSPR	LENGTH (A)	COLOR	FINISH
S96	NOT PRE-CUT	○ CHARCOAL GRAY	Z ANTIQUE BRONZE
P96	PRE-CUT		S SATIN NICKEL

COMPLEMENTARY PRODUCT
LOW-VOLTAGE PENDANTS P. 82

PRODUCT DIMENSIONS

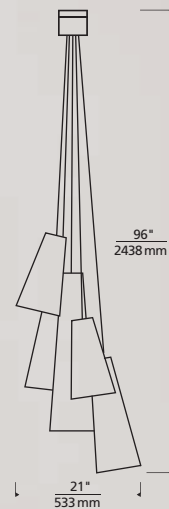



Now available in small



TRACE SUSPENSION



Streams of glass piping formed into a graceful glass bowl and highlighted with metal details. Creates an unmistakable sparkle in any space. Large incandescent includes four 120 volt, 60 watt or equivalent clear A19 medium base lamps. Small incandescent includes two 120 volt, 60 watt or equivalent clear A19 medium base lamps. Large fluorescent includes four 18 watt GU24 base self-ballasted compact fluorescent lamps. Small fluorescent includes two 18 watt GU24 base self-ballasted lamps. Incandescent version dimmable with standard incandescent dimmer.

PRODUCT DIMENSIONS

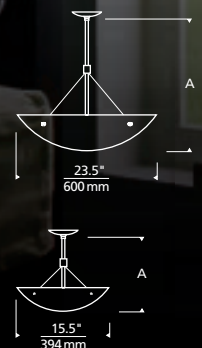

700TRAS	SIZE	LENGTH (A)	COLOR	FINISH	LAMP
16	SMALL (16" DIAMETER)	16 16"	C CRYSTAL	Z ANTIQUE BRONZE	INCANDESCENT
23	LARGE (23" DIAMETER)	24 24"		S SATIN NICKEL	-CF COMPACT FLUORESCENT
		36 36"			

COMPLEMENTARY PRODUCT
SEMI-FLUSH MOUNT P. 352



RIVER ROCK CHANDELIER

Four shades inspired by rocks along a river bed captured through a hand-blown glass process consisting of (1) Oblong Oval in blue slate, (1) Round in sand, (1) Wedge in green slate, and (1) Wedge in pebble brown pendants. Please note: the bottom of the pendant will not hang parallel to the floor. All pendants are suspended from a FreeJack 4 port round canopy. Includes four low-voltage, 35 watt halogen bi-pin lamps. Each pendant includes six feet of field-cutttable suspension cable, however, for best appearance we recommend cutting the cables to 12, 14, 17 and 22" length. Dimmable with standard incandescent dimmer.

700CHRIV4 FINISH
 Z ANTIQUE BRONZE
 S SATIN NICKEL

COMPLEMENTARY PRODUCT
 LOW-VOLTAGE PENDANT P. 132

PRODUCT DIMENSIONS

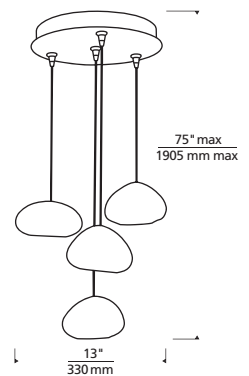



BEACH AMBER

SURF WHITE

SAND

LARKSPUR SUSPENSION



Slumped glass bowl embedded with soft, textured pattern and highlighted with metal details. Incandescent includes two 120 volt, 100 watt or equivalent A19 medium base lamps. Fluorescent includes two 27 watt GU24 base self-ballasted compact fluorescent lamps. Integrated ball joint accommodates sloped ceilings up to 45°. Incandescent version dimmable with standard incandescent dimmer.

PRODUCT DIMENSIONS

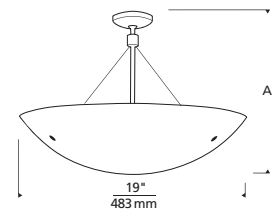

700LRKS19	LENGTH (A)	COLOR	FINISH	LAMP
	14 16"	A BEACH AMBER	Z ANTIQUE BRONZE	INCANDESCENT
	24 24"	S SAND	S SATIN NICKEL	-CF COMPACT FLUORESCENT 120V
	36 36"	W SURF WHITE		

COMPLEMENTARY PRODUCT
LOW-VOLTAGE PENDANT P. 126 / LINE-VOLTAGE PENDANT P. 274 / WALL P. 384

Pendant Cluster Canopies / Track Adapter / Swag Hook



PENDANT CLUSTER CANOPIES*

Use to suspend a combination of pendants from a single mounting location (pendants sold separately). Available in two styles: suspend three pendants or five pendants from a single round canopy. For use with incandescent pendants only.

700TDCLP	STYLE	FINISH
3R	3 PENDANT ROUND	Z ANTIQUE BRONZE
5R	5 PENDANT ROUND	B BLACK
		S SATIN NICKEL
		W WHITE

NOTE: CONSULT FACTORY TO ORDER COMPACT FLUORESCENT VERSIONS. SEE P. 314 FOR WOOD MULTI-PORT CHANDELIER CANOPIES.

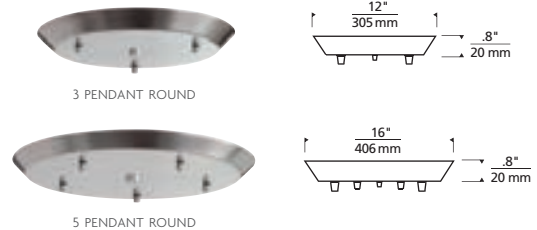

SWAG HOOK

Use as a creative tool to gracefully change a pendant's point of suspension from the mounting canopy to any point on the ceiling. Order one for each pendant.

700TDSWG	FINISH
Z	ANTIQUÉ BRONZE
B	BLACK
S	SATIN NICKEL
W	WHITE

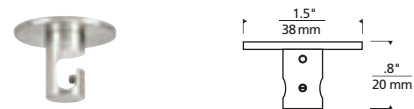

* NOT COMPATIBLE WITH CLOTH CORDS.

LINE-VOLTAGE PENDANT TRACK ADAPTER*

Allows 120 volt Line-Voltage Pendants to be use on most popular single-circuit track lighting systems.

INCANDESCENT / GU24 COMPACT FLUORESCENT PENDANTS

For use with 120 volt incandescent and GU24 base compact fluorescent pendants that hang from a single cord. Order the 700TD pendant + one Track Adapter for each pendant.



COMPACT FLUORESCENT
PIN-BASED PENDANT



INCANDESCENT / GU24 PENDANT

700TD	TYPE**	FINISH
	HASP FITS HALO	B BLACK
	JUSP FITS JUNO	W WHITE
	LISP FITS LIGHTOLIER	

4-PIN COMPACT FLUORESCENT PENDANTS

For use with 120 volt 4-pin compact fluorescent pendants that hang from a single cord. In the item number, substitute 700TD with one of the following:

	TYPE**
700TH	FITS HALO
700TJ	FITS JUNO
700TI	FITS LIGHTOLIER

And substitute the finish with one of the following:

	FINISH (TRACK ADAPTER / PENDANT)
BZ	BLACK / ANTIQUE BRONZE
BS	BLACK / SATIN NICKEL
WZ	WHITE / ANTIQUE BRONZE
WS	WHITE / SATIN NICKEL

For example, instead of 700TDECPLUS-CF, the item number for a white HALO-compatible Track Adapter with the Echo pendant 700THECPLUWS-CF.

LINE-VOLTAGE PORT ALONE*

Minimal canopy. Can be installed in a range of locations. Includes integral junction box. Access to back of ceiling is not needed. For use with incandescent pendants and GU24 base compact fluorescent lamps only.



700TDFCP	FINISH
	Z ANTIQUE BRONZE
	S SATIN NICKEL
	W WHITE

* NOT COMPATIBLE WITH CLOTH CORDS.

** TECH LIGHTING IS NOT AFFILIATED WITH, NOR IS IT ENDORSED BY ANY OF THE COMPANIES LISTED NOR DOES TECH LIGHTING DISTRIBUTE ANY OF THEIR PRODUCTS.

Line-Low 7-port canopy p. 318 with Sara pendant p. 94 and Sara Grande pendant p. 262



MULTI-PORT CHANDELIERS



THE POSSIBILITIES ARE ENDLESS

Tech Lighting products have long been known for their modularity and customization. We love putting the design in the hands of our customers. In this vein, we are very excited to expand our family of multi-port metal and wood canopies. They allow the ultimate flexibility to create an elegant custom chandelier – perfect for an entryway, living room, dining room – even over a kitchen island or conference room table.

Offered in low-voltage, line-voltage and combination low- and line-voltage, multiple wood and metal finish options and three different shape configurations, the possibilities are almost limitless. We have included several examples in the following pages, but there are literally thousands of different possibilities. Let your imagination run free.

Line-Low 11-port canopy p. 318 with Fire pendant p. 111 and Fire Grande pendant p. 243



Photographer: Nancy Nolan, Nancy Nolan Photography Interior Design: Meridith Hamilton, MLH Designs

Line-Low 11-port canopy p. 318
with Manchon pendant p. 94



Line-Low 11-port canopy p. 318 with Fire pendant p. 111
and Fire Grande pendant p. 243



MULTI-PORT CANOPIES*



Mounts to a standard 4" junction box with round plaster ring (provided by electrician). Drywall anchors included for additional support. All low-voltage ports include electronic transformers. 7-Port FJPJ (FreeJack PowerJack) combo includes 4 low-voltage FreeJack ports and 3 line-voltage PowerJack ports. 11-Port combo includes 5 low-voltage FreeJack ports and 6 line-voltage PowerJack ports.

700	SYSTEM	SHAPE	CANOPY	FINISH	TYPE
FJPJ	COMBO FREEJACK AND POWERJACK	LD3 3-PORT LINEAR**	M MAPLE WOOD	Z ANTIQUE BRONZE	STANDARD
FJ	LOW-VOLTAGE FREEJACK	LD7 7-PORT RECTANGULAR	W WALNUT WOOD	S SATIN NICKEL	-LED LED***
PJ	LINE-VOLTAGE POWERJACK	RD11 11-PORT ROUND	T METAL		

* NOT COMPATIBLE WITH FABRIC CORDS

** NOT AVAILABLE IN FJPJ

*** LED IS ONLY AVAILABLE FOR THE FJ PORTS

CANOPY FINISHES



ANTIQU
BRONZE
METAL

MAPLE
WOOD

SATIN
NICKEL
METAL

WALNUT
WOOD

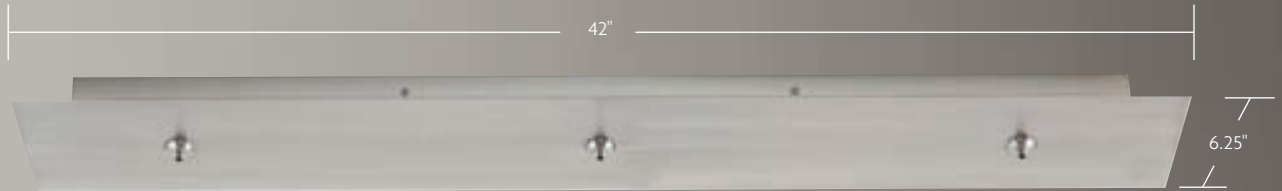

3-PORT LINEAR CANOPY (SHOWN IN FREEJACK / SATIN NICKEL METAL)

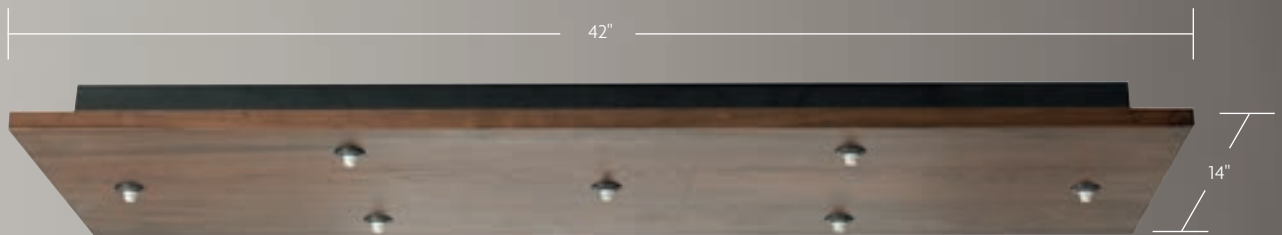

7-PORT RECTANGULAR CANOPY (SHOWN IN FREEJACK / WALNUT WOOD)

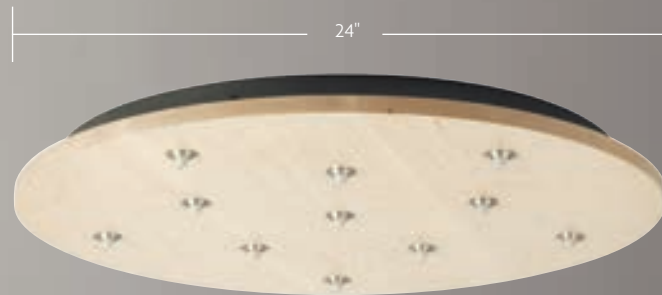

11-PORT ROUND CANOPY (SHOWN IN FREEJACK / MAPLE WOOD)

IMPORTANT NOTES:

To order compatible FreeJack pendants, refer to pp. 52-153. All low-voltage pendants are compatible with the canopies on this page.

To order compatible PowerJack pendants, refer to pp. 214-313. Substitute 700PJ instead of 700TD in the item number to indicate the PJ version of the pendant which is compatible with these multi-port canopies. For example, instead of ordering 700TDKIELPBKS, order 700PKIELPBKS. Please note, some line-voltage pendants are not compatible due to size and weight limitations. The following line-voltage pendants are compatible: Beacon, Cabo Grande, Echo, Echo Grande, Emerge, Fino Large, Fino Small, Fire Grande, Fire Onyx, Hudson, Kami, Kiev Large, Liza Grande, Melrose, Ovation, Peyton Grande, Piper Grande, Playa, Sara Grande*, Small Nest, Soda, Taza, and Veil Grande.

NOTE: PowerJack incandescent pendants and compact fluorescent pendants that use GU24 base self-ballasted compact fluorescent lamps may be used with multi-port canopies. Pin-based fluorescent lamps will require a specific lamp + ballast combination. Please contact our custom quotes department at 847.410.4400 to order canopies with pin-based compact fluorescent lamps.

* DUE TO THE WEIGHT OF THE CRYSTAL WE DO NOT RECOMMEND HANGING MORE THAN 3 SARA GRANDES FROM A SINGLE CANOPY

FreeJack 7-port canopy p. 318 with Mini Echo pendant p. 86



FreeJack 11-port canopy p. 318 with Piper pendant p. 72
and Mini Hudson pendant p. 107





LINEAR SUSPENSION







BIZA



P. 580

Geometries converge to make the seemingly complex simply beautiful. The bottom diffuser is composed of clear injection molded plastic inserts which add remarkable depth and illusion when viewed from below. Additional molded plastic inserts in either silver or black sit atop the fixture reinforcing its thoughtful shape. Horizontal and vertical lines intersect throughout adding additional visual interest. Ships with 21 feet of field-cuttable cord and twelve feet of aircraft cable. Inside sit 40 watts of field-replaceable LED strips making this fixture applicable to many different residential and commercial environments (4000 lumens, 3000K). Dimmable with low-voltage electronic dimmer.

700LSBIZA

FINISH	LAMP
B BLACK	-LED LED 3000K 120V
S SATIN NICKEL	-LED277 LED 3000K 277V

PRODUCT DIMENSIONS

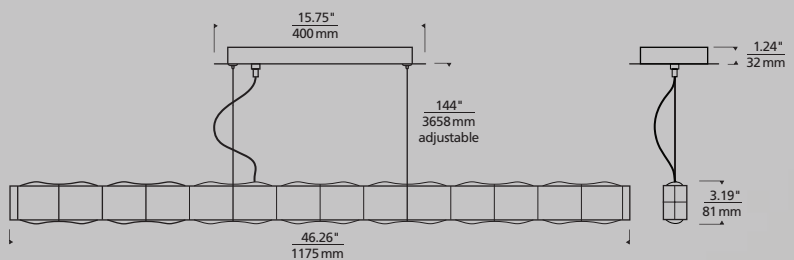

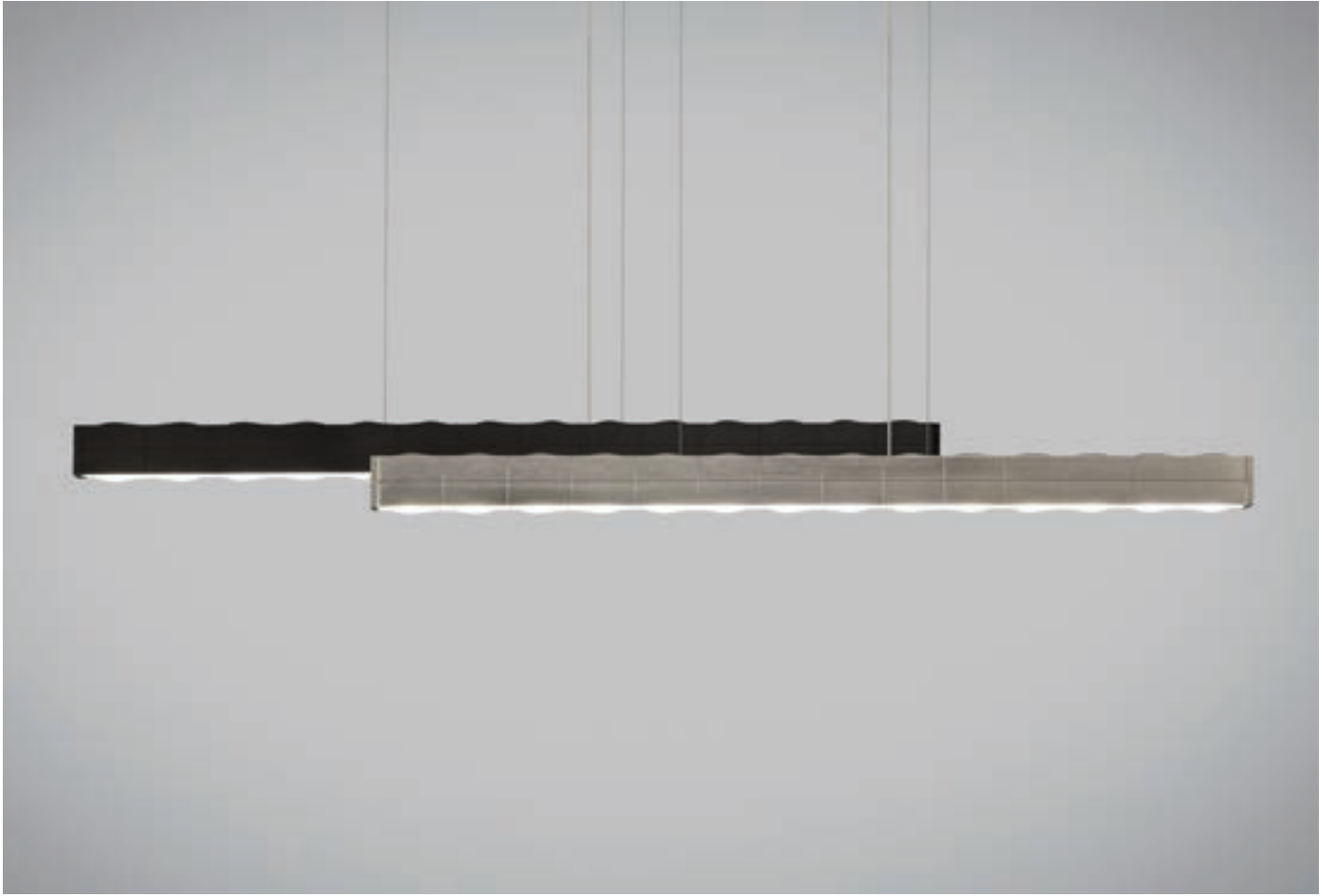



JORN



H

P. 580

Sharp angles create a daring, structured light sculpture sure to make a modern statement in any space. 47 watts of LED face up towards the matte white inner metal shade providing a glare free wash of indirect light (2350 lumens, 3000K). Ships with twelve feet of field-cuttable cable. Dimmable with low-voltage electronic dimmer.

700LSJORN	FINISH	LAMP
B	BLACK (RUBBERIZED)	-LED LED 3000K 120V
S	SATIN NICKEL	-LED277 LED 3000K 277V

PRODUCT DIMENSIONS

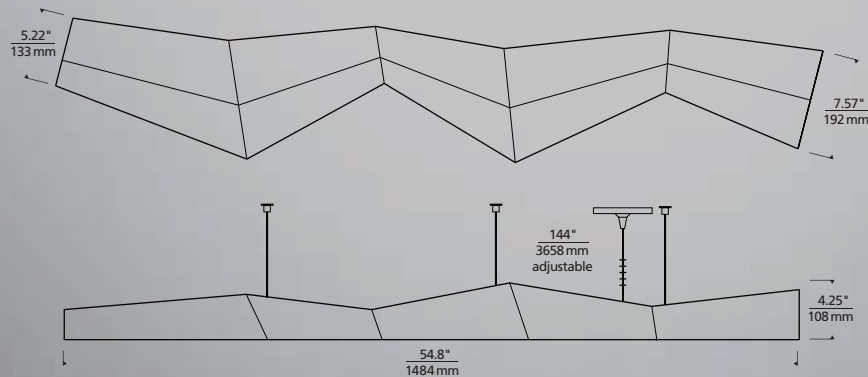





ZHANE



Hard and soft lines converge in this elegantly simple silhouette equally suitable for both residential and commercial settings. A bottom acrylic diffuser provides a glare free wash of light. A highly reflective inner white housing and two high output fluorescent lamps ensure this fixture performs as well as it looks. Offered in 38" which includes two 39 watt high output T5 linear fluorescent lamps or 2600 lumen, 3000K linear LED strips and 49" which includes two 54 watt high output T5 linear fluorescent lamps or 3500 lumen, 3000K linear LED strips. Has a maximum drop length of 6 feet.

700LSZHN	LENGTH	FINISH	LAMP
	38 38"	Z ANTIQUE BRONZE	-CF FLUORESCENT 120V
	49 49"	B BLACK (RUBBERIZED)	-CF277 FLUORESCENT 277V
		G SATIN GOLD	-LED LED 3000K 120V
		S SATIN NICKEL	-LED77 LED 3000K 277V

COMPLEMENTARY PRODUCT
SUSPENSION P. 246

SEE P. 26 FOR ADDITIONAL APPLICATION PHOTO



PRODUCT DIMENSIONS

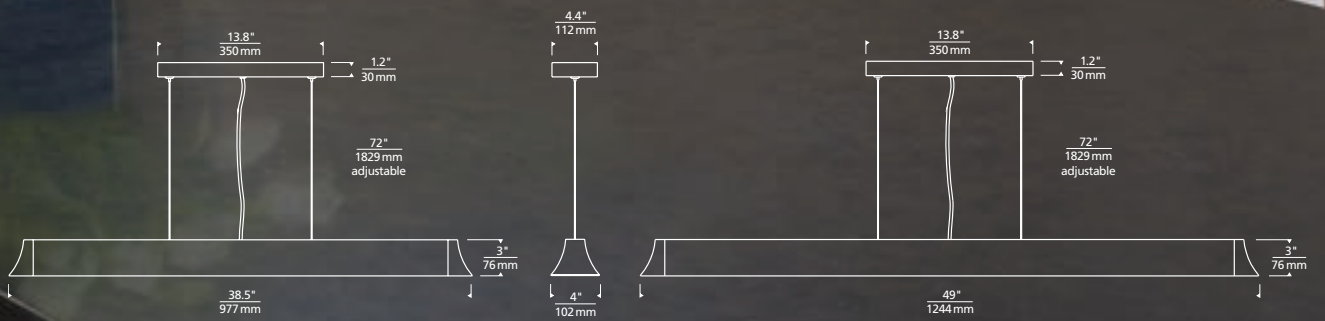

NOTE: FLUORESCENT VERSION IS 51"

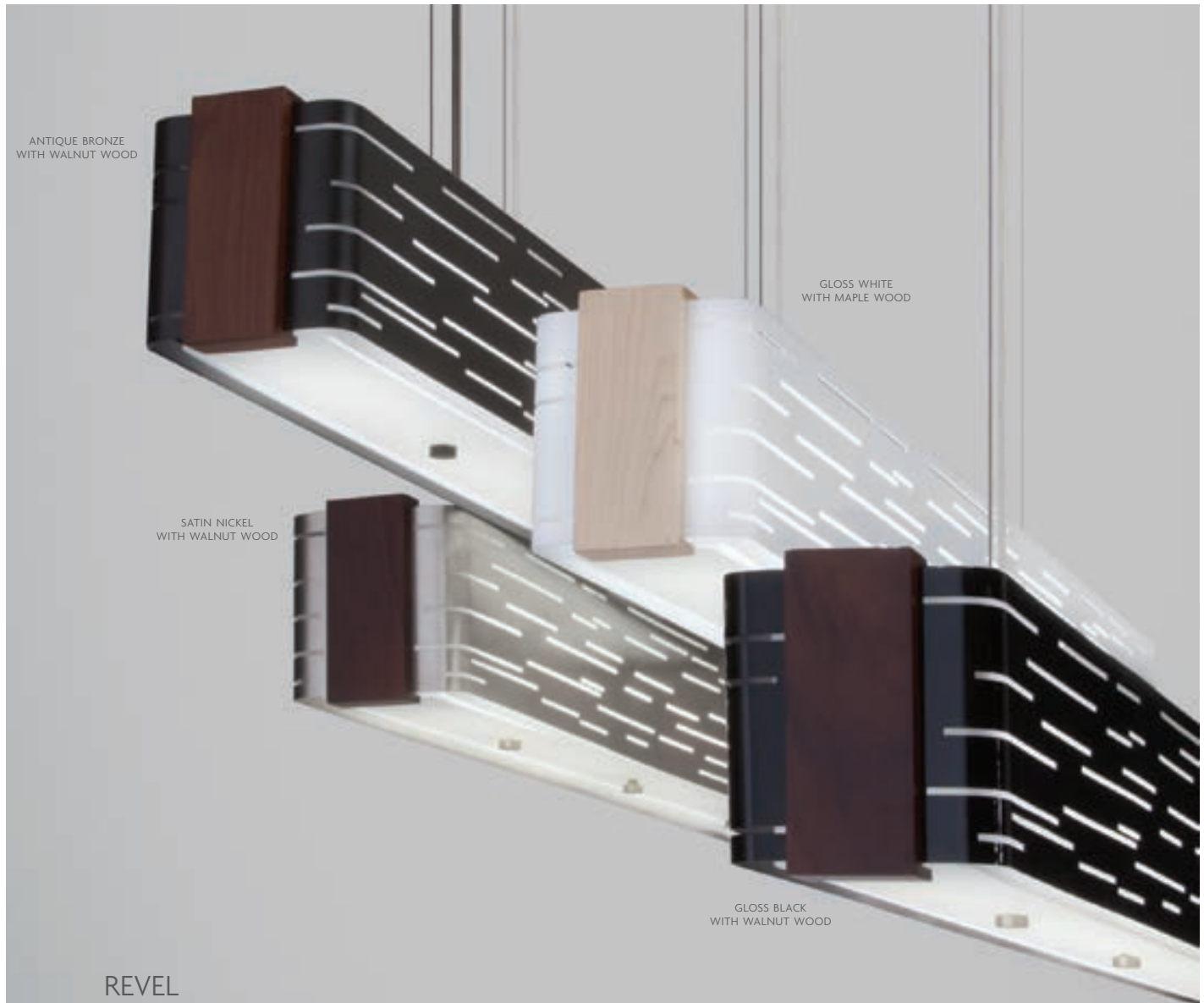

ANTIQUe BRONZE
WITH WALNUT WOOD

GLOSS WHITE
WITH MAPLE WOOD

SATIN NICKEL
WITH WALNUT WOOD

GLOSS BLACK
WITH WALNUT WOOD

REVEL



This dramatic linear suspension fixture captures light in motion. The sleek metal surface is laser-cut with horizontal slots which allow light to shine through the inner white diffuser. Optional wood end caps complement the design with a touch of warmth in an unexpected way. A bottom glass diffuser provides a glare free wash of light. Includes two 54 watt high output T5 linear fluorescent lamps. Has a maximum drop length of 8 feet. Ships with extra center power feed canopy and side post for applications with a centered junction box.

700LSRVL	SHADE COLOR	TRIM COLOR	LAMP
Z	ANTIQUe BRONZE	M MAPLE WOOD	-CF FLUORESCENT 120V
B	GLOSS BLACK	W WALNUT WOOD	-CF277 FLUORESCENT 277V
W	GLOSS WHITE	T METAL	
S	SATIN NICKEL		

OPTIONAL END CAP FINISHES



MAPLE WOOD
WALNUT WOOD

PRODUCT DIMENSIONS

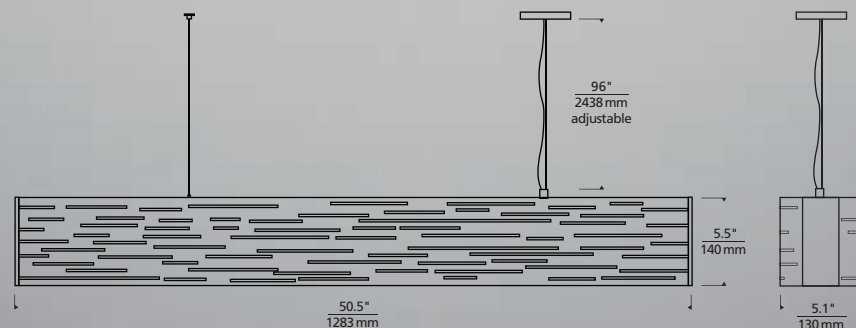

COMPLEMENTARY PRODUCT
LOW-VOLTAGE PENDANT P. 57 /
WALL P. 364

SEE P. 322 FOR ADDITIONAL
APPLICATION PHOTO





CROSSROADS



P. 580

Inspired by the sheen of big city streets and intersections illuminated at night. Composed of sheets of raw steel protected with a clear lacquer coat and accented by brass spot welding at the joints, this suspension fixture has a purposefully imperfect, rugged, industrial design. Includes four 120 volt, 40 watt G9 halogen bi-pin lamps or two 20 watt, field-replaceable LED strips (3500 lumens, 3000K). Halogen may also be lamped with four 120 volt, 60 watt G9 halogen bi-pin lamps (not included). Ships with 21 feet of field-cutttable cord and twelve feet of aircraft cable. Incandescent version dimmable with standard incandescent dimmer. LED dimmable with low-voltage electronic dimmer.

700LSCRS	FINISH	LAMP
S	STEEL	HALOGEN 120V
		-LED LED 3000K 120V
		-LED277 LED 3000K 277V

COMPLEMENTARY PRODUCT
LOW-VOLTAGE PENDANT P. 66 / WALL P. 366

PRODUCT DIMENSIONS

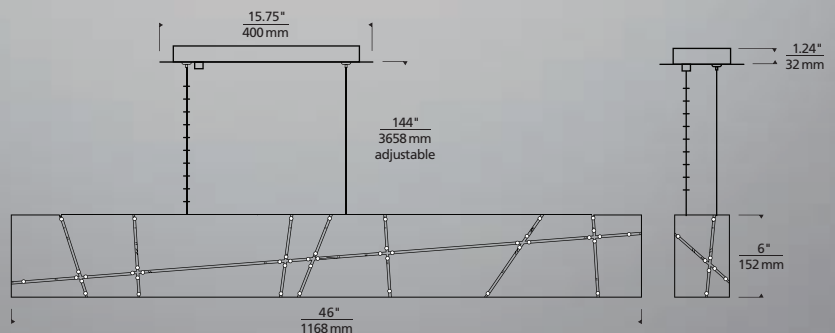





KNOX



Strong lines. Industrial simplicity. This LED suspension fixture performs as it must with such a simple yet handsome design and lets the light itself take center stage. Equally at home over a kitchen island or dining room table as it is in a professional setting over a conference table, lighting a desk space or welcoming guests. At 40 watts of field-replaceable LED strips, it will provide incredible illumination in virtually any environment (3500 lumens, 3000K). Ships with 21 feet of field-cuttable cord and twelve feet of aircraft cable. Dimmable with low-voltage electronic dimmer.

700LSKNOX	FINISH	LAMP
B	BLACK (RUBBERIZED)	-LED LED 3000K 120V
M	GUNMETAL	-LED277 LED 3000K 277V
S	SATIN NICKEL	

PRODUCT DIMENSIONS

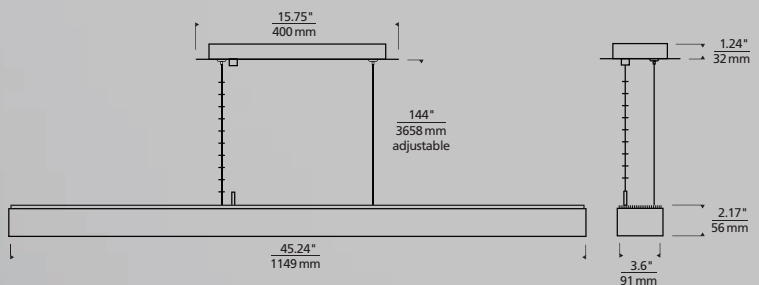



LINEAR SUSPENSION



UNISON



P. 580

The soft lines of the figure 8-shaped acrylic diffuser and die-cast metal end-caps contribute to an unexpected and playful modern interpretation of a suspension fixture. The bold lines of the heat sink extrusion speak to the design's functionality as 40 watts of field-replaceable LED strips make the fixture a work-horse that is equally suitable for residential and commercial applications (3500 lumens, 3000K). Also available with one 54 watt high output T5 Linear fluorescent lamp. Ships with 21 feet of field-cuttable cord and twelve feet of aircraft cable. Dimmable with low-voltage electronic dimmer.

700LSUNS	COLOR	FINISH	LAMP
F	FROST	S	SATIN NICKEL
			-CF FLUORESCENT 120V
			-CF277 FLUORESCENT 277V
			-LED LED 3000K 120V
			-LED277 LED 3000K 277V

PRODUCT DIMENSIONS

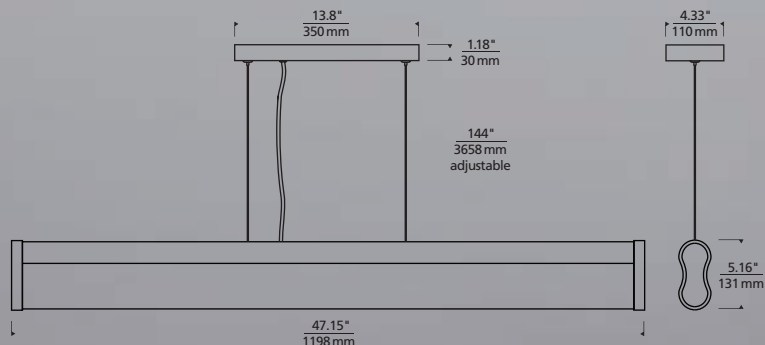





WHITE

MERCER SUSPENSION



Large rectangular tapered fabric shade suspended by rigid stems from a rectangular canopy. Acrylic diffuser provides a glare free wash of light. Available in two lamp configurations: incandescent and fluorescent. Incandescent version includes four 100 watt or equivalent A19 medium base lamps. Fluorescent version includes four 27 watt GU24 base self-ballasted compact fluorescent lamps. Incandescent version dimmable with standard incandescent dimmer.

700TDMERC	LENGTH (A)	COLOR	FINISH	LAMP
36	36"	C DESERT CLAY	Z ANTIQUE BRONZE	INCANDESCENT
48	48"	W WHITE	S SATIN NICKEL	-CF COMPACT FLUORESCENT 120V
60	60"			



PRODUCT DIMENSIONS

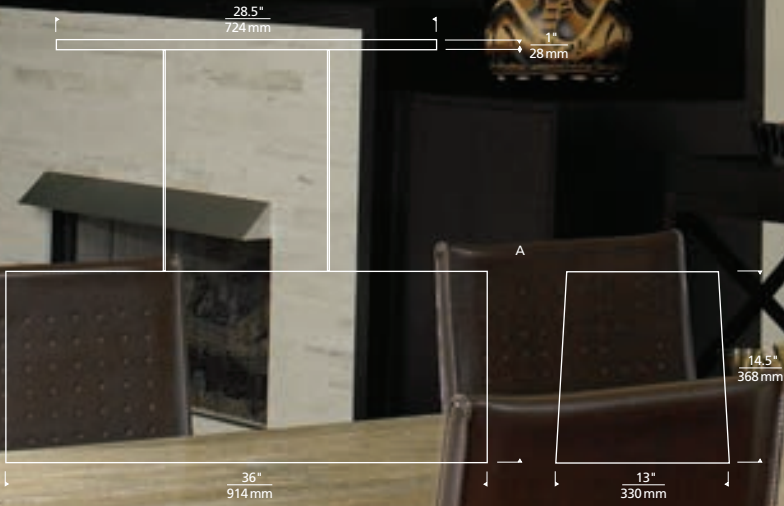



FLUSH & SEMI-FLUSH MOUNT



FLUSH & SEMI-FLUSH MOUNT



LARGE



SMALL

BOXIE



P. 580



Clean square pressed glass shade with polished surface suspended from a die-cast base. Compact fluorescent and LED may be mounted on the wall. Available in three lamp configurations incandescent and fluorescent. Large incandescent includes two 120 volt, 40 watt G9 base halogen lamps; small incandescent includes one 120 volt 40 watt G9 base halogen lamp; large fluorescent includes two 13 watt 2GX7 base twin tube lamps and electronic ballast. Large LED includes two 10 watt, 750 lumen, 2700K LED modules. Small LED includes one 10 watt, 750 lumen, 2700K LED module. Incandescent version dimmable with a standard incandescent dimmer. LED version dimmable with low-voltage electronic dimmer. Ceiling mount suitable for wet locations. ADA compliant.

PRODUCT DIMENSIONS

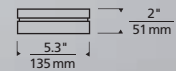

SMALL

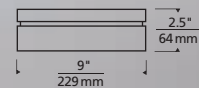

LARGE

700BX	SIZE	FINISH	LAMP
S	SMALL	Z ANTIQUE BRONZE	INCANDESCENT 120V
L	LARGE	C CHROME	COMPACT FLUORESCENT 120V (LARGE ONLY)
		S SATIN NICKEL	COMPACT FLUORESCENT 277V (LARGE ONLY)
			-CF
			-CF277
			-LED
			-LED277

SEE P. 340 FOR ADDITIONAL APPLICATION PHOTO



LARGE



SMALL

CIRQUE



P. 580



Beautiful round pressed glass shade with polished surface suspended from a die-cast base. Compact fluorescent and LED may be mounted on the wall. Available in three lamp configurations incandescent and fluorescent. Large incandescent includes two 120 volt, 40 watt G9 base halogen lamps; small incandescent includes one 120 volt 40 watt G9 base halogen lamp; large fluorescent includes two 13 watt 2GX7 base twin tube lamps and electronic ballast. Large LED includes two 10 watt, 750 lumen, 2700K LED modules. Small LED includes one 10 watt, 750 lumen, 2700K LED module. Incandescent version dimmable with a standard incandescent dimmer. LED version dimmable with low-voltage electronic dimmer. Ceiling mount suitable for wet locations. ADA compliant.

PRODUCT DIMENSIONS

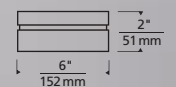

SMALL

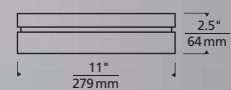

LARGE

700CQ	SIZE	FINISH	LAMP
S	SMALL	Z ANTIQUE BRONZE	INCANDESCENT 120V
L	LARGE	C CHROME	COMPACT FLUORESCENT 120V (LARGE ONLY)
		S SATIN NICKEL	COMPACT FLUORESCENT 277V (LARGE ONLY)
			-CF
			-CF277
			-LED
			-LED277



FLUSH & SEMI-FLUSH MOUNT



SATIN NICKEL, LARGE



ANTIQUe BRONZE, SMALL

FLUID SQUARE



The Fluid is created by pouring molten glass into a contoured mold, letting it cool, and then fire-polishing it to a glossy finish. It gives the impression of flowing water frozen in time. The unique and elegant look of the piece changes at every angle based on how light hits the surface of the glass. Compact fluorescent and LED option may be mounted on the wall. Large incandescent includes two 120 volt, 40 watt G9 base halogen lamps; small incandescent includes one 120 volt 40 watt G9 base halogen lamp; large fluorescent includes two 13 watt 2GX7 base twin tube compact fluorescent and electronic ballast. Large LED includes two 10 watt, 750 lumen, 2700K LED modules. Small LED includes one 10 watt, 750 lumen, 2700K LED module. Incandescent version dimmable with standard incandescent dimmer. LED version dimmable with low-voltage electronic dimmer. Ceiling mount suitable for wet locations. ADA compliant.

PRODUCT DIMENSIONS

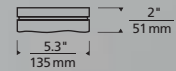

SMALL

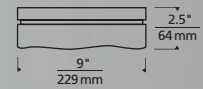

LARGE

700FMFLDS

SIZE	FINISH	LAMP
S SMALL	Z ANTIQUe BRONZE	-INCANDESCENT 120V
L LARGE	C CHROME	-CF COMPACT FLUORESCENT 120V (LARGE ONLY)
	S SATIN NICKEL	-CF277 COMPACT FLUORESCENT 277V (LARGE ONLY)
		-LED LED 2700K 120V
		-LED277 LED 2700K 277V



ANTIQUe BRONZE, LARGE



SATIN NICKEL, SMALL

FLUID ROUND



The Fluid is created by pouring molten glass into a contoured mold, letting it cool, and then fire-polishing it to a glossy finish. It gives the impression of flowing water frozen in time. The unique and elegant look of the piece changes at every angle based on how light hits the surface of the glass, may be mounted on the ceiling or wall. Large incandescent includes two 120 volt, 40 watt G9 base halogen lamps; small incandescent includes one 120 volt 40 watt G9 base halogen lamp; large fluorescent includes two 13 watt 2GX7 base twin tube compact fluorescent and electronic ballast. Large LED includes two 10 watt, 750 lumen, 2700K LED modules. Small LED includes one 10 watt, 750 lumen, 2700K LED module. Incandescent version dimmable with standard incandescent dimmer. LED version dimmable with low-voltage electronic dimmer. Ceiling mount suitable for wet locations. ADA compliant.

PRODUCT DIMENSIONS

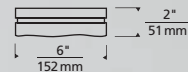

SMALL

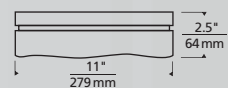

LARGE

700FMFLDR

SIZE	FINISH	LAMP
S SMALL	Z ANTIQUe BRONZE	-INCANDESCENT 120V
L LARGE	C CHROME	-CF COMPACT FLUORESCENT 120V (LARGE ONLY)
	S SATIN NICKEL	-CF277 COMPACT FLUORESCENT 277V (LARGE ONLY)
		-LED LED 2700K 120V
		-LED277 LED 2700K 277V



SATIN NICKEL, LARGE



ANTIQUE BRONZE, SMALL

90



Square shaped glass shade mounts flush to plated formed base. Provides general light. Available in two lamp configurations; incandescent and fluorescent. Large incandescent includes two 120 volt, 40 watt G9 base halogen lamps; large fluorescent includes two 13 watt 2GX7 base twin tube lamps and electronic ballast; small incandescent includes one 120 volt, 40 watt G9 base halogen lamp. Incandescent version dimmable with a standard incandescent dimmer. Fluorescent version can be wall mounted. ADA compliant.

700FM90	SIZE	FINISH	LAMP
S	SMALL	Z ANTIQUE BRONZE	INCANDESCENT 120V
L	LARGE	S SATIN NICKEL	-CF COMPACT FLUORESCENT 120V (LARGE ONLY)
			-CF277 COMPACT FLUORESCENT 277V (LARGE ONLY)

PRODUCT DIMENSIONS

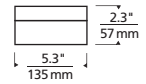

SMALL

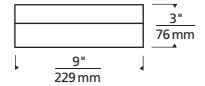

LARGE



ANTIQUE BRONZE, LARGE



SATIN NICKEL, SMALL

360



Round shaped glass shade mounts flush to plated formed base. Provides general light. Available in two lamp configurations; incandescent and fluorescent. Large incandescent includes two 120 volt, 40 watt G9 base halogen lamps; large fluorescent includes two 13 watt 2GX7 base twin tube lamps and electronic ballast; small incandescent includes one 120 volt, 40 watt G9 base halogen lamp. Incandescent version dimmable with a standard incandescent dimmer. Fluorescent version can be wall mounted. ADA compliant.

700FM360	SIZE	FINISH	LAMP
S	SMALL	Z ANTIQUE BRONZE	INCANDESCENT 120V
L	LARGE	S SATIN NICKEL	-CF COMPACT FLUORESCENT 120V (LARGE ONLY)
			-CF277 COMPACT FLUORESCENT 277V (LARGE ONLY)

PRODUCT DIMENSIONS

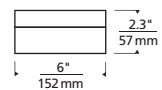

SMALL

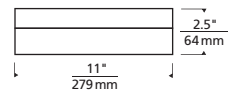

LARGE



WHITE, SMALL



DESERT CLAY, LARGE

CHAMBERS CEILING



Square fabric flush mount. Glass diffuser provides a glare free wash of light highlighted with satin nickel detail. Available in two sizes and two lamp configurations. Small version includes two or equivalent A19 medium base lamps or two 18 watt GX24Q-2 base triple tube compact fluorescent lamps. Large version includes four 60 watt or equivalent A19 medium base lamps or four 18 watt GX24Q-2 base triple tube compact fluorescent lamps.

700TDCHAFM	SIZE	COLOR	FINISH	LAMP
	S SMALL	C DESERT CLAY	S SATIN NICKEL	INCANDESCENT 120V
	L LARGE	W WHITE		-CF COMPACT FLUORESCENT 120V
				-CF277 COMPACT FLUORESCENT 277V

PRODUCT DIMENSIONS

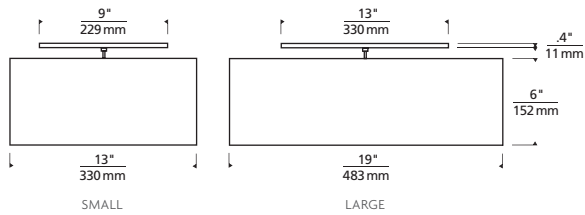

MULBERRY CEILING



Round fabric flush mount. Glass diffuser provides a glare free wash of light highlighted with satin nickel detail. Available in two sizes and two lamp configurations. Small version includes two or equivalent A19 medium base lamps or two 18 watt GX24Q-2 base triple tube compact fluorescent lamps. Large version includes four 60 watt or equivalent A19 medium base lamps or four 18 watt GX24Q-2 base triple tube compact fluorescent lamps.

700TDMULFM	SIZE	COLOR	FINISH	LAMP
	S SMALL	C DESERT CLAY	S SATIN NICKEL	INCANDESCENT 120V
	L LARGE	W WHITE		-CF COMPACT FLUORESCENT 120V
				-CF277 COMPACT FLUORESCENT 277V

PRODUCT DIMENSIONS

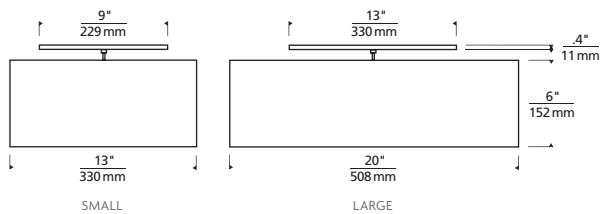

DESERT CLAY, SMALL



WHITE, LARGE

COMPLEMENTARY PRODUCT
LOW-VOLTAGE PENDANT P. 122 / LINE-VOLTAGE PENDANT P. 292

SEE P. 28 FOR ADDITIONAL APPLICATION PHOTO





BLACK FABRIC



IVORY FABRIC



METAL



WHITE FABRIC

BAXTER



Round flush mount with a tailored fabric shade. Two die-cast metal arms add a nice contrast. A glass diffuser provides a glare free wash of light. Includes two 60 watt or equivalent BT15 medium base lamps or two 26 watt GX24Q-3 base quad compact fluorescent lamps (electronic ballast included). Incandescent version dimmable with standard incandescent dimmer.

PRODUCT DIMENSIONS

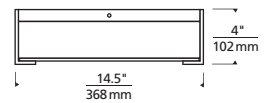

700FMBXT	COLOR	FINISH	LAMP
FB	BLACK FABRIC	Z ANTIQUE BRONZE	INCANDESCENT 120V
FI	IVORY FABRIC	S SATIN NICKEL	-CF COMPACT FLUORESCENT 120V
FW	WHITE FABRIC		-CF277 COMPACT FLUORESCENT 277V
MT	METAL		



BLACK FABRIC



IVORY FABRIC



METAL



WHITE FABRIC

PROVINCE



CF

Square flush mount with a tailored fabric shade. Two die-cast metal arms add a nice contrast. A glass diffuser provides a glare free wash of light. Includes two 60 watt or equivalent BT15 medium base lamps or two 26 watt GX24Q-3 base quad compact fluorescent lamps (electronic ballast included). Incandescent version dimmable with standard incandescent dimmer.

PRODUCT DIMENSIONS

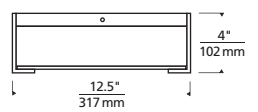

700FMPRV

COLOR	FINISH	LAMP
FB BLACK FABRIC	Z ANTIQUE BRONZE	INCANDESCENT 120V
FI IVORY FABRIC	S SATIN NICKEL	-CF COMPACT FLUORESCENT 120V
FW WHITE FABRIC		-CF277 COMPACT FLUORESCENT 277V
MT METAL		



HEATHER GRAY WITH WALNUT TRIM



WHITE WITH MAPLE TRIM

TOPO FLUSH MOUNT



This modern drum shade is elevated to a richer, warmer dimension with a sophisticated combination of fabric and wood. The bands of wood trim are spline joined around the circumference of the shade, a delicate feat of quality craftsmanship. Includes four 120 volt, 60 watt or equivalent medium base A19 lamps or four 18 watt GX24Q-2 base triple tube compact fluorescent lamps (electronic ballast included). Incandescent version dimmable with standard incandescent dimmer.

700FMTPO	SHADE COLOR	TRIM	FINISH	LAMP			
Y	HEATHER GRAY	M	MAPLE	Z	ANTIQUE BRONZE	INCANDESCENT 120V	
W	WHITE	W	WALNUT	N	POLISHED NICKEL	-CF	COMPACT FLUORESCENT 120V
				S	SATIN NICKEL	-CF277	COMPACT FLUORESCENT 277V

PRODUCT DIMENSIONS

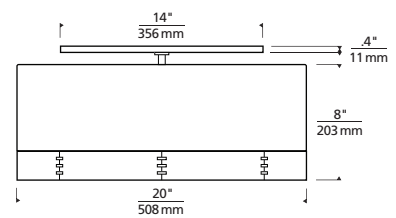

COMPLEMENTARY PRODUCT
LOW-VOLTAGE PENDANT P. 80 / SUSPENSION P. 228





TRACE SEMI-FLUSH MOUNT



CF



Streams of glass piping formed into a graceful glass bowl and highlighted with metal details. Creates an unmistakable sparkle in any space. Large incandescent includes four 120 volt, 60 watt or equivalent clear A19 medium base lamps. Small incandescent includes two 120 volt, 60 watt or equivalent clear A19 medium base lamps. Large fluorescent includes four 18 watt GU24 base self-ballasted compact fluorescent lamps. Small fluorescent includes two 18 watt GU24 base self-ballasted lamps. Incandescent version dimmable with standard incandescent dimmer.

PRODUCT DIMENSIONS

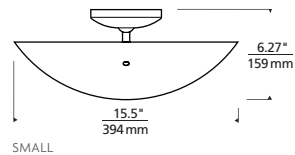
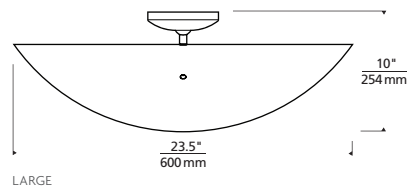

700FMTRAS

SIZE	COLOR	FINISH	LAMP
LARGE (23" DIAMETER)	C CRYSTAL	Z ANTIQUE BRONZE	INCANDESCENT 120V
S SMALL (16" DIAMETER)	S SATIN NICKEL	-CF	COMPACT FLUORESCENT 120V

COMPLEMENTARY PRODUCT
SUSPENSION P. 309



FLUSH & SEMI-FLUSH MOUNT



ANTIQUÉ BRONZE



POLISHED NICKEL

TAVERN CEILING



Traditional schoolhouse-style glass shade. Incandescent includes 120 volt 100 watt or equivalent medium base, A19 lamp; fluorescent includes 26 watt GX24Q-3 base, triple tube lamp and electronic ballast. Fluorescent may also be lamped with 32 watt GX24Q-3 base, triple tube lamp. Incandescent version dimmable with standard incandescent dimmer.

600TVRC	COLOR	FINISH	LAMP
	W WHITE	Z ANTIQUÉ BRONZE N POLISHED NICKEL S SATIN NICKEL	INCANDESCENT 120V -CF COMPACT INCANDESCENT 120V

PRODUCT DIMENSIONS

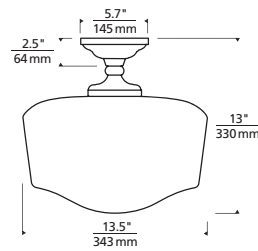

COMPLEMENTARY PRODUCT
LOW-VOLTAGE PENDANT P. 104 / SUSPENSION P. 286



ANTIQUÉ BRONZE



POLISHED NICKEL

MONROE CEILING



Dome-shaped schoolhouse glass shade. Incandescent includes 120 volt 100 watt or equivalent, A19 medium base lamp; fluorescent includes 26 watt GX24Q-3 base, triple tube lamp and electronic ballast. Fluorescent may also be lamped with 32 watt GX24Q-3 base, triple tube lamp. Incandescent version dimmable with standard incandescent dimmer.

600MNRC	COLOR	FINISH	LAMP
	W WHITE	Z ANTIQUÉ BRONZE N POLISHED NICKEL S SATIN NICKEL	INCANDESCENT 120V -CF COMPACT FLUORESCENT 120V

PRODUCT DIMENSIONS

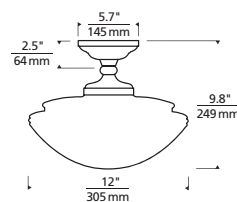

COMPLEMENTARY PRODUCT
SUSPENSION P. 284



CLEAR WITH ANTIQUE BRONZE



CLEAR WITH POLISHED NICKEL



HAVANA BROWN WITH ANTIQUE BRONZE



WHITE WITH ANTIQUE BRONZE

CLARK CEILING



CF

Classic cylinder in either clear, havana brown, or white glass. Incandescent includes 120 volt 40 watt or equivalent medium base Classic Edison Style lamp; fluorescent includes 18 watt GX24Q-2 base, triple tube lamp and electronic ballast. Incandescent version dimmable with standard incandescent dimmer.

600CLKC	COLOR	FINISH	LAMP
C	CLEAR	Z ANTIQUE BRONZE	INCANDESCENT 120V
B	HAVANA BROWN	N POLISHED NICKEL	-CF COMPACT FLUORESCENT 120V*
W	WHITE	S SATIN NICKEL	

COMPLEMENTARY PRODUCT
LINE-VOLTAGE PENDANT P. 258

* WHITE GLASS ONLY

PRODUCT DIMENSIONS

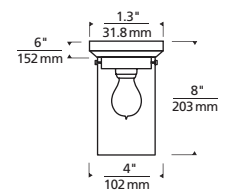



WALL COLLECTION



WALL COLLECTION



ENSU
(SHOWN WITH ALINA PENDANT)



ENSU
(SHOWN WITH LIZA PENDANT)



ENSU
(SHOWN WITH CROSSROADS PENDANT)

TURN VIRTUALLY ANY TECH LIGHTING LOW-VOLTAGE FREEJACK PENDANT INTO A WALL SCONCE



ENSU



P. 580

Turn virtually any Tech Lighting low-voltage FreeJack pendant (P. 52-153) into a wall sconce. The integrated telescoping arm accommodates any pendant under 7.5 inches in diameter. The EnsU wall canopy can mount to either a 4" square electrical box with round plaster ring or an octagonal electrical box (not included). Includes low-voltage electronic transformer.

PRODUCT DIMENSIONS

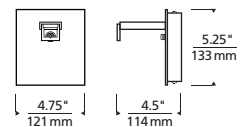

700WSENSU	FINISH	LAMP
Z	ANTIQUÉ BRONZE	HALOGEN 120V
C	CHROME	-277 HALOGEN 277V
S	SATIN NICKEL	-LED LED 2700K 120V
		-LED277 LED 2700K 277V





WHITE
THREE-QUARTER VIEW



BLACK
WITH SATIN NICKEL

KATANA



F
P. 580



Named after the Japanese word for “sword,” the Katana features a thin, front blade which encases a sleek, 6-watt LED package directing light toward the back plate with its matte, rubberized insert to diffuse the light. Continuing the Japanese influence of minimalistic ornamentation and clean lines, the silhouette adds unique drama to any space. The LED-centric design would be impossible to duplicate with traditional lamping. Mounts up only. Includes 6 watt, 275 lumen, 3000K linear LED. Dimmable with low-voltage electronic dimmer. ADA compliant.

PRODUCT DIMENSIONS

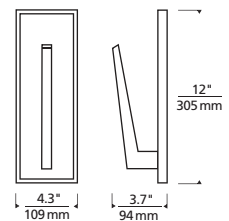

700WSKTNA	COLOR	FINISH	LAMP
B	BLACK	S	SATIN NICKEL
W	WHITE	W	WHITE
		-LED	LED 3000K 120V
		-LED277	LED 3000K 277V



SMOKE GLASS
FRONT VIEW

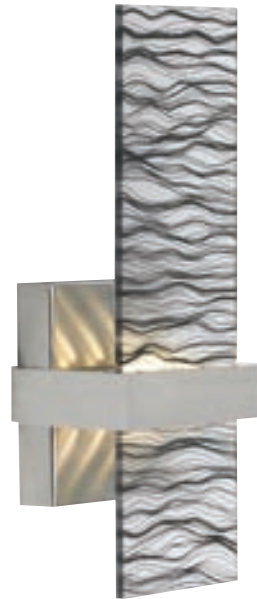

VERITAS SATIN BLACK WAVE
THREE-QUARTER VIEW



FROST GLASS
THREE-QUARTER VIEW



SMOKE GLASS
THREE-QUARTER VIEW

MURA



H
P. 580



The small nature of the LED source allows the hand-carved glass or Veritas® ResinArt™ panel (made from 40% recycled content) to take center stage. The organic pattern of waves across the panels is inspired by the flow of a river. Mounts up only. Includes 8 watts of 3000K (400 lumen) LED. Dimmable with low-voltage electronic dimmer. ADA compliant.

700WSMUR

COLOR	FINISH	LAMP
GF FROST GLASS	Z ANTIQUE BRONZE	-LED LED 3000K 120V
GK SMOKE GLASS	S SATIN NICKEL	-LED277 LED 3000K 277V
VB VERITAS SATIN BLACK WAVE		

PRODUCT DIMENSIONS

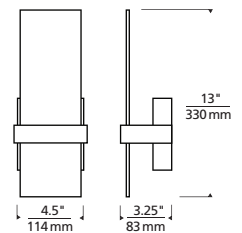



BLACK
WITH BLACK CORD



BLACK
WITH GRAY CORD



BLACK
WITH ORANGE CORD



WHITE
WITH BLACK CORD



WHITE
WITH GRAY CORD



WHITE
WITH ORANGE CORD

PULL SMALL



H
P. 580



Inspired by mid-century modern design, the Pull is both fun and functional with its clean lines and nearly limitless uses. The seamless metal shade is painted in an indulgent rubberized matte finish while the fabric cord adds both a pop of color against the monochromatic shade and also serves as the “pull” to turn the LED lamping on and off. Mounts up only. Includes 8 watt, 400 lumen, 3000K LED module. Dimmable with low-voltage electronic dimmer. ADA compliant.

PRODUCT DIMENSIONS

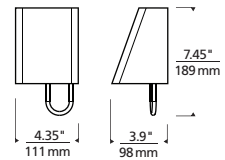

700WSPLSM	CORD COLOR*	FINISH	LAMP
B	BLACK	B BLACK	-LED LED 3000K 120V
Y	GRAY	W WHITE	-LED277 LED 3000K 277V
O	ORANGE		

SEE P. 356 FOR APPLICATION PHOTO

PRODUCT DETAILS*



BLACK
CORD

GRAY
CORD

ORANGE
CORD

* CONTACT FACTORY FOR CUSTOM CORD COLORS

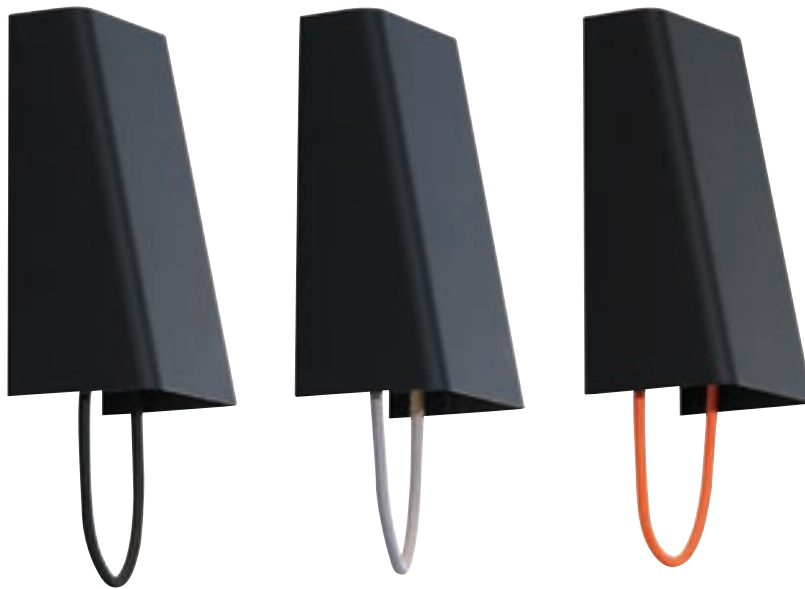

BLACK
WITH BLACK CORD

BLACK
WITH GRAY CORD

BLACK
WITH ORANGE CORD



WHITE
WITH BLACK CORD

WHITE
WITH GRAY CORD

WHITE
WITH ORANGE CORD

PULL LARGE

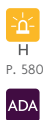

Inspired by mid-century modern design, the Pull is both fun and functional with its clean lines and nearly limitless uses. The seamless metal shade is painted in an indulgent rubberized matte finish while the fabric cord adds both a pop of color against the monochromatic shade and also serves as the “pull” to turn the LED lamping on and off. Mounts up only. Includes 8 watt 400 lumen, 3000K LED module. Dimmable with low-voltage electronic dimmer. ADA compliant.

700WSPLLG	CORD COLOR*	FINISH	LAMP
B	BLACK	B BLACK	-LED LED 3000K 120V
Y	GRAY	W WHITE	-LED277 LED 3000K 277V
O	ORANGE		

PRODUCT DETAILS*



BLACK
CORD

GRAY
CORD

ORANGE
CORD

* CONTACT FACTORY FOR CUSTOM CORD COLORS

PRODUCT DIMENSIONS

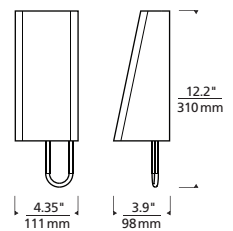



GLOSS WHITE, NO TRIM
THREE-QUARTER VIEW

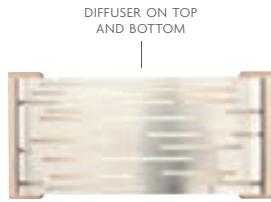

SATIN NICKEL WITH MAPLE WOOD



GLOSS BLACK, NO TRIM

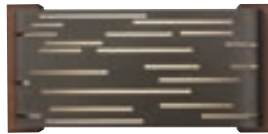

ANTIQUE BRONZE WITH WALNUT WOOD

DIFFUSER ON TOP
AND BOTTOM

REVEL



P. 580



Captures light in motion. The sleek metal surface is laser-cut with several horizontal slots which allows light to shine through the inner white acrylic diffuser. The diffuser wraps around the inner top and bottom to conceal the hardware and lamping when viewed from any angle – above and below or if mounted vertically, both sides. Optional wood end caps complement the design with a touch of warmth in an unexpected way. May be mounted horizontally or vertically. Includes two 13 watt 2GX7 base twin tube compact fluorescent lamps (electronic ballast included) or one 10 watt, 750 lumen, 2700K LED module. LED version dimmable with low-voltage electronic dimmer. ADA compliant.

700WSRVL		SHADE COLOR	TRIM COLOR	LAMP	
Z	ANTIQU BRONZE	M	MAPLE WOOD	-CF	FLUORESCENT 120V
B	GLOSS BLACK	W	WALNUT WOOD	-CF277	FLUORESCENT 277V
W	GLOSS WHITE	T	NO TRIM	-LED	LED 2700K 120V
S	SATIN NICKEL			-LED277	LED 2700K 277V

PRODUCT DIMENSIONS

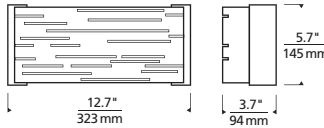

OPTIONAL END CAP FINISHES



COMPLEMENTARY PRODUCT
LOW-VOLTAGE PENDANT P. 57 / LINEAR SUSPENSION P. 330

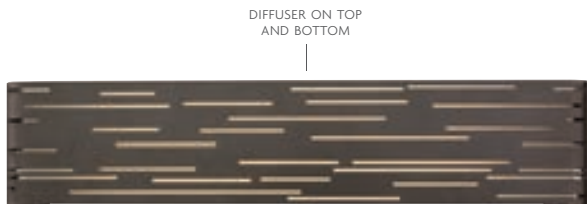

ANTIQU BRONZE, NO TRIM



GLOSS BLACK WITH WALNUT WOOD



SATIN NICKEL WITH WALNUT WOOD



GLOSS WHITE WITH MAPLE WOOD

DIFFUSER ON TOP
AND BOTTOM

REVEL LINEAR



P. 580



Captures light in motion. The sleek metal surface is laser-cut with several horizontal slots which allows light to shine through the inner white acrylic diffuser. The diffuser wraps around the inner top and bottom to conceal the hardware and lamping when viewed from any angle – above and below or if mounted vertically, both sides. Optional wood end caps complement the design with a touch of warmth in an unexpected way. May be mounted horizontally or vertically. Includes two 14 watt high output T5 linear fluorescent lamps (electronic ballast included), for two 24 watt high output lamps contact the factory, or 18.5 watt, 1300 lumen, 2700K LED strip. LED version dimmable with low-voltage electronic dimmer. ADA compliant.

700WSRVLL		SHADE COLOR	TRIM COLOR	LAMP	
Z	ANTIQU BRONZE	M	MAPLE WOOD	-CF	FLUORESCENT 120V
B	GLOSS BLACK	W	WALNUT WOOD	-CF277	FLUORESCENT 277V
W	GLOSS WHITE	T	NO TRIM	-LED	LED 2700K 120V
S	SATIN NICKEL			-LED277	LED 2700K 277V

PRODUCT DIMENSIONS

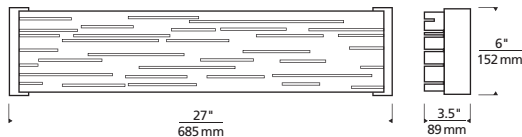

OPTIONAL END CAP FINISHES



MAPLE WOOD WALNUT WOOD

COMPLEMENTARY PRODUCT
LOW-VOLTAGE PENDANT P. 57 / LINEAR SUSPENSION P. 330





THREE-QUARTER VIEW

CROSSROADS



H

P. 580



Inspired by the sheen of big city streets and intersections illuminated at night. Composed of raw sheet steel protected with a clear lacquer coat and accented by brass spot welding at the joints, it has a purposefully imperfect, rugged, industrial design. Mounts horizontally only. Includes two 120 volt, 40 watt G9 base halogen bi-pin lamps or 10 watt, 500 lumen, 3000K LED module. Halogen may also be lamped with two 60 watt G9 base halogen bi-pin lamps. Halogen version dimmable with standard incandescent dimmer. LED version dimmable with low-voltage electronic dimmer. ADA compliant.

PRODUCT DIMENSIONS

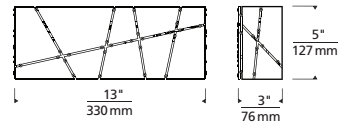

700WSCRS	FINISH	LAMP
S	STEEL	HALOGEN 120V LED 3000K 120V
		-LED -LED277 LED 3000K 277V

COMPLEMENTARY PRODUCT
LOW-VOLTAGE PENDANT P. 66 / LINEAR SUSPENSION P. 332



KINZE



The flowing texture of the die-cast aluminum end caps and soft edges of the rounded hand-blown glass bring tranquility to the design. A top and bottom glass diffuser completes the look and prevents seeing the internal components from above or below. Mounts horizontally only. Includes 120 volt, 40 watt G9 base halogen bi-pin lamp or 10 watt, 750 lumen, 2700K field-replaceable LED module. Halogen version dimmable with standard incandescent dimmer. LED version dimmable with low-voltage electronic dimmer. ADA compliant.

PRODUCT DIMENSIONS

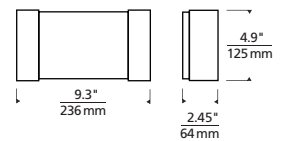

700WSKNZE	COLOR	FINISH	LAMP
W	WHITE	C CHROME	HALOGEN 120V
		M GUNMETAL	-LED LED 2700K 120V
		S SATIN NICKEL	-LED277 LED 2700K 277V

COMPLEMENTARY PRODUCT
BATH P. 414



STEEL BLUE
THREE-QUARTER VIEW

JAXON



P. 580



Slumped transparent glass over inner glass diffuser provides a modern, sophisticated look that is both simple and elegant. Includes 120 volt, 75 watt or equivalent T8 medium base lamp, 18 watt 2G11 base twin tube compact fluorescent lamp or two 10 watt, 750 lumen, 2700K LED modules. Incandescent version dimmable with standard incandescent dimmer. LED version dimmable with a low-voltage electronic dimmer. ADA compliant.

700WSJXN

COLOR	FINISH	LAMP
C CLEAR	Z ANTIQUE BRONZE	INCANDESCENT 120V
N HAVANA BROWN	S SATIN NICKEL	-CF COMPACT FLUORESCENT 120V
K SMOKE		-CF277 COMPACT FLUORESCENT 277V
U STEEL BLUE		-LED LED 2700K 120V
		-LED277 LED 2700K 277V

PRODUCT DIMENSIONS

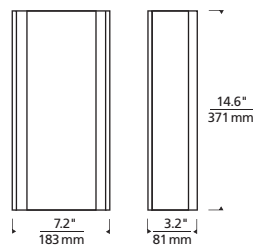

SEE P. 51 FOR APPLICATION PHOTO



CLEAR



HAVANA BROWN



SMOKE

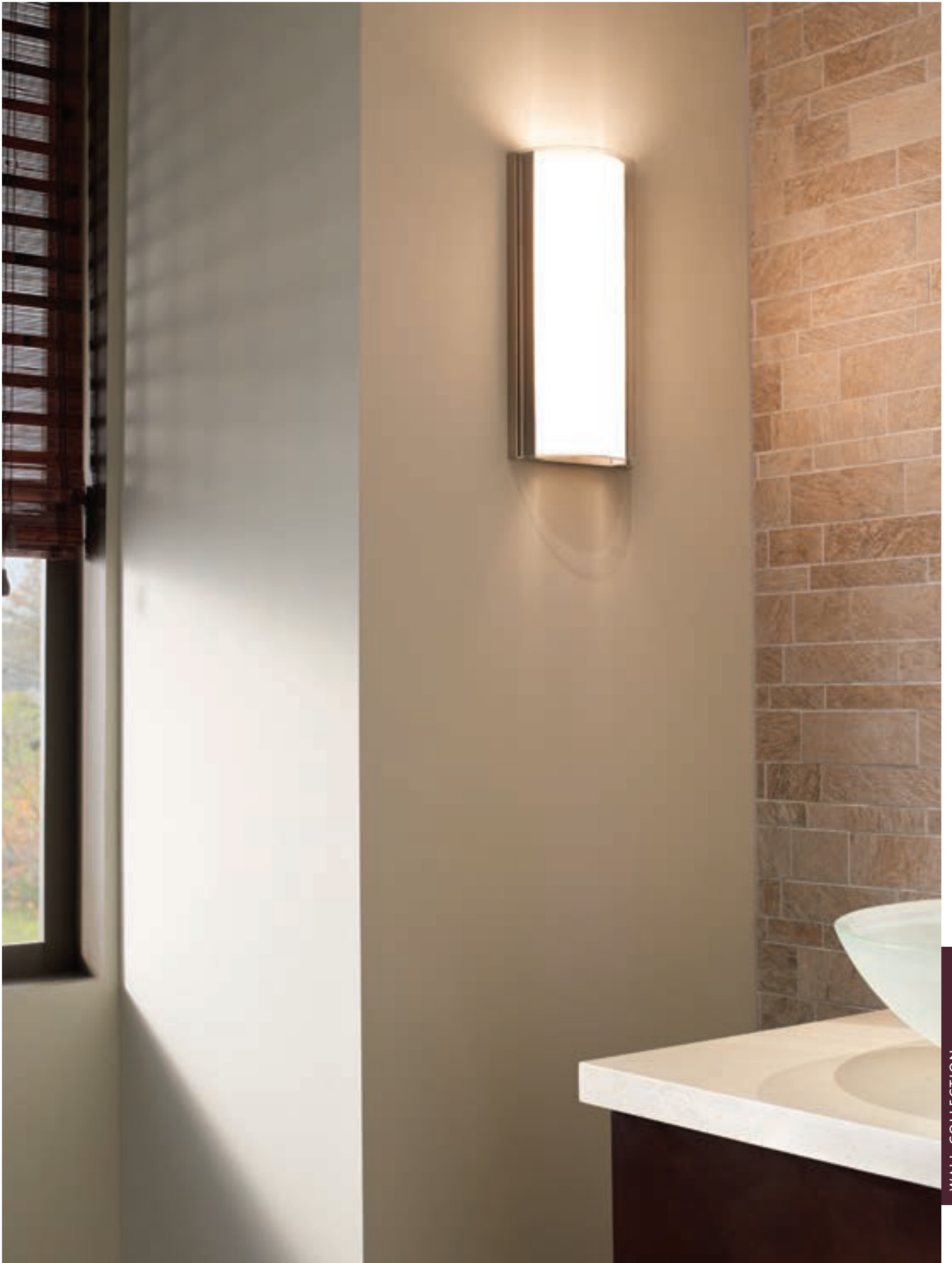



HAVANA BROWN
THREE-QUARTER VIEW

EMBER



Slumped transparent glass surrounds a Classic Edison style lamp for a beautiful and classic warmth. Includes 120 volt, 30 watt or equivalent medium base T9 Classic Edison lamp. Dimmable with standard incandescent dimmer. ADA compliant.

700WSEMB		COLOR	FINISH
C	CLEAR	N	HAVANA BROWN
K	SMOKE	S	SATIN NICKEL
U	STEEL BLUE	Z	ANTIQUE BRONZE

PRODUCT DIMENSIONS

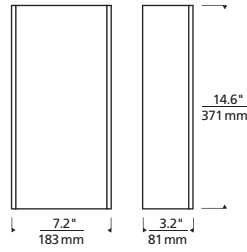

CLEAR



SMOKE



STEEL BLUE



WHITE
THREE-QUARTER VIEW



DESERT CLAY

LEXINGTON



CF



E

P. 580



ADA

Half-cylinder fabric shade with rolled edges and minimal metal base. Includes 120 volt, 60 watt or equivalent medium base BT15 halogen lamp, 2G11 base 18 watt twin tube compact fluorescent lamp (electronic ballast included) or two 10 watt, 750 lumen, 2700K LED modules. Incandescent version dimmable with standard incandescent dimmer. LED version dimmable with low-voltage electronic dimmer. ADA compliant.

700WSLEX

COLOR	FINISH	LAMP
C DESERT CLAY	Z ANTIQUE BRONZE	INCANDESCENT 120V
W WHITE	S SATIN NICKEL	-CF COMPACT FLUORESCENT 120V
		-CF277 COMPACT FLUORESCENT 277V
		-LED LED 2700K 120V
		-LED277 LED 2700K 277V

PRODUCT DIMENSIONS

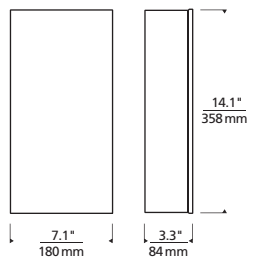

COMPLEMENTARY PRODUCT
LINE-VOLTAGE PENDANT P. 290



SARA



Pure indulgence, the Sara is cut from a solid block of crystal and formed into an elegant cylinder which surrounds a hand-blown inner white glass diffuser and sits atop a die-cast metal base. Instantly elevates any space. Incandescent includes 120 volt, 60 watt or equivalent T10 medium base lamp. Fluorescent includes 120 volt 26 watt GX24Q-3 base triple tube compact fluorescent lamp. May also be lamped with 32 watt GX24Q-3 base triple tube compact fluorescent lamp (not included). Incandescent version dimmable with standard incandescent dimmer.

700WSSAR	COLOR	FINISH	LAMP
C	CLEAR	Z ANTIQUE BRONZE C CHROME S SATIN NICKEL	INCANDESCENT 120V -CF COMPACT FLUORESCENT 120V

PRODUCT DIMENSIONS

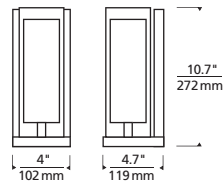

COMPLEMENTARY PRODUCT
LOW-VOLTAGE PENDANT P. 94 / LINE-VOLTAGE PENDANT P. 262 / BATH P. 416



JAYDEN



Pure indulgence, the Jayden is cut from a solid block of crystal and formed into an elegant rectangular prism which surrounds a hand-blown inner white glass diffuser and sits atop a die-cast metal base. Instantly elevates any space. Incandescent includes 120 volt, 60 watt or equivalent T10 medium base lamp. Fluorescent includes 120 volt 26 watt GX24Q-3 base triple tube compact fluorescent lamp. May also be lamped with 32 watt GX24Q-3 base triple tube compact fluorescent lamp (not included). Incandescent version dimmable with standard incandescent dimmer.

700WSJDN	COLOR	FINISH	LAMP
C	CLEAR	Z ANTIQUE BRONZE C CHROME S SATIN NICKEL	INCANDESCENT 120V -CF COMPACT FLUORESCENT 120V

PRODUCT DIMENSIONS

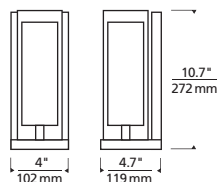

COMPLEMENTARY PRODUCT
LINE-VOLTAGE PENDANT P. 262





WHITE ACRYLIC
THREE-QUARTER VIEW



AMBER FRIT



FROST WHITE



WHITE FRIT

COSMO



CF

Rectilinear glass with metal base. Provides ambient and up-light. Includes two 120 volt, 40 watt mini-candelabra base lamps, 18 watt 2G11 base twin tube compact fluorescent lamp (electronic ballast included), or energy saving



H

P. 580

10 watt, 500 lumen, 3000K LED module. Incandescent version dimmable with standard incandescent dimmer.

LED version dimmable with low-voltage electronic dimmer. ADA compliant.



700WSCOS

COLOR	FINISH	LAMP
A AMBER FRIT	Z ANTIQUE BRONZE	INCANDESCENT 120V
F FROST WHITE	C CHROME	COMPACT FLUORESCENT 120V
Y WHITE ACRYLIC*	S SATIN NICKEL	-CF2777 COMPACT FLUORESCENT 277V
W WHITE FRIT		-LED LED 3000K 120V
		-LED2777 LED 3000K 277V

PRODUCT DIMENSIONS

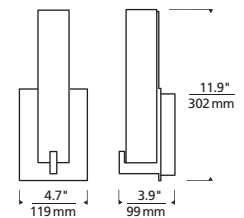

COMPLEMENTARY PRODUCT
BATH P. 420, 422

SEE PP. 341, 423 FOR ADDITIONAL APPLICATION PHOTOS

* WHITE ACRYLIC NOT AVAILABLE WITH INCANDESCENT LAMP



Photographer: Mark O'Tyson



LINDEN



Nineteenth century, neoclassical-inspired cast metal base with elegant blown glass cylinder. Incandescent includes 120 volt 40 watt or equivalent medium base, T10 lamp; fluorescent includes 18 watt 2G11 base, twin tube lamp and electronic ballast. Incandescent version dimmable with standard incandescent dimmer. Both versions feature integrated on / off switch.

600LNDW	COLOR	FINISH	LAMP
F	FROST	Z ANTIQUE BRONZE	INCANDESCENT 120V
W	WHITE FRIT	N POLISHED NICKEL	-CF COMPACT FLUORESCENT 120V
		S SATIN NICKEL	

PRODUCT DIMENSIONS

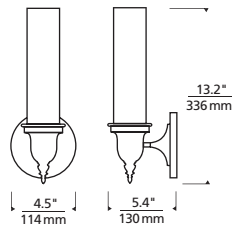

COMPLEMENTARY PRODUCT
BATH P. 418



LASALLE



Classically-styled solid brass wall sconce offered with Polished Nickel Finish. Incandescent includes 120 volt 75 watt medium base lamp; fluorescent includes 26 watt GX24Q-3 base, triple tube lamp and electronic ballast. Both versions feature integrated on / off switch.

600LASW	COLOR	FINISH	LAMP
CW	CLEAR / WHITE	N POLISHED NICKEL	INCANDESCENT 120V
			-CF COMPACT FLUORESCENT 120V

PRODUCT DIMENSIONS

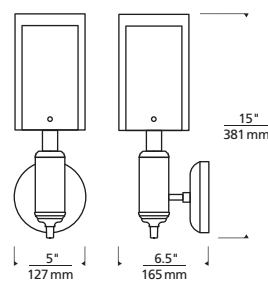





AMBER



AQUAMARINE



CLEAR



HAVANA BROWN



SMOKE



STEEL BLUE

ECHO



CF



Vivid glass shade over white case glass inner cylinder suspended from a round base and highlighted with three satin nickel cylinder details. Provides ambient, up- and down-light. Includes 120 volt, 75 watt or equivalent A19 medium base lamp or 18 watt GU24 base self-ballasted compact fluorescent lamp. Incandescent version dimmable with standard incandescent dimmer.

PRODUCT DIMENSIONS

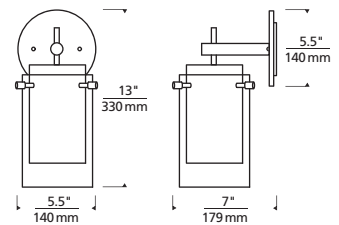

700TDECS	COLOR	FINISH	LAMP
A	AMBER	S SATIN NICKEL	INCANDESCENT 120V
Q	AQUAMARINE		
C	CLEAR		-CF COMPACT FLUORESCENT 120V
B	HAVANA BROWN		
S	SMOKE		
U	STEEL BLUE		

COMPLEMENTARY PRODUCT
LOW-VOLTAGE PENDANT P. 86 / LINE-VOLTAGE PENDANTS PP. 252, 254





BROWN
THREE-QUARTER VIEW



NATURAL
THREE-QUARTER VIEW



WHITE
THREE-QUARTER VIEW

PLAYA



Elegant multi-toned shade comprised of natural shell panels with die-cast base. Provides ambient, up- and down-light. Includes 120 volt, 60 watt or equivalent A19 medium base lamp or 18 watt GU24 base self-ballasted compact fluorescent lamp. Incandescent version dimmable with standard incandescent dimmer.

700WSPLA		COLOR	FINISH	LAMP
B	BROWN	Z	ANTIQUE BRONZE	INCANDESCENT 120V
N	NATURAL	C	CHROME	-CF COMPACT FLUORESCENT 120V
W	WHITE	S	SATIN NICKEL	

PRODUCT DIMENSIONS

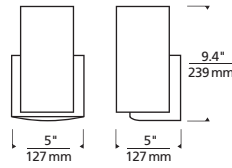

COMPLEMENTARY PRODUCT
LOW-VOLTAGE PENDANT P. 88 / LINE-VOLTAGE PENDANT P. 270



WHITE
THREE-QUARTER VIEW

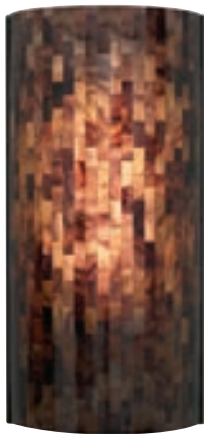

BROWN



NATURAL

PLAYA FLUSH



P. 580



Elegant multi-toned shade comprised of natural shell panels with a minimal metal base. Mounts vertically only. Includes 120 volt, 75 watt or equivalent medium base T8 lamp, 2G11 base 18 watt twin tube compact fluorescent lamp (electronic ballast included) or two 10 watt, 750 lumen, 2700K LED modules. Incandescent version dimmable with standard incandescent dimmer. LED version dimmable with low-voltage electronic dimmer. ADA compliant.

700WSPLAF		COLOR	FINISH	LAMP
B	BROWN	Z	ANTIQUE BRONZE	INCANDESCENT 120V
N	NATURAL	S	SATIN NICKEL	-CF COMPACT FLUORESCENT 120V
W	WHITE			-CF277 COMPACT FLUORESCENT 277V
				-LED LED 2700K 120V
				-LED277 LED 2700K 277V

PRODUCT DIMENSIONS

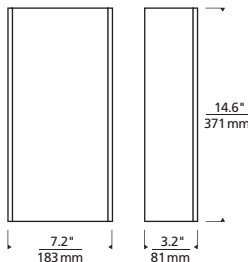

COMPLEMENTARY PRODUCT
LOW-VOLTAGE PENDANT P. 88 / LINE-VOLTAGE PENDANT P. 270

SEE P. 30 FOR APPLICATION PHOTO



GLASS

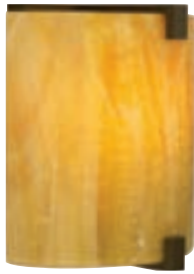

SAND GLASS
THREE-QUARTER VIEW



BEACH AMBER GLASS



IVORY / BROWN / AMBER GLASS



SURF WHITE GLASS

STARSHINE® GLASS*



WHEAT
THREE-QUARTER VIEW



CLEAR

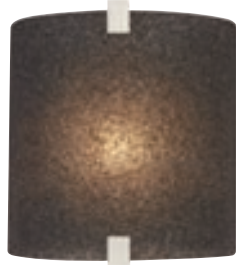

SMOKE

FABRIC



DESERT CLAY FABRIC



WHITE FABRIC

SHELL



BROWN



NATURAL



WHITE

* Starshine® out of Plattling, Germany, is internationally recognized as a producer of revolutionary glass surfaces. We use their patented Starshine® face technology where they sinter colored glass granulates onto a glass panel at a temperature of 700°C. The effect is beautiful diffusion of the light source and illumination of the glass surface.

ESSEX



P. 580



Glass, shell or fabric shade options with minimal metal detail. Provides ambient, up- and down-light. Includes 120 volt, 60 watt G9 base halogen lamp, 120 volt 18 watt GU24 base self-ballasted compact fluorescent lamp or 10 watt, 750 lumen, 2700K LED module. Incandescent version dimmable with standard incandescent dimmer. LED version dimmable with low-voltage electronic dimmer. ADA compliant.

700WSESX

COLOR	FINISH	LAMP
GLASS		
GA BEACH AMBER	Z ANTIQUE BRONZE	INCANDESCENT 120V
IBA IVORY / BROWN / AMBER	C CHROME	-CF COMPACT FLUORESCENT 120V
GS SAND	S SATIN NICKEL	-LED LED 2700K 120V
GW SURF WHITE		-LED277 LED 2700K 277V
STARSHINE GLASS		
SC CLEAR		
SK SMOKE		
SH WHEAT		
FABRIC		
FC DESERT CLAY		
FW WHITE		
SHELL		
PB BROWN		
PN NATURAL		
PW WHITE		

PRODUCT DIMENSIONS

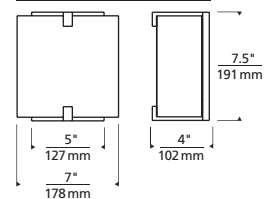

COMPLEMENTARY PRODUCT
LOW-VOLTAGE PENDANT P. 88, 124 /
LINE-VOLTAGE PENDANT P. 270



WHITE
THREE-QUARTER VIEW



BROWN



LATTE

VEIL



CF



Crushed glass textured, cylindrical shade with inner layer of gold or silver mounted on a die-cast metal base. Incandescent includes 120 volt, 60 watt or equivalent medium base BT15 lamp. Fluorescent includes 120 volt 18 watt GU24 base self-ballasted compact fluorescent lamp. May also be lamped with 27 watt GU24 base self-ballasted compact fluorescent lamp (not included). Incandescent version dimmable with standard incandescent dimmer.

700WSVEI	COLOR	FINISH	LAMP
N	BROWN	Z ANTIQUE BRONZE	INCANDESCENT 120V
L	LATTE	C CHROME	-CF COMPACT FLUORESCENT 120V
W	WHITE	S SATIN NICKEL	

PRODUCT DIMENSIONS

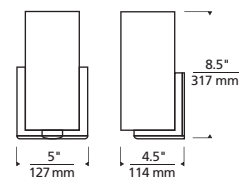

COMPLEMENTARY PRODUCT
LOW-VOLTAGE PENDANT P. 90 / LINE-VOLTAGE PENDANT P. 273



BEACH AMBER
THREE-QUARTER VIEW



SAND



SURF WHITE

MINI LARKSPUR



Cone shaped, slumped glass shade, rich with color and pattern. Provides ambient up-light. Includes 120 volt, 40 watt G9 bi-pin lamp, 13 watt 2GX7 base twin tube compact fluorescent lamp (electronic ballast included) or 10 watt, 750 lumen, 2700K LED module. Incandescent version dimmable with standard incandescent dimmer. LED version dimmable with low-voltage electronic dimmer. ADA compliant.

700WSLRKS

COLOR	FINISH	LAMP
A BEACH AMBER	Z ANTIQUE BRONZE	INCANDSCENT 120V
S SAND	C CHROME	-CF COMPACT FLUORESCENT 120V
W SURF WHITE	S SATIN NICKEL	-LED LED 2700K 120V
		-LED277 LED 2700K 277V

PRODUCT DIMENSIONS

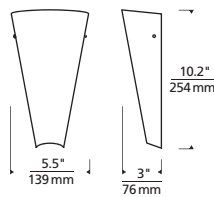

PRODUCT DETAILS



COMPLEMENTARY PRODUCT
LOW-VOLTAGE PENDANT P. 126 / LINE-VOLTAGE PENDANT P. 274 / SUSPENSION P. 311



SURF WHITE
THREE-QUARTER VIEW



BEACH AMBER



SAND

LARKSPUR



Cone shaped, slumped glass shade, rich with color and pattern. Provides ambient, up- and down-light. Includes 120 volt, 75 watt or equivalent T8 medium base lamp, 36 watt 2G11 base twin tube compact fluorescent lamp (electronic ballast included) or two 10 watt, 750 lumen, 2700K LED modules. Incandescent version dimmable with standard incandescent dimmer. LED version dimmable with low-voltage electronic dimmer. ADA compliant.

700TDLRKS

COLOR	FINISH	LAMP
A BEACH AMBER	Z ANTIQUE BRONZE	INCANDSCENT 120V
S SAND	S SATIN NICKEL	-CF COMPACT FLUORESCENT 120V
W SURF WHITE		-LED LED 2700K 120V
		-LED277 LED 2700K 277V

PRODUCT DIMENSIONS

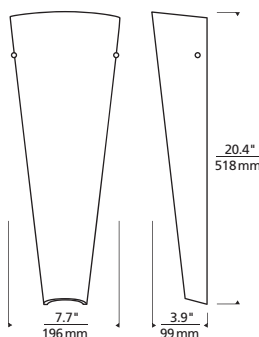

COMPLEMENTARY PRODUCT
LOW-VOLTAGE PENDANT P. 126 / LINE-VOLTAGE PENDANT P. 274 / SUSPENSION P. 311





BROWN
THREE-QUARTER VIEW



AMBER



WHITE

NEBBIA



Hand-blown glass with an elegantly fused glass wrap and a metal base. Incandescent includes 120 volt, 40 watt G9 base halogen lamp. Incandescent may also use 120 volt, 60 watt G9 base halogen lamp (not included). Fluorescent includes 120 volt, 18 watt GU24 base self-ballasted compact fluorescent lamp. Fluorescent may also use 120 volt, 27 watt GU24 base self-ballasted compact fluorescent lamp (not included). Incandescent version dimmable with standard incandescent dimmer.

700WSNEB

COLOR	FINISH	LAMP
A AMBER	Z ANTIQUE BRONZE	INCANDESCENT 120V
N BROWN	S SATIN NICKEL	-CF COMPACT FLUORESCENT 120V
W WHITE		

PRODUCT DIMENSIONS

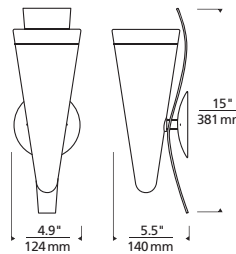

COMPLEMENTARY PRODUCT
LOW-VOLTAGE PENDANT P. 107



TAHOE PINE AMBER
THREE-QUARTER VIEW



TORTOISE SHELL
THREE-QUARTER VIEW

OVATION



Hand pulled glass shade, richly layered in brilliant color, with handmade wrought iron base. Provides ambient and up-light. Includes 120 volt, 100 watt or equivalent A19 medium base lamp or 18 watt GU24 base self-ballasted compact fluorescent lamp. Incandescent version dimmable with standard incandescent dimmer.

700TDOVS

COLOR	FINISH	LAMP
A TAHOE PINE AMBER	Z ANTIQUE BRONZE	INCANDESCENT 120V
T TORTOISE SHELL	B BLACK IRON	-CF COMPACT FLUORESCENT 120V
W WHITE FRIT	S SATIN NICKEL	

PRODUCT DIMENSIONS

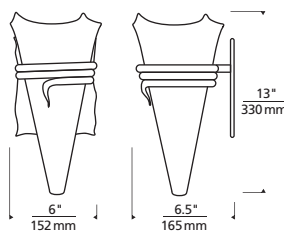

COMPLEMENTARY PRODUCT
LOW-VOLTAGE PENDANT P. 142 / LINE-VOLTAGE PENDANT P. 303



WHITE FRIT
THREE-QUARTER VIEW

Ovation pendant p. 303 with optional Black Iron Wrap accessory p. 568



Photographer: www.peterrymwid.com



CORBEL



Thick outer cast glass is created by pouring molten glass into a mold. Encapsulated bubbles and subtle texture provide visual warmth and interest. Incandescent includes 120 volt, 60 watt or equivalent medium base BT15 halogen lamp. Fluorescent includes 120 volt 18 watt triple-tube compact fluorescent lamp and electronic ballast. Incandescent version dimmable with standard incandescent dimmer.

PRODUCT DIMENSIONS

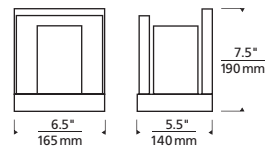

700WSCRBI	COLOR	FINISH	LAMP
A	AMBER	Z ANTIQUE BRONZE	INCANDESCENT 120V
C	CLEAR	S SATIN NICKEL	-CF COMPACT FLUORESCENT 120V
K	SMOKE		



CORBEL CLASSIC

Thick outer cast glass is created by pouring molten glass into a mold. Encapsulated bubbles and subtle texture provide visual warmth and interest. Includes 60 watt or equivalent medium base Classic Edison style lamp. Dimmable with standard incandescent dimmer.

PRODUCT DIMENSIONS

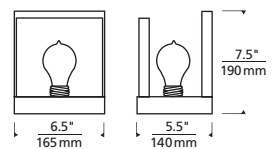

700WSCRBI	COLOR	FINISH
A	AMBER	Z ANTIQUE BRONZE
C	CLEAR	S SATIN NICKEL
K	SMOKE	





WHITE GLASS
THREE-QUARTER VIEW



HONEY ONYX

CABO

Onyx or glass cylinder with die-cast base. Provides ambient and up-light. Mounts up only. Includes transformer and 12 volt, 50 watt halogen bi-pin lamp. Dimmable with standard incandescent dimmer.

700WSCBO		COLOR	FINISH
H	HONEY ONYX	Z	ANTIQUE BRONZE
W	WHITE GLASS	C	CHROME
		S	SATIN NICKEL

PRODUCT DIMENSIONS

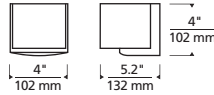

COMPLEMENTARY PRODUCT
LOW-VOLTAGE PENDANT P. 134 /
LINE-VOLTAGE PENDANT P. 296



HONEY ONYX
THREE-QUARTER VIEW



WHITE

CABO GRANDE



Onyx or glass cylinder and die-cast base. Mounts up only. Includes 120 volt, 60 watt G9 base halogen lamp or 120 volt, GU24 base 18 watt self-ballasted compact fluorescent lamp. Incandescent version dimmable with standard incandescent dimmer.

700WSCBOG		COLOR	FINISH	LAMP
H	HONEY ONYX	Z	ANTIQUE BRONZE	INCANDESCENT 120V
W	WHITE GLASS	C	CHROME	-CF COMPACT FLUORESCENT 120V
		S	SATIN NICKEL	

PRODUCT DIMENSIONS

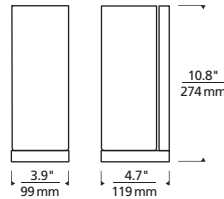

COMPLEMENTARY PRODUCT
LOW-VOLTAGE PENDANT P. 134 /
LINE-VOLTAGE PENDANT P. 296



HONEY ONYX
THREE-QUARTER VIEW



WHITE

CORONADO



E
P. 580



Rectangular onyx or glass shade with metal frame. Provides ambient, up- and down-light. Includes 120 volt, 100 watt R7S base, 118mm double-ended halogen lamp, 18 watt 2G11 base twin tube compact fluorescent lamp (electronic ballast included) or 10 watt, 750 lumen, 2700K LED module. Incandescent version dimmable with standard incandescent dimmer. LED version dimmable with low-voltage electronic dimmer. ADA compliant.

700WSCOR		COLOR	FINISH	LAMP
H	HONEY ONYX	Z	ANTIQUE BRONZE	INCANDESCENT 120V
W	WHITE GLASS	S	SATIN NICKEL	-CF COMPACT FLUORESCENT 120V
				-LED LED 2700K 120V
				-LED277 LED 2700K 277V

PRODUCT DIMENSIONS

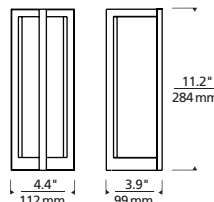

COMPLEMENTARY PRODUCT
LOW-VOLTAGE PENDANT P. 135





FROST
THREE-QUARTER VIEW



AMBER

CUBE



Classic geometric shape made of pressed glass. Die-cast base. Provides ambient and up-light. Includes transformer and 12 volt, 35 watt halogen bi-pin lamp. Dimmable with standard incandescent dimmer. ADA compliant.

700WSCUB

COLOR	FINISH
A AMBER	Z ANTIQUE BRONZE
F FROST	C CHROME
	S SATIN NICKEL

PRODUCT DIMENSIONS

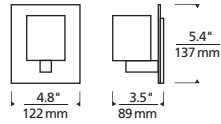

 COMPLEMENTARY PRODUCT
LOW-VOLTAGE PENDANT P. 96



ANTIQU BRONZE,
PATTERN DOWN
THREE-QUARTER VIEW



ANTIQU BRONZE,
PATTERN DOWN
UP LIGHT
DOWN LIGHT

RUE



H
P. 580



This elegantly simple sconce features a minimalist embellishment across the face plate. With light glowing through the diffusers at both ends, it can easily be mounted up, down or horizontally. Includes two 5 watt, 500 lumen, 3000K linear LEDs. Dimmable with low-voltage electronic dimmer. ADA compliant.

700WSRUE

FINISH	LAMP
ZZ ANTIQU BRONZE	-LED LED 3000K 120V
SS SATIN NICKEL	-LED277 LED 3000K 277V

PRODUCT DIMENSIONS

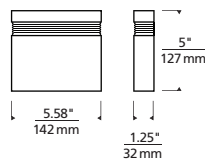

SATIN NICKEL,
PATTERN UP
THREE-QUARTER VIEW





AMBER



CLEAR

FIRE



Amber or clear Murano glass surrounds a small frost interior glass. Die-cast base. Provides ambient and up-light. Includes 120 volt, 60 watt G9 base halogen lamp. Dimmable with standard incandescent dimmer. ADA compliant.

700WSFIR

COLOR	FINISH
A AMBER	Z ANTIQUE BRONZE
CF CLEAR	C CHROME
	S SATIN NICKEL

PRODUCT DIMENSIONS

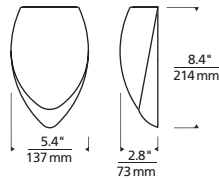

COMPLEMENTARY PRODUCT
LOW-VOLTAGE PENDANT P. 111 / LINE-VOLTAGE PENDANT P. 243



OWL
THREE-QUARTER VIEW

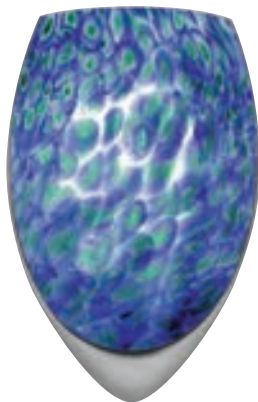

PEACOCK



SWAN

FIREBIRD



Patterned Murano glass surrounds a small frost interior glass. Die-cast base. Provides ambient and up-light. Includes 120 volt, 60 watt G9 base halogen lamp. Dimmable with standard incandescent dimmer. ADA compliant.

700WSFIR

COLOR	FINISH
O OWL	Z ANTIQUE BRONZE
P PEACOCK	C CHROME
S SWAN	S SATIN NICKEL

PRODUCT DIMENSIONS

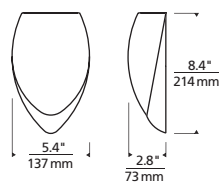

COMPLEMENTARY PRODUCT
LOW-VOLTAGE PENDANT P. 114 / ACCESSORY P. 570

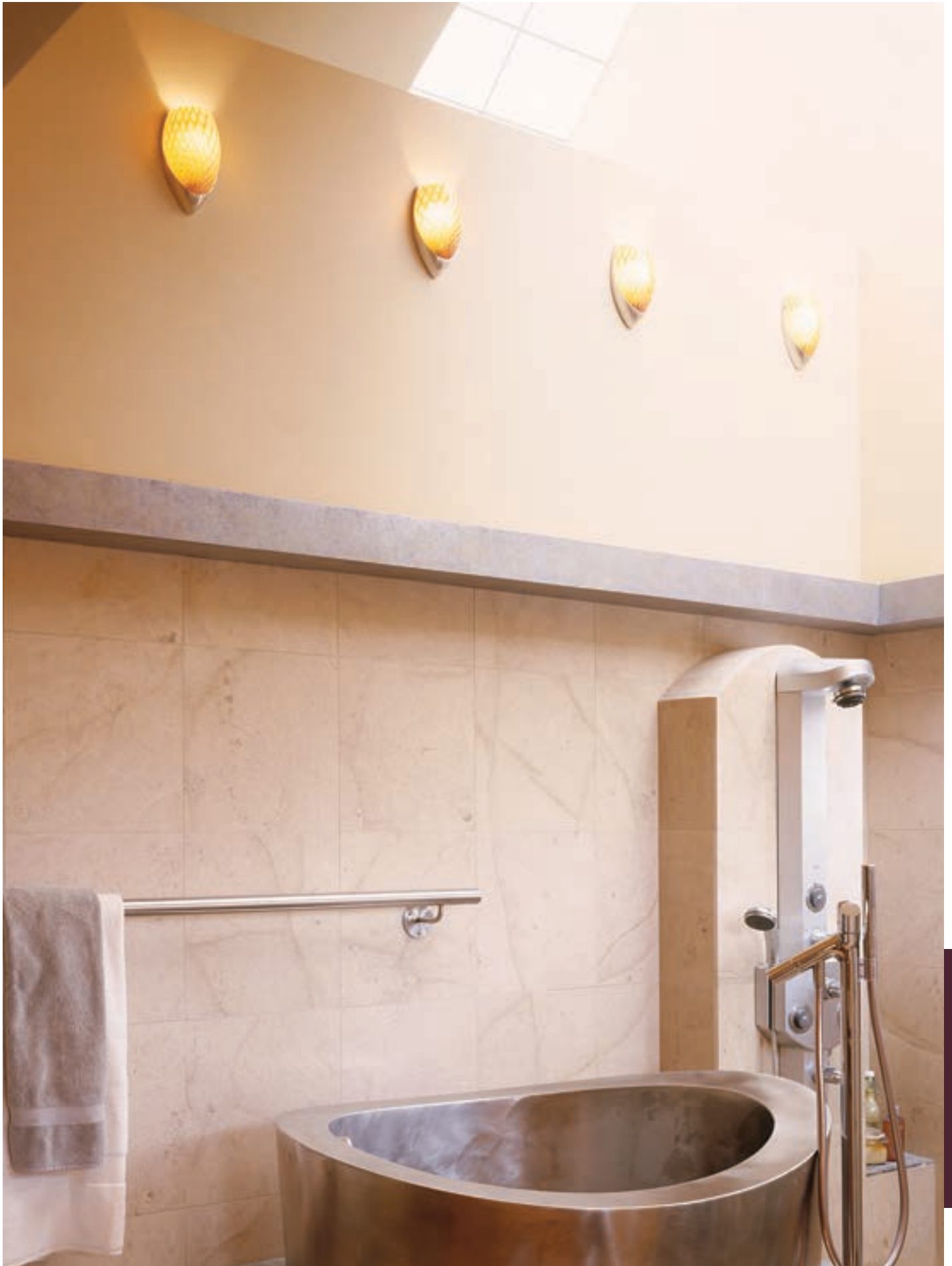

Photographer: Eric Tadsen Design: Bouril Design Studio



STONE FABRIC, SQUARE
THREE-QUARTER VIEW



IVORY FABRIC, SQUARE



CHARCOAL GRAY FELT, ROUND



STONE FABRIC, ROUND

SABLE



Clean, contemporary metal base available with round and square, felt and fabric shade options. Provides ambient and up and down light. Includes 120 volt, 40 watt or equivalent A19 medium base lamp or 120 volt, 18 watt GU24 base self-ballasted compact fluorescent lamp. Incandescent version dimmable with standard incandescent dimmer. Mounts up only.

700WSSBL	SHAPE	COLOR	FINISH	LAMP		
R	ROUND	O	CHARCOAL GRAY FELT	Z	ANTIQUE BRONZE	INCANDESCENT 120V
S	SQUARE	I	IVORY FABRIC	S	SATIN NICKEL	-CF
		S	STONE FABRIC			COMPACT FLUORESCENT 120V

PRODUCT DIMENSIONS

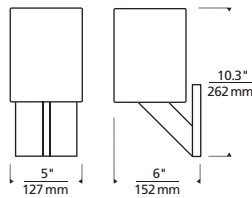

CHELSEA



Simple and sophisticated tailored modern fabric drum sits atop sleek die cast aluminum base with white glass diffuser. Incandescent includes 120 volt, 75 watt or equivalent A19 medium base lamp. Fluorescent includes 120 volt 27 watt GU24 base self-ballasted compact fluorescent lamp. Incandescent version dimmable with standard incandescent dimmer. Mounts up only.

700WSCHL	COLOR	FINISH	LAMP	
B	BLACK	Z	ANTIQUE BRONZE	INCANDESCENT 120V
Y	HEATHER GRAY	N	POLISHED NICKEL	-CF
W	WHITE	S	SATIN NICKEL	COMPACT FLUORESCENT 120V

PRODUCT DIMENSIONS

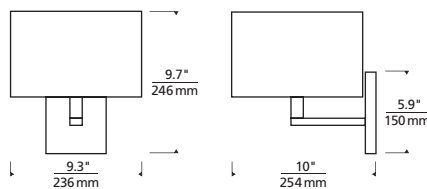

HEATHER GRAY
THREE-QUARTER VIEW



BLACK



WHITE



DRAKE

Die-cast metal base with a well-defined swing arm detail; offered with either Murano wave-patterned glass or fabric shade. Includes 120 volt 75 watt or equivalent medium base, A19 lamp and integral on / off switch; dimmable with standard incandescent dimmer. Suitable for damp locations.

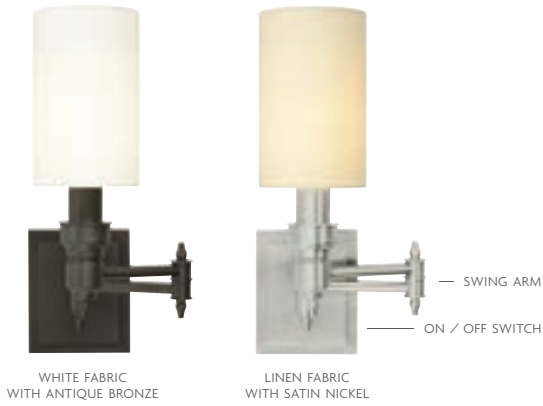

600DRKW

COLOR	FINISH
FABRIC SHADE	Z ANTIQUE BRONZE
FL LINEN	N POLISHED NICKEL
FW WHITE	S SATIN NICKEL
GLASS SHADE	
GL LATTE	
GW WHITE	

PRODUCT DIMENSIONS

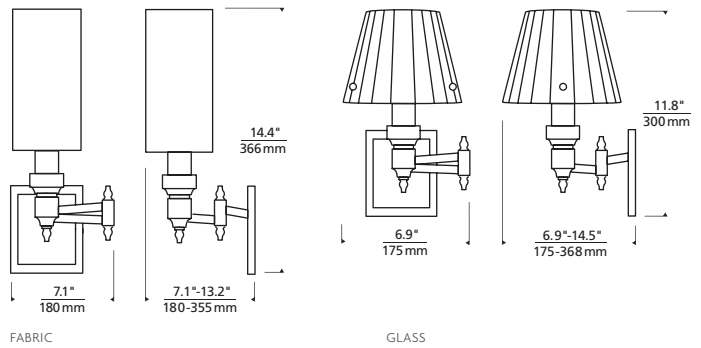

DRAKE SIMPLE

Die-cast metal base with a well-defined arm detail; offered with either Murano wave-patterned glass or fabric shade. Includes 120 volt 75 watt or equivalent medium base, A19 lamp and integral on / off switch; dimmable with standard incandescent dimmer.



600DRKSW

COLOR	FINISH
FABRIC SHADE	Z ANTIQUE BRONZE
FL LINEN	N POLISHED NICKEL
FW WHITE	S SATIN NICKEL
GLASS SHADE	
GL LATTE	
GW WHITE	

PRODUCT DIMENSIONS

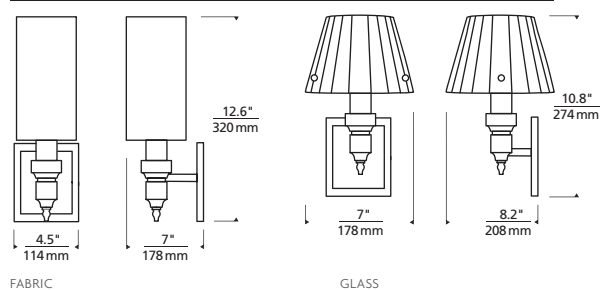





BOREAL



P. 580



Natural hemp fabric shade with recycled paper backing and recycled sand-cast bronze metal work. The fabric shade and recycled bronze are both sourced locally within 20 miles of our facility. The product also ships in environmentally-friendly recycled packaging. Mounts up only. Includes 120 volt, 60 watt or equivalent medium base BT15 halogen lamp, GX24Q-2 base 18 watt triple tube compact fluorescent lamp (electronic ballast included), or 10 watt, 750 lumen, 2700K LED module. Incandescent may also use 75 watt medium base BT15 halogen lamp (not included). Incandescent version dimmable with standard incandescent dimmer. LED version dimmable with low-voltage electronic dimmer. ADA compliant.

PRODUCT DIMENSIONS

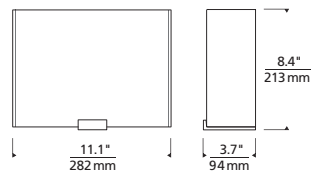

COMPLEMENTARY PRODUCT
LOW-VOLTAGE PENDANT P. 120

700WSBOR

COLOR	FINISH*	LAMP
I IVORY	Z ANTIQUE BRONZE	INCANDESCENT 120V
	S WHITE BRONZE	COMPACT FLUORESCENT 120V
		-CF COMPACT FLUORESCENT 277V
		-LED LED 2700K 120V
		-LED277 LED 2700K 277V

* WHILE WE FEEL THEY LOOK VERY NICE TOGETHER, THE BOREAL FINISHES WILL NOT BE AN EXACT MATCH TO EXISTING SATIN NICKEL AND ANTIQUE BRONZE HARDWARE





WHITE WITH CAGE,
POLISHED NICKEL
THREE-QUARTER VIEW



DESERT CLAY WITH CAGE,
ANTIQUE BRONZE



DESERT CLAY WITHOUT CAGE,
ANTIQUE BRONZE
THREE-QUARTER VIEW



WHITE WITHOUT CAGE,
POLISHED NICKEL
THREE-QUARTER VIEW

WEBSTER

Cast diamond shaped back plate with an elegant fabric shade; available with or without decorative metal cage. Includes 120 volt 60 watt G9 base, halogen lamp. Dimmable with standard incandescent dimmer.

600WEBW

COLOR	FINISH
WITHOUT CAGE	Z ANTIQUE BRONZE
C DESERT CLAY	N POLISHED NICKEL
W WHITE	S SATIN NICKEL
WITH CAGE	
CC DESERT CLAY	
WC WHITE	

PRODUCT DIMENSIONS

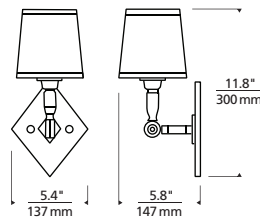

ANTIQUE BRONZE
THREE-QUARTER VIEW



SATIN NICKEL
THREE-QUARTER VIEW

BRIDGEPORT



Carriage light inspired cylinder glass shade with elegant metal plate and hand-welded fitter detail. Incandescent includes 120 volt 60 watt G9 base, halogen lamp; compact fluorescent includes 18 watt GX24Q-2 base triple tube lamp and electronic ballast. Incandescent version dimmable with standard incandescent dimmer.

600BRGW

COLOR	FINISH	LAMP
W WHITE	Z ANTIQUE BRONZE	INCANDESCENT 120V
	N POLISHED NICKEL	-CF COMPACT FLUORESCENT 120V
	S SATIN NICKEL	

PRODUCT DIMENSIONS

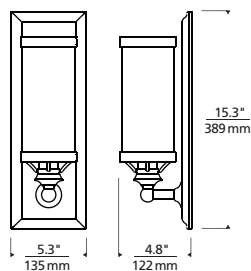





SATIN NICKEL
THREE-QUARTER VIEW

ANTIQUÉ BRONZE

HUDSON



Clean pure style up- and down-light. Cylindrical glass shades with a simple metal base. Includes two 120 volt, 75 watt or equivalent A19 medium base lamps or two 18 watt G24Q-2 base quad tube compact fluorescent lamps (electronic ballast included). Incandescent version dimmable with standard incandescent dimmer. ADA compliant.

700WSHUD2W

FINISH	LAMP
Z ANTIQUE BRONZE	INCANDESCENT 120V
C CHROME	-CF COMPACT FLUORESCENT 120V
S SATIN NICKEL	

PRODUCT DIMENSIONS

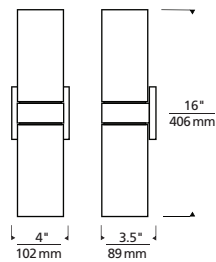

COMPLEMENTARY PRODUCT
LOW-VOLTAGE PENDANT P. 107 / LINE-VOLTAGE PENDANT P. 264



SATIN NICKEL, UP
THREE-QUARTER VIEW

ANTIQUÉ BRONZE, DOWN

KISDON



Rectangular glass with die-cast metal detail. Provides ambient and up- or down- light. Includes two 120 volt, 60 watt G9 base halogen lamps or one 18 watt 2G11 base twin tube compact fluorescent lamps. Incandescent version dimmable with standard incandescent dimmer. ADA compliant. Mounts up or down.

700WSKISWW

FINISH	LAMP
Z ANTIQUE BRONZE	INCANDESCENT 120V
C CHROME	-CF COMPACT FLUORESCENT 120V
S SATIN NICKEL	

PRODUCT DIMENSIONS

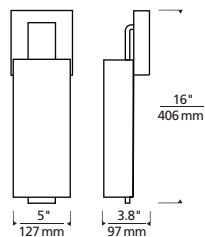

COMPLEMENTARY PRODUCT
BATH P. 426





ANTIQU BRONZE
THREE-QUARTER VIEW



SATIN NICKEL

VENTANA



CF



E

P. 580



ADA

A graceful curve of metal with intricate, asymmetric cutouts. The inner white case glass softens the light shining through this dramatic piece. Includes 120 volt, 60 watt or equivalent medium base BT15 halogen lamp, 18 watt GX24Q-2 base compact fluorescent lamp, or 10 watt, 750 lumen, 2700K LED Module. Incandescent version dimmable with standard incandescent dimmer. LED dimmable with low-voltage electronic dimmer. ADA compliant.

PRODUCT DIMENSIONS

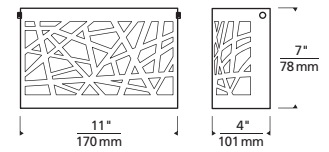

700WSVNT

FINISH	LAMP
Z ANTIQUE BRONZE	INCANDESCENT 120V
S SATIN NICKEL	-CF COMPACT FLUORESCENT 120V
	-LED LED 2700K 120V

COMPLEMENTARY PRODUCT
LOW-VOLTAGE PENDANT P. 66 / LINE-VOLTAGE PENDANT P. 249



SATIN NICKEL
THREE-QUARTER VIEW



ANTIQU BRONZE

CORVA



CF



E

P. 580



ADA

Elliptical glass shade with metal band detail. Provides task and ambient light. Incandescent version may only be mounted vertically; compact fluorescent and LED versions may be mounted vertically or horizontally. Includes 120 volt, 60 watt or equivalent medium base BT15 halogen lamp, 13 watt 2GX7 base twin tube compact fluorescent lamp (electronic ballast included) or 10 watt, 750 lumen, 3000K LED module. Incandescent version dimmable with standard incandescent dimmer. LED version dimmable with low-voltage electronic dimmer. ADA compliant.

PRODUCT DIMENSIONS

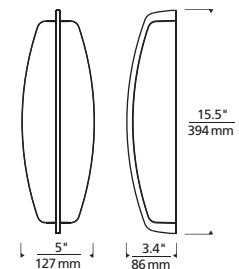

700WSCRVV

FINISH	LAMP
Z ANTIQUE BRONZE	INCANDESCENT 120V
C CHROME	-CF COMPACT FLUORESCENT 120V
S SATIN NICKEL	-LED LED 3000K 120V

COMPLEMENTARY PRODUCT
BATH P. 426





ANTIQUE BRONZE
THREE-QUARTER VIEW



POLISHED NICKEL

ADMIRAL SIMPLE



Nautical-inspired mariner light with white glass diffuser and classic cage detail; solid brass construction. Incandescent includes 120 volt 100 watt or equivalent medium base A19 lamp; fluorescent includes 26 watt GX24Q-3 base, triple tube lamp and electronic ballast. Fluorescent may also be lamped with 32 watt GX24Q-3 base, triple tube lamp. Incandescent version dimmable with standard incandescent dimmer. Suitable for wet locations.

600ADMSW	COLOR	FINISH	LAMP
W	WHITE	Z ANTIQUE BRONZE N POLISHED NICKEL	INCANDESCENT 120V -CF COMPACT FLUORESCENT 120V

PRODUCT DIMENSIONS

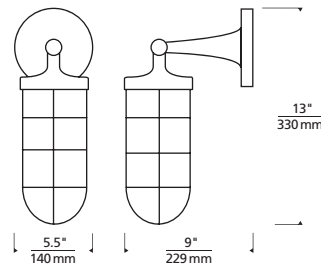

ANTIQUE BRONZE
THREE-QUARTER VIEW



POLISHED NICKEL

ADMIRAL CLASSIC



Nautical-inspired mariner light with white glass diffuser, classic cage and rain guard detail; solid brass construction. Incandescent includes 120 volt 100 watt or equivalent medium base A19 lamp; fluorescent includes 26 watt GX24Q-3 base, triple tube lamp and electronic ballast. Fluorescent may also be lamped with 32 watt GX24Q-3 base, triple tube lamp. Incandescent version dimmable with standard incandescent dimmer. Suitable for wet locations.

600ADMCW	COLOR	FINISH	LAMP
W	WHITE	Z ANTIQUE BRONZE N POLISHED NICKEL	INCANDESCENT 120V -CF COMPACT FLUORESCENT 120V

PRODUCT DIMENSIONS

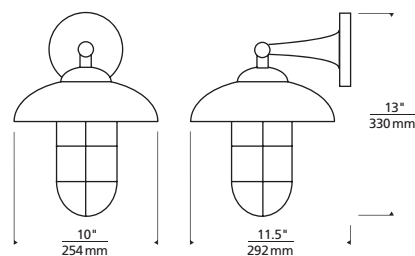

COMPLEMENTARY PRODUCT
LOW-VOLTAGE PENDANT P. 69



POLISHED NICKEL
THREE-QUARTER VIEW

ANTIQUe BRONZE

VAN BUREN [CIRCA 1920]



Acorn-shaped Holophane® prismatic glass diffuses light throughout the shade to reduce glare and enhance visual comfort; solid brass construction. Incandescent includes 120 volt 75 watt or equivalent clear medium base, A19 lamp; compact fluorescent includes 18 watt GX24Q-2 base triple tube lamp and electronic ballast. Incandescent version dimmable with standard incandescent dimmer. Suitable for wet locations.

600VBNW	COLOR	FINISH	LAMP
C	CLEAR	Z ANTIQUE BRONZE	INCANDESCENT 120V
N	POLISHED NICKEL	-CF	COMPACT FLUORESCENT 120V
S	SATIN NICKEL		

PRODUCT DIMENSIONS

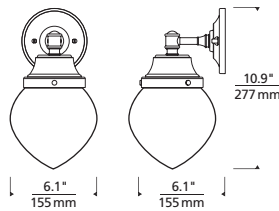

PRODUCT DETAILS



COMPLEMENTARY PRODUCT
LOW-VOLTAGE PENDANT P. 99 / LINE-VOLTAGE PENDANT P. 280



POLISHED NICKEL
THREE-QUARTER VIEW

ANTIQUe BRONZE

WRIGHTWOOD [CIRCA 1920]



Globe-shaped prismatic glass diffuses light throughout the shade to reduce glare and enhance visual comfort; solid brass construction. Incandescent includes 120 volt 75 watt or equivalent clear medium base, A19 lamp; compact fluorescent includes 18 watt GX24Q-2 base triple tube lamp and electronic ballast. Incandescent version dimmable with standard incandescent dimmer. Suitable for wet locations.

600WRIW	COLOR	FINISH	LAMP
C	CLEAR	Z ANTIQUE BRONZE	INCANDESCENT 120V
N	POLISHED NICKEL	-CF	COMPACT FLUORESCENT 120V
S	SATIN NICKEL		

PRODUCT DIMENSIONS

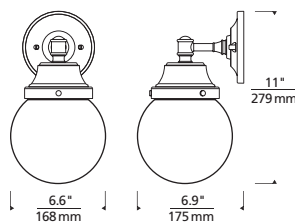

PRODUCT DETAILS



COMPLEMENTARY PRODUCT
LOW-VOLTAGE PENDANT P. 280

VERSATILE BATH & WALL SCONCES

While we list our bath bars in a separate section, they are very well suited for many different interior environments outside the bathroom.



ZONE
P. 415



SARA DOUBLE
P. 416



SOLACE
P. 424

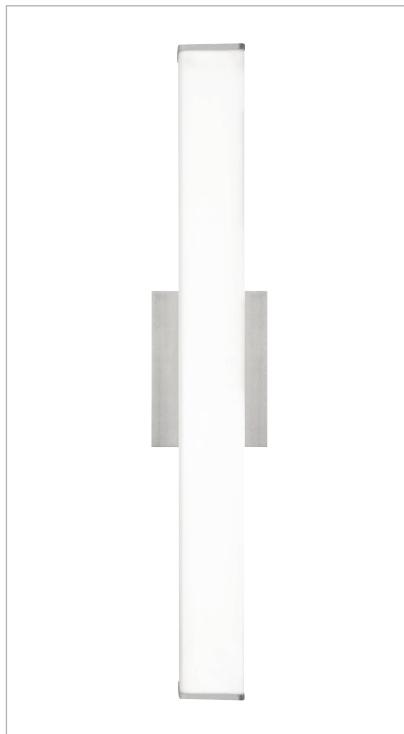

LYNN BATH
P. 424



LUNA
P. 426

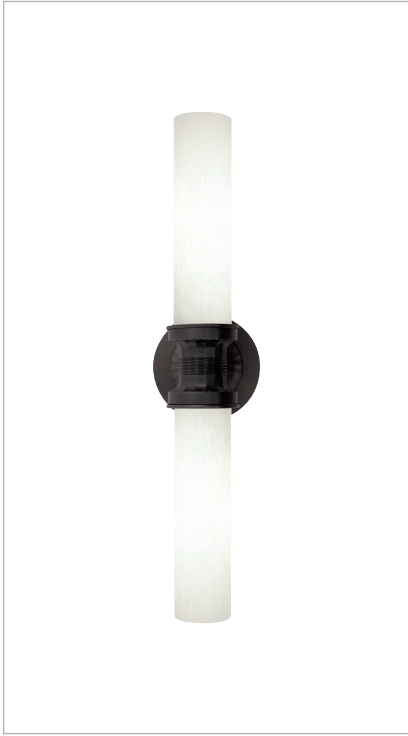

LINDEN
P. 418

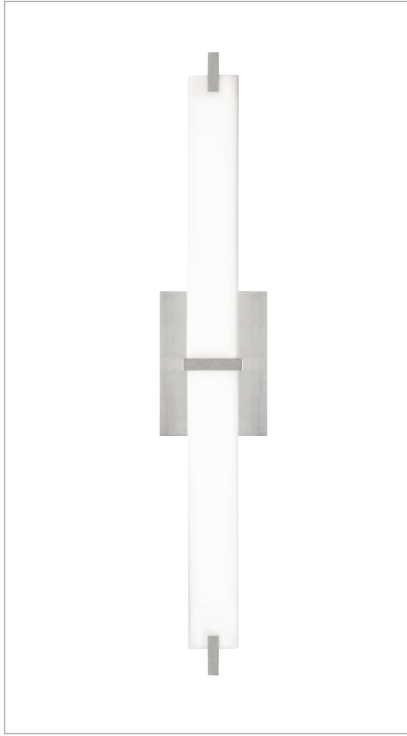

METRO
P. 420



CORVA BATH
P. 426



KISDON
P. 426

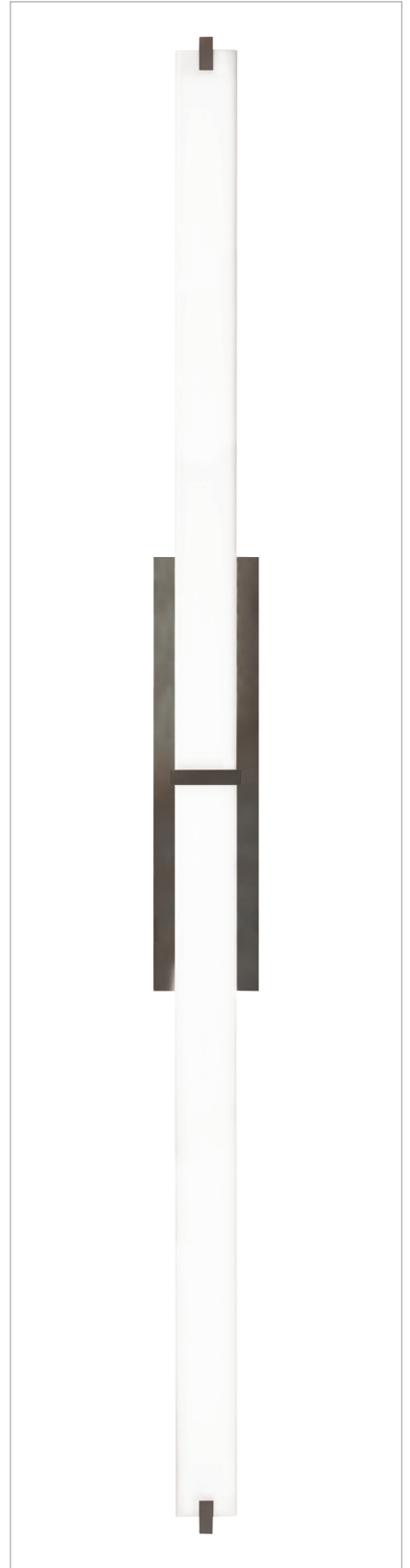

METRO LONG
P. 422



BATH COLLECTION



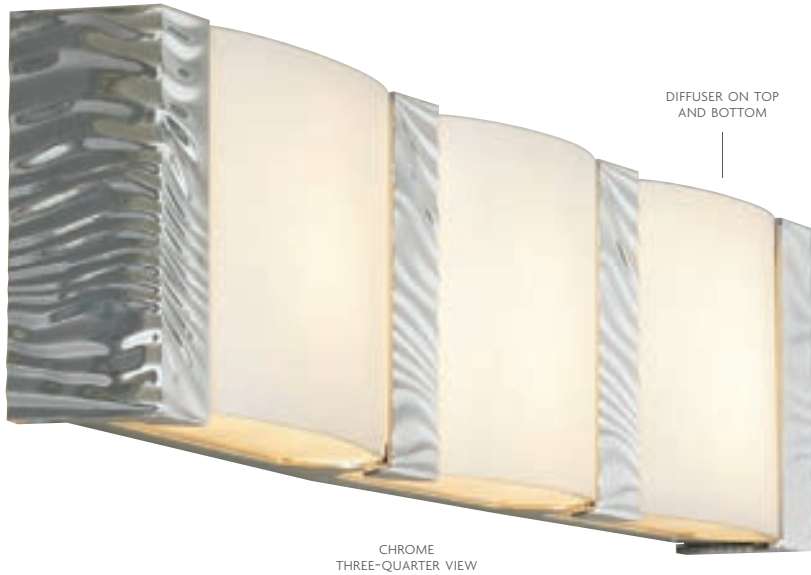

CHROME
THREE-QUARTER VIEW



GUNMETAL

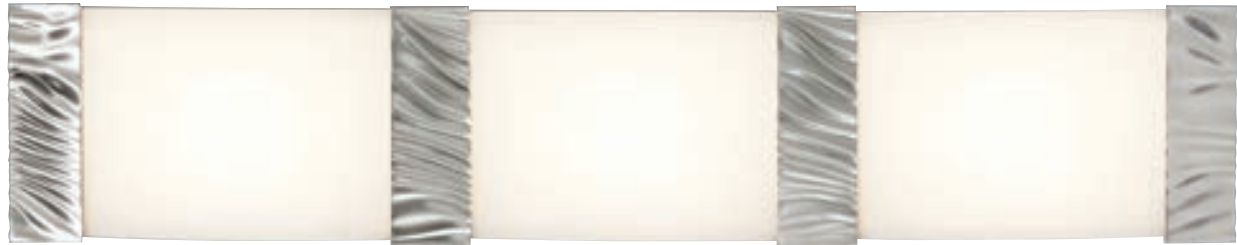

SATIN NICKEL

KINZE



E
P. 580



The flowing texture of the die-cast aluminum end and center caps and soft edges of the rounded hand-blown glass bring tranquility to the design. Top and bottom glass diffusers complete the look and prevent seeing the internal components from above or below. Mounted horizontally only.

Includes three 120 volt, 40 watt G9 base halogen bi-pin lamps or three 10 watt, 750 lumens, 2700K field-replaceable LED modules. Incandescent version dimmable with standard incandescent dimmer. Dimmable with low-voltage electronic dimmer. ADA compliant.

PRODUCT DIMENSIONS

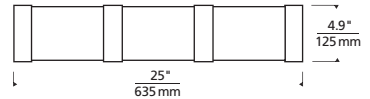

700BCKNZE	COLOR	FINISH	LAMP
	W WHITE	C CHROME	INCANDESCENT 120V
		M GUNMETAL	LED 2700K 120V
		S SATIN NICKEL	-LED277 LED 2700K 277V

COMPLEMENTARY PRODUCT
WALL P. 367



SATIN NICKEL WITH GOLD WING NUTS
THREE-QUARTER VIEW



BRONZE WITH BRONZE WING NUTS



BRONZE WITH GOLD WING NUTS



SATIN NICKEL WITH GOLD WING NUTS



SATIN NICKEL WITH SATIN NICKEL WING NUTS

ZONE



Beautiful, hand-carved glass is held in place with a pair of decorative wing-nuts. All fixtures ship with two sets of wing-nuts, one that matches the metal finish of the fixture and one pair in a Gold Finish for a contrasting aesthetic. May be mounted vertically or horizontally. Includes 18.5 watt, 1300 lumens, 2700K field-replaceable LED module. Dimmable with low-voltage electronic dimmer. ADA compliant.

700BCZONE	COLOR	FINISH	LAMP
W	WHITE	Z ANTIQUE BRONZE	-LED LED 2700K 120V
C	CHROME	S SATIN NICKEL	-LED277 LED 2700K 277V

PRODUCT DIMENSIONS

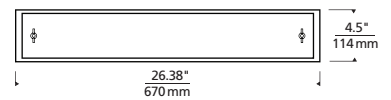



SARA DOUBLE



Pure indulgence, the Sara is cut from a solid block of crystal and formed into two elegant cylinders which surround hand-blown inner white glass diffusers that sit atop a die-cast metal base. Instantly elevates any space. May be mounted vertically or horizontally. Incandescent includes two 120 volt, 60 watt or equivalent T10 medium base lamps. Fluorescent includes two 18 watt 2GX7 base twin tube compact fluorescent lamps. Incandescent version dimmable with standard incandescent dimmer.

700WSSARDC	FINISH	LAMP
Z	ANTIQUE BRONZE	INCANDESCENT 120V
C	CHROME	-CF COMPACT FLUORESCENT 120V
S	SATIN NICKEL	

PRODUCT DIMENSIONS

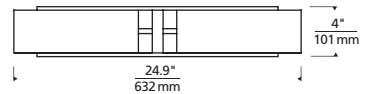

COMPLEMENTARY PRODUCT
 LOW-VOLTAGE PENDANT P. 94 / LINE-VOLTAGE PENDANT P. 262 / WALL P. 372





FROST
WITH POLISHED NICKEL



WHITE FRIT
WITH ANTIQUE BRONZE

LINDEN



Nineteenth century, neoclassical-inspired cast metal base with elegant blown glass cylinders. May be mounted horizontally or vertically. Incandescent includes two 120 volt 60 watt or equivalent medium base, T10 lamps; compact fluorescent includes two 18 watt 2G11 base twin tube lamps and electronic ballast. Incandescent version dimmable with standard incandescent dimmer.

600LNDB	COLOR	FINISH	LAMP
F	FROST	Z ANTIQUE BRONZE	INCANDESCENT 120V
W	WHITE FRIT	N POLISHED NICKEL	-CF COMPACT FLUORESCENT 120V
		S SATIN NICKEL	

PRODUCT DIMENSIONS

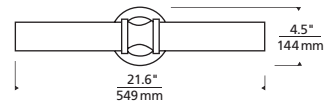

COMPLEMENTARY PRODUCT
WALL P. 376





ANTIQUÉ BRONZE



SATIN NICKEL

METRO



P. 580



Rectilinear shaped light bar with multi-layered white glass or white acrylic. Plated pressure formed frame. Provides task and ambient light. May be mounted vertically or horizontally. Available in three lamp configurations: one 24 watt high output T5 linear fluorescent lamp (lamp and electronic ballast included); four 120 volt, 40 watt halogen mini-candelabra base lamps (included), or energy saving 20 watt, 1000 lumens, 3000K LED module (included). Incandescent version dimmable with standard incandescent dimmer. LED version dimmable with low-voltage electronic dimmer. ADA compliant.

700BCMET	COLOR	FINISH	LAMP
	WHITE GLASS	Z ANTIQUE BRONZE	INCANDESCENT 120V
Y	WHITE ACRYLIC*	C CHROME	-CF FLUORESCENT 120V
		S SATIN NICKEL	-CF277 FLUORESCENT 277V
			-LED LED 3000K 120V

PRODUCT DIMENSIONS

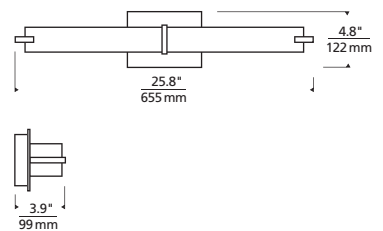

COMPLEMENTARY PRODUCT
WALL P. 374

SEE PP. 32, 413 FOR ADDITIONAL APPLICATION PHOTOS

* WHITE ACRYLIC NOT AVAILABLE WITH INCANDESCENT LAMP





ANTIQUe BRONZE



SATIN NICKEL

METRO LONG



Rectilinear shaped light bar with white acrylic shade and pressure formed frame. Provides task and ambient light. May be mounted vertically or horizontally. Includes one 54 watt high output T5 linear fluorescent lamp and electronic ballast. Dimmable fluorescent unit ships standard with two wire Advance Mark X dimming ballast. Dimmers supplied by others. Dimmer and ballast compatibility to be field verified. Consult factory for custom ballast availability and pricing.

700BCMETL	COLOR	FINISH	LAMP
Y	WHITE ACRYLIC	Z ANTIQUE BRONZE	-CF FLUORESCENT 120V
C	CHROME	S SATIN NICKEL	-CF277 FLUORESCENT 277V
S	SATIN NICKEL		-CFD FLUORESCENT 120V DIMMABLE
			-CFD277 FLUORESCENT 277V DIMMABLE

COMPLEMENTARY PRODUCT
WALL P. 347

PRODUCT DIMENSIONS

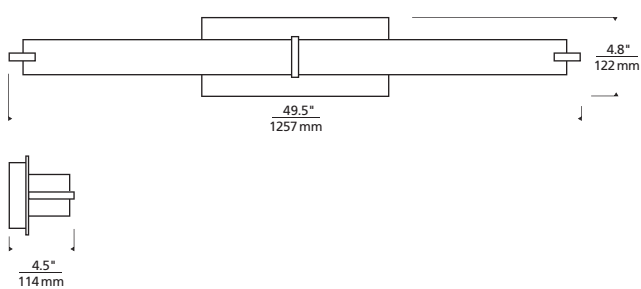



Cosmo wall p. 374





ANTIQUÉ BRONZE



SATIN NICKEL

SOLACE



Clean frosted glass on a minimal metal base. Provides task and ambient light. May be mounted vertically or horizontally. Incandescent includes five 120 volt 40 watt G9 base halogen lamps; fluorescent includes two 24 watt T5 high output linear fluorescent lamps and electronic ballast. Incandescent version dimmable with standard incandescent dimmer. ADA compliant.

PRODUCT DIMENSIONS

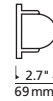
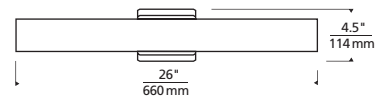

700BCSLC26W

FINISH	LAMP
Z ANTIQUE BRONZE	INCANDESCENT 120V
C CHROME	-CF FLUORESCENT 120V
S SATIN NICKEL	-CF277 FLUORESCENT 277V

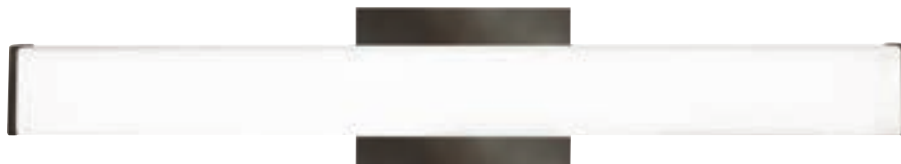

FULLY ENCLOSED

ANTIQUÉ BRONZE



SATIN NICKEL

LYNN BATH



P. 580



Sleek linear fully enclosed glass or acrylic shade finished with metal end caps. Provides task and ambient light. May be mounted horizontally or vertically. Incandescent includes five 120 volt, 40 watt G9 base halogen lamps; fluorescent includes one 24 watt T5 high output linear fluorescent lamp and electronic ballast. LED includes 20 watt, 1000 lumens, 3000K LED module. Incandescent version dimmable with a standard incandescent dimmer. LED version dimmable with low-voltage electronic dimmer. ADA compliant.

PRODUCT DIMENSIONS

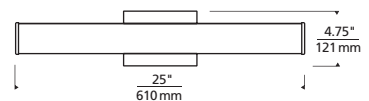

700BCLYNN

COLOR	FINISH	LAMP
Y WHITE ACRYLIC*	Z ANTIQUE BRONZE	INCANDESCENT 120V
W WHITE GLASS	C CHROME	-CF COMPACT FLUORESCENT 120V
	S SATIN NICKEL	-CF277 COMPACT FLUORESCENT 277V
		-LED LED 3000K 120V

* WHITE ACRYLIC NOT AVAILABLE WITH INCANDESCENT LAMP





LUNA



CF



Floating crescent of multi-layered white case glass. Plated pressure formed base. Provides task and ambient light. May be mounted vertically or horizontally. Available in two lamp configurations: two 14 watt T5 linear fluorescent lamps (lamps and electronic ballast included); or four 120 volt, 60 watt mini-candelabra base lamps (included). Incandescent version dimmable with standard incandescent dimmer. ADA compliant.

700BCLUN24	FINISH	LAMP
C	CHROME	FLUORESCENT 120V
S	SATIN NICKEL	-CF277 FLUORESCENT 277V
		-HL INCANDESCENT 120V

PRODUCT DIMENSIONS

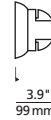
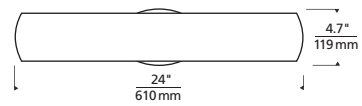

ANTIQU BRONZE



SATIN NICKEL

CORVA BATH



CF



Fully enclosed elliptical glass shade with metal band detail. Provides task and ambient light. May be mounted vertically or horizontally. Incandescent includes four 120 volt 40 watt G9 base halogen lamps; fluorescent includes two 14 watt T5 linear fluorescent lamps and electronic ballast. Incandescent version dimmable with standard incandescent dimmer. ADA compliant.

700BCCR30W	FINISH	LAMP
Z	ANTIQU BRONZE	INCANDESCENT 120V
C	CHROME	-CF FLUORESCENT 120V
S	SATIN NICKEL	-CF277 FLUORESCENT 277V

PRODUCT DIMENSIONS

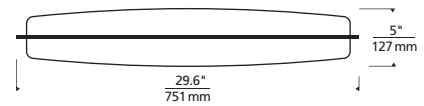

COMPLEMENTARY PRODUCT
WALL P. 406



ANTIQU BRONZE



SATIN NICKEL

KISDON



CF



Rectangular glass with die-cast metal detail. Includes four 120 volt, 60 watt G9 base halogen lamps or two 18 watt 2G11 base twin tube compact fluorescent lamps. Incandescent version dimmable with standard incandescent dimmer. ADA compliant. May be mounted vertically or horizontally.

700BCKIS	COLOR	FINISH	LAMP
W	WHITE GLASS	Z ANTIQU BRONZE	INCANDESCENT 120V
		C CHROME	-CF FLUORESCENT 120V
		S SATIN NICKEL	-CF277 FLUORESCENT 277V

PRODUCT DIMENSIONS

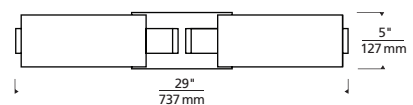

COMPLEMENTARY PRODUCT
WALL P. 404





RECESSED



SURFACE

SIBER MIRROR



CF



Rectangular mirror surrounded by a cove of diffused white light. Available in two styles: recessed and surface. Provides shadow-free task and ambient light. Halogen includes eight 120 volt, 40 watt G9 base halogen lamps; compact fluorescent includes two 39 watt T5 high output linear fluorescent lamps and electronic ballast. Halogen version dimmable with a standard incandescent dimmer. Recessed version requires modifications to existing wall construction. ADA compliant.

700BCSIB	STYLE	FINISH	LAMP
R	RECESSED	C CHROME	HALOGEN
S	SURFACE	S SATIN NICKEL	-CF FLUORESCENT 120V
			-CF277 FLUORESCENT 277V

PRODUCT DIMENSIONS

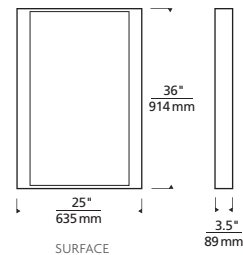
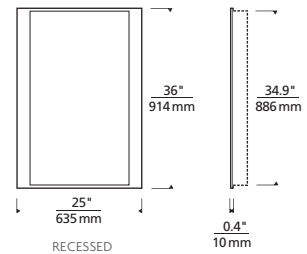

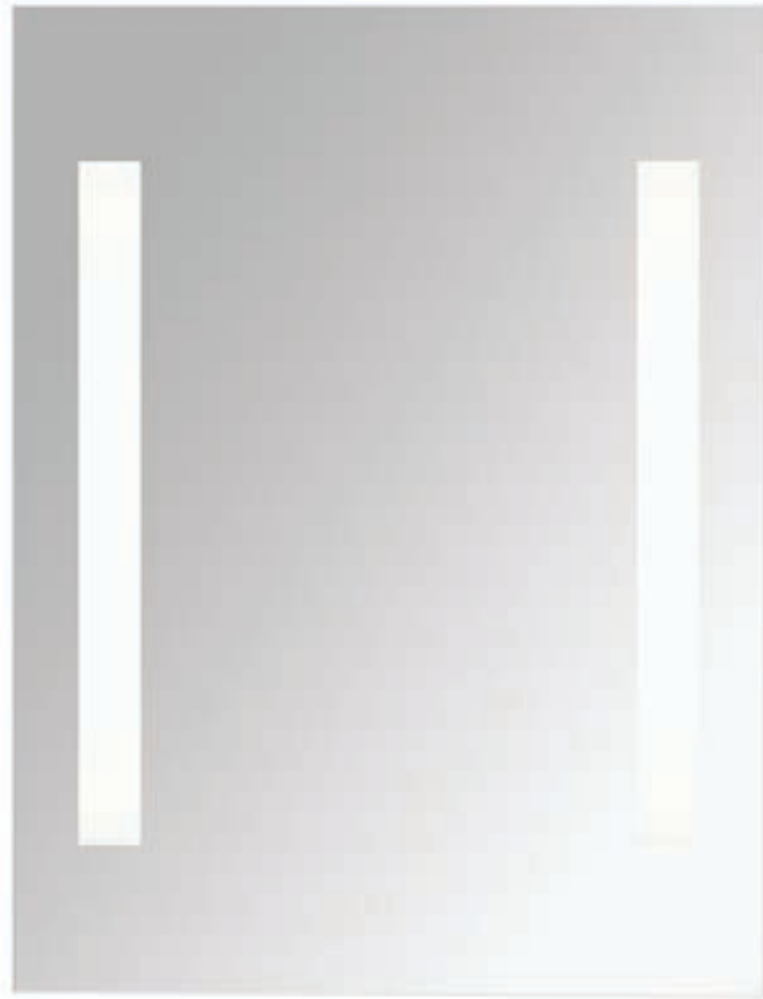

REFLECTION MIRROR



CF

Rectangular mirror with imbedded sidelights, behind frosted glass, provides task lighting. Includes two 24 watt mini bi-pin base T5HO lamps and electronic ballast. ADA compliant



ADA

700VNRFL-CF

PRODUCT DIMENSIONS

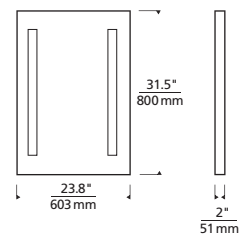



TIGRIS MIRROR ROUND



Round mirror surrounded by a cove of diffused white light. Available in two styles: recessed and surface. Plated pressure formed frame. Provides shadow-free task and ambient light.



Mirror swings open for easy relamping. Halogen includes transformer and nine 120 volt, 40 watt G9 base halogen lamps; compact fluorescent includes six 9 watt 2G7 base twin tube lamps and electronic ballast. Halogen version dimmable with a standard incandescent dimmer. Recessed version requires modifications to existing wall construction. ADA compliant.

700BCTIGR	STYLE	FINISH	LAMP
R30	RECESSED	C CHROME	HALOGEN
S32	SURFACE	S SATIN NICKEL	-CF COMPACT FLUORESCENT 120V (SURFACE ONLY)
			-CF277 COMPACT FLUORESCENT 277V (SURFACE ONLY)

PRODUCT DIMENSIONS

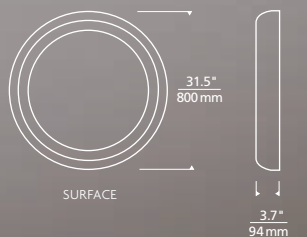
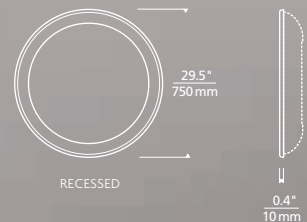





TIGRIS MIRROR OVAL



Oval mirror surrounded by a cove of diffused white light. Available in two styles: recessed and surface. Plated pressure formed frame. Provides shadow-free task and ambient light. Mirror swings open for easy relamping. Halogen includes transformer and eight 120 volt, 40 watt G9 base halogen lamps; compact fluorescent includes six 9 watt 2G7 base twin tube lamps and electronic ballast. Halogen version dimmable with a standard incandescent dimmer. Recessed version requires modifications to existing wall construction. ADA compliant.

700BCTIGO	STYLE	FINISH	LAMP
R24	RECESSED	C CHROME	HALOGEN
S26	SURFACE	S SATIN NICKEL	-CF COMPACT FLUORESCENT 120V (SURFACE ONLY)
			-CF277 COMPACT FLUORESCENT 277V (SURFACE ONLY)

PRODUCT DIMENSIONS

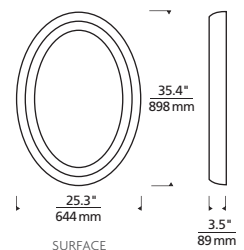
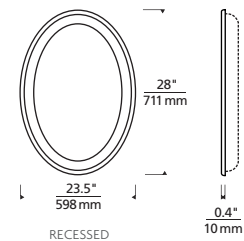



REDEFINING UNDERCABINET LIGHTING

Undercabinet lighting was one of the first applications to go LED. Since that time, there has been little in way of innovation. That is because most undercabinet fixtures were designed around traditional undercabinet housings and discrete LEDs. The result: Hot Spots. Glare. Multiple shadows on the surface. Unnecessarily deep housings. Poor or non-existent dimming. Until now.

Tech Lighting is proud to offer Unilume LED undercabinet, the latest innovation in LED undercabinet lighting. Utilizing tightly clustered blue pump LEDs, a 98% reflective mixing chamber and an Intematix ChromaLit™ remote phosphor lens, the result is consistent illumination with ultra high efficiency – all in a housing that is less than $\frac{3}{4}$ of an inch deep. An integrated LED driver makes installation easy and allows smooth dimming down to 15% using a TRIAC or ELV dimmer.

Perfect not only for the home, but also for the office, retail displays and more.

UNILUME LED UNDERCABINET



UNILUME LED UNDERCABINET

Jayden Grande pendant p. 262





UNILUME LED UNDERCABINET

TECH LIGHTING'S UNILUME LED UNDERCABINET

VS.

TYPICAL LED UNDERCABINET

REMOTE PHOSPHOR SOLUTION

Thirty LEDs per foot, 98% reflective mixing chamber and Intematix Chromalit™ remote phosphor lens, consuming just 4, 8.5, 10.5 and 18 watts for the 7", 13", 19" and 30" respectively.

REMOTE PHOSPHOR SOLUTION

Because the entire remote phosphor lens illuminates, we are able to achieve an extremely consistent and even wash of light. This is both attractive and easier on the eyes when viewed from below.

ELIMINATES DISTRACTING 'MULTI-SHADOWS'

Because the entire remote phosphor lens is illuminated, multiple shadows are not produced. Therefore it is much more desirable to view objects below. This is particularly helpful in a task application (e.g. working on a cutting board) or when displaying merchandise.

WIDE BEAM DISTRIBUTION

The entire phosphor lens is illuminated and sits at the surface of the housing creating a much wider beam distribution. This makes it possible to use fewer undercabinet units spread at greater distances with more even output over the entire space.

COLOR CONSISTENCY OVER TIME

The phosphor sits away from the LED and remains cooler over time. Therefore the phosphor does not experience the same level of degradation.

HIGH EFFICIENCY

With the remote phosphor lens, we do not need a secondary diffusing lens. This helps us achieve 50-60+ lumens per watt depending on length.

MULTIPLE COLOR TEMPERATURE & CRI OPTIONS

Offered in 2700K and 3000K color temperatures. Additional color temperatures are easily available on a custom basis (contact the factory). 80+ CRI (Color Rendering Index) or 90+ CRI for more discerning applications.

INTEGRATED DRIVER & SMOOTH DIMMING

120 volt input makes installation easy. Smooth dimming down to 15% using a standard incandescent or low-voltage electronic dimmer. Jumper cables make it easy to link one unit to another. Each unit has an integrated on-off switch.

RUGGED, MINIMALIST DESIGN

Heavy gauge aluminum housing with die-cast steel end-caps and less than ¾ of an inch deep. Can be mounted vertically or horizontally.

A few discrete LEDs spaced several inches apart.

When viewing the fixture from below, each LED appears extremely glary – particularly in the sight-line of a young child. Unattractive dots of light appear on any reflective surface below like a granite countertop.

Each point source of light hits an object beneath at a different angle and creates a shadow at that angle. For every LED, a unique shadow is created. Thus, a 12 inch LED solution that uses four individual LEDs creates four distracting shadows beneath the object.

LEDs are typically recessed into the housing or hidden behind a diffusing lens. This causes light cut-off at the edges.

Overtime, LEDs can experience some level of color shift. This is caused in large part by the degradation of the phosphor that sits directly on the LED due to heat coming directly off the LED.

In order to minimize glare created by individual LEDs, most traditional products utilize a diffusing lens. This typically creates an efficiency loss of 15% to 35%. In fixtures without a diffusing lens, high efficiency can be achieved at the cost of significant glare.

Typically offered in only a single color temperature option and 80 CRI (Color Rendering Index).

May require an external power supply making installation more complicated. Dimming may be non-existent or require a more expensive low-voltage electronic dimmer.

Thinner gauge housing and plastic components, often in housings 1-1.5 inches deep.



WHAT IS REMOTE PHOSPHOR TECHNOLOGY?

Most white LEDs are actually blue LEDs with a phosphor coating. The phosphor absorbs the blue light and re-emits the photons at longer wavelengths which we perceive as white light. In most lighting applications, the phosphor is directly on the LED chip; and this is the right approach for many applications. However, by utilizing a remote phosphor solution – a linear phosphor lens that sits above the LEDs – we are able to achieve performance levels not possible with traditional LED undercabinet lights.

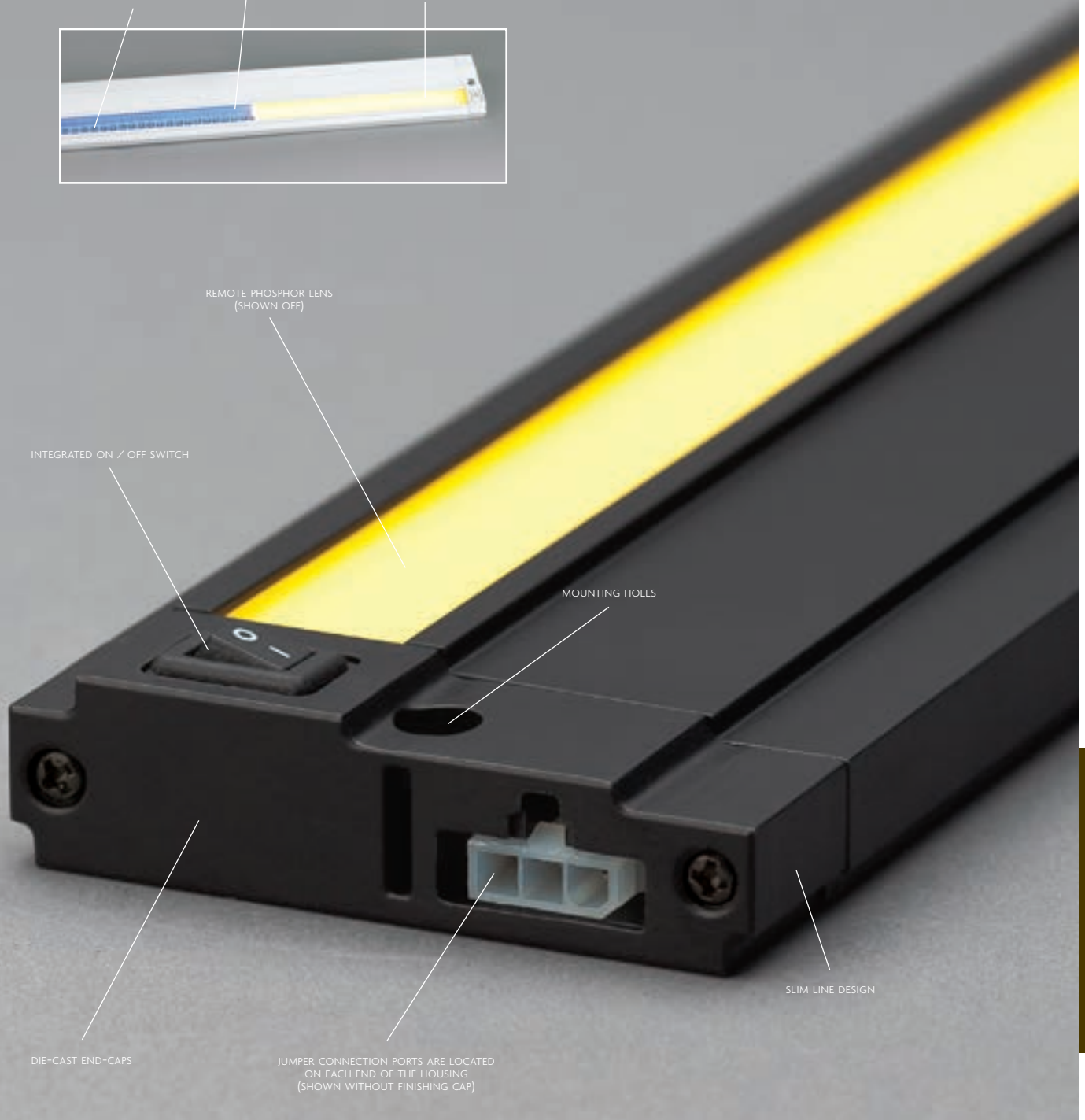
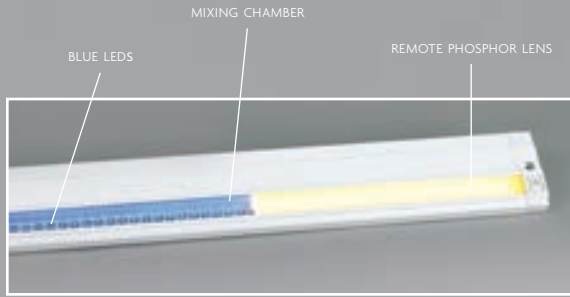

UNILUME GIVES CONSISTENT, EVEN ILLUMINATION



TYPICAL LED UNDERCABINET



UNILUME HAS RUGGED, MINIMALIST DESIGN



TYPICAL LED UNDERCABINET



UNILUME HAS WIDE BEAM SPREAD



TYPICAL LED UNDERCABINET



UNILUME ELIMINATES DISTRACTING 'MULTI-SHADOWS' IN RETAIL



TYPICAL LED UNDERCABINET



UNILUME ELIMINATES DISTRACTING 'MULTI-SHADOWS' IN OFFICE



TYPICAL LED UNDERCABINET



UNILUME ELIMINATES DISTRACTING 'MULTI-SHADOWS' IN KITCHEN



TYPICAL LED UNDERCABINET



UNILUME LED UNDERCABINET



BLACK
(SHOWN ON)



WHITE
(SHOWN OFF)

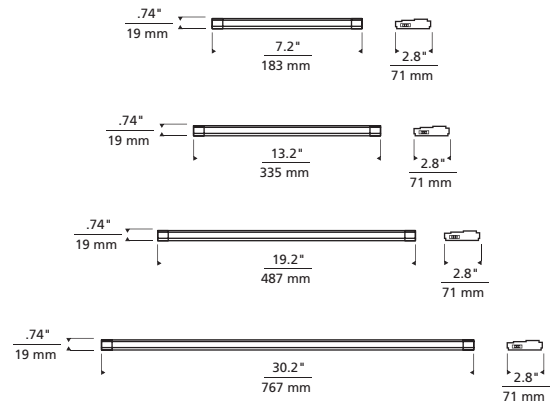

UNILUME LED UNDERCABINET



700UCF	LENGTH	CRI	COLOR TEMPERATURE	FINISH	LAMP TYPE
07	7.2"	8	80+ 2 2700K	B BLACK	-LED LED
13	13.2"	9	90+ 3 3000K	W WHITE	
19	19.2"				
30	30.2"				

TECHNICAL SPECIFICATIONS*

	7" Length	13" Length	19" Length	30" Length
System Power:	4.0 watts	8.5 watts	10.5 watts	18.0 watts
System Lumens:	215	432	645	1100
System Efficacy:	54 lms / watt	51 lms / watt	61 lms / watt	61 lms / watt
Color Temperature:	2700K, 3000K	2700K, 3000K	2700K, 3000K	2700K, 3000K
Color Rendering Index:	80+, 90+	80+, 90+	80+, 90+	80+, 90+
Rated Average Life:	50,000 hours to 70%	50,000 hours to 70%	50,000 hours to 70%	50,000 hours to 70%
Power Factor:	0.94	0.94	0.94	0.94
Dimming:	To 15% with TRIAC or ELV Dimmer	To 15% with TRIAC or ELV Dimmer	To 15% with TRIAC or ELV Dimmer	To 15% with TRIAC or ELV Dimmer
Warranty:	5 years	5 years	5 years	5 years

INDUSTRIES SERVED

- Assisted Living
- Custom Closets
- Display / POP
- Healthcare
- Hotels
- Libraries
- Museums
- Offices / Cubicles
- Residential
- Restaurants
- Retail
- Schools
- Universities

CUSTOM CAPABILITIES

- Color Temperature
- Color Rendering Index (CRI)
- Finish

* BASED ON 3000K, 80+ CRI OPTION

ACCESSORIES

SPLICE BOX

Required for hardwire applications. A connection port is located on each side to feed runs in both directions. The 1" Jumper Connector can be used to place the Splice Box next to the Undercabinet Housing or a longer Jumper Connector can be used to place the Splice Box in a more convenient or remote location. Includes Romex / ½ inch conduit connector.

700UCSB	FINISH
	B BLACK
	W WHITE

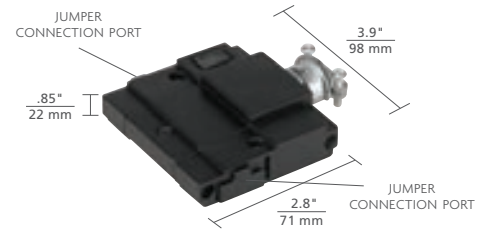

JUMPER CONNECTORS

Can be used to link one Undercabinet Housing to another or to a Splice Box. The maximum wattage for a single run is 600 watts. Use Female to Female Connector to create longer lengths or contact us for custom lengths.

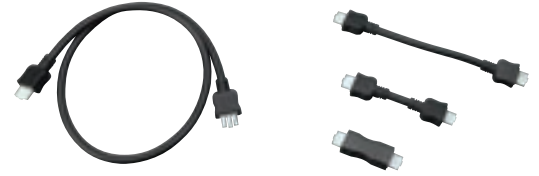

700UCJC	LENGTH*	COLOR
	01 1"	B BLACK
	03 3"	W WHITE
	12 12"	
	24 24"	

FEMALE TO FEMALE CONNECTOR

Joins two Jumper Connectors together.

700UCFFC	COLOR
	B BLACK
	W WHITE



"T" CONNECTOR

Used to join three male connectors together.

700UCTC	COLOR
	B BLACK
	W WHITE



PLUG-IN WALL FEED

Can be used to plug one Undercabinet Housing directly into an outlet.

700UCPL	LENGTH*	COLOR
	24 24"	B BLACK
	72 72"	W WHITE



* SIGNIFIES THE DISTANCES BETWEEN TWO UNITS WHEN USING A PARTICULAR JUMPER CONNECTOR



FREEJACK



Cone pendant p. 108



Photographer: Eric Roth



Photographer: Mike Kaskel Designer: Christine Julian, Julian Kitchen Design, Inc.

Mini Larkspur pendant p. 126





The Basics of FreeJack

ONE DESIGN YOUR FREEJACK SYSTEM



The first step in designing your FreeJack system is to determine what it is you are trying to light. You'll need to decide where the elements should be installed to put light where you want it. See compatible elements on pp. 52-193. Refer to the indicated pages for detailed specifications. Choose your elements then add accessories if desired. We offer a broad range of colorful and decorative accessories and functional optical controls (pp. 566-579).

TWO CHOOSE YOUR CANOPY



Use the information on pp. 452-454 to help you choose the right FreeJack Canopy. Select one Single-Port Canopy for every element or a Multi-Port Canopy that contains the same number of ports as the number of elements you have chosen. The Single- and Multi-Port Canopies include a transformer or transformers. The Single Ports on p. 454 are used to power a series of Elements from a remote transformer which is sold separately (p. 468). Select from one of the FreeJack Adapters (p. 454) to hang FreeJack Elements on standard track lighting, T-TRAK systems or existing recessed cans. If you are using LED heads or pendants, be sure to choose a canopy that is compatible with LED fixtures.

NOTE ADJUSTING CABLE TO DESIRED LENGTH



Adjusting FreeJack cable is easy. Loosen, but do not remove, the set screw on the tip of the FreeJack connector and the oval head set screw on the conical connector. Pull out the coaxial cable and cut it to the desired length. Gently twist the end of the cable between your thumb and forefinger, then feed it through the conical connector. The outer wire will come to a stop point about 3/4 of an inch into the connector. Keep pushing the cable into the connector while rotating the connector, which makes feeding the inner wire into the connector tip easier. Look into the sight hole on the top of the connector to ensure that the inner wire makes contact with the end of the connector. Hold the cable in place and tighten the set screw on the tip of the connector. Make sure the connection is tight! Tighten the set screw on the conical connector firmly. Finally, pull the coaxial cable toward the fixture to smooth out the wrinkles in the outer wire.



FJ KIEV PENDANT

BI-PIN LAMP

Canopies

SINGLE-PORT CANOPIES

4" ROUND FLUSH CANOPY



Mounts to a standard 4" junction box with round plaster ring (provided by electrician). Electronic transformer (included) fits in junction box. One FreeJack port; for ceiling or wall.



700FJ4RF	FINISH	VOLTAGE
Z	ANTIQUE BRONZE	120V IN / 12V OUT
B	BLACK	024 120V IN / 24V OUT
C	CHROME	277 277V IN / 12V OUT
S	SATIN NICKEL	-LED 120V IN / 12V OUT LED
W	WHITE	-LED277 277V IN / 12V OUT LED

4" SQUARE FLUSH CANOPY



Mounts to a standard 4" junction box with round plaster ring (provided by electrician). Electronic transformer (included) fits in junction box. One FreeJack port; for ceiling or wall.



700FJ4SQ	FINISH	VOLTAGE
Z	ANTIQUE BRONZE	120V IN / 12V OUT
B	BLACK	024 120V IN / 24V OUT
C	CHROME	277 277V IN / 12V OUT
S	SATIN NICKEL	-LED 120V IN / 12V OUT LED
W	WHITE	-LED277 277V IN / 12V OUT LED

4" ROUND FLUSH WOOD CANOPY



Mounts to a standard 4" junction box with round plaster ring (provided by electrician). Electronic transformer (included) fits in junction box. One FreeJack port; for ceiling or wall. **MINIMUM 12" DROP LENGTH FOR PENDANTS AND HEADS.**



700FJ4RD	WOOD	FINISH	VOLTAGE
M	MAPLE	Z ANTIQUE BRONZE	120V IN / 12V OUT
W	WALNUT	S SATIN NICKEL	024 120V IN / 24V OUT
			277 277V IN / 12V OUT
			-LED 120V IN / 12V OUT LED
			-LED277 277V IN / 12V OUT LED

4" SQUARE FLUSH WOOD CANOPY



Mounts to a standard 4" junction box with round plaster ring (provided by electrician). Electronic transformer (included) fits in junction box. One FreeJack port; for ceiling or wall. **MINIMUM 12" DROP LENGTH FOR PENDANTS AND HEADS.**



700FJ4SQD	WOOD	FINISH	VOLTAGE
M	MAPLE	Z ANTIQUE BRONZE	120V IN / 12V OUT
W	WALNUT	S SATIN NICKEL	024 120V IN / 24V OUT
			277 277V IN / 12V OUT
			-LED 120V IN / 12V OUT LED
			-LED277 277V IN / 12V OUT LED

2" SQUARE FLUSH CANOPY



Mounts to a special 2" square, 6" deep junction box (included). Electronic transformer (included) fits in junction box. One FreeJack port; for ceiling only.



700FJ2SQ67	FINISH	VOLTAGE
Z	ANTIQUE BRONZE	120V IN / 12V OUT
B	BLACK	024 120V IN / 24V OUT
C	CHROME	277 277V IN / 12V OUT
S	SATIN NICKEL	-LED 120V IN / 12V OUT LED
W	WHITE	-LED277 277V IN / 12V OUT LED



SURFACE CANOPY



Mounts to a standard 4" junction box with round plaster ring (provided by electrician). Vaulted version available for ceilings up to 45°. Electronic transformer inside 2" high, 4.5" diameter housing. One FreeJack port; for ceiling or wall.



FLAT



VAULTED

700FJSF	CEILING	FINISH	VOLTAGE
4	FLAT	Z ANTIQUE BRONZE	120V IN / 12V OUT
4V	VAULTED	B BLACK	024 120V IN / 24V OUT
		C CHROME	277 277V IN / 12V OUT
		S SATIN NICKEL	-LED 120V IN / 12V OUT LED
		W WHITE	-LED277 277V IN / 12V OUT LED

VENUS CANOPY



Mounts to a standard 4" junction box with round plaster ring (provided by electrician). Electronic transformer inside 3" high, 4.5" diameter housing. One FreeJack port; for ceiling or wall.



700FJSFV	FINISH	VOLTAGE
Z	ANTIQUE BRONZE	120V IN / 12V OUT
B	BLACK	024 120V IN / 24V OUT
C	CHROME	277 277V IN / 12V OUT
S	SATIN NICKEL	-LED 120V IN / 12V OUT LED
W	WHITE	-LED277 277V IN / 12V OUT LED



INDICATES WHICH TRANSFORMERS ARE COMPATIBLE WITH LED ELEMENTS

TIP: 120V FreeJack canopies are dimmable with a standard incandescent dimmer. 120V LED FreeJack canopies are dimmable with a low-voltage electronic dimmer. 277V FreeJack canopies are dimmable with 277V incandescent dimmer. 277V LED canopies are dimmable with 277V low-voltage electronic dimmer.

MULTI-PORT CANOPIES

See pp. 314-321 for additional options.

4-PORT SQUARE CANOPY



Mounts to a standard 4" junction box with round plaster ring (provided by electrician). Electronic transformers inside an 11" by 11" housing. Four FreeJack ports; for ceiling only.



700FJS4	FINISH	VOLTAGE
Z	ANTIQUÉ BRONZE	120V IN / 12V OUT
B	BLACK	277 277V IN / 12V OUT
C	CHROME	-LED 120V IN / 12V OUT LED
S	SATIN NICKEL	-LED277 277V IN / 12V OUT LED
W	WHITE	

3-PORT LINEAR CANOPY



Mounts to a standard 4" junction box with round plaster ring (provided by electrician). Electronic transformers inside a 28" by 4" housing. Three FreeJack ports; for ceiling only.



700FJL3	FINISH	VOLTAGE
Z	ANTIQUÉ BRONZE	120V IN / 12V OUT
B	BLACK	277 277V IN / 12V OUT
C	CHROME	-LED 120V IN / 12V OUT LED
S	SATIN NICKEL	-LED277 277V IN / 12V OUT LED
W	WHITE	

3 & 5-PORT ROUND CANOPIES



Mounts to a standard 4" junction box with round plaster ring (provided by electrician). Available in two styles. 3-port canopy has electronic transformers inside 12" diameter housing. 5-port canopy has electronic transformers inside 16" diameter housing. Three or five FreeJack ports; for ceiling only.



3-PORT



5-PORT

700FJR	STYLE	FINISH	VOLTAGE
3	3-PORT	Z ANTIQUÉ BRONZE	120V IN / 12V OUT
5	5-PORT	B BLACK	277 277V IN / 12V OUT
		C CHROME	-LED 120V IN / 12V OUT LED
		S SATIN NICKEL	-LED277 277V IN / 12V OUT LED
		W WHITE	

4-PORT ROUND CANOPY



Mounts to a standard 4" junction box with round plaster ring (provided by electrician). Electronic transformers in a 12" diameter housing. Four FreeJack ports. For ceiling only.



4-PORT ANTIQUÉ BRONZE



4-PORT SATIN NICKEL

700FJR4	FINISH	VOLTAGE
Z	ANTIQUÉ BRONZE	120V IN / 12V OUT
S	SATIN NICKEL	277 277V IN / 12V OUT
		-LED 120V IN / 12V OUT LED
		-LED277 277V IN / 12V OUT LED



INDICATES WHICH TRANSFORMERS ARE COMPATIBLE WITH LED ELEMENTS

Canopies

SINGLE-PORTS

Use to power a series of Heads or Pendants from a remote transformer (sold separately; see p. 468).

PORT ALONE

Minimal 1-1/2" diameter, 2-1/2" deep. Can be installed in a range of locations. Access to back of ceiling is not needed.

700FJFCP	FINISH
Z	ANTIQUÉ BRONZE
C	CHROME
S	SATIN NICKEL



PORT WITH CANOPY

4" round and 4" square canopies mount to a standard 4" junction box with round plaster ring (provided by electrician). 2" square canopy mounts to our special 2" square, 3.5" deep junction box (included).

700FJFCP	CANOPY	FINISH
4R	4" ROUND	Z ANTIQUÉ BRONZE
2S	2" SQUARE	B BLACK
4S	4" SQUARE	C CHROME
		S SATIN NICKEL
		W WHITE



4" ROUND



4" SQUARE



2" SQUARE

ADAPTERS

TRACK ADAPTER



LED

Allows FreeJack Heads or Pendants to be used on most popular 120 volt track lighting systems. Transformer concealed in black or white housing.



JUNO/HALO



LIGHTOLIER

700FJ	TYPE	FINISH	VOLTAGE
HASP	FITS JUNO / HALO*	B BLACK	12V 75W ELECTRONIC TRANSFORMER
LISP	FITS LIGHTOLIER*	W WHITE	-LED 12V 60W ELECTRONIC TRANSFORMER

T~TRAK FREEJACK CONNECTOR



LED

Use to adapt any low-voltage FreeJack head or pendant to T-TRAK system. Order one T-TRAK FreeJack Connector for each FreeJack head or pendant. Specify Single-Circuit T-TRAK or Two-Circuit T-TRAK. Includes transformer. 75 watt version dimmable with a standard incandescent dimmer. 10 watt version dimmable with low-voltage electronic dimmer.



700	SYSTEM	CHEDFJ	FINISH	VOLTAGE
TT	SINGLE-CIRCUIT T-TRAK	Z	ANTIQUÉ BRONZE	12V 75W ELECTRONIC TRANSFORMER
TT2	TWO-CIRCUIT T-TRAK	S	SATIN NICKEL	-LED 12V 10W ELECTRONIC TRANSFORMER
		W	WHITE	

RECESSED CAN ADAPTER



LED

Use to retrofit existing recessed down- lights for use with FreeJack elements. Includes transformer. 75 watt version dimmable with a standard incandescent dimmer. 10 watt version dimmable with low-voltage electronic dimmer. Mounts to any recessed can that is 6-1/4" to 6-1/2" in diameter and has "C" shaped hooks on the inside can wall.



700FJRCAD	FINISH	VOLTAGE
Z	ANTIQUÉ BRONZE	12V 75W ELECTRONIC TRANSFORMER
C	CHROME	-LED 12V 10W ELECTRONIC TRANSFORMER
S	SATIN NICKEL	
W	WHITE	

ETL CLASSIFIED FOR USE WITH THE FOLLOWING RECESSED CANS: JUNO IC2, JUNO IC22, TC2, AND TC2R; HALO H7T AND H7RT; COOPER LIGHTING H27RT; CAPRI (THOMAS) LIGHTING PR75ASIC / TPR75ASIC-8DY6431; PROGRESS LIGHTING P7TG, P8-TG, AND P-8TG & PIO8-TG.*

* TECH LIGHTING IS NOT AFFILIATED WITH, NOR IS IT ENDORSED BY ANY OF THE COMPANIES LISTED ABOVE. TECH LIGHTING DOES NOT DISTRIBUTE OR SELL ANY OF THE PRODUCTS LISTED ABOVE. CALL FOR MORE INFORMATION.



LED

INDICATES WHICH TRANSFORMERS ARE COMPATIBLE WITH LED ELEMENTS

SYSTEM CONNECTORS

Use to adapt any FreeJack element to any Tech Lighting system.

MONORAIL FREEJACK CONNECTOR

700MOCHED	FINISH
Z	ANTIQUÉ BRONZE
C	CHROME
S	SATIN NICKEL



TWO-CIRCUIT MONORAIL FREEJACK CONNECTOR

700MO2CHED	FINISH
Z	ANTIQUÉ BRONZE
C	CHROME
S	SATIN NICKEL



WALL MONORAIL FREEJACK CONNECTOR

700WMOCHED	FINISH
Z	ANTIQUÉ BRONZE
C	CHROME
S	SATIN NICKEL

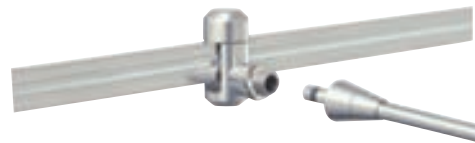

KABLE LITE FREEJACK CONNECTOR

For cable separations of 8" or less. May be field cut to desired separation (2" minimum).

700KABCO	FINISH
C	CHROME
S	SATIN NICKEL



Aero head p. 169 and Round Glass Shield accessory p. 569



MONORAIL



Spot head p. 171



Photographer: Eric Roth Architecture: LDa Architecture & Interiors



Sprocket head p. 172

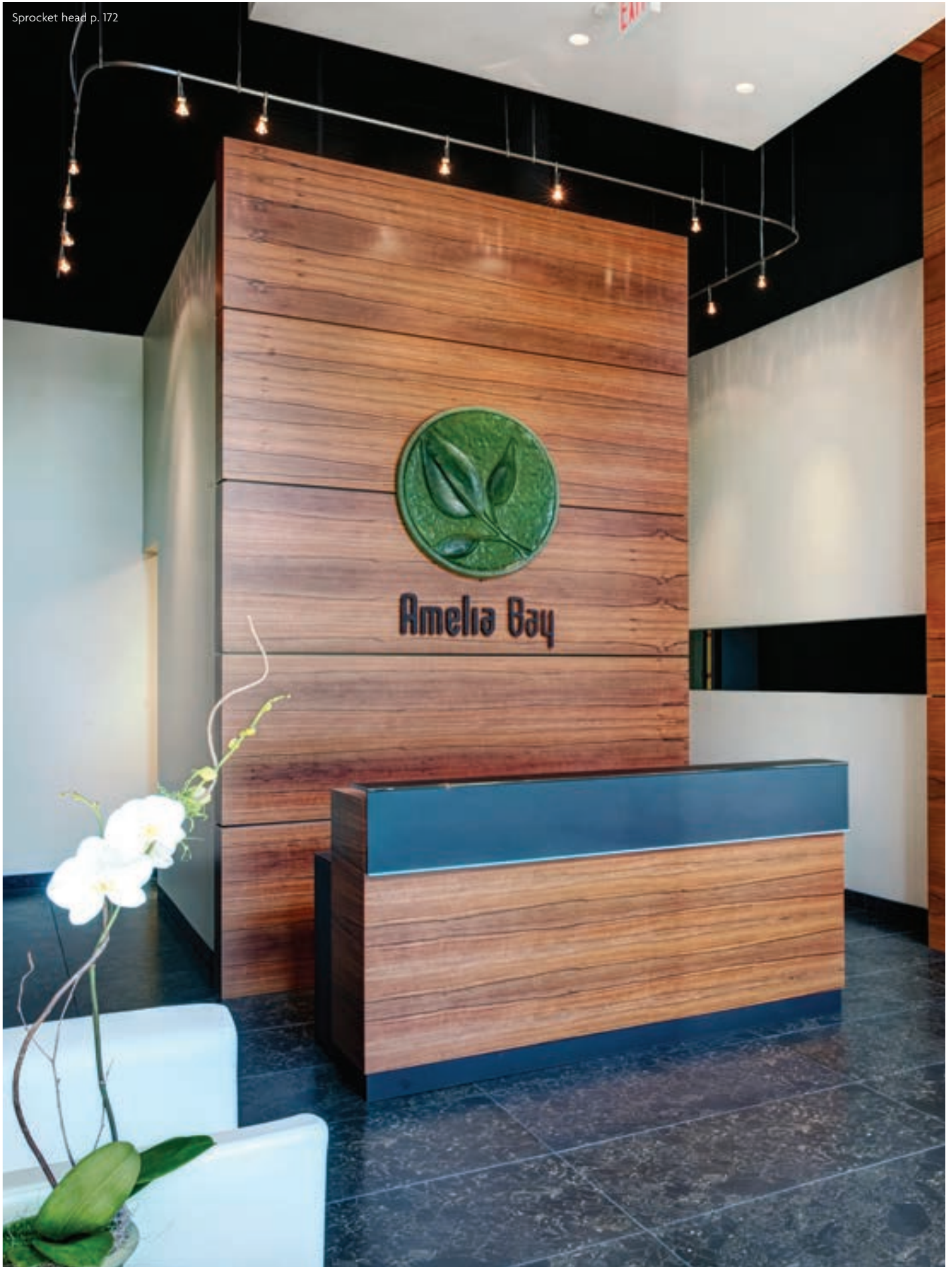

Photographer: © Galina Coadă



Photographer: © Galina Coad

The Basics of MonoRail

Need help designing your system? Visit our online order configurator at configurator.techlighting.com



ONE DESIGN YOUR MONORAIL SYSTEM



The first step in designing your MonoRail system is to determine what it is you are trying to light. You'll need to decide where the elements should be installed to put light where you want it. See compatible elements on pp. 52-193. Choose your elements then add accessories if desired. We offer a broad range of colorful and decorative accessories and functional optical controls (pp. 566-579).



Draw in your MonoRail run. Remember, MonoRail can be shaped by hand to follow architectural details or to create an organic shape. Factory pre-bent shapes are also offered in several configurations. Your MonoRail run must be placed so it runs directly beneath the junction box with surface transformer or power feed canopy. Determine how many pieces of rail you'll need (p. 464). Add a pair of end caps to each end of the run for an elegant finishing touch (p. 465).

TWO ADD POWER AND HARDWARE TO COMPLETE YOUR SYSTEM

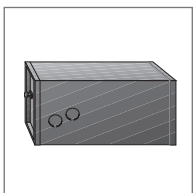

Add up the wattages of the lamps you'll be using on the system: this will help you select a transformer. A remote transformer with power feed canopy provides the cleanest look, but the remote transformer must be installed in an accessible, remote location. A surface transformer simply mounts to a junction box. The remodel recessed transformer provides the same clean look of a remote transformer but doesn't require access to a remote location. However, it will not work with concrete ceilings. Use the information on pp. 592-593 to help you choose the right transformer for your installation; see pp. 468-473 for MonoRail transformer and power feed options. If you are using LED heads or pendants, be sure to choose a transformer that is compatible with LED fixtures.



Determine how far from the ceiling you want the system to drop. Power feed canopies place the rail one or two inches from the ceiling; surface transformers drop it from one to five inches, depending on the type of transformer. If this drop is shorter than you require, you'll need to add a power extender (p. 469) to your canopy or surface transformer. The maximum standard drop for MonoRail is eight feet.



Next, add standoffs that match the drop of your power feed to support the system (p. 466). Adjustable standoffs provide a clean, elegant look. Choose rigid standoffs for curvy runs, or runs with multiple glass pendants. You'll need one standoff for every three feet of MonoRail. The power feed counts as a support, so begin adding standoffs three feet from the power feed.

Note: Power extenders and standoffs are field-cuttable, so it's easy to achieve a custom drop length.

MONORAIL KITS

To simplify ordering, we offer several convenient MonoRail Kits (pp. 478-479).

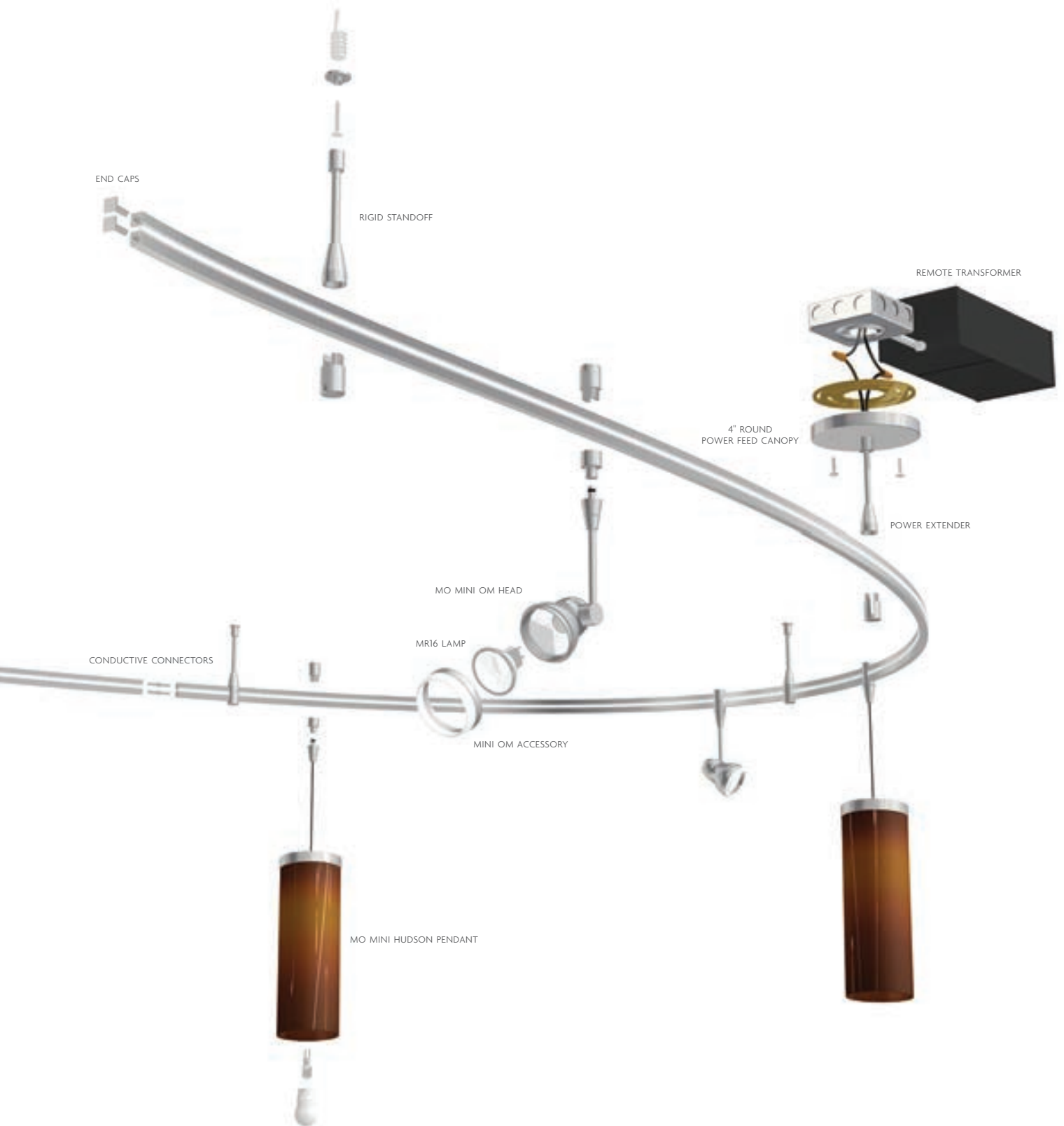

For design harmony, all the power, standoff, and element connections to the MonoRail are shaped identically. Note that standoffs and elements can be positioned to cover where two rails are joined to maintain the smooth line.

For other MonoRail system options, such as mounting to a vaulted or T-bar ceiling or to a wall, see Special Installations on pp. 474-477.

MonoRail

MONORAIL

Hand-bendable, field-cutable MonoRail is rated for 300 watts at 12 volts, 600 watts at 24 volts. Each piece of rail is shipped with conductive connectors to join rail pieces end to end. Order additional connectors (p. 465) if cutting and rejoining rails.



700MOA	LENGTH	FINISH / INSULATOR
24	24" (.61 m)	BRZ ANTIQUE BRONZE WITH BROWN INSULATOR
48	48" (1.2 m)	Z ANTIQUE BRONZE WITH CLEAR INSULATOR
96	96" (2.4 m)	C CHROME WITH CLEAR INSULATOR
		S SATIN NICKEL WITH CLEAR INSULATOR

ANTIQUÉ BRONZE - BROWN INSULATOR



FOR A HOLISTIC ANTIQUÉ BRONZE FINISH, A BROWN INSULATOR IS RECOMMENDED

ANTIQUÉ BRONZE - CLEAR INSULATOR



CHROME - CLEAR INSULATOR



SATIN NICKEL - CLEAR INSULATOR



ACTUAL SIZE

PRE-BENT S-CURVE MONORAIL

MonoRail pre-bent into a horizontal S curve. Consult the drawing for approximate dimensions. For a factory bend not shown, please call for a custom quotation.

700MOBHSC60	FINISH / INSULATOR
BRZ	ANTIQUÉ BRONZE WITH BROWN INSULATOR
Z	ANTIQUÉ BRONZE WITH CLEAR INSULATOR
C	CHROME WITH CLEAR INSULATOR
S	SATIN NICKEL WITH CLEAR INSULATOR

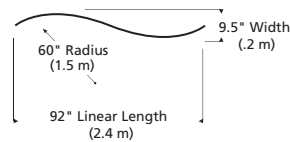

PRE-BENT 90° CURVE MONORAIL

Horizontal 90° curves are sold by radius, or the distance from the center of the circle to the outside edge. Join four 90° curves to create a circle with a diameter (overall width) equal to twice the specified radius. For a factory bend not shown, please call for a custom quotation.

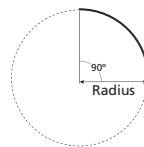

700MOBH90	RADIUS	FINISH / INSULATOR
12	12"	BRZ ANTIQUÉ BRONZE WITH BROWN INSULATOR
18	18"	Z ANTIQUÉ BRONZE WITH CLEAR INSULATOR
24	24"	C CHROME WITH CLEAR INSULATOR
36	36"	S SATIN NICKEL WITH CLEAR INSULATOR
48	48"	
60	60"	

Standard MonoRail bends horizontally to a radius as small as 6" and vertically to a radius as small as 24". For custom factory bends, provide degree and radius of curve.

TIP: To calculate the amount of rail you'll need for an organic shape, draw the MonoRail run to scale (for example, 1/4" = 1'). Use a piece of string to "trace" the drawing. Measure the length of string, then convert from your scale.

Connectors

CONDUCTIVE CONNECTORS

Conductive connectors join sections of rail together end to end and are included with all MonoRail pieces. Order separately if cutting and rejoining rails. Pair.

700MOCCN	FINISH
Z	ANTIQU BRONZE
C	CHROME
S	SATIN NICKEL



ISOLATING CONNECTORS

Isolating connectors join sections of rail and isolate power feeds from each other. Two common uses are in runs using more than 300w or in runs over 30ft where two power feeds are required to avoid voltage drop. All dual-feed canopies and dual-feed surface transformers are shipped with isolating connectors; order additional if required by layout. Pair.



700MOCINC

FLEXIBLE HORIZONTAL CONNECTORS

These conductive connectors join sections of rail together end to end at desired sharp horizontal angle. Pair.

700MOCFXH	FINISH
Z	ANTIQU BRONZE
C	CHROME
S	SATIN NICKEL



FLEXIBLE VERTICAL CONNECTORS

These conductive connectors join sections of rail together end to end at desired vertical angle. Pair.

700MOCFXV	FINISH
Z	ANTIQU BRONZE
C	CHROME
S	SATIN NICKEL



END CAPS

Decorative end caps fit into ends of MonoRail run for a finished look. Pair; order one pair for each end.

700MOCCAP	FINISH
Z	ANTIQU BRONZE
C	CHROME
S	SATIN NICKEL



Standoffs

Use standoff supports every three feet of MonoRail run and at corners. Standoffs can be positioned to cover points where rails are joined.

RIGID STANDOFF

The field-cuttable rigid standoff is recommended for curvy runs or runs with heavier Heads, Pendants or Functional art, such as glass pendants. Rigid standoffs are compatible with various power feed options: Use the chart below to determine the appropriate standoff for your run.

To determine the shortest compatible standoff for any power feed or surface transformer option, see pp. 469-472.

LENGTH	STANDOFF	FINISH
1" (1.0)*	700MOS01	(Z, C, OR S)**
2" (1.9)*	700MOS02	(Z, C, OR S)
3" (3.6)*	700MOS03	(Z, C, OR S)
4" (4.8)*	700MOS04	(Z, C, OR S)
5" (5.8)*	700MOS05	(Z, C, OR S)
6**	700MOS06	(Z, C, OR S)
12**	700MOS12	(Z, C, OR S)
24**	700MOS24	(Z, C, OR S)
36**	700MOS36	(Z, C, OR S)
48**	700MOS48	(Z, C, OR S)
96**	700MOS96	(Z, C, OR S)

* ACTUAL LENGTH FROM CEILING TO TOP OF RAIL

** MAY ONLY BE USED WITH MONORAIL LOW-PROFILE POWER FEED CANOPY (P. 469) OR MONORAIL LOW-PROFILE REMODEL RECESSED TRANSFORMER (P. 473) OR PASS-THROUGH TRANSFORMER. NOT COMPATIBLE WITH STANDOFF VAULT ADAPTER. NOT FIELD-CUTTABLE

ADJUSTABLE STANDOFF

The adjustable standoff's cable virtually disappears for a clean and elegant look. It is best used on fairly straight runs with a drop greater than 6". A wire grip allows you to easily shorten or lengthen the cable to size it for use.

700MOSADJ	LENGTH	FINISH
	12' OF CABLE	Z ANTIQUE BRONZE
3	30' OF CABLE	C CHROME
		S SATIN NICKEL

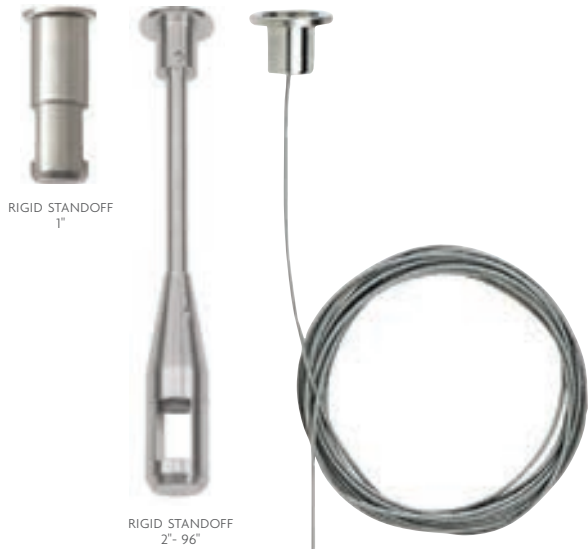

RIGID STANDOFF
1"

RIGID STANDOFF
2" - 96"

TIP: For best appearance, place the last standoff 4-6" from the end of the rail, and place standoffs symmetrically.

ADJUSTABLE STANDOFF















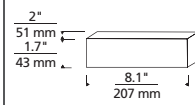

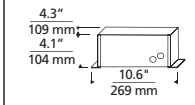
Photographer: © Galina Coadă

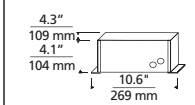
Remote Transformers

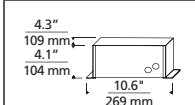
Remote transformers install in an accessible location behind the ceiling or wall. For technical information on remote transformers, see pp. 592-593. Requires canopy (p. 469) or special power feed (pp. 474-475).

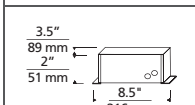
INPUT VOLTAGE OUTPUT VOLTAGE WATTAGE TYPE	ITEM NUMBER	COMPATIBLE DIMMER TYPE	COMPATIBLE DIMMING COIL	PLUG-IN TRANSFORMER OPTION INCLUDES 16' CORD	RECESSED REMOTE TRANSFORMER OPTION*	277 VOLT INPUT OPTION
--	-------------	---------------------------	----------------------------	---	---	--------------------------

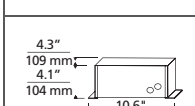
SINGLE-FEED OPTIONS

		1 X 120V 12V 1 X 60 WATTS** ELECTRONIC AC	700AT060EL	LOW-VOLTAGE ELECTRONIC 450 WATTS	—	—	—
		1 X 120V 12V 1 X 75 WATTS** MAGNETIC AC	700AT075T	LOW-VOLTAGE MAGNETIC 600 WATTS	—	700AT075P	700AT075T277
		1 X 120V 12V 1 X 150 WATTS** MAGNETIC AC	700AT150T	LOW-VOLTAGE MAGNETIC 600 WATTS	700DIM150 (P. 593)	700AT150P	700AT150T277
		1 X 120V 12V 1 X 150 WATTS** ELECTRONIC DC	700AT152EL	LOW-VOLTAGE ELECTRONIC 600 WATTS	—	—	—
		1 X 120V 12V 1 X 300 WATTS** MAGNETIC AC	700AT300T	LOW-VOLTAGE MAGNETIC 600 WATTS	700DIM300 (P. 593)	700AT300P	700AT300T277 700AT300TR277*
		1 X 120V 12V 1 X 300 WATTS ELECTRONIC DC	700AT300EL	LOW-VOLTAGE ELECTRONIC 600 WATTS	—	700AT300ELP	—
		1 X 120V 12V 1 X 300 WATTS** ELECTRONIC DC	700AT302EL	LOW-VOLTAGE ELECTRONIC 600 WATTS	—	—	—
		1 X 120V 24V 1 X 300 WATTS MAGNETIC AC	700AT3024T	LOW-VOLTAGE MAGNETIC 600 WATTS	700DIM300 (P. 593)	700AT3024P	700AT3024TR 700AT3024TR277*
		1 X 120V 24V 1 X 600 WATTS MAGNETIC AC	700AT6024T	LOW-VOLTAGE MAGNETIC 1000 WATTS	700DIM600 (P. 593)	700AT6024P	700AT6024TR 700AT6024TR277*

DUAL-FEED OPTIONS

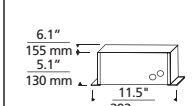
		1 X 120V 12V 2 X 300 WATTS** MAGNETIC AC	700AT600T	LOW-VOLTAGE MAGNETIC 1000 WATTS	700DIM600 (P. 593)	700AT600P	700AT600TR 700AT600TR277*
--	---	---	-----------	---------------------------------------	-----------------------	-----------	------------------------------

* IN-WALL RECESSED REMOTE TRANSFORMERS ALSO AVAILABLE FOR MAGNETIC 300 AND 600 WATT MODELS FOR USE IN APPLICATIONS WHERE A REMOTE TRANSFORMER IS DESIRED BUT THERE ISN'T ACCESS TO A REMOTE LOCATION. SEE WWW.TECHLIGHTING.COM FOR DIMENSIONS AND FURTHER DETAILS.



** AS A GENERAL RULE WHEN USING LED FIXTURES WE DO NOT RECOMMEND USING GREATER THAN 70% OF SPECIFIED MAXIMUM WATTAGE ON THE TRANSFORMER DUE TO INRUSH CURRENT. FOR ASSISTANCE, PLEASE CONTACT OUR TECHNICAL SUPPORT DEPARTMENT.







INDICATES WHICH TRANSFORMERS ARE COMPATIBLE WITH LED ELEMENTS





Power Feed Canopies

ITEM NUMBER	MOUNTS TO	SHORTEST COMPATIBLE RIGID STANDOFF (P.466)	TO DROP FROM CEILING GREATER THAN SHORTEST COMPATIBLE RIGID STANDOFF
-------------	-----------	--	--

SINGLE-FEED OPTIONS USE WITH ONE SINGLE-FEED REMOTE TRANSFORMER

 <p>4" ROUND LOW-PROFILE SINGLE-FEED**</p>	BRONZE: 700MOP4C01Z CHROME: 700MOP4C01C SATIN NICKEL: 700MOP4C01S	STANDARD 4" JUNCTION BOX WITH ROUND PLASTER RING (PROVIDED BY ELECTRICIAN)	ONLY COMPATIBLE WITH 1" RIGID STANDOFF (P.466)	NOT COMPATIBLE WITH POWER EXTENDERS
 <p>4" ROUND SINGLE-FEED</p>	BRONZE: 700MOP4C02Z BLACK: 700MOP4C02B* CHROME: 700MOP4C02C SATIN NICKEL: 700MOP4C02S WHITE: 700MOP4C02W*	STANDARD 4" JUNCTION BOX WITH ROUND PLASTER RING (PROVIDED BY ELECTRICIAN)	2" (P.466)	ADD ONE POWER EXTENDER (BELOW)
 <p>2" SQUARE SINGLE-FEED</p>	BRONZE: 700MOP2C02Z BLACK: 700MOP2C02B* CHROME: 700MOP2C02C SATIN NICKEL: 700MOP2C02S WHITE: 700MOP2C02W*	SPECIAL 2" SQUARE JUNCTION BOX (INCLUDED)	2" (P.466)	ADD ONE POWER EXTENDER (BELOW)
 <p>2" X 4" RECTANGULAR SINGLE-FEED</p>	BRONZE: 700MOPRC02Z BLACK: 700MOPRC02B* CHROME: 700MOPRC02C SATIN NICKEL: 700MOPRC02S WHITE: 700MOPRC02W*	STANDARD SINGLE GANG OR GEM BOX (PROVIDED BY ELECTRICIAN)	2" (P.466)	ADD ONE POWER EXTENDER (BELOW)

DUAL-FEED OPTIONS USE WITH ONE DUAL-FEED REMOTE TRANSFORMER (ISOLATING CONNECTORS INCLUDED)

 <p>4" ROUND LOW-PROFILE DUAL-FEED**</p>	BRONZE: 700MOP4C401Z CHROME: 700MOP4C401C SATIN NICKEL: 700MOP4C401S	STANDARD 4" JUNCTION BOX WITH ROUND PLASTER RING (PROVIDED BY ELECTRICIAN)	ONLY COMPATIBLE WITH 1" RIGID STANDOFF (P.466)	NOT COMPATIBLE WITH POWER EXTENDERS
 <p>4" ROUND DUAL-FEED</p>	BRONZE: 700MOP4C402Z BLACK: 700MOP4C402B* CHROME: 700MOP4C402C SATIN NICKEL: 700MOP4C402S WHITE: 700MOP4C402W*	STANDARD 4" JUNCTION BOX WITH ROUND PLASTER RING (PROVIDED BY ELECTRICIAN)	2" (P.466)	ADD TWO POWER EXTENDERS (BELOW)
 <p>2" SQUARE DUAL-FEED</p>	BRONZE: 700MOP2C402Z BLACK: 700MOP2C402B* CHROME: 700MOP2C402C SATIN NICKEL: 700MOP2C402S WHITE: 700MOP2C402W*	SPECIAL 2" SQUARE JUNCTION BOX (INCLUDED)	2" (P.466)	ADD TWO POWER EXTENDERS (BELOW)
 <p>2" X 4" RECTANGULAR DUAL-FEED</p>	BRONZE: 700MOPRC402Z BLACK: 700MOPRC402B* CHROME: 700MOPRC402C SATIN NICKEL: 700MOPRC402S WHITE: 700MOPRC402W*	STANDARD SINGLE GANG OR GEM BOX (PROVIDED BY ELECTRICIAN)	2" (P.466)	ADD TWO POWER EXTENDERS (BELOW)

PLUG OPTION

16' cord and plug for standard 120 volt power outlets.

700A1- COLOR
 WHT WHITE
 BLK BLACK



POWER EXTENDER

Add to power feed canopy or surface transformer to drop power from ceiling. For dual-feed canopies and transformers, order two. Field-cuttable.

700MOP	LENGTH	FINISH
03	3"	Z ANTIQUE BRONZE
06	6"	C CHROME
12	12"	S SATIN NICKEL
24	24"	
36	36"	
48	48"	
96	96"	

* BLACK AND WHITE FINISH OPTIONS HAVE SATIN NICKEL FEEDS
 ** NOT COMPATIBLE WITH POWER EXTENDERS OR POWER VAULT ADAPTER

Pass-Through Surface Transformers

The Pass-Through combines a sleek design with the ability to use 1" standoffs and ease of installation. First, the installer mounts and wires the upper canopy in much the same way a standard line-voltage pendant would be mounted. Second, the installer connects the rail connector to the rail. Finally, the installer snaps the lower canopy into the upper canopy without the need for any tools. The electrical connections are made automatically due to the mating components. The transformer bay is housed completely in the bottom canopy, so should there be any problems with the transformer at any time, only the bottom canopy would need to be removed. The upper canopy and the entire MonoRail run can remain in place. It's that easy.

The Low-Profile works in almost the exact same manner, but the rail drops below the canopy where a drop is preferred. Simply order a Power Extender (p. 469).

THE PASS-THROUGH



Sleek, minimalist design meets easy installation. The MonoRail practically hugs the ceiling. Mounts to a standard 4" ceiling junction box with round plaster ring (provided by electrician). Can be used with 1" Standoffs (p. 466). Not compatible with Pre-Bent S Curve or Pre-Bent 90° Curve MonoRail.

700MOPRT301E	FINISH	TYPE
Z	ANTIQUE BRONZE	HALOGEN
S	SATIN NICKEL	-LED LED

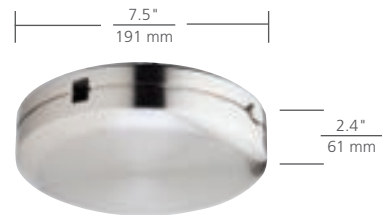

THE LOW-PROFILE



Sleek, minimalist design meets easy installation. For use when a longer drop is preferred. Mounts to a standard 4" ceiling junction box with round plaster ring (provided by electrician). Can be used with 4" or greater Standoffs (p. 466) and a Power Extender (p. 469).

700MOPRT30E	FINISH	TYPE
Z	ANTIQUE BRONZE	HALOGEN
S	SATIN NICKEL	-LED LED

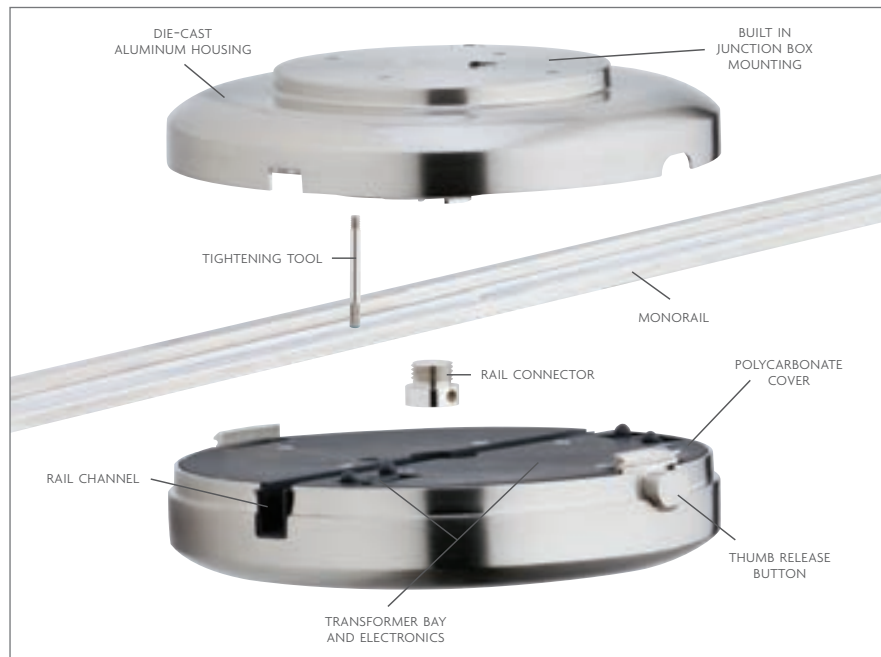
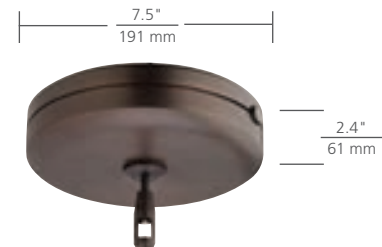

INDICATES WHICH TRANSFORMERS ARE COMPATIBLE WITH LED ELEMENTS

AS A GENERAL RULE WHEN USING LED FIXTURES WE DO NOT RECOMMEND USING GREATER THAN 70% OF SPECIFIED MAXIMUM WATTAGE ON THE TRANSFORMER DUE TO INRUSH CURRENT. FOR ASSISTANCE, PLEASE CONTACT OUR TECHNICAL SUPPORT DEPARTMENT.

Mini Surface Transformer

The Mini answers the question, how small can it be? At 1.4 inches deep and 5.25 inches in diameter, it is the smallest 300 watt surface MonoRail transformer in the industry. It installs similarly to our existing family of 300 watt transformers and practically disappears on the MonoRail system.

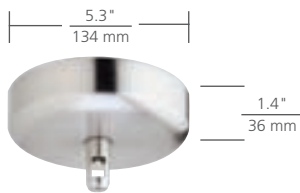

THE MINI



Truly minimalist design and the industry's smallest 300 watt surface transformer. Constructed of die-cast aluminum. Mounts to a standard 4" ceiling junction box with round plaster ring (provided by electrician). Can be used with 2" or greater Standoffs (p. 466) and a Power Extender (p. 469).

700MOMRT30E	FINISH	TYPE
Z	ANTIQUE BRONZE	HALOGEN
S	SATIN NICKEL	-LED LED

INPUT VOLTAGE OUTPUT VOLTAGE WATTAGE TYPE	ITEM NUMBER	COMPATIBLE DIMMER TYPE	COMPATIBLE DIMMING COIL	COMPATIBLE RIGID STANDOFF	TO DROP FROM CEILING	TO PLUG IN
--	-------------	---------------------------	-------------------------------	---------------------------------	-------------------------	------------

SINGLE-FEED OPTIONS

	1 X 120V 12V 1 X 300 WATTS* ELECTRONIC AC	BRONZE: 700MOPRT30IEZ BRONZE, LED: 700MOPRT30IEZ-LED SATIN NICKEL: 700MOPRT30IES SATIN NICKEL, LED: 700MOPRT30IES-LED	LOW-VOLTAGE ELECTRONIC 600 WATTS	—	1" (P.466)	—	—
	1 X 120V 12V 1 X 300 WATTS* ELECTRONIC AC	BRONZE: 700MOPRT30EZ BRONZE, LED: 700MOPRT30EZ-LED SATIN NICKEL: 700MOPRT30ES SATIN NICKEL, LED: 700MOPRT30ES-LED	LOW-VOLTAGE ELECTRONIC 600 WATTS	—	4" (P.466)	ADD ONE POWER EXTENDER (P.469)	—
	1 X 120V 12V 1 X 300 WATTS* ELECTRONIC AC	BRONZE: 700MOMRT30EZ BRONZE, LED: 700MOMRT30EZ-LED SATIN NICKEL: 700MOMRT30ES SATIN NICKEL, LED: 700MOMRT30ES-LED	LOW-VOLTAGE ELECTRONIC 600 WATTS	—	2" (P.466)	ADD ONE POWER EXTENDER (P.469)	—

* AS A GENERAL RULE WHEN USING LED FIXTURES WE DO NOT RECOMMEND USING GREATER THAN 70% OF SPECIFIED MAXIMUM WATTAGE ON THE TRANSFORMER DUE TO INRUSH CURRENT. FOR ASSISTANCE, PLEASE CONTACT OUR TECHNICAL SUPPORT DEPARTMENT.























INDICATES WHICH TRANSFORMERS ARE COMPATIBLE WITH LED ELEMENTS

Surface Transformers



All surface transformers mount to a standard 4" ceiling junction box with round plaster ring (provided by electrician). For technical information on surface transformers, see pp. 592-593.

INPUT VOLTAGE OUTPUT VOLTAGE WATTAGE TYPE	ITEM NUMBER	COMPATIBLE DIMMER TYPE	COMPATIBLE DIMMING COIL	COMPATIBLE RIGID STANDOFF	TO DROP FROM CEILING	TO PLUG IN
--	-------------	---------------------------	----------------------------	---------------------------------	-------------------------	------------

SINGLE-FEED OPTIONS

		1 X 120V 12V 1 X 60 WATTS** ELECTRONIC AC	BRONZE: 700MOFRT60EZ-LED BLACK: 700MOFRT60EB-LED* CHROME: 700MOFRT60EC-LED SATIN NICKEL: 700MOFRT60ES-LED WHITE: 700MOFRT60EW-LED*	LOW-VOLTAGE ELECTRONIC 600 WATTS	—	2" (P. 466)	ADD ONE POWER EXTENDER (P. 469)	—
		1 X 120V 12V 1 X 60 WATTS** ELECTRONIC AC	BRONZE: 700MOSRT60EZ-LED BLACK: 700MOSRT60EB-LED* CHROME: 700MOSRT60EC-LED SATIN NICKEL: 700MOSRT60ES-LED WHITE: 700MOSRT60EW-LED*	LOW-VOLTAGE ELECTRONIC 600 WATTS	—	3" (P. 466)	ADD ONE POWER EXTENDER (P. 469)	—
		1 X 120V 12V 1 X 75 WATTS** MAGNETIC AC	BRONZE: 700MOSRT75DZ BLACK: 700MOSRT75DB* CHROME: 700MOSRT75DC SATIN NICKEL: 700MOSRT75DS WHITE: 700MOSRT75DW*	LOW-VOLTAGE MAGNETIC 600 WATTS	—	3" (P. 466)	ADD ONE POWER EXTENDER (P. 469)	—
		1 X 120V 12V 1 X 100 WATTS** ELECTRONIC AC	BRONZE: 700MOSRT100EZ-LED BLACK: 700MOSRT100EB-LED* CHROME: 700MOSRT100EC-LED SATIN NICKEL: 700MOSRT100ES-LED WHITE: 700MOSRT100EW-LED*	LOW-VOLTAGE ELECTRONIC 600 WATTS	—	3" (P. 466)	ADD ONE POWER EXTENDER (P. 469)	—
		1 X 120V 12V 1 X 150 WATTS** MAGNETIC AC	BRONZE: 700MOSRT15DZ BLACK: 700MOSRT15DB* CHROME: 700MOSRT15DC SATIN NICKEL: 700MOSRT15DS WHITE: 700MOSRT15DW*	LOW-VOLTAGE MAGNETIC 600 WATTS	INCLUDED	3" (P. 466)	ADD ONE POWER EXTENDER (P. 469)	ADD PLUG OPTION (P. 469)
		1 X 120V 12V 1 X 150 WATTS ELECTRONIC AC	BRONZE: 700MOSRT15EZ BLACK: 700MOSRT15EB* CHROME: 700MOSRT15EC SATIN NICKEL: 700MOSRT15ES WHITE: 700MOSRT15EW*	LOW-VOLTAGE ELECTRONIC 600 WATTS	—	3" (P. 466)	ADD ONE POWER EXTENDER (P. 469)	ADD PLUG OPTION (P. 469)
		1 X 120V 12V 1 X 300 WATTS** MAGNETIC AC	BRONZE: 700MOSRT30DZ BLACK: 700MOSRT30DB* CHROME: 700MOSRT30DC SATIN NICKEL: 700MOSRT30DS WHITE: 700MOSRT30DW*	LOW-VOLTAGE MAGNETIC 600 WATTS	INCLUDED	4" (P. 466)	ADD ONE POWER EXTENDER (P. 469)	ADD PLUG OPTION (P. 469)
		1 X 120V 12V 1 X 300 WATTS ELECTRONIC DC	BRONZE: 700MOSRT30EZ BLACK: 700MOSRT30EB* CHROME: 700MOSRT30EC SATIN NICKEL: 700MOSRT30ES WHITE: 700MOSRT30EW*	LOW-VOLTAGE ELECTRONIC 600 WATTS	—	4" (P. 466)	ADD ONE POWER EXTENDER (P. 469)	ADD PLUG OPTION (P. 469)
		1 X 120V 24V 1 X 300 WATTS MAGNETIC AC	BRONZE: 700MOSRT324DZ BLACK: 700MOSRT324DB* CHROME: 700MOSRT324DC SATIN NICKEL: 700MOSRT324DS WHITE: 700MOSRT324DW*	LOW-VOLTAGE MAGNETIC 600 WATTS	INCLUDED	4" (P. 466)	ADD ONE POWER EXTENDER (P. 469)	ADD PLUG OPTION (P. 469)
		1 X 120V 24V 1 X 600 WATTS MAGNETIC AC	BRONZE: 700MOSRT624DZ BLACK: 700MOSRT624DB* CHROME: 700MOSRT624DC SATIN NICKEL: 700MOSRT624DS WHITE: 700MOSRT624DW*	LOW-VOLTAGE MAGNETIC 1000 WATTS	INCLUDED	5" (P. 466)	ADD ONE POWER EXTENDER (P. 469)	ADD PLUG OPTION (P. 469)

DUAL-FEED OPTIONS (ISOLATING CONNECTORS INCLUDED)

		1 X 120V 12V 2 X 300 WATTS** MAGNETIC AC	BRONZE: 700MOSRT60DZ BLACK: 700MOSRT60DB* CHROME: 700MOSRT60DC SATIN NICKEL: 700MOSRT60DS WHITE: 700MOSRT60DW*	LOW-VOLTAGE MAGNETIC 1000 WATTS	INCLUDED	5" (P. 466)	ADD TWO POWER EXTENDERS (P. 469)	ADD PLUG OPTION (P. 469)
--	---	---	--	---------------------------------------	----------	----------------	---	--------------------------------

* BLACK AND WHITE FINISH OPTIONS HAVE SATIN NICKEL FEEDS

** AS A GENERAL RULE WHEN USING LED FIXTURES WE DO NOT RECOMMEND USING GREATER THAN 70% OF SPECIFIED MAXIMUM WATTAGE ON THE TRANSFORMER DUE TO INRUSH CURRENT. FOR ASSISTANCE, PLEASE CONTACT OUR TECHNICAL SUPPORT DEPARTMENT.



INDICATES WHICH TRANSFORMERS ARE COMPATIBLE WITH LED ELEMENTS

Remodel Recessed Transformers

Remodel Recessed Transformers install in a similar fashion as remodel recessed downlights and are concealed inside a housing that recesses above the ceiling. The decorative canopy is the only visible portion of the transformer once installed.



Remodel Recessed Transformers look similar from below the ceiling to the power feed canopies used with remote transformers and are preferred for their clean look. An additional benefit they have over remote transformers is that they do not require access to a remote location because the transformer sits just above the ceiling. However, they are not compatible with all finished ceilings because an electrician will need to install the Remodel Recessed Transformer in close proximity to an existing junction box, drill through the finished ceiling in the location where the Remodel Recessed Transformer will be installed, and cover the existing junction box with the provided field-paintable metal cover. In new construction, an electrician can simply bring power to the Remodel Recessed Transformer directly.

The Remodel Recessed Transformer has an integral power feed so there is no need for a separate power feed; however, the transformer must be installed directly above the rail run. Insulation must be kept at least 3 inches away from the transformer and housing. This transformer is equipped with fast-acting short circuit and overload protection that will safely turn off the system should a short occur. Once the short is removed, the unit can be reset by simply flipping the wall switch off and back on.





INPUT VOLTAGE OUTPUT VOLTAGE WATTAGE TYPE	ITEM NUMBER	COMPATIBLE DIMMER TYPE	COMPATIBLE RIGID STANDOFF	TO DROP FROM CEILING GREATER THAN SHORTEST COMPATIBLE RIGID STANDOFF
--	-------------	---------------------------	------------------------------	---

LOW-PROFILE SINGLE-FEED OPTIONS**

	1 X 120V 12V 1 X 150 WATTS ELECTRONIC DC	BRONZE: 700MOSRR15IEZ CHROME: 700MOSRR15IEC SATIN NICKEL: 700MOSRR15IES WHITE: 700MOSRR15IEW*	LOW-VOLTAGE ELECTRONIC 600 WATTS	1" (P. 466)	NOT COMPATIBLE WITH POWER EXTENDERS
	1 X 120V 12V 1 X 300 WATTS ELECTRONIC DC	BRONZE: 700MOSRR30IEZ CHROME: 700MOSRR30IEC SATIN NICKEL: 700MOSRR30IES WHITE: 700MOSRR30IEW*	LOW-VOLTAGE ELECTRONIC 600 WATTS	1" (P. 466)	NOT COMPATIBLE WITH POWER EXTENDERS

EXTENDABLE SINGLE-FEED OPTIONS

	1 X 120V 12V 1 X 150 WATTS ELECTRONIC DC	BRONZE: 700MOSRR15EZ CHROME: 700MOSRR15EC SATIN NICKEL: 700MOSRR15ES WHITE: 700MOSRR15EW*	LOW-VOLTAGE ELECTRONIC 600 WATTS	2" (P. 466)	ADD ONE POWER EXTENDER (P. 469)
	1 X 120V 12V 1 X 300 WATTS ELECTRONIC DC	BRONZE: 700MOSRR30EZ CHROME: 700MOSRR30EC SATIN NICKEL: 700MOSRR30ES WHITE: 700MOSRR30EW*	LOW-VOLTAGE ELECTRONIC 600 WATTS	2" (P. 466)	ADD ONE POWER EXTENDER (P. 469)

* WHITE FINISH OPTION HAS SATIN NICKEL FEED

** NOT COMPATIBLE WITH POWER EXTENDERS OR POWER VAULT ADAPTER

Special Installations

USING A DIRECT-END POWER FEED

These direct-end power feeds bring power from a remote transformer to the rail at an end of the run and mounts to a wall perpendicular to the run. Use with a single-feed remote transformer (p. 468).

4" ROUND DIRECT-END POWER FEED

Mounts to a standard 4" junction box with round plaster ring (provided by electrician).

700MOP4CD FINISH
 Z ANTIQUE BRONZE
 C CHROME
 S SATIN NICKEL



2" SQUARE DIRECT-END POWER FEED

Mounts to special 2" square junction box (included).

700MOP2CD FINISH
 Z ANTIQUE BRONZE
 C CHROME
 S SATIN NICKEL



RECTANGULAR DIRECT-END POWER FEED

Mounts to a gem or single gang junction box (provided by electrician).

700MOPRCD FINISH
 Z ANTIQUE BRONZE
 C CHROME
 S SATIN NICKEL



TO CANTILEVER FROM A WALL

There are two types of outside riggers—one for power, one for support. Both types of outside rigger extend 36" from the wall and are field-cutttable.

POWER OUTSIDE RIGGER

Supports and power feeds rail from a remote transformer. Includes 4" round canopy and 2" square canopy. Use with a single-feed remote transformer (p. 468).

700MOPORG2	FINISH
Z	ANTIQUÉ BRONZE
C	CHROME
S	SATIN NICKEL

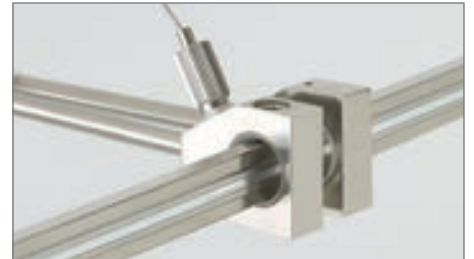

SUPPORT OUTSIDE RIGGER

Extends from the wall to support rail. Use every three feet of run.

700MOSORG	FINISH
Z	ANTIQUÉ BRONZE
C	CHROME
S	SATIN NICKEL



USING END AND CENTER POWER FEEDS

End and center power feeds are generally used to bring power to a MonoRail system when the transformer cannot be located directly above the run. The power feed can be mounted to a standard 4" junction box with round plaster ring (provided by electrician), directly to a Remote Transformer (p. 468), or to a Kable Lite Surface Transformer (pp. 528-529).

END POWER FEED

The end power feed pushes into an end of the MonoRail and includes a removable 4" round canopy and 12' field-cutttable softwire leads.

700MOPEND	FINISH
Z	ANTIQUÉ BRONZE
C	CHROME
S	SATIN NICKEL



CENTER POWER FEED

The center power feed can be used anywhere within the run and includes a removable 4" round canopy and 12' field-cutttable softwire leads. Specify dual-feed when using a dual-feed transformer.

700MOPCEN	TYPE	FINISH
	SINGLE-FEED	Z ANTIQUÉ BRONZE
4	DUAL-FEED	C CHROME
		S SATIN NICKEL



SINGLE-FEED



Special Installations

INSTALLING MONORAIL TO A VAULTED CEILING

To install a MonoRail system to a vaulted ceiling, add a power vault adapter to each power feed and add a standoff vault adapter to each standoff.

POWER VAULT ADAPTER

Installs to the power feed (sold separately) and adjusts to any angle to position rail parallel to the floor.

700MOPVLT	FINISH
Z	ANTIQUÉ BRONZE
C	CHROME
S	SATIN NICKEL



STANDOFF VAULT ADAPTER

Installs between the rigid or adjustable standoff (sold separately) and the ceiling to position rail parallel to the floor. Includes several rod lengths to achieve the proper pitch when used with a surface transformer.



700MOCVLT	FINISH
Z	ANTIQUÉ BRONZE
C	CHROME
S	SATIN NICKEL

INSTALLING MONORAIL TO A T-BAR DROP CEILING

To install a MonoRail system to a T-bar drop ceiling, add a T-bar connector to every standoff (sold separately). The T-bar clip twists into the slat. (Use only if local electrical codes allow).

T-BAR CONNECTOR

Specify 15/16" or 9/16" slat.

700MOTBAR	SLAT	FINISH
C	15/16"	B BLACK
9C	9/16"	W WHITE

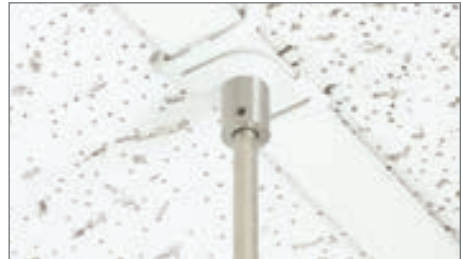

USING A “T” OR “X” CONNECTOR

Use the special “T” or “X” connectors to make a clean splice into a straight horizontal rail run. These connectors are conductive, so you may power the system from any of the runs.

“T” CONNECTOR

The “T” connector joins three pieces of MonoRail to form a “T”. At least one standoff must be located near the connector.

700MOCTT	FINISH
Z	ANTIQU BRONZE
C	CHROME
S	SATIN NICKEL



“X” CONNECTOR

The “X” connector joins four pieces of MonoRail to form an “X”. At least one standoff must be located near the connector.

700MOCTX	FINISH
Z	ANTIQU BRONZE
C	CHROME
S	SATIN NICKEL

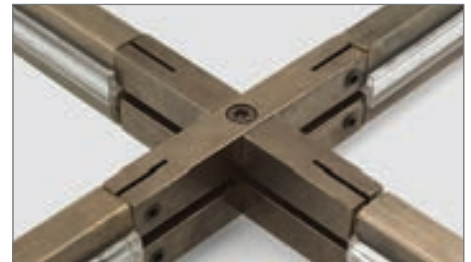
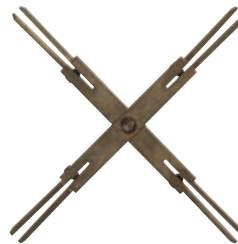

USING A RECESSED CAN TRANSFORMER

Use to retrofit an existing recessed down light to power a MonoRail system. Mounts to any recessed can that is 6-1/4” to 6-1/2” in diameter and has “C” shaped hooks on the inside can wall.

RECESSED CAN TRANSFORMER

Compatible with 2” Rigid Standoff. Includes white canopy, antique bronze, chrome or satin nickel Power Feed and 150 watt electronic transformer. Dimmable with a low-voltage electronic dimmer.

700MOREC15E	FINISH
Z	ANTIQU BRONZE
C	CHROME
S	SATIN NICKEL



ETL CLASSIFIED FOR USE WITH THE FOLLOWING RECESSED CANS: JUNO IC2, JUNO IC22, TC2, AND TC2R; HALO H7T AND H7RT; COOPER LIGHTING H27RT, CAPRI (THOMAS) LIGHTING PR75ASIC / TPR75ASIC-8DY6431; PROGRESS LIGHTING P7TG, P8-TG, AND P-8TG & PIO8-TG.

TECH LIGHTING IS NOT AFFILIATED WITH, NOR IS IT ENDORSED BY ANY OF THE COMPANIES LISTED ABOVE. TECH LIGHTING DOES NOT DISTRIBUTE OR SELL ANY OF THE PRODUCTS LISTED ABOVE. CALL FOR MORE INFORMATION.

MonoRail Kits

ALL MONORAIL KITS INCLUDE:

8' long hand-bendable MonoRail. Choose between:

ANTIQUÉ BRONZE - BROWN INSULATOR



CHROME - CLEAR INSULATOR



SATIN NICKEL - CLEAR INSULATOR



ACTUAL SIZE

Two sets of decorative end caps



Two rigid standoffs. Size will vary depending on kit.



12 volt 150 or 300 watt magnetic surface transformer with power feed or 300 watt magnetic remote transformer with power feed.

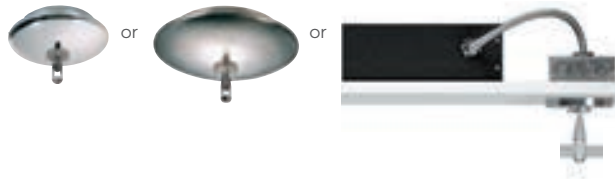

SURFACE TRANSFORMERS

REMOTE TRANSFORMER

PICKING A KIT IS EASY

below are two simple steps to walk you through choosing your kable lite kit.

ONE CHOOSE A KIT (SEE BELOW & ON THE RIGHT)

You may choose between a 12 volt 150 watt surface transformer, 300 watt surface transformer or 300 watt remote transformer kit.

SURFACE TRANSFORMER KITS

150 WATT KIT

Magnetic Surface Transformer mounts to a standard 4" junction box with round plaster ring (provided by electrician), rail drops 3.6" from ceiling. Add up to three 50 watt elements or up to four 35 or 37 watt elements.

700MOKTS150	FINISH
Z	ANTIQUÉ BRONZE
C	CHROME
S	SATIN NICKEL



300 WATT KIT

Magnetic Surface Transformer mounts to a standard 4" junction box with round plaster ring (provided by electrician), rail drops 4.8" from ceiling. Add up to six 50 watt elements or up to eight 35 or 37 watt elements.

700MOKTS300	FINISH
Z	ANTIQUÉ BRONZE
C	CHROME
S	SATIN NICKEL



SURFACE TRANSFORMER KITS

300 WATT MINI KIT



Mini Electronic Transformer mounts to a standard 4" junction box with round plaster plate (provided by electrician), rail drops 2" from the ceiling. Add up to six 50 watt elements or up to eight 35 or 37 watt elements.

700MOKTSM30E	FINISH	TYPE
Z	ANTIQUÉ BRONZE	HALOGEN
S	SATIN NICKEL	-LED LED



300 WATT PASS-THROUGH KIT



Pass-Through Electronic Transformer mounts to a standard 4" junction box with round plaster plate (provided by electrician), rail drops 1" from the ceiling. Add up to six 50 watt elements or up to eight 35 or 37 watt elements.

700MOKTS301E	FINISH	TYPE
Z	ANTIQUÉ BRONZE	HALOGEN
S	SATIN NICKEL	-LED LED



OR

REMOTE TRANSFORMER KITS

300 WATT KIT

Magnetic Remote Transformer installs in an accessible location behind the ceiling or wall. Canopy mounts to a standard 4" junction box with round plaster ring (provided by electrician), rail drops 2" from ceiling. Add up to six 50 watt elements or up to eight 35 or 37 watt elements.



700MOKTA300	FINISH
Z	ANTIQUÉ BRONZE
C	CHROME
S	SATIN NICKEL

TWO SELECT YOUR ELEMENTS (PP. 52-193)

You can choose from over 100 heads and pendants to complete your system.



INDICATES WHICH TRANSFORMERS ARE COMPATIBLE WITH LED ELEMENTS



TWO-CIRCUIT MONORAIL



TWO-CIRCUIT MONORAIL

Swivel head p. 174 with Backlight Shield accessory p. 576 and MR16 Snout accessory p. 577



Photographer: Gazston





Tilt head p. 169 and Tinkerbell accessory p. 574

Photographer: © Galina Coadu Lighting: Yaacov Golan



The Basics of Two-Circuit MonoRail

Need help designing your system? Visit our online order configurator at configurator.techlighting.com



ONE DESIGN YOUR TWO-CIRCUIT MONORAIL SYSTEM



The first step in designing your Two-Circuit MonoRail system is to determine what it is you are trying to light. You'll need to decide where the elements should be installed to put light where you want it, and which elements will be controlled by each circuit. The placement of the conductive metal set screw on the Two-Circuit MonoRail FreeJack connector determines which circuit is controlling the element. See compatible elements on pp. 52-193. Choose your elements then add accessories if desired. We offer a broad range of colorful and decorative accessories and functional optical controls (pp. 566-579).



Draw your Two-Circuit MonoRail run. Remember, Two-Circuit MonoRail can be shaped by hand to follow architectural details or to create an organic shape. Factory pre-bent shapes are also offered in several configurations. Your run must be placed so it runs directly beneath the surface transformer or power feed and intersects the locations of all the elements. Determine how many pieces of rail you'll need (p. 488). Add one set of end caps to each end of the run for an elegant finishing touch (p. 489).

TWO ADD POWER AND HARDWARE TO COMPLETE YOUR SYSTEM



Add up the wattages of the lamps you'll be using on the system: this will help you select a transformer. A remote transformer with power feed canopy provides the cleanest look, but the remote transformer must be installed in an accessible, remote location. The surface transformer simply mounts to a junction box. Two-Circuit MonoRail transformers come pre-wired with either two or four 120 volt input lines to allow for independent switching of the circuits. 24 volt transformers cannot be used with Two-Circuit MonoRail. Use the information on pp. 592-593 to help you choose the right transformer for your installation; see pp. 492-493 for Two-Circuit MonoRail transformer and power feed options.

Determine how far from the ceiling you want the system to drop. Power feed canopies place the rail two inches from the ceiling; Two-Circuit MonoRail surface transformers place the rail six inches from the ceiling. If this drop is shorter than you require, you'll need to add a power extender (p. 493) to your canopy or surface transformer. The maximum standard drop for Two-Circuit MonoRail is eight feet.



Next, add standoffs that match the drop of your power feed to support the system (p. 490). Adjustable standoffs provide a clean, elegant look. Choose rigid standoffs for curvy runs, or runs with multiple glass pendants. You'll need one standoff for every three feet of Two-Circuit MonoRail. The power feed counts as a support, so begin adding standoffs three feet from the power feed. Note: Power extenders and standoffs are field-cuttable, so it's easy to achieve a custom drop length.



For design harmony, all the power, standoff, and elements connections to the Two-Circuit MonoRail are shaped identically. Note that standoffs and elements can be positioned to cover where rails are joined to maintain the smooth line.

For other Two-Circuit MonoRail system options, such as mounting to a vaulted or T-bar ceiling or to a wall, see Special Installations on pp. 494-496.

Two-Circuit MonoRail



TWO-CIRCUIT MONORAIL

Hand-bendable, field-cuttable Two-Circuit MonoRail is rated for 300 watts per circuit at 12 volts. Each piece of rail is shipped with conductive connectors to join rail pieces end to end. Order additional connectors (p. 489) if cutting and rejoining rails.

700MO2A	LENGTH	FINISH / INSULATOR
24	24" (.61 m)	BRZ ANTIQUE BRONZE WITH BROWN INSULATOR
48	48" (1.2 m)	Z ANTIQUE BRONZE WITH CLEAR INSULATOR
96	96" (2.4 m)	C CHROME WITH CLEAR INSULATOR
		S SATIN NICKEL WITH CLEAR INSULATOR

ANTIQUÉ BRONZE - BROWN INSULATOR



FOR A HOLISTIC ANTIQUÉ BRONZE FINISH, A BROWN INSULATOR IS RECOMMENDED

ANTIQUÉ BRONZE - CLEAR INSULATOR



CHROME - CLEAR INSULATOR



SATIN NICKEL - CLEAR INSULATOR



ACTUAL SIZE

PRE-BENT S-CURVE TWO-CIRCUIT MONORAIL

Two-Circuit MonoRail pre-bent into a horizontal S curve. Consult the drawing for approximate dimensions. For a factory bend not shown below, please call for a custom quotation.

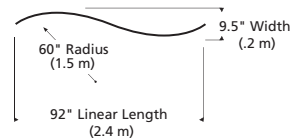

700MO2BHSC60	FINISH / INSULATOR
BRZ	ANTIQUÉ BRONZE WITH BROWN INSULATOR
Z	ANTIQUÉ BRONZE WITH CLEAR INSULATOR
C	CHROME WITH CLEAR INSULATOR
S	SATIN NICKEL WITH CLEAR INSULATOR

PRE-BENT 90° CURVE TWO-CIRCUIT MONORAIL

Horizontal 90° curves are sold by radius, or the distance from the center of the circle to the outside edge. Join four 90° curves to create a circle with a diameter (overall width) equal to twice the specified radius. For a factory bend not shown below, please call for a custom quotation.

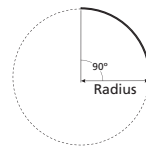

Two-Circuit MonoRail bends horizontally to a radius as small as 12'. It cannot be bent vertically in the field. For custom factory bends, provide degree and radius of curve.

TIP: To calculate the amount of rail you'll need for an organic shape, draw the Two-Circuit MonoRail run to scale (for example, 1/4" = 1'). Use a piece of string to "trace" the drawing. Measure the length of string, then convert from your scale.

700MO2BH90	RADIUS	FINISH / INSULATOR
12	12"	BRZ ANTIQUÉ BRONZE WITH BROWN INSULATOR
18	18"	Z ANTIQUÉ BRONZE WITH CLEAR INSULATOR
24	24"	C CHROME WITH CLEAR INSULATOR
36	36"	S SATIN NICKEL WITH CLEAR INSULATOR
48	48"	
60	60"	

Connectors

CONDUCTIVE CONNECTORS

Conductive connectors join sections of rail together end to end and are included with all Two-Circuit MonoRail pieces. Order separately if cutting and rejoining rails. Set of three.

700MO2CCN FINISH
Z ANTIQUE BRONZE
C CHROME
S SATIN NICKEL

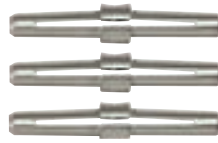

ISOLATING CONNECTORS

Isolating connectors join sections of rail and isolate power feeds from each other. Two common uses are in runs using more than 300w or in runs over 30ft where a two power feeds are required to avoid voltage drop. All dual-feed canopies are shipped with isolating connectors; order additional if required by layout. Set of three.

700MO2CINC

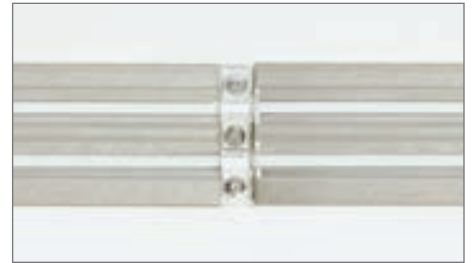

FLEXIBLE HORIZONTAL CONNECTORS

These conductive connectors join sections of rail together end to end at desired sharp horizontal angle. Set of three.

700MO2CFXH FINISH
Z ANTIQUE BRONZE
C CHROME
S SATIN NICKEL



END CAPS

Decorative end caps fit into ends of Two-Circuit MonoRail run for a finished look. Set of three; order one set for each end.

700MO2CCAP FINISH
Z ANTIQUE BRONZE
C CHROME
S SATIN NICKEL



Standoffs

Use standoff supports every three feet of Two-Circuit MonoRail run and at corners. Standoffs can be positioned to cover points where rails are joined.

RIGID STANDOFF

The field-cutttable rigid standoff is recommended for curvy runs or runs with heavier elements, such as glass pendants. Rigid standoffs are compatible with various power feed options: Use the chart below to determine the appropriate standoff for your run.

To determine the shortest compatible standoff for any power feed or surface transformer option, see pp. 493-494.

LENGTH	STANDOFF	FINISH
2" (1.9)*	700MO2502	(Z, C, OR S)
3" (3.6)*	700MO2503	(Z, C, OR S)
6**	700MO2506	(Z, C, OR S)
12**	700MO2512	(Z, C, OR S)
24**	700MO2524	(Z, C, OR S)
36**	700MO2536	(Z, C, OR S)
48**	700MO2548	(Z, C, OR S)
96**	700MO2596	(Z, C, OR S)

* ACTUAL LENGTH FROM CEILING TO TOP OF RAIL

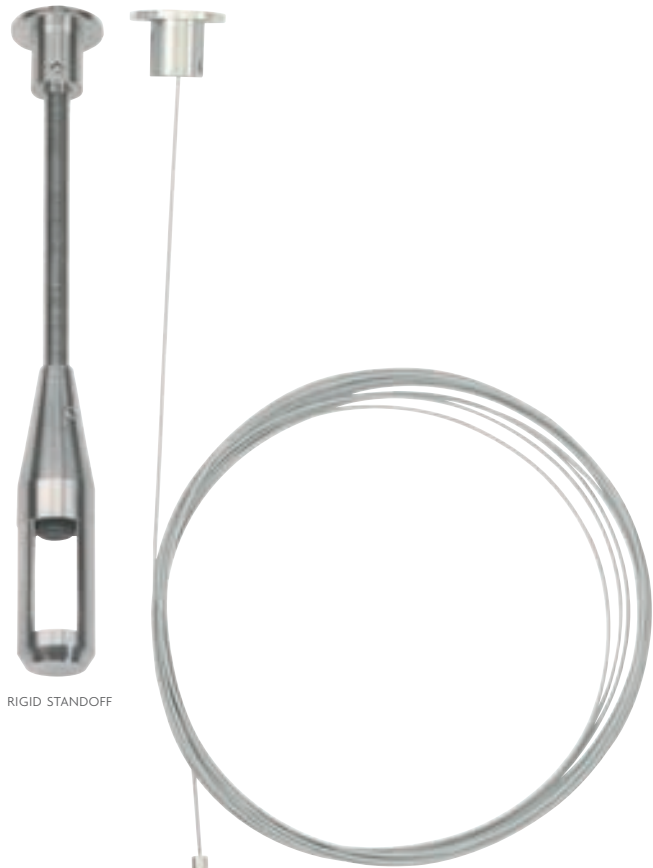

RIGID STANDOFF

ADJUSTABLE STANDOFF

The adjustable standoff's cable virtually disappears for a clean and elegant look. It is best used on fairly straight runs with a drop greater than 6". A wire grip allows you to easily shorten or lengthen the cable to size it for use.

700MO25ADJ	LENGTH	FINISH
	12' OF CABLE	Z ANTIQUE BRONZE
	3 30' OF CABLE	C CHROME
		S SATIN NICKEL



ADJUSTABLE STANDOFF

TIP: For best appearance, place the last standoff 4-6" from the end of the rail, and place standoffs symmetrically.







Photographer: Jeff Millies, Hedrich Blessing Designer: Wright and Company

Remote Transformers

Remote transformers install in an accessible location behind the ceiling or wall. For technical information on remote transformers, see pp. 592-593. Requires canopy (p. 493) or special power feed (pp. 494-496).

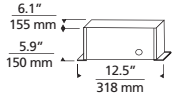
INPUT VOLTAGE OUTPUT VOLTAGE WATTAGE TYPE	ITEM NUMBER	COMPATIBLE DIMMER TYPE	COMPATIBLE DIMMING COIL	PLUG-IN TRANSFORMER OPTION	277 VOLT INPUT OPTION
--	-------------	---------------------------	----------------------------	----------------------------------	--------------------------

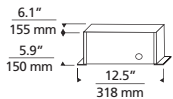
SINGLE-FEED OPTIONS

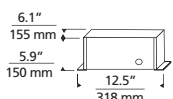
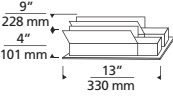
 LED	 <p>6.1" 155 mm 5.9" 150 mm 12.5" 318 mm</p>	2 X 120V 12V 2 X 75 WATTS* MAGNETIC AC	700AT2X075T	UP TO TWO LOW-VOLTAGE MAGNETIC 600 WATTS	—	ADD TWO PLUG OPTIONS (P. 493)	—
 LED	 <p>6.1" 155 mm 5.9" 150 mm 12.5" 318 mm</p>	2 X 120V 12V 2 X 150 WATTS* MAGNETIC AC	700AT2X150T	UP TO TWO LOW-VOLTAGE MAGNETIC 600 WATTS	—	ADD TWO PLUG OPTIONS (P. 493)	—
 LED	 <p>6.1" 155 mm 5.9" 150 mm 12.5" 318 mm</p>	2 X 120V 12V 2 X 150 WATTS* MAGNETIC AC	700AT2X300T	UP TO TWO LOW-VOLTAGE MAGNETIC 600 WATTS	ADD TWO 700DIM300 (P. 593)	ADD TWO PLUG OPTIONS (P. 493)	700AT2X300T277
	 <p>9" 228 mm 4" 101 mm 13" 330 mm</p>	2 X 120V 12V 2 X 300 WATTS ELECTRONIC DC	700AT2X300EL	UP TO TWO LOW-VOLTAGE ELECTRONIC 600 WATTS	—	ADD TWO PLUG OPTIONS (P. 493)	—

DUAL-FEED OPTIONS

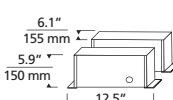
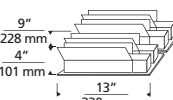
 LED	 <p>6.1" 155 mm 5.9" 150 mm 12.5" 318 mm</p>	4 X 120V 12V 4 X 300 WATTS* MAGNETIC AC	700AT4X300T	UP TO FOUR LOW-VOLTAGE MAGNETIC 600 WATTS	ADD FOUR 700DIM300 (P. 593)	ADD FOUR PLUG OPTIONS (P. 493)	700AT4X300T277
	 <p>9" 228 mm 4" 101 mm 13" 330 mm</p>	4 X 120V 12V 4 X 300 WATTS ELECTRONIC DC	700AT4X300EL	UP TO TWO LOW-VOLTAGE ELECTRONIC 600 WATTS	—	ADD FOUR PLUG OPTIONS (P. 493)	—

* AS A GENERAL RULE WHEN USING LED FIXTURES WE DO NOT RECOMMEND USING GREATER THAN 70% OF SPECIFIED MAXIMUM WATTAGE ON THE TRANSFORMER DUE TO INRUSH CURRENT. FOR ASSISTANCE, PLEASE CONTACT OUR TECHNICAL SUPPORT DEPARTMENT.



LED

INDICATES WHICH TRANSFORMERS ARE COMPATIBLE WITH LED ELEMENTS

Power Feed Canopies

ITEM NUMBER	MOUNTS TO	SHORTEST COMPATIBLE RIGID STANDOFF	TO DROP FROM CEILING GREATER THAN SHORTEST COMPATIBLE RIGID STANDOFF
-------------	-----------	------------------------------------	--

SINGLE-FEED OPTIONS USE WITH ONE SINGLE-FEED REMOTE TRANSFORMER

 <p>4" ROUND SINGLE-FEED</p>	BRONZE: 700MO2P4C02Z BLACK: 700MO2P4C02B* CHROME: 700MO2P4C02C SATIN NICKEL: 700MO2P4C02S WHITE: 700MO2P4C02W*	STANDARD 4" JUNCTION BOX WITH ROUND PLASTER RING (PROVIDED BY ELECTRICIAN)	2" (P. 490)	ADD ONE POWER EXTENDER (SEE BELOW)
---	--	--	-------------	------------------------------------

DUAL-FEED OPTIONS USE WITH ONE DUAL-FEED REMOTE TRANSFORMER (ISOLATING CONNECTORS INCLUDED)

 <p>4" ROUND DUAL-FEED</p>	BRONZE: 700MO2P4C402Z BLACK: 700MO2P4C402B* CHROME: 700MO2P4C402C SATIN NICKEL: 700MO2P4C402S WHITE: 700MO2P4C402W*	STANDARD 4" JUNCTION BOX WITH ROUND PLASTER RING (PROVIDED BY ELECTRICIAN)	2" (P. 490)	ADD ONE POWER EXTENDER (SEE BELOW)
---	---	--	-------------	------------------------------------

PLUG OPTION

16' cord and plug for standard 120 volt power outlets.

700A1-	COLOR
	WHT WHITE
	BLK BLACK



POWER EXTENDER

Add to power feed canopy or surface transformer to drop power from ceiling. For dual-feed canopies and transformers, order two. Field-cuttable.

700MO2P	LENGTH	FINISH
03	3"	Z ANTIQUE BRONZE
06	6"	C CHROME
12	12"	S SATIN NICKEL
24	24"	
36	36"	
48	48"	
96	96"	







Surface Transformers

All surface transformers mount to a standard 4" junction box with round plaster ring (provided by electrician). For technical information on surface transformers, see p. 592-593.

INPUT VOLTAGE OUTPUT VOLTAGE WATTAGE	ITEM NUMBER	COMPATIBLE DIMMER TYPE	COMPATIBLE DIMMING COIL	SHORTEST COMPATIBLE RIGID STANDOFF	TO DROP FROM CEILING	PLUG-IN TRANSFORMER OPTION
---	-------------	---------------------------	----------------------------	--	-------------------------	----------------------------------

SINGLE-FEED OPTIONS

 	2 X 120V 12V 2 X 150 WATTS** MAGNETIC AC	BRONZE: 700MO2SRT30DZ BLACK: 700MO2SRT30DB* CHROME: 700MO2SRT30DC SATIN NICKEL: 700MO2SRT30DS WHITE: 700MO2SRT30DW*	UP TO TWO LOW-VOLTAGE MAGNETIC 600 WATTS	INCLUDED	6" (P. 490)	ADD ONE POWER EXTENDER (SEE ABOVE)	ADD TWO PLUG OPTIONS (ABOVE)
 	2 X 120V 12V 2 X 250 WATTS** MAGNETIC AC	BRONZE: 700MO2SRT50DZ BLACK: 700MO2SRT50DB* CHROME: 700MO2SRT50DC SATIN NICKEL: 700MO2SRT50DS WHITE: 700MO2SRT50DW*	UP TO TWO LOW-VOLTAGE MAGNETIC 600 WATTS	INCLUDED	6" (P. 490)	ADD ONE POWER EXTENDER (SEE ABOVE)	ADD TWO PLUG OPTIONS (ABOVE)

* BLACK AND WHITE FINISH OPTIONS HAVE SATIN NICKEL FEEDS

** AS A GENERAL RULE WHEN USING LED FIXTURES WE DO NOT RECOMMEND USING GREATER THAN 70% OF SPECIFIED MAXIMUM WATTAGE ON THE TRANSFORMER DUE TO INRUSH CURRENT. FOR ASSISTANCE, PLEASE CONTACT OUR TECHNICAL SUPPORT DEPARTMENT.



INDICATES WHICH TRANSFORMERS ARE COMPATIBLE WITH LED ELEMENTS

Special Installations

USING A DIRECT-END POWER FEED

These direct-end power feeds bring power from a remote transformer to the rail at an end of the run and mounts to a wall perpendicular to the run. Use with a single-feed remote transformer (p. 492).

4" ROUND DIRECT-END POWER FEED

Mounts to a standard 4" junction box with round plaster ring (provided by electrician).

700MO2P4CD	FINISH
Z	ANTIQUÉ BRONZE
C	CHROME
S	SATIN NICKEL



USING A CENTER POWER FEED

A center power feed is generally used to bring power to a Two-Circuit MonoRail system when the transformer or junction box cannot be located directly above the run. The power feed can be mounted to a standard 4" junction box with round plaster ring (provided by electrician) or directly to a Remote Transformer.

CENTER POWER FEED

The center power feed can be used anywhere within the run and includes a removable 4" round canopy and 12' field-cuttable softwire leads. Specify dual-feed when using a dual-feed transformer.



SINGLE-FEED

700MO2PCEN	TYPE	FINISH
	SINGLE-FEED	Z ANTIQUÉ BRONZE
4	DUAL-FEED	C CHROME
		S SATIN NICKEL



INSTALLING TWO-CIRCUIT MONORAIL TO CANTILEVER FROM A WALL

There are two types of outside riggers—one for power, one for support. Both types of outside rigger extend 36" from the wall and are field-cuttable.

POWER OUTSIDE RIGGER

Supports and power feeds rail from a remote transformer. Includes 4" round canopy and two support outside riggers. Use with a single-feed remote transformer (p. 492).



700MO2PORG4

FINISH	
BRZ	ANTIQUÉ BRONZE WITH BROWN INSULATOR
Z	ANTIQUÉ BRONZE
C	CHROME
S	SATIN NICKEL

SUPPORT OUTSIDE RIGGER

Extends from the wall to support rail. Use every three feet of run.

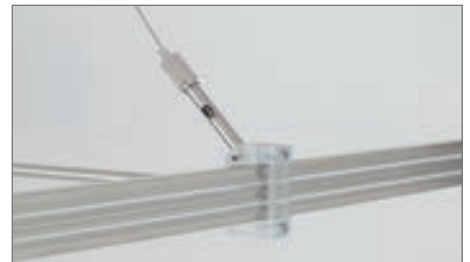

700MO2SORG

FINISH	
Z	ANTIQUÉ BRONZE
C	CHROME
S	SATIN NICKEL

USING A "T" OR "X" CONNECTOR

Use the special "T" or "X" connector to make a clean splice into a straight rail run.

"T" CONNECTOR

The "T" connector joins three pieces of Two-Circuit MonoRail to form a "T". It is conductive, so you may power the system from any of the runs. At least one standoff must be located near the connector.

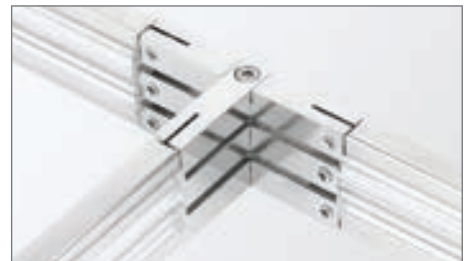

700MO2CTT

FINISH	
Z	ANTIQUÉ BRONZE
C	CHROME
S	SATIN NICKEL

"X" CONNECTOR

The "X" connector joins four pieces of Two-Circuit MonoRail to form an "X". It is conductive, so you may power the system from any of the runs. At least one standoff must be located near the connector.



700MO2CTX

FINISH	
Z	ANTIQUÉ BRONZE
C	CHROME
S	SATIN NICKEL

Special Installations

INSTALLING TWO-CIRCUIT MONORAIL TO A VAULTED CEILING

To install a Two-Circuit MonoRail system to a vaulted ceiling, add a power vault adapter to each power feed and add a standoff vault adapter to each standoff.

POWER VAULT ADAPTER

Installs to the power feed (sold separately) and adjusts to any angle to position rail parallel to the floor.

700MO2PVLT	FINISH
	Z ANTIQUE BRONZE
	C CHROME
	S SATIN NICKEL



STANDOFF VAULT ADAPTER

Installs between the rigid or adjustable standoff (sold separately) and the ceiling to position rail parallel to the floor. Includes several rod lengths to achieve the proper pitch when used with a surface transformer.



700MO2CVLT	FINISH
	Z ANTIQUE BRONZE
	C CHROME
	S SATIN NICKEL

INSTALLING TWO-CIRCUIT MONORAIL TO A T-BAR DROP CEILING

To install a Two-Circuit MonoRail system to a T-bar drop ceiling, add a T-bar connector to every standoff (sold separately). The T-bar clip twists into the slat. (Use only if local electrical codes allow).

T-BAR CONNECTOR

Specify 15/16" or 9/16" slat.



700MO2TBAR	SLAT	FINISH
	C 15/16"	B BLACK
	9C 9/16"	W WHITE

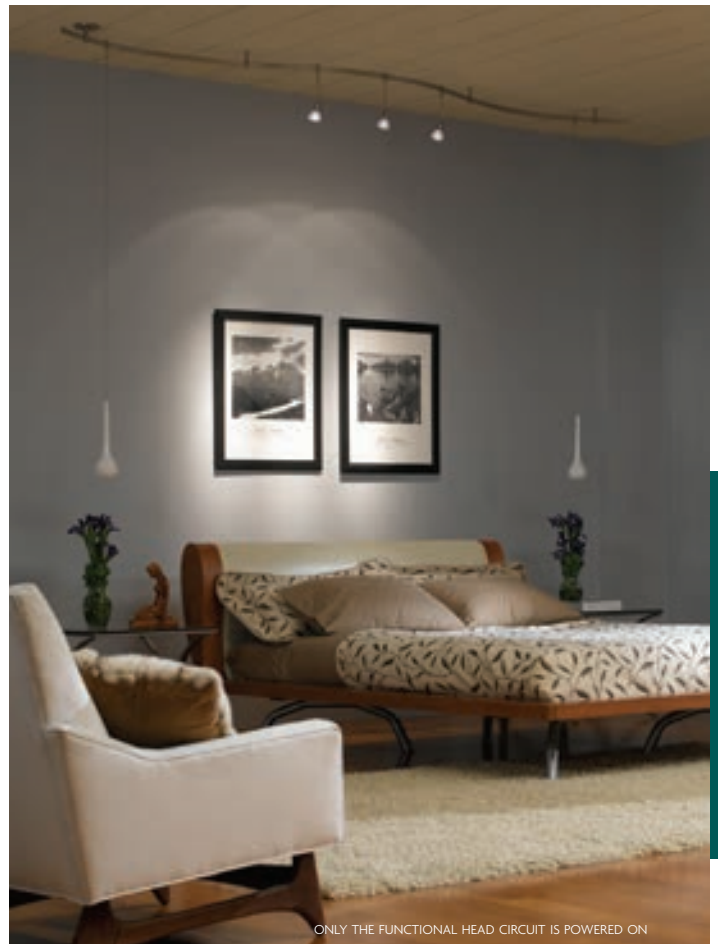
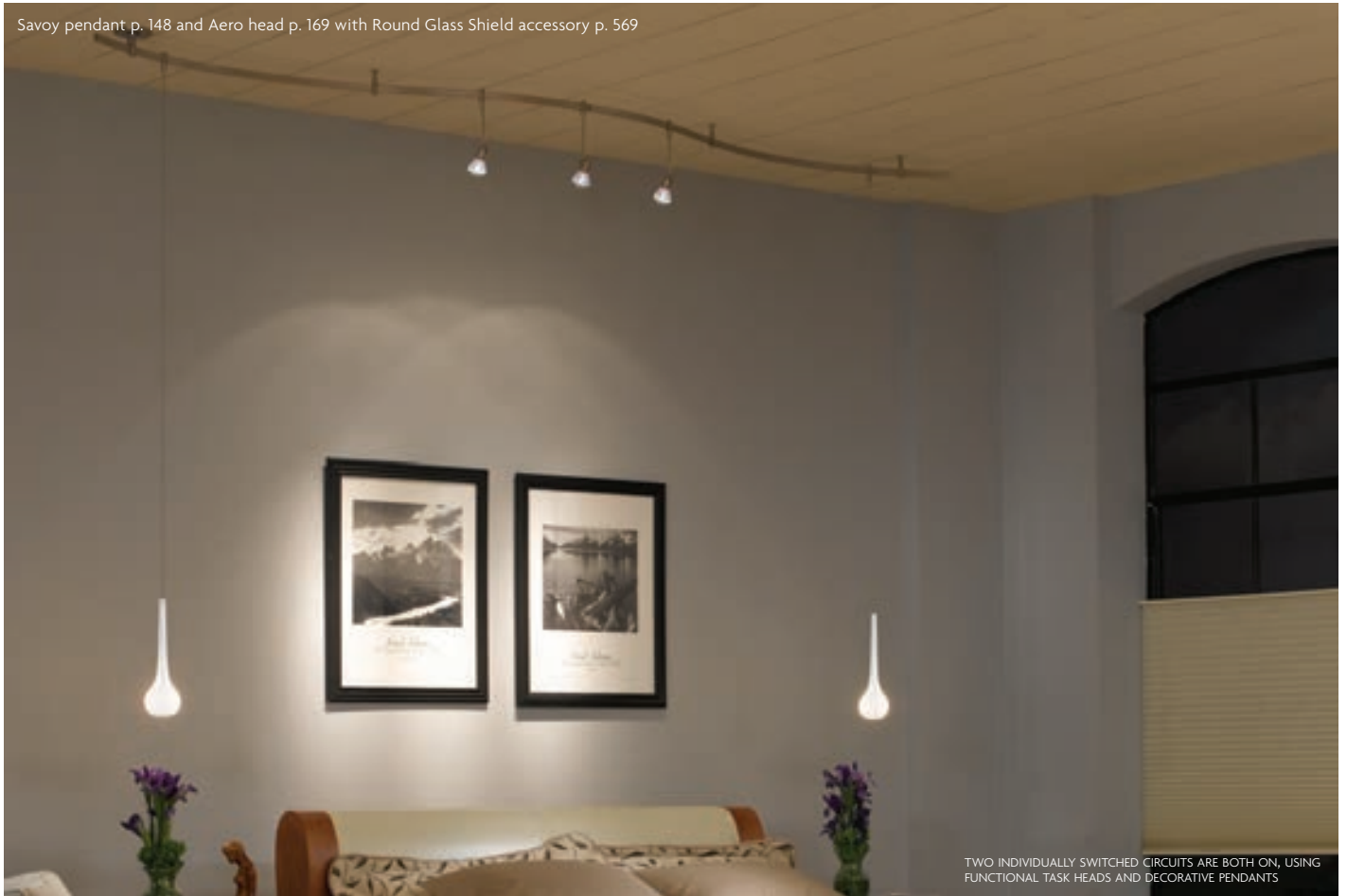



WALL MONORAIL



WALL MONORAIL

Wall Georgi head p. 190



Photographer: © Galina Coda



Wall Telescope head p. 191





Photographer: Sharon Risedorph

The Basics of Wall MonoRail

Need help designing your system? Visit our online order configurator at configurator.techlighting.com



ONE DESIGN YOUR WALL MONORAIL SYSTEM



The first step in designing your Wall MonoRail system is to determine what it is you are trying to light. You will need to decide where the elements should be installed to put light where you want it. See compatible elements on pp. 52-193. Choose your elements, then add accessories if desired. We offer a broad range of colorful and decorative accessories and functional optical controls (pp. 566-579).

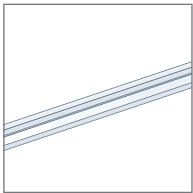

Draw in your Wall MonoRail run. Remember, Wall MonoRail can be shaped by hand to follow a curved wall or soffit. Your Wall MonoRail must be placed so it runs directly in front of the junction box if using a remote transformer or within two feet of the junction box if using a surface transformer. Determine how many pieces of rail you'll need (p. 506). Add a pair of end caps to each end of the run for an elegant finishing touch (p. 507).

TWO ADD POWER AND HARDWARE TO COMPLETE YOUR SYSTEM



Add up the wattages of the lamps you'll be using on the system: this will help you select a transformer. A remote transformer with power feed canopy provides the cleanest look, but the remote transformer must be installed in an accessible, remote location. A surface transformer simply mounts to a nearby junction box and requires end or center power feed connectors to bring power from the transformer to the run. Use the information on pp. 592-593 to help you choose the right transformer for your installation; see pp. 508-511 for Wall MonoRail transformer and power feed options. If you are using LED fixtures, be sure to choose a transformer that is compatible with LED elements.

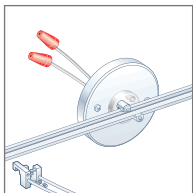

If using a remote transformer, determine what shape power feed canopy you would like to use (p. 509).



Next, add standoffs (p. 506). You'll need one standoff for every three feet of Wall MonoRail. The power feed canopy counts as a support, so begin adding standoffs three feet from the power feed canopy.

WALL MONORAIL KITS

To simplify ordering, we offer several convenient Wall MonoRail Kits (p. 512).

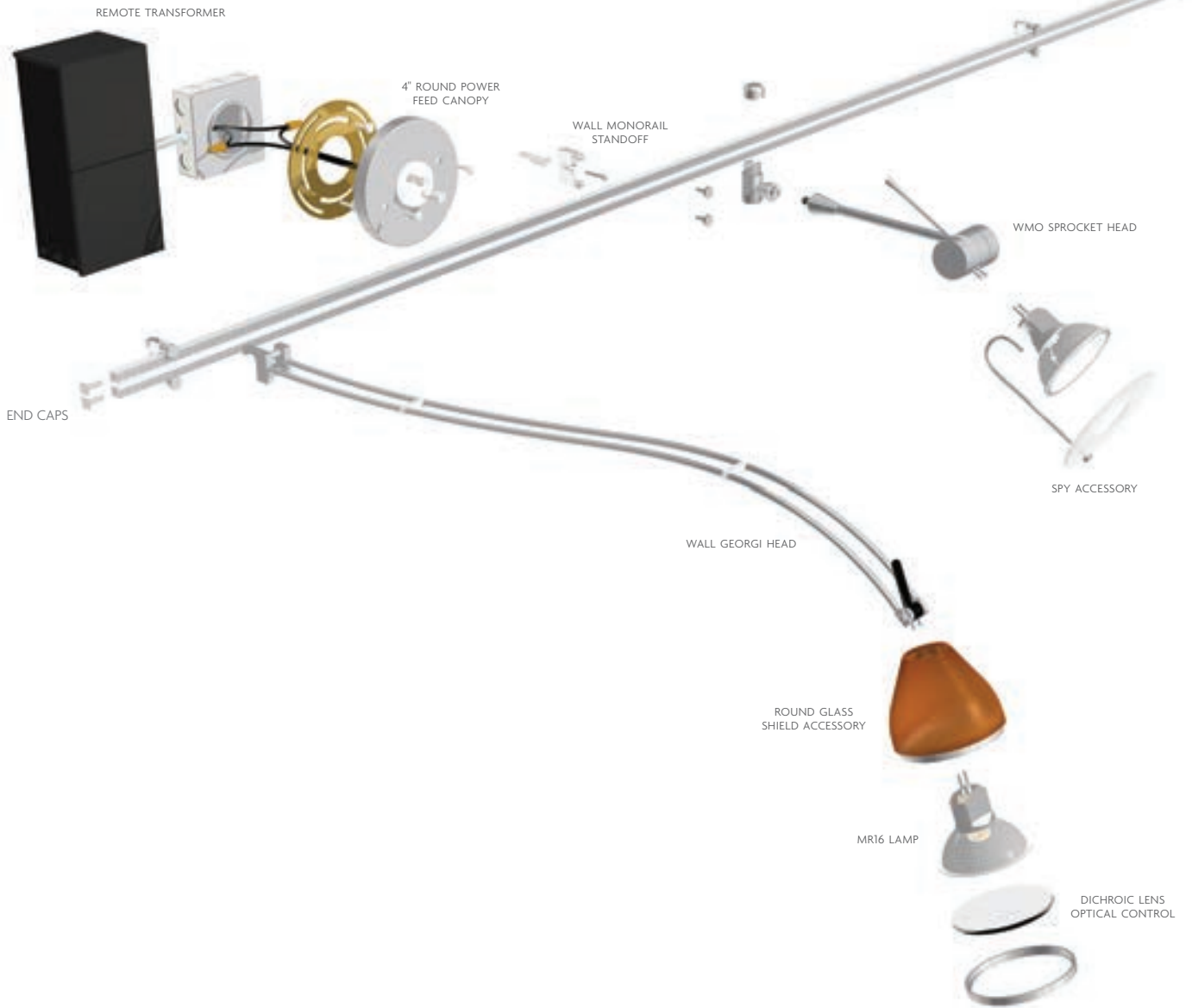

Wall MonoRail



WALL MONORAIL

Hand-bendable, field-cuttable Wall MonoRail is rated for 300 watts at 12 volts, 600 watts at 24 volts. Each piece of rail is shipped with conductive connectors to join rail pieces end to end. Order additional connectors (p. 507) if cutting and rejoining rails.

700MOA	LENGTH	FINISH / INSULATOR
24	24" (.61 m)	BRZ ANTIQUE BRONZE WITH BROWN INSULATOR
48	48" (1.2 m)	Z ANTIQUE BRONZE WITH CLEAR INSULATOR
96	96" (2.4 m)	C CHROME WITH CLEAR INSULATOR
		S SATIN NICKEL WITH CLEAR INSULATOR

ANTIQUÉ BRONZE - BROWN INSULATOR



FOR A HOLISTIC ANTIQUÉ BRONZE FINISH, A BROWN INSULATOR IS RECOMMENDED

ANTIQUÉ BRONZE - CLEAR INSULATOR



CHROME - CLEAR INSULATOR



SATIN NICKEL - CLEAR INSULATOR



ACTUAL SIZE

Wall MonoRail bends horizontally to a radius as small as 6" and vertically to a radius as small as 24". For custom factory bends, provide degree and radius of curve.

TIP: To calculate the amount of rail you'll need for an organic shape, draw the Wall MonoRail run to scale (for example, 1/4" = 1'). Use a piece of string to "trace" the drawing. Measure the length of string, then convert from your scale.

Standoffs

Use standoff supports every three feet of Wall MonoRail run and at corners. Standoffs can be positioned to cover points where rails are joined.

WALL MONORAIL STANDOFF

Positions rail 1" from the wall. Order one for every three feet of run.

700WMOS01	FINISH
	Z ANTIQUÉ BRONZE
	C CHROME
	S SATIN NICKEL

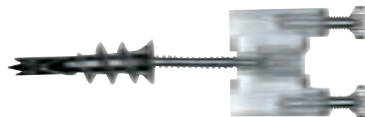

TIP: For best appearance, place the last standoff 4-6" from the end of the rail, and place standoffs symmetrically.

Connectors

CONDUCTIVE CONNECTORS

Conductive connectors join sections of rail together end to end and are included with all Wall MonoRail pieces. Order separately if cutting and rejoining rails. Pair.

700MOCCN FINISH
 Z ANTIQUE BRONZE
 C CHROME
 S SATIN NICKEL



ISOLATING CONNECTORS

Isolating connectors join sections of rail and isolate power feeds from each other. All dual-feed canopies are shipped with isolating connectors; order additional if required by layout. Pair.

700MOCINC



FLEXIBLE HORIZONTAL CONNECTORS

These conductive connectors join sections of rail together end to end at desired sharp horizontal angle. Pair.

700MOCFXH FINISH
 Z ANTIQUE BRONZE
 C CHROME
 S SATIN NICKEL



FLEXIBLE VERTICAL CONNECTORS

These conductive connectors join sections of rail together end to end at desired vertical angle. Pair.

700MOCFXV FINISH
 Z ANTIQUE BRONZE
 C CHROME
 S SATIN NICKEL



END CAPS

Decorative end caps fit into ends of Wall MonoRail run for a finished look. Pair; order one pair for each end.

700MOCCAP FINISH
 Z ANTIQUE BRONZE
 C CHROME
 S SATIN NICKEL











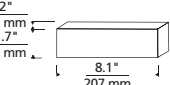

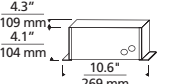

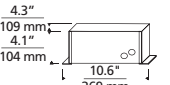

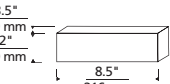
Remote Transformers

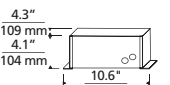
Remote transformers install in an accessible location behind the ceiling or wall. For technical information on remote transformers, see pp. 592-593. Requires canopy (p. 509) or special power feed (p. 511).

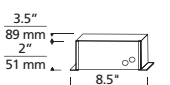
INPUT VOLTAGE OUTPUT VOLTAGE WATTAGE TYPE	ITEM NUMBER	COMPATIBLE DIMMER TYPE	COMPATIBLE DIMMING COIL	PLUG-IN TRANSFORMER OPTION (INCLUDES 16' CORD)	RECESSED REMOTE TRANSFORMER OPTION*	277 VOLT INPUT OPTION
--	-------------	------------------------------	-------------------------------	---	---	--------------------------

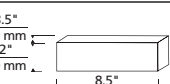
SINGLE-FEED OPTIONS

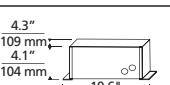
		1 X 120V 12V 1 X 60 WATTS** ELECTRONIC AC	700AT060EL	LOW-VOLTAGE ELECTRONIC 450 WATTS	—	—	—	—
		1 X 120V 12V 1 X 75 WATTS** MAGNETIC AC	700AT075T	LOW-VOLTAGE MAGNETIC 600 WATTS	—	700AT075P	—	700AT075T277
		1 X 120V 12V 1 X 150 WATTS** MAGNETIC AC	700AT150T	LOW-VOLTAGE MAGNETIC 600 WATTS	700DIM150 (P. 593)	700AT150P	—	700AT150T277
		1 X 120V 12V 1 X 150 WATTS** ELECTRONIC DC	700AT152EL	LOW-VOLTAGE ELECTRONIC 600 WATTS	—	—	—	—
		1 X 120V 12V 1 X 300 WATTS** MAGNETIC AC	700AT300T	LOW-VOLTAGE MAGNETIC 600 WATTS	700DIM150 (P. 593)	700AT300P	700AT300TR	700AT300T277 700AT300TR277*
		1 X 120V 12V 1 X 300 WATTS ELECTRONIC DC	700AT300EL	LOW-VOLTAGE ELECTRONIC 600 WATTS	—	700AT300LP	—	—
		1 X 120V 12V 1 X 300 WATTS** ELECTRONIC DC	700AT302EL	LOW-VOLTAGE ELECTRONIC 600 WATTS	—	—	—	—
		1 X 120V 24V 1 X 300 WATTS MAGNETIC AC	700AT3024T	LOW-VOLTAGE MAGNETIC 600 WATTS	700DIM300 (P. 593)	700AT3024P	700AT3024TR	700AT3024T277 700AT3024TR277*

* IN-WALL RECESSED REMOTE TRANSFORMERS ALSO AVAILABLE FOR MAGNETIC 300 AND 600 WATT MODELS FOR USE IN APPLICATIONS WHERE A REMOTE TRANSFORMER IS DESIRED BUT THERE ISN'T ACCESS TO A REMOTE LOCATION. SEE WWW.TECHLIGHTING.COM FOR DIMENSIONS AND FURTHER DETAILS.

** AS A GENERAL RULE WHEN USING LED FIXTURES WE DO NOT RECOMMEND USING GREATER THAN 70% OF SPECIFIED MAXIMUM WATTAGE ON THE TRANSFORMER DUE TO INRUSH CURRENT. FOR ASSISTANCE, PLEASE CONTACT OUR TECHNICAL SUPPORT DEPARTMENT.

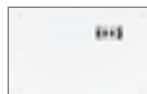

INDICATES WHICH TRANSFORMERS ARE COMPATIBLE WITH LED ELEMENTS

Power Feed Canopies

ITEM NUMBER	MOUNTS TO
-------------	-----------







SINGLE-FEED OPTIONS USE WITH ONE SINGLE-FEED REMOTE TRANSFORMER

<p>4" ROUND SINGLE-FEED</p> 	<p>BRONZE: 700WMOP4RZ CHROME: 700WMOP4RC SATIN NICKEL: 700WMOP4RS WHITE: 700WMOP4RW*</p>	<p>STANDARD 4" JUNCTION BOX WITH ROUND PLASTER RING (PROVIDED BY ELECTRICIAN)</p>
<p>2" SQUARE SINGLE-FEED</p> 	<p>BRONZE: 700WMOP2SQZ CHROME: 700WMOP2SQC SATIN NICKEL: 700WMOP2SQS WHITE: 700WMOP2SQW*</p>	<p>SPECIAL 2" SQUARE JUNCTION BOX (INCLUDED)</p>
<p>2" X 4" RECTANGULAR SINGLE-FEED</p> 	<p>BRONZE: 700WMOPRBZ CHROME: 700WMOPRBC SATIN NICKEL: 700WMOPRBS WHITE: 700WMOPRBW*</p>	<p>STANDARD SINGLE GANG OR GEM BOX (PROVIDED BY ELECTRICIAN)</p>

TIP: If using a dual-feed transformer, order 2 single-feed canopies and 1 isolating connector.

INPUT VOLTAGE OUTPUT VOLTAGE WATTAGE TYPE	ITEM NUMBER	COMPATIBLE DIMMER TYPE
--	-------------	------------------------

POWER FEED CANOPIES WITH LED TRANSFORMER

 <p>4" ROUND DIRECT SINGLE-FEED</p> 	<p>1 X 120V 12V 1 X 60 WATTS* ELECTRONIC</p>	<p>BRONZE: 700WMOP4R60EZ-LED CHROME: 700WMOP4R60EC-LED SATIN NICKEL: 700WMOP4R60ES-LED WHITE: 700WMOP4R60EW-LED*</p>	<p>LOW-VOLTAGE ELECTRONIC 600 WATTS</p>
 <p>4" ROUND FLEXIBLE END POWER FEED</p> 	<p>1 X 120V 12V 1 X 60 WATTS* ELECTRONIC</p>	<p>BRONZE: 700MOPEND60EZ-LED CHROME: 700MOPEND60EC-LED SATIN NICKEL: 700MOPEND60ES-LED WHITE: 700MOPEND60EW-LED*</p>	<p>LOW-VOLTAGE ELECTRONIC 600 WATTS</p>
 <p>4" ROUND FLEXIBLE CENTER POWER FEED</p> 	<p>1 X 120V 12V 1 X 60 WATTS* ELECTRONIC</p>	<p>BRONZE: 700MOPCEN60EZ-LED CHROME: 700MOPCEN60EC-LED SATIN NICKEL: 700MOPCEN60ES-LED WHITE: 700MOPCEN60EW-LED*</p>	<p>LOW-VOLTAGE ELECTRONIC 600 WATTS</p>

* WHITE FINISH OPTIONS HAVE SATIN NICKEL FEEDS

** AS A GENERAL RULE WHEN USING LED FIXTURES WE DO NOT RECOMMEND USING GREATER THAN 70% OF SPECIFIED MAXIMUM WATTAGE ON THE TRANSFORMER DUE TO INRUSH CURRENT. FOR ASSISTANCE, PLEASE CONTACT OUR TECHNICAL SUPPORT DEPARTMENT.













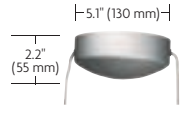

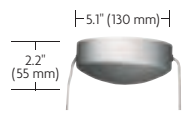

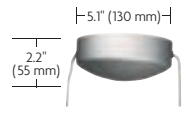

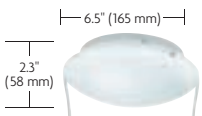
INDICATES WHICH TRANSFORMERS ARE COMPATIBLE WITH LED ELEMENTS

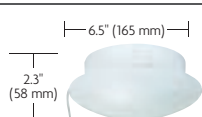
Surface Transformers

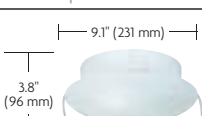
All surface transformers mount to a nearby standard 4" junction box with round plaster ring (provided by electrician). For technical information on surface transformers, see pp. 592-593. Requires end or center power feed (p. 511). Surface transformers cannot be placed directly between Wall MonoRail and the wall.

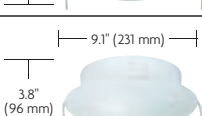
INPUT VOLTAGE OUTPUT VOLTAGE WATTAGE TYPE	ITEM NUMBER	COMPATIBLE DIMMER TYPE	COMPATIBLE DIMMING COIL	REQUIRED FEEDS	TO PLUG IN
--	-------------	------------------------------	-------------------------------	----------------	---------------

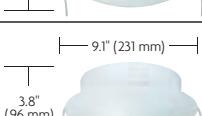
SINGLE-FEED OPTIONS

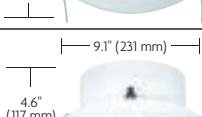
		1 X 120V 12V 1 X 60 WATTS** ELECTRONIC AC	BRONZE: 700SRT60EZ-LED BLACK: 700SRT60EB-LED* CHROME: 700SRT60EC-LED SATIN NICKEL: 700SRT60ES-LED WHITE: 700SRT60EW-LED*	LOW-VOLTAGE ELECTRONIC 600 WATTS	—	REQUIRES ONE END OR SINGLE-FEED CENTER POWER FEED (P. 509)	—
		1 X 120V 12V 1 X 75 WATTS** MAGNETIC AC	BRONZE: 700SRT75DZ BLACK: 700SRT75DB* CHROME: 700SRT75DC SATIN NICKEL: 700SRT75DS WHITE: 700SRT75DW*	LOW-VOLTAGE MAGNETIC 600 WATTS	—	REQUIRES ONE END OR SINGLE-FEED CENTER POWER FEED (P. 509)	—
		1 X 120V 12V 1 X 100 WATTS** ELECTRONIC AC	BRONZE: 700SRT100EZ-LED BLACK: 700SRT100EB-LED* CHROME: 700SRT100EC-LED SATIN NICKEL: 700SRT100ES-LED WHITE: 700SRT100EW-LED*	LOW-VOLTAGE ELECTRONIC 600 WATTS	—	REQUIRES ONE END OR SINGLE-FEED CENTER POWER FEED (P. 509)	—
		1 X 120V 12V 1 X 150 WATTS** MAGNETIC AC	BRONZE: 700SRT15DZ BLACK: 700SRT15DB* CHROME: 700SRT15DC SATIN NICKEL: 700SRT15DS WHITE: 700SRT15DW*	LOW-VOLTAGE MAGNETIC 600 WATTS	INCLUDED	REQUIRES ONE END OR SINGLE-FEED CENTER POWER FEED (P. 509)	ADD PLUG OPTION (P. 511)
		1 X 120V 12V 1 X 150 WATTS ELECTRONIC AC	BRONZE: 700SRT15EZ BLACK: 700SRT15EB* CHROME: 700SRT15EC SATIN NICKEL: 700SRT15ES WHITE: 700SRT15EW*	LOW-VOLTAGE ELECTRONIC 600 WATTS	—	REQUIRES ONE END OR SINGLE-FEED CENTER POWER FEED (P. 509)	ADD PLUG OPTION (P. 511)
		1 X 120V 12V 1 X 300 WATTS** MAGNETIC AC	BRONZE: 700SRT30DZ BLACK: 700SRT30DB* CHROME: 700SRT30DC SATIN NICKEL: 700SRT30DS WHITE: 700SRT30DW*	LOW-VOLTAGE MAGNETIC 600 WATTS	INCLUDED	REQUIRES ONE END OR SINGLE-FEED CENTER POWER FEED (P. 509)	ADD PLUG OPTION (P. 511)
		1 X 120V 12V 1 X 300 WATTS ELECTRONIC DC	BRONZE: 700SRT30EZ BLACK: 700SRT30EB* CHROME: 700SRT30EC SATIN NICKEL: 700SRT30ES WHITE: 700SRT30EW*	LOW-VOLTAGE ELECTRONIC 600 WATTS	—	REQUIRES ONE END OR SINGLE-FEED CENTER POWER FEED (P. 509)	ADD PLUG OPTION (P. 511)
		1 X 120V 24V 1 X 300 WATTS MAGNETIC AC	BRONZE: 700SRT3024DZ BLACK: 700SRT3024DB* CHROME: 700SRT3024DC SATIN NICKEL: 700SRT3024DS WHITE: 700SRT3024DW*	LOW-VOLTAGE MAGNETIC 600 WATTS	INCLUDED	REQUIRES ONE END OR SINGLE-FEED CENTER POWER FEED (P. 509)	ADD PLUG OPTION (P. 511)
		1 X 120V 24V 1 X 600 WATTS MAGNETIC AC	BRONZE: 700SRT6024DZ BLACK: 700SRT6024DB* CHROME: 700SRT6024DC SATIN NICKEL: 700SRT6024DS WHITE: 700SRT6024DW*	LOW-VOLTAGE MAGNETIC 1000 WATTS	INCLUDED	REQUIRES ONE END OR SINGLE-FEED CENTER POWER FEED (P. 509)	ADD PLUG OPTION (P. 511)

DUAL-FEED OPTIONS (ISOLATING CONNECTORS INCLUDED)

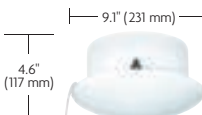
		1 X 120V 12V 2 X 300 WATTS** MAGNETIC AC	BRONZE: 700SRT60DZ BLACK: 700SRT60DB* CHROME: 700SRT60DC SATIN NICKEL: 700SRT60DS WHITE: 700SRT60DW*	LOW-VOLTAGE MAGNETIC 1000 WATTS	INCLUDED	REQUIRES ONE END OR SINGLE-FEED CENTER POWER FEED (P. 509)	ADD PLUG OPTION (P. 511)
--	---	---	--	---------------------------------------	----------	---	--------------------------------

* BLACK AND WHITE FINISH OPTIONS HAVE CHROME FEEDS

** AS A GENERAL RULE WHEN USING LED FIXTURES WE DO NOT RECOMMEND USING GREATER THAN 70% OF SPECIFIED MAXIMUM WATTAGE ON THE TRANSFORMER DUE TO INRUSH CURRENT. FOR ASSISTANCE, PLEASE CONTACT OUR TECHNICAL SUPPORT DEPARTMENT.



LED

INDICATES WHICH TRANSFORMERS ARE COMPATIBLE WITH LED ELEMENTS

Special Installations

End and center power feeds are generally used to bring power to a Wall MonoRail system when the junction box cannot be located directly behind the rail. The power feed can be mounted to a standard 4" junction box with round plaster ring (provided by electrician), directly to a Remote Transformer (p. 508), or nearby Surface Transformer (p. 510).

END POWER FEED

The end power feed pushes into an end of the MonoRail and includes a removable 4" round canopy and 12' field-cutttable softwire leads.

700MOPEND	FINISH
Z	ANTIQUÉ BRONZE
C	CHROME
S	SATIN NICKEL



CENTER POWER FEED

The center power feed can be used anywhere within the run and includes a removable 4" round canopy and 12' field-cutttable softwire leads. Specify dual-feed when using a dual-feed transformer.

700MOPCEN	TYPE	FINISH
	SINGLE-FEED	Z ANTIQUÉ BRONZE
4	DUAL-FEED	C CHROME
		S SATIN NICKEL



SINGLE-FEED



PLUG OPTION

16' cord and plug for standard 120 volt power outlets.

700A1-	COLOR
WHT	WHITE
BLK	BLACK



Wall MonoRail Kits

ALL WALL MONORAIL KITS INCLUDE:

8' long Wall MonoRail. Choose between:

ANTIQUÉ BRONZE - BROWN INSULATOR



CHROME - CLEAR INSULATOR



SATIN NICKEL - CLEAR INSULATOR



ACTUAL SIZE



One set of decorative end caps



Three Wall MonoRail standoffs

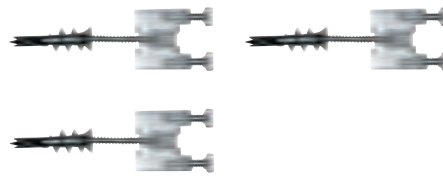

12 volt 300 watt plug-in magnetic remote transformer with end power feed.



WALL MONORAIL KIT

700WMKTA300 FINISH
Z ANTIQUÉ BRONZE
C CHROME
S SATIN NICKEL

SELECT YOUR ELEMENTS (PP. 52-193)





Mini Cargo Solid pendant p. 69 and K-Hello head p. 182



KABLE LITE



KABLE LITE

K-Johnny head p. 186





Photographer: © Galina Coadă

K-Hello head p. 182



Trends Publishing International Photographer: John Umberber Design: Rao Design Studio

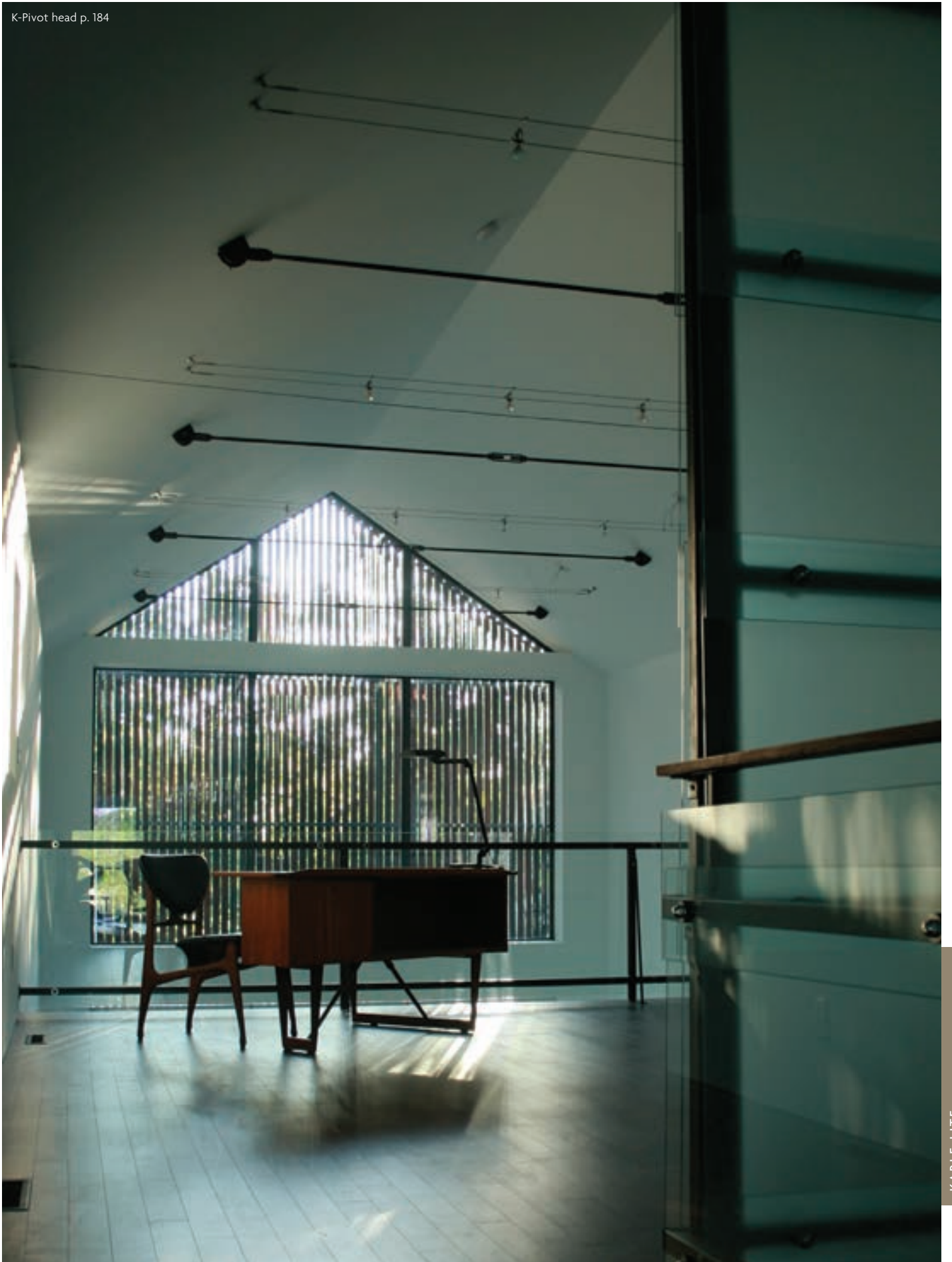

The Basics of Kable Lite

Need help designing your system? Visit our online order configurator at configurator.techlighting.com



ONE DESIGN YOUR KABLE LITE SYSTEM

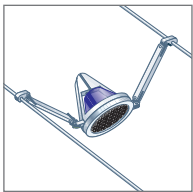

The first step in designing your Kable Lite system is to determine what it is you are trying to light. You'll need to decide where the elements should be installed to put light where you want it. See compatible elements on pp. 52-193. Choose your elements then add accessories if desired. We offer a broad range of colorful and decorative accessories and functional optical controls (pp. 566-579).

Determine the cable separation of the run. Generally, the higher the ceiling, the wider the cable separation can be. We recommend the following:

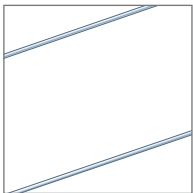

CEILING HEIGHT	CABLE SEPARATION NOT TO EXCEED
8'	3.5"
9'	5.5"
10'	8"

Different elements have different cable separation requirements, so make sure the elements you've chosen are compatible with the cable separation.

Draw in your Kable Lite run. Remember, Kable Lite is designed to make straight lines and simple turns. The cables must be placed so they pass over the locations of all the elements. Kable Lite surface transformers and power feed canopies have 24" feeds, so your Kable Lite run must pass within two feet of the junction box. Determine how many feet of cable you'll need (p. 522).

TWO ADD POWER AND HARDWARE TO COMPLETE YOUR SYSTEM

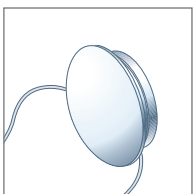

Add up the wattages of the lamps you'll be using on the system: this will help you select a transformer. A remote transformer with power feed canopy provides the cleanest look, but the remote transformer must be installed in an accessible, remote location. The surface transformer simply mounts to a junction box. Use the information on pp. 592-593 to help you choose the right transformer for your installation; see pp. 526-529 for Kable Lite transformer and power feed options. If you are using LED heads or pendants, be sure to choose a transformer that is compatible with LED fixtures. Kable Lite power feed canopies and surface transformers have 24" feeds. If this drop is shorter than you require, or if you prefer the look of hardwire, you'll need to add optional hardwire feeds (p. 527).

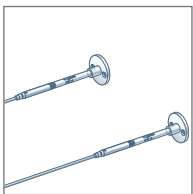

See p. 523 for guidelines on selecting turnbuckles. We recommend putting a pair of turnbuckles on each side of the run for visual symmetry.

You will not need to add supports to your run unless it's long (over twenty feet) or has heavier elements (such as glass pendants). Review pp. 523-525 and add support or turn hardware if required.

KABLE LITE KITS

To simplify ordering, we offer several convenient Kable Lite Kits that include all the power and hardware required for most basic installations (pp. 532-533).



For other Kable Lite system options, such as feeding power through a wall or ceiling or changing cable separation within the run, see Special Installations on pp. 529-531.

Cable

BARE CABLE

Rated for 300 watts at 12 volts, 600 watts at 24 volts. Load: 300 watt maximum at 12 volts to 30' before voltage drop occurs; 600 watt maximum at 24 volts to 60' before voltage drop occurs.

#10 gauge tin-plated copper cable with kevlar core.



700KLABAREC

INSULATED CABLE

Use insulated cable where required by local codes or in coastal areas, where salty air might oxidize bare cables. #10 gauge tin-plated copper

#10 gauge tin-plated copper cable with kevlar core; sheathed in clear.



700KLAINSL



Tip: Cable is sold by the foot (0.3 m).
Order the length of your Kable Lite
run x 2 and add 10 percent.

Turnbuckles

Turnbuckles are the key to the Kable Lite system. They tighten and secure the cables and provide the necessary tension for a clean look. All turnbuckles include mounting hardware for drywall. Special hardware is available for brick, cement, or plaster surfaces (see p. 530). For long runs of over twenty feet, turnbuckles should be reinforced with wood blocking behind the wall.

FOR LONG OR TURNING RUNS OVER 20' (WALL-TO-WALL OR CEILING MOUNTED)

UNIVERSAL TURNBUCKLES

5.5" long, 1.75" diameter. When ceiling mounted, cables drop 2.5" from ceiling. Pair. If mounting to metal, order isolating connector for each pair of turnbuckles (sold separately, p. 525).

700PARTT	FINISH
C	CHROME
S	SATIN NICKEL

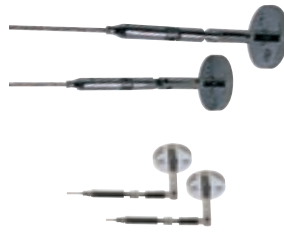

FOR CEILING MOUNTED RUNS UNDER 20'

WAVE TURNBUCKLES

Use on both ends of the run. For ceiling only. Cables drop 5" from ceiling. Pair. If mounting to metal, order isolating connectors for each pair of turnbuckles (sold separately, p. 525).

700KWAVE	FINISH
C	CHROME
S	SATIN NICKEL



FOR SHORT, STRAIGHT RUNS OVER 20' (WALL-TO-WALL OR CEILING MOUNTED)

SLIMLINE TURNBUCKLES

4" long, 0.5" diameter. When ceiling mounted, cables drop 1" from ceiling. Pair. If mounting to metal, order isolating version.

700PRTT1	FINISH
C	CHROME
S	SATIN NICKEL
IC	ISOLATING CHROME
IS	ISOLATING SATIN NICKEL



SOFT TURNBUCKLES

Stylish satin nickel turnbuckle. 4" long, 0.5" diameter. When ceiling mounted, cables drop 1" from ceiling. Pair. If mounting to metal, order isolating connectors for each pair of turnbuckles (sold separately, p. 525).

700KSOFTTS



SLIMLINE ANCHORS

Use to secure cables at one end of run (with turnbuckles at other end). 1" long, 0.5" diameter. Pair.

700PRTT0	FINISH
C	CHROME
S	SATIN NICKEL



SOFT ANCHORS

Use to secure cables at one end of run (with turnbuckles at other end). 1" long, 0.5" diameter. Satin nickel. Pair.

700KSOFT0S



Ceiling Supports

SUPPORTING RUNS OVER 20'

ADJUSTABLE STANDOFF

Suspension cable virtually disappears for a clean and elegant look. Wire grip allows easy adjustability. Standard with twelve feet of field-cuttable suspension cable; may also be specified with thirty feet of cable. Horizontal rod is 12" wide; field cut to desired cable separation (3.5" minimum).

700PRTD3	LENGTH	FINISH
	12' OF CABLE	C CHROME
3	30' OF CABLE	S SATIN NICKEL



SUPPORTING RUNS OVER 20' OR CHANGING CABLE DROP

RIGID T STANDOFF

Mounts to ceiling. Offered for a range of drops and cable separations. Not field-cuttable.

700KTSO	DROP	SEPARATION	FINISH
01	1"	01 1"	C CHROME
02	2.5"	02 2"	S SATIN NICKEL
05	5"	03 3.5"	
12	12"	05 5.5"	
		08 8"	



CHANGING CABLE DROP OR TURNING

RIGID POST STANDOFF / STANDOFF TURN

Can be used for cable separations from 2" to 36". Standoffs can also be specified with a turn support to provide tension for clean turns. Pair. Not field-cuttable.

700	TYPE	DROP	FINISH
KSO	STANDOFF ALONE	01 1"	C CHROME
KSOT	STANDOFF TURN	02 2.5"	S SATIN NICKEL
		05 5"	
		12 12"	

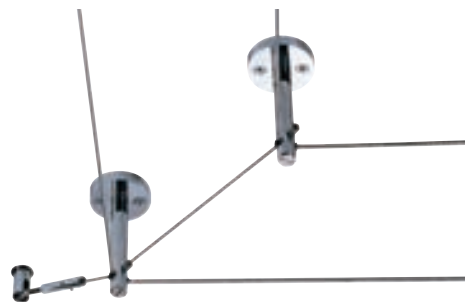

STANDOFF TURN

Wall Supports

TURNING CABLE AT THE WALL

A wall turn attaches to a surface to make simple turns. Includes insulating tubing to cover where cables cross. Pair.

WALL TURN

700KWSO01 FINISH
 C CHROME
 S SATIN NICKEL



TURNING CABLE HORIZONTALLY FROM A WALL

Directional hardware for making a floating horizontal or vertical turn when the ceiling is inaccessible. Each includes six feet of field-cuttable cable to provide tension for turn.

HORIZONTAL TURN

700PRTC6 FINISH
 C CHROME
 S SATIN NICKEL



INSTALLING CABLE TO CANTILEVER FROM A WALL

This outside rigger attaches to the wall to secure cables 12" from the wall at 2" cable separation. Use when a wall-to-wall installation is impractical and the ceiling is not accessible. Not field-cuttable. Pair.

OUTSIDE RIGGER

700KWSO1202 FINISH
 C CHROME
 S SATIN NICKEL



Connectors

JOINING CABLE END TO END

CONDUCTIVE CONNECTORS

Connectors join cables end to end.

700PARTD2 FINISH
 C CHROME
 S SATIN NICKEL



ISOLATING CONNECTORS

Plastic connectors join cables end to end and isolate power feeds from each other. All dual-feed canopies and dual-feed surface transformers are shipped with isolating connectors; order additional if required by layout. Pair.

700PARTD1 FOR USE WITH BARE CABLE
700PARTD1L FOR USE WITH INSULATED CABLE

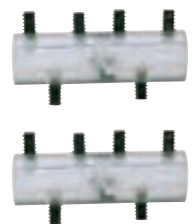









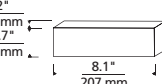

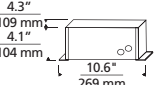

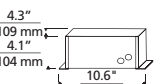

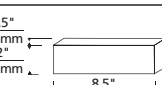

Remote Transformers

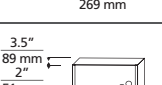
Remote transformers install in an accessible location behind the ceiling or wall. For technical information on remote transformers, see pp. 592-593. Requires canopy (p. 527) or special power feed (p. 531).

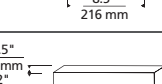
INPUT VOLTAGE OUTPUT VOLTAGE WATTAGE TYPE	ITEM NUMBER	COMPATIBLE DIMMER TYPE	COMPATIBLE DIMMING COIL	PLUG-IN TRANSFORMER OPTION (INCLUDES 16' CORD)	RECESSED REMOTE TRANSFORMER OPTION	277 VOLT INPUT OPTION
--	-------------	------------------------------	-------------------------------	---	--	--------------------------

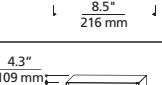
SINGLE-FEED OPTIONS

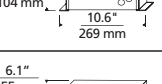
		1 X 120V 12V 1 X 60 WATTS** ELECTRONIC AC	700AT060EL	LOW-VOLTAGE ELECTRONIC 450 WATTS	—	—	—
		1 X 120V 12V 1 X 75 WATTS** MAGNETIC AC	700AT075T	LOW-VOLTAGE MAGNETIC 600 WATTS	—	700AT075P	700AT075T277
		1 X 120V 12V 1 X 150 WATTS** MAGNETIC AC	700AT150T	LOW-VOLTAGE MAGNETIC 600 WATTS	700DIM150 (P. 593)	700AT150P	700AT150T277
		1 X 120V 12V 1 X 150 WATTS** ELECTRONIC DC	700AT152EL	LOW-VOLTAGE ELECTRONIC 600 WATTS	—	—	—
		1 X 120V 12V 1 X 300 WATTS** MAGNETIC AC	700AT300T	LOW-VOLTAGE MAGNETIC 600 WATTS	700DIM150 (P. 593)	700AT300P	700AT300TR 700AT300TR277*
		1 X 120V 12V 1 X 300 WATTS ELECTRONIC DC	700AT300EL	LOW-VOLTAGE ELECTRONIC 600 WATTS	—	700AT300LP	—
		1 X 120V 12V 1 X 300 WATTS** ELECTRONIC DC	700AT302EL	LOW-VOLTAGE ELECTRONIC 600 WATTS	—	—	—
		1 X 120V 24V 1 X 300 WATTS MAGNETIC AC	700AT3024T	LOW-VOLTAGE MAGNETIC 600 WATTS	700DIM300 (P. 593)	700AT3024P	700AT3024TR 700AT3024T277 700AT3024TR277*
		1 X 120V 24V 1 X 600 WATTS MAGNETIC AC	700AT6024T	LOW-VOLTAGE MAGNETIC 1000 WATTS	700DIM600 (P. 593)	700AT6024P	700AT6024TR 700AT6024T277 700AT6024TR277*

DUAL-FEED OPTIONS

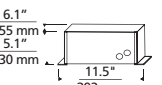
		1 X 120V 12V 1 X 300 WATTS** MAGNETIC AC	700AT600T	LOW-VOLTAGE MAGNETIC 1000 WATTS	700DIM600 (P. 593)	700AT600P	700AT600TR 700AT600T277 700AT600TR277*
--	---	---	-----------	---------------------------------------	-----------------------	-----------	--

* IN-WALL RECESSED REMOTE TRANSFORMERS ALSO AVAILABLE FOR MAGNETIC 300 AND 600 WATT MODELS FOR USE IN APPLICATIONS WHERE A REMOTE TRANSFORMER IS DESIRED BUT THERE ISN'T ACCESS TO A REMOTE LOCATION. SEE WWW.TECHLIGHTING.COM FOR DIMENSIONS AND FURTHER DETAILS.

** AS A GENERAL RULE WHEN USING LED FIXTURES WE DO NOT RECOMMEND USING GREATER THAN 70% OF SPECIFIED MAXIMUM WATTAGE ON THE TRANSFORMER DUE TO INRUSH CURRENT. FOR ASSISTANCE, PLEASE CONTACT OUR TECHNICAL SUPPORT DEPARTMENT.





INDICATES WHICH TRANSFORMERS ARE COMPATIBLE WITH LED ELEMENTS

Power Feed Canopies

ITEM NUMBER	MOUNTS TO	COMPATIBLE RIGID STANDOFF	FEED LENGTH	TO DROP FROM CEILING GREATER THAN FEED LENGTH
-------------	-----------	---------------------------	-------------	---

SINGLE-FEED OPTIONS Use with one single-feed remote transformer

 <p>4" Round Single-Feed</p>	BLACK: 700K4C24B* CHROME: 700K4C24C SATIN NICKEL: 700K4C24S WHITE: 700K4C24W*	STANDARD 4" JUNCTION BOX WITH ROUND PLASTER RING (PROVIDED BY ELECTRICIAN)	ANY (P. 524)	24"	ADD ONE PAIR HARDWIRE FEEDS (BELOW)
 <p>2" Square Single-Feed</p>	BLACK: 700K2C24B* CHROME: 700K2C24C SATIN NICKEL: 700K2C24S WHITE: 700K2C24W*	SPECIAL 2" SQUARE JUNCTION BOX (INCLUDED)	ANY (P. 524)	24"	ADD ONE PAIR HARDWIRE FEEDS (BELOW)

DUAL-FEED OPTIONS Use with one dual-feed remote transformer (isolating connectors included)

 <p>4" Round Dual-Feed</p>	BLACK: 700K4C424B* CHROME: 700K4C424C SATIN NICKEL: 700K4C424S WHITE: 700K4C424W*	STANDARD 4" JUNCTION BOX WITH ROUND PLASTER RING (PROVIDED BY ELECTRICIAN)	ANY (P. 524)	24"	ADD ONE PAIR HARDWIRE FEEDS (BELOW)
---	--	--	--------------	-----	-------------------------------------

HARDWIRE FEEDS

Pair of field-cutable, hand bendable hardwire feeds to replace standard feeds. For dual-feed canopies and dual-feed surface transformers, order two pair.

700HWD	LENGTH	FINISH
24	24"	C CHROME
48	48"	S SATIN NICKEL
72	72"	
96	96"	













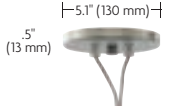

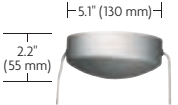

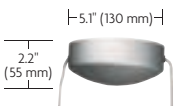

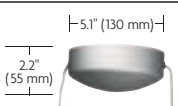
* BLACK AND WHITE FINISH OPTIONS HAVE CHROME FEEDS

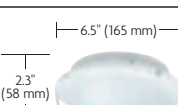
Surface Transformers

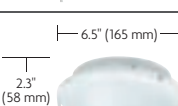
All surface transformers mount to a nearby standard 4" junction box with round plaster ring (provided by electrician). For technical information on surface transformers, see pp. 592-593. Surface transformers cannot be placed directly between Kable Lite and the wall.

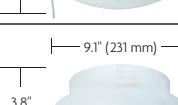
INPUT VOLTAGE OUTPUT VOLTAGE WATTAGE TYPE	ITEM NUMBER	COMPATIBLE DIMMER TYPE	COMPATIBLE DIMMING COIL	FEEDS	FOR HARDWARE FEEDS	TO PLUG IN
--	-------------	------------------------------	-------------------------------	-------	--------------------------	---------------

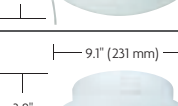
SINGLE-FEED OPTIONS

		1 X 120V 12V 1 X 60 WATTS** ELECTRONIC AC	BLACK: 700FRT60EB-LED* CHROME: 700FRT60EC-LED SATIN NICKEL: 700FRT60ES-LED WHITE: 700FRT60EW-LED*	LOW-VOLTAGE ELECTRONIC 600 WATTS	—	24" SOFTWIRE	—	—
		1 X 120V 12V 1 X 60 WATTS** ELECTRONIC AC	BLACK: 700SRT60EB-LED* CHROME: 700SRT60EC-LED SATIN NICKEL: 700SRT60ES-LED WHITE: 700SRT60EW-LED*	LOW-VOLTAGE ELECTRONIC 600 WATTS	—	24" SOFTWIRE	ADD ONE PAIR (P. 527)	ADD PLUG OPTION (P. 529)
		1 X 120V 12V 1 X 75 WATTS** MAGNETIC AC	BLACK: 700SRT75DB* CHROME: 700SRT75DC SATIN NICKEL: 700SRT75DS WHITE: 700SRT75DW*	LOW-VOLTAGE MAGNETIC 600 WATTS	—	24" SOFTWIRE	ADD ONE PAIR (P. 527)	ADD PLUG OPTION (P. 529)
		1 X 120V 12V 1 X 100 WATTS** ELECTRONIC AC	BLACK: 700SRT100EB-LED* CHROME: 700SRT100EC-LED SATIN NICKEL: 700SRT100ES-LED WHITE: 700SRT100EW-LED*	LOW-VOLTAGE ELECTRONIC 600 WATTS	—	24" SOFTWIRE	ADD ONE PAIR (P. 527)	ADD PLUG OPTION (P. 529)
		1 X 120V 12V 1 X 150 WATTS** MAGNETIC AC	BLACK: 700SRT15DB* CHROME: 700SRT15DC SATIN NICKEL: 700SRT15DS WHITE: 700SRT15DW*	LOW-VOLTAGE MAGNETIC 600 WATTS	INCLUDED	24" SOFTWIRE	ADD ONE PAIR (P. 527)	ADD PLUG OPTION (P. 529)
		1 X 120V 12V 1 X 150 WATTS** ELECTRONIC AC	BLACK: 700SRT15EB* CHROME: 700SRT15EC SATIN NICKEL: 700SRT15ES WHITE: 700SRT15EW*	LOW-VOLTAGE ELECTRONIC 600 WATTS	—	24" SOFTWIRE	ADD ONE PAIR (P. 527)	ADD PLUG OPTION (P. 529)
		1 X 120V 12V 1 X 300 WATTS** MAGNETIC AC	BLACK: 700SRT30DB* CHROME: 700SRT30DC SATIN NICKEL: 700SRT30DS WHITE: 700SRT30DW*	LOW-VOLTAGE MAGNETIC 600 WATTS	INCLUDED	24" SOFTWIRE	ADD ONE PAIR (P. 527)	ADD PLUG OPTION (P. 529)
		1 X 120V 12V 1 X 300 WATTS** ELECTRONIC DC	BLACK: 700SRT30EB* CHROME: 700SRT30EC SATIN NICKEL: 700SRT30ES WHITE: 700SRT30EW*	LOW-VOLTAGE ELECTRONIC 600 WATTS	—	24" SOFTWIRE	ADD ONE PAIR (P. 527)	ADD PLUG OPTION (P. 529)
		1 X 120V 24V 1 X 300 WATTS** MAGNETIC AC	BLACK: 700SRT3024DB* CHROME: 700SRT3024DC SATIN NICKEL: 700SRT3024DS WHITE: 700SRT3024DW*	LOW-VOLTAGE MAGNETIC 600 WATTS	INCLUDED	24" SOFTWIRE	ADD ONE PAIR (P. 527)	ADD PLUG OPTION (P. 529)
		1 X 120V 24V 1 X 600 WATTS** MAGNETIC AC	BLACK: 700SRT6024DB* CHROME: 700SRT6024DC SATIN NICKEL: 700SRT6024DS WHITE: 700SRT6024DW*	LOW-VOLTAGE MAGNETIC 1000 WATTS	INCLUDED	24" SOFTWIRE	ADD ONE PAIR (P. 527)	ADD PLUG OPTION (P. 529)

* BLACK AND WHITE FINISH OPTIONS HAVE SATIN NICKEL FEEDS

** AS A GENERAL RULE WHEN USING LED FIXTURES WE DO NOT RECOMMEND USING GREATER THAN 70% OF SPECIFIED MAXIMUM WATTAGE ON THE TRANSFORMER DUE TO INRUSH CURRENT. FOR ASSISTANCE, PLEASE CONTACT OUR TECHNICAL SUPPORT DEPARTMENT.



INDICATES WHICH TRANSFORMERS ARE COMPATIBLE WITH LED ELEMENTS

INPUT VOLTAGE OUTPUT VOLTAGE WATTAGE TYPE	ITEM NUMBER	COMPATIBLE DIMMER TYPE	COMPATIBLE DIMMING COIL	FEEDS	FOR HARDWARE FEEDS	TO PLUG IN
--	-------------	------------------------------	-------------------------------	-------	--------------------------	---------------

DUAL-FEED OPTIONS

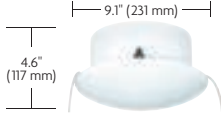
		1 X 120V 12V 2 X 600 WATTS** MAGNETIC AC	BLACK: 700SRT60DB* CHROME: 700SRT60DC SATIN NICKEL: 700SRT60DS WHITE: 700SRT60DW*	LOW-VOLTAGE MAGNETIC 1000 WATTS	INCLUDED	24" SOFTWIRE	ADD ONE PAIR (P. 527)	ADD PLUG OPTION (BELOW)
---	---	---	--	---------------------------------------	----------	--------------	-----------------------------	-------------------------------

* BLACK AND WHITE FINISH OPTIONS HAVE SATIN NICKEL FEEDS

** AS A GENERAL RULE WHEN USING LED FIXTURES WE DO NOT RECOMMEND USING GREATER THAN 70% OF SPECIFIED MAXIMUM WATTAGE ON THE TRANSFORMER DUE TO INRUSH CURRENT. FOR ASSISTANCE, PLEASE CONTACT OUR TECHNICAL SUPPORT DEPARTMENT.



LED
INDICATES WHICH TRANSFORMERS ARE COMPATIBLE WITH LED ELEMENTS

PLUG OPTION

16' cord and plug for standard 120 volt power outlets.

700A1-	COLOR
WHT	WHITE
BLK	BLACK



Special Installations

FEEDING POWER THROUGH A WALL OR CEILING

Use the power feed turnbuckles to pipe power from a single feed remote transformer (p. 526) through an accessible wall or ceiling and terminate the run. Power feed standoffs bring power to the cables within the run. Back of wall or ceiling must be accessible.

POWER FEED TURNBUCKLES

Pair of insulated slimline turnbuckles with power feed capability. Minimum cable separation: 2"; maximum cable run: twenty feet, unless reinforced.

700PRC14	FINISH
C	CHROME
S	SATIN NICKEL



POWER FEED STANDOFFS

Pair of rigid standoffs with power feed capability. Minimum cable separation: 3.5".

700KPFSO	DROP	FINISH
01	1"	Z ANTIQUE BRONZE
02	2.5"	C CHROME
12	12"	S SATIN NICKEL



Special Installations

MOUNTING TO BRICK, CEMENT, OR PLASTER

Turnbuckles and anchors come standard with mounting hardware for drywall. To mount to other surfaces, order this special hardware. Sold in pairs.

BRICK OR CEMENT ANCHORS

700PRTD14



PLASTER ANCHORS

700PRTD15



CRIS-CROSSING CABLE RUNS

POWER JUMPERS

Pair of power jumpers transfers power from one cable run to another. Includes 24" of insulating tubing to cover where cables cross.

700PARTD9 FINISH
 C CHROME
 S SATIN NICKEL



INSULATING TUBING

Clear plastic tubing insulates bare cable from another cable or metal. Sold by the foot.



700PARTD4

SUPPORTING CABLE ON RUNS WITH LONGER DROPS

Use these heavy duty standoffs to support Kable Lite systems that drop 18" or 24" from the ceiling.

HEAVY DUTY STANDOFFS

These longer standoffs have 4" diameter bases for stability and require a minimum 5.5" cable separation. Pair. Not field-cuttable. May require longer hardwire feeds (p. 527).

700KSOHD DROP FINISH
 18 18" C CHROME
 24 24" S SATIN NICKEL



MAINTAINING TENSION IN TURN-HEAVY RUNS

Kable Lite systems with several turns will require inline turnbuckles to provide tension within the run.

INLINE TURNBUCKLES

Conductive (T2) turnbuckles continue power; insulated (T3) turnbuckles isolate power feeds from each other. Pair.

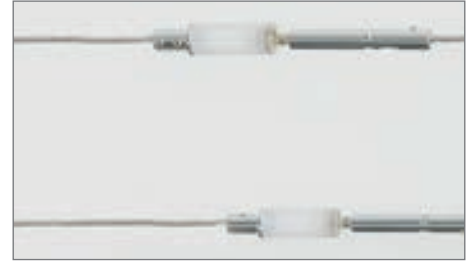
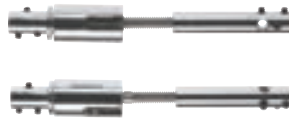

700PART	TYPE	FINISH
T2	CONDUCTIVE	C CHROME
T3	INSULATED	S SATIN NICKEL

USING A CENTER POWER FEED

A center power feed is generally used to bring power to a Kable Lite system when the transformer or junction box cannot be located directly above the run. The power feed can be mounted to a standard 4" junction box with round plaster ring (provided by electrician), directly to a Remote Transformer, or Kable Lite Surface Transformer when the available junction box is not located directly above the run.

CENTER POWER FEED

The center power feed can be used anywhere within the run and includes 12' field-cutable softwire leads. Specify single or dual-feed. Specify dual-feed when using a dual-feed transformer.



SINGLE-FEED



700KPCEN	FINISH	FINISH
	SINGLE-FEED	C CHROME
4	DUAL-FEED	S SATIN NICKEL

Kable Lite Kits

ALL KABLE LITE KITS INCLUDE:

45' of bare cable—enough for a twenty foot wall-to-wall run.



Two pair of slimline turnbuckles



12 volt 150 or 300 watt magnetic transformer with power feed

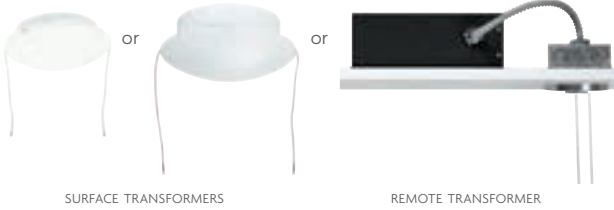

SURFACE TRANSFORMERS

REMOTE TRANSFORMER



K-Johnny head p. 186

Trends Publishing International Architect: Kanner Architects Photographer: John Linden

PICKING A KIT IS EASY

below are two simple steps to walk you through choosing your kable lite kit.

ONE CHOOSE A KIT (SEE BELOW)

You may choose between a 12 volt 150 watt surface transformer, 300 watt surface transformer or 300 watt remote transformer kit.

SURFACE TRANSFORMER KITS

150 WATT KIT

Magnetic Surface Transformer mounts to a standard 4" junction box with round plaster ring (provided by electrician) and includes 24" softwire feeds. Add up to three 50 watt elements or up to four 35 or 37 watt elements.

700KLKTS150	<u>HARDWARE FINISH</u>	<u>TRANSFORMER FINISH</u>
C	CHROME	MATCHES HARDWARE
S	SATIN NICKEL	W WHITE



300 WATT KIT

Magnetic Surface Transformer mounts to a standard 4" junction box with round plaster ring (provided by electrician) and includes 24" softwire feeds. Add up to six 50 watt elements or up to eight 35 or 37 watt elements.

700KLKTS300	<u>HARDWARE FINISH</u>	<u>TRANSFORMER FINISH</u>
C	CHROME	MATCHES HARDWARE
S	SATIN NICKEL	W WHITE



OR

REMOTE TRANSFORMER KITS

300 WATT KIT

Magnetic Remote Transformer installs in an accessible location behind the ceiling or wall. Canopy mounts to a standard 4" junction box with round plaster ring (provided by electrician) and includes 24" softwire leads. Add up to six 50 watt elements or up to eight 35 or 37 watt elements.

700KLKTA300	<u>FINISH</u>
C	CHROME
S	SATIN NICKEL



TWO SELECT YOUR ELEMENTS (PP. 52-193)

You can choose from over 100 heads and pendants to complete your system.



Spot head p. 204



T~TRAK



Sprocket head p. 172 with Spy Accessory p. 577 and T-TRAK FreeJack Connector p. 553





Photographer: Eric Roth Design: Siemasko + Verbridge

Sportster head p. 203



Design: Aidin Darling



Photographer: David Wakely

The Basics of T~TRAK

ONE DESIGN YOUR SINGLE OR TWO-CIRCUIT T~TRAK SYSTEM



The first step in designing your T-TRAK system is to determine what it is you are trying to light. You'll need to decide where the heads or pendants should be installed to put light where you want it. See Compatible Heads and Pendants on pp. 194-313 for all available fixtures with lamp type and maximum wattage. Refer to the indicated pages for detailed specifications. Choose your heads and pendants then add accessories and optical controls, if desired. When ordering low-voltage FreeJack fixtures for a T-TRAK system, order a T-TRAK FreeJack Connector (sold separately, p. 553) for each FreeJack fixture.



Draw in your T-TRAK run. Remember, T-TRAK can be shaped by hand to follow architectural details or to create an organic shape. Factory pre-bent shapes are also offered in several configurations. Your T-TRAK run should be placed so it intersects the locations of all the heads and pendants and runs directly beneath the ceiling junction box that will be used to power the system (see pp. 544-545). Determine if you will be using Single-Circuit T-TRAK or Two-Circuit T-TRAK then specify how many sections of track you'll need (p. 542).

TWO ADD HARDWARE TO COMPLETE THE SYSTEM



Determine how far from the ceiling you want the system to drop. Choose a power feed canopy (pp. 544-545) of the appropriate length and style. The maximum standard drop for T-TRAK is eight feet.



Add rigid standoffs with connector to join sections of T-TRAK end to end while supporting the system (p. 543). Order one for each connection point between track sections. Select the appropriate length to match the specified drop for the system.



Add rigid standoffs without connector to support the system (p. 543). Order one for the center of each 8' track section plus two for the ends of the run. This ensures support for T-TRAK every four feet. For especially curvy runs, order additional standoffs without connector to support peaks of curves and heavy heads and pendants, as required. Select the appropriate length to match the specified drop for the system.

Note: Standoffs and power feed canopies are field-cuttable, so it's easy to achieve a custom drop length.

For additional T-TRAK system options, such as using adjustable standoffs or mounting to a vaulted ceiling, see Special Installations on pp. 546-548.



RIGID STANDOFF
WITHOUT CONNECTOR

4" ROUND POWER FEED CANOPY
WITHOUT CONNECTOR

RIGID STANDOFF
WITH CONNECTOR

SINGLE CIRCUIT
T-TRAK

ENVISION LED HEAD

ECHO GRANDE PENDANT

T~TRAK



SATIN NICKEL



WHITE

T~TRAK™

A hand-bendable, field-cutable line-voltage track system. Single-Circuit T-TRAK is a track system rated for 20 amps and bends horizontally to a radius as small as 36". Two-Circuit T-TRAK is a two-circuit track system with each circuit having its own dedicated neutral for two separately switchable 20 amp circuits and bends horizontally to a radius as small as 60". Each section of track is shipped with two end caps to cover the open ends of the track. Order additional end caps (p. 543) if cutting and separating track sections.



SINGLE-CIRCUIT
7/8" HEIGHT X 3/8" WIDTH

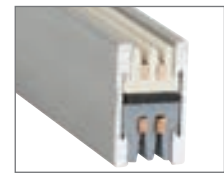

TWO-CIRCUIT
7/8" HEIGHT X 1/2" WIDTH

700	SYSTEM	LENGTH	FINISH
TTA	SINGLE-CIRCUIT T-TRAK	48 48"	S SATIN NICKEL
TT2A	TWO-CIRCUIT T-TRAK	96 96"	W WHITE

PRE-BENT T~TRAK

T-TRAK bends very easily by hand to almost any imaginable shape, but we also offer the following pre-bent track options to make the most common bends perfectly shaped and even easier to install. For a factory bend not shown below, please call for a custom quotation.

PRE-BENT S-CURVE T~TRAK

T-TRAK pre-bent into a horizontal S curve. Consult the drawing for approximate dimensions.

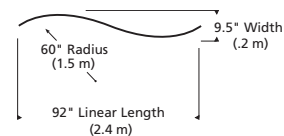

700	SYSTEM	BHSC60	FINISH
TT	SINGLE-CIRCUIT T-TRAK	S	SATIN NICKEL
TT2	TWO-CIRCUIT T-TRAK	W	WHITE

PRE-BENT 90° CURVE T~TRAK

Horizontal 90° curves are sold by radius, or the distance from the center of a circle to the outside edge. Join four 90° curves to create a circle with a diameter (overall width) equal to twice the specified radius.

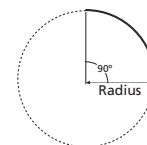

700	SYSTEM	BH90	RADIUS	FINISH
TT	SINGLE-CIRCUIT T-TRAK	36	36" RADIUS*	S SATIN NICKEL
TT2	TWO-CIRCUIT T-TRAK	48	48" RADIUS*	W WHITE
		60	60" RADIUS	

* SINGLE-CIRCUIT T-TRAK ONLY

Connectors & Standoffs

END CAP

All sections of track are shipped with the required end cap on each end of the track. Order separately for each open end of the track if cutting and separating track sections.



700	SYSTEM	CCAP	FINISH
TT	SINGLE-CIRCUIT T-TRAK	S	SATIN NICKEL
TT2	TWO-CIRCUIT T-TRAK	W	WHITE

FLEXIBLE CONNECTOR

This connector joins sections of track together end to end at desired sharp horizontal angle (90° to 270°). Order two additional rigid standoffs without connector (below) to support track near corner.



700	SYSTEM	CFXH	TYPE	FINISH
TT	SINGLE-CIRCUIT T-TRAK		CONDUCTIVE	S SATIN NICKEL
TT2	TWO-CIRCUIT T-TRAK	I	ISOLATING	W WHITE

TIP: Use standoff supports every four feet of a T-TRAK™ run. For best appearance, place the last standoff 4-6" from the end of the run, and place standoffs symmetrically, alternating between standoffs with connector where track sections join together and standoffs without connector in the center of each 8' track section.

RIGID STANDOFF WITH CONNECTOR

The field-cuttable rigid standoff with connector is used to join sections of track together end to end while supporting the system. Order one for each connection point between track sections. Use conductive type to continue power through connection. Use isolating type to isolate multiple circuits on one continuous run. Select the appropriate length to match the specified drop for the system.

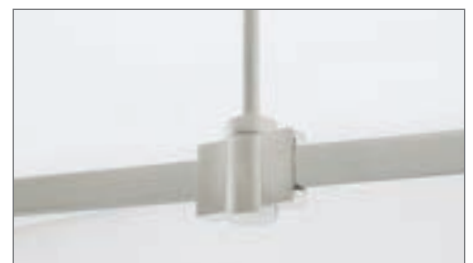
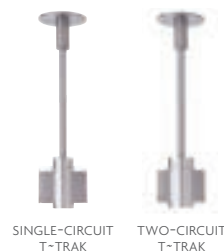

700	SYSTEM	S	TYPE	LENGTH	FINISH
TT	SINGLE-CIRCUIT T-TRAK	CC	CONDUCTIVE	02 2"	S SATIN NICKEL
TT2	TWO-CIRCUIT T-TRAK	IC	ISOLATING	06 6"	W WHITE
				12 12"	
				24 24"	
				36 36"	
				48 48"	
				96 96"	

RIGID STANDOFF WITHOUT CONNECTOR

The field-cuttable rigid standoff without connector is used in the center of each 8' track section and at each end of the run. For especially curvy runs, order additional standoffs without connector to support peaks of curves and heavy elements, as required. Select the appropriate length to match the specified drop for the system.

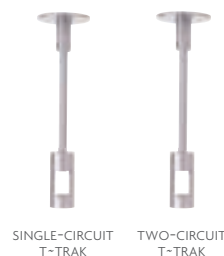

700	SYSTEM	S	LENGTH	FINISH
TT	SINGLE-CIRCUIT T-TRAK	02	2"	S SATIN NICKEL
TT2	TWO-CIRCUIT T-TRAK	06	6"	W WHITE
		12	12"	
		24	24"	
		36	36"	
		48	48"	
		96	96"	

Power Feed Canopies

USING A POWER FEED CANOPY

Standard power feed canopies mount to a ceiling junction box with round plaster ring located directly above the track. Select the appropriate length to match the specified drop for the system. Lengths longer than 2" are field-cuttable.

For projects designed to meet energy efficiency standards determine the maximum amperage required on the circuit and specify the correct current limiter.



CURRENT LIMITER

4" ROUND POWER FEED CANOPY WITHOUT CONNECTOR

Mounts to a standard 4" ceiling junction box with round plaster ring (provided by electrician). Use to power system from any point along track section.

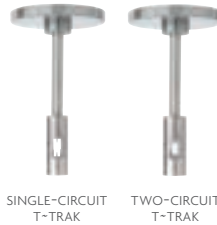

700	SYSTEM	P4C	LENGTH	FINISH	CURRENT LIMITER*
TT	SINGLE-CIRCUIT T-TRAK	02 2"	S SATIN NICKEL	WITHOUT	
TT2	TWO-CIRCUIT T-TRAK	06 6"	W WHITE	-2	2.5 AMP
		12 12"		-4	4 AMP
		24 24"		-6	6 AMP
		36 36"		-8	8 AMP
		48 48"		-10	10 AMP
		96 96"		-12	12 AMP
				-14	14 AMP
				-16	16 AMP
				-18	18 AMP

4" ROUND POWER FEED CANOPY WITH CONNECTOR

Mounts to a standard 4" ceiling junction box with round plaster ring (provided by electrician). Use to power system while joining sections of track together end to end.

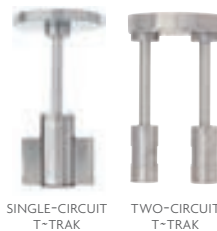

700	SYSTEM	P4CCC	LENGTH	FINISH	CURRENT LIMITER*
TT	SINGLE-CIRCUIT T-TRAK	02 2"	S SATIN NICKEL	WITHOUT	
TT2	TWO-CIRCUIT T-TRAK	06 6"	W WHITE	-2	2.5 AMP
		12 12"		-4	4 AMP
		24 24"		-6	6 AMP
		36 36"		-8	8 AMP
		48 48"		-10	10 AMP
		96 96"		-12	12 AMP
				-14	14 AMP
				-16	16 AMP
				-18	18 AMP

4" ROUND POWER FEED CANOPY WITH L CONNECTOR

"L" power feed canopies mount to a ceiling junction box located directly above the Single-Circuit T-TRAK run and join sections of track together into an "L" configuration. Select the appropriate length to match the specified drop for the system. Lengths longer than 2" are field-cuttable.

For projects designed to meet energy efficiency standards determine the maximum amperage required on the circuit and specify the correct current limiter.

Mounts to a standard 4" ceiling junction box with round plaster ring (provided by electrician).



CURRENT LIMITER

700	SYSTEM	P4C	TYPE	LENGTH	FINISH	CURRENT LIMITER*	
TT	SINGLE-CIRCUIT T-TRAK (ONLY)	L	L CONNECTOR	02 2"	S SATIN NICKEL	WITHOUT	
				06 6"	W WHITE	-2	2.5 AMP
				12 12"		-4	4 AMP
				24 24"		-6	6 AMP
				36 36"		-8	8 AMP
				48 48"		-10	10 AMP
				96 96"		-12	12 AMP
						-14	14 AMP
						-16	16 AMP
						-18	18 AMP



* CONSULT FACTORY FOR LOWER AMPERAGE CURRENT LIMITERS

USING A FLEXIBLE POWER FEED WITH CANOPY

Flexible power feeds with canopy bring power from a ceiling or wall mounted junction box to the track when the junction box is not located directly above or at the end of the track. Each includes 12' of field-cutable flexible conduit. Available in two styles: center feed can be used to power the track anywhere within the run; end feed powers the track from the end of the run.

For projects designed to meet energy efficiency standards determine the maximum amperage required on the circuit and specify the correct current limiter.



CURRENT LIMITER

FLEXIBLE POWER FEED WITH 4" ROUND CANOPY

Mounts to a standard 4" junction box with round plaster ring (provided by electrician).

700	SYSTEM	P4C	TYPE	FINISH	CURRENT LIMITER*
TT	SINGLE-CIRCUIT T-TRAK	CEN	CENTER FEED	S SATIN NICKEL	WITHOUT
TT2	TWO-CIRCUIT T-TRAK	END	END FEED	W WHITE	-2 2.5 AMP
					-4 4 AMP
					-6 6 AMP
					-8 8 AMP
					-10 10 AMP
					-12 12 AMP
					-14 14 AMP
					-16 16 AMP
					-18 18 AMP



CENTER-FEED



END-FEED



USING A DIRECT-END POWER FEED WITH CANOPY

Direct-end power feed canopies mount to a wall junction box perpendicular to the end of the run.

4" ROUND DIRECT-END POWER FEED CANOPY

Mounts to a standard 4" wall junction box with round plaster ring (provided by electrician).

700	SYSTEM	P4CD	FINISH
TT	SINGLE-CIRCUIT T-TRAK	S	SATIN NICKEL
TT2	TWO-CIRCUIT T-TRAK	W	WHITE



SINGLE-CIRCUIT T-TRAK



TWO-CIRCUIT T-TRAK



* CONSULT FACTORY FOR LOWER AMPERAGE CURRENT LIMITERS

Special Installations

INSTALLING T~TRAK TO A VAULTED CEILING

To install a T-TRAK system to a vaulted ceiling, add a power vault adapter to each power feed canopy, and add a standoff vault adapter to each standoff (with and without connector).

POWER VAULT ADAPTER

Installs to any standard power feed canopy or Single-Circuit T-TRAK power feed canopy with "L" Connector (sold separately) and adjusts to any angle to position track parallel to the floor. Not compatible with Power Feed Canopies that use current limiters.



700	SYSTEM	PVLT	FINISH
TT	SINGLE-CIRCUIT T-TRAK	S	SATIN NICKEL
TT2	TWO-CIRCUIT T-TRAK	W	WHITE

STANDOFF VAULT ADAPTER

Installs between the rigid or adjustable standoff (with and without connector) (sold separately) and the ceiling to position track parallel to the floor.



700	SYSTEM	SVLT	FINISH
TT	SINGLE-CIRCUIT T-TRAK	S	SATIN NICKEL
TT2	TWO-CIRCUIT T-TRAK	W	WHITE

USING ADJUSTABLE STANDOFFS

To ease T-TRAK installation in spaces with high and / or uneven ceiling surfaces, use adjustable standoffs to easily adjust height and level of the system. Adjustable standoffs are not recommended on curvy runs or on runs with heavy heads, such as die cast ceramic metal halide heads.

ADJUSTABLE STANDOFF WITHOUT CONNECTOR

The adjustable standoff without connector is used in the center of a track section or at the end of a run. A wire grip allows you to easily shorten or lengthen the cable to size it for use.

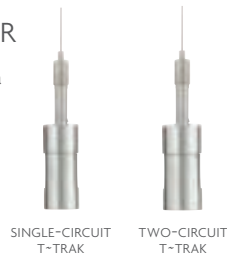

700	SYSTEM	SADJ	LENGTH	FINISH
TT	SINGLE-CIRCUIT T-TRAK		12' OF CABLE	S SATIN NICKEL
TT2	TWO-CIRCUIT T-TRAK	3	30' OF CABLE	W WHITE

ADJUSTABLE STANDOFF WITH CONNECTOR

The adjustable standoff with connector is used to join sections of track together end to end while supporting the system. A wire grip allows you to easily shorten or lengthen the cable to size it for use. Use conductive type to continue power through connection. Use isolating type to isolate multiple circuits on one continuous run.

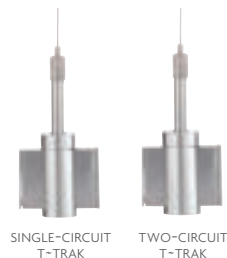

700	SYSTEM	S	TYPE	ADJ	LENGTH	FINISH
TT	SINGLE-CIRCUIT T-TRAK	CC	CONDUCTIVE		12' OF CABLE	S SATIN NICKEL
TT2	TWO-CIRCUIT T-TRAK	IC	ISOLATING	3	30' OF CABLE	W WHITE

USING X / T / L STANDOFFS

To join sections of Single-Circuit T-TRAK together into an "X", "T", or "L" configuration, use the field-cuttable rigid standoff with conductive "X", "T", or "L" connector.

RIGID STANDOFF WITH X / T / L CONNECTOR

Select the appropriate length to match the specified drop for the system. Conductive only.

700	SYSTEM	S	TYPE	LENGTH	FINISH
TT	SINGLE-CIRCUIT T-TRAK (ONLY)	X	X CONNECTOR	02 2" 06 6" 12 12" 24 24" 36 36" 48 48" 96 96"	S SATIN NICKEL W WHITE
		T	T CONNECTOR		
		L	L CONNECTOR		



INSTALLING T-TRAK TO A T-BAR DROP CEILING

To install a T-TRAK system to a T-bar drop ceiling, add a T-bar connector to every standoff (with and without connector, sold separately). The T-bar clip twists into the slat. (Use only if local electrical codes allow).

T-BAR CONNECTOR

Specify 15/16" or 9/16" slat.

700	SYSTEM	TBAR	SLAT	COLOR	FINISH
TT	SINGLE-CIRCUIT T-TRAK	C	15/16"	B BLACK	S SATIN NICKEL
TT2	TWO-CIRCUIT T-TRAK	9C	9/16"	W WHITE	W WHITE



Special Installations

INSTALLING T~TRAK™ TO CANTILEVER FROM A WALL

Use support outside rigger to support a T-TRAK system 36" off of wall. Field-cutttable.

SUPPORT OUTSIDE RIGGER WITHOUT CONNECTOR

Extends from the wall to support track. Use every four feet of run to support system in the center of a track or at the end of a run.



700	SYSTEM	SORG	FINISH
TT	SINGLE-CIRCUIT T-TRAK	S	SATIN NICKEL
TT2	TWO-CIRCUIT T-TRAK	W	WHITE

SUPPORT OUTSIDE RIGGER WITH CONNECTOR

Extends from the wall to support track. Use every four feet of run to support system while joining sections of track together end to end.

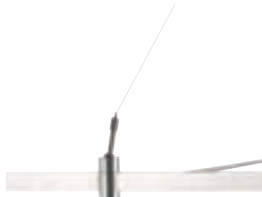

700	SYSTEM	SORG	TYPE	FINISH
TT	SINGLE-CIRCUIT T-TRAK	CC	CONDUCTIVE	S SATIN NICKEL
TT2	TWO-CIRCUIT T-TRAK	IC	ISOLATING	W WHITE

INSTALLING T~TRAK™ TO CANTILEVER FROM A WALL

Use power outside rigger to support and power a T-TRAK system 36" off of wall. Field-cutttable. For use on Single-Circuit T-TRAK system only. To power a cantilevered Two-Circuit T-TRAK run see power feed options (pp. 544-545).

POWER OUTSIDE RIGGER WITH CONNECTOR

Extends from the wall to support and power feed track. Includes 4" round canopy. Use to power system while joining sections of track together end to end.



700	SYSTEM	PORGCC	FINISH
TT	SINGLE-CIRCUIT T-TRAK (ONLY)	S	SATIN NICKEL
		W	WHITE



Photographer: Garrett Maas (CLD-E) Lighting Designer: CLD-E

Power Jack

POWER JACK CANOPY

Mounts to a standard 4" junction box with round plaster ring (provided by electrician). One Power Jack port; for ceiling mount only. For use with Power Jack heads below (sold separately).

700PJCINC FINISH
B BLACK
S SATIN NICKEL
W WHITE



POWER JACK CANOPY
 (SHOWN WITH SPORTSTER HEAD, SOLD SEPARATELY)

COMPATIBLE INCANDESCENT HEADS (CANOPY SOLD SEPARATELY, ABOVE)

All of the line-voltage heads shown on these pages are available for Power Jack. Refer to the indicated pages for specifications and ordering codes.



BREEZE INCANDESCENT
 PAR
 P. 210



ENVISION
 P. 196



OM INCANDESCENT PAR
 P. 198



SPORTSTER
 INCANDESCENT PAR
 P. 204



SPOT INCANDESCENT PAR
 P. 202



TWEAK INCANDESCENT
 PAR
 P. 208

* SHOWN ACCESSORIZED. ACCESSORIES SOLD SEPARATELY

POWER JACK CANOPY

Mounts to a standard 4" junction box with round plaster ring (provided by electrician). One Power Jack port; for ceiling mount only. For use with Power Jack heads below (sold separately). Specify canopy wattage to match head wattage; 20, 39 or 70.

700PJCCMH	WATTAGE	FINISH
20	20 WATTS	B BLACK
39	39 WATTS	S SATIN NICKEL
70	70 WATTS	W WHITE



POWER JACK CANOPY WITH CERAMIC METAL HALIDE BALLAST
(SHOWN WITH TWEAK HEAD, SOLD SEPARATELY)

COMPATIBLE CMH HEADS (CANOPY SOLD SEPARATELY, ABOVE)

All of the line-voltage heads shown on these pages are available for Power Jack. Refer to the indicated pages for specifications and ordering codes.



BREEZE CERAMIC METAL
HALIDE PAR
P. 211



BREEZE CERAMIC METAL
HALIDE T4
P. 212



OM CERAMIC METAL
HALIDE MR16 / PAR
P. 199



OM CERAMIC METAL
HALIDE T4
P. 200



SPORTSTER CERAMIC
METAL HALIDE MR16 / PAR
P. 203



SPOT CERAMIC METAL
HALIDE PAR
P. 206



TWEAK CERAMIC METAL
HALIDE MR16 / PAR
P. 209

Line-Voltage Track Adapter

DESCRIPTION

Use to adapt several T-TRAK heads and T-TRAK / Tech Lighting 120 volt pendants to popular single circuit 120 volt track lighting systems. Ceramic metal halide and compact fluorescent ballasts are concealed in the injection molded plastic adapter housings.

SYSTEMS

Compatible with single circuit 120 volt Halo, Juno and Lightolier track systems*. Specify track style at time of ordering.

FINISH

Adapters available in standard black or white finishes.



INCANDESCENT HEAD



CMH HEAD

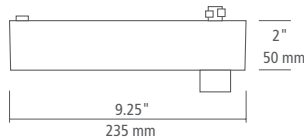
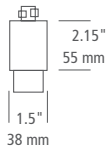

LINE-VOLTAGE HEADS

Envision LED, OM CMH MR16/PAR, OM CMH T4, OM Incandescent PAR, Sportster CMH MR16/PAR and Sportster Incandescent PAR

To order this head for use with Halo*, Juno* or Lightolier* 120 volt single-circuit track, substitute 700TT with one of the following:

FITS*	
700TH	HALO
700TJ	JUNO
700TI	LIGHTOLIER

And by substituting the finish with one of the following:

TRACK ADAPTER / HEAD FINISH	
BS	BLACK / SATIN NICKEL
BW	BLACK / WHITE
WS	WHITE / SATIN NICKEL
WW	WHITE / WHITE



LED ENVISION
P. 196

OM
P. 198

SPORTSTER
P. 203

For example, instead of 700TTENVLL3106S the item number for a black Halo compatible head adapter with the Envision LED satin nickel head is 700THENVLL3106BS

* TECH LIGHTING IS NOT AFFILIATED, NOR IS IT ENDORSED BY ANY OF THE COMPANIES LISTED NOR DOES TECH LIGHTING DISTRIBUTE ANY OF THEIR PRODUCTS.

T~TRAK FREEJACK CONNECTOR



Use to adapt any low-voltage FreeJack head or pendant to T-TRAK system. Order one T-TRAK FreeJack Connector for each FreeJack head or pendant. Specify Single-Circuit T-TRAK or Two-Circuit T-TRAK. Includes transformer. 75 watt version dimmable with a standard incandescent dimmer. 10 watt version dimmable with low-voltage electronic dimmer.

700	SYSTEM	CHEDFJ	FINISH	VOLTAGE
TT	SINGLE-CIRCUIT T-TRAK	Z	ANTIQUÉ BRONZE	12V 75W ELECTRONIC TRANSFORMER
TT2	TWO-CIRCUIT T-TRAK	S	SATIN NICKEL	-LED 12V 10W ELECTRONIC TRANSFORMER
		W	WHITE	



LOW-VOLTAGE PENDANTS



LOW-VOLTAGE HEAD



DISPLAY & EXHIBIT



DJ-Wally Lite head p. 563 and MonoRail p. 456 with Piper pendant p. 72





DISPLAY & EXHIBIT

DJ-Wally Lite head p. 563





CP Display Fixtures

Flexibility is the hallmark of all Compact Series (CP) display fixtures. The CP's arms telescope from 9" to 25" and angle up to 180°; the lamp rotates 330° and the CP holds steady however it's positioned. It automatically shuts itself off in case of short circuit (if arms cross), then turns on again when the short is corrected.

Compatible accessories and optical controls (sold separately, pp. 566-579): Backlight Shield, Barndoors, Cone Glass Shield, Eggcrate Louver, Flight Paper, Glass Lens, Lil Egypt, Lil Wok, Louver Lens Holder, MR16 Snout, Round Glass Shield, Snap Louver Holder or Taza Accessory.

CP1 CLAMP-ON LIGHT

Lightweight and versatile, CP1 features a universal clamp that provides a secure grip on any surface shape—from 1/2" pipe to 4" wall. Complete with 12 volt plug-in transformer with in-line switch and 10' cord. Chrome arms with black or white clamp. Specify 50 or 75 watts. 12 volt, MR16 lamp not included.

700CP1	WATTAGE	CLAMP
-	50 WATT	BK BLACK
7	75 WATT	WH WHITE



CP1 CLAMP-ON LIGHT
WITH MESH BACKLIGHT SHIELD ACCESSORY
DESIGN PATENT # D362,323

TIP: For more telescoping fixture options see the Tele fixture on p. 178 and Freejack canopy options on pp. 452-454.

CP SCREW-ON

Designed with a special screw-on bracket to fit lightweight portable booths. Leave two screws in or on top of the wall for quick mounting of the keyhole bracket. Complete with plug-in transformer with in-line switch and 10' cord. Specify 50 or 75 watts. 12 volt, MR16 lamp not included.

700CPSO	WATTAGE	CLAMP
-	50 WATT	B BLACK
7	75 WATT	C CHROME



CP SCREW-ON LIGHT
WITH MESH BACKLIGHT SHIELD ACCESSORY

CP CORD EXTENDER

Use to add an additional 8' of cord to CP1 and Display Jack connector ports (p. 562).

700CPEXT	COLOR
	B BLACK
	W WHITE



Lite Clamp Fixtures

A lightweight clamp-on display light specially designed for banner frames and portable booths. The Lite Clamp's attractive round clamp grips securely to a panel as slim as 1/4" or as thick as 1". The banner channel allows a tight hold to 5/16" banner frames. The length of the fixture may be adjusted by sliding the arms back and forth through the clamp. Includes 12 volt, 75 watt plug-in transformer on a 10' cord to plug into a standard outlet.

Compatible accessories and optical controls (sold separately, pp. 566-579): Backlight Shield, Barndoors, Cone Glass Shield, Eggcrate Louver, Firebird Glass Shield Flight Paper, Glass Lens, Lil Egypt, Lil Wok, Louver Lens Holder, MR16 Snout, Round Glass Shield, Snap Louver Holder or Taza Accessory.

LC-ARCHIE

17.5" long, with a 10" high swooping curve. Pivots at head to direct beam. 12 volt, MR16 lamp of up to 75 watts (not included). Chrome finish.

700LCARCHC



LC-ARCHIE
WITH LIL WOK ACCESSORY

LC-GEORGI

18" long with a 3" high gentle curve. Pivots at head to direct beam. 12 volt, MR16 lamp of up to 75 watts (not included). Chrome finish.

700LCGRGC



LC-WALLY LITE

Available in two lengths. Pivots at head to direct beam. 12 volt, MR16 lamp of up to 75 watts (not included). Chrome finish.

700LCWALC 24" LONG

700LCWAL12C 12" LONG



Display Jack

The cleanest, easiest display lighting solution yet. Select a mounting option: 4" round canopy, 2" square canopy, connector ports, 4" round swivel canopy, or DJ Screw-on and install. Push the DisplayJack element's arms (p. 563) into the canopy or port. After the show, pull the DisplayJack element out—the canopy or ports stay in place for next time. No need for an electrician.

4" ROUND CANOPY

Mounts to a standard 4" junction box with round plaster ring (provided by electrician). 12 volt, 75 watt electronic transformer (included) fits inside junction box.

700DJ4RF CANOPY
B BLACK
C CHROME



2" SQUARE CANOPY

Mounts to our special 2" square, 6" deep junction box (included). 12 volt, 75 watt electronic transformer (included) fits inside junction box.

700DJ2SQ6 CANOPY
B BLACK
C CHROME



CONNECTOR PORTS

Install these two receptacle ports through panel up to 4" thick. Access to back of panel required. 12 volt, 75 watt plug-in transformer with 10' cord plugs into a standard outlet. Chrome only.

700DJFCPC



4" ROUND SWIVEL CANOPY

Mounts to a standard 4" junction box with round plaster ring (provided by electrician). 12 volt, 75 watt electronic transformer (included) fits inside junction box. Fixture pivots up and down at canopy.

700DJ4RS CANOPY
B BLACK
C CHROME



DJ SCREW-ON

Designed with a special screw-on bracket to fit lightweight portable booths. Leave two screws in or on top of wall for quick mounting of the keyhole bracket. Complete with 12 volt, 75 watt plug-in transformer and 10' cord. Chrome only.

700DJSOC



Display Jack Elements

Compatible accessories and optical controls (sold separately, pp. 566-579): Backlight Shield, Barndoors, Cone Glass Shield, Eggcrate Louver, Flight Paper, Glass Lens, Lil Egypt, Lil Wok, Louver Lens Holder, MR16 Snout, Round Glass Shield, Snap Louver Holder or Taza Accessory.

DJ-ARCHIE

17.5" long, with a 10" high swooping curve. Pivots at head to direct beam. 12 volt, MR16 lamp of up to 75 watts (not included). Chrome finish.

700DJARCHC



DJ-ARCHIE
WITH CONNECTOR PORTS

DJ-GEORGI

18" long with a 3" high gentle curve. Pivots at head to direct beam. 12 volt, MR16 lamp of up to 75 watts (not included). Chrome finish.

700DJGRGC

SEE PP. 49, 554 FOR APPLICATION PHOTOS



DJ-GEORGI
WITH CONNECTOR PORTS

DJ-WALLY LITE

Available in two lengths. Pivots at head to direct beam. Field-cutable. 12 volt, MR16 lamp of up to 75 watts (not included). Chrome finish.

700DJWALC 24" LONG
700DJWAL12C 12" LONG

SEE PP. 48, 556, 558 FOR APPLICATION PHOTOS



DJ-WALLY LITE
WITH CONNECTOR PORTS

DJ-TELESCOPE

Telescopes from 9" to 25". Pivots at head to direct beam 12 volt, MR16 lamp of up to 75 watts (not included). Chrome finish.

700DJTELC



DJ-TELESCOPE
WITH 4" ROUND CANOPY

Joshua Ceiling

Joshua comes in a range of lengths to bring the light right where you need it. Joshua pivots left to right and the lamp rotates 330°. Specify chrome arms with chrome or black canopy. May be dimmed with a standard incandescent dimmer. Custom lengths and bends available.

Compatible accessories and optical controls (sold separately, pp. 566-579): Backlight Shield, Barndoors, Cone Glass Shield, Eggcrate Louver, Flight Paper, Glass Lens, Lil Egypt, Lil Wok, Louver Lens Holder, MR16 Snout, Round Glass Shield, Snap Louver Holder or Taza Accessory.

JOSHUA 2" CANOPY

2" square flush canopy mounts to our special 2" square, 6" deep junction box (included). Electronic transformer fits inside junction box. For ceiling only. 3" length: 12 volt, MR16 up to 50 watts. Other lengths: 12 volt, MR16 up to 75 watts. Lamp not included.

700JS2C	LENGTH	FINISH
03	3"	B BLACK
067	6"	C CHROME
127	12"	
367	36"	
607	60"	
727	72"	



JOSHUA 2" CANOPY
WITH BACKLIGHT SHIELD ACCESSORY

JOSHUA 4" ROUND FLUSH CANOPY

4" round flush canopy mounts to a standard 4" square junction box with round plaster ring (provided by electrician). Electronic transformer fits inside junction box. 3" to 24" versions for wall or ceiling mount, 36" to 72" versions for ceiling only. 3" length: 12 volt, MR16 up to 50 watts. Other lengths: 12 volt, MR16 up to 75 watts. Lamp not included.

700JSC	LENGTH	FINISH
03	3"	B BLACK
067	6"	C CHROME
127	12"	
367	36"	
487	48"	
607	60"	
727	72"	

SEE P. 49 FOR APPLICATION PHOTO



JOSHUA 4" ROUND FLUSH CANOPY

Portable Fixtures & Picture Lights

LIL WONDER

Just 4" tall, Lil Wonder goes anywhere! The canopy can screw onto a wall or sit on the floor. Automatic shut-off if tipped over. Complete with 12 volt plug-in transformer with in-line switch and 10' cord and 35 watt MR11 lamp.



700F2-	FINISH
BLK	BLACK
SN	SATIN NICKEL
WHT	WHITE

LIL BIG WONDER

A compact, powerful accent lamp with a plug-in transformer, 4.75" tall. The canopy can screw onto a wall or sit on the floor. Automatic shut-off if tipped over. Complete with 12 volt plug-in transformer with in-line switch and 10' cord and 50 watt MR16 lamp.



700F1-	FINISH
BLK	BLACK
SN	SATIN NICKEL
WHT	WHITE

JOSHUA AND MEG PICTURE LIGHTS

These elegant, unobtrusive picture lights are designed to properly illuminate your artwork and eliminate glare. Choose a lamp that will provide the proper beam spread. By changing lamps or adding a lens, you can light an area as small as four inches square or as large as four feet square!

Both Joshua and Meg are available to plug in or junction box mount. Plug-in version has 10' cord with in-line switch and plug-in transformer. Each includes 12 volt 60 watt transformer, matching Lil Wok accessory, lens holder clip, and UV-protected MR16 lamp.

Joshua and Meg junction box are dimmable with a standard incandescent dimmer.

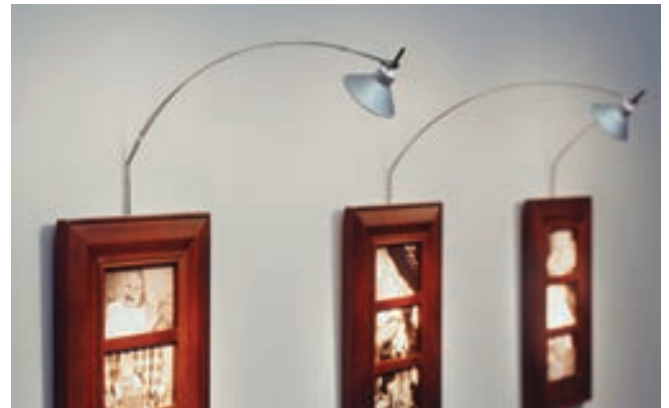

700	TYPE	MOUNTING	FINISH
JOS	JOSHUA	CP	J-BOX MOUNT
MEG	MEG	PL	PLUG-IN
		B	BLACK
		C	CHROME
		G	GOLD (BRASS)

FIXTURE	LAMP	ALONE	WITH DIFFUSOR LENS	WITH SPREAD LENS
JOSHUA	7° 20W	4" X 4"	20" X 24"	4"W X 36"H
	15° 50W	6" X 6"	24" X 30"	6"W X 36"H
	27° 20W	10" X 10"	30" X 36"	12"W X 36"H
	36° 20W	13" X 13"	29" X 30"	12"W X 36"H
	38° 50W*	20" X 32"	36" X 42"	12"W X 36"H
60° 50W	30" X 45"	48" X 48"	12"W X 36"H	
MEG	36° 20W	8" X 8"	16" X 20"	7"W X 24"H
	60° 50W*	14" X 14"	24" X 14"	10"W X 26"H

PRODUCT DIMENSIONS

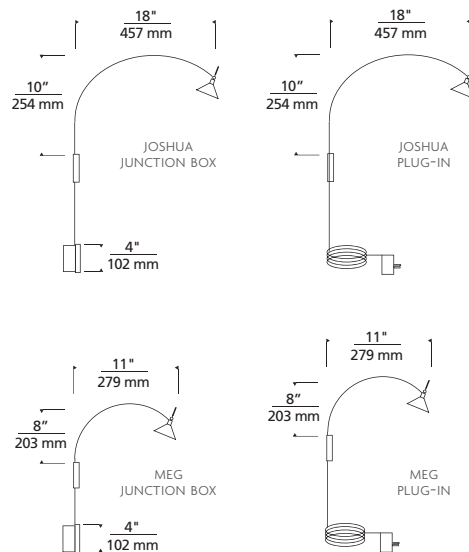

* INCLUDED WITH PICTURE LIGHT

MonoRail p. 456 with Aero head p. 169 and Round Glass Shield accessory p. 569



ACCESSORIES & OPTICAL CONTROLS





MINI OVATION (P. 142) IN TORTOISE SHELL WITH IRON WRAP ACCESSORY

IRON WRAP ACCESSORY

LOW-VOLTAGE, MINI OVATION ACCESSORY

700FJMOVR	FINISH
I	BLACK IRON
S	SATIN NICKEL

LINE-VOLTAGE, OVATION ACCESSORY

700FJMOVLR	FINISH
I	BLACK IRON
S	SATIN NICKEL



AERO (P. 169) WITH SODA GLASS SHADE WITH WOOD HANDLE ACCESSORY

AERO WOOD HANDLE ACCESSORY

700AERWOOD	TYPE	FINISH
W	WALNUT	Z ANTIQUE BRONZE
		C CHROME
		S SATIN NICKEL



SWAG HOOK

Use to change a low-voltage pendant's point of suspension to any point on the ceiling. Order one for each pendant.



LOW-VOLTAGE SWAG HOOK

Use with FreeJack Low-Voltage Pendants.

700FJSWG	FINISH	PRODUCT DIMENSIONS
Z	ANTIQUÉ BRONZE	
C	CHROME	
S	SATIN NICKEL	



LINE-VOLTAGE SWAG HOOK

Use with Line-Voltage Pendants that hang from a single cord.

700TDSWG	FINISH	PRODUCT DIMENSIONS
B	BLACK	
Z	ANTIQUÉ BRONZE	
S	SATIN NICKEL	
W	WHITE	



INDUSTRIAL HANG STRAIGHT

Industrial-inspired sloped ceiling adapter. For use with Cargo Solid Suspension, Monroe Suspension, Pullman Suspension, Tavern Suspension, and Union Large Suspension. 45° maximum slope. Not compatible with fixtures that hang from cable.

600HNGST	FINISH	TYPE
B	ANTIQUÉ BRASS	INCANDESCENT
Z	ANTIQUÉ BRONZE	-CF COMPACT FLUORESCENT
N	POLISHED NICKEL	
S	SATIN NICKEL	



AERO (P. 169)
WITH ROUND GLASS SHIELD

ROUND GLASS SHIELD



Colorful translucent round glass. Integrated Louver Lens Holder in aluminum or antique bronze. Can hold up to two lenses or louvers. MR16 of up to 50 watts. Available for use on Adler, Aero, CPI, DJ-Archie, DJ-Georgi, DJ-Telescope, DJ-Wally Lite, Helios, Joshua Ceiling, LC-Archie, LC-Georgi, LC-Wally Lite, K-Bye-Bye, K-Giro, K-Jane, K-Johnny, K-Pivot, K-Telescope, MO-Pivot, Sullivan, Swivel, Tele, Tilt, Torpedo Pendant, Wall Archie, Wall Georgi, Wall Telescope, Wally Lite (sold separately).

700MR16G

COLOR		FINISH
A	AMBER	ALUMINUM
B	COBALT	Z ANTIQUE BRONZE
F	FROST	
G	GREEN	



PRODUCT DIMENSIONS

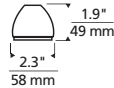

SWIVEL (P. 174)
WITH CONE GLASS SHIELD

CONE GLASS SHIELD



Colored frosted cone glass. Includes optional cone louver lens holder. Can hold up to two lenses or louvers. MR16 of up to 50 watts. Available for use on Adler, Aero, CPI, DJ-Archie, DJ-Georgi, DJ-Telescope, DJ-Wally Lite, Helios*, Joshua Ceiling, K-Giro, K-Jane, K-Johnny, K-Pivot, K-Telescope, LC-Archie, LC-Georgi, LC-Wally Lite, MO-Pivot, Sullivan, Swivel, Tele, Tilt, Torpedo Pendant, Wall Archie, Wall Georgi, Wall Telescope, Wally Lite (sold separately).

700LICO

COLOR	
AM	AMBER
FR	FROST



PRODUCT DIMENSIONS

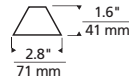

TILT (P. 169)
WITH CONE ONYX SHIELD

CONE ONYX SHIELD



Natural onyx cone. Includes optional Snap Louver Lens Holder. Can hold one lens or louver. Low-voltage MR16 lamp of up to 50 watts. Available for use on Adler, Aero, Helios*, Sullivan, Tilt, Torpedo Pendant (sold separately).

700LICOHX

PRODUCT DIMENSIONS

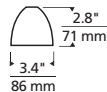

SHOWS LAMP TYPE AND
MAXIMUM WATTAGE



INCLUDES A LOUVER
LENS HOLDER



INCLUDES A SNAP LOUVER
LENS HOLDER

* LENSES AND LOUVERS CANNOT BE USED WITH THE HELIOS HEAD OTHER THAN WHEN THE LENS HOLDER IS INTEGRATED INTO THE ACCESSORY



AERO (P. 169)
WITH FIREBIRD GLASS SHIELD

FIREBIRD GLASS SHIELD



Patterned Murano glass. Includes Snap Louver Lens Holder. Can hold a single lens or louver. MR16 of up to 50 watts. Available for use on Adler, Aero, Helios*, Sullivan, Tilt, Torpedo Pendant (sold separately).



700FIRA		COLOR	FINISH		
O	OWL (AMBER)	P	PEACOCK (BLUE)	Z	ANTIQUÉ BRONZE
S	SWAN (WHITE)	C	CHROME	S	SATIN NICKEL

PRODUCT DIMENSIONS

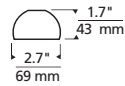

AERO (P. 169)
WITH SCAVO GLASS SHADE

SCAVO GLASS SHADE



Curve shaped scavo glass finish provides old world charm. Includes Snap Louver Lens Holder. Can hold a single lens or louver. MR16 of up to 50 watts. Available for use on Adler, Aero, Helios*, Sullivan, Tilt, Torpedo Pendant (sold separately).



700SCAVO		COLOR	FINISH
A	AMBER	Z	ANTIQUÉ BRONZE
M	AMETHYST	C	CHROME
F	FROST	S	SATIN NICKEL
G	GREEN		

PRODUCT DIMENSIONS

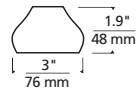

AERO (P. 169)
WITH SODA GLASS SHADE

SODA GLASS SHADE



Cone shaped glass shade infused with bubbles. Includes Snap Louver Lens Holder. Can hold a single lens or louver. MR16 of up to 50 watts. Available for use on Adler, Aero, Tilt, Helios*, Sullivan, Torpedo Pendant (sold separately).



700SDA		COLOR	FINISH
A	AMBER	Z	ANTIQUÉ BRONZE
F	FROST	C	CHROME
		S	SATIN NICKEL

PRODUCT DIMENSIONS

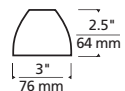

MR11 MR16
SHOWS LAMP TYPE AND
MAXIMUM WATTAGE

L
INCLUDES A LOUVER
LENS HOLDER

S
INCLUDES A SNAP LOUVER
LENS HOLDER

* LENSES AND LOUVERS CANNOT BE USED WITH THE HELIOS HEAD OTHER THAN WHEN THE LENS HOLDER IS INTEGRATED INTO THE ACCESSORY



TILT (P. 169)
WITH DICHRIC GLASS SHIELD

DICHRIC GLASS SHIELD



Iridescent spectrum of colored glass. Includes Snap Louver Lens Holder. Can hold a single lens or louver. MR16 of up to 50 watts. Available for use on Adler, Aero, Helios*, Sullivan, Tilt, Torpedo Pendant (sold separately).

700DCH

FINISH	
Z	ANTIQUÉ BRONZE
C	CHROME
S	SATIN NICKEL

PRODUCT DIMENSIONS

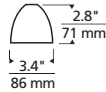

TILT (P. 169)
WITH SUGAR ACCESSORY

SUGAR ACCESSORY



Streams of glass piping formed into a coned shape. Includes Snap Louver Lens Holder. Can hold a single lens or louver. MR16 of up to 50 watts. Available for use on Adler, Aero, Helios*, Sullivan, Tilt, Torpedo Pendant (sold separately).

700SUG

COLOR	FINISH		
A	AMBER	Z	ANTIQUÉ BRONZE
Q	AQUA	C	CHROME
R	RED	S	SATIN NICKEL
V	VIOLET		
W	WHITE		

PRODUCT DIMENSIONS

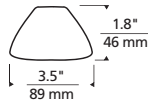

AERO (P. 169)
WITH TAZA ACCESSORY

TAZA ACCESSORY



Cone glass accessory with intensely twisted rich color. Low-voltage MR16 lamp of up to 50 watts (not included). Available for use on Adler, Aero, CPI, DJ-Archie, DJ-Georgi, DJ-Telescope, DJ-Wally Lite, Helios, Joshua Ceiling, K-Giro, K-Jane, K-Johnny, K-Pivot, K-Telescope, LC-Archie, LC-Georgi, LC-Wally Lite, MO-Pivot, Sullivan, Swivel, Tele, Tilt, Torpedo Pendant, Wall Archie, Wall Georgi, Wall Telescope, Wally Lite (sold separately).

700TAZA

COLOR	
A	AMBER
C	CREAM
N	BROWN
R	RED

PRODUCT DIMENSIONS

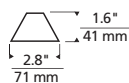

SHOWS LAMP TYPE AND
MAXIMUM WATTAGE



INCLUDES A LOUVER
LENS HOLDER



INCLUDES A SNAP LOUVER
LENS HOLDER

* LENSES AND LOUVERS CANNOT BE USED WITH THE HELIOS HEAD OTHER THAN WHEN THE LENS HOLDER IS INTEGRATED INTO THE ACCESSORY



AERO (P. 169)
WITH MARTINI GLASS SHIELD

MARTINI GLASS SHIELD



Layers of brilliant glass. Includes Snap Louver Lens Holder. Can hold a single lens or louver. MR16 of up to 50 watts. Available for use on Adler, Aero, Helios*, Sullivan, Tilt, Torpedo Pendant (sold separately).



700MRT

COLOR	FINISH
A AMBER FRIT	Z ANTIQUE BRONZE
M MULTICOLOR FRIT	C CHROME
W WHITE FRIT	S SATIN NICKEL

PRODUCT DIMENSIONS

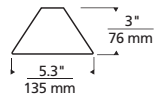

AERO (P. 169)
WITH LIL EGYPT

LIL EGYPT



Finely handcrafted beaded shade. Includes Snap Louver Lens Holder. Can hold a single lens or louver. MR16 of up to 50 watts. Available for use on Adler, Aero, CPI, DJ-Archie, DJ-Georgi, DJ-Telescope, DJ-Wally Lite, Helios*, Joshua Ceiling, K-Giro, K-Jane, K-Johnny, K-Pivot, K-Telescope, LC-Archie, LC-Georgi, LC-Wally Lite, Metal Man, MO-Pivot, Parachute, Sullivan, Swivel, Tele, Tilt, Torpedo Pendant, Wall Archie, Wall Georgi, Wall Telescope, Wally Lite (sold separately).



700LEGY

COLOR
AM AMBER
CB COBALT
DA DARK AMBER
FR FROST
RD RED

PRODUCT DIMENSIONS

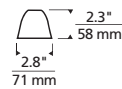

TILT (P. 169)
WITH PRISM GLASS SHIELD

PRISM GLASS SHIELD



Ribbed glass. Includes Snap Louver Lens Holder. Can hold a single lens or louver. MR16 of up to 50 watts. Available for use on Adler, Aero, Helios*, Sullivan, Tilt, Torpedo Pendant (sold separately).



700PRISM

COLOR
AS AMBER
CS CLEAR

PRODUCT DIMENSIONS

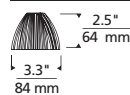

MR11 MR16
SHOWS LAMP TYPE AND
MAXIMUM WATTAGE

(L)
INCLUDES A LOUVER
LENS HOLDER

(S)
INCLUDES A SNAP LOUVER
LENS HOLDER

* LENSES AND LOUVERS CANNOT BE USED WITH THE HELIOS HEAD OTHER THAN WHEN THE LENS HOLDER IS INTEGRATED INTO THE ACCESSORY



ADLER (P. 181)
WITH HURRICANE GLASS SHIELD

HURRICANE GLASS SHIELD



Backlight shield of flared frosted glass. Includes Snap Louver Lens Holder. Can hold a single lens or louver. MR16 of up to 50 watts. Available for use on Adler, Aero, Helios*, Sullivan, Tilt, Torpedo Pendant (sold separately).



600MR16HUR

COLOR
A AMBER
F FROST

PRODUCT DIMENSIONS

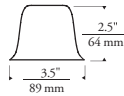

ADLER (P. 181)
WITH FLUTE GLASS SHIELD

FLUTE GLASS SHIELD



Backlight shield of frosted glass. Includes Snap Louver Lens Holder. Can hold a single lens or louver. MR16 of up to 50 watts. Available for use on Adler, Aero, Helios*, Sullivan, Tilt, Torpedo Pendant (sold separately).



600MR16FLT

COLOR
A AMBER
F FROST

PRODUCT DIMENSIONS

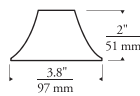

SULLIVAN (P. 181)
WITH MISSION GLASS SHIELD

MISSION GLASS SHIELD



Backlight shield of Mission-inspired pressed glass. Includes Snap Louver Lens Holder. Can hold a single lens or louver. MR16 of up to 50 watts. Available for use on Adler, Aero, Helios*, Sullivan, Tilt, Torpedo Pendant (sold separately).



600MR16MSN

COLOR
A AMBER
F FROST

PRODUCT DIMENSIONS

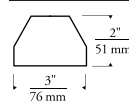

* LENSES AND LOUVERS CANNOT BE USED WITH THE HELIOS HEAD OTHER THAN WHEN THE LENS HOLDER IS INTEGRATED INTO THE ACCESSORY



AERO (P. 169)
WITH TINKERBELL

TINKERBELL



Small Metal Shade. Includes Snap Louver Lens Holder. Can hold a single lens or louver. Antique bronze, antique bronze mesh and black MR16 of up to 35 watts. Chrome, satin nickel and chrome mesh MR16 of up to 50 watts. Available for use on Adler, Aero, Helios*, Sullivan, Tilt, Torpedo Pendant (sold separately).

700TNKBELL ZCOLOR

BZ	ANTIQUE BRONZE
ZM	ANTIQUE BRONZE MESH
BK	BLACK
CH	CHROME
CM	CHROME MESH
SN	SATIN NICKEL



PRODUCT DIMENSIONS

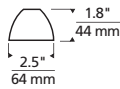

TINKERBELL WITH INTEGRATED LENS HOLDER



Small Metal Shade with integral Louver Lens Holder. Can hold up to two lenses or louvers. Antique bronze, MR16 of up to 35 watts. Chrome and Satin Nickel MR16 of up to 50 watts. Available for use on Adler, Aero, Helios, Sullivan, Tilt, Torpedo Pendant (sold separately).

700TNKBELLV COLOR

BZ	ANTIQUE BRONZE
SN	SATIN NICKEL



PRODUCT DIMENSIONS

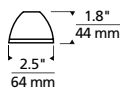

HELIOS (P. 160) WITH TINKERBELL
WITH INTEGRATED LENS HOLDER

BELLADONNA



Large bell-shaped metal shade with plated finish. Includes Eggcrate Louver. MR16 of up to 50 watts. Available for use on Adler, Aero, Helios, Sullivan, Tilt, Torpedo Pendant (sold separately).

700BELL COLOR

BZ	ANTIQUE BRONZE
CH	CHROME
SN	SATIN NICKEL



PRODUCT DIMENSIONS

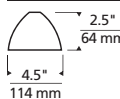

TILT (P. 169)
WITH BELLADONNA

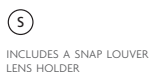

* LENSES AND LOUVERS CANNOT BE USED WITH THE HELIOS HEAD OTHER THAN WHEN THE LENS HOLDER IS INTEGRATED INTO THE ACCESSORY



AERO (P. 169)
WITH BELL

BELL



Bell-shaped metal shade with plated or painted finish. Includes Eggcrate Louver. MR16 of up to 35 watts. Available for use on Adler, Aero, Helios, Sullivan, Tilt, Torpedo Pendant (sold separately).

700AERBELL

COLOR	
BZ	ANTIQUÉ BRONZE
BK	BLACK
CH	CHROME
SN	SATIN NICKEL

PRODUCT DIMENSIONS

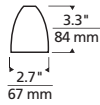

SPROCKET (P. 172)
WITH FLIGHT PAPER

FLIGHT PAPER



Decorative shade of white heat-resistant paper. MR16 of up to 50 watts; MR11 of up to 35 watts. Available for use on CPI, DJ-Archie, DJ-Georgi, DJ-Telescope, DJ-Wally Lite, Joshua Ceiling, K-Giro, K-Jane, K-Johnny, K-Pivot, K-Telescope, LC-Archie, LC-Georgi, LC-Wally Lite, Metal Man, MO-Pivot, Parachute, Sprocket, Swivel, Tele, Wall Archie, Wall Georgi, Wall Telescope, Wally Lite (sold separately).

700FP

TYPE	WH
11	MR11
16	MR16

PRODUCT DIMENSIONS

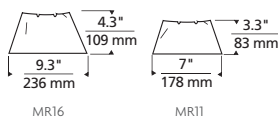

K-JOHNNY (P. 186)
WITH LIL WOK

LIL WOK



Decorative metal shade. Includes Snap Louver Lens Holder. Can hold a single lens or louver. Silver and black for MR16 of up to 50 watts. Antique bronze for MR16 up to 20 watts only. Available for use on CPI, DJ-Archie, DJ-Georgi, DJ-Telescope, DJ-Wally Lite, Joshua Ceiling, K-Giro, K-Johnny, K-Pivot, K-Telescope, LC-Archie, LC-Georgi, LC-Wally Lite, Metal Man, MO-Pivot, Parachute, Swivel, Tele, Wall Archie, Wall Georgi, Wall Telescope, Wally Lite (sold separately).

700LMPCO

COLOR	
Z	ANTIQUÉ BRONZE
B	BLACK
S	SILVER

PRODUCT DIMENSIONS

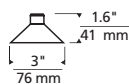

SHOWS LAMP TYPE AND
MAXIMUM WATTAGE



INCLUDES A LOUVER
LENS HOLDER



INCLUDES A SNAP LOUVER
LENS HOLDER

* LENSES AND LOUVERS CANNOT BE USED WITH THE HELIOS HEAD OTHER THAN WHEN THE LENS HOLDER IS INTEGRATED INTO THE ACCESSORY



SWIVEL (P. 174)
WITH BACKLIGHT SHIELD

BACKLIGHT SHIELD



Decorative mesh or solid metal shade. Includes Louver Lens Holder. MR16 holds up to two lenses or louvers. MR11 (solid only) can hold up to two lenses or louvers. Available for use on CPI, DJ-Archie, DJ-Georgi, DJ-Telescope, DJ-Wally Lite, Joshua Ceiling, K-Giro, K-Jane, K-Johnny, K-Pivot, K-Telescope, LC-Archie, LC-Georgi, LC-Wally Lite, Metal Man, MO-Pivot, Parachute, Sprocket, Swivel, Tele, Wall Archie, Wall Georgi, Wall Telescope, Wally Lite (sold separately).

700MR	TYPE	FINISH
115	MR11 SOLID	CH ALUMINUM
165	MR16 SOLID	BZ ANTIQUE BRONZE
16M	MR16 MESH	BK BLACK

PRODUCT DIMENSIONS

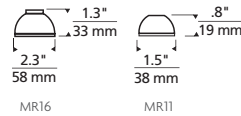

SPROCKET (P. 172)
WITH LOUVER LENS HOLDER
& COLORED LENS

LOUVER LENS HOLDER

Secures to front of lamp to hold lenses or louvers. MR16 holds up to two lenses or louvers. MR11 can hold a single lens or louver. Available for use on CPI, DJ-Archie, DJ-Georgi, DJ-Telescope, DJ-Wally Lite, Joshua Ceiling, K-Giro, K-Jane, K-Johnny, K-Pivot, K-Telescope, LC-Archie, LC-Georgi, LC-Wally Lite, Metal Man, MO-Pivot, Parachute, Sprocket, Swivel, Tele, Wall Archie, Wall Georgi, Wall Telescope, Wally Lite (sold separately).

700A01	TYPE	FINISH
-	MR16	BZ ANTIQUE BRONZE
1	MR11	BK BLACK
		AL ALUMINUM

PRODUCT DIMENSIONS

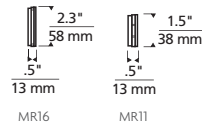

SPROCKET (P. 172)
WITH SNAP LOUVER LENS HOLDER

SNAP LOUVER LENS HOLDER

Snaps on front of MR16 lamp to hold a single lens or louver. Available for use on CPI, DJ-Archie, DJ-Georgi, DJ-Telescope, DJ-Wally Lite, Joshua Ceiling, K-Giro, K-Jane, K-Johnny, K-Pivot, K-Telescope, LC-Archie, LC-Georgi, LC-Wally Lite, Metal Man, MO-Pivot, Parachute, Sprocket, Swivel, Tele, Wall Archie, Wall Georgi, Wall Telescope, Wally Lite (sold separately).

700A06-CH

PRODUCT DIMENSIONS

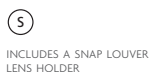
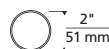



SWIVEL (P. 174)
WITH MR16 SNOUT

MR16 SNOUT

Prevents side glare from MR16 lamp. Requires Louver Lens Holder (sold separately). Available for use on CP1, DJ-Archie, DJ-Georgi, DJ-Telescope, DJ-Wally Lite, Joshua Ceiling, K-Bye-Bye, K-Giro, K-Hello, K-Jane, K-Johnny, K-Pivot, K-Telescope, LC-Archie, LC-Georgi, LC-Wally Lite, Metal Man, MO-Pivot, Parachute, Sprocket, Swivel, T156, Tele, Wall Archie, Wall Georgi, Wall Telescope, Wally Lite (sold separately).

700SNOUT FINISH
A ALUMINUM
B BLACK

PRODUCT DIMENSIONS

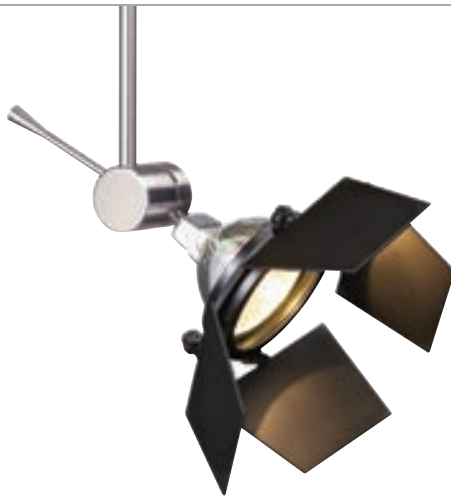

SPROCKET (P. 172)
WITH BARNDOORS

BARNDOORS

Secures to front of MR16 lamp to control light. Includes Louver Lens Holder. Can hold up to two lenses or louvers. Available for use on CP1, DJ-Archie, DJ-Georgi, DJ-Telescope, DJ-Wally Lite, Joshua Ceiling, K-Giro, K-Jane, K-Johnny, K-Pivot, K-Telescope, LC-Archie, LC-Georgi, LC-Wally Lite, Metal Man, MO-Pivot, Parachute, Sprocket, Swivel, Tele, Wall Archie, Wall Georgi, Wall Telescope, Wally Lite (sold separately).

700A08-BK

PRODUCT DIMENSIONS

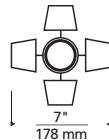

SPROCKET (P. 172) IN SATIN NICKEL
WITH SPY ACCESSORY

SPROCKET SPY ACCESSORY

700SPSPY FINISH
Z ANTIQUE BRONZE
C CHROME
S SATIN NICKEL





GOBO HOLDER

Two threaded rods plus gobo holder and one magnifying lens. Attaches to T156 fixture (p. 176). The result is a projected pattern or logo onto any surface. Includes MR16 Snout.

700AC156	FINISH
	C CHROME
	S SATIN NICKEL



GOBO MAGNIFYING LENS

Add this optional magnifying lens to the gobo holder to increase the size of the projected image.

700MAGGL	FINISH
	C CHROME
	S SATIN NICKEL



CUSTOMIZABLE GOBO TEMPLATE

Gobos are available in standard and custom patterns; metal and glass. For additional information on standard and custom gobos, please call 847.410.4400.



SPROCKET (P. 172)
WITH SNAP LOUVER LENS HOLDER
AND UV FILTER

UV FILTERS

Efficiently blocks UV radiation while transmitting high quality visible light.

140UV	SIZE	DIAMETER
MR11	MR11	1.4" / 35 MM
MR16	MR16 / PAR16	2.0" / 51 MM
P20	PAR20	2.5" / 64 MM
P30	PAR30	3.75" / 95 MM
P36	PAR36	4.0" / 102 MM

PRODUCT DIMENSIONS





SPROCKET (P. 172)
WITH SNAP LOUVER LENS HOLDER
AND DIFFUSER

DIFFUSER, SPREAD & SOFT FOCUS LENSES

Diffuser lenses diffuse the beam; linear spread lenses elongates the beam; soft focus lenses reduce lamp glare and blur the sharp lines of lamp images.

140	SIZE	TYPE	DIAMETER
MR11	MR11	DF DIFFUSER	1.4" / 35 MM
MR16	MR16 / PAR16	LL LINEAR SPREAD	2.0" / 51 MM
P20	PAR20	SF SOFT FOCUS	2.5" / 64 MM
P30	PAR30		3.75" / 95 MM
P38	PAR38		4.75" / 121 MM



SPROCKET (P. 172) WITH
LOUVER LENS HOLDER
& COLORED LENS

COLOR & DICHROIC LENSES

Colored lenses wash the light with color; dichroic lenses filter for a pure effect.

140	TYPE	SIZE	COLOR	DIAMETER
FIL	COLORED LENS	11 MR11	BLU BLUE	1.4" / 35MM
DIC	DICHROIC LENS	MR16 / PAR16	GRN GREEN	2.0" / 51MM
20	PAR20	30 PAR30	RED RED	2.5" / 64MM
38	PAR38	38 PAR38	YEL YELLOW	3.75" / 95MM
				4.75" / 121MM



SPOT (P. 171) WITH
EGGCRATE LOUVER

EGGCRATE LOUVER

Hexcell louver cuts glare from lamp.

700	TYPE	DIAMETER
A03-BK	MR11	1.4" / 35 MM
A02-BK	MR16 / PAR16	2.0" / 51 MM
A03-20	PAR20	2.5" / 64 MM
A03-30	PAR30	3.75" / 95 MM
A02-36	AR111	4.0" / 102 MM
A03-38	PAR38	4.75" / 121 MM



LED Specifications*



Applications: Low-Voltage Pendants
Lumens: 360 net of optic / driver
Watts: 6 (LED + Driver)
CRI: 80+
Color Temperature: 3000K
Binning: 3-Step
Life: 30,000 hrs to L70
LED: Citizen



Applications: Wall
Lumens: 275 gross
Watts: 6 (LED)
CRI: 80+
Color Temperature: 3000K
Binning: 3-Step
Life: 35,000 hrs to L70
LED: Lynk Labs



Applications: Low-Voltage Heads
Lumens: 360 net of optic / driver
Watts: 6 (LED + Driver)
CRI: 80+
Color Temperature: 3000K
Binning: 3-Step
Life: 30,000 hrs to L70
LED: Citizen



Applications: Suspension
Lumens: 1155+ gross
Watts: 10 (per foot) (LED)
CRI: 80+
Color Temperature: 3000K
Binning: 3-Step
Life: 50,000 hrs to L70
LED: Samsung



Applications: Low-Voltage Heads
Lumens: 850+ net of optic / driver
Watts: 16 (LED + Driver)
CRI: 80+
Color Temperature: 2700K, 3000K
Binning: 3-Step
Life: 50,000 hrs to L70
LED: Philips



Applications: Wall, Bath
Lumens: 50 per LED
Watts: 1 per LED
CRI: 80+
Color Temperature: 3000K
Binning: 3-Step
Life: 35,000 hrs to L70
LED: Lynk Labs



Applications: Line-Voltage Pendant, Head
Lumens: 1074+ net of optic / driver
Watts: 19 (LED + Driver)
CRI: 80+
Color Temperature: 2700K, 3000K
Binning: 3-Step
Life: 50,000 hrs to L70
LED: Citizen



Applications: Wall
Lumens: 1300 gross
Watts: 18.5 (LED)
CRI: 80+
Color Temperature: 2700K
Binning: 3-Step
Life: 50,000 hrs to L70
LED: Seoul Semiconductor



Applications: Low-Voltage Head, Wall, Flush Mount, Bath
Lumens: 750+ gross
Watts: 10 (LED)
CRI: 85+
Color Temperature: 2700K, 3000K
Binning: 3-Step
Life: 50,000 hrs to L70
LED: Nichia



* SUBJECT TO CHANGE. SOMETIMES MORE THAN ONE UNIT IS USED PER FIXTURE. ALL LED PRODUCT CARRIES A 5-YEAR WARRANTY.

Replacement Lamps

RECOMMENDED LED MR16 REPLACEMENT LAMPS

For too long, many in our industry have used the term “LED replacement lamp” a bit too loosely. As heavy users of MR16 lamps, we have been evaluating LED MR16 lamps for years and finally feel that the time is right to recommend true LED replacement lamps for our fixtures.

We are excited to partner with Soraa® because we feel their MR16 lamps are true halogen replacements, both in output and quality of light. At the same time, they exceed the definition of “replacement” on several other criteria and serve as a long-lasting, energy efficient, high CRI complement to our fixtures.



WHY SORAA?

Soraa is a leading developer of LED technology built on pure gallium nitride substrates, commonly referred to as GaN on GaN™.

GaN on GaN™ LEDs provide more light per area than other LED on the market and can also handle more thermal stress – which means they can accept higher input wattage to produce higher output in the same MR16 footprint than competing LED lamps. GaN on GaN also enables a high CRI (95) and color rendering that more closely resembles traditional halogen than other LED solutions.

Soraa lamps exhibit exceptional optical quality, beam control, and smooth dimming to 20%. They incorporate thermal feedback - this allows them to stay within recommended operating temperature range even in the most thermally-constrained environments. Most other LED MR16s that run too hot will become far less reliable.

Finally, Soraa lamps are beautiful. Thought has been given not just to technology, but to the aesthetic design as well.

ITEM NUMBER	MANUFACTURER	VOLTS	WATTS	LAMP SHAPE	BASE TYPE	BEAM SPREAD	COLOR TEMP (K)	CRI	LUMENS	CBCP	RATED AVG LIFE*
300BLV451	SORAA VIVID	12	9	MR16	GU5.3	24°	2700	95	280	1660	25,000
300BLV452	SORAA VIVID	12	9	MR16	GU5.3	14°	3000	95	220	2780	25,000
300BLV453	SORAA VIVID	12	9	MR16	GU5.3	24°	3000	95	300	1720	25,000
300BLV454	SORAA VIVID	12	9	MR16	GU5.3	36°	3000	95	300	800	25,000

We have also evaluated several other LED replacement lamps. Below, you will find several recommendations for a variety of applications.

ITEM NUMBER	MANUFACTURER	VOLTS	WATTS	LAMP SHAPE	BASE TYPE	BEAM SPREAD	COLOR TEMP (K)	CRI	LUMENS	CBCP	RATED AVG LIFE*
300BLV455	LIGHTING SCIENCE DIFINITY™	12	8	MR16	GU5.3	25°	2700	83	500	2230	25,000
300BLV456	LIGHTING SCIENCE DIFINITY™	12	8	MR16	GU5.3	25°	3000	83	525	2350	25,000
300BLV457	LIGHTING SCIENCE DIFINITY™	12	8	MR16	GU5.3	40°	2700	83	500	1000	25,000
300BLV458	LIGHTING SCIENCE DIFINITY™	12	8	MR16	GU5.3	40°	3000	83	525	1045	25,000
300BLV459	PRIVATE LABEL	12	6	MR16	GU5.3	25°	3000	83	360	1620	25,000











Note: Lamp availability and technical specifications are subject to change. Please consult factory.

*LED Lamp life is based on L70 lumen depreciation.

** Please note, while we can recommend the Soraa lamp for our enclosed fixtures (due to the thermal feedback note above) we do not recommend using most LED MR16 replacements in fully enclosed fixtures (e.g. tight accessory) due to thermal strain and the resultant loss in output and life.

Lamp Information

ITEM #	DESCRIPTION	VOLTS	WATTS	LAMP SHAPE	BASE TYPE	BEAM SPREAD	COLOR TEMP (K)	CRI	CENTER BEAM CANDLE POWER	INITIAL LUMENS	RATED AVG LIFE	
12 VOLT INCANDESCENT LAMPS												
12 Volt Halogen Bi-Pin												
	300BLV034	12v Hal T3 G4 20w Bi-pin CL	12	20	T3	G4	na	3000	100	na	320	2,000
	300BLV026	12v Hal T4 GY6.35 35w Bi-pin CL	12	35	T4	GY6.35	na	3000	100	na	600	2,000
	300BLV035	12v Hal T4 GY6.35 50w Bi-pin CL	12	50	T4	GY6.35	na	3000	100	na	930	2,000
	300BLV037	12v Hal T4 GY6.35 50w Bi-pin FR	12	50	T4	GY6.35	na	3000	100	na	930	2,000
12 Volt Xenon Bi-Pin												
	300BLV030	12v Xenon T3 G4 5w Bi-pin	12	5	T3	G4	na	2800	100	na	60	10,000
	300BLV032	12v Xenon T3 G4 10w Bi-pin	12	10	T3	G4	na	2800	100	na	125	10,000
	300BLV031	12v Xenon T3 G4 15w Bi-pin	12	15	T3	G4	na	2800	100	na	180	10,000
	300BLV025	12v Xenon T3 G4 20w Bi-pin	12	20	T3	G4	na	2800	100	na	250	10,000
	300BLV359	12v Xenon T4 GY6.35 35w Bi-pin	12	35	T4	GY6.35	na	2900	100	na	525	10,000
12 Volt MR11												
	300BLV052	12v Hal MR11 GZ4 10" 20w	12	20	MR11	GZ4	10	2925	100	3,000	na	2,000
	300BLV063	12v Hal MR11 GZ4 17" 20w	12	20	MR11	GZ4	17	2925	100	1,400	na	2,000
	300BLV067	12v Hal MR11 GZ4 30" 20w	12	20	MR11	GZ4	30	2925	100	600	na	2,000
	300BLV055	12v Hal MR11 GZ4 10" 35w	12	35	MR11	GZ4	10	2925	100	6,000	na	2,000
	300BLV056	12v Hal MR11 GZ4 20" 35w	12	35	MR11	GZ4	20	2925	100	2,400	na	2,000
	300BLV068	12v Hal MR11 GZ4 30" 35w	12	35	MR11	GZ4	30	2800	100	2,925	1,300	2,000
12 Volt MR16												
	300BLV129	12v Hal MR16 GU5.3 12" 20w	12	20	MR16	GU5.3	12	2950	100	3,500	na	5,000
	300BLV128	12v Hal MR16 GU5.3 36" 20w	12	20	MR16	GU5.3	36	2950	100	600	na	5,000
	300BLV102	12v Hal MR16 GU5.3 24" 35w	12	35	MR16	GU5.3	24	2950	100	2,300	na	5,000
	300BLV105	12v Hal MR16 GU5.3 36" 35w	12	35	MR16	GU5.3	36	2950	100	1,300	na	5,000
	300BLV132	12v Hal MR16 GU5.3 12" 50w	12	50	MR16	GU5.3	12	3000	100	11,000	na	5,000
	300BLV133	12v Hal MR16 GU5.3 24" 50w	12	50	MR16	GU5.3	24	3000	100	3,600	na	5,000
	300BLV131	12v Hal MR16 GU5.3 36" 50w	12	50	MR16	GU5.3	36	3000	100	2,000	na	5,000
	300BLV110	12v Hal MR16 GU5.3 60" 50w	12	50	MR16	GU5.3	60	3000	100	850	na	5,000
	300BLV112	12v Hal MR16 GU5.3 12" 75w	12	75	MR16	GU5.3	12	3000	100	13,000	na	5,000
	300BLV115	12v Hal MR16 GU5.3 24" 75w	12	75	MR16	GU5.3	24	3000	100	4,800	na	5,000
	300BLV116	12v Hal MR16 GU5.3 36" 75w	12	75	MR16	GU5.3	36	3000	100	2,700	na	5,000
12 Volt MR16 GE Constant Color												
	300BLV130	12v GE CC. Hal MR16 GU5.3 15" 20w	12	20	MR16	GU5.3	15	2900	100	3,150	na	5,000
	300BLV127	12v GE CC. Hal MR16 GU5.3 40" 20w	12	20	MR16	GU5.3	40	2900	100	475	na	5,000
	300BLV124	12v GE CC. Hal MR16 GU5.3 20" 35w	12	35	MR16	GU5.3	20	3000	100	3,200	na	5,000
	300BLV126	12v GE CC. Hal MR16 GU5.3 40" 35w	12	35	MR16	GU5.3	40	3000	100	900	na	5,000
	300BLV141	12v GE CC. Hal MR16 GU5.3 15" 50w	12	50	MR16	GU5.3	15	3050	100	8,400	na	6,000
	300BLV138	12v GE CC. Hal MR16 GU5.3 25" 50w	12	50	MR16	GU5.3	25	3050	100	2,900	na	6,000
	300BLV139	12v GE CC. Hal MR16 GU5.3 40" 50w	12	50	MR16	GU5.3	40	3050	100	1,500	na	6,000
	300BLV136	12v GE CC. Hal MR16 GU5.3 55" 50w	12	50	MR16	GU5.3	55	3050	100	850	na	6,000
	300BLV140	12v GE CC. Hal MR16 GU5.3 40" 71w	12	71	MR16	GU5.3	40	3050	100	2,000	na	4,000
12 Volt MR16 IR												
	300BLV254	12v IR MR16 GU5.3 10" 37w	12	37	MR16	GU5.3	10	3000	100	12,500	na	5,000
	300BLV255	12v IR MR16 GU5.3 25" 37w	12	37	MR16	GU5.3	25	3000	100	4,400	na	5,000
	300BLV256	12v IR MR16 GU5.3 35" 37w	12	37	MR16	GU5.3	35	3000	100	2,200	na	5,000
12 Volt MR16 10,000 Hour												
	300BLV411	12v MR16 GU5.3 24" 50w	12	50	MR16	GU5.3	24	3100	100	2,700	na	10,000
	300BLV410	12v MR16 GU5.3 36" 50w	12	50	MR16	GU5.3	36	3100	100	1,500	na	10,000
12 Volt MR16 Aluminized Reflector												
	300BLV412	12v Slid Bk MR16 GU5.3 12" 50w alu	12	50	MR16	GU5.3	12	3000	100	11,000	na	3,500
	300BLV413	12v Slid Bk MR16 GU5.3 24" 50w alu	12	50	MR16	GU5.3	24	3000	100	3,600	na	3,500
	300BLV414	12v Slid Bk MR16 GU5.3 36" 50w alu	12	50	MR16	GU5.3	36	3000	100	2,000	na	3,500
12 Volt MR16 Solid Back												
	300BLV144	12v Slid Bk MR16 GU5.3 24" 50w blk	12	50	MR16	GU5.3	24	3000	100	3,000	na	3,500
	300BLV145	12v Slid Bk MR16 GU5.3 36" 50w blk	12	50	MR16	GU5.3	36	3000	100	1,580	na	3,500
	300BLV146	12v Slid Bk MR16 GU5.3 24" 50w sil	12	50	MR16	GU5.3	24	3000	100	3,000	na	3,500
	300BLV147	12v Slid Bk MR16 GU5.3 36" 50w sil	12	50	MR16	GU5.3	36	3000	100	1,580	na	3,500

ITEM #	DESCRIPTION	VOLTS	WATTS	LAMP SHAPE	BASE TYPE	BEAM SPREAD	COLOR TEMP (K)	CRI	CENTER BEAM CANDLE POWER	INITIAL LUMENS	RATED AVG LIFE
--------	-------------	-------	-------	------------	-----------	-------------	----------------	-----	--------------------------	----------------	----------------

12 VOLT INCANDESCENT LAMPS (CONTINUED)

12 Volt Frost Line

	300BLV415	12v Frostline MR16 GU5.3 20w	12	20	MR16	GU5.3	na	2900	100	na	na	4,000
---	-----------	------------------------------	----	----	------	-------	----	------	-----	----	----	-------

12 Volt AR111

	300BLV280	12v AR111 G53 4" 35w	12	35	AR111	G53	4	3000	100	40,000	na	3,000
	300BLV285	12v AR111 G53 4" 50w	12	50	AR111	G53	4	3000	100	45,000	na	3,000
	300BLV286	12v AR111 G53 8" 50w	12	50	AR111	G53	8	3000	100	20,000	na	3,000
	300BLV287	12v AR111 G53 25" 50w	12	50	AR111	G53	25	3000	100	4,000	na	3,000
	300BLV290	12v AR111 G53 8" 75w	12	75	AR111	G53	8	3000	100	30,000	na	3,000
	300BLV291	12v AR111 G53 25" 75w	12	75	AR111	G53	25	3000	100	5,300	na	3,000
	300BLV292	12v AR111 G53 45" 75w	12	75	AR111	G53	45	3000	100	2,000	na	3,000

24 VOLT INCANDESCENT LAMPS

24 Volt Halogen Bi-Pin

	300BLV350	24v Hal T3 G4 20w Bi-pin	24	20	T3	G4	na	na	100	na	na	2,000
	300BLV351	24v Hal T3 GY6.35 35w Bi-pin	24	35	T3	GY6.35	na	na	100	na	na	2,000
	300BLV352	24v Hal T3 GY6.35 50w Bi-pin	24	50	T3	GY6.35	na	na	100	na	na	2,000

24 Volt Xenon Bi-Pin

	300BLV356	24v Xenon T3 G4 5w Bi-pin	24	5	T3	G4	na	2800	100	na	55	10,000
	300BLV357	24v Xenon T3 G4 10w Bi-pin	24	10	T3	G4	na	2800	100	na	125	10,000
	300BLV358	24v Xenon T3 G4 20w Bi-pin	24	20	T3	G4	na	2800	100	na	250	10,000
	300BLV360	24v Xenon T3 G4 35w Bi-pin	24	35	T4	GY6.35	na	2900	100	na	525	10,000

24 Volt MR11

	300BLV310	24v Hal MR11 GZ4 30" 20w	24	20	MR11	GZ4	30	2950	100	600	na	2,000
	300BLV314	24v Hal MR11 GZ4 10" 35w	24	35	MR11	GZ4	10	2950	100	4,100	na	2,000
	300BLV315	24v Hal MR11 GZ4 30" 35w	24	35	MR11	GZ4	30	2950	100	850	na	2,000

24 Volt MR16

	300BLV301	24v Hal MR16 GU5.3 12" 50w	24	50	MR16	GU5.3	12	2950	100	7,000	na	4,000
	300BLV302	24v Hal MR16 GU5.3 24" 50w	24	50	MR16	GU5.3	24	2950	100	2,900	na	4,000
	300BLV303	24v Hal MR16 GU5.3 36" 50w	24	50	MR16	GU5.3	36	2950	100	1,600	na	4,000

24 Volt MR16 GE Constant Color

	300BLV306	24v GE CC. Hal MR16 GU5.3 40" 35w	24	35	MR16	GU5.3	40	2950	100	920	na	4,000
	300BLV307	24v GE CC. Hal MR16 GU5.3 15" 50w	24	50	MR16	GU5.3	15	2950	100	8,400	na	4,000
	300BLV308	24v GE CC. Hal MR16 GU5.3 40" 50w	24	50	MR16	GU5.3	40	2950	100	1,570	na	4,000

LINE-VOLTAGE INCANDESCENT LAMPS

A-Lamp Incandescent

	300BHV396	120v A19 E26 Med 60w Cl.	120	60	A19	E26 Med	na	2700	100	na	790	2,000
	300BHV108	120v A19 E26 Med 60w Wh.	120	60	A19	E26 Med	na	2700	100	na	805	1,000
	300BHV109	120v A19 E26 Med 75w Wh.	120	75	A19	E26 Med	na	2700	100	na	1,190	750
	300BHV457	120v A19 E26 Med 75w Cl.	120	75	A19	E26 Med	na	2700	100	na	1,080	1,500
	300BHV392	120v A21 E26 Med 150w Wh.	120	150	A21	E26 Med	na	2700	100	na	2,780	750

A-Lamp Halogen

	300BHV486	120v A19 E26 Med 72w Wh. (Replaces 300BHV111)	120	72	A19	E26 Med	na	3000	100	na	1490	1,000
---	-----------	--	-----	----	-----	---------	----	------	-----	----	------	-------

BT15 Lamp Halogen

	300BHV114	120v BT15 E26 Med 60w WH	120	60	BT15	E26 Med	na	2800	100	na	760	3,000
---	-----------	--------------------------	-----	----	------	---------	----	------	-----	----	-----	-------













Classic Edison Style A-Lamp Incandescent

	300BHV389	120v EDISON A19 E26 Med 40w Cl.	120	40	A19 EDISON	E26 Med	na	2700	na	na	118	3,000
	300BHV466	120v EDISON A19 E26 Med 60w Cl.	120	60	A19 EDISON	E26 Med	na	2700	na	na	500	2,500

Classic Edison Style Squirrel Cage Incandescent

	300BHV480	120v Squirrel Cage S21 E26 Med 60w Cl.	120	60	S21 SqrL Cage	E26 Med	na	2700	na	na	100	3,000
---	-----------	--	-----	----	---------------	---------	----	------	----	----	-----	-------

Lamp Information

ITEM #	DESCRIPTION	VOLTS	WATTS	LAMP SHAPE	BASE TYPE	BEAM SPREAD	COLOR TEMP (K)	CRI	CENTER BEAM CANDLE POWER	INITIAL LUMENS	RATED AVG LIFE	
LINE-VOLTAGE INCANDESCENT LAMPS (CONTINUED)												
Classic Edison Style T9 Incandescent												
	300BHV473	120v Edison T9 E26 Med 30w Cl.	120	30	T9 EDISON	E26 Med	na	2700	na	na	na	3,000
Medium Globe Incandescent												
	300BHV487	120v G40 E26 Med 60w CL.	120	60	G40	E26 Med	na	2700	100	na	565	2,500
	300BHV485	120v G40 E26 Med 60w Half Chrome	120	60	G40	E26 Med	na	2700	100	na	565	1,500
	300BHV122	120v G40 E26 Med 150w WH	120	150	G40	E26 Med	na	2700	100	na	1,770	2,500
Medium T8 Incandescent												
	300BHV126	120v T8 E26 Med 75w Fr.	120	60	T8	E26 Med	na	2700	100	na	874	2,000
Medium T10 Incandescent												
	300BHV127	120v T9 E26 Med 40w Fr.	120	40	T10	E26 Med	na	2850	100	na	415	1,000
	300BHV128	120v T9 E26 Med 60w Fr.	120	60	T10	E26 Med	na	2850	100	na	600	1,000
Mini-Candelabra Krypton/Halogen												
	300BHV153	120v T3 E11 Mini-can. 40w Cl. Kry	120	40	T3	E11 Mini-Cand.	na	2800	100	na	560	2,000
	300BHV439	120v T3 E11 Mini-can. 60w Cl. Kry	120	60	T3	E11 Mini-Cand.	na	2800	100	na	960	2,000
	300BHV150	120v T4 E11 Mini-can. 75w Cl. Hal	120	75	T4	E11 Mini-Cand.	na	2850	100	na	1,125	1,000
	300BHV151	120v T4 E11 Mini-can. 100w Cl. Hal	120	100	T4	E11 Mini-Cand.	na	2850	100	na	1,600	1,000
	300BHV152	120v T4 E11 Mini-can. 150w Cl. Hal	120	150	T4	E11 Mini-cand.	na	2900	100	na	2,800	2,00
Double-Ended Halogen												
	300BHV443	120v T3 R7S 100w 118mm	120	100	T3	RS7	NA	2950	100	na	1,650	2,000
G9 Bi-Pin Halogen												
	300BHV361	120v Hal G9 bi-pin T4 40w Fr.	120	40	T4	G9 Bi-Pin	NA	2900	100	na	480	2,000
	300BHV364	120v Hal G9 bi-pin T4 60w Fr.	120	60	T4	G9 Bi-Pin	NA	2900	100	na	790	2,000
PAR16 GU10 Halogen												
	300BHV411	120v Hal PAR16 GU10 40° 50w	120	50	PAR16	GU10	40	2950	100	400	640	2,000
PAR20 Halogen												
	300BHV412	120v Hal PAR20 E26 Med 10° 35w	120	35	PAR20	E26 Med	10	2950	100	3,000	360	2,500
	300BHV413	120v Hal PAR20 E26 Med 30° 35w	120	35	PAR20	E26 Med	30	2950	100	800	360	2,500
	300BHV414	120v Hal PAR20 E26 Med 40° 35w	120	35	PAR20	E26 Med	40	2950	100	500	360	2,500
	300BHV415	120v Hal PAR20 E26 Med 10° 50w	120	50	PAR20	E26 Med	10	2950	100	4,600	550	2,500
	300BHV416	120v Hal PAR20 E26 Med 30° 50w	120	50	PAR20	E26 Med	30	2950	100	1,200	550	2,500
	300BHV417	120v Hal PAR20 E26 Med 40° 50w	120	50	PAR20	E26 Med	40	2950	100	900	550	2,500
PAR30 Short Halogen												
	300BHV418	120v Hal PAR30 E26 Med 9° 50w	120	50	PAR30	E26 Med	9	2950	100	8,800	660	2,500
	300BHV419	120v Hal PAR30 E26 Med 25° 50w	120	50	PAR30	E26 Med	25	2950	100	2,300	660	2,500
	300BHV420	120v Hal PAR30 E26 Med 40° 50w	120	50	PAR30	E26 Med	40	2950	100	1,300	660	2,500
	300BHV421	120v Hal PAR30 E26 Med 9° 75w	120	75	PAR30	E26 Med	9	2950	100	15,400	1,130	2,500
	300BHV422	120v Hal PAR30 E26 Med 25° 75w	120	75	PAR30	E26 Med	25	2950	100	4,000	1,130	2,500
	300BHV423	120v Hal PAR30 E26 Med 40° 75w	120	75	PAR30	E26 Med	40	2950	100	2,100	1,130	2,500
PAR30 Long Halogen												
	300BHV424	120v Hal PAR30L E26 Med 9° 50w	120	50	PAR30LN	E26 Med	9	2950	100	8,800	660	2,500
	300BHV425	120v Hal PAR30L E26 Med 25° 50w	120	50	PAR30LN	E26 Med	25	2950	100	2,300	660	2,500
	300BHV426	120v Hal PAR30L E26 Med 50° 50w	120	50	PAR30LN	E26 Med	50	2950	100	900	660	2,500
	300BHV427	120v Hal PAR30L E26 Med 9° 75w	120	75	PAR30LN	E26 Med	9	2950	100	15,400	1,130	2,500
	300BHV428	120v Hal PAR30L E26 Med 25° 75w	120	75	PAR30LN	E26 Med	25	2950	100	4,000	1,130	2,500
	300BHV429	120v Hal PAR30L E26 Med 50° 75w	120	75	PAR30LN	E26 Med	50	2950	100	1,100	1,130	2,500
PAR38 Halogen												
	300BHV430	120v Hal PAR38 E26 Med 9° 60w	120	60	PAR38	E26 Med	9	2950	100	16,000	850	3,000
	300BHV431	120v Hal PAR38 E26 Med 30° 60w	120	60	PAR38	E26 Med	30	2950	100	2,500	850	3,000
	300BHV432	120v Hal PAR38 E26 Med 9° 90w	120	90	PAR38	E26 Med	9	2950	100	19,000	1,310	2,500
	300BHV433	120v Hal PAR38 E26 Med 30° 90w	120	90	PAR38	E26 Med	30	2950	100	3,500	1,310	2,500
	300BHV434	120v Hal PAR38 E26 Med 50° 90w	120	90	PAR38	E26 Med	50	2950	100	1,600	1,310	2,500
	300BHV435	120v Hal PAR38 E26 Med 10° 120w	120	120	PAR38	E26 Med	10	2950	100	22,500	1,800	3,000
	300BHV436	120v Hal PAR38 E26 Med 30° 120w	120	120	PAR38	E26 Med	30	2950	100	4,600	1,800	3,000
	300BHV437	120v Hal PAR38 E26 Med 55° 120w	120	120	PAR38	E26 Med	55	2950	100	2,000	1,800	3,000

ITEM # DESCRIPTION VOLTS WATTS LAMP SHAPE BASE TYPE BEAM SPREAD COLOR TEMP (K) CRI CENTER BEAM CANDLE POWER INITIAL LUMENS RATED AVG LIFE

FLUORESCENT LAMPS

Compact Fluorescent Twin Tube

	300BH388	Flr 2G7 Twin Tube 7w	na	7	CFL Twin	2G7	na	2700	82	na	400	10,000
	300BH454	Flr 2G7 Twin Tube 9w	na	9	CFL Twin	2G7	na	2700	82	na	580	10,000
	300BH367	Flr 2GX7 Twin Tube 13w	na	13	CFL Twin	2GX7	na	2700	82	na	800	10,000
	300BH387	Flr 2G11 Twin Tube 18w	na	18	CFL Twin	2G11	na	3000	82	na	1,250	12,000
	300BH381	Flr 2G11 Twin Tube 36w	na	36	CFL Twin	2G11	na	3000	82	na	2,900	12,000

Compact Fluorescent Quad Tube

	300BH458	Flr G24Q-2 Quad Tube 18w	na	18	CFL Quad	G24Q-2	na	2700	82	na	1,200	12,000
	300BH395	Flr G24Q-3 Quad Tube 26w	na	26	CFL Quad	G24Q-3	na	2700	82	na	1,710	12,000

Compact Fluorescent Triple Tube

	300BH370	Flr GX24Q-1 Triple Tube 13w	na	13	CFL Triple	GX24Q-1	na	2700	82	na	900	12,000
	300BH371	Flr GX24Q-2 Triple Tube 18w	na	18	CFL Triple	GX24Q-2	na	2700	82	na	1,200	12,000
	300BH378	Flr GX24Q-3 Triple Tube 26w	na	26	CFL Triple	GX24Q-3	na	2700	82	na	1,800	12,000
	300BH386	Flr GX24Q-3 Triple Tube 32w	na	32	CFL Triple	GX24Q-3	na	2700	82	na	2,328	12,000

Compact Fluorescent GU24 Self-Ballasted

	300BH450	120v Flr Self-Ballasted GU24 Spiral 13w	120	13	CFL Spiral	GU24	na	2700	82	na	900	10,000
	300BH451	120v Flr Self-Ballasted GU24 Spiral 18w	120	18	CFL Spiral	GU24	na	2700	82	na	1,200	10,000
	300BH452	120v Flr Self-Ballasted GU24 Spiral 27w	120	27	CFL Spiral	GU24	na	2700	82	na	1,800	10,000
	300BH471	120v Flr Self-Ballasted GU24 Spiral 32w	120	32	CFL Spiral	GU24	na	2700	82	na	2,100	10,000
	300BH472	120v Flr Self-Ballasted GU24 Spiral 42w	120	42	CFL Spiral	GU24	na	2700	82	na	2,800	10,000

Compact Fluorescent Plumen Self-Ballasted

	300BH488	120v Flr Self-Ballasted Baby Plumen 9w	120	9	CFL Plumen	E26 Med	na	2700	82	na	435	10,000
	300BH479	120v Flr Self-Ballasted Plumen 11w	120	11	CFL Plumen	E26 Med	na	2700	82	na	630	8,000

Linear Fluorescent

	300BH369	Flr T5 Mini Bi-Pin 14w 22"	na	14	T5	Mini Bi-Pin	na	3000	82	na	1,350	20,000
	300BH382	Flr T5HO Mini Bi-Pin 24w 22"	na	24	T5 HO	Mini Bi-Pin	na	3000	82	na	2,000	20,000
	300BH467	Flr T5HO Mini-Bi-Pin 39w 34"	na	39	T5 HO	Mini Bi-Pin	na	3000	85	na	3,100	20,000
	300BH468	Flr T5HO Mini-Bi-Pin 54w 46"	na	54	T5 HO	Mini Bi-Pin	na	3000	85	na	4,450	25,000

LINE-VOLTAGE LED LAMPS

Philips Remote Phosphor LED A19 Replacement

	300BH477	120v Philips LED A19 Remote Phosphor	120	12.5	LED A19	E26 Med	na	2700	80	na	800	25,000
---	----------	--------------------------------------	-----	------	---------	---------	----	------	----	----	-----	--------

Lighting Science LED A19 Replacement

	300BH483	120v Lighting Science LED A19	120	8	LED A19	E26 Med	na	3000	85	na	425	50,000
---	----------	-------------------------------	-----	---	---------	---------	----	------	----	----	-----	--------

Philips LED PAR Replacement

	300BH489	120v Philips LED PAR20 25°	120	7	LED PAR20	E26 Med	25°	3000	85	1300	310	45,000
	300BH484	120v Philips LED PAR30L 22°	120	11	LED PAR30LN	E26 Med	22°	3000	85	1880	440	40,000

CERAMIC METAL HALIDE LAMPS (CMH)

CMH T4.5

	300BH401	CMH T4.5 Bi-Pin 20w	na	20	T4.5 Bi-Pin	G8.5	na	3000	>80	na	1,700	6,000
	300BH402	CMH T4.5 Bi-Pin 39w	na	39	T4.5 Bi-Pin	G8.5	na	3000	>80	na	3,400	9,000
	300BH403	CMH T4.5 Bi-Pin 70w	na	70	T4.5 Bi-Pin	G8.5	na	3000	>80	na	6,200	9,000

CMH MR16 GE Constant Color

	300BH440	GE CMH MR16 GX10 12° 20w	na	20	MR16	GX10	12	3000	80	9,000	1,000	12,000
	300BH441	GE CMH MR16 GX10 25° 20w	na	20	MR16	GX10	25	3000	80	2,900	1,000	12,000
	300BH442	GE CMH MR16 GX10 40° 20w	na	20	MR16	GX10	40	3000	80	1,500	1,000	12,000
	300BH459	GE CMH MR16 GX10 12° 39w	na	39	MR16	GX10	12	3000	90	16,000	2,100	10,000
	300BH460	GE CMH MR16 GX10 25° 39w	na	39	MR16	GX10	25	3000	90	5,500	2,100	10,000
	300BH461	GE CMH MR16 GX10 40° 39w	na	39	MR16	GX10	40	3000	90	3,000	2,100	10,000

Lamp Information

ITEM # DESCRIPTION VOLTS WATTS LAMP SHAPE BASE TYPE BEAM SPREAD COLOR TEMP (K) CRI CENTER BEAM CANDLE POWER INITIAL LUMENS RATED AVG LIFE

CERAMIC METAL HALIDE LAMPS (CMH) (CONTINUED)

CMH PAR20

300BHV462	CMH PAR20 Medium 8" 20w	na	20 PAR20	E26 Medium	8	3000	81	13,000	1,000	12,000
300BHV463	CMH PAR20 Medium 25" 20w	na	20 PAR20	E26 Medium	25	3000	81	3,750	1,000	12,000
300BHV410	CMH PAR20 Medium 10" 39w	na	39 PAR20	E26 Medium	10	3000	>85	22,000	2,100	10,000
300BHV409	CMH PAR20 Medium 25" 39w	na	39 PAR20	E26 Medium	25	3000	>85	7,500	2,100	10,000

CMH PAR30 Long

300BHV464	CMH PAR30L Medium 10" 20w	na	20 PAR30L	E26 Medium	10	3000	81	19,800	1,200	12,000
300BHV465	CMH PAR30L Medium 25" 20w	na	20 PAR30L	E26 Medium	25	3000	81	4,900	1,200	12,000
300BHV406	CMH PAR30L Medium 10" 39w	na	39 PAR30L	E26 Medium	10	3000	>80	39,600	2,400	10,000
300BHV405	CMH PAR30L Medium 25" 39w	na	39 PAR30L	E26 Medium	25	3000	>80	11,000	2,400	10,000
300BHV407	CMH PAR30L Medium 15" 70w	na	70 PAR30L	E26 Medium	15	3000	>80	43,000	4,700	10,000
300BHV408	CMH PAR30L Medium 40" 70w	na	70 PAR30L	E26 Medium	40	3000	>80	10,000	4,700	10,000

Selected Lamp Photometrics

12 VOLT MR11

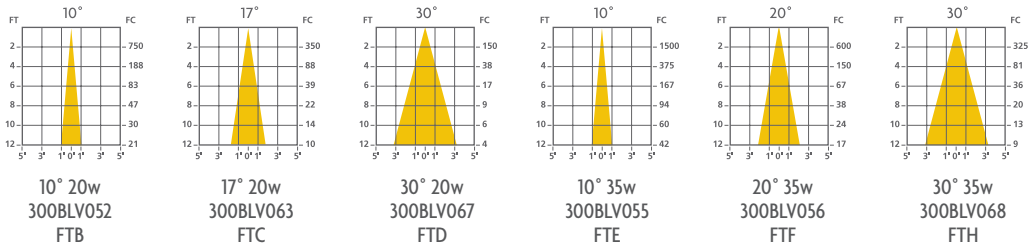

12 VOLT MR16

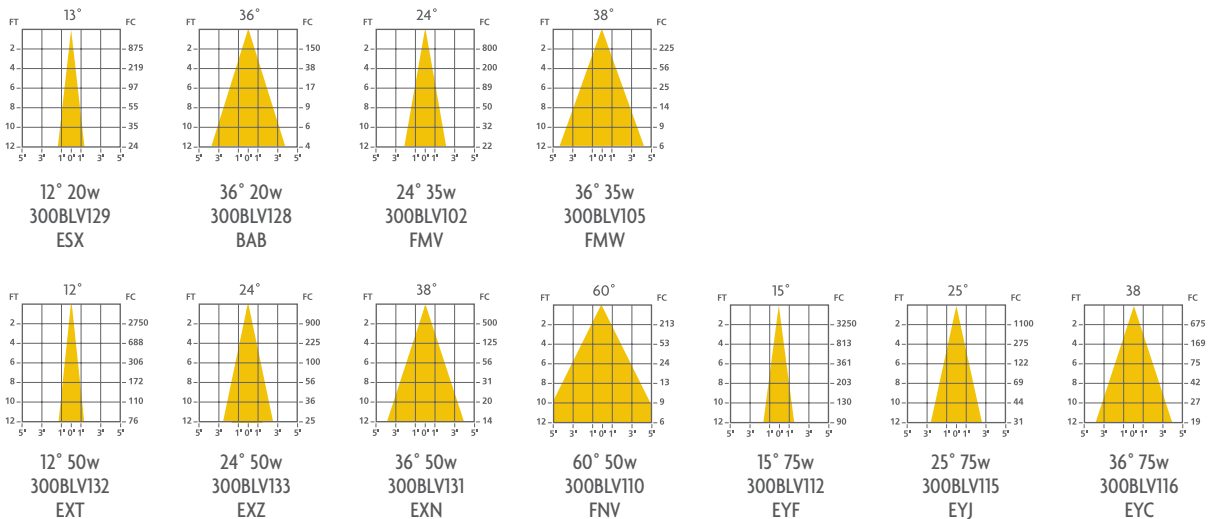

Photometrics

- A Aiming angle of fixture, measured from 0°
- DH Vertical distance from fixture to horizontal surface
- DW Distance from fixture to wall
- FC Footcandles at beam center
- X Vertical distance from beam center to ceiling
- L Length of beam
- W Width of beam
- CBCP Centerbeam Candlepower

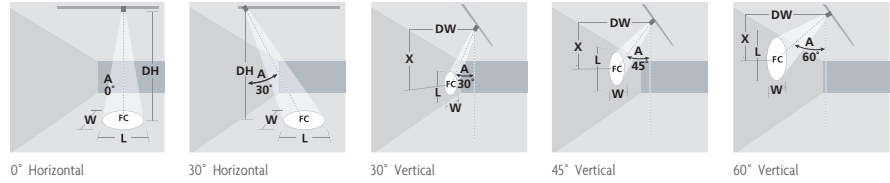

Fixture Usage	Lamp Type/ Part Number	Beam Spread	CBCP	Horizontal Surfaces									Vertical Surfaces											
				0°				30°			30°		45°				60°							
				DH	FC	L	W	FC	L	W	DW	FC	X	L	W	FC	X	L	W	FC	X	L	W	
CMH T4.5 Lamps																								
Breeze Om	CMH T4.5 20w 3008HV401	15°	10106	10	101	2.6	2.6	66	3.5	3.0	4	79	6.9	4.4	2.1	223	4.0	2.1	1.5	410	2.3	1.4	1.2	
				12	70	3.2	3.2	46	4.2	3.7	6	35	10.4	6.7	3.2	99	6.0	3.2	2.2	182	3.5	2.1	1.8	
				14	52	3.7	3.7	33	4.9	4.3	8	20	13.9	8.9	4.2	56	8.0	4.3	3.0	103	4.6	2.8	2.4	
				16	39	4.2	4.2	26	5.6	4.8	10	13	17.3	11.1	5.3	36	10.0	5.4	3.7	66	5.8	3.5	3.0	
		18	31	4.7	4.7	20	6.4	5.4	12	9	20.8	13.3	6.3	25	12.0	6.4	4.5	46	6.9	4.2	3.6			
		30°	3331	10	33	5.4	5.4	22	7.3	6.2	4	26	6.9	10.9	4.3	74	4.0	4.6	3.0	135	2.3	2.9	2.5	
				12	23	6.4	6.4	15	8.8	7.4	6	12	10.4	16.4	6.4	33	6.0	6.9	4.5	60	3.5	4.4	3.7	
				14	17	7.5	7.5	11	10.2	8.7	8	7	13.9	21.9	8.6	18	8.0	9.2	6.1	34	4.6	5.9	5.0	
				16	13	8.6	8.6	8	11.7	9.9	10	4	17.3	27.3	10.7	12	10.0	11.5	7.6	22	5.8	7.3	6.2	
		18	10	9.6	9.6	7	13.2	11.1	12	3	20.8	32.8	12.9	8	12.0	13.9	9.1	15	6.9	8.8	7.4			
		45°	1420	10	14	8.3	8.3	18	11.7	9.6	4	11	6.9	27.3	6.6	31	4.0	8.0	4.7	58	2.3	4.7	3.8	
				12	10	9.9	9.9	13	14.1	11.5	6	5	10.4	41.0	9.9	14	6.0	12.0	7.0	26	3.5	7.0	5.7	
				14	7	11.6	11.6	9	16.4	13.4	8	3	13.9	54.6	13.3	8	8.0	16.0	9.4	14	4.6	9.4	7.7	
				16	6	13.3	13.3	7	18.7	15.3	10	2	17.3	68.3	16.6	5	10.0	20.0	11.7	9	5.8	11.7	9.6	
		18	4	14.9	14.9	6	21.1	17.2	12	1	20.8	81.9	19.9	3	12.0	24.0	14.1	6	6.9	14.1	11.5			
		60°	614	10	6	11.5	11.5	4	17.3	13.3	4	5	6.9	*	9.2	14	4.0	13.9	6.5	25	2.3	6.9	5.3	
12	4			13.9	13.9	3	20.8	16.1	6	2	10.4	*	13.9	6	6.0	20.8	9.8	11	3.5	10.4	8.0			
14	3			16.2	16.2	2	24.2	18.7	8	1	13.9	*	18.5	3	8.0	27.7	13.1	6	4.6	13.9	10.7			
16	2			18.5	18.5	2	27.7	21.4	10	1	17.3	*	23.1	2	10.0	34.6	16.3	4	5.8	17.3	13.3			
18	2	20.8	20.8	1	31.2	24.0	12	1	20.8	*	27.7	2	12.0	41.6	19.6	3	6.9	20.8	16.0					
Breeze Om	CMH T4.5 39w 3008HV402	15°	20212	10	202	2.6	2.6	131	3.5	3.0	4	158	6.9	4.4	2.1	447	4.0	2.1	1.5	821	2.3	1.4	1.2	
				12	140	3.2	3.2	91	4.2	3.7	6	70	10.4	6.7	3.2	199	6.0	3.2	2.2	365	3.5	2.1	1.8	
				14	103	3.7	3.7	67	4.9	4.3	8	39	13.9	8.9	4.2	112	8.0	4.3	3.0	205	4.6	2.8	2.4	
				16	79	4.2	4.2	51	5.6	4.8	10	25	17.3	11.1	5.3	71	10.0	5.4	3.7	131	5.8	3.5	3.0	
		18	62	4.7	4.7	41	6.4	5.4	12	18	20.8	13.3	6.3	50	12.0	6.4	4.5	91	6.9	4.2	3.6			
		30°	6662	10	67	5.4	5.4	43	7.3	6.2	4	52	6.9	10.9	4.3	147	4.0	4.6	3.0	270	2.3	2.9	2.5	
				12	46	6.4	6.4	30	8.8	7.4	6	23	10.4	16.4	6.4	65	6.0	6.9	4.5	120	3.5	4.4	3.7	
				14	34	7.5	7.5	22	10.2	8.7	8	13	13.9	21.9	8.6	37	8.0	9.2	6.1	68	4.6	5.9	5.0	
				16	26	8.6	8.6	17	11.7	9.9	10	8	17.3	27.3	10.7	24	10.0	11.5	7.6	43	5.8	7.3	6.2	
		18	21	9.6	9.6	13	13.2	11.1	12	6	20.8	32.8	12.9	16	12.0	13.9	9.1	30	6.9	8.8	7.4			
		45°	2840	10	28	8.3	8.3	18	11.7	9.6	4	22	6.9	27.3	6.6	63	4.0	8.0	4.7	115	2.3	4.7	3.8	
				12	20	9.9	9.9	13	14.1	11.5	6	10	10.4	41.0	9.9	28	6.0	12.0	7.0	51	3.5	7.0	5.7	
				14	14	11.6	11.6	9	16.4	13.4	8	6	13.9	54.6	13.3	16	8.0	16.0	9.4	29	4.6	9.4	7.7	
				16	11	13.3	13.3	7	18.7	15.3	10	4	17.3	68.3	16.6	10	10.0	20.0	11.7	18	5.8	11.7	9.6	
		18	9	14.9	14.9	6	21.1	17.2	12	2	20.8	81.9	19.9	7	12.0	24.0	14.1	13	6.9	14.1	11.5			
		60°	1228	10	12	11.5	11.5	8	17.3	13.3	4	10	6.9	*	9.2	27	4.0	13.9	6.5	50	2.3	6.9	5.3	
12	9			13.9	13.9	6	20.8	16.1	6	4	10.4	*	13.9	12	6.0	20.8	9.8	22	3.5	10.4	8.0			
14	6			16.2	16.2	4	24.2	18.7	8	2	13.9	*	18.5	7	8.0	27.7	13.1	12	4.6	13.9	10.7			
16	5			18.5	18.5	3	27.7	21.4	10	2	17.3	*	23.1	4	10.0	34.6	16.3	8	5.8	17.3	13.3			
18	4	20.8	20.8	2	31.2	24.0	12	1	20.8	*	27.7	3	12.0	41.6	19.6	6	6.9	20.8	16.0					

*Steep aiming angle, length of beam extends beyond 25'

Photometrics

- A Aiming angle of fixture, measured from 0°
- DH Vertical distance from fixture to horizontal surface
- DW Distance from fixture to wall
- FC Footcandles at beam center
- X Vertical distance from beam center to ceiling
- L Length of beam
- W Width of beam
- CBCP Centerbeam Candlepower

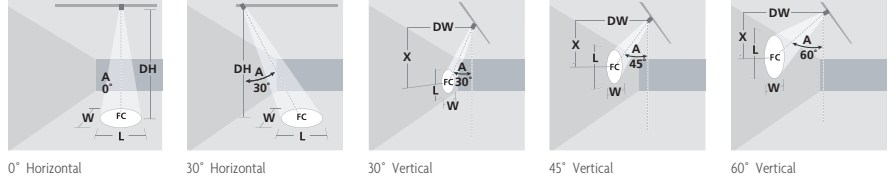

Fixture Usage	Lamp Type/ Part Number	Beam Spread	CBCP	Horizontal Surfaces									Vertical Surfaces								
				0°			30°			30°			45°			60°					
				DH	FC	L W	FC	L W	DW	FC	X L W	FC	X L W	FC	X L W						

CMH T4.5 Lamps (continued)

Breeze Om 	CMH T4.5 70w 300BHV403		36866	10	369	2.6	2.6	239	3.5	3.0	4	288	6.9	4.4	2.1	815	4.0	2.1	1.5	1497	2.3	1.4	1.2
				12	256	3.2	3.2	166	4.2	3.7	6	128	10.4	6.7	3.2	362	6.0	3.2	2.2	665	3.5	2.1	1.8
				14	188	3.7	3.7	122	4.9	4.3	8	72	13.9	8.9	4.2	204	8.0	4.3	3.0	374	4.6	2.8	2.4
				16	144	4.2	4.2	94	5.6	4.8	10	46	17.3	11.1	5.3	130	10.0	5.4	3.7	239	5.8	3.5	3.0
				18	114	4.7	4.7	74	6.4	5.4	12	32	20.8	13.3	6.3	91	12.0	6.4	4.5	166	6.9	4.2	3.6
			12151	10	122	5.4	5.4	79	7.3	6.2	4	95	6.9	10.9	4.3	269	4.0	4.6	3.0	493	2.3	2.9	2.5
				12	84	6.4	6.4	55	8.8	7.4	6	42	10.4	16.4	6.4	119	6.0	6.9	4.5	219	3.5	4.4	3.7
				14	62	7.5	7.5	40	10.2	8.7	8	24	13.9	21.9	8.6	67	8.0	9.2	6.1	123	4.6	5.9	5.0
				16	47	8.6	8.6	31	11.7	9.9	10	15	17.3	27.3	10.7	43	10.0	11.5	7.6	79	5.8	7.3	6.2
				18	38	9.6	9.6	24	13.2	11.1	12	11	20.8	32.8	12.9	30	12.0	13.9	9.1	55	6.9	8.8	7.4
			5179	10	14	8.3	8.3	9	11.7	9.6	4	40	6.9	27.3	6.6	114	4.0	8.0	4.7	210	2.3	4.7	3.8
				12	10	9.9	9.9	6	14.1	11.5	6	18	10.4	41.0	9.9	51	6.0	12.0	7.0	93	3.5	7.0	5.7
				14	7	11.6	11.6	5	16.4	13.4	8	10	13.9	54.6	13.3	29	8.0	16.0	9.4	53	4.6	9.4	7.7
				16	6	13.3	13.3	4	18.7	15.3	10	6	17.3	68.3	16.6	18	10.0	20.0	11.7	34	5.8	11.7	9.6
				18	4	14.9	14.9	3	21.1	17.2	12	4	20.8	81.9	19.9	13	12.0	24.0	14.1	23	6.9	14.1	11.5
			2240	10	22	11.5	11.5	15	17.3	13.3	4	18	6.9	*	9.2	49	4.0	13.9	6.5	91	2.3	6.9	5.3
				12	16	13.9	13.9	10	20.8	16.1	6	8	10.4	*	13.9	22	6.0	20.8	9.8	40	3.5	10.4	8.0
				14	11	16.2	16.2	7	24.2	18.7	8	4	13.9	*	18.5	12	8.0	27.7	13.1	23	4.6	13.9	10.7
				16	9	18.5	18.5	6	27.7	21.4	10	3	17.3	*	23.1	8	10.0	34.6	16.3	15	5.8	17.3	13.3
				18	7	20.8	20.8	4	31.2	24.0	12	2	20.8	*	27.7	5	12.0	41.6	19.6	10	6.9	20.8	16.0

CMH PAR Lamps

Om Sportster Tweak 	CMH MR16 GX10 20w 12° 300BHV440		9000	8	140.6	1.7	1.7	91.3	2.3	1.9	4	70.3	6.9	3.5	1.7	196.9	4.0	1.7	1.2	365.4	2.3	1.1	1.0
				10	90.0	2.1	2.1	58.5	2.8	2.4	6	31.3	10.4	5.2	2.5	88.4	6.0	2.6	1.8	162.4	3.5	1.7	1.5
				12	62.5	2.5	2.5	40.6	3.4	2.9	8	17.6	13.9	7.0	3.4	49.7	8.0	3.4	2.4	91.3	4.6	2.3	1.9
				14	45.9	2.9	2.9	29.8	3.9	3.4	10	11.3	17.3	8.7	4.2	31.8	10.0	4.3	3.0	58.5	5.8	2.8	2.4
				16	35.2	3.4	3.4	22.8	4.5	3.9	12	7.8	20.8	10.4	5.0	22.1	12.0	5.1	3.6	40.6	6.9	3.4	2.9
	CMH MR16 GX10 20w 25° 300BHV441		2900	8	45.3	3.5	3.5	29.4	4.8	4.1	4	22.7	6.9	8.3	3.5	64.1	4.0	3.7	2.5	117.7	2.3	2.4	2.0
				10	29.0	4.4	4.4	18.8	6.0	5.1	6	10.1	10.4	12.5	5.3	28.5	6.0	5.6	3.8	52.3	3.5	3.6	3.1
				12	20.1	5.3	5.3	13.1	7.2	6.1	8	5.7	13.9	16.6	7.1	16.0	8.0	7.5	5.0	29.4	4.6	4.8	4.1
				14	14.8	6.2	6.2	9.6	8.4	7.2	10	3.6	17.3	20.8	8.9	10.3	10.0	9.3	6.3	18.8	5.8	6.0	5.1
				16	11.3	7.1	7.1	7.4	9.6	8.2	12	2.5	20.8	25.0	10.6	7.1	12.0	11.2	7.5	13.1	6.9	7.2	6.1
	CMH MR16 GX10 20w 40° 300BHV442		1500	8	23.4	5.8	5.8	15.2	8.1	6.7	4	11.7	6.9	19.3	5.8	33.1	4.0	6.7	4.1	60.9	2.3	4.1	3.4
				10	15.0	7.3	7.3	9.7	10.2	8.4	6	5.2	10.4	29.0	8.7	14.7	6.0	10.1	6.2	27.1	3.5	6.1	5.0
				12	10.4	8.7	8.7	6.8	12.2	10.1	8	2.9	13.9	38.7	11.6	8.3	8.0	13.4	8.2	15.2	4.6	8.1	6.7
				14	7.7	10.2	10.2	5.0	14.2	11.8	10	1.9	17.3	48.3	14.6	5.3	10.0	16.8	10.3	9.7	5.8	10.2	8.4
				16	5.9	11.6	11.6	3.8	16.2	13.4	12	1.3	20.8	58.0	17.5	3.7	12.0	20.1	12.4	6.8	6.9	12.2	10.1
Om Sportster Spot 	CMH PAR20 39w 10° 300BHV410		22000	10	220	1.7	1.7	143	2.3	2.0	4	172	6.9	2.9	1.4	486	4.0	1.4	1.0	893	2.3	0.9	0.8
				12	153	2.1	2.1	99	2.8	2.4	6	76	10.4	4.3	2.1	216	6.0	2.1	1.5	397	3.5	1.4	1.2
				14	112	2.4	2.4	73	3.3	2.8	8	43	13.9	5.7	2.8	122	8.0	2.8	2.0	223	4.6	1.9	1.6
				16	86	2.8	2.8	56	3.7	3.2	10	28	17.3	7.2	3.5	78	10.0	3.5	2.5	143	5.8	2.3	2.0
				18	68	3.1	3.1	44	4.2	3.6	12	19	20.8	8.6	4.2	54	12.0	4.2	3.0	99	6.9	2.8	2.4
	CMH PAR20 39w 25° 20w 25° 300BHVO9		7500	10	75	4.4	4.4	49	6.0	5.1	4	59	6.9	8.3	3.5	166	4.0	3.7	2.5	304	2.3	2.4	2.0
				12	52	5.3	5.3	34	7.2	6.1	6	26	10.4	12.5	5.3	74	6.0	5.6	3.8	135	3.5	3.6	3.1
				14	38	6.2	6.2	25	8.4	7.2	8	15	13.9	16.6	7.1	41	8.0	7.5	5.0	76	4.6	4.8	4.1
				16	29	7.1	7.1	19	9.6	8.2	10	9	17.3	20.8	8.9	27	10.0	9.3	6.3	49	5.8	6.0	5.1
				18	23	8.0	8.0	15	10.8	9.2	12	7	20.8	25.0	10.6	18	12.0	11.2	7.5	34	6.9	7.2	6.1
Breeze Om Sportster Tweak 	CMH PAR30 LONG 39w 10° 300BHV406		39600	10	396	1.7	1.7	257	2.3	2.0	4	309	6.9	2.9	1.4	875	4.0	1.4	1.0	1608	2.3	0.9	0.8
				12	275	2.1	2.1	179	2.8	2.4	6	138	10.4	4.3	2.1	389	6.0	2.1	1.5	714	3.5	1.4	1.2
				14	202	2.4	2.4	131	3.3	2.8	8	77	13.9	5.7	2.8	219	8.0	2.8	2.0	402	4.6	1.9	1.6
				16	155	2.8	2.8	100	3.7	3.2	10	50	17.3	7.2	3.5	140	10.0	3.5	2.5	257	5.8	2.3	2.0
				18	122	3.1	3.1	79	4.2	3.6	12	34	20.8	8.6	4.2	97	12.0	4.2	3.0	179	6.9	2.8	2.4

*Steep aiming angle, length of beam extends beyond 25'

Photometrics

- A Aiming angle of fixture, measured from 0°
- DH Vertical distance from fixture to horizontal surface
- DW Distance from fixture to wall
- FC Footcandles at beam center
- X Vertical distance from beam center to ceiling
- L Length of beam
- W Width of beam
- CBCP Centerbeam Candlepower

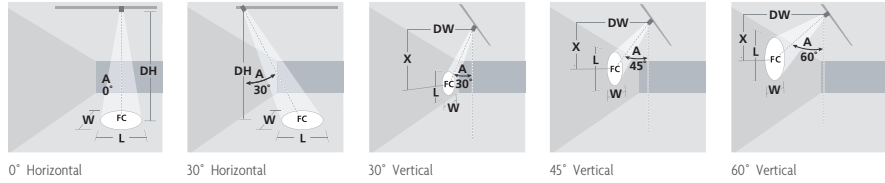

Fixture Usage	Lamp Type/ Part Number	Beam Spread	CBCP	Horizontal Surfaces									Vertical Surfaces										
				0°			30°			30°			45°			60°							
				DH	FC	L W	FC	L W	DW	FC	X L W	FC	X L W	FC	X L W								
CMH PAR Lamps (continued)																							
	CMH PAR30 LONG 39w 25° 300BHV405		11000	10	110	4.4	4.4	71	6.0	5.1	4	86	6.9	8.3	3.5	243	4.0	3.7	2.5	447	2.3	2.4	2.0
				12	76	5.3	5.3	50	7.2	6.1	6	38	10.4	12.5	5.3	108	6.0	5.6	3.8	198	3.5	3.6	3.1
				14	56	6.2	6.2	36	8.4	7.2	8	21	13.9	16.6	7.1	61	8.0	7.5	5.0	112	4.6	4.8	4.1
				16	43	7.1	7.1	28	9.6	8.2	10	14	17.3	20.8	8.9	39	10.0	9.3	6.3	71	5.8	6.0	5.1
				18	34	8.0	8.0	22	10.8	9.2	12	10	20.8	25.0	10.6	27	12.0	11.2	7.5	50	6.9	7.2	6.1
	CMH PAR30 LONG 39w 25° 300BHV407		43000	10	430	2.6	2.6	279	3.5	3.0	4	336	6.9	4.4	2.1	950	4.0	2.1	1.5	1746	2.3	1.4	1.2
				12	299	3.2	3.2	194	4.2	3.7	6	149	10.4	6.7	3.2	422	6.0	3.2	2.2	776	3.5	2.1	1.8
				14	219	3.7	3.7	142	4.9	4.3	8	84	13.9	8.9	4.2	238	8.0	4.3	3.0	436	4.6	2.8	2.4
				16	168	4.2	4.2	109	5.6	4.8	10	54	17.3	11.1	5.3	152	10.0	5.4	3.7	279	5.8	3.5	3.0
				18	133	4.7	4.7	86	6.4	5.4	12	37	20.8	13.3	6.3	106	12.0	6.4	4.5	194	6.9	4.2	3.6
	CMH PAR30 LONG 39w 25° 300BHV408		10000	10	100	7.3	7.3	65	10.2	8.4	4	78	6.9	19.3	5.8	221	4.0	6.7	4.1	406	2.3	4.1	3.4
				12	69	8.7	8.7	45	12.2	10.0	6	35	10.4	29.0	8.7	98	6.0	10.1	6.2	180	3.5	6.1	5.0
				14	51	10.2	10.2	33	14.2	11.8	8	20	13.9	38.7	11.6	55	8.0	13.4	8.2	101	4.6	8.1	6.7
				16	39	11.6	11.6	25	16.2	13.4	10	13	17.3	48.3	14.6	35	10.0	16.8	10.3	65	5.8	10.2	8.4
				18	31	13.1	13.1	20	18.3	15.1	12	9	20.8	58.0	17.5	25	12.0	20.1	12.4	45	6.9	12.2	10.1
Incandescent PAR Lamps																							
	PAR16 GU10 50w 40° 300BHV411		800	8	13	5.8	5.8	8	8.1	6.7	4	6	6.9	19.3	5.8	18	4.0	6.7	4.1	32	2.3	4.1	3.4
				10	8	7.3	7.3	5	10.2	8.4	6	3	10.4	29.0	8.7	8	6.0	10.1	6.2	14	3.5	6.1	5.0
				12	6	8.7	8.7	4	12.2	10.0	8	2	13.9	38.7	11.6	4	8.0	13.4	8.2	8	4.6	8.1	6.7
				14	4	10.2	10.2	3	14.2	11.8	10	1	17.3	48.3	14.6	3	10.0	16.8	10.3	5	5.8	10.2	8.4
				16	3	11.6	11.6	2	16.2	13.4	12	1	20.8	58.0	17.5	2	12.0	20.1	12.4	4	6.9	12.2	10.1
	PAR20 35w 10° 300BHV412		3000	8	47	1.4	1.4	30	1.9	1.6	4	23	6.9	2.9	1.4	66	4.0	1.4	1.0	122	2.3	0.9	0.8
				10	30	1.7	1.7	19	2.3	2.0	6	10	10.4	4.3	2.1	29	6.0	2.1	1.5	54	3.5	1.4	1.2
				12	21	2.1	2.1	14	2.8	2.4	8	6	13.9	5.7	2.8	17	8.0	2.8	2.0	30	4.6	1.9	1.6
				14	15	2.4	2.4	10	3.3	2.8	10	4	17.3	7.2	3.5	11	10.0	3.5	2.5	19	5.8	2.3	2.0
				16	12	2.8	2.8	8	3.7	3.2	12	3	20.8	8.6	4.2	7	12.0	4.2	3.0	14	6.9	2.8	2.4
	PAR20 35w 30° 300BHV413		800	8	13	4.3	4.3	8	5.9	5.0	4	6	6.9	10.9	4.3	18	4.0	4.6	3.0	32	2.3	2.9	2.5
				10	8	5.4	5.4	5	7.3	6.2	6	3	10.4	16.4	6.4	8	6.0	6.9	4.5	14	3.5	4.4	3.7
				12	6	6.4	6.4	4	8.8	7.4	8	2	13.9	21.9	8.6	4	8.0	9.2	6.1	8	4.6	5.9	5.0
				14	4	7.5	7.5	3	10.2	8.7	10	1	17.3	27.3	10.7	3	10.0	11.5	7.6	5	5.8	7.3	6.2
				16	3	8.6	8.6	2	11.7	9.9	12	1	20.8	32.8	12.9	2	12.0	13.9	9.1	4	6.9	8.8	7.4
	PAR20 35w 40° 300BHV414		500	8	8	5.8	5.8	5	8.1	6.7	4	4	6.9	19.3	5.8	11	4.0	6.7	4.1	20	2.3	4.1	3.4
				10	5	7.3	7.3	3	10.2	8.4	6	2	10.4	29.0	8.7	5	6.0	10.1	6.2	9	3.5	6.1	5.0
				12	3	8.7	8.7	2	12.2	10.0	8	1	13.9	38.7	11.6	3	8.0	13.4	8.2	5	4.6	8.1	6.7
				14	3	10.2	10.2	2	14.2	11.8	10	1	17.3	48.3	14.6	2	10.0	16.8	10.3	3	5.8	10.2	8.4
				16	2	11.6	11.6	1	16.2	13.4	12	0	20.8	58.0	17.5	1	12.0	20.1	12.4	2	6.9	12.2	10.1
	PAR20 50w 10° 300BHV415		4600	8	72	1.4	1.4	47	1.9	1.6	4	36	6.9	2.9	1.4	102	4.0	1.4	1.0	187	2.3	0.9	0.8
				10	46	1.7	1.7	30	2.3	2.0	6	6	10.4	4.3	2.1	45	6.0	2.1	1.5	83	3.5	1.4	1.2
				12	32	2.1	2.1	21	2.8	2.4	8	9	13.9	5.7	2.8	25	8.0	2.8	2.0	47	4.6	1.9	1.6
				14	23	2.4	2.4	15	3.3	2.8	10	6	17.3	7.2	3.5	16	10.0	3.5	2.5	30	5.8	2.3	2.0
				16	18	2.8	2.8	12	3.7	3.2	12	4	20.8	8.6	4.2	11	12.0	4.2	3.0	21	6.9	2.8	2.4
	PAR20 50w 30° 300BHV416		1200	8	19	4.3	4.3	12	5.9	5.0	4	9	6.9	10.9	4.3	27	4.0	4.6	3.0	49	2.3	2.9	2.5
				10	12	5.4	5.4	8	7.3	6.2	6	4	10.4	16.4	6.4	12	6.0	6.9	4.5	22	3.5	4.4	3.7
				12	8	6.4	6.4	5	8.8	7.4	8	2	13.9	21.9	8.6	7	8.0	9.2	6.1	12	4.6	5.9	5.0
				14	6	7.5	7.5	4	10.2	8.7	10	2	17.3	27.3	10.7	4	10.0	11.5	7.6	8	5.8	7.3	6.2
				16	5	8.6	8.6	3	11.7	9.9	12	1	20.8	32.8	12.9	3	12.0	13.9	9.1	5	6.9	8.8	7.4
	PAR20 50w 40° 300BHV417		900	8	14	5.8	5.8	9	8.1	6.7	4	7	6.9	19.3	5.8	20	4.0	6.7	4.1	37	2.3	4.1	3.4
				10	9	7.3	7.3	6	10.2	8.4	6	3	10.4	29.0	8.7	9	6.0	10.1	6.2	16	3.5	6.1	5.0
				12	6	8.7	8.7	4	12.2	10.0	8	2	13.9	38.7	11.6	5	8.0	13.4	8.2	9	4.6	8.1	6.7
				14	5	10.2	10.2	3	14.2	11.8	10	1	17.3	48.3	14.6	3	10.0	16.8	10.3	6	5.8	10.2	8.4
				16	4	11.6	11.6	2	16.2	13.4	12	1	20.8	58.0	17.5	2	12.0	20.1	12.4	4	6.9	12.2	10.1

Photometrics

- A Aiming angle of fixture, measured from 0°
- DH Vertical distance from fixture to horizontal surface
- DW Distance from fixture to wall
- FC Footcandles at beam center
- X Vertical distance from beam center to ceiling
- L Length of beam
- W Width of beam
- CBCP Centerbeam Candlepower

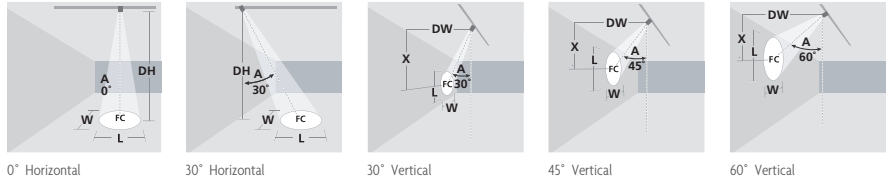

Fixture Usage	Lamp Type/ Part Number	Beam Spread	CBCP	Horizontal Surfaces									Vertical Surfaces										
				0°			30°			30°			45°			60°							
				DH	FC	L W	FC	L W	DW	FC	X L W	FC	X L W	FC	X L W								
Incandescent PAR Lamps (continued)																							
Breeze Om Sportster Spot Tweak	PAR30 SHORT 50w 9° 300BH418	9°	8800	8	138	1.3	1.3	89	1.7	1.5	4	69	6.9	2.6	1.3	194	4.0	1.3	0.9	357	2.3	0.8	0.7
				10	88	1.6	1.6	57	2.1	1.8	6	31	10.4	3.8	1.9	86	6.0	1.9	1.3	159	3.5	1.3	1.1
				12	61	1.9	1.9	40	2.5	2.2	8	17	13.9	5.1	2.5	49	8.0	2.5	1.8	89	4.6	1.7	1.5
				14	45	2.2	2.2	29	2.9	2.5	10	11	17.3	6.4	3.1	31	10.0	3.2	2.2	57	5.8	2.1	1.8
				16	34	2.5	2.5	22	3.4	2.9	12	8	20.8	7.7	3.8	22	12.0	3.8	2.7	40	6.9	2.5	2.2
	PAR30 SHORT 50w 25° 300BH419	25°	2300	8	36	3.5	3.5	23	4.8	4.0	4	18	6.9	8.3	3.5	51	4.0	3.7	2.5	93	2.3	2.4	2.0
				10	23	4.4	4.4	15	6.0	5.1	6	8	10.4	12.5	5.3	23	6.0	5.6	3.8	41	3.5	3.6	3.1
				12	16	5.3	5.3	10	7.2	6.1	8	4	13.9	16.6	7.1	13	8.0	7.5	5.0	23	4.6	4.8	4.1
				14	12	6.2	6.2	8	8.4	7.2	10	3	17.3	20.8	8.9	8	10.0	9.3	6.3	15	5.8	6.0	5.1
				16	9	7.1	7.1	6	9.6	8.2	12	2	20.8	25.0	10.6	6	12.0	11.2	7.5	10	6.9	7.2	6.1
	PAR30 SHORT 50w 40° 300BH420	40°	1300	8	20	5.8	5.8	13	8.1	6.7	4	10	6.9	19.3	5.8	29	4.0	6.7	4.1	53	2.3	4.1	3.4
				10	13	7.3	7.3	8	10.2	8.4	6	5	10.4	29.0	8.7	13	6.0	10.1	6.2	23	3.5	6.1	5.0
				12	9	8.7	8.7	6	12.2	10.0	8	3	13.9	38.7	11.6	7	8.0	13.4	8.2	13	4.6	8.1	6.7
				14	7	10.2	10.2	4	14.2	11.8	10	2	17.3	48.3	14.6	5	10.0	16.8	10.3	8	5.8	10.2	8.4
				16	5	11.6	11.6	3	16.2	13.4	12	1	20.8	58.0	17.5	3	12.0	20.1	12.4	6	6.9	12.2	10.1
	PAR30 SHORT 75w 9° 300BH421	9°	15400	8	241	1.3	1.3	156	1.7	1.5	4	120	6.9	2.6	1.3	340	4.0	1.3	0.9	625	2.3	0.8	0.7
				10	154	1.6	1.6	100	2.1	1.8	6	53	10.4	3.8	1.9	151	6.0	1.9	1.3	278	3.5	1.3	1.1
				12	107	1.9	1.9	69	2.5	2.2	8	30	13.9	5.1	2.5	85	8.0	2.5	1.8	156	4.6	1.7	1.5
				14	79	2.2	2.2	51	2.9	2.5	10	19	17.3	6.4	3.1	54	10.0	3.2	2.2	100	5.8	2.1	1.8
				16	60	2.5	2.5	39	3.4	2.9	12	13	20.8	7.7	3.8	38	12.0	3.8	2.7	69	6.9	2.5	2.2
	PAR30 SHORT 75w 25° 300BH422	25°	4000	8	63	3.5	3.5	41	4.8	4.0	4	31	6.9	8.3	3.5	88	4.0	3.7	2.5	162	2.3	2.4	2.0
				10	40	4.4	4.4	26	6.0	5.1	6	14	10.4	12.5	5.3	39	6.0	5.6	3.8	72	3.5	3.6	3.1
				12	28	5.3	5.3	18	7.2	6.1	8	8	13.9	16.6	7.1	22	8.0	7.5	5.0	41	4.6	4.8	4.1
				14	20	6.2	6.2	13	8.4	7.2	10	5	17.3	20.8	8.9	14	10.0	9.3	6.3	26	5.8	6.0	5.1
				16	16	7.1	7.1	10	9.6	8.2	12	3	20.8	25.0	10.6	10	12.0	11.2	7.5	18	6.9	7.2	6.1
	PAR30 SHORT 75w 40° 300BH423	40°	2100	8	33	5.8	5.8	21	8.1	6.7	4	16	6.9	19.3	5.8	46	4.0	6.7	4.1	85	2.3	4.1	3.4
				10	21	7.3	7.3	14	10.2	8.4	6	7	10.4	29.0	8.7	21	6.0	10.1	6.2	38	3.5	6.1	5.0
				12	15	8.7	8.7	9	12.2	10.0	8	4	13.9	38.7	11.6	12	8.0	13.4	8.2	21	4.6	8.1	6.7
				14	11	10.2	10.2	7	14.2	11.8	10	3	17.3	48.3	14.6	7	10.0	16.8	10.3	14	5.8	10.2	8.4
				16	8	11.6	11.6	5	16.2	13.4	12	2	20.8	58.0	17.5	5	12.0	20.1	12.4	9	6.9	12.2	10.1
Breeze Om Sportster Tweak	PAR30 LONG 50w 9° 300BH424	9°	8800	8	138	1.3	1.3	89	1.7	1.5	4	69	6.9	2.6	1.3	194	4.0	1.3	0.9	357	2.3	0.8	0.7
				10	88	1.6	1.6	57	2.1	1.8	6	31	10.4	3.8	1.9	86	6.0	1.9	1.3	159	3.5	1.3	1.1
				12	61	1.9	1.9	40	2.5	2.2	8	17	13.9	5.1	2.5	49	8.0	2.5	1.8	89	4.6	1.7	1.5
				14	45	2.2	2.2	29	2.9	2.5	10	11	17.3	6.4	3.1	31	10.0	3.2	2.2	57	5.8	2.1	1.8
				16	34	2.5	2.5	22	3.4	2.9	12	8	20.8	7.7	3.8	22	12.0	3.8	2.7	40	6.9	2.5	2.2
	PAR30 LONG 50w 25° 300BH425	25°	2300	8	36	3.5	3.5	23	4.8	4.0	4	18	6.9	8.3	3.5	51	4.0	3.7	2.5	93	2.3	2.4	2.0
				10	23	4.4	4.4	15	6.0	5.1	6	8	10.4	12.5	5.3	23	6.0	5.6	3.8	41	3.5	3.6	3.1
				12	16	5.3	5.3	10	7.2	6.1	8	4	13.9	16.6	7.1	13	8.0	7.5	5.0	23	4.6	4.8	4.1
				14	12	6.2	6.2	8	8.4	7.2	10	3	17.3	20.8	8.9	8	10.0	9.3	6.3	15	5.8	6.0	5.1
				16	9	7.1	7.1	6	9.6	8.2	12	2	20.8	25.0	10.6	6	12.0	11.2	7.5	10	6.9	7.2	6.1
	PAR30 LONG 50w 50° 300BH426	50°	1300	8	20	7.5	7.5	13	10.7	8.7	4	10	6.9	42.9	7.5	29	4.0	9.5	5.3	53	2.3	5.4	4.3
				10	13	9.3	9.3	8	13.4	10.7	6	5	10.4	64.4	11.2	13	6.0	14.3	7.9	23	3.5	8.0	6.5
				12	9	11.2	11.2	6	16.1	12.9	8	3	13.9	85.8	14.9	7	8.0	19.1	10.6	13	4.6	10.7	8.6
				14	7	13.1	13.1	4	18.8	15.1	10	2	17.3	107.3	18.7	5	10.0	23.8	13.2	8	5.8	13.4	10.8
				16	5	14.9	14.9	3	21.5	17.2	12	1	20.8	128.8	22.4	3	12.0	28.6	15.8	6	6.9	16.1	12.9
	PAR30 LONG 75w 9° 300BH427	9°	15400	8	241	1.3	1.3	156	1.7	1.5	4	120	6.9	2.6	1.3	340	4.0	1.3	0.9	625	2.3	0.8	0.7
				10	154	1.6	1.6	100	2.1	1.8	6	53	10.4	3.8	1.9	151	6.0	1.9	1.3	278	3.5	1.3	1.1
				12	107	1.9	1.9	69	2.5	2.2	8	30	13.9	5.1	2.5	85	8.0	2.5	1.8	156	4.6	1.7	1.5
				14	79	2.2	2.2	51	2.9	2.5	10	19	17.3	6.4	3.1	54	10.0	3.2	2.2	100	5.8	2.1	1.8
				16	60	2.5	2.5	39	3.4	2.9	12	13	20.8	7.7	3.8	38	12.0	3.8	2.7	69	6.9	2.5	2.2

*Steep aiming angle, length of beam extends beyond 25'

Photometrics

- A Aiming angle of fixture, measured from 0°
- DH Vertical distance from fixture to horizontal surface
- DW Distance from fixture to wall
- FC Footcandles at beam center
- X Vertical distance from beam center to ceiling
- L Length of beam
- W Width of beam
- CBCP Centerbeam Candlepower

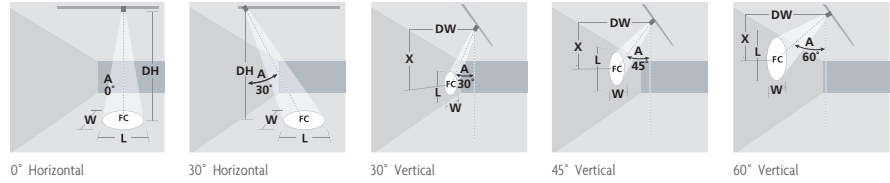

Fixture Usage	Lamp Type/ Part Number	Beam Spread	CBCP	Horizontal Surfaces									Vertical Surfaces										
				0°			30°			30°			45°			60°							
				DH	FC	L W	FC	L W	DW	FC	X L W	FC	X L W	FC	X L W								
Incandescent PAR Lamps (continued)																							
	PAR30 LONG 75w 25° 300BHV428	25°	4000	8	241	3.5	3.5	156	4.8	4.0	4	31	6.9	8.3	3.5	88	4.0	3.7	2.5	162	2.3	2.4	2.0
				10	154	4.4	4.4	100	6.0	5.1	6	14	10.4	12.5	5.3	39	6.0	5.6	3.8	72	3.5	3.6	3.1
				12	107	5.3	5.3	69	7.2	6.1	8	8	13.9	16.6	7.1	22	8.0	7.5	5.0	41	4.6	4.8	4.1
				14	79	6.2	6.2	51	8.4	7.2	10	5	17.3	20.8	8.9	14	10.0	9.3	6.3	26	5.8	6.0	5.1
				16	60	7.1	7.1	39	9.6	8.2	12	3	20.8	25.0	10.6	10	12.0	11.2	7.5	18	6.9	7.2	6.1
	PAR30 LONG 75w 50° 300BHV429	50°	2100	8	33	7.5	7.5	21	10.7	8.7	4	16	6.9	42.9	7.5	46	4.0	9.5	5.3	85	2.3	5.4	4.3
				21	9.3	9.3	14	13.4	10.7	6	7	10.4	64.4	11.2	21	6.0	14.3	7.9	38	3.5	8.0	6.5	
				12	15	11.2	11.2	9	16.1	12.9	8	4	13.9	85.8	14.9	12	8.0	19.1	10.6	21	4.6	10.7	8.6
				14	11	13.1	13.1	7	18.8	15.1	10	3	17.3	107.3	18.7	7	10.0	23.8	13.2	14	5.8	13.4	10.8
				16	8	14.9	14.9	5	21.5	17.2	12	2	20.8	128.8	22.4	5	12.0	28.6	15.8	9	6.9	16.1	12.9
Sportster Tweak	PAR38 60w 9° 300BHV430	9°	16000	8	250	1.3	1.3	162	1.7	1.5	4	125	6.9	2.6	1.3	354	4.0	1.3	0.9	650	2.3	0.8	0.7
				10	160	1.6	1.6	104	2.1	1.8	6	56	10.4	3.8	1.9	157	6.0	1.9	1.3	289	3.5	1.3	1.1
				12	111	1.9	1.9	72	2.5	2.2	8	31	13.9	5.1	2.5	88	8.0	2.5	1.8	162	4.6	1.7	1.5
				14	82	2.2	2.2	53	2.9	2.5	10	20	17.3	6.4	3.1	57	10.0	3.2	2.2	104	5.8	2.1	1.8
				16	63	2.5	2.5	41	3.4	2.9	12	14	20.8	7.7	3.8	39	12.0	3.8	2.7	72	6.9	2.5	2.2
	PAR38 60w 30° 300BHV431	30°	2500	8	39	4.3	4.3	25	5.9	5.0	4	20	6.9	10.9	4.3	55	4.0	4.6	3.0	101	2.3	2.9	2.5
				10	25	5.4	5.4	16	7.3	6.2	6	9	10.4	16.4	6.4	25	6.0	6.9	4.5	45	3.5	4.4	3.7
				12	17	6.4	6.4	11	8.8	7.4	8	5	13.9	21.9	8.6	14	8.0	9.2	6.1	25	4.6	5.9	5.0
				14	13	7.5	7.5	8	10.2	8.7	10	3	17.3	27.3	10.7	9	10.0	11.5	7.6	16	5.8	7.3	6.2
				16	10	8.6	8.6	6	11.7	9.9	12	2	20.8	32.8	12.9	6	12.0	13.9	9.1	11	6.9	8.8	7.4
	PAR38 90w 9° 300BHV432	9°	22200	8	347	1.3	1.3	225	1.7	1.5	4	173	6.9	2.6	1.3	491	4.0	1.3	0.9	901	2.3	0.8	0.7
				10	222	1.6	1.6	144	2.1	1.8	6	77	10.4	3.8	1.9	218	6.0	1.9	1.3	401	3.5	1.3	1.1
				12	154	1.9	1.9	100	2.5	2.2	8	43	13.9	5.1	2.5	123	8.0	2.5	1.8	225	4.6	1.7	1.5
				14	113	2.2	2.2	74	2.9	2.5	10	28	17.3	6.4	3.1	78	10.0	3.2	2.2	144	5.8	2.1	1.8
				16	87	2.5	2.5	56	3.4	2.9	12	19	20.8	7.7	3.8	55	12.0	3.8	2.7	100	6.9	2.5	2.2
	PAR38 90w 30° 300BHV433	30°	3500	8	55	4.3	4.3	36	5.9	5.0	4	27	6.9	10.9	4.3	77	4.0	4.6	3.0	142	2.3	2.9	2.5
				10	35	5.4	5.4	23	7.3	6.2	6	12	10.4	16.4	6.4	34	6.0	6.9	4.5	63	3.5	4.4	3.7
				12	24	6.4	6.4	16	8.8	7.4	8	7	13.9	21.9	8.6	19	8.0	9.2	6.1	36	4.6	5.9	5.0
				14	18	7.5	7.5	12	10.2	8.7	10	4	17.3	27.3	10.7	12	10.0	11.5	7.6	23	5.8	7.3	6.2
				16	14	8.6	8.6	9	11.7	9.9	12	3	20.8	32.8	12.9	9	12.0	13.9	9.1	16	6.9	8.8	7.4
	PAR38 90w 50° 300BHV434	50°	1600	8	25	7.5	7.5	16	10.7	8.7	4	13	6.9	42.9	7.5	35	4.0	9.5	5.3	65	2.3	5.4	4.3
				10	16	9.3	9.3	10	13.4	10.7	6	6	10.4	64.4	11.2	16	6.0	14.3	7.9	29	3.5	8.0	6.5
				12	11	11.2	11.2	7	16.1	12.9	8	3	13.9	85.8	14.9	9	8.0	19.1	10.6	16	4.6	10.7	8.6
				14	8	13.1	13.1	5	18.8	15.1	10	2	17.3	107.3	18.7	6	10.0	23.8	13.2	10	5.8	13.4	10.8
				16	6	14.9	14.9	4	21.5	17.2	12	1	20.8	128.8	22.4	4	12.0	28.6	15.8	7	6.9	16.1	12.9
	PAR38 120w 10° 300BHV435	10°	22500	8	352	1.4	1.4	228	1.9	1.6	4	176	6.9	2.9	1.4	497	4.0	1.4	1.0	913	2.3	0.9	0.8
				10	225	1.7	1.7	146	2.3	2.0	6	78	10.4	4.3	2.1	221	6.0	2.1	1.5	406	3.5	1.4	1.2
				12	156	2.1	2.1	101	2.8	2.4	8	44	13.9	5.7	2.8	124	8.0	2.8	2.0	228	4.6	1.9	1.6
				14	115	2.4	2.4	75	3.3	2.8	10	28	17.3	7.2	3.5	80	10.0	3.5	2.5	146	5.8	2.3	2.0
				16	88	2.8	2.8	57	3.7	3.2	12	20	20.8	8.6	4.2	55	12.0	4.2	3.0	101	6.9	2.8	2.4
	PAR38 120w 30° 300BHV436	30°	4600	8	72	4.3	4.3	47	5.9	5.0	4	36	6.9	10.9	4.3	102	4.0	4.6	3.0	187	2.3	2.9	2.5
				10	46	5.4	5.4	30	7.3	6.2	6	16	10.4	16.4	6.4	45	6.0	6.9	4.5	83	3.5	4.4	3.7
				12	32	6.4	6.4	21	8.8	7.4	8	9	13.9	21.9	8.6	25	8.0	9.2	6.1	47	4.6	5.9	5.0
				14	23	7.5	7.5	15	10.2	8.7	10	6	17.3	27.3	10.7	16	10.0	11.5	7.6	30	5.8	7.3	6.2
				16	18	8.6	8.6	12	11.7	9.9	12	4	20.8	32.8	12.9	11	12.0	13.9	9.1	21	6.9	8.8	7.4
	PAR38 120w 55° 300BHV437	55°	2000	8	31	8.3	8.3	20	12.2	9.6	4	16	6.9	89.1	8.3	44	4.0	11.4	5.9	81	2.3	6.1	4.8
				10	20	10.4	10.4	13	15.3	12.0	6	7	10.4	133.6	12.5	20	6.0	17.1	8.8	36	3.5	9.2	7.2
				12	14	12.5	12.5	9	18.3	14.4	8	4	13.9	178.1	16.7	11	8.0	22.9	11.8	20	4.6	12.2	9.6
				14	10	14.6	14.6	7	21.4	16.9	10	3	17.3	222.7	20.8	7	10.0	28.6	14.7	13	5.8	15.3	12.0
				16	8	16.7	16.7	5	24.4	19.3	12	2	20.8	267.2	25.0	5	12.0	34.3	17.7	9	6.9	18.3	14.4

Transformer Information

SELECTING A TRANSFORMER

The transformer is the key to a low-voltage system. It reduces standard line-voltage to 12 or 24 volts, which is safe to the touch. The total output wattage of the transformers determines the total wattage of the elements that can be used on the system. For example, a 300 watt transformer can power up to six 50 watt heads ($6 \times 50 = 300$). There are several transformer options from which to choose. Knowing the advantages of each will help you to select the best transformer for your application.

REMOTE

Remote transformers are preferred for their clean look and range of power feed options. They are mounted in accessible locations, but out of view. Power is brought to the rail or cable system through a low-profile power feed canopy or other power feed option (sold separately).



VS.

SURFACE

Surface transformers are decorative and will be visible in the room. They are best suited for applications where there is an existing junction box in a finished ceiling. The surface transformer has an integral power feed—there is no need for a separate power feed; however, the surface transformer must be placed within range of the rail or cable run.



VS.

REMODEL RECESSED

Remodel Recessed Transformers look similar from below the ceiling to the power feed canopies used with remote transformers and are preferred for their clean look. An additional benefit they have over remote transformers is that they do not require access to a remote location because the transformer sits just above the ceiling. However, they are not compatible with all finished ceilings because an electrician will need to install the Remodel Recessed Transformer in close proximity to an existing junction box, drill through the finished ceiling in the location where the Remodel Recessed Transformer will be installed, and cover the existing junction box with the field-paintable provided metal cover. The Remodel Recessed Transformer has an integral power feed – there is no need for a separate power feed; however, the transformer must be installed directly above the rail run.



MAGNETIC

Magnetic transformers have historically been the choice of lighting professionals due to their reliability and can be used to power both halogen and LED elements. We offer a wide range of output wattages for magnetic transformers. When dimming a magnetic transformer, it is important to use a low-voltage magnetic dimmer.



VS.

ELECTRONIC

Electronic transformers are much smaller and lighter than their magnetic counterparts and have the advantage of being resettable at the wall switch in the event of a system short circuit. We offer 12 volt electronic remote and surface transformers in a variety of output options. Not all electronic transformers can be used to power LED elements. Any electronic transformer with an LED icon is compatible with our LED elements. When dimming an electronic transformer, it is important to use a low-voltage electronic dimmer.



12 VOLT

12 volt transformers are most common. A 12 volt system requires that the elements on the system have 12 volt lamps, which are readily available in a range of wattages and beam spreads. A 12 volt transformer can power a run with 300 watts per power feed (600 watts for a dual-feed), running up to thirty feet in each direction from the power feed.



VS.

24 VOLT

24 volt transformers are best suited for installations with limited power feed locations. The elements on the system must have 24 volt lamps, which are not as widely available and offer fewer beam spreads. A 24 volt transformer can power a run with 600 watts per power feed (1200 watts for a dual feed canopy), running up to sixty feet in each direction from the power feed. 24 volt transformers cannot be used on Two-Circuit MonoRail.



ALL OF OUR TRANSFORMERS COMPLY WITH GUIDELINES ESTABLISHED BY THE NATIONAL ELECTRICAL CODE, WITH A MAXIMUM WATTAGE ON A 12 VOLT SYSTEM AT 300 WATTS PER FEED AND A MAXIMUM WATTAGE ON A 24 VOLT SYSTEM AT 600 WATTS PER FEED.

ABOUT SURFACE TRANSFORMERS

Surface transformers mount to a standard 4" junction box with round plaster ring (provided by electrician) and are best suited for applications where there is an existing junction box. The magnetic or electronic transformer is concealed inside a decorative housing with an integral power feed—there is no need to purchase a separate power feed. The surface transformer for a MonoRail or Two-Circuit MonoRail system must be placed directly above the system. The surface transformer for a Kable Lite system must be placed within two feet of the system. Surface transformers have a specific minimum drop depending on the wattage of the transformer—this dimension must be considered in determining how far the run will drop from the ceiling. Longer drops can be achieved by adding a power extender (for MonoRail or Two-Circuit MonoRail), or hardwire feeds or center power feeds (for Kable Lite).

Tech Lighting's magnetic surface transformers come standard with a debuzzing dimming coil to reduce noise when using a low-voltage magnetic dimmer.

ABOUT REMODEL RECESSED TRANSFORMERS

Remodel recessed transformers provide a clean, minimal look because the transformer is installed above the ceiling out of view. Power is brought to the system through the integral power feed. In a remodel situation, the remodel recessed transformer should be installed within close proximity to an existing junction box. UL requires that the existing junction box still be accessible, so we include a removable, field-paintable cover. In new construction, an electrician can simply bring power to the remodel recessed transformer directly. In either situation, the remodel recessed transformer must be placed directly above the system. At this time, we are only offering electronic remodel recessed transformers which can easily be reset at the wall switch in the event of a system short circuit.

ABOUT REMOTE TRANSFORMERS

Remote transformers provide a clean, minimal look because the transformer is installed in a remote, accessible location (such as above the ceiling or in a closet) out of view. Power is brought to the system with a system-compatible power feed canopy or other power feed option (sold separately).

The remote transformer can be anchored to the wall or ceiling with screws or toggle bolts and should be installed no more than twenty feet from the power feed. It is important that the electrician supply the correct gauge of THHN wire from the transformer to the junction box to prevent voltage drop, which can cause fixtures to appear dim. See the chart below for proper wire gauge. For optimum performance, remote transformers should be loaded to at least 80 percent of capacity.

Power Taps

Magnetic remote transformers have multiple secondary power taps to compensate for variations in voltage. An input voltage exceeding 120 volts may result in more than 12 or 24 volts on the system, which can shorten lamp life. Follow the installation instructions packaged with the transformer to determine which power tap to use.

Voltages

Tech Lighting transformers are standard for 120 volt input and for 277 volt input where noted. Other input voltages are available upon request.

LOW-VOLTAGE WIRE SIZE TABLE

Use to determine the correct THHN wire size for a recommended 3 percent drop in voltage at the specified wattage. The length shown is the length of wire from the transformer to the power feed.

12 VOLT	5 ft.	6-15 ft.	16-20 ft.	21-40 ft.	41-60 ft.	61-90 ft.
150 watt	#12 GA	#8 GA	#6 GA	#4 GA	#2 GA	#1 GA
300 watt	#10 GA	#6 GA	#4 GA	#1 GA	1/0	3/0
24 VOLT	5 ft.	6-15 ft.	16-20 ft.	21-40 ft.	41-60 ft.	61-90 ft.
300 watt	#14 GA	#12 GA	#10 GA	#6 GA	#6 GA	#4 GA
600 watt	#12 GA	#8 GA	#6 GA	#4 GA	#2 GA	#1 GA

DIMMING

All Tech Lighting transformers may be dimmed with the appropriate dimmer: a low voltage magnetic dimmer for a magnetic transformer; a low voltage electronic dimmer for an electronic transformer, or a standard incandescent dimmer where indicated. The dimmer is placed on the line voltage side of the input line. Consult the transformer charts in each system section of the catalog for the compatible dimmer type. It is very important to use the compatible dimmer type: failure to do so will substantially shorten the useful life of the transformer. Remote transformers are generally placed outside the room, so any buzzing that may be caused by dimming is not noticeable. If using a remote magnetic transformer and a buzzing noise is apparent, a debuzzing dimming coil may be wired in series on one of the 120 volt input lines. Select the correct dimming coil (see below) based on the wattage of your transformer.

DEBUZZING DIMMING COIL ALONE

	DIAMETER	DEPTH
700DIM150	1.75"	.75"
700DIM300	2.25"	1"
700DIM600	2.5"	1"



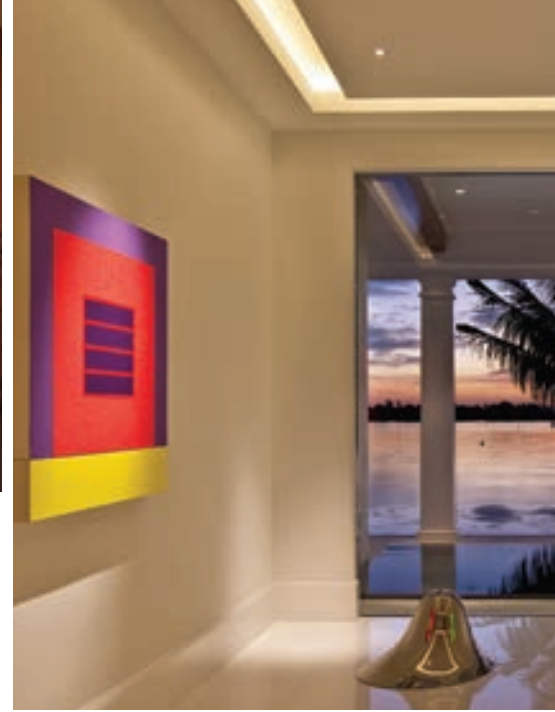

ELEMENT

by Tech Lighting®

Tech Lighting launched ELEMENT because we felt we could deliver incredibly engineered downlights backed by the best service levels in the industry and offer them at an excellent value. Over the past five years, our success in achieving this vision must be attributed in large part to the design community that guides our development process every day.

You helped us define ELEMENT as a modern interpretation of specification-grade downlighting. Our goal is to design for you – to help you solve real lighting challenges. We accomplish that because what matters to you also matters to us.

ABOVE THE CEILING MATTERS: Our thoughtful engineering makes complex solutions elegantly simple, and we take great care to ensure every component and every connection are made at the highest quality. So you can be confident even the things you cannot see are exceptional.

AT THE CEILING MATTERS: It is all in the details. A highly engineered housing deserves a premium trim. Every ELEMENT trim is solid die cast aluminum. No seams. No warping. No sagging.

BELOW THE CEILING MATTERS: Beautiful aesthetics cannot come at the expense of poor performance, therefore, ELEMENT allows you to deliver beautiful light exactly where you need it. After installation, we are committed to delivering the highest level of customer service and technical support in the industry to ensure you are completely satisfied.

The lighting industry will continue to experience rapid and significant change, and Tech Lighting engineers and designers will continually seek to develop the truly game-changing ELEMENT products you will need to meet lighting challenges yet unknown.







7400 Linder Ave.
Skokie, IL 60077

T 847 410 4400
F 847 410 4500
W techlighting.com