

As the leading manufacturer of steel products, Orbit offers one of the largest selections of steel boxes and rings in the industry. Using state-of-the-art factories and trained engineers, we provide innovative high quality products all ready to ship at your convenience.

With innovation as our main priority, Orbit offers electrical boxes with a variety of labor saving features to ensure the greatest savings. Orbit is constantly developing new solution-based products to keep you competitive in this rapidly changing market. We are your one stop source for all your electrical needs!

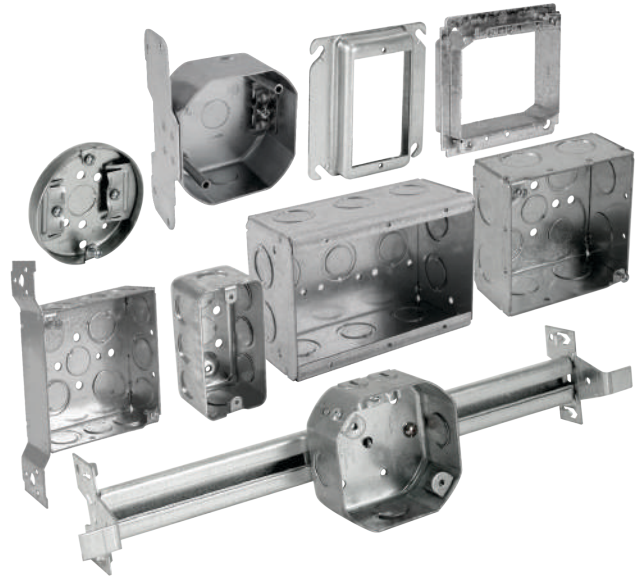

VARIETY OF COST SAVING FEATURES:

KNOCKOUTS
Variety of options

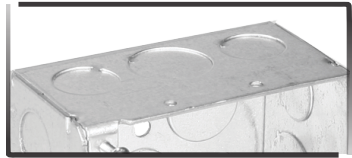

CLEAN BOXES AND NO SHARP EDGES
Clean and deburred boxes



EMBOSS AND PIGTAIL
*Reduce waste and time
10" length pigtail on selected boxes*

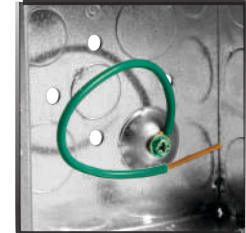

PRE-INSTALLED RAISED SCREWS
Easy installation out of box



CLAMPS
Accommodates metal and non-metallic cables



BRACKET

Up to 7 different types

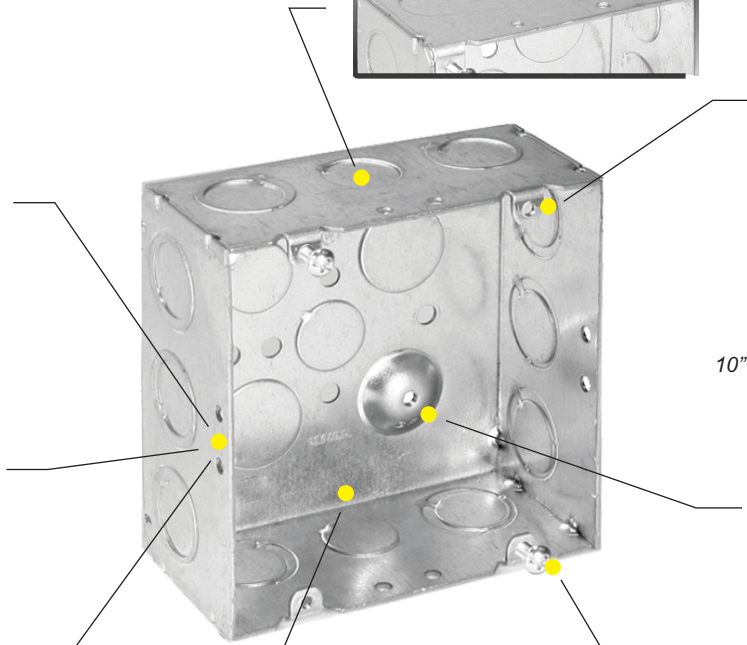
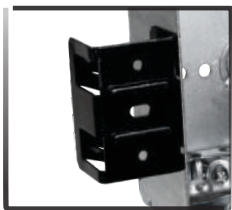
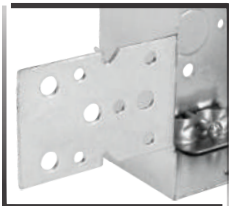

Bracket Specification

BRACKET TYPE	AB	B (for S)	FB (for S)	FB (for FSB)	FB (for R)	FB (for H)	LB	MS	OB	WB
Length	5-7/8"	3"	7-3/8"	5-1/2"	7-1/4"	7"	2 - 3/8"	2-1/2"	6-3/4"	7-1/2"
Width	7/8"	2"	1-9/16"	2-1/8"	3/4"	1"	2 - 23/32"	1-3/8"	1-3/16"	1-9/16"
Offset	0" (Flush)	0" (Flush)	0" (Flush)	9/16"	1/2"	9/16"	1/4"	0" (Flush)	1-5/16"	0" (Flush)

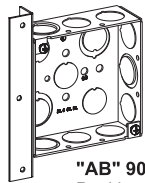

"AB" 90° BRACKET
Positions box against face and side of stud.

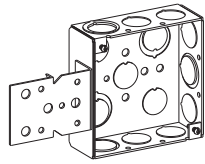

"B" BRACKET for Square Box
Face mounts on front edge of wood stud.

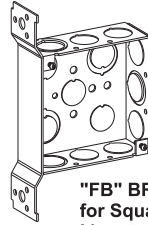

"FB" BRACKET for Square Box
Mounts on flat side of stud.

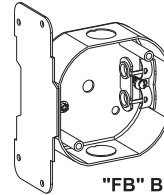

"FB" BRACKET for FSB
Flush-Mounts on flat side of stud or joist.

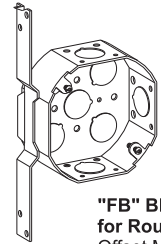

"FB" BRACKET for Round Box
Offset Mounts on flat side of stud or joist.

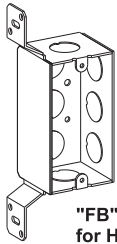

"FB" BRACKET for Handy Box
Mounts on flat side of stud.

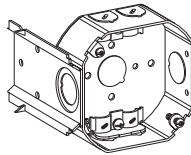

"LB" BRACKET
With spurs, slotted holes for toe-nailing.

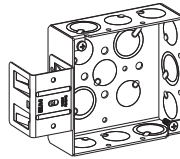

"MS" BRACKET
Self-Gripping Metal Stud Bracket with Box Support Clip.
***Model Revised Feb. 2008**

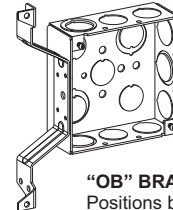

"OB" BRACKET
Positions box away from side of stud for door frame trim clearance.

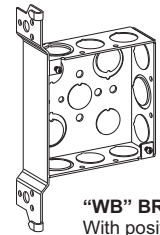

"WB" BRACKET
With positioning spurs to mount box on side of stud.

Clamp Specification

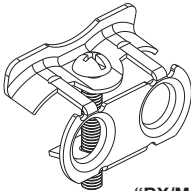

"BX/MC" Clamp
Accommodates Metal Clad Cables from size #14-2 to #10-4
****All MC series boxes are suitable for use with MCAP™-Aluminum, MCAP is a trademark of Southwire Company**

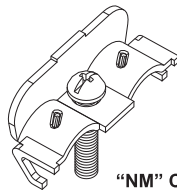

"NM" CLAMP
Accommodates #14-2 to #10-3 Non-Metallic Cables with ground.

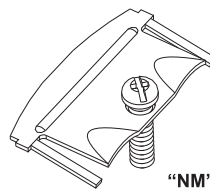

"NM" CLAMP for Pancake Box
Accommodates #14-2 Non-Metallic Sheathed Cables with ground.

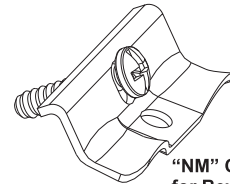

"NM" CLAMP for Beveled Switch Box
Accommodates #14-2 to #10-3 Non-Metallic Sheathed Cables with ground. 45° & 90° Screw Mounting.

Knockout & Pryout Specification

1/2" K.O.

3/4" K.O.

1" K.O.

1-1/4" K.O.

MOON K.O. (MKO)

CONCENTRIC K.O. (CKO)

LOOM PRYOUTS

CIRCULAR PRYOUTS

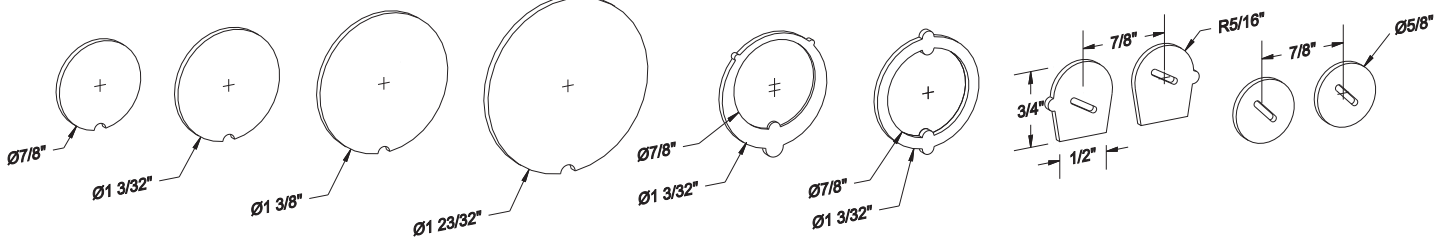

4" CEILING FAN & LIGHT FIXTURE SUPPORT PRODUCTS

WITH NON-METALLIC (NM) SHEATHED CABLE CONNECTOR

Features:

- NM Clamp installed in 1-1/2" & 2-1/8" Boxes
- Easy-to-follow Instruction Sheet
- Complies with NEC 314.27 (A)(C)(D) for **up to 70 lbs. of ceiling fan load or 70 lbs. of fixture load** (for more information see pg. W14)

Note:

- Hardware Pack include variety of fasteners for all installation types
- Replaceable MC Clamp supplied in Hardware Pack

Bar Hanger Features:

- NBH:** New Construction Bar Hanger slides apart to fit joist spacing from 16" to 24"
- OBH:** Old Work Bar Hanger for joist spacing from 16" to 24", No tools necessary for expansion of the bar

BX/MC Clamp Features:

- All MC series boxes are suitable for use with MCAP™-Aluminum
- MCAP is a trademark of Southwire Company

Cat. No.	Depth	Clamp Type	Bracket, Setback or Expansion	Knockouts	Cu. In.	Std. Pkg.
FSB	1-1/2"	BX/MC, NM	-	3 - 1/2", 2 - Loom	15.5	20
FSDB	2-1/8"	BX/MC, NM	-	3 - 1/2", 2 - Loom	21.5	20
FSB-FB	1-1/2"	BX/MC, NM	FB, 1/2"	2 - 1/2", 2 - Loom	15.5	20
FSDB-FB	2-1/8"	BX/MC, NM	FB, 1/2"	2 - 1/2", 2 - Loom	21.5	20
FSB-NBH	1-1/2"	BX/MC, NM	NBH, 16" TO 24"	3 - 1/2", 2 - Loom	15.5	10
FSDB-NBH	2-1/8"	BX/MC, NM	NBH, 16" TO 24"	3 - 1/2", 2 - Loom	21.5	10
FSB-OBH	1-1/2"	BX/MC, NM	OBH, 16" TO 24"	3 - 1/2", 2 - Loom	15.5	10
FSDB-OBH	2-1/8"	BX/MC, NM	OBH, 16" TO 24"	3 - 1/2", 2 - Loom	21.5	10
FS4PB	1/2"	-	-	2 - 1/2"	5.8	20
FS4PB-NBH	1/2"	-	NBH, 16" TO 24"	2 - 1/2"	5.8	10

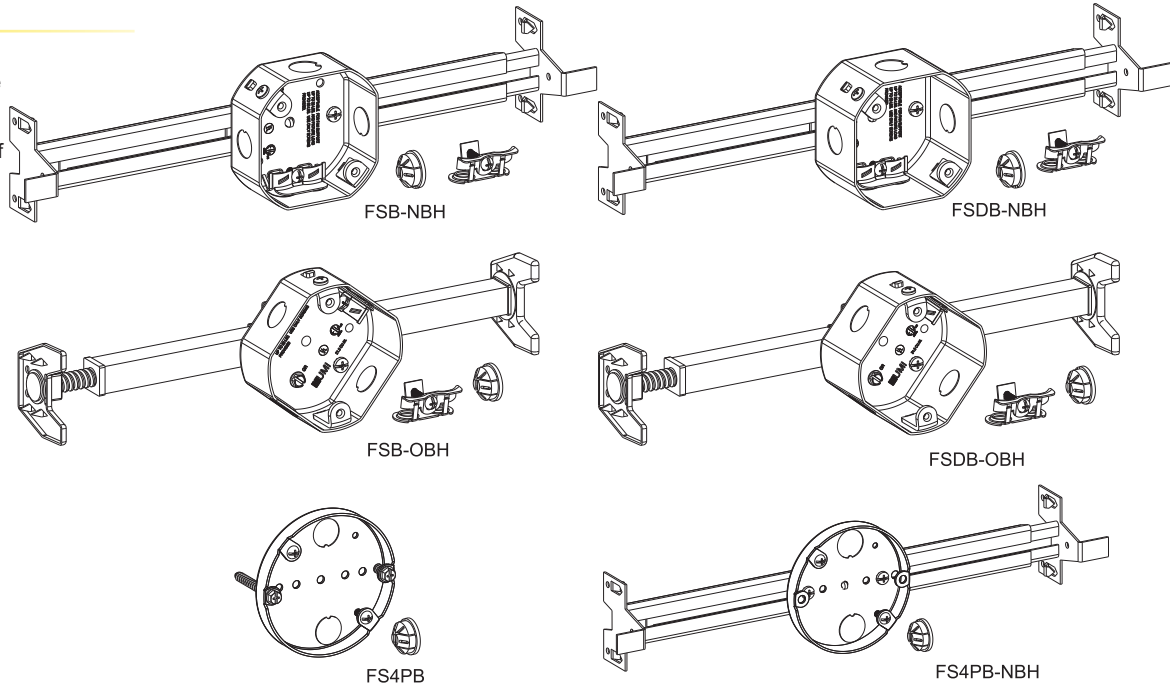
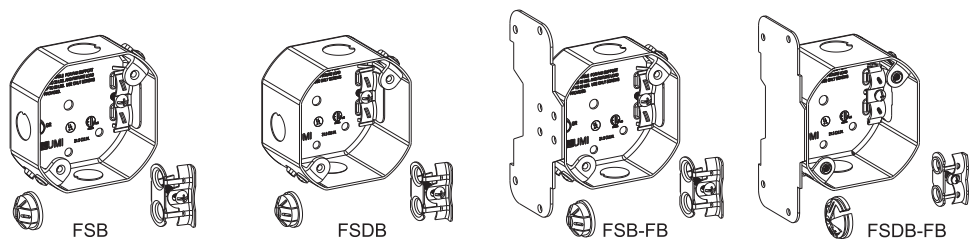

FAN SUPPORT BAR HANGERS

Cat. No.	Description	Std. Pkg.
FS-NBH	16" to 24" Adjustable New Construction Bar Hanger for use with Fan Support Boxes	10
FS-OBH	16" to 24" Adjustable Old Work Bar Hanger for use with Fan Support Boxes	10

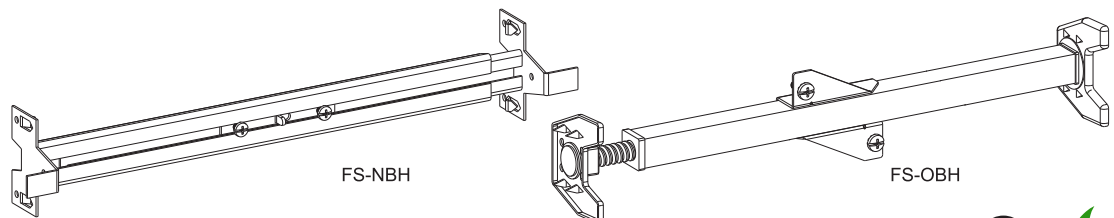



3-3/8" & 4" ROUND PANCAKE BOXES

Note:
• Not for use as Ceiling Fan Support Boxes (See Page A1)

Cat. No.	Depth	Clamp Type	Knockouts	Box Diameter	Cu. In.	Std. Pkg.
3PB-NM	1/2"	NM	1 - 1/2", 4 - Circ. Pryouts	3-3/8"	3.9	50
3PDB-NM	3/4"	NM	1 - 1/2", 4 - Circ. Pryouts	3-3/8"	5.0	50
4PB	1/2"	-	5 - 1/2"	4"	5.8	50
4PB-NM	1/2"	NM	3 - 1/2", 4 - Circ. Pryouts	4"	5.8	50

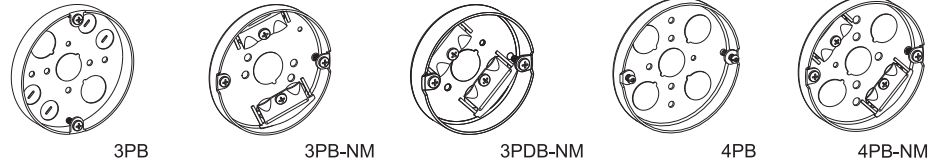

3-1/2" OCTAGON (30) BOXES & EXTENSION RING

DRAWN
1-1/2" DEEP
9.0 Cu. In.

Cat. No.	Bracket & Setback	Knockouts		Std. Pkg.
		Sides	Bottom	
3RB-50	-	4 - 1/2"	1 - 1/2"	50
3RB-50-FB	FB, 1/2"	3 - 1/2"	1 - 1/2"	50
3RB-50-EXT	-	4 - 1/2"	-	50

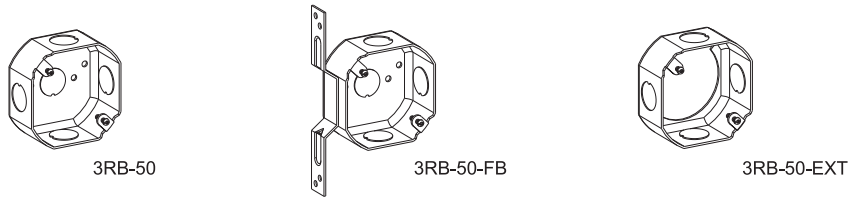

3-1/2" OCTAGON (30) BOXES

DRAWN
1-1/2" DEEP
9.0 Cu. In.

WITH NON-METALLIC (NM)
SHEATHED CABLE CLAMPS

Cat. No.	Bracket & Setback	Knockouts		Std. Pkg.
		Sides	Bottom	
3RB-NM	-	2 - 1/2", 4 - Loom	1 - 1/2"	50
3RB-NM-E NEW	Ears	2 - 1/2", 4 - Loom	1 - 1/2"	50
3RB-NM-FB	FB, 1/2"	1 - 1/2", 4 - Loom	1 - 1/2"	50

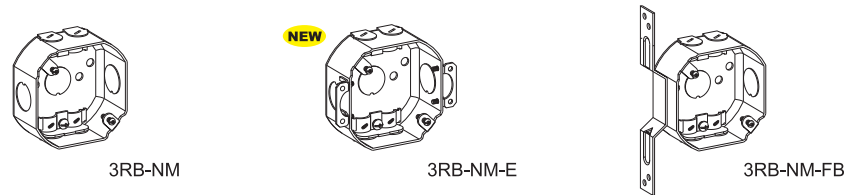

3-1/2" ROUND COVERS

Cat. No.	Description	Std. Pkg.
3RBC	Flat, Blank	50
3RBCK	Flat, 1/2" KO	50
3RC-TS	Flat, Toggle Switch	50
3RC-DR	Flat, Duplex Receptacle	50
3RC-SR	Flat, 1.406" Diameter, 15A Single Receptacle	50
3RC-PO	Flat, 1.594" Diameter, 20A Power Outlet	50

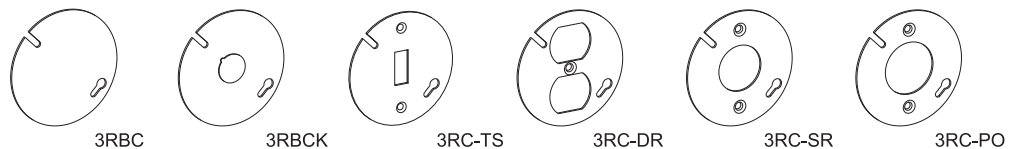

4" OCTAGON (40) BOXES

DRAWN

1-1/2" DEEP

15.5 Cu. In.

Cat. No.	Features	Knockouts		Std. Pkg.
		Sides	Bottom	
D4RB-50	Drawn Box	4 - 1/2"	5 - 1/2"	50
D4RB-50/75	Drawn Box	2 - 1/2", 2 - 3/4"	3 - 1/2", 2 - 3/4"	50
D4RB-75	Drawn Box	4 - 3/4"	3 - 1/2", 2 - 3/4"	50

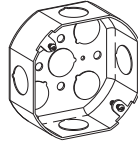

D4RB-50

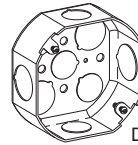

D4RB-50/75

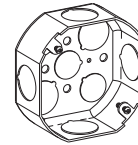

D4RB-75

4" OCTAGON (40) BOXES & EXTENSION RINGS

WELDED

1-1/2" DEEP

15.5 Cu. In.

Bar Hanger Features:

- **BHA:** Adjustable Bar Hanger allows installation of box anywhere along length of stud
- 4RB-50-BHA includes 3/8" - 18 NPS trade sized stud to accommodate fixture stem

Cat. No.	Bracket & Setback	Knockouts		Std. Pkg.
		Sides	Bottom	
4RB-50	-	4 - 1/2"	5 - 1/2"	50
4RB-MKO	-	2 - 1/2", 2 - MKO	3 - 1/2", 2 - 3/4"	50
4RB-50-FB	FB, 1/2"	3 - 1/2"	5 - 1/2"	50
4RB-MKO-FB	FB, 1/2"	1 - 1/2", 2 - MKO	3 - 1/2", 2 - 3/4"	50
4RB-50-LB	LB, 1/2"	4 - 1/2"	5 - 1/2"	50
4RB-50-BHA	BHA, 14-1/2" to 22-1/2"	4 - 1/2"	4 - 1/2"	25
4RB-50-EXT	-	4 - 1/2"	-	50
4RB-MKO-EXT	-	2 - 1/2", 2 - MKO	-	50

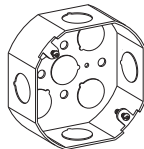

4RB-50

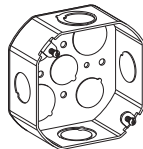

4RB-MKO

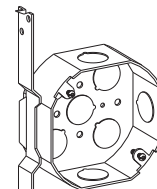

4RB-50-FB

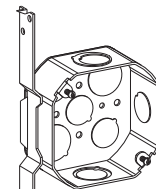

4RB-MKO-FB

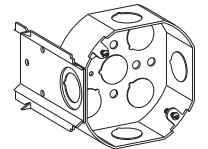

4RB-50-LB

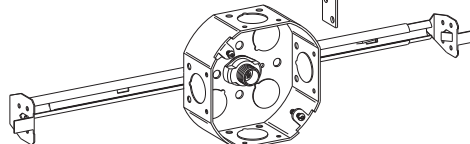

4RB-50-BHA

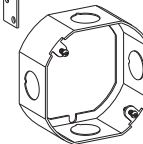

4RB-50-EXT

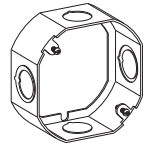

4RB-MKO-EXT

4" OCTAGON (40) BOXES

WELDED

1-1/2" DEEP

15.5 Cu. In.

WITH NON-METALLIC (NM) SHEATHED CABLE CLAMPS

Cat. No.	Bracket & Setback	Knockouts		Std. Pkg.
		Sides	Bottom	
4RB-NM	-	2 - 1/2", 4 - Loom	1 - 1/2"	50
4RB-NM-E	Ears	2 - 1/2", 4 - Loom	1 - 1/2"	50
4RB-NM-FB	FB, 1/2"	1 - 1/2", 4 - Loom	1 - 1/2"	50
4RB-NM-LB	LB, 1/2"	2 - 1/2", 4 - Loom	1 - 1/2"	50
4RB-NM-SG	Swing Bracket - Old Work	4 - Loom	1 - 1/2"	50
4RB-NM-BHA	BHA, 14-1/2" to 22-1/2"	2 - 1/2", 4 - Loom	-	25

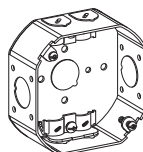

4RB-NM

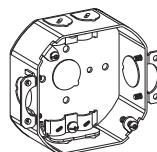

4RB-NM-E

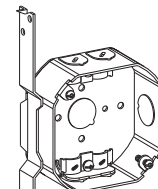

4RB-NM-FB

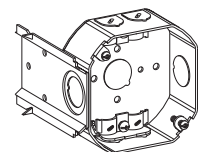

4RB-NM-LB

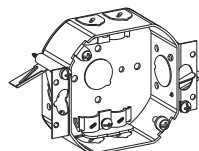

4RB-NM-SG

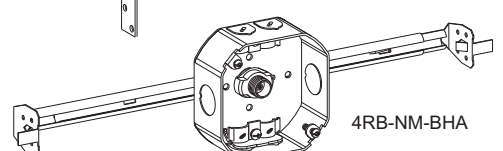

4RB-NM-BHA

• **600V** MKO's and CKO's suitable for bonding without any additional bonding means up to 600V

• Visit www.ul.com or QCIT Guide on page W1 for more information

4" OCTAGON (40) BOXES

WELDED

1-1/2" DEEP

15.5 Cu. In.

BX/MC Clamp Features:

- All MC series boxes are suitable for use with MCAP™-Aluminum
- MCAP is a trademark of Southwire Company

Cat. No.	Bracket & Setback	Knockouts		Std. Pkg.
		Sides	Bottom	
4RB-MC	-	2 - 1/2", 4 - Loom	1 - 1/2"	50
4RB-MC-E	Ears	2 - 1/2", 4 - Loom	1 - 1/2"	50
4RB-MC-FB	FB, 1/2"	1 - 1/2", 4 - Loom	1 - 1/2"	50
4RB-MC-LB	LB, 1/2"	2 - 1/2", 4 - Loom	1 - 1/2"	50
4RB-MC-BHA	BHA, 14-1/2" to 22-1/2"	2 - 1/2", 4 - Loom	-	25

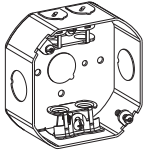

4RB-MC

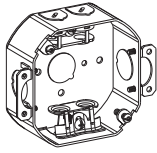

4RB-MC-E

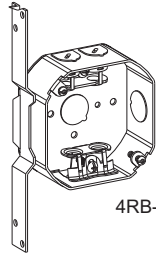

4RB-MC-FB

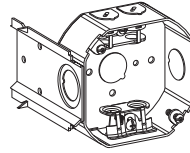

4RB-MC-LB

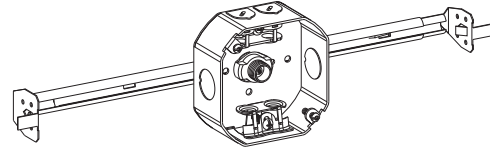

4RB-MC-BHA

See Page A3 for BHA Description

4" OCTAGON (40)

DEEP BOXES

WELDED

2-1/8" DEEP

21.5 Cu. In.

Cat. No.	Bracket & Setback	Knockouts		Std. Pkg.
		Sides	Bottom	
4RDB-MKO	-	2 - 1/2", 2 - MKO	3 - 1/2", 2 - 3/4"	50
4RDB-MKO-FB	FB, 1/2"	1 - 1/2", 2 - MKO	3 - 1/2", 2 - 3/4"	25

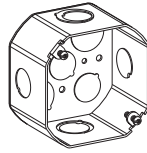

4RDB-MKO

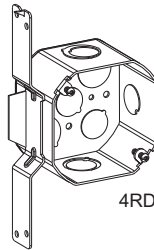

4RDB-MKO-FB

4" OCTAGON (40)

DEEP BOXES

WELDED

2-1/8" DEEP

21.5 Cu. In.

Cat. No.	Bracket & Setback	Knockouts		Std. Pkg.
		Sides	Bottom	
4RDB-MC	-	2 - MKO, 4 - Loom	1 - 1/2"	50
4RDB-MC-FB	FB, 1/2"	1 - MKO, 4 - Loom	1 - 1/2"	25
4RDB-MC-LB	LB, 1/2"	2 - MKO, 4 - Loom	1 - 1/2"	25

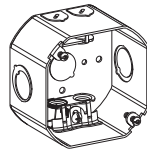

4RDB-MC

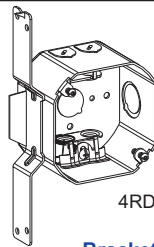

4RDB-MC-FB

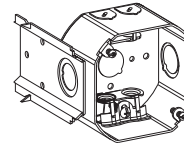

4RDB-MC-LB

WITH METAL CLAD (BX/MC)
CABLE CLAMPS

4" OCTAGON (40)

DEEP BOXES

WELDED

2-1/8" DEEP

21.5 Cu. In.

Cat. No.	Bracket & Setback	Knockouts		Std. Pkg.
		Sides	Bottom	
4RDB-NM	-	2 - MKO, 4 - Loom	1 - 1/2"	50
4RDB-NM-FB	FB, 1/2"	1 - MKO, 4 - Loom	1 - 1/2"	25
4RDB-NM-LB	LB, 1/2"	2 - MKO, 4 - Loom	1 - 1/2"	25

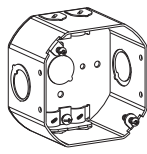

4RDB-NM

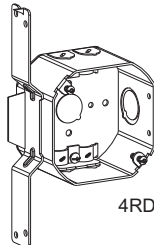

4RDB-NM-FB

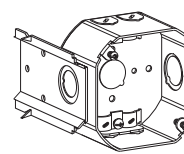

4RDB-NM-LB

WITH NON-METALLIC (NM)
SHEATHED CABLE CLAMPS

- 600V** MKO's and CKO's suitable for bonding without any additional bonding means up to 600V
- Visit www.ul.com or QCIT Guide on page W1 for more information



4" ROUND COVERS FLAT OR DRAWN

*Use with 40 boxes (page A3,4)
or 4" concrete boxes
(page A27)*

*Only fits 4" Concrete Boxes

Cat. No.	Description	Cu. Inch	Std. Pkg.
4RBC	Flat, Blank (Octagonal)	-	50
*4RBC-R	Flat, Blank (Round)	-	50
4RBCK	Flat, 1/2" KO	-	50
4RBC-MKO	Flat, MKO	-	50
4RC-TS	Flat, Toggle Switch	-	50
4RC-DR	Flat, Duplex Receptacle	-	50
4RC-SR	Flat, 1.4" Dia. Single Receptacle	-	50
4RC-PO	Flat, 1.6" Dia. Power Outlet	-	50
*4R000	Flat, Open, Ears 2-3/4" O.C.	-	50
*4R000S NEW	Flat, Open, Ears 2-3/4" O.C. Universal Mounting	-	25
*4R050	Raised 1/2", Open, Ears 2-3/4" O.C.	3.0	50
*4R058	Raised 5/8", Open, Ears 2-3/4" O.C.	4.0	50
*4R075	Raised 3/4", Open, Ears 2-3/4" O.C.	5.0	50
*4R100	Raised 1", Open, Ears 2-3/4" O.C.	6.8	25
*4R125	Raised 1-1/4", Open, Ears 2-3/4" O.C.	8.5	25
*4R150	Raised 1-1/2", Open, Ears 2-3/4" O.C.	9.7	25
*4R200	Raised 2", Open, Ears 2-3/4" O.C.	12.9	25
*4R1000 NEW	Flat, 1-Gang Device Ring	-	50
*4R1058 NEW	Raised 5/8", 1-Gang Device Ring	3.5	50

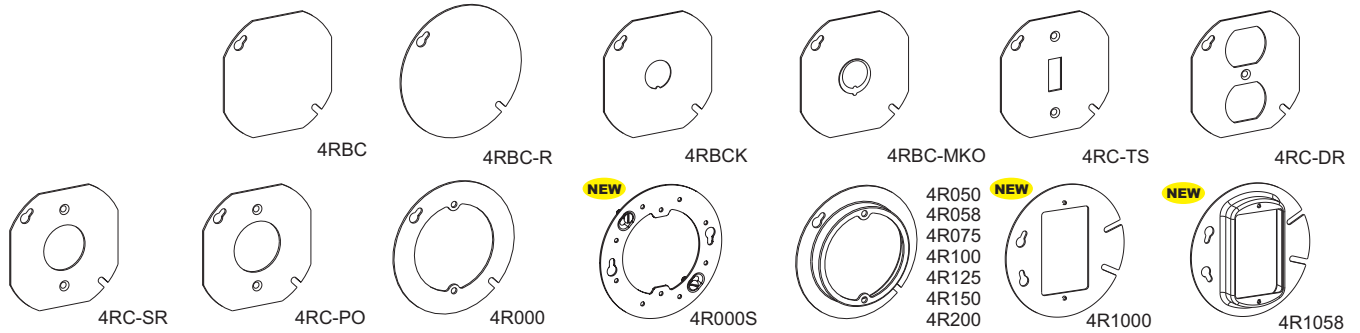

4" SWIVEL-TYPE COVER PLATES

Features:

- 20° Swivel Angle
- Complies with NEC 314.27 (A)(D) for up to 90 lbs. of fixture load (for more information see pg. W14)

Cat. No.	Description	Swivel Thread Size	Std. Pkg.
SCR-75	4" Round Swivel-Type Cover	3/4" Plus 1/2" Reducing Bushing	25
SCS-75	4" Square Swivel-Type Cover	3/4" Plus 1/2" Reducing Bushing	25



*Optional 1/2" Conduit Adapter Included

5" ROUND CLOSURE PLATES WITH UNIVERSAL-MOUNT STRAP

Features:

- For covering up to 4" Round and Octagonal Boxes

Cat. No.	Description	Color	Std. Pkg.
CP-5	Hard Aluminum 5" dia. Blank Cover Plate	White	50
CP-5NM NEW	Non-metallic 5-3/8" dia. Blank Cover Plate	White	50

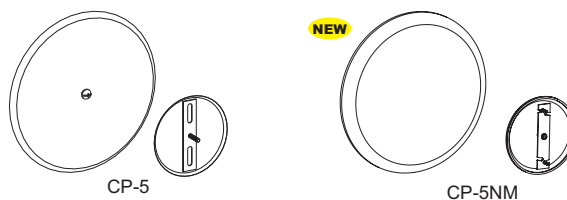

4" SQUARE (4S) SHALLOW BOX

DRAWN

1-1/4" DEEP

18.0 Cu. In.

WITH RAISED GROUND EMBOSS & 10-32 GROUND SCREW

Cat. No.	Knockouts		Std. Pkg.
	Sides	Bottom	
D4SSB-50	10 - 1/2"	4 - 1/2"	50

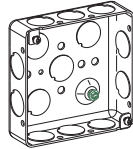

D4SSB-50

4" SQUARE (4S) BOXES

DRAWN

1-1/2" DEEP

21.0 Cu. In.

WITH RAISED GROUND EMBOSS & 10-32 GROUND SCREW

Pigtail Features:

- 7" Solid Cu. #12AWG Pigtail
- Pre-assembled with Ground Emboss and 10-32 Ground Screw

Cat. No.	Bracket & Setback	Knockouts		Std. Pkg.
		Sides	Bottom	
D4SB-50	-	12 - 1/2"	4 - 1/2"	50
D4SB-50/75	-	8 - 1/2", 4 - 3/4"	2 - 1/2", 2 - 3/4"	50
D4SB-50/75-PT	-	8 - 1/2", 4 - 3/4"	2 - 1/2", 2 - 3/4"	50
D4SB-75	-	8 - 3/4"	2 - 1/2", 2 - 3/4"	50
D4SB-75-PT	-	8 - 3/4"	2 - 1/2", 2 - 3/4"	50
D4SB-CKO	-	8 - 1/2", 4 - CKO	2 - 1/2", 2 - 3/4"	50
D4SB-50-FB	FB, Flush	9 - 1/2"	4 - 1/2"	24
D4SB-50/75-FB	FB, Flush	6 - 1/2", 3 - 3/4"	2 - 1/2", 2 - 3/4"	24
D4SB-CKO-FB	FB, Flush	6 - 1/2", 3 - CKO	2 - 1/2", 2 - 3/4"	24



D4SB-50

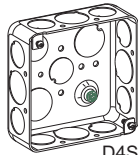

D4SB-50/75

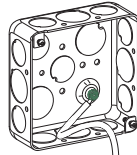

D4SB-50/75-PT

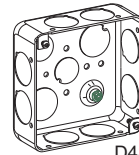

D4SB-75

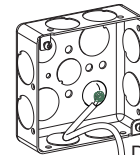

D4SB-75-PT



D4SB-CKO

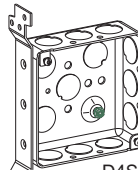

D4SB-50-FB

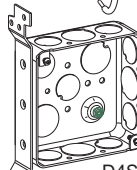

D4SB-50/75-FB

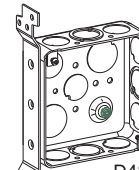

D4SB-CKO-FB

4" SQUARE (4S) DEEP BOXES

DRAWN

2-1/8" DEEP

30.3 Cu. In.

WITH RAISED GROUND EMBOSS & 10-32 GROUND SCREW

Cat. No.	Bracket & Setback	Knockouts		Std. Pkg.
		Sides	Bottom	
D4SDB-50	-	12 - 1/2"	2 - 1/2", 2 - 3/4"	24
D4SDB-50-FB	FB, Flush	9 - 1/2"	2 - 1/2", 2 - 3/4"	24
D4SDB-50/75	-	8 - 1/2", 4 - 3/4"	2 - 1/2", 2 - 3/4"	24
D4SDB-75	-	8 - 3/4"	2 - 1/2", 2 - 3/4"	24
D4SDB-75-FB	FB, Flush	6 - 3/4"	2 - 1/2", 2 - 3/4"	24
D4SDB-CKO	-	8 - 1/2", 4 - CKO	2 - 1/2", 2 - 3/4"	24
D4SDB-CKO-FB	FB, Flush	6 - 1/2", 3 - CKO	2 - 1/2", 2 - 3/4"	24

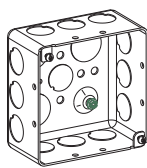

D4SDB-50

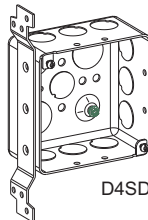

D4SDB-50-FB

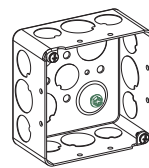

D4SDB-50/75

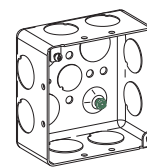

D4SDB-75

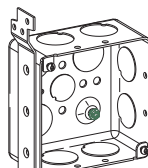

D4SDB-75-FB

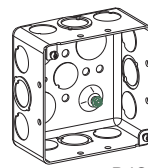

D4SDB-CKO

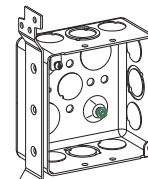

D4SDB-CKO-FB

- **600V** MKO's and CKO's suitable for bonding without any additional bonding means up to 600V
- Acceptable for use in 2-hour rated walls
- Visit www.ul.com or QCIT Guide on page W1 for more information



File E227970

4" SQUARE (4S) BOXES & EXTENSION RINGS

WELDED

1-1/2" DEEP

21.0 Cu. In.

WITH RAISED GROUND EMBOSS (EXCEPT FOR BRACKETED AND EXTENSION BOXES)

Metal Stud Bracket Features:

- U.S. Patent No.: 8,262,043
- Metal Stud (MS) Bracket engages on either side of metal stud
- *Model Revised Feb. 2008

Boxes with Pigtail Features:

- 7" Solid Cu. #12AWG Pigtail Pre-assembled with Ground Emboss and 10-32 Ground Screw
- **600V** MKO's and CKO's suitable for bonding without any additional bonding means up to 600V
- Acceptable for use in 2-hour rated walls
- Visit www.ul.com or QCIT Guide on page W1 for more information

Cat. No.	Bracket & Setback	Knockouts		Std. Pkg.
		Sides	Bottom	
4SB-50	-	12 - 1/2"	4 - 1/2"	50
4SB-50-FB	FB, Flush	9 - 1/2"	5 - 1/2"	24
4SB-50/75	-	8 - 1/2", 4 - 3/4"	2 - 1/2", 2 - 3/4"	50
4SB-50/75-PT NEW	-	8 - 1/2", 4 - 3/4"	2 - 1/2", 2 - 3/4"	50
4SB-50/75-FB	FB, Flush	6 - 1/2", 3 - 3/4"	3 - 1/2", 2 - 3/4"	24
4SB-50/75-MS*	MS, Self-Gripping + Box Support Clip	6 - 1/2", 3 - 3/4"	3 - 1/2", 2 - 3/4"	24
4SB-75	-	8 - 3/4"	2 - 1/2", 2 - MKO	50
4SB-75-FB	FB, Flush	6 - 3/4"	1 - 1/2", 4 - 3/4"	24
4SB-MKO	-	8 - 1/2", 4 - MKO	2 - 1/2", 2 - MKO	50
4SB-MKO-PT	-	8 - 1/2", 4 - MKO	2 - 1/2", 2 - MKO	50
4SB-MKO-FB	FB, Flush	6 - 1/2", 3 - MKO	3 - 1/2", 2 - MKO	24
4SB-MKO-B	B, Flush	6 - 1/2", 3 - MKO	3 - 1/2", 2 - MKO	24
4SB-MKO-AB	AB, Flush	6 - 1/2", 3 - MKO	3 - 1/2", 2 - MKO	24
4SB-MKO-MS*	MS, Self-Gripping + Box Support Clip	6 - 1/2", 3 - MKO	3 - 1/2", 2 - MKO	24
4SB-MKO-OB	OB, 1-5/16"	6 - 1/2", 3 - MKO	3 - 1/2", 2 - MKO	24
4SB-MKO-WB	WB, Flush	6 - 1/2", 3 - MKO	3 - 1/2", 2 - MKO	24
4SB-50-EXT	-	12 - 1/2"	-	50
4SB-50/75-EXT	-	8 - 1/2", 4 - 3/4"	-	50
4SB-MKO-EXT	-	8 - 1/2", 4 - MKO	-	50
4SB-MKO-EHB	Extension Ring to Handy Box	8 - 1/2", 4 - MKO	-	50

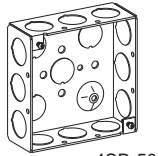

4SB-50

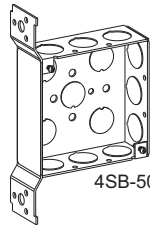

4SB-50-FB

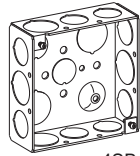

4SB-50/75

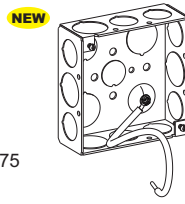

4SB-50/75-PT

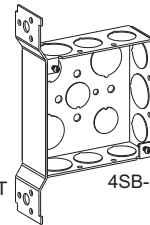

4SB-50/75-FB

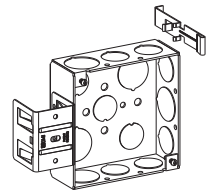

4SB-50/75-MS*

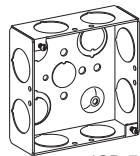

4SB-75

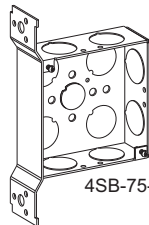

4SB-75-FB

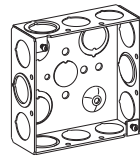

4SB-MKO

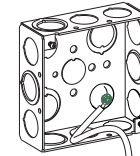

4SB-MKO-PT

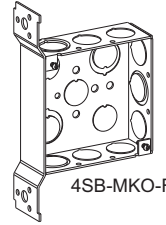

4SB-MKO-FB

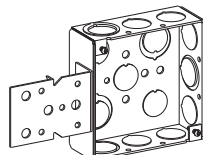

4SB-MKO-B

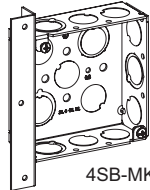

4SB-MKO-AB

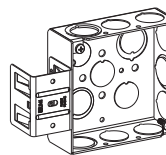

4SB-MKO-MS*

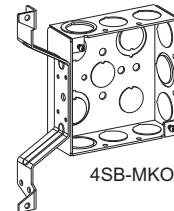

4SB-MKO-OB

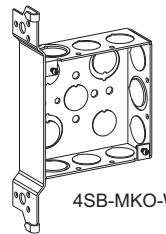

4SB-MKO-WB

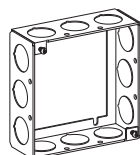

4SB-50-EXT

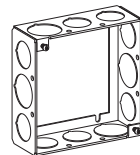

4SB-50/75-EXT

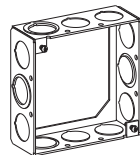

4SB-MKO-EXT

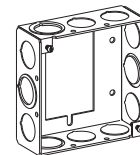

4SB-MKO-EHB

4" SQUARE (4S) BOXES

WELDED 1-1/2" DEEP

21.0 Cu. In.

WITH NON-METALLIC (NM) SHEATHED CABLE CLAMPS

Metal Stud Bracket Features:

- U.S. Patent No.: 8,262,043
- Metal Stud (MS) Bracket engages on either side of metal stud
- *Model Revised Feb. 2008

Cat. No.	Bracket & Setback	Knockouts		Std. Pkg.
		Sides	Bottom	
4SB-NM	-	4 - 1/2", 2 - MKO, 4 - Loom	1 - 1/2"	50
4SB-NM-B	B, Flush	2 - 1/2", 1 - MKO, 4 - Loom	1 - 1/2"	24
4SB-NM-FB	FB, Flush	2 - 1/2", 1 - MKO, 4 - Loom	1 - 1/2"	24
4SB-NM-MS*	MS, Self-Gripping + Box Support Clip	2 - 1/2", 1 - MKO, 4 - Loom	1 - 1/2"	24
4SB-NM-WB	WB, Flush	2 - 1/2", 1 - MKO, 4 - Loom	1 - 1/2"	24

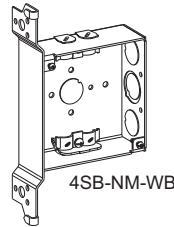
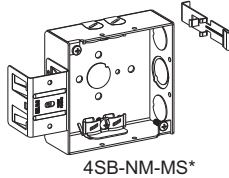
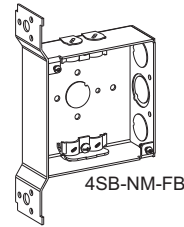
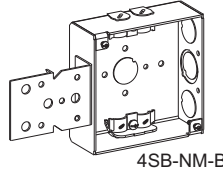
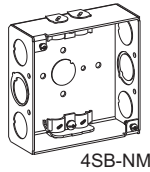

4" SQUARE (4S) BOXES

WELDED 1-1/2" DEEP

21.0 Cu. In.

WITH METAL CLAD (BX/MC) CABLE CLAMPS

BX/MC Clamp Features:

- All MC series boxes are suitable for use with MCAP™-Aluminum
- MCAP is a trademark of Southwire Company

Cat. No.	Bracket & Setback	Knockouts		Std. Pkg.
		Sides	Bottom	
4SB-MC	-	4 - 1/2", 2 - MKO, 4 - Loom	1 - 1/2"	50
4SB-MC-PT NEW	-	4 - 1/2", 2 - MKO, 4 - Loom	1 - 1/2"	50
4SB-MC-B	B, Flush	2 - 1/2", 1 - MKO, 4 - Loom	1 - 1/2"	24
4SB-MC-FB	FB, Flush	2 - 1/2", 1 - MKO, 4 - Loom	1 - 1/2"	24
4SB-MC-FB-PT NEW	FB, Flush	2 - 1/2", 1 - MKO, 4 - Loom	1 - 1/2"	24
4SB-MC-WB	WB, Flush	2 - 1/2", 1 - MKO, 4 - Loom	1 - 1/2"	24
4SB-MC-MS*	MS + Box Support Clip	2 - 1/2", 1 - MKO, 4 - Loom	1 - 1/2"	24
4SB-MC-MS-PT*	MS + Box Support Clip	2 - 1/2", 1 - MKO, 4 - Loom	1 - 1/2"	24

Boxes with Pigtail Features:

- 7" Solid Cu. #12AWG Pigtail
- Pre-assembled with Ground Emboss and 10-32 Ground Screw

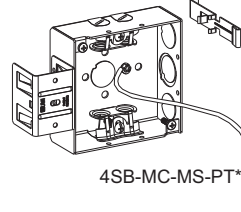
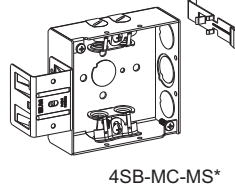
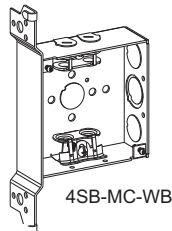
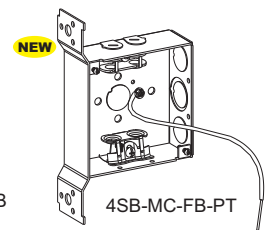
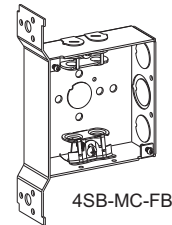
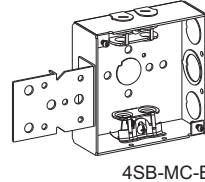
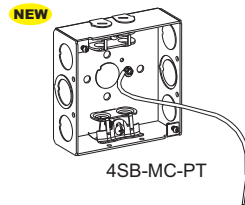
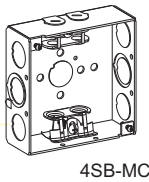

- **600V** MKO's and CKO's suitable for bonding without any additional bonding means up to 600V
- Acceptable for use in 2-hour rated walls
- Visit www.ul.com or QCIT Guide on page W1 for more information

4S Deep Boxes

4" SQUARE (4S) DEEP BOXES

WELDED

2-1/8" DEEP

30.3 Cu. In.

WITH RAISED GROUND EMBOSS
(EXCEPT FOR BRACKETED BOXES)

Metal Stud Bracket Features:

- U.S. Patent No.: 8,262,043 Metal Stud (MS) Bracket engages on either side of metal stud
- *Model Revised Feb. 2008

Boxes with Pigtail Features:

- 7" Solid Cu. #12AWG Pigtail pre-assembled with Ground Emboss and 10-32 Ground Screw

Note:

- MKO configuration changed October 2012
- **600V** MKO's and CKO's suitable for bonding without any additional bonding means up to 600V
- Acceptable for use in 2-hour rated walls
- Visit www.ul.com or QCIT Guide on page W1 for more information

Cat. No.	Bracket & Setback	Knockouts		Std. Pkg.
		Sides	Bottom	
4SDB-50	-	12 - 1/2"	4 - 1/2"	24
4SDB-50-FB	FB, Flush	9 - 1/2"	5 - 1/2"	24
4SDB-50/75	-	8 - 1/2", 4 - 3/4"	2 - 1/2", 2 - 3/4"	24
4SDB-50/75-FB	FB, Flush	6 - 1/2", 3 - 3/4"	3 - 1/2", 2 - 3/4"	24
4SDB-50/75-MS*	MS, Self-Gripping + Box Support Clip	6 - 1/2", 3 - 3/4"	3 - 1/2", 2 - 3/4"	24
4SDB-75	-	8 - 3/4"	2 - 1/2", 2 - MKO	24
4SDB-75-FB	FB, Flush	6 - 3/4"	1 - 1/2", 4 - 3/4"	24
4SDB-75/100	-	4 - 3/4", 4 - 1"	2 - 1/2", 2 - 3/4"	24
4SDB-100	-	8 - 1"	2 - 1/2", 2 - 3/4"	24
4SDB-100-FB	FB, Flush	6 - 1"	3 - 1/2", 2 - 3/4"	24
4SDB-MKO	-	8 - 1/2", 4 - MKO	2 - 1/2", 2 - MKO	24
4SDB-MKO-PT	-	8 - 1/2", 4 - MKO	2 - 1/2", 2 - MKO	24
4SDB-MKO-FB	FB, Flush	6 - 1/2", 3 - MKO	3 - 1/2", 2 - MKO	24
4SDB-MKO-MS*	MS, Self-Gripping + Box Support Clip	6 - 1/2", 3 - MKO	3 - 1/2", 2 - MKO	24
4SDB-MKO-WB	WB, Flush	6 - 1/2", 3 - MKO	3 - 1/2", 2 - MKO	24
4SDB-MKO-EXT	-	8 - 1/2", 4 - MKO	-	24

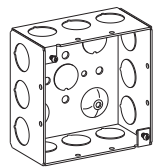

4SDB-50

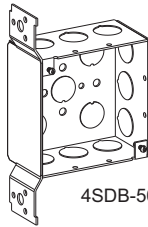

4SDB-50-FB

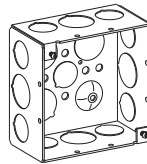

4SDB-50/75

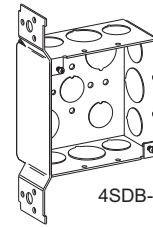

4SDB-50/75-FB

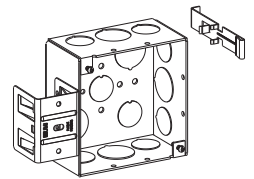

4SDB-50/75-MS*

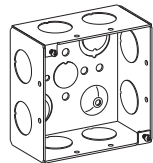

4SDB-75

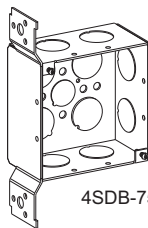

4SDB-75-FB

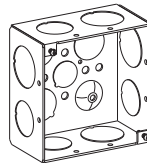

4SDB-75/100

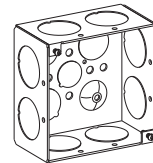

4SDB-100

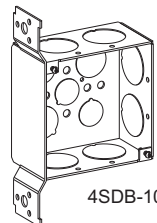

4SDB-100-FB

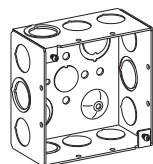

4SDB-MKO

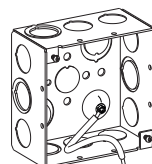

4SDB-MKO-PT

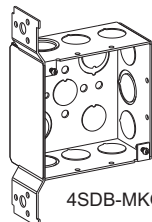

4SDB-MKO-FB

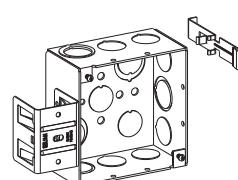

4SDB-MKO-MS*

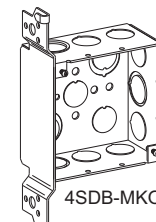

4SDB-MKO-WB

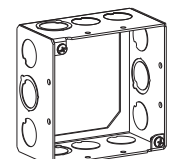

4SDB-MKO-EXT



4" SQUARE (4S) DEEP BOXES

WELDED

2-1/8" DEEP

30.3 Cu. In.

WITH NON-METALLIC (NM)
SHEATHED CABLE CLAMPS

Cat. No.	Bracket & Setback	Knockouts		Std. Pkg.
		Sides	Bottom	
4SDB-NM	-	4 - 1/2", 2-MKO, 4-Loom	1 - 1/2"	24
4SDB-NM-B	B, Flush	2 - 1/2", 1-MKO, 4-Loom	1 - 1/2"	24
4SDB-NM-FB	FB, Flush	2 - 1/2", 1-MKO, 4-Loom	1 - 1/2"	24
4SDB-NM-WB	WB, Flush	2 - 1/2", 1-MKO, 4-Loom	1 - 1/2"	24

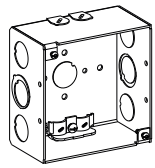

4SDB-NM

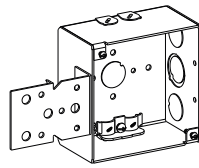

4SDB-NM-B

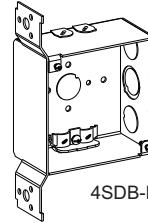

4SDB-NM-FB

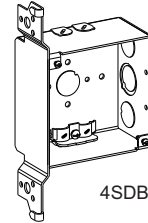

4SDB-NM-WB

4" SQUARE (4S) DEEP BOXES

WELDED

2-1/8" DEEP

30.3 Cu. In.

WITH METAL CLAD (BX/MC)
CABLE CLAMPS

BX/MC Clamp Features:

- All MC series boxes are suitable for use with MCAP™-Aluminum
- MCAP is a trademark of Southwire Company

Cat. No.	Bracket & Setback	Knockouts		Std. Pkg.
		Sides	Bottom	
4SDB-MC	-	4 - 1/2", 2-MKO, 4-Loom	1 - 1/2"	24
4SDB-MC-B	B, Flush	2 - 1/2", 1-MKO, 4-Loom	1 - 1/2"	24
4SDB-MC-FB	FB, Flush	2 - 1/2", 1-MKO, 4-Loom	1 - 1/2"	24
4SDB-MC-FB-PT NEW	FB, Flush	2 - 1/2", 1-MKO, 4-Loom	1 - 1/2"	24
4SDB-MC-MS*	MS, Self-Gripping	2 - 1/2", 1-MKO, 4-Loom	1 - 1/2"	24
4SDB-MC-MS-PT*	MS, Self-Gripping	2 - 1/2", 1-MKO, 4-Loom	1 - 1/2"	24
4SDB-MC-WB	WB, Flush	2 - 1/2", 1-MKO, 4-Loom	1 - 1/2"	24

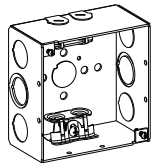

4SDB-MC

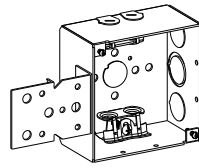

4SDB-MC-B

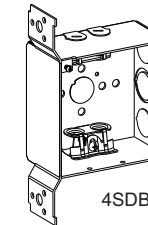

4SDB-MC-FB

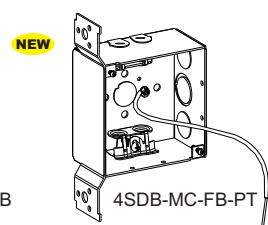

4SDB-MC-FB-PT

Metal Stud Bracket Features:

- U.S. Patent No.: 8,262,043
- Metal Stud (MS) Bracket engages on either side of metal stud
- *Model Revised Feb. 2008

Boxes with Pigtail Features:

- 7" Solid Cu. #12AWG Pigtail pre-assembled with Ground Emboss and 10-32 Ground Screw

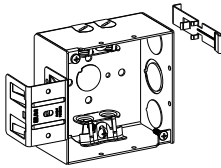

4SDB-MC-MS*

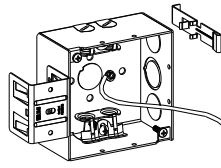

4SDB-MC-MS-PT*

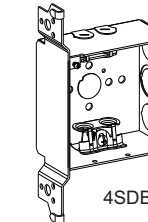

4SDB-MC-WB

4" SQUARE (4S) EXTRA DEEP BOXES

WELDED

3-1/2" DEEP

46.0 Cu. In.

Cat. No.	Bracket & Setback	Knockouts		Std. Pkg.
		Sides	Bottom	
4SEDB-CKO	-	12 - CKO	4 - CKO	24
4SEDB-CKO-FB	FB, 1/2" thru 1-1/4"	10 - CKO	4 - CKO	10

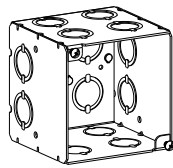

4SEDB-CKO

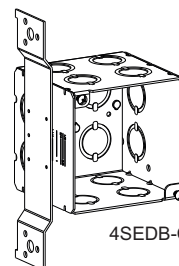

4SEDB-CKO-FB

- 600V MKO's and CKO's suitable for bonding without any additional bonding means up to 600V
- Acceptable for use in 2-hour rated walls
- Visit www.ul.com or QCIT Guide on page W1 for more information



File E227970

4S Deep Boxes (BSA) & 4S Covers

4" SQUARE (4S) DEEP BOXES

WELDED

2-1/8" DEEP

30.3 Cu. In.

WITH RAISED GROUND EMBOSS

Boxes with Pigtail Features:

- 10" Solid Cu. #12AWG Pigtail pre-assembled with Ground Emboss and 10-32 Ground Screw

BSA Features:

- UMI Back Support Arm installed on this box provides support for studs up to 6" deep
- An excellent choice for pre-fab applications

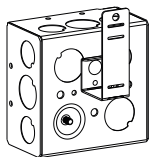

Adjustable Rings Features:

- For more information see Page A13

Note:

- MKO configuration revised October 2012

Cat. No.	Bracket & Setback	Knockouts		Std. Pkg.
		Sides	Bottom	
4SDB-50/75-PT-BSA	With Back Support Arm	8 - 1/2", 4 - 3/4"	1 - 1/2", 2 - 3/4"	24
4SDB-50/75-AB-PT-BSA	With AB, Flush, Back Support Arm	6 - 1/2", 3 - 3/4"	1 - 1/2", 2 - 3/4"	24
4SDB-MKO-PT-BSA	With Back Support Arm	8 - 1/2", 4 - MKO	1 - 1/2", 2 - MKO	24
4SDB-MKO-AB-PT-BSA	With AB, Flush, Back Support Arm	6 - 1/2", 3 - MKO	1 - 1/2", 2 - MKO	24
4SDB-MKO-AR1G	AB, Flush, Back Support Arm w/ 4SA1RG	6 - 1/2", 3 - MKO	1 - 1/2", 2 - MKO	24
4SDB-MKO-AR2G	AB, Flush, Back Support Arm w/ 4SA2RG	6 - 1/2", 3 - MKO	1 - 1/2", 2 - MKO	24

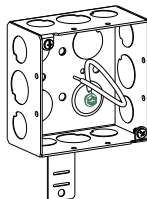

4SDB-50/75-PT-BSA

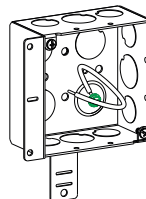

4SDB-50/75-AB-PT-BSA

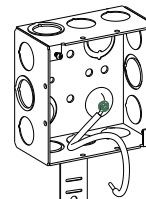

4SDB-MKO-PT-BSA

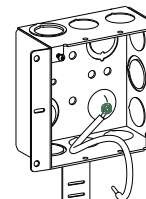

4SDB-MKO-AB-PT-BSA

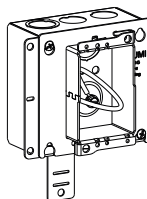

4SDB-MKO-AR1G

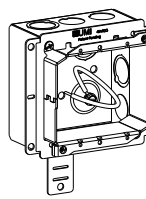

4SDB-MKO-AR2G



4" SQUARE (4S) COVERS

FLAT OR DRAWN

Cat. No.	Description	Cu. Inch	Std. Pkg.
4BC	Flat, Blank	-	50
4BCK	Flat, 1/2" KO	-	50
4BC-MKO	Flat, MKO	-	50
43000	Flat, Open, Ears 2-3/4" O.C.	-	50
43050	Raised 1/2", Open, Ears 2-3/4" O.C.	3.0	50
43058	Raised 5/8", Open, Ears 2-3/4" O.C.	4.0	50
43075	Raised 3/4", Open, Ears 2-3/4" O.C.	5.0	50
43100	Raised 1", Open, Ears 2-3/4" O.C.	6.8	25
43125	Raised 1-1/4", Open, Ears 2-3/4" O.C.	8.5	25
43150	Raised 1-1/2", Open, Ears 2-3/4" O.C.	9.7	25
43200	Raised 2", Open, Ears 2-3/4" O.C.	12.9	25

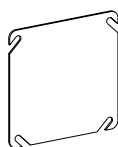

4BC

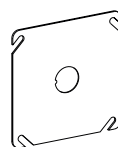

4BCK

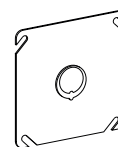

4BC-MKO

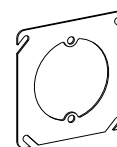

43000

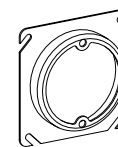

- 43050
- 43075
- 43100
- 43125
- 43150
- 43200

- **600V** MKO's and CKO's suitable for bonding without any additional bonding means up to 600V
- Acceptable for use in 2-hour rated walls
- Visit www.ul.com or QCIT Guide on page W1 for more information



**4" SQUARE (4S)
1-GANG & 2-GANG
DEVICE RINGS
FLAT, DRAWN & TILE (T)**

Cat. No.	Cat. No.	Description	Gangs	Cu. In.	Std. Pkg.
41000	-	Flat	1	-	50
41025	-	Raised 1/4"	1	1.8	50
41050	41050T	Raised 1/2"	1	3.8	50
41058	-	Raised 5/8"	1	4.3	50
41075	41075T	Raised 3/4"	1	5.5	50
41100	41100T	Raised 1"	1	7.5	25
41125	41125T	Raised 1-1/4"	1	9.4	25
41150	41150T	Raised 1-1/2"	1	11.2	25
41200	41200T	Raised 2"	1	14.4	25
42000	-	Flat	2	-	50
42025	-	Raised 1/4"	2	3.0	50
42050	42050T	Raised 1/2"	2	5.8	50
42058	-	Raised 5/8"	2	7.5	50
42075	42075T	Raised 3/4"	2	8.8	50
42100	42100T	Raised 1"	2	11.8	25
42125	42125T	Raised 1-1/4"	2	14.5	25
42150	42150T	Raised 1-1/2"	2	15.5	25
42200	42200T	Raised 2"	2	20.7	25

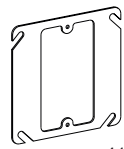

41000

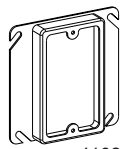

41025
41050
41058
41075
41100
41125
41150
41150
41200

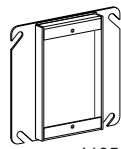

41050T
41075T
41100T
41125T
41150T
41200T

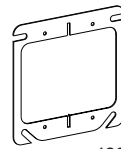

42000

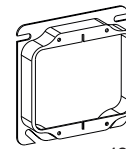

42025
42050
42058
42075
42100
42125
42150
42200

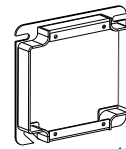

42050T
42075T
42100T
42125T
42150T
42200T

**4" SQUARE (4S) BOXES
LOW-VOLTAGE
PARTITIONS**

Cat. No.	Description	For Use with 2-Gang Rings:	Std. Pkg.
4SP-100	For Use With 1-1/2" Deep Boxes	Flat, 1/4", 1/2", 3/4", 1"	25
4SP-200	For Use With 1-1/2" Deep Boxes	5/8", 1-1/4", 1-1/2", 1-3/4", 2"	25
4SDP-100	For Use With 2-1/8" Deep Boxes	Flat, 1/4", 1/2", 3/4", 1"	25
4SDP-200	For Use With 2-1/8" Deep Boxes	5/8", 1-1/4", 1-1/2", 1-3/4", 2"	25



4SP-100



4SP-200



4SDP-100

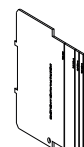

4SDP-200

4S Adjustable Rings & Universal Box Brackets

ADJUSTABLE RINGS

U.S. Patent No.: 7,468,486

Features:

- For use with 4" Square 2-1/8" or deeper boxes
- 1/4" to 1-1/4" adjustability range
- Solution to stocking multiple items
- Provide flexibility at the job site



Cat. No.	Description	Standard	With One Extension Installed		Std. Pkg.
			+ 1GX75	+ 2GX75	
4SAR1G	1-Gang Adjustable ring for 4S Deep Boxes	1/4" to 1-1/4"	1" to 2"	-	25
4SAR2G	2-Gang Adjustable ring for 4S Deep Boxes	1/4" to 1-1/4"	-	1" to 2"	25
UPC	Gangable, Steel Universal Protective Cover protects any device during drywall, painting, routing, mudding & plastering				25
UPCTS	Optional Plastic Insert for UPC to protect Toggle Switch				25

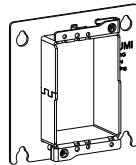

4SAR1G

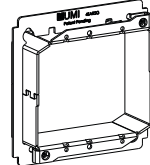

4SAR2G



UPC



UPCTS

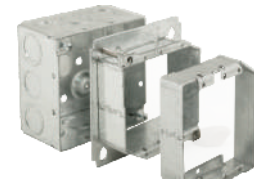

Exploded View

EXTENSIONS

U.S. Patent No.: 7,468,486

Features:

- Extensions ensure flush finish regardless of wall thickness
- Attach to adjustable ring for additional 3/4" of depth
- Mount easily to ring with two 8-32 screws
- Multiple extensions can be installed on one ring



Cat. No.	Description	For Use With	Std. Pkg.
1GX75	1-Gang 3/4" Extension	4SAR1G or 5SAR1G	50
2GX75	2-Gang 3/4" Extension	4SAR2G or 5SAR2G	50

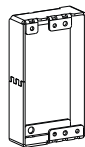

1GX75

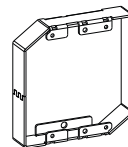

2GX75

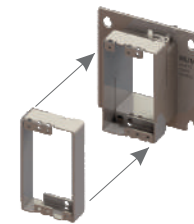

UNIVERSAL BOX BRACKETS

U.S. Patent No.: 7,468,486

Features:

- Accept 4S or 5S boxes in line voltage application
- Mount to any stud, shear wall, 6" X 6" NEMA 1 enclosure, or USB wall and floor brackets.
- Can be used standalone for low voltage communications applications



Cat. No.	Description	To Extend Use	Std. Pkg.
WBAR1G	1-Gang Universal Box Bracket	1GX75	25
WBAR2G	2-Gang Universal Box Bracket	2GX75	25

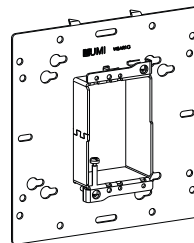

WBAR1G

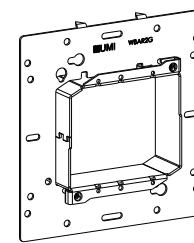

WBAR2G



**4" SQUARE (4S)
INDUSTRIAL COVERS
RAISED 1/2"**

7.0 Cu. In.

**WITH CRUSHED CORNERS
(Except for 4414, 4424, 4444)**

Cat. No.	Description	Std. Pkg.
4400	Blank	50
4401	Toggle Switch	50
4402	Duplex Receptacle	50
4403	Single Receptacle, 15A, 1.406" diameter	50
4404	GFCI or Decorative Switch	50
4405	Power Outlet, 20A, 1.60" diameter	50
4406	Power Outlet, 30A Locking, 1.750" diameter	50
4407	Power Outlet, 40 to 50A, 2.155" diameter	50
4408	Power Outlet, 30 to 60A, 2.625" diameter	50
4409	Power Outlet, 40 to 50A, 2.155" diameter, off-centered	50
4411	2 Toggle Switches	50
4412	Toggle Switch / Duplex	50
4413	Toggle Switch / Single Receptacle, 1.406" diameter	50
4414	Toggle Switch / GFCI	50
4422	2 Duplex Receptacles	50
4423	Duplex / Single Receptacle, 1.406" diameter	50
4424	Duplex / GFCI	50
4433	2 Single Receptacles, 1.406" dia. each	50
4444	2 GFCIs or 2 Decorative Switches	50

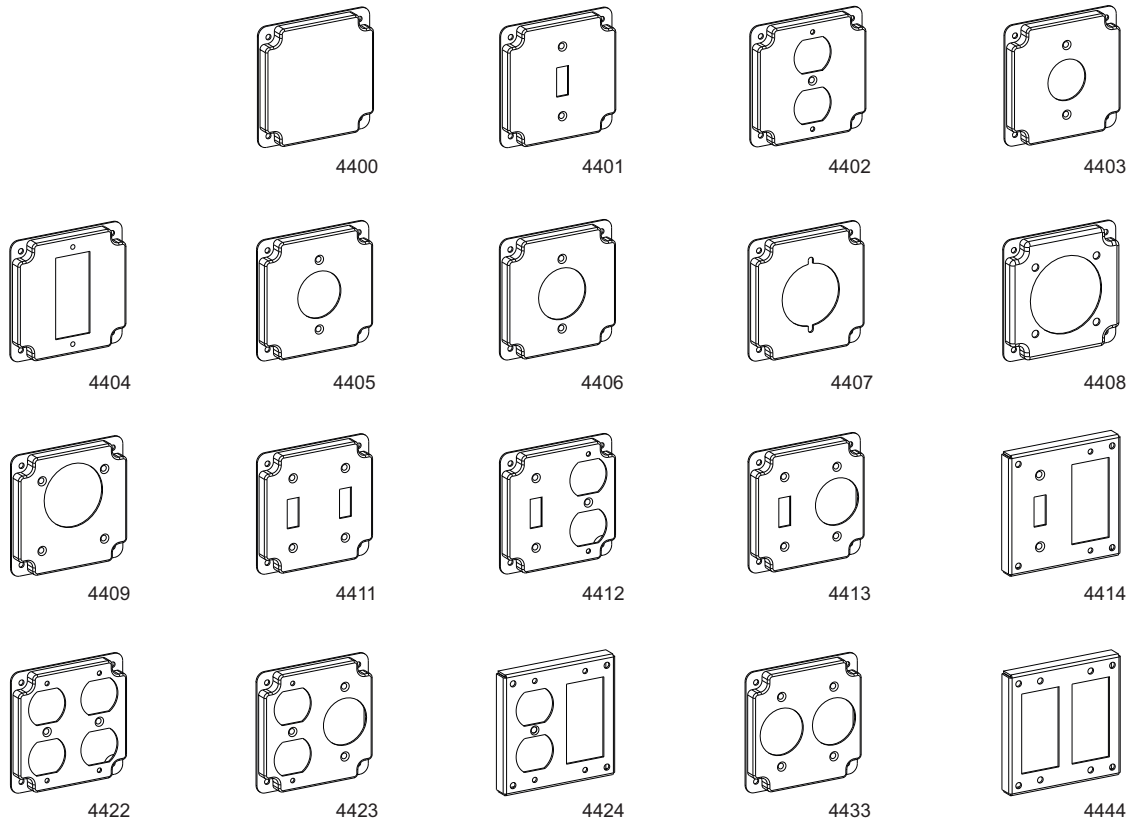

4-11/16" SQUARE (5S) BOXES

DRAWN

2-1/8" DEEP

42.0 Cu. In.

WITH RAISED GROUND EMBOSS & 10-32 GROUND SCREW



Cat. No.	Bracket & Setback	Knockouts		Std. Pkg.
		Sides	Bottom	
D5SDB-50/75	-	8 - 1/2", 4 - 3/4"	2 - 1/2", 2 - 3/4"	24
D5SDB-50/75-FB	FB, Flush	6 - 1/2", 3 - 3/4"	2 - 1/2", 2 - 3/4"	24
D5SDB-CKO	-	2 - 1/2", 10 - CKO	2 - 1/2", 2 - 3/4"	24
D5SDB-CKO-FB	FB, Flush	2 - 1/2", 7 - CKO	2 - 1/2", 2 - 3/4"	24
D5SDB-CKO-S	-	2 - 1/2", 10 - CKO	3 - 3/4"	24

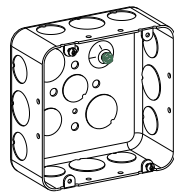

D5SDB-50/75

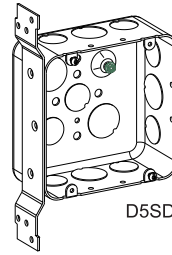

D5SDB-50/75-FB

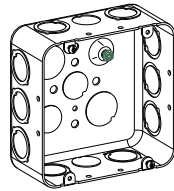

D5SDB-CKO

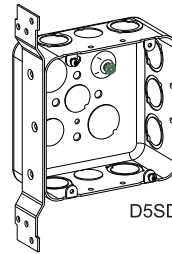

D5SDB-CKO-FB

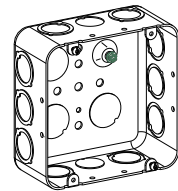

D5SDB-CKO-S

4-11/16" SQUARE (5S) SUPER SHALLOW BOX & EXTENSION RING

WELDED

1-1/2" DEEP

29.5 Cu. In.

WITH RAISED GROUND EMBOSS (EXCEPT FOR EXTENSION RING)

Cat. No.	Knockouts		Std. Pkg.
	Sides	Bottom	
5SSB-MKO	8 - 1/2", 4 - MKO	2 - 1/2", 2 - MKO	24
5SSB-MKO-EXT	8 - 1/2", 4 - MKO	-	24

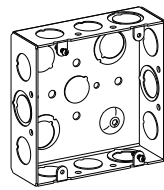

5SSB-MKO

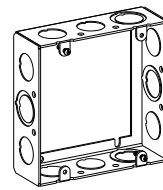

5SSB-MKO-EXT

4-11/16" SQUARE (5S) LARGE CAPACITY BOXES

WELDED

2-1/2" DEEP

49.4 Cu. In.

WITH RAISED GROUND EMBOSS & TWO #8-32 x 1/2" MOUNTING SCREWS

Features:

- Suitable for Datacom & Electrical Applications



Cat. No.	Knockouts		Std. Pkg.
	Sides	Bottom	
5SLB-MKO	8 - 1/2", 4 - 1/2" & 3/4" M.K.O.	2 - 1/2", 2 - 3/4"	24
5SLB-2MKO	4 - 3/4" & 1" M.K.O., 4 - 1" & 1 - 1/4" M.K.O.	2 - 1/2", 2 - 3/4"	24

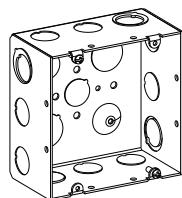

5SLB-MKO

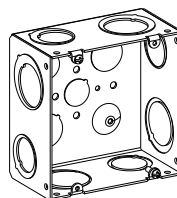

5SLB-2MKO

- **600V** MKO's and CKO's suitable for bonding without any additional bonding means up to 600V
- Visit www.ul.com or QCIT Guide on page W1 for more information

4-11/16" SQUARE (5S) BOXES

WELDED

2-1/8" DEEP

42.0 Cu. In.

WITH RAISED GROUND EMBOSS (EXCEPT FOR BRACKETED BOXES AND EXTENSION RINGS)

Metal Stud Bracket Features:

- U.S. Patent No.: 8,262,043
- Metal Stud (MS) Bracket engages on either side of metal stud
- *Model Revised Feb. 2008

Boxes with Pigtail Features:

- 7" Solid Cu. #12AWG Pigtail Pre-assembled with Ground Emboss and 10-32 Ground Screw
- 10" Pigtail for BSA Series

BSA Features:

- See page A11

- **600V** MKO's and CKO's suitable for bonding without any additional bonding means up to 600V
- Visit www.ul.com or QCIT Guide on page W1 for more information

Cat. No.	Bracket & Setback	Knockouts		Std. Pkg.
		Sides	Bottom	
5SDB-50	-	12 - 1/2"	4 - 1/2"	24
5SDB-50-FB	FB, Flush	9 - 1/2"	5 - 1/2"	24
5SDB-50/75	-	8 - 1/2", 4 - 3/4"	2 - 1/2", 2 - 3/4"	24
5SDB-50/75-FB	FB, Flush	6 - 1/2", 3 - 3/4"	3 - 1/2", 2 - 3/4"	24
5SDB-75	-	12 - 3/4"	2 - 1/2", 2 - 3/4"	24
5SDB-75-FB	FB, Flush	9 - 3/4"	3 - 1/2", 2 - 3/4"	24
5SDB-75/100	-	4 - 3/4", 4 - 1"	2 - 1/2", 2 - 3/4"	24
5SDB-75/100-FB	FB, Flush	3 - 3/4", 3 - 1"	3 - 1/2", 2 - 3/4"	24
5SDB-100	-	8 - 1"	2 - 1/2", 2 - 3/4"	24
5SDB-100-FB	FB, Flush	6 - 1"	3 - 1/2", 2 - 3/4"	24
5SDB-125	-	6 - 1-1/4"	2 - 1/2", 2 - 3/4"	24
5SDB-MKO	-	2 - 1/2", 10 - MKO	2 - 1/2", 2 - MKO	24
5SDB-MKO-PT	-	12 - MKO	1 - 1/2", 3 - MKO	24
5SDB-MKO-FB	FB, Flush	2 - 1/2", 7 - MKO	3 - 1/2", 2 - MKO	24
5SDB-MKO-MS*	MS, Self-Gripping + Box Support Clip	2 - 1/2", 7 - MKO	3 - 1/2", 2 - MKO	24
5SDB-50/75-EXT	-	8 - 1/2", 4 - 3/4"	-	24
5SDB-MKO-EXT	-	2 - 1/2", 10 - MKO	-	24
5SDB-50/75-PT-BSA	Back Support Arm	8 - 1/2", 4 - 3/4"	3 - 3/4"	24
5SDB-50/75-AB-PT-BSA	AB, Flush, Back Support Arm	6 - 1/2", 3 - 3/4"	3 - 3/4"	24

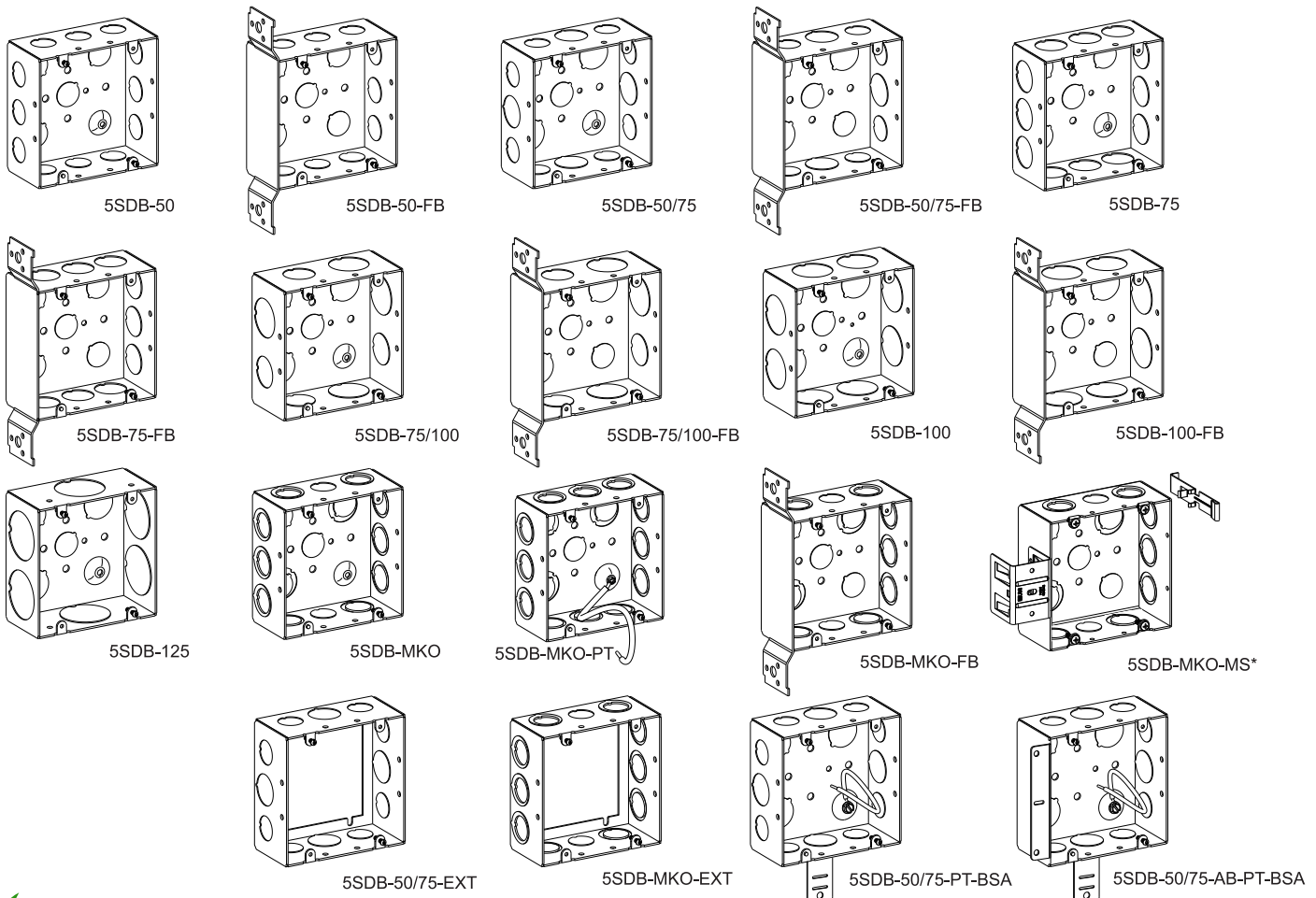

5S Deep Boxes, Covers & Low-Voltage Partitions

4-11/16" SQUARE (5S) BOXES

WELDED

2-1/8" DEEP

42.0 Cu. In.

BX/MC Clamp:

- All MC series boxes are suitable for use with MCAP™-Aluminum
- MCAP is a trademark of Southwire Company

Metal Stud Bracket:

- U.S. Patent No.: 8,262,043 Metal Stud (MS) Bracket Engages On Either Side Of A Metal Stud
- *Model Revised Feb. 2008**

Cat. No.	Bracket & Setback	Knockouts		Std. Pkg.
		Sides	Bottom	
5SDB-MC	-	6 - MKO, 4 - Loom	3 - 1/2", 2 - 3/4"	24
5SDB-MC-FB	FB, Flush	3 - MKO, 4 - Loom	3 - 1/2", 2 - 3/4"	24
5SDB-MC-MS*	MS, Self-Gripping + Box Support Clip	3 - MKO, 4 - Loom	3 - 1/2", 2 - 3/4"	24
5SDB-MC2-MS* NEW	MS, Self-Gripping + Box Support Clip	1 - MKO, 8 - Loom	1 - MKO	24

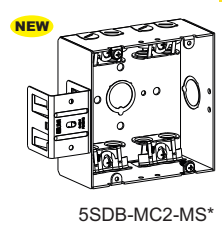
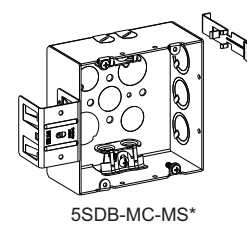
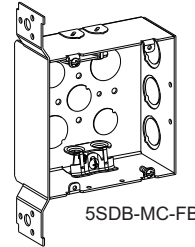
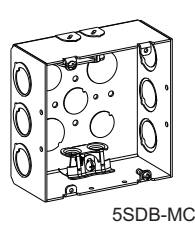

4-11/16" SQUARE (5S) COVERS

FLAT OR DRAWN

Cat. No.	Description	Cu. Inch	Std. Pkg.
5BC	Flat, Blank	-	50
5BCK	Flat, 1/2" KO	-	50
5BC-MKO	Flat, MKO	-	50
53000	Flat, Open, Ears 2-3/4" O.C.	-	50
53050	Raised 1/2", Open, Ears 2-3/4" O.C.	3.0	50
53058	Raised 5/8", Open, Ears 2-3/4" O.C.	4.0	50
53075	Raised 3/4", Open, Ears 2-3/4" O.C.	5.0	50
53100	Raised 1", Open, Ears 2-3/4" O.C.	6.8	25
53125	Raised 1-1/4", Open, Ears 2-3/4" O.C.	8.8	25
53150	Raised 1-1/2", Open, Ears 2-3/4" O.C.	9.7	25
53200	Raised 2", Open, Ears 2-3/4" O.C.	12.9	25

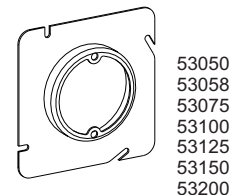
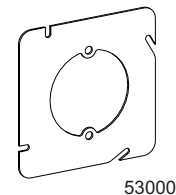
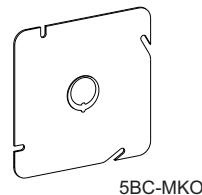
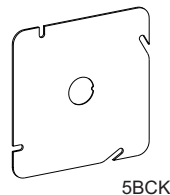
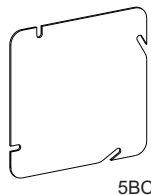

4-11/16" SQUARE (5S) BOXES LOW-VOLTAGE PARTITIONS

Cat. No.	Description	For Use with 2-Gang Rings:	Std. Pkg.
5SDP-100	For use with 2-1/8" Deep Boxes	Flat, 1/4", 1/2", 3/4", 1"	25
5SDP-200	For use with 2-1/8" Deep Boxes	5/8", 1-1/4", 1-1/2", 1-3/4", 2"	25
5SLP-100 NEW	For use with 2-1/2" Deep Boxes	Flat, 1/4", 1/2", 3/4", 1"	25
5SLP-200 NEW	For use with 2-1/2" Deep Boxes	5/8", 1-1/4", 1-1/2", 1-3/4", 2"	25

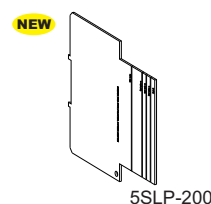
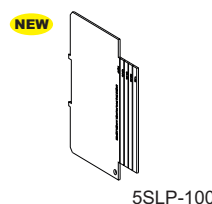
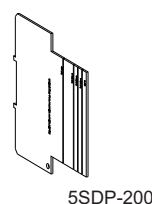
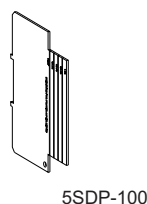

- 600V** MKO's and CKO's suitable for bonding without any additional bonding means up to 600V
- Visit www.ul.com or QCIT Guide on page W1 for more information

4-11/16" SQUARE (5S) 1-GANG & 2-GANG DEVICE RINGS FLAT OR DRAWN

Cat. No.	Description	Gangs	Cu. Inch	Std. Pkg.
51000	Flat	1	-	50
51025	Raised 1/4"	1	1.8	50
51050	Raised 1/2"	1	3.8	50
51058	Raised 5/8"	1	4.3	50
51075	Raised 3/4"	1	5.5	50
51100	Raised 1"	1	7.5	25
51125	Raised 1-1/4"	1	9.4	25
51150	Raised 1-1/2"	1	11.2	25
51200	Raised 2"	1	14.4	25
52000	Flat	2	-	50
52025	Raised 1/4"	2	3.0	50
52050	Raised 1/2"	2	5.8	50
52058	Raised 5/8"	2	7.5	50
52075	Raised 3/4"	2	8.8	50
52100	Raised 1"	2	11.8	25
52125	Raised 1-1/4"	2	14.5	25
52150	Raised 1-1/2"	2	15.5	25
52200	Raised 2"	2	20.7	25

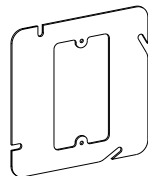

51000

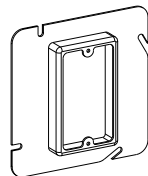

51025
51050
51058
51075
51100
51125
51150
51200

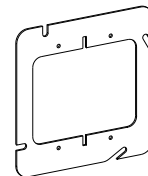

52000

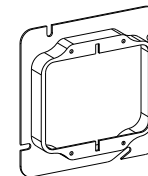

52025
52050
52058
52075
52100
52125
52150
52200

ADJUSTABLE RINGS

U.S. Patent No.: 7,468,486

Product Features:

- For use with 4-11/16" Square (5S) 2-1/8" or deeper boxes
- 1/4" to 1-1/4" adjustability range
- Solution to stocking multiple items
- Provide flexibility at the job site

Cat. No.	Description	Standard	With One Extension Installed		Std. Pkg.
			+ 1GX75	+ 2GX75	
5SAR1G	1-Gang Adjustable Ring for 5S Deep Boxes	1/4" to 1-1/4"	1" to 2"	-	25
5SAR2G	2-Gang Adjustable Ring for 5S Deep Boxes	1/4" to 1-1/4"	-	1" to 2"	25
UPC	Gangable, Steel Universal Protective Cover protects any device during drywall, painting, routing, mudding & plastering.				25
UPCTS	Optional Plastic Insert for UPC to protect Toggle Switch.				25

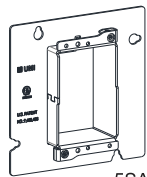

5SAR1G

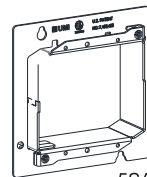

5SAR2G

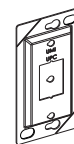

UPC



UPCTS

EXTENSIONS

U.S. Patent No.: 7,468,486

Product Features:

- Extensions ensure flush finish regardless of wall thickness
- Attach to adjustable ring for additional 3/4" of depth
- Mount easily to ring with two 8-32 screws
- Multiple extensions can be installed on one ring

Cat. No.	Description	For Use With	Std. Pkg.
1GX75	1-Gang 3/4" Extension	4SAR1G or 5SAR1G	50
2GX75	2-Gang 3/4" Extension	4SAR2G or 5SAR2G	50

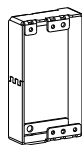

1GX75

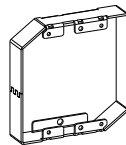

2GX75



**4-11/16" SQUARE (5S)
INDUSTRIAL COVERS
RAISED 1/2"**
10 Cu. In.



Cat. No.	Description	Std. Pkg.
5501	Toggle Switch	25
5502	Duplex Receptacle	25
5503	Single Receptacle, 15A, 1.406" diameter	25
5504	GFCI or Decorative Switches	25
5505	Power Outlet, 20A, 1.60" diameter	25
5506	Power Outlet, 30A Locking, 1.750" diameter	25
5507	Power Outlet, 30 to 50A, 2.156" diameter	25
5508	Power Outlet, 30 to 60A, 2.625" diameter	25
5511	2 Toggle Switches	25
5512	Toggle Switch / Duplex Receptacle	25
5514	Toggle Switch / GFCI or Decorative Switches	25
5522	2 Duplex Receptacles	25
5524	Duplex Receptacle / GFCI or Decorative Switches	25
5544	2 GFCIs or 2 Decorative Switches	25

Steel Products

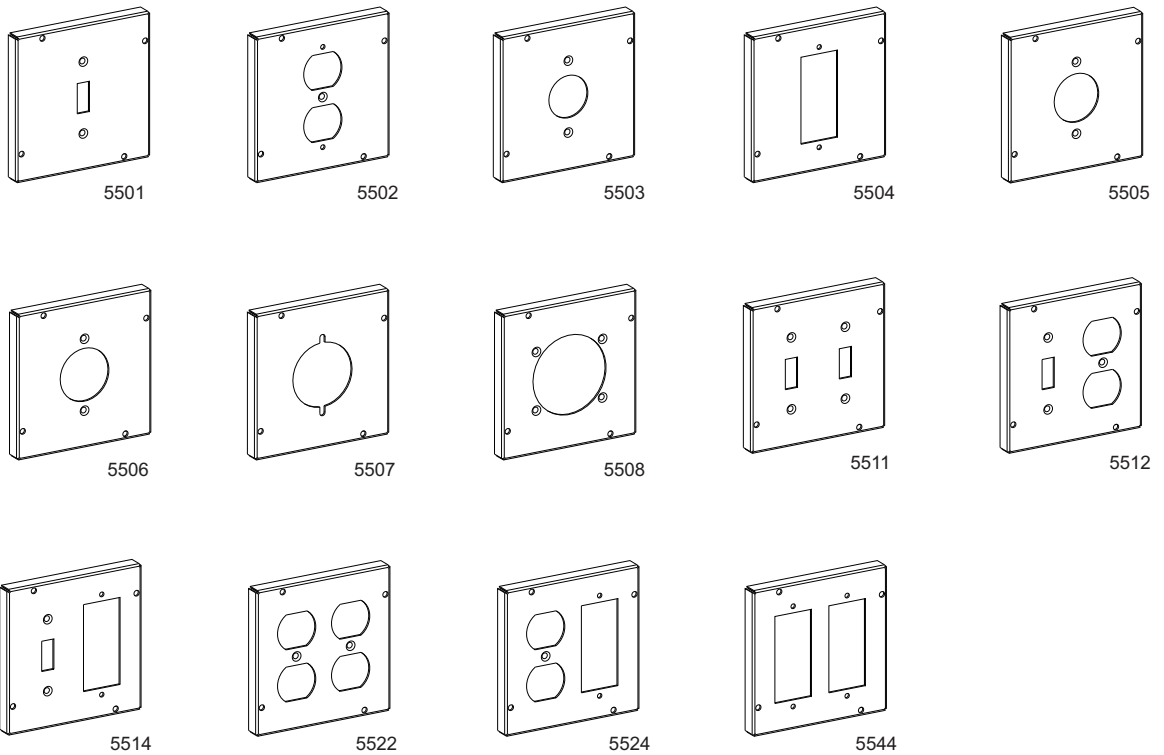



FIRE ALARM BOXES & COVERS

Features:

- Provide easy identification of products containing cabling of Fire Alarm Systems
- Prevent need for repainting
- Industrial, Commercial or Residential Use
- Durable Red Powder Coat Finish

Note:

- Additional specs located with corresponding models without red finish in catalog
- **600V** MKO's and CKO's suitable for bonding without any additional bonding means up to 600V
- Acceptable for use in 2-hour rated walls (4S Box only)
- Visit www.ul.com or QCIT Guide on page W1 for more information

Cat. No.	Description	Specs on Page No.	Std. Pkg.
FA-4RBC	4" Octagon Cover	A5	50
FA-4RDB-MKO	4" Octagon Box, MKO	A4	50
FA-4BC	4" Square Blank Cover	A11	50
FA-4SB-MKO	4" Square Box, MKO	A7	50
FA-4SB-MKO-EXT	4" Square Extension Ring, MKO	A7	50
FA-4SDB-MKO	4" Square 2-1/8" Deep Box, MKO	A9	24
FA-4SDB-MKO-FB	4" Square 2-1/8" Deep Box, FB Bracket, MKO	A9	24
FA-5BC	5" Square Blank Cover	A17	50
FA-5SDB-MKO	5" Square 2-1/8" Deep Box, MKO	A16	24
FA-4SEDB-CKO	4" Square 3-1/2" Deep Box, CKO For Oversized Alarm Devices	A10	24
FA-4SEDB-CKO-FB NEW	4" Square 3-1/2" Deep Box, FB Bracket, CKO with set-back marks for 1/2" through 1-1/4" drywall	A10	10
FA-5SXB-5075 NEW	5-1/2" Square 3-1/2" Deep Box, 1/2 & 3/4 K.O.s	-	24



FA-4RBC



FA-4RDB-MKO



FA-4BC



FA-4SB-MKO

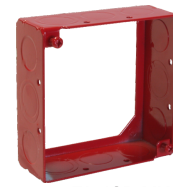

FA-4SB-MKO-EXT



FA-4SDB-MKO



FA-4SDB-MKO-FB



FA-5BC



FA-5SDB-MKO



FA-4SEDB-CKO

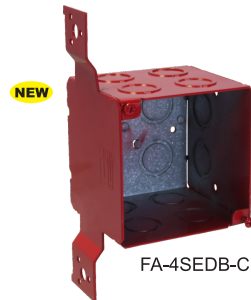

NEW

FA-4SEDB-CKO-FB



NEW

FA-5SXB-5075

Ultimate Support Bracket System

FLOOR/WALL SUPPORT BRACKET

Features:

- Can be floor or wall mounted on wooden or metal studs
- Infinite height and width combinations
- Provides flexibility at the job site

Note:

- US4SB or US5SB must be used to attach steel box to USB

For Additional Support Brackets: See Page A40

Cat. No.	Description	Std. Pkg.
USB	Ultimate Support Bracket, Adj. 8"-24" as floor bracket or 14"-24" as wall bracket	12
US4SB	Mounting Bracket for 4" (4S) Box, snaps to USB	24
US5SB	Mounting Bracket for 4-11/16" (5S) Box, snaps to USB	50
USBS	Far-Side Back Support for 4" (4S) and 4-11/16" (5S) Boxes	50
USDBM	For use with USB to create a double box in floor mount assembly with built-in back support	50
USTBM	For use with USB to create a triple box in floor mount assembly with built-in back support	50
USTS	USB floor mount stud to stud top support	50
USB-4SDB-50/75-PT	Complete Pre-Assembled Floor Bracket with a 4" (4S) 2-1/8" Deep Box mounted, Includes installed Far-Side Back Support and Ground Pigtail	12
USB-5SDB-50/75-PT	Complete Pre-Assembled Floor Bracket with a 4-11/16" (5S) 2-1/8" Deep Box mounted, Includes installed Far-Side Back Support and Ground Pigtail	12

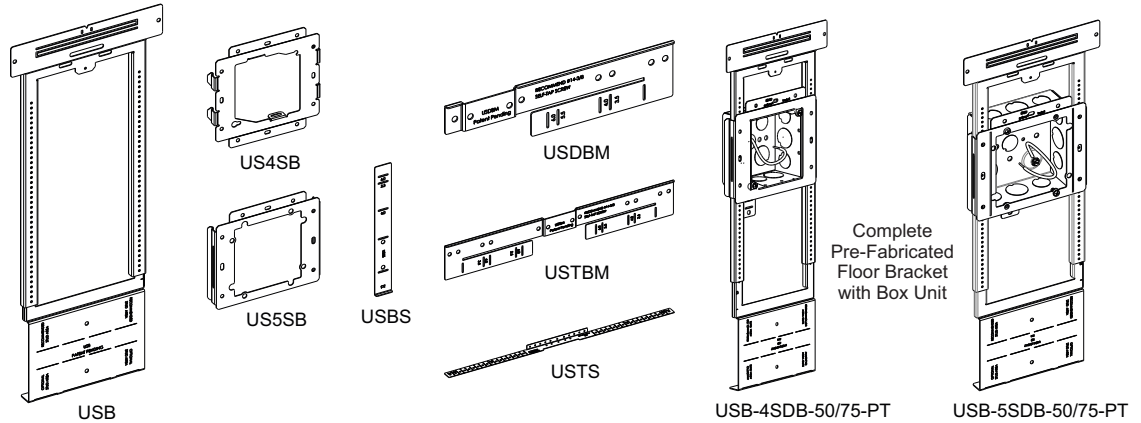

Installation Views

Patented Revolutionary New System

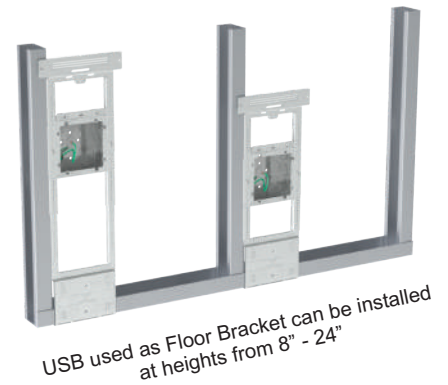
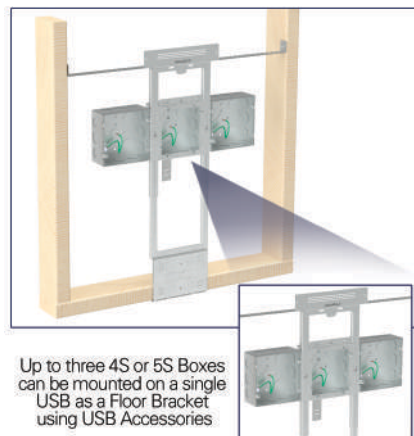
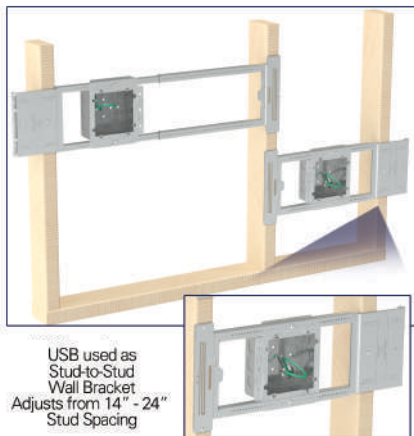

MULTIGANG SWITCH BOXES

DRAWN
2-1/8" DEEP

WITH RAISED GROUND EMBOSS & DEVICE EARS

Boxes with Pigtail Features:

- 7" Solid Cu. #12AWG Pigtail
- Pre-assembled with Ground Emboss and 10-32 Ground Screw

Cat. No.	No. of Gangs	Bracket & Setback	Knockouts		Dimension W x H	Cu. Inch	Std. Pkg.
			Sides	Bottom			
DHB-2	2	-	4 - 1/2", 4 - CKO	2 - 1/2", 2 - 3/4"	4" x 4"	30.3	25
DHB-2-B	2	B, 9/16"	2 - 1/2", 4 - CKO	2 - 1/2", 2 - 3/4"	4" x 4"	30.3	25
DHB-2-FB	2	FB, 9/16"	2 - 1/2", 4 - CKO	2 - 1/2", 2 - 3/4"	4" x 4"	30.3	25
DHB-3	3	-	4 - 1/2", 6 - CKO	2 - 1/2", 2 - 3/4"	5-3/4" x 4"	44.0	25
DHB-3-PT NEW	3	-	4 - 1/2", 6 - CKO	2 - 1/2", 2 - 3/4"	5-3/4" x 4"	44.0	25
DHB-3-B	3	B, 9/16"	2 - 1/2", 6 - CKO	2 - 1/2", 2 - 3/4"	5-3/4" x 4"	44.0	20
DHB-3-FB	3	FB, 9/16"	2 - 1/2", 6 - CKO	2 - 1/2", 2 - 3/4"	5-3/4" x 4"	44.0	20
DHB-4	4	-	4 - 1/2", 8 - CKO	5 - 1/2", 4 - 3/4"	7-1/2" x 4"	57.8	20
DHB-4-B	4	B, 9/16"	2 - 1/2", 8 - CKO	5 - 1/2", 4 - 3/4"	7-1/2" x 4"	57.8	20
DHB-4-FB	4	FB, 9/16"	2 - 1/2", 8 - CKO	5 - 1/2", 4 - 3/4"	7-1/2" x 4"	57.8	20

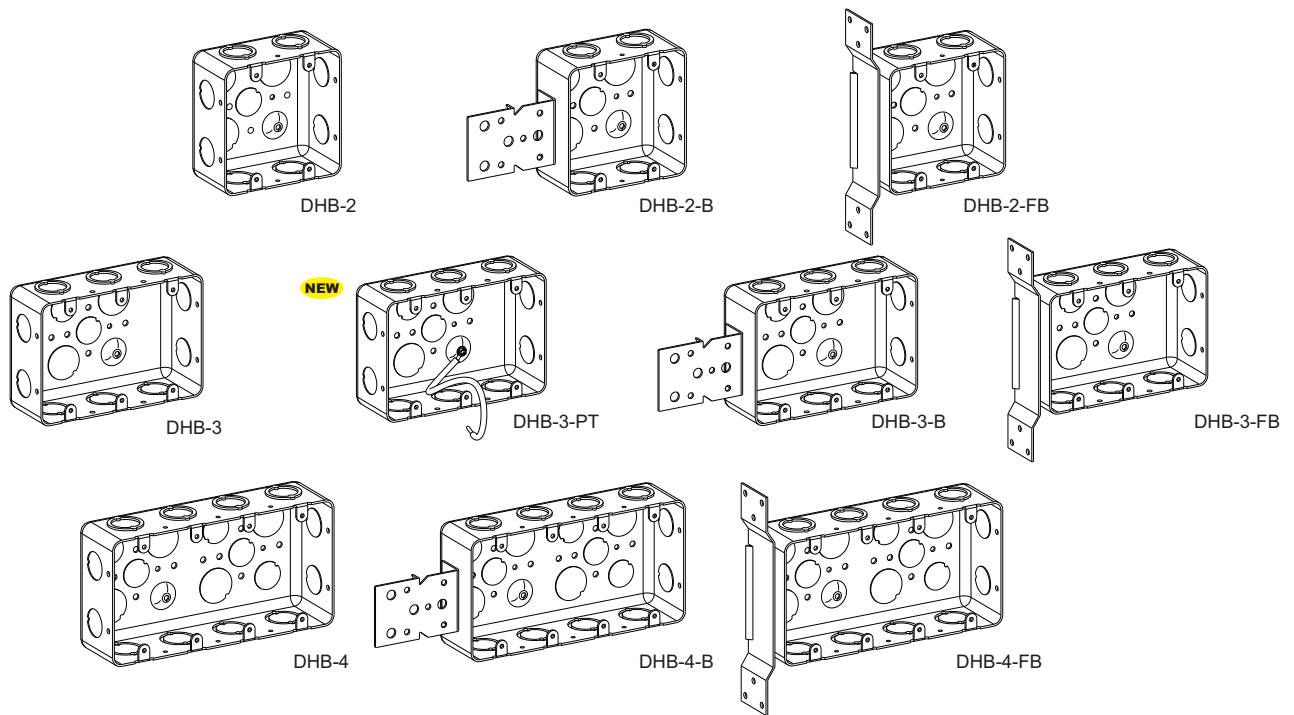

MASONRY BOXES WITH DEVICE EARS 2-1/2" DEEP

Cat. No.	No. of Gangs	Bracket & Setback	Knockouts		Dimension W x H	Cu. Inch	Std. Pkg.
			Sides	Bottom			
MSB-3-FB	3	FB, 9/16"	8 - CKO	3 - CKO	5-1/2" x 3-3/4"	47.9	20
MSB-4-FB	4	FB, 9/16"	10 - CKO	4 - CKO	7-3/8" x 3-3/4"	63.6	20
MSB-5-FB	5	FB, 9/16"	12 - CKO	5 - CKO	9-1/8" x 3-3/4"	79.6	20
MB-D	2-1/2" / 3-1/2" Partition for MSB and MB boxes				3-1/4" x 3-1/2"	-	25

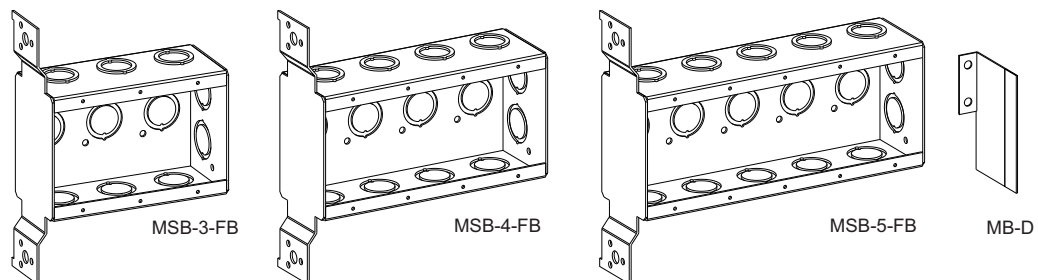

- **600V** MKO's and CKO's suitable for bonding without any additional bonding means up to 600V
- Acceptable for use in 2-hour rated walls (2-Gang only)
- Visit www.ul.com or QCIT Guide on page W1 for more information

MASONRY BOXES WITH CONCENTRIC KNOCKOUTS (CKO) 2-1/2" DEEP

Cat. No.	No. of Gangs	Knockouts			Dimension W x H	Cu. Inch	Std. Pkg.
		Ends	Bottom	Sides			
MSBG-1	1, Gangable	2	1	4	1-7/8" x 3-3/4"	16.1	25
MSB-1	1	2	1	4	1-7/8" x 3-3/4"	16.1	25
MSB-2	2	4	2	4	3-3/4" x 3-3/4"	31.9	10
MSB-3	3	6	3	4	5-1/2" x 3-3/4"	47.9	10
MSB-4	4	8	4	4	7-3/8" x 3-3/4"	63.6	10
MSB-5	5	10	5	4	9-1/8" x 3-3/4"	79.6	10
MSB-6	6	12	6	4	11" x 3-3/4"	95.3	1

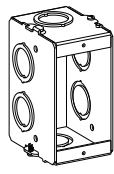

MSBG-1

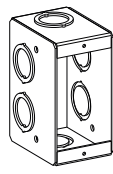

MSB-1

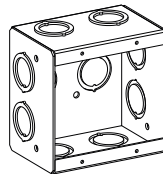

MSB-2

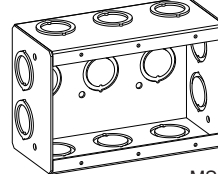

MSB-3

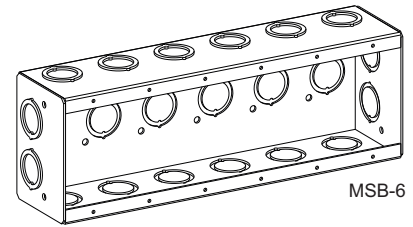

MSB-6

MASONRY BOXES WITH CONCENTRIC KNOCKOUTS (CKO) 3-1/2" DEEP

Cat. No.	No. of Gangs	Knockouts			Dimension W x H	Cu. Inch	Std. Pkg.
		Ends	Bottom	Sides			
MBG-1	1, Gangable	4	1	4	1-7/8" x 3-3/4"	23.5	25
MB-1	1	4	1	4	1-7/8" x 3-3/4"	23.5	25
MB-2	2	8	2	4	3-3/4" x 3-3/4"	46.9	10
MB-3	3	12	3	4	5-1/2" x 3-3/4"	69.3	10
MB-4	4	16	4	4	7-3/8" x 3-3/4"	92.1	10
MB-5	5	20	5	4	9-1/8" x 3-3/4"	116.1	10
MB-6	6	24	6	4	11" x 3-3/4"	139.0	1

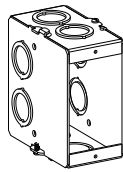

MBG-1

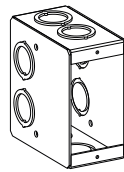

MB-1

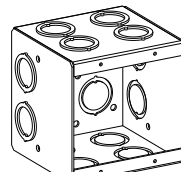

MB-2

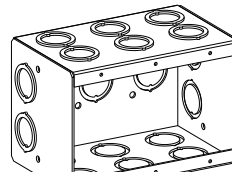

MB-3

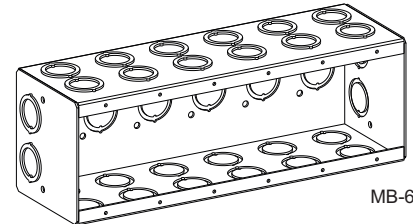

MB-6

MASONRY BOX PARTITION

Cat. No.	Description	Dimension W x H	Std. Pkg.
MB-D	2-1/2" / 3-1/2" Partition for MSB and MB Boxes	3-1/4" x 3-1/2"	25

Features:

- Fits 2-1/2" & 3-1/2" Masonry Boxes



MB-D

- 600V** CKO's suitable for bonding without any additional bonding means up to 600V
- Visit www.ul.com or QCIT Guide on page W1 for more information



MASONRY THRU BOXES WITH CONCENTRIC KNOCKOUTS (CKO)

Cat. No.	Dimension W x H	Depth	Knockouts		Cu. Inch	Std. Pkg.
			Ends	Sides		
MTB-350	2" x 3-3/4"	3-1/2"	2	4	24.0	25
MTB-550	2" x 3-3/4"	5-1/2"	4	8	38.0	25
MTB-750	2" x 3-3/4"	7-1/2"	6	12	52.3	25

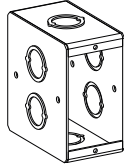

MTB-350

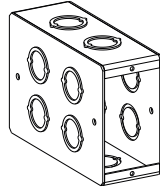

MTB-550

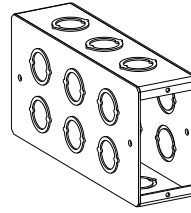

MTB-750

4" THRU BOX WITH BRACKET 4-5/16" DEEP

Cat. No.	Dimension W x H	Bracket & Setback	Knockouts		Cu. Inch	Std. Pkg.
			Ends	Side		
HTB-FB	2-1/8" x 4"	2 - FB, 3/8"	2 - 1/2", 2 - MKO	1 - MKO	33.0	25

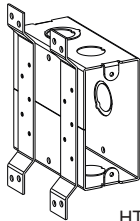

HTB-FB

- **600V** MKO's and CKO's suitable for bonding without any additional bonding means up to 600V
- Visit www.ul.com or QCIT Guide on page W1 for more information

Multigang Switch Boxes

MULTIGANG SWITCH BOXES 1-5/8" DEEP

& LOW VOLTAGE PARTITION

Cat. No.	No. of Gangs	Knockouts		Dimension W x H	Cu. Inch	Std. Pkg.	
		Sides	Bottom				
SB-2	2	6 - 1/2", 6 - MKO	3 - 1/2", 2 - 3/4"	6-13/16" x 4-9/16"	56.3	5	
SB-3	3	8 - 1/2", 6 - MKO	6 - 1/2", 4 - 3/4"	8-5/8" x 4-9/16"	65.0	5	
SB-4	4	8 - 1/2", 8 - MKO	6 - 1/2", 4 - 3/4"	10-7/16" x 4-9/16"	80.0	5	
SB-5	5	10 - 1/2", 8 - MKO	6 - 1/2", 4 - 3/4"	12-1/4" x 4-9/16"	94.8	5	
SB-6	6	10 - 1/2", 10 - MKO	6 - 1/2", 4 - 3/4"	14-1/16" x 4-9/16"	111.1	1	
SB-7	7	12 - 1/2", 10 - MKO	9 - 1/2", 6 - 3/4"	15-7/8" x 4-9/16"	127.0	1	
SB-8	8	12 - 1/2", 12 - MKO	9 - 1/2", 6 - 3/4"	17-11/16" x 4-9/16"	142.1	1	
SB-9	9	14 - 1/2", 12 - MKO	9 - 1/2", 6 - 3/4"	19-1/2" x 4-9/16"	157.9	1	
SB-10	10	14 - 1/2", 14 - MKO	9 - 1/2", 6 - 3/4"	21-3/8" x 4-9/16"	172.1	1	
SB-D	Partition for 1-5/8" SB Boxes, flat or raised cover						25

Steel Products

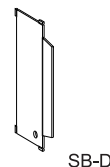
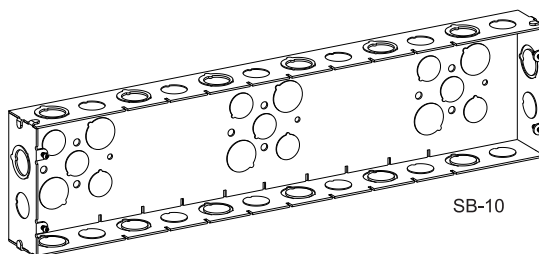
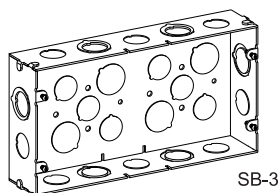
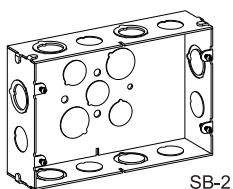

MULTIGANG DEEP SWITCH BOXES 2-1/2" DEEP

& LOW VOLTAGE PARTITION

Cat. No.	No. of Gangs	Knockouts		Dimension W x H	Cu. Inch	Std. Pkg.	
		Sides	Bottom				
SDB-2	2	4 - 3/4", 8 - 1/2" & 3/4" MKO	3 - 1/2", 2 - 3/4"	6-13/16" x 4-9/16"	70.0	5	
SDB-3	3	8 - 3/4", 6 - 1/2" & 3/4" MKO	6 - 1/2", 4 - 3/4"	8-5/8" x 4-9/16"	90.0	5	
SDB-4	4	4 - 3/4", 8 - 1/2" & 3/4" MKO	6 - 1/2", 4 - 3/4"	10-7/16" x 4-9/16"	110.0	5	
SDB-5	5	6 - 3/4", 8 - 1/2" & 3/4" MKO	6 - 1/2", 4 - 3/4"	12-1/4" x 4-9/16"	130.0	5	
SDB-6	6	6 - 3/4", 8 - 1/2" & 3/4" MKO	6 - 1/2", 4 - 3/4"	14-1/16" x 4-9/16"	150.0	1	
SDBL-2	2	4 - 3/4", 8 - 3/4" & 1" MKO	3 - 1/2", 2 - 3/4"	6-13/16" x 4-9/16"	70.0	5	
SDBL-3	3	8 - 3/4", 6 - 3/4" & 1" MKO	6 - 1/2", 4 - 3/4"	8-5/8" x 4-9/16"	90.0	5	
SDBL-4	4	4 - 3/4", 8 - 3/4" & 1" MKO	6 - 1/2", 4 - 3/4"	10-7/16" x 4-9/16"	110.0	5	
SDBL-5	5	6 - 3/4", 8 - 3/4" & 1" MKO	6 - 1/2", 4 - 3/4"	12-1/4" x 4-9/16"	130.0	5	
SDBL-6	6	6 - 3/4", 8 - 3/4" & 1" MKO	6 - 1/2", 4 - 3/4"	14-1/16" x 4-9/16"	150.0	1	
SDB-D	Partition for 1-5/8" Deep SB Boxes, flat, and & 2-1/2" SDB Boxes, flat or raised cover						25

1/2" & 3/4" Knockouts

3/4" & 1" Knockouts

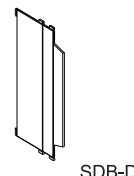
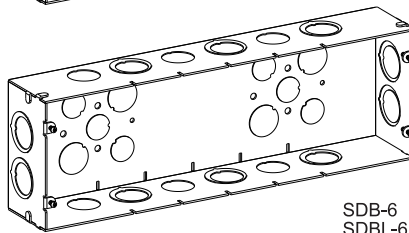
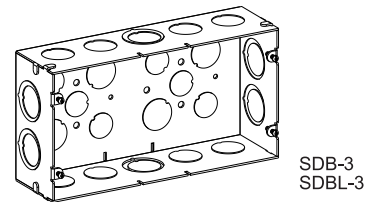
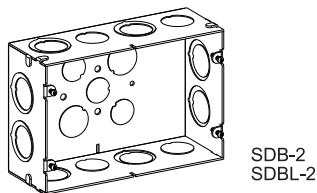

- **600V** MKO's and CKO's suitable for bonding without any additional bonding means up to 600V
- Acceptable for use in 2-hour rated walls (2-Gang only)
- Visit www.ul.com or QCIT Guide on page W1 for more information

STEEL FLAT BLANK AND FLAT DEVICE COVERS FOR MULTIGANG BOXES 2 TO 10 GANGS

Note:

- Same W & H dimensions as SB & SR Series

Cat. No.	No. of Gangs	Description	Std. Pkg.
4M2-B	2	Flat, Blank Cover	5
4M3-B	3	Flat, Blank Cover	5
4M4-B	4	Flat, Blank Cover	5
4M5-B	5	Flat, Blank Cover	5
4M6-B	6	Flat, Blank Cover	1
4M7-B	7	Flat, Blank Cover	1
4M8-B	8	Flat, Blank Cover	1
4M9-B	9	Flat, Blank Cover	1
4M10-B	10	Flat, Blank Cover	1
<hr/>			
4M2-DR	2	Flat, Duplex Receptacle Cover	5
4M3-DR	3	Flat, Duplex Receptacle Cover	5
4M4-DR	4	Flat, Duplex Receptacle Cover	5
4M5-DR	5	Flat, Duplex Receptacle Cover	5
4M6-DR	6	Flat, Duplex Receptacle Cover	1
4M7-DR	7	Flat, Duplex Receptacle Cover	1
4M8-DR	8	Flat, Duplex Receptacle Cover	1
4M9-DR	9	Flat, Duplex Receptacle Cover	1
4M10-DR	10	Flat, Duplex Receptacle Cover	1
<hr/>			
4M2-GFI	2	Flat, Decorative or GFCI Cover	5
4M3-GFI	3	Flat, Decorative or GFCI Cover	5
4M4-GFI	4	Flat, Decorative or GFCI Cover	5
4M5-GFI	5	Flat, Decorative or GFCI Cover	5
4M6-GFI	6	Flat, Decorative or GFCI Cover	1
4M7-GFI	7	Flat, Decorative or GFCI Cover	1
4M8-GFI	8	Flat, Decorative or GFCI Cover	1
4M9-GFI	9	Flat, Decorative or GFCI Cover	1
4M10-GFI	10	Flat, Decorative or GFCI Cover	1
<hr/>			
4M2-TS	2	Flat, Toggle Switch Cover	5
4M3-TS	3	Flat, Toggle Switch Cover	5
4M4-TS	4	Flat, Toggle Switch Cover	5
4M5-TS	5	Flat, Toggle Switch Cover	5
4M6-TS	6	Flat, Toggle Switch Cover	1
4M7-TS	7	Flat, Toggle Switch Cover	1
4M8-TS	8	Flat, Toggle Switch Cover	1
4M9-TS	9	Flat, Toggle Switch Cover	1
4M10-TS	10	Flat, Toggle Switch Cover	1

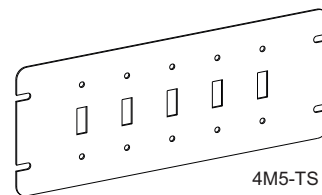
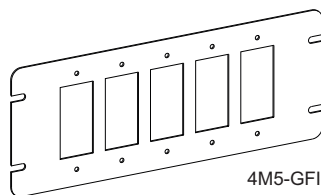
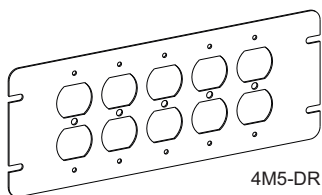
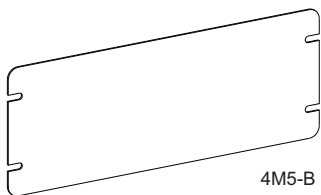

Multigang Device Rings & Concrete Boxes

DEVICE RINGS FOR MULTIGANG BOXES 2 TO 10 GANGS RAISED 3/4"

Cat. No.	No. of Gangs	Dimension W x H	Cu. Inch	Std. Pkg.
SR-2	2	6-13/16" x 4-9/16"	9.1	5
SR-3	3	8-5/8" x 4-9/16"	14.9	5
SR-4	4	10-7/16" x 4-9/16"	21.0	5
SR-5	5	12-1/4" x 4-9/16"	25.5	5
SR-6	6	14-1/16" x 4-9/16"	30.8	1
SR-7	7	15-7/8" x 4-9/16"	36.1	1
SR-8	8	17-11/16" x 4-9/16"	41.1	1
SR-9	9	19-1/2" x 4-9/16"	46.4	1
SR-10	10	21-3/8" x 4-9/16"	51.3	1

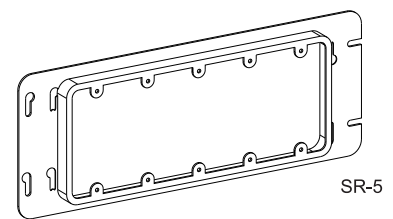
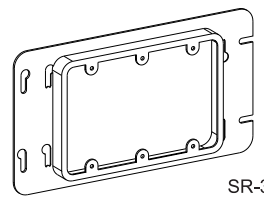
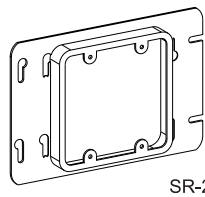

4" OCTAGONAL CONCRETE BOXES

* Fan rated

Cat. No.	Depth	Knockouts		Cu. Inch	Std. Pkg.
		Sides 1, 3, 5, 7	Sides 2, 4, 6, 8		
2CB	2"	1 - 1/2"	1 - 3/4"	24.4	25
25CB	2-1/2"	1 - 1/2"	1 - 3/4"	30.5	25
3CB	3"	1 - 1/2"	1 - 3/4"	37.0	25
3CB-75/100 NEW	3"	1 - 3/4"	1 - 1"	37.0	25
35CB	3-1/2"	2 - 1/2"	2 - 3/4"	43.0	25
35CB-75/100 NEW	3-1/2"	1 - 3/4"	1 - 1"	43.0	25
4CB	4"	2 - 1/2"	2 - 3/4"	49.2	25
4CB-75/100 NEW	4"	2 - 3/4"	2 - 1"	49.2	25
*4CB-F NEW	4"	Side 1, 5: (1)-1/2" Side 3, 7: (2)-1/2"	Side 2, 6: (1)-3/4" Side 4, 8: (2)-3/4"	49.2	25
5CB	5"	2 - 1/2"	2 - 3/4"	61.7	10
6CB	6"	2 - 1/2"	2 - 3/4"	73.5	10

For Additional Covers & Rings Option:
See page A5

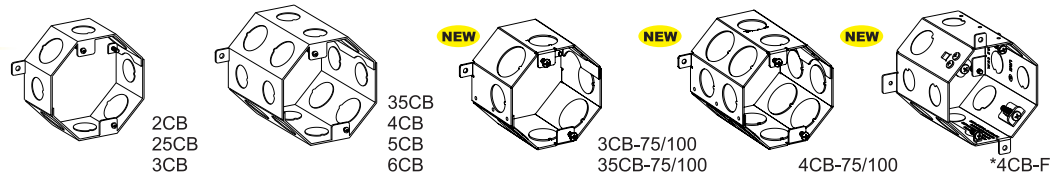

4" OCTAGONAL CONCRETE BOX COVERS

Cat. No.	Description	Std. Pkg.
CB-B	Flat, Blank	25
CB-B-PT	Flat, Blank - With 12" #12AWG Solid Pigtail	25
CB-BK NEW	Flat With 3 - 1/2" KOs & 2 - 3/4" KOs	25
CB-BK-STUD	2 - 1/2" KOs & 2 - 3/4" KO's - With #3/8-18 Threaded Fixture Stud	25

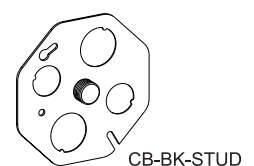
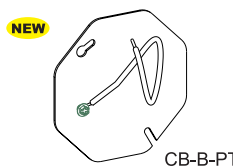
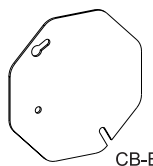

SUPER SHALLOW HANDY BOX

DRAWN
1-1/4" DEEP
 2" W x 4" H
 8.5 Cu. In.

Cat. No.	Knockouts		Std. Pkg.
	Sides	Bottom	
DHSSB-1-50	8 - 1/2"	3 - 1/2"	50

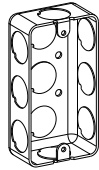

DHSSB-1-50

SHALLOW HANDY BOXES AND EXTENSION RING

WELDED
1-1/2" DEEP
 2" W x 4" H
 11.5 Cu. In.

Cat. No.	Bracket & Setback	Knockouts		Std. Pkg.
		Sides	Bottom	
HSB-1-50	-	8 - 1/2"	3 - 1/2"	50
HSB-1-50-B	B, 1/4"	5 - 1/2"	3 - 1/2"	50
HSB-1-50-EXT	-	8 - 1/2"	-	50

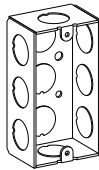

HSB-1-50

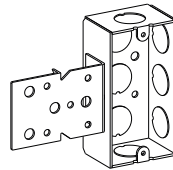

HSB-1-50-B

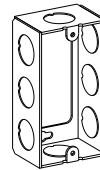

HSB-1-50-EXT

HANDY BOX

DRAWN
1-7/8" DEEP
 2" W x 4" H
 13.0 Cu. In.

Cat. No.	Knockouts		Std. Pkg.
	Sides	Bottom	
DHB-1-50	8 - 1/2"	2 - 1/2"	50
DHB-1-75	6 - 3/4"	2 - 1/2"	50

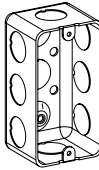

DHB-1-50

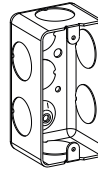

DHB-1-75

WITH RAISED GROUND EMBOSS

HANDY BOXES AND EXTENSION RINGS

WELDED
1-7/8" DEEP
 2" W x 4" H
 13.0 Cu. In.

Cat. No.	Bracket & Setback	Knockouts		Std. Pkg.
		Sides	Bottom	
HB-1-50	-	8 - 1/2"	2 - 1/2"	50
HB-1-50-FB	FB, 9/16"	5 - 1/2"	3 - 1/2"	50
HB-1-50-EXT	-	8 - 1/2"	-	50
HB-1-MKO	-	4 - 1/2", 4 - MKO	1 - 1/2", 1 - MKO	50
HB-1-MKO-AB	AB, 9/16"	2 - 1/2", 3 - MKO	2 - 1/2", 1 - MKO	50
HB-1-MKO-FB	FB, 9/16"	2 - 1/2", 3 - MKO	2 - 1/2", 1 - MKO	50
HB-1-MKO-EXT	-	4 - 1/2", 4 - MKO	-	50

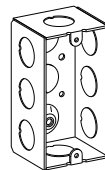

HB-1-50

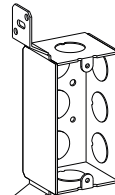

HB-1-50-FB

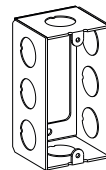

HB-1-50-EXT

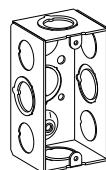

HB-1-MKO

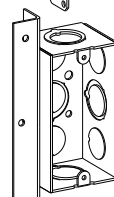

HB-1-MKO-AB

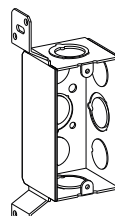

HB-1-MKO-FB

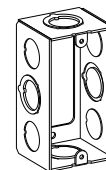

HB-1-MKO-EXT

- **600V** MKO's and CKO's suitable for bonding without any additional bonding means up to 600V
- Acceptable for use in 2-hour rated walls
- Visit www.ul.com or QCIT Guide on page W1 for more information

Deep Handy Boxes & Covers

DEEP HANDY BOXES WELDED 2-1/8" DEEP

2" W x 4" H
16.5 Cu. In.

Cat. No.	Bracket & Setback	Knockouts		Std. Pkg.
		Sides	Bottom	
HDB-1-50	-	8 - 1/2"	2 - 1/2"	50
HDB-1-50-FB	FB, 9/16"	5 - 1/2"	3 - 1/2"	50
HDB-1-MKO	-	4 - 1/2", 4 - MKO	1 - 1/2", 1 - MKO	50
HDB-1-MKO-AB	AB, 9/16"	2 - 1/2", 3 - MKO	2 - 1/2", 1 - MKO	50
HDB-1-MKO-FB	FB, 9/16"	2 - 1/2", 3 - MKO	2 - 1/2", 1 - MKO	50

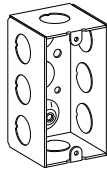

HDB-1-50

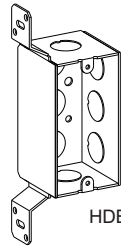

HDB-1-50-FB

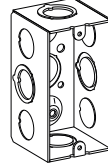

HDB-1-MKO

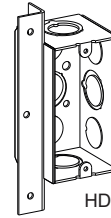

HDB-1-MKO-AB

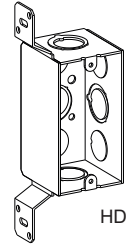

HDB-1-MKO-FB

HANDY BOX COVERS

2-5/16" W x 4-3/16" H

Cat. No.	Description	Std. Pkg.
HBC-B	Blank	25
HBC-BK	1/2" K.O.	25
HBC-DR	Duplex Receptacle	25
HBC-GFI	GFCI / Decorative Switch	25
HBC-SR	Single Receptacle, 15A, 1.406" diameter	25
HBC-PO	Power Outlet, 20A, 1.60" diameter	25
HBC-TS	Toggle Switch	25

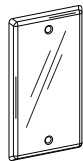

HBC-B

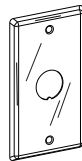

HBC-BK

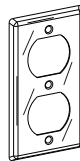

HBC-DR

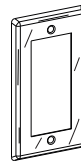

HBC-GFI

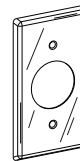

HBC-SR

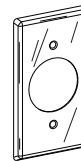

HBC-PO

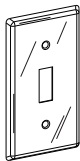

HBC-TS

SPECIAL APPLICATION UTILITY BOX AND COVERS

2-1/2" W x 4-1/8" H

- **600V** MKO's and CKO's suitable for bonding without any additional bonding means up to 600V
- Acceptable for use in 2-hour rated walls
- Visit www.ul.com or QCIT Guide on page W1 for more information

Cat. No.	Description	Std. Pkg.
WDHB-1-50	1-7/8" Raised Deep Drawn Box w/ Ground Emboss, 17.0 Cu. In., 10 - 1/2" K.O.s	25
WHBC-B	3/16" Raised Cover, Blank	25
WHBC-BK	3/16" Raised Cover, 1/2" K.O.	25
WHBC-DR	3/16" Raised Cover, Duplex Receptacle	25
WHBC-GFI	3/16" Raised Cover, GFCI / Decorative Switch	25
WHBC-SR	3/16" Raised Cover, Single Receptacle, 15A, 1.406" diameter	25
WHBC-TS	3/16" Raised Cover, Toggle Switch	25

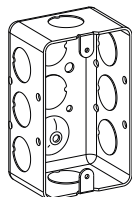

WDHB-1-50

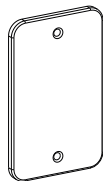

WHBC-B

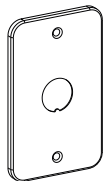

WHBC-BK

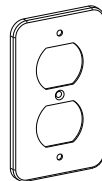

WHBC-DR

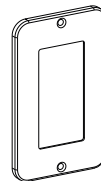

WHBC-GFI

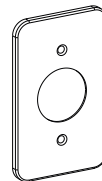

WHBC-SR

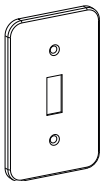

WHBC-TS

EXTRA SHALLOW GANGABLE SWITCH BOXES

1-1/2" DEEP

2" W x 3" H
7.5 Cu. In.

BX/MC Clamp Features:

- All MC series boxes are suitable for use with MCAP™-Aluminum
- MCAP is a trademark of Southwire Company

Cat. No.	Description	Knockouts			Std. Pkg.
		Sides	Ends	Bottom	
GESB-1	Ears only	-	2 - 1/2"	2 - 1/2"	50
GESB-1-NM	With NM Cable Clamps	-	4 - Loom	1 - 1/2"	50
GESB-1-MC	With BX/MC Cable Clamps	-	4 - Loom	1 - 1/2"	50

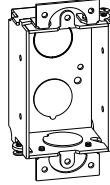

GESB-1

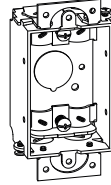

GESB-1-NM

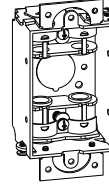

GESB-1-MC

SHALLOW GANGABLE SWITCH BOXES

2" DEEP

2" W x 3" H
10.0 Cu. In.

Cat. No.	Description	Knockouts			Std. Pkg.
		Sides	Ends	Bottom	
GSB-1	Ears only	4 - 1/2"	2 - 1/2"	2 - 1/2"	50
GSB-1-NM	With NM Cable Clamps	4 - 1/2"	4 - Loom	1 - 1/2"	50
GSB-1-MC	With BX/MC Cable Clamps	4 - 1/2"	4 - Loom	1 - 1/2"	50
GSB-1-OW	For Old Work, with Locking Grips	4 - 1/2"	2 - 1/2"	2 - 1/2"	50

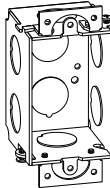

GSB-1

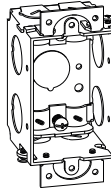

GSB-1-NM

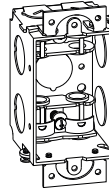

GSB-1-MC

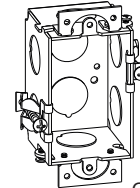

GSB-1-OW

GANGABLE SWITCH BOXES BEVELED CORNERS

2-1/4" DEEP

2" W x 3" H
10.5 Cu. In.

WITH NM CLAMPS INSTALLED THROUGH BEVELED CORNERS

Cat. No.	Description	Knockouts			Std. Pkg.
		Bevels	Ends	Bottom	
GBV	Ears only	4 - Loom	2 - 1/2"	1 - 1/2"	50
GBV-B	With 9/16" Setback B Bracket	4 - Loom	2 - 1/2"	1 - 1/2"	50
GBV-FB	With 9/16" Setback FB Bracket	4 - Loom	2 - 1/2"	1 - 1/2"	50
GBV-NE	No ears, with Leveling Bumps	4 - Loom	2 - 1/2"	1 - 1/2"	50
GBV-OW	For Old Work, with Locking Grips	4 - Loom	2 - 1/2"	1 - 1/2"	50

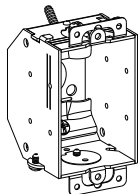

GBV

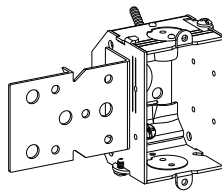

GBV-B

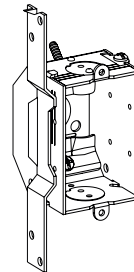

GBV-FB

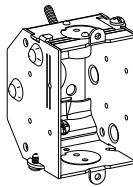

GBV-NE

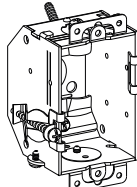

GBV-OW

- 600V** MKO's and CKO's suitable for bonding without any additional bonding means up to 600V
- Acceptable for use in 2-hour rated walls (Up to 2-Gang)
- Visit www.ul.com or QCIT Guide on page W1 for more information

Gangable Switch Boxes



A31

2-1/2" DEEP

GANGABLE SWITCH BOXES

12.5 Cu. In.
2" W x 3" H
(Except for TGW)
2-1/4" W x 3" H, 15.0 Cu.In.)

*TGW Features:

- Non-gangable wide old-work switch box for easy installation of GFCI or other large devices
- Use with Mid-Size or Jumbo Wallplates

BX/MC Clamp:

- All MC series boxes are suitable for use with MCAP™-Aluminum
- MCAP is a trademark of Southwire Company

- **600V** MKO's suitable for bonding without any additional bonding means up to 600V
- Acceptable for use in 2-hour rated walls (Up to 2-Gang)
- Visit www.ul.com or QCIT Guide on page W1 for more information

Cat. No.	Description	Knockouts			Std. Pkg.
		Sides	Ends	Bottom	
GB-1-NE	No Ears, with Leveling Bumps	2 - 1/2"	2 - 1/2"	2 - 1/2"	50
GB-1	Ears only	4 - 1/2"	2 - 1/2"	2 - 1/2"	50
GB-1-MKO	Ears only, M.K.O.	2 - 1/2"	2 - MKO	1 - 1/2"	50
GB-1-B	With B Bracket (9/16" Setback)	2 - 1/2"	2 - 1/2"	2 - 1/2"	50
GB-1-FB	With FB Bracket (9/16" Setback)	2 - 1/2"	2 - 1/2"	2 - 1/2"	50
GB-1-OW	For Old Work, with Locking Grips	-	2 - 1/2"	2 - 1/2"	50
GB-1-NM	With NM Cable Clamps	4 - 1/2"	2 - 1/2", 4 - Loom	1 - 1/2"	50
GB-1-NM-B	With NM Cable Clamps & B Bracket	2 - 1/2"	2 - 1/2", 4 - Loom	1 - 1/2"	50
GB-1-NM-FB	With NM Cable Clamps & FB Bracket	2 - 1/2"	2 - 1/2", 4 - Loom	1 - 1/2"	50
GB-1-NM-OW	With NM Cable Clamps For Old Work, with Locking Grips	-	2 - 1/2", 4 - Loom	1 - 1/2"	50
GB-1-MC	With BX/MC Cable Clamps	4 - 1/2"	2 - 1/2", 4 - Loom	1 - 1/2"	50
GB-1-MC-B	With BX/MC Cable Clamps & B Bracket	2 - 1/2"	2 - 1/2", 4 - Loom	1 - 1/2"	50
GB-1-MC-FB	With BX/MC Cable Clamps & FB Bracket	2 - 1/2"	2 - 1/2", 4 - Loom	1 - 1/2"	50
GB-1-MC-OW	With BX/MC Cable Clamps For Old Work, with Locking Grips	-	2 - 1/2", 4 - Loom	1 - 1/2"	50
TG-1	Old Work Tigergrip	4 - 1/2"	2 - 1/2"	2 - 1/2"	50
TG-1-NM	Old Work Tigergrip, NM Cable Clamps	4 - 1/2"	2 - 1/2", 4 - Loom	1 - 1/2"	50
TG-1-MC	Old Work Tigergrip, BX/MC Cable Clamps	4 - 1/2"	2 - 1/2", 4 - Loom	1 - 1/2"	50
TGW*	Wide Old Work Tigergrip (Non-Gangable) Must be used with Mid-Size or Jumbo Wall Plate	4 - 1/2"	2 - 1/2"	2 - 1/2"	50

Steel Products

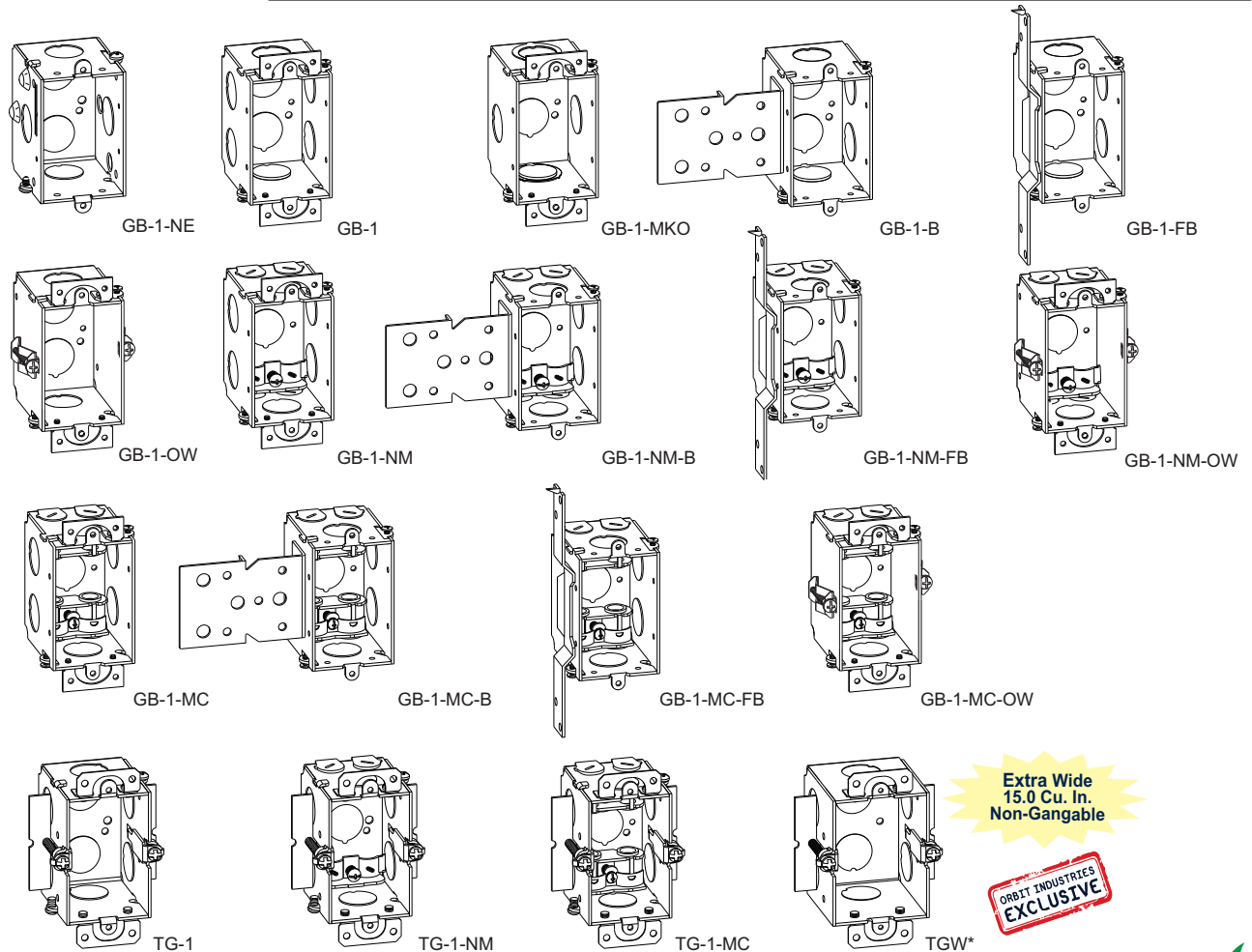

**Extra Wide
15.0 Cu. In.
Non-Gangable**

**ORBIT INDUSTRIES
EXCLUSIVE**



2-3/4" DEEP

GANGABLE SWITCH BOXES

(Intermediate Depth)

2" W x 3" H - 4" W x 3" H
14.0 Cu. In. - 28.0 Cu. In.
(Except for TGMW
2-1/4" W x 3" H, 18.5 Cu.In.)

**WITH PRE-ASSEMBLED
10-32 GROUND SCREW &
7" SOLID CU. #12AWG PIGTAIL
(EXCEPT FOR GMB-1-NE
AND TGMW)**

Features:

- 2-Gang Gangable Switch Boxes can be expanded to multi-gang with GMB-1-NE to non-bracket side

***TGMW Features:**

- Non-gangable wide old-work switch box for easy installation of GFCI or other large devices
- Use with Mid-Size or Jumbo Wall Plate

BX/MC Clamp Features:

- All MC series boxes are suitable for use with MCAP™-Aluminum
- MCAP is a trademark of Southwire Company

- **600V** MKO's suitable for bonding without any additional bonding means up to 600V
- Acceptable for use in 2-hour rated walls (Up to 2-Gang)
- Visit www.ul.com or QCIT Guide on page W1 for more information



Cat. No.	Description	Knockouts			Std. Pkg.
		Sides	Ends	Bottom	
GMB-1-NE	No Ears, with Leveling Bumps	2 - 1/2"	2 - MKO	2 - 1/2"	50
GMB-1	Ears only	4 - 1/2"	2 - MKO	2 - 1/2"	50
GMB-2-B <small>NEW</small>	With B Bracket	2 - 1/2"	4 - MKO	4 - 1/2"	25
GMB-1-FB	With FB Bracket (9/16" Setback)	2 - 1/2"	2 - MKO	2 - 1/2"	50
GMB-2-FB <small>NEW</small>	With FB Bracket (9/16" Setback)	2 - 1/2"	4 - MKO	4 - 1/2"	25
GMB-1-NM	With NM Cable Clamps	4 - 1/2"	2 - 1/2", 4 - Loom	1 - 1/2"	50
GMB-1-NM-B	NM Clamps & B Bracket (9/16" Setback)	2 - 1/2"	2 - 1/2", 4 - Loom	1 - 1/2"	50
GMB-1-NM-FB	NM Clamps & FB Bracket (9/16" Setback)	2 - 1/2"	2 - 1/2", 4 - Loom	1 - 1/2"	50
GMB-2-NM-FB <small>NEW</small>	NM Clamps & FB Bracket (9/16" Setback)	2 - 1/2"	4 - 1/2", 8 - Loom	2 - 1/2"	25
GMB-1-NM-OW	With NM Cable Clamps, Old Work Grips	4 - 1/2"	2 - 1/2", 4 - Loom	1 - 1/2"	50
GMB-1-MC	With BX/MC Cable Clamps	4 - 1/2"	2 - 1/2", 4 - Loom	1 - 1/2"	50
GMB-1-MC-B	BX/MC Clamps & B Bracket (9/16" Setback)	2 - 1/2"	2 - 1/2", 4 - Loom	1 - 1/2"	50
GMB-1-MC-FB	BX/MC Clamps & FB Bracket (9/16" Setback)	2 - 1/2"	2 - 1/2", 4 - Loom	1 - 1/2"	50
GMB-2-MC-FB <small>NEW</small>	BX/MC Clamps & FB Bracket (9/16" Setback)	2 - 1/2"	4 - 1/2", 8 - Loom	2 - 1/2"	25
GMB-1-MC-OW	With MC Cable Clamps, Old Work Grips	4 - 1/2"	2 - 1/2", 4 - Loom	1 - 1/2"	50
SGM-1	Gangable Old Work Switch Box	4 - 1/2"	2 - MKO	2 - 1/2"	50
SGM-1-NM	Gangable Old Work NM Switch Box	4 - 1/2"	2 - 1/2", 4 - Loom	1 - 1/2"	50
SGM-1-MC	Gangable Old Work BX/MC Switch Box	4 - 1/2"	2 - 1/2", 4 - Loom	1 - 1/2"	50
TGMW* <small>NEW</small>	Wide Old Work Tigerrip (Non-Gangable) Must be used with Mid-Size or Jumbo Wall Plate	4 - 1/2"	2 - 1/2"	2 - 1/2"	50

Gangable Switch Boxes

orbit
Orbit Industries, Inc.

A33

Steel Products

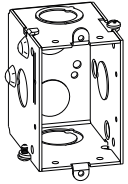

GMB-1-NE

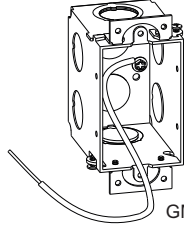

GMB-1

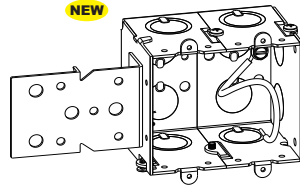

GMB-2-B

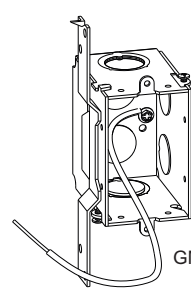

GMB-1-FB

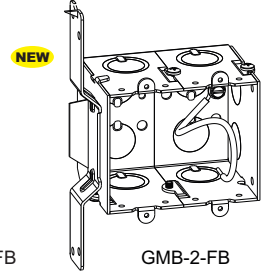

GMB-2-FB

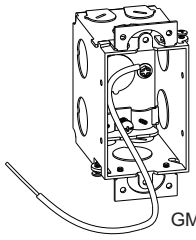

GMB-1-NM

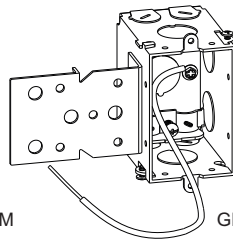

GMB-1-NM-B

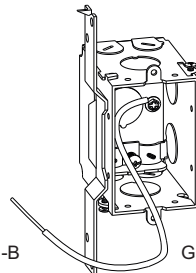

GMB-1-NM-FB

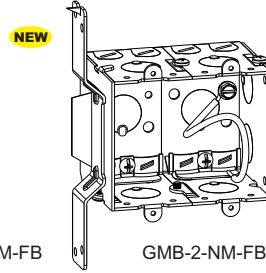

GMB-2-NM-FB

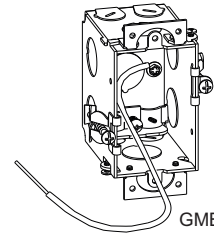

GMB-1-NM-OW

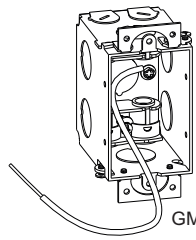

GMB-1-MC

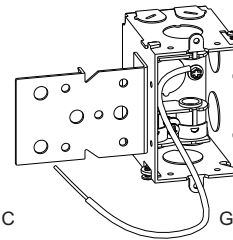

GMB-1-MC-B

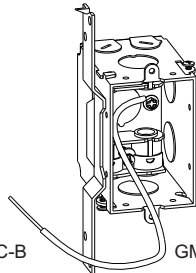

GMB-1-MC-FB

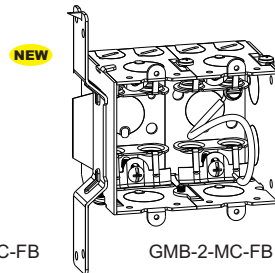

GMB-2-MC-FB

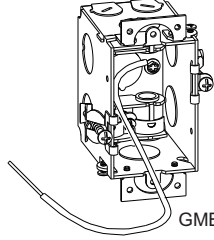

GMB-1-MC-OW

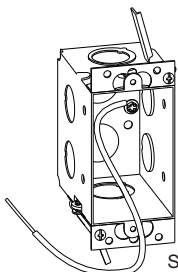

SGM-1

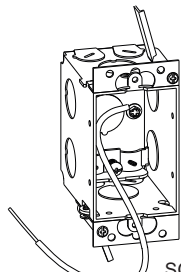

SGM-1-NM

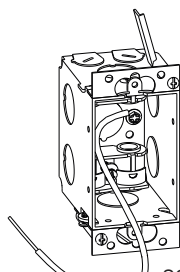

SGM-1-MC

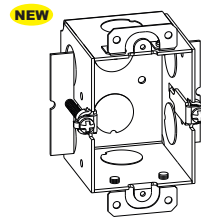

TGMW*

Extra Wide
18.5 Cu. In.
Non-Gangable

ORBIT INDUSTRIES
EXCLUSIVE

- **600V** MKO's suitable for bonding without any additional bonding means up to 600V
- Acceptable for use in 2-hour rated walls (Up to 2-Gang)
- Visit www.ul.com or QCIT Guide on page W1 for more information

2-3/4" DEEP

NON-GANGABLE NAIL-ON SWITCH BOXES

(Intermediate Depth)

2-1/8" W x 3" H
15.9 Cu. In.

WITH TWO MOUNTING NAILS

BX/MC Clamp Features:

- All MC series boxes are suitable for use with MCAP™-Aluminum
- MCAP is a trademark of Southwire Company

Cat. No.	Description	Knockouts			Std. Pkg.
		Sides	Ends	Bottom	
GMB-NM-NO	Nail-On Non-Gangable, with NM Clamps	-	2 - 1/2", 4 - Loom	1 - 1/2"	50
GMB-MC-NO	Nail-On Non-Gangable, with BX/MC Clamps	-	2 - 1/2", 4 - Loom	1 - 1/2"	50

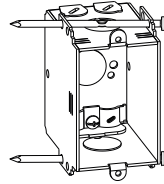

GMB-NM-NO

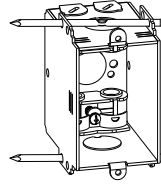

GMB-MC-NO

3-1/2" DEEP

GANGABLE SWITCH BOXES

2" W x 3" H
18.0 Cu. In.

WITH PRE-ASSEMBLED 10-32 GROUND SCREW & 7" SOLID CU. #12AWG PIGTAIL (EXCEPT FOR GDB-1-NE)

Cat. No.	Description	Knockouts			Std. Pkg.
		Sides	Ends	Bottom	
GDB-1-NE	No Ears, with Leveling Bumps	4 - 1/2"	2 - 1/2", 2 - MKO	2 - 1/2"	50
GDB-1	Ears only	4 - 1/2"	2 - 1/2", 2 - MKO	2 - 1/2"	50
GDB-1-NM	With NM Cable Clamps	4 - 1/2"	2 - 1/2", 4 - Loom	1 - 1/2"	50
GDB-1-NM-B	With NM Cable Clamps & B Bracket	4 - 1/2"	2 - 1/2", 4 - Loom	1 - 1/2"	50
GDB-1-NM-FB	With NM Cable Clamps & FB Bracket	4 - 1/2"	2 - 1/2", 4 - Loom	1 - 1/2"	50
GDB-1-MC	With BX/MC Cable Clamps	4 - 1/2"	2 - 1/2", 4 - Loom	1 - 1/2"	50
GDB-1-MC-B	With BX/MC Cable Clamps & B Bracket	4 - 1/2"	2 - 1/2", 4 - Loom	1 - 1/2"	50
GDB-1-MC-FB	With BX/MC Cable Clamps & FB Bracket	4 - 1/2"	2 - 1/2", 4 - Loom	1 - 1/2"	50
TGD-1	Gangable Old Work Tigerrip	4 - 1/2"	2 - 1/2", 2 - MKO	2 - 1/2"	50

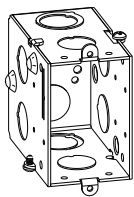

GDB-1-NE

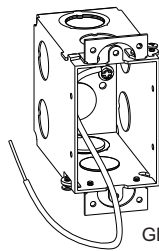

GDB-1

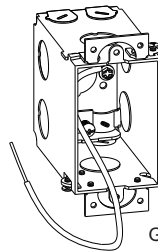

GDB-1-NM

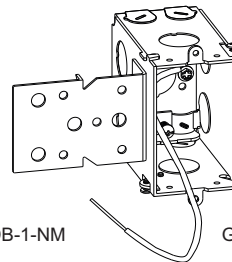

GDB-1-NM-B

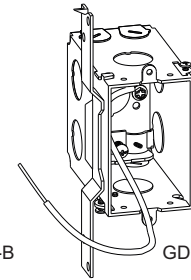

GDB-1-NM-FB

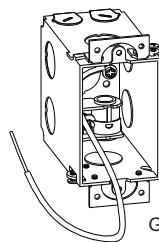

GDB-1-MC

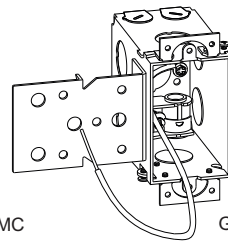

GDB-1-MC-B

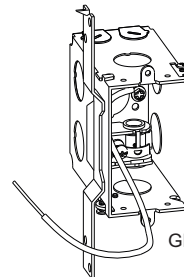

GDB-1-MC-FB

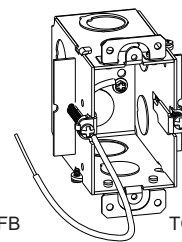

TGD-1

- 600V** MKO's suitable for bonding without any additional bonding means up to 600V
- Acceptable for use in 2-hour rated walls (Up to 2-Gang)
- Visit www.ul.com or QCIT Guide on page W1 for more information



File E227970

Floor Box Assemblies



A35

FLOOR BOX ASSEMBLY FLIP & ROUND PLUG TYPE

Features:

- 125 VAC
- All Orbit floor boxes are available as complete assemblies
- Adjustable floor box allows for fast and easy installation for both new and existing work
- For use in wood floors
- Also available with round and rectangular cover plates

Tamper Resistant:

- See Page W4 for more Tamper Resistant Information

Note:

- Additional Receptacle colors available upon request (see page E6)



Cat. No.	Description	Std. Pkg.
FLB-D-C-BR NEW	Floor Box Cover only, Flip Type with Duplex Receptacle, Tamper Resistant , Brass	10
FLB-D-C-SS NEW	Floor Box Cover only, Flip Type with Duplex Receptacle, Tamper Resistant , Stainless Steel	10
FLB-R1G-C-BR NEW	Floor Box Cover only, Round Plug Type with Duplex Receptacle, Tamper Resistant , Brass	10
FLB-R1G-C-SS NEW	Floor Box Cover only, Round Plug Type with Duplex Receptacle, Tamper Resistant , Stainless Steel	10
FLB-D-BR	Floor Box Flip Type with Duplex Receptacle and Adjustable Box, Tamper Resistant , Brass	10
FLB-D-SS	Floor Box Flip Type with Duplex Receptacle and Adjustable Box, Tamper Resistant , Stainless Steel	10
FLB-R1G-BR NEW	Floor Box Round Plug Type with Duplex Receptacle and Adjustable Box, Tamper Resistant , Brass	10
FLB-R1G-SS NEW	Floor Box Round Plug Type with Duplex Receptacle and Adjustable Box, Tamper Resistant , Stainless Steel	10
1GAB NEW	1-Gang Adjustable Box only, from 0" to 2"	10



FLB-D-C-BR



FLB-D-C-SS



FLB-R1G-C-BR



FLB-R1G-C-SS



FLB-D-BR

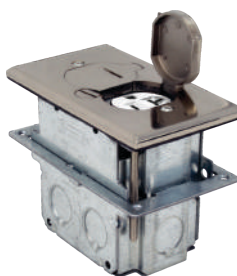

FLB-D-SS



FLB-R1G-BR



FLB-R1G-SS



1GAB



EXPLODED DRAWING
FLB Series

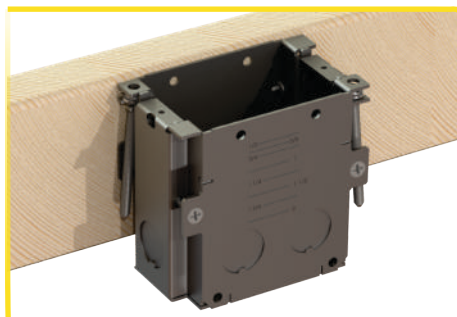
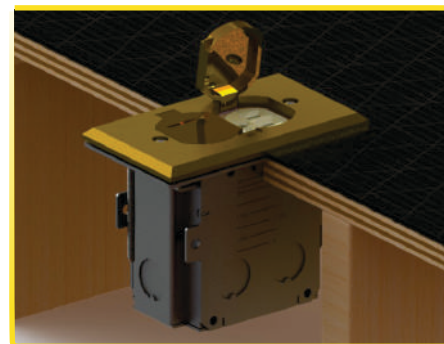

SIDE MOUNT INSTALLATION

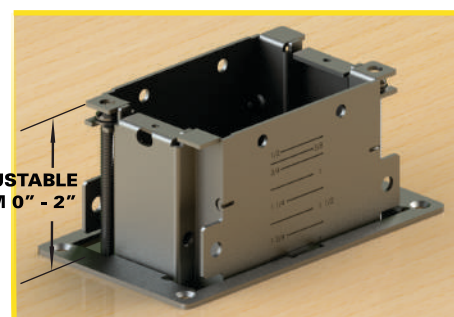

ADJUSTABLE
FROM 0" - 2"

SUB-FLOOR INSTALLATION

FLOOR BOX ASSEMBLY POP-UP TYPE

- Features:**
- 125 VAC
 - All Orbit floor boxes are available as complete assemblies
 - Steel floor boxes must be installed flush with finished floor prior to final installation
 - For use in wood or concrete floors
 - Also available with round and rectangular cover plates

- Tamper Resistant:**
- See Page W4 for more Tamper Resistant Information

ONE GANG BOX

- Dimension:**
- 4" x 4" x 3-1/2", 46.0 Cu. In.

TWO GANG BOX

- Dimension:**
- 4" x 7-15/16" x 3, 74.0 Cu. In.

Cat. No.	Description	Std. Pkg.
FLBPU-D-R-BR	Floor Box Pop-Up with Duplex Receptacle, Tamper Resistant , Round Cover, Brass	10
FLBPU-D-R-SS	Floor Box Pop-Up with Duplex Receptacle, Tamper Resistant , Round Cover, Stainless Steel	10
FLBPU-D-S-BR NEW	Floor Box Pop-Up with Duplex Receptacle, Tamper Resistant , Square Cover, Brass	10
FLBPU-D-S-SS NEW	Floor Box Pop-Up with Duplex Receptacle, Tamper Resistant , Square Cover, Stainless Steel	10
FLBPU-L-R-BR NEW	Floor Box Pop-Up with Low-Voltage (RJ45), Round Cover, Brass	10
FLBPU-L-R-SS NEW	Floor Box Pop-Up with Low-Voltage (RJ45), Round Cover, Stainless Steel	10
FLBPU-L-S-BR	Floor Box Pop-Up with Low-Voltage (RJ45), Square Cover, Brass	10
FLBPU-L-S-SS NEW	Floor Box Pop-Up with Low-Voltage (RJ45), Square Cover, Stainless Steel	10
FLBPU-DD-BR NEW	Floor Box Pop-Up with 2 Duplex Receptacles, Tamper Resistant , Brass	10
FLBPU-DD-SS NEW	Floor Box Pop-Up with 2 Duplex Receptacles, Tamper Resistant , Stainless Steel	10
FLBPU-LL-BR NEW	Floor Box Pop-Up with 2 Low-Voltage (RJ45), Brass	10
FLBPU-LL-SS NEW	Floor Box Pop-Up with 2 Low-Voltage (RJ45), Stainless Steel	10
FLBPU-DL-BR	Floor Box Pop-Up with Duplex Receptacle, Tamper Resistant , & Low-Voltage (RJ45), Brass	10
FLBPU-DL-SS	Floor Box Pop-Up with Duplex Receptacle, Tamper Resistant , & Low-Voltage (RJ45), Stainless Steel	10
FLBPU-D-R-C-BR NEW	Floor Box Pop-Up Cover only, with Duplex Receptacle, Tamper Resistant , Round Cover, Brass	10
FLBPU-D-R-C-SS NEW	Floor Box Pop-Up Cover only, with Duplex Receptacle, Tamper Resistant , Round Cover, Stainless Steel	10
FLBPU-D-S-C-BR NEW	Floor Box Pop-Up Cover only, with Duplex Receptacle, Tamper Resistant , Square Cover, Brass	10
FLBPU-D-S-C-SS NEW	Floor Box Pop-Up Cover only, with Duplex Receptacle, Tamper Resistant , Square Cover, Stainless Steel	10
FLBPU-L-R-C-BR NEW	Floor Box Pop-Up Cover only, with Low-Voltage (RJ45), Round Cover, Brass	10
FLBPU-L-R-C-SS NEW	Floor Box Pop-Up Cover only, with Low-Voltage (RJ45), Round Cover, Stainless Steel	10
FLBPU-L-S-C-BR NEW	Floor Box Pop-Up Cover only, with Low-Voltage (RJ45), Square Cover, Brass	10
FLBPU-L-S-C-SS NEW	Floor Box Pop-Up Cover only, with Low-Voltage (RJ45), Square Cover, Stainless Steel	10
FLBPU-AR NEW	PVC Adapter Ring for Floor Box Pop-Up Cover, fits all Round Covers (Sold Separately)	10
FLBC-P-R NEW	Round PVC Floor Box for Concrete Floors (Sold Separately)	10



FLBPU-D-R-BR



FLBPU-D-R-SS



FLBPU-D-S-BR



FLBPU-D-S-SS



FLBPU-L-R-BR



FLBPU-L-R-SS



FLBPU-L-S-BR



FLBPU-L-S-SS



Floor Box Assemblies

orbit
Orbit Industries, Inc.

A37

Steel Products



FLBPU-DD-BR



FLBPU-DD-SS



FLBPU-LL-BR



FLBPU-LL-SS



FLBPU-DL-BR



FLBPU-DL-SS



FLBPU-D-R-C-BR



FLBPU-D-R-C-SS



FLBPU-D-S-C-BR



FLBPU-D-S-C-SS



FLBPU-L-R-C-BR



FLBPU-L-R-C-SS



FLBPU-L-S-C-BR



FLBPU-L-S-C-SS



FLBPU-AR



FLBC-P-R



EXPLODED VIEW OF ASSEMBLY
(Sold Separately)

GROUND SCREWS & CLIP

Cat. No.	Description	Std. Pkg.	Master Carton
GS-1032	Ground Screw 10-32 x 3/8", Green, Slotted/Philips/Hex Washer Head	100	1,000
GS-1032-PT	GS-1032 with 7" Solid Cu. #12AWG Pigtail	50	250
GC	Grounding Clip, for #14 - #10 AWG Copper	100	1,000

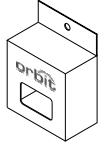

In Display Boxes



GS-1032

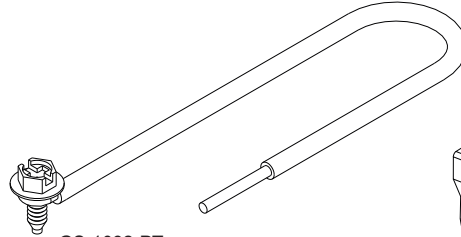

GS-1032-PT

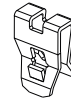

GC

ACCESSORIES

Cat. No.	Description	Std. Pkg.
SB-EXT	Switch Box Extension fits any 1-Gang Box, adjustable from 1/4" to 1" to shield combustible wall surfaces from wiring system, 3.5 Cu. In.	25
SBS	Switch Box Support with bendable tabs, 20GA	100
DLR-1G NEW	Device Leveler and Retainer, 1-Gang	50

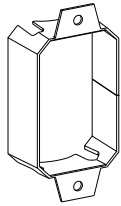

SB-EXT



Installation View

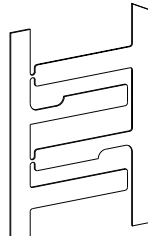

SBS



Installation View

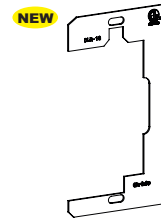

DLR-1G



Installation View

FLEX BUSHING

Features:

- Used to Insulate Cut Flex when Conduit is used for Data Cables without a Junction Box
- Zinc Plated Steel

Cat. No.	Trade Size	Std. Pkg.	Master Ctn.
FB-50	1/2"	100	1000
FB-75	3/4"	100	500
FB-100	1"	25	250



Shown Installed

FIXED BAR HANGERS

Features:

- For Stud and T-Bar

Cat. No.	Description	Std. Pkg.
BHT-1	24" T-Bar bracket for use with boxes 1-1/2" or 2-1/8" Deep	50
BHT-1A	24" T-Bar bracket - 8" height adjustable	50
BH-1	24" Straight bar hanger for mounting ceiling boxes, Slotted, Includes 2 Stove Bolts per Unit	50
BH-1C	24" Straight bar hanger for mounting ceiling boxes, with BH-C Box Clip	50
BH-1S	20" Straight bar hanger for mounting ceiling boxes, Slotted, Includes 2 Stove Bolts per Unit	50
BH-1SC	20" Straight bar hanger for mounting ceiling boxes, With Box Clip BH-C	50
BH-2	21" Offset (1-1/2") bar hanger for mounting boxes with ring	50
BH-2NC	21" Offset (1-1/2") bar hanger for mounting boxes with ring, Slotted, Includes 2 Stove Bolts/Unit	50
BH-C	Additional box clip & screw set for use with BH-1, BH-1S & BH-2NC	100
BH-3	Straight bracket for mounting architectural recess lights 25-1/4" long with notches 24" apart for use on T-Bar	50
BHT-C	Additional box clip & screw set for use with BHT-1 & BHT-1A	100

Steel Products

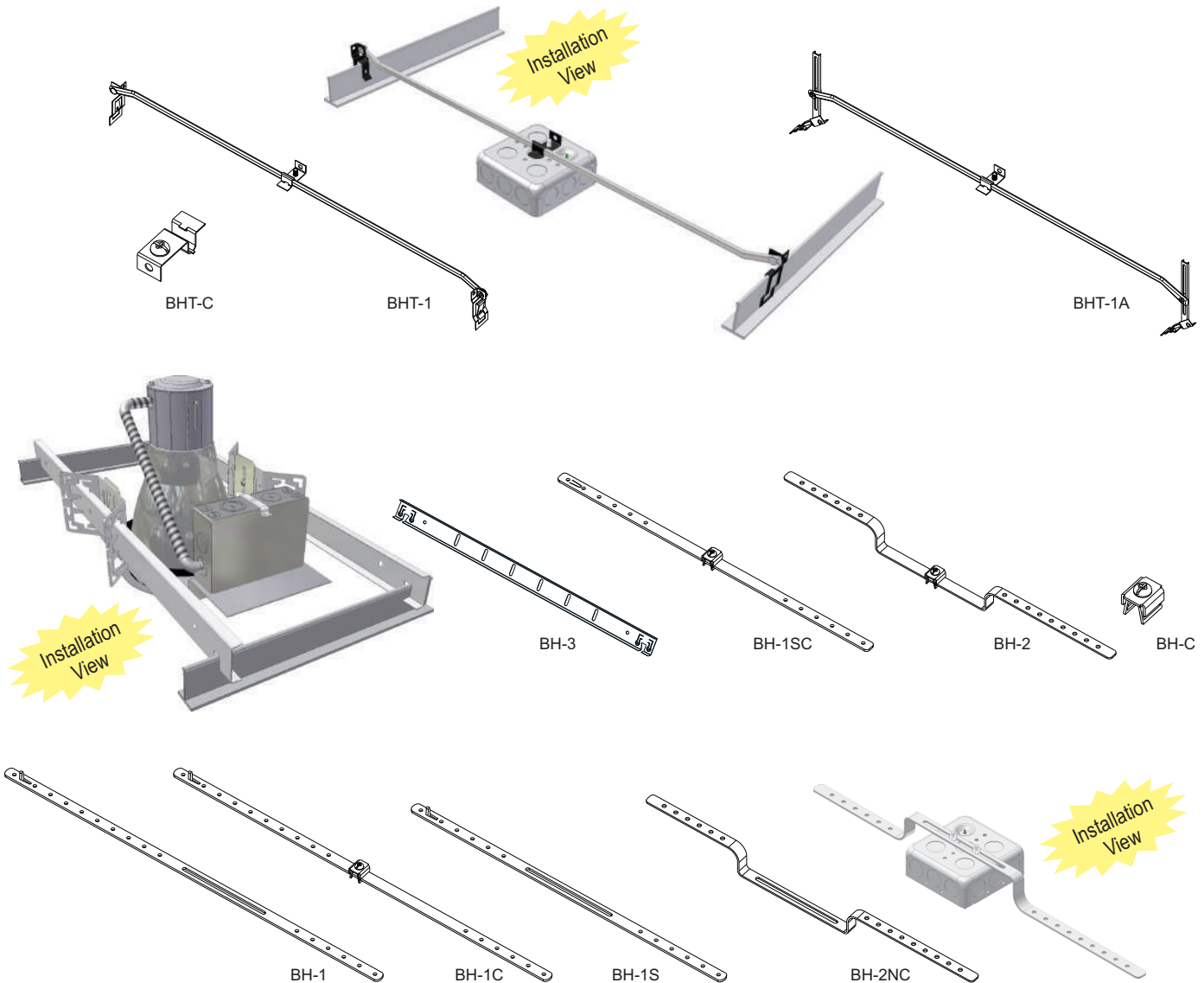

ADJUSTABLE BAR HANGERS

Cat. No.	Description	Std. Pkg.
BHA-1	Adjustable Bar Hanger with stud for joist spacing 16" to 24" with #3/8-18 NPS Threaded Stud	50
BHA-1C	Adjustable Bar Hanger with stud for joist spacing 16" to 24" with Box Clip	50
BHA-16	11" to 18" Adjustable Box Bracket - Mount Box with self-tapping screws on notches Ends bend and wrap around stud - Can be used with boxes 1-1/2" or 2-1/8" deep	50
BHA-24	17" to 26" Adjustable Box Bracket - Mount Box with self-tapping screws on notches Ends bend and wrap around stud - Can be used with boxes 1-1/2" or 2-1/8" deep	50
ABS	Far-Side Box Support for 1-1/2" & 2-1/8" Deep Boxes, for use with 4" Metal Studs.	50
ABS-6	Far-Side Box Support for 1-1/2" & 2-1/8" Deep Boxes, for use with 6" Metal Studs.	50
OWG	Clips and locks old-work steel boxes tightly to wall. 2 required per box.	100

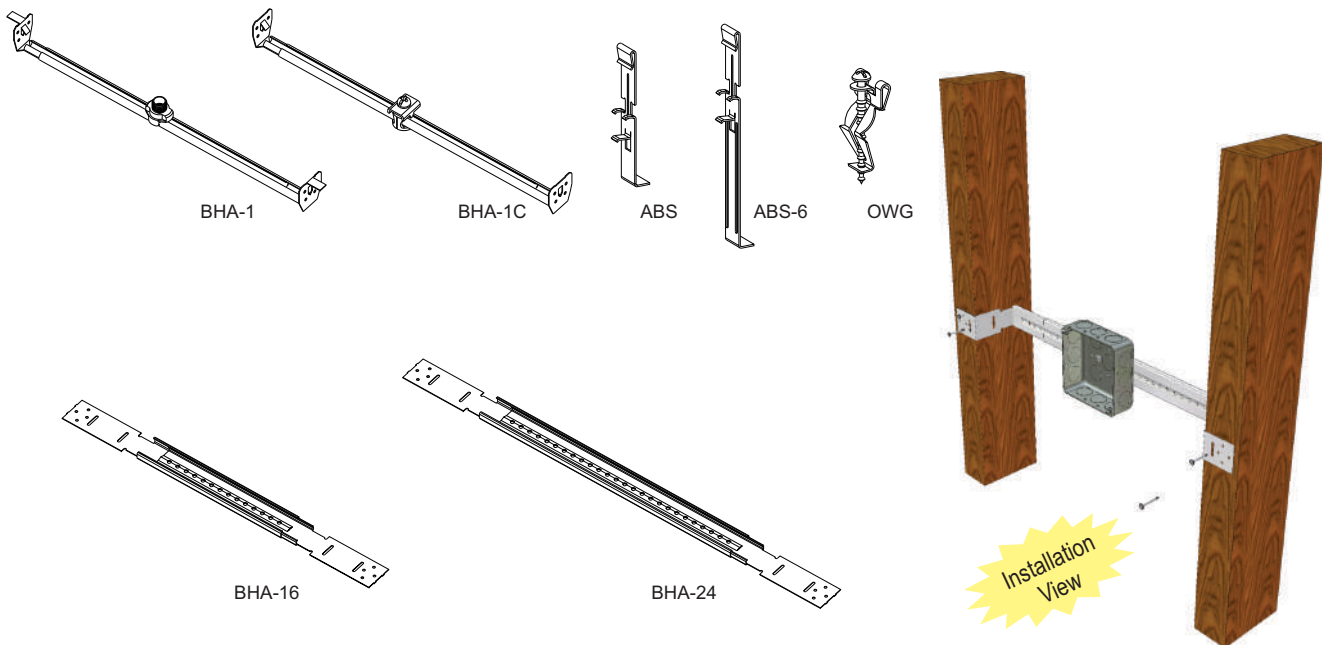

MULTIPLE-BOX BAR HANGER FLAT

Cat. No.	Application	Dimensions (W x L)	Box		Std. Pkg.
			Sizes	Depth	
MBBH-16	For 16" Stud spacing	6" x 16"	4" & 4-11/16"	1-1/2" & 2-1/8"	50
MBBH-24	For 24" Stud spacing	6" x 24"	4" & 4-11/16"	1-1/2" & 2-1/8"	50

Features:

- Pre-galvanized 18 Gauge sheet metal
- Individual brackets accommodate 4S and 5S steel boxes
- Allows steel boxes to adjust easily horizontally along the bracket
- Reduces assembly time on job site

NEW

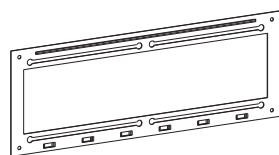

MBBH-16

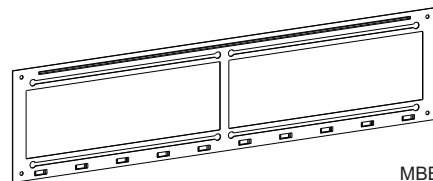

MBBH-24

NAIL SAFETY PLATES

Cat. No.	Features	Dimensions (W x L)	Thickness	Std. Pkg.
SP-1	With 2 Mounting Prongs & 1 Nail Hole each end	1.5" x 2.75"	16 GA	100
SP-1-500	With 2 Mounting Prongs & 1 Nail Hole each end	1.5" x 2.75"	16 GA	500
SP-35	With 2 Mounting Prongs & 1 Nail Hole each end	3" x 5"	16 GA	100
SP-6	With 2 Mounting Prongs & 1 Nail Hole each end	1.5" x 6"	16 GA	100
SP-9	With 4 Nail Holes each end	1.5" x 9"	16 GA	50
SP-12	With 4 Nail Holes each end	1.5" x 12"	16 GA	50
SP-18	With 6 Nail Holes each end	1.5" x 18"	16 GA	50
SP-24	With 6 Nail Holes each end	1.5" x 24"	16 GA	50
SPH-9	Heavy-Duty, With 4 Nail Holes each end	1.5" x 9"	12 GA	50
SPH-12	Heavy-Duty, With 4 Nail Holes each end	1.5" x 12"	12 GA	50
SPH-18	Heavy-Duty, With 6 Nail Holes each end	1.5" x 18"	12 GA	50
SPH-24	Heavy-Duty, With 6 Nail Holes each end	1.5" x 24"	12 GA	50



Installation View

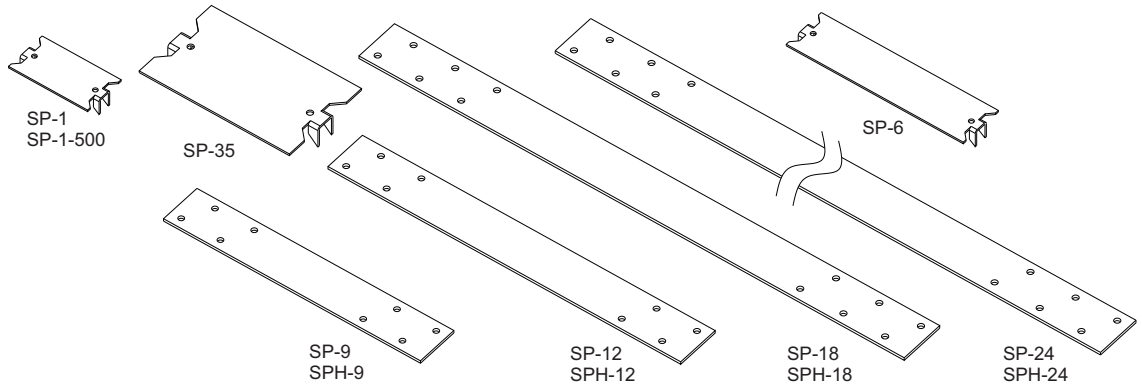

FLEX/RIGID/EMT NAIL STRAPS

Cat. No.	FLEX/RIGID Size	EMT Size	Description	Std. Pkg.	Master Carton
NS-50	-	1/2"	EMT Nail Strap	100	1,000
NS-50/75	1/2"	3/4"	Flex/Rigid/EMT Nail Strap	100	1,000
NS-100	3/4"	1"	Flex/Rigid/EMT Nail Strap	100	1,000

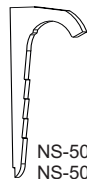

NS-50
NS-50/75
NS-100

BOX & CONDUIT HANGER SUPPORT

Features:

- 16 Gauge Steel, Pre-Galvanized
- No cutting required
- Stamped markings provide guide lines
- Pin holes and slots allow for use of conduit straps
- Self-reinforcing as more conduit is added
- Requires only one rod for installation
- Easy to preassemble to save time and material
- ETL rated for up to 100lbs

NEW



Cat. No.	Description	Std. Pkg.
BCHS-10	Fits up to 6" x 6" Box	25
BCHS-6	Provide bent tabs for vertical mounting, fits up to 6" x 6" Box	10
BCHS-6S	Provide bent tabs for vertical mounting, and enable the use of one-hole straps, fits up to 6" x 6" Box	10
BCHS-12	Provide bent tabs for vertical mounting, fits up to one 12" x 12" Box or multiple small sized boxes	5

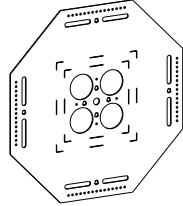

BCHS-10

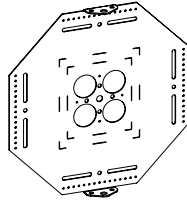

BCHS-6

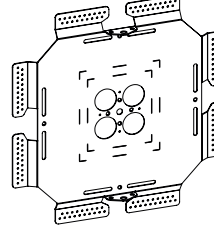

BCHS-6S

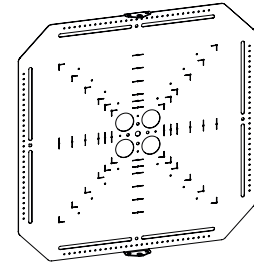

BCHS-12



BCHS-10

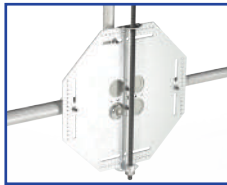

BCHS-6



BCHS-6S



BCHS-12

Fits up to 3 Boxes!

ORBIT'S EXCLUSIVE Prefabrication Plate

SAVE TIME, MONEY, AND MAKE ALL YOUR CONDUIT & BOX INSTALLATIONS EASIER

BCHS - 6S
Allows for use of one-hole strap

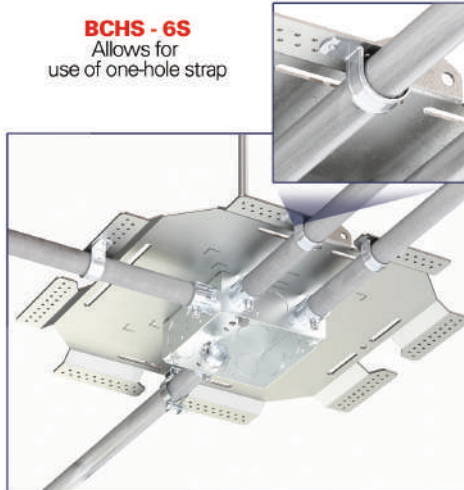

BCHS - 12
Fits up to one 12" x 12" Box or multiple small sized boxes

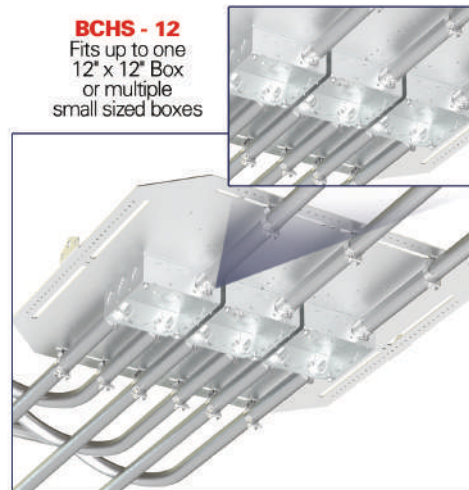

EASY ACCESS LIGHTING BOX 2-1/8" DEEP

30.2 Cu. In.

Features:

- Fast and efficient installations
- Sliding cover plate for one person installations
- Available with either standard or swivel sliding cover plate
- Swivel reduces damage to hanging fixtures when struck
- Complies with NEC 314.27 (A)(D) for up to 90 lbs. of fixture load (for more information see pg. W14)

NEW



ORBIT INDUSTRIES EXCLUSIVE

Cat. No.	Description	Dimensions (W x H)	Knockouts		Std. Pkg.
			Sides	Bottom	
EALB	Easy Access Lighting Box	4" X 4"	4-CKO	3-1/2", 1-3/4"	50
EALBS	Easy Access Lighting Box with Sliding Swivel	4" X 4"	4-CKO	3-1/2", 1-3/4"	10

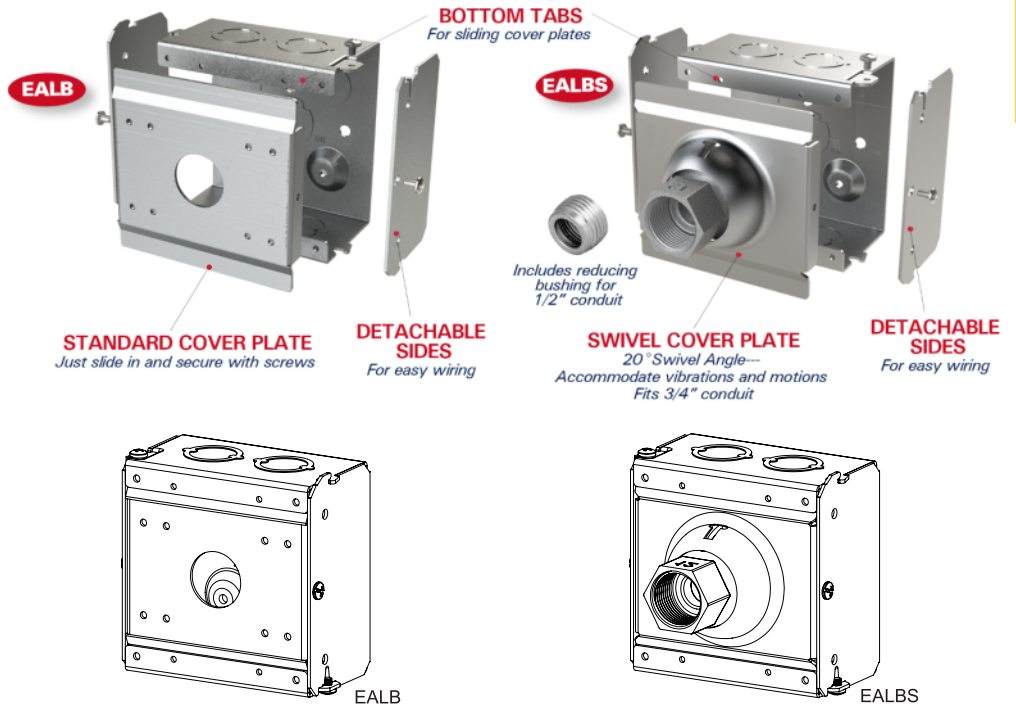

50% COST SAVINGS

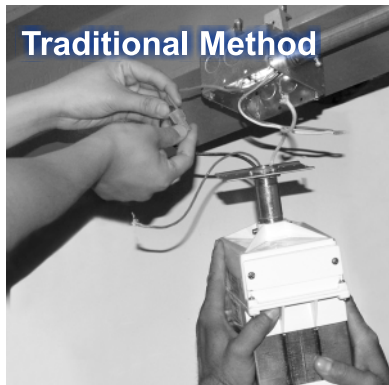

REQUIRES TWO INSTALLERS



ONE INSTALLER ONLY



(1) Install EALB with side plate and cover plate REMOVED

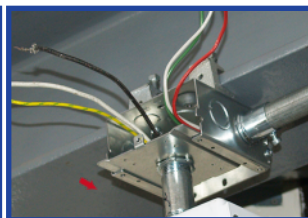

(2) Install cover plate on lighting fixture and slide it back into the box

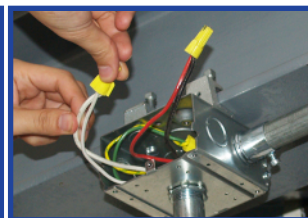

(3) Complete wiring



(4) Attach side plate with screws to finish installation

JACK CHAIN

Features:

- Steel
- Electroplated Zinc
- 25 lbs. Max. Load
- In Steel Reel



Cat. No.	Trade Size	Std. Pkg.
JC-12	12GA	100

“S” HOOK

Features:

- Steel
- Electroplated Zinc
- 25 lbs. Max. Load



Cat. No.	Trade Size	Std. Pkg.	Master Ctn.
SH-2	12GA, 1-1/4"	100	1000

HANGER SCREW WITH SINGLE HOLE

Features:

- Steel
- Wood Screw Thread



Cat. No.	Description	Dimension	Std. Pkg.	Master Ctn.
H-SCREW	Flat Hanger Screw	1/4" x 3"	100	500

FIXTURE HANGER

Features:

- Steel

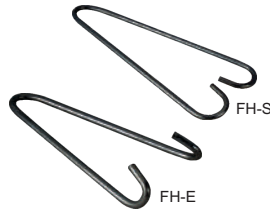

Cat. No.	For Use With	Mount Position	Std. Pkg.	Master Ctn.
FH-E	2, 3, or 4 Light Fixtures	End Mount	100	500
FH-S	2, 3, or 4 Light Fixtures	Side Mount	100	500

PORCELAIN WIRE HOLDERS

Features:

- Porcelain & Galvanized Steel
- Varies According to Sizes

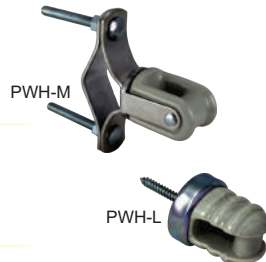

Cat. No.	Description	Trade Size	Std. Pkg.	Master Ctn.
PWH-L	With 2-1/4" Lag Bolt	2-3/4"	5	20
PWH-M	With Steel Clip for 1-1/4" to 3" Mast	1-1/4" to 3"	5	20

TIE WIRE

Features:

- Black Annealed Steel
- 16GA



Cat. No.	Description	Trade Size	Std. Pkg.
TW	Tie Wire	16GA, 400'	20

Stainless Steel Wallplates Quick Reference

For More Information See Wiring Devices Starting on Page E22



OS13



OS1



OS8



OS26



OS23



OS2



OS82



OS262



OS33



OS3



OS83



OS263



OS43



OS4



OS84

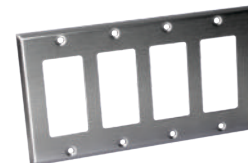

OS264



OS7



OS705



OS11



OS737



OS724



OS113



OS18



OS126



OS826



OS226

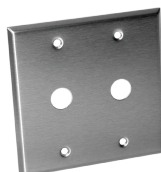

OS21

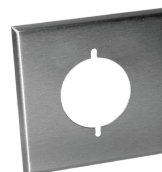

OS703



OS701