

# Wallplates

## INDEX

Decora® Plus Screwless Snap-On . . . . .	E2, E4, E5
Decora® . . . . .	E3, E4, E5
Wallplate Overview . . . . .	E6
Toggle . . . . .	E7-E9
Duplex Receptacle . . . . .	E10, E11
Single Receptacle . . . . .	E12
Telephone or Cable Outlet, Box Mount . . . . .	E13, E14
Telephone or Cable Outlet, Strap Mount . . . . .	E14, E15
Blank, Box Mount . . . . .	E16, E17
Blank, Strap Mount . . . . .	E17, E18
Power Outlet Receptacles . . . . .	E19, E20
Two-Gang with Centered Opening . . . . .	E21
Louvre Plates . . . . .	E22
Combination Wallplates	
Toggle and Single Receptacle . . . . .	E23
Toggle and Duplex Receptacle . . . . .	E23, E24
Toggle and Decora/GFCI . . . . .	E25
Toggle and Blank . . . . .	E26
Standard Combinations-2-Gang . . . . .	E26-E28
Standard Combinations-3-Gang/4-Gang . . . . .	E28
Sectional for Multi-Gang Installations . . . . .	E29
Hot Stamped and Engraved . . . . .	E29, E30
Voice/Data/CATV . . . . .	E31
Weather Resistant Covers	
Raintight While-In-Use . . . . .	E32
Industrial Grade . . . . .	E33
Die-cast Zinc . . . . .	E34
Thermoplastic . . . . .	E35
Stainless Steel Lockout . . . . .	E34, E35
Accessories . . . . .	E36
Custom Wallplates . . . . .	E37-E40



# DECORA® PLUS SCREWLESS SNAP-ON WALLPLATES

## Residential and Commercial Grade Wallplates

### Decora Plus Screwless Snap-On Wallplates

- Sleek, smooth contemporary architectural styling enhances fine décor
- Exclusive new design eliminates subplate screws
- "Hook and Snap" subplate and wallplate mounting provides easy, time saving installation
- Decora-compatible two-piece kit allows easy retrofit to any Decora installation
- Tough, unbreakable polycarbonate construction
- Now available in standard and midway sizes that can be mounted onto larger-volume wallboxes and/or used to hide wall irregularities.



80301-SW  
Standard Size



SJ26-SW  
Midway Size

Standard Size  
Single-Gang Screwless Snap-On Wallplate

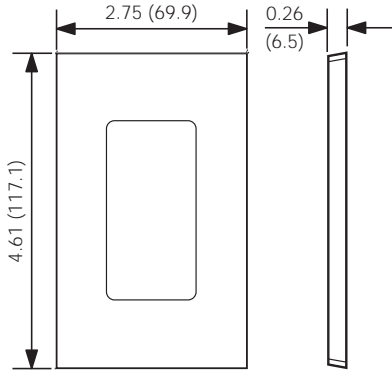

80301-S

Midway Size  
Single-Gang Screwless Snap-On Wallplate

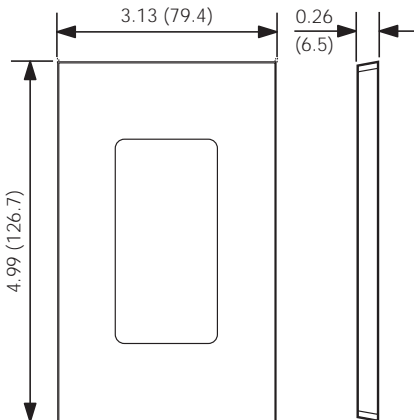

SJ26-S

Midway wallplates can be mounted onto larger-volume outlet boxes and/or used to hide wall irregularities. Midway wallplates are a full 0.375" higher and wider than standard size wallplates.

NOTE: Add 1.81" (46.0mm) for each additional gang.

### Decora Plus Screwless Snap-On Wallplates

DESCRIPTION	COLOR	STANDARD	MIDWAY
1-Gang 1-Decora	Ivory	80301-SI	SJ26-SI
	Ebony/Black	80301-SE	SJ26-SE
	Gray	80301-SGY	SJ26-SGY
	White	80301-SW	SJ26-SW
	Mahogany/Brown	80301-S	SJ26-S
	Almond	80301-SA	SJ26-SA
	Light Almond	80301-ST	SJ26-ST
2-Gang 2-Decora	Ivory	80309-SI	SJ262-SI
	Ebony/Black	80309-SE	SJ262-SE
	Gray	80309-SGY	SJ262-SGY
	White	80309-SW	SJ262-SW
	Mahogany/Brown	80309-S	SJ262-S
	Almond	80309-SA	SJ262-SA
	Light Almond	80309-ST	SJ262-ST
3-Gang 3-Decora	Ivory	80311-SI	SJ263-SI
	Ebony/Black	80311-SE	SJ263-SE
	White	80311-SW	SJ263-SW
	Almond	80311-SA	SJ263-SA
	Light Almond	80311-ST	SJ263-ST
4-Gang 4-Decora	Ivory	80312-SI	SJ264-SI
	White	80312-SW	SJ264-SW
	Almond	80312-SA	SJ264-SA
	Light Almond	80312-ST	SJ264-ST
5-Gang 5-Decora	Ivory	80321-SI	SJ265-SI
	White	80321-SW	SJ265-SW
	Almond	80321-SA	SJ265-SA
	Light Almond	80321-ST	SJ265-ST
6-Gang 6-Decora	Ivory	80326-SI	SJ266-SI
	White	80326-SW	SJ266-SW
	Almond	80326-SA	SJ266-SA
	Light Almond	80326-ST	SJ266-ST

#### TESTING AND CODE COMPLIANCE

- UL Listed (File #E-13397)
- Meets NEMA Standards WD-1, WD-6
- CSA Certified (File #LR-16347)
- NOM Certified (File #057)
- Backed by a Limited Ten-Year Warranty

#### MATERIAL CHARACTERISTICS

Environmental: Flammability UL-94, V2 Rating  
Operating Temperature: -40°C to 120°C

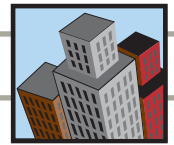

Residential and Commercial Grade Decora Wallplates

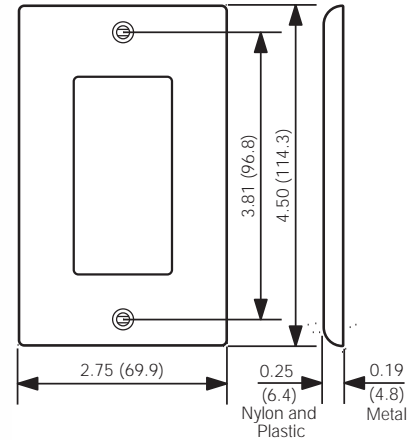

Standard Size Single-Gang

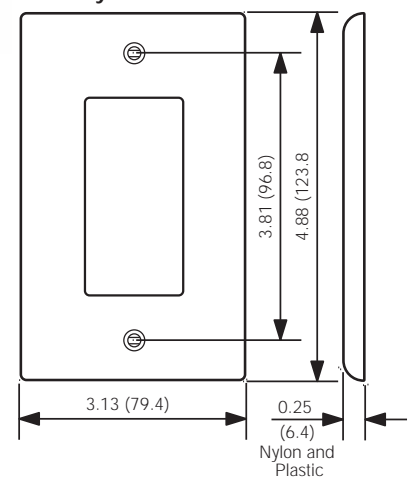

Midway Size Single-Gang

Midway wallplates can be mounted onto larger-volume outlet boxes and/or used to hide wall irregularities. Midway wallplates are a full 0.375" higher and wider than standard size wallplates.

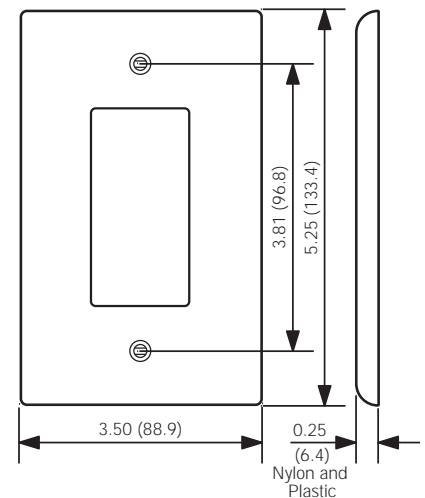

Oversized Single-Gang

Oversized wallplates are used to conceal greater wall irregularities than those hidden by Midway wallplates. Oversized wallplates are a full 0.75" higher and wider than standard size wallplates.

NOTE: Add 1.81" (46.0mm) for each additional gang.

All Decora Wallplates

- Accent any wall covering with a wide selection of colors and finishes
- Smooth face and rounded edges resist dust accumulation
- Individual plastic wrapping to protect wallplate's surface
- Color-matched metal mounting screws supplied

Residential Grade Thermoset Wallplates

- Photoelectrically color-matched to Leviton Decora devices
- Designed for high dielectric strength and arc resistance
- Meet or surpass UL 514 testing requirements
- Resistant to fading, discoloration, grease, oils, organic solvents and moisture scratches
- Backed by a Limited Two-Year Warranty

Commercial Grade Thermoplastic Wallplates

- Molded thermoplastic for maximum resistance to impact, abrasion, fading and discoloration
- Resistant to mechanical stress associated with high abuse applications
- Backed by a Limited Ten-Year Warranty

Commercial Grade Metal Wallplates

- Rounded edges to prevent injury and wall damage
- Deluxe stainless steel is non-magnetic Type 302, .032" thick
- Standard magnetic stainless steel Type 430, .032" thick, also available
- Brass is 70/30 alloy 260, .040" thick
- Aluminum is 3004 alloy, .040" thick
- Backed by a Limited Ten-Year Warranty

TESTING AND CODE COMPLIANCE

- Thermoplastic and Thermoset: UL Listed (File #E-13397)
- Metal: UL Listed (File #E-16347)
- Meets NEMA Standards WD-1, WD-6
- CSA Certified (File #LR-16347)
- NOM Certified (File #057)

MATERIAL CHARACTERISTICS

Environmental: Flammability UL-94, V2 Rating  
Operating Temperature: -40°C to 120°C

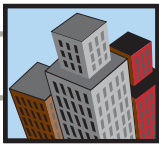

# WALLPLATES

## Residential and Commercial Grade Decora Wallplates

### Decora

DESCRIPTION 1-Gang 1-Decora	Thermoset			Thermoplastic		Screwless Snap-On Polycarbonate		Assorted Metals		
	STANDARD P26	MIDWAY SPJ26	OVERSIZE PO26	STANDARD N26	MIDWAY PJ26	STANDARD	MIDWAY	MATERIAL	STANDARD	OVERSIZE
Ivory	80401-I	80601-I	86601	80401-NI	PJ26-I	80301-SI	SJ26-SI	Chrome	*	—
Black	80401-E	—	—	80401-NE	PJ26-E	80301-SE	SJ26-SE	Aluminum	<b>A26</b> 83401	—
Gray	80401-GY	—	—	80401-NGY	PJ26-GY	80301-SGY	SJ26-SGY	Brass	<b>B26</b> 81401	—
White	80401-W	80601-W	88601	80401-NW	PJ26-W	80301-SW	SJ26-SW	Polished Brass	81401-PB	—
Brown	80401	80601	—	80401-N	PJ26	80301-S	SJ26-S	430 S/S	*	*
Almond	80401-A	80601-A	82601	80401-NA	PJ26-A	80301-SA	SJ26-SA	302 S/S	<b>SN26-N</b> 84401-40	<b>S026</b> S026
Light Almond	80401-T	80601-T	—	80401-NT	PJ26-T	80301-ST	SJ26-ST			
Red	—	—	—	80401-NR	—	—	—			
Blue	—	—	—	80401-NB	PJ26-BU	—	—			

DESCRIPTION 2-Gang 2-Decora	Thermoset			Thermoplastic		Screwless Snap-On Polycarbonate		Assorted Metals		
	STANDARD P262	MIDWAY SPJ262	OVERSIZE PO262	STANDARD N262	MIDWAY PJ262	STANDARD	MIDWAY	MATERIAL	STANDARD	OVERSIZE
Ivory	80409-I	80609-I	86602	80409-NI	PJ262-I	80309-SI	SJ262-SI	Chrome	*	—
Black	80409-E	—	—	80409-NE	PJ262-E	80309-SE	SJ262-SE	Aluminum	<b>A262</b> 83409	—
Gray	80409-GY	—	—	80409-NGY	PJ262-GY	80309-SGY	SJ262-SGY	Brass	<b>B262</b> 81409	—
White	80409-W	80609-W	88602	80409-NW	PJ262-W	80309-SW	SJ262-SW	Polished Brass	81409-PB	—
Brown	80409	80609	—	80409-N	PJ262	80309-S	SJ262-S	430 S/S	*	*
Almond	80409-A	80609-A	82602	80409-NA	PJ262-A	80309-SA	SJ262-SA	302 S/S	<b>S262-N</b> 84409-40	<b>S0262</b> S0262
Light Almond	80409-T	80609-T	—	80409-NT	PJ262-T	80309-ST	SJ262-ST			
Red	—	—	—	80409-NR	—	—	—			
Blue	—	—	—	80409-NB	—	—	—			

DESCRIPTION 3-Gang 3-Decora	Thermoset			Thermoplastic		Screwless Snap-On Polycarbonate		Assorted Metals		
	STANDARD P263	MIDWAY SPJ263	OVERSIZE	STANDARD N263	MIDWAY PJ263	STANDARD	MIDWAY	MATERIAL	STANDARD	OVERSIZE
Ivory	80411-I	80611-I	—	80411-NI	PJ263-I	80311-SI	SJ263-SI	Chrome	*	—
Black	80411-E	—	—	—	—	80311-SE	SJ263-SE	Aluminum	<b>A263</b> 83411	—
Gray	80411-GY	—	—	80411-NGY	PJ263-GY	—	—	Brass	<b>B263</b> 81411	—
White	80411-W	80611-W	—	80411-NW	PJ263-W	80311-SW	SJ263-SW	Polished Brass	81411-PB	—
Brown	80411	80611	—	80411-N	—	—	—	430 S/S	*	*
Almond	80411-A	80611-A	—	80411-NA	PJ263-A	80311-SA	SJ263-SA	302 S/S	<b>S263-N</b> 84411-40	<b>S0263</b> S0263
Light Almond	80411-T	80611-T	—	80411-NT	PJ263-T	80311-ST	SJ263-ST			

\*Consult your Leviton representative for ordering details: allow 3-4 weeks for delivery.

**NOTE: Where applicable, Industry Number indicated in BOLD FACE. For some wallplates, Industry Number and Leviton Catalog Number are identical.**

Residential and Commercial Grade Decora Wallplates

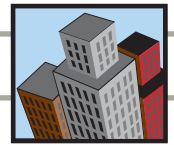

Decora

	Thermoset			Thermoplastic		Screwless Snap-On Polycarbonate		Assorted Metals		
<b>DESCRIPTION</b> 4-Gang 4-Decora										
<b>COLOR</b>	<b>STANDARD P264</b>	<b>MIDWAY SPJ264</b>	<b>OVERSIZE</b>	<b>STANDARD N264</b>	<b>MIDWAY PJ264</b>	<b>STANDARD</b>	<b>MIDWAY</b>	<b>MATERIAL</b>	<b>STANDARD</b>	<b>OVERSIZE</b>
Ivory	80412-I	80612-I	—	80412-NI	PJ264-I	80312-SI	SJ264-SI	Chrome	*	—
Black	80412-E	—	—	—	—	80312-SE	SJ264-SE	Brass	<b>B264</b> 81412	—
Gray	80412-GY	—	—	—	PJ264-GY	—	—	430 S/S	*	—
White	80412-W	80612-W	—	80412-NW	PJ264-W	80312-SW	SJ264-SW	302 S/S	<b>S264-N</b> 84412-40	—
Brown	80412	—	—	80412-N	—	—	—			
Almond	80412-A	80612-A	—	80412-NA	PJ264-A	80312-SA	SJ264-SA			
Light Almond	80412-T	80612-T	—	80412-NT	PJ264-T	80312-ST	SJ264-ST			
<b>DESCRIPTION</b> 5-Gang 5-Decora										
<b>COLOR</b>	<b>STANDARD P265</b>	<b>MIDWAY</b>	<b>OVERSIZE</b>	<b>STANDARD N265</b>	<b>MIDWAY</b>	<b>STANDARD</b>	<b>MIDWAY</b>	<b>MATERIAL</b>	<b>STANDARD</b>	<b>OVERSIZE</b>
Ivory	80423-I	—	—	—	—	80321-SI	SJ265-SI	Brass	<b>B265</b> 81423	—
Black	80423-E	—	—	—	—	—	—	430 S/S	*	—
Gray	80423-GY	—	—	—	—	—	—	302 S/S	<b>S265</b> 84423-40	—
White	80423-W	—	—	—	—	80321-SW	SJ265-SW			
Brown	80423	—	—	—	—	—	—			
Almond	80423-A	—	—	—	—	80321-SA	SJ265-SA			
Light Almond	80423-T	—	—	80423-NT	—	80321-ST	SJ265-ST			
<b>DESCRIPTION</b> 6-Gang 6-Decora										
<b>COLOR</b>	<b>STANDARD P266</b>	<b>MIDWAY</b>	<b>OVERSIZE</b>	<b>STANDARD N266</b>	<b>MIDWAY</b>	<b>STANDARD</b>	<b>MIDWAY</b>	<b>MATERIAL</b>	<b>STANDARD</b>	<b>OVERSIZE</b>
Ivory	80436-I	—	—	—	—	80326-SI	SJ266-SI	Brass	<b>B266</b> *	—
Black	80436-E	—	—	—	—	—	—	430 S/S	—	—
Gray	80436-GY	—	—	—	—	—	—	302 S/S	<b>S266-N</b> 84436-40	—
White	80436-W	—	—	—	—	80326-SW	SJ266-SW			
Brown	80436	—	—	—	—	—	—			
Almond	80436-A	—	—	80436-NA	—	80326-SA	SJ266-SA			
Light Almond	80436-T	—	—	—	—	80326-ST	SJ266-ST			
<b>DESCRIPTION</b> 7-Gang 7-Decora										
<b>COLOR</b>	<b>STANDARD S607</b>	<b>MIDWAY</b>	<b>OVERSIZE</b>	<b>STANDARD</b>	<b>MIDWAY</b>	<b>STANDARD</b>	<b>MIDWAY</b>	<b>MATERIAL</b>	<b>STANDARD</b>	<b>OVERSIZE</b>
Ivory	80407-I†	—	—	—	—	—	—	Brass	<b>B607</b> *	—
White	80407-W†	—	—	—	—	—	—	430 S/S	*	—
								302 S/S	<b>S607-N</b> *	—
<b>DESCRIPTION</b> 8-Gang 8-Decora										
<b>COLOR</b>	<b>STANDARD S609</b>	<b>MIDWAY</b>	<b>OVERSIZE</b>	<b>STANDARD</b>	<b>MIDWAY</b>	<b>STANDARD</b>	<b>MIDWAY</b>	<b>MATERIAL</b>	<b>STANDARD</b>	<b>OVERSIZE</b>
Ivory	80408-I†	—	—	—	—	—	—	Brass	<b>B609</b> *	—
White	80408-W†	—	—	—	—	—	—	430 S/S	*	—
								302 S/S	<b>S609-N</b> *	—

\*Consult your Leviton representative for ordering details: allow 3-4 weeks for delivery. †Painted metal





## LARGER SIZE WALLPLATES

### Residential and Commercial Grade Wallplates

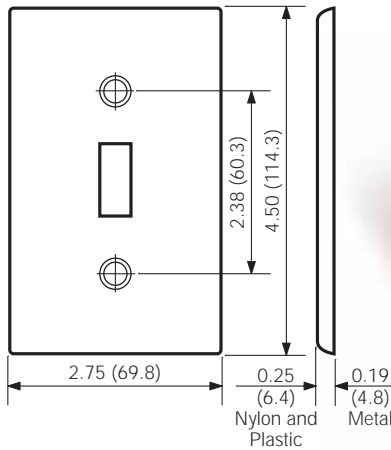

Standard Size Single-Gang

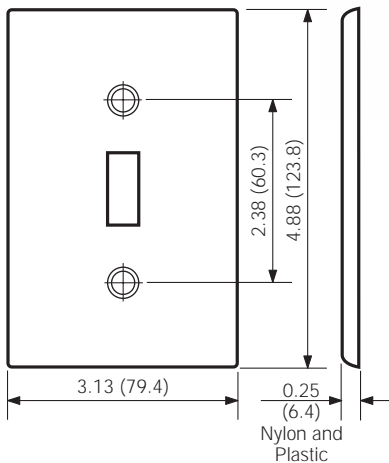

Midway Size Single-Gang

Midway wallplates can be mounted onto larger-volume outlet boxes and/or used to hide wall irregularities. Midway wallplates are a full 0.375" higher and wider than standard size wallplates.

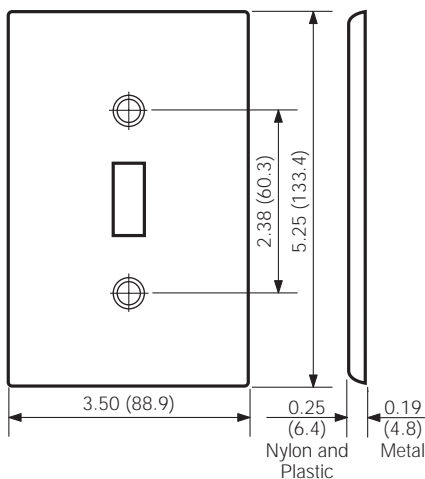

Oversized Single-Gang

Oversized wallplates are used to conceal greater wall irregularities than those hidden by Midway wallplates. Oversized wallplates are a full 0.75" higher and wider than standard size wallplates.

NOTE: Add 1.81" (46.0mm) for each additional gang.

### A COMPLETE SELECTION OF WALLPLATES FOR INDUSTRIAL, COMMERCIAL AND RESIDENTIAL APPLICATIONS



### Features and Benefits of All Leviton Wallplates

- Easy to Clean, smooth finish
- Noncombustible
- Individual plastic wrapping to protect wallplate surface
- Color-matched metal mounting screws supplied in an envelope to protect plate from scratches
- UL Listed and CSA Certified
- Conform to NEMA and ANSI Standards

### Residential Grade Thermoset (Plastic) Wallplates

- Photoelectrically color-matched to Leviton Decora devices
- Designed for high dielectric strength and arc resistance
- Meet or surpass UL 514 testing requirements
- Resistant to fading, discoloration, grease, oils, organic solvents and moisture scratches
- Backed by a Limited Two-Year Warranty

### Commercial Grade Thermoplastic (Nylon) Wallplates

- Molded thermoplastic for maximum resistance to impact, abrasion, fading and discoloration
- Resistant to mechanical stress associated with high abuse applications
- Backed by a Limited Ten-Year Warranty

### Commercial Grade Metal Wallplates

- Rounded edges to prevent injury and wall damage
- Deluxe stainless steel is non-magnetic Type 302, .032" thick
- Standard magnetic stainless steel Type 430, .032" thick, also available
- Brass is 70/30 alloy 260, .040" thick
- Aluminum is 3004 alloy, .040" thick
- Backed by a Limited Ten-Year Warranty

#### TESTING AND CODE COMPLIANCE

- UL Listed
- Meets NEMA Standards WD-1, WD-6
- CSA Certified

#### MATERIAL CHARACTERISTICS

Environmental: Flammability UL-94, V2 Rating  
Operating Temperature: -40°C to 120°C

Residential and Commercial Grade Wallplates

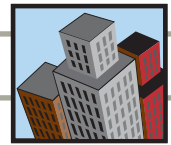

Toggle

Thermoset (Plastic)	Thermoplastic (Nylon)	Assorted Metals
---------------------	-----------------------	-----------------

DESCRIPTION	STANDARD P1		OVERSIZE PO1	STANDARD N1	MIDWAY PJ1	MATERIAL	STANDARD	OVERSIZE
1-Gang 1-Toggle								
COLOR	STANDARD P1	MIDWAY SPJ1	OVERSIZE PO1	STANDARD N1	MIDWAY PJ1	MATERIAL	STANDARD	OVERSIZE
Ivory	86001	80501-I	86101	80701-I	PJ1-I	Chrome	<b>C1</b> 1901	—
Black	—	—	—	80701-E	PJ1-E	Aluminum	<b>A1</b> 83001	—
Gray	87001	—	—	80701-GY	PJ1-GY	Brass	<b>B1</b> 81001	—
Red	—	—	—	80701-R	—	Polished Brass	81001-PB	—
White	88001	80501-W	88101	80701-W	PJ1-W	430 S/S	<b>S1</b> 84001	<b>S01</b> 84101
Brown	85001	80501	85101	80701	PJ1	302 S/S	<b>S1-N</b> 84001-40	<b>S01-N</b> 84101-40
Almond	82001	80501-A	—	80701-A	PJ1-A			
Light Almond	78001	80501-T	—	80701-T	PJ1-T			

DESCRIPTION	STANDARD P2		OVERSIZE PO2	STANDARD N2	MIDWAY PJ2	MATERIAL	STANDARD	OVERSIZE
2-Gang 2-Toggles								
COLOR	STANDARD P2	MIDWAY SPJ2	OVERSIZE PO2	STANDARD N2	MIDWAY PJ2	MATERIAL	STANDARD	OVERSIZE
Ivory	86009	80509-I	86109	80709-I	PJ2-I	Chrome	1909	—
Black	—	—	—	80709-E	PJ2-E	Aluminum	<b>A2</b> 83009	—
Gray	87009	—	—	80709-GY	PJ2-GY	Brass	<b>B2</b> 81009	—
Red	—	—	—	80709-R	—	Polished Brass	81009-PB	—
White	88009	80509-W	88109	80709-W	PJ2-W	430 S/S	<b>S2</b> 84009	—
Brown	85009	80509	85109	80709	—	302 S/S	<b>S2-N</b> 84009-40	<b>S02-N</b> 84109-40
Almond	82009	80509-A	—	80709-A	PJ2-A			
Light Almond	78009	80509-T	—	80709-T	PJ2-T			

DESCRIPTION	STANDARD P3		OVERSIZE PO3	STANDARD N3	MIDWAY PJ3	MATERIAL	STANDARD	OVERSIZE
3-Gang 3-Toggles								
COLOR	STANDARD P3	MIDWAY SPJ3	OVERSIZE PO3	STANDARD N3	MIDWAY PJ3	MATERIAL	STANDARD	OVERSIZE
Ivory	86011	80511-I	86111	80711-I	PJ3-I	Chrome	*	—
Black	—	—	—	80711-E	PJ3-E	Aluminum	<b>A3</b> 83011	—
Gray	87011	—	—	80711-GY	—	Brass	<b>B3</b> 81011	—
Red	—	—	—	80711-R	—	Polished Brass	81011-PB	—
White	88011	80511-W	88111	80711-W	PJ3-W	430 S/S	<b>S3</b> 84011	—
Brown	85011	80511	—	80711	PJ3	302 S/S	<b>S3-N</b> 84011-40	<b>S03-N</b> 84111-40
Almond	82011	80511-A	—	80711-A	PJ3-A			
Light Almond	78011	80511-T	—	80711-T	PJ3-T			

\*Consult your Leviton representative for ordering details: allow 3-4 weeks for delivery.

**NOTE: Where applicable, Industry Number indicated in BOLD FACE. For some wallplates, Industry Number and Leviton Catalog Number are identical.**



# WALLPLATES

## Residential and Commercial Grade Wallplates

### Toggle

	Thermoset (Plastic)			Thermoplastic (Nylon)		Assorted Metals		
DESCRIPTION 4-Gang 4-Toggles								
COLOR	STANDARD P4	MIDWAY SPJ4	OVERSIZE	STANDARD N4	MIDWAY PJ4	MATERIAL	STANDARD	OVERSIZE
Ivory	86012	80512-I	—	80712-I	PJ4-I	Chrome	*	—
Black	—	—	—	80712-E	—	Aluminum	<b>A4</b> 83012	—
Gray	87012	—	—	—	—	Brass	<b>B4</b> 81012	—
						Polished Brass	81012-PB	—
White	88012	80512-W	—	80712-W	PJ4-W	430 S/S	<b>S4</b> 84012	*
Brown	85012	80512	—	—	—	302 S/S	<b>S4-N</b> 84012-40	<b>S04-N</b> 84112-40
Almond	82012	80512-A	—	80712-A	PJ4-A			
Light Almond	78012	80512-T	—	80712-T	PJ4-T			
DESCRIPTION 5-Gang 5-Toggles								
COLOR	STANDARD P5	MIDWAY	OVERSIZE	STANDARD N5	MIDWAY	MATERIAL	STANDARD	OVERSIZE
Ivory	86023	—	—	80723-I	—	Chrome	*	—
White	88023	—	—	80723-W	—	Aluminum	<b>A5</b> *	—
Brown	85023	—	—	—	—	Brass	<b>B5</b> 81023	—
Almond	82023	—	—	—	—	Polished Brass	81023-PB	—
Light Almond	78023	—	—	—	—	430 S/S	<b>S5</b> *	—
						302 S/S	<b>S5-N</b> 84023-40	—
DESCRIPTION 6-Gang 6-Toggles								
COLOR	STANDARD P6	MIDWAY	OVERSIZE	STANDARD N6	MIDWAY	MATERIAL	STANDARD	OVERSIZE
Ivory	86036	—	—	80736-I	—	Chrome	*	—
White	88036	—	—	80736-W	—	Aluminum	<b>A6</b> *	—
Brown	85036	—	—	—	—	Brass	<b>B6</b> 81036	—
Almond	82036	—	—	—	—	430 S/S	<b>S6</b> *	—
Light Almond	78036	—	—	—	—	302 S/S	<b>S6-N</b> 84036-40	—

\*Consult your Leviton representative for ordering details: allow 3-4 weeks for delivery.

**NOTE: Where applicable, Industry Number indicated in BOLD FACE. For some wallplates, Industry Number and Leviton Catalog Number are identical.**



Residential and Commercial Grade Wallplates

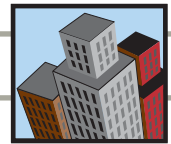

Toggle

	Thermoset (Plastic)			Thermoplastic (Nylon)		Assorted Metals		
DESCRIPTION 7-Gang 7-Toggles								
COLOR	STANDARD S601	MIDWAY	OVERSIZE	STANDARD	MIDWAY	MATERIAL	STANDARD	OVERSIZE
Ivory	S601-I†	—	—	—	—	Chrome	*	—
White	S601-W†	—	—	—	—	Brass	<b>B601</b> *	—
						430 S/S	*	—
						302 S/S	<b>S601-N</b> 84070-40	—

†Painted metal wallplate.

DESCRIPTION 8-Gang 8-Toggles								
COLOR	STANDARD S602	MIDWAY	OVERSIZE	STANDARD N6	MIDWAY	MATERIAL	STANDARD	OVERSIZE
Ivory	S602-I†	—	—	—	—	Chrome	*	—
White	S602-W†	—	—	—	—	Brass	<b>B602</b> *	—
						430 S/S	*	—
						302 S/S	<b>S602-N</b> 84048-40	—

†Painted metal wallplate.

DESCRIPTION 9-Gang 9-Toggles								
COLOR	STANDARD S603	MIDWAY	OVERSIZE	STANDARD	MIDWAY	MATERIAL	STANDARD	OVERSIZE
Ivory	S603-I†	—	—	—	—	Chrome	*	—
White	S603-W†	—	—	—	—	Brass	<b>B603</b> *	—
						430 S/S	*	—
						302 S/S	<b>S603-N</b> 84049-40	—

†Painted metal wallplate.

DESCRIPTION 10-Gang 10-Toggles								
COLOR	STANDARD S604	MIDWAY	OVERSIZE	STANDARD	MIDWAY	MATERIAL	STANDARD	OVERSIZE
Ivory	S604-I†	—	—	—	—	Chrome	*	—
White	S604-W†	—	—	—	—	Brass	<b>B604</b> *	—
						302 S/S	<b>S604-N</b> 84050-40	—

†Painted metal wallplate.

\*Consult your Leviton representative for ordering details: allow 3-4 weeks for delivery.

**NOTE: Where applicable, Industry Number indicated in BOLD FACE. For some wallplates, Industry Number and Leviton Catalog Number are identical.**



# WALLPLATES

## Residential and Commercial Grade Wallplates

### Receptacle

	Thermoset (Plastic)			Thermoplastic (Nylon)		Assorted Metals		
--	---------------------	--	--	-----------------------	--	-----------------	--	--

#### DESCRIPTION 1-Gang 1-Duplex



COLOR	STANDARD P8	MIDWAY SPJ8	OVERSIZE	STANDARD N8	MIDWAY PJ8	MATERIAL	STANDARD	OVERSIZE
Ivory	86003	80503-I	86103	80703-I	PJ8-I	Chrome	<b>C8</b> 1903	—
Black	—	—	—	80703-E	PJ8-E	Aluminum	<b>A8</b> 83003	—
Gray	87003	—	—	80703-GY	PJ8-GY	Brass	<b>B8</b> 81003	—
Red	—	—	—	80703-R	PJ8-R	Polished Brass	81003-PB	—
White	88003	80503-W	88103	80703-W	PJ8-W	430 S/S	<b>S8</b> 84003	<b>S08</b> 84103
Brown	85003	80503	85103	80703	PJ8	302 S/S	<b>S8-N</b> 84003-40	<b>S08-N</b> 84103-40
Blue	—	—	—	80703-BU	PJ8-BU			
Almond	82003	80503-A	—	80703-A	PJ8-A			
Light Almond	78003	80503-T	—	80703-T	PJ8-T			

#### DESCRIPTION 2-Gang 2-Duplex



COLOR	STANDARD P82	MIDWAY SPJ82	OVERSIZE	STANDARD N82	MIDWAY PJ82	MATERIAL	STANDARD	OVERSIZE
Ivory	86016	80516-I	86116	80716-I	PJ82-I	Chrome	<b>C82</b> *	—
Black	—	—	—	80716-E	PJ82-E	Aluminum	<b>A82</b> 83016	—
Gray	87016	—	—	80716-GY	PJ82-GY	Brass	<b>B82</b> 81016	—
Red	—	—	—	80716-R	PJ82-R	Polished Brass	*	—
White	88016	80516-W	88116	80716-W	PJ82-W	430 S/S	<b>S82</b> 84016	<b>S082</b> 84116
Brown	85016	80516	85116	80716	PJ82	302 S/S	<b>S82-N</b> 84016-40	<b>S082-N</b> 84116-40
Orange	—	—	—	80716-ORG	—			
Blue	—	—	—	80716-BU	—			
Almond	82016	80516-A	—	80716-A	PJ82-A			
Light Almond	78016	80516-T	—	80716-T	PJ82-T			

#### DESCRIPTION 3-Gang 3-Duplex

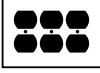

COLOR	STANDARD P83	MIDWAY	OVERSIZE	STANDARD	MIDWAY	MATERIAL	STANDARD	OVERSIZE
Ivory	86030	—	—	80730-I	—	Chrome	*	—
						Aluminum	*	—
Gray	—	—	—	80730-GY	—	Brass	*	—
Red	—	—	—	80730-R	—	430 S/S	<b>S83</b> *	—
White	88030	—	—	80730-W	—	302 S/S	<b>S83-N</b> 84030-40	<b>S083-N</b> 84130-40
Brown	85030	—	—	—	—			
Light Almond	—	—	—	78030	—			

\*Consult your Leviton representative for ordering details: allow 3-4 weeks for delivery.

**NOTE:** Where applicable, Industry Number indicated in BOLD FACE. For some wallplates, Industry Number and Leviton Catalog Number are identical.

Residential and Commercial Grade Wallplates

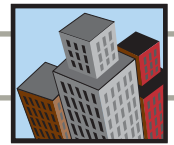

Duplex Receptacle

	Thermoset (Plastic)			Thermoplastic (Nylon)		Assorted Metals		
--	---------------------	--	--	-----------------------	--	-----------------	--	--

DESCRIPTION 4-Gang 4-Duplex								
COLOR	STANDARD	MIDWAY	OVERSIZE	STANDARD	MIDWAY	MATERIAL	STANDARD	OVERSIZE
Ivory	86041	—	—	—	—	Chrome	*	—
White	88041	—	—	—	—	Aluminum	*	—
Brown	85041	—	—	—	—	Brass	*	—
						430 S/S	<b>S84</b> 84041	*
						302 S/S	<b>S84-N</b> *	*

DESCRIPTION 5-Gang 5-Duplex								
COLOR	STANDARD	MIDWAY	OVERSIZE	STANDARD	MIDWAY	MATERIAL	STANDARD	OVERSIZE
						Chrome	*	—
						Brass	<b>B85</b> *	—
						302 S/S	<b>S85-N</b> 84055-40	—

DESCRIPTION 6-Gang 6-Duplex								
COLOR	STANDARD	MIDWAY	OVERSIZE	STANDARD	MIDWAY	MATERIAL	STANDARD	OVERSIZE
						Chrome	*	—
						Brass	<b>B86</b> *	—
						302 S/S	<b>S86-N</b> 84056-40	—

DESCRIPTION 7-Gang 7-Duplex								
COLOR	STANDARD	MIDWAY	OVERSIZE	STANDARD	MIDWAY	MATERIAL	STANDARD	OVERSIZE
						Chrome	*	—
						Brass	<b>B608</b> *	—
						430 S/S	<b>S608</b> *	—
						302 S/S	*	—

DESCRIPTION 8-Gang 8-Duplex								
COLOR	STANDARD	MIDWAY	OVERSIZE	STANDARD	MIDWAY	MATERIAL	STANDARD	OVERSIZE
						Chrome	*	—
						Brass	<b>B6082</b> *	—
						430 S/S	<b>S6082</b> *	—
						302 S/S	*	—

\*Consult your Leviton representative for ordering details: allow 3-4 weeks for delivery.

NOTE: Where applicable, Industry Number indicated in BOLD FACE. For some wallplates, Industry Number and Leviton Catalog Number are identical.



# WALLPLATES

## Residential and Commercial Grade Wallplates

Single Receptacle—15 Amp and 20 Amp Straight Blade and 15 Amp Locking  
 Thermoset (Plastic)      Thermoplastic (Nylon)

Assorted Metals

**DESCRIPTION**

1-Gang  
 1-Single 1.406" dia. Hole



COLOR	STANDARD P7	MIDWAY SPJ7	OVERSIZE	STANDARD N7	MIDWAY PJ7	MATERIAL	STANDARD	OVERSIZE
Ivory	86004	80504-I	—	80704-I	PJ7-I	Chrome	*	—
Black	—	—	—	80704-E	—	Aluminum	<b>A7</b> 83004	—
Gray	—	—	—	80704-GY	—	Brass	<b>B7</b> 81004	—
Red	—	—	—	80704-R	PJ7-R	430 S/S	<b>S7</b> *	*
White	88004	80504-W	—	80704-W	PJ7-W	302 S/S	<b>S7-N</b> 84004-40	<b>S07-N</b> 84104-40
Brown	85004	80504	—	80704	—			
Orange	—	—	—	80704-ORG	—			
Almond	82004	80504-A	—	80704-A	PJ7-A			
Light Almond	78004	80504-T	—	80704-T	PJ7-T			

**DESCRIPTION**

2-Gang  
 2-Singles 1.406" dia. Holes



COLOR	STANDARD P72	MIDWAY SPJ82	OVERSIZE	STANDARD N82	MIDWAY PJ82	MATERIAL	STANDARD	OVERSIZE
Ivory	86052	—	—	—	—	Chrome	*	—
White	88052	—	—	—	—	Aluminum	*	—
Brown	85052	—	—	—	—	Brass	*	—
						430 S/S	<b>S72</b> *	—
						302 S/S	<b>S72-N</b> 84052-40	—

**DESCRIPTION**

3-Gang  
 3-Singles 1.406" dia. Holes

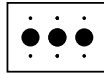

COLOR	STANDARD	MIDWAY	OVERSIZE	STANDARD	MIDWAY	MATERIAL	STANDARD	OVERSIZE
						Brass	*	—
						430 S/S	<b>S73</b> *	—
						302 S/S	<b>S73-N</b> S73-N	—

**DESCRIPTION**

4-Gang  
 4-Singles 1.406" dia. Holes

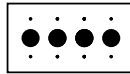

COLOR	STANDARD	MIDWAY	OVERSIZE	STANDARD	MIDWAY	MATERIAL	STANDARD	OVERSIZE
						Brass	*	—
						430 S/S	<b>S74</b> *	—
						302 S/S	<b>S74-N</b>	—

**DESCRIPTION**

5-Gang  
 5-Singles 1.406" dia. Holes

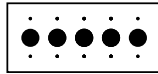

COLOR	STANDARD	MIDWAY	OVERSIZE	STANDARD	MIDWAY	MATERIAL	STANDARD	OVERSIZE
						Brass	*	—
						430 S/S	<b>S75</b> *	—
						302 S/S	<b>S75-N</b>	—

**DESCRIPTION**

6-Gang  
 6-Singles 1.406" dia. Holes

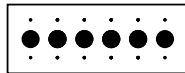

COLOR	STANDARD	MIDWAY	OVERSIZE	STANDARD	MIDWAY	MATERIAL	STANDARD	OVERSIZE
						Brass	*	—
						430 S/S	<b>S76</b> *	—
						302 S/S	<b>S76-N</b>	—

\*Consult your Leviton representative for ordering details: allow 3-4 weeks for delivery.

**NOTE: Where applicable, Industry Number indicated in BOLD FACE. For some wallplates, Industry Number and Leviton Catalog Number are identical.**



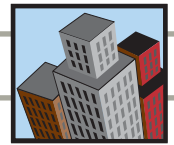

Residential and Commercial Grade Wallplates

Telephone or Cable Outlet Wallplates—Box Mounted

Thermoset (Plastic)	Thermoplastic (Nylon)	Assorted Metals
---------------------	-----------------------	-----------------

DESCRIPTION  
1-Gang  
Phone/Cable .312" dia. Hole, Box Mount



COLOR	STANDARD	MIDWAY SPJ738	OVERSIZE	STANDARD	MIDWAY	MATERIAL	STANDARD	OVERSIZE
Ivory	—	80513-I	—	—	—	Aluminum	<b>A738</b> 83013	—
White	—	80513-W	—	—	—	Brass	<b>B738</b> 81013	—
Almond	—	80513-A	—	—	—	Polished Brass	81013-PB	—
Light Almond	—	80513-T	—	—	—	430 S/S	<b>S738</b> 84013	—
						302 S/S	<b>S7-N</b> 84013-40	—

DESCRIPTION  
1-Gang  
Phone/Cable .406" dia. Hole, Box Mount



COLOR	STANDARD P11	MIDWAY	OVERSIZE	STANDARD	MIDWAY PJ11	MATERIAL	STANDARD	OVERSIZE
Ivory	86013	—	—	—	PJ11-I	Aluminum	*	—
Black	—	—	—	—	PJ11-E	Brass	*	—
Gray	—	—	—	—	PJ11-GY	430 S/S	*	—
White	88013	—	—	—	PJ11-W	302 S/S	<b>S11-N</b> 84061-40	*
						—	—	—
Almond	82013	—	—	—	PJ11-A	—	—	—
Light Almond	78013	—	—	—	PJ11-T	—	—	—

DESCRIPTION  
1-Gang  
Phone/Cable .625" dia. Hole, Box Mount



COLOR	STANDARD P737	MIDWAY	OVERSIZE	STANDARD	MIDWAY	MATERIAL	STANDARD	OVERSIZE
Ivory	86017	—	—	—	—	Aluminum	<b>A737</b> *	—
White	88017	—	—	—	—	Brass	<b>B737</b> 81017	—
						430 S/S	<b>S737</b> *	—
						302 S/S	<b>S737-N</b> 84017-40	—

DESCRIPTION  
2-Gang  
Phone/Cable .406" dia. Hole, Box Mount



COLOR	STANDARD P21	MIDWAY	OVERSIZE	STANDARD	MIDWAY	MATERIAL	STANDARD	OVERSIZE
Ivory	86062	—	—	—	—	Brass	*	—
White	88062	—	—	—	—	430 S/S	*	—
						302 S/S	<b>S21-N</b> 84062-40	—

DESCRIPTION  
3-Gang  
Phone/Cable .406" dia. Hole, Box Mount

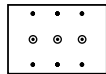

COLOR	STANDARD	MIDWAY	OVERSIZE	STANDARD	MIDWAY	MATERIAL	STANDARD	OVERSIZE
						Brass	*	—
						430 S/S	*	—
						302 S/S	<b>S31-N</b>	—

\*Consult your Leviton representative for ordering details: allow 3-4 weeks for delivery.

NOTE: Where applicable, Industry Number indicated in BOLD FACE. For some wallplates, Industry Number and Leviton Catalog Number are identical.

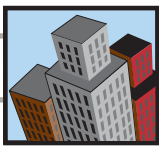



# WALLPLATES

## Residential and Commercial Grade Wallplates

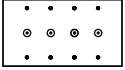
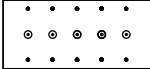
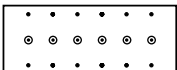
### Telephone or Cable Outlet Wallplates—Box Mounted

Thermoset (Plastic)			Thermoplastic (Nylon)			Assorted Metals		
<b>DESCRIPTION</b> 4-Gang Phone/Cable .406" dia. Hole, Box Mount 								
<b>COLOR</b>	STANDARD	MIDWAY	OVERSIZE	STANDARD	MIDWAY	<b>MATERIAL</b>	STANDARD	OVERSIZE
						Brass	*	—
						430 S/S	*	—
						302 S/S	<b>S41-N</b> *	—
<b>DESCRIPTION</b> 5-Gang Phone/Cable .406" dia. Hole, Box Mount 								
<b>COLOR</b>	STANDARD	MIDWAY	OVERSIZE	STANDARD	MIDWAY	<b>MATERIAL</b>	STANDARD	OVERSIZE
						Brass	*	—
						430 S/S	*	—
						302 S/S	<b>S51-N</b> *	—
<b>DESCRIPTION</b> 6-Gang Phone/Cable .406" dia. Hole, Box Mount 								
<b>COLOR</b>	STANDARD	MIDWAY	OVERSIZE	STANDARD	MIDWAY	<b>MATERIAL</b>	STANDARD	OVERSIZE
						Brass	*	—
						430 S/S	*	—
						302 S/S	<b>S61-N</b> *	—

### Telephone or Cable Outlet Wallplates—Strap Mounted

Thermoset (Plastic)			Thermoplastic (Nylon)			Assorted Metals		
<b>DESCRIPTION</b> 1-Gang Phone/Cable .406" dia. Hole, Strap Mount With knockout to enlarge hole to .625" 								
<b>COLOR</b>	STANDARD P12	MIDWAY	OVERSIZE	STANDARD	MIDWAY	<b>MATERIAL</b>	STANDARD	OVERSIZE
Ivory	86018	—	—	—	—	Aluminum	*	—
White	88018	—	—	—	—	Brass	*	—
Brown	85018	—	—	—	—	430 S/S	<b>S12</b> *	—
						302 S/S	<b>S12-N</b> 84018-40	—
<b>DESCRIPTION</b> 1-Gang Phone/Cable .406" dia. Hole, Strap Mount 								
<b>COLOR</b>	STANDARD	MIDWAY	OVERSIZE PO12	STANDARD N12	MIDWAY	<b>MATERIAL</b>	STANDARD	OVERSIZE
Ivory	—	—	86113	80718-I	—	Brass	*	—
Black	—	—	—	80718-E	—	430 S/S	*	—
Gray	—	—	—	80718-GY	—	302 S/S	*	—
White	—	—	88113	80718-W	—			
Brown	—	—	—	80718	—			
<b>DESCRIPTION</b> 1-Gang Phone/Cable .625" dia. Hole, Strap Mount 								
<b>COLOR</b>	STANDARD P730	MIDWAY	OVERSIZE	STANDARD	MIDWAY	<b>MATERIAL</b>	STANDARD	OVERSIZE
White	88037	—	—	—	—	Brass	*	—
						430 S/S	*	<b>S0730</b> *
						302 S/S	<b>S730-N</b> 84037-40	<b>S0730-N</b> 84137-40

\*Consult your Leviton representative for ordering details: allow 3-4 weeks for delivery.

**NOTE:** Where applicable, Industry Number indicated in BOLD FACE. For some wallplates, Industry Number and Leviton Catalog Number are identical.





Residential and Commercial Grade Wallplates

Telephone or Cable Outlet Wallplates—Strap Mounted

Thermoset (Plastic)      Thermoplastic (Nylon)      Assorted Metals

DESCRIPTION 2-Gang Phone/Cable .406" dia. Hole, Strap Mount	Thermoset (Plastic)			Thermoplastic (Nylon)		Assorted Metals		
	STANDARD	MIDWAY	OVERSIZE	STANDARD	MIDWAY	MATERIAL	STANDARD	OVERSIZE
Ivory	P22-1†	—	—	—	—	Brass	—	—
						430 S/S	*	—
						302 S/S	<b>S22-N</b>	*

†Painted metal wallplate.

DESCRIPTION 3-Gang Phone/Cable .406" dia. Hole, Strap Mount	Thermoset (Plastic)			Thermoplastic (Nylon)		Assorted Metals		
	STANDARD	MIDWAY	OVERSIZE	STANDARD	MIDWAY	MATERIAL	STANDARD	OVERSIZE
	P32	—	—	—	—	Brass	—	—
						430 S/S	*	—
						302 S/S	<b>S32-N</b>	*

†Painted metal wallplate.

DESCRIPTION 4-Gang Phone/Cable .406" dia. Hole, Strap Mount	Thermoset (Plastic)			Thermoplastic (Nylon)		Assorted Metals		
	STANDARD	MIDWAY	OVERSIZE	STANDARD	MIDWAY	MATERIAL	STANDARD	OVERSIZE
	P32	—	—	—	—	Brass	*	—
						430 S/S	*	—
						302 S/S	<b>S42-N</b>	*

†Painted metal wallplate.

DESCRIPTION 5-Gang Phone/Cable .406" dia. Hole, Strap Mount	Thermoset (Plastic)			Thermoplastic (Nylon)		Assorted Metals		
	STANDARD	MIDWAY	OVERSIZE	STANDARD	MIDWAY	MATERIAL	STANDARD	OVERSIZE
	P32	—	—	—	—	Brass	*	—
						430 S/S	*	—
						302 S/S	<b>S52-N</b>	*

†Painted metal wallplate.

DESCRIPTION 6-Gang Phone/Cable .406" dia. Hole, Strap Mount	Thermoset (Plastic)			Thermoplastic (Nylon)		Assorted Metals		
	STANDARD	MIDWAY	OVERSIZE	STANDARD	MIDWAY	MATERIAL	STANDARD	OVERSIZE
	P32	—	—	—	—	Brass	*	—
						430 S/S	*	—
						302 S/S	<b>S62-N</b>	*

†Painted metal wallplate.

\*Consult your Leviton representative for ordering details: allow 3-4 weeks for delivery.

**NOTE: Where applicable, Industry Number indicated in BOLD FACE. For some wallplates, Industry Number and Leviton Catalog Number are identical.**







# WALLPLATES

## Residential and Commercial Grade Wallplates

### Blank Wallplates—Box Mounted

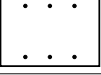
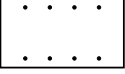
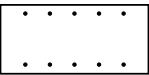
Thermoset (Plastic)			Thermoplastic (Nylon)			Assorted Metals		
<b>DESCRIPTION</b> 1-Gang 1-Blank, Box Mounted 								
COLOR	STANDARD P13	MIDWAY SPJ13	OVERSIZE P013	STANDARD N13	MIDWAY PJ13	MATERIAL	STANDARD	OVERSIZE
Ivory	86014	80514-I	86114	80714-I	PJ13-I	Chrome	*	—
Black	—	—	—	80714-E	PJ13-E	Aluminum	<b>A13</b> 83014	—
Gray	87014	—	—	80714-GY	PJ13-GY	Brass	<b>B13</b> 81014	—
Red	—	—	—	80714-R	PJ13-R	430 S/S	<b>S13</b> 84014	<b>S013</b> 84114
White	88014	80514-W	88114	80714-W	PJ13-W	302 S/S	<b>S13-N</b> 84014-40	<b>S013-N</b> 84114-40
Brown	85014	80514	85114	80714	PJ13			
Almond	82014	80514-A	—	80714-A	PJ13-A			
Light Almond	78014	80514-T	—	80714-T	PJ13-T			
<b>DESCRIPTION</b> 2-Gang 2-Blanks, Box Mounted 								
COLOR	STANDARD P23	MIDWAY SPJ23	OVERSIZE	STANDARD N24	MIDWAY PJ23	MATERIAL	STANDARD	OVERSIZE
Ivory	86025	80525-I	—	80725-I	PJ23-I	Aluminum	83025	—
Black	—	—	—	80725-E	—	Brass	<b>B23</b> 81025	—
Gray	87025	—	—	80725-GY	PJ23-GY	Polished Brass	81025-PB	—
White	88025	80525-W	—	80725-W	PJ23-W	430 S/S	<b>S23</b> 84025	—
Brown	85025	80525	—	80725	—	302 S/S	<b>S23-N</b> 84025-40	<b>S023-N</b> 84125-40
Almond	82025	80525-A	—	80725-A	PJ23-A			
Light Almond	78025	80525-T	—	80725-T	PJ23-T			
<b>DESCRIPTION</b> 3-Gang 3-Blanks, Box Mounted 								
COLOR	STANDARD P33	MIDWAY	OVERSIZE	STANDARD	MIDWAY	MATERIAL	STANDARD	OVERSIZE
Ivory	86033	80533-I	—	80735-I	—	Aluminum	*	—
Black	—	—	—	80735-E	—	Brass	*	—
Gray	—	—	—	80735-GY	—	430 S/S	*	—
White	88033	80533-W	—	80735-W	—	302 S/S	<b>S33-N</b> 84033-40	<b>S033-N</b> 84133-40
Brown	85033	—	—	—	—			
Almond	—	—	—	80735-A	—			
<b>DESCRIPTION</b> 4-Gang 4-Blanks, Box Mounted 								
COLOR	STANDARD P43	MIDWAY	OVERSIZE	STANDARD	MIDWAY	MATERIAL	STANDARD	OVERSIZE
Ivory	86064	—	—	—	—	Aluminum	*	—
White	88064	—	—	—	—	Brass	*	—
Brown	85064	—	—	—	—	430 S/S	<b>S43</b> 84064	*
						302 S/S	<b>S43-N</b> 84064-40	*
<b>DESCRIPTION</b> 5-Gang 5-Blanks, Box Mounted 								
COLOR	STANDARD	MIDWAY	OVERSIZE	STANDARD	MIDWAY	MATERIAL	STANDARD	OVERSIZE
						Brass	*	—
						302 S/S	<b>S53-N</b> 84065-40	—

\*Consult your Leviton representative for ordering details: allow 3-4 weeks for delivery.

**NOTE:** Where applicable, Industry Number indicated in BOLD FACE. For some wallplates, Industry Number and Leviton Catalog Number are identical.

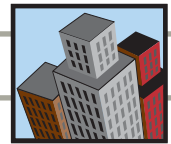

Residential and Commercial Grade Wallplates

Blank Wallplates—Box Mounted

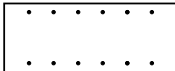
Thermoset (Plastic)			Thermoplastic (Nylon)			Assorted Metals		
DESCRIPTION 6-Gang 6-Blanks, Box Mounted 								
COLOR	STANDARD	MIDWAY	OVERSIZE	STANDARD	MIDWAY	MATERIAL	STANDARD	OVERSIZE
						Brass	*	—
						302 S/S	<b>S63-N</b> 84066-40	—

DESCRIPTION 7-Gang 7-Blanks, Box Mounted 								
COLOR	STANDARD	MIDWAY	OVERSIZE	STANDARD	MIDWAY	MATERIAL	STANDARD	OVERSIZE
						Brass	*	—
						302 S/S	<b>S6013-N</b> 84067-40	—

DESCRIPTION 8-Gang 8-Blanks, Box Mounted 								
COLOR	STANDARD	MIDWAY	OVERSIZE	STANDARD	MIDWAY	MATERIAL	STANDARD	OVERSIZE
						Brass	*	—
						302 S/S	<b>S6023-N</b> 84068-40	—

Blank Wallplates—Strap Mounted

Thermoset (Plastic)			Thermoplastic (Nylon)			Assorted Metals		
DESCRIPTION 1-Gang 1-Blank, Strap Mounted 								
COLOR	STANDARD	MIDWAY	OVERSIZE	STANDARD	MIDWAY	MATERIAL	STANDARD	OVERSIZE
Ivory	86019	—	—	80719-I	—	Aluminum	*	—
Black	—	—	—	80719-E	—	Brass	*	—
Gray	—	—	—	80719-GY	—	430 S/S	<b>S14</b> 84019	*
Red	—	—	—	80719-R	—	302 S/S	<b>S14-N</b> 84019-40	<b>S014-N</b> 84119-40
White	88019	—	—	80719-W	—			
Brown	85019	—	—	80719	—			

DESCRIPTION 2-Gang 2-Blank, Strap Mounted 								
COLOR	STANDARD	MIDWAY	OVERSIZE	STANDARD	MIDWAY	MATERIAL	STANDARD	OVERSIZE
Ivory	86034	—	—	80734-I	—	430 S/S	*	—
Black	—	—	—	80734-E	—	302 S/S	<b>S24-N</b> 84034-40	<b>S024-N</b> 84134-40
Red	—	—	—	80734-R	—			
White	88034	—	—	80734-W	—			

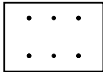
DESCRIPTION 3-Gang 3-Blank, Strap Mounted 								
COLOR	STANDARD	MIDWAY	OVERSIZE	STANDARD	MIDWAY	MATERIAL	STANDARD	OVERSIZE
Ivory	86035	—	—	—	—	Brass	*	—
White	88035	—	—	—	—	430 S/S	*	*
						302 S/S	<b>S34-N</b> 84035-40	—

\*Consult your Leviton representative for ordering details: allow 3–4 weeks for delivery.

NOTE: Where applicable, Industry Number indicated in BOLD FACE. For some wallplates, Industry Number and Leviton Catalog Number are identical.



# WALLPLATES

## Residential and Commercial Grade Wallplates

### Blank Wallplates—Strap Mounted

Thermoset			Thermoplastic			Assorted Metals		
DESCRIPTION 4-Gang 4-Blank, Strap Mounted								
COLOR	STANDARD	MIDWAY	OVERSIZE	STANDARD	MIDWAY	MATERIAL	STANDARD	OVERSIZE
Ivory	86057	—	—	—	—	Brass	*	—
White	88057	—	—	—	—	430 S/S	*	*
						302 S/S	<b>S44-N</b> 84057-40	—
DESCRIPTION 5-Gang 5-Blank, Strap Mounted								
COLOR	STANDARD	MIDWAY	OVERSIZE	STANDARD	MIDWAY	MATERIAL	STANDARD	OVERSIZE
						Brass	*	—
						430 S/S	*	—
						302 S/S	<b>S54-N</b> S54-N	—
DESCRIPTION 6-Gang 6-Blank, Strap Mounted								
COLOR	STANDARD	MIDWAY	OVERSIZE	STANDARD	MIDWAY	MATERIAL	STANDARD	OVERSIZE
						Brass	*	—
						430 S/S	*	—
						302 S/S	<b>S64-N</b> *	—
DESCRIPTION 7-Gang 7-Blank, Strap Mounted								
COLOR	STANDARD	MIDWAY	OVERSIZE	STANDARD	MIDWAY	MATERIAL	STANDARD	OVERSIZE
						Brass	*	—
						430 S/S	*	—
						302 S/S	<b>S6014-N</b> *	—
DESCRIPTION 8-Gang 8-Blank, Strap Mounted								
COLOR	STANDARD	MIDWAY	OVERSIZE	STANDARD	MIDWAY	MATERIAL	STANDARD	OVERSIZE
						Brass	*	—
						430 S/S	*	—
						302 S/S	<b>S6024-N</b> *	—

\*Consult your Leviton representative for ordering details: allow 3-4 weeks for delivery.

**NOTE:** Where applicable, Industry Number indicated in BOLD FACE. For some wallplates, Industry Number and Leviton Catalog Number are identical.

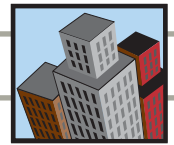

Residential and Commercial Grade Wallplates

Power Outlet Receptacle – One Gang  
Thermoset (Plastic)

Thermoplastic (Nylon)

Assorted Metals

DESCRIPTION  
20A & 30A Locking Receptacles  
1-Gang 1.60" dia. Hole



COLOR	STANDARD	MIDWAY	OVERSIZE	STANDARD N726	MIDWAY	MATERIAL	STANDARD	OVERSIZE
Ivory	—	—	—	80720-I	—	Brass	*	—
Black	—	—	—	80720-E	—	430 S/S	*	—
Gray	—	—	—	80720-GY	—	302 S/S	<b>S720-N</b> 84020-40	—
Red	—	—	—	80720-R	—			
White	—	—	—	80720-W	—			
Brown	—	—	—	80720	—			

DESCRIPTION  
30A & 50A Power Receptacle  
1-Gang 2.15" dia. Hole  
Use with 278, 279, 5206, 5207, 5371, 5372, 5373, 5374



COLOR	STANDARD	MIDWAY P724	OVERSIZE	STANDARD	MIDWAY N724	MATERIAL	STANDARD	OVERSIZE
Ivory	—	80528-I	—	—	80728-I	Aluminum	<b>A724</b> 83028	—
Black	—	80528-BLK	—	—	80728-E	Steel, Brass Finish	<b>B724</b> 4928	—
Gray	—	—	—	—	80728-GY	Steel, Aluminum Finish	<b>S724-GY</b> 4927	—
White	—	80528-W	—	—	80728-W	430 S/S	<b>S724</b> 84028	—
Brown	—	—	—	—	80728			

Power Outlet Receptacle—Two Gang  
Thermoset (Plastic)

Thermoplastic (Nylon)

Assorted Metals

DESCRIPTION  
30A & 50A Power Receptacle  
2-Gang 2.15" dia. Hole  
For use with 278,279, 5206, 5207, 5371, 5372, 5373, 5374



COLOR	STANDARD	MIDWAY PJ 703	OVERSIZE	STANDARD	MIDWAY N703	MATERIAL	STANDARD	OVERSIZE
Ivory	—	80526-I	—	—	80726-I	Brass	<b>B703</b> *	—
Black	—	80526-BLK	—	—	—	Alum	<b>A703</b> 83026	—
White	—	80526-W	—	—	80726-W	Steel, Alum Fin.	<b>S703-GY</b> 4934	—
Brown	—	—	—	—	80726	430 S/S	<b>S703</b> 84026	—

\*Consult your Leviton representative for ordering details: allow 3-4 weeks for delivery.

NOTE: Where applicable, Industry Number indicated in BOLD FACE. For some wallplates, Industry Number and Leviton Catalog Number are identical.

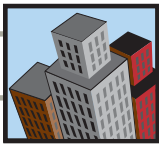

# WALLPLATES

## Residential and Commercial Grade Wallplates

### Power Outlet Receptacle – Two Gang

Thermoset (Plastic)

Thermoplastic (Nylon)

Assorted Metals

#### DESCRIPTION

2-Gang  
2.15" dia. Hole Offset



COLOR	STANDARD	MIDWAY	OVERSIZE	STANDARD	MIDWAY	MATERIAL	STANDARD	OVERSIZE
						430 S/S	<b>S705</b> 84022	—

#### DESCRIPTION

30A & 50A Power Receptacle  
2-Gang 2.465" dia. Hole



COLOR	STANDARD	MIDWAY	OVERSIZE	STANDARD	MIDWAY	MATERIAL	STANDARD	OVERSIZE
Ivory	—	80530-I	—	—	—	Steel, Alum Fin	<b>S701-GY</b> S701-GY	—
Black	—	80530-BLK	—	—	—	430 S/S	<b>S701</b> *	—
White	—	80530-W	—	—	—	302 S/S	S701-40	—
Almond	—	80530-A	—	—	—			
Light Almond	—	80530-T	—	—	—			

\*Consult your Leviton representative for ordering details: allow 3–4 weeks for delivery.

**NOTE:** Where applicable, Industry Number indicated in **BOLD FACE**. For some wallplates, Industry Number and Leviton Catalog Number are identical.



Residential and Commercial Grade Wallplates

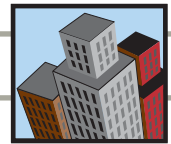

Two Gang with Centered Opening  
Thermoset (Plastic)

DESCRIPTION 2-Gang 1-Toggle	Thermoset (Plastic)			Thermoplastic (Nylon)		Assorted Metals			
	COLOR	STANDARD	MIDWAY	OVERSIZE	STANDARD	MIDWAY	MATERIAL	STANDARD	OVERSIZE
							Brass	81040	—
							430 S/S	—	—
							302 S/S	<b>S740-N</b> 84040-40	—

DESCRIPTION 2-Gang 1-Phone/Cable .406" Hole, Box Mount	Thermoset (Plastic)			Thermoplastic (Nylon)		Assorted Metals			
	COLOR	STANDARD	MIDWAY	OVERSIZE	STANDARD	MIDWAY	MATERIAL	STANDARD	OVERSIZE
							Brass	*	—
							430 S/S	*	—
							302 S/S	*	—

DESCRIPTION 2-Gang 1-Phone/Cable .406" Hole, Strap Mount	Thermoset (Plastic)			Thermoplastic (Nylon)		Assorted Metals			
	COLOR	STANDARD	MIDWAY	OVERSIZE	STANDARD	MIDWAY	MATERIAL	STANDARD	OVERSIZE
							Brass	*	—
							430 S/S	*	—
							302 S/S	*	—

DESCRIPTION 2-Gang Blank Box Mount	Thermoset (Plastic)			Thermoplastic (Nylon)		Assorted Metals			
	COLOR	STANDARD	MIDWAY	OVERSIZE	STANDARD	MIDWAY	MATERIAL	STANDARD	OVERSIZE
							Brass	*	—
							430 S/S	*	—
							302 S/S	*	—

DESCRIPTION 2-Gang Blank Strap Mount	Thermoset (Plastic)			Thermoplastic (Nylon)		Assorted Metals			
	COLOR	STANDARD	MIDWAY	OVERSIZE	STANDARD	MIDWAY	MATERIAL	STANDARD	OVERSIZE
							Brass	—	—
							430 S/S	—	—
							302 S/S	*	—

DESCRIPTION 2-Gang 1-Decora	Thermoset (Plastic)			Thermoplastic (Nylon)		Assorted Metals			
	COLOR	STANDARD	MIDWAY	OVERSIZE	STANDARD	MIDWAY	MATERIAL	STANDARD	OVERSIZE
							Brass	—	—
							430 S/S	*	—
							302 S/S	<b>S746-N</b> S746-N	—

DESCRIPTION 2-Gang 1 Single Outlet 1.406" dia. Hole	Thermoset (Plastic)			Thermoplastic (Nylon)		Assorted Metals			
	COLOR	STANDARD	MIDWAY	OVERSIZE	STANDARD	MIDWAY	MATERIAL	STANDARD	OVERSIZE
							Brass	—	—
							430 S/S	*	—
							302 S/S	<b>S747-N</b> 84092-40	—

DESCRIPTION 2-Gang 1-Duplex	Thermoset (Plastic)			Thermoplastic (Nylon)		Assorted Metals			
	COLOR	STANDARD	MIDWAY	OVERSIZE	STANDARD	MIDWAY	MATERIAL	STANDARD	OVERSIZE
							302 S/S	<b>S748-N</b> 84039-40	—

\*Consult your Leviton representative for ordering details: allow 3-4 weeks for delivery.

NOTE: Where applicable, Industry Number indicated in BOLD FACE. For some wallplates, Industry Number and Leviton Catalog Number are identical.

For answers to technical questions, call Leviton's Techline at 1-800-824-3005





# WALLPLATES

## Residential and Commercial Grade Wallplates

### Louvre Plates

Thermoset (Plastic)

Thermoplastic (Nylon)

Assorted Metals

DESCRIPTION  
1-Gang Center  
1-Louvre Plate  
Horizontal Box Mount



COLOR	Thermoset (Plastic)			Thermoplastic (Nylon)		MATERIAL	Assorted Metals	
	STANDARD P760	MIDWAY	OVERSIZE	STANDARD	MIDWAY		STANDARD	OVERSIZE
Ivory	86079†	—	—	—	—	Brass	<b>B760</b> 81079	—
White	88079†	—	—	—	—	430 S/S	*	—
						302 S/S	<b>S760-N</b> 84079-40	—

DESCRIPTION  
1-Gang  
1-Louvre Plate  
Strap Mount



COLOR	Thermoset (Plastic)			Thermoplastic (Nylon)		MATERIAL	Assorted Metals	
	STANDARD P771	MIDWAY	OVERSIZE	STANDARD	MIDWAY		STANDARD	OVERSIZE
Ivory	86080†	—	—	—	—	Brass	<b>B771</b> 81080	—
White	88080†	—	—	—	—	430 S/S	*	—
Almond	82080†	—	—	—	—	302 S/S	<b>S771-N</b> 84080-40	—

DESCRIPTION  
2-Gang  
2-Louvre Plate  
Strap Mount



COLOR	Thermoset (Plastic)			Thermoplastic (Nylon)		MATERIAL	Assorted Metals	
	STANDARD	MIDWAY	OVERSIZE	STANDARD	MIDWAY		STANDARD	OVERSIZE
						Brass	*	—
						430 S/S	*	—
						302 S/S	<b>S772-N</b> 84081-40	—

DESCRIPTION  
3-Gang  
3-Louvre Plate  
Strap Mount



COLOR	Thermoset (Plastic)			Thermoplastic (Nylon)		MATERIAL	Assorted Metals	
	STANDARD	MIDWAY	OVERSIZE	STANDARD	MIDWAY		STANDARD	OVERSIZE
						Brass	*	—
						430 S/S	*	—
						302 S/S	*	—

†Painted metal wallplate.

\*Consult your Leviton representative for ordering details: allow 3-4 weeks for delivery.

**NOTE: Where applicable, Industry Number indicated in BOLD FACE. For some wallplates, Industry Number and Leviton Catalog Number are identical.**

Residential and Commercial Grade Wallplates



Combination Wallplates  
Toggle Switch and Single Receptacle  
Thermoset (Plastic)

Thermoplastic (Nylon)

Assorted Metals

DESCRIPTION

2-Gang  
1-Toggle 1-Single 1.406" dia. Hole



COLOR	STANDARD P17	MIDWAY	OVERSIZE	STANDARD	MIDWAY	MATERIAL	STANDARD	OVERSIZE
Ivory	86007	---	---	---	---	Aluminum	*	---
White	88007	---	---	---	---	Brass	*	---
						430 S/S	<b>S17</b> 84007	---
						302 S/S	<b>S17-N</b> 84007-40	---

DESCRIPTION

3-Gang  
2-Toggles 1-Single 1.406" dia. Hole



COLOR	STANDARD	MIDWAY	OVERSIZE	STANDARD	MIDWAY	MATERIAL	STANDARD	OVERSIZE
						Aluminum	*	---
						Brass	*	---
						430 S/S	*	---
						302 S/S	<b>S27-N</b> 84088-40	---

DESCRIPTION

4-Gang  
3-Toggles 1-Single 1.406" dia. Hole



COLOR	STANDARD	MIDWAY	OVERSIZE	STANDARD	MIDWAY	MATERIAL	STANDARD	OVERSIZE
						Aluminum	*	---
						Brass	*	---
						430 S/S	*	---
						302 S/S	<b>S37-N</b> 84042-40	---

Combination Wallplates  
Toggle Switch and Duplex Receptacle  
Thermoset (Plastic)

Thermoplastic (Nylon)

Assorted Metals

DESCRIPTION

2-Gang  
1-Toggle 1-Duplex



COLOR	STANDARD P18	MIDWAY SPJ18	OVERSIZE P018	STANDARD N18	MIDWAY	MATERIAL	STANDARD	OVERSIZE
Ivory	86005	80505-I	86105	80705-I	PJ18-I	Aluminum	<b>A18</b> 83005	---
Black	---	---	---	80705-E	PJ18-E	Brass	<b>B18</b> 81005	---
Gray	87005	---	---	80705-GY	---	430 S/S	<b>S18</b> 84005	*
Red	---	---	---	80705-R	---	302 S/S	<b>S18-N</b> 84005-40	<b>S018-N</b> 84105-40
White	88005	80505-W	88105	80705-W	PJ18-W			
Brown	85005	80505	---	80705	----			
Almond	82005	80505-A	---	80705-A	PJ18-A			
Light Almond	78005	80505-T	---	80705-T	PJ18-T			

\*Consult your Leviton representative for ordering details: allow 3-4 weeks for delivery.

NOTE: Where applicable, Industry Number indicated in BOLD FACE. For some wallplates, Industry Number and Leviton Catalog Number are identical.



# WALLPLATES

## Residential and Commercial Grade Wallplates

### Combination Wallplates Toggle Switch and Duplex Receptacle

Thermoset (Plastic)			Thermoplastic (Nylon)			Assorted Metals		
DESCRIPTION 3-Gang 2-Toggles 1-Duplex 								
COLOR	STANDARD P28	MIDWAY SPJ28	OVERSIZE	STANDARD N28	MIDWAY	MATERIAL	STANDARD	OVERSIZE
Ivory	86021	80521-I	—	80721-I	—	Aluminum	*	—
Black	—	—	—	80721-E	—	Brass	<b>B28</b> 81021	—
						430 S/S	*	*
White	88021	80521-W	—	80721-W	—	302 S/S	<b>S28-N</b> 84021-40	<b>S028-N</b> 84121-40
Brown	85021	80521	—	—	—			
Almond	82021	80521-A	—	—	—			
Light Almond	78021	80521-T	—	—	—			

DESCRIPTION 4-Gang 3-Toggles 1-Duplex 								
COLOR	STANDARD P38	MIDWAY	OVERSIZE	STANDARD	MIDWAY	MATERIAL	STANDARD	OVERSIZE
Ivory	P38-I	—	—	80743-I	—	Aluminum	*	—
White	P38-W	—	—	80743-W	—	Brass	*	—
Brown	P38	—	—	—	—	430 S/S	84043	*
Almond	P38-A	—	—	—	—	302 S/S	*	—
Light Almond	P38-T	—	—	—	—			

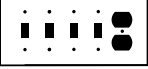
DESCRIPTION 5-Gang 4-Toggles 1-Duplex 								
COLOR	STANDARD P48	MIDWAY	OVERSIZE	STANDARD	MIDWAY	MATERIAL	STANDARD	OVERSIZE
Ivory	P48-I†	—	—	—	—	Brass	*	—
White	P48-W†	—	—	—	—	430 S/S	*	—
						302 S/S	<b>S48-N</b> S48-N	—

†Painted Metal Wallplate

\*Consult your Leviton representative for ordering details: allow 3–4 weeks for delivery.

**NOTE:** Where applicable, Industry Number indicated in **BOLD FACE**. For some wallplates, Industry Number and Leviton Catalog Number are identical.

Residential and Commercial Grade Wallplates

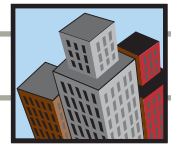

Combination Wallplates  
Toggle Switch and Decora/GFCI  
Thermoset (Plastic)

DESCRIPTION			Thermoplastic (Nylon)			Assorted Metals		
2-Gang 1-Toggle 1-Decora/GFCI								
COLOR	STANDARD P126	MIDWAY SPJ126	OVERSIZE P0126	STANDARD	MIDWAY PJ126	MATERIAL	STANDARD	OVERSIZE
Ivory	80405-I	80605-I	86605	80707-I	PJ126-I	Brass	*	—
Black	80405-E	—	—	80707-E	—	430 S/S	S126 S126	—
Gray	80405-GY	—	—	80707-GY	—	302 S/S	*	—
Red	—	—	—	80707-R	—			
White	80405-W	80605-W	88605	80707-W	PJ126-W			
Brown	80405	80605	—	80707	PJ126			
Almond	80405-A	80605-A	82605	80707-A	PJ126-A			
Light Almond	80405-T	80605-T	—	80707-T	PJ126-T			

DESCRIPTION								
3-Gang 2-Toggles 1-Decora/GFCI								
COLOR	STANDARD P226	MIDWAY SPJ226	OVERSIZE	STANDARD	MIDWAY SPJ226	MATERIAL	STANDARD	OVERSIZE
Ivory	80421-I	—	—	80745-I	PJ226-I	Brass	*	—
Black	80421-E	—	—	—	—	430 S/S	*	—
White	80421-W	—	—	80745-W	PJ226-W	302 S/S	S226-N 84421-40	—
Brown	80421	—	—	—	PJ226			
Almond	80421-A	—	—	80745-A	PJ226-A			
Light Almond	80421-T	—	—	—	PJ226-T			

DESCRIPTION								
3-Gang 2-Decora/GFCI 1 - Toggle								
COLOR	STANDARD P1262	MIDWAY	OVERSIZE	STANDARD	MIDWAY	MATERIAL	STANDARD	OVERSIZE
Ivory	80431-I	—	—	80731-I	—	Brass	*	—
Black	—	—	—	80731-E	—	430 S/S	*	—
Gray	80431-GY	—	—	80731-GY	—	302 S/S	*	—
White	80431-W	—	—	80731-W	—			
Brown	80431	—	—	—	—			
Almond	80431-A	—	—	—	—			
Light Almond	80431-T	—	—	—	—			

DESCRIPTION								
4-Gang 2-Toggles 2-Decora/GFCI								
COLOR	STANDARD P326	MIDWAY	OVERSIZE	STANDARD	MIDWAY	MATERIAL	STANDARD	OVERSIZE
Ivory	P326-I	—	—	80732-I	—	Brass	*	—
White	P326-W	—	—	80732-W	—	430 S/S	*	—
Brown	P326	—	—	—	—	302 S/S	*	—
Almond	P326-A	—	—	—	—			
Light Almond	P326-T	—	—	—	—			

DESCRIPTION								
4-Gang 3-Toggles 1-Decora/GFCI								
COLOR	STANDARD P2262	MIDWAY	OVERSIZE	STANDARD	MIDWAY SPJ826	MATERIAL	STANDARD	OVERSIZE
Ivory	P2262-I†	—	—	—	—	Brass	*	—
White	P2262-W†	—	—	—	—	430 S/S	*	—
						302 S/S	*	—

DESCRIPTION								
5-Gang 4-Toggles 1-Decora/GFCI								
COLOR	STANDARD	MIDWAY	OVERSIZE	STANDARD	MIDWAY SPJ826	MATERIAL	STANDARD	OVERSIZE
						Brass	*	—
						430 S/S	*	—
						302 S/S	S426-N S426-N	—

†Painted metal wallplate.  
\*Consult your Leviton representative for ordering details: allow 3-4 weeks for delivery.

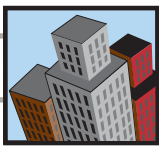

# WALLPLATES

## Residential and Commercial Grade Wallplates

### Combination Wallplates Toggle Switch and Blank—Box Mount and Strap Mount

Thermoset (Plastic)			Thermoplastic (Nylon)		Assorted Metals			
DESCRIPTION 2-Gang 1-Toggle 1-Blank, Strap Mount								
COLOR	STANDARD	MIDWAY	OVERSIZE	STANDARD	MIDWAY	MATERIAL	STANDARD	OVERSIZE
Ivory	—	—	—	80706-I	—	Aluminum	*	—
Gray	—	—	—	80706-GY	—	Brass	*	—
Red	—	—	—	80706-R	—	430 S/S	*	—
White	—	—	—	80706-W	—	302 S/S	<b>S114-N</b> 84077-40	—
Almond	—	—	—	80706-A	—			
Light Almond	—	—	—	80706-T	—			

DESCRIPTION 3-Gang 2-Toggles 1-Blank, Strap Mount								
COLOR	STANDARD	MIDWAY	OVERSIZE	STANDARD	MIDWAY	MATERIAL	STANDARD	OVERSIZE
						Brass	*	—
						430 S/S	*	—
						302 S/S	<b>S214-N</b> S214-N	—

DESCRIPTION 2-Gang 1-Toggle 1-Blank, Box Mount								
COLOR	STANDARD	MIDWAY	OVERSIZE	STANDARD	MIDWAY	MATERIAL	STANDARD	OVERSIZE
	P113	SPJ113	P0113			Brass	*	—
Ivory	86006	80506-I	86106	—	—	430 S/S	*	—
White	88006	80506-W	88106	—	—	302 S/S	<b>S113-N</b> 84006-40	—
Brown	85006	80506	—	—	—			

### Combination Wallplates Standard Combinations—Two Gang

Thermoset (Plastic)			Thermoplastic (Nylon)		Assorted Metals			
DESCRIPTION 2-Gang 1-Single 1.406" dia. hole 1-Duplex								
COLOR	STANDARD	MIDWAY	OVERSIZE	STANDARD	MIDWAY	MATERIAL	STANDARD	OVERSIZE
	P78					Aluminum	*	—
Ivory	86046†	—	—	—	—	Brass	*	—
White	88046†	—	—	—	—	430 S/S	*	*
						302 S/S	<b>S78-N</b> 84046-40	<b>S078-N</b> 84146-40

†Painted metal wallplate.

\*Consult your Leviton representative for ordering details: allow 3–4 weeks for delivery.

**NOTE:** Where applicable, Industry Number indicated in BOLD FACE. For some wallplates, Industry Number and Leviton Catalog Number are identical.



Residential and Commercial Grade Wallplates



Combination Wallplates  
Standard Combinations—Two Gang  
Thermoset (Plastic)

Thermoplastic (Nylon)

Assorted Metals

DESCRIPTION

2-Gang  
1-Duplex 1-Decora/GFCI



COLOR	STANDARD P826	MIDWAY	OVERSIZE	STANDARD	MIDWAY PJ826	MATERIAL	STANDARD	OVERSIZE
Ivory	80455-I	—	—	80746-I	—	Aluminum	*	—
Black	—	—	—	80746-E	—	Brass	*	—
Gray	—	—	—	80746-GY	—	430 S/S	*	—
Red	—	—	—	80746-R	—	302 S/S	<b>S826-N</b> 84455-40	—
White	80455-W	—	—	80746-W	—			
Brown	80455	—	—	80746	—			
Almond	80455-A	—	—	80746-A	—			
Light Almond	80455-T	—	—	80746-T	—			

DESCRIPTION

2-Gang  
1-Toggle 1-Phone/Cable .406" dia. hole, Strap Mount



COLOR	STANDARD P112	MIDWAY	OVERSIZE	STANDARD	MIDWAY	MATERIAL	STANDARD	OVERSIZE
Ivory	86077	—	—	—	—	Brass	*	—
White	88077	—	—	—	—	430 S/S	*	—
						302 S/S	<b>S112-N</b> S112-N	—

DESCRIPTION

2-Gang  
1-Phone/Cable .406" dia. hole, Strap Mount 1 – Duplex



COLOR	STANDARD	MIDWAY	OVERSIZE	STANDARD	MIDWAY	MATERIAL	STANDARD	OVERSIZE
Ivory	86078	—	—	—	—	Brass	*	—
White	88078	—	—	—	—	430 S/S	*	—
						302 S/S	<b>S128-N</b> 84078-40	—

DESCRIPTION

2-Gang  
1-Phone/Cable .406" dia. hole 1 – Blank, Strap Mount



COLOR	STANDARD	MIDWAY	OVERSIZE	STANDARD	MIDWAY	MATERIAL	STANDARD	OVERSIZE
						Brass	*	—
						430 S/S	*	—
						302 S/S	*	—

DESCRIPTION

2-Gang  
1-Phone/Cable .406" dia. hole 1 – Blank, Strap Mount



COLOR	STANDARD P1226	MIDWAY	OVERSIZE	STANDARD	MIDWAY	MATERIAL	STANDARD	OVERSIZE
Ivory	80479-I	—	—	—	—	Brass	*	—
White	80479-W	—	—	—	—	430 S/S	*	—
						302 S/S	*	—

DESCRIPTION

2-Gang  
1-Blank 1- Duplex, Box Mount



COLOR	STANDARD P138	MIDWAY SPJ138	OVERSIZE P0138	STANDARD N138	MIDWAY	MATERIAL	STANDARD	OVERSIZE
Ivory	86008	80508-I	86108	N138-I	—	Brass	*	—
White	88008	80508-W	—	—	—	430 S/S	*	—
Brown	85008	—	—	—	—	302 S/S	<b>S138-N</b> 84008-40	—

\*Consult your Leviton representative for ordering details: allow 3-4 weeks for delivery.

NOTE: Where applicable, Industry Number indicated in BOLD FACE. For some wallplates, Industry Number and Leviton Catalog Number are identical.



# WALLPLATES

## Residential and Commercial Grade Wallplates

### Combination Wallplates Standard Combinations—Two Gang Thermoset (Plastic)

DESCRIPTION	Thermoset (Plastic)			Thermoplastic (Nylon)		Assorted Metals		
	STANDARD	MIDWAY	OVERSIZE	STANDARD	MIDWAY	MATERIAL	STANDARD	OVERSIZE
2-Gang 1-Blank 1- Duplex, Strap Mount	P148			PJ826				
Ivory	86087†	—	—	—	—	Brass	*	—
White	88087†	—	—	—	—	430 S/S	*	—
						302 S/S	<b>S148-N</b> 84087-40	—

### DESCRIPTION 2-Gang 1-Blank 1-Single 1.406" dia. hole, Strap Mount

DESCRIPTION	STANDARD	MIDWAY	OVERSIZE	STANDARD	MIDWAY	MATERIAL	STANDARD	OVERSIZE
2-Gang 1-Blank 1-Single 1.406" dia. hole, Strap Mount	P147-I							
Ivory	86085†	—	—	—	—	Aluminum	*	—
White	88085†	—	—	—	—	Brass	*	—
						430 S/S	*	—
						302 S/S	<b>S147-N</b> 84085-40	—

### DESCRIPTION 2-Gang 1-Blank 1-Decora/GFCI, Strap Mount

DESCRIPTION	STANDARD	MIDWAY	OVERSIZE	STANDARD	MIDWAY	MATERIAL	STANDARD	OVERSIZE
2-Gang 1-Blank 1-Decora/GFCI, Strap Mount	P1426	SPJ1326						
Ivory	P1426-I†	80608-I	—	80708-I	—	Brass	*	—
Black	—	—	—	80708-E	—	430 S/S	*	*
Gray	—	—	—	80708-GY	—	302 S/S	<b>S1426-N</b> S1426-N	*
White	P1426-W†	80608-W	—	80708-W	—			
Brown	—	80608	—	80708	—			
Almond	—	80608-A	—	80708-A	—			
Light Almond	—	80608-T	—	80708-T	—			

### STANDARD COMBINATIONS—THREE GANG

#### DESCRIPTION 3-Gang 1-Toggle 2-Duplex

DESCRIPTION	STANDARD	MIDWAY	OVERSIZE	STANDARD	MIDWAY	MATERIAL	STANDARD	OVERSIZE
3-Gang 1-Toggle 2-Duplex	P182							
Ivory	86047	—	—	80747-I	—	Brass	*	—
White	88047	—	—	80747-W	—	430 S/S	*	*
Brown	85047	—	—	—	—	302 S/S	<b>S182-N</b> 84047-40	<b>S0182-N</b> 84147-40

### STANDARD COMBINATIONS—FOUR GANG

#### DESCRIPTION 4-Gang 2-Toggle 2-Duplex

DESCRIPTION	STANDARD	MIDWAY	OVERSIZE	STANDARD	MIDWAY	MATERIAL	STANDARD	OVERSIZE
4-Gang 2-Toggle 2-Duplex	P1226							
						Aluminum	*	—
						Brass	<b>B282</b> 81045	—
						430 S/S	*	—
						302 S/S	<b>S282-N</b> 84045-40	—

†Painted metal wallplate.

\*Consult your Leviton representative for ordering details: allow 3–4 weeks for delivery.

**NOTE: Where applicable, Industry Number indicated in BOLD FACE. For some wallplates, Industry Number and Leviton Catalog Number are identical.**

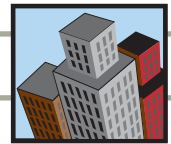

### Sectional Wallplates for Multi-Gang Installations† Thermoplastic Construction

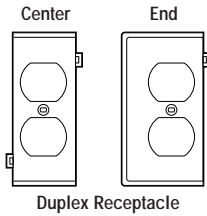

Duplex Receptacle

DESCRIPTION	COLOR	CENTER PANELS CAT. NO.	END PANELS CAT. NO.
Duplex Receptacle	White Ivory	PSC 8-W PSC 8-I	PSE 8-W PSE 8-I
Toggle Switch	White Ivory	PSC 1-W PSC 1-I	PSE 1-W PSE 1-I
Single Receptacle, 1.406" dia. hole	White Ivory	PSC 7-W PSC 7-I	PSE 7-W PSE 7-I
Blank, Strap-Mount	White Ivory	PSC 14 PSC14-I	PSE 14-W PSE 14-I
Decora	White Ivory	PSC 26-W PSC 26-I	PSE 26-W PSE 26-I

† Outer dimensions of wallplates created from two or more sectional panels will be the same as standard multi-gang plates.

### Horizontal Split Plate for Terminated Cable

DESCRIPTION  
Horizontal Split Plate for Terminated Cable  
1-Gang .625" dia. Hole w/Grommet .406" inner dia.



COLOR	CAT. NO.	IND. NO.	METAL	CAT. NO.	IND. NO.
Ivory	N751-I	N751-I	BRASS	*	—
White	N751-W	N751-W	430 S/S	*	—
			302 S/S	S751-N	S751-N

### Hot Stamped And Engraved Plates Thermoset (Plastic)

### Thermoplastic (Nylon)

### Assorted Metals (Engraved)

DESCRIPTION  
1-Gang 1-Duplex  
Stamped And Engraved  
"EMERGENCY"



COLOR	STANDARD	MIDWAY	OVERSIZE	STANDARD	MIDWAY	MATERIAL	STANDARD	OVERSIZE
Red	—	—	—	80703-RE	PJ8-RE	302 S/S	84003-E40	—

2-Gang 2-Duplex  
Stamped And Engraved  
"EMERGENCY"



COLOR	STANDARD	MIDWAY	OVERSIZE	STANDARD	MIDWAY	MATERIAL	STANDARD	OVERSIZE
Red	—	—	—	80716-RE	PJ82-RE	302 S/S	84016-E40	—

1-Gang 1-Duplex  
Stamped And Engraved  
"ISOLATED GROUND"



COLOR	STANDARD	MIDWAY	OVERSIZE	STANDARD	MIDWAY	MATERIAL	STANDARD	OVERSIZE
Orange	—	—	—	80703-IG	PJ8-IG	302 S/S	84003-IG	—
White	—	—	—	80703-IGW	—			

2-Gang 2-Duplex  
Stamped And Engraved  
"ISOLATED GROUND"



COLOR	STANDARD	MIDWAY	OVERSIZE	STANDARD	MIDWAY	MATERIAL	STANDARD	OVERSIZE
Orange	—	—	—	80716-IG	—	302 S/S	*	—

1-Gang 1-Single, 1.406" Dia. Hole  
Stamped And Engraved  
"ISOLATED GROUND"



COLOR	STANDARD	MIDWAY	OVERSIZE	STANDARD	MIDWAY	MATERIAL	STANDARD	OVERSIZE
Orange	—	—	—	80704-IG	—	302 S/S	*	—



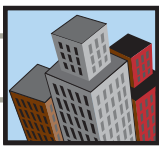





\*Consult The End Of This Wallplate Section For Ordering Details: Allow 3-4 Weeks For Delivery.



# ENGRAVED WALLPLATES

## Residential and Commercial Grade Wallplates

### Hot Stamped and Engraved Plates

Thermoset (Plastic)			Thermoplastic (Nylon)			Assorted Metals (Engraved)		
<b>DESCRIPTION</b>								
1-Gang 1-Single, 1.60" Dia. Hole Stamped And Engraved "ISOLATED GROUND" For Use With 20A & 30A Single Locking Receptacles								
								
COLOR	STANDARD	MIDWAY	OVERSIZE	STANDARD	MIDWAY	MATERIAL	STANDARD	OVERSIZE
Orange	—	—	—	80720-IG	—	302 S/S	*	—
<b>1-Gang 1-Toggle Stamped And Engraved "EMERGENCY"</b>								
								
COLOR	STANDARD	MIDWAY	OVERSIZE	STANDARD	MIDWAY	MATERIAL	STANDARD	OVERSIZE
Red	—	—	—	80701-RE	—	302 S/S	84001-E40	—
<b>1-Gang 1-Duplex No Stamp</b>								
								
COLOR	STANDARD	MIDWAY	OVERSIZE	STANDARD	MIDWAY	MATERIAL	STANDARD	OVERSIZE
Orange	—	—	—	80703-ORG	—	—	—	—
<b>1-Gang 1-Duplex Stamped "GFCI PROTECTED"</b>								
								
COLOR	STANDARD	MIDWAY	OVERSIZE	STANDARD	MIDWAY	MATERIAL	STANDARD	OVERSIZE
Ivory	—	—	—	80703-GFI	—	302 S/S	*	—
White	—	—	—	80703-GRW	—	302 S/S	*	—
<b>1-Gang 1-Duplex Stamped "COMPUTER ONLY"</b>								
								
COLOR	STANDARD	MIDWAY	OVERSIZE	STANDARD	MIDWAY	MATERIAL	STANDARD	OVERSIZE
Ivory	—	—	—	80703-COI	—	302 S/S	*	—
White	—	—	—	80703-COW	—	302 S/S	*	—
Orange	—	—	—	80703-COO	—	—	—	—
<b>1-Gang 1-Decora Stamped "SURGE PROTECTED"</b>								
								
COLOR	STANDARD	MIDWAY	OVERSIZE	STANDARD	MIDWAY	MATERIAL	STANDARD	OVERSIZE
—	—	—	—	*	—	302 S/S	*	—
<b>1-Gang 1-Decora Stamped "ISOLATED GROUND"</b>								
								
COLOR	STANDARD	MIDWAY	OVERSIZE	STANDARD	MIDWAY	MATERIAL	STANDARD	OVERSIZE
Orange	—	—	—	80401-IG	—	302 S/S	*	—
<b>1-Gang 1-Decora Stamped "GFCI"</b>								
								
COLOR	STANDARD	MIDWAY	OVERSIZE	STANDARD	MIDWAY	MATERIAL	STANDARD	OVERSIZE
Ivory	—	—	—	80401-GFI	—	302 S/S	*	—
White	—	—	—	80401-GFW	—	302 S/S	*	—
<b>1-Gang 1-Decora Stamped "COMPUTER ONLY"</b>								
								
COLOR	STANDARD	MIDWAY	OVERSIZE	STANDARD	MIDWAY	MATERIAL	STANDARD	OVERSIZE
Ivory	—	—	—	80401-COI	—	302 S/S	*	—
White	—	—	—	80401-COW	—	302 S/S	*	—

\*Consult The End Of This Wallplate Section For Ordering Details: Allow 3-4 Weeks For Delivery.

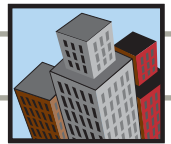

**Voice/Data/CATV Wallplates**

These sturdy, high-impact wallplates for the 46000 series voice/data devices are available for single-gang applications with standard or Decora-compatible styling.



**Standard Size  
Voice/Data/Catv Wallplates\***

DESCRIPTION		COLOR (NYLON)	METAL	CAT. NO.
1-Gang Type "F" Connector		Ivory	—	80781-I
		White	—	80781-W
		Almond	—	80781-A
		Light Almond	—	80781-T
1-Gang Duplex Type "F" Connector		Ivory	—	80782-I
		White	—	80782-W
		Almond	—	80782-A
		Light Almond	—	80782-T
1-Gang* Db9 Data Connector Db15 Data Connector		—	302 S/S	84441-40
		—	302 S/S	84442-40
1-Gang* Bnc/Tnc "D" Connector		—	302 S/S	84444-40

For more information regarding Voice/Data/CATV Wallplates, refer to Section L.

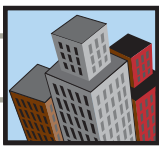

# WEATHER-RESISTANT COVERS

## Commercial Grade

### Features and Benefits

#### Plastic

- Impact resistant thermoplastic construction
- Pre-installed gasket for easy, reliable installation
- Tongue and groove plate-to-cover construction
- Offset device opening (horizontal only) for easier cord exit
- Thermoplastic inserts prevent insect and debris accumulation

#### Plastic and Metal

- Self-closing
- Vertical and horizontal mounting
- Die cast aluminum or impact-resistant thermoplastic covers and bases
- Weather-resistant gaskets
- Stainless steel springs
- Gray or clear finish



### Raintight While-In-Use Covers

DESCRIPTION	MOUNTING	CAT. NO.
Telescoping While-In-Use Smoked Cover	Vertical	T5979-W
With Colored Base And Matching Duplex, Decora And Single Receptacle Wallplates	Vertical	T5979-T
	Vertical	T5979-GY
	Vertical	T5979
Duplex Receptacle, Gray, Standard	Vertical	5976-GY
Duplex Receptacle, Gray, Extra Deep	Vertical	5976-DGY
Duplex Receptacle, Clear, Standard	Vertical	5976-CL
Duplex Receptacle, Clear, Extra Deep	Vertical	5976-DCL
Decora/GFCI, Clear, Standard	Vertical	5977-CL
Decora/GFCI, Clear, Extra Deep	Vertical	5977-DCL
Single Receptacle, Gray, Standard	Vertical	5978-GY
Single Receptacle, Clear, Standard	Vertical	5978-CL
Single Receptacle, Gray, Extra Deep	Vertical	5978-DGY
Single Receptacle, Clear, Extra Deep	Vertical	5978-DCL
Duplex Receptacle, Gray, Standard	Horizontal	5996-GY
Duplex Receptacle, Gray, Extra Deep	Horizontal	5996-DGY
Duplex Receptacle, Clear, Standard	Horizontal	5996-CL
Decora/GFCI, Gray, Standard	Horizontal	5997-GY
Decora/GFCI, Gray, Extra Deep	Horizontal	5997-DGY
Decora/GFCI, Clear, Standard	Horizontal	5997-CL
Decora/GFCI, Clear, Extra Deep	Horizontal	5997-DCL
Single Receptacle, Gray, Standard	Horizontal	5998-GY
Single Receptacle, Gray, Extra Deep	Horizontal	5998-DGY
Single Receptacle, Clear, Standard	Horizontal	5998-CL

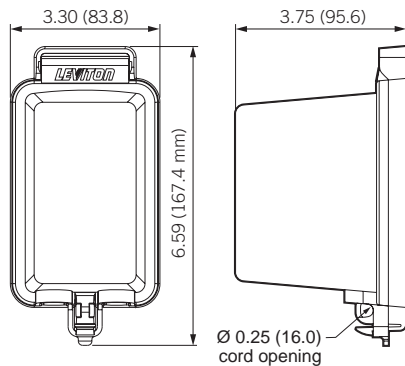
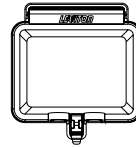
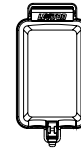

**VERTICAL MOUNT, EXTRA DEEP**  
5976-D

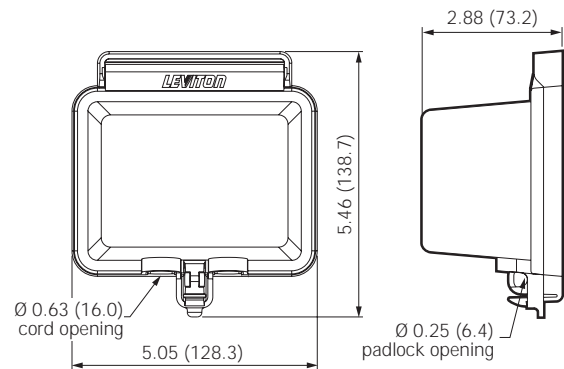

**HORIZONTAL MOUNT, STANDARD**  
5997

#### SPECIFICATIONS & FEATURES

- Mounting Screws and rubber gasket included for fast, easy installation onto surface-mounted outdoor-type boxes or flush-mounted wall boxes
- Easy-grip self-closing covers with durable, non-corrosive stainless steel screws
- acked by a Limited Two-Year Warranty

#### TESTING AND CODE COMPLIANCE

- Full compliance with UL, CSA and NEC Section 410-57 requirements for damp and wet locations with cover closed
- Raintight while-in-use covers are NEMA 3R rated for use with unattended plugs engaged in "live" receptacles in wet or damp locations

#### \*COLOR

Basic Cat. No. denotes Brown. For other color selections, add suffix to catalog numbers as follows: White (-W), Light Almond (-T), Gray (-GY).

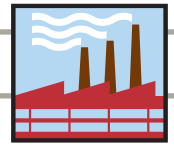

### Features and Benefits

- Glass-filled thermoplastic cover and plate for outstanding impact resistance and durability
- UL 94-VO Flammability Rating
- Superior IP 54 Suitability rating protects against dust particles and splashing water
- NEMA Type 3R enclosure rating ensures protection against rain, sleet and damage from external ice formation
- Dual gaskets, one under plate and one under lid, for weather-resistant fit
- Stainless steel hinge-pin, spring and mounting screws for excellent corrosion resistance
- Triple-combination screws accept Phillips, straight-blade or Robertson-head screwdrivers
- Oversized cover tab for easier opening with gloved hands
- Mounts to panel or FS/FD boxes
- UL Listed and CSA certified for wet locations with cover closed



### Industrial Weather-Resistant Covers

DESCRIPTION	COLOR	CAT. NO.
For use with 15-amp locking, 15-amp and 20-amp straight-blade flanged inlets and outlets	GRAY	WP1
For use with 20-amp and 30-amp 3-, 4-, and 5-wire locking flanged inlets and outlets; 30-amp and 50-amp 3-wire power receptacles	GRAY	WP2
For use with 20-amp and 30-amp and FS/FD boxes single locking receptacles	YELLOW	7420-CR

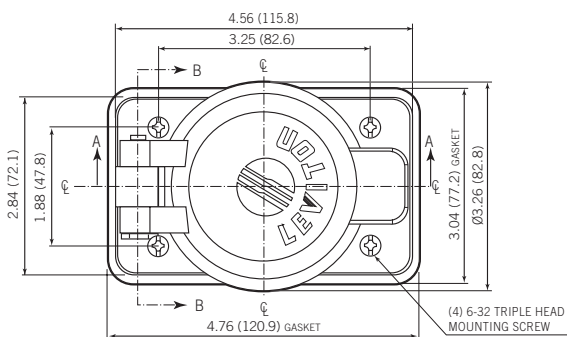

WATER RESISTANT COVER  
WP1 and 7420-CR

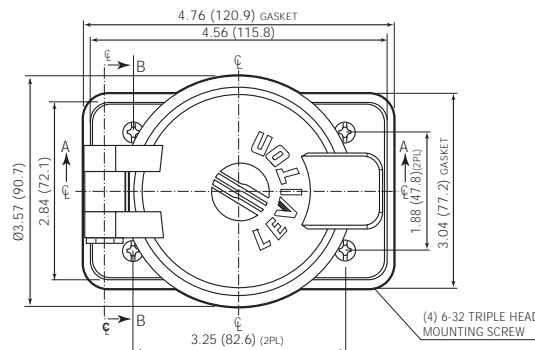

WATER RESISTANT COVER  
WP2

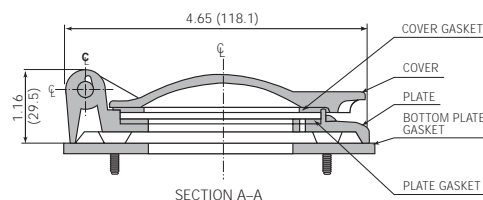
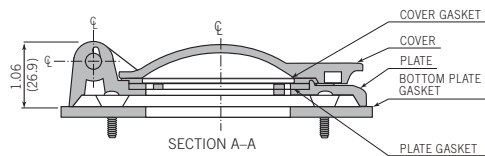

#### TESTING AND CODE COMPLIANCE

- UL Listed (File # E-13397)
- CSA Certified (File # LR-16347)
- NOM Certified (# 057)
- IP 54 Suitability rating (protected against dust and splashing water)
- NEMA Type 3R enclosure rating
- Backed by a Limited 10-Year Warranty

#### MATERIAL CHARACTERISTICS

Environmental: VO Flammability Rating per UL 94  
Operating Temperature: -40°C to 75°C



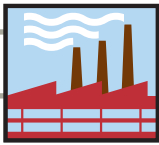





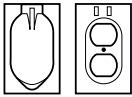
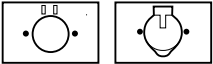
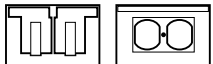
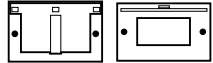
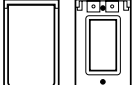

# WEATHER-RESISTANT COVERS

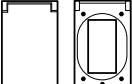
## Industrial Grade

### Die-Cast Zinc Weather-Resistant Covers

DESCRIPTION		MOUNTING	CAT. NO.
Duplex Receptacle 1-GANG		Vertical	4926
Single Receptacle 1-GANG Self-Closing Lid 1.406 Dia. Hole		Horizontal	4925-2
Duplex Receptacle or Combination Device 1-GANG Two Independent Self-Closing Lids★		Horizontal	4970
Decora/GFCI 1-GANG Self-Closing Lid		Horizontal	4990
Decora/GFCI 1-GANG Self-Closing Lid★		Vertical	4992
Decora/GFCI 1-GANG Self-Closing Lid for mounting on FS type box		Horizontal	6196-FS
Decora/GFCI 1-GANG Self-Closing Lid for mounting on FS type box		Vertical	6196-VFS
Weatherproof Wallplate & Switch 15A 120V AC		Horizontal or Vertical	1432
NEMA 1 Steel Enclosure without Switch		Vertical	N13NC
DESCRIPTION		COLOR	CAT. NO.
Lockout Wallplate (lock sold separately)		S/S	84001-LOK

All devices are UL Listed . Also CSA Certified except where indicated by★



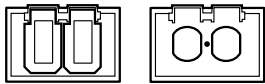
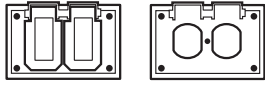
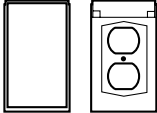
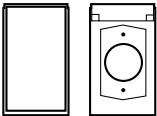
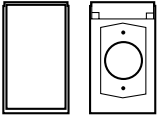
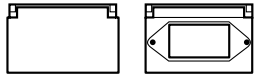
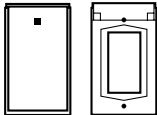
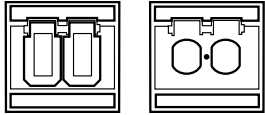

### Thermoplastic Weather-Resistant Covers

DESCRIPTION		MOUNTING	CAT. NO.
Duplex Receptacle or Combination Device 1-GANG Two Independent Self-Closing Lids		Horizontal	4976-GY 4976-W
Duplex Receptacle or Combination Device 1-GANG for mounting on FS type box Two Independent Lids		Horizontal	4976-FS
Duplex Receptacle or Combination Device 1-GANG Self-Closing Lid		Vertical	4978-GY 4978-W
Single Receptacle 1-GANG Self-Closing Lid 1.406" Dia. Hole		Vertical	4979-GY
Single 20A or 30A Locking Receptacle 1-GANG Self-Closing Lid 1.60" Dia. Hole		Vertical	4980-GY
Decora/GFCI 1-GANG Self-Closing Lid		Horizontal	4996-GY 4996-W
Decora/GFCI 1-GANG Self-Closing Lid		Vertical	4998-GY 4998-W
Oversized Duplex 1-GANG Two Independent Self-Closing Lids		Horizontal	4986-GY

### Blank Box Mounted Wallplates with Gasket

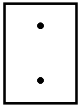
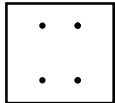
DESCRIPTION		MOUNTING	CAT. NO.
1-GANG Aluminum, Box Mount		N/A	83014-EXT
2-GANG Aluminum, Box Mount		N/A	83025-EXT

### Type 302 Stainless Steel Wallplate—Box Mount

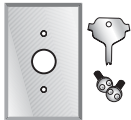
DESCRIPTION		COLOR	CAT. NO.
Type 302 Stainless Steel Wallplate w/Tamper-Resistant Screws and Spanner Tool		S/S	84071-40

All devices are UL Listed and CSA Certified.



# WALLPLATE ACCESSORIES

## Commercial Grade

### Wallplate Screws

DESCRIPTION	COLOR	CAT. NO.
Oval Head Milled Slot 5/16" long—6-32 thread 100 per box	Ivory Gray White Brown Almond S/S	86400-PRT 87400-PRT 88400-PRT 85400-PRT 82400-PRT 84400-PRT
Oval Head Milled Slot 1/2" long—6-32 thread 100 per box	Ivory Black Gray White Brown S/S	86000-PRT 83000-PRT 87000-PRT 88000-PRT 85000-PRT 84000-PRT
Oval Head Milled Slot 7/8" long—6-32 thread 50 per box	Ivory Red White Brown S/S	86500-PRT 89500-PRT 88500-PRT 85500-PRT 84500-PRT

### Pilot Light Jewels

DESCRIPTION	COLOR	CAT. NO.
Round Fits single receptacle hole 1.375–1.406" dia.	Green Red	405 GR 405 R
Rectangular Fits toggle switch hole .406 x .942"	Green Red	406 GR 406 R
Lampholder Assembly for use with jewels or louvre plates—use with standard 2.5" box and 4 watt bulb (bulb included)		2152

### Mounting Screws

DESCRIPTION	COLOR	CAT. NO.
Phillips/Standard 7/8" long—6-32 thread 50 per bag	S/S	84440

### Decora Plus Standard Size Plastic Adapters

DESCRIPTION	COLOR	CAT. NO.
CATV Jack	Ivory Black Gray White Almond Light Almond	80381-I 80381-E 80381-GY 80381-W 80381-A 80381-T
Blank No Hole	Ivory Black Gray White Almond Light Almond	80314-I 80314-E 80314-GY 80314-W 80314-A 80314-T

All devices are UL Listed and CSA Certified.

### Tamper-Resistant Spanner Head Screws

DESCRIPTION	COLOR	CAT. NO.
Spanner Head 1/2" long—6-32 thread, 100 per box	S/S	84000-T
Screwdriver for Spanner head or Tamper-Resistant screws	Black	84000-TSD

### Plastic Wallplate Adapters

DESCRIPTION	COLOR	CAT. NO.
These adapters permit the use of rotary dimmers in multi-gang Decora installations or fill blank holes in multi-device Decora or toggle wallplates.		
Dimmer Shaft .406" dia. Hole	Ivory Black Gray Brown White Almond Light Almond	80400-I 80400-E 80400-GY 80400 80400-W 80400-A 80400-T
Blank Decora No Hole	Ivory Black Gray Brown White Almond Light Almond	80414-I 80414-E 80414-GY 80414 80414-W 80414-A 80414-T
Blank Toggle No Hole	Ivory Gray Brown White Almond Light Almond	80700-I 80700-GY 80700 80700-W 80700-A 80700-T
Wallbox Adapter Extends shallow wallbox to fit GFCI/Decora devices	Ivory Brown White	6197-I 6197 6197-W

Snap in Grommet reduces 1.406" to 1.00" for use with single receptacle wallplates	Black	403-E
--	-------	-------

Thermoplastic Yoke/Mounting Strap w/screws Custom wallplate configurations 11, 23, 27 and 31 are supplied with strap kits. See page G42		404
---	--	-----

### Special Wallplates

The Order Form and instructions requesting custom wallplate configurations are found on the following pages. Custom wallplates are available in a variety of metals and can be requested from Leviton through special order, beginning on the next page.

All devices are UL Listed and CSA Certified.



How to Order Custom Wallplates



General Information

Custom wallplates, up to twelve gangs in size, made of brass, stainless steel, painted steel, aluminum or chrome, can be special ordered from Leviton. Any combination of the configurations shown can be specified to meet your needs. In addition, standard and custom metal wallplates can be engraved, and standard nylon wallplates can be hot stamped, with the message of your choice. Follow the steps below to fill out the Custom Wallplate Order Form completely and accurately. The finished order form must include:

1. The wallplate catalog number
2. The type of wallplate material desired (from the Material Code Chart)
3. The quantity of wallplates desired
4. The wallplate configurations in proper order (from the Configuration Code Chart)
5. The wallplate color, selected from the Wallplate Color Code Chart
6. Engraved or hot stamped message, if desired, with message location and letter size
7. Engraved or hot stamped message filler color, selected from the Fill-In Color Chart

Photocopy the blank Custom Wallplate Order Form at the back of this section and refer to the completed sample Custom Wallplate Order Form shown when filling out your order. Your Leviton representative can provide you with additional forms if needed. The sample order grid below shows the custom wallplate pictured at right:

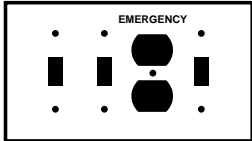

Sample Grid

CAT. NO. 90004 MATERIAL CODE S3 QTY. 1

(1) (2) (3) (4) (5) (6) (7) (8) (9) (10) (11) (12)

01	01	EMERGENCY 03	01								
----	----	-----------------	----	--	--	--	--	--	--	--	--

COLOR CODE ENGRAVED  HOT STAMPED LETTER SIZE 3/8"

FILLER CODE XR PRICE

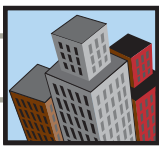

# WALLPLATES

## How to Order Custom Wallplates

### How to Fill Out the Custom Wallplate Order Form

#### STEP 1: DETERMINE THE WALLPLATE CATALOG NUMBER

The catalog number for a custom wallplate is determined as follows: a single-gang custom wallplate is Cat. No. 90001, a double-gang custom wallplate is Cat.No. 90002, a three-gang custom wallplate is Cat. No. 90003, and so on through the sequence to Cat. No. 90010 for the ten-gang custom wallplate. Enter the number in the space on the Order Form marked "CAT. NO." If you are ordering a standard metal wallplate for custom engraving, use the 90000 series number. If you are ordering a standard nylon wallplate for custom hot stamping, enter that wallplate's catalog number in the space on the Order Form marked "CAT. NO."

#### STEP 2: SELECT THE WALLPLATE MATERIAL

Choose the custom wallplate material desired from the Wallplate Material Chart below. Enter the Material Code for the material selected in the space marked "MATERIAL CODE" on the Order Form. When ordering Custom Hot Stamped wallplates, enter NYLON.

MATERIAL	MATERIAL CODE
Aluminum <sup>†</sup>	AL
Brass (Satin) Polished Brass	BR PB
Non-Magnetic Stainless Steel-Type 302/304	S3
Oversize Non-Magnetic Stainless Steel-Type 302/304*	S30
Painted Steel	S5
Oversize Painted Steel*	S50
Chrome	CRM
Raw Steel	RAW























<sup>†</sup>6-Gang maximum size, standard size only  
\*4-Gang maximum size

#### STEP 3: DETERMINE THE QUANTITY OF THE WALLPLATE ORDER

Enter the quantity of wallplates needed in the space marked "QUANTITY" on the Order Form.

#### STEP 4: DETERMINE THE CUSTOM WALLPLATE CONFIGURATION

The Wallplate Configuration Chart below shows all the configurations that can be specified for Leviton custom metal wallplates. Each configuration has a specific Configuration Code number in the lower right-hand corner of its corresponding space on the chart. Enter this configuration code in the center of the corresponding square on the Order Form Grid to match its desired position on the finished custom wallplate. Refer to the Sample Order Form Grid for clarification on configurations and their placement, if necessary (page G43).

 Toggle Switch 01	 Duplex Receptacle 03	 Louvre Horizontal Mount 05	 Louvre Vertical Mount* 07	 Blank Box Mount 09	 Blank Strap Mount 11
 Decora/ GFCI 13	 Single 1.406" dia. Receptacle 15	 1.60" dia. Hole 17	 2.15" dia. Hole** 19	 2.647" dia. Hole** 21	 .312" dia. Hole Strap Mount 23
 .312" dia. Hole Box Mount 25	 .406" dia. Hole Strap Mount 27	 .406" dia. Hole Box Mount 29	 .625" dia. Hole Strap Mount 31	 .625" dia. Hole Box Mount 33	 Interchangeable 1-Device Vertical 35
 Interchangeable 1-Device Horizontal 37	 Interchangeable 2-Device 39	 Interchangeable 3-Device 41	 2.460" dia. Hole 2-Gang Only** 47	0.880" dia. Hole for Key Lock Power Switch**. Tamper-resistant screws and screwdriver included w/Key Lock configurations. Device mount unless specified otherwise. For 1-gang, order 84071-40.	
 49					

Enter the code number for the configurations you select in the center box on each desired wallplate position on the Custom Wallplate Order Form.

\*3-Gang minimum  
\*\*2-Gang minimum



How to Fill Out the Custom Wallplate Order Form (continued)

**STEP 5: SELECT THE WALLPLATE COLOR**

For painted metal, select one of the following colors and enter its color code in the space marked "COLOR CODE" on the order form:

COLOR	WALLPLATE COLOR CODE
Almond	PA
Black	PE
Brown	PB
Gray	PG
Ivory	PI
Orange	PO
Red	PR
White	PW

**STEP 6: ENTER ENGRAVING INFORMATION**

**NOTE: WE CAN ENGRAVE NYLON AND PAINTED AND UNPAINTED METAL WALLPLATES. After completing steps 1-5:**

**6A)** Type or clearly print the message(s) (i.e., TURN OFF) as you wish it to appear on the lines provided in the appropriate Grid box(es). **6B)** Select the size of the letters you desire for the wallplate message from the dimensions shown below and enter that size in the space marked "LETTER SIZE" on the Order Form. **6C)** Select the fill-in color for the message letter from the chart below and enter the code for the color chosen in the space marked "FILLER CODE."

**FILLER COLOR CODES** for Engraved Wallplates

COLOR	CODE
Black	XE
White	XW
Red	XR
No Filler	XX

**LETTER SIZE GAUGE** for Engraved Wallplates

1/8"	3/16"	1/4"	5/16"	3/8"
E	E	E	E	E

**STEP 7: ENTER HOT STAMPING INFORMATION**

**7A)** Select the message(s) desired from the Message Library below. Enter the message on the lines provided in the appropriate Grid box(es) where they should appear. The message will be stamped in 3/16"-high text.

**HOT STAMPING MESSAGE LIBRARY FOR CUSTOM NYLON WALLPLATES**

1. SHOWER	7. HEAT	13. ON	19. ISOLATED	25. EQUIP
2. VANITY	8. DATA	14. PROTECTED	20. GROUND	26. FLUORESCENT
3. VOICE	9. COMPUTER	15. OFF	21. CONDITIONED	27. OIL
4. ONLY	10. GFCI	16. OIL BURNER	22. CONDITIONED POWER	28. POWER
5. ISOLATED GROUND	11. SURGE	17. PC	23. CRITICAL	29. UPS
6. EMERGENCY	12. FAN	18. DEDICATED	24. ELEC.	

**7B)** Select the fill-in color for the message letter from the chart below and enter the code for the color chosen in the space marked "FILLER CODE."

COLOR	CODE
Black	XE
White	XW
Red	XR
No Filler	XX

To order nylon wallplates with custom hot stamped message, contact your Leviton salesman or customer service representative.

**8)** NOTE: Sequential engraving is available. Consult factory for ordering instructions.



# WALLPLATES

## How to Order Custom Wallplates

### Custom Wallplate Order Form

BILL TO:

SHIP TO:

\_\_\_\_\_  
 \_\_\_\_\_  
 \_\_\_\_\_  
 \_\_\_\_\_

\_\_\_\_\_  
 \_\_\_\_\_  
 \_\_\_\_\_  
 \_\_\_\_\_

CAT. NO. \_\_\_\_\_ MATERIAL CODE \_\_\_\_\_ QTY. \_\_\_\_\_

(1) (2) (3) (4) (5) (6) (7) (8) (9) (10) (11) (12)

<input type="checkbox"/>	<input type="checkbox"/>	<input type="checkbox"/>	<input type="checkbox"/>	<input type="checkbox"/>	<input type="checkbox"/>	<input type="checkbox"/>	<input type="checkbox"/>	<input type="checkbox"/>	<input type="checkbox"/>	<input type="checkbox"/>	<input type="checkbox"/>
--------------------------	--------------------------	--------------------------	--------------------------	--------------------------	--------------------------	--------------------------	--------------------------	--------------------------	--------------------------	--------------------------	--------------------------

COLOR CODE \_\_\_\_\_ ENGRAVED \_\_\_\_\_ HOT STAMPED \_\_\_\_\_ LETTER SIZE \_\_\_\_\_

FILLER CODE \_\_\_\_\_ PRICE \_\_\_\_\_

### ENGRAVING INFORMATION (Please print per corresponding gang number.)

(1)

(2)

(3)

(4)

(5)

(6)

(7)

(8)

(9)

(10)

(11)

(12)

#### DESCRIPTION

(Use this space to add additional information that may be helpful.)

#### TERMS

- Please take care to complete your order carefully. Custom wallplates cannot be returned
- Custom orders are shipped in three to four weeks
- All engraving shall be centered within its corresponding gang unless specifically instructed to span across multiple gangs
- All engravings on toggle configurations shall appear above the mounting screw holes unless specifically instructed otherwise
- All engravings on GFCI/Decora configurations shall appear below the mounting screw hole unless specifically instructed otherwise

