

Electrical Sector Solutions

Volume 12: **Aftermarket, Renewal Parts and Life Extension Solutions**



EATON

Powering Business Worldwide

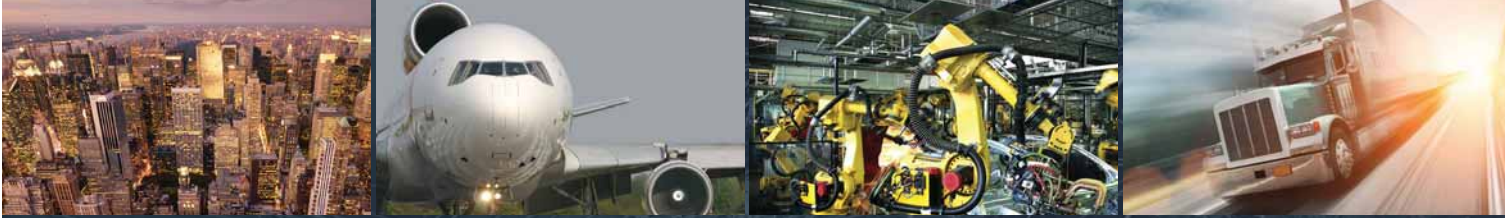

Energizing a world that demands more.

We deliver:

- **Electrical solutions** that use less energy, improve power reliability and make the places we live and work safer and more comfortable
- **Hydraulic and electrical solutions** that enable machines to deliver more productivity without wasting power
- **Aerospace solutions** that make aircraft lighter, safer and less costly to operate, and help airports operate more efficiently
- **Vehicle drivetrain and powertrain solutions** that deliver more power to cars, trucks and buses, while reducing fuel consumption and emissions

Discover today's Eaton.

Powering business worldwide

As a global power management company, we help customers worldwide manage the power needed for buildings, aircraft, trucks, cars, machinery and businesses.

Eaton's innovative technologies help customers manage electrical, hydraulic and mechanical power more reliably, efficiently, safely and sustainably.

We provide integrated solutions that help make energy, in all its forms, more practical and accessible.

With 2015 sales of \$20.9 billion, Eaton has approximately 100,000 employees around the world and sells products in more than 175 countries.

Eaton.com

EATON

Powering Business Worldwide

Molded-Case Circuit Breakers



Motor Control

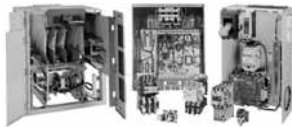

Switchgear



- Introduction** 1
- Distribution System** 2
- Molded-Case Circuit Breakers** 3
- Panelboards** 4
- Loadcenters** 5
- Meter Centers** 6
- Safety Switches** 7
- Dry-Type Distribution Transformers** 8
- Busway (Low Voltage)** 9
- IQ Products** 10
- Communication Systems** 11
- Programmable Logic Controllers** 12
- Motor Control** 13
- Motor Control Centers** 14
- Distribution Switchboards (Low Voltage)** 15
- High Resistance Grounding System** 16
- Switchgear** 17
- Medium Voltage Fuses** 18
- Network Protectors** 19
- Automatic Transfer Switches** 20
- Power Factor Correction Capacitors** 21
- Eaton's Electrical Services & Systems** 22
- Pushbuttons and Indicating Lights** 23
- Counters, Panel Meters, Tachometers and Timers** 24
- Sales & Service Locations*
- Appendix 1—Eaton Terms & Conditions*
- Appendix 2—Alphabetical Product Index*

1
2
3
4
5
6
7
8
9
10
11
12
13
14
15
16
17
18
19
20
21
22
23
24

Dimensions, Weights and Ratings

Dimensions, weights and ratings given in this catalog **are approximate and should not be used for construction purposes**. Drawings containing exact dimensions are available upon request. All listed product specifications and ratings are subject to change without notice. Photographs are representative of production units.

Terms and Conditions

All prices and discounts are subject to change without notice. When price changes occur, they are published in *Eaton's Price and Availability Digest* (PAD). All orders accepted by Eaton's Electrical Sector are subject to the general terms and conditions as set forth in Appendix 1—Eaton Terms & Conditions.

Technical and Descriptive Publications

This catalog contains brief technical data for proper selection of products. Further information is available in the form of technical information publications and in illustrated brochures. If additional product information is required, contact your local Eaton Products Distributor, call **1-800-525-2000** or visit our website at **www.eaton.com**.

Compliance with Nuclear Regulation 10 CFR 21

Eaton products are sold as commercial grade products not intended for application in facilities or activities licensed by the United States Nuclear Regulatory Commission for atomic purposes, under 10 CFR 21. Further certification will be required for use of these products in a safety-related application in any nuclear facility licensed by the United States Nuclear Regulatory Commission.

WARNING

The installation and use of Eaton products should be in accordance with the provisions of the U.S. National Electrical Code® and/or other local codes or industry standards that are pertinent to the particular end use. Installation or use not in accordance with these codes and standards could be hazardous to personnel and/or equipment.

These catalog pages do not purport to cover all details or variations in equipment, nor to provide for every possible contingency to be met in connection with installation, operation or maintenance. Should further information be desired or should particular problems arise that are not covered sufficiently for the purchaser's purposes, the matter should be referred to the local Eaton Products Distributor or Sales Office. The contents of this catalog shall not become part of or modify any prior or existing agreement, commitment or relationship. The sales contract contains the entire obligation of Eaton's Electrical Sector. The warranty contained in the contract between the parties is the sole warranty of Eaton. Any statements contained herein do not create new warranties or modify the existing warranty.



Powering Business Worldwide

Eaton is a global leader in power distribution, power quality, control and automation, and monitoring products.

At Eaton, we believe a reliable, efficient and safe power system is the foundation of every successful enterprise. Through innovative technologies, cutting-edge products and our highly skilled services team, we empower businesses around the world to achieve a powerful advantage.

In addition, Eaton is committed to creating and maintaining powerful customer relationships built on a foundation of excellence. From the products we manufacture to our dedicated customer service and support, we know what's important to you.

Solutions

Eaton takes the complexity out of power systems management with a holistic and strategic approach, leveraging our industry-leading technology, solutions and services. We focus on the following three areas in all we do:

- Reliability—maintain the appropriate level of power continuity without disruption or unexpected downtime
- Efficiency—minimize energy usage, operating costs, equipment footprint and environmental impact
- Safety—identify and mitigate electrical hazards to protect what you value most

Using the Eaton Catalog Library

As we grow, it becomes increasingly difficult to include all products in one or two comprehensive catalogs. Knowing that each user has their specific needs, we have created a library of catalogs for our products that when complete, will contain 15 volumes. Since the volumes will continuously be a work in progress and updated, each volume will stand alone. Refer to our volume directory, MZ08100001E, for a quick glance of where to look for the products you need. The 15 volumes include:

- Volume 1—Residential and Light Commercial (CA08100002E)
- Volume 2—Commercial Distribution (CA08100003E)
- Volume 3—Power Distribution and Control Assemblies (CA08100004E)
- Volume 4—Circuit Protection (CA08100005E)
- Volume 5—Motor Control and Protection (CA08100006E)
- Volume 6—Solid-State Motor Control (CA08100007E)
- Volume 7—Logic Control, Operator Interface and Connectivity Solutions (CA08100008E)
- Volume 8—Sensing Solutions (CA08100010E)
- Volume 9—Original Equipment Manufacturer (CA08100011E)
- Volume 10—Enclosed Control (CA08100012E)
- Volume 11—Vehicle and Commercial Controls (CA08100013E)
- Volume 12—Aftermarket, Renewal Parts and Life Extension Solutions (CA08100014E)
- Volume 13—Counters, Timers and Tachometers (CA08100015E)—Available in electronic format only
- Volume 14—Fuses (CA08100016E)—Available in electronic format only
- Volume 15—Solar Inverters and Electrical Balance of System (CA08100018E)

These volumes are not all-inclusive of every product, but they are meant to be an overview of our product lines. For our full range of product solutions and additional product information, consult Eaton.com/electrical and other catalogs and product guides in our literature library. These references include:

- The Consulting Application Guide (CA08104001E)
- The Eaton Power Quality Product Guide (COR01FYA)

If you don't have the volume that contains the product or information that you are looking for, not to worry. You can access every volume of the catalog library at Eaton.com/electrical in the Literature Library.

By installing our Automatic Tab Updater (ATU), you can be sure you always have the most recent version of each volume and tab.

Icons



Green Leaf

Eaton Green Solutions are products, systems or solutions that represent Eaton benchmarks for environmental performance. The green leaf symbol is our promise that the solution has been reviewed and documented as offering exceptional, industry-leading environmental benefits to customers, consumers and our communities. Though all of Eaton's products and solutions are designed to meet or exceed applicable government standards related to protecting the environment, our products with the Green Leaf designation further provide "exceptional environmental benefit."



Learn Online

When you see the Learn Online icon, go to Eaton.com/electrical and search for the product or training page. There you will find 100-level training courses, podcasts, webcasts or games and puzzles to learn more.



Drawings Online

When you see the Drawings Online icon, go to Eaton.com/electrical and find the products page. There you will find a tab that includes helpful product drawings and illustrations.

Contact Us

If you need additional help, you can find contact information under the Customer Care heading of Eaton.com/electrical.

**Continuous Support for the
Installed Base**



1

Introduction

Welcome	V12-T1-2
Logo History	V12-T1-2
Eaton	V12-T1-2
The Installed Base	V12-T1-3
One Source for All Your Aftermarket Needs	V12-T1-3
What's New?	V12-T1-3
Using the Catalog	V12-T1-3
Catalog Format	V12-T1-3
What Does the Shaded Area Mean?	V12-T1-3
Eaton's Electrical Business on the World Wide Web	V12-T1-3
Eaton	V12-T1-3

Welcome

Welcome to the latest edition of Eaton's *Aftermarket, Renewal Parts and Life Extension Solutions* catalog (formerly YES catalog). In this fifth expanded edition, you will find increased solutions to extend the life, modernize and upgrade your installed base of electrical distribution and industrial control equipment.

Logo History

The installed base of Westinghouse and Cutler-Hammer® distribution and control equipment can be found everywhere. Whether in an industrial facility such as paper, chemical, pharmaceutical, auto and steel, or commercial installations including universities, hospitals, airports and just about any type of government building; you will find equipment that was manufactured by Eaton or one of its acquired companies.

In some situations due to the age of the equipment, the original nameplate information may be difficult to obtain. This is why the logo history is provided. If all else fails, the logo on the front of the equipment will help you identify when it was manufactured. Knowing this, and the type of product, you can refer to the applicable section of the catalog to find the solutions available to support it.

Eaton

Eaton is backed by more than 100 years of history and experience. This experience has resulted in many innovations in distribution and industrial control products each incorporating leading-edge technology to provide the highest value to our customers. This same technology and engineering expertise is applied to solutions to upgrade existing installed older equipment.

Our engineers and scientists are recognized throughout the industry and around the world as experts in a wide range of disciplines including: photoelectric optical technology, arc interruption, vacuum technology, digital and analog electronics, and communications technology.

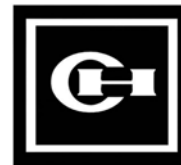

1994-2000



1960-1994

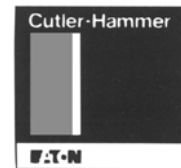

1980-1994



1953-1960



1960-1980



1940-1953



1933-1960



1922-1940



1914-1933



1910-1922



1900-1914



1900-1910

The Installed Base

The installed base of electrical distribution and control equipment is a product of the economic changes that have occurred over the last 15 or 20 years.

They could:

- Be operating beyond capacity
- Have higher fault currents because of additions
- Pose major safety issues
- Cause increased unscheduled outages having a direct impact on productivity

It has also been a witness to:

- Reductions in budgets and people resources
- Increases in maintenance intervals
- Decreases in support from the original manufacturer

Where do you go for help?

One Source for All Your Aftermarket Needs

The *Aftermarket, Renewal Parts and Life Extension Solutions* catalog is a reference tool to help you identify existing electrical distribution and control equipment and then provide a wide range of solutions available from Eaton to support it. Regardless of the vintage or the original manufacturer, we can provide solutions that will extend the useful life of your existing equipment.

What's New?

Our catalog has a new name to reflect our membership in the family of electrical solutions catalogs—the *Aftermarket, Renewal Parts and Life Extension Solutions* catalog replaces the former *YES (Your Electrical Solutions)* catalog. It continues to offer cutting-edge engineered life extension solutions—it just has a new look and a new name.

Additionally, as the number of available solutions has grown, so has the catalog. Incorporated in this latest edition are increased capabilities that have been introduced since the last printing in 2003. For example, in order to address ongoing safety concerns, Eaton has engineered the Arcflash Reduction Maintenance System™ and the universal remote power racking system. Also, there are new product offerings in the area of trip unit retrofit kits, low voltage power breakers and medium voltage vacuum replacement breakers, just to name a few. With changes to the molded-case circuit breaker product line, this catalog is simpler to use with an updated replacement breaker cross-reference section. Additionally, automatic transfer switches and power factor correction capacitors are included in brand-new tabs in this edition.

Using the Catalog

You can find information in several ways. **The Table of Contents** in the front and the detailed **Alphabetical Product Index** in the back will refer you to the correct section. The capabilities overview in **Tab 2** highlights various capabilities, and provides the tab number where that capability is listed. Also included in this tab is a pictorial representation of a typical distribution system illustrating the various products and where they can be found.

Catalog Format

Each section of the catalog includes the following elements:

- Product Description
- Product History
- Product History Time Line
- Replacement Capabilities
- Technology Upgrades (where applicable)
- Further Information
- Pricing Information

Where relevant, Additional Information, Customer Required Information, General Information and Support Services are included.

What Does the Shaded Area Mean?

In some sections of the catalog, you will again see tables and text that have been shaded. The shaded areas indicate obsolete or discontinued product, and although the product is no longer manufactured, it is still shown for historical reference. In the molded-case circuit breaker section (**Tab 3**), many of the tables have shaded areas. Although the product is no longer manufactured, cross-reference tables have been developed to provide alternative solutions using current manufactured molded-case circuit breakers. The cross-reference tables begin on **Page V12-T3-115** and are in alphanumeric order, based on style or catalog number of the obsolete or discontinued product.

Eaton's Electrical Business on the World Wide Web

Our *Aftermarket, Renewal Parts and Life Extension Solutions* catalog is designed to be your everyday, at-your-fingertips, at-a-glance reference for our wide range of products and services that support your installed base. But it's just the paper "tip" of the electronic "iceberg" of continuously updated information that you can access, online, anytime.

<http://www.eaton.com>

Eaton

At Eaton, we're energized by the challenge of powering a world that demands more. With over 100 years experience in electrical power management, we have the expertise to see beyond today. From ground breaking products to turnkey design and engineering services, critical industries around the globe count on Eaton.

We power businesses with reliable, efficient and safe electrical power management solutions. Combined with our personal service, support and bold thinking, we are answering tomorrow's needs today. With 2015 sales of \$20.9 billion, Eaton has approximately 100,000 employees around the world and sells products in more than 175 countries. Follow the charge with Eaton. Visit www.eaton.com.

**Technology Upgrades
for the Installed Base**



2

Distribution System

A Commitment to the Installed Base	V12-T2-2
Replacement Components and Renewal Parts	V12-T2-2
Equipment Modernization and Upgrades	V12-T2-2
Products and Services Overview	V12-T2-4

Distribution System

A Commitment to the Installed Base

Our employees are committed to supporting all Cutler-Hammer® and Westinghouse® Distribution and Control equipment, no matter when it was manufactured by Eaton's electrical business, or how long it has been in service. Our dedicated Aftermarket Organization provides products, services and expertise through a focused management team, sales engineers and technicians that work to keep customers' equipment operating.

Eaton also offers multiple solutions to extend the life of other manufacturers' equipment, including modernization, technology upgrades, reconditioning and repair. Support for other manufacturers' equipment include:

- General Electric®
- Square D®
- Federal Pacific®
- ITE®
- Siemens®
- Siemens-Allis™
- Allen-Bradley®
- Allis-Chalmers

Eaton's innovative engineering provides the highest level of life extension to support the industry's installed base, regardless of the original manufacturer.

Replacement Components and Renewal Parts

A full line of replacement components and renewal parts is available for the existing installed base of Cutler-Hammer and Westinghouse equipment. These replacement components and renewal parts are *new*, not used or surplus material. The use of original production tooling, assembly fixtures, and original specifications and drawings guarantees compatibility with existing equipment.

Equipment Modernization and Upgrades

Cutler-Hammer equipment modernization and upgrades can extend the life of your existing equipment. They can economically upgrade Cutler-Hammer and Westinghouse products, as well as those of other manufacturers. These state-of-the-art upgrades are engineered to provide:

- Solutions for obsolete electrical equipment
- New technology for aging equipment
- Retrofit, repair and remanufacturing processes
- Monitoring, protection and control capabilities to your system
- Genuine new replacement components and renewal parts

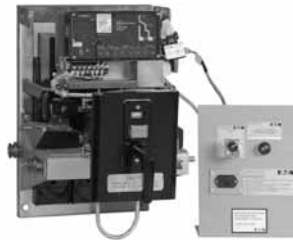

Breaker Reconditioning and Trip System Upgrades with Arcflash Reduction Maintenance System™

Digitrip™ RMS trip unit retrofit kits are available for Eaton, Westinghouse and other manufacturers of low voltage power breakers. These retrofits will improve circuit protection while increasing breaker and electrical system reliability. See **Tab 17**.

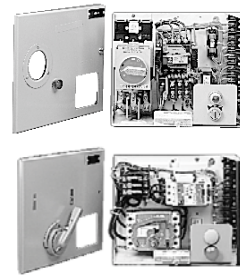

Motor Control Center Bucket Retrofits

Freedom™ 2100, Advantage™ and *IT* replacement starter units can be used to increase the capacity of a motor control center without investing in a completely new assembly. Competitive retrofits and new buckets are also available for other manufacturers' units, using current Eaton technology. See **Tab 14**.



Power Breaker Replacement

New DB, DS, DSII, Magnum™ DS and SPB power breakers are available for replacement, to fill existing cells, or in a cell retrofit package for upgrading existing older low voltage switchgear. These breakers are electrically and mechanically identical to the original vintages of DB, DS, DSII, Magnum DS and SPB breakers. See **Tab 17**.

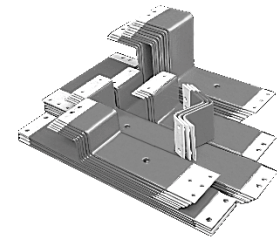

Switchgear Fluidized Epoxy Bus

Existing switchgear bus can be replaced or returned to our factory, regardless of the original manufacturer for reinsulation, using the custom fluidized epoxy bed process. It is available from 600V to 15 kV for switchgear, bus runs and other equipment. See **Tab 17**.



Medium Voltage Starter Upgrades

Vacuum contactors can be retrofitted or refilled into existing medium voltage air magnetic starters, achieving the benefits of vacuum technology without the expense of a completely new assembly. See **Tab 13**.

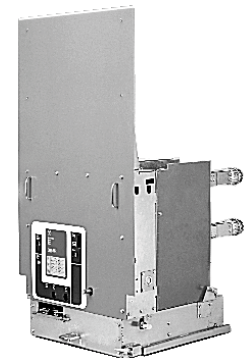

Replacement Vacuum Breakers

MVVR (Medium Voltage Vacuum Replacement) breakers provide a means to cost-effectively modernize **existing** air magnetic medium voltage switchgear while further increasing its effective life. See **Tab 17**.



PowerNet

Eaton's Cutler-Hammer PowerNet™ system is designed to manage the power distribution system. This integrated power management system is the ideal tool to help manage energy costs, to troubleshoot power quality problems, and to ensure the reliability and integrity of the electrical distribution system. See **Tab 11**.

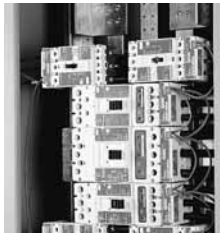

Submetering Retrofits

Eaton's Cutler-Hammer IQ Energy Sentinel submetering device can be easily retrofitted on Series C® breakers, or those of other manufacturers, in existing equipment. When combined with the PowerNet system, the IQ Energy Sentinel can now provide submetering at numerous levels of monitoring and energy management. See **Tabs 4** and **10**.



Power Management Products

Eaton's Cutler-Hammer IQ Metering and Protective Relaying products are multifunctional communicating products based on micro-processor technology. They are designed to replace existing electromechanical devices and can be applied at low, medium and high voltage points in the electrical distribution system. These devices offer communications capabilities to link electrical distribution equipment to PowerNet Power Management Software. See **Tab 10**.



Replacement Molded-Case Breakers and Accessories

Circuit breaker replacements and upgrades are designed for use in panelboards, switchboards, motor control centers, control panels, combination starters, individual enclosures, and bus duct plug-in units. See **Tabs 3, 4, 9** and **14**.



SPD System Retrofits

Protect solid-state devices from the damaging effects of transient overvoltages. The Eaton SPD products can be installed in low voltage distribution gear or retrofitted into existing switchboards, panelboards and motor control centers to eliminate the effects of surges before it reaches sensitive equipment. See **Tabs 4** and **17**.



Low Voltage High Resistance Grounding Systems

Type C-HRG provides service continuity by providing a ground path for ground current via resistance that limits current magnitude and includes a means to trace the fault source. See **Tab 16**.



Installation and Startup Services

Installation and startup services can be provided for Eaton equipment, as well as equipment manufactured by other organizations. See **Tab 23**.



Genuine LV Control Renewal Parts

Genuine factory-warranted low voltage control renewal parts are available to support the complete line of Cutler-Hammer and Westinghouse design starters and contactors. Renewal parts include contact kits, coils, overload relays and heaters, to name a few. See **Tab 13**.

Product and Services for Life Extension and Equipment Upgrades Overview

1	Digitrip RMS Trip Unit Retrofit Kits	17
2	Motor Control Center Bucket Retrofits	2
3	DHP-VR Vacuum Replacement Breaker	17
4	Switchgear Fluidized Epoxy Bus	17
5	Retrofit/Replace with Vacuum Contactors	17
6	Cell Retrofit with DSII/SPB Circuit Breakers	17
7	Low Voltage High Resistance Grounding Systems	16
8	PowerNet Communication System	11
9	Retrofit Front Panel with IQ Devices	10
10	Retrofit with IQ Energy Sentinel for Submetering	10
11	Retrofit with Surge Protective Devices (SPD)	4, 9, 14, 15
12	Replacement Molded-Case Breakers and Parts	3
13	Rebuilding/Remanufacturing Service	3, 13, 15
14	Renewal/Replacement Parts	ALL
15	Service Capability	ALL
16	Power Factor Correction Capacitors	21
17	Automatic Transfer Switches	20
18	Arcflash Reduction Maintenance System	17
19	Remote Power Racking	17

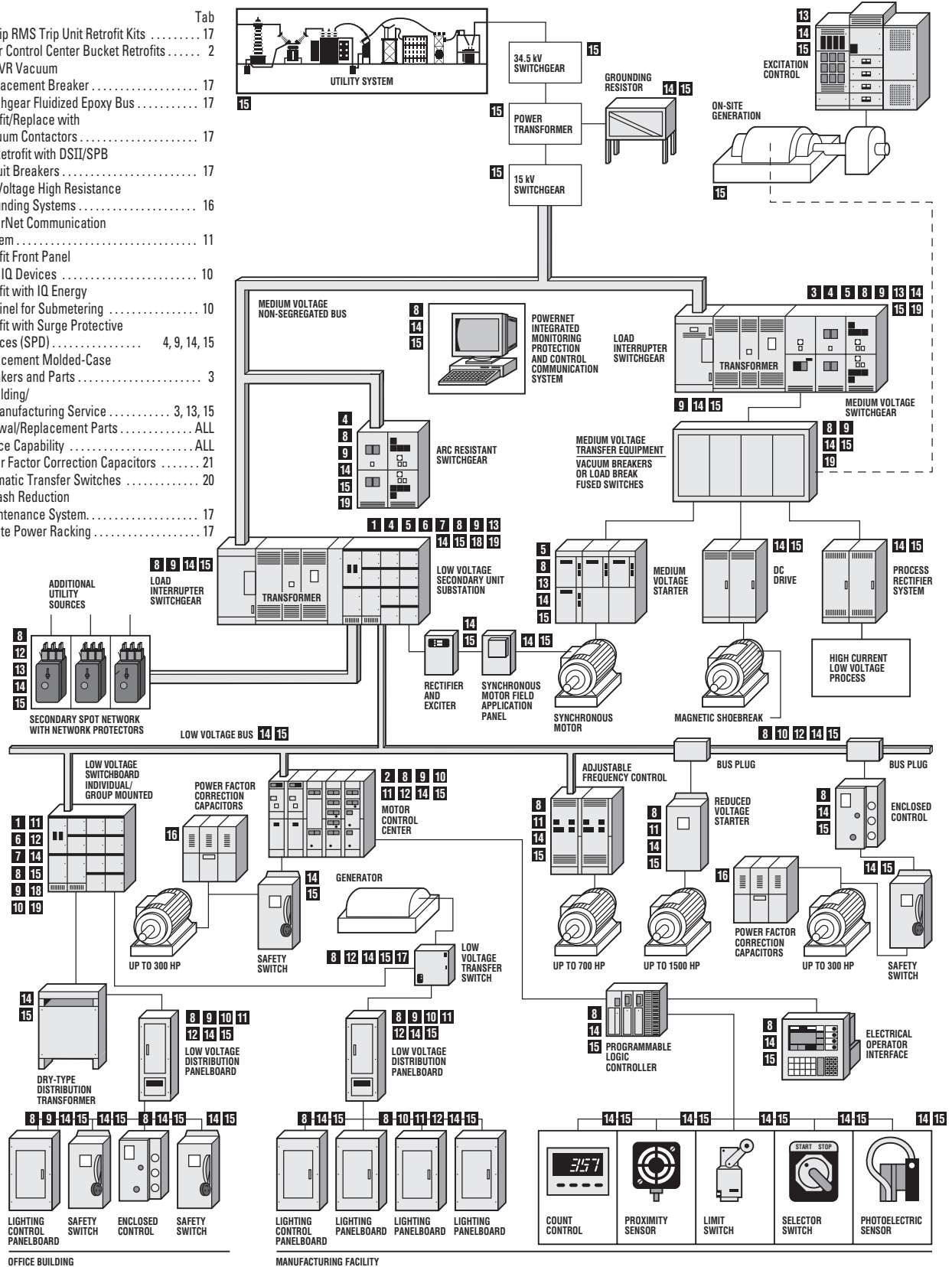

Molded-Case Circuit Breakers

Molded-Case Circuit Breakers Family



3

Molded-Case Circuit Breakers

Product Description, History, Major Product Introduction	V12-T3-2
General Information	V12-T3-3
Nameplate Data	V12-T3-3
Identifying Factory Original Circuit Breakers	V12-T3-4
Replacement and Upgrade Options	V12-T3-5
Replacement Guides	
Miniature Circuit Breakers	V12-T3-6
Molded-Case Circuit Breakers	V12-T3-10
Replacement Devices	
Circuit Breakers	V12-T3-15
Molded-Case Switches	V12-T3-61
Motor Circuit Protectors	V12-T3-63
Accessories	V12-T3-63
Panelboard Replacement Breakers	V12-T3-80
Replacement Guide	V12-T3-81
Motor Control Center Replacement Breakers	V12-T3-88
Technology Upgrades for Circuit Breakers	V12-T3-91
Handle Mechanisms	V12-T3-95
Replacement and Service Capabilities	V12-T3-112
Cross-Reference	
Westinghouse, Challenger and Bryant Replacements	V12-T3-113
Breaker Replacements	V12-T3-115
Mining Breaker Replacements	V12-T3-162
Pricing Information	V12-T3-168

Molded-Case Circuit Breakers



Molded-Case Circuit Breaker Family

Product Description

Eaton’s molded-case circuit breakers are designed to provide circuit protection for low voltage distribution systems. They are described by NEMA® as “. . . a device for closing and interrupting a circuit between separable contacts under both normal and abnormal conditions,” and furthermore as “. . . a breaker assembled as an integral unit in supporting an enclosed housing of insulating material.” The NEC® describes them as “. . . a device designed to open and close a circuit by non-automatic means, and to open the circuit automatically on a predetermined overload of current, without injury to itself when properly applied within its rating.”

Circuit breakers protect against overloads in conductors and protects against short circuits in connected apparatus such as motors and motor starters.

Circuit breakers are designed for use in panelboards, switchboards, motor control centers, control panels, combination starters, individual enclosures and bus duct plug-in units.

Product History

Originally a Westinghouse Product

The need for molded-case circuit breakers came about in 1918 when numerous applications for electrical motors resulted in a demand for a device that would ensure safe operation and, at the same time, protect electrical circuits.

During this period, individual motors were used for the first time in industrial plants to operate machine tools and in private homes to operate appliances. Plant electricians were constantly changing fuses blown during motor startups because of the lack of properly designed fuses for motor circuit protection. Homes experienced similar problems when electrical circuits were overloaded. Inspectors were concerned about fire hazards because of plug fuses being bridged with pennies and the installation of fuses with too high an ampere rating.

Inspection authorities became involved and

attempted to find a solution to the problem. Meetings with switch manufacturers were initiated in an effort to find a solution. Switch manufacturers were asked to develop a switching device that would interrupt a circuit under prolonged overload conditions. The device would have to be safe, reliable and tamperproof. It should also be resettable so as to be reusable after an interruption without replacing any parts. This search for better circuit protection resulted in many different but unacceptable approaches to the problem. These early meetings and subsequent efforts prepared the groundwork for the eventual development of the molded-case circuit breaker.

After intensive research and development, Westinghouse produced the DE-ION® arc extinguisher for use in large oil circuit breakers. Although too large in its initial form to be practical for small circuit breakers, the arc extinguisher was eventually modified into a usable size. The first compact, workable circuit breaker was developed in

1923 when the modified arc extinguisher was coupled with a thermal tripping mechanism. It was not until four years later, however, that Westinghouse research engineers found the ideal combination of materials and design that permitted circuit breakers to interrupt fault currents of 5000A at 120 Vac or Vdc. One year later, Westinghouse placed the first circuit breaker on the market. Its acceptance was instantaneous.

Since that initial introduction in 1927, Westinghouse continued to be at the forefront of circuit breaker technology with an unprecedented series of circuit protective enhancements and introductions as chronicled below. In 1994, Eaton, another world-class technology leader, acquired the Westinghouse Distribution and Control Business Unit (DCBU) and integrated it with their Cutler-Hammer business unit forming a powerful, new combination, poised to meet the challenges of the next 100 years.

Time Line—Major Product Introductions

Year	Product	1920	1930	1940	1950	1960	1970	1980	1990	1995	2000	2002	Present	
1923	First compact, workable circuit breaker developed by Westinghouse	[Timeline bar from 1923 to Present]												
1927	Westinghouse introduced the first complete circuit breaker line, rated 10–600A, 600V	[Timeline bar from 1927 to Present]												
1939	Along with ordering information and style numbers, the various maximum current ratings came to be known by frame designations: 50A E-Frame 100A F-Frame (non-interchangeable trip) 100A G-Frame 225A K-Frame 600A L-Frame	[Timeline bar from 1939 to Present]												
1970	Motor Circuit Protector (MCP) introduced—first sensitive, low level protection designed specifically for motor circuits	[Timeline bar from 1970 to Present]												
1973	SELTRONIC™ introduced—first molded-case circuit breaker with an electronic trip unit	[Timeline bar from 1973 to Present]												
1979	Current Limit-R circuit breaker introduced—first true current limiting trip unit	[Timeline bar from 1979 to Present]												
1982	Series C® Family introduced—new world-class standard, meeting increasing interrupting requirements without sacrificing compact size	[Timeline bar from 1982 to Present]												
1994	Westinghouse Distribution and Control Business Unit (DCBU) acquired by Eaton, integrated with Cutler-Hammer (the Cutler-Hammer line of molded case circuit breakers was sold when merged with Westinghouse)	[Timeline bar from 1994 to Present]												
1995	OPTIM™ Family introduced—first truly programmable molded-case circuit breaker	[Timeline bar from 1995 to Present]												
2002	Next Generation E125, J250	[Timeline bar from 2002 to Present]												
2004	Series G® First Global Breaker Line	[Timeline bar from 2004 to Present]												

Breaker Identification

Nameplate Data

A circuit breaker is identified by data found on the nameplate.

This includes:

- Catalog number
- Shop order number
- Style number
- Amperage
- Number of poles
- Voltage class
- Temperature rating

In most instances, the catalog number, style number or shop order number will supply enough information to identify the circuit breaker.

However, it is always advisable to obtain all data from the nameplate to facilitate identification.

A **Catalog Number** begins with a series of letters followed by numbers that identify:

- Circuit breaker type
- Number of poles
- Maximum amperage
- **Example:** Catalog number F3020 indicates a Type F circuit breaker, three poles, 20A

A **Shop Order Number** begins with one or two numbers followed by a single letter and four additional numbers.

A shop order number is listed in place of a catalog number and indicates that the circuit breaker was modified at the factory, i.e., addition of a shunt trip, special calibration, etc. **Every shop order number must be researched with the factory to properly identify modifications.** Call your Cutler-Hammer Field Sales office for this information.

- **Example:** 70E2121

Note: Eaton does not recommend replacing a circuit breaker identified by a **Shop Order Number** with a standard “off-the-shelf” circuit breaker without first identifying the modifications. **They may be critical to safe and reliable operation.**

Accessories

Most circuit breaker accessories are mounted internally and are not visible with a quick inspection.

However, because many accessories rely on or supply an external signal, there may be electrical leads exiting the circuit breaker case. Inspect for these leads when obtaining full descriptive information for circuit breaker replacement. Examples of common accessories:

Shunt Trip

Used to remotely trip the circuit breaker using an electrical signal. Typically two wires extend through the case.

Undervoltage Release (UVR)

Trips the circuit breaker when voltage drops below a specified percentage of coil voltage (typically 70%). Typically two wires extend through the case.

Auxiliary Switch

Provides remote indication of the circuit breaker status (open/closed). Typically three wires extend through the case in a single-pole 1A/1B application.

Alarm Lockout Switch

For remote indication of an automatic trip operation. Typically two or three wires extend through the case.



Pre-Series C Breaker with Original Label (Labels updated in 1997)

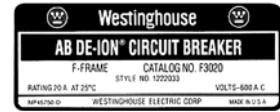

Series C Breaker with Original Label (Labels updated in 1997)

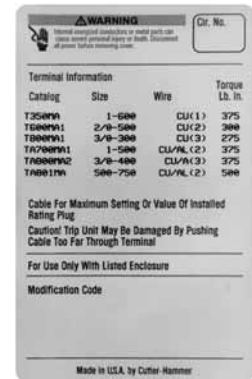

Vintage Label for Typical SELTRONIC Molded-Case Circuit Breaker

Factory Original Circuit Breakers

Why Insist on Only Genuine, New MCCBs Purchased Through Authorized Distributors?

Eaton defines “New” product as that which has not yet been installed in an electrical circuit, purchased through authorized channels in factory original condition and packaged in unopened Eaton cartons.

- The only way to ensure safe and reliable operation of your system is to use genuine, new, Eaton’s Cutler-Hammer products exclusively. Eaton does not resell the component parts for molded-case circuit breakers, the only way for third-party breaker refurbishers to get parts for the breakers that they are rebuilding is to cannibalize other used breakers or to use counterfeit components. Neither is a very good option for the end user
- In some cases, unauthorized resellers of molded-case circuit breakers have been found to misrepresent used, rebuilt or surplus products. Only products purchased as “new” through authorized channels are covered under the Eaton warranty policy
- There have been instances where third-party refurbishers have rebuilt breakers using the wrong parts, with parts missing or the factory lubrication removed in the cleaning process—any of which may result in devices that may not be depended upon to function properly to protect equipment and personnel

Identifying Genuine, Factory Original Westinghouse Circuit Breakers Manufactured by Eaton

The features on a molded-case circuit breaker that identify it as genuine or counterfeit may or may not be readily apparent. In fact, there may be differences not detectable by an external investigation.

A genuine Eaton brand molded-case circuit breaker manufactured by Eaton will have a serialized bar code unique to the breaker as well as an unbroken seal where the case comes together. This barcode and seal were placed at the factory and ensures the internal integrity of the breaker. If, for any reason the barcode is missing or the seal is broken, do not accept the breaker. (Seal does not appear on interchangeable trip breakers.)



Unbroken Seal

There is a manufacturing date code on the back of genuine molded-case circuit breakers stamped in silver and white. If this coding is missing, it may mean the breaker has been subjected to tampering. Frequently, this date code is wiped off in an attempt to represent the breaker as new.



Manufacturing Date Code

Another way to tell if a breaker has been tampered with is to examine the sealant used to cover the screws on the top rear of the breaker. If the sealant appears sloppy or is missing, it indicates that the unit may have been subjected to tampering.



Sealant Used to Cover Screws

A UL® label on a genuine Westinghouse breaker is either exactly as shown in the photo or is stamped in white ink onto the frame in older pre-Series C breakers. Anything other than this may indicate fraud.

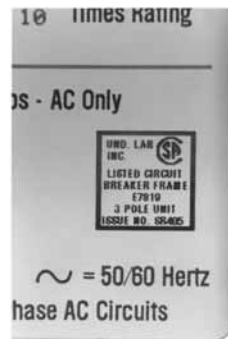

UL Label

If front cover screw shows marks from use, someone has attempted to open the breaker. The front covers are either black or gray on genuine Westinghouse molded-case circuit breakers.



Front Cover Screws

Westinghouse molded-case circuit breakers manufactured by Eaton are packed individually and shipped in Eaton labeled cartons. Anything other than this is not to be considered new and should be suspect.

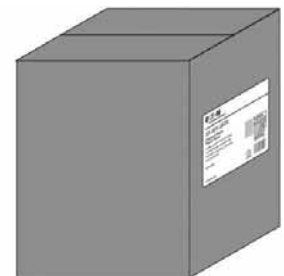

Eaton Labeled Cartons

Replacement Capabilities Series C and Series G Molded-Case Circuit Breakers

When and Where to Use

- Generally a first choice wherever physically and electrically practical
- Where communications, arc flash protection, energy and power quality monitoring are desired
- As a direct replacement or add-on to already installed Series C or Series G product, including Westinghouse breakers (see **Page V12-T3-114**)
- For special applications such as DC engine generator

Advantages

- The most current molded-case circuit breaker technology
- Higher interrupting capacities in each frame size
- Smaller and lighter for a given frame size than other options
- Generally less expensive than other replacement breaker options
- Readily available throughout range, high levels of stock
- Available from stock
- One-year warranty

Current Production Replacement Circuit Breakers

When and Where to Use

- As a direct, one-for-one replacement of current production pre-Series C product
- Where you know the catalog/style number but not the physical or electrical specifics about the application

Advantages

- Ease of selection and certainty of replacement
- Guaranteed to be both a physical and electrical duplicate of original
- Still in production
- Newly manufactured
- UL listed
- Available from stock
- One-year warranty

Replacement of Current Panelboard Molded-Case Circuit Breakers

When and Where to Use

- When replacing Series C circuit breakers in a current design panelboard

Advantages

- Newly manufactured and tested to the latest technology
- UL Listed
- Available from stock in most frame sizes
- One-year warranty. Refer to **Page V12-T3-91** for Series C connector kits

Replacement of Out-of-Production Panelboard Molded-Case Circuit Breakers (Including Westinghouse)

When and Where to Use

- When replacing out-of-production circuit breakers in an existing panelboard
- When replacing Westinghouse breakers. Refer to **Pages V12-T3-81–V12-T3-90** and **Page V12-T3-114**

Advantages

- Newly manufactured and tested to the latest applicable standards
- Both physically and electrically interchangeable with the circuit breakers that they are designed to replace
- UL Listed
- Available from stock in most frame sizes
- One-year warranty

Replacement of Out-of-Production Motor Control Center Molded-Case Circuit Breakers and Upgrades

When and Where to Use

- When replacing out-of-production circuit breakers in an existing motor control center: 5 Star, Type W and F10 designs
- When upgrading Westinghouse breakers with a Series C technology upgrade breaker

Advantages

- Newly manufactured and tested to the latest technology
- Series C retrofit kits are physically and electrically interchangeable with the circuit breakers that they are designed to replace
- UL Listed
- Available from stock in most frame sizes
- One-year warranty. Refer to **Page V12-T3-91**

Contact: 1-800-OLD-UNIT.

Service for Molded-Case Circuit Breakers

When and Where to Use

- Where circuit breaker has sustained minor physical damage to a handle, lug, etc., that otherwise would be fully functional
- Large frame circuit breaker (600A and above) that has experienced some normal wear, but is in generally good condition, as an economically driven alternative to new
- When replacing Westinghouse breakers. Refer to **Page V12-T3-114**





Advantages

- Prevents loss of circuit breakers due to minor damage
- Reduces overall breaker costs
- Prevents use of potentially unreliable third-party refurbishers
- Includes full one-year Eaton Electrical Inc. warranty
- Ensures reliability through dealing with the original manufacturer with a long and well-recognized tradition of product safety, integrity and quality
- Provides a simple and convenient solution





Contact Eaton's Breaker Service Center: 1-877-BRK-SRVC.

QUICKLAG and Eaton Miniature Circuit Breaker Replacement Guide







QUICKLAG and Eaton Plug-In Industrial Circuit Breakers—Dimensions in Inches

Description	Maximum Amperes			
	150A	125A	100A	30A
Current Design				
These circuit breakers replace the out-of-production circuit breakers listed below.	HQP 	QPHW 	QHPX 	QHPW 
	Width: 1.00 Height: 2.94 Depth: 2.38	Width: 1.00 Height: 2.94 Depth: 2.38	Width: 1.00 Height: 2.94 Depth: 2.38	Width: 1.00 Height: 2.94 Depth: 2.38
Out-of-Production Westinghouse Circuit Breakers				
These circuit breakers are no longer manufactured. Recommended QUICKLAG circuit breakers listed above.	HQNPL, HQNPAL, HQNP, HQNPA, QP, QPA, QPAH, QNPL, QNPAL, QNP, Type P, PL	QPH	No previous circuit breaker existed	QHPL QHP

QUICKLAG Bolt-On Industrial Circuit Breakers—Dimensions in Inches

Description	Maximum Amperes			
	150A	125A	100A	30A
Current Design				
These circuit breakers replace the out-of-production circuit breakers listed below.	BAB 	QBHW 	HBAX 	HBAW 
	Width: 1.00 Height: 2.94 Depth: 2.38	Width: 1.00 Height: 2.94 Depth: 2.38	Width: 1.00 Height: 2.94 Depth: 2.38	Width: 1.00 Height: 2.94 Depth: 2.38
Out-of-Production Westinghouse Circuit Breakers				
These circuit breakers are no longer manufactured. Recommended QUICKLAG circuit breakers listed above.	HQNB, HQNBA, QB, BA, QNBL, QNBAL	QBH	No previous circuit breaker existed	HBA

QUICKLAG and Eaton Cable-In/Cable-Out Industrial Circuit Breakers—Dimensions in Inches

Description	Maximum Amperes						
	60A	100A	100A	100A	30A	40A	
Current Design							
These circuit breakers replace the out-of-production circuit breakers listed below.	QCR 	QCF 	QC 	QCHW 	QHCX 	QHCW 	WMZ/FAZ 
	Width: 0.50 Height: 3.94 Depth: 2.44	Width: 1.00 Height: 3.75 Depth: 2.44	Width: 1.00 Height: 3.75 Depth: 2.44	Width: 1.00 Height: 3.75 Depth: 2.44	Width: 1.00 Height: 3.75 Depth: 2.44	Width: 1.00 Height: 3.75 Depth: 2.44	Width: 0.70 Height: 4.10 Depth: 2.60
Out-of-Production Westinghouse Circuit Breakers							
These circuit breakers are no longer manufactured. Recommended QUICKLAG circuit breakers listed above.	No previous circuit breaker existed	HQCL, HQCAL, HQC, HQCA, QCA	QCH	No previous circuit breaker existed	QHCL, QHC	WMT	

Note: For supplementary protectors, the Eaton WMZS and FAZ Series replace the WMS supplementary protectors that are no longer manufactured.

QUICKLAG Miniature Circuit Breakers

QUICKLAG is the largest and most complete family of industrial thermal-magnetic miniature circuit breakers. They provide the exclusive features of steel frame calibration and arc chutes in every pole.

QUICKLAG circuit breakers are provided in ranges from 5 to 125A continuous in single-, two- and three-pole configurations with interrupting capacities from 10,000 AIC to 65,000 AIC. QUICKLAG circuit breakers have been series rated up to 200,000 AIC in conjunction

with larger Westinghouse/Cutler-Hammer current limiting circuit breakers.

Each QUICKLAG rating is available for plug-in (Type P), bolt-on (Type B) and cable-to-cable connections (Type C) for line/load feed applications. They are also available with one of the industry's widest

selection of accessories, including shunt trip, and can be custom modified to meet special application requirements.

Circuit Breaker Selection Guide

Circuit Breaker Type	Circuit Breaker Type Code	Continuous Ampere Rating at 40°C	No. of Poles	Volts		Federal Spec. W-C-375b	UL Listed Interrupting Ratings rms Symmetrical Amperes					
				AC	DC		AC Ratings Volts			DC ①		
							120	120/240	240	24	48	80
HQP	P	5-70	1	120/240	24, 48, 80	10a, 11a, 12a	—	10,000	—	5000	5000	2000
HQP	P	10-125	2	120/240	24, 48, 80	10a, 12a	—	10,000	—	5000	5000	5000
HQP	P	10-100	2, 3	240	—	10b, 11b, 12b	—	—	10,000	—	—	—
QPHW	P	15-70	1	120/240	24, 48, 80	14a	—	22,000	—	5000	5000	2000
QPHW	P	15-125	2	120/240	24, 48, 80	14a	—	22,000	—	5000	5000	5000
QPHW	P	15-100	2, 3	240	—	14b	—	—	22,000	—	—	—
QHPX	P	15-70	1	120/240	24, 48, 80	—	—	42,000	—	5000	5000	2000
QHPX	P	15-100	2	120/240	24, 48, 80	—	—	42,000	—	5000	5000	5000
QHPX	P	15-100	3	240	—	—	—	—	42,000	—	—	—
QHPW	P	15-30	1	120/240	24, 48, 80	15a	—	65,000	—	5000	5000	2000
QHPW	P	15-30	2	120/240	24, 48, 80	15a	—	65,000	—	5000	5000	5000
QHPW	P	15-30	3	240	—	15b	—	—	65,000	—	—	—
QPGF	P, GF	15-30	1	120	—	10a, 11a, 12a	10,000	—	—	—	—	—
QPGF	P, GF	15-50	2	120/240	—	10a, 11a, 12a	—	10,000	—	—	—	—
QPHGF	P, GF	15-30	1	120	—	10a, 11a, 12a	22,000	—	—	—	—	—
QPHGF	P, GF	15-50	2	120/240	—	10a, 11a, 12a	—	22,000	—	—	—	—
QPGFEP	P, GFEP	15-30	1	120	—	—	10,000	—	—	—	—	—
QPGFEP	P, GFEP	15-50	2	120/240	—	—	—	10,000	—	—	—	—
QPHGFEP	P, GFEP	15-30	1	120	—	—	22,000	—	—	—	—	—
QPHGFEP	P, GFEP	15-30	2	120/240	—	—	22,000	—	—	—	—	—
BAB	B	5-70	1	120/240	24, 48, 80	10a, 11a, 12a	—	10,000	—	5000	5000	2000
BAB	B	10-125	2	120/240	24, 48, 80	10a, 12a	—	10,000	—	5000	5000	5000
BAB	B	10-100	2, 3	240	—	10b, 11b, 12b	—	—	10,000	—	—	—
QBHW	B	15-70	1	120/240	24, 48, 80	14a	—	22,000	—	5000	5000	2000
QBHW	B	15-125	2	120/240	24, 48, 80	14a	—	22,000	—	5000	5000	5000
QBHW	B	15-100	2, 3	240	—	14b	—	—	22,000	—	—	—
HBAX	B	15-70	1	120/240	24, 48, 80	—	—	42,000	—	5000	5000	2000
HBAX	B	15-100	2	120/240	24, 48, 80	—	—	42,000	—	5000	5000	5000
HBAX	B	15-100	3	240	—	—	—	—	42,000	—	—	—
HBAW	B	15-30	1	120/240	24, 48, 80	15a	—	65,000	—	5000	5000	2000
HBAW	B	15-30	2	120/240	24, 48, 80	15a	—	65,000	—	5000	5000	5000
HBAW	B	15-30	3	240	—	15b	—	—	65,000	—	—	—
QBGF	B, GF	15-30	1	120	—	10a, 11a, 12a	10,000	—	—	—	—	—
QBGF	B, GF	15-50	2	120/240	—	10a, 11a, 12a	—	10,000	—	—	—	—

Notes

① Two-pole DC interrupting rating based on two poles connected in series.
Circuit breaker type codes: **P** Plug-in; **B** Bolt-on; **C** Cable-in/Cable-out; **GF** Ground Fault, 5 mA; **GFEP** Ground Fault, 30 mA.

Circuit Breaker Selection Guide, continued

Circuit Breaker Type	Circuit Breaker Type Code	Continuous Ampere Rating at 40°C	No. of Poles	Volts		Federal Spec. W-C-375b	UL Listed Interrupting Ratings rms Symmetrical Amperes					
				AC	DC		AC Ratings Volts			DC ^①		
							120	120/240	240	24	48	80
QBHGF	B, GF	15–30	1	120	—	10a, 11a, 12a	22,000	—	—	—	—	—
QBHGF	B, GF	15–30	2	120/240	—	10a, 11a, 12a	—	22,000	—	—	—	—
QBGFEP	B, GFEP	15–30	1	120	—	—	10,000	—	—	—	—	—
QBGFEP	B, GFEP	15–50	2	120/240	—	—	—	10,000	—	—	—	—
QBHGFEP	B, GFEP	15–30	1	120	—	—	22,000	—	—	—	—	—
QBHGFEP	B, GFEP	15–30	2	120/240	—	—	22,000	—	—	—	—	—
QC	C	5–70	1	120/240	24, 48, 80	10a, 11a, 12a	—	10,000	—	5000	5000	2000
QC	C	10–100	2	120/240	24, 48, 80	10a, 12a	—	10,000	—	5000	5000	5000
QC	C	10–100	2, 3	240	—	10b, 11b, 12b	—	—	10,000	—	—	—
QC	C	15–100	4	240	—	10b, 11b, 12b	—	—	10,000	—	—	—
QCF	C	10–60	1, 2	120/240	—	—	10,000	10,000	—	—	—	—
QCR	C	10–60	1, 2	120/240	—	—	10,000	10,000	—	—	—	—
QCHW	C	15–70	1	120/240	24, 48, 80	14a	—	22,000	—	5000	5000	2000
QCHW	C	15–100	2	120/240	24, 48, 80	14a	—	22,000	—	5000	5000	5000
QCHW	C	15–100	2, 3	240	—	14b	—	—	22,000	—	—	—
QHCX	C	15–70	1	120/240	24, 48, 80	—	—	42,000	—	5000	5000	2000
QHCX	C	15–100	2	120/240	24, 48, 80	—	—	42,000	—	5000	5000	5000
QHCX	C	15–100	3	240	—	—	—	—	42,000	—	—	—
QHCW	C	15–30	1	120/240	24, 48, 80	15a	—	65,000	—	5000	5000	2000
QHCW	C	15–30	2	120/240	24, 48, 80	15a	—	65,000	—	5000	5000	5000
QHCW	C	15–30	3	240	—	15b	—	—	65,000	—	—	—
QCGF	C, GF	15–30	1	120	—	—	10,000	—	—	—	—	—
QCGF	C, GF	15–50	2	120/240	—	—	10,000	10,000	—	—	—	—
QCHGF	C, GF	15–30	1	120	—	—	22,000	—	—	—	—	—
QCHGF	C, GF	15–30	2	120/240	—	—	22,000	22,000	—	—	—	—
QCGFEP	C, GFEP	15–30	1	120	—	—	10,000	—	—	—	—	—
QCGFEP	C, GFEP	15–30	2	120/240	—	—	10,000	10,000	—	—	—	—
QCHGFEP	C, GFEP	15–30	1	120	—	—	22,000	—	—	—	—	—
QCHGFEP	C, GFEP	15–30	2	120/240	—	—	22,000	22,000	—	—	—	—

Notes

① Two-pole DC interrupting rating based on two poles connected in series.

Circuit breaker type codes: **P** Plug-in; **B** Bolt-on; **C** Cable-in/Cable-out; **GF** Ground Fault, 5 mA; **GFEP** Ground Fault, 30 mA.

CHB Circuit Breaker

Originally a Cutler-Hammer Product

The CHB breaker continues to be available as a replacement breaker for use in Cutler-Hammer Type PB panelboards.

When combined with the mounting base, CHB breakers were also used for surface and DIN rail mount cable-in/cable-out applications. (See photo below.)

For “new” cable-in/cable-out applications, Eaton recommends the use of our most current product offering:

- QUICKLAG Type QC breakers (1.00-inch per pole)
- QCR breakers—rear mount (0.50-inch per pole)
- QCF breakers—front mount (0.50-inch per pole)

QCR and QCF breakers provide a 50% space savings over 1.00-inch per pole designs of the same rating.



CHB Breaker Mounting Base

CHB Mounting Bases

Description		Catalog Number
Low Ampere		
15–50A	Single-pole	CHB9L1
15–50A	Two-pole	CHB9L250
15–50A	Three-pole	CHB9L350
High Ampere		
25–50A	Single-pole	CHB9H1
25–125A	Two-pole	CHB9H2125
25–100A	Three-pole	CHB9H3100

CHB Circuit Breaker Catalog Numbering System

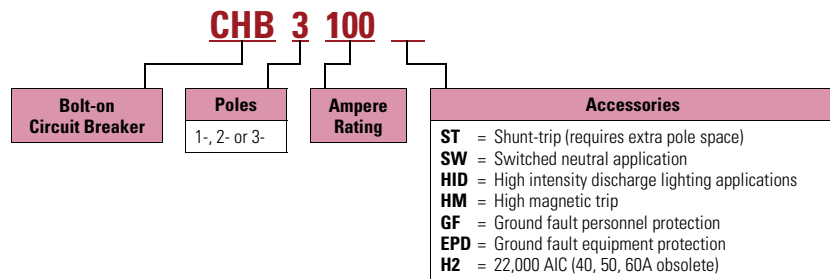



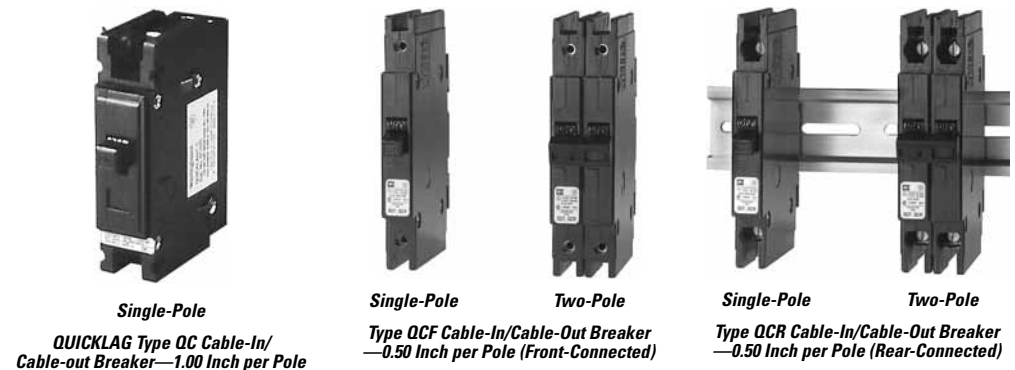















Replacement Capabilities



Series C Molded-Case Circuit Breaker Replacement Guide





















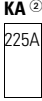
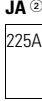

Series C Industrial Circuit Breakers—Dimensions in Inches (Per Three-Pole Breaker)

Description	Maximum Amperes					
	100A	100A/125A	225A	100A	100A	
Current Design						
Series C circuit breakers are the current offering and, as such, are a logical first choice when upgrading or retrofitting equipment. All circuit breakers listed in a column are ELECTRICALLY INTERCHANGEABLE.	GHC	EG GD	ED, EDH, EDC	EHD	FDB, FD, HFD, FDC	
						
	Width: 3.00 Height: 4.88 Depth: 2.94	Width: 3.00 Height: 4.88 Depth: 2.81	Width: 4.13 Height: 6.00 Depth: 3.38	Width: 4.13 Height: 6.00 Depth: 3.38	Width: 4.13 Height: 6.00 Depth: 3.38	
	Replacement Circuit Breakers					
	These new UL labeled circuit breakers continue to be manufactured and are primarily applied to achieve exact physical and electrical replacement of previously installed Cutler-Hammer/Westinghouse circuit breakers of the same style number and rating.	EB ①	No previous circuit breaker existed	EHB ①	FB ①, HFB	
		 Width: 4.13 Height: 6.00 Depth: 3.38		 Width: 4.13 Height: 6.00 Depth: 3.38	 Width: 4.13 Height: 6.00 Depth: 3.38	
Out-of-Production Westinghouse Circuit Breakers						
These circuit breakers are no longer manufactured. *Indicates the last date of manufacture. As an option, any of these circuit breakers can be reconditioned at the original factory. For details, see Page V12-T3-5 , or contact your local Eaton Field Sales office.	E, EA	QCC	EH	FA, HFA		
	 *1974 Width: 4.13 Height: 6.00 Depth: 3.38	 * 1968 Width: 4.50 Height: 7.00 Depth: 3.38	 * 1974 Width: 4.13 Height: 6.50 Depth: 3.38	 * 1974 Width: 4.13 Height: 6.50 Depth: 3.38		
		CA, CAH, HCA ①		F, HF		
		 Width: 4.13 Height: 6.50 Depth: 2.69		 1974 Width: 4.13 Height: 9.38 Depth: 4.06		
			G			
			 1965 Width: 8.25 Height: 9.38 Depth: 4.06			
Out-of-Production Cutler-Hammer Circuit Breakers Last Manufactured by Eaton in 1994						
		FS EC, EHC	FS, FH, FC, HFC			
		 Width: 4.13 Height: 6.13 Depth: 3.38	 Width: 4.13 Height: 6.13 Depth: 3.19			
			FL			
			 Width: 4.13 Height: 9.31 Depth: 3.19			

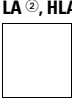
Note

① These frames are obsolete. For replacement solutions see the cross-reference on **Pages V12-T3-114–V12-T3-167**.

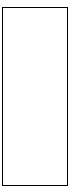
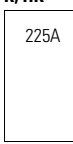
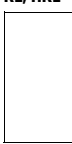
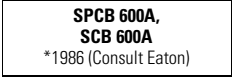
Series C Industrial Circuit Breakers—Dimensions in Inches (Per Three-Pole Breaker), Continued

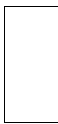
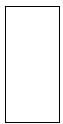
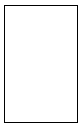
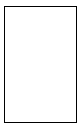
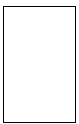
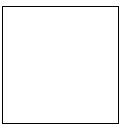





Maximum Amperes						
150A	225A, 250A		400A	600A		
Current Design						
FDB, FD, HFD, FDC	JG, JD, HJD, JDC 250A	JDB 250A	DK ①	KD, HKD, KDC ①	KDB	LG, LD, HLD, LDB
						
Width: 4.13 Height: 6.00 Depth: 3.38	Width: 4.13 Height: 10.00 Depth: 4.06	Width: 4.13 Height: 10.00 Depth: 4.06	Width: 5.50 Height: 10.13 Depth: 4.06	Width: 5.50 Height: 10.13 Depth: 4.06	Width: 5.50 Height: 10.13 Depth: 4.06	Width: 8.25 Height: 10.75 Depth: 4.06
Replacement Circuit Breakers						
FB ②, HFB	KB ②, HKB ② 250A	JB ② 250A	DA ②	LB ②, HLB ①	LBB ②	LC ②, HLC
						
Width: 4.13 Height: 6.00 Depth: 3.38	Width: 4.13 Height: 10.00 Depth: 4.06	Width: 4.13 Height: 10.00 Depth: 4.06	Width: 5.50 Height: 10.13 Depth: 4.06	Width: 5.50 Height: 10.13 Depth: 4.06	Width: 5.50 Height: 10.13 Depth: 4.06	Width: 8.25 Height: 10.75 Depth: 4.06
	KA ②, HKA ② 225A	JA ② 225A		LA ②, HLA	LAB ②	LA ②, HLA
						
	Width: 5.50 Height: 10.13 Depth: 4.06	Width: 5.50 Height: 10.13 Depth: 4.06		Width: 8.25 Height: 10.75 Depth: 4.06	Width: 8.25 Height: 10.75 Depth: 4.06	Width: 8.25 Height: 10.75 Depth: 4.06
Out-of-Production Westinghouse Circuit Breakers						
FA, HFA	JK 225A	J 225A		JKL		L, LM, HLM
						
*1974	*1967	*1967		*1967		*1967
Width: 4.13 Height: 6.50 Depth: 3.38	Width: 8.25 Height: 10.75 Depth: 4.06	Width: 8.25 Height: 10.13 Depth: 4.06		Width: 8.25 Height: 10.75 Depth: 4.06		Width: 8.25 Height: 22.00 Depth: 5.50
*Indicates the last date of manufacture.	K, HK 225A			KL, HKL		SPCB 600A, SCB 600A *1986 (Consult Eaton)
						
	*1967			*1967		
	Width: 8.25 Height: 15.50 Depth: 4.06			Width: 8.25 Height: 5.75 Depth: 4.06		Width: 8.25 Height: 10.75 Depth: 4.06
Out-of-Production Cutler-Hammer Circuit Breakers Last Manufactured by Eaton in 1994						
FS, FH, FC, HFC	JS, JH, JL	JS	KS-D, KS	KS-D, KH-D, KS, KH	KS-D, KH-D, KS, KH	LS(E), LH(E), LS(A), LH(A)
						
Width: 4.25 Height: 6.13 Depth: 3.19	Width: 4.25 Height: 12.00 Depth: 3.81	Width: 4.25 Height: 12.00 Depth: 3.81	Width: 5.50 Height: 10.13 Depth: 3.81	Width: 5.50 Height: 10.13 Depth: 3.81	Width: 5.50 Height: 10.13 Depth: 3.81	Width: 8.25 Height: 10.75 Depth: 3.81

Notes

① When upgrading a HLB, LBB to a Series C K-Frame in a panelboard application, also order TAD3 spacer kit.

② These frames are obsolete. For replacement solutions see the cross-reference on Pages V12-T3-114–V12-T3-167.

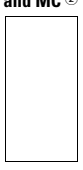
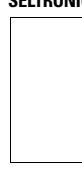
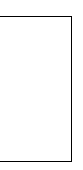
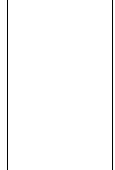
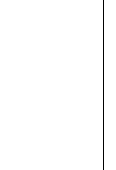
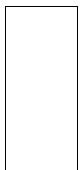
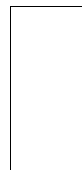
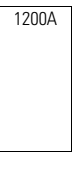
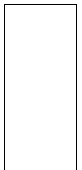
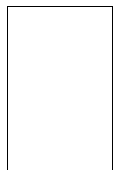
Series C Industrial Circuit Breakers—Dimensions in Inches (Per Three-Pole Breaker), Continued

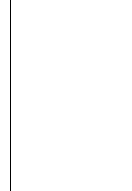



Description	Maximum Amperes				
	800A		1200A	1600A/2000A/2500A ①	
Current Design					
Series C circuit breakers are the current offering and, as such, are a logical first choice when upgrading or retrofitting equipment. All circuit breakers listed in a column are ELECTRICALLY INTERCHANGEABLE.	MDL, HMDL  Width: 8.25 Height: 16.00 Depth: 4.06	NG ND, HND, NDC  Width: 8.25 Height: 16.00 Depth: 5.50	NG ND, HND, NDC  Width: 8.25 Height: 16.00 Depth: 5.50	RG RD  Width: 15.50 Height: 16.00 Depth: 9.75	
	Replacement Circuit Breakers				
These new UL labeled circuit breakers continue to be manufactured and are primarily applied to achieve exact physical and electrical replacement of previously installed Cutler-Hammer/Westinghouse circuit breakers of the same style number and rating. PB/PC breakers are not UL Listed.	MA ②, HMA, MD ②, MDS ② and MC ②  Width: 8.25 Height: 16.00 Depth: 4.06	MA ②, HMA and MC ②, MCC ② SELTRONIC™ ②  Width: 8.25 Height: 16.00 Depth: 4.06	NC ②, HNC and NB ②, HNB  Width: 8.25 Height: 16.00 Depth: 5.50	PC, PCC  Width: 12.06 Height: 22.06 Depth: 9.06	PB  Width: 12.06 Height: 22.06 Depth: 9.06
	Out-of-Production Westinghouse Circuit Breakers				
These circuit breakers are no longer manufactured. *Indicates the last date of manufacture. As an option, any of these circuit breakers can be reconditioned at the original factory. For details, see Page V12-T3-5 , or contact your local Eaton Field Sales office.	LM, HLM and M  *1967 Width: 8.25 Height: 22.00 Depth: 5.50	LM, HLM and M  *1967 Width: 8.25 Height: 22.00 Depth: 5.50	MA, HMA 1200A  *1968 Width: 8.25 Height: 16.00 Depth: 5.50	MA, HLM  *1967 Width: 8.25 Height: 22.00 Depth: 5.50	PA  *1974 Width: 12.00 Height: 22.00 Depth: 9.06
	SPCB 1200A, SCB 1200A *1986 (Consult Eaton) Width: 8.25 Height: 16.00 Depth: 5.50			SPCB 2000–3000A, SCB 2000–3000A *1986 (Consult Eaton) Width: 12.06 Height: 22.06 Depth: 9.06	
Out-of-Production Cutler-Hammer Circuit Breakers Last Manufactured by Eaton in 1994					
MS, MH  Width: 8.25 Height: 16.00 Depth: 4.06	NS, NH  Width: 8.25 Height: 16.00 Depth: 5.50	No equivalent Cutler-Hammer brand frame size existed		No equivalent Cutler-Hammer brand frame size existed	

Notes

① RD breaker replaces PC, PCC and PB breakers for 2000 and 2500A only.

② These frames are obsolete. For replacement solutions, see the cross-reference on **Pages V12-T3-114–V12-T3-167**.

Current Limiting Circuit Breakers—Dimensions in Inches (Per Three-Pole Breaker)

Description	Maximum Amperes				
	100A	250A	400A	100A	225A
Current Design					
All circuit breakers listed in a column are ELECTRICALLY INTERCHANGEABLE.	FCL Current Limit-R (non-fused) 	LCL Current Limit-R (non-fused) 	LCL Current Limit-R (non-fused) 	FB TRI-PAC® (fused) 	LA TRI-PAC (fused) 
	Width: 4.13 Height: 8.75 Depth: 3.38	Width: 8.25 Height: 16.00 Depth: 4.06	Width: 8.25 Height: 16.00 Depth: 4.06	Width: 4.13 Height: 8.75 Depth: 3.50	Width: 8.25 Height: 16.00 Depth: 4.75



Replacement Circuit Breakers

These new UL labeled circuit breakers continue to be manufactured and are primarily applied to achieve exact physical and electrical replacement of previously installed Cutler-Hammer/Westinghouse circuit breakers of the same style number and rating.

Out-of-Production Westinghouse Circuit Breakers

These circuit breakers are no longer manufactured.

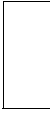
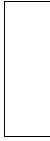

*Indicates the last date of manufacture. As an option, any of these circuit breakers can be reconditioned at the original factory. For details, see **Page V12-T3-5**, or contact your local Eaton Field Sales office.

FA TRI-PAC	F TRI-PAC	K TRI-PAC
		
*1968	*1968	*1968
Width: 4.13 Height: 9.38 Depth: 3.19	Width: 4.63 Height: 11.81 Depth: 3.81	Width: 8.25 Height: 19.63 Depth: 4.06

Out-of-Production Cutler-Hammer Circuit Breakers Last Manufactured by Eaton in 1994

No Equivalent Cutler-Hammer Brand Frame Sizes Existed

Current Limiting Circuit Breakers—Dimensions in Inches (Per Three-Pole Breaker)

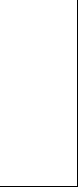
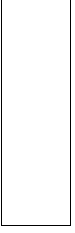
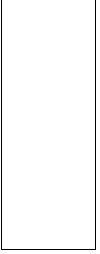
Description	Maximum Amperes		
	400A	800A	1600A
Current Design			
All circuit breakers listed in a column are ELECTRICALLY INTERCHANGEABLE.	LA TRI-PAC® (Fused) 	NB TRI-PAC (Fused) 	PB TRI-PAC (Fused) 
	Width: 8.25 Height: 16.00 Depth: 4.75	Width: 8.25 Height: 22.00 Depth: 5.50	Width: 12.06 Height: 22.13 Depth: 9.06
Replacement Circuit Breakers			
These new UL labeled circuit breakers continue to be manufactured and are primarily applied to achieve exact physical and electrical replacement of previously installed Cutler-Hammer/Westinghouse circuit breakers of the same style number and rating.			
Out-of-Production Westinghouse Circuit Breakers			
These circuit breakers are no longer manufactured. *Indicates the last date of manufacture. As an option, any of these circuit breakers can be reconditioned at the original factory. For details, see Page V12-T3-5 , or contact your local Eaton Field Sales office.	KL TRI-PAC 	L TRI-PAC 	MA TRI-PAC 
	*1968 Width: 8.25 Height: 19.63 Depth: 4.06	*1968 Width: 8.25 Height: 26.91 Depth: 5.50	*1968 Width: 8.25 Height: 22.00 Depth: 5.50
Out-of-Production Cutler-Hammer Circuit Breakers Last Manufactured by Eaton in 1994			
No equivalent Cutler-Hammer brand frame sizes existed			

Shaded area denotes obsolete or discontinued products and services. ^①

EB: 120, 240 Vac;
125/250 Vdc



Type EB Single-, Two-, Three-Pole; 240 Vac Maximum; Thermal-Magnetic and Saf-T-Vue^{®②}

Continuous Ampere Rating at 40°C	Single-Pole, 120 Vac, 125 Vdc ^③		Two-Pole, 240 Vac, 125/250 Vdc ^③		Three-Pole, 240 Vac, 125/250 Vdc ^③	
	Standard Catalog Number		Standard Catalog Number		Standard Catalog Number	Saf-T-Vue ^④ Catalog Number
15	EB1015 ^⑤		EB2015		EB3015	EB3015S
20	EB1020 ^⑤		EB2020		EB3020	EB3020S
25	EB1025		EB2025		EB3025	EB3025S
30	EB1030		EB2030		EB3030	EB3030S
35	EB1035		EB2035		EB3035	EB3035S
40	EB1040		EB2040		EB3040	EB3040S
45	EB1045		EB2045		EB3045	EB3045S
50	EB1050		EB2050		EB3050	EB3050S
60	EB1060		EB2060		EB3060	EB3060S
70	EB1070		EB2070		EB3070	EB3070S
80	EB1080		EB2080		EB3080	EB3080S
90	EB1090		EB2090		EB3090	EB3090S
100	EB1100		EB2100		EB3100	EB3100S
		Approximate shipping weight is 2 lbs		Approximate shipping weight is 3 lbs		Approximate shipping weight is 4.5 lbs

EHB: 277, 480 Vac;
250 Vdc



Type EHB Single-, Two-, Three-Pole; 480 Vac Maximum; Thermal-Magnetic and Saf-T-Vue^{®②}

Continuous Ampere Rating at 40°C	Single-Pole, 277 Vac, 125 Vdc ^③		Two-Pole, 480 Vac, 250 Vdc ^③		Three-Pole, 480 Vac	
	Standard Catalog Number		Standard Catalog Number		Standard Catalog Number	Saf-T-Vue ^④ Catalog Number
15	EHB1015 ^⑤		EHB2015		EHB3015	EHB3015S
20	EHB1020 ^⑤		EHB2020		EHB3020	EHB3020S
25	EHB1025		EHB2025		EHB3025	EHB3025S
30	EHB1030		EHB2030		EHB3030	EHB3030S
35	EHB1035		EHB2035		EHB3035	EHB3035S
40	EHB1040		EHB2040		EHB3040	EHB3040S
45	EHB1045		EHB2045		EHB3045	EHB3045S
50	EHB1050		EHB2050		EHB3050	EHB3050S
60	EHB1060		EHB2060		EHB3060	EHB3060S
70	EHB1070		EHB2070		EHB3070	EHB3070S
80	EHB1080		EHB2080		EHB3080	EHB3080S
90	EHB1090		EHB2090		EHB3090	EHB3090S
100	EHB1100		EHB2100		EHB3100	EHB3100S
		Approximate shipping weight is 2 lbs		Approximate shipping weight is 3 lbs		Approximate shipping weight is 4.5 lbs

UL Listed Interrupting Ratings^⑦

Maximum Volts	Amperes
EB Breakers	
120 and 240 AC	10,000 asymmetrical, symmetrical
125/250 DC	5000 ^③
EHB, FB Breakers	
240 AC	20,000 asymmetrical, 18,000 symmetrical
277 AC (EHB)	15,000 asymmetrical, 14,000 symmetrical
480 AC	15,000 asymmetrical, 14,000 symmetrical
600 AC (FB)	15,000 asymmetrical, 14,000 symmetrical
250 DC	10,000 ^③

Notes

- ① These frames are obsolete. For replacement solutions, see the cross-reference on **Pages V12-T3-114–V12-T3-167**.
- ② Includes load terminals only.
- ③ DC ratings apply to substantially non-inductive circuits.
- ④ Not UL Listed.
- ⑤ Switching duty rated for 120 Vac fluorescent light applications only.
- ⑥ Switching duty rated for 277 Vac fluorescent light applications only.
- ⑦ Interrupting capacities shown do not apply to molded-case switches.

Shaded area denotes obsolete or discontinued products and services. ①

FB, HFB: 600 Vac;
250 Vdc



3

Type FB, HFB Single-, Two-, Three-, Four-Pole; 480V Max.; Thermal-Magnetic MARK 75® Saf-T-Vue

Continuous Ampere Rating at 40°C	Single-Pole 277 Vac; 125 Vdc ②		Two-Pole 600 Vac; 250 Vdc ②		Three-Pole 600 Vac		Four-Pole ③④ 600 Vac
	MARK 75 ⑤ Catalog Number	Standard Catalog Number	MARK 75 ⑤ Catalog Number	Standard Catalog Number	Saf-T-Vue ⑥ Catalog Number	MARK 75 ⑦ Catalog Number	Standard Catalog Number
15	HFB1015 ⑧	FB2015	HFB2015	FB3015	FB3015S	HFB3015L	FB4015
20	HFB1020 ⑧	FB2020	HFB2020	FB3020	FB3020S	HFB3020L	FB4020
25	HFB1025	FB2025	HFB2025	FB3025	FB3025S	HFB3025L	FB4025
30	HFB1030	FB2030	HFB2030	FB3030	FB3030S	HFB3030L	FB4030
35	HFB1035	FB2035	HFB2035	FB3035	FB3035S	HFB3035L	FB4035
40	HFB1040	FB2040	HFB2040	FB3040	FB3040S	HFB3040L	FB4040
45	HFB1045	FB2045	HFB2045	FB3045	FB3045S	HFB3045L	FB4045
50	HFB1050	FB2050	HFB2050	FB3050	FB3050S	HFB3050L	FB4050
60	HFB1060	FB2060	HFB2060	FB3060	FB3060S	HFB3060L	FB4060
70	HFB1070	FB2070	HFB2070	FB3070	FB3070S	HFB3070L	FB4070
80	HFB1080	FB2080	HFB2080	FB3080	FB3080S	HFB3080L	FB4080
90	HFB1090	FB2090	HFB2090	FB3090	FB3090S	HFB3090L	FB4090
100	HFB1100	FB2100	HFB2100	FB3100	FB3100S	HFB3100L	FB4100
110	—	—	—	FB3110	FB3110S	HFB3110	—
125	—	—	—	FB3125	FB3125S	HFB3125	—
150	—	—	—	FB3150	FB3150S	HFB3150	—

UL Listed Interrupting Ratings ⑩

Maximum Volts	Amperes
MARK 75 Type HFB	
240 AC	75,000 asymmetrical, 65,000 symmetrical
277 AC ⑥	75,000 asymmetrical, 65,000 symmetrical
480 AC	30,000 asymmetrical, 25,000 symmetrical
250 DC (two-pole)	20,000 ②⑩

Special Breakers Type FB, Magnetic Only, Front Adjustable

Continuous Ampere Rating	Magnetic Trip Range Amperes	Two-Pole, 600 Vac		Three-Pole, 600 Vac		MARK 75 ⑦ Catalog/Style Number
		Standard Catalog/Style Number	MARK 75 Catalog/Style Number	Standard Catalog/Style Number	Saf-T-Vue Catalog/Style Number	
3	7–22	FB2022MRL	HFB2022ML	FB3022MRL	FB3022SMRL	HFB3022ML
5	15–45	FB2045MRL	HFB2045ML	FB3045MRL	FB3045SMRL	HFB3045ML
10	35–110	FB2110MRL	HFB2110ML	FB3110MRL	FB3110SMRL	HFB3110ML
25	32–80	2610D53G12	4994D96G12	2610D53G30	4998D89G30	2610D57G30
25	66–190	FB2190MRL	HFB2190ML	FB3190MRL	FB3190SMRL	HFB3190ML
30	50–150	1268C14G05	—	1268C14G06	—	—
30	90–270	FB2270MRL	HFB2270ML	FB3270MRL	FB3270SMRL	HFB3270ML
50	66–190	1268C14G01	—	1268C14G02	—	—
50	160–480	FB2480MRL	HFB2480ML	FB3480MRL	FB3480SMRL	HFB3480ML
70	100–270	2610D53G13	4994D96G13	2610D53G31	2610D58G31	4994D96G31
100	150–480	1268C14G03	—	1268C14G04	81E4647	65E4667
100	450–1550	FB21550MRL	HFB21550ML	FB31550MRL	FB31550SMRL	HFB31550ML

Notes

- ① These frames are obsolete. For replacement solutions, see the cross-reference on Pages V12-T3-114–V12-T3-167.
- ② DC ratings apply to substantially non-inductive circuits.
- ③ Not UL Listed.
- ④ All four poles have thermal-magnetic trip elements. Can be supplied with three protected poles and one unprotected, non-automatic pole if required. Order by description with no price or dimensional differences.
- ⑤ 15–30A rated 75,000 AIC. 40–100A rated 30,000A asymmetrical, 25,000A symmetrical.
- ⑥ Two-pole breakers are supplied in three-pole frames with current carrying parts omitted from center pole.
- ⑦ Includes line and load terminals. MARK 75 frame color changed from gray to black in mid-2002.
- ⑧ Switching duty rated for 277 Vac fluorescent light applications only.
- ⑨ Interrupting capacities shown do not apply to molded-case switches.
- ⑩ Ratings above 10,000A not UL Listed.

Accessories and Modifications

Terminals

Breakers include load terminals only. Terminals are UL Listed as suitable for wire type and size. When used with aluminum conductors, use joint compound. When line terminals are required, order by style number from the table at no charge with the breaker.

Note: Magnetic only breakers include both line and load terminals.

Note: Suffix "L" on catalog number indicates line and load terminals included. If factory installation is required, specify on order.

Terminals

Maximum Amperes	Wire Type	Wire Range	Package of Three Line Terminals ^① Style Number
Standard Pressure Type Terminals			
20 (EB, EHB)	Al/Cu	#14-#10	624B100G14
100	Al/Cu	#14-1/0	624B100G02
150	Al/Cu	#4-4/0	624B100G17
Optional Al/Cu Pressure Terminals			
50	Al/Cu	#14-#4	624B100G10
100	Al/Cu	#4-4/0	624B100G17

Terminal Style 624B100G02

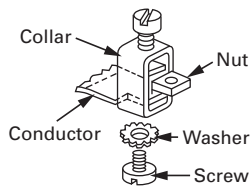

Insert collar enclosing conductor as shown. Locate nut on top of conductor and tighten securely with screw and washer. **Caution:** Collar must surround conductor.

Terminal Style 624B100G10

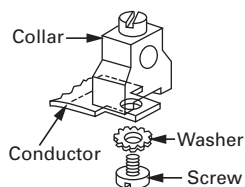

Assemble collar on top of conductor as shown. Tighten securely with screw and washer.

Terminal Style 624B100G17

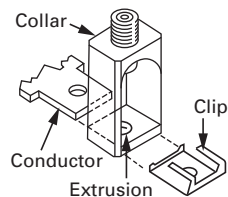

Insert collar enclosing conductor and center on extrusion on collar. Install clip with legs on top of conductor and snap end around bottom of collar.

Terminal Style 624B100G14

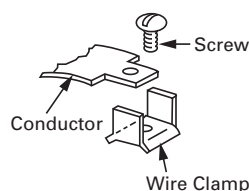

Assemble wire clamp to bottom of conductor as shown.

Shaded area denotes obsolete or discontinued products and services.

LFB Current Limiter Attachment

The LFB current limiter is an attachment that bolts to the load end of a standard FB thermal-magnetic or magnetic only breaker, providing 200,000A interrupting capacity (AIC) at up to 600 Vac. Limiters for thermal-magnetic breakers are UL Listed. Current limiters must be applied as indicated in the table on **Page V12-T3-16**.

Standard LFB terminals are suitable for Cu/Al cable. Ratings through 70A accept (1) #14-#2, and 100 and 150A accept (1) #1-4/0.

Note: Cannot be used with plug-in adapters. Ratings through 70A can be supplied with terminals for Cu cable only (#14-#2). Order by description.

LFB Current Limiter Attachment ^②

Breaker Rating, Amperes	Limiter Catalog Number
For Thermal-Magnetic Breakers ^③	
15-70	LFB3070R ^④
80-150	LFB3150R ^⑤
For Magnetic Only Breakers ^{③⑥}	
3	LFB3003MR
5	LFB3005MR
10	LFB3010MR
25	LFB3025MR
30	LFB3030MR
50	LFB3050MR
70	LFB3070MR
100	LFB3100MR
150	LFB3150MR

Notes

- ① Style listed is for package of three terminals.
- ② These frames are obsolete. For replacement solutions, see the cross-reference on **Pages V12-T3-114-V12-T3-167**.
- ③ Ratings through 70A can be supplied with terminals for Cu cable only (#14-#2). Order by description.
- ④ Superseded by LFD3070R.
- ⑤ Superseded by LFD3150R.
- ⑥ Replace with Series C HMCP and ELC current limiters or replace with MCP and EL current limiters

Special Calibrations

Special calibration price additions apply to ampere ratings not listed as standard or for ambients other than 40°C or 50°C. For frequencies other than 0-60 Hz AC, refer to Eaton. See Application Data 29-160 for information regarding special conditions. Maximum calibration for 400 Hz is 135A.

Note: Not UL Listed.

50°C Calibration

Add suffix "V" to catalog number for complete breaker, listed above, when ordering breakers to be used in 50°C ambients.

Note: Not UL Listed.

Ambient Compensating Breakers

To order, add suffix letter "A" to standard thermal-magnetic breaker catalog number.

Available in all standard ratings of EB, EHB, FB and HFB breakers up to ratings of 100A. Factory adder 20%.

Note: Not UL Listed.

Federal Specification Classifications

EB, EHB, FB and HFB breakers meet requirements of Federal Specification W-C-375b as follows:

- EB: single-pole, Class 11a; two-, three-pole, Classes 10b, 11b, 12b
- EHB: single-pole, Class 13a; two-, three-pole, Class 13b
- FB: two-, three-pole, Class 18a
- HFB: single-pole, Class 13a; two-, three-pole, Class 22a

For all three-phase delta, grounded B phase applications, contact Avery Creek, NC, Technical Resource Center at **1-800-356-1243**.

Type CCV 120/240V Tenant Main Circuit Breaker 10,000A and 25,000A Interrupting Capacity, 100–225A



Type CCV Two-Pole
120/240V Tenant
Main Circuit Breaker

Product Description

Ratings

- 120/240 Vac, two-pole, through 225 continuous amperes, calibrated at 40°C

Tripping Characteristics

- Thermal-magnetic trip, calibrated and sealed after assembly. Indirectly heated thermal tripping—bimetal elements

Product Selection

Ampere Rating	Two-Pole Breaker		10,000 AIC	25,000 AIC
	Wire Size Range, Al/Cu			
100	#2/0–300 kcmil		CCV2100	CCVH2100
125	#2/0–300 kcmil		CCV2125	CCVH2125
150	#2/0–300 kcmil		CCV2150	CCVH2150
175	#2/0–300 kcmil		CCV2175	CCVH2175
200	#2/0–300 kcmil		CCV2200	CCVH2200
225	#2/0–300 kcmil		CCV2225	CCVH2225

Interrupting Capacity at 120/240 Vac

- Type CCV—10,000A rms symmetrical
- Type CCVH—25,000A rms symmetrical

Handles

- Trip-free with “ON-TRIPPED-OFF” positions. Reset past “OFF” is required to latch breaker contacts after tripping

Terminals

- Standard lugs (wire connectors) suitable for either CU or AL wire

Standards

- Complies with UL Standard 489, breakers are listed under UL File #E781

Backward Compatibility

- CCV and CCVH retains same profile and footprint of the CC and CCH breaker allowing use in the same applications

Terminal Options

Terminal configurations available by adding the following designator on the suffix:

W = No terminals

X = Load side terminals only

Y = Line side terminals only

CCV as tenant main breaker with CC as aftermarket option.

Cross-Reference

CCV Catalog Number	CC Catalog Number	CCV Catalog Number	CC Catalog Number
CCV2100	CC2100	CCVH2100	CCH2100
CCV2100W	CC2100W	CCVH2100W	CCH2100W
CCV2100X	CC2100X	CCVH2100X	CCH2100X
CCV2100Y	CC2100Y	CCVH2100Y	CCH2100Y
CCV2125	CC2125	CCVH2125	CCH2125
CCV2125W	CC2125W	CCVH2125W	CCH2125W
CCV2125X	CC2125X	CCVH2125X	CCH2125X
CCV2125Y	CC2125Y	CCVH2125Y	CCH2125Y
CCV2150	CC2150	CCVH2150	CCH2150
CCV2150W	CC2150W	CCVH2150W	CCH2150W
CCV2150X	CC2150X	CCVH2150X	CCH2150X
CCV2150Y	CC2150Y	CCVH2150Y	CCH2150Y
CCV2175	CC2175	CCVH2175	CCH2175
CCV2175W	CC2175W	CCVH2175W	CCH2175W
CCV2175X	CC2175X	CCVH2175X	CCH2175X
CCV2175Y	CC2175Y	CCVH2175Y	CCH2175Y
CCV2200	CC2200	CCVH2200	CCH2200
CCV2200W	CC2200W	CCVH2200W	CCH2200W
CCV2200X	CC2200X	CCVH2200X	CCH2200X
CCV2200Y	CC2200Y	CCVH2200Y	CCH2200Y
CCV2225	CC2225	CCVH2225	CCH2225
CCV2225W	CC2225W	CCVH2225W	CCH2225W
CCV2225X	CC2225X	CCVH2225X	CCH2225X
CCV2225Y	CC2225Y	CCVH2225Y	CCH2225Y

Type JB

Shaded area denotes obsolete or discontinued products and services. ①

JB: 600 Vac; 250 Vdc



Type JB 90–250A, 600 Vac, 250 Vdc, Two- and Three-Pole, Fixed Trip, Thermal-Magnetic, Saf-T-Vue (Suitable for Reverse-Feed)

Continuous Ampere Rating at 40°C	Magnetic Trip Setting, Amperes (Set on High Side, Adjustable to Lower Limits)		Complete Breaker Includes Pressure Type Aluminum Terminals ②		Breaker Without Terminals		
	Low	High	Standard Catalog Number	Saf-T-Vue ③ Catalog Number	Standard Catalog Number	Saf-T-Vue ③ Catalog Number	
Two-Pole, 600 Vac, 250 Vdc ④							
70	350	700	JB2070	JB2070S	JB2070W	JB2070SW	
90	450	900	JB2090	JB2090S	JB2090W	JB2090SW	
100	500	1000	JB2100	JB2100S	JB2100W	JB2100SW	
125	625	1250	JB2125	JB2125S	JB2125W	JB2125SW	
150	750	1500	JB2150	JB2150S	JB2150W	JB2150SW	
175	875	1750	JB2175	JB2175S	JB2175W	JB2175SW	
200	1000	2000	JB2200	JB2200S	JB2200W	JB2200SW	
225	1125	2250	JB2225	JB2225S	JB2225W	JB2225SW	
250	1250	2500	JB2250	JB2250S	JB2250W	JB2250SW	
				Approx. shipping weight, 12 lbs		Approx. shipping weight 12 lbs	
Three-Pole, 600 Vac Only							
70	350	700	JB3070	JB3070S	JB3070W	JB3070SW	
90	450	900	JB3090	JB3090S	JB3090W	JB3090SW	
100	500	1000	JB3100	JB3100S	JB3100W	JB3100SW	
125	625	1250	JB3125	JB3125S	JB3125W	JB3125SW	
150	750	1500	JB3150	JB3150S	JB3150W	JB3150SW	
175	875	1750	JB3175	JB3175S	JB3175W	JB3175SW	
200	1000	2000	JB3200	JB3200S	JB3200W	JB3200SW	
225	1125	2250	JB3225	JB3225S	JB3225W	JB3225SW	
250	1250	2500	JB3250	JB3250S	JB3250W	JB3250SW	
				Approx. shipping weight 14 lbs		Approx. shipping weight 12 lbs	

Magnetic Only Breakers, Front Adjustable ③

Continuous Ampere Rating at 40°C	Magnetic Trip Setting, Amperes (Set on High Side, Adjustable to Lower Limits)		Breaker Only, No Terminals ⑤			
	Low	High	Two-Pole ④		Three-Pole	
			Standard Catalog Number	Saf-T-Vue Catalog Number	Standard Catalog Number	Saf-T-Vue Catalog Number
250	350	700	JB2700MW	JB2700SMW	JB3700MW	JB3700SMW
250	625	1250	JB21250MW	JB21250SMW	JB31250MW	JB31250SMW
250	750	1500	JB21500MW	JB21500SMW	JB31500MW	JB31500SMW
250	875	1750	JB21750MW	JB21750SMW	JB31750MW	JB31750SMW
250	1125	2250	JB22250MW	JB22250SMW	JB32250MW	JB32250SMW
250	1250	2500	JB22500MW	JB22500SMW	JB32500MW	JB32500SMW

Notes

- ① These frames are obsolete. For replacement solutions, see the cross-reference on **Pages V12-T3-114–V12-T3-167**.
- ② Terminals are shipped separately from breaker frame.
- ③ Not UL Listed.
- ④ Two-pole breakers are supplied in three-pole frames with current carrying parts omitted from center pole.
- ⑤ Select desired terminal from table and order as separate item.

UL Listed Interrupting Ratings ①

Maximum Volts	Amperes
240 AC	30,000 asymmetrical, 25,000 symmetrical
480 AC	25,000 asymmetrical, 22,000 symmetrical
600 AC	15,000 asymmetrical, 14,000 symmetrical
250 DC	10,000

Terminals

Maximum Amperes	Number of Cables, Wire Range, Type	Catalog Number
Standard Al/Cu Pressure Terminals		
250	(1) #4–350 kcmil Al/Cu	TA250KB
Optional Pressure Terminals		
250	(1) #4–350 kcmil Cu	T250KB

Note

① Ratings above 10,000A not UL Listed.

Accessories and Modifications

■ Shaded area denotes obsolete or discontinued products and services.

Special Calibrations

Special calibration price additions apply to ampere ratings not listed as standard or for ambients other than 40°C or 50°C. For frequencies other than 0–60 Hz AC, refer to Eaton.

Note: Not UL Listed.

50°C Calibration

Add suffix “V” to catalog number for complete breaker when ordering breakers to be used in 50°C ambients. Same price as standard 40°C breakers.

For CSA®, see Page V12-T3-48.

Type JB breakers meet requirements of Class 19a circuit breakers as defined by Federal Specification W-C-375b.

Note: Not UL Listed.

UL Listed Interrupting Rating (see table)

For all three-phase delta, grounded B phase applications, contact Avery Creek, NC, Technical Resource Center at **1-800-356-1243**.

Terminals (see table)

Two terminals are required per pole.

Terminals are UL Listed for wire type and range listed left. When used with aluminum conductors, use joint compound. To order optional copper only terminals, add suffix “C” to complete breaker catalog number.

Note: Terminals are shipped separately from breaker frame.

Magnetic Only Breakers

For description, refer to Application Data 29-160.

Additional Accessories and Modifications

Refer to **Pages V12-T3-65–V12-T3-79**.

Types KB and HKB

Shaded area denotes obsolete or discontinued products and services. ①

KB/MARK 75/HKB:
600 Vac; 250 Vdc



Type KB and MARK 75 Type HKB 90–250A, 600 Vac, 250 Vdc, Two- and Three-Pole, Interchangeable Trip Thermal-Magnetic, Saf-T-Vue

Continuous Ampere Rating at 40°C	Magnetic Trip Setting Amperes ③		Complete Breaker Includes Pressure Type Aluminum Terminals ③			Shipped as Frame, Trip Unit and Terminals ②			Trip Unit Only Standard Saf-T-Vue MARK 75 Catalog Number
	Low	High	Standard Catalog Number	Saf-T-Vue Catalog Number ③	MARK 75 Catalog Number	Standard Catalog Number	Saf-T-Vue Catalog Number ④	MARK 75 Catalog Number	
Two-Pole, 600 Vac, 250 Vdc ③									
70	350	700	KB2070	KB2070S	HKB2070	KB2250F	KB2250FS	HKB2250F	HKB2070T
90	450	900	KB2090	KB2090S	HKB2090	KB2250F	KB2250FS	HKB2250F	HKB2090T
100	500	1000	KB2100	KB2100S	HKB2100	KB2250F	KB2250FS	HKB2250F	HKB2100T
125	625	1250	KB2125	KB2125S	HKB2125	KB2250F	KB2250FS	HKB2250F	HKB2125T
150	750	1500	KB2150	KB2150S	HKB2150	KB2250F	KB2250FS	HKB2250F	HKB2150T
175	875	1750	KB2175	KB2175S	HKB2175	KB2250F	KB2250FS	HKB2250F	HKB2175T
200	1000	2000	KB2200	KB2200S	HKB2200	KB2250F	KB2250FS	HKB2250F	HKB2200T
225	1125	2250	KB2225	KB2225S	HKB2225	KB2250F	KB2250FS	HKB2250F	HKB2225T
250	1250	2500	KB2250	KB2250S	HKB2250	KB2250F	KB2250FS	HKB2250F	HKB2250T
Approx. shipping weight 12 lbs						Approx. shipping weight 9 lbs			Approx. shipping weight 2 lbs
Three-Pole, 600 Vac Only									
70	350	700	KB3070	KB3070S	HKB3070	KB3250F	KB3250FS	HKB3250F	HKB3070T
90	450	900	KB3090	KB3090S	HKB3090	KB3250F	KB3250FS	HKB3250F	HKB3090T
100	500	1000	KB3100	KB3100S	HKB3100	KB3250F	KB3250FS	HKB3250F	HKB3100T
125	625	1250	KB3125	KB3125S	HKB3125	KB3250F	KB3250FS	HKB3250F	HKB3125T
150	750	1500	KB3150	KB3150S	HKB3150	KB3250F	KB3250FS	HKB3250F	HKB3150T
175	875	1750	KB3175	KB3175S	HKB3175	KB3250F	KB3250FS	HKB3250F	HKB3175T
200	1000	2000	KB3200	KB3200S	HKB3200	KB3250F	KB3250FS	HKB3250F	HKB3200T
225	1125	2250	KB3225	KB3225S	HKB3225	KB3250F	KB3250FS	HKB3250F	HKB3225T
250	1250	2500	KB3250	KB3250S	HKB3250	KB3250F	KB3250FS	HKB3250F	HKB3250T
Approx. shipping weight 14 lbs					Approx. shipping weight 11 lbs			Approx. shipping weight 2 lbs	

Magnetic Only, Front Adjustable Breakers ④

Continuous Ampere Rating	Magnetic Trip Setting Amperes ⑤		Trip Units Only	
	Low	High	Two-Pole ④ Catalog Number	Three-Pole Catalog Number
250	350	700	HKB2700TM	HKB3700TM
250	500	1000	HKB21000TM	HKB31000TM
250	625	1250	HKB21250TM	HKB31250TM
250	750	1500	HKB21500TM	HKB31500TM
250	875	1750	HKB21750TM	HKB31750TM
250	1125	2250	HKB22250TM	HKB32250TM
250	1250	2500	HKB22500TM	HKB32500TM

Notes

- ① These frames are obsolete. For replacement solutions, see the cross-reference on Pages V12-T3-114–V12-T3-167.
- ② Terminals shipped separately from breaker frame.
- ③ Not UL Listed.
- ④ Two-pole breakers are supplied in three-pole frames with current carrying parts omitted from center pole.
- ⑤ Set on high side, adjustable to lower limit.

UL Listed Interrupting Ratings

Maximum Volts	Amperes
Standard Breakers	
240 AC	30,000 asymmetrical, 25,000 symmetrical
480 AC	25,000 asymmetrical, 22,000 symmetrical
600 AC	15,000 asymmetrical, 14,000 symmetrical
250 DC	10,000
MARK 75 Breakers	
240 AC	75,000 asymmetrical., 65,000 symmetrical.
480 AC	30,000 asymmetrical, 25,000 symmetrical
600 AC	20,000 asymmetrical, 18,000 symmetrical
250 DC	20,000 ^①

Terminals ^②

Maximum Amperes	Number of Cables, Wire Range, Type	Catalog Number
Standard Al/Cu Pressure Terminals		
250	(1) #4–350 kcmil Al/Cu	TA250KB
Optional Pressure Terminals		
250	(1) #4–350 kcmil Cu	T250KB

Notes

- ① Ratings above 10,000A not UL Listed.
 ② Terminals shipped separately from breaker frame.

Accessories and Modifications

Shaded area denotes obsolete or discontinued products and services.

Magnetic Only, Front Adjustable Breakers (see table on Page V12-T3-21)

Special Calibrations

Special calibration price additions apply to ampere ratings not listed as standard or for ambients other than 40°C or 50°C. For frequencies other than 0–60 Hz AC, refer to Eaton.

Note: Two-pole breakers are supplied in three-pole frames with current carrying parts omitted from center pole.

50°C Calibration

Add suffix “V” to catalog number for complete breaker, listed on Page V12-T3-21, when ordering breakers to be used in 50°C ambients.

For CSA, see Page V12-T3-48.

Note: Two-pole breakers are supplied in three-pole frames with current carrying parts omitted from center pole.

Type KB breakers meet requirements for Class 19a, as defined by Federal Specification W-C-375b. Type HKB breakers not defined in W-C-375b.

UL Listed Interrupting Ratings (see table)

For all three-phase delta, grounded B phase applications, contact Avery Creek, NC, Technical Resource Center at **1-800-356-1243**.

Terminals (see table)

Two terminals are required per pole.

Terminals are UL Listed for wire type and range listed below. When used with aluminum conductors, use joint compound. To order optional copper only terminals, add suffix “C” to complete breaker catalog number.

Magnetic Only Breakers

For description, refer to Application Data 29-160. To order these breakers, select frame, trip unit and terminals.

Additional Accessories and Modifications

Refer to Pages V12-T3-65–V12-T3-79.

Type JA

Shaded area denotes obsolete or discontinued products and services. ①

JA: 600 Vac; 250 Vdc



Type JA 70–225A, 600 Vac, 250 Vdc, Two- and Three-Pole, Fixed Trip, Thermal-Magnetic, Saf-T-Vue (Suitable for Reverse-Feed)

Continuous Ampere Rating at 40°C	Magnetic Trip Setting, Amperes (Set on High Side, Adjustable to Lower Limits)		Complete Breaker Includes Pressure Type Aluminum Terminals ②		Breaker Without Terminals		
	Low	High	Standard Catalog Number	Saf-T-Vue Catalog Number	Standard Catalog Number	Saf-T-Vue Catalog Number	
Two-Pole, 600 Vac, 250 Vdc ③							
70	350	700	JA2070	JA2070S	JA2070W	JA2070SW	
90	450	900	JA2090	JA2090S	JA2090W	JA2090SW	
100	500	1000	JA2100	JA2100S	JA2100W	JA2100SW	
125	625	1250	JA2125	JA2125S	JA2125W	JA2125SW	
150	750	1500	JA2150	JA2150S	JA2150W	JA2150SW	
175	875	1750	JA2175	JA2175S	JA2175W	JA2175SW	
200	1000	2000	JA2200	JA2200S	JA2200W	JA2200SW	
225	1125	2250	JA2225	JA2225S	JA2225W	JA2225SW	
				Approx. shipping weight 12 lbs		Approx. shipping weight 12 lbs	

Three-Pole, 600 Vac Only

70	350	700	JA3070	JA3070S	JA3070W	JA3070SW	
90	450	900	JA3090	JA3090S	JA3090W	JA3090SW	
100	500	1000	JA3100	JA3100S	JA3100W	JA3100SW	
125	625	1250	JA3125	JA3125S	JA3125W	JA3125SW	
150	750	1500	JA3150	JA3150S	JA3150W	JA3150SW	
175	875	1750	JA3175	JA3175S	JA3175W	JA3175SW	
200	1000	2000	JA3200	JA3200S	JA3200W	JA3200SW	
225	1125	2250	JA3225	JA3225S	JA3225W	JA3225SW	
				Approx. shipping weight 14 lbs		Approx. shipping weight 12 lbs	

Special Breakers ④

Continuous Ampere Rating at 40°C	Magnetic Trip Setting, Amperes (Set on High Side, Adjustable to Lower Limits)		Two-Pole ④		Three-Pole	
	Low	High	Standard Catalog Number	Saf-T-Vue Catalog Number	Standard Catalog Number	Saf-T-Vue Catalog Number
Magnetic Only Breakers, Front Adjustable—Without Terminals ⑤						
225	350	700	JA2700MW	JA2700SMW	JA3700MW	JA3700SMW
225	625	1250	JA21250MW	JA21250SMW	JA31250MW	JA31250SMW
225	750	1500	JA21500MW	JA21500SMW	JA31500MW	JA31500SMW
225	875	1750	JA21750MW	JA21750SMW	JA31750MW	JA31750SMW
225	1125	2250	JA22250MW	JA22250SMW	JA32250MW	JA32250SMW

Ambient Compensating Breakers

70	350	700	JA2070A	—	JA3070A	—
100	500	1000	JA2100A	—	JA3100A	—
125	625	1250	JA2125A	—	JA3125A	—
150	750	1500	JA2150A	—	JA3150A	—
175	875	1750	JA2175A	—	JA3175A	—
200	1000	2000	JA2200A	—	JA3200A	—
225	1125	2250	JA2225A	—	JA3225A	—

Notes

- ① These frames are obsolete. For replacement solutions, see the cross-reference on Pages V12-T3-114–V12-T3-167.
- ② Terminals are shipped separately from breaker frame.
- ③ Not UL Listed.
- ④ Two-pole breakers are supplied in three-pole frames with current carrying parts omitted from center pole.
- ⑤ Select desired terminal from table and order as separate item.

UL Listed Interrupting Ratings

Maximum Volts	Amperes
240 AC	30,000 asymmetrical, 25,000 symmetrical
480 AC	25,000 asymmetrical, 22,000 symmetrical
600 AC	25,000 asymmetrical, 22,000 symmetrical
250 DC	10,000

Terminals

Maximum Amperes	Number of Cables, Wire Range, Type	Catalog Number
Standard Al/Cu Pressure Terminals		
70–225	(1) #6–350 kcmil Cu, or (1) #4–350 kcmil Al	TA225LA1
Optional Copper Pressure Terminals		
70–225	(1) #6–350 kcmil Cu	T225LA
70–225 ①	(1) #6–250 kcmil Cu	T225LBF

Note

① Optional terminal.

Accessories and Modifications

■ Shaded area denotes obsolete or discontinued products and services.

Special Calibrations (see table on Page V12-T3-23)

Special calibration price additions apply to ampere ratings not listed as standard or for ambients other than 40°C or 50°C. For frequencies other than 0–60 Hz AC, refer to Eaton.

See Application Data 29-160 for information regarding special conditions.

Note: Not UL Listed.

50°C Calibration

Add suffix “V” to catalog number for complete breaker when ordering breakers to be used in 50°C ambients.

For CSA, see Page V12-T3-48.

Type JA breakers meet requirements of Class 19a and 20a circuit breakers as defined by Federal Specification W-C-375b.

For all three-phase delta, grounded B phase applications, contact Avery Creek, NC, Technical Resource Center at **1-800-356-1243**.

Terminals (see table)

Two terminals are required per pole.

Terminals are UL Listed for wire type and range listed left. When used with aluminum conductors, use joint compound. To order optional copper only terminals, add suffix “C” to complete breaker catalog number.

Note: Terminals are shipped separately from breaker frame.

Note: If upgrading a JA breaker to a Series C K-Frame in a panelboard application, order TAD3 spacer kit.

UL Listed Interrupting Ratings (see table)**Magnetic Only and Ambient Compensating Breakers**

For description, refer to Application Data 29-160. To order, select catalog number from table on **Page V12-T3-23**.

Types KA and HKA

Shaded area denotes obsolete or discontinued products and services. ①

KA: 600 Vac; 250 Vdc



Type KA 70–225A, 600 Vac, 250 Vdc, Two- and Three-Pole, Interchangeable Trip, Thermal-Magnetic, Saf-T-Vue and MARK 75 Type HKA

Continuous Ampere Rating at 40°C	Magnetic Trip Setting Amperes ②		Complete Breaker Includes Pressure Type Aluminum Terminals ③			Shipped as Frame, Trip Unit and Terminals			Trip Unit Only Standard MARK 75 or Saf-T-Vue Catalog Number
	Low	High	Standard Catalog Number	Saf-T-Vue Catalog Number	MARK 75 Catalog Number	Standard Catalog Number	Saf-T-Vue Catalog Number	MARK 75 Catalog Number	
Two-Pole, 600 Vac, 250 Vdc ④									
70	350	700	KA2070	KA2070S	HKA2070	KA2225F	KA2225FS	HKA2225F	HKA2070T
90	450	900	KA2090	KA2090S	HKA2090	KA2225F	KA2225FS	HKA2225F	HKA2090T
100	500	1000	KA2100	KA2100S	HKA2100	KA2225F	KA2225FS	HKA2225F	HKA2100T
125	625	1250	KA2125	KA2125S	HKA2125	KA2225F	KA2225FS	HKA2225F	HKA2125T
150	750	1500	KA2150	KA2150S	HKA2150	KA2225F	KA2225FS	HKA2225F	HKA2150T
175	875	1750	KA2175	KA2175S	HKA2175	KA2225F	KA2225FS	HKA2225F	HKA2175T
200	1000	2000	KA2200	KA2200S	HKA2200	KA2225F	KA2225FS	HKA2225F	HKA2200T
225	1125	2250	KA2225	KA2225S	HKA2225	KA2225F	KA2225FS	HKA2225F	HKA2225T
Approx. shipping weight 12 lbs						Approx. shipping weight 9.5 lbs			Approx. shipping weight 2 lbs
Three-Pole, 600 Vac Only									
70	350	700	KA3070	KA3070S	HKA3070	KA3225F	KA3225FS	HKA3225F	HKA3070T
90	450	900	KA3090	KA3090S	HKA3090	KA3225F	KA3225FS	HKA3225F	HKA3090T
100	500	1000	KA3100	KA3100S	HKA3100	KA3225F	KA3225FS	HKA3225F	HKA3100T
125	625	1250	KA3125	KA3125S	HKA3125	KA3225F	KA3225FS	HKA3225F	HKA3125T
150	750	1500	KA3150	KA3150S	HKA3150	KA3225F	KA3225FS	HKA3225F	HKA3150T
175	875	1750	KA3175	KA3175S	HKA3175	KA3225F	KA3225FS	HKA3225F	HKA3175T
200	1000	2000	KA3200	KA3200S	HKA3200	KA3225F	KA3225FS	HKA3225F	HKA3200T
225	1125	2250	KA3225	KA3225S	HKA3225	KA3225F	KA3225FS	HKA3225F	HKA3225T
Approx. shipping weight 14 lbs					Approx. shipping weight 11 lbs			Approx. shipping weight 2.5 lb.	

Trip Units Only for Magnetic Only and Ambient Compensating Breakers ⑤

Continuous Ampere Rating	Magnetic Trip Setting, Amperes ②		Two-Pole ④ Catalog Number	Three-Pole Catalog Number
	Low	High		
Magnetic Only, Front Adjustable Breakers				
225	350	700	HKA2700TM	HKA3700TM
225	625	1250	HKA21250TM	HKA31250TM
225	750	1500	HKA21500TM	HKA31500TM
225	875	1750	HKA21750TM	HKA31750TM
225	1125	2250	HKA22250TM	HKA32250TM
Ambient Compensating Breakers				
70	350	700	HKA2070TA	HKA3070TA
100	500	1000	HKA2100TA	HKA3100TA
125	625	1250	HKA2125TA	HKA3125TA
150	750	1500	HKA2150TA	HKA3150TA
175	875	1750	HKA2175TA	HKA3175TA
200	1000	2000	HKA2200TA	HKA3200TA
225	1125	2250	HKA2225TA	HKA3225TA

Notes

- ① These frames are obsolete. For replacement solutions, see the cross-reference on Pages V12-T3-114–V12-T3-167.
- ② Set on high side, adjustable to lower limit.
- ③ Terminals are shipped separately from breaker frame.
- ④ Two-pole breakers are supplied in three-pole frames with current carrying parts omitted from center pole.
- ⑤ Not UL Listed.

UL Listed Interrupting Ratings

Maximum Volts	Amperes
Standard Breakers	
240 AC	30,000 asymmetrical, 25,000 symmetrical
480 AC	25,000 asymmetrical, 22,000 symmetrical
600 AC	25,000 asymmetrical, 22,000 symmetrical
250 DC	10,000
MARK 75 Breakers	
240 AC	75,000 asymmetrical, 65,000 symmetrical
480 AC	40,000 asymmetrical, 35,000 symmetrical
600 AC	30,000 asymmetrical, 25,000 symmetrical
250 DC	20,000 ^①

Terminals

Maximum Amperes	Number of Cables, Wire Range, Type	Catalog Numbers
Standard Al/Cu Pressure Terminals		
225	(1) #6–350 kcmil Cu, or (1) #4–350 kcmil Al	TA225LA1
Optional Copper Pressure Terminals		
225	(1) #6–350 kcmil Cu	T225LA
225 ^②	(1) #6–250 kcmil Cu	T225LBF

Notes

- ^① Ratings above 10,000A not UL Listed.
^② Optional terminal.

Accessories and Modifications

■ Shaded area denotes obsolete or discontinued products and services.

Special Calibrations

Special calibration price additions apply to ampere ratings not listed as standard or for ambients other than 40°C or 50°C. For frequencies other than 0–60 Hz AC, refer to Eaton. See Application Data 29-160 for information regarding special conditions.

Note: Not UL Listed.

50°C Calibration

Add suffix "V" to catalog number for complete breaker when ordering breakers to be used in 50°C ambients.

Note: Not UL Listed.

Terminals (see table)

Two terminals are required per pole.

Terminals are UL Listed for wire type and range listed below. When used with aluminum conductors, use joint compound. To order optional copper only terminals, add suffix "C" to complete breaker catalog number.

Type KA breakers meet requirements for Class 19a and 20a circuit breakers, and Type HKA meet requirements for Class 23a as defined by Federal Specification W-C-375b.

For all three-phase delta, grounded B phase applications, contact Avery Creek, NC, Technical Resource Center at **1-800-356-1243**.

Note: Terminals are shipped separately from breaker frame.

Note: If upgrading a KA, HKA breaker to a Series C K-Frame in a panelboard application, also order TAD3 spacer kit.

UL Listed Interrupting Ratings (see table)**Magnetic Only Breakers**

For description, refer to Application Data 29-160. To order these breakers, select frame, trip unit and terminals.

Type LBB

Shaded area denotes obsolete or discontinued products and services. ①

LBB: 600 Vac; 250 Vdc



Type LBB 125–400A, 600 Vac, 250 Vdc, Two- and Three-Pole, Fixed Trip, Thermal-Magnetic, Saf-T-Vue (Suitable for Reverse-Feed)

Continuous Ampere Rating at 40°C	Magnetic Trip Setting, Amperes ②		Complete Breaker Includes Pressure Type Aluminum Terminals ③		Breaker Without Terminals		
	Low	High	Standard Catalog Number	Saf-T-Vue Catalog Number	Standard Catalog Number	Saf-T-Vue Catalog Number	
Two-Pole, 600 Vdc, 250 Vdc ④							
125	625	1250	LBB2125	LBB2125S	LBB2125W	LBB2125SW	
150	750	1500	LBB2150	LBB2150S	LBB2150W	LBB2150SW	
175	875	1750	LBB2175	LBB2175S	LBB2175W	LBB2175SW	
200	1000	2000	LBB2200	LBB2200S	LBB2200W	LBB2200SW	
225	1125	2250	LBB2225	LBB2225S	LBB2225W	LBB2225SW	
250	1250	2500	LBB2250	LBB2250S	LBB2250W	LBB2250SW	
300	1500	3000	LBB2300	LBB2300S	LBB2300W	LBB2300SW	
350	1750	3500	LBB2350	LBB2350S	LBB2350W	LBB2350SW	
400	2000	4000	LBB2400	LBB2400S	LBB2400W	LBB2400SW	
				Approx. shipping weight 13 lbs		Approx. shipping weight 13 lbs	
Three-Pole, 600 Vac Only							
125	625	1250	LBB3125	LBB3125S	LBB3125W	LBB3125SW	
150	750	1500	LBB3150	LBB3150S	LBB3150W	LBB3150SW	
175	875	1750	LBB3175	LBB3175S	LBB3175W	LBB3175SW	
200	1000	2000	LBB3200	LBB3200S	LBB3200W	LBB3200SW	
225	1125	2250	LBB3225	LBB3225S	LBB3225W	LBB3225SW	
250	1250	2500	LBB3250	LBB3250S	LBB3250W	LBB3250SW	
300	1500	3000	LBB3300	LBB3300S	LBB3300W	LBB3300SW	
350	1750	3500	LBB3350	LBB3350S	LBB3350W	LBB3350SW	
400	2000	4000	LBB3400	LBB3400S	LBB3400W	LBB3400SW	
				Approx. shipping weight 15 lbs		Approx. shipping weight 15 lbs	

Notes

- ① These frames are obsolete. For replacement solutions, see the cross-reference on Pages V12-T3-114–V12-T3-167.
- ② Set on high side, adjustable to lower limits.
- ③ Terminals are shipped separately from breaker.
- ④ Two-pole breakers or trips are supplied in three-pole frames with current carrying parts omitted from center pole.

Shaded area denotes obsolete or discontinued products and services. ①

Magnetic Only, Ambient Compensating Breakers ②

Continuous Ampere Rating	Magnetic Trip Setting, Amperes ③		Two-Pole Breakers ④		Three-Pole Breakers	
	Low	High	Standard Catalog Number	Saf-T-Vue Catalog Number	Standard Catalog Number	Saf-T-Vue Catalog Number
Magnetic Only Breakers, Front Adjustable—Without Terminals ⑤						
400	350	700	LBB2700MW	LBB2700SMW	LBB3700MW	LBB3700SMW
400	625	1250	LBB21250MW	LBB21250SMW	LBB31250MW	LBB31250SMW
400	750	1500	LBB21500MW	LBB21500SMW	LBB31500MW	LBB31500SMW
400	875	1750	LBB21750MW	LBB21750SMW	LBB31750MW	LBB31750SMW
400	1125	2250	LBB22250MW	LBB22250SMW	LBB32250MW	LBB32250SMW
400	1500	3000	LBB23000MW	LBB23000SMW	LBB33000MW	LBB33000SMW
400	2000	4000	LBB24000MW	LBB24000SMW	LBB34000MW	LBB34000SMW

Ambient Compensating Breakers—Includes Terminals

125	625	1250	LBB2125A	LBB2125SA	LBB3125A	LBB3125SA
150	750	1500	LBB2150A	LBB2150SA	LBB3150A	LBB3150SA
175	875	1750	LBB2175A	LBB2175SA	LBB3175A	LBB3175SA
200	1000	2000	LBB2200A	LBB2200SA	LBB3200A	LBB3200SA
225	1125	2250	LBB2225A	LBB2225SA	LBB3225A	LBB3225SA
250	1250	2500	LBB2250A	LBB2250SA	LBB3250A	LBB3250SA
300	1500	3000	LBB2300A	LBB2300SA	LBB3300A	LBB3300SA
350	1750	3500	LBB2350A	LBB2350SA	LBB3350A	LBB3350SA
400	2000	4000	LBB2400A	LBB2400SA	LBB3400A	LBB3400SA

UL Listed Interrupting Ratings

Maximum Volts	Amperes
240 AC	50,000 asymmetrical, 42,000 symmetrical
480 AC	35,000 asymmetrical, 30,000 symmetrical
600 AC	25,000 asymmetrical, 22,000 symmetrical
250 DC	20,000 ⑥

Accessories and Modifications

Shaded area denotes obsolete or discontinued products and services.

Special Calibrations

Special calibration price additions apply to ampere ratings not listed as standard or for ambients other than 40°C or 50°C. For frequencies other than 0–60 Hz AC, refer to Eaton. See Application Data 29-160 for information regarding special conditions. Maximum calibration for 400 Hz is 300A.

Note: Not UL Listed.

50°C Calibration

Add suffix "V" to catalog number for complete breaker when ordering breakers to be used in 50°C ambients.

Note: Not UL Listed.

Terminals

Two terminals required per pole.

Select from **Page V12-T3-35**.

Note: Terminals are shipped separately from breaker.

Note: If upgrading an LBB breaker to a Series C K-Frame in a panelboard application, also order TAD3 spacer kit.

For CSA, see Page V12-T3-48.

Type LBB breakers meet requirements for Class 21a circuit breakers, as defined by Federal Specification W-C-375b.

UL Listed Interrupting Ratings (see table)

For all three-phase delta, grounded B phase applications, contact Avery Creek, NC, Technical Resource Center at **1-800-356-1243**.

Magnetic Only Breakers

For description, refer to Application Data 29-160. To order, select catalog number from table above.

Notes

- ① These frames are obsolete. For replacement solutions, see the cross-reference on **Pages V12-T3-114–V12-T3-167**.
- ② Not UL Listed.
- ③ Set on high side, adjustable to lower limits.
- ④ Two-pole breakers or trips are supplied in three-pole frames with current carrying parts omitted from center pole.
- ⑤ Select desired terminals from **V12-T3-30**, and order as separate item.
- ⑥ Ratings above 10,000A not UL Listed.

Types LB and HLB

Shaded area denotes obsolete or discontinued products and services. ①

LB: 600 Vac; 250 Vdc



Type LB and MARK 75 Type HLB 70–400A, 600 Vac, 250 Vdc, Two- and Three-Pole, Interchangeable Trip, Thermal-Magnetic, Saf-T-Vue and MARK 75

Continuous Ampere Rating at 40°C	Magnetic Trip Setting Amperes ②		Complete Breaker Includes Pressure Type Aluminum Terminals ③			Shipped as Frame, Trip Unit and Terminals ③				
	Low	High	Standard Catalog Number	Saf-T-Vue Catalog Number	MARK 75 Catalog Number	Frame Only		Trip Unit Only		
						Standard Catalog Number	Saf-T-Vue Catalog Number	MARK 75 Catalog Number	Standard Saf-T-Vue, MARK 75 Catalog Number	
Two-Pole, 600 Vac, 250 Vdc ④										
70	350	700	LB2070	LB2070S	—	LB2400F	LB2400FS	HLB2400F	HLB2070T	
90	450	900	LB2090	LB2090S	—	LB2400F	LB2400FS	HLB2400F	HLB2090T	
100	500	1000	LB2100	LB2100S	—	LB2400F	LB2400FS	HLB2400F	HLB2100T	
125	625	1250	LB2125	LB2125S	HLB2125	LB2400F	LB2400FS	HLB2400F	HLB2125T	
150	750	1500	LB2150	LB2150S	HLB2150	LB2400F	LB2400FS	HLB2400F	HLB2150T	
175	875	1750	LB2175	LB2175S	HLB2175	LB2400F	LB2400FS	HLB2400F	HLB2175T	
200	1000	2000	LB2200	LB2200S	HLB2200	LB2400F	LB2400FS	HLB2400F	HLB2200T	
225	1125	2250	LB2225	LB2225S	HLB2225	LB2400F	LB2400FS	HLB2400F	HLB2225T	
250	1250	2500	LB2250	LB2250S	HLB2250	LB2400F	LB2400FS	HLB2400F	HLB2250T	
300	1500	3000	LB2300	LB2300S	HLB2300	LB2400F	LB2400FS	HLB2400F	HLB2300T	
350	1750	3500	LB2350	LB2350S	HLB2350	LB2400F	LB2400FS	HLB2400F	HLB2350T	
400	2000	4000	LB2400	LB2400S	HLB2400	LB2400F	LB2400FS	HLB2400F	HLB2400T	
					Approx. shipping weight 13 lbs		Approx. shipping weight 10 lbs		Approx. shipping weight 2 lbs	
Three-Pole, 600 Vac Only										
70	350	700	LB3070	LB3070S	—	LB3400F	LB3400FS	HLB3400F	HLB3070T	
90	450	900	LB3090	LB3090S	—	LB3400F	LB3400FS	HLB3400F	HLB3090T	
100	500	1000	LB3100	LB3100S	—	LB3400F	LB3400FS	HLB3400F	HLB3100T	
125	625	1250	LB3125	LB3125S	HLB3125	LB3400F	LB3400FS	HLB3400F	HLB3125T	
150	750	1500	LB3150	LB3150S	HLB3150	LB3400F	LB3400FS	HLB3400F	HLB3150T	
175	875	1750	LB3175	LB3175S	HLB3175	LB3400F	LB3400FS	HLB3400F	HLB3175T	
200	1000	2000	LB3200	LB3200S	HLB3200	LB3400F	LB3400FS	HLB3400F	HLB3200T	
225	1125	2250	LB3225	LB3225S	HLB3225	LB3400F	LB3400FS	HLB3400F	HLB3225T	
250	1250	2500	LB3250	LB3250S	HLB3250	LB3400F	LB3400FS	HLB3400F	HLB3250T	
300	1500	3000	LB3300	LB3300S	HLB3300	LB3400F	LB3400FS	HLB3400F	HLB3300T	
350	1750	3500	LB3350	LB3350S	HLB3350	LB3400F	LB3400FS	HLB3400F	HLB3350T	
400	2000	4000	LB3400	LB3400S	HLB3400	LB3400F	LB3400FS	HLB3400F	HLB3400T	
					Approx. shipping weight 15 lbs		Approx. shipping weight 12 lbs		Approx. shipping weight 2.5 lbs	

Notes

- ① These frames are obsolete. For replacement solutions, see the cross-reference on **Pages V12-T3-126–V12-T3-167**.
- ② Set on high side, adjustable to lower limits.
- ③ Terminals are shipped separately from breaker.
- ④ Two-pole breakers or trips are supplied in three-pole frames with current carrying parts omitted from center pole.

Shaded area denotes obsolete or discontinued products and services. ①

Special Breakers—Trip Units Only ②

Continuous Ampere Rating	Magnetic Trip Setting, Amperes ③		Trip Unit Only	
	Low	High	Two-Pole ④ Catalog Number	Three-Pole Catalog Number
Magnetic Only Breakers, Front Adjustable				
400	350	700	HLB2700TM	HLB3700TM
400	625	1250	HLB21250TM	HLB31250TM
400	750	1500	HLB21500TM	HLB31500TM
400	875	1750	HLB21750TM	HLB31750TM
400	1125	2250	HLB22250TM	HLB32250TM
400	1125	2250	HLB22250TM	HLB32250TM
400	1500	3000	HLB23000TM	HLB33000TM
400	2000	4000	HLB24000TM	HLB34000TM

Ambient Compensating Breakers

70	350	700	HLB2070TA	HLB3070TA
90	450	900	HLB2090TA	HLB3090TA
100	500	1000	HLB2100TA	HLB3100TA
125	625	1250	HLB2125TA	HLB3125TA
150	750	1500	HLB2150TA	HLB3150TA
175	875	1750	HLB2175TA	HLB3175TA
200	1000	2000	HLB2200TA	HLB3200TA
225	1125	2250	HLB2225TA	HLB3225TA
250	1250	2500	HLB2250TA	HLB3250TA
300	1500	3000	HLB2300TA	HLB3300TA
350	1750	3500	HLB2350TA	HLB3350TA
400	2000	4000	HLB2400TA	HLB3400TA

Accessories and Modifications

Shaded area denotes obsolete or discontinued products and services.

Special Calibrations

Special calibration price additions apply to ampere ratings not listed as standard or for ambients other than 40°C or 50°C. For frequencies other than 0–60 Hz AC circuits, refer to Eaton. See Application Data 29-160 for information regarding special conditions. Maximum calibration for 400 Hz is 300A.

Note: Not UL Listed.

50°C Calibration

Add suffix “V” to catalog number for complete breaker or trip unit only, when ordering breakers to be used in 50°C ambients.

Note: Not UL Listed.

Magnetic Only Breakers

For description, refer to Application Data 29-160. To order, select trip unit from table above, frame and terminals.

Note: Not UL Listed.

For CSA, see Page V12-T3-48.

Type LB breakers meet requirements for Class 21a circuit breakers, and Type HLB meet requirements for Class 23a, as defined by Federal Specification W-C-375b.

UL Listed Interrupting Ratings

Maximum Volts	Amperes
Standard Breakers	
240 AC	50,000 asymmetrical, 42,000 symmetrical
480 AC	35,000 asymmetrical, 30,000 symmetrical
600 AC	25,000 asymmetrical, 22,000 symmetrical
250 DC	20,000 ⑤
MARK 75 Breakers	
240 AC	75,000 asymmetrical, 65,000 symmetrical
480 AC	40,000 asymmetrical, 35,000 symmetrical
600 AC	30,000 asymmetrical, 25,000 symmetrical
250 DC	20,000 ⑤

For all three-phase delta, grounded B phase applications, contact Avery Creek, NC, Technical Resource Center at **1-800-356-1243**.

Terminals

Two terminals are required per pole.

Terminals are UL Listed for wire type and range listed below. When used with aluminum cable, use joint compound. To order optional copper only terminals, add suffix “C” to complete breaker catalog number.

Note: Terminals are shipped separately from breaker. If upgrading an LB, HLB breaker to a Series C K-Frame in a panelboard application, also order TAD3 spacer kit.

Terminals

Maximum Amperes	Number of Cables, Wire Range, Type	Catalog Number
Standard Pressure Terminals		
225	(1) #6–350 kcmil Cu, or (1) #4–350 kcmil Al	TA225LA1
350	(1) 250–500 kcmil Al/Cu	TA350DA
400	(2) 3/0–250 kcmil Cu only	T400DA2
Optional Copper Pressure Terminals		
225	(1) #6–350 kcmil Cu	T225LA
225 ⑥	(1) #6–250 kcmil Cu	T225LBF
350	(1) 250–500 kcmil Cu	T350DA

Notes

- ① These frames are obsolete. For replacement solutions, see the cross-reference on **Pages V12-T3-126–V12-T3-167**.
- ② Not UL Listed.
- ③ Set on high side, adjustable to lower limits.
- ④ Two-pole breakers or trips are supplied in three-pole frames with current carrying parts omitted from center pole.
- ⑤ Ratings above 10,000A not UL Listed.
- ⑥ Optional terminal.

Type DA

■ Shaded area denotes obsolete or discontinued products and services. ①

DA: 240 Vac; 250 Vdc



Type DA Breakers 250–400A, 240 Vac, 250 Vdc, Two- and Three-Pole, Fixed Trip, Thermal-Magnetic (Suitable for Reverse-Feed)

Continuous Ampere Rating at 40°C	Breakers With Line Terminals Only		Breakers With Line and Load Terminals	
	Two-Pole ② Catalog Number	Three-Pole Catalog Number	Two-Pole ② Catalog Number	Three-Pole Catalog Number
250	DA2250Y	DA3250Y	DA2250	DA3250
300	DA2300Y	DA3300Y	DA2300	DA3300
350	DA2350Y	DA3350Y	DA2350	DA3350
400	DA2400Y	DA3400Y	DA2400	DA3400
	Approx. shipping weight 13 lbs	Approx. shipping weight 15 lbs	Approx. shipping weight 13 lbs	Approx. shipping weight 13 lbs

Accessories and Modifications

■ Shaded area denotes obsolete or discontinued products and services

Type DA breakers meet requirements of Federal Specification W-C-375b., Class 14b.

UL Listed Interrupting Ratings

Maximum Volts	Amperes
240 AC	25,000 asymmetrical, 22,000 symmetrical
250 DC	10,000

For all three-phase delta, grounded B phase applications, contact Avery Creek, NC, Technical Resource Center at **1-800-356-1243**.

Terminals

Terminals are UL Listed for the wire type and size listed below. When used with aluminum conductors, use joint compound.

Terminals

Maximum Amperes	Number of Cables, Wire Range, Type	Catalog Number
Standard Pressure Terminals		
350	(1) 250–500 kcmil Al/Cu	TA350DA
400	(2) 3/0–250 kcmil Cu only	T400DA2
Optional Terminals (for Copper Cable)		
350	(1) 250–500 kcmil Cu	T350DA

Note: If upgrading a DA breaker to a Series C K-Frame in a panelboard application, also order TAD3 spacer kit.

For CSA, see Page V12-T3-48.

Special Calibrations

Special calibration price additions apply to ampere ratings not listed as standard or for ambients other than 40°C or 50°C. For frequencies other than 0–60 Hz AC circuits, refer to Eaton. See Application Data 29-160 for information regarding special conditions. Maximum 400 Hz calibrations: Type DA, 300A.

Note: Not UL Listed.

50°C Calibration

Add suffix “V” to catalog number for complete breaker when ordering breakers to be used in 50°C ambients. Same price as standard 40°C breakers.

Note: Not UL Listed.

Notes

- ① These frames are obsolete. For replacement solutions, see the cross-reference on Pages V12-T3-114–V12-T3-167.
- ② Two-pole breakers are supplied in three-pole frames.

3

Molded-Case Circuit Breakers

Replacement Capabilities

Type LAB

Shaded area denotes obsolete or discontinued products and services. ①

LAB: 600 Vac; 250 Vdc

Type LAB 125–400A, 600 Vac, 250 Vdc, Two- and Three-Pole, Fixed Trip, Thermal-Magnetic, Saf-T-Vue (Suitable for Reverse-Feed)



3

Continuous Ampere Rating at 40°C	Magnetic Trip Setting, Amperes ②		Complete Breaker Includes Pressure Type Aluminum Terminals ③		Breaker Without Terminals		
	Low	High	Standard Catalog Number	Saf-T-Vue Catalog Number	Standard Catalog Number	Saf-T-Vue Catalog Number	
Two-Pole, 600 Vac, 250 Vdc ④							
125	625	1250	LAB2125	LAB2125S	LAB2125W	LAB2125SW	
150	750	1500	LAB2150	LAB2150S	LAB2150W	LAB2150SW	
175	875	1750	LAB2175	LAB2175S	LAB2175W	LAB2175SW	
200	1000	2000	LAB2200	LAB2200S	LAB2200W	LAB2200SW	
225	1125	2250	LAB2225	LAB2225S	LAB2225W	LAB2225SW	
250	1250	2500	LAB2250	LAB2250S	LAB2250W	LAB2250SW	
300	1500	3000	LAB2300	LAB2300S	LAB2300W	LAB2300SW	
350	1750	3500	LAB2350	LAB2350S	LAB2350W	LAB2350SW	
400	2000	4000	LAB2400	LAB2400S	LAB2400W	LAB2400SW	
				Approx. shipping weight 22 lbs		Approx. shipping weight 22 lbs	
Three-Pole, 600 Vac Only							
125	625	1250	LAB3125	LAB3125S	LAB3125W	LAB3125SW	
150	750	1500	LAB3150	LAB3150S	LAB3150W	LAB3150SW	
175	875	1750	LAB3175	LAB3175S	LAB3175W	LAB3175SW	
200	1000	2000	LAB3200	LAB3200S	LAB3200W	LAB3200SW	
225	1125	2250	LAB3225	LAB3225S	LAB3225W	LAB3225SW	
250	1250	2500	LAB3250	LAB3250S	LAB3250W	LAB3250SW	
300	1500	3000	LAB3300	LAB3300S	LAB3300W	LAB3300SW	
350	1750	3500	LAB3350	LAB3350S	LAB3350W	LAB3350SW	
400	2000	4000	LAB3400	LAB3400S	LAB3400W	LAB3400SW	
				Approx. shipping weight 24.5 lbs		Approx. shipping weight 24.5 lbs	

Notes

- ① These frames are obsolete. For replacement solutions, see the cross-reference on Pages V12-T3-114–V12-T3-167.
- ② Set on high side, adjustable to lower limits.
- ③ Terminals shipped separately from breaker.
- ④ Two-pole breakers or trips are supplied in three-pole frames with current carrying parts omitted from center pole.

Shaded area denotes obsolete or discontinued products and services. ①

Special Breakers ②

Continuous Ampere Rating	Magnetic Trip Setting, Amperes ③		Breaker Catalog Number		Breaker Catalog Number	
	Low	High	Two-Pole ④ Standard Catalog Number	Saf-T-Vue Catalog Number	Three-Pole Standard Catalog Number	Saf-T-Vue Catalog Number
Magnetic Only Breakers, Front Adjustable—Without Terminals ⑤						
400	350	700	LAB2700MW	LAB2700SMW	LAB3700MW	LAB3700SMW
400	625	1250	LAB21250MW	LAB21250SMW	LAB31250MW	LAB31250SMW
400	750	1500	LAB21500MW	LAB21500SMW	LAB31500MW	LAB31500SMW
400	875	1750	LAB21750MW	LAB21750SMW	LAB31750MW	LAB31750SMW
400	1125	2250	LAB22250MW	LAB22250SMW	LAB32250MW	LAB32250SMW
400	1500	3000	LAB23000MW	LAB23000SMW	LAB33000MW	LAB33000SMW
400	2000	4000	LAB24000MW	LAB24000SMW	LAB34000MW	LAB34000SMW

Ambient Compensating Breakers—Includes Terminals

125	625	1250	LAB2125A	—	LAB3125A	—
150	750	1500	LAB2150A	—	LAB3150A	—
175	875	1750	LAB2175A	—	LAB3175A	—
200	1000	2000	LAB2200A	—	LAB3200A	—
225	1125	2250	LAB2225A	—	LAB3225A	—
250	1250	2500	LAB2250A	—	LAB3250A	—
300	1500	3000	LAB2300A	—	LAB3300A	—
350	1750	3500	LAB2350A	—	LAB3350A	—
400	2000	4000	LAB2400A	—	LAB3400A	—

Accessories and Modifications

Shaded area denotes obsolete or discontinued products and services.

Special Calibrations

Special calibration price additions apply to ampere ratings not listed as standard or for ambients other than 40°C or 50°C. For frequencies other than 0–60 Hz AC circuits, refer to Eaton. See Application Data 29-160 for information regarding special conditions. Maximum calibration for 400 Hz is 300A.

Note: Not UL Listed.

50°C Calibration

Add suffix “V” to catalog number for complete breaker when ordering breakers to be used in 50°C ambients. **For CSA, see Page V12-T3-48.**

Note: Not UL Listed.

Type LAB breakers meet requirements for Class 21a circuit breakers, as defined by Federal Specification W-C-375b.

UL Listed Interrupting Ratings ⑥

Maximum Volts	Amperes
240 AC	50,000 asymmetrical, 42,000 symmetrical
480 AC	35,000 asymmetrical, 30,000 symmetrical
600 AC	25,000 asymmetrical, 22,000 symmetrical
250 DC	20,000 ⑦

For all three-phase delta, grounded B phase applications, contact Avery Creek, NC, Technical Resource Center at **1-800-356-1243**.

Terminals

Two terminals required per pole.

Select from the table on **Page V12-T3-36**.

Note: Terminals shipped separately from breaker.

Magnetic Only and Ambient Compensating Breakers

To order, select catalog number from “Special Breakers” table above.

Additional Accessories and Modifications

Refer to **Pages V12-T3-65–V12-T3-79**.

Notes

- ① These frames are obsolete. For replacement solutions, see the cross-reference on **Pages V12-T3-114–V12-T3-167**.
- ② Not UL Listed.
- ③ Set on high side, adjustable to lower limits.
- ④ Two-pole breakers or trips are supplied in three-pole frames with current carrying parts omitted from center pole.
- ⑤ Select desired terminals from **Page V12-T3-39** and order as separate item.
- ⑥ Interrupting capacities shown do not apply to molded-case switches.
- ⑦ Ratings above 10,000A not UL Listed.

Types LA and HLA

Shaded area denotes obsolete or discontinued products and services. ①

LA: 600 Vac; 250 Vdc



3

Type LA and MARK 75 Type HLA 70–400A, 600 Vac, 250 Vdc, Two- and Three-Pole, Interchangeable Trip

Continuous Ampere Rating at 40°C	Magnetic Trip Setting Amperes ②		Complete Breaker Includes Pressure Type Aluminum Terminals ③			Shipped as Frame, Trip Unit and Terminals Frame Only			Trip Unit Only Standard, MARK 75, Saf-T-Vue Catalog Number
	Low	High	Standard Catalog Number	Saf-T-Vue Catalog Number	MARK 75 Catalog Number	Standard Catalog Number	Saf-T-Vue Catalog Number	MARK 75 Catalog Number	
400A Frame Breakers ④—Two-Pole, 600 Vac, 250 Vdc ⑤									
70 ⑥	350	700	LA2070	LA2070S	HLA2070	LA2400F	LA2400FS	HLA2400F	HLA2070T
90 ⑥	450	900	LA2090	LA2090S	HLA2090	LA2400F	LA2400FS	HLA2400F	HLA2090T
100 ⑥	500	1000	LA2100	LA2100S	HLA2100	LA2400F	LA2400FS	HLA2400F	HLA2100T
125	625	1250	LA2125	LA2125S	HLA2125	LA2400F	LA2400FS	HLA2400F	HLA2125T
150	750	1500	LA2150	LA2150S	HLA2150	LA2400F	LA2400FS	HLA2400F	HLA2150T
175	875	1750	LA2175	LA2175S	HLA2175	LA2400F	LA2400FS	HLA2400F	HLA2175T
200	1000	2000	LA2200	LA2200S	HLA2200	LA2400F	LA2400FS	HLA2400F	HLA2200T
225	1125	2250	LA2225	LA2225S	HLA2225	LA2400F	LA2400FS	HLA2400F	HLA2225T
250	1250	2500	LA2250	LA2250S	HLA2250	LA2400F	LA2400FS	HLA2400F	HLA2250T
300	1500	3000	LA2300	LA2300S	HLA2300	LA2400F	LA2400FS	HLA2400F	HLA2300T
350	1750	3500	LA2350	LA2350S	HLA2350	LA2400F	LA2400FS	HLA2400F	HLA2350T
400	2000	4000	LA2400	LA2400S	HLA2400	LA2400F	LA2400FS	HLA2400F	HLA2400T
Approx. shipping weight 21.75 lbs						Approx. shipping weight 17.5 lbs			Approx. shipping weight 2.25 lbs

Three-Pole, 600 Vac Only

70 ⑥	350	700	LA3070	LA3070S	HLA3070	LA3400F	LA3400FS	HLA3400F	HLA3070T
90 ⑥	450	900	LA3090	LA3090S	HLA3090	LA3400F	LA3400FS	HLA3400F	HLA3090T
100 ⑥	500	1000	LA3100	LA3100S	HLA3100	LA3400F	LA3400FS	HLA3400F	HLA3100T
125	625	1250	LA3125	LA3125S	HLA3125	LA3400F	LA3400FS	HLA3400F	HLA3125T
150	750	1500	LA3150	LA3150S	HLA3150	LA3400F	LA3400FS	HLA3400F	HLA3150T
175	875	1750	LA3175	LA3175S	HLA3175	LA3400F	LA3400FS	HLA3400F	HLA3175T
200	1000	2000	LA3200	LA3200S	HLA3200	LA3400F	LA3400FS	HLA3400F	HLA3200T
225	1125	2250	LA3225	LA3225S	HLA3225	LA3400F	LA3400FS	HLA3400F	HLA3225T
250	1250	2500	LA3250	LA3250S	HLA3250	LA3400F	LA3400FS	HLA3400F	HLA3250T
300	1500	3000	LA3300	LA3300S	HLA3300	LA3400F	LA3400FS	HLA3400F	HLA3300T
350	1750	3500	LA3350	LA3350S	HLA3350	LA3400F	LA3400FS	HLA3400F	HLA3350T
400	2000	4000	LA3400	LA3400S	HLA3400	LA3400F	LA3400FS	HLA3400F	HLA3400T
Approx. shipping weight 24.5 lbs					Approx. shipping weight 19 lbs			Approx. shipping weight 3 lbs	

Notes

- ① These frames are obsolete. For replacement solutions, see the cross-reference on **Pages V12-T3-114–V12-T3-167**.
- ② Set on high side, adjustable to lower limits.
- ③ Terminals shipped separately from breaker.
- ④ Terminals, trip units and accessories are not interchangeable between 400 and 600A frames.
- ⑤ Two-pole breakers or trips are supplied in three-pole frames with current carrying parts omitted from center pole.
- ⑥ These ratings have interrupting capacities reduced to 25,000A symmetrical at 240V, 20,000A symmetrical at 480V, and 15,000A symmetrical at 600V.

■ Shaded area denotes obsolete or discontinued products and services. ①

Special Breakers ②—Trip Units Only

Continuous Ampere Rating	Magnetic Trip Setting, Amperes ③		Two-Pole ④ Catalog Number	Three-Pole Catalog Number
	Low	High		
Magnetic Only Breakers, Front Adjustable—400A Frame Breakers ⑤				
400	350	700	HLA2700TM	HLA3700TM
400	625	1250	HLA21250TM	HLA31250TM
400	750	1500	HLA21500TM	HLA31500TM
400	875	1750	HLA21750TM	HLA31750TM
400	1125	2250	HLA22250TM	HLA32250TM
400	1500	3000	HLA23000TM	HLA33000TM
400	2000	4000	HLA24000TM	HLA34000TM
Ambient Compensating Breakers—400A Frame Breakers Only ⑤				
70 ⑥	350	700	HLA2070TA	HLA3070TA
90 ⑥	450	900	HLA2090TA	HLA3090TA
100 ⑥	500	1000	HLA2100TA	HLA3100TA
125	625	1250	HLA2125TA	HLA3125TA
150	750	1500	HLA2150TA	HLA3150TA
175	875	1750	HLA2175TA	HLA3175TA
200	1000	2000	HLA2200TA	HLA3200TA
225	1125	2250	HLA2225TA	HLA3225TA
250	1250	2500	HLA2250TA	HLA3250TA
300	1500	3000	HLA2300TA	HLA3300TA
350	1750	3500	HLA2350TA	HLA3350TA
400	2000	4000	HLA2400TA	HLA3400TA

Notes

- ① These frames are obsolete. For replacement solutions, see the cross-reference on **Pages V12-T3-114–V12-T3-167**.
- ② Not UL Listed.
- ③ Set on high side, adjustable to lower limits.
- ④ Two-pole breakers or trips are supplied in three-pole frames with current carrying parts omitted from center pole.
- ⑤ Terminals, trip units and accessories are not interchangeable between 400 and 600A frames.
- ⑥ These ratings have interrupting capacities reduced to 25,000A symmetrical at 240V, 20,000A symmetrical at 480V, and 15,000A symmetrical at 600V.

Accessories and Modifications

■ Shaded area denotes obsolete or discontinued products and services.

3

Special Calibrations

Special calibration price additions apply to ampere ratings not listed as standard or for ambients other than 40°C or 50°C. For frequencies other than 0–60 Hz AC, refer to Eaton. See Application Data 29-160 for information regarding special conditions. Maximum 400 Hz calibration: 400A frame, 300A.

Note: Not UL Listed.

50°C Calibration

Add suffix “V” to catalog number for complete breaker or trip unit only, when ordering breakers to be used in 50°C ambients.

Note: Not UL Listed.

Terminals

Two terminals required per pole.

Select from table at right.

Note: Terminals shipped separately from breaker.

Magnetic Only Breakers

To order, select trip unit from the table on **Page V12-T3-35**, frame and terminals from table at right.

Note: Not UL Listed. MARK 75 frame color changed from gray to black in mid-2002.

UL Listed Except as Noted

Type LA breakers meet requirements for Class 21a circuit breakers, and Type HLA meet requirements for Class 23a as defined by Federal Specification W-C-375b.

UL Listed Interrupting Ratings ^①

	Maximum Volts	Amperes
Standard Breakers		
240 AC	50,000 asymmetrical, 42,000 symmetrical	
480 AC	35,000 asymmetrical, 30,000 symmetrical	
600 AC	25,000 asymmetrical, 22,000 symmetrical	
250 DC	20,000 ^②	
MARK 75 Breakers		
240 AC	75,000 asymmetrical, 65,000 symmetrical	
480 AC	40,000 asymmetrical, 35,000 symmetrical	
600 AC	30,000 asymmetrical, 25,000 symmetrical	
250 DC	20,000 ^②	

For all three-phase delta, grounded B phase applications, contact Avery Creek, NC, Technical Resource Center at **1-800-356-1243**.

Terminals

Two terminals are required per pole.

Terminals are UL Listed for wire type and range listed below. When used with aluminum cable, use joint compound. To order optional

copper only terminals, add suffix “C” to complete breaker catalog number.

Note: Terminals shipped separately from breaker. Terminals, trip units and accessories are not interchangeable between 400 and 600A frames.

Terminals

Maximum Amperes	Number of Cables, Wire Range, Type	Catalog Number
Standard Al/Cu Pressure Terminals		
225 ^③	(1) #6–350 kcmil Cu, or (1) #4–350 kcmil Al	TA225LA1
400 ^③	(1) #4–250 kcmil Al/Cu, plus (1) 3/0–600 kcmil Al/Cu	TA400LA1
Optional Copper Pressure Terminals		
225 ^③	(1) #6–350 kcmil Cu	T225LA
225 ^{③④}	(1) #6–250 kcmil Cu	T225LBF
400 ^③	(1) #4–250 kcmil Cu, plus (1) 3/0–600 kcmil Cu	T401LA

Notes

- ① Interrupting capacities do not apply to molded-case switches.
- ② Ratings above 10,000A not UL Listed.
- ③ 400A frame only.
- ④ Optional terminal.

Types LA and HLA

Shaded area denotes obsolete or discontinued products and services. ①

LA: 600 Vac; 250 Vdc



Type LA and MARK 75 Type HLA 250–600A, 600 Vac, 250 Vdc, Two-, Three-Pole, Interchangeable Trip Thermal-Magnetic, Saf-T-Vue and MARK 75 Breakers

Continuous Ampere Rating at 40°C	Magnetic Trip Setting, Amperes ②		Complete Breaker Includes Pressure Type Aluminum Terminals ③			Shipped as Frame, Trip Unit and Terminals ④			
	Low	High	Standard Catalog Number	Saf-T-Vue Catalog Number	MARK 75 Catalog Number	Frame Only		Trip Unit Only Standard Saf-T-Vue, MARK 75 Catalog Number	
			Standard Catalog Number	Saf-T-Vue Catalog Number	MARK 75 Catalog Number	Standard Catalog Number	Saf-T-Vue Catalog Number	MARK 75 Catalog Number	MARK 75 Catalog Number
600A Frame Breakers ④—Two-Pole, 600 Vac, 250 Vdc ⑤									
250	1250	2500	2603D50G01	2603D50G13	1256C10G02	LA2600F	LA2600FS	HLA2600F	2603D46G07
300	1500	3000	2603D50G02	2603D50G14	1256C10G03	LA2600F	LA2600FS	HLA2600F	2603D46G08
350	1750	3500	2603D50G03	2603D50G15	1256C10G04	LA2600F	LA2600FS	HLA2600F	2603D46G09
350	1750	3500	2603D50G03	2603D50G15	1256C10G04	LA2600F	LA2600FS	HLA2600F	2603D46G09
400	2000	4000	2603D50G04	2603D50G16	1256C10G05	LA2600F	LA2600FS	HLA2600F	2603D46G10
500	2500	5000	LA2500	LA2500S	HLA2500	LA2600F	LA2600FS	HLA2600F	HLA2500T
600	3000	6000	LA2600	LA2600S	HLA2600	LA2600F	LA2600FS	HLA2600F	HLA2600T
Three-Pole, 600 Vac Only									
250	1250	2500	2603D50G07	2603D50G019	1256C10G12	LA3600F	LA3600FS	HLA3600F	2603D46G26
300	1500	3000	2603D50G08	2603D50G020	1256C10G13	LA3600F	LA3600FS	HLA3600F	2603D46G27
350	1750	3500	2603D50G09	2603D50G021	1256C10G14	LA3600F	LA3600FS	HLA3600F	2603D46G28
400	2000	4000	2603D50G10	2603D50G022	1256C10G15	LA3600F	LA3600FS	HLA3600F	2603D46G29
500	2500	5000	LA3500	LA3500S	HLA500	LA3600F	LA3600FS	HLA3600F	HLA3500T
600	3000	6000	LA3600	LA3600S	HLA3600	LA3600F	LA3600FS	HLA3600F	HLA3600T

Type Special Breakers ⑥—Trip Units Only

Continuous Ampere Rating	Magnetic Trip Setting, Amperes		Two-Pole ⑥ Catalog Number	Three-Pole Catalog Number
	Low	High		
600A Frame Breakers ④—Magnetic Only Breakers, Front Adjustable				
600	1125	2250	2603D47G07	2603D47G26
600	1500	3000	2603D47G08	2603D47G27
600	2000	4000	2603D47G10	2603D47G29
600	2500	5000	HLA25000TM	HLA35000TM
600	3000	6000	HLA26000TM	HLA36000TM
600A Frame Breakers—Ambient Compensating Breakers				
250	1250	2500	5683D88G07	5683D88G26
300	1500	3000	5683D88G08	5683D88G27
350	1750	3500	5683D88G09	5683D88G28
400	2000	4000	5683D88G10	5683D88G29
500	2500	5000	HLA2500TA	HLA3500TA
600	3000	6000	HLA2600TA	HLA3600TA

Notes

- ① These frames are obsolete. For replacement solutions, see the cross-reference on Pages V12-T3-114–V12-T3-167.
- ② Set on high side, adjustable to lower limits.
- ③ Terminals shipped separately from breakers.
- ④ Terminals, trip units and accessories are not interchangeable between 400 and 600A frames.
- ⑤ Two-pole breakers or trips are supplied in three-pole frames with current carrying parts omitted from center pole.
- ⑥ Not UL Listed.

Accessories and Modifications

■ Shaded area denotes obsolete or discontinued products and services.

3

Special Calibrations

Special calibration price additions apply to ampere ratings not listed as standard or for ambients other than 40°C or 50°C. For frequencies other than 0–60 Hz AC, refer to Eaton. See Application Data 29-160 for information regarding special conditions. Maximum 400 Hz calibration: 600A frame, 450A.

Note: Not UL Listed.

50°C Calibration

Add suffix “V” to catalog number for complete breaker or trip unit only, when ordering breakers to be used in 50°C ambients. Same price as standard 40°C breakers.

For CSA, see Page V12-T3-48.

Type LA breakers meet requirements for Class 21a circuit breakers, and type HLA meet requirements for Class 23a as defined by Federal Specification W-C-375b.

Note: Not UL Listed. MARK 75 frame color changed from gray to black in mid-2002.

UL Listed Interrupting Ratings ^①

Maximum Volts	Amperes
Standard Breakers	
240 AC	50,000 asymmetrical, 42,000 symmetrical
480 AC	35,000 asymmetrical, 30,000 symmetrical
600 AC	25,000 asymmetrical, 22,000 symmetrical
250 DC	20,000 ^②
MARK 75 Breakers	
240 AC	75,000 asymmetrical, 65,000 symmetrical
480 AC	40,000 asymmetrical, 35,000 symmetrical
600 AC	30,000 asymmetrical, 25,000 symmetrical
250 DC	20,000 ^②

For all three-phase delta, grounded B phase applications, contact Avery Creek, NC, Technical Resource Center at **1-800-356-1243**.

Terminals

Two terminals are required per pole. Terminals are UL Listed for wire type and range listed below. When used with aluminum cable, use joint compound. To order optional copper only terminals, add suffix “C” to complete breaker catalog number.

Note: Terminals shipped separately from breakers. Terminals, trip units and accessories are not interchangeable between 400 and 600A frames.

Terminals

Maximum Amperes	Number of Cables, Wire Range, Type	Catalog Number
Standard Al/Cu Pressure Terminals		
600 ^③	(2) 250–500 kcmil Al/Cu	TA600LA
Optional Copper Pressure Terminals		
600 ^③	(2) 250–500 kcmil Cu	T600LA

Notes

- ^① Interrupting capacities shown do not apply to molded case switches.
- ^② Ratings above 10,000A not UL Listed.
- ^③ For 600A frame breakers only.

Magnetic Only Breakers

To order, select frame, trip unit and terminals from tables on this page.

Accessories and Modifications

Refer to **Pages V12-T3-65–V12-T3-79**.

Type LAY

■ Shaded area denotes obsolete or discontinued products and services. ①

LAY: 240 Vac



Type LAY 250–600A, 240 Vac, Three-Pole, Interchangeable Trip Thermal-Magnetic, 600A Frame ②

Continuous Ampere Rating at 40°C	Magnetic Trip Setting Amperes ③		Complete Breaker Includes Pressure Type Aluminum Terminals ④	Shipped as Frame, Trip Unit and Terminals ⑤	
	Low	High	Catalog Number	Frame Only Catalog Number	Trip Unit Only Catalog Number
250	1250	2500	LAY3250	LAY3600F	2603D46G26
300	1500	3000	LAY3300	LAY3600F	2603D46G27
350	1750	3500	LAY3350	LAY3600F	2603D46G28
400	2000	4000	LAY3400	LAY3600F	2603D46G29
500	2500	5000	LAY3500	LAY3600F	HLA3500T
600	3000	6000	LAY3600	LAY3600F	HLA3600T

Accessories and Modifications

■ Shaded area denotes obsolete or discontinued products and services.

Special Calibrations

Special calibration price additions apply to ampere ratings not listed as standard or for ambients other than 40°C or 50°C. For frequencies other than 0–60 Hz AC, refer to Eaton. See Application Data 29-160 for information regarding special conditions. Maximum 400 Hz calibration: 600A frame, 450A.

Note: Not UL Listed.

50°C Calibration

Add suffix “V” to catalog number for complete breaker or trip unit only, when ordering breakers to be used in 50°C ambients. Same price as standard 40°C breakers.

For CSA, see Page V12-T3-48.

Type LAY breakers are not defined by Federal Specification W-C-375b.

Note: Not UL Listed.

For all three-phase delta, grounded B phase applications, contact Avery Creek, NC, Technical Resource Center at **1-800-356-1243**.

UL Listed Interrupting Ratings

Maximum Volts	Amperes
240 AC	115,000 asymmetrical, 100,000 symmetrical

Terminals

Two terminals are required per pole.

Terminals are UL Listed for wire type and range listed below. When used with aluminum cable, use joint compound.

Note: Terminals shipped separately from breaker.

Additional Accessories and Modifications

Refer to **Pages V12-T3-65–V12-T3-79**.

Terminals

Maximum Amperes	Number of Cables, Wire Range, Type	Catalog Number
Standard Al/Cu Pressure Terminals		
500 ⑤	(2) 3/0–250 kcmil Al/Cu	TA602LD
600 ⑤	(2) 400–500 kcmil Al/Cu	TA603LA
600 ⑤	(2) 250–500 kcmil Al/Cu	TA600LA
Optional Copper Pressure Terminals		
600 ⑥	(2) 250–500 kcmil Cu	T600LA

Notes

- ① These frames are obsolete. For replacement solutions, see the cross-reference on **Pages V12-T3-114–V12-T3-167**.
- ② Optional terminal.
- ③ Set on high side, adjustable to lower limits.
- ④ Terminals shipped separately from breaker.
- ⑤ For 600A frame breakers only.
- ⑥ Not UL Listed.

Types MA and HMA

Shaded area denotes obsolete or discontinued products and services. ①

MA: 600 Vac; 250 Vdc

Type MA 125–800A, 600 Vac, 250 Vdc ②, Two- and Three-Pole, Interchangeable Trip



3

Continuous Ampere Rating at 40°C	Magnetic Trip Setting Amperes ③		Complete Breaker Includes Pressure Type Copper Terminals ④			Shipped as Frame, Trip Unit and Terminals ④ Frame Only			Trip Unit Only Standard Saf-T-Vue, MARK 75 Catalog Number
	Low	High	Standard Catalog Number	Saf-T-Vue Catalog Number	MARK 75 Catalog Number	Standard Catalog Number	Saf-T-Vue Catalog Number	MARK 75 Catalog Number	
Two-Pole, 600 Vac, 250 Vdc ②⑤									
125	625	1250	MA2125	MA2125S	HMA2125	MA2800F	MA2800FS	HMA2800F	HMA2125T
150	750	1500	MA2150	MA2150S	HMA2150	MA2800F	MA2800FS	HMA2800F	HMA2150T
175	875	1750	MA2175	MA2175S	HMA2175	MA2800F	MA2800FS	HMA2800F	HMA2175T
200	1000	2000	MA2200	MA2200S	HMA2200	MA2800F	MA2800FS	HMA2800F	HMA2200T
225	1125	2250	MA2225	MA2225S	HMA2225	MA2800F	MA2800FS	HMA2800F	HMA2225T
250	1250	2500	MA2250	MA2250S	HMA2250	MA2800F	MA2800FS	HMA2800F	HMA2250T
300	1500	3000	MA2300	MA2300S	HMA2300	MA2800F	MA2800FS	HMA2800F	HMA2300T
350	1750	3500	MA2350	MA2350S	HMA2350	MA2800F	MA2800FS	HMA2800F	HMA2350T
400	2000	4000	MA2400	MA2400S	HMA2400	MA2800F	MA2800FS	HMA2800F	HMA2400T
500	2500	5000	MA2500	MA2500S	HMA2500	MA2800F	MA2800FS	HMA2800F	HMA2500T
600	3000	6000	MA2600	MA2600S	HMA2600	MA2800F	MA2800FS	HMA2800F	HMA2600T
700	3000	6000	MA2700 ⑥	MA2700S	HMA2700	MA2800F	MA2800FS	HMA2800F	HMA2700T ⑥
800	3000	6000	MA2800 ⑥	MA2800S	HMA2800	MA2800F	MA2800FS	HMA2800F	HMA2800T ⑥
800	MCS ⑦	—	MA2800WK	MA2800WSK	—	—	—	—	Incl. in Frame
					Approx. shipping weight 37 lbs		Approx. shipping weight 24 lbs		Approx. shipping weight 3.5 lbs
Three-Pole, 600 Vac Only									
125	625	1250	MA3125	MA3125S	HMA3125	MA3800F	MA3800FS	HMA3800F	HMA3125T
150	750	1500	MA3150	MA3150S	HMA3150	MA3800F	MA3800FS	HMA3800F	HMA3150T
175	875	1750	MA3175	MA3175S	HMA3175	MA3800F	MA3800FS	HMA3800F	HMA3175T
200	1000	2000	MA3200	MA3200S	HMA3200	MA3800F	MA3800FS	HMA3800F	HMA3200T
225	1125 ⑧	2250	MA3225	MA3225S	HMA3225	MA3800F	MA3800FS	HMA3800F	HMA3225T
250	1250	2500	MA3250	MA3250S	HMA3250	MA3800F	MA3800FS	HMA3800F	HMA3250T
300	1500	3000	MA3300	MA3300S	HMA3300	MA3800F	MA3800FS	HMA3800F	HMA3300T
350	1750	3500	MA3350	MA3350S	HMA3350	MA3800F	MA3800FS	HMA3800F	HMA3350T
400	2000	4000	MA3400	MA3400S	HMA3400	MA3800F	MA3800FS	HMA3800F	HMA3400T
500	2500	5000	MA3500	MA3500S	HMA3500	MA3800F	MA3800FS	HMA3800F	HMA3500T
600	3000	6000	MA3600	MA3600S	HMA3600	MA3800F	MA3800FS	HMA3800F	HMA3600T
700	3000	6000	MA3700 ⑥	MA3700S	HMA3700	MA3800F	MA3800FS	HMA3800F	HMA3700T ⑥
800	3000	6000	MA3800 ⑥	MA3800S	HMA3800	MA3800F	MA3800FS	HMA3800F	HMA3800T ⑥
800	MCS ⑦	—	MA3800WK	MA3800WSK	—	—	—	—	Incl. in Frame
					Approx. shipping weight 44 lbs		Approx. shipping weight 28 lbs		Approx. shipping weight 4 lbs

Notes

- ① These frames are obsolete. For replacement solutions, see the cross-reference on **Pages V12-T3-114–V12-T3-167**.
 - ② Above 600A, DC rating applies to magnetic only breakers.
 - ③ Set on high side, adjustable to lower limits.
 - ④ Terminals are shipped separately from breaker.
 - ⑤ Two-pole breakers are supplied in three-pole frames with current carrying parts omitted from center pole.
 - ⑥ 60 Hz AC only.
 - ⑦ Interrupting capacities shown do not apply to high magnetic molded-case switches.
- MARK 75 frame color changed from gray to black in mid-2002. Also magnetic only trip units available: HMA8000TM 4000–8000A.

■ Shaded area denotes obsolete or discontinued products and services. ①

Magnetic Only Breakers, Front Adjustable ②

Continuous Ampere Rating	Magnetic Trip Range ④		Trip Unit Only	
	Low	High	Two-Pole ④ Catalog Number	Three-Pole Catalog Number
800	625	1250	HMA21250TM	HMA31250TM
800	1000	2000	HMA22000TM	HMA32000TM
800	1500	3000	HMA23000TM	HMA33000TM
800	2000	4000	HMA24000TM	HMA34000TM
800	3000	6000	HMA26000TM	HMA36000TM
800	4000	8000	HMA28000TM	HMA38000TM

Ambient Compensating Breakers ②

Continuous Ampere Rating	Magnetic Trip Range ④		Trip Unit Only	
	Low	High	Two-Pole Catalog Number	Three-Pole Catalog Number
125	625	1250	HMA2125TA	HMA3125TA
150	750	1500	HMA2150TA	HMA3150TA
175	875	1750	HMA2175TA	HMA3175TA
200	1000	2000	HMA2200TA	HMA3200TA
220	1125	2250	HMA2225TA	HMA3225TA
250	1250	2500	HMA2250TA	HMA3250TA
300	1500	3000	HMA2300TA	HMA3300TA
350	1750	3500	HMA2350TA	HMA3350TA
400	2000	4000	HMA2400TA	HMA3400TA
500	2500	5000	HMA2500TA	HMA3500TA
600	3000	6000	HMA2600TA	HMA3600TA
700	3000	6000	HMA2700TA	HMA3700TA
800	3000	6000	HMA2800TA	HMA3800TA

Type MA Accessories and Modifications

Special Calibrations

Special calibration price additions apply to ampere ratings not listed as standard or for ambients other than 40°C or 50°C. For frequencies other than 0–60 Hz AC (50 Hz AC minimum, 60 Hz AC maximum, refer to Eaton. See Application Data 29-160 for additional information regarding special conditions.

Note: Not UL Listed.

50°C Calibration

Add suffix “V” to catalog number for complete breaker or trip unit only, when ordering breakers to be used in 50°C ambients.

Note: Not UL Listed.

For CSA, see Page V12-T3-48.

Type MA breakers meet requirements for Class 21a circuit breakers, and Type HMA meet requirements for Class 23a, as defined by Federal Specification W-C-375b.

For all three-phase delta, grounded B phase applications, contact Avery Creek, NC, Technical Resource Center at **1-800-356-1243**.

Type MA UL Listed Interrupting Ratings ⑤

Maximum Volts	Amperes
Standard Breakers	
240 AC	50,000 asymmetrical, 42,000 symmetrical
480 AC	35,000 asymmetrical, 30,000 symmetrical
600 AC	25,000 asymmetrical, 22,000 symmetrical
250 DC ⑥	20,000 ⑦
MARK 75 Breakers	
240 AC	75,000 asymmetrical, 65,000 symmetrical
480 AC	40,000 asymmetrical, 35,000 symmetrical
600 AC	30,000 asymmetrical, 25,000 symmetrical
250 DC ⑥	20,000 ⑦

Notes

- ① These frames are obsolete. For replacement solutions, see the cross-reference on **Pages V12-T3-114–V12-T3-167**.
- ② Not UL Listed.
- ③ Set on high side, adjustable to lower limits.
- ④ Two-pole breakers are supplied in three-pole frames with current carrying parts omitted from center pole.
- ⑤ Interrupting capacities shown do not apply to high magnetic molded-case switches.
- ⑥ Above 600A, DC rating applies to magnetic only breakers.
- ⑦ Ratings above 10,000A not UL Listed.

Shaded area denotes obsolete or discontinued products and services.

Terminals

Two terminals are required per pole.

Terminals are UL Listed for wire type and range listed below. When used with aluminum conductors, use joint compound.

Terminals ^①

Maximum Amperes	Number of Cables, Wire Range, Type	Catalog Number
Standard Al/Cu Pressure Terminals		
600	(2) #1–500 kcmil Al/Cu	TA700MA1
800 (Std.)	(3) 3/0–400 kcmil Al/Cu	TA800MA2
800 ^②	(2) 500–750 kcmil Al/Cu	TA801MA
Optional Copper Pressure Terminals		
350	(1) #1–600 kcmil Cu	T350MA
600	(2) 2/0–500 kcmil Cu	T600MA1
800	(3) 3/0–300 kcmil Cu	T800MA1

Note: Terminals are shipped separately from breaker.

Magnetic Only and Ambient Compensating Breakers

To order a complete breaker, select trip unit plus frame and terminals.

Type MAY Accessories and Modifications

Type MAY 600–800A, 240 Vac, Three-Pole, Interchangeable Trip ^①

Continuous Ampere Rating at 40°C	Magnetic Trip Setting, Amperes ^③		Complete Breaker Includes Pressure Type Aluminum Terminals ^④ Catalog Number	Shipped as Frame, Trip Unit and Terminals ^④	
	Low	High		Frame Only Catalog Number	Trip Unit Only Catalog Number
Three-Pole, 240 Vac Only					
600	3000	6000	MAY3600	MAY3800F	HMA3600T
700 ^⑤	3000	6000	MAY3700	MAY3800F	HMA3700T
800 ^⑤	3000	6000	MAY3800	MAY3800F	HMA3800T

Type MAY breakers are not defined by Federal Specification W-C-375b.

Note: Not UL listed.

Type MAY UL Listed Interrupting Ratings

Maximum Volts	Amperes
240 Vac	115,000 asymmetrical, 100,000 symmetrical

For all three-phase delta, grounded B phase applications, contact Avery Creek, NC, Technical Resource Center at **1-800-356-1243**.

Additional Accessories and Modifications

Refer to **Pages V12-T3-65–V12-T3-79**.

Notes

- ^① These frames are obsolete. For replacement solutions, see the cross-reference on **Pages V12-T3-114–V12-T3-167**.
- ^② Not UL Listed.
- ^③ Set on high side, adjustable to lower limits.
- ^④ Terminals are shipped separately from breaker.
- ^⑤ 60 Hz AC only.

Types NB and NHB

Shaded area denotes obsolete or discontinued products and services. ①

NB: 600 Vac; 250 Vdc



Type NB 700–1200A, 600V, 60 Hz AC ②, 250 Vdc ③, Two- and Three-Pole Interchangeable Trip

Continuous Ampere Rating at 40°C	Magnetic Trip Setting, Amperes ④		Complete Breaker Includes Pressure Type Copper Terminals ⑤			Shipped as Frame, Trip Unit and Terminals ⑥			Trip Unit Only Standard Saf-T-Vue, MARK 75 Catalog Number	
	Low	High	Standard Catalog Number	Saf-T-Vue Catalog Number	MARK 75 Catalog Number	Frame Only Standard Catalog Number	Saf-T-Vue Catalog Number	MARK 75 Catalog Number		
Two-Pole, 600 Vac, 250V DC ③⑥										
700	3000	6000	NB2700	NB2700S	HNB2700	NB21200F	NB21200FS	HNB21200F	HNB2700T	
800	3000	6000	NB2800	NB2800S	HNB2800	NB21200F	NB21200FS	HNB21200F	HNB2800T	
900	4000	8000	NB2900	NB2900S	HNB2900	NB21200F	NB21200FS	HNB21200F	HNB2900T	
1000	4000	8000	NB21000	NB21000S	HNB21000	NB21200F	NB21200FS	HNB21200F	HNB21000T	
1200	4000	8000	NB21200	NB21200S	HNB21200	NB21200F	NB21200FS	HNB21200F	HNB21200T	
600	3000	6000							HNB31200F	HNB3600T
					Approx. shipping weight 43 lbs		Approx. shipping weight 29 lbs		Approx. shipping weight 3.5 lbs	
Three-Pole, 600 Vac Only										
700	3000	6000	NB3700	NB3700S	HNB3700	NB31200F	NB31200FS	HNB31200F	HNB3700T	
800	3000	6000	NB3800	NB3800S	HNB3800	NB31200F	NB31200FS	HNB31200F	HNB3800T	
900	4000	8000	NB3900	NB3900S	HNB3900	NB31200F	NB31200FS	HNB31200F	HNB3900T	
1000	4000	8000	NB31000	NB31000S	HNB31000	NB31200F	NB31200FS	HNB31200F	HNB31000T	
1200	4000	8000	NB31200	NB31200S	HNB31200	NB31200F	NB31200FS	HNB31200F	HNB31200T	
					Approx. shipping weight 51 lbs		Approx. shipping weight 32 lbs		Approx. shipping weight 4 lbs	

Magnetic Only Breakers, Front Adjustable ⑦⑧

Continuous Ampere Rating	Magnetic Trip Range ④		Trip Unit Only	
	Low	High	Two-Pole ⑥ Catalog Number	Three-Pole Catalog Number
1200	3000	6000	HNB26000TM	HNB36000TM
1200	4000	8000	HNB28000TM	HNB38000TM
1200	5000	10000	HNB210000TM	HNB310000TM
1200	6000	12000	HNB212000TM	HNB312000TM

Notes

- ① These frames are obsolete. For replacement solutions, see the cross-reference on **Pages V12-T3-114–V12-T3-167**.
- ② Higher frequency calibration not available. Minimum of 50 Hz calibration available on special order.
- ③ 250 Vdc rating applied only to magnetic only type breakers.
- ④ Set on high side, adjustable to lower limits.
- ⑤ Terminals shipped separately from breaker.
- ⑥ Two-pole breakers supplied in three-pole frames with current carrying parts omitted from center pole.
- ⑦ Frames, terminals, studs, mounting hardware, dimensions and shipping weights are same as standard thermal-magnetic breakers.
- ⑧ Not UL Listed.

UL Listed Interrupting Ratings

Maximum Volts	Amperes
Standard Breakers	
240 AC	50,000 asymmetrical, 42,000 symmetrical
480 AC	35,000 asymmetrical, 30,000 symmetrical
600 AC	25,000 asymmetrical, 22,000 symmetrical
250 DC ^{①②}	20,000 ^③
MARK 75 Breakers	
240 AC	75,000 asymmetrical, 65,000 symmetrical
480 AC	40,000 asymmetrical, 35,000 symmetrical
600 AC	30,000 asymmetrical, 25,000 symmetrical
250 DC ^{①②}	20,000 ^③

Terminals ^④

Maximum Amperes	Number of Cables, Wire Range, Type,	Catalog Number
Standard Al/Cu Pressure Terminals		
1000	(3) 3/0–400 kcmil Al/Cu	TA1000NB1
1200	(4) 4/0–500 kcmil Al/Cu	TA1200NB1
Optional Copper or Al/Cu Pressure Terminals		
1000	(3) 3/0–500 kcmil Cu	T1000NB1
1200	(4) 3/0–400 kcmil Cu	T1200NB1
1200	(3) 500–750 kcmil Al/Cu	TA1201NB1

Accessories and Modifications

■ Shaded area denotes obsolete or discontinued products and services.

Special Calibrations

Special calibration price additions apply to ampere ratings not listed as standard or for ambients other than 40°C or 50°C. For frequencies other than 0–60 Hz AC (50 Hz AC minimum, 60 Hz AC maximum for ratings of 700A and above), refer to Eaton. See Application Data 29-160 for additional information regarding special conditions. Maximum 400 Hz calibration for type MA is 475A.

Note: Not UL Listed.

50°C Calibration

Add suffix “V” to catalog number for complete breaker or trip unit only, when ordering breakers to be used in 50°C ambients. **For CSA, see Page V12-T3-48.**

Note: Not UL Listed.

Type NB breakers meet requirements for Class 21a circuit breakers, and Type HNB meet requirements for Class 23a, as defined by Federal Specification W-C-375b.

For all three-phase delta, grounded B phase applications, contact Avery Creek, NC, Technical Resource Center at **1-800-356-1243**.

Terminals

Two terminals are required per pole.

Terminals are UL Listed for wire type and range listed below. When used with aluminum conductors, use joint compound. To order optional copper terminals, add suffix “C” to complete breaker catalog number.

Note: Frames, terminals, studs, mounting hardware, dimensions and shipping weights are same as standard thermal magnetic breakers.

Magnetic Only Breakers

To order a complete breaker, select trip unit, plus frame and terminals.

Note: Not UL Listed.

Additional Accessories and Modifications

Refer to **Pages V12-T3-65–V12-T3-79**.

Notes

- ① 250 Vdc rating applied only to magnetic only type breakers.
- ② Terminals shipped separately from breaker.
- ③ Ratings above 10,000A not UL Listed.
- ④ MARK 75 frame color changed from gray to black in mid-2002.

Type NBY

Shaded area denotes obsolete or discontinued products and services. ①

NBY: 240 Vac

Type NBY 700–1200A, 240V, 60 Hz AC ②, Three-Pole, Interchangeable Trip



Continuous Ampere Rating at 40°C	Magnetic Trip Setting Amperes ③		Complete Breaker Includes Pressure Type Aluminum Terminals ④ Catalog Number	Shipped as Frame, Trip Unit and Terminals ④	
	Low	High		Frame Only Catalog Number	Trip Unit Only Catalog Number
Three-Pole, 600 Vac Only					
700	3000	6000	NBY3700	NBY31200F	HNB3700T
800	3000	6000	NBY3800	NBY31200F	HNB3800T
900	4000	8000	NBY3900	NBY31200F	HNB3900T
1200	4000	8000	NBY31200	NBY31200F	HNB31200T

UL Listed Interrupting Ratings

Maximum Volts	Amperes
240 AC	115,000 asymmetrical, 100,000 symmetrical

For all three-phase delta, grounded B phase applications, contact Avery Creek, NC, Technical Resource Center at **1-800-356-1243**.

Terminals

Two terminals are required per pole.

Terminals are UL Listed for wire type and range listed below. When used with aluminum conductors, use joint compound.

Note: Terminals shipped separately from breaker.

Terminals

Max. Amperes	Number of Cables, Wire Range, Type,	Catalog Number
Standard Al/Cu Pressure Terminals		
1000	(3) 3/0–400 kcmil Al/Cu	TA1000NB1
1200	(4) 4/0–500 kcmil Al/Cu	TA1200NB1
1200	(3) 500–750 kcmil Al/Cu	TA1201NB1
Alternate Copper Pressure Terminals		
1000	(3) 3/0–500 kcmil Cu	T1000NB1
1200	(4) 3/0–400 kcmil Cu	T1200NB1

Accessories and Modifications

Shaded area denotes obsolete or discontinued products and services.

Special Calibrations

Special calibration price additions apply to ampere ratings not listed as standard or for ambients other than 40°C or 50°C. For frequencies other than 0–60 Hz AC (50 Hz AC minimum, 60 Hz AC maximum), refer to Eaton. See Application Data 29-160 for additional information regarding special conditions.

Note: Not UL Listed.

50°C Calibration

Add suffix “V” to catalog number for complete breaker or trip unit only, when ordering for breakers to be used in 50°C ambients.

Note: Not UL Listed.

For CSA, see Page V12-T3-48.

Type NBY breakers are not defined by Federal Specification W-C-375b.

Additional Accessories and Modifications

Refer to **Pages V12-T3-65–V12-T3-79**.

Notes

- ① These frames are obsolete. For replacement solutions, see the cross-reference on **Pages V12-T3-114–V12-T3-167**.
- ② Higher frequency calibration not available. Minimum of 50 Hz calibration available on special order.
- ③ Set on high side, adjustable to lower limits.
- ④ Terminals shipped separately from breaker.

Type PB

■ Shaded area denotes obsolete or discontinued products and services. ①

Rear Connected PB
Breaker: 600 Vac



3

Type PB 600–25s00A, 600V, 60 Cycle AC ②, 250 Vdc ③, Two- and Three-Pole, Interchangeable Trip

Continuous Ampere Rating at 40°C	Magnetic Trip Setting, Amperes ④⑤		Complete Breaker Includes Busbar Connectors ⑥ Catalog Number	Shipped as Frame, Trip Unit and Rear Connectors	
	Low	High		Frame Only Catalog Number	Trip Unit Only Catalog Number
Two-Pole, 600 Vac Only ⑦					
600	1500	5000	PB2600	PB22500F	PB2600T
700	1500	5000	PB2700	PB22500F	PB2700T
800	1500	5000	PB2800	PB22500F	PB2800T
900	1500	5000	PB2900	PB22500F	PB2900T
1000	1500	5000	PB21000	PB22500F	PB21000T
1200	2000	6000	PB21200	PB22500F	PB21200T
1400	2500	7000	PB21400	PB22500F	PB21400T
1600	3000	8000	PB21600	PB22500F	PB21600T
1800	3000	8000	PB21800	PB22500F	PB21800T
2000	3000	8000	PB22000	PB22500F	PB22000T
	Approx. shipping weight		132 lbs	98 lbs	18 lbs
2500	3000	8000	PB22500	PB22500F	PB22500T
	Approx. shipping weight		144 lbs	98 lbs	18 lbs
Three-Pole, 600 Vac Only—Not UL Listed					
600	1500	5000	PB3600	PB32500F	PB3600T
700	1500	5000	PB3700	PB32500F	PB3700T
800	1500	5000	PB3800	PB32500F	PB3800T
900	1500	5000	PB3900	PB32500F	PB3900T
1000	1500	5000	PB31000	PB32500F	PB31000T
1200	2000	6000	PB31200	PB32500F	PB31200T
1400	2500	7000	PB31400	PB32500F	PB31400T
1600	3000	8000	PB31600	PB32500F	PB31600T
1800	3000	8000	PB31800	PB32500F	PB31800T
2000	3000	8000	PB32000	PB32500F	PB32000T
	Approx. shipping weight		155 lbs	108 lbs	23 lbs
2500	3000	8000	PB32500	PB32500F	PB32500T
	Approx. shipping weight		173 lbs	108 lbs	23 lbs

Notes

- ① These frames are obsolete. For replacement solutions, see the cross-reference on **Pages V12-T3-114–V12-T3-167**.
- ② Higher frequency calibration not available. Minimum of 50 Hz calibration available on special order.
- ③ Available only on magnetic only breakers.
- ④ Higher magnetic trip settings are available as special calibration. Refer to magnetic only breakers for specific trip ranges.
- ⑤ Set on high side, adjustable to lower limits.
- ⑥ Shipped separately from breaker.
- ⑦ Two-pole breakers are supplied in three-pole frames with current carrying parts omitted from center pole.

Type PBF

■ Shaded area denotes obsolete or discontinued products and services. ①

PBF Front Connected:
600 Vac



Type PBF Front-Connected 600–2000A, 600V, 60 Cycle AC ②, 250 Vdc ③, Two- and Three-Pole, Interchangeable Trip

Continuous Ampere Rating at 40°C	Magnetic Trip Setting, Amperes (Set on High Side, Adjustable to Lower Limits)		Complete Breaker Includes Busbar Connectors ④ Catalog Number	Shipped As:		Trip Unit Only Catalog Number
	Low	High		Frame Only Includes Busbar Connectors ④ Catalog Number		
Two-Pole, 600 Vac ⑤						
600	1500	5000	PBF2600	PBF22000F	PBF2600T	
700	1500	5000	PBF2700	PBF22000F	PBF2700T	
800	1500	5000	PBF2800	PBF22000F	PBF2800T	
900	1500	5000	PBF2900	PBF22000F	PBF2900T	
1000	1500	5000	PBF21000	PBF22000F	PBF21000T	
1200	2000	6000	PBF21200	PBF22000F	PBF21200T	
1400	2500	7000	PBF21400	PBF22000F	PBF21400T	
1600	3000	8000	PBF21600	PBF22000F	PBF21600T	
1800	3000	8000	PBF21800	PBF22000F	PBF21800T	
2000	3000	8000	PBF22000	PBF22000F	PBF22000T	
Three-Pole, 600 Vac—Not UL Listed						
600	1500	5000	PBF3600	PBF32000F	PBF3600T	
700	1500	5000	PBF3700	PBF32000F	PBF3700T	
800	1500	5000	PBF3800	PBF32000F	PBF3800T	
900	1500	5000	PBF3900	PBF32000F	PBF3900T	
1000	1500	5000	PBF31000	PBF32000F	PBF31000T	
1200	2000	6000	PBF31200	PBF32000F	PBF31200T	
1400	2500	7000	PBF31400	PBF32000F	PBF31400T	
1600	3000	8000	PBF31600	PBF32000F	PBF31600T	
1800	3000	8000	PBF31800	PBF32000F	PBF31800T	
2000	3000	8000	PBF32000	PBF32000F	PBF32000T	

Notes

- ① These frames are obsolete. For replacement solutions, see the cross-reference on **Pages V12-T3-114–V12-T3-167**.
- ② Higher frequency calibration not available. Minimum of 50 Hz calibration available on special order.
- ③ Available only on magnetic only breakers.
- ④ Included with frame.
- ⑤ Two-pole breakers are supplied in three-pole frames with current carrying parts omitted from center pole.

Types PB and PBF Accessories and Modifications

Shaded area denotes obsolete or discontinued products and services. ①

PB breakers are not UL Listed.

Special Breakers ② Magnetic Only, Front Adjustable ③ Trip Unit Only

Continuous Ampere Rating	Magnetic Trip Range, Amperes ④		Two-Pole ⑤ Catalog Number	Three-Pole Catalog Number
	Low	High		

For Rear-Connected Type PB Breakers

2000	1500	5000	PB25000TM	PB35000TM
2000	2000	6000	PB26000TM	PB36000TM
2000	2500	7000	PB27000TM	PB37000TM
2000	3000	8000	PB28000TM	PB38000TM
2000	3500	10,000	PB210000TM	PB310000TM
2000	4000	12,000	PB212000TM	PB312000TM
2500	4000	12,000	373D488G08	373D488G09

For Front-Connected Type PBF Breakers

2000	1500	5000	PBF25000TM	PBF35000TM
2000	2000	6000	PBF26000TM	PBF36000TM
2000	2500	7000	PBF27000TM	PBF37000TM
2000	3000	8000	PBF28000TM	PBF38000TM
2000	3500	10,000	PBF210000TM	PBF310000TM
2000	4000	12,000	PBF212000TM	PBF312000TM

Accessories and Modifications

Shaded area denotes obsolete or discontinued products and services.

Special Calibrations

Special calibration price additions apply to ampere ratings not listed as standard, or for ambients other than 40°C or 50°C. For frequencies other than 0–60 Hz AC, refer to Eaton. See Application Data 29-160 for information regarding special conditions.

Note: Not UL Listed.

50°C Calibration

Add suffix "V" to catalog number for complete breaker or trip unit only, when ordering breakers to be used in 50°C ambients.

Type PB breakers meet the requirements for Class 25a circuit breakers as defined by Federal Specification W-C-375b.

Interrupting Ratings

Maximum Volts	Amperes
240 AC ②	150,000 asymmetrical, 125,000 symmetrical
480 AC ②	115,000 asymmetrical, 100,000 symmetrical
600 AC ②	115,000 asymmetrical, 100,000 symmetrical
250 DC ②	75,000A ⑥

For all three-phase delta, grounded B phase applications, contact Avery Creek, NC, Technical Resource Center at **1-800-356-1243**.

Magnetic Only Breakers

To order a complete breaker, select trip unit, plus frame and connectors.

Note: Not UL Listed.

Busbar Connections

"T" Connector



Busbar Connections— "T" Connector (For Cu/Al Bus)

Catalog Number

BA2000PB

Two required per pole. For rear bus connection of breakers through 2000A. Accepts up to four bus bolts. May be rotated 90°.

Note: Shipped separately from breaker.

"C" Connector



"C" Connector (For Cu/Al Bus)

Breaker Amperes

2500

Catalog Number

BA2500PB

Two required per pole. For rear bus connection of 2500A breakers.

Cable Connector



Cable Connector

Catalog Number

505C706G04

Fits "T" Connector and 2000A front-connected breakers. Accepts four 400–600 kcmil copper cables.

Notes

- ① These frames are obsolete. For replacement solutions, see the cross-reference on **Pages V12-T3-114–V12-T3-167**.
- ② Not UL Listed.
- ③ Frames, connectors, dimensions and shipping weights are same as thermal-magnetic breakers.
- ④ Set on high side, adjustable to lower limits.
- ⑤ Two-pole breakers are supplied in three-pole frames with current carrying parts omitted from center pole.
- ⑥ Based on NEMA test procedure.

Types LC, LCC, LCA, LCCA, MARK 75 Types HLC, HLCC, HLCA, HLCCA SELTRONIC with Solid-State Trip Units 600 Vac, 50/60 Hz

Complete breaker requires frame and rating plug. See the table and terminals on **Page V12-T3-60**. Extra current transformer included for neutral. See accessories on **Page V12-T3-65** for remote ground fault trip indicator.

■ Shaded area denotes obsolete or discontinued products and services. ①

LCA: 600 Vac



Breakers for Standard Applications—Frame Only

Number of Poles ②	Standard (Long Delay and Short Time) Catalog Number	Short Time Only ③ Catalog Number	Long Delay, Short Time and Adjustable Short Delay Time (0.06–0.22 sec.) Catalog Number
Types LC 150 and LCA 150 (75–150A)			
2	LC2150F	LC2150FM	LCA2150F
3	LC3150F	LC3150FM	LCA3150F
MARK 75 Types HLC 150 and HLCA 150 (75–150A)			
2	HLC2150F	HLC2150FM	HLCA2150F
3	HLC3150F	HLC3150FM	HLCA3150F
Types LC 300 and LCA 300 (150–300A)			
2	LC2300F	LC2300FM	LCA2300F
3	LC3300F	LC3300FM	LCA3300F
MARK 75 Types HLC 300 and HLCA 300 (150–300A)			
2	HLC2300F	HLC2300FM	HLCA2300F
3	HLC3300F	HLC3300FM	HLCA3300F
Types LC 400 and LCA 400 (200–400A)			
2	LC2400F	LC2400FM	LCA2400F
3	LC3400F	LC3400FM	LCA3400F
MARK 75 Types HLC 400 and HLCA 400 (200–400A)			
2	HLC2400F	HLC2400FM	HLCA2400F
3	HLC3400F	HLC3400FM	HLCA3400F
Types LC 600 and LCA 600 (300–600A)			
2	LC2600F	LC2600FM	LCA2600F
3	LC3600F	LC3600FM	LCA3600F
MARK 75 Types HLC 600 and HLCA 600 (300–600A)			
2	HLC2600F	HLC2600FM	HLCA2600F
3	HLC3600F	HLC3600FM	HLCA3600F

Breakers for Applications at 100% Rating—Frame Only

Number of Poles ②	Standard (Long Delay and Short Time) Catalog Number	Short Time Only ③ Catalog Number	Long Delay, Short Time and Adjustable Short Delay Time (0.06–0.22 sec.) Catalog Number
Types LCC 600 and LCCA 600 (300–600A)			
3	LCC3600F	—	LCCA3600F
MARK 75 Types HLCC 600 and HLCCA 600 (300–600A)			
3	HLCC3600F	—	HLCCA3600F

Notes

① These frames are obsolete. For replacement solutions, see the cross-reference on **Pages V12-T3-114–V12-T3-167**.

② Two-pole breakers are supplied in three-pole frames with current carrying parts omitted from center pole.

③ UL Recognized component.

MARK 75 frame color changed from gray to black in mid-2002.

Types LCG, LCCG, LCGA, LCCGA, MARK 75 HLCG, HLCCG, HLCGA, HLCCGA SELTRONIC with Built-In Ground Fault Protection

Complete breaker requires frame and rating plug. See the table and terminals on **Page V12-T3-60**. Extra current transformer included for neutral. See accessories on **Page V12-T3-65** for remote ground fault trip indicator.

Shaded area denotes obsolete or discontinued products and services.

Note: Available without extra CT for neutral. Order by description as similar to above except without neutral CT or external CT terminal connections at same price. Note the standard ground fault unit can also be used without the neutral CT.

Note: These breakers use LC terminals. The fourth CT uses MC breaker terminals, **Page V12-T3-53**.

Shaded area denotes obsolete or discontinued products and services. ①

Breakers for Standard Application—Frame Only

Number of Poles ②	Standard (Long Delay, Short Time) and Ground Fault Trip		Long Delay, Short Time, Adjustable Short Delay Time and Ground Fault Trip	Ground Fault Characteristics	
	Catalog Number			Pickup Setting Amperes	Time Setting
Types LCG 150 and LCGA 150 (75–150A) ③					
3	LCG3150F	LCGA3150F	50–150	3.5–30 Cy	
MARK 75 Types HLCG 150 and HLCGA 150 (75–150A) ③					
3	HLCG3150F	HLCGA3150F	50–150	3.5–30 Cy	
Types LCG 300 and LCGA 300 (150–300A) ③					
3	LCG3300F	LCGA3300F	60–300	3.5–30 Cy	
MARK 75 Types HLCG 300 and HLCGA 300 (150–300A) ③					
3	HLCG3300F	HLCGA3300F	60–300	3.5–30 Cy	
Types LCG 400 and LCGA 400 (200–400A) ③					
3	LCG3400F	LCGA3400F	0–400	3.5–30 Cy	
MARK 75 Types HLCG 400 and HLCGA 400 (200–400A) ③					
3	HLCG3400F	HLCGA3400F	80–400	3.5–30 Cy	
Types LCG 600 and LCGA 600 (300–600 Amperes) ③					
3	LCG3600F	LCGA3600F	120–600	3.5–30 Cy	
MARK 75 Types HLCG 600 and HLCGA 600 (300–600A) ③					
3	HLCG3600F	HLCGA3600F	120–600	3.5–30 Cy	

Breakers for Application at 100% Rating—Frame Only

Number of Poles ②	Standard (Long Delay, Short Time) and Ground Fault Trip		Long Delay, Short Time, Adjustable Short Delay Time and Ground Fault Trip	Ground Fault Characteristics	
	Catalog Number			Pickup Setting Amperes	Time Setting
Types LCCG 600 and LCCGA 600 (300–600A) ③					
3	LCCG3600F	LCCGA3600F	120–600	3.5–30 Cy	
MARK 75 Types HLCCG 600 and HLCCGA 600 (300–600A) ③					
3	HLCCG3600F	HLCCGA3600F	120–600	3.5–30 Cy	

Notes

- ① These frames are obsolete. For replacement solutions, see the cross-reference on **Pages V12-T3-114–V12-T3-167**.
- ② Two-pole breakers supplied in three-pole frames with current carrying parts omitted from center pole.
- ③ For applications other than standard residual scheme, see Application Data 29-160.
- MARK 75 frame color changed from gray to black in mid-2002.

Types LCG, LCCG, LCGA, LCCGA, MARK 75 HLCG, HLCCG, HLCGA, HLCCGA SELTRONIC with Built-In Ground Fault Protection Accessories and Modifications

Field-Mountable Attachments ①②③④⑤

Description	Style Number
Provision to trip flux transfer shunt trip from external source 32 to 120 Vdc to 60 Hz ⑥	1371D11G22
240 to 600 Vac, 50/60 Hz ⑦	1371D11G32
Provision to trip flux transfer shunt trip from external source, plus a 1A-1B auxiliary switch 32 to 120 Vdc to 60 Hz ⑥	1371D11G15
240 to 600 Vac, 50/60 Hz ⑦	1371D11G25
Provision to trip flux transfer shunt trip from 24 Vdc source	1371D93G01
1A-1B auxiliary switch	1371D11G03
24 Vdc shunt trip and 1A-1B auxiliary switch	1371D94G08

For CSA, see Page V12-T3-48.

Type LC breakers meet requirements for Class 21a circuit breakers, and Type HLC meet requirements for Class 23a as defined by Federal Specification W-C-375b.

UL Listed Interrupting Ratings ⑧

Maximum Volts	Amperes
Standard Breakers	
240 AC	50,000 Asymmetrical, 42,000 Symmetrical
480 AC	35,000 Asymmetrical, 30,000 Symmetrical
600 AC	25,000 Asymmetrical, 22,000 Symmetrical
MARK 75 Breakers	
240 AC	75,000 Asymmetrical, 65,000 Symmetrical
480 AC	40,000 Asymmetrical, 35,000 Symmetrical
600 AC	30,000 Asymmetrical, 25,000 Symmetrical

For all three-phase delta, grounded B phase applications, contact Avery Creek, NC, Technical Resource Center at **1-800-356-1243**.

Additional Accessories and Modifications

Refer to Pages V12-T3-65–V12-T3-79.

Terminals

Note: Order separately.

Two terminals are required per pole.

Terminals are UL Listed for wire type and range listed below. When used with aluminum cable, use joint compound.

150, 300 and 400A Frames Only

Maximum Amperes	Number of Cables, Wire Range, Type	Catalog Number
Al/Cu Pressure Terminals		
225	(1) #6–350 kcmil Cu, or (1) #4–350 kcmil Al	TA225LA1
400	(1) #4–250 kcmil Al/Cu, plus (1) 3/0–600 kcmil Al/Cu	TA400LA1
Optional Copper Pressure Terminals		
225	(1) #6–350 kcmil Cu	T225LA
225	(1) #6–250 kcmil Cu	T225LBF
400	(1) #4–250 kcmil Cu, plus (1) 3/0–600 kcmil Cu	T401LA

600A Frame Only

Maximum Amperes	Number of Cables, Wire Range, Type	Catalog Number
Al/Cu Pressure Terminals		
500	(2) 250–350 kcmil Al/Cu	TA602LD
600	(2) 400–500 kcmil Al/Cu	TA603LA
600 (std.)	(2) 250–500 kcmil Al/Cu	TA600LA
Optional Copper Pressure Terminals		
600	(2) 250–500 kcmil Cu	T600LA

Notes

- ① Only one attachment may be mounted per breaker.
 - ② Contact Avery Creek, NC, Technical Resource Center for other combinations.
 - ③ Molded-case switches do not use standard SELTRONIC attachments, and should be ordered by description for factory mounting.
 - ④ Does not void listing of UL Listed breakers.
 - ⑤ Left pole mounting.
 - ⑥ Rated 48 volts minimum for ground fault applications requiring tripping at 55% of voltage.
 - ⑦ Not for use on ground fault applications.
 - ⑧ Interrupting capacities shown do not apply to molded-case switches.
- MARK 75 frame color changed from gray to black in mid-2002.

Types MC, MCC, MCA, MCCA, MARK 75 Types HMC, HMCC, HMCA, HMCCA SELTRONIC with Solid-State Trip Units 600 Vac, 50/60 Hz
 Shaded area denotes obsolete or discontinued products and services. ①

MCA: 600 Vac



Breakers for Standard Applications—Frame Only

Number of Poles ②	Standard (Long Delay and Short Time) Catalog Number	Short Time Only ③ Catalog Number	Long Delay, Short Time and Adjustable Short Delay Time (0.08–0.30 seconds) Catalog Number
Types MC and MCA (400–800A)			
2	MC2800F	MC2800FM	MCA2800F
3	MC3800F	MC3800FM	MCA3800F
MARK 75 Types HMC and HMCA (400–800A)			
2	HMC2800F	HMC2800FM	HMCA2800F
3	HMC3800F	HMC3800FM	HMCA3800F

Breakers for Application at 100% Rating—Frame Only ①

Number of Poles ②	Standard (Long Delay and Short Time) Catalog Number	Short Time Only ③ Catalog Number	Long Delay, Short Time and Adjustable Short Delay Time (0.08–0.30 seconds) Catalog Number
Types MCC and MCCA (400–800A)			
3	MCC3800F	—	MCCA3800F
MARK 75 Types HMCC and HMCCA (400–800A)			
3	HMCC3800F	—	HMCCA3800F

Notes

① These frames are obsolete. Effective 2/1/02, only the MARK 75 version is available. For replacement solutions, see the cross-reference on **Pages V12-T3-114–V12-T3-167**.

② Two-pole breakers are supplied in three-pole frames with current-carrying parts omitted from center pole.

③ UL Recognized component.

Type MC800 molded-case switch; refer to **Page V12-T3-62**. MARK 75 frame color changed from gray to black in mid-2002.

Types MCG, MCCG, MCGA, MCCGA and MARK 75 Types HMCG, HMCCG, HMCGA, HMCCGA SELTRONIC with Built-In Ground Fault Protection

Complete breaker requires frame and rating plug. See the table and terminals on **Page V12-T3-60**. Extra current transformer included for neutral. See accessories on **Page V12-T3-65** for remote ground fault trip indicator.

■ Shaded area denotes obsolete or discontinued products and services. ①

Note: Available without extra CT for neutral. Order by description as similar to above except without neutral CT or external CT terminal connections at same price.

Note: Order two of the desired terminals for each pole of the breaker and two for the neutral CT. The standard ground fault unit can also be used without the neutral CT. MARK 75 frame color changed from gray to black in mid-2002.

Breakers for Standard Applications—Frame Only

Number of Poles	Standard (Long Delay, Short Time and Ground Fault Trip)	Long Delay, Short Time, Adjustable Short Delay Time and Ground Fault Trip	Ground Fault Characteristics	Pickup Setting Amperes	Time Setting
	Catalog Number	Catalog Number			
Types MCG and MCGA (400–800A) ②					
3	MCG3800F	MCGA3800F	80–800		3.5–30 Cy
MARK 75 Types HMCG and HMCGA (400–800A) ②					
3	HMCG3800F	HMCGA3800F	80–800		3.5–30 Cy

Breakers for Application at 100% Rating—Frame Only

Number of Poles	Standard (Long Delay, Short Time and Ground Fault Trip)	Long Delay, Short Time, Adjustable Short Delay Time and Ground Fault Trip	Ground Fault Characteristics	Pickup Setting Amperes	Time Setting
	Catalog Number	Catalog Number			
Types MCCG and MCCGA (400–800A) ②					
3	MCCG3800F	MCCGA3800F	80–800		3.5–30 Cy
MARK 75 Types HMCCG and HMCCGA (400–800A) ②					
3	HMCCG3800F	HMCCGA3800F	80–800		3.5–30 Cy

Accessories and Modifications

Field-Mountable Attachments ③④⑤⑥

Description	Style Number
Provision to trip flux transfer shunt trip from external source 32 to 120 Vdc to 60 Hz ⑦	1371D72G22
240 to 600 Vac, 50/60 Hz ⑧	1371D72G32
Provision to trip flux transfer shunt trip from external source, plus 1a-1b auxiliary switch 32 to 120 Vdc to 60 Hz ⑦	1371D72G15
240 to 600 Vac, 50/60 Hz ⑧	1371D72G25
Provision to trip flux transfer shunt trip from external 24 Vdc source	1370D85G01
1A-1B auxiliary switch	1371D72G03

Additional Accessories and Modifications

Refer to **Pages V12-T3-65–V12-T3-79**.

Rating Plugs

Select from the table on **Page V12-T3-60**.

For CSA, see **Page V12-T3-48**.

Type MC SELTRONIC breakers meet requirements for Class 21a, and MARK 75. Type HMC meet Class 23a as defined by Federal Spec. W-C-375b.

UL Listed Interrupting Capacity, rms Symmetrical Amperes ⑨

Breaker	AC Volts		
	240	480	600
MC, MCG	42,000	30,000	22,000
HMC, HMCG	65,000	50,000	25,000

Terminals

Terminals—Two Terminals Required Per Pole

Maximum Amperes	Number of Cables, Wire Range, Type	Catalog Number
Al/Cu Pressure Terminals		
600	(2) #1–500 kcmil	TA700MA1 ⑩
800 (std.)	(3) 3/0–400 kcmil	TA800MA2 ⑩
800	(2) 500–750 kcmil	TA801MA ⑩
Optional Copper Pressure Terminals		
600	(2) 2/0–500 kcmil	T600MA1
800	(3) 3/0–300 kcmil	T800MA1

Notes

- ① These frames are obsolete. Effective 2/1/02, only the MARK 75 version is available. For replacement solutions, see the cross-reference on **Pages V12-T3-114–V12-T3-167**.
- ② For applications other than standard residual scheme, see Application Data 29-160.
- ③ Does not void listing of UL Listed breakers.
- ④ Only one of the attachments may be mounted per breaker.
- ⑤ For other possible combinations, refer to factory.
- ⑥ Molded-case switches do not use standard SELTRONIC attachments and should be ordered by description.
- ⑦ Rated 48V minimum for ground fault applications requiring tripping at 55% of voltage.
- ⑧ Not for ground fault applications.
- ⑨ Interrupting capacities shown do not apply to molded-case switches.
- ⑩ Type Al/Cu pressure terminal.

Also used on breakers with ground fault and on separately mounted neutral current transformers. MARK 75 frame color changed from gray to black in mid-2002.

Types NC, NCA, NCG, NCGA, MARK 75 Type HNC, HNCA, HNCG, HNCGA SELTRONIC with Solid-State Trip Units, 600 Vac

Complete breaker requires frame and rating plug. See the table and terminals on **Page V12-T3-60**. Extra current transformer included for neutral. See accessories on **Page V12-T3-65** for remote ground fault trip indicator.

Shaded area denotes obsolete or discontinued products and services. ①

3

NC: 600 Vac



Type NC, NCA, MARK 75 Type HNC, HNCA SELTRONIC with Solid-State Trip Units, 600 Vac—Frame Only ②

Number of Poles ③	Standard (Long Delay and Short Time) Catalog Number	Short Time Only ④ Catalog Number	Long Delay, Short Time and Adjustable Short Delay Time (0.08–0.30 Seconds) Catalog Number
Types NC and NCA (800–1200A)			
2	NC21200F	NC21200FM	NCA21200F
3	NC31200F	NC31200FM	NCA31200F
Mark 75 Types HNC and HNCA (800–1200A)			
2	HNC21200F	HNC21200FM	HNCA21200F
3	HNC31200F	HNC31200FM	HNCA31200F

Types NCG, NCGA, and MARK 75 Types HNCG, HNCGA SELTRONIC with Built-In Ground Fault Protection

Complete breaker requires frame and rating plug. See the table and terminals on **Page V12-T3-60**. Extra current transformer included for neutral. See accessories on **Page V12-T3-65** for remote ground fault trip indicator.

Note: The standard ground fault unit above can also be used without the neutral CT. Order two of the desired terminals for each pole of the breaker and two for the neutral CT.

Types NCG, NCGA and MARK 75 Type HNCG, HNCGA SELTRONIC with Built-In Ground Fault Protection—Frame Only

Number of Poles	Standard (Long Delay, Short Time and Ground Fault Trip) Catalog Number	Long Delay, Short Time, Adjustable Short Delay Time, and Ground Fault Trip Catalog Number	Ground Fault Characteristics	
			Pickup Setting Amperes	Time Setting
Types NCG and NCGA (800–1200A) ⑤				
3	NCG31200F	NCGA31200F	120–1200	3.5–30 Cy
MARK 75 Types HNCG and HNCGA (800–1200A) ⑤				
3	HNCG31200F	HNCGA31200F	120–1200	3.5–30 Cy

Notes

① These frames are obsolete. Effective 2/1/02, only the MARK 75 version is available. For replacement solutions, see the cross-reference on **Pages V12-T3-114–V12-T3-167**.

② Complete breaker requires frame and rating plug. See the table on **Page V12-T3-60**. For terminals, see the table on **Page V12-T3-55**.

③ Two-pole breakers are supplied in three-pole frames with current-carrying parts omitted from center pole.

④ UL Recognized component.

⑤ For applications other than standard residual scheme, see Application Data 29-160.

Type NC 1200A molded-case switch; refer to **Page V12-T3-62**. MARK 75 frame color changed from gray to black in mid-2002.

Types NC, NCA, NCG, NCGA, MARK 75 Type HNC, HNCA, HNCG, HNCGA SELTRONIC with Solid-State Trip Units, 600 Vac Accessories and Modifications

Field-Mountable Attachments—Left Handed ^{①②③④⑤}

Description	Style Number
Provision to trip flux transfer shunt trip from external source 32 to 120 Vdc to 60 Hz ^⑥	1372D39G13
240 to 600 Vac, 50/60 Hz ^⑦	1372D39G23
Provision to trip flux transfer shunt trip from external source, plus a 1A-1B auxiliary switch 32 to 120 Vdc to 60 Hz ^⑥	1372D39G16
240 to 600 Vac, 50/60 Hz ^⑦	1372D39G26
Provision to trip flux transfer shunt trip from external 24 Vdc source	1371D94G05
1A-1B auxiliary switch	1371D39G03
24 Vdc shunt trip and 1A-1B auxiliary switch	1371D94G08

For CSA, see Page V12-T3-48.

Type NC SELTRONIC breakers meet requirements for Class 21a, and MARK 75. Type HNC meet Class 23a as defined by Federal Spec. W-C-375b.

UL Listed Interrupting Capacity, rms Symmetrical Amperes ^⑧

Breaker	AC Volts		
	240	480	600
NC, NCG	42,000	30,000	22,000
HNC, HNCG	65,000	50,000	25,000

Rating Plugs

Select from the table on Page V12-T3-60.

Terminals

Note: Two terminals required per pole.

Terminals ^⑨

Maximum Amperes	Number of Cables, Wire Range, Type	Catalog Number
Al/Cu Pressure Terminals		
1000	(3) 3/0–400 kcmil	TA1000NB1 ^⑩
1200 (std.)	(4) 4/0–500 kcmil	TA1200NB1 ^⑩
1200	(3) 500–750 kcmil	TA1201NB1 ^⑩
Optional Copper Pressure Terminals		
1000	(3) 3/0–500 kcmil	T1000NB1
1200	(4) 3/0–400 kcmil	T1200NB1

Additional Accessories and Modifications

Refer to Pages V12-T3-65–V12-T3-79.

Note: MARK 75 frame color changed from gray to black in mid-2002.

Notes

- ① For other possible combinations, refer to factory.
- ② Molded-case switches do not use standard SELTRONIC attachments and should be ordered by description.
- ③ Does not void listing of UL Listed breakers.
- ④ Only one of the attachments may be mounted per breaker.
- ⑤ Left pole mounting.
- ⑥ Rated 48V minimum for ground fault applications requiring tripping at 55% of voltage.
- ⑦ Not for ground fault applications.
- ⑧ Interrupting capacities shown do not apply to molded-case switches.
- ⑨ Also used on breakers with ground fault and on separately mounted neutral current transformers.
- ⑩ Type Al/Cu pressure terminal.

Types PC, PCA, PCC, PCCA 2000, 2500 and 3000A SELTRONIC with Solid-State Trip Units, 600 Vac, 50/60 Hz

Complete breaker requires frame and rating plug. See the table on **Page V12-T3-60** and rear connectors (connectors are included in 3000A and all front-connected frames.) Suitable for reverse-feed applications.

Shaded area denotes obsolete or discontinued products and services. ①

3

PC: 600 Vac

**Breakers for Standard Applications—Frame Only**

Number of Poles ②	Standard (Long Delay and Short Time) Catalog Number	Short Time Only ③ Catalog Number	Long Delay, Short Time Trip, and Adjustable Short Delay Time (0.08–0.30 seconds) Catalog Number
Type PC 2000, 1000 to 2000A ④ Rear-Connected Breakers		Type PCA 2000 ④ Rear-Connected Breakers	
2	PC22000F	PC22000FM	PCA22000F
3	PC32000F	PC32000FM	PCA32000F
Front-Connected Breakers		Front-Connected Breakers	
2	PCF22000F	PCF22000FM	PCFA22000F
3	PCF32000F	PCF32000FM	PCFA32000F
Type PC 2500, 1400 to 2500A ④ Rear-Connected Breakers		Type PCA 2500 ④ Rear-Connected Breakers	
2	PC22500F	PC22500FM	PCA22500F
3	PC32500F	PC32500FM	PCA32500F
Front-Connected Breakers		Front-Connected Breakers	
2	PCF22500F	PCF22500FM	PCFA22500F
3	PCF32500F	PCF32500FM	PCFA32500F
Type PC 3000, 1600 to 3000A ④		Type PCA 3000 ④	
2	PC23000F	PC23000FM	PCA23000F
3	PC33000F	PC33000FM	PCA33000F

Breakers for Standard Application at 100% Rating—Frame Only

Number of Poles ②	Standard (Long Delay and Short Time) Catalog Number	Short Time Only ③ Catalog Number	Long Delay, Short Time Trip, and Adjustable Short Delay Time (0.08–0.30 seconds) Catalog Number
Type PCC 2000, 1000 to 2000A ⑤—Rear-Connected Breakers			
2	PCC22000F	PCC22000FM	PCCA22000F
3	PCC32000F	PCC32000FM	PCCA32000F
Front Connected Breakers			
2	PCCF22000F	PCCF22000FM	PCCFA22000F
3	PCCF32000F	PCCF32000FM	PCCFA32000F
Type PCC 2500, 1400 to 2500A ⑤—Rear-Connected Breakers			
2	PCC22500F	PCC22500FM	PCCA22500F
3	PCC32500F	PCC32500FM	PCCA32500F
Front-Connected Breakers			
2	PCCF22500F	PCCF22500FM	PCCFA22500F
3	PCCF32500F	PCCF32500FM	PCCFA32500F
Type PC 3000, 1600 to 3000A ⑤			
2	PCC23000F	PCC23000FM	PCCA23000F
3	PCC33000F	PCC33000FM	PCCA33000F

Notes

- ① These frames are obsolete. For replacement solutions, see the cross-reference on **Pages V12-T3-114–V12-T3-167**.
- ② Two-pole breakers are supplied in three-pole frames with current carrying parts omitted from center pole.
- ③ UL Recognized component.
- ④ UL Listed for standard applications.
- ⑤ These breakers are UL Listed for application at 100% of rating per NEC exceptions when used in a properly ventilated and listed enclosure.

Accessories and Modifications

Drawout Mounting Breakers, Three-Pole Only

Breaker frame and complete drawout frame with safety tripping interlock.

Order by description. Secondary contacts supplied as required at no extra charge. Order required rating plug separately. Refer to **Page V12-T3-79**.

Note: Includes breakers without adjustable short delay time.

Rating Plugs

Select from the table on **Page V12-T3-60**.

Stationary portion of drawout frame only for future breaker installations, three-pole only. Refer to **Page V12-T3-79**.

Special Type PCC Breakers for SCR Power Supplies

These drawout mounting breakers are designed with a 2 to 4 times magnetic trip adjustment and special time delay trip characteristics to provide maximum protection and coordination with SCR power supplies on offshore drilling rigs. Suitable for application at 100% of rating.

Order by description. Secondary contacts supplied as required. Order standard rating plugs separately.

Availability: PCC2000, PCC2500 drawout-mounting breakers.

Type PC and PCC meet requirements of Class 25a as defined in Federal Spec. W-C-375b.

For CSA, see Page V12-T3-48.

UL Listed Interrupting Capacity rms Symmetrical Amperes (Standard and Ground Fault Breakers) ^①

Breaker	AC Volts		
	240	480	600
PC, PCC	125,000	100,000	100,000

Note

^① Interrupting capacities shown do not apply to molded-case switches.

Additional Accessories and Modifications

Refer to **Pages V12-T3-65–V12-T3-79**.

Types PCG, PCGA, PCCG, PCCGA SELTRONIC with Built-In Ground Fault Protection Includes Extra Current Transformer for Neutral (Optional Remote Ground Fault Trip Indicator Kit, Page V12-T3-65)

Complete breaker requires frame and rating plug. See the table on **Page V12-T3-60** and rear connectors (except front-connected frames and 3000A frames include connectors).

Shaded area denotes obsolete or discontinued products and services.

Note: Available without extra CT for neutral. Order by description as similar to above except without neutral CT or external CT terminal connections at same price. Older catalog numbers: PCFGX—"X" means without fourth CT.

Note: The standard ground fault unit listed can also be used without the neutral CT.

Breakers for Standard Application—Frame Only

Number of Poles	Standard (Long Delay, Short Time and Ground Fault Trip) Catalog Number	Long Delay, Short Time, Ground Fault Trip, and Adjustable Short Delay Time (0.08–0.30 Seconds) Catalog Number	Ground Fault Characteristics	
			Pickup Setting	Time Setting
Type PCG 2000 ①②—Rear-Connected Breakers				
3	PCG32000F	PCGA32000F	200–1200	3.5–30 cycles
Front-Connected Breakers				
3	PCFG32000F	PCFGA32000F	200–1200	3.5–30 cycles
Type PCG 2500 ①②—Rear-Connected Breakers				
3	PCG32500F	PCGA32500F	240–1200	3.5–30 cycles
Front-Connected Breakers				
3	PCFG32500F	PCFGA32500F	240–1200	3.5–30 cycles
Type PCG 3000 ①②				
3	PCG33000F	PCGA33000F	300–1200	3.5–30 cycles

Breakers for Application at 100% Rating—Frame Only

Number of Poles	Standard (Long Delay, Short Time and Ground Fault Trip) Catalog Number	Long Delay, Short Time, Ground Fault Trip, and Adjustable Short Delay Time (0.08–0.30 Seconds) Catalog Number	Ground Fault Characteristics	
			Pickup Setting	Time Setting
Type PCCG 2000 ③—Rear-Connected Breakers				
3	PCCG32000F	PCCGA32000F	200–1200	3.5–30 cycles
Front-Connected Breakers				
3	PCCFG32000F	PCCFGA32000F	200–1200	3.5–30 cycles
Type PCCG 2500 ③—Rear-Connected Breakers				
3	PCCG32500F	PCCGA32500F	240–1200	3.5–30 cycles
Front-Connected Breakers				
3	PCCFG32500F	PCCFGA32500F	240–1200	3.5–30 cycles
Type PCCG 3000 ③				
3	PCCG33000F	PCCGA33000F	300–1200	3.5–30 cycles

Notes

- ① UL Listed for standard applications.
- ② For application other than standard residual schemes, refer to Application Data 29-160.
- ③ These breakers are UL Listed for application at 100% of rating per NEC exceptions when used in a properly ventilated and listed enclosure.

Types PCG, PCGA, PCCG, PCCGA SELTRONIC with Built-In Ground Fault Protection Accessories and Modifications

PC breakers are not UL Listed.

Field-Mountable Attachments ^{①②③}

Description	Style Number
Provision to trip flux transfer shunt trip from external source 32 to 120 Vdc to 60 Hz ^④	1372D35G22
240 to 600 Vac, 50/60 Hz ^⑤	1372D35G32
Provision to trip flux transfer shunt trip from external source plus 1A-1B auxiliary switch 32 to 120 Vdc to 60 Hz ^④	1372D35G15
240 to 600 Vac, 50/60 Hz ^⑤	1372D35G25
2A-2B auxiliary switch	1372D35G18
Provision to trip flux transfer shunt trip from external 24 Vdc source	1371D95G01
1A-1B auxiliary switch	1372D35G03
1A-1B auxiliary switch and 24 Vdc shunt trip	1371D95G04
2A-2B auxiliary switch and 24 Vdc shunt trip	1371D95G07
3A-3B auxiliary switch and 24 Vdc shunt trip	1371D95G10

Rear Bus Connectors

Two required per pole. Fixed mounting breakers.

Rear Bus Connectors

Breaker Frame ^⑥	Connector Style/Catalog Number
PC2000 ^⑦ , PCC2000 ^⑦	BA2000PB
PC2500 ^⑦ , PCC2500 ^⑦	BA2500PB
PC3000, PCC3000	Included in frame

Racking Crank for Drawout Frames

To engage or withdraw the moving portion of the drawout. A standard 0.50-inch hex socket with extension can be used for this purpose.

Racking Crank

Style Number

765A767G01

Cell Switches Mounted on Drawout Frames, All Ratings

A maximum of four switches can be provided. Order by description. Each switch provides a NO and NC contact that transfers before reaching the test position when being withdrawn, and after the test position when being racked in.

Approximate Shipping Weights, PC and PCC Breakers (Three-Pole)

Rating	Breaker			
	PC, PCC	PCF, PCCF	PCG, PCCG	PCFG, PCCFG
2000	136 lbs	163 lbs	160 lbs	185 lbs
2500	145 lbs	175 lbs	170 lbs	200 lbs
3000	220 lbs	—	245 lbs	—

Busbar Connections

"T" Connector



Busbar Connections— "T" Connector (For Cu/Al Bus)

Catalog Number

BA2000PB

Two required per pole. For rear bus connection of breakers through 2000A. Accepts up to four bus bolts. May be rotated 90°.

Note: Shipped separately from breaker.

"C" Connector



"C" Connector (For Cu/Al Bus)

Breaker Amperes

2500

Catalog Number

BA2500PB

Two required per pole. For rear bus connection of 2500A breakers.

Cable Connector



Cable Connector

Catalog Number

505C706G04

Fits "T" Connector and 2000A front-connected breakers. Accepts four 400–600 kcmil copper cables.

Notes

- ① For other possible combinations, contact your local Eaton Field Sales office.
- ② Only one of these attachments may be mounted per breaker.
- ③ Left pole mounting.
- ④ Rated 48V minimum for ground fault applications.
- ⑤ Not for ground fault applications.
- ⑥ Also apply to equivalent ratings of PCG and PCCG ground fault breakers.
- ⑦ Not required for front-connected frames.

SELTRONIC Rating Plug Selection Data

Rating plugs listed below are for both standard breakers and breakers with built-in ground fault protection.

Rating Plug Selection Data

Rating Plugs Only (For Two- or Three-Pole Frames)

Continuous Ampere Rating ^①	Magnetic Trip Setting, Amperes		Fixed Rating Plugs Catalog Number	Adjustable Rating Plugs ^{②③} Catalog Number
	Low	High		
For 150A Frames: LC, LCA, LCG, LCGA, HLC, HLCA, HLCG, HLCGA				
75	225	750	1LC75	—
90	270	900	1LC90	—
100	300	1000	1LC100	A1LC100 ^④
125	375	1250	1LC125	A1LC125
150	450	1500	1LC150	A1LC150 ^⑤
For 300A Frames: LC, LCA, LCG, LCGA, HLC, HLCA, HLCA, HLCG, HLCGA				
150	450	1500	3LC150	—
175	525	1750	3LC175	—
200	600	2000	3LC200	—
225	675	2250	3LC225	A3LC225
250	750	2500	3LC250	A3LC250
275	825	2750	3LC275	A3LC275
300	900	3000	3LC300	A3LC300 ^⑤
For 400A Frames: LC, LCA, LCG, LCGA, HLC, HLCA, HLCG, HLCGA				
200	600	2000	4LC200	—
225	675	2250	4LC225	—
250	750	2500	4LC250	—
300	900	3000	4LC300	A4LC300
350	1050	3500	4LC350	A4LC350
400	1200	4000	4LC400	A4LC400 ^⑤
For 600A Frames: LC, LCA, LCG, LCGA, HLC, HLCA, HLCG, HLCGA, LCC, LCCA, HLCC, HLCCA, LCCG, LCCGA, HLCCG, HLCCGA				
300	900	3000	6LC300	—
350	1050	3500	6LC350	—
400	1200	4000	6LC400	A6LC400 ^④
450	1350	4500	6LC450	A6LC450
500	1500	5000	6LC500	A6LC500
600	1800	6000	6LC600	A6LC600 ^⑤
For 800A Frames: MC, MCA, MCG, MCGA, HMC, HMCA, HMC, HMCG, HMCGA, MCC, MCCA, HMCC, HMCCA, MCCG, MCCGA, HMCCG, HMCCGA, MDS				
400	1200	4000	8MC400	—
500	1500	5000	8MC500	A8MC500 ^⑤
600	1800	6000	8MC600	A8MC600
700	2100	7000	8MC700	A8MC700
800	2400	8000	8MC800	A8MC800 ^⑤

Rating Plugs Only (For Two- or Three-Pole Frames)

Continuous Ampere Rating ^①	Magnetic Trip Setting, Amperes		Fixed Rating Plugs Catalog Number	Adjustable Rating Plugs ^{②③} Catalog Number
	Low	High		
For 1200A Frames: NC, NCA, NCG, NCGA, HNC, HNCA, HNCG, HNCGA				
800	1600	6400	12NC800	A12NC800 ^④
900	1800	7200	12NC900	A12NC900
1000	2000	8000	12NC1000	A12NC1000
1200	2400	9600	12NC1200	A12NC1200 ^⑤
For 2000A Frames: PC, PCA, PCC, PCCA, PCG, PCGA, PCCG, PCCGA				
1000	2000	8000	20PC1000	—
1200	2400	9600	20PC1200	—
1400	2800	11,200	20PC1400	—
1600	3200	12,800	20PC1600	A20PC1600
1800	3600	14,400	20PC1800	A20PC1800
2000	4000	16,000	20PC2000	A20PC2000 ^⑤
For 2500A Frames: PC, PCA, PCC, PCCA, PCG, PCGA, PCCG, PCCGA				
1400	2800	11,200	25PC1400	—
1600	3200	12,800	25PC1600	—
1800	3600	14,400	25PC1800	A25PC1800
2000	4000	16,000	25PC2000	A25PC2000
2500	5000	20,000	25PC2500	A25PC2500 ^⑤
For 3000A Frames: PC, PCA, PCC, PCCA, PCG, PCGA, PCCG, PCCGA				
1600	3200	12,800	30PC1600	—
1800	3600	14,400	30PC1800	—
2000	4000	16,000	30PC2000	—
2500	5000	20,000	30PC2500	A30PC2500
3000	6000	24,000	30PC3000	A30PC3000 ^⑤

Notes

- ① Ampere rating when used in short time only frames:
 LC-150: 150A MC-800: 800A PC-3000: 3000A
 LC-300: 300A NC-1200: 1200A LCL-250: 250A
 LC-400: 400A PC-2000: 2000A LCL-400: 400A
 LC-600: 600A PC-2500: 2500A
- ② Magnetic trip range of adjustable rating plugs:
 LC, HLC, MC, HMC: 3 to 10 times ampere setting
 NC, HNC, PC, PCC, LCL-400: 2 to 8 times ampere setting
 LCL-250: 3 to 9 times ampere setting
- ③ Adjustable 70 to 100% except as noted.
- ④ Adjustable 75 to 100%.
- ⑤ Adjustable 50 to 100%.
- ⑥ Adjustable 80 to 100%.

Contact Avery Creek, NC, Technical Resource Center for old style (three prong) ground fault rating plugs.

Molded-Case Switches

Molded-case switches are UL Listed devices and are available only as high magnetic trip type with fixed trip setting.

■ Shaded area denotes obsolete or discontinued products and services. ^①

Molded-Case Switches with High Magnetic Trip (Fixed Trip Setting)

Number of Poles	Maximum Volts	Maximum Amperes	Switch Catalog Number ^{②③}
2	240	400	DA2400WK
3	240	400	DA3400WK
1	120	100	EB1100LK
2	240	100	EB2100LK
3	240	100	EB3100LK
3	240	100	EB3100SLK
1	277	100	EHB1100LK
2	480	100	EHB2100LK
3	480	100	EHB3100LK
3	480	100	EHB3100SLK
2	600	100	FB2100LK
2	600	150	FB2150LK
3	600	100	FB3100LK
3	600	150	FB3150LK
3	600	150	FB3150SLK
4	277/480	100	FB4100LK
4	277/480	150	FB4150LK
2	600	225	JA2225WK
2	600	225	JA2225WSK
3	600	225	JA3225WK
3	600	225	JA3225WSK
2	600	250	JB2250WK
2	600	250	JB2250WSK
3	600	250	JB3250WK
3	600	250	JB3250WSK
2	600	225	KA2225WK
2	600	225	KA2225WSK
3	600	225	KA3225WK
3	600	225	KA3225WSK
2	600	250	KB2250WK
2	600	250	KB2250WSK
3	600	250	KB3250WK
3	600	250	KB3250WSK
2	600	400	LB2400WK
2	600	400	LB2400WSK
3	600	400	LB3400WK
3	600	400	LB3400WSK
2	600	400	LBB2400WK
2	600	400	LBB2400WSK
3	600	400	LBB3400WK
3	600	400	LBB3400WSK

Molded-Case Switch Terminal Data

MCS Type	Maximum Switch Amperes	Wire Type	Number of Wires	Wire Range	Terminal Type or Catalog Number
Standard Terminals					
DA, LB, LBB	400	Cu only	2	3/0–250 kcmil	T400DA2
EB, EHB, FB	100	Cu	1	#14–1/0	Pressure
FB	150	Cu/Al	1	#4–4/0	Pressure
JA, KA	225	Cu/Al	1	#4–350 kcmil	TA225LA1
JB, KB	250	Cu/Al	1	#4–350 kcmil	TA250KB
Optional Terminals					
DA, LB, LBB	400	—	—	—	—
EB, EHB, FB	100	Cu/Al	1	#4–4/0	Pressure
FB	150	—	—	—	—
JA, KA	225	Cu	1	#6–350 kcmil	T225LA
JB, KB	250	Cu	1	#4–350 kcmil	T250KB

Molded-Case Switches with High Magnetic Trip—Trip Setting and Tolerance

Frame	Rating	Trip Setting (Amperes)	Tolerance (%)
EB	100	1000	±20
EHB/FB	100	1200	±20
FB	150	1500	±20
DA/LB/LBB	400	4000	+10 –0
JA/KA	225	2250	+10 –0
JB/KB	250	2500	+10 –0

Notes

- ① These frames are obsolete. For replacement solutions, see the cross-reference on **Pages V12-T3-114–V12-T3-167**.
- ② Catalog number suffix identification:
 K = Molded-case switch with high magnetic trip (fixed trip setting)
 S = Saf-T-Vue cover
 L = With line and load terminals
 W = No terminals
- ③ Molded-case switch dimensions are the same as the equivalent thermal-magnetic breaker. Refer to Dimension Sheet 29-171.

Shaded area denotes obsolete or discontinued products and services. ①

Molded-Case Switches with High Magnetic Trip (Fixed Trip Setting)

Number of Poles	Maximum Volts	Maximum Amperes	Switch Catalog Number ②③
2	240	225	CA2225KW
3	240	225	CA3225KW
2	600	400	LA2400WK
2	600	400	LA2400WSK
2	600	600	LA2600WK
2	600	600	LA2600WSK
3	600	400	LA3400WK
3	600	400	LA3400WSK
3	600	400	LA3600WK
3	600	400	LA3600WSK
2	600	400	LAB2400WK
2	600	400	LAB2400WSK
3	600	400	LAB3400WK
3	600	400	LAB3400WSK
2	600	600	LC2600WK ④
3	600	600	LC3600WK ④
2	600	600	LCC2600WK ④
3	600	600	LCC3600WK ④
2	600	800	MA2800WK
2	600	800	MA2800WSK
3	600	800	MA3800WK
3	600	800	MA3800WSK
2	600	800	MC2800WK ④
3	600	800	MC3800WK ④
2	600	800	MCC2800WK ④
3	600	800	MCC3800WK ④
2	600	1200	NB21200WK
2	600	1200	NB21200WSK
3	600	1200	NB31200WK
3	600	1200	NB31200WSK
2	600	1200	NC21200WK ④
3	600	1200	NC31200WK ④
2	600	2000	PB22000WK
2	600	2500	PB22500WK
3	600	2000	PB32000WK
3	600	2500	PB32500WK
2	600	2000	PBF22000K
3	600	2000	PBF32000K
2 ⑤	600	2000	PC22000WK
2 ⑤	600	2500	PC22500WK
2 ⑤	600	3000	PC23000K
3 ⑤	600	2000	PC32000WK
3 ⑤	600	2500	PC32500WK
3 ⑤	600	3000	PC33000K
2 ⑤	600	2000	PCC22000WK
2 ⑤	600	2500	PCC22500WK
2 ⑤	600	3000	PCC23000K
3 ⑤	600	2000	PCC32000WK
3 ⑤	600	2500	PCC32500WK
3 ⑤	600	3000	PCC33000K
2 ⑤	600	2000	PCF22000K
3 ⑤	600	2000	PCF32000K

Molded-Case Switch Terminal Data

MCS Type	Maximum Switch Amperes	Wire Range	Wire Type	Number of Wires	Terminal Type or Catalog Number
Standard Terminals (Aluminum Body)					
CA	225	#1–300 kcmil	Cu/Al	1	TA225CA2
LA400, LAB	400	#4–250 kcmil, plus 3/0–600 kcmil	Cu/Al	1	TA400LA1
LA600, LC600	600	250/500 kcmil	Cu/Al	2	TA600LA
MC, MA	800	3/0–400 kcmil	Cu/Al	3	TA800MA2
NC, NB	1200	4/0–500 kcmil	Cu/Al	4	TA1200NB1
NC, NB	1200	—	—	—	—
PC2000, PCC2000	2000	BA2000PB rear bus connector			
PC2500, PCC2500	2500	BA2500PB rear bus connector			
PC3000, PCC3000	3000	Rear bus connector included in frame			
Optional Terminals					
CA	225	—	—	—	—
LA400, LAB	400	#4–250 kcmil, plus 3/0–600 kcmil	Cu	1	T401LA
LA600, LC600	600	250/500 kcmil	Cu	2	T600LA
MC, MA	800	3/0–300 kcmil	Cu	3	T800MA1
NC, NB	1200	3/0–400 kcmil	Cu	4	T1200NB1
NC, NB	1200	500–750 kcmil	Cu/Al	3	TA1201NB1
PC2000, PCC2000	2000	BA2000PB rear bus connector			
PC2500, PCC2500	2500	BA2500PB rear bus connector			
PC3000, PCC3000	3000	Rear bus connector included in frame			

Molded-Case Switches With High Magnetic Trip—Trip Setting and Tolerance

Frame	Rating	Trip Setting (Amperes)	Tolerance (%)
CA	225	2250	+20 –10
LA (400)	400	4000	+10 –0
LA/LC	600	6000	+10 –0
MA/MC	800	8000	+10 –0
NB/NC	1200	12,000	+10 –0
PB/PC	2000–3000	12,000	+10 –0

Notes

- ① These frames are obsolete. For replacement solutions, see the cross-reference on Pages V12-T3-114–V12-T3-167.
- ② Catalog number suffix identification:
K = Molded-case switch with high magnetic trip (fixed trip setting)
S = Saf-T-Vue cover
W = No terminals
- ③ Molded-case switch dimensions are the same as the equivalent thermal-magnetic breaker. Refer to Dimension Sheet 29-171.
- ④ For molded-case switch types LC, LCC—use LA attachments;
MC and MCC—use MA attachments; NC—use NB attachments.
- ⑤ For molded-case switch types PC, PCC and PCF, rating plug is included and use SELTRONIC PC attachments.

Type MCP Motor Circuit Protector

The motor circuit protector (MCP) is designed specifically for the protection of motor circuits. It operates on the magnetic principle with a current sensing coil in each of the three poles, with the trip-point adjustable from the front. MCPs are the fastest devices available for clearing low level faults and offer circuit breaker features and convenience—resettable, quick-make quick-break, deadfront and protection against single phasing.

MCPs are rated to correspond to NEMA starter size.

Current Limiter Attachment

The EL current limiter is an attachment that bolts to the load end of the MCP to provide increased interrupting capacity. The combination is UL Listed as a recognized component for application at up to 200,000A symmetrical at 600 Vac. It is coordinated with the MCP so that normal short circuits will be cleared automatically by the MCP, opening all three poles, and only the rare high fault will cause the limiter to function. Current limiters must be applied as shown in the terminal table above.

Note: Sizes 0–4 only.

Terminals

Terminals are included with both the MCP and the current limiter. Standard terminals are aluminum alloy, with non-aluminum terminals optional for use with only the MCP. Both standard and optional terminals will accommodate aluminum or copper conductors.

Note: Except 400A Size 5. Non-aluminum terminal suitable for copper only.

When using aluminum conductors, use of joint compound is recommended. Wire ranges are listed in the terminal table above.

Sizes 0–4 MCP with Current Limiter



Size 5 MCP 532500



Terminals

MCP or Limiter (Amperes)	Standard Aluminum	Optional Non-Aluminum
Size 0, 1, 2	#14–#4	#14–1/0
Size 3	#6–3/0	#14–1/0
Size 4	#4–4/0	#4–4/0
Size 5 (250)	#4–350 kcmil	#4–350 kcmil
Size 5 (400)	—	(2) 3/0–250 kcmil
Limiters to 50	#14–#2	—
Limiters to 100	#1–4/0	—
Limiters to 150	#1–4/0	—

Motor Circuit Protectors

Shaded area denotes obsolete or discontinued products and services. ①

Starter Size	Trip Range, Amperes	Continuous Ampere Rating	With Standard Aluminum Alloy Terminals Catalog Number	With Optional Non-Aluminum Terminals ② Catalog Number
0	7–22	3	MCP0322R	MCP0322CR
0	18–58	7	MCP0358R	MCP0358CR
0	50–150	15	MCP03150R	MCP03150CR
1	100–300	30	MCP13300R	MCP13300CR
2	160–480	50	MCP23480R	MCP23480CR
3	275–1000	100	MCP331000R	MCP331000CR
4	450–1550	150	MCP431550R	MCP431550CR
4	575–1800	150	MCP431800R	MCP431800CR
5	1250–2500	250	MCP532500	MCP532500C
5	2000–4000	400	—	MCP534000C

UL Listed

The MCP is UL Listed as a recognized component and requires additional listing by the control manufacturer in combination with a contactor and overload relay.

Modifications for MCP

These modifications must be factory installed. Consult factory for pricing.

Modifications for MCP ③

Description
Auxiliary switches ④—1A and 1B, 2As and 2Bs
Shunt trip ④
Undervoltage release ④⑤⑥
Moisture-fungus treatment

Accessories for MCP

For handle mechanisms refer to **Pages V12-T3-95–V12-T3-112**.

Note: On 400A Size 5, an external resistor is supplied for voltages, above 240 Vac and 24 Vdc.

Accessories for MCP

For MCP Size	Use Accessories For
Sizes 0–4	FB
5 (250A)	KB
5 (400A)	LB

Current Limiters

Limiter Catalog Numbers	For MCP Catalog Numbers ①
EL3003R	MCP0322R
EL3007R	MCP0358R
EL3015R	MCP03150R
EL3030R	MCP13300R
EL3050R	MCP23480R
EL3100R	MCP331000R
EL3150R	MCP431550R
EL3150R	MCP431800R

Interrupting Ratings

Maximum application current shall be determined by testing the MCP in combination with a contactor and overload relay. Additional capacity can be obtained by using the current limiter attachment.

Base Mounting Hardware

No charge when ordered with MCP. Order separately when required.

Base Mounting Hardware

Description	Style Number
Sizes 0–4	21C6782G18
Size 5 (250A)	673B125G12
Size 5 (400A)	21C6782G22

Notes

- ① These frames are obsolete. For replacement solutions, see the cross-reference on **Pages V12-T3-114–V12-T3-167**.
- ② Catalog numbers ending in CR were previously listed ending in RC. This is a catalog number change only, not a material change.
- ③ Not UL Listed.
- ④ Mounts only in right pole; only one Modification marked can be used in MCP (Sizes 0–4).
- ⑤ On 400A Size 5, an external resistor is supplied for voltages above 240 Vac and 24 Vdc.
- ⑥ On Sizes 0–4 and 250A Size 5, an external resistor is supplied for customer mounting, except for 120 Vac, 12, 24, 125 Vdc.
- ⑦ Also applicable to MCPs with optional terminals.

Series C 30 mA Ground Fault (Earth Leakage)

The Series C units (prefix only listed below) that included a breaker and integral Earth Leakage module have been replaced by the Series G solution that has the flexibility to add the Earth Leakage module in the field. The Series G solution has an extended range of 15–630A.

Series C 30 mA Ground Fault (Earth Leakage)

Ampere Range—15–400A

Catalog Prefix

Three-Pole	Four-Pole
ELFD	EL4FD
ELFW	EL4FW
ELHMCP	EL4HFD
ELHFD	EL4HFW
ELHFW	EL4HJW
ELHJD	EL4HKW
ELHJW	EL4JW
ELHKD	EL4KW
ELHKW	—
ELJD	—
ELJW	—
ELKD	—
ELKW	—

Note: Please contact Eaton customer service for assistance with crossing from the obsolete product to the new Series G.

Earth Leakage

Ampere Rating	Series C Four-Pole	Series G MCCB	Series G MCCB Alt	Series G Earth Leakage Module
15	EL4FD3015L	EGS4015FFG	EGC4015FFG	ELEBN4125G
20	EL4FD3020L	EGS4020FFG	EGC4020FFG	ELEBN4125G
25	EL4FD3025L	EGS4025FFG	EGC4025FFG	ELEBN4125G
30	EL4FD3030L	EGS4030FFG	EGC4030FFG	ELEBN4125G
35	EL4FD3035L	EGS4035FFG	EGC4035FFG	ELEBN4125G
40	EL4FD3040L	EGS4040FFG	EGC4040FFG	ELEBN4125G
45	EL4FD3045L	EGS4045FFG	EGC4045FFG	ELEBN4125G
50	EL4FD3050L	EGS4050FFG	EGC4050FFG	ELEBN4125G
60	EL4FD3060L	EGS4060FFG	EGC4060FFG	ELEBN4125G
70	EL4FD3070L	EGS4070FFG	EGC4070FFG	ELEBN4125G
80	EL4FD3080L	EGS4080FFG	EGC4080FFG	ELEBN4125G
90	EL4FD3090L	EGS4090FFG	EGC4090FFG	ELEBN4125G
100	EL4FD3100L	EGS4100FFG	EGC4100FFG	ELEBN4125G
110	EL4FD3110L	EGS4110FFG	EGC4110FFG	ELEBN4125G
125	EL4FD3125L	EGS4125FFG	EGC4125FFG	ELEBN4125G
150	EL4FD3150L	JGE4150FAG	JGC4150FAG	ELJBN4150W
50	EL4FW3050JL	GES4050AFM	—	ELEBE4125G
50	EL4FWC3050JL	GEC4050AFM	—	ELEBE4125G
15	EL4HFD3015L	EGH4015FFG	—	ELEBN4125G
20	EL4HFD3020L	EGH4020FFG	—	ELEBN4125G
25	EL4HFD3025L	EGH4025FFG	—	ELEBN4125G
30	EL4HFD3030L	EGH4030FFG	—	ELEBN4125G
35	EL4HFD3035L	EGH4035FFG	—	ELEBN4125G
40	EL4HFD3040L	EGH4040FFG	—	ELEBN4125G
45	EL4HFD3045L	EGH4045FFG	—	ELEBN4125G
50	EL4HFD3050L	EGH4050FFG	—	ELEBN4125G
60	EL4HFD3060L	EGH4060FFG	—	ELEBN4125G
70	EL4HFD3070L	EGH4070FFG	—	ELEBN4125G
80	EL4HFD3080L	EGH4080FFG	—	ELEBN4125G
90	EL4HFD3090L	EGH4090FFG	—	ELEBN4125G
100	EL4HFD3100L	EGH4100FFG	—	ELEBN4125G
110	EL4HFD3110L	EGH4110FFG	—	ELEBN4125G
125	EL4HFD3125L	EGH4125FFG	—	ELEBN4125G
150	EL4HFD3150L	JGH3150FAG	—	ELJBN4150W

Portable Test Kit and Remote Ground Fault Trip Indicator

Portable Test Kit



Provides verification of performance of all frame sizes of SELTRONIC breakers while devices are still in service under varying load and/or phase unbalance. The tester operates on 120V, 50/60 Hz, and includes complete instructions and test times for testing the long time, instantaneous operation and optional ground fault operation of the breaker.

Portable Test Kit

Style Number

STK2

Remote Ground Fault Trip Indicator



For use only with SELTRONIC circuit breakers (LCG, HLCG, MCG, HMCG, NCG, HNCG, PCG and PCCG) with built-in ground fault protection.

Note: UL Listed as a recognized component.

The SELTRONIC ground fault indicator is a remotely mounted device with a combination indicating light/reset/test button that will light when the breaker trips on a ground fault. Tripping from overloads or short circuits will not activate the device. A separate 120V, 50/60 Hz power source is required to power the light and internal relay, which has 1NO/1NC contacts for customer connected alarm, etc. Designed for panel mounting, it can be face-mounted by ordering the optional mounting bracket below.

Remote Ground Fault Indicator

Style Number	Catalog Number
1259C14G01	GFAU

Face Mounting Bracket



Face Mounting Bracket for Ground Fault Indicator

Style Number

1264C67G01

Accessories

Rear-Connected Studs

For complete stud assembly, order a stud and an appropriate tube based on thickness of customer's

mounting panel. A short stud must be assembled adjacent to a long stud to maintain clearances required by Underwriters Laboratories.

400A LA studs of the same length have sufficient clearance; however, customer connections may make it necessary to use a short stud

adjacent to a long stud. Two studs are required per pole. Refer to DS29171 Dimension Sheets for stud sizes and extensions behind breaker.

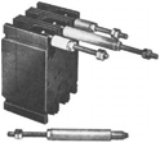
Rear Connected Stud**For DA, EB, EHB, FB, JA, KA, JB, KB, LB, LBB, HFB, HKA, HKB and HLB Breakers** ①

Mounting Panel Thickness, Inches	Stud ② Length	Style Number	Tube ③ Length	Style Number
DA, LB, LBB and HLB Breakers				
3/4-1	Short	656D565G03	27/32	313C909H17
3/4-1	Long	656D565G04	3-25/32	313C909H20
1/2-3/4	Short	656D565G03	1-3/32	313C909H18
1/2-3/4	Long	656D565G04	4-1/32	313C909H21
1/4-1/2	Short	656D565G03	1-11/32	313C909H19
1/4-1/2	Long	656D565G04	4-9/32	313C909H22
EB, EHB, FB and HFB (100A Maximum)				
1	Short	451D874G01	1-1/16	32B9446H20
1	Long	451D874G02	3-7/16	32B9446H24
1-1/16-15/16	Short	451D874G01	1-3/8	32B9446H21
1-1/16-15/16	Long	451D874G02	3-3/4	32B9446H25
3/8-5/8	Short	451D874G01	1-11/16	32B9446H22
3/8-5/8	Long	451D874G02	4-1/16	32B9446H26
1/4-5/16	Short	451D874G01	2	32B9446H23
1/4-5/16	Long	451D874G02	4-3/8	32B9446H27
FB, HFB 150 Ampere Breakers				
1	Short	374D883G01	1-1/16	374D883H06
1	Long	374D883G02	4-5/16	374D883H10
11/16-15/16	Short	374D883G01	1-3/8	374D883H07
11/16-15/16	Long	374D883G02	4-5/8	374D883H11
3/8-5/8	Short	374D883G01	1-11/16	374D883H08
3/8-5/8	Long	374D883G02	4-15/16	374D883H12
1/4-5/16	Short	374D883G01	2	374D883H09
1/4-5/16	Long	374D883G02	5-1/4	374D883H13
JA, KA and HKA Breakers				
3/4-1	Short	656D565G01	27/32	456D983H05
3/4-1	Long	656D565G02	3-25/32	456D983H08
1/2-3/4	Short	656D565G01	1-3/32	456D983H06
1/2-3/4	Long	656D565G02	4-1/32	456D983H09
1/4-1/2	Short	656D565G01	1-11/32	456D983H07
1/4-1/2	Long	656D565G02	4-9/32	456D983H10
JB, KB and HKB Breakers				
3/4-1	Short	5010D23G01	27/32	456D983H05
3/4-1	Long	5010D23G02	3-7/8	5010D23H05
1/2-3/4	Short	5010D23G01	1-3/32	456D983H06
1/2-3/4	Long	5010D23G02	4-1/8	5010D23H06
1/4-1/2	Short	5010D23G01	1-11/32	456D983H07
1/4-1/2	Long	5010D23G02	4-3/8	5010D23H07

Notes

- ① For insulated panels only; two required per pole.
- ② Not UL Listed.
- ③ Included at no charge when ordered with stud.

For LAB, LA, MA, HLA, HMA and HNB Breakers ^①

Stud Ampere Rating	Diameter, Inches and Thread	Extension Back of Breaker, Inches	Stud Style Number
LAB, LA, HLA, LC and HLC Breakers			
225 ^②	1/2-13	3-7/32	1241 345
225 ^②	1/2-13	6-9/32	1241 346
225 ^{②③}	1/2-13	4-31/32	1241 392
400 ^②	3/4-16	5-15/32	5B7383G15
400 ^②	3/4-16	7-31/32	5B7383G16
400 ^②	3/4-16	10-15/32	5B7383G17
600 ^④	1-12	5-29/32	314C960G07
600 ^④	1-12	5-13/32	314C960G08
600 ^④	1-12	5-29/32	314C960G09
MA, HMA, MC, HMC, MD and MDS Breakers			
225	1/2-13	3-21/32	314C960G01
400	3/4-16	5-29/32	314C960G04
400	3/4-16	8-13/32	314C960G05
400	3/4-16	10-29/32	314C960G06
600	1-12	5-29/32	314C960G07
600	1-12	8-13/32	314C960G08
600	1-12	10-29/32	314C960G09
800	1-1/8-12	5-29/32	314C960G10
800	1-1/8-12	8-13/32	314C960G11
800	1-1/8-12	10-29/32	314C960G12
NB, HNB, NC and HNC Breakers			
800	1-1/8-12	5-1/2	623B222G01
800	1-1/8-12	8	623B222G02
800	1-1/8-12	10-1/2	623B222G03
1200	1-1/4-12	5-1/2	373B375G04
1200	1-1/4-12	10-1/2	373B375G03

Notes

- ① For insulated panels only; two required per pole.
 ② 150, 250, 300 and 400A frames only.
 ③ This is a special stud that includes six contact nuts for use where bus contact nuts must be used.
 ④ 600A frames only.

Panelboard Connecting Straps

For connecting line end of breakers to panelboard bus.

Panelboard Connecting Strap

3

For DA, EB, EHB, FB, JA, KA, JB, KB, LB, LBB, HFB, HKB and HLB Breakers

Ampere Rating	Connector Type ^①	Style Number
EB, EHB, FB and HFB Breakers Narrow Distribution Panelboards ^②		
50	Center	673B142G02
50	Outside	673B142G09
100	Center	673B142G02
100	Outside	673B142G10
150	Center	673B142G04
150	Outside	673B142G03
Power Panelboards (Convertible) ^③		
50	Center	1253C72G01
50	Outside	1253C72G03
100	Center	1253C73G03
100	Outside	1253C73G06
150	Center	1253C73G01
150	Outside	1253C73G05
Three-pole mounting bracket		624B600H01
Two-pole mounting bracket		624B600H02
DA, LB, LBB and HLB Breakers ^③		
400	Center	314C940G04
400	Outside	505C680G01
Mounting bracket (one required)		208B264H01
JA, KA and HKA Breakers ^③		
225	Center	314C940G03
225	Outside	180C074G01
Mounting bracket (one required)		208B264H01
JB, KB and HKB Breakers ^③		
250	Center	2600D26G01
250	Outside	2600D26G02
Mounting bracket (one required)		1576707

For CA, LAB, LA, MA, HLA, HMA and HNB Breakers

Ampere Rating	Connector Type ^①	Style Number
CA Breaker Power Panelboards (Convertible) ^③		
225	Center	1253C74G01
225	Outside	1253C74G02
Three-pole mounting bracket		624B624H01
Two-pole mounting bracket		624B624H02
LAB, LA, HLA, LC, HLC 150, 300 and 400A Frames ^③		
400	Center	32B4570G02
400	Outside	314C541G01
Mounting bracket (two required)		208B297H01
LA, HLA, LC and HLC 600A Frames ^③		
600	Center	624B609G01
600	Outside	506C052G01
Mounting bracket (two required)		208B297H01
MA, HMA, MC, HMC, MD and MDS Breakers ^③		
800	Short	314C996G01
800	Medium	314C996G02
800	Long	314C996G03
Mounting bracket (four required)		315C270H01
NB, HNB, NC and HNC Breakers ^③		
1200	Short	505C606G04
1200	Medium	505C606G05
1200	Long	505C606G06
Mounting bracket (four required)		315C270H01

Notes

- ① Not UL Listed.
- ② Bus spacing 2.75 inches in box 5.75 inches deep (600V maximum).
- ③ Bus spacing 3.50 inches.

Plug-In Adapter Kits

For rear-connected applications such as switchboards. Facilitates ease of installation and front removal of breaker. Includes conductor for mounting on breaker, plug-in mounting blocks with matching conductor, rear studs and mounting hardware. Order two mounting blocks style number when line and load are required; order one mounting block style number when either line or load is required.

■ Shaded area denotes obsolete or discontinued products and services. ①

Flat Bus Type



Flat Bus Type

Description	Style Number
EB, EHB, FB Thermal-Magnetic Breakers ② Flat Bus Type—One Mounting Block, Line or Load	
Two-pole, 100A	1480D13G05
Two-pole, 150A	1480D13G05
Three-pole, 100A	1480D13G06
Three-pole, 150A	1480D13G06
FB and HFB Magnetic Only, HFB Thermal-Magnetic ② Flat Bus Type—One Mounting Block, Line or Load	
Two-pole, 100A	1480D13G05
Two-pole, 150A	1480D13G05
Three-pole, 100A	1480D13G06
Three-pole, 150A	1480D13G06
JB, KB, HKB Breakers ① Flat Bus Type— Two Mounting Blocks, Line and Load	
Two-pole	506C144G17
Three-pole	506C144G18
One Mounting Block, Line Only	
Two-pole	1260C86G01
Three-pole	1260C86G02
Two-pole	1260C86G03
Three-pole	1260C86G04
LAB, LA, HLA, LC and HLC (150, 250, 300 and 400A Frame) (Threaded Studs Type)— Two Mounting Blocks, Line and Load	
Two-pole	313C644G25
Three-pole	313C644G26
One Mounting Block, Line or Load	
Two-pole	450D010G15
Three-pole	450D010G16
DA, LB, LBB, HLB Breakers ② Flat Bus Type— Two Mounting Blocks, Line and Load	
Two-pole	313C644G45
Three-pole	313C644G46
One Mounting Block, Line or Load	
Two-pole	314C932G03
Three-pole	314C932G04
MA, HMA, MC, HMC, MD and MDS Breakers ③ Threaded Studs—Two Mounting Blocks, Line and Load	
Two-pole, 125–600A	313C644G27
Two-pole, 700–800A	176C544G01 ③
Three-pole, 125–600A	313C644G28
Three-pole, 700–800A	176C544G02 ③
One Mounting Block, Line or Load	
Two-pole, 125–600A	313C370G03
Two-pole, 700–800A	507C049G01 ④
Three-pole, 125–600A	313C370G04
Three-pole, 700–800A	507C049G02 ④

Threaded Stud Type



Threaded Studs Type

Description	Style Number
JA, KA and HKA Breakers ④ (Threaded Studs Type)—Two Mounting Blocks, Line and Load	
Two-pole	313C644G29
Three-pole	313C644G30
One Mounting Block, Line or Load	
Two-pole	314C932G01
Three-pole	314C932G02
LA, HLA, LC and HLC (600A Frames) ② (Threaded Studs)—Two Mounting Blocks, Line and Load	
Two-pole	313C644G50
Three-pole	313C644G51
One Mounting Block, Line or Load	
Two-pole	506C059G03
Three-pole	506C059G04
One Mounting Block, Line or Load Flat Bus Type	
Two-pole	1288C19G01
Three-pole	1288C19G02
MA, HMA, MC, HMC, MD, MDS, NB, HNB, NC, HNC and NB TRI-PAC Breakers ④ (Flat Bus Type)— One Mounting Block, Line or Load	
MA, HMA, MC, HMC, MD, MDS two-pole	2614D53G05
MA, HMA, MC, HMC, MD, MDS three-pole	2614D53G06
NB, HNB, NC, HNC, NB TRI-PAC two-pole	2614D53G03
NB, HNB, NC, HNC, NB TRI-PAC three-pole	2614D53G04

Mounting Plates

Description	Style Number
Predrilled panels for:	
EB, EHB, FB, HFB	507C047H01
JB, KB	179C207H01
JA, KA	504C823H01
DA, LB, LBB, ALB	178C781H01
LA, LAB, HLA, LC, HLC	504C824H01
MA, HMA, MC, MMC, NB, HNB, NC, HNC	1290C73H01

Notes

- ① These accessories are no longer available.
- ② These plug-in adapter kits are UL Listed as recognized components.
- ③ 700–1200A adapter kit is front removable, bolt-on design—not plug-in type.
- ④ Not UL Listed.

Extended Line Terminal Shields

For shielding line side terminal connections. One shield required per breaker. Order separately when needed. Sold only in lots of 10, including hardware.

3

Line Terminal Shield



Extended Line Terminal Shields ①

Breaker Frame	Style Number
JB, KB, HKB	1266C07G01
MA, HMA, MC, HMC	208B966G01
NB, HNB, NC, HNC	208B966G02
LAB, LA, (Saf-T-Vue)	314C420G02
JA, KA, LB, LBB (Saf-T-Vue)	314C420G04
LAB, LA, HLA, LC, HLC	314C420G05
DA	314C420G06
JA, KA, HKA, LB, LBB, HLB (standard breaker)	314C420G06
EB, EHB, FB, HFB	625B229G08 ②

Base Mounting Hardware

No charge when ordered with breaker. Order separately when needed.

Line Terminal Shield



Base Mounting Hardware

Description	Style Number
Single-Pole Breakers	
EB, EHB, HFB ③	624B375G01
EB, EHB, HFB ④	624B375G02
Two- and Three-Pole Breakers	
LAB, LA, HLA, LC, HLC, MA, NB, HMA, HNB, MC	21C6782G05
HMC, NC, HNC	1091716
PB, PC, PCC	624B375G22
DA, JA, KA, HKA, LB, LBB, HLB	21C6782G22
EB, EHB, FB, HFB, MCP	21C6782G18
JB, KB, HKB	673B125G12
CA two-pole	21C6782G28
CA three-pole	21C6782G29

Fuse Mounting Base for PB Breakers

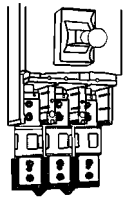

For 2000A non-automatic breakers only.

Fuse Mounting Base for PB Breakers

Style Number

6635C78G02 ①

For use with non-automatic, three-pole circuit breaker. Includes fuse mounting base and hardware to mount standard Class L current limiting fuses, 801–2000A (fuses not included).

Note: Interrupters used with fuse mounting base will accept all standard PB accessories. See Dimension Sheet 29-171 for mounting details.

For complete installation, order:

1. Front-connected, non-automatic PB breaker. (Order similar to standard front connected, except omit load conductor extensions.)
2. Fuse mounting base.
3. Fuses (from distributor).

Handle Locks

Non-Padlockable

For prevention of unintentional operation of breaker. Fits over breaker handle and may be removed.

Padlockable

For prevention of unauthorized operation of breaker. Is non-removable once installed on breaker. Meets Underwriters Laboratories and California Code requirements.

Handle Locks



Handle Locks ①⑤

Breaker Frame	Style Number
Non-Padlockable	
FA, EA, CA, EB, EHB, FB, HFB	29B2721H01
LAB, LA, LC, HLC, MA, NB, HLA, HMA, HNB, MC, HMC, NC, HNC	28B4596G01
GB, GC, GHB, GHC	1294C01H01
DA, JA, KA, HKA, LB, LBB, HLB	29B2721H04
Padlockable	
CA	506C438G01
FA, EA, EB, EHB, FB, HFB, MCP150	765A754G01
DA, JA, KA, LB, LBB, HKA, HLB, MCP400	673B796G02
JB, KB, HKB, MCP250	673B796G01
LAB, LA, HLA, LC, HLC	373B591G02
MA, HMA, MC, HMC, MD, MDS	6591C30G02–OFF
MA, HMA, MC, HMC, MD, MDS	6591C30G05–ON/OFF
NB, HNB, NC, HNC	6591C30G01–OFF
NB, HNB, NC, HNC	6591C30G04–ON/OFF
PA, SPCB, PB, Tri-Pac PB, PC	6591C30G03–OFF

Notes

- ① Not UL Listed.
- ② One of style 625B229G08 is one package of 10.
- ③ Individually mounted.
- ④ Group mounted.
- ⑤ All breakers are trip free and will trip with handle locks attached. Cannot be used when handle extension is used.

Cable Connectors

The fuse mounting base will accept the following terminals for front cable connection (omit "T" connectors from rear connected breakers).

Cable Connectors

Wire Range, Type Number of Cables	Style Number
(3) 3/0–400 kcmil Cu	672B655G01
(4) 400–500 kcmil Cu	180C046G03

Molded Type Handle Extension

For LAB, LA and HLA Breakers ①

Style Number

372B399G01

For MA, HMA, MC, HMC, NB, HNB, NC and HNC Breakers ①

Style Number

1251C65G01 ②

For PB, PC, PCC and PA/RD Breakers ①

Style Number

6635C78G02 ②

Modifications

Only two internally mounted modifications—shunt trip, undervoltage release, auxiliary switch, alarm switch—may be mounted in EB through PB. Only one of these modifications may be mounted in FB, HFB magnetic only, two-pole EB, EHB, FB and SELTRONIC breakers. None are available in single-pole breakers except alarm switch in EB, EHB and HFB. Contact Avery Creek, NC, Technical Resource Center for possible special combinations of the following modifications not in tabulations. Contact factory for pricing if accessories are factory installed.

Shunt Trip

For tripping breaker from a remote point. A solenoid device mounts within breaker case. Breaker trips when coil is energized.

Shunt trips should not be used as circuit interlocks using maintained contact pilot devices.

A cutoff switch breaks the circuit to the momentary rated coil when the breaker opens. Available for control voltages up to 250 Vdc or 600 Vac. Voltage and frequency must be specified. Standard leads extend 18.00 inches outside the breaker. Longer leads may be specified.

Factory-Mounted Shunt Trips

Factory-mounted shunt trips only can be supplied for the following breakers: CA, HCA, CAH, HFB magnetic only and PB/PBF non-automatic breakers (molded-case switches). They are 120 Vac rated, suitable for 55% pickup for ground fault application. Right hand mounting is standard and they are not UL Listed.

Notes

- ① Not UL listed.
- ② Included with frame at no charge.

Shaded area denotes obsolete or discontinued products and services. ④

Shunt Trip



Shunt Trip for Field Mounting ①②③

Voltage/Hz	Breaker Type Catalog Number						
	EB, EHB, FB, HFB ⑤ (Thermal-Magnetic Only)	JB, KB, HKB	JA, KA, HKA, DA, LB, LBB, HLB	LA, LAB, HLA	MA, HMA	NB, HNB	PB TRI-PAC and PA
Right-Hand Mounting							
600/50–60 Hz	2609D39G15	2609D42G15	2605D15G15	2606D56G15	2606D57G15	2606D58G15	2606D59G15
480/50–60 Hz	2609D39G16	2609D42G16	2605D15G16	2606D56G16	2606D57G16	2606D58G16	2606D59G16
240/50–60 Hz	2609D39G17	2609D42G17	2605D15G17	2606D56G17	2606D57G17	2606D58G17	2606D59G17
208/50–60 Hz	2609D39G18	2609D42G18	2605D15G18	2606D56G18	2606D57G18	2606D58G18	2606D59G18
120/50–60 Hz	2609D39G19	2609D42G19	2605D15G19	2606D56G19	2606D57G19	2606D58G19	2606D59G19
60/50–60 Hz	2609D39G20	2609D42G20	2605D15G20	2606D56G20	2606D57G20	2606D58G20	2606D59G20
48/50–60 Hz	2609D39G21	2609D42G21	2605D15G21	2606D56G21	2606D57G21	2606D58G21	2606D59G21
24/50–60 Hz	2609D39G22	2609D42G22	2605D15G22	2606D56G22	2606D57G22	2606D58G22	2606D59G22
250 DC	2609D39G23	2609D42G23	2605D15G23	2606D56G23	2606D57G23	2606D58G23	2606D59G23
125 DC	2609D39G24	2609D42G24	2605D15G24	2606D56G24	2606D57G24	2606D58G24	2606D59G24
60 DC	2609D39G25	2609D42G25	2605D15G25	2606D56G25	2606D57G25	2606D58G25	2606D59G25
48 DC	2609D39G26	2609D42G26	2605D15G26	2606D56G26	2606D57G26	2606D58G26	2606D59G26
24 DC	2609D39G27	2609D42G27	2605D15G27	2606D56G27	2606D57G27	2606D58G27	2606D59G27
12 DC	2609D39G28	2609D42G28	2605D15G28	2606D56G28	2606D57G28	2606D58G28	2606D59G28
Left-Hand Mounting							
600/50–60 Hz	2609D39G01	2609D42G01	2605D15G01	2606D56G01	2606D57G01	2606D58G01	2606D59G01
480/50–60 Hz	2609D39G02	2609D42G02	2605D15G02	2606D56G02	2606D57G02	2606D58G02	2606D59G02
240/50–60 Hz	2609D39G03	2609D42G03	2605D15G03	2606D56G03	2606D57G03	2606D58G03	2606D59G03
208/50–60 Hz	2609D39G04	2609D42G04	2605D15G04	2606D56G04	2606D57G04	2606D58G04	2606D59G04
120/50–60 Hz	2609D39G05	2609D42G05	2605D15G05	2606D56G05	2606D57G05	2606D58G05	2606D59G05
60/50–60 Hz	2609D39G06	2609D42G06	2605D15G06	2606D56G06	2606D57G06	2606D58G06	2606D59G06
48/50–60 Hz	2609D39G07	2609D42G07	2605D15G07	2606D56G07	2606D57G07	2606D58G07	2606D59G07
24/50–60 Hz	2609D39G08	2609D42G08	2605D15G08	2606D56G08	2606D57G08	2606D58G08	2606D59G08
250 DC	2609D39G09	2609D42G09	2605D15G09	2606D56G09	2606D57G09	2606D58G09	2606D59G09
125 DC	2609D39G10	2609D42G10	2605D15G10	2606D56G10	2606D57G10	2606D58G10	2606D59G10
60 DC	2609D39G11	2609D42G11	2605D15G11	2606D56G11	2606D57G11	2606D58G11	2606D59G11
48 DC	2609D39G12	2609D42G12	2605D15G12	2606D56G12	2606D57G12	2606D58G12	2606D59G12
24 DC	2609D39G13	2609D42G13	2605D15G13	2606D56G13	2606D57G13	2606D58G13	2606D59G13
12 DC	2609D39G14	2609D42G14	2605D15G14	2606D56G14	2606D57G14	2606D58G14	2606D59G14

Notes

- ① 120 Vac ratings suitable for 55% pickup for ground fault applications.
- ② Not field mountable on non-automatic breakers (molded-case switches).
- ③ Field mounting voids breakers' UL listing except on LA, HLA, MA, HMA, NB, HNB, PB, KB, HKB, KA, HKA, LB, HLB and SELTRONIC breakers.
- ④ These frames are obsolete. For replacement solutions, see the cross-reference on **Pages V12-T3-114–V12-T3-168**.
- ⑤ Available similar to this except "Leads out the load end—(not UL Listed)." Order by description.

Left-Hand Mounting Kits for SELTRONIC Breakers

Left-Hand Mounting Kits for SELTRONIC Breakers

Description	Breaker Type	Style Number
Provision to trip flux transfer shunt trip from external 32 to 120 Vdc and Vac to 60 Hz source ^{①②}	MC, HMC	1371D72G22
	NC, HNC	1372D39G13
	PC, PCC	1372D35G22
	LC, HLC	1371D11G22
Provision to trip flux transfer shunt trip from external 240 to 600 Vac, 50/60 Hz source ^{②③}	MC, HMC	1371D72G32
	NC, HNC	1372D39G23
	PC, PCC	1372D35G32
	LC, HLC	1371D11G32

Shunt Trip Coil Data

Shunt Trip Voltage Rating	For All Breakers Listed in Previous Table and on Previous Page Except CA and SELTRONIC Coil Inrush		SELTRONIC Coil Inrush	
	Amperes	Volt-Amperes	Amperes	Volt-Amperes
600 AC	0.105	63.0	—	—
480 AC	0.085	40.8	—	—
240 AC	1.7	408.0	—	—
208 AC	1.4	291.2	—	—
120 AC	0.88	105.6	15	18
60 AC	9.10	546.0	—	—
48 AC	7.50	360.0	—	—
24 AC	3.95	94.8	—	—
250 DC	2.5	625.0	—	—
125 DC	0.975	121.9	—	—
60 DC	0.525	31.5	—	—
48 DC	1.3	62.4	—	—
24 DC (FB)	6	144.0	—	—
24 DC (KB)	3.8	91.2	—	—
24 DC (others)	8	192	—	—
12 DC	6	72	—	—

Notes

- ① Rated 48V minimum for ground fault applications.
- ② Also available for 24 Vdc. Order by description.
- ③ Not for ground fault.

Standard Undervoltage Release

For undervoltage protection. A solenoid device mounts within a breaker case. Coil must be energized before closing breaker. Trips breaker when voltage drops below 35 to 70% of coil rating. Picks up and seals in at 85% of coil rating. For line voltages up to 250 Vdc or 600 Vac. Externally mounted resistors are supplied for certain ratings. Standard leads extend 18.00 inches outside of breaker. Longer leads may be specified.

Note: Undervoltage release attachments are not designed for, and should not be used as, circuit interlocks. For further information, Contact Avery Creek, NC, Technical Resource Center at **1-800-356-1243**.

Factory-Mounted Undervoltage Releases

All of the above undervoltage releases can be specified for factory mounting. Contact factory for pricing. These attachments have the leads out the side and are UL Listed when factory mounted unless other non-UL Listed modifications are used.

Note: Right-hand mounting is considered standard unless specified otherwise except JA, KA, DA, HKA, LB, LBB, HLB and SELTRONIC available for left-hand only. JB, KB, HKB are obsolete.

Factory-mounted undervoltage releases only can be supplied for the following breakers:

- SELTRONIC breakers (120 Vac, 60 Hz only standard), MC, HMC, NC, HNC, PC, PCC, LC, HLC
- SELTRONIC breakers with remote trip provisions, MC, HMC ②, NC, HNC ②, PC, PCC ②, LC, HLC ②
- EB ③, EHB ③, FB ③, HFB ③, FB ④⑤ and HFB magnetic only ④⑤
- No UVR available for CA, CAH and HCA

Standard Undervoltage Release



Undervoltage Release Attachment Kits for Field Mounting ⑥⑦

Attachment Voltage, Hz	Breaker Type				
	JA, KA, DA, HKA, LB, LBB, HLB	LA, LAB, HLA	MA, HMA	NB, HNB	PB, PA ④
For Right-Hand Mounting					
24, 60	—	60A9355G17	—	—	—
48, 60	—	60A9355G08	—	—	5674D29G16
120, 60	—	60A9355G01	457D727G01	373D632G01	5674D29G09
208, 60	—	60A9355G02	457D727G19	373D632G19	5674D29G10
240, 60	—	60A9355G03	457D727G02	373D632G02	5674D29G11
480, 60	—	60A9355G05	457D727G03	373D632G03	5674D29G13
600, 60	—	60A9355G06	457D727G04	373D632G04	5674D29G14
12 DC	—	458D020G01	457D727G09	372D032G01	4976D85G01
24 DC	—	458D020G02	457D727G10	372D032G02	4976D85G02
48 DC	—	458D020G03	457D727G11	372D032G03	4976D85G03
60 DC	—	458D020G04	457D727G21	—	4976D85G04
125 DC	—	458D020G07	457D727G12	372D032G04	4976D85G07
250 DC	—	458D020G08	457D727G13	372D032G05	4976D85G08
For Left-Hand Mounting					
48, 60	—	60A9355G16	—	—	5674D29G08
120, 60	458D070G01	60A9355G09	457D727G05	373D632G05	5674D29G01
208, 60	458D070G05	60A9355G10	457D727G20	373D632G20	5674D29G02
240, 60	458D070G02	60A9355G11	457D727G06	373D632G06	5674D29G03
480, 60	458D070G03	60A9355G13	457D727G07	373D632G07	5674D29G05
600, 60	458D070G04	60A9355G14	457D727G08	373D632G08	5674D29G06
12 DC	458D070G09	458D020G11	457D727G14	372D032G06	4976D85G11
24 DC	458D070G10	458D020G12	457D727G15	372D032G07	4976D85G12
48 DC	458D070G11	458D020G13	457D727G16	372D032G08	4976D85G13
60 DC	—	458D020G14	457D727G22	—	4976D85G14
125 DC	458D070G12	458D020G17	457D727G17	372D032G09	4976D85G17
250 DC	458D070G13	458D020G18	457D727G18	372D032G10	4976D85G18

Notes

- ① Cannot be used with other attachments except a small 1A-1B auxiliary switch rated 250V can be supplied in right-hand pole.
- ② Provided with two leads (total of four) for use with a remote normally open contact (pushbutton, etc.) to trip the breaker. No external power required.
- ③ Not available on ambient compensating breakers.
- ④ Not UL Listed.
- ⑤ Right-hand mounting only.
- ⑥ Not field mountable on non-automatic breakers (molded-case switches).
- ⑦ Field mounting voids UL listing of breaker except on LA, HLA, MA, HMA, NB, HNB, PB, KA, HKA, LB and HLB.

Undervoltage Release Coil Data

Voltage Rating Hz	Breaker Type			JA, KA, HKA, DA, LB, LBB and HLB			LA, LAB, HLA and PB		
	EB, EHB, FB, HFB, JB, KB and HKB			Coil Amperes	External Series Resistance (Ohms)	Total VA	Coil Amperes	External Series Resistance (Ohms)	Total VA
600 AC	0.020	25,000	12.0	0.012	50,000	7.2	0.029	20,000	17.4
480 AC	0.016	20,000	7.7	0.013	30,000	6.3	0.014	—	6.8
240 AC	0.021	6000	5.1	0.013	—	3.2	0.036	—	8.7
208 AC	0.019	6000	4.0	0.018	—	3.8	0.036	—	7.5
120 AC	0.023	—	2.8	0.023	—	2.8	0.073	—	8.8
60 AC	0.203	250	12.2	—	—	—	—	—	—
48 AC	0.245	150	11.8	—	—	—	0.152	—	7.3
24 AC	0.250	50	6.0	—	—	—	—	—	—
250 DC	0.026	5000	6.5	0.013	16,500	3.3	0.035	5000	8.8
125 DC	0.026	—	3.3	0.013	6500	1.7	0.039	1500	4.9
60 DC	0.248	200	14.9	0.013	1500	0.8	0.034	—	2.1
48 DC	0.260	150	12.5	0.012	600	0.6	0.040	—	2.0
24 DC	0.141	—	3.4	0.023	—	0.6	0.069	—	1.7
12 DC	0.286	—	3.5	0.048	—	0.6	0.136	—	1.7
	MA and HMA			NB and HNB			MC, HMC, NC, HNC, PC, PCC, LC and HLC		
	Coil Amperes	External Series Resistance (Ohms)	Total VA	Coil Amperes	External Series Resistance (Ohms)	Total VA	Coil Amperes	External Series Resistance (Ohms)	Total VA
600 AC	0.012	50,000	7.2	0.016	35,000	9.6	—	—	—
480 AC	0.013	30,000	6.3	0.013	30,000	6.3	—	—	—
240 AC	0.013	—	3.2	0.013	—	3.2	—	—	—
208 AC	0.018	—	3.8	0.018	—	3.8	—	—	—
120 AC	0.023	—	2.8	0.023	—	2.8	0.5	—	6
60 AC	—	—	—	—	—	—	—	—	—
48 AC	—	—	—	—	—	—	—	—	—
24 AC	—	—	—	—	—	—	—	—	—
250 DC	0.013	16,500	3.3	0.013	16,500	3.3	—	—	—
125 DC	0.013	6500	1.7	0.013	6500	1.7	—	—	—
60 DC	0.013	1500	0.8	—	—	—	—	—	—
48 DC	0.012	600	0.6	0.012	600	0.6	—	—	—
24 DC	0.02	—	0.6	0.023	—	0.6	—	—	—
12 DC	0.048	—	0.6	0.048	—	0.6	—	—	—

3

Alarm Switch

Availability: EB through PC. For light or alarm indication when breaker trips. Does not function with manual operation. Automatically resets when breaker is relatched. Standard leads extend 18.00 inches outside of breaker. Longer leads may be specified. Not field mountable.

Alarm Switch Contact Rating (Non-Inductive)

- MC, HMC, LA, LAB, HLA, LC, HLC: 10A, 120 Vac; 5A, 240 Vac
- EB, EHB, FB, HFB: 5A, 120 Vac
- All other breakers: 10A, 120–240 Vac

Auxiliary Switch

For auxiliary control circuits. Miniature switches mount within breaker. Commonly used for remote indication of open or closed breaker and electrically interlocking component control circuits. "A" contacts are closed when breaker is closed. "B" contacts are open when breaker is closed. Standard leads extend 18.00 inches outside of breaker. Longer leads may be specified.

Note: Right-hand mounting standard for EB, EHB, FB, HFB, JB, KB and HKB. All others are left-hand mounting as standard unless otherwise specified.

Factory-Mounted Auxiliary Switches

All of the above auxiliary switches can be specified for factory mounting at the same price as listed for the kit. These attachments have the leads out the side of the breaker and are UL Listed when factory mounted unless other non-UL Listed modifications are used (except as noted).

Note: Right-hand mounting standard for EB, EHB, FB, HFB, JB, KB and HKB. All others are left-hand mounting as standard unless otherwise specified.

Factory-mounted switches only can be supplied for the following breaker:

- JB, LBB, LAB, JA, DA, FB[Ⓜ] magnetic only^{ⓂⓈ} and HFB magnetic only^{ⓂⓈ}

Switch Schematic

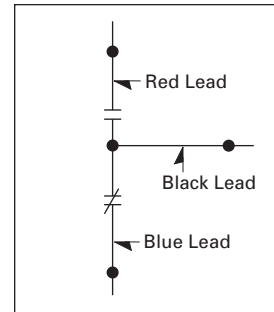

Switch with 2A-2B Contacts



Alarm Switch

Breaker Frame	Normal Pole Mounting	Contact Operation (Specify Type Desired)
DA ^①	Left	Make or break
EB ^① , EHB ^① , FB ^① , HFB ^{ⓂⓈ}	Mechanism	Make or break
JA ^① , KA ^① , LB ^① , LBB ^① , HKA, HLB	Left	Make or break
JB ^① , KB ^① , HKB ^①	Left	Make or break
LAB ^① , LA ^① , MA ^① , NB ^① , HLA, HMA, HNB	Left	Make or break
LC ^① , HLC	Left ^④	Make or break
MC ^① , HMC	Left only ^④	Make or break
NC ^① , HNC	Left only ^④	Make or break
PB	Left	Make or break
PC, PCC	Left ^{④⑤}	Make or break

Shaded area denotes obsolete or discontinued products and services. [Ⓢ]

Auxiliary Switch Attachment Kits for Field Mounting ^{Ⓢ②③}

Breaker Type	Maximum AC Voltage Rating [Ⓢ]	Non-inductive Amperes	For Left-Hand Mounting		For Right-Hand Mounting	
			1A-1B	2A-2B	1A-1B	2A-2B
EB, EHB, FB, HFB [Ⓢ]	240	5	4979D06G03	4979D06G09	4979D06G03	4979D06G08
JA, KA, DA, HKA, LB	480	10	458D067G03	—	458D067G08	—
LBB, HLB	240	5	—	656D527G01 ^②	—	656D527G09 ^②
JB, KB, HKB	480	10	2600D97G03	—	2600D97G08	—
JB, KB, HKB	240	5	—	2609D45G03 [Ⓢ]	—	2609D45G08 [Ⓢ]
LA, LAB, HLA	480	10	655D555G12	655D555G13	655D555G05	655D555G06
MA, HMA	480	10	458D013G12	458D013G13	458D013G05	458D013G06
NB, HNB	480	10	4980D16G12	4980D16G13	4980D16G05	4980D16G06
PB, PA	480	10	2602D32G11	2602D32G12	2602D32G14	2602D32G15
MC, HMC, MCG, HMCG	480	6 (10 at 24)	1371D72G03	1371D72G06	—	—
NC, HNC, NCG, HNCG	480	6 (10 at 24)	1372D39G03	1372D39G06	—	—
PC, PCC, PCG, PCCG	480	6 (10 at 24)	1372D35G03	1372D35G06	—	—
LC, HLC, LCG, HLCG	480	6 (10 at 24)	1371D11G03	1371D11G06	—	—

Notes

- ① Alarm switches are no longer available for these frames.
- ② Not UL Listed.
- ③ Not available for magnetic only, ambient compensating, or breakers with undervoltage release.
- ④ When alarm switch is used in conjunction with auxiliary switch, the auxiliary switch is rated 250 Vac, 5A maximum.

- ⑤ Except when other attachments are used, must be mounted in right pole.
- ⑥ Not for use on molded-case switches.
- ⑦ All switches are multiples of 1A-1B with a common electrical connection (see diagram above right).
- ⑧ Field mounting voids UL listing of breaker except on LA, HLA, MA, HMA, NB, HNB, KB, HKB, KA, HKA, LB, HLB and SELTRONIC breakers.

- ⑨ These accessories are no longer available.
- ⑩ For DC applications, refer to factory.
- ⑪ Thermal-magnetic only.
- ⑫ Auxiliary switches are no longer available for these frames.
- ⑬ Right-hand mounting only.

Shaded area denotes obsolete or discontinued products and services.

Moisture-Fungus-Corrosion Treatment

Availability: EB through PC.

Treatment can be provided to meet customer's specific atmospheric conditions. Moisture-fungus treating material used meets JAN-T-152; treatment meets MIL-V-173a. Requests and orders should specify government specifications or conditions to be met.

Note: Not UL Listed.

Mechanical Interlocks (A-C)

For mechanically interlocking a pair of breakers so that only one may be closed at one time, but both may be open simultaneously.

Note: Not UL Listed.

A. Walking Beam Type



Walking Beam

Availability: EB through PC.

Mounts on panel (not included) at rear of breaker. Standard breaker spacing: center to center; LAB, LA, LC, HLC, MA, MC, NB, NC, HLA, HMA, HMC, HNB and HNC 8.50-inch center to center; PB, PC and PCC 12.25-inch center to center; DA, JA, KA, HKA, LB, LBB and HLB 5.75 inch center to center; EB, EHB, FB, JB, KB, HFB and HKB 4.375 inch center to center. Order as a set of two special factory drilled breakers and one walking beam interlock. Specify breaker type, panel thickness and center to center dimension of breakers.

Note: Not UL Listed. 2000A maximum for PB breaker. Not available on drawout breakers.

B. Sliding Bar Type (Field Mountable)



Sliding Bar Type

Availability: HFB through PC.

Mounts on panel (not included) fitting over front of breakers. Standard breaker spacing: HLC, HLA, HMA, HMC, HNB and HNC 8.50-inch center to center; HKA and HLB 5.75-inch center to center; HFB 4.1875-inch center to center.

C. Kirk Key Interlock



Kirk Key Interlock

Availability: EB through PC.

Permits interlocking of two breakers or one breaker with other devices. Before breaker can be closed, key must be inserted and turned in breaker interlock. Breaker must be opened before key can be removed. It can then be inserted in interlock or other devices to permit their closure. Requests and orders should completely outline interlocking scheme, ultimate user and address.

Note: Not available on motor operated breakers. (No CA, LCL, FCL breakers.)

Center Studs



Center Studs

Availability: 600A frames (LA) through (NB) 1200A frames except SELTRONIC and current limiting breakers.

Provides connections for dual voltage generators, so that same trip unit can be used for protection at both voltages. At higher voltage, the trip unit carries full load current. At lower voltage, half the current bypasses the trip unit through the center studs. Trip rating cannot exceed 50% of frame rating.

Field Discharge Switch

Availability: 400, 600A frame (LA).

Breaker is used exclusively to discharge the field of a DC motor or generator, usually through a resistor. When the two outer poles open, the center pole closes.

Note: Not UL Listed.

Motor Operators

Motor operators provide complete remote control by means of a pushbutton or a similar pilot device.

Note: The pilot device must be maintained contact type for EB, EHB, FB, HFB, DA, JA, KA, JB, KB, HKB and LB mechanisms, momentary contact type for all others.

Positive switching action is accomplished by use of an operating arm engaging the breaker handle. The unit is energized momentarily to actuate the lever arm moving it to either the ON or OFF position. The control is broken by an internal cutoff switch. Means for emergency manual operations is provided.

Motor operations are available with motors rated 120 Vac, 208 Vac and 240 Vac.

Note: LA and larger available for 125 Vdc.

The 480V operators use a 120 Vac motor in conjunction with a 480/240V to 120V dual voltage transformer. (On LA and larger operators, the transformer is supplied for separate mounting by the customer.)

Note: The motor operator is intended only for infrequent operation in line with Underwriters Laboratories endurance standards for molded-case breakers. Minimum 1 kVA transformer is required for use with all motor operations.

Back Mounting Plates

Breaker Type	120, 208, 240, 480 Vac Style Number
EB, EHB, FB, HFB	503C707G01
DA, JA, KA, LB, HLB	503C981G01



For LAB, LA, HLA Breakers



For MA, HMA, NB, HNB Breakers



For PB Breakers

For EB, EHB, FB and HFB



Motor Operator Selection ^{①②}

Breaker Type	Style Number—AC Voltage				Style Number—DC Voltage	
	120	208	240	480	125	24
EB, EHB, FB, HFB	656D148G11	656D148G04	656D148G02	656D148G13	—	—
DA, JA, KA, HKA	657D819G23	657D819G10	657D819G08	657D819G24	—	—
LB, LBB, HLB	657D819G25	657D819G16	657D819G14	657D819G26	—	—
LAB, LA, HLA, LC, HLC	2607D97G37	2607D97G40	2607D97G38	2607D97G39	2607D97G51	2607D97G42
MA, HMA, MC, HMC	5664D54G75	5664D54G78	5664D54G76	5664D54G77	5664D54G96	5664D54G81
NB, HNB, NC, HNC, SPCB1200	1494D60G31	1494D60G32	1494D60G33	1494D60G34	1494D60G35	1494D60G36
PB, PC, PCC, PA, SPCB2000	5661D52G01	5661D52G04	5661D52G02	5661D52G03	5661D52G17	—

For DA, JA, KA, JB, LB, LBB, HKA, HKB and HLB Breakers



Motor Data

Breaker Type	Motor Type	Hp	Inrush Current, Ampere (Peak)			Continuous Current (rms)			Operating Time, Open or Close
			120V	208V	240V	120V	208V	240V	
EB, EHB, FB, HFB	Split-phase	1/75	10	4	5	2.3	1.17	1.65	1.5 seconds
DA, JA, KA, JB, KB, LB, LBB, HKB, HLB	Split-phase	1/50	14	6	7	3.5	1.6	1.75	1.5 seconds
LAB, LA, HLA	Reversing	—	8	5	4	—	—	—	12 cycles
MA, HMA, NB, HNB, SPCB1200	Reversing	—	11	7	6	—	—	—	12 cycles
PB, PA, SPCB2000	Reversing	—	20	12	11	—	—	—	10 cycles

Notes

- ① AC voltage rated operators are UL Listed as recognized components.
- ② See Dimension Sheet 29-170.

Drawout Frame

These drawout frames are for use with standard three-pole Cutler-Hammer molded-case circuit breakers. They consist of two separate parts: stationary mounting frame and movable carrier frame. Slide rails are drawer-type, and a screw mechanism is used to engage or withdraw the movable carrier frame.

The drawout frames have three positions: connected, test and disconnected. The frames do not include a safety tripping interlock or secondary contacts. These are optional items and may be ordered at additional cost.

Breakers mounted in the drawout frames can be equipped with standard breaker accessories including shunt trip, undervoltage release, auxiliary switch, alarm switch and motor operator.

Optional Features

Safety Interlock

This feature trips the breaker as the movable carrier frame is withdrawn, and must be factory installed. Order as follows.

Note: Safety interlock not available on MC, NC, HMC, HNC, LC and HLC.

For LA, MA and NB Breakers

Order standard stationary mounting frame. Order breaker and movable carrier frame assembled with safety interlock.

Secondary Contacts

These are used to disconnect auxiliary circuits when attachments such as shunt trip or motor operator are used. Available in multiples of four contacts with a maximum of 24 contacts for the LA 600 or 32 contacts for the MA and NB. They must be factory mounted. Order by description as similar to stationary or moving frame and specify number of contacts required.

Drawout Frame



Selection Data ^{①②}

Breaker Type	Stationary Mounting Frame Style Number	Movable Carrier Frame Style Number
HLA600, HLC600, LA600, LD, HLD ^③	2603D84G01	2608D35G06
HMA, HMC, MDL, HMDL ^③	2603D85G01	2608D34G10
HNB, HNC, ND, HND ^③	2603D85G01	2608D34G08
PB, PC, PCC 2000A ^④	2601D18G04	Order by description ^⑤
PB 2500A, PC, PCC 2500A and 3000A ^④	2601D18G05	Order by description ^⑤

Ordering Information

Note: SELTRONIC circuit breakers with built-in ground fault require a special breaker frame with leads out the side in place of standard terminal block. Order by description the breaker frame and carrier as one assembly.

Standard Installation

Order one stationary mounting frame and one movable carrier frame.

Order breakers without terminals or rear connectors.

Order any attachments desired (shunt trip, undervoltage release, etc.)

Order secondary contacts as required:

- A shunt trip, an undervoltage release or an alarm switch requires two contacts
- A 1A-1B auxiliary switch requires three contacts
- A motor operator requires a maximum of four contacts
- Others as required

With Safety Interlock

Order stationary mounting frame and movable carrier frame as directed under optional features.

Racking Crank

A special crank to engage or withdraw the moving portion of the drawout. A standard 0.50-inch hex socket with extension can be used for this purpose.

Racking Crank

Style Number

765A767G01

Cell Switches Mounted on Drawout Frames, All Ratings

Up to four switches can be provided. Order by description.

Each switch provides NO and NC contact that transfers before reaching the test position when being withdrawn, and after the test position when being racked in. Contact factory for pricing.

Notes

- ① Safety interlock not available on MC, NC, HMC, HNC, LC and HLC.
- ② SELTRONIC circuit breakers with built-in ground fault require a special breaker frame with leads out the side in place of standard terminal block. Order by description the breaker frame and carrier as one assembly.
- ③ These units are UL Listed.
- ④ Not UL Listed.
- ⑤ Factory installed only.

Panelboard “Only” Replacement Breaker Selection Guide

Panelboard “Only” replacement breakers are generally for use as replacement for out-of-production panelboard branch circuit breakers where both physical and electrical interchangeability is required. Where possible, consideration should be given to application of either current Series C or Series G circuit breakers.

For additional information, consult the charts on **Pages V12-T3-84 and V12-T3-85** or contact your local Eaton Field Sales office or the Breaker Service Centers.

Replacement Chart ①

Current Panelboard Circuit Breaker Type	Out-of-Production Circuit Breaker Type	Vac (50/60 Hz)		
		240	480	600
REA ①	EA ①	■		
RE	E ①	■		
REH	EH ①		■	
RFA ①	FA ①			■
RHFA	HFA ①			■
RF ①	F ①			■
RHF	HF ①			■
RJ	J ②			■
RK ①	K ②			■
RHK	HK ②			■
RKL ①	KL ②			■
RHKL	HKL ②			■
RLM ①	LM ②			■
RHLM	HLM ②			■
HLA	JK ②			■
HLA ①	JKL ②			■

■ Shaded area denotes obsolete or discontinued products and services. ③

Panelboard “Only” Replacement Breaker Selection Guide

Breaker Type	Amperes	Panelboard Replacement Breaker Interrupting Ampere Rating												
		120 Vac		240 Vac		277 (Single-Pole)		480 Vac		600 Vac		125 (Single-Pole)		250 Vdc
		Sym.	Asym.	Sym.	Asym.	Sym.	Asym.	Sym.	Asym.	Sym.	Asym.	Sym.	Asym.	
RE	15–20	—	—	—	—	10,000	10,000	—	—	—	—	—	—	—
RE	15–100	7500	7500	7500	7500	—	—	—	—	—	—	—	5000	5000
REA	15–20	—	—	—	—	10,000	10,000	—	—	—	—	—	—	—
REA	15–100	7500	7500	7500	7500	—	—	—	—	—	—	—	5000	5000
REH	15–100	—	—	18,000	20,000	10,000	10,000	14,000	15,000	—	—	—	—	10,000
RF	15–100	—	—	18,000	20,000	—	—	14,000	15,000	14,000	15,000	—	—	10,000
RFA	15–150	—	—	18,000	20,000	—	—	14,000	15,000	14,000	15,000	—	—	10,000
RHF	15–100	—	—	65,000	75,000	—	—	25,000	30,000	18,000	20,000	—	—	20,000
RHFA	15–100	—	—	65,000	75,000	—	—	25,000	30,000	18,000	20,000	—	—	20,000
RJ	70–225	—	—	22,000	25,000	—	—	18,000	20,000	14,000	15,000	—	—	10,000
HLA	70–225	—	—	42,000	50,000	—	—	30,000	35,000	22,000	25,000	—	—	20,000
HLA	125–400	—	—	42,000	50,000	—	—	30,000	35,000	22,000	25,000	—	—	20,000
RK	70–225	—	—	42,000	50,000	—	—	22,000	25,000	22,000	25,000	—	—	10,000
RKL	125–400	—	—	42,000	50,000	—	—	30,000	35,000	22,000	25,000	—	—	20,000
RLM	125–800	—	—	42,000	50,000	—	—	30,000	35,000	22,000	25,000	—	—	20,000
RHK	70–225	—	—	65,000	75,000	—	—	35,000	40,000	25,000	30,000	—	—	20,000
RHKL	125–400	—	—	65,000	75,000	—	—	35,000	40,000	25,000	30,000	—	—	20,000
RHLM	125–800	—	—	65,000	75,000	—	—	35,000	40,000	25,000	30,000	—	—	20,000

Replacement of all out-of-production panelboard circuit breakers are designated by the easily identifiable addition of an “R” prefix to the out-of-production circuit breaker catalog number that they replace.

An Example:

RHF3100 is a newly manufactured, three-pole, 100A trip panelboard replacement breaker for an out-of-production **HF3100**.

R Designates new panelboard “only” replacement breaker.

HF Identifies the out-of-production circuit breaker frame.

3 Number of poles.

100 Trip ampere rating.

Notes:







- Panelboard “only” replacement circuit breakers have non-interchangeable trip units and the same interrupting capacity as the out-of-production circuit breakers that they replace.
- The RE breaker has off-center terminals just like the E breaker it is replacing.
- For out-of-production breakers, the “B” suffix denotes 277 Vac rating for the panelboard replacement breaker. (Example: RE3020B)
- Some panelboard “only” replacement breakers do not have the same physical dimensions or mounting holes as the breakers that they replace. For example, the types REH and RHFA are 6.00 inches in length and the breakers that they replace, EH and HFA, are 6.50 inches in length.
- Panelboard “only” replacement breakers can be installed in the following styles of out-of-production Westinghouse panelboards:

6. ABH	NEB
A2B	NHDP
NHEB	NH1B
NA1B	NLAB-AB
NA1B-LX	NLAB-ABH
NDP	

Notes

- ① Last manufacture date—1974.
- ② Last manufacture date—1967.
- ③ These frames are obsolete. For replacement solutions, see the cross-reference on **Pages V12-T3-114–V12-T3-167** or call 803-481-6843 for other panelboard solutions.

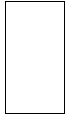
Panelboard “Only” Replacement Circuit Breaker Guide—Dimensions in Inches (Per Three-Pole Breaker)

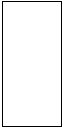
Description	Maximum Amperes			
	100A	225A		
Current Design				
Panelboard “only” replacement circuit breakers These circuit breakers, when used in a panelboard, are direct replacements for the circuit breakers listed below both electrically and physically.	RE ①, REA ② 	REH 	RFA ③, RHFA 	RF ④, RHF 
	Width: 4.13 Height: 6.00 Depth: 3.38	Width: 4.13 Height: 6.00 Depth: 3.38	Width: 4.13 Height: 6.00 Depth: 3.38	Width: 4.13 Height: 9.38 Depth: 3.81
Out-of-Production Westinghouse Circuit Breakers				
These circuit breakers are no longer manufactured These circuit breakers, when used in a panelboard, are directly replaced by the circuit breakers listed above. *Indicates last date of manufacture.	E, EA 	EH 	FA, HFA 	F, HF 
	*1974 Width: 4.13 Height: 6.00 Depth: 3.38	*1974 Width: 4.13 Height: 6.50 Depth: 3.38	*1974 Width: 4.13 Height: 6.50 Depth: 3.38	*1974 Width: 4.13 Height: 9.38 Depth: 3.81

Notes

- ① Obsolete—no replacement.
- ② Obsolete—use REH (available in three-pole only).
- ③ Obsolete—use RHFA (available in three-pole only).
- ④ Obsolete—use RHF (available in three-pole only).

Panelboard “Only” Replacement Circuit Breaker Guide—Dimensions in Inches (Per Three-Pole Breaker), continued

Maximum Amperes

225A

400A

400A

800A

Current Design

RJ



RK ①, RHK



RKL ②, RHKL



RLM ③, RHLM

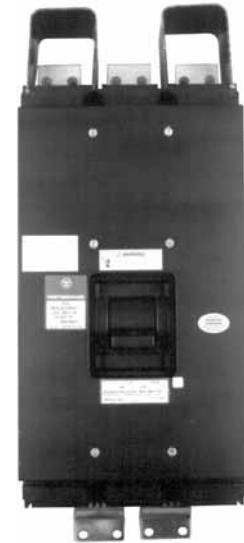

Width: 8.25
Height: 10.13
Depth: 4.06

Width: 8.25
Height: 15.50
Depth: 4.06

Width: 8.25
Height: 16.00
Depth: 4.06

Width: 8.25
Height: 22.00
Depth: 5.50

Out-of-Production Westinghouse Circuit Breakers

J

K, HK

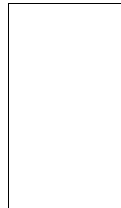

KL, HKL

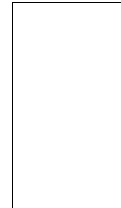

LM, HLM

*1967

*1967

*1967

*1967

Width: 8.25
Height: 10.13
Depth: 4.06

Width: 8.25
Height: 15.50
Depth: 4.06

Width: 8.25
Height: 16.00
Depth: 4.06

Width: 8.25
Height: 22.00
Depth: 5.50

Further Information

Publication Number	Description
IL 15558	Mounting information for the RE, REA breakers
IL 15559	Mounting information for the RF, RHF breakers
IL 15562	Mounting information for the REH, RFA, RHFA breakers
IL 15563	Mounting information for the RJ breaker
IL 15564	Mounting information for the RK, RHK breakers
IL 15565	Mounting information for the RKL, RHKL breakers
IL 15566	Mounting information for the RLM, RHLM breakers

Notes

- ① Obsolete—use RHK (available in three-pole only).
- ② Obsolete—use RHKL (available in three-pole only).
- ③ Obsolete—use RHLM (available in three-pole only).

Shaded area denotes obsolete or discontinued products and services. ①

Type REA



Type REA, Single-, Two- and Three-Pole, 240 Vac Maximum, Thermal-Magnetic

Continuous Ampere Rating at 40°C	Catalog Number		
	Single-Pole, 120 Vac	Two-Pole, 240 Vac	Three-Pole, 240 Vac
10	REA1010	—	—
15	REA1015	REA2015	REA3015
20	REA1020	REA2020	REA3020
25	REA1025	REA2025	REA3025
30	REA1030	REA2030	REA3030
40	REA1040	REA2040	REA3040
50	REA1050	REA2050	REA3050
60	REA1060	REA2060	REA3060
70	REA1070	REA2070	REA3070
80	REA1080	REA2080	REA3080
90	REA1090	REA2090	REA3090
100	REA1100	REA2100	REA3100

Type REH



Type REH, Single-, Two- and Three-Pole, 480 Vac Maximum, Thermal-Magnetic

Continuous Ampere Rating at 40°C	Catalog Number		
	Single-Pole, 277 Vac	Two-Pole, 480 Vac	Three-Pole, 480 Vac
10	REH1010	—	—
5	REH1015	REH2015	REH3015
20	REH1020	REH2020	REH3020
25	REH1025	REH2025	REH3025
30	REH1030	REH2030	REH3030
40	REH1040	REH2040	REH3040
50	REH1050	REH2050	REH3050
60	REH1060	REH2060	REH3060
70	REH1070	REH2070	REH3070
80	REH1080	REH2080	REH3080
90	REH1090	REH2090	REH3090
100	REH1100	REH2100	REH3100

Type RE



Type RE, Single-, Two- and Three-Pole, 240 Vac Maximum, Thermal-Magnetic

Continuous Ampere Rating at 40°C	Catalog Number		
	Single-Pole, 120 Vac	Two-Pole, 240 Vac	Three-Pole, 240 Vac
10	RE1010	—	—
15	RE1015	RE2015	RE3015
20	RE1020	RE2020	RE3020
25	RE1025	RE2025	RE3025
30	RE1030	RE2030	RE3030
40	RE1040	RE2040	RE3040
50	RE1050	RE2050	RE3050
60	RE1060	RE2060	RE3060
70	RE1070	RE2070	RE3070
80	RE1080	RE2080	RE3080
90	RE1090	RE2090	RE3090
100	RE1100	RE2100	RE3100

Terminals

Maximum Amperes	Wire Type	Wire Range	Style Number ②
Standard Pressure Type Terminals			
20 (EB, EHB)	Al/Cu	#14-#10	624B100G14
100	Al/Cu	#14-1/0	624B100G02
150	Al/Cu	#4-4/0	624B100G17
Optional Al/Cu Pressure Terminals			
50	Al/Cu	#14-#4	624B100G10
100	Al/Cu	#4-4/0	624B100G17

Accessories and Modifications

All accessories and modifications available for Replacement Breakers Types EB, EHB and FB are also available for Panelboard Replacement Breakers Types RE, REH, RFA, RF, RHF, REA and RHFA.

For accessories and modifications, refer to **Pages V12-T3-65-V12-T3-79**.

Terminals

See table on **Page V12-T3-83**.

50°C Calibration

Add suffix "V" to catalog number for breakers to be used in 50°C ambients. Same price as standard 40°C breakers.

Note: Not UL Listed.

Notes

- ① These frames are obsolete. For replacement solutions, see the cross-reference on **Pages V12-T3-114-V12-T3-167** or call 803-481-6843 for other panelboard solutions.
- ② Package of three.

Shaded area denotes obsolete or discontinued products and services. ①

Panelboard Replacement Circuit Breakers (Includes Terminals on Load Side Only)

Continuous Ampere Rating at 40°C	Catalog Number	
	Two-Pole, 600 Vac	Three-Pole, 600 Vac
Type RFA Two-, Three-Pole, 600 Vac Maximum, Thermal-Magnetic		
15	RFA2015	RFA3015
20	RFA2020	RFA3020
25	RFA2025	RFA3025
30	RFA2030	RFA3030
35	RFA2035	RFA3035
40	RFA2040	RFA3040
50	RFA2050	RFA3050
60	RFA2060	RFA3060
70	RFA2070	RFA3070
80	RFA2080	RFA3080
90	RFA2090	RFA3090
100	RFA2100	RFA3100
125	RFA2125	RFA3125
150	RFA2150	RFA3150
Type RF Two-, Three-Pole, 600 Vac Maximum, Thermal-Magnetic		
15	RF2015	RF3015
20	RF2020	RF3020
25	RF2025	RF3025
30	RF2030	RF3030
35	RF2035	RF3035
40	RF2040	RF3040
50	RF2050	RF3050
60	RF2060	RF3060
70	RF2070	RF3070
80	RF2080	RF3080
90	RF2090	RF3090
100	RF2100	RF3100
Type RHFA Two-, Three-Pole, 600 Vac Maximum, Thermal-Magnetic		
15	RHFA2015	RHFA3015
20	RHFA2020	RHFA3020
25	RHFA2025	RHFA3025
30	RHFA2030	RHFA3030
35	RHFA2035	RHFA3035
40	RHFA2040	RHFA3040
50	RHFA2050	RHFA3050
60	RHFA2060	RHFA3060
70	RHFA2070	RHFA3070
80	RHFA2080	RHFA3080
90	RHFA2090	RHFA3090
100	RHFA2100	RHFA3100
125	RHFA2125	RHFA3125
150	RHFA2150	RHFA3150

Note

① These frames are obsolete. For replacement solutions, see the cross-reference on **Pages V12-T3-114–V12-T3-167** or call 803-481-6843 for other panelboard solutions.

Type RFA



Type RF





Type RHFA



Shaded area denotes obsolete or discontinued products and services. ①

Panelboard Replacement Circuit Breakers (Includes Terminals on Load Side Only)

	Continuous Ampere Rating at 40°C	Catalog Number Two-Pole, 600 Vac	Three-Pole, 600 Vac
	Type RHF Two-, Three-Pole, 600 Vac Maximum, Thermal-Magnetic		
Type RHF 	15	RHF2015	RHF3015
	20	RHF2020	RHF3020
	25	RHF2025	RHF3025
	30	RHF2030	RHF3030
	40	RHF2040	RHF3040
	50	RHF2050	RHF3050
	60	RHF2060	RHF3060
	70	RHF2070	RHF3070
	80	RHF2080	RHF3080
	90	RHF2090	RHF3090
	100	RHF2100	RHF3100
Type RJ Two-, Three-Pole, 600 Vac Maximum, Thermal-Magnetic			
Type RJ 	70	RJ2070	RJ3070
	90	RJ2090	RJ3090
	100	RJ2100	RJ3100
	125	RJ2125	RJ3125
	150	RJ2150	RJ3150
	175	RJ2175	RJ3175
	200	RJ2200	RJ3200
	225	RJ2225	RJ3225
	225 MCS	RJ2225K	RJ3225K
Type RK Two-, Three-Pole, 600 Vac Maximum, Thermal-Magnetic			
Type RK 	70	RK2070	RK3070
	90	RK2090	RK3090
	100	RK2100	RK3100
	125	RK2125	RK3125
	150	RK2150	RK3150
	175	RK2175	RK3175
	200	RK2200	RK3200
	225	RK2225	RK3225
	225 MCS	RK2225K	RK3225K
Type RKL Two-, Three-Pole, 600 Vac Maximum, Thermal-Magnetic			
Type RKL 	125	RKL2125	RKL3125
	150	RKL2150	RKL3150
	175	RKL2175	RKL3175
	200	RKL2200	RKL3200
	225	RKL2225	RKL3225
	250	RKL2250	RKL3250
	300	RKL2300	RKL3300
	350	RKL2350	RKL3350
	400	RKL2400	RKL3400
	400 MCS	RKL2400K	RKL3400K

Note

① These frames are obsolete. For replacement solutions, see the cross-reference on **Pages V12-T3-114–V12-T3-167** or call 803-481-6843 for other panelboard solutions.

3

Molded-Case Circuit Breakers

Replacement Capabilities

Shaded area denotes obsolete or discontinued products and services. ①

Panelboard Replacement Circuit Breakers (Includes Terminals on Load Side Only)

Continuous Ampere Rating at 40°C Catalog Number
Two-Pole, 600 Vac Three-Pole, 600 Vac

3

Type RLM



Type RLM Two-, Three-Pole, 600 Vac Maximum, Thermal-Magnetic

125	RLM2125	RLM3125
150	RLM2150	RLM3150
175	RLM2175	RLM3175
200	RLM2200	RLM3200
225	RLM2225	RLM3225
250	RLM2250	RLM3250
275	RLM2275	RLM3275
300	RLM2300	RLM3300
350	RLM2350	RLM3350
400	RLM2400	RLM3400
500	RLM2500	RLM3500
600	RLM2600	RLM3600
600 MCS	RLM2600K	RLM3600K
700	RLM2700	RLM3700
800	RLM2800	RLM3800

Type RHK



Type RHK Two-, Three-Pole, 600 Vac Maximum, Thermal-Magnetic

70	RHK2070	RHK3070
90	RHK2090	RHK3090
100	RHK2100	RHK3100
125	RHK2125	RHK3125
150	RHK2150	RHK3150
175	RHK2175	RHK3175
200	RHK2200	RHK3200
225	RHK2225	RHK3225
225 MCS	RHK2225K	RHK3225K

Type RHKL



Type RHKL Two-, Three-Pole, 600 Vac Maximum, Thermal-Magnetic

125	RHKL2125	RHKL3125
150	RHKL2150	RHKL3150
175	RHKL2175	RHKL3175
200	RHKL2200	RHKL3200
225	RHKL2225	RHKL3225
250	RHKL2250	RHKL3250
300	RHKL2300	RHKL3300
350	RHKL2350	RHKL3350
400	RHKL2400	RHKL3400
400 MCS	RHKL2400K	RHKL3400K

Note

① These frames are obsolete. For replacement solutions, see the cross-reference on **Pages V12-T3-114–V12-T3-167** or call 803-481-6843 for other panelboard solutions.

Shaded area denotes obsolete or discontinued products and services. ①

Type RHLM



Panelboard Replacement Circuit Breakers (Includes Terminals on Load Side Only)

Continuous Ampere Rating at 40°C	Catalog Number	
	Two-Pole, 600 Vac	Three-Pole, 600 Vac
Type RHLM Two-, Three-Pole, 600 Vac Maximum, Thermal-Magnetic		
125	RHLM2125	RHLM3125
150	RHLM2150	RHLM3150
175	RHLM2175	RHLM3175
200	RHLM2200	RHLM3200
225	RHLM2225	RHLM3225
250	RHLM2250	RHLM3250
275	RHLM2275	RHLM3275
300	RHLM2300	RHLM3300
325	RHLM2325	RHLM3325
350	RHLM2350	RHLM3350
400	RHLM2400	RHLM3400
450	RHLM2450	RHLM3450
500	RHLM2500	RHLM3500
550	RHLM2550	RHLM3550
600	RHLM2600	RHLM3600
600 MCS	RHLM2600K	RHLM3600K
700	RHLM2700	RHLM3700
800	RHLM2800	RHLM3800

Accessories and Modifications

All accessories and modifications available for replacement breakers types KA, LA and MA are also available for panelboard replacement breakers types RJ, RK, RKL, RLM, RHK, RHKL and RHLM.

For additional accessories and modifications, refer to **Pages V12-T3-65–V12-T3-79**.

Terminals

Panelboard Circuit Breakers	Terminals ②
RJ	TA225LA1
RK	TA225LA1
RHK	TA225LA1
RKL	TA400LA1
RHKL	TA400LA1
RLM	TA700MA1 (for <600A)
RHLM	TA800MA1 (for 700–800A)

50°C Calibration

Add suffix “V” to catalog number for breakers to be used in 50°C ambients. Same price as standard 40°C breakers.

Note: Not UL Listed.

Special Breakers

Magnetic only (includes load terminals). Available for all ampere ratings for two- and three-pole RJ, RK, RKL, RLM, RHK, RHKL and RHLM.

High magnetic molded-case switches (K suffix) are available to replace out-of-production non-automatic breakers (N suffix).

Note: Not UL Listed.

Panelboard and Switchboard Replacement Breaker Ordering Instructions

1. Choose the breaker frame and amperage.
2. Select the proper connector kit (if needed).
3. Call your local distributor with catalog numbers and request Eaton's Free Express Service.

Compatible with Panelboards and Switchboards from: Westinghouse Distribution and Control Business Unit

1987–1998



1991–1998

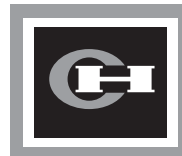

1994–2000



Cutler-Hammer

2000–2009



2009–Present

Connector Kits for Pow-R-Line 4 Panelboards and Pow-R-Line C Switchboards

Breaker Type	Catalog Number	
	Single	Twin
F-Frame	—	KPRL4FD
J-Frame	KPRL4JDS	KPRL4JDT
K-Frame	KPRL4KDS	KPRL4KDT
L-Frame	KPRL4LD	—
M-Frame	KPRL4MC	—
N-Frame	KPRL4ND	—

For further information, reference Page **V12-T3-168** in this catalog.

Notes

① These frames are obsolete. For replacement solutions, see the cross-reference on **Pages V12-T3-114–V12-T3-167** or call 803-481-6843 for other panelboard solutions.

② Packaged individually.

Shaded area denotes obsolete or discontinued products and services.

Replacement Capabilities

Cutler-Hammer motor control center replacement circuit breakers are newly manufactured and tested to the latest applicable standards at the Eaton molded-case circuit breaker plant in Beaver, PA. This plant has a long and well-recognized tradition of product safety, integrity and quality.

The motor control center replacement circuit breaker solution eliminates the need to consider alternative approaches. Eaton customers are ensured that the high standards of product quality and reliability do not have to be sacrificed when replacing Westinghouse out-of-production circuit breakers.

All motor control center replacement circuit breakers are easily identified by the prefix "RMC" added to the out-of-production type circuit breaker catalog number they replace.

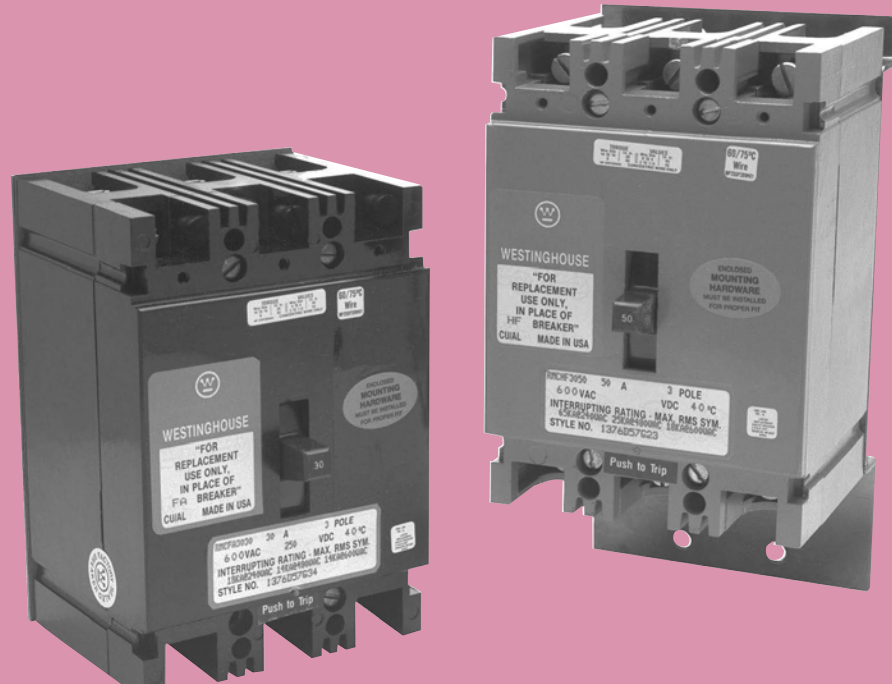

Replacement Motor Control Center Breakers

Replacement Chart

Current MCC Circuit Breaker Type	Out-of-Production Circuit Breaker Type ①	Volts AC (50/60 Hz) 600
RMCF	FA	■
RMCF	HFA	■
RMCF	F	■
RMCF	HF	■

Motor Control Center Replacement Breaker Interrupting Ampere Ratings

Breaker Type	Ampers	240 Vac	480 Vac	600 Vac	250 Vac
RMCF ②③	15–100	18,000	14,000	14,000	10,000
RMCF ②③④	15–150	18,000	14,000	14,000	10,000
RMCF ②③	15–100	65,000	25,000	18,000	20,000
RMCF ②③④	15–150	65,000	25,000	18,000	20,000

Example:

An **RMCF3100** is a newly manufactured, three-pole, 100A trip panelboard replacement circuit breaker. It replaces an out-of-production F circuit breaker.

Example:

RMC Designates new motor control center replacement circuit breaker.

F Identifies the out-of-production circuit breaker frame.

3 Number of poles.

100 Trip unit ampere rating.

Contact **1-800-OLD-UNIT** for replacement or **Page V12-T3-91** for Series C retrofit kits.



Notes

- ① Last manufacture date—1974.
- ② Motor control center replacement breakers do not have the same physical dimensions or mounting holes as the breakers they replace. Types **RMCF** and **RMCF** are 6.00 inches long and the breakers they replace, **FA** and **HFA**, are 6.50 inches long. Types **RMCF** and **RMCF** are 6.00 inches long and the breakers they replace, **F** and **HF**, are 9.375 inches long. A mounting plate is provided with each breaker to resolve these differences, and must be installed to ensure a proper fit.
- ③ Motor control center replacement circuit breakers have non-interchangeable trip units and the same interrupting capacity as the out-of-production circuit breakers they replace.
- ④ **RMCF** and **RMCF** two-pole breakers are supplied in a three-pole frame with current carrying parts omitted from the center pole.

Types RMCFA, RMCF, RMCHFA and RMCHF—Motor Control Center Replacement

■ Shaded area denotes obsolete or discontinued products and services. ①

Motor Control Center Replacement Circuit Breakers

	Continuous Ampere Rating at 40°C	Catalog Number		
		Single-Pole	Two-Pole	Three-Pole
Type RMCFA	Type RMCFA – 15–100A Two-, Three-Pole, 600 Vac Maximum, Thermal-Magnetic			
	15	—	RMCF2015	RMCF3015
	20	—	RMCF2020	RMCF3020
	25	—	RMCF2025	RMCF3025
	30	—	RMCF2030	RMCF3030
	35	—	RMCF2035	RMCF3035
	40	—	RMCF2040	RMCF3040
	50	—	RMCF2050	RMCF3050
	60	—	RMCF2060	RMCF3060
	70	—	RMCF2070	RMCF3070
	80	—	RMCF2080	RMCF3080
	90	—	RMCF2090	RMCF3090
100	—	RMCF2100	RMCF3100	
Type RMCF	Type RMCF – 15–150A Two-, Three-Pole, 600 Vac Maximum, Thermal-Magnetic			
	15	—	RMCHF2015	RMCHF3015
	20	—	RMCHF2020	RMCHF3020
	25	—	RMCHF2025	RMCHF3025
	30	—	RMCHF2030	RMCHF3030
	35	—	RMCHF2035	RMCHF3035
	40	—	RMCHF2040	RMCHF3040
	50	—	RMCHF2050	RMCHF3050
	60	—	RMCHF2060	RMCHF3060
	70	—	RMCHF2070	RMCHF3070
	80	—	RMCHF2080	RMCHF3080
	90	—	RMCHF2090	RMCHF3090
100	—	RMCHF2100	RMCHF3100	
	125	—	RMCHF2125	RMCHF3125
	150	—	RMCHF2150	RMCHF3150

Notes

① These frames are obsolete. For more information, call 1-800-OLD-UNIT for Cutler-Hammer motor control solutions.

See Page V12-T3-91 for Series C retrofit kits.

Shaded area denotes obsolete or discontinued products and services. ①

Motor Control Center Replacement Circuit Breakers

Continuous Ampere Rating at 40°C	Catalog Number		
	Single-Pole	Two-Pole	Three-Pole
Type RMCHFA – 15–100A Two-, Three-Pole, 600 Vac Maximum, Thermal-Magnetic			
15	—	RMCHFA2015	RMCHFA3015
20	—	RMCHFA2020	RMCHFA3020
25	—	RMCHFA2025	RMCHFA3025
30	—	RMCHFA2030	RMCHFA3030
35	—	RMCHFA2035	RMCHFA3035
40	—	RMCHFA2040	RMCHFA3040
50	—	RMCHFA2050	RMCHFA3050
60	—	RMCHFA2060	RMCHFA3060
70	—	RMCHFA2070	RMCHFA3070
80	—	RMCHFA2080	RMCHFA3080
90	—	RMCHFA2090	RMCHFA3090
100	—	RMCHFA2100	RMCHFA3100
125	—	RMCHFA2125	RMCHFA3125
150	—	RMCHFA2150	RMCHFA3150

Type RMCHF – 15–100A Two-, Three-Pole, 600 Vac Maximum, Thermal-Magnetic

15	—	RMCHF2015	RMCHF3015
20	—	RMCHF2020	RMCHF3020
25	—	RMCHF2025	RMCHF3025
30	—	RMCHF2030	RMCHF3030
35	—	RMCHF2035	RMCHF3035
40	—	RMCHF2040	RMCHF3040
50	—	RMCHF2050	RMCHF3050
60	—	RMCHF2060	RMCHF3060
70	—	RMCHF2070	RMCHF3070
80	—	RMCHF2080	RMCHF3080
90	—	RMCHF2090	RMCHF3090
100	—	RMCHF2100	RMCHF3100

Notes

① These frames are obsolete. For more information, call **1-800-OLD-UNIT** for Cutler-Hammer motor control solutions.

See **Page V12-T3-91** for Series C retrofit kits.



Technology Upgrades

Series C Retrofit Kits

Series C Retrofit Kits are to be used to upgrade existing Type W and 5 Star motor control center units by changing out the old breakers with new Series C models. These kits can be applied to both starter and feeder units.

Some of the breakers that these kits will upgrade include:

- MCP, F, FA, FB, HFB, K, KA, KB, HKB, L, LA, LB and HLB breakers

5 Star Series C Retrofit Kit



5 Star Series C Retrofit Kit

The 5 Star Series C retrofit kit includes:

- Series C device, 65 kA (either HMCP or thermal-magnetic breaker)
- Operating handle, including tripped indication and push-to-trip mechanism
- Label stating that the MCC unit has been retrofitted with Series C device suitable for 65 kA (similar to UL quality label)
- Templates for desired frame size
- Assembly instructions

Customer benefits:

- Ease of ordering—one catalog number for all required parts
- Series C technology—higher AIC rating
- All new components associated with the breaker, including new stab assembly, operating mechanism and door, if required

Type W Series C Retrofit Kit



Type W Series C Retrofit Kit

The Type W Series C retrofit kit includes:

- Series C device, 65 kA (either HMCP or thermal-magnetic breaker)
- Operating handle, including tripped indication and push-to-trip mechanism
- Label stating that the MCC unit has been retrofitted with Series C device suitable for 65 kA (similar to UL quality label)
- Templates for proper hole placement for desired frame size
- Series C breaker mounting hardware
- New door and hardware
- New stab assembly
- Assembly instructions

310+ Electronic Trip Unit

The 310+ electronic trip unit has advantages and upgraded features over the Series C 310 electronic trip unit as follows:

- Adjustable I_r continuous current setting eliminates the need for rating plugs
- Cause of trip information can be extracted from the breaker
- Zone selective interlocking option for breaker coordination
- Ground fault alarm only option to keep critical equipment on-line when a ground fault is present
- Arcflash Reduction Maintenance System™ to improve worker safety

Note: Available only for the LG, NG, RG/RD 310+ models.

The 310+ electronic trip unit is available for the following MCCB breakers:

- Series C FDE
- Series G JG
- Series G LG
- Series G NG
- Series G RG
- Series C RD (available as a field retrofit kit)

Series C to Series G Upgrades

The Series C 250A JD and 600A LD breakers are being replaced by Series G 250A JG and 600A LG breakers respectively. There are several advantages in moving from these Series C to Series G breakers.

Series G 250A JG Molded-Case Circuit Breaker

- Smaller breaker footprint than Series C JD
- Breaker is dual rated, UL and IEC
- Interruption ratings up to 200 kAIC at 480 Vac
- Accessories are field installable thru-cover
- Now available with an electronic, 310+ trip unit
- Can accommodate the ANSI C12.1 Power Monitoring/Metering Module (PM3)

Series G 600A LG Molded-Case Circuit Breaker:

- Smaller breaker footprint Series C LD
- Breaker is dual rated, UL and IEC
- Interruption ratings up to 200 kAIC at 480 Vac
- Accessories are field installable thru-cover
- Upgraded from 310 electronic trip unit to a 310+ electronic trip unit
- Can accommodate the ANSI C12.1 Power Monitoring Metering Module (PM3)

Advantages of 310+ Electronic Trip Unit Technology Versus the 310 Electronic Trip Unit:

- Adjustable I_r continuous current setting eliminates the need for rating plugs
- Cause of trip information can be extracted from the breaker
- Zone selective interlocking option for breaker coordination
- Ground fault alarm only option to keep critical equipment on-line when a ground fault is present
- Arcflash Reduction Maintenance System to improve worker safety (not available in the JG 310+ electronic trip unit)

F10 Series C Retrofit Kit**F10 Series C Retrofit Kit**

The F10 Series C retrofit kit includes:

- Series C device, 65 kA (either HMCP or thermal-magnetic breaker)
- Operating handle mechanism, including tripped indication push-to-trip
- Label stating that the MCC unit has been retrofitted with Series C device suitable for 65 kA (similar to UL quality label)
- Templates for desired frame size
- Assembly instructions

Series C Molded-Case Circuit Breakers

Frame Type	Interrupting Rating (kAIC)			Trip Rating Amperes	Catalog Number
	240V	480V	600V		
HFD	100	65	25	15	HFD3015
HFD	100	65	25	20	HFD3020
HFD	100	65	25	25	HFD3025
HFD	100	65	25	30	HFD3030
HFD	100	65	25	40	HFD3040
HFD	100	65	25	50	HFD3050
HFD	100	65	25	60	HFD3060
HFD	100	65	25	70	HFD3070
HFD	100	65	25	80	HFD3080
HFD	100	65	25	90	HFD3090
HFD	100	65	25	100	HFD3100
HFD	100	65	25	125	HFD3125
HFD	100	65	25	150	HFD3150
FDC	200	100	35	15	FDC3015
FDC	200	100	35	20	FDC3020
FDC	200	100	35	25	FDC3025
FDC	200	100	35	30	FDC3030
FDC	200	100	35	40	FDC3040
FDC	200	100	35	50	FDC3050
FDC	200	100	35	60	FDC3060
FDC	200	100	35	70	FDC3070
FDC	200	100	35	80	FDC3080
FDC	200	100	35	90	FDC3090
FDC	200	100	35	100	FDC3100
FDC	200	100	35	125	FDC3125
FDC	200	100	35	150	FDC3150
HJD	100	65	25	175	HJD3175
HJD	100	65	25	200	HJD3200
HJD	100	65	25	225	HJD3225
HJD	100	65	25	250	HJD3250
JDC	200	100	35	175	JDC3175
JDC	200	100	35	200	JDC3200
JDC	200	100	35	225	JDC3225
JDC	200	100	35	250	JDC3250
HKD	100	65	35	300	HKD3300
HKD	100	65	35	350	HKD3350
HKD	100	65	35	400	HKD3400
KDC	200	100	50	300	KDC3300
KDC	200	100	50	350	KDC3350
KDC	200	100	50	400	KDC3400

Series C Motor Circuit Protectors

Starter Size	Magnetic Trip Range Amperes	Continuous Rating Amperes	Catalog Number
0	9–30	3	HMCP003A0
0	21–70	7	HMCP007C0
0	45–150	15	HMCP015E0
0	40–60	25	HMCP025D0
1	90–300	30	HMCP030H1
2	80–120	50	HMCP050G2
2	150–500	50	HMCP050K2
2	115–170	70	HMCP070J2
2	210–700	70	HMCP070M2
3	160–240	100	HMCP100L3
3	300–1000	100	HMCP100R3
4	450–1500	150	HMCP150T4
4	750–2500	150	HMCP150U4
4, 5	350–700	250	HMCP250A5
5	450–900	250	HMCP250C5
5	500–1000	250	HMCP250D5
5	625–1250	250	HMCP250F5
5	750–1500	250	HMCP250G5
5	875–1750	250	HMCP250J5
5	1000–2000	250	HMCP250K5
5	1125–2250	250	HMCP250L5
5	1250–2500	250	HMCP250W5
5	500–1000	400	HMCP400D5
5	625–1250	400	HMCP400F5
5	750–1500	400	HMCP400G5
5	875–1750	400	HMCP400J5
5	1000–2000	400	HMCP400K5
5	1125–2250	400	HMCP400L5
5	1250–2500	400	HMCP400M5
5	1500–3000	400	HMCP400N5
5	1750–3500	400	HMCP400R5
5, 6	2000–4000	400	HMCP400X5

Series C Retrofit Kit Catalog Numbering System

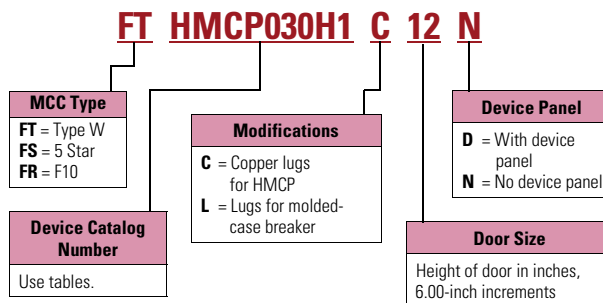

How to Order

Step 1: Select the correct Series C molded-case circuit breaker from the table on **Page V12-T3-92** or the Series C motor circuit protector from the table on this page.

Step 2: Create a catalog number based on the MCC type, device selected, modifications, door size and device panel.

Step 3: Select price from PL04304002E.

OPTIM 550 Trip Units for Upgrading Thermal/Magnetic Trips



Digitrip OPTIM 550

Replacement of the OPTIM 550 trip units and the associated accessories allows a customer to easily upgrade an existing Series C, K- or L-Frame molded-case circuit breaker equipped with a standard thermal-magnetic trip unit, without the need to purchase a new circuit breaker.

Key features and benefits of the OPTIM 550 trip unit include:

- 10 set points providing for premium protection and coordination
- Cause-of-Trip indication (LEDs and digital memory)
- Load monitoring to provide information for energy management
- Diagnostics to assist in system troubleshooting
- Communications and zone interlocking options—field or factory installed

OPTIM 550 Trip Units for Upgrading Thermal/Magnetic Trips

Maximum Ampere Rating (Sensor)	Catalog Number		
	Type of OPTIM 550 Trip Unit		
	LSI	LSIA	LSIG
KD, HKD, KDC, CKD and CHKD Breaker Frames			
125	KEP3125T52	KEP3125T57	KEP3125T56
250	KEP3250T52	KEP3250T57	KEP3250T56
400	KEP3400T52	KEP3400T57	KEP3400T56
LD, HLD, LDC, CLD, CHLD and CLDC Breaker Frames			
125	LEP3125T52	LEP3125T57	LEP3125T56
250	LEP3250T52	LEP3250T57	LEP3250T56
400	LEP3400T52	LEP3400T57	LEP3400T56
600	LEP3600T52	LEP3600T57	LEP3600T56

Cutler-Hammer PowerNet™ and Zone Interlock Kits (OPTIM 550 Only) K-, L- and N-Frames

PowerNet Communication Kit

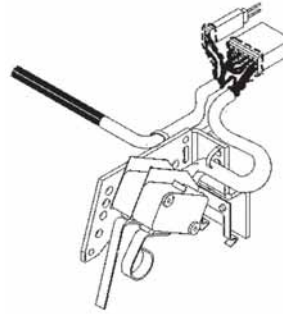

The Cutler-Hammer PowerNet communications kit can be ordered to add PowerNet communications to an existing OPTIM 550 breaker in the field. An 18.00-inch wiring pigtail is routed to the rear of the breaker: two wires for PowerNet and two wires for 24 Vdc (45 mA load). It is recommended that the power supply be an “isolated high quality” unit.

PowerNet and Zone Interlock Kits

Circuit Breaker	PowerNet		Zone Interlocking/ Ground ①		PowerNet and Zone Interlocking/Ground ①	
	Factory Install Suffix	Catalog Number	Factory Install Suffix	Catalog Number	Factory Install Suffix	Catalog Number
K-Frame	PN	ICK550K	ZG	ZGK550K	ZGP	ZGPK550K
L-Frame	PN	ICK550L	ZG	ZGK550L	ZGP	ZGPK550L
N-Frame	PN	ICK550N	ZG	ZGK550N	ZGP	ZGPK550N

Notes

① Includes a ground fault alarm signal that can drive the ground fault alarm unit (catalog number GFAU).

Instruction leaflet numbers (K) 29C506, (L) 29C897, (N) 29C898.

Handle Mechanisms

■ Shaded area denotes obsolete or discontinued products and services.

MCCB Handle Mechanism Introduction

Eaton offers a broad range of handle mechanisms for molded-case circuit breakers. Each of these has been designed specifically for safe, dependable operation and ease of installation.

Handle mechanisms are used in a wide variety of applications including enclosed molded-case circuit breakers, control panels and motor control centers.

Whether replacing a damaged handle mechanism with a like unit, switching from fuses to circuit breakers in order to limit downtime, or upgrading to take advantage of the many benefits associated with applying communicating, programmable molded-case circuit breaker technology, Eaton has the handle mechanism solution that is right for you.



Flex-Shaft Type—Page V12-T3-107



Slide Plate Type—Page V12-T3-99



Vari-Depth Type—Page V12-T3-105



*Type SM Safety Handle—
Page V12-T3-101*

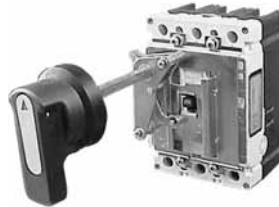

*Universal Rotary Type—
Page V12-T3-110*



*Type MC Motor Control—
Page V12-T3-103*



*Type AMT Vari-Depth—
Page V12-T3-104*

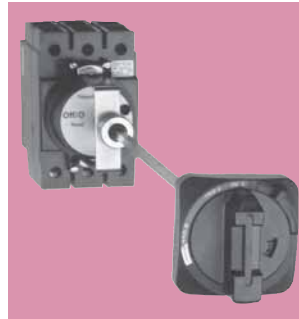

G-Frame Vari-Depth



Series C Rotary Type—Page V12-T3-109



Universal Direct—Page V12-T3-111



G Direct—Page V12-T3-111



Euro IEC Direct—Page V12-T3-111

3

Handle Mechanism Selection and Availability Guide

Circuit Breaker and Switch Type	Door Mounted				Flange Mounted			
	Vari-Depth	Series C ^① Rotary	Slide Plate	MC	Series C ^① Flex Shaft	SM	AMT Fixed Width	AMT Vari-Depth
Series C Breakers								
F-Frame/F HMCP ^②	■	■	■	■	■	■	■	■
J-Frame/J HMCP	■	■	■	■	■	■	■	■
K-Frame/K HMCP	■	■	■	■	■	■	■	■
L-Frame/L HMCP	■	■	■	■	■	■	■	■
M-Frame	■	■	■	■	■	■		■
N-Frame		■			■			
R-Frame			■		■			
Other Industrial Breakers								
GB/GHB/GC/GHC/GD/GMCP	■							
LA/LAB/HLA	■		■	■		■	■	■
LC/HLC/LCG	■		■	■		■	■	■
MA/HMA	■		■	■		■		■
MC/HMC	■		■	■		■		■
NB/HNB	■		■	■		■		■
NC/HNC	■		■	■		■		■
PB			■					
PC/PCC			■					
FB TRI-PAC	■		■	■		■		■
LA TRI-PAC	■		■			■		■
NB TRI-PAC	■		■			■		■
PB TRI-PAC			■					
FCL	■			■		■		
LCL	■			■		■		■
EB/EHB/FB/HFB	■		■	■		■	■	■
JA/KA/HKA/DA/LB/LBB/HLB	■		■	■		■	■	■
Disconnect Switches								
DE-ION [®] 30, 60, 100	■		■					
DS 30, 60, 100, 200	■		■	■		■	■	■
DS 400, 600			■					
Visi-Flex Model "T" 30, 60, 100			■					

Notes

① For application only with Series C molded-case circuit breakers and HMCPs.

② Series C F-Frame includes EHD, ED, FDB, FD, HFD and FDC designations.

Vari-Depth Type

General purpose vari-depth handle mechanisms are suitable for use with Type 1 fabricated enclosures. They are designed for use with breakers or disconnect switches when used in deep enclosures.

Required for a standard application are a padlockable operating handle, a shaft and a mechanism. Two variable depth shafts are offered to better cover the wide range of depths of various enclosures...these are referred to in the table as the standard and the long shaft. The dimensions for panel depth given in the following

table are from the mounting surface of the breaker or the disconnect to the inside of the enclosure cover.

Standard mechanisms do not include an internal lockoff device. Mechanisms with this feature are, however, offered as an optional item. The internal lockoff provides a means of padlocking the breaker or the switch in the OFF position while the enclosure door is open.

These mechanisms may also be used in conjunction with Type 4, 7 and 9 cast enclosures. When used with these enclosures, the special handle kits shown as accessory items must be

ordered in place of the standard handle.

The adapter bushing, a component of the special handle kit, may be ordered separately.

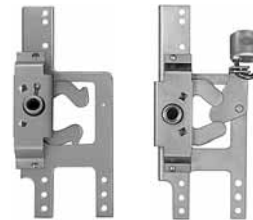

Mechanism



Handle

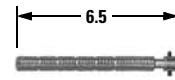

Standard Shaft

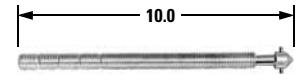

Long Shaft

3

Vari-Depth Type



Vari-Depth Type Catalog Numbers

For Complete Applications, Order Mechanism, Handle and Shaft	Mechanism ①②		Handle ③	Shaft	Standard Panel Depth	Standard Style Number	Long Panel Depth	Long Style Number
	Standard—(No Internal Lockoff) Style Number	Special—(With Internal Lockoff) Style Number	Type 1, 3R, 12 (With Hardware) Style Number	Standard Panel Depth				
Circuit Breakers								
Series C F-Frame and HMCP F ④	373D958G22	373D958G23	504C323G07	5-10-1/4	47A4446G36	10-1/2-14	47A4446G37	
EB, EHB, FB, HFB, MCP	373D958G05	373D958G06	504C323G07	5-10-1/4	47A4446G36	10-1/2-14	47A4446G37	
CA	458D493G20	458D493G21	504C323G07	4-3/4-9-3/4	47A4446G36	9-3/4-13-1/2	47A4446G37	
Series C J-Frame and HMCP J	5092A62G03	5092A62G04	504C323G07	5-7/8-11-1/8	47A4446G36	11-1/8-14-7/8	47A4446G37	
Series C K-Frame and HMCP K	5092A62G01	5092A62G02	504C323G07	5-7/8-11-1/8	47A4446G36	11-1/8-14-7/8	47A4446G37	
Series C L-Frame and HMCP L	5092A62G05	5092A62G06	504C323G07	6-1/8-11-1/4	47A4446G36	11-1/4-15	47A4446G37	
JA, KA, HKA, DA, LB, LBB, HLB	458D493G03	458D493G11	504C323G07	5-7/8-11-1/8	47A4446G36	11-1/8-14-7/8	47A4446G37	
LA, HLA, LC, HLC	458D493G04	458D493G12	504C323G07	6-1/8-11-1/4	47A4446G36	11-1/4-15	47A4446G37	
TRI-PAC FB	373D958G10	373D958G11	504C323G07	5-10-1/4	47A4446G36	10-1/4-14	47A4446G37	
FCL	373D958G16	373D958G17	504C323G07	5-10-1/4	47A4446G36	10-1/4-14	47A4446G37	
MA, HMA, MC, HMC, Series C MD, MDS Frame (not MDL)	458D493G05	458D493G13	504C323G07	6-11/16-11-13/16	47A4446G36	11-13/16-15-9/16	47A4446G37	
NB, HNB, NC, HNC	373D958G07	373D958G08	504C323G07	7-15/16-13-1/4	47A4446G36	12-15/16-16-15/16	47A4446G37	
TRI-PAC LA	374D075G02	374D075G01	504C323G07	6-1/8-11-1/4	47A4446G36	11-1/4-15	47A4446G37	
TRI-PAC NB	373D958G12	373D958G13	504C323G07	7-15/16-13-1/4	47A4446G36	12-15/16-16-15/16	47A4446G37	
LCL	458D493G22	458D493G23	504C323G07	6-11/16-11-13/16	47A4446G36	11-13/16-15-9/16	47A4446G37	
Circuit Breakers								
30, 60, 100A DE-ION ⑤	47A4446G34	—	⑥	5-3/4-11	⑥	11-14-3/4	47A4446G37	
Type DS 30, 60, 100A	4987D14G02	—	504C323G07	5-3/8-10-5/8	47A4446G36	10-3/8-14-5/16	47A4446G37	
Type DS 200A	4987D14G01	—	504C323G07	6-11/16-11-3/16	47A4446G36	10-7/8-14-7/8	47A4446G37	
200A DE-ION	458D493G04	458D493G12	504C323G07	6-1/8-11-1/4	47A4446G36	11-1/4-15	47A4446G37	

Notes

- ① Includes hardware.
- ② When used with plug-in adapter kits or rear-connected studs, special mounting hardware is required. Refer to Eaton.
- ③ UL File No. E56845 Vol. 1 Section 4.
- ④ Extra long shaft includes support bracket for Series C F-Frame with no internal lockoff. Order 373D958G24, which includes the mechanism, shaft and bracket. Order handle separately. Panel depth 16-3/8-24-1/4.
- ⑤ Mechanism style includes a handle and a standard shaft. A long shaft may be ordered separately if required.

Vari-Depth Type

Special Handles

Meet **Type 4 sheet steel requirements**. These handles are similar to standard handles, except they include an internal neoprene gasket. Due to gasketing effect between handle and housing, handle will not indicate a tripped position when used with circuit breakers.

UL File No. E56845 Vol. 1 Section 4.

Handle Kits

These kits are for use with **Type 4, 7 and 9 cast enclosures**. They include a special operating handle, mounting bolts and an adapter bushing (bushing may be purchased separately). Kits may be used with standard mechanisms and shafts. Instruction drawing **314C809** applies for assembly.

Handle Kits



Handle Kits

Description	Style Number
Standard finish	504C323G08
For Type 4, 9 enclosure	314C794G10
For Type 7 enclosure	314C794G09
Adapter bushing only	314C794G04

Slide Plate Type

These compact slide plate handle mechanisms are especially designed for use with AB DE-ION circuit breakers and disconnect switches when they are mounted in a shallow enclosure. They are suitable for use on Type 1 applications.

Because of the mechanisms' simplified installation—three mounting holes—and preassembled construction, these units are commonly used where high volume, standardized enclosures are being fabricated.

The mechanism styles listed on this page are for use on enclosures that have covers hinged on the right side. If these mechanisms are used on enclosures that have covers hinged on the left side, the door interlock will not function.

Vertical and Horizontal Mounting



Standard Slide Plate Mechanism Catalog Numbers

Enclosure Cover Hinged on Right	Vertical Mounting		Horizontal Mounting
	Padlocks in OFF Position Style Number	Padlocks in ON or OFF Position Style Number	Padlocks in OFF Position Style Number
Circuit Breakers			
KL and HKL frame MA, HMA, MC and HMC breaker LA, HLA, LC and HLC breaker JA, KA, HKA, DA, LB, LBB and HLB breaker NB, HNB, NC and HNC breaker JB, KB and HKB breaker LCL breaker	314C386G01	314C386G08	314C386G04
EH breaker 2P with long handle EH breaker 3P with long handle F-Frame 2P F- and HF-Frame 3P Type AQB and NQB 100A frames and Type PF 15–100A frame	314C386G02	314C386G09	314C386G05
EH standard 2P EH standard 3P and FA magnetic only 2 and 3P FA 2 and 3P thermal-magnetic EB, EHB, FB, HFB 3P MCP, HMCP (0-4) 2P FCL breaker	314C386G03	314C386G10	314C386G06
PB, TRI-PAC PB, PC, PCC, PCF	505C294G03	—	—
Series C Circuit Breakers			
F-Frame Series C + HMCP-F	314C386G03	314C386G10	314C386G06
J-Frame Series C + HMCP-J K-Frame Series C + HMCP-K	314C386G02	314C386G09	314C386G05
L-Frame Series C + HMCP-L, MDL	314C386G18	314C386G08	314C386G04
M-Frame Series C	314C386G01	314C386G08	314C386G04
R-Frame ①	505C294G03	—	—
TRI-PAC switches			
225A TRI-PAC Type K 400A TRI-PAC Type KL LA TRI-PAC NB TRI-PAC	314C386G01	314C386G08	314C386G04
100A TRI-PAC	314C386G02	314C386G09	314C386G05
FB TRI-PAC	314C386G03	314C386G10	314C386G06
Visi-Flex Switches (Model T) ②			
60–100A Visi-Flex	314C386G01	314C386G08	314C386G04
30A and Special 60A Visi-Flex	314C386G02	314C386G09	314C386G05
DE-ION Switches and Disconnect Switches			
30–60A (long handle) DE-ION 100A (long handle) DE-ION 200A disconnect switch 200 DS switch	314C386G01	314C386G08	314C386G04
30–60A disconnect switch 100A disconnect switch	314C386G02	314C386G09	314C386G05
30, 60, 100A DS switch	314C386G03	314C386G10	314C386G06
400 and 60A DS switch	314C386G15	—	—

Notes

- ① Does not padlock in OFF position. Type 3R version available as special. Contact Avery Creek, NC, Technical Resource Center.
- ② Handle mechanisms cannot be used on Visi-Flex switches with 200A fuse kits.

Outdoor or Hazardous Type

This handle mechanism is designed for use with fabricated or cast, Type 3, 4 or 5 enclosures. A butterfly cam type mechanism may be used on enclosures with either right- or left-hand hinged covers or on enclosures with bolted covers. The mechanism has a provision for padlocking. Will accept up to three locks. Assembly of this mechanism is accomplished by welding it to the enclosure door or the cover. Refer to IL29C287 for drilling plan. For PB, PC and RD, refer to drawing 372D690.

Outdoor or Hazardous Location Type**Mechanisms for Outdoor or Hazardous Locations**

Description	Drilling Plan Reference	Complete Handle Mechanisms Type 3, 4, 5	
		Padlocks in OFF Position Style Number	Padlocks in ON or OFF Position Style Number
Circuit Breakers			
Series C F-Frame EB, EHB, FB, HFB	48A3656	48A3656G03	48A3656G04
JA, KA, LA, MA, HKA, HLA, HMA, LB, HLB	452D028	452D028G01	—
DE-ION Switches			
30, 60, 100A	48A3656	48A3656G03	48A3656G04

Accessories**Door Interlock Kits**

Description	Drilling Plan Reference	Style Number
3 point—for mechanisms, style numbers: 314C386G01, 02, 03, 04, 05, 06, 08, 09, 10	208B624	28A2656G08
2 point—for PB mechanism, style number 505C294G03	372D690	1532990

Note: For use with slide plate mechanisms used in larger panels where regular interlock is not adequate.

Type SM Safety Handle



Enclosed Breaker with SM Handle

Type SM safety handle mechanism is designed to prevent tampering by unauthorized individuals and provides the optimum in personnel safety. When properly applied, these mechanisms conform to Type 12 and J.I.C. requirements, and are well-suited for use by the automotive and machine tool industries.

Completely preassembled in a rugged cast housing, the Type SM safety handle mechanism includes a predrilled mounting plate for simplified customer installation. Standard handles are 5.125 inches long and can be padlocked in the OFF position with as many as three padlocks. A shorter handle 3.875 inches long can be supplied on SM100, SM101 or SM150 mechanisms when specified.

All Type SM safety handle mechanisms can be used on any size enclosure. Order handle mechanism from the table at right, plus desired door hardware for complete application. Dress nameplate required to meet automotive specifications is available from accessories section.



Type SM Safety Handle Mechanism Catalog Numbers

Handle Mechanism for Use With:	Catalog Number ^①	
	Right-Hand Mounting Enclosure Cover Hinged On Left	Left-Hand Mounting Enclosure Cover Hinged On Right
Series C—F-Frame, MCP, HMCP F, EB, EHB, FB, HFB breakers, and Type DS 30, 60, 100A non-fusible switches	SM150R	SM150L
Type DS 30, 60, 100A fusible switches	SM100SFR	SM100SFL
FB TRI-PAC, FB breaker with current limiter, or Type FCL	SM101PR	SM101PL
30, 60, 100A DE-ION switches	SM100R	SM100L
DA, JA, KA, HKA, LB, LBB, HLB breakers	SM225R	SM225L
Series C—J-Frame, HMCP J	SM250JR	SM250JL
Series C—K-Frame, HMCP K	SM400KR	SM400KL
LAB, LA, HLA, LC, HLC breakers (400 and 600A)	SM400R	SM400L
Series C—L-Frame, HMCP L, MDL	SM600R	SM600L
Series C—M-Frame, MD, MDS	SM800R	SM800L
MA, HMA, MC, HMC breakers	SM800R	SM800L
TRI-PAC LA breaker	SM400PR	SM400PL
TRI-PAC NB	SM800PR	SM800PL
NB, HNB, NC, HNC breakers	SM1200R	SM1200L
Type DS 200A non-fusible switch	SM200SR	SM200SL
Type DS 200A fusible switch	SM200SFR	SM200SFL
Type LCL	SM400LCLR	SM400LCLL

Further Information

Publication Number	Description
IL 14439	F-Frame, EB, EHB, FB, FCL, HFB, MCP, FB-P, 30–100A DS switch
IL 29C274	J- and K-Frame
IL 29C284	L-Frame
IL 13282	JA, KA, JB, KB, LAB, LA, MA, NB, HLA, NB-P, 200A DS switch
IL 13327	DH1L door hardware
IL 13326	DH1R door hardware
IL 13325	DH2R door hardware
IL 13324	DH3L door hardware
IL 13322	DH3R door hardware
IL 13287	Electrical interlock

Notes

^① Must be ordered with door hardware; if not, door-operated defeater kit is required.

Mechanisms for Type 4 Applications—Mechanisms with stainless steel parts and special gasketing can be supplied. Order by description. 30% adder.





Type SM Safety Handle

Door Hardware

Three choices of door hardware and an auxiliary handle are offered to provide the best latching scheme for individual needs. The door hardware is designed with a provision for padlocking, and a coin-proof slot that requires the use of a tool to open the door, for maximum security.

Select desired hardware from the table below. Additional latches can be ordered from accessories section if desired. Type 1, 12 only.

Door Hardware

Description	Catalog Number	
	Right Hand	Left Hand
 With sliding latches for smaller panels up to approximately 30.00 inches high	DH1R ①	DH1L ②
 With 2-roller latches for intermediate panels up to approximately 40.00 inches high	DH2R ①	DH2L ②
 With 3-roller latches for larger panels, approximately 40.00 inches and higher	DH3R ①	DH3L ②
 Auxiliary handle for larger panels	DH4R ①	DH4L ②

Dress Nameplates

Required to meet automotive specifications. Mounts from inside enclosure and covers operating mechanism mounting bolts, making mechanism non-removable when enclosure door is closed.

Dress Nameplate

Description	Style Number
For SM100, SM150 mechanisms	373D260G05
For SM200, and larger mechanisms	373D260G05

Auxiliary Latch Kits

Provide an additional latch for use with applications where 2-point latching may not be adequate.

Slide and Roller Latches



Auxiliary Latch Kits

Description	Style Number
Door hardware using sliding latches, right- or left-hand mounting	656D669G01
Door hardware using roller latches, right-hand mounting	370D801G04
Left-hand mounting	370D802G04

Electrical Interlock Kit

Provides 1NC and 1NO contacts (SPDT switch) for use with auxiliary circuits. Mounts to end of mechanism housing as shown.

Electrical Interlock Kit



Electrical Interlock Kit

Style Number

622B747G01

Door Operated Interlock Defeater Kit

Required when door hardware is not used; operates as door closes. Additional method of securing door such as screw latch, also required (to be supplied by box manufacturer).

Door Operated Interlock Defeater Kit

Style Number

623B214G02

Notes

- ① Enclosure cover hinged on left.
- ② Enclosure cover hinged on right.

Type MC Motor Control



225A Mechanism

Type MC handle mechanisms are linear drive, fixed depth mechanisms designed for through-door mounting in standardized or shallow depth enclosures such as motor control centers or enclosed circuit breakers.

Mounting directly to the front of the disconnect, these mechanisms provide positive operation and handle indication. Both disconnect and mechanism mount simultaneously with mounting hardware supplied with the mechanism.

For security, the handle can be padlocked in the OFF position with up to three 0.375-inch hasp padlocks. Also, the mechanism is interlocked with the enclosure door so that the disconnect must be OFF before the door can be opened. A defeater is provided to bypass this interlock.

Catalog numbers listed include the mechanism, mounting hardware and door interlock clip.



Type MC Motor Control Catalog Numbers

Handle Mechanism ^① For Use With	Catalog Number ^{②③}	
	Type 1 Enclosure	Type 12 Enclosure
Series C F-Frame HMCP F	SMCU150FD	CMCU150FD
EB, EHB, FB, HFB breakers and MCP (Size 0–4)	SMCU150FD	CMCU150FD
FB TRI-PAC	SMCU100FBP	CMCU100FBP
FCL breakers	SMCU100FCL	CMCU100FCL
30, 60, 100A DS switch fusible, non-fusible	SMCU100DS	CMCU100DS
200A DS switch fusible, non-fusible	SMCU200DS	CMCU200DS
Series C J-Frame HMCP J	SMCU250JD	CMCU250JD
Series C K-Frame HMCP K, DA, JA, KA, HKA, LB, LBB, HLB Breakers, Size 5 MCP (400A)	SMCU400KD	CMCU400KD
Series C L-Frame HMCP L, MDL	SMCU600LD	CMCU600LD
Series C M-Frame not MDL	SMCU800MA	CMCU800MA
LAB, LA, HLA, LC, HLC breakers (400 and 600A frame)	SMCU400LA	SMCU400LA
LA TRI-PAC	SMCU400LAP	SMCU400LAP
MA, HMA, MC, HMC Breakers (800A frame)	SMCU800MA	SMCU800MA
NB, HNB, NC, HNC Breakers (1200A frame)	SMCU1200NB	SMCU1200NB
LCL225 and 400	SMCU400LCL	SMCU400LCL
Series C L-Frame HMCP L	SMCU600LD	SMCU600LD

Further Information

Publication Number	Description
IL 14572	F-Frame, EB, EHB, FB, MCP, HFB
IL 29C273	J- and K-Frame
IL 29C283	L-Frame
IL 14571	FB-P
IL 14938	JB, KB
IL 14573	30, 60, 100A DS switch
IL 14574	200A DS switch

Notes

- ① Mechanisms are shown mounted on breaker for illustration purposes only. Breakers are not included.
- ② These mechanisms are recognized under the component program of Underwriters Laboratories.
- ③ Selection data for handle mechanism only; circuit breaker not included.

AMT Vari-Depth

Fixed Width Type—Type AMT for Below Handle Mounting



3

Breaker or Switch Type	Complete Assembly ^{①②} Catalog Number	Backplate and Yoke Assembly Catalog Number	Rod and Brace Assembly Catalog Number	Pivot Mechanism Assembly Catalog Number	Operating Handle Assembly Catalog Number
Below the Handle—Fixed Width—with Short Brace and/or Rod as Listed (For all enclosures including Hoffman A-25 Enclosures)					
Series C F-Frame HMCP F ^③	AMTFDBSFH	AMTFD-B	AMTR	AMTPM-FH	AMTOP
Series C J-Frame HMCP J ^③	AMTJDBSFH	AMTKB-B	AMTRB1	AMTPM-FSH	AMTOP
Series C K-Frame HMCP K ^③	AMTKDBSFH	AMTLB-B	AMTRB1	AMTPM-FSH	AMTOP
Series C L-Frame HMCP L ^③	AMTLDBSFH	AMTLD-B	AMTRB1	AMTPM-FS	AMTOP
DS-30, 60, 100 unfused	AMTDSBSFH	AMTDS100-B	AMTR	AMTPM-FH	AMTOP
DS-30, 60, 100 fused ^④	AMTDSFBSFH	AMTDS100F-B	AMTR	AMTPM-FH	AMTOP
DS-30, 60, 100 fused ^⑤	AMTDSF1BSFH	AMTDS100F1-B	AMTR	AMTPM-FH	AMTOP
DS-200 unfused	AMTDS2BSFH	AMTDS200-B	AMTRB1	AMTPM-FSH	AMTOP
DS-200 fused	AMTDS2FBSFH	AMTDS200F-B	AMTRB1	AMTPM-FSH	AMTOP
Below the Handle—Fixed Width—with Short Brace and/or Rod as Listed (Not for use with Hoffman A-25 Enclosures)					
EB, EHB, FB, HFB, MCP (0-4)	AMTFBBSF	AMTFD-B	AMTR	AMTPM-F	AMTOP
JB, KB, MCP (250A)	AMTKBBSF	AMTKB-B	AMTRB1	AMTPM-FS	AMTOP
JA, KA, HKA, LB, LBB, HLB, DA MCP (400A)	AMTLBBSF	AMTLB-B	AMTRB1	AMTPM-FS	AMTOP
FB TRI-PAC, FCL	AMTFBPBSF	AMTFBP-B	AMTR	AMTPM-F	AMTOP
Optional rod and brace ^⑥					
AMTRB2 long rod and brace					
AMTRB3 extended rod and brace					

Standard Door Hardware ^{⑦⑧}

Catalog Number

DH1R

DH2R

DH3R

Door Hardware Adapter Kit ^⑨

Catalog Number

AMTDHA

Door Hardware Kit for Hoffman A-25 Enclosure ^{⑩⑪}

Catalog Number

HDH-2R ^⑫

HDH-3R ^⑬

Further Information

Publication Number	Description
IL 29C277	AMT Vari-Depth Handle Mechanism

Notes

- AMTR is rod only; AMTRI is rod and brace assembly.
- Complete assembly not available, order components parts listed above.
- Also for use with equivalent HMCP Frame.
- For switches using 30, 60, 100A, 600V NEC Class H, R or J fuses.
- For switches using 30, 60, 100A, 250V NEC Class H or R fuses.
- AMTR and AMTRB1 for use with enclosure depth of 6.50–14.25 inches. For 12.25–18.25 inch depth, use optional AMTRB2. For 18.00–24.00 inch depth, use optional AMTRB3.

- Requires adapter kit shown in Door Hardware Adapter Kit table.
- For standard door hardware description, see **Page V12-T3-102**.
- Required on standard door hardware only when used with any AMT handle mechanisms.
- Kit consists of special door hardware and door interlock pin. Available for right-hand flange mounting only.
- For use with AMT fixed width mechanisms only.
- 2-point latch for use with panels up to approximately 40.00 inches high.
- 3-point latch for use with panels approximately 40.00 inches and higher.

AMT Vari-Depth Vari-Width Type— Type AMT for Above Handle Mounting

The Type AMT is an extra heavy-duty handle mechanism designed for mounting in flange-type enclosures, and has provisions for mounting in various depth enclosures and for varying the width relationship between the disconnect device and the external handle.

A door interlock is provided to prevent opening the enclosure door with the disconnect in the ON position or to close the disconnect with the enclosure door open. The external handle can be locked in the OFF position with up to three padlocks. The AMT mechanism is supplied for mounting in right-hand flange enclosures but can be easily converted for left-hand mounting.

AMT mechanisms are available for above the handle mounting or below the handle mounting. Mechanisms for below the handle mounting are also available as fixed width units. When door hardware is used with an AMT handle mechanism, a door hardware adapter kit is required.

Accessories

Spacer kit to Vari-Width (not for use with fixed mechanisms) catalog number AMTSK1 for up to 1.00-inch variation.

Note: This spacer kit is for up to 1.00-inch variation and consists of multiples of thin spacers to be used as required. A maximum of two kits per installation may be used. Due to the possible variation in dimensions, hardware is not supplied. Use standard 1/4–20 bolts.

Further Information

Pub. Number	Description
IL 14946	AMT Vari-Depth handle mechanism

MD, MSM Vari-Width Type— Type AMT for Above Handle Mounting



Breaker or Switch Type	Complete Assembly ^{①②} Catalog Number	Backplate and Yoke Assembly Catalog Number	Operating Rod and Brace Assembly Catalog Number	Flange Mounted Pivot Mechanism Assembly ^{③④} Catalog Number	External Operating Handle Catalog Number
Above the Handle Mounting with Short Rod and Brace					
Series C F-Frame ^⑤ EB, EHB, FB, HFB, MCP (0–4)	AMTFDASV	AMTFB	AMTRB1	AMTPM	AMTOP
Series C J-Frame ^⑤	AMTJDASV	AMTJD	AMTRB1	AMTPM	AMTOP
Series C K-Frame ^⑤	AMTKDASV	AMTKD	AMTRB1	AMTPM	AMTOP
Series C L-Frame, MDL ^⑤	AMTLDASV	AMTLD	AMTRB1	AMTPM	AMTOP
JA, KA, HKA, LB, LBB, HLB, DA, MCP (400A)	AMTLBASV	AMTLB	AMTRB1	AMTPM	AMTOP
LA, HLA, LC, HLC	AMTLAASV	AMTLA	AMTRB1	AMTPM	AMTOP
MD, MDS, MA, HMA, MC, HMC, Series C M-Frame, LCL	AMTMAASV	AMTMA	AMTRB1	AMTPM	AMTOP
NB, HNB, NC, HNC	AMTNBASV	AMTNB	AMTRB1	AMTPMNB	AMTOP
FB TRI-PAC, FCL	AMTFBASV	AMTFB	AMTRB1	AMTPM	AMTOP
LA TRI-PAC	AMTLAPASV	AMTLAP	AMTRB1	AMTPM	AMTOP
NB TRI-PAC	AMTNBPASV	AMTNBP	AMTRB1	AMTPMNB	AMTOP
DS-30, 60, 100 unfused	AMTDSASV	AMTDS100	AMTRB1	AMTPM	AMTOP
DS-30, 60, 100 fused ^⑥	AMTDSFASV	AMTDS100F	AMTRB1	AMTPM	AMTOP
DS-30, 60, 100 fused ^⑦	AMTDSF1ASV	AMTDS100F1	AMTRB1	AMTPM	AMTOP
DS-200 unfused	AMTDS2ASV	AMTDS200	AMTRB1	AMTPM	AMTOP
DS-200 fused	AMTDS2FASV	AMTDS200F	AMTRB1	AMTPM	AMTOP
Above the Handle Mounting with Long Rod and Brace					
Series C F-Frame ^⑤ EB, EHB, FB, HFB, MCP (0–4)	AMTFDALV	AMTFB	AMTRB2	AMTPM	AMTOP
Series C J-Frame ^⑤	AMTJDALV	AMTJD	AMTRB2	AMTPM	AMTOP
Series C K-Frame ^⑤	AMTKDALV	AMTKD	AMTRB2	AMTPM	AMTOP
Series C L-Frame, MDL ^⑤	AMTLDALV	AMTLD	AMTRB2	AMTPM	AMTOP
JA, KA, HKA, LB, LBB, HLB, DA, MCP (400A)	AMTLBALV	AMTLB	AMTRB2	AMTPM	AMTOP
LA, HLA, LC, HLC	AMTLAALV	AMTLA	AMTRB2	AMTPM	AMTOP
MD, MDS, MA, HMA, MC, HMC, Series C M-Frame, LCL	AMTMAALV	AMTMA	AMTRB2	AMTPM	AMTOP
NB, HNB, NC, HNC	AMTNBALV	AMTNB	AMTRB2	AMTPMNB	AMTOP
FB TRI-PAC, FCL	AMTFBALV	AMTFB	AMTRB2	AMTPM	AMTOP
LA TRI-PAC	AMTLAPALV	AMTLAP	AMTRB2	AMTPM	AMTOP
NB TRI-PAC	AMTNBPALV	AMTNBP	AMTRB2	AMTPMNB	AMTOP
DS-30, 60, 100 unfused	AMTDSALV	AMTDS100	AMTRB2	AMTPM	AMTOP
DS-30, 60, 100 fused ^⑥	AMTDSFALV	AMTDS100F	AMTRB2	AMTPM	AMTOP
DS-30, 60, 100 fused ^⑦	AMTDSF1ALV	AMTDS100F1	AMTRB2	AMTPM	AMTOP
DS-200 unfused	AMTDS2ALV	AMTDS200	AMTRB2	AMTPM	AMTOP
DS-200 fused	AMTDS2FALV	AMTDS200F	AMTRB2	AMTPM	AMTOP

Notes

- ① Assembled Type AMT for above handle mounting (breaker not included).
- ② Complete assembly not available, order components parts listed above.
- ③ Width spacer kit not included.

- ④ This spacer kit is for up to 1.00-inch variation and consists of multiples of thin spacers to be used as required. A maximum of two kits per installation may be used. Due to the possible variation in dimensions, hardware is not supplied. Use standard 1/4–20 bolts.

- ⑤ Also for use with equivalent HMCP frame.
- ⑥ For switches using 30, 60, 100A, 600V NEC Class H, R or J fuses.
- ⑦ For switches using 30, 60, 100A, 600V NEC Class H or R fuses.

Vari-Width Type—Type AMT for Below Handle Mounting



3

Breaker or Switch Type	Complete Assembly ^{①②} Catalog Number	Backplate and Yoke Assembly Catalog Number	Rod and Brace Assembly Catalog Number	Flange Mounted Pivot Mechanism Assembly ^{③④} Catalog Number	External Operating Handle Assembly Catalog Number
Below the Handle Mounting with Short Rod and Brace					
Series C F-Frame ^⑤ EB, EHB, FB, HFB, MCP (0–4)	AMTFDBSV	AMTFD-B	AMTRB1	AMTPM-B	AMTOP
Series C J-Frame ^⑤	AMTJDBSV	AMTJD-B	AMTRB1	AMTPM-B	AMTOP
Series C K-Frame ^⑤	AMTKDBSV	AMTKD-B	AMTRB1	AMTPM-B	AMTOP
Series C L-Frame MDL ^⑤	AMTLDBSV	AMTLD-B	AMTRB1	AMTPM-B	AMTOP
JA, KA, HKA, LB, LBB, HLB, DA, MCP (400A)	AMTLBBSV	AMTLB-B	AMTRB1	AMTPM-B	AMTOP
LA, HLA, LC, HLC	AMTLABSV	AMTLA-B	AMTRB1	AMTPM-B	AMTOP
MD, MDS, MA, HMA, MC, HMC, Series C M-Frame, LCL	AMTMABSV	AMTMA-B	AMTRB1	AMTPM-B	AMTOP
NB, HNB, NC, HNC	AMTNBSV	AMTNB-B	AMTRB1	AMTPM-B	AMTOP
FB TRI-PAC, FCL	AMTFBPSV	AMTFBP-B	AMTRB1	AMTPM-B	AMTOP
LA TRI-PAC	AMTLAPSV	AMTLAP-B	AMTRB1	AMTPM-B	AMTOP
NB TRI-PAC	AMTNBPSV	AMTNBP-B	AMTRB1	AMTPM-B	AMTOP
DS-30, 60, 100 unfused	AMTDSBSV	AMTDS100-B	AMTRB1	AMTPM-B	AMTOP
DS-30, 60, 100 fused ^⑥	AMTDSFBSV	AMTDS100F-B	AMTRB1	AMTPM-B	AMTOP
DS-30, 60, 100 fused ^⑦	AMTDSF1BSV	AMTDS100F1-B	AMTRB1	AMTPM-B	AMTOP
DS-200 unfused	AMTDS2BSV	AMTDS200-B	AMTRB1	AMTPM-B	AMTOP
DS-200 fused	AMTDS2FBSV	AMTDS200F-B	AMTRB1	AMTPM-B	AMTOP
Below the Handle Mounting with Long Rod and Brace					
Series C F-Frame ^⑤ EB, EHB, FB, HFB, MCP (0–4)	AMTFDBLV	AMTFD-B	AMTRB2	AMTPM-B	AMTOP
Series C J-Frame ^⑤	AMTJDBLV	AMTJD-B	AMTRB2	AMTPM-B	AMTOP
Series C K-Frame ^⑤	AMTKDBLV	AMTKD-B	AMTRB2	AMTPM-B	AMTOP
Series C L-Frame MDL ^⑤	AMTLDBLV	AMTLD-B	AMTRB2	AMTPM-B	AMTOP
JA, KA, HKA, LB, LBB, HLB, DA, MCP (400A)	AMTLBBLV	AMTLB-B	AMTRB2	AMTPM-B	AMTOP
LA, HLA, LC, HLC	AMTLABLV	AMTLA-B	AMTRB2	AMTPM-B	AMTOP
MD, MDS, MA, HMA, MC, HMC, Series C M-Frame, LCL	AMTMABLV	AMTMA-B	AMTRB2	AMTPM-B	AMTOP
NB, HNB, NC, HNC	AMTNBBLV	AMTNB-B	AMTRB2	AMTPM-B	AMTOP
FB TRI-PAC, FCL	AMTFBPBLV	AMTFBP-B	AMTRB2	AMTPM-B	AMTOP
LA TRI-PAC	AMTLAPBLV	AMTLAP-B	AMTRB2	AMTPM-B	AMTOP
NB TRI-PAC	AMTNBPBLV	AMTNBP-B	AMTRB2	AMTPM-B	AMTOP
DS-30, 60, 100 unfused	AMTDSBLV	AMTDS100-B	AMTRB2	AMTPM-B	AMTOP
DS-30, 60, 100 fused ^⑥	AMTDSFBLV	AMTDS100F-B	AMTRB2	AMTPM-B	AMTOP
DS-30, 60, 100 fused ^⑦	AMTDSF1BLV	AMTDS100F1-B	AMTRB2	AMTPM-B	AMTOP
DS-200 unfused	AMTDS2BLV	AMTDS200-B	AMTRB2	AMTPM-B	AMTOP
DS-200 fused	AMTDS2FBLV	AMTDS200F-B	AMTRB2	AMTPM-B	AMTOP

Notes

- ① AMTR is rod only; AMTRI is rod and brace assembly.
- ② Complete assembly not available, order components parts listed above.
- ③ Width spacer kit not included.
- ④ This spacer kit is for up to 1-inch variation and consists of multiples of thin spacers to be used as required. A maximum of two kits per installation may be used. Due to the possible variation in dimensions, hardware is not supplied. Use standard 1/4–20 bolts.
- ⑤ Also for use with equivalent HMCP Frame.
- ⑥ For switches using 30, 60, 100A, 600V NEC Class H, R or J fuses.
- ⑦ For switches using 30, 60, 100A, 600V NEC Class H or R fuses.

Accessories

Spacer kit to Vari-Width (not for use with fixed mechanisms) catalog number AMTSK1 for up to 1.00-inch variation.

Note: This spacer kit is for up to 1.00-inch variation and consists of multiples of thin spacers to be used as required. A maximum of two kits per installation may be used. Due to the possible variation in dimensions, hardware is not supplied. Use standard 1/4–20 bolts.

Ordering Information

- Complete assembly not available, order components parts as listed on **Pages V12-T3-104, V12-T3-105 and V12-T3-106**
- Order spacer kits or door hardware adapter as required
- Individual component parts may be ordered by catalog number

Flex Shaft

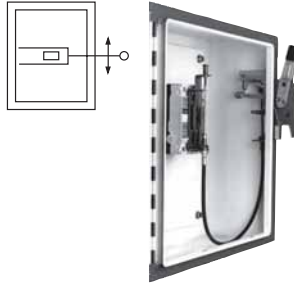

Flex Shaft

The Flex Shaft is an extra heavy-duty mechanism that includes a flexible shaft in various lengths, 3 feet (0.9m)

through 10 feet (3m) for use with various size enclosures.

The Flex Shaft handle will accept up to three padlock shackles, each with a maximum diameter of 0.375-inch (9.5 mm). Can be used with Type 1, 3R and 12 fabricated enclosures. An optional handle is available for Flex Shaft that is suitable for use with Type 4 and 4X environments. Flex Shaft comes preset from the factory, requiring only minor field adjustments on installation, which takes about 10 minutes—

a significant time savings compared to installation of other types of flange handle mechanisms. The Flex Shaft mechanism also takes up less interior enclosure space than competitive designs and the handle fits standard flange cutouts. Flex Shaft handle can be remotely mounted from breaker, where an operator can use it by “funneling” the cable through conduit.

Flex Shaft is UL Listed under File E64983 and meets CSA requirements.

Flex Shaft Ordering Information (Three-Pole Only) ①②③

Breaker Frame	Flexible Shaft Length in Feet (m)							
	3.00 (0.9)	4.00 (1.2)	5.00 (1.5)	6.00 (1.8)	7.00 (2.1)	8.00 (2.4)	9.00 (2.7)	10.00 (3.0)
E125	EHMFS03	EHMFS04	EHMFS05	EHMFS06	—	—	—	—
J250	JHMFS03	JHMFS04	JHMFS05	JHMFS06	JHMFS07	JHMFS08	JHMFS09	JHMFS10
G	F0S03C	F0S04C	F0S05C	F0S06C	—	—	—	—
F	F1S03C	F1S04C	F1S05C	F1S06C	F1S07C	F1S08C	F1S09C	F1S10C
F (Dual)	F1S03CD	F1S04CD	F1S05CD	F1S06CD	F1S07CD	F1S08CD	F1S09CD	F1S10CD
J	F2S03C	F2S04C	F2S05C	F2S06C	F2S07C	F2S08C	F2S09C	F2S10C
K	F3S03C	F3S04C	F3S05C	F3S06C	F3S07C	F3S08C	F3S09C	F3S10C
L and MDL	—	F4S04C	F4S05C	F4S06C	—	—	—	F4S10C
N	—	F5S04C	F5S05C	F5S06C	—	—	—	F5S10C
R	—	F6S04	F6S05	F6S06	—	—	—	—
MD	—	F7S04C	F7S05C	F7S06C	—	—	—	F7S10C

Flex Shaft Accessories (F- through R-Frame)

NEMA 12 Safety Door Hardware for Flex Shaft ④

Handle Length in Inches (mm)	Catalog Number ⑤
4.00 (101.6)	C361KJ4
6.00 (152.4)	C361KJ6
Roller latch ⑥	C361KR

Notes

- Type 4/4X handle mechanisms are available. Add Suffix **X** to complete catalog number. Add Suffix **I** to complete catalog number for IEC handle. Add Suffix **L** (Standard on F, J, K and L) to complete catalog number for 6.00-inch (152.4 mm) handle. Original narrow handle design (no **C** suffix) is available. Remove **C** from catalog number.
- When selecting the length of shaft, ensure minimum bending radius of 4.00 inches (101.6 mm) is maintained to operate properly. The standard method of shipment includes the mechanism preset at the factory; however, minor field adjustments may be required.

- Dual breakers operator available on F-Frame only.
- Customer: Consult with box manufacturer for correct door hardware and any adapters required for assembly.
- The 0.25 inch x 0.50 inch (6.35 x 12.7 mm) standard mill rectangular locking bar is not supplied with these kits.
- Third roller latch for use with 4.00- or 6.00-inch (101.6 or 152.4 mm) handle when 3-point latching is required.

Refer to handle mechanisms in the molded-case circuit breaker section of Volume 4—Circuit Protection Catalog, CA08100005E, Tab 2.

The Type C371 circuit breaker operating mechanisms are designed for installation in control enclosures where main or branch circuit protective devices are required. All circuit breaker mechanisms are suitable for right-hand mounting.

Auxiliary contacts are not available for mounting on operating mechanisms. Where required, have them installed in circuit breaker.

Type C371 is UL Listed under File E62635.

Type C371 Ordering Information—Dimensions in Inches (mm)

Circuit Breaker or Motor Circuit Protector	Frame Size	Variable Depth Mounting Range Min./Max. ①②	Operating Mechanism Only ③ Catalog Number	Operating Mechanism With 4.00-Inch Handle	
				For Type 1–12 Enclosure Catalog Number	For Type 4 Enclosure Catalog Number
HMCP and Series C EHD, FDB, FD, FDC, HFD, ED	150	6.50–16.0 (165.1–406.4)	C371E	C371E1	C371E2
HMCP and Series C HJD, JD, JDB, JDC	250	6.50–16.63 (165.1–422.4)	C371F	C371F5	C371F6
HMCP and Series C DK, HKD, KD, KDB	400	6.50–16.63 (165.1–422.4)	C371F	C371F5	C371F6
Series C HLD, LD, LDC	600	8.50–22.00 (215.9–558.8)	C371G	C371G5	C371G6
Series C MD, MDS	800	8.75–22.00 (222.3–558.8)	C371K	C371K5	C371K6
Series C HND, ND, NDC	1200	9.75–22.00 (247.7–558.8)	C371K	C371K5	C371K6

Handle Only—Dimensions in Inches (mm)

Circuit Breaker Frame Size (Amperes)	NEMA Enclosure Type	Operating Handle Length	Catalog Number
150	1, 3R, 3, 12	4.00 (101.6)	C371H1
	4/4X	4.00 (101.6)	C371H2
	1, 3R, 3, 12	4.00 (101.6)	C371H3
	4/4X	4.00 (101.6)	C371H4
250–1200	1, 3R, 3, 12	4.00 (101.6)	C371H5
	4/4X	4.00 (101.6)	C371H6
	1, 3R, 3, 12	4.00 (101.6)	C371H7
	4/4X	4.00 (101.6)	C371H8

Channel Support Kit (Rod Not Supplied) ④

Catalog Number
C371CS6

Connecting Rods ⑤

Application	Catalog Number
Disconnect switches (30, 60, 100, 200A sizes)	C371CS1
Circuit breakers (150, 250, 400A sizes)	C371CS1
Circuit breakers (600, 800, 1200A sizes)	C371CS2

Flange-Mounted Instruction Leaflets

Breaker Frame	Instruction Leaflet Number
Flex Shaft	
E125	IL0510TE0002
J250	IL0510TE0005
G	TBD
F	15609
J	15605
K	15604
L and M	15606
N	15606
R	15606

Notes

- ① For increased maximum allowable depth, see connecting rods table to the left.
- ② Dimensions shown are from panel flange surface.
- ③ Does not include handle.
- ④ For use to prevent bending of the operating handle mounting surface. This is especially useful when the operating handle is mounted on a channel in a multi-door enclosure. Included in 600–1200A.
- ⑤ Increase maximum allowable depth by 5.00 inches (127.0 mm).

Refer to handle mechanisms in the molded-case circuit breaker section of Volume 4—Circuit Protection Catalog, CA08100005E, Tab 2.

Series C Rotary and Universal Rotary



Series C Rotary

Series C rotary and universal rotary handle mechanisms are for use with molded-case circuit breakers (G, F, J, K, L, MDL), molded-case switches and motor circuit protectors.

Series C rotary is suitable for use with Type 1, 3R, 12 and 4/4X enclosure types. Type 4/4X application requires special handle, see "Ordering Information."

The universal rotary is suitable for use with Type 1 and 12 enclosure types. All rotary handle mechanisms include a handle "Lock Off," to prevent turning the breaker ON while in the OFF position. All rotary handles indicate ON/OFF/Tripped/Reset positions; however, Universal Rotary has the added feature of international markings for ON (I) and OFF (O). Series C rotary handle is metal. Universal rotary is made of molded material. Series C rotary handle is black and universal rotary is available in black or yellow/red.

Series C rotary handle was ergonomically designed with extra clearance for a "gloved hand" to operate. Handle has a 45° rotation. Universal Rotary has a 90° rotation ("pipe valve" operation) where ON is vertical and OFF is horizontal. Shafts include a support brace to ensure proper alignment.

In addition, the 16.00-inch (406.4 mm) and 24.00-inch (609.6 mm) extra long shafts include an adjustable support bracket.

Series C rotary and universal rotary, are UL Listed and meet CSA requirements. Universal rotary also meets IEC947-1/2 for international compliance. Rotary UL File Number is E64983.

Series C Rotary Ordering Information

Shaft Length Inches (mm)	Complete Catalog Number ①	Separate Catalog Number		Shaft ④	Catalog Number	
		Standard Handle ②	Breaker Mechanism ③		IEC IP65 ⑤⑥	IEC IP66 ⑤⑥
F-Frame						
6.00 (152.4)	HM1R06	6648C22G01	6648C23G11	4217B37G04	WHM1R06	WHM1R06X
12.00 (304.8)	HM1R12	6648C22G01	6648C23G11	4217B37G01	WHM1R12	WHM1R12X
16.00 (406.4)	HM1R16	6648C22G01	6648C23G11	4217B37G02	WHM1R16	WHM1R16X
24.00 (609.6)	HM1R24	6648C22G01	6648C23G11	4217B37G03	WHM1R24	WHM1R24X
J-Frame						
6.00 (152.4)	HM2R06	6648C22G01	6648C23G21	4217B37G04	WHM2R06	WHM2R06X
12.00 (304.8)	HM2R12	6648C22G01	6648C23G21	4217B37G01	WHM2R12	WHM2R12X
16.00 (406.4)	HM2R16	6648C22G01	6648C23G21	4217B37G02	WHM2R16	WHM2R16X
24.00 (609.6)	HM2R24	6648C22G01	6648C23G21	4217B37G03	WHM2R24	WHM2R24X
K-Frame						
6.00 (152.4)	HM3R06	6648C22G01	6648C23G25	4217B37G04	WHM3R06	WHM3R06X
12.00 (304.8)	HM3R12	6648C22G01	6648C23G25	4217B37G01	WHM3R12	WHM3R12X
16.00 (406.4)	HM3R16	6648C22G01	6648C23G25	4217B37G02	WHM3R16	WHM3R16X
24.00 (609.6)	HM3R24	6648C22G01	6648C23G25	4217B37G03	WHM3R24	WHM3R24X
L- and MDL-Frame						
6.00 (152.4)	HM4R06	6648C22G11	6648C23G19	4217B37G04	WHM4R06	WHM4R06X
12.00 (304.8)	HM4R12	6648C22G11	6648C23G19	4217B37G01	WHM4R12	WHM4R12X
16.00 (406.4)	HM4R16	6648C22G11	6648C23G19	4217B37G02	WHM4R16	WHM4R16X
24.00 (609.6)	HM4R24	6648C22G11	6648C23G19	4217B37G03	WHM4R24	WHM4R24X
MD/MDS						
6.00 (152.4)	HM7R06	6648C22G21	6648C23G17	4217B37G04	—	—
12.00 (304.8)	HM7R12	6648C22G21	6648C23G17	4217B37G01	—	—
16.00 (406.4)	HM7R16	6648C22G21	6648C23G17	4217B37G02	—	—
24.00 (609.6)	HM7R24	6648C22G21	6648C23G17	4217B37G03	—	—
N-Frame						
6.00 (152.4)	HM5R06	6648C22G21	6648C23G08	4217B37G04	WHM5R06	WHM5R06X
12.00 (304.8)	HM5R12	6648C22G21	6648C23G08	4217B37G01	WHM5R12	WHM5R12X
16.00 (406.4)	HM5R16	6648C22G21	6648C23G08	4217B37G02	WHM5R16	WHM5R16X
24.00 (609.6)	HM5R24	6648C22G21	6648C23G08	4217B37G03	WHM5R24	WHM5R24X

Notes

- ① Complete catalog number includes the standard handle, mechanism, shaft and support brace/bracket.
- ② Handle is designed suitable for Types 1, 3R and 12 enclosures. Use style number **6648C22G03** for Type 4/4X handle or add **X** Suffix to complete catalog number.
- ③ Breaker mechanism includes a shaft support bracket and its parts.
- ④ Longer shafts, 16.00-inch (406.4 mm) and 24.00-inch (609.6 mm), include an adjustable support extension.
- ⑤ IEC handle mechanism supplied with metric thread mounting hardware.
- ⑥ Complete catalog number includes a handle, mechanism and shaft.

Refer to handle mechanisms in the molded-case circuit breaker section of Volume 4—Circuit Protection Catalog, CA08100005E, Tab 2.

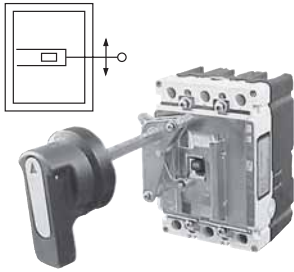
Universal Rotary**Universal Rotary**

Type 4/4X handles are similar to standard handles except that they include an internal neoprene gasket. Type 4/4X handle style number is 6648C22G03. Due to gasketing effect between the handle and the housing, the handle may not indicate a tripped position.

Series C Rotary Accessories

As an option, an auxiliary switch is offered so that the control panel builder may electrically indicate the status of the breaker. This accessory would be mounted on the mechanism and comes with 24.00-inch (609.6 mm) pigtail leads.

Series C Auxiliary Switch**Catalog Number****5108A61G01****Universal Rotary Ordering Information**

Shaft Length in Inches (mm)	Handle Color	Complete Catalog Number
E125 Frame		
6.00 (152.4)	Black	EHMVD06B
12.00 (304.8)	Black	EHMVD12B
6.00 (152.4)	Red	EHMVD06R
12.00 (304.8)	Red	EHMVD12R
J250 Frame		
6.00 (152.4)	Black	FJHMVD06B
12.00 (304.8)	Black	FJHMVD12B
6.00 (152.4)	Red	FJHMVD06R
12.00 (304.8)	Red	FJHMVD12R
G-Frame		
6.00 (152.4)	Black	GHMVD06B
12.00 (304.8)	Black	GHMVD12B
6.00 (152.4)	Red	GHMVD06R
12.00 (304.8)	Red	GHMVD12R
F-Frame		
6.00 (152.4)	Black	FHMVD06B
12.00 (304.8)	Black	FHMVD12B
6.00 (152.4)	Red	FHMVD06R
12.00 (304.8)	Red	FHMVD12R
J-Frame		
6.00 (152.4)	Black	JHMVD06B
12.00 (304.8)	Black	JHMVD12B
6.00 (152.4)	Red	JHMVD06R
12.00 (304.8)	Red	JHMVD12R
K-Frame		
6.00 (152.4)	Black	KHMVD06B
12.00 (304.8)	Black	KHMVD12B
6.00 (152.4)	Red	KHMVD06R
12.00 (304.8)	Red	KHMVD12R
L- and MDL-Frames		
6.00 (152.4)	Black	LHMVD06B
12.00 (304.8)	Black	LHMVD12B
6.00 (152.4)	Red	LHMVD06R
12.00 (304.8)	Red	LHMVD12R

Through-the-Door Instruction Leaflets Number

Breaker Frame	Series C Rotary	Universal Rotary
E125	—	IL0510TE0001
J250	—	IL0510TE0001
G	—	29C250
F	15594	29C250
J	15599	29C250
K	15600	29C250
L and MDL	15601	29C250
N	15602	—

Note: Refer to handle mechanisms in the molded-case circuit breaker section of Volume 4—Circuit Protection Catalog, CA08100005E, Tab 2.

Direct (Close-Coupled) Handle Mechanisms



Universal Direct



Euro IEC Direct



G Direct

Direct (close-coupled) handle mechanisms mount directly to the circuit breaker. They are used in shallow enclosures where the standard variable depth through-the-door type mechanism is not practical or cannot be used. They are typically for applications where high volume, standardized enclosures are being fabricated.

The Universal Direct handle mechanism is designed exclusively for the new Cutler-Hammer E125 and J250 circuit breakers. It is available as standard with a door interlock to prevent opening the enclosure while the circuit breaker is in the ON position. It is also available without a door interlock.

The Euro IEC Direct handle mechanism can be used on F- through R-Frames.

The G Direct is available with a black or a yellow handle, and with or without a shroud. It is suitable for use with Type 1 enclosures. It is for use only with the G-Frame (GD, GC, GHC, GMCP).

An escutcheon ring and an interlock clip are provided as standard. The standard design includes a lock-off feature.

The Universal Direct handle mechanism is UL 489 Listed, IEC947-1/2 and meets CSA requirements. The Euro IEC Direct handle mechanism is IEC-240-1. G Direct is UL Listed and meets CSA requirements.

Universal Direct Ordering Information

Frame	Universal Direct Domestic		International
	With Interlock (White) Catalog Number	Without Interlock (White) Catalog Number	Without Interlock (Charcoal With Global Label) Catalog Number
E125	EHMCCBI	EHMCCB	EHMCCR
J250	JHMCCBI	JHMCCB	JHMCCR

Euro IEC Direct Ordering Information

Frame	Black Handle Catalog Number	Red Handle Catalog Number
F	HMCC1B	HMCC1R
J	HMCC2B	HMCC2R
K	HMCC3B	HMCC3R
L and M	HMCC4B	HMCC4R
N	HMCC5B	HMCC5R
R	HMCC6B	HMCC6R

G Direct Ordering Information ^①

Frame	Black Handle		Yellow Handle	
	With Shroud Catalog Number	Without Shroud Catalog Number	With Shroud Catalog Number	Without Shroud Catalog Number
GD/GHC	HRGCC1S	HRGCC10	HRGCC3S	HRGCC30
GMCP	HRGMC1S	HRGMC10	HRGMC3S	HRGMC30

Direct (Close-Coupled) Instruction Leaflets

Frame	Instruction Leaflet Number		
	Universal Direct	Euro IEC Direct	G Direct
E125	29C255	—	—
J250	29C256	—	—
G	—	—	15567
F	—	29C288A	—
J	—	29C288A	—
K	—	29C288A	—
L and MDL	—	29C289	—
N	—	29C290	—
R	—	29C291	—

Notes

^① Suitable for use on two- or three-pole G-Frame.

Refer to handle mechanisms in the molded-case circuit breaker section of Volume 4—Circuit Protection Catalog, CA08100005E, Tab 2.

Handle Extensions**Handle Extension**

Handle extension is not included with J-, K-, L- and M-Frame breakers. It must be purchased separately.

Handle Extension

Frame	Style Number
J, K	HEX3
L, M	HEX4

Handle extension is included with breaker with N- and R-Frame breakers.

Handle Extension

Frame	Style Number
N	HEX5
R	HEX6

Note: Refer to handle mechanisms in the molded-case circuit breaker section of Volume 4—Circuit Protection Catalog, CA08100005E, Tab 2.

Replacement and Service Capabilities**Breaker Service Center Factory Service for Mining and Industrial Molded-Case Circuit Breakers**

Eaton owns and operates two fully authorized Breaker Service Centers (BSC) in Skelton, WV, and Evansville, IN. They are available to support all non-warranty service needs for Cutler-Hammer industrial molded-case breakers 600A and above and all frames of mining duty breakers.

The Breaker Service Centers, as extensions of our manufacturing plants, are the only facilities authorized to provide breaker service solutions for Eaton, Cutler-Hammer and historic Westinghouse molded-case circuit breakers. Staff are dedicated to providing genuine factory-supported solutions to our customers.

This is just another example of how Eaton supports a complete offering of solutions for circuit breakers.

See the following for the benefits of choosing the BSC and our service offerings.

Offerings**Basic Tune-Up**

Clean, test and re-certify.

Basic Modification

Replace accessories and attachments including terminals, trip units, UVRs, shunt trips and auxiliary switches.

Basic Service

Replace components including covers, handles and stationary contacts.

Custom Service

Replace frame or trip unit, with or without accessories.

Full Service

Replace both frame and trip unit, with or without accessories.

Factory Modifications

For new or existing operational breakers

- Trip unit upgrades
- Addition of accessories and attachments
- UL modifications to factory-sealed breakers

Facilities

- Dedicated sites supported by engineering and manufacturing
- Staffed by factory trained technicians with experience servicing molded-case circuit breakers
- State-of-the-art cleaning and testing equipment

The Breaker Service Centers are open to help you. Give us a call at **1-877-BRK-SRVC** or contact your local Eaton authorized distributor or sales office for more information.

Know What You're Getting—Here's the Reality of Third-Party Repair

- Breakers are serviced using least worn, counterfeit or reverse engineered components
- You get no technical support from the original manufacturer
- There is no option for an upgrade to new technology
- You could end up with a breaker that doesn't perform as expected

Reasons to Use Eaton's Breaker Service Centers

- Eaton is a world leader in circuit breaker technology and manufacturing
- The Breaker Service Centers are staffed by factory trained technicians
- One year warranty.
- Eaton uses only genuine replacement parts and components
- Full engineering support—original product specifications and manufacturing data
- State-of-the-art cleaning equipment—uses a non-destructive cleaning process while maintaining integrity of the breaker
- Modern test equipment—the breaker service center uses the same hi-tech test equipment used by engineering, development and manufacturing facilities. This allows the breaker service center to match original test conditions at the factory
- Exchange option—we can upgrade to the newest technology
- Competitive price—all the benefits of third-party prices

For more information on Eaton products and services, call 1-877-386-2273. Select option 1 for technical support and select option 6 for Eaton's Electrical Services & Systems, or visit our website at www.eaton.com/electrical.

Cross-Reference

Westinghouse and Challenger

Cross-Reference for Cutler-Hammer Industrial MCB/MCCBs

Circuit Breaker Brand and Type

Westinghouse	Challenger	Cutler-Hammer
BAB	CBB	BAB
BAB-H	CBB-H	BAB-H
CA	CD	CA
CAH	CDH	CAH
CHKD	CKHC	CHKD
CHLD	CLHC	CHLD
CHND	CNHC	CHND
CKD	CKC	CKD
CKDC	CKVC	CKDC
CLD	CLC	CLD
CLDC	CLVC	CLDC
CND	CNC	CND
CNDC	CNVC	CNDC
CRD	CRC	CRD
CRDC	CRVC	CRDC
DK	CDK	DK
EB	—	EB
ED	CED	ED
EDC	CEV	EDC
EDH	CEH	EDH
EHB	—	EHB
EHD	CE	EHD
FB	—	FB
FB-P	CTB	FB-P
FCL	CXF	FCL
FD	CF	FD
FDB	CFS	FDB
FDC	CFV	FDC
GB	CG	GB
GC	CGL	GC
GDB	CGDB	GDB
GHB	CH	GHB
GHBS	CSCB	GHBS
GHC	CHL	GHC
HCA	CDT	HCA
HFB	—	HFB
HFD	CFH	HFD
HJD	CJH	HJD
HKB	—	HKB
HKD	CKH	HKD
HLA	—	HLA
HLC	CSHL	HLC
HLCC	CSHLC	HLCC
HLD	CLH	HLD
HMA	—	HMA

Circuit Breaker Brand and Type

Westinghouse	Challenger	Cutler-Hammer
HMC	CSHM	HMC
HMCC	CSHMC	HMCC
HNB	—	HNB
HNC	CSHN	HNC
HND	CNH	HND
JB, KB	—	JB, KB
JD	CJ	JD
JDB	CJS	JDB
JDC	CJV	JDC
KD	CK	KD
KDB	CKS	KDB
KDC	CKV	KDC
LA	—	LA
LA-P	CTL	LA-P
LC	CSL	LC
LCC	CSLC	LCC
LCL	CXL	LCL
LCY	CSLY	LCY
LD	CL	LD
LDB	CK	LDB
LDC	CLV	LDC
MA	—	MA
MC	CSM	MC
MCC	CSMC	MCC
MCY	CSMY	MCY
MDS	CSMD	MDS
MDSC	CSMDC	MDSC
MDSY	CSMDY	MDSY
NB	—	NB
NB-P	CTN	NB-P
NC	CSN	NC
NCY	CSNY	NCY
ND	CN	ND
NDC	CNV	NDC
PB-P	CTP	PB-P
PC	CSP	PC
PCC	CSPC	PCC
QBGF	CBBGF	QBGF
QBGFEP	CBBGFEP	QBGFEP
QBHGF	CBBHGF	QBHGF
QBHGFEP	CBBHGFEP	QBHGFEP
QBHW	CBBH	QBHW
QBHW-H	CBBH-H	QBHW-H
RD	CR	RD
RDC	CRV	RDC

Westinghouse, Challenger and Bryant**Cross-Reference for Cutler-Hammer Residential MCBs****Circuit Breaker Brand and Type**

Westinghouse	Challenger	Bryant	Cutler-Hammer
BR	C	BR	BR
BRD	A	BRD	BRD
BRH	HC	BRH	BRH
BRHH	VC	BRHH	BRHH
—	XC	—	BRX
BRO	C	BRO	BRO
GFCB	HAGF	GFCB	GFCB
GFCBH	HAGFH	GFCBH	GFCBH
GFEP	HAGFEP	GFEP	GFEP
GFEPH	HAGFEPH	GFEPH	GFEPH
—	CM	—	BW
—	CMH	—	BWH
—	CMV	—	BWHH
—	CB	—	CC
WFL	QFL	—	QFL
WFP	QFP	—	QFP

Notes for Replacement Breaker and Mining Breaker Replacement Tables (Pages V12-T3-113–V12-T3-167)

- Many of the suggested Series C replacements are electrical replacements only, and may have different dimensions, mountings, handle forces and throw (which would require a handle mechanism change). The MARK 75 replacement would have the same dimensions, mountings, handle forces and throw. Only three-pole MARK 75 available.
- Replacement breaker frames, trips, plugs and some of the terminals and attachments are not interchangeable with the Series C. Obsolete frames and trips, etc., may require a complete breaker change.
- Replacing with a Higher IC MARK 75 or Series C breaker does not increase the IC rating of the assembly (panelboard, switchboard, etc.).
- Saf-T-Vue is no longer available on the replacement breaker line. Eaton Canada does make the Series C with Saf-T-Vue and may be sourced through our **Canadian Distribution Center** at **905-631-4318**.
- Suggested replacements also apply to breakers that had suffixes such as "L," line and load terminals, "V" 50C calibration and "W" without terminals.
- The HFB two-pole breaker is on a three-pole frame. The Series C replacement is a true two-pole.
- Continuous amperes and/or trip range may be a little different on the replacement Series C.
- Replacement breaker MARK 75 breakers with interchangeable trip units are to be supplied as frame, trip, terminals and attachment as separate items (except when accessories must be factory installed). No single-phase, ambient compensated, Saf-T-Vue, reverse-feed, or SELTRONIC magnetic only are available on replacement breakers.
- JA, DA, KA, HKA, LB, LBB and HLB breakers when replaced with a Series C breaker "K" frame, when bussed on the line side such as a panelboard, requires a TAD3 spacer kit.
- Contact the local Eaton Satellite for complete panelboard replacement or new interior replacement. Use Panelboard Replacement Breakers where possible. MARK 75 and three-pole only replacements are available. Contact the **Breaker Service Center** at **1-877-275-7782** for reconditioned breaker solutions.

Note: If accessories are to be factory installed, contact the factory for pricing.

Cross-Reference

Replacement Breaker Cross-Reference

Replacement Breaker			Replacements			Notes
Catalog Number	Style Number	Status ^①	MARK 75 Catalog Number	MARK 75 Style Number	Series C Catalog Number	(See Page V12-T3-114)
1256C10G03	1256C10G03	0	—	—	LD2300	1–3, 5, 8
1256C10G04	1256C10G04	0	—	—	LD2350	1–3, 5, 8
1256C10G05	1256C10G05	0	—	—	LD2400	1–3, 5, 8
1256C10G12	1256C10G12	A	—	—	KD3250	1–3, 5, 8
1256C10G13	1256C10G13	A	—	—	LD3300	1–3, 5, 8
1256C10G14	1256C10G14	A	—	—	LD3350	1–3, 5, 8
1256C10G15	1256C10G15	A	—	—	LD3400	1–3, 5, 8
1268C14G01	1268C14G01	0	—	—	HMCP050G2C	1–3, 7
1268C14G02	1268C14G02	0	—	—	HMCP050G2C	1–3, 7
1268C14G03	1268C14G03	0	65E4667	65E466	HMCP100L3C	1–3, 7
1268C14G04	1268C14G04	0	65E4667	65E4667	HMCP100L3C	1–3, 7
1268C14G05	1268C14G05	0	—	—	HMCP050G2C	1–3, 7
1268C14G06	1268C14G06	0	—	—	HMCP050G2C	1–3, 7
2603D46G07	2603D46G07	0	—	—	KT2250T	2, 8
2603D46G08	2603D46G08	0	—	—	LT2300T	2, 8
2603D46G09	2603D46G09	0	—	—	LT2350T	2, 8
2603D46G10	2603D46G10	0	—	—	LT2400T	2, 8
2603D46G26	2603D46G26	A	—	—	KT3250T	2, 8
2603D46G27	2603D46G27	A	—	—	LT3300T	2, 8
2603D46G28	2603D46G28	A	—	—	LT3350T	2, 8
2603D46G29	2603D46G29	A	—	—	LT3400T	2, 8
2603D47G07	2603D47G07	0	—	—	—	2, 8
2603D47G08	2603D47G08	0	—	—	—	2, 8
2603D47G10	2603D47G10	0	—	—	—	2, 8
2603D47G26	2603D47G26	A	—	—	—	2, 8
2603D47G27	2603D47G27	A	—	—	—	2, 8
2603D47G29	2603D47G29	A	—	—	—	2, 8
2603D50G01	2603D50G01	0	—	—	KD2250	1–3, 5, 8
2603D50G02	2603D50G02	0	—	—	LD2300	1–3, 5, 8
2603D50G03	2603D50G03	0	—	—	LD2350	1–3, 5, 8
2603D50G04	2603D50G04	0	—	—	LD2400	1–3, 5, 8
2603D50G07	2603D50G07	0	—	—	KD3250	1–3, 5, 8
2603D50G08	2603D50G08	0	1256C10G13	1256C10G13	LD3300	1–3, 5, 8
2603D50G09	2603D50G09	0	1256C10G14	1256C10G14	LD3350	1–3, 5, 8
2603D50G10	2603D50G10	0	1256C10G15	1256C10G15	LD3400	1–3, 5, 8
2603D50G13	2603D50G13	0	—	—	KD2250	1–5, 8
2603D50G14	2603D50G14	0	—	—	LD2300	1–5, 8
2603D50G15	2603D50G15	0	—	—	LD2350	1–5, 8
2603D50G16	2603D50G16	0	—	—	LD2400	1–5, 8
2603D50G19	2603D50G19	0	1256C10G12	1256C10G12	KD3250	1–5, 8
2603D50G20	2603D50G20	0	1256C10G13	1256C10G13	LD3300	1–5, 8
2603D50G21	2603D50G21	0	1256C10G14	1256C10G14	LD3350	1–5, 8
2603D50G22	2603D50G22	0	1256C10G15	1256C10G15	LD3400	1–5, 8
2610D53G12	2610D53G12	0	4994D96G30	4994D96G30	HMCP025DOC	1–3, 7
2610D53G13	2610D53G13	0	4994D96G31	4994D96G31	HMCP07QJ2C	1–3, 7

Note

① 0 = Obsolete, A = Available.

Replacement Breaker Cross-Reference

Replacement Breaker		Status ①	Replacements			Notes (See Page V12-T3-114)
Catalog Number	Style Number		MARK 75 Catalog Number	MARK 75 Style Number	Series C Catalog Number	
2610D53G30	2610D53G30	0	4994D96G30	4994D96G30	HMCP025DOC	1-3, 7
2610D53G31	2610D53G31	0	4994D96G31	4994D96G31	HMCP070J2C	1-3, 7
2610D58G31	2610D58G31	0	—	—	—	1-4, 7
373D488G08	373D488G08	0	373D488G09	373D488G09	—	2, 8
4994D96G12	4994D96G12	0	4994D96G30	4994D96G30	HMCP025DOC	1-3, 7
4994D96G13	4994D96G13	0	4994D96G31	4994D96G31	HMCP070J2C	1-3, 7
4994D96G30	4994D96G30	A	—	—	HMCP025DOC	1-3, 7
4994D96G31	4994D96G31	A	—	—	HMCP070J2C	1-3, 7
4998D89G30	4998D89G30	0	—	—	—	1-4, 7
5683D88G07	5683D88G07	0	—	—	KT2250T	2, 8
5683D88G08	5683D88G08	0	—	—	LT2300T	2, 8
5683D88G09	5683D88G09	0	—	—	LT2350T	2, 8
5683D88G10	5683D88G10	0	—	—	LT2400T	2, 8
5683D88G26	5683D88G26	0	2603D46G26	2603D46G26	KT3250T	2, 8
5683D88G27	5683D88G27	0	2603D46G27	2603D46G27	LT3300T	2, 8
5683D88G28	5683D88G28	0	2603D46G28	2603D46G28	LT3350T	2, 8
5683D88G29	5683D88G29	0	2603D46G29	2603D46G29	LT3400T	2, 8
65E4667	65E4667	A	—	—	HMCP100L3C	1-3, 7
81E4647	81E4647	0	—	—	—	1-4, 7
DA2250	375D152G11	0	—	—	DK2250	1-3, 5, 8, 9
DA2250Y	376D872G11	0	—	—	DK2250Y	1-3, 5, 8, 9
DA2300	375D152G12	0	—	—	DK2300	1-3, 5, 8, 9
DA2300Y	376D872G12	0	—	—	DK2300Y	1-3, 5, 8, 9
DA2350	375D152G13	0	—	—	DK2350	1-3, 5, 8, 9
DA2350Y	376D872G13	0	—	—	DK2350Y	1-3, 5, 8, 9
DA2400	375D152G14	0	—	—	DK2400	1-3, 5, 8, 9
DA2400WK	752B050G01	0	—	—	DK2400KW	1-3, 5, 8
DA2400Y	376D872G14	0	—	—	DK2400Y	1-3, 5, 8, 9
DA3250	375D152G26	0	—	—	DK3250	1-3, 5, 8, 9
DA3250Y	376D872G26	0	—	—	DK3250Y	1-3, 5, 8, 9
DA3300	375D152G27	0	—	—	DK3300	1-3, 5, 8, 9
DA3300Y	376D872G27	0	—	—	DK3300Y	1-3, 5, 8, 9
DA3350	375D152G28	0	—	—	DK3350	1-3, 5, 8, 9
DA3350Y	376D872G28	0	—	—	DK3350Y	1-3, 5, 8, 9
DA3400	375D152G29	0	—	—	DK3400	1-3, 5, 8, 9
DA3400WK	752B050G06	0	—	—	DK3400KW	1-3, 5, 8
DA3400Y	376D872G29	0	—	—	DK3400Y	1-3, 5, 8, 9
EB1015	4990D03G02	0	—	—	EHD1015	1-3, 5
EB1020	4990D03G03	0	—	—	EHD1020	1-3, 5
EB1025	4990D03G04	0	—	—	EHD1025	1-3, 5
EB1030	4990D03G05	0	—	—	EHD1030	1-3, 5
EB1035	4990D03G06	0	—	—	EHD1035	1-3, 5
EB1040	4990D03G07	0	—	—	EHD1040	1-3, 5
EB1045	4990D03G14	0	—	—	EHD1045	1-3, 5
EB1050	4990D03G08	0	—	—	EHD1050	1-3, 5
EB1060	4990D03G09	0	—	—	EHD1060	1-3, 5
EB1070	4990D03G10	0	—	—	EHD1070	1-3, 5

Note

① 0 = Obsolete, A = Available.

Replacement Breaker Cross-Reference

Replacement Breaker			Replacements			Notes
Catalog Number	Style Number	Status ①	MARK 75 Catalog Number	MARK 75 Style Number	Series C Catalog Number	(See Page V12-T3-114)
EB1080	4990D03G65	0	—	—	EHD1080	1–3, 5
EB1090	4990D03G11	0	—	—	EHD1090	1–3, 5
EB1100	4990D03G12	0	—	—	EHD1100	1–3, 5
EB1100LK	1226C25G01	0	—	—	—	1–3, 5, 8
EB2015	4990D03G18	0	—	—	EHD2015	1–3, 5
EB2020	4990D03G19	0	—	—	EHD2020	1–3, 5
EB2025	4990D03G20	0	—	—	EHD2025	1–3, 5
EB2030	4990D03G21	0	—	—	EHD2030	1–3, 5
EB2035	4990D03G22	0	—	—	EHD2035	1–3, 5
EB2040	4990D03G23	0	—	—	EHD2040	1–3, 5
EB2050	4990D03G24	0	—	—	EHD2050	1–3, 5
EB2060	4990D03G25	0	—	—	EHD2060	1–3, 5
EB2070	4990D03G26	0	—	—	EHD2070	1–3, 5
EB2080	4990D03G32	0	—	—	EHD2080	1–3, 5
EB2090	4990D03G27	0	—	—	EHD2090	1–3, 5
EB2100	4990D03G28	0	—	—	EHD2100	1–3, 5
EB2100LK	1226C25G02	0	—	—	EHD2100KL	1–3, 5, 8
EB3015	4990D03G34	0	HFB3015L	4997D19G34	EHD3015	1–3, 5
EB3015S	4991D35G02	0	HFB3015L	4997D19G34	EHD3015	1–5
EB3020	4990D03G35	0	HFB3020L	4997D19G35	EHD3020	1–3, 5
EB3020S	4991D35G03	0	HFB3020L	4997D19G35	EHD3020	1–5
EB3025	4990D03G36	0	HFB3025L	4997D19G36	EHD3025	1–3, 5
EB3025S	4991D35G04	0	HFB3025L	4997D19G36	EHD3025	1–5
EB3030	4990D03G37	0	HFB3030L	4997D19G37	EHD3030	1–3, 5
EB3030S	4991D35G05	0	HFB3030L	4997D19G37	EHD3030	1–5
EB3035	4990D03G38	0	HFB3035L	4997D19G38	EHD3035	1–3, 5
EB3035S	4991D35G06	0	HFB3035L	4997D19G38	EHD3035	1–5
EB3040	4990D03G39	0	HFB3040L	4997D19G39	EHD3040	1–3, 5
EB3040S	4991D35G07	0	HFB3040L	4997D19G39	EHD3040	1–5
EB3045	4990D03G46	0	HFB3045L	4997D19G54	EHD3045	1–3, 5
EB3045S	4990D03G40	0	HFB3045L	4997D19G54	EHD3045	1–5
EB3050	4991D35G08	0	HFB3050L	4997D19G40	EHD3050	1–3, 5
EB3050S	4990D03G41	0	HFB3050L	4997D19G40	EHD3050	1–5
EB3060	4991D35G09	0	HFB3060L	4997D19G41	EHD3060	1–3, 5
EB3060S	4990D03G42	0	HFB3060L	4997D19G41	EHD3060	1–5
EB3070	4991D35G10	0	HFB3070L	4997D19G42	EHD3070	1–3, 5
EB3070S	4990D03G48	0	HFB3070L	4997D19G42	EHD3070	1–5
EB3080	4990D03G43	0	HFB3080L	4997D19G55	EHD3080	1–3, 5
EB3080S	4991D35G11	0	HFB3080L	4997D19G55	EHD3080	1–5
EB3090	4990D03G43	0	HFB3090L	4997D19G43	EHD3090	1–3, 5
EB3090S	4991D35G11	0	HFB3090L	4997D19G43	EHD3090	1–5
EB3100	4990D03G44	0	HFB3100L	4997D19G44	EHD3100	1–3, 5
EB3100LK	1226C25G03	0	—	—	EHD3100KL	1–3, 5, 8
EB3100S	4991D35G12	0	HFB3100L	4997D19G44	EHD3100	1–5
EB3100SLK	1226C25G04	0	—	—	EHD3100KL	1–3, 5, 8
EHB1015	4989D52G02	0	—	—	EHD1015	1–3, 5
EHB1020	4989D52G03	0	—	—	EHD1020	1–3, 5

Note

① 0 = Obsolete, A = Available.

Replacement Breaker Cross-Reference

Replacement Breaker		Status ①	Replacements			Notes (See Page V12-T3-114)
Catalog Number	Style Number		MARK 75 Catalog Number	MARK 75 Style Number	Series C Catalog Number	
EHB1025	4989D52G04	0	—	—	EHD1025	1–3, 5
EHB1030	4989D52G05	0	—	—	EHD1030	1–3, 5
EHB1035	4989D52G06	0	—	—	EHD1035	1–3, 5
EHB1040	4989D52G07	0	—	—	EHD1040	1–3, 5
EHB1050	4989D52G08	0	—	—	EHD1050	1–3, 5
EHB1060	4989D52G09	0	—	—	EHD1060	1–3, 5
EHB1070	4989D52G10	0	—	—	EHD1070	1–3, 5
EHB1080	4989D52G14	0	—	—	EHD1080	1–3, 5
EHB1090	4989D52G11	0	—	—	EHD1090	1–3, 5
EHB1100	4989D52G12	0	—	—	EHD1100	1–3, 5
EHB1100LK	1226C25G11	0	—	—	—	1–3, 5, 8
EHB2015	4989D52G18	0	—	—	EHD2015	1–3, 5
EHB2020	4989D52G19	0	—	—	EHD2020	1–3, 5
EHB2025	4989D52G20	0	—	—	EHD2025	1–3, 5
EHB2030	4989D52G21	0	—	—	EHD2030	1–3, 5
EHB2035	4989D52G22	0	—	—	EHD2035	1–3, 5
EHB2040	4989D52G23	0	—	—	EHD2040	1–3, 5
EHB2045	4989D52G29	0	—	—	EHD2045	1–3, 5
EHB2050	4989D52G24	0	—	—	EHD2050	1–3, 5
EHB2060	4989D52G25	0	—	—	EHD2060	1–3, 5
EHB2070	4989D52G26	0	—	—	EHD2070	1–3, 5
EHB2090	4989D52G27	0	—	—	EHD2090	1–3, 5
EHB2100	4989D52G28	0	—	—	EHD2100	1–3, 5
EHB2100LK	1226C25G12	0	—	—	EHD2100KL	1–3, 5, 8
EHB3015	4989D52G34	0	HFB3015L	4997D19G34	EHD3015	1–3, 5
EHB3015S	4991D35G18	0	HFB3015L	4997D19G34	EHD3015	1–5
EHB3020	4989D52G35	0	HFB3020L	4997D19G35	EHD3020	1–3, 5
EHB3020S	4991D35G19	0	HFB3020L	4997D19G35	EHD3020	1–5
EHB3025	4989D52G36	0	HFB3025L	4997D19G36	EHD3025	1–3, 5
EHB3025S	4991D35G20	0	HFB3025L	4997D19G36	EHD3025	1–5
EHB3030	4989D52G37	0	HFB3030L	4997D19G37	EHD3030	1–3, 5
EHB3030S	4991D35G21	0	HFB3030L	4997D19G37	EHD3030	1–5
EHB3035	4989D52G38	0	HFB3035L	4997D19G38	EHD3035	1–3, 5
EHB3035S	4991D35G22	0	HFB3035L	4997D19G38	EHD3035	1–5
EHB3040	4989D52G39	0	HFB3040L	4997D19G39	EHD3040	1–3, 5
EHB3040S	4991D35G23	0	HFB3040L	4997D19G39	EHD3040	1–5
EHB3045	4989D52G45	0	HFB3045L	4997D19G54	EHD3045	1–3, 5
EHB3045S	NO STYLE	0	HFB3045L	4997D19G54	EHD3045	1–5
EHB3050	4993D67G40	0	HFB3050L	4997D19G40	EHD3050	1–3, 5
EHB3050S	4991D35G24	0	HFB3050L	4997D19G40	EHD3050	1–5
EHB3060	4993D67G41	0	HFB3060L	4997D19G41	EHD3060	1–3, 5
EHB3060S	4991D35G25	0	HFB3060L	4997D19G41	EHD3060	1–5
EHB3070	4993D67G42	0	HFB3070L	4997D19G42	EHD3070	1–3, 5
EHB3070S	4991D35G26	0	HFB3070L	4997D19G42	EHD3070	1–5
EHB3080	4993D67G46	0	HFB3080L	4997D19G55	EHD3080	1–3, 5
EHB3080S	NO STYLE	0	HFB3080L	4997D19G55	EHD3080	1–5
EHB3090	4993D67G43	0	HFB3090L	4997D19G43	EHD3090	1–3, 5

Note

① 0 = Obsolete, A = Available.

Replacement Breaker Cross-Reference

Replacement Breaker			Replacements			Notes
Catalog Number	Style Number	Status ①	MARK 75 Catalog Number	MARK 75 Style Number	Series C Catalog Number	(See Page V12-T3-114)
EHB3090S	4991D35G27	0	HFB3090L	4997D19G43	EHD3090	1-5
EHB3100	4993D67G44	0	HFB3100L	4997D19G44	EHD3100	1-3, 5
EHB3100LK	1226C25G13	0	—	—	EHD3100KL	1-3, 5, 8
EHB3100S	4991D35G28	0	—	—	EHD3100	1-5
EHB3100SLK	1226C25G14	0	—	—	EHD3100KL	1-3, 5, 8
FB2015	4975D71G18	0	—	—	FD2015	1-3, 5
FB2020	4975D71G19	0	—	—	FD2020	1-3, 5
FB2022MRL	2610D53G03	0	—	—	HMCP003AOC	1-3, 7
FB2025	4975D71G20	0	—	—	FD2025	1-3, 5
FB2030	4975D71G21	0	—	—	FD2030	1-3, 5
FB2035	4975D71G22	0	—	—	FD2035	1-3, 5
FB2040	4975D71G23	0	—	—	FD2040	1-3, 5
FB2045MRL	2610D53G04	0	—	—	HMCP007COC	1-3, 7
FB2050	4975D71G24	0	—	—	FD2050	1-3, 5
FB2060	4975D71G25	0	—	—	FD2060	1-3, 5
FB2070	4975D71G26	0	—	—	FD2070	1-3, 5
FB2080	4975D71G02	0	—	—	FD2080	1-3, 5
FB2090	4975D71G27	0	—	—	FD2090	1-3, 5
FB2100	4975D71G28	0	—	—	FD2100	1-3, 5
FB2100LK	1226C25G21	0	—	—	FD2100KL	1-3, 5, 8
FB2110MRL	2610D53G05	0	—	—	HMCP015E0C	1-3, 7
FB2150LK	1226C25G22	0	—	—	FD2150KL	1-3, 5, 8
FB21550MRL	2610D53G08	0	—	—	HMCP150T4C	1-3, 7
FB21800MRL	2610D53G11	0	—	—	HMCP150U4C	1-3, 7
FB2190MRL	2610D53G06	0	—	—	HMCP030H1C	1-3, 7
FB2270MRL	2610D53G10	0	—	—	HMCP030H1C	1-3, 7
FB2480MRL	2610D53G07	0	—	—	HMCP050K2C	1-3, 7
FB3015	4975D71G34	0	HFB3015L	4997D19G34	FD3015	1-3, 5
FB3015S	4991D35G34	0	HFB3015L	4997D19G34	FD3015	1-5
FB3020	4975D71G35	0	HFB3020L	4997D19G35	FD3020	1-3, 5
FB3020S	4991D35G35	0	HFB3020L	4997D19G35	FD3020	1-5
FB3022MRL	2606D96G21	0	HFB3022ML	4994D96G21	HMCP003AOC	1-3, 7
FB3022SMRL	2610D58G21	0	HFB3022ML	4994D96G21	HMCP003AOC	1-4, 7
FB3025	4975D71G36	0	HFB3025L	4997D19G36	FD3025	1-3, 5
FB3025S	4991D35G36	0	HFB3025L	4997D19G36	FD3025	1-5
FB3030	4975D71G37	0	HFB3030L	4997D19G37	FD3030	1-3, 5
FB3030S	4991D35G37	0	HFB3030L	4997D19G37	FD3030	1-5
FB3035	4975D71G38	0	HFB3035L	4997D19G38	FD3035	1-3, 5
FB3040	4975D71G39	0	HFB3040L	4997D19G39	FD3040	1-3, 5
FB3040S	4991D35G39	0	HFB3040L	4997D19G39	FD3040	1-5
FB3045L	4975D71G05	0	HFB3045L	4997D19G54	FD3045	1-3, 5
FB3045MRL	2610D53G22	0	HFB3045ML	4994D96G22	HMCP007COC	1-3, 7
FB3045S	NO STYLE	0	HFB3045L	4997D19G54	FD3045	1-5
FB3045SMRL	2610D58G22	0	HFB3045ML	4994D96G22	HMCP007COC	1-4, 7
FB3050	4975D71G40	0	HFB3050L	4997D19G40	FD3050	1-3, 5
FB3050S	4991D35G40	0	HFB3050L	4997D19G40	FD3050	1-5
FB3060	4975D71G41	0	HFB3060L	4997D19G41	FD3060	1-3, 5

Note

① 0 = Obsolete, A = Available.

Replacement Breaker Cross-Reference

Replacement Breaker		Status ①	Replacements			Notes (See Page V12-T3-114)
Catalog Number	Style Number		MARK 75 Catalog Number	MARK 75 Style Number	Series C Catalog Number	
FB3060S	4991D35G41	0	HFB3060L	4997D19G41	FD3060	1-5
FB3070	4975D71G42	0	HFB3070L	4997D19G42	FD3070	1-3, 5
FB3070S	4991D35G42	0	HFB3070L	4997D19G42	FD3070	1-5
FB3080	4975D71G06	0	HFB3080L	4997D19G55	FD3080	1-3, 5
FB3080S	NO STYLE	0	HFB3080L	4997D19G55	FD3080	1-5
FB3090	4975D71G43	0	HFB3090L	4997D19G43	FD3090	1-3, 5
FB3090S	4991D35G43	0	HFB3090L	4997D19G43	FD3090	1-5
FB3100	4975D71G44	0	HFB3100L	4997D19G44	FD3100	1-3, 5
FB3100LK	1226C25G23	0	—	—	FD3100KL	1-3, 5, 8
FB3100S	4991D35G44	0	HFB3100L	4997D19G44	FD3100	1-5
FB3110	4975D71G07	0	—	—	FD3110	1-3, 5
FB3110MRL	2610D53G23	0	HFB3110ML	4994D96G23	HMCPO15E0C	1-3, 7
FB3110S	NO STYLE	0	—	—	FD3110	1-5
FB3110SMRL	2610D58G23	0	—	—	HMCPO15E0C	1-4, 7
FB3125	4975D71G45	0	—	—	FD3125	1-3, 5
FB3125S	4991D35G45	0	—	—	FD3125	1-4, 5
FB3150	4975D71G46	0	—	—	FD3150	1-3, 5
FB3150LK	1226C25G24	0	—	—	FD3150KL	1-3, 5, 8
FB3150S	4991D35G46	0	—	—	FD3150	1-5
FB3150SLK	1226C25G25	0	—	—	FD3150KL	1-3, 5, 8
FB31550MRL	2610D53G26	0	HFB31550ML	4994D96G26	HMCPO150T4C	1-3, 7
FB31550SMRL	2610D58G26	0	HFB31550ML	4994D96G26	HMCPO150T4C	1-4, 7
FB31800MRL	2610D53G29	0	—	—	HMCPO150U4C	1-3, 7
FB31800SMRL	2610D58G29	0	—	—	HMCPO150U4C	1-4, 7
FB3190MRL	2610D53G24	0	HFB3190ML	4994D96G24	HMCPO30H1C	1-3, 7
FB3190SMRL	2610D58G24	0	HFB3190ML	4994D96G24	HMCPO30H1C	1-4, 7
FB3270MRL	2610D53G28	0	HFB3270ML	4994D96G28	HMCPO30H1C	1-3, 7
FB3270SMRL	2610D58G28	0	HFB3270ML	4994D96G28	HMCPO30H1C	1-4, 7
FB3480MRL	2610D53G25	0	HFB3480ML	4994D96G25	HMCPO50K2C	1-3, 7
FB3480SMRL	2610D58G25	0	HFB3480ML	4994D96G25	HMCPO50K2C	1-4, 7
FB4015	4975D71G50	0	—	—	FD4015	1-3, 5
FB4020	4975D71G51	0	—	—	FD4020	1-3, 5
FB4025	4975D71G52	0	—	—	FD4025	1-3, 5
FB4030	4975D71G53	0	—	—	FD4030	1-3, 5
FB4035	4975D71G54	0	—	—	FD4035	1-3, 5
FB4040	4975D71G55	0	—	—	FD4040	1-3, 5
FB4045	NO STYLE	0	—	—	FD4045	1-3, 5
FB4050	4975D71G56	0	—	—	FD4050	1-3, 5
FB4060	4975D71G57	0	—	—	FD4060	1-3, 5
FB4070	4975D71G58	0	—	—	FD4070	1-3, 5
FB4080	NO STYLE	0	—	—	FD4080	1-3, 5
FB4090	4975D71G59	0	—	—	FD4090	1-3, 5
FB4100	4975D71G60	0	—	—	FD4100	1-3, 5
FB4100LK	1226C25G26	0	—	—	FD4100KL	1-3, 5, 8
FB4150LK	1226C25G27	0	—	—	FD4150KL	1-3, 5, 8
HFB1015	4976D04G02	0	—	—	HFD1015	1-3, 5
HFB1020	4976D04G03	0	—	—	HFD1020	1-3, 5

Note

① 0 = Obsolete, A = Available.

Replacement Breaker Cross-Reference

Replacement Breaker			Replacements			Notes
Catalog Number	Style Number	Status ^①	MARK 75 Catalog Number	MARK 75 Style Number	Series C Catalog Number	(See Page V12-T3-114)
HFB1025	4976D04G04	0	—	—	HFD1025	1–3, 5
HFB1030	4976D04G05	0	—	—	HFD1030	1–3, 5
HFB1035	4976D04G06	0	—	—	HFD1035	1–3, 5
HFB1040	4976D04G07	0	—	—	HFD1040	1–3, 5
HFB1045	4976D04G49	0	—	—	HFD1045	1–3, 5
HFB1050	4976D04G08	0	—	—	HFD1050	1–3, 5
HFB1060	4976D04G09	0	—	—	HFD1060	1–3, 5
HFB1070	4976D04G10	0	—	—	HFD1070	1–3, 5
HFB1080	4976D04G50	0	—	—	HFD1080	1–3, 5
HFB1090	4976D04G11	0	—	—	HFD1090	1–3, 5
HFB1100	4976D04G12	0	—	—	HFD1100	1–3, 5
HFB2015	4976D04G18	0	—	—	FD3015	1–3, 5, 6
HFB2020	4976D04G19	0	—	—	FD3020	1–3, 5, 6
HFB2022ML	2610D57G03	0	—	—	HMCP003AOC	1, 2, 3, 7
HFB2025	4976D04G20	0	—	—	FD3025	1, 2, 3, 5, 6
HFB2030	4976D04G21	0	—	—	FD3030	1, 2, 3, 5, 6
HFB2035	4976D04G22	0	—	—	FD3035	1, 2, 3, 5, 6
HFB2040	4976D04G23	0	—	—	FD3040	1, 2, 3, 5, 6
HFB2045	4976D04G51	0	—	—	FD3045	1, 2, 3, 5, 6
HFB2045ML	2610D57G04	0	—	—	HMCP007COC	1, 2, 3, 7
HFB2050	4976D04G24	0	—	—	FD3050	1, 2, 3, 5, 6
HFB2060	4976D04G25	0	—	—	FD3060	1, 2, 3, 5, 6
HFB2070	4976D04G26	0	—	—	FD3070	1, 2, 3, 5, 6
HFB2080	4976D04G52	0	—	—	FD3080	1, 2, 3, 5, 6
HFB2090	4976D04G27	0	—	—	FD3090	1, 2, 3, 5, 6
HFB2100	4976D04G28	0	—	—	FD3100	1, 2, 3, 5, 6
HFB2125	4976D04G29	0	—	—	FD3125	1, 2, 3, 5, 6
HFB2150	4976D04G30	0	—	—	FD3150	1, 2, 3, 5, 6
HFB2110ML	2610D57G05	0	—	—	HMCP015E0C	1, 2, 3, 7
HFB21550ML	2610D57G08	0	—	—	HMCP150T4C	1, 2, 3, 7
HFB21800ML	2610D57G11	0	—	—	HMCP150U4C	1, 2, 3, 7
HFB2190ML	2610D57G06	0	—	—	HMCP030H1C	1, 2, 3, 7
HFB2270ML	2610D57G10	0	—	—	HMCP030H1C	1, 2, 3, 7
HFB2480ML	2610D57G07	0	—	—	HMCP050K2C	1, 2, 3, 7
HFB3015	4976D04G34	0	HFB3015L	4997D19G34	FD3015	1, 2, 3, 5
HFB3020	4976D04G35	0	HFB3020L	4997D19G35	FD3020	1, 2, 3, 5
HFB3022ML	2610D57G21	A	—	—	HMCP003AOC	1, 2, 3, 7
HFB3025	4976D04G36	0	HFB3025L	4997D19G36	FD3025	1, 2, 3, 5
HFB3030	4976D04G37	0	HFB3030L	4997D19G37	FD3030	1, 2, 3, 5
HFB3035	4976D04G38	0	HFB3035L	4997D19G38	FD3035	1, 2, 3, 5
HFB3040	4976D04G39	0	HFB3040L	4997D19G39	FD3040	1–3, 5
HFB3045	4976D04G54	0	HFB3045L	4997D19G54	FD3045	1–3, 5
HFB3045ML	2610D57G22	A	—	—	HMCP007COC	1–3, 7
HFB3050	4976D04G40	0	HFB3050L	4997D19G40	FD3050	1–3, 5
HFB3060	4976D04G41	0	HFB3060L	4997D19G41	FD3060	1–3, 5
HFB3070	4976D04G42	0	HFB3070L	4997D19G42	FD3070	1–3, 5
HFB3080	4976D04G55	0	HFB3080L	4997D19G55	FD3080	1–3, 5

Note

① 0 = Obsolete, A = Available.

Replacement Breaker Cross-Reference

Replacement Breaker		Status ①	Replacements			Notes (See Page V12-T3-114)
Catalog Number	Style Number		MARK 75 Catalog Number	MARK 75 Style Number	Series C Catalog Number	
HFB3090	4976D04G43	0	HFB3090L	4997D19G43	FD3090	1-3, 5
HFB3100	4976D04G44	0	HFB3100L	4997D19G44	FD3100	1-3, 5
HFB3110	4976D04G56	0	—	—	FD3110	1-3, 5
HFB3110ML	2610D57G23	A	—	—	HMCP015EOC	1-3, 7
HFB3125	4976D04G45	0	—	—	FD3125	1-3, 5
HFB3150	4976D04G46	0	—	—	FD3150	1-3, 5
HFB31550ML	2610D57G26	0	—	—	HMCP150T4C	1-3, 7
HFB31800ML	2610D57G29	0	—	—	HMCP150U4C	1-3, 7
HFB3190ML	2610D57G24	A	—	—	HMCP030H1C	1-3, 7
HFB3270ML	2610D57G28	A	—	—	HMCP030H1C	1-3, 7
HFB3480ML	2610D57G25	A	—	—	HMCP050K2C	1-3, 7
HKA2070	1255C59G02	0	—	—	JD2070	1-3, 5, 8, 9
HKA2070T	2602D83G02	0	—	—	—	2, 8
HKA2070TA	459D987G02	0	—	—	JT2070T	2, 8
HKA2090	1255C59G03	0	—	—	JD2090	1-3, 5, 8, 9
HKA2090T	657D789G03	0	—	—	—	2, 8
HKA2090TA	459D987G03	0	—	—	—	2, 8
HKA2100	1255C59G04	0	—	—	KD2100	1-3, 5, 8, 9
HKA2100T	2602D83G04	0	—	—	—	2, 8
HKA2100TA	459D987G04	0	—	—	—	2, 8
HKA2125	1255C59G05	0	—	—	KD2125	1-3, 5, 8, 9
HKA21250TM	2602D84G05	0	—	—	—	2, 8
HKA2125T	2602D83G05	0	—	—	—	2, 8
HKA2125TA	459D987G05	0	—	—	—	2, 8
HKA2150	1255C59G06	0	—	—	KD2150	1-3, 5, 8, 9
HKA21500TM	2602D84G06	0	—	—	—	2, 8
HKA2150T	2602D83G06	0	—	—	—	2, 8
HKA2150TA	459D987G06	0	—	—	—	2, 8
HKA2175	1255C59G07	0	—	—	KD2175	1-3, 5, 8, 9
HKA21750TM	2602D84G07	0	—	—	—	2, 8
HKA2175T	2602D83G07	0	—	—	—	2, 8
HKA2175TA	459D987G07	0	—	—	—	2, 8
HKA2200	1255C59G08	0	—	—	KD2200	1-3, 5, 8, 9
HKA2200T	2602D83G08	0	—	—	—	2, 8
HKA2200TA	459D987G08	0	—	—	—	2, 8
HKA2225	1255C59G09	0	—	—	KD2225	1-3, 5, 8, 9
HKA22250TM	2602D84G09	0	—	—	—	2, 8
HKA2225F	2602D86G05	0	—	—	KD2400F	2, 8
HKA2225T	2602D83G09	0	—	—	KT2225T	2, 8
HKA2225TA	459D987G09	0	—	—	KT2225T	2, 8
HKA2700TM	2602D84G02	0	—	—	—	2, 8
HKA3070	1255C59G17	0	—	—	JD3070	1-3, 5, 8, 9
HKA3070T	657D788G17	A	—	—	—	2, 5
HKA3070TA	459D987G17	0	HKA3070T	657D789G17	—	2, 8
HKA3090	1255C59G18	0	—	—	JD3090	1-3, 5, 8, 9
HKA3090T	2602D83G18	A	—	—	—	2, 5
HKA3090TA	459D987G18	0	HKA3090T	657D789G18	—	2, 8

Note

① 0 = Obsolete, A = Available.

Replacement Breaker Cross-Reference

Replacement Breaker			Replacements			Notes
Catalog Number	Style Number	Status ^①	MARK 75 Catalog Number	MARK 75 Style Number	Series C Catalog Number	(See Page V12-T3-114)
HKA3100	1255C59G19	0	—	—	KD3100	1-3, 5, 8, 9
HKA3100T	2602D83G19	A	—	—	—	2, 5
HKA3100TA	459D987G19	0	HKA3100T	657D789G19	—	2, 8
HKA3125	1255C59G20	0	—	—	KD3125	1-3, 5, 8, 9
HKA3125T	2602D83G20	A	—	—	—	2, 5
HKA3125TA	459D987G20	0	HKA3125T	657D789G20	—	2, 8
HKA3150	1255C59G21	0	—	—	KD3150	1-3, 5, 8, 9
HKA3150T	2602D83G21	A	—	—	—	2, 5
HKA3150TA	459D987G21	0	HKA3150T	657D789G21	—	2, 8
HKA3175	1255C59G22	0	—	—	KD3175	1-3, 5, 8, 9
HKA3175T	2602D83G22	A	—	—	—	2, 5
HKA3175TA	459D987G22	0	HKA3175T	657D789G22	—	2, 8
HKA3200	1255C59G23	0	—	—	KD3200	1-3, 5, 8, 9
HKA3200T	2602D83G23	A	—	—	—	2, 5
HKA3200TA	459D987G23	0	HKA3200T	657D789G23	—	2, 8
HKA3225	1255C59G24	0	—	—	KD3225	1-3, 5, 8, 9
HKA3225F	2602D86G06	0	—	—	KD3400F	2, 8
HKA3225T	2602D83G24	A	—	—	—	2, 5
HKA3225TA	459D987G24	0	HKA3225T	657D789G24	—	2, 8
HKB2070	1291C44G01	0	—	—	JD2070	1-3, 5
HKB2070T	1293C31G01	0	—	—	—	2, 5
HKB2090	1291C44G02	0	—	—	JD2090	1-3, 5
HKB2090T	1293C31G02	0	—	—	—	—
HKB2100	1291C44G03	0	—	—	JD2100	1-3, 5
HKB21000TM	1293C35G03	0	—	—	—	—
HKB2100T	1293C31G03	0	—	—	—	—
HKB2125	1291C44G04	0	—	—	JD2125	1-3, 5
HKB21250TM	1293C35G04	0	—	—	—	—
HKB2125T	1293C31G04	0	—	—	—	—
HKB2150	1291C44G05	0	—	—	JD2150	1-3, 5
HKB21500TM	1293C35G05	0	—	—	—	—
HKB2150T	1293C31G05	0	—	—	—	—
HKB2175	1291C44G06	0	—	—	JD2175	1-3, 5
HKB21750TM	1293C35G06	0	—	—	—	—
HKB2175T	1293C31G06	0	—	—	—	—
HKB2200	1291C44G07	0	—	—	JD2200	1-3, 5
HKB2200T	1293C31G07	0	—	—	—	—
HKB2225	1291C44G08	0	—	—	JD2225	1-3, 5
HKB22250TM	1293C35G07	0	—	—	—	—
HKB2225T	1293C31G08	0	—	—	—	—
HKB2250	1291C44G09	0	—	—	JD2250	1-3, 5
HKB22500TM	1293C35G09	0	—	—	—	—
HKB2250F	2601D44G15	0	—	—	JD2250F	—
HKB2250T	4974D52G12	0	—	—	—	—
HKB2700TM	1293C35G01	0	—	—	—	—
HKB3070	1291C44G16	0	—	—	JD3070	1-3, 5
HKB3070T	1293C32G01	0	—	—	—	—

Note

① 0 = Obsolete, A = Available.

Replacement Breaker Cross-Reference

Replacement Breaker		Status ①	Replacements			Notes (See Page V12-T3-114)
Catalog Number	Style Number		MARK 75 Catalog Number	MARK 75 Style Number	Series C Catalog Number	
HKB3090	1291C44G17	0	—	—	JD3090	1–3, 5
HKB3090T	1293C32G02	0	—	—	—	—
HKB3100	1291C44G18	0	—	—	JD3100	1–3, 5
HKB31000TM	1293C36G03	0	—	—	—	—
HKB3100T	1293C32G03	0	—	—	—	—
HKB3125	1291C44G19	0	—	—	JD3125	1–3, 5
HKB31250TM	1293C36G04	0	—	—	—	—
HKB3125T	1293C32G04	0	—	—	—	—
HKB3150	1291C44G20	0	—	—	JD3150	1–3, 5
HKB31500TM	1293C36G05	0	—	—	—	—
HKB3150T	1293C32G05	0	—	—	—	—
HKB3175	1291C44G21	0	—	—	JD3175	1–3, 5
HKB31750TM	1293C36G06	0	—	—	—	—
HKB3175T	1293C32G06	0	—	—	—	—
HKB3200	1291C44G22	0	—	—	JD3200	1–3, 5
HKB3200T	1293C32G06	0	—	—	—	—
HKB3225	1291C44G23	0	—	—	JD3225	1–3, 5
HKB32250TM	1293C36G08	0	—	—	—	—
HKB3225T	1293C32G07	0	—	—	—	—
HKB3250	1291C44G24	0	—	—	JD3250	1–3, 5
HKB32500TM	1293C36G09	0	—	—	—	2, 5
HKB3250F	2601D44G16	0	—	—	JD3250F	—
HKB3250FS	NO STYLE	0	—	—	JD3250F	—
HKB3250T	1293C32G08	0	—	—	—	—
HKB3700TM	1293C36G01	0	—	—	—	—
HLA2070T	2602D98G02	0	—	—	—	2, 8
HLA2070TA	457D581G02	0	—	—	—	2, 8
HLA2090T	2602D98G03	0	—	—	—	2, 8
HLA2090TA	457D581G03	0	—	—	—	2, 8
HLA2100T	2602D98G04	0	—	—	—	2, 8
HLA2100TA	457D581G04	0	—	—	—	2, 8
HLA2125	1255C74G05	0	—	—	KD2125	1–3, 5, 8
HLA21250TM	2602D97G03	0	—	—	—	2, 8
HLA2125T	2602D98G05	0	—	—	—	2, 8
HLA2125TA	457D581G05	0	—	—	—	2, 8
HLA2150	1255C74G06	0	—	—	KD2150	1–3, 5, 8
HLA21500TM	2602D97G04	0	—	—	—	2, 8
HLA2150T	2602D98G06	0	—	—	—	2, 8
HLA2150TA	457D581G06	0	—	—	—	2, 8
HLA2175	1255C74G07	0	—	—	KD2175	1–3, 5, 8
HLA21750TM	2602D97G05	0	—	—	—	2, 8
HLA2175T	2602D98G07	0	—	—	—	2, 8
HLA2175TA	457D581G07	0	—	—	—	2, 8
HLA2200	1255C74G08	0	—	—	KD2200	1–3, 5, 8
HLA2200T	2602D98G08	0	—	—	—	2, 8
HLA2200TA	457D581G08	0	—	—	—	2, 8
HLA2225	1255C74G09	0	—	—	KD2225	1–3, 5, 8

Note

① 0 = Obsolete, A = Available.

Replacement Breaker Cross-Reference

Replacement Breaker			Replacements			Notes
Catalog Number	Style Number	Status ^①	MARK 75 Catalog Number	MARK 75 Style Number	Series C Catalog Number	(See Page V12-T3-114)
HLA22250TM	2602D97G06	0	—	—	—	2, 8
HLA2225T	2602D98G09	0	—	—	—	2, 8
HLA2225TA	457D581G09	0	—	—	—	2, 8
HLA2250	1255C74G10	0	—	—	KD2250	1–3, 5, 8
HLA2250T	2602D98G10	0	—	—	—	2, 8
HLA2250TA	457D581G10	0	—	—	—	2, 8
HLA2300	1255C74G11	0	—	—	KD2300	1–3, 5, 8
HLA23000TM	2602D97G07	0	—	—	—	2, 8
HLA2300T	2602D98G11	0	—	—	—	2, 8
HLA2300TA	457D581G11	0	—	—	—	2, 8
HLA2350	1255C74G12	0	—	—	KD2350	1–3, 5, 8
HLA2350T	2602D98G12	0	—	—	—	2, 8
HLA2350TA	457D781G12	0	—	—	—	2, 8
HLA2400	1255C74G13	0	—	—	KD2400	1–3, 5, 8
HLA24000TM	2602D97G08	0	—	—	—	2, 8
HLA2400F	673B352G01	0	—	—	KD2400F	1–3, 5, 8
HLA2400T	2602D98G13	0	—	—	—	2, 8
HLA2400TA	457D581G13	0	—	—	—	2, 8
HLA2500	1256C10G10	0	—	—	LD2500	1–3, 5, 8
HLA25000TM	2603D47G12	0	—	—	—	2, 8
HLA2500T	2603D46G12	0	—	—	—	2, 8
HLA2500TA	5683D88G12	0	—	—	—	2, 8
HLA2600	1256C10G07	0	—	—	LD2600	1–3, 5, 8
HLA26000TM	2603D47G13	0	—	—	—	2, 8
HLA2600F	375D400G09	0	—	—	LD2600F	1–3, 5, 8
HLA2600T	2603D46G13	0	—	—	—	2, 8
HLA2600TA	5683D88G13	0	—	—	—	2, 8
HLA2700TM	2602D97G02	0	—	—	—	2, 8
HLA3070T	2602D98G21	A	—	—	—	2, 8
HLA3070TA	457D581G21	0	HLA3070T	370D749G21	—	2, 8
HLA3090T	2602D98G22	A	—	—	—	2, 8
HLA3090TA	457D581G22	0	HLA3090T	370D749G22	—	2, 8
HLA3100T	2602D98G23	A	—	—	—	2, 8
HLA3100TA	457D581G23	0	HLA3100T	370D749G23	—	2, 8
HLA3125	504C740G20	A	—	—	KD3125	1–3, 5, 8
HLA31250TM	2602D97G25	A	—	—	—	2, 8
HLA3125T	2602D98G24	A	—	—	—	2, 8
HLA3125TA	457D581G24	0	HLA3125T	370D749G24	—	2, 8
HLA3150	504C740G21	A	—	—	KD3150	1–3, 5, 8
HLA31500TM	2602D97G26	A	—	—	—	2, 8
HLA3150T	2602D98G25	A	—	—	—	2, 8
HLA3150TA	457D581G25	0	HLA3150T	370D749G25	—	2, 8
HLA3175	504C740G22	A	—	—	KD3175	1–3, 5, 8
HLA31750TM	2602D97G27	A	—	—	—	2, 8
HLA3175T	2602D98G26	A	—	—	—	2, 8
HLA3175TA	457D581G26	0	HLA3175T	370D749G26	—	2, 8
HLA3200	504C740G23	A	—	—	KD3200	1–3, 5, 8

Note

① 0 = Obsolete, A = Available.

Replacement Breaker Cross-Reference

Replacement Breaker		Status ①	Replacements			Notes (See Page V12-T3-114)
Catalog Number	Style Number		MARK 75 Catalog Number	MARK 75 Style Number	Series C Catalog Number	
HLA3200T	2602D98G27	A	—	—	—	2, 8
HLA3200TA	457D581G27	O	HLA3200T	370D749G27	—	2, 8
HLA3225	504C740G24	A	—	—	KD3225	1–3, 5, 8
HLA32250TM	2602D97G28	A	—	—	—	2, 8
HLA3225T	2602D98G28	A	—	—	—	2, 8
HLA3225TA	457D581G28	O	HLA3225T	370D749G28	—	2, 8
HLA3250	504C740G25	A	—	—	KD3250	1–3, 5, 8
HLA3250T	2602D98G29	A	—	—	—	2, 8
HLA3250TA	457D581G29	O	HLA3250T	370D749G29	—	2, 8
HLA3300	504C740G26	A	—	—	KD3300	1–3, 5, 8
HLA33000TM	2602D97G29	A	—	—	—	2, 8
HLA3300T	2602D98G30	A	—	—	—	2, 8
HLA3300TA	457D581G30	O	HLA3300T	370D749G30	—	2, 8
HLA3350T	2602D98G31	A	—	—	—	2, 8
HLA3350TA	457D581G31	O	HLA3350T	370D749G31	—	2, 8
HLA3400	504C740G28	A	—	—	KD3400	1–3, 5, 8
HLA34000TM	2602D97G30	A	—	—	—	2, 8
HLA3400F	673B352G02	A	—	—	KD3400F	1–3, 5, 8
HLA3400T	2602D98G32	A	—	—	—	2, 8
HLA3400TA	457D581G32	O	HLA3400T	370D749G32	—	2, 8
HLA3500	177C429G16	A	—	—	LD3500	1–3, 5, 8
HLA35000TM	2603D47G31	A	—	—	—	2, 8
HLA3500T	2603D46G31	A	—	—	—	2, 8
HLA3500TA	5683D88G31	O	HLA3500T	375D259G31	—	2, 8
HLA3600	177C429G17	A	—	—	LD3600	1–3, 5, 8
HLA36000TM	2603D47G32	A	—	—	—	2, 8
HLA3600F	2603D48G06	A	—	—	LD3600F	1–3, 5, 8
HLA3600T	2603D46G32	A	—	—	—	2, 8
HLA3600TA	5683D88G32	O	HLA3600T	375D259G32	—	2, 8
HLA3700TM	455D565G24	A	—	—	—	2, 8
HLB2070T	5680D04G07	O	—	—	—	2, 8
HLB2070TA	5680D04G31	O	—	—	—	2, 8
HLB2090T	5680D04G08	O	—	—	—	2, 8
HLB2090TA	5680D04G32	O	—	—	—	2, 8
HLB2100T	5680D04G09	O	—	—	—	2, 8
HLB2100TA	5680D04G33	O	—	—	—	2, 8
HLB2125	179C848G04	O	—	—	KD2125	1–3, 5, 8, 9
HLB21250TM	5680D04G56	O	—	—	—	2, 8
HLB2125T	5680D04G10	O	—	—	—	2, 8
HLB2125TA	5680D04G34	O	—	—	—	2, 8
HLB2150	179C848G05	O	—	—	KD2150	1–3, 5, 8, 9
HLB21500TM	5680D04G57	O	—	—	—	2, 8
HLB2150T	5680D04G11	O	—	—	—	2, 8
HLB2150TA	5680D04G35	O	—	—	—	2, 8
HLB2175	179C848G06	O	—	—	KD2175	1–3, 5, 8, 9
HLB21750TM	5680D04G58	O	—	—	—	2, 8
HLB2175T	5680D04G12	O	—	—	—	2, 8

Note

① O = Obsolete, A = Available.

Replacement Breaker Cross-Reference

Replacement Breaker			Replacements			Notes
Catalog Number	Style Number	Status ①	MARK 75 Catalog Number	MARK 75 Style Number	Series C Catalog Number	(See Page V12-T3-114)
HLB2175TA	5680D04G36	0	—	—	—	2, 8
HLB2200	179C848G07	0	—	—	KD2200	1-3, 5, 8, 9
HLB2200T	5680D04G13	0	—	—	—	2, 8
HLB2200TA	5680D04G37	0	—	—	—	2, 8
HLB2225	179C848G08	0	—	—	KD2225	1-3, 5, 8, 9
HLB22250TM	5680D04G59	0	—	—	—	2, 8
HLB2225T	5680D04G14	0	—	—	—	2, 8
HLB2225TA	5680D04G38	0	—	—	—	2, 8
HLB2250	179C848G09	0	—	—	KD2250	1-3, 5, 8, 9
HLB2250T	5680D04G15	0	—	—	—	2, 8
HLB2250TA	5680D04G39	0	—	—	—	2, 8
HLB2300	179C848G10	0	—	—	KD2300	1-3, 5, 8, 9
HLB23000TM	5680D04G60	0	—	—	—	2, 8
HLB2300T	5680D04G16	0	—	—	—	2, 8
HLB2300TA	5680D04G40	0	—	—	—	2, 8
HLB2350	179C848G11	0	—	—	KD2350	1-3, 5, 8, 9
HLB2350TA	5680D04G41	0	—	—	—	2, 8
HLB2400	179C848G12	0	—	—	KD2400	1-3, 5, 8, 9
HLB24000TM	5680D04G61	0	—	—	—	2, 8
HLB2400F	5680D03G09	0	—	—	KD2400F	1-3, 5, 8, 9
HLB2400T	5680D04G18	0	—	—	—	2, 8
HLB2400TA	5680D04G42	0	—	—	—	2, 8
HLB2700TM	5680D04G55	0	—	—	—	2, 8
HLB3070T	5680D04G19	0	—	—	—	2, 8
HLB3070TA	5680D04G43	0	—	—	—	2, 8
HLB3090T	5680D04G20	0	—	—	—	2, 8
HLB3090TA	5680D04G44	0	—	—	—	2, 8
HLB3100T	5680D04G21	0	—	—	—	2, 8
HLB3100TA	5680D04G45	0	—	—	—	2, 8
HLB3125	179C848G19	0	—	—	KD3125	1-3, 5, 8, 9
HLB31250TM	5680D04G63	0	—	—	—	2, 8
HLB3125T	5680D04G22	0	—	—	—	2, 8
HLB3125TA	5680D04G46	0	—	—	—	2, 8
HLB3150	179C848G20	0	—	—	KD3150	1-3, 5, 8, 9
HLB31500TM	5680D04G64	0	—	—	—	2, 8
HLB3150T	5680D04G23	0	—	—	—	2, 8
HLB3150TA	5680D04G47	0	—	—	—	2, 8
HLB3175	179C848G21	0	—	—	KD3175	1-3, 5, 8, 9
HLB31750TM	5680D04G65	0	—	—	—	2, 8
HLB3175T	5680D04G24	0	—	—	—	2, 8
HLB3175TA	5680D04G48	0	—	—	—	2, 8
HLB3200	179C848G22	0	—	—	KD3200	1-3, 5, 8, 9
HLB3200T	5680D04G25	0	—	—	—	2, 8
HLB3200TA	5680D04G49	0	—	—	—	2, 8
HLB3225	179C848G23	0	—	—	KD3225	1-3, 5, 8, 9
HLB32250TM	5680D04G66	0	—	—	—	2, 8
HLB3225T	5680D04G26	0	—	—	—	2, 8

Note

① 0 = Obsolete, A = Available.

Replacement Breaker Cross-Reference

Replacement Breaker		Status ①	Replacements			Notes (See Page V12-T3-114)
Catalog Number	Style Number		MARK 75 Catalog Number	MARK 75 Style Number	Series C Catalog Number	
HLB3225TA	5680D04G50	0	—	—	—	2, 8
HLB3250	179C848G24	0	—	—	KD3250	1-3, 5, 8, 9
HLB3250T	5680D04G27	0	—	—	—	2, 8
HLB3250TA	5680D04G51	0	—	—	—	2, 8
HLB3300	179C848G25	0	—	—	KD3300	1-3, 5, 8, 9
HLB3300TM	5680D04G67	0	—	—	—	2, 8
HLB3300T	5680D04G28	0	—	—	—	2, 8
HLB3300TA	5680D04G52	0	—	—	—	2, 8
HLB3350TA	5680D04G53	0	—	—	—	2, 8
HLB3400	179C848G27	0	—	—	KD3400	1-3, 5, 8, 9
HLB3400TM	5680D04G68	0	—	—	—	2, 8
HLB3400F	5680D03G10	0	—	—	KD3400F	1-3, 5, 8, 9
HLB3400T	5680D04G30	0	—	—	—	2, 8
HLB3400TA	5680D04G54	0	—	—	—	2, 8
HLB3700TM	5680D04G62	0	—	—	—	2, 8
HLC2150F	1242C92G01	0	—	—	KD3400F/KES3150LS	1-3, 5, 8
HLC2150FM	1242C92G03	0	—	—	KD3400F/KES3150LS	1-3, 5, 8
HLC2300F	1242C92G05	0	—	—	KD3400F/KES3400LS	1-3, 5, 8
HLC2300FM	1242C92G07	0	—	—	KD3400F/KES3400LS	1-3, 5, 8
HLC2400F	1242C92G09	0	—	—	KD3400F/KES3400LS	1-3, 5, 8
HLC2400FM	1242C92G11	0	—	—	KD3400F/KES3400LS	1-3, 5, 8
HLC2600F	1242C92G13	0	—	—	LD3600F/LES3600LS	1-3, 5, 8
HLC2600FM	1242C92G15	0	—	—	LD3600F/LES3600LS	1-3, 5, 8
HLC3150F	1242C92G02	A	—	—	KD3400F/KES3150LS	1-3, 5, 8
HLC3150FM	1242C92G04	0	HLC3150F	1284C66G02	KD3400F/KES3150LS	1-3, 5, 8
HLC3300F	1242C92G06	A	—	—	KD3400F/KES3400LS	1-3, 5, 8
HLC3300FM	1242C92G08	0	HLC3300F	2612D41G46	KD3400F/KES3400LS	1-3, 5, 8
HLC3400F	1242C92G10	A	—	—	KD3400F/KES3400LS	1-3, 5, 8
HLC3400FM	1242C92G12	0	HLC3400F	2613D44G08	KD3400F/KES3400LS	1-3, 5, 8
HLC3600F	1242C92G14	A	—	—	LD3600F/LES3600LS	1-3, 5, 8
HLC3600FM	1242C92G16	0	HLC3600F	2612D41G48	LD3600F/LES3600LS	1-3, 5, 8
HLCA2150F	1242C92G23	0	—	—	KD3400F/KES3150LSI	1-3, 5, 8
HLCA2300F	1242C92G27	0	—	—	KD3400F/KES3400LSI	1-3, 5, 8
HLCA2400F	1242C92G31	0	—	—	KD3400F/KES3400LSI	1-3, 5, 8
HLCA2600F	1242C92G35	0	—	—	LD3600F/LES3600LSI	1-3, 5, 8
HLCA3150F	1242C92G24	A	—	—	KD3400F/KES3150LSI	1-3, 5, 8
HLCA3300F	1242C92G28	A	—	—	KD3400F/KES3400LSI	1-3, 5, 8
HLCA3400F	1242C92G32	A	—	—	KD3400F/KES3400LSI	1-3, 5, 8
HLCA3600F	1284C66G36	A	—	—	LD3600F/LES3600LSI	1-3, 5, 8
HLCC3600F	6590C11G14	A	—	—	CLD3600F/LES3600LS	1-3, 5, 8
HLCCA3600F	6590C11G36	A	—	—	CLD3600F/LES3600LSI	1-3, 5, 8
HLCCG3600F	1242C94G04	A	—	—	CLD3600F/LES3600LSG	1-3, 5, 8
HLCCGA3600F	1242C94G12	A	—	—	CLD3600F/LES3600LSIG	1-3, 5, 8
HLCG3150F	1242C89G01	A	—	—	KD3400F/KES3150LSG	1-3, 5, 8
HLCG3300F	1242C89G02	A	—	—	KD3400F/KES3400LSG	1-3, 5, 8
HLCG3400F	1242C89G03	A	—	—	KD3400F/KES3400LSG	1-3, 5, 8
HLCG3600F	1371D17G40	A	—	—	LD3600F/LES3600LS	1-3, 5, 8

Note

① 0 = Obsolete, A = Available.

Replacement Breaker Cross-Reference

Replacement Breaker			Replacements			Notes
Catalog Number	Style Number	Status ^①	MARK 75 Catalog Number	MARK 75 Style Number	Series C Catalog Number	(See Page V12-T3-114)
HLCGA3150F	1242C89G09	A	—	—	KD3400F/KES3150LSIG	1–3, 5, 8
HLCGA3300F	1242C89G10	A	—	—	KD3400F/KES3400LSIG	1–3, 5, 8
HLCGA3400F	1242C89G11	A	—	—	KD3400F/KES3400LSIG	1–3, 5, 8
HLCGA3600F	1270C61G12	A	—	—	LD3600F/LES3600LSIG	1–3, 5, 8
HMA2125	1252C22G01	0	—	—	KD2125	1–3, 5, 8
HMA21250TM	457D455G07	0	—	—	—	2, 8
HMA2125T	371D371G05	0	—	—	—	2, 8
HMA2125TA	457D458G05	0	—	—	—	2, 8
HMA2150	1252C22G02	0	—	—	KD2150	1–3, 5, 8
HMA2150T	371D371G06	0	—	—	—	2, 8
HMA2150TA	457D458G06	0	—	—	—	2, 8
HMA2175	1252C22G03	0	—	—	KD2175	1–3, 5, 8
HMA2175T	371D371G07	0	—	—	—	2, 8
HMA2175TA	457D458G07	0	—	—	—	2, 8
HMA2200	1252C22G04	0	—	—	KD2200	1–3, 5, 8
HMA22000TM	457D455G08	0	—	—	—	2, 8
HMA2200T	371D371G08	0	—	—	—	2, 8
HMA2200TA	457D458G08	0	—	—	—	2, 8
HMA2225	1252C22G05	0	—	—	KD2225	1–3, 5, 8
HMA2225T	371D371G09	0	—	—	—	2, 8
HMA2225TA	457D458G09	0	—	—	—	2, 8
HMA2250	1252C22G06	0	—	—	KD2250	1, 2, 3, 5, 8
HMA2250T	371D371G10	0	—	—	—	2, 8
HMA2250TA	457D458G10	0	—	—	—	2, 8
HMA2300	1252C22G07	0	—	—	MDL2300	1–3, 5, 8
HMA23000TM	457D455G09	0	—	—	—	2, 8
HMA2300T	371D371G11	0	—	—	—	2, 8
HMA2300TA	457D458G11	0	—	—	—	2, 8
HMA2350	1252C22G08	0	—	—	MDL2350	1–3, 5, 8
HMA2350T	371D371G12	0	—	—	—	2, 8
HMA2350TA	457D458G12	0	—	—	—	2, 8
HMA2400	1252C22G09	0	—	—	MDL2400	1–3, 5, 8
HMA24000TM	457D455G10	0	—	—	—	2, 8
HMA2400T	371D371G13	0	—	—	—	2, 8
HMA2400TA	457D458G13	0	—	—	—	2, 8
HMA2500	1252C22G10	0	—	—	MDL2500	1–3, 5, 8
HMA2500T	371D372G06	0	—	—	—	2, 8
HMA2500TA	457D459G06	0	—	—	—	2, 8
HMA2600	1252C22G11	0	—	—	MDL2600	1–3, 5, 8
HMA2600T	371D372G08	0	—	—	—	2, 8
HMA2600TA	457D459G08	0	—	—	—	2, 8
HMA2700	1252C22G12	0	—	—	MDL2700	1, 2, 3, 5, 8
HMA2700T	371D373G10	0	—	—	—	2, 8
HMA2700TA	457D460G10	0	—	—	—	2, 8
HMA2800	1252C22G13	0	—	—	MDL2800	1, 2, 3, 5, 8
HMA28000TM	457D455G12	0	—	—	—	2, 8
HMA2800F	373B237G03	0	—	—	MDL2800F	—

Note

① 0 = Obsolete, A = Available.

Replacement Breaker Cross-Reference

Replacement Breaker		Status ①	Replacements			Notes (See Page V12-T3-114)
Catalog Number	Style Number		MARK 75 Catalog Number	MARK 75 Style Number	Series C Catalog Number	
HMA2800T	371D373G12	O	—	—	—	2, 8
HMA2800TA	457D460G12	O	—	—	—	2, 8
HMA3125	1252C22G16	A	—	—	KD3125	1, 2, 3, 5, 8
HMA31250TM	457D455G23	A	—	—	—	2, 8
HMA3125T	371D371G21	A	—	—	—	2, 8
HMA3125TA	457D458G21	O	HMA3125T	371D371G21	—	2, 8
HMA3150	1252C22G17	A	—	—	KD3150	1, 2, 3, 5, 8
HMA3150T	371D371G22	A	—	—	—	2, 8
HMA3150TA	457D458G22	O	HMA3150T	371D371G22	—	2, 8
HMA3175	1252C22G18	A	—	—	KD3175	1, 2, 3, 5, 8
HMA3175T	371D371G23	A	—	—	—	2, 8
HMA3175TA	457D458G23	O	HMA3175T	371D371G23	—	2, 8
HMA3200	1252C22G19	A	—	—	KD3200	1, 2, 3, 5, 8
HMA32000TM	457D455G24	A	—	—	—	2, 8
HMA3200T	371D371G24	A	—	—	—	2, 8
HMA3200TA	457D458G24	O	HMA3200T	371D371G24	—	2, 8
HMA3225	1252C22G20	A	—	—	KD3225	1, 2, 3, 5, 8
HMA3225T	371D371G25	A	—	—	—	2, 8
HMA3225TA	457D458G25	O	HMA3225T	371D371G25	—	2, 8
HMA3250	1252C22G21	A	—	—	KD3250	1, 2, 3, 5, 8
HMA3250T	371D371G26	A	—	—	—	2, 8
HMA3250TA	457D458G26	O	HMA3250T	371D371G26	—	2, 8
HMA3300	1252C22G22	A	—	—	MDL3300	1, 2, 3, 5, 8
HMA33000TM	457D455G25	A	—	—	—	2, 8
HMA3300T	371D371G27	A	—	—	—	2, 8
HMA3300TA	457D458G27	O	HMA3300T	371D371G27	—	2, 8
HMA3350	1252C22G23	A	—	—	MDL3350	1, 2, 3, 5, 8
HMA3350T	371D371G28	A	—	—	—	2, 8
HMA3350TA	457D458G28	O	HMA3350T	371D371G28	—	2, 8
HMA3400	1252C22G24	A	—	—	MDL3400	1, 2, 3, 5, 8
HMA34000TM	457D455G26	A	—	—	—	2, 8
HMA3400T	371D371G29	A	—	—	—	2, 8
HMA3400TA	457D458G29	O	HMA3400T	371D371G29	—	2, 8
HMA3500	1252C22G25	A	—	—	MDL3500	1, 2, 3, 5, 8
HMA3500T	371D372G22	A	—	—	—	2, 8
HMA3500TA	457D459G22	O	HMA3500T	371D372G22	—	2, 8
HMA3600	1252C22G26	A	—	—	MDL3600	1, 2, 3, 5, 8
HMA36000TM	457D455G27	A	—	—	—	2, 8
HMA3600T	371D372G24	A	—	—	—	2, 8
HMA3600TA	457D459G24	O	HMA3600T	371D372G24	—	2, 8
HMA3700	1252C22G27	A	—	—	MDL3700	1, 2, 3, 5, 8
HMA3700T	371D373G26	A	—	—	—	2, 8
HMA3700TA	457D460G26	O	HMA3700T	371D373G26	—	2, 8
HMA3800	1252C22G28	A	—	—	MDL3800	1, 2, 3, 5, 8
HMA38000TM	457D455G28	A	—	—	—	2, 8
HMA3800F	2600D43G10	A	—	—	MDL3800F	2, 8
HMA3800T	371D373G28	A	—	—	—	2, 8

Note

① O = Obsolete, A = Available.

Replacement Breaker Cross-Reference

Replacement Breaker			Replacements			Notes (See Page V12-T3-114)
Catalog Number	Style Number	Status ①	MARK 75 Catalog Number	MARK 75 Style Number	Series C Catalog Number	
HMA3800TA	457D460G28	0	HMA3800T	371D373G28	—	2, 8
HMC2800F	6590C16G05	0	—	—	MDL3800F/MES3800LS	1, 2, 3, 5, 8
HMC2800FM	6590C16G07	0	—	—	MDL3800F/MES3800LS	1, 2, 3, 5, 8
HMC3800F	6590C16G06	A	—	—	MDL3800F/MES3800LS	1, 2, 3, 5, 8
HMC3800FM	6590C16G08	0	HMC3800F	6590C16G06	MDL3800F/MES3800LS	1, 2, 3, 5, 8
HMCA2800F	6590C16G17	A	—	—	MDL3800F/MES3800LSI	1, 2, 3, 5, 8
HMCA3800F	6590C16G18	A	—	—	MDL3800F/MES3800LSI	1–3, 5, 8
HMCC3800F	6590C14G06	A	—	—	CMDL3800F/MES3800LS	1–3, 5, 8
HMCCA3800F	6590C14G18	A	—	—	CMDL3800F/MES3800LSI	1–3, 5, 8
HMCCG3800F	1242C62G09	A	—	—	CMDL3800F/MES3800LSG	1–3, 5, 8
HMCCGA3800F	1242C62G11	A	—	—	CMDL3800F/MES3800LSIG	1–3, 5, 8
HMCG3800F	1242C60G09	A	—	—	MDL3800F/MES3800LSG	1–3, 5, 8
HMCGA3800F	1242C60G11	A	—	—	MDL3800F/MES3800LSIG	1–3, 5, 8
HNB21000	1234C26G15	0	—	—	ND212T33W/12NES1000T+	1–3, 5, 8
HNB210000TM	371D590G13	0	—	—	—	2, 8
HNB21000T	371D589G13	0	—	—	—	2, 8
HNB21200	1234C26G17	0	—	—	ND212T33W/12NES1200T+	1–3, 5, 8
HNB212000TM	371D590G14	0	—	—	—	2, 8
HNB21200F	2610D64G19	0	—	—	ND212T33W	1–3, 5, 8
HNB21200T	371D589G15	0	—	—	—	2, 8
HNB26000TM	371D590G11	0	—	—	—	2, 8
HNB2700	1234C26G12	0	—	—	ND2800T33W/8NES700T+	1–3, 5, 8
HNB2700T	371D589G10	0	—	—	—	2, 8
HNB2800	1234C26G13	0	—	—	ND2800T33W/8NES800T+	1–3, 5, 8
HNB28000TM	371D590G12	0	—	—	—	2, 8
HNB2800T	371D589G11	0	—	—	—	2, 8
HNB2900	1234C26G14	0	—	—	ND212T33W/12NES900T+	1–3, 5, 8
HNB2900T	371D589G12	0	—	—	—	2, 8
HNB31000	1234C26G33	A	—	—	ND312T33W/12NES1000T+	1–3, 5, 8
HNB310000TM	371D590G29	A	—	—	—	2, 8
HNB31000T	371D589G29	A	—	—	—	2, 8
HNB31200	1234C26G35	A	—	—	ND312T33W/12NES1200T+	1–3, 5, 8
HNB312000TM	371D590G30	A	—	—	—	2, 8
HNB31200F	625B494G08	A	—	—	ND312T33W	1–3, 5, 8
HNB31200T	371D589G31	A	—	—	—	2, 8
HNB36000TM	371D590G27	A	—	—	—	2, 8
HNB3700	1234C26G30	A	—	—	ND3800T33W/8NES700T+	1–3, 5, 8
HNB3700T	371D589G26	A	—	—	—	2, 8
HNB3800	1234C26G31	A	—	—	ND3800T33W/8NES800T+	1–3, 5, 8
HNB38000TM	371D590G28	A	—	—	—	2, 8
HNB3800T	371D589G27	A	—	—	—	2, 8
HNB3900	1234C26G32	A	—	—	ND312T33W/12NES900T+	1–3, 5, 8
HNB3900T	371D589G28	A	—	—	—	2, 8
HNC21200F	2613D29G06	0	—	—	ND212T33W	1–3, 5, 8
HNC21200FM	2613D29G08	0	—	—	—	1–3, 5, 8
HNC31200F	2613D29G05	A	—	—	ND312T33W	1–3, 5, 8
HNC31200FM	2613D29G07	0	HNC31200F	2613D29G05	—	1–3, 5, 8

Note

① 0 = Obsolete, A = Available.

Replacement Breaker Cross-Reference

Replacement Breaker		Status ①	Replacements			Notes (See Page V12-T3-114)
Catalog Number	Style Number		MARK 75 Catalog Number	MARK 75 Style Number	Series C Catalog Number	
HNCA21200F	2613D29G18	0	HNCA31200F	2613D29G17	ND212T32W	1-3, 5, 8
HNCA31200F	2613D29G17	A	—	—	ND312T32W	1-3, 5, 8
HNCG31200F	1242C72G04	A	—	—	ND312T35W	1-3, 5, 8
HNCGA31200F	1242C72G12	A	—	—	ND312T36W	1-3, 5, 8
JA2070	371D957G02	0	—	—	JDB2070	1-3, 5, 8, 9
JA2070A	456D988G80	0	—	—	JDB2070	1-3, 8, 9
JA2070S	657D791G46	0	—	—	JDB2070	1-5, 8, 9
JA2070SW	657D791G26	0	—	—	JDB2070W	1-5, 8, 9
JA2070W	657D791G02	0	—	—	JDB2070W	1-3, 5, 8, 9
JA2090	371D957G03	0	—	—	JDB2090	1-3, 5, 8, 9
JA2090A	456D988G81	0	—	—	JDB2090	1-3, 8, 9
JA2090S	657D791G47	0	—	—	JDB2090	1-5, 8, 9
JA2090SW	657D791G27	0	—	—	JDB2090W	1-5, 8, 9
JA2090W	657D791G03	0	—	—	JDB2090W	1-3, 5, 8, 9
JA2100	371D957G04	0	—	—	KDB2100	1-3, 5, 8, 9
JA2100A	456D988G82	0	—	—	KDB2100	1-3, 8, 9
JA2100S	657D791G48	0	—	—	KDB2100	1-5, 8, 9
JA2100SW	657D791G28	0	—	—	KDB2100W	1-5, 8, 9
JA2100W	657D791G04	0	—	—	KDB2100W	1-3, 5, 8, 9
JA2125	371D957G05	0	—	—	KDB2125	1-3, 5, 8, 9
JA21250MW	371D957G67	0	—	—	HM2P400F5W	1-3, 8, 9
JA21250SMW	NO STYLE	0	—	—	HM2P400F5W	1-4, 8, 9
JA2125A	456D988G83	0	—	—	KDB2125	1-3, 8, 9
JA2125S	657D791G49	0	—	—	KDB2125	1-5, 8, 9
JA2125SW	657D791G29	0	—	—	KDB2125W	1-5, 8, 9
JA2125W	657D791G05	0	—	—	KDB2125W	1-3, 5, 8, 9
JA2150	371D957G06	0	—	—	KDB2150	1-3, 5, 8, 9
JA21500MW	371D957G68	0	—	—	HM2P400G5W	1-3, 8, 9
JA21500SMW	NO STYLE	0	—	—	HM2P400G5W	1-4, 8, 9
JA2150A	456D988G84	0	—	—	KDB2150	1-3, 8, 9
JA2150S	657D791G50	0	—	—	KDB2150	1-5, 8, 9
JA2150SW	657D791G30	0	—	—	KDB2150W	1-5, 8, 9
JA2150W	657D791G06	0	—	—	KDB2150W	1-3, 5, 8, 9
JA2175	371D957G07	0	—	—	KDB2175	1-3, 5, 8, 9
JA21750MW	371D957G69	0	—	—	HM2P400J5W	1-3, 8, 9
JA21750SMW	NO STYLE	0	—	—	HM2P400J5W	1-4, 8, 9
JA2175A	456D988G85	0	—	—	KDB2175	1-3, 8, 9
JA2175S	657D791G51	0	—	—	KDB2175	1-5, 8, 9
JA2175SW	657D791G31	0	—	—	KDB2175W	1-5, 8, 9
JA2175W	657D791G07	0	—	—	KDB2175W	1-3, 5, 8, 9
JA2200	371D957G08	0	—	—	KDB2200	1-3, 5, 8, 9
JA2200A	456D988G86	0	—	—	KDB2200	1-3, 8, 9
JA2200S	657D791G52	0	—	—	KDB2200	1-5, 8, 9
JA2200SW	657D791G32	0	—	—	KDB2200W	1-5, 8, 9
JA2200W	657D791G08	0	—	—	KDB2200W	1-3, 5, 8, 9
JA2225	371D957G09	0	—	—	KDB2225	1-3, 5, 8, 9
JA22250MW	371D957G70	0	—	—	HM2P400L5W	1-3, 8, 9

Note

① 0 = Obsolete, A = Available.

Replacement Breaker Cross-Reference

Replacement Breaker			Replacements			Notes
Catalog Number	Style Number	Status ①	MARK 75 Catalog Number	MARK 75 Style Number	Series C Catalog Number	(See Page V12-T3-114)
JA22250SMW	NO STYLE	0	—	—	HM2P400L5W	1-4, 8, 9
JA2225A	456D988G87	0	—	—	KDB2225	1-3, 8, 9
JA2225S	657D791G53	0	—	—	KDB2225	1-5, 8, 9
JA2225SW	657D791G33	0	—	—	KDB2225W	1-5, 8, 9
JA2225W	657D791G09	0	—	—	KDB2225W	1-3, 5, 8, 9
JA2225WK	752B047G01	0	—	—	KDB2400KW	1-3, 5, 8, 9
JA2225WSK	752B047G02	0	—	—	KDB2400KW	1-3, 5, 8, 9
JA2250W	NO STYLE	0	—	—	KDB2250W	1-3, 5, 8, 9
JA2700MW	371D957G66	0	—	—	HM2P400D5W	1-3, 5, 7, 8, 9
JA2700SMW	NO STYLE	0	—	—	HM2P400D5W	1-5, 7-9
JA3070	371D957G12	0	—	—	JDB3070	1-3, 8, 9
JA3070A	456D988G90	0	—	—	JDB3070	1-3, 8, 9
JA3070S	657D791G56	0	—	—	JDB3070	1-5, 8, 9
JA3070SW	657D791G36	0	—	—	JDB3070W	1-5, 8, 9
JA3070W	657D791G12	0	—	—	JDB3070W	1-3, 5, 8, 9
JA3090	371D957G13	0	—	—	JDB3090	1-3, 8, 9
JA3090A	456D988G91	0	—	—	JDB3090	1-3, 8, 9
JA3090S	657D791G57	0	—	—	JDB3090	1-5, 8, 9
JA3090SW	657D791G37	0	—	—	JDB3090W	1-5, 8, 9
JA3090W	657D791G13	0	—	—	JDB3090W	1-3, 5, 8, 9
JA3100	371D957G14	0	—	—	KDB3100	1-3, 8, 9
JA3100A	456D988G92	0	—	—	KDB3100	1-3, 8, 9
JA3100S	657D791G58	0	—	—	KDB3100	1-5, 8, 9
JA3100SW	657D791G38	0	—	—	KDB3100W	1-5, 8, 9
JA3100W	657D791G14	0	—	—	KDB3100W	1-3, 5, 8, 9
JA3125	371D957G15	0	—	—	KDB3125	1-3, 8, 9
JA31250MW	371D957G74	0	—	—	HMCP400F5W	1-3, 8, 9
JA31250SMW	NO STYLE	0	—	—	HMCP400F5W	1-4, 8, 9
JA3125A	456D988G93	0	—	—	KDB3125	1-3, 8, 9
JA3125S	657D791G59	0	—	—	KDB3125	1-5, 8, 9
JA3125SW	657D791G39	0	—	—	KDB3125W	1-5, 8, 9
JA3125W	657D791G15	0	—	—	KDB3125W	1-3, 5, 8, 9
JA3150	371D957G16	0	—	—	KDB3150	1-3, 8, 9
JA31500MW	371D957G75	0	—	—	HMCP400G5W	1-3, 8, 9
JA31500SMW	82E2537	0	—	—	HMCP400G5W	1-4, 8, 9
JA3150A	456D988G94	0	—	—	KDB3150	1-3, 8, 9
JA3150S	657D791G60	0	—	—	KDB3150	1-5, 8, 9
JA3150SW	657D791G40	0	—	—	KDB3150W	1-5, 8, 9
JA3150W	657D791G16	0	—	—	KDB3150W	1-3, 5, 8, 9
JA3175	371D957G17	0	—	—	KDB3175	1-3, 8, 9
JA31750MW	371D957G76	0	—	—	HMCP400J5W	1-3, 8, 9
JA31750SMW	82E0668	0	—	—	HMCP400J5W	1-4, 8, 9
JA3175A	456D988G95	0	—	—	KDB3175	1-3, 8, 9
JA3175S	657D791G61	0	—	—	KDB3175	1-5, 8, 9
JA3175SW	657D791G41	0	—	—	KDB3175W	1-5, 8, 9
JA3175W	657D791G17	0	—	—	KDB3175W	1-3, 5, 8, 9
JA3200	371D957G18	0	—	—	KDB3200	1-3, 8, 9

Note

① 0 = Obsolete, A = Available.

Replacement Breaker Cross-Reference

Replacement Breaker		Status ①	Replacements		Series C Catalog Number	Notes (See Page V12-T3-114)
Catalog Number	Style Number		MARK 75 Catalog Number	MARK 75 Style Number		
JA3200A	456D988G96	0	—	—	KDB3200	1-3, 8, 9
JA3200S	657D791G62	0	—	—	KDB3200	1-5, 8, 9
JA3200SW	657D791G42	0	—	—	KDB3200W	1-5, 8, 9
JA3200W	657D791G18	0	—	—	KDB3200W	1-3, 5, 8, 9
JA3225	371D957G19	0	—	—	KDB3225	1-3, 8, 9
JA32250MW	371D957G77	0	—	—	HMCP400L5W	1-3, 8, 9
JA32250SMW	82E8642	0	—	—	HMCP400L5W	1-4, 8, 9
JA3225A	456D988G97	0	—	—	KDB3225	1-3, 8, 9
JA3225S	657D791G63	0	—	—	KDB3225	1-5, 8, 9
JA3225SW	657D791G43	0	—	—	KDB3225W	1-5, 8, 9
JA3225W	657D791G19	0	—	—	KDB3225W	1-3, 5, 8, 9
JA3225WK	752B047G06	0	—	—	KDB3400KW	1-3, 5, 8, 9
JA3225WSK	752B047G07	0	—	—	KDB3400KW	1-3, 5, 8, 9
JA3250W	NO STYLE	0	—	—	KDB3250W	1-3, 5, 8, 9
JA3700MW	NO STYLE	0	—	—	HMCP400D5W	1-3, 5, 7-9
JA3700SMW	NO STYLE	0	—	—	HMCP400D5W	1-5, 7-9
JB2070	NO STYLE	0	—	—	JDB2070	1-3, 5
JB2070S	NO STYLE	0	—	—	JDB2070	1-5
JB2070SW	NO STYLE	0	—	—	JDB2070W	1-5
JB2070W	752B417G34	0	—	—	JDB2070W	1-3, 5
JB2090	NO STYLE	0	—	—	JDB2090	1-3, 5
JB2090S	NO STYLE	0	—	—	JDB2090	1-5
JB2090SW	NO STYLE	0	—	—	JDB2090W	1-5
JB2090W	752B417G35	0	—	—	JDB2090W	1-3, 5
JB2100	NO STYLE	0	—	—	JDB2100	1-3, 5
JB2100S	NO STYLE	0	—	—	JDB2100	1-5
JB2100SW	NO STYLE	0	—	—	JDB2100W	1-5
JB2100W	752B417G01	0	—	—	JDB2100W	1-3, 5
JB2125	NO STYLE	0	—	—	JDB2125	1-3, 5
JB21250MW	752B416G02	0	—	—	HM2P250F5W	1-3
JB21250SMW	752B416G14	0	—	—	HM2P250F5W	1-4
JB2125S	NO STYLE	0	—	—	JDB2125	1-5
JB2125SW	NO STYLE	0	—	—	JDB2125W	1-5
JB2125W	752B417G02	0	—	—	JDB2125W	1-3, 5
JB2150	NO STYLE	0	—	—	JDB2150	1-3, 5
JB21500MW	752B416G03	0	—	—	HM2P250G5W	1-3
JB21500SMW	752B416G15	0	—	—	HM2P250G5W	1-4
JB2150S	NO STYLE	0	—	—	JDB2150	1-5
JB2150SW	NO STYLE	0	—	—	JDB2150W	1-5
JB2150W	752B417G03	0	—	—	JDB2150W	1-3, 5
JB2175	NO STYLE	0	—	—	JDB2175	1-3, 5
JB21750MW	752B416G04	0	—	—	HM2P250J5W	1-3
JB21750SMW	752B416G16	0	—	—	HM2P250J5W	1-4
JB2175S	NO STYLE	0	—	—	JDB2175	1-5
JB2175SW	NO STYLE	0	—	—	JDB2175W	1-5
JB2175W	752B417G04	0	—	—	JDB2175W	1-3, 5
JB2200	NO STYLE	0	—	—	JDB2200	1-3, 5

Note

① 0 = Obsolete, A = Available.

Replacement Breaker Cross-Reference

Replacement Breaker			Replacements			Notes
Catalog Number	Style Number	Status ①	MARK 75 Catalog Number	MARK 75 Style Number	Series C Catalog Number	(See Page V12-T3-114)
JB2200S	81E6623	0	—	—	JDB2200	1-5
JB2200SW	NO STYLE	0	—	—	JDB2200W	1-5
JB2200W	752B417G05	0	—	—	JDB2200W	1-3, 5
JB2225	NO STYLE	0	—	—	JDB2225	1-3, 5
JB22250MW	752B416G05	0	—	—	HM2P250L5W	1-3
JB22250SMW	752B416G17	0	—	—	HM2P250L5W	1-3, 4
JB2225S	NO STYLE	0	—	—	JDB2225	1-5
JB2225SW	NO STYLE	0	—	—	JDB2225W	1-5
JB2225W	752B417G06	0	—	—	JDB2225W	1-3, 5
JB2250	NO STYLE	0	—	—	JDB2250	1-3, 5
JB2250MW	752B416G06	0	—	—	HM2P250W5W	1-3
JB2250SMW	752B416G18	0	—	—	HM2P250W5W	1-3, 4
JB2250S	NO STYLE	0	—	—	JDB2250	1-5
JB2250SW	NO STYLE	0	—	—	JDB2250W	1-5
JB2250SWK	NO STYLE	0	—	—	JDB2250KW	1-3, 5, 8
JB2250W	752B417G07	0	—	—	JDB2250W	1-3, 5
JB2250WK	752B046G01	0	—	—	JDB2250KW	1-3, 5, 8
JB2700MW	752B416G01	0	—	—	HM2P250A5W	1-3
JB2700SMW	752B416G13	0	—	—	HM2P250A5W	1-4
JB3070	NO STYLE	0	—	—	JDB3070	1-3, 5
JB3070S	NO STYLE	0	—	—	JDB3070	1-5
JB3070SW	NO STYLE	0	—	—	JDB3070W	1-5
JB3070W	752B417G08	0	—	—	JDB3070W	1-3, 5
JB3090	NO STYLE	0	—	—	JDB3090	1-3, 5
JB3090S	NO STYLE	0	—	—	JDB3090	1-5
JB3090SW	NO STYLE	0	—	—	JDB3090W	1-5
JB3090W	752B417G09	0	—	—	JDB3090W	1-3, 5
JB3100	NO STYLE	0	—	—	JDB3100	1-3, 5
JB3100S	NO STYLE	0	—	—	JDB3100	1-5
JB3100SW	NO STYLE	0	—	—	JDB3100W	1-5
JB3100W	752B417G10	0	—	—	JDB3100W	1-3, 5
JB3125	NO STYLE	0	—	—	JDB3125	1-3, 5
JB31250MW	752B416G08	0	—	—	HMCP250F5W	1-3
JB3100W	752B417G10	0	—	—	JDB3100W	1-3, 5
JB3125	NO STYLE	0	—	—	JDB3125	1-3, 5
JB31250MW	752B416G08	0	—	—	HMCP250F5W	1-3
JB31250SMW	752B416G20	0	—	—	HMCP250F5W	1-4
JB3125S	NO STYLE	0	—	—	JDB3125	1-5
JB3125SW	NO STYLE	0	—	—	JDB3125W	1-5
JB3125W	752B417G11	0	—	—	JDB3125W	1-3, 5
JB3150	NO STYLE	0	—	—	JDB3150	1-3, 5
JB31500MW	752B416G09	0	—	—	HMCP250G5W	1-3
JB31500SMW	752B416G21	0	—	—	HMCP250G5W	1-4
JB3150S	NO STYLE	0	—	—	JDB3150	1-5
JB3150SW	NO STYLE	0	—	—	JDB3150W	1-5
JB3150W	752B417G12	0	—	—	JDB3150W	1-3, 5
JB3175	69E1870	0	—	—	JDB3175	1-3, 5

Note

① 0 = Obsolete, A = Available.

Replacement Breaker Cross-Reference

Replacement Breaker		Status ①	Replacements		Series C Catalog Number	Notes (See Page V12-T3-114)
Catalog Number	Style Number		MARK 75 Catalog Number	MARK 75 Style Number		
JB31750MW	752B416G10	0	—	—	HMCP250J5W	1-3
JB31750SMW	752B416G22	0	—	—	HMCP250J5W	1-4
JB3175S	NO STYLE	0	—	—	JDB3175	1-5
JB3175SW	NO STYLE	0	—	—	JDB3175W	1-5
JB3175W	752B417G13	0	—	—	JDB3175W	1-3, 5
JB3200	69E9992	0	—	—	JDB3200	1-3, 5
JB3200S	NO STYLE	0	—	—	JDB3200	1-5
JB3200SW	NO STYLE	0	—	—	JDB3200W	1-5
JB3200W	752B417G14	0	—	—	JDB3200W	1-3, 5
JB3225	80E9836	0	—	—	JDB3225	1-3, 5
JB32250MW	752B416G11	0	—	—	HMCP250L5W	1-3
JB32250SMW	752B416G23	0	—	—	HMCP250L5W	1-4
JB3225S	63E6442	0	—	—	JDB3225	1-5
JB3225SW	752B417G15	0	—	—	JDB3225W	1-5
JB3225W	80E8211	0	—	—	JDB3225W	1-3, 5
JB3250	752B416G12	0	—	—	JDB3250	1-3, 5
JB32500MW	752B416G24	0	—	—	HMCP250W5W	1-3
JB32500SMW	NO STYLE	0	—	—	HMCP250W5W	1-4
JB3250S	NO STYLE	0	—	—	JDB3250	1-5
JB3250SW	NO STYLE	0	—	—	JDB3250W	1-5
JB3250W	752B417G16	0	—	—	JDB3250W	1-3, 5
JB3250WK	752B046G06	0	—	—	JDB3250KW	1-3, 5, 8
JB3250WSK	752B046G07	0	—	—	JDB3250KW	1-3, 5, 8
JB3700MW	752B416G07	0	—	—	HMCP250A5W	1-3
JB3700SMW	752B416G19	0	—	—	HMCP250A5W	1-4
KA2070	1255C53G02	0	—	—	JD2070	1-3, 5, 8, 9
KA2070S	1255C54G02	0	—	—	JD2070	1-5, 8, 9
KA2090	1255C53G03	0	—	—	JD2090	1-3, 5, 8, 9
KA2090S	1255C54G03	0	—	—	JD2090	1-5, 8, 9
KA2100	1255C53G04	0	—	—	KD2100	1-3, 5, 8, 9
KA2100S	1255C54G04	0	—	—	KD2100	1-5, 8, 9
KA2125	1255C53G05	0	—	—	KD2125	1-3, 5, 8, 9
KA2125S	1255C54G05	0	—	—	KD2125	1-5, 8, 9
KA2150	1255C53G06	0	—	—	KD2150	1-3, 5, 8, 9
KA2175	1255C53G07	0	—	—	KD2175	1-3, 5, 8, 9
KA2175S	1255C54G07	0	—	—	KD2175	1-5, 8, 9
KA2200	1255C53G08	0	—	—	KD2200	1-3, 5, 8, 9
KA2200S	1255C54G08	0	—	—	KD2200	1-5, 8, 9
KA2225	1255C53G09	0	—	—	KD2225	1-3, 5, 8, 9
KA2225F	2602D86G01	0	—	—	KD2400F	2, 8
KA2225FS	2602D86G03	0	—	—	KD2400F	2, 4, 8
KA2225S	1255C54G09	0	—	—	KD2225	1-5, 8, 9
KA2225WK	752B047G03	0	—	—	KD2400KW	1-3, 5, 8, 9
KA2225WSK	752B047G04	0	—	—	KD2400KW	1-3, 5, 8, 9
KA2150S	1255C54G06	0	—	—	KD2150	1-5, 8, 9
KA3070	1255C53G17	0	—	—	JD3070	1-3, 5, 8, 9
KA3070S	1255C54G17	0	—	—	JD3070	1-5, 8, 9

Note

① 0 = Obsolete, A = Available.

Replacement Breaker Cross-Reference

Replacement Breaker			Replacements			Notes
Catalog Number	Style Number	Status ^①	MARK 75 Catalog Number	MARK 75 Style Number	Series C Catalog Number	(See Page V12-T3-114)
KA3090	1255C53G18	0	—	—	JD3090	1-3, 5, 8, 9
KA3090S	1255C54G18	0	—	—	JD3090	1-5, 8, 9
KA3100	1255C53G19	0	—	—	KD3100	1-3, 5, 8, 9
KA3100S	1255C54G19	0	—	—	KD3100	1-5, 8, 9
KA3125	1255C53G20	0	—	—	KD3125	1-3, 5, 8, 9
KA3125S	1255C54G20	0	—	—	KD3125	1-5, 8, 9
KA3150	1255C53G21	0	—	—	KD3150	1-3, 5, 8, 9
KA3150S	1255C54G21	0	—	—	KD3150	1-5, 8, 9
KA3175	1255C53G22	0	—	—	KD3175	1-3, 5, 8, 9
KA3175S	504C335G22	0	—	—	KD3175	1-5, 8, 9
KA3200	504C335G23	0	—	—	KD3200	1-3, 5, 8, 9
KA3200S	504C335G23	0	—	—	KD3200	1-5, 8, 9
KA3225	504C336G24	0	—	—	KD3225	1-3, 5, 8, 9
KA3225F	2602D86G02	0	—	—	KD3400F	2, 8
KA3225FS	2602D86G04	0	—	—	KD3400F	2, 4, 8
KA3225S	504C335G24	0	—	—	KD3225	1-5, 8, 9
KA3225WK	752B047G08	0	—	—	KD3400KW	1-3, 5, 8, 9
KA3225WSK	752B047G09	0	—	—	KD3400KW	1-3, 5, 8, 9
KB2070	1291C40G01	0	—	—	JD2070	1-3, 5
KB2090	1291C40G02	0	—	—	JD2090	1-3, 5
KB2100	1291C40G03	0	—	—	JD2100	1-3, 5
KB2125	1291C40G04	0	—	—	JD2125	1-3, 5
KB2150	1291C40G05	0	—	—	JD2150	1-3, 5
KB2175	1291C40G06	0	—	—	JD2175	1-3, 5
KB2200	1291C40G07	0	—	—	JD2200	1-3, 5
KB2225	1291C40G08	0	—	—	JD2225	1-3, 5
KB2250	1291C40G09	0	—	—	JD2250	1-3, 5
KB2250F	2601D44G13	0	—	—	JD2250F	—
KB2250FS	2601D44G17	0	—	—	JD2250F	—
KB2250WK	752B046G03	0	—	—	JD2250KW	1-3, 5, 8
KB2250WSK	752B046G04	0	—	—	JD2250KW	1-3, 5, 8
KB3070	1291C40G16	0	—	—	JD3070	1-3, 5
KB3090	1291C40G17	0	—	—	JD3090	1-3, 5
KB3100	1291C40G18	0	—	—	JD3100	1-3, 5
KB3125	1291C40G19	0	—	—	JD3125	1-3, 5
KB3150	1291C40G20	0	—	—	JD3150	1-3, 5
KB3175	1291C40G21	0	—	—	JD3175	1-3, 5
KB3200	1291C40G22	0	—	—	JD3200	1-3, 5
KB3225	1291C40G23	0	—	—	JD3225	1-3, 5
KB3250	1291C40G24	0	—	—	JD3250	1-3, 5
KB3250F	2601D44G14	0	—	—	JD3250F	—
KB3250WK	752B046G08	0	—	—	JD3250KW	1-3, 5, 8
KB3250WSK	752B046G09	0	—	—	JD3250KW	1-3, 5, 8
LA2070	1255C72G02	0	—	—	KD2070	1-3, 5, 8
LA2070S	1255C73G02	0	—	—	KD2070	1-5, 8
LA2090	1255C72G03	0	—	—	KD2090	1-3, 5, 8
LA2090S	1255C73G03	0	—	—	KD2090	1-5, 8

Note

① 0 = Obsolete, A = Available.

Replacement Breaker Cross-Reference

Replacement Breaker		Status ①	Replacements		Series C Catalog Number	Notes (See Page V12-T3-114)
Catalog Number	Style Number		MARK 75 Catalog Number	MARK 75 Style Number		
LA2100	1255C72G04	0	—	—	KD2100	1-3, 5, 8
LA2100S	1255C73G04	0	—	—	KD2100	1-5, 8
LA2125	1255C72G05	0	—	—	KD2125	1-3, 5, 8
LA2125S	1255C73G05	0	—	—	KD2125	1-5, 8
LA2150	1255C72G06	0	—	—	KD2150	1-3, 5, 8
LA2150S	1255C73G06	0	—	—	KD2150	1-5, 8
LA2175	1255C72G07	0	—	—	KD2175	1-3, 5, 8
LA2175S	1255C73G07	0	—	—	KD2175	1-5, 8
LA2200	1255C72G08	0	—	—	KD2200	1-3, 5, 8
LA2200S	1255C73G08	0	—	—	KD2200	1-5, 8
LA2225	1255C72G09	0	—	—	KD2225	1-3, 5, 8
LA2225S	1255C73G09	0	—	—	KD2225	1-5, 8
LA2250	1255C72G10	0	—	—	KD2250	1-3, 5, 8
LA2250S	1255C73G10	0	—	—	KD2250	1-5, 8
LA2300	1255C72G11	0	—	—	KD2300	1-3, 5, 8
LA2300S	1255C73G11	0	—	—	KD2300	1-5, 8
LA2350	1255C72G12	0	—	—	KD2350	1-3, 5, 8
LA2350S	1255C73G12	0	—	—	KD2350	1-5, 8
LA2400	1255C72G13	0	—	—	KD2400	1-3, 5, 8
LA2400F	2602D99G01	0	—	—	KD2400F	1-3, 5, 8
LA2400FS	2602D99G03	0	—	—	KD2400F	1-5, 8
LA2400S	1255C73G13	0	—	—	KD2400	1-5, 8
LA2400WK	752B042G01	0	—	—	KD2400KW	1-3, 5, 8
LA2400WSK	752B042G02	0	—	—	KD2400KW	1-3, 5, 8
LA2500	2603D50G05	0	—	—	LD2500	1-3, 5, 8
LA2500S	2603D50G17	0	—	—	LD2500	1-5, 8
LA2600	2603D50G06	0	—	—	LD2500	1-3, 5, 8
LA2600F	2603D48G01	0	—	—	LD2600F	1-3, 5, 8
LA2600FS	2603D48G03	0	—	—	LD2600F	1-5, 8
LA2600S	2600D50G18	0	—	—	LD2600	1-5, 8
LA2600WK	752B043G01	0	—	—	LD2600KW	1-3, 5, 8
LA2600WSK	752B043G02	0	—	—	LD2600KW	1-3, 5, 8
LA3070	1255C72G17	0	HLA3070	504C740G17	KD3070	1-3, 5, 8
LA3070S	504C612G17	0	HLA3070	504C740G17	KD3070	1-5, 8
LA3090	1255C72G18	0	HLA3090	504C740G18	KD3090	1-3, 5, 8
LA3090S	504C612G18	0	HLA3090	504C740G18	KD3090	1-5, 8
LA3100	1255C72G19	0	HLA3100	504C740G19	KD3100	1-3, 5, 8
LA3100S	504C612G19	0	HLA3100	504C740G19	KD3100	1-5, 8
LA3125	1255C72G20	0	HLA3125	504C740G20	KD3125	1-3, 5, 8
LA3125S	504C612G20	0	HLA3125	504C740G20	KD3125	1-5, 8
LA3150	1255C72G21	0	HLA3150	504C740G21	KD3150	1-3, 5, 8
LA3150S	504C612G21	0	HLA3150	504C740G21	KD3150	1-5, 8
LA3175	1255C72G22	0	HLA3175	504C740G22	KD3175	1-3, 5, 8
LA3175S	504C612G22	0	HLA3175	504C740G22	KD3175	1-5, 8
LA3200	1255C72G23	0	HLA3200	504C740G23	KD3200	1-3, 5, 8
LA3200S	504C612G23	0	HLA3200	504C740G23	KD3200	1-5, 8
LA3225	1255C72G24	0	HLA3225	504C740G24	KD3225	1-3, 5, 8

Note

① 0 = Obsolete, A = Available.

Replacement Breaker Cross-Reference

Replacement Breaker			Replacements			Notes
Catalog Number	Style Number	Status ①	MARK 75 Catalog Number	MARK 75 Style Number	Series C Catalog Number	(See Page V12-T3-114)
LA3225S	504C612G24	0	HLA3225	504C740G24	KD3225	1-5, 8
LA3250	1255C72G25	0	HLA3250	504C740G25	KD3250	1-3, 5, 8
LA3250S	504C612G25	0	HLA3250	504C740G25	KD3250	1-5, 8
LA3300	1255C72G26	0	HLA3300	504C740G26	KD3300	1-3, 5, 8
LA3300S	504C612G26	0	HLA3300	504C740G26	KD3300	1-5, 8
LA3350	1255C72G27	0	HLA3350	504C740G27	KD3350	1-3, 5, 8
LA3350S	504C612G27	0	HLA3350	504C740G27	KD3350	1-5, 8
LA3400	1255C72G27	0	HLA3400	504C740G28	KD3400	1-3, 5, 8
LA3400F	2602D99G02	0	HLA3400F	673B352G02	KD3400F	1-3, 5, 8
LA3400FS	673B352G02	0	HLA3400F	673B352G02	KD3400F	1-5, 8
LA3400S	1255C73G28	0	HLA3400	504C740G28	KD3400	1-5, 8
LA3400WK	752B042G06	0	—	—	KD3400KW	1-3, 5, 8
LA3400WSK	752B042G07	0	—	—	KD3400KW	1-3, 5, 8
LA3500	376D551G11	0	HLA3500	177C429G16	LD3500	1-3, 5, 8
LA3500S	376D551G23	0	HLA3500	177C429G16	LD3500	1-5, 8
LA3600	376D551G12	0	HLA3600	177C429G17	LD3600	1-3, 5, 8
LA3600F	375D400G02	0	HLA3600F	375D400G10	LD3600F	1-3, 5, 8
LA3600FS	375D400G04	0	HLA3600F	375D400G10	LD3600F	1-5, 8
LA3600S	376D551G24	0	HLA3600	177C429G17	LD3600	1-5, 8
LA3600WK	752B043G06	0	—	—	LD3600KW	1-3, 5, 8
LA3600WSK	752B043G07	0	—	—	LD3600KW	1-3, 5, 8
LAB2125	372D300G05	0	—	—	KDB2125	1-3, 5, 8
LAB21250MW	371D426G03	0	—	—	HM2P400F5W	1-3, 5, 8
LAB21250SMW	371D426G23	0	—	—	HM2P400F5W	1-5, 8
LAB2125A	372D301G45	0	—	—	KDB2125	1-3, 5, 8
LAB2125S	372D300G37	0	—	—	KDB2125	1-5, 8
LAB2125SW	371D333G37	0	—	—	KDB2125W	1-5, 8
LAB2125W	371D333G05	0	—	—	KDB2125W	1-3, 5, 8
LAB2150	372D300G06	0	—	—	KDB2150	1-3, 5, 8
LAB21500MW	371D426G04	0	—	—	HM2P400G5W	1-3, 5, 8
LAB21500SMW	371D426G24	0	—	—	HM2P400G5W	1-5, 8
LAB2150A	372D301G46	0	—	—	KDB2150	1-3, 5, 8
LAB2150S	372D300G38	0	—	—	KDB2150	1-5, 8
LAB2150SW	371D333G38	0	—	—	KDB2150W	1-5, 8
LAB2150W	371D333G06	0	—	—	KDB2150W	1-3, 5, 8
LAB2175	372D300G07	0	—	—	KDB2175	1-3, 5, 8
LAB21750MW	371D426G05	0	—	—	HM2P400J5W	1-3, 5, 8
LAB21750SMW	371D426G25	0	—	—	HM2P400J5W	1-5, 8
LAB2175A	372D301G47	0	—	—	KDB2175	1-3, 5, 8
LAB2175S	372D300G39	0	—	—	KDB2175	1-5, 8
LAB2175SW	371D333G39	0	—	—	KDB2175W	1-5, 8
LAB2175W	371D333G07	0	—	—	KDB2175W	1-3, 5, 8
LAB2200	372D300G08	0	—	—	KDB2200	1-3, 5, 8
LAB2200A	371D301G48	0	—	—	KDB2200	1-3, 5, 8
LAB2200S	372D300G40	0	—	—	KDB2200	1-5, 8
LAB2200SW	371D333G40	0	—	—	KDB2200W	1-5, 8
LAB2200W	371D333G08	0	—	—	KDB2200W	1-3, 5, 8

Note

① 0 = Obsolete, A = Available.

Replacement Breaker Cross-Reference

Replacement Breaker		Status ①	Replacements		Series C Catalog Number	Notes (See Page V12-T3-114)
Catalog Number	Style Number		MARK 75 Catalog Number	MARK 75 Style Number		
LAB2225	372D300G09	0	—	—	KDB2225	1-3, 5, 8
LAB22250MW	371D426G06	0	—	—	HM2P400L5W	1-3, 5, 8
LAB22250SMW	371D426G26	0	—	—	HM2P400L5W	1-5, 8
LAB2225A	372D301G49	0	—	—	KDB2225	1-3, 5, 8
LAB2225S	372D300G41	0	—	—	KDB2225	1-5, 8
LAB2225SW	371D333G41	0	—	—	KDB2225W	1-5, 8
LAB2225W	371D333G09	0	—	—	KDB2225W	1-3, 5, 8
LAB22400A	NO STYLE	0	—	—	KDB2400	1-3, 5, 8
LAB2250	372D300G10	0	—	—	KDB2250	1-3, 5, 8
LAB2250A	372D301G50	0	—	—	KDB2250	1-3, 5, 8
LAB2250S	372D300G42	0	—	—	KDB2250	1-5, 8
LAB2250SW	371D333G42	0	—	—	KDB2250W	1-5, 8
LAB2250W	371D333G10	0	—	—	KDB2250W	1-3, 5, 8
LAB2300	372D300G11	0	—	—	KDB2300	1-3, 5, 8
LAB23000MW	371D426G07	0	—	—	HM2P400N5W	1-3, 5, 8
LAB23000SMW	371D426G27	0	—	—	HM2P400N5W	1-5, 8
LAB2300A	372D301G51	0	—	—	KDB2300	1-3, 5, 8
LAB2300S	372D300G43	0	—	—	KDB2300	1-5, 8
LAB2300SW	371D333G43	0	—	—	KDB2300W	1-5, 8
LAB2300W	371D333G11	0	—	—	KDB2300W	1-3, 5, 8
LAB2350	372D300G12	0	—	—	KDB2350	1-3, 5, 8
LAB2350A	372D301G52	0	—	—	KDB2350	1-3, 5, 8
LAB2350S	372D300G44	0	—	—	KDB2350	1-5, 8
LAB2350W	371D333G12	0	—	—	KDB2350W	1-3, 5, 8
LAB2400	372D300G13	0	—	—	KDB2400	1-3, 5, 8
LAB24000MW	371D426G08	0	—	—	HM2P400X5W	1-3, 5, 8
LAB24000SMW	371D426G28	0	—	—	HM2P400X5W	1-5, 8
LAB2400S	372D300G45	0	—	—	KDB2400	1-5, 8
LAB2400SW	371D333G45	0	—	—	KDB2400W	1-5, 8
LAB2400W	371D333G13	0	—	—	KDB2400W	1-3, 5, 8
LAB2400WK	752B042G03	0	—	—	KDB2400KW	1-3, 5, 8
LAB2400WSK	752B042G04	0	—	—	KDB2400KW	1-3, 5, 8
LAB2700MW	371D426G02	0	—	—	HM2P400D5W	1-3, 5, 8
LAB2700SMW	371D426G22	0	—	—	HM2P400D5W	1-3, 5, 8
LAB3125	372D300G20	0	HLA3125	504C740G20	KDB3125	1-3, 5, 8
LAB31250MW	371D426G13	0	HLA31250MW	—	HMCP400F5W	1-3, 5, 8
LAB31250SMW	371D426G33	0	HLA31250MW	—	HMCP400F5W	1-5, 8
LAB3125A	372D301G60	0	HLA3125	504C740G20	KDB3125	1-3, 5, 8
LAB3125S	372D300G52	0	HLA3125	504C740G20	KDB3125	1-5, 8
LAB3125SW	371D333G52	0	HLA3125W	—	KDB3125W	1-5, 8
LAB3125W	371D333G20	0	HLA3125W	—	KDB3125W	1-3, 5, 8
LAB3150	372D300G21	0	HLA3150	504C740G21	KDB3150	1-3, 5, 8
LAB31500MW	371D426G14	0	HLA31500MW	—	HMCP400G5W	1-3, 5, 8
LAB31500SMW	371D426G34	0	HLA31500MW	—	HMCP400G5W	1-5, 8
LAB3150A	372D301G61	0	HLA3150	504C740G21	KDB3150	1-3, 5, 8
LAB3150S	372D300G53	0	HLA3150	504C740G21	KDB3150	1-5, 8
LAB3150SW	371D333G53	0	HLA3150W	—	KDB3150W	1-5, 8

Note

① 0 = Obsolete, A = Available.

Replacement Breaker Cross-Reference

Replacement Breaker			Replacements			Notes
Catalog Number	Style Number	Status ^①	MARK 75 Catalog Number	MARK 75 Style Number	Series C Catalog Number	(See Page V12-T3-114)
LAB3150W	371D333G21	0	HLA3150W	—	KDB3150W	1–3, 5, 8
LAB3175	372D300G22	0	HLA3175	504C740G22	KDB3175	1–3, 5, 8
LAB31750MW	371D426G15	0	HLA31750MW	—	HMCP400J5W	1–3, 5, 8
LAB31750SMW	371D426G35	0	HLA31750MW	—	HMCP400J5W	1–5, 8
LAB3175A	372D301G62	0	HLA3175	504C740G22	KDB3175	1–3, 5, 8
LAB3175S	372D300G54	0	HLA3175	504C740G22	KDB3175	1–5, 8
LAB3175SW	371D333G54	0	HLA3175W	—	KDB3175W	1–5, 8
LAB3175W	371D333G22	0	HLA3175W	—	KDB3175W	1–3, 5, 8
LAB3200	372D300G23	0	HLA3200	504C740G23	KDB3200	1–3, 5, 8
LAB3200A	372D301G63	0	HLA3200	504C740G23	KDB3200	1–3, 5, 8
LAB3200S	372D300G55	0	HLA3200	504C740G23	KDB3200	1–5, 8
LAB3200SW	371D333G55	0	HLA3200W	—	KDB3200W	1–5, 8
LAB3200W	371D333G23	0	HLA3200W	—	KDB3200W	1–3, 5, 8
LAB3225	372D300G24	0	HLA3225	504C740G24	KDB3225	1–3, 5, 8
LAB32250MW	371D426G16	0	HLA32250MW	—	HMCP400L5W	1–3, 5, 8
LAB32250SMW	371D426G36	0	HLA32250MW	—	HMCP400L5W	1–5, 8
LAB3225A	372D301G64	0	HLA3225	504C740G24	KDB3225	1–3, 5, 8
LAB3225S	372D300G56	0	HLA3225	504C740G24	KDB3225	1–5, 8
LAB3225SW	371D333G56	0	HLA3225W	—	KDB3225W	1–5, 8
LAB3225W	371D333G24	0	HLA3225W	—	KDB3225W	1–3, 5, 8
LAB3250	372D300G25	0	HLA3250	504C740G25	KDB3250	1–3, 5, 8
LAB3250A	372D301G65	0	HLA3250	504C740G25	KDB3250	1–3, 5, 8
LAB3250S	372D300G57	0	HLA3250	504C740G25	KDB3250	1–5, 8
LAB3250SW	371D333G57	0	HLA3250W	—	KDB3250W	1–5, 8
LAB3250W	371D333G25	0	HLA3250W	—	KDB3250W	1–3, 5, 8
LAB3300	372D300G26	0	HLA3300	504C740G26	KDB3300	1–3, 5, 8
LAB33000MW	371D426G17	0	HLA33000MW	—	HMCP400N5W	1–3, 5, 8
LAB33000SMW	371D426G37	0	HLA33000MW	—	HMCP400N5W	1–5, 8
LAB3300A	372D301G66	0	HLA3300	504C740G26	KDB3300	1–3, 5, 8
LAB3300S	372D300G58	0	HLA3300	504C740G26	KDB3300	1–5, 8
LAB3300SW	371D333G58	0	HLA3300W	—	KDB3300W	1–, 5, 8
LAB3300W	371D333G26	0	HLA3300W	—	KDB3300W	1–3, 5, 8
LAB3350A	372D301G67	0	HLA3350	504C740G27	KDB3350	1–3, 5, 8
LAB3350S	372D300G59	0	HLA3350	504C740G27	KDB3350	1–5, 8
LAB3350SW	371D333G59	0	HLA3350W	—	KDB3350W	1–5, 8
LAB3400	372D300G28	0	HLA3400	504C740G28	KDB3400	1–3, 5, 8
LAB34000MW	371D426G18	0	HLA34000MW	—	HMCP400X5W	1–3, 5, 8
LAB34000SMW	371D426G38	0	HLA34000MW	—	HMCP400X5W	1–5, 8
LAB3400A	372D301G68	0	HLA3400	504C740G28	KDB3400	1–3, 5, 8
LAB3400S	372D300G60	0	HLA3400	504C740G28	KDB3400	1–5, 8
LAB3400SW	371D333G60	0	HLA3400W	—	KDB3400W	1–5, 8
LAB3400W	371D333G28	0	HLA3400W	—	KDB3400W	1–3, 5, 8
LAB3400WK	752B042G08	0	—	—	KDB3400KW	1–3, 5, 8
LAB3400WSK	752B042G09	0	—	—	KDB3400KW	1–3, 5, 8
LAB3700MW	371D426G12	0	HLA3700MW	—	HMCP400D5W	1–3, 5, 8
LAB3700SMW	371D426G32	0	HLA3700MW	—	HMCP400D5W	1–5, 8
LAY3250	NO STYLE	0	—	—	HKD3250	—

Note

① 0 = Obsolete, A = Available.

Replacement Breaker Cross-Reference

Replacement Breaker		Status ①	Replacements			Notes (See Page V12-T3-114)
Catalog Number	Style Number		MARK 75 Catalog Number	MARK 75 Style Number	Series C Catalog Number	
LAY3300	NO STYLE	0	—	—	HLD3300	—
LAY3350	NO STYLE	0	—	—	HLD3350	—
LAY3400	NO STYLE	0	—	—	HLD3400	—
LAY3500	NO STYLE	0	—	—	HLD3500	—
LAY3600	NO STYLE	0	—	—	HLD3600	—
LAY3600F	1240C53G01	0	—	—	HLD3600F	—
LB2070	179C800G01	0	—	—	KD2070	1–3, 5, 8, 9
LB2070S	179C803G01	0	—	—	KD2070	1–5, 8, 9
LB2090	179C800G02	0	—	—	KD2090	1–3, 5, 8, 9
LB2090S	179C803G02	0	—	—	KD2090	1–5, 8, 9
LB2100	179C800G03	0	—	—	KD2100	1–3, 5, 8, 9
LB2100S	179C803G03	0	—	—	KD2100	1–5, 8, 9
LB2125	179C800G04	0	—	—	KD2125	1–3, 5, 8, 9
LB2125S	179C803G04	0	—	—	KD2125	1–5, 8, 9
LB2150	179C800G05	0	—	—	KD2150	1–3, 5, 8, 9
LB2150S	179C803G05	0	—	—	KD2150	1–5, 8, 9
LB2175	179C800G06	0	—	—	KD2175	1–3, 5, 8, 9
LB2175S	179C803G06	0	—	—	KD2175	1–5, 8, 9
LB2200	179C800G07	0	—	—	KD2200	1–3, 5, 8, 9
LB2200S	179C803G07	0	—	—	KD2200	1–5, 8, 9
LB2225	179C800G08	0	—	—	KD2225	1–3, 5, 8, 9
LB2225S	179C803G08	0	—	—	KD2225	1–5, 8, 9
LB2250	179C800G09	0	—	—	KD2250	1–3, 5, 8, 9
LB2250S	179C803G09	0	—	—	KD2250	1–5, 8, 9
LB2300	179C800G10	0	—	—	KD2300	1–3, 5, 8, 9
LB2300S	179C803G10	0	—	—	KD2300	1–5, 8, 9
LB2350	179C800G11	0	—	—	KD2350	1–3, 5, 8, 9
LB2400	179C800G12	0	—	—	KD2400	1–3, 5, 8, 9
LB2400F	5680D03G07	0	—	—	KD2400F	1–3, 5, 8, 9
LB2400FS	5680D03G11	0	—	—	KD2400F	1–5, 8, 9
LB2400S	179C803G12	0	—	—	KD2400	1–5, 8, 9
LB2400WK	752B048G02	0	—	—	KD2400KW	1–3, 5, 8, 9
LB2400WSK	752B048G04	0	—	—	KD2400KW	1–3, 5, 8, 9
LB3070	179C800G16	0	—	—	KD3070	1–3, 5, 8, 9
LB3070S	179C803G16	0	—	—	KD3070	1–5, 8, 9
LB3090	179C800G17	0	—	—	KD3090	1–3, 5, 8, 9
LB3090S	179C803G17	0	—	—	KD3090	1–5, 8, 9
LB3100	179C800G18	0	—	—	KD3100	1–3, 5, 8, 9
LB3100S	179C803G18	0	—	—	KD3100	1–5, 8, 9
LB3125	179C800G19	0	—	—	KD3125	1–3, 5, 8, 9
LB3125S	179C803G19	0	—	—	KD3125	1–5, 8, 9
LB3150	179C800G20	0	—	—	KD3150	1–3, 5, 8, 9
LB3150S	179C803G20	0	—	—	KD3150	1–5, 8, 9
LB3175	179C800G21	0	—	—	KD3175	1–3, 5, 8, 9
LB3175S	179C803G21	0	—	—	KD3175	1–5, 8, 9
LB3200	179C800G22	0	—	—	KD3200	1–3, 5, 8, 9
LB3200S	179C803G22	0	—	—	KD3200	1–5, 8, 9

Note

① 0 = Obsolete, A = Available.

Replacement Breaker Cross-Reference

Replacement Breaker			Replacements			Notes
Catalog Number	Style Number	Status ①	MARK 75 Catalog Number	MARK 75 Style Number	Series C Catalog Number	(See Page V12-T3-114)
LB3225	179C800G23	0	—	—	KD3225	1-3, 5, 8, 9
LB3225S	179C803G23	0	—	—	KD3225	1-5, 8, 9
LB3250	179C800G24	0	—	—	KD3250	1-3, 5, 8, 9
LB3250S	179C803G24	0	—	—	KD3250	1-5, 8, 9
LB3300	179C800G25	0	—	—	KD3300	1-3, 5, 8, 9
LB3300S	179C803G25	0	—	—	KD3300	1-5, 8, 9
LB3350	179C800G26	0	—	—	KD3350	1-3, 5, 8, 9
LB3400	179C800G27	0	—	—	KD3400	1-3, 5, 8, 9
LB3400F	5680D03G08	0	—	—	KD3400F	1-3, 5, 8, 9
LB3400FS	5680D03G12	0	—	—	KD3400F	1-5, 8, 9
LB3400S	179C803G27	0	—	—	KD3400	1-5, 8, 9
LB3400WK	752B048G07	0	—	—	KD3400KW	1-3, 5, 8, 9
LB3400WSK	752B048G09	0	—	—	KD3400KW	1-3, 5, 8, 9
LBB2125	179C806G04	0	—	—	KDB2125	1-3, 5, 8, 9
LBB21250MW	179C811G02	0	—	—	HM2P400F5W	1-3, 5, 8, 9
LBB21250SMW	179C832G02	0	—	—	HM2P400F5W	1-5, 8, 9
LBB2125A	179C807G04	0	—	—	KDB2125	1-3, 5, 8, 9
LBB2125S	179C827G04	0	—	—	KDB2125	1-5, 8, 9
LBB2125SA	179C828G04	0	—	—	KDB2125	1-5, 8, 9
LBB2125SW	179C830G04	0	—	—	KDB2125W	1-5, 8, 9
LBB2125W	179C809G04	0	—	—	KDB2125W	1-3, 5, 8, 9
LBB2150	179C806G05	0	—	—	KDB2150	1-3, 5, 8, 9
LBB21500MW	179C811G03	0	—	—	HM2P400G5W	1-3, 5, 8, 9
LBB21500SMW	179C832G03	0	—	—	HM2P400G5W	1-5, 8, 9
LBB2150A	179C807G05	0	—	—	KDB2150	1-3, 5, 8, 9
LBB2150S	179C827G05	0	—	—	KDB2150	1-5, 8, 9
LBB2150SA	179C828G05	0	—	—	KDB2150	1-5, 8, 9
LBB2150SW	179C830G05	0	—	—	KDB2150W	1-5, 8, 9
LBB2150W	179C809G05	0	—	—	KDB2150W	1-3, 5, 8, 9
LBB2175	179C806G06	0	—	—	KDB2175	1-3, 5, 8, 9
LBB21750MW	179C811G04	0	—	—	HM2P400J5W	1-3, 5, 8, 9
LBB21750SMW	179C832G04	0	—	—	HM2P400J5W	1-5, 8, 9
LBB2175A	179C807G06	0	—	—	KDB2175	1-3, 5, 8, 9
LBB2175S	179C827G06	0	—	—	KDB2175	1-5, 8, 9
LBB2175SA	179C828G06	0	—	—	KDB2175	1-5, 8, 9
LBB2175SW	179C830G06	0	—	—	KDB2175W	1-5, 8, 9
LBB2175W	179C809G06	0	—	—	KDB2175W	1-3, 5, 8, 9
LBB2200	179C806G07	0	—	—	KDB2200	1-3, 5, 8, 9
LBB2200A	179C807G07	0	—	—	KDB2200	1-3, 5, 8, 9
LBB2200S	179C827G07	0	—	—	KDB2200	1-5, 8, 9
LBB2200SA	179C828G07	0	—	—	KDB2200	1-5, 8, 9
LBB2200SW	179C830G07	0	—	—	KDB2200W	1-5, 8, 9
LBB2200W	179C809G07	0	—	—	KDB2200W	1-3, 5, 8, 9
LBB2225	179C806G08	0	—	—	KDB2225	1-3, 5, 8, 9
LBB22250MW	179C811G05	0	—	—	HM2P400L5W	1-3, 5, 8, 9
LBB22250SMW	179C832G05	0	—	—	HM2P400L5W	1-5, 8, 9
LBB2225A	179C807G08	0	—	—	KDB2225	1-3, 5, 8, 9

Note

① 0 = Obsolete, A = Available.

Replacement Breaker Cross-Reference

Replacement Breaker		Status ①	Replacements			Notes (See Page V12-T3-114)
Catalog Number	Style Number		MARK 75 Catalog Number	MARK 75 Style Number	Series C Catalog Number	
LBB2225S	179C827G08	0	—	—	KDB2225	1-5, 8, 9
LBB2225SA	179C828G08	0	—	—	KDB2225	1-5, 8, 9
LBB2225SW	179C830G08	0	—	—	KDB2225W	1-5, 8, 9
LBB2225S	179C827G08	0	—	—	KDB2225	1-5, 8, 9
LBB2225SA	179C828G08	0	—	—	KDB2225	1-5, 8, 9
LBB2225SW	179C830G08	0	—	—	KDB2225W	1-5, 8, 9
LBB2225W	179C809G08	0	—	—	KDB2225W	1-3, 5, 8, 9
LBB2250	179C806G09	0	—	—	KDB2250	1-3, 5, 8, 9
LBB2250A	179C807G09	0	—	—	KDB2250	1-3, 5, 8, 9
LBB2250S	179C827G09	0	—	—	KDB2250	1-5, 8, 9
LBB2250SA	179C828G09	0	—	—	KDB2250	1-5, 8, 9
LBB2250SW	179C830G09	0	—	—	KDB2250W	1-5, 8, 9
LBB2250W	179C809G09	0	—	—	KDB2250W	1-3, 5, 8, 9
LBB2300	179C806G10	0	—	—	KDB2300	1-3, 5, 8, 9
LBB2300MW	179C811G06	0	—	—	HM2P400N5W	1-3, 5, 8, 9
LBB2300SMW	179C832G06	0	—	—	HM2P400N5W	1-5, 8, 9
LBB2300A	179C807G10	0	—	—	KDB2300	1-3, 5, 8, 9
LBB2300S	179C827G10	0	—	—	KDB2300	1-5, 8, 9
LBB2300SA	179C828G10	0	—	—	KDB2300	1-5, 8, 9
LBB2300SW	179C830G10	0	—	—	KDB2300W	1-5, 8, 9
LBB2300W	179C809G10	0	—	—	KDB2300W	1-3, 5, 8, 9
LBB2350	179C806G11	0	—	—	KDB2350	1-3, 5, 8, 9
LBB2350A	179C807G11	0	—	—	KDB2350	1-3, 5, 8, 9
LBB2350SA	179C828G11	0	—	—	KDB2350	1-5, 8, 9
LBB2350SW	179C830G11	0	—	—	KDB2350W	1-5, 8, 9
LBB2350W	179C809G11	0	—	—	KDB2350W	1-3, 5, 8, 9
LBB2400	179C806G12	0	—	—	KDB2400	1-3, 5, 8, 9
LBB2400MW	179C811G07	0	—	—	HM2P400X5W	1-3, 5, 8, 9
LBB2400SMW	179C832G07	0	—	—	HM2P400X5W	1-5, 8, 9
LBB2400A	179C807G12	0	—	—	KDB2400	1-3, 5, 8, 9
LBB2400S	179C827G12	0	—	—	KDB2400	1-5, 8, 9
LBB2400SA	179C828G12	0	—	—	KDB2400	1-5, 8, 9
LBB2400SW	179C830G12	0	—	—	KDB2400W	1-5, 8, 9
LBB2400W	179C809G12	0	—	—	KDB2400W	1-3, 5, 8, 9
LBB2400WK	752B048G01	0	—	—	KDB2400KW	1-3, 5, 8, 9
LBB2400WSK	752B048G03	0	—	—	KDB2400KW	1-3, 5, 8, 9
LBB2700MW	179C811G01	0	—	—	HM2P400D5W	1-3, 5, 7-9
LBB2700SMW	179C832G01	0	—	—	HM2P400D5W	1-5, 7-9
LBB3125	179C806G19	0	—	—	KDB3125	1-3, 5, 8, 9
LBB3125MW	179C811G17	0	—	—	HMCP400F5W	1-3, 5, 8, 9
LBB3125SMW	179C832G17	0	—	—	HMCP400F5W	1-5, 8, 9
LBB3125A	179C807G19	0	—	—	KDB3125	1-3, 5, 8, 9
LBB3125S	179C827G19	0	—	—	KDB3125	1-5, 8, 9
LBB3125SA	179C828G19	0	—	—	KDB3125	1-5, 8, 9
LBB3125SW	179C830G19	0	—	—	KDB3125W	1-5, 8, 9
LBB3125W	179C809G19	0	—	—	KDB3125W	1-3, 5, 8, 9
LBB3150	179C806G20	0	—	—	KDB3150	1-3, 5, 8, 9

Note

① 0 = Obsolete, A = Available.

Replacement Breaker Cross-Reference

Replacement Breaker			Replacements			Notes
Catalog Number	Style Number	Status ①	MARK 75 Catalog Number	MARK 75 Style Number	Series C Catalog Number	(See Page V12-T3-114)
LBB31500MW	179C811G18	0	—	—	HMCP400G5W	1–3, 5, 8, 9
LBB31500SMW	179C832G18	0	—	—	HMCP400G5W	1–5, 8, 9
LBB3150A	179C807G20	0	—	—	KDB3150	1–3, 5, 8, 9
LBB3150S	179C827G20	0	—	—	KDB3150	1–5, 8, 9
LBB3150SA	179C828G20	0	—	—	KDB3150	1–5, 8, 9
LBB3150SW	179C830G20	0	—	—	KDB3150W	1–5, 8, 9
LBB3150W	179C809G20	0	—	—	KDB3150W	1–3, 5, 8, 9
LBB3175	179C806G21	0	—	—	KDB3175	1–3, 5, 8, 9
LBB31750MW	179C811G19	0	—	—	HMCP400J5W	1–3, 5, 8, 9
LBB31750SMW	179C832G19	0	—	—	HMCP400J5W	1–5, 8, 9
LBB3175A	179C807G21	0	—	—	KDB3175	1–3, 5, 8, 9
LBB3175S	179C827G21	0	—	—	KDB3175	1–5, 8, 9
LBB3175SA	179C828G21	0	—	—	KDB3175	1–5, 8, 9
LBB3175SW	179C830G21	0	—	—	KDB3175W	1–5, 8, 9
LBB3175W	179C809G21	0	—	—	KDB3175W	1–3, 5, 8, 9
LBB3200	179C806G22	0	—	—	KDB3200	1–3, 5, 8, 9
LBB3200A	179C807G22	0	—	—	KDB3200	1–3, 5, 8, 9
LBB3200S	179C827G22	0	—	—	KDB3200	1–5, 8, 9
LBB3200SA	179C828G22	0	—	—	KDB3200	1–5, 8, 9
LBB3200SW	179C830G22	0	—	—	KDB3200W	1–5, 8, 9
LBB3200W	179C809G22	0	—	—	KDB3200W	1–3, 5, 8, 9
LBB3225	179C806G23	0	—	—	KDB3225	1–3, 5, 8, 9
LBB32250MW	179C811G20	0	—	—	HMCP400L5W	1–3, 5, 8, 9
LBB32250SMW	179C832G20	0	—	—	HMCP400L5W	1–5, 8, 9
LBB3225S	179C827G23	0	—	—	KDB3225	1–5, 8, 9
LBB3225SA	179C828G23	0	—	—	KDB3225	1–5, 8, 9
LBB3225SW	179C830G23	0	—	—	KDB3225W	1–5, 8, 9
LBB3225W	179C809G23	0	—	—	KDB3225W	1–3, 5, 8, 9
LBB3250	179C806G24	0	—	—	KDB3250	1–3, 5, 8, 9
LBB3250A	179C807G24	0	—	—	KDB3250	1–3, 5, 8, 9
LBB3250S	179C827G24	0	—	—	KDB3250	1–5, 8, 9
LBB3250SA	179C828G24	0	—	—	KDB3250	1–5, 8, 9
LBB3250SW	179C830G24	0	—	—	KDB3250W	1–5, 8, 9
LBB3250W	179C809G24	0	—	—	KDB3250W	1–3, 5, 8, 9
LBB3300	179C806G25	0	—	—	KDB3300	1–3, 5, 8, 9
LBB33000MW	179C811G21	0	—	—	HMCP400N5W	1–3, 5, 8, 9
LBB33000SMW	179C832G21	0	—	—	HMCP400N5W	1–5, 8, 9
LBB3300A	179C807G25	0	—	—	KDB3300	1–3, 5, 8, 9
LBB3300S	179C827G25	0	—	—	KDB3300	1–5, 8, 9
LBB3300SA	179C828G25	0	—	—	KDB3300	1–5, 8, 9
LBB3300SW	179C830G25	0	—	—	KDB3300W	1–5, 8, 9
LBB3300W	179C809G25	0	—	—	KDB3300W	1–3, 5, 8, 9
LBB3350	179C806G26	0	—	—	KDB3350	1–3, 5, 8, 9
LBB3350A	179C807G26	0	—	—	KDB3350	1–3, 5, 8, 9
LBB3350SA	179C828G26	0	—	—	KDB3350	1–5, 8, 9
LBB3350W	179C809G26	0	—	—	KDB3350W	1–3, 5, 8, 9
LBB3400	179C806G27	0	—	—	KDB3400	1–3, 5, 8, 9

Note

① 0 = Obsolete, A = Available.

Replacement Breaker Cross-Reference

Replacement Breaker		Status ①	Replacements			Notes (See Page V12-T3-114)
Catalog Number	Style Number		MARK 75 Catalog Number	MARK 75 Style Number	Series C Catalog Number	
LBB34000MW	179C811G22	0	—	—	HMCP400X5W	1-3, 5, 8, 9
LBB34000SMW	179C832G22	0	—	—	HMCP400X5W	1-5, 8, 9
LBB3400A	179C807G27	0	—	—	KDB3400	1-3, 5, 8, 9
LBB3400S	179C827G27	0	—	—	KDB3400	1-5, 8, 9
LBB3400SA	179C828G27	0	—	—	KDB3400	1-5, 8, 9
LBB3400SW	179C830G27	0	—	—	KDB3400W	1-5, 8, 9
LBB3400W	179C809G27	0	—	—	KDB3400W	1-3, 5, 8, 9
LBB3400WK	752B048G06	0	—	—	KDB3400KW	1-3, 5, 8, 9
LBB3400WSK	752B048G08	0	—	—	KDB3400KW	1-3, 5, 8, 9
LBB3700MW	179C811G16	0	—	—	HMCP400D5W	1-3, 5, 7-9
LBB3700SMW	179C832G16	0	—	—	HMCP400D5W	1-5, 7-9
LC2150F	1242C91G01	0	—	—	KD3400F/KES3150LS	1-3, 5, 8
LC2150FM	1242C91G03	0	—	—	KD3400F/KES3150LS	1-3, 5, 8
LC2300F	1242C91G05	0	—	—	KD3400F/KES3400LS	1-3, 5, 8
LC2300FM	1242C91G07	0	—	—	KD3400F/KES3400LS	1-3, 5, 8
LC2400F	1242C91G09	0	—	—	KD3400F/KES3400LS	1-3, 5, 8
LC2400FM	1242C91G11	0	—	—	KD3400F/KES3400LS	1-3, 5, 8
LC2600F	1242C91G13	0	—	—	LD3600F/LES3600LS	1-3, 5, 8
LC2600FM	1242C91G15	0	—	—	LD3600F/LES3600LS	1-3, 5, 8
LC2600WK	752B043G03	0	—	—	LD2600WK	1-3, 5, 8
LC3150F	1242C91G02	0	HLC3150F	1284C66G02	KD3400F/KES3150LS	1-3, 5, 8
LC3150FM	1242C91G04	0	HLC3150F	1284C66G02	KD3400F/KES3150LS	1-3, 5, 8
LC3300F	1242C91G06	0	HLC3300F	2612D41G46	KD3400F/KES3400LS	1-3, 5, 8
LC3300FM	1242C91G08	0	HLC3300F	2612D41G46	KD3400F/KES3400LS	1-3, 5, 8
LC3400F	1242C91G10	0	HLC3400F	2613D44G08	KD3400F/KES3400LS	1-3, 5, 8
LC3400FM	1242C91G12	0	HLC3400F	2613D44G08	KD3400F/KES3400LS	1-3, 5, 8
LC3600F	1242C91G14	0	HLC3600F	2612D41G48	LD3600F/LES3600LS	1-3, 5, 8
LC3600FM	1242C91G16	0	HLC3600F	2612D41G48	LD3600F/LES3600LS	1-3, 5, 8
LC3600WK	752B043G08	0	—	—	LD3600WK	1-3, 5, 8
LCA2150F	1242C91G23	0	—	—	KD3400F/KES3150LSI	1-3, 5, 8
LCA2150FM	1242C91G25	0	—	—	KD3400F/KES3150LSI	1-3, 5, 8
LCA2300F	1242C91G27	0	—	—	KD3400F/KES3400LSI	1-3, 5, 8
LCA2300FM	1242C91G29	0	—	—	KD3400F/KES3400LSI	1-3, 5, 8
LCA2400F	1242C91G31	0	—	—	KD3400F/KES3400LSI	1-3, 5, 8
LCA2400FM	1242C91G33	0	—	—	KD3400F/KES3400LSI	1-3, 5, 8
LCA2600F	1242C91G35	0	—	—	LD3600F/LES3600LSI	1-3, 5, 8
LCA2600FM	1242C91G37	0	—	—	LD3600F/LES3600LSI	1-3, 5, 8
LCA3150F	1242C91G24	0	HLCA3150F	1242C92G24	KD3400F/KES3150LSI	1-3, 5, 8
LCA3150FM	1242C91G26	0	HLCA3150F	1242C92G24	KD3400F/KES3150LSI	1-3, 5, 8
LCA3300F	1242C91G28	0	HLCA3300F	1242C92G28	KD3400F/KES3400LSI	1-3, 5, 8
LCA3300FM	1242C91G30	0	HLCA3300F	1242C92G28	KD3400F/KES3400LSI	1-3, 5, 8
LCA3400F	1242C91G32	0	HLCA3400F	1242C92G32	KD3400F/KES3400LSI	1-3, 5, 8
LCA3400FM	1242C91G34	0	HLCA3400F	1242C92G34	KD3400F/KES3400LSI	1-3, 5, 8
LCA3600F	1242C91G36	0	HLCA3600F	1284C66G36	LD3600F/LES3600LSI	1-3, 5, 8
LCA3600FM	1242C91G38	0	HLCA3600F	1284C66G36	LD3600F/LES3600LSI	1-3, 5, 8
LCC2600WK	NO STYLE	0	—	—	—	1-3, 5, 8
LCC3600F	6590C10G14	0	HLCC3600F	6590C11G14	CLD3600F/LES3600LS	1-3, 5, 8

Note

① 0 = Obsolete, A = Available.

Replacement Breaker Cross-Reference

Replacement Breaker			Replacements			Notes
Catalog Number	Style Number	Status ^①	MARK 75 Catalog Number	MARK 75 Style Number	Series C Catalog Number	(See Page V12-T3-114)
LCC3600WK	NO STYLE	0	—	—	—	1-3, 5, 8
LCCA3600F	6590C10G36	0	HCCA3600F	6590C11G36	CLD3600F/LES3600LSI	1-3, 5, 8
LCCG3600F	1242C93G04	0	HCCG3600F	1242C94G04	CLD3600F/LES3600LSG	1-3, 5, 8
LCCGA3600F	1242C93G12	0	HCCGA3600F	1242C94G12	CLD3600F/LES3600LSIG	1-3, 5, 8
LCG3150F	1242C88G01	0	HLCG3150F	1242C89G01	KD3400F/KES3150LSG	1-3, 5, 8
LCG3300F	1242C88G02	0	HLCG3300F	1242C89G02	KD3400F/KES3400LS	1-3, 5, 8
LCG3400F	1242C88G03	0	HLCG3400F	1242C89G03	KD3400F/KES3400LSG	1-3, 5, 8
LCG3600F	1242C88G04	0	HLCG3600F	1371D17G40	LD3600F/LES3600LSG	1-3, 5, 8
LCGA3150F	1242C88G09	0	HLCGA3150F	1242C89G09	KD3400F/KES3150LSIG	1-3, 5, 8
LCGA3300F	1242C88G10	0	HLCGA3300F	1242C89G10	KD3400F/KES3400LSIG	1-3, 5, 8
LCGA3400F	1242C88G11	0	HLCGA3400F	1242C89G11	KD3400F/KES3400LSIG	1-3, 5, 8
LCGA3600F	1242C88G12	0	HLCGA3600F	1270C61G12	LD3600F/LES3600LSIG	1-3, 5, 8
LCY3600F	6590C12G04	0	—	—	HLD3600F/LES3600LS	1-3, 5, 8
LCYA3600F	6590C12G08	0	—	—	HLD3600F/LES3600LSI	1-3, 5, 8
LCYG3600F	1242C95G04	0	—	—	HLD3600F/LES3600LSG	1-3, 5, 8
LCYGA3600F	1242C95G08	0	—	—	HLD3600F/LES3600LSIG	1-3, 5, 8
MA2125	1252C17G01	0	—	—	KD2125	1-3, 5, 8
MA2125S	1252C21G01	0	—	—	KD2125	1-5, 8
MA2150	1252C17G02	0	—	—	KD2150	1-3, 5, 8
MA2150S	1252C21G02	0	—	—	KD2150	1-5, 8
MA2175	1252C17G03	0	—	—	KD2175	1-3, 5, 8
MA2175S	1252C21G03	0	—	—	KD2175	1-5, 8
MA2200	1252C17G04	0	—	—	KD2200	1-3, 5, 8
MA2200S	1252C21G04	0	—	—	KD2200	1-5, 8
MA2225	1252C17G05	0	—	—	KD2225	1-3, 5, 8
MA2225S	1252C21G05	0	—	—	KD2225	1-5, 8
MA2250	1252C17G06	0	—	—	KD2250	1-3, 5, 8
MA2250S	1252C21G06	0	—	—	KD2250	1-5, 8
MA2300	1252C17G07	0	—	—	MDL2300	1-3, 5, 8
MA2300S	1252C21G07	0	—	—	MDL2300	1-5, 8
MA2350	1252C17G08	0	—	—	MDL2350	1-3, 5, 8
MA2350S	1252C21G08	0	—	—	MDL2350	1-5, 8
MA2400	1252C17G09	0	—	—	MDL2400	1-3, 5, 8
MA2400S	1252C21G09	0	—	—	MDL2400	1-5, 8
MA2500	1252C17G10	0	—	—	MDL2500	1-3, 5, 8
MA2500S	1252C21G10	0	—	—	MDL2500	1-5, 8
MA2600	1252C17G11	0	—	—	MDL2600	1-3, 5, 8
MA2600S	1252C21G11	0	—	—	MDL2600	1-5, 8
MA2700	1252C17G14	0	—	—	MDL2700	1-3, 5, 8
MA2700S	1252C21G14	0	—	—	MDL2700	1-5, 8
MA2800	1252C17G15	0	—	—	MDL2800	1-3, 5, 8
MA2800F	2600D43G01	0	—	—	MDL2800F	1-3, 5, 8
MA2800FS	2600D43G03	0	—	—	MDL2800F	1-5, 8
MA2800S	1252C21G15	0	—	—	MDL2800	1-5, 8
MA2800WK	752B071G01	0	—	—	MDL2800WK	1-3, 5, 8
MA2800WSK	752B071G02	0	—	—	MDL2800WK	1-3, 5, 8
MA3125	1252C17G16	0	HMA3125	504C741G16	KD3125	1-3, 5, 8

Note

① 0 = Obsolete, A = Available.

Replacement Breaker Cross-Reference

Replacement Breaker		Status ①	Replacements			Notes (See Page V12-T3-114)
Catalog Number	Style Number		MARK 75 Catalog Number	MARK 75 Style Number	Series C Catalog Number	
MA3125S	1252C21G16	0	HMA3125	504C741G16	KD3125	1-5, 8
MA3150	1252C17G17	0	HMA3150	504C741G17	KD3150	1-3, 5, 8
MA3150S	1252C21G17	0	HMA3150	504C741G17	KD3150	1-5, 8
MA3175	1252C17G18	0	HMA3175	504C741G18	KD3175	1-3, 5, 8
MA3175S	1252C21G18	0	HMA3175	504C741G18	KD3175	1-5, 8
MA3200	1252C17G19	0	HMA3200	504C741G19	KD3200	1-3, 5, 8
MA3200S	1252C21G19	0	HMA3200	504C741G19	KD3200	1-5, 8
MA3225	1252C17G20	0	HMA3225	504C741G20	KD3225	1-3, 5, 8
MA3225S	1252C21G20	0	HMA3225	504C741G20	KD3225	1-5, 8
MA3250	1252C17G21	0	HMA3250	504C741G21	KD3250	1-3, 5, 8
MA3250S	1252C21G21	0	HMA3250	504C741G21	KD3250	1-5, 8
MA3300	1252C17G22	0	HMA3300	504C741G22	MDL3300	1-3, 5, 8
MA3300S	1252C21G22	0	HMA3300	504C741G22	MDL3300	1-5, 8
MA3350	1252C17G23	0	HMA3350	504C741G23	MDL3350	1-3, 5, 8
MA3350S	1252C21G23	0	HMA3350	504C741G23	MDL3350	1-5, 8
MA3400	1252C17G24	0	HMA3400	504C741G24	MDL3400	1-3, 5, 8
MA3400S	1252C21G24	0	HMA3400	504C741G24	MDL3400	1-5, 8
MA3500	1252C17G25	0	HMA3500	504C741G25	MDL3500	1-3, 5, 8
MA3500S	1252C21G25	0	HMA3500	504C741G25	MDL3500	1-5, 8
MA3600	1252C17G26	0	HMA3600	504C741G26	MDL3600	1-3, 5, 8
MA3600S	1252C21G26	0	HMA3600	504C741G26	MDL3600	1-5, 8
MA3700	1252C17G27	0	HMA3700	504C741G27	MDL3700	1-3, 5, 8
MA3700S	1252C21G27	0	HMA3700	504C741G27	MDL3700	1-5, 8
MA3800	1252C17G28	0	HMA3800	504C741G28	MDL3800	1-3, 5, 8
MA3800F	2600D43G02	0	HMA3800F	373B237G04	MDL3800F	—
MA3800FS	2600D43G04	0	HMA3800F	373B237G04	MDL3800F	1-5, 8
MA3800S	1252C21G28	0	HMA3800	504C741G28	MDL3800	1-5, 8
MA3800WK	752B071G06	0	—	—	MDL3800WK	1-3, 5, 8
MA3800WSK	752B071G07	0	—	—	MDL3800WK	1-3, 5, 8
MAY3600	NO STYLE	0	—	—	HMDL3600	—
MAY3700	NO STYLE	0	—	—	HMDL3700	—
MAY3800	NO STYLE	0	—	—	HMDL3800	—
MAY3800F	1240C54G01	0	—	—	HMDL3800F	—
MC2800F	6590C16G01	0	—	—	MDL3800F/MES3800LS	1-3, 5, 8
MC2800FM	6590C16G03	0	—	—	MDL3800F/MES3800LS	1-3, 5, 8
MC2800WK	752B071G03	0	—	—	MDL2800WK	1-3, 5, 8
MC3800F	6590C16G02	0	HMC3800F	6590C16G06	MDL3800F/MES3800LS	1-3, 5, 8
MC3800FM	6590C16G04	0	HMC3800F	6590C16G06	MDL3800F/MES3800LS	1-3, 5, 8
MC3800WK	752B071G08	0	—	—	MDL3800WK	1-3, 5, 8
MCA2800F	6590C16G13	0	—	—	MDL3800F/MES3800LSI	1-3, 5, 8
MCA3800F	6590C16G14	0	HMCA3800F	6590C16G18	MDL3800F/MES3800LSI	1-3, 5, 8
MCC2800WK	NO STYLE	0	—	—	—	1-3, 5, 8
MCC3800F	6590C14G02	0	HMCC3800F	6590C14G06	CMDL3800F/MES3800LS	1-3, 5, 8
MCC3800WK	NO STYLE	0	—	—	—	1-3, 5, 8
MCCA3800F	6590C14G14	0	HMCCA3800F	6590C14G18	CMDL3800F/MES3800LSI	1-3, 5, 8
MCCG3800F	1242C62G01	0	HMCCG3800F	1242C62G09	CMDL3800F/MES3800LSG	1-3, 5, 8
MCCGA3800F	1242C62G03	0	HMCCGA3800F	1242C62G11	CMDL3800F/MES3800LSIG	1-3, 5, 8

Note

① 0 = Obsolete, A = Available.

Replacement Breaker Cross-Reference

Replacement Breaker			Replacements			Notes
Catalog Number	Style Number	Status ^①	MARK 75 Catalog Number	MARK 75 Style Number	Series C Catalog Number	(See Page V12-T3-114)
MCG3800F	1242C60G01	O	HMCG3800F	2612D86G08	MDL3800F/MES3800LSG	1-3, 5, 8
MCGA3800F	1270C62G03	O	HMCGA3800F	1242C60G11	MDL3800F/MES3800LSIG	1-3, 5, 8
MCP03150CR	2610D55G04	A	—	—	HMCP015E0C	1-3, 5, 7, 8
MCP03150R	2610D54G24	A	—	—	HMCP015E0	1-3, 5, 7, 8
MCP0322CR	2610D55G02	A	—	—	HMCP003A0C	1-3, 5, 7, 8
MCP0322R	2610D54G22	A	—	—	HMCP003A0	1-3, 5, 7, 8
MCP0358CR	2610D55G03	A	—	—	HMCP007C0C	1-3, 5, 7, 8
MCP0358R	2610D54G23	A	—	—	HMCP007C0	1-3, 5, 7, 8
MCP13300CR	2610D55G05	A	—	—	HMCP030H1C	1-3, 5, 7, 8
MCP13300R	2610D54G25	A	—	—	HMCP030H1	1-3, 5, 7, 8
MCP23480CR	2610D55G06	A	—	—	HMCP050K2C	1-3, 5, 7, 8
MCP23480R	2610D54G26	A	—	—	HMCP050K2	1-3, 5, 7, 8
MCP331000CR	2610D55G07	A	—	—	HMCP100R3C	1-3, 5, 7, 8
MCP331000R	2610D54G27	A	—	—	HMCP100R3	1-3, 5, 7, 8
MCP431550CR	2610D55G09	A	—	—	HMCP150T4C	1-3, 5, 7, 8
MCP431550R	2610D54G28	A	—	—	HMCP150T4	1-3, 5, 7, 8
MCP431800CR	2610D55G08	A	—	—	HMCP150U4C	1-3, 5, 7, 8
MCP431800R	2610D54G30	A	—	—	HMCP150U4	1-3, 5, 7, 8
MCP532500	752B418G21	O	—	—	HMCP250W5	1-3, 5, 7, 8
MCP532500C	752B418G11	O	—	—	HMCP250W5C	1-3, 5, 7, 8
MCP534000	673B019G15	O	HLB34000M	179C850G22	HMCP400X5	1-3, 5, 7, 8
MCP534000C	673B019G21	O	HLB34000M	179C850G22	HMCP400X5C	1-3, 5, 7, 8
NB21000	1234C24G15	O	—	—	ND212T33W/12NES1000T+	1-3, 5, 8
NB21000S	1234C25G16	O	—	—	ND212T33W/12NES1000T+	1-5, 8
NB21200	1234C24G17	O	—	—	ND212T33W/12NES1200T+	1-3, 5, 8
NB21200F	2610D64G01	O	—	—	ND212T33W	—
NB21200FS	4997D20G03	O	—	—	ND212T33W/12NES1200T+	1-5, 8
NB21200S	1234C25G18	O	—	—	ND212T33W/12NES1200T+	1-5, 8
NB21200WK	752B682G01	O	—	—	ND312WK	1-3, 5, 8
NB21200WSK	752B682G02	O	—	—	ND312WK	1-3, 5, 8
NB2700	1234C24G12	O	—	—	ND2800T33W/8NES700T+	1-3, 5, 8
NB2700S	1234C25G13	O	—	—	ND2800T33W/8NES700T+	1-5, 8
NB2800	1234C24G13	O	—	—	ND2800T33W/8NES800T+	1-3, 5, 8
NB2800S	1234C25G14	O	—	—	ND2800T33W/8NES800T+	1-5, 8
NB2900	1234C25G14	O	—	—	ND212T33W/12NES900T+	1-3, 5, 8
NB2900S	1234C25G15	O	—	—	ND212T33W/12NES900T+	1-5, 8
NB31000	1234C24G33	O	HNB31000	177C099G33	ND312T33W/12NES1000T+	1-3, 5, 8
NB31000S	1234C25G33	O	HNB31000	177C099G33	ND312T33W/12NES1000T+	1-5, 8
NB31200	1234C24G35	O	HNB31200	177C099G35	ND312T33W/12NES1200T+	1-3, 5, 8
NB31200F	2610D64G02	O	HNB31200F	625B494G08	ND312T33W	—
NB31200FS	2610D64G04	O	HNB31200F	625B494G08	ND312T33W	1-5, 8
NB31200S	1234C25G35	O	HNB31200	177C099G35	ND312T33W/12NES1200T+	1-5, 8
NB31200WK	752B682G06	O	—	—	ND312WK	1-3, 5, 8
NB31200WSK	752B682G07	O	—	—	ND312WK	1-3, 5, 8
NB3700	1234C24G30	O	HNB3700	177C099G30	ND3800T33W/8NES700T+	1-3, 5, 8
NB3700S	1234C25G30	O	HNB3700	177C099G30	ND3800T33W/8NES700T+	1-5, 8
NB3800	1234C24G31	O	HNB3800	177C099G31	ND3800T33W/8NES800T+	1-3, 5, 8

Note

① O = Obsolete, A = Available.

Replacement Breaker Cross-Reference

Replacement Breaker			Replacements			Notes (See Page V12-T3-114)
Catalog Number	Style Number	Status ①	MARK 75 Catalog Number	MARK 75 Style Number	Series C Catalog Number	
NB3800S	1234C25G31	0	HNB3800	177C099G31	ND3800T33W/8NES800T+	1-5, 8
NB3900	1234C24G32	0	HNB3900	177C099G32	ND312T33W/12NES900T+	1-3, 5, 8
NB3900S	1234C25G32	0	HNB3900	177C099G32	ND312T33W/12NES900T+	1-5, 8
NBY31000	NO STYLE	0	—	—	HND312T33W/12NES1000T+	—
NBY31200F	1240C62G01	0	—	—	HND312T33W/12NES1200T+	—
NBY3700	NO STYLE	0	—	—	HND3800T33W/8NES700T+	—
NBY3800	NO STYLE	0	—	—	HND3800T33W/8NES800T+	—
NBY3900	NO STYLE	0	—	—	HND312T33W/12NES900T+	—
NC21200F	2613D29G10	0	—	—	ND212T33W	1-3, 5, 8
NC21200FM	2613D29G12	0	—	—	ND212T33W	1-3, 5, 8
NC21200WK	752B682G03	0	—	—	ND312WK	1-3, 5, 8
NC31200F	2613D29G09	0	HNC31200F	2613D29G05	ND312T33W	1-3, 5, 8
NC31200FM	2613D29G11	0	HNC31200F	2613D29G05	ND312T33W	1-3, 5, 8
NC31200WK	752B682G08	0	—	—	ND312WK	1-3, 5, 8
NCA21200F	2613D29G22	0	OMIT	OMIT	ND312T32W	1-3, 5, 8
NCA31200F	2613D29G21	0	HNCA31200F	2613D29G17	ND312T32W	1-3, 5, 8
NCG31200F	1242C72G18	0	HNCG31200F	2612D87G07	ND312T35W	1-3, 5, 8
NCGA31200F	1242C72G11	0	HNCGA31200F	1373D87G12	ND312T36W	1-3, 5, 8
PB21000	177C181G29	0	—	—	RD316T33W/16RES10T+	1-3, 5, 8
PB210000TM	373D488G04	0	—	—	—	2, 8
PB21200	177C181G30	0	—	—	RD316T33W/16RES12T+	1-3, 5, 8
PB212000TM	373D488G06	0	—	—	—	2, 8
PB21400	177C181G31	0	—	—	RD316T33W/16RES14T	1-3, 5, 8
PB21600	177C181G32	0	—	—	RD316T33W/16RES16T	1-3, 5, 8
PB21800	177C181G33	0	—	—	—	—
PB22000	177C181G34	0	—	—	RD320T33W/20RES20T	1-3, 5, 8
PB22000WK	752B076G01	0	—	—	RD320WK	1-3, 5, 8
PB22500F	654D456G05	0	—	—	—	1-3, 5, 8
PB22500WK	752B076G02	0	—	—	—	1-3, 5, 8
PB25000TM	373D487G02	0	—	—	—	2, 8
PB2600	177C181G25	0	—	—	RD316T33W/16RES08T	1-3, 5, 8
PB26000TM	373D487G04	0	—	—	—	2, 8
PB2700	177C181G26	0	—	—	RD316T33W/16RES08T	1-3, 5, 8
PB27000TM	373D487G06	0	—	—	—	2, 8
PB2800	177C181G27	0	—	—	RD316T33W/16RES08T	1-3, 5, 8
PB28000TM	373D488G02	0	—	—	—	2, 8
PB2900	177C181G28	0	—	—	—	—
PB31000	177C181G41	A	—	—	RD316T33W/16RES10T+	1-3, 5, 8
PB31200	177C181G42	A	—	—	RD316T33W/16RES12T+	1-3, 5, 8
PB31400	177C181G43	A	—	—	RD316T33W/16RES14T+	1-3, 5, 8
PB31600	177C181G44	A	—	—	RD316T33W/16RES16T+	1-3, 5, 8
PB31800	177C181G45	A	—	—	—	—
PB32000	177C181G46	A	—	—	RD320T33W/20RES20T+	1-3, 5, 8
PB32000WK	752B076G12	A	—	—	RD320WK	1-3, 5, 8
PB32500F	654D456G06	A	—	—	RD325T33W	1-3, 5, 8
PB32500WK	752B076G13	A	—	—	—	1-3, 5, 8
PB3600	177C181G37	A	—	—	—	—

Note

① 0 = Obsolete, A = Available.

Replacement Breaker Cross-Reference

Replacement Breaker			Replacements			Notes
Catalog Number	Style Number	Status ^①	MARK 75 Catalog Number	MARK 75 Style Number	Series C Catalog Number	(See Page V12-T3-114)
PB3700	177C181G38	A	—	—	—	—
PB3800	177C181G39	A	—	—	RD316T33W+/16RES08T	1–3, 5, 8
PB3900	177C181G40	A	—	—	—	—
PBF21000	177C771G05	O	—	—	RD316T33W/16RES10T+	1–3, 5, 8
PBF210000TM	506C131G32	O	—	—	—	2, 8
PBF21200	177C771G06	O	—	—	RD316T33W/16RES12T+	1–3, 5, 8
PBF212000TM	506C131G33	O	—	—	—	2, 8
PBF21400	177C771G07	O	—	—	RD316T33W/16RES14T	1–3, 5, 8
PBF21600	177C771G08	O	—	—	RD316T33W/16RES16T	1–3, 5, 8
PBF21800	177C771G09	O	—	—	—	—
PBF22000	177C771G10	O	—	—	RE320T33W/20RES20T	1–3, 5, 8
PBF22000F	5663D38G03	O	—	—	—	1–3, 5, 8
PBF22000K	PBF22000K	O	—	—	RD320WK	1–3, 5, 8
PBF25000TM	506C131G28	O	—	—	—	2, 8
PBF2600	177C771G01	O	—	—	—	—
PBF26000TM	506C131G29	O	—	—	—	2, 8
PBF2700	177C771G02	O	—	—	—	—
PBF27000TM	506C131G30	O	—	—	—	2, 8
PBF2800	177C771G03	O	—	—	RD316T33W/16RES08T	1–3, 5, 8
PBF28000TM	506C131G31	O	—	—	—	2, 8
PBF2900	177C771G04	O	—	—	—	—
PBF31000	177C771G17	A	—	—	RD316T33W+	1–3, 5, 8
PBF31200	177C771G18	A	—	—	RD316T33W+	1–3, 5, 8
PBF31400	177C771G19	A	—	—	RD316T33W+	1–3, 5, 8
PBF31600	177C771G20	A	—	—	RD316T33W+	1–3, 5, 8
PBF31800	177C771G21	A	—	—	—	—
PBF32000	177C771G22	A	—	—	RD320T33W+	1–3, 5, 8
PBF32000F	5663D38G01	A	—	—	—	1–3, 5, 8
PBF32000WK	752B076G13	A	—	—	RD320WK	1–3, 5, 8
PBF3600	177C771G13	A	—	—	RD316T33W/16RES08T+	1–3, 5, 8
PBF3700	177C771G14	A	—	—	RD316T33W/16RES08T+	1–3, 5, 8
PBF3800	177C771G15	A	—	—	RD316T33W/16RES08T+	1–3, 5, 8
PBF3900	177C771G16	A	—	—	RD316T33W/16RES10T+	1–3, 5, 8
PC22000F	6590C19G01	O	—	—	RD320T33W	1–3, 5, 8
PC22000FM	6590C19G03	O	—	—	RD320T33W	1–3, 5, 8
PC22000WK	753B081G04	O	—	—	RD320WK	1–3, 5, 8
PC22500F	6590C19G05	O	—	—	RD325T33W	1–3, 5, 8
PC22500FM	6590C19G07	O	—	—	RD325T33W	1–3, 5, 8
PC22500WK	752B076G05	O	—	—	—	1–3, 5, 8
PC23000F	6590C19G09	O	—	—	—	1–3, 5, 8
PC23000FM	6590C19G11	O	—	—	—	1–3, 5, 8
PC23000K	753B081G06	O	—	—	—	1–3, 5, 8
PC32000F	6590C19G02	A	—	—	RD320T33W	1–3, 5, 8
PC32000FM	6590C19G04	O	PC32000F	6590C19G02	RD320T33W	1–3, 5, 8
PC32000WK	753B081G15	A	—	—	RD320WK	1–3, 5, 8
PC32500F	6590C19G06	A	—	—	RD325T33W	1–3, 5, 8
PC32500FM	6590C19G08	O	PC32500F	6590C19G06	RD325T33W	1–3, 5, 8

Note

① O = Obsolete, A = Available.

Replacement Breaker Cross-Reference

Replacement Breaker		Status ^①	Replacements			Notes (See Page V12-T3-114)
Catalog Number	Style Number		MARK 75 Catalog Number	MARK 75 Style Number	Series C Catalog Number	
PC32500WK	753B081G16	A	—	—	—	1-3, 5, 8
PC33000F	6590C19G10	A	—	—	—	1-3, 5, 8
PC33000FM	6590C19G12	O	PC33000F	6590C19G10	—	1-3, 5, 8
PC33000K	753B081G17	A	—	—	—	1-3, 5, 8
PCA22000F	6590C19G17	O	—	—	RD320T32W	1-3, 5, 8
PCA22500F	6590C19G21	O	—	—	RD325T32W	1-3, 5, 8
PCA22500FM	6590C19G07	O	—	—	RD325T32W	1-3, 5, 8
PCA23000F	6590C19G25	O	—	—	—	1-3, 5, 8
PCA32000F	6590C19G18	A	—	—	RD320T32W	1-3, 5, 8
PCA32500F	6590C19G22	A	—	—	RD325T32W	1-3, 5, 8
PCA33000F	6590C19G26	A	—	—	—	1-3, 5, 8
PCC22000F	6590C20G01	O	—	—	CRD320T33W	1-3, 5, 8
PCC22000FM	6590C20G03	O	—	—	CRD320T33W	1-3, 5, 8
PCC22000WK	752B076G09	O	—	—	—	1-3, 5, 8
PCC22500F	6590C20G05	O	—	—	—	1-3, 5, 8
PCC22500FM	6590C20G07	O	—	—	—	1-3, 5, 8
PCC22500WK	753B081G05	O	—	—	—	1-3, 5, 8
PCC23000F	6590C20G09	O	—	—	—	1-3, 5, 8
PCC23000FM	6590C20G11	O	—	—	—	1-3, 5, 8
PCC23000K	753B081G11	O	—	—	—	1-3, 5, 8
PCC32000F	6590C20G02	A	—	—	CRD320T33W	1-3, 5, 8
PCC32000FM	6590C20G04	O	PCC32000F	6590C20G02	CRD320T33W	1-3, 5, 8
PCC32000WK	753B081G20	A	—	—	—	1-3, 5, 8
PCC32500F	6590C20G06	A	—	—	—	1-3, 5, 8
PCC32500FM	6590C20G08	O	PCC32500F	6590C20G06	—	1-3, 5, 8
PCC32500WK	753B081G21	A	—	—	—	1-3, 5, 8
PCC33000F	6590C20G10	A	—	—	—	1-3, 5, 8
PCC33000FM	6590C20G12	O	PCC33000F	6590C20G10	—	1-3, 5, 8
PCC33000K	753B081G22	A	—	—	—	1-3, 5, 8
PCCA22000F	6590C20G17	O	—	—	CRD320T32W	1-3, 5, 8
PCCA22500F	6590C20G21	O	—	—	—	1-3, 5, 8
PCCA23000F	6590C20G25	O	—	—	—	1-3, 5, 8
PCCA32000F	6590C20G18	A	—	—	CRD320T32W	1-3, 5, 8
PCCA32500F	6590C20G22	A	—	—	—	1-3, 5, 8
PCCA33000F	6590C20G26	A	—	—	—	1-3, 5, 8
PCCF22000F	6590C18G01	O	—	—	CRD320T33W	1-3, 5, 8
PCCF22000FM	6590C18G03	O	—	—	CRD320T33W	1-3, 5, 8
PCCF22500F	6590C18G05	O	—	—	—	1-3, 5, 8
PCCF22500FM	6590C18G07	O	—	—	—	1-3, 5, 8
PCCF32000F	6590C18G02	A	—	—	CRD320T33W	1-3, 5, 8
PCCF32000FM	6590C18G04	O	PCCF32000F	6590C18G02	CRD320T33W	1-3, 5, 8
PCCF32500F	6590C18G06	A	—	—	—	1-3, 5, 8
PCCF32500FM	6590C18G08	O	PCCF32500F	6590C18G06	—	1-3, 5, 8
PCCFA22000F	1225C07G13	O	—	—	CRD320T32W	1-3, 5, 8
PCCFA22500F	6590C18G17	O	—	—	—	1-3, 5, 8
PCCFA32000F	6590C18G14	A	—	—	CRD320T32W	1-3, 5, 8
PCCFA32500F	6590C18G18	A	—	—	—	1-3, 5, 8

Note

^① O = Obsolete, A = Available.

Replacement Breaker Cross-Reference

Replacement Breaker			Replacements			Notes
Catalog Number	Style Number	Status ①	MARK 75 Catalog Number	MARK 75 Style Number	Series C Catalog Number	(See Page V12-T3-114)
PCCFG32000F	1242C76G17	A	—	—	CRD320T35W	1–3, 5, 8
PCCFG32500F	1242C76G18	A	—	—	—	1–3, 5, 8
PCCFGA32000F	1242C78G21	A	—	—	CRD320T36W	1–3, 5, 8
PCCFGA32500F	1242C78G22	A	—	—	—	1–3, 5, 8
PCCG32000F	1242C75G25	A	—	—	CRD320T35W	1–3, 5, 8
PCCG32500F	1242C75G26	A	—	—	—	1–3, 5, 8
PCCG33000F	1242C75G27	A	—	—	—	1–3, 5, 8
PCCGA32000F	1242C75G31	A	—	—	CRD320T36W	1–3, 5, 8
PCCGA32500F	1242C75G32	A	—	—	—	1–3, 5, 8
PCCGA33000F	1242C75G33	A	—	—	—	1–3, 5, 8
PCF22000F	6590C17G01	O	—	—	RD320T33W	1–3, 5, 8
PCF22000FM	6590C17G03	O	—	—	RD320T33W	1–3, 5, 8
PCF22000K	753B081G08	O	—	—	RD320WK	1–3, 5, 8
PCF22500FM	6590C17G07	O	—	—	RD325T33W	1–3, 5, 8
PCF32000F	6590C17G02	A	—	—	RD320T33W	1–3, 5, 8
PCF32000FM	6590C17G04	O	PCF32000F	6590C17G02	RD320T33W	1–3, 5, 8
PCF32000K	753B081G19	A	—	—	RD320WK	1–3, 5, 8
PCF32500F	6590C17G06	A	—	—	RD325T33W	1–3, 5, 8
PCF32500FM	6590C17G08	O	PCF32500F	6590C17G06	RD325T33W	1–3, 5, 8
PCFA22000F	6590C17G13	O	—	—	RD320T32W	1–3, 5, 8
PCFA22500F	6590C17G17	O	—	—	RD325T32W	1–3, 5, 8
PCFA32000F	6590C17G14	A	—	—	RD320T32W	1–3, 5, 8
PCFA32500F	6590C17G18	A	—	—	RD325T32W	1–3, 5, 8
PCFG32000F	1242C76G01	A	—	—	RD320T35W	1–3, 5, 8
PCFG32500F	1242C76G02	A	—	—	RD325T35W	1–3, 5, 8
PCFGA32000F	1242C76G05	A	—	—	RD320T36W	1–3, 5, 8
PCFGA32500F	1242C76G06	A	—	—	RD325T36W	1–3, 5, 8
PCG32000F	1242C75G01	A	—	—	RD320T35W	1–3, 5, 8
PCG32500F	1242C75G02	A	—	—	RD325T35W	1–3, 5, 8
PCG33000F	1242C75G03	A	—	—	—	1–3, 5, 8
PCGA32000F	1242C75G07	A	—	—	RD320T36W	1–3, 5, 8
PCGA32500F	1242C75G08	A	—	—	RD325T36W	1–3, 5, 8
PCGA33000F	1242C75G09	A	—	—	—	1–3, 5, 8
RE1010	1375D81G01	O	—	—	—	3, 10
RE1015	1375D81G02	O	—	—	Reconditioned E1015	10
RE1020	1375D81G03	O	—	—	Reconditioned E1020	10
RE1025	1375D81G04	O	—	—	Reconditioned E1025	10
RE1030	1375D81G05	O	—	—	Reconditioned E1030	10
RE1040	1375D81G07	O	—	—	Reconditioned E1040	10
RE1050	1375D81G08	O	—	—	Reconditioned E1050	10
RE1060	1375D81G09	O	—	—	Reconditioned E1060	10
RE1070	1375D81G10	O	—	—	Reconditioned E1070	10
RE1080	1375D81G11	O	—	—	Reconditioned E1080	10
RE1090	1375D81G12	O	—	—	Reconditioned E1090	10
RE1100	1375D81G13	O	—	—	Reconditioned E1100	10
RE2015	1375D81G18	O	—	—	Reconditioned E2015	10
RE2020	1375D81G19	O	—	—	Reconditioned E2020	10

Note

① O = Obsolete, A = Available.

Replacement Breaker Cross-Reference

Replacement Breaker		Status ^①	Replacements		Series C Catalog Number	Notes (See Page V12-T3-114)
Catalog Number	Style Number		MARK 75 Catalog Number	MARK 75 Style Number		
RE2025	1375D81G20	0	—	—	Reconditioned E2025	10
RE2030	1375D81G21	0	—	—	Reconditioned E2030	10
RE2040	1375D81G23	0	—	—	Reconditioned E2040	10
RE2050	1375D81G24	0	—	—	Reconditioned E2050	10
RE2060	1375D81G25	0	—	—	Reconditioned E2060	10
RE2070	1375D81G26	0	—	—	Reconditioned E2070	10
RE2080	1375D81G27	0	—	—	Reconditioned E2080	10
RE2090	1375D81G28	0	—	—	Reconditioned E2090	10
RE2100	1375D81G29	0	—	—	Reconditioned E2100	10
RE3015	1375D81G34	0	—	—	Reconditioned E3015	10
RE3020	1375D81G35	0	—	—	Reconditioned E3020	10
RE3025	1375D81G36	0	—	—	Reconditioned E3025	10
RE3030	1375D81G37	0	—	—	Reconditioned E3030	10
RE3040	1375D81G39	0	—	—	Reconditioned E3040	10
RE3050	1375D81G40	0	—	—	Reconditioned E3050	10
RE3060	1375D81G41	0	—	—	Reconditioned E3060	10
RE3070	1375D81G42	0	—	—	Reconditioned E3070	10
RE3080	1375D81G43	0	—	—	Reconditioned E3080	10
RE3090	1375D81G44	0	—	—	Reconditioned E3090	10
RE3100	1375D81G45	0	—	—	Reconditioned E3100	10
REA1010	1375D82G01	0	—	—	—	—
REA1015	1375D82G02	0	—	—	Reconditioned EA1015	10
REA1020	1375D82G03	0	—	—	Reconditioned EA1020	10
REA1025	1375D82G04	0	—	—	Reconditioned EA1025	10
REA1030	1375D82G05	0	—	—	Reconditioned EA1030	10
REA1035	1375D82G06	0	—	—	Reconditioned EA1035	10
REA1040	1375D82G07	0	—	—	Reconditioned EA1040	10
REA1050	1375D82G08	0	—	—	Reconditioned EA1050	10
REA1060	1375D82G09	0	—	—	Reconditioned EA1060	10
REA1070	1375D82G10	0	—	—	Reconditioned EA1070	10
REA1080	1375D82G11	0	—	—	Reconditioned EA1080	10
REA1090	1375D82G12	0	—	—	Reconditioned EA1090	10
REA1100	1375D82G13	0	—	—	Reconditioned EA1100	10
REA2015	1375D82G18	0	—	—	Reconditioned EA2015	10
REA2020	1375D82G19	0	—	—	Reconditioned EA2020	10
REA2025	1375D82G20	0	—	—	Reconditioned EA2025	10
REA2030	1375D82G21	0	—	—	Reconditioned EA2030	10
REA2040	1375D82G23	0	—	—	Reconditioned EA2040	10
REA2050	1375D82G24	0	—	—	Reconditioned EA2050	10
REA2060	1375D82G25	0	—	—	Reconditioned EA2060	10
REA2070	1375D82G26	0	—	—	Reconditioned EA2070	10
REA2080	1375D82G27	0	—	—	Reconditioned EA2080	10
REA2090	1375D82G28	0	—	—	Reconditioned EA2090	10
REA2100	1375D82G29	0	—	—	Reconditioned EA2100	10
REA3015	1375D82G34	0	—	—	Use REH3015	10
REA3020	1375D82G35	0	—	—	Use REH3020	10
REA3025	1375D82G36	0	—	—	Use REH3025	10

Note

^① 0 = Obsolete, A = Available.

Replacement Breaker Cross-Reference

Replacement Breaker			Replacements			Notes
Catalog Number	Style Number	Status ^①	MARK 75 Catalog Number	MARK 75 Style Number	Series C Catalog Number	(See Page V12-T3-114)
REA3030	1375D82G37	0	—	—	Use REH3030	10
REA3040	1375D82G39	0	—	—	Use REH3040	10
REA3050	1375D82G40	0	—	—	Use REH3050	10
REA3060	1375D82G41	0	—	—	Use REH3060	10
REA3070	1375D82G42	0	—	—	Use REH3070	10
REA3080	1375D82G43	0	—	—	Use REH3080	10
REA3090	1375D82G44	0	—	—	Use REH3090	10
REA3100	1375D82G45	0	—	—	Use REH3100	10
REH1010	1375D83G01	0	—	—	—	3, 10
REH1015	1375D83G02	0	—	—	Reconditioned EH1015	10
REH1020	1375D83G03	0	—	—	Reconditioned EH1020	10
REH1025	1375D83G04	0	—	—	Reconditioned EH1025	10
REH1030	1375D83G05	0	—	—	Reconditioned EH1030	10
REH1040	1375D83G07	0	—	—	Reconditioned EH1040	10
REH1050	1375D83G08	0	—	—	Reconditioned EH1050	10
REH1060	1375D83G09	0	—	—	Reconditioned EH1060	10
REH1070	1375D83G10	0	—	—	Reconditioned EH1070	10
REH1080	1375D83G11	0	—	—	Reconditioned EH1080	10
REH1090	1375D83G12	0	—	—	Reconditioned EH1090	10
REH1100	1375D83G13	0	—	—	Reconditioned EH1100	10
REH2015	1375D83G18	0	—	—	Reconditioned EH2015	10
REH2020	1375D83G19	0	—	—	Reconditioned EH2020	10
REH2025	1375D83G20	0	—	—	Reconditioned EH2025	10
REH2030	1375D83G21	0	—	—	Reconditioned EH2030	10
REH2040	1375D83G23	0	—	—	Reconditioned EH2040	10
REH2050	1375D83G24	0	—	—	Reconditioned EH2050	10
REH2060	1375D83G25	0	—	—	Reconditioned EH2060	10
REH2070	1375D83G26	0	—	—	Reconditioned EH2070	10
REH2080	1375D83G27	0	—	—	Reconditioned EH2080	10
REH2090	1375D83G28	0	—	—	Reconditioned EH2090	10
REH2100	1375D83G29	0	—	—	Reconditioned EH2100	10
REH3015	1375D83G34	A	—	—	—	3, 10
REH3020	1375D83G35	A	—	—	—	3, 10
REH3025	1375D83G36	A	—	—	—	3, 10
REH3030	1375D83G37	A	—	—	—	3, 10
REH3040	1375D83G39	A	—	—	—	3, 10
REH3050	1375D83G40	A	—	—	—	3, 10
REH3060	1375D83G41	A	—	—	—	3, 10
REH3070	1375D83G42	A	—	—	—	3, 10
REH3080	1375D83G43	A	—	—	—	3, 10
REH3090	1375D83G44	A	—	—	—	3, 10
REH3100	1375D83G45	A	—	—	—	3, 10
RF2015	1375D86G02	0	—	—	Reconditioned F2015	3, 10
RF2020	1375D86G03	0	—	—	Reconditioned F2020	3, 10
RF2025	NO STYLE	0	—	—	Reconditioned F2025	3, 10
RF2030	1375D86G05	0	—	—	Reconditioned F2030	3, 10
RF2040	1375D86G07	0	—	—	Reconditioned F2040	3, 10

Note

① 0 = Obsolete, A = Available.

Replacement Breaker Cross-Reference

Replacement Breaker		Status ①	Replacements		Series C Catalog Number	Notes (See Page V12-T3-114)
Catalog Number	Style Number		MARK 75 Catalog Number	MARK 75 Style Number		
RF2050	1375D86G08	0	—	—	Reconditioned F2050	3, 10
RF2060	1375D86G09	0	—	—	Reconditioned F2060	3, 10
RF2070	1375D86G10	0	—	—	Reconditioned F2070	3, 10
RF2080	1375D86G11	0	—	—	Reconditioned F2080	3, 10
RF2090	1375D86G12	0	—	—	Reconditioned F2090	3, 10
RF2100	1375D86G13	0	—	—	Reconditioned F2100	3, 10
RF3015	1375D86G18	0	RHF3015	1375D87G18	—	3, 10
RF3020	1375D86G19	0	RHF3020	1375D87G19	—	3, 10
RF3025	1375D86G20	0	RHF3025	1375D87G20	—	3, 10
RF3030	1375D86G21	0	RHF3030	1375D87G21	—	3, 10
RF3040	1375D86G23	0	RHF3040	1375D87G23	—	3, 10
RF3050	1375D86G24	0	RHF3050	1375D87G24	—	3, 10
RF3060	1375D86G25	0	RHF3060	1375D87G25	—	3, 10
RF3070	1375D86G26	0	RHF3070	1375D87G26	—	3, 10
RF3080	1375D86G27	0	RHF3080	1375D87G27	—	3, 10
RF3090	1375D86G28	0	RHF3090	1375D87G28	—	3, 10
RF3100	1375D86G29	0	RHF3100	1375D87G29	—	3, 10
RFA2010	1375D84G01	0	—	—	—	3, 10
RFA2015	1375D84G02	0	—	—	Reconditioned FA2015	3, 10
RFA2020	1375D84G03	0	—	—	Reconditioned FA2020	3, 10
RFA2025	1375D84G04	0	—	—	Reconditioned FA2025	3, 10
RFA2030	1375D84G05	0	—	—	Reconditioned FA2030	3, 10
RFA2040	1375D84G07	0	—	—	Reconditioned FA2040	3, 10
RFA2045	1375D84G16	0	—	—	Reconditioned FA2045	3, 10
RFA2050	1375D84G08	0	—	—	Reconditioned FA2050	3, 10
RFA2060	1375D84G09	0	—	—	Reconditioned FA2060	3, 10
RFA2070	1375D84G10	0	—	—	Reconditioned FA2070	3, 10
RFA2080	1375D84G11	0	—	—	Reconditioned FA2080	3, 10
RFA2090	1375D84G12	0	—	—	Reconditioned FA2090	3, 10
RFA2100	1375D84G13	0	—	—	Reconditioned FA2100	3, 10
RFA2100K	1375D84G17	0	—	—	—	3, 10
RFA3010	1375D84G21	0	RHFA3010	1375D85G21	—	—
RFA3015	1375D84G22	0	RHFA3015	1375D85G22	—	3, 10
RFA3020	1375D84G23	0	RHFA3020	1375D85G23	—	3, 10
RFA3025	1375D84G24	0	RHFA3025	1375D85G24	—	3, 10
RFA3030	1375D84G25	0	RHFA3030	1375D85G25	—	3, 10
RFA3040	1375D84G27	0	RHFA3040	1375D85G27	—	3, 10
RFA3045	1375D84G36	0	RHFA3045	1375D85G36	—	3, 10
RFA3050	1375D84G28	0	RHFA3050	1375D85G28	—	3, 10
RFA3060	1375D84G29	0	RHFA3060	1375D85G29	—	3, 10
RFA3070	1375D84G30	0	RHFA3070	1375D85G30	—	3, 10
RFA3080	1375D84G31	0	RHFA3080	1375D85G31	—	3, 10
RFA3090	1375D84G32	0	RHFA3090	1375D85G32	—	3, 10
RFA3100	1375D84G33	0	RHFA3100	1375D85G33	—	3, 10
RFA3100K	1375D84G37	0	—	—	—	—
RHF2015	1375D87G02	0	—	—	Reconditioned HF2015	10
RHF2020	1375D87G03	0	—	—	Reconditioned HF2020	10

Note

① 0 = Obsolete, A = Available.

Replacement Breaker Cross-Reference

Replacement Breaker			Replacements			Notes
Catalog Number	Style Number	Status ^①	MARK 75 Catalog Number	MARK 75 Style Number	Series C Catalog Number	(See Page V12-T3-114)
RHF2030	1375D87G05	0	—	—	Reconditioned HF2030	10
RHF2040	1375D87G07	0	—	—	Reconditioned HF2040	10
RHF2050	1375D87G08	0	—	—	Reconditioned HF2050	10
RHF2060	1375D87G09	0	—	—	Reconditioned HF2060	10
RHF2070	1375D87G10	0	—	—	Reconditioned HF2070	10
RHF2080	1375D87G11	0	—	—	Reconditioned HF2080	10
RHF2090	1375D87G12	0	—	—	Reconditioned HF2090	10
RHF2100	1375D87G13	0	—	—	Reconditioned HF2100	10
RHF3015	1375D87G18	A	—	—	—	10
RHF3020	1375D87G19	A	—	—	—	10
RHF3025	1375D87G20	A	—	—	—	10
RHF3030	1375D87G21	A	—	—	—	10
RHF3040	1375D87G23	A	—	—	—	10
RHF3050	1375D87G24	A	—	—	—	10
RHF3060	1375D87G25	A	—	—	—	10
RHF3070	1375D87G26	A	—	—	—	10
RHF3080	1375D87G27	A	—	—	—	10
RHF3090	1375D87G28	A	—	—	—	10
RHF3100	1375D87G29	A	—	—	—	10
RHFA2015	1375D85G02	0	—	—	Reconditioned FA2015	10
RHFA2020	1375D85G03	0	—	—	Reconditioned FA2020	10
RHFA2025	1375D85G04	0	—	—	Reconditioned FA2025	10
RHFA2030	1375D85G05	0	—	—	Reconditioned FA2030	10
RHFA2040	1375D85G07	0	—	—	Reconditioned FA2040	10
RHFA2050	1375D85G08	0	—	—	Reconditioned FA2050	10
RHFA2060	1375D85G09	0	—	—	Reconditioned FA2060	10
RHFA2070	1375D85G10	0	—	—	Reconditioned FA2070	10
RHFA2080	1375D85G11	0	—	—	Reconditioned FA2080	10
RHFA2090	1375D85G12	0	—	—	Reconditioned FA2090	10
RHFA2100	1375D85G13	0	—	—	Reconditioned FA2100	10
RHFA2150	1375D85G15	0	—	—	Reconditioned FA2150	10
RHFA3015	1375D85G22	A	—	—	—	10
RHFA3020	1375D85G23	A	—	—	—	10
RHFA3025	1375D85G24	A	—	—	—	10
RHFA3030	1375D85G25	A	—	—	—	10
RHFA3040	1375D85G27	A	—	—	—	10
RHFA3050	1375D85G28	A	—	—	—	10
RHFA3060	1375D85G29	A	—	—	—	10
RHFA3070	1375D85G30	A	—	—	—	10
RHFA3080	1375D85G31	A	—	—	—	10
RHFA3090	1375D85G32	A	—	—	—	10
RHFA3100	1375D85G33	A	—	—	—	10
RHFA3150	1375D85G35	A	—	—	—	10
RHK2070	1376D14G02	0	—	—	Reconditioned HK2070	10
RHK2090	1376D14G03	0	—	—	Reconditioned HK2090	10
RHK2100	1376D14G04	0	—	—	Reconditioned HK2100	10
RHK2125	1376D14G05	0	—	—	Reconditioned HK2125	10

Note

① 0 = Obsolete, A = Available.

Replacement Breaker Cross-Reference

Replacement Breaker		Status ①	Replacements		Series C Catalog Number	Notes (See Page V12-T3-114)
Catalog Number	Style Number		MARK 75 Catalog Number	MARK 75 Style Number		
RHK2150	1376D14G06	0	—	—	Reconditioned HK2150	10
RHK2175	1376D14G07	0	—	—	Reconditioned HK2175	10
RHK2200	1376D14G08	0	—	—	Reconditioned HK2200	10
RHK2225	1376D14G09	0	—	—	Reconditioned HK2225	10
RHK2225K	NO STYLE	0	—	—	—	—
RHK3070	1376D14G22	A	—	—	—	10
RHK3090	1376D14G23	A	—	—	—	10
RHK3100	1376D14G24	A	—	—	—	10
RHK3125	1376D14G25	A	—	—	—	10
RHK3150	1376D14G26	A	—	—	—	10
RHK3175	1376D14G27	A	—	—	—	10
RHK3200	1376D14G28	A	—	—	—	10
RHK3225	1376D14G29	A	—	—	—	10
RHK3225K	NO STYLE	0	—	—	—	—
RHKL2125	1376D15G05	0	—	—	Reconditioned KL2125	10
RHKL2150	1376D15G06	0	—	—	Reconditioned KL2150	10
RHKL2175	1376D15G07	0	—	—	Reconditioned KL2175	10
RHKL2200	1376D15G08	0	—	—	Reconditioned KL2200	10
RHKL2225	1376D15G09	0	—	—	Reconditioned KL2225	10
RHKL2250	1376D15G10	0	—	—	Reconditioned KL2250	10
RHKL2300	1376D15G12	0	—	—	Reconditioned KL2300	10
RHKL2350	1376D15G14	0	—	—	Reconditioned KL2350	10
RHKL2400	1376D15G15	0	—	—	Reconditioned KL2400	10
RHKL2400K	NO STYLE	0	—	—	—	—
RHKL3125	1376D15G25	A	—	—	—	10
RHKL3150	1376D15G26	A	—	—	—	10
RHKL3175	1376D15G27	A	—	—	—	10
RHKL3200	1376D15G28	A	—	—	—	10
RHKL3225	1376D15G29	A	—	—	—	10
RHKL3250	1376D15G30	A	—	—	—	10
RHKL3300	1376D15G32	A	—	—	—	10
RHKL3350	1376D15G34	A	—	—	—	10
RHKL3400	1376D15G35	A	—	—	—	10
RHKL3400K	NO STYLE	A	—	—	—	10
RHLM2125	1376D16G05	0	—	—	Reconditioned LM2125	10
RHLM2150	1376D16G06	0	—	—	Reconditioned LM2150	10
RHLM2175	1376D16G07	0	—	—	Reconditioned LM2175	10
RHLM2200	1376D16G08	0	—	—	Reconditioned LM2200	10
RHLM2225	1376D16G09	0	—	—	Reconditioned LM2225	10
RHLM2250	1376D16G10	0	—	—	Reconditioned LM2250	10
RHLM2275	1376D16G11	0	—	—	Reconditioned LM2275	10
RHLM2300	1376D16G12	0	—	—	Reconditioned LM2300	10
RHLM2350	1376D16G14	0	—	—	Reconditioned LM2350	10
RHLM2400	1376D16G15	0	—	—	Reconditioned LM2400	10
RHLM2450	1376D16G16	0	—	—	Reconditioned LM2450	10
RHLM2500	1376D16G17	0	—	—	Reconditioned LM2500	10
RHLM2550	1376D16G18	0	—	—	Reconditioned LM2550	10

Note

① 0 = Obsolete, A = Available.

Replacement Breaker Cross-Reference

Replacement Breaker			Replacements			Notes
Catalog Number	Style Number	Status ^①	MARK 75 Catalog Number	MARK 75 Style Number	Series C Catalog Number	(See Page V12-T3-114)
RHLM2600	1376D16G19	0	—	—	Reconditioned LM2600	10
RHLM2600K	1376D16G20	0	—	—	—	—
RHLM2700	NO STYLE	0	—	—	Reconditioned LM2700	10
RHLM2800	1376D16G22	0	—	—	Reconditioned LM2800	10
RHLM3125	1376D16G35	A	—	—	—	10
RHLM3150	1376D16G36	A	—	—	—	10
RHLM3175	1376D16G37	A	—	—	—	10
RHLM3200	1376D16G38	A	—	—	—	10
RHLM3225	1376D16G39	A	—	—	—	10
RHLM3250	1376D16G40	A	—	—	—	10
RHLM3275	1376D16G41	A	—	—	—	10
RHLM3300	1376D16G42	A	—	—	—	10
RHLM3325	1376D16G43	A	—	—	—	10
RHLM3350	1376D16G44	A	—	—	—	10
RHLM3400	1376D16G45	A	—	—	—	10
RHLM3450	1376D16G46	A	—	—	—	10
RHLM3500	1376D16G47	A	—	—	—	10
RHLM3550	1376D16G48	A	—	—	—	10
RHLM3600	1376D16G49	A	—	—	—	10
RHLM3600K	1376D16G50	0	—	—	—	—
RHLM3700	1376D16G51	A	—	—	—	10
RHLM3800	1376D16G52	A	—	—	—	10
RJ2070	1376D10G02	0	—	—	Reconditioned J2070	3, 10
RJ2090	1376D10G03	0	—	—	Reconditioned J2090	3, 10
RJ2100	1376D10G04	0	—	—	Reconditioned J2100	3, 10
RJ2125	1376D10G05	0	—	—	Reconditioned J2125	3, 10
RJ2150	1376D10G06	0	—	—	Reconditioned J2150	3, 10
RJ2175	1376D10G07	0	—	—	Reconditioned J2175	3, 10
RJ2200	1376D10G08	0	—	—	Reconditioned J2200	3, 10
RJ2225	1376D10G09	0	—	—	Reconditioned J2225	3, 10
RJ2225K	NO STYLE	0	—	—	—	—
RJ3070	1376D10G22	A	—	—	—	3, 10
RJ3090	1376D10G23	A	—	—	—	3, 10
RJ3100	1376D10G24	A	—	—	—	3, 10
RJ3125	1376D10G25	A	—	—	—	3, 10
RJ3150	1376D10G26	A	—	—	—	3, 10
RJ3175	1376D10G27	A	—	—	—	3, 10
RJ3200	1376D10G28	A	—	—	—	3, 10
RJ3225	1376D10G29	A	—	—	—	3, 10
RJ3225K	NO STYLE	0	—	—	—	—
RK2070	1376D11G02	0	—	—	Reconditioned K2070	3, 10
RK2090	1376D11G03	0	—	—	Reconditioned K2090	3, 10
RK2100	1376D11G04	0	—	—	Reconditioned K2100	3, 10
RK2125	1376D11G05	0	—	—	Reconditioned K2125	3, 10
RK2150	1376D11G06	0	—	—	Reconditioned K2150	3, 10
RK2175	1376D11G07	0	—	—	Reconditioned K2175	3, 10
RK2200	1376D11G08	0	—	—	Reconditioned K2200	3, 10

Note

① 0 = Obsolete, A = Available.

Replacement Breaker Cross-Reference

Replacement Breaker		Status ①	Replacements			Notes (See Page V12-T3-114)
Catalog Number	Style Number		MARK 75 Catalog Number	MARK 75 Style Number	Series C Catalog Number	
RK2225	1376D11G09	0	—	—	Reconditioned K2225	3, 10
RK2225K	1376D11G10	0	—	—	—	—
RK3070	1376D11G22	0	RHK3070	1376D14G22	—	3, 10
RK3090	1376D11G23	0	RHK3090	1376D14G23	—	3, 10
RK3100	1376D11G24	0	RHK3100	1376D14G24	—	3, 10
RK3125	1376D11G25	0	RHK3125	1376D14G25	—	3, 10
RK3150	1376D11G26	0	RHK3150	1376D14G26	—	3, 10
RK3175	1376D11G27	0	RHK3175	1376D14G27	—	3, 10
RK3200	1376D11G28	0	RHK3200	1376D14G28	—	3, 10
RK3225	1376D11G29	0	RHK3225	1376D14G29	—	3, 10
RK3225K	1376D11G30	0	—	—	—	—
RKL2125	1376D12G05	0	—	—	Reconditioned L2125	3, 10
RKL2150	1376D12G06	0	—	—	Reconditioned L2150	3, 10
RKL2175	1376D12G07	0	—	—	Reconditioned L2175	3, 10
RKL2200	1376D12G08	0	—	—	Reconditioned L2200	3, 10
RKL2225	1376D12G09	0	—	—	Reconditioned L2225	3, 10
RKL2250	1376D12G10	0	—	—	Reconditioned L2250	3, 10
RKL2275	NO STYLE	0	—	—	—	3, 10
RKL2300	1376D12G12	0	—	—	Reconditioned L2300	3, 10
RKL2350	1376D12G14	0	—	—	Reconditioned L2350	3, 10
RKL2400	1376D12G15	0	—	—	Reconditioned L2400	3, 10
RKL2400K	NO STYLE	0	—	—	—	—
RKL3125	1376D12G25	0	RHKL3125	1376D15G25	—	3, 10
RKL3150	1376D12G26	0	RHKL3150	1376D15G26	—	3, 10
RKL3175	1376D12G27	0	RHKL3175	1376D15G27	—	3, 10
RKL3200	1376D12G28	0	RHKL3200	1376D15G28	—	3, 10
RKL3225	1376D12G29	0	RHKL3225	1376D15G29	—	3, 10
RKL3250	1376D12G30	0	RHKL3250	1376D15G30	—	3, 10
RKL3300	1376D12G32	0	RHKL3300	1376D15G32	—	3, 10
RKL3350	1376D12G34	0	RHKL3350	1376D15G34	—	3, 10
RKL3400	1376D12G35	0	RHKL3400	1376D15G35	—	3, 10
RLM2125	1376D13G05	0	—	—	Reconditioned LM2125	3, 10
RLM2150	1376D13G06	0	—	—	Reconditioned LM2150	3, 10
RLM2175	1376D13G07	0	—	—	Reconditioned LM2175	3, 10
RLM2200	1376D13G08	0	—	—	Reconditioned LM2200	3, 10
RLM2225	1376D13G09	0	—	—	Reconditioned LM2225	3, 10
RLM2250	1376D13G10	0	—	—	Reconditioned LM2250	3, 10
RLM2275	1376D13G11	0	—	—	Reconditioned LM2275	3, 10
RLM2300	1376D13G12	0	—	—	Reconditioned LM2300	3, 10
RLM2350	1376D13G14	0	—	—	Reconditioned LM2350	3, 10
RLM2400	1376D13G15	0	—	—	Reconditioned LM2400	3, 10
RLM2500	1376D13G17	0	—	—	Reconditioned LM2500	3, 10
RLM2600	1376D13G19	0	—	—	Reconditioned LM2600	3, 10
RLM2600K	1376D13G20	0	—	—	—	—
RLM2700	1376D13G21	0	—	—	Reconditioned LM2700	3, 10
RLM3150	1376D13G36	0	RHLM3150	1376D16G36	—	3, 10
RLM3175	1376D13G37	0	RHLM3175	1376D16G37	—	3, 10

Note

① 0 = Obsolete, A = Available.

Replacement Breaker Cross-Reference

Replacement Breaker			Replacements			Notes (See Page V12-T3-114)
Catalog Number	Style Number	Status ^①	MARK 75 Catalog Number	MARK 75 Style Number	Series C Catalog Number	
RLM3200	1376D13G38	0	RHLM3200	1376D16G38	—	3, 10
RLM3225	1376D13G39	0	RHLM3225	1376D16G39	—	3, 10
RLM3250	1376D13G40	0	RHLM3250	1376D16G40	—	3, 10
RLM3275	1376D13G41	0	RHLM3275	1376D16G41	—	3, 10
RLM3300	1376D13G42	0	RHLM3300	1376D16G42	—	3, 10
RLM3350	1376D13G44	0	RHLM3350	1376D16G44	—	3, 10
RLM3400	1376D13G45	0	RHLM3400	1376D16G45	—	3, 10
RLM3500	1376D13G47	0	RHLM3500	1376D16G47	—	3, 10
RLM3600	1376D13G49	0	RHLM3600	1376D16G49	—	3, 10
RLM3600K	1376D13G50	0	—	—	—	—
RLM3700	1376D13G51	0	RHLM3700	1376D16G51	—	3, 10
RLM3800	1376D13G52	0	RHLM3800	1376D16G52	—	3, 10

Note

^① 0 = Obsolete, A = Available.

Mining Breaker Replacement Cross-Reference

Replacement Breaker Mining and 1000V Catalog Number		Style Number	Status ^①	Replacements MARK 75 Catalog Number	E2 Style Number	Notes (See Page V12-T3-114)
1227C36G09	1227C36G09	0	—	1227C36G11	E2N312W	1-3, 5, 7, 8
1227C36G10	1227C36G10	0	—	1227C36G12	E2N310W	1-3, 5, 7, 8
1227C36G11	1227C36G11	A	—	—	E2NM312W	1-3, 5, 7, 8
1227C36G12	1227C36G12	A	—	—	E2NM310W	1-3, 5, 7, 8
1227C36G13	1227C36G13	0	—	—	E2N310WS10	1-3, 5, 7, 8
1227C36G14	1227C36G14	0	—	—	E2N312WS10	1-3, 5, 7, 8
1227C36G19	1227C36G19	0	—	—	E2N312MW	1-3, 5, 7, 8
1227C37G15	1227C37G15	0	—	—	E2N310WU66	1-3, 5, 7, 8
1227C37G16	1227C37G16	0	—	—	E2N312WU66	1-3, 5, 7, 8
1227C37G17	1227C37G17	0	—	1227C36G12	E2N310W	1-3, 5, 7, 8
1227C37G18	1227C37G18	0	—	1229C37G19	E2N310WU66	1-3, 5, 7, 8
1227C37G19	1227C37G19	0	—	—	E2N310WS10	1-3, 5, 7, 8
1227C37G21	1227C37G21	0	—	—	E2N312WS10	1-3, 5, 7, 8
1227C37G22	1227C37G22	0	—	1227C36G12	E2N312W	1-3, 5, 7, 8
1227C37G23	1227C37G23	0	—	1229C37G20	E2N312WU66	1-3, 5, 7, 8
1227C37G27	1227C37G27	0	—	—	E2N312MW	1-3, 5, 7, 8
1227C37G28	1227C37G28	0	—	1229C37G18	E2N312MWU66	1-3, 5, 7, 8
1228C81G01	1228C81G01	A	—	—	—	1-3, 5, 7, 8
1228C81G02	1228C81G02	A	—	—	—	1-3, 5, 7, 8
1228C81G03	1228C81G03	A	—	—	—	1-3, 5, 7, 8
1228C81G04	1228C81G04	A	—	—	—	1-3, 5, 7, 8
1228C82G01	1228C82G01	A	—	—	—	1-3, 5, 7, 8
1228C82G02	1228C82G02	A	—	—	—	1-3, 5, 7, 8
1228C82G03	1228C82G03	A	—	—	—	1-3, 5, 7, 8
1228C82G04	1228C82G04	A	—	—	—	1-3, 5, 7, 8
1229C37G13	1229C37G13	0	—	—	E2N310WU66	1-3, 5, 7, 8
1229C37G14	1229C37G14	0	—	—	E2N312WU66	1-3, 5, 7, 8
1229C37G15	1229C37G15	0	—	1229C37G19	E2N310WU66	1-3, 5, 7, 8
1229C37G16	1229C37G16	0	—	—	E2N312WU66	1-3, 5, 7, 8
1229C37G17	1229C37G17	0	—	1227C37G28	E2N312MWU66	1-3, 5, 7, 8
1229C37G18	1229C37G18	A	—	—	E2NM312MWU66	1-3, 5, 7, 8
1229C37G19	1229C37G19	A	—	—	E2NM310WU66	1-3, 5, 7, 8
1229C37G20	1229C37G20	A	—	—	E2NM312WU66	1-3, 5, 7, 8
1259C52G12	1259C52G12	0	—	—	E2FM050YM	1-3, 5, 7, 8
1259C52G13	1259C52G13	0	—	—	E2FM050KM	1-3, 5, 7, 8
1259C52G14	1259C52G14	0	—	—	E2FM100KM	1-3, 5, 7, 8
1259C52G15	1259C52G15	0	—	—	E2FM150TM	1-3, 5, 7, 8
1259C52G16	1259C52G16	0	—	—	E2FM050YM	1-3, 5, 7, 8
1259C52G17	1259C52G17	0	—	—	E2FM100KM	1-3, 5, 7, 8
1278C71G03	1278C71G03	0	—	5685D48G87	E2KE3225W	1-3, 5, 7, 8
1278C71G04	1278C71G04	0	—	5685D48G86	E2KE3225W	1-3, 5, 7, 8
1278C71G07	1278C71G07	0	—	—	E2KE3225WS10	1-3, 5, 7, 8
1278C71G08	1278C71G08	0	—	—	E2KE3225WS10	1-3, 5, 7, 8
1278C71G11	1278C71G11	0	—	—	E2KE3225MW	1-3, 5, 7, 8
1278C71G12	1278C71G12	0	—	—	E2KE3225MW	1-3, 5, 7, 8
1278C72G02	1278C72G02	0	—	5685D48G85	E2KE34002W	1-3, 5, 7, 8

Note

① 0 = Obsolete, A = Available.

Mining Breaker Replacement Cross-Reference

Replacement Breaker Mining and 1000V Catalog Number	Style Number	Status ①	Replacements MARK 75 Catalog Number	E2 Style Number	Notes (See Page V12-T3-114)
1278C72G04	1278C72G04	0	—	E2KE34002WS10	1-3, 5, 7, 8
1278C72G06	1278C72G06	0	—	E2KE3400M2W	1-3, 5, 7, 8
1278C73G01	1278C73G01	0	—	E2N3600WU66	1-3, 5, 7, 8
1278C73G02	1278C73G02	0	—	E2N3800WU66	1-3, 5, 7, 8
1278C73G03	1278C73G03	0	5685D48G84	E2N3600WU66	1-3, 5, 7, 8
1278C73G04	1278C73G04	0	2609D60G28	E2N3600WU66	1-3, 5, 7, 8
1278C73G05	1278C73G05	0	—	E2N3600WS10	1-3, 5, 7, 8
1278C73G07	1278C73G07	0	—	E2N3800WS10	1-3, 5, 7, 8
1278C73G08	1278C73G08	0	5685D48G83	E2N3800W	1-3, 5, 7, 8
1278C73G09	1278C73G09	0	2609D60G29	E2N3800WU66	1-3, 5, 7, 8
1278C73G11	1278C73G11	0	—	E2N3800MW	1-3, 5, 7, 8
1278C73G12	1278C73G12	0	2609D60G57	E2N3800MWU66	1-3, 5, 7, 8
1278C73G13	1278C73G13	0	—	E2N3800MW	1-3, 5, 7, 8
1278C73G14	1278C73G14	0	2609D60G58	E2N3800MWU66	1-3, 5, 7, 8
1284C67G01	1284C67G01	0	1284C68G01	E2KE3150W	1-3, 5, 7, 8
1284C67G02	1284C67G02	0	1284C68G02	E2KE3150WS10	1-3, 5, 7, 8
1284C67G03	1284C67G03	0	1284C68G03	E2KE3150WU66	1-3, 5, 7, 8
1284C67G04	1284C67G04	0	1284C68G04	E2KE3150WU66	1-3, 5, 7, 8
1284C67G05	1284C67G05	0	1284C68G05	E2LE3300W	1-3, 5, 7, 8
1284C67G06	1284C67G06	0	1284C68G06	E2LE3300WS10	1-3, 5, 7, 8
1284C67G07	1284C67G07	0	1284C68G07	E2LE3300WU66	1-3, 5, 7, 8
1284C67G08	1284C67G08	0	1284C68G08	E2LE3300WU66	1-3, 5, 7, 8
1284C67G09	1284C67G09	0	1284C68G09	E2LE3600W	1-3, 5, 7, 8
1284C67G10	1284C67G10	0	1284C68G10	E2LE3600WS10	1-3, 5, 7, 8
1284C67G11	1284C67G11	0	1284C68G11	E2LE3600WU66	1-3, 5, 7, 8
1284C67G12	1284C67G12	0	1284C68G12	E2LE3600WU66	1-3, 5, 7, 8
1284C68G01	1284C68G01	A	—	E2KEM3150W	1-3, 5, 7, 8
1284C68G02	1284C68G02	A	—	E2KEM3150WS10	1-3, 5, 7, 8
1284C68G03	1284C68G03	A	—	E2KEM3150WU66	1-3, 5, 7, 8
1284C68G04	1284C68G04	A	—	E2KEM3150WU66	1-3, 5, 7, 8
1284C68G05	1284C68G05	A	—	E2KEM3400W	1-3, 5, 7, 8
1284C68G06	1284C68G06	A	—	E2KEM3400WS10	1-3, 5, 7, 8
1284C68G07	1284C68G07	A	—	E2KEM3400WU66	1-3, 5, 7, 8
1284C68G08	1284C68G08	A	—	E2KEM3400WU66	1-3, 5, 7, 8
1284C68G09	1284C68G09	A	—	E2LEM3600W	1-3, 5, 7, 8
1284C68G10	1284C68G10	A	—	E2LEM3600WS10	1-3, 5, 7, 8
1284C68G11	1284C68G11	A	—	E2LEM3600WU66	1-3, 5, 7, 8
1284C68G12	1284C68G12	A	—	E2LEM3600WU66	1-3, 5, 7, 8
1284C80G01	1284C80G01	0	1284C68G01	E2KE3150W	1-3, 5, 7, 8
1284C80G02	1284C80G02	0	1284C68G02	E2KE3150WS10	1-3, 5, 7, 8
1284C80G03	1284C80G03	0	1284C68G03	E2KE3150WU66	1-3, 5, 7, 8
1284C80G04	1284C80G04	0	1284C68G04	E2KE3150WU66	1-3, 5, 7, 8
1284C80G05	1284C80G05	0	1284C68G05	E2LE3300W	1-3, 5, 7, 8
1284C80G06	1284C80G06	0	1284C68G06	E2LE3300WS10	1-3, 5, 7, 8
1284C80G07	1284C80G07	0	1284C68G07	E2LE3300WU66	1-3, 5, 7, 8
1284C80G08	1284C80G08	0	1284C68G08	E2LE3300WU66	1-3, 5, 7, 8

Note

① 0 = Obsolete, A = Available.

Mining Breaker Replacement Cross-Reference

Replacement Breaker Mining and 1000V Catalog Number		Style Number	Status ^①	Replacements MARK 75 Catalog Number	E2 Style Number	Notes (See Page V12-T3-114)
1284C80G09	1284C80G09	0		1284C68G09	E2LE3600W	1-3, 5, 7, 8
1284C80G10	1284C80G10	0		1284C68G10	E2LE3600WS10	1-3, 5, 7, 8
1284C80G11	1284C80G11	0		1284C68G11	E2LE3600WU66	1-3, 5, 7, 8
1284C80G12	1284C80G12	0		1284C68G12	E2LE3600WU66	1-3, 5, 7, 8
1284C81G01	1284C81G01	0		1284C83G01	E2N3800W	1-3, 5, 7, 8
1284C81G02	1284C81G02	0		1284C83G02	E2N3800WS10	1-3, 5, 7, 8
1284C81G03	1284C81G03	0		1284C83G03	E2N3800WU66	1-3, 5, 7, 8
1284C81G04	1284C81G04	0		1284C83G04	E2N3800WU66	1-3, 5, 7, 8
1284C82G01	1284C82G01	0		1284C83G01	E2N3800W	1-3, 5, 7, 8
1284C82G02	1284C82G02	0		1284C83G02	E2N3800WS10	1-3, 5, 7, 8
1284C82G03	1284C82G03	0		1284C83G03	E2N3800WU66	1-3, 5, 7, 8
1284C82G04	1284C82G04	0		1284C83G04	E2N3800WU66	1-3, 5, 7, 8
1284C83G01	1284C83G01	A		—	E2NM3800W	1-3, 5, 7, 8
1284C83G02	1284C83G02	A		—	E2NM3800WS10	1-3, 5, 7, 8
1284C83G03	1284C83G03	A		—	E2NM3800WU66	1-3, 5, 7, 8
1284C83G04	1284C83G04	A		—	E2NM3800WU66	1-3, 5, 7, 8
1291C26G01	1291C26G01	0		—	E2K3225AWU66	1-3, 5, 7, 8
1291C26G02	1291C26G02	0		—	E2K3225DWU66	1-3, 5, 7, 8
1291C26G03	1291C26G03	0		1291C26G12	E2K3225AWU66	1-3, 5, 7, 8
1291C26G04	1291C26G04	0		1291C26G13	E2K3225DWU66	1-3, 5, 7, 8
1291C26G05	1291C26G05	0		1291C26G14	E2K3400MAWU66	1-3, 5, 7, 8
1291C26G06	1291C26G06	0		1291C26G15	E2K3400MDWU66	1-3, 5, 7, 8
1291C26G07	1291C26G07	0		—	E2K3400MAWU66	1-3, 5, 7, 8
1291C26G08	1291C26G08	0		1291C26G16	E2K3400MAWU66	1-3, 5, 7, 8
1291C26G12	1291C26G12	A		—	E2KEM3225WU66	1-3, 5, 7, 8
1291C26G13	1291C26G13	A		—	E2KEM3225WU66	1-3, 5, 7, 8
1291C26G14	1291C26G14	A		—	E2KEM3225MWU66	1-3, 5, 7, 8
1291C26G15	1291C26G15	A		—	E2KEM3225MWU66	1-3, 5, 7, 8
1291C26G16	1291C26G16	A		—	E2KEM3225MWU66	1-3, 5, 7, 8
1291C26G17	1291C26G17	0		—	E2KE3225WU66	1-3, 5, 7, 8
1291C26G18	1291C26G18	0		—	E2KE3225WU66	1-3, 5, 7, 8
1291C26G19	1291C26G19	0		1291C26G12	E2KE3225WU66	1-3, 5, 7, 8
1291C26G20	1291C26G20	0		1291C26G13	E2KE3225WU66	1-3, 5, 7, 8
1291C26G21	1291C26G21	0		—	E2KE3225MWU66	1-3, 5, 7, 8
1291C26G22	1291C26G22	0		1291C26G15	E2KE3225MWU66	1-3, 5, 7, 8
1291C32G01	1291C32G01	0		—	E2LE3400WU66	1-3, 5, 7, 8
1291C32G02	1291C32G02	0		1291C32G07	E2LE3400WU66	1-3, 5, 7, 8
1291C32G03	1291C32G03	0		OMIT	E2LE3400WU66	1-3, 5, 7, 8
1291C32G04	1291C32G04	0		1291C32G09	E2LE3400MWU66	1-3, 5, 7, 8
1291C32G05	1291C32G05	0		—	E2KE3400WU66	1-3, 5, 7, 8
1291C32G06	1291C32G06	0		1291C32G07	E2KE34002WU66	1-3, 5, 7, 8
1291C32G07	1291C32G07	A		—	E2KEM34002WU66	1-3, 5, 7, 8
1291C32G08	1291C32G08	0		1291C32G09	E2KE3400M2WU66	1-3, 5, 7, 8
1291C32G09	1291C32G09	A		—	E2KEM3400M2WU66	1-3, 5, 7, 8
1366D21G01	1366D21G01	0		—	E2F030EM	1-3, 5, 7, 8
1366D21G02	1366D21G02	0		—	E2F050YM	1-3, 5, 7, 8

Note

① 0 = Obsolete, A = Available.

Mining Breaker Replacement Cross-Reference

Replacement Breaker Mining and 1000V Catalog Number		Style Number	Status ^①	Replacements MARK 75 Catalog Number	E2 Style Number	Notes (See Page V12-T3-114)
1366D21G03	1366D21G03		0	—	E2F050YM+ 625B229G08	1-3, 5, 7, 8
1366D21G04	1366D21G04		0	—	E2F100KM	1-3, 5, 7, 8
1366D21G05	1366D21G05		0	—	E2F100KMU62+ 625B229G08	1-3, 5, 7, 8
1366D21G06	1366D21G06		0	—	E2F050YM+ 625B229G08	1-3, 5, 7, 8
1366D21G07	1366D21G07		0	—	E2F100KMU62+ 625B229G08	1-3, 5, 7, 8
1366D21G08	1366D21G08		0	—	E2F030EM	1-3, 5, 7, 8
1366D21G09	1366D21G09		0	—	E2F030EM+ 625B229G08	1-3, 5, 7, 8
1366D21G10	1366D21G10		0	—	E2F030EMU62+ 625B229G08	1-3, 5, 7, 8
1366D21G11	1366D21G11		0	—	E2F030EMS22+ 625B229G08	1-3, 5, 7, 8
1366D21G12	1366D21G12		0	—	E2F030EMU62	1-3, 5, 7, 8
1366D21G13	1366D21G13		0	—	E2F030EM	1-3, 5, 7, 8
1366D21G14	1366D21G14		0	—	E2F3030	1-3, 5, 7, 8
1366D21G15	1366D21G15		0	—	E2F3030U62	1-3, 5, 7, 8
1366D21G16	1366D21G16		0	—	E2F3030S22	1-3, 5, 7, 8
1366D21G17	1366D21G17		0	—	E2F050YM	1-3, 5, 7, 8
1366D21G18	1366D21G18		0	—	E2F100KM	1-3, 5, 7, 8
1366D21G19	1366D21G19		0	—	E2F100KM+ 625B229G08	1-3, 5, 7, 8
1366D21G20	1366D21G20		0	—	E2F100KMU62+ 625B229G08	1-3, 5, 7, 8
1366D21G22	1366D21G22		0	—	E2F100KMS22+ 625B229G08	1-3, 5, 7, 8
1366D21G23	1366D21G23		A	—	E2F100KM+ 625B229G08	1-3, 5, 7, 8
1366D21G24	1366D21G24		A	—	E2F100KMU62+ 625B229G08	1-3, 5, 7, 8
1366D21G27	1366D21G27		0	—	E2F100KMU62	1-3, 5, 7, 8
1366D21G28	1366D21G28		0	—	E2F3100	1-3, 5, 7, 8
1366D21G29	1366D21G29		0	—	E2F3100U62	1-3, 5, 7, 8
1366D21G30	1366D21G30		A	—	E2F100KM	1-3, 5, 7, 8
1366D21G31	1366D21G31		A	—	E2F100KMU62	1-3, 5, 7, 8
1366D21G32	1366D21G32		A	—	E2F100KMS22	1-3, 5, 7, 8
1366D21G33	1366D21G33		0	—	E2F3100S22	1-3, 5, 7, 8
1366D21G34	1366D21G34		0	—	E2F050YMU62	1-3, 5, 7, 8
1366D21G35	1366D21G35		0	—	E2F050YM+ 625B229G08	1-3, 5, 7, 8
1366D21G36	1366D21G36		0	—	E2F050YMU62+ 625B229G08	1-3, 5, 7, 8
1366D21G37	1366D21G37		0	—	E2F050YMS22	1-3, 5, 7, 8
1366D21G38	1366D21G38		A	—	E2F050YMU62	1-3, 5, 7, 8
1366D21G39	1366D21G39		A	—	E2F050YM+ 625B229G08	1-3, 5, 7, 8

Note

① 0 = Obsolete, A = Available.

Mining Breaker Replacement Cross-Reference

Replacement Breaker Mining and 1000V Catalog Number	Style Number	Status ^①	Replacements MARK 75 Catalog Number	E2 Style Number	Notes (See Page V12-T3-114)
1366D21G40	1366D21G40	A	—	E2F050YMU62+ 625B229G08	1-3, 5, 7, 8
1366D21G41	1366D21G41	A	—	E2F050YMS22	1-3, 5, 7, 8
1366D21G42	1366D21G42	A	—	E2F030EMU62+ 625B229G08	1-3, 5, 7, 8
1366D21G43	1366D21G43	O	—	E2F100KMS22+ 625B229G08	1-3, 5, 7, 8
1366D21G44	1366D21G44	A	—	E2F100KMS22+ 625B229G08	1-3, 5, 7, 8
1366D21G45	1366D21G45	O	—	E2F100RMS22	1-3, 5, 7, 8
1366D21G46	1366D21G46	O	—	E2F3015U62	1-3, 5, 7, 8
1373D88G13	1373D88G13	O	1373D89G09	E2N312W	1-3, 5, 7, 8
1373D88G14	1373D88G14	O	1373D89G10	E2N312WS10	1-3, 5, 7, 8
1373D88G15	1373D88G15	O	1373D89G11	E2N312WU66	1-3, 5, 7, 8
1373D88G16	1373D88G16	O	1373D89G12	E2N312WU66	1-3, 5, 7, 8
1373D88G17	1373D88G17	O	1373D89G09	E2N312W	1-3, 5, 7, 8
1373D88G18	1373D88G18	O	1373D89G10	E2N312WS10	1-3, 5, 7, 8
1373D88G19	1373D88G19	O	1373D89G11	E2N312WU66	1-3, 5, 7, 8
1373D88G20	1373D88G20	O	1373D89G12	E2N312WU66	1-3, 5, 7, 8
1373D89G09	1373D89G09	A	—	E2NM312W	1-3, 5, 7, 8
1373D89G10	1373D89G10	A	—	E2NM312WS10	1-3, 5, 7, 8
1373D89G11	1373D89G11	A	—	E2NM312WU66	1-3, 5, 7, 8
1373D89G12	1373D89G12	A	—	E2NM312WU66	1-3, 5, 7, 8
2600D43G11	2600D43G11	O	1264C99G03	—	—
2600D43G12	2600D43G12	O	1264C99G03	—	—
2600D43G14	2600D43G14	O	1264C99G03	—	—
2602D86G11	2602D86G11	O	1264C99G05	—	—
2602D86G12	2602D86G12	O	1264C99G05	—	—
2602D86G13	2602D86G13	O	1264C99G05	—	—
2602D86G14	2602D86G14	O	1264C99G05	—	—
2602D99G05	2602D99G05	O	1264C99G02	—	—
2602D99G06	2602D99G06	O	1264C99G02	—	—
2602D99G07	2602D99G07	O	1264C99G02	—	—
2602D99G08	2602D99G08	O	1264C99G02	—	—
2603D48G07	2603D48G07	O	2603D48G09	—	—
2603D48G08	2603D48G08	O	2603D48G09	—	—
2609D60G01	2609D60G01	O	—	E2K3225AWS10	1-3, 5, 7, 8
2609D60G02	2609D60G02	O	—	E2K3225DWS10	1-3, 5, 7, 8
2609D60G03	2609D60G03	O	—	E2LE3400WS10	1-3, 5, 7, 8
2609D60G04	2609D60G04	O	—	E2N3600WS10	1-3, 5, 7, 8
2609D60G05	2609D60G05	O	—	E2N3800WS10	1-3, 5, 7, 8
2609D60G08	2609D60G08	O	—	E2FM100KM	1-3, 5, 7, 8
2609D60G09	2609D60G09	O	—	E2FM100KMU13	1-3, 5, 7, 8
2609D60G10	2609D60G10	O	—	E2FM050YM	1-3, 5, 7, 8
2609D60G17	2609D60G17	O	—	E2N3600WU66	1-3, 5, 7, 8
2609D60G18	2609D60G18	O	—	E2N3800WU66	1-3, 5, 7, 8
2609D60G19	2609D60G19	O	—	E2N3600W	1-3, 5, 7, 8
2609D60G20	2609D60G20	O	2609D60G29	E2N3800WU66	1-3, 5, 7, 8

Note

① O = Obsolete, A = Available.

Mining Breaker Replacement Cross-Reference

Replacement Breaker Mining and 1000V Catalog Number	Style Number	Status ①	Replacements MARK 75 Catalog Number	E2 Style Number	Notes (See Page V12-T3-114)
2609D60G28	2609D60G28	A	—	E2LEM36002WU66	1-3, 5, 7, 8
2609D60G29	2609D60G29	A	—	E2NM3800WU66	1-3, 5, 7, 8
2609D60G40	2609D60G40	O	—	E2K3400MAW	1-3, 5, 7, 8
2609D60G41	2609D60G41	O	—	E2K3400MDW	1-3, 5, 7, 8
2609D60G44	2609D60G44	O	—	E2LE3400MW	1-3, 5, 7, 8
2609D60G46	2609D60G46	O	—	E2N3800MW	1-3, 5, 7, 8
2609D60G47	2609D60G47	O	—	E2N3800MWU66	1-3, 5, 7, 8
2609D60G48	2609D60G48	O	—	E2N3800MW	1-3, 5, 7, 8
2609D60G49	2609D60G49	O	2609D60G58	E2N3800MWU66	1-3, 5, 7, 8
2609D60G57	2609D60G57	A	—	E2NM3800MW	1-3, 5, 7, 8
2609D60G58	2609D60G58	A	—	E2NM312MW	1-3, 5, 7, 8
2609D60G61	2609D60G61	O	—	E2LE3400MWS86	1-3, 5, 7, 8
2609D60G63	2609D60G63	O	—	E2LE34002WU66	1-3, 5, 7, 8
2609D60G64	2609D60G64	O	—	E2K3400MAW	1-3, 5, 7, 8
2609D60G66	2609D60G66	O	—	E2K3400MAWS10	1-3, 5, 7, 8
2609D60G67	2609D60G67	O	2609D60G70	E2K3400MAW	1-3, 5, 7, 8
2609D60G69	2609D60G69	O	—	E2K3400MAWS10	1-3, 5, 7, 8
2609D60G70	2609D60G70	A	—	E2KEM3225MW	1-3, 5, 7, 8
2610D64G07	2610D64G07	O	2610D64G13	—	—
2610D64G08	2610D64G08	O	2610D64G13	—	—
2610D64G09	2610D64G09	O	2610D64G13	—	—
2610D64G10	2610D64G10	O	2610D64G13	—	—
5685D48G45	5685D48G45	O	—	E2FM100KMU13+ 625B229G08	1-3, 5, 7, 8
5685D48G71	5685D48G71	O	5685D48G83	E2N3800W	1-3, 5, 7, 8
5685D48G72	5685D48G72	O	5685D48G84	E2N3600W	1-3, 5, 7, 8
5685D48G73	5685D48G73	O	5685D48G85	E2LE3400W	1-3, 5, 7, 8
5685D48G74	5685D48G74	O	5685D48G86	E2K3225DW	1-3, 5, 7, 8
5685D48G75	5685D48G75	O	1291C26G12	E2K3225AW	1-3, 5, 7, 8
5685D48G83	5685D48G83	A	—	E2NM3800W	1-3, 5, 7, 8
5685D48G84	5685D48G84	A	—	E2LEM36002W	1-3, 5, 7, 8
5685D48G85	5685D48G85	A	—	E2KEM34002W	1-3, 5, 7, 8
5685D48G86	5685D48G86	A	—	E2KEM3225W	1-3, 5, 7, 8
5685D48G87	5685D48G87	A	—	E2KEM3225W	1-3, 5, 7, 8
5685D48G88	5685D48G88	O	—	E2FM100KM+ 625B229G08	1-3, 5, 7, 8
5685D48G89	5685D48G89	O	—	E2FM050YM+ 625B229G08	1-3, 5, 7, 8
5685D48G90	5685D48G90	O	—	E2FM050YMU13	1-3, 5, 7, 8
2609D99G06	2609D99G06	O	—	—	—
5685D48G42	5685D48G42	O	—	—	—
5685D48G36	5685D48G36	O	—	—	—
5685D48G30	5685D48G30	O	—	—	—
5685D48G24	5685D48G24	O	—	—	—
5685D48G18	5685D48G18	O	—	—	—
5685D48G12	5685D48G12	O	—	—	—
5685D48G06	5685D48G06	O	—	—	—

Note

① O = Obsolete, A = Available.

Pricing Information

Price and Availability Digest (PAD)

Vista/VISTALINE Discount Symbol RCB-2

Westinghouse PRL3



4

Panelboards

Product Description	V12-T4-2
Product History	V12-T4-2
Product History Time Line	V12-T4-3
Replacement Capabilities	V12-T4-4
CDP	V12-T4-9
FDP	V12-T4-10
PB/PH/PH-L	V12-T4-11
MP40	V12-T4-12
EE	V12-T4-13
EP	V12-T4-14
PRL1 and PRL2 Panelboards	V12-T4-15
PRL1a and PRL2a Panelboards	V12-T4-15
PRL3	V12-T4-16
PRL3a	V12-T4-17
PRL4B	V12-T4-18
PRL4F	V12-T4-19
Technology Upgrades	V12-T4-20
Surge Protection Device—SPD Series	V12-T4-20
Pow-R-Command	V12-T4-20
Panelboard Retrofits	V12-T4-21
Pow-R-Line 1R and 2R Renovation Panel	V12-T4-21
Product Support Services—Satellite Locations	V12-T4-22
Further Information	V12-T4-23
Pricing Information	V12-T4-23

Product Description

Panelboards and switchboards are enclosed assemblies for lighting and distribution that accept incoming power and consist of a series of circuit breakers and/or fusible switches. These devices protect each circuit by providing overcurrent and short-circuit protection.

4

Product History

In 1994, Eaton acquired the Distribution and Control Business Unit (DCBU) of Westinghouse and integrated it with their Cutler-Hammer® business unit forming a powerful new combination. This product history tracks the evolution of panelboard and switchboard products for both manufacturers.

In the 1920s, prior to the development of circuit breakers, Westinghouse sold panelboards designed for main and branch circuit fuses. Circuit breakers were first introduced in 1927 and put Westinghouse in the forefront of circuit breaker technology. A few years later the first Westinghouse “NOFUSE” circuit breakers were introduced. “NOFUSE” panelboards were initially available in ratings up to 225A at 250V. Panelboards were designed at higher ratings as circuit breakers’ ratings became available. By 1958, panelboards were available at ratings up to 800A and 600V.

The most significant panelboard types were the CDP and FDP panels. For more than 34 years, these two types encompassed most Westinghouse molded-case circuit breakers and fusible switches.

In 1962, Eaton’s electrical business entered the panelboard and switchboard market with the purchase of Mullenbach. Soon after the Mullenbach acquisition, Cutler-Hammer entered into an agreement with Westinghouse to supply breakers and fusible devices for panelboards and switchboards, and Eaton also began manufacturing Westinghouse-type panelboards under the agreement. This relationship made in the early 1960s provided users of both trade name products access to aftermarket service for add-on branch devices and hardware. Classic Cutler-Hammer panelboards and switchboards were designed and listed for use with Westinghouse breakers.

In 1988, Westinghouse redesigned the panelboard and switchboard line to incorporate the new Series C® design breakers. This new design became a true family of products. These new panelboards and switchboards became today’s Pow-R-Line® family, which are manufactured in state-of-the-art facilities strategically located throughout the United States.

Eaton’s unique Satellite Plants support aftermarket services for all current Pow-R-Line panelboard and switchboard products. Aftermarket service for out-of-production panelboards and switchboards for both the classic Westinghouse and Cutler-Hammer designs is supported by the **Aftermarket Center in Sumter, SC**, (see **Page V12-T4-22**), and is staffed with experienced and knowledgeable representatives.



Cutler-Hammer NFB



Westinghouse FDP

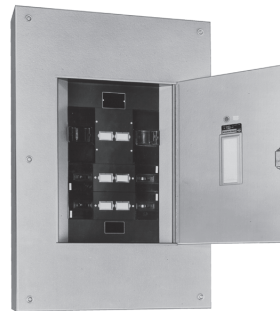

Cutler-Hammer MP40



Westinghouse Pow-R-Line 3



Cutler-Hammer CHB

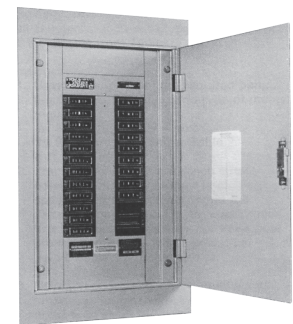

Westinghouse WEB



Cutler-Hammer EE



Westinghouse CDP

Product History Time Line

Page	Product	1935	1940	1945	1950	1955	1960	1965	1970	1975	1980	1985	1990	1995	2000	Present
V12-T4-7	Westinghouse A2B		█													
	Westinghouse NM/NMM		█													
V12-T4-7	Westinghouse NA1B		█	█	█	█	█	█	█							
V12-T4-7	Westinghouse NLAB		█	█	█	█	█	█	█							
V12-T4-7	Westinghouse NAB			█	█	█	█	█	█							
V12-T4-7	Westinghouse ABH			█	█	█	█	█	█							
V12-T4-7	Westinghouse NDP					█	█	█	█							
V12-T4-4	Cutler-Hammer CDP							█	█	█						
V12-T4-7	Westinghouse CDP/FDP					█	█	█	█	█	█	█	█	█	█	█
V12-T4-7	Westinghouse NQB/NQC/NQP							█	█	█	█	█	█	█	█	█
V12-T4-7	Westinghouse NEB/NHEB							█	█	█	█	█	█	█	█	█
V12-T4-7	Westinghouse WCA/WEB/WEHB/ WFB/WGB/WGHB							█	█	█	█	█	█	█	█	█
V12-T4-4	Cutler-Hammer CHP/CHB								█	█	█	█	█	█	█	█
V12-T4-4	Cutler-Hammer NFB								█	█	█	█	█	█	█	█
V12-T4-5	Cutler-Hammer MP40/MP100								█	█	█	█	█	█	█	█
V12-T4-7	Westinghouse B10B/Q10P									█	█	█	█	█	█	█
V12-T4-5	Cutler-Hammer PB										█	█	█	█	█	█
V12-T4-5	Cutler-Hammer PH											█	█	█	█	█
V12-T4-6	Cutler-Hammer EE											█	█	█	█	█
V12-T4-7	Westinghouse W10B/W10P											█	█	█	█	█
V12-T4-6	Cutler-Hammer EP												█	█	█	█
V12-T4-8	Westinghouse PRL3												█	█	█	█
V12-T4-8	Westinghouse PRL1, PRL2												█	█	█	█
V12-T4-8	Cutler-Hammer PRL1a, 2a													█	█	█
V12-T4-8	Cutler-Hammer PRL3a													█	█	█
V12-T4-8	Westinghouse PRL4B, F												█	█	█	█
V12-T4-5	Cutler-Hammer PRL5P														█	█

Replacement Capabilities

How to Select Replacement Breakers

A complete line of new, UL® Listed products, physically and electrically interchangeable molded-case circuit breakers is offered by Eaton.

To properly select the breaker for your existing panelboard:

1. Identify the panel type and the existing branch breaker.
2. Select the appropriate breaker from the direct replacement solution column. As shown, three options are available.

Option 1: Series C breakers are available as direct replacement for installation in Cutler-Hammer panelboards. They are available at your local distributors and are the most economical solution.

Option 2: Original, but still-in-production breakers, (sometimes referred to as replacement breakers) are available from Eaton national warehouses. These are identical to the existing branch breakers.

Option 3: Panelboard replacement breakers, available for out-of-production molded-case breakers, are physically and electrically interchangeable with the existing breaker. Available in three-pole only. Refer to **Pages V12-T3-80** through **V12-T3-87** for further information.

3. For additional information, contact Avery Creek, NC, Technical Resource Center at **1-800-356-1243** or your local Eaton Satellite plant.

Original Cutler-Hammer Panelboard Breaker Replacement Chart

Cutler-Hammer Panelboard Type	Original Branch Circuit Breaker	Replacement Solutions		Panelboard Replacement Breaker ①
		New Panelboard Type	New Breaker	
CHP ②	CH	PRL1a	CH	—
CHB ②	CHB	PRL1a	CHB	—
NPLAB ②	P	PRL1a	—	—
NLAB ②	QL	PRL1a	—	—
NA1B ②	E	PRL3a	—	REH
	EA	PRL3a	—	REH
NH1B ②	EH	PRL3a	—	REH
NDP ②	E	PRL3a	—	REH
	EA	PRL3a	—	REH
HNDP ②	EH	PRL3a	—	REH
NFB	EB	PRL3a or PRL4B	EHD	—
	EHB	PRL3a or PRL4B	EHD	—
	EHC	PRL3a or PRL4B	FD	—
	EC	PRL3a or PRL4B	EHD	—
	CA	PRL3a or PRL4B	CA	—
	CC	PRL3a or PRL4B	CC	—
	FB	PRL3a or PRL4B	FD	—
	HFB	PRL3a or PRL4B	FD	—
	FD	PRL3a or PRL4B	FD	—
	FC	PRL3a or PRL4B	FD	—
	FH	PRL3a or PRL4B	HFD	—
	FS	PRL3a or PRL4B	FD	—
	HFC	PRL3a or PRL4B	HFD	—
	CCH	PRL3a or PRL4B	—	—
	CHH	PRL3a or PRL4B	CHH	—
CDP ③	E	PRL4B	—	REH
	EA	PRL4B	—	REH
	EH	PRL4B	—	REH
	EB	PRL4B	EHD	—
	EHB	PRL4B	EHD	—
	F	PRL4B	—	RHF
	FA	PRL4B	—	RHFA
	HF	PRL4B	—	RHF
	HFA	PRL4B	—	RHFA
	FB	PRL4B	FDB	—
	HFB	PRL4B	FD	—
	CA	PRL4B	CA	—
	DA	PRL4B	DK	—
	JA	PRL4B	KDB	—
	KA	PRL4B	KD	—
	HKA	PRL4B	HKD	—
	HK	PRL4B	—	RHK
	HKL	PRL4B	—	RHKL
	LA	PRL4B	LD	—
	HLA	PRL4B	LD	—
	LAB	PRL4B	LDB	—
	LM	PRL4B	—	RHLM
	HLM	PRL4B	—	RHLM
	MA	PRL4B	MDL	—
	HMA	PRL4B	MDL	—
	NB	PRL4B	ND	—
	HNB	PRL4B	ND	—
	CC	PRL4B	CC	—
	CCH	PRL4B	—	—
	CHH	PRL4B	CHH	—

Notes

① New breakers that are a direct physical and electrical replacement for out-of-production breakers. Available in three-pole only. See **Pages V12-T3-80** through **V12-T3-87** for further information.

② Connectors not available.

③ Not rated for 100% rated breakers.

Original Cutler-Hammer Panelboard Breaker
Replacement Chart, continued

Cutler-Hammer Panelboard Type	Original Branch Circuit Breaker	Replacement Solutions	
		New Panelboard Type	New Breaker
MP40 ①	CC	PRL4B	ED
	CCH	PRL4B	—
	CHH	PRL4B	ED
	EB	PRL4B	EHD
	EHB	PRL4B	EHD
	EC	PRL4B	EHD
	EHC	PRL4B	FD
	FB	PRL4B	FDB
	HFB	PRL4B	FD
	FC	PRL4B	FDB
	HFC	PRL4B	HFD
	FH	PRL4B	HFD
	FS	PRL4B	FD
	JA	PRL4B	KDB
	JB	PRL4B	JB
	JS	PRL4B	HJD
	JH	PRL4B	HJD
	JH	PRL4B	HJD
	JL	PRL4B	JDC
	KA	PRL4B	KD
	KB	PRL4B	JD
	HKB	PRL4B	JD
	KS-D	PRL4B	KD
	KH-D	PRL4B	KD
	DA	PRL4B	DK
	LA	PRL4B	LD
	HLA	PRL4B	LD
	HLA	PRL4B	LD
	LAB	PRL4B	LDB
	LB	PRL4B	KD
LBB	PRL4B	KDB	
HLB	PRL4B	KD	

Cutler-Hammer Panelboard Type	Original Branch Circuit Breaker	Replacement Solutions	
		New Panelboard Type	New Breaker
MP40 ①	LC	PRL4B	LD
	LS (A)	PRL4B	LD
	LH (A)	PRL4B	HLD
	MA	PRL4B	MDL
	HMA	PRL4B	MDL
	MC	PRL4B	MDL
	HMC	PRL4B	MDL
	MS	PRL4B	MDL
	MH	PRL4B	MDL
	NB	PRL4B	ND
	HNB	PRL4B	ND
	NC	PRL4B	ND
	HNC	PRL4B	ND
	NS	PRL4B	ND
	NH	PRL4B	ND
MP100	M50 Fusible switch	PRL4F	M50 Fusible switch
PH ②	CH	PRL3a	CH
	CHB	PRL3a	CHB
	CC	PRL3a	CC
	CCH	PRL3a	CCH
	CHH	PRL3a	CHH
	EB	PRL3a	EHD
	EHB	PRL3a	EHD
	EC	PRL3a	EHD
	EC	PRL3a	EHD
	EHD	PRL3a	EHD
	FC	PRL3a	FD
	FS	PRL3a	FD
	FH	PRL3a	HFD
FD	PRL3a	FD	
PB ②③	CH	PRL1a	CH
	CHB	PRL1a	CHB

Notes

- ① See also Page V12-T4-12.
- ② See also Page V12-T4-11.
- ③ Connectors not available.

Plug-In Power Panelboards and Switchboards

Cutler-Hammer Panelboard Type	Original Branch Circuit Breaker	Replacement Solutions	
		New Panelboard Type	New Breaker
EE ①②	FS	PRL5P	FD
	FH	PRL5P	HFD
	FL	PRL5P	HDC
	JS	PRL5P	JD
	JH	PRL5P	HJD
	JL	PRL5P	JDC
	KS	PRL5P	KD
	KH	PRL5P	HKD
	LS	PRL5P	LD
	LS(A)	PRL5P	LD
	LS(E)	PRL5P	LD
	LH(B)	PRL5P	HLD
	LH(A)	PRL5P	HLD
	LL(E)	PRL5P	LDC
	LS(B)	PRL5P	LD
	LH(E)	PRL5P	HLD
	MS	PRL5P	MDL
	NS	PRL5P	ND
	MH	PRL5P	—
	CC	PRL5P	CC
	CCH	PRL5P	—
	CHH	PRL5P	CHH

Cutler-Hammer Panelboard Type	Original Branch Circuit Breaker	Replacement Solutions	
		New Panelboard Type	New Breaker
EP ①③	FS	PRL5P	FD
	FH	PRL5P	HFD
	FL	PRL5P	FDC
	JS	PRL5P	JD
	JH	PRL5P	HJD
	JL	PRL5P	JDC
	KS	PRL5P	KD
	KH	PRL5P	HKD
	LS	PRL5P	LD
	LS(A)	PRL5P	LD
	LS(E)	PRL5P	LD
	LH(B)	PRL5P	HLD
	LH(A)	PRL5P	HLD
	LL(E)	PRL5P	LDC
	LS(B)	PRL5P	LD
	LH(E)	PRL5P	HLD
	MS	PRL5P	MDL
	NS	PRL5P	ND
	MH	PRL5P	—
	NH	PRL5P	HND
	CC	PRL5P	CC
	CCH	PRL5P	—
	CHH	PRL5P	CHH

Notes

- ① Not rated for 100% rated breakers.
- ② See also **Page V12-T4-13**.
- ③ See also **Page V12-T4-14**.

Original Westinghouse Panelboard Breaker Replacement Chart

Westinghouse Panelboard Type	Existing Branch Circuit Breaker	Replacement Solutions New Panelboard Type	New Breaker	Panelboard Replacement Breaker ①
Panelboards Manufactured Between 1937 and 1988				
ABH ②	E	PRL3a	—	REH
A2B ②	E	PRL3a	—	REH
B10B ②	BA	PRL1a	BAB	—
B10B-LX ②	BA	PRL1aLX	BAB	—
B10B-LXX ②	BA	PRL1aLX	BAB	—
B65B ②	HBA	PRL1a	—	HBAW, HBAX
CDP/HCDP ②③	E, EA, EH, F, FA	PRL4B	—	REH, RHF, RHFA
CDP/HCDP ③④	EB, EHB, EHD, FB, HFB, FDB, FD, HFD, FDC	PRL4B	EHD, FDB, FD, HFD, FDC	⑤
	FB-P TRI-PAC	PRL4B	FB-P TRI-PAC	⑤
	JB, KB, HKB, JDB, JD, HJD, JDC	PRL4B	JDB, JD, HJD, JDC	⑤
	CA, CAH, HCA	PRL4B	ED, EDH, EDC	⑤
	DA, LB, LBB, HLB ⑥	PRL4B	⑥	⑤
	JA, KA, HKA, DK, KD, HKD, KDC	PRL4B	DK, KD, HKD, KDC	⑤
	LA, LAB, HLA (400A)	PRL4B	LD, HLD	⑤
	LA-P TRI-PAC	PRL4B	LA-P TRI-PAC	⑤
	LA, LC, HLA (600A)	PRL4B	LD, HLD, LDC	⑤
	MA, HMA, MC, HMC	PRL4B	MDL	⑤
	LCL	PRL4B	LCL	⑤
	NB, HNB, NC, HNC	PRL4B	ND, HND	⑤
NB-P TRI-PAC ⑥	PRL4B	NB-P TRI-PAC	⑤	
FDP ⑦	Fusible switches	PRL4F	—	Fusible switches
H10P ②	HQP	PRL2a	HQP	—
H10B ②	BA	PRL2a	BAB	—
NAB ②	E	PRL3a	—	REH
NA1B ②	E	PRL3a	—	REH
NDP ②	E, EA, EAH	PRL3a	—	REH
NEB ②	EA	PRL3a	—	REH
NHDP ②	EH	PRL3a	—	REH
NHEB ②	EH, FA	PRL3a	—	REH, RHFA
NH1B ②	E-277	PRL2a	—	REH
NLAB ②	QC	PRL1a	—	—
NLAB-LX ②	QC	PRL1aLX	—	—
NLAB-AB ②	QC	PRL3a	—	—
NLAB-ABH ②	QC	PRL3a	—	—
NPLAB ②	QP	PRL1a	HQP	—
NPLAPQ ②	QP	PRL1a	HQP	—
NQC ②	QC	PRL1a	—	—
NQB ②	BA	PRL1a	BAB	—
NQP ②	QP	PRL1a	HQP	—
Q10P ②	QP	PRL1a	HQP	—
Q22P ②	QPH	PRL1a	QPHW	—
Q22B ②	QBH	PRL1a	QBHW	—
Q65P ②	HP	PRL2a	QHPW	—
W10B ②	BA	PRL1a	BAB	—
W10P ②	HQP	PRL1a	HQP	—
W22B ②	QBH	PRL1a	QBHW	—
W22P ②	QPH	PRL1a	QPHW	—
WCA	CA	PRL3a	CA	—
WEB	EB	PRL3a	EB, EHD	—
WEHB	EHB	PRL3a	EHB, EHD	—
WFB	FB	PRL3a	FB, FDB	—
WGB ②	GB	PRL2a	GB	—
WGHB ②	GHB	PRL2a	GHB	—

Notes

- ① Not rated for 100% rated breakers. Available in three-pole only. See **Pages V12-T3-80 through V12-T3-87** for further information.
- ② Connectors not available.
- ③ See also **Page V12-T4-9**.
- ④ Only breakers of the same frame size can be installed across from each other (i.e., in the same horizontal plane). For other configurations, contact the Aftermarket Center in Sumter, SC (see **Page V12-T4-22**).
- ⑤ Contact your local Eaton Field Sales office.
- ⑥ KD breakers can be mounted across from LB breakers if a TAD3 line side adapter is used. All hardware works with this configuration.
- ⑦ See also **Page V12-T4-10**.

Original Westinghouse Panelboard Breaker Replacement Chart, continued

Westinghouse Panelboard Type	Original Branch Circuit Breaker	Replacement Solutions		Panelboard Replacement Breaker
		New Panelboard Type	New Breaker	
Panelboards Manufactured After 1988				
PRL1 ①	BAB, QBHW	PRL1a ①	BAB, QBHW	—
	HQP, QPHW	PRL1a ①	BAB, QBHW	—
PRL2 ①	GB, GHB, GHBS	PRL2a ①	GB, GHB, GHBS-D	—
PRL3 ②	BAB, QBH	PRL3a ③	BAB, QBHW	—
	GB, GHB, GHBS	PRL3a ③	GB, GHB, GHBS-D	—
	EHD, FD, FDB, HFD, FDC	PRL3a ③	EHD, FD, FDB, HFD, FDC	—
	ED, EDH, EDC	PRL3a ③	ED, EDH, EDC	—
	CA, HCA, CAH	PRL3a ③	ED	—
PRL4B ④	EHD, FD, FDB, HFD, FDC	PRL4B	EHD, FD, FDB, HFD, FDC	—
	ED, EDH, EDC	PRL4B	ED, EDH, EDC	—
	CA, CAH, HCA	PRL4B	CA, CAH, HCA	—
	FCL, FB-P, FDB/LFB	PRL4B	FCL, FB-P, FDB/LFB	—
	JD, JDB, HJD, JDC	PRL4B	JD, JDB, HJD, JDC	—
	DK, KDB, KD, HKD, KDC	PRL4B	DK, KDB, KD, HKD, KDC	—
	LCL	PRL4B	LCL	—
	LA-P TRI-PAC	PRL4B	LA-P TRI-PAC	—
	LC, HLC, LA, HLA	PRL4B	LC, HLC, LA, HLA	—
	LD, HLD, LDC, MD, MDS, ND, HND, NDC	PRL4B	LD, HLD, LDC, MDL, ND, HND, NDC	—
	MC, HMC, MA, HMA	PRL4B	MC, HMC, MA, HMA	—
	NC, HNC, NB, HNB	PRL4B	NC, HNC, NB, HNB	—
	NB-P TRI-PAC	PRL4B	NB-P TRI-PAC	—
	BAB, QBGF, QBHW, QBHGF, GB, GHB	PRL4B	BAB, QBGF, QBHW, QBHGF, GB, GHB	—
PRL4F ⑤	Fusible switches ⑥	PRL4F	—	Fusible switches

Notes

- ① See also **Page V12-T4-15**.
 ② See also **Page V12-T4-16**.
 ③ See also **Page V12-T4-17**.
 ④ See also **Page V12-T4-18**.
 ⑤ See also **Page V12-T4-19**.
 ⑥ 400A, 600A, 800A, 1200A, FDP connectors are **NOT** compatible with FDPW switches.

CDP

Originally a Westinghouse Product

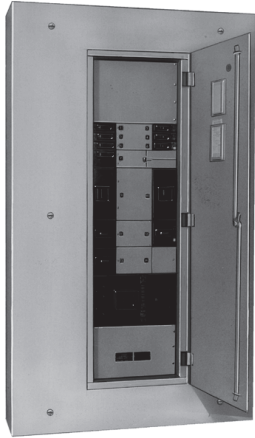

Westinghouse CDP

The panel layouts shown on this and the following pages will aid in determining the space available for the addition of molded-case circuit breakers into your existing CDP panelboards.

- Determine the amount of space available in the panelboard for adding circuit breakers. 1.38 inches (35.1 mm) of panel height = one X space
- Determine the type of breaker needed for the required ampere rating and number of poles

Ratings

- 1600A maximum

Replacement Capabilities

Breakers

Refer to renewal parts data RP01400002E for a complete list of available parts including branch device retrofit kits, which include the device, as well as, the bus connectors and the required mounting hardware. Contact the Aftermarket Center in Sumter, SC (see **Page V12-T4-22**).

CDP Panel Layout

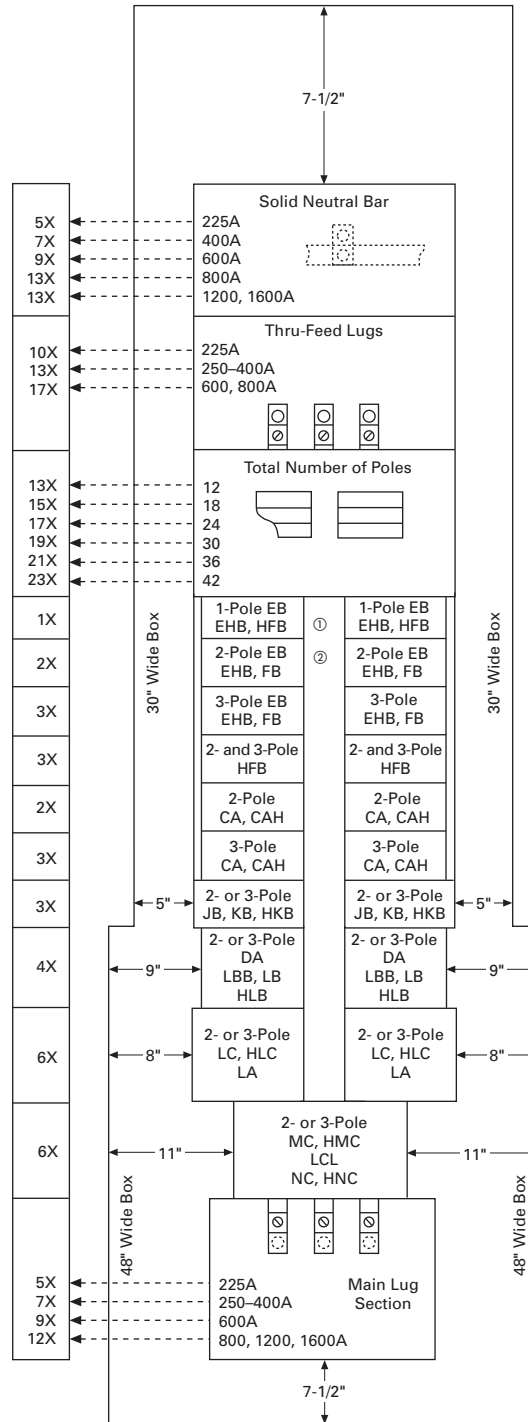

**One X space = 1.38 inches (35.1 mm).
Blank fillers are required for unused X space.**

Notes

- ① When only one EB, EHB or HFB single-pole breaker is required in conjunction with other frame size breakers, the single-pole breaker space required changes from 1X to 2X.
- ② Must use three-pole connector kit.

FDP

Originally a Westinghouse Product



Westinghouse FDP

The panel layouts shown on this and the following pages will aid in determining the space available for the addition of fusible switches into your existing FDP panelboards.

- Determine the amount of space available in the panelboard for adding fusible switches. 1.38 inches (35.1 mm) of panel height = one X space
- Determine the type of fusible switch needed for the required ampere rating and number of poles

Ratings

- 1600A maximum

Replacement Capabilities

Fusible Switches

Refer to renewal parts data RP01400002E for a complete list of available parts including branch device retrofit kits, which include the device, as well as, the bus connectors and the required mounting hardware. Contact the Aftermarket Center in Sumter, SC (see **Page V12-T4-22**).

FDP Panel Layout

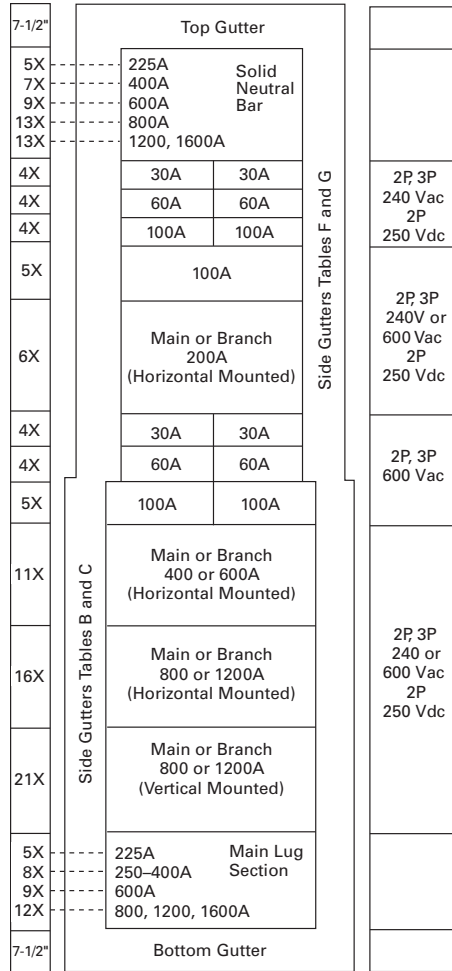

One X space = 1.38 inches (35.1 mm).
Blank fillers are required for unused X space.

FDP and CDP Bus Dimensions

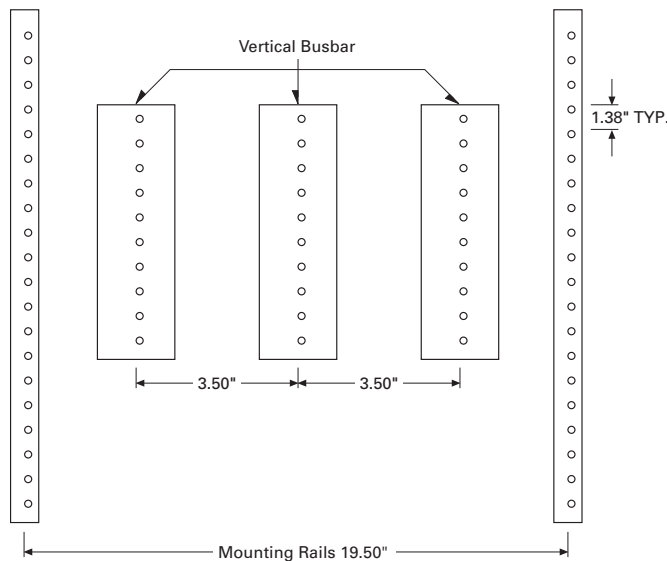

PB/PH/PH-L
Originally a
Cutler-Hammer Product

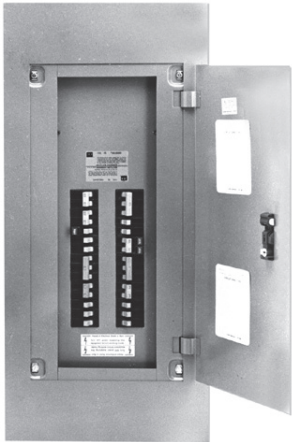

**15 or 21 Inches Wide
Cutler-Hammer PB**



**21 Inches Wide
Cutler-Hammer PH-L**

Ratings

- **PB**
400A maximum
- **PH**
800A main lug only or
600A main breaker
- **PH-L**
225A maximum

Replacement Capabilities

Breakers

Refer to renewal parts data RP01400003E for a complete list of available parts including branch device retrofit kits, which include the device, as well as, the bus connectors and the required mounting hardware. Contact the Aftermarket Center in Sumter, SC (see **Page V12-T4-22**).



**21 or 26 Inches Wide
Cutler-Hammer PH**

MP40

Originally a
Cutler-Hammer Product

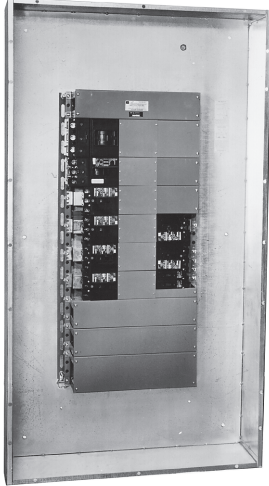

Cutler-Hammer MP40

The panel layouts shown on this and the following pages will aid in determining the space available for the addition of molded-case circuit breakers into your existing MP40 panelboards.

- Determine the amount of space available in the panelboard for adding circuit breakers. 1.38 inches (35.1 mm) of panel height = one X space
- Determine the type of breakers needed for the required ampere rating and number of poles

Ratings

- 1600A maximum

Replacement Capabilities

Breakers

Refer to renewal parts data RP01400003E for a complete list of available parts including branch device retrofit kits, which include the device, as well as, the bus connectors and the required mounting hardware. Contact the Aftermarket Center in Sumter, SC (see **Page V12-T4-22**).

MP40 Panel Layout

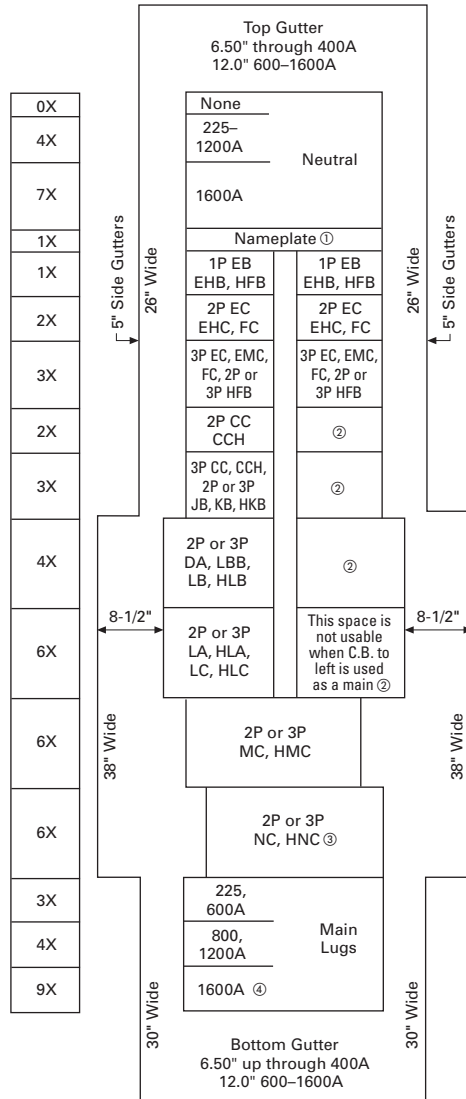

Notes

- ① If the panelboard has a main breaker, no neutral, no split bus, or no sub-feed or feed-through lugs, add 1X to provide space for a nameplate.
- ② Breakers of the same frame size, regardless of poles, may be mounted opposite of each other.
- ③ Only Type NC and HNC breakers require a 11.38-inch (289.1 mm) deep box. Standard box depth is 10.50 inches (266.7 mm).
- ④ When 1600A lug mains are for (4)–600 kcmil maximum copper cables per phase, the X unit space can be reduced to 4X.

EE

Originally a
Cutler-Hammer Product

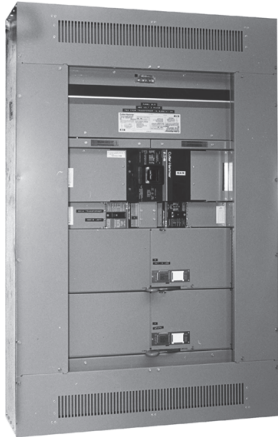

Cutler-Hammer EE Panelboard

The panel layouts shown on this and the following pages will aid in determining the space available for the addition of molded-case circuit breakers and fusible switches into your existing EE panelboards.

- Determine the amount of space available in the panelboard for adding replacement devices. 1.38 inches (35.1 mm) of panel height = one X space
- Determine the type of replacement device needed for the required ampere rating and number of poles

Ratings

- 1200A maximum

**Replacement Capabilities
Breakers and
Fusible Switches**

Refer to renewal parts data RP01400003E for a complete list of available parts including branch device retrofit kits, which include the device, as well as, the bus connectors and the required mounting hardware. Contact the Aftermarket Center in Sumter, SC (see **Page V12-T4-22**).

EE Panelboard Panel Layout

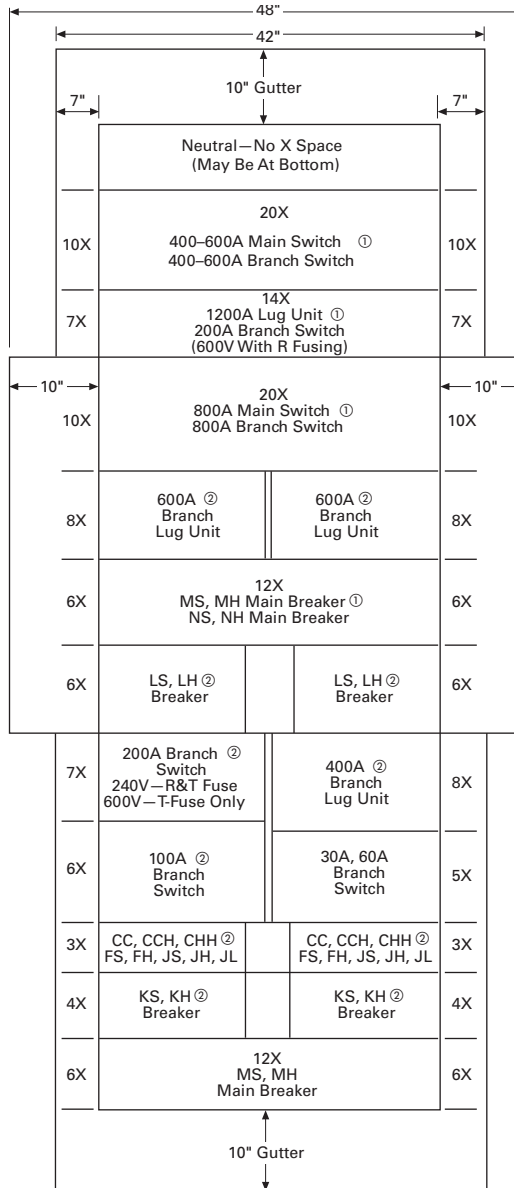

Notes

- ① Main device must be mounted at neutral end of double-bus panel.
- ② May be used in 30.00-inch (762.0 mm) wide single bus interiors.

EP

Originally a
Cutler-Hammer Product

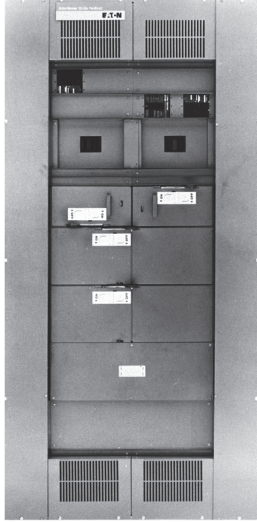

Cutler-Hammer EP Panelboard

The panel layouts shown on this and the following pages will aid in determining the space available for the addition of molded-case circuit breakers into your existing EP panelboards.

- Determine the amount of space available in the panelboard for adding circuit breakers.
1.38 inches (35.1 mm) of panel height = one X space
- Determine the type of breaker needed for the required ampere rating and number of poles

Ratings

- 1200A maximum

Replacement Capabilities

Breakers

Refer to renewal parts data RP01400003E for a complete list of available parts including branch device retrofit kits, which include the device, as well as, the bus connectors and the required mounting hardware. Contact the Aftermarket Center in Sumter, SC (see **Page V12-T4-22**).

EP Panelboard Panel Layout

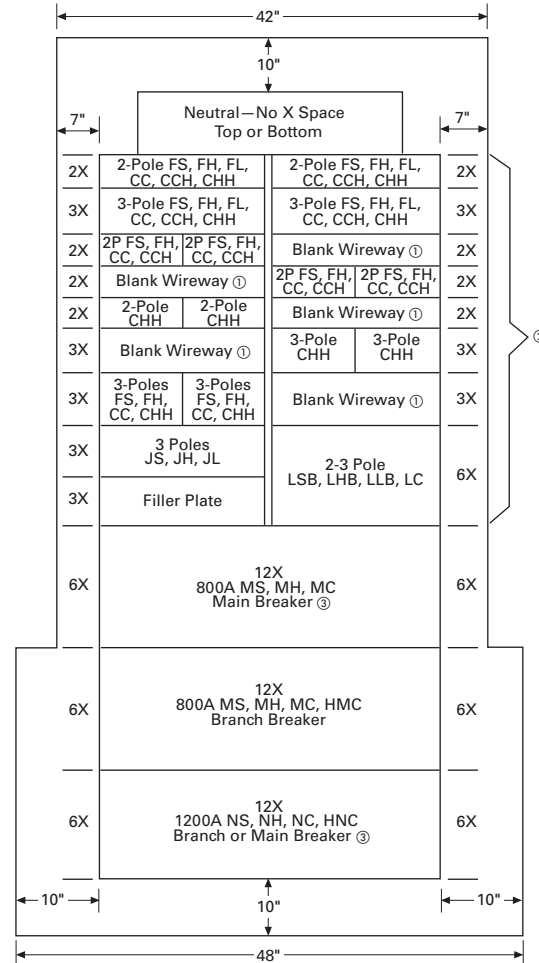

Notes

- ① Blank wireway fillers are required opposite any dual breaker unit or adapter.
- ② May be used in 30.00-inch (762.0 mm) wide single bus interiors.
- ③ Main device must be mounted at neutral end of double-bus panel.

PRL1 and PRL2 Panelboards
Originally a Westinghouse Product



PRL2 with Trim

Ratings

- 600A maximum

Replacement Capabilities

Breakers

Refer to renewal parts data RP01400002E for a complete list of available parts including branch device bus connectors mounting hardware. For further information, contact the Aftermarket Center in Sumter, SC. Refer to **Page V12-T4-22**.

PRL1a and PRL2a Panelboards
Current Product



PRL1a

Ratings

- 400A maximum

Replacement Capabilities

Breakers

Refer to renewal parts data RP01400001E and RP01414001E for a complete list of available parts including branch device bus connectors and mounting hardware. Renewal parts are available from your Eaton Satellite plant. Refer to **Page V12-T4-22**.

PRL3

Originally a Westinghouse Product

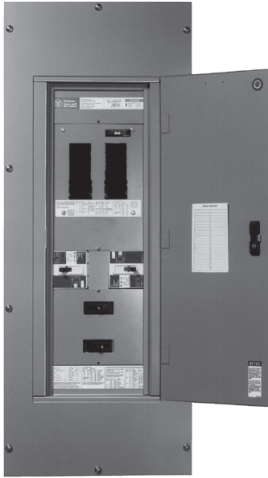

Westinghouse PRL3

The panel layouts shown on this and the following pages will aid in determining the space available for the addition of molded-case circuit breakers into your existing PRL3 panelboards.

- Determine the amount of space available in the panelboard for adding circuit breakers. 1.38 inches (35.1 mm) of panel height = one X space
- Determine the type of breaker needed for the required ampere rating and number of poles

Ratings

- 600A maximum

Replacement Capabilities

Breakers

Refer to renewal parts data RP01400002E for a complete list of available parts including branch device retrofit kits, which include the device, as well as, the bus connectors and the required mounting hardware. Contact the Aftermarket Center in Sumter, SC (see **Page V12-T4-22**).

PRL3 Panel Layout

No Neutral		2X 100–600A																		
Neutral Section		2X 100, 225A 8X 400, 600A																		
Sub Chassis		<table border="0"> <tr> <td style="text-align: center;"> </td> <td style="vertical-align: middle;"> <table border="0"> <tr><td colspan="2">Poles</td></tr> <tr><td>10X-12</td><td rowspan="6">} (100A Max.)</td></tr> <tr><td>13X-18</td></tr> <tr><td>15X-24</td></tr> <tr><td>17X-30</td></tr> <tr><td>19X-36</td></tr> <tr><td>21X-42</td></tr> </table> </td> </tr> <tr> <td></td> <td></td> <td> <table border="0"> <tr><td>BAB ①②</td></tr> <tr><td>QBH ①</td></tr> <tr><td>GB ③④</td></tr> <tr><td>GHB ③④</td></tr> </table> </td> </tr> </table>		<table border="0"> <tr><td colspan="2">Poles</td></tr> <tr><td>10X-12</td><td rowspan="6">} (100A Max.)</td></tr> <tr><td>13X-18</td></tr> <tr><td>15X-24</td></tr> <tr><td>17X-30</td></tr> <tr><td>19X-36</td></tr> <tr><td>21X-42</td></tr> </table>	Poles		10X-12	} (100A Max.)	13X-18	15X-24	17X-30	19X-36	21X-42			<table border="0"> <tr><td>BAB ①②</td></tr> <tr><td>QBH ①</td></tr> <tr><td>GB ③④</td></tr> <tr><td>GHB ③④</td></tr> </table>	BAB ①②	QBH ①	GB ③④	GHB ③④
	<table border="0"> <tr><td colspan="2">Poles</td></tr> <tr><td>10X-12</td><td rowspan="6">} (100A Max.)</td></tr> <tr><td>13X-18</td></tr> <tr><td>15X-24</td></tr> <tr><td>17X-30</td></tr> <tr><td>19X-36</td></tr> <tr><td>21X-42</td></tr> </table>	Poles		10X-12	} (100A Max.)	13X-18	15X-24		17X-30	19X-36	21X-42									
Poles																				
10X-12	} (100A Max.)																			
13X-18																				
15X-24																				
17X-30																				
19X-36																				
21X-42																				
		<table border="0"> <tr><td>BAB ①②</td></tr> <tr><td>QBH ①</td></tr> <tr><td>GB ③④</td></tr> <tr><td>GHB ③④</td></tr> </table>	BAB ①②	QBH ①	GB ③④	GHB ③④														
BAB ①②																				
QBH ①																				
GB ③④																				
GHB ③④																				
400A Maximum Bus Rating																				
1-Pole	1-Pole	1X EHD (100A Max.)																		
2-Pole	2-Pole	2X } (150A Max.)																		
1-Pole	3-Pole																			
2-Pole		3X } (150A Max.)																		
2- and 3-Pole		3X CA, CAH, HCA ⑤ (225A Max.)																		
Main Lug Section		2X 100, 225A 7X 400, 600A																		
Horizontal Mounting		3X 2P EHD (100A Max.) ⑥ 3X 2P FDB, FD, HFD, FDC ⑥ (150A Max.) 4X 3P EHD (100A Max.) ⑥ 4X 3P FDB, FD, HFD, FDC (150A Max.) ⑥ 4X 2P and 3P CA, CAH, HCA ⑥ (225A Max.)																		
Main Breaker Section																				
Vertically Mounted		7X EHD (100A Max.) 7X FDB, FD, HFD, FDC (150A Max.) 9X CA, CAH (225A Max.) 9X FCL, FB-P ⑦ (100A Max.) 14X JD, JDB, HJD, JDC (250A Max.) 14X DK, KD, KDB, HKD, KDC (400A Max.) 19X LC, HLC, LA (600A Max.) 22X LCL ⑧, LA-P ⑨ (400A Max.)																		

Notes

- ① If panel contains only BAB or QBH branch breakers, use a PRL1 panelboard.
- ② BAB and QBH breakers with shunt trips require one additional pole space, i.e.; one-pole is two-pole size, two-pole is three-pole size, and three-pole is four-pole size.
- ③ GB and GHB breakers cannot be mixed on same subchassis as BAB or QBH.
- ④ If panel contains only GB or GHB branch breakers, use a PRL2 panelboard.
- ⑤ Not recommended for motor loads. Use JD circuit breaker.
- ⑥ Horizontally mounted 15–150A main breakers EHD, FDB, FD, HFD and FDC will be furnished as branch breaker construction. Branch breakers one, two or three poles as required, may be located opposite these main breakers.
- ⑦ FBP and LAP top mounting only.
- ⑧ 100% rated breaker.
- ⑨ LCL main breaker requires 6.50-inch (165.1 mm) deep box.

PRL3a
Current Product



PRL3a

The panel layouts shown on this and the following pages will aid in determining the space available for the addition of molded-case circuit breakers into your existing PRL3a panelboards.

- Determine the amount of space available in the panelboard for adding circuit breakers. 1.38 inches (35.1 mm) of panel height = one X space
- Determine the type of breaker needed for the required ampere rating and number of poles

Ratings

- 600A maximum

Replacement Capabilities

Breakers

Refer to renewal parts data RP01400001E and RP01414001E for a complete list of available parts including branch device retrofit kits, which include the device, as well as, the bus connectors and the required mounting hardware. Retrofit kits and renewal parts are available from your Eaton Satellite plant. Refer to **Page V12-T4-22**.

PRL3a Panel Layout

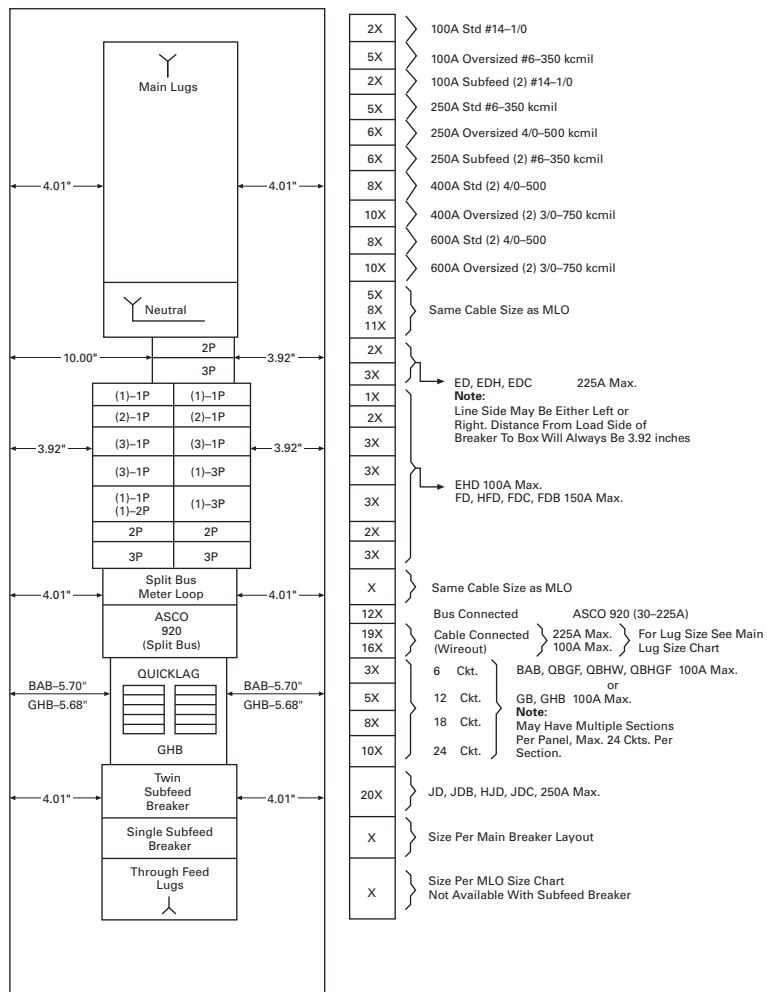

PRL4B

Current Product (Originally a Westinghouse Product)



PRL4B

The panel layouts shown on this and the following pages will aid in determining the space available for the addition of molded-case circuit breakers into your existing PRL4B panelboards.

- Determine the amount of space available in the panelboard for adding circuit breakers. 1.38 inches (35.1 mm) of panel height = one X space
- Determine the type of breaker needed for the required ampere rating and number of poles

Ratings

- 1200A maximum

Replacement Capabilities

Breakers

Refer to renewal parts data RP01400001E and RP01414001E for a complete list of available parts including branch device retrofit kits, which include the device, as well as, the bus connectors and the required mounting hardware. Retrofit kits and renewal parts are available from your Eaton Satellite plant. Refer to **Page V12-T4-22**.

PRL4B Panel Layout

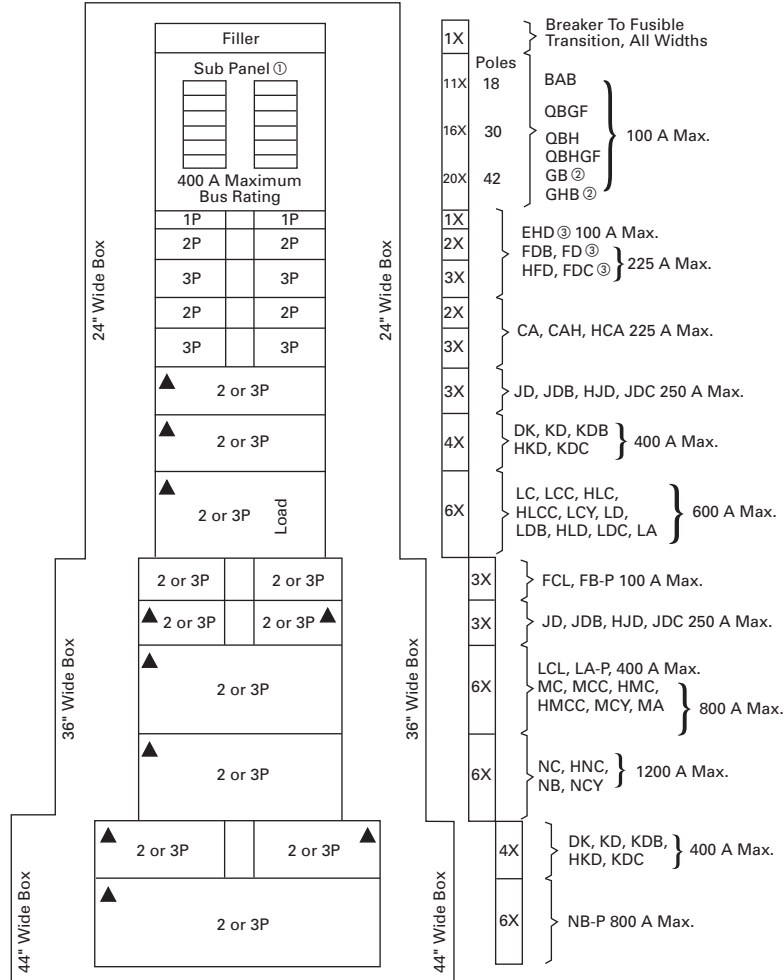

One X space = 1.38 inches (35.1 mm).
Blank fillers are required for unused X space.

Notes

- ① Maximum amperes connected to any one connector cannot exceed 140A.
- ② GB and GHB breakers cannot be mixed on the same subchassis as BAB or QBHW.
- ③ When only one single-pole breaker of the group is required on either side of chassis, the single-pole breaker space required changes from 1X to 2X.

PRL4F

Current Product (Originally a Westinghouse Product)



PRL4F

The panel layouts shown on this and the following pages will aid in determining the space available for the addition of fusible switches into your existing PRL4F panelboards.

- Determine the amount of space available in the panelboard for adding fusible switches.
1.38 inches (35.1 mm) of panel height = one X space
- Determine the type of fusible switch needed for the required ampere rating and number of poles

Ratings

- 1200A maximum

Replacement Capabilities

Fusible Switches

Refer to renewal parts data RP01400001E and RP01414001E for a complete list of available parts including branch device retrofit kits, which include the device, as well as, the bus connectors and the required mounting hardware. Retrofit kits and renewal parts are available from your Eaton Satellite plant. Refer to **Page V12-T4-22**.

PRL4F Panel Layout

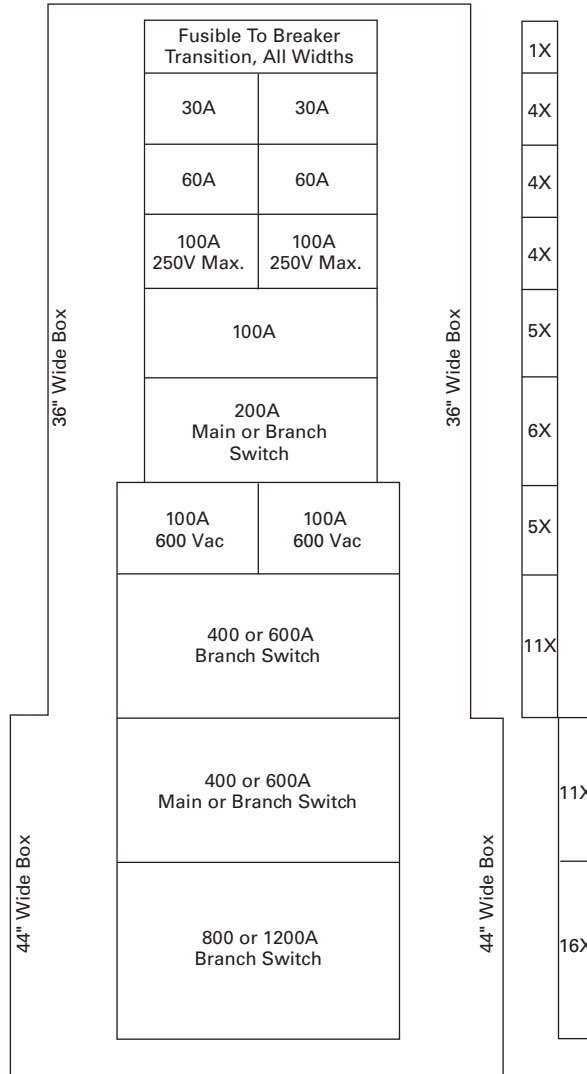

Technology Upgrades

Surge Protection Devices— SPD Series



**Eaton SPD Series—
Surge Protective Device**

The Eaton SPD Series of surge protection products ensures that equipment is protected with the safest, most reliable and most advanced UL 1449 3rd Edition certified surge protectors. The array of features, options and configurations ensures that there is a unit for all electrical applications, including service entrances, distribution switchboards, panelboards and point-of-use applications. Field installation is required.

Benefits

- The SPD Series can be externally mounted to existing distribution equipment
- Surge ratings: 50, 80, 100, 120, 160, 200, 250, 300 and 400 kA
- Standard NEMA 1 enclosure, optional NEMA 4 and 4X
- Surface or flush mounting
- Full range of diagnostic and monitoring options
- Remote mountable display panel
- Available with optional internal disconnect

For more information about the SPD Series surge protection, contact your local Eaton Field Sales office.

Pow-R-Command™

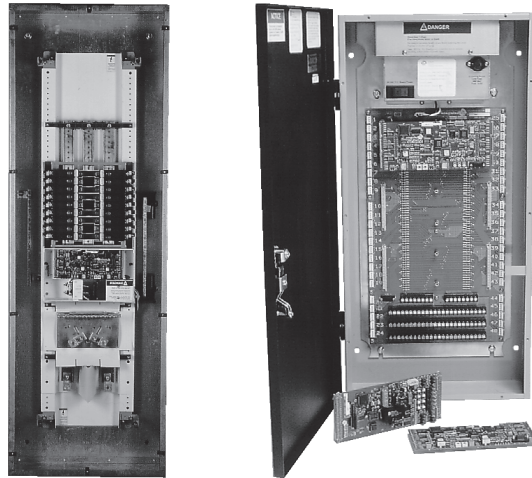

Pow-R-Command Lighting Control

Eaton's Pow-R-Command is a family of microprocessor-based lighting control systems designed for today's modern facilities. They may be used as a standalone, or networked for the control of lighting and other branch circuits.

Existing facilities can be retrofitted to include various Pow-R-Command scenarios allowing customers varying degrees of control. For more information on upgrading your building to include the energy savings and control of Pow-R-Command lighting control systems, contact your local Eaton Field Sales office.

System Features

- Day/Date/Time of Day scheduling
- Holiday scheduling—up to 30 days/year
- Astronomical time scheduling
- Real-time clock
- Hardware diagnostics
- Off warning by blinking lights
- Manual load override control
- Brownout and power failure recovery
- Telephone override of schedules
- Switch override of schedules
- Remote access to system
- Dimming systems for fluorescent fixtures
- Priority load management

Panelboard Retrofits



Type PRL1a

Another Custom-Assembled Panelboard Capability from Your Local Eaton Satellite

Save time and money when upgrading and expanding existing electrical services by using existing panelboard enclosures and conduit runs.

Retrofitting existing panelboards can be an effective solution for:

- Providing additional circuits for load growth
- Replacing obsolete equipment
- Upgrading protective device interrupting ratings
- Accommodating system change and additions
- Adding ground fault circuit interrupters
- Adding lighting controls
- Adding surge protection devices

The unique capabilities of the Eaton Satellite plants can provide special configurations to meet the special needs encountered in retrofit applications.

Pow-R-Line 1R and 2R renovation panelboards, or custom-built panelboard interiors and trims can be provided to retrofit most any manufacturer's existing panelboard enclosure.

Armed with the necessary information about the existing installation and the needed upgrade, the professional staff at your local Satellite plant can offer the assistance and application support to ensure an accurate quotation and on-time delivery of a quality retrofit product.

Pow-R-Line 1R and 2R Renovation Panel

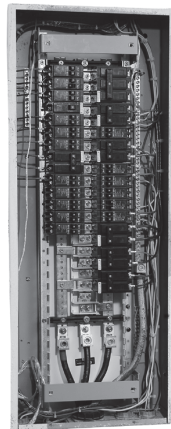

Renovation Panel

Product Description

- 240 and 480 Vac
- Single-phase three-wire or single-phase two-wire
- Three-phase three-wire or three-phase four-wire
- 225A maximum
- 100A maximum branch breakers
- Fits existing box depths from 4.50 to 6.00 inches (114.3 to 152.4 mm) deep
- Integrally mounted neutral assembly
- Ground bar and bonding conductor included
- Neutral and ground convertible from left-right
- Bolt-on branch breakers
- Factory assembled—custom and standard trims available

Application Description

- Lighting and appliance branch panelboards
- Fully rated or series rated
- Interrupting capacities to 100 kA symmetrical
- Suitable for use as service entrance equipment where specified on the order

Standards and Certifications

- UL 67
- Federal Specification W-P-115c
- CSA® C22.2 No. 29

The Pow-R-Line 1R and 2R retrofit panelboard is designed specifically for use in the renovation of existing electrical systems. This innovative solution employs a chassis design that enables the use of the existing back box, conduit and cables. An exclusive depth-adjusting mechanism and an integrated trim assembly provides for fast, trouble-free mounting of the new panelboard interior into any existing enclosure.

The panelboard chassis is designed for the use of main lugs or a main breaker and can accommodate 18, 30 or 42 branch circuits.

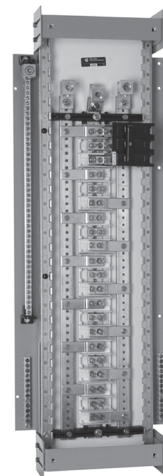

Pow-R-Line 1R Retrofit Chassis

Chassis Features

Designed to accommodate minimal box widths at 14.00 inches (355.6 mm).

Innovative telescoping chassis accommodates depths from 4.50 to 6.00 inches (114.3 to 152.4 mm) without the need for box modifications.

Universal mounting locations allow the neutral and grounds to be relocated from top to bottom or left to right side of back plate.

High quality laser cut trim with lock.

Trim and door mount directly to the chassis assembly. Concealed trim hardware is not dependent on back box for mounting.

Refer to publication **CA01417001E** for complete information.

Product Support Services

Satellite Locations

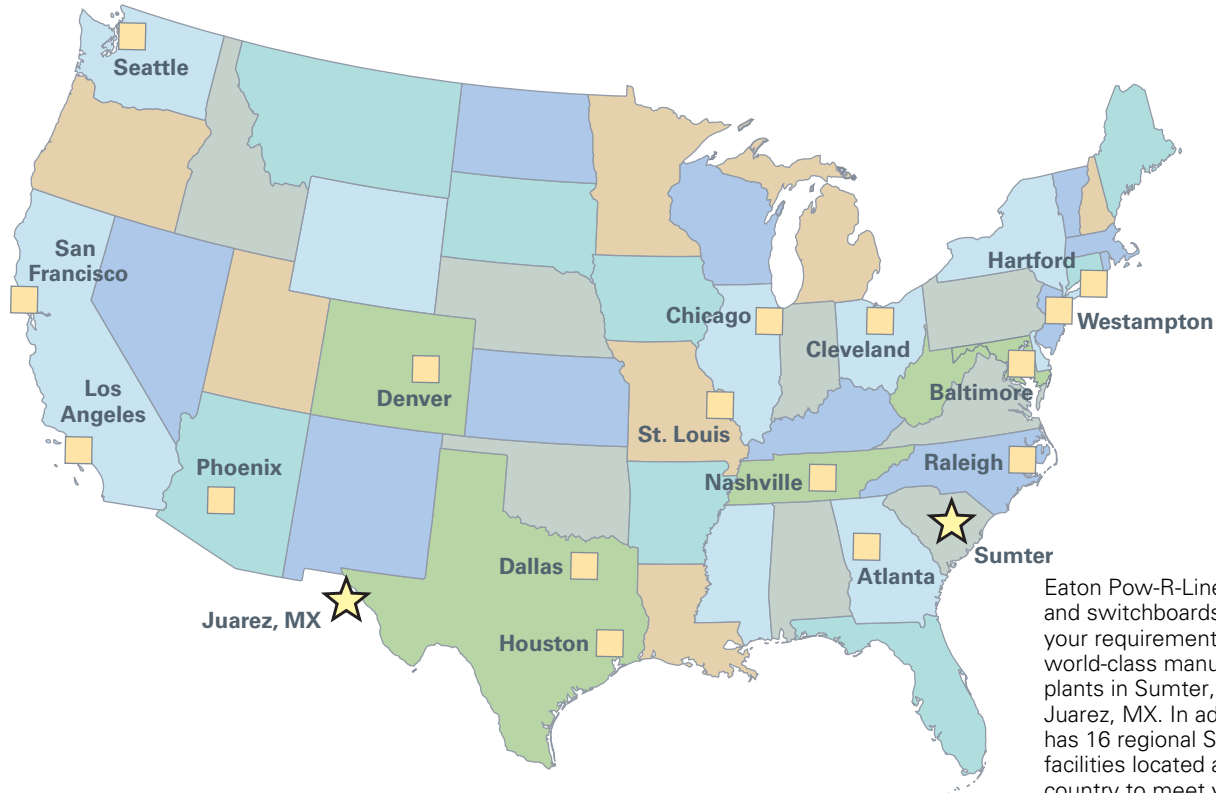

Eaton Pow-R-Line panelboards and switchboards are built to your requirements at our world-class manufacturing plants in Sumter, SC and Juarez, MX. In addition, Eaton has 16 regional Satellite facilities located across the country to meet your panelboard and switchboard service needs.

For an unparalleled commitment to your specific needs, please visit your local Satellite facility.

Atlanta

7000 Highlands Parkway SE
Suite 102
Smryna, GA 30082
678.309.4260

Baltimore

7451 Coca Cola Drive
Suite C
Hanover, MD 21076
410.796.7777

Chicago

230 Windy Point Drive
Glendale Heights, IL 60139
630.260.6303

Cleveland

12875 Corporate Drive
Unit E
Parma, OH 44130
216.265.3284

Dallas

631 Westport Parkway
Suite 100
Grapevine, TX 76051
817.251.6733

Denver

2450 Airport Road
Suite C
Aurora, CO 80011
303.366.2080

Hartford

40A International Drive
Windsor, CT 06095
860.298.1305

Houston

14825 Northwest Freeway
Suite 100
Houston, TX 77040
713.744.7530

Juarez

Prolongacion Hermanos
Escobar #7014,
Parque Industrial Omega
Adicion Oriental Cd.
Juarez, Chihuahua
Mexico 32648

Los Angeles

13201 Dahlia Street
Suite 300
Fontana, CA 92337
919.428.8903

Nashville

1421 Gould Boulevard
Suite C
La Vergne, TN 37086
615.287.3200

Phoenix

560 N 54th Street
Suite 1
Chandler, AZ 85226
480.449.4222

Raleigh

9400 Globe Center Drive
Suite 121
Morrisville, NC 27560
919.544.7074

St. Louis

56 Soccer Park Road
Fenton, MO 63026
636.717.3500

Sumter

Main Manufacturing Plant
845 Corporate Circle
Sumter, SC 29154
803.481.3131

San Francisco

20923 Cabot Boulevard
Hayward, CA 94545
510.784.8981

Seattle

1604 15th Street SW
Suite 114
Auburn, WA 98001
253.833.5021

Westampton

96 Stemmers Lane
Westampton, NJ 08060
609.835.4230

Further Information

Publication Number	Description
RP01400003E	Renewal Parts Data for MP40 and MP-200
RP01400003E	Renewal Parts Data for PB, PH, PH-L, EP and EE
RP01400002E	Renewal Parts Data for CDP/HCDP, FDP, PRL1-LX, PRL1, PRL2 and PRL3
RP01400001E	Renewal Parts Data for PRL1a, PRL2a, PRL3a, PRL4B, PRL4F and PRL5P
RP01414001E	Panelboard Renewal Parts Supplement

Pricing Information

Price List for MP40 and MP-200—PL01400003E

Price List for PB, PH, PH-L, EP and EE—PL01400003E

Price List for CDP/HCDP, FDP, PRL1-LX, PRL1, PRL2 and PRL3—PL01400002E

Price List for PRL1a, PRL2a, PRL3a, PRL4B, PRL4F and PRL5P—PL01400001E

Discount Symbol CE9

BR Renovation and CH Loadcenters



5

Loadcenters

Product Description	V12-T5-2
Product History	V12-T5-2
Type CH Family	V12-T5-2
Type BR Family	V12-T5-2
Product History Time Line	V12-T5-3
Replacement Capabilities	V12-T5-4
Type CH Replacement Parts and Mechanical Interlocks	V12-T5-4
Type CH Vintage Replacement Covers	V12-T5-12
Type BR Replacement Parts and Covers	V12-T5-14
Classified Replacement Breakers	V12-T5-24
Type CL and CHQ	V12-T5-24
Type CHNT	V12-T5-24
Type CTL and CHT	V12-T5-24
Technology Upgrades	V12-T5-25
Renovation Loadcenter	V12-T5-25
Plug-On Neutral	V12-T5-26
Retrofit Interiors	V12-T5-27
Surge Panel	V12-T5-29
Further Information	V12-T5-30
Pricing Information	V12-T5-30

Product Description

Loadcenters are enclosed assemblies used for power distribution and circuit protection in residential, commercial and light industrial applications. The assembly consists of an enclosure, an interior assembly and a cover. The interior assembly consists of a backpan where the bus assembly is mounted. Incoming power is terminated at main lugs or a main circuit breaker. Load circuit protection is provided by molded-case circuit breakers that plug onto the

bus assembly. Loadcenters are used on services providing no more than 240 Vac, and are available with bus rated from 40 to 600A. Loadcenter covers are available as surface, flush or combination.

Product History

Type CH Family

Eaton's electrical business began manufacturing the CH series of loadcenters and circuit breakers in 1962. Changes have occurred over the years due to code changes, UL® listed

requirements and product enhancements. Three major design changes occurred in 1969, 1982 and 1995. The 3/4-inch wide feeder circuit breakers, silver flash plated copper bus, sandalwood (tan) painted box and industry-leading warranties have been the trademarks of this premium product through the years.

Type BR Family

With the acquisition of Westinghouse's Distribution and Control Business Unit (DCBU) in 1994, Eaton gained the circuit breaker and loadcenter manufacturing

and marketing operations of Westinghouse. Prior to 1989, these products were manufactured by Westinghouse's Bryant subsidiary in Bridgeport, CT. The products from this facility bore the Westinghouse and Bryant nameplates. In 1988, Westinghouse purchased Challenger Electric, redesigned the product, and moved all production from Bridgeport to Jackson, MS. As Eaton integrated the product lines in 1995, all loadcenter production shifted to the Lincoln, IL, facility.

Type CH Loadcenter

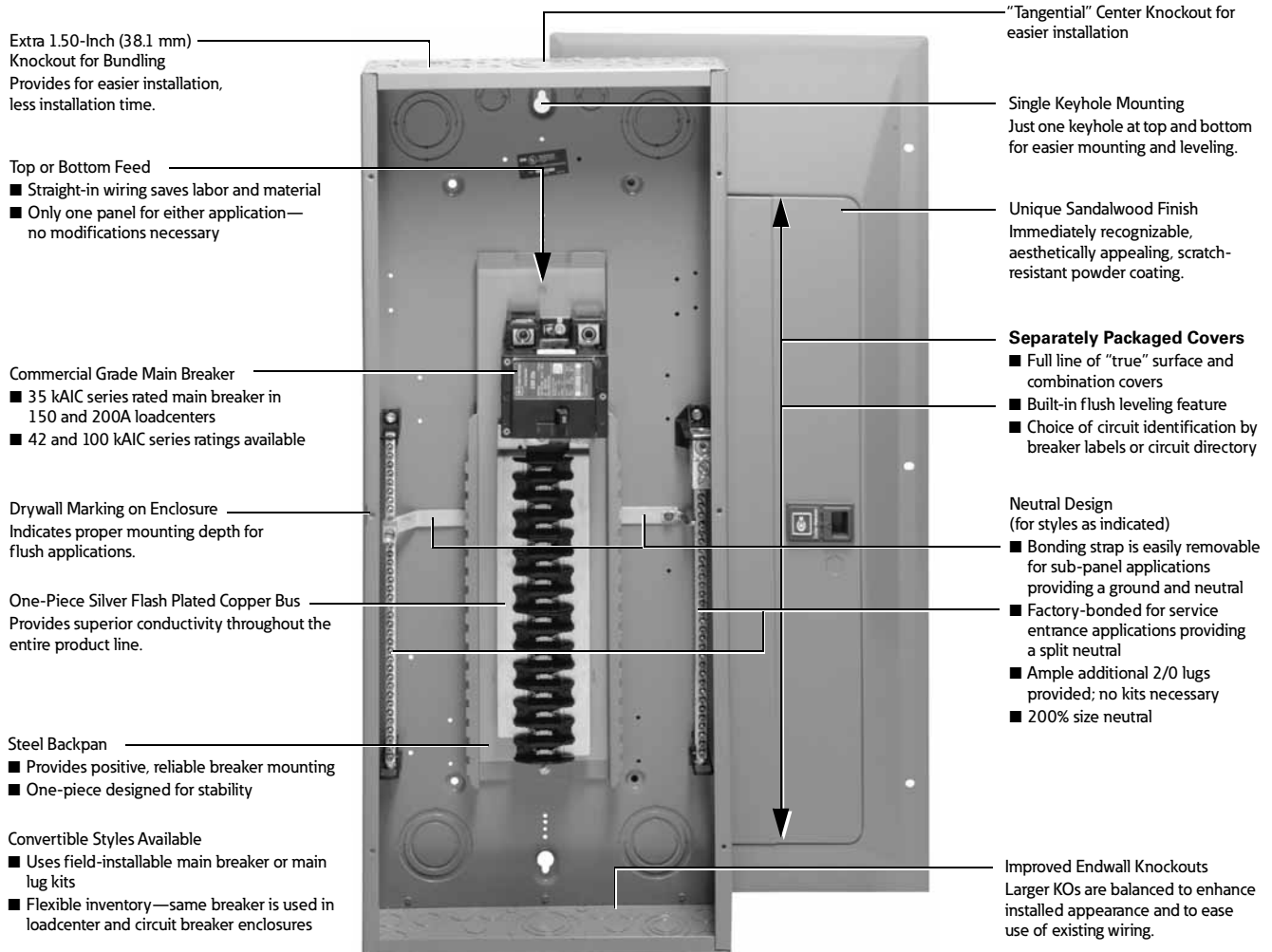

GBK14



Replacement Ground Bar Kits

Description (See Legend)	Length Inches (mm)	Ordering Quantity ^①	Catalog Number
●○○○○○●○	2.54 (64.5)	1	GBK5 ^②
●○○○○○●■	3.59 (91.2)	1	GBK520 ^②
●○○○○○●○○○○○	4.29 (109.0)	1	GBK10 ^②
●○○○○○●○○○○○■	5.34 (135.6)	1	GBK1020 ^②
●○○○○○■○○○○○■	4.61 (117.1)	1	GBK13 ^②
●○○○○○●○○○○○	5.69 (144.5)	1	GBK14 ^②
●○○○○○●○○○○○■	6.74 (171.2)	1	GBK1420 ^②
●○○○○○●○○○○○	8.14 (206.8)	1	GBK21 ^②
●○○○○○●○○○○○■	9.19 (233.4)	1	GBK2120 ^②
○○○○○○○●○○○○○●○○○○○	7.94 (201.7)	1	CH9GP21 ^{③④}
○○○○○○○■○○○○○■	5.78 (146.8)	1	BRGBK39512 ^{⑤⑥}
○○○○○	1.84 (46.7)	1	GB4NM ^⑦

Ground Bar Legend

- = (3) #14-#10 Cu/Al or (1) #14-#4 Cu/Al
- = (1) #6-2/0 Cu/Al
- = (1) 1/0-14 or (3) #10-12 Cu/Al
- = (1) #14-1/0 Cu/Al or (3) #14-#10 Cu/Al
- = Mounting hole

Product History Time Line

Originally a Cutler-Hammer Product—3/4-Inch Non-Interchangeable Product Line

Type	Design Features	1960	1965	1970	1975	1980	1985	1990	1995	2000	Present
Current Vintage (CH) ^⑧	Door latch is tan plastic, twin neutrals, CH8_S or F. (Blank is 1 letter indicating box size, i.e., B, C, E, J, K.)									■	■
Vintage-1 (CH1) ^⑧	Metal latch, single neutral, CH7_S or F. (Blank is 2 letters indicating box size, i.e., BB, CC, JJ, KK.)						■	■	■		
Vintage-2 (CH2) ^⑧	Cover catalog numbers CH7_S or F. (Blank is 1 letter indicating box size, i.e., B, C, D, 3, G, J, K.)			■	■	■					

Originally a Westinghouse Product—1-Inch Interchangeable Product Line

Type	Design Features	1960	1965	1970	1975	1980	1985	1990	1995	2000	Present
Current Vintage (BR) ^⑧	Catalog numbers start with "BR" or "3BR"									■	■
Vintage-1 (BR1) ^⑧	Twin neutral, combination trim							■	■		
Vintage-2 (BR2) ^⑧	Single neutral, combination trim						■				
Vintage-3 (BR3) ^⑧	Single neutral, surface or flush trim						■				

Notes







- ① Must be purchased in multiples of ordering quantities indicated.
- ② Distance between mounting holes is 1.75 inches (44.5 mm).
- ③ For single- and three-phase 400 A loadcenters.
- ④ Distance between mounting holes is 2.40 inches (61.0 mm).
- ⑤ For single- and three-phase 400 and 600 A applications.
- ⑥ Distance between mounting holes is 2.34 inches (59.5 mm).
- ⑦ For non-metallic enclosures. Snaps into molded base.
- ⑧ CH and BR are the current product designations. CH1, CH2, BR1, BR2 and BR3 are used only to identify previous generations of the product described in the replacement capabilities chart above. These are not actual product designations.

Replacement Capabilities

Replacement Capabilities

Type	Loadcenter Generations						
	CH	CH1	CH2	BR	BR1	BR2	BR3
Breakers	■	■	■	■	■	■	■
Surge arresters	■	■	■	■	■	■	■
Covers	■	■		■	■		
Deadfronts (NEMA® 3R)	■	■		■	■		
Door assemblies (NEMA 3R)	■	■		■	■		
MCB kits	■	■		■	■		
Neutral bars	■	■	■	■	■	■	■
Ground bars	■	■	■	■	■	■	■
Breaker accessories	■	■	■	■	■	■	■
Labels	■	■	■	■	■	■	■
Lugs	■	■		■	■		
Door locks	■	■	■	■			
Door latches	■			■			
Paint	■	■	■	■	■	■	■
Closure plates	■	■	■	■	■	■	■
Hubs	■	■		■	■		
Spare parts kit	■			■			
Whole house AC surge protection	■	■	■	■	■	■	■









Type CH Replacement Parts

	Description	Ordering Quantity ^②	Catalog Number
	CHSF2125 Subfeed lug blocks—two-pole, 125 A, 3/4-inch (19.1 mm) spaces needed	1	CHSF2125
	CHSF3125 Subfeed lug blocks—three-pole, 125 A, 3/4-inch (19.1 mm) spaces needed	1	CHSF3125
	NL20 Neutral/ground lug—add-on neutral or ground lug	1	NL20
	NL30	1	NL30
	NL300	1	NL300
	CHFP Filler plates—3/4-inch (19.1 mm) space circuit breaker space	25	CHFP

Notes

- ① Catalog number of loadcenter required to obtain correct part.
 ② Must be purchased in multiples of ordering quantities indicated.







Type CH Replacement Parts, continued

	Description	Ordering Quantity ^①	Catalog Number
CSRFP 	CSR main circuit breaker filler plate (with hardware)	1	CSRFP
TDL 	Door lock—12–42 circuits, and 100–225 A	1	TDL
SPCSW 	Sandalwood spray paint	1	SPCSW
SPC61 	ANSI-61 light gray touchup paint for outdoor loadcenters	1	SPC61
BINA 	Isolated neutral assembly (computer circuits)	1	BINA
TCD 	Circuit directory—adhesive backed	10	TCD
LCCS 	Cover screws	25	LCCS
CHRLS 	Cover replacement latch 14-5/16 inch (363.55 mm) wide loadcenters only	1	CHRLS
	Cover replacement latch 14-5/16 inch (363.55 mm) wide loadcenters only	1	CHRLS (white version)

Note

^① Must be purchased in multiples of ordering quantities indicated.









Type CH Replacement Parts, continued

	Description	Ordering Quantity ^①	Catalog Number
	CHMS Circuit marking strip (next to breakers)	1	CHMS
	CHBL Circuit identification label (preprinted breaker labels next to breakers)	10	CHBL
	SRL Series rated caution label	25	SRL
	CHNS Branch circuit numbering strip	25	CHNS
	BSSUSE Bonding strap with screw	20	BSSUSE
	CH125RB 125 A retainer bracket for sub-fed devices	1	CH125RB
	Replacement lock 400 A devices	1	52-2751
	CH3RLATCH Replacement latch for NEMA 3R—four circuits and above	1	CH3RLATCH
	Lock for vintage CH7 cover	1	CH9FL

Note

^① Must be purchased in multiples of ordering quantities indicated.







Breaker Replacement Accessories

	Description	Ordering Quantity ^①	Catalog Number
CHHT 	Handle Ties ^② Handle tie bar for physically joining the handles of two adjacent single-pole Type CH circuit breakers (molded plastic handle cover)	25	CHHT
CHPL 	Handle Lockoffs ^{③④} Padlockable device for locking the handle of single-, two- or three-pole Type CH circuit breakers (escutcheon mounted) ^⑤	1	CHPL
CHPLGF 	Padlockable device for locking the handle of a single-, two- or three-pole Type CHGFI circuit breaker (escutcheon mounted) ^⑤	1	CHPLGF
CCPL 	Padlockable device for locking the handle of main circuit breaker Types CC and CCH into the ON or OFF position.(screw mounted) ^⑥	1	CCPL
MCBPL 	Padlockable device for locking the handle of main breaker Types BW and CSR into the ON or OFF position (escutcheon mounted) ^⑤	1	MCBPL
CHLO 	Handle Lockdogs ^{④⑦} Device used to secure handle in ON or OFF position for single-pole Type CH circuit breakers (handle mounted) ^⑧	10	CHLO
CH125RB 	Hold-Down Kits ^⑨ Hold-down retainer kit for single-, two-, three-pole Type CH circuit breakers. For 6–24 circuit 125 A single- and three-phase, 12–42 circuit single-phase 225 A and 24–42 circuit three-phase 225 A MLO Type CH loadcenters	1	CH125RB
CH125RB24 	Hold-down retainer kit for single-, two-, three-pole Type CH circuit breakers for 2–4 circuit MLO CH loadcenters.	1	CH125RB24

Notes

- ① Must be purchased in multiples of ordering quantities indicated.
- ② Handle ties: typically used to join two similar independent single-pole breakers to form a two-pole noncommon trip breaker.
- ③ Handle lockoffs: devices that use a padlock to lock the circuit breaker's handle in the ON or OFF position.
- ④ Requires one additional pole space.
- ⑤ Escutcheon mounted: device mounted semipermanently to the face of the circuit breaker and secured by the loadcenter deadfront.
- ⑥ Screw mounted: device permanently mounted to the face of the circuit breaker by the use of a non-removable screw.
- ⑦ Handle lockdogs: devices that are used to secure a circuit breaker's handle in the ON or OFF position. Handle lockdogs are not padlockable devices.
- ⑧ Handle mounted: device mounted above or below handle using spring pressure.
- ⑨ Hold-down kits: devices used to secure the circuit breaker to the loadcenter for back-feed main application. See NEC Article 384.16(g).

Breaker Replacement Accessories, continued

Part Number	Description	Ordering Quantity ^①	Catalog Number
CH9MB270	Mounting Bases Mounting base for two-pole Type CH circuit breaker—70 A maximum	1	CH9MB270
			
CCL300	Main Breaker Lug Kits Types CC and CCH main breaker lug kit (2) 300 kcmil	1	CCL300
			
MCBL300	Type CSR main breaker lug kit (2) 300 kcmil	1	MCBL300
			
CHML	Mechanical Interlock Type CH for two-, three- and four-pole breakers	10	CHML
			
CHPLOFF	Type CH for two-, three- and four-pole breakers	10	CHPLOFF
			
CHPLOFFA	Type CH for two-, three- and four-pole breakers	10	CHPLOFFA
			
	CH 3/4-inch loadcenter and breaker accessories, handle lockdog	10	CHL1P
		10	CHL2P

Note

^① Must be purchased in multiples of ordering quantities indicated.

Renewal Parts List for Type CH Loadcenter Covers and Deadfronts**Single-Phase with Main Circuit Breaker**

Catalog Number	Combination Covers	Surface Covers	NEMA 3R Covers	NEMA 3R Deadfronts	Catalog Number	Combination Covers	Surface Covers	NEMA 3R Covers	NEMA 3R Deadfronts
CH1420B100B	CH8BF	CH8BS	—	—	CH30B125R	—	—	CH3RDOOR10	CH3RDF6
CH1420B100R	—	—	CH3RDOOR5	CH3RDF4	CH3242B200J	CH8JF	CH8JS	—	—
CH14B100B	CH8BF	CH8BS	—	—	CH3242B200R	—	—	CH3RDOOR12	CH3RDF9
CH14B100R	—	—	CH3RDOOR5	CH3RDF4	CH32B150J	CH8JF	CH8JS	—	—
CH1824B100C	CH8CF	CH8CS	—	—	CH32B150R	—	—	CH3RDOOR12	CH3RDF9
CH1824B100R	—	—	CH3RDOOR8	CH3RDF5	CH32B200J	CH8JF	CH8JS	—	—
CH18B100C	CH8CF	CH8CS	—	—	CH32B200R	—	—	CH3RDOOR12	CH3RDF9
CH18B100R	—	—	CH3RDOOR8	CH3RDF5	CH32B225J	CH8JF	CH8JS	—	—
CH20H100C	CH8CF	CH8CS	—	—	CH32B225R	—	—	CH3RDOOR12	CH3RDF9
CH20H100R	—	—	CH3RDOOR7	CH3RDF5	CH32H150L	CH8LF	CH8LS	—	—
CH22B100C	CH8CF	CH8CS	—	—	CH32H150R	—	—	CH3RDOOR6	CH3RDF10
CH22B100R	—	—	CH3RDOOR7	CH3RDF5	CH32H200L	CH8LF	CH8LS	—	—
CH22B125C	CH8CF	CH8CS	—	—	CH32H200R	—	—	CH3RDOOR6	CH3RDF11
CH22B125R	—	—	CH3RDOOR8	CH3RDF5	CH42B200K	CH8KF	CH8KS	—	—
CH24B150E	CH8EF	CH8ES	—	—	CH42B200R	—	—	CH3RDOOR13	CH3RDF10
CH24B150R	—	—	CH3RDOOR11	CH3RDF7	CH42B225K	CH8KF	CH8KS	—	—
CH24B200E	CH8EF	CH8ES	—	—	CH42B225R	—	—	CH3RDOOR13	CH3RDF10
CH24B200R	—	—	CH3RDOOR11	CH3RDF7	CH42H200L	CH8LF	CH8LS	—	—
CH28H100D	CH8DF	CH8DS	—	—	CH42H200R	—	—	CH3RDOOR6	CH3RDF11
CH28H100R	—	—	CH3RDOOR9	CH3RDF6	CH42H225L	CH8LF	CH8LS	—	—
CH28H125D	CH8DF	CH8DS	—	—	CH42H225R	—	—	CH3RDOOR6	CH3RDF11
CH28H125R	—	—	CH3RDOOR9	CH3RDF6	CH42PM300	CH7PMF (flush)	CH7PMS	—	—
CH30B100D	CH8DF	CH8DS	—	—	CH42PM400	CH7PMF (flush)	CH7PMS	—	—
CH30B100R	—	—	CH3RDOOR10	CH3RDF6	CH8B150RF	—	—	CH3RDOOR11	CH3RDF7
CH30B125D	CH8DF	CH8DS	—	—	CH8B200RF	—	—	CH3RDOOR11	CH3RDF7

Single-Phase with Main Lugs

Catalog Number	Combination Covers	Surface Covers	NEMA 3R Covers	NEMA 3R Deadfronts	Catalog Number	Combination Covers	Surface Covers	NEMA 3R Covers	NEMA 3R Deadfronts
CH4L125RP	—	—	CH3RDOOR2	CH3RDF2	CH2L125SP	—	CH82S	—	—
CH12L125B	CH8BF	CH8BS	—	—	CH2L40FP	—	—	—	—
CH12L125R	—	—	CH3RDOOR5	CH3RDF4	CH2L40RP	—	—	BKRCVR	—
CH12L200D	CH8DF	CH8DS	—	—	CH2L40SP	—	—	—	—
CH12L200R	—	—	CH3RDOOR9	CH4RDF6	CH2L70FP	—	—	—	—
CH1624L125B	CH8BF	CH8BS	—	—	CH2L70RP	—	—	BKRCVR	—
CH1624L125R	—	—	CH3RDOOR5	CH3RDF4	CH2L70SP	—	—	—	—
CH16L125B	CH8BF	CH8BS	—	—	CH3242L225D	CH8DF	CH8DS	—	—
CH16L125R	—	—	CH3RDOOR5	CH3RDF4	CH3242L225R	—	—	CH3RDOOR11	CH3RDF6
CH16L200D	CH8DF	CH8DS	—	—	CH32L150D	CH8DF	CH8DS	—	—
CH16L200R	—	—	CH3RDOOR11	CH3RDF6	CH32L150R	—	—	CH3RDOOR11	CH3RDF6
CH20L125C	CH8CF	CH8CS	—	—	CH32L225D	CH8DF	CH8DS	—	—
CH20L125R	—	—	CH3RDOOR8	CH3RDF5	CH32L225R	—	—	CH3RDOOR11	CH3RDF6
CH24L125C	CH8CF	CH8CS	—	—	CH42L225G	CH8GF	CH8GS	—	—
CH24L125R	—	—	CH3RDOOR8	CH3RDF5	CH42L225R	—	—	CH3RDOOR12	CH3RDF8
CH24L150D	CH8DF	CH8DS	—	—	CH42PL400	CH7PF (flush)	CH7PS	—	—
CH24L150R	—	—	CH3RDOOR11	CH3RDF6	CH4L125FP	CH84F (flush)	—	—	—
CH24L225D	CH8DF	CH8DS	—	—	CH4L125SP	—	CH84S	—	—
CH24L225R	—	—	CH3RDOOR11	CH3RDF6	CH8L125FP	CH88F (flush)	—	—	—
CH2L125FP	CH8ZF (FLUSH)	—	—	—	CH8L125RP	—	—	CH3RDOOR4	CH3RDF3
CH2L125RE2P	—	—	—	—	CH8L125SP	—	CH88S	—	—
CH2L125RP	—	—	CH3RDOOR1	CH3RDF1					

Single-Phase Convertible

Catalog Number	Combination Covers	Surface Covers	NEMA 3R Covers	NEMA 3R Deadfronts
CH22N125C	CH8CF	CH8CS	—	—
CH22N125R	—	—	—	—
CH32N200J	CH8JF	CH8JS	—	—
CH32N200R	—	—	CH3RDOOR12	CH3RDF9
CH42N225K	CH8KF	CH8KS	—	—
CH42N225R	—	—	—	—
CH8N200RF	—	—	—	CH3RDF7

Three-Phase with Main Circuit Breakers

Catalog Number	Combination Covers	Surface Covers	NEMA 3R Covers	NEMA 3R Deadfronts
CH30B3150L	CH8LF	CH8LS	—	—
CH30B3150R	—	—	CH3RDOOR6	CH3RDF11
CH30B3200L	CH8LF	CH8LS	—	—
CH30B3200R	—	—	CH3RDOOR6	CH3RDF11
CH30B3225L	CH8LF	CH8LS	—	—
CH30B3225R	—	—	CH3RDOOR6	CH3RDF11
CH30H3200L	CH8LF	CH8LS	—	—
CH30H3200R	—	—	CH3RDOOR6	CH3RDF11
CH424PM300	CH7PMF (flush)	CH7PMS	—	—
CH424PM400	CH7PMF (flush)	CH7PMS	—	—
CH42B3200L	CH8LF	CH8LS	—	—
CH42B3200R	—	—	CH3RDOOR6	CH3RDF11
CH42B3225L	CH8LF	CH8LS	—	—
CH42B3225R	—	—	CH3RDOOR6	CH3RDF11
CH42H3200L	CH8LF	CH8LS	—	—
CH42H3200R	—	—	CH3RDOOR6	CH3RDF11
CH42H3225L	CH8LF	CH8LS	—	—
CH42H3225R	—	—	CH3RDOOR6	CH3RDF11

Three-Phase with Main Lugs

Catalog Number	Combination Covers	Surface Covers	NEMA 3R Covers	NEMA 3R Deadfronts
CH12L3125B	CH8BF	CH8BS	—	—
CH12L3125R	—	—	CH3RDOOR5	CH3RDF4
CH18L3125C	CH8CF	CH8CS	—	—
CH18L3125R	—	—	CH3RDOOR8	CH3RDF5
CH24L3125C	CH8CF	CH8CS	—	—
CH24L3125R	—	—	CH3RDOOR8	CH3RDF5
CH24L3225D	CH8DF	CH8DS	—	—
CH24L3225R	—	—	CH3RDOOR11	CH3RDF6
CH30L3150D	CH8DF	CH8DS	—	—
CH30L3150R	—	—	CH3RDOOR11	CH3RDF6
CH30L3225D	CH8DF	CH8DS	—	—
CH30L3225R	—	—	CH3RDOOR11	CH3RDF6
CH424PL400	CH7PF (flush)	CH7PS	—	—
CH42L3225R	—	—	CH3RDOOR12	CH3RDF8
CH42L3225G	CH8GF	CH8GS	—	—
CH6L3125FP	CH86F (flush)	—	—	—
CH6L3125RP	—	—	CH3RDOOR3	CH3RDF3
CH6L3125SP	—	CH86F	—	—

Renewal Parts List for Vintage Type CH Loadcenter Covers and Deadfronts**Single-Phase with Main Circuit Breaker**

Catalog Number	Surface Covers	Flush Covers	Surface Covers w/ Mechanical Interlock	Flush Covers w/ Mechanical Interlock
CH22CCM100N	CH7CCS	CH7CCF	CH7CCSM	CH7CCFM
CH30JJM150N	CH7JJS	CH7JJF	—	—
CH30JJM200N	CH7JJS	CH7JJF	—	—
CH40KKM200N	CH7KKS	CH7KKF	—	—
CH14BBM100	CH7BBS	CH7BBF	CH7BBSM	CH7BBFM
CH14BBM100R	—	—	—	—
CH18CCM100	CH7CCS	CH7CCF	—	—
CH18CCM100R	—	—	—	—
CH22CCM125	CH7CCS	CH7CCF	—	—
CH22CCM125R	—	—	—	—
CH20JJM150	CH7JJS	CH7JJF	—	—
CH20JJM150R	—	—	—	—
CH20JJM200	CH7JJS	CH7JJF	—	—
CH20JJM200R	—	—	—	—
CH24JJM150	CH7JJS	CH7JJF	—	—
CH24JJM150R	—	—	—	—
CH24JJM200	CH7JJS	CH7JJF	—	—
CH24JJM200R	—	—	—	—
CH30JJM150	CH7JJS	CH7JJF	—	—
CH30JJM150R	—	—	—	—
CH30JJM200	CH7JJS	CH7JJF	—	—
CH30JJM200R	—	—	—	—
CH30KKM225	CH7KKS	CH7KKF	—	—
CH30KKM225R	—	—	—	—
CH40KKM200	CH7KKS	CH7KKF	—	—
CH40KKM200R	—	—	—	—
CH42KKM225	CH7KKS	CH7KKF	—	—
CH42KKM225R	—	—	—	—
CH42PM300	CH7PMS	CH7PMF	—	—
CH42PM400	CH7PMS	CH7PMF	—	—
CH20CCM100H2	CH7CCS	CH7CCF	—	—
CH20CCM100H2R	—	—	—	—
CH26EEM125H2	CH7EES	CH7EEF	—	—
CH26EEM125H2R	—	—	—	—
CH20CCM100H4	CH7CCS	CH7CCF	—	—
CH20CCM100H4R	—	—	—	—
CH26EEM100H4	CH7EES	CH7EEF	—	—
CH26EEM100H4R	—	—	—	—
CH26EEM125H4	CH7EES	CH7EEF	—	—
CH26EEM125H4R	—	—	—	—
CH30JJM150H	CH7JJS	CH7JJF	—	—
CH30JJM150HR	—	—	—	—
CH30JJM200H	CH7JJS	CH7JJF	—	—
CH30JJM200HR	—	—	—	—
CH40KKM200H	CH7KKS	CH7KKF	—	—
CH40KKM200HR	—	—	—	—
CH42KKM225H	CH7KKS	CH7KKF	—	—
CH42KKM225HR	—	—	—	—
CH1420BBM100	CH7BBS	CH7BBF	—	—
CH1420BBM100R	—	—	—	—
CH1824CCM100	CH7CCS	CH7CCF	—	—
CH1824CCM100R	—	—	—	—
CH3040JJM200	CH7JJS	CH7JJF	—	—
CH3040JJM200	—	—	—	—

Single-Phase with Main Lugs

Catalog Number	Surface Covers	Flush Covers	Surface Covers w/ Mechanical Interlock	Flush Covers w/ Mechanical Interlock
CH2S	—	—	—	—
CH2F	—	—	—	—
CH2R	—	—	—	—
CH2AS	—	—	—	—
CH2AF	—	—	—	—
CH2AR	—	—	—	—
CH2BS	—	—	—	—
CH2BF	—	—	—	—
CH2BR	—	—	—	—
CH4S	—	—	—	—
CH4F	—	—	—	—
CH4R	—	—	—	—
CH8S	—	—	—	—
CH8F	—	—	—	—
CH8R	—	—	—	—
CH12BB	CH7BBS	CH7BBF	CH7BBSM	CH7BBFM
CH12BBR	—	—	—	—
CH12EE200	CH7EES	CH7EEF	—	—
CH12EE200R	—	—	—	—
CH16BB	CH7BBS	CH7BBF	CH7BBSM	CH7BBFM
CH16BBR	—	—	—	—
CH16EE200	CH7EES	CH7EEF	—	—
CH16EE200R	—	—	—	—
CH20CC	CH7CCS	CH7CCF	CH7CCSM	CH7CCFM
CH20CCR	—	—	—	—
CH24CC	CH7CCS	CH7CCF	CH7CCSM	CH7CCFM
CH24CCR	—	—	—	—
CH24EE150	CH7EES	CH7EEF	CH7EESM	CH7EEFM
CH24EE150R	—	—	—	—
CH24EE225	CH7EES	CH7EEF	—	—
CH24EE225R	—	—	—	—
CH30EE	CH7EES	CH7EEF	CH7EESM	CH7EEFM
CH30EER	—	—	—	—
CH30EE225	CH7EES	CH7EEF	—	—
CH30EE225R	—	—	—	—
CH42GG	CH7GGS	CH7GGF	CH7GGSM	CH7GGFM
CH42GGR	—	—	—	—
CH42PL400	CH7PS	CH7PF	—	—
CH48S	—	—	—	—
CH48F	—	—	—	—
CH48R	—	—	—	—
CH816S	—	—	—	—
CH816F	—	—	—	—
CH816R	—	—	—	—
CH1624BB	CH7BBS	CH7BBF	—	—
CH1624BBR	—	—	—	—
CH3042EE225	CH7EES	CH7EEF	—	—
CH3042EE225R	—	—	—	—

Three-Phase with Main Lugs

Catalog Number	Surface Covers	Flush Covers	Surface Covers w/ Mechanical Interlock	Flush Covers w/ Mechanical Interlock
CH64S	—	—	—	—
CH64R	—	—	—	—
CH124BB	CH7BBS	CH7BBF	CH7BBSM	CH7BBFM
CH124BBR	—	—	—	—
CH184CC	CH7CCS	CH7CCF	CH7CCSM	CH7CCFM
CH184CCR	—	—	—	—
CH244CC	CH7CCS	CH7CCF	CH7CCSM	CH7CCFM
CH244CCR	—	—	—	—
CH244EE225	CH7EES	CH7EEF	CH7EESM	CH7EEFM
CH244EE225R	—	—	—	—
CH304EE	CH7EES	CH7EEF	CH7EESM	CH7EEFM
CH304EER	—	—	—	—
CH304EE225	CH7EES	CH7EEF	—	—
CH304EE225R	—	—	—	—
CH424GG225	CH7GGS	CH7GGF	CH7GGS	CH7GGFM
CH424GG225R	—	—	—	—
CH424PL400	CH7PS	CH7PF	—	—

Three-Phase with Main Circuit Breaker

Catalog Number	Surface Covers	Flush Covers	Surface Covers w/ Mechanical Interlock	Flush Covers w/ Mechanical Interlock
CH304JJM150	CH7JJS	CH7JF	—	—
CH304JJM150R	—	—	—	—
CH304JJM200	CH7JJS	CH7JF	—	—
CH304JJM200R	—	—	—	—
CH304LLM225	CH7LLS	CH7LLF	—	—
CH424KKM200	CH7KKS	CH7KKF	—	—
CH424KKM200R	—	—	—	—
CH424LLM225	CH7LLS	CH7LLF	—	—
CH424PM300	CH7PMS	CH7PMF	—	—
CH424PM400	CH7PMS	CH7PMF	—	—
CH304JJM200H	CH7JJS	CH7JF	—	—
CH304JJM200HR	—	—	—	—
CH424KKM200H	CH7KKS	CH7KKF	—	—
CH424KKM200HR	—	—	—	—
CH424LLM225H	CH7LLS	CH7LLF	—	—

Type CH Loadcenter Interior Assemblies

Catalog Number	Ampere Rating	Maximum Number 1.00-Inch (25.4 mm) Spaces		UL File Reference	Main Terminal Wire Size Range (per phase) Cu/Al 60°C or 75°C	Standard Package Quantity
		Single-Pole				
Single-Phase, Single-Row Breaker Mounting—Copper Bus 120/24 Vac, Three-Wire						
CH9MB270	70	2	2	E8741	(1) #8–#2 AWG Cu/Al	1
CH2L125INT	125	2	2	E8741	(1) 2/0–#6 AWG Cu/Al	20
Single-Phase, Double-Row Breaker Mounting—Copper Bus 120/240 Vac, Three-Wire						
CH4L125INT	125	4	4	E8741	(1) 2/0–#14 AWG Cu/Al	20
CH8L125INT	125	8	8	E8741	(1) 2/0–#6 AWG Cu/Al	20
CH12L125INT	125	12	12	E8741	(1) 2/0–#6 AWG Cu/Al	20
CH16L125INT	125	16	16	E8741	(1) 2/0–#6 AWG Cu/Al	20
CH12L200INT	200	12	12	E8741	(1) 300 kcmil–#4 AWG Cu/Al	20
CH16L200INT	200	16	16	E8741	(1) 300 kcmil–#4 AWG Cu/Al	10
CH24L225INT	225	24	24	E8741	(1) 300 kcmil–#4 AWG Cu/Al	10
CH32L225INT	225	32	32	E8741	(1) 300 kcmil–#4 AWG Cu/Al	10
CH42L225INT	225	42	42	E8741	(1) 300 kcmil–#4 AWG Cu/Al	10
Three-Phase, Double-Row Breaker Mounting—Copper Bus 208Y/120 Vac, Four-Wire—240 Vac, Three-Wire—120/240 Vac, Four-Wire Delta						
CH12L3125INT	125	12	12	E8741	(1) 2/0–#6 AWG Cu/Al	10
CH18L3125INT	125	18	18	E8741	(1) 2/0–#6 AWG Cu/Al	10
CH24L3125INT	125	24	24	E8741	(1) 2/0–#6 AWG Cu/Al	10
CH24L3225INT	225	24	24	E8741	(1) 300 kcmil–#4 AWG Cu/Al	10
CH30L3225INT	225	30	30	E8741	(1) 300 kcmil–#4 AWG Cu/Al	10
CH42L3225INT	225	42	42	E8741	(1) 300 kcmil–#4 AWG Cu/Al	10











Type BR Replacement Parts and Covers

	Number of Poles	Ampere Rating	Number of 1.00-Inch (25.4 mm) Spaces Needed	Wire Size Range Cu/Al 60 °C or 75 °C	Ordering Quantity ^①	Catalog Number
BRSF125 	Main and Subfeed Lug Blocks					
	2	125	2	#8–2/0	1	BRSF125
BRSF150 		150	2	#8–2/0	1	BRSF150 ^②
BRS225 		225	4	#2–300 kcmil	1	BRS225
3BRSF150 	3	150	3	#8–2/0	1	3BRSF150 ^②
3BRSF225 		225	6	#2–300 kcmil	1	3BRS225
BRL200 	Main Lugs					
	Two-pole, 200 A stud mounted (includes deadfront filler plate)			#1–300 kcmil	1	BRL200
NL20 	Neutral/ground lug Add-on neutral or ground lug			#2/0 maximum	1	NL20
NL30 	Neutral/ground lug Add-on neutral or ground lug			#3/0 maximum	1	NL30
NL300 	Neutral/ground lug Add-on neutral or ground lug			300 kcmil maximum	1	NL300
BRFP 	Filler Plates					
	1.00-inch (25.4 mm) circuit breaker space				25	BRFP
BRFP 	BW main circuit breaker space (with hardware)				1	BWFP

Notes

- ① Must be purchased in multiples of ordering quantities indicated.
 ② #8–2/0 wire size range is 75 °C rated only.

Type BR Replacement Parts and Covers, continued

	Number of Poles	Ampere Rating	Number of 1.00-Inch (25.4 mm) Spaces Needed	Wire Size Range Cu/Al 60 °C or 75 °C	Ordering Quantity ①	Catalog Number
Filler Plates, continued						
TDL 					1	TDL
						Door lock—12–42 circuits, and 100–225 A
					1	CH9FL
						Door lock—4–8 circuits, 12 5A
SPC61 					1	SPC61
						ANSI-61 light gray touchup paint for current loadcenters
BINA 					1	BINA
						Isolated neutral assembly (computer circuits)
TCD 					10	TCD
						Circuit directory—adhesive backed
LCCS 					25	LCCS
						Cover screws
BRRL 					1	BRRL
						Cover replacement latch (gray) 14-5/16 (363.5 mm) wide loadcenters only
BRMS 					10	BRMS
						Circuit marking strip (next to breaker)
CHBL 					25	CHBL
						Circuit identification label (preprinted breaker labels)
SRL 					25	SRL
						Series rated caution label
BSSUSE 					1	BSSUSE
						Bonding strip with screw

Note

① Must be purchased in multiples of ordering quantities indicated.





Mechanical Interlock Cover

Covers mechanically interlock two breakers—Type BW or BWH main breaker with a Type BR branch breaker.

BR4040B200**Mechanical Interlock Covers**

Fits Loadcenter Catalog Number	Mechanical Interlock Panel Cover Catalog Number
BR816B200RF	BR3RDF5M
BR2040B200R	BR3RDF11M
BR3040B200R	BR3RDF12M
BR4040B200R	BR3RDF13M
BR2040B200	BRCOV20D1FM
BR3040B200	BRCOV30G1FM
BR4040B200	BRCOV40L1FM









Replacement Breaker Accessories

Description	Ordering Quantity ^①	Catalog Number
BHT		
Handle Ties ^②		
 Handle tie bar for physically joining the handles of two adjacent single-pole Type BR circuit breakers (metal cylinder pin type)	10	BHT
THOW		
 Handle tie bar for joining two independent outside poles of Types BQ and BQC Quadplex and outside poles of two Type BD duplex circuit breakers	10	THOW
THS1		
 Handle tie bar for joining two adjacent outside poles of Types BQ and BQC Quadplex and outside poles of two Type BD duplex circuit breakers	10	THS1
BRLW		
Handle Lockoffs ^③		
 Padlockable device for locking the handle of single-, two- or three-pole Type BR Circuit Breakers and single-pole of a Type BD Duplex or one independent outside pole of a Type BQ or BQC Quadplex circuit breakers (escutcheon mounted) ^④	10	BRLW
BRLW1		
 Padlockable device for locking the handle of a single-pole Type BR circuit breaker.(handle mounted) ^④	10	BRLW1

Notes

- ① Must be purchased in multiples of ordering quantities indicated.
- ② Handle ties: typically used to join two similar independent single-pole breakers to form a two-pole noncommon trip breaker.
- ③ Handle lockoffs: devices that use a padlock to lock the circuit breaker's handle in the ON or OFF position.
- ④ Handle mounted: device mounted directly to the handle by the use of a set screw.











Replacement Breaker Accessories, continued

3RLW2	Description	Ordering Quantity ^①	Catalog Number
	Handle Lockoffs, continued ^② Padlockable device for locking the handle of a two- and three-pole Type BR circuit breaker (handle mounted) ^③	10	BRLW2
BRDL1	Padlockable device for locking the handle of a single-pole Type BD Duplex, BQ or BQC Quadplex breaker (handle mounted) ^③	10	BRDL1
			
BRQLW	Padlockable device for locking the handle of the two center poles and the two outer poles of a two-pole Types BQ and BQC quadplex circuit breakers (escutcheon mounted) ^④	10	BRQLW
			
CCPL	Padlockable device for locking the handle of main circuit breaker Types CC and CHH into the ON or OFF position (screw mounted) ^⑤	1	CCPL
			
MCBPL	Padlockable device for locking the handle of main breaker Types BW and BWH into the ON or OFF position (escutcheon mounted) ^④	1	MCBPL
			
BHLW	Handle Lockdog ^⑥ Device used to secure handle in ON or OFF position for single-, two- or three-pole Type BR circuit breakers and single-pole of Type BD duplex and one independent outside pole of Type BQ or BQC Quadplex circuit breakers (escutcheon mounted) ^③	10	BHLW
			
BHLW1	Device used to secure handle in ON or OFF position for single-pole Type BR circuit breakers (handle mounted) ^③	10	BHLW1
			
BHLW2	Device used to secure handle in ON or OFF position for two- and three-pole Type BR circuit breakers (handle mounted) ^③	10	BHLW2
			

Notes

- ① Must be purchased in multiples of ordering quantities indicated.
- ② Handle lockoffs: devices that use a padlock to lock the circuit breaker's handle in the ON or OFF position.
- ③ Handle mounted: device mounted directly to the handle by the use of a set screw.
- ④ Escutcheon mounted: device mounted semipermanently to the face of the circuit breaker and secured by the loadcenter deadfront.
- ⑤ Screw mounted: device permanently mounted to the face of the circuit breaker by the use of a non-removable screw.
- ⑥ Handle lockdogs: devices that are used to secure a circuit breaker's handle in the ON or OFF position. Handle Lockdogs are not padlockable devices.

Replacement Breaker Accessories, continued

	Description	Ordering Quantity ^①	Catalog Number
BHGW	Handle Lockdog, continued ^②		
	Device used to secure handle in ON or OFF position for single-pole Type GFBC ground fault circuit breakers (handle mounted) ^③	10	BHGW
HLW1	Handle Lockdog, continued ^②		
	Device used to secure handle in ON or OFF position for one independent outside pole of Types BQ and BQC Quadplex or single-pole Type BD duplex circuit breakers (handle mounted) ^③	10	HLW1
BRHDB	Hold-Down Kits ^④		
	Hold-down retainer kit for three-pole Type BR circuit breakers in S3100 and 3100R loadcenters only	1	BRHDB
BRQS125	Hold-Down Kits ^④		
	Hold-down screw kit for two-pole Type BR circuit breakers in single-phase MLO loadcenters through 125 A	1	BRQS125
BRHK125	Hold-Down Kits ^④		
	Hold-down screw kit for two-pole Type BR circuit breakers in MLO loadcenters 150–225 A (single-phase only)	1	BRHK125
BJHDS	Hold-Down Kits ^④		
	Hold-down screw kit for two-pole Types BJ and BJH circuit breakers in MLO loadcenters 125–225 A	1	BJHDS
BJHDS3P	Hold-Down Kits ^④		
	Hold-down screw kit for three-pole Types BJ and BJH circuit breakers in MLO loadcenters 125–225 A	1	BJHDS3P
CCL300	Main Breaker Lug Kits		
	Types CC and CHH main breaker lug kit (2) 300 kcmil	1	CCL300
MCBL300	Main Breaker Lug Kits		
	Types BW/BWH main breaker lug kit (2) 300 kcmil	1	MCBL300
BRML	Mechanical Interlock		
	Types BR for two-, three- and four-pole breakers	10	BRML

Notes

- ① Must be purchased in multiples of ordering quantities indicated.
- ② Handle lockdogs: devices that are used to secure a circuit breaker's handle in the ON or OFF position. Handle Lockdogs are not padlockable devices.
- ③ Handle mounted: device mounted directly to the handle by the use of a set screw.
- ④ Hold-down kits: devices used to secure the circuit breaker to the loadcenter for back-feed main application. See NEC Article 384.16(g).

Renewal Parts for Type BR Loadcenter Covers and Deadfronts**Single-Phase with Main Circuit Breakers**

Catalog Number	Combination Covers	Surface Covers	NEMA 3R Covers	NEMA 3R Deadfronts	Catalog Number	Combination Covers	Surface Covers	NEMA 3R Covers	NEMA 3R Deadfronts
B4242DFN	315-003-28	—	—	—	BR2040B150R	—	—	BR3RDOOR8	BR3RDF11
B4242DR1N	—	—	Not available	—	BR2040B200	BRCOVC35	—	—	—
B4242DSN	—	315-003-27	—	—	BR2040B200R	—	—	BR3RDOOR9	BR3RDF11
B4242EFN	315-003-28	—	—	—	BR2040H200	BRCOVC35	—	—	—
B4242ESN	—	315-003-27	—	—	BR2430B150	BRCOVC40	—	—	—
BR1020B100RF	—	—	BR3RDOOR2	BR3RDF1	BR2440B200	BRCOVC41	—	—	—
BR1212B100	BRCOVC12	—	—	—	BR3030BC100	BRCOVC59	—	—	—
BR1220B100	BRCOVC12	—	—	—	BR3030B150	BRCOVC40	—	—	—
BR1224B100R	—	—	BR3RDOOR2	BR3RDF1	BR3030B150R	—	—	BR3RDOOR10	BR3RDF12
BR1224B100SFG	47-37466	—	—	47-37469	BR3030BC150	BRCOVC40	—	—	—
BR1616B100	BRCOVC16	—	—	—	BR3040B150	BRCOVC40	—	—	—
BR1620B100	BRCOVC16	—	—	—	BR3040B200	BRCOVC41	—	—	—
BR1624B100	BRCOVC16	—	—	—	BR3040B200R	—	—	BR3RDOOR11	BR3RDF12
BR1624B100R	—	—	BR3RDOOR3	BR3RDF2	BR3040H200	BRCOVC41	—	—	—
BR1624B125	BRCOVC17	—	—	—	BR304242F	315-003-28	—	—	—
BR1630B150	BRCOVC29	—	—	—	BR304242S	—	315-003-27	—	—
BR1632B200	BRCOVC31	—	—	—	BR4040B200	BRCOVC44	—	—	—
BR2020B100	BRCOVC22	—	—	—	BR4040BC200	BRCOVC44	—	—	—
BR2024B100R	—	—	BR3RDOOR4	BR3RDF4	BR4040B200R	—	—	BR3RDOOR12	BR3RDF13
BR2024B125	BRCOVC23	—	—	—	BR4040H200	BRCOVC44	—	—	—
BR2024B125R	—	—	BR3RDOOR4	BR3RDF4	BR4242B225	BRCOVC53 (2)	—	—	—
BR2024H100	BRCOVC22	—	—	—	BR4242B225R	—	—	BR3RDOOR13	BR3RDF15
BR2030B150	BRCOVC32	—	—	—	BR48B200RF	—	—	BR3RDOOR15	BR3RDF14
BR2030B150R	—	—	BR3RDOOR8	BR3RDF11	BR816B100	BRCOVC10	—	—	—
BR2030H150	BRCOVC32	—	—	—	BR816B150RF	—	—	BR3RDOOR5	BR3RDF5
BR2040B150	BRCOVC40	—	—	—	BR816B200RF	—	—	BR3RDOOR6	BR3RDF5

Convertible

Catalog Number	Combination Covers	Surface Covers	NEMA 3R Covers	NEMA 3R Deadfronts
3BR1224N125	BRCOVC20	—	—	—
3BR1224N125R	—	—	BR3RDOOR29	BR3RDF2
3BR1224N125S	—	BRCOVS20	—	—
3BR3030N100	BRCOVC37	—	—	—
3BR3030N100R	—	—	BR3RDOOR30	—
3BR3030N100S	—	BRCOVS37	—	—
BR1224N125	BRCOVC13	—	—	—
BR1224N125R	—	—	BR3RDOOR2	BR3RDF1
BR1224NC125R	—	—	BR3RDOOR2	—
BR1224N200	BRCOVC30	—	—	—
BR1224N200R	—	—	BR3RDOOR6	BR3RDF5
BR1624N125	BRCOVC17	—	—	—
BR1624N125R	—	—	BR3RDOOR3	BR3RDF2
BR1632N200	BRCOVC31	—	—	—
BR1632N200SFG	—	—	47-37460	47-37375
BR2024N125	BRCOVC23	—	—	—
BR2024N125R	—	—	BR3RDOOR4	BR3RDF4
BR2040N200	BRCOVC35	—	—	—
BR2040N200R	—	—	BR3RDOOR9	BR3RDF11
BR2440N200	BRCOVC41	—	—	—
BR3040N200	BRCOVC41	—	—	—
BR3040N200R	—	—	BR3RDOOR11	BR3RDF12
BR4040N200	BRCOVC44	—	—	—
BR4040N200R	—	—	BR3RDOOR12	BR3RDF13
BR816N200RF	—	—	BR3RDOOR6	BR3RDF5
BR4040NL200G	BRCOVC44 + BWFP	—	—	—

Manufactured Housing Loadcenters
Single-Phase with Main Circuit Breaker

Catalog Number	Cover Number
BR1020B100GK	MBCOVC10
BR1020B100PK	MBCOVC10
BR1220B100GK	MBCOVC11
BR1220B100PK	MBCOVC11
BR1224B100PK	MBCOVC24
BR1224B100GK	MBCOVC24
BR1224B100GK	MBCOVC25 ①
BR1224B150GK	MBCOVC12
BR1224B150PK	MBCOVC12
BR1630B150GK	MBCOVC13
BR1630B150PK	MBCOVC13
BR1224B200GK	MBCOVC14
BR1224B200PK	MBCOVC14
BR1632B200GK	MBCOVC15
BR1632B200PK	MBCOVC15
BR2040B200GK	MBCOVC16
BR2040B200PK	MBCOVC16
BR1020B100PKW	MBCOVC17 ①
BR1220B100PKW	MBCOVC18 ①
BR1224B100PKW	MBCOVC25 ①
BR1224B150PKW	MBCOVC19 ①
BR1630B150PKW	MBCOVC20 ①
BR1224B200PKW	MBCOVC21 ①
BR1632B200PKW	MBCOVC22 ①
BR2040B200PKW	MBCOVC23 ①

Note

① These covers are painted white (standard color is gray).

Single-Phase with Main Lugs

Catalog Number	Combination Covers	Surface Covers	NEMA 3R Covers	NEMA 3R Deadfronts	Catalog Number	Combination Covers	Surface Covers	NEMA 3R Covers	NEMA 3R Deadfronts
1224DRIN	—	—	Not available	—	BR24L70RP	—	—	Not available	—
1224DSN	—	Not available	—	—	BR24L70SGP	—	Not available	—	—
2442DSN	—	Not available	—	—	BR24L70SP	—	Not available	—	—
2460FGNM	—	—	—	—	BR1224L125RIS	BRCOVC66	—	—	—
2460FNM	—	—	—	—	BR1224L125RISBP	BRCOVC66	—	—	—
2460RNM	—	—	—	—	BR2024L125RIS	BRCOVC66	—	—	—
2460SGNM	—	—	—	—	BR3040L200	BRCOVC36	—	—	—
2460SNM	—	—	—	—	BR3040L200G	BRCOVC36	—	—	—
4242DFN	315-003-06	—	—	—	BR3040L200R	—	—	BR3RDOOR9	BR3RDF8
4242DRIN	—	Not available	—	—	BR4040L200	BRCOVC42	—	—	—
4242DSN	—	315-003-05	—	—	BR4040L200R	—	—	BR3RDOOR11	BR3RDF9
4242ESN	—	315-003-05	—	—	BR4242L225	BRCOVC45	—	—	—
BR1212L125	BRCOVC11	—	—	—	BR4242L225R	—	—	BR3RDOOR14	BR3RDF10
BR1224L125	BRCOVC11	—	—	—	BR48L125FDP	BRCOVC62 (flush)	—	—	—
BR1224L125DG	BRCOVC11	—	—	—	BR48L125FGP	BRCOVC63 (flush)	—	—	—
BR1224L125G	BRCOVC11	—	—	—	BR48L125FP	BRCOVC61 (flush)	—	—	—
BR1224L125R	—	—	BR3RDOOR1	BR3RDF3	BR48L125RP	—	—	BR3RDOOR26	BR3RDF22
BR1224L200	BRCOVC15	—	—	—	BR48L125SGP	—	BRCOVS60	—	—
BR1224L200R	—	—	BR3RDOOR7	BR3RDF6	BR48L125SP	—	BRCOVS59	—	—
BR1616L125	BRCOVC14	—	—	—	BR612L125FDGP	BRCOVC08	—	—	—
BR1624L125	BRCOVC14	—	—	—	BR612L125FDP	BRCOVC08	—	—	—
BR1624L125G	BRCOVC14	—	—	—	BR612L125FGP	BRCOVC63	—	—	—
BR1624L125R	—	—	BR3RDOOR2	BR3RDF1	BR612L125FP	BRCOVC08	—	—	—
BR1630L150	BRCOVC25	—	—	—	BR612L125RP	—	—	BR3RDOOR27	BR3RDF23
BR2020L125	BRCOVC18	—	—	—	BR612L125SDGP	—	BRCOVS08	—	—
BR2024L125	BRCOVC18	—	—	—	BR612L125SDP	—	BRCOVS08	—	—
BR2024L125G	BRCOVC18	—	—	—	BR612L125SGP	—	BRCOVS60	—	—
BR2024L125R	—	—	BR3RDOOR3	BR3RDF2	BR612L125SP	—	BRCOVS59	—	—
BR2030L150	BRCOVC25	—	—	—	BR816L125FDGP	BRCOVC64 (flush)	—	—	—
BR2040L200	BRCOVC25	—	—	—	BR816L125FDP	BRCOVC64 (flush)	—	—	—
BR2040L200G	BRCOVC25	—	—	—	BR816L125FGP	BRCOVC09	—	—	—
BR2040L200R	—	—	BR3RDOOR6	BR3RDF7	BR816L125FP	BRCOVC09	—	—	—
BR2424L125	BRCOVC24	—	—	—	BR816L125RP	—	—	BR3RDOOR28	BR3RDF23
BR2424L125G	BRCOVC24	—	—	—	BR816L125SDGP	—	BRCOVS61	—	—
BR2440L200	BRCOVC33	—	—	—	BR816L125SDP	—	BRCOVS61	—	—
BR24L125FP	BRCOVC60 (FLUSH)	—	—	—	BR816L125SGP	—	BRCOVS09	—	—
BR24L125RP	—	—	BR3RDOOR25	BR3RDF21	BR816L125SP	—	BRCOVS09	—	—
BR24L125RSE2P	—	—	—	BR3RDF21	BR816L200RF	—	—	BR3RDOOR7	BR3RDF6
BR24L125RSEP	—	—	—	BR3RDF21	BR816LC125FDP	BRCOVC64 (flush)	—	—	—
BR24L125SP	—	BRCOVS62	—	—	TT120FLGNM	—	—	—	—
BR24L70FGP	Not available	—	—	—	TT120SLGNM	—	—	—	—

Three-Phase with Main Lugs

Catalog Number	Combination Covers	Surface Covers	NEMA 3R Covers	NEMA 3R Deadfronts
31836DFN	Not available	—	—	—
31836DR1N	—	—	Not available	—
31836DSN	—	Not available	—	—
32442DSN	—	Not available	—	—
34242DFN	315-003-06	—	—	—
34242DR1N	—	—	Not available	—
34242DSN	—	315-003-05	—	—
34242EFN	315-003-06	—	—	—
34242ESN	—	315-003-05	—	—
3BR1224L125	BRCOVC21	—	—	—
3BR1224L125R	—	—	BR3RDOOR29	BR3RDF2
3BR1224L125S	—	BRCOVS21	—	—
3BR1224L200	BRCOVC34	—	—	—
3BR1224L200R	—	—	BR3RDOOR16	BR3RDF7
3BR1224L200S	—	BRCOVS34	—	—
3BR1836L150	BRCOVC27	—	—	—
3BR1836L150R	—	—	BR3RDOOR17	BR3RDF7
3BR1836L150S	—	BRCOVS27	—	—
3BR1836L200	BRCOVC34	—	—	—
3BR1836L200R	—	—	BR3RDOOR16	BR3RDF7
3BR1836L200S	—	BRCOVS34	—	—
3BR2442L150	BRCOVC39	—	—	—
3BR2442L150R	—	—	BR3RDOOR18	BR3RDF16
3BR2442L150S	—	BRCOVS39	—	—
3BR2442L200	BRCOVC43	—	—	—
3BR2442L200S	—	BRCOVS43	—	—
3BR3042L200	BRCOVC43	—	—	—
3BR3042L200R	—	—	BR3RDOOR19	BR3RDF18
3BR3042L200S	—	BRCOVS43	—	—
3BR4242L200	BRCOVC48	—	—	—
3BR4242L200R	—	—	BR3RDOOR21	BR3RDF20
3BR4242L200S	—	BRCOVS48	—	—
3BR4242L225	BRCOVC49	—	—	—
3BR4242L225R	—	—	BR3RDOOR24	BR3RDF20
3BR4242L225S	—	BRCOVS49	—	—

Three-Phase with Main Circuit Breaker

Catalog Number	Combination Covers	Surface Covers	NEMA 3R Covers	NEMA 3R Deadfronts
3B4242DFN	315-003-28	—	—	—
3B4242DR1N	—	—	Not available	—
3B4242DSN	—	315-003-27	—	—
3B4242EFN	315-003-28	—	—	—
3B4242ESN	—	315-003-27	—	—
3BR1224B100	BRCOVC19	—	—	—
3BR1224B100R	—	—	BR3RDOOR29	BR3RDF2
3BR1224B100S	—	BRCOVS19	—	—
3BR1224H100	BRCOVC19	—	—	—
3BR1224H100S	—	BRCOVS19	—	—
3BR3042B125	BRCOVC54	—	—	—
3BR3042B125S	—	BRCOVS54	—	—
3BR3042B150	BRCOVC55	—	—	—
3BR3042B150R	—	—	BR3RDOOR20	BR3RDF17
3BR3042B150S	—	BRCOVS55	—	—
3BR3042B200	BRCOVC56	—	—	—
3BR3042B200R	—	—	BR3RDOOR21	BR3RDF17
3BR3042B200S	—	BRCOVS56	—	—
3BR3042H150	BRCOVC55	—	—	—
3BR3042H150S	—	BRCOVS55	—	—
3BR3042H200	BRCOVC56	—	—	—
3BR3042H200S	—	BRCOVS56	—	—
3BR4242B200	BRCOVC57	—	—	—
3BR4242B200R	—	—	BR3RDOOR22	BR3RDF19
3BR4242B200S	—	BRCOVS57	—	—
3BR4242B225	BRCOVC58	—	—	—
3BR4242B225R	—	—	BR3RDOOR23	BR3RDF19
3BR4242B225S	—	BRCOVS58	—	—
3BR4242H200	BRCOVC57	—	—	—
3BR4242H200S	—	BRCOVS57	—	—

Replacement Interior Assembly

BR Loadcenter
Interior Assembly

Type BR Loadcenter Interior Assemblies

Ampere Rating	Maximum Number 1.00-Inch (25.4 mm) Spaces	Single Poles	UL File Reference	Main Terminal Size (Per Phase)	Standard Package Quantity	Catalog Number
Single-Phase Single Row Breaker Mounting—Aluminum Bus—120/240 Vac, Three-Wire						
70	2	4	—	(1) #8-#2 AWG Cu/Al	20	24INT70B
125	2	4	E8741	(1) 1/0-#14 AWG Cu 2/0-12 AWG AlI	20	24INT125B
125	6	12	E52977	(1) 2/0-#14 AWG Cu/Al	20	612INT125SRB
Single-Phase Double Row Breaker Mounting—Aluminum Bus—120/240 Vac, Three-Wire						
125	4	8	E8741	(1) 2/0-#14 AWG Cu/Al	20	48INT125B
125	6	12	E8741	(1) 2/0-#14 AWG Cu/Al	20	612INT125B
125	8	16	E8741	(1) 2/0-#14 AWG Cu/Al	20	816INT125B
125	12	12	E52977	(1) 2/0-#14 AWG Cu/Al	20	1212INT125B
125	12	24	E52977	(1) 2/0-#14 AWG Cu/Al	20	1224INT125B
125	16	24	E52977	(1) 2/0-#14 AWG Cu/Al	20	1624INT125B
125	20	24	E52977	(1) 2/0-#14 AWG Cu/Al	10	2024INT125B
125	24	24	E52977	(1) 2/0-#14 AWG Cu/Al	10	2424INT125B
200	8	16	E52977	(1) 300 kcmil-#1 AWG Cu/Al	20	816INT200B
200	12	24	E52977	(1) 300 kcmil-#1 AWG Cu/Al	20	1224INT200B
200	30	40	E52977	(1) 300 kcmil-#1 AWG Cu/Al	10	3040INT200B
200	42	42	E52977	(1) 300 kcmil-#1 AWG Cu/Al	10	4242INT225B
Single-Phase Double Row Breaker Mounting—Copper Bus—120/240 Vac, Three-Wire						
125	8	16	E5297	(1) 2/0-#14 AWG Cu/Al	20	816INT125BC
125	12	12	E5297	(1) 2/0-#14 AWG Cu/Al	20	1212INT125BC
200	12	24	E5297	(1) 300 kcmil-#1 AWG Cu/Al	20	1224INT200BC
Three-Phase Double Row Breaker Mounting—Aluminum Bus—208Y/120 Vac, Four-Wire—240 Vac, Three-Wire—120/240 Vac, Four-Wire Delta						
125	12	34	E52977	(1) 2/0-#8 AWG Cu/Al	10	1224INT3125B
150	18	36	E52977	(1) 300 kcmil-#2 AWG Cu/Al	10	1836INT3150B
150	24	42	E52977	(1) 300 kcmil-#2 AWG Cu/Al	10	2442INT3150B
200	30	42	E52977	(1) 300 kcmil-#2 AWG Cu/Al	10	3042INT3200B
225	42	42	E52977	(1) 300 kcmil-#2 AWG Cu/Al	10	4242INT3225B
Three-Phase Double Row Breaker Mounting—Copper Bus—208Y/120 Vac, Four-Wire—240 Vac, Three-Wire—120/240 Vac, Four-Wire Delta						
125	12	24	E52977	(1) 2/0-#8 AWG Cu/Al	10	1224INT3125BC
200	12	24	E52977	(1) 300 kcmil-#2 AWG Cu/Al	10	1224INT3200BC

Product Description

Eaton UL classified replacement circuit breakers are available in both 3/4-inch Type CHQ and 1.00-inch Type CL, single- and two-pole configurations. These breakers are classified as direct replacements by Underwriters Laboratories. In addition to a UL listing, they also come with a 15-year warranty.

Specified vs. UL Classified

Specified breakers are listed by the manufacturer of the panelboard for use in a particular panel. This doesn't mean that the panelboard manufacturer produced the specified breaker; it merely means that the panelboard manufacturer has tested the breaker in the panel. In fact, through the years, Eaton has manufactured thousands of breakers for other panelboard manufacturers.

UL classified breakers are produced by one manufacturer for use in place of the breakers specified on the panelboard. Like specified breakers, UL classified breakers have been tested in the panels for which they are approved.

Testing

Classified breakers are tested extensively in numerous General Electric®, Siemens®, Murray®, Thomas & Betts®, Square D® and Crouse-Hinds® panels. The tests are conducted with witnesses from Underwriters Laboratories and involve short circuit, temperature and insertion/withdrawal applications. This level of testing ensures that the breakers meet identified standards and have been found suitable by UL for the specified purpose.

Understanding Classified Breaker Terminology

Definitions

Specified Circuit Breaker—

Each manufacturer lists the brands of circuit breakers that can be used in their panelboards. Often, manufacturers will not list competitors as specified, even though they are suitable replacements.

Classified Circuit Breaker—

A breaker that is considered suitable, by a qualified third-party organization, for use in another manufacturer's panelboard.

Listed Breaker—The listing of a circuit breaker is by an independent third party. Eaton classified breakers are listed by UL.

Labeled Breaker—A breaker with a label affixed by an independent third party.

Non-CTL Plug-On Replacement Circuit Breakers, Type CHNT 10 kAIC, 120/240 Vac

For use as replacement in loadcenters built prior to 1968 and within the current style loadcenters as indicated in the loadcenter section.

3/4-Inch (19.1 mm) per Pole 120 Vac, Non-CTL 10 kAIC

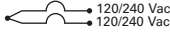
Ampere Rating	Wire Size Range Cu/Al 60°C or 75°C	Single-Pole Requires One 3/4-Inch (19.1 mm) Space 10 per Shelf Carton Catalog Number
15–15	#14–8	 CHNT1515 ①②
15–20	#14–8	CHNT1520 ①②
20–20	#14–8	CHNT2020 ①②

CTL Plug-On Circuit Breakers, Type CHT Twin 10 kAIC, 120/240 Vac

All circuit breakers have rejection feature. Use only with loadcenters marked for use with CHT breakers.

Type CH and CHT Circuit Breakers Mounted in Twin Breaker Panel

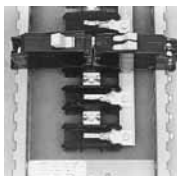

Twin (CTL) 3/4-Inch (19.1 mm) per Pole 120 Vac Class CTL 10 kAIC

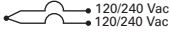
Ampere Rating	Wire Size Range Cu/Al 60°C or 75°C	Single-Pole Requires One 3/4-Inch (19.1 mm) Space 10 per Shelf Carton Catalog Number
15–15	#14–8	 CHT1515 ①②
15–20	#14–8	CHT1520 ①②
20–20	#14–8	CHT2020 ①②

Notes

- ① Switching duty rated.
- ② HACR rated.

Type CH Renovation Loadcenter

Product Description

Eaton's Renovation Loadcenter is designed for the service contractor. With the addition of a five-circuit terminal block factory mounted in the top left corner of the loadcenter, the service contractor can terminate short-circuit wires instead of having to use expensive wire nuts. Also, the Renovation Loadcenter incorporates a twin-stacked neutral design that places the neutral and ground terminations higher in the loadcenter.

Both of these features were added without increasing any size from a standard loadcenter. These features will eliminate the need for wire nuts and make for a much neater installation. There is a provision to field mount a second five-circuit terminal block (RN5TB) in the top right corner of the loadcenter. Choose amongst Eaton's Type CH breaker family for use in the Renovation Panel.

Product Selection

Renewal Parts List for Type CH Renovation Loadcenter Covers and Deadfronts

Renovation Panel



Single-Phase, Three-Wire—120/240 Vac—Factory-Bonded Stacked Split Neutral

Main Breaker Type	Main Ampere Rating	Max. Number 3/4-Inch (19.1 mm) of Poles	Enclosure Type	Box Size	Wire Size Range Cu/Al 60 or 70°C for Main Breakers	Loadcenter Catalog Number	Cover Catalog Number ②	
							Combination	Surface
CH	100	20	Indoor	C	#6-1/0	CH22B100CRN	CH8CFF	CH8CS
CSH	150	32	Indoor	J	#2-300 kcmil	CH32B150JRN	CH8JF	CH8JS
CSH	200	32	Indoor	J	#2-300 kcmil	CH32B200JRN	CH8J	CH8JS
CSH	200	42	Indoor	K	#2-300 kcmil	CH42B200KRN	CH8KF	CH8KS

Branch Circuit Breakers (CH)

See Volume 1—Residential and Light Commercial, CA08100002E, Tab 1.

Renovation Loadcenter

Description	Catalog Number
Five-circuit terminal block kit	RN5TB
Ground bar kits (two maximum per panel)	(See Page V12-T5-4)

Notes

① 100A main breaker is rated 10 kAIC.

② Combination style covers may be used in surface or flush applications.

All main circuit breaker loadcenters are listed for use as service entrance equipment. Loadcenters are factory-bonded for service entrance applications. Remove bonding strap for separate neutral and ground bars for sub-feed applications.

Plug-On Neutral Loadcenter

Product Description

Code changes and higher safety standards are leading to more arc fault and ground fault circuit interrupter installations. Eaton offers a unique product solution that enables a direct connection of the breaker to the neutral bar, eliminating the need for wiring a pigtail.

Features and Benefits

- Time savings up to 25% per AFCI/GFCI installation
- Eliminates nuisance tripping due to loose pigtail connections
- Clean gutter space
- Easier troubleshooting due to less wiring
- Backed by a limited lifetime warranty

Product Selection

Plug-On Neutral Loadcenter



Main Breaker Plug-On Neutral Loadcenters

Main Breaker Type	Main Ampere Rating	Max. Number 3/4-Inch Circuits	Max. Number of Poles	Enclosure Type	Box Size	Wire Size Range Cu/Al	Catalog Number	Cover Catalog Number	
								Combination	Surface
CSH 35 kAIC	100	24	24	Indoor	E	#2–300 kcmil	CH24BPN100E	CH8EF	CH8ES
	200	32	32	Indoor	J	#2–300 kcmil	CH32BPN200J	CH8JF	CH8JS
	200	42	42	Indoor	K	#2–300 kcmil	CH42BPN200K	CH8KF	CH8KS
	200	60	120 ^①	Indoor	N	#2–300 kcmil	CH60BPN200N	CH8NF	—

Main Lug Only/Convertible Plug-On Neutral Loadcenters—With Factory Installed Main Lugs

Max. Ampere Rating	Max. Number 3/4-Inch Poles	Enclosure Type	Box Size	Catalog Number	Wire Size Range for Main Lug	Main Breaker Kit	Wire Size Range For Main Breaker	Cover Catalog Number	
								Combination	Surface
125	24	Indoor	E	CH24NLPN125E	#6–300 kcmil	CSH2100N	#2–300 kcmil	CH8NLEF	CH8NLES
						CSH2125N			
225	32	Indoor	J	CH32NLPN225J	#6–300 kcmil	CSH2125N	#2–300 kcmil	CH8NLJF	CH8NLJS
						CSH2200N			
						CSH2100N			
225	42	Indoor	K	CH42NLPN225K	#6–300 kcmil	CSH2125N	#2–300 kcmil	CH8NLKF	CH8NLKS
						CSH2150N			
						CSH2200N			

Note

^① Requires the use of type CHNT breakers.

Type CH Retrofit Interior Kits

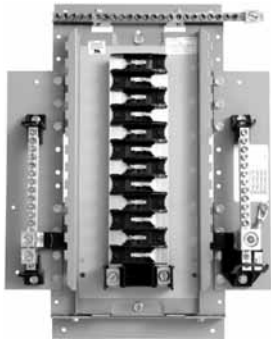

Type CH Retrofit Adjustable Interior



Type CH Retrofit Interior Collar and Assembly with Trim

Product Description

Replacing existing loadcenters and panelboards can be a time consuming and expensive job. CH retrofit kits can be the solution to save time and money. The kit consists of a standard trim to fit the interior, a picture frame trim to fit the existing box, and a field-adjustable interior assembly that includes neutral and ground bars. These are especially applicable when the existing box is flush mounted in drywall, plaster or block wall. The existing box, and many times existing wiring, can remain.

Features and Benefits

Upgrading Existing Electrical Infrastructure is Simple

- Replaces vintage brands that have hard to find, expensive replacement breakers
- Allows safety upgrade to arc fault and ground fault breakers
- Maximizes number of circuits available with compact design
- Meets 2008 NEC wire bending requirements
- Eco-friendly in asbestos-filled environments
- Exclusive design

Save Time and Money Throughout the Installation

- Uses existing panel box and wires
- Eliminates expensive drywall/paint repair
- Saves 2–3 hours compared to a complete panel changeout—get off the job faster
- Eliminates precise measurements with field-adjustable kit

Detailed Product Guide

All standard retrofit kits are suitable for a range of existing box sizes:

- Box width ranging from 14.50 to 22.00 inches (368.3 to 558.8 mm)
- Box depth ranging from 4.25 inches (108.0 mm) for CH to 6.00 inches (152.4 mm)
- Box height ranging from 21.00 to 45.00 inches (533.4 to 1143.0 mm)

For box dimensions outside of these ranges, contact the Lincoln Flex Center at 800-330-6479. Be sure to provide the existing incoming line wire size.

Standards and Certifications

Interiors are UL Recognized under UL 67, Panelboard standard.

Product Selection

To select the retrofit kit:

1. From the existing box size determine which retrofit groups are suitable (may be more than one).
2. Use type of interior, number of phases, and type of main to find the selection chart.

3. Select part number from chart (if main breaker, replace XXX with specific amp rating).
4. Note that the overlap of the existing wall is the retro cover size minus the existing box size. If specific measurements are needed, communicate that you need a custom trim size.
5. Contact the Lincoln Flex Center at 800-330-6479 for pricing, lead-times and order entry instructions.

Retro Size Groups

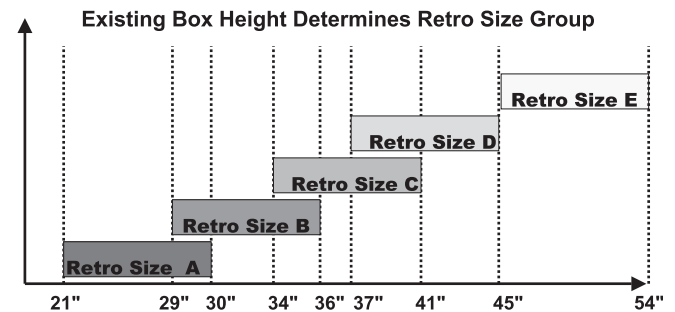

Retrofit Stocking Kits (BR and CH Kits Available) ①②

Five recommended groups: existing box height determines retro group size.

Description	Retrofit Kit Interior Catalog Number	Collar Catalog Number	Cover Catalog Number	Existing Enclosure Parameters—Inches (mm)			Existing Box Height Determines Retro Size Group—Inches (mm)
				Height	Width	Depth	
BR-Aluminum Bus/CH-Copper Bus							
BR 125A MLO 12/24 circuit retro kit	RAABR12L125	Included	Included	14.00–18.00 (355.6–457.2)	10.50–12.50 (266.7–317.5)	3.50–5.25 (88.9–133.35)	Retro size AA/size 14.00–21.00 (355.6–533.4)
BR 100A MCB 10/20 circuit retro kit	RAABR10B100	Included	Included	14.00–18.00 (355.6–457.2)	10.50–12.50 (266.7–317.5)	3.50–5.25 (88.9–133.35)	Retro size AA/size 14.00–21.00 (355.6–533.4)
BR 125A MLO 12/24 circuit retro kit	RAABR12L125A	Included	Included	14.00–21.00 (355.6–533.4)	10.50–15.50 (266.7–393.7)	3.50–5.25 (88.9–133.35)	Retro size AA/size 14.00–21.00 (355.6–533.4)
BR 100A MCB 10/20 circuit retro kit	RAABR10B100A	Included	Included	14.00–21.00 (355.6–533.4)	10.50–15.50 (266.7–393.7)	3.50–5.25 (88.9–133.35)	Retro size AA/size 14.00–21.00 (355.6–533.4)
CH interior 125A MCB 22 circuits	RACH22B125I	RACHFRAME	CH8CF	21.00–30.00 (533.4–762.0)	13.00–22.00 (330.2–558.8)	4.25–6.00 (108.0–152.4)	Retro size A/size 21.00–30.00 (533.4–762.0)
CH interior 125A MLO 24 circuits	RACH24L125I	RACHFRAME	CH8CF	21.00–30.00 (533.4–762.0)	13.00–22.00 (330.2–558.8)	4.25–6.00 (108.0–152.4)	Retro size A/size 21.00–30.00 (533.4–762.0)
CH interior 150A MCB 24 circuits	RBCH24B150I	RACHFRAME	CH8EF	29.00–36.00 (736.6–914.4)	13.00–22.00 (330.2–558.8)	4.25–6.00 (108.0–152.4)	Retro size B/size 29.00–36.00 (736.6–914.4)
CH interior 225A MLO 32 circuits	RBCH32L225I	RACHFRAME	CH8DF	29.00–36.00 (736.6–914.4)	13.00–22.00 (330.2–558.8)	4.25–6.00 (108.0–152.4)	Retro size B/size 29.00–36.00 (736.6–914.4)
CH interior 200A MCB 32 circuits	RCCH32B200I	RCCHFRAME	CH8JF	34.00–41.00 (863.3–1041.4)	13.00–22.00 (330.2–558.8)	4.25–6.00 (108.0–152.4)	Retro size C/size 34.00–41.00 (863.3–1041.4)
CH interior 225A MLO 42 circuits	RCCH42L225I	RCCHFRAME	CH8GF	34.00–41.00 (863.3–1041.4)	13.00–22.00 (330.2–558.8)	4.25–6.00 (108.0–152.4)	Retro size C/size 34.00–41.00 (863.3–1041.4)
CH interior 200A MCB 42 circuits	RDCH42B200I	RDCHFRAME	CH8KF	37.00–45.00 (939.8–1143.0)	13.00–22.00 (330.2–558.8)	4.25–6.00 (108.0–152.4)	Retro size D/size 37.00–45.00 (939.8–1143.0)
CH interior 225A MLO 42 circuits	RDCH42L225I	RDCHFRAME	CH8KF	37.00–45.00 (939.8–1143.0)	13.00–22.00 (330.0–558.8)	4.25–6.00 (108.0–152.4)	Retro size D/size 37.00–45.00 (939.8–1143.0)

Notes

- ① Other options are available.
 ② CH retrofit interiors and collar cartons are color coded to ensure accuracy of kit.

Surge Panel

Product Description

Eaton's Type CH Surge Loadcenter includes a factory-mounted and wired surge suppressor device. There is a knockout in the cover that allows the user to view the status indication lights on the surge suppressor. The CH Surge Loadcenter reduces the surge current, helping to protect sensitive home electronic equipment.



Save labor by installing a factory-mounted surge protective device.

Factory-Installed Surge Protection

- Includes a CHSPULTRA and a two-pole 15A circuit breaker
- Increases the effectiveness of surge protection due to reduced lead length
- A modified deadfront allows for easy viewing of indicating lights

Surge Ready

- Provides a mounting provision for CHSPULTRA
- A modified deadfront allows for easy viewing of indicating lights

Surge Panel



Replacement Covers for Surge Panels

Catalog Number	Cover Number	Replacement Module
CHSUR22B100D	CHPC8DF	CHSPT2ULTRA
CHSUR24L125D	CHPC8DF	CHSPT2ULTRA
CHPC22B100D	CHPC8DF	CHSPT2ULTRA
CHPC24L125D	CHPC8DF	CHSPT2ULTRA
CHPC12L125C	CHPC8CF	CHSPT2ULTRA
CHPC30B100J	CHPC8JF	CHSPT2ULTRA
CHPC32L150J	CHPC8JF	CHSPT2ULTRA
CHSUR32B150L	CHPC8B32LF	CHSPT2ULTRA
CHSUR32B200L	CHPC8B32LF	CHSPT2ULTRA
CHSUR32L225L	CHPC8B32LF	CHSPT2ULTRA
CHPC32B125L	CHPC8B32LF	CHSPT2ULTRA
CHPC32B150L	CHPC8B32LF	CHSPT2ULTRA
CHPC32B200L	CHPC8B32LF	CHSPT2ULTRA
CHPC32N200L	CHPC8B32LF	CHSPT2ULTRA
CHSUR42B200L	CHPC8B42LF	CHSPT2ULTRA
CHPC42B150L	CHPC8B42LF	CHSPT2ULTRA
CHPC42B200L	CHPC8B42LF	CHSPT2ULTRA
CHPC42N200L	CHPC8B42LF	CHSPT2ULTRA
CHSUR42L225L	CHPC8L42LF	CHSPT2ULTRA
CHPC42L225L	CHPC8L42LF	CHSPT2ULTRA

Further Information

Publication Number	Description
CA08100002E	Volume 1—Residential and Light Commercial Catalog, Tab 1
CA08100011E	Volume 9—OEM Product Guide

Pricing Information

Price and Availability Digest (PAD)

Vista/VISTALINE™ Discount Symbol 22CD

Group Metering Lineup

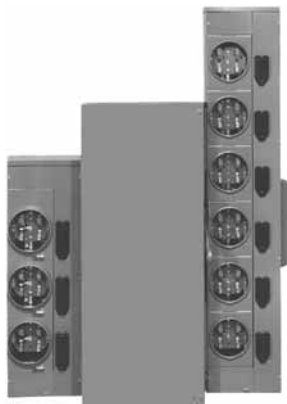

6 Meter Centers

Product Description	V12-T6-2
Product History	V12-T6-2
Replacement Capabilities	V12-T6-2
Meter Packs	V12-T6-3
Main Devices	V12-T6-4
Residential Meter Stacks—Ring	V12-T6-7
Residential Meter Stacks—Ringless	V12-T6-8
Commercial Meter Stacks	V12-T6-8
Miscellaneous Parts	V12-T6-9
Further Information	V12-T6-9
Pricing Information	V12-T6-9

Meter Centers

Product Description

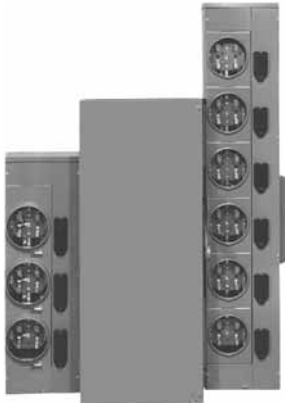

WCG3 Meter Center

Cutler-Hammer® Meter Centers from Eaton's electrical business are designed for use where an individually metered distribution center is required. Meter centers house meter sockets that measure power consumption at service entrances. Metering is designed for use with multi-family dwelling units, commercial units and light industrial applications.

Product History

In the beginning, all multiple metering applications were assembled at the job site using wire troughs, individual meter sockets and enclosed circuit breakers.

In the early 1960s, factory-assembled meter packs began to be made on a job-by-job basis. Soon after, modular metering was introduced for single-phase 200A maximum ring-style applications.

In 1981, a few utilities began to require ringless meter covers and, in 1983, the first three-phase commercial meter modules with lever type bypass were introduced.

The Westinghouse Meter Center designs, Type WM and/or WP, and facilities were sold to Thomas & Betts in 1994. Today, wall-hung multiple metering is used in virtually all areas of the country for both residential and commercial applications.

Main ratings range from 250 to 2000A, and 125, 200 and 320A sockets are available in both single-phase and three-phase versions.

Product History Time Line

Product	1970	1975	1980	1985	1990	1995	2000	Present
Westinghouse QS, QP		■	■	■	■			
Cutler-Hammer CG2, 4		■	■					
Cutler-Hammer CG3, 5, 7, 9, 11			■	■	■	■		
Westinghouse WM, WP					■	■		
Cutler-Hammer/Westinghouse WCG3, 5, 7, 9, 11						■	■	
Cutler-Hammer 1MM, 3MM, 35MM, 37MM, 35SS, 37SS							■	■

Replacement Capabilities

Type	Accessories	Covers	Jaws	Bussed End Caps	Tenant Breaker Hinged Cover	Drip Hoods	Socket Replacement
CG3	■	■	■	■	■		■
CG5	■	■	■		■		■
CG7	■	■		■	■	■	■
CG9	■	■		■	■	■	■
CG11	■	■		■	■	■	
WCG3	■	■	■	■	■	■	■
WCG5	■	■	■		■	■	■
WCG7	■	■		■	■	■	■
WCG9	■	■		■	■	■	■
WCG11	■	■		■	■	■	
1MM	■	■		■	■	■	■
3MM	■	■		■	■	■	■
35MM	■	■		■	■	■	■
37MM	■	■		■	■	■	■
35SS	■	■		■	■	■	■
37SS	■	■		■	■	■	■

Meter Packs

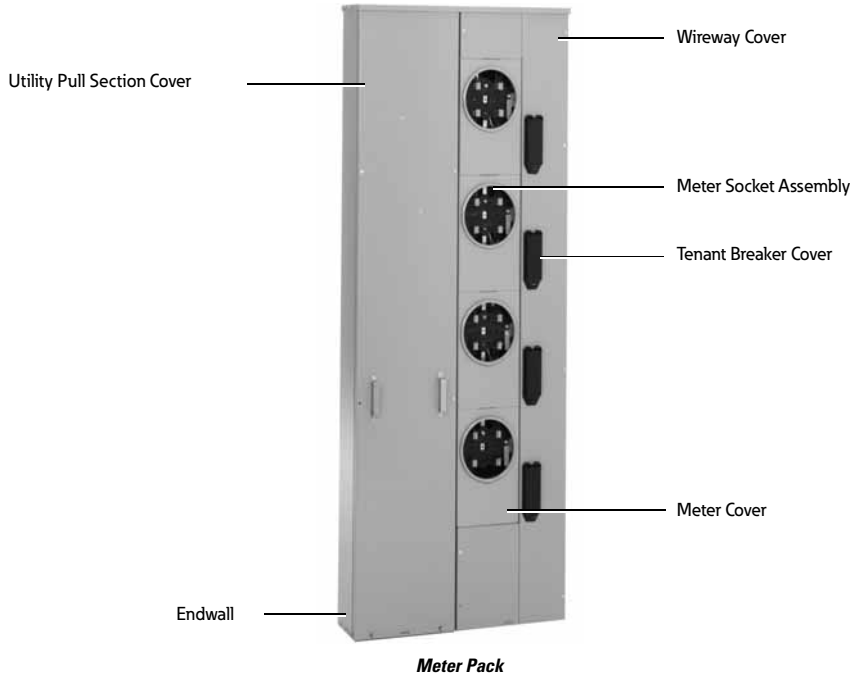

Meter Packs

Catalog Number

Meter Pack	Utility Pull Section Cover	Wireway Cover	Meter Socket Assembly	Tenant Breaker Cover	Meter Cover	Endwall (with Knockouts)	Endwall (without Knockouts)	Vertical Busbars
1MP2122R	MP2122UCVR	MPCCVR01	1MMMS	1MMBC1	1MMCP1 ①	MP122NWLK	MP122NWL	MM1223VBUS
1MP3124R	MP1234UCVR	MPCCVR04	1MMMS	1MMBC1	1MMCP1	MP1234NWLK	MP1234NWL	MM1223VBUS
1MP4124R	MP1234UCVR	MPCCVR05	1MMMS	1MMBC1	1MMCP1	MP1234NWLK	MP1234NWL	MM1224VBUS
1MP5126R	MP1256UCVR	MPCCVR02 ②	1MMMS	1MMBC1	1MMCP1 ③	MP1256NWLK	MP1256NWL	MM1223VBUS
1MP6126R	MP1256UCVR	MPCCVR03 ②	1MMMS	1MMBC1	1MMCP1 ③	MP1256NWLK	MP1256NWL	MM1223VBUS
1MP2204R	MP202UCVR	MPCCVR06	1MMMS	1MMBC2	1MMCP2	MP2024NWLK	MP2024NWL	MM202VBUS
1MP3206R	MP2034UCVR	MPCCVR09	1MMMS	1MMBC2	1MMCP2	MP2024NWLK	MP2024NWL	MM2023VBUS
1MP4206R	MP2034UCVR	MPCCVR10	1MMMS	1MMBC2	1MMCP2	MP2024NWLK	MP2024NWL	MM204VBUS
1MP5206R	MP2056UCVR	MPCCVR07 ④	1MMMS	1MMBC2	1MMCP2	MP2056NWLK	MP2056NWL	MM2023VBUS
1MP6206R	MP2056UCVR	MPCCVR08 ④	1MMMS	1MMBC2	1MMCP2	MP2056NWLK	MP2056NWL	MM2023VBUS
1MP2122RRL ⑤	MP2122LUCVR	MPCCVR01	1MMMS ⑥	1MMBC1	1MMRC125 ⑦	MP122NWLK	MP122NWL	MM1223VBUS
1MP3124RRL ⑤	MP1234UCVR	MPCCVR04	1MMMS ⑥	1MMBC1	1MMRC125 ⑦	MP1234NWLK	MP1234NWL	MM1223VBUS
1MP4124RRL ⑤	MP1234UCVR	MPCCVR05	1MMMS ⑥	1MMBC1	1MMRC125	MP1234NWLK	MP1234NWL	MM124VBUS
1MP5126RRL ⑤	MP1256UCVR	MPCCVR02	1MMMS ⑥	1MMBC1	1MMRC125 ⑦	MP1256NWLK	MP1256NWL	MM1223VBUS
1MP6126RRL ⑤	MP1256UCVR	MPCCVR03	1MMMS ⑥	1MMBC1	1MMRC125 ⑦	MP1256NWLK	MP1256NWL	MM1223VBUS
1MP2204RRL ⑤	MP202UCVR	MPCCVR06	1MMMS ⑥	1MMBC2	1MMRC200 ⑦	MP2024NWLK	MP2024NWL	MM202VBUS
1MP3206RRL ⑤	MP2034UCVR	MPCCVR09	1MMMS ⑥	1MMBC2	1MMRC200	MP2024NWLK	MP2024NWL	MM2023VBUS
1MP4206RRL ⑤	MP2034UCVR	MPCCVR10	1MMMS ⑥	1MMBC2	1MMRC200	MP2024NWLK	MP2024NWL	MM204VBUS
1MP5206RRL ⑤	MP2056UCVR	MPCCVR07	1MMMS ⑥	1MMBC2	1MMRC200	MP2056NWLK	MP2056NWL	MM2023VBUS
1MP6206RRL ⑤	MP2056UCVR	MPCCVR08	1MMMS ⑥	1MMBC2	1MMRC200	MP2056NWLK	MP2056NWL	MM2023VBUS

Notes

- ① For top position, use meter socket cover **1MMCP1T**.
- ② For center wireway cover, order **MPCCVR1**.
- ③ For top position, use meter socket cover **1MMCP1T**.
- ④ For center wireway cover, order **MPCCVR2**.
- ⑤ For catalog numbers with a "B" suffix (ringless with horn bypass), all replacement parts are the same with the exception of the meter socket assembly. Refer to Footnote 6 for correct catalog number.
- ⑥ For ringless style meter packs with horn bypass, order **1MMMSB**.
- ⑦ For top position, use meter socket cover **1MMRC200T**.

Main Devices

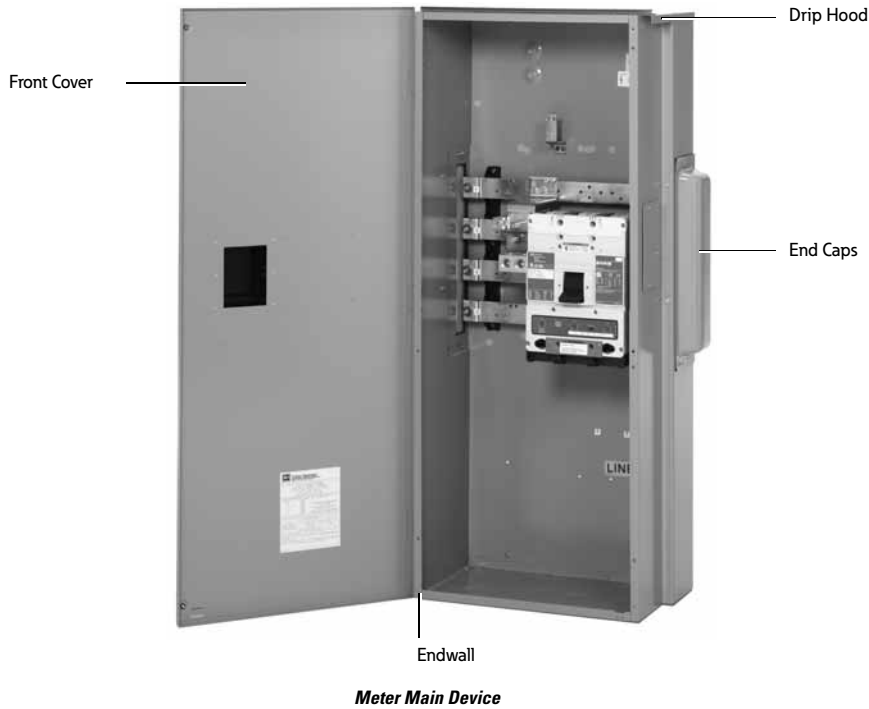

End Caps

Description	Catalog Number
Right side (bumped)	47-28172-2A
Left side (flat)	47-24139A

Terminal Box

Catalog Number	Front Cover	Drip Hood	Endwall (with Knockouts)	Endwall (without Knockouts)
1MTB800R	MMFCVR1	MMDH1	MMEW1	MMEWNK01
1MTB1200R	MMFCVR1	MMDH1	MMEW1	MMEWNK01
3MTB400R	MTBFCVR1	MMDH4	MTBEW1	MTBEWNK01
3MTB600R	MTBFCVR1	MMDH4	MTBEW1	MTBEWNK01
3MTB800R	MMFCVR1	MMDH1	MMEW1	MMEWNK01
3MBT1200R	MMFCVR1	MMDH1	MMEW1	MMEWNK01

Main Circuit Breaker

Catalog Number

Circuit Breaker	Front Cover	Drip Hood	Endwall (with Knockouts)	Endwall (without Knockouts)	Main Breaker Cover
1MCB250R	MCBFCVR1	MMDH1	MMEW1	MMEWNK01	49-7060
1MHCB250R	MCBFCVR1	MMDH1	MMEW1	MMEWNK01	49-7060
1MCB300R	MCBFCVR1	MMDH1	MMEW1	MMEWNK01	49-7060
1MHCB300R	MCBFCVR1	MMDH1	MMEW1	MMEWNK01	49-7060
1MCB350R	MCBFCVR1	MMDH1	MMEW1	MMEWNK01	49-7060
1MHCB350R	MCBFCVR1	MMDH1	MMEW1	MMEWNK01	49-7060
1MCB400R	MCBFCVR1	MMDH1	MMEW1	MMEWNK01	49-7060
1MHCB400R	MCBFCVR1	MMDH1	MMEW1	MMEWNK01	49-7060
1MCB500R	MCBFCVR1	MMDH1	MMEW1	MMEWNK01	49-7060
1MHCB500R	MCBFCVR1	MMDH1	MMEW1	MMEWNK01	49-7060
1MCB600R	MCBFCVR1	MMDH1	MMEW1	MMEWNK01	49-7060
1MHCB600R	MCBFCVR1	MMDH1	MMEW1	MMEWNK01	49-7060
1MCB700R	MCBFCVR2	MMDH1	MMEW1	MMEWNK01	49-7060
1MHCB700R	MCBFCVR2	MMDH1	MMEW1	MMEWNK01	49-7060
1MCB800R	MCBFCVR2	MMDH1	MMEW1	MMEWNK01	49-7060
1MHCB800R	MCBFCVR2	MMDH1	MMEW1	MMEWNK01	49-7060
1MCB900R	MCBFCVR2	MMDH1	MMEW1	MMEWNK01	49-7060
1MHCB900R	MCBFCVR2	MMDH1	MMEW1	MMEWNK01	49-7060
1MCB1000R	MCBFCVR2	MMDH1	MMEW1	MMEWNK01	49-7060
1MHCB1000R	MCBFCVR2	MMDH1	MMEW1	MMEWNK01	49-7060
1MCB1200R	MCBFCVR2	MMDH1	MMEW1	MMEWNK01	49-7060
1MHCB1200R	MCBFCVR2	MMDH1	MMEW1	MMEWNK01	49-7060
1MCB1400RB	MCBFCVR3	MCBDH1	—	MMEWNK03	49-7060
1MCB1400RT	MCBFCVR3	MCBDH1	—	MMEWNK03	49-7060
1MCB1600RB	MCBFCVR3	MCBDH1	—	MMEWNK03	49-7060
1MCB1600RT	MCBFCVR3	MCBDH1	—	MMEWNK03	49-7060
1MCB2000RB	MCBFCVR3	MCBDH1	—	MMEWNK03	49-7060
1MCB2000RT	MCBFCVR3	MCBDH1	—	MMEWNK03	49-7060
3MCB250R	MCBFCVR1	MMDH1	MMEW1	MMEWNK01	49-7060
3MHCB250R	MCBFCVR1	MMDH1	MMEW1	MMEWNK01	49-7060
3MCB300R	MCBFCVR1	MMDH1	MMEW1	MMEWNK01	49-7060
3MHCB300R	MCBFCVR1	MMDH1	MMEW1	MMEWNK01	49-7060
3MCB350R	MCBFCVR1	MMDH1	MMEW1	MMEWNK01	49-7060
3MHCB350R	MCBFCVR1	MMDH1	MMEW1	MMEWNK01	49-7060
3MCB400R	MCBFCVR1	MMDH1	MMEW1	MMEWNK01	49-7060
3MHCB400R	MCBFCVR1	MMDH1	MMEW1	MMEWNK01	49-7060
3MCB500R	MCBFCVR1	MMDH1	MMEW1	MMEWNK01	49-7060
3MHCB500R	MCBFCVR1	MMDH1	MMEW1	MMEWNK01	49-7060
3MCB600R	MCBFCVR1	MMDH1	MMEW1	MMEWNK01	49-7060
3MHCB600R	MCBFCVR1	MMDH1	MMEW1	MMEWNK01	49-7060
3MCB700R	MCBFCVR2	MMDH1	MMEW1	MMEWNK01	49-7060
3MHCB700R	MCBFCVR2	MMDH1	MMEW1	MMEWNK01	49-7060
3MCB800R	MCBFCVR2	MMDH1	MMEW1	MMEWNK01	49-7060
3MHCB800R	MCBFCVR2	MMDH1	MMEW1	MMEWNK01	49-7060
3MCB900R	MCBFCVR2	MMDH1	MMEW1	MMEWNK01	49-7060
3MHCB900R	MCBFCVR2	MMDH1	MMEW1	MMEWNK01	49-7060
3MCB1000R	MCBFCVR2	MMDH1	MMEW1	MMEWNK01	49-7060
3MHCB1000R	MCBFCVR2	MMDH1	MMEW1	MMEWNK01	49-7060
3MCB1200R	MCBFCVR2	MMDH1	MMEW1	MMEWNK01	49-7060
3MHCB1200R	MCBFCVR2	MMDH1	MMEW1	MMEWNK01	49-7060
3MCB1400RB	MCBFCVR3	MCBDH1	—	MMEWNK03	—
3MCB1400RT	MCBFCVR3	MCBDH1	—	MMEWNK03	—
3MCB1600RB	MCBFCVR3	MCBDH1	—	MMEWNK03	—
3MCB1600RT	MCBFCVR3	MCBDH1	—	MMEWNK03	—
3MCB2000RB	MCBFCVR3	MCBDH1	—	MMEWNK03	—
3MCB2000RT	MCBFCVR3	MCBDH1	—	MMEWNK03	—

Main Fusible Switch

Catalog Number

Fusible Switch	Front Cover	Drip Hood	Endwall (with Knockouts)	Endwall (without Knockouts)
1MFS400RB	MMFCVR1	MMDH1	MMEW1	MMEWVK01
1MFS400RT	MFSFCVR1	MMDH1	—	MMEWVK01
1MFS600RB	MMFCVR1	MMDH1	MMEW1	MMEWVK01
1MFS600RT	MFSFCVR1	MMDH1	—	MMEWVK01
1MFS800RB	MMFCVR1	MMDH1	MMEW1	MMEWVK01
1MFS800RT	MFSFCVR1	MMDH1	—	MMEWVK01
1MFS1200RB	MFSFCVR2	MMDH2	MMEW2	MMEWVK02
3MFS400RB	MMFCVR1	MMDH1	MMEW1	MMEWVK01
3MFS400RT	MFSFCVR1	MMDH1	—	MMEWVK01
3MFS600RB	MMFCVR1	MMDH1	MMEW1	MMEWVK01
3MFS600RT	MFSFCVR1	MMDH1	—	MMEWVK01
3MFS800RB	MMFCVR1	MMDH1	MMEW1	MMEWVK01
3MFS800RT	MFSFCVR1	MMDH1	—	MMEWVK01
3MFS1200RB	MFSFCVR2	MMDH2	MMEW2	MMWENK02

Main Bolted Pressure Contact Switch

Catalog Number

Bolted Pressure Contact Switch	Front Cover	Drip Hood	Endwall (with Knockouts)	Endwall (without Knockouts)
1BPS1200RB	No replacement parts available at this time.			
1BPS1200RT				
3BPS1200RB				
3BPS1200RT				
3BPS1600RB	No replacement parts available at this time.			
3BPS1600RT				
3BPS2000RB				
3BPS2000RT				

Main Fusible Switch with Pullbox

Catalog Number

Fusible Switch with Pullbox	Front Cover	Pullbox Cover	Drip Hood	Endwall (with Knockouts)	Endwall (without Knockouts)
1MFS400RUG	MFPFCVR1	MFPBCVR1	MMDH1	MMEW1	MMEWVK01
1MFS600RUG	MFPFCVR1	MFPBCVR1	MMDH1	MMEW1	MMEWVK01
1MFS800RUG	MFPFCVR1	MFPBCVR1	MMDH1	MMEW1	MMEWVK01
1MFS1200RUG	MFPFCVR2	MFPBCVR2	MMDH2	MMEW2	MMEWVK02
3MFS400RUG	MFPFCVR1	MFPBCVR1	MMDH1	MMEW1	MMEWVK01
3MFS600RUG	MFPFCVR3	MFPBCVR3	MMDH5	MMEW4	MMEWVK04
3MFS800RUG	MFPFCVR3	MFPBCVR3	MMDH5	MMEW4	MMEWVK04
3MFS1200RUG	MFPFCVR2	MFPBCVR2	MMDH2	MMEW2	MMEWVK02

Pullbox

Catalog Number

Pullbox	Front Cover Pullbox Cover	Drip Hood	Endwall (with Knockouts)	Endwall (without Knockouts)
1UGPB400R	PBFCVR1	PBDH1	PBEW1	PBEWVK01
1UGPB800R	PBFCVR2	PBDH2	PBEW2	PBEWVK02
1UGPB1200R	PBFCVR3	PBDH3	PBEW3	PBEWVK03
3UGPB400R	PBFCVR1	PBDH1	PBEW1	PBEWVK01
3UGPB800R	PBFCVR2	PBDH2	PBEW2	PBEWVK02
3UGPB1200R	PBFCVR3	PBDH3	PBEW3	PBEWVK03

Residential Meter Stacks—Ring

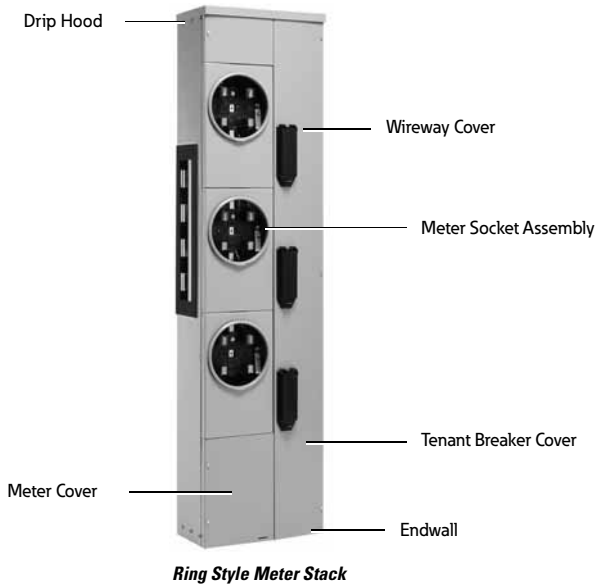

Residential Meter Stacks—Ring

Catalog Number

Meter Stack	Wireway Cover	Meter Socket Assembly	Tenant Breaker Cover	Meter Cover	Endwall (with Knockouts)	Endwall (without Knockouts)	Drip Hood	Vertical Busbar
3MM212	MMCCVR2123	—	①	1MMCP1 ②	MM12N1WLK	MM12N1WL	MMDH3	MM1223VBUS
3MM212R	MMCCVR2123R	1MMMS	1MMBC1	1MMCP1 ②	MM12N1WLK	MM12N1WL	MMDH3	MM1223VBUS
1MM312	MMCCVR3121	1MMMS	①	1MMCP1 ②	MM12N1WLK	MM12N1WL	MMDH3	MM1223VBUS
1MM312R	MMCCVR3121R	1MMMS	1MMBC1	1MMCP1 ②	MM12N1WLK	MM12N1WL	MMDH3	MM1223VBUS
3MM312	MMCCVR3123	1MMMS	①	1MMCP1 ②	MM12N1WLK	MM12N1WL	MMDH3	MM1223VBUS
3MM312R	MMCCVR3123R	1MMMS	1MMBC1	1MMCP1 ②	MM12N1WLK	MM12N1WL	MMDH3	MM1223VBUS
1MM412	MMCCVR4121	1MMMS	①	1MMCP1 ②	MM12N1WLK	MM12N1WL	MMDH3	MM124VBUS
1MM412R	MMCCVR4121R	1MMMS	1MMBC1	1MMCP1 ②	MM12N1WLK	MM12N1WL	MMDH3	MM124VBUS
3MM412	MMCCVR4123	1MMMS	①	1MMCP1 ②	MM12N1WLK	MM12N1WL	MMDH3	MM124VBUS
3MM412R	MMCCVR4123R	1MMMS	1MMBC1	1MMCP1 ②	MM12N1WLK	MM12N1WL	MMDH3	MM124VBUS
1MM512	MMCCVR5121	1MMMS	①	1MMCP1 ②	MM12N1WLK	MM12N1WL	MMDH3	MM125VBUS
1MM512R	MMCCVR5121R	1MMMS	1MMBC1	1MMCP1 ②	MM12N1WLK	MM12N1WL	MMDH3	MM125VBUS
3MM512	MMCCVR5123	1MMMS	①	1MMCP1 ②	MM12N1WLK	MM12N1WL	MMDH3	MM125VBUS
3MM512R	MMCCVR5123R	1MMMS	1MMBC1	1MMCP1 ②	MM12N1WLK	MM12N1WL	MMDH3	MM125VBUS
1MM612	MMCCVR6121	1MMMS	①	1MMCP1 ②	MM12N1WLK	MM12N1WL	MMDH3	MM126VBUS
1MM612R	MMCCVR6121R	1MMMS	1MMBC1	1MMCP1 ②	MM12N1WLK	MM12N1WL	MMDH3	MM126VBUS
3MM612	MMCCVR6123	1MMMS	①	1MMCP1 ②	MM12N1WLK	MM12N1WL	MMDH3	MM126VBUS
3MM612R	MMCCVR6123R	1MMMS	1MMBC1	1MMCP1 ②	MM12N1WLK	MM12N1WL	MMDH3	MM126VBUS
3MM220	MMCCVR2203	1MMMS	①	1MMCP2 ③	MM20N1WLK	MM20N1WL	MMDH4	MM2023VBUS
3MM220R	MMCCVR2203R	1MMMS	1MMBC2	1MMCP2 ③	MM20N1WLK	MM20N1WL	MMDH4	MM2023VBUS
1MM320	MMCCVR3201	1MMMS	①	1MMCP2 ③	MM20N1WLK	MM20N1WL	MMDH4	MM2023VBUS
1MM320R	MMCCVR3201R	1MMMS	1MMBC2	1MMCP2 ③	MM20N1WLK	MM20N1WL	MMDH4	MM2023VBUS
3MM320	MMCCVR3203	1MMMS	①	1MMCP2 ③	MM20N1WLK	MM20N1WL	MMDH4	MM2023VBUS
3MM320R	MMCCVR3203R	1MMMS	1MMBC2	1MMCP2 ③	MM20N1WLK	MM20N1WL	MMDH4	MM2023VBUS
1MM420	MMCCVR4201	1MMMS	①	1MMCP2 ③	MM20N1WLK	MM20N1WL	MMDH4	MM204VBUS
1MM420R	MMCCVR4201R	1MMMS	1MMBC2	1MMCP2 ③	MM20N1WLK	MM20N1WL	MMDH4	MM204VBUS
3MM420	MMCCVR4203	1MMMS	①	1MMCP2 ③	MM20N1WLK	MM20N1WL	MMDH4	MM204VBUS
3MM420R	MMCCVR4203R	1MMMS	1MMBC2	1MMCP2 ③	MM20N1WLK	MM20N1WL	MMDH4	MM204VBUS

Notes

- ① Type 1 meter stacks do not come with breaker covers.
- ② For top position, order meter cover **1MMCP1T**.
- ③ For top position, order meter cover **1MMCP2T**.

Residential Meter Stacks—Ringless

Residential Meter Stacks—Ringless

Catalog Number

Meter Stack	Wireway Cover	Meter Socket Assembly	Tenant Breaker Cover	Meter Cover	Endwall (with Knockouts)	Endwall (without Knockouts)	Drip Hood	Vertical Busbar
3MM212RRL ①	MMCCVR2123R	1MMMS ②	1MMBC1	1MMRC125 ③	MM12NWLK	MM12NWL	MMDH3	MM1223VBUS
1MM312RRL ①	MMCCVR3121R	1MMMS ②	1MMBC1	1MMRC125 ③	MM12NWLK	MM12NWL	MMDH3	MM1223VBUS
3MM312RRL ①	MMCCVR3123R	1MMMS ②	1MMBC1	1MMRC125 ③	MM12NWLK	MM12NWL	MMDH3	MM1223VBUS
1MM412RRL ①	MMCCVR3121R	1MMMS ②	1MMBC1	1MMRC125	MM12NWLK	MM12NWL	MMDH3	MM124VBUS
3MM412RRL ①	MMCCVR4123R	1MMMS ②	1MMBC1	1MMRC125	MM12NWLK	MM12NWL	MMDH3	MM124VBUS
1MM512RRL ①	MMCCVR5121R	1MMMS ②	1MMBC1	1MMRC125	MM12NWLK	MM12NWL	MMDH3	MM125VBUS
3MM512RRL ①	MMCCVR5123R	1MMMS ②	1MMBC1	1MMRC125	MM12NWLK	MM12NWL	MMDH3	MM125VBUS
1MM612RRL ①	MMCCVR6121R	1MMMS ②	1MMBC1	1MMRC125	MM12NWLK	MM12NWL	MMDH3	MM126VBUS
3MM612RRL ①	MMCCVR6123R	1MMMS ②	1MMBC1	1MMRC125	MM12NWLK	MM12NWL	MMDH3	MM126VBUS
3MM220RRL ①	MMCCVR2203R	1MMMS ②	1MMBC2	1MMRC200	MM20NWLK	MM20NWL	MMDH4	MM2023VBUS
1MM320RRL ①	MMCCVR3201R	1MMMS ②	1MMBC2	1MMRC200	MM20NWLK	MM20NWL	MMDH4	MM2023VBUS
3MM320RRL ①	MMCCVR3203R	1MMMS ②	1MMBC2	1MMRC200	MM20NWLK	MM20NWL	MMDH4	MM2023VBUS
1MM420RRL ①	MMCCVR4201R	1MMMS ②	1MMBC2	1MMRC200	MM20NWLK	MM20NWL	MMDH4	MM204VBUS
3MM420RRL ①	MMCCVR4203R	1MMMS ②	1MMBC2	1MMRC200	MM20NWLK	MM20NWL	MMDH4	MM204VBUS

Commercial Meter Stacks

Commercial Meter Stacks (Lever Bypass)

Catalog Number

Meter Stack	Wireway Cover	Meter Socket Assembly	Tenant Breaker Cover	Meter Cover	Endwall (with Knockouts)	Endwall (without Knockouts)	Drip Hood
35MM120R12	MSLWCVR1	—	MSLMSA1	MSBCVR1	MSLMCVR1 ④	37MMSK1 ⑤	MSLEW1 MSLDH1
35MM220R12	MSLWCVR2	—	MSLMSA1	MSBCVR1	MSLMCVR1 ④	37MMSK1 ⑤	MSLEW1 MSLDH1
35MM320R12	MSLWCVR3	—	MSLMSA1	MSBCVR1	MSLMCVR1 ④	37MMSK1 ⑤	MSLEW1 MSLDH1
35MM420R12	MSLWCVR4 ④	MSLWCVR13 ⑤	MSLMSA1	MSBCVR1	MSLMCVR1 ④	37MMSK1 ⑤	MSLEW2 MSLDH2
37MM140R12	MSLWCVR9 ④	MSLWCVR14 ⑤	MSLMSA2	MSBCVR1	MSLMCVR1 ④	37MMSK1 ⑤	MSLEW1 MSLDH1
37MM120R12	MSLWCVR5 ④	MSLWCVR15 ⑤	MSLMSA2	MSBCVR1	MSLMCVR1 ④	37MMSK1 ⑤	MSLEW1 MSLDH1
37MM220R12	MSLWCVR6 ④	MSLWCVR16 ⑤	MSLMSA2	MSBCVR1	MSLMCVR1 ④	37MMSK1 ⑤	MSLEW1 MSLDH1
37MM320R12	MSLWCVR7 ④	MSLWCVR17 ⑤	MSLMSA2	MSBCVR1	MSLMCVR1 ④	37MMSK1 ⑤	MSLEW1 MSLDH1
37MM420R12	MSLWCVR8 ④	MSLWCVR18 ⑤	MSLMSA2	MSBCVR1	MSLMCVR1 ④	37MMSK1 ⑤	MSLEW2 MSLDH2

Commercial Meter Stack (Test Bypass)

Catalog Number

Meter Stack	Wireway Cover	Meter Socket Assembly	Tenant Breaker Cover	Meter Cover	Endwall (with Knockouts)	Endwall (without Knockouts)	Drip Hood
35SS120RAB	MSTWCVR1	MSTMSA1	MSBCVR1	MSTMCCR1	MSTEW1	MSTEWNK01	MSTDH1
35SS120RAC	MSTWCVR2	MSTMSA1	MSBCVR1	MSTMCCR1	MSTEW1	MSTEWNK01	MSTDH1
35SS120RBC	MSTWCVR3	MSTMSA1	MSBCVR1	MSTMCCR1	MSTEW1	MSTEWNK01	MSTDH1
35SS220RAB	MSTWCVR4	MSTMSA1	MSBCVR1	MSTMCCR1	MSTEW2	MSTEWNK02	MSTDH1
35SS220RAC	MSTWCVR5	MSTMSA1	MSBCVR1	MSTMCCR1	MSTEW2	MSTEWNK02	MSTDH1
35SS220RBC	MSTWCVR6	MSTMSA1	MSBCVR1	MSTMCCR1	MSTEW2	MSTEWNK02	MSTDH1
35SS320RAB	MSTWCVR7	MSTMSA1	MSBCVR1	MSTMCCR1	MSTEW2	MSTEWNK02	MSTDH1
35SS320RAC	MSTWCVR8	MSTMSA1	MSBCVR1	MSTMCCR1	MSTEW2	MSTEWNK02	MSTDH1
35SS320RBC	MSTWCVR9	MSTMSA1	MSBCVR1	MSTMCCR1	MSTEW2	MSTEWNK02	MSTDH1
37SS120R	MSTWCVR10	MSTMSA2	MSBCVR1	MSTMCCR1	MSTEW1	MSTEWNK01	MSTDH1
37SS220R	MSTWCVR11	MSTMSA2	MSBCVR1	MSTMCCR1	MSTEW2	MSTEWNK02	MSTDH1
37SS320R	MSTWCVR12	MSTMSA2	MSBCVR1	MSTMCCR1	MSTEW2	MSTEWNK02	MSTDH1

Notes

- ① For catalog numbers with a “B” suffix (ringless with horn bypass), all replacement parts are the same with the exception of the meter socket assembly. Refer to Footnote ② for correct catalog number.
- ② For ringless style meter stacks with horn bypass, order **1MMMSB** meter socket assembly.
- ③ For top position, use meter socket cover **1MMRC125T**.
- ④ Used for product built October 2002 and prior.
- ⑤ Used for product built after October 2002.

Miscellaneous Parts

Miscellaneous Parts

Description	Part Number
Phase balancing kit, single-phase commercial metering	99-4177-3
A and C phase balancing kit (3MM)	99-4184
Breaker mounting kit, commercial metering (one three-pole breaker per kit)	99-4176-2
Breaker mounting kit, 1MM/1MP, 200A, (one two-pole breaker per kit)	99-4176
Mounting kit, meter center	99-4172
Mounting kit, meter pack	99-4173
Bonding strap kit, all meter packs (except CECHA three and four socket)	99-4174
Bonding strap kit, CHECA three and four socket meter packs	99-2379
Sealing screw kit, ringless devices (six screws)	99-4175
Sealing screw kit, three and four meter sockets, ringless devices (four screws)	99-2589
Padlock bracket	99-2512-5
Mounting bracket kit—all breaker and fusible mains	99-4183
Mounting bracket kit—400 and 600A 3MTB	99-4183-3
Exterior breaker cover	49-6070

Further Information

Publication Number	Description
RP32A01BTE	Renewal parts data for new 1MM, 3MM, 35MM, 37MM, 35SS and 37SS
RP00501001E	Renewal parts data for multiple metering

Pricing Information

Price and Availability Digest (PAD)
 Vista/VISTALINE™ Discount Symbol 22-CD

Safety Switch Product Family



7

Safety Switches

Product Description	V12-T7-2
Product History	V12-T7-2
Product History Time Line	V12-T7-2
Replacement Capabilities	V12-T7-2
Further Information	V12-T7-2
Pricing Information	V12-T7-2

Safety Switches



Safety Switch Product Family

Product Description

Eaton’s Cutler-Hammer® series of safety switches have a number of applications from service entrance to branch circuit protection. They are also horsepower rated for use as motor circuit switches. Non-fusible safety switches provide a means to manually connect or disconnect the load from the source. Fusible safety switches provide a means to manually open and close a circuit and overcurrent protection by means of installed fuses. Safety switches offer a wide variety of switching capabilities with general-duty, heavy-duty and double-throw switches.

Product History

Eaton began manufacturing safety switches with the 4103 line in 1957. In 1977, the new 4105 line was moved from the New York plant to the manufacturing facility in Lincoln, IL. The last design change came in 1983, where the manufacture of the new K-Series switch was moved to Eaton’s Cleveland, TN, facility. The K-Series design represents our current product offering and is still manufactured at the Cleveland plant.

The Westinghouse safety switch design and facilities were sold to Thomas & Betts in 1994. Prior to this, there were various design and code changes that caused changes in catalog numbering and utilization of the switches. In 1984, an “N” was added to

the middle of the catalog numbers to signify the new National Electrical Code® (NEC®) regulations. During this time period, Westinghouse’s safety switches were manufactured in Beaver, PA. In 1989, the manufacture of the switches

was moved to Vidalia, GA. There was then another code change in 1992 that necessitated another change in catalog numbering. The previous “N” in the middle of the catalog number was deleted for the 400 to 1200A units.

Product History Time Line

Product	1955	1960	1965	1970	1975	1980	1985	1990	1995	2000	2005	2010	Present
Cutler-Hammer 4103	█												
Cutler-Hammer 4105						█							
Cutler-Hammer K-Series							█	█					
Westinghouse HFN365N (Bacalyte Base)							█						
Westinghouse HFN365N							█	█					
Westinghouse HF365N (Red Base, 400–1200A)									█				
Eaton R-Series Rotary Disconnects												█	█
Cutler-Hammer C362/C363 Rotary Disconnects											█	█	
Eaton’s Pringle® Bolted Pressure Switches												█	█

Replacement Capabilities

Type	Operating Handle	Ground	Neutral	Fuse Base	Fuse Block	Line Shield	Operating Mechanism	Switching Base
K-Series	█	█	█	█	█	█	█	█

Note: Specific applicable renewal parts for safety switches are identified on the inside door label of the product.

Further Information

Publication Number	Description
RP00801001E	Safety Switch Renewal Parts
CA08100003E	Commercial Distribution Catalog, Volume 2, Tab 1 (Switching Devices)
CA08104001E	Consulting Application Guide
CA08100006E	Motor Control & Protection Catalog, Volume 5, Tab 8 (Rotary Disconnects)
PG00802002E	Rotary Disconnect Product Guide

Pricing Information

Price and Availability Digest (PAD)

Vista/VISTALINE™ Discount Symbol SWD-1, SWD-2, SWD-3 for Safety Switches

Dry-Type Distribution Transformers

Family of Dry-Type
Distribution Transformers



8	Dry-Type Distribution Transformers	
	Product Description	V12-T8-2
	Product History	V12-T8-2
	Product History Time Line	V12-T8-2
	Replacement Capabilities	V12-T8-3
	Further Information	V12-T8-4
	Pricing Information	V12-T8-4

Dry-Type Distribution Transformers



Family of Dry-Type Distribution Transformers

Product Description

Eaton's Cutler-Hammer® series of dry-type distribution transformers are electrical devices that transfer energy by magnetic induction from one circuit to another. They are typically used to change the voltage in an electric power system from its distribution level to the proper level for practical and safe use.

Typical loads for dry-type distribution transformers include lighting, heating, air conditioning, fans and machine tools. Such loads are found in commercial, institutional, industrial and residential structures.

Different types of dry-type distribution transformers are used for various applications throughout facilities. Therefore, dry-type distribution transformers are classified in distinct product groups as follows: general purpose—sand and resin encapsulated (EP and EPT); general purpose—ventilated (DS-3, DT-3, CSL3-2007, NEMA® Premium®); energy efficient (NEMA TP-1); shielded isolation; motor drive isolation (MD); nonlinear (KT); mini-power center (MPC); hazardous location, Buck-Boost and industrial control (MTA and MTC).

Product History

Originally a Westinghouse Product

The first transformer built in the United States was manufactured by Westinghouse Electric in 1892. It was a 2 kVA dry-type transformer. For over a century, Westinghouse

manufactured numerous varieties of transformers for countless applications worldwide.

The Westinghouse design transformer is now available through Eaton. Dry-type transformers, the workhorse of modern industry, are the foundation of modern AC power distribution. It is a

transformer that solves the problems of maintenance, installation, safety and efficiency by using air to cool the coils instead of liquids. Many older transformers, which in some cases pre-date the product families listed above, can be updated to the modern designs currently manufactured by Eaton.

Product History Time Line

Type	1955	1960	1965	1970	1975	1980	1985	1990	1995	2000	2005	2010	Present
DS-3													
DT-3													
MTA													
MTC													
EP													
EPT													
MPC													
MD													
KT													
NEMA TP-1													
HMT													
CSL3													
NEMA Premium													

Replacement Capabilities

Replacement Parts

Terminal Lug Kits for Type DT-3 Transformers ^①

Typical Sizing	Terminal Lugs Cable Range	Terminal Lugs Quantity	Hardware Bolt Size	Hardware Quantity	Catalog Number
15–37.5 kVA single-phase	#14–#2	8	1/4–20 x 3/4	8	LKS1
15–45 kVA three-phase	#6–250 kcmil	4			
50–75 kVA single-phase	#6–250 kcmil	12	1/4–20 x 3/4	8	LKS2
75–112.5 kVA three-phase			1/4–20 x 1-3/4	8	
100–167 kVA single-phase	#6–250 kcmil	3	1/4–20 x 3/4	3	LKS3
150–300 kVA three-phase	#2–600 kcmil	22	3/8–16 x 2	16	
500 kVA three-phase	#2–600 kcmil	29	3/8–16 x 2	18	LKS4

Rodent Screens

Description	Frame Size(s) ^②	Catalog Number
Rodent screens are used to discourage entry by birds or rodents.	908, 909	RS01
	910A, 911, 912	RS02
	913B, 914B, 915B	RS03
	916	RS04
	917, 918, 918A	RS05
	919, 920	RS06
	916A, 916B	RS07
	922	RS08
	923	RS09
	814, 821	RS11
	815	RS12
	816	RS13
	817, 818	RS14
	819, 820	RS15
	912B	RS16
	914D, 915D	RS17
924	RS18	
928	RS19	
929	RS20	

Replacement Parts for Mini-Power Centers

Frame	Deadfront Cover (Breaker Cover) Part Number	Front Cover Part Number
283	47-37503	7074C98H04
284	47-37503-2	7074C98H01
285	47-37503-3	7074C98H02
286	47-37503-4	7074C98H02
287	47-37503-5	7074C98H03
289	47-37459	7074C44H01
290	47-37459-2	7074C44H02
291	47-37459-3	7074C44H03
289A	47-42072-1	7074C44H01
290A	47-42072-2	7074C44H02
291A	47-42072-3	7074C44H03

Notes

- ① Lugs are rated Al/Cu and are suitable for use with either aluminum or copper conductors.
- ② Effective June 1, 2001, frame numbers have a prefix of FR, i.e., **FR819**. Dimensions, accessories, etc. are still applicable as if the FR did not exist.

Replacement Parts**Case Parts for Ventilated Transformers**

Frame(s) ①	Panels Front or Back Part Number	Side (Two Required Per Transformer) Part Number	Bottom Part Number	Top Cover Part Number
Three-Phase, 600V Class				
908, 909	7073C37P01	1714C44P03	7073C20P05	1714C45P01
910, 911, 912	1714C46P01	1714C44P01	7073C20P01	1714C45P01
913A, 914A, 915A	1714C47P03	1714C44P07	7073C20P02	1714C45P02
916	1714C60P01	1714C56P01	7073C20P03	1714C58P01
917, 918	1714C65P01	1714C64P01	7073C20P04	1714C67P01
918A	47-41801	47-41800	47-41799	47-41802
919, 920	2D46331P03 (upper panel) 2D46331P04 (lower panel)	2D46332P01 2D46331P01 (cutout cover plate)	— —	2D46331P02
922	2D46391H03 (back upper panel) 2D46391H06 (front upper panel) 2D46391H08 (lower panel)	2D46392H01	— — —	2D46391H02
923	47-45927-1	47-45925-1	47-45759-1	47-45926-1
910A, 911A, 912A	47-40592	47-40591	47-40589	1714C45P01
913B, 914B, 915B	47-40580	47-40578 47-41789	47-41792	1714C45P02
916A	47-41790	47-41789	47-41788	47-41791
FR916B	47-47351-1	47-47350-1	47-47-347-1	47-41791
912B	47-49323-1	47-49321-1	47-51964-1	47-49322-1
914D, 915D	47-49317-1	47-49315-1	47-51965-1	47-49316-1
924	47-53089-2 (upper panel) 47-53089-1 (lower panel)	47-53088-1	47-53087-1	47-53089-1
928	47-53777-1	47-53779-1	47-53778-1	1714C67H15
929	47-53786-1	47-53788-1	47-53787-1	47-41802-3
Single-Phase, 600V Class				
809	7073C16P03	7073C18P04	7073C14P03	7073C17P01
810, 811, 835	7073C16P01	7073C18P01	7073C14P01	7073C17P01
812, 813, 836, 837, 838	7073C16P02	7073C18P02	7073C14P02	7073C17P02
814	7073C54P01	7073C18P05	7073C14P04	7073C17P03
815	47-39433	47-39430	47-39429	47-39431
816	47-40452	47-40451	47-40449	47-40453
817, 818	47-40457	47-40456	47-40454	47-40458
819, 820	47-40574	47-40573	47-40459	47-40575

Further Information

Publication Number	Description
B.36B.01.S.E	K-Factor Dry-Type Distribution Transformer Brochure
CA08100003E	Commercial Distribution Catalog, Volume 2, Tab 2
CA08104001E	Consulting Application Guide
B1228A	Industrial Control Transformer Binder
B.36F.01.S.E	Mini-Power Center Brochure
B.36D.01.S.E	Class 1, Division 2, Hazardous Location Transformer Brochure

Pricing Information

Price and Availability Digest (PAD)

Vista/VISTALINE™ (Discount Symbol DT-1)

Notes

① Effective June 1, 2001 frame numbers have a prefix of FR, i.e., **FR819**. Dimensions, accessories, etc. are still applicable as if the FR did not exist.

Parts listed are for standard catalog listed transformers. Units with modifications may require different parts. (Frame No. from transformer nameplate required.) Transformer nameplate and UL® label are not field replaceable.

Circuit Breaker Enclosure



9

Busway (Low Voltage)

Product Description	V12-T9-2
Product History	V12-T9-2
Product History Time Line	V12-T9-3
Replacement Capabilities	V12-T9-4
Plug-In Units	V12-T9-4
Vintage Busway Products	V12-T9-4
100 Ampere Busway	V12-T9-6
Standard Plug-In Busway	V12-T9-7
Standard and Low Impedance	V12-T9-8
Quick-Assembled Plugs	V12-T9-10
CP2, CP3 or CP4 SAFETYBUS Busway Plug-In Units	V12-T9-11
Technology Upgrades	V12-T9-14
Clipper Power Systems, Busway TVSS Protection	V12-T9-14
IQ Energy Sentinel for Bus Plugs	V12-T9-15
Further Information	V12-T9-15
Pricing Information	V12-T9-15

Busway (Low Voltage)



Standard Plug-In

Product Description

Eaton's Cutler-Hammer® low voltage busway consists of aluminum or copper bars inside a metal housing used for power distribution. Busway is available in ampere ratings of 100–5000A. Busway is available as feeder (indoor or outdoor) and plug-in. Feeder busway routes power from point-to-point, whereas plug-in busway allows for power to be tapped off along a run as needed. Busway is typically used in manufacturing buildings and high-rise office buildings.

Product History

Westinghouse began marketing low voltage busway in 1938. The first product offering was power distribution busway, using a multiple bolt joint that later evolved into standard plug-in busway. Victory bus duct was developed during the Second World War to comply with federal limitations placed on usage of materials such as steel and copper, which were critical to the war effort. In 1947, Westinghouse began manufacturing busway at the newly acquired facility in Beaver, PA, with standard

plug-in and feeder bus in ratings up to 1500A. All of these early designs used separated, uninsulated busbars inside a totally enclosed or perforated steel housing.

In 1951, low impedance feeder busway was introduced as the first design to use heat-shrinkable tubing for insulation on the busbars and a ventilated steel housing. An internal ground bus was not available with this product line, but provisions were made for mounting an external ground bus directly to the busway housing. Low impedance feeder and standard plug-in busway accounted for the majority of busway business written by Westinghouse through the 1950s and into the 1960s. Low impedance plug-in busway was introduced in 1961. With this design, the product offering was expanded to a maximum of 5000A for feeder and 4000A for plug-in.

During the 1950s, various other designs were introduced to meet specific customer needs. Westinghouse Lifeline Unibus, rolled out in 1955, provided low impedance characteristics with plug-in openings and incorporated flexible armored cable into the design for use as elbows, offsets and flat to edgewise adapters.

Westinghouse high frequency busway was introduced in 1958 to address the inherent problems of transmitting power at frequencies from 180 to 20,000 Hz. Cutler-Hammer high frequency BV (balanced voltage) busway was also marketed during the late 1950s and early 1960s. Westinghouse high frequency busway and Cutler-Hammer BV busway both found success in aircraft manufacturing plants, industrial induction heating systems, military missiles and radar bases.

Electric utility busway was also introduced by Westinghouse in 1958 and was designed to conduct direct current with low voltage drop. By 1963, electric utility busway had been expanded to meet the growing industrial market for direct current power and was marketed simply as DC busway. This product line was applied to feeding plating processes, welding installations, mill drives and motors.

In 1958, Westinghouse sold the rights to the Life Line Unibus product line to EDP of Allentown, PA, which marketed EDP Unibus until 1962 when EDP became a wholly owned subsidiary of Eaton. Eaton successfully marketed Unibus until the product line was discontinued in 1974.

In 1966, Westinghouse introduced its first true sandwich bus design with H5000 feeder busway. H5000 was also the first single bolt joint design offered by Westinghouse and it initially used a PVC shrink tubing and later a Mylar® wrap for busbar insulation. A combination of steel and aluminum channels were used to form a lightweight non-magnetic housing. The grounding method for H5000 was similar to low impedance busway and an external ground bus mounted onto the housing was the only offering. H5000 plug-in busway rolled out in 1968 as a non-sandwich design with separated and uninsulated busbars.

In 1970, the Eaton's Cutler-Hammer Bethlehem, PA, plant introduced CP2 SAFETYBUS that used an innovative single bolt, bridge joint design with a steel housing for plug-in, and a combination of steel and aluminum channels for the feeder housing. CP2 used a Mylar wrap for busbar insulation and an Alstan® process for plating. The feeder busway was a sandwich design while the plug-in design used separated busbars that were braced and supported by corrugations formed in the housing sides.

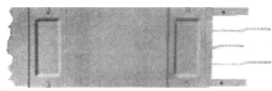

Standard Plug-In

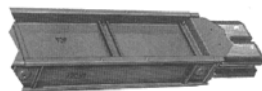

H5000 Feeder

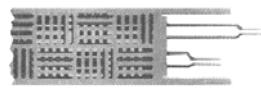

Electric Utility (DC)

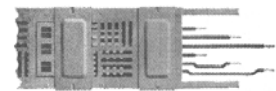

Low Impedance Plug-In

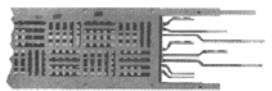

Low Impedance Feeder

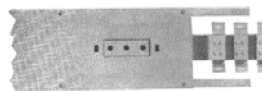

High Frequency



H5000 Plug-In 225–1000A

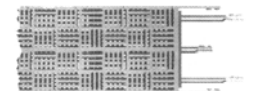

Current Limiting



Typical Pow-R-Way Plug-In Straight Length



Typical Pow-R-Way II Plug-In Straight Length

Westinghouse introduced the Pow-R-Way product line in 1971. Pow-R-Way employed the sandwich design in both feeder and plug-in. At that time, Pow-R-Way used a combination of PVC, applied by the fluidized bed process, and Mylar sheeting for busbar insulation that achieved a Class A, 105°C rating. Silver-plating of all joint and contact surfaces was applied by a Zincate process. Pow-R-Way is a bolt-end/slot-end design with a single bolt connection at the joint and is rated from 600 to 5000A. Pow-R-Way II was rolled out in 1975 with ratings of 225A and 400A in feeder and plug-in. Pow-R-Way II is a single, captive bolt per bar design for indoor, horizontal applications only.

During 1980, the Cutler-Hammer busway design was upgraded and they began marketing CP3 SAFETYBUS. CP3 featured an improved bridge joint package and a polyethylene terephthalate wrap for busbar insulation. CP3 maintained the CP2 housing design with busbar separation in the plug-in product configuration.

Cutler-Hammer CP4 SAFETYBUS was introduced in 1985 and incorporated the sandwich design into the plug-in busway. CP4 featured a UL® recognized case ground path rating and 130°C Mylar busbar insulation. CP4 used the CP3 bridge joint package and accepted CP2 and CP3 bus plugs. The CP4 product line was successful in both the commercial and industrial markets until it was discontinued in 1994.

In 1988, Westinghouse moved the busway product line to the Greenwood, SC, manufacturing facility. At that time, an improved Alstan plating process was implemented for silver-plating the joint and contact surfaces. In 1993, the automated fluidized bed process was changed to Class B, 130°C, epoxy insulation.

Cutler-Hammer Pow-R-Way III® was introduced in 1997. As in the past, specific customer needs have driven the design of this product line. High short-circuit ratings, finger-safe protection at the plug-in openings, integral housing ground path, two-piece extruded aluminum housing and an optional 200% neutral are just some of the features with this product line.

Product History Time Line

Product	1935	1940	1945	1950	1955	1960	1965	1970	1975	1980	1985	1990	1995	2000	Present
Power distribution bus															
Victory bus duct															
Standard plug-in															
Low impedance bus															
Life line Unibus															
High frequency bus															
Cutler-Hammer BV bus															
Current limiting bus															
Electric utility bus															
DC busway															
100 ampere busway															
Low impedance plug-in															
Cutler-Hammer Unibus															
H5000 feeder															
H5000 plug-in															
Cutler-Hammer CP2															
Pow-R-Way															
Pow-R-Way II															
Cutler-Hammer CP3															
Cutler-Hammer CP4															
Pow-R-Way III															

Replacement Capabilities

Plug-In Units

Replacement Capabilities

Busway Types	Bus	Adapter ^①	Plugs
Power distribution bus	No	No	No
Victory bus duct	No	No	No
Standard plug-in	Yes	No	Yes
Low impedance bus	No	Yes	—
Life line Unibus	No	No	No
High frequency bus	No	No	No
Cutler-Hammer BV bus	No	No	No
Current limiting bus	No	Yes	—
Electric utility bus	No	No	No
DC busway	No	No	No
100 ampere busway	Yes	No	Yes
Low impedance plug-in	No	Yes	Yes
Cutler-Hammer Unibus	No	No	No
H5000 feeder	No	No	—
H5000 plug-in	No	No	Yes
Cutler-Hammer CP2	No	Yes	Yes ^②
Pow-R-Way	Yes	No	Yes
Pow-R-Way II	Yes	No	Yes
Cutler-Hammer CP3	No	Yes	Yes ^②
Cutler-Hammer CP4	No	Yes	Yes ^②
Pow-R-Way III	Yes	—	Yes

Notes

- ① Busway adapter (transposition) available from old line to Pow-R-Way III only.
- ② Fusible units only. No breaker units available.

Vintage Busway Products

- Replacement pieces or additions to vintage Cutler-Hammer bus (CP2, CP3, CP4) are being handled whenever possible by making transition to Eaton's current design Pow-R-Way III bus
- Obtain style number and complete nameplate information from existing busway and contact your local Eaton Field Sales office for pricing and availability
- Plugs for vintage Cutler-Hammer bus, Pow-R-Way bus, and Pow-R-Way III bus are not interchangeable

Pow-R-Way Plug-In Unit

Stab base assembly for breaker and fusible types.

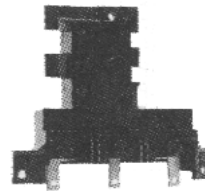

Top View

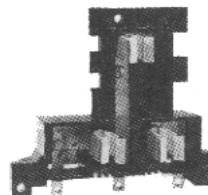

Bottom View

Vintage Busway Plug-In Unit

Stab base assembly for breaker and fusible types.

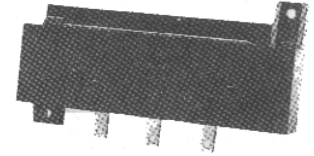

Top View

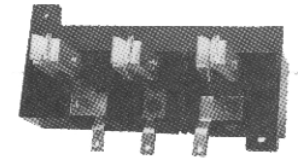

Bottom View

Fuse Base Assembly

For all busway.

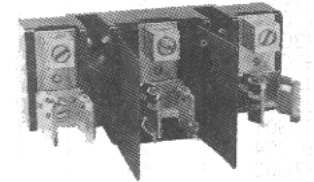

30A Maximum

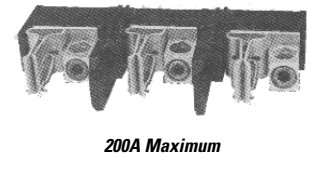

200A Maximum

Originally a Westinghouse Product

Breaker Plug-In Units

Reference Catalog Number for Existing Complete Plug-In Unit ^①	Replacement Stab Base Assembly
Pow-R-Way	
IBPFB	2528D04G01
IBPFBP	2528D04G01
IBPFCL	2528D04G01
IBPFD	2528D04G01
IBPJD	2528D04G12
IBPKB	2528D04G07
IBPKD	2554D03G06
IBPLAP	2532D45G06
IBPLB	2554D03G05
IBPLCL	2554D03G03
IBPMC	2537D17G03
IBPNBP	2537D17G07
Standard Plug-In and Low Impedance Busway ^②	
BPFB	2528D03G01
BPFBP	2528D03G01
BPFCL	2528D03G01
BPFD	2528D03G01
BPJD	2528D03G10
BPKB	2528D03G07
BPKD	2537D20G06
BPLB	2537D20G05
BPLCL	2537D20G01
BPMC	374D017G03

Fusible Plug-In Units

Reference Catalog Number for Existing Complete Plug-In Unit ^①	Replacement Stab Base Assembly	Replacement Fuse Base
Pow-R-Way		
ITAP321	2528D04G02	5009D52G01
ITAP361	2528D04G02	5009D52G13
ITAP322	2528D04G02	5009D52G03
ITAP362	2528D04G02	5009D52G04
ITAP323	2528D04G02	5009D52G05
ITAP363	2528D04G02	5009D52G05
ITAP324	767A373G02	2532D78G01
ITAP364	767A373G02	2532D78G01
ITAP325	2554D03G03	627B426G02
ITAP365	2554D03G03	627B426G02
ITAP326	2554D03G02	627B426G04
ITAP366	2554D03G02	627B426G04
ITAP367	2554D03G01	2553D93G02
ITAP361H	2528D04G02	2535D92G09
ITAP362H	2528D04G02	2535D92G10
ITAP363H	2528D04G02	2535D92G11
ITAP364H	2568D13G09	2532D78G02
ITAP365H	2554D03G03	1205C02G02
ITAP366H	2554D03G02	2599D97G02
Standard Plug-In and Low Impedance Busway ^②		
TAP321	2528D03G02	5009D52G01
TAP361	2528D03G02	5009D52G13
TAP322	2528D03G02	5009D52G03
TAP362	2528D03G02	5009D52G04
TAP323	2528D03G02	5009D52G05
TAP363	2528D03G02	5009D52G05
TAP324	767A373G01	2532D78G01
TAP364	767A373G01	2532D78G01
TAP325	2537D20G04	627B426G02
TAP365	2537D20G04	627B426G02
TAP326	2584D73G01	627B426G04
TAP366	2584D73G01	627B426G02
TAP361H	2528D03G02	2535D92G09
TAP362H	2528D03G02	2535D92G10
TAP363H	2528D03G02	2535D92G11
TAP364H	767A373G01	2532D78G02
TAP365H	2537D20G04	1448D09G05
TAP366H	374D017G03	373D043G06

Notes

- ^① Check Vista for pricing and minimum order quantities.
- ^② Replacement stab base assembly and fuse base style numbers specified correspond to the most recent design of the reference catalog number for the complete plug-in unit. For verification that this style number is the correct replacement for your existing plug-in unit, contact your local Eaton Field Sales office.

100 Ampere Busway



Elbow, Busway and Cable Tap Box

100 Ampere Busway—Copper (Includes 50% Internal Ground Bar)

Description	Three-Phase, Three-Wire 600V Maximum Catalog Number	Three-Phase, Four-Wire FN 277/480V Catalog Number	Single-Phase, Three-Wire 120/240V Catalog Number
Straight Lengths			
10 ft (3048 mm)	CST13G	CST14G	CST13NG
5 ft (1524 mm)	CST135G	CST145G	CST13N5G
3 ft (914.4 mm)	CST133G	CST143G	CST13N3G
2 ft (609.6 mm)	CST132G	CST142G	CST13N2G
1 ft (304.8 mm)	CST131G	CST141G	CST13N1G
Elbows			
Forward	CFE13G	CFE14G	CFE13NG
Rearward	CRE13G	CRE14G	CRE13NG
Upward	CUE13G	CUE14G	CUE13NG
Downward	CDE13G	CDE14G	CDE13NG
Tees			
Forward	CFT13G	CFT14G	CFT13NG
Rearward	CRT13G	CRT14G	CRT13NG
Upward	CUT13G	CUT14G	CUT13NG
Downward	CDT13G	CDT14G	CDT13NG

Cable Tap Boxes

Description	Three-Wire or Four-Wire Catalog Number	Ground (If Required) Catalog Number
Plug-in	PIB14	PIGS100
End	EB14	GL100
Center	CBIB14G	(Included)

Fusible Plug-In Units

Voltage Rating	Ampere Rating	Fusible Enclosure Catalog Number	Ground (If Required) Catalog Number
240	30	FAN321	PIGS100
240	60	FAN322	PIGS100
240	100	FAN323	PIGS100
600	30	FAN361	PIGS100
600	60	FAN362	PIGS100
600	100	FAN363	PIGS100

Circuit Breaker Plug-In Units

Voltage Rating	Ampere Rating	Circuit Breaker Enclosure Catalog Number	Receptacle Enclosure Catalog Number	Ground (If Required) Catalog Number	External Handle (Required for Hook-Stick Operation) Catalog Number
QUICKLAG HQP	15–50	PINQP	LCNQP	PIGS100	HMQP
ED, EHD, FDB	15–100	PINFD	LCNFD	PIGS100	HMFD

Accessories

Item	Catalog Number
End closer	EC1
Outlet cover	OC1
Edgewise hanger	EH1
"C" clamp hanger	FH1
Slip-on wall flange	WF1

End Closers—EC1

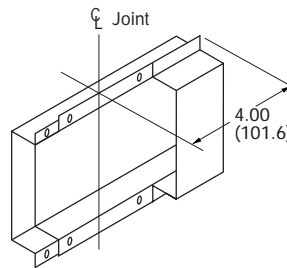

Replacement Outlet Cover—OC1

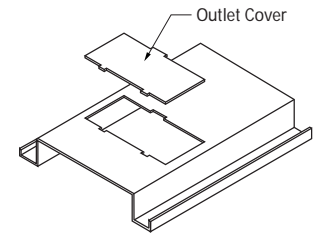

Standard Plug-In Busway Originally a Westinghouse Product

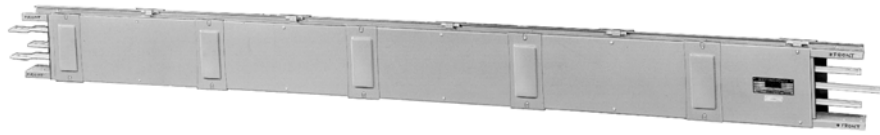

Typical Standard Plug-In Straight Length

Catalog Numbers

Ampere Rating	Catalog Number for 10-Foot Lengths ^②		Fittings (Price of Footage Through Each Fitting Must be Added)		
	Aluminum Catalog Number	Copper Catalog Number	Universal Cable Tap Box (Lugs Included) ^③ Catalog Number	End Closer Aluminum Catalog Number	Copper Catalog Number
Three-Phase, Three-Wire, 600V with 50% Ground Bus					
225	AST302G	ST302G	UCTB302G	UEC10	UEC10
400	AST304G	ST304G	UCTB304G	UEC20	UEC15
600	AST306G	ST306G	UCTB306G	UEC35	UEC20
800	AST308G	ST308G	UCTB308G	UEC50	UEC30
1000	AST310G	ST310G	UCTB310G	UEC60	UEC40
Three-Phase, Four-Wire, Full Neutral, 277/480V with 50% Ground Bus					
225	AST502G	ST502G	UCTB402G	UEC10	UEC10
400	AST504G	ST504G	UCTB404G	UEC20	UEC15
600	AST506G	ST506G	UCTB406G	UEC35	UEC20
800	AST508G	ST508G	UCTB408G	UEC50	UEC30
1000	AST510G	ST510G	UCTB410G	UEC60	UEC40

Cantilever Hangers

Ampere Rating	Aluminum Catalog Number	Copper Catalog Number
Three-Phase, Three-Wire, 600V		
225	CLH10	CLH10
400	CLH20	CLH15
600	CLH35	CLH20
800	CLH50	CLH30
1000	CLH60	CLH40
Three-Phase, Four-Wire, Full Neutral, 277/480V		
225	CLH10	CLH10
400	CLH20	CLH15
600	CLH35	CLH20
800	CLH50	CLH30
1000	CLH60	CLH40

Miscellaneous Accessories

Description
Wall/floor flange
Extra cantilever hangers
Hookstick kit (8–14 feet) HSB-14 ^④
Renewal Parts
Joint hardware—EXWK10
Access covers (two)
Splice plates (two)

Notes

- ① When ordering from stock, all hangers must be shown as a separate item marked included in price.
- ② Suitable for horizontal mounting only. Contact your local Eaton Field Sales office for pricing and lead times.
- ③ If UCTB is used on end of run, an end closer must also be used for that end.
- ④ Normally available from stock.

Standard and Low Impedance

Originally a Westinghouse Product

Circuit Breaker Plug-In Units



Circuit Breaker Plug-In Unit (Closed)

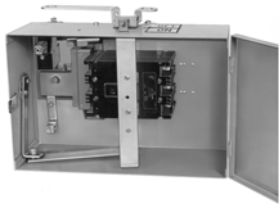

Circuit Breaker Plug-In Unit (Open)

The enclosure, circuit breaker, neutral and ground are ordered and shipped assembled.

Note: Breaker and fusible plugs must be ordered as assembled units. See **V12-T9-10** for instructions on how to build the assembled catalog numbers.

Note: For units mounting at the joint and feeder type ducts, see bolt-on units—standard plug-in, low impedance and H5000.

Circuit Breaker Selection and Interrupting Ratings

Breaker Frame	Ampere Rating	Symmetrical Amperes		
		240 Vac	480 Vac	600 Vac
EHD	15–60	18,000	14,000	—
	70–100	18,000	14,000	—
FDB	15–60	18,000	14,000	14,000
	70–100	18,000	14,000	14,000
	110–150	18,000	14,000	14,000
FD	15–60	65,000	25,000	18,000
	70–100	65,000	25,000	18,000
	110–150	65,000	25,000	18,000
HFD	15–60	100,000	65,000	25,000
	70–100	100,000	65,000	25,000
	110–150	100,000	65,000	25,000
FDC	15–60	200,000	100,000	50,000
	70–100	200,000	100,000	50,000
	110–150	200,000	100,000	50,000
JDB	70–225	65,000	25,000	18,000
	250	65,000	25,000	18,000
JD	70–225	65,000	25,000	18,000
	250	65,000	25,000	18,000
HJD	70–225	100,000	65,000	25,000
	250	100,000	65,000	25,000
JDC	70–225	200,000	100,000	50,000
	250	200,000	100,000	50,000
KDB	250–400	65,000	35,000	25,000
KD	250–400	65,000	35,000	25,000
HKD	250–400	100,000	65,000	35,000
KDC	250–400	200,000	100,000	50,000
LDB	300–600	65,000	45,000	25,000
LD	300–600	65,000	45,000	25,000
HLD	300–600	100,000	65,000	35,000
LDC	300–600	200,000	100,000	50,000
MDL	400–800	65,000	50,000	25,000
HMDL	400–800	100,000	65,000	35,000
NP	400–1200	65,000	50,000	25,000
HND	400–1200	100,000	65,000	35,000
FB (TRI-PAC®)	15–100A	200,000	200,000	200,000
	LA (TRI-PAC)	70–400	200,000	200,000
NB (TRI-PAC)	600–800	200,000	200,000	200,000
	600–800	200,000	150,000	200,000

Notes

- ① Full neutral. For half neutral, contact your local Eaton Field Sales office.
- ② Not available for low impedance bus duct.
- ③ Normally available from stock.
- ④ Contact your local Eaton Field Sales office for delivery. Order by description on suffix **BUS**.
- ⑤ Obsolete; no longer available.

Catalog Numbers

Breaker Frame	Enclosure Catalog Number	Neutral (If Required) ①		Ground (If Required) ②
		Standard Plug-In Catalog Number	Low Impedance Catalog Number	
EHD, FDB, FD, HFD, FDC (15–150A)	BPFD ③	N110 (15–110A) ③ N250KB (125–150A) ③	ZN110 (15–110A) ③ ZN250KB (125–150A)	GS104 ③
JDB, JD, HJD, JDC (70–250A)	BPJD ③	N250KB (125–250A) ③	ZN250KB (125–250A) ③	GS104 ③
KDB, KD, HKD, KDC (125–400A)	BPKD	N400 (250–400A) ③	ZN400 (250–400A) ③	GS104 ③
LDB, LD, HLD, LDC (300–600A)	BPLD	④	④	④
MC, HMC (500–800A)	BPMD	N/A	④	④
NC, HNC (900–1200A)	BPND	④	④	④
FB (TRI-PAC®) (15–100A)	BPFBP	N110 (15–100A) ③	ZN110 (15–100A)	GS104 ③
LA (TRI-PAC) (125–400A)	BPLAP ⑤	N400 (125–400A) ③	ZN400 (125–400A) ③	GS104 ③
NB (TRI-PAC) (500–800A)	BPBPNB	④	④	GS104 ③

Replacement Capabilities—Standard and Low Impedance

Originally a Westinghouse Product

Fusible Plug-In Units

- For standard plug-in and low impedance plug-in busway (not for use on Pow-R-Way busway. Not available for low impedance bus duct)
- Fuses not included
- Mechanical lugs only
- Plug-in unit, neutral and ground can be ordered separately and shipped unassembled

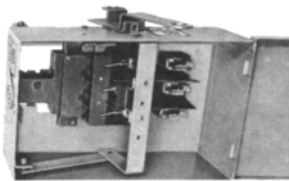

Fusible TAP

Special Industry Fusible Plug-In Units

- Special industry plugs are I²t rated
- Knockouts are not provided
- Grounding lug included on 200A and above
- Lugs ordered and shipped separately
- Fuses are not included
- If neutral or ground assembly is required, contact your local Eaton Field Sales office

Fusible Switch Horsepower Ratings

Ampere Rating	240V		480V		600V	
	NEC® Standard	Time Delay	NEC Standard	Time Delay	NEC Standard	Time Delay
30	3	7-1/2	5	15	7-1/2	20
60	7-1/2	15	15	30	15	50
100	15	30	25	60	30	75
200	25	60	50	125	60	150
400	50	100	100	250	125	350
600	75	100	200	400	200	500

Fusible Plug-In Units ①

Ampere Rating	600V Catalog Number	240V Catalog Number	Neutral (If Required)		Ground (If Required) Catalog Number	Class R Fuse Clips (If Required)	
			Standard Plug-In Catalog Number	Low Impedance Catalog Number		600V Catalog Number	240V Catalog Number
30	TAP361 ②	TAP321 ②	N110 ②	ZN110 ②	GS104 ①②	RFK161 ②	RFK121 ②
60	TAP362 ②	TAP322 ②	N110 ②	ZN110 ②	GS104 ①②	RFK262 ②	RFK222 ②
100	TAP363 ②	TAP323 ②	N110 ②	ZN110 ②	GS104 ①②	RFK464 ②	RFK464 ②
200	TAP364 ②	TAP324 ②	N250KB ②	ZN250KB	GS104 ①②	RFK464 ②	RFK464 ②
400	TAP365	TAP325	N400 ②	②	GS104 ①②	RFK666 ②	RFK666 ②
600	TAP366	TAP326	N400 ②③	ZN400 ②	④	RFK666 ②	RFK666 ②
800	⑤	⑤	—	④	—	—	—

Special Industry Fusible Plug-In Units

Three-Wire, 600V Plug-In Unit		If Required		Terminal Kits for Industry Fusible Plug-In Units					
Ampere Rating	Catalog Number	Neutral Catalog Number	Ground Catalog Number	Mechanical Lugs ②			Compression Lugs ②		
				Catalog Number	Lugs Per Phase	Wire Size	Catalog Number	Lugs Per Phase	Wire Size
30	TAP361H ⑥	⑥	⑥	MTK30SC	1	#14-#4	CTK30SC	1	#12-#10
60	TAP362H ⑥	⑥	⑥	MTK160SC	1	#14-1/0	CTK60SC	1	#8
100	TAP363H ⑥	⑥	⑥	MTK160SC	1	#14-1/0	CTK100SC	1	#4
200	TAP364H ⑥	⑥	⑥	MTK200SC	1	#6-350 kcmil	CTK200BSC	1	2/0
400	TAP365H ⑥	⑥	⑥	MTK400DPW	2	#2-4/0	CTK400SPW	1	750 kcmil
600	TAP366H ⑥	⑥	⑥	MTK600DFW	2	500 kcmil	CTK600DPM	2	500 kcmil

Three-Wire—Ground Detector and Neutralizer Plug

Maximum Volts	Catalog Number
600	GND36

Notes

- ① Not available for low impedance bus duct.
- ② Normally available from stock.
- ③ Only half neutral available. For full neutral, use a TAP366BO or TAP326BO unit.
- ④ Must be factory assembled. Order by description on suffix BUS.
- ⑤ Plug-in unit not available. Contact your local Eaton Field Sales office for bolt-on type.
- ⑥ Must be factory assembled. Order by description.

Quick-Assembled Plugs

The Mod Center in Spartanburg, SC, will perform the assembly of the bus plugs in 3 days or less for most orders. Bid Manager™ enables you to “build” the appropriate catalog number. When the order is entered in Bid Manager, it will automatically transfer the order to suffix “QAP.” Please see the following rules for building the assembled catalog number.

Catalog Numbering Selection

Quick-Assembled Plugs—Breaker Unit ^{①②}

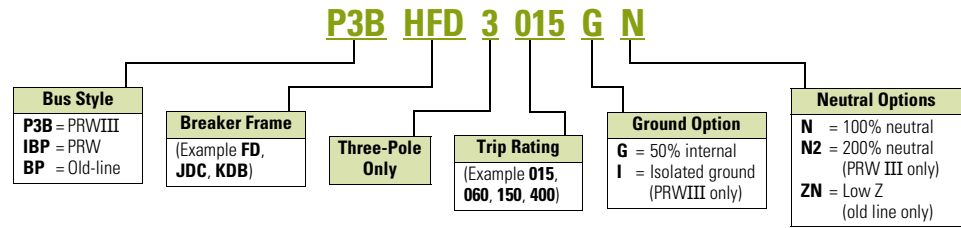

Quick-Assembled Plugs—Fusible Unit ^{②③④}

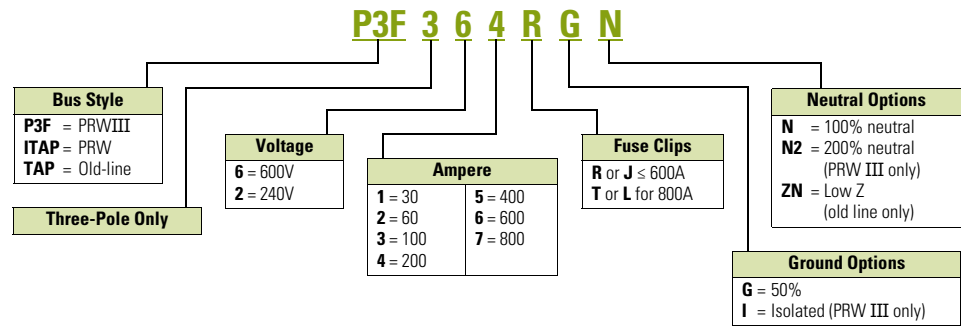

Notes

- ① Do not leave space between characters. Example: **P3BHFD3015GN**.
- ② Contact your local Eaton Field Sales office for help in assigning a catalog number for a specific application.
- ③ Do not leave space between characters. Example: **P3F264RGN**.
- ④ “H” clips are standard for Pow-R-Way and vintage busway products unless specified by adding “R” or “J” in the catalog number. Example: **P3F264RGN**, **ITAP361JGN**.

Replacement Capabilities—CP2, CP3 or CP4 SAFETYBUS Busway Plug-In Units

CP2, CP3 or CP4 SAFETYBUS Busway Plug-In Units

Originally a Westinghouse Product

Bolt-On Units ①

Breaker Frame	Ampere Rating	Enclosure Catalog Number	Neutral ② (If Required) Catalog Number	Ground ③ (If Required) Catalog Number
Circuit Breaker Bolt-On Units (Breaker Not Included)				
EHD, FDB, FD HFD, FDC	15–150	BPFDBO	④	④
JDB, JD, HJD, JDC	125–250	BPJDBO	④	④
KDB, KD, HKD, KDC	250–400	BPKDBO	④	④
LDB, LD, HLD LDC	300–600	BPLDBO	④	④
MDL, HMDL	400–800	BPMDBO	④	④
FB (TRI-PAC)	15–100	BPFBPBO	④	④
LA (TRI-PAC)	125–400	BPLAPBO	④	④
NB (TRI-PAC)	500–800	BPNBPBO	④	④
Fusible Bolt-On Units ⑤				
240V	30	TAP321BO	④	④
	60	TAP322BO	④	④
	100	TAP323BO	④	④
	200	TAP324BO	④	④
	400	TAP325BO	④	④
	600	TAP326BO	④	④
	800	TAP327BO	④	④
600V	30	TAP361BO	④	④
	60	TAP362BO	④	④
	100	TAP363BO	④	④
	200	TAP364BO	④	④
	400	TAP365BO	④	④
	600	TAP366BO	④	④
	800	TAP367BO	④	④

Circuit Breaker Selection and Interrupting Ratings ⑥

Breaker Frame	Ampere Rating	Symmetrical Amperes		
		240 Vac	480 Vac	600 Vac
EHD	15–60	18,000	14,000	—
	70–100	18,000	14,000	—
FDB	15–60	18,000	14,000	14,000
	70–100	18,000	14,000	14,000
	110–150	18,000	14,000	14,000
FD	15–60	65,000	25,000	18,000
	70–100	65,000	25,000	18,000
	110–150	65,000	25,000	18,000
HFD	15–60	100,000	65,000	25,000
	70–100	100,000	65,000	25,000
	110–150	100,000	65,000	25,000
FDC	15–60	200,000	100,000	50,000
	70–100	200,000	100,000	50,000
	110–150	200,000	100,000	50,000
JDB	70–225	65,000	25,000	18,000
	250	65,000	25,000	18,000
JD	70–225	65,000	25,000	18,000
	250	65,000	25,000	18,000
HJD	70–225	100,000	65,000	25,000
	250	100,000	65,000	25,000
JDC	70–225	200,000	100,000	50,000
	250	200,000	100,000	50,000
KDB	250–400	65,000	35,000	25,000
KD	250–400	65,000	35,000	25,000
HKD	250–400	100,000	65,000	35,000
KDC	250–400	200,000	100,000	50,000
LDB	300–600	65,000	45,000	25,000
LD	300–600	65,000	45,000	25,000
HLD	300–600	100,000	65,000	35,000
LDC	300–600	200,000	100,000	50,000
MDL	400–800	65,000	50,000	25,000
HMDL	400–800	100,000	65,000	35,000
NP	400–1200	65,000	50,000	25,000
HND	400–1200	100,000	65,000	35,000
FB (TRI-PAC)	15–100	200,000	200,000	200,000
LA (TRI-PAC)	70–400	200,000	200,000	200,000
	70–400	200,000	200,000	200,000
NB (TRI-PAC)	600–800	200,000	200,000	200,000
	600–800	200,000	150,000	200,000

Notes

- ① Factory assembled. Contact your local Eaton Field Sales office for delivery and order entry information. When ordering, you must specify:
 1. Load left or load right.
 2. Front or rear mounting.
 3. Type of busway to which unit is to be mounted.
- ② Full neutral. For half neutral, contact your local Eaton Field Sales office.
- ③ Not available for low impedance bus duct.
- ④ Order by description with bolt-on unit.
- ⑤ These bolt-on units include an adapter for mounting at the joint. They do not require a power take-off unit.
- ⑥ Refer to the current *Price and Availability Digest (PAD)* for breaker list prices.

Originally a Cutler-Hammer Product

Fusible Switch Plug-In Units

Class R Fuse Clip Included

Ampere Rating	Maximum hp Rating ^①	Catalog Number	Maximum hp Rating ^{①②}	Catalog Number ^③
240V, Three-Phase, Three-Wire			120–208V, Three-Phase, Four-Wire	
30	7-1/2	CP4HD321	5	CP4HD421
60	15	CP4HD322	10	CP4HD422
100	30	CP4HD323	25	CP4HD423
200	60	CP4HD324	60	CP4HD424
400	100	CP4HD325	250	CP4HD425
600 ^④	100	CP4HD326	400	CP4HD426
600V, Three-Phase, Three-Wire			277–480V, Three-Phase, Four-Wire	
30	20	CP4HD361	15	CP4HD461
60	50	CP4HD362	30	CP4HD462
100	75	CP4HD363	60	CP4HD463
200	100	CP4HD364	100	CP4HD464
400	350	CP4HD365	250	CP4HD465
600 ^④	500	CP4HD366	400	CP4HD466

Plug-In Cable Tap Boxes—Plug Into CP2, CP3 or CP4 Busway ^⑤—600A and 800A Sizes Also Have Bolt-On Clips

Approximate Dimensions in Inches

Volts	Ampere Rating	Approximate Dimensions in Inches			Mounting Clearance		Conduit Sizes	Load Lugs Each Phase	Catalog Number
		Wide	High	Deep	Top	Front			
Three-phase, three-wire 600V maximum	225	15.50	8.10	6.90	6.30	10.50	1-1/2, 2, 2-1/2, 3	(1) #6–300 kcmil Al/Cu	CP2SB34
	400	22.30	8.10	7.90	7.00	11.30	1-1/2, 2, 2-1/2, 3	(1) #1/0–750 kcmil Al/Cu ^⑥	CP2SB35
	600	37.20	15.80	11.70	12.50	16.80	1-1/2, 2, 2-1/2, 3	(2) #2–600 kcmil Al/Cu	CP2SB36 ^④
	800	37.20	15.80	11.70	12.50	16.80	1-1/2, 2, 2-1/2, 3	(3) #2–600 kcmil Al/Cu	CP2SB37 ^④
Three-phase, four-wire 120/208V or 277/480V 100% neutral	225	15.50	8.10	6.90	6.30	10.50	1-1/2, 2, 2-1/2, 3	(1) #6–300 kcmil Al/Cu	CP2SB44
	400	22.30	8.10	7.90	7.00	11.30	1-1/2, 2, 2-1/2, 3	(1) #1/0–750 kcmil Al/Cu ^⑥	CP2SB45
	600	37.20	15.80	11.70	12.50	16.80	1-1/2, 2, 2-1/2, 3	(2) #2–600 kcmil Al/Cu	CP2SB46 ^④
	800	37.20	15.80	11.70	12.50	16.80	1-1/2, 2, 2-1/2, 3	(3) #2–600 kcmil Al/Cu	CP2SB47 ^④

Notes

- ① Maximum hp ratings apply when time delay fuses are used.
- ② 120–208V hp ratings are based on 200V motor usage.
- ③ All units ship as three-phase, four-wire plugs.
- ④ Requires two adjacent plug-in outlets that do not span a busway joint.
- ⑤ For ground stab to engage internal ground bus, add suffix “G” to catalog number.
- ⑥ Also accepts (2) #1–300 kcmil Al/Cu.

Replacement Capabilities—CP2, CP3 or CP4 SAFETYBUS Busway Plug-In Units

Originally a Cutler-Hammer Product
Approximate Dimensions

Required Mounting Clearances

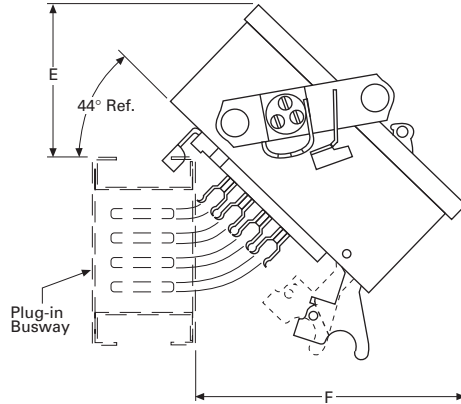

Typical Side and Front

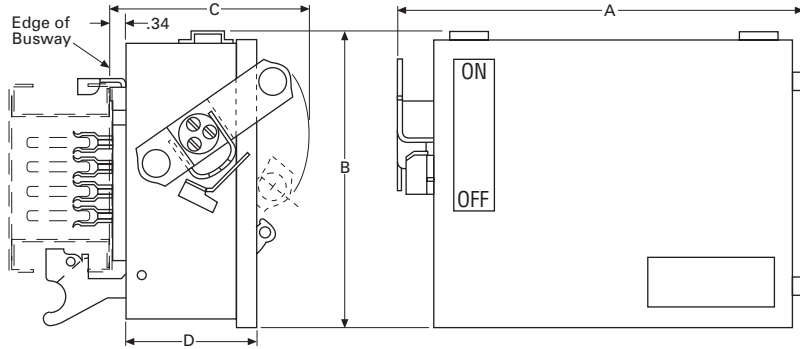

Plug-In Units—May be Used with Either CP2, CP3 or CP4 Plug-In Busway Sections—Fusible Switch Type

Frame or Type	Maximum Ampere Rating	Dimensions in Inches						Conduit Sizes Top, Bottom and Side	Wire Size Range Al/Cu
		A	B	C	D	E	F		
CP4HD	30	19.30	11.50	8.80	5.20	7.00	9.00	1/2, 3/4, 1, 1-1/4, 1-1/2, 2	(1) #14-2
	60	19.30	11.50	8.80	5.20	7.00	9.00	1/2, 3/4, 1, 1-1/4, 1-1/2, 2	(1) #14-2
	100	19.30	11.50	8.80	5.20	7.00	9.00	1/2, 3/4, 1, 1-1/4, 1-1/2, 2	(1) #14-1/0
CP4HD	200	23.00	16.50	9.20	6.00	7.50	13.30	1-1/2, 2, 2-1/2, 3	(1) #6-300 kcmil
	400 ^{①②}	45.60	24.30	15.80	13.10	14.00	20.50	1-1/2, 2, 2-1/2, 3	(1) #1/0-300 kcmil or (1) 750 kcmil
	600 ^{①②}	45.60	24.30	15.80	13.10	14.00	20.50	1-1/2, 2, 2-1/2, 3	(2) #2-600 kcmil

Notes

- ① Provided with busway bolt-on clip and straps for 0.50-inch hanger rods.
- ② Unit extends 10.50 inches below busway.

Technology Upgrades

Clipper Power Systems, Busway TVSS Protection

The low voltage busway aftermarket product offering includes transient voltage surge suppression (TVSS), which is ideal for busway fed distribution systems. Eaton has developed the Clipper Power System (CPS) family of products to ensure that the quality power required to maximize productivity in today's competitive environment is supplied to commercial, industrial, medical and institutional facilities. Without power

protection devices, microprocessors and electronic-based loads are not provided with the noise and disturbance-free power that they require. Because microprocessor-based loads are now common in every facility, engineers must ensure the AC power supply is properly filtered. The CPS busway family of products consists of TVSS and filter components (TVSS filter) integrated into a bus plug with a fusible disconnect. TVSS bus plugs are available for the following types of plug-in busway:

- Westinghouse standard plug-in
- Westinghouse low impedance plug-in
- Westinghouse H5000 plug-in
- Cutler-Hammer CP2 plug-in
- Cutler-Hammer CP3 plug-in
- Cutler-Hammer CP4 plug-in
- Westinghouse Pow-R-Way
- Westinghouse Pow-R-Way II
- Cutler-Hammer Pow-R-Way III

Significant performance advantages are achieved by integrating TVSS filters into busway systems. Because the TVSS unit is directly connected to the busway, the CPS minimizes let-through voltage. This is a significant performance advantage compared to cable-connected TVSS solutions. Due to the integrated design, the CPS bus plug also saves the user wall space and greatly reduces the installed project cost.

Catalog Numbering Selection

Visor Series Bus Plug

P3BCPS 250 480Y S A

Bus Style	
P3BCPS	= Pow-R-Way
TAPCPS	= Std. plug-in
ZTAPCPS	= Low impedance
HTAPCPS	= H5000
CP4CPS	= CP2/CP3/CP4
ITAPCPS	= Pow-R-Way

Surge Rating (kA/Phase)
100 = 100
120 = 120
160 = 160
200 = 200
250 = 250
300 = 300
400 = 400
500 = 500

Voltage Code	Voltage Requirements			
	120/208 240V	230/400 400V	277/480 480V	347/600 600V
Three-phase wye (4W+G)	208Y	400Y	480Y	600Y
Three-phase delta (4W+G)	240D	—	480D	600D

Diagnostics Package	
A	= AdVisor complete with status indicator lights on each phase. Form C. Audible Alarm—Enable/Disable
S	= SuperVisor complete with status indicator lights on each phase, 1-Form C. Audible Alarm—Enable/Disable, Transient Counter, Push-to-Test, PQ Meter (no date stamp)
N	= NetVisor complete with status indicator lights on each phase. Form C. Audible Alarm—Enable/Disable, Transient Counter, Push to Test, PQ Meter (no date stamp), Modbus® and Ethernet Communications Port, % Life Remaining, % Voltage THD

IQ Energy Sentinel for Bus Plugs

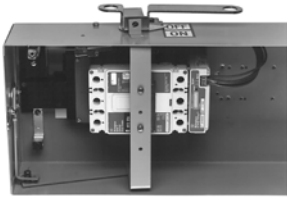

Bus Plug with Energy Sentinel

Customer Required Information

If Originally a Westinghouse Product

1. Style number or shop order number from existing busway nameplate and complete nameplate information.
2. Height and width dimensions of housing from existing busway.
3. Order by style number on suffix Q77.

If Originally a Cutler-Hammer Product

1. Check Vista for pricing.
2. Order by catalog number on suffix Q73.

The Cutler-Hammer IQ Energy Sentinel™ was designed as part of the PowerNet™ system and is a highly accurate, microprocessor-based submeter that monitors power and energy. It offers a centralized alternative to individually mounted wattmeters, watthour meters and watt demand meters.

Key advantages include unmatched savings in space, lower installation costs, and the capability to communicate data readings in a variety of ways. IQ Energy Sentinels with built-in current transformers (CTs) and communications have the added benefit of overall system accuracy. The IQ Energy Sentinel mounts on the load side of Cutler-Hammer F, J and K breakers within the bus-plug enclosure.

The IQ Energy Sentinel is also available with a universal mounting that uses external CTs and is offered for fusible bus plug applications. Sub-metering application examples for the IQ Energy Sentinel include energy monitoring and demand management, energy cost analysis/allocation, and tenant or interdepartmental billing. To accomplish the communications system, the customer must provide a twisted pair communication cable in 1/2-inch conduit between the IQ Energy Sentinel bus plug and a Cutler-Hammer Central Energy Display, or customer computer to display the information. IQ Energy Sentinel bus plugs are available for Pow-R-Way, Pow-R-Way II and Pow-R-Way III busway.

Further Information

Publication Number	Description
AD 30-560	Application Data for Pow-R-Way
AD 30-560	Application Data for Pow-R-Way II
TD01701001E	Technical Data for Pow-R-Way III
TD01701002E	Technical Data for 100 Ampere Busway

Pricing Information

Vista/VISTALINE™ Discount Symbols CE3 and CE4

Note: Contact your local Eaton Field Sales office.

Note: Additional information may be required for manufacturing.

Power Management Products



10 IQ Products

Product Description	V12-T10-2
Product History	V12-T10-3
Product History Time Line	V12-T10-3
General Information	
Metering Selection Chart	V12-T10-4
Protective Relay Selection Chart	V12-T10-12
Technology Upgrades	
Power Xpert 4000/6000/8000 Series Meters	V12-T10-15
Power Xpert 2000 Series Meters	V12-T10-17
Power Xpert Multi-Point Meter	V12-T10-18
IQ 250/260	V12-T10-19
IQ 130/140/150	V12-T10-20
IQ 150S/250S	V12-T10-21
IQ 35M	V12-T10-22
Enclosed Meters	V12-T10-23
Current Products	
IQ Analyzer 6400/6600	V12-T10-24
IQ DP-4000/4100	V12-T10-25
IQ Energy Sentinel	V12-T10-26
IQ 230	V12-T10-27
MP-3000 Motor Protection	V12-T10-28
FP-5000 Feeder Protection	V12-T10-29
Digitrip 3000 (DT-3000)	V12-T10-30
Accessories	
IQ Flange	V12-T10-31
IQ 250-PMMAK	V12-T10-31
IQ DC Power Supply	V12-T10-31
IQ Cable	V12-T10-31
IQ Floor-Mounted Enclosure	V12-T10-31
Addressable Relay II	V12-T10-32
Power Modules	V12-T10-32
CTs	V12-T10-33
Discontinued Product—Recommended Replacement	
IQ 2000	V12-T10-36
IQ Analyzer 6000/6200	V12-T10-36
RTD Modules	V12-T10-36
IQ 1000 and IQ 1000 II	V12-T10-37
IQ Data Plus and IQ Data Plus II	V12-T10-37
IQ Data	V12-T10-37
IQ Generator	V12-T10-38
IQ 300	V12-T10-38
IQ 210/220	V12-T10-39
IQ 110/115	V12-T10-40
IQ Power Sentinel	V12-T10-41
IQ Multipoint Energy Submeter II	V12-T10-42
Further Information	V12-T10-43
Pricing Information	V12-T10-43

Electronic Metering and Protection



Power Management Products

Product Description

Eaton's electrical business IQ Metering and Protection group of Cutler-Hammer® series products are multifunctional communicating products based on microprocessor technology. They are designed to replace existing electromechanical devices and can be applied at low, medium and high voltage points in the electrical distribution system. These devices offer communications capabilities to link electrical distribution equipment to Eaton's PowerNet™ Power Management Software.

These products generally surpass capabilities available with older analog/electromechanical technologies. Depending on the features available from each device, information from these devices may be used to record and analyze power system and power quality events or problems and may improve power systems protection and coordination. With communications, these devices may be used for energy monitoring and management with trended data for use in future power system planning.

Product History

Originally a Westinghouse Product

In the early 1980s, power metering and protective relaying functions were performed by electro-mechanical devices. Analog meters and induction disk protective relays were found on virtually every switchgear lineup manufactured up to that time. With the maturing of solid-state electronics, microprocessor-based replacements for the electro-mechanical devices became available. These new devices provided increased functionality and flexibility, in a smaller space, for less cost. Westinghouse led the movement toward electronic metering and protection devices with the introduction of the IQ 2000 motor protection and control relay. In 1987, the IQ 2000 functions were split and two new products were introduced—the IQ 1000 and the IQ Data Plus. The IQ 1000 provided all current monitoring and motor protection functions and was developed for use on AMPGARD® medium voltage starters and low voltage motor control assemblies. The IQ Data Plus provided complete electrical metering and system voltage protection, and was developed for use on low and medium voltage switchgear, as well as AMPGARD and low voltage motor control assemblies.

The latest next generation addition to metering is the Power Xpert® Meter product series. The Power Xpert Meter power quality instrument monitors critical aspects of an electrical distribution system. This premier power quality metering instrument uses the latest in advanced technology to make it simple to use, powerful, scalable and highly flexible. Power Xpert Meters offer a new level of intuitive user interface design, presenting critical electrical distribution system information in a simple-to-navigate and easy-to-understand information architecture.

The Power Xpert Meter’s 4000/6000/8000 graphic display visualizes the information from up to 16 Power Xpert PQ instruments. The embedded Web server displays complex power quality data using standard Internet browsers and allows for device configuration from the browser. Both the local graphic display and the embedded Web server present real time, historical and event information in a browser-style graphical format to help the user interpret key circuit information such as current loading, voltage and power levels, power factor, energy usage, I/O status and power quality measurements, as well as harmonic plots, disturbance and transient waveforms, and an ITIC disturbance summary screen.

The Power Xpert 2000 Series Meter offers the same level of intuitive user interface design as the Power Xpert 4000/6000/8000 Meter with its embedded Web server to provide data logging and e-mail and the ability to visualize steady-state harmonic content as well as waveform recording that is critical for power quality analysis.

Since then, the IQ Metering and Protection product family has grown to include additional products for both metering and protective functions.

The IQ 250 and IQ 260 meters provide revenue grade accuracy with standard Modbus® communications and optional I/O capability.

The IQ 130/140/150 meters provide basic monitoring and energy metering for feeder applications and optional Modbus communications.

The IQ 35M provides energy monitoring at the panelboard level as well as retrofit applications.

The IQ 150S/250S provides wireless energy metering.

The enclosed metering offering adds flexibility in monitoring with Eaton’s latest line of meters where metering is needed.

The IQ DP-4000 and the IQ Analyzer provide advanced metering functions including the ability to monitor power quality parameters. IQ Energy Sentinels provide a low cost method to monitor energy usage for individual feeders or loads.

The Power Xpert Multi-Point Meter provides cost-effective and space-saving energy submetering for a wide variety of applications.

The MP-3000 added increased motor protection capability. The FP-5000, introduced in 2001, provides overcurrent protection for distribution feeders.

Product History Time Line

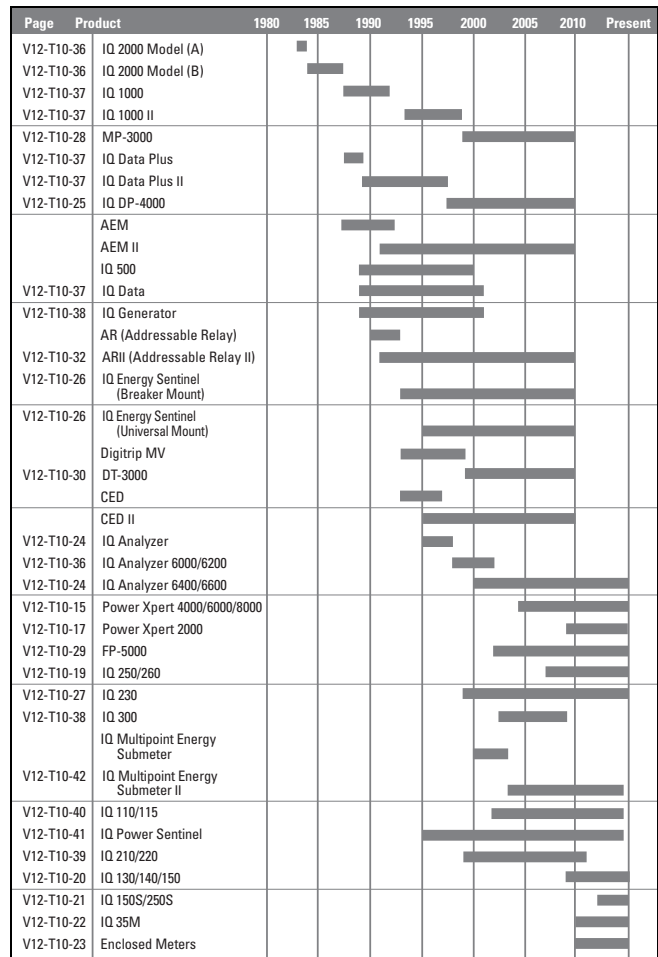

Metering Selection Chart—Dimensions in Inches (mm)

Device Name
Accessories
See Page V12-T10-31

Power Xpert 4000/6000/8000 Series



Power Xpert 2000



IQ 250/260 Series



Section Page Number	V12-T10-15	V12-T10-17	V12-T10-19
Electrical Parameters			
Volts	0.1% of RV + 0.02% FS	0.1% of RV	0.1% of RV
Amperes	0.05% of RV + 0.01% FS	0.1% of RV	0.1% of RV
Current range (% of nominal)	0.005–20A (400%)	0.1–200%	0.1–200%
Watts	0.1% of RV + 0.0025% FS	0.2% of RV	0.2% of RV
VARs	0.1% of RV + 0.0025% FS	0.2% of RV	0.2% of RV
VA	0.1% of RV + 0.0025% FS	0.2% of RV	0.2% of RV
PF-apparent	0.1%	0.2% of RV	0.2% of RV
PF-displacement	0.1%	—	—
Frequency	±0.01 Hz	±0.03 Hz	±0.03 Hz
THD-voltage	127th	40th ②③④⑤	40th ⑥
THD-current	127th	40th ②③④⑤	40th ⑥
Watt-hours	±0.2% per ANSI C12.20 0.2 Class ①	±0.2% per ANSI C12.20 0.2 Class ①	±0.2% per ANSI C12.20 0.2 Class ①
VAR-hours	±0.2% per ANSI C12.20 0.2 Class ①	±0.2% per ANSI C12.20 0.2 Class ①	±0.2% per ANSI C12.20 0.2 Class ①
VA-hours	±0.2% per ANSI C12.20 0.2 Class ①	±0.2% per ANSI C12.20 0.2 Class ①	±0.2% per ANSI C12.20 0.2 Class ①
Ampere-demand	0.05% of RV + 0.01% FS	±0.1% per ANSI C12.20 0.2 Class	±0.1% per ANSI C12.20 0.2 Class
Watt-demand	±0.2% per ANSI C12.20 0.2 Class ①	±0.2% per ANSI C12.20 0.2 Class ①	±0.2% per ANSI C12.20 0.2 Class ①
VAR-demand	±0.2% per ANSI C12.20 0.2 Class ①	±0.2% per ANSI C12.20 0.2 Class ①	±0.2% per ANSI C12.20 0.2 Class ①
VA-demand	±0.2% per ANSI C12.20 0.2 Class ①	±0.2% per ANSI C12.20 0.2 Class ①	±0.2% per ANSI C12.20 0.2 Class ①
Revenue accuracy	±0.2% per ANSI C12.20 0.2 Class ①	ANSI C12.20 (0.2%)	ANSI C12.20 (0.2%)
Individual ampere harmonics	85th ⑦	40th ③④⑤	—
Individual voltage harmonics	85th ⑦	40th ③④⑤	—
Interharmonics	Yes	—	—
Minimum and/or Maximum Values			
Volts	L-L, L-N, N-G, VAUX L-L	L-L, L-N	L-L, L-N
Current	A, B, C, N, G	A, B, C, N	A, B, C
Power	Watt, VAR, VA	Watt, VAR, VA	Watt, VAR, VA
Power Factor	Apparent/displacement	Apparent	Apparent
Frequency	Hertz	Hertz	Hertz
THD	Amperes/volts (L-L, L-N, AUX L-L)	Amperes/volts ②③④⑤	Amperes/volts ⑥
Demand values	kW, kVAR, kVA, amperes	kW, kVAR, kVA, amperes	kW, kVAR, kVA, amperes
Trend analysis	2 / 4 ⑧ / 8 ⑨ GB	256 / 512 ② / 768 ③④⑤ MB	128 KB ⑩
Event logging	2 / 4 ⑧ / 8 ⑨ GB	100,000 alarms/events with timestamp	⑩
Disturbance recording	2 / 4 ⑧ / 8 ⑨ GB 60 cycles per event	768 MB ④⑤ up to 64 cycles per event ④⑤	—

Notes

- ① Under typical operating conditions.
- ② PXM 2260 only.
- ③ PXM 2270 only.
- ④ PXM 2280 only.
- ⑤ PXM 2290 only.
- ⑥ IQ 260 only.

- ⑦ Individual values reported to 85th harmonic; anti-alias filtering prevents higher frequencies from distorting readings (see IEC 61000-4-7).
- ⑧ PMX 6000 only.
- ⑨ PXM 8000 only.
- ⑩ Optional.
- ⑪ At computer only.

- Legend:** PG = Programmable
FS = Full scale
RV = Read value

- Auxiliary voltage (optional) = Provides three additional voltage inputs to the meter: Va2, Vb2, Vc2.
Interharmonics = Power Xpert Meter 6000/8000 supported.

Metering Selection Chart—Dimensions in Inches (mm), continued

Device Name
Accessories
See Page V12-T10-31

Power Xpert 4000/6000/8000 Series

Power Xpert 2000

IQ 250/260 Series



Section Page Number

V12-T10-15

V12-T10-17

V12-T10-19

Other Features

Storage	2 / 4 ^① / 8 ^② GB	256 / 512 ^③ / 768 ^④ MB Standard	128 KB for logging, up to 8 parameters every 15 minutes for 30 days
PG output relays	5 maximum	Optional (2) Form C, 5A or (4) Form A, 120 mA	Optional (2) Form C, 5A or (4) Form A, 120 mA
PG analog outputs	—	Optional (4) 4–20 mA or (4) 0–1 mA	Optional (4) 4–20 mA or (4) 0–1 mA
Discrete contact inputs	8	Optional (2) or (4)	Optional (2) or (4)
Analog inputs	—	—	—
Synch-input kW utility	Via status input	Via end of interval pulse with optional digital inputs	Via end of interval pulse with optional digital inputs
Auxiliary voltage ^⑤	Yes	—	—
kWh pulse initiator	Yes	Yes	Yes
Waveform display	Local/computer	^⑥	—
Waveform capture, samples/cycle	Yes, 512 (4096 oversampling)	Yes, up to 64 ^⑦ , up to 512 ^⑧	—
Frequency distribution display	—	—	—
Display type	LCD ^⑨	Red LED	Red LED
Display lines/character	Graphic (320 x 240 pixels)	3 lines, 4 characters	3 lines, 4 characters
Display character height	5.5 mm H x 4 mm W	0.56 (14.2) H	0.56 (14.2) H
Communications	Serial: Modbus RTU, Modbus ASCII Network: Modbus TCP, Ethernet TCP/IP, HTTP, SNMP, SMTP, FTP, DNP 3.0 ^⑩	Serial: Modbus RTU, Modbus ASCII, DNP 3.0 Network: Modbus TCP, BACnet/IP, Ethernet TCP/IP, HTTP, HTTPS, SNMP, SMTP	Serial: Modbus RTU, Modbus ASCII, DNP 3.0 Network: Modbus TCP via Power Xpert Gateway
Setup configuration	Via Web browser/display	Via Web browser/display	Via configuration software/display
Dimensions	Refer to TD02601007E	Refer to TD02601017E	Refer to TD02601016E
Operating temperature range	–20° to 60°C display unit –20° to 70°C meter base unit	–20° to 70°C	–20° to 70°C
Reference literature	TD02601007E	TD02601017E	TD02601016E

Notes

- ① PXM 6000 only.
- ② PXM 8000 only.
- ③ PXM 2260 only.
- ④ PXM 2270 only.
- ⑤ The auxiliary voltage option adds three additional voltage input channels to Power Xpert Meters.
- ⑥ At computer only.
- ⑦ PXM 2280 only.
- ⑧ PXM 2290 only.
- ⑨ Optional.

Legend: PG = Programmable
FS = Full scale
RV = Read value

Auxiliary voltage (optional) = Provides three additional voltage inputs to the meter: Va2, Vb2, Vc2.
Interharmonics = Power Xpert Meter 6000/8000 supported.

Metering Selection Chart, continued

Device Name
Accessories
See Page V12-T10-31

IQ 130/140/150 Series



IQ 150S/250S Series



IQ 35M Series



Section Page Number

V12-T10-20

V12-T10-21

V12-T10-22

Electrical Parameters

Volts	±0.25% of RV	0.1% of RV	0.4% +0.015% per °C deviation from 25°C
Amperes	±0.25% of RV	0.1% of RV	0.4% (5–100%), 0.8% (1–5%) +0.015% per °C from 25°C
Current range (% of nominal)	0.1–200%	0.1–200%	1–120%
Watts	0.5% of RV ^①	0.2% of RV	0.5% per ANSI C12.20 and IEC 62053-22 Class 0.5S
VARs	0.5% of RV ^①	0.2% of RV	2.0% per IEC 62053-23 Class 2
VA	0.5% of RV ^①	0.2% of RV	Calculated: vector sum of watts and VARs
PF-apparent	0.5% of RV ^①	0.2% of RV	Calculated: Watts / VAs
PF-displacement	—	—	—
Frequency	±0.03% Hz ^①	±0.03 Hz	±0.02 Hz
THD-voltage	—	—	—
THD-current	—	—	—
Watt-hours	±0.5% per ANSI C12.20 0.5 Class ^②	±0.2% per ANSI C12.20 0.2 Class	0.5% per ANSI C12.20 and IEC 62053-22 Class 0.5S
Var-hours	±0.5% per ANSI C12.20 0.5 Class ^②	±0.2% per ANSI C12.20 0.2 Class	±2.0% per IEC 62053-23 Class 2
VA-hours	±0.5% per ANSI C12.20 0.5 Class ^②	±0.2% per ANSI C12.20 0.2 Class	—
Ampere-demand	±0.5% per ANSI C12.20 0.5 Class ^②	±0.1% per ANSI C12.20 0.2 Class	—
Watt-demand	±0.5% per ANSI C12.20 0.5 Class ^②	±0.2% per ANSI C12.20 0.2 Class	0.5% per ANSI C12.20 and IEC 62053-22 Class 0.5S
VAR-demand	±0.5% per ANSI C12.20 0.5 Class ^②	±0.2% per ANSI C12.20 0.2 Class	2.0% per IEC 62053-23 Class 2
VA-demand	±0.5% per ANSI C12.20 0.5 Class ^②	±0.2% per ANSI C12.20 0.2 Class	Calculated: vector sum of watts and VARs
Revenue accuracy	ANSI C12.20 (0.5%)	ANSI C12.20 (0.2%)	0.5% per ANSI C12.20 and IEC 62053-22 Class 0.5S
Individual ampere harmonics	—	—	—
Individual voltage harmonics	—	—	—
Interharmonics	—	—	—

Minimum and/or Maximum Values

Volts	L-L, L-N	L-L, L-N	—
Current	A, B, C	A, B, C	—
Power	Watt, VAR, VA	Watt, VAR, VA	—
Power factor	Apparent ^①	Apparent	Apparent (low alert)
Frequency	Hertz ^①	Hertz	Hertz (out of range alert)
THD	Ampere/Volts	—	—
Demand values	kW, kVAR, kVA, amperes ^③	kW, kVAR, kVA, amperes	kW, kVAR, kVA; Maximum kW, kVAR, kVA
Trend analysis	^③	2 MB ^⑤	—
Event logging	^③	2 MB ^⑤	Logging on demand interval or Modbus command ^④
Disturbance recording	—	—	—

Notes

- ① IQ 140 and IQ 150.
- ② IQ 150 only.
- ③ At computer only.
- ④ Optional.
- ⑤ IQ 250S only.

Legend: PG = Programmable
FS = Full scale
RV = Read value

Metering Selection Chart, continued

Device Name
Accessories
See Page V12-T10-31

IQ 130/140/150 Series



IQ 150S/250S Series



IQ 35M Series



Section Page Number	V12-T10-20	V12-T10-21	V12-T10-22
Other Features			
Storage	—	2 MB ^②	10 registers (16 bit) by 5760 entries each (115 KB) ^①
PG output relays	—	—	—
PG analog outputs	—	—	—
Discrete contact inputs	—	—	2 pulse inputs with BACnet
Analog inputs	—	—	—
Synch-input kW Utility	—	—	Optional demand synchronization via Modbus
Auxiliary voltage ^③	—	—	—
kWh pulse initiator	^①	Yes	Yes
Waveform display	—	—	—
Waveform capture	—	—	—
Frequency distribution display	—	—	—
Display type	Red LED	Red LED	Backlit LCD
Display lines/character	3 lines, 4 characters	3 lines, 4 characters	2 lines by 5 characters each (full alphanumeric top row)
Display character height	0.56 (14.2) H	0.56 (14.2) H	7.5 mm
Communications	Serial: Modbus RTU, Modbus ASCII ^① Network: Modbus TCP ^①	Serial: Modbus RTU, Modbus ASCII, DNP 3.0 Network: Modbus TCP, wired or wireless	Serial: Modbus RTU ^① , BACnet MS/TP ^① Network: Modbus TCP via Power Xpert Gateway
Setup configuration	Via configuration software/display	Via configuration software/display	Via display/configuration software
Dimensions	4.85 (123.2) H x 4.85 (123.2) W x 4.97 (126.2) D	7.90 (200.7) H x 7.50 (190.5) W x 3.10 (78.7) D	3.60 (91.4) H x 4.20 (106.7) W x 2.30 (58.4) D
Operating temperature range	-20 to 70°C	-20 to 70°C	-20 to 70°C
Reference literature	TD02601015E	TD02601019E	TD02601015E

Notes

- ^① Optional.
- ^② IQ 250S only.
- ^③ The auxiliary voltage option adds three additional voltage input channels to Power Xpert Meters.

Legend: PG = Programmable
FS = Full scale
RV = Read value

Metering Selection Chart—Dimensions in Inches (mm), continued

Device Name
Accessories
See Page V12-T10-31

IQ Analyzer 6400/6600 Series



IQ DP-4000 Series



IQ 230 Series



Section Page Number

V12-T10-24

V12-T10-25

V12-T10-27

Electrical Parameters

Volts	±0.2% FS ①	±0.3% FS	±0.5% FS
Amperes	±0.2% FS ①	±0.3% FS	±0.5% FS
Current range (% of nominal)	3–800%	10–250%	1–200%
Watts	0.4% FS, 6 RV ②	±0.6% FS	±1.0% FS
VARs	0.4% FS, 6 RV ③	±0.6% FS	±1.0% FS
VA	0.4% FS, 6 RV ②	±0.6% FS	±1.0% FS
PF-apparent	0.8% FS ①	±1.0% FS	±2.0% FS
PF-displacement	0.8% FS ①	±1.0% FS	±2.0% FS
Frequency	0.04% ① or 0.01 Hz	±0.17% FS	±0.1% Hz
THD-voltage	50th	31st	—
THD-current	50th	31st	—
Watt-hours	0.5% RV ②	±0.6% FS	±1.0% per ANSI C12
Var-hours	1% RV ③	±0.6% FS	±1.0% per ANSI C12
VA-hours	0.5% RV ②	±0.6% FS	±1.0% per ANSI C12
Ampere-demand	±0.2% FS ①	±0.3%	±0.5% per ANSI C12
Watt-demand	±0.4% FS ①	±0.6%	±1.0% per ANSI C12
VAR-demand	±0.4% FS ①	±0.6%	±1.0% per ANSI C12
VA-demand	±0.4% FS ①	±0.6%	±1.0% per ANSI C12
Revenue accuracy	ANSI C12.20 (0.5%)	—	ANSI C12.1 (1%)
Individual ampere harmonics	50th	—	—
Individual voltage harmonics	50th	—	—
Interharmonics	—	—	—

Minimum and/or Maximum Values

Volts	L-L, L-N	L-L, L-N	L-L, L-N
Current	A, B, C, N, G	A, B, C	A, B, C
Power	Watt, VAR, VA	Watt, VAR, VA	Watt, VAR, VA
Power factor	Apparent/displacement	Apparent/displacement	Apparent/displacement
Frequency	Hertz	Hertz	Hertz
THD	Amperes/volts	Amperes/volts	—
Demand values	All	All	All
Trend analysis	Time/date	2 alarms	④
Event logging	504 events w/timestamp	④	④
Disturbance recording	10 waveform events	—	—

Notes

- ① From 3–300% of FS.
- ② At unity power factor and 5–300% of FS.
- ③ At a power factor <±0.5 and 5–300% of FS.
- ④ At computer only.

Legend: PG = Programmable
FS = Full scale
RV = Read value

Metering Selection Chart—Dimensions in Inches (mm), continued

Device Name
Accessories
See Page V12-T10-31

IQ Analyzer 6400/6600 Series



IQ DP-4000 Series



IQ 230 Series



Section Page Number	V12-T10-24	V12-T10-25	V12-T10-27
Other Features			
Storage	90 KB	15 parameters	—
PG output relays	(4) 10A Form C ^①	(3) 10A Form C ^②	(2) 100 mA Form A
PG analog outputs	(4) 0–10/4–20 mA	—	—
Discrete contact inputs	(3) +30 Vdc differential	(1) kW Demand ^②	(2) +30 Vdc differential
Analog inputs	(1) 0–20/4–20 mA	—	(1) 4–20 mA
Synch-input kW Utility	At device or via communications	At device or via communications ^②	Via communications only
Auxiliary voltage	—	—	—
kWh pulse initiator	Yes	Yes ^②	Yes
Waveform display	Local ^② /computer	—	—
Waveform capture, samples/cycle	Yes, 128	—	—
Frequency distribution display	Local ^② /computer	—	—
Display type	Graphic LCD with LED backlight	7 Segment LED	Backlit LCD
Display lines/character	7 lines, 147 characters	1 line, 7 characters	4 lines, 20 characters
Display character height	Up to 7 lines	1 line	1.60 (40.6) H x.09 (2.3) W
Communications	Serial: INCOM ^③ Network: via Power Xpert Gateway ^③	Serial: INCOM ^③ Network: via Power Xpert Gateway ^③	Serial: INCOM, Modbus RTU ^④ Network: via Power Xpert Gateway
Setup configuration	Via configuration software/display	Via configuration software/display	Via configuration software/display
Dimensions	Refer to TD1702BTE	Refer to TD1703ATE	Refer to TD1706ATE
Operating temperature range	–20° to 70°C	–20° to 70°C	0° to 50°C
Reference literature	TD1702BTE	TD1703ATE	TD1706ATE

Notes

- ① Relays programmable to operate on any measured function.
- ② Optional.
- ③ An IPONI is required.
- ④ IQ 230M only.

Legend: PG = Programmable
FS = Full scale
RV = Read value

Metering Selection Chart—Dimensions in Inches (mm), continued

Device Name
Accessories
See Page V12-T10-31

Power Xpert Multi-Point Meter



IQ Energy Sentinel



Section Page Number

V12-T10-18

V12-T10-26

Electrical Parameters

Volts	±0.2% RV	—
Amperes	±0.2% RV	—
Current range (% of nominal)	—	—
Watts	±0.5% RV	±1.0% FS
VARs	±0.5% RV	—
VA	±0.5% RV	—
PF-apparent	±0.5% RV	—
PF-displacement	—	—
Frequency	±0.1 Hz	—
THD-voltage	—	—
THD-current	—	—
Watthours	±0.5% per ANSI C12.20 0.5 class	±1.0% FS
VAR-hours	±0.5% per ANSI C12.20 0.5 class	—
VA-hours	±0.5% per ANSI C12.20 0.5 class	—
Ampere-demand	—	—
Watt-demand	±0.5% per ANSI C12.20 0.5 class	±1.0% FS
VAR-demand	±0.5% per ANSI C12.20 0.5 class	—
VA-demand	±0.5% per ANSI C12.20 0.5 class	—
Revenue accuracy	ANSI C12.20 (0.5%)	—
Individual ampere harmonics	—	—
Individual voltage harmonics	—	—
Interharmonics	—	—

Minimum and/or Maximum Values

Volts	L-L, L-N	—
Current	A, B, C	—
Power	Watts, VAR, VA	—
Power factor	Apparent	—
Frequency	Hertz	—
THD	—	—
Demand values	Watts (Delivered & Received), Watts (Q1–Q4), VA (Q1, Q4), VA (Q2, Q3)	—
Trend analysis	Interval data	①
Event logging	20 latest events and historical	①
Disturbance recording	—	—

Note

① At computer only.

Legend: PG = Programmable
FS = Full scale
RV = Read value

Metering Selection Chart—Dimensions in Inches (mm), continued

Device Name
Accessories
See Page V12-T10-31

Power Xpert Multi-Point Meter

IQ Energy Sentinel



Section Page Number	V12-T10-18	V12-T10-26
Other Features		
Storage	256 MB standard, 2 GB optional	—
PG output relays	1 standard, 8 each module ①	—
Discrete contact inputs	3 standard, 8 each module ①	—
Analog inputs	—	—
Synch-input kW utility	Via communications and digital input	Via communications only
Auxiliary voltage	—	—
kWh pulse initiator	Aggregate or main-digital output, LED output on meter modules (accuracy check)	—
Waveform display	—	—
Waveform capture	—	—
Frequency distribution display	—	—
Display type	LCD color touchscreen	—
Display lines/character	6-inch diagonal	—
Display character height	Graphics	—
Communications	Serial: Modbus RTU ① Network: Modbus TCP, BACnet/IP, Ethernet TCP/IP, HTTP, HTTPS, SNMP, SMTP, SFTP	Serial: INCOM Network: via Power Xpert Gateway
Setup configuration	Via PXMP configuration software	Via configuration software
Dimensions	Refer to TD150006EN	Refer to TD1707TE
Operating temperature range	-20° to 70°C	-25° to 70°C
Reference literature	TD150006EN	TD1707TE

Note
① Optional.

Legend PG = Programmable
FS = Full Scale
RV = Read Value

Protective Relay Selection Chart

DT-3000



FP-5000





MP-3000



For Further Details and Information,
See TD02600001TE.

Technical Data Number	Device Name	IEEE Device Number	TD.17.10.TE	TD02602003E	TD.17.11.TE
Protection Functions					
Directional power	32			■	
Phase directional	67			■	
Ground directional	67N			■	
Phase inst. OC	50	■	■	■	■
Phase TOC	51	■	■	■	■
Calc. residual ground IOC	50G			■	
Calc. residual ground TOC	51G			■	
Ground inst. OC (measured)	50G (N)	■	■	■	
Ground TOC (measured)	51G (N)	■	■	■	■
Phase voltage restrained OC	51VR			■	
No. of curves (ANSI/IEC/thermal)			11	10	1
TOC time reset				■	
Negative sequence OC (unbalance)	46			■	■
Negative sequence voltage	47			■	
Overvoltage	59			■	
Undervoltage	27			■	
Underfrequency	81U			■	
Overfrequency	81O			■	
Breaker failure	50BF			■	
Zone interlocking			■	■	
Thermal overload	49				■
Locked rotor	49S/51				■
Jam/stall	51R				■
Cold load pickup				■	
Loss of load					■
Power factor	55			■	
Control Functions					
Synchronization check	25			■	
Remote open/close		■	■	■	Trip only
Programmable I/O		■	■	■	■
Programmable logic				■	
Multiple setting groups				■	
Number of starts limit					■
Starts per hour					■
Time between starts					■
Emergency restart					■
Reduced voltage starting					■
Trip lockout		■	■	■	■

Protective Relay Selection Chart, continued

		DT-3000 	FP-5000 	MP-3000 
For Further Details and Information, See TD02600001TE.	Device Name			
Technical Data Number	IEEE Device Number	TD.17.10.T.E	TD02602003E	TD.17.11.T.E
Metering Functions				
Amperes		■	■	■
Ampere demand		■	■	
Volts			■	
Phase angle current voltage			■	
Positive, negative and zero sequence			■	
Watts			■	
Watt demand			■	
Watt-hour			■	
VARs			■	
VAR-demand			■	
VAR-hour			■	
VA			■	
VA-demand			■	
VA-hour			■	
Frequency			■	
Trending (load profile)			■	
Minimum/maximum recording			■	
Monitoring Functions				
Trip circuit monitor			■	
Breaker wear			■	
Failure to close			■	
Oscillography			■	
Sequence of events			■	■
Trip target data		■	■	■
Clock			■	■
Number of starts				■
Acceleration time				■
RTD temperature				■
Hottest RTD				■
Communications				
Local HMI		■	■	■
Local communication port RS-232			■	
Local communication port RS-485			■	
Remote communication port		■	■	■
FSK		■	■	Optional
Addressable		■	■	■
Protocols				
INCOM™		■	■	■
Modbus			■	

Protective Relay Selection Chart, continued)

DT-3000



FP-5000



MP-3000



For Further Details and Information,
See TD02600001TE.

Technical Data Number	Device Name	TD.17.10.TE	TD.17.30.TE	TD.17.11.TE
	IEEE Device Number			
Construction				
Panel-mount case		■	■	■
Drawout		Optional	■	Optional
Operating temperature range		-30°C to +55°C	-40°C to +60°C	-20°C to +60°C
Power supply options		120–240 Vac 24–250 Vdc	48–125 Vac/Vdc 100–240 Vac/Vdc	120–240 Vac
Dual source power supply		Optional		
AC current inputs		■	■	■
AC voltage inputs			■	
Wye PTs			■	
Delta/open delta PTs			■	
Binary inputs		1	8	2
Alarm outputs		2 Form C	2 Form C	3
Trip outputs		2	5	1
Analog outputs			Optional	1
Local display		■	■	■
LEDs (local targets)		■	■	■
Standards				
ANSI		■	■	■
IEC		■	■	■
UL®		■	■	■
CE		DT-3030 only	■	
CSA®		■	■	■

Power Xpert 4000/6000/8000 Series Meters



Power Xpert 4000/6000/8000 Series Display and Meter

General Description

The Power Xpert Meter 4000/6000/8000 Series monitors the critical aspects of an electrical distribution system. This premier power quality metering instrument is simple to use, powerful, scalable and highly flexible.

The Power Xpert Meter 4000/6000/8000 offers a new level of intuitive user interface design, presenting critical electrical distribution system information in simple-to-navigate and easy-to-understand information architecture. The Power Xpert Meter 4000/6000/8000 graphic display visualizes the information from up to 16 meter modules. The embedded Web server displays complex power quality data using standard Internet browsers and allows for device configuration from the browser.

Both the local graphic display and the embedded Web server present real time, historical and event information in a browser-style graphical format to help the user interpret key circuit information, such as:

- Current loading
- Voltage and power levels
- Power factor
- Energy usage
- I/O status
- Power quality measurements
- Harmonic plots
- Disturbance and transient waveforms
- ITIC disturbance summary screen

The Power Xpert Meter 4000/6000/8000 graphic display uses a simple “twist and click” navigation control dial to easily navigate the menus and drill down into increasing levels of important detail. A “back” key enhances the browser-like navigation of the graphic display.

The Web server provides the energy and demand readings required to help manage the cost of energy. It also provides critical information regarding power quality, such as harmonic distortion, flicker, crest factor, K-factor and more.

Note: Features and functionality may vary depending on the meter model and options being used. Review the Features and Benefits chart on **Page V12-T10-16** for details.

Catalog Number Selection

Power Xpert 4000/6000/8000 Meter

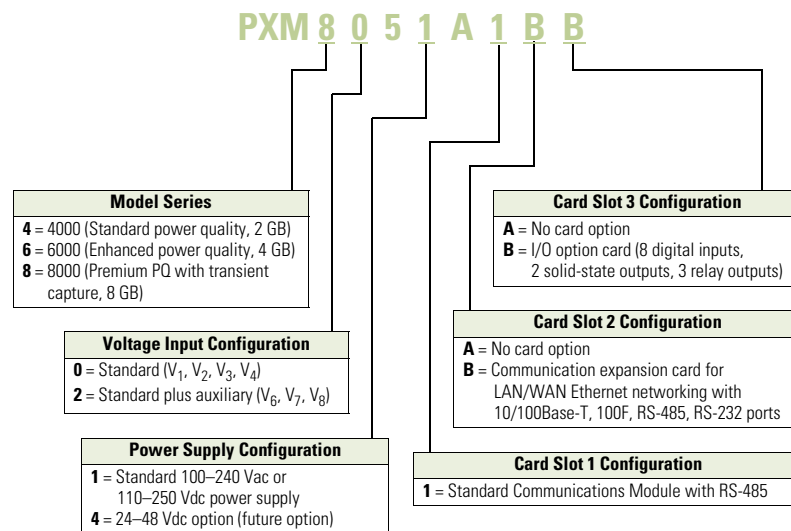

Example 1: **PXM8251A1BB** (PXM 8000 meter, w/ VAUX, std. pwr., com. exp. and I/O cards)
 Example 2: **PXM6251A1BA** (PXM 6000 meter, w/ VAUX, std. pwr., com. exp. card)

Accessories

Power Xpert Meter 4000/6000/8000

Description	Catalog Number
Graphic display module	PXD-MMG
Communication expansion card for LAN/WAN Ethernet networking: 100FX fiber-optic, 10/100T, RS-485, RS-232	PXMCE-B ①
Digital I/O card: eight digital input, two solid-state output, three relay output	PXMIO-B ①
Panel mounting bracket assembly for back-to-back meter to graphic display mounting	PX-PMBA
Panel mounting bracket assembly for retrofitting a graphic display to an IQ Analyzer cutout	PX-PMBB
Panel mounting bracket assembly for reduced graphic display rear clearance	PX-PMBC
Power Xpert Meter 4000 to 6000 license upgrade key	PXM-4KUPG

Notes

① These items can be ordered separately or preinstalled in the meter by selecting option B in the model number.
 Communication cable (standard Modbus RTU) is not included in the package for meter module connection.

Features and Benefits

Power Xpert 4000/6000/8000 Meters

Feature	Power Xpert			Benefit
	4000	6000	8000	
General				
Embedded Web server	■	■	■	Use a standard Web browser to monitor and manage the meter over the network, Internet
TOU metering support	■	■	■	Time of usage can be set up to support 4 different schedules
Firmware flash update support	■	■	■	Enables you to flash the meter with the latest firmware updates
Self-learning capability (characterizes “normal” per circuit)	■	■	■	The meter can automatically adjust to the environment and alarm only when “real” events occur
Power, Energy and Demand				
Voltage, current: per phase minimum, maximum, average, trend graph analysis, export, print	■	■	■	Review voltage and current trends, export, print and analyze parameters right on the meter or external software
Energy and demand plot comparisons month-to-month, week-to-week	■	■	■	Plot two months or two weeks for vivid energy or demand comparison
Power: power factor, apparent, real, reactive, frequency	■	■	■	Review power usage and power factor and avoid potential PF penalties
Energy, demand: forward, reverse, net, sum, tou, profile, previous month comparison, graph analysis, export, print	■	■	■	Keep track of your energy usage, compare time of usage and usage against previous month, identify peaks to conserve energy usage
Power Quality Analysis				
Statistical analysis (min., max., average)	■	■	■	Review statistical trends, identify past and future problem areas
Sag and swell monitoring, management and recording	■	■	■	Capture electrical sags and swells and analyze the waveforms
Symmetrical Components: Zero, Negative, Positive	■	■	■	Analyze possibly unbalanced three-phase power systems
Low frequency transient detection and capture	■	■	■	Capture lower frequency transient waveforms for retrospective analysis or e-mailing
Sampling rate, maximum samples/cycle	4096 ^①	4096 ^①	100,000	Extremely high sampling rate will effectively capture impulsive transients
“Number of Nines” uptime data (e.g., 6 nines = 99.9999%)	■	■	■	Review uptime availability per cent
K-factor	■	■	■	Review the ratio of eddy current losses, e.g., when driving nonlinear and linear loads
Crest factor	■	■	■	Review the peak-to-average ratio of the waveform
Security				
Secure 5 level user access privileges	■	■	■	Define appropriate security access level per user
Communications and I/O				
Modbus TCP	■	■	■	Easy integration with standard protocol to power management and other software
Modbus RTU	■	■	■	Integrate meters to existing Modbus networks, daisy chain several (1–16) meters together
HTML	■	■	■	Communicate to the meter over the Internet via standard Web browser
SNMP (simple network management protocol)	■	■	■	Communicate with the meter via Simple Network Protocol; hook to existing NMS system
SMTP (simple mail transfer protocol)	■	■	■	Send e-mail messages via standard Simple Mail Transfer Protocol
FTP (file transfer protocol)	■	■	■	Access, copy, paste, cut waveform capture files on the meter with an FTP Client
NTP (network time protocol)	■	■	■	Network Time Protocol support enables the meter to synchronize time over the network up to the 1 millisecond resolution
COMTRADE, open IEEE Standard file format for Waveform capture export	■	■	■	Import waveform captures in standard IEEE (C37.111-1999) COMTRADE file format to third-party software
DNP 3.0 over Ethernet (Distributed Network Protocol)	■	■	■	Communicate with the meter via DNP 3.0 over Ethernet; hook to existing utility systems
Trend measurements CSV file export	■	■	■	Easily export trend measurements to third-party applications, e.g., Microsoft Excel in standard CSV file format
I/O (8 digital inputs, 3 relay outputs, 2 solid-state KYZ outputs)	■	■	■	The Power Xpert I/O Card is extremely flexible and can be used in a large variety of different applications. Digital inputs and relay outputs can be programmed to interact during various conditions defined by the user. Various third-party devices, such as alarm, pulse meters, trip units, sensors can be easily integrated to the Power Xpert Meter. Triggers and events can be tied to the meters standard functions such as e-mail, logs and trends

Notes

^① Delta-Sigma A/D oversampling rate.

These specifications are subject to change without notice and represent the maximum capabilities of the product with all options installed. This is not a complete feature list. Features and functionality may vary depending on selected options, firmware version and product model. Please refer to the technical data sheet and User Manual for detailed specifications.

Power Xpert 2000 Series Meters



Power Xpert 2000 Series

General Description

The Power Xpert Meter 2000 Series power quality instrument monitors the most critical aspects of an electrical distribution system. This premier power quality metering instrument uses the latest in advanced technology to make it simple to use, powerful, scalable and highly flexible. The Power Xpert Meter 2000 offers the same level of intuitive user interface design as the Power Xpert Meter 4000/6000/8000, presenting critical electrical distribution system information in a simple to navigate and easy-to-understand information architecture.

The embedded Web server displays comprehensive power quality data using standard Internet browsers and allows for device configuration from the browser. The embedded Web server presents real time, historical and event

information in a browser-style graphical format to help the user interpret information such as current loading, voltage and power levels, power factor, energy usage, I/O status, power quality measurements, as well as harmonic plots. The embedded Web server also allows for waveform capture and for visualizing steady-state harmonic content that is critical for power quality analysis.

The Web server provides the energy and demand readings required to help manage the cost of energy.

Catalog Number Selection

Power Xpert 2000 Meter

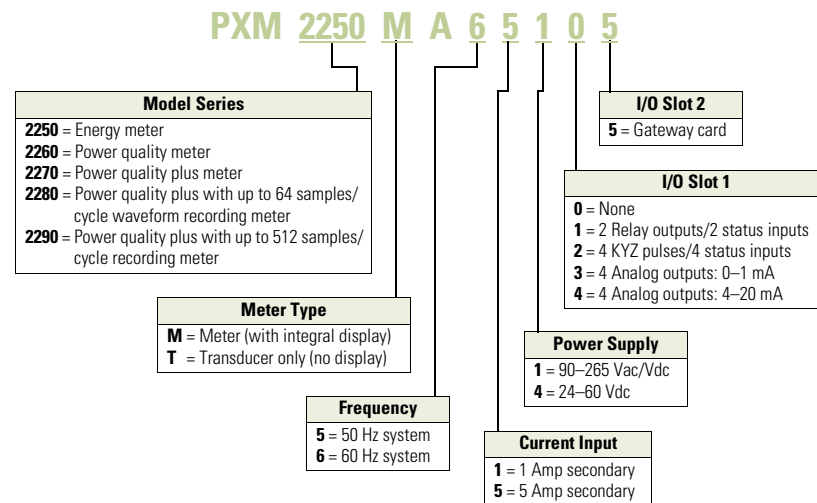

Example 1: **PXM2270MA65145** (PXM 2270 Meter/Display 60 Hz, 5A, 90–265 Vac/Vdc W/4A0)
 Example 2: **PXM2250MA65105** (PXM 2250 Meter/Display 60 Hz, 5A, 90–265 Vac/Vdc)

Accessories

Power Xpert 2000 Meter

Description	Catalog Number
Panel-mounting bracket assembly for retrofitting a PXM 2000 to an IQ Analyzer/IQ DP-4000/IQ Data cutout	IQ250-PMAK
PXM 2000 Gateway Card kit to upgrade an IQ 250/260 to a PXM 2000	PXM2000-GCK

Power Xpert Meter 2000 I/O Cards

Description	Catalog Number
PXM 2000 I/O card—2 relay outputs/2 status inputs	IQ250/260-I01
PXM 2000 I/O card—4 KYZ Pulses/4 status inputs	IQ250/260-I02
PXM 2000 I/O card—4 analog outputs—0–1 mA	IQ250/260-I03
PXM 2000 I/O card—4 analog outputs—4–20 mA	IQ250/260-I04

Power Xpert™ Multi-Point Meter



Power Xpert Multi-Point Meter

General Description

Eaton's Power Xpert Multi-Point Meter is an ANSI C12.20 revenue class Web enabled electronic submetering device that can be mounted in panelboards, switchboards or enclosures. When mounted in a panelboard or a switchboard, the Power Xpert Multi-Point Meter provides customers with an integrated power distribution and energy metering solution that saves space, reduces installation labor and lowers total cost. The Eaton Power Xpert Multi-Point Meter (PXMP Meter) offers a highly modular approach to high-density metering applications in electrical power distribution systems. The PXMP Meter is compatible with most three-phase industrial, commercial and single-phase residential low voltage electrical power systems. The PXMP is equipped with two Modbus RTU communication ports for local display and remote serial communications. The PXMP also has optional pulse input and digital output modules along with one standard digital output and three digital inputs. The PXMP Energy Portal Module is Web enabled, making it suitable for use with Ethernet networks and modems.

The Power Xpert Multi-Point Meter can measure up to any of the following number of circuits:

- Sixty single-phase, two-wire (single-pole)
- Thirty single-phase, three-wire (two-pole)
- Twenty three-phase, four-wire (three-pole)

The circuits listed above can be mixed provided that the total number of current sensors does not exceed 60.

The Power Xpert Multi-Point Meter can be used with three different ratings of current sensors: 100 mA, 10 mA or 333 mV. Switchboard/panelboard applications will use the 100 mA current sensors, which are highly accurate, self-protecting in the event of an open circuit condition under load and are supplied with an integral plug-in connector. The PXMP automatically detects the rating of the current sensor that is connected. The PXMP can also use 10 mA current sensors that were previously installed for IQMESII retrofit applications. Additionally the PXMP can use 333 mV split core current sensors for retrofit applications where metering has not previously existed. The 10 mA and 333 mV current sensors are also self-protecting in the event of an open circuit condition under load.

Application Description

The Power Xpert Multi-Point Meter is ideally suited to handle submetering in low voltage power distribution equipment applications with the use of voltage and current transformers.

The Power Xpert Multi-Point Meter provides a cost-effective solution for residential or commercial metering installations, including:

- High-rise buildings
- Government institutions
- K-12, universities and campuses
- Office buildings
- Medical facilities
- Apartment and condominium complexes
- Airports
- Shopping malls
- Industrial sites
- Mixed-use facilities

Product Selection

Power Xpert Multi-Point Meter Products

Description	Catalog Number
Meter Bases and Meter Modules with ABCN Voltage Inputs	
PXMP meter base—three-phase with ABCN voltage inputs	PXMP-MB
PXMP meter module with six 100 mA inputs for use with PXMP current sensors	PXMP-MM100MA
PXMP meter module with six 10 mA inputs for use with IQMESII current sensors	PXMP-MM10MA
PXMP meter module with six 333 mV inputs for use with 333 mV current sensors	PXMP-MM333MV
Meter Bases and Meter Modules with ABN Voltage Inputs	
PXMP meter base—single-phase, three-wire with ABN voltage inputs	PXMP-MB-AB
PXMP meter module with six 100 mA inputs for use with PXMP current sensors	PXMP-MM100MA-AB
PXMP meter module with six 10 mA inputs for use with IQMESII current sensors	PXMP-MM10MA-AB
PXMP meter module with six 333 mV inputs for use with 333 mV current sensors	PXMP-MM333MV-AB
IO Modules	
PXMP meter pulse input module with eight inputs	PXMP-PIM
PXMP meter digital output module with eight outputs	PXMP-DOM
Communication Module	
PXMP meter energy portal module	PXMP-EPM
Current Sensor Kits	
KIT, PXMP CS125 sensor, quantity of 3	PXMP-CS125-3
KIT, PXMP CS250 sensor, quantity of 3	PXMP-CS250-3
KIT, PXMP CS400 sensor, quantity of 3	PXMP-CS400-3
Current Sensor Cable Kits	
KIT, PXMP sensor cable, 4 ft (1.2m), quantity of 3	PXMP-SC4-3
KIT, PXMP sensor cable, 6 ft (1.8m), quantity of 3	PXMP-SC6-3
KIT, PXMP sensor cable, 8 ft (2.4m), quantity of 3	PXMP-SC8-3
KIT, PXMP sensor cable, 12 ft (3.7m), quantity of 3	PXMP-SC12-3
Current Sensor Extension Cable Kits	
KIT, PXMP sensor extension cable, 8 ft (2.4m), quantity of 3	PXMP-SCE-8-3
KIT, PXMP sensor extension cable, 16 ft (4.9m), quantity of 3	PXMP-SCE-16-3
Interface Modules	
PXMP current sensor interface module for 333 mV, kit X 3	PXMP-IM333MV-3

Note

Total sensor lead length must not exceed 28 ft (8.5m).

Power Xpert Multi-Point Meter Support Products

Description	Catalog Number
Communication cable, 1000 ft (305m), 600V insulation	IMPCABLE
PXMP meter display—6-inch color touchscreen (with cable)	PXMP-DISP-6
Power supply—single-phase 90–264 Vac, 24 Vdc at 2.5A	PSG60E
Power supply—three-phase 360–575 Vac, 24 Vdc at 2.5A	PSG60F
Power supply—three-phase 600 Vac, 24 Vdc	PSS55D

IQ 250/260 Electronic Power Meters



IQ 250/260 Electronic Power Meter

General Description

The IQ 250 and IQ 260 Meters provide capabilities you would not normally expect in affordable, ultra-compact meters, such as fast sampling rate and accurate metering for a full range of power attributes. Providing the first line of defense against costly power problems, Eaton’s IQ 250 and IQ 260 electronic power meters can perform the work of an entire wall of legacy metering equipment using today’s technology.

When space is at a premium, yet you need ANSI C12.20 accuracy, the IQ 250/ 260 series fit the bill. These meters are ideal for electrical equipment assemblies, machine control panels, such as panelboard and switchboard mains and feeders, low voltage metal-enclosed switchgear feeders and motor control centers. Requiring far less space than other meters with similar functionality, IQ 250/260 series fit into a standard ANSI or IEC cutout on a panelboard or other electrical equipment, and therefore fit easily into retrofit applications.

Catalog Number Selection

IQ 250/260 Meter

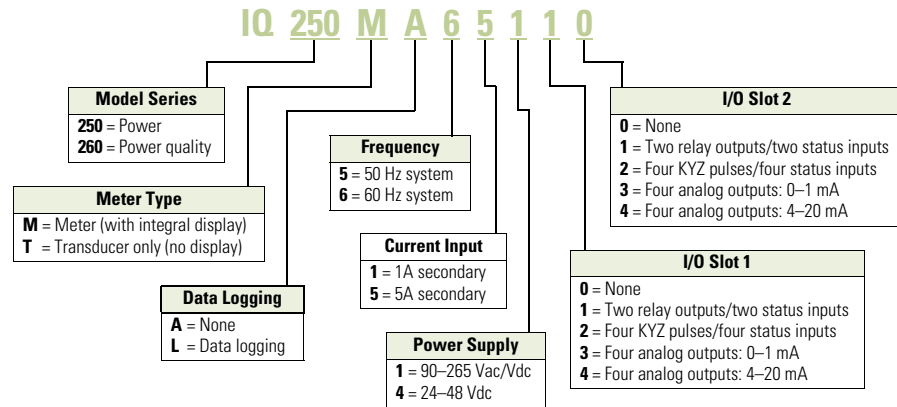

Accessories

IQ 250/260 Meter

Description	Catalog Number
Panel-mounting adapter for retrofitting an IQ 250/260 to an IQ Analyzer/IQ DP-4000/IQ Data cutout	IQ250-PMAX
PXM 2000 Gateway Card kit to upgrade an IQ 250/260 to a PXM 2000	PXM2000-GCK

IQ 250/260 Meter I/O Cards

Description	Catalog Number
IQ 250/260 I/O card—2 relay outputs/2 status inputs	IQ250/260-I01
IQ 250/260 I/O card—4 KYZ pulses/4 status inputs	IQ250/260-I02
IQ 250/260 I/O card—4 analog outputs—0–1 mA	IQ250/260-I03
IQ 250/260 I/O card—4 analog outputs—4–20 mA	IQ250/260-I04

**IQ 130/140/150 Series
Electronic Power Meters**



IQ 100 Electronic Power Meter

General Description

The IQ 100 Meter family provides capabilities you would not normally expect in affordable, compact meters, such as fast sampling rate and accurate metering for a full range of power attributes. Providing the first line of defense against costly power problems, Eaton's IQ 100 series electronic power meters can perform the work of an entire wall of legacy metering equipment utilizing today's technology.

When space is at a premium, yet you need ANSI C12.20 accuracy, the IQ 100 series fit the bill. These meters are ideal for electrical equipment assemblies, machine control panels, such as panelboard and switchboard mains and feeders, low voltage metal-enclosed switchgear feeders and motor control centers. Requiring far less space than other meters with similar functionality, IQ 100 series fit into a standard ANSI or IEC cutout on a panelboard or other electrical equipment, and therefore fit easily into retrofit applications.

Catalog Number Selection

IQ 130/140/150 Meters

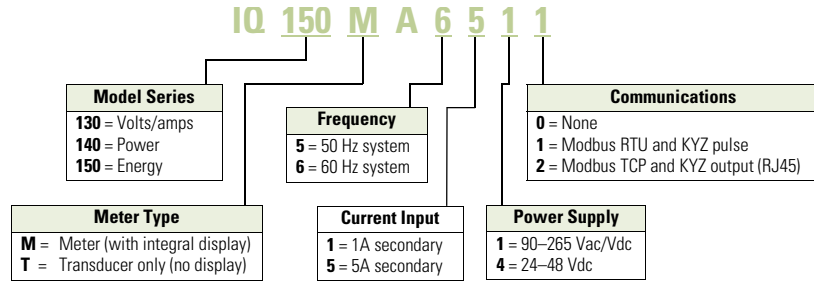

Accessories

IQ 130/140/150 Meters

Description	Catalog Number
Panel Mounting Adapter for retrofitting an IQ 100 to an IQ Analyzer/IQ DP-4000/IQ Data Cutout	IQ250-PMAK

IQ 150S/250S Self-Enclosed Electronic Meters



IQ 150S/250S Self-Enclosed Electronic Meters

Catalog Number Selection

IQ 150S/250S Meter

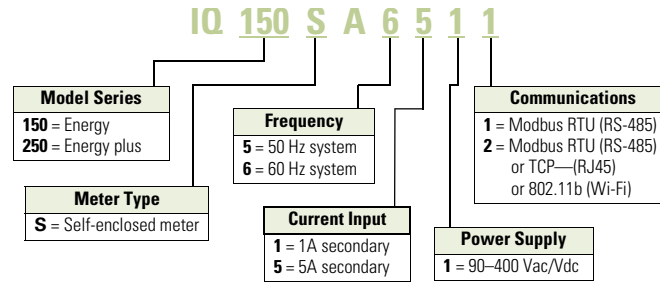

General Description

With energy costs skyrocketing, you need the ability to verify the accuracy of utility billing and allocation of energy costs among business units, different manufacturing areas or facilities, and tenants. Production equipment and IT systems are vulnerable to power anomalies; therefore, you must ensure that power is always up to specifications. If your infrastructure is an established facility, you may not currently have metering or may have addressed these concerns by deploying a variety of analog gauges and meters—one for volts, one for amperes and so on, with separate meters for each measurement.

If you're planning an upgrade or a new power infrastructure, no doubt you would like to capitalize on the latest technology to improve upon that cumbersome architecture and its patchwork view.

IQ 35M



IQ 35M

General Description

The Eaton IQ 35M Meter is a DIN rail meter that combines exceptional performance and easy installation to deliver a cost-effective solution for energy and power monitoring applications, as well as sub-metering applications. Most models include pulse output, alarm contact and phase alarms for true versatility. The BACnet version offers two digital inputs for accumulating other meter pulses in place of the digital output and alarm contact. The Modbus output options offer added flexibility for configuration and data analysis. The IQ 35M allows you to:

- Verify energy bills
- Make informed load shifting and shedding decisions
- Fairly and accurately allocate energy costs to users
- Identify wasteful practices
- Decrease unnecessary usage
- Produce an energy profile
- Secure the optimum utility rate structure

Catalog Number Selection

IQ 35M Meter

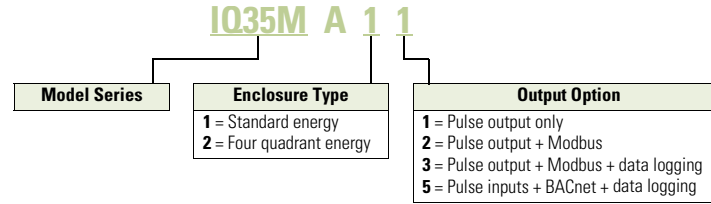

Accessories

IQ 35M Accessories

Description	Catalog Number
IQ35M enclosure, NEMA 4X	IQ35M-ENC
IQ35M fuse pack, single, 1/2A slow-blow	IQ35M-FP1
IQ35M fuse pack, double, 1/2A slow-blow	IQ35M-FP2
IQ35M fuse pack, triple, 1/2A slow-blow	IQ35M-FP3
IQ35M replacement mounting clips	IQ35M-RMC
IQ35M DIN rail	IQ35M-DR
IQ35M DIN rail stop clips (10 pack)	IQ35M-DRSC

IQ 35M Current Transformers

Description	Catalog Number
Solid Core	
IQ35M CT, solid core, 5A:0.33 Vac, 0.30 inch	IQ35M-SO-030-5
IQ35M CT, solid core, 20A:0.33 Vac, 0.30 inch	IQ35M-SO-030-20
IQ35M CT, solid core, 50A:0.33 Vac, 0.50 inch	IQ35M-SO-050-50
IQ35M CT, solid core, 50A:0.33 Vac, 0.75 inch	IQ35M-SO-075-50
IQ35M CT, solid core, 100A:0.33 Vac, 1.25 inch	IQ35M-SO-125-100
IQ35M CT, solid core, 200A:0.33 Vac, 1.25 inch	IQ35M-SO-125-200
IQ35M CT, solid core, 250A:0.33 Vac, 1.25 inch	IQ35M-SO-125-250
IQ35M CT, solid core, 300A:0.33 Vac, 1.25 inch	IQ35M-SO-125-300
IQ35M CT, solid core, 400A:0.33 Vac, 1.25 inch	IQ35M-SO-125-400
Split Core	
IQ35M CT, split core, 5A:0.33 Vac, 0.75 inch	IQ35M-SP-075-5
IQ35M CT, split core, 30A:0.33 Vac, 0.75 inch	IQ35M-SP-075-30
IQ35M CT, split core, 50A:0.33 Vac, 0.75 inch	IQ35M-SP-075-50
IQ35M CT, split core, 100A:0.33 Vac, 0.75 inch	IQ35M-SP-075-100
IQ35M CT, split core, 200A:0.33 Vac, 0.75 inch	IQ35M-SP-075-200
IQ35M CT, split core, 250A:0.33 Vac, 1.25 inch	IQ35M-SP-125-250
IQ35M CT, split core, 300A:0.33 Vac, 1.25 inch	IQ35M-SP-125-300
IQ35M CT, split core, 400A:0.33 Vac, 1.25 inch	IQ35M-SP-125-400
IQ35M CT, split core, 600A:0.33 Vac, 1.25 inch	IQ35M-SP-125-600
IQ35M CT, split core, 800A:0.33 Vac, 2.50 inch	IQ35M-SP-253-800
IQ35M CT, split core, 1000A:0.33 Vac, 2.50 inch	IQ35M-SP-255-1000
IQ35M CT, split core, 1200A:0.33 Vac, 2.50 inch	IQ35M-SP-255-1200
IQ35M CT, split core, 1600A:0.33 Vac, 2.50 inch	IQ35M-SP-255-1600
IQ35M CT, split core, 2000A:0.33 Vac, 2.50 inch	IQ35M-SP-255-2000
IQ35M CT, split core, 2400A:0.33 Vac, 2.50 inch	IQ35M-SP-255-2400

Note: Specifications are subject to change without notice and represent the maximum capabilities of the product with all options installed. This is not a complete feature list. Features and functionality may vary depending on selected options, firmware version and product model. Please refer to User Manual for detailed specifications.

Enclosed Meters



NEMA 12 Single- and Multi-Unit Enclosed Meters

General Description

The Eaton enclosed meter line provides a complete energy metering and data acquisition solution in a single enclosure. Designed for Eaton’s IQ 35M, IQ 150, IQ 250/260, and Power Xpert® 2000/4000/6000/8000 and Multi-Point Meters, Eaton’s enclosed meter line offers mounting and installation flexibility, especially in retrofit applications where no metering compartment or mounting space is available in the existing electrical distribution equipment or where installation time is a premium. Factory designed and wired, Eaton’s enclosed meter line offers savings in labor and installation costs because input current and voltage wiring as well as I/O wiring is prewired to terminal blocks inside the enclosure.

The enclosed meter line has two standard offerings: single-, prewired unit (specific IQ 150, IQ 250/260, PXM 2000, PXM 4000/6000/8000 or PXMP) and a multi-unit (specific IQ 150, IQ 250/260 or IQ 35M models). Because the multi-unit automatically includes Eaton’s Power Xpert Gateway 200E, it facilitates measurement and verification of the energy usage on processes and in buildings. This provides a convenient way to monitor energy usage from multiple points, collect and log specific energy use parameters, and display and generate logs for historical energy usage reports. Simply put, Eaton’s

multi-unit enclosed meter solution helps meet any measurement and verification requirement to show energy efficiency improvements and

results. In addition to the standard offering, Eaton can also provide an enclosed metering solution tailored around your project needs.

Catalog Number Selection

Single Unit Enclosed Meter

PXM2250MA65105 - 2 B

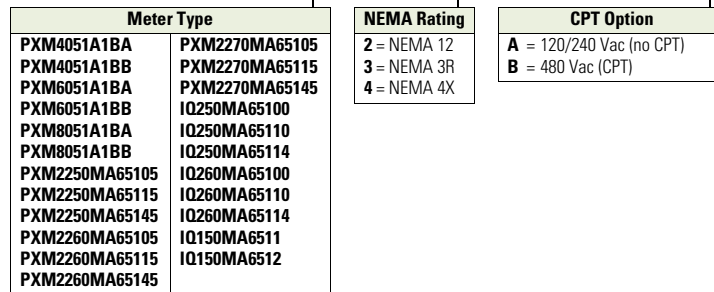

Enclosed PXMP Meter

PXMP - 2 B D

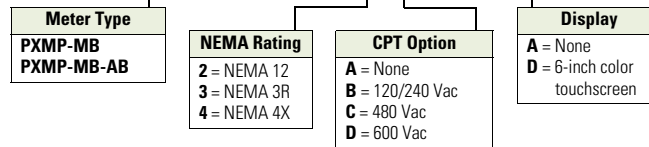

Multi Unit Enclosed Meter

IQ150MA6511 - 2 B 4 C

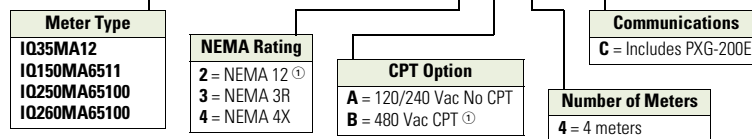

Accessories

Meter Subpanel Assembly

Description	Catalog Number
Meter subpanel assembly for PXM 2000 and IQ 150/250/260 Meters	PXM2K-MSPA-A
Meter subpanel assembly with CPT for PXM 2000 and IQ 150/250/260 Meters	PXM2K-MSPA-B

Notes

- ① Not available with IQ 35M.
- Other meter models available upon request in single- and multi-unit enclosed versions.

IQ Analyzer 6400/6600**IQ Analyzer 6400/6600****General Description**

Eaton's IQ Analyzer 6400/6600 is a complete solution for users who want to monitor all aspects of their electrical distribution system. It provides extensive metering, power quality analysis, remote input monitoring, control relaying, analog input/outputs and communications capability. All programming can be done through the faceplate or through the communications option. Its online Help pushbutton feature displays information on device operation, programming and troubleshooting.

Features and Benefits

- All information is accessible through the communications port
- Quality true rms readings through 50th harmonic
- Meets ANSI C12.16 Class 10 revenue metering specifications
- Accurate readings for non-sinusoidal waveforms with up to 3.0 crest factor
- Screens display auto ranging units, kilo units and mega units as needed
- 10-digit energy readings
- Displays multiple parameters at the same time
- Programmable custom screens

The new IQ Analyzer Model 6600 with waveform display at the device and sub-cycle

voltage disturbance capture provides the capability to monitor a wide range of harmonic parameters. These include harmonic voltage, current magnitudes and phase angles as well as system disturbances such as transient voltage disturbances and sub-cycle voltage interruptions.

Product Selection**IQ Analyzer 6400/6600 Ordering Information**

Description	Catalog Number
IQ Analyzer, separate source power module	IQA6410
IQ Analyzer, 24–48 Vdc power module	IQA6420
IQ Analyzer, three-phase power module	IQA6430
IQ Analyzer, separate source power module with waveform display and sub-cycle voltage distribution capture	IQA6610
IQ Analyzer, 24–48 Vdc power module with waveform display and sub-cycle voltage distribution capture	IQA6620
IQ Analyzer, three-phase power module with waveform display and sub-cycle voltage distribution capture	IQA6630
IQ Flange, to provide extra clearance when mounting	IQFLANGE
45.00-inch (114.3 mm) extension cable for remote mounting of power module	IQA45CABLE
24–48 Vdc separate source power module	IQMDCPM
100–240 Vac and 100–250 Vdc separate source power module	IQMSSPM
Three-phase, self-powered power module	IQM3PPM
INCOM communication module	IPONI
RS-485 communication module with Modbus protocol	MPONI

IQ DP-4000/4100**IQ DP-4000/4100****General Description**

Eaton's IQ DP-4000 is a microprocessor-based meter providing complete electrical metering and system voltage protection. In one compact, standard package the IQ DP-4000 provides an alternative to individually mounted and wired conventional meters and switches. The IQ DP-4000 also monitors apparent power (VA), reactive energy (VAR-hours), apparent energy (VA-hours), and % total harmonic distortion (THD) to provide the user with basic power quality information. The IQ DP-4000 meets and surpasses UL/CSA/CE standards.

Features and Benefits

- Space savings in structure—replaces conventional individual metering devices
- Standardization of design—one door-mounted device
- Direct voltage input up to 600V
- New DIP switch design
- Standardization of CT and PT connections
- With additional PTs and set points the device can be used in HV setting
- Relaying included in I/O module (Model 4100)
- Optional interface capability to computer network for data collection, storage and/or printout via PowerNet—Eaton leading power distribution monitoring network
- Retains present parameters through power failure with non-volatile memory

Product Selection**IQ DP-4000/4100 Ordering Information**

Description	Catalog Number
Separate source without I/O capability	IQDP4010
Separate source control power without I/O, DC supply	IQDP4020
Three-phase without I/O capability	IQDP4030
Separate source with I/O capability	IQDP4110
Separate source control power with three Form C relay output contacts and one sync pulse input, DC supply	IQDP4120
Three-phase with I/O capability	IQDP4130

IQ Energy Sentinels™**IQ Energy Sentinels**

Eaton's IQ Energy Sentinel is a highly accurate, microprocessor-based submeter designed to monitor power and energy readings. It represents an alternative to installing separate wattmeters, watthour meters and watt-demand meters.

Key advantages include unmatched savings in space, lower installation costs, and the capability to communicate data readings in a variety of ways.

IQ Energy Sentinels with built-in CTs and communications have the added benefit of greater overall system accuracy. Conventional metering often is less accurate because external CTs and separate transducers may each have inaccuracies of 1% or more.

The IQ Energy Sentinel provides a unique and cost-effective method to implement energy submetering at lower levels in the distribution system economically.

Submetering application examples for the IQ Energy Sentinel include energy monitoring and demand management, product cost analysis, process/machine tool efficiency and productivity improvement. Additional applications include energy cost allocation of tenant billing for commercial, industrial, recreational and residential facilities.

Retrofitting

The space-saving design characteristics of the breaker mount IQ Energy Sentinels allow them to be added to existing Series C® circuit breakers at any time—often with no additional space or modifications required. Or, they may be installed when upgrading to Series C from older circuit breakers—often with no additional space or modifications required.

The Universal Mount IQ Energy Sentinel with internal CTs may be used wherever breaker mounting is not feasible or possible.

The Universal Mount IQ Energy Sentinel for external CTs may be used for monitoring loads larger than 400A or for when the use of existing CTs is desired.

Product Selection**IQ Energy Sentinels Ordering Information**

Description	Catalog Number
For F-Frame breakers	IQESF __ __ ①
For J-Frame breakers	IQESJ __ __ ①
For K-Frame breakers	IQESK __ __ ①
Universal with internal CTs	IQESUI __ __ ①
Universal for external CTs	IQESUE __ __ ①

Note

① Final three characters of catalog number are for voltage rating, i.e., 2 0 8 for 120/240, 240, 208Y/120 systems.

IQ 230**IQ 230****General Description**

Eaton's IQ 230 compact size and flexible mounting capabilities make it perfectly suited for machine control panels such as panelboard and switchboard mains and feeders, low voltage metal-enclosed switchgear feeders, motor control centers, and especially for individual load monitoring. The base module can be display mounted, panel mounted, DIN rail mounted or side mounted. The display fits into a standard 1/4 DIN cutout, and for retrofit applications, a 100 mm ANSI collar is available.

One IQ 230 provides an alternative to an assortment of individually wired and mounted ammeters, voltmeters, ammeter and voltmeter switches, wattmeters, VAR-meters, power factor meters, frequency meters, watthour and demand meters.

ANSI C12 Class 10 revenue metering accuracy makes the IQ 230 an ideal choice for submetering and sub-billing applications.

The IQ 230 can be easily programmed and monitored from the faceplate keypad that features a 4 line x 20 character LED backlit LCD display. Opting for the compatible PowerNet system allows the user to program and monitor the meter remotely from a PC.

Retrofit Opportunities

- Retrofit of existing electrical distribution systems with the IQ 230 for load and energy monitoring
- Five mounting options makes installation easier

Ratings

- Application to 200 kV, no PTs to 600V
- CT ratios selectable 5 to 8000A
- Single-phase two- or three-wire; three-phase three- or four-wire

Product Selection**IQ 230 Ordering Information**

Description	Catalog Number
IQ 230 complete meter with base module, display and 14.00-inch (355.6 mm) cable—with INCOM communications, pulse output, two contact outputs, two digital inputs, one analog input and anti-tamper seal	IQ230
IQ 230M complete meter with base module, display and 14.00-inch (355.6 mm) cable—with RS-485 Modbus communications, pulse output, two contact outputs, two digital inputs, one analog input and anti-tamper seal	IQ230M
3 foot (0.9m) Category 5 cable	IQ23CABLE
6 foot (2.0m) Category 5 cable	IQ26CABLE
10 foot (3.0m) Category 5 cable	IQ210CABLE

MP-3000 Motor Protection



MP-3000 Motor Protection

General Description

Eaton's MP-3000 motor protection relay is a multi-functional microprocessor-based protective relay for the protection of three-phase AC motors. Though it may be applied to any size motor at any voltage level, it is most commonly applied on medium voltage or larger motors. The MP-3000 relay is a current only device that provides complete and reliable motor protection, monitoring and starting control functions.

The MP-3000 motor protection relay is available in either a fixed mount, semi-flush case or in a semi-flush quick release drawout case. Both housings are compact and fit a standard IQ cutout.

The optional quick release drawout case features two-stage contact disconnects and self-shorting CT circuit terminal blocks. A spare self-shorting terminal pair is available for use as relay removal alarm or for continuous motor operation (non-failsafe mode) on relay removal. The optional communication module is externally mounted on the fixed mount case and internally mounted in the drawout case.

The MP-3000 motor protection relay has three phase and one ground current inputs. Both a 5A and 1A version are available. The ground protection and metering functions can be used with either a zero sequence ground CT or from the residual connection of the phase CTs. The zero sequence ground CT provides greater ground fault sensitivity than the residual connection. The unit is user-programmable for 60 Hz or 50 Hz operation.

The MP-3000 motor protection relay provides adaptive overload trip characteristics based on motor temperature when motor RTDs are connected through an optional URTD module. Metering of RTD inputs (individual winding, motor bearing, load and auxiliary temperatures) is also provided.

The MP-3000 motor protection relay has two discrete inputs, four Form C (1NO and 1NC) contacts and one 4 to 20 mA analog output. The relay provides maximum user flexibility to configure the I/O. All inputs and outputs (except for the trip output) are user-programmable. In addition, the relay has 10 LEDs for the indication of protection on, program mode, monitor mode, view setting mode, history mode, log mode, trip, alarm, auxiliary 1 and auxiliary 2 operation. A test page in the program mode provides display indication of the discrete input states and testing of the output relays, target LEDs and analog circuit.

A user-friendly operator interface and display provides quick access to the settings, monitored values, motor history and operational logs. Large LED alphanumeric character display provides easy viewing from any angle in any light. Simple keypad operation provides quick and easy navigation through all settings and stored data. The program mode and emergency override buttons are access restricted via sealing provisions and latched cover. An integrated help function provides an online description display of functions, abbreviations and operations.

Optimum Motor Protection

The MP-3000 motor protection relay has been designed for maximum motor operation and protection. It permits running the motor as close to its design limits while protecting it against excessive heating and damaging overload conditions. The MP-3000 field-proven protection algorithms were developed based on motor designs and operating parameters for optimum operation and protection while minimizing nuisance tripping.

The MP-3000 motor protection relay uses a protection algorithm and measurement technique based on proven positive and negative (unbalance) sequence current sampling and true rms calculations.

Product Selection

MP-3000 Motor Protection Ordering Information

Description	Catalog Number
Motor protection in fixed case, 5A CT, communication capable with PONI	MP-3000
Motor protection in drawout case, 5A CT, no communication	MP-3001
Motor protection in drawout case, 5A CT, with INCOM PONI	MP-3002
Motor protection in fixed case, 1A CT, communication capable with PONI	MP-3100
Motor protection in drawout case, 1A CT, no communication	MP-3101
Motor protection in drawout case, 1A CT, with INCOM PONI	MP-3102
Motor protection drawout case inner chassis, 5A, CT, no communication	MP3001-IC
Motor protection drawout case inner chassis, 5A, CT, with INCOM PONI	MP3002-IC
Motor protection drawout case inner chassis, 1A, CT, no communication	MP-3101-IC
Motor protection drawout case inner chassis, 1A, CT, with INCOM PONI	MP3102-IC
Motor protection drawout case outer chassis	MP3-OC
Motor protection, 5A, URTD, INCOM PONI, fiber optic link	MP3000VPI
Motor protection, 1A, URTD, INCOM PONI, fiber optic link	MP3100VPI
16-foot (5m) fiber optic cable for MP-3000/URTD communication	MPFO-5
Universal RTD module	URTP

FP-5000 Feeder Protection



Feeder Protection FP-5000

General Description

- Microprocessor-based protection with monitoring and control for medium voltage main and feeder applications
- Current, voltage, frequency and power protection for electric power distribution systems
- Complete metering of voltage, currents, power, energy, minimum/maximum and demand functions
- Programmable logic control functions for main-tie-main transfer schemes
- Trip logs, event logs and waveform capture for better fault analysis and system restoration
- Data Logger to provide energy usage profiles for better planning, utilization and energy usage
- Compact, drawout case design
- Meets ANSI, UL and cUL® standards
- Multiple setting groups
- ANSI, IEC and thermal protection curves for greater flexibility

Application Description

Eaton’s FP-5000 feeder protection relay provides complete three-phase and ground overcurrent and voltage protection plus metering in a single, compact drawout case. It may be used as primary protection on feeders, mains and tie circuit breaker applications, and as backup protection for transformers, high voltage lines and differential protection. The relay is most commonly used on medium voltage switchgear applications.

The FP-5000 takes full advantage of its microprocessor technology providing the user new freedoms and a wealth of data-gathering features. The relay performs self-checking of all major hardware and firmware protection elements to ensure their operation in the event of a system or component electrical failure or fault. Protection functions are well suited for main and distribution feeder circuit applications. Programmable logic control functions make the FP-5000 relay ideally suited for main-tie-main and main 1/main 2 transfer schemes.

The multiple settings groups can be used for arc flash mitigation when an alternative setting group, set to have instantaneous elements only is activated using a selector switch and the programmable I/O in the FP-5000.

Features and Benefits

The zone interlocking feature can be used for bus protection instead of an expensive and complicated bus differential (87B) scheme. The FP-5000 works directly with the Eaton Digitrip 3000 and Digitrip MV relays. Breaker failure logic provides faster remote backup clearing times for stuck breaker operation.

The FP-5000 provides trip and close circuit monitoring and alarming features. It continually monitors the complete trip and close circuits for continuity and readiness to trip. Open and close pushbuttons are conveniently located on the front of the relay for local breaker operation.

Loss-of-vacuum monitoring is activated when the breaker is open. Residual current is monitored and alarmed if detected.

When an electrical fault or disturbance occurs, the FP-5000 begins to store the following in non-volatile memory:

- Voltage and current sampled data
- Calculated values
- Status of internal protection functions, logic, contact inputs and outputs

Retrieval and viewing of the data is easy, aiding in the quick analysis and restoration of your electric power system.

When the FP-5000 isn’t responding to disturbances in the power system, it’s providing valuable metering information at the relay and remotely. It provides energy usage and demand reading, and can alarm when usage reaches a set value. Power factor measurements can be used for capacitor bank switching to control cover demand. Inboard data trending can provide load profiles for up to 40 days.

Catalog Number Selection

FP-5000 Feeder Protection

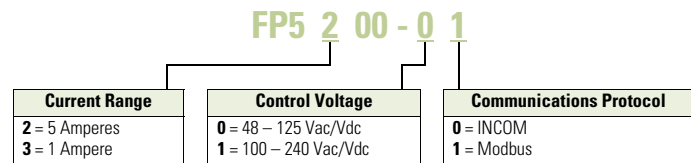

Digitrip 3000 (DT-3000)**DT-3000****General Description**

- Microprocessor-based, three-phase and ground overcurrent relay
- Independent phase and ground measuring circuits and operation
- ANSI, IEC and thermal protection curves
- Fixed mount or drawout design
- Dual-source power supply option for AC control power applications

Eaton's Digitrip 3000 trip unit (DT-3000) is a multifunction, microprocessor-based overcurrent trip unit designed for both ANSI and IEC applications. The DT-3000 design provides true rms sensing design of each phase and ground current.

It can be power from either AC or DC control power. The DT-3000 can be used for any application where instantaneous and/or time overcurrent protection is required.

The DT-3000 may be applied as the transformer primary protection or as backup to the differential protection. The DT-3000 also has zone selective interlocking to minimize equipment damage resulting from a phase or ground fault in an area where long time and/or short time delay is in use.

Product Selection**DT-3000 Ordering Information**

Description	Catalog Number
DT-3000 protective relay	DT3000
DT-3000 protective relay Chicago version	DT3100
DT-3030 protective relay (24–48 Vdc CE Mark version)	DT3030
DT-3000 drawout case protective relay	DT3001
DT-3000 Chicago version drawout case protective relay	DT3101
DT-3030 drawout case protective relay (24–48 Vdc CE Mark version)	DT3031
DT-3000 protective relay with 120 Vac dual-source power supply	DT3010
DT-3000 protective relay with 240 Vac dual-source power supply	DT3020

The integral Dual-Source Power Supply allows the DT-3000 to operate solely from the main CTs during a fault if the normally connected AC voltage is not available, i.e., an electromechanical or electronic “self powered” relay.

Electrical Power System Protection

The DT-3000 provides phase and ground protection for most types of medium voltage electrical power distribution systems.

Protection curves are similar to those on low voltage power circuit breaker trip units, and provide close coordination with downstream devices, as well as upstream fuse and/or electromagnetic relays. Just one DT-3000 replaces the normal complement of three or four conventional electromagnetic overcurrent relays, an ammeter, a demand ammeter, an ammeter switch and, in some situations, a lockout relay switch (device 86).

IQ Flange



IQ Flange

For applications where extra door-mounting space is required, a flange-mounting unit is available. Eaton’s IQ Flange provides an extra 2.50 inches (63.5 mm) of clearance for the device.

Product Selection

IQ Flange

Description	Catalog Number
IQ Flange option, to provide extra clearance when mounting	IQFLANGE

Panel Mounting Adapter Kit for IQ 100/200 Series and PXM 2000 Meters



Panel Mounting Adapter Kit

The flange adapter plate can be installed as follows:

1. Remove the old meter from the panel or door. Many IQ metering products use the typical IQ drilling pattern shown in for mounting.
2. Install the flange adapter plate. Mount it from the rear using the six screws provided in the kit. The flange adapter plate screw hole pattern should match the typical IQ drilling pattern. If not, perform the next step.
3. Drill six holes in the panel or the door to mount the flange adapter plate. Follow the typical IQ drilling pattern. You need only the top, center and bottom sets of holes.
4. Install the new IQ 100/200 Series or PXM 2000 meter in the flange adapter plate. Secure it from behind with four flat washers, lock washers and nuts provided with the meter.

Product Selection

Ordering Information

Description	Catalog Number
Panel mounting adapter kit IQ 100/200 and PXM 2000 Series adapter kit to IQ Analyzer/IQ DP-4000/IQ Data	IQ250-PMAX

IQ DC Power Supply



IQ DC Power Supply

The IQ DC Power Supply is a DC to AC inverter module intended for use where DC power is available, but some AC is required. The unit will operate an MP-3000 or other AC powered IQ devices requiring no more than 75 VA of power at any power factor.

Product Selection

IQ DC Power Supply

Description	Catalog Number
IQ DC power supply	IQDCPS

IQ Cable



IQ Cable

For applications where remote mounting of the power supply is required, an extension cable is available.

Two types of cable are available. The first (catalog number **IQCABLE**) is for the obsolete IQ Data, Generator, and Data Plus II. The second (catalog number **IQA45CABLE**) is for the IQ Analyzer and IQ DP-4000.

Product Selection

IQ Cable

Description	Catalog Number
36.00-inch (914.4 mm) extension cable IQ Data, Generator, Data Plus II	IQCABLE
45.00-inch (1143.0 mm) extension cable IQ Analyzer/IQ DP-4000	IQA45CABLE

IQ Floor-Mounted Enclosure



Two 10-Inch Wide Enclosures (Shown with Optional 10-Inch High Bus Compartment)

Type 1

Standard AMPGARD structure construction, painted ASA-61. To be used as a lineup extension for mounting IQ products. Each 10.00-inch (254.0 mm) wide section comes with (two) doors with “works-in-a-drawer” drawout panel. Each door has three standard IQ cutouts with device panels, and can be supplied with or without IQ devices.

Product Selection

IQ Floor-Mounted Enclosure

Description	Style Number
10.00-inch W x 30.00-inch D x 90.00-inch H (254.0 mm W x 762.0 mm D x 2286.0 mm H) Bus compartment optional	2147A95G35

Addressable Relay II



Addressable Relay II

The Addressable Relay II has two status inputs and a Form C contact output.

- Input rating: 48–120 Vac, 48–125 Vdc
- Output contact rating: 10A at 277 Vac, 10A at 30 Vdc

Features include a communications watchdog and relay pulse. Baud rate is selectable.

Product Selection

Addressable Relay II

Description	Catalog Number
Addressable Relay II	ARII

Power Modules

Eaton and Westinghouse have produced a number of different meters dating back to the 1980s. Many of these meters used and continue to use power modules to provide voltage sensing isolation and control power to the meter.

Power modules are available to power the meter directly from the voltage source being sensed or for separate control power input. Renewal part power modules are available for the meters shown in the table below.

Product Selection

Power Modules

Description	Used with Meter Style Number	Power Module Catalog Number
Old IQ DP-4000 and IQ Analyzer self-powered three-phase power module	2D82302GXX ①	IQA3PPM
	4D13110GXX ①	
Old IQ DP-4000 and IQ Analyzer separate source 110 to 240 Vac or 110 to 250 Vdc power module	2D82302GXX ①	IQASSPM
	4D13110GXX ①	
New IQ DP-4000 and IQ Analyzer self-powered three-phase power module	66D2045GXX ①	IQM3PPM
	66D2040GXX ①	
New IQ DP-4000 and IQ Analyzer 24/48 Vdc power module	66D2045GXX ①	IQMDCPM
	66D2040GXX ①	
New IQ DP-4000 and IQ Analyzer separate source 110 to 240 Vac or 110 to 250 Vdc power module	66D2045GXX ①	IQMSSPM
	66D2040GXX ①	

Note

① The adjacent power modules will work with each basic meter style, regardless of the last two digits of the meter style number.

Current Transformers (CTs)



Current Transformers (CTs)

General Description

Eaton's low voltage current transformers are available in both solid core and split core designs. Engineered for electronic metering applications, all solid core designs and selected split core designs offer ANSI metering quality accuracy. The solid core designs also meet ANSI C57.13 relay accuracy requirements including over-ranging capabilities. The current transformer offering has a 5 ampere secondary at the rated primary current.

Split core CTs are specifically designed to be installed around primary conductors without disconnecting wires or breaking the circuit to be monitored. These current transformers are perfect solutions for energy management applications and are manufactured for installation ease.

Product Selection

Solid Core ANSI Metering Accuracy

Primary Current Rating	ANSI B0.1 Metering Class at 60 Hz (Accuracy in %)	Window Size in Inches (mm) Diameter	Catalog Number	Mounting Bracket Catalog Number
1.25 (31.8) Window				
50	1.2	1.25 (31.8)	S060-500	①
100	0.6	1.25 (31.8)	S060-101	①
150	0.3	1.25 (31.8)	S060-151	①
200	0.3	1.25 (31.8)	S060-201	①
1.56 (39.6) Window				
300	0.3	1.56 (39.6)	S050-301	S050BRAC
400	0.3	1.56 (39.6)	S050-401	S050BRAC
500	0.3	1.56 (39.6)	S050-501	S050BRAC
600	0.3	1.56 (39.6)	S050-601	S050BRAC
750	0.3	1.56 (39.6)	S050-751	S050BRAC
800	0.3	1.56 (39.6)	S050-801	S050BRAC
1000	0.3	1.56 (39.6)	S050-102	S050BRAC
1200	0.3	1.56 (39.6)	S050-122	S050BRAC
3.25 (82.6) Window				
400	0.3	3.25 (82.6)	S080-401	S080BRAC
500	0.3	3.25 (82.6)	S080-501	S080BRAC
600	0.3	3.25 (82.6)	S080-601	S080BRAC
750	0.3	3.25 (82.6)	S080-751	S080BRAC
800	0.3	3.25 (82.6)	S080-801	S080BRAC
1000	0.3	3.25 (82.6)	S080-102	S080BRAC
1200	0.3	3.25 (82.6)	S080-122	S080BRAC
4.25 (108.0) Window				
500	0.3	4.25 (108.0)	S090-501	S090BRAC
600	0.3	4.25 (108.0)	S090-601	S090BRAC
750	0.3	4.25 (108.0)	S090-751	S090BRAC
800	0.3	4.25 (108.0)	S090-801	S090BRAC
1000	0.3	4.25 (108.0)	S090-102	S090BRAC
1200	0.3	4.25 (108.0)	S090-122	S090BRAC
1500	0.3	4.25 (108.0)	S090-152	S090BRAC
1600	0.3	4.25 (108.0)	S090-162	S090BRAC
2000	0.3	4.25 (108.0)	S090-202	S090BRAC
2500	0.3	4.25 (108.0)	S090-252	S090BRAC
3000	0.3	4.25 (108.0)	S090-302	S090BRAC
6.31 (160.3) Window				
600	0.3	6.31 (160.3)	S025-601	S025BRAC
750	0.3	6.31 (160.3)	S025-751	S025BRAC
800	0.3	6.31 (160.3)	S025-801	S025BRAC
1000	0.3	6.31 (160.3)	S025-102	S025BRAC
1200	0.3	6.31 (160.3)	S025-122	S025BRAC
1500	0.3	6.31 (160.3)	S025-152	S025BRAC
1600	0.3	6.31 (160.3)	S025-162	S025BRAC
2000	0.3	6.31 (160.3)	S025-202	S025BRAC
2500	0.3	6.31 (160.3)	S025-252	S025BRAC
3000	0.3	6.31 (160.3)	S025-302	S025BRAC
3500	0.3	6.31 (160.3)	S025-352	S025BRAC
4000	0.3	6.31 (160.3)	S025-402	S025BRAC

Note

① Contact Eaton for further information.

Split Core ANSI Metering Accuracy

Primary Current Rating	ANSI B0.1 Metering Class at 60 Hz (Accuracy in %)	Window Size in Inches (mm)	Catalog Number
2.00 x 5.50 (50.8 x 139.7)			
400	2.4	2.00 x 5.50 (50.8 x 139.7)	M000-401
500	2.4	2.00 x 5.50 (50.8 x 139.7)	M000-501
600	2.4	2.00 x 5.50 (50.8 x 139.7)	M000-601
800	1.2	2.00 x 5.50 (50.8 x 139.7)	M000-801
1000	1.2	2.00 x 5.50 (50.8 x 139.7)	M000-102
1200	0.6	2.00 x 5.50 (50.8 x 139.7)	M000-122
1500	0.6	2.00 x 5.50 (50.8 x 139.7)	M000-152
1600	0.6	2.00 x 5.50 (50.8 x 139.7)	M000-162
2000	0.6	2.00 x 5.50 (50.8 x 139.7)	M000-202
4.10 x 7.10 (104.1 x 180.3)			
600	4.8	4.10 x 7.10 (104.1 x 180.3)	M050-601
750	4.8	4.10 x 7.10 (104.1 x 180.3)	M050-751
800	2.4	4.10 x 7.10 (104.1 x 180.3)	M050-801
1000	2.4	4.10 x 7.10 (104.1 x 180.3)	M050-102
1200	1.2	4.10 x 7.10 (104.1 x 180.3)	M050-122
1500	1.2	4.10 x 7.10 (104.1 x 180.3)	M050-152
2000	0.6	4.10 x 7.10 (104.1 x 180.3)	M050-202
2500	0.6	4.10 x 7.10 (104.1 x 180.3)	M050-252
3000	0.6	4.10 x 7.10 (104.1 x 180.3)	M050-302
3500	0.6	4.10 x 7.10 (104.1 x 180.3)	M050-352
4000	0.3	4.10 x 7.10 (104.1 x 180.3)	M050-402

Split Core Current Transformers

Primary Current Rating	Accuracy at 60 Hz (in %)	Window Size in Inches (mm)	Catalog Number
0.80 x 1.95 (20.3 x 49.5)			
100	5.0	0.80 x 1.95 (20.3 x 49.5)	M030-101
150	5.0	0.80 x 1.95 (20.3 x 49.5)	M030-151
200	4.0	0.80 x 1.95 (20.3 x 49.5)	M030-201
300	2.0	0.80 x 1.95 (20.3 x 49.5)	M030-301
400	2.0	0.80 x 1.95 (20.3 x 49.5)	M030-401
1.42 x 1.53 (36.1 x 38.9)			
100	5.0	1.42 x 1.53 (36.1 x 38.9)	M040-101
150	4.0	1.42 x 1.53 (36.1 x 38.9)	M040-151
200	1.5	1.42 x 1.53 (36.1 x 38.9)	M040-201
300	1.5	1.42 x 1.53 (36.1 x 38.9)	M040-301
400	1.5	1.42 x 1.53 (36.1 x 38.9)	M040-401
2.60 x 2.75 (66.0 x 69.9)			
200	1.0	2.60 x 2.75 (66.0 x 69.9)	M060-201
300	1.0	2.60 x 2.75 (66.0 x 69.9)	M060-301
400	1.0	2.60 x 2.75 (66.0 x 69.9)	M060-401
500	1.0	2.60 x 2.75 (66.0 x 69.9)	M060-501
600	1.0	2.60 x 2.75 (66.0 x 69.9)	M060-601
750	1.0	2.60 x 2.75 (66.0 x 69.9)	M060-751
800	1.0	2.60 x 2.75 (66.0 x 69.9)	M060-801
1000	1.0	2.60 x 2.75 (66.0 x 69.9)	M060-102
1200	1.0	2.60 x 2.75 (66.0 x 69.9)	M060-122
2.60 x 6.25 (66.0 x 158.8)			
500	1.0	2.60 x 6.25 (66.0 x 158.8)	M080-501
600	1.0	2.60 x 6.25 (66.0 x 158.8)	M080-601
800	1.0	2.60 x 6.25 (66.0 x 158.8)	M080-801
1000	1.0	2.60 x 6.25 (66.0 x 158.8)	M080-102
1200	1.0	2.60 x 6.25 (66.0 x 158.8)	M080-122
1500	1.0	2.60 x 6.25 (66.0 x 158.8)	M080-152
1600	1.0	2.60 x 6.25 (66.0 x 158.8)	M080-162
2000	1.0	2.60 x 6.25 (66.0 x 158.8)	M080-202
2500	1.0	2.60 x 6.25 (66.0 x 158.8)	M080-252
3000	1.0	2.60 x 6.25 (66.0 x 158.8)	M080-302

Clamp-On Current Transformers



IQ Accessories—Clamp-On CTs

General Description

Eaton's optional Clamp-on Current Transformers (CTs) are designed to be used in cases where there are no existing CTs or the existing CTs cannot be accessed, these clamp-on CTs can be used.

These clamp-on CTs are packaged individually. Most applications will require at least three clamp-on CTs, one for each phase.

Product Selection

Ordering Information

Description	Catalog Number
150–300–600A	IQAPORT0600CT
500–1000–1500A	IQAPORT1500CT

Shaded area denotes obsolete or discontinued products and services.

IQ 2000



IQ 2000 Model A



IQ 2000 Model B

Recommended Replacement

Production of IQ 2000 devices has been discontinued. The IQ 2000 can be replaced with the MP-3000 electronic motor protective relay and the IQ DP-4000 electronic meter. The MP-3000 provides motor current protective relaying, while the IQ DP-4000 provides complete electrical metering and voltage protective alarming functions. For specific application consideration, contact your local Eaton Field Sales office.

IQ Analyzer 6000/6200



IQ Analyzer 6000/6200

Eaton’s Cutler-Hammer IQ Analyzer 6000/6200 is a complete solution for users who want to monitor all aspects of their electrical distribution system. It provides extensive metering, power quality analysis, remote input monitoring, control relaying, analog input/outputs and communications capability. All programming can be done through the faceplate or through the communications option. Its online Help Pushbutton feature displays information on device operation, programming and troubleshooting.

Features and Benefits

- All information accessible through communications port
- Quality true rms readings through 50th harmonic
- Meets ANSI C12.16 Class 10 revenue metering spec
- Accurate readings for non-sinusoidal waveforms with up to 3.0 crest factor
- Screens display auto ranging units, kilo units, mega units as needed
- 10-digit energy readings
- Displays multiple parameters at the same time
- Programmable custom screens. The IQ Analyzer Model 6200 with waveform display at the device and sub-cycle voltage disturbance capture provides the capability to monitor a wide range of harmonic parameters. These include harmonic voltage, current magnitudes and phase angles, as well as system disturbances such as transient voltage disturbances and sub-cycle voltage interruptions. This unit is also available in a portable version.

Recommended Replacement

Eaton’s IQ Analyzer 6400/6600

RTD Modules



Universal RTD Module

Recommended Replacement

The RTD Modules for the IQ 2000 have been discontinued. Now available is the new Universal RTD Module that replaces all of the RTD modules for the Model A and B IQ 2000 units, as well as the IQ 1000, IQ 1000 II and all current IQ metering and protection products.

Product Selection

Universal RTD

Description	Catalog Number
Universal module	URTD

Shaded area denotes obsolete or discontinued products and services.

IQ Data Plus and IQ Data Plus II



IQ Data Plus II

Eaton’s Cutler-Hammer IQ Data Plus was discontinued in 1989 and was replaced by the IQ Data Plus II. The IQ Data Plus II was discontinued in 1998.

Recommended Replacement

IQ DP-4000

IQ 1000 and IQ 1000 II



IQ 1000 II

Recommended Replacement

Both the IQ 1000 and the IQ 1000 II have been discontinued and replaced by the MP-3000 for complete motor protection. A detailed application note (MP3K01R4.PDF) describing replacement of the IQ 1000 II with an MP-3000 is available at www.eaton.com.

IQ Data



IQ Data

Eaton’s Cutler-Hammer IQ Data provides simultaneous current and voltage metering. In one compact, standard package, this device provides an alternative to individually mounted and wired ammeters, voltmeters, and ammeter and voltmeter switches.

Features and Benefits

- Space savings in structure—replaces ammeter, voltmeter, selector switches and frequency meter (IQ Generator)
- Standardization of design—one door-mounted device
- Direct voltage input up to 600V—no additional potential transformers (PTs) required
- User-friendly—field-settable DIP switches
- Standard model derives power from separate source 120/240 Vac supply
- Only two style numbers
- No need to stock multiple units for different current transformers (CT) and PT ratios
- Interface capability to computer network for data collection, storage and/or printout via IMPACC
- Membrane faceplate, designed and tested to perform in a harsh industrial environment (Type 3R, 12)

- Retains preset parameters through power failure with use of field-settable DIP switches (no batteries)

Product Selection

IQ Data

Description	Catalog Number
Basic metering	IQDATA
Basic metering with three-phase power module	IQDATAPM

Recommended Replacement

IQ DP-4000

Shaded area denotes obsolete or discontinued products and services.

IQ Generator



IQ Generator

Eaton’s Cutler-Hammer IQ Generator provides simultaneous current and voltage metering. In addition, the IQ Generator monitors frequency. This device provides an alternative to individually mounted and wired ammeters, voltmeters, ammeter and voltmeter switches, and frequency meters.

Features and Benefits

- Space savings in structure—replaces ammeter, voltmeter, selector switches and frequency meter (IQ Generator)
- Standardization of design—one door-mounted device
- Direct voltage input up to 600V—no additional PTs required
- User-friendly—field-settable DIP switches
- Standard model derives power from separate source 120/240 Vac supply
- Only two style numbers
- No need to stock multiple units for different CT and PT ratios
- Interface capability to computer network for data collection, storage and/or printout via IMPACC
- Membrane faceplate, designed and tested to perform in harsh industrial environment (Type 3R, 12)
- Retains preset parameters through power failure with use of field-settable DIP switches (no batteries)

Product Selection

IQ Generator

Description	Catalog Number
Basic metering	IQGEN
Basic metering with three-phase power module	IQGENPM

Recommended Replacement

IQ DP-4000

IQ 300



IQ 300

Eaton’s Cutler-Hammer IQ 300’s thin display and flexible mounting capabilities make it perfectly suited for any application where an accurate, multifunction meter is desired, such as panelboard and switchboard mains and feeders, motor control centers, and both low voltage and high voltage metal-enclosed switchgear.

Features and Benefits

- Bright display with eight large numeric digits along with a 10-character description of the measured value makes the IQ 300 ideal for switchgear mounting
- Base unit can be display mounted for simple, one-hole installation
- Base unit can be mounted up to 10 feet (3m) away from display and has three mounting options

Product Selection

IQ 300

Description	Catalog Number
IQ 310 complete meter with base module, display and 14.00-inch (355.6 mm) cable—no communications, no pulse output	IQ310
IQ 320 complete meter with base module, display and 14.00-inch (355.6 mm) cable—with INCOM communications and pulse output	IQ320
IQ 330 complete meter with base module, display and 14.00-inch (355.6 mm) cable—with INCOM communications, pulse output, two contact outputs, two digital inputs, one analog input and anti-tamper seal	IQ330
IQ 330M complete meter with base module, display and 14.00-inch (355.6 mm) cable—with RS-485 Modbus communications, pulse output, two contact outputs, two digital inputs, one analog input and anti-tamper seal	IQ330M
IQ 300D display module only	IQ300D

Recommended Replacement

IQ DP-4000/4100

Shaded area denotes obsolete or discontinued products and services.

IQ 210/220



IQ 210/220

General Description

Eaton’s IQ 210/220 compact size and flexible mounting capabilities make it perfectly suited for machine control panels such as panelboard and switchboard mains and feeders, low voltage metal-enclosed switchgear feeders, motor control centers, and especially for individual load monitoring. The base module can be display mounted, panel mounted, DIN rail mounted or side mounted. The display fits into a standard 1/4 DIN cutout, and for retrofit applications, a 100 mm ANSI collar is available.

One IQ 210/220 provides an alternative to an assortment of individually wired and mounted ammeters, voltmeters, ammeter and voltmeter switches, wattmeters, VAR-meters, power factor meters, frequency meters, watthour and demand meters.

ANSI C12 Class 10 revenue metering accuracy makes the IQ 200 an ideal choice for submetering and sub-billing applications.

The IQ 200 can be easily programmed and monitored from the faceplate keypad that features a 4 line x 20 character LED backlit LCD display. Opting for the compatible PowerNet system allows the user to program and monitor the meter remotely from a PC.

Retrofit Opportunities

- Retrofit of existing electrical distribution systems with the IQ 210/220 for load and energy monitoring
- Five mounting options makes installation easier

Ratings

- Application to 200 kV, no PTs to 600V
- CT ratios selectable 5 to 8000A
- Single-phase two- or three-wire; three-phase three- or four-wire

Product Selection

IQ 210/220 Ordering Information

Description	Catalog Number
IQ 210 complete meter — includes base, display and 14.00-inch (355.6 mm) cable	IQ210
IQ 220 complete meter — includes base display module and 14.00-inch (355.6 mm) cable with INCOM communications and KYZ output	IQ220
IQ 220 transducer base only with INCOM communications and KYZ output	IQ220TRAN
IQ 200D IQ 210/220 display module	IQ200D
3 foot (0.9m) Category 5 cable	IQ23CABLE
6 foot (2.0m) Category 5 cable	IQ26CABLE
10 foot (3.0m) Category 5 cable	IQ210CABLE

Recommended Replacement

IQ 230

Shaded area denotes obsolete or discontinued products and services.

IQ 110/115 Electronic Power Meters



IQ 110 Electronic Power Meter

General Description

The IQ 100 Meter family provides capabilities you would not normally expect in affordable, compact meters, such as fast sampling rate and accurate metering for a full range of power attributes. Providing the first line of defense against costly power problems, Eaton’s IQ 100 series electronic power meters can perform the work of an entire wall of legacy metering equipment utilizing today’s technology.

When space is at a premium, yet you need ANSI C12.20 accuracy, the IQ 100 series fit the bill. These meters are ideal for electrical equipment assemblies, machine control panels, such as panelboard and switchboard mains and feeders, low voltage metal-enclosed switchgear feeders and motor control centers. Requiring far less space than other meters with similar functionality, IQ 100 series fit into a standard ANSI or IEC cutout on a panelboard or other electrical equipment, and therefore fit easily into retrofit applications.

Features and Benefits

- Measure and display real-time information about critical power parameters with a sampling rate of 400 samples per cycle
- Monitor power utilization and quality with ANSI C12.20 accuracy (0.5%)
- Verify meter accuracy with KYZ test pulse self-certification capabilities
- Optional Modbus RTU communications
- Available as transducer only or with display
- Designed to accommodate upgrades
- Integrate into Eaton’s Power Xpert Architecture for a holistic system-level view

Product Selection

IQ 110/115 Ordering Information

Description	Catalog Number
Measures voltage and current	IQ 110
Measures voltage, current and frequency	IQ 115

Recommended Replacement

IQ 130/140

Shaded area denotes obsolete or discontinued products and services.

IQ Power Sentinel



IQ Power Sentinel

General Description

Like the IQ Energy Sentinel, the IQ Power Sentinel is a highly accurate microprocessor-based submeter designed to monitor power and energy. In addition to watts, watthour and watt-demand, the IQ power sentinel monitors current, voltage, reactive power (VARs), apparent power (VA), power factor and frequency. The IQ Power Sentinel offers an accurate and economic alternative to separate meters and transducers.

The IQ Power Sentinel is only available in the universal mount with internal CTs up to 400 amperes.

Features and Benefits

Features

- Monitors (accuracy stated full scale)
 - AC line current (each phase) $\pm 0.5\%$
 - AC line-to-line voltage $\pm 0.5\%$
 - AC line-to-neutral voltages $\pm 0.5\%$
 - Watts (each phase and total) $\pm 1.0\%$
 - VARs (each phase and total) $\pm 1.0\%$
 - VA (each phase and total) $\pm 1.0\%$
 - Apparent Power Factor (each phase and total) $\pm 0.5\%$
 - Displacement Power Factor (each phase and total) $\pm 0.5\%$
 - Demand (total watts) $\pm 1.0\%$
 - Frequency $\pm 0.5\%$
 - Watthours $\pm 1.0\%$

- Built-in CTs version up to 400 amperes
- Panel or DIN rail mounted
- Powered directly off the line
- Built-in communication capability
 - Address set by DIP switches
 - Communication at 9600 baud
 - Noise immune INCOM protocol
- Choice of operator interfaces
 - Subnetwork Master Local Display
 - Breaker Interface Module
 - Power Management Energy Billing software
 - Power Management Software
- UL and CSA listed
- CE mark

Benefits

- One device replaces multiple meters and/or transducers
- Improved system accuracy
- Savings in product cost
- Savings in space
- Savings in installation cost
- No external power source is needed
- Permits remote monitoring and interconnection with programmable logic controllers and building management systems. For further information see section on Power Management Software Systems
- Designed to interface directly with Power Management Software Energy Billing software
- Flexibility—displays what is needed where it is needed
- Power Management Software

Product Selection

IQ Power Sentinel Ordering Information

Description	Catalog Number
Universal with internal CTs, 120/240, 240, 208Y/120	IQPSUI208
Universal with internal CTs, 220/380, 230/400, 240/415	IQPSUI400
Universal with internal CTs, 480, 480Y/277	IQPSUI480
Universal with internal CTs, 600, 600Y/347	IQPSUI600

Recommended Replacement

PM3

Shaded area denotes obsolete or discontinued products and services.

IQ Multipoint Energy Submeter II



IQ Multipoint Energy Submeter II

General Description

Eaton's IQ Multipoint Energy Submeter II is a revenue class electronic submetering device that can be mounted in panelboards or switchboards. When mounted in a panelboard or switchboard, the IQ Multipoint Energy Submeter II provides customers with an integrated power distribution and energy metering solution that saves space, reduces installation labor and lowers total cost.

Features and Benefits

The IQ Multipoint Energy Submeter II offers low-cost metering of kW and kWh for multiple tenants of residential and commercial office buildings for one- to three-phase voltage loads not exceeding 347/600 volts. The IQ Multipoint Energy Submeter II contains INCOM networking to chain together multiple meters in locations throughout the facility. See above for a typical apartment building layout.

- Multipoint electrical energy metering
- Built-in communication interface

- Flexible metering configuration
- Monitors single-phase and three-phase loads from 120 Vac to 600 Vac in three voltage ranges
- Monitors power in watts and energy in watthours for up to 16 Current Sensors
- Very low profile design, less than 1.50 inches (38.1 mm) in height
- Energy values stored in non-volatile memory
- Stores extensive energy profile data for each metering point. Can be used to identify coincidental peak demand contribution
- Space-saving stacking design allows two units to be mounted together
- Supports Time-of-Use energy monitoring
- Demand interval adjustable from 5 to 60 minutes
- Measures bus voltage
- Front panel LEDs provide status of unit and communication activity
- Meets rigid ANSI C12.1 and IEC 61036 accuracy specifications for revenue meters
- Can be directly mounted in a UL-approved panelboard or switchboard

Product Selection

IQ Multipoint Energy Submeter II Ordering Information

Description	Catalog Number
IQ Multipoint Energy Submeter II 120V with INCOM	IQMESIIN1
IQ Multipoint Energy Submeter II 277V with INCOM	IQMESIIN2
IQ Multipoint Energy Submeter II 347V with INCOM	IQMESIIN3
Current Sensors—5 amperes, Qty. 3	CS005 ^①
Current Sensors—50 amperes, Qty. 6	CS050
Current Sensors—70 amperes, Qty. 6	CS070
Current Sensors—125 amperes, Qty. 3	CS125
Current Sensors—200 amperes, Qty. 3	CS200
Current Sensors—400 amperes, Qty. 3	CS400
Current Sensor Extensions—4 feet (1.2m), Qty. 6	CSET04
Current Sensor Extensions—8 feet (2.4m), Qty. 3	CSET08
Current Sensor Extensions—16 feet (4.9m), Qty. 3	CSET16

^① CS005 is not discontinued and is still being used.

Recommended Replacement

Power Xpert Multi-Point Meter

Replacement Capabilities—Discontinued Product—Recommended Replacement

Further Information

Publication Number	Description
Metering Devices	
TD02600001E	Selection Chart
TD02601007E	Power Xpert 4000/6000/8000
TD02601017E	Power Xpert 2000
TD150006EN	Power Xpert Multi-Point Meter
TD02601016E	IQ 250/260
TD02601015E	IQ 130/140/150
TD02601019E	IQ 150S/250S
TD02601018E	IQ 35M
TD.17.02B.T.E	IQ Analyzer
TD.17.03A.T.E	IQ DP-4000
TD.17.31.T.E	IQ 300
TD.17.06A.T.E	IQ 200
TD02601003E	IQ 110/115
TD.17.07.T.E	IQ Sentinels
TD17C02TE	IQ Multipoint Energy Submeter II
TD17C01TE	Portable IQ Analyzer
TD17C03TE	Optional Clamp-on CTs
TD.17.08A.T.E	IQ DP-4000 I/O Module
TD.17.08A.T.E	IQ Analyzer/IQ DP-4000 Auxiliary Power Supply
TD02601002E	Current Transformers
Protective Relays	
TD02600001E	Selection Chart
TD.17.10.T.E	Digitrip 3000 Overcurrent Relay
TD.17.11.T.E	MP-3000 Motor Protection Relay
TD.17.30.T.E	FP-5000 Feeder Relay
TD.17.12.T.E	Dual-Source Power Supply
TD.17.13.T.E	Digitrip 3000 Optional Drawout Case
TD.17.14.T.E	Universal RTD Module
TD.17.08A.T.E	IQ DC Power Supply

Pricing Information**IQ/PXM Products**

Vista/VISTALINE™ Discount
Symbol C10-S24.

DT-3000

Vista/VISTALINE Discount
Symbol MV-3.

Monitoring Software
and Communications



11 Communication Systems

Product Description	V12-T11-2
PowerNet Software	V12-T11-2
Eaton's Electrical Services & Systems	V12-T11-3
Power Xpert Software	V12-T11-4
Power Xpert Reporting	V12-T11-6
Technology Upgrades	V12-T11-8
Communications Hardware	V12-T11-12
mMINT	V12-T11-12
Power Xpert Gateway 200E	V12-T11-13
Power Xpert Gateway 400E/600E/800E	V12-T11-16
PONI Devices	V12-T11-25
IPONI/MPONI	V12-T11-25
MINT II	V12-T11-25
Addressable Relay II	V12-T11-25
IMPCABLE	V12-T11-26
Further Information	V12-T11-26
Pricing Information	V12-T11-26

PowerNet Software

Integrated PowerNet Support

PowerNet™ (available on the Power Xpert® Software DVD). Updates to the PowerNet system are available; however, the recommended update path is to upgrade to Power Xpert Software. See **Page V12-T11-4** for details on Power Xpert Software.

General Description

The features of Eaton's PowerNet software suite are available as a standard part of Power Xpert Software. PowerNet is a family of software applications, client/server configuration, that help provide a window into an electrical distribution system. Existing PowerNet systems can be easily integrated with Power Xpert Software.

PowerNet Features

- Connectivity bundle
 - Communication to 1000 INCOM™ devices
 - Auto learn of all INCOM connected devices for maximum usability
 - Security configuration
 - Trending/logging configurations
 - Device set point editing/printing/viewing
 - MSDE/SQL data storage
 - Dynamic Data Exchange (DDE) server
 - OLE for Process Control (OPC) server
 - Modbus RTU Gateway to data from Eaton INCOM communicating devices
- Power quality bundle
 - Viewing of captured waveforms
 - Up to eight cycles of actual waveform
 - Zoomed-in view of high-speed waveform samples
 - Spectrum chart showing frequency content and magnitude (Fourier analysis)
 - CBEMA/ITIC representation of events
 - Top down access to specific Waveform events from event lists and CBEMA/ITIC curves
 - Trip curve display for coordination and selectivity needs
 - Log-log coordination curve plotted on-screen for trip units and motor protective relays with the click of a button
- Online modification of trip curve pickups and time delays; instant verification of coordination with an updated trip curve
- Automatic scale adjustment based on device pickup level
- Addition or removal of trip curves directly from the display screen
- Color-coded curves tied to the device description for added clarity
- Overlay multiple curves
- View motor start profiles next to motor protection relay trip curve



PowerNet Digitrip Screen Viewed in Power Xpert Software

Eaton's Electrical Services & Systems

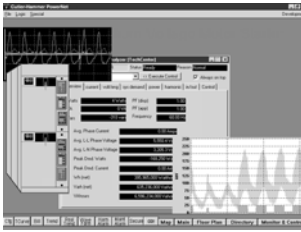

PowerNet Software

Supplementing the hardware and software, Eaton's Electrical Services & Systems can provide local startup and integration services to customize the PowerNet system to your specific business needs. Basic field startup, integration of PowerNet into other plant systems, and remote

monitoring of the plant with industry experts in energy and power quality are all services provided by our local field representatives. These services will ensure that you get maximum return on all of your system investments.

Note: PowerNet systems do not consist of exclusively Cutler-Hammer® (Eaton) products. Hundreds of drivers exist to communicate with many third-party meters, protective relays and PLCs.

Flexible Network Architecture

A PowerNet network can be built in a variety of configurations. Systems can be built using existing Ethernet networks as the backbone, as well as on a dedicated

twisted shielded pair running throughout a facility. Telephone, radio and fiber modems can be used to create networks where it is cost prohibitive to run dedicated cables. The most flexible, highest performance network architecture includes a dedicated twisted shielded pair network within the switchboard or equipment room connecting into a high speed Ethernet backbone. For a layout of a typical facility network, refer to the *15th Edition of the Consulting Application Guide*.

Ethernet Backbone

TCP/IP Ethernet networks have become the worldwide standard for moving information. Industry has recognized Ethernet as a high

speed, flexible, low-cost network that is not vendor dependent. The PowerNet network uses a standard TCP/IP Ethernet as the high speed backbone for carrying information to clients across the plant or across the world.

Dedicated Twisted Shielded Pair

Customers who desire to run a dedicated network for the power monitoring network have a choice between a dedicated Ethernet network or running a twisted shielded pair. A network of 1000 devices running up to 10,000 feet can be networked through one twisted shielded pair of wire.

Eaton PowerNet System

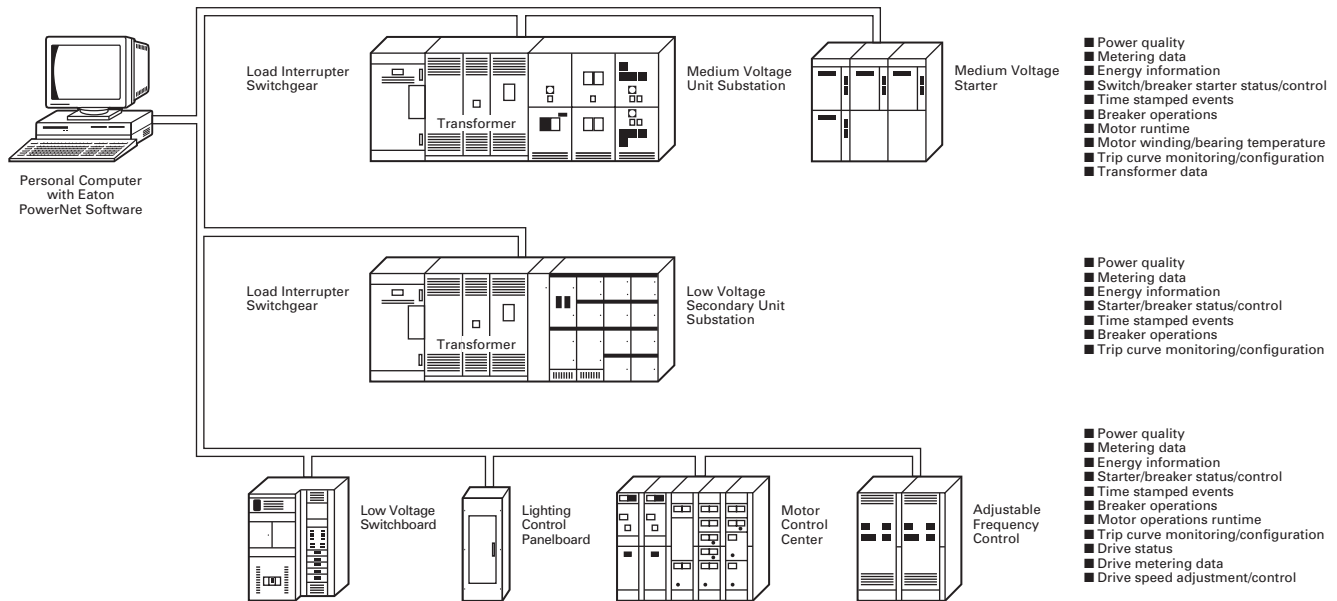

Power Xpert Software

General Description

Power Xpert Software aggregates the information arriving from different types of device families via various communication methods. Its unique Web-based design, alarm bubble-up and advanced trend and waveform analysis tools help you to quickly turn your attention to the most important events and to identify reliability issues and cost-saving opportunities. The standard custom graphic package, the Layout Manager, with an icon library and standard vertical templates, allows you to import and mimic your physical environment and gauges. Open protocol support makes Power Xpert Software compatible with most newer generation third-party equipment. Older legacy, proprietary protocols are supported by Power Xpert Gateways (see **Page V12-T11-13**), and custom software drop-in drivers made available by Eaton. Power Xpert Software is the first power system software of this caliber to put all these powerful features at your fingertips.

Product Selection Guide

Power Xpert Software Professional Edition

- Geared toward end users, with built-in support for Eaton power distribution products such as switchgear, UPSs, breakers, PDUs, RPPs, meters, relays, VFDs and MCCs, among others
- Eaton products connect with the software directly via an Ethernet connection, while legacy devices use a Power Xpert Gateway to Web-enable their communications
- A subset of third-party meters and devices are supported as standard via the gateway connection

Power Xpert Software Enterprise Edition

- Geared toward advanced power users, system integrators and enterprises with heterogeneous device spectrum and system developers who can take advantage of the included SNMP and Modbus integration development utilities
- Extensive support for third-party devices via standard SNMP and Modbus TCP protocols
- Large variety of ready made, optional third-party drop in drivers available

Key Features

- Connects to your existing network
- Data trending and graphing for detailed information for troubleshooting, problem prevention and costs savings
- Web-based views that allow access to critical information from any location via a Web browser
- A modular, scalable architecture that allows the addition of capabilities and devices as the power system expands
- Alarm conditions bubble up through the system to allow personnel to identify which device is in alarm and where it is located
- All the functionality of Eaton's PowerNet software suite
- Connectivity to a wide range of Eaton and third-party devices. For a full list of compatible devices, refer to the hardware compatibility list found at www.eaton.com/pxs



Power Xpert Software Layout Manager

The Power Xpert Software Layout Manager module provides the user a library of powerful design tools and standard templates for the creation of custom Human-Machine Interface (HMI) graphical layouts. Objects can be easily animated, various gauges can be selected, and custom bitmaps can be imported with little effort.

Power Xpert Software Edition Features

Feature Sets	Power Xpert Software Professional Edition	Power Xpert Software Enterprise Edition
Server module	■	■
Trend viewer module	■	■
Layout manager module	■	■
Quality manager module	■	■
Eaton device support (switchgear, UPSs, breakers, ePDUs, meters, relays, VDFs, MCCs, etc.)	■	■
Power Xpert Gateway third-party device support	■	■
SNMP connector		■
Modbus connector		■
Optional third-party driver support		■
Custom third-party device driver support		■

Note: For a full list of supported devices, see the Hardware Compatibility List at www.eaton.com/pxs.

For detailed information regarding Power Xpert Software modules, system requirements, supported devices and more, please see www.eaton.com/pxs or the *Consulting Application Guide*, CA08104001E, Tab 2.

Power Xpert Software General Features

Features

General

Web browser user interface
 Web-based monitoring capabilities
 Downloadable software version updates

Event Notification

Event notification via e-mail notification
 Event notification via pagers, text message or third-party interfaces
 Alarm state management
 Event indicator displayed without Web page active
 Alarm/event searching and filtering
 Waveform attached to applicable power event
 Web browser based waveform viewing
 Alarm capabilities based on device driven events

Analysis and Trending

Graphic trend viewer
 Chart or data option selection
 Multiple trends display
 Multiple axis support
 View multiple variables (i.e., Ia, Ib, Ic, Vab, Vbc, etc.) for a single waveform
 Standard COMTRADE file format support
 Customizable trend viewer look and feel
 Fixed or custom time frames
 Trend analysis capabilities
 Data export

Custom Graphics and Layouts

Custom graphics development via Web browser
 Four user view example templates included as standard
 iFrame capability
 Browser portal widget support
 Streaming media support
 Graphic object library included as standard
 ISO standard electrical picture objects available
 Graphic files import capability
 Graphic object animation capability
 Gauge object library support
 External Web Links support
 Alarm bubble-up support through several page layers

Features

UPS Shutdown

File saving during shutdown
 Automatic, orderly and sequential shutdown
 Parallel redundant UPS shutdown capability

Security and Administration

Windows authentication security
 Two tier secure system access support
 SSL
 Secure Web browser access (support for HTTPS)
 Trend object support

Time Synchronization

Time synchronization support for connected devices with 1 millisecond time resolution

Export and Integration

Extended Excel® spreadsheet support
 SQL database query support

Logs

System log
 Error log

Service

Eaton help desk services (1-877-ETN-CARE)
 Turnkey startup service

System Backup

Power Xpert Software system backup

Documentation and Training Videos

System Administrator's Guide
 Power Xpert Software User's Guide
 Layout Manager Guide
 Quick Start Guide
 Power Xpert Software introduction and training video
 Power Xpert Reporting introduction and training video

Power Xpert Reporting

Power Xpert Reporting Architectural Overview

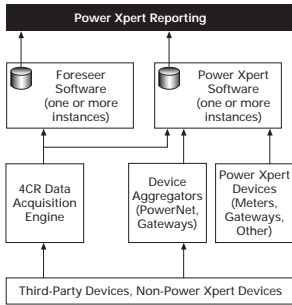

Power Xpert Reporting brings the power system information together to compare and contrast. Power Xpert Reporting provides a standard set of reports, including:

- **Data Center Efficiency Report:** A summary of data center infrastructure efficiency and power usage effectiveness, including such information as temperature and humidity, and energy consumption

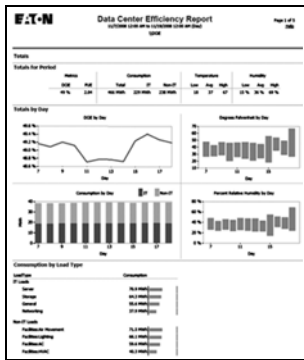

Data Center Efficiency Report

- **Greenhouse Gas Report:** Captures the six offensive greenhouse gases: carbon dioxide, sulfur dioxide, nitrogen oxide, mercury, methane and nitrous oxide broken down by selected locations within a facility

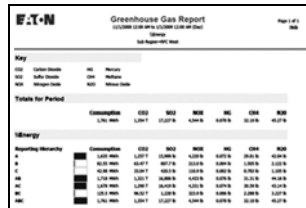

Greenhouse Gas Report

- **Utilities Report:** Captures consumption of water, air, gas, electricity and steam (WAGES)

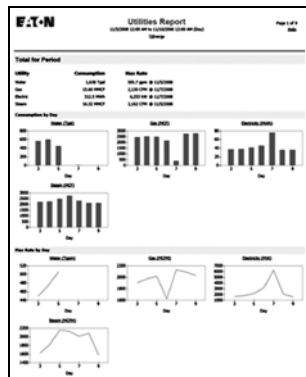

Utilities Report

- **Capacity Summary Report:** The summary of top- and bottom-loaded circuits, as well as loading details for each circuit according to user-defined date/time range and facility hierarchy location

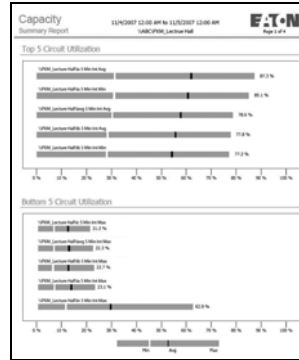

Capacity Summary Report

- **Branch Circuit Monitoring Report:** Determine branch circuit loading levels at a glance with color-coded graphics indicating loading status against capacity. Redundant sources can be reviewed, as well as single source loads



Branch Circuit Monitoring Report

- Energy Summary Report:** The summary of consumption (kWh) and demand (kW) for a user-defined date/time range and facility hierarchy location

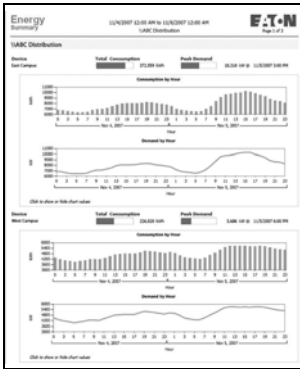

Energy Summary Report

- Energy Cost Allocation Report:** The total energy bill dollar value or a cost per kWh across a facility hierarchy for a user-defined date/time range

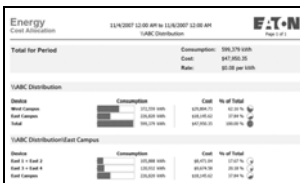

Energy Cost Allocation Report

- Power Quality Report:** The distribution and trend for amps, volts and THD according to user-defined date/time ranges and facility hierarchy location

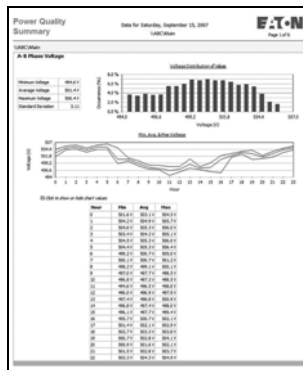
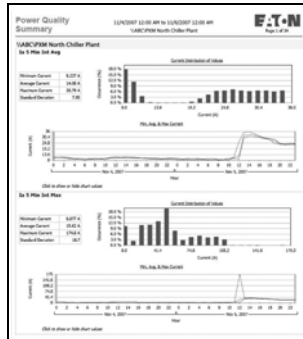

Power Quality Report

- Event Summary Report:** Provides a Pareto chart of events according to user-defined date/time ranges and facility hierarchy location

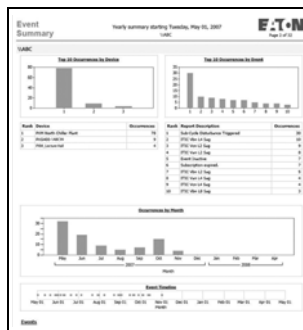

Event Summary Report

- Joint Commission Report:** Standard Joint Commission Compliant Report supports hospital power test requirements. It checks events, key metrics of generators and automatic transfer switches (ATS) during generator testing at user-defined date/time ranges and facility hierarchy location

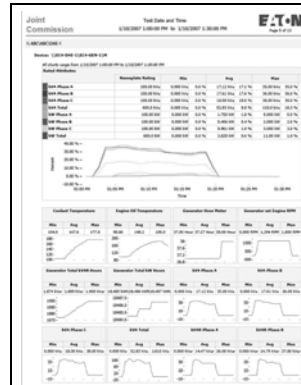

Joint Commission Report

- Service Offerings Available Power Xpert Startup Service Packs**

At Eaton, we want to make it as easy and non-disruptive as possible to implement our Power Xpert products. Eaton offers several startup service packs from partial help to full turnkey solution implementation.

All services are performed by authorized Eaton's Electrical Services & Systems group personnel.

Startup Service Packs Include the Following Services

- Startup Scope Determination:** Eaton services will help you to evaluate your service needs and check that the service pack you have selected has appropriate coverage for your circumstances
- Pre-Installation Checklist:** Eaton services will contact you to go through the pre-installation checklist, which ensures efficient, prime quality installation and configuration services
- Installation and Configuration:** Eaton services will install Power Xpert Software and configure it for operation according to startup scope determination. Configuration may also include creating custom graphic layouts if necessary and if required
- System Test:** Eaton services will test the Power Xpert Software for operability and will validate communications with key components
- Optional Hands-On Training:** If required, Eaton services can provide hands-on training for Power Xpert Software, using the software on-site or using simulated demo systems

Selecting the Appropriate Service Pack ①

Startup Service Product	Number of Eaton Devices to be Integrated				Non-Eaton Devices ③
	<15 ②	15-30 ②	31-75 ②	>75 ②	
Power Xpert 1 Day	■				
Power Xpert 2 Day		■			
Power Xpert 5 Day			■		
Customer Fixed Price Quote ④				■	■

Notes

- ① Available and valid in continental United States only.
- ② Typical number of Eaton devices that can be configured in the Power Xpert Software during the course of the selected Startup Service Pack.
- ③ We strongly recommend a review of the latest Hardware Capability List at www.eaton.com/pxs.
- ④ Please call the Technical Resource Center for custom Startup Service at 800-809-2772, option 4, 1, for a price quote.

The number of devices that can be configured during the course of a selected Start Pack can vary depending on the devices' installation readiness levels. Maximum numbers indicated require full configuration readiness levels defined in the Power Xpert Startup Services Checklist document in the service's brochure at www.eaton.com/pxs.

Technology Upgrades

The INCOM network consists of a twisted shielded pair of conductors that interface to one of the following hardware devices:

- Master INCOM Network Translator II (MINT II) attached to the COM port of computer
- Power Xpert Gateway (PXG 200E, PXG 400E, PXG 600E, PXG 800E)

When updating the software at an existing installation, careful consideration should be administered and all new PowerNet interface hardware options considered when constructing the update bill of material.

In some instances, the computer running the Series III software is an industrial computer that has no monitor, keyboard or mouse, and is installed as a part of a larger system solution. This device is referred to as the Power Xpert Gateway, catalog numbers PXG 200E, PXG 400E, PXG 600E and PXG 800E. In these situations, there is, typically, a main system computer that uses additional software solutions to integrate the system. The Power Xpert Gateway is used as a way of using the infrastructure of the currently installed Local Area Network (LAN) as a means of collecting data from remote substations. This is not the only item that will require updating if existing in the system.

Series III system solutions, in some cases, incorporated a lot of non-standard equipment to meet various connectivity needs. In some instances, where multiple COM ports are required, port splitters were used to expand one COM port into 8, or even 16, equivalent COM ports for communications with remote or local MINT II devices (DIGIBOARD). These various system configuration requirements will have to be ascertained and accounted for before updating.

Update Path

Note: When updating the computer for the new system software, ISA slots may not be available. In these instances, PXG-E products are typically employed.

- MINT II devices are compatible with PowerNet and will not require updating
- NetLink products should be replaced with PXG 600E or PXG 800E hardware
- mMINT

For those unique applications that may have Ethernet and Modbus® on the same gateway node. For Ethernet, use the correct PXG-E model, and for Modbus serial, use the mMINT.

In all other instances where custom third-party equipment was used to achieve connectivity solutions, third-party vendors should be consulted for appropriate update paths and careful consideration of compatibility with the new PowerNet software to ensure a smooth update path.

Inventory Existing Series III Software

Series III software consists of the main Series III package that includes the engine communicating to the devices through the MINT II hardware. Series III came in various packages supporting 20, 200 and/or 1000 devices. The Series III software included most functionality in a single operator interface. It included, but was not limited to, the following features:

- Monitoring of all real-time parameters from the configured devices
- Access to change or to view the set points of those devices that support this functionality
- Logging of selected parameters to ASCII Comma Separated Variable (CSV) files
- Device Alarming notification and confirmation viewable via user interface and historically captured in ASCII CSV files
- Built-in Dynamic Data Exchange (DDE) server capabilities

In addition to the basic Series III software package, add-on applications were available that expanded the basic functionality of the monitoring software including, but not limited to, the following features:

- Energy billing and cost allocation
- Waveform display
- Trip curve display
- Modbus Gateway capabilities

Master PC Requirements

When planning to update a Series III system, replacement of the personal computer will be required. Due to the operating system as well as memory requirements, the Series III computer will not meet the requirements for a PowerNet computer.

Update Path

The PC requirements may change with later versions of the PowerNet software applications. Please refer to the Eaton website for updated information on PC requirements: www.eaton.com.

Series III and Old NetPower Codes with PowerNet Product Codes

Description	New PowerNet v. 3.3x Product Codes	IMPACC Series III Product Codes										PowerNet v.3.22 and Older Product Codes																								
		Core			Add-on Mods			Energy Billing				Core			Add-on Mods				Energy Billing																	
		S3020	S30200	S31000	WDISP3	MODGATE3	TRIPDP3	ELOG3	EBILL20	EBILL200	EBILLUL	ETREND	ETRACK	NP CORE2	NP CORE20	NP CORE100	NP CORE200	NP CORE1000	NP MONITOR	NPEVENT	NP WAVEFORM	NP SETPOINT	NP TREND	NP OPC	NP DDE	NP MODBUS	NP COREMOD	NP BILL20	NP BILL200	NP BILL1000	NP BILLTRACK	NP BILLDDE				
Connectivity Bundles Device Support																																				
5-device	PNCONNECT5																																			
10-device	PNCONNECT10																																			
32-device	PNCONNECT34	■														■																				
100-device	PNCONNECT100																■																			
200-device	PNCONNECT200		■															■																		
500-device	PNCONNECT500																																			
1000-device	PNCONNECT1000			■															■																	
PowerNet Bundles																																				
Standard client	PNSTD																																			
Power quality	PNPQ				■		■																													
Integrator Package																																				
Includes OPC, DDE, and Modbus Gateway	PNINTEGRATOR				■																															

Identify Graphics Interface Used

The IMPACC Series III software was sold with an option for an Enhanced Graphics application, a Wonderware InTouch software HMI solution. The screens were typically developed by Eaton as a turnkey solution, but this software could be purchased separately with development performed by the customer, or by independent local integrators.

The graphics application could be located on the local Series III computer or on remote networked computers. It is important to identify all computers in the system that have the Enhanced Graphics application installed.

Update Path

PowerNet is compatible with Wonderware InTouch version 7.1 and above. All HMI software locations will require updating to the latest version via the following catalog numbers:

Note: When updating the graphics application to interface with the PowerNet DDE Server, due to DDE Tag changes, a review of the Tags displayed and used for control will be required for proper modification. Development time must be allocated for this update.

For those computers networked and running Wonderware InTouch runtime or view-only nodes, PowerNet DDE can be removed and local DDE Server client applications installed for more reliable and quality local DDE communications.

Identify Connectivity Solutions Employed

Communication system solutions will, in some cases, implement software and/or hardware equipment to share the information gathered from installed meters, relays and I/O devices with other software and/or systems including Distributed Control Systems (DCS), Building Management Systems (BMS) or Programmable Logic Controllers (PLC).

Connectivity with the Series III system solutions included the following methods:

Dynamic Data Exchange (DDE)

Used in conjunction with Human Machine Interface (HMI) software applications such as Wonderware and Intellusion. These applications could also be installed on remote computers when PowerNet DDE is used to share information over a network.

When reviewing an installation, this fact may not be readily discernible and some investigation may be necessary.

Update Path

When updating the Series III software in the section above, DDE comes as a part of the update path.

Note: For remote nodes running Wonderware or any other HMI software application, the following catalog number can be purchased and installed on the remote PC, eliminating the need for implementation of the Microsoft® NETDDE solution.

NP DDE PowerNet DDE Server client application software.

Locate this software on the same computer as the HMI software.

Modbus (Series III Computer as Modbus Gateway)

Used in conjunction with Building Management Systems, Distributed Control Systems, or even PLCs where the Modbus master equipment is connected to the communication serial port of the Series III computer. The Modbus add-on to Series III enables the COM port of the computer to be configured as a Modbus slave, providing the customer the ability to configure input and holding registers.

Update Path

NPMODBUS: Client application that turns the COM port of the computer into a Modbus server application. Client can be located on any computer with appropriate operating system and on the same network as the rest of the PowerNet system software.

NPCOREMOD: Turns the COM port of the computer running the PowerNet software core into a Modbus server. This can only be located where the Core software application is located.

Modbus (Industrial PC as Modbus Gateway)

Used in conjunction with Building Management Systems, Distributed Control Systems or even PLCs where the Modbus master equipment is connected to the communication serial port of the Series III computer. Available for sale was an industrial computer (no monitor, keyboard or mouse) with a Modbus server software application installed. The functionality of the software installed on the industrial PC focuses on Modbus register configuration and availability. Other monitor, DDE and trending features common to Series III are not available.

Update Path

Power Xpert Gateway

RS-232 (MINT II with Custom Driver in Master System)

Used in conjunction with Building Management Systems, Distributed Control Systems or even PLCs. In this case, the customer has written or contracted to have written a custom driver that communicates directly to the installed INCOM devices via the MINT II RS-232 interface.

Update Path

Series III software is not a part of this configuration. There is no update path; the MINT II is still a viable solution. For those applications that connect with the Johnson Controls® Metasys® System via the MINT II and Metasys Integrator, the JMI should be used.

RS-232 (Series III PC COM Port Gateway, Custom Driver in Master System)

Used in conjunction with Building Management Systems, Distributed Control Systems or even PLCs. Most common applications include BMS software such as Johnson Controls Metasys System integration. Where customers implemented this solution, the need for the functionality of the Series III is apparent but the sharing of data is required. When updating to PowerNet, customers must pay close attention to this need.

Update Path

Series III had the ability to configure the COM port of the computer into a gateway, which made the COM port look like a MINT II to the master communicating software application. This functionality is not included in the PowerNet software suite of applications. Connectivity is left to DDE, OPC or Modbus communications. Before updating, the master software suite vendor should be consulted as to which of the above protocols is supported and the appropriate steps for integration taken.

PowerNet Device Selection Chart

Communicating Device Function Selection Chart	Metering Devices				LV Breaker Trip Units					Protective Relays				Miscellaneous Devices							
	IQ Analyzer	IQ DP-4000/ IQ DP-4100	IQ 200/IQ 300	Power Sentinel	Energy Sentinel	Digitrip 1150	Digitrip RMS 910	Digitrip RMS 810	Digitrip OPTIM 1050	Digitrip OPTIM 750	Network Protector Relays	FP-5000	Digitrip 3000	MP-3000	IQ 500	RTD Module	Advantage	IQ Transfer Switch	Addressable Relay II	Power Manager	Quad XYZ
Voltage (phase-phase)	■	■	■	■		■	■	■	■		■	■						■			
Voltage (phase-neutral)	■	■	■	■		■	■	■	■		■	■						■			
Current phases	■	■	■	■		■	■	■	■	■	■	■	■	■	■		■				
Current ground	■											■	■	■	■						
Power																					
kW	■	■	■	■	■	■	■	■	■		■	■								■	
kWh	■	■	■	■	■	■	■	■	■			■								■	
kVA	■	■	■	■		■						■									
kVAh	■	■	■			■						■									
VARs	■	■	■	■		■					■	■									
VARh	■	■	■			■						■									
PF	■	■	■	■		■	■		■		■	■									
Demand																					
kW demand	■	■	■	■	■	■	■	■	■			■									
kVA demand	■	■	■			■			■			■									
Ampere demand	■	■	■			■			■	■		■	■								
kVAR demand	■	■	■			■			■	■		■									
Power Quality																					
THD	50	31					31	31			■										
Current THD	■	■				■	■				■										
Voltage THD	■	■					■				■										
CBEMA/crest factor	■																				
Frequency	■	■	■	■		■					■										
Current waveform	■					■	■				■										
Voltage waveform	■										■										
Other Features																					
Downloadable set points	■	■	■	■	■	■		■	■		■	■	■					■		■	
Operations count						■	■	■	■	■			■					■			
High load						■	■	■	■	■		■	■								
Trip target data						■	■	■	■	■		■	■	■	■		■				
Remote open/close						■	■	■	■	■	■	■	■				■	■	■		
Start profile													■								
Auxiliaries										■	■										
Input/Output																					
Digital input	3	1										1	2						2		4
Digital output	4(3)	3									8	5	4						1		
Analog input	1														11						
Analog output	4												1								
Communication Modules																					
IPONI	≥1.06	■											■					■			
INCOM communications std.			■	■	■	■	■	■	■	■	■	■	■	■				■	■	■	■
BIM				■	■	■	■	■	■	■											

Communications Hardware

mMINT



mMINT Module

Product Description

The mMINT (Modbus Master INCOM Network Translator) Module is an Eaton accessory product that will provide communication between a Modbus RTU network and an INCOM (Industrial Communications) network (see the mMINT in a Communications Network figure). This module is transparent to the Modbus network. It communicates to a master on the Modbus network using the Modbus RTU (Remote Terminal Unit) protocol. It communicates to slave devices on the INCOM network using the IMPACC (Integrated Monitoring, Protection, and Control Communication) protocol. The catalog number of this product is mMINT.

Features

The mMINT module is a slave device on the Modbus network and as such requires a master that will exchange register objects with the mMINT module.

- Handles generic pass-through commands (Modbus/INCOM/Modbus)
- Capable of passing Modbus register objects from Eaton's existing products and newer PnP (Plug-'n-Play) products to a Modbus RTU master
- Data in IEEE® Floating Point format and fixed point
- Modbus RTU communications data transfer rates of 1200, 9600 or 19,200 baud with one start bit, eight data bits, no parity, and either one or two stop bits
- Up to 32 products connected to INCOM network port (246 unique addresses maximum)
- Flashing Status LED to indicate an active module
- LED indicators for INCOM transmit and receive communications exchanges
- LED indicators for Modbus RS-485 transmit and receive communications exchanges
- Input power for the module from either 120 Vac or 24–125 Vdc
- DIN rail mount package
- 0° to 60°C ambient operation

Module Mounting

When mounting the mMINT, verify that an 11 mm H x 28 mm W DIN rail is used and that it is within an enclosed space.

Simplified Wiring Rules

INCOM Network

The following simplified rules apply to a given system consisting of a single daisy-chained main cable link between master and slave devices (see figure below). For more complex configurations including star configurations, please refer to the IMPACC wiring specification T.D. 17513.

mMINT in a Communications Network

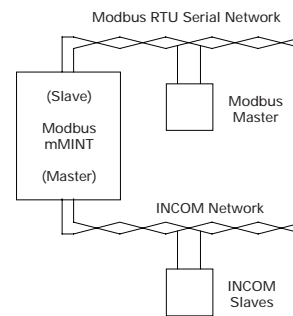

- Recommended INCOM cable styles are Belden 9463 or C-H style 2A957805G01
- The maximum system capacity is 10,000 feet of communications cable and 32 slave devices on the INCOM network under the mMINT
- Non-terminated taps, up to 200 feet in length, off the main link are permitted, but add to the total cable length
- Make sure that there is twisted-pair wire that is recommended for IMPACC network use. Use shielded twisted-pair wire to connect each slave to the INCOM network, daisy-chain style. The polarity of the twisted pair is not important

Modbus RS-485 Network

The following simplified rules apply to a given system consisting of a cable link between master and slave devices (see figure below). For more complex configurations, please refer to standard Modbus RTU wiring specification rules for the RS-485 network.

- The recommended Modbus cable has twisted-pair wires (24 AWG stranded 7x32 conductors with PVC insulation) having an aluminum/mylar foil shield with drain wire
- The maximum system capacity is 4000 feet of communications cable and 247 devices on the Modbus RTU network
- Make sure that there is twisted-pair wire that is recommended for Modbus RTU network use. Use shielded twisted-pair wire to connect each slave to the Modbus RTU network, daisy-chain style. The polarity of the twisted pair is critically important

mMINT Module Dimensions

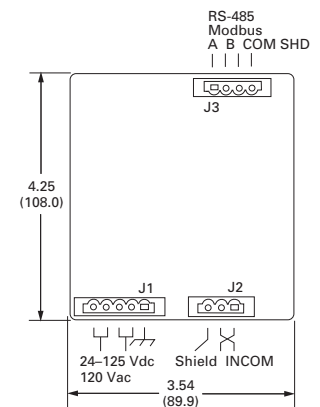

Burden

- 24 Vac/Vdc, 3 VA

Safety Standards

- UL®
- CSA®
- CE mark

Communications Speed

- INCOM: 1200, 9600 baud
- N2 bus: 9600 baud

Power Xpert Gateway 200E



Power Xpert Gateway 200E

Product Description

The Power Xpert Gateway 200E (PXG 200E) is designed to provide a Web-enabled gateway to serially communicating energy meters via a standard Web browser. These can be new or existing meters. The PXG 200E supports revenue grade single and multipoint energy meters via Modbus RTU and INCOM. This product provides a cost-effective, retrofit hardware solution for better energy management without the need for software.

The PXG 200E allows you to:

- Monitor energy usage patterns and reveal opportunities for efficiency improvements using existing communicating meters
- Remotely monitor real-time conditions and profile 5-minute interval trend logs, and export data in csv, without a software implementation
- Allocate energy costs to departments or processes
- Reduce peak demand surcharges
- Reduce power factor penalties
- Identify billing discrepancies
- Allows user to daisy-chain multiple Ethernet compatible downstream devices via RJ-45 port (for specifics, see **Page V12-T11-15, PXG-E Daisy Chain Application**)
- Connect to downstream devices via a Web browser, Modbus master or SNMP client separately or concurrently

Fixed list of supported devices (no ability to add new product support via EDS upload); however, new supported devices will be added during firmware updates.

- IQ 35M
- IQ Energy Sentinel
- IQ 130
- IQ 140
- IQ 150
- IQ 220/230
- IQ 220M/230M
- IQ 250
- IQ 260
- IQ MESII
- DIM KYZ (WAGES)
- EI NEXUS 1200 Series
- PM710

For detailed technical specifications, please reference the Technical Data Sheet for this product at www.eaton.com/pxg, then the Power Xpert Gateway 200E link.

Power Xpert Gateway Screenshots



Home Page



Bus Page



Device Page

Technical Data and Specifications

PXG 200E Part Numbers

Description	Style Number	Catalog Number
Power Xpert Gateway 200E	103008420-5591	PXG200E
Power supply—24 Vdc	ELC-PS02	ELC-PS02
Mounting bracket kit	66B2146G01	PXGACC01

Features

PXG 200E Features

Features	PXG 200E
Total number of supported devices	64
Maximum number of INCOM devices supported	64
Maximum number of Modbus devices supported	32
Protocols supported on downstream devices: (INCOM and Modbus RTU)	Yes
Number of downstream communication ports	2
Number of downstream protocols supported simultaneously	2
USB port for configuration	Yes
Two RJ-45 Ethernet ports—10/100Base-T	Yes
Modbus TCP/IP protocols supported	Yes
SNMP client access v.1	Yes
INCOM slave action commands supported	Yes
INCOM date and time settings supported	Yes
Modbus write commands supported from Modbus master	Yes
Device summary screens per main, bus and device	Yes
Event notification via the Web interface	Yes
Secure Ethernet communications—SSL encryption	Yes
Secure communication ports via access control/trusted host list	Yes
IPv4 support	Yes
Save and restore configuration file	Yes
Interval logging—csv file format, downloadable to Excel	Yes
Ability to upload additional or modified EDS files	No
Device waveform access and storage—COMTRADE file format	No
Set user-defined events	No
Trend graph displayed	Yes
Data logging—csv file format, downloadable to Excel	No
Event logging—csv file format, downloadable to Excel	No
E-mail notification on events and threshold alarms	No
Custom summary Web page creation	No
Ability to create custom events	No
Supports SAM3Z energy meters	No
BACnet/IP support ①	Yes

Note

① Expected availability 2Q12.

Supported Devices

Supported Devices			HTTP	Web Services	MB TCP	INCOM Pass-Thru	SNMP	File Export csv	Modbus Pass-Thru	BACnet/IP
Protocol	Device Type	Device Name								
INCOM	I/O	DIM KYZ (WAGES)	■	■	■	■	■	■		■
INCOM	Meter	IQ MESII	■	■	■	■	■	■		■
INCOM	Meter	IQ 220/230	■	■	■	■	■	■		■
INCOM	Meter	IQ Energy Sentinel	■	■	■	■	■	■		■
Modbus	Meter	IQ 130	■	■	■		■	■	■	■
Modbus	Meter	IQ 140	■	■	■		■	■	■	■
Modbus	Meter	IQ 150	■	■	■		■	■	■	■
Modbus	Meter	IQ 220M/230M	■	■	■		■	■	■	■
Modbus	Meter	IQ 250	■	■	■		■	■	■	■
Modbus	Meter	IQ 260	■	■	■		■	■	■	■
Modbus	Meter	EI NEXUS 1200 Series	■	■	■		■	■	■	■
Modbus	Meter	IQ 35M	■	■	■		■	■	■	■

The Eaton Power Xpert Gateway 200E Includes:

- The Power Xpert Gateway module
- Mounting provisions and required hardware for panel and DIN rail mounting
- CD-ROM: contains the user manual, Modbus register maps, USB driver and other associated files

Power Xpert Gateway with DIN Rail Mounting (Brackets Included)

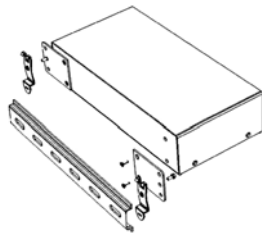

Power Xpert Gateway—Dimensions in Inches (mm)

Power Xpert Gateway 200E

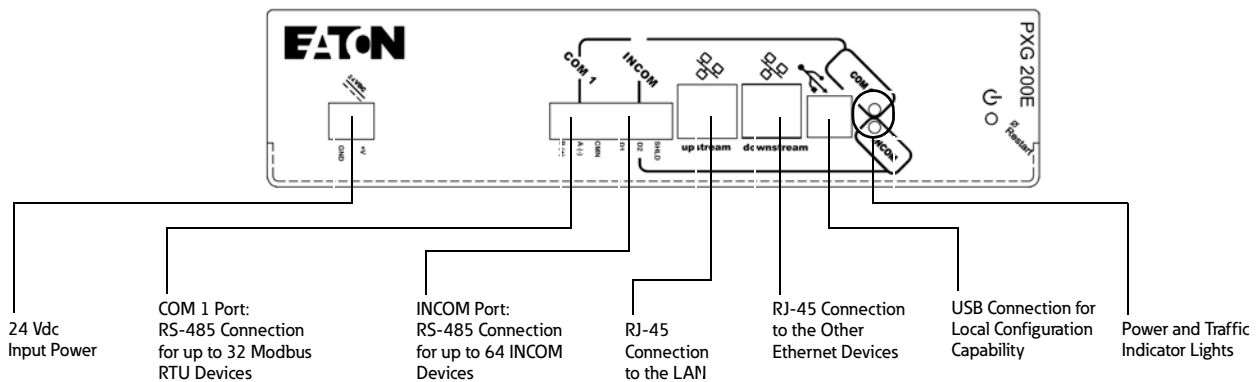

Power Xpert Gateway 200E with Standard Panel Mounting (Brackets Included)

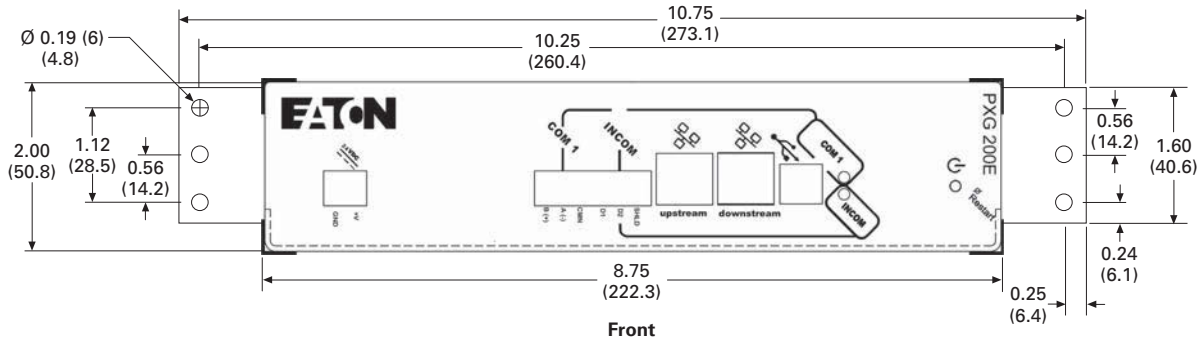

Power Xpert Gateway 200E

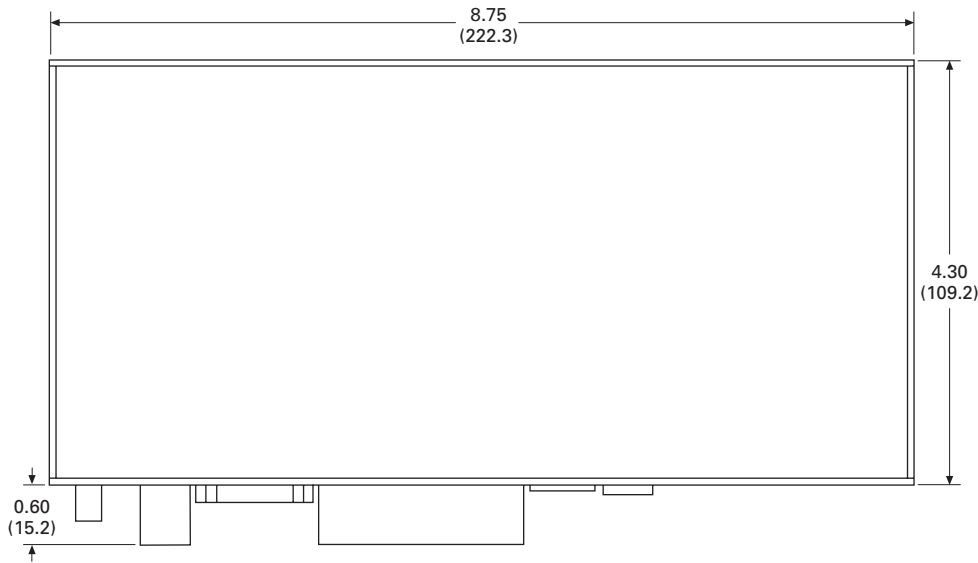

PXG-E Daisy Chain Application

The PXG-E allows for units to be connected together through two RJ-45 10/100 connectors on the front of the PXG-E series of products. This arrangement is a pass-through of Ethernet communications allowing a single network drop to

connect up to five Ethernet communicating devices. The maximum length of a copper cable run should not exceed 295 ft (90m) total.

Note: In this configuration, if any of the PXG-E units go offline or lose power, the communication to the downstream Ethernet devices will lose connection to the LAN.

PXG-E Daisy Chain Application

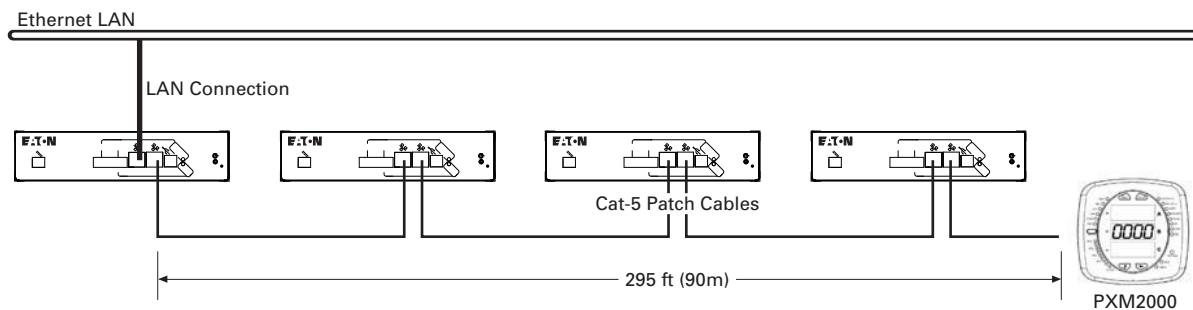

Power Xpert Gateway 400E/600E/800E



Power Xpert Gateways 400E,
600E and 800E

Power Xpert Gateways 400E, 600E and 800E are typically installed in an electrical assembly—a motor control center, low/medium voltage switchgear or switchboard to consolidate data available from components such as trip units, meters, motor controllers and protective relays. It can be installed later to provide the same valuable information.

Product Description

Power Xpert Gateways 400E, 600E and 800E (PXG 400E/600E/800E) provide a cost-effective method to easily Web-enable Eaton and third-party products.

The PXG 400E/600E/800E series offers improved performance over the previously offered series, including logging in the PXG 600E/800E, daisy chaining capabilities (Page V12-T11-19, Figure PXG-E Daisy Chain Application) and design enhancements including a new processor and additional RAM and Flash memory.

The gateway consists of an embedded Web server that allows the user to connect to installed Eaton products such as breakers, meters and relays found in MCCs, LV and MV switchgear and switchboards—to name a few—that communicate via Eaton protocols INCOM and QCPort, in addition to third-party products that communicate via Modbus RTU. The Gateway provides the central connection point for the power metering/monitoring/protective devices, allowing their parameters to be monitored via the Web.

The PXG 400E/600E/800E provide data communications to Eaton's Power Xpert Software and other third-party systems to facilitate centralizing and gathering data for long-term data archival, analysis and trending features.

The PXG 400E/600E/800E are compatible with and facilitate integration with many third-party building and factory automation systems via Modbus TCP and Web services.

Note: Enclosed solution available. Contact your Eaton sales office for more details.

The PXG 600E/800E allow you to enable pre-selected parameters to be trended for each supported device. Selecting the trend symbol will generate a real-time graph for that parameter and can be viewed for the past 24 hours, seven days, 30 days or all past history.

The PXG 600E/800E also offer direct e-mail notifications to up to 10 users. Select from event notifications, data logs, interval log, event logs and heartbeat e-mails.

The PXG 800E brings this communication hardware-only solution closer to those requirements that have previously only been met by a software package. The PXG 800E includes all the functionality of the PXG 600E. Additional features include:

- Creation of custom summary Web pages on the user interface
- Ability to create custom events from existing device parameters or events
- Ability to communicate wirelessly with the SAM3Z submetering system

In the PXG 400E/600E/800E, information is presented in organized, user-friendly Web pages and includes, but is not limited to, the following:

- Device status
- Comm status
- Voltage
- Current
- Power
- Power factor
- Energy
- Power quality
- Temperature
- I/O states

Power Xpert Gateway Screenshots

Downstream devices on the Power Xpert Gateways often report key operating status information that warrants immediate attention. The PXG identifies a set of key status values for each device and generates "Events" in response to changes in these status values. An example of a device event is an overcurrent trip on a circuit breaker.

In addition to displaying events on its home page, the PXG reports events to monitoring software such as Power Xpert Software. These events will then be integrated with those from across the power system, providing unified enterprise level event management.



Home Page



Bus Page



Device Page



Trending Page (PXG 600E/800E Only)

For detailed technical specifications, please reference the Technical Data Sheet for this product series at www.eaton.com/pxg, then the Power Xpert Gateway 400E/600E/800E link.

Features of the PXG-E Product Offering

Features	PXG 400E	PXG 600E	PXG 800E
Total number of supported devices	64	96	96
Maximum number of INCOM devices supported	64	64	64
Protocols supported on downstream devices: (INCOM, Modbus RTU and QPort)	Yes	Yes	Yes
Number of downstream communication ports	2	3	3
Number of downstream protocols supported simultaneously	2	3	3
USB port for configuration	Yes	Yes	Yes
Two RJ-45 Ethernet ports—10/100Base-T	Yes	Yes	Yes
Modbus TCP/IP protocols supported	Yes	Yes	Yes
SNMP client access v.1	Yes	Yes	Yes
INCOM slave action commands supported	Yes	Yes	Yes
INCOM date and time settings supported	Yes	Yes	Yes
Modbus write commands supported from Modbus master	Yes	Yes	Yes
Device summary screens per main, bus and device	Yes	Yes	Yes
Event notification via the Web interface	Yes	Yes	Yes
Secure Ethernet communications—SSL encryption	Yes	Yes	Yes
Secure communication ports via access control/trusted host list	Yes	Yes	Yes
IPv4 support	Yes	Yes	Yes
Ability to upload additional or modified EDS files	Yes	Yes	Yes
Save and restore configuration file	Yes	Yes	Yes
Device waveform access and storage—COMTRADE file format	No	Yes	Yes
Set user-defined events	No	Yes	Yes
Trend graph displayed	No	Yes	Yes
Data logging—csv file format, downloadable to Excel	No	Yes	Yes
Interval logging—csv file format, downloadable to Excel	No	Yes	Yes
Event logging—csv file format, downloadable to Excel	No	Yes	Yes
E-mail notification on events and threshold alarms	No	Yes	Yes
Custom summary Web page creation	No	No	Yes
Ability to create custom events	No	No	Yes
Supports SAM3Z energy meters	No	No	Yes
BACnet/IP protocol supported ^①	—	—	—

The Eaton Power Xpert Gateway includes:

- The Power Xpert Gateway module
- Mounting provisions and required hardware for panel and DIN rail mounting
- CD-ROM: contains the user manual, Modbus register maps, USB driver and other associated files

Power Xpert Gateway with DIN Rail Mounting (Brackets Included)

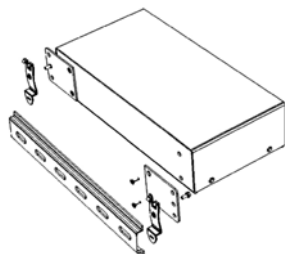

Note

^① Expected availability 2012.

Power Xpert Gateway 400E/600E/800E

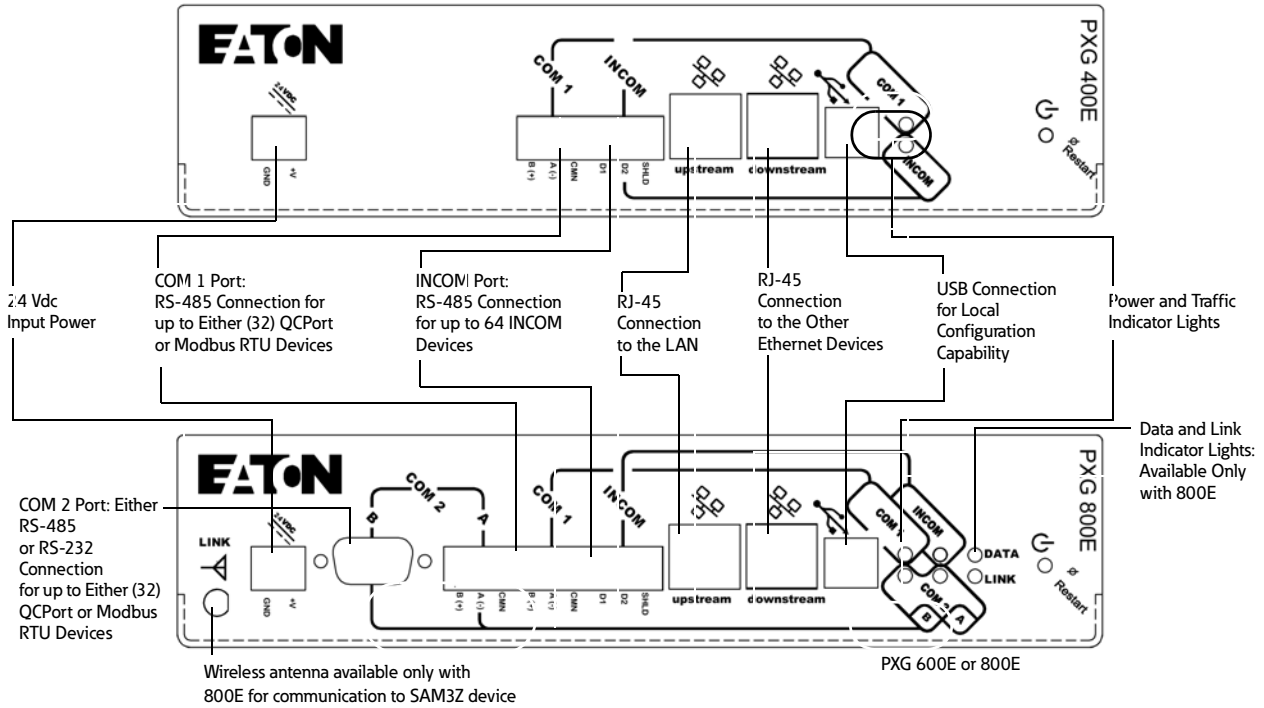

PXG-E Daisy Chain Application

The PXG-E allows for units to be connected together through two RJ-45 10/100 connectors on the front of the PXG-E series of products. This arrangement is a pass-through

of Ethernet communications allowing a single network drop to connect up to five Ethernet communicating devices. The maximum length of a copper cable run should not exceed 295 ft (90m) total.

Note: In this configuration, if any of the PXG-E units go offline or lose power, the communication to the downstream Ethernet devices will lose connection to the LAN.

PXG-E Daisy Chain Application

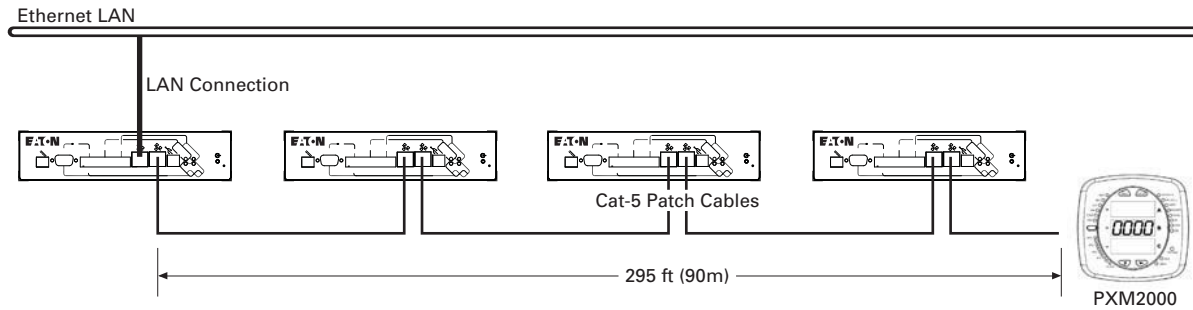

Technical Data and Specifications

PXG Part Numbers

Description	Style Number	Catalog Number
Power Xpert Gateway 400E	103008421-5591	PXG400E
Power Xpert Gateway 600E	103008422-5591	PXG600E
Power Xpert Gateway 800E	103008423-5591	PXG800E
Wireless energy meter for PXG 800E	P-103000007-591	SAM3Z
Wireless repeater module for SAM3Z	P-103000008-591	EZR
Power supply—24 Vdc	ELC-PS02	ELC-PS02
Mounting bracket kit	66B2146G01	PXGACC01

Data Acquisition and Integration Table for Supported Devices

Supported Devices



Device Type	Device Name	PXG 400E/600E/800E							PXG 600E/800E Only		
		HTTP (Web Browser)	Web Services (Power Xpert Software)	Modbus TCP (BMS and SCADA)	Pass-through INCOM (PowerNet)	Pass-through OCPort (CHStudio)	SNMP (NMS)	BACnet/IP	SMTP (E-mail Client)	File Export (Data File Format)	File Export (Waveform File Export)
INCOM											
Drive	Accutrol 400	■	■	■	■		■	■	■	■	
Drive	AF97	■	■	■	■		■	■	■	■	
I/O	Universal RTD	■	■	■	■		■	■	■	■	
I/O	DIM	■	■	■	■		■	■	■	■	
I/O	DIM KYZ	■	■	■	■		■	■	■	■	
Meter	IQ DP-4000 ①	■	■	■	■		■	■	■	■	
Meter	IQ Energy Sentinel	■	■	■	■		■	■	■	■	
Meter	IQ 220/IQ 320	■	■	■	■		■	■	■	■	
Meter	IQ 230/IQ 330	■	■	■	■		■	■	■	■	
Meter	IQ Analyzer (6000/6200) ①	■	■	■	■		■	■	■	■	■
Meter	IQ Analyzer (6400/6600) ①	■	■	■	■		■	■	■	■	■
Meter	IQ Data ①	■	■	■	■		■	■	■	■	
Meter	IQ Data Plus ①	■	■	■	■		■	■	■	■	
Meter	IQ Data Plus II ①	■	■	■	■		■	■	■	■	
Meter	Power Manager	■	■	■	■		■	■	■	■	
Meter	IQ Power Sentinel	■	■	■	■		■	■	■	■	
Meter point	IQ MES II	■	■	■	■		■	■	■	■	
Protective	Digitrip 3000	■	■	■	■		■	■	■	■	
Protective	Digitrip 3200	■	■	■	■		■	■	■	■	
Protective	FP-6000	■	■	■	■		■	■	■	■	■
Protective	FP-5000	■	■	■	■		■	■	■	■	■
Protective	FP-4000	■	■	■	■		■	■	■	■	■
Protective	MP-3000 ①	■	■	■	■		■	■	■	■	
Protective	MP-4000 ①	■	■	■	■		■	■	■	■	
Protective	Digitrip 520MC	■	■	■	■		■	■	■	■	
Protective	NRX520	■	■	■	■		■	■	■	■	
Protective	IQ 500	■	■	■	■		■	■	■	■	
Protective	MPCV Relay	■	■	■	■		■	■	■	■	
Protective	Digitrip 1150/DT1150V	■	■	■	■		■	■	■	■	■
Protective	Digitrip 810	■	■	■	■		■	■	■	■	
Protective	Digitrip 910	■	■	■	■		■	■	■	■	
Protective	Digitrip MV	■	■	■	■		■	■	■	■	
Protective	Digitrip OPTIM 1050	■	■	■	■		■	■	■	■	■
Protective	Digitrip OPTIM 550	■	■	■	■		■	■	■	■	■
Protective	Digitrip OPTIM 750	■	■	■	■		■	■	■	■	■
Starter	Advantage ②	■	■	■	■		■	■	■	■	
Starter	Advantage ACM ②	■	■	■	■		■	■	■	■	
Subnetwork master	AEM II ①	■	■	■	■		■	■	■	■	
Subnetwork master	BIM II ①	■	■	■	■		■	■	■	■	
Subnetwork master	CMU ②	■	■	■	■		■	■	■	■	
Subnetwork master	IQ CED II ①	■	■	■	■		■	■	■	■	
Subnetwork master	IQ MES II	■	■	■	■		■	■	■	■	
Transfer switch	ATC-400 ①	■	■	■	■		■	■	■	■	
Transfer switch	ATC-600 ①	■	■	■	■		■	■	■	■	
Transfer Switch	ATC-800 ①	■	■	■	■		■	■	■	■	

Notes

- ① Required IPONI for connection to the Power Xpert Gateway.
- ② Required a WPONI for connection to the Power Xpert Gateway.

Information subject to change without notice. Visit www.eaton.com/pxg for latest up-to-date details on connectivity.

Data Acquisition and Integration Table for Supported Devices (continued)

Supported Devices



Device Type	Device Name	PXG 400E/600E/800E							PXG 600E/800E Only		
		HTTP (Web Browser)	Web Services (Power Xpert Software)	Modbus TCP (BMS and SCADA)	Pass-through INCOM (PowerNet)	Pass-through QCPort (CHStudio)	SNMP (NMS)	BACnet/IP	SMTP (E-mail Client)	File Export (Data File Format)	File Export (Waveform File Export)
Modbus											
Drive	MVX9000	■	■	■			■	■	■	■	
Drive	SVX9000	■	■	■			■	■	■	■	
Insulation monitor	InsulGard	■	■	■			■	■	■	■	
Meter	IQ 130	■	■	■			■	■	■	■	
Meter	IQ 140	■	■	■			■	■	■	■	
Meter	IQ 150	■	■	■			■	■	■	■	
Meter	IQ 220M/230M	■	■	■			■	■	■	■	
Meter	IQ 250	■	■	■			■	■	■	■	
Meter	IQ 260	■	■	■			■	■	■	■	
Meter	IQ 35M	■	■	■			■	■	■	■	
Meter	Nexus 1262	■	■	■			■	■	■	■	
Meter	SQD CM3000 Series	■	■	■			■	■	■	■	
Meter	SQD CM4000 Series	■	■	■			■	■	■	■	
Meter	SQD PM710	■	■	■			■	■	■	■	
Meter	SQD PM850	■	■	■			■	■	■	■	
Meter	PML 7350	■	■	■			■	■	■	■	
Meter	PML 7550	■	■	■			■	■	■	■	
Meter	PML 7650	■	■	■			■	■	■	■	
Meter	PM3	■	■	■			■	■	■	■	
Protective	GE 369 Motor Relay	■	■	■			■	■	■	■	
Protective	GE 469 Motor Relay	■	■	■			■	■	■	■	
Protective	FP-4000/FP-5000	■	■	■			■	■	■	■	
Protective	FP-6000	■	■	■			■	■	■	■	
Overload relay	C441	■	■	■			■	■	■	■	
Temp monitor	Qualitrol 118	■	■	■			■	■	■	■	
Temp monitor	TC-50	■	■	■			■	■	■	■	
Temp monitor	TC-100	■	■	■			■	■	■	■	
Transformer differential relay	ABB TPU 2000	■	■	■			■	■	■	■	
QCPort											
I/O	D77A-AI16	■	■	■		■	■	■	■	■	
I/O	D77A-AI8	■	■	■		■	■	■	■	■	
I/O	D77A-DI16	■	■	■		■	■	■	■	■	
I/O	D77A-DI8	■	■	■		■	■	■	■	■	
Starter	IT .S811 (MV811)	■	■	■		■	■	■	■	■	
Starter	IT .Starter ①	■	■	■		■	■	■	■	■	
Starter	IT .Starter QSNAP ①	■	■	■		■	■	■	■	■	

Notes

① Requires a QSNAP for connection to the Power Xpert Gateway.

Information subject to change without notice. Visit www.eaton.com/pxg for latest up-to-date details on connectivity.

Additional supported devices will be available via firmware updates. Contact your local Eaton sales office for help with devices not currently listed in table above.

Power Xpert Gateway—Dimensions in Inches (mm)

Power Xpert Gateway 400E/600E/800E with Standard Panel Mounting (Brackets Included)

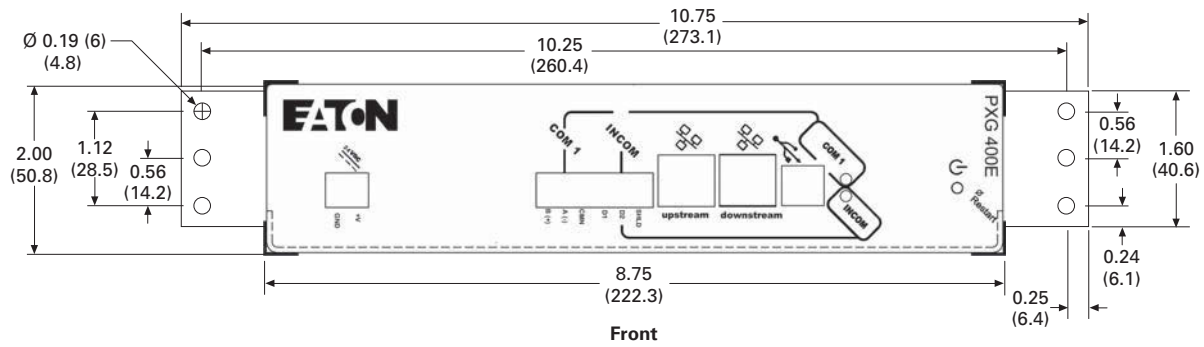

Power Xpert Gateway 400E/600E/800E

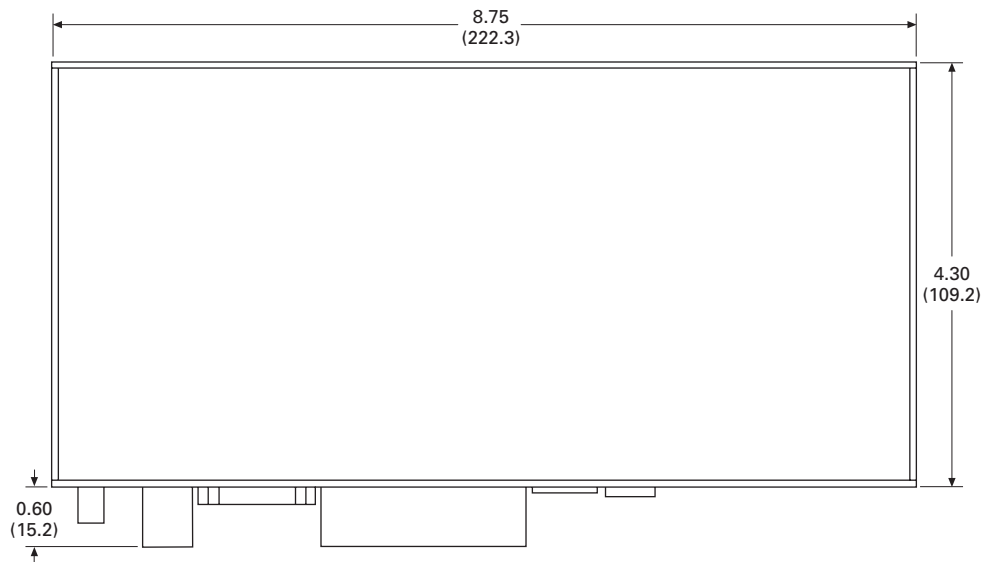

Product Operated Network Interface (PONI) Devices



PONI Family

The Product Operated Network Interface (PONI) cards attach to Cutler-Hammer/Eaton devices to enable communications. These cards serve various functions from Ethernet-type applications, to non-Ethernet-type applications, ultimately playing a key role in facilitating the access to information that each of the Cutler-Hammer/Eaton devices offer.

The IPONI enables communications over a twisted shielded pair INCOM device network. Each PONI attaches to its associated product. The PONI modules obtain power from the host product. PONI modules can be used as solutions for various applications.

The non-Ethernet product offerings include the IPONI and the MPONI. These devices are typically applied where there are more than one device connected in a network of devices by a dedicated twisted shielded pair of conductors (Ref. IMPCABLE).

The communications medium is formatted to enable clean noise-immune communications even when routed around areas of high noise and typical electrical communication disrupting equipment. The IPONI and MPONI daisy chain are in the same format as that used in devices that have built-in communications such as the Digitrip trip units and can be used in series with these communication network wiring. To Ethernet enable IPONI and MPONI products, use the PXG-E series Power Xpert Gateways.

The PXG-E with IPONI or MPONI product offering puts a Cutler-Hammer/Eaton metering product on the Web. No other software is required when specifying a PXG-E. All software needed to enable any internet browser program such as Microsoft Internet Explorer or Mozilla Firefox is packed into the PXG-E. The data can then be viewed directly in any Internet Web browser window. The WEBPONI provides live updating data for the meter being monitored, as well as waveform display capabilities and e-mail direct from the device to defined key e-mail addresses that need to know when an event occurs.

IPONI/MPONI

With the addition of the IPONI or the MPONI card, a Cutler-Hammer/Eaton device or series of devices can communicate with the PowerNet software via a master unit such as a MINT II and the PXG-E. The PONIs can be easily mounted to the appropriate Cutler-Hammer/Eaton device and daisy chain together to form a robust deterministic communication network of devices in a system solution. Systems employing the IPONI/MPONI type communications medium provide deterministic communication performance relied on by those critical solution applications, where this is of the utmost importance.

MINT II



Master INCOM Network Translator (MINT) II

The MINT II interfaces the IMPACC network to a master control unit with an RS-232 port, such as a personal computer serial port, a programmable controller RS-232 "smart card," building management system interface card, etc. (Some software will have to be written in the master control unit to request and receive messages. The MINT II protocol is 10-character, ASCII coded hex.)

The MINT II can be used to interface multiple IMPACC devices to Broadband LANs, telephone modem or short haul modem. It can also be used to allow additional branches of the INCOM data line (five additional branches per MINT II). The MINT II can be either table or panel mounted and requires a 120 Vac, 60 Hz supply. Selectable communication rate of 1200 or 9600 baud is available. The burden for the MINT II is 7 VA.

Addressable Relay II (ARII)



Addressable Relay II

The Addressable Relay II is designed for use where information or control of non-communicating devices is required remotely. The relays communicate on the PowerNet system. Devices are assigned a three-digit address to uniquely identify them on the daisy-chained twisted shielded pair network.

The ARII has a Form C relay on board with two status indicating circuit inputs. The output relay can be activated and monitored remotely. Input status 1 and 2 can be monitored remotely.

IMPCABLE

The IMPCABLE was designed to be run in switchgear where codes require a 600V insulation rating. Typical “blue hose” cables are rated at 300V. The IMPCABLE is an 18 AWG cable with a 100 ohm impedance at 100 kHz tuned to work optimally with the FSK signal from Cutler-Hammer/Eaton devices. The cable has been designed with characteristics that allow up to 1000 devices or distances up to 10,000 feet from the master.

IMPCABLE

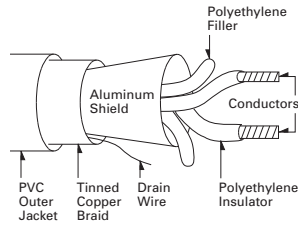

Further Information

Publication Number	Description
TD.17.15.TE	PowerNet
TD17B.01.TE	PowerPort
TD02603010E	Power Xpert Gateway 200E
TB02603002E	Power Xpert Gateway 400E/600E/800E
TB02603002E	mMINT
TD.17.19.TE	MINT II RS-232 Converter
TD.17.20.TE	PONI Communication Modules
TB02603002E	MPONI
TD.17.22.TE	Addressable Relay II
TD.17.24.TE	Breaker Interface Module (BIM)
TD.17.26.TE	Advantage Central Monitoring Unit (CMU)
TD.17.28.TE	IMPCABLE

Pricing Information

Price and Availability Digest (PAD)

Vista/VISTALINE™ Discount Symbol C10-S25

Programmable Logic Controllers

Programmable Logic Controllers



12	Programmable Logic Controllers	
	Product Description	V12-T12-2
	D32LT	V12-T12-2
	D320	V12-T12-2
	Product History	V12-T12-2
	Product History Time Line	V12-T12-3
	Discontinued Products—Replacement Capabilities	V12-T12-3
	100/110 Series.	V12-T12-3
	300 Series.	V12-T12-3
	400 Series.	V12-T12-4
	D120 Series	V12-T12-4
	MPC1 Series.	V12-T12-4
	D500 Series	V12-T12-4
	Product Support Services	V12-T12-4
	Further Information	V12-T12-4
	Pricing Information	V12-T12-4

Programmable Logic Controllers

Product Description

D32LT



D32LT

Cutler-Hammer® D32LT from Eaton's electrical business handles applications that are too large for a D50 but don't quite need the power and performance of the D320. The D32LT is expandable up to 256 I/O points, capable of handling analog, digital, high speed inputs and outputs making the D32LT one of the more versatile PLCs on the market. With access to the real-time clock, 8 PID loops and two communication ports allow you to interface with multiple networks including Modbus® RTU, ASCII, binary, or interface to a RS-232 to Ethernet adapter.

D320



D320

The D320 PLC delivers superior processing power, modular flexibility, enhanced scan speed, and advanced functions and communications capabilities with a combination of 2K program memory, up to 2048 I/O expansion points, real-time clock functionality and PID loop control capability. I/O modules cover all standard control voltages and current ranges for both digital and analog signals. Special function modules provide an array of specific-purpose solutions, such as networking and remote I/O applications.

Product History

The company has offered programmable controller products since the early 1970s.

These products have been marketed under several trade names such as Numa-Logic and model names such as D100.

Westinghouse entered the solid-state logic and control business with the Numa-Logic 300 series products. The 300 series was a set of hardwired logic components that could be custom wired to perform the desired logic functions.

Westinghouse NL-500

The Numa-Logic 500 was a remote I/O system that consisted of a "master" chassis and a "slave" chassis connected by a single twisted pair cable. Signals entered into one chassis would be repeated over the twisted pair and made available as a signal at the opposite chassis.

Chronology

1975 through 1980 (largely superseded by remote I/O capabilities of PC700 and PC900).

Replacement

D320 Remote I/O PLC.

Note: NL-500 is different than PC-500.

Westinghouse PC-700

The PC-700 was a programmable controller that supported up to 256 digital and 32 analog I/O, either local or remote with up to 8K of memory.

Chronology

1980 through 1998.

Replacement

D32LT PLC.

Westinghouse PC-900

The PC-900 programmable controller supported up to 128 digital and 16 analog I/O, either local or remote with up to 3.5K of memory.

Chronology

1981 through 1998.

Replacement

D32LT PLC.

Westinghouse PC-1100/1200/1250

This family of programmable controllers featured built in LAN, PID functions and supported up to 16K memory.

Chronology

1982 through 1998.

Replacement

Direct replacement unavailable, best replacement D32LT or D320 PLC.

Westinghouse I/O Plus

Operator interface that was originally manufactured by Cincinnati ElectroSystems and brand-labeled with the Westinghouse logo for Westinghouse.

Chronology

1989 through 1992.

Replacement

No direct replacement available, but the PanelMate product family provides far more functionality.

Westinghouse PC50/55

Programmable controller manufactured by Siemens® (S5-90, S5-95 for PC50 and PC55, respectively) and brand-labeled with Westinghouse logo for Westinghouse.

Chronology

1992 through 1994.

Replacement

Siemens still offers replacement parts for this system.

Westinghouse PC-500

Programmable controller manufactured by Siemens (S5-100U, S5-102U, S5-103 for PC500, PC502 and PC503 respectively) and brand-labeled with Westinghouse logo for Westinghouse.

Chronology

1988 through 1997.

Replacement

Siemens still offers replacement parts for this system.

Westinghouse PC-2000

Programmable controller manufactured by Siemens (S5-115U) and brand-labeled with Westinghouse logo for Westinghouse.

Chronology

1988 through 1997.

Replacement

Siemens still offers replacement parts for this system.

Eaton entered the market with its first programmable control in 1977. The unit was called the D120 and was a true programmable control with no hardwiring required.

Many models have been introduced since then.

Today, three PLC product families are available: D50, D32LT and D320. One software package can program each of these platforms. Contact your local Eaton salesperson or distributor for more details.

Product History Time Line

Page	Product	1965	1970	1975	1980	1985	1990	1995	2000	Present
V12-T12-3	Westinghouse PC50/55							■		
	Westinghouse NL100/110					■	■			
V12-T12-3	Westinghouse NL300		■	■	■	■	■			
V12-T12-4	Westinghouse PC400			■	■					
V12-T12-2	Westinghouse NL500			■	■					
	Westinghouse PC700				■	■	■	■		
	Westinghouse PC900				■	■	■	■		
	Westinghouse PC1100				■	■	■	■		
	Westinghouse PC1200/1250						■	■		
	Westinghouse PC1500/1700					■	■	■		
	Westinghouse PC500						■	■		
	Westinghouse PC2000							■	■	
	Westinghouse I/O Plus							■		
V12-T12-4	Cutler-Hammer D120			■	■					
V12-T12-4	Cutler-Hammer MPC1					■	■			
	Cutler-Hammer D100					■	■	■		
V12-T12-4	Cutler-Hammer D500						■	■		
	Cutler-Hammer D200						■	■		
	Cutler-Hammer D50							■	■	
V12-T12-2	Cutler-Hammer D300							■	■	
	Cutler-Hammer D320								■	■
V12-T12-2	Cutler-Hammer D32LT								■	■

Replacement Capabilities Discontinued Products

100/110 Series



100/110 Series

The Numa-Logic 100/110 Series, known as “the Pico,” consisted of the PC-100 and PC-110 models. Both products were “brick” style PLCs and provided a small number of digital inputs and outputs mounted in the same enclosure as the processor.

Various styles offered the ability to select the type and amount of I/O required. I/O expanders were available to expand the I/O capacity.

Chronology

The 100/110 Series PLCs were offered as current product from 1981 until 1989. In 1989 the product was discontinued.

Replacement

No direct replacement available, contact a local Eaton salesperson or distributor about upgrading to a D50, D32LT or D320 PLC.

300 Series

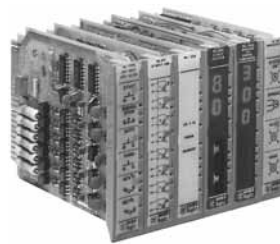

300 Series

The Numa-Logic 300 Series was Westinghouse’s original solid-state controls offering. The 300 Series consisted of printed circuit boards (modules) that performed specific logic functions (AND, OR, NOT, etc.). These modules could then be custom wired by the user to perform the required control functions.

All 300 Series components can be identified by catalog numbers of NL-3XX.

Chronology

The Numa-Logic 300 Series products were manufactured by Westinghouse beginning in the early 1970s and continuing until 1988. Replacement products are currently available from Instrument Specialties, Inc.

Replacement

For replacement of the 300 Series, contact:

Instrument Specialties, Inc.
248-542-5640

400 Series

The Numa-Logic 400 Series was Westinghouse's first PLC offering. After being manufactured for two years, the 400 Series was replaced by the 700 Series of products. Few, if any, 400 Series systems remain in service today.

Chronology

The 400 Series was manufactured by Westinghouse in Madison Heights, MI from 1975 until 1978. The product was no longer manufactured after 1979.

Replacement

No direct replacement available, contact a local Eaton salesperson or distributor about upgrading to a D50, D32LT or D320 PLC.

D120 Series



D120 Series

The D120 family of PLCs consisted of several I/O cards and the racks used to mount them.

The self-contained troubleshooting was identical in concept to the buzzer and jumpers common to relay controls. The D120 requires no new language. It utilizes decimal numbering and memory size is determined simply by adding all elements on the ladder diagram.

Chronology

The Cutler-Hammer D120 products were offered from 1976 through 1983.

Replacement

For replacements of the D120 products, contact:

ATS Inc.
Peoria, IL
1-800-328-7287

MPC1 Series



MPC1 Series

The MPC1 was a complete PLC system for applications up to 128 I/O. Programmed in easily understood relay ladder logic with digital and analog capabilities. Analog processor has the same functions as the discrete version and supports "intelligent" analog input and output modules.

Chronology

The Cutler-Hammer MPC1 products were offered from 1983 through 1993.

Replacement

For replacements of the MPC1 products, contact:

ICS Inc.
Decatur, IL
217-422-6700

D500 Series



D500 Series

The D500 family of PLCs consisted of several I/O cards and the racks used to mount them. The D500 was a full function programmable logic controller offering all of the capabilities of larger frame PLCs in a compact, economical, space-saving design.

Chronology

The Cutler-Hammer D500 products were offered from 1985 through 1994.

Replacement or parts are no longer available for D500 products.

Product Support Services

Technical Application Assistance

Eaton can provide technical application assistance via the Technical Resource Center. Available by telephone, Eaton personnel quickly respond to customer needs, including troubleshooting, analyzing system operation, and coordinating component repair or replacement. The Technical Resource Center can be reached at: **1-800-356-1243**

Further Information

Publication Number	Description
CA08100011E	Volume 9—OEM Product Guide

Pricing Information

Vista/VISTALINE™ Discount Symbol 2CD-3.

Motor Control

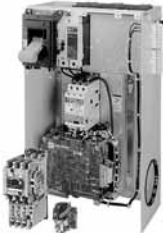
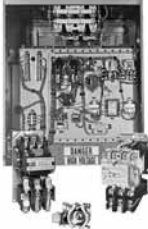

13 Motor Control

- Contactors, Starters and Brakes **V12-T13-2**
- Adjustable Frequency AC Drives **V12-T13-72**
- Synchronous **V12-T13-76**
- Starters (Medium Voltage) **V12-T13-87**

Contents

<i>Description</i>	<i>Page</i>
Pre 3-Star	
Product History Time Line, Replacement Capabilities, Technology Upgrades	V12-T13-4
3-Star	
Product History Time Line, Replacement Capabilities, Technology Upgrades	V12-T13-5
Citation	
Product History Time Line	V12-T13-6
Replacement Capabilities	V12-T13-7
Type N	
Product History Time Line, Replacement Capabilities, Technology Upgrades	V12-T13-22
A200	
Product History Time Line, Replacement Capabilities	V12-T13-23
Technology Upgrades	V12-T13-26
A202	
Product History Time Line, Replacement Capabilities	V12-T13-33
V201 and V200	
Replacement Capabilities	V12-T13-36
Freedom	
Product Description, Product History Time Line . . .	V12-T13-37
Replacement Capabilities	V12-T13-38
Technology Upgrades	V12-T13-46
IT. Electromechanical NEMA	
Product Description, Product History Time Line, Replacement Capabilities, Technology Upgrades . .	V12-T13-47
IT. Electromechanical IEC	
Product Description, Product History Time Line, Replacement Capabilities, Technology Upgrades . .	V12-T13-48
XT IEC Power Control	
Product Description, Product History Time Line, Replacement Capabilities,	V12-T13-49
Advantage	
Product Description, Product History Time Line, Replacement Capabilities, Technology Upgrades . .	V12-T13-51
Definite Purpose	
Product History Time Line, Replacement Capabilities, Technology Upgrades	V12-T13-53
JF Autostarter	
Product History Time Line, Replacement Capabilities, Technology Upgrades	V12-T13-56
ME and MD DC Contactors	
Product Description, Product History, Product History Time Line, Replacement Capabilities	V12-T13-57
Technology Upgrades	V12-T13-60
C80 Mill Type DC Contactors	
Product Description, Product History Time Line, Replacement Capabilities, Technology Upgrades . .	V12-T13-61

<i>Description</i>	<i>Page</i>
511 AC and DC Brakes	
Product Description, Product History Time Line, Replacement Capabilities, Technology Upgrades . . .	V12-T13-63
DPM-Contactor	
Product Description, Product History Time Line, Replacement Capabilities, Technology Upgrades . . .	V12-T13-65
AVD-Contactor	
Product Description, Product History, Product History Time Line, Replacement Capabilities, Technology Upgrades . . .	V12-T13-66
D-Contactor	
Product Description, Product History, Product History Time Line, Replacement Capabilities, Technology Upgrades	V12-T13-67
Reversing/Assignment Contactors	
Product Description, Product History, Product History Time Line, Replacement Capabilities, Technology Upgrades	V12-T13-68
P- and S-Contactors	
Product Description, Product History, Product History Time Line, Replacement Capabilities, Technology Upgrades	V12-T13-69

Overview

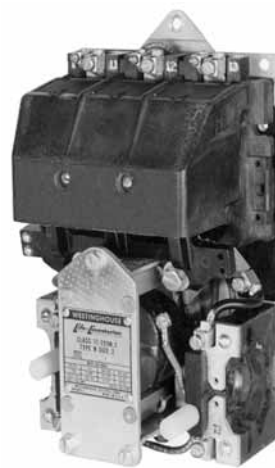

Type N Contactor

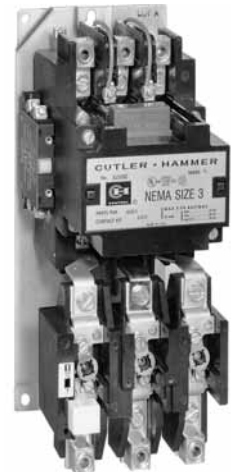

Citation Starter

Product Description

Cutler-Hammer® Starters and Contactors from Eaton's electrical business were and are designed to control functions of a connected motor by starting, stopping, reversing, regulating and protecting. When functions do not include speed regulation, this device is known as a starter rather than a controller.

Applications for starter functions are fans, pumps, constant horsepower, constant or variable torque machine tools, constant torque metalworking machinery, variable torque and horsepower fans and blowers, constant power heating, lighting, pumps and motors for all types of applications.

Product History



Freedom

The Cutler-Hammer line of contactors and starters dates back to the early 1920s in Milwaukee, WI. Changes in coil construction, making the first moisture-proof vacuum with impregnated coils, were innovations in this line of contactors and starters manufactured before the 3-Star line (now known as the Pre 3-Star). Eutectic alloy overloads were used later in this design with the design change to the 3-Star line. A few of the new features of the 3-Star line of contactors and starters were the first standard three-coil overload relays, new molding compounds, new metals and cast resin coils.



A200

The Type F magnetic contactor is the first magnetically controlled contactor in our Westinghouse® records. It was open in design, simple in construction and was state-of-the-art due to its magnetically controlled armature. The Type F contactor was replaced by the DE-ION® contactor, which featured the Westinghouse trademark DE-ION arc quenching. The DE-ION was followed by the Type DN, Type N and the Type A, today known as the A200. The Type B was developed in the late 1970s and was obsoleted two or three years later. The A200 open control is still a current offering. Prior to 1985, some of the larger sizes (5–9) were known as GCA and GCD.

The Citation line of contactors and starters was introduced in 1968 with many new features: the new CI non-wearing totally enclosed permanent air gap magnet structure; dual wound magnet coil with plug-in feature; color coded, twin break dust-safe contacts; and straight-through wiring. Although the Citation line was obsoleted in 1997, replacement contact kits, magnet coils and heater coils will continue to be available.

Today, the Freedom™ contactor, launched in 1986, is the flagship NEMA offering while **XT** is the IEC offering.

Pre 3-Star

Originally a Cutler-Hammer Product



Size 1 Contactor

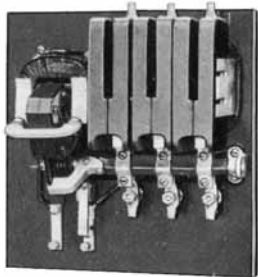

Size 2 Contactor

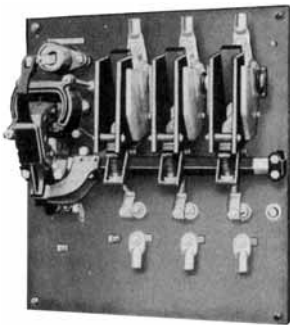

Size 5 Contactor

Parts are no longer available for Pre-3 Star.

Product History Time Line for Pre 3-Star, Bulletin 9586 ①

Size	1920	1940	1960	1980	2000	Present
Sizes 00 – 5	██████████		██████████			

Replacement Capabilities

There are no replacement parts available. Replace with new contactor or starter.

Technology Upgrades

Size 00–3—Freedom
 Sizes 4–5—Freedom

Note

① For all NEMA® rated starters, please contact Standard Open Control Aftermarket at **1-800-535-8992**.

3-Star

Originally a Cutler-Hammer Product

Product History Time Line for 3-Star, Bulletin 9560, 9586, 9589, 9591, 9556, 9658, 9736 and 9739 ①



Typical Size 0—Starter

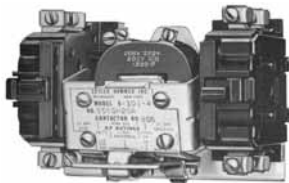

Typical Size 1—Contactor

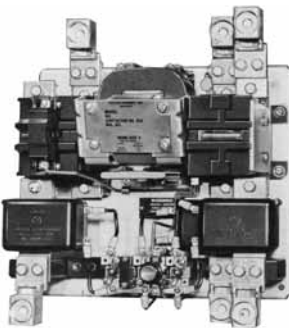

Typical Size 5—Starter

Size	1950	1955	1960	1965	1970	1975	1985	2000	Present
Size 0		████████████████████	████████████████████	████████████████████	████████████████████	████████████████████			
Size 1		████████████████████	████████████████████	████████████████████	████████████████████	████████████████████			
Size 2		████████████████████	████████████████████	████████████████████	████████████████████	████████████████████			
Size 3			████████████████████	████████████████████	████████████████████	████████████████████			
Size 4				████████████████████	████████████████████	████████████████████			
Size 5					████████████████████	████████████████████	████████████████████		

Replacement Capabilities

There are no replacement parts available. Replace with new contactor or starter.

Technology Upgrades

Sizes 00–3—Freedom
 Sizes 4–5—Freedom

Note

① For all NEMA rated Bulletin 9586 starters, please contact Standard Open Control Aftermarket at **1-800-535-8992**.

Citation

Originally a Cutler-Hammer Product

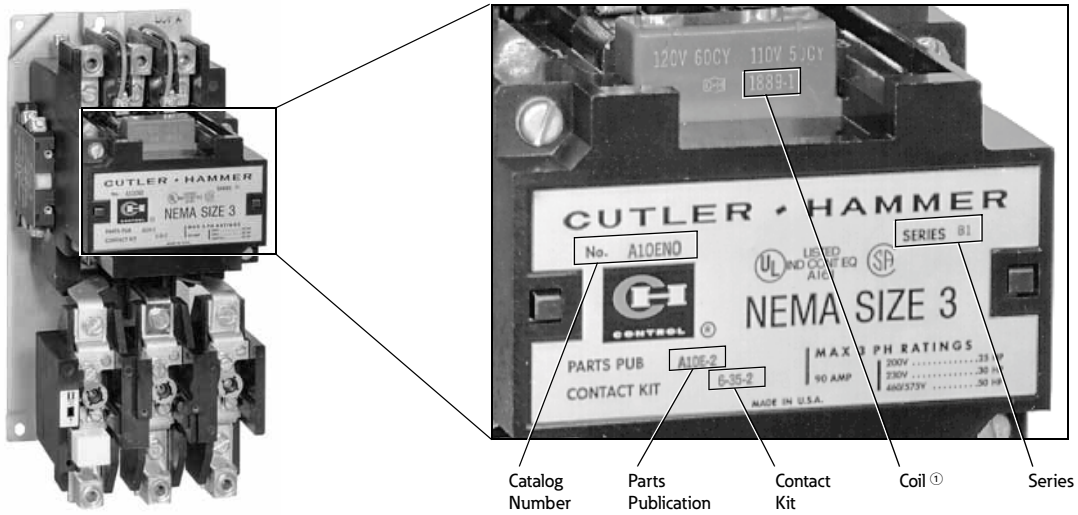

Citation Starter and Nameplate

Product History Time Line for Citation A10, A11, A13, A30, A31, A40, A41, A50, A51, A70, A71, A80, A81, B10, B11, B50, B51, B52, C10, C30 and C50

NEMA Size	Series	1965	1970	1975	1980	1985	1990	1995	2000	Present
Size 00	A1		████████████████████							
	B1					████████████████████				
	C1						████████████████████			
	D1							████████████████████		
Size 0	A1	████████████████████	████████████████████	████████████████████	████████████████████	████████████████████	████████████████████	████████████████████		
	B1									
Size 1	A1	████████████████████	████████████████████	████████████████████	████████████████████	████████████████████	████████████████████	████████████████████		
	B1									
Size 2	A1	████████████████████	████████████████████	████████████████████	████████████████████	████████████████████	████████████████████	████████████████████		
	B1									
Size 3	A1	████████████████████	████████████████████	████████████████████	████████████████████	████████████████████	████████████████████	████████████████████		
	B1									
Size 4	A1	████████████████████	████████████████████	████████████████████	████████████████████	████████████████████	████████████████████	████████████████████		
	B1									
Size 5	A1									
	B1									
Size 6	A1			████████████████████	████████████████████	████████████████████	████████████████████	████████████████████		
	B1									
	C1									
Size 7	A1		████████████████████	████████████████████	████████████████████	████████████████████	████████████████████	████████████████████		
	B1									
Size 8	A1		████████████████████	████████████████████	████████████████████	████████████████████	████████████████████	████████████████████		
	B1									

Note

① Although the number "9" is not imprinted on the coil, it must be used when ordering. For example, the proper ordering number for a 120V, 60 Hz, AC magnet coil would be 9-1887-1 (refer to the style numbers on **Page V12-T13-7**).

Replacement Capabilities

Replacement Capabilities—Contacts and Coils

Description	Coil Suffix	Style and Part Numbers									
		Size 00 Series A1 ①	Size 00 Series B1	Size 00 Series C1	Size 00 Series D1	Size 0	Size 1	Size 2 Series A1	Size 2 Series B1	Size 3 Series A1	Size 3 Series B1
Contact Kits											
Part number on contactor or starter nameplate											
Two-pole without interlock	—	6-21	②	②	②	6-22	6-23	6-24	6-34	6-25	6-35
Three-pole without interlock	—	6-21-2	②	②	②	6-22-2	6-23-2	6-24-2	6-34-2	6-25-2	6-35-2
Three-pole with interlock	—	6-21-3	②	②	—	—	—	—	—	—	—
Four-pole without interlock	—	—	—	—	—	6-22-3	6-23-3	—	6-34-3	—	—
Five-pole without interlock	—	—	—	—	—	6-22-4	6-23-4	—	6-34-4	—	—
Magnet Coils											
120V, 60 Hz or 110V, 50 Hz	A	9-1945-1	9-2183-1	9-2650-1	9-2823-1	9-1887-1	9-1887-1	9-1889-1	9-2526-1	9-1891-1	9-1889-1
240V, 60 Hz or 220V, 50 Hz	B	9-1945-2	9-2183-2	9-2650-2	9-2823-2	9-1887-2	9-1887-2	9-1889-2	9-2526-2	9-1891-2	9-1889-2
480V, 60 Hz or 440V, 50 Hz	C	9-1945-3	9-2183-5	9-2650-3	9-2823-3	9-1887-3	9-1887-3	9-1889-3	9-2526-3	9-1891-3	9-1889-3
600V, 60 Hz or 550V, 50 Hz	D	9-1945-4	9-2183-19	9-2650-4	9-2823-4	9-1887-4	9-1887-4	9-1889-4	9-2526-4	9-1891-4	9-1889-4
208V, 60 Hz	E	9-1945-5	9-2183-17	9-2650-5	9-2823-5	9-1887-5	9-1887-5	9-1889-13	9-2526-5	9-1891-13	9-1889-13
24V, 60 Hz	T	9-1945-8	9-2183-16	9-2650-7	9-2823-18	9-1887-7	9-1887-7	9-1889-20	9-2526-6	9-1891-15	9-1889-20
380V, 50 Hz	L	9-1945-6	9-2183-3	9-2650-6	9-2421-18 ③	9-1887-8	9-1887-8	9-1889-14	9-2526-7	9-1891-14	9-1889-14
277V, 60 Hz	H	9-1945-16	9-2183-18	9-2650-13	9-2823-12	9-1887-16	9-1887-16	9-1889-31	9-2526-15	9-1891-26	9-1889-31
					9-2823-17						
120 Vdc ④	A1	—	—	—	—	9-2024-2	9-2024-2	9-2025-2	9-2626-2	9-2026-2	9-2025-2
240 Vdc ④	B1	—	—	—	—	9-2024-1	9-2024-1	9-2025-1	9-2626-1	9-2026-1	9-2025-1
24 Vdc ④	T1	—	—	—	—	9-2024-4	9-2024-4	9-2025-4	9-2626-4	9-2026-4	9-2025-4
48 Vdc ④	W1	—	—	—	—	9-2024-3	9-2024-3	9-2025-3	9-2626-3	9-2026-3	9-2025-3

Replacement Capabilities—Contacts and Coils, continued

Description	Coil Suffix	Style and Part Numbers									
		Size 4 Series A1	Size 4 Series B1	Size 5	Size 6 Series A1	Size 6 Series B1	Size 6 Series C1	Size 7 Series A1	Size 7 Series B1	Size 8 Series A1	Size 8 Series B1
Contact Kits											
Part number on contactor or starter nameplate											
Two-pole	—	6-26	6-36-3	6-27	6-28	—	6-601-2	6-28	—	—	—
Three-pole	—	6-26-2	6-36-4	6-27-2	6-28-2	6-570	6-601	6-28-2	6-570	646C829G05	6-571
Magnet Coils											
120V, 60 Hz or 110V, 50 Hz	A	9-1891-1	9-1891-1	9-1891-1	9-1875-1	9-2651	9-2698	9-1875-1	9-2651	438C805G12	9-2654
240V, 60 Hz or 220V, 50 Hz	B	9-1891-2	9-1891-2	9-1891-2	9-1875-2	9-2651-2	9-2698-2	9-1875-2	9-2651-2	438C805G11	9-2654-2
480V, 60 Hz or 440V, 50 Hz	C	9-1891-3	9-1891-3	9-1891-3	9-1875-3	9-2651-3	9-2698-3	9-1875-3	9-2651-3	438C805G10	9-2654-3
600V, 60 Hz or 550V, 50 Hz	D	9-1891-4	9-1891-4	9-1891-4	9-1875-4	9-2651-4	9-2698-4	9-1875-4	9-2651-4	—	9-2654-4
208V, 60 Hz	E	9-1891-13	9-1891-13	9-1891-13	9-1875-14	9-2651-6	9-2698-5	9-1875-14	9-2651-6	438C805G11	9-2654-6
24V, 60 Hz	T	9-1891-15	9-1891-15	9-1891-15	—	—	—	—	—	—	—
380V, 50 Hz	L	9-1891-14	9-1891-14	9-1891-14	—	9-2651-5	9-2698-6	—	9-2651-5	438C805G15	9-2654-5
277V, 60 Hz	H	9-1891-26	9-1891-26	9-1891-26	—	—	—	—	—	—	—
120 Vdc ④	A1	9-2026-2	9-2026-2	9-2026-2	—	—	—	—	—	—	—
240 Vdc ④	B1	9-2026-1	9-2026-1	9-2026-1	—	—	—	—	—	—	—
24 Vdc ④	T1	9-2026-4	9-2026-4	9-2026-4	—	—	—	—	—	—	—
48 Vdc ④	W1	9-2026-3	9-2026-3	9-2026-3	—	—	—	—	—	—	—

Notes

- ① Citation overload relays are no longer available. A Freedom overload may be an option. Contact Control Aftermarket at 1-800-535-8992.
- ② Replace complete contactor.
- ③ Non-encapsulated coil.
- ④ For use in existing DC operated devices. Not for conversion of existing AC operated devices to DC.

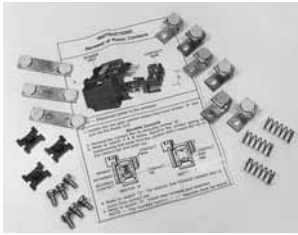

Three-Pole Contact Kit, Size 3, Series B1

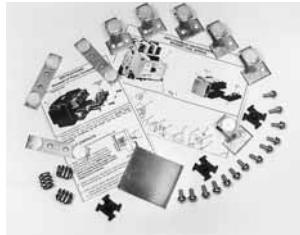

Three-Pole Contact Kit, Size 5



Magnet Coil, 120V/60 Hz for Size 3, Series A1

Replacement Capabilities—Overload Relays

Description	Style and Part Numbers									
	Size 00 Series A1	Size 00 Series B1	Size 00 Series C1	Size 00 Series D1	Size 0	Size 1	Size 2 Series A1	Size 2 Series B1	Size 3 Series A1	Size 3 Series B1
Overload Relays										
Without mounting plates— for replacement on existing starters										
Standard trip (Class 20)	①	①	①	①	①	①	①	①	①	①
Eutectic — 1 Element										
3 Element										
3 Element with alarm circuit										
Slow trip (Class 30)	①	①	①	①	①	①	①	①	①	①
Eutectic — 1 Element										
3 Element										
Replacement Thermal Elements										
Standard trip eutectic	②	②	②	②	②	②	②	②	②	②
Slow trip eutectic	10-5018 ③	10-5018 ③	10-5018 ③	10-5018 ③	10-5018 ③	10-5018 ③	10-5018 ③	10-5018 ③	10-5018 ③	10-5018 ③

Replacement Capabilities—Overload Relays, continued

Description	Style and Part Numbers									
	Size 4 Series A1	Size 4 Series B1	Size 5	Size 6 Series A1	Size 6 Series B1	Size 6 Series C1	Size 7 Series A1	Size 7 Series B1	Size 8 Series A1	Size 8 Series B1
Overload Relays										
Without mounting plates— for replacement on existing starters										
Standard trip (Class 20)	①	①	①	①	①	①	①	①	①	①
Eutectic — 1 Element										
3 Element										
3 Element with alarm circuit										
Replacement Thermal Elements										
Standard trip eutectic	②	②	②	②	②	②	②	②	②	②
Slow trip eutectic	10-5018 ③	10-5018 ③	10-5018 ③	—	—	—	—	—	—	—
Current transformer	—	—	—	—	42-3418-3 ④	42-3418-3 ④	—	—	—	—

Technology Upgrades

Sizes 00–3—Freedom

Sizes 4–6—Freedom

Sizes 7–8—Freedom

Adapter Plates

The adapter plates make it possible to replace a Citation starter with a Freedom starter and the same mounting holes can be used.

Notes

- ① Citation overload relays are no longer available. Replace with up-to-date starter, or contact Standard Open Control Aftermarket at **1-800-535-8992** to determine Freedom overload relay compatibility.
- ② No longer available. Replace with up-to-date overload relay or starter.
- ③ Will no longer be available once stock is depleted. If stock is out, replace with up-to-date overload relay or starter.
- ④ On Vista; no price.

Adapter Plates Ordering Information

NEMA Size	Adapter Plate Catalog Number Freedom
00, 0	C321CMP0
1	C321CMP1
2	C321CMP2
3	C321CMP3
4	C321CMP4
5	C321CMP5

Heaters

Overload relays do not include heaters. Please see table for heater element index.

Heater Selection

For Replacement in Existing Applications Only

Heaters are rated to protect 40°C rise of motors; and, open and drip-proof motors having a service factor of 1.15 where the motor and the controller are at the same ambient temperature.

For other conditions:

1. For 50°C, 55°C and 75°C (122°F, 131°F and 167°F) rise motors and enclosed motors having a service factor of 1.0, select one size smaller.
2. Ambient temperature of the starter lower than the motor by 26°C (79°F), use one size smaller.
3. Ambient temperature of the starter higher than the motor by 26°C (79°F), use one size larger.

Ultimate tripping current of heaters is approximately 1.25 times the minimum current rating listed in the tables.

Heater Selection Index

Note: Use this index to cross-reference tables on **Pages V12-T13-9 through V12-T13-21.**

Index of Overload Relay Heater Selection Tables

Starter Type Catalog Prefix	Type	Heater Selection Table Number NEMA Size of Starter							
		00-0-1 (1-1/2)	2	3	4	5	6	7	8
A10	Open	ST-1	ST-3	ST-5	ST-7	ST-16	ST-10	ST-11	ST-12
	Enclosed	ST-2	ST-4	ST-6	ST-7	ST-16	ST-10	ST-11	ST-12
A11	Open	BNC-1	BNC-3	BNC-5	BNC-7	BNC-9	—	—	—
	Enclosed	BNC-2	BNC-4	BNC-6	BNC-7	BNC-9	—	—	—
A13	Open	LT-2	LT-4	LT-6	LT-7	LT-8	—	—	—
	Enclosed	LT-1	LT-3	LT-5	LT-7	LT-8	—	—	—
A30 and A40	Enclosed	ST-9	ST-3	ST-6	ST-7	ST-16	ST-10	ST-11	ST-12
A31 and A41	Enclosed	BNC-8	BNC-3	BNC-6	BNC-7	BNC-9	—	—	—
A50	Open	ST-1	ST-3	ST-5	ST-7	ST-16	ST-10	ST-11	ST-12
	Enclosed	ST-2	ST-4	ST-6	ST-7	ST-16	ST-10	ST-11	ST-12
A51	Open	BNC-1	BNC-3	BNC-5	BNC-7	BNC-9	—	—	—
	Enclosed	BNC-2	BNC-4	BNC-6	BNC-7	BNC-9	—	—	—
A70 and A80	Enclosed	ST-9	ST-3	ST-6	ST-7	ST-16	ST-10	ST-11	ST-12
A71 and A81	Enclosed	BNC-8	BNC-3	BNC-5	BNC-7	BNC-9	—	—	—
A400-A420	Enclosed	—	—	ST-14	ST-15	ST-16	ST-10	ST-11	ST-12
A460 ①	Enclosed	ST-2 ①	ST-4 ①	ST-6 ①	ST-7 ①	ST-16 ①	ST-10 ①	ST-11 ①	ST-12 ①
A490 ②	Enclosed	ST-2 ②	ST-4 ②	ST-6 ②	ST-7 ②	ST-16 ②	ST-10 ②	ST-11 ②	ST-12 ②
A700	Open	ST-1	ST-3	ST-5	ST-7	ST-16	—	—	—
	Enclosed	ST-2	ST-4	ST-6	ST-7	ST-16	ST-10	—	—
A800-A803	Enclosed	ST-9	ST-3	ST-5	ST-7	ST-16	ST-10	ST-11	—
A804-A806	Enclosed	ST-9	ST-3	ST-5	—	—	—	—	—
A808-A809	Enclosed	—	ST-13	ST-5	ST-5	—	—	—	—
B10 and B50	Enclosed	ST-1	ST-3	ST-5	ST-7	—	—	—	—
B11 and B51	Open	BNC-1	—	—	—	—	—	—	—
	Enclosed	BNC-2	BNC-3	BNC-5	—	—	—	—	—
C300	Open and enclosed	ST-1	ST-3	ST-5	ST-7	—	—	—	—
C301	Open and enclosed	BNC-1	BNC-4	BNC-5	BNC-7	—	—	—	—
C303	Open and enclosed	LT-2	LT-4	LT-6	LT-7	—	—	—	—

Notes

① Select heaters for 50% of rated full load current.

② Select heaters for 68% of rated full load current.

Individually boxed heaters master packed 10 per carton.

Overload Relay Heater Selection Tables

Type ST Standard Trip Eutectic Alloy

For replacement in existing applications only; for motors with 1.15 service factor.

Table ST-1 NEMA Sizes 00, 0, 1, 1-1/2 For <i>Open Type</i> Catalog Prefix A10, A50, A700, B10, B50, C300 For <i>Enclosed Type</i> Catalog Prefix B10, B50, C300 Heater Ampere Range	Table ST-2 NEMA Sizes 00, 0, 1, 1-1/2 For <i>Enclosed Type</i> Catalog Prefix A10, A50, A460 ^① , A490 ^② , A700	Table ST-3 NEMA Size 2 For <i>Open Type</i> Catalog Prefix A10, A50, A700, B10, C300 For <i>Enclosed Type</i> Catalog Prefix B10, C300, A30, A40, A70, A80, A800-A803	Table ST-4 NEMA Size 2 For <i>Enclosed Type</i> Catalog Prefix A10, A50, A460 ^① , A490 ^② , A700	Table ST-5 NEMA Size 3 For <i>Open Type</i> Catalog Prefix A10, A50, A700, B10, C300 For <i>Enclosed Type</i> Catalog Prefix A70, A80, A800-A803, A808-A809, B10	Heater Catalog Number
0.167–0.187	0.155–0.173	—	—	—	H1101
0.188–0.210	0.174–0.195	—	—	—	H1102
0.211–0.237	0.196–0.220	—	—	—	H1103
0.238–0.266	0.221–0.247	—	—	—	H1104
0.267–0.298	0.248–0.278	—	—	—	H1105
0.299–0.334	0.279–0.310	—	—	—	H1106
0.335–0.376	0.311–0.349	—	—	—	H1107
0.377–0.422	0.350–0.391	—	—	—	H1108
0.423–0.474	0.392–0.441	—	—	—	H1109
0.475–0.532	0.442–0.495	—	—	—	H1110
0.533–0.598	0.496–0.555	—	—	—	H1111
0.599–0.672	0.556–0.624	—	—	—	H1112
0.673–0.757	0.625–0.703	—	—	—	H1113
0.758–0.855	0.704–0.795	—	—	—	H1114
0.865–0.959	0.796–0.895	—	—	—	H1115
0.960–1.07	0.896–0.999	—	—	—	H1116
1.08–1.21	1.00–1.12	—	—	—	H1117
1.22–1.35	1.13–1.25	—	—	—	H1018
1.36–1.52	1.26–1.41	—	—	—	H1019
1.53–1.70	1.42–1.58	—	—	—	H1020
1.71–1.90	1.59–1.77	—	—	—	H1021
1.91–2.10	1.78–1.96	—	—	—	H1022
2.11–2.33	1.97–2.17	—	—	—	H1023
2.34–2.62	2.18–2.44	—	—	—	H1024
2.63–2.93	2.45–2.72	—	—	—	H1025
2.94–3.27	2.73–3.04	—	—	—	H1026
3.28–3.64	3.05–3.38	—	—	—	H1066
3.65–4.06	3.39–3.73	3.72–4.10	—	—	H1027
4.07–4.55	3.74–4.18	4.11–4.59	3.86–4.31	—	H1028
4.56–5.03	4.19–4.63	4.60–5.07	4.32–4.77	—	H1029

Notes

① For A460 controllers, select heaters at 50% of rated full load current.

② For A490 controllers, select heaters at 58% of rated full load current.

Individually boxed heaters master packed 10 per carton.

Type ST Standard Trip Eutectic Alloy, continued

For replacement in existing applications only; for motors with 1.15 service factor.

Table ST-1 NEMA Sizes 00, 0, 1, 1-1/2 For <i>Open Type</i> Catalog Prefix A10, A50, A700, B10, B50, C300 For <i>Enclosed Type</i> Catalog Prefix B10, B50, C300 Heater Ampere Range	Table ST-2 NEMA Sizes 00, 0, 1, 1-1/2 For <i>Enclosed Type</i> Catalog Prefix A10, A50, A460 ^① , A490 ^② , A700	Table ST-3 NEMA Size 2 For <i>Open Type</i> Catalog Prefix A10, A50, A700, B10, C300 For <i>Enclosed Type</i> Catalog Prefix B10, C300, A30, A40, A70, A80, A800-A803	Table ST-4 NEMA Size 2 For <i>Enclosed Type</i> Catalog Prefix A10, A50, A460 ^① , A490 ^② , A700	Table ST-5 NEMA Size 3 For <i>Open Type</i> Catalog Prefix A10, A50, A700, B10, C300 For <i>Enclosed Type</i> Catalog Prefix A70, A80, A800-A803, A808-A809, B10	Heater Catalog Number
5.04–5.59	4.64–5.15	5.08–5.65	4.78–5.31	—	H1030
5.60–6.25	5.16–5.68	5.66–6.29	5.32–5.90	—	H1031
6.26–6.92	5.69–6.30	6.30–7.00	5.91–6.55	—	H1032
6.93–7.75	6.31–7.05	7.01–7.82	6.56–7.33	—	H1033
7.76–8.63	7.06–7.76	7.83–8.79	7.34–8.15	8.32–9.27	H1034
8.64–9.59	7.77–8.63	8.80–9.67	8.16–9.03	9.28–10.1	H1035
9.60–10.6	8.64–9.51	9.68–10.8	9.04–10.1	10.2–11.4	H1036
10.7–11.9	9.52–10.5	10.9–12.0	10.2–11.2	11.5–12.8	H1037
12.0–13.3	10.6–11.8	12.1–13.4	11.3–12.5	12.9–14.3	H1038
13.4–14.7	11.9–13.1	13.5–14.9	12.6–13.9	14.4–16.0	H1039
14.8–16.6	13.2–14.8	15.0–17.6	14.0–15.7	16.1–17.8	H1040
16.7–18.8	14.9–16.7	17.7–19.0	15.8–17.5	17.9–20.3	H1041
18.9–21.2	16.8–18.9	19.1–21.5	17.6–19.8	20.4–22.9	H1042
21.3–23.9	19.0–21.3	21.6–24.5	19.9–22.3	23.0–26.0	H1043
24.0–27.0	21.4–24.1	24.6–27.9	22.4–25.4	26.1–29.5	H1044
—	24.2–27.0	28.0–32.0	25.5–28.7	29.6–33.5	H1045
—	—	32.1–36.6	28.8–32.5	33.6–37.8	H1046
—	—	36.7–41.8	32.6–36.6	37.9–42.8	H1047
—	—	41.9–45.0	36.7–41.0	42.9–48.5	H1048
—	—	—	41.1–45.0	48.6–55.1	H1049
—	—	—	—	55.2–62.3	H1050
—	—	—	—	62.4–69.5	H1051
—	—	—	—	69.6–79.1	H1052
—	—	—	—	79.2–90.0	H1054
—	—	—	—	—	H1055
—	—	—	—	—	H1056
—	—	—	—	—	H1057
—	—	—	—	—	H1058

Notes

① For A460 controllers, select heaters at 50% of rated full load current.

② For A490 controllers, select heaters at 58% of rated full load current.

Individually boxed heaters master packed 10 per carton.

Type ST Standard Trip Eutectic Alloy, continued

For replacement in existing applications only; for motors with 1.15 service factor.

Table ST-6 NEMA Size 3	Table ST-7 NEMA Size 4	Table ST-8 NEMA Size 5	Table ST-9 NEMA Size 0 and 1	Table ST-10 NEMA Size 6	Heater Catalog Number
For <i>Enclosed Type</i> Catalog Prefix A10, A30, A40, A50, A460 ^① , A490 ^② , A700	For <i>Open Type</i> Catalog Prefix A10, A50, C300 For <i>Enclosed Type</i> Catalog Prefix A10, A30, A40, A50, A70, A80, A460 ^① , A490 ^② , A700, A800-A803	For <i>Open and Enclosed</i> Catalog Prefix A10, A50, A30-40, A70, A80, A400, A410, A420, A460, A490, A800-A801	For <i>Enclosed Type</i> Catalog Prefix A30, A40, A70, A80, A800-A803	For <i>Open Type</i> Catalog Prefix A10, A50, A700 For <i>Enclosed Type</i> Catalog Prefix A10, A30, A40, A50, A70, A80, A400, A460 ^① , A490 ^② , A700	
Heater Ampere Range					
—	—	—	0.164–0.183	—	H1101
—	—	—	0.184–0.205	—	H1102
—	—	—	0.206–0.232	—	H1103
—	—	—	0.233–0.260	—	H1104
—	—	—	0.261–0.293	—	H1105
—	—	—	0.294–0.328	—	H1106
—	—	—	0.329–0.369	—	H1107
—	—	—	0.370–0.414	—	H1108
—	—	—	0.415–0.465	—	H1109
—	—	—	0.466–0.522	—	H1110
—	—	—	0.523–0.586	—	H1111
—	—	—	0.587–0.659	—	H1112
—	—	—	0.660–0.743	—	H1113
—	—	—	0.744–0.839	—	H1114
—	—	—	0.840–0.943	—	H1115
—	—	—	0.944–1.05	—	H1116
—	—	—	1.06–1.17	—	H1117
—	—	—	1.18–1.31	—	H1018
—	—	—	1.32–1.47	154–171	H1019
—	—	92–101	1.48–1.66	172–192	H1020
—	—	102–113	1.67–1.85	193–215	H1021
—	—	114–125	1.86–2.04	216–237	H1022
—	—	126–139	2.05–2.26	238–263	H1023
—	—	140–157	2.27–2.54	264–295	H1024
—	—	158–175	2.55–2.85	296–330	H1025
—	—	176–196	2.86–3.18	331–369	H1026
—	—	197–218	3.19–3.53	370–410	H1066
—	—	219–243	3.54–3.95	411–458	H1027
—	—	244–270	3.96–4.41	459–512	H1028
—	—	—	4.42–4.88	513–574	H1029

Notes

① For A460 controllers, select heaters for 50% of rated full load current.

② For A490 controllers, select heaters for 58% of rated full load current.

Individually boxed heaters master packed 10 per carton.

Type ST Standard Trip Eutectic Alloy, continued

For replacement in existing applications only; for motors with 1.15 service factor.

Table ST-6 NEMA Size 3	Table ST-7 NEMA Size 4	Table ST-8 NEMA Size 5	Table ST-9 NEMA Size 0 and 1	Table ST-10 NEMA Size 6	Heater Catalog Number
For <i>Enclosed Type</i> Catalog Prefix A10, A30, A40, A50, A460 ①, A490 ②, A700	For <i>Open Type</i> Catalog Prefix A10, A50, C300 For <i>Enclosed Type</i> Catalog Prefix A10, A30, A40, A50, A70, A80, A460 ①, A490 ②, A700, A800-A803	For <i>Open and Enclosed</i> Catalog Prefix A10, A50, A30-40, A70, A80, A400, A410, A420, A460, A490, A800-A801	For <i>Enclosed Type</i> Catalog Prefix A30, A40, A70, A80, A800-A803	For <i>Open Type</i> Catalog Prefix A10, A50, A700 For <i>Enclosed Type</i> Catalog Prefix A10, A30, A40, A50, A70, A80, A400, A460 ①, A490 ②, A700	
Heater Ampere Range					
—	—	—	4.89–5.42	—	H1030
—	—	—	4.89–5.42	—	H1031
—	—	—	6.08–6.64	—	H1032
—	—	—	6.65–7.43	—	H1033
8.24–9.19	—	—	7.44–8.23	—	H1034
9.20–10.1	—	—	8.24–9.19	—	H1035
10.2–11.3	—	—	9.20–10.1	—	H1036
11.4–12.7	—	—	10.2–11.3	—	H1037
12.8–14.1	—	—	11.4–12.6	—	H1038
14.2–15.8	—	—	12.7–14.0	—	H1039
15.9–17.7	—	—	14.1–15.7	—	H1040
17.8–20.1	—	—	15.8–17.7	—	H1041
20.2–22.7	20.6–23.3	—	17.8–19.8	—	H1042
22.8–25.5	23.4–26.3	—	19.9–22.0	—	H1043
25.6–28.9	26.4–30.8	—	22.1–24.9	—	H1044
29.0–32.5	30.9–34.0	—	25.0–27.0	—	H1045
32.6–36.7	34.1–38.3	—	—	—	H1046
36.8–41.0	38.4–43.4	—	—	—	H1047
41.1–46.0	43.5–49.3	—	—	—	H1048
46.1–51.8	49.4–55.8	—	—	—	H1049
51.9–58.6	55.9–63.1	—	—	—	H1050
58.7–64.6	63.2–70.4	—	—	—	H1051
64.7–72.7	70.5–79.9	—	—	—	H1052
72.8–83.1	80.0–92.7	—	—	—	H1054

Notes

① For A460 controllers, select heaters for 50% of rated full load current.

② For A490 controllers, select heaters for 58% of rated full load current.

Individually boxed heaters master packed 10 per carton.

Type ST Standard Trip Eutectic Alloy, continued

For replacement in existing applications only; for motors with 1.15 service factor.

Table ST-11 NEMA Size 7 For <i>Open Type</i> Catalog Prefix A10, A50, A700 For <i>Enclosed Type</i> Catalog Prefix A10, A30, A40, A50, A70, A80, A400, A460 ①, A490 ②, A700 Heater Ampere Range	Table ST-12 NEMA Size 8 For <i>Open Type</i> Catalog Prefix A10, A50, A700 For <i>Enclosed Type</i> Catalog Prefix A10, A30, A40, A50, A70, A80, A400, A460 ①, A490 ②, A700	Table ST-13 NEMA Size 2 For <i>Enclosed Type</i> Catalog Prefix A808, A809	Table ST-14 NEMA Size 3 For <i>Enclosed Type</i> Catalog Prefix A400	Table ST-15 NEMA Size 4 For <i>Enclosed Type</i> Catalog Prefix A400	Heater Catalog Number
—	—	—	—	—	H1101
—	—	—	—	—	H1102
—	—	—	—	—	H1103
—	—	—	—	—	H1104
—	—	—	—	—	H1105
—	—	—	—	—	H1106
—	—	—	—	—	H1107
—	—	—	—	—	H1108
—	—	—	—	—	H1109
—	—	—	—	—	H1110
—	—	—	—	—	H1111
—	—	—	—	—	H1112
—	—	—	—	—	H1113
—	—	—	—	—	H1114
—	—	—	—	—	H1115
—	—	—	—	—	H1116
—	—	—	—	—	H1117
229–255	—	—	—	—	H1018
256–287	384–429	—	—	—	H1019
288–321	430–482	—	—	—	H1020
322–359	483–538	—	—	—	H1021
360–397	539–595	—	—	—	H1022
398–439	596–657	—	—	—	H1023
440–492	658–741	—	—	—	H1024
493–551	742–827	—	—	—	H1025
552–615	828–924	—	—	—	H1026
616–685	925–1027	—	—	—	H1066
686–763	1028–1147	—	—	—	H1027
764–855	1148–1285	3.89–4.35	—	—	H1028
—	—	4.36–4.81	—	—	H1029

Notes

- ① For A460 controllers, select heaters for 50% of rated full load current.
- ② For A490 controllers, select heaters for 58% of rated full load current.

Individually boxed heaters master packed 10 per carton.

Type ST Standard Trip Eutectic Alloy, continued

For replacement in existing applications only; for motors with 1.15 service factor.

Table ST-11 NEMA Size 7 For <i>Open Type</i> Catalog Prefix A10, A50, A700 For <i>Enclosed Type</i> Catalog Prefix A10, A30, A40, A50, A70, A80, A400, A460 ①, A490 ②, A700 Heater Ampere Range	Table ST-12 NEMA Size 8 For <i>Open Type</i> Catalog Prefix A10, A50, A700 For <i>Enclosed Type</i> Catalog Prefix A10, A30, A40, A50, A70, A80, A400, A460 ①, A490 ②, A700	Table ST-13 NEMA Size 2 For <i>Enclosed Type</i> Catalog Prefix A808, A809	Table ST-14 NEMA Size 3 For <i>Enclosed Type</i> Catalog Prefix A400	Table ST-15 NEMA Size 4 For <i>Enclosed Type</i> Catalog Prefix A400	Heater Catalog Number
—	—	4.82–5.35	—	—	H1030
—	—	5.36–5.96	—	—	H1031
—	—	5.97–6.63	—	—	H1032
—	—	6.64–7.41	—	—	H1033
—	—	7.42–8.23	7.84–8.71	—	H1034
—	—	8.24–9.19	8.72–9.67	—	H1035
—	—	9.20–10.2	9.68–10.8	—	H1036
—	—	10.3–11.4	10.9–12.0	—	H1037
—	—	11.5–12.8	12.1–13.5	—	H1038
—	—	12.9–14.1	13.6–15.0	—	H1039
—	—	14.2–15.9	15.1–16.8	—	H1040
—	—	16.0–18.1	16.9–19.1	—	H1041
—	—	18.2–20.4	19.2–21.6	19.5–21.9	H1042
—	—	20.5–23.3	21.7–24.5	22.0–24.7	H1043
—	—	23.4–26.5	24.6–27.8	24.8–29.0	H1044
—	—	26.6–30.3	27.9–31.5	29.1–31.9	H1045
—	—	30.4–34.7	31.6–35.5	32.0–36.1	H1046
—	—	34.8–39.6	35.6–40.3	36.2–40.7	H1047
—	—	39.7–45.0	40.4–45.6	40.8–46.2	H1048
—	—	—	45.7–51.8	46.3–52.4	H1049
—	—	—	51.9–58.6	52.5–59.2	H1050
—	—	—	58.7–65.2	59.3–66.3	H1051
—	—	—	65.3–74.3	66.4–75.1	H1052
—	—	—	74.4–86.3	75.2–87.1	H1054

Notes

- ① For A460 controllers, select heaters for 50% of rated full load current.
- ② For A490 controllers, select heaters for 58% of rated full load current.

Individually boxed heaters master packed 10 per carton.

Type BNC Bimetal

For replacement in existing applications only; for motors with 1.15 service factor.

Table BNC-1 NEMA Sizes 00, 0, 1, 1-1/2 For <i>Open</i> Type Catalog Prefix A11, A51, B11, B51, C301 For <i>Enclosed</i> Type Catalog Prefix C301 Heater Ampere Range	Table BNC-2 NEMA Sizes 00, 0, 1, 1-1/2 For <i>Enclosed</i> Type Catalog Prefix A11, A51, B11, B51	Table BNC-3 NEMA Size 2 For <i>Open</i> Type Catalog Prefix A11, A51, B11, C301 For <i>Enclosed</i> Type Catalog Prefix A31, A41, A71, A81, B11	Table BNC-4 NEMA Size 2 For <i>Enclosed</i> Type Catalog Prefix A11, A51, C301	Heater Catalog Number
0.180–0.201	0.167–0.187	—	—	H1101
0.202–0.226	0.188–0.210	—	—	H1102
0.227–0.254	0.211–0.236	—	—	H1103
0.255–0.285	0.237–0.266	—	—	H1104
0.286–0.320	0.267–0.297	—	—	H1105
0.321–0.357	0.298–0.332	—	—	H1106
0.358–0.402	0.333–0.373	—	—	H1107
0.403–0.451	0.374–0.419	—	—	H1108
0.452–0.506	0.420–0.470	—	—	H1109
0.507–0.568	0.471–0.528	—	—	H1110
0.569–0.638	0.529–0.592	—	—	H1111
0.639–0.716	0.593–0.663	—	—	H1112
0.717–0.799	0.664–0.743	—	—	H1113
0.800–0.911	0.744–0.847	—	—	H1114
0.912–1.01	0.848–0.951	—	—	H1115
1.02–1.14	0.952–1.06	—	—	H1116
1.15–1.29	1.07–1.20	—	—	H1117
1.30–1.44	1.21–1.33	—	—	H1018
1.45–1.61	1.34–1.49	—	—	H1019
1.62–1.80	1.50–1.67	—	—	H1020
1.81–2.03	1.68–1.89	—	—	H1021
2.04–2.25	1.90–2.09	—	—	H1022
2.26–2.49	2.10–2.32	—	—	H1023
2.50–2.76	2.33–2.57	—	—	H1024
2.77–3.05	2.58–2.83	—	—	H1025
3.06–3.39	2.84–3.15	—	—	H1026
3.40–3.83	3.16–3.51	3.87–4.18	—	H1066
3.84–4.22	3.52–3.87	4.19–4.60	3.94–4.33	H1027
4.23–4.63	3.88–4.25	4.61–5.10	4.34–4.78	H1028
4.64–5.19	4.26–4.76	5.11–5.60	4.79–5.27	H1029

Note

Individually boxed heaters master packed 10 per carton.

Type BNC Bimetal

For replacement in existing applications only; for motors with 1.15 service factor.

Table BNC-1 NEMA Sizes 00, 0, 1, 1-1/2 For <i>Open</i> Type Catalog Prefix A11, A51, B11, B51, C301 For <i>Enclosed</i> Type Catalog Prefix C301 Heater Ampere Range	Table BNC-2 NEMA Sizes 00, 0, 1, 1-1/2 For <i>Enclosed</i> Type Catalog Prefix A11, A51, B11, B51	Table BNC-3 NEMA Size 2 For <i>Open</i> Type Catalog Prefix A11, A51, B11, C301 For <i>Enclosed</i> Type Catalog Prefix A31, A41, A71, A81, B11	Table BNC-4 NEMA Size 2 For <i>Enclosed</i> Type Catalog Prefix A11, A51, C301	Heater Catalog Number
5.20–5.73	4.77–5.27	5.61–6.20	5.28–5.83	H1030
5.74–6.49	5.28–5.90	6.21–6.92	5.84–6.51	H1031
6.50–7.32	5.91–6.63	6.93–7.76	6.52–7.29	H1032
7.33–8.07	6.64–7.35	7.77–8.63	7.30–8.07	H1033
8.08–9.03	7.36–8.15	8.64–9.67	8.08–9.03	H1034
9.04–9.99	8.16–8.87	9.68–10.5	9.04–9.99	H1035
10.0–11.1	8.88–9.99	10.6–11.8	10.0–11.1	H1036
11.2–12.5	10.0–11.1	11.9–13.2	11.2–12.3	H1037
12.6–14.1	11.2–12.5	13.3–15.0	12.4–14.1	H1038
14.2–15.9	12.6–14.1	15.1–17.2	14.2–16.1	H1039
16.0–18.0	14.2–16.1	17.3–19.1	16.2–17.8	H1040
18.1–19.8	16.2–17.7	19.2–21.5	17.9–19.9	H1041
19.9–22.2	17.8–19.8	21.6–23.6	20.0–21.9	H1042
22.3–25.0	19.9–22.2	23.7–27.0	22.0–24.7	H1043
25.1–27.0	22.3–25.0	27.1–30.6	24.8–27.9	H1044
—	25.1–27.0	30.7–35.1	28.0–31.6	H1045
—	—	35.2–39.8	31.7–35.3	H1046
—	—	39.9–45.0	35.4–39.4	H1047
—	—	—	39.5–44.4	H1048
—	—	—	44.5–45.0	H1049
—	—	—	—	H1050
—	—	—	—	H1051
—	—	—	—	H1052
—	—	—	—	H1054
—	—	—	—	H1055
—	—	—	—	H1056
—	—	—	—	H1057
—	—	—	—	H1058

Note

Individually boxed heaters master packed 10 per carton.

Type BNC Bimetal, continued

For replacement in existing applications only; for motors with 1.15 service factor.

Table BNC-5 NEMA Size 3 For <i>Open</i> Type Catalog Prefix A11, B11, A51, C301 For <i>Enclosed</i> Type Catalog Prefix B11, A71, A81 Heater Ampere Range	Table BNC-6 NEMA Size 3 For <i>Enclosed</i> Type Catalog Prefix A11, A31, A41, A51	Table BNC-7 NEMA Size 4 For <i>Open</i> Type Catalog Prefix A11, A51, C301 For <i>Enclosed</i> Type Catalog Prefix A11, A31, A41, A51, A71, A81	Table BNC-8 NEMA Sizes 0 and 1 For <i>Enclosed</i> Type Catalog Prefix A31, A41, A71, A81	Table BNC-9 NEMA Size 5 For <i>Open</i> and <i>Enclosed</i> Type Catalog Prefix A11, A31-41, A51, A71, A81	Heater Catalog Number
—	—	—	0.176–0.198	—	H1101
—	—	—	0.199–0.221	—	H1102
—	—	—	0.222–0.249	—	H1103
—	—	—	0.250–0.279	—	H1104
—	—	—	0.280–0.313	—	H1105
—	—	—	0.314–0.350	—	H1106
—	—	—	0.351–0.395	—	H1107
—	—	—	0.396–0.442	—	H1108
—	—	—	0.443–0.497	—	H1109
—	—	—	0.498–0.556	—	H1110
—	—	—	0.557–0.626	—	H1111
—	—	—	0.627–0.703	—	H1112
—	—	—	0.704–0.783	—	H1113
—	—	—	0.784–0.895	—	H1114
—	—	—	0.896–0.999	—	H1115
—	—	—	1.00–1.12	—	H1116
—	—	—	1.13–1.25	—	H1117
—	—	—	1.26–1.40	—	H1018
—	—	—	1.41–1.56	—	H1019
—	—	—	1.57–1.74	96.8–108	H1020
—	—	—	1.75–1.97	109–121	H1021
—	—	—	1.98–2.19	122–135	H1022
—	—	—	2.20–2.42	136–149	H1023
—	—	—	2.43–2.68	150–166	H1024
—	—	—	2.69–2.95	167–182	H1025
—	—	—	2.96–3.29	183–203	H1026
—	—	—	3.30–3.72	204–229	H1066
—	—	—	3.73–4.10	230–253	H1027
—	—	—	4.11–4.49	254–283	H1028
—	—	—	4.50–5.04	—	H1029

Note

Individually boxed heaters master packed 10 per carton.

Type BNC Bimetal, continued

For replacement in existing applications only; for motors with 1.15 service factor.

Table BNC-5 NEMA Size 3	Table BNC-6 NEMA Size 3	Table BNC-7 NEMA Size 4	Table BNC-8 NEMA Sizes 0 and 1	Table BNC-9 NEMA Size 5	
<i>For Open Type</i> Catalog Prefix A11, B11, A51, C301 <i>For Enclosed Type</i> Catalog Prefix B11, A71, A81	<i>For Enclosed Type</i> Catalog Prefix A11, A31, A41, A51	<i>For Open Type</i> Catalog Prefix A11, A51, C301 <i>For Enclosed Type</i> Catalog Prefix A11, A31, A41, A51, A71, A81	<i>For Enclosed Type</i> Catalog Prefix A31, A41, A71, A81	<i>For Open and Enclosed Type</i> Catalog Prefix A11, A31-41, A51, A71, A81	Heater Catalog Number
Heater Ampere Range					
—	—	—	5.05–5.56	—	H1030
—	—	—	5.57–6.23	—	H1031
—	—	—	6.24–7.03	—	H1032
7.57–8.47	7.57–8.39	—	7.04–7.75	—	H1033
8.48–9.35	8.40–9.27	—	7.76–8.71	—	H1034
9.36–10.1	9.28–10.1	—	8.72–9.59	—	H1035
10.2–11.2	10.2–11.1	—	9.60–10.5	—	H1036
11.3–12.2	11.2–12.1	—	10.6–11.8	—	H1037
12.3–13.7	12.2–13.6	—	11.9–13.3	—	H1038
13.8–15.7	13.7–15.5	—	13.4–14.9	—	H1039
15.8–17.3	15.6–17.2	—	15.0–16.9	—	H1040
17.4–19.9	17.3–19.8	—	17.0–18.5	—	H1041
20.0–22.9	19.9–22.7	20.0–22.9	18.6–20.7	—	H1042
23.0–26.4	22.8–26.0	23.0–26.4	20.8–23.0	—	H1043
26.5–30.6	26.1–30.0	26.5–30.6	23.1–25.7	—	H1044
30.7–35.5	30.1–34.4	30.7–35.5	25.8–27.0	—	H1045
35.6–41.2	34.5–39.5	35.6–41.2	—	—	H1046
41.3–46.5	39.6–44.3	41.3–46.5	—	—	H1047
46.6–52.4	44.4–49.9	46.6–52.4	—	—	H1048
52.5–57.8	50.0–54.3	52.5–57.8	—	—	H1049
57.9–63.6	54.4–59.8	57.9–63.6	—	—	H1050
63.7–69.9	59.9–65.1	63.7–69.9	—	—	H1051
70.0–79.5	65.2–73.1	70.0–79.5	—	—	H1052
79.6–90.0	73.2–83.9	79.6–92.0	—	—	H1054

Note

Individually boxed heaters master packed 10 per carton.

Type 8LT Slow Trip Eutectic Alloy

For replacement in existing applications only; for motors with 1.15 service factor.

Table LT-1 NEMA Size 00, 0, 1, 1-1/2 For Enclosed Type Catalog Prefix A13	Table LT-2 For Open Type Catalog Prefix A13, C303 For Enclosed Type Catalog Prefix C303	Table LT-3 NEMA Size 2 For Enclosed Type Catalog Prefix A13	Table LT-4 NEMA Size 2 For Open Type Catalog Prefix A13, C303 For Enclosed Type Catalog Prefix C303	Table LT-5 NEMA Size 3 For Enclosed Type Catalog Prefix A13	Table LT-6 NEMA Size 3 For Open Type Catalog Prefix A13, C303	Table LT-7 NEMA Size 4 For Open Type Catalog Prefix A13, C303 For Enclosed Type Catalog Prefix A13	Table LT-8 NEMA Size 5 For Open and Enclosed Type Catalog Prefix A13	Heater Catalog Number
Heater Ampere Range								
0.167–0.186	0.167–0.186	—	—	—	—	—	—	H1001
0.187–0.209	0.187–0.209	—	—	—	—	—	—	H1002
0.210–0.233	0.210–0.233	—	—	—	—	—	—	H1003
0.234–0.260	0.234–0.260	—	—	—	—	—	—	H1004
0.261–0.293	0.261–0.293	—	—	—	—	—	—	H1005
0.294–0.329	0.294–0.329	—	—	—	—	—	—	H1006
0.330–0.373	0.330–0.373	—	—	—	—	—	—	H1007
0.374–0.417	0.374–0.417	—	—	—	—	—	—	H1008
0.418–0.471	0.418–0.471	—	—	—	—	—	—	H1009
0.472–0.531	0.472–0.531	—	—	—	—	—	—	H1010
0.532–0.591	0.532–0.591	—	—	—	—	—	—	H1011
0.592–0.660	0.592–0.660	—	—	—	—	—	—	H1012
0.661–0.739	0.661–0.739	—	—	—	—	—	—	H1013
0.740–0.823	0.740–0.823	—	—	—	—	—	—	H1014
0.824–0.919	0.824–0.919	—	—	—	—	—	—	H1015
0.920–1.01	0.920–1.01	—	—	—	—	—	—	H1016
1.02–1.14	1.02–1.14	—	—	—	—	—	—	H1017
1.15–1.27	1.15–1.27	—	—	—	—	—	—	H1018
1.28–1.41	1.28–1.41	—	—	—	—	—	—	H1019
1.42–1.61	1.42–1.61	—	—	—	—	—	—	H1020
1.62–1.86	1.62–1.86	—	—	—	—	—	96.8–111	H1021
1.87–2.01	1.87–2.01	—	—	—	—	—	112–120	H1022
2.02–2.27	2.02–2.27	—	—	—	—	—	121–136	H1023
2.28–2.51	2.28–2.51	—	—	—	—	—	137–150	H1024
2.52–2.80	2.52–2.80	—	—	—	—	—	151–168	H1025
2.81–3.21	2.81–3.21	—	—	—	—	—	169–192	H1026
3.22–3.51	3.22–3.51	—	—	—	—	—	193–210	H1066
3.52–3.86	3.52–3.86	3.67–3.99	3.67–3.99	—	—	—	211–231	H1027
3.87–4.36	3.87–4.36	4.00–4.51	4.00–4.51	—	—	—	232–261	H1028
4.37–4.78	4.37–4.83	4.52–5.03	4.52–5.03	—	—	—	262–293	H1029

Notes

Individually boxed heaters master packed 10 per carton.

Individually boxed heater coils master packed 10 per carton.

Type LT Slow Trip Eutectic Alloy, continued

For replacement in existing applications only; for motors with 1.15 service factor.

Table LT-1 NEMA Size 00, 0, 1, 1-1/2 For Enclosed Type Catalog Prefix A13	Table LT-2 For Open Type Catalog Prefix A13, C303 For Enclosed Type Catalog Prefix C303	Table LT-3 NEMA Size 2 For Enclosed Type Catalog Prefix A13	Table LT-4 NEMA Size 2 For Open Type Catalog Prefix A13, C303 For Enclosed Type Catalog Prefix C303	Table LT-5 NEMA Size 3 For Enclosed Type Catalog Prefix A13	Table LT-6 NEMA Size 3 For Open Type Catalog Prefix A13, C303	Table LT-7 NEMA Size 4 For Open Type Catalog Prefix A13, C303 For Enclosed Type Catalog Prefix A13	Table LT-8 NEMA Size 5 For Open and Enclosed Type Catalog Prefix A13	Heater Catalog Number
Heater Ampere Range								
4.79–5.35	4.84–5.41	5.04–5.59	5.04–5.59	—	—	—	—	H1030
5.36–6.00	5.42–6.07	5.60–6.20	5.60–6.20	—	—	—	—	H1031
6.01–6.59	6.08–6.66	6.21–6.88	6.21–6.88	—	—	—	—	H1032
6.60–7.35	6.67–7.51	6.89–7.80	6.89–7.80	—	—	—	—	H1033
7.36–8.14	7.52–8.31	7.81–8.71	7.81–8.71	8.16–9.11	8.24–9.19	—	—	H1034
8.15–9.11	8.32–9.27	8.72–9.59	8.72–9.59	9.12–9.99	9.20–10.0	—	—	H1035
9.12–10.0	9.28–10.3	9.60–10.5	9.60–10.7	10.0–11.2	10.1–11.3	—	—	H1036
10.1–11.3	10.4–11.7	10.6–11.8	10.8–12.0	11.3–12.3	11.4–12.5	—	—	H1037
11.4–12.5	11.8–13.0	11.9–13.3	12.1–13.4	12.4–13.9	12.6–14.1	—	—	H1038
12.6–13.9	13.1–14.5	13.4–14.8	13.5–14.9	14.0–15.5	14.2–15.7	—	—	H1039
14.0–15.5	14.6–16.3	14.9–16.6	15.0–16.8	15.6–17.4	15.8–17.6	—	—	H1040
15.6–17.0	16.4–18.1	16.7–18.5	16.9–18.8	17.5–19.6	17.7–19.8	—	—	H1041
17.1–18.9	18.2–20.3	18.6–20.7	18.9–21.1	19.7–21.9	19.9–22.1	20.0–22.3	—	H1042
19.0–21.2	20.4–23.0	20.8–23.3	21.2–24.1	22.0–24.7	22.2–25.2	22.4–25.5	—	H1043
21.3–23.3	23.1–25.9	23.4–26.5	24.2–27.3	24.8–28.1	25.3–28.7	25.6–28.9	—	H1044
23.4–26.1	26.0–27.0	26.6–30.0	27.4–31.3	28.2–31.8	28.8–32.7	29.0–33.7	—	H1045
26.2–27.0	—	30.1–33.7	31.4–35.5	31.9–36.1	32.8–37.3	33.8–37.5	—	H1046
—	—	33.8–37.5	35.6–40.3	36.2–40.7	37.4–42.3	37.6–42.6	—	H1047
—	—	37.6–41.9	40.4–45.0	40.8–45.5	42.4–47.9	42.7–48.2	—	H1048
—	—	42.0–45.0	—	45.6–52.0	48.0–55.4	48.3–55.9	—	H1049
—	—	—	—	52.1–58.2	55.5–61.9	56.0–62.3	—	H1050
—	—	—	—	58.3–63.2	62.0–67.9	62.4–68.4	—	H1051
—	—	—	—	63.3–68.3	68.0–73.3	68.5–73.7	—	H1052
—	—	—	—	68.4–79.9	73.4–87.9	73.8–88.7	—	H1054

Notes

Individually boxed heaters master packed 10 per carton.

Individually boxed heater coils master packed 10 per carton.

Type N

Originally a Westinghouse Product

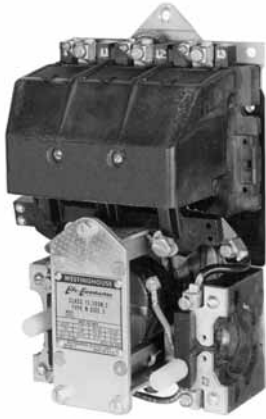

Type N Contactor

Product History Time Line for Type N

Size	1940	1950	1960	1970	1980	1990	2000	Present
0-4	[Timeline bar showing continuous production from 1940 to Present]							

Replacement Capabilities

Contact Kits

NEMA Size	Poles	Style Number
0	3	1605226
1	3	1605212
2	3	1605202
3	3	1625563
4	3	1625564

AC Coils

Voltage	Hz	Part Number		Part Number	
		Two-, Three-Pole Original	New	Four-, Five-Pole Original	New
Sizes 0, 1					
220/380/440	25/50/60	1470243	9969D90G03	1470263	9969D90G18
550	60	1470244	9969D90G04	N/A	N/A
120	60	1605268	9969D90G09	N/A	N/A
115/208/230	60/60/60	1605513	9969D90G15	N/A	N/A
600	60	1470245	9969D90G20	N/A	N/A
Size 2					
110/208/220	25/60/60	1470202	9969D92G02	1470222	9969D93G02
220/380/440/480	25/50/60/60	1470203	9969D92G03	N/A	N/A
600	60	1470205	9969D92G08	1470225	9969D93G08
120/110	60/50	1605478	9969D92G10	N/A	N/A
Size 3					
110/208/220	25/60/60	1490646	9969D96G05	1490646	9969D96G05
220/380/400/440	25/50/50/60	1490647	9969D96G06	1490647	9969D96G06
120/110	60/50	1600770	9969D96G09	1600770	9969D96G09
600/500	60/50	1490649	9969D96G21	1490649	9969D96G21
Size 4					
110/208/220	25/60/60	1490658	9969D96G11	1597724	9969D96G02
600/500	60/50	1596635	9969D96G16	1490649	9969D96G21
440	60	1490659	9969D96G12	N/A	N/A
120/110	60/50	1600771	9969D96G20	N/A	N/A

Technology Upgrades

Sizes 00-3—Freedom or *IT*.

Sizes 4-5—Freedom, Vacuum or *IT*.

A200

Originally a Westinghouse Product



A200 Size 1 Starter



Contact Kit for A200 Model J, Size Two-, Three-Pole



A200 AC Coil, 120/110V, 60/50 Hz, Two-, Three-, Four-Pole, Sizes 00, 0 and 1

Product History Time Line for A200, A201, A203, A204, A206, A210, A211, A213, A214, A216, A220, A223, A224, A226, A250, A251, A600, A603, A604, A606, A700, A703, A704, A706, A800, A804 and A806

Size	Model	1960	1965	1970	1975	1980	1985	1990	1995	2000	Present
00-3	J										
4	J										
4	K										
5-6	Electrically held										
5-6	Mechanically held										
7-8											
9											

Replacement Capabilities

Kits for Model J, Sizes 00, 0, 1 and 2 ①

Description	Poles	Size 00	Size 0	Size 1	Size 2
Contact kit	2	373B331G17	373B331G02	373B331G07	373B331G11
	3	373B331G18	373B331G04	373B331G09	373B331G12
	4	373B331G18	373B331G04	373B331G09	373B331G13 ②
	5	373B331G19	373B331G05	373B331G10	373B331G14 ③
	Arc box ④	2-4	6714C74G01	6714C74G02	6714C74G03
Cross bar	5	6714C74G04	6714C74G05	6714C74G06	6714C74G08 (four-, five-pole)
	2-3	N/A	N/A	N/A	672B788G32
Upper base (for single rated coils only)	4-5	N/A	N/A	N/A	672B788G34
	2-3	N/A	N/A	N/A	672B788G33
Lower base	4-5	N/A	N/A	N/A	672B788G35
	2-3	N/A	N/A	N/A	1250C33G09
KD spring (pk. of 10)	All	N/A	N/A	N/A	1250C33G05
Terminal line/load (pk. of 3)	All	N/A	N/A	N/A	503C796G01
					371B870G03

AC Coils

Voltage	Hz	Sizes 00, 0 and 1		Size 2	
		Two-, Three-, Four-Pole	Five-Pole	Two-, Three-Pole	Four-, Five-Pole
120/110	60/50	505C806G01	505C808G01	505C806G01	505C818G01
208	60	505C806G02	505C808G02	505C806G02	505C818G02
600/550	60/50	505C806G05	505C808G05	505C806G05	505C818G05
380	50	505C806G07	505C808G07	505C806G07	505C818G07
240/220	60/50	505C806G12	505C808G12	505C806G12	505C818G12
480/440	60/50	505C806G13	505C808G13	505C806G13	505C818G13
24	60	505C806G16	N/A	505C806G16	505C818G15
277	60	505C806G18	505C808G16	505C806G18	505C818G16
240/480 ⑤	60/60	505C806G03	505C808G03	505C806G03	505C818G03
120/240 ⑤	60/60	505C806G10	505C808G10	505C806G10	505C818G10

Notes

- ① Model C contact kits and coils 00-4, two-, three-, four- and five-pole contactors are same as Model J. All other parts are unavailable.
- ② Use quantity two—373B331G11 (two-pole kit).
- ③ Use one each of 373B331G11 (two-pole kit) and 373B331G12 (three-pole kit).
- ④ Mounting hardware included.
- ⑤ Dual voltage coils. Use only on contactors or starters originally supplied with a dual voltage coil.



A200 AC Coil, 110/120V, 60 Hz, Size 6

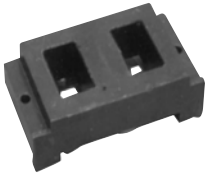

A200 AC Coil, 120/110V, 60/50 Hz, Two-, Three-Pole, Sizes 3 and 4, Model J

DC Coils ①

Voltage	Size 0	Size 1	Size 2
	Single-, Two-, Three-, Four-Pole	Single-, Two-, Three-, Four-Pole	Single-, Two-, Three-, Four-Pole
12	1268C86G07	1268C86G07	1268C86G07
24	1268C86G04	1268C86G04	1268C86G04
48	1268C86G05	1268C86G05	1268C86G05
125	1268C86G02	1268C86G02	1268C86G02
250	1268C86G01	1268C86G01	1268C86G01
125/250 ②	1268C86G03	1268C86G03	1268C86G03

Kits for Model J-K, Sizes 3 and 4 ③

Description	Poles	Size 3—Model J	Size 4—Model J	Size 4—Model K ④
Contact kit	2	626B187G12	626B187G16	5250C81G16
	3	626B187G13	626B187G17	5250C81G17
	4	626B187G14 ⑤	626B187G18 ⑦	5250C81G18
	5	626B187G15 ⑥	626B187G19 ⑧	5250C81G19
	Arc box	2-3	6714C74G09	6714C74G11
Cross bar	4-5	6714C74G10	6714C74G12	6714C74G12
	2-3	672B788G36	672B788G36	672B788G40
Upper base	4-5	672B788G38	672B788G38	—
	2-3	672B788G37	672B788G37	672B788G52
Lower base	4-5	672B788G39	672B788G39	—
	2-3	1250C33G03	1250C33G03	1250C33G10
KO spring (pk. of 10)	4-5	1250C33G06	1250C33G06	—
	All	503C796G02	503C796G02	672B788G50
Terminals line/load (pk. of 3)	All	372B357G12	372B357G13	372B357G13

AC Coils

Voltage	Hz	Model J, Sizes 3-4		Model K, Size 4 ⑨	
		Two-, Three-Pole	Four-, Five-Pole	Two-, Three-Pole	Four-, Five-Pole
120/110	60/50	505C633G01	505C635G01	5250C79G01	5250C80G01
208	60	505C633G02	505C635G02	5250C79G02	5250C80G02
600/550	60/50	505C633G05	505C635G05	5250C79G05	5250C80G05
380	50	505C633G07	505C635G07	5250C79G07	5250C80G07
240/220	60/50	505C633G12	505C635G12	5250C79G12	5250C80G12
480/440	60/50	505C633G13	505C635G13	5250C79G13	5250C80G13
24	60	505C633G34	N/A	5250C79G34	N/A
277	60	505C633G14	N/A	5250C79G14	N/A
240/480 ⑩	60/60	505C633G03	505C635G03	5250C79G03	5250C80G03
120/240 ⑩	60/60	505C633G10	505C635G10	5250C79G10	5250C80G10

DC Coils ⑪

Voltage	Model J, Sizes 3-4
	Two-, Three-Pole
24	1255C68G04
48	1255C68G05
125	1255C68G01
250	1255C68G02
125/250	1255C68G03

Notes

- ① Use only on contactors originally supplied with a DC coil.
- ② Dual voltage coils. Use only on contactors or starters originally supplied with a dual voltage coil.
- ③ Model C contact kits and coils 00-4, two-, three-, four- and five-pole contactors are same as Model J. All other parts are unavailable.
- ④ Model K replaces Model J.
- ⑤ Use quantity two—626B187G12 (two-pole kits).
- ⑥ Use one of each of 626B187G12 (two-pole kit) and 626B187G13 (three-pole kit).
- ⑦ Use quantity two—626B187G16 (two-pole kit).
- ⑧ Use one each of 626B187G16 (two-pole kit) and 626B187G17 (three-pole kit).
- ⑨ Model K replaces Model J.
- ⑩ Dual voltage coils. Use only on contactors or starters originally supplied with a dual voltage coil.
- ⑪ Use only on units originally supplied with DC coil.

Kits for GCA 530/630, Sizes 5–9—and GPD Sizes 7–9 ①

Kit	Size 5	Size 6	Size 7	Size 8	Size 9
Contact kit (one per pole)	477B477G05 ②	2066A10G11	461A757G17	646C829G05	5264C42G01 (rear connected) 5264C42G02 (front connected)
Arc box	2050A15G45	2066A10G45	831D580G01	831D580G01	9917D69G02
Magnet assembly	2050A15G46	2050A15G46	N/A	N/A	N/A
Magnet spacing kit	2050A15G47	2050A15G47	N/A	N/A	N/A
Arc cup kit	2050A15G48	N/A	N/A	N/A	N/A
Load connection kit	2050A15G49	2066A10G49	N/A	N/A	N/A
Line connection kit	2050A15G50	2066A10G50	N/A	N/A	N/A
KO spring-6	2050A15G51	2066A10G46	N/A	N/A	N/A
CT 300/5	655C285H03	N/A	N/A	N/A	N/A
CT 400/5	655C285H04	—	—	—	—
CT 600/5	N/A	2066A10G18 ③	N/A	N/A	N/A
CT 800/5	N/A	2066A10G19 ③	N/A	N/A	N/A
Phase barrier	N/A	N/A	640C441G01	640C441G01	5264C35G03 (rear connected)
Cross bar	2050A15G12	2066A10G15	N/A	N/A	N/A
Shunt	N/A	2066A10G48	650C129G01	646C831G02 (set of three)	5264C39G02 (set of four)

Coils

Voltage	Hz	Size 5	Size 6
110/120	60	2050A14G05	2050A12G05
110/120	50	2050A14G06	2050A12G06
200/208	50	2050A14G07	2050A12G07
220/240	50	2050A14G08	2050A12G08
200/208	60	2050A14G09	2050A12G09
220/240	60	2050A14G10	2050A12G10
277/303	60	2050A14G12	2050A12G12
380/415	50	2050A14G14	2050A12G14
440/480	60	2050A14G15	2050A12G15
440/480	50	2050A14G16	2050A12G16
550/600	60	2050A14G17	2050A12G17
550/600	50	2050A14G18	2050A12G18
380/415	60	2050A14G19	2050A12G19
120/240	60	2050A14G20	2050A12G20
24 DC	—	2050A14G21	2050A12G21
48 DC	—	2050A14G22	2050A12G22
125 DC	—	2050A14G25	2050A12G25
250 DC	—	2050A14G27	2050A12G27

Coils

Line Voltage	Sizes 7–8	Required	Size 9
115 Vdc	438C805G01	2	100 Vdc
125 Vdc	438C805G04	2	5264C34G01 (contains coil and resistor)
230 Vdc	438C805G02	2	
250 Vdc	438C805G03	2	
110/120 Vac ④⑤	438C805G12	2	
220/240 Vac ⑥⑦	438C805G11	2	
380 Vac ⑥⑦	438C805G15	2	
440/480 Vac ⑥⑦	438C805G10	2	
550/575 Vac ⑥⑦	438C805G13	2	

Notes

- ① Catalog No. A201/A200 Series replaces GCA/GPD Series. Renewal parts are the same.
- ② Use **477B477G06** for Silver Tungsten applications.
- ③ CT Kit replaces the single molded one CT assembly used on the old Size 6 airbrake. The kit includes a single molded three CT assembly, two busbars and hardware. This CT Kit also replaces the single molded three CT assembly used on the present Size 6 airbrake and Size 6 vacuum contactor.
- ④ Rectifier 125V **2018A40G01** (one required).
- ⑤ Rectifier 250V **2018A40G02** (one required).
- ⑥ Rectifier 600V **2018A40G03** (one required).
- ⑦ These coils require an external rectifier. If the rectifier needs to be replaced, order by the appropriate style number.



**DC Coil Conversion Kit—
Style Number 7864A29G01**

A rectifier circuit converts the AC supply to DC supply. This conversion provides quiet operation and improves pickup and dropout characteristics. All necessary parts are included in the kit.



L63—Style Number 578D461G01

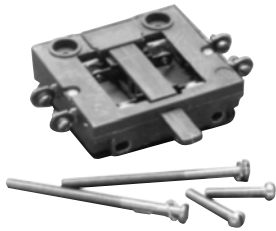

L64—Style Number 843D943G04

Accessories for Size 5–9 AC Contactors—Coils

AC Contactors	Voltage	AC/DC Coil Conversion Kit	Replacement Coil
Size 5	120 Vac	7864A28G01	7856A15G05
	240 Vac	7864A28G02	7856A15G10
	480 Vac	7864A28G03	7856A15G15
Size 6	120 Vac	7864A29G01	7856A16G05
	240 Vac	7864A29G02	7856A16G10
	480 Vac	7864A29G03	7856A16G15

Accessories for Size 5–9 AC Contactors—Auxiliary Electrical Interlock

Contactor Size	Catalog Number (Obsolete)	Style Number (Obsolete)	Circuits	Catalog Number (Current)	Style Number (Current)
00–6	(L-56)	(2609D01G01)	1NO and 1NC	J11	9084A17G01
	(L-56D)	(2609D01G02)	2NO	J20	9084A17G02
	(L-56E)	(2609D01G03)	1NO and 1NC	J11	9084A17G01
	(L-56B)	(2609D01G04)	2NO	J20	9084A17G02
	(L-56H)	(2609D01G05)	2NO	J20	9084A17G02
	(L-56J)	(2609D01G06)	1NO and 1NC DB	J1C	N/A
	(T-56A)	(2609D01G07)	N/A	N/A	N/A
	(T-56A)	(2609D01G07)	N/A	N/A	N/A
	(T-56B)	(2609D01G08)	N/A	N/A	N/A
	(L-56F)	(2609D01G09)	N/A	N/A	N/A
	(L-56G)	(2609D01G10)	1NO and 1NC DB	J1C	9084A17G04
	(L-56C)	(2609D01G11)	2NC	J02	9084A17G03
	(L-56M)	(2609D01G12)	N/A	N/A	N/A
	(L-56P)	(2609D01G17)	1NO and 1NC	J11	9084A17G01
	(L-56R)	(2609D01G18)	2NC	J02	9084A17G03
(L-56S)	(2609D01G19)	1NO and 1NC	J11	9084A17G01	
7–8	L63	—	NO	—	578D461G01
	L63	—	NC	—	578D461G03
9	L64	—	NO/NC	—	843D943G04
	L64	—	2NO	—	843D943G05
	L64	—	2NC	—	843D943G06

Technology Upgrades

Sizes 00–3—Freedom or **IT**.
 Sizes 4–6—Freedom, Vacuum or **IT**.
 Sizes 7–8—Freedom
 Size 9—No upgrade available

Manual Reset, Class 20, Thermal Type B Overload Relay

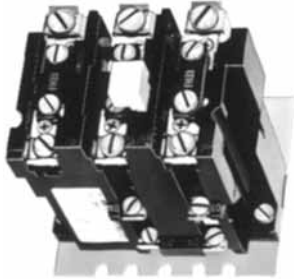

Type B Overload Relay, Panel Mounted



Field-Mountable Alarm Contact

Note: Alarm contact available as factory modification of field mountable. For factory modification, add suffix B.

Application Description

The Type B overload relay is designed to protect industrial motors against overload conditions. Using modern block-type, bimetallic design, this relay will provide Class 20 operation in either single-phase or three-phase applications.

Features

- Ambient compensation standard
- Alarm contact field mountable
- Class 20—600V design
- Inverse time delay trip
- Test trip device for weld check
- High visibility up-front trip indication
- Trip-free reset mechanism

Operation

The Type B overload relay is a bimetallic actuated device. The bimetal elements are operated by precisely calibrated heaters. The heater elements connect either directly in the circuit to be measured, or through current transformers on applications NEMA Size 5 and larger.

As the bimetals are heated by motor current flow, a deflection force is produced. Upon a sustained level of abnormal current flow, the deflection becomes great enough to open the snap action output contact.

Ambient Compensation

The Type B ambient compensated design is supplied as standard on all A200 starters. This design uses a second compensating bimetal responsive to ambient air temperature in the surrounding enclosure. This feature reduces nuisance tripping in applications using compact control panels and motor control centers where internal temperature rise is significant compared to motor ambient temperature. The compensating characteristic is maintained in ambient temperatures from 40°C to 77°C.

Design Standards

UL® 508, CSA®, ANSI/NEMA ICS 2-222.

Overload Relay Selection Table

For replacement in existing applications only.

Motor Full Load Amperes	Panel Mounted Catalog Number Ambient Comp.	Starter Mounted Catalog Number		Replacement for Type A Overload Relays in Manual Reset Mode (Three-Pole Only) ①		
		Non-Comp.	Replacement for Type B Overload Relays Ambient Comp.	Non-Comp.	Ambient Comp.	Non-Comp.
Single-Pole (One NC Contact)						
0.25–26.2	BA11JP	BN11JP	BA11A	BN11A	—	—
26.3–45.0	BA21JP	BN21JP	BA21A	BN21A	—	—
19.0–90.0	Use three-pole design, wire three-poles in series					
19.0–135.0						
Three-Pole (One NC Contact)						
0.25–26.2	BA13JP	BN13JP	BA13A ②	BN13A ②	BA13J	BN13J
26.3–45.0	BA23JP	BN23JP	BA23A	BN23A	BA23J	BN23J
19.0–90.0	BA33P	BN33P	BA33A	BN33A	BA33A	BN33A
19.0–135.0	BA43P	BN43P	BA43A	BN43A	BA43A	BN43A

Alarm Contact Kit Selection

Type B Overload Relay Size	Catalog Number
1, 2	B3NO-2
3, 4	B3NO-4

Heaters

Price of overload relay does not include heaters. Select from the tables on **Pages V12-T13-30 to V12-T13-32.**

Notes

- ① Includes contactor mounting bracket, overload relay and connection straps to contactor.
- ② For replacement on B200 sizes 00, 0 and 1, use **BA23A** instead of **BA13A** and use **BN23A** instead of **BN13A**.

Auto/Manual Reset, Class 20, Thermal Type A Overload Relay

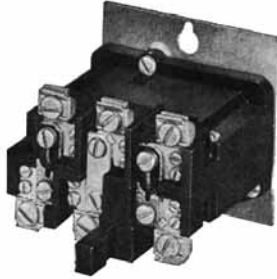

Three-Pole Panel Mounted

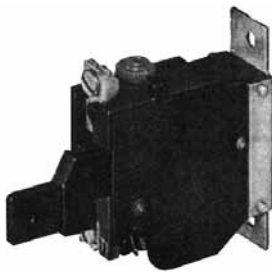

Single-Pole Panel Mounted

Application Description

The Type A overload relay is designed to protect industrial motors against overload conditions. Using modern block-type, bimetallic design, this relay will provide Class 20 operation in either single-phase or three-phase applications.

Features

- Field selectable manual/auto reset
- Alarm contact factory available
- Class 20—600V design
- Inverse time delay trip
- Adjustable trip rating $\pm 15\%$
- Color-coded reset rod: Compensated (gray) Non-compensated (red)

Operation

The Type A overload relay is a bimetallic actuated device. The bimetal elements are operated by precisely calibrated heaters. The heater elements connected either directly in the circuit to be measured, or through current transformers on applications NEMA Size 5 and larger.

As the bimetals are heated by motor current flow, a deflection force is produced. Upon a sustained level of abnormal current flow, the deflection becomes great enough to open the snap action output contact.

Automatic Reset

The Type A overload relay can be supplied as an option on all A200 starters to provide automatic reset operation. The overload relay is always shipped in the non-automatic mode. To set up auto operation, reposition the reset rod by loosening and re-tightening a hold-down clamp at the base of overload relay.

Design Standards

UL 508, CSA, ANSI/NEMA ICS 2-222.

Overload Relay Selection Table

For replacement in existing applications only.

Motor Full Load Amperes	Panel Mounted Catalog Number		Starter Mounted Catalog Number	
	Ambient Comp.	Non-Comp.	Ambient Comp.	Non-Comp.
Single-Pole (One NC Contact)				
0.25–26.2	AA11P	AN11P	AA11A	AN11A
26.3–45.0	AA21P	AN21P	AA21A	AN21A
19.0–90.0	AA31P	AN31P	AA31A	AN31A
19.0–135.0	AA41P	AN41P	AA41A	AN41A
Three-Pole (One NC Contact) ^①				
0.25–26.2	AA13P	AN13P	AA13A	AN13A
26.3–45.0	AA23P	AN23P	AA23A	AN23A
19.0–90.0	AA33P	AN33P	AA33A	AN33A
19.0–135.0	AA43P	AN43P	AA43A	AN43A

Heaters

Price of overload relay does not include heaters. Select from the tables on **Pages V12-T13-30 to V12-T13-32.**

Notes

- ^① Three-pole Type B Overload Relay is a suitable alternative to a three-pole Type A Overload Relay in Manual Reset Mode. For example, use **BA13JP** for **AA13P** and **BN23J** for **AN23A**, etc. (See **Page V12-T13-27.**)

Alarm contact available only as factory modification on Type A relay.

Type FT Fast Trip, Class 10 Overload Relay

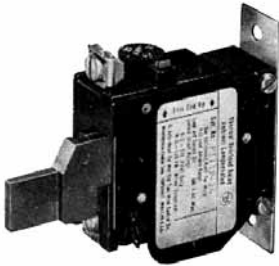

Single-Pole Fast Trip, Panel Mounted

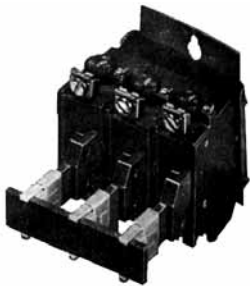

Three-Pole Fast Trip, Panel Mounted

Application Description

The Type FT overload relay is designed to protect special purpose motors having restricted thermal and locked rotor capabilities. Using modern block-type, bimetallic design, this relay will provide Class 10 operation in single-phase or three-phase applications.

Features

- Class 10—600V design
- Inverse time delay trip
- Color-coded reset rod—green
- Alarm contact factory available
- Field selectable manual/ auto reset
- Adjustable trip rating ±20%
- Ambient compensation included

Operation

The Type FT overload relay is a bimetallic actuated device. The bimetal elements are operated directly from line current, thus separate calibrating heater elements are not used. The overload relay may be wired directly in the motor circuit, or through current transformers on applications larger than 150A.

As the bimetals are heated by motor current flow, a deflection is produced. Upon a sustained level of abnormal current flow, the deflection becomes great enough to open the snap action output contact.

Overload Relay Selection Table

For replacement in existing applications only.

Motor Full Load Amperes	Panel Mounted Catalog Number		Starter Mounted Catalog Number ^①	
	Single-Pole ^①	Three-Pole ^②	NEMA Size	Single-Pole
Single-Pole (One NC Contact); Three-Phase (Three NC Contacts in Series)				
0.76–1.1	FT11P-1.1	FT13P-1.1	—	FT11A-1.1
1.1–1.6	FT11P-1.6	FT13P-1.6	—	FT11A-1.6
1.6–2.4	FT11P-2.4	FT13P-2.4	0, 1	FT11A-2.4
2.4–3.6	FT11P-3.6	FT13P-3.6	0, 1	FT11A-3.6
3.6–5.4	FT11P-5.4	FT13P-5.4	0, 1	FT11A-5.4
5.4–8.0	FT11P-8	FT13P-8	0, 1	FT11A-8
8.0–12	FT11P-12	FT13P-12	0, 1	FT11A-12
12–18	FT11P-18	FT13P-18	1	FT11A-18
16–24	FT11P-24	FT13P-24	1	FT11A-24
22–32	FT11P-32	FT13P-32	0, 1	FT11A-32
24–36	FT21P-36	FT23P-36	2	FT21A-36
36–54	FT21P-54	FT23P-54	2	FT21A-54
22–32	FT31P-32	FT33P-32	3	FT31A-32
32–48	FT31P-48	FT33P-48	3	FT31A-48
48–72	FT31P-72	FT33P-72	3	FT31A-72
72–110	FT41P-110	FT43P-110	4	FT41A-110
100–150	FT41P-150	FT43P-150	4	FT41A-150

Notes

- ① Single-pole (one NO–NC contact): Add suffix B.
 - ② Three-pole (three NO–NC contacts): Add suffix B. Example: **FT13PB-12**.
- Alarm contact available only as factory modification on FT relay.

Heaters for Thermal Types A and B Overload Relays

Product Description

Each heater is identified by a catalog number stamped on one terminal. The heater application table indicates the range of full load motor current to which a given heater may be applied.

Heaters should be selected on the basis of the actual full load current and service factor as shown on the motor nameplate or in the manufacturer's published literature.

When motor and overload relay are in the same ambient and the service factor of the motor is 1.15 to 1.25, select heaters from the heater application table. If the service factor of the motor is 1.0, or there is no service factor shown, or a maximum of 115% protection is desired, select one size smaller heater than indicated.

When motor and overload relay are in different ambients and when using non-compensated overload relays, select heaters from the tables on **Pages V12-T13-30** through **V12-T13-32** using adjusted motor currents as follows: decrease rated motor current 1% for each °C motor ambient exceeds controller ambient. Increase rated motor current 1% for each °C controller ambient exceeds motor ambient.

For temperature compensated overload relays, select heaters according to the tables on **Pages V12-T13-30** through **V12-T13-32** and selection information above regardless of ambient.

Protect the starter against short circuits by providing branch circuit protection per National Electrical Code® (NEC®).

Heater Selection for Types A and B Overload Relays, Sizes 00, 0, 1 and 2 Starters

Non-Compensated Open Starters and Ambient Compensated Open and Enclosed Starters		Non-Compensated Enclosed Starters		Heater Catalog Number
Block-Type Overload Using Three Heaters	Single-Pole Type Overload	Block-Type Overload Using Three Heaters	Single-Pole Type Overload	
Full Load Current of Motor (Amperes) ①②				
For Sizes 0, 1 and 2 Starters				
0.25–0.27	0.29–0.31	0.24–0.25	0.28–0.30	FH03
0.28–0.31	0.32–0.35	0.26–0.28	0.31–0.34	FH04
0.32–0.34	0.36–0.39	0.29–0.31	0.35–0.37	FH05
0.35–0.38	0.40–0.43	0.32–0.35	0.38–0.42	FH06
0.39–0.42	0.44–0.48	0.36–0.39	0.43–0.47	FH07
0.43–0.46	0.49–0.53	0.40–0.43	0.48–0.52	FH08
0.47–0.50	0.54–0.58	0.44–0.47	0.53–0.56	FH09
0.51–0.55	0.59–0.64	0.48–0.51	0.57–0.63	FH10
0.56–0.62	0.65–0.71	0.52–0.57	0.64–0.70	FH11
0.63–0.68	0.72–0.79	0.58–0.63	0.71–0.77	FH12
0.69–0.75	0.80–0.87	0.64–0.70	0.78–0.85	FH13
0.76–0.83	0.88–0.96	0.71–0.77	0.86–0.94	FH14
0.84–0.91	0.97–1.06	0.78–0.85	0.95–1.03	FH15
0.92–1.00	1.07–1.16	0.86–0.93	1.04–1.13	FH16
1.01–1.11	1.17–1.28	0.94–1.03	1.14–1.25	FH17
1.12–1.22	1.29–1.41	1.04–1.13	1.26–1.38	FH18
1.23–1.34	1.42–1.55	1.14–1.25	1.39–1.52	FH19
1.35–1.47	1.56–1.71	1.26–1.37	1.53–1.67	FH20
1.48–1.62	1.72–1.87	1.38–1.51	1.68–1.83	FH21
1.63–1.78	1.88–2.06	1.52–1.65	1.84–2.01	FH22
1.79–1.95	2.07–2.26	1.66–1.81	2.02–2.21	FH23
1.96–2.15	2.27–2.48	1.82–1.99	2.22–2.43	FH24
2.16–2.35	2.49–2.72	2.00–2.19	2.44–2.66	FH25
2.36–2.58	2.73–2.99	2.20–2.39	2.67–2.92	FH26
2.59–2.83	3.00–3.28	2.40–2.63	2.93–3.21	FH27
2.84–3.11	3.29–3.60	2.64–2.89	3.22–3.53	FH28
3.12–3.42	3.61–3.95	2.90–3.17	3.54–3.87	FH29
3.43–3.73	3.96–4.31	3.18–3.47	3.88–4.22	FH30
3.74–4.07	4.32–4.71	3.48–3.79	4.23–4.61	FH31
4.08–4.39	4.72–5.14	3.80–4.11	4.62–4.9	FH32
4.40–4.87	5.15–5.6	4.12–4.55	5.0–5.5	FH33
4.88–5.3	5.7–6.2	4.56–5.0	5.6–6.0	FH34

Notes

① Based on 60°C and 75°C wire for 30A or less.

② Based on 60°C wire for 31 to 95A.

Heaters are packaged in strips of six. Minimum ordering quantity is 12.

Heater Selection for Types A and B Overload Relays, Sizes 00, 0, 1 and 2 Starters, continued

Non-Compensated Open Starters and Ambient Compensated Open and Enclosed Starters		Non-Compensated Enclosed Starters		Heater Catalog Number
Block-Type Overload Using Three Heaters	Single-Pole Type Overload	Block-Type Overload Using Three Heaters	Single-Pole Type Overload	
Full Load Current of Motor (Amperes) ^{①②}				
For Sizes 0, 1 and 2 Starters				
5.4–5.9	6.3–6.8	5.1–5.5	6.1–6.6	FH35
6.0–6.4	6.9–7.5	5.6–5.9	6.7–7.3	FH36
6.5–7.1	7.6–8.2	6.0–6.6	7.4–8.0	FH37
7.2–7.8	8.3–9.0	6.7–7.2	8.1–8.7	FH38
7.9–8.5	9.1–9.9	7.3–7.9	8.8–9.7	FH39
8.6–9.4	10.0–10.8	8.0–8.7	9.8–10.5	FH40
9.5–10.3	10.9–11.9	8.8–9.5	10.6–11.7	FH41
10.4–11.3	12.0–13.1	9.6–10.5	11.8–12.7	FH42
11.4–12.4	13.2–14.3	10.6–11.5	12.8–14.0	FH43
12.5–13.5	14.4–15.7	11.6–12.6	14.1–15.3	FH44
13.6–14.9	15.8–17.2	12.7–13.8	15.4–16.6	FH45
15.0–16.3	—	13.9–15.1	—	FH46
16.4–18.0	—	15.2–16.7	—	FH47
For Sizes 1 and 2 Starters				
—	17.3–18.9	—	16.7–18.3	FH46
—	19.0–20.8	—	18.4–20.0	FH47
18.1–19.8	20.9–22.9	16.8–18.3	20.1–21.9	FH48
19.9–21.7	23.0–25.2	18.4–20.2	22.0–23.9	FH49
21.8–23.9	25.3–27.6	20.3–22.2	24.0–26.2	FH50
24.0–26.2	—	22.3–24.3	—	FH51
—	—	24.4–26.6	—	FH52
For Size 2 Starters				
—	27.7–30.3	—	26.3–28.8	FH51
26.3–28.7	30.4–33.3	—	28.9–31.4	FH52
28.8–31.4	33.4–36.4	26.7–29.1	31.5–34.5	FH53
31.5–34.0	36.5–39.9	29.2–32.0	34.6–37.9	FH54
34.6–37.9	42.0–43.9	32.1–35.2	38.0–41.9	FH55
38.0–41.5	—	35.3–38.5	42.0–45.0	FH56
41.6–45.0	—	38.6–42.3	—	FH57

Notes

① Based on 60°C and 75°C wire for 30A or less.

② Based on 60°C wire for 31 to 95A.

Heaters are packaged in strips of six. Minimum ordering quantity is 12.

Heater Selection for Types A and B Overload Relays, Sizes 3 and 4 Starters ^{①②③}

Ambient Compensated Enclosed Starters	Non-Compensated Enclosed Starters	Heater Catalog Number
All Applications		
Full Load Current of Motor (Amperes) ^①		
For Sizes 3 and 4 Starters		
12.8–14.1	11.9–13.0	FH68
14.2–15.5	13.1–14.3	FH69
15.6–17.1	14.4–15.9	FH70
17.2–18.9	16.0–17.4	FH71
19.0–20.8	17.5–19.1	FH72
20.9–22.9	19.2–21.1	FH73
23.0–25.2	21.2–23.2	FH74
25.3–27.8	23.3–25.6	FH75
27.9–30.6	25.7–28.1	FH76
30.7–33.5	28.2–30.8	FH77
33.6–37.5	30.9–34.5	FH78
37.6–41.5	34.6–38.2	FH79
41.6–46.3	38.3–42.6	FH80
46.4–50	42.7–46	FH81
51–55	47–51	FH82
56–61	52–56	FH83
62–66	57–61	FH84
67–73	62–67	FH85
74–78	68–72	FH86
79–84	73–77	FH87
85–92	78–84	FH88
—	85–91	FH89
For Size 4 Starters		
93–101	—	FH89
102–110	92–99	FH90
111–122	100–110	FH91
123–129	111–122	FH92
130–133	123–128	FH93
—	129–133	FH94

Heater Selection for Types A and B Overload Relays, Sizes 5 and 6 Starters ^④

Compensated Overload Relay		Heater Catalog Number
Open Starter	Enclosed Starter	
Full Load Current of Motor (Amperes)		
Size 5 (With 300/5 Current Transformers)		
—	—	FH23
118–129	118–129	FH24
130–141	130–141	FH25
142–155	142–155	FH26
156–170	156–170	FH27
171–187	171–187	FH28
188–205	188–205	FH29
206–224	206–224	FH30
225–244	225–244	FH31
245–263	245–263	FH32
264–292	264–292	FH33
293–300	—	FH34
Size 6 (With 600/5 Current Transformers)		
—	—	FH23
236–259	236–259	FH24
260–283	260–283	FH25
284–310	284–310	FH26
311–340	311–340	FH27
341–374	341–374	FH28
375–411	375–411	FH29
412–448	412–448	FH30
449–489	449–489	FH31
490–527	490–527	FH32
528–585	528–540	FH33
586–600	—	FH34
Size 7 and Larger		
Advise full load current		

Notes

- ① Based on 60°C and 75°C wire for 30A or less.
- ② Based on 60°C wire for 31 to 95A.
- ③ Based on 75°C wire for greater than 95A.
- ④ Based on 75°C wire.

Heaters are packaged in strips of six. Minimum ordering quantity is 12.

**A202 Lighting Contactor
(Electrically Held/
Magnetically Latched)**

*Originally a Westinghouse
Product*



30A, Four-Pole Magnetically Latched

**Product History Time Line for A202 Lighting Contactor
(Electrically Held/Magnetically Latched)**

Size	Amperes	Model	1965	1970	1975	1980	1985	1990	1995	2000	Present
Size 1	30										
Size 2	60										
Size 3	100										
Size 4	200	J									
Size 4	200	K									

Replacement Capabilities

A202 Kits for 30 to 200A

Description	Poles	30A	60A	100A	200A— Model J ①	200A— Model K ②
Contact kit	2	373B331G07	373B331G11	626B187G12	626B187G16	5250C81G16
	3	373B331G09	373B331G12	626B187G13	626B187G17	5250C81G17
	4	373B331G09	③	⑤	⑦	5250C81G18
	5	373B331G10	④	⑥	⑧	5250C81G19
Arc box	2, 3, 4	6714C74G03	6714C74G07	6714C74G09	6714C74G11	6714C74G11
	5	6714C74G06	6714C74G08	6714C74G10	6714C74G12	6714C74G12
Cross bar	2-3	—	672B788G32	672B788G36	672B788G36	672B788G40
	4-5	—	672B788G34	672B788G38	672B788G38	—
Upper base (for single rated coils only)	2-3	—	672B788G33	672B788G37	672B788G37	672B788G52
	4-5	—	672B788G35	672B788G39	672B788G39	—
Lower base	2-3	—	1250C33G09	1250C33G03	1250C33G03	1250C33G10
	4-5	—	1250C33G05	1250C33G06	1250C33G06	—
Electrically Held Only						
KO spring (pack of 10)	All	—	503C796G01	503C796G02	503C796G02	672B788G50
Terminal line/load (pack of 3)	All	—	371B870G03	372B357G12	372B357G13	372B357G13

Notes

- ① For 200A A202 Magnetically Latched Lighting Contactors, order three-pole contact kit style **672B788G07**.
- ② Model K replaces Model J, offering superior design and life characteristics. Renewal parts are different.
Use parts for proper model only.
- ③ Use quantity two—**373B331G11** (two-pole kit).
- ④ Use one each of **373B331G11** (two-pole kit) and **373B331G12** (three-pole kit).
- ⑤ Use quantity two—**626B187G12** (two-pole kit).
- ⑥ Use one each of **626B187G12** (two-pole kit) and **626B187G13** (three-pole kit).
- ⑦ Use quantity two—**626B187G16** (two-pole kit).
- ⑧ Use one each of **626B187G16** (two-pole kit) and **626B187G17** (three-pole kit).

120V Coil for
Electrically Held
Lighting Contactor—
Style Number
505C633G01



AC Coils Electrically Held

Voltage	Hz	30A		60A	
		Two-, Three-, Four-Pole	Five-Pole	Two-, Three-Pole	Four-, Five-Pole
120/110	60/50	505C806G01	505C808G01	505C806G01	505C818G01
208	60	505C806G02	505C808G02	505C806G02	505C818G02
600/550	60/50	505C806G05	505C808G05	505C806G05	505C818G05
380	50	505C806G07	505C808G07	505C806G07	505C818G07
240/220	60/50	505C806G12	505C808G12	505C806G12	505C818G12
480/440	60/50	505C806G13	505C808G13	505C806G13	505C818G13
24	60	505C806G16	N/A	505C806G16	505C818G15
227	60	505C806G18	505C808G16	505C806G18	505C818G16
240/480 ①	60/60	505C806G03	505C808G03	505C806G03	505C818G03
120/240 ①	60/60	505C806G10	505C808G10	505C806G10	505C818G10

AC Coils Electrically Held, continued

Voltage	Hz	100 and 200A—Model J		200A—Model K ②	
		Two-, Three-Pole	Four-, Five-Pole	Two-, Three-Pole	Four-, Five-Pole
120/110	60/50	505C633G01	505C635G01	52050C79G01	5250C80G01
208	60	505C633G02	505C635G02	52050C79G02	5250C80G02
600/550	60/50	505C633G05	505C635G05	52050C79G05	5250C80G05
380	50	505C633G07	505C635G07	52050C79G07	5250C80G07
240/220	60/50	505C633G12	505C635G12	52050C79G12	5250C80G12
480/440	60/50	505C633G13	505C635G13	52050C79G13	5250C80G13
24	60	505C633G34	N/A	52050C79G34	N/A
227	60	505C633G14	N/A	52050C79G14	N/A
240/480 ①	60/60	505C633G03	505C635G03	52050C79G03	5250C80G03
120/244 ①	60/60	505C633G10	505C635G10	52050C79G10	5250C80G10

Notes

- ① Dual voltage coils. Use only on contactors or starters originally supplied with a dual voltage coil.
 ② Model K replaces Model J. Renewal parts are different. **Use parts for proper model only.**

AC Coils Magnetically Latched

Voltage	Hz	Two-Pole	Three-Pole	Four-Pole	Five-Pole
30A					
110/120	50/60	7874A93G01	7874A93G01	7874A93G01	7874A89G01
208/240	50/60	7874A93G02	7874A93G02	7874A93G02	7874A89G02
277	50/60	7874A93G03	7874A93G03	7874A93G03	7874A89G03
440/480	50/60	7874A93G04	7874A93G04	7874A93G04	7874A89G04
575	50/60	7874A93G05	7874A93G05	7874A93G05	7874A89G05
60A					
110/120	50/60	7874A93G01	7874A93G01	7874A87G01	7874A87G01
208/240	50/60	7874A93G02	7874A93G02	7874A87G02	7874A87G02
277	50/60	7874A93G03	7874A93G03	7874A87G03	7874A87G03
440/480	50/60	7874A93G04	7874A93G04	7874A87G04	7874A87G04
110/120	50/60	7874A93G01	7874A93G01	7874A87G01	7874A87G05
100 and 200A					
110/120	50/60	7874A85G01	7874A85G01	7874A83G01	7874A83G01
208/240	50/60	7874A85G02	7874A85G02	7874A83G02	7874A83G02
277	50/60	7874A85G03	7874A85G03	7874A83G03	7874A83G03
440/480	50/60	7874A85G04	7874A85G04	7874A83G04	7874A83G04
550/575	50/60	7874A85G05	7874A85G05	7874A83G05	7874A83G05

Terminals (Line and Load)

Size	Two-Pole		Three-Pole		Four-Pole		Five-Pole	
30A	N/A		N/A		N/A		N/A	
60A	179C755G17		179C755G16		179C755G17 ①		179C755G16 + G17 ②	
100A	179C755G19		179C755G18		179C755G19 ①		179C755G18 + G19 ②	
200A	Model K	Model J	Model K	Model J	Model K	Model J	Model K	Model J
	179C755G28	179C755G31	179C755G27	179C755G30	179C755G28 ①	179C755G3 ①	179C755G27 + G28 ②	179C755G30 + G3 ②

Other Accessories

Size	Control Module (Rectifier)
30 to 200A	3915B98G01

Notes

- ① Order quantity of two for four-pole design.
- ② Group numbers for the five-pole terminals represent the combination of the two-pole and three-pole number.

V201 and V200 Vacuum Contactors and Starters

Originally a Westinghouse Product



Size 4 Vacuum Contactors

Heater Coils

Heater Coil Selection for Type B Overload Relay

Motor Full Load Current in Amperes for Use with Three Heaters Only

Open Starter
Ambient Compensated Overload Relay

Heater Catalog Number ^①

Size 4 and 160A

12.8–14.1	FH68
14.2–15.5	FH69
15.6–17.1	FH70
17.2–18.9	FH71
19.0–20.8	FH72
20.9–22.9	FH73
23.0–25.2	FH74
25.3–27.8	FH75
27.9–30.6	FH76
30.7–33.5	FH77
33.6–37.5	FH78
37.6–41.5	FH79
41.6–46.3	FH80
46.4–50	FH81
51–55	FH82
56–61	FH83
62–66	FH84
67–73	FH85
74–78	FH86
79–84	FH87

85–92	FH88
93–101	FH89
102–110	FH90
111–122	FH91
123–129	FH92
130–133	FH93
—	FH94

Size 5 and 320A with 300/5 Current Transformers

107–117	FH23
118–129	FH24
130–141	FH25
142–155	FH26
156–170	FH27

171–187	FH28
188–205	FH29
206–224	FH30
225–244	FH31
245–263	FH32
264–292	FH33
293–318	FH34
319–350	FH35

Size 6 and 540A with 600/5 Current Transformers

236–259	FH24
260–283	FH25
284–310	FH26
311–340	FH27
341–374	FH28
375–411	FH29
412–448	FH30
449–489	FH31
490–527	FH32
528–585	FH33
586–600	FH34

Replacement Coils

Vacuum Contactor—Replacement Coils

Description	Suffix	Part Number
Size 4		
110/120 Vac, 50/60 Hz	J	9085A57G01
220/240 Vac, 50/60 Hz	K	9085A57G02
380/415 Vac, 50/60 Hz	H	ID89221G07
440/480 Vac, 50/60 Hz	U	9085A57G03
Size 5		
24 Vdc	—	7874A09G07
48 Vdc	—	7874A09G08
110/120 Vac, 50/60 Hz	J	7874A09G01 ^②
220/240 Vac, 50/60 Hz	K	7874A09G04 ^③
380/415 Vac, 50/60 Hz	H	7874A09G10
440/480 Vac, 50/60 Hz	U	7874A09G05
Size 6		
110/120 Vac, 50/60 Hz	J	7874A24G01 ^②
220/240 Vac, 50/60 Hz	K	7874A24G02 ^③
380/415 Vac, 50/60 Hz	H	7874A24G07
440/480 Vac, 50/60 Hz	U	7874A24G03

Notes

- ① Three are required per overload relay.
- ② 125 Vdc can be directly applied to the Size 5 and 6 coil rated for 120V/60 Hz AC (cannot be applied to Size 4).
- ③ 250 Vdc can be directly applied to the Size 5 and 6 coil rated for 240V/60 Hz AC (cannot be applied to Size 4).

**Freedom Series—
NEMA and IEC**
*Originally a Cutler-Hammer
Product*

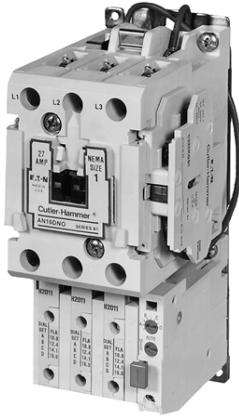

Freedom

Product Description

The Cutler-Hammer Freedom Series starters and contactors feature a compact space-saving design using state-of-the-art technology and the latest in high strength, impact and temperature-resistant insulating materials. Starters and contactors are available in two rating/configuration styles—NEMA (National Electrical Manufacturers Association) and IEC (International Electrotechnical Commission). The NEMA devices are sized based on traditional NEMA classifications and the IEC devices on international ratings. Internationally rated starters and contactors, as compared to NEMA devices, generally are physically downsized to provide higher ratings in a smaller package.

Product History Time Line for Freedom CN15 and AN15

NEMA Size	Series	1986	1988	1990	1992	1994	1996	1998	2000	Present	
Size 00	A1	█									
	B1			█							
Size 0	A1	█									
	B1			█							
Size 1	A1	█									
	B1			█							
Size 2	A1	█									
	B1						█				
Size 3	A1		█								
Size 4	A1		█								
	B1						█				
Size 5	A1		█								
Size 6	A1		█								
	B1						█				
Size 7	A1			█							
Size 8	A1			█							

Note: See contactor/starter nameplate to determine Series A1, B1 or C1.

Replacement Capabilities**NEMA Sizes 00, 0, 1, 2 and 3****NEMA Sizes 00 and 0—See Contactor/Starter Nameplate to Determine Series A1, B1 or C1**

Description Renewal Parts Publication Number	NEMA Size 00–0 Series A1 Part Number None	NEMA Size 00 Series B1 Part Number None	NEMA Size 00 Series C1 Part Number None	NEMA Size 0 Series B1 Part Number None	NEMA Size 0 Series C1 Part Number None
Contact Kits					
Two-pole	①	①	①	①	①
Three-pole	①	①	①	①	①
Four-pole	①	①	①	①	①
Five-pole	①	①	①	①	①
Magnet Coils					
	Coil Suffix				
120V, 60 Hz or 110V, 50 Hz	A	9-2650-1	9-2875-1	9-2875-1	9-2876-1
240V, 60 Hz or 220V, 50 Hz	B	9-2650-2	9-2875-2	9-2875-2	9-2876-2
480V, 60 Hz or 440V, 50 Hz	C	9-2650-3	9-2875-3	9-2875-3	9-2876-3
600V, 60 Hz or 550V, 50 Hz	D	9-2650-4	9-2875-4	9-2875-4	9-2876-4
208V, 60 Hz	E	9-2650-5	9-2875-5	9-2875-5	9-2876-5
277V, 60 Hz	H	9-2650-13	9-2875-12	9-2875-12	9-2876-12
208/240V, 60 Hz	J	—	9-2875-37	9-2875-37	9-2876-17
240V, 50 Hz	K	9-2650-12	9-2875-11	9-2875-11	9-2876-11
380–415V, 50 Hz	L	9-2650-6	9-2875-6	9-2875-6	9-2876-6
380V, 50 Hz	L	—	—	—	—
415V, 50 Hz	M	—	—	—	—
550V, 50 Hz	N	—	—	—	—
24V, 60 Hz–24V, 50 Hz	T	—	9-2875-36	9-2875-36	9-2876-36
24V, 60 Hz	T	9-2650-7	—	—	—
24V, 50 Hz	U	9-2650-14	9-2875-36	9-2875-36	9-2876-36
32V, 50 Hz	V	9-2650-9	9-2875-16	9-2875-16	9-2876-16
48V, 60 Hz	W	9-2650-8	9-2875-8	9-2875-8	9-2876-8
48V, 50 Hz	Y	9-2650-10	9-2875-9	9-2875-9	9-2876-9
Magnet Frame Armature					
Lower magnet frame	①	①	①	①	①
Upper magnet frame	①	①	①	①	①

Note

① Replace with complete contactor.

NEMA Sizes 1, 2 and 3—See Contactor/Starter Nameplate to Determine Series A1 or B1

Description Renewal Parts Publication Number	NEMA Size 1		NEMA Size 2		NEMA Size 3
	Series A1 Part Number	Series B1 Part Number	Series A1 Part Number	Series B1 Part Number	Part Number
Contact Kits					
Two-pole	6-65	6-65	6-65-7	6-65-7	6-43-5
Three-pole	6-65-2	6-65-2	6-65-8	6-65-8	6-43-6
Four-pole	6-65-9	6-65-9	6-65-15	6-65-15	—
Five-pole	6-65-10	6-65-10	6-65-16	6-65-16	—
Magnet Coils					
	Coil Suffix				
120V, 60 Hz or 110V, 50 Hz	A	9-2703-1	9-2703-1	9-2703-1	9-2756-1
240V, 60 Hz or 220V, 50 Hz	B	9-2703-2	9-2703-2	9-2703-2	9-2756-2
480V, 60 Hz or 440V, 50 Hz	C	9-2703-3	9-2703-3	9-2703-3	9-2756-3
600V, 60 Hz or 550V, 50 Hz	D	9-2703-4	9-2703-4	9-2703-4	9-2756-4
208V, 60 Hz	E	9-2703-9	9-2703-9	9-2703-9	9-2756-5
277V, 60 Hz	H	9-2703-7	9-2703-7	9-2703-7	9-2756-9
208/240V, 60 Hz	J	—	—	—	—
240V, 50 Hz	K	9-2703-14	9-2703-14	9-2703-14	9-2756-13
380–415V, 50 Hz	L	99-2703-8	9-2703-8	9-2703-8	—
380V, 50 Hz	L	—	—	—	9-2756-12
415V, 50 Hz	M	—	—	—	9-2756-8
550V, 50 Hz	N	—	—	—	9-2756-14
24V, 60 Hz–24V, 50 Hz	T	—	—	—	—
24V, 60 Hz	T	9-2703-6	9-2703-6	9-2703-6	9-2756-6
24V, 50 Hz	U	9-2703-12	9-2703-12	9-2703-12	9-2756-11
32V, 50 Hz	V	9-2703-10	9-2703-10	9-2703-10	9-2756-10
48V, 60 Hz	W	9-2703-11	9-2703-11	9-2703-11	9-2756-15
48V, 50 Hz	Y	9-2703-13	9-2703-13	9-2703-13	9-2756-7
Magnet Frame Armature					
Lower magnet frame		17-18200	17-18200	17-18200	17-8955-2
Upper magnet frame		48-1936	48-1936	48-1936	48-1902

NEMA Sizes 4, 5 and 6—See Contactor/Starter Nameplate to Determine Series A1 or B1

Description		NEMA Size 4 Series A1 Part Number	NEMA Size 4 Series B1 Part Number	NEMA Size 5 Series A1 Part Number	NEMA Size 5 Series B1 Part Number	NEMA Size 6 Series A1 Part Number	NEMA Size 6 Series B1 Part Number
Renewal Parts Publication Number		20428	20428	20429	20429	20146	20146
Contact Kits							
Two-pole		6-44	6-26	6-45	6-45	6-601-2	6-648
Three-pole		6-44-2	6-26-2	6-45-2	6-45-2	6-601	—
Magnet Coils							
	Coil Suffix						
120V, 60 Hz or 110V, 50 Hz	A	9-1891-1	9-1891-1	9-1891-1	9-1891-1	9-2698	9-2698
240V, 60 Hz or 220V, 50 Hz	B	9-1891-2	9-1891-2	9-1891-2	9-1891-2	9-2698-2	9-2698-2
480V, 60 Hz or 440V, 50 Hz	C	9-1891-3	9-1891-3	9-1891-3	9-1891-3	9-2698-3	9-2698-3
600V, 60 Hz or 550V, 50 Hz	D	9-1891-4	9-1891-4	9-1891-4	9-1891-4	9-2698-4	9-2698-4
208V, 60 Hz	E	9-1891-13	9-1891-13	9-1891-13	9-1891-13	9-2698-5	9-2698-5
277V, 60 Hz	H	9-1891-26	9-1891-26	9-1891-26	9-1891-26	—	—
208/240V, 60 Hz	J	—	—	—	—	—	—
240V, 50 Hz	K	9-1891-20	9-1891-20	9-1891-20	9-1891-20	—	—
380–415V, 50 Hz	L	—	—	—	—	9-2698-6	9-2698-6
380V, 50 Hz	L	9-1891-14	9-1891-14	9-1891-14	9-1891-14	—	—
415V, 50 Hz	M	9-1891-21	9-1891-21	9-1891-21	9-1891-21	—	—
550V, 50 Hz	N	9-1891-8	9-1891-8	9-1891-8	9-1891-8	—	—
24V, 60 Hz–24V, 50 Hz	T	—	—	—	—	—	—
24V, 60 Hz	T	9-1891-15	9-1891-15	9-1891-15	9-1891-15	—	—
24V, 50 Hz	U	9-1891-16	9-1891-16	9-1891-16	9-1891-16	—	—
32V, 50 Hz	V	9-1891-27	9-1891-27	9-1891-27	9-1891-27	—	—
48V, 60 Hz	W	—	—	—	—	9-2698-8	9-2698-8
48V, 50 Hz	Y	9-1891-18	9-1891-18	9-1891-18	9-1891-18	—	—
Overload Relays							
For replacement on existing starters three-pole—ambient compensated bimetallic		10-6530-4	10-6530-4	C306DN3B	C306DN3B	C306DN3B	C306DN3B
Current Transformer							
For replacement on existing starters only		—	—	42-3564	42-3564	42-3598	42-3598
Magnet Frame Armature							
Lower magnet frame		48-1030-2	48-1030-2	48-1030-2	48-1030-2	—	—
Upper magnet frame		48-1029-4	48-1029-4	48-1029-4	48-1029-4	—	—

NEMA Sizes 7 and 8—See Contactor/Starter Nameplate to Determine Series A1 or B1

Description		NEMA Size 7 Series A1 Part Number	NEMA Size 7 Series B1 Part Number	NEMA Size 8 Series A1 Part Number	NEMA Size 8 Series B1 Part Number
Renewal Parts Publication Number		20848	20848	20849	20849
Contact Kits					
Two-pole		—	—	—	—
Three-pole		6-613	6-613	6-571	6-571
Magnet Coils		Coil Suffix			
120V, 60 Hz or 110V, 50 Hz	A	9-2698	9-2698	9-2654	9-2654
240V, 60 Hz or 220V, 50 Hz	B	9-2698-2	9-2698-2	9-2654-2	9-2654-2
480V, 60 Hz or 440V, 50 Hz	C	9-2698-3	9-2698-3	9-2654-3	9-2654-3
600V, 60 Hz or 550V, 50 Hz	D	9-2698-4	9-2698-4	9-2654-4	9-2654-4
208V, 60 Hz	E	9-2698-5	9-2698-5	9-2654-6	9-2654-6
277V, 60 Hz	H	—	—	—	—
208/240V, 60 Hz	J	—	—	—	—
240V, 50 Hz	K	—	—	—	—
380–415V, 50 Hz	L	—	—	—	—
380V, 50 Hz	L	9-2698-6	9-2698-6	9-2654-5	9-2654-5
415V, 50 Hz	M	—	—	—	—
550V, 50 Hz	N	—	—	—	—
24V, 60 Hz–24V, 50 Hz	T	—	—	—	—
24V, 60 Hz	T	—	—	—	—
24V, 50 Hz	U	—	—	—	—
32V, 50 Hz	V	—	—	—	—
48V, 60 Hz	W	—	—	—	—
48V, 50 Hz	Y	—	—	—	—
Overload Relays					
For replacement on existing starters three-pole—ambient compensated bimetallic		C306DN3B	C306DN3B	C306DN3B	C306DN3B
Magnet Frame Armature ①					
Lower magnet frame		—	—	—	—
Upper magnet frame		—	—	—	—

Note

① Contact Standard Open Control Aftermarket at 1-800-535-8992 for assistance.

IEC Sizes A–F—See Contactor/Starter Nameplate to Determine Series A1, B1 or C1

Description Renewal Parts Publication Number	IEC Sizes A–F		IEC Sizes A–C ^①		IEC Sizes D–F ^①	
	Series A1 Part Number	Series B1 Part Number	Series A1 Part Number	Series B1 Part Number	Series A1 Part Number	Series B1 Part Number
None						
Contact Kits						
Two-pole	②	②	②	②	②	②
Three-pole	②	②	②	②	②	②
Four-pole	②	②	②	②	②	②
Five-pole	②	②	②	②	②	②
Magnet Coils		Coil Suffix				
120V, 60 Hz or 110V, 50 Hz	A	9-2650-1	9-2875-1	9-2875-1	9-2876-1	9-2876-1
240V, 60 Hz or 220V, 50 Hz	B	9-2650-2	9-2875-2	9-2875-2	9-2876-2	9-2876-2
480V, 60 Hz or 440V, 50 Hz	C	9-2650-3	9-2875-3	9-2875-3	9-2876-3	9-2876-3
600V, 60 Hz or 550V, 50 Hz	D	9-2650-4	9-2875-4	9-2875-4	9-2876-4	9-2876-4
208V, 60 Hz	E	9-2650-5	9-2875-5	9-2875-5	9-2876-5	9-2876-5
277V, 60 Hz	H	9-2650-13	9-2875-12	9-2875-12	9-2876-12	9-2876-12
208/240V, 60 Hz	J	—	9-2875-37	9-2875-37	9-2876-37	9-2876-37
240V, 50 Hz	K	9-2650-12	9-2875-11	9-2875-11	9-2876-11	9-2876-11
380–415V, 50 Hz	L	9-2650-6	9-2875-6	9-2875-6	9-2876-6	9-2876-6
24V, 60 Hz–24V, 50 Hz	T	—	9-2875-36	9-2875-36	9-2876-36	9-2876-36
24V, 60 Hz	T	9-2650-7	—	—	—	—
24V, 50 Hz	U	9-2650-14	9-2875-13	9-2875-13	9-2876-13	9-2876-13
32V, 50 Hz	V	9-2650-9	9-2875-16	9-2875-16	9-2876-16	9-2876-16
48V, 60 Hz	W	9-2650-8	9-2875-8	9-2875-8	9-2876-8	9-2876-8
48V, 50 Hz	Y	9-2650-10	9-2875-9	9-2875-9	9-2876-9	9-2876-9
Overload Relays						
For replacement on existing starters: three-pole—ambient compensated bimetallic	C306DN3B	C306DN3B	C306DN3B	C306DN3B	C306DN3B	C306DN3B
Current Transformer						
Transformer	—	—	—	—	—	—
Magnet Frame Armature						
Lower magnet frame	②	②	②	②	②	②
Upper magnet frame	②	②	②	②	②	②

Notes

- ① Non-encapsulated coils.
② Replace with complete contactor.

IEC Sizes G and H—See Contactor/Starter Nameplate to Determine Series A1 and B1

Description Renewal Parts Publication Number	IEC Size G		IEC Size H	
	Series A1 Part Number	Series B1 Part Number	Series A1 Part Number	Series B1 Part Number
	20862	22178	20862	22178
Contact Kits				
Two-pole	6-65-3	6-65-3	6-65-5	6-65-5
Three-pole	6-65-4	6-65-4	6-65-6	6-65-6
Four-pole	6-65-11	6-65-11	6-65-13	6-65-13
Five-pole	6-65-12	6-65-12	6-65-14	6-65-14
Magnet Coils				
	Coil Suffix			
120V, 60 Hz or 110V, 50 Hz	A	9-2703-1	9-2703-1	9-2703-1
240V, 60 Hz or 220V, 50 Hz	B	9-2703-2	9-2703-2	9-2703-2
480V, 60 Hz or 440V, 50 Hz	C	9-2703-3	9-2703-3	9-2703-3
600V, 60 Hz or 550V, 50 Hz	D	9-2703-4	9-2703-4	9-2703-4
208V, 60 Hz	E	9-2703-9	9-2703-9	9-2703-9
277V, 60 Hz	H	9-2703-7	9-2703-7	9-2703-7
240V, 50 Hz	K	9-2703-14	9-2703-14	9-2703-14
380–415V, 50 Hz	L	9-2703-8	9-2703-8	9-2703-8
24V, 60 Hz–24V, 50 Hz	T	—	—	—
24V, 60 Hz	T	9-2703-6	9-2703-6	9-2703-6
24V, 50 Hz	U	9-2703-12	9-2703-12	9-2703-12
32V, 50 Hz	V	9-2703-10	9-2703-10	9-2703-10
48V, 60 Hz	W	9-2703-11	9-2703-11	9-2703-11
48V, 50 Hz	Y	9-2703-13	9-2703-13	9-2703-13
Overload Relays				
For replacement on existing starters: three-pole—ambient compensated bimetallic	C306DN3B	C306DN3B	C306DN3B	C306DN3B
Current Transformer				
Transformer	—	—	—	—
Magnet Frame Armature				
Lower magnet frame	17-18200	17-1820	17-18200	17-18200
Upper magnet frame	48-1936	48-1936	48-1936	48-1936

IEC Sizes J and K—See Contactor/Starter Nameplate to Determine Series A1 and B1

Description	IEC Size J Series A1 Part Number	IEC Size J Series B1 Part Number	IEC Size K Series A1 Part Number	IEC Size K Series B1 Part Number
Renewal Parts Publication Number	20862	22178	20862	22178
Contact Kits				
Two-pole	6-65-7	6-65-7	6-65-18	6-65-20
Three-pole	6-65-8	6-65-8	6-65-17	6-65-19
Four-pole	6-65-15	6-65-15	—	—
Five-pole	6-65-16	6-65-16	—	—
Magnet Coils				
	Coil Suffix			
120V, 60 Hz or 110V, 50 Hz	A	9-2703-1	9-2703-1	9-2703-1
240V, 60 Hz or 220V, 50 Hz	B	9-2703-2	9-2703-2	9-2703-2
480V, 60 Hz or 440V, 50 Hz	C	9-2703-3	9-2703-3	9-2703-3
600V, 60 Hz or 550V, 50 Hz	D	9-2703-4	9-2703-4	9-2703-4
208V, 60 Hz	E	9-2703-9	9-2703-9	9-2703-9
277V, 60 Hz	H	9-2703-7	9-2703-7	9-2703-7
240V, 50 Hz	K	9-2703-14	9-2703-14	9-2703-14
380–415V, 50 Hz	L	9-2703-8	9-2703-8	9-2703-8
24V, 60 Hz–24V, 50 Hz	T	—	—	—
24V, 60 Hz	T	9-2703-6	9-2703-6	9-2703-6
24V, 50 Hz	U	9-2703-12	9-2703-12	9-2703-12
32V, 50 Hz	V	9-2703-10	9-2703-10	9-2703-10
48V, 60 Hz	W	9-2703-11	9-2703-11	9-2703-11
48V, 50 Hz	Y	9-2703-13	9-2703-13	9-2703-13
Overload Relays				
For replacement on existing starters: three-pole—ambient compensated bimetallic	C306GN3B	C306GN3B	C306GN3B	C306GN3B
Current Transformer				
Transformer	—	—	—	—
Magnet Frame Armature				
Lower magnet frame	17-18200	17-18200	17-18200	17-18200
Upper magnet frame	48-1936	48-1936	48-1936	48-1936

IEC Sizes L, M and N

Description	IEC Size L Part Number	IEC Size M Part Number	IEC Size N Part Number
Contact Kits			
Two-pole	6-43-3	6-43	6-43-5
Three-pole	6-43-4	6-43-2	6-43-6
Four-pole	—	—	—
Five-pole	—	—	—
Magnet Coils			
	Coil Suffix		
120V, 60 Hz or 110V, 50 Hz	A	9-2756-1	9-2756-1
240V, 60 Hz or 220V, 50 Hz	B	9-2756-2	9-2756-2
480V, 60 Hz or 440V, 50 Hz	C	9-2756-3	9-2756-3
600V, 60 Hz or 550V, 50 Hz	D	9-2756-4	9-2756-4
208V, 60 Hz	E	9-2756-5	9-2756-5
277V, 60 Hz	H	9-2756-9	9-2756-9
240V, 50 Hz	K	9-2756-13	9-2756-13
380–415V, 50 Hz	L	—	—
380V, 50 Hz	L	9-2756-12	9-2756-12
415V, 50 Hz	M	9-2756-8	9-2756-8
550V, 50 Hz	N	9-2756-14	9-2756-14
24V, 60 Hz–24V, 50 Hz	T	—	—
24V, 60 Hz	T	9-2756-6	9-2756-6
24V, 50 Hz	U	9-2756-11	9-2756-11
32V, 50 Hz	V	9-2756-10	9-2756-10
48V, 60 Hz	W	9-2756-15	9-2756-15
48V, 50 Hz	Y	9-2756-7	9-2756-7
Overload Relays			
For replacement on existing starters three-pole—ambient compensated bimetallic	10-6530	10-6530-2	10-6530-3
Current Transformer			
Transformer	—	—	—
Magnet Frame Armature			
Lower magnet frame	17-8955-2	17-8955-2	17-8955-2
Upper magnet frame	48-1902	48-1902	48-1902

IEC Sizes P, R and S

Description		IEC Size P	IEC Size R	IEC Size S
Renewal Parts Publication Number		22278	22278	22278
Contact Kits	Size	6-294	6-288	6-286
Magnet Coils		Coil Suffix		
120V, 60 Hz or 110V, 50 Hz	A	9-1891-1	9-1891-1	9-1891-1
200V, 50 Hz or 118V, 60 Hz	E	—	—	—
240V, 60 Hz or 220V, 50 Hz	B	9-1891-2	9-1891-2	9-1891-2
254V, 50 Hz or 277V, 60 Hz	H	—	—	—
380V, 50 Hz or 415V, 60 Hz	L	—	—	—
480V, 60 Hz or 440V, 50 Hz	C	9-1891-3	9-1891-3	9-1891-3
600V, 60 Hz or 550V, 50 Hz	D	9-1891-4	9-1891-4	9-1891-4
208V, 60 Hz	E	9-1891-13	9-1891-13	9-1891-13
277V, 60 Hz	H	9-1891-26	9-1891-26	9-1891-26
240V, 50 Hz	K	9-1891-20	9-1891-20	9-1891-20
380V, 50 Hz	L	9-1891-14	9-1891-14	9-1891-14
415V, 50 Hz	M	9-1891-21	9-1891-21	9-1891-21
24V, 60 Hz	T	9-1891-15	9-1891-15	9-1891-15
Overload Relays				
Reference C316 overload relays				
Magnet Frame Armature				
Lower magnet frame		48-1030-2	48-1030-2	48-1030-2
Upper magnet frame		48-1029-4	48-1029-4	48-1029-4

IEC Size T, U and V

Description		IEC Size T	IEC Size U	IEC Size V
Renewal Parts Publication Number		22275	22276	22586
Contact Kits	Size	6-621	6-622	6-601
Magnet Coils		Coil Suffix		
120V, 60 Hz or 110V, 50 Hz	A	9-3006	9-3006	9-2698
200V, 50 Hz or 118V, 60 Hz	E	9-3006-5	9-3006-5	—
240V, 60 Hz or 220V, 50 Hz	B	9-3006-2	9-3006-2	9-2698-2
254V, 50 Hz or 277V, 60 Hz	H	9-3006-6	9-3006-6	9-2698-2
380V, 50 Hz or 415V, 60 Hz	L	9-3006-7	9-3006-7	9-2698-6
480V, 60 Hz or 440V, 50 Hz	C	9-3006-3	9-3006-3	9-2698-3
600V, 60 Hz or 550V, 50 Hz	D	9-3006-4	9-3006-4	9-2698-4
208V, 60 Hz	E	—	—	9-2698-5
277V, 60 Hz	H	—	—	—
240V, 50 Hz	K	—	—	—
380V, 50 Hz	L	—	—	—
415V, 50 Hz	M	—	—	—
24V, 60 Hz	T	—	—	—
Overload Relays				
Reference C316 overload relays				
Magnet Frame Armature				
Lower magnet frame		—	—	—
Upper magnet frame		—	—	—

Technology Upgrades

This product currently listed in **Volume 5—Motor Control and Protection, CA08100006E, Tab 1.**

IT. Electromechanical NEMA



NEMA Full Voltage Non-reversing Starter, Size 0

Product Description

The Cutler-Hammer Intelligent Technologies® (IT.) electromechanical starter from Eaton’s electrical business consists of an IT. electromechanical contact block or contactor and an IT. electromechanical solid-state overload relay as a full voltage non-reversing (FVNR) or a full voltage reversing (FVR) device. Size 00 to Size 5 Starters are factory or field assembled.

Product History Time Line for IT. Electromechanical NEMA

Product	2000	2005	Present
IT. Electromechanical NEMA			

Replacement Capabilities

Replacements for NEMA Contacts and Starters

NEMA Size	Description	Catalog Number
Contact Kits		
1	40A	EMHCKT40 ①
1	50A	EMHCKT50 ①
2	65A	EMHCKT65 ①
2	85A	EMHCKT85 ①
2	100A	EMHCKT100 ①
3, 4	125A	EMCKT125
3, 4	160A	EMCKT160
3, 4	200A	EMCKT200
5	250A	EMCKT250
5	315A	EMCKT315
5	400A	EMCKT400
Coils ②		
1	Coil	EMCC
2	Coil	EMCD
3, 4	Coil	EMCE
5	Coil	EMCF
DIN Rail Catch		
00, 0, 1	Catch with leaf spring and pad	EMDRCB
2	Catch with leaf spring and pad	EMDRCD
Lug Kits		
1	Lug	EMLUGKTC
2	Lug	EMLUGKTD
3, 4	Lug	EMLUGKTE
5	Horizontal box lug kit	EMLUGKTFA
5	Vertical box lug kit	EMLUGKTFB
5	Dual lug kit	EMLUGKTFC
Overload Busbars		
00, 0	For contactors and starters	EMBBB
1	For starters	EMBBC
1	For reversing contactors and reversing starters	EMBBRC
2	For starters	EMBBDD
2	For reversing contactors and reversing starters	EMBBRD
3, 4	For starters	EMBBE
3, 4	For reversing contactors and reversing starters	EMBBRE
5	Overload relay	EMBBOF

Notes

- ① H = Hold-Open.
- ② For reversing contactors and starters, order two.

Technology Upgrades

This product currently listed in **Volume 5—Motor Control and Protection, CA08100006E, Tab 2.**

IT. Electromechanical IEC



IEC FVNR Starter, C-Frame

Product Description

The Cutler-Hammer Intelligent Technologies (IT.) electromechanical starter from Eaton's electrical business consists of an IT. electromechanical contact block or contactor and IT. electromechanical solid-state overload relay as a full voltage non-reversing (FVNR) or full voltage reversing (FVR) device. A-Frame (27 mm) to F-Frame (140 mm) Starters are factory or field assembled.

Product History Time Line for IT. Electromechanical IEC

Product	2000	2005	Present
IT. Electromechanical IEC			

Replacement Capabilities

Replacements for IEC Contacts and Starters

Frame Size	Description	Catalog Number
Contact Kits		
C	40A	EMCKT40
C	50A	EMCKT50
D	65A	EMCKT65
D	85A	EMCKT85
D	100A	EMCKT100
E	125A	EMCKT125
E	160A	EMCKT160
E	200A	EMCKT200
F	250A	EMCKT250
F	315A	EMCKT315
F	400A	EMCKT400
Coils ②		
C	Coil	EMCC
D	Coil	EMCD
E	Coil	EMCE
F	Coil	EMCF
DIN Rail Catch		
B, C	Catch with leaf spring and pad	EMDRCB
D	Catch with leaf spring and pad	EMDRCD
Lug Kits		
C	Lug	EMLUGKTC
D	Lug	EMLUGKTD
E	Lug	EMLUGKTE
F	Horizontal box lug kit	EMLUGKTFA
F	Vertical box lug kit	EMLUGKTFB
F	Dual lug kit	EMLUGKTFC
Overload Busbars		
B	For contactors and starters	EMBBB
C	For starters	EMBBC
C	For reversing contactors and reversing starters	EMBBRC
D	For starters	EMBBDD
D	For reversing contactors and reversing starters	EMBBRD
E	For starters	EMBBE
E	For reversing contactors and reversing starters	EMBBRE
F	Overload relay	EMBBOF

Note

① For reversing contactors and starters, order two.

Technology Upgrades

This product currently listed in **Volume 5—Motor Control and Protection, CA08100006E, Tab 2.**

XTIEC and NEMA Power Control



XT Family of Contactors

Product Description

Eaton’s line of **XT** Contactors and Starters includes non-reversing and reversing contactors, overload relay and a variety of related accessories. Because **XT** meets NEMA, IEC, UL, CSA, CCC and CE standards, it is the perfect product solution for applications all over the world. The compact, space saving and easy to install **XT** line of contactors and starters is the efficient and effective solution for customer applications from 7A to 2000A and NEMA 0–5.

Product History Time Line for XT Power Control

Product	2005	Present
XTIEC and NEMA Power Control		

Replacement Capabilities

Replacement Coils

Voltage	Coil Suffix	Catalog Number
Frame C—Size 1		
110/50 120/60	A	XTCERENCOILCA
110–130 Vdc	AD	XTCERENCOILCAD
220/50 240/80	B	XTCERENCOILCB
200–240 Vdc	BD	XTCERENCOILCBD
415/50 460/60	C	XTCERENCOILCC
550/50 600/60	D	XTCERENCOILCD
208/60	E	XTCERENCOILCE
230/50	F	XTCERENCOILCF
190/50 220/60	G	XTCERENCOILCG
240/50 277/60	H	XTCERENCOILCH
380/50 440/60	L	XTCERENCOILCL
400/50	N	XTCERENCOILCN
380/60	P	XTCERENCOILCP
12/50 12/60	R	XTCERENCOILCR
12–14 Vdc	RD	XTCERENCOILCRD
24/50 24/60	T	XTCERENCOILCT
24–27 Vdc	TD	XTCERENCOILCTD
24/50 42/50	U	XTCERENCOILCU
48/60	W	XTCERENCOILCW
48–60 Vdc	WD	XTCERENCOILCWD
48/50	Y	XTCEBENCOILCY
Frame D—Size 2		
110/50 120/60	A	XTCERENCOILDA
110–130 Vdc	AD	XTCERENCOILDAD
220/50 240/80	B	XTCERENCOILDB
200–240 Vdc	BD	XTCERENCOILDBD
415/50 480/60	C	XTCERENCOILDC
550/50 600/60	D	XTCERENCOILDD
208/60	E	XTCERENCOILDE
230/50	F	XTCERENCOILDF
190/50 220/60	G	XTCERENCOILDG
240/50 277/60	H	XTCERENCOILDH
380/50 440/60	L	XTCERENCOILDL
400/50	N	XTCERENCOILDN
380/60	P	XTCERENCOILDP
12/50 12/60	R	XTCERENCOILDR
12–14 Vdc	RD	XTCERENCOILDRD
24/50 24/60	T	XTCERENCOILDT
24–27 Vdc	TD	XTCERENCOILDTD
24/50 42/50	U	XTCERENCOILDU
48/60	W	XTCERENCOILDW
48–60 Vdc	WD	XTCERENCOILDWD
48/50	Y	XTCERENCOILDY

Replacement Coils, continued

Voltage	Coil Suffix	Catalog Number
Frame F—Size 3		
110/50 120/60	A	XTCERENCOILFA
110–130 Vdc	AD	XTCERENCOILFAD
220/50 240/60	B	XTCERENCOILFB
200–240 Vdc	BD	XTCERENCOILFBD
415/50 480/60	C	XTCERENCOILFC
550/50 600/60	D	XTCERENCOILFD
208/60	E	XTCERENCOILFE
230/50	F	XTCERENCOILFF
190/50 220/60	G	XTCERENCOILFG
240/50 277/60	H	XTCERENCOILFH
380/50 440/60	L	XTCERENCOILFL
400/50	N	XTCERENCOILFN
380/60	P	XTCERENCOILFP
12/50 12/60	R	XTCERENCOILFR
24/50 24/60	T	XTCERENCOILFT
24–27 Vdc	TD	XTCERENCOILFTD
24/50	U	XTCERENCOILFU
42/50 48/60	W	XTCERENCOILFW
48–60 Vdc	WD	XTCERENCOILFWD
48/50	Y	XTCERENCOILFY
Frame G—Size 4		
100–120V 50/60	A	XTCERENCOILGA
110–130 Vdc	AD	XTCERENCOILGAD
190–240V 50/60	B	XTCERENCOILGB
200–240 Vdc	BD	XTCERENCOILGBD
480–500V 50/60	C	XTCERENCOILGC
380–440V 50/60	L	XTCERENCOILGL
24/50 24/60	T	XTCERENCOILGT
24–27 Vdc	TD	XTCERENCOILGTD
42–48V 50/60	W	XTCERENCOILGW
48–60 Vdc	WD	XTCERENCOILGWD
Frame L—Size 5 ^①		
110–250 Vac/Vdc	A	XTCERENCOILLA
250–500V 40–60	C	XTCERENCOILLC
24–48 Vdc	TD	XTCERENCOILLTD
48–110 Vac/Vdc	Y	XTCERENCOILLY
Frame M ^①		
110–250 Vac/Vdc	A	XTCERENCOILMA
250–500V 40–60	C	XTCERENCOILMC
24–48 Vdc	TD	XTCERENCOILMTD
48–110 Vac/Vdc	Y	XTCERENCOILMY
Frame N ^①		
110–250 Vac/Vdc	A	XTCERENCOILNA
250–500V 40–60	C	XTCERENCOILNC
48–110 Vac/Vdc	Y	XTCERENCOILNY

Replacement Contact Kits

For use with...	Catalog Number
XTAE040D–XTAE065D	XTCERENCONTACTD
XTCE185L–XTCE250L	XTCERENCONTACTL
XTCE300M–XTCE500M	XTCERENCONTACTM

Replacement Vacuum Tube Assembly

For use with...	Catalog Number
XTCE580N	XTCERENVACT580
XTCE650N	XTCERENVACTBB0
XTCE750N	XTCERENVACT750
XTCE820N	XTCERENVACT820

Replacement Arc Chambers

For use with...	Catalog Number
XTCE185L	XTCERENARC185
XTCE225L	XTCERENARC225
XTCE250L	XTCERENARC250
XTCE300M	XTCERENARC300
XTCE400M	XTCERENARC400
XTCE500M	XTCERENARC500

Note

^① Electronic modules including coils.

Advantage™
Originally a Westinghouse Product



Advantage Starter

Product Description

Setting a new standard in motor control, revolutionary in design, Advantage motor starters employ state-of-the-art technology in solving motor control application problems that have existed for ages. Customer focus group input and 66,000 man-hours of engineering ingenuity have been combined to create a motor starter that dramatically extends operating life in a physical space requirement one half the size of conventional motor starters.

Product History Time Line for Advantage Contactors and Starters

Size	1991	1995	2000	Present
Sizes 1–6				

Replacement Capabilities

Replacements for Contact Kits and Coils

Contact Kits

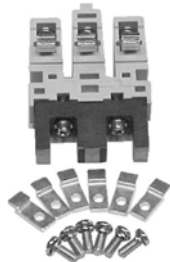

Coils



Description	Catalog Number
Replacement contact kit, size single, three-pole	WCK13
Replacement contact kit, size two, three-pole	WCK23
Replacement contact kit, size three, three-pole	WCK33
Replacement contact kit, size four, three-pole	WCK43
Replacement contact kit, size five, three-pole	WCK53
Replacement contact kit, size six, three-pole	WCK63
Size one and two, 110/120V, 60 Hz	WCOIL12F
Size three and four, 110/120V, 60 Hz	WCOIL34F
Size five and six, 110/120V, 60 Hz	WCOIL56F

Advantage / A200 Series Support and Transition to Freedom-C400 Series Power Control New Technologies

Eaton has consolidated the Advantage and Advantage+ product lines into a single offering effective July 19, 2013. This product consolidation will ensure Eaton’s ability to continue supporting the Advantage installed base.

The Advantage+ series features:

- Enhanced control board circuitry
- Same footprint as the Advantage series
- No change in accessories
- Backwards compatibility of control boards for NEMA Sizes 3–6

As a result of the consolidation, Advantage series part numbers will be replaced by the Advantage+ series.

However, please note the following:

- Replacement control boards for Advantage NEMA Sizes 1L, 1 & 2 are not interchangeable; therefore, Eaton will continue to manufacture these replacement boards
- Overload boards are no longer available. Overloads are to be replaced with a complete starter
- All other sizes will accept an Advantage+ replacement board. Please see the table below for additional details

Replacements for Control and Overload Boards

Offering	Replaced By
Advantage contactors (sizes 1L–6)	Advantage+ contactors (sizes 1L–6)
Advantage starters (sizes 1L–6)	Advantage+ starters (sizes 1L–6)
Advantage overload relays	Advantage+ starter
Replacement control boards (Sizes 1L, 1, 2)	No change: continue to order Advantage
Replacement control boards (Size 3, 4, 5, 6, 5DP, 6DP)	Advantage+ control boards
Accessories	No change

Technology Upgrades

This product is currently listed in **Volume 5—Motor Control and Protection, CA08100006E, Tab 2.**

C440 Electronic Overload



Freedom Series Starters—C440 Electronic Overload

Description (With Ground Fault Protection)	Overload Range (Amperes)	Catalog Number
NEMA Size 1 starter	1–5	AN19DN0A5G005
NEMA Size 1 starter	4–20	AN19DN0A5G020
NEMA Size 2 starter	9–45	AN19GN0A5G045
NEMA Size 3 starter	20–100	AN19KN0A5G100
NEMA Size 4 starter	28–140	AN19NN0A5G140
NEMA Size 5 starter	60–300	AN19SN0A5G300

C441 Motor Insight



Freedom Series Contactor—C441 Motor Insight

Overload Range (Amperes)	Freedom Contactor Catalog Number	Motor Insight Catalog Number (no display on unit)	Motor Insight Display Catalog Number (in the door mounting)
1–9	CN15DN3AB Size 1	C4410109NOUI	C4411 & D77E-QPIP100
5–90	CN15DN3AB Size 1	C4410590NOUI	C4411 & D77E-QPIP100
5–90	CN15GN3AB Size 2	C4410590NOUI	C4411 & D77E-QPIP100
5–90	CN15KN3A Size 3	C4410590NOUI	C4411 & D77E-QPIP100
60–135	CN15NN3A Size 4	C4410109NOUI & C441CTKIT150	C4411 & D77E-QPIP100
120–270	CN15SN3A Size 5	C4410109NOUI & C441CTKIT300	C4411 & D77E-QPIP100

Replacement Circuit Boards

Description	Existing Starter	Replacement Circuit Board
Standard NEMA Size 1L starter board 60 Hz	W200MLCFC	WCBSLF
Standard NEMA Size 1 starter board 60 Hz	W200M1CFC	WCBS1F
Standard NEMA Size 2 starter board 60 Hz	W200M2CFC	WCBS2F
Advantage+ NEMA Size 1L starter board 60 Hz	W+200MLCFC	W+CBSLF
Advantage+ NEMA Size 1 starter board 60 Hz	W+200M1CFC	W+CBS1F
Advantage+ NEMA Size 2 starter board 60 Hz	W+200M2CFC	W+CBS2F
Standard or Advantage+ NEMA Size 3 starter board 60 Hz	W200M3CFC or W+200M3CFC	W+CBS3F
Standard or Advantage+ NEMA Size 4 starter board 60 Hz	W200M4CFC or W+200M4CFC	W+CBS4F
Standard or Advantage+ NEMA Size 5 starter board 60 Hz	W200M5CFC or W+200M5CFC	W+CBS5F
Standard or Advantage+ NEMA Size 6 starter board 60 Hz	W200M6CFC or W+200M6CFC	W+CBS6F

Definite Purpose

Originally a Cutler-Hammer Product

Product History Time Line for Definite Purpose, Bulletin 9560, 9584 and 9586

Pole	Amperes	1955	1960	1965	1970	1975	1980	1985	1990	1995	2000	Present	
9560 Contactors													
2P, 3P, 4P	25, 30, 40		[Bar]										
2P, 3P	50, 60		[Bar]										
2P, 3P	75, 90				[Bar]								
9584 Starters													
1P	30		[Bar]										
	40			[Bar]									
	50		[Bar]										
	60		[Bar]										
9586 Starters													
1P	30		[Bar]										
	40			[Bar]									
	50		[Bar]										
	60		[Bar]										
C25 Contactors													
2P, 3P, 4P	25, 30, 40							[Bar]					
2P, 3P	15, 60, 75, 90							[Bar]					
3P	120, 200, 300, 360							[Bar]					

Replacement Capabilities

Contact Kits for Types 9560, 9584, 9586

Description	Contact Kit Part Number					
	Contactor or Starter Size, Ampere Rating					
	12A Inductive 15A Resistive	25, 30A Inductive 30, 40A Resistive	40A Inductive 50A Resistive	50, 60A Inductive 60, 75A Resistive	75A Inductive 90A Resistive	90A Inductive 120A Resistive
Single-pole kit	①	6-331-3	6-331-4	—	6-331-8	6-331-8
Three-pole kit	①	—	—	6-331-39	—	—

Magnetic Coils for Types 9560, 9584 and 9586

Coil Suffix	Coil Voltage		Coil Part Number		
	60 Hz	50 Hz	Ampere Rating		
			12, 25 and 30A Inductive 15, 30 and 40A Resistive	40A Inductive 50A Resistive	50, 60, 75 and 90A Inductive 60, 75, 90 and 120A Resistive
-7	—	380	①	①	①
-47	277	—	①	①	①
-49	104–120	104–120	①	①	①
-50	208–240	208–240	①	①	①
-69	24	24	①	①	①
-72	480	480	①	①	①
-74	600	600	①	①	①

Technology Upgrades

Definite Purpose Technology Upgrades

Type	A25	C25	C32	B25
9560 Contactors	—	15–90A	120–350A	—
9584 Starters	—	—	—	25–40A
9586 Starters	25–60A	—	—	—

Note

① Replace with new Definite Purpose contactor or starter.

Renewal Parts

Renewal Contact Kits for C25 Definite Purpose Contactors

- Replace complete contactor for:
 - C25A_
 - C25B_
 - C25C_
 - C25D_

Renewal Contact Kits for C25 Definite Purpose Contactors

Catalog Number	Single-Pole Kit	Two-Pole Kit	Three-Pole Kit
	Part Number	Part Number	Part Number
C25FNF250	—	6-65-5	—
C25FNF350	—	—	6-65-6
C25FNF260	—	6-65-7	—
C25FNF360	—	—	6-65-8
C25FNF275	—	6-65-20	—
C25FNF375	—	—	6-65-19
C25GNF290	—	—	—
C25GNF390	—	—	—
C25HNE3120	—	—	6-43-6
C25KNE3200	—	—	6-288
C25KNE3300	—	—	6-286
C25LNE3360	—	—	6-45-2

Product Selection

AC Coils

AC Coil Voltage	Frequency	Coil Suffix	Part Number
15, 25, 30 and 40A—Two- and Three-Pole (Series D1 and E1)			
12	60	R	9-3185-5
24		T	9-3185-6
110/120		A	9-3185-1
208/240		B	9-3185-2
220/240	60	J	9-3185-10
440/480		C	9-3185-3
550/600		D	9-3185-4
277		H	9-3185-7
380/415	50	L	9-3185-8
15, 25, 30 and 40A—Two- and Three-Pole (Series C1)			
12	60	R	9-3125-5
24		T	9-3125-6
104/120		A	9-3125-1
208/240	50	B	9-3125-2
440/480		C	9-3125-3
550/600		D	9-3125-4
277	60	H	9-3125-8
380/415	50	L	9-3125-8
15, 25, 30 and 40A—Two- and Three-Pole (Series D1 and E1)			
12	60	R	9-3252-5
24		T	9-3252-6
110/120		A	9-3252-1
208/240		B	9-3252-2
220/240	60	J	9-3252-10
440/480		C	9-3252-3
550/600		D	9-3252-4
277		H	9-3252-7
380/415	50	L	9-3252-8
50A—Two- and Three-Pole (Series D1 and E1)			
12	60	R	9-3186-5
24		T	9-3186-6
110/120		A	9-3186-1
208/240		B	9-3186-2
220/240	60	J	9-3186-10
440/480		C	9-3186-3
550/600		D	9-3186-4
277		H	9-3186-7
380/415	50	L	9-3186-8

AC Coils, continued

AC Coil Voltage	Frequency	Coil Suffix	Part Number
50A – Two- and Three-Pole (Series D1 and E1)			
12	60	R	9-3253-5
24		T	9-3253-6
110/120		A	9-3253-1
208/240		B	9-3253-2
220/240	60	J	9-3253-10
440/480		C	9-3253-3
550/600		D	9-3253-4
277		H	9-3253-7
380/415	50	L	9-3253-8
60 and 75A – Two- and Three-Pole; 25, 30 and 40A – Four-Pole			
12	60	R	9-3256-5
24		T	9-3256-6
104/120		A	9-3256-1
208/240	50	B	9-3256-2
440/480		C	9-3256-3
550/600		D	9-3256-4
277	60	H	9-3256-7
380/415	50	L	9-3256-8
90A – Two- and Three-Pole (Series F1)			
24	50/60	T	9-3080-1
110/120		A	9-3080-2
208–220		B	9-3080-3
380–415	50/60	C	9-3080-5
277	60	H	9-3080-4
120A – Three-Pole			
24	50/60	T	9-2756-16
110/120		A	9-2756-1
220/240		B	9-2756-2
440/480		C	9-2756-3
550/600		D	9-2756-4
208	60	E	9-2756-5
277		H	9-2756-9
200, 300 and 360A – Three-Pole			
110/120	50/60	A	9-1891-1
220/240		B	9-1891-2
440/480		C	9-1891-3
550/600		D	9-1891-4
208	60	E	9-1891-13
277		H	9-1891-26

DC Operation

These DC coils have separate pick-up and seal windings. The pick-up winding must be connected to an early break normally closed auxiliary contact block and provide the magnetic force required to close the magnet. As the magnet approaches the closed position, the early break normally closed contact is opened and the holding coil is inserted in series with the pick-up winding.

The early break contact block (C320KGD1) has to be attached to the side of the contactor, taking up one of the positions available for add-on auxiliary contact blocks.

DC Coil Elementary Diagram—Contactors and Starters

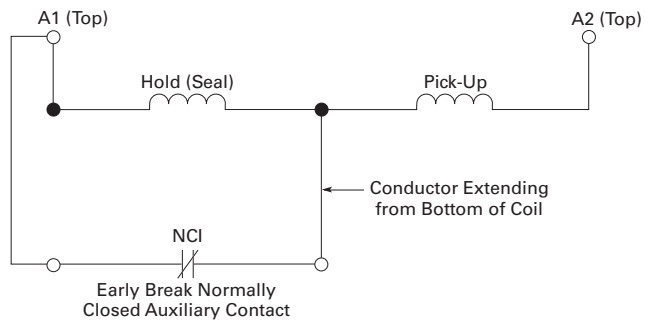

DC Coils ①

DC Coil Voltage	Coil Suffix	Part Number
15, 25, 30 and 40A – Two- and Three-Pole (Series D1 and E1)		
12	1R	9-3254-2
24	1T	9-3254-3
48	1W	9-3254-4
120	1A	9-3254-5
50A – Two- and Three-Pole (Series D1 and E1)		
12	1R	9-3255-2
24	1T	9-3255-3
48	1W	9-3255-4
120	1A	9-3255-5
15, 25, 30 and 40A – Two- and Three-Pole (Series C1)		
12	1R	9-3126-1
24	1T	9-3126-2
48	1W	9-3126-3
60 and 75A – Two- and Three-Pole; 25, 30 and 40A – Four-Pole (Series C1)		
12	1R	9-3257-1
24	1T	9-3257-2
48	1W	9-3257-3
120	1A	9-3257-4

Note

① DC coils require an early break NC auxiliary contact C320KGD1 (1NCI) or C320KGD2 (1NO-1NCI). Order separately, not included with replacement coil.

JF Autostarter

Originally a Westinghouse Product



Start Kit—Style Number 550D409G18

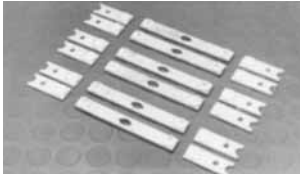

Run Kit—Style Number 550D409G19

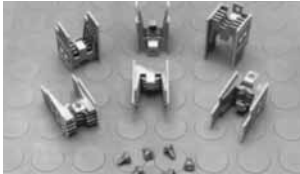

Grid Kit—Style Number 3354D90G10

Product Description

Kits contain a complete set of moving contacts, stationary contacts and springs.

Product History Time Line for JF Autostarter

Type	1930	1935	1940	1945	1950	1955	1960	1965	1975	1985	1995	2000	Present
AF		█	█										
A				█	█	█	█						
MB							█	█					
JF							█	█	█	█	█		

Replacement Capabilities

Manual Autostarter Kits

Frame Size	Required	Start Contacts	Required	Run Contacts	Required	Grid Stack Kit
2-3	1	38A7018G12	1	38A7018G13	1	3354D90G10
4-5, 5L	1	550D409G18	1	550D409G19	1	3354D90G10
5M-5MM	1	3354D90G08	1	3354D90G09	2	3354D90G10

Solenoid Assembly with Coil (All Sizes)

Volt	Hz	Style ②
115	60	5264C05H01
230	60	5264C05H02
460	60	5264C05H03
575	60	5264C05H04

Technology Upgrades

ECN42-ECN44 reduced voltage auto-transformer starter or *IT* solid-state reduced voltage starter.

Notes

- ① When replacing solenoid assembly series 416C160, use adapter plate style 9917D02H01—quantity one required.
- ② These styles replace coil style 296B892G_-. When ordering new style as replacement, customer must order adapter plate 9917D02H01—quantity one required.

ME and MD DC Contactors

Originally a Westinghouse Product



Single-Pole, Cat. No. MD510 with L-64 Auxiliary Contact

Product Description

The Cutler-Hammer ME and MD line of DC contactors were and are designed to control functions of a connected motor by starting, stopping, reversing and regulating. Motor protection is provided when the contactors are combined with an appropriate protective device such as an overcurrent relay.

Application Description

Typical applications for the contactor functions are as variable voltage controller disconnects, fans, pumps, conveyors, rolling mills, cranes, or anywhere a DC motor is used.

Product History

The Cutler-Hammer ME and MD line of DC contactors dates back to the early 1940s in East Pittsburgh, PA, where the development of the M contactors was begun by the Westinghouse Electric Corporation to be used in steel rolling mills and nicknamed “mill duty” devices. Added frame sizes were developed to complete the line in Buffalo in the late

1940s. These devices were primarily mounted on insulating plates and were rear connected for ease of wiring the motor current conductors. In the 1960s, front-mounted MD versions of the devices were developed to mount devices on steel panels because the insulating panels were expensive and difficult to manufacture.

In the late 1970s, rear-connected devices were rare and the ME contactor line was created for front connection, with a rear connection kit available and the M rear connected version discontinued. The MR normally closed line was also introduced as a standard at that time.

Product History Time Line for M Series DC Contactors

NEMA Size	1941	1945	1948	1952	1958	1964	1977	1978	1993	2000	2014	Present
Sizes 0–1 small frame Type M Type MD Type ME		■	■				■	■	■	■	■	■
Large frame Type M			■	■	■	■	■	■				
Size 2 large frame Type M Type ME			■	■	■	■	■	■	■	■	■	■
Sizes 3–4 Type MME Type ME			■	■	■	■	■	■	■	■	■	■
Sizes 3–4 Type M Type MD		■	■	■	■	■	■	■				
Size 5 front connected Type M Type MD		■	■	■	■	■	■	■	■	■	■	■
Rear connected Type MR								■	■	■	■	■
Sizes 6–9 front connected Type M Type MD			■	■	■	■	■	■	■	■	■	■
Rear connected Type MR									■	■	■	■

Replacement Capabilities

ME Series Renewal Parts—Kits

Description	1NO Pole		2NO Poles		1NC Pole		1NO/NC Pole	
	Qty.	Part Number	Qty.	Part Number	Qty.	Part Number	Qty.	Part Number
Contact kit	1	2184A10G14	2	2184A10G14	1	2184A10G14	2	2184A10G14
Arc box 10/25/50A	1	2184A10G09	2	2184A10G09	1	2184A10G09	2	2184A10G09
Arc box 100/150A	1	2184A10G10	2	2184A10G10	1	2184A10G10	2	2184A10G10
Shunt kit	1	2184A10G21	1	2184A20G16	1	2084A01G07	1	2184A11G07
Armature kit	1	2184A10G19	1	2184A20G15	1	2084A01G06	1	2184A11G06
Blowout assembly								
10A	1	2184A10G15	1	2184A20G11	1	2184A10G15	2	2184A10G15
25A	1	2184A10G16	1	2184A20G12	1	2184A10G16	2	2184A10G16
50A	1	2184A10G17	1	2184A20G13	1	2184A10G17	2	2184A10G17
110/150A	1	2184A10G18	1	2184A20G14	1	2184A10G18	2	2184A10G18
Rear connection kit	1	2184A10G08	1	2184A10G08	1	2184A10G08	1	2184A10G08

ME Series Renewal Parts—Coils

Voltage	Part Number		
	Operating Coils 10/25/50/100/150 Ampere Sizes	Holding Coils (Lower) ^① — 1NO/1NC Contactors Only	
		10/25/50 Ampere Sizes	100/150 Ampere Sizes
65	30B4376G06	44A6366G10	30B4376G27
90/92	30B4376G25	44A6366G12	427C048G16
115	30B4376G07	44A6366G13	30B4376G01
125	30B4376G08	44A6366G19	30B4376G26
230/240	30B4376G09	44A6366G15	30B4376G02
250	30B4376G10	44A6366G23	30B4376G17
500	30B4376G14	N/A	N/A
550	30B4376G11	44A6366G18	30B4376G03

Note

^① If lower coils are required, order separately.

MR and MD Series ① Sizes 5–9 Renewal Parts—Kits

Type MR and MD	Part Number Current
Contact Kit	
501/501R	26D2610G22
510	26D2610G15
601/701	26D2610G24
610/710	26D2610G16
810	26D2610G18
810R	26D2610G19
910	26D2610G20
Shunt	
501/501R	25A1650G02
510	25A1641G02
601	25A1666G03
610	25A1654G03
701	25A1666G04
710	25A1654G04
810/810R	25A1693G02
910	45A1425G02
Arc Box	
501/510	25A1646G01
601/610, 701/710	25A1662G01
810/910	25A1677G05
Armature Kit	
501/501R	25A1649G05
510	25A1640G05
601/701	25A1667G03
610/710	25A1655G04
810/810R	25A1694G05
910	38A2269G02
Blowout Coil Assembly Kit ②	
M501/510	25A1644G05
M601/610	25A1659G05
M701/710	25A1660G03
M810/810R	25A1698G03
M910	238A2273G02
Blowout Coil Assembly Kit ③	
M501/510	857D505G05
M601/610	857D506G08
M701/710	857D516G05
M810	857D508G07
M910	857D509G04

Notes

- ① MR = rear connected; MD = front connected.
- ② Type MR only.
- ③ Type MD only.

M and MD Series Sizes 5–9—Coils

Voltage	M and MD 501		M and MD 510		M and MD 610/710	
	Part Number	Symmetrical Wiring	Part Number	Symmetrical Wiring	Part Number	Symmetrical Wiring
65	N/A	—	45A5515G11	—	—	—
90/92	N/A	—	45A5515G23	—	30B4377G17	—
115	30B4375G04	—	45A5515G01	—	30B4377G04	—
125	30B4375G24	—	45A5515G07	—	30B4377G10	—
230	30B4375G05	—	45A5515G04	—	30B4377G05	—
250	30B4375G12	—	45A5515G12	—	30B4377G07	—
550	30B4375G06	—	45A5515G05	—	30B4377G08	—

Voltage	M and MD 601/701		M and MD 810		M and MD 910	
	Part Number	Symmetrical Wiring	Part Number	Symmetrical Wiring	Part Number	Symmetrical Wiring
92	—	—	435A928G01	①	435A930G01	①
115	30B4377G23	①	435A929G01	①	L483507G01	①
115	30B4377G01	②	L482211G01	②	L483507G01	②
125	30B4377G24	①	435A966G01	①	435A967G01	①
125	30B4377G13	②	—	—	—	—
230	30B4377G01	①	L482211G01	①	L483507G01	①
230	30B4377G02	②	—	—	—	—
250	30B4377G13	①	334P064G01	①	LR549720G01	②
250	30B4377G08	②	—	—	—	—
550	30B4377G25	①	L482213G01	②	L483508G01	②
550	30B4377G03	②	—	—	—	—
600	—	—	N/A	—	L548879G01	①

Voltage	M and MD 810R		Resistor		Resistor Mounting	
	Coil Part Number	Symmetrical Wiring	Part Number	Symmetrical Wiring	Part Number	Symmetrical Wiring
115	N/A	—	N/A	—	N/A	—
230	L482211G0	①	57D1336G10	③	57D1340G02	—
550	N/A	①	57D1336G12	④	57D1340G02	—

Technology Upgrades

This product currently listed in **Volume 5—Motor Control and Protection, CA08100006E, Tab 4.**

Notes

- ① Two coils connected in series.
- ② Two coils connected in parallel.
- ③ Two resistors connected in parallel.
- ④ Resistors connected in series.

C80 Mill Type DC Contactors

Originally a Cutler-Hammer Product

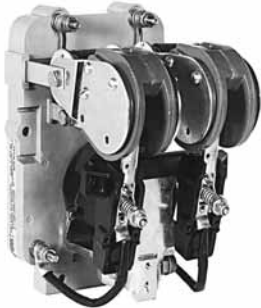

Size 2—Two-Pole Contactor

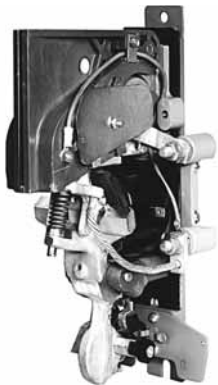

NO Contactor

Product Description

These DC mill type contactors are designed for heavy industry service and are suitable for use on moving machinery. The contactors listed in this section are for surface mounting on steel panels and front-of-panel wiring. The power stud assembly is

mounted on the side of the contactor, rather than as part of a separate mounting kit.

The contactors feature forged steel armature levers and magnet frames for superior physical strength. Self-lubricating bearings eliminate the need for lubricating the contactor.

New hot-molded arc chute assemblies contain no asbestos and have better arc extinction characteristics for longer contact life. The short stroke armature results in a mechanical life of more than 20 million operations.



Product History Time Line for C80 Mill Type DC Contactors

Size	1980	1985	1990	1995	2000	Present
Sizes 2 – 8		[Timeline bar spanning from 1985 to Present]				

Note: The C80 contactors were renumbered in 1984 from the old 6002 Series, which date back to 1919. Consult factory for old 6002 Series replacements and parts.

Replacement Capabilities

Replacement Capabilities for C80 Mill Type DC Contactors

Description	Part Numbers						
	Size 2 Single-Pole, Two-Pole, Three-Pole and Ltl® 25 and 50A	Size 3 Single-Pole NO, NC and Ltl 100A	Size 4 Single-Pole NO, NC and Ltl 150A	Size 5 Single-Pole NO, NC and Ltl 300A	Size 6 Single-Pole NO, NC and Ltl 600A	Size 6A Single-Pole NO, NC and Ltl 810A	Size 8 Single-Pole NO 1350A
Set of Contact	Set of Contacts						
 Single-pole copper	6-599	6-189	6-189	6-189-3	6-189-4	6-189-4	6-215
Single-pole silver	—	6-189-5	6-189-6	6-189-7	6-189-8	6-189-8	6-215-2
Two-pole copper	6-169-4	—	—	—	—	—	—
Three-pole copper	6-169-5	—	—	—	—	—	—
Arc Shield	Arc Shield						
 Right hand	73-2676-2	62-791	62-791	62-793	62-840	62-840	62-804
Left hand	73-2676	62-791-2	62-791-2	62-793-2	62-840-2	62-840-2	62-804
Coils	Coils						
 Single-pole NO 100V	9-1549-18	9-1583-15	9-1583-15	9-1589-10	9-1688-8	9-1688-8	9-547-7 ①
115V	9-1549-2	9-1583-2	9-1583-2	9-1589-2	9-1688-2	9-1688-2	9-547-7 ①
115V	9-1549-2	9-1583-2	9-1583-2	9-1589-2	9-1688-2	9-1688-2	9-547-7 ①
550V	9-1549-3	9-1583-3	9-1583-3	9-1589-3	9-1688-3	9-1688-3	9-547-28 ①
Single-pole NC 100V	—	9-1585-18	9-1585-18	9-967-13	9-1717-4	—	—
115V	—	9-1585-2	9-1585-2	9-967-8	9-1717-1	—	—
230V	—	9-1585-1	9-1585-1	9-967-7	9-1717-2	—	—
550V	—	9-1585-3	9-1585-3	9-967-12	9-1717-3	—	—
Single-pole Ltl ② 100V	9-1549-18	9-1583-15	9-1583-15	9-1589-10	9-1688-8	—	—
115V	9-1549-2	9-1583-2	9-1583-2	9-1589-2	9-1688-2	—	—
230V	9-1549-1	9-1583-1	9-1583-1	9-1589-1	9-1688-1	—	—
550V	9-1549-3	9-1583-3	9-1583-3	9-1589-3	9-1688-3	—	—
Two-pole 100V	9-1585-18	—	—	—	—	—	—
115V	9-1585-2	—	—	—	—	—	—
230V	9-1585-1	—	—	—	—	—	—
550V	9-1585-3	—	—	—	—	—	—
Three-pole 100V	9-1585-18	—	—	—	—	—	—
115V	9-1585-2	—	—	—	—	—	—
230V	9-1585-1	—	—	—	—	—	—
550V	9-1585-3	—	—	—	—	—	—

Technology Upgrades

This product currently listed in **Volume 5—Motor Control and Protection, CA08100006E, Tab 4.**

Notes

- ① Series resistor used with coil for voltage shown.
- ② Magnet closing coil only. If holdout coil is required, give number stamped on coil or advise Bulletin or Serial Number of controller.

511 AC and DC Brakes

Originally a Cutler-Hammer Product

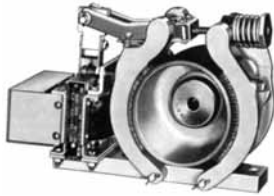

Size 4-Inch Brake and Wheel

Product Description

Cutler-Hammer Type S brakes are field-proven AC/DC brakes. For applications up to 1800 rpm/50 hp. Precision holding and stopping in 4, 5.5, 7 and 10-inch wheel sizes. With 15 standard bore sizes—straight or tapered, non-asbestos linings and off-the-shelf availability, electrically released and spring applied, providing “fail-safe” operation.

The retarding torque developed is directly proportional to the spring pressure.

Typical applications include conveyors, machine tools, printing presses, small cranes, overhead doors, dumb waiters, vacuum molding machines and carnival rides.

Product History Time Line for 511 AC and DC Brakes

Types	1934	1940	1950	1960	1970	1980	1990	2000	Present
4-inch Small Solenoid	[Bar from 1934 to ~1985]								
4-inch Large Solenoid	[Bar from 1934 to Present]								
5-1/2-inch Old Style	[Bar from 1934 to ~1980]								
5-1/2-inch Updated	[Bar from ~1985 to Present]								
7-inch	[Bar from 1934 to Present]								
7-inch High Torque	[Bar from ~1985 to Present]								
8-1/2-inch	[Bar from ~1975 to ~1985]								
10-inch	[Bar from 1934 to Present]								

Replacement Capabilities

Renewal Parts for Cat. No. 511 Shoe Brakes ^①

Description	Coil Suffix	Part Numbers					
		4-Inch Brake 3, 10 and 15 Lb Torque	5-1/2-Inch Brake 25 and 35 Lb Torque	7-Inch Brake 50 and 75 Lb Torque	85 and 110 Lb Torque	10-Inch Brake 125 Lb Torque	160 Lb Torque
Magnet Coils	Coil Suffix						
120V, 60 Hz	-39	9-591-9	9-585-9	9-941-20	9-941-8	9-758-36	9-758-37
110V, 50 Hz	-5	9-591-9	9-585-9	9-585-9	9-941-39	9-758-26	9-758-10
120/110V, 50/60 Hz	-66	9-591-9	9-585-9	—	—	—	—
208V, 60 Hz	-45	9-591-16	9-585-33	9-941-35	9-941-45	9-758-30	9-758-31
208/240V, 50/60 Hz	-50	9-591-3	—	—	—	—	—
240V, 60 Hz	-40	9-591-10	9-585-10	9-941-15	9-941-4	9-758-2	9-758-30
220/240V, 50/60 Hz	-67	9-591-10	9-585-10	—	—	—	—
480V, 60 Hz	-41	9-591-11	9-585-16	9-941-12	9-941-6	9-758-4	9-758-20
440/480V, 50/60 Hz	-70	9-591-11	—	—	—	—	—
600V, 60 Hz	-58	9-591-12	9-585-26	9-941-32	9-941-25	9-758-13	9-758-5
550/600V, 50/60 Hz	-71	9-591-12	—	—	—	—	—
220V, 50 Hz	-6	9-591-10	9-585-10	9-585-10	9-941-29	9-758-6	9-758-2
380V, 50 Hz	-7	9-591-13	9-585-5	9-585-5	9-941-30	9-758-4	9-758-28
440V, 50 Hz	-8	9-591-11	9-585-11	9-585-11	9-941-3	9-758-7	9-758-4
550V, 50 Hz	-9	9-591-12	9-585-12	9-585-12	9-941-41	9-758-27	9-758-13
120 Vdc	-97	9-1346-3	9-1347-10	9-1347-10	9-1347-12	—	—
240 Vdc	-98	9-1346-4	9-1347-11	9-1347-11	9-1347-13	—	—
Lining kit with rivets ^②		6-166	6-166-2	6-166-5	6-166-5	6-166-4	
Shoe with lining		48-306 ^③	48-1787 ^③	48-1200-3 ^③	48-1200-3 ^③	24-2146-3 Inner ^③	24-2146-4 Outer ^③
Solenoid without coil	AC	88-1553-8	88-2930-4	88-1342-11	88-1342-11	17-17199	
	DC	88-521-6	88-521-5	88-521-5	88-521-5	—	
RP publication number		19320 AC	17377 AC	15475 AC	15475 AC	17379	
		13864 DC	17378 DC	15477 DC	15477 DC	—	

Technology Upgrades

This product currently listed in **Volume 5—Motor Control and Protection, CA08100006E, Tab 2.**

- ① Parts listed are for current line of 511 brakes.
- ② Kit contains two linings and rivets for one brake.
- ③ Part number covers one shoe only.

DPM-Contactor



DPM 1000 Vdc Contactor

Product Description

The Cutler-Hammer DPM 1000 Vdc Definite Purpose Contactor has been designed to meet severe environmental and vibration conditions found in your worst applications. The contactor is of unit construction, assembled on a molded insulated base, providing maximum performance in minimum space.

Product History Time Line for DPM-Contactor

Device	1970	1980	1990	2000	Present
DPM-Contactor		[Timeline bar spanning from 1980 to Present]			

Replacement Capabilities

DPM-Contactor Renewal Parts

Description	Catalog Number
Contact kit	2131A94G10
Arc box	2131A94G03
Shunt	3534C86G01
Coils	
28 Vdc	2114A92G04
36 Vdc	2114A92G05
55 Vdc	2114A92G06
74 Vdc	2114A92G09
110/115 Vdc	2114A92G14
125 Vdc	2114A92G15
275 Vdc	2114A92G16
600 Vdc	2114A92G20

Technology Upgrades

This product currently listed in **Volume 5—Motor Control and Protection, CA08100006E, Tab 4.**

AVD-Contactor



2000 Vdc Contactor

Product Description

The AVD-Contactor is a single-pole normally open, load break, bi-directional definite purpose DC contactor. The device is rated at 1400A continuous and is capable of switching up to 2000 Vdc loads.

Operating Coil Characteristics

Coil Voltage	Current Draw at Nominal Voltage (± 5% at 20°C)	Catalog Number
28	1.87	9-3004-2
37	1.58	9-3004-3
74	0.79	9-3004-1
100	0.62	9-3004-5
230	0.25	9-3004-4

Product History

The Cutler-Hammer AVD (Advanced DC Contactor) was released for sale in 1995. The device has not gone through any significant redesigns since its introduction.

Product History Time Line for AVD-Contactor

Device	1993	1995	2000	Present
AVD-Contactor				

Replacement Capabilities

Replacement Coils

Coil Voltage (Vdc)	Catalog Number
28	9-3004-2
37	9-3004-3
74	9-3004-1
100	9-3004-5
230	9-3004-4

Auxiliary Contacts

Contact Configuration	Terminal Configuration	Catalog Number
1NO/1NC	Fast-on	10-3519-5
2NO	Fast-on	10-3519-6
2NC	Fast-on	10-3519-7
1NO/1NC	Screw type	10-6817
2NO	Screw type	10-6817-2
2NC	Screw type	10-6817-3

Replacement Contacts and Arc Chute

Description	Quantity Required per Contactor	Catalog Number
Stationary contact	1	23-7253
Movable contact	2	23-7255
Arc chute	1	62-1038

Technology Upgrades

This product currently listed in **Volume 5—Motor Control and Protection, CA08100006E, Tab 4.**

D-Contactor

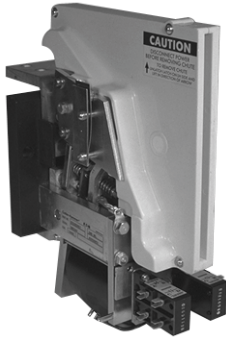

750 Vdc Contactor

Product Description

The D-Contactor is a single-pole normally open, load break, bi-directional definite purpose DC contactor. Two devices are available rated at 1800 and 3000A at 750 Vdc.

Operating Coil Characteristics

Coil Voltage	Current Draw at Nominal Voltage (± 7.5% at 20°C)	Catalog Number
12	3.96	9-1688-15
24	2.00	9-1688-7
32	1.44	9-1688-9
48	1.00	9-1688-12
74	.97	9-2064-3
100	.45	9-1688-8
115	.37	9-1688-2
230	.20	9-1688-1

Product History

The Cutler-Hammer D-Contactor was released for sale in early 1970s. The original device included a permanent magnet blowout coil and square main contacts. The permanent magnet blowout coil device was uni-directional or the current could only flow through the device in one direction. As such, it was essential that the polarity as marked on the power terminals be maintained. The permanent magnet blowout device is no longer offered.

The device was redesigned in the early 1980s to include round main contacts and an intermittent duty blowout coil in lieu of the permanent magnet blowout. The blowout coil device is bi-directional or current can flow through the device in either direction. Although contact life is maximized if the +terminal is at the top of the device, it is not essential that polarity be maintained. The present blowout coil device is a form, fit, function replacement for the original

permanent magnet blowout device. In addition, the present contact kits with the round contacts can be used on the original devices that employed the square main contacts. Subsequent minor product enhancements have been made with the new parts being a direct replacement for the parts that they replaced.

Product History Time Line for D-Contactor

Device	1970	1980	1990	2000	Present
Permanant Magnet Blowout Device	█				
Blowout Coil Device		█			

Replacement Capabilities

Replacement Coils

Coil Voltage (Vdc)	Catalog Number
12	9-1688-15
24	9-1688-7
32	9-1688-9
48	9-1688-12
74	9-2064-3
100	9-1688-8
115	9-1688-2
230	9-1688-1

Auxiliary Contacts

Contact Configuration	Terminal Configuration	Catalog Number
1NO/1NC	Fast-on	10-3519-5
2NO	Fast-on	10-3519-6
2NC	Fast-on	10-3519-7
1NO/1NC	Screw type	10-6817
2NO	Screw type	10-6817-2
2NC	Screw type	10-6817-3

Replacement Contacts, Blowout Coil and Arc Chute

Device Rating Amperes	Main Contact Configuration	Contacts	Catalog Number
1800	Two-main	Main contacts	6-497
1800	Two-main	Arcing contacts	23-5449
3000	Four-main	Main contacts	6-496
3000	Four-main	Arcing contacts	23-5448
1800 and 3000	Two- and four-main	Blowout coil	9-2592
1800 and 3000	Two- and four-main	Arc chute	62-822

Technology Upgrades

This product currently listed in **Volume 5—Motor Control and Protection, CA08100006E, Tab 4.**

Reversing/Assignment Contactors

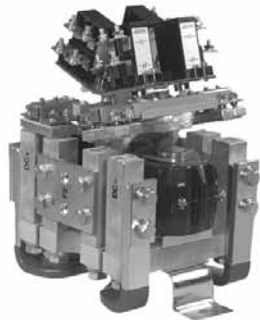

1000 Vdc Contactor

Product Description

The Reversing/Assignment Contactor is a double-pole, double-throw, non-load break definite purpose DC contactor. A three-position center-off and a two-position magnetically-latched configuration is available. The device is rated for 1100A, 1000 Vdc. The Reversing Contactor includes cross-over busbars for DC motor reversing applications; the Assignment Contactor omits the cross-over busbars for motor assignment applications.

Operating Coil Characteristics

Coil Voltage	Current Draw at Nominal Voltage (± 7.5% at 20°C)	Catalog Number
24	1.60	9-1903-9
28	1.30	9-1903-1
36	1.06	9-1903-3
74	0.49	9-1903-7
110	0.33	9-1903-6
125	0.33	9-1903-4
250	0.17	9-1903-8

Product History

The Cutler-Hammer Reversing/Assignment Contactor was released for sale in the early 1970s. The original device incorporated a leaf spring contact assembly and square contacts. The device was redesigned in the

early 1980s to incorporate a coil spring contact assembly with round contacts. The present device is a form, fit, function replacement for the original device. In addition, the original leaf spring contact assembly devices can be

upgraded to the new coil spring contact assembly with the one-time purchase of a contact upgrade kit. The standard contact kit can then be used for subsequent contact replacements.

Product History Time Line for Reversing/Assignment Contactors

Device	1970	1980	1990	2000	Present
Leaf Spring Contact Assembly Device	[Bar spanning 1970-1980]				
Coil Spring Contact Assembly Device		[Bar spanning 1980-Present]			

Replacement Capabilities

Replacement Coils

Coil Voltage (Vdc)	Catalog Number
24	9-1903-9
28	9-1903-1
36	9-1903-3
74	9-1903-7
110	9-1903-6
125	9-1903-4
250	9-1903-8

Auxiliary Contacts

Contact Configuration	Terminal Configuration	Catalog Number
1NO/1NC	Fast-on	10-3519-5
2NO	Fast-on	10-3519-6
2NC	Fast-on	10-3519-7
1NO/1NC	Screw type	10-6817
2NO	Screw type	10-6817-2
2NC	Screw type	10-6817-3

Replacement Contacts

Device	Configuration	Catalog Number
Reversing/assignment	Three-position	6-602
Reversing/assignment upgrade kit ①	Three-position	6-602-3
Magnetic latched reversing/assignment	Two-position	6-602-5

Technology Upgrades

This product currently listed in **Volume 5—Motor Control and Protection, CA08100006E, Tab 4.**

Note

① The 6-602-3 contact kit will upgrade the three-position, reversing/assignment device from the original design that incorporated a leaf spring contact structure to the present design that incorporates a coil spring contact structure. The 6-602 contact kit can then be used after the device has been upgraded for the subsequent contact replacement.

P- and S-Contactors

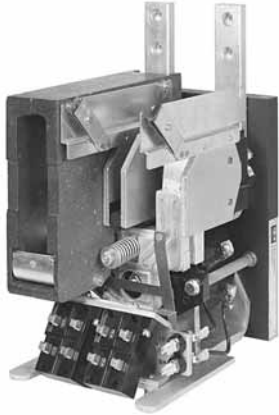

Power Contactor

Product Description

The P- and S-Contactors are single-pole normally open, load break DC contactors. Although the devices have two arc shields, they are functionally single-pole devices. The contactors typically carried a 1000 Vdc, 1000A rating and were applied in locomotive, rapid transit and high horsepower DC drive applications.

Product History

The Cutler-Hammer P-Contactor and S-Contactor were released for sale in the 1960s. These were single-pole DC contactors that used two arc chutes.

They typically carried a 1000 Vdc, 1200A rating and were discontinued in the mid 1980s. A few renewal parts are still available.

Product History Time Line for P- and S-Contactors

Device	1960	1970	1980	2000	Present
P- & S-Contactors	████████████████████				

Replacement Capabilities

A few renewal parts are still available.

Auxiliary Contacts

Contact Configuration	Terminal Configuration	Catalog Number
1NO/1NC	Fast-on	10-3519-5
2NO	Fast-on	10-3519-6
2NC	Fast-on	10-3519-7
1NO/1NC	Screw type	10-6817
2NO	Screw type	10-6817-2
2NC	Screw type	10-6817-3

Replacement Contacts, Blowout Coil and Arc Chute

Description	Quantity Required per Contactor	Catalog Number
Contact kit	1	6-332
Arc chute	2	62-469
Blowout coil	2	62-532

Technology Upgrades

This product can potentially be replaced with the DPM-Contactor or D-Contactor depending on the application. Please contact our Technical Resource Center for replacement device selection.

Further Information

Publication Number	Description
PT03304001E	Genuine Cutler-Hammer Replacement Contact Kits and Coils Wall Chart
BBF01SE	Vacuum Starters and Contactors
CA08100006E	Volume 5—Motor Control and Protection

For further replacement parts information, contact Standard Open Control Aftermarket at **1-800-535-8992**.

Pricing Information

Price and Availability Digest (PAD)

Vista/VISTALINE Discount Symbols 1CD-5C, 1CD-1C, 15CD3 and 1CD-1

Contents

<i>Description</i>	<i>Page</i>
Low Voltage Soft Starter	
Product Description, Product History, Product History Time Line	V12-T13-70
Replacement Capabilities, Technology Upgrades	V12-T13-71
Low Voltage Adjustable Frequency AC Drives	
Product Description, Product History Time Line	V12-T13-72
Replacement Capabilities, Technology Upgrades	V12-T13-74

Soft Starters



S811+ and S801+ Soft Starter

Product Description

Soft starters serve to provide reduced voltage starting, protection and control for standard three-phase induction motors. They are commonly found in applications like conveyors, compressors, extruders, pumps and blowers, etc.

Reduced voltage starting is beneficial because current and torque are reduced during the motor starting process. This reduces the electrical and mechanical shock experienced during motor starting, prolonging motor and equipment life. Soft starters also provide for maximum efficiency of the motor duty cycle by electronically sensing the motor load and reducing the voltage applied to the motor when it is running at less than full load torque.

Soft starters also provide short circuit and various types of electronic protective functions. Common features include phase loss, undervoltage, current balance, phase rotation, current limit, overtemperature, etc.

Soft start controllers are similar to reduced voltage motor starters, except they include no overload or short-circuit protection. Soft start controllers are applied in series with conventional electromechanical starters to provide the benefits of reduced voltage starting at lower cost. Electromechanical starter contact life is also improved by the soft start controller.

Product History

Eaton’s present line of Cutler-Hammer soft starters is the culmination of 38 years of product development. In 1958, Vectrol Engineering began manufacturing SCR Gate Driver circuitry and progressed into their own soft starter product line, known as the Vectrol Motor Starter (VMS). In 1980, Vectrol was purchased by Westinghouse. The VMS was quickly phased out of production and the Vectrol ES (Energy Saver) solid-state reduced voltage starter was introduced. The Vectrol ES combined features of automatic power factor adjustment and reduced voltage, maximizing the efficiency of the motor duty cycle. The Vectrol ES starter was actively manufactured until 1988 when the Easy-Start Motor Starter was introduced.

Eaton entered the market in 1975 with the A415, A445 and A485 product lines. By 1983, Eaton had released the A515/A545 Model A solid-state reduced voltage starter and followed up in late 1984 with the improved Model B A515. This starter used a solid-state controller, an overload relay and a six SCR full-wave power section. In 1988, Westinghouse introduced its Easy-Start and Easy-Start Jr. product lines that also used a solid-state control circuit and a six SCR full-wave power section. In 1995, the newly formed Solid-State Motor Control Division (SSMC) of the new Eaton released the Easy-Start EA Reduced Voltage Starter, combining the voltage control of SCRs with the durability of the Advantage motor starter into a uniquely small package.

The EA, EJ and the ES product lines have been replaced by the S801+ and S811+ line of soft starters. Introduced in October of 1999, the S801+ and S811+ soft starter is compact, easy to install, easy to program and is the most advanced soft starter available anywhere.

Product History Time Line

Product	1975	1980	1985	1990	1995	2000	Present
Cutler-Hammer A415/A445/A485	[Bar from 1975 to 1983]						
Westinghouse Vectrol VMS	[Bar from 1978 to 1980]						
Westinghouse Vectrol Energy Saver	[Bar from 1980 to 1988]						
Westinghouse Vectrol Startrol	[Bar from 1980 to 1981]						
Westinghouse Vectrol Startrol Power Miser	[Bar from 1983 to 1985]						
Cutler-Hammer A515/A545 Model A	[Bar from 1984 to 1986]						
Westinghouse Power Miser 2	[Bar from 1985 to 1989]						
Cutler-Hammer A515/A545 Model B	[Bar from 1984 to 1990]						
Westinghouse Easy-Start	[Bar from 1988 to 1995]						
Westinghouse Easy-Start 120	[Bar from 1988 to 1995]						
Cutler-Hammer Easy-Start ES	[Bar from 1988 to 1995]						
Westinghouse Power Miser 2, Model 3	[Bar from 1990 to 1992]						
Cutler-Hammer C514	[Bar from 1990 to 1995]						
Cutler-Hammer Easy-Start EC	[Bar from 1990 to 1995]						
Westinghouse Easy-Start Jr.	[Bar from 1990 to 1995]						
Westinghouse Easy-Start 100	[Bar from 1990 to 1995]						
Cutler-Hammer Easy-Start EJ	[Bar from 1990 to 1995]						
Cutler-Hammer Easy-Start EA	[Bar from 1995 to 2000]						
Cutler-Hammer S801+/S811+ Soft Starter	[Bar from 1999 to Present]						

Replacement Capabilities

In most cases, recommended replacement product is the Cutler-Hammer S811+ Soft Starter. Eaton’s Electrical Services & Systems (EESS) has trained technicians nationwide. See **Tab 22** in this catalog for further information about EESS capabilities.

Adjustable Frequency AC Drives

Product Description

Cutler-Hammer Adjustable Frequency Controllers (AFCs) serve to provide adjustable speed and control for standard AC induction motors. AFCs rectify the incoming AC line voltage to supply a fixed potential DC bus. An inverter section is employed to invert the DC bus voltage to an adjustable frequency output voltage. The solid-state logic section

controls the inverter and ultimately the magnitude and frequency of the output voltage to the motor. Input to the solid-state logic can be manual (from an operator type keypad) or automatic (from design features programmed into the drive logic).

The advent of microprocessor-based logic and the advancements of solid-state power technology have dramatically reduced the costs of AFCs and enhanced

their product features. This has permitted a more economical solution for adjustable speed motor applications because AFCs permit the use of standard squirrel cage induction motors instead of DC motors, which are more expensive and harder to maintain. AFCs are ideal for variable torque applications like centrifugal pumps and fans, and constant torque applications like conveyers and extruders.

Typical Adjustable Frequency Controller Block Diagram

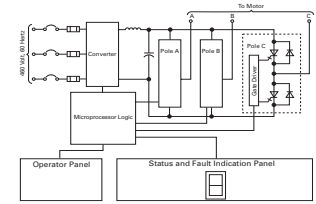

Product History Time Line

Product	1965	1970	1975	1980	1985	1990	1995	2000	2005	Present
Dynamatic AF-3000		█	█	█						
Dynamatic VLT-5		█	█							
Dynamatic AF-2000			█	█	█					
Dynamatic AF-300 (Responder)				█	█	█				
Dynamatic AF-6000				█	█					
Westinghouse Accutrol 100				█	█					
Dynamatic AF-7000				█	█	█	█			
Dynamatic IS-7000				█	█	█	█			
Dynamatic AF-8000				█	█					
Westinghouse Accutrol 300				█	█	█				
Westinghouse Accutrol 150				█	█					
Westinghouse Accutrol 200				█	█	█				
Westinghouse Accuflow				█	█	█				
Dynamatic AF-1000					█	█				
Dynamatic AF-5000					█	█				
Westinghouse Accutrol 110					█	█	█			
Westinghouse Accuflow Jr.					█	█	█			
Dynamatic AF-1500					█	█	█			
Westinghouse Accuflow 110					█	█	█			
Dynamatic AF-1600						█	█			
Westinghouse Accutrol 400						█	█			
Westinghouse Accutrol 700						█	█	█		
Cutler-Hammer AF97						█	█	█		
Dynamatic AF-5000+						█	█	█		
Dynamatic IS-5000+						█	█	█		
Cutler-Hammer AF93							█	█		
Cutler-Hammer AF95							█	█		
Cutler-Hammer AF91								█	█	
Cutler-Hammer SV9000								█	█	
Cutler-Hammer HV9000								█	█	
Cutler-Hammer CP9000								█	█	
Cutler-Hammer BP9000								█	█	
Eaton CH MVX 9000								█	█	█
Eaton CH SVX 9000								█	█	█
Eaton CH HVX 9000								█	█	█

Adjustable Frequency AC Drives—Solid-State Low Voltage

General Information

Model	hp Range	Input Voltage	Output Devices	Output Algorithm	Control Type
VLT-5	1–5	240, 415	SCR	VVI	Analog
AF-1000	1–5 ^①	230, 480	Transistors	PWM	Analog
AF-1500	1–30	240, 480	Transistors	PWM	Digital
AF-1600	1–20	240, 480	IGBT	Vector PWM	Digital
AF-2000	5–10	230	SCR	VVI	Analog
AF-300	N/A	N/A	SCR	CSI	Analog
AF-3000 ^②	30–250	230, (460 opt)	SCR	PWM	Analog
AF-5000	5–100	380–480	Transistor	PWM	Analog
AF-5000+	5–600	380–480	Transistor	PWM	Digital
AF-6000	15–300	480	SCR	VVI	Analog
AF-7000	20–600	480, 575	Transistor	VVI	Analog
AF-8000	3 and 5	480	SCR	PWM	Analog
Accutrol 100	1–5	230	Transistor	PWM	Analog
Accutrol 110	1–75	230, 460	Transistor	PWM	Digital ^③
Accutrol 150	3–50	460	Transistor ^④	PWM	Analog
Accutrol 200	3–250	460	Transistor ^④	PWM	Analog
Accutrol 300	15–600	460, 575	Gate turn-off thyristor	VVI	Analog
Accutrol 400	3–150	460	Transistor	PWM	Digital
Accutrol 700	100–600	480	IGBT	Vector PWM	Digital
AF93	2–20	240, 480	Insulated gate bipolar transistor	Vector PWM	Digital
AF95	15–200	480	Insulated gate bipolar transistor	PWM	Digital
AF97	100–600	480	Insulated gate bipolar transistor	Vector PWM	Digital
AF91	Fractional to 10	240, 460	Insulated gate bipolar transistor	PWM	Digital
MVX9000	Fractional to 10	120, 240, 480	Insulated gate bipolar transistor	PWM	Digital
9000 Series	Fractional to 1100	208–575	Insulated gate bipolar transistor	PWM	Digital
SVX9000	Fractional to 2000	208–575	Insulated gate bipolar transistor	PWM	Digital

Notes

- ① Also available with a single-phase output.
- ② Standard 220V output only.
- ③ Analog controls on pre-1988 models.
- ④ Gate Turn-off Thyristor (GTO) output devices on pre-1986 models. Transistor versions have a **T** as the third character in the style number.

Replacement Capabilities

Replacement Capabilities

Model	Recommended Replacement
Dynatronic Adjustable Frequency Drives	
VLT-5	MVX9000
AF-1000	MVX9000
AF-1500 ①	MVX9000
AF-1600	MVX9000
AF-2000	MVX9000
AF-300 (Responder)	SV/HV/CP9000
AF-3000	SV/HV/CP9000
AF-5000	SV/HV/CP9000
AF-5000+ / IS-5000+	SV/HV/CP9000
AF-6000	SV/HV/CP9000
AF-7000 / IS-7000	SV/HV/CP9000
AF-8000	AF91SV
Westinghouse Adjustable Frequency Drives	
Accutrol 100	MVX9000
Accutrol 110/Accuflow Jr. ①	MVX9000
Accutrol 150	SVX/HVX/CPX9000
Accutrol 200/Accuflow	SVX/HVX/CPX9000
Accutrol 300	SVX/HVX/CPX9000
Accutrol 400	SVX/HVX/CPX9000
Accutrol 700	SVX/HVX/CPX9000
Cutler-Hammer Drives	
AF91	MVX9000
AV91	MVX9000
AF93	SVX/HVX/CPX9000
AF95	SVX/HVX/CPX9000
AF97	SVX/HVX/CPX9000
SV9000	SVX9000
HV9000	HVX9000
CP9000	CPX9000

Eaton's Electrical Services & Systems (EESS) has trained technicians nationwide. See **Tab 22** in this catalog for further information about EESS capabilities.

Technology Upgrades

The SVX9000 improves upon the SV9000 with modular construction and greater program capability. Clean power, 18-pulse configurations are available to meet IEEE-519 requirements for electro-magnetic compliance. The HVX9000 provides a simpler parameter set geared toward the HVAC industry, and the HVX Intellipass provides automatic bypass with 24 Vdc control. Additionally, the MVX9000 gives customers a compact, low-cost alternative to the full-featured drives of 10 hp or less. The same general controls are available, with the exception of closed-loop (encoder) control. The MVX9000 boasts a PLC-like control in the form of a step sequence program for repeated process applications. These units combine digital microprocessor control, a user-friendly keypad, IGBT technology, and a Windows®-based programmer to provide an adjustable frequency drive that can be customized to almost any application.

Note

① The AF-1500, Accutrol 110 and Accuflow Jr. are identical units.

Support Chart for Non-Current Vintage Products

Model	(See below for topic definitions)					
	PCB Repair	Upgrade Kits	Factory Repair	Field Service	Technical Support	Spare Parts
Dynamic Adjustable Frequency Drives						
VLT-5						
AF-1000						
AF-1500 ①	■		■	■	■	■
AF-1600	■		■	■	■	■
AF-2000						
AF-300 (Responder)						
AF-3000						
AF-5000	■		■	■	■	■
AF-5000+ / IS-5000+	■		■	■	■	■
AF-6000						
AF-7000 / IS-7000	■		■	■	■	■
AF-8000						
Westinghouse Adjustable Frequency Drives						
Accutrol 100						
Accutrol 110/Accuflow Jr. ①	■		■	■	■	■
Accutrol 150	■	■ ②	■	■	■	■
Accutrol 200/Accuflow	■	■ ②	■	■	■	■
Accutrol 300	■		■	■	■	■ ③
Accutrol 400	■		■	■	■	■
Accutrol 700	■	■	■	■	■	■
Cutler-Hammer Drives						
AF93						
AF95	■	■	■	■	■	■
AF97	■	■	■	■	■	■

Advanced Technology Services, 8200 N. University, Peoria, IL 61615, now provides support for these products. Their toll-free number is **1-877-645-3606**.

Definitions

PCB Repair

Printed circuit boards may be returned to Advanced Technology Services for repair. All PCBs are upgraded to the most current revision at the time of the repair.

Upgrade Kits

Kits are available to upgrade the basic performance of certain vintage products. Contact Advanced Technology Services for more information.

Service Depot Repairs

Entire assemblies may be returned to Advanced Technology Services for repair, upgrade or refurbishment.

Field Service

Eaton’s Electrical Services & Systems (EESS) has trained technicians nationwide. See **Tab 22** in this catalog for further information about EESS capabilities.

Technical Support

The trained technicians at Advanced Technology Services are available to provide assistance over the telephone.

Spare Parts

Advanced Technology Services maintains a complete inventory of spare parts.

Product Support Services

For all Product Support Services for these “legacy” products, contact Advanced Technology Services at **1-877-645-3606**. For technical support with Eaton’s current line of variable frequency drives, contact the Drives Technical Resource Center at **1-800-322-4986**.

Notes

- ① The AF-1500, Accutrol 110 and Accuflow Jr. are identical units.
- ② No upgrades are available for Gate Turn-off Thyristor (GTO) versions. Transistor versions are identified by a leading “A1T” or “A2T” in the model number.
- ③ GTOs are not available as spare parts for models below 100 hp.

Contents

<i>Description</i>	<i>Page</i>
Brush Type Relay Slipsyn Class 14-100 Field Application Panel	
Product	
Description, Technology	
Upgrades	V12-T13-78
Brush Type Mark V Solid-State Slipsyn Class 14-100 Field Application Panel	
Product	
Description	V12-T13-80
Replacement	
Capabilities, Technology	
Upgrades	V12-T13-81
Brush Type Mark V Solid-State Slipsyn Class 14-100 Low Voltage Motor Starters	
Product	
Description, Technology	
Upgrades	V12-T13-82
Brushless Type Relay Slipsyn Class 14-100 Field Application Panel	
Product	
Description	V12-T13-83
Replacement	
Capabilities, Technology	
Upgrades	V12-T13-84
Brushless Type Mark V Solid-State Slipsyn Class 14-100 Field Application Panel	
Product	
Description, Technology	
Upgrades	V12-T13-85
Relay and Solid-State Slipsyn Control	
Further Information, Pricing	
Information	V12-T13-86

Synchronous—Relay or Solid-State Mark V Slipsyn for Brush and Brushless Motors

Product Description

Synchronous Motors

Polyphase synchronous motors are used primarily to obtain high pullout torques, constant operating speed, or generation of leading reactive kVA for power factor (PF) correction. To bring a motor to a constant speed, DC power is applied to a special winding in a synchronous motor. This winding is called a field coil winding and is controlled by "field control." Power (DC) for a brush type motor is usually supplied with the starter and entails using an exciter. Power (DC) for a brushless type motor is supplied by an exciter mounted on the motor.

Synchronous Motor Control

Synchronous motor "field application control" generally includes a synchronous device to apply DC power to the motor field circuit at the optimum speed. It may also include protective features such as locked rotor protection, failure to synchronize, incomplete sequence, field failure, pullout protection, etc. depending on the type of field application control selected.

Relay Type vs. Solid-State Type—Mark V

Relay Type

The relay type used the ASR synchronizing relay. Inherent in using the relay type are the problems that are associated with using contacts or mechanical closing devices such as arcing, spring and bearing deterioration and wear, dirty atmospheres, etc.

Solid-State—Mark V

The Mark V is 100% solid-state and features a "soft-turn-on" circuit that applies DC field voltage to the motor field. It enables all required functions for correct synchronization to be accomplished without the use of moving contacts or mechanical closing devices.

With the Mark V, the static exciter power supply is always supplied and is part of the "system."

Also available as a modification with the Mark V is a VAR or power factor, DC field current regulator. The regulator consists of a printed circuit board, auxiliary devices and potentiometers for adjustment.

Product History

Originally a Westinghouse Product

Synchronous Motor Control

Brush type synchronous field control was originally available in the 1940s. Motor starters for brushless synchronous motors have been offered since the late 1960s. Synchronous motors can be medium voltage (2300–7200V) or low voltage (600V and below). A synchronous motor starter includes the basic motor control PLUS the synchronous control and protection functions. Typically, the basic motor control and the field application control are mounted in separate compartments within the starter. Ratings of synchronous control are in terms of the maximum DC field amperes required by the motor. Current ratings are 45, 90, 135, 160, 200 or 270A DC, through 6000 hp at 5 kV.

Relay and Solid-State Type Control

Relay type Slipsyn was introduced in 1947 and uses the ASR synchronizing relay. Forms of solid-state type Slipsyn were introduced in the late 1950s and early 1960s, but were not completely solid-state and had some of the operation problems that the relay type control encountered. These were called Mark I and Mark II Static Slipsyn. In 1989, the Mark V Solid-State Slipsyn field control was introduced.

Medium Voltage (AMPGARD®) Starters

The AMI AMPGARD synchronous starter (1957–1970) used a 60-inch deep enclosure with the synchronous control in the low voltage section in the front bottom two thirds of the starter enclosure. The basic motor control was located in the rear bottom two thirds of the enclosure, barriered off from the low voltage section. The AMI AMPGARD for synchronous motors used the ASR relay type control.

The LF AMPGARD (1962–1988) primarily used the ASR field application relay control. Mark I and Mark II Static Slipsyn were also used during their availability periods. The LF AMPGARD for synchronous motors included the basic induction motor control (ISO® switch, contactor and starter control) in the bottom half of the structure.

Synchronous—Relay or Solid-State Mark V Slipsyn for Brush and Brushless Motors

The upper half contained the step-down static excitation transformer with current limiting fuses, the Silicon Controlled Rectifier (SCR) type static exciter and the synchronizing control and motor field protection panel.

The SJ AMPGARD (1982–2000) family of synchronous control is very similar to the LF AMPGARD. Until the availability of the Mark V solid-state synchronous control, the SJ used the ASR relay type field control. With the advent of the Mark V, most of the synchronous starters are supplied with this type of control. In both ASR and Mark V control schemes, the synchronous gear is usually mounted in the top half of the starter.

The SL AMPGARD (2000–present) is similar to the SJ AMPGARD but uses the Mark V solid-state synchronous controller, exclusively.

Low Voltage Synchronous Starters

Low voltage synchronous starters are similar in nature to high voltage synchronous starters except in two regards. High voltage starters, unlike low voltage starters, must isolate the low voltage from the high voltage. The components for the field control are the same.

The second difference lies in the primary disconnect used in the starters. Low voltage starters can be supplied with no short-circuit protection, with a non-fusible disconnect, a fusible disconnect switch or with a molded-case circuit breaker. Low voltage synchronous starters were manufactured in the late 1940s with the introduction of the ASR relay, until September of 1989. In 1991, the product was reintroduced using the Mark V solid-state field control.

Product History Time Line

Page	Product	1945	1955	1965	1975	1985	1995	2000	Present
V12-T13-74	ASR Relay Slipsyn (Brush Type)	[Timeline bar from 1945 to 1989]							
	Mark I Static Slipsyn (Brush Type)			[Timeline bar from 1965 to 1975]					
	Mark II Static Slipsyn (Brush Type)				[Timeline bar from 1975 to 1985]				
V12-T13-80	Mark V Slipsyn						[Timeline bar from 1991 to Present]		
V12-T13-81	Brushless Motor Control				[Timeline bar from 1975 to Present]				

Relay Slipsyn Automatic Field Application Panel

Product Description

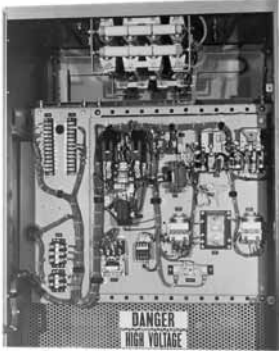

Relay Field Panel

Shaded area denotes obsolete or discontinued products and services.

Automatic Field Application Control

The field application panel provides Slipsyn automatic field application identical to that in complete synchronous motor starters. It is designed for use in conjunction with a primary line closing device such as a circuit breaker or a linestarter. One interlock on the primary device is used to actuate the field application control. When the motor accelerates to proper speed for pull-in, the field is automatically applied.

The controller is available for floor mounting. Floor-mounted cabinets are NEMA 1 with hinged front door and removable rear plates.

Typical Schematic

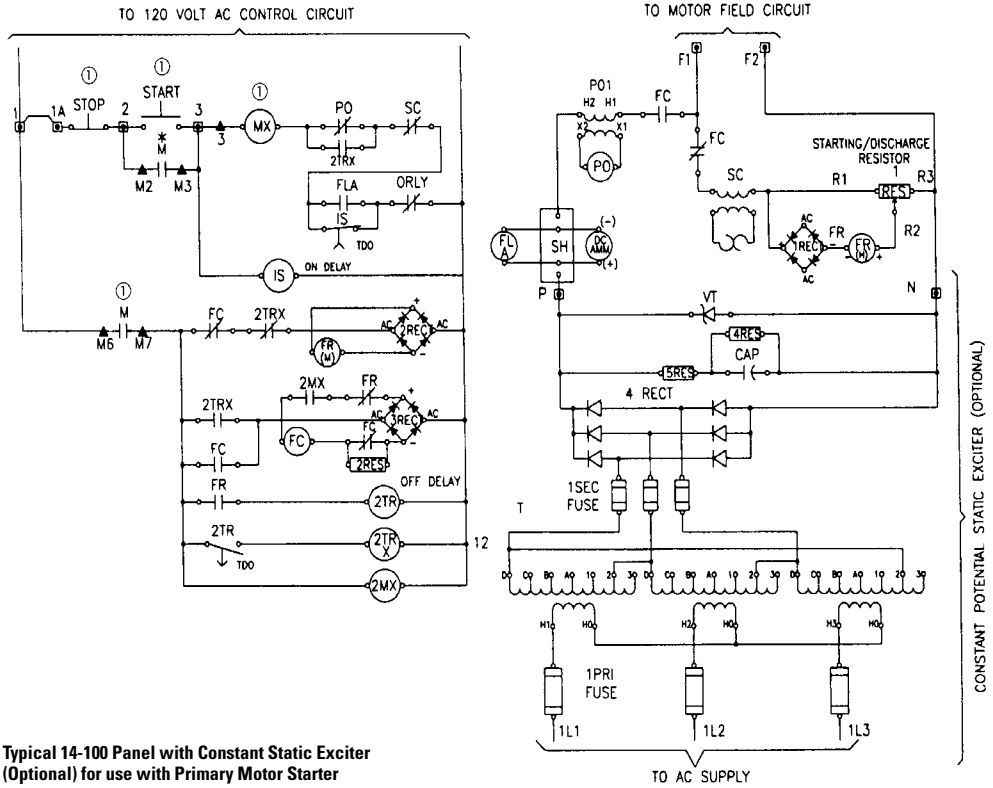

Typical 14-100 Panel with Constant Static Exciter (Optional) for use with Primary Motor Starter

Note

① Not supplied with 14-100 panel or static exciter.

Shaded area denotes obsolete or discontinued products and services.

The cabinets contain the following equipment:

- 1– Polarized slip frequency field application relay type ASR (FR) with half-wave rectifier (REC).
- 1– Time relay with contacts available for unloader circuit (2TR).
- 1– Pullout relay and transformer (PO).
- 1– Field contactor, two-pole (FC).
- 1– Damper winding protective relay (SC).
- 1– Starting and field discharge resistor when size permits; otherwise, provided for separate mounting (1RES).
- 1– DC field ammeter, panel type, semi-flush mounted (DC AMM).
- 1– DC field ammeter shunt (SH).
- 1– DC field failure protection (FLA).
- 2– Auxiliary relays (2TRX), (2MX).
- 1– Incomplete sequence relay (IS).

Static Excitation Power Supply Panel

Constant Potential Type

Power conversion AC to DC units are designed for individual synchronous motor field excitation.

These units are convection cooled, solid-state and are completely assembled and wired as a self-contained package with a relay Slipsyn automatic field application control. The connections necessary to the external circuits are line leads, motor leads, field connections and control interconnection.

The static system consists of a convection-cooled silicon rectifier three-phase full-wave bridge assembly, a set of current limiting fuses in the secondary side of the transformer and a set of surge protecting devices. The transformer has secondary taps that are adjustable with four course taps that provide approximately 12% adjustment per tap, and three fine taps that provide 4% adjustment per tap.

Adjustable Potential Type

An adjustable potential exciter is similar to the constant potential exciter except that it uses SCRs and the voltage adjustment is made with a potentiometer mounted on the door.

Technology Upgrades

For Brush-Type, Relay-Panel Slipsyn (Class 14-100) Upgrades

New synchronous field controllers using the latest solid-state technology are usually available. Upgrades for primary starter and contactor components may also be available.

Information Required from Customer for Upgrade Evaluation

1. Original assembly nameplate data including general order "GO" number as well as any drawing numbers.
2. Complete motor data including horsepower, phase, voltage/Hz, RPM, FLA, LRA, full-load DC amperes, power factor, excitation voltage, induced field amperes at 95% speed and at 0% speed, recommended discharge resistor ohms and maximum time at zero speed (locked rotor).
3. Excitation control detail such as "constant-potential" or "adjustable-potential." Adjustable-potential usually requires a field rheostat (motor field-resistor).
4. Detail on the motor's function such as the application data and other service conditions such as duty-cycle, etc.

Slipsyn Automatic Field Application Panel with Static Exciter

Product Description



Mark V Field Controller

Automatic Field Application Control

The Slipsyn panel provides automatic field application identical to that in complete synchronous motor starters. It is designed for use in conjunction with a primary line closing device, such as a circuit breaker or a linestarter. When the motor accelerates to proper speed for pull-in, the field is automatically applied.

The solid-state Mark V Slipsyn controller will provide the following protective functions:

- A. Locked rotor protection.
- B. Incomplete sequence.
- C. Failure to synchronize.
- D. Fuse failure (Mark V).
- E. Pullout protection.
- F. DC current failure protection.

Also the application of the DC power to the motor field windings is accomplished without mechanically moving parts, and the device features a “soft-turn-on” circuit when applying DC voltage to the motor field.

Depending on the size of the solid-state application panel, the controller is available in a NEMA 1 floor-mounted enclosure or an AMPGARD type cell construction.

In both designs, a hinged front door with externally ventilated heat sinks will be provided.

The cabinets will contain the following equipment:

- 1 – Step-down exciter transformer—three-phase (TX).
- 3 – Primary fuses (3 PRI).
- 3 – Secondary fuses (3 SEC).
- 1 – “SCR” power supply panel.
- 1 – Synchronous control board (CB).
- 1 – DC ammeter—panel type (DC AMM).
- 3 – “MOV” for surge protection (MOV).
- 1 – Starting and field discharge resistor (when size permits; otherwise provided for separate mounting).
- 1 – Field failure relay (FLA).
- 1 – Incomplete SEQ Timer (FLT).
- 1 – Start timer (SYTR).
- 1 – Potentiometer (P2).

Typical Schematic

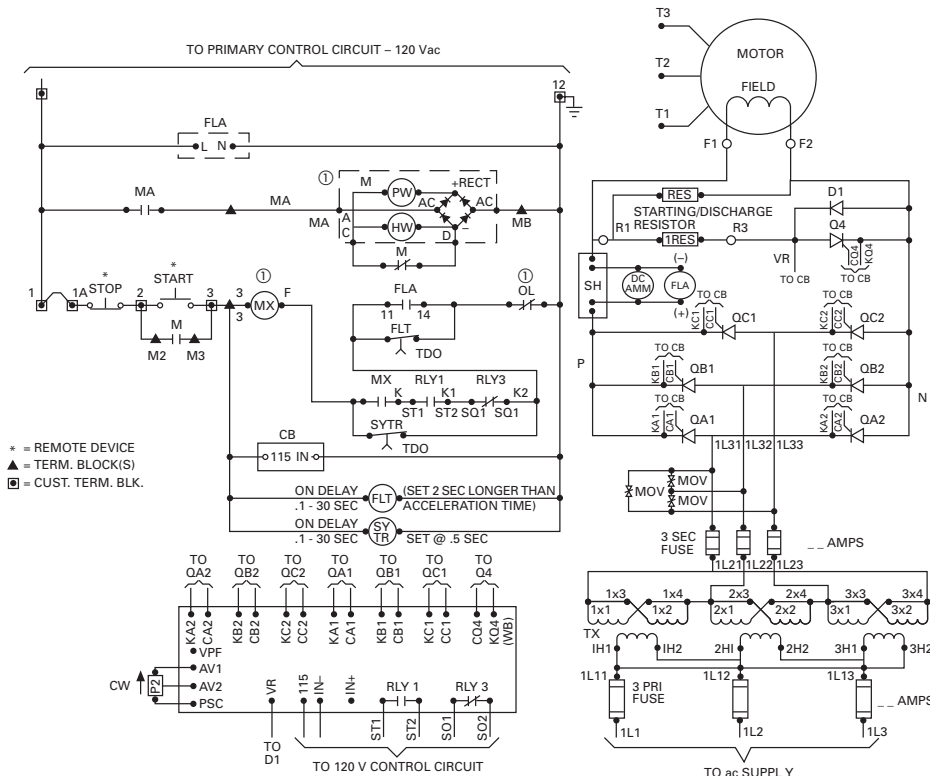

Note

① Not supplied with Mark V.

Synchronous—Brush Type Mark V Solid-State Slipsyn Class 14-100 Panel

**Replacement Capabilities—
Typical Solid-State
Components**



Power Module, 200A, Three Required



Heat Sink



MOV

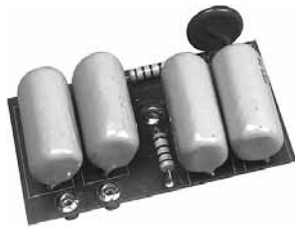

Snubber for Thyristor Stack

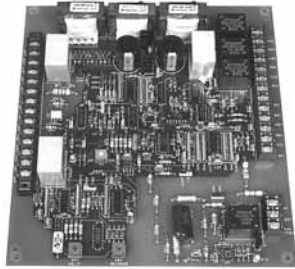

**Main Synchronizing Control/
Protection Board**

Note: Typical solid-state components used in Mark V Slipsyn—Refer to RPD 8855S for renewal parts for synchronous control.

**Field Panel with Static Exciter
20 kW Maximum—Approximate Dimensions in Inches**

Open Cell			Floor Mounted — NEMA 1		
Height	Width	Depth	Height	Width	Depth
45	36	30	90	36	30

Technology Upgrades

For Brush Type Mark V Solid-State Slipsyn (Class 14-100) Upgrades

New synchronous field controllers using the latest solid-state technology are available. Replacements and upgrades for primary starter and contactor components are also available.

Information Required from Customer for Upgrade Evaluation

1. Original assembly nameplate data including general order "GO" number as well as any drawing numbers.
2. Complete motor data including horsepower, phase, voltage/Hz, RPM, FLA, LRA, full-load DC amperes, power factor, excitation voltage, induced field amperes at 95% speed and at 0% speed, recommended discharge resistor ohms and maximum time at zero speed (locked rotor).
3. Excitation control detail such as "constant-potential" or "adjustable-potential." Adjustable-potential usually requires a field rheostat (motor field-resistor).
4. Detail on the motor's function such as the application data and other service conditions such as duty-cycle, etc.

Synchronous—Brush Type Mark V Solid-State Slipsyn Class 14-200 LV Motor Starter



600V, NEMA Size 8, Synchronous Starter

Product Description

Slipsyn magnetic starters provide reliable, automatic starting of synchronous motors. Automatic synchronization is provided by the Mark V Solid-State Field Panel, which ensures application of the field at proper motor speed, and at a favorable angular position of stator and rotor poles. As a result, line disturbance resulting from synchronization is reduced and effective motor pull-in torque is increased. Application of DC power to motor field windings is accomplished without mechanically moving parts, and the device features a “soft-turn on” circuit when applying DC voltage to the motor field.

The solid-state Mark V Slipsyn controller will provide the following protective functions:

- A. Locked rotor protection.
- B. Incomplete sequence.
- C. Failure to synchronize.
- D. Fuse failure (Mark V).
- E. Pullout protection.
- F. DC current failure protection.

The cabinet will contain the following:

- 1 – Primary starter full voltage or reduced voltage.
- 1 – Ammeter shunt (when required).
- 1 – Auxiliary relay for main line contactor (when required) (MX).
- 1 – Starting and field discharge resistor (IRES).
- 1 – Current transformer for AC ammeter through NEMA Size 4; Sizes 5 and larger use three current transformers for overload relays and AC ammeter.
- 1 – Set control circuit terminal blocks.
- 3 – Type AN manual reset thermal overload relay and three heater elements (OL).
- 1 – Step-down exciter transformer—three-phase (TX).
- 3 – Primary fuses (3 PRI).
- 3 – Secondary fuses (3 SEC).
- 1 – SCR power supply panel.
- 1 – Synchronous control board (CB).
- 3 – MOV for surge protection (MOV).
- 1 – Starting and field discharge resistor (when size permits; otherwise provided for separate mounting).
- 1 – AC ammeter, panel type (AM).
- 1 – DC ammeter, panel type (DC AMM).
- 1 – Exciter field potentiometer (P2).
- 1 – Field failure relay (FLA).
- 1 – Incomplete SEQ Timer (FLT).
- 1 – Start timer (SYTR).

Typical Schematic Full Voltage Starter, Class 14-200, Non-Combination Type

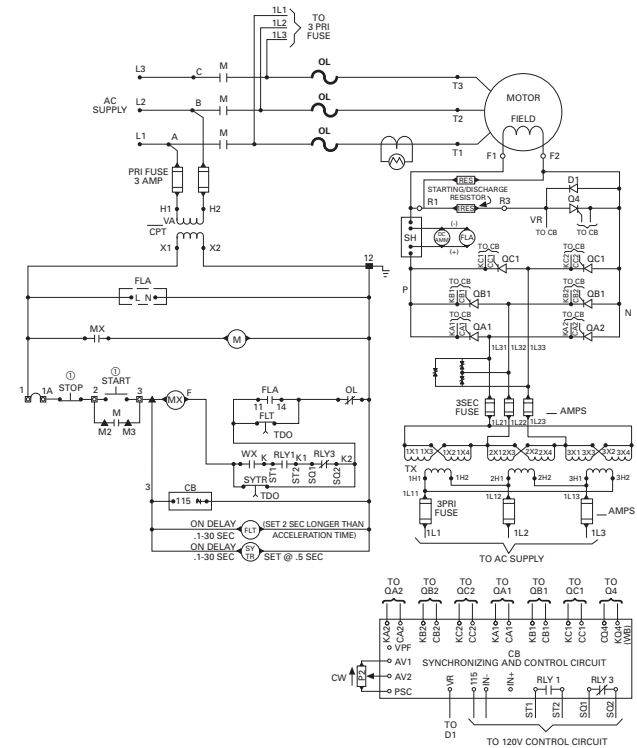

Technology Upgrades

For Brush-Type Mark V Solid-State Slipsyn (Class 14-200) Low Voltage Motor Starter Upgrades

New synchronous field controllers using the latest solid-state technology are usually available. Replacements and upgrades for primary starter and contactor components are also usually available.

Information Required from Customer for Upgrade Evaluation

1. Original assembly nameplate data including General Order “GO” number as well as any drawing numbers.
2. Complete motor data including horsepower, phase, voltage/Hz, RPM, FLA, LRA, full-load DC amperes, power factor, excitation voltage, induced field amperes at 95% speed and at 0% speed, recommended discharge resistor ohms and maximum time at zero speed (locked rotor).

3. Excitation control detail such as “constant-potential” or “adjustable-potential.” Adjustable-potential usually requires a field rheostat (motor field-resistor).
4. Detail on the motor’s function such as the application data and other service conditions such as duty-cycle, etc.

Note

- ① Remote device.

Relay Slipsyn Automatic Field Application Panel

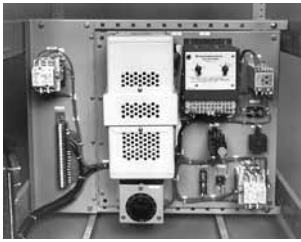

Brushless Field Panel

Product Description

This field application panel provides DC power to the exciter field and is designed for use in conjunction with a primary line closing device such as a contactor motor starter or a circuit breaker motor starter. A normally open electrical interlock on the primary device is used to actuate the field application control. This panel utilizes electromechanical devices to apply DC power to the motor exciter field circuit.

Note: The power rectifiers for the motor field circuit and automatic synchronizer are mounted on the synchronous motor rotor.

Brushless Synchronous Control

The controller can be supplied with or without enclosure. Panel mounted or open cell are suitable for mounting within other larger enclosures.

The cabinet or open panel or open cell contains the following equipment:

- 1 – Solar transformer (1 CPT).
- 1 – Power factor relay (PO).
- 1 – Auto-transformer (AT) Powerstat.
- 1 – Damper winding protection relay (DP).
- 1 – Field contactor (FC).
- 1 – Volt trap (VT).
- 1 – Rectifier (REC).
- 1 – Sequence relay (TR).
- 1 – Damper winding protection hold-in relay (DPX)—if required.
- 2 – Fuses (SEC FU), (2 SEC FU).
- 1 – DC ammeter—panel type (DC AMM).

Typical Starter Schematic

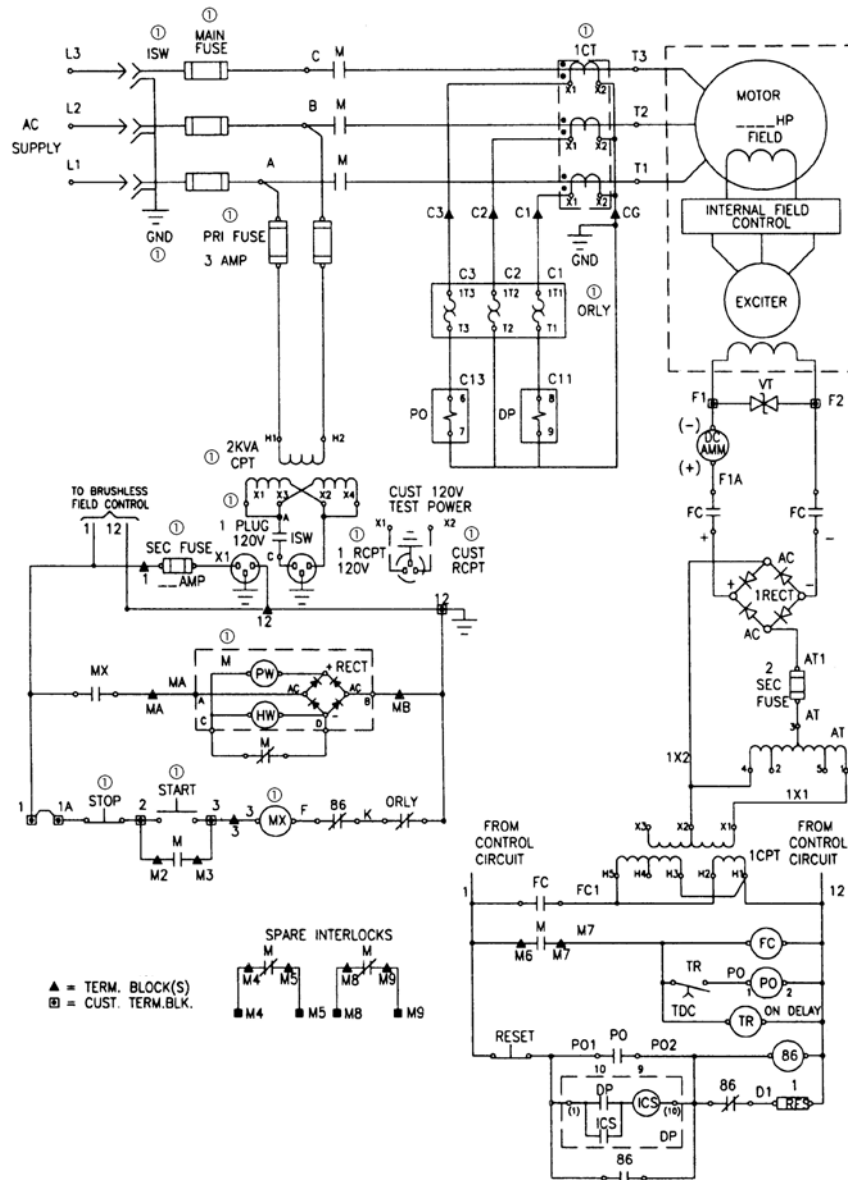

Notes

- ① Starter devices not supplied with field panel.
- Devices shown without a a constitute 14-100 panel.

Replacement Capabilities—Typical Components



Rectifier



Damper Winding Protection Relay



Volt Trap



Pullout/Power Factor Relay



Powerstat

Note: Typical components used in Relay Slipsyn Brushless Control—Refer to RPD 8855S for renewal parts for synchronous control.

Technology Upgrades

For Brushless-Type Relay-Panel Slipsyn (Class 14-100) Upgrades

New synchronous field controllers using the latest solid-state technology are available. Replacements and upgrades for primary starter and contactor components are also available.

Information Required from Customer for Upgrade Evaluation

1. Original assembly nameplate data including general order "GO" number as well as any drawing numbers.
2. Complete motor data including horsepower, phase, voltage/Hz, RPM, FLA, LRA, full-load DC amperes, power factor, excitation voltage, induced field amperes at 95% speed and at 0% speed, and maximum time at zero speed (locked rotor).
3. Excitation control detail such as "constant-potential" or "adjustable-potential." Adjustable-potential usually requires a field rheostat (motor field-resistor).
4. Detail on the motor's function such as the application data and other service conditions such as duty-cycle, etc.

Synchronous—Brushless Type Mark V Solid-State Slipsyn Class 14-100 Panel

Slipsyn Automatic Field Application Panel with Static Exciter

Product Description

Automatic Field Application Control

The field application panel provides Slipsyn automatic field application identical to that in complete synchronous motor starters. It is designed for use in conjunction with a primary line closing device such as a circuit breaker or a linestarter. Automatic synchronization is provided by the Mark V solid-state field panel, which ensures application of the field at proper motor speed and at a favorable angular position of stator and rotor poles. As a result, line disturbance resulting from synchronization is reduced and effective motor pull-in torque is increased. Application of DC power to motor field windings is accomplished without mechanically moving parts, and the device features a "soft-turn-on" circuit when applying DC field voltage to the motor field.

This unit also comes standard with a VAR or power factor, DC field current regulator. The VAR regulator controls the AC reactive current flow out of the motor during varying load conditions by varying the motor field excitation. The PF regulator controls the motor power factor under varying load conditions by varying the motor field excitation. The DC field current regulator compensates for the motor field resistance as the motor field heats up by increasing the motor field voltage.

Note: Power factor regulation—cannot provide regulation below 50% of rated voltage and/or 25% of rated current. Regulation cannot be accomplished on light loads, i.e., less than 20% load.

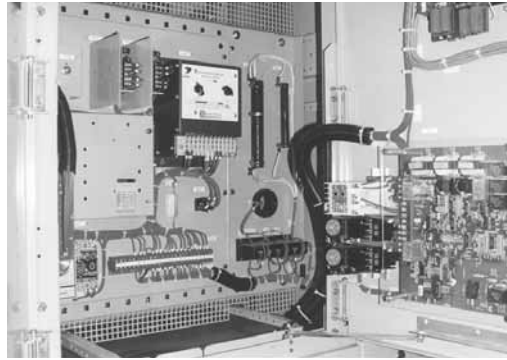

Mark V Brushless Field Controller

The solid-state Mark V Slipsyn controller will provide the following protective functions:

- A. Locked rotor protection.
- B. Incomplete sequence.
- C. Failure to synchronize.
- D. Fuse failure (Mark V).
- E. Pullout protection.
- F. DC current failure protection.

This control is available in a NEMA 1 floor-mounted enclosure or an AMPGARD type cell construction. In both designs, a hinged front door with externally ventilated heat sinks will be provided.

The cabinets will contain the following equipment:

- 1 – Step-down exciter transformer—three-phase (TX).
- 3 – Primary fuses (3 PRI).
- 3 – Secondary fuses (3 SEC).
- 1 – SCR power supply panel.
- 1 – Synchronous control board (CB).
- 3 – MOV for surge protection (MOV).
- 1 – AC ammeter, panel type (AM).
- 1 – DC ammeter, panel type (DC AMM).
- 4 – Potentiometer (P2, P3, P4, P5).

- 1 – Field failure relay (FLA).
- 1 – Incomplete SEQ Timer (FLT).
- 1 – Start timer (SYTR).
- 1 – MP-3000 without RTD module.
- 1 – DP-4000.
- 1 – VAR/PF/DC field current board (CB1).
- 1 – Auto/manual selector switch (SSI).
- 1 – Timer (AUTO).
- 1 – Pullout relay (PO).

Approximate Dimensions in Inches

Open Cell			Floor Mounted—NEMA 1		
Height	Width	Depth	Height	Width	Depth
45	36	30	90	36	30

Technology Upgrades

For Brushless-Type Mark V Solid-State Slipsyn (Class 14-100) Upgrades

New synchronous field controllers using the latest solid-state technology are available. Replacements and upgrades for primary starter and contactor components are also available.

Information Required from Customer for Upgrade Evaluation

1. Original assembly nameplate data including general order "GO" number as well as any drawing numbers.
2. Complete motor data including horsepower, phase, voltage/Hz, RPM, FLA, LRA, full-load DC amperes, power factor, excitation voltage, induced field amperes at 95% speed and at 0% speed, and maximum time at zero speed (locked rotor).
3. Excitation control detail such as "constant-potential" or "adjustable-potential." Adjustable-potential usually requires a field rheostat (motor field-resistor).
4. Detail on the motor's function such as the application data and other service conditions such as duty-cycle, etc.

Identifying Renewal Parts

Renewal parts data for the entire history of synchronous control is contained in RPD 8855S, which provides the proper identification of standard parts that may be required under normal operation:

1. Identify the design of synchronous control (Relay, Mark I, Mark II or Mark V Slipsyn) from the synchronous panel nameplate.
2. Now that you have identified the type of the synchronous control, determine from the photographs in RPD 8855S which parts are required and identify them by style number.
3. Because many starters are supplied to meet specific customer requirements, other parts not shown in RPD 8855S might occasionally be needed. Price and availability of parts not listed may be obtained by providing a complete description of the part, along with the complete data on the starter nameplate, which is found in the low voltage area. Be sure to include the following: ratings, shop order and diagram reference.

Further Information

Publication Number	Description
RP04304009E	Common Replacement Parts for Mark V Synchronous Field Controller
RPD 8855S	Renewal Parts Data for Synchronous Control
TD.48A.01.T.E	Descriptive Bulletin for AMPGARD Starters
IL 17097	Instruction Leaflet for Relay Slipsyn
IB 48008	Instruction Leaflet for Solid-State Slipsyn
IB 48009	Instruction Leaflet for Mark V VAR/PF/DC Field Current Regulator

Pricing Information

Price and Availability Digest (PAD)

Contents

<i>Description</i>	<i>Page</i>
AMI AMPGARD Product Description, Technology Upgrades	V12-T13-91
LF Air AMPGARD Product Description, Replacement Capabilities, Technology Upgrades	V12-T13-92
SL and SJ Vacuum AMPGARD Product Description, Replacement Capabilities	V12-T13-94
Technology Upgrades	V12-T13-95
Further Information, Pricing Information	V12-T13-99

AMPGARD

Originally a Westinghouse Product



AMPGARD Motor Control Assembly



(AMI Vintage), 5000V 200A, 2500V 200A, 2500/5000V 400A (LF-Air Vintage)

Product Description

A medium voltage starter is an assembly used to control and protect an alternating current (AC) electric motor rated at 2300, 4160 or 7200V. The controlling function is provided by a magnetically held contactor. The overload protection is provided by an overload relay of some type, and the short-circuit protection is provided by a non-load break fused disconnect switch. 400A starters are typically mounted two-high in a 90-inch high enclosure. 800A starters are mounted one-high.

Product History

The AMPGARD starter line originated in the early 1940s and has undergone two major design changes and one major evolution.

Prior to the introduction of the AMI, the AMPGARD was simply a fused motor starter in a cabinet with no disconnect switch. It was built in the early 1940s through the 1950s. There was no standard design.

The AMI AMPGARD (1950s through 1960s) was a standardized design. The AMI was one starter per structure designed to cover all ratings and incorporated a disconnect switch (ISO-Switch) in the upper compartment and either an air or oil contactor in the bottom compartment.

In the mid 1960s, a full line of starters was introduced, tailored to the horsepower requirement of the motor and using the LF air contactor. The starter incorporated the ISO-Switch and power fuses into the same cell as the air contactor. Starters were one-, two- or three-high per structure, depending on the rating required. The ratings of the LF AMPGARD were 200, 400 and 700A.

Cutler-Hammer manufactured MV motor control from 1966–1976. It was Bulletin 9950 Series, stacked two-high, with no specific trade name (such as AMPGARD).

The manufacturing facility moved from Buffalo, NY, to Asheville, NC, in 1978.

In the 1980s with the advent of vacuum technology, the LF air contactor design was discontinued. The SJ vacuum contactor was matched with a fused isolation switch. Now two current ratings are offered — 400 amperes, one- or two- high, and 800 amperes, one-high. Starters are sized per the motor horsepower and full load amperes.

Product History Time Line

Page	Product	1945	1950	1955	1960	1965	1970	1975	1980	1985	1990	1995	2000	2005	Present
Classic AMPGARD	V12-T13-89 AMPGARD OIL AMPGARD AH AMI AMPGARD	█		█		█		█		█		█		█	
	V12-T13-90, V12-T13-91 LF Air – 25L2 200A – 50L2 200A – 25/50L4 400A – 25/50L7 700A	█		█		█		█		█		█		█	
	V12-T13-92 SJ Vacuum – SJA 400A (roll-out) – SJA 800A (roll-out) – SJS 400A (slide-out)	█		█		█		█		█		█		█	
V12-T13-92 SL Vacuum – SLW 400A (roll-out) – SLF 400A (slide-out)	█		█		█		█		█		█		█		
Next Generation AMPGARD	V12-T13-94 SLB (bolted) SLS (stab)	█		█		█		█		█		█		█	

Catalog Number Selection

Old Catalog Numbering System—Contactors Only

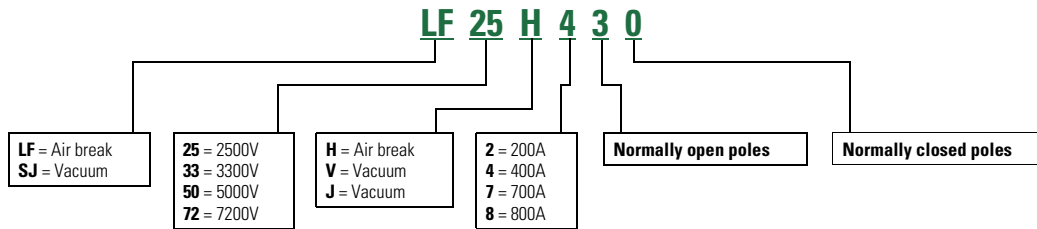

Old Catalog Numbering System—Contactors Only

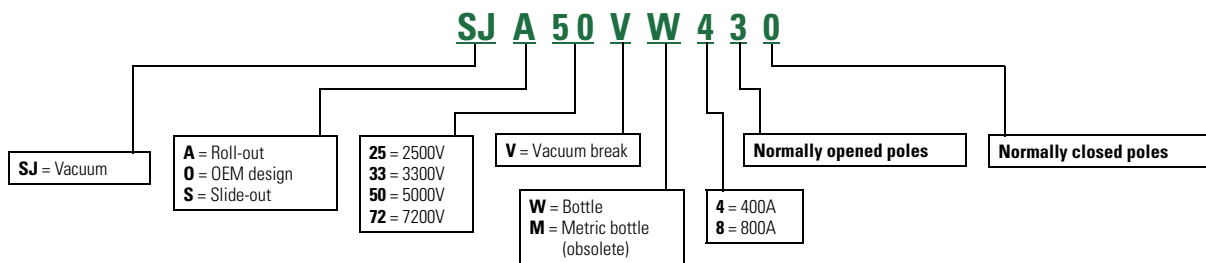

Old Catalog Numbering System—Starters (with Isolating Switch, Power Fuses, Contactor, etc.)

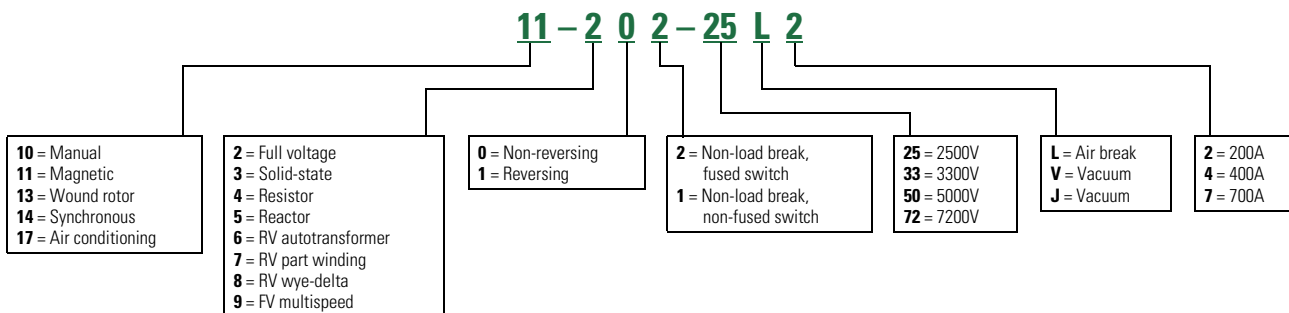

Old Catalog Numbering System—Starters (with Isolating Switch, Power Fuses, Contactors, etc.)

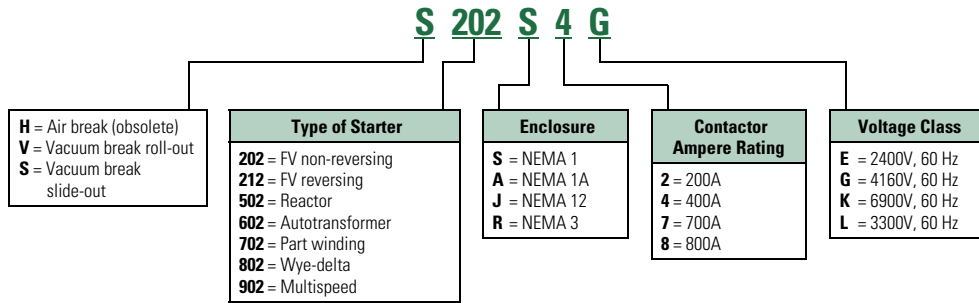

Old Catalog Numbering System—Contactors Only

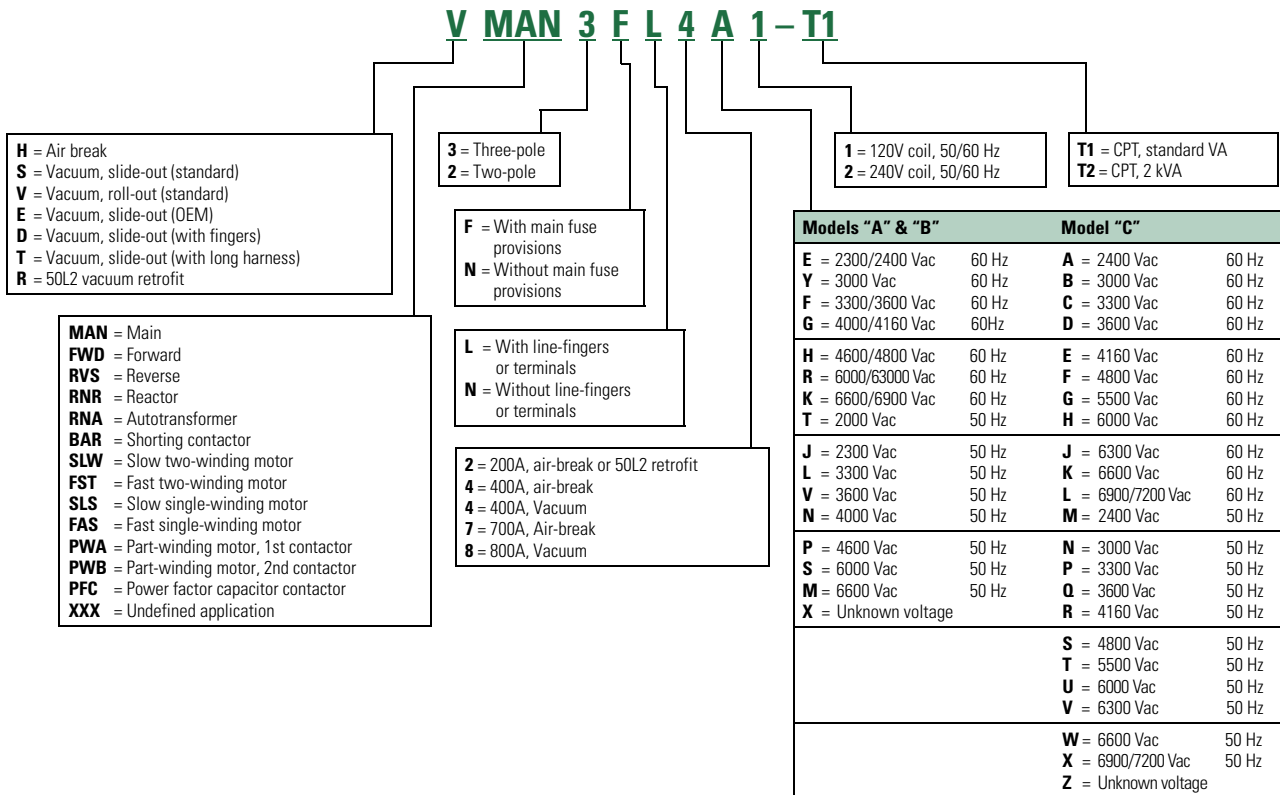

New Catalog Numbering System—SL Contactors Only

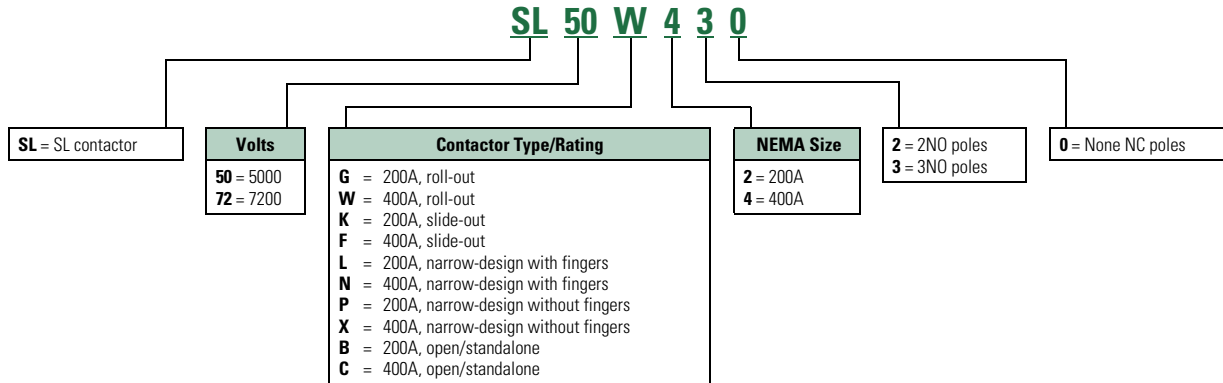

New Catalog Numbering System—SL Starters Only

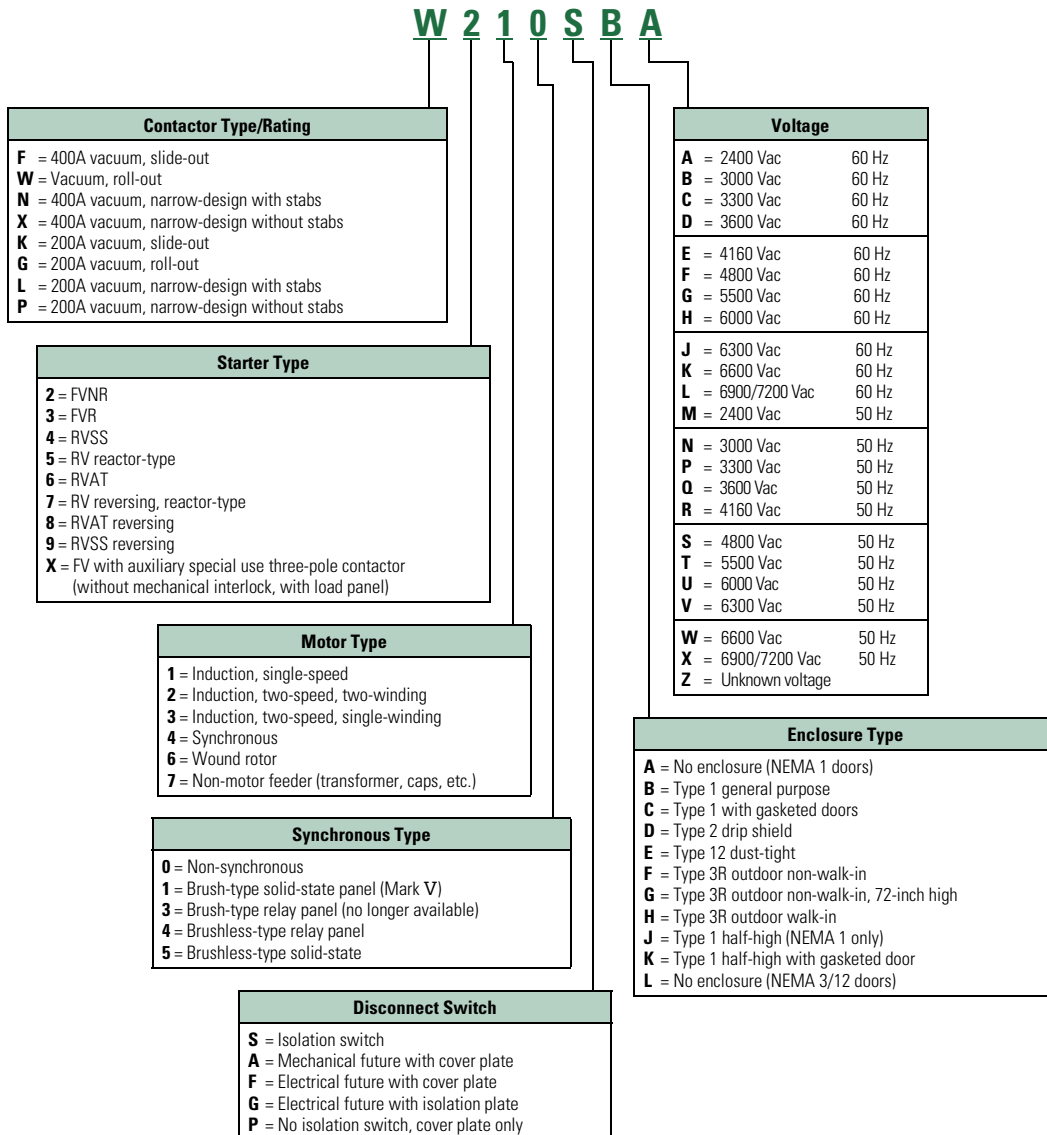

AMI AMPGARD

Originally a Westinghouse Product



AMI AMPGARD Starter

Product Description

The AMI design AMPGARD starter introduced in 1957 was a complete line of starters for magnetic control of squirrel cage, wound rotor and synchronous motors. The AMI was the first front-accessible starter and was available with air break (Type H) or oil immersed (Type K) contactors. The standard AMI for full voltage starting was 30 inches deep, 38 inches wide and 90 inches high. All components were accessible from the front through three doors that opened into separate compartments. The top compartment enclosed the isolating switch and current limiting power fuses. The middle compartment enclosed the AC low voltage control panel and behind it the CTs. The bottom compartment housed the contactor.

Note: The pre-AMI design was a rear-access assembly with two compartments—current limiting fuses on the top and the contactor below.

Ratings (Maximum)

400A 1500 hp at 2500V;
2500 hp at 5000V.

Chronology

The AMI design AMPGARD was manufactured from 1957 until 1970 at the General Control Division in Buffalo, NY, and Westinghouse Manufacturing and Repair (M&R) facilities around the country. The air contactor was available through 1966. The oil contactor was available through 1970.

Replacement Capabilities

The AMI vintage is obsolete but upgrading to the latest vacuum technology with a cell-retrofill solution is available. See Technology Upgrades for further information.

Add-On Structure

New add-on vacuum structures as an extension to the AMI type structure may be connected directly to the main bus without a transition section using special bus links. Contact your local Eaton Field Sales office.

Technology Upgrades

Standard AMI 36-Inch Wide Vacuum Starter Cell-Retrofill

This kit includes a standard full-voltage non-reversing vacuum starter in a welded cell assembly with horizontal top barriers and deep flanged doors. Optional components include a new electronic motor protection relay MP-3000 and electronic meter DP-4000. It will retrofit the AMI designs that are at least 36 inches wide and 30 inches deep. The cell is 45 inches high.

Narrow AMI 30-Inch Wide Vacuum Starter Cell-Retrofill

This kit includes a standard full-voltage non-reversing vacuum starter in a welded cell assembly with horizontal top barriers and deep flanged doors. Optional components include a new electronic motor protection relay MP-3000 and electronic meter DP-4000. It will retrofit the AMI designs that are at least 30 inches wide and 30 inches deep. The cell is 58 inches high.

Standard AMI 36-Inch Wide Vacuum Starter Cell-Retrofill Style Number

Description	Style Number
SJ Contactor	2147A95G41
SL Contactor	2147A95G61

Narrow AMI 30-Inch Wide Vacuum Starter Cell-Retrofill Style Number

Description	Style Number
SJ Contactor	2147A95G42
SL Contactor	2147A95G62

AMI Starter Cell-Retrofill

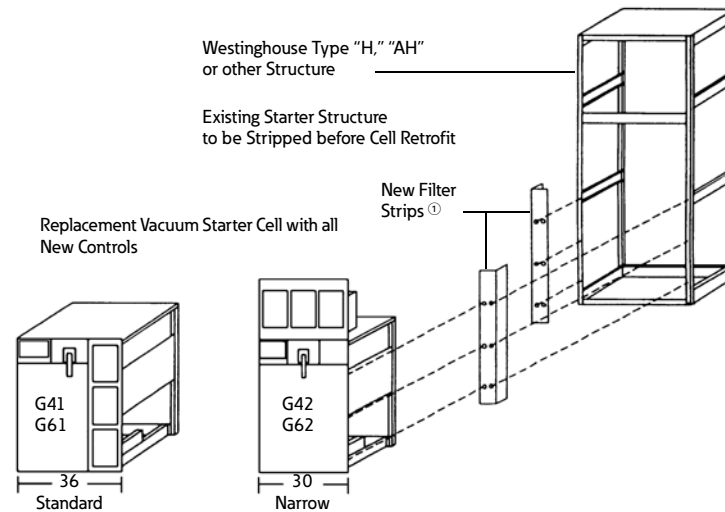

Note

① Upper filler cover may require field modification.

LF Air AMPGARD

Originally a Westinghouse Product



The LF Air-Break Design AMPGARD Starter

Product Description

The LF air-break design AMPGARD starter was introduced in 1962. The LF design introduced the component-to-component circuitry concept. This design greatly reduced the current-carrying connections and allowed for significant space savings.

The 25L2 and 50L2 floor-mounted NEMA 1 structures were 26 inches wide x 30 inches deep x 90 inches high. The 25L2 came in 1, 2 or 3 starters per structure. The 50L2 came in 1 or 2 starters per structure.

The 25L4 and 50L4 floor-mounted NEMA 1 starters were 36 inches wide x 30 inches deep x 90 inches high. These 400A starters could have been mounted two-high per structure.

The 25L7 and 50L7 floor-mounted NEMA 1 starters were 40 inches wide x 30 inches deep x 90 inches high. These 700A starters were mounted one per vertical structure.

Ratings (Maximum)

200, 400 and 700A 2500 hp at 2500V; 4500 hp at 5000V.

Chronology

The LF air-break design starter was introduced in 1962, first with the 2500V, 200A starter, then with the 5000V design and the 400 and 700A ratings. The starters were built in Buffalo, NY, until the operation was transferred to Asheville, NC, in 1978, where it was discontinued in the late 1980s.

Replacement Capabilities

Renewal and Replacement Parts for LF Design Starters

Refer to RPD 8855A for identifying the parts needed. Among the parts available are:

- Current and potential transformers
- Control transformers
- Fuses
- O/L relays and heaters
- Isolation switches
- Some air-break contactor parts

Technology Upgrades

Add-On Vacuum Starter Structures

New add-on vacuum structures as an extension to the LF type starter assembly may be connected directly to the main bus without a transition section.

50L4 (400A) Vacuum Replacement Contactor

For replacing an existing 400A LF air contactor with the directly interchangeable 400A vacuum contactor.



50L4 Vacuum Replacement (Front)



50L4 Vacuum Replacement (Rear)

400A Air-to-Vacuum Contactor Replacement

Description	Style Number
Basic contactor 2300/120V, 750 VA transformer:	
SJ contactor	2147A45G01
SL contactor	2147A50G01
Basic contactor 2300/120V, 2 kVA transformer:	
SJ contactor	2147A45G02
SL contactor	2147A50G02
Basic contactor 4160/120V, 600 VA transformer:	
SJ contactor	2147A45G03
SL contactor	2147A50G03
Basic contactor 4160/120V, 2 kVA transformer:	
SJ contactor	2147A45G04
SL contactor	2147A50G04

Note: Style numbers listed above identify a basic contactor that might not include other available accessories that were specified on a customer order. Contact factory with original general order number starter drawing number and date of manufacture for assistance.

400A Air-to-Vacuum Starter Cell Kit

Complete full-voltage, non-reversing, induction, vacuum AMPGARD motor starter, 400A, 7200V maximum, for mounting in existing 36-inch wide enclosure. Includes main contactor, isolation switch, three power fuses, MP-3000 motor protection without RTD module, three-phase current transformer, vertical bus, high and low voltage doors, and welded cell assembly for mounting in existing 36-inch wide enclosure.

400A Air-to-Vacuum Starter Cell Kit

Description	Style Number
Slide-out with SJ	2147A95G01
Roll-out with SJ	2147A95G02
Slide-out with SL	2147A95G03
Roll-out with SL	2147A95G04



Completely New Starter Cell

LF Air AMPGARD Starters (Medium Voltage)



50L7 Vacuum Retrofit

700A Air-to-Vacuum Conversion Kits

These kits will convert an existing full-voltage non-reversing 700A air break starter to vacuum.

700A Air-to-Vacuum Conversion Kit

Description	Style Number
450–630A maximum	2147A95G31
720A maximum	2147A95G32

25L2 Vacuum Replacement Contactor



25L2 Vacuum Replacement—Front View

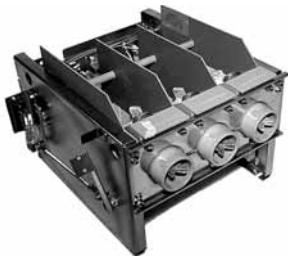

25L2 Vacuum Replacement—Rear View

This solution uses the latest technology “SL” contactor and is designed to replace vintage 25L2, 2500V, 200A, 1962 air-break contactors.

50L2 Air-to-Vacuum Retrofit Kit

This kit replaces the out-of-production 5000V, 200A air-break contactor with an SJ vacuum contactor, for starters built after 1974 with ISO-Switch shutter mechanism mounted in the cell. The customer keeps the existing starter cell and isolation switch and modifies the cell to accept the SJ contactor that is mechanically interlocked with the isolation switch. The rating remains 200A.

50L2 Air-to-Vacuum Retrofit Kit

Description	Style Number
200A maximum	2147A95G30

Ampacity upgrade to 320A design for pre-1974 50L2 retrofit kits available.

Metering and Protective Relay Upgrades

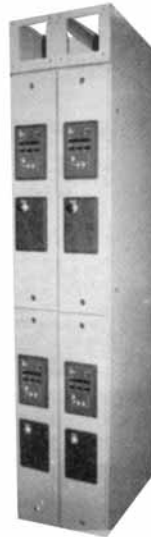

IQ Floor-Mounted Enclosure

IQ Floor-Mounted Enclosure

This kit is for mounting IQ family products. Includes standard AMPGARD structure construction to be used as a lineup extension. Each 90-inch high x 30-inch deep section comes with two doors, each with a works-in-a-drawer drawout panel. Each door has a maximum of three standard IQ cutouts with device panels. Supplied with or without IQ and PB devices. (Photo left shows two auxiliary sections with optional bus enclosure, IQ and PB devices.)

IQ Floor-Mounted Upgrade

Description	Style Number
Auxiliary section with cutouts only. 10-inch wide x 30-inch deep x 90-inch high (does not include bus enclosure, IQ or PB devices)	2147A95G35

MP-3000 and DP-4000 upgrades used for upgrading overload-relay technology from “Type-A,” IQ 2000A, IQ 2000B or IQ 1000II to the latest technology. Also upgrades with a new, slideout, LV control panel.

The kit includes:

- Typical starter schematic
- 0.50-inch deep, flange LV door with three cut-outs for new devices
- Works-in-a-drawer slide-out panel for LV control devices

Metering and Protective Relay Upgrades

Description	Style Number
DP-4000 and MP-3000 (without RTD)	2147A95G37
MP-3000 (without RTD) only	2147A95G39
DP-4000 only	2147A95G48
IQ 300 only	2147A95G49

Works-in-a-Drawer Metering and Protective Relay LV Device Panel

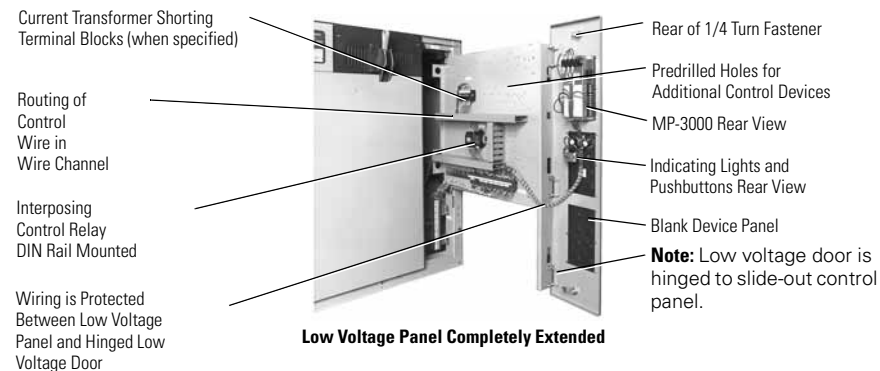

Classic AMPGARD

SL and SJ Vacuum AMPGARD

Originally a Westinghouse Product



SJ Vacuum AMPGARD Assembly

Product Description

The SJ vacuum contactor was designed and engineered specifically for use in AMPGARD starters. The contactor is a low-chop design that permits application matching of the starter to the motor for 2200–7200V and ratings of 400 and 800A. The 400A contactor is available in both slide-out and roll-out configurations. The 800A contactor is available in the roll-out design only. The SJ AMPGARD is a horsepower specific starter design that uses the component-to-component circuitry concept. The full-voltage 400A rating in a NEMA 1 enclosure is 36 inches wide x 30 inches deep x 90 inches high. These 400A starters are mounted one- or two-high per structure. The 800A rating in an enclosure is 40 inches wide x 30 inches deep x 90 inches high in a one-high construction for a full-voltage starter.

Ratings (Maximum)

400 and 800A, 3000 hp at 2500V; 5500 hp at 5000V; 8000 hp at 7200V.

Chronology

The SJ vacuum design AMPGARD starter was introduced in 1982 with the 400A rating. The 800A rating followed in 1987. With the introduction of the vacuum contactor, the air-break starter has been gradually phased out and is rarely specified in an assembly. The starters are built in Asheville, NC.

AMPGARD assemblies were made available with the new SL Contactor in late 1999. Except for the 400A frame contactor, SJ and SL AMPGARD assemblies are virtually identical.

Replacement Capabilities

Renewal and Replacement Parts for SJ Design Starters

Refer to RP.48J.01.T.E for identifying the parts needed.

Common Replacement Parts for SL Design Starters

Refer to RP02003002E for identifying the parts needed.

Add-On Vacuum Starter Structures

New add-on vacuum structures as an extension to the SJ type structure may be connected directly to the main bus without a transition section. Contact your local Eaton Field Sales office.

Replacement Vacuum Contactors

New replacement vacuum break contactors are available for all SJ model ratings.

400A Vacuum Roll-out Replacement Contactor

Description	Style Number
Basic contactor 2300/120V, 750 VA transformer:	
SJ contactor	2147A45G01
SL contactor	2147A50G01
Basic contactor 2300/120V, 2 kVA transformer:	
SJ contactor	2147A45G02
SL contactor	2147A50G02
Basic contactor 4160/120V, 750 VA transformer:	
SJ contactor	2147A45G03
SL contactor	2147A50G03
Basic contactor 4160/120V, 2 kVA transformer:	
SJ contactor	2147A45G04
SL contactor	2147A50G04

Note: Style numbers listed above identify a basic contactor that might not include other available accessories that were specified on a customer order. Contact factory with original general order number, starter drawing number, and date of manufacture for assistance.

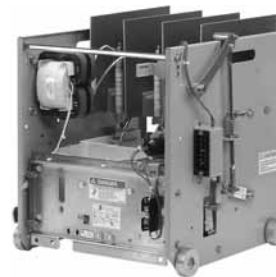

400A SL Roll-Out Replacement (Front)



400A SL Slide-Out Replacement (Front)



400A SL Roll-Out Replacement (Rear)



400A SL Slide-Out Replacement (Rear)

SL and SJ Vacuum AMPGARD Starters (Medium Voltage)



Completely New Starter Cell

400A Vacuum Starter Cell Kit

The 400A vacuum starter cell kit is used to fill a blank cell in an SL or SJ AMPGARD assembly or to completely replace an existing 400A SL or SJ starter.

It is a complete full-voltage, non-reversing, induction, vacuum AMPGARD motor starter, 400A, 7200V maximum, for mounting in existing 36-inch wide enclosure. It includes main contactor, isolation switch three power fuses, MP-3000 motor protection without RTD module, three-phase current transformer, vertical bus, high and low voltage doors, and welded cell assembly for mounting in existing 36-inch wide customer enclosure.

400A Vacuum Starter Retrofit Kit

Description	Style Number
Slide-out with SJ	2147A95G01
Roll-out with SJ	2147A95G02
Slide-out with SL	2147A95G03
Roll-out with SL	2147A95G04

Technology Upgrades

MP-3000 and DP-4000 upgrades used for upgrading overload-relay technology from "Type-A," IQ 2000A, IQ 2000B or IQ 1000II to the latest technology. Also upgrades with a new, slideout, LV control panel.

The kit includes:

- Typical starter schematic
- 0.50-inch deep, flange LV door with three cut-outs for new devices
- Works-in-a-drawer slide-out panel for LV control devices

Metering and Protective Relay Upgrades

Description	Style Number
DP-4000 and MP-3000 (without RTD)	2147A95G37
MP-3000 (without RTD) only	2147A95G39
DP-4000 only	2147A95G48
IQ Data only	2147A95G49

Works-in-a-Drawer Metering and Protective Relay LV Device Panel

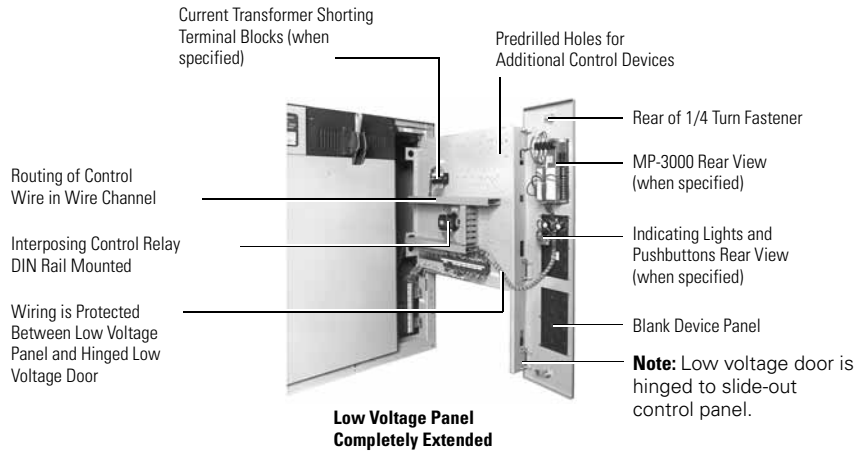

Next Generation AMPGARD

SLB and SLS Contactors AMPGARD



*Next Generation AMPGARD Lineup—
Front View*

Product Description

Medium voltage control reaches a higher level of design with the next generation of Cutler-Hammer AMPGARD starters from Eaton. This product incorporates 60 years of experience with over 75,000 units installed worldwide. The SLB and SLS contactor is a low-chop design that controls 200–8000 hp motors with ratings of 400 and 800A vacuum contactors. The contactor is available in a stab (SLS) or bolted (SLB) design within the starter cell. The two-high structure design can accommodate two 400A or one 800A contactor/starter designs. The two-high structure is 36 W x 92 H x 30 D inches (914.4 x 2336.8 x 762.0 mm), which includes a 12-inch high top-mounted main bus compartment.

Ratings (Maximum)

400 and 800A 3000 hp at 2500V; 5500 hp at 5000V; 8000 hp at 7200V.

Chronology

The SLB and SLS vacuum design AMPGARD starter was introduced in 2005 with both 400 and 800A ratings to be incorporated into the next generation of AMPGARD assembly. The starters are built in Asheville, NC. The new SLS and SLB contactors will not be interchangeable with the existing SJ or SL contactors.

Replacement Capabilities

For further information, contact the Asheville plant at **1-800-523-3775**.



*Stab-In AMPGARD 400A
Contactor—Rear View*



*Stab-In AMPGARD 800A
Contactor—Rear View*

SL and SJ Vacuum AMPGARD Starters (Medium Voltage)

AMPGARD IT. Soft Start Components

The Cutler-Hammer AMPGARD **IT**. Soft Start components are now available for upgrading existing full-voltage and reduced-voltage starters. The requirements to convert starters into AMPGARD **IT**. Soft Start will depend on specific configurations of the existing starter. Space will be required for two 36-inch wide, 45-inch high cells that are ideally mounted in the same vertical structure. The upper compartment contains the 'M' Contactor Cell and the lower compartment contains the SCR Truck Cell. The new door provided with the SCR Truck Cell includes the MV801 control module and is made to interlock with the door on the upper compartment.

If the targeted upgrade is for a FVNR AMPGARD starter presently located in the upper compartment, then the conversion is simplified by using the existing FVNR starter as the 'M' contactor cell and converting the bottom compartment into the SCR truck cell. The 'M' contactor load terminals are connected to the SCR truck cell terminals using three copper bus connectors. Available SCR truck ratings include 200A and 400A. See **Page V12-T13-98** for a description of other existing starter configurations. The advanced diagnostics included in the MV801 control module include:

- Phase loss
- Phase imbalance
- Jam
- Stall
- Over/undervoltage
- Motor overload



MV801 Control Module



AMPGARD IT. Soft Start (Doors Open)



AMPGARD IT. Soft Start



SCR Truck (Rear)



SCR Truck Cell

Typical AMPGARD Starter Configurations

**Example 1
(Before Retrofit)**

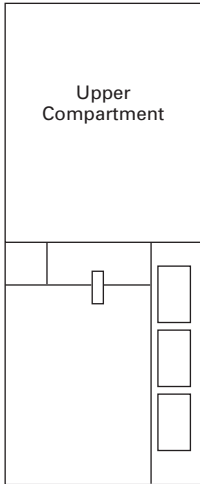

Note: Example 1—Upper Compartment must be converted to 'M' contactor cell. Lower compartment must be converted into SCR truck cell.

**Example 2
(Before Retrofit)**

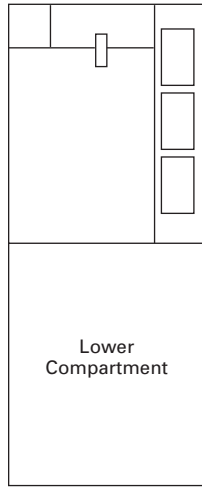

Note: Example 2—Upper compartment FVNR can be used as the 'M' contactor cell. Lower compartment must be converted to SCR truck cell.

**Example 1 and 2
(After Retrofit)**

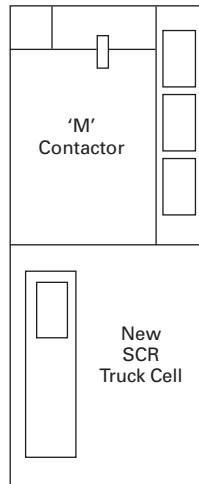

Example 3 (Before Retrofit)

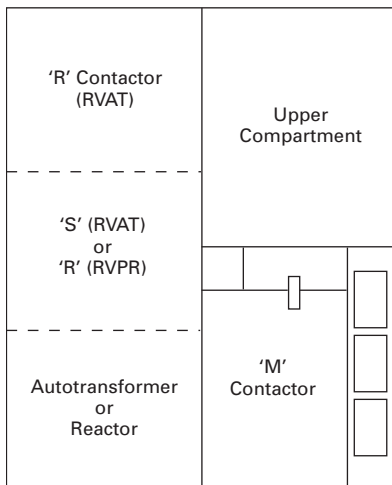

Note: Example 3—'M' contactor cell can be relocated to upper compartment. Lower compartment must be converted into SCR truck cell.

Example 3 (After Retrofit)

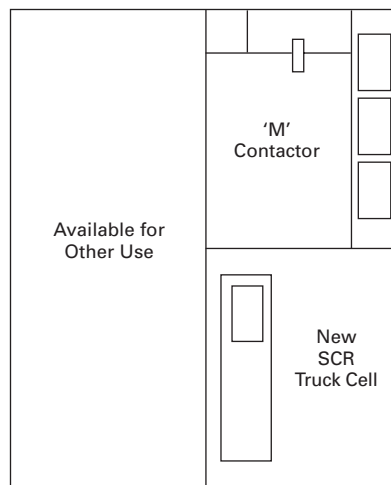

AMPGARD Solutions Overview

AMPGARD Selection Table

Installed Equipment	Vintage	AMPGARD Aftermarket Products Available					Vacuum Replacements	Class 1 Reconditioning	Reference Material
		Add-on Structure ①	Cell ②	Isolation Switch ③	Contactor ④	Parts ⑤			
AMPGARD OIL	1945–1957						■		—
AMPGARD AH	1948–1957						■		—
AMPGARD AMI	1948–1957						■		—
AMPGARD 25L2	1962–1990	■				■ ⑥	■	■	RPD8855A
AMPGARD 50L2	1963–1981	■				■ ⑥	■	■	RPD8855A
AMPGARD 50V4	1972–1979	■	■	■			■	■	RP48J01TE
AMPGARD 25/50L4	1966–1989	■	■	■		■ ⑥	■	■	RPD8855A
AMPGARD 25/50L7	1969–1989	■		■		■ ⑥	■	■	RPD8855A
AMPGARD V202 (SJ) 400A	1982–2000	■	■	■	■	■	■	■	RP48J01TE
AMPGARD S202 (SJ) 400A	1987–2000	■	■	■	■	■	■	■	RP48J01TE
AMPGARD W210 (SL) 400A	2000–	■	■	■	■	■	■	■	RP02003002E
AMPGARD F210 (SL) 400A	2000–	■	■	■	■	■	■	■	RP02003002E
AMPGARD V202 (SJ) 800A	1985–	■		■	■	■	■	■	RP48J01TE
Synchronous Control	1950–	■	■			■			RP04304009E

Notes

- ① Add-on structures contain vacuum starters only.
- ② Complete cell including frame, ISO-switch, vacuum or air contactor, and all components to complete a starter.
- ③ Isolation switch only (LFR replaced LFM after 1974).
- ④ Complete contactor, available in SJ or SL.
- ⑤ New, genuine parts per original specs.
 Vacuum replacements— OIL, AH, AMI (one-high starters) Complete Cell Retrofit
 25L2 Vacuum Replacement Contactor
 50L2 Vacuum Retrofit Kit
 50V4 Vacuum Replacement Contactor
 25/50L4 Vacuum Replacement Contactor
 Synchronous Mark V Solid-State Control Retrofit
 25/50L7 Vacuum Replacement Contactor and Some Cell Modification
- ⑥ Check with factory.

Further Information

Publication Number	Description
RPD8855A	Renewal Parts Data for AMPGARD LF Air-Break Vintage 200–700A
RPD8855S	Renewal Parts Data for AMPGARD Slipsyn Synchronous Control
RP48J01TE	Renewal Parts for AMPGARD SJ Vacuum-Break Vintage 400–800A
RP02003002E	Common Renewal Parts for AMPGARD SL 400A Vacuum Contactors
TD48A01ATE	Technical Data for AMPGARD MV Starters
PG48C01TE	Product Guide “SL” Medium Voltage Vacuum Contactors
IB48008	Instructions for AMPGARD Mark V Solid-State, Brush-Type, Synchronous Motor Controllers
IB48009	Instructions for AMPGARD Synchronous Motor Field Regulator with VAR and PF Control

Pricing Information

Price and Availability Digest (PAD)

DeviceNet I/O Starter Unit Upgrade

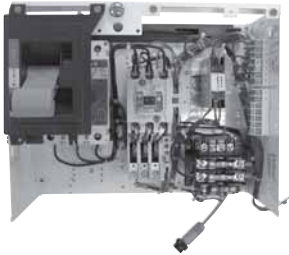

14 Motor Control Centers

Product Description	V12-T14-2
Product History	V12-T14-2
Product History Time Line	V12-T14-2
General Information	V12-T14-3
Low Voltage MCCs	
11-300—Product Description, Replacement Capabilities	V12-T14-5
9800—Product Description, Replacement Capabilities	V12-T14-6
Type W—Product Description, Replacement Capabilities	V12-T14-7
F10—Product Description, Replacement Capabilities	V12-T14-8
Freedom Unitrol—Product Description, Replacement Capabilities	V12-T14-9
5 Star/Series 2100—Product Description, Replacement Capabilities	V12-T14-10
Advantage™—Product Description, Replacement Capabilities	V12-T14-11
F2100—Product Description, Replacement Capabilities	V12-T14-12
Replacement Capabilities (Structure/Bus/Unit Parts)	V12-T14-13
Technology Upgrades	
<i>IT</i> . Soft Start	V12-T14-14
IQ Retrofit Kits	V12-T14-14
DeviceNet Interface Module Upgrade (DN65)	V12-T14-14
SPD Upgrade	V12-T14-15
SV9000 Drives	V12-T14-15
Advantage Technology	V12-T14-15
Series C® Retrofit Kits	V12-T14-15
How to Order, Catalog Numbering System	V12-T14-17
Competitive Retrofit Upgrades	V12-T14-18
Customer Required Information,	V12-T14-18
Product Support Services	V12-T14-19
Further Information and Pricing Information	V12-T14-19



F2100

Product Description

Nearly 50 years ago, Eaton's electrical business and Westinghouse® introduced the low voltage motor control center (MCC) assembly, enabling the group mounting of low voltage (600V class) electrical controls. This allowed for supervision and safe operation of motor starter units, feeder tap units and auxiliary equipment in a flexible structure arrangement at a centralized location.

The foundation for today's MCCs is a modular plug-in combination motor controller

assembly with components of proven electrical and mechanical integrity. These assemblies are enclosed in metal structures that prevent accidental contact with live electrical parts.

Eaton's Cutler-Hammer® MCC structure consists of structural steel, horizontal and vertical wireways for conduit and load cable entry and exit, and vertical and horizontal bus systems for distributing power throughout the MCC. The starter unit consists of a rugged steel shell (wrapper) for mounting the unit components, a combination motor starter with factory wired control, a handle mechanism for ON/OFF operation and a rigid unit door.

Product History

Group-mounted motor control was originally developed by Westinghouse in 1935. What came to be known as motor control centers were built in 14 manufacturing and repair shops around the country, including a plant in Chicago, IL, that opened in 1941. In 1963, Chicago became the primary MCC manufacturing plant. The Fayetteville, NC, operation was opened in 1980 to relieve some of Chicago's volume. The Fayetteville plant was expanded in 1984 and the Chicago operation was closed. Motor control centers

are currently manufactured in Fayetteville and in eight service centers around the country.

The Westinghouse plug-in starter design for group-mounted control (called motor control centers) was first introduced in 1935, and in 1950 became known as the Type 11-300 motor control center and used the 11-200 motor starter. The Type W MCC replaced the 11-300 in 1965, first using the 11-200 starter and then moving to the A200 starter. The 5 Star was introduced in 1975 to replace the Type W. It, too, used the A200 motor starter. The Series 2100 updated the 5 Star design in 1987, but is mechanically compatible with the 5 Star. The Advantage MCC was introduced as a sister product to the Series 2100 in 1992 with the introduction of the Advantage starter. It was also mechanically compatible with the 5 Star. With the merger of Eaton's electrical Cutler-Hammer business unit and Westinghouse's Distribution and Control Business Unit (DCBU) in 1994, a new hybrid motor control center line was introduced. It was called the F2100 MCC and featured the Freedom™ starter.

The Cutler-Hammer plug-in starter design motor control center was introduced in the late 1950s as the 9800 Series

Unitrol. These motor control centers used the 3-Star type motor starter. In 1968, the Citation line of starters replaced the 3-Star type in the 9800 MCC. The motor control center was totally redesigned around the Citation starter in 1972 and was called the F10 Unitrol. The next generation of MCC was introduced in 1988, using the Freedom line of starters called the Freedom Unitrol. Freedom Unitrol was discontinued in 1994 and replaced with the Cutler-Hammer F2100 motor control center.

Cutler-Hammer motor control centers were originally built in Milwaukee, WI. In 1962, manufacturing moved out of Milwaukee to plants in Atlanta, GA; Bethlehem, PA; Chicago, IL; Los Angeles, CA; Dallas, TX; San Francisco, CA; and Cleveland, TN. In 1972, these plants consolidated to Atlanta, Bethlehem, Chicago, Dallas and Los Angeles. In 1984, another consolidation left manufacturing in only Atlanta and Los Angeles. With the introduction of the Freedom starter in 1989, all manufacturing was moved to Atlanta. After the merger, all motor control center manufacturing moved to the Fayetteville, NC, location.

Product History Time Line

Page	Product	1935	1950	1955	1960	1965	1970	1975	1980	1985	1990	1995	2000	Present
V12-T14-5	Westinghouse 11-300	█												
V12-T14-6	Cutler-Hammer 9800			█										
V12-T14-7	Westinghouse Type W					█								
V12-T14-8	Cutler-Hammer F10						█							
V12-T14-10	Westinghouse 5 Star							█						
V12-T14-9	Cutler-Hammer Freedom Unitrol										█			
V12-T14-10	Westinghouse Series 2100										█			
V12-T14-11	Westinghouse Advanage™											█		
V12-T14-12	Cutler-Hammer F2100												█	
	Cutler-Hammer <i>IT</i> . MCC ①													█

Note

① No additional information at this time.

General Information

Procedure for Identifying Motor Control Center Types ^①

	MCC Type	Type of Handle Mechanism	Starter Type	Bucket Width (Inches)	Door Width (Inches)	Page Number
11-300 	11-300	Rotary	11-200 Life Line Type N	15-3/4	20	V12-T14-5
9800 	9800	Rotary and lever	3 Star	16-1/8	19-3/8	V12-T14-6
Type W 	Type W	Slider	A200 or 11-200	11-3/4	13-3/8	V12-T14-7
F10 	F10	Slider and lever	Citation	14	14-3/4 with wireway 19-1/2 without wireway	V12-T14-8
Freedom Unitrol 	Freedom Unitrol	Slider	Freedom Series	13-7/8	15-1/2	V12-T14-9
5 Star/Series 2100 	5 Star/Series 2100	Lever	A200	13-3/4	15-5/8	V12-T14-10
Advantage 	Advantage	Lever	Advantage	13-3/4	15-5/8	V12-T14-11
F2100 	F2100	Lever	Freedom Series	13-3/4	15-5/8	V12-T14-12
	IT MCC	Rotary	IT-EM	13-3/4	15-5/8	^②

Notes

- ^① In the event that the nameplate is missing, it is possible to identify the MCC design by the type of handle mechanism, starter type, bucket width and door width.
- ^② Contact **1-800-OLD-UNIT**.

Identification by Original Handle Mechanism



Freedom 2100, Advantage, Series 2100, 5 Star



F10 Unitrol Lever (Obsolete)



IT-EM Handles



Freedom Unitrol



F10 Unitrol Slider

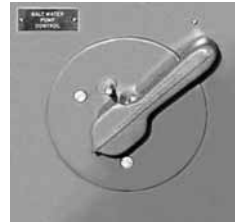

9800 Unitrol (Obsolete)



11-300



Type W

11-300

Originally a Westinghouse Product



Unit with A200 Starter

Product Description

Introduced in 1937, Westinghouse manufactured the 11-300 MCC through 1965 and it was available as match and lineup until 1974. It used standard structures each 20.00 inches wide, 90.38 inches high, and either 20.25 inches or 12.00 inches deep for front mounted and 20.25 inches for back-to-back mounting. Vertical sections could be bolted together to form a single lineup with continuous horizontal bus and open horizontal wireways.

Unit height was measured in either 9.33-inch or 14.00-inch increments up to a maximum of 70.00 inches of usable vertical space. ANSI 61 light gray enamel was used on all structural parts. The unit door hinged on the right and covered the entire width of the structure.

The 11-300 starter unit was most easily recognized by the rotary type of handle mechanism. Bus and support systems were typically braced to withstand fault currents of 25,000A.

Maximum Ratings

Three-phase, 600V, 600 hp, 2500A bus.



20.00-Inch Wide/Single 11-300 MCC Structure

Replacement Capabilities

Replacement Starter Units

Replacement starter cell units are available for all plug-in MCC designs. A complete unit for adding to an existing MCC includes a unit door, a divider pan and all the necessary mounting hardware. Features of the replacement unit include:

- Size 1–5 starter units
- UL® labeled
- Series C disconnect device
- A200 standard—*IT*, Freedom or Advantage starter optional
- New tin-plated copper stab assembly
- New door, handle mechanism and hardware



Unit with IT-EM Starter

Add-on MCCs

New *IT*, F2100 or Advantage can be added to an existing lineup. **Cable connected only.**

Replacement Feeder Units

Replacement feeder cell units are available for all plug-in MCC designs. A complete unit for adding to an existing MCC includes a unit door, a divider pan and all the necessary mounting hardware. Features of the replacement unit include:

- Feeder breakers and fusible switches through 400A
- UL labeled
- Series C disconnect device
- New tin-plated copper stab assembly
- New door, handle mechanism and hardware



11-300 Dual Feeder

9800

Originally a Cutler-Hammer Product

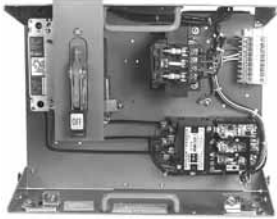

Unit with Citation Starter

Product Description

Introduced in 1956, the Cutler-Hammer 9800 was the initial offering in the motor control center product grouping. The door of the unit measured 19.38 inches wide and the bucket width measured 16.13 inches. Unit height was measured in 9.33-inch and 14.00-inch increments. The MCC did not use a wireway.

ANSI 49 was applied to the units, structural framework, roof, side sheets and all exterior doors.

9800 starter units were originally supplied with a 3-Star starter and a rotary handle mechanism. Replacements today use the newer Freedom starter, and a slider handle mechanism and a new door. The rotary handle mechanism is no longer available. Bus and bus systems were typically braced to withstand fault currents of 25,000A.

Maximum Ratings

Three-phase, 600V, 100 hp, 2500A bus.



20.00-Inch Wide/Single 9800 MCC Structure

Replacement Capabilities

Replacement Starter Units

Replacement starter cell units are available for all plug-in MCC designs. A complete unit for adding to an existing MCC includes a unit door, a divider pan and all the necessary mounting hardware. Features of the replacement unit include:

- Sizes 1–4 starter units
- UL labeled
- Series C disconnect device
- Freedom standard—**IT**, A200 or Advantage starter optional
- New tin-plated copper stab assembly
- New door, handle mechanism and hardware



Unit with IT-EM Starter

Note: Replacement 9800 units will be supplied with slider handle mechanism as shown.

Add-on MCCs

New **IT**, F2100 or Advantage can be added to an existing lineup. **Cable connected only.**

Replacement Feeder Units

Replacement feeder cell units are available for all plug-in MCC designs. A complete unit for adding to an existing MCC includes a unit door, a divider pan and all the necessary mounting hardware. Features of the replacement unit include:

- Feeder breakers and fusible switches through 400A
- UL labeled
- Series C disconnect device
- New tin-plated copper stab assembly
- New door, handle mechanism and hardware

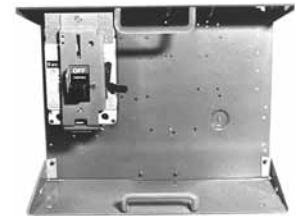

9800 Feeder Unit

Note: Handle mechanism pictured above is also used with F10 Unitrol units.

Type W

Originally a Westinghouse Product



Unit with A200 Starter

Product Description

Manufactured from 1965 to 1975, this Westinghouse MCC used standard structures each 19.00 inches wide, 90.00 inches high, and either 15.00 inches or 20.00 inches deep for front mounted or 20.00 inches deep for back-to-back mounting. Vertical sections were bolted together forming a single lineup with continuous horizontal bus. Unit height is measured in 6.00-inch increments up to a maximum of 72.00 inches of usable vertical space. Starter units are 13.50 inches wide.

A two-tone light/dark enamel paint system was used with an ANSI 70 off-white applied to the structural framework and cover plates. A dark gray was used for unit and wireway doors.

The Type W starter units are easily recognized by their sliding handle mechanism, the MC motor control type. Bus and bus support systems were typically braced to withstand fault currents of 22,000A.

Maximum Ratings

Three-phase, 600V, 400 hp, 2500A bus.



20.00-Inch Wide Type W MCC Structure

Replacement Capabilities

Replacement Starter Units

Replacement starter cell units are available for all plug-in MCC designs. A complete unit for adding to an existing MCC includes a unit door, a divider pan and all the necessary mounting hardware. Features of the replacement unit include:

- Size 1–5 starter units
- UL labeled
- Series C disconnect device
- A200 standard—*IT*, Freedom or Advantage starter optional
- New tin-plated copper stab assembly
- New door, handle mechanism and hardware



Unit with IT-EM Starter

Add-on MCCs

New *IT*, F2100 or Advantage MCCs can be added to an existing lineup through a 10.00-inch bus transition section.

Replacement Feeder Units

Replacement feeder cell units are available for all plug-in MCC designs. A complete unit for adding to an existing MCC includes a unit door, a divider pan and all the necessary mounting hardware. Features of the replacement unit include:

- Feeder breakers and fusible switches through 400A
- UL labeled
- Series C disconnect device
- New tin-plated copper stab assembly
- New door, handle mechanism and hardware

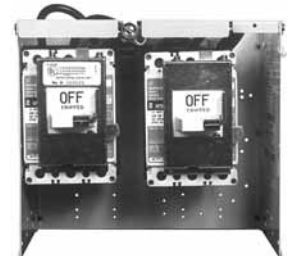

Type W Dual Feeder

F10

**Originally a
Cutler-Hammer Product**

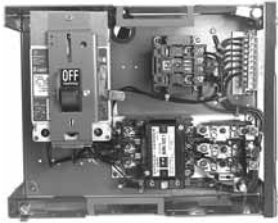

Unit with Citation Starter

Product Description

Introduced in 1972, this Cutler-Hammer MCC was available in both 16.00 inches wide (with wireway) and 20.00 inches wide (without wireway). Bucket width is 14.00 inches and replacement units are available with both designs. Unit height is measured in 6.00-inch increments.

ANSI 40 was applied to the units, structural framework, roof, side sheets and all exterior doors.

The F10 MCC used the Citation starter and was identified by the slider type handle mechanism. Bus and bus support systems were typically braced to withstand fault currents of 42,000A.

Maximum Ratings

Three-phase, 600V, 150 hp, 2000A bus.



20.00-Inch Wide F10 MCC Structure

Replacement Capabilities

Replacement Starter Units

Replacement starter cell units are available for all plug-in MCC designs. A complete unit for adding to an existing MCC includes a unit door, a divider pan and all the necessary mounting hardware. Features of the replacement unit include:

- Size 1–5 starter units
- UL labeled
- Series C disconnect device
- Freedom standard—*IT*, A200 or Advantage starter optional
- New tin-plated copper stab assembly
- New door, handle mechanism and hardware

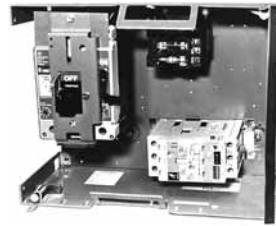

Unit with Advantage Starter

Add-on MCCs

New *IT*, F2100 or Advantage MCCs can be added to an existing lineup through a bus splice kit and channel sills.

Replacement Feeder Units

Replacement feeder cell units are available for all plug-in MCC designs. A complete unit for adding to an existing MCC includes a unit door, a divider pan and all the necessary mounting hardware. Features of the replacement unit include:

- Feeder breakers 600A and fusible switches 400A
- UL labeled
- Series C disconnect device
- New tin-plated copper stab assembly
- New door, handle mechanism and hardware



F10 Feeder Unit

Freedom Unitrol

*Originally a
Cutler-Hammer Product*

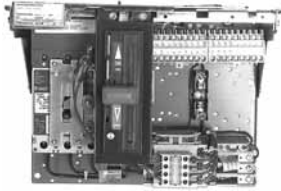

Unit with Freedom Starter

Product Description

Introduced in 1989, this Cutler-Hammer MCC had vertical structures that measured 20.00 inches wide, 91.50 inches high, and either 15.00 inches or 20.00 inches deep. It allowed a 6.00-inch Size 1 unit design.

ANSI 49 was applied to the units, structural framework, roof, side sheets and all exterior doors.

The Freedom Unitrol used the Freedom starter and was identified by the slider type handle mechanism. Bus and bus support systems were typically braced to withstand fault currents of 42,000A with the option to increase to 65,000A.

Maximum Ratings

Three-phase, 600V, 400 hp, 2500A bus.



*20.00-Inch Wide Freedom
Unitrol MCC Structure*

Replacement Capabilities

Replacement Starter Units

Replacement starter cell units are available for all plug-in MCC designs. A complete unit for adding to an existing MCC includes a unit door, a divider pan and all the necessary mounting hardware. Features of the replacement unit include:

- Size 1–5 starter units
- UL labeled
- Series C disconnect device
- Freedom standard—*IT*, A200 or Advantage starter optional
- New tin-plated copper stab assembly
- New door, handle mechanism and hardware

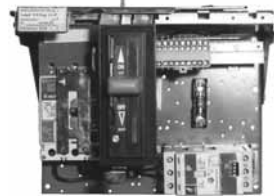

Unit with Advantage Starter

Add-on MCCs

New *IT*, F2100 or Advantage MCCs can be added to an existing lineup through a bus splice kit.

Replacement Feeder Units

Replacement feeder cell units are available for all plug-in MCC designs. A complete unit for adding to an existing MCC includes a unit door, a divider pan and all the necessary mounting hardware. Features of the replacement unit include:

- Feeder breakers and fusible switches through 600A
- UL labeled
- Series C disconnect device
- New tin-plated copper stab assembly
- New door, handle mechanism and hardware



Freedom Unitrol Feeder Unit

5 Star/Series 2100

Originally a Westinghouse Product



Unit with A200 Starter

Product Description

The 5 Star MCC was introduced by Westinghouse in 1975. The structure design was the basis for the Series 2100, Advantage and F2100 products later. The Series 2100 updated the 5 Star design in 1987 with higher ratings and newer components.

The vertical structures are normally 20.00 inches wide, 90.00 inches high, and 16.00 inches or 21.00 inches deep. Vertical sections may be bolted together forming a single lineup with continuous horizontal bus and open horizontal wireways. Unit height is measured in 6.00-inch increments up to a maximum of 72.00 inches of usable vertical space.

A two-tone light/dark enamel paint system is used for this design. ANSI 61 gray is applied to the roof and side sheets and all exterior doors. Starter units are 13.75 inches wide.

The 5 Star/Series 2100 starter unit's handle mechanism is a gray toggle type handle with a black exterior mounting panel and is used on the Advantage and F2100 designs. Bus and bus support systems are typically braced to withstand fault currents of 42,000A on the 5 Star and 65,000A on the Series 2100.

Maximum Ratings

Three-phase, 600V, 600 hp, 2500A bus.



20.00-Inch Wide 5-Star MCC Structure

Replacement Capabilities

Replacement Starter Units

Replacement starter cell units are available for all plug-in MCC designs. A complete unit for adding to an existing MCC includes a unit door, a divider pan and all the necessary mounting hardware. Features of the replacement unit include:

- Size 1–5 starter units
- UL labeled
- Series C disconnect device
- A200 starter standard—*IT*, starter optional
- New tin-plated copper stab assembly
- New door, handle mechanism and hardware



Unit with A200 Starter

Add-on MCCs

New *IT*, F2100 or Advantage MCCs can be added to an existing lineup through a bus splice kit.

Replacement Feeder Units

Replacement feeder cell units are available for all plug-in MCC designs. A complete unit for adding to an existing MCC includes a unit door, a divider pan and all the necessary mounting hardware. Features of the replacement unit include:

- Feeder breakers and fusible switches through 600A
- UL labeled
- Series C disconnect device
- New tin-plated copper stab assembly
- New door, handle mechanism and hardware



5 Star/Series 2100 Feeder Unit

Advantage

Originally a Westinghouse Product

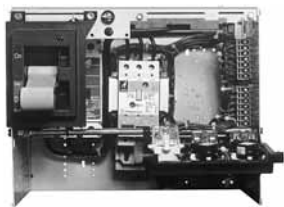

Unit with Advantage Starter

Product Description

Introduced in 1991 as a sister to the Westinghouse Series 2100 MCC, the Advantage starter design revolutionized the industry. It uses state-of-the-art technology to solve motor control application problems, such as coil burnout and contact chatter/welding.

The vertical structures are normally 20.00 inches wide, 90.00 inches high, and 16.00 inches or 21.00 inches deep. Vertical sections may be bolted together forming a single lineup with continuous horizontal bus and open horizontal wireways. Unit height is measured in 6.00-inch increments up to a maximum of 72.00 inches of usable vertical space.

A two-tone light/dark enamel paint system is used for this design. ANSI 61 gray is applied to all exterior back sheets, side sheets and doors. Starter units are 13.75 inches wide and are interchangeable with the 5 Star and Series 2100 design.

The Advantage starter unit's handle mechanism is a gray toggle type handle with a black exterior mounting panel and is used on the 5 Star/ Series 2100 and Freedom 2100 designs. Bus and bus support systems were typically braced to withstand fault currents of 65,000A.

Maximum Ratings

Three-phase, 600V, 1100 hp, 3200A bus.



20.00-Inch Wide Advantage MCC Structure

Replacement Capabilities

Replacement Starter Units

Replacement starter cell units are available for all plug-in MCC designs. A complete unit for adding to an existing MCC includes a unit door, a divider pan and all the necessary mounting hardware. Features of the replacement unit include:

- Size 1–5 starter units
- UL labeled
- Series C disconnect device
- Advantage starter
- New tin-plated copper stab assembly
- New door, handle mechanism and hardware

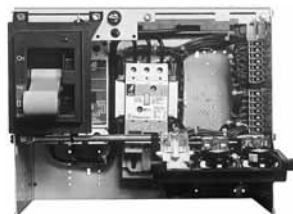

Unit with Advantage Starter

Device Panel Upgrade

While incorporating Advantage starters, increase the information shown on the unit device panel with one or two of the Advantage control modules (ACMs) available. These units fit into the standard device panel cutout and provide pushbutton, pilot light and metering functions with reduced wiring costs.

The device panel is hinged on a horizontal rod extending across the front of the unit. With the unit door open, loosening two captive retaining screws at the top of the panel and sliding it a 0.50-inch left permits it to swing down. This provides ready access to the rear of the panel and increased accessibility to the unit interior.



Advantage Device Panel with ACM and Metering Module

Replacement Feeder Units

Replacement feeder cell units are available for all plug-in MCC designs. A complete unit for adding to an existing MCC includes a unit door, a divider pan and all the necessary mounting hardware. Features of the replacement unit include:

- Feeder breakers and fusible switches through 600A
- UL labeled
- Series C disconnect device
- New tin-plated copper stab assembly
- New door, handle mechanism and hardware



Advantage Feeder Unit

F2100

The Cutler-Hammer F2100 was introduced in 1995



Unit with Freedom Starter

Product Description

The structure is based on the 5 Star, Series 2100 and Advantage MCC design. Vertical structures are normally 20.00 inches wide, 90.00 inches high, and 16.00 inches or 21.00 inches deep. Vertical sections may be bolted together forming a single lineup with continuous horizontal bus and open horizontal wireways. Unit height is measured in 6.00-inch increments up to a maximum of 72.00 inches of usable vertical space.

A two-tone paint system is used for this design. ANSI 61 gray is applied to the exterior and doors. Starter units are 13.75 inches wide with 4.63-inch wireways.

The Freedom starter is used in this design along with the HMCP motor circuit protector.

The F2100 starter unit's handle mechanism is a gray toggle type handle with a black exterior mounting panel and is used on the Advantage and 5 Star/Series 2100 designs. Bus and bus support systems are typically braced to withstand fault currents of 65,000A.

Maximum Ratings

Three-phase, 600V, 1100 hp, 3200A bus.



20.00-Inch Wide F2100 MCC Structure

Replacement Capabilities

Replacement Starter Units

Replacement starter cell units are available for all plug-in MCC designs. A complete unit for adding to an existing MCC includes a unit door, a divider pan and all the necessary mounting hardware. Features of the replacement unit include:

- Size 1–5 starter units
- UL labeled
- Series C disconnect device
- Freedom starter standard—*IT* starter optional
- New tin-plated copper stab assembly
- New door, handle mechanism and hardware



Unit with Freedom Starter

Replacement Feeder Units

Replacement feeder cell units are available for all plug-in MCC designs. A complete unit for adding to an existing MCC includes a unit door, a divider pan and all the necessary mounting hardware. Features of the replacement unit include:

- Feeder breakers and fusible switches through 600A
- UL labeled
- Series C disconnect device
- New tin-plated copper stab assembly
- New door, handle mechanism and hardware



F2100 Feeder Unit

Replacement Capabilities

Replacement Parts

In addition to replacement units, a large number of replacement parts are available for each vintage.

Note: For information on these and additional parts, refer to RPD listed on **Page V12-T14-19** of this catalog. For parts not listed or shown in the RPD, contact your local Eaton Field Sales office or Service Center. See **Page V12-T14-19** of this catalog.

Examples



F2100 Horizontal Wireway Door



9800 Unit Mounting Hardware Kit

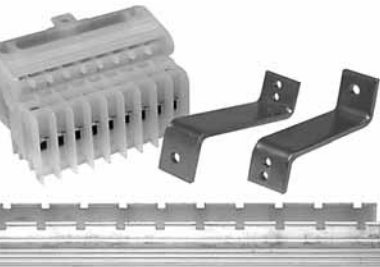

Freedom Unitrol Terminal Block Mounting Kit



F10 Handle Mechanism



Series 2100 Bus Splice Kit



Type W Horizontal Busbar

Technology Upgrades

IT. Soft Start

**Intelligent Technologies (IT.)
Soft Starters**

Eaton's Cutler-Hammer Intelligent Technologies (IT) solid-state starters provide high-performance motor control in the most compact packages in the industry. The IT. Series of solid-state starters are available in retrofit units through 200 hp in all Cutler-Hammer and Westinghouse MCC vintages. Each IT. solid-state starter unit includes a disconnect, starter, a DC power supply, a 120 Vac interposing relay, and a 100 VA CPT. The IT. solid-state starter design incorporates an integral, parallel run contact that engages once the starter reaches full speed. Available soft starter options include: pump control software, line/load MOV protection and motor isolation contactor.

IQ Retrofit Kits

IQ Analyzer (The Ultimate in Monitoring)

IQ Analyzer

The Cutler-Hammer IQ Analyzer displays the most comprehensive list of metered parameters in its class. The dot-matrix, gas plasma display provides the flexibility of exhibiting large characters with high visibility and small characters for detailed descriptions. Multiple parameters (e.g., currents of phases A, B and C) are displayed simultaneously for more thorough real-time monitoring. Custom screens can also be configured. Available information includes current, voltage, power, energy, demand and an extensive array of harmonic data.

IQ 320



IQ 320

The Cutler-Hammer IQ 320 is the most cost-effective metering solution for monitoring main incoming line electrical values. Through the bright two-line LCD display, the IQ 320 provides accurate readings for voltage, amperes, watts, hertz, power factor and VA. Key features of the IQ 320 include ANSI C312.16 revenue class metering accuracy, PowerNet™ capable communications port and user intuitive four-button front panel interface.

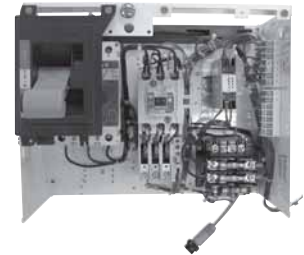
DeviceNet Interface Module Upgrade (DN65)

DeviceNet I/O Starter Unit Upgrade

Using the DN65 Discrete DeviceNet™ I/O module, all Cutler-Hammer and Westinghouse vintage MCCs may be upgraded with the latest Freedom motor starters to provide wire savings and communications capability. The DN65 DeviceNet I/O Module adds increased functionality and intelligence in a small footprint. Standard MCC starter units accommodate the DN65 DeviceNet module and provide the ability to perform START/STOP control over an open network. Additionally, contactor, overload and breaker status may be communicated through the DN65 upstream to a host PC, PLC or DCS system.

Technology Upgrades

SPD Upgrade



F2100 SPD Unit

Surge Protective Device—MCC

The Eaton SPD Series surge protective device is a hybrid MOV filter-based suppression system that protects sensitive electronic equipment from damaging transients, lightning surges and electrical line noise. The SPD is installed in parallel to the electrical circuits in a motor control center and provides clean power to the motor starting circuits. The SPD only reacts and keeps damaging surge current and high frequency noise away from motor starting circuits when the system's nominal operating voltage is exceeded. The latest Eaton SPD Series protective devices are substantially smaller, safer and more compact than their predecessors, providing better performance and easier installation.

The new Eaton SPD Series are available in size ranges from 50 to 400 kA and can be retrofitted to all Cutler-Hammer and Westinghouse vintage MCCs. Consult the factory for further information.

SV9000 Drives



SV9000 AC Drive

Cutler-Hammer SV9000 adjustable frequency drives are available for retrofit units in a number of MCC vintages. For current vintage Freedom and Advantage MCCs, SV9000 drives are available through 1100 hp at 480V. Type W, F10, Freedom Unitrol motor control center vintage units are available with SV9000 drive in plug-in configurations through 30 hp at 480V. Each retrofit unit includes an SV9000 drive (variable or constant torque) disconnect, a CPT and a 3% input and output line reactor. SV9000 drives provide the highest performance and reliability available for flexible and smooth motor control.

IT-EM Technology

In addition to standard retrofit capabilities, every vintage of MCC can be upgraded with IT-EM motor starters. Consult factory for other manufacturer's motor control centers.



5 Star/2100



Type W



F10

Series C Retrofit Kits

Series C retrofit kits are to be used to upgrade existing Type W, 5 Star and F10 motor control center buckets by changing out the old breakers with the Series C. These kits can be applied to both starter and feeder units.

The old breakers that these kits will upgrade include, but are not limited to, the MCP, F, FA, FB, HFB, K, KA, KB, HKB, L, LA, LB and HLB breakers.

5 Star Series C Retrofit Kit



5 Star Series C Retrofit Kit

The 5 Star Series C retrofit kit includes:

- Series C device, 65 kA (either HMCP or thermal-magnetic breaker)
- Operating handle mechanism, including tripped indication and push-to-trip
- Label stating that the MCC unit has been retrofitted with Series C device suitable for 65 kA (similar to UL quality label)
- Templates for desired frame size
- Assembly instructions

Note: The upgrade interrupting rating of the breaker does not upgrade the withstand rating of the existing bus.

Type W Series C Retrofit Kit

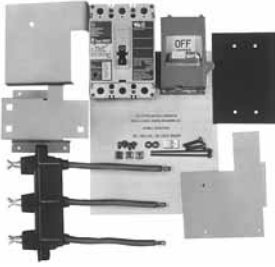

Type W Series C Retrofit Kit

The Type W Series C retrofit kit includes:

- Series C device, 65 kA (either HMCP or thermal-magnetic breaker)
- Operating handle mechanism, including tripped indication and push-to-trip
- Label stating that the MCC unit has been retrofitted with Series C device suitable for 65 kA (similar to UL quality label)
- Templates for proper hole placement for desired frame size
- Series C breaker mounting hardware
- New door and hardware
- New stab assembly
- Assembly instructions

Note: The upgrade interrupting rating of the breaker does not upgrade the withstand rating of the existing bus.

F10 Series C Retrofit Kit



F10 Series C Retrofit Kit

The F10 Series C retrofit kit includes:

- Series C device, 65 kA (either HMCP or thermal-magnetic breaker)
- Operating handle mechanism, including tripped indication push-to-trip
- Label stating that the MCC unit has been retrofitted with Series C device suitable for 65 kA (similar to UL quality label)
- Templates for desired frame size
- Assembly instructions

Note: The upgrade interrupting rating of the breaker does not upgrade the withstand rating of the existing bus.

Series C Molded-Case Circuit Breakers

Frame Type	Interrupting Rating (kAIC)			Trip Rating Amperes	Catalog Number
	240V	480V	600V		
HFD	100	65	25	15	HFD3015
HFD	100	65	25	20	HFD3020
HFD	100	65	25	25	HFD3025
HFD	100	65	25	30	HFD3030
HFD	100	65	25	40	HFD3040
HFD	100	65	25	50	HFD3050
HFD	100	65	25	60	HFD3060
HFD	100	65	25	70	HFD3070
HFD	100	65	25	80	HFD3080
HFD	100	65	25	90	HFD3090
HFD	100	65	25	100	HFD3100
HFD	100	65	25	125	HFD3125
HFD	100	65	25	150	HFD3150
FDC	200	100	35	15	FDC3015
FDC	200	100	35	20	FDC3020
FDC	200	100	35	25	FDC3025
FDC	200	100	35	30	FDC3030
FDC	200	100	35	40	FDC3040
FDC	200	100	35	50	FDC3050
FDC	200	100	35	60	FDC3060
FDC	200	100	35	70	FDC3070
FDC	200	100	35	80	FDC3080
FDC	200	100	35	90	FDC3090
FDC	200	100	35	100	FDC3100
FDC	200	100	35	125	FDC3125
FDC	200	100	35	150	FDC3150
HJD	100	65	25	175	HJD3175
HJD	100	65	25	200	HJD3200
HJD	100	65	25	225	HJD3225
HJD	100	65	25	250	HJD3250
JDC	200	100	35	175	JDC3175
JDC	200	100	35	200	JDC3200
JDC	200	100	35	225	JDC3225
JDC	200	100	35	250	JDC3250
HKD	100	65	35	300	HKD3300
HKD	100	65	35	350	HKD3350
HKD	100	65	35	400	HKD3400
KDC	200	100	50	300	KDC3300
KDC	200	100	50	350	KDC3350
KDC	200	100	50	400	KDC3400

Series C Motor Circuit Protectors

Starter Size	Magnetic Trip Range Amperes	Continuous Rating Amperes	Catalog Number
0	9–30	3	HMCP003A0
0	21–70	7	HMCP007C0
0	45–150	15	HMCP015E0
0	40–60	25	HMCP025D0
1	90–300	30	HMCP030H1
2	80–120	50	HMCP050G2
2	150–500	50	HMCP050K2
2	115–170	70	HMCP070J2
2	210–700	70	HMCP070M2
3	160–240	100	HMCP100L3
3	300–1000	100	HMCP100R3
4	450–1500	150	HMCP150T4
4	750–2500	150	HMCP150U4
4, 5	350–700	250	HMCP250A5
5	450–900	250	HMCP250C5
5	500–1000	250	HMCP250D5
5	625–1250	250	HMCP250F5
5	750–1500	250	HMCP250G5
5	875–1750	250	HMCP250J5
5	1000–2000	250	HMCP250K5
5	1125–2250	250	HMCP250L5
5	1250–2500	250	HMCP250W5
5	500–1000	400	HMCP400D5
5	625–1250	400	HMCP400F5
5	750–1500	400	HMCP400G5
5	875–1750	400	HMCP400J5
5	1000–2000	400	HMCP400K5
5	1125–2250	400	HMCP400L5
5	1250–2500	400	HMCP400M5
5	1500–3000	400	HMCP400N5
5	1750–3500	400	HMCP400R5
5, 6	2000–4000	400	HMCP400X5

Catalog Numbering System

Series C Retrofits

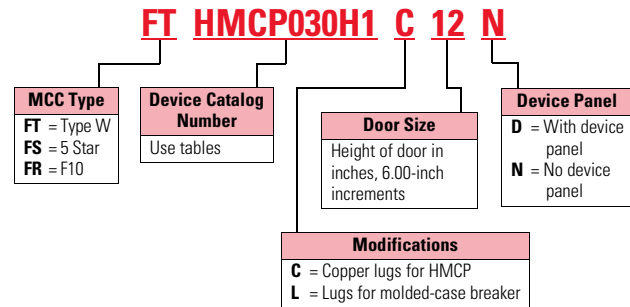

How to Order

Step 1: Select the correct Series C device from the table in the applicable RPD

- 5 Star—RP04304003E
- Type W—RP04304006E
- F10—RP04304005E

Step 2: Create a catalog number based on the MCC type, device selected, modification, door size and device panel.

Step 3: Select price from PL04304002E.

Competitive Retrofit Upgrades

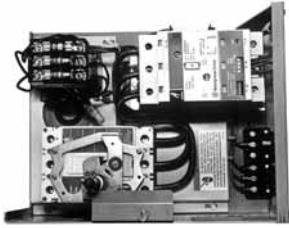

GE770 Unit Retrofitted with Advantage and HMCP

The following competitive retrofit units can be obtained from the Fayetteville manufacturing plant.

- Allis-Chalmers
- Allen-Bradley®
- Arrow Hart®
- General Electric®
- Klockner-Moeller®
- Siemens®
- Other

Factory Retrofit

We replace the starter, the breaker and the handle mechanism. A new door is provided for most competitor's units. The original unit, the pan and the stabs are refurbished.

Panel Retrofit

New components are mounted on a "panel" that is easily installed into the competitor's unit. Included are a new pan, a starter, a breaker, a handle mechanism and a door if available. Requires field installation by Eaton's Electrical Services & Systems (EESS) or a qualified contractor.

Note: See **Page V12-T14-19** for most competitor retrofit units.

Note: Please consult factory for additional retrofit opportunities.

New Units

Brand new ITET 5600, GE 7700/8000 and Allen-Bradley Centerline™ replacement units include:

- New bucket
- New stabs
- All new Cutler-Hammer components
- Complete with manufacturer UL label

Note: For additional information and designs for other motor control centers, call the Aftermarket Products Center in Fayetteville, NC.

Customer Required Information

Procedure for identifying renewal parts:

1. Renewal parts listed in PL04304002E below identify those replacement parts that are most frequently ordered and that are readily available from manufacturing stock.
2. For parts not shown in *Aftermarket, Renewal Parts and Life Extension Solutions* or listed in Further Information on **Page V12-T14-19**, contact your local Eaton Field Sales office or call **1-800-OLD-UNIT**.



PL04304002E



Poster PST03A01TE

Product Support Services

The following replacement units can be obtained from the Fayetteville manufacturing plant and the service centers.

- F2100
- Advantage
- 5 Star/Series 2100
- Freedom Unitrol
- F10
- Type W
- 9800
- 11-300
- Technology Upgrade Kits
- Allen-Bradley Centerline
- Federal Pacific Electric® (FPE)
- Sylvania® Clark (no UL)
- Square D® Model 3 (no UL)
- Telemecanique®
- Gould®
- ITE
- GE 7700/8000

New Units

Seven Customer Manufacturing Solution Centers

Atlanta

(678) 309-4270

Chicago

(847) 299-1911

Denver

(303) 366-9949

Hartford

(860) 683-4221

Brand new ITE 5600, GE 7700/8000 and Allen-Bradley Centerline replacement units include:

- New bucket
- New stabs
- All new Cutler-Hammer components
- Complete with manufacturer UL label

Note: For additional information and designs for other motor control centers, call the Aftermarket Products Center in Fayetteville, NC, **1-800-OLD-UNIT**. If you are in Canada, call **1-855-656-2882**.

Houston

(713) 939-9696

Los Angeles

(562) 944-6413

Portland

(503) 636-8333

Support of Installed Equipment

Fayetteville

1-800-OLD-UNIT

Airdrie, Canada

1-855-656-2882

Further Information

Publication Number	Description
RP04304001E	F2100—1995–Present
RP04304002E	Advantage—1992–Present
RP04304003E	Series 2100—1987–1995
RP04304003E	5 Star—1975–1987
RP04304004E	Freedom Unitrol—1988–1994
RP04304005E	F10 Unitrol—1972–1989
RP04304006E	Type W—1965–1975
RP04304007E	9800 Unitrol—1956–74
RP04304008E	11-300—1935–1965
RP04304010E	5600—2003–Present
SA-11848	Sales Aid—Advantage MCC
SA-162	Sales Aid—F2100
SA.8K.02.S.E	Sales Aid—QDS II sAftermarket Tri-fold
PST.03A.01.T.E	Sales Aid—MCC Wall Poster
LEM002A	Tri-fold Mailer “We Have The Solutions”
LEM005	Tri-fold Mailer “MCC Units with TVSS”
LEM006	Tri-fold Mailer “Technology Upgrades”
PA.8K.01.S.E	MCC Competitive Retrofit Units

Pricing Information

Price List—All MCC Vintages—PL04304002E

Price List—Freedom 2100—PL03A01EPE

Price List—Advantage MCC—PL04301001E

Price and Availability Digest (PAD)

Vista/VISTALINE™ Discount Symbol 1CD-2C

Distribution Switchboards (Low Voltage)

**Pow-R-M-S/F Switchboard
with Fixed SPB Breakers**



15 Distribution Switchboards (Low Voltage)

Product Description	V12-T15-2
Product History	V12-T15-2
Product History Time Line	V12-T15-2
WRI, Pow-R-I, Pow-R-M-S/F, Pow-R-Line <i>i</i> Assemblies Power Circuit Breakers	V12-T15-3
Product Description	V12-T15-3
Replacement Capabilities	V12-T15-3
Technology Upgrades	V12-T15-3
Pow-R-Gear, Pow-R-M-S Assemblies, SPB Circuit Breakers	V12-T15-4
Product Description	V12-T15-4
Replacement Capabilities	V12-T15-4
Technology Upgrades	V12-T15-4
WF/WRP, ES, Pow-R-Line C [®] Assemblies, Circuit Breakers	V12-T15-5
Product Description	V12-T15-5
Replacement Capabilities	V12-T15-5
Further Information	V12-T15-6
Pricing Information	V12-T15-6

Assemblies and Circuit Breakers



WRI Switchboard, St. Louis Vintage with Fixed Molded-Case Breakers
Pow-R-I is of similar look)



Pow-R-M-S/F Switchboard with Fixed SPB Breakers

Distribution switchboards can be a free-standing structure(s) or close coupled as the secondary section of a power center or substation. Power distribution switchboards primarily use individually mounted, fixed or drawout devices. Service distribution switchboards primarily use main devices as individually mounted, fixed or drawout with group-mounted molded-case circuit breakers. Numerous combinations of devices can be used depending on the specification. Class III (power distribution) and Class II (service distribution) switchboards are commonly used descriptions for the class of distribution switchboards. Distribution switchboards are built in accordance with all applicable provisions of UL® 891 and NEMA® PB-2.

Product History

Distribution switchboards have been around since the 1950s. Most of the original switchboards were custom assembled with very little standardization of design.

From the mid-1970s through the 1980s, distribution boards became somewhat more

standardized and were manufactured in St. Louis, MO. These vintages included:

- WRI
- WF/WRP
- Pow-R-Gear

“WRI” used individually mounted, molded-case circuit breakers for both mains and feeders.

“WF/WRP” used group-mounted, molded-case circuit breakers or FDP fusible switches for the feeders. For the mains, this design used either DS, SPB, bolted-pressure switch (CBC-type), or MCCBs.

“Pow-R-Gear” used SPB drawout, insulated-case power circuit breakers for both mains and feeders.

Some specialty switchboards, including generator-control, were manufactured in Cincinnati, OH, until the plant was closed in 1985.

During the mid-1980s, some of the switchboard manufacturing was moved to a plant in Visalia, CA, and another plant in Sumter, SC. Those designs included WF/WRP and WRI.

During the late 1980s and early 1990s the switchboard products were relocated to two different locations:

- Asheville, NC
- Sumter, SC

The products that moved to Asheville included the “Pow-R-Gear,” which later evolved into the “Pow-R-M-S” design (the “Pow-R-M-S/F is the fixed-mounted version). Also included in the move to Asheville was the “WRI” product, which later evolved into the “Pow-R-I” design. The “Pow-R-I” design was short-lived and in 1991 it evolved into two different products—the “Pow-R-M-S/F mentioned above and the “Pow-R-Line i” mentioned in the next paragraph.

The first product that moved to Sumter, SC, was the “WF/WRP,” which evolved into the “Pow-R-Line C” design—it uses Series C® MCCBs. The second product evolved from Asheville’s “Pow-R-I” and is called the “Pow-R-Line i” design.

Product Description

Cutler-Hammer low voltage distribution switchboards from Eaton’s electrical business serve to switch power and to protect circuits in industrial and commercial distribution systems. Distribution switchboards can be classified into two categories—power distribution and service distribution. The power distribution switchboards typically use insulated-case SPB or air DS power circuit breakers as mains and individually compartmentalized feeders. The service distribution switchboards use insulated-case SPB, air DS, molded-case (all types), and fusible switches as mains and molded-case circuit breakers as feeders.

Product History Time Line

Page	Product	1955	1960	1965	1970	1975	1980	1985	1990	1995	2000	Present
V12-T15-5	WF/WRP Switchboard						█	█				
V12-T15-3	WRI Switchboard		█	█	█	█	█	█				
V12-T15-4	Pow-R-Gear Switchboard						█	█				
V12-T15-5	Pow-R-line C Switchboard								█	█	█	█
V12-T15-4	Pow-R-M-S Switchboard								█	█	█	█
V12-T15-3	Pow-R-I Switchboard								█	█	█	█
V12-T15-5	ES Switchboard								█	█	█	█
V12-T15-3	Pow-R-M-S/F Switchboard								█	█	█	█
V12-T15-3	Pow-R-Line i Switchboard								█	█	█	█

WRI, Pow-R-I, Pow-R-M-S/F and Pow-R-Line *i*



WRI Switchboard with Individually Mounted Molded-Case Breakers



Pow-R-Line *i* Switchboard with Individually Mounted Molded-Case Breakers

Product Description

This class of switchboard is commonly called a Class III switchboard. Generally speaking, this means individually mounted main and feeder devices.

The WRI switchboard that was built by Westinghouse in St. Louis, MO consisted of rear- and front-accessible enclosures with all sections flush front to rear. The WRI board was designed for mounting away from the wall.

Main devices could be DS, SPB, SCB-II or molded-case circuit breakers and (CBC) bolted pressure or FDP fusible switches. Individually mounted feeders could be either FDP fusible switches or molded-case circuit breakers. The WRI design moved to Asheville, NC, as the Pow-R-I design with little change, except fusible was not offered with Pow-R-I. Some different structural and bussing methods were used on the Pow-R-I also.

The Pow-R-I product was split in 1991. Switchboards requiring main and individually mounted feeders using SPB breakers and the RD Series C breaker were incorporated in the Pow-R-M-S/F design using the same design as the drawout Pow-R-M-S switchboard except fixed devices. The smaller current individually mounted devices were incorporated into the Pow-R-Line *i* design introduced in 1991 at Sumter, SC.

Ratings

Device	Rating
WRI/Pow-R-I	
Switchboard bus	800–4000A
Protective devices	400–4000A
Voltage	120–600V
Interrupting capacity	30–200 kA
Pow-R-M-S/F	
Switchboard bus	800–5000A
SPB/RD breaker	400–5000A
Voltage	240–600V
Interrupting capacity	42–100 kA
Pow-R-Line <i>i</i>	
Switchboard bus	800–4000A
Protective devices	70–4000A
Voltage	240–600V
Interrupting capacity	30–200 kA

Replacement Capabilities



Parts for WRI Switchboard

New Circuit Breakers

New SPB, DS and RD molded-case circuit breakers are available for replacement provisions or to fill existing cells. All breakers are newly manufactured.

Circuit Breaker Cell Provisions

These are used to convert blank cell compartments into breaker cell compartments. Provisions are no longer available for WRI dated 1967 or earlier but might be available for newer versions. Cell provisions are no longer available for Pow-R-I and Pow-R-M-S/F (fix-mounted). Provisions are sometimes available for the Pow-R-Line *i* design. In all cases, care must be taken to properly identify the original shop order before proceeding or making final determination.

Repair Service for SPB Breakers

Factory authorized non-warranty repair for all SPB breaker frames.

Class 1 Reconditioning for DS Breakers

Repairs are available for DS circuit breakers. This service includes trip unit replacements.

Circuit Breaker Parts

An extensive inventory of newly manufactured breaker renewal parts are available for SPB, DS and RD molded-case circuit breakers.

Technology Upgrades

IQ and PowerNet™ Communications Retrofits

Cutler-Hammer IQ products replace existing analog meters, instruments and protective relays with microprocessor-based solid-state true rms sensing devices. IQ products can be furnished as components for field installation on the switchgear. The IQ products include the IQ Analyzer, IQ DP-4000, IQ 200 and IQ 300. Communications can then be tied to the Cutler-Hammer PowerNet system.

Digitrip™ Trip Unit Retrofit Kits

Trip unit retrofit kits are available for all SPB and DS breaker frames. Refer to **Tab 17, Pages V12-T17-33 to V12-T17-36.**

SPD Series Surge Protective Devices

Refer to **Page V12-T15-6** of this publication.

Pow-R-Gear, Pow-R-M-S and SPB

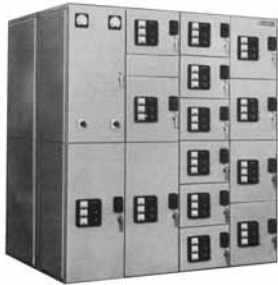

Pow-R-Gear Switchboard, St. Louis Vintage with Drawout SPB Breakers



Pow-R-M-S Switchboard, Current Asheville Design with Drawout SPB Breakers

Product Description

Pow-R-Gear, and now Pow-R-M-S, switchboards were/are designed exclusively for the systems Pow-R breaker line of encased power circuit breakers. These switchboards were/are designed for high current applications and include the following features: drawout breaker elements, individual breaker compartmentalization, in-gear breaker contact inspection and minimum floor space design. Both versions were/are manufactured in accordance with all applicable provisions of UL 891 and NEMA PB-2 covering low voltage distribution switchboards.

The primary differences between the original Pow-R-Gear and its successor Pow-R-M-S are: structural (frame design), trip units (Pow-R-Gear used the Pow-R-Trip 7; Pow-R-M-S uses the Digitrip RMS sensing trip family), bus design (Pow-R-Gear used aluminum of varying heights;

Pow-R-M-S uses bolted copper of full height) and vertical spacing (Pow-R-Gear accommodated six-high 800A breakers, Pow-R-M-S accommodates four-high 800A breakers).

Ratings

Device	Rating
Pow-R-Gear	
Switchboard bus	800–4000A
Protective devices	100–5000A
Voltage	120–600V
Interrupting capacity	100 kA
Pow-R-M-S	
Switchboard bus	800–5000A
SPB breaker	400–5000A
Voltage	240–600V
Interrupting capacity	42–100 kA

Chronology

Pow-R-Gear was built by Westinghouse in St. Louis, MO, from 1977 to 1990. Pow-R-M-S was built by Westinghouse, and later Cutler-Hammer in Asheville, NC, from 1990 to 2003.

Replacement Capabilities



Systems Pow-R Breaker Type SPB-65 with Pow-R-Trip 7 Trip Unit

Factory Repair Service for SPB Breakers

These repair services apply to breakers that have exceeded the original factory warranty and are now referred to as non-warranty repairs. The Systems Pow-R Breaker family consists of fixed breakers, either front connected or rear connected, and drawout breakers, either behind-the-door or through-the-door design. Four-pole breakers are only available in the fixed design front or rear connected.

The Cutler-Hammer SPB factory authorized non-warranty repair service features:

- Quality SPB repair specified and audited by factory engineers according to procedures
- Only genuine new Cutler-Hammer replacement parts are used
- Original factory specifications and design drawings are used by factory trained technicians

New SPB Circuit Breakers

New SPB breakers are available for replacement or to fill existing vacant cells. All breakers are newly manufactured and are mechanically and electrically the same as the breakers originally specified and supplied.

SPB Breaker Cell Provisions

These are used to convert blank cell compartments into breaker cell compartments. Provisions are usually available for Pow-R-M-S drawout designs. However, provisions are not available for Pow-R-M-S/F fixed designs or for the Pow-R-Gear design. In all cases, care must be taken to properly identify the original shop order before proceeding or making final determination.

SPB Circuit Breaker Parts

An extensive inventory of newly manufactured breaker renewal parts is available for SPB circuit breakers.

Technology Upgrades

Pow-R-Trip 7 Trip Unit Upgrades

Pow-R-Trip 7 was the solid-state trip unit used on Pow-R-Gear switchboards. An upgrade from the Pow-R-Trip 7 trip unit is also available. Modification to the breaker and existing switchboard is required. Refer to **Tab 17, Pages V12-T17-35 to V12-T17-36.**

Digitrip Trip Unit Retrofit Kits

Trip unit retrofit kits are available for all SPB breaker frames. Refer to **Tab 17, Pages V12-T17-35 to V12-T17-36.**

IQ and PowerNet Communications Retrofits

Cutler-Hammer IQ products replace existing analog meters, instruments, and protective relays with microprocessor-based solid-state true rms sensing devices. IQ products can be furnished as components for field installation on the switchgear. The IQ products include the IQ Analyzer, IQ DP-4000, IQ 200 and IQ 300. Communications can then be tied to the Cutler-Hammer PowerNet system.

SPD Series Surge Protective Devices

Refer to **Page V12-T15-6** of this publication.

WF/WRP, ES and Pow-R-Line C

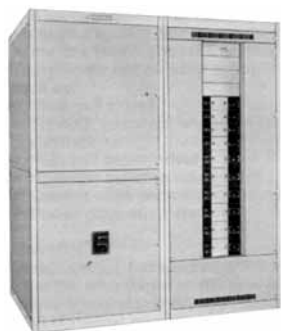

WRP Switchboard, Rear Access with Panel-Mounted Molded-Case Breakers



Pow-R-Line C Switchboard, Front Access with Panel-Mounted Molded-Case Breakers

Product Description

This class of switchboard is commonly called a Class II switchboard. Generally speaking, this means individually or panel-mounted main and panel-mounted feeder devices.

The WF/WRP switchboard that was built by Westinghouse in St. Louis, MO, consisted of front- or rear-accessible enclosures with various depths depending on the devices within the structure. In the front access design, Type WF, the rear of the switchboard was flush for all structures; the rear access design, Type WRP, was flush in the front and rear.

The WF/WRP switchboard design accommodated the use of DS, SPB, bolted pressure switch (CBC), molded-case circuit breaker or FDP fusible switches as main devices. Panel-mounted feeder devices could be either molded-case circuit breakers or FDP fusible switches. The WF/WRP design was moved to Sumter, SC, and Visalia, CA, and consequently enhanced with the introduction of the Series C breaker and some structural and busing changes.

In 1962, Eaton entered the switchboard market with the purchase of Mullenbach. Soon after the Mullenbach acquisition, Eaton entered into an agreement with Westinghouse to supply breakers and fusible devices for panelboards and switchboards. This led to the introduction of the ES switchboard using exclusively Westinghouse molded-case circuit breakers.

In the late 1980s, Westinghouse introduced a new and improved version of the WF/WRP switchboard using the Series C breaker. This new switchboard line, Pow-R-Line C, designates a family of service distribution switchboards incorporating new design concepts that fit the ever increasing need for applications on high short-circuit systems, while retaining maximum standardization, safety and convenience throughout the line.

Ratings

Device	Rating
WF/WRP	
Switchboard bus	600–4000A
Protective devices	15–4000A
Voltage	120–600V
Interrupting capacity	10–200 kA
ES	
ES switchboard bus	600–4000A
Protective devices	15–4000A
Voltage	120–600V
Interrupting capacity	10–200 kA
Pow-R-Line C	
Switchboard bus	600–6000A
Protective devices	15–6000A
Voltage	208–600V
Interrupting capacity	10–200 kA

Chronology

WF/WRP was introduced by Westinghouse in St. Louis, MO, in 1955. In 1988, the design was transferred to Sumter, SC, and Visalia, CA, as Pow-R-Line C switchboards. Consequently, the Cutler-Hammer Type ES switchboard version was later introduced in 1991 as a replacement for their version of the WF/WRP switchboard.

Replacement Capabilities

Eaton offers an extensive amount of products to support WF/WRP, ES and Pow-R-Line C switchboards.

Pow-R-Line C Match and Lineup Cubicles

Newly manufactured Pow-R-Line C switchboard structures to match and line up to existing WF/WRP switchboards. New Pow-R-Line C structures can also connect to existing switchboards (Type ES) with a transition section.

New Circuit Breakers

New SPB, DS and RD molded-case circuit breakers are available for replacement or to fill existing vacant cells. All breakers are newly manufactured and are mechanically and electrically the same as the breakers originally specified and supplied.

Circuit Breaker Provisions/Connector

Breaker provisions are required in switchboards when there is an existing space in a structure that is to be filled with a breaker. Provisions/connectors are available for most ratings of the WF/WRP design. Provisions are available for all ratings of the Pow-R-Line C designs including all parts required to complete the cell in accordance with the switchboard as originally supplied.

Factory Repair Service for SPB Breakers

Factory authorized non-warranty repair for all SPB breaker frames. Refer to **Page V12-T15-4** of this publication.

Circuit Breaker Parts

An extensive inventory of newly manufactured breaker renewal parts are available for SPB, DS and RD molded-case circuit breakers.

Switchboard Structure Parts

Switchboard parts are available for most designs. Newly manufactured replacement parts (such as doors, breaker provisions, lift trucks, metering, etc.) are available.

Technology Upgrades**Digitrip Trip Unit Retrofit Kits**

Trip unit retrofit kits are available for all SPB and DS breaker frames. Refer to **Tab 17, Pages V12-T17-33 to V12-T17-36**.

SPD Series Surge Protective Devices

Surge Protective Device

Product Description

Eaton SPD series of surge protective devices ensures that equipment is protected with the safest, most reliable and most advanced UL 1449 3rd Edition certified protectors. The array of features, options and configurations ensures that there is a unit for all electrical applications. The SPD family protects equipment from the damaging effects of surges and electrical line noise. Field installation is required.

Benefits

- SPD Series can be externally mounted to existing distribution equipment
- Surge ratings: 50, 80, 100, 120, 160, 200, 250, 300 and 400 kA
- Standard NEMA 1 enclosure, optional NEMA 4 and NEMA 4X enclosures.
- Surface or flush mounting
- Full range of diagnostic and monitoring options
- Remote mountable display panel

For more information about the Eaton family of surge products, contact your local Eaton Field Sales office.

IQ and PowerNet Communications Retrofits

Cutler-Hammer IQ products replace existing analog meters, instruments and protective relays with microprocessor-based solid-state true rms sensing devices. IQ products can be furnished as components for field installation on the switchboard or can be provided as new replacement front panels. The new replacement front panels available for switchboard assemblies include the IQ devices mounted and wired. The IQ products can be matched in numerous combinations to include the IQ Analyzer, IQ DP-4000, IQ 200 and IQ 300. Communications can then be tied to the Cutler-Hammer PowerNet System.

Further Information

Publication Number	Description
CA08100003E	Volume 2—Commercial Distribution, Switchboards, Tab 4
RP01301013E	Systems Pow-R Breakers Renewal Parts and Accessories

Pricing Information

Price List for Pow-R-M-S switchboard—PL 32-624A

Price List for SPB breakers—PL.22A.01.P.E

High Resistance Grounding System

Type C-HRG Products



16 High Resistance Grounding System

Type C-HRG (Low Voltage)	V12-T16-2
Product Description	V12-T16-2
Product History	V12-T16-2
Product History Time Line	V12-T16-2
General Information	V12-T16-2
Sequence of Operations	V12-T16-3
Catalog Numbering System	V12-T16-4
Further Information	V12-T16-4
Type C-HRG (Medium Voltage)	V12-T16-5
Product Description	V12-T16-5
Product History	V12-T16-5
Product History Time Line	V12-T16-5
General Information	V12-T16-5
Sequence of Operations	V12-T16-6
Catalog Numbering System	V12-T16-7

Type C-HRG (Low Voltage)

Originally a Westinghouse Product



Wall-Mounted C-HRG (resistors not shown)



Free-Standing C-HRG

Product Description

Cutler-Hammer® Type C-HRG from Eaton's electrical business is designed to improve the continuity of electrical service to critical processes. Systems designers sometimes use ungrounded distribution systems to avoid interrupting service during a ground fault. However, ungrounded systems have a significant disadvantage—the distribution system is subject to the harmful effects of ground faults, like high transient overvoltages. The Type C-HRG helps customers add the benefits of a grounded system to their ungrounded system.

Product History

High resistance grounding technology has been offered as an integral system within Eaton low voltage switchgear and switchboard products since the early 1970s. In 1994, Eaton adopted the technology into the C-HRG, which is a standalone or wall-mounted product ideal for adapting to the existing electrical system.

Product History Time Line

Product	1994	2000	Present
C-HRG Low Voltage			

General Information

Overview

Where continuity of service is a high priority, high resistance grounding can add the safety of a grounded system while minimizing the risk of service interruptions due to grounds. The concept is a simple one: provide a path for ground current via a resistance that limits the current magnitude, and monitor to determine when an abnormal condition exists.

The ground current path is provided at the point where the service begins by placing resistance in the connection from system neutral-to-ground. Control equipment continuously measures ground current; a relay detects when the current exceeds a predetermined level. An alarm alerts building personnel that a ground exists. The system has built-in fault tracing means to assist in finding the source of the ground. An integral transformer provides control power from the primary source.

Minimum Criteria for Use

High resistance grounding systems can be applied to either grounded or ungrounded three-wire distribution systems. Per NEC® 1996, 250.5(b) exception No. 5, the following criteria must be met before using the C-HRG:

- The conditions of maintenance and supervision ensure that only qualified persons will service the installation
- Continuity of power is required
- Ground detectors are installed on the system
- Line-to-neutral loads are not served

Wye or Delta System

Adding the Type C-HRG to a wye connected system requires only that the resistors supplied be connected in series with the neutral-to-ground connection of the power source. Adding the Type C-HRG to an ungrounded delta system requires the creation of a neutral point. Transformers are supplied for that purpose in the enclosure. The resistors supplied are then connected at that point. In both cases, the components supplied are chosen to limit the ground current to a maximum value of 5A.

Typical C-HRG Application

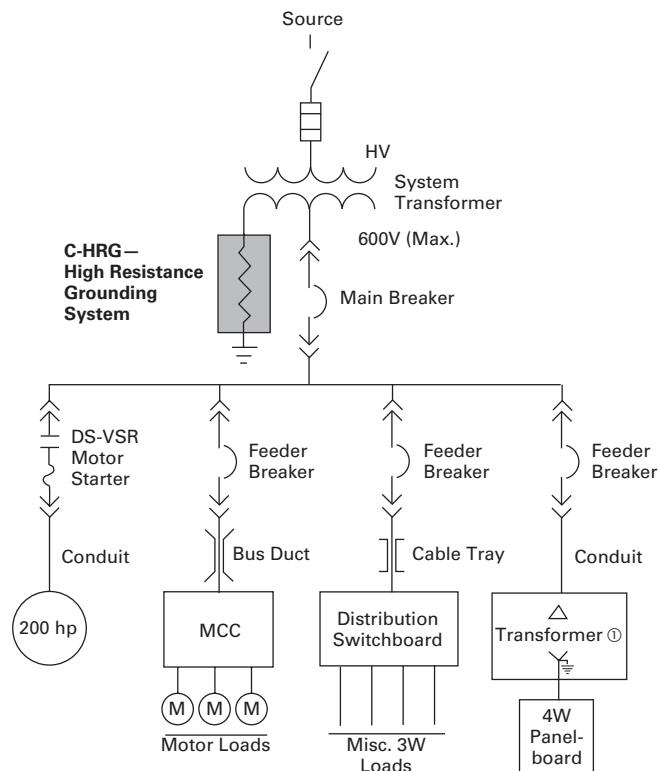

Ground Fault Detection

When one phase of a system becomes grounded, additional current will flow. As all ground current must flow through the grounding resistor assembly, a current sensing relay is placed in this circuit, allowing detection when a ground fault occurs. If chosen, a voltage-sensing relay can be provided to accomplish the same function.

Pulser Circuit

The pulser circuit offers a convenient means to locate the faulted feeder and to trace the fault to its origin. The pulser is available any time a fault has been detected. The "pulse" light flashes on and off, corresponding to the ON-OFF cycles of the pulsing contactor. The pulser contactor switches a bank of resistors on and off, allowing a momentary increase in the ground current.

Ground Fault Location

The current pulses can be noted with a clamp-on ammeter when the ammeter is placed around the cables or the conduit feeding the fault. The operation tests each conduit or set of cables until the pulsing current is noted. By moving the ammeter along the conduit, the fault can be traced to its origin. The fault may be located at the point where the pulsing current drops off or stops. If little or no change in the pulsing current is noted along the entire length of a conduit, then the fault may be in the connected load.

Sequence of Operations

Normal

- Green "normal" light on
- Red "ground fault" light off
- White "pulse" light off
- System control switch in "normal" position
- Reset control switch in either "auto" or "manual"

Test

- Turn and hold the system control switch in the "test" position. Phase B will be grounded via the test resistor
- The ground current will activate the sensing circuit, causing the green "normal" light to turn off and the red "ground fault" light to turn on. The pulser will be activated as well
- The white "pulse" light will turn on and off as the pulser contactor closes and opens
- The ground current ammeter will display the total ground current, including the incremental pulse current
- When ready, return the system control switch to "normal." The pulser will stop. If the reset control is in the "manual" position, turn it to "reset" to reset the fault sensing circuit
- The red "ground fault" light will turn off, and the green "normal" light will turn on
- Test mode is not available if the system is detecting a ground. The sensing circuit will disable the test circuit.

Ground Fault

- When the sensing circuit detects a fault, the green "normal" light will turn off and the red "ground fault" light will turn on
- The ground current ammeter will indicate the total ground current
- To use the pulser, turn the system control switch to "pulse." The pulser contactor will cycle on and off as controlled by the recycle timer relay
- Use the clamp-on ammeter to locate the faulted feeder. Open the feeder and clear the fault
- If the reset control switch is in the "manual" position, turn it to "reset" to reset the sensing circuit

Note: If reset control is in "auto," it will reset itself.

- When ready to restore service to the load, close the feeder
- Return the system control to "normal"

Note

① Phase-to-neutral loads cannot be fed from the same system transformer to which the C-HRG is connected. These loads must be fed from a downstream, delta-wye transformer with a solidly grounded neutral on the secondary.

Catalog Numbering System

Decoding the Catalog Numbering System

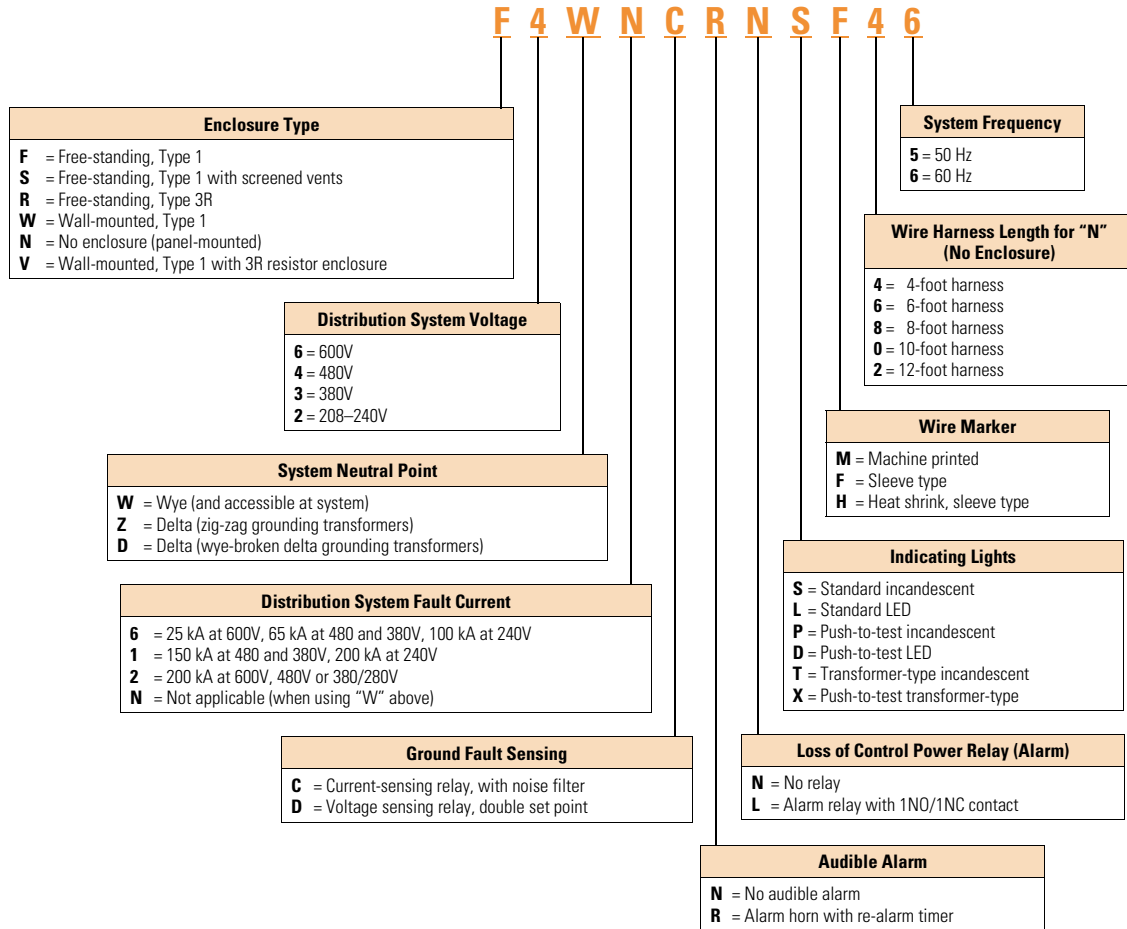

Further Information

Publication Number	Description
SN.44C.01.S.E	Sales Notes for C-HRG
—	Bidman pricing
TD.44C.01.T.E	Technical Data for C-HRG
SA-32-602B	Sales Aid for high resistance grounding systems
IB 32-698C	Instruction Booklet for high resistance grounding system
CA08104001E	Eaton's Consulting Application Guide

Type C-HRG (Medium Voltage)



Free-Standing C-HRG

Product Description

The Type C-HRG is designed to improve the continuity of electrical service to critical processes. Systems designers sometimes use ungrounded distribution systems to avoid interrupting service during a ground fault. However, ungrounded systems have a significant disadvantage—the distribution system is subject to the harmful effects of ground faults, like high transient overvoltages. The Type C-HRG helps customers add the benefits of a grounded system to their ungrounded system.

Product History

High resistance grounding technology has been offered as an integral system within medium voltage switchgear for many years. In 1996, Eaton adopted the technology into the C-HRG, which is a stand-alone product ideal for adapting to the existing electrical system.

Product History Time Line

Product	1995	2000	Present
C-HRG Low Voltage			

General Information

High Resistance Grounding System

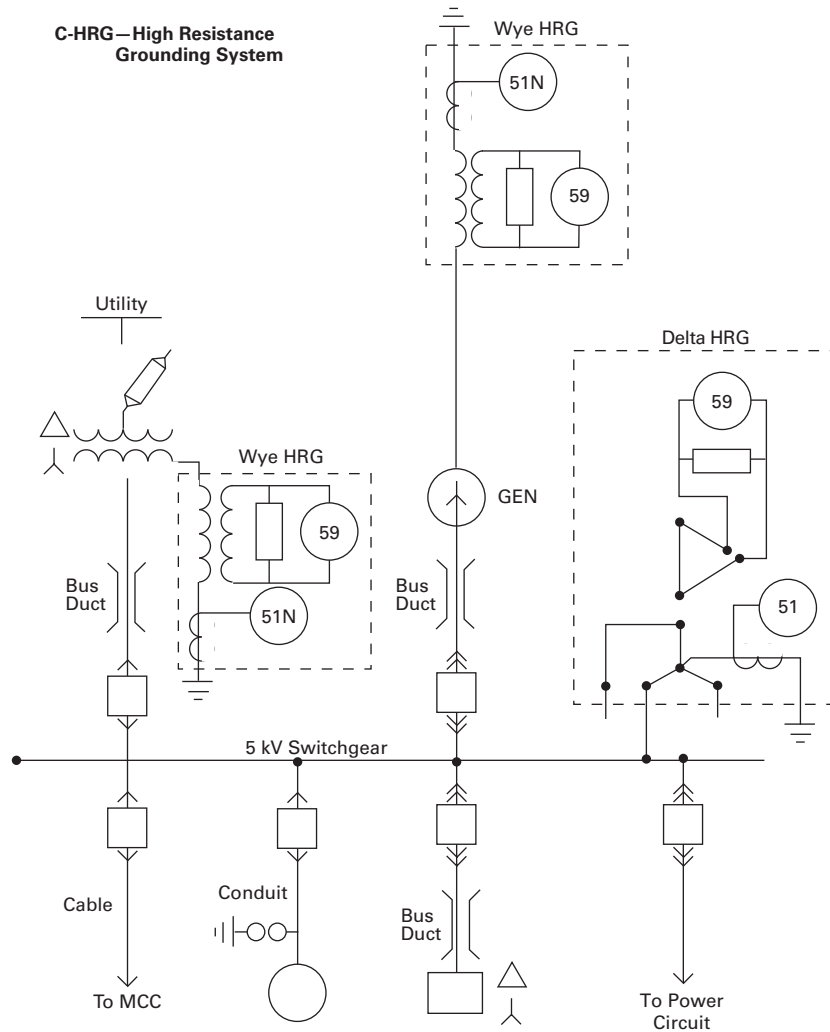

Overview

Where continuity of service is a high priority, high resistance grounding can add the safety of a grounded system while minimizing the risk of service interruptions due to grounds. The concept is a simple one: provide a path for ground current via a grounding transformer (with adjustable resistance across its secondary) that limits the current magnitude and a monitor to determine when an abnormal condition exists.

The ground current path is provided at the point where the service begins, by placing a predominantly resistive impedance in the connection from system neutral to ground. Control equipment continuously measures ground current; a relay detects when the current exceeds a predetermined level. An alarm alerts building personnel that a ground exists. The system has built-in fault tracing means to assist in finding the source of the ground. A 120 Vac supply (remote) is required for control power for the system.

Minimum Criteria for Use

The C-HRG MV is offered at the 5 kV class rating. It can be applied to delta or wye ungrounded three-wire distribution systems. Standard dimensions are 36.00 W x 40.00 D x 92.00 H inches (914.4 W x 1016.0 D x 2336.8 H mm).

Wye or Delta System

To add high resistance grounding to a wye-connected system, resistors are placed across the secondary of a grounding transformer whose primary is placed in series with the neutral-to-ground connection of the power source. To add high resistance grounding to an ungrounded delta-connected system, a neutral point must be created. Three single-phase transformers can be interconnected in a wye-broken delta configuration to provide such a neutral point.

Ground Fault Detection

When one phase becomes grounded, additional current above the charging level will flow. As all ground current must flow through the grounding resistor/grounding transformer assembly, an ammeter in this circuit will read the total amount of ground current. By placing a current-sensing relay in series with the ammeter, the current relay can be adjusted to pick up at a level in excess of the capacitive charging current, thus indicating the abnormal condition. Alternatively, an optional voltmeter relay can be connected across the grounding resistors, to accomplish the same function.

Pulser Circuit

The pulser circuit offers a convenient means to locate the faulted feeder and to trace the fault to its origin. The pulser is available any time a fault has been detected. The pulse intervals are controlled by an adjustable recycle timer. The "pulse" light flashes on and off, corresponding to the ON-OFF cycles of the pulser contactor. The pulser contactor switches a bank of resistors on and off, thus allowing a momentary increase in the ground current.

Ground Fault Location

The current pulses can be noted with a clamp-on ammeter when the ammeter is placed around the cables or the conduit feeding the fault. The operator tests each conduit or set of cables until the pulsing current is noted. By moving the ammeter along the conduit, or checking the conduit periodically along its length, the fault can be traced to its origin. The fault may be located at the point where the pulsing current drops off or stops. If little or no change in the pulsing current is noted along the entire length of a conduit, then the fault may be in the connected load.

Standard Features

- Current sensing ground fault detection (2–10A pickup/0.5–20 second delay)
- Ground current transformer (10/10 ratio)
- Control circuit pull fuseblock
- Ground current ammeter (0–10A, 1% accuracy)
- Indicating lights Red (ground fault), Green (normal), White (pulse)
- Adjustable pulsing timer (0–10 seconds)
- Tapped resistors (limits primary current to 3–6A)
- Three-position selector switch (normal, pulse, test)
- Control switch for manual or automatic reset
- Ground fault contacts (1NO/1NC)
- Shorting terminal block for ground current CT
- UL® label
- Wiremarkers

Sequence of Operations**Normal**

- Green "normal" light on
- Red "ground fault" light off
- White "pulse" light off
- System control switch in "normal" position
- Reset control switch in either "auto" or "manual"

Test

- Turn and hold the system control switch in the "test" position
- This mode will test the control circuitry only. It will bypass the sensing circuit and cause the green "normal" light to turn off and the red "ground fault" light to turn on. The pulser will be activated as well
- The white "pulse" light will turn on and off as the pulser contactor closes and opens. However, the ground current ammeter will not display the total ground current, including the incremental pulse current
- When ready, return the system control switch to "normal." The pulser will stop. If the reset control is in the "manual" position, turn it to "reset" to reset the fault sensing circuit
- The red "ground fault" light will turn off, and the green "normal" light will turn on
- Test mode is not available if the system is detecting a ground. The sensing circuit will disable the test circuit

Ground Fault

- When the sensing circuit detects a fault, the green "normal" light will turn off and the red "ground fault" light will turn on
- The ground current ammeter will indicate the total ground current
- To use the pulser, turn the system control switch to "pulse." The pulser contactor will cycle on and off as controlled by the recycle timer relay
- Use the clamp-on ammeter to locate the faulted feeder. Open the feeder and clear the fault
- If the reset control switch is in the "manual" position, turn it to "reset" to reset the sensing circuit

Note: If reset control is in "auto," it will reset itself.

- When ready to restore service to the load, close the feeder
- Return the system control to "normal"

Catalog Numbering System

Customer Required Information

A C-HRG High Resistance Grounding Assembly can be completely described by an 8-digit catalog number: MVRG-_____

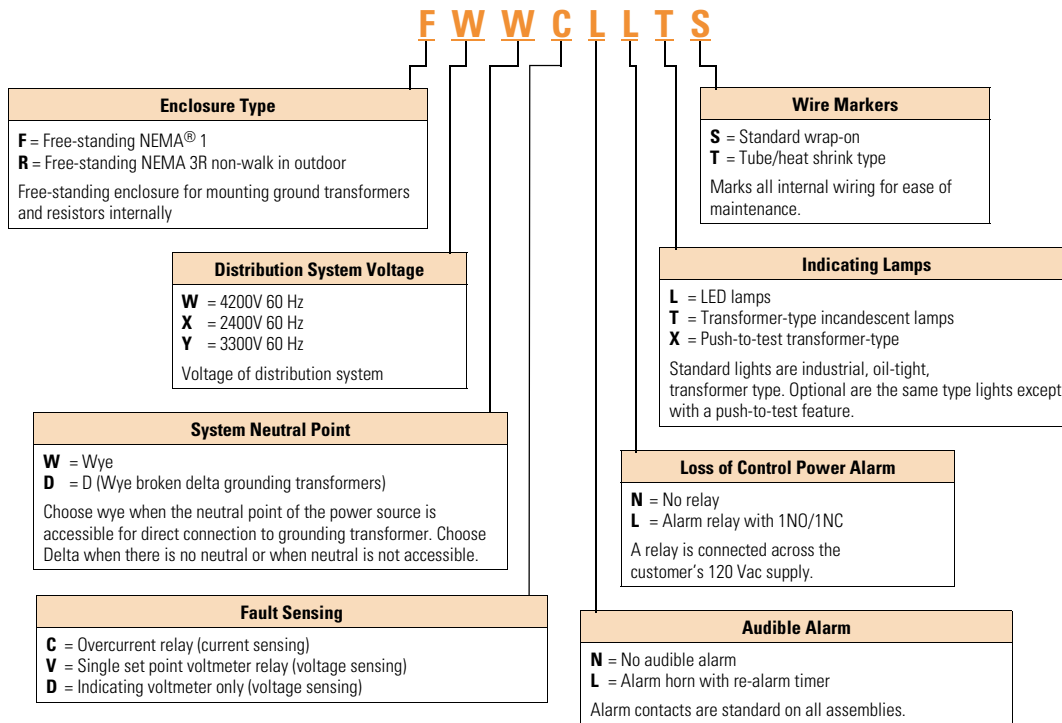

Example: MVRG-FWWCLLTS defines a free-standing Type 1 enclosure, 4200 V/60 Hz, Wye-connected system, current-sensing control scheme, alarm horn with re-alarm timer, alarm relay with 1NO and 1NC, transformer type incandescent lights, wrap-on wiremarkers.

DS Low Voltage Switchgear



DHP Medium Voltage Switchgear



17 Switchgear

Low Voltage Switchgear

Product Description, Product History, Product History Time Line	V12-T17-2
DB Assemblies and Power Circuit Breakers Product Description, Replacement Capabilities	V12-T17-3
DS Assemblies and Power Circuit Breakers Product Description, Replacement Capabilities	V12-T17-5
Technology Upgrades	V12-T17-5
DSII Assemblies and Power Circuit Breakers Product Description	V12-T17-6
Replacement Capabilities	V12-T17-7
Magnum DS Assemblies and Power Circuit Breakers Product Description, Replacement Capabilities	V12-T17-8

Systems Pow-R Breaker (SPB)

Product Description	V12-T17-14
Product History	V12-T17-14
Product History Time Line	V12-T17-15
Replacement Capabilities, Technology Upgrades	V12-T17-15
Product Support Services—Breaker Service Center	V12-T17-16
Further Information, Pricing Information	V12-T17-16

Trip Unit Retrofit Kits

Product Description, Product History	V12-T17-17
--	-------------------

Medium Voltage Switchgear

Product Description, Product History, Product History Time Line	V12-T17-53
DH—Product Description, Replacement Capabilities	V12-T17-55
DHP—Product Description, Replacement Capabilities	V12-T17-56
VCP—Product Description, Replacement Capabilities	V12-T17-57
VCP-W—Product Description, Replacement Capabilities	V12-T17-58
Technology Upgrades	V12-T17-59
Competitive Upgrades	V12-T17-60
SURE CLOSE	V12-T17-62
Further Information, Pricing Information	V12-T17-64

Medium Voltage Load Interrupter

Product Description, Product History, Product History Time Line	V12-T17-65
LBF	V12-T17-66
Replacement Capabilities—WLI/MVS/MVS2	V12-T17-67
Further Information, Pricing Information	V12-T17-70

Assemblies and Power Circuit Breakers



DS Switchgear



DSII Switchgear Assembly



Magnum DS Switchgear

Product Description

Cutler-Hammer® low voltage switchgear assemblies from Eaton’s electrical business are metal enclosures that typically contain power circuit breakers, control/measuring devices such as relays and meters, and the power bus work. The rated maximum voltage is 600V, for AC power systems. Low voltage switchgear is used to protect, control and monitor the electrical power system. Present design low voltage switchgear conforms to the following standards: ANSI C37.20.1, C37.51, UL® 1558, NEMA® SG3, NEMA SG5 and CSA®.

Perhaps the most unique benefit of switchgear is the power circuit breakers within—they have a “withstand rating” and more flexible trip units, all which provide better coordination of downstream

circuit breakers. It is also common to find this switchgear coupled to a power distribution transformer, making the entire assembly called a secondary unit substation.

Product History

It is very uncommon to find any more installed-base of the Westinghouse® DA or DK vintage switchgear—both vintages preceded the Westinghouse DB switchgear design dated 1950.

It is very common to find DB switchgear with hundreds of thousands of DB circuit breakers still in operation.

In 1967, Westinghouse introduced DS switchgear along with the DS and DSL circuit breakers. The first DS breakers used the original solid-state trip unit called the Amptector®. The Amptector was later replaced by the microprocessor-based, true rms sensing, Digitrip™ trip unit models 500, 600, 700 and 800.

In 1994, the DS breaker became available in the new DSII switchgear assembly. DSII switchgear is designed to be much easier to install and to maintain. It also uses new “U” shape vertical bus design. Perhaps the most noticeable external difference

is the removable control circuit terminal block tray, which is charcoal-gray and located above each breaker door. Upon its arrival in 1996, the DSII breaker became the standard offering in DSII switchgear assemblies. The DSII breaker was the first breaker to use the newer family of Digitrip trip unit models 510, 610, 810, 910, OPTIM™ 750 and 1050. DSII breakers also provide genuine standardization of breaker wiring, particularly the secondary contact points, without reducing features and options.

In 1998, the Magnum™ DS switchgear along with the new Magnum DS breaker was introduced. One major advantage of the Magnum DS design is higher ratings in less space. Perhaps the most visible difference with Magnum is the “through-the-door” design, permitting visibility of the breaker’s trip unit without opening the door. Another new feature of the Magnum design is the secondary contact block location at the top-front of each cell, rather than in the rear as with previous designs. Magnum DS switchgear assemblies also have an isolated secondary control wireway, uniquely located at the side of each structure.

Product History Time Line

Page	Product	1950	1955	1960	1965	1970	1975	1980	1985	1990	1995	2000	Present
V12-T17-3	DB Switchgear—East Pittsburgh	[Timeline bar from 1950 to 1980]											
V12-T17-4	DS Switchgear—East Pittsburgh (Vintage 1)					[Timeline bar from 1970 to 1975]							
V12-T17-4	DS Switchgear—East Pittsburgh (Vintage 2)						[Timeline bar from 1975 to 1980]						
V12-T17-4	WPA Switchgear—St. Louis							[Timeline bar from 1975 to 1985]					
V12-T17-4	DS Switchgear—St. Louis (Vintage 3)								[Timeline bar from 1985 to 1990]				
V12-T17-4	DS Switchgear—St. Louis (Vintage 4)									[Timeline bar from 1990 to 1995]			
V12-T17-4	DS Switchgear—Asheville (Vintage 5)										[Timeline bar from 1995 to 2000]		
V12-T17-6	DSII Switchgear with DS Breaker—Asheville											[Timeline bar from 2000 to Present]	
V12-T17-6	DSII Switchgear with DSII Breaker—Asheville											[Timeline bar from 2000 to Present]	
V12-T17-8	Magnum DS Switchgear											[Timeline bar from 2000 to Present]	

DB Assemblies and Power Circuit Breakers



DB Switchgear with DB Air Circuit Breakers

Product Description

DB switchgear should be found only with the Westinghouse logo and nameplates. The last assembly shipped about 15 years before the acquisition by Eaton.

Many breakers were originally shipped with electromechanical trip units, but it is common to find many of them retrofitted with Amptector or Digitrip trip units.

One characteristic of this switchgear is the viewable, through-the-door breaker handle, which could be operated without opening the door.

DB assemblies were offered with either “Fixed-Mounted” breakers or “Drawout (three-position) type. Fixed breakers have no test position.

The breakers in this switchgear design include:

- DB15, DB25, DB50, DB75, DB100 (standard)
- DBL15, DBL25, DBL50 (current limiting)

Special application breakers include:

- DBF6, DBF16, DBF40 (DC field discharge)
- DBW15, DBW25, DBW50 (resistance welding)

The DB switchgear structures were approximately 90 3/8-inch high construction with a universal frame that accommodated breaker compartment widths of 18.00, 26.00, 30.00 and 36.00 inches. All main bus joints and tap connections are silver plated and tightly clamped with through-bolts to ensure maximum conductivity. The outdoor switchgear was a walk-in type with rear hinged doors for easy access to connections.

Ratings

- DB switchgear bus 800–4000A
- DB breaker 15–4000A
- Voltage 208–600V
- Interrupting capacity 15–150 kA

Chronology

This switchgear was manufactured in East Pittsburgh, PA, from 1950 to 1980.

Replacement Capabilities

DB-AR Replacement Breakers



DB25-AR600NM—Front View

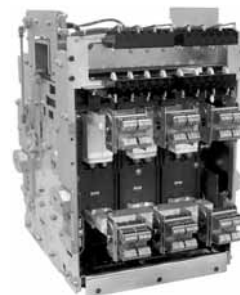

DB25-AR600NM—Rear View

The DB-AR breakers are brand new air replacements (AR-Series) designed to replace the original DB breaker. This solution is available for most three-position drawout DB breakers within original Westinghouse switchgear. The new AR-Series breaker permits DB switchgear modernization by using state-of-the-art Eaton Magnum breaker technology. The DB-AR is designed, manufactured and tested to applicable IEEE/ANSI standards.

Class 1 Reconditioning

Reconditioning Service is available for most frame sizes of the DB breaker. Class 1 Reconditioning is Eaton’s process of maintaining low voltage power breakers to their fullest capability. We disassemble each breaker, clean and test each part using component-specific methods, then reassemble and perform final testing to ensure that each breaker is restored to operating condition—all using the original manufacturer’s instructions and parts. New trip units can also be retrofitted during this process.

DB Breaker Parts

DB breaker replacement parts are available built from the original drawings and design specifications. Among the items stocked are asbestos-free arc chutes, complete pole units, contacts, primary disconnects and coils.

DB Air Circuit Breakers

New factory manufactured breakers are available in three-position drawout configurations only for the DB15, DBF6 and DBF16. Fix-mounted and single-position configuration breakers are available for the DB15, DB25, DBL25, DB50 or DBL50.

Technology Upgrades

Digitrip Trip Unit Retrofit Kits

Available for all DB breaker frame sizes. Please see the switchgear trip unit retrofit kits on **V12-T17-17** through **V12-T17-51** for more detail.

DB-VSR (Vacuum Starter Retrofits)

For FVNR, motor-starting applications ONLY—this solution significantly lengthens the life-span of the “motor starter” and provides better motor overload protection. The DB25-LV-VSR contains the V201 vacuum contactor and the C440 motor overload relay.



DB25-LV-VSR

DS Switchgear Assemblies General Information

Description	Ratings	Chronology
DS Switchgear Vintage I and II, 1969–1984 at East Pittsburgh, PA		
<p>The first vintage of DS switchgear was the first switchgear that incorporated the DS breaker with a solid-state trip unit (Amptector). During this time, the DS532 breaker was used. The DS532 breaker was a 3000A frame breaker with an interrupting rating of 50,000 symmetrical amperes. The structures themselves were of a stepped roof design that incorporated a standard bolted copper or flash welded aluminum bus design. Other characteristics of this switchgear include the following: rear frame height was 87.50 inches, flat roof sheets, ventilated front doors, wire ducts, removable instrument modules and a welded frame design. The breaker compartments were also different with fuse trucks stacked above the mains, the DS840, DS532 and the newly developed DS632. The outdoor design incorporated the use of a walk-in type side door entry.</p> <p>The second vintage of switchgear was a new design that incorporated the use of both bolted copper and welded extruded aluminum rise bus. It is basically the same as the first vintage but with a revised bus design.</p>	800–4000A 208/600V	The first vintage was built from September of 1969 to approximately September of 1973 in East Pittsburgh, PA, using the shop order numbers with a prefix of 24Y. The second DS vintage was also built in East Pittsburgh, which used the 27Y prefix on shop orders. This vintage was built the same time as the WPA design in St. Louis, MO. The switchgear in East Pittsburgh was designed to be used for industrial applications, whereas the St. Louis design was built for commercial applications.
WPA Switchgear, 1973–1984 at St. Louis, MO		
<p>The WPA switchgear was designed for commercial applications that also used DS breakers, which was similar to the East Pittsburgh design for industrial applications. The two designs differed structurally but used the same breakers. Some characteristics of the WPA design are as follows: riser bus was tapered design, frames were bolted and not welded, height of 9.00 inches, neutral bus mounted on rear frame, did not use removable instrument compartments and outdoor design had front and rear doors. In all, the WPA design differed extensively compared to the East Pittsburgh design.</p>	800–4000A 208/600V	This vintage was built from February of 1973 to approximately October of 1984 in St. Louis. Usually the switchgear is identified by General Order and Item numbers. Shop order numbers were not used.
DS Switchgear Vintage III, 1984 at St. Louis, MO		
<p>The third generation of DS switchgear was introduced due to the change of plant locations. It is classified as a vintage because it was the beginning of the merge between two plants (St. Louis and East Pittsburgh). The engineering was completed in East Pittsburgh and the assembly was built in St. Louis, along with the Cincinnati, OH, plant to help pick up the slack until full production in St. Louis. This vintage was similar to the previous 27Y style with a few modifications. It was the first time that both DS and DSL were used in switchgear by the use of a conjunction box. The physical appearance also changed by increasing the height to 92.00 inches and adding top hat vents that protruded 4.00 inches above the switchgear. Internally the neutral bus was located in the bus compartment along with unified breaker compartments for the variety of breakers.</p>	800–4000A 208/600V	This vintage lasted from May of 1984 to approximately October of 1984 in East Pittsburgh. Usually the switchgear shop order number is defined by a prefix of 28Y.
DS Switchgear Vintage IV, 1984–1990 at St. Louis, MO		
<p>This vintage of switchgear was a combination of the St. Louis WPA and East Pittsburgh design. The design was classified as a hybrid between the two that consisted of the East Pittsburgh design in the front compartments that held the DS breaker, and the St. Louis design in the rear compartment that housed the bus. The rear compartment still used the tapered riser bus (a characteristic of the St. Louis design), which was used right up until the DS switchgear moved to Asheville, NC. The design was very similar to the design today except for the different riser bus along with the height being 92.00 inches.</p>	800–4000A 208/600V	This vintage was built from October of 1984 to approximately May of 1990 in St. Louis. Usually the switchgear is identified by general order and item numbers. 28Y shop order numbers started in 1987 and continued into the Asheville design.
DS Switchgear Vintage V, 1990–1996 at Asheville, NC		
<p>The vintage was built from May of 1990 to the end of 1996 in Asheville. The switchgear is identified by shop order number 28Y. The switchgear incorporates both designs with the option for the variety of IQ products. The riser bus went back to a full rated type that is bolted copper only. Aluminum bus work was initially done only on special orders at customer request. The switchgear also has many improvements such as the design of an instrument panel door that was able to accommodate three device panels across DS632 in the C and D compartments and a variety of communication capabilities with IMPACC. The outdoor design changed with the concept of a side walk-in enclosure.</p>	800–4000A 208/600V	This vintage was built from May of 1990 to the end of 1996 in Asheville. The switchgear is identified by shop order number 28Y.

DS Assemblies and Power Circuit Breakers



*DS Switchgear Assembly
Typical Design, 1991*

Product Description

DS switchgear was introduced in 1969 and would be found mostly with the Westinghouse logo and nameplates. However, some assemblies shipped after the 1994 acquisition by Eaton could likely have product labels with both Westinghouse and Cutler-Hammer product names.

DS switchgear uses the drawout version of the DS and DSL low voltage power breakers. Each breaker is located within an individual compartment. Each compartment has extension rails for supporting the breaker while removing it from the compartment. The breaker can be in either of the following positions with the door closed:

- Connect
- Test
- Disconnect
- Remove

The original DS breaker contained the original solid-state trip unit—Amptector. The Amptector was later replaced by the original family of microprocessor-based, true rms sensing, Digitrip trip unit models 500, 600, 700 and 800. In the late 1990s, DS breakers started shipping with Digitrip models 510, 610, 810 or 910.

The breakers in this design included:

- DS206, 206H, 206E, 416, 416H, 416C, 420, 532, 632 or 840
- DSL206, 416, 420, 632 or 840

DS metal-enclosed switchgear was designed to meet the following standards:

- ANSI C37.20.1
- UL 1558
- NEMA SG5

DS low voltage power air circuit breakers (LVPACB) were designed to meet the following standards:

- ANSI C37.13, C37.16, C37.50 and C37.51
- UL 1066
- NEMA SG3

Chronology

There are five vintages of DS switchgear. Please see General Information on **Page V12-T17-4** for more detail.

Replacement Capabilities



DS206H—Front



DS206H—Rear



DS Cell Provisions

New DS Air Circuit Breakers

New DS circuit breakers are available for replacement or to fill existing vacant cells. All breakers are newly manufactured and are mechanically and electrically the same as the breakers as originally specified and supplied.

DS Circuit Breaker Cell Provisions

Breaker provisions are required in switchgear when there is an existing space in a structure that is to be filled with a breaker. Provisions are available for all ratings and include all parts required to complete the cell in accordance with the switchgear as originally supplied in vintages IV and V only.

DS Breaker Parts

An extensive inventory of newly manufactured renewal parts for DS and DSL power circuit breakers are available.

DS Switchgear Structure Parts

DS switchgear parts are available for most DS designs. Newly manufactured replacement parts (such as doors, breaker provisions, lift trucks, metering, etc.) are available.

Class 1 Reconditioning

Reconditioning Service is available for the entire family of DS breakers. Class 1 Reconditioning is Eaton's process of maintaining low voltage power breakers to their fullest capability. We disassemble each breaker, clean and test each part using component-specific methods, then reassemble and perform final testing to ensure that each breaker is restored to operating condition—all using the original manufacturer's instructions and parts. New trip units can also be retrofitted during this process.

Technology Upgrades

IQ and PowerNet™ Communications

Digital IQ-type products can be used to upgrade existing analog devices such as meters. The new IQ-type products can be furnished as loose, individual components for field retrofitting or can be furnished on new replacement doors, such as in the photo to the left. The new instrument compartment door will fit all vintages of DS assemblies from 1968 to the present. Please see IQ products **Tab 10** for further details on the latest offerings.

Digitrip Trip Unit Retrofit Kits

Retrofit kits are available for all DS breaker frame sizes. Please see the switchgear trip unit retrofit kits on **Pages V12-T17-17–V12-T17-51** for more detail.

DSII Assemblies and Power Circuit Breakers



DSII Switchgear Assembly

Product Description

The DSII low voltage switchgear design was first introduced in 1994 but was originally available with only the DS or DSL breakers. Upon its arrival in 1996, the DSII breaker became the standard offering in DSII switchgear assemblies.

The DSII switchgear design uses only the drawout version of the power breakers. Each breaker is located within an individual compartment. Each compartment has extension rails for supporting the breaker while removing it from the compartment. The breaker can be in either of the following positions with the door closed:

- Connect
- Test
- Disconnect
- Remove

The DSII switchgear is basically designed for easier installation and maintenance. Control circuit terminal blocks are mounted in a completely removable tray located at the front of the assembly above each circuit breaker—helping customers perform routine inspection of control wires. This tray is charcoal-gray and is perhaps the most noticeable external difference between the DSII and the DS designs.

The DSII breaker is very similar to the DS. In fact, the DSII breaker uses most of the same internal components—renewal parts can often be shared. The DSII breaker was the first to include the newer family of Digitrip RMS trip units: model 510, 610, 810, 910, and OPTIM 750 or 1050. Unlike the DS breaker, however, the DSII breaker provides genuine standardization of breaker wiring, including secondary contact points—without reducing features and options. This is achieved with a larger secondary contact block. The DSII breaker has up to four 12-point, white secondary contact blocks whereas the DS breaker, has up to four 8-point, black secondary contact blocks. DSII breakers therefore cannot be installed into a DS breaker cell.

DSII metal-enclosed switchgear was designed to meet the following standards:

- ANSI C37.20.1
- UL 1558
- NEMA SG5

DSII low voltage power air circuit breakers (LVPACB) were designed to meet the following standards:

- ANSI C37.13, C37.16, C37.50 and C37.51
- UL 1066
- NEMA SG3
- CSA

Ratings of DSII Switchgear

- 2000–5000A vertical and cross bus
- 6000A cross bus option
- 600V maximum
- 100,000A bus bracing standard
- 200,000A bus bracing optional

DSII Switchgear Assemblies Dated 1994–Present with Shop Order Numbers Ranging from 82Y1000 to 82Y3000

- Built from April of 1994 to the present, these assemblies contain the following DS breakers:
 - DS-206, DS-206H, DS-206E, DS-416, DS-416H, DS-420, DS-632 or DS-840
 - DSL-206, DSL-416, DSL-420, DSL-632 (with fuse truck) or DSL-840 (with fuse truck)
 - DSII switchgear assemblies dated 1996–present with shop order numbers 82Y3001 and larger

DSII Switchgear Assemblies Dated 1994–Present with Shop Order Numbers 82Y3001 and Larger

- Built from April of 1996 to the present, these assemblies contain the following DSII breakers:
 - DSII-308, DSII-508, DSII-608, DSII-516, DSII-616, DSII-620, DSII-632, DSII-840 or DSII-850
 - DSLII-308, DSLII-516, DSLII-620, DSLII-632 (with fuse truck) or DSLII-840 (with fuse truck)

DSII Low Voltage Assemblies and Power Circuit Breakers

Replacement Capabilities*DSII308—Front**DSII308—Rear**DSII Cell Provisions***New DSII Air Circuit Breakers**

New DSII circuit breakers are available for replacement or to fill existing vacant cells. All breakers are newly manufactured and are mechanically and electrically the same as the breakers originally specified and supplied.

DSII Circuit Breaker Provisions

Breaker provisions are required in switchgear when there is an existing space in a structure that is to be filled with a breaker. Provisions are available for all ratings and include all parts required to complete the cell in accordance with the switchgear as originally supplied.

Class 1 Reconditioning

Reconditioning service is available for the entire family of DSII breakers. Class 1 Reconditioning is Eaton's process of maintaining low voltage power breakers to their fullest capability. We disassemble each breaker, clean and test each part using component-specific methods, then reassemble and perform final testing to ensure that each breaker is restored to operating condition—all using the original manufacturer's instructions and parts. New trip units can also be retrofitted during this process.

Please see **Page V12-T17-9** for breaker accessories.

DSII Breaker Parts

An extensive inventory of newly manufactured renewal parts for DSII and DSLII circuit breakers are available.

DSII Switchgear Structure Parts

DSII switchgear parts are available for most DS designs. Newly manufactured replacement parts (such as doors, breaker provisions, lift trucks, metering, etc.) are available.

Technology Upgrades*DSII-VSR—Front***DSII-VSR (Vacuum Starter Replacement)**

For FVNR, motor-starting applications ONLY—this solution might be available to significantly lengthen the life-span of the "motor starter" as well as to provide better motor overload protection. The DSII-VSR is manufactured as a new assembly and is designed to rack into the same switchgear cells that a DSII breaker is removed from. It will physically fit into any of the "quarter-high" cells ranging from the DSII-308 to the DSII-620. However, the maximum FLA rating is currently 425A. The current design DS-VSR contains the V201 vacuum contactor and appropriate overload protection.

Digitrip Trip Unit Retrofit Kits

Retrofit kits are available for all DSII breaker frame sizes. Please see the switchgear trip unit retrofit kits on **Pages V12-T17-17–V12-T17-51** for more detail.

Magnum DS Assemblies and Power Circuit Breakers



Magnum DS Switchgear

Product Description

Cutler-Hammer Magnum DS switchgear started shipping in 1998. Perhaps the most distinctive feature when compared to the original DS vintage is the “through-the-door” design.

The following functions may be performed without opening the circuit breaker door: levering the breaker between positions; operating manual charging system, including viewing of the spring charge status flag; closing and opening the breaker; viewing/adjusting the trip unit and reading the breaker rating nameplate.

The breakers are four-position drawout design—connected, test, disconnected or removed.

The breakers can also be equipped with ARMs technologies, which will reduce arc flash energy available at downstream devices during maintenance periods.

A unique vertical and cross bus configuration provides an optional industry-leading short-circuit withstand rating of 200,000A without the need for upstream current-limiting fuses.

Vertical and cross bus ratings are based on a UL and ANSI standard temperature rise of 65°C above a maximum ambient air temperature of 40°C.

Magnum DS switchgear and breakers conform to the following standards:

- ANSI C37.20.1, C37.51
- UL 1558, UL 1066
- NEMA SG5, SG3
- CSA

The assemblies have undergone an extensive seismic qualification program. The test program used ANSI standard C37.81, the Uniform Building Code (UBC®) and the California Building Code (CBC) as a basis for the test program. The assemblies have been tested and qualified to exceed these requirements.

Magnum DS Switchgear Ratings

- Cross bus ampacity
 - 2000, 3200, 4000, 5000, 6000
- Vertical bus ampacity
 - 2000, 3200, 4000, 5000
- Bus bracing
 - 100, 150 or 200 kA

Magnum DS Without Current Limiters

Maximum Amperes	Breaker Designation	Interrupting Rating (kA)	Short-Time Rating (kA)
800	MDS-408	42	42
800	MDS-608	65	65
800	MDS-808	85	85
800	MDS-C08	100	85
1600	MDS-616	65	65
1600	MDS-816	85	85
1600	MDS-C16	100	85
2000	MDS-620	65	65
2000	MDS-820	85	85
2000	MDS-C20	100	85
3200	MDS-632	65	65
3200	MDS-832	85	85
3200	MDS-C32	100	85
4000	MDS-840	85 ①	85
4000	MDS-C40	100 ①	100
5000	MDS-850	85 ①	85
5000	MDS-C50	100 ①	100

Replacement Capabilities



800–3200A Drawout Breaker

New Magnum DS Breakers

New breakers are readily available for all frame sizes and interruption ratings.

Renewal Parts and Accessories

New breaker parts and accessories are readily available for all frame sizes and interruption ratings.

Cell Provisions and Upgrades

Switchgear cell provisions are required when an existing structure blank space needs to be filled with a new Magnum DS circuit breaker. Cell upgrades are required when the provision already exists, but the need to upgrade ampacity and/or interrupting rating is necessary. Sometimes, new riser bus must also be installed with this offering.

Class 1 Reconditioning

Reconditioning service is available for the entire family of Magnum DS breakers. Class 1 reconditioning is Eaton’s process of maintaining low voltage power breakers to their fullest capability. We disassemble each breaker, clean and test each part using component-specific methods, then reassemble and perform final testing to ensure that each breaker is restored to operating condition—all using the original manufacturer’s instructions and parts.

Note

① Interrupting rating is 130 kA at 240V.



Breaker Cell

Magnum DS Low Voltage Assemblies and Power Circuit Breakers

Breaker Accessories

Breaker Test Kits

Test Kit Unit



Test Kit

This test kit can be used for testing DS, DSII and Magnum breakers that are equipped with either Amptector or Digitrip RMS trip units. Test kit2 includes test unit and adapter.

Note: Each kit contains the 140D481G03 basic tester (Amptector-Ready) and the adapter for the selected breaker Digitrip style.

Test Kit

Description	Catalog Number
DS/DSII Digitrip test kit	8779C02G02
Magnum Digitrip test kit	8779C02G05

Adapters



Adapter

In May of 1993, the test port changed on DS circuit breakers that have Digitrip RMS trip units. The test port was moved from the front cover to the left-hand side, as you face the front of the breaker. The port was also changed from an 11-pin banana plug to a 9-pin plug. The adapter is for using a 140D481(G02R), (G02RR) or (G03) tester to test DS breakers with Digitrip that have the side-mounted, 9-pin plug. The adapter converts the banana plugs on the tester to a 9-pin plug. DO NOT use the adapter with the old 140D481G01 or 140D481G02 tester.

On Magnum breakers, the test port is located on the front cover of the trip unit. The port is a 14-pin plug; the adapter converts the banana plugs on the tester to a 14-pin plug.

Adapters

Description	Catalog Number
DS/DSII	8779C02G03
Magnum	8779C02G05

Breaker Test Cabinet



Breaker Test Cabinet

Test cabinet for electrically operated breakers, with pushbuttons, control cable and receptacle, for separate mounting.

Breaker Test Cabinet

Description	Catalog Number
DS	
120 Vac/125 Vdc	6500C57G01
240 Vac/125 Vdc	6500C57G02
DSII	
120 Vac/125 Vdc	6500C57G03
240 Vac/125 Vdc	6500C57G04
Magnum	
120 Vac/125 Vdc	9253C25G01
240 Vac/125 Vdc	9253C25G02
120 Vac capacitor trip	9253C25G03
Test breaker plug	9253C25G04

Background Information on Trip Unit Test Kits

Description	Catalog Number
Obsolete test unit, only for use with Amptector	140D481G01
Obsolete test unit, only for use with Amptector	140D481G02
Same as 140D481G02, except retrofitted to test both Amptector and Digitrip	140D481G02R
Same as 140D481G02, except retrofitted to test both Amptector and Digitrip	140D481G02RR
Obsolete Test Kit Adapter, superseded by 8779C02G03	8779C02G01
Wire harness with female banana plugs for temporary connection direct from tester to the auxiliary CT module on the retrofitted breaker ①	6503C53G01
Adapter harness for converting banana from the tester to a 12-pin plug for retrofitted breakers equipped with a 6503C55G01 ①	6503C54G01
New adapter for converting 12-pin plug on 6503C55G01 into 9-pin plug for connecting to the test unit adapter style # 8779C02G03 ①	6503C54G02
Wire harness with 12-pin plug for permanent connection to auxiliary CT module on the retrofitted breaker; plug connects to 6503C54G01 or 6503C54G02 ①	6503C55G01
Current auxiliary power module for supplying power to Digitrip trip unit during test procedures; also identical to catalog number PRTAAPM ①	1267C16G01

Note

① These parts are used with any breaker that was upgraded with "Digitrip Retrofit Kits."

Procedure for Identifying Renewal Parts

For all switchgear requests, include information from the list below to ensure that parts and breakers supplied will consist of correct options and settings. With the variety of switchgear vintages, the information is needed to supply the correct parts. There might be modifications needed to the breaker cell or to the bus work to accommodate the breaker that will only be recognized by the drawings.

For all requests include the following:

- Shop order number
- Front view drawing number
- General order number (GO#)
- Manufacturing date
- Item number
- Metering required
- Optional relays
- CTs
- What changes have been made since equipment was originally installed in the field?

Requests requiring additional or replacement breakers also require the following information:

- Breaker type
- Trip rating
- MO or EO
- Trip unit
- Three-wire or four-wire
- Trip settings (LSIG)
- Fixed or drawout
- Which compartment
- Any new options

Further Information

Publication Number	Description
DB Breakers	
RPD 32-254	Renewal Parts Data for DB, DBL, DBF breakers
SA-11745	Sales Aid for custom fluidized switchgear bus
DS Breakers	
RP.22B.01.T.E	Renewal Parts Data for DS breakers
PL.22G.01.P.E	Price List for DS breakers and accessories, discount symbol DS-1
DSII Breakers	
RP.22B.02.T.E	Renewal Parts Data for DSII breakers
IB 694C694-02	Instruction, operation and maintenance for DSII/DSLII breakers
IL 32-691C	Instructions for DS-DSII (trip units 500-910) tester
PL.22B.01.P.E	Price List for DSII breakers and accessories
DS/DSII Switchgear Assemblies	
RP.44B.01.T.E	Renewal Parts Data for DS/DSII switchgear accessories
DSII Switchgear and Breaker	
SA-32-610A	Sales Aid for DSII low voltage switchgear
AD 32-650A	Application Data for DSII switchgear
DS Switchgear	
IB 32-690F	Instructions for DS metal-enclosed LV switchgear
DS and DSL Breakers	
IB 33-790-1I	Instruction, operation and maintenance for DS/DSL breakers
DSII Switchgear	
TD.44B.01A.T.E	Technical Data for DSII metal-enclosed LV switchgear
DSII Switchgear with DS Breakers	
IB 32-695C	Instructions for DSII switchgear containing DS breakers
DSII Switchgear with DSII Breakers	
IB 32-694B	Instructions for DSII switchgear containing DSII breakers
Magnum DS Switchgear	
PA.44A.01.S.E	Product Aid (1pg.) for Magnum DS switchgear
TD.44A.01B.T.E	Technical Data for Magnum DS metal-enclosed LV switchgear
IB 32-697A	Instructions for Magnum DS metal-enclosed LV switchgear
RP01901001E	Magnum DS switchgear common replacement parts and accessories
Magnum DS Switchgear and Breakers	
B.44A.01.S.E	Brochure (20 pg.) for Magnum DS switchgear and breakers
Magnum DS Breakers	
RP.22F.02.T.E	Renewal parts and accessories catalog for Magnum DS breakers
IB 2C12060H03	Instructions, operation and maintenance for Magnum DS breakers
B.22F.01.S.U	Brochure (16 pg.) for Magnum DS breakers
PL.22F.01A.P.E	Price List for Magnum DS breakers
IB.44A.05.T.E	Instructions for Magnum DS (trip units 520-1150) tester
IL 32-696A	Instructions for Magnum DS breaker test cabinet

Low Voltage Competitive Upgrades—AR-Series Replacement Breakers

**Competitive Upgrades—
Low Voltage Power
Air Breakers**

**AR-Series
Replacement Breakers**

The AR-Series (air-replacement) breakers are not retrofits. They are 100% new breakers used to completely replace the original drawout type power air circuit breaker. This solution uses state-of-the-art Cutler-Hammer Magnum breaker technology that provides maximum life-extension and switchgear modernization. The offering includes a new breaker, a cassette with extension rails and a standard door. No modifications are required to the original line/load power stabs or the secondary disconnect contacts.

This solution can eliminate safety problems caused by defective racking and/or operator mechanisms. Additional safety against arc flash incidents can be obtained by equipping the breaker with ARMs Technologies, thereby reducing the arc flash energy available at downstream devices during maintenance periods. Additional switchgear maintenance problems such as parts unavailability and lengthy maintenance procedures can be eliminated. This solution often provides a substantial total installed cost savings when compared to completely replacing the switchgear assembly.

In many instances, the AR-Series replacement breaker can be combined with engineering services to provide continuous current and/or interruption rating upgrades.

The AR-Series breakers are designed, manufactured and tested to modern IEEE/ANSI standards.

Designs are available for a wide variety of drawout type low voltage power air circuit breakers (LVPACB) originally manufactured by Westinghouse, Federal Pacific Electric, Allis-Chalmers, ITE and General Electric.

Pictured on this page are several examples of available designs. Contact your local Eaton sales representative for information on other breaker types.

Westinghouse



Original DB-25 *DB25-AR600NM*



Original DB-50 *DB50-AR1600M*

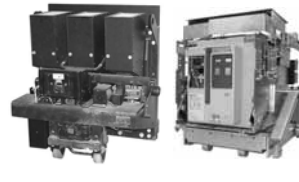

Original DB-75 *DB75-AR3000M*

Allis-Chalmers



Original LA-600 *LA600-AR600NM*

ITE



Original K-600 *K-600-AR600NM*

Federal Pacific Electric



Original FP-25 *FP25-AR600NM*



Original FP-50 *FP50-AR1600M*



Original FP-75 *FP75-AR3000M*

General Electric



Original AK-2A-50 *AK2A50-AR1600M*



Original AKR-4A-30 *AKR4A30-AR800NM*

Low Voltage Breaker Drawout Vacuum Starter Replacement



DB-25-LV-VSR Shown

Product Description

Eaton's low voltage VSR is a self-contained vacuum starter replacement for a low voltage drawout air circuit breaker used for motor starting applications.

In some cases, low voltage air circuit breakers are used for motor starting applications. Air circuit breakers are not designed to withstand the frequent switching service and the mechanical stresses associated with repetitive motor starting duty. This is due to the breaker mechanism that must be designed to close and latch against a fault. In order to meet these requirements, the mechanism must close at high speeds with a great deal of force. Frequent closing operations stress and deteriorate the breaker mechanisms.

Eaton's LV-VSR is a self-contained replacement vacuum starter for a low voltage drawout air circuit breaker. The LV-VSR is interchangeable with the drawout breaker element and requires no cell modifications.

Features

Advantages

The use of an LV-VSR vacuum starter can prolong device life and significantly reduce maintenance repair and downtime.

A low voltage air circuit breaker has an effective life of 4000 operations while an LV-VSR vacuum starter has an effective life of 1,000,000 operations. For example, a motor starting application that required two starts per hour on continuous duty would require a major rebuild of the low voltage breaker within three months. The expected life of an LV-VSR vacuum starter would be over 50 years.

The LV-VSR vacuum starter uses state-of-the-art Eaton vacuum interrupters. The interrupters employ the latest vacuum technology with long life, resistance to environmental contaminants and positive contact wear indicators.

The integral, solid-state, trip units used on the air circuit breakers are designed primarily for cable and transformer protection. Motors require more precisely set overcurrent devices that prevent motor damage as well as avoiding nuisance tripping. A solid-state relay, Eaton Type C440, provides overload protection and phase unbalance protection. This relay was exclusively designed for motor protection.

Motor Starter

The LV-VSR consists of an Eaton V201 vacuum contactor, Class J current limiting fuses, multi-function motor protective relay, three current transformers and an integral control power transformer.

Vacuum Contactor

Eaton's V201 vacuum contactor is designed for starting and controlling three-phase, 50/60 Hz AC motors. Current interruption is contained within the vacuum bottles and no arc byproducts are vented to the outside environment. Contact condition is given by wear indicators.

Series Current Limiting Fuses

Class J current limiting fuses provide short-circuit protection and allow a combination rating of 100 kA at 480 or 600V.

C440 Electronic Overload Relay

Eaton's C440 multi-function electronic, motor protection relay provides the following features:

- Overload protection, Class 10A, 10, 20 or 30
- Phase unbalance protection, selectable (ON/OFF)
- Ground fault selectable (ON/OFF)
- Remote reset
- Alarm relay output contact
- LED status indication
- Communication modules available

VSR Designs

- Westinghouse DB and DS
- GE
- ITE
- and others

Contact EESS at 877-276-9379 for more details.

Life

Exceptional electrical and mechanical life is offered by the V201 contactor—up to 1,000,000 electrical operations and 2,500,000 mechanical operations, even under harsh conditions.

Drawout Capability

The LV-VSR is mounted on a drawout frame and maintains the safety interlocking system of the low voltage switchgear.

Ease of Installation

The LV-VSR may be inserted into a standard breaker compartment without modification to the compartment. The primary and secondary contact structures and drawout mechanism are identical. The LV-VSR control scheme will interface with standard switchgear wiring with no cell modifications and remote control schemes, if existing, are maintained.

Low Voltage Breaker Drawout Vacuum Starter Replacement

Safety Features

The LV-VSR vacuum starter retains all the safety features of the low voltage switchgear including:

- Racking the LV-VSR vacuum starter is prevented while the contactor is in the closed position. Closing the LV-VSR vacuum starter is prevented while racking
- Breaker position indication is provided (connected, test, disconnect, remove)
- The LV-VSR vacuum starter is padlockable (optional) in either the connect, test or disconnect positions
- Positive ground connection is maintained
- Closed door tripping
- Closed-door control, if existing, can be maintained

LV-VSR Control Features

LV-VSR vacuum starter offers the following standard control features. Other devices can be supplied on request.

- Start–stop pushbuttons
- Eaton C440 electronic overload relay
- Provision for remote control operation
- Custom-designed wiring schemes

Ease of Maintenance

The LV-VSR control components are front-mounted for easy access.

The LV-VSR uses the same line and load finger clusters, secondary contact assemblies and drawout mechanism as the original circuit breaker. Renewal parts are readily available.

Technical Data and Specifications**Ratings**

The LV-VSR vacuum starter is rated as follows:

- Maximum continuous current—425A
- Maximum voltage rating—600V
- Short-circuit rating at 240–600V, 200 kA
- Maximum motor hp at 550/575V, 400 hp
- Maximum motor hp at 440/460V, 300 hp
- Maximum motor hp at 220/230V, 150 hp

Systems Pow-R Breaker (SPB)

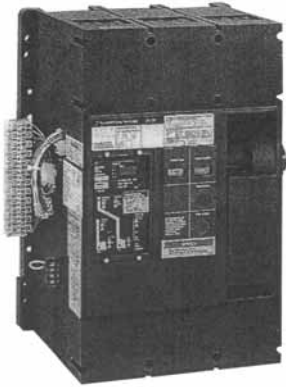

SPB-100 Series—3000A

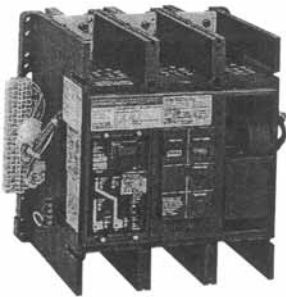

SPB-65 Series—1600A

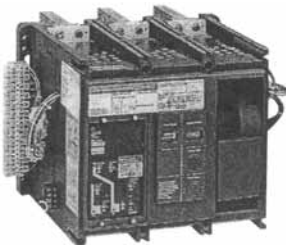

SPB-50 Series—800A

Product Description

The Cutler-Hammer Systems Pow-R Breaker is an encased power breaker designed to provide benefits of special interest to distribution systems designers.

Systems Pow-R Breakers can be applied as individual breakers in separate enclosures or in switchboards as mains, ties or feeder breakers. They can be applied in low voltage distribution systems through 600 Vac, 50 or 60 Hz. Because they combine high interrupting capacity with short-time delay tripping, Systems Pow-R

Breakers can be applied in fully rated, selective systems while providing full selectivity through the applied breaker's short-time rating.

Both mechanical and electrically operated versions of the breaker feature a true two-step stored energy mechanism with no change in dimensions. This mechanism allows maximum five-cycle closing usually required for generator paralleling.

An interrupting capacity of 150,000A at 480V without fuses and short-time capabilities of up to 85,000A are available. Systems Pow-R Breakers are UL Listed for 100% application.

Systems Pow-R Breakers must be applied within their published ratings in accordance with UL and NEMA Standards defined as "Usual Service Conditions."

Four basic frame sizes (400/800/1200A, 1600/2000A, 2500/3000A and 4000/5000A) cover the continuous ampere range of 100 to 5000A.

The Systems Pow-R Breakers use the proven microprocessor-based trip unit technology that was pioneered by Eaton. Developments in microprocessor technology have given us the new family of Digitrip RMS electronic trip units and the even newer OPTIM programmable trip unit.

All breakers come standard with the Digitrip RMS 510 trip units that have long time and instantaneous (LI) tripping functions. Short-time delay and three- or four-wire ground fault protection can be supplied as optional tripping characteristics, thereby providing for up to nine phase and ground current settings. This provides maximum flexibility in trip curve shaping and system coordination. Any combination of these trip functions (LI, LS, LSI, LIG, LSG or LSIG) can be provided within the Digitrip family of trip units.

Optional trip units such as the Digitrip RMS 610 that has a large four-digit alphanumeric display of load currents, cause of trip and self diagnostics can also be specified. The RMS 810, which in addition to the 610 features, displays and transmits via the IMPACC/PowerNet communications network power and energy values, may also be provided. The RMS 910 also displays power quality data, power factor and phase-to-phase voltages, and transmits waveform capture information.

The most technologically advanced trip unit in the Digitrip family is the Digitrip OPTIM. The OPTIM 750 has features similar to the Digitrip 610 and the OPTIM 1050 has features similar to the Digitrip 910. Both have the additional feature of being programmable, rather than having to be set by discrete switches. This programmability allows for an almost infinite number of trip settings, which in turn provides for even closer system coordination.

All trip units use completely interchangeable rating plugs. These plugs, when applied with the appropriate sensors, give the breakers a tripping range of 100 to 5000A.

The Systems Pow-R Breaker can be supplied in either fixed or drawout mounting configurations. The drawout assembly consists of a stationary frame and a moving carriage with four positions: connected, test, disconnected and fully withdrawn. The fixed configuration can be supplied as either front or rear connected.

The Systems Pow-R Breaker has available a complete family of integrally mounted accessories. Shunt trip, spring release solenoid, undervoltage release, auxiliary switches, key interlocks, mechanical interlocks and covers for the close and/or open pushbuttons are just an example of the accessories that can be mounted on the breaker.

Product History

Since its introduction to the market in 1976, the SPB has provided long and reliable service. Tens of thousands of SPBs have been manufactured and placed into service throughout the world in switchboards, automatic transfer switches and other specialty OEM manufactured power distribution products.

Systems Pow-R Breakers can be identified using two unique numbers. One is the S.O. (shop order number). The shop order number is located either on the breaker's nameplate or on the left side of the breaker.

An example of this number is S.O. 74E2792.01.

The second number is a 30-digit feature and option number. The first 10 characters of the feature and option number are considered to be the feature or style number, the next 20 characters are the option or edge number. This number is also located on the breaker's nameplate or on the left side of the breaker.

An example of this number is:

Feature and option
8702C35G012297240000000
1000144

Feature/style 8702C35G01

Option/edge
22972400000001000144

Product History Time Line

Product	1970	1975	1980	1985	1990	1995	2000	Present
Westinghouse SPB			■					
Cutler-Hammer SPB						■		

Replacement Capabilities

Genuine new SPB replacement parts and accessories, including those listed in SPB Renewal Parts Data RP01301013E, dated February 2006, are available. Contact **1-800-222-9773** for price and availability, or check Vista.

The following parts and accessories are available:

Mechanism and Related Parts

- Charging handle
- Cover assembly
- Mechanism assembly
- Trip unit cover plate assembly

Electrical Attachments

- Shunt trip assembly
- CT ground fault
- Undervoltage release
- Remote time delay
- Auxiliary switch
- Capacitor trip device
- Secondary connectors
- Plate assembly
- T-connectors
- Pressure terminals

Spring Release Solenoid Electrical Operator Breaker Accessories

- Key interlock
- Cover accessories
- Deadfront shield
- Door escutcheon
- Fixed-mounted breakers
- Behind-the-door and through-the-door drawout breakers

Trip Units

- Digitrip 500, 600, 700, 800
- Digitrip 510
- Digitrip 610
- Digitrip 810
- Digitrip 910
- OPTIM 750
- OPTIM 1050
- Pow-R-Trip 7 rating plugs
- Digitrip rating plugs for 500, 600, 700, 800

Technology Upgrades

Upgrade solutions for SPB breakers include trip unit upgrades. These solutions focus on replacing the older technology tripping systems with the latest technology offerings. The latest technology permits significant improvements to be realized in improved coordination and protection, remote metering and monitoring, network communications and energy management information.

Is the old technology breaker still good enough?

That depends on the answers to the following questions.

Can the problem be solved with renewal parts?

Some problems can be solved quickly and simply with the installation of replacement parts and accessories. Eaton continues to manufacture new genuine replacement parts and accessories for SPBs.

Does the breaker reliably perform as expected?

If the breaker does not perform reliably even when properly maintained or serviced, the mechanism or the entire breaker should be considered for replacement.

Does the breaker trip system perform reliably?

Older SPB breakers used trip systems that are no longer being supported by Eaton. Due to changes in the typical distribution system and the addition of numerous harmonic generating loads, some early vintage electronic trip systems could experience unreliable or inaccurate trip behavior. If this is the case, the trip system should be replaced.

Is there a need for energy management?

Breakers with older technology trip systems could not support the demands of energy management. Modern trip systems provide not only improved protection, but energy monitoring, power quality measurement and communications. If any of these are desired, the trip system should be replaced.

Are the recommended maintenance intervals being followed?

There is a tendency to stretch the maintenance interval well beyond the manufacturer's recommendations. This is dangerous. Some studies have shown that if a circuit breaker is left closed for a period of five to seven years, it may not operate as expected when needed to do so.

If the answers to the above questions all indicate that the existing trip system or the circuit breaker does not need to be replaced, then the old technology breaker is still good enough, and maintenance solutions are recommended:

1. Maintain the breaker at one- to two-year intervals using original OEM parts.
2. Use factory authorized service for more extensive repair needs and mechanism replacement.

Eaton can provide loaner breakers to maintain system uptime while the maintenance or factory authorized service is being performed. If any answer to the above questions indicate that the trip system or the circuit breaker should be replaced, then the old technology breaker is no longer good enough, and **Upgrade Solutions** are recommended.

Eaton offers a choice of two upgrade solutions:

1. Trip system retrofit.
2. New SPB breaker.

In summary, how do we choose the right upgrade solution?**Does the breaker perform reliably except for the trip system?**

If “Yes,” then a Trip System Retrofit is the preferred solution.

Does the breaker perform reliably but energy management, power quality measurement or communications are desired?

If “Yes,” then a Trip System Retrofit is still the preferred solution.

Is breaker reliability an issue and will it require extensive service or repairs?

If “Yes,” then a new SPB breaker is the appropriate solution.

See **Pages V12-T17-35** and **V12-T17-36** for information on Digitrip retrofits.

Product Support Services

Factory authorized non-warranty service is available from the Breaker Service Center in Skelton, WV.

The Breaker Service Center can perform:

- All service and testing needs
- Repairs to cracked and broken cases and frames
- Repairs to damaged contact assemblies
- Mechanism replacements
- Trip unit upgrades

The Breaker Service Center also stocks a variety of loaner SPB breakers to keep your customer up and running while their breaker is being serviced.

If you have an opportunity or need further information, call Eaton’s Breaker Service Center at **1-877-275-7782**.

Field Service and Testing (Performed at Customer site):

Provided by Eaton’s Electrical Services & Systems (EESS), Field Service and Testing includes initial inspection, secondary injection testing, service to electrical operators, handles and hub assemblies, installation of most renewal parts, and trip unit upgrades to the Digitrip 510. Contact your local EESS office for more information.

Service and Testing (Performed at local EESS facility):

EESS has a variety of service options for SPB breakers including primary injection testing, mechanism replacement, replacement of key interlocks and ground fault CT, service to finger clusters and stationary contacts, and trip unit upgrades to Digitrip 610/810/910. Contact your local EESS office for more information.

Further Information

Publication Number	Description
IL 15156B	Removal and replacement of moving and stationary conductors and operating mechanism in a Systems Pow-R breaker.
IL 6647C21H03	Key interlock installation instructions for through-the-door drawout Systems Pow-R breakers.
LEM010	Problems with SPB breakers/we have the solutions tri-fold.
RP01301013E	Systems Pow-R breakers renewal parts and accessories.

Pricing Information

Newly manufactured replacement SPB breakers and cassettes for existing switchgear manufactured in Asheville, NC; St. Louis, MO; or East Pittsburgh, PA, are available through the Aftermarket Product Center in Asheville, NC. Call **1-800-257-3278** for price and availability.

New, genuine SPB replacement parts and accessories can be identified in publication RP01301013E. Call **1-800-222-9773** for price and availability or check Vista.

Price and Availability Digest (PAD)

Vista/VISTALINE™ (Discount Symbol LVPCB)

Trip Unit Retrofit Kits

Application Description

Digitrip RMS trip unit retrofit kits are fully engineered, field-installable retrofit kits that enable the user to completely replace an existing tripping system. They are applicable to (600 Vac) low voltage power breakers and are designed for application on various manufacturers' power breakers.

Digitrip RMS trip unit retrofit kits provide true rms sensing, the most accurate and current state-of-the-art technology for measuring amperage loads. True rms sensing removes the possibility of false tripping due to harmonic distortion of the power waveform and enables greater accuracy in selective coordination of the power distribution system. The microprocessor-based Digitrip trip unit also allows communications for remote monitoring to a host computer or local Assemblies Electronic Monitor (AEM) via the Integrated Monitoring Protection and Control Communications (PowerNet) communication system.

Ratings

Digitrip RMS trip unit retrofit kits are available for a wide variety of various manufacturers' low voltage power breaker frames. Ratings range from 100 to 4000A. Multi-tapped CTs, interchangeable rating plugs, programmable pickup and time delay settings provide the user with flexibility.

Product History

Originally a Westinghouse Product

In the past, there have been three types of automatic control for low voltage power breakers: electromechanical trip units, solid-state peak sensing trip units and state-of-the-art true rms sensing trip units.

Electromechanical Trip Units

Electromechanical trip units were initially used in the early 1940s and phased out by all manufacturers in the mid-1970s.

Westinghouse used these trip devices on types DA and DK power circuit breakers. They were also used initially on the DB power circuit breaker. The electromechanical trip units were the conventional form of protection on all manufacturers' breakers, up until the 1970s.

Electromechanical trip units were composed of a solenoid, springs, a diaphragm, seals and air venting apertures. Three trip units were required per breaker. Due to age or harsh environments these devices would fail or lose calibration. They required a great deal of preventative maintenance.

Solid-State Peak Sensing Trip Units

In 1970, the Amptector Trip Unit was introduced as the standard trip unit on the Westinghouse type DS power circuit breaker. The Amptector solid-state trip system provided much greater accuracy and reliability, and included new features like ground fault (G) protection, mode of trip indication and the ability to perform secondary injection testing.

Electromechanical trip devices immediately became obsolete, creating a retrofit market. Amptector retrofit kits were introduced to convert the type DB breakers that had been factory equipped with the electromechanical type trip units.

In 1976, the POW-R-Trip 7 trip unit was introduced on the Westinghouse SPB insulated-case power circuit breaker. A more simplified version with only two trip functions, known as the POW-R-Trip, became available in 1978. Then in 1982, the POW-R Digitrip trip unit became available and was offered on the SPB breakers.

In 1985, RK trip units and retrofit kits were introduced to provide a solid-state trip unit small enough to retrofit General Electric breakers as well as the Westinghouse type DB breakers.

Peak sensing trip units were an improvement and provided improved reliability and accuracy. Only one trip unit was required per breaker; however, peak sensing trip units were not able to handle harmonic conditions. They caused nuisance tripping and unnecessary downtime.

True rms Sensing Trip Units

In 1987, Westinghouse introduced the Digitrip II RMS trip unit (standard version) for use on type DS and SPB power circuit breakers. Digitrip II RMS was the first microprocessor-based true rms sensing trip unit.

True rms trip units enabled the measuring of current rather than the sensing of current.

Because they are microprocessor-based digital devices, they are capable of taking discrete samples of the current waveform in each phase. By applying a mathematical algorithm, the current is accurately mapped out and measured. This method of measurement provides the ability to adapt to a changing harmonic content while providing repeatable and reliable protection.

Product History Time Line

Page	Product	1955	1960	1965	1970	1975	1980	1985	1990	1995	2000	Present	
	Electromechanical Trip Devices (B Breakers)	[Timeline bar from 1955 to 1975]											
	Amptector Trip Units and Accessories (DS Breakers)	[Timeline bar from 1970 to 1995]											
	Amptector Retrofit Kits, Trip Units, and Accessories (DB Breakers)	[Timeline bar from 1970 to 1995]											
	POW-R-Trip 7 Trip Units (SPB Breakers)	[Timeline bar from 1970 to 1995]											
	POW-R-Trip Trip Units (SPB Breakers)	[Timeline bar from 1975 to 1990]											
	POW-R-Digitrip I Trip Units (SPB Breakers)	[Timeline bar from 1980 to 1990]											
V12-T17-24	Rating Plugs	[Timeline bar from 1975 to 2000]											
	RK Retrofit Kits, Trip Units and Accessories (DB Breakers)	[Timeline bar from 1985 to 1995]											
	RK Retrofit Kits, Trip Units and Accessories (GE AK-2A Breakers)	[Timeline bar from 1985 to 1995]											
V12-T17-21	Digitrip II RMS Trip Units (RMS500, RMS600, RMS700, RMS800)	[Timeline bar from 1990 to 2000]											
V12-T17-21	Digitrip III RMS Trip Units (RMS510, RMS610, RMS710, RMS810)	[Timeline bar from 1990 to 2000]											
	Digitrip III RMS Retrofit Kits for:												
V12-T17-29	• Westinghouse DA and DK Breakers	[Timeline bar from 1995 to 2000]											
V12-T17-31	• Westinghouse DB Breakers	[Timeline bar from 1995 to 2000]											
V12-T17-33	• Westinghouse DS Breakers	[Timeline bar from 1995 to 2000]											
V12-T17-35	• Westinghouse SPB Breakers	[Timeline bar from 1995 to 2000]											
V12-T17-33	• GE® AK-1, AK-2/2A, AK-3/3A, AKR-50, AL-2E0, AL-2-50 Breakers	[Timeline bar from 1995 to 2000]											
V12-T17-41	• Allis-Chalmers LA Series Breakers	[Timeline bar from 1995 to 2000]											
V12-T17-43	• ITE® K-Line Breakers	[Timeline bar from 1995 to 2000]											
V12-T17-47	• Siemens® – Allis Breakers	[Timeline bar from 1995 to 2000]											
V12-T17-49	• Federal Pacific® Breakers	[Timeline bar from 1995 to 2000]											
V12-T17-51	• Other Breakers	[Timeline bar from 1995 to 2000]											

General Information

State-of-the-Art Features

Digitrip RMS trip unit retrofit kits come in several different model types. Among these types, they provide a variety of accommodating features (see table on **Page V12-T17-20**).

True rms measurement and protection. Extremely accurate and able to compensate for harmonic content and disturbances.

Ground fault may be added to an existing power breaker. Ground fault is offered in a three-wire and a four-wire version.

Zone interlocking is available on the short time and ground fault modes of protection. This enables enhanced selectivity for high fault and ground fault coordination between the main and the feeder breakers.

Local monitoring via a display. A red light emitting diode (LED) display enables the user to step through and read currents and energy readings for each phase and ground.

Communications via the PowerNet system

allows all pertinent information, regarding static and dynamic operation of the breaker, to be remotely monitored either by a host computer or an IQ AEM. This facilitates energy management and power management. Remember, *“If you can’t measure it, you can’t manage it.”*

The Packaged Kit

Each Digitrip RMS trip unit retrofit kit includes a Digitrip trip unit, an auxiliary CT module, a direct trip actuator (DTA), quantity (three) current sensors, a rating plug, interconnecting wiring harnesses, mounting brackets, copper connectors (when required), hardware, and installation instructions. Digitrip RMS retrofit kits are complete tripping systems engineered specifically for each breaker type and frame rating. All kits are designed for field installation.

Application and Service Condition

In order to ensure that Digitrip RMS trip unit retrofit kits are successfully applied, installation must only be done by a qualified individual.

Appropriate testing must be performed to qualify the retrofitted breaker prior to placing the breaker in service. Digitrip RMS trip unit retrofit kits will provide protection based on their published time-current curves when the breaker is properly maintained and operated in accordance with the original manufacturer’s specification and instructions.

Service Life

The physical structure, the bus assemblies and control wiring of switchgear are normally in good condition. The replacement of the trip system coupled along with either refurbishment or reconditioning of the breaker will prolong the life of the switchgear and provide modern state-of-the-art protection.

Availability

Digitrip RMS trip unit retrofit kits are currently available for select breaker frames from the following manufacturers:

- Westinghouse
- General Electric
- ITE
- Allis-Chalmers
- Siemens-Allis
- Federal Pacific
- Roller-Smith
- Other manufacturers

Order Information

In order to obtain the proper kit, the following information should be provided to your authorized Eaton distributor:

- Breaker manufacturer
- Breaker frame designation
- Breaker frame rating
- Breaker continuous current rating
- Kit type (see table on **Page V12-T17-20**) (i.e., RMS 510...RMS 810)
- Modes of protection
- Sensor rating
- Rating plug rating

Definitions of Replacement and Upgrade Capabilities

Replacement Digitrip Trip Units and Rating Plugs

Replacement trip units and rating plugs are available and are used when replacing components with similar functionality and protective features. A complete listing of replacement trip units and rating plugs is found on **Pages V12-T17-21–V12-T17-27**.

Digitrip Trip Unit Upgrades

Trip unit upgrades can be used when upgrading the trip system only requires a change in trip unit with no additional hardware. This option is used to replace an obsolete Digitrip 500/600/700/800 or as outlined in the table below. Use the replacement trip unit and rating plug tables on **Pages V12-T17-21–V12-T17-27**.

Digitrip Trip Unit Upgrades

Digitrip Trip Unit	
Existing	Upgrade
500	510
600	610
700	810/910
800	810/910
810	910

For advanced upgrades requiring more than just a trip unit replacement, a trip unit retrofit kit or upgrade retrofit kit is the correct solution.

Digitrip RMS Trip Unit Retrofit Kits

Digitrip RMS trip unit retrofit kits are fully engineered, field-installable retrofit kits that enable the user to completely retrofit an existing trip system on low voltage power breakers. They are applied on breakers that do not have existing Digitrip trip systems installed. Reference **Pages V12-T17-28–V12-T17-51** for information on retrofit kits.

For breakers previously retrofitted or shipped from the factory with a Digitrip trip system, refer to trip unit and rating plug replacement, Digitrip trip unit upgrades or upgrade retrofit kits.

Upgrade Retrofit Kits

An upgrade retrofit kit is used when upgrading a breaker (previously retrofitted or supplied from the factory with a Digitrip 500/510) to an advanced Digitrip 610/810/910. These are complete kits minus the components common with a basic Digitrip 500/510 retrofit kit. A "U" in the last position of the catalog number denotes an upgrade retrofit kit. Reference **Pages V12-T17-28–V12-T17-51** for information on upgrade retrofit kits.

Arcflash Reduction Maintenance System™

NFPA® 70E-2004 defines flash hazard as: "A dangerous condition associated with the release of energy caused by an electric arc." This is primarily heat energy and may result in serious or life threatening burns.

When properly applied to a power breaker, the Arcflash Reduction Maintenance System reduces fault-clearing time and lowers the available arc flash energy at the connected downstream devices. The result is a reduction of the hazard risk category, allowing for improved personnel safety while eliminating the need for higher levels of costly personal protective equipment (PPE).

The Arcflash Reduction Maintenance System is controlled by a lockable switch that can easily activate a faster tripping time at the work location and be incorporated into a lock-out tag-out (LOTO) procedure. This switch can be applied to any low voltage power breaker by modifying the existing Digitrip trip system, or retrofitting a breaker with a Digitrip retrofit kit (see Accessories table on **Page V12-T17-28**).

For further information, contact your local Eaton's Electrical Services & Systems office (see **Tab 24**), or the Digitrip Retrofit Kit Service Center at **1-800-937-5487**.



Modified Digitrip Trip System with Arcflash Reduction Maintenance System



Digitrip Retrofit with Arcflash Reduction Maintenance System

Functional Comparison of Trip Units

Past Technology						Present Technology				
RMS 500	RMS 500 Zone	RMS 600	RMS 700	RMS 800	Features	RMS 510	RMS 510 Zone	RMS 610	RMS 810	RMS 910
Trip Unit Features										
■	■	■	■		Cause-of-trip LED indicators	■	■	■	■	■
■	■	■	■	■	Integral self test	■	■	■	■	■
■	■	■	■	■	Trip reset button	■	■	■	■	■
■	■	■	■	■	Hardware driven thermal memory					
					Software driven thermal memory (sel. 0/0)	■	■	■	■	■
■	■	■	■	■	Discriminator circuit on LS and LSG protection modes					
					Discriminator circuit on LS and LSG protection modes selectable (on/off)	■	■	■	■	■
	■	■	■	■	Zone protective interlocking for short time and ground fault modes of protection		■	■	■	■
	■	■	■	■	Auxiliary contact for long time, short circuit and ground fault functions			■	■	■
		■		■	Local display of phase currents			■	■	■
		■		■	Local display of ground currents			■	■	■
		■		■	Local display of cause of trip			■	■	■
				■	Local display of energy (MWh)				■	■
				■	Local display of peak demand (MW)				■	■
				■	Local display of present demand (MW)				■	■
PowerNet Communication Features										
		■	■		Data communicated with PowerNet includes: all display values, trip unit status, high load alarm, cause of trip, rating plug status, breaker status, reason for breaker status				■	■
					Trip settings				■	■
					Power factor				■	■
		■	■		Control via the PowerNet system (open/close)				■	■
					Voltage phase-to-phase, displayed on trip unit and communicated via PowerNet communications					■
					Total harmonic distortion (THD); phase A, B, C. Displayed on trip unit and communicated via PowerNet communications					■
					Total harmonic distortion per harmonic from the 2nd through the 27th harmonic displayed on trip unit and communicated via PowerNet communications					■
					System power factor. Displayed on trip unit and communicated via PowerNet communications					■

Replacement Digitrip RMS Trip Units for Power Circuit Breakers

Replacement Capabilities

Digitrip RMS Trip Units for Power Circuit Breakers

Digitrip RMS Trip Unit Replacement

When a Digitrip RMS trip unit requires replacement, it can be replaced directly using the enclosed charts. Observe the following restrictions:

The group function (G) cannot be added in the field just by changing the trip unit.

Trip Functions

All Digitrip RMS retrofit kit types are available with the necessary combinations of long, short, instantaneous and ground fault (LSIG) modes of protection as depicted and deemed necessary by industry standards.

The combinations of modes of protection are:

- LI
- LSI
- LS
- LIG
- LSG
- LSIG

Rating Plug Replacement

When changing or replacing rating plugs, use the charts provided on **Pages V12-T17-25–V12-T17-27** for DS, SPB and all other retrofitted breakers.



Digitrip Units—Standard, Horizontal and Vertical Configurations

Standard Retrofit RMS Replacement Trip Units for DS and SPB Breakers

Shaded area denotes obsolete or discontinued products and services. ①②

Digitrip Model	Protective Functions	Catalog Number	Style Number	Digitrip Model	Protective Functions	Catalog Number	Style Number
Past Technology				Present Technology			
RMS 500	LI	T51BLI	1230C97G01	RMS 510	LI	S51LI	7829C05G01
RMS 500	LSI	T52BLSI	1230C97G02	RMS 510	LSI	S52LSI	7829C05G02
RMS 500	LS	T53BLS	1230C97G03	RMS 510	LS	S53LS	7829C05G03
RMS 500	LIG	T54BLIG	1230C97G04	RMS 510	LIG	S54LIG	7829C05G04
RMS 500	LSG	T55BLSG	1230C97G05	RMS 510	LSG	S55LSG	7829C05G05
RMS 500	LSIG	T56BLSIG	1230C97G06	RMS 510	LSIG	S56LSIG	7829C05G06
RMS 600	LI	T61BLI	1230C97G07	RMS 610	LI	S61LI	7829C10G01
RMS 600	LSI	T62BLSI	1230C97G08	RMS 610	LSI	S62LSI	7829C10G02
RMS 600	LS	T63BLS	1230C97G09	RMS 610	LS	S63LS	7829C10G03
RMS 600	LIG	T64BLIG	1230C97G10	RMS 610	LIG	S64LIG	7829C10G04
RMS 600	LSG	T65BLSG	1230C97G11	RMS 610	LSG	S65LSG	7829C10G05
RMS 600	LSIG	T66BLSIG	1230C97G12	RMS 610	LSIG	S66LSIG	7829C10G06
RMS 700 ③	LI	T71BLI	1230C97G19	RMS 810	LI	S81LI	7829C08G01
RMS 700 ③	LSI	T72BLSI	1230C97G20	RMS 810	LSI	S82LSI	7829C08G02
RMS 700 ③	LS	T73BLS	1230C97G21	RMS 810	LS	S83LS	7829C08G03
RMS 700 ③	LIG	T74BLIG	1230C97G22	RMS 810	LIG	S84LIG	7829C08G04
RMS 700 ③	LSG	T75BLSG	1230C97G23	RMS 810	LSG	S85LSG	7829C08G05
RMS 700 ③	LSIG	T76BLSIG	1230C97G24	RMS 810	LSIG	S86LSIG	7829C08G06
RMS 800	LI	T81BLI	1230C97G13	RMS 910	LI	S91LI	7829C09G01
RMS 800	LSI	T82BLSI	1230C97G14	RMS 910	LSI	S92LSI	7829C09G02
RMS 800	LS	T83BLS	1230C97G15	RMS 910	LS	S93LS	7829C09G03
RMS 800	LIG	T84BLIG	1230C97G16	RMS 910	LIG	S94LIG	7829C09G04
RMS 800	LSG	T85BLSG	1230C97G17	RMS 910	LSG	S95LSG	7829C09G05
RMS 800	LSIG	T86BLSIG	1230C97G18	RMS 910	LSIG	S96LSIG	7829C09G06

Notes

- ① At the time of this publication, the standard trip units for low voltage Digitrip retrofit kits are the RMS 510/610/810/910. From 1989 to 1996, the standard trip units were the RMS 500/600/700/800. **These trip units are no longer in production.** Replacement orders for the 500/600/700/800 trip units will be filled by the equivalent 510/610/810/910 trip units. Remember, when replacing a 500/600/700/800 unit with a 510/610/810/910, the rating plug must also be replaced.
- ② Rating plugs for the 500/600/700/800 trip units will still be available. **These rating plugs are not interchangeable with the 510/610/810/910 trip units. Likewise, rating plugs for the 510/610/810/910 are not interchangeable with the 500/600/700/800 trip units.**
- ③ There is no direct replacement for Digitrip RMS 700. Use Digitrip RMS 810 or 910.

Horizontal Retrofit RMS/R Replacement Trip Units for all Other Breakers

Shaded area denotes obsolete or discontinued products and services. ^{①②}

Digitrip Model	Protective Functions	Catalog Number	Style Number	Digitrip Model	Protective Functions	Catalog Number	Style Number
Past Technology				Present Technology			
RMS/R 500 Horizontal	LI	RH51BLI	1232C84G01	RMS 510	LI	SRH51LI	7801C36G01
RMS/R 500 Horizontal	LSI	RH52BLSI	1232C84G02	RMS 510	LSI	SRH52LSI	7801C36G02
RMS/R 500 Horizontal	LS	RH53BLS	1232C84G03	RMS 510	LS	SRH53LS	7801C36G03
RMS/R 500 Horizontal	LIG	RH54BLIG	1232C84G04	RMS 510	LIG	SRH54LIG	7801C36G04
RMS/R 500 Horizontal	LSG	RH55BLSG	1232C84G05	RMS 510	LSG	SRH55LSG	7801C36G05
RMS/R 500 Horizontal	LSIG	RH56BLSIG	1232C84G06	RMS 510	LSIG	SRH56LSIG	7801C36G06
RMS/R 600 Horizontal	LI	RH61BLI	1232C84G07	RMS 610	LI	SRH61LI	7801C46G01
RMS/R 600 Horizontal	LSI	RH62BLSI	1232C84G08	RMS 610	LSI	SRH62LSI	7801C46G02
RMS/R 600 Horizontal	LS	RH63BLS	1232C84G09	RMS 610	LS	SRH63LS	7801C46G03
RMS/R 600 Horizontal	LIG	RH64BLIG	1232C84G10	RMS 610	LIG	SRH64LIG	7801C46G04
RMS/R 600 Horizontal	LSG	RH65BLSG	1232C84G11	RMS 610	LSG	SRH65LSG	7801C46G05
RMS/R 600 Horizontal	LSIG	RH66BLSIG	1232C84G12	RMS 610	LSIG	SRH66LSIG	7801C46G06
RMS/R 700 Horizontal ^③	LI	RH71BLI	1232C84G19	RMS 810	LI	SRH81LI	7801C48G01
RMS/R 700 Horizontal ^③	LSI	RH72BLSI	1232C84G20	RMS 810	LSI	SRH82LSI	7801C48G02
RMS/R 700 Horizontal ^③	LS	RH73BLS	1232C84G21	RMS 810	LS	SRH83LS	7801C48G03
RMS/R 700 Horizontal ^③	LIG	RH74BLIG	1232C84G22	RMS 810	LIG	SRH84LIG	7801C48G04
RMS/R 700 Horizontal ^③	LSG	RH75BLSG	1232C84G23	RMS 810	LSG	SRH85LSG	7801C48G05
RMS/R 700 Horizontal ^③	LSIG	RH76BLSIG	1232C84G24	RMS 810	LSIG	SRH86LSIG	7801C48G06
RMS/R 800 Horizontal	LI	RH81BLI	1232C84G13	RMS 910	LI	SRH91LI	7801C49G01
RMS/R 800 Horizontal	LSI	RH82BLSI	1232C84G14	RMS 910	LSI	SRH92LSI	7801C49G02
RMS/R 800 Horizontal	LS	RH83BLS	1232C84G15	RMS 910	LS	SRH93LS	7801C49G03
RMS/R 800 Horizontal	LIG	RH84BLIG	1232C84G16	RMS 910	LIG	SRH94LIG	7801C49G04
RMS/R 800 Horizontal	LSG	RH85BLSG	1232C84G17	RMS 910	LSG	SRH95LSG	7801C49G05
RMS/R 800 Horizontal	LSIG	RH86BLSIG	1232C84G18	RMS 910	LSIG	SRH96LSIG	7801C49G06

Notes

- ^① At the time of this publication, the standard trip units for low voltage Digitrip retrofit kits are the RMS 510/610/810/910. From 1989 to 1996, the standard trip units were the RMS 500/600/700/800. **These trip units are no longer in production.** Replacement orders for the 500/600/700/800 trip units will be filled by the equivalent 510/610/810/910 trip units. Remember, when replacing a 500/600/700/800 unit with a 510/610/810/910, the rating plug must also be replaced.
- ^② Rating plugs for the 500/600/700/800 trip units will still be available. **These rating plugs are not interchangeable with the 510/610/810/910 trip units. Likewise, rating plugs for the 510/610/810/910 are not interchangeable with the 500/600/700/800 trip units.**
- ^③ There is no direct replacement for Digitrip RMS 700. Use Digitrip RMS 810 or 910.

Replacement Digitrip RMS Trip Units for Power Circuit Breakers

Vertical Retrofit RMS/R Replacement Trip Units for all Other Breakers

Shaded area denotes obsolete or discontinued products and services. ^{①②}

Digitrip Model	Protective Functions	Catalog Number	Style Number	Digitrip Model	Protective Functions	Catalog Number	Style Number
Past Technology				Present Technology			
RMS/R 500 Vertical	LI	RV51BLI	1232C97G01	RMS 510	LI	SRV51LI	7801C37G01
RMS/R 500 Vertical	LSI	RV52BLSI	1232C97G02	RMS 510	LSI	SRV52LSI	7801C37G02
RMS/R 500 Vertical	LS	RV53BLS	1232C97G03	RMS 510	LS	SRV53LS	7801C37G03
RMS/R 500 Vertical	LIG	RV54BLIG	1232C97G04	RMS 510	LIG	SRV54LIG	7801C37G04
RMS/R 500 Vertical	LSG	RV55BLSG	1232C97G05	RMS 510	LSG	SRV55LSG	7801C37G05
RMS/R 500 Vertical	LSIG	RV56BLSIG	1232C97G06	RMS 510	LSIG	SRV56LSIG	7801C37G06
RMS/R 600 Vertical	LI	RV61BLI	1232C97G07	RMS 610	LI	SRV61LI	7801C41G01
RMS/R 600 Vertical	LSI	RV62BLSI	1232C97G08	RMS 610	LSI	SRV62LSI	7801C41G02
RMS/R 600 Vertical	LS	RV63BLS	1232C97G09	RMS 610	LS	SRV63LS	7801C41G03
RMS/R 600 Vertical	LIG	RV64BLIG	1232C97G10	RMS 610	LIG	SRV64LIG	7801C41G04
RMS/R 600 Vertical	LSG	RV65BLSG	1232C97G11	RMS 610	LSG	SRV65LSG	7801C41G05
RMS/R 600 Vertical	LSIG	RV66BLSIG	1232C97G12	RMS 610	LSIG	SRV66LSIG	7801C41G06
RMS/R 700 Vertical ^③	LI	RV71BLI	1232C97G19	RMS 810	LI	SRV81LI	7801C42G01
RMS/R 700 Vertical ^③	LSI	RV72BLSI	1232C97G20	RMS 810	LSI	SRV82LSI	7801C42G02
RMS/R 700 Vertical ^③	LS	RV73BLS	1232C97G21	RMS 810	LS	SRV83LS	7801C42G03
RMS/R 700 Vertical ^③	LIG	RV74BLIG	1232C97G22	RMS 810	LIG	SRV84LIG	7801C42G04
RMS/R 700 Vertical ^③	LSG	RV75BLSG	1232C97G23	RMS 810	LSG	SRV85LSG	7801C42G05
RMS/R 700 Vertical ^③	LSIG	RV76BLSIG	1232C97G24	RMS 810	LSIG	SRV86LSIG	7801C42G06
RMS/R 800 Vertical	LI	RV81BLI	1232C97G13	RMS 910	LI	SRV91LI	7801C43G01
RMS/R 800 Vertical	LSI	RV82BLSI	1232C97G14	RMS 910	LSI	SRV92LSI	7801C43G02
RMS/R 800 Vertical	LS	RV83BLS	1232C97G15	RMS 910	LS	SRV93LS	7801C43G03
RMS/R 800 Vertical	LIG	RV84BLIG	1232C97G16	RMS 910	LIG	SRV94LIG	7801C43G04
RMS/R 800 Vertical	LSG	RV85BLSG	1232C97G17	RMS 910	LSG	SRV95LSG	7801C43G05
RMS/R 800 Vertical	LSIG	RV86BLSIG	1232C97G18	RMS 910	LSIG	SRV96LSIG	7801C43G06

Notes

- ^① At the time of this publication, the standard trip units for low voltage Digitrip retrofit kits are the RMS 510/610/810/910. From 1989 to 1996, the standard trip units were the RMS 500/600/700/800. **These trip units are no longer in production.** Replacement orders for the 500/600/700/800 trip units will be filled by the equivalent 510/610/810/910 trip units. Remember, when replacing a 500/600/700/800 unit with a 510/610/810/910, the rating plug must also be replaced.
- ^② Rating plugs for the 500/600/700/800 trip units will still be available. **These rating plugs are not interchangeable with the 510/610/810/910 trip units. Likewise, rating plugs for the 510/610/810/910 are not interchangeable with the 500/600/700/800 trip units.**
- ^③ There is no direct replacement for Digitrip RMS 700. Use Digitrip RMS 810 or 910.

Digitrip RMS Rating Plugs

Product Description



SPB Rating Plug and Details

Rating plugs for Digitrip RMS trip units determine the continuous current rating of the circuit breaker. All protection function settings on the face of the trip unit are expressed in per unit multiples of the rating plug ampere rating (I_n).

The rating plug is interlocked with the tripping mechanism to automatically “open” the breaker when the plug is removed. The breaker will remain “trip free” with the plug removed.

SPB rating plugs must be selected to match the desired continuous current rating of the breaker, as well as the frame rating and the system frequency, i.e., 50 or 60 Hz.

DS and retrofit rating plugs must be selected to match the desired continuous current rating of the breaker, the sensor tap setting and the system frequency, i.e., 50 or 60 Hz.

Rating plugs are equipped with a backup battery to maintain the mode of trip operation following a circuit breaker tripping when external power is not available. The battery is a long-life lithium type, which is accessible from the front of the trip unit, without removing the rating plug. Replacement types and instructions are provided in Application Data 33-855.

Following a trip operation and with no supplementary control power available, the battery will maintain the mode of trip LED for approximately 60 hours.

Note: At the time of this publication, the standard trip units for low voltage Digitrip retrofit kits are the RMS 510/610/810/910. From 1989 to 1996, the standard trip units were the RMS 500/600/700/800. **These trip units are no longer in production.**

Replacement orders for the 500/600/700/800 trip units will be filled by the equivalent 510/610/810/910 trip units. Remember, when replacing a 500/600/700/800 unit with a 510/610/810/910, the rating plug must also be replaced.

Note: Rating plugs for the 500/600/700/800 trip units will still be available. **These rating plugs are not interchangeable with the 510/610/810/910 trip units. Likewise, rating plugs for the 510/610/810/910 are not interchangeable with the 500/600/700/800 trip units.**



Rating Plug for All Other Retrofitted Breakers



DS Rating Plug

Replacement Digitrip RMS Rating Plugs for DS Breakers

Replacement Capabilities

Rating Plugs for DS Breakers ①②③④

Past Technology (500/600/700/800)				Present Technology (510/610/810/910)			
Sensor Tap Connection	Rating Plug Rating	60 Hz Catalog Number ⑤	60 Hz Style Number ⑤	Sensor Tap Connection	Rating Plug Rating	50/60 Hz Catalog Number ⑥	50/60 Hz Style Number ⑥
200	100	PD6D02A010	2613D10G01	200	100	RP6D02A010	3D86734G01
200	200	PD6D02A020	2613D10G02	200	200	RP6D02A020	3D86734G02
300	200	PD6D03A020	2613D10G03	300	200	RP6D03A020	3D86734G03
300	250	PD6D03A025	2613D10G04	300	250	RP6D03A025	3D86734G04
300	300	PD6D03A030	2613D10G05	300	300	RP6D03A030	3D86734G05
400	200	PD6D04A020	2613D10G06	400	200	RP6D04A020	3D86734G06
400	250	PD6D04A025	2613D10G07	400	250	RP6D04A025	3D86734G07
400	300	PD6D04A030	2613D10G08	400	300	RP6D04A030	3D86734G08
400	400	PD6D04A040	2613D10G09	400	400	RP6D04A040	3D86734G09
600	300	PD6D06A030	2613D10G10	600	400	RP6D06A030	3D86734G10
600	400	PD6D06A040	2613D10G11	600	400	RP6D06A040	3D86734G11
600	600	PD6D06A060	2613D10G12	600	600	RP6D06A060	3D86734G12
800	400	PD6D08A040	2613D10G13	800	400	RP6D08A040	3D86734G13
800	600	PD6D08A060	2613D10G14	800	600	RP6D08A060	3D86734G14
800	800	PD6D08A080	2613D10G15	800	800	RP6D08A080	3D86734G15
1200	600	PD6D12A060	2613D10G16	1200	600	RP6D12A060	3D86734G16
1200	800	PD6D12A080	2613D10G17	1200	800	RP6D12A080	3D86734G17
1200	1000	PD6D12A100	2613D10G18	1200	1000	RP6D12A100	3D86734G18
1200	1200	PD6D12A120	2613D10G19	1200	1200	RP6D12A120	3D86734G19
1600	800	PD6D16A080	2613D10G20	1600	800	RP6D16A080	3D86734G20
1600	1000	PD6D16A100	2613D10G21	1600	1000	RP6D16A100	3D86734G21
1600	1200	PD6D16A120	2613D10G22	1600	1200	RP6D16A120	3D86734G22
1600	1600	PD6D16A160	2613D10G23	1600	1600	RP6D16A160	3D86734G23
2000	1000	PD6D20A100	2613D10G24	2000	1000	RP6D20A100	3D86734G24
2000	1200	PD6D20A120	2613D10G25	2000	1200	RP6D20A120	3D86734G25
2000	1600	PD6D20A160	2613D10G26	2000	1600	RP6D20A160	3D86734G26
2000	2000	PD6D20A200	2613D10G27	2000	2000	RP6D20A200	3D86734G27
2400	1600	PD6D24A160	2613D10G28	2400	1600	RP6D24A160	3D86734G28
2400	2000	PD6D24A200	2613D10G29	2400	2000	RP6D24A200	3D86734G29
2400	2400	PD6D24A240	2613D10G30	2400	2400	RP6D24A240	3D86734G30
3200	1600	PD6D32A160	2613D10G31	3200	1600	RP6D32A160	3D86734G31
3200	2000	PD6D32A200	2613D10G32	3200	2000	RP6D32A200	3D86734G32
3200	2400	PD6D32A240	2613D10G33	3200	2400	RP6D32A240	3D86734G33
3200	3200	PD6D32A320	2613D10G34	3200	3200	RP6D32A320	3D86734G34
4000	2000	PD6D40A200	2613D10G35	4000	2000	RP6D40A200	3D86734G35
4000	2400	PD6D40A240	2613D10G36	4000	2400	RP6D40A240	3D86734G36
4000	3200	PD6D40A320	2613D10G37	4000	3200	RP6D40A320	3D86734G37
4000	4000	PD6D40A400	2613D10G38	4000	4000	RP6D40A400	3D86734G38

Notes

- ① Choose the rating plug to match the sensor tap selected and the continuous current rating.
- ② When ordering as part of a retrofit kit, refer to **Pages V12-T17-28** through **V12-T17-51**.
- ③ At the time of this publication, the standard trip units for low voltage Digitrip retrofit kits are the RMS 510/610/810/910. From 1989 to 1996, the standard trip units were the RMS 500/600/700/800. **These trip units are no longer in production.** Replacement orders for the 500/600/700/800 trip units will be filled by the equivalent 510/610/810/910 trip units. Remember, when replacing a 500/600/700/800 unit with a 510/610/810/910, the rating plug must also be replaced.
- ④ Rating plugs for the 500/600/700/800 trip units will still be available. **These rating plugs are not interchangeable with the 510/610/810/910 trip units. Likewise, rating plugs for the 510/610/810/910 are not interchangeable with the 500/600/700/800 trip units.**
- ⑤ 50 Hz rating plugs are available. Contact your local Eaton Field Sales office for details.
- ⑥ Rating plugs may be ordered separately by above style number or as part of a complete retrofit kit.

Rating Plugs for SPB Breakers ①②③④

Past Technology (500/600/700/800)				Present Technology (510/610/810/910)			
Sensor Tap Connection	Rating Plug Rating	60 Hz Catalog Number ⑤	60 Hz Style Number ⑥	Sensor Tap Connection	Rating Plug Rating	50/60 Hz Catalog Number ⑤	50/60 Hz Style Number ⑥
400	200	PD6S04A020	2613D09G01	400	200	RP6S04A020	3D86737G01
400	250	PD6S04A025	2613D09G02	400	250	RP6S04A025	3D86737G02
400	300	PD6S04A030	2613D09G03	400	300	RP6S04A030	3D86737G03
400	400	PD6S04A040	2613D09G04	400	400	RP6S04A040	3D86737G04
800	400	PD6S08A040	2613D09G05	800	400	RP6S08A040	3D86737G05
800	600	PD6S08A060	2613D09G07	800	600	RP6S08A060	3D86737G07
800	800	PD6S08A080	2613D09G08	800	800	RP6S08A080	3D86737G08
1200	600	PD6S12A060	2613D09G09	1200	600	RP6S12A060	3D86737G09
1200	800	PD6S12A080	2613D09G10	1200	800	RP6S12A080	3D86737G10
1200	1000	PD6S12A100	2613D09G11	1200	1000	RP6S12A100	3D86737G11
1200	1200	PD6S12A120	2613D09G12	1200	1200	RP6S12A120	3D86737G12
1600	800	PD6S16A080	2613D09G13	1600	800	RP6S16A080	3D86737G13
1600	1000	PD6S16A100	2613D09G14	1600	1000	RP6S16A100	3D86737G14
1600	1200	PD6S16A120	2613D09G15	1600	1200	RP6S16A120	3D86737G15
1600	1600	PD6S16A160	2613D09G16	1600	1600	RP6S16A160	3D86737G16
2000C	1000	PD6S21A100	2613D09G17	2000C	1000	RP6S21A100	3D86737G17
2000C	1200	PD6S21A120	2613D09G18	2000C	1200	RP6S21A120	3D86737G18
2000C	1600	PD6S21A160	2613D09G19	2000C	1600	RP6S21A160	3D86737G19
2000C	2000	PD6S21A200	2613D09G20	2000C	2000	RP6S21A200	3D86737G20
2000	1600	PD6S20A160	2613D09G21	2000	1600	RP6S20A160	3D86737G21
2000	2000	PD6S20A200	2613D09G22	2000	2000	RP6S20A200	3D86737G22
2500	1600	PD6S25A160	2613D09G23	2500	1600	RP6S25A160	3D86737G23
2500	2000	PD6S25A200	2613D09G24	2500	2000	RP6S25A200	3D86737G24
2500	2500	PD6S25A250	2613D09G25	2500	2500	RP6S25A250	3D86737G25
3000	1600	PD6S30A160	2613D09G26	3000	1600	RP6S30A160	3D86737G26
3000	2000	PD6S30A200	2613D09G27	3000	2000	RP6S30A200	3D86737G27
3000	2500	PD6S30A250	2613D09G28	3000	2500	RP6S30A250	3D86737G28
3000	3000	PD6S30A300	2613D09G29	3000	3000	RP6S30A300	3D86737G29
4000	2000	PD6S40A200	2613D09G30	4000	2000	RP6S40A200	3D86737G30
4000	2500	PD6S40A250	2613D09G31	4000	2500	RP6S40A250	3D86737G31
4000	3000	PD6S40A300	2613D09G32	4000	3000	RP6S40A300	3D86737G32
4000	3200	PD6S40A320	2613D09G33	4000	3200	RP6S40A320	3D86737G33
4000	4000	PD6S40A400	2613D09G34	4000	4000	RP6S40A400	3D86737G34
4000	2000	PD6S40A200	2613D09G30	4000	2000	RP6S40A200	3D86737G30
4000	2500	PD6S40A250	2613D09G31	4000	2500	RP6S40A250	3D86737G31
4000	3000	PD6S40A300	2613D09G32	4000	3000	RP6S40A300	3D86737G32
4000	3200	PD6S40A320	2613D09G33	4000	3200	RP6S40A320	3D86737G33
4000	4000	PD6S40A400	2613D09G34	4000	4000	RP6S40A400	3D86737G34
5000	3000	PD6S50A300	2613D09G35	5000	3000	RP6S50A300	3D86737G35
5000	3200	PD6S50A320	2613D09G36	5000	3200	RP6S50A320	3D86737G36
5000	4000	PD6S50A400	2613D09G37	5000	4000	RP6S50A400	3D86737G37
5000	5000	PD6S50A500	2613D09G38	5000	5000	RP6S50A500	3D86737G38

Notes

- ① Choose the rating plug to match the sensor tap selected and the continuous current rating.
- ② When ordering as part of a retrofit kit, refer to **Pages V12-T17-28** through **V12-T17-51**.
- ③ At the time of this publication, the standard trip units for low voltage Digitrip retrofit kits are the RMS 510/610/810/910. From 1989 to 1996, the standard trip units were the RMS 500/600/700/800. **These trip units are no longer in production.** Replacement orders for the 500/600/700/800 trip units will be filled by the equivalent 510/610/810/910 trip units. Remember, when replacing a 500/600/700/800 unit with a 510/610/810/910, the rating plug must also be replaced.
- ④ Rating plugs for the 500/600/700/800 trip units will still be available. **These rating plugs are not interchangeable with the 510/610/810/910 trip units. Likewise, rating plugs for the 510/610/810/910 are not interchangeable with the 500/600/700/800 trip units.**
- ⑤ 50 Hz rating plugs are available. Contact your local Eaton Field Sales office for details.
- ⑥ Rating plugs may be ordered separately by above style number or as part of a complete retrofit kit.

Replacement Digitrip RMS Rating Plugs for DS Breakers

Rating Plugs for All Other Breakers ①②③④

Past Technology (500/600/700/800)				Present Technology (510/610/810/910)			
Sensor Tap Connection	Rating Plug Rating	60 Hz Catalog Number ⑤	60 Hz Style Number ⑤	Sensor Tap Connection	Rating Plug Rating	50/60 Hz Catalog Number ⑤	50/60 Hz Style Number ⑤
200	100	PR6A02A010	3D86709G01	200	100	RP6A02A010	3D86766G01
200	200	PR6A02A020	3D86709G02	200	200	RP6A02A020	3D86766G02
250	250	PR6A02A025	3D86709G11	250	250	RP6A02A025	3D86766G11
300	200	PR6A03A020	3D86709G36	300	200	RP6A03A020	3D86766G36
300	250	PR6A03A025	3D86709G12	300	250	RP6A03A025	3D86766G12
300	300	PR6A03A030	3D86709G37	300	300	RP6A03A030	3D86766G37
400	200	PR6A04A020	3D86709G13	400	200	RP6A04A020	3D86766G13
400	250	PR6A04A025	3D86709G14	400	250	RP6A04A025	3D86766G14
400	300	PR6A04A030	3D86709G15	400	300	RP6A04A030	3D86766G15
400	400	PR6A04A040	3D86709G03	400	400	RP6A04A040	3D86766G03
600	300	PR6A06A030	3D86709G16	600	300	RP6A06A030	3D86766G16
600	400	PR6A06A040	3D86709G17	600	400	RP6A06A040	3D86766G17
600	600	PR6A06A060	3D86709G04	600	600	RP6A06A060	3D86766G04
800	400	PR6A08A040	3D86709G18	800	400	RP6A08A040	3D86766G18
800	600	PR6A08A060	3D86709G19	800	600	RP6A08A060	3D86766G19
800	800	PR6A08A080	3D86709G05	800	800	RP6A08A080	3D86766G05
1200	600	PR6A12A060	3D86709G20	1200	600	RP6A12A060	3D86766G20
1200	800	PR6A12A080	3D86709G21	1200	800	RP6A12A080	3D86766G21
1200	1000	PR6A12A100	3D86709G22	1200	1000	RP6A12A100	3D86766G22
1200	1200	PR6A12A120	3D86709G10	1200	1200	RP6A12A120	3D86766G10
1600	800	PR6A16A080	3D86709G23	1600	800	RP6A16A080	3D86766G23
1600	1000	PR6A16A100	3D86709G24	1600	1000	RP6A16A100	3D86766G24
1600	1200	PR6A16A120	3D86709G25	1600	1200	RP6A16A120	3D86766G25
1600	1600	PR6A16A160	3D86709G06	1600	1600	RP6A16A160	3D86766G06
2000	1000	PR6A20A100	3D86709G26	2000	1000	RP6A20A100	3D86766G26
2000	1200	PR6A20A120	3D86709G27	2000	1200	RP6A20A120	3D86766G27
2000	1600	PR6A20A160	3D86709G28	2000	1600	RP6A20A160	3D86766G28
2000	2000	PR6A20A200	3D86709G07	2000	2000	RP6A20A200	3D86766G07
3000	1600	PR6A30A160	3D86709G29	3000	1600	RP6A30A160	3D86766G29
3000	2000	PR6A30A200	3D86709G30	3000	2000	RP6A30A200	3D86766G30
3000	2500	PR6A30A250	3D86709G31	3000	2500	RP6A30A250	3D86766G31
3000	3000	PR6A30A300	3D86709G08	3000	3000	RP6A30A300	3D86766G08
3200	1600	PR6A32A160	3D86709G39	3200	1600	RP6A32A160	3D86766G39
3200	2000	PR6A32A200	3D86709G40	3200	2000	RP6A32A200	3D86766G40
3200	2400	PR6A32A240	3D86709G41	3200	2400	RP6A32A240	3D86766G41
3200	3200	PR6A32A320	3D86709G42	3200	3200	RP6A32A320	3D86766G42
4000	2000	PR6A40A200	3D86709G32	4000	2000	RP6A40A200	3D86766G32
4000	2500	PR6A40A250	3D86709G33	4000	2500	RP6A40A250	3D86766G33
4000	3000	PR6A40A300	3D86709G34	4000	3000	RP6A40A300	3D86766G34
4000	3200	PR6A40A320	3D86709G35	4000	3200	RP6A40A320	3D86766G35
4000	4000	PR6A40A400	3D86709G09	4000	4000	RP6A40A400	3D86766G09

Notes

- ① Choose the rating plug to match the sensor tap selected and the continuous current rating.
- ② When ordering as part of a retrofit kit, refer to **Pages V12-T17-28** through **V12-T17-51**.
- ③ At the time of this publication, the standard trip units for low voltage Digitrip retrofit kits are the RMS 510/610/810/910. From 1989 to 1996, the standard trip units were the RMS 500/600/700/800. **These trip units are no longer in production.** Replacement orders for the 500/600/700/800 trip units will be filled by the equivalent 510/610/810/910 trip units. Remember, when replacing a 500/600/700/800 unit with a 510/610/810/910, the rating plug must also be replaced.
- ④ Rating plugs for the 500/600/700/800 trip units will still be available. **These rating plugs are not interchangeable with the 510/610/810/910 trip units. Likewise, rating plugs for the 510/610/810/910 are not interchangeable with the 500/600/700/800 trip units.**
- ⑤ 50 Hz rating plugs are available. Contact your local Eaton Field Sales office for details.
- ⑥ Rating plugs may be ordered separately by above style number or as part of a complete retrofit kit.

Customer Required Information

How to Select a Retrofit Kit

To properly select a retrofit kit, the following information is required:

- Breaker nameplate information
 - Manufacturer
 - Breaker type
 - Ampere frame size
 - Manually or electrically operated
- Drawout or fixed mounting
- Fused or non-fused
- Digitrip trip unit type required
 - 510, 610, 810, 910
- Protective functions required
 - LI, LSI, LS, LIG, LSG, LSIG
- Continuous current rating required (trip rating of breaker)
- Three- or four-wire system (determines number of sensors required)

To properly select options, the following questions need to be answered:

- Will customer supply 120 Vac control power or is breaker-mounted CPT needed?
 - Applies only to Digitrip 610, 810 and 910
- Are zone interlocks required?
- Does the application require relay outputs from the Digitrip 610, 810 or 910 for remote indication?
- Does the breaker have an existing amptector or Digitrip trip unit installed? If so, what is it?

How to Generate a Catalog Number

Refer to **Pages V12-T17-30 to V12-T17-51** to view the retrofit kit catalog numbers for specific breaker manufacturers and frames. When used in conjunction with the information obtained from this page, these pages contain all the information necessary to generate a catalog number.

How to Price a Kit

To correctly price a Low voltage Digitrip retrofit kit, refer to the *Retrofit Kit Product Guide*. This product guide includes base prices, adders and options for all low voltage Digitrip retrofit kits. For a copy of the *Retrofit Kit Product Guide*, contact your local Eaton Field Sales office or the Digitrip Retrofit Kit Service Center at **1-800-937-5487**.

Accessories

Description	Catalog Number	Style Number
Auxiliary power module	PRTAAPM	1267C16G01
Amptector and Digitrip test set (tests for both)		8779C02G02
Amptector adapter harness		6503C53G01
Amptector two-piece adapter harness (test set half)		6503C54G01
Amptector two-piece adapter harness (breaker half)		6503C55G01
External harness (zone interlock shorting plug non-DS)		6502C83G01
Simplified cell harness 1 ft		6506C34G01
Simplified cell harness 6 ft		6506C34G02
Simplified cell harness 4 ft		6506C34G03
Arcflash Reduction Maintenance System (ARMS)		
Non-DS		9A10160G01
DS with new Digitrip kit		9A10160G02
DS for existing Digitrip system		9A10160G03

Notes

At the time of this publication, the standard trip units for low voltage Digitrip retrofit kits are the RMS 510/610/810/910. From 1989 to 1996, the standard trip units were the RMS 500/600/700/800. **These trip units are no longer in production.** Replacement orders for the 500/600/700/800 trip units will be filled by the equivalent 510/610/810/910 trip units. Remember, when replacing a 500/600/700/800 unit with a 510/610/810/910, the rating plug must also be replaced.

Rating plugs for the 500/600/700/800 trip units will still be available. **These rating plugs are not interchangeable with the 510/610/810/910 trip units. Likewise, rating plugs for the 510/610/810/910 are not interchangeable with the 500/600/700/800 trip units.**

Digitrip RMS Trip Unit Retrofit Kits for Westinghouse DA and DK Breakers

Replacement and Upgrade Capabilities

Replacement and upgrade capabilities include replacement Digitrip trip units and rating plugs, Digitrip trip unit upgrades, Digitrip RMS trip unit retrofit kits and upgrade retrofit kits. For definitions of these solutions see **Page V12-T17-19**.

For Digitrip RMS trip unit retrofit kits and upgrade retrofit kits, create the Digitrip RMS retrofit kit catalog number to match the Westinghouse DA or DK breaker type, retrofit kit type, protection function, rating plug type, current sensor type, CPT, and type of kit required for application. See the example provided on **Page V12-T17-30**.

Application Notes for DA and DK Power Circuit Breakers

1. Retrofit kits are for use on 50 and 60 Hz distribution systems.
2. All retrofit kits are designed for drawout power circuit breakers only. Refer all fixed-mounted breaker applications to the Digitrip retrofit kit Technical Service Center at **1-800-937-5487**.
3. The breaker compartment doors on the switchgear assembly must be free of panel-mounted instruments and devices (i.e., ammeters, switches, etc.) or the retrofitted breaker may interfere with these devices when the compartment door is closed.
4. When the ground fault (G) option is selected, please observe the following:
 - a. For three-phase, three-wire solidly grounded systems, choose quantity three current sensors in the catalog number development.
 - b. For three-phase, four-wire solidly grounded systems, choose quantity four current sensors in the catalog number development. Three sensors are mounted on the breaker and one sensor is mounted on the switchgear neutral. Hardware to mount the current sensor on the switchgear neutral and provisions to wire it into the trip unit circuit (including a required pair of breaker secondary disconnecting contacts) are not included in the kit.
5. RMS 510 Zone, 610, 810 and 910 retrofit kits include a cell terminal block assembly that must be installed in the switchgear assembly. Internal switchgear wiring to accommodate the customer application schemes must be added in the field.
6. RMS 610, 810 and 910 retrofit kits require a customer supplied 120 Vac source connected to the cell terminal block assembly to power the Digitrip RMS digital displays and communications functions (as applicable).

Digitrip RMS Retrofit Kits for Westinghouse DA and DK Breakers Catalog Numbering System

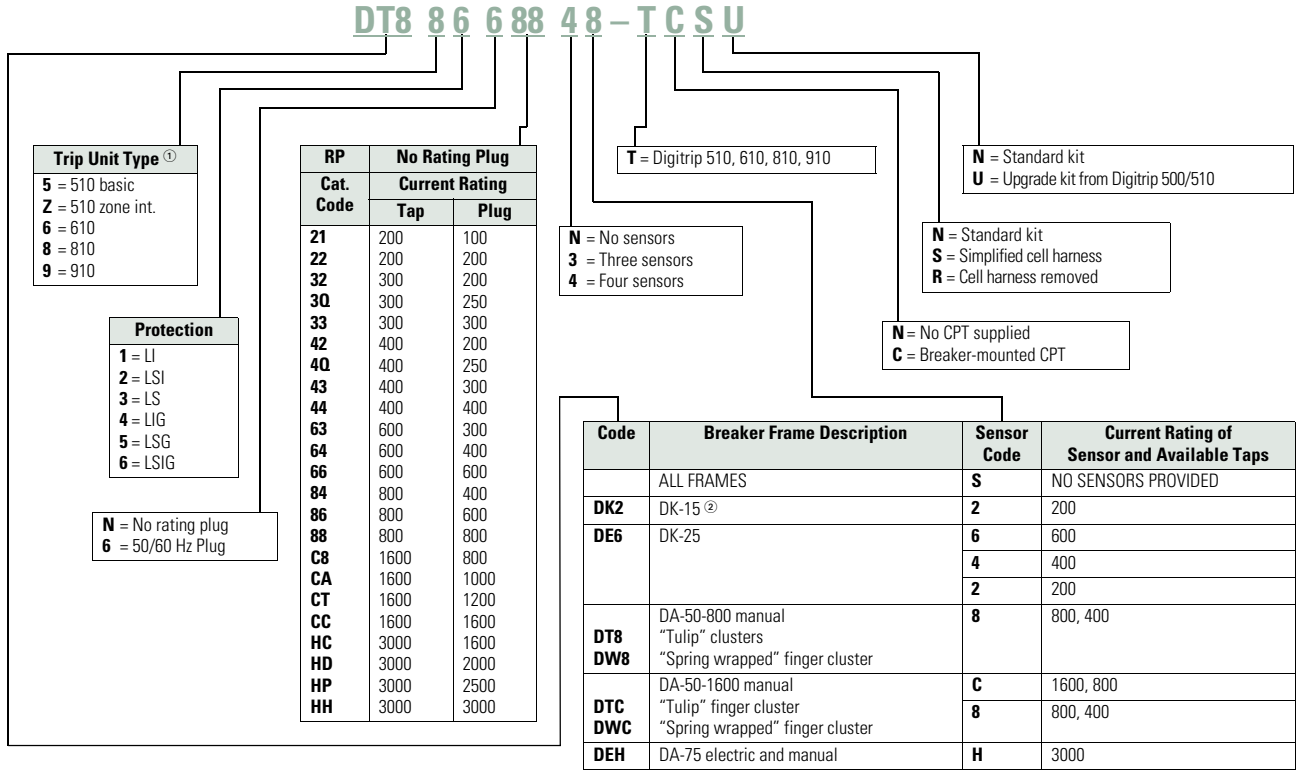

Notes

- ① At the time of this publication, the standard trip units for low voltage Digitrip retrofit kits are the RMS 510/610/810/910.
- ② Maximum ampere rating is 200A.

Example shown is a Digitrip retrofit kit for a DA-50-800 manual, with an RMS 810 trip unit, with LSIG protection, with a 60 Hz plug, rated at 800A for a sensor tap of 800A, four sensors (for a four-wire ground system) that have a sensor tap of 800A, there is a breaker-mounted CPT with the kit, the cell wiring is simplified (only 6 wires vs. 16), and the breaker was previously retrofitted with a Digitrip 500/510, so this is an upgrade kit.

This information is subject to change. Updated pricing and availability information is included in the *Retrofit Kit Product Guide*. For a copy of the *Retrofit Kit Product Guide*, contact your local Eaton Field Sales office or the Digitrip Retrofit Kit Service Center at **1-800-937-5487**.

Digitrip RMS Retrofit Kits for Westinghouse DB Breakers



DB-25 Breaker Retrofitted with Digitrip RMS 810 Retrofit Kit



Typical Digitrip RMS 810 Retrofit Kit for a DB-25 Power Circuit Breaker

Product Description

Digitrip RMS retrofit kits for Westinghouse DB and DBL power circuit breakers were first introduced in 1989. For a complete description of the Digitrip RMS trip system and the features of models RMS 510, 610, 810 and 910, see **Page V12-T17-20**.

Ratings

Digitrip RMS retrofit kits are applied on DB breakers with frame ratings from 225A (DB-15) to 4000A (DB-100) as identified below. The rating plug and the current sensor rating act in concert to provide for a wide spectrum of overload and short-circuit settings.

Chronology

Digitrip RMS retrofit kits and replacement trip units for DB breakers became available around 1989. The Digitrip RMS 510 model is the modern day replacement for the Amptector and RK trip systems.

Replacement and Upgrade Capabilities

Replacement and upgrade capabilities include replacement Digitrip trip units and rating plugs, Digitrip trip unit upgrades, Digitrip RMS trip unit retrofit kits and upgrade retrofit kits. For definitions of these solutions, see

Page V12-T17-19.

For Digitrip RMS trip unit retrofit kits and upgrade retrofit kits, create the Digitrip RMS retrofit kit catalog number to match the Westinghouse DB breaker type, retrofit kit type, protection function, rating plug type, current sensor type, CPT and type of kit required for application. See the example provided on **Page V12-T17-32.**

Application Notes for Westinghouse DB and DBL Power Circuit Breakers

1. Retrofit kits are for use on 50 and 60 Hz distribution systems.
2. All retrofit kits are designed for drawout power circuit breakers only. Refer all fixed-mounted breaker applications to the Digitrip Retrofit Kit Service Center at **1-800-937-5487**.
3. The breaker compartment doors on the switchgear assembly must be free of panel-mounted instruments and devices (i.e., ammeters, switches, etc.) or the retrofitted breaker may interfere with these devices when the compartment door is closed.

4. Type DB-15 and DBL breaker components may have a metal baffle on the inside of the compartment door. If so, the baffle will have to be removed to accommodate the retrofitted DB breaker.
5. Contact your local Eaton office if the existing DB breaker has both an undervoltage trip device (UVTA) and a shunt trip.
6. When the ground fault (G) option is selected, please observe the following:
 - a. For three-phase, three-wire solidly grounded systems, choose quantity three current sensors in the catalog number development.
 - b. For three-phase, four-wire solidly grounded systems, choose a quantity of four current sensors in the catalog number development. Three sensors are mounted on the breaker and one sensor is mounted on the switchgear neutral. Hardware to mount the current sensor on the switchgear neutral and provisions to wire it into the trip unit circuit (including a required pair of breaker secondary disconnecting contacts) are not included in the kit.
7. RMS 510 Zone, 610, 810 and 910 retrofit kits include a cell terminal block assembly that must be installed in the switchgear assembly. Internal switchgear wiring to accommodate the customer application schemes must be added in the field.
8. RMS 610, 810 and 910 retrofit kits require a customer supplied 120 Vac source connected to the cell terminal block assembly to power the Digitrip RMS digital displays and communications functions (as applicable).
9. If the existing DB breaker has been retrofitted with an Amptector trip system, and a Digitrip RMS retrofit is desired, contact the Digitrip Retrofit Kit Service Center at **1-800-937-5487** for details.

Digitrip RMS Retrofit Kits for Westinghouse DB Breakers Catalog Numbering System

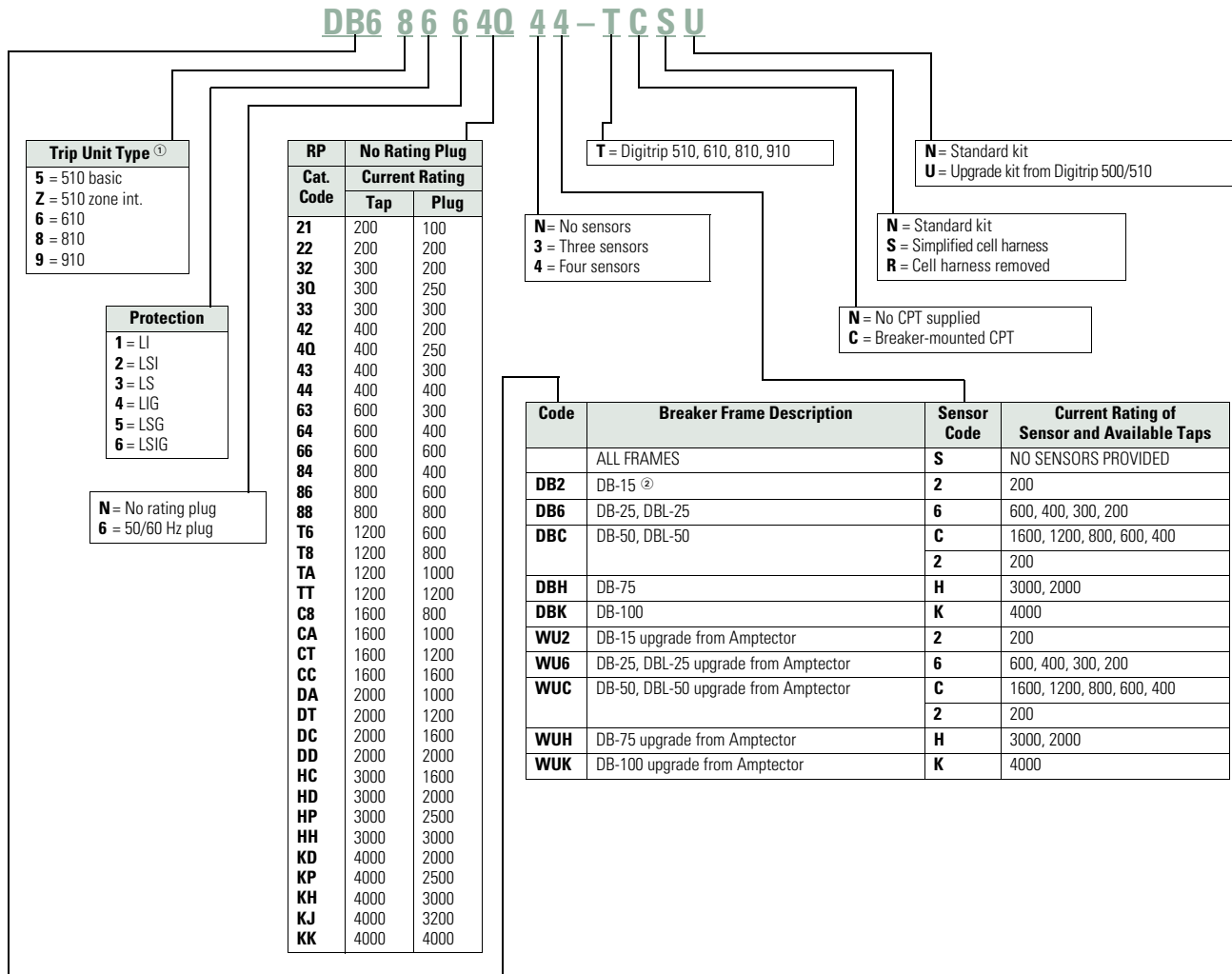

Notes

- ① At the time of this publication, the standard trip units for low voltage Digitrip retrofit kits are the RMS 510/610/810/910.
- ② Maximum ampere rating is 200A.

Sample shown is a Digitrip retrofit kit for a DB-25, with an RMS 810 trip unit, with LSIG protection, with a 60 Hz Plug, rated at 250A for a sensor tap of 400A, four sensors (for a four-wire ground system) that have sensor taps of 600, 400, 300 and 200A, there is a breaker-mounted CPT with the kit, the cell wiring is simplified (only 6 wires vs. 16), and the breaker was previously retrofitted with a Digitrip 500/510, so this is an upgrade kit.

This information is subject to change. Updated pricing and availability information is included in the *Retrofit Kit Product Guide*. For a copy of the *Retrofit Kit Product Guide*, contact your local Eaton Field Sales office or the Digitrip Retrofit Kit Service Center at **1-800-937-5487**.

Digitrip RMS Retrofit Kits for Westinghouse DS Breakers



DS Breaker Retrofitted with Digitrip RMS 810 Retrofit Kit



Typical Digitrip RMS 810 Retrofit Kit for a DS Power Circuit Breaker

Product Description

Digitrip RMS retrofit kits for Westinghouse DS and DSL power circuit breakers were first introduced in 1987. For a complete description of the Digitrip RMS Trip System and the features of models RMS 510, 610, 810 and 910, see **Page V12-T17-20**.

Ratings

Digitrip RMS retrofit kits are applied on DS breakers with frame ratings from 800A (DS-206) to 4000A (DS-840) as identified below. The rating plug and the current sensor rating act in concert to provide for a wide spectrum of overload and short-circuit settings.

Chronology

Digitrip RMS retrofit kits and replacement trip units for DS breakers became available around 1987. The Digitrip RMS 510 model is the modern day replacement for the Amptector trip systems.

Replacement and Upgrade Capabilities

Replacement and upgrade capabilities include replacement Digitrip trip units and rating plugs, Digitrip trip unit upgrades, Digitrip RMS trip unit retrofit kits and upgrade retrofit kits. For definitions of these solutions, see **Page V12-T17-19**.

For Digitrip RMS trip unit retrofit kits and upgrade retrofit kits, create the Digitrip RMS retrofit kit catalog number to match the Cutler-Hammer or Westinghouse DS breaker type, retrofit kit type, protection function, rating plug type, current sensor type, CPT, and type of kit required for application. See the example provided on **Page V12-T17-34**.

Application Notes for Cutler-Hammer or Westinghouse DS and DSL Power Circuit Breakers

1. Retrofit kits are for use on 50 and 60 Hz distribution systems.
2. All retrofit kits are designed for drawout power circuit breakers only. Refer all fixed-mounted breaker applications to the Eaton Digitrip Retrofit Kit Service Center at **1-800-937-5487**.

3. The breaker compartment doors on the switchgear assembly must be free of panel-mounted instruments and devices (i.e., ammeters, switches, etc.) or the retrofitted breaker may interfere with these devices when the compartment door is closed.
4. When the ground fault (G) option is selected, please observe the following:
 - a. For three-phase, three-wire solidly grounded systems, choose quantity three current sensors in the catalog number development.
 - b. For three-phase, four-wire solidly grounded systems, choose quantity four current sensors in the catalog number development. Three sensors are mounted on the breaker and one sensor is mounted on the switchgear neutral. Hardware to mount the current sensor on the switchgear neutral and provisions to wire it into the trip unit circuit (including a required pair of breaker secondary disconnecting contacts) are not included in the kit.
5. RMS 510, 610, 810 and 910 retrofit kits include a cell terminal block assembly that must be installed in the switchgear assembly. Internal switchgear wiring to accommodate the customer application schemes must be added in the field.
6. RMS 610, 810 and 910 retrofit kits require a customer supplied 120 Vac source connected to the cell terminal block assembly to power the Digitrip RMS digital displays and communications functions (as applicable).

Digitrip RMS Retrofit Kits for Westinghouse DS Breakers Catalog Numbering System

DR6 86 64Q 44 - T N N N

Trip Unit Type ①

- 1 = OPTIM 1050
- 5 = 510 basic
- Z = 510 zone int.
- 6 = 610
- 7 = OPTIM 750
- 8 = 810
- 9 = 910

Protection

- 1 = LI
- 2 = LSI
- 3 = LS
- 4 = LIG
- 5 = LSG
- 6 = LSIG
- 7 = LSIA

N = No rating plug
6 = 50/60 Hz plug

RP Cat. Code	No Rating Plug Current Rating	
	Tap	Plug
21	200	100
22	200	200
32	300	200
3Q	300	250
33	300	300
42	400	200
4Q	400	250
43	400	300
44	400	400
63	600	300
64	600	400
66	600	600
84	800	400
86	800	600
88	800	800
T6	1200	600
T8	1200	800
TA	1200	1000
TT	1200	1200
C8	1600	800
CA	1600	1000
CT	1600	1200
CC	1600	1600
DA	2000	1000
DT	2000	1200
DC	2000	1600
DD	2000	2000
FC	2400	1600
FD	2400	2000
FF	2400	2400
JC	3200	1600
JD	3200	2000
JF	3200	2400
JJ	3200	3200
KD	4000	2000
KP	4000	2500
KJ	4000	3200
KK	4000	4000

P = OPTIM
T = Digitrip 510, 610, 810, 910

N = No sensors
3 = Three sensors
4 = Four sensors

N = Standard kit
U = Upgrade kit from factory modular mounting ②
B = Upgrade kit from factory box mounting ②

N = Standard kit
S = Simplified cell harness
R = Cell harness removed

N = No CPT supplied
C = Breaker-mounted CPT

Code	Breaker Frame Description	Sensor Code	Current Rating of Sensor and Available Taps
	ALL FRAMES	S	NO SENSORS PROVIDED
DR6	DS(L)-206	8	800
		6	600
		4	400
		3	300
		2	200
DRC	DS(L)-416	C	1600
		T	1200
		8	800
		6	600
		4	400
DRD	DS-420	D	2000
		C	1600
		T	1200
		8	800
		6	600
DRJ	DS-632 (Must replace Amptector Sensors)	J	3200
		F	2400
DRK	DS-840	K	4000
		J	3200

Notes

- ① At the time of this publication, the standard trip units for low voltage Digitrip retrofit kits are the RMS 510/610/810/910.
- ② If breaker has been previously retrofitted, call the Digitrip Retrofit Kit Service Center at **1-800-937-5487**.

Sample shown is a Digitrip retrofit kit for a DS-206, with an RMS 810 trip unit, with LSIG protection, with a 60 Hz plug, rated at 250A for a sensor tap of 400A, four sensors (for a four-wire ground system) that have a sensor tap of 400A, and there are no other features so this is a standard original kit.

This information is subject to change. Updated pricing and availability information is included in the *Retrofit Kit Product Guide*. For a copy of the *Retrofit Kit Product Guide*, contact your local Eaton Field Sales office or the Digitrip Retrofit Kit Service Center at **1-800-937-5487**.

Digitrip RMS Retrofit Kits for Westinghouse SPB Breakers



**SPB-100 Series—3000A Frame
—Digitrip RMS**



**Rear View of Plug Adapter Box
and Digitrip RMS 510 (Typical Parts
of Retrofit Kit)**

Product Description

Digitrip RMS retrofit kits for Westinghouse SPB power circuit breakers equipped with Pow-R Trip 7 or Pow-R Digitrip trip units were first introduced in 1989. Field retrofits are limited to the RMS 510 model. For a complete description of the Digitrip RMS trip system, see **Page V12-T17-20**.

Ratings

Digitrip RMS 510 retrofit kits are applied on SPB breakers with frame ratings from 400A (SPB-50) to 5000A (SPB-150) as identified on **Page V12-T17-25**. The rating plug and the current sensor rating act in concert to provide for a wide spectrum of overload and short-circuit settings.

Chronology

Digitrip RMS retrofit kits for SPB breakers became available around 1989. The Digitrip RMS 510 model is the only model that is available. Retrofits are limited to SPB breakers equipped with a Pow-R Trip 7 or Pow-R Digitrip (also known as Digitrip 1) trip units.

Replacement and Upgrade Capabilities

Replacement and upgrade capabilities include replacement Digitrip trip units and rating plugs, Digitrip trip unit upgrades, Digitrip RMS trip unit retrofit kits and upgrade retrofit kits. For definitions of these solutions see **Page V12-T17-19**.

For Digitrip RMS trip unit retrofit kits and upgrade retrofit kits, create the Digitrip RMS retrofit kit catalog number to match the Cutler-Hammer or Westinghouse SPB breaker type, retrofit kit type, protection function, rating plug type, current sensor type, CPT and type of kit required for application. See the example provided on **Page V12-T17-36**.

Application Notes for Cutler-Hammer or Westinghouse SPB Power Circuit Breakers

1. Retrofit kits are for use on 50 and 60 Hz distribution systems.
2. Only SPB breakers equipped with a Pow-R Trip 7 or Pow-R Digitrip (also known as Digitrip 1) trip units are retrofittable at this time. Breakers equipped with a Pow-R trip cannot be retrofitted.
3. SPB breakers installed in automatic transfer switches and equipped with a bell alarm contact cannot be retrofitted at this time.

4. An automatic trip relay (ATR) is a remote mounted accessory designed to provide visual trip mode indication, alarm and lockout interlocking circuitry following a breaker automatic tripping operation. SPB breakers equipped with Pow-R Trip 7 and this ATR must purchase a separate ATR adapter kit. SPB adapter kit with ground fault: 4A35718G02. SPB adapter kit without ground fault: 4A35718G01.
5. An SPB breaker with a 250A frame rating can not be retrofitted.
6. Ground fault protection cannot be added to the SPB breaker. The breaker must be originally equipped with ground fault protection, for ground fault protection to be selected. Changing the ground fault protection from three-wire to four-wire is not permitted. Interchanging between LI, LS, LSI, LIG, LSG or LSIG is not permitted.
7. SPB breakers equipped with zone interlocking for short time and/or ground fault time delays can be retrofitted, provided that the existing zone interlock configuration is not changed.
8. For Digitrip RMS trip unit replacements, see **Page V12-T17-21**. For Pow-R Trip 7 trip unit replacements, see **Page V12-T17-36**.
9. A factory retrofit is possible for applications requiring Digitrip RMS 610, 810 and 910. Call factory for more information at **1-800-222-9773**.
10. SPB breakers retrofitted with Digitrip RMS can be tested with primary injection testing and trip unit self test. Secondary injection testing is not available.

Digitrip RMS Retrofit Kits for Westinghouse SPB Breakers Catalog Numbering System

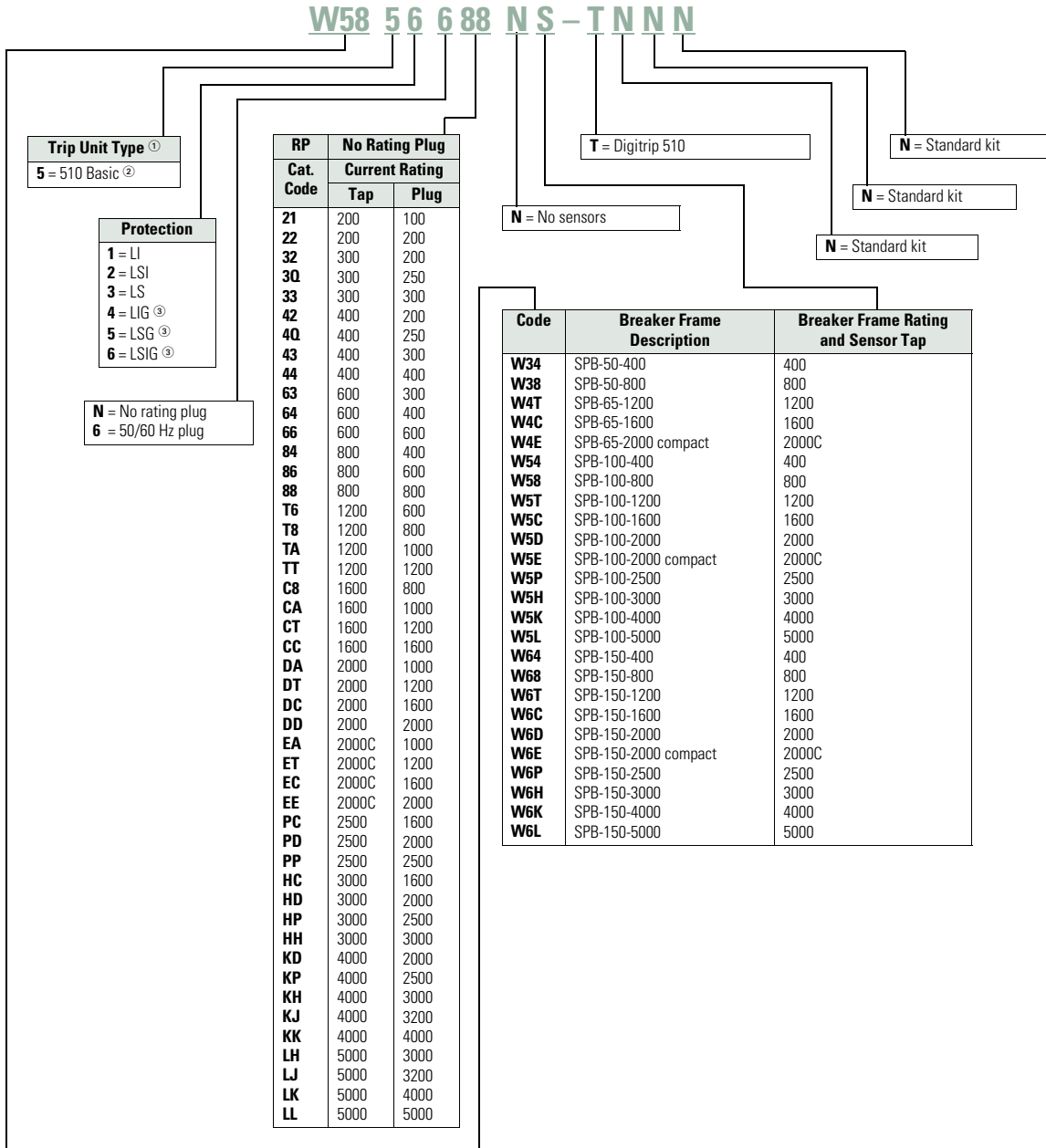

Notes

- ① At the time of this publication, the standard trip units for low voltage Digitrip retrofit kits are the RMS 510/610/810/910.
- ② Digitrip 610, 810 and 910 are not available for SPB breaker retrofit kits. A factory upgrade program is available. Call factory for more information at **1-800-222-9773**.
- ③ SPB breakers supplied from factory without ground fault (G) cannot be retrofitted in the field to include ground fault.

This information is subject to change. Updated pricing and availability information is included in the *Retrofit Kit Product Guide*. For a copy of the *Retrofit Kit Product Guide*, contact your local Eaton Field Sales office or the Digitrip Retrofit Kit Service Center at **1-800-937-5487**.

Digitrip RMS Retrofit Kits for Westinghouse DB Breakers



DB-25 Breaker Retrofitted with Digitrip RMS 810 Retrofit Kit



Typical Digitrip RMS 810 Retrofit Kit for a DB-25 Power Circuit Breaker

Product Description

Digitrip RMS retrofit kits for Westinghouse DB and DBL power circuit breakers were first introduced in 1989. For a complete description of the Digitrip RMS trip system and the features of models RMS 510, 610, 810 and 910, see **Page V12-T17-20**.

Ratings

Digitrip RMS retrofit kits are applied on DB breakers with frame ratings from 225A (DB-15) to 4000A (DB-100) as identified below. The rating plug and the current sensor rating act in concert to provide for a wide spectrum of overload and short-circuit settings.

Chronology

Digitrip RMS retrofit kits and replacement trip units for DB breakers became available around 1989. The Digitrip RMS 510 model is the modern day replacement for the Amptector and RK trip systems.

Replacement and Upgrade Capabilities

Replacement and upgrade capabilities include replacement Digitrip trip units and rating plugs, Digitrip trip unit upgrades, Digitrip RMS trip unit retrofit kits and upgrade retrofit kits. For definitions of these solutions, see **Page V12-T17-19**.

For Digitrip RMS trip unit retrofit kits and upgrade retrofit kits, create the Digitrip RMS retrofit kit catalog number to match the Westinghouse DB breaker type, retrofit kit type, protection function, rating plug type, current sensor type, CPT and type of kit required for application. See the example provided on **Page V12-T17-32**.

Application Notes for Westinghouse DB and DBL Power Circuit Breakers

1. Retrofit kits are for use on 50 and 60 Hz distribution systems.
2. All retrofit kits are designed for drawout power circuit breakers only. Refer all fixed-mounted breaker applications to the Digitrip Retrofit Kit Service Center at **1-800-937-5487**.
3. The breaker compartment doors on the switchgear assembly must be free of panel-mounted instruments and devices (i.e., ammeters, switches, etc.) or the retrofitted breaker may interfere with these devices when the compartment door is closed.
4. Type DB-15 and DBL breaker components may have a metal baffle on the inside of the compartment door. If so, the baffle will have to be removed to accommodate the retrofitted DB breaker.
5. Contact your local Eaton office if the existing DB breaker has both an undervoltage trip device (UVTA) and a shunt trip.
6. When the ground fault (G) option is selected, please observe the following:
 - a. For three-phase, three-wire solidly grounded systems, choose quantity three current sensors in the catalog number development.
 - b. For three-phase, four-wire solidly grounded systems, choose a quantity of four current sensors in the catalog number development. Three sensors are mounted on the breaker and one sensor is mounted on the switchgear neutral. Hardware to mount the current sensor on the switchgear neutral and provisions to wire it into the trip unit circuit (including a required pair of breaker secondary disconnecting contacts) are not included in the kit.
7. RMS 510 zone, 610, 810 and 910 retrofit kits include a cell terminal block assembly that must be installed in the switchgear assembly. Internal switchgear wiring to accommodate the customer application schemes must be added in the field.
8. RMS 610, 810 and 910 retrofit kits require a customer supplied 120 Vac source connected to the cell terminal block assembly to power the Digitrip RMS digital displays and communications functions (as applicable).
9. If the existing DB breaker has been retrofitted with an Amptector trip system, and a Digitrip RMS retrofit is desired, contact the Digitrip Retrofit Kit Service Center at **1-800-937-5487** for details.

Digitrip RMS Retrofit Kits for General Electric AK Breakers Catalog Numbering System

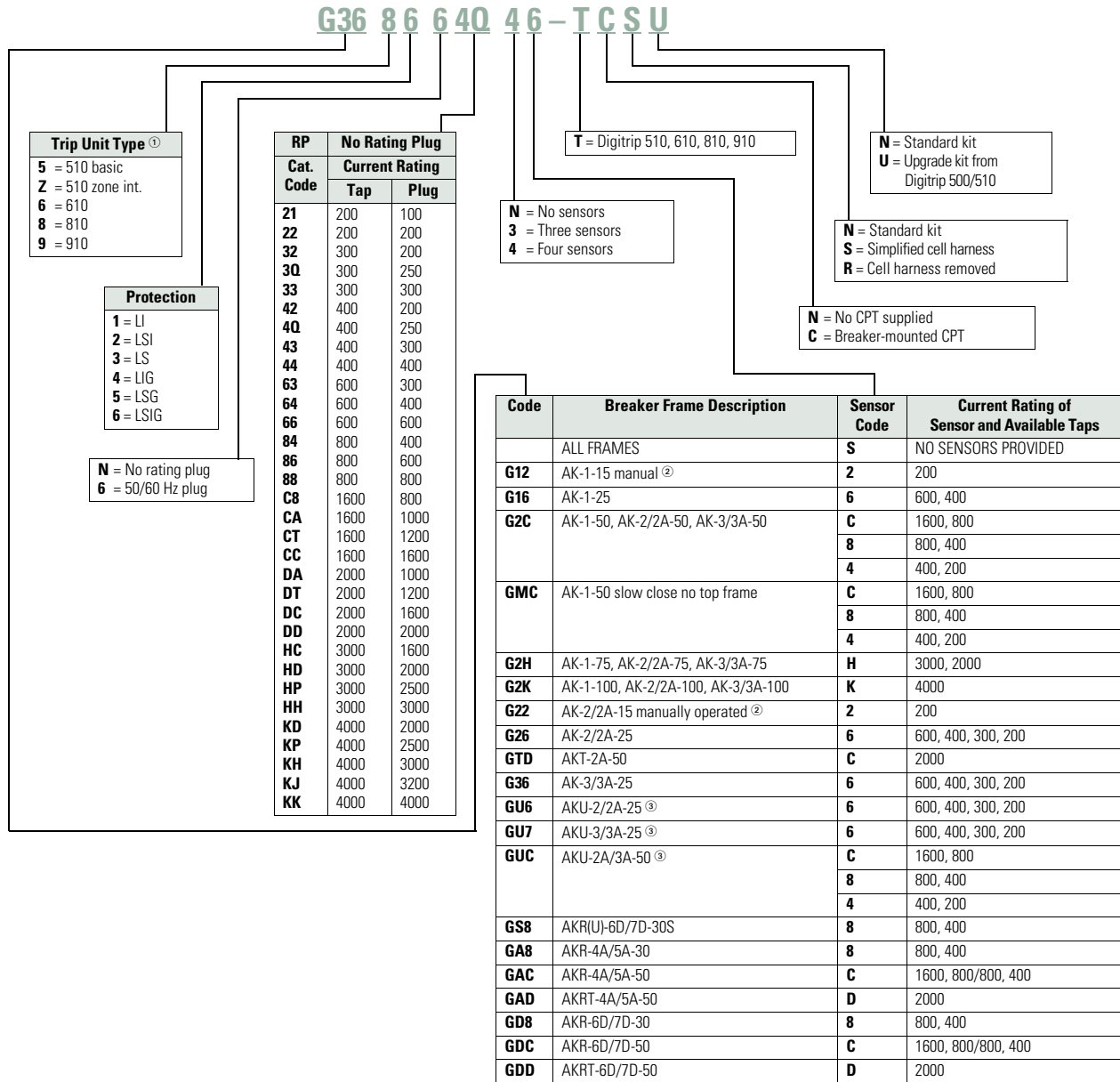

Notes

- ① At the time of this publication, the standard trip units for low voltage Digitrip retrofit kits are the RMS 510/610/810/910.
- ② Maximum ampere rating is 200A.
- ③ Use GU6, GU7, GUC kits only for breakers with top-mounted fuses. For breakers with bottom-mounted fuses, use standard kit.

This information is subject to change. Updated pricing and availability information is included in the *Retrofit Kit Product Guide*. For a copy of the *Retrofit Kit Product Guide*, contact your local Eaton Field Sales office or the Digitrip Retrofit Kit Service Center at **1-800-937-5487**.

General Electric AL-2-50-75 Breakers—Trip Unit Retrofit Kits

Digitrip RMS Retrofit Kits for General Electric AL-2-50-75 Breakers Catalog Numbering System

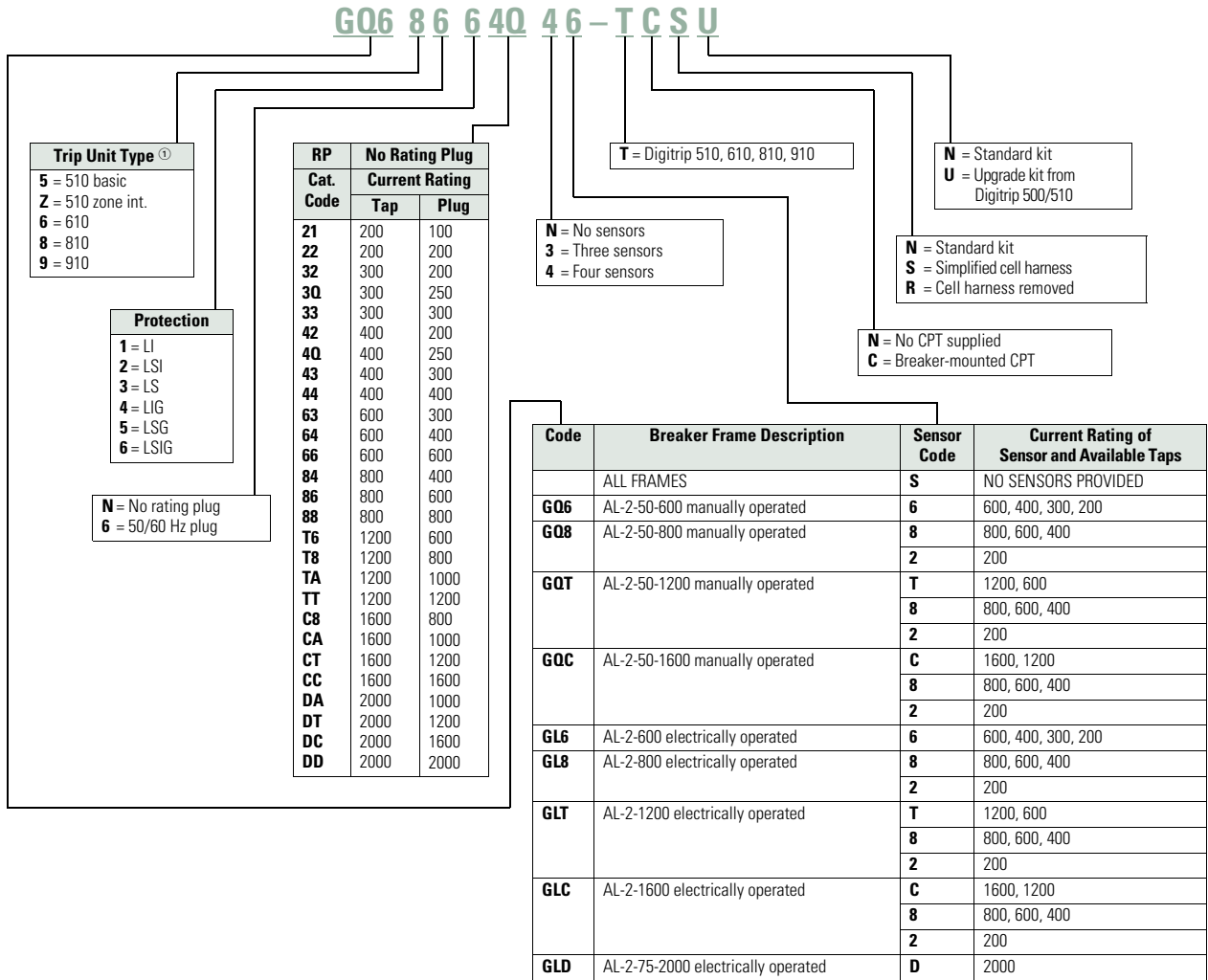

Note

① At the time of this publication, the standard trip units for low voltage Digitrip retrofit kits are the RMS 510/610/810/910.

Sample shown is a Digitrip retrofit kit for an AL-2-50-600 manually operated, with an RMS 810 trip unit, with LSIG protection, with a 60 Hz plug, rated at 250A for a sensor tap of 400A, four sensors (for a four-wire ground system) that have sensor taps of 600, 400, 300 and 200A, there is a breaker-mounted CPT with the kit, the cell wiring is simplified (only 6 wires vs. 16), and the breaker was previously retrofitted with a Digitrip 500/510, so this is an upgrade kit.

This information is subject to change. Updated pricing and availability information is included in the *Retrofit Kit Product Guide*. For a copy of the *Retrofit Kit Product Guide*, contact your local Eaton Field Sales office or the Digitrip Retrofit Kit Service Center at **1-800-937-5487**.

Digitrip RMS Retrofit Kits for Other General Electric Breakers Catalog Numbering System

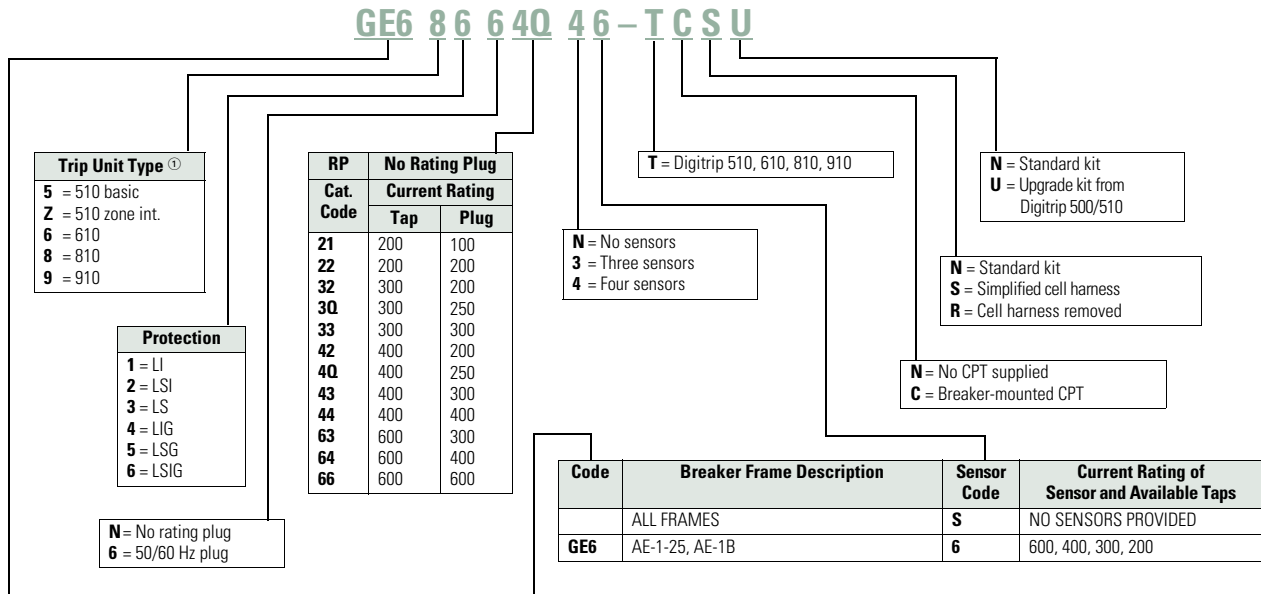

Note

① At the time of this publication, the standard trip units for low voltage Digitrip retrofit kits are the RMS 510/610/810/910.

Sample shown is a Digitrip retrofit kit for an AE-1-25, with an RMS 810 trip unit, with LSIG protection, with a 60 Hz plug, rated at 250A for a sensor tap of 400A, four sensors (for a four-wire ground system) that have sensor taps of 600, 400, 300 and 200A, there is a breaker-mounted CPT with the kit, the cell wiring is simplified (only 6 wires vs. 16), and the breaker was previously retrofitted with a Digitrip 500/510, so this is an upgrade kit.

This information is subject to change. Updated pricing and availability information is included in the *Retrofit Kit Product Guide*. For a copy of the *Retrofit Kit Product Guide*, contact your local Eaton Field Sales office or the Digitrip Retrofit Kit Service Center at **1-800-937-5487**.

Digitrip RMS Retrofit Kits for Allis-Chalmers LA Breakers



**Allis-Chalmers LA 600 Gold Breaker
Retrofitted with Digitrip
RMS 810 Retrofit Kit**



**Typical RMS 810 Retrofit Kit
for Allis-Chalmers LA 600
Gold Power Circuit Breaker**

Product Description

Digitrip RMS retrofit kits for Allis-Chalmers LA power circuit breakers were first introduced in 1991. For a complete description of the Digitrip RMS trip system and the features of models RMS 510, 610, 810 and 910, see **Page V12-T17-20**.

Ratings

Digitrip RMS retrofit kits are applied on Allis-Chalmers breakers from 600A (LA 600) to 3000A (LA 3000). The rating plug and the current sensor act in concert to provide for a wide spectrum of overload and short-circuit settings.

Chronology

Digitrip RMS retrofit kits and replacement trip units for Allis-Chalmers LA breakers became available in 1991. The Digitrip RMS 510 model is the modern day replacement for electromechanical trip device or peak sensing solid-state trip systems.

Replacement and Upgrade Capabilities

Replacement and upgrade capabilities include replacement Digitrip trip units and rating plugs, Digitrip trip unit upgrades, Digitrip RMS trip unit retrofit kits and upgrade retrofit kits. For definitions of these solutions, see **Page V12-T17-19**.

For Digitrip RMS trip unit retrofit kits and upgrade retrofit kits, choose or create the Digitrip RMS retrofit kit catalog number to match the Allis-Chalmers LA breaker type, retrofit kit type, protection function, rating plug type, current sensor type, CPT and type of kit required for application. See the example provided on **Page V12-T17-42**.

Application Notes for Allis-Chalmers LA Power Circuit Breakers

1. Retrofit kits are for use on 50 and 60 Hz distribution systems.
2. All retrofit kits are designed for drawout power circuit breakers only. Refer all fixed-mounted breaker applications to the Digitrip Retrofit Kit Service Center at **1-800-937-5487**.

3. The breaker compartment doors on the switchgear assembly must be free of panel-mounted instruments (i.e., meters, instruments, control switches, indicating lamps, etc.) or the retrofitted breaker may interfere with these devices when the compartment door is closed.
4. When the ground fault (G) option is selected, please observe the following:
 - a. For three-phase, three-wire solidly grounded systems, choose quantity three current sensors in the catalog number development.
 - b. For three-phase, four-wire solidly grounded systems, choose quantity four current sensors in the catalog number development. Three sensors are mounted on the breaker and one sensor is mounted on the switchgear neutral. Hardware to mount the current sensor on the switchgear neutral and provisions to wire it into the trip unit circuit (including a required pair of breaker secondary disconnecting contacts) are not included in the kit.
5. RMS 510 Zone, 610, 810 and 910 retrofit kits include a cell terminal block assembly that must be installed in the switchgear assembly. Internal switchgear wiring to accommodate the customer application schemes must be added in the field.
6. RMS 610, 810 and 910 retrofit kits require a customer supplied 120 Vac source connected to the cell terminal block assembly to power the Digitrip RMS digital displays and communications functions (as applicable).
7. Refer all LAF (LA breakers with current limiters) breakers to the Digitrip Retrofit Kit Service Center at **1-800-937-5487** for evaluation.

Digitrip RMS Retrofit Kits for Allis-Chalmers LA Breakers Catalog Numbering System

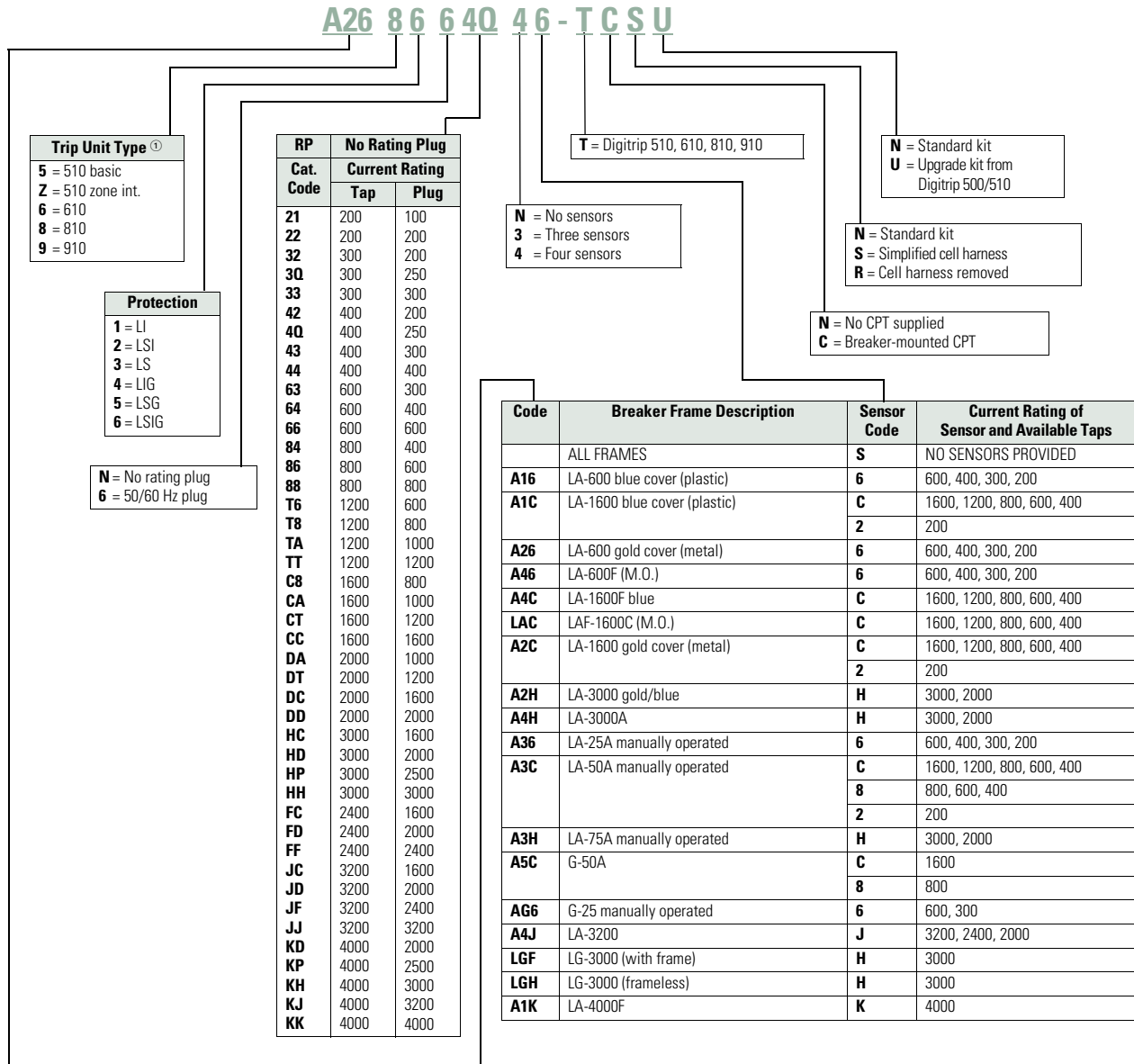

Note

① At the time of this publication, the standard trip units for low voltage Digitrip retrofit kits are the RMS 510/610/810/910.

Sample shown is a Digitrip retrofit kit for an LA-600 gold, with an RMS 810 trip unit, with LSIG protection, with a 60 Hz Plug, rated at 250A for a sensor tap of 400A, four sensors (for a four-wire ground system) that have sensor taps of 600, 400, 300 and 200A, there is a breaker-mounted CPT with the kit, the cell wiring is simplified (only 6 wires vs. 16), and the breaker was previously retrofitted with a Digitrip 500/510, so this is an upgrade kit.

This information is subject to change. Updated pricing and availability information is included in the *Retrofit Kit Product Guide*. For a copy of the *Retrofit Kit Product Guide*, contact your local Eaton Field Sales office or the Digitrip Retrofit Kit Service Center at **1-800-937-5487**.

Digitrip RMS Retrofit Kits for ITE K-Line Breakers

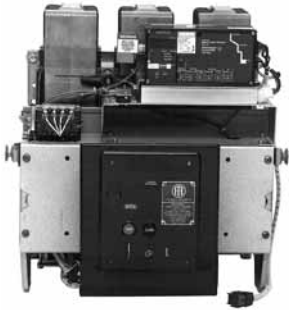

K-1600 Breaker Retrofitted with Digitrip RMS 810 Retrofit Kit



Typical Digitrip RMS 810 Retrofit Kit for ITE K-1600 Power Circuit Breaker

Product Description

Digitrip RMS retrofit kits for ITE K-Line power circuit breakers were first introduced in 1991. For a complete description of the Digitrip RMS trip system and the features of models RMS 510, 610, 810 and 910, see **Page V12-T17-20**.

Ratings

Digitrip RMS retrofit kits are applied on ITE K-Line breakers from 225A (K-225) to 3000A (K-3000), the rating plug and the current sensor rating act in concert to provide for a wide spectrum of overload and short-circuit settings.

Chronology

Digitrip RMS retrofit kits and replacement trip units for ITE K-Line breakers became available in 1991. The Digitrip RMS 510 model is the modern day replacement for electromechanical trip device or peak sensing solid-state trip systems.

Replacement and Upgrade Capabilities

Replacement and upgrade capabilities include replacement Digitrip trip units and rating plugs. Digitrip trip unit upgrades, Digitrip RMS trip unit retrofit kits and upgrade retrofit kits. For definitions of these solutions, see **Page V12-T17-19**.

For Digitrip RMS trip unit retrofit kits and upgrade retrofit kits, choose or create the Digitrip RMS retrofit kit catalog number to match the ITE K-Line and other breaker types, retrofit kit type, protection function, rating plug type, current sensor type, CPT and type of kit required for application. See the examples provided on **Page V12-T17-44**.

Application Notes for ITE K-Line and other Power Circuit Breakers

1. Retrofit kits are for use on 50 and 60 Hz distribution systems.
2. All retrofit kits are designed for drawout power circuit breakers only. Refer all fixed-mounted breaker applications to the Digitrip Retrofit Kit Service Center at **1-800-937-5487**.

3. The breaker compartment doors on the switchgear assembly must be free of panel-mounted instruments and devices (i.e., ammeters, switches, etc.) or the retrofitted breaker may interfere with these devices when the compartment door is closed.
4. When the ground fault (G) option is selected, please observe the following:
 - a. For three-phase, three-wire solidly grounded systems, choose quantity three current sensors in the catalog number development.
 - b. For three-phase, four-wire solidly grounded systems, choose quantity four current sensors in the catalog number development. Three sensors are mounted on the breaker and one sensor is mounted on the switchgear neutral. Hardware to mount the current sensor on the switchgear neutral and provisions to wire it into the trip unit circuit (including a required pair of breaker secondary disconnecting contacts) are not included in the kit.
5. RMS 510 zone, 610, 810 and 910 retrofit kits include a cell terminal block assembly that must be installed in the switchgear assembly. Internal switchgear wiring to accommodate the customer application schemes must be added in the field.
6. RMS 610, 810 and 910 retrofit kits require a customer supplied 120 Vac source connected to the cell terminal block assembly to power the Digitrip RMS digital displays and communications functions (as applicable).
7. Refer all K-DON Series (K-Line breakers with current limiters) breakers to the Digitrip Retrofit Kit Service Center at **1-800-937-5487** for evaluation.

Digitrip RMS Retrofit Kits for ITE K-Line Breakers Catalog Numbering System

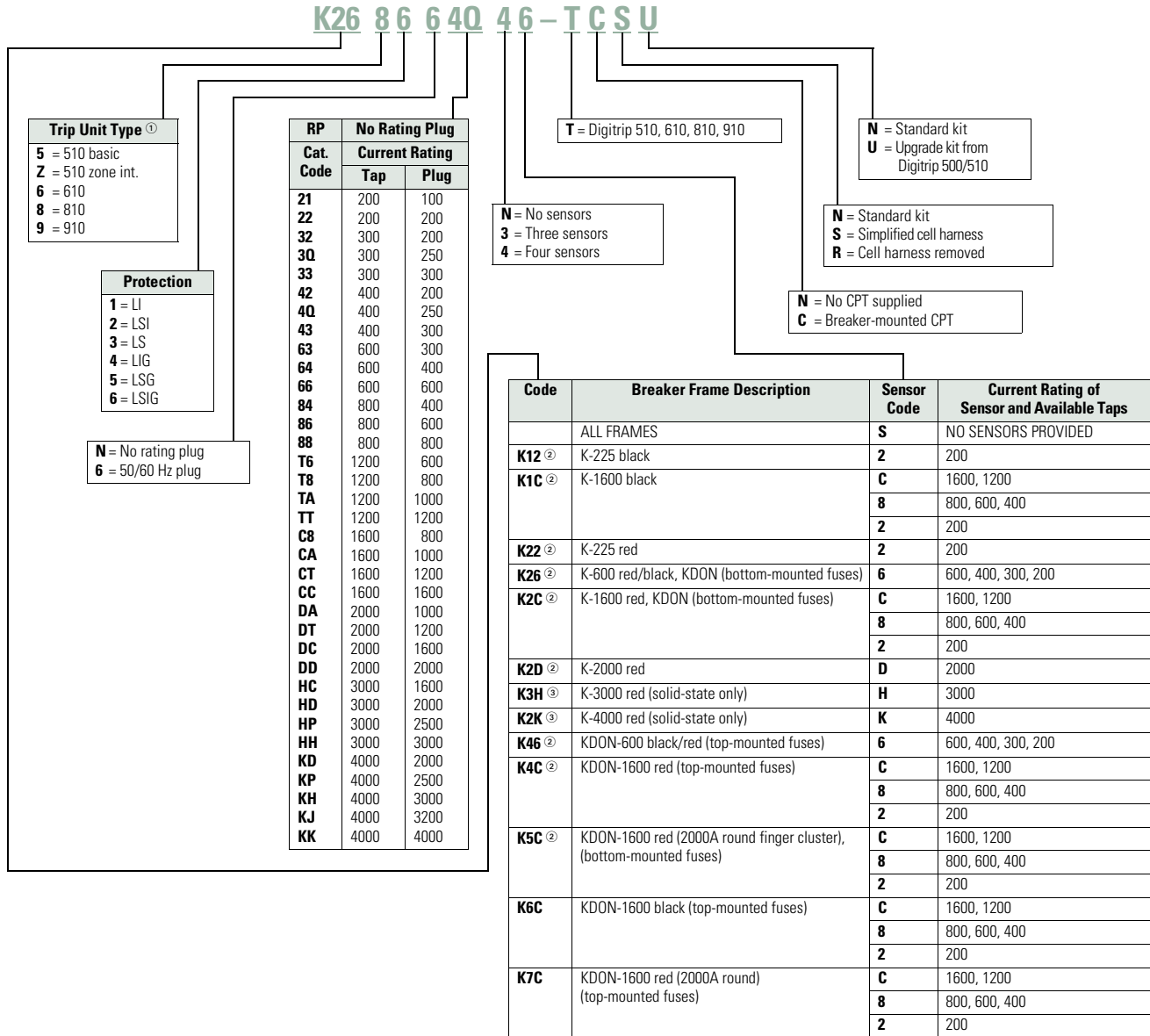

Notes

- ① At the time of this publication, the standard trip units for low voltage Digitrip retrofit kits are the RMS 510/610/810/910.
- ② Black and red refer to the color of the back plane insulation material.
- ③ If your breaker is not solid-state, call the Digitrip Retrofit Kit Service Center at **1-800-937-5487** for technical clarification on these kits.

Sample shown is a Digitrip retrofit kit for a K-600 with red back plane insulation, with an RMS 810 trip unit, with LSI protection, with a 60 Hz plug, rated at 250A for a sensor tap of 400A, four sensors (for a four-wire ground system) that have a sensor taps of 600, 400, 300 and 200A, there is a breaker-mounted CPT with the kit, the cell wiring is simplified (only 6 wires vs. 16), and the breaker was

previously retrofitted with a Digitrip 500/510, so this is an upgrade kit.

This information is subject to change. Updated pricing and availability information is included in the *Retrofit Kit Product Guide*. For a copy of the *Retrofit Kit Product Guide*, contact your local Eaton Field Sales office or the Digitrip Retrofit Kit Service Center at **1-800-937-5487**.

Digitrip Retrofit Kits for Other ITE Breakers



KE-4000 Breaker Retrofitted with Digitrip RMS 810 Retrofit Kit



Typical Digitrip RMS 810 Retrofit Kit for ITE KE-4000 Power Circuit Breaker

Product Description

Digitrip retrofit kits for ITE power circuit breakers were first introduced in 1992. For a complete description of the Digitrip RMS trip system and the features of models RMS 510, 610, 810 and 910, see **Page V12-T17-20**.

Ratings

Digitrip RMS retrofit kits are applied on ITE breakers from 600A (KB-600) to 3000A (KE-4000), the rating plug and the current sensor rating act in concert to provide for a wide spectrum of overload and short-circuit settings.

Chronology

Digitrip retrofit kits and replacement trip units for ITE breakers became available in 1992. The Digitrip RMS 510 model is the modern day replacement for electromechanical trip device or peak sensing solid-state trip systems.

Replacement and Upgrade Capabilities

Replacement and upgrade capabilities include replacement Digitrip trip units and rating plugs, Digitrip trip unit upgrades, Digitrip RMS trip unit retrofit kits and upgrade retrofit kits. For definitions of these solutions, see **Page V12-T17-19**.

For Digitrip RMS trip unit retrofit kits and upgrade retrofit kits, choose or create the Digitrip RMS retrofit kit catalog number to match the ITE and other breaker types, retrofit kit type, protection function, rating plug type, current sensor type, CPT and type of kit required for application. See the examples provided on **Page V12-T17-46**.

Application Notes for ITE and Other Power Circuit Breakers

1. Retrofit kits are for use on 50 and 60 Hz distribution systems.
2. All retrofit kits are designed for drawout power circuit breakers only. Refer all fixed-mounted breaker applications to the Digitrip Retrofit Kit Service Center at **1-800-937-5487**.

3. The breaker compartment doors on the switchgear assembly must be free of panel-mounted instruments and devices (i.e., ammeters, switches, etc.) or the retrofitted breaker may interfere with these devices when the compartment door is closed.
4. When the ground fault (G) option is selected, please observe the following:
 - a. For three-phase, three-wire solidly grounded systems, choose quantity three current sensors in the catalog number development.
 - b. For three-phase, four-wire solidly grounded systems, choose a quantity of four current sensors in the catalog number development. Three sensors are mounted on the breaker and one sensor is mounted on the switchgear neutral. Hardware to mount the current sensor on the switchgear neutral and provisions to wire it into the trip unit circuit (including a required pair of breaker secondary disconnecting contacts) are not included in the kit.
5. RMS 510 Zone, 610, 810 and 910 retrofit kits include a cell terminal block assembly that must be installed in the switchgear assembly. Internal switchgear wiring to accommodate the customer application schemes must be added in the field.
6. RMS 610, 810 and 910 retrofit kits require a customer supplied 120 Vac source connected to the cell terminal block assembly to power the Digitrip RMS digital displays and communications functions (as applicable).
7. Refer all ITE breakers with current limiters to the Digitrip Retrofit Kit Service Center at **1-800-937-5487** for evaluation.

Digitrip RMS Retrofit Kits for Other ITE Breakers Catalog Numbering System

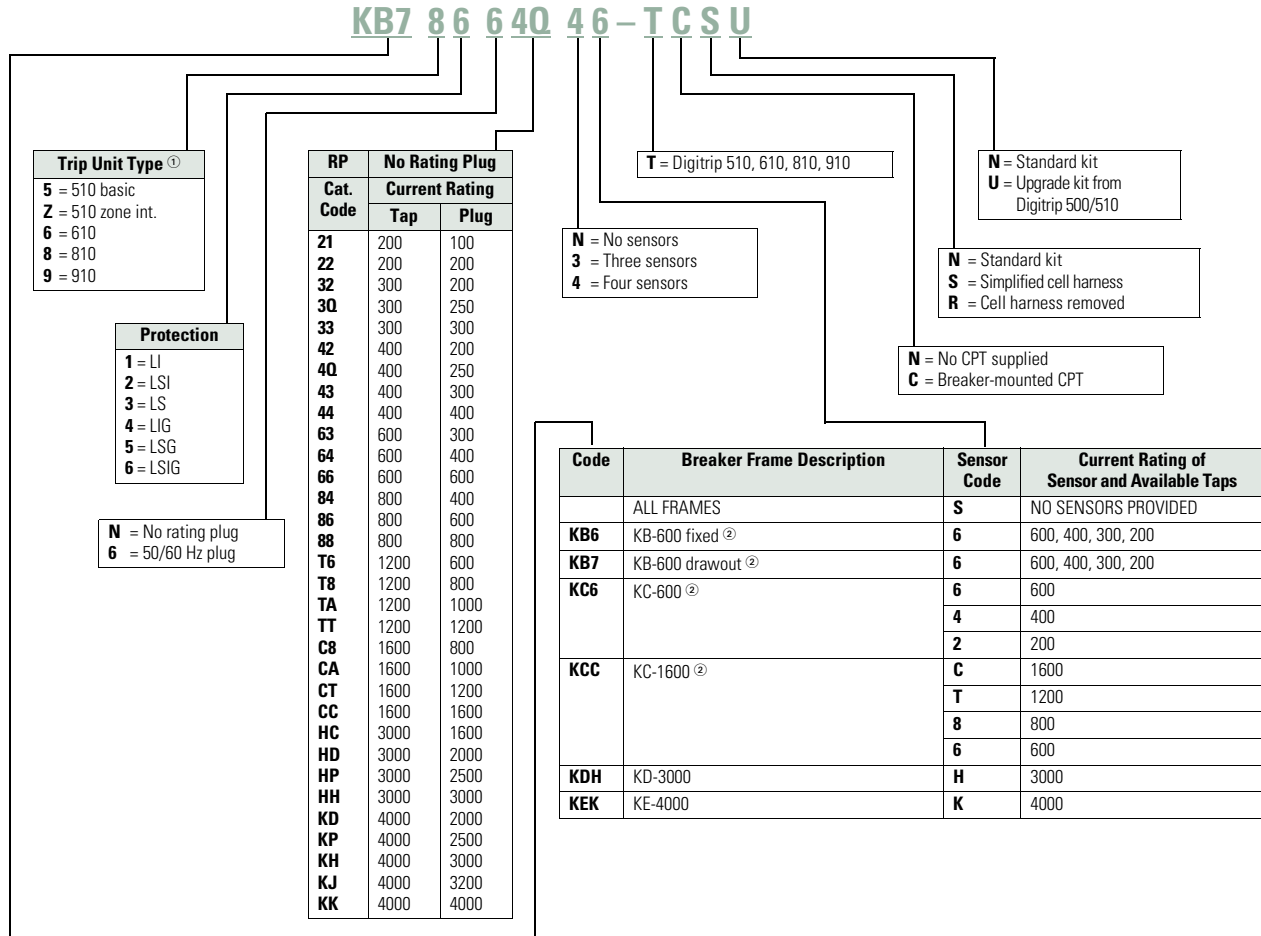

Notes

- ① At the time of this publication, the standard trip units for low voltage Digitrip retrofit kits are the RMS 510/610/810/910.
- ② Call the Digitrip Retrofit Kit Service Center at **1-800-937-5487** for technical clarification on these kits.

Sample shown is a Digitrip retrofit kit for a KB-600 drawout breaker, with an RMS 810 trip unit, with LSIG protection, with a 60 Hz plug, rated at 250A for a sensor tap of 400A, four sensors (for a four-wire ground system) that have sensor taps of 600, 400, 300 and 200A, there is a breaker-mounted CPT with the kit, the cell wiring is simplified (only 6 wires vs. 16), and the breaker was previously retrofitted with a Digitrip 500/510, so this is an upgrade kit.

This information is subject to change. Updated pricing and availability information is included in the *Retrofit Kit Product Guide*. For a copy of the *Retrofit Kit Product Guide*, contact your local Eaton Field Sales office or the Digitrip Retrofit Kit Service Center at **1-800-937-5487**.

Digitrip Retrofit Kits for Siemens and Siemens-Allis Breakers



LAF-800 Breaker Retrofitted with Digitrip RMS 810 Retrofit Kit



Typical Digitrip RMS 810 Retrofit Kit for Siemens-Allis LAF-800 Power Circuit Breaker

Product Description

Digitrip retrofit kits for Siemens and Siemens-Allis power circuit breakers were first introduced in 1993. For a complete description of the Digitrip RMS trip system and the features of models RMS 510, 610, 810 and 910, see **Page V12-T17-20**.

Ratings

Digitrip RMS retrofit kits are applied on Siemens and Siemens-Allis breakers from 800A (LAF-800) to 4000A (RL-3000), the rating plug and the current sensor rating act in concert to provide for a wide spectrum of overload and short-circuit settings.

Chronology

Digitrip retrofit kits and replacement trip units for Siemens and Siemens-Allis breakers became available in 1992. The Digitrip RMS 510 model is the modern day replacement for electromechanical trip device or peak sensing solid-state trip systems.

Replacement and Upgrade Capabilities

Replacement and upgrade capabilities include replacement Digitrip trip units and rating plugs, Digitrip trip unit upgrades, Digitrip RMS trip unit retrofit kits and upgrade retrofit kits. For definitions of these solutions, see **Page V12-T17-19**.

For Digitrip RMS trip unit retrofit kits and upgrade retrofit kits, choose or create the Digitrip RMS retrofit kit catalog number to match the Siemens and Siemens-Allis breaker types, retrofit kit type, protection function, rating plug type, current sensor type, CPT and type of kit required for application. See the examples provided on **Page V12-T17-48**.

Application Notes for Siemens and Siemens-Allis Power Circuit Breakers

1. Retrofit kits are for use on 50 and 60 Hz distribution systems.
2. All retrofit kits are designed for drawout power circuit breakers only. Refer all fixed-mounted breaker applications to the Digitrip Retrofit Kit Service Center at **1-800-937-5487**.

3. The breaker compartment doors on the switchgear assembly must be free of panel-mounted instruments and devices (i.e., ammeters, switches, etc.) or the retrofitted breaker may interfere with these devices when the compartment door is closed.
4. When the ground fault (G) option is selected, please observe the following:
 - a. For three-phase, three-wire solidly grounded systems, choose quantity three current sensors in the catalog number development.
 - b. For three-phase, four-wire solidly grounded systems, choose a quantity of four current sensors in the catalog number development. Three sensors are mounted on the breaker and one sensor is mounted on the switchgear neutral. Hardware to mount the current sensor on the switchgear neutral and provisions to wire it into the trip unit circuit (including a required pair of breaker secondary disconnecting contacts) are not included in the kit.
5. RMS 510 zone, 610, 810 and 910 retrofit kits include a cell terminal block assembly that must be installed in the switchgear assembly. Internal switchgear wiring to accommodate the customer application schemes must be added in the field.
6. RMS 610, 810 and 910 retrofit kits require a customer supplied 120 Vac source connected to the cell terminal block assembly to power the Digitrip RMS Digital displays and communications functions (as applicable).
7. Refer all Siemens and Siemens-Allis breakers with current limiters to the Digitrip Retrofit Kit Service Center at **1-800-937-5487** for evaluation.

Digitrip Retrofit Kits for Siemens and Siemens-Allis Breakers Catalog Numbering System

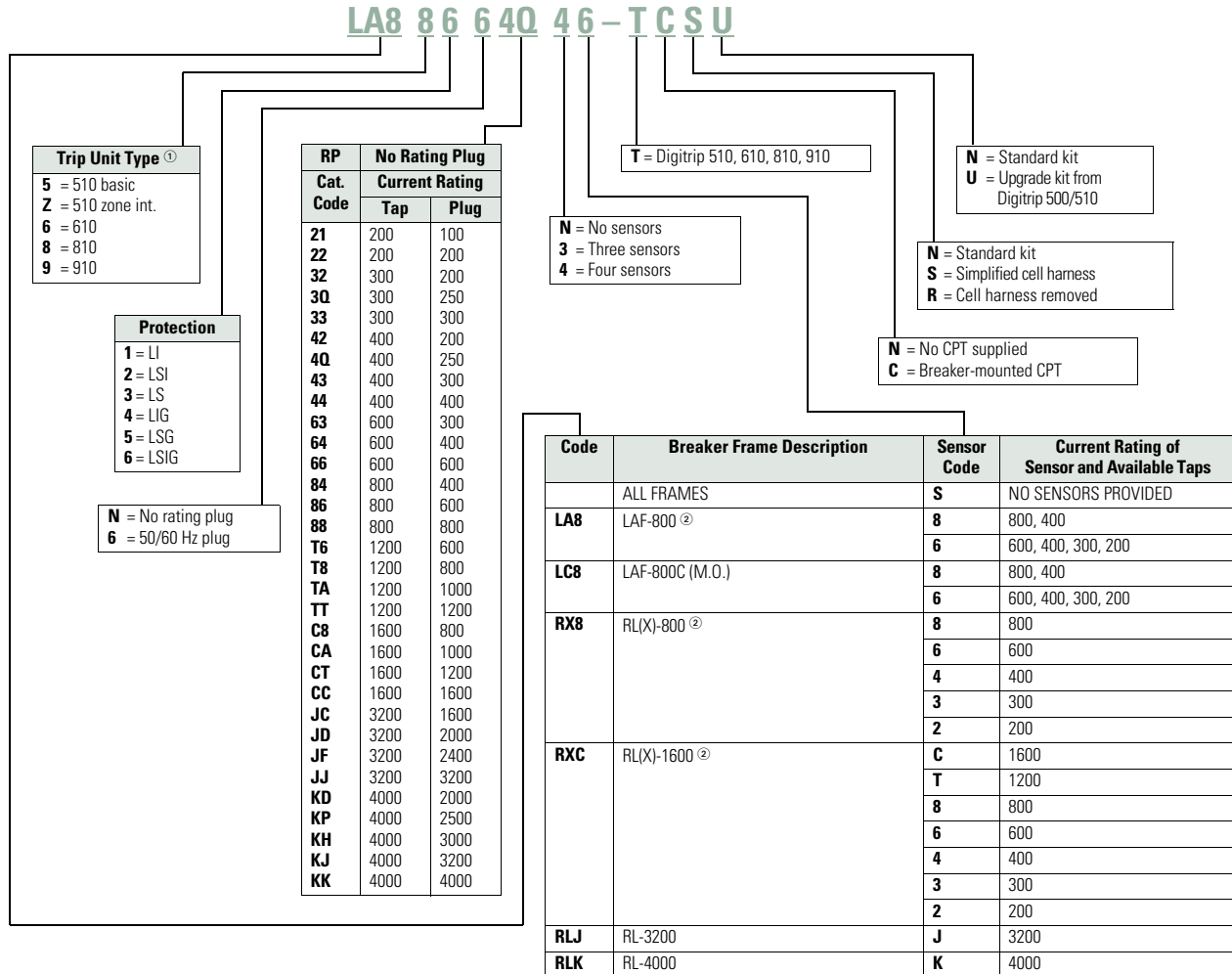

Notes

- ① At the time of this publication, the standard trip units for low voltage Digitrip retrofit kits are the RMS 510/610/810/910.
- ② Call the Digitrip Retrofit Kit Service Center at **1-800-937-5487** for technical clarification on these kits.

Sample shown is a Digitrip retrofit kit for an LAF-800, with an RMS 810 trip unit, with LSIG protection, with a 60 Hz plug, rated at 250A for a sensor tap of 400A, four sensors (for a four-wire ground system) that have sensor taps of 600, 400, 300 and 200A, there is a breaker-mounted CPT with the kit, the cell wiring is simplified (only 6 wires vs. 16), and the breaker was previously retrofitted with a Digitrip 500/510, so this is an upgrade kit.

This information is subject to change. Updated pricing and availability information is included in the *Retrofit Kit Product Guide*. For a copy of the *Retrofit Kit Product Guide*, contact your local Eaton Field Sales office or the Digitrip Retrofit Kit Service Center at **1-800-937-5487**.

Digitrip Retrofit Kits for Federal Pacific Breakers

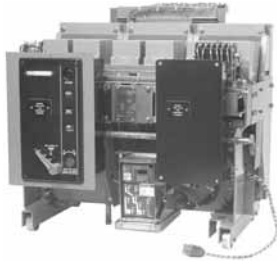

FPS-75 Breaker Retrofitted with Digitrip RMS 810 Retrofit Kit



Typical Digitrip RMS 810 Retrofit Kit for Federal Pacific FPS-75 Power Circuit Breaker

Product Description

Digitrip RMS retrofit kits for Federal Pacific power circuit breakers were first introduced in 1992. For a complete description of the Digitrip RMS trip system and the features of models RMS 510, 610, 810 and 910, see **Page V12-T17-20**.

Ratings

Digitrip RMS retrofit kits are applied on Federal Pacific breakers from 600A (FP-25) to 3000A (FPS-75), the rating plug and the current sensor rating act in concert to provide for a wide spectrum of overload and short-circuit settings.

Chronology

Digitrip retrofit kits and replacement trip units for Federal Pacific breakers became available in 1992. The Digitrip RMS 510 model is the modern day replacement for electromechanical trip device or peak sensing solid-state trip systems.

Replacement and Upgrade Capabilities

Replacement and upgrade capabilities include replacement Digitrip trip units and rating plugs, Digitrip trip unit upgrades, Digitrip RMS trip unit retrofit kits and upgrade retrofit kits. For definitions of these solutions, see **Page V12-T17-19**.

For Digitrip RMS trip unit retrofit kits and upgrade retrofit kits, choose or create the Digitrip RMS retrofit kit catalog number to match the Federal Pacific breaker types, retrofit kit type, protection function, rating plug type, current sensor type, CPT and type of kit required for application. See the examples provided on **Page V12-T17-50**.

Application Notes for Federal Pacific Power Circuit Breakers

1. Retrofit kits are for use on 50 and 60 Hz distribution systems.
2. All retrofit kits are designed for drawout power circuit breakers only. Refer all fixed-mounted breaker applications to the Digitrip Retrofit Kit Service Center at **1-800-937-5487**.

3. The breaker compartment doors on the switchgear assembly must be free of panel-mounted instruments and devices (i.e., ammeters, switches, etc.) or the retrofitted breaker may interfere with these devices when the compartment door is closed.
4. When the ground fault (G) option is selected, please observe the following:
 - a. For three-phase, three-wire solidly grounded systems, choose quantity three current sensors in the catalog number development.
 - b. For three-phase, four-wire solidly grounded systems, choose quantity four current sensors in the catalog number development. Three sensors are mounted on the breaker and one sensor is mounted on the switchgear neutral. Hardware to mount the current sensor on the switchgear neutral and provisions to wire it into the trip unit circuit (including a required pair of breaker secondary disconnecting contacts) are not included in the kit.
5. RMS 510 zone, 610, 810 and 910 retrofit kits include a cell terminal block assembly that must be installed in the switchgear assembly. Internal switchgear wiring to accommodate the customer application schemes must be added in the field.
6. RMS 610, 810 and 910 retrofit kits require a customer supplied 120 Vac source connected to the cell terminal block assembly to power the Digitrip RMS digital displays and communications functions (as applicable).
7. Refer all Federal Pacific breakers with current limiters to the Digitrip Retrofit Kit Service Center at **1-800-937-5487** for evaluation.

Digitrip Retrofit Kits for Federal Pacific Breakers Catalog Numbering System

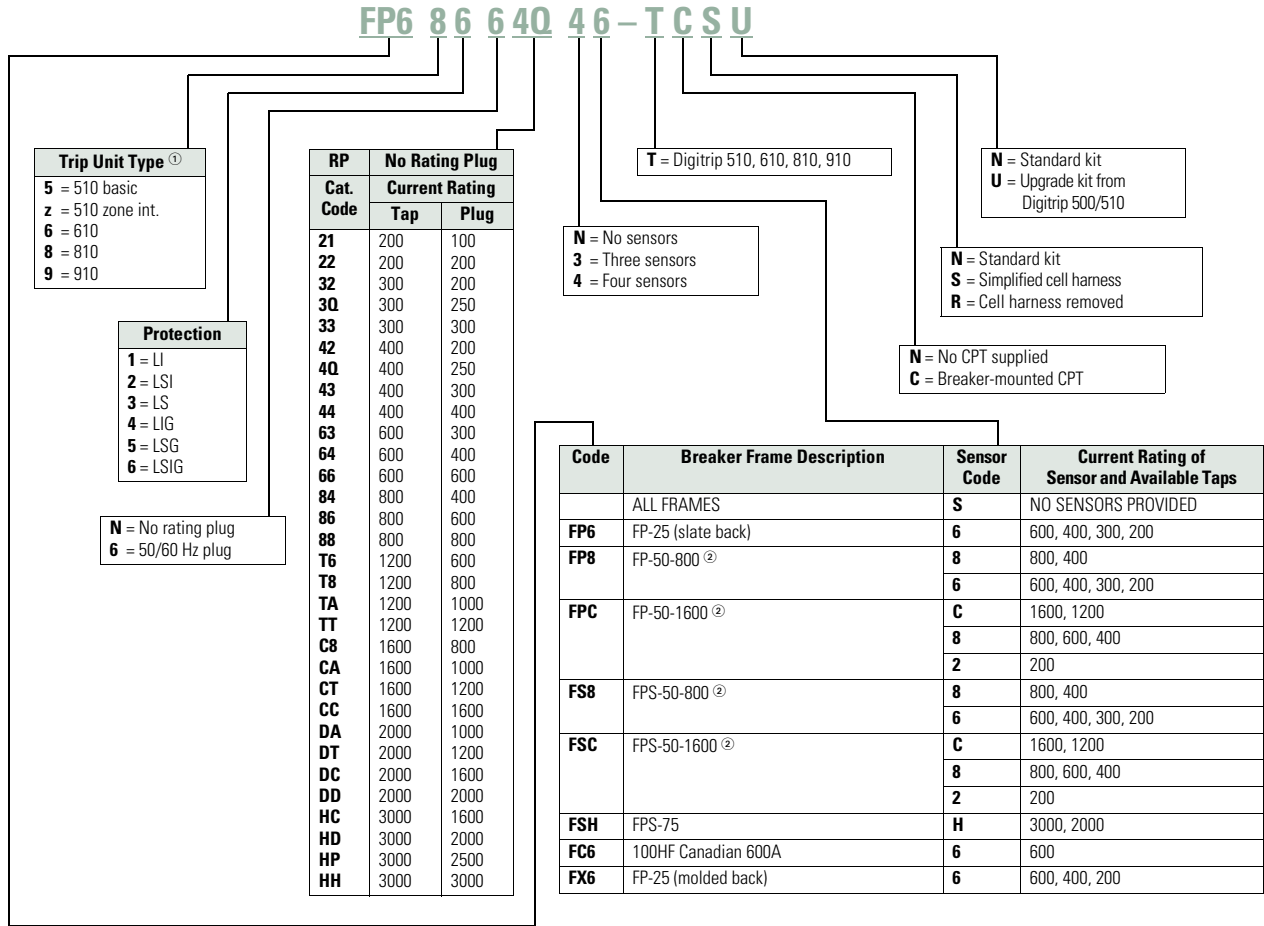

Notes

- ① At the time of this publication, the standard trip units for low voltage Digitrip retrofit kits are the RMS 510/610/810/910.
- ② Call the Digitrip Retrofit Kit Service Center at **1-800-937-5487** for technical clarification on these kits.

Sample shown is a Digitrip retrofit kit for an FP-25, with an RMS 810 trip unit, with LSIG protection, with a 60 Hz plug, rated at 250A for a sensor tap of 400A, four sensors (for a four-wire ground system) that have sensor taps of 600, 400, 300 and 200A, there is a breaker-mounted CPT with the kit, the cell wiring is simplified (only 6 wires vs. 16), and the breaker was previously retrofitted with a Digitrip 500/510, so this is an upgrade kit.

This information is subject to change. Updated pricing and availability information is included in the *Retrofit Kit Product Guide*. For a copy of the *Retrofit Kit Product Guide*, contact your local Eaton Field Sales office or the Digitrip Retrofit Kit Service Center at **1-800-937-5487**.

Digitrip Retrofit Kits for Other Breakers Catalog Numbering System

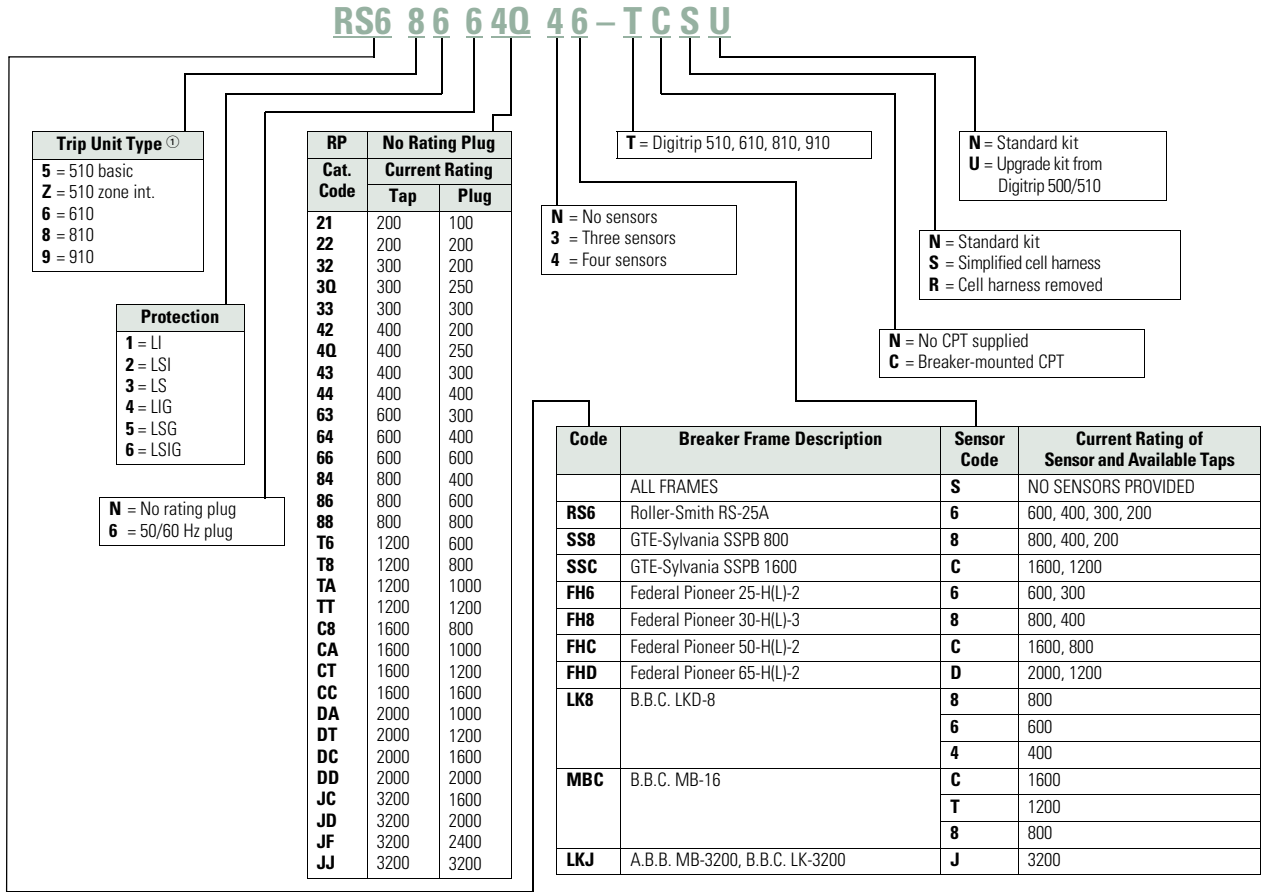

Note

① At the time of this publication, the standard trip units for low voltage Digitrip retrofit kits are the RMS 510/610/810/910.

Sample shown is a Digitrip Retrofit Kit for an RS-25A, with an RMS 810 trip unit, with LSIG protection, with a 60 Hz plug, rated at 250A for a sensor tap of 400A, four sensors (for a four-wire ground system) that have sensor taps of 600, 400, 300 and 200A, there is a breaker-mounted CPT with the kit, the cell wiring is simplified (only 6 wires vs. 16), and the breaker was previously retrofitted with a Digitrip 500/510, so this is an upgrade kit.

This information is subject to change. Updated pricing and availability information is included in the *Retrofit Kit Product Guide*. For a copy of the *Retrofit Kit Product Guide*, contact your local Eaton Field Sales office or the Digitrip Retrofit Kit Service Center at **1-800-937-5487**.

Further Information**Publication**

Number	Description
B.22D.01.S.E	Sales Brochure for Digitrip RMS retrofit kits
AD 33-855-3	Instructions for the Application of Digitrip RMS Retrofit Kits on power circuit breakers
SA-11581D	Sales Aid for Digitrip trip units
IL 29-885-A	Instruction Leaflet for Digitrip RMS 510 trip unit
IL 29-886-B	Instruction Leaflet for Digitrip RMS 610 trip unit
IL 29-888-A	Instruction Leaflet for Digitrip RMS 810 trip unit
IL 29-889-A	Instruction Leaflet for Digitrip RMS 910 trip unit
AD 32-870	Application Data for time current curves for DS and DSL circuit breakers
PA01301011E	Product Aid for Arcflash Reduction Maintenance System

Pricing Information

*Price and Availability
Digest (PAD)*

*Retrofit Kit Product Guide
(Contact Digitrip Retrofit Kit
Service Center)*

Vista/VISTALINE
discount symbol Y1-R

Medium Voltage Metal-Clad—Assemblies and Power Circuit Breakers

Assemblies and Power Circuit Breakers

Originally a Westinghouse Product



Medium Voltage Switchgear Assembly (Type DHP with Drawout Breaker)

Product Description

Medium voltage switchgear serves to channel and switch power in industrial, commercial and utility electrical distribution systems. It is manufactured to industry standards that define the requirements for its ratings, design, construction and testing. ANSI C37.20.2 is the current applicable industry standard for medium voltage metal-clad switchgear, defining the rated maximum voltage range to be from 4.76 kV to 38 kV.

Medium voltage switchgear consists of one or more metal structures that house drawout power circuit breakers, phase bus conductors, auxiliary, control, metering and protective devices. These switchgear components are customized in various combinations during manufacturing to satisfy the application requirements of the switchgear user. Control switches, meters, instruments and protective relays are generally mounted on the switchgear front panels to provide breaker control, metering and circuit protection.

Medium voltage switchgear is typically characterized by metal-clad construction, which means that the switchgear compartments enclosing primary voltage are separated from adjacent compartments by grounded metal barriers.

Product History

In 1939, Westinghouse introduced type DH medium voltage air magnetic power circuit breakers and associated switchgear. Initially, DH breakers were rated up to 5 kV with a maximum interrupting capacity of 150 MVA. Product design enhancements evolved and additional variations of the DH breaker became available. In 1946, the maximum rated voltage of the DH breaker was extended to 15 kV. Eventually, the maximum rated interrupting capacity of the DH breaker reached 1000 MVA.

In 1963, Westinghouse introduced type DHP medium voltage Porcel-line® air magnetic power circuit breakers and associated switchgear with all live parts insulated to ground by high-strength porcelain insulation. Porcelain provided excellent high dielectric, non-tracking, non-combustible, non-hygroscopic and non-aging insulation characteristics. This was a technological improvement over the first DH breakers, which were furnished with a paper phenolic insulation. DHP switchgear was manufactured in ratings from 5 kV, 75 MVA to 15 kV, 1000 MVA. In 1978, Westinghouse introduced the

DVP breaker, the first Westinghouse medium voltage power circuit breaker to use vacuum interrupters. The DVP vacuum breaker was manufactured in 500 and 750 MVA interrupting ratings and was directly interchangeable with DHP air magnetic breakers of the same ratings.

In 1981, Westinghouse introduced VacClad medium voltage metal-clad switchgear with type VCP vacuum power circuit breakers. VCP breakers were furnished with vacuum interrupters, greatly reducing breaker size and weight. The reduced size permitted most breaker ratings to be stacked two-high in the switchgear enclosure, saving on switchgear installation space. VCP breakers included a design improvement called the V-Flex current transfer system, which eliminated the transfer of primary current over a moving hinge or a sliding contact assembly on the breaker. Porcelain insulation was maintained on the breaker elements and in the switchgear, except for the 5 kV switchgear cell insulation that was glass polyester. The switchgear phase bus was insulated with a fluidized bed epoxy insulation system, which was a technological

improvement over the epoxy impregnated kraft paper or noryl sleeving that was used over phase busbars in previous switchgear designs. VacClad switchgear was manufactured in ratings from 5 kV, 250 MVA to 15 kV, 1000 MVA.

In 1986, Westinghouse introduced VacClad-W World-Class medium voltage metal-clad switchgear with type VCP-W vacuum power circuit breakers. VCP-W switchgear included product improvements in manufacturing design and product performance. However, many of the attractive design features of VCP switchgear were maintained, including two-high breaker stacking, V-Flex breaker current transfer and fluidized epoxy insulation on the switchgear phase buses. VCP-W breakers and switchgear were furnished with high-grade glass polyester insulation as standard. Optional insulation upgrades included cycloaliphatic epoxy insulation for breaker element insulation (VCP-WSE breakers) and porcelain insulation for the switchgear cell contact bottles. VacClad-W switchgear is manufactured in ratings from 5 kV, 250 MVA to 15 kV, 1500 MVA to 27 kV and 38 kV, 40 kA.

Product History Time Line

Page	Product	1955	1960	1965	1970	1975	1980	1985	1990	1995	2000	Present
V12-T17-55	Westinghouse DH Switchgear and Breakers	█										
V12-T17-56	Westinghouse DHP Switchgear and Breakers		█									
V12-T17-55	DHP-VR Replacement Breaker								█			
V12-T17-57	Westinghouse VCP VacClad Switchgear and Breakers						█					
V12-T17-58	Cutler-Hammer VCP-W VacClad Switchgear and Breakers								█			
V12-T17-60	Competitive Replacement Breakers									█		

General Information

Medium Voltage Switchgear Support

Product	Brand	Introduced to Market	New Structures	Assembly Parts	Breaker	Breaker Parts	Switch	Switch Parts
Metal-Clad Switchgear								
DH	Westinghouse	1939	No	No	DH Breaker Replacement by DH-VR Breaker	No (contact Homewood Products at 412-665-2700)	N/A	N/A
DHP	Westinghouse	1963	No (contact the factory)	Yes	DHP breaker replacement by DHP-VR breaker. Class I reconditioning of DHP breakers and repair service.	Yes (contact the Power Breaker Center 1-877-276-9379)	N/A	N/A
VCP VacClad	Westinghouse	1981	New VCP-W structures can be directly coupled to VCP structures	Some	Yes	Yes	N/A	N/A
VCP-W VacClad	Westinghouse Cutler-Hammer	1986 1995	Yes	Yes	Yes	Yes	N/A	N/A
VCP-W VacClad arc resistant	Cutler-Hammer	1995	Yes	Yes	Yes	Yes	N/A	N/A
VCP-ND VacClad narrow design	Cutler-Hammer	1994	Yes	Yes	Yes	Yes	N/A	N/A
C-HRG high resistance pulsing ground system	Cutler-Hammer	1999	Yes	Yes	N/A	N/A	N/A	N/A
Metal-Enclosed Switchgear—Switch								
LBF	Westinghouse	1952	No	No (contact Cleveland-Price at 724-864-4177)	N/A	N/A	No	No (Contact Cleveland-Price at 724-864-4177)
WLI	Westinghouse Cutler-Hammer	1972	No	Yes	N/A	N/A	Yes	Yes
MVS	Cutler-Hammer	1999	Yes	Yes	N/A	N/A	Yes	Yes
UPC, Unitized Power Center	Cutler-Hammer	1999	Yes	Yes	N/A	N/A	Yes	Yes
Pad Mount	Cutler-Hammer	1999	Yes	Yes	N/A	N/A	Yes	Yes
Mini-MVS	Cutler-Hammer	2003	Yes	Yes	N/A	N/A	Yes	Yes
Metal-Enclosed Switchgear—Switch and Breaker								
WVB	Westinghouse	1991	No	Yes	Yes	Yes	Yes	Yes
MEB	Cutler-Hammer	1999	Yes	Yes	Yes— VCP-W breaker	Yes— VCP-W breaker	Yes	Yes
Metal-Enclosed Switchgear—Breaker								
Station Distribution Breaker	Cutler-Hammer	1994	Yes	Yes	Yes— VCP-W breaker	Yes— VCP-W breaker	N/A	N/A
MSB	Cutler-Hammer	1999	Yes	Yes	Yes—VCP-TR fixed-mounted breaker	Yes—VCP-TR fixed-mounted breaker	N/A	N/A

DH Medium Voltage Metal-Clad—Assemblies and Power Circuit Breakers

DH Switchgear Assemblies and Power Circuit Breakers

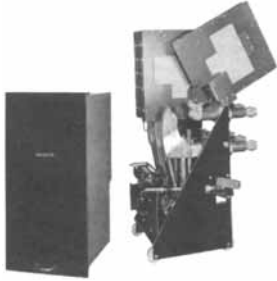

Westinghouse DH Drawout Air Magnetic Power Circuit Breaker (Interphase Barrier Removed)

Product Description

Westinghouse DH medium voltage metal-clad switchgear with type DH “DE-ION®” air circuit breakers was introduced in 1939. The drawout breaker element consists of an operating mechanism that drives a set of three-pole units. When the breaker is tripped, the moving and stationary contacts separate. The resulting arc on each phase is drawn up and into the arc chutes, which dissipate the arc through ceramic splitter plates. The de-ionizing interruption process is aided magnetically by the arc chute blow out coil assembly.

DH switchgear was available in indoor and in sheltered aisle and aisle-less outdoor enclosures. DH metal-clad switchgear structure dimensions were standardized, but varied with individual breaker ratings. Widths varied from 20.00 inches for the 50DH75 (1200A) light duty rating, to 26.00 inches for the 50DH250 (1200A) rating, to 36.00 inches for most 2000A and 7.5 and 15 kV ratings.

Ratings

DH switchgear ratings started with the light duty 50DH75 (5 kV, 75 MVA) 1200A breaker. The spectrum of ratings also included 7.5 and 15 kV ratings. The maximum breaker rating produced was the 150DH1000 (15 kV, 1000 MVA) 3000A.

Chronology

DH switchgear was introduced in 1939 and was actively manufactured by Westinghouse in complete switchgear assemblies until the introduction of DHP switchgear in 1963. As production activity tapered after 1963, only match and lineup additions to existing DH switchgear were manufactured along with complete replacement circuit breakers and renewal parts. The last new manufactured DH breakers and switchgear cells were produced in 1983.

Replacement Capabilities



150DH-VR 1200A VR-Series Circuit Breaker

Eaton offers the following to support DH switchgear.

DH-VR Vacuum Replacement Breakers

The DH-VR is a brand new vacuum replacement breaker (VR-Series) for DH air magnetic breakers. The DH-VR breaker permits DH switchgear modernization by using state-of-the-art Eaton VCP-W vacuum breaker technology. The DH-VR is designed, manufactured and tested to applicable IEEE/ANSI standards.

Ratings are available to replace: 5 kV through 15 kV, 50DH150 through 150DH1000, 1200 through 3000A (4000A fan-cooled).

Additional VR-Series breakers are available to upgrade competitors’ air magnetic breakers. See **Pages V12-T17-60 and V12-T17-61**.

SURE CLOSE

All VR Series breakers that are furnished with MOC operators incorporate Eaton’s exclusive *SURE CLOSE* MOC technology. See additional information on **Page V12-T17-62**.

Renewal Parts

Eaton no longer offers new manufactured renewal parts for DH switchgear structures. For DH renewal parts, contact Homewood Products at **412-665-2700**.

Note: New DH factory manufactured switchgear structures and breakers are no longer available.

DHP Switchgear Assemblies and Power Circuit Breakers

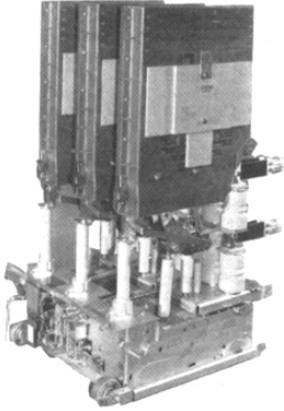

Type DHP Drawout Air Magnetic Power Circuit Breaker
(Front Interphase Barrier Removed)

Product Description

Westinghouse DHP medium voltage porcelain metal-clad switchgear with type DHP air magnetic power circuit breakers was introduced in 1963. DHP breakers and switchgear were similar to, but not interchangeable with, the older DH product. DHP was provided with porcelain insulation on all live parts to ground in the switchgear and on the breaker element. DHP switchgear was available in indoor and in sheltered aisle and aisle-less outdoor enclosures.

DHP air magnetic breakers were subject to three major design changes that were phased in during their manufacturing life. The first DHP breakers were furnished with solenoid operated mechanisms with cast parts and monolithic pole units. From 1964 to 1968, the stored energy spring mechanism gradually phased out the solenoid operator. After 1968, cast mechanisms were phased out by fabricated mechanisms. After 1970, monolithic pole units were phased out by the post-insulator pole unit (PIP) design.

DVP vacuum breakers were introduced in 1978. DVP breakers were first generation vacuum breakers that were interchangeable in DHP switchgear with DHP air magnetic breakers of the same ratings.

Ratings

- DHP breakers:
 - 5 kV (75, 250 and 350 MVA)
 - 7.5 kV (500 MVA)
 - 15 kV (500, 750 and 1000 MVA)
- DVP breakers:
 - 7.5 kV (500 MVA)
 - 15 kV (500 and 750 MVA)

Chronology

DHP switchgear was introduced in 1963 and was actively manufactured by Westinghouse in complete switchgear assemblies until 1984.

Replacement Capabilities



DHP-VR VR-Series Circuit Breaker

Eaton offers the following to support DHP switchgear.

DHP-VR Vacuum Replacement Breakers

The DHP-VR is a brand new vacuum replacement breaker (VR-Series) for DHP air magnetic and DVP vacuum breakers. The DHP-VR breaker permits DHP switchgear modernization by using state-of-the-art Cutler-Hammer VCP-W vacuum breaker technology. The DHP-VR is designed, manufactured and tested to applicable IEEE/ANSI standards.

Ratings are available to replace: 5 kV through 15 kV, 50DHP75 through 150DHP1000, 1200–3000A.

Additional VR-Series breakers are available to upgrade competitors' air magnetic breakers. See **Pages V12-T17-60 and V12-T17-61.**

SURE CLOSE

All VR Series breakers that are furnished with MOC operators incorporate Eaton exclusive *SURE CLOSE* MOC technology. See additional information on **Page V12-T17-62.**

Class 1 Reconditioned DHP Breakers and Repair Service

Class 1 Reconditioning of DHP breakers and repair service for DHP breakers are available.

Renewal Parts

Eaton offers an inventory of newly manufactured renewal parts for most DHP switchgear structures and breakers.

Effective 12/17/2002, DHP match and lineup cubicles, DHP air magnetic breakers and arc chutes will no longer be available.

Fluidized Switchgear Bus

Eaton offers new fluidized epoxy bus—insulated bus to replace existing switchgear phase bus insulation. See **Page V12-T17-59.**

VCP VacClad Medium Voltage Metal-Clad—Assemblies and Power Circuit Breakers

VCP VacClad Switchgear Assemblies and Power Circuit Breakers



VacClad Switchgear with Type VCP Drawout Vacuum Power Circuit Breakers

Product Description

Westinghouse VacClad medium voltage metal-clad switchgear with type VCP vacuum power circuit breakers was introduced in 1981. Vacuum interrupter technology provided many advantages over the previous DH and DHP air magnetic breaker designs. Vacuum interrupters permitted the breaker size and weight to be significantly reduced, allowing for two-high stacking construction of most breaker ratings in the switchgear enclosure. VCP breakers withdraw onto switchgear rail assemblies for ease of inspection. Maintenance associated with air magnetic arc chutes was eliminated and contact maintenance was reduced to visual inspection of wear gap indicators.

VCP breakers included a design improvement called the V-Flex current transfer system, which eliminated the transfer of primary current over a moving hinge (like DHP breakers) or a sliding contact assembly (like DVP breakers). Porcelain insulation was maintained on the breaker elements and in the switchgear except for the 5 kV switchgear cell insulation, which was glass polyester as standard. The switchgear phase bus was insulated with a fluidized bed epoxy insulation system, which was a major improvement over the epoxy impregnated kraft paper or noryl that was used as sleeving on phase busbars in previous switchgear designs. VacClad switchgear was manufactured in indoor and in sheltered aisle and aisle-less outdoor enclosures.

Ratings

VCP switchgear provided the first complete line of Westinghouse vacuum breakers in the medium voltage ratings:

- 5 kV (250 and 350 MVA)
- 7.5 kV (500 MVA)
- 15 kV (500, 750 and 1000 MVA)

Chronology

VacClad switchgear was introduced in 1981 and was manufactured by Westinghouse in complete switchgear assemblies until the introduction of VacClad-W switchgear in 1986. Today, many capabilities still exist to support VacClad switchgear.

Replacement Capabilities

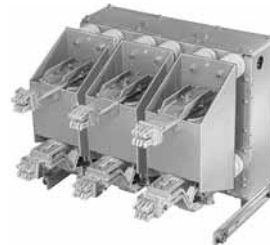

Type VCP Vacuum Power Circuit Breaker (Front and Rear Views)

Eaton offers the following to support VacClad switchgear.

Remanufactured VCP Breakers and Factory Repair Service

Factory remanufacturing of VCP breakers and factory repair service for VCP breakers are available.

Renewal Parts

Eaton offers an extensive inventory of newly manufactured renewal parts for VCP switchgear structures and breakers.

Fluidized Switchgear Bus

Eaton offers new fluidized epoxy bus—insulated bus to replace existing switchgear phase bus insulation. See [Page V12-T17-59](#).

VCP-W VacClad Switchgear Assemblies and Power Circuit Breakers



VacClad-W Switchgear with Type VCP-W Drawout Vacuum Power Circuit Breakers

Product Description

VacClad-W world-class medium voltage metal-clad switchgear with type VCP-W vacuum power circuit breakers was introduced by Westinghouse in 1986. VCP-W breakers and switchgear were similar to but not interchangeable with the original VacClad (VCP) product.

The VCP-W design includes a consolidation of improvements in product design and performance that enables the introduction of IEC and 27 kV breaker

ratings. However, VCP-W still includes many of the proven product features of VCP switchgear design, including two-high breaker stacking, V-Flex breaker current transfer and fluidized epoxy insulation on the switchgear phase buses. VCP-W breakers withdraw onto removable switchgear rail assemblies for ease of inspection. VCP-W breakers and switchgear were furnished with high-grade glass polyester insulation as standard. Optional insulation upgrades included cycloaliphatic epoxy insulation for breaker element insulation (VCP-WSE breakers) and porcelain insulation for the switchgear cell contact bottles. VacClad-W switchgear is manufactured in indoor and in outdoor sheltered aisle and aisle-less enclosures. Another option offered for VacClad indoor switchgear is arc-resistance. Eaton was a leader in the development and design of arc-resistant switchgear. Arc-resistant metal-clad switchgear is metal-clad switchgear tested for resistance to the effects of arcing due to an internal fault.

Chronology

VacClad-W switchgear was introduced in 1986 and is the current state-of-the-art Eaton switchgear product. The VCP-WSE breaker with special cycloaliphatic epoxy insulation and the 27 kV VCP-W rating were introduced in 1990. IEC VCP-W ratings were introduced in 1991. 38 kV was introduced in 1995.

Arc-resistant VCP-W switchgear was introduced in 1995.

Replacement Capabilities



Type VCP-W Vacuum Power Circuit Breaker (Front and Rear Views)

Eaton offers the following to support VacClad-W switchgear.

Complete New VacClad-W Switchgear Assemblies

Complete new manufactured VacClad-W switchgear assemblies are available to replace obsolete existing switchgear with new Cutler-Hammer state-of-the-art vacuum switchgear.

VacClad-W Match and Lineup Cubicles

New manufactured VacClad-W switchgear structures to match and line up to existing Westinghouse and Cutler-Hammer VacClad-W switchgear. New VCP-W structures can also connect to existing Westinghouse indoor switchgear (types DH, DHP and VCP) with a transition section.

New VCP-W Vacuum Breakers

Completely new factory manufactured VCP-W vacuum power circuit breakers are available in all published ratings.

Renewal Parts

Eaton offers an extensive inventory of newly manufactured renewal parts for VCP-W switchgear structures and breakers.

Fluidized Switchgear Bus

Eaton offers new fluidized epoxy bus—insulated bus to replace existing switchgear phase bus insulation. See **Page V12-T17-59**.

ANSI and IEC Ratings

ANSI Ratings	IEC Ratings
5 kV (250 and 350 MVA)	3.6 kV (25, 31.5, 40 kA rms SC Make)
7.5 kV (500 MVA)	7.2 kV (25, 31.5, 40 kA rms SC Make)
15 kV (500, 750, 1000 and 1500 MVA)	12 kV (25, 31.5, 40 kA rms SC Make)
27 kV (750, 1000 and 1250 MVA, and 40 kA)	17.5 kV (31.5, 40 kA rms SC Make)
38 kV (16, 21, 25, 31.5 and 40 kA)	24 kV (25 kA rms SC Make)

Technology Upgrades Front Panel Retrofit with IQ Devices and PowerNet Communications

DHP, VCP, VCP-W



New VCW Front Panel with Upgraded Control Devices

Eaton can provide an upgrade to your system by replacing existing analog meters, instruments and protective relays with microprocessor-based solid-state true rms sensing devices. New replacement front panels are available for DHP, VCP and VCW switchgear assemblies, and they can be provided with devices mounted and wired.

Wire markers and wiring diagrams are provided for the hinged panel. The existing panel is removed, the new panel is set in place and the solid-state devices are wired into the switchgear unit.

Fluidized Switchgear Bus

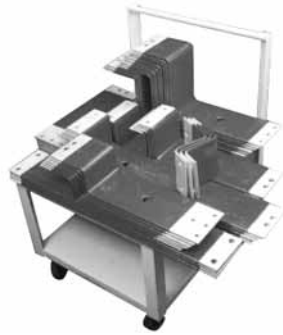

Any Busbar Shape or Configuration is Uniformly Coated. There are No Dielectric Weak Spots and Taping is Not Necessary

Eaton offers a cost-effective program that can extend the life of any manufacturer's equipment by replacing the bus and insulating it with fluidized bed epoxy. The bus insulation in many existing switchgear assemblies may be NORYL®, Micarta®, redacta, heat shrink tubing or fiberglass. These materials are adversely affected by aging, environment and operating conditions. The solution to these concerns can be answered with the high quality, state-of-the-art system and superiority offered by the fluidized bed epoxy process.

Customers can use any of the following services to fit specific switchgear applications from 600V to 38 kV:

- Bus replacement
- Bus duct replacement

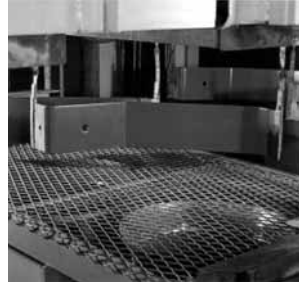

Coated Busbars Pass Through a Post-heat Oven to Cure and Fuse the Epoxy

Switchgear Upgrades

DHP, VCP, VCP-W

Switchgear upgrades are available to increase the MVA and continuous current ratings of the entire assembly.

Competitive Upgrades Medium Voltage Vacuum Replacement Breakers

General Electric MagneBlast



**GE-AM13.8-VR VR-Series
Circuit Breaker**

Eaton manufactures an extensive line of VR-Series breakers to replace General Electric MagneBlast air magnetic breakers.

Ratings are available to replace:

- AM4.16 5 kV, 150–350 MVA, 1200–3000A
- AM5 5 kV, 150–250 MVA, 1200 and 2000A
- AM7.2 7.5 kV, 500 MVA, 1200 and 2000A.
- AM7.5 7.5 kV, 250–500 MVA, 1200 and 2000A
- AM13.8 15 kV, 250–1000 MVA, 1200 and 3750A (both short and tall frames)
- AM15 15 kV, 250–750 MVA, 1200 and 2000A

Allis-Chalmers RUPTAIR



MA-VR VR-Series Circuit Breaker

An extensive line of Eaton VR-Series breakers are manufactured to replace Allis-Chalmers RUPTAIR type AM, MA, FA, FB and FC air magnetic breakers.

Ratings are available to replace:

- AM 5 kV, 100–250 MVA, 1200 and 2000A
- MA 5 kV, 150–350 MVA, 1200 and 2000A
- FA 5 kV, 350 MVA, 3000A
- FB 7.5 kV, 500 MVA, 1200 and 2000A
- FC 15 kV, 500–1000 MVA, 1200–3000A

Federal Pacific Electric



DST-2-VR VR-Series Circuit Breaker

An extensive line of Eaton VR-Series breakers are manufactured to replace Federal Pacific Electric air magnetic breakers.

Ratings are available to replace:

- DST 5–15 kV, 150–750 MVA, 1200 and 2000A
- DST-2 5–15 kV, 150 000 MVA, 1200–2000A

SURE CLOSE

All VR-Series breakers that are furnished with MOC operators incorporate Eaton's exclusive *SURE CLOSE* MOC technology. See additional information on **Page V12-T17-62**.

ITE



15HK-VR VR-Series Circuit Breaker

Eaton manufactures an extensive line of VR-Series breakers to replace ITE air magnetic breakers.

Ratings are available to replace:

- 5HV 5 kV, 100–250 MVA, 600–2000A
- 5HK-Model 03, 5 kV, 250–350 MVA, 1200 and 2000A
- 15HK-Model 03, 15 kV, 500–1000 MVA, 1200 and 2000A
- 15VHK-Model 20, 15 kV, 500–750 MVA, 1200A

Medium Voltage Competitive Upgrades—Vacuum Replacement Breakers

McGraw & Edison

**PSD-VR and WSA-VR VR-Series
Circuit Breakers**

An extensive line of Eaton VR-Series breakers are manufactured to replace McGraw-Edison air magnetic breakers.

Ratings are available to replace:

- PSD-15 15 kV, 500–750 MVA, 1200 and 2000A
- WSA-5 5 kV, 250 MVA, 1200 and 2000A
- WSA-15 15 kV, 500–750 MVA, 1200 and 2000A

SURE CLOSE

All VR-Series breakers that are furnished with MOC operators incorporate Eaton's exclusive *SURE CLOSE* MOC technology. See additional information on **Page V12-T17-62**.

Remote Power Racking

Remote Power Racking (RPR-2)

Eaton's remote power racking (RPR-2) unit provides a means of remotely racking most power circuit breakers that use the rotation of a shaft for insertion and removal. Personnel can be up to 25 feet (8m) or more away from the switchgear door during the racking process. This need for distance away from the switchgear is due to safety precautions from potential arc flash occurrences.

Many arc flash incidences with low voltage and medium voltage switchgear occur during the process of inserting and removing (racking) power circuit breakers in switchgear cubicles. Personnel are typically within 2 feet (0.6m) of the front of the power circuit breaker during the racking process and this close proximity to an arc flash can cause serious injury. The best way to limit exposure to arc flash during the process of racking power circuit breakers is to put more distance between the person and the possible point of exposure.

NFPA 70E provides guidance for the requirements of personal protective equipment (PPE) to protect personnel from arc flash exposure. Eaton's RPR-2 allows personnel to wear a lower level of PPE, increasing worker comfort and mobility, while operating the RPR-2 from an increased distance from the power circuit breaker.

The RPR-2 system is the solution that provides the value and the features that customers request.

SURE CLOSE

An Eaton Solution for an Industry-Wide Problem



SURE CLOSE

Background

Mechanism Operated Contacts (MOCs) are external to the breaker (mounted in the switchgear cell) and are driven by the breaker mechanism through a mechanical interface. These contacts are used to provide extra contacts for breaker status and for other control functions. As the circuit breaker closes, an MOC operator causes the MOC switches to operate.

Air-magnetic breakers have massive mechanisms with high forces and inertia. The resultant travel times and the velocities are slow. The figure (A-M) shows the closing curve of a typical air-magnetic breaker and the MOC operator. It closes in approximately 100 msec (a tenth of a second), measured from the time the breaker begins to close.

Problem

A vacuum replacement breaker (VR) is much smaller and lighter than the air-magnetic breaker it replaces. The vacuum contacts move a smaller distance and much faster. When a VR breaker is applied to the cell that originally contained an air-magnetic breaker, the resultant speed of operation of the MOC becomes much faster when it is directly driven by the breaker operating mechanism. The result is higher impact loads and mismatched inertia with the existing switchgear MOC. The effect of the system mismatch is shown in the figure (VR Direct Drive).

When a VR breaker without SURE CLOSE drives the MOC, the breaker and the MOC complete the closing stroke in the same time; 25 msec, versus the 100 msec for the original air-magnetic breaker. Notice the over-travel with the direct drive MOC. The velocity of the MOC system is essentially four times what it is with the air-magnetic breaker. Because kinetic energy (the energy associated with motion) is proportional to the velocity squared, the kinetic energy of the MOC has increased to 16 times that of the original design. This faster operation causes:

- Significant MOC over-travel and bounce
- MOC component wear
- A worn or broken MOC could cause a breaker to stall

Solution

SURE CLOSE is a stored energy device, internal to the breaker, which allows the MOC to open and close independently from the speed of the breaker mechanism and:

- Eliminates the possibility of the MOC stalling the breaker
- Slows down the MOC operation
- Prevents damage to MOC cell components

Conclusion

In the figure below, you can see that the SURE CLOSE MOC drive approximates the original air-magnetic MOC response much better than the VR direct drive. The VR-Series breaker with the SURE CLOSE drive does NOT cause MOC switch contact bounce or abnormal wear.

SURE CLOSE Components

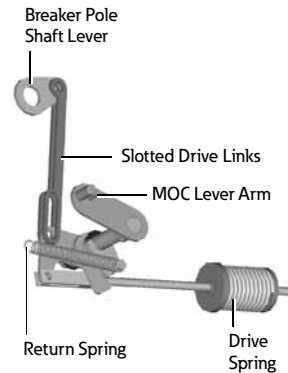

MOC Closing Times—Air-Magnetic, VR without SURE CLOSE and VR with SURE CLOSE

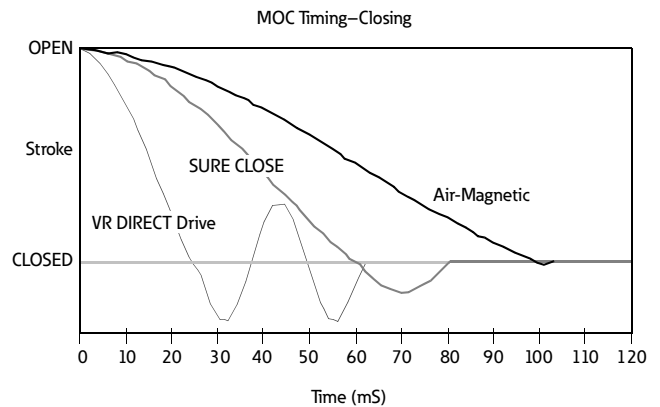

VacClad-W Motorized Remote Racking (VCP-W MR2)



Remote Racking

Product Description

Eaton's VCP-W MR2 motorized remote racking device provides a means of remotely inserting or removing any drawout circuit breaker used in VacClad-W switchgear, to help mitigate arc flash exposure.

The VCP-W MR2 permits the operator to safely move a VCP-W breaker between three pre-determined positions within the circuit breaker compartment. Standing at a safe distance, well outside the arc flash boundary of the equipment, an operator can use remote controls to select disconnect, test or connected positions for the circuit breaker.

The Danger

Electric arcs result from thermal ionization that occurs when current flow is interrupted by the separation of conductors. Thermal ionization can generate temperatures as high as 35,000°F. Conductor materials melt into metal vapor and the surrounding air is ionized.

External arcs create a violent explosion, resulting in an inferno of ionized gases, molten debris, metal shrapnel and a flash of light (an arc flash). Inside a switchgear/switchboard cabinet, an arc event can dislodge compartment doors and turn hardware into high-speed projectiles.

Increased safety precautions and the need to protect personnel from the dangers of potential arc flash occurrences suggest the need to increase the distance between an operator and the front of a switchgear lineup during racking operations.

Features

- Self powered when switchgear is energized
- Provisions energize the system racking motors with an external 120 Vac power source
- Available for all breakers in VacClad-W switchgear
- Factory installed and tested in circuit breaker compartment
- Permanently installed racking motors eliminate the need to lift and manipulate, and align heavy, bulky equipment
- Simple hand-held pendant controller is available with indicating lights to clearly indicate position and status of the circuit breaker
- 25 ft umbilical cord between hand-held controller and circuit breaker compartment

- All circuit breaker safety interlocks remain intact per IEEE C37.20.2
- Logic is built into the device to sense an interference issue
- Logic will not accept a command to connect a circuit breaker that has experienced interference until after it has been moved to the disconnect position
- Controls can be integrated into switchgear secondary control circuits, and/or SCADA systems using Modbus® interface or discrete wiring
- Permissive circuit provision for disabling remote racking until the right system conditions are satisfied
- Pendant will override system when plugged into a specific circuit breaker

Benefits

- Automatic racking reduces installation effort
- Permanently installed system will not get lost between service intervals

- You do not lose the ability to manually operate your circuit breaker racking mechanism
- Operators can open and disconnect all circuit breakers remotely before entering the equipment room, which ensures no exposure to arc flash energy

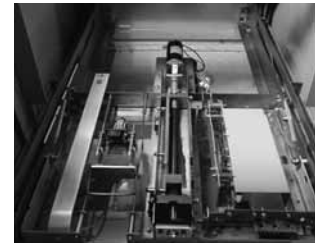

Racking Pan

Motor, logic controller and safety interlocks are built into the circuit breaker compartment. System is factory installed and tested with VCP-W circuit breakers. Each switchgear system that is purchased with remote racking capabilities will come with a hand-held pendant for simple operation of a single circuit breaker at a time.

PanelMate® Interface for Integrated Controls

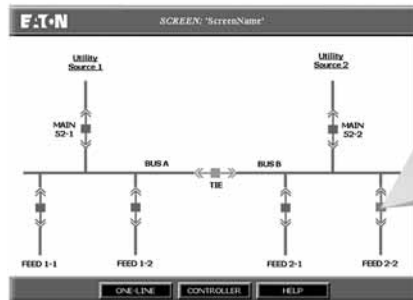

Further Information

Publication Number	Description
DHP Switchgear and Breaker	
RPD 32-253-4D	Renewal Parts Data for DHP breaker and switchgear parts
PA02707017E	Sales Aid for the DHP-VR vacuum replacement breaker
RP01301006E	Renewal Parts Data for the DHP-VR vacuum replacement breaker
VCP Switchgear and Breaker	
RPD 32-274	Renewal Parts Data for VCP breaker and switchgear parts
LEL007A	Sales Aid for the VCP remanufacture program
VCP-W Switchgear and Breaker	
RP02201001E	VCP-W 5 and 15 kV switchgear common replacement parts
RP02204001E	Renewal Parts Data for VCP-W switchgear parts
SA-11671	Sales Aid for VCP-W switchgear
DB 32-255	Descriptive Bulletin for VCP-W switchgear
AD 32-265	Application Data for VCP-W switchgear
Fluidized Bus	
SA-11745	Sales Aid for custom fluidized switchgear bus
General Information	
LEL004A	Sales Aid for breaker remanufacture program
SA02204001E	Sales Aid for MV switchgear replacement front panels with IQ devices
DH Breakers	
PA02707011E	Sales Aid for the DH-VR vacuum replacement breaker
GE MagneBlast Breakers	
PA02707021E	Sales Aid for GE AM4.16 and AM13.8 vacuum replacement breakers
Allis-Chalmers Breakers	
PA02707032E	Sales Aid for Allis-Chalmers Type MA vacuum replacement breakers
PA02707031E	Sales Aid for Allis-Chalmers Type AM 250 vacuum replacement breakers
PA02707033E	Sales Aid for Allis-Chalmers Type F-Series vacuum replacement breakers
Federal Pacific Electric Breakers	
PA02707041E	Sales Aid for Federal Pacific Electric Type DST vacuum replacement breakers
PA02707042E	Sales Aid for Federal Pacific Electric Type DST-2 vacuum replacement breakers
ITE Breakers	
PA02707052E	Sales Aid for ITE Type HK (Model 03) vacuum replacement breakers
PA02707051E	Sales Aid for ITE 5HV vacuum replacement breakers
McGraw-Edison Breakers	
PA02707062E	Sales Aid for McGraw-Edison PSD vacuum replacement breakers
PA02707061E	Sales Aid for McGraw-Edison WSA vacuum replacement breakers
Universal Remote Power Racking	
PA02707071E	Sales Aid for universal remote power racking system (RPR-2)

Pricing Information**VCP-W Breaker**

Price List for VCP-W Breaker Parts—PL 33-729

VCP-WR Breaker

Price List for VCP-WR Fixed Vacuum Breakers—PL 33-724

MV Air/Vacuum Switchgear Parts

Vista/VISTALINE Discount Symbol Y1

VR-Series Breakers

Price List for VR-Series Replacement Breakers—PL02707001E

Medium Voltage Metal-Enclosed Load Interrupter Switch Assembly and Switches

WLI Load Interrupter Metal-Enclosed Switchgear

Originally a Westinghouse Product

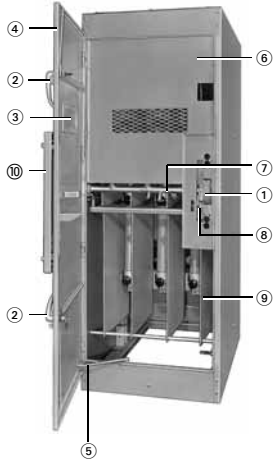

WLI Design

Standard Manually Operated Fused WLI Switch

- ① Switch position indicator/operator mechanism
- ② Provisions for padlocking door
- ③ Inspection window (4 x 16 inches)
- ④ Full height main door
- ⑤ Door stop, foot operated
- ⑥ Grounded metal safety barrier
- ⑦ Door interlock
- ⑧ Switch interlock
- ⑨ Interphase barrier
- ⑩ Switch operator mechanism access door

Product Description

The WLI (Westinghouse Load Interrupter) medium voltage switchgear is generally composed of a three-phase load interrupter housed in a metal-enclosed structure. The switch is rated for use in four voltage classes: 4 kV, 15 kV, 25 kV and 38 kV. 600A and 1200A current ratings are available. The switch is typically applied in series with three medium voltage fuses on the load side of the switch. WLI switchgear is used for economical protection of unit substation transformers and medium voltage power distribution (via a lineup of these switches). The WLI product line also offered a compact Unitized Power Center (UPC) that used the WLI switch on the primary of the UPC transformer.

LBF and WLI look similar in design. They can be differentiated by the nameplate located behind the operating handle access door. The front is largely covered by the main door, with a 4 x 16-inch viewing window, providing access to the switch and fuse compartment. A smaller access door on the main door allows access to the switch operating mechanism. Upon opening the main door, the switch in the upper part of the structure is covered

by a protective screen barrier that allows visual inspection. The fuses, when provided, are located in the lower part of the structure, and are readily visible for easy maintenance when the main door is open. The rear of the switch structure is generally used for cable entrance and/or exit. Access to the cable entrance/exit area is via a rear cover or door.

The MVS design offers many enhancements over the previous WLI design. A few of the exterior features include a galvanized base and a larger viewing window. Interior features include a hinged barrier, rustproof latches, nylon finned insulators and a switch that is a removable component.

The WVB (Westinghouse Vacuum breaker) switchgear was introduced in 1991, providing a fixed-mounted medium voltage vacuum breaker on the load side of the switch. The medium voltage vacuum breaker was used in lieu of fuses, providing the capability to instantly reset the breaker after a trip condition and the ability to adjust to a wide variety of coordination curves in the field.

The MEB (Metal-Enclosed Breaker) and MSB (Medium Voltage Switch and Breaker) designs replaced the WVB product offering. The MEB

design uses the VCP-TR medium voltage fixed-mounted vacuum breaker. The MSB offering employs a three-phase load interrupter to provide a means to isolate the fixed-mounted breaker.

Product History

Metal-enclosed load break air interrupter switches were first produced in 1952 under the name Load Break Fusible (LBF) at M & R facilities around the country. In 1964, the manufacturing of the product was consolidated in the Cincinnati, OH, facility. The product was discontinued in 1972 and replaced with Westinghouse Load Interrupter (WLI), having many design changes and improvements. Parts for the two products are incompatible, but the WLI design can be added to existing LBF lineups. The WLI product line was moved to the Sumter, SC, manufacturing facility in 1979.

The current MVS design was first introduced in Sumter, SC, in 1999 and built concurrently with the previous design until December 2001. The product line was relocated to Greenwood, SC, in late 2001. As of January 2002, only the current MVS design was manufactured.

Product History Time Line

Page	Product	1950	1960	1970	1980	1990	1995	2000	Present
V12-T17-66	Westinghouse LBF		█	█					
V12-T17-66	Westinghouse/C-H WLI				█	█	█	█	
V12-T17-66	Cutler-Hammer MVS							█	█

WLI/MVS Load Interrupter Switchgear

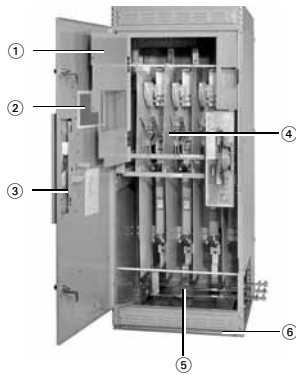

MVS Design

Standard Manually Operated Fused MVS Improvements

- ① Standard hinged barrier
- ② Larger, lower window (8.00 x 16.00-inch) double viewing area
- ③ Rustproof latches
- ④ Removable switch
- ⑤ Nylon finned insulators
- ⑥ G90 galvanized base

LBF/WLI Product Description

The LBF (load break) switch standard structure was 33.00 inches wide, 90.38 inches high (indoor) and 98.88 inches high (outdoor). The WLI (Load Interrupter) switch structure was offered in both 33.00-inch and 36.00-inch wide enclosures in the 5 kV and 15 kV ratings. Both designs used vertical sections that were freestanding, close coupled to transformers, and bolted together in lineups. Starting in 1984, ANSI 61 light gray was the standard internal and external color for all WLI structures. Prior to 1984, the exterior surfaces of outdoor enclosures were ANSI 24 dark gray. LBF was only offered in the 5 kV and 15 kV voltage ratings. WLI was offered in 5 kV, 15 kV, 25 kV and 38 kV voltage ratings using 600A and 1200A switches.

MVS Product Description

The MVS standard structures for 5 kV and 15 kV gear is 33.00 to 48.00 inches wide, 90.38 inches high (indoor), 98.88 inches high (outdoor), with varying depths. The standard structures for 27 kV and 38 kV gear is 48.00 to 54.00 inches wide, 101.50 or 127.00 inches high (indoor), 110.00 or 135.50 inches high (outdoor), with varying depths. Vertical sections are freestanding, close coupled to transformers and bolted together forming lineups.

Switch Ratings

- LBF
 - 5 kV
 - 15 kV
- WLI
 - 5 kV
 - 15 kV
 - 25 kV
 - 38 kV
- MVS
 - 5 kV (600 and 1200A)
 - 15 kV (600 and 1200A)
 - 27 kV (600A)
 - 38 kV (600A)

Replacement Capabilities

LBF





The LBF product line was discontinued in 1972. Due to design change and retooling, replacement parts are only available through Cleveland-Price, Inc. at **724-864-4177**.

WLI/MVS

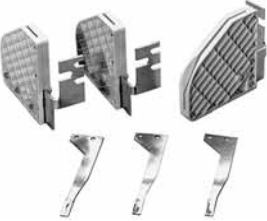

Eaton offers an inventory of newly manufactured renewal parts of WLI/MVS switchgear. See **Pages V12-T17-67** through **V12-T17-69**.

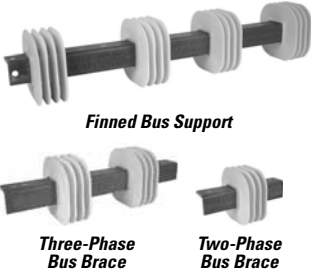
WLI/MVS Medium Voltage Metal-Enclosed Load Break Switch Replacement Parts

Replacement Parts—WLI/MVS/MVS2 Load Break Switch

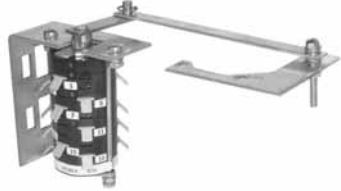

Description	Part Description	Quantity per Switch	Style Number	
Switch Pole Assemblies				
	Switch Pole Assemblies Three-pole set includes main and flicker blades, break jaws and arc chutes.			
	(60 kV BIL or 95 kV BIL) 5 and 15 kV—600A	1 set	7278A27G01	
	5 and 15 kV—1200A	1 set	7278A27G02	
	(125 kV BIL or 150 kV BIL) 25 and 38 kV—600A	1 set	7278A27G05	
	MVS2 5/15 kV—600A MVS2 5/15 kV—1200A	1 set 1 set	7278A27G43 7278A27G44	
Arcing Contact Assemblies				
	Arcing Contact Assemblies Three-pole set includes flicker blades and arc chutes. This kit is not required when switch pole assemblies above are ordered.			
	(60 kV BIL or 95 kV BIL) 5 and 15 kV—600A	1 set	7278A27G06	
	5 and 15 kV—1200A	1 set	7278A27G07	
	(125 kV BIL or 150 kV BIL) 25 and 38 kV—600A	1 set	7278A27G08	
Drive Rod Link (Polyester)				
	Drive Rod Link (polyester, set of three)			
	5 kV (60 kV BIL)	1 set	7278A27G09	
	15 kV (95 kV BIL)	1 set	7278A27G10	
	25 and 38 kV (125 kV BIL or 150 kV BIL)	1 set	7278A27G12	
	MVS2 5/15 kV MVS2 5/15 kV manufactured after May 2011	1 set 1 set	7278A27G45 7278A27G53	
Finned Bus Support				
 <p style="text-align: center;">Finned Bus Support</p> <p>Three-Phase Bus Brace Two-Phase Bus Brace</p>	Finned Bus Support (one each) 36.00-inch wide (glass polyester) Three-phase bus brace (glass polyester) Two-phase bus brace (glass polyester)	1 each 1 each 1 each	260C003H51 260C005H51 260C005H53	
	36.00-inch wide (epoxy) Three-phase bus brace (epoxy) Two-phase bus brace (epoxy)	1 each 1 each 1 each	260C003H11 260C005H11 260C003H13	
	Insulators			
	 <p>Polyester Epoxy</p>	Insulators (one each) (60 kV BIL) 5 kV glass polyester 5 kV epoxy	as required as required	4892A97H01 4892A97H07
		(95 kV BIL) 15 kV glass polyester 15 kV epoxy	as required as required	4892A97H02 4892A97H08
		(125 kV BIL or 150 kV BIL) 25 and 38 kV epoxy	as required	4892A97H18

Replacement Parts—WLI/MVS/MVS2 Load Break Switch, Continued

Description	Part Description	Quantity per Switch	Style Number
Removable Handle			
	Removable handle All ratings	1 each	7274A49H01
Switch Spring Mounted Assembly			
	Switch Spring Mounting Assembly 5–15 kV—40 kA fault close 5–15 kV—61 kA fault close 25 kV—20 kA fault close 25 kV—40 kA fault close 25 kV—60 kA fault close 38 kV—20 kA fault close 38 kV—30 kA fault close	1 set 1 set 1 set 1 set 1 set 1 set 1 set	7278A27G16 7278A27G18 7278A27G19 7278A27G20 7278A27G21 7278A27G22 7278A27G23
Switch or Fuse Barrier Assembly			
	Switch Barrier Assembly 5 and 15 kV 25 and 38 kV MVS2 5 kV MVS2 15 kV	1 set 1 set 1 set 1 set	7278A27G24 7278A27G25 7278A27G46 7278A27G47
	Fuse Barrier Assembly 15 kV (WLI design) 25 and 38 kV (WLI design) 15 kV (MVS/MVS2 design) (tightening knob or quick disconnect) 15kV (MVS2 design—bolt in fuses)	1 set 1 set 1 set 1 set	7278A27G26 7278A27G27 7278A27G43 7278A27G01
Open Close Indicator/Interlock Cam			
	WLI/MVS Standard Open-Close Indicator/Interlock Cam For lock open/close (top) or lock open (bottom)	1 each	220C934G01
	MVS2 Standard Open-Close Indicator/Interlock Cam For lock close (top) or lock open (bottom)	1 each	220C934G02
Auxiliary Switch Assembly			
	Auxiliary Switch Assembly (5NO and 5NC contacts)	1 each	7278A27G28
Switch Adjustment Tool Kit			
	Switch WLI/MVS Adjustment Tool Kit	1 each	221C113G031

WLI/MVS Medium Voltage Metal-Enclosed Load Break Switch Replacement Parts

Replacement Parts—WLI/MVS/MVS2 Load Break Switch, Continued

Description	Part Description	Quantity per Switch	Style Number
Fuse Live Part Kit			
	Fuse Live Part Kit (WLI Design)		
	Non-disconnect (three-phase—top and bottom)		
	RBA200 5–15 kV	1 each	7278A27G29
	RBA400 5–15 kV	1 each	7278A27G30
	RBA200 25–38 kV	1 each	7278A27G31
	RBA400 25–38 kV	1 each	7278A27G32
	CLE-1 5–15 kV	1 each	7278A27G33
	CLE-2 5–15 kV	1 each	7278A27G34
	CX 5–15 kV	1 each	7278A27G36
	CXN-1 5–15 kV (single barrel—3.00-inch diameter)	1 each	7278A27G37
	CXN-1 5–15 kV (single barrel—4.00-inch diameter)	1 each	7278A27G38
	CXN-2 5–15 kV (double barrel—3.00-inch diameter)	1 each	7278A27G39
	CXN-2 5–15 kV (double barrel—4.00-inch diameter)	1 each	7278A27G40
	NX25 kV	1 each	7278A27G41
	EJO38 kV	1 each	7278A27G42
	Fuse Live Part Kit (MVS Design)		
	Non-disconnect (three-phase—top and bottom)		
	RBA200 5 kV	1 each	98A1125G22
	RBA200 15 kV	1 each	98A1125G23
	RBA400 5 kV	1 each	98A1125G24
	RBA400 15 kV	1 each	98A1125G25
RBA800 5 kV	1 each	98A1125G26	
RBA800 15 kV	1 each	98A1125G27	
CLE-1 5 kV	1 each	98A1125G03	
CLE-1 15 kV	1 each	98A1125G04	
CLE-2 5 kV	1 each	98A1125G05	
CLE-2 15 kV	1 each	98A1125G06	
CX 5 kV	1 each	98A1125G09	
CX 15 kV	1 each	98A1125G10	
CXN-1 5–15 kV (single barrel—3.00-inch diameter)	1 each	98A1125G11	
CXN-1 5–15 kV (single barrel—4.00-inch diameter)	1 each	98A1125G12	
CXN-2 5–15 kV (double barrel—3.00-inch diameter)	1 each	98A1125G13	
CXN-2 5–15 kV (double barrel—4.00-inch diameter)	1 each	98A1125G14	
Space Heaters			
	Space Heaters (low watt density)		
	125V (WLI design)	as required	220C974G03
	250V (WLI design)	as required	220C974G04
	125V (MVS design)	as required	3614A50H01
250V (MVS design)	as required	3614A50H02	
Shunt Trip Coil			
	Shunt Trip Coil		
	48 Vdc	1 each	7278A78H01
	125 Vdc	1 each	7278A78H02
	250 Vdc	1 each	7278A78H03
	115 Vac	1 each	7278A78H04
	230 Vac	1 each	7278A78H05
CAP TRIP	1 each	7278A78H06	

Other Replacement Parts

Other replacement parts are available but shall be considered on a job-by-job basis.

Include switch nameplate information located behind the switch operating handle access door with any correspondence. Be sure this includes the "CN" or "SM" number.

Renewal Parts

When ordering parts, specify the part description and mini-MVS switchgear assembly catalog number found on the nameplate.

Enter on Suffix Q50.

Replacement Parts

Part Description	Quantity per Assembly	Style Number
Switch pole assembly epoxy (three-pole set, includes arc chute, switch blade, drive rod and insulators)	1	7997A57G03
Non-fused switch and CLE fused switch barrier assemblies (set of four)	1	7997A57G06
Switch operator lever assembly	1	7997A57G11
Auxiliary switch assembly	1	7997A57G12
Space heater	1	7997A57G13
Filter (set of two)	1	7997A57G05
Key interlock provision kit ^①	1	7826C86G01

Replacement Fuses

Fuse Continuous Ampere Rating	Quantity per Assembly	CLE Style Number
10	3	5981C29G01
15	3	5981C29G02
20	3	5981C29G03
25	3	5981C29G04
30	3	5981C29G05
40	3	5981C65G01
50	3	5981C65G02
65	3	5981C65G03
80	3	5981C65G04
100	3	5981C65G05
125	3	5981C65G06
150	3	5981C65G07
175	3	5981C65G08
200	3	5981C65G09

Torque Values

Tighten the hardware per the table below.

Torque Values

Bolt Diameter in Inches	Nominal Torque, ft lbs (Nm)
0.25	4 (5.42)
0.31	8 (10.85)
0.38	25 (33.90)
0.50	50 (67.79)
0.63	65 (88.13)

Further Information

Publication Number	Description
DB 31-935	Descriptive bulletin for WLI load interrupter metal-enclosed switchgear
DB 31-950	Descriptive bulletin for unitized dry-type power centers
IL 31-930-D	Instructions for WLI and WVB metal-enclosed switchgear

Pricing Information

Vista/VISTALINE Discount Symbol Y2

Note

^① Key interlock(s) provided by others.

Medium Voltage Fuses

Medium Voltage Fuses



18

Medium Voltage Fuses

Product Description	V12-T18-2
Product History	V12-T18-2
Product History Time Line	V12-T18-2
Product Application and Naming	V12-T18-3
Current-Limiting Fuses	V12-T18-4
Expulsion Fuses	V12-T18-5
Product Selection	V12-T18-6
Further Information	V12-T18-8
Pricing Information	V12-T18-8

Current-Limiting and Expulsion Fuses

Originally a Westinghouse Product



Medium Voltage Fuses

Product Description

Eaton medium voltage fuses offer such a range of characteristics that almost any fuse application, within the practical range of such interrupting devices, may be satisfied. This range of characteristics is offered in part by the production of both expulsion and current-limiting power fuses.

Expulsion and current-limiting fuses provide such diverse characteristics by employing different areas of fuse technology. These differences in technology, along with the diverse characteristics, require that different questions be answered when applying expulsion and current-limiting fuses.

Product History

The Eaton power fuse product line was introduced in the 1930s by Westinghouse Electric Corporation. As power systems grew in size, the need to sectionalize utility feeders and to protect equipment became apparent. The initial fuse development efforts resulted in the creation of non-current-limiting, expulsion type fuses. As the available fault currents grew, the need for a current-limiting fuse was apparent and this resulted in new interruption techniques.

While basic fuse technology has not changed greatly over the years, gradual improvements have been made to make the fuses more current-limiting and easier to manufacture and install. Because standards for fuses (ANSI C37) detail only test methods and basic performance requirements, many different varieties of fuses (length, diameter, short-circuit interruption curves) have been introduced over the years.

Eaton presently manufactures medium voltage fuses in Haina, DR.

Product History Time Line

Page	Product	1935	1940	1945	1950	1955	1960	1965	1970	1975	1980	1985	1990	2000	Present
	BAL ①														
	BAL-R ②														
V12-T18-4	CLE														
V12-T18-4	CLS														
V12-T18-4	CLPT														
V12-T18-4	CLT														
V12-T18-4	CX/CXN														
V12-T18-4	HLE														
	BA ③														
	DBA ④														
V12-T18-5	RBA														
V12-T18-5	RDB														
	DBS ⑤														
V12-T18-5	DBU														

General Information

Fuses in Perspective

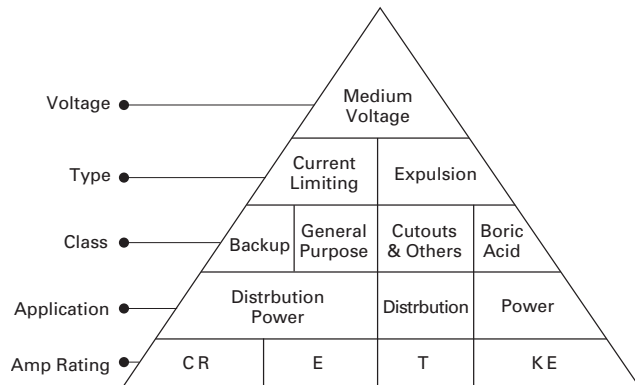

Advantages

Medium Voltage Fuse Comparison

Expulsion	Current-Limiting
Vented	Sealed
Electromechanical	Static
Expels gases/noise	No gases/noise
Interrupts at natural current zero	Limits fault current
Generally higher voltage/current applications	Generally higher interrupting ratings
Differences in time/current characteristics	Differences in time/current characteristics

Notes

- ① BAL superseded by CLE.
- ② BAL-R superseded by CLS.
- ③ BA—Refills and holders only, new installations use RBA.
- ④ DBA—Refills only.
- ⑤ DBS—Superseded by DBU.

Application Guide

Selection Guide

Type	Class	Use	Brand	Ratings kV, Ampere, kA	Feeder Circuit Section- alizing	Fused Switches	Power Trans- formers	Substation Service Trans- formers	DIP Pole	Underground Distribution Transformers	Pole- Mounted Trans- formers	Pad- Mounted Distribution Transformers	Motor Starters	Potential Trans- formers	Sub- station Capacitor Banks	
Current limiting	General purpose	Power	BHLE/ CLE/ HLE/ HCL	2.4–15.5 kV 10E–1350A to 85 kA	■	■	■		■						■	
		Dist.	CX/ CXN	4.3–15.5 kV 3.5C–300C 50 kA				■				■				
			CLT	2.4–15.5 kV 4A–150A 25 kA								■				
	Backup	Power	CLPT	2.4–38 kV 0.25E–10E to 80 kA										■		
	Power	BCLS/ CLS	2.4–8.3 kV 2R–36R 50 kA										■			
Expulsion	Boric acid	Power	RBA	4.8–34.5 kV 0.5E–720E	■	■	■								■	
			RDB	4.8–34.5 kV 0.5E–720E	■		■	■	■						■	■
			DBU	14.4–38 kV 5E–200E 15SE–200SE 3K–200K	■	■	■	■	■						■	

Guide to Names

BCLS—Bolt-in version of CLS fuse.

BHLE—Bolt-in version of HLE fuse.

CLE—Current-limiting E-rated.

HLE/HCL—Current-limiting E-rated, interchangeable with General Electric and Gould Shawmut.

CX/CXN—Current-limiting interchangeable with McGraw-Edison’s NX brand fuses, C-rated.

CLT—Current-limiting transformer fuse.

CLPT—Current-limiting E-rated for potential transformers.

CLS—Current-limiting for motor starters, R-rated.

RBA—Refillable boric acid expulsion fuse (indoor use).

RDB—Refillable dropout boric acid expulsion fuse (outdoor use).

DBU—Dropout boric acid fuse interchangeable with S&C’s SMU-20 refill.

Guide to Ampere Ratings

“E” Designation

Fuse rated 100E or below will melt in 300 seconds at a current value between 2.0 and 2.4 times the E number.

Fuse rated above 100E will melt in 600 seconds at a current value between 2.2 and 2.64 times the E number.

If the current is higher than 2.4 or 2.64 times the E number, the user must consult the time-current curves for that particular fuse.

“R” Designation

The fuse will melt in 15 to 35 seconds when the current equals 100 times the R number.

If the current is higher than 100 times the R number, the user must consult the time-current curves for that fuse.

“C” Designation

The fuse will melt in 1000 seconds at a current value, between 1.7 and 2.4 times the C number.

If the current is higher than 2.4 times the C number, the user must consult the time-current curves for that particular fuse.

“A” Designation

Fuses that do not comply with “E,” “R” or “C” designations.

Expulsion fuses can also be E-rated, K-rated and T-rated, and are also covered in the ANSI standards. The K and T ratings refer, respectively, to relatively “fast” and “slow” melting expulsion fuses. Detailed time-current tables adequately define these ratings.

Current-Limiting Fuses



CLE and HLE Current-Limiting—E-Rated



CLPT Current-Limiting E-Rated for Potential Transformer Protection



CLS Current-Limiting for Motor Starter



CX Current-Limiting—Interchangeable with McGraw Edison's NX Type



CLT Current-Limiting for Transformer Protection

Product Description

Current-limiting fuses are constructed with pure silver fuse elements, a high-purity silica sand filler, a specially designed core and a glass resin outer casing.

A high fault current melts the silver element almost instantly and loses energy to the surrounding sand. The sand melts and forms fulgurite, a glass-like substance.

The arc voltage rapidly increases to nearly three times the fuse voltage rating and forces the current to zero. Low fault current melts a solder drop on the silver fuse element that, in turn, melts the silver.

The element burns back until there is a sufficient internal gap to interrupt the current. This is known as the M-effect.

Eaton current-limiting fuses are offered in two basic types: backup and general purpose. Backup fuses have a published minimum interrupting current and require a series device for breaking the circuit for currents below this minimum level. General purpose fuses have improved low current interruption capability and are designed to interrupt low fault currents that cause the fuse to melt in one hour or less.

General Information

Applications

Current-limiting technologies can be used to meet almost every fuse application. Typical applications for utility, industrial, construction and OEM customers include:

- Feeder circuit sectionalizing
- Power transformers
- Substation service transformers
- Underground distribution transformers
- Pole-mounted transformers
- Pad-mounted distribution transformers
- Fused switches
- DIP poles
- Motor starters
- Potential transformers
- Substation capacitor banks

Accessories

A wide assortment of mountings, live parts and end fittings are available to facilitate power fuse installation.

Mountings include a base, porcelain or glass polyester insulators and live parts. They help enable the fuse to be safely attached to the gear. Mountings can be either disconnect or nondisconnect.

Live Parts attach the fuse to the mountings and are considered part of the mounting. All parts above the insulators are live parts.



Live Parts

End Fittings are metal parts that attach to each end of the fuse at the ferrules. They are used only on disconnect fuses or when converting a nondisconnect to a disconnect fuse.

Expulsion Fuses



RBA—Refillable Boric Acid



RDB—Refillable Dropout Boric Acid



**DBU—Dropout Boric Acid—
Interchangeable with S&C's SMU-20**

Product Description

Eaton expulsion fuses use boric acid as the interrupting medium. Under a fault condition, arc heat decomposes the boric acid, which produces gases and boric anhydride. The water vapor blast extinguishes the arc in a deionizing action and exits from the bottom of the fuse.

Type RBA indoor expulsion fuses are fitted with a filter or condenser that moderates the discharge exhaust. The discharge filter limits the exhaust to a small and relatively inert amount of gas and lowers the noise level without affecting the fuse interrupting rating. Steam discharge, that can affect the interrupting, is fully restricted by the condenser.

Each type RDB outdoor dropout fuse includes an ejector pin that is forced through the top of the fuse. The ejector pin releases a latch on the mounting and the fuseholder is kicked outward and swings into the dropout position, through 180° with a vertical mounting, or 90° with an underslug mounting.

Refill units can be field installed into RBA and RDB expulsion fuses. Once the old unit has been removed, the separately purchased unit can be easily installed into the fuse holder.

General Information

Applications

Expulsion technologies can be used to meet a number of fuse applications. Typical applications for utility, industrial construction and OEM customers include:

- Feeder circuit sectionalizing
- Fused switches
- Power transformers
- Substation service transformers
- DIP poles
- Potential transformers
- Substation capacitor banks

Accessories

The following accessories are available for expulsion fuses:

Mountings include a base, porcelain or glass polyester insulators and live parts. They help enable the fuse to be safely attached to the gear. Mountings can be either disconnect, nondisconnect or dropout. Fuses may be vertical or underhung.

Live Parts attach the fuse to the mountings and are considered part of the mounting. All parts above the insulators are live parts.

End Fittings must be mounted on DBU fuse units to enable them to be fitted into the mounting.

Filters and Condensers are for indoor applications of RBA expulsion fuses. They confine the arc within the fuse and substantially reduce the noise and exhaust when the fuse interrupts.

Mufflers are used with DBU fuses in indoor applications to virtually eliminate offensive noise and exhaust gases when the fuse interrupts.

Product Selection

Easy to Use, Easy to Order!

Eaton's fuse catalog numbering system makes it easy to order the right fuse. The catalog numbers are easy to remember, unique to each fuse, and are broken down in three descriptive segments: fuse type, voltage rating and current rating.

These catalog numbers can be entered directly and easily:

- No change in order processing will occur if you use either a style number or its corresponding catalog number. You will get the same fuse
- In the back of this ordering guide is a style number to catalog number cross-reference chart

Current-Limiting Fuse Examples

- **5CLE-30E**
5.5 max. kV, CLE fuse unit, 30E amperes
- **15CXN-45C**
15.5 max. kV, CXN fuse unit, 45C amperes
- **5CLS-GDM-E**
5.5 max. kV, CLS fuse unit, glass polyester nondisconnect mounting
- **CLE-DL-D**
CLE, disconnect live parts, size D

Catalog Numbering System

Current-Limiting Fuses

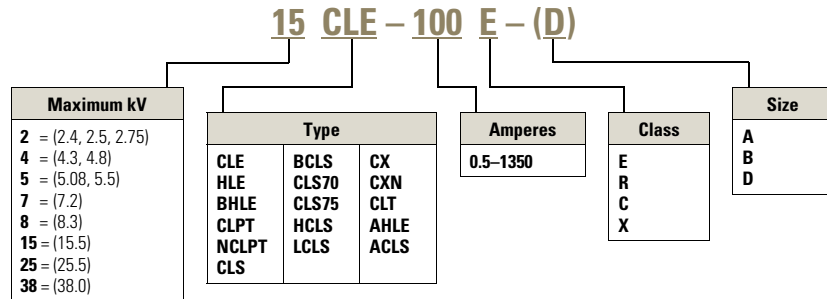

Current-Limiting Fuse Accessories

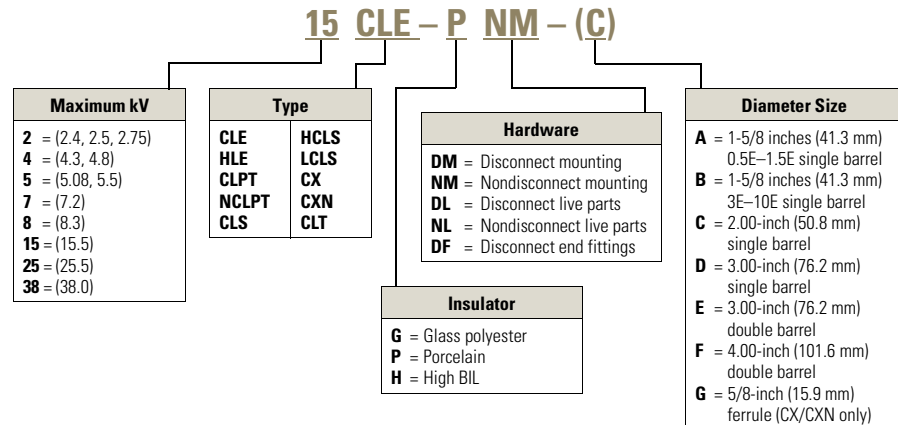

Product Selection

Expulsion Fuse Examples

- **8RBA2-10E**
8.3 max. kV, RBA-200 refill, 10E amperes
- **DBU17-30K**
17.1 max. kV, DBU fuse unit, 30 amperes
- **15RBA8-INH**
15.5 max. kV, RBA-800, indicating nondisconnect holder
- **RBA4-FLTR**
RBA-400 filter

Catalog Numbering System

Expulsion Fuse Units

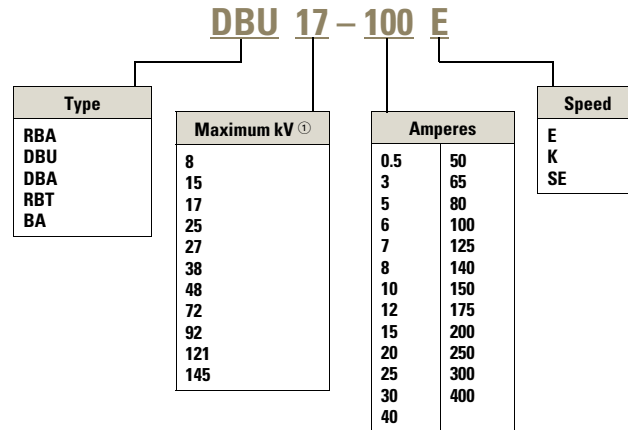

Expulsion Fuse Accessories

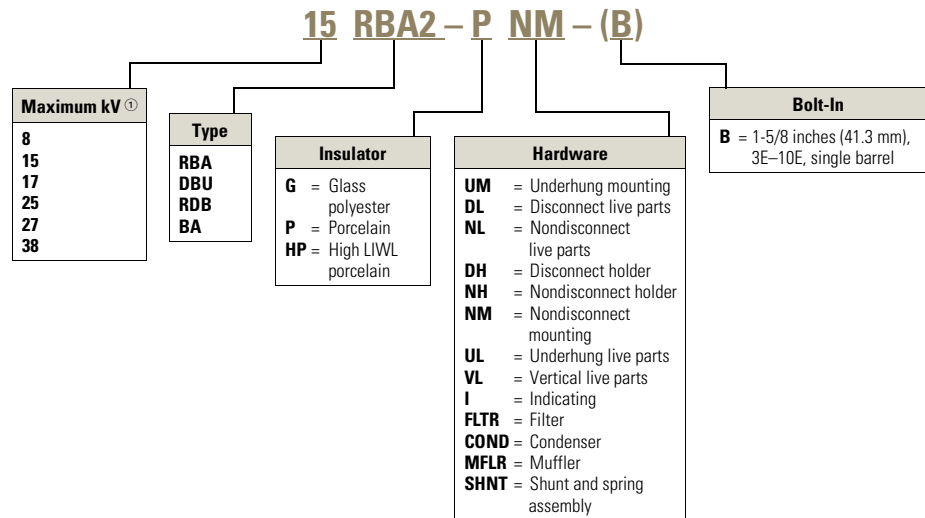

Note

^① Maximum kV occurs after DBU or before BA, DBA, RBA, RBT or RDB.

Further Information**Publication**

Number	Description
Current-Limiting Fuses	
CA08100016E	Fuse Catalog, Volume 14, Tab 3
Expulsion Fuses	
CA08100016E	Fuse Catalog, Volume 14, Tab 2
General Information	
CA08100016E	Fuse Catalog, Volume 14

Current-Limiting Fuses**Expulsion Fuses****General Information****Pricing Information***Price and Availability Digest (PAD)*

Vista/VISTALINE™ Discount Symbols Y1-F, Y1-FE, Y1-FH

CM52 Network Protector



19 Network Protectors

Product Description	V12-T19-2
Product History	V12-T19-2
Product History Time Line	V12-T19-2
Replacement Capabilities	V12-T19-3
Technology Upgrades—Relays and Communications	V12-T19-3
Further Information	V12-T19-4
Pricing Information	V12-T19-4

Network Protectors

Originally a Westinghouse Product



CM-22

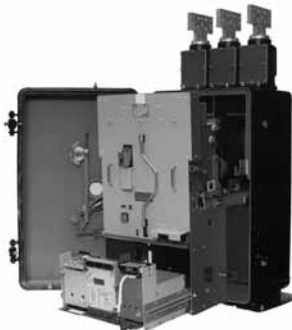

CMD



CM52

Product Description

Cutler-Hammer® network protectors from Eaton's electrical business are special self-contained air breaker units having a full complement of current, potential and control transformers, as well as relay functions. The network protector enables the paralleling of two or more primary feeders on the same low voltage bus. They are available for transformer mounting in submersible or non-submersible housings, or suitable for mounting within a low voltage switchgear assembly. The protective relay automatically closes the

protector if power flow is forwarded into the collector bus. It also trips the protector upon flow of reverse fault or magnetizing currents.

Product History

The network protector product line began manufacturing in 1922 under the name of Westinghouse Electric and Manufacturing Company. Over the years a number of different production models were produced. The most widely installed model is the type CM-22, which was first marketed in 1934 and is still manufactured today.

New production CM-22, CMD, CMR-8 and CM52 units are available from the Greenwood, SC, facility. Renewal parts are also available for these units.

The old type electromechanical relays which have a large installed base, are field replaceable with the current solid-state Type MPCV relays.

Eaton has also developed parts and relays to support old style GE Type MG-8 and MG-9 network protectors. GE discontinued the manufacture of these products in 1996.

Product History Time Line

Product	1920	1930	1940	1950	1960	1970	1980	1990	2000	Present
Network Protector										
CM		■								
CM-1		■								
CM-2		■								
CM-22			■	■	■	■	■	■	■	■
CMR-8						■	■	■	■	■
CMD							■	■	■	■
CM52									■	■
Relays										
CNJ, CN-33			■	■	■	■	■	■	■	■
MPCR								■	■	■
MPCV									■	■

Replacement Capabilities

New

Several current Cutler-Hammer production designs of network protectors are available:

- CM52
- CMD
- CMR-8
- CM-22

Retro-Build

Retro-building is a complete reworking of all the major components of a network protector including preliminary inspection, rebuilding, and re-testing equipment. Included in the process: removing all asbestos materials (where applicable), applying a new wiring harness, rebuilding the complete mechanism with motor and shunt trip, replacing the relay panel and completely reconditioning any enclosure. Modern components change the “as built” vintage to current production designs.

Cutler-Hammer and Westinghouse

- CM-22
- CMD
- CMR-8

General Electric®

- MG-8
- MG-9

Retrofit

General Electric MG-8 and MG-9 network protectors up to 2000A are retrofittable with a new CM52 roll-in replacement breaker. This retrofitting option uses existing enclosures and bus, replacing the remaining with the most recent technology of the CM52.

CMD style network protectors are retrofittable with a new CM52 drawout circuit breaker and is available for all ampere ratings and voltages.

Contact the Network Protector Group for additional information and availability at **1-800-525-6821** or **1-877-737-8328**.

Technology Upgrades—Relays

Electromechanical and older solid-state relays can be replaced with new micro-processor MPCV designs.

The MPCV network relay can be field installed into ANY network protector regardless of the age or the manufacturer. Field installation is accomplished without breaker modification or any rewiring of the breaker control harness.

Communications Capability

The MPCV relay has the capability of communicating information over a wide range of media.

Hardwire (fiber or twisted pair), wireless (cellular or radio) are options available using Eaton’s VaultGard Communication platform. This system provides data for extensive engineering analysis, vault diagnostics, preventive maintenance and additionally provides DNP 3.0 objects direct to a SCADA system.

MPCV Relay for Cutler-Hammer and Westinghouse Network Protectors

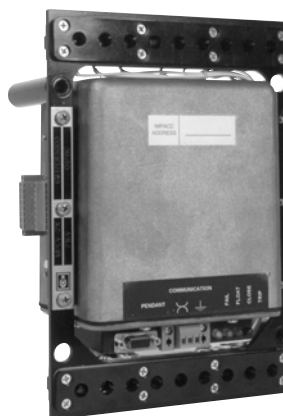

Front View



Rear View

MPCV Relay for GE Network Protectors



Front View

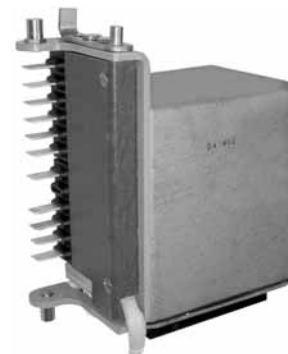

Rear View

Parts

Eaton offers an extensive inventory of newly manufactured renewal parts for the following network protectors:

Cutler-Hammer and Westinghouse

- CM-22
- CMD
- CMR-8
- CM52

General Electric

- MG-8
- MG-9

Test Sets



HWT-500 Test Kit

The HWT-500 test kit is offered to provide complete testing capabilities for

network protectors with 208 through 480V delta or wye connected systems. This is supplied in a rugged, wheeled case with retractable handle.

Training

The product line offers the following network protector training seminars:

- **Safety and Maintenance Seminar**—This two-day seminar covers fundamentals of network systems, network relay history and theory and maintenance overview of the CM-22, CMD, CM52 and MPCV relay
- **Troubleshooting Network Protector Seminar**—This three-day seminar encompasses all material included in the safety and maintenance seminar and also covers the GE network protectors. A combination of classroom and hands-on troubleshooting are provided

Further Information

Publication Number	Description
CM-22	
DB 35-550G	Descriptive Bulletin
RPD 35-550H	Renewal Parts Data Book
RP02401002E	Renewal Parts Guide
IB 35-5001E	Instruction Book
CMD	
DB 35-552B	Descriptive Bulletin
RPD 35-552	Renewal Parts Data Book
RP02401001E	Renewal Parts Guide
IB 35-552-G	Instruction Book
CMR-8	
RPD 35-575(E)	Renewal Parts Data Book
IB 35-575-A	Instruction Book
CM52	
B.52.01.S.E	Sale Brochure
IB 52-01-TE	Instruction Book
MPCR Relay	
IB 35-581A	Instruction Book
MPCV Relay	
IB 35-581B	Instruction Book
ST-156	Sales Engineer's Notes
SA-376	Sales Aid MPCV Relay
SA.52.01.S.E	T&D Reprint—Pepco System
HWT-500 Test Kit	
IB 35-557	Instruction Book
LWT-450 Test Kit	
IB 35-556-C	Instruction Book
SA-11898	Sales Aid

Pricing Information

Call Eaton's Network Protector Group in Greenwood, SC.
Toll Free: **1-800-525-6821**
or **1-877-737-8328**.

CMD Network Protector Renewal Parts

Eaton's Cutler-Hammer CMD Network Protector

Description	Current Catalog Number
Electrical Components	
Finger cluster assembly (800–1875A)	593C841G01
Finger cluster assembly (2000–3000A)	682C347G02
Micro-switch assembly	436B162G01
Anti-close coil and switch (800–1875A)	436B169G01
Anti-close coil and switch (2000–3000A)	436B169G02
Auxiliary switch assembly (800–3000A)	591C950G01
Anti-close relay assembly	765A881G03
Motor close relay	765A880G01
Trip coil assembly (1875–3000A)	8230A23G02
Trip coil only	677C903G03
Capacitor only	8310A96H01
BN dummy plate (CMD)	435D857G03
CNJ dummy plate (CMD)	508B559G01
Mechanical Devices	
Motor assembly—two lead only (800–3000A)	437B494G01
Operations counter	592C040H02
Levering-in assembly (800–1875A)	442D145G01
Levering-in assembly (2000–3000A)	6897D33G01
Hardware	
Network relay hold-down nuts	5765A44G01
Combination nuts	1087024
Breaker crank	589C063G01
X-washer and contact grease kit	8264A32G01
Breaker rollers	349A473H01
Breaker blocking bar	3670A85H01
Breaker contact test gauge (1875A)	3670A81G01
Control Resistors and Rectifiers	
Diode	8310A96H03
Rectifier	3615A35H01
Electromechanical resistor assembly	664A956G01
3100 ohm resistor	499A067H04
Motor close rheostat	8230A16G01
Fuses (125–216V and 277/480V)	
NPL fuse (800A)	140D318G04
NPL fuse (1200A)	140D318G05
NPL fuse (1600–1875A)	140D318G01
NPL fuse (2000–2825A)	140D318G02
NPL fuse (3000A)	140D318G06
Transformers	
Current transformer (multi-ratio: 800/1200/1600A)	8230A85H01
Current transformers (2000A)	8313A73G02
Current transformers (2500A)	8313A73G01
Current transformers (3000A)	8313A73G03
Potential transformer	7526A14G01
Control power transformer	8230A18H01

Description	Current Catalog Number
Current Carrying Components	
Moving arcing contact (800–1875A)	695C128G02
Moving arcing contact (2000–3000A)	695C134G01
Stationary arcing contact assembly (800–1875A)	593C842G01
Stationary arcing contact assembly (2000–3000A)	6897D10G02
Arc chute (800–1875A)	6914D18G02
Arc chute (2000–3000A)	9147D18G01
Enclosure Parts—NEMA and Submersible (800–3000A)	
Fuse housing (800–1875A)	595F152G01
Fuse housing (2000–3000A)	693C719G01
Spade terminal (800–1875A)	437B477G01
Stud terminal (800–1875A)	589C074G01
Spade terminal (2000–3000A)	690C292G01
Stud terminal (2000–3000A)	506B827G01
Fuse housing cover with gasket (800–1875A)	6390C82G01
Fuse housing cover with gasket (2000–3000A)	6390C84G01
Fuse housing cover with window (800–1875A)	592C092G01
Fuse housing cover with window (2000–3000A)	592C092G02
Fuse housing tank gasket (800–1875A)	505B339H01
Fuse housing tank gasket (2000–3000A)	590C508H01
8-point stationary secondary contact	591C497G01
8-point moving secondary contact (breaker mounted)	591C498G06
12-point moving secondary contact (breaker mounted)	693C618G01
12-point stationary secondary contact	9246C47G01
Door hinge and clamp kit (open side)	6418C71G01
Door hinge and clamp kit (hinge side)	6418C71G02
Hinge bolt only	1640799
Tank window kit	545B314G02
Tank window only	310C536H12
Tank window gasket only	5863A16H01
Submersible Tank Door Gasketing	
Flat molded, pre 12/87 (800–1875A)	437C089H01
Flat molded, pre 12/87 (2000–3000A)	590C512H01
1.25-inch (31.8 mm) diameter tubular Sep. MDT. —166 inches (4216.4 mm) (800–1875A)	8309A37H01
1.25-inch (31.8 mm) diameter tubular Sep. MDT. —140 inches (3556.0 mm) (800–1875A)	8309A37H02
1.25-inch (31.8 mm) diameter tubular Sep. MDT. —152 inches (3860.8 mm) (2000–3000A)	8309A37H01
Flat molded, pre 12/87 (2000–3000A)	437C089H01
Barrier assembly tanking (800–1875A)	567F830G01
Barrier assembly tanking (2000A plus)	693C717G02

CM-22 Network Protector Renewal Parts

Eaton's Cutler-Hammer CM-22 Network Protector

Description	Current Catalog Number
Electrical Components	
Motor contactor assembly (replaces G01, G02 and SG relay)	503B286G03
"J" switch assembly (664A948H01)	1572037
"J" switch contact only	657A239H01
Motor cutoff "W" switch assembly (for three lead motor)	310C629G01
Motor cutoff "W" switch assembly (for two lead motor)	310C629G03
Auxiliary switch 12-pole 46A5916G13 + G14	310C626G02
Auxiliary switch eight-pole (replaces type "W")	310C626G03
Network relay terminal block (lower)	310C356G05
Network relay terminal block (upper)	310C356G03
CNJ terminal block	310C356G02
BN terminal block (lower)	310C356G01
BN terminal block (upper)	310C356G04
BN dummy plate	435D857G03
CNJ dummy plate	508B559G01
Mechanical Devices	
Motor—three lead	592C071G03
Motor—three lead with amp plug	592C071G01
Motor—two lead	592C071G02
Shunt trip device (208V)	1114739
Shunt trip device (250V)	1630111
Shunt trip coil only (208V)	0918738
Shunt trip coil only (250V)	1041078
Operations counter	592C040H03
Hardware	
Mechanical links, springs and caps	8312A08G01
Fuse disconnect nut	1087025
Fuse disconnect nut	1087024
Relay combo nut (large)	5765A44G01
Overtoggle link assembly	436D164G02
Micarta® link (left side of overtoggle assembly)	1572053
Micarta link (right side of overtoggle assembly)	1572054
Operating handle	17B9956G01
Mechanism bumper and pins pack (sold in packs of three)	6419C75G01
Control Resistors and Rectifiers	
Phasing resistor—3 ohm	499A067H05
Phasing resistor—3100 ohm	499A067H04
Motor circuit—3 ohm resistor assembly	664A956G02
Motor circuit—3 ohm fixed and adjustable resistor assembly	664A956G01
Transformers	
Lighting transformer assembly (250V)	542B075G01
Lighting transformer assembly (125V)	542B075G02
Potential transformer (single only, six required in assembly)	7526A14G01
Potential transformer assembly (left and right)	60A3930G03
Control power transformer (sold separately)	8234A01G01
Control power transformer with mounting kit	508B560G02

Description	Current Catalog Number
Current Transformers	
Multi-ratio 1600/1200/800A:5A	745C148G01
Fixed ratio 1600A:5A	592C554G01
Fixed ratio 2000A:5A	6109C13G01
Fixed ratio 2500A:5A	592C556G01
Fixed ratio 3000A:5A	592C557G01
Current Carrying Components	
Stationary conductor (800–1875A, left and right)	310C352G02
Stationary conductor (800–1875A, center)	310C352G01
Stationary main contact assembly (2000–3000A, includes arcing contact)	310C358G02
Stationary main contact assembly (3500A, includes arcing contact)	310C358G01
Moving contact (800–1875A, left and right)	310C353G01
Moving contact (800–1875A, center)	310C353G02
Moving contact assembly (2000–3500A, right)	436D166G01
Moving contact assembly (2000–3500A, left and center)	436D166G02
Arcing contact moving (2000–3500A)	09A2605G05
Arcing contact stationary (800–1875A)	1529542
Arcing and main stationary contact assembly (2000–3500A)	310C357G01
Arc chute (all sizes)	17B9967G01
Enclosure Parts—NEMA and Submersible	
Breaker barrier kit (800–1875A)	6549C10G01
Breaker barrier kit (2000–3000A)	6914D10G01
4-point stationary disconnect device (left hand)	678C170G03
4-point stationary disconnect device (right hand)	678C170G04
Moving disconnect device (left hand)	678C169G02
Moving disconnect device (right hand)	678C169G03
Round sight glass kit (tempered glass)	545B314G02
Door hinge and clamp kit (open side)	6418C71G01
Door hinge and clamp kit (hinge side)	6418C71G02
Submersible Tank Door Gasketing	
0.75-inch (19.1 mm) diameter tubular, pre '62 only —139 inches (3530.6 mm) (800–1875A)	8311A01H01
1.25-inch (31.8 mm) diameter tubular —139 inches (3530.6 mm) (800–1875A)	6337C85H40
1.25-inch (31.8 mm) diameter tubular —61 inches (4089.4 mm) (2000–3000A)	6337C95H40
1.25-inch (31.8 mm) diameter tubular —181 inches (4597.4 mm) (2000–3000A)	6337C97H40

Automatic Transfer Switches

Automatic Transfer Switch
Product Family



20 Automatic Transfer Switches

Product Description	V12-T20-2
Product History	V12-T20-2
Product History Time Line	V12-T20-2
Replacement Capabilities	V12-T20-3
Further Information	V12-T20-3
Pricing Information	V12-T20-3

Automatic Transfer Switches



Automatic Transfer Switch Family

Product Description

Eaton's Cutler-Hammer® automatic transfer switches are reliable, rugged, versatile and compact assemblies for transferring essential loads and electrical distribution systems from one power source to another.

Product History

A transfer switch is a critical component of any emergency or standby power system. When the normal (preferred) source of power is lost, a transfer switch quickly and safely shifts the load circuit from the normal source of power to the emergency (alternate) source of power. This permits critical loads to continue running with minimal or no outage. After the normal source of power has been restored, the re-transfer process returns the load circuit to the normal power source.

Eaton is one of the pioneering electrical manufacturers and has been focused on providing reliable backup power systems with transfer switch equipment for over 75 years. The automatic transfer switches provide a safe and reliable means to automatically start your generator, and transfer loads to a standby power source when normal power is available. Eaton offers three reliable and sophisticated transfer switch options for you to choose from—contactor-based, molded-case and circuit breaker style switches.

Product History Time Line

Product (Catalog Prefix)	1960	1965	1970	1975	1980	1985	1990	1995	2000	2005	Present
ATSRM/DTSRM											
ATSRD/DTSRD											
ATSBI/DTSBI											
ATSBM/DTSBM											
ATSBR											
MTSRM/MTSRD											
MTSBM											
MTSSM/MTSDM											
MBS											
ATVE/ATHA											
BIHS											
ATVSSP											
ATVS/ATHS											
RTHE											
PPVA/PPHA											
ATVA/ATHA											
ATVM/ATHM											
NTVSSP											
PPV2/PPH2											
NTVS/NTHS											
ATV2/ATH2											
ATV4/ATH4											
CBVI											
CTVIMG											
NTVESP											
ATVIMG											
ATVISP/CTVISP											
BIVIMG											
BIVISP											
BIHI											
PPV3/PPH3											
PPVX/PPHX											
MBHE											
NTVE/NTHE											
MTVX/MTHX											
ATVI/ATHI											
ATV3/ATH3											
RTHM											
RLCM											

Replacement Capabilities

Type	Logic	Power Panel	Transformer Panel	Wiring	Enclosure	Lugs
All Styles	■	■	■	■	■	■

Note: Specific applicable renewal parts for automatic transfer switches are identified on the inside door label of the product.

Further Information

Publication Number	Description
IB01602008E	ATC-300 automatic transfer switch controller
IB01602001E	ATC-400 automatic transfer switch controller
5715B46.PDF	ATC-600 automatic transfer switch controller (IB ATS-I005)
8165A37.PDF	ATC-800 automatic transfer switch controller (IB ATS-CI03)
IB01602010E	O & M Manual for the RLCM automatic transfer switch
IB01602009E	ATC-300 automatic transfer switch
IB01602001E	ATC-400 automatic transfer switch
IB01602015E	Automatic transfer switch contactor-based switch
IB01602011E	Magnum™ transfer switches
CA08100003E	Volume 2—Commercial Distribution, Tab 5

Pricing Information

Priced using Eaton's Bid Manager™ configuration tool, Vistaline on the Web (accessible by your local Distributor or Manufacturer's Rep.), or Eaton's website.

Power Factor Correction Capacitors

Low Voltage Fixed and Automatic
Power Factor Correction Systems



21 Power Factor Correction Capacitors

Product Description	V12-T21-2
Product History	V12-T21-2
Product History Time Line	V12-T21-2
Replacement Capabilities	V12-T21-3
Technology Upgrades	V12-T21-4
Further Information	V12-T21-5
Pricing Information	V12-T21-5

Power Factor Correction Capacitors



UNIPAK and AUTOVAR

Product Description

Power factor correction capacitors and harmonic filters are an essential part of modern electric power systems. Power factor correction capacitors are the simplest and most economical means of increasing the transmission capacity of a power system, minimizing energy losses and correcting load power factor. In addition, power factor penalties can be reduced and power quality can be greatly enhanced.

There are two main reasons to correct poor power factor. The first is to reduce or eliminate a power factor penalty charged by your local utility. Another reason is that your existing transformer is, or shortly will be, at full capacity and installing power factor correction capacitors can be a very cost-effective solution to installing a brand new service.

Depending on the amount of power factor correction (amount of kVAR required for the electrical system to improve the power factor) and the dynamic nature of the load, a fixed or switched capacitor bank may be the best solution. When capacity becomes a problem, the choice of a solution will be dependent upon the size of the increase needed. Like all power quality solutions, there are many factors that need to be considered when determining which solution will be best to solve your power factor problem.

Harmonic Filtering

As the world becomes more dependent on electric and electronic equipment, the likelihood that the negative impact of harmonic distortion increases dramatically. The efficiency and productivity gains from these increasingly sophisticated pieces of equipment have a negative side effect—increased harmonic distortion in the power lines. The difficult thing about harmonic distortion is determining the cause. Once this has been determined, the solution can be easy. Passive harmonic filtering equipment will mitigate specific harmonic issues, and correct poor power factor as well.

Product History

Eaton's Cutler-Hammer® power factor correction product line began as Sprague Electric in Massachusetts in 1942. They were the first manufacturers of dry capacitor cells in the United States. Throughout the next 40 years, they manufactured capacitors in both the dry and oil-filled designs.

In 1986, the company was purchased and renamed Commonwealth Sprague. Eaton's Cutler-Hammer Power Quality Division began a name brand relationship with Commonwealth Sprague in 2001, and purchased the Commonwealth Sprague capacitor systems business in 2003. At that time, manufacturing was moved to the Asheville, NC, manufacturing plant.

Product History Time Line

Page	Product	1940	1950	1960	1970	1980	1990	2000	Present
	Sprague Electric								
	UNIPAK								
	Eccol UNIPAK								
	Eccopak								
	Eccovar								
	UNIVAR								
	Eccol UNIVAR								
	UNIVAR AUTOVAR								
	Commonwealth Sprague								
	UNIPAK								
	AUTOVAR								
	UNIVAR								
V12-T21-4	Eaton/Cutler-Hammer								
V12-T21-4	UNIPAK								
V12-T21-4	AUTOVAR								
V12-T21-4	UNIVAR								

Replacement Capabilities

Capacitor Cells—Dry-Type

- **Terminals:** Threaded for secure connection, all sizes. 10 kVAC stand-off terminal bushings. Rated for 30 kV BIL
- **Dielectric fill:** Thermosetting polymer resin
 - Flash point: +415°F (+212°C)
 - Fire point: +500°F (+260°C)
- **Dielectric film:** Self-healing metallized polypropylene. Losses less than 1/2 watt per kVAR
- **Pressure-sensitive interrupter:** Built-in, three-phase interrupter design. UL® Recognized. Removes capacitor from line before internal pressures can cause case rupture
- **Discharge resistors:** Reduce residual voltage to less than 50V within one minute of deenergization. Mounted on terminal stud assemblies. Selected for 20-year nominal life. Exceeds NEC® requirements
- **Capacitor operating temperature:** -40°F (-40°C) to +115°F (+46°C)

PCDM Cell Showing Threaded Nut and Stud Terminal Connection

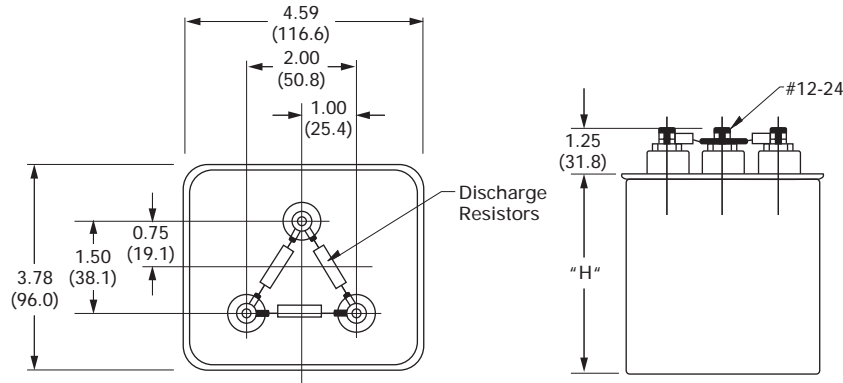

Dry Cell Chart

Voltage Rating	kVAR ①	Height—Inches (mm)	Approximate Weight—Lbs (kg)	Catalog Number ②
240	0.50	4.00 (101.6)	2.1 (1.0)	243PCDMF
240	1.00	4.00 (101.6)	2.1 (1.0)	443PCDMF
240	1.50	4.00 (101.6)	2.1 (1.0)	643PCDMF
240	2.00	4.00 (101.6)	2.1 (1.0)	843PCDMF
240	2.50	4.50 (114.3)	2.6 (1.2)	1043PCDMF
240	3.00	5.50 (139.7)	3.2 (1.5)	12X43PCDMF
240	4.00	6.00 (152.4)	3.5 (1.6)	16S43PCDMF
240	5.00	5.00 (127.0)	2.6 (1.2)	523PCDMF
240	6.25	6.00 (152.4)	3.2 (1.5)	6A23PCDMF
240	7.50	6.00 (152.4)	3.5 (1.6)	7X23PCDMF
240	8.33	7.00 (177.8)	3.5 (1.6)	8B23PCDMF
480	1.00	4.00 (101.6)	2.1 (1.0)	143PCDMF
480	2.00	4.00 (101.6)	2.1 (1.0)	243PCDMF
480	2.50	4.00 (101.6)	2.1 (1.0)	2X43PCDMF
480	3.00	4.00 (101.6)	2.1 (1.0)	343PCDMF
480	4.00	4.00 (101.6)	2.1 (1.0)	443PCDMF
480	5.00	4.00 (101.6)	2.1 (1.0)	543PCDMF
480	6.00	4.00 (101.6)	2.1 (1.0)	643PCDMF
480	7.50	4.00 (101.6)	2.1 (1.0)	7X43PCDMF
480	8.00	4.00 (101.6)	2.1 (1.0)	843PCDMF
480	10.00	5.00 (127.0)	2.6 (1.2)	1043PCDMF
480	12.50	5.50 (139.7)	3.2 (1.5)	12X43PCDMF
480	15.00	6.00 (152.4)	3.2 (1.5)	1543PCDMF
480	16.67	6.00 (152.4)	3.5 (1.6)	16S43PCDMF
480	17.50	7.00 (177.8)	3.5 (1.6)	17X43PCDMF
480	20.00	7.00 (177.8)	4.2 (1.9)	2043PCDMF
600	2.00	4.00 (101.6)	2.1 (1.0)	263PCDMF
600	2.50	4.00 (101.6)	2.1 (1.0)	2X63PCDMF
600	5.00	4.00 (101.6)	2.1 (1.0)	563PCDMF
600	7.50	4.00 (101.6)	2.1 (1.0)	7X63PCDMF
600	10.00	5.00 (127.0)	2.6 (1.2)	1063PCDMF
600	12.50	6.00 (152.4)	3.2 (1.5)	12X63PCDMF
600	15.00	6.00 (152.4)	3.5 (1.6)	1563PCDMF
600	16.67	7.00 (177.8)	3.5 (1.6)	16S63PCDMF
600	17.50	7.00 (177.8)	3.5 (1.6)	17X63PCDMF
600	20.00	8.75 (222.3)	5.0 (2.3)	2063PCDMF

Notes

- ① kVAR rating standard. NEMA® kVAR tolerance is +15%–0%.
- ② Catalog number as shown is for three-phase units.

Dry-type. Thermoplastic encapsulation medium. On all units, customer must provide overcurrent protection as tabulated or equivalent (fuse interruption rating shall be

100,000A or greater). All units supplied unpainted. Case material terne plate steel approximately 0.017 thick.

Technology Upgrades **UNIPAK**



UNIPAK

Fixed power factor correction for retrofit and upgrades. Units are available in 240–600V and 1–400 kVAR ratings for retail, commercial and industrial applications for single point correction. Units can also be configured to include harmonic filters in order to reduce harmonics in applications with large amounts of nonlinear loads, such as variable speed drives. They are most commonly applied to low voltage motors, motor control centers and incoming switchboards.

UNIPUMP



UNIPUMP

Fixed power factor correction for retrofit or upgrade of indoor or outdoor pump motor applications. Units are available in 240–600V and 2–20 kVAR ratings. Units include mounting brackets and a 4-foot flexible power cable attached for simple mounting and connection.

AUTOVAR



AUTOVAR 300



AUTOVAR 600

Switched power factor correction for retrofit or upgrade at the substation of facility level. An intelligent controller senses the customer's current power factor, and automatically steps on and off stages of capacitance in order to achieve the customer's programmed target power factor. Units are available in 240–600V and 25–840 kVAR ratings in wall and floor-mount designs. Higher ratings are available—contact the factory for assistance. Units can also be configured to include harmonic filters in order to reduce harmonics in applications with large amounts of nonlinear loads, such as variable speed drives.

Harmonic Correction Unit



Harmonic Correction Units

Active harmonic filters provide active harmonic control. The active harmonic filter will monitor the distorted electrical signal, determine the frequency and magnitude of the harmonic content, and then cancel those harmonics with the dynamic injection of opposing current. Active harmonic control provides the benefit of traditional passive filters with simpler engineering requirements, easier and less expensive installation, comprehensive control, and assured compliance with the IEEE® 519-1992 standard.

Medium Voltage UNIVAR and AUTOVAR



Metal-Enclosed Medium Voltage Power Factor Correction System

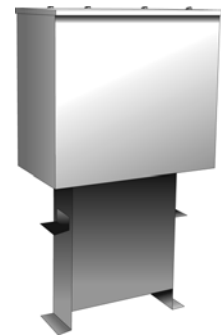

UNIVAR Fixed Medium Voltage PFC Unit

Eaton's Cutler-Hammer metal-enclosed medium voltage capacitor, systems and harmonic filters are designed for indoor or outdoor commercial, industrial and utility power systems requiring motor start support, power factor correction, harmonic filtering, IEEE 519 compliance and increased system capacity. Fixed motor start capacitors are available to assist in motor starting applications. Engineered designs are available with a host of options and accessories to fit the requirements and the desired configurations of virtually any installation. Single-stage and multi-stage, tuned or de-tuned filter banks can be supplied. Metal-enclosed medium voltage capacitor banks are designed for industrial, commercial and utility power systems involving motors, feeder circuits, and transmission and distribution lines where power factor improvement is required.

Further Information

Publication Number	Description
TD02607001E	Low voltage power factor correction capacitor banks and harmonic filters
TD02607011E	Metal-enclosed medium voltage power factor correction and harmonic filter systems

Pricing Information

Price and Availability Digest (PAD)

Vista/VISTALINE™ Discount Symbol C10-S27 for Systems

Vista/VISTALINE Discount Symbol C10-ST for Replacement Capacitor Cells

Price List—PL02607002E

Eaton's Electrical Services & Systems

Protection and Control Solutions



22 Eaton's Electrical Services & Systems

- Solving the Operating Performance Puzzle **V12-T22-2**
- PowerChain Management® Solutions **V12-T22-2**
- Power Systems Engineering Solutions **V12-T22-4**
- Predictive Maintenance **V12-T22-5**
- Continuous and Remote Partial Discharge
Monitoring for Medium Voltage Equipment **V12-T22-5**
- Medium Voltage Vacuum Replacement Breakers (MVVR) **V12-T22-6**
- Class 1 Reconditioning **V12-T22-7**
- Automation Services **V12-T22-7**
- Integrated Project Solutions **V12-T22-7**
- Replacement and Upgrading **V12-T22-8**
- Additional Services **V12-T22-8**
- Eaton's Electrical Services & Systems **V12-T22-8**
- Further Information **V12-T22-8**

Solving the Operating Performance Puzzle

As electrical equipment and systems become increasingly sophisticated and complex, so too does the challenge of maintaining peak levels of availability, performance, security and protection.

Eaton's Electrical Services & Systems (EESS) recognizes that superior hardware is only part of the answer. Effective power strategies require intelligent system design, integration, coordination and control. That means working with a dedicated service partner who understands on-site and remote access diagnostics, installation, modernization and predictive maintenance. Whether it's a single power strategy application or a total Integrated Project Solution, EESS has the method by which to enhance power performance, to reduce operating costs and to maximize the reliability, safety and integrity of your electrical equipment and system assets.



Uptime



Reliability

EESS is a one-stop service provider focused on integrating and maintaining power quality. In addition to complying with IEEE® and ANSI standards, many EESS engineers and technicians are 1E-certified to perform a full scope of on-site service operations in nuclear plants, including hardware retrofits.

EESS offers intelligent solutions for maximizing operating performance. Some of these solutions include:

Power Equipment Services

Critical electrical equipment requires systematic maintenance to ensure maximum performance and in-service life... while minimizing unscheduled downtime, aging, wear related hazards and total operating costs.

EESS is the ideal complement to your existing in-house service. For more complex projects, they can act as a single point outsource for all of your facility's ongoing maintenance needs, including:

- **Installation/Startup**
EESS can install any make or manufacturer of power equipment to precise vendor specifications, with minimal disruption of ongoing facility operations
- **Routine/Emergency Service**
EESS is on call 24/7, providing an unrivaled array of services, including disaster recovery and crisis response. One call to **1-800-498-2678**, and uptime engineers and technicians can be assembled with the sole purpose of bringing electrical systems back online quickly

- **Warranty Service**
EESS delivers a new level of confidence to customers by adding an additional one-year warranty extension to the Eaton products they install
- **Strategic Alliances**
because Eaton is truly universal in presence, scope and capability, EESS offers exceptional partnership opportunities to customers who operate multiple facilities on a regional, national or international level. As a dedicated service extension, EESS can establish and maintain consistent levels of availability, reliability and performance across your operation. Additionally, EESS can create uniform methods and procedures for performance benchmarking, predictive maintenance programs, inventory management and an array of other services designed to help maximize your investment



Life Extension

PowerChain Management Solutions



PowerChain Benefits

How Managing the PowerChain Empowers Business

By actively managing an enterprise's power infrastructure in a holistic manner, PowerChain Management solutions offer a company these advantages:

Greater Reliability

Among the clear advantages of a PowerChain Management solution are enhanced reliability and availability afforded by state-of-the-art technologies, such as predictive analysis and remote monitoring, to ensure business continuity.

Operating Cost Efficiencies

PowerChain Management solutions encompass savings that begin with intelligent design and innovation and continue through heightened energy management and a system-wide approach to cost-effective management practices, including life-cycle management.

Effective Use of Capital

By providing a single point of coordination, a PowerChain Management solution speeds the time from planning to installation and commissioning. In terms of life-cycle management, this approach provides for timely upgrades to avert the high cost of complete rebuilds.

Safety

A PowerChain Management solution enhances safety by working at the system level, applying the right equipment, supporting technology, training and procedures. By definition, it always optimizes system design and engineering for safety.

Risk Mitigation

With a single point of accountability for every aspect of the PowerChain, enterprises gain broad improvements in managing risks, including: meeting critical schedules, launch windows and compliance requirements; protecting critical data and equipment; and ensuring safety and regulatory compliance.

PowerChain End-to-End Capabilities**End-to-End Capabilities for Your PowerChain's Entire Life Cycle**

Eaton has over 100 years of experience and support behind its products. Our vast team of field engineers and a global service network ensures the highest level of responsiveness to your PowerChain needs. In addition, Eaton offers replacement part depots that make it easy to keep your electrical system running at peak performance.

With an exceptionally broad portfolio of award-winning AC and DC products, Eaton is an industry leader. From the invention of the circuit breaker, our roots are steeped in innovation. Our worldwide research centers continue to deliver advanced hardware and software solutions that are enabling new generations of proactive, intelligent electrical systems. And Eaton's global brands are helping our customers meet their needs for global standards such as IEEE, NFPA®, UL®, ANSI, IEC, NEMA® and CNCA.

Optimizing your organization's electrical system via PowerChain Management solutions offers you a breadth of resources including the following services and products.

Services

Engineering and Consulting Services provide upfront analysis and design prior to project implementation. Through a PowerChain Management Audit, our power system engineers will help you to quickly diagnose problems or proactively identify ways to improve your electrical system's performance and operation. Included are:

- System design engineering
- Power audits and studies
- Arc flash and safety studies
- Energy management
- Consulting support

Turnkey and Modernization Services offer field resources to get your project plan underway. From project management on a rebuild or refurbishment, to turnkey services for a new facility or upgrade, we can help you reduce time and costs. Included are:

- Project management
- Switchgear and UPS modification
- Integrated project solutions
- Existing equipment upgrades and rebuilding
- Installation, startup and commissioning assistance

Contract and Support Services ensure that your PowerChain continues to operate optimally around the clock. In addition to scheduled maintenance programs, Eaton offers a world-class service and emergency response capability with 24/7 monitoring so that you have peace of mind and confidence. Included are:

- Factory trained and certified field technicians
- Predictive and calendar-based preventive maintenance programs
- Spare part kits, modifications and upgrades
- On-site training and technical support

- Remote monitoring and diagnostic support
- Battery monitoring with replacement coverage (asset optimization)
- Parts and labor service contracts with on-site response times

PowerChain Life-Cycle Approach**Eaton's PowerChain Management Solutions—A Life-Cycle Approach**

Because Eaton's PowerChain Management solutions bring a system-wide view, address all decision points—planning, design, finance, engineering, construction, installation, upgrading and monitoring—and consider life-cycle impacts to the PowerChain, they free up businesses to concentrate on core capabilities. This provides a far more strategic partnership, one in which Eaton brings to bear its wide range of expertise and field-proven performance for which it has been known for over a century.

The ease of doing business with a single point of accountability gains enterprises these advantages: better schedule management over the course of an entire project; an advanced ability to anticipate and solve problems; and a more comprehensive approach to prevention and troubleshooting.

Eaton's electrical group has recognized the criticality of addressing the entire PowerChain in an integrated way to give organizations the benefits of greater reliability, operating cost efficiencies, effective use of capital, safety and risk mitigation. Through a combination of acquisitions, alliances and internal development, Eaton now delivers the products, services, in-depth expertise and exceptional performance to address complete PowerChain needs.

Eaton's PowerChain Management solutions encompass:

- **Power Audits**
Eaton's extensive audit capabilities assess an enterprise's complete PowerChain in terms of reliability, safety and energy management issues.
- **System Design/Build/Engineering/Construction/Installation**
Eaton is renowned for innovation. Our specialized knowledge transforms concepts into practical PowerChain solutions that take into account cost/benefit, multi-vendor integration and equipment selection. On-site construction management and engineering staff are well versed in the practical aspects of integrating power protection into existing buildings, as well as in new construction.
- **Monitoring and Analysis**
Assessing the status of equipment, predicting imminent failures and identifying power anomalies are critical to a PowerChain Management solution. Eaton provides a full complement of these services.
- **Life-Cycle Management**
Life-cycle management services begin with product design and engineering, and continue through monitoring, maintenance, upgrades and, ultimately, replacement
- **End-to-End Equipment Capabilities**
Eaton's PowerChain Management solutions extend from research, design, enhancement and factory testing, to on-site installation

PowerChain Audit

The PowerChain Management Audit

Many facilities have gone through upgrades and changes over the years. Electrical loads have been added to automate processes, computer loads have been added to the facilities, harmonics have been introduced to the system, and the loads are often much more susceptible to power quality issues. Dealing with these issues is most efficiently done systematically by performing a site audit looking for specific problems and potential areas of improvement. By using proven techniques and strategic monitoring, Eaton will identify the areas of greatest vulnerability and will address the options for providing protection from utility issues, as well as system protection from new and ever-changing load requirements.

Eaton offers PowerChain Management Audits to evaluate power system designs and to improve the availability and reliability of the power system. This method uses proven IEEE Gold Book methods for analysis and helps to determine whether upgrading critical elements of the power system, modernizing the system or simply rehabilitating the system is the most cost-effective method of improving reliability prior to a failure.

Eaton's PowerChain Management Audits consist of visual inspections, electrical measurements using power quality monitoring equipment, interviews with on-site personnel, and reviews of utility bills and data. Specifically, Eaton will address interruptions, voltage sags, harmonics, surge protection, grounding, energy management and arc flash safety.

Eaton will investigate methods of improving the reliability of the power system to help you avoid costly downtime and repairs. The present state of the existing personal protective equipment is also evaluated. Cost and payback information will be presented where appropriate.

Eaton reviews energy consumption to determine possible savings with utility rate structures, energy usage, time of use (on- or off-peak), power factor correction and various methods of metering. By monitoring trouble areas of the facility, Eaton will identify other potential areas for improvement and savings.

Eaton's electrical group recognizes the criticality of addressing the entire PowerChain to give organizations the benefits of greater reliability, operating cost efficiencies, effective use of capital, safety and risk mitigation. With a PowerChain Management Audit, power management problems can be resolved through a single, integrated solution at every level in a facility, delivering products, services, expertise and exceptional performance to address your complete PowerChain needs. The purpose of this audit is to show areas of improvement in the electrical infrastructure and to point out areas that are well designed, maintained and operating at or above expectations.

PowerChain Management Audit Features

- Evaluate wiring and grounding methods
- Evaluate backup protection including the use of UPS power, backup generation, sag correction and power conditioning
- Review energy management processes to determine demand-side management opportunities and analyze energy-efficient electrical loads

- Evaluate surge protection at the utility connection point and at the downstream loads
- Evaluate the use of harmonic solutions including tuned filters, line reactors and phase shifting transformers
- Evaluate and review present arc flash safety compliance status
- Evaluate the quality of the voltage and current at the main service equipment
- Interview key electrical personnel on site to determine the type of operating problems, the equipment affected, and the time of occurrences

Power Systems Engineering Solutions

As technology advances and more businesses come to rely on sophisticated equipment, the demand for consistent, top-quality power increases. Power systems that were installed 15, 10 or even 5 years ago were not designed to handle today's power demand. The key to a healthy power system is consistent configuration and familiarity with the operating power system. The most definitive way to accomplish this is through a Protection and Coordination Study by Eaton's Power Systems Engineers.



Energy Efficiency

EESS provides methodical testing and monitoring practices on power systems. Tests are run to analyze safety, reliability, power quality and energy management.

These services have proven to be an effective way of protecting expensive equipment and preventing downtime.

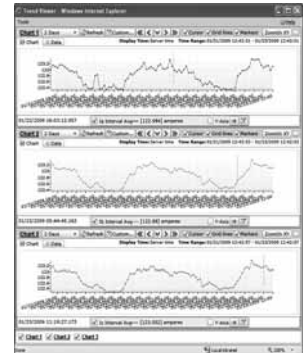

Screen Shot

Preventing future system distress and creating a safe power environment that will be both economical and electrically sound is another reason to bring in the power systems specialists. It is a proactive, system conscious move involving power systems engineers and technicians when upgrading to a new distribution system, adding additional loads or processes to the current power system, or contracting with a utility. Power quality and energy management studies can take place during normal plant operation or scheduled around an annual plant shutdown.

The first step to consistent and safe power is to fully understand the intricacies of the power system. No one can do that better than Eaton's Electrical Services & Systems.



System Testing

Predictive Maintenance

Eaton predictive maintenance applies the latest technologies to support online condition assessment of critical electrical distribution equipment. Advancements have resulted in new applications that allow for predictive diagnostics measurements via existing electrical components.

- Performance-based maintenance
- PM program design and implementation
- Periodic testing and PM services
- Thermographic survey
- Troubleshooting
- Testing
- Predictive diagnostics
- Transformer oil processing

With extensive field experience, EESS can quickly develop a customized application to schedule and document essential system services, which allows for cost savings while improving system reliability. Limited maintenance dollars are prioritized for equipment that is critical and is in greater need of service. By implementing our predictive maintenance software with complete monitoring capabilities, equipment outages are anticipated and averted before they happen.

Continuous and Remote Partial Discharge Monitoring for Medium Voltage Equipment



Eaton InsulGard

Eaton understands the pressures that you face trying to reduce costs while at the same time maximizing your electrical system's uptime and reliability. That's why we invented the Eaton InsulGard™, a system that changes the rules of power equipment maintenance. Until now, there were only two options.

1. Wait for equipment to break down and fix it and/or
2. Periodically take equipment out of service to perform tests and maintenance—whether it's needed or not.

Now there is a third, revolutionary option. InsulGard is the first continuous, online, medium voltage, predictive maintenance system that can be used in a variety of applications including switchgear, bus duct, power centers, generators and motors. Through monitoring, it can ascertain the relative condition of insulation, the deterioration of which is the leading cause of electrical failures. And, it can monitor these conditions better than alternative testing methods. Further, you won't have to take equipment out of service or send personnel to conduct tests. In effect, the InsulGard system is a lower-cost alternative to forced outages and rigid, and sometimes unnecessary, maintenance schedules. We believe that

you will find the InsulGard system to be the best planning tool available today.

At the heart of the system is the InsulGard monitor. Whether you use it to monitor switchgear or rotating equipment, only some internal circuitry changes. The variable part of the system is the broad array of sensors we've developed to function with key electrical assets. Yet, each sensor is specifically designed to work with the InsulGard monitor to provide seamless and accurate data. They are also designed to work with existing Resistive Temperature Devices (RTDs) already present within the windings of generators and the motor. Design integrity is important when it comes to protecting your investment. The InsulGard system has it.

Generators and Motors

The InsulGard system is available with a variety of sensors appropriate for motors and generators. One of these is the RTD module that connects to existing resistive temperature devices (RTDs) already embedded within the windings of the generator or the motor. Another sensor that checks for partial discharge is the coupling capacitor, which is used on the line side. A third sensor, ideal for generators and motors, is the radio frequency current transformer (RFCT). The RFCT embraces cable shielding and is used in the line part of the winding. Used alone or in combination, the sensors connect to the InsulGard monitor where partial discharges and other variables such as humidity, load and temperature are monitored and recorded for analysis.

Specifically, here are the issues that partial discharge analysis can tell you about your rotating equipment:

- Early stages of insulation deterioration
- Sparks in voids and between windings
- Corona on end windings

Switchgear

Available sensors for switchgear include coupling capacitors or a combination of radio frequency voltage sensors (RFVSS) and radio frequency current transformers (RFCTS). Coupling capacitors detect partial discharges in a cubicle and/or adjacent cubicles and are typically installed on the load side of the feeder breakers or on the main bus. Radio frequency voltage sensors (RFVSS) are also used to detect discharges within the cubicle. They are typically installed on the load side of the feeder breakers, or on the main bus. They are connected to the current or the potential transformer's secondary neutral terminal.

Large Power Transformers

Eaton InsulGard G is available for transformers that contain a capacitive tap at the base of the bushing. This tap is normally used for power-factor measurements. Transformers with a primary voltage of 13.8 kV can be monitored using our standard partial discharge sensor.

Software

InsulGard software is part of the InsulGard system. It allows you to view the dynamics captured by the monitor and to analyze the condition of insulation based on the guidelines and parameters provided by Eaton predictive diagnostics specialists. The eventual goal of predictive diagnostics is to create a Web-based service whereby you can statistically compare the relative condition of your equipment to others who have similar equipment in operation by equipment type, manufacturer, voltage class ratings, partial discharge activity longevity, etc. Users will benefit by comparing their own measured partial discharge data with our extensive database to predict outcomes and to plan maintenance. This database will not identify customer sites or locations in order to guard the privacy of our customers.

Medium Voltage Vacuum Replacement Breakers (MVVR)

New Replacement Breakers from the Ground Up

VR-Series medium voltage vacuum replacement (MVVR) breakers are brand new breakers that have been designed, manufactured and fully tested to be functional electrical and mechanical replacements for almost any manufacturers' original air magnetic and some vacuum circuit breakers. However, if cell structure modifications are required, they are reversible.

Unnecessary downtime is avoided because the breakers are new, and only require one outage for removal and installation. By only replacing the breakers, equipment costs are reduced while the life of the existing switchgear is extended.

Many circuit breakers require additional contacts, mechanism operated contacts (MOCs), that are mounted external to the circuit breaker mechanism. When these contacts are operated by high speed vacuum breakers, they travel almost four times faster than existing air magnetic circuit breakers and can transfer up to 16 times the kinetic energy to the MOC switch. The increased forces can damage the existing MOC switch and cell components, and in some cases, stall the breaker when trying to close. A SURE CLOSE MOC system balances the speed and force of the breaker's MOC operator to prevent stalling and damage to the cell and the MOC switch.



Replacement

Eaton manufactures over 158 different models of VR-Series MVVR breakers that replace air magnetic circuit breakers originally manufactured by: Westinghouse®, General Electric®, Allis-Chalmers, Federal Pacific Electric®, ITE® and McGraw-Edison®.

Competitive Upgrades—Low Voltage Power Air Breakers

AR-Series Replacement Breakers

The AR-Series (air-replacement) breakers are not retrofits. They are 100% new breakers used to completely replace the original drawout type power air circuit breaker. This solution uses state-of-the-art Eaton Magnum™ breaker technology that provides maximum life-extension and switchgear modernization. The offering includes a new breaker, a cassette with extension rails and a standard door. No modifications are required to the original line/load power stabs or to the secondary disconnect contacts.

This solution can eliminate safety problems caused by defective racking and/or operator mechanisms. Additional safety against arc flash incidents can be obtained by equipping the breaker with ARMS Technologies, thereby reducing the arc flash energy available at downstream devices during maintenance periods. Additional switchgear maintenance problems such as parts unavailability and lengthy maintenance procedures can be eliminated. This solution often provides a substantial total installed cost savings when compared to completely replacing the switchgear assembly.

In many instances, the AR-Series replacement breaker can be combined with engineering services to provide continuous current and/or interruption rating upgrades.

The AR-Series breakers are designed, manufactured and tested to modern IEEE/ANSI standards.

Designs are available for a wide variety of drawout type low voltage power air circuit breakers (LVPACB) originally manufactured by Westinghouse, Federal Pacific Electric, Allis-Chalmers, ITE and General Electric.

Pictured on this page are several examples of available designs. Contact your local Eaton sales representative for information on other breaker types.

Westinghouse



Original DB-25 DB25-AR600NM



Original DB-50 DB50-AR1600M



Original DB-75 DB75-AR3000M

Allis-Chalmers



Original LA-600 LA600-AR600NM

ITE



Original K-600 K-600-AR600NM

Federal Pacific Electric



Original FP-25 FP25-AR600NM



Original FP-50 FP50-AR1600M



Original FP-75 FP75-AR3000B

General Electric



Original AK-2A-50 AK2A50-AR1600M



Original AKR-4A-30 AKR4A30-AR800NM

Class 1 Reconditioning



Better Than New

The useful life capacity and performance of vintage or damaged motor controls and power distribution equipment can be extended and enhanced through Eaton's Aftermarket Centers of Excellence (ACE). Their strategic locations enable rapid response through a cost-effective program of selective hardware retrofits.

Each ACE strictly adheres to all national standards and quality processes. Field experts use evolving technology to ensure the most advanced retrofit upgrade possible. Access to vintage parts won't be a problem; each ACE has both Cutler-Hammer and Westinghouse renewal parts available.



Proven

In the ongoing battle of maximizing operating performance and safety, Eaton's Class 1 reconditioning service helps to restore the integrity of electrical protection equipment to its required level of reliability.

Automation Services

Effectively applying leading-edge technologies is often the key to enhanced performance, improved output, and reduced frequency and severity of outages. Engineering these new technologies into an existing equipment configuration is an EESS specialty.



System Integrator

EESS is a full service systems integrator with proven expertise in power and energy management systems.

EESS provides a unique alternative to conventional manufacturer-integrator-contractor teams. With project management expertise, EESS offers single-point responsibility from a major controls manufacturer. Industry knowledge allows for seamless integration of new products, regardless of equipment manufacturer.



Process Improvement

EESS has the capabilities to address the entire scope of integration and automation needs, including:

- Power management systems (IQ, IMPACC, Power Xpert® Software, Foreseer® Services)
- Automatic transfer schemes
- Distributed generation/generator control systems
- Demand management—load shedding/peak shaving systems
- Generator and ATS system monitoring and testing
- Health care emergency power supply systems
- PLC systems (Eaton, Allen-Bradley®, Modicon®, GE Fanuc® and Siemens®)

Integrated Project Solutions

The project management group within EESS provides integrated project solutions to customers in the government, industrial, commercial and utility sectors. Eaton's Federal Systems Group also focuses on mission-critical government installations, providing project solutions, on-going maintenance and remote monitoring.

- New substation design and construction
- Integrated emergency power requirements, including UPS, generators and alternate feeders
- Plant automation
- PLC control and load shedding
- Electrical plant monitoring and control
- Process automation and system integration



Design

The integrated project solutions engineers manage the technical and commercial risk inherent in meeting project objectives. These engineers focus on performance, cost and time goals, while controlling or maintaining the scope of the project.



Speed of Response

By hiring the EESS project management group, you can release the burden of multi-supplier coordination. EESS offers single-point accountability for all technical, financial and commercial coordination within the scope of the project.

Replacement and Upgrading

OEM Equipment Serviced and Upgraded

- Westinghouse
- Cutler-Hammer
- Square D®
- General Electric
- ITE
- ABB®
- Allis-Chalmers
- Siemens
- Federal Pacific
- and others...

Plant Life Extension

- MV vacuum breaker replacement
- MV motor starter upgrading
- Generator excitation and motor control
- System metering and control—PowerNet/IMPACC
- LV breaker (all OEMs) trip systems
- Class 1 circuit breaker reconditioning
- Nuclear equipment services
- UPS or battery systems

Additional Services

Consulting and Advisory Support

- Arc flash studies and solutions
- Power system studies, design and analysis
- Failure/root cause analysis
- Reliability analysis
- Power quality and harmonic analysis
- Reliability centered maintenance (RCM)
- Short-circuit/coordination studies
- Power systems training

Startup and Commissioning

- Installation support and supervision
- Acceptance testing (NETA equivalent)
- Startup and training
- Ground-fault certifications
- Installation construction services

Instant Response CenterSM

- Monitoring and diagnostics
- 24 hours a day, 7 days a week, 365 days a year
- Power quality experts
- Energy management

Eaton's Electrical Services & Systems

Asset Optimization

Outsource the responsibility for the electrical distribution system and the associated equipment to Eaton's Electrical Services & Systems. Offerings involve cost savings and performance guarantees for greater focus on the core business. Asset optimization uses all the tools and capabilities within the other service platforms, resulting in improved reliability, life expectancy and overall cost.

Knowledge Management

Collect and transform your system data to useful knowledge; allow for proactive planning, energy management, optimized decision-making, failure prediction and, ultimately, cost savings.

Integrated Project Solutions

Engineering, design, procurement, installation and commissioning of power systems equipment; a total turnkey approach.

Power Systems Engineering Solutions

Power systems automation, design engineering, training, predictive diagnostics, power quality and power systems studies/analysis to decrease costs and increase productivity.

Power Systems Modernization

Keep systems operating at peak efficiency, reliability and safety; extend the life of the electrical asset through equipment life extension and upgrade solutions using new technologies.

New Equipment Services

Installation, testing and commissioning of virtually any electrical equipment.

Field Services

Power system and equipment service, maintenance programs, testing, upgrades and Aftermarket solutions; 24/7 emergency service; crisis response and disaster recovery.

Further Information

For further information on Eaton Service Solutions, call **1-800-498-2678** or visit our website at: www.eaton.com/EESS.

Pushbuttons and Indicating Lights

E22/EM22 Pilot Devices



23 Pushbuttons and Indicating Lights

Product Description	V12-T23-2
Product History	V12-T23-2
Product History Time Line	V12-T23-2
Replacement Capabilities	V12-T23-3
Further Information	V12-T23-14
Pricing Information	V12-T23-14

Pushbuttons and Indicating Lights



E22/EM22 Pilot Devices

Product Description

Eaton's Cutler-Hammer® 22.5 mm industrial heavy-duty pushbutton line offers a wide array of functional, smartly styled illuminated and non-illuminated pushbuttons, selector switches, push-pulls, alternate action and twist-to-release operators. The complete line also includes transformer, full voltage, resistor, LED or neon light units.

E22 operators are available with either a traditional chrome or matte black front-of-panel appearance. The space-saving design and modular construction of the E22 line makes on-the-job assembly fast and simplifies the stocking of both components and complete devices.

Eaton's Cutler-Hammer EM22 metal series is a rugged line of metal construction 22.5 mm pushbutton devices. They are an extension of the industrially proven E22 heavy-duty double insulated 22.5 mm pushbutton family.

EM22 operators are heavy-duty zinc die-cast construction plated with a corrosion-resistant chromate finish. Operators are complete with a very durable chrome-plated metal bezel. Indicating light units in the EM22 series feature smartly styled round lenses that enhance their appearance and brightness.

All EM22 operators are compatible with existing E22 contact blocks, light units, accessories and enclosures.

EM22 metal operators and indicating lights are grounded when mounted to metal panels through the toothed mounting nut. They are not grounded when mounted to plastic panels.

Product History

E22 was first sold in 1983. The line has had one major change in the mid 1990s to increase the size of the button plates to be roughly equivalent to a 30mm pushbutton. Then in 2002, the EM22 extension of the line was introduced. Since then, only minor changes/additions have occurred. While the entire product breadth is not available anymore as aftermarket, most functionality is available in the products shown in this catalog.

Product History Time Line

Product	1980	1985	1990	1995	2000	2005	Present
E22		■					
EM22						■	

Replacement Capabilities

Momentary Contact Pushbuttons, Non-Illuminated—UL (NEMA) Type 3, 3R, 4, 4X, 12, 13

Will accept maximum of three contact blocks (six circuits) when used with supplied three-way adapter and optional operator plug.

25 mm Diameter Flush Button

Color	E22 Series—Plastic Operators		EM22 Series—Metal Operators	
	Black Bezel Catalog Number	Chrome Bezel Catalog Number	Black Bezel Catalog Number	Chrome Bezel Catalog Number
Black	E22PB1	E22P1	E22P1	EM22P1
Red	E22PB2	E22P2	E22P2	EM22P2
Green	E22PB3	E22P3	E22P3	EM22P3

25 mm Diameter Extended Button

Color	E22 Series—Plastic Operators		EM22 Series—Metal Operators	
	Black Bezel Catalog Number	Chrome Bezel Catalog Number	Black Bezel Catalog Number	Chrome Bezel Catalog Number
Red	E22EB2	E22E2	E22E2	EM22E2

40 mm Diameter Mushroom Head Button

Color	E22 Series—Plastic Operators		EM22 Series—Metal Operators	
	Black Bezel Catalog Number	Chrome Bezel Catalog Number	Black Bezel Catalog Number	Chrome Bezel Catalog Number
Black	E22LB1	E22L1	E22L1	EM22L1
Red	E22LB2	E22L2	E22L2	EM22L2

50 mm Diameter Mushroom Head Button—Plastic

Color	E22 Series—Plastic Operators		EM22 Series—Metal Operators	
	Black Bezel Catalog Number	Chrome Bezel Catalog Number	Black Bezel Catalog Number	Chrome Bezel Catalog Number
Red	E22JP2	E22JP2	E22JP2	EM22JP2



Note

Operator plug E22BA2 required if third contact block is used. See Page V12-T23-11.



Illuminated Pushbuttons, Non-Illuminated—UL (NEMA) Type 3, 3R, 4, 4X, 12, 13

Will accept maximum of two contact blocks (four circuits) when used with supplied three-way adapter.

25 mm Diameter Flush Lens

Color	E22 Series—Plastic Operators		EM22 Series—Metal Operators	
	Black Bezel Catalog Number		Chrome Bezel Catalog Number	
Red	E22NB2		E22N2	EM22N2
Green	E22NB3		E22N3	EM22N3
White	E22NB5		E22N5	EM22N5
Amber	E22NB9		E22N9	EM22N9

25 mm Diameter Extended Lens

Color	E22 Series—Plastic Operators		EM22 Series—Metal Operators	
	Black Bezel Catalog Number		Chrome Bezel Catalog Number	
Red	E22TB2		E22T2	EM22T2
Green	E22TB3		E22T3	EM22T3
Amber	E22TB9		E22T9	EM22T9

Alternate Action (Push-Push) Components Non-Illuminated Push-Push Operators

Will accept a maximum of two contact blocks when used with supplied three-way adapter, five-way mounting adapters are not to be used.

Flush, Non-Illuminated Push-Push Operators—UL (NEMA) Type 3, 3R, 4, 4X, 12, 13 ①

Black Bezel



Chrome Bezel



Color	E22 Series—Plastic Operators	
	Black Bezel Catalog Number	Chrome Bezel Catalog Number
Black	E22PPB1	E22PP1
White	E22PPB5	E22PP5
Gray	E22PPB7	E22PP7

Emergency Stop Components

Maximum of two contact blocks (four circuits) when used with supplied three-way adapter (unless otherwise noted).

Standard Emergency Stop and Emergency OFF Operators—UL (NEMA) Type 3, 3R, 4, 4X, 12, 13

E22LTA2



E22LTA2N123



Action	Color	Button Diameter/ Material	Legend/ Engraving	Plastic—Black Bezel Catalog Number
Maintained Trigger action Twist-to-release	Red	40 mm/plastic	—	E22LTA2 ②
Maintained Trigger action Twist-to-release	Red	40 mm/plastic	EMO	E22LTA2N123 ②

Notes

① In order to comply with NFPA 79 and IEC 60204-1 requirements: The colors black, white or gray shall be used for Push-Push operators that act alternately as START/ON and STOP/OFF pushbuttons. White shall be used for illuminated Push-Push operators. Push-Push operators shall only be used for functions that cannot result in a hazardous condition.

IEC 60204-1 recommends that Push-Push operators acting alternately as START/ON and STOP/OFF pushbuttons be marked with the IEC symbol for Push-Push pushbuttons.

② Compliant with EN418 Machinery Safety Directive.

Twist-to-Release, Push-Pull and Key Release Components

Maintained Contact Mushroom Head Operators, Non-Illuminated—UL (NEMA) Type 3, 3R, 4, 4X, 12, 13

Will accept maximum of two contact blocks (four circuits) when used with supplied three-way adapter.

Twist-to-Release—28 mm Diameter Button (Push to Latch—Twist to Release)

E22 Series—Plastic Operators		EM22 Series—Metal Operators	
Color	Black Bezel Catalog Number	Chrome Bezel Catalog Number	Chrome Bezel Catalog Number
Red	E22MLB2	E22ML2	EM22ML2

Twist-to-Release—40 mm Diameter Button (Push to Latch—Twist to Release)

E22 Series—Plastic Operators		EM22 Series—Metal Operators	
Color	Black Bezel Catalog Number	Chrome Bezel Catalog Number	Chrome Bezel Catalog Number
Red	E22LLB2	E22LL2	EM22LL2

Push-Pull—40 mm Diameter Button (Push to Latch—Pull to Release)

E22 Series—Plastic Operators		EM22 Series—Metal Operators	
Color	Black Bezel Catalog Number	Chrome Bezel Catalog Number	Chrome Bezel Catalog Number
Red	E22LPB2	E22LP2	EM22LP2

Push-Pull—50 mm Diameter Button (Push to Latch—Pull to Release)

E22 Series—Plastic Operators		EM22 Series—Metal Operators	
Color	Black Bezel Catalog Number	Chrome Bezel Catalog Number	Chrome Bezel Catalog Number
Red	E22JPLB2	E22JPL2	EM22JPL2
Red (metal) EMERGENCY STOP	E22JLB2N8	E22JL2N8	EM22JL2N8

Key Release—40 mm Diameter Button (Push to Latch—Turn Key to Release) ①

E22 Series—Plastic Operators		EM22 Series—Metal Operators	
Color	Black Bezel Catalog Number	Chrome Bezel Catalog Number	Chrome Bezel Catalog Number
Red	E22GB2	E22G2	EM22G2

Note

① For legend plates, use oversize plates, Catalog Numbers E22VA2 or VA8 listed on Page V12-T23-11.

Indicating Light Units—One-Piece LED

- One-piece body style
- Plastic operators
- Full voltage LEDs
- Cluster-style integrated LED (non-removable)
- Plastic lenses

Non-Removable LED



Non-Removable LED

Cluster LED Type Indicating Lights—Non-Removable LEDs—UL (NEMA) Type 3, 3R, 4, 4X, 12, 13

Description	Supply Voltage	LED Color	Lamp Life ①	Catalog Number
Includes permanently attached lens and board mounted, cluster style LEDs	24 Vac/Vdc	Red	100,000	E22HL2X4
		Green	100,000	E22HL3X4
		Amber	100,000	E22HL9X4
	110/120 Vac/Vdc	Red	100,000	E22HL2X8
		Green	100,000	E22HL3X8
		Amber	100,000	E22HL9X8

Indicating Light Units—One-Piece Incandescent

- One-piece body style
- Plastic operators
- Full voltage
- Bayonet base incandescent lamp

Incandescent Standard Lens



Incandescent Standard Lens Type Indicating Lights—UL (NEMA) Type 3, 3R, 4, 4X, 12, 13

Description	Supply Voltage	Color	Lamp Life ①	Catalog Number
Includes lens and T 3-1/4 bayonet base lamp	24 Vac/Vdc #1819 lamp	Red	2500	E22HV2X4
		Green	2500	E22HV3X4
		Amber	2500	E22HV9X4
	110/120 Vac/Vdc W1121 lamp	Red	1000	E22HV2X8
		Green	1000	E22HV3X8
		Amber	1000	E22HV9X8

Note

① Published theoretical lamp lives are based on ideal laboratory conditions and should be used for comparison only. Actual life may be shorter due to application conditions.

Indicating Light Components

E22



EM22



Indicating Lights—Without Light Unit—UL (NEMA) Type 3, 3R, 4, 4X, 12, 13

Color	E22 Series—Plastic Operators Catalog Number	EM22 Series—Metal Operators Catalog Number
25 mm Diameter Standard Lens ^①		
Red	E22H2	EM22H2
Green	E22H3	EM22H3
White	E22H5	EM22H5
Amber	E22H9	EM22H9
Clear	E22H0	EM22H0

Push-Pull Components—Illuminated Operators

Will accept a maximum of two contact blocks when used with supplied three-way adapter. Five-way mounting adapters are not to be used with three-position operators.

E22 Black



E22 Chrome



EM22 Chrome



Illuminated Push-Pull Operators—UL (NEMA) Type 3, 3R, 4, 4X, 12, 13

Color	E22 Series—Plastic Operators		EM22 Series—Metal Operators
	Black Bezel Catalog Number	Chrome Bezel Catalog Number	Chrome Bezel Catalog Number
Two-Position—40 mm Diameter Lens ^② (Maintained)			
Red	E22GDB2 ^①	E22GD2 ^①	EM22GD2 ^①
Green	E22GDB3	E22GD3	EM22GD3
Three-Position—40 mm Diameter Lens ^② (Spring Return to Center)			
Red	E22HDB2	E22HD2	—
Green	E22HDB3	E22HD3	—

Notes



^① For LED/incandescent lamps, see **Page V12-T23-10**.

^② All illuminated Push-Pull operators require tall LEDs from **Page V12-T23-10**.

Selector Switches





45° Throw Non-Illuminated Lever and Knob Operated Selector Switches—Plastic

Will accept a maximum of two contact blocks (four circuits) with supplied three-way mounting adapter. Optional five-way adapter will accept a maximum of five contact blocks (10 circuits).

		45° Throw Non-Illuminated Lever and Knob Operated Selector Switches— UL (NEMA) Type 3, 3R, 4, 4X, 12, 13					
		Operating Mode M = Maintained S = Momentary					
	Left	Center	Right	Cam Code	Plastic—Black Bezel Catalog Number	Plastic—Chrome Bezel Catalog Number	
Black Bezel, Lever							
Chrome Bezel, Lever							
Two-Position—45° Throw—Black Lever							
	—	M	M	2	E22VBF1	E22VF1	
	M	—	M	2	E22VB51	E22V51	
Three-Position—45° Throw—Black Lever							
Black Bezel, Lever	M	M	M	1	E22VBG1	E22VG1	
	S	M	S	1	E22VBL1	E22VL1	
Chrome Bezel, Lever	M	—	M	2	E22XB51	E22X51	
Two-Position—45° Throw—Black Knob							
	M	M	M	1	E22XBG1	E22XG1	
	S	M	S	1	E22XBL1	E22XL1	

60° Throw Non-Illuminated Lever and Knob Operated Selector Switches

Will accept a maximum of two contact blocks (four circuits) with supplied three-way mounting adapter. Optional five-way adapter will accept a maximum of five contact blocks (10 circuits).

		60° Throw Non-Illuminated Lever and Knob Operated Selector Switches— UL (NEMA) Type 3, 3R, 4, 4X, 12, 13					
		Operating Mode M = Maintained S = Momentary					
	Left	Center	Right	Cam Code	E22 Series—Plastic Operators		EM22 Series—Metal Operators
					Black Bezel Catalog Number	Chrome Bezel Catalog Number	Chrome Bezel Catalog Number
E22 Black Bezel, Knob							
E22 Chrome Bezel, Knob							
Two-Position—60° Throw—Black Knob							
	M	—	M	2	E22XB561	E22X561	EM22X561
Three-Position—60° Throw—Black Knob							
EM22 Black Knob	M	M	M	1	E22XBG61	E22XG61	EM22XG61

Key Operated Selector Switches

Key removal from maintained positions only—will accept a maximum of two contact blocks (four circuits) with supplied three-way mounting adapter. Optional five-way adapter will accept a maximum of five contact blocks (10 circuits).

Plastic Black Bezel



Plastic Chrome Bezel



Metal Chrome Bezel



Key Operated Selector Switches—UL (NEMA) Type 3, 3R, 4, 4X, 12, 13

Operating Mode
M = Maintained
S = Momentary

			E22 Series—Plastic Operators		EM22 Series—Metal Operators	
Left	Center	Right	Cam Code	45° Black Bezel Catalog Number ^①	45° Chrome Bezel Catalog Number ^①	60° Chrome Bezel Catalog Number ^①
Two-Position						
M	—	M	2	E22KB52	E22K52	—
M	—	M	2	E22KB53	E22K53	EM22K53
M	—	S	2	E22KB62	E22K62	EM22K62
—	M	M	2	E22KF4	E22KF4	EM22KF4
Three-Position						
M	M	M	1	E22KBG7	E22KG7	—

Spare Key

Description	Reference Number Stamped on Key	Catalog Number
Standard lock	92239	E22KS2

Specialty Operators

Mechanical Push Rod



Flush Pushbutton Operators with Mechanical Push Rod—UL (NEMA) Type 3, 3R, 4, 4X, 12, 13

Description	Color	Plastic—Black Bezel Catalog Number	Plastic—Chrome Bezel Catalog Number
25 mm diameter flush pushbutton Operators supplied with mechanical push rod—suitable for external mechanical reset of overload relays. Push rod must be cut to desired length	Gray	E22PB7L	E22P7L

Double-Headed Pushbuttons

Double-Headed Pushbuttons



Illuminated and Non-Illuminated Double-Headed Pushbuttons—UL (NEMA) Type 1; IP40

Description	Operator Colors	Marking	Plastic—Black Bezel Catalog Number
Non-illuminated double-headed pushbutton	Green—Red	I	E22DB1A21

Contact Blocks

Contact Blocks



Contact Blocks

Description	Catalog Number
1NC	E22B1 ^②
1NO	E22B2
1NO-1NC	E22B11 ^②
2NO	E22B20
One self-monitoring 1NC	E22CB1M ^{②③}

Notes

^① Final digit of catalog number represents key removal position per the chart below.

Key Removal Position	Code Suffix	Key Removal Position	Code Suffix
Left only	2	Center only	4
Right and left	3	Right, left and center	7

^② Marked with direct opening action (DOA) symbol per IEC 60947-5-1 (Annex K) and NEMA ICS 5 (Part 6).

^③ For use with trigger action emergency stop (E22LTA2) operators.

Light Units and Lamps

E22 light units consist of two versions—standard size LED lamps and tall LED lamps. Select the standard LED light units for all indicating lights, illuminated pushbuttons, push-push (alternate action) or double-headed pushbutton operators. Select the tall LED light units for all illuminated selector switches and push-pull operators.

Tall LED Light Unit **LED Light Units—Includes a T3-1/4 (BA9) Bayonet Base LED**

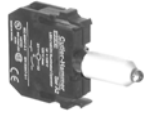

Standard LED Light Unit



Type	Supply Voltage	LED Color	Standard LED ^① Catalog Number	Tall LED ^① Catalog Number
Full voltage	Unit without lamp	—	E22DE	E22DE
	24 Vac/Vdc	Red	E22DL24R	E22DLT24R
		Green	E22DL24G	E22DLT24G
		Yellow	E22DL24Y	—
		White	E22DL24W	—
120 Vac/Vdc	Red	Red	E22DL120R	E22DLT120R
		Green	E22DL120G	E22DLT120G
		Yellow	E22DL120Y	—
		White	E22DL120W	—

E22 light units consist of two versions—with standard bulb or with tall bulbs. Select the standard bulb light units for all indicating lights, illuminated pushbuttons, push-push (alternate action) or double-headed pushbutton operators. Select the tall bulb light units for all illuminated selector switches and push-pull operators.

Caution: Please note that 120V full voltage light units (E22D120) are only suitable for indicating light operators and will overheat in other operators.

Incandescent Light Units **Incandescent Light Units—Includes a T3-1/4 (BA9) Bayonet Base Lamp (Except When Noted)**



Type	Supply Voltage 50/60 Hz	Lamp Voltage	Standard Bulb Catalog Number
Full voltage AC/DC	Unit without lamp	—	E22D
	24	24	E22D24
	120	120	E22D120 ^②
Resistor AC/DC	120	60	E22R2
Transformer AC only	120	6	E22TL1
	240	6	E22TL2

PresTest Unit **PresTest Units—Includes Prewired 1NO-1NC Contact Blocks**











Type	Supply Voltage 50/60 Hz	Lamp Voltage	Standard Bulb Catalog Number
Full voltage AC/DC	Unit without lamp	—	E22D0C
	24	24	E22D24C
Resistor AC/DC	120	60	E22R2C
Transformer AC only	120	6	E22TL1C

Notes

- ① Use tall LEDs for Pull/Push operators. For all other illuminated devices, use standard LEDs.
- ② E22D120 light units are suitable for indicating light operators only.

Accessories

EM22 and E22 Series Accessories		
Hole Plug	Description	Catalog Number
	Hole Plug Forms oil- and watertight seal for unused panel holes — UL Listed Type 4-4X-13 black nylon	E22BHP
Enlarge Yellow Legend Plates	Enlarge Yellow Legend Plates ①	
	1.77 inches (45 mm) blank	E22VA2
	2.76 inches (70 mm) printed EMERGENCY STOP	E22VA8
Mounting Adapter	Mounting Adapter	
	Supplied as standard with E22 operators. Provides contact block and light unit mounting.	E22BA1
Auto Latch Mounting Adapter	Auto Latch Mounting Adapter	
	Supplied as standard with EM22 operators. Provides contact block and light unit mounting.	E22BA1A
Operator Plug	Operator Plug	
	Must be inserted into rear of momentary action pushbutton and mushroom head operators when third contact block is installed in center position. Not to be used with maintained action or illuminated operators—minimum order quantity 10 pieces. To assemble, push plug into the rear of the operator. On mushroom operators, cut down the plug to 0.62 inches (15.2 mm) prior to assembly. Plug is notched to indicate cut down length.	E22BA2
Locating Ring	Locating Ring	
	Provides additional anti-rotation features when using optional panel mounting hole notch—minimum order quantity 10 pieces (metal)	E22LRM
Padlockable Transparent Cover	Padlockable Transparent Cover	
	Suitable for use with 25 mm flush and extended pushbutton operators only	E22PCM
	Suitable for use with 28 mm mushroom operators, knob and key selector switches	E22BA9
Mushroom Guard	Mushroom Guard	
	For 40 mm trigger action switch—to be used with E22LTA2 and E22LTA2N123 operators	E22MGTA
	Note ① Yellow plates comply with EN418 machine safety standard background requirements for E-Stops.	

Options

Engraved Legend Plates with Standard Markings—1/8-Inch High Character Size

Aluminum—Aluminum legend plates have a plastisol backing to help prevent rotation of the operator when installed in an unnotched hole. Operators installed with aluminum legend plates and legend plates with clip-in inserts maintain their UL Listed Type 4-4X-13 rating.

Plastic—Both the laminated plastic legend plates and the legend plates with clip-in inserts offer the choice of four background colors. Either side of the legend plate or insert can be field engraved.

Color Diagram and Approximate Dimensions in Inches (mm)

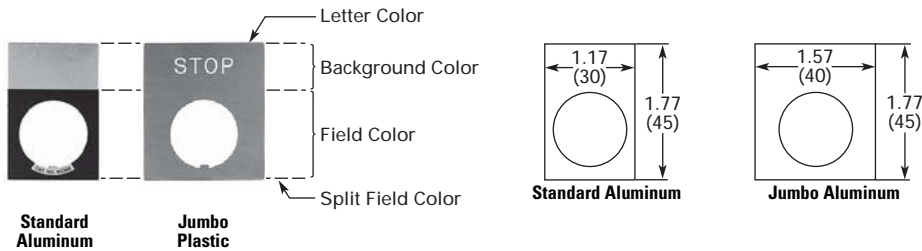

Engraved Legend Plates

Nameplate Type	Standard Aluminum with Plastisol Backing NEMA 3, 3R, 4, 4X, 12, 13 ①		Standard Plastic, NEMA 1 Only	
	Letter Color	Background Color	Letter Color	Background Color
Standard Aluminum with Plastisol Backing	Black	Silver	White	White
Standard Plastic	Black	Black	Black	Red
Standard Plastic	Black	Red	Black	Red
Pushbutton				
No engraving	E22NS36	E22NS37	E22NSP77	E22NSP77
CLOSE	E22NS11	—	—	—
DOWN	E22NS12	—	—	—
EMERG. STOP	—	E22NS13	—	—
FORWARD	E22NS15	—	—	—
JOG	E22NS19	—	—	—

Note

① To order jumbo legend plates, replace the fifth character with an **L**. For example E22NL87 is an aluminum, Jumbo legend plate marked "FASTER."

Engraved Legend Plates, Continued

Standard Aluminum with Plastisol Backing NEMA 3, 3R, 4, 4X, 12, 13 and Self-Adhesives Used on Enclosures ^①

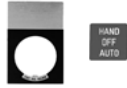

Nameplate Type	Black	Black
Letter Color	Silver	Silver
Background Color	Black	Red
Field Color		
Pushbutton		
MOTOR RUN	E22NS81	—
MOTOR STOP	E22NS82	—
ON	E22NS25	—
OPEN	E22NS26	—
POWER ON	E22NS80	—
REVERSE	E22NS30	—
RUN	E22NS31	—
START	E22NS33	—
STOP	—	E22NS34
UP	E22NS35	—
Two-Position Selector Switch		
FOR/REV	E22NS38	—
HAND/AUTO	E22NS39	—
JOG/ RUN	E22NS41	—
OFF/ON	E22NS42	—
OPEN/CLOSE	E22NS43	—
UP/DOWN	E22NS48	—
Three-Position Selector Switch		
FOR/OFF/REV	E22NS50	—
HAND/OFF/AUTO	E22NS51	—

Approximate Dimensions in Inches (mm)

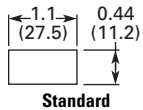

Legend Plates and Legend Plate Carriers

Plastic with Clip-In Insert without Carrier
NEMA 3, 3R, 4, 4X, 12, 13



Nameplate Type	White
Letter Color	Black
Background Color	Black
Field Color	
Pushbutton	
Legend plate carrier ^②	E22ND

Enclosures

These totally insulated, NEMA 4, 4X, 12, 13 rated polycarbonate enclosures are available in 1, 2, 3, 4, 6 and 9 hole configurations in single or double depth.

E22CSP1



Enclosures—UL (NEMA) 4, 4X, 12, 13

Cover Holes, Centerlines and Legend Plate Selection

Usable Depth Inches (mm)	Catalog Number
2.5 (64)	E22CSP1
3.4 (87)	E22CDP1

Will accommodate 2.65 inch (65 mm) legend plates listed on Page V12-T23-11

E22CSP1Y



Usable Depth Inches (mm)	Catalog Number
2.2 (57)	E22CSP1Y ^③
3.15 (80)	E22CDP1Y ^③

With safety yellow cover

E22CSP2



Usable Depth Inches (mm)	Catalog Number
2.2 (57)	E22CSP2

1.42 inch (36 mm)
Will accommodate self-adhesive legend plates listed on Pages V12-T23-12 and V12-T23-13

E22CSP4



Usable Depth Inches (mm)	Catalog Number
2.2 (57)	E22CSP4

1.18 inch (30 mm)
Will accommodate self-adhesive legend plates listed on Pages V12-T23-12 and V12-T23-13

Notes

- ^① To order jumbo legend plates, replace the fifth character with an L. For example, E22NLB7 is an aluminum, jumbo legend plate marked "FASTER."
- ^② One carrier required for each clip-in insert.
- ^③ Yellow covers comply with background requirements for EN418 Safety of Machinery Standard.

Further Information**Publication
Number****Description**

Publication Number	Description
TD04712001E	E22/EM22 Technical Data

Pricing Information

For pricing information, please consult Eaton's Price and Availability Digest (PAD) or your local authorized Eaton distributor.

Counters, Panel Meters, Tachometers and Timers

CS Series Stroke Counter



Eclipse Series Panel Meter



Hour Meter



Fusion Integrated Machine Control



24 Counters, Panel Meters, Tachometers and Timers

Totalizers	
Mechanical Totalizers (Stroke)	V12-T24-4
Mechanical Totalizers (Revolution)	V12-T24-11
Electromechanical Totalizers	V12-T24-25
Electronic Totalizers	V12-T24-35
Count Controls/Preset Counters/Totalizers	
1/16 DIN Battery Powered LCD Count Control	V12-T24-46
1/16 DIN LCD Preset Counters with Rate and Time	V12-T24-48
President Series (Count Control)	V12-T24-50
Ambassador Series (Totalizers)	V12-T24-53
Ambassador Series (Count Control)	V12-T24-56
PD-Q and PD-ER Series	V12-T24-60
Tachometers/Ratemeters	
Courier Series	V12-T24-64
Eclipse Series	V12-T24-66
Ambassador Series	V12-T24-69
Digital Panel Meters	
E5-324-E Series	V12-T24-73
Eclipse Series	V12-T24-75
Timers/Hour Meters	
Electronic Timers/Hour Meters	V12-T24-81
Electromechanical Timers/Hour Meters	V12-T24-86
Hour Meter/Counter	V12-T24-90
Fusion Integrated Machine Control	
Fusion Integrated Machine Control	V12-T24-91
Temperature Controls	
TC Series	V12-T24-96
Accessories and Encoders	
DIN Rail Adapter	V12-T24-100
C-Face Ring Tachometer	V12-T24-101
Magnetic Pickup Sensor and Gear	V12-T24-101
Rotary Contactor—ES9513/ES9513RS	V12-T24-102
Measuring Wheels	V12-T24-102
Mounting Bracket	V12-T24-103
Shaft Encoders	V12-T24-103
Accessories	
Accessories	V12-T24-110

Totalizers



Contents

Description

	<i>Page</i>
Totalizers	
Product Selection Guide	V12-T24-3
Mechanical	
Stroke	V12-T24-4
Revolution	V12-T24-11
Electromechanical	V12-T24-25
Electronic	V12-T24-35



Product Overview

Totalizers are used in a wide variety of applications where accurate totals are needed. Typical applications include counting the number of parts produced, amount of material used, or the number of machine cycles occurring. Totalizers are the simplest and most common type of counter. As an added bonus, some models can perform both totalizing and ratemeter functions.

Typical Application

Parts are fed into a machine or process, an operation is performed, and the finished parts exit the machine or process. The subtract totalizer is used to indicate the number of parts in process.

Application Example

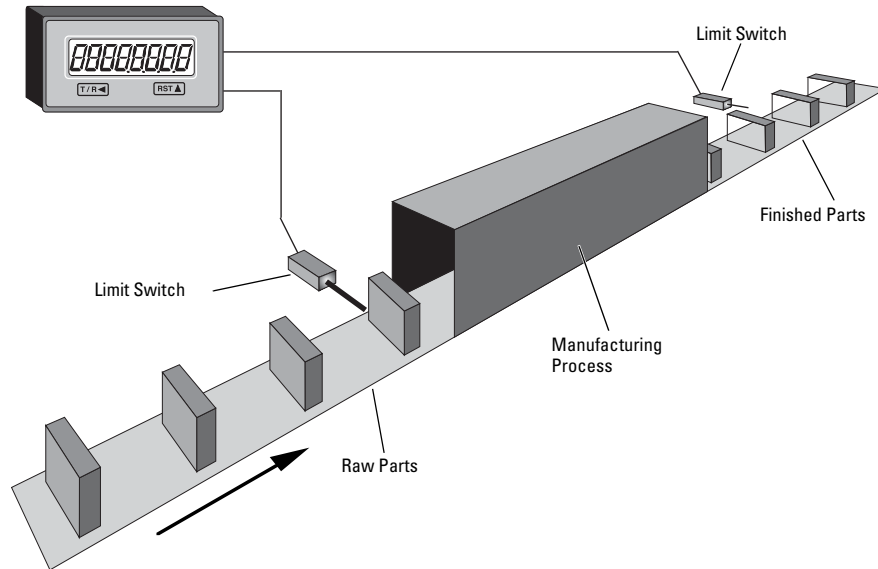

Product Selection Guide

Totalizers

	Characteristics	Typical Applications	Panel Cutout in Inches (mm)	Page
Mechanical 	Various size ranges for different duty cycles and environments No power supply needed Long life and always readable display	Winding and spooling equipment Position display Mechanical piece/cycle counting	Various mounting configurations	V12-T24-4
Electromechanical 	Various price, voltage and size ranges for different duty cycles and environments Long life and always readable display	Coin-operated equipment Gaming machines Printing presses Secondary machines (e.g. punch press)	Various mounting configurations	V12-T24-25
E5-024-C 	Non-replaceable battery (min. eight-year life) Compact, low cost and high efficiency Eight-digit LCD totalizers Manual or electrical reset Various counting modes/inputs	Replacement for mechanical counters Transaction counting Parts counting Position indication or measurement	0.870 x 1.772 (22 x 45)	V12-T24-36
E5-24-E 	Compact device with bright, LED display Multiple functions available: count, time, rate, multifunction, double-function 24 Vdc Power	Count, measure, time where small package and easy-to-read display required Position display Motor/pulley RPM	0.870 x 1.772 (22 x 45)	V12-T24-38
Courier 	Replaceable lithium battery Eight-digit, high-visibility LCD display Optional backlighting Various input options available	Portable/mobile/remote flow monitoring (e.g. sewer pumping, pesticide application) Position display, RPM Length measurement (e.g. carpet, cable)	1.299 x 2.677 (33 x 68)	V12-T24-40
E5-496-E 	Economical, multifunction display Large, LED characters AC or DC power options	Large, easy-to-read display Position display Motor/pulley RPM	1.772 x 3.780 (45 x 96)	V12-T24-42
Ambassador 	Eight-digit, high-visibility, two-line LCD display User-configurable control inputs Highly flexible control/display	Flow control where simultaneous total and rate display are required Cut-to-length and other simple processes where flexibility of inputs/outputs required	2.667 x 2.667 (68 x 68)	V12-T24-53
Hour Meter/Counter 	Combination counter consists of time meter and adding counter in one Without reset High shock resistance Magnified figures Protection IP52 (front) Data retention if power is lost Long service life UL approved	General counting Service interval for measurement systems (respiratory ventilators, oxygen machines, dialysis machines) Small appliances UV lamps Display panels in cars	1.988 (50.5) dia. or DIN rail	V12-T24-90

Mechanical Totalizers (Stroke)



Contents

Description	Page
Mechanical Totalizers (Stroke)	
X Series/Pushbutton Desk Tally	V12-T24-5
CS Series	V12-T24-6
H Series	V12-T24-8
D Series	V12-T24-10
Mechanical Totalizers (Revolution)	V12-T24-11
Electromechanical Totalizers	V12-T24-25
Electronic Totalizers	V12-T24-35

Mechanical Totalizers (Stroke)

Product Overview

Eaton's mechanical totalizers are available in a variety of heavy-duty configurations for applications when power is unavailable.

Features

- Variety of reset methods available
- Accurate counting without need for power

X Series/Pushbutton Desk Tally

Product Description

X Series Counters

Model X Series is a dustproof and rustproof series of counters for light and medium-duty work. They are sound and durable, requiring a minimum of driving effort, and have been especially designed for incorporation as integral parts of a variety of machines and equipment.

Pushbutton Desk Tally

Ruggedly constructed counters with feather-touch pushbutton operation and maximum readability. Specifications and dimensions are basically the same as the X Series counters. Will give long and accurate service in areas requiring hand counting or during hand operations.

Product Selection

When Ordering Specify

To determine a model number from the Product Selection table for Model X Series Stroke Counters and Pushbutton Desk Tallies, consider:

- Number of figures
- Drive

X Series Stroke Counter



X Series Stroke Counters and Pushbutton Desk Tallies

No. of Figures	Drive	Reset	Mounting	Catalog Number	Order Number
5	LH lever	Knob	Base	5-X-1-1-L	40272401
4	RH lever	Knob	Base	4-X-1-1-R	40263401
5	RH lever	Knob	Base	5-X-1-1-R	40272402
<hr/>					
Pushbutton Desk Tally					
5	LH lever	Knob	Base	5-X-1-1-L-REV ①	40272400
5	RH lever	Knob	Base	5-X-1-1-R-REV ①	40272403
4	Push bar	Knob	Base	4-X-2	21619400
4	Pushbutton	Knob	Base	4-X-2-A	33245400

Technical Data and Specifications

General Specifications

Description	Specification
Figures	4 or 5
Speed	1000 cpm
Shaft	0.125 in (3.2 mm) diameter stainless steel
Drive	Drive parts of nylon
Bearings	Oil-less, maintenance free
Finish	Black frame and Cyclocac black cover
Stroke operation	33° minimum; 58° maximum ①
Figure size	3/16 in (4.8 mm) high, white-on-black background
Reset	Knob

Note

① Reverse stroke.

Totalizers

Dimensions

Approximate Dimensions in Inches (mm)

X Series

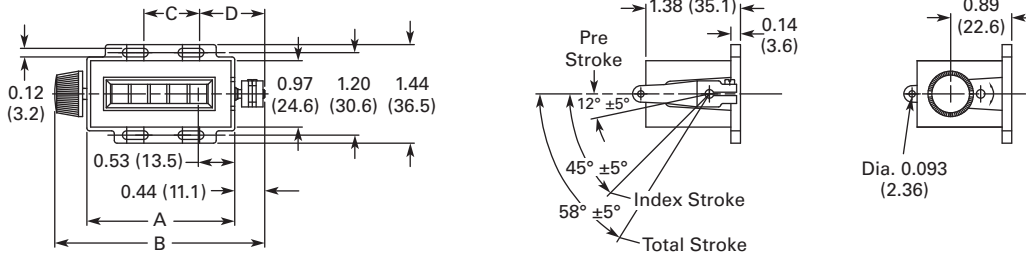

Model	A	B	C	D
4-X-1-1_	1.86 (47.2)	2.76 (70.2)	0.62 (15.7)	0.89 (22.6)
5-X-1-1_	2.16 (54.8)	3.06 (77.8)	0.81 (20.6)	0.95 (24.1)

Note

① Operating stroke angles apply to forward stroke counter only. Check factory for angles of reverse stroke counter.

CS Series

Product Description

Model CS Series of small, compact, top reading stroke counters is designed for use in most industrial

applications. These counters are ruggedly built and feature a single casting case, which assures great rigidity and a tight seal for working parts.

Product Selection

When Ordering Specify

To determine a model number from the Product Selection table for Model CS Series Stroke Counters, consider:

- Number of figures
- Drive lever

CS Series Stroke Counter



CS Series Stroke Counters

No. of Figures	Drive	Reset	Mounting	Catalog Number	Order Number
5	RH lever	Wing nut	Base	5-CS-1-1-R	31062401
5	RH lever	Wing nut	Base	5-CS-1-1-R-RP ①	01464400

Technical Data and Specifications

General Specifications

Description	Specification
Figures	4 or 5
Speed	600 cpm
Stroke operation	37-1/2° minimum; 75° maximum
Shaft	0.25 in (6.4 mm) diameter stainless steel, rustproof
Drive	Accurately machined, hardened steel parts
Bearings	Oil-less, maintenance free
Figure size	11/32 in (8.7 mm) high, black-on-white background
Reset	Contoured wing nut
Finish	Black frame
Operating lever	Cast zinc. Adjustable to any position. Furnished complete with pull spring.

Dimensions

Approximate Dimensions in Inches (mm)

CS Series

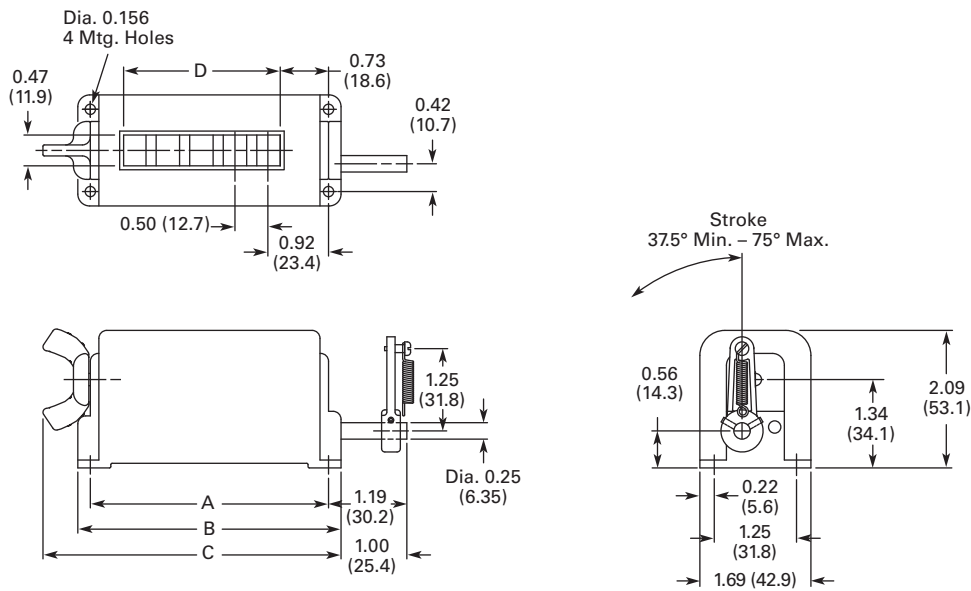

Model	A	B	C	D
4-CS-1_	3.12 (79.2)	3.50 (88.9)	4.03 (102.3)	1.87 (47.6)
5-CS-1_	3.62 (91.9)	4.00 (101.6)	4.53 (115.0)	2.38 (60.5)

Note

① Special feature: rustproof.

H Series

Product Description

Model H Series heavy-duty counters are designed for hard usage and long, trouble-free service. They are high speed, streamlined counters constructed of the highest quality materials and drive shaft moves in oil-less bearings. All shafts are stainless steel. The drive action is designed with overstroke so counter does not bottom, increasing life and permitting easier installation. The sturdy cover

is stamped steel, locked into position on a heavy, die-cast base of a special alloy. A heavy steel mounting plate is adjustable for either bottom or back mounting. Model "H" has earned the reputation of being the "work horse" of industrial counters. Wing nut or tamper-proof reset lock which requires a key to reset the counter, guarding against unauthorized resetting or tampering.

Product Selection

When Ordering Specify

To determine a model number from the Product Selection table for Model H Series Stroke Counters, consider:

- Number of figures
- Drive lever location (left or right side)
- Type of reset (lock or wing nut)

Shaded area denotes obsolete or discontinued products and services.

H Series Stroke Counter



H Series Stroke Counters

No. of Figures	Drive	Reset	Mounting	Catalog Number	Order Number
5	RH lever	Wing nut	Base	5-H-1-1-R	40205400
5	LH lever	Wing nut	Base	5-H-1-1-L	40205401
5	RH lever	Wing nut	Base	5-H-1-1-R-REV ①	00597400
5	LH lever	Wing nut	Base	5-H-1-1-L-REV ①	00598400
5	RH lever	Lock reset	Base	5-H-1-2-R	40206404
5	LH lever	Lock reset	Base	5-H-1-2-L	40206405
5	RH lever	Lock reset	Base	5-H-1-2-R-RP ②	40206400
5	LH trip arm	Wing nut	Base	5-H-5-C	31049402
5	LH trip arm	Wing nut	Base	5-H-5-D	31049403
5	RH trip arm	Lock reset	Base	5-H-6-A	01533400
5	RH trip arm	Lock reset	Base	5-H-6-B	01534400
5	LH trip arm	Lock reset	Base	5-H-6-D	01536400

Technical Data and Specifications

Direction Location for 5H5 and 5H6

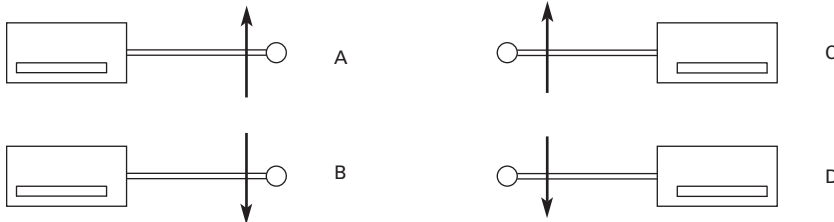

Notes

- ① Special feature: Reverse stroke.
- ② Special feature: Rustproof.

General Specifications

Description	Specification
Figures	5
Speed	800 cpm
Stroke operation	37° stroke to count; 60° maximum stroke
Shaft	0.31 in (7.9 mm) diameter stainless steel, rustproof
Drive	Accurately machined, hardened steel parts; Geneva drive for extra long life
Bearings	Oil-less, maintenance free
Figure sizes	11/32 in (8.7 mm) high, black-on-white background
Reset	Wing nut or tumbler lock reset
Finish	Black frame and cover
Operating lever	Adjustable to any position. Furnished complete with pull spring for attaching.

Dimensions

Approximate Dimensions in Inches (mm)

H Series

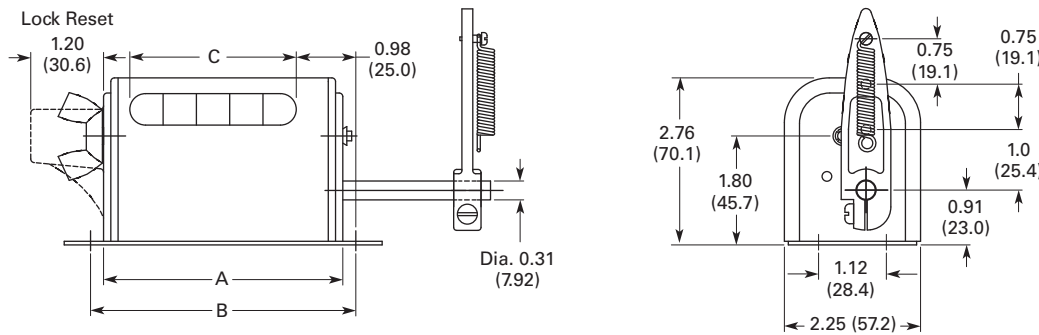

Model	A	B	C
Five figure units	3.95 (100.4)	4.38 (111.3)	2.75 (69.9)

D Series

Product Description

Model D Series are medium-duty stroke counters available with 4, 5 or 6 figures that have been designed for general service on small production machines.

Although compact, "D" models are sturdily constructed and thoroughly tested for accuracy and efficient operation.

Product Selection

When Ordering Specify

To determine a model number from the Product Selection table for Model D Series Stroke Counters, consider:

- Number of figures
- Drive lever

D Series Stroke Counter



D Series Stroke Counters

No. of Figures	Drive	Reset	Mounting	Catalog Number	Order Number
4	RH lever	Wing nut	Base	4-D-1-1-R	34269401
5	RH lever	Wing nut	Base	5-D-1-1-R	34269402
6	RH lever	Wing nut	Base	6-D-1-1-R	34269403
4	LH lever	Wing nut	Base	4-D-1-1-L	34269405
5	LH lever	Wing nut	Base	5-D-1-1-L	34269406

Technical Data and Specifications

General Specifications

Description	Specification
Figures	4, 5 and 6
Speed	400 cpm
Shaft	0.25 in (6.4 mm) diameter stainless steel, rustproof
Drive	Nylon ratchet and Delrin drive plate. Right-hand drive standard; left-hand drive available
Bearings	Oil-less, maintenance free
Figure size	1/4 in (6.4 mm) high, black-on-white background
Reset	Wing nut
Finish	Black frame and cover
Operating lever	Adjustable to any position. Furnished complete with pull string

Dimensions

Approximate Dimensions in Inches (mm)

D Series

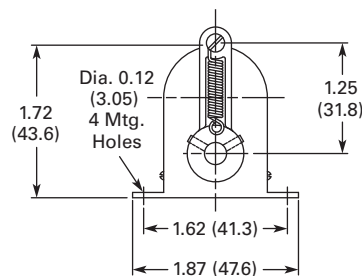
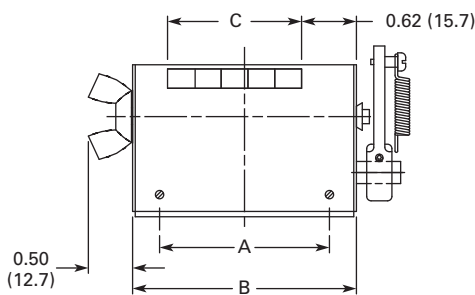

Model	A	B	C
4-D-1-1_	1.59 (40.4)	2.20 (55.9)	1.20 (30.6)
5-D-1-1_	1.92 (48.8)	2.53 (64.3)	1.51 (38.5)
6-D-1-1_	2.26 (57.5)	2.87 (73.0)	1.83 (46.4)

Mechanical Totalizers (Revolution)**Contents**

Description	Page
Mechanical Totalizers (Stroke)	V12-T24-4
Mechanical Totalizers (Revolution)	
X Series	V12-T24-12
CS Series	V12-T24-14
D-7 Series	V12-T24-16
D-6 Series	V12-T24-18
HDW Series	V12-T24-20
T Series	V12-T24-21
H Series	V12-T24-23
Electromechanical Totalizers	V12-T24-25
Electronic Totalizers	V12-T24-35

Mechanical Totalizers (Revolution)**Product Overview**

Eaton's mechanical totalizers are available in a variety of heavy-duty configurations for applications when power is unavailable.

Features

- Variety of reset configurations available
- Accurate length measurement for application where power is not available

X Series

Product Description

Model X Series are dust- and rust-proof counters designed for small, medium-duty units, accurate, durable and require a minimum of driving effort.

They are especially designed for incorporation as integral parts of a variety of equipment that gets severe usage under adverse climatic conditions.

Product Selection

When Ordering Specify

To determine a model number from the Product Selection table for Model X Series Revolution Counters, consider:

- Number of figures
- Ratio
- Drive shaft location
- Shaft rotation direction

X Series Revolution Counter



X Series Revolution Counters

No. of Figures	Drive	Rotation	Reset	Mounting	Catalog Number	Order Number
4	LH	Clockwise ①	Knob	Base	4-X-7-1-L-CL	40270406
4	LH	Anti-clockwise ②	Knob	Base	4-X-7-1-L-AC	40270404
4	RH	Clockwise ③	Knob	Base	4-X-7-1-R-CL	40270407
4	RH	Anti-clockwise ④	Knob	Base	4-X-7-1-R-AC	40270405
5	RH	Anti-clockwise ④	Knob	Base	5-X-7-1-R-AC	40275406
4	LH	Clockwise ①	Knob	Base	4-X-7-1-L-CL ⑤	40270402
5	LH	Clockwise ①	Knob	Base	5-X-7-1-L-CL ⑤	40275402
4	LH	Anti-clockwise ②	Knob	Base	4-X-7-1-L-AC ⑤	40270400
5	LH	Anti-clockwise ②	Knob	Base	5-X-7-1-L-AC ⑤	40275400
4	RH	Clockwise ③	Knob	Base	4-X-7-1-R-CL ⑤	40270403
5	RH	Clockwise ③	Knob	Base	5-X-7-1-R-CL ⑤	40275403
4	RH	Anti-clockwise ④	Knob	Base	4-X-7-1-R-AC ⑤	40270401
5	RH	Anti-clockwise ④	Knob	Base	5-X-7-1-R-AC ⑤	40275401

Top View—Left-Hand Drive



Clockwise Shaft Rotation

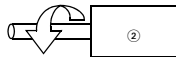

Anti-Clockwise Shaft Rotation

Top View—Right-Hand Drive



Clockwise Shaft Rotation

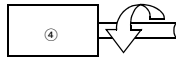

Anti-Clockwise Shaft Rotation

Notes

When shaft is turned in the reverse direction of rotation, the counter will subtract.

- ① Top view—left-hand drive with clockwise shaft rotation.
- ② Top view—left-hand drive with anti-clockwise shaft rotation.
- ③ Top view—right-hand drive with clockwise shaft rotation.
- ④ Top view—right-hand drive with anti-clockwise shaft rotation.
- ⑤ Special feature: 10:1 ratio.

Technical Data and Specifications

General Specifications

Description	Specification
Figures	4 or 5
Speed	1000 cpm in 1:1 ratio; 10,000 cpm in 10:1 ratio for intermittent duty
Rotation direction	Clockwise or anti-clockwise when viewed from right-hand end of counter
Ratio	1:1 and 10:1 standard in 4-X-7 models 10:1 standard in 5-X-7 models
Shaft	0.125 in (3.2 mm) diameter stainless steel; standard length 0.44 in (11.1 mm)
Bearings	Oil-less, maintenance free
Figure size	3/16 in (4.8 mm) high, white-on-black background
Reset	Knob
Finish	Black frame, Cyclocac black cover
Drive	Right- or left-hand drive; drive parts of Delrin
Ratio information	1:1 is one count to each revolution of drive shaft, 10:1 is ten counts to each revolution

Dimensions

Approximate Dimensions in Inches (mm)

X Series

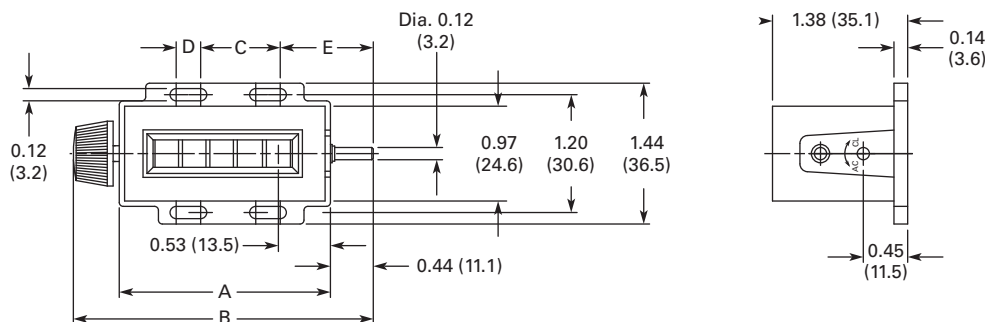

Model	A	B	C	D	E
4-X-7-1_	1.86 (47.2)	2.76 (70.2)	0.62 (15.7)	0.19 (4.8)	0.89 (22.6)
5-X-7-1_	2.16 (54.8)	3.06 (77.8)	0.81 (20.6)	0.25 (6.4)	0.95 (24.1)

CS Series

Product Description

Model CS Series top reading revolution counters are designed for use in most industrial applications. The entire case is a single casting.

This provides greater rigidity, tighter seal of working parts and more streamlined contour. The unit is compact, rugged and features a flush mounted window to assure greater visibility.

Product Selection

When Ordering Specify

To determine a model number from the Product Selection table for Model CS Series Revolution Counters, consider:

- Number of figures
- Ratio
- Drive shaft location
- Shaft rotation direction

CS Series Revolution Counter



CS Series Revolution Counters

No. of Figures	Drive	Rotation	Reset	Mounting	Catalog Number	Order Number
5	RH	Anti-clockwise ^②	Wing nut	Base	5-CS-7-1-R-AC	31060411
4	RH	Anti-clockwise ^②	Wing nut	Base	4-CS-7-1-R-AC ^③	31057403
5	RH	Anti-clockwise ^②	Wing nut	Base	5-CS-7-1-R-AC ^③	00443400
4	RH and LH	Clockwise ^④	None	Base	4-CS-7-3-CL ^⑤	31057408
4	RH and LH	Anti-clockwise ^⑥	None	Base	4-CS-7-3-AC ^⑥	31057409

Top View—Right-Hand Drive



Clockwise Shaft Rotation

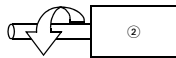

Anti-Clockwise Shaft Rotation

Top View—Right- and Left-Hand Drive



Clockwise Shaft Rotation

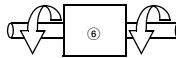

Anti-Clockwise Shaft Rotation

Notes

When shaft is turned in the reverse direction of rotation, the counter will subtract.

- ① Top view—right-hand drive with clockwise shaft rotation.
- ② Top view—right-hand drive with anti-clockwise shaft rotation.
- ③ Special feature: 10:1 ratio.
- ④ Top view—right- and left-hand drive with clockwise shaft rotation.
- ⑤ Special feature: 10:1 ratio, non-reset, double shaft.
- ⑥ Top view—right- and left-hand drive with anti-clockwise shaft rotation.

Technical Data and Specifications

General Specifications

Description	Specification
Figures	4 or 5
Speed	600 cpm in 1:1 ratio
Rotation direction	Clockwise or anti-clockwise when viewed from right-hand end of counter
Ratio	1:1 standard
Shaft	0.25 in (6.4 mm) diameter stainless steel; standard length 1 in (25.4 mm)
Drive	Spur gear
Bearings	Oil-less, maintenance free
Figure size	11/32 in (8.7 mm) high, black-on-white background
Reset	Contoured wing nut
Finish	Black frame

Dimensions

Approximate Dimensions in Inches (mm)

CS Series

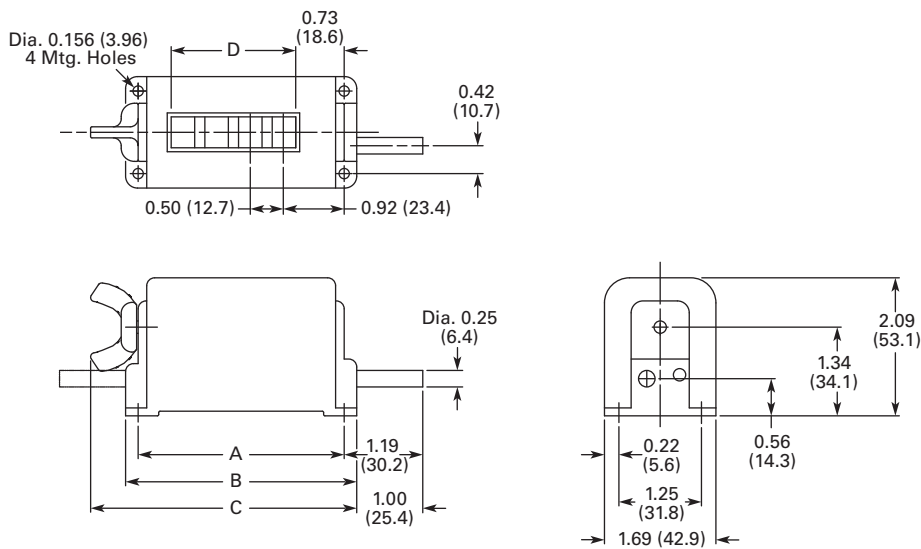

Model	A	B	C	D
4-CS-7_	3.12 (79.2)	3.50 (88.9)	4.03 (102.3)	1.89 (47.9)
5-CS-7_	3.62 (91.9)	4.00 (101.6)	4.53 (115.0)	2.38 (60.5)

D-7 Series

Product Description

Model D-7 Series spur gear end drive units are compact counters that meet a variety of needs. Accurate, dependable and moderately

priced, they are especially recommended for braiding machines, low-speed coil winders, wire measuring equipment and all medium-duty revolution applications.

Product Selection

When Ordering Specify

To determine a model number from the Product Selection table for Model D-7 Series Revolution Counters, consider:

- Number of figures
- Shaft drive
- Shaft rotation direction
- Reset or non-reset

D-7 Series Revolution Counter



D-7 Series Revolution Counters

No. of Figures	Drive	Rotation	Reset	Mounting	Catalog Number	Order Number
5	LH	Clockwise ①	Wing nut	Base	5-D-7-1-L-CL	31127408
5	LH	Anti-clockwise ②	Wing nut	Base	5-D-7-1-L-AC	31127405
5	RH	Clockwise ③	Wing nut	Base	5-D-7-1-R-CL	31127431
5	RH	Anti-clockwise ④	Wing nut	Base	5-D-7-1-R-AC	31127400
5	LH	Anti-clockwise ②	None	Base	5-D-7-3-L-AC	31127412
5	RH	Clockwise ③	None	Base	5-D-7-3-R-CL	31127438

Top View—Left-Hand Drive

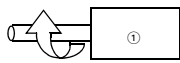

Clockwise Shaft Rotation

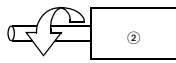

Anti-Clockwise Shaft Rotation

Top View—Right-Hand Drive

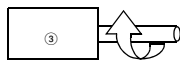

Clockwise Shaft Rotation

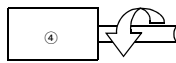

Anti-Clockwise Shaft Rotation

Notes

When shaft is turned in the reverse direction of rotation, the counter will subtract.

- ① Top view—left-hand drive with clockwise shaft rotation.
- ② Top view—left-hand drive with anti-clockwise shaft rotation.
- ③ Top view—right-hand drive with clockwise shaft rotation.
- ④ Top view—right-hand drive with anti-clockwise shaft rotation.

Technical Data and Specifications

General Specifications

Description	Specification
Figures	5 standard
Speed	Up to 800 cpm in 1:1 ratio
Rotation direction	Clockwise or anti-clockwise when viewed from right-hand end of counter
Ratio	1:1 standard
Shaft	0.31 in (7.9 mm) diameter stainless steel; 0.66 in (16.7 mm) right-hand drive, 0.63 in (15.9 mm) left-hand drive
Drive	Right- or left-hand spur gear drive
Bearings	Oil-less, maintenance free
Figure size	1/4 in (6.4 mm) high, black-on-white background
Finish	Black frame and cover
Reset	Wing nut or non-reset

Dimensions

Approximate Dimensions in Inches (mm)

D-7 Series

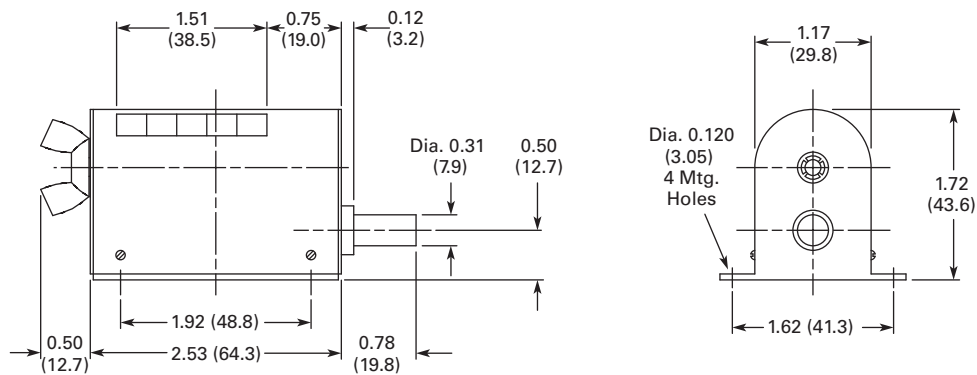

D-6 Series

Product Description

Model D-6 right-angle worm drive counters are ruggedly designed for high speeds on light-duty applications. Small “D” counters are easily

adapted as accessory equipment on machinery where right-angle drive is desired to permit full view reading of the counter.

Product Selection

When Ordering Specify

To determine a model number from the Product Selection table for Model D-6 Series Revolution Counters, consider:

- Shaft rotation direction

Shaded area denotes obsolete or discontinued products and services.

D-6 Series Revolution Counter



D-6 Series Revolution Counters

No. of Figures	Drive	Rotation	Reset	Mounting	Catalog Number	Order Number
5	Front and rear	Anti-clockwise ①	Wing nut	Base	5-D-6-1-AC	31052401
6	Front and rear	Anti-clockwise ①	Wing nut	Base	6-D-6-1-AC	31052402
5	Front and rear	Clockwise ②	Wing nut	Base	5-D-6-1-CL	31052404
6	Front and rear	Clockwise ②	Wing nut	Base	6-D-6-1-CL	31052405
5	Front and rear	Anti-clockwise ①	Wing nut	Base	5-D-8-1-AC ③	40187401
5	Front and rear	Clockwise ②	Wing nut	Base	5-D-8-1-CL ③	40187417
6	Front and rear	Clockwise ②	Wing nut	Base	6-D-8-1-CL ③	40187418
5	Front and rear	Clockwise ②	Wing nut	Base	5-D-9-1-CL ④	40187404
5	Front and rear	Anti-clockwise ①	Wing nut	Base	5-D-9-1-AC ④	40187410
5	Front and rear	Clockwise ②	Wing nut	Base	5-D-90-1-CL ⑤	40187414
5	Front and rear	Anti-clockwise ①	Wing nut	Base	5-D-90-1-AC ⑤	40187408

Top View of Counter

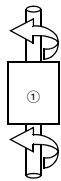

Anti-Clockwise Shaft Rotation

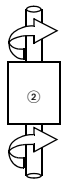

Clockwise Shaft Rotation

Notes

When shaft is turned in the reverse direction of rotation, the counter will subtract.

- ① Top view of counter—anti-clockwise shaft rotation.
- ② Top view of counter—clockwise shaft rotation.
- ③ Special feature: Measuring wheels and brackets available for lineal measurement in feet.
- ④ Special feature: Measuring wheels and brackets available for lineal measurement in yards and 1/8ths.
- ⑤ Special feature: Measuring wheels and brackets available for lineal measurement in yards.

Technical Data and Specifications

General Specifications

Description	Specification
Figures	5 or 6
Speed	Up to 1500 cpm in 1:1 ratio
Rotation direction	Clockwise or anti-clockwise when viewed from right-hand end of counter
Ratio	1:1 standard
Shaft	0.31 in (7.9 mm) diameter stainless steel; 1.25 in (31.8 mm) length standard
Drive	Worm drive
Bearings	Oil-less, maintenance free
Figure size	1/4 in (6.4 mm) high, black-on-white background
Finish	Black frame and cover
Reset	Wing nut

Dimensions

Approximate Dimensions in Inches (mm)

D-6 Series

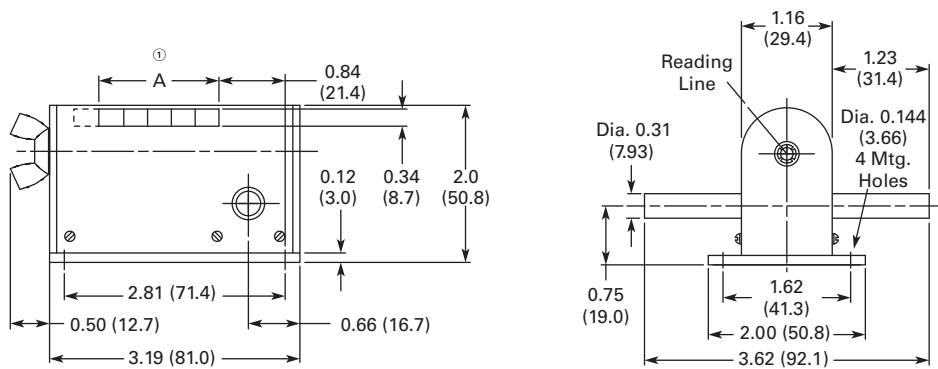

Note

① A = 1.85 in (46.9 mm) for 6 figures and 1.53 in (38.9 mm) for 5 figures.

HDW Series

Product Description

Model HDW Series are high speed, end drive revolution counters that have the rugged features of all “H” counters, with the addition of double worm drive that produces speeds up to 2000 cpm. Lightweight precision molded wheels reduce centrifugal force and

eliminate slipping. They are particularly recommended for quick starting and stopping machines, such as coil winders and wire measuring or reeling equipment and on applications where continuous high speed measuring is required.

Product Selection

When Ordering Specify

To determine a model number from the Product Selection table for Model HDW Series Revolution Counters, consider:

- Shaft drive
- Shaft rotation direction

HDW Series Revolution Counter



HDW Series Revolution Counters

No. of Figures	Drive	Rotation	Reset	Mounting ①	Catalog Number	Order Number
5	RH	Clockwise ②	Wing nut	Base	5-HDW-7-1-R-CL	31050400
5	RH	Anti-clockwise ③	Wing nut	Base	5-HDW-7-1-R-AC	31050401
5	LH	Clockwise ④	Wing nut	Base	5-HDW-7-1-L-CL	31050402
5	LH	Anti-clockwise ⑤	Wing nut	Base	5-HDW-7-1-L-AC	31050403

Top View – Right-Hand Drive

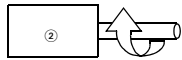

Clockwise Shaft Rotation

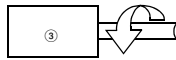

Anti-Clockwise Shaft Rotation

Top View – Left-Hand Drive

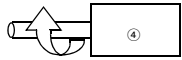

Clockwise Shaft Rotation

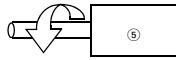

Anti-Clockwise Shaft Rotation

Notes

When shaft is turned in the reverse direction of rotation, the counter will subtract.

- ① Mounting plate is adjustable for base or back mounting.
- ② Top view—right-hand drive with clockwise shaft rotation.
- ③ Top view—right-hand drive with anti-clockwise shaft rotation.
- ④ Top view—left-hand drive with clockwise shaft rotation.
- ⑤ Top view—left-hand drive with anti-clockwise shaft rotation.

Technical Data and Specifications

General Specifications

Description	Specification
Figures	5
Speed	Up to 2000 cpm
Rotation direction	Clockwise or anti-clockwise when viewed from right-hand end of counter
Ratio	1:1 only
Shaft	0.31 in (7.9 mm) diameter stainless steel; standard length 2 in (50.8 mm)
Drive	Right- or left-hand drive
Bearings	Oil-less, maintenance free
Figure size	11/16 in (17.5 mm) high, white-on-black background
Reset	Wing nut or tumbler lock reset
Finish	Black frame and cover

Dimensions

Approximate Dimensions in Inches (mm)

HDW Series

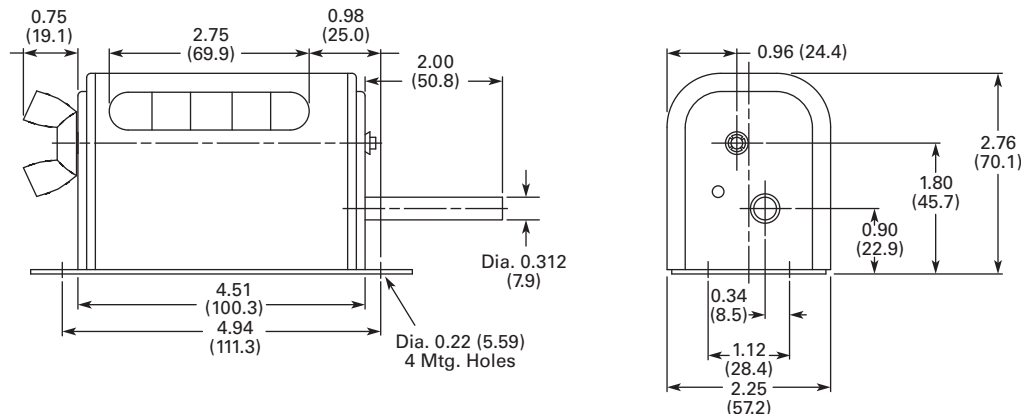

T Series

Product Description

Model T Series worm drive revolution counters are sturdy, high speed instruments used on many

heavy machines, engines or motors. Variety of drive permits direct connection. Suitable for panel mounting.

Product Selection

When Ordering Specify

To determine a model number from the Product Selection table for Model T Series Revolution Counters, consider:

- Shaft rotation direction

T Series Revolution Counter



T Series Revolution Counters

No. of Figures	Drive	Rotation	Reset	Mounting	Catalog Number	Order Number
5	Top and bottom	Anti-clockwise ②	Wing nut	Back	5-T-6-1-AC	40342401

Top View of Counter

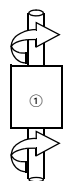

Clockwise Shaft Rotation

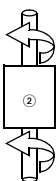

Anti-Clockwise Shaft Rotation

Notes

When shaft is turned in the reverse direction of rotation, the counter will subtract.

- ① Top view of counter—clockwise shaft rotation.
- ② Top view of counter—anti-clockwise shaft rotation.
- ③ Special feature: Measuring wheels and brackets available for lineal measurement in feet.
- ④ Special feature: Measuring wheels and brackets available for lineal measurement in yards and 1/8ths.
- ⑤ Special feature: Measuring wheels and brackets available for lineal measurement in yards.

Technical Data and Specifications

General Specifications

Description	Specification
Figures	5 standard
Speed	1500 cpm in 1:1 ratio
Rotation direction	Clockwise or anti-clockwise determined top looking down
Ratio	1:1 standard
Shaft	0.31 in (7.9 mm) diameter stainless steel; standard extends 2 in (50.8 mm) top and bottom
Drive	Hobbed steel and bronze worm gearing; subtracts when reversed
Bearings	Oil-less, maintenance free
Figure size	11/32 in (8.7 mm) high, black-on-white background
Reset	Left-hand wing nut standard
Finish	Black frame and face plate

Dimensions

Approximate Dimensions in Inches (mm)

T Series

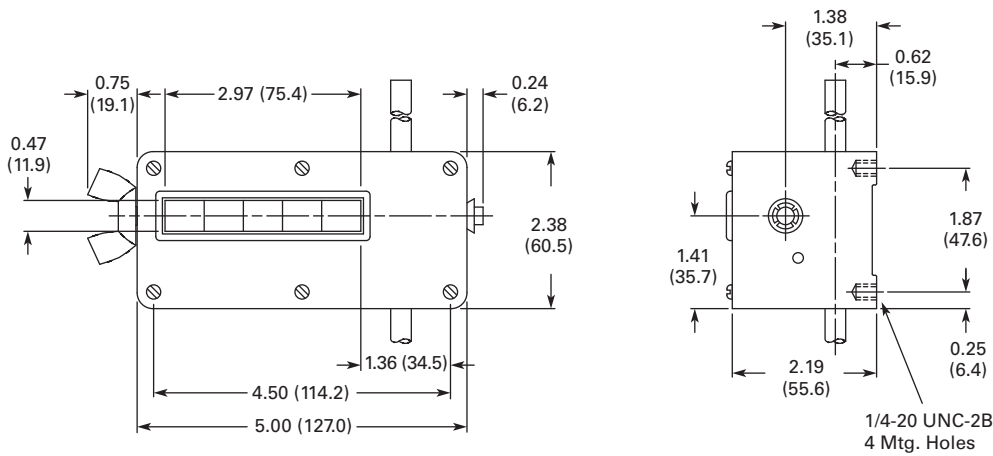

H Series

Product Description

Model H Series are heavy-duty, end drive revolution counters designed for industrial use; suitable for

speeds up to 800 cpm. They are available with either right- or left-hand drive, and with wing nut reset.

Product Selection

When Ordering Specify

To determine a model number from the Product Selection table for Model H Series Revolution Counters, consider:

- Drive shaft location
- Shaft rotation direction

H Series Revolution Counter



H Series Revolution Counters

No. of Figures	Drive	Rotation	Reset	Mounting ^①	Ratio	Catalog Number	Order Number
5	LH	Clockwise ^②	Wing nut	Base	1.1	5-H-7-1-L-CL	00509400
5	LH	Anti-clockwise ^③	Wing nut	Base	1.1	5-H-7-1-L-AC	00510400
5	RH	Clockwise ^④	Wing nut	Base	1.1	5-H-7-1-R-CL	00513400
5	RH	Anti-clockwise ^⑤	Wing nut	Base	1.1	5-H-7-1-R-AC	00514400
5	LH	Clockwise ^⑥	Wing nut	Base	3.2	5-H-8-1-L-CL ^⑦	00601400
5	LH	Anti-clockwise ^⑥	Wing nut	Base	3.2	5-H-8-1-L-AC ^⑦	00602400
5	RH	Clockwise ^⑥	Wing nut	Base	3.2	5-H-8-1-R-CL ^⑦	00605400
5	RH	Anti-clockwise ^⑥	Wing nut	Base	3.2	5-H-8-1-R-AC ^⑦	00606400
5	LH	Clockwise ^⑥	Wing nut	Base	1.2	5-H-9-1-L-CL ^⑨	00619400
5	LH	Anti-clockwise ^⑥	Wing nut	Base	1.2	5-H-9-1-L-AC ^⑨	00620400
5	RH	Clockwise ^⑥	Wing nut	Base	1.2	5-H-9-1-R-CL ^⑨	00617400
5	RH	Anti-clockwise ^⑥	Wing nut	Base	1.2	5-H-9-1-R-AC ^⑨	00618400
5	LH	Clockwise ^⑥	Wing nut	Base	1.2	5-H-9-0-1-L-CL ^⑩	00611400
5	RH	Clockwise ^⑥	Wing nut	Base	1.2	5-H-9-0-1-R-CL ^⑩	00609400
5	RH	Anti-clockwise ^⑥	Wing nut	Base	1.2	5-H-9-0-1-R-AC ^⑩	00610400

For 5-H-8 and 5-H-9 Series Counters, drive shaft extends from both sides of the counter. Specifying RH or LH drive will determine the location of the reset (i.e. LH drive will have reset on the right-hand side of the counter, and RH drive will have reset on left-hand side of the counter).

Top View—LH Drive

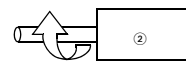

Clockwise Shaft Rotation

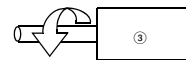

Anti-Clockwise Shaft Rotation

Top View—RH Drive

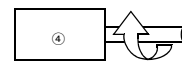

Clockwise Shaft Rotation

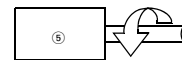

Anti-Clockwise Shaft Rotation

Top View—RH and LH Drive

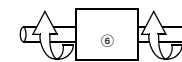

Clockwise Shaft Rotation

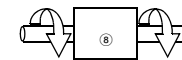

Anti-Clockwise Shaft Rotation

Notes

When shaft is turned in the reverse direction of rotation, the counter will subtract.

- ① Mounting plate is adjustable for base or back mounting.
- ② Top view—left-hand drive with clockwise shaft rotation.
- ③ Top view—left-hand drive with anti-clockwise shaft rotation.
- ④ Top view—right-hand drive with clockwise shaft rotation.
- ⑤ Top view—left-hand drive with anti-clockwise shaft rotation.
- ⑥ Top view—right-hand and left hand drive with clockwise shaft rotation.
- ⑦ Special feature: Measuring wheels and brackets available for lineal measurement in feet.
- ⑧ Top view—right-hand and left hand drive with anti-clockwise shaft rotation.
- ⑨ Special feature: Measuring wheels and brackets available for lineal measurement in yards and 1/8ths.
- ⑩ Special feature: Measuring wheels and brackets available for lineal measurement in yards.

Technical Data and Specifications

General Specifications

Description	Specification
Figures	5
Speed	Up to 800 cpm
Rotation direction	Clockwise or anti-clockwise when viewed from right-hand end of counter
Shaft	0.31 in (7.9 mm) diameter stainless steel; standard length 2 in (50.8 mm)
Drive	Right- or left-hand drive
Bearings	Oil-less, maintenance free
Figure size	11/32 in (8.7 mm) high, white-on-black background
Reset	Wing nut
Finish	Black frame and cover
Mounting bracket available	Order number 01465400

Dimensions

Approximate Dimensions in Inches (mm)

H Series

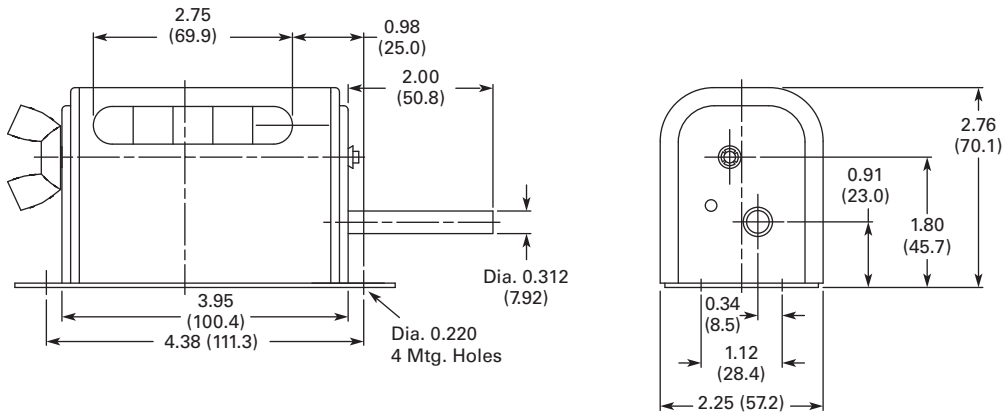

Electromechanical Totalizers**Contents**

Description	Page
Mechanical Totalizers	
Stroke	V12-T24-4
Revolution	V12-T24-11
Electromechanical Totalizers	
Micro Display Counter	V12-T24-26
SE Series	V12-T24-27
MF Series	V12-T24-29
RMF Series	V12-T24-31
ME Series	V12-T24-32
Electronic Totalizers	V12-T24-35

Electromechanical Totalizers**Product Overview**

Eaton's electromechanical counters provide accurate counting from a variety of electrical signals and a display that is always readable, even when power is not present.

Features

- Available with reset and without
- Always readable display
- Variety of mounting options

Standards and Certifications

- UL certifications on some products (see individual product pages for details)



Micro Display Counter

Product Description

Eaton's micro display counter is perfect for 12 Vdc applications where small size is important.

Features

- Seven-digit micro adding counter
- High shock resistance
- Low power consumption; suitable for battery consumption
- Small dimensions
- Large optical figures
- Different viewing possibilities
- Flush mount with integrated spring clip
- Protection IP65
- Stores value also at power failure
- Long service life

Standards and Certifications

- cRU[®]us certified
- CE marked



Product Selection

Micro Display Counter



Micro Display Counter

Description	Catalog Number
Micro display counter	7-Y-3013PM-401

Technical Data and Specifications

General Specifications

Description	Specification
Electrical connections	Built-in counter, flying leads, AWG 22, approx. 5.9 in (150 mm)
Power consumption	At 68 °F (20 °C) and nominal voltage At 25 Imp/s: approx. 250 mW
Rated voltage	12 Vdc ±10%
Counting frequency	25 Imp/s
Pulse duration	Min. 20 ms
Pulse interval	Min. 20 ms
Cycle duration factor	100%
Number of digits	7
Counting system	Adding
Figure size	0.05 x 0.16 in (1.2 x 4 mm) high optical
Color of figures	White-on-black
Reset	No reset
Ambient temperature	14 to 140 °F (−10 to 60 °C)
Mounting position	Any
Operating Life	>50 x 10 ⁶ pulses
Protection	IP65 (only front side)
Housing	Clear plastic
Weight	0.53–0.71 oz (15–18 g)

Dimensions

Approximate Dimensions in Inches (mm)

Micro Display Counter

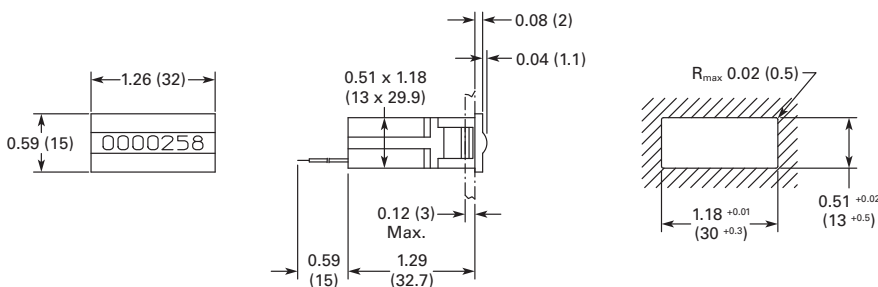

SE Series**Product Description**

Compact electromechanical counters.

Features

- Low-cost electromechanical counter
- Multiple voltage ranges for almost any application
- Compact with various mounting options
- Wire leads for electrical connections

Standards and Certifications

- UL recognized

**Product Selection****SE Series Counter—
Electromechanical****SE Series Electromechanical Counters**

Description	Catalog Number	Order Number
Six-Digit Electric Counter		
Bottom mount sub-miniature 12 Vdc	6-Y-41610-401-SE	41610401
Bottom mount sub-miniature 24 Vdc	6-Y-41610-402-SE	41610402
Bottom mount sub-miniature 120 Vac	6-Y-41610-406-SE	41610406
Bottom mount sub-miniature 240 Vac	6-Y-41610-407-SE	41610407
Base mount sub-miniature 12 Vdc	6-Y-41611-401-SE	41611401
Base mount sub-miniature 24 Vdc	6-Y-41611-402-SE	41611402
Base mount sub-miniature 120 Vac	6-Y-41611-406-SE	41611406
Base mount sub-miniature 240 Vac	6-Y-41611-407-SE	41611407
Panel mount sub-miniature 12 Vdc	6-Y-41613-401-SE	41613401
Panel mount sub-miniature 24 Vdc	6-Y-41613-402-SE	41613402
Panel mount sub-miniature 120 Vac	6-Y-41613-406-SE	41613406
Panel mount sub-miniature 240 Vac	6-Y-41613-407-SE	41613407
Special base mount sub-miniature 12 Vdc	6-Y-41622-401-SE	41622401
Special base mount sub-miniature 24 Vdc	6-Y-41622-402-SE;	41622402
Special base mount sub-miniature 120 Vac	6-Y-41622-406-SE	41622406
Special top mount sub-miniature 12 Vdc	6-Y-41623-401-SE	41623401
Special top mount sub-miniature 24 Vdc	6-Y-41623-402-SE	41623402
Special top mount sub-miniature 120 Vac	6-Y-41623-406-SE	41623406
Special top mount sub-miniature 240 Vac	6-Y-41623-407-SE	41623407
Snap-in mount sub-miniature 12 Vdc	6-Y-42613-401-SE	42613401
Snap-in mount sub-miniature 24 Vdc	6-Y-42613-402-SE	42613402
Snap-in mount sub-miniature 120 Vac	6-Y-42613-406-SE	42613406
Snap-in mount sub-miniature 240 Vac	6-Y-42613-407-SE	42613407

Technical Data and Specifications**General Specifications**

Description	Specification
Figures	6
Count speed	600 cpm
Figure size	5/32 in (4.0 mm)
Reset	None
Mounting	Base, bottom, top, panel or snap-in
Finish	Black, self-extinguishing plastic
Power requirements	DC: 1.5W, AC: 5.0V

Dimensions

Approximate Dimensions in Inches (mm)

SE Series

Bottom Mount

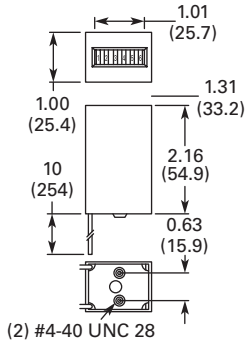

Base Mount

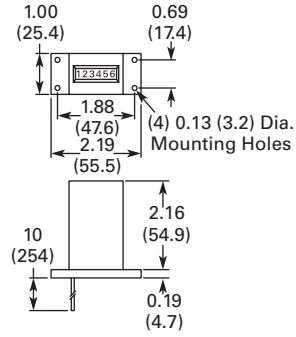

Top Mount

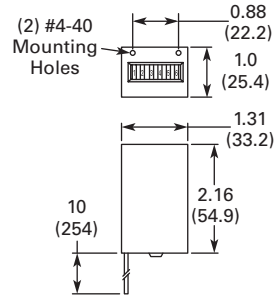

Panel Mount

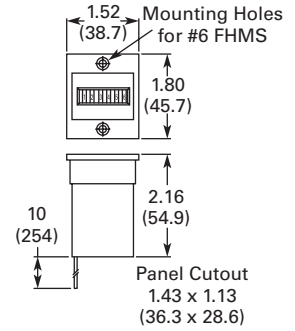

Special Base Mount

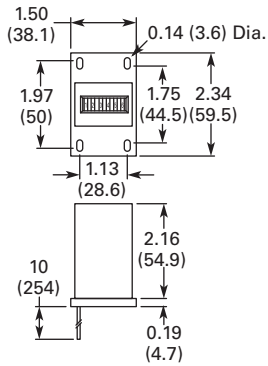

Special Top Mount

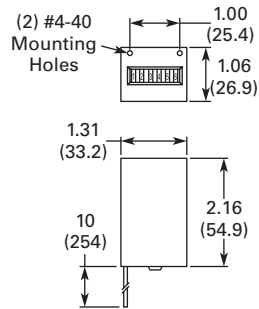

Snap Mount

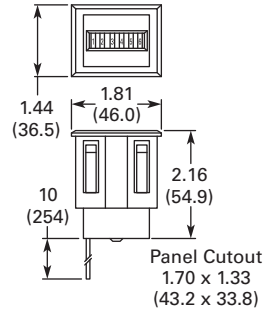

MF Series

Product Description

Model MF Series are shaded pole electric counters with straight AC operation and feature a non-rectified, shaded pole coil designed to withstand transient, high voltage spikes. This feature,

combined with a simplified, hinged escapement drive, also eliminates the possibility of miscounts and greatly adds to the life of the counter. Tallies at speeds up to 750 cpm.

Product Selection

MF Series Electric Counter



MF Series Electric Counters

No. of Figures	Voltage	Reset	Mounting	Catalog Number	Order Number
6	120 Vac	Knob	Base	6-Y-1-MF-120A ①	32651400
7	120 Vac	Knob	Panel	7-Y-1-MF-PM-120A ①	32652400
7	120 Vac	Non-reset	Panel	7-Y-13-MF-PM-120A ①	32652402
6	120 Vac	Knob	Panel	6-Y-1-MF-PM-120A ①	32653400
6	120 Vac	Keylock reset	Panel	6-Y-12-MF-PM-120A ①	32654400
6	24 Vac	Keylock reset	Panel	6-Y-12-MF-PM-24A	32654403
7	120 Vac	Keylock reset	Panel	7-Y-12-MF-PM-120A ①	32655400

Technical Data and Specifications

General Specifications

Description	Specification
Figures	6 or 7
Speed	Up to 750 cpm
Figure size	3/16 in (4.8 mm) high, white-on-black background
Reset	Knob, key or non-reset
Mounting	Base or panel mount
Finish	Black frame and side covers
Electrical connections	Two-wire leads, 9 in (229 mm) long, AWG 22 (0.34 mm ²), stripped 0.38 in (9.5 mm)
Power requirements	12 watts
Coils	Various AC voltages and frequencies can be supplied on special order. Count coils are designed for continuous duty at rated voltage.

Note

① UL Recognized.

Dimensions

Approximate Dimensions in Inches (mm)

MF Series

Panel Mounted

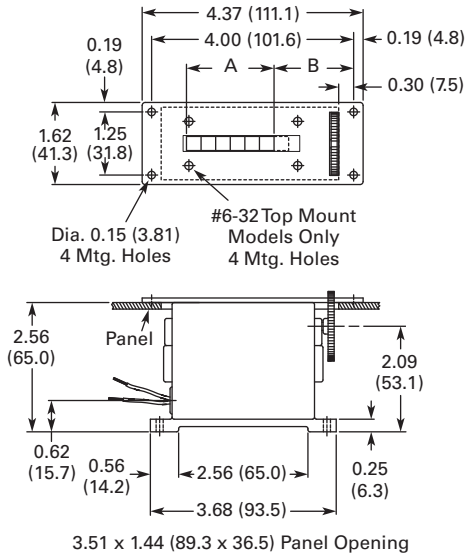

Panel Mounted with Tumbler Lock

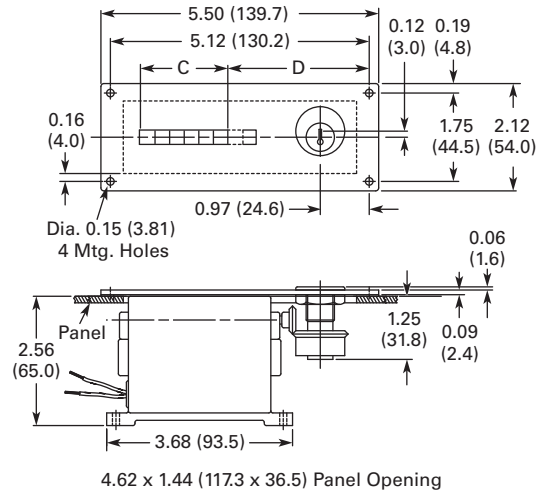

Base Mounted

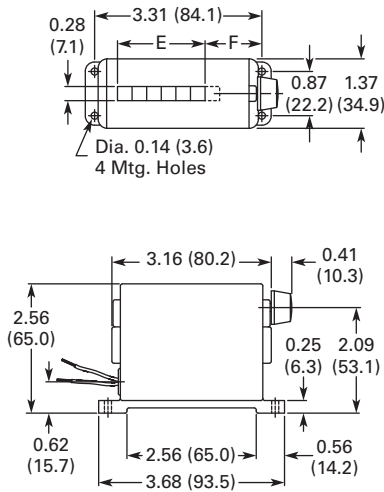

Model	A	B	C	D	E	F
Six figures	1.73 (44.0)	1.58 (40.0)	1.73 (43.9)	2.80 (71.1)	1.73 (44.0)	1.12 (28.6)
Seven figures	2.02 (51.4)	1.29 (32.7)	2.03 (51.6)	2.50 (63.5)	2.02 (51.4)	0.84 (21.2)

RMF Series

Product Description

Model RMF Series of electric counters are designed to give accurate counts through a wide range of speeds up to 1000 cpm. It features a strong, silent, fast operating DC electromagnetic drive

with a compact, dependable built-in higher capacity rectifier for AC operation. The counter has a minimum of moving parts that never need lubrication under normal operating conditions.

Compact and rigid, it continues to operate dependably even when subject to severe shock and vibrations. Entirely enclosed to prevent damage from moisture and dust. Available in 6 or 7 figures.

Product Selection

When Ordering Specify

To determine a model number from the Product Selection table for Model RMF Series Electronic Counters, consider:

- Number of figures
- Voltage
- Type of reset
- Type of mounting

Shaded area denotes obsolete or discontinued products and services.

RMF Series Counter— Electromechanical



RMF Series Electromechanical Counters

No. of Figures	Voltage	Reset	Mounting	Catalog Number	Order Number
6	24 Vdc	Knob	Panel	6-Y-1-RMF-PM-24D	31013400
7	24 Vdc	Knob	Panel	7-Y-1-RMF-PM-24D	31019400
7	115 Vac	Knob	Base	7-Y-1-RMF-115A ①	31025400
7	115 Vac	Non-reset	Base	7-Y-13-RMF-115A ①	31026400
7	115 Vac	Knob	Panel	7-Y-1-RMF-PM-115A ①	31026401
7	115 Vac	Non-reset	Panel	7-Y-13-RMF-PM-115A ①	31026402
6	115 Vac	Non-reset	Base	6-Y-13-RMF-115A ①	31039400
6	230 Vac	Knob	Panel	6-Y-1-RMF-PM-230A	31066413
6	115 Vac	Knob	Panel	6-Y-1-RMF-PM-115A ①	31066416
6	115 Vac	Keylock reset	Panel	6-Y-12-RMF-PM-115A ①	31083403
6	230 Vac	Keylock reset	Panel	6-Y-12-RMF-PM-230A	31083405
7	115 Vac	Keylock reset	Panel	7-Y-12-RMF-PM-115A ①	31083409
6	24 Vac	Keylock reset	Panel	6-Y-12-RMF-PM-24A	31083411
6	24 Vdc	Keylock reset	Panel	6-Y-12-RMF-PM-24D	31083415
7	24 Vdc	Keylock reset	Panel	7-Y-12-RMF-PM-24D	31083421
7	230 Vac	Keylock reset	Panel	7-Y-12-RMF-PM-230A	31083427
6	24 Vac	Knob	Base	6-Y-1-RMF-24A	31155400
6	240 Vac	Knob	Base	6-Y-1-RMF-240A	31155401
6	115 Vac	Knob	Base	6-Y-1-RMF-115A ①	31155402
6	115 Vac	Non-reset	Panel	6-Y-13-RMF-PM-115A ①	31155405
7	24 Vdc	Non-reset	Panel	7-Y-13-RMF-PM-24D	33183400

Technical Data and Specifications

General Specifications

Description	Specification
Figures	6 or 7
Speed	Up to 1000 cpm
Figure size	3/16 in (4.8 mm) high, white-on-black background
Reset	Knob, key or non-reset
Mounting	Base or panel mount
Finish	Black frame and side covers
Electrical connections	Two-wire leads, 9 in (229 mm) long, AWG 22 (0.34 mm ²), stripped 0.38 in (9.5 mm)
Power requirements	7 watts
Coils	Various voltages and frequencies can be supplied on special order. Count coils are designed for continuous duty at rated voltage

Dimensions

Refer to table and illustrations on **Page V12-T24-30** for information.

Note

① UL recognized.

ME Series

Product Description

Small in size and price, but large in design versatility and model variety is the ME Series of miniature electric counters. Models in most popular AC or DC voltages operate on as little as 3 watts, with the non-reset

models measuring only 1 x 1.593 x 2.187 in (25.4 x 40.5 x 55.5 mm) and weighing just three ounces (85 grams).

Available in 4, 6 or 7 figures, the counters feature stainless steel self-lubricating shafts, nylatron pinions and a synchronous electromagnetic drive to assure accurate,

reliable, long life operation. Designed for mounting flexibility and aesthetic attractiveness, the miniature electric counters are available with three types of mounting and a glare retarding finish Delrin, with crisp easy-to-read numerals set close to a tamper-proof sealed figure window.

Standards and Certifications

- UL recognized



Product Selection

When Ordering Specify

When ordering ME Series Miniature Electric Counters, specify catalog numbers according to the features selected.

Bottom Mount Wire Leads

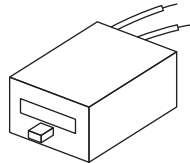

Base Mount Wire Leads

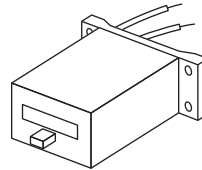

Panel Mount Wire Leads

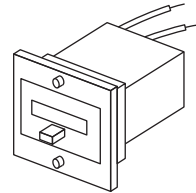

Shaded area denotes obsolete or discontinued products and services.

ME Series Miniature Electric Counter



ME Series Miniature Electric Counters

No. of Figures	Voltage	Reset	Mounting	Catalog Number	Order Number
4	12 Vdc	Pushbutton	Bottom	4-Y-41312-401-MEQ	41312401
4	24 Vdc	Pushbutton	Bottom	4-Y-41312-402-MEQ	41312402
4	120 Vac	Pushbutton	Bottom	4-Y-41312-406-MEQ	41312406
4	24 Vdc	Pushbutton	Base	4-Y-41313-402-MEQ	41313402
4	120 Vac	Pushbutton	Base	4-Y-41313-406-MEQ	41313406
4	240 Vac	Pushbutton	Base	4-Y-41313-407-MEQ	41313407
4	12 Vdc	Pushbutton	Panel	4-Y-41314-401-MEQ	41314401
4	24 Vdc	Pushbutton	Panel	4-Y-41314-402-MEQ	41314402
4	120 Vac	Pushbutton	Panel	4-Y-41314-406-MEQ	41314406
4	240 Vac	Pushbutton	Panel	4-Y-41314-407-MEQ	41314407

Shaded area denotes obsolete or discontinued products and services.

ME Series Miniature Electric Counter



ME Series Miniature Electric Counters, continued

No. of Figures	Voltage	Reset	Mounting	Catalog Number	Order Number
6	24 Vdc	Non-reset	Bottom	6-Y-41119-402-ME	41119402
6	120 Vac	Non-reset	Bottom	6-Y-41119-406-ME	41119406
6	12 Vdc	Non-reset	Base	6-Y-41345-401-ME	41345401
6	24 Vdc	Non-reset	Base	6-Y-41345-402-ME	41345402
6	120 Vac	Non-reset	Base	6-Y-41345-406-ME	41345406
6	240 Vac	Non-reset	Base	6-Y-41345-407-ME	41345407
6	12 Vdc	Non-reset	Panel	6-Y-41346-401-ME	41346401
6	24 Vdc	Non-reset	Panel	6-Y-41346-402-ME	41346402
6	120 Vac	Non-reset	Panel	6-Y-41346-406-ME	41346406
6	240 Vac	Non-reset	Panel	6-Y-41346-407-ME	41346407
7	12 Vdc	Non-reset	Bottom	7-Y-41238-401-ME	41238401
7	24 Vdc	Non-reset	Bottom	7-Y-41238-402-ME	41238402
7	120 Vac	Non-reset	Bottom	7-Y-41238-406-ME	41238406
7	12 Vdc	Non-reset	Base	7-Y-41337-401-ME	41337401
7	24 Vdc	Non-reset	Base	7-Y-41337-402-ME	41337402
7	120 Vac	Non-reset	Base	7-Y-41337-406-ME	41337406
7	12 Vdc	Non-reset	Panel	7-Y-41349-401-ME	41349401
7	24 Vdc	Non-reset	Panel	7-Y-41349-402-ME	41349402
7	120 Vac	Non-reset	Panel	7-Y-41349-406-ME	41349406
7	240 Vac	Non-reset	Panel	7-Y-41349-407-ME	41349407

Technical Data and Specifications

General Specifications

Description	Specification
Figures	4, 6 and 7
Speed	Up to 1000 cpm
Figure size	3/16 in (4.8 mm) high
Reset	Pushbutton and non-reset
Reset force	Pushbutton models only, 20 oz. (568 grams) maximum
Mounting	Base, bottom, panel
Finish	Black self-extinguishing plastic
Electrical connections	Wire leads, 10 in (254 mm) long, AWG 20, stripped 3/8 in (9.5 mm), and pin terminals
Power requirements	3W
Coils	Count coils are designed for continuous duty at rated voltage

Dimensions

Approximate Dimensions in Inches (mm)

ME Series Counters

Panel Mounted

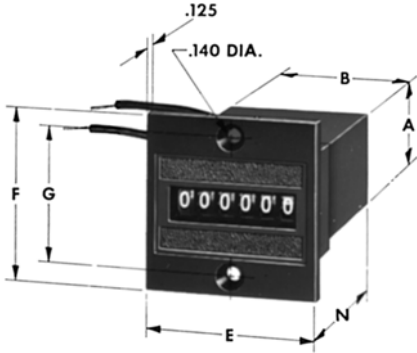

Bottom Mounted

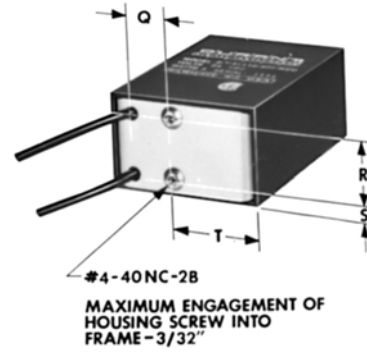

Base Mounted

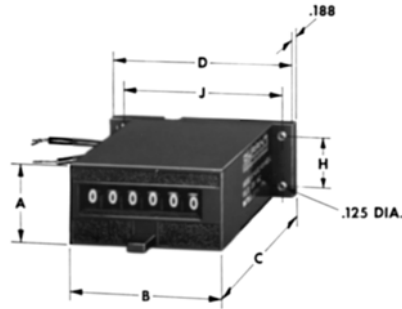

Bottom Mounted

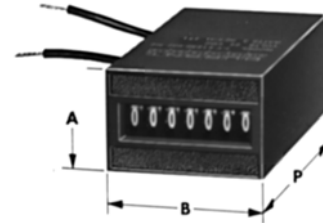

ME Series Counters

4 Figure Pushbutton Reset Counters

Dimension	Inches (mm)
A	1.00 (25.4)
B	1.60 (40.6)
C	2.64 (67.1)
D	2.19 (55.6)
E	1.80 (45.7)
F	1.80 (45.7)
G	1.40 (35.6)
H	0.69 (17.5)
J	1.88 (47.8)
K	0.50 (12.7)
L	0.49 (12.4)
M	0.94 (23.9)
N	2.45 (62.2)
P	2.45 (62.2)
Q	0.45 (11.4)
R	0.63 (16.0)
S	0.19 (4.8)
T	0.68 (17.3)

6 and 7 Figure Non-Reset Counters

Dimension	Inches (mm)
A	1.00 (25.4)
B	1.60 (40.6)
C	2.38 (60.5)
D	2.19 (55.6)
E	1.80 (45.7)
F	1.80 (45.7)
G	1.40 (35.6)
H	0.69 (17.5)
J	1.88 (47.8)
K	0.50 (12.7)
L	0.49 (12.4)
M	0.94 (23.9)
N	2.19 (55.6)
P	2.19 (55.6)
Q	0.45 (11.4)
R	0.63 (16.0)
S	0.19 (4.8)
T	0.88 (22.4)

Recommended Panel Mount Cut-Outs

4 Figure Counters Pushbutton Reset

1.72 x 1.11 (43.7 x 28.2)

6 and 7 Figure Counters Non-Reset

1.72 x 1.11 (43.7 x 28.2)

Electronic Totalizers



Contents

Description	Page
Mechanical Totalizers	
Stroke	V12-T24-4
Revolution	V12-T24-11
Electromechanical Totalizers	V12-T24-25
Electronic Totalizers	
1/32 DIN LCD Totalizers	V12-T24-36
1/32 DIN LED Multifunction Totalizer/Timer/Ratemeter	V12-T24-38
Courier Series	V12-T24-40
1/8 DIN LED Multifunction Totalizer/Timer/Ratemeter	V12-T24-42

Electronic Totalizers

Product Overview

Eaton's electric totalizers provide a flexible and accurate method of displaying count and measurement data in an easily readable format.

Features

- LED and LCD readouts
- Variety of sizes and packages
- Programmable inputs and displays available

Standards and Certifications

- Most products are UL certified (see individual product pages for details)
- CE



1/32 DIN LCD Totalizers

Product Description

Compact battery powered totalizers where AC power is unavailable.

Features

- Low price and high efficiency
- Large eight-digit LCD display, height of the figures 0.31 in (8 mm)
- Various counting modes like up/down differential available
- High voltage input for 10–260 Vac/Vdc voltage pulses
- IP65
- Screw terminals, RM 5 mm
- Lifetime of the battery approximately eight years
- Locking of the reset key
- Operating temperature 14 to 140 °F (–10 to 60 °C)
- All version of positive or negative counting edge
- Filter function for bounce-free counting with mechanical contacts

Standards and Certifications

- UL recognized
- CE marked



Product Selection

E5-024-C04_



1/32 DIN LCD Totalizers

Description	Catalog Number
Eight-Digit LCD Totalizer, Battery Power	
4–30 Vdc powered, NPN/PNP 0.94 x 1.89 in (24 x 48 mm)	E5-024-C0400
10–120V input AC/DC powered, NPN only 0.94 x 1.89 in (24 x 48 mm)	E5-024-C0408
Count up/down 4–30 Vdc powered, NPN only, 0.94 x 1.89 in (24 x 48 mm)	E5-024-C0410

Technical Data and Specifications

1/32 DIN LCD Totalizers

Description	Specification
Power supply	Non-replaceable lithium battery (lifetime approximately eight years at 68 °F (20 °C))
Display	LCD, eight-digits
Figure size	0.31 in (8 mm) high
Mode	Adding or subtracting (selectable), counting direction, differential counting or phase discriminator single or dual evaluation (selectable)
Display range	–9999999 to 99999999, with overflow display
Reset	Manual and electrical
Interference emissions	EN 55011 Class B, EN 61 000-6-2, EN 61010 Section 1 (only AC versions)
Housing	Dark gray RAL 7021
Operating temperature	14 to 131 °F (–10 to 55 °C)
Ambient temperature	14 to 140 °F (–10 to 60 °C)
Storage temperature	–4 to 158 °F (–20 to 70 °C)
Protection	IP65 (from front)
Weight	Approx. 1.76 oz (50 g)

1/32 DIN LCD Totalizers, continued

Description	Specification
Counting inputs:	
Counting input of the DC version	Max. 30 Vdc
Slow counting input	Max. 30 Hz (NPN)
Fast counting input	Max. 12 kHz (PNP)
Switching level	NPN: Low 0–0.7V, High 3–30 Vdc PNP: Low 0–0.7V, High 3–30 Vdc
Counting Input of the high voltage versions	
Counting input	Optocoupler input, max. 30 Hz
Min. pulse time	16 ms
Switching level	Low: 0–2 Vac/Vdc High: 10–260 Vac/Vdc
Counting direction switching (only DC versions)	
	Contact input, open collector NPN (switching at 0 Vdc) Switching level, NPN—Low, 0–0.7V, High 3–5 Vdc
Reset input (only DC and high voltage)—	
Minimum pulse time	DC: 50 ms; high voltage: 16 ms
Contact input NPN	Low: 0–0.7V High: 3–30 Vdc
High voltage input	10–260 Vac/Vdc
Electrical reset key locking (for DC and AC)	
	Contact input, open collector NPN (switching at 0V) Switching level, NPN—Low, 0–0.7V, High 3–5 Vdc

Dimensions

Approximate Dimensions in Inches (mm)

1/32 DIN LCD Totalizers

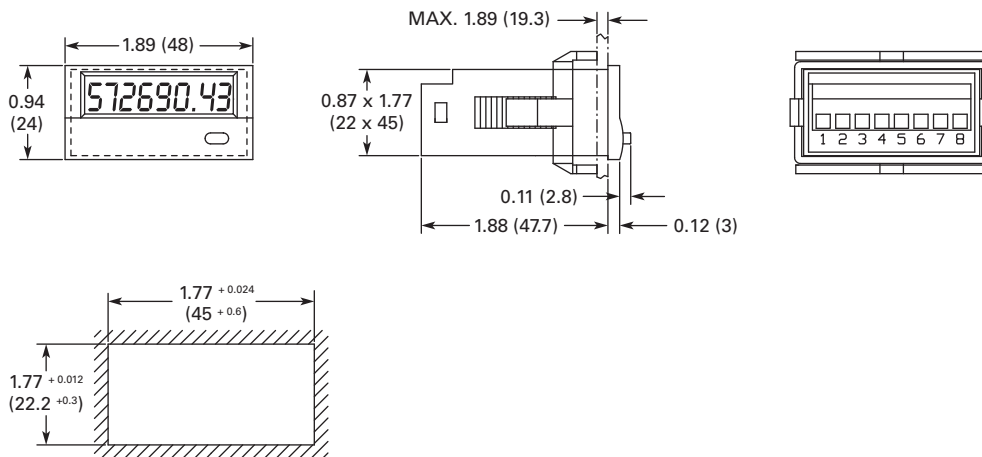

1/32 DIN LED Multifunction Totalizer/Timer/Ratemeter**Product Description**

Compact LED display for a variety of input signals.

Features

- Display counter adding and subtracting
- Position display
- Frequency counter/ratemeter
- Timer
- Display range: –199.999 to 999.999 with zero blanking
- Screw terminal
- Locking SET-key

Standards and Certifications

- UL recognized
- CE marked

**Product Selection**

E5-024-C04

**1/32 DIN LED Multifunction Totalizer/Timer/Ratemeter**

Description	Catalog Number
LED Single channel totalizer, 10–30 Vdc power 0.94 x 1.89 in (24 x 48 mm)	E5-024-E0402
LED multifunction totalizer/timer/ratemeter 10–30 Vdc power 0.94 x 1.89 in (24 x 48 mm)	E5-424-E0402
LED double-function totalizer/timer/ratemeter 10–30 Vdc power 0.94 x 1.89 in (24 x 48 mm)	E5-524-E0402
LED totalizer with quadrature, 10–30 Vdc power 0.94 x 1.89 in (24 x 48 mm)	E5-024-E0432

Technical Data and Specifications**General Specifications**

Description	Specification
Supply voltage	10–30 Vdc with reverse polarity protection
Current consumption	Max. 55 mA
Display	Six-digit red, seven-segment LED display
Figure size	0.31 in (8 mm) high
Data backup	EEPROM
Housing	Dimension 3.78 x 1.89 in (48 x 24 mm) according to DIN 43 700; RAL 7021 gray
Polarity of inputs	Programmable, NPN or PNP
Input resistance	Approx. 10 Kohms
Counting frequency	60 kHz, can be damped to 30 Hz, position display max. 25 kHz
Resolution	Timer 0.001 sec.
Reset time	5 ms
Level of inputs	
High	0.6 x U _B –30 Vdc
Low	0–0.2 x U _B (Vdc)
Error	
Tachometer	<0.1%
Timer	<50 ppm
Ambient temperature	4 to 131 °F (–20 to 55 °C)
Storage temperature	–13 to 167 °F (–25 to 75 °C)
EMC	According to EC EMC directive 89/36/EWG
Immunity to interference	EN 61 000-6-4/ EN 55011 Class B
Emitted interference	EN 61 000-6-2
Protection	IP65 (from front)
Weight	Approx. 5.29 oz (150 g)

Dimensions

Approximate Dimensions in Inches (mm)

1/32 DIN LED Multifunction Totalizer/Timer/Ratemeter

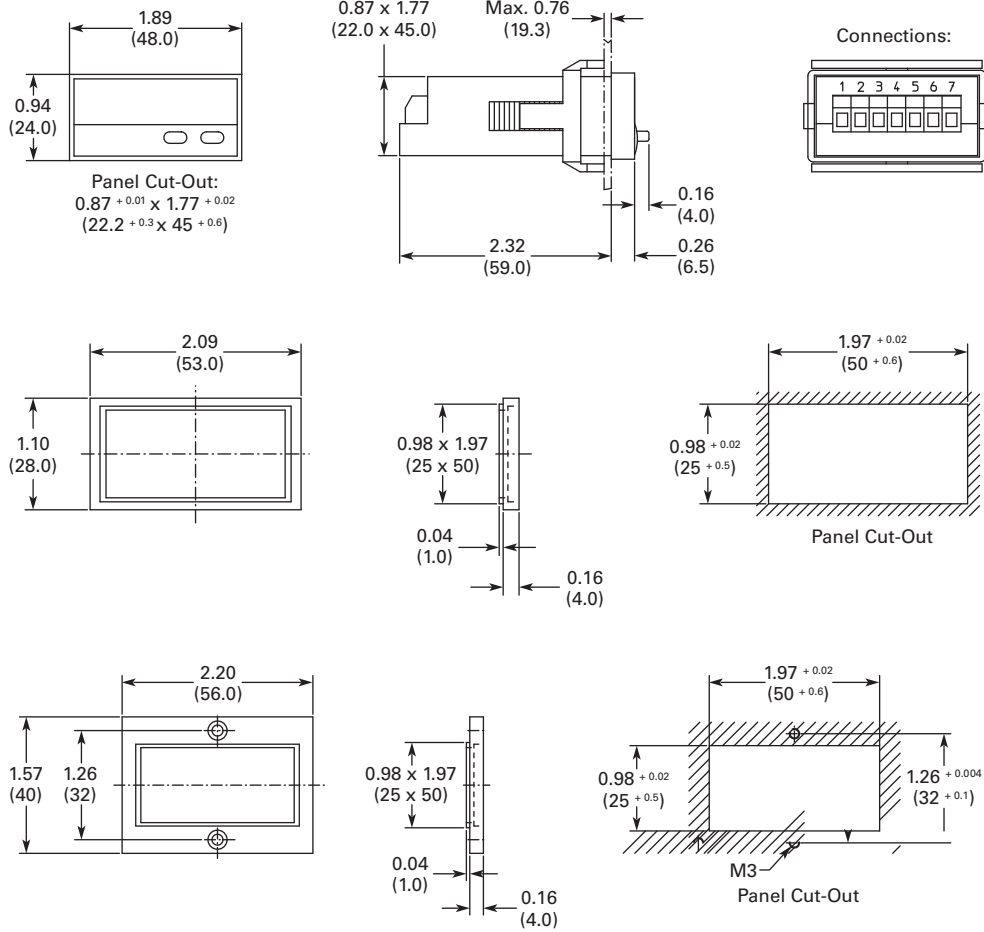

Courier Series

Product Description

Eaton's Courier Series is a high quality totalizer powered by a replaceable lithium battery.

Features

- Eight-digit totalizer
- 1/Tau ratemeter
- Scaling capabilities
- Remote reset terminal
- 0.43 in (10.9 mm) display
- Front panel reset
- NEMA 4X

Standards and Certifications

- CE marked



Product Selection

When Ordering Specify

When ordering Courier Series Electronic Totalizers and Ratemeters, specify order numbers according to the features selected.

Courier Series



Courier Series, Eight-Digit LCD

Description	Catalog Number
Totalizer, battery	53300400
Add/subtract (10 kHz, PNP input) totalizer, battery	53300401
Add/subtract (20 Hz, NPN/contact input) totalizer, battery	53300402
Totalizer/ratemeter, battery	53300405
RMF panel mount totalizer, key reset, 60–160 Vac/Vdc count input	53300800
RMF panel mount totalizer, dry contact input	53300850
RMF panel mount totalizer, 60–160 Vac/Vdc count input	53300851
Totalizer—extended temperature range, battery	53301400
Totalizer—1/Tau ratemeter—extended temperature range	53301404
Totalizer/ratemeter—extended temperature range, battery	53301405
Totalizer/ratemeter, mag pickup, battery	53301475
Backlight totalizer, battery	53302400
Backlight add/subtract (10 kHz, PNP input) totalizer, battery	53302401
Backlight add/subtract (20 Hz, NPN/contact input) totalizer, battery	53302402
Backlight totalizer/ratemeter, battery	53302405

Technical Data and Specifications

General Specifications

Description	Specification
Power	
Internal battery	3V, lithium
Life expectancy	5 years +
Replacement part	36367-202
Backlight	
Backlight	10–30 Vdc at 30 mA max. ^① Reverse polarity protected
Physical	
Operating temperature	–4 to 158 °F (–20 to 70 °C)
Storage temperature	–4 to 158 °F (–20 to 70 °C)
Operating humidity	60% noncondensing
Weight	2.2 oz (62 g) net
Figure size	0.43 in (10.9 mm) high
Front panel rating	NEMA 4X when mounted with gasket provided
Case material	Cyclocac X-17
Totalizer	
Type	UP counting
Digits	Eight
Count Accuracy	
Operated within specifications	100%

Note

^① Derate operating temperature 1 °C/volt above 17 Vdc.

General Specifications, continued

Description	Specification
DC Common (Terminal 1) Count Inputs	
Input B (terminal 2) low speed input designed for contact closures to DC common	
Speed	0 to 20 Hz
Min. low time	10 ms
Min. high time	40 ms
Input impedance	101 Kohms
Voltage thresholds	
Low	0–0.4 Vdc
High	2.0–28 Vdc
Max. high	28 Vdc
Input A (terminal 3) high speed input requiring a voltage source such as a current sourcing sensor or a current sinking sensor used with the provided pull up resistors	
Speed	0 to 10 kHz
Min. low time ^②	80 ms
Min. high time ^②	20 ms
Input impedance	2 Kohms above 5 Vdc
Voltage thresholds	
Low	0–1.2 Vdc
High	2.0–28 Vdc
Max. high	28 Vdc
Reset Input	
Reset input (terminal 4) designed for contact closures to DC common	
Min. low ^③	0.25 to 1 sec. (reset is maintained)
Voltage thresholds	
Low	0–0.4 Vdc
High	2.0–28 Vdc
Front Panel Reset Enable	
Front panel reset enable (terminal 5)	
Operation	Level sensitive (maintained)

Dimensions

Approximate Dimensions in Inches (mm)

Courier Series

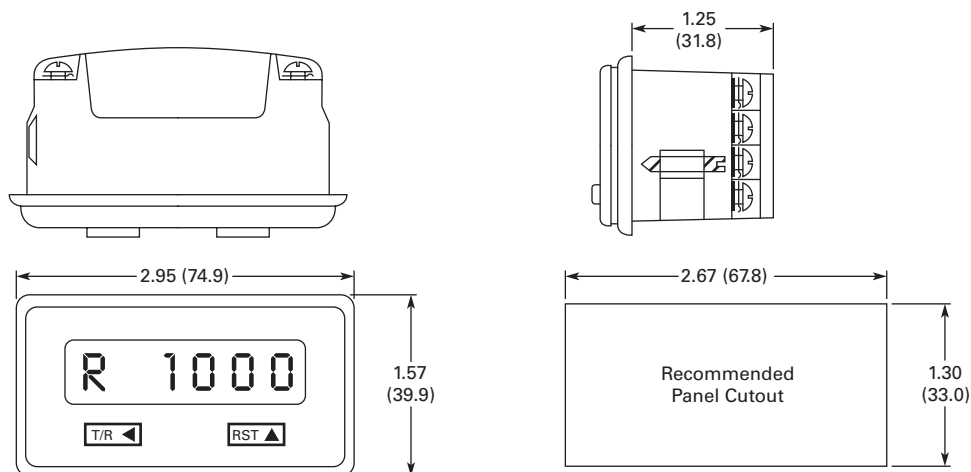

Notes

- ① Derate operating temperature 1 °C/volt above 17 Vdc.
- ② The times are with a 0–5.0V swing.
- ③ The required pulse width varies with count speed, scale factor and number of digits displayed.

1/8 DIN LED Multifunction Totalizer/Timer/Ratemeter**Product Description**

LED display for a variety of input signals.

Features

- Display counter adding and subtracting
- Position display
- Frequency counter/ratemeter
- Timer, res. up to 0.001 second
- Programmable mode
- Display range: –199.999 to 999.999 with zero blanking
- Connection with screw terminal
- Locking SET-key for reset

Standards and Certifications

- UL recognized
- CE marked

**Product Selection**

E5-496-E040_

1/8 DIN LED Multifunction Totalizer/Timer/Ratemeter

Description	Catalog Number
LED Multifunction Counter/Timer/Ratemeter	
90–260 Vac power 3.78 x 1.89 in (96 x 48 mm)	E5-496-E0401
10–30 Vdc power 3.78 x 1.89 in (96 x 48 mm)	E5-496-E0402

Technical Data and Specifications**General Specifications**

Description	Specification
Supply voltage	10–30 Vdc with reverse polarity protection; 90–260 Vac
Current consumption	Max. 50 mA 6 VA
Display	Six-digit red, seven-segment LED display
Figure size	0.55 in (14 mm) high
Data backup	EEPROM
Housing	Dimension 3.78 x 1.89 in (96 x 48 mm) according to DIN 43 700; RAL 7021 gray
Polarity of inputs	Programmable, NPN or PNP for all inputs
Input resistance	Approx. 10 Kohms
Counting frequency	60 kHz, can be damped to 30 Hz depending on operating mode at position display max. 25 kHz ^①
Reset time	5 ms
Resolution timer	Up to 0.001 second
Input switching level	
DC version (standard version)	High: 0.6 x U _B –30 Vdc Low: 0–0.2 x U _B (Vdc)
AC version	High: 12–30 Vdc Low: 0–4 Vdc
Voltage supply for sensors	24 Vdc ±15%/100 mA at AC versions
Accuracy	
Tachometer	<0.1%
Timer	<50 ppm
Ambient temperature	–4 to 149 °F (–20 to 65 °C)
Storage temperature	–13 to 167 °F (–25 to 75 °C)
EMC	According to EC EMC directive 89/36/EWG
Immunity to interference	EN 61 000-6-4/ EN 55011 Class B
Emitted interference	EN 61-000-6-2
Protection	IP65 (from front)
Weight	Approx. 5.29 oz (150 g)

Note

^① For further specifications, please refer to the user manual.

Dimensions

Approximate Dimensions in Inches (mm)

1/8 DIN LED Multifunction Totalizer/Timer/Ratemeter

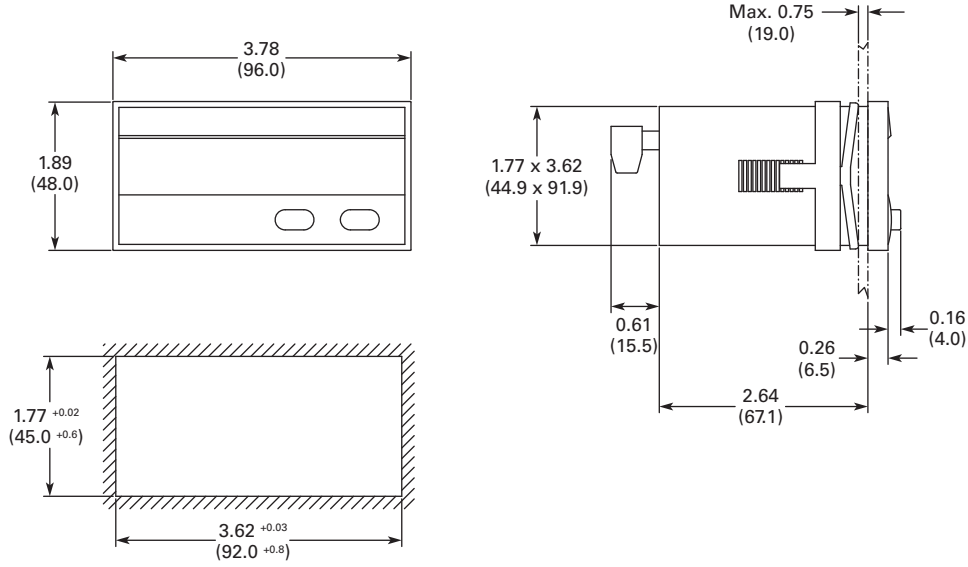

Count Controls/Preset Counters



Contents

<i>Description</i>	<i>Page</i>
Count Controls/Preset Counters	
Product Selection Guide	V12-T24-45
1/16 DIN Battery Powered LCD Count Control	V12-T24-46
1/16 DIN LCD Preset Counters with Rate and Time	V12-T24-48
Ambassador Series (Totalizers)	V12-T24-53
Ambassador Series (Count Control)	V12-T24-56
PD-Q and PD-ER Series	V12-T24-60



Learn
Online

Product Overview

Count controls are counters that provide output signal(s) at preset count value(s). Typical applications include cut-to-length, batching, filling, mixing and dispensing. A variety of count controls in different sizes, display types and feature sets are available from Eaton.

Application Description



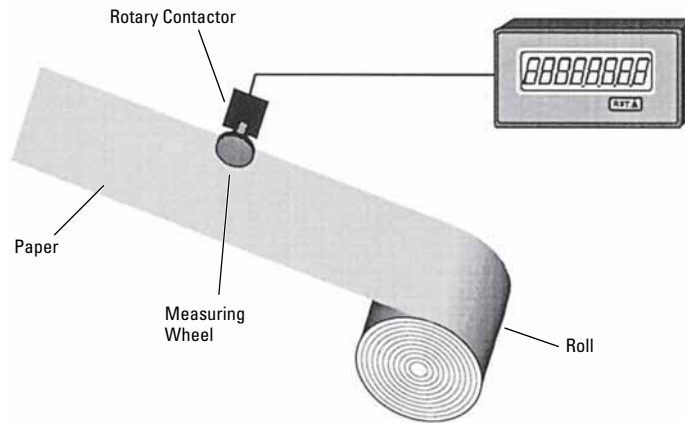

The illustration shows a simple cut-to-length application. The roll of paper is measured using a measuring wheel and rotary contactor (or encoder). Once the desired length is reached, an output signal may be directed to a shear for activation. Following the cut-off, the count control will reset to zero and begin measurement of the next piece. Options such as batch counting, where the number of cut pieces is counted, are also typical of this application.

Application Example



Product Selection Guide

Count Controls/Preset Counters/Totalizers

	Characteristics	Panel Cutout in Inches (mm)	Page
 <p>E5-148-C</p>	<p>Low cost, simple count control</p> <p>Battery operated</p> <p>Easy-to-change preset values</p> <p>Two-line display: input and preset values</p>	1.772 x 1.772 (45 x 45)	V12-T24-46
 <p>E5-648-C</p>	<p>Two-line display: counter, timer or tachometer</p> <p>AC or DC power options</p> <p>Wide choice of count modes for pulse inputs, time or frequency</p> <p>Two or four presets</p>	1.772 x 1.772 (45 x 45)	V12-T24-48
 <p>Ambassador</p>	<p>Six-digit, high-visibility, two-line LCD display</p> <p>User-configurable control inputs</p> <p>Highly flexible control/display</p>	2.667 x 2.667 (68 x 68)	V12-T24-56
 <p>PD-Q and PD-ER</p>	<p>Electromechanical pre-set counter</p> <p>Easy setpoint adjustment using pushbuttons</p> <p>Base mount or panel mount</p>	2.72 x 1.59 (69 x 40.5) (panel mount model)	V12-T24-60
 <p>Fusion</p>	<p>Integrated controller combines operator interface, ladder logic and high-speed counting</p>	2.667 x 5.433 (68 x 138)	V12-T24-91

1/16 DIN Battery Powered LCD Count Control

Product Description

Battery-powered electronic preset counter.

Features

- Replacement for electromechanical preset counters
- No power supply necessary (battery operated)
- Count and reset input electrically separated from counter through optocoupler input range 12–250 Vac/Vdc
- Two-line LC display count, preset and level of the output
- Screw terminal
- Data security, through two exchangeable lithium batteries, lifetime minimum eight years
- Easy programming
- Counter presets easily via presetting keys allocated to each decade
- Output: Potential free relay, programmable normally open or normally closed contact

Standards and Certifications

- cRU[®]us approval
- CE marked



Product Selection

E5-148-C1400



1/16 DIN Battery Powered LCD Count Control

Description	Catalog Number
Single Preset Count Control	
Battery power 1.89 x 1.89 in (48 x 48 mm)	E5-148-C1400

Technical Data and Specifications

General Specifications

Description	Specification
Power supply	2 pcs user exchangeable lithium batteries, type 1/2 AA lithium 3.6V
Display	Two-line LCD display, six digits; 999999
Figure size	0.28 in (7 mm) or 0.18 in (4.5 mm) high
Input	Reset, count and keylock inputs
Input polarity	Bi-directional optocoupler input for the reset count inputs; reset, count and keyboard lock is connected to 3 Vdc
Input min. pulse duration	Reset input 50 ms; keyboard lock input 15 ms
Input switching levels	
Low	<3 Vac/Vdc
High	12–250 Vac/Vdc
Input frequency	Max. 25 Hz
Input resistance	110 Kohms
Output	Bistable relay with potential free contact (programmable as normally closed or normally open contact)
Max. switching voltage	250 Vac/220 Vdc
Max. switching current	2A
Max. switching capacity	60 VA/30W
Output response time	<20 ms, max. 4 Hz
Data retention	Via two batteries, eight years or 5x10 ⁶ power operations of the output relay and an ambient temperature of 77 °F (25 °C)
Ambient temperature	14 to 122 °F (–10 to 50 °C)
Storage temperature	–13 to 140 °F (–25 to 60 °C)
EMC	According to EC EMC directive 89/36/EWG, EN 61 000-6-4/ EN 55011 Class B, EN 61 000-6-2
Protection	IP65 (front)
Weight	Approx. 2.82 oz (80 g)

Dimensions

Approximate Dimensions in Inches (mm)

1/16 DIN Battery Powered LCD Count Control

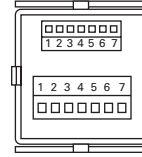
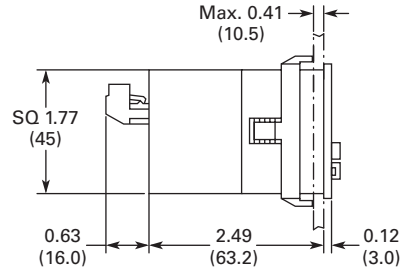
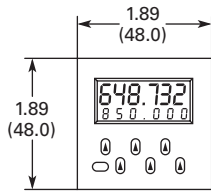

Panel Cut-Out 1.77 x 1.77 (45 x 45)

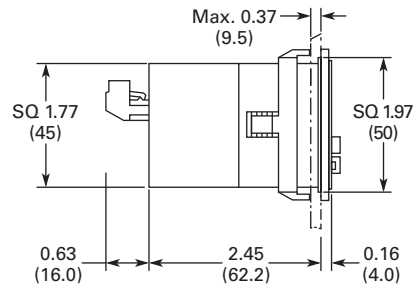
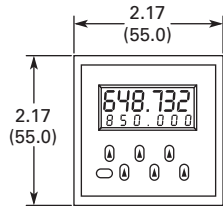

With Front Bezel No. 2
Panel Cut-Out 1.97 x 1.97 (50 x 50)

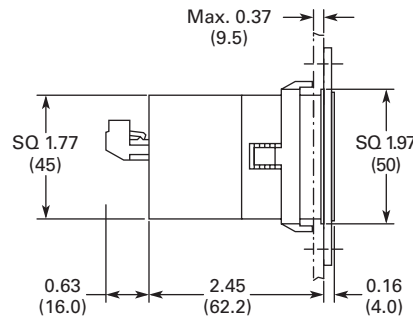
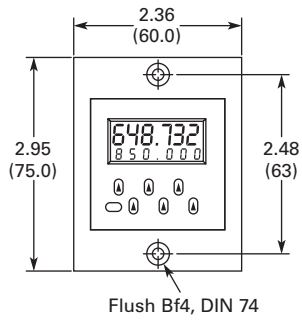

With Front Bezel No. 3
Panel Cut-Out 1.97 x 1.97 (50 x 50)

1/16 DIN LCD Preset Counters with Rate and Time

Product Description

AC or DC powered preset counters that can function as timer or tachometer/ratemeter.

Features

- Two-line display with green backlight (E5-648-C2421 and E5-648-C2422) or multi-color red/green LED backlighting (E5-648-C4461 and E5-648-C4462)
- Programmable as preset counter, batch counter or totalizer
- Power supply: 90–260 Vac or 10–30 Vdc
- Direct input of the presets via front keys or Teach-In input
- Relay outputs
- Scaling by multiplication and division factors 0.0001 to 99.999
 - Two preset values, two outputs
 - Four preset values, four outputs

Standards and Certifications

- cRU[®]us approval
- CE marked



Product Selection

E5-648-C_



1/16 DIN Two-Line LCD Count Control

Description	Catalog Number
Two Preset LCD Count Control with Backlighting	
90–260 Vac power 1.89 x 1.89 in (48 x 48 mm)	E5-648-C2421
10–30 Vdc power 1.89 x 1.89 in (48 x 48 mm)	E5-648-C2422
Four Preset LCD Count Control with Multi-Color Display	
90–260 Vac power 1.89 x 1.89 in (48 x 48 mm)	E5-648-C4461
10–30 Vdc power 1.89 x 1.89 in (48 x 48 mm)	E5-648-C4462 ①

Technical Data and Specifications

General Specifications

Description	Specification
Power supply	10–30 Vdc external fuse protection 90–260 Vac max. 8 VA external fuse protection
Display	Two-line LCD display, six digits with programmable decimal point
Figure size	0.35 in (9 mm) high upper line 0.28 in (7 mm) high lower line
Count inputs	Two count inputs (A and B), programmable for count/count direction, up/up, up/down, quadrature, quad2, quad4, A/B or (A-B)/A x 100%
Input polarity	Programmable for all inputs in common NPN/PNP
Input resistance	Approx. 5 Kohms
Count frequency	Max. 55 kHz with programmable filter for 30 Hz (see manual for details)
Input min. pulse duration	10 ms for control inputs/1 ms for reset input
Switching levels	
DC supply voltage	
High	0.6 x UB–30 Vdc
Low	0–0.2 x UB (Vdc)
AC supply voltage	
High	12–30 Vdc
Low	0–4 Vdc
Pulse shape	Variable (Schmitt-Trigger characteristics)

Note

① Not a stocked product, contact Eaton Care for assistance.

General Specifications, continued

Description	Specification
Output 1	
Relay	Programmable as normally open or normally closed
Switching voltage max.	250 Vac/110 Vdc
Switching current max.	3 A Vac/3 A Vdc
Switching current at DC min.	30 mA Vdc
Switching power at DC	90 W
Switching power at AC max.	750 VA
Output 2	
Relay	Relay with changeover/Form C contact
Switching voltage max.	250 Vac/110 Vdc
Switching current max.	3 A Vac/3 A Vdc
Switching current at DC min.	30 mA Vdc
Switching power at DC	90 W
Switching power at AC max.	750 VA
Reaction time of the outputs	Approximately 10 ms
Data retention	Min. 10 years or 1 million memory cycles
Sensor supply voltage	
AC powered unit	24 Vdc \pm 15%, 80 mA
DC powered unit	Max. 80 mA, DC voltage is connected through
Ambient operating temperature	-4 to 149 °F (-20 to +65 °C)
Storage temperature	-13 to 167 °F (-25 to 75 °C)
EMC	
Emitted interference	EN 55011 Class B
Immunity to interference	EN 61000-6-2
Protection	IP65 (front)
Weight	Approx. 4.4 oz (125 g)

Dimensions

Approximate Dimensions in mm [Inches]

1/16 DIN Two-Line LCD Count Control

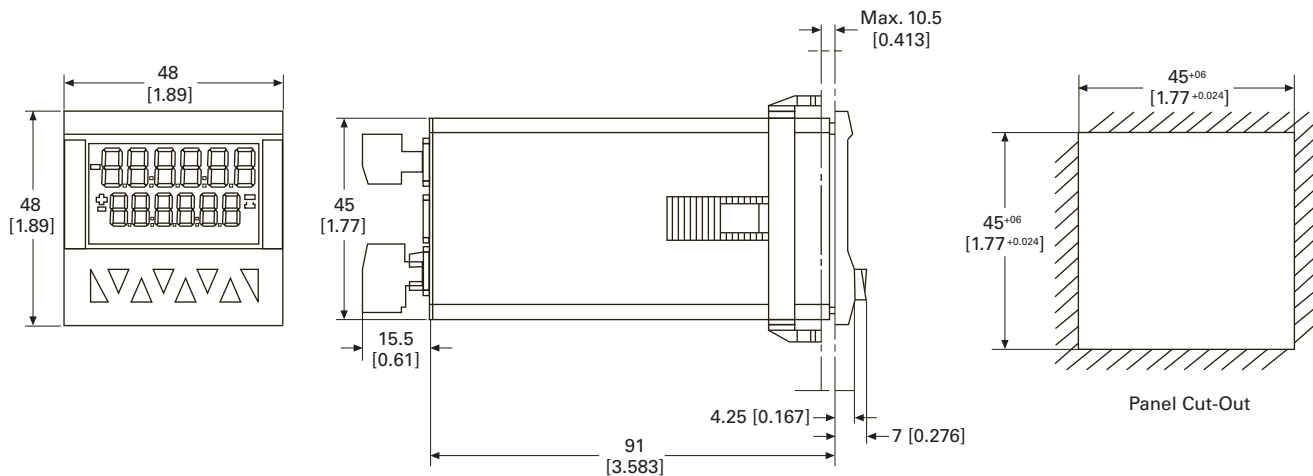

President Series (Count Control)

Product Description

Eaton's President Series features an easy-to-read LED and a simple preset input by means of the large keypad.

Features

- Five- or six-digit, LED display, 0.56 in (14 mm)
- 2 or 3 presets
- 15 Vdc at 100 mA output power
- Rear panel screw terminals
- 20 mA current loop communications
- 2 Form C relays
- Tactile keypad NEMA 4 front panel

Standards and Certifications

- UL listed
- CSA marked
- CE marked



Product Selection

Shaded area denotes obsolete or discontinued products and services.

58831400

President Series Count Control



Description	Features					Main Counter	Presets	Digits	Catalog Number
	Totalizer	Batch Counter	Rate	Scaler	Crop-Cut				
Dual preset	—	—	—	✓	—	1	2	5	58831400
Dual preset with totalizer or batch counter	①	①	—	✓	✓	1	2	6	58851400
Three presets with floating pre-warn	—	—	—	✓	—	1	3	6	58861400
Main counter, batch and totalizer presets	②	②	✓	✓	—	3	1 ea.	6	58827400
Two independent count registers	③	③	✓	✓	—	3	1 ea.	6	58827410

Notes

- ① These models have, in addition to the main count register, a register that may be configured to be used as either a totalizer or single preset batch counter. These two functions are mutually exclusive.
- ② The model 58827-400 has both a totalizer and a batch counter, each with a single preset. In addition, the batch counter may be configured as an additional totalizer with control instead of batch counter.
- ③ The model 58827-410 has two completely independent count input channels feeding two independent, single preset count registers. In addition, a third single preset register may be used as either a totalizer or a batch counter for one or both of the two main counters.

Technical Data and Specifications

President Series—Count Control

Description	Model			
	58831400	58851400	58827400	58827410
AC power requirements	120V/240V +10%/-20%, 47–63 Hz	120V/240V +10%/-20%, 47–63 Hz	120V/240V +10%/-20%, 47–63 Hz	120V/240V +10%/-20%, 47–63 Hz
DC power requirements	11–28 Vdc	11–28 Vdc	11–28 Vdc	11–28 Vdc
Power consumption	18 watts max.	18 watts max.	18 watts max.	18 watts max.
DC power output ^①	15 Vdc +1/-2; 150 mA if powered from AC or less than 24 Vdc, 100 mA if powered from 24 Vdc or greater			
Operating temperature	32 to 130 °F (0 to 55 °C)	32 to 130 °F (0 to 55 °C)	32 to 130 °F (0 to 55 °C)	32 to 130 °F (0 to 55 °C)
Operating humidity	85% relative, noncondensing	85% relative, noncondensing	85% relative, noncondensing	85% relative, noncondensing
Storage temperature	–10 to 160 °F (–40 to 71 °C)	–10 to 160 °F (–40 to 71 °C)	–10 to 160 °F (–40 to 71 °C)	–10 to 160 °F (–40 to 71 °C)
Front panel rating	NEMA 4 rating when mounted with gasket provided	NEMA 4 rating when mounted with gasket provided	NEMA 4 rating when mounted with gasket provided	NEMA 4 rating when mounted with gasket provided
Main counter scaler range	5 Digits (0.0001 to 9.9999)	5 digits (0.0001 to 9.9999)	5 digits (0.0001 to 9.9999)	5 digits (0.0001 to 9.9999)
Count input frequency	See table on Page V12-T24-51	See table on Page V12-T24-51	See table on Page V12-T24-51	See table on Page V12-T24-52
Control input impedance	4.5 Kohms to +5 Vdc	6.8 Kohms to 15 Vdc when control is powered by AC line; 6.8 Kohms to 10 Vdc when control is powered by DC line		
Control input response time	Min. high 5.3 ms; min. low 3.9 ms	High 10.5 to 24.5 Vdc; Low 0.0 to 4.5 Vdc when powered by AC		
Relay contact output ratings	SPDT Form C; 10 amps resistive at 24 Vdc or 230 Vac; 1/3 hp at 115 Vac or 230 Vac; 150 Vdc max switched voltage; 5,000,000 operations mechanical life, 100,000 operations at resistive rating			
Transistor output ratings	Open collector NPN transistor with Zener diode transient surge protection; 30 Vdc max. load; 300 mA max. per transistor; 480 mA total for all transistors. Use 5 mA per relay coil when calculating total transistor current			
Communications	Dual port 20 mA current loop, standard ASCII code			

58831400 and 58861400 Count Frequency

Scale Factor	Count Speed (Pulses per Second)	
	Nominal Count	Quadrature and/or Doubled Count
<1.0000	5,000	2,500
1.0000	7,500	3,750
1.9999	4,000	2,000
2.0000	6,000	3,000
9.0000	2,000	1,000
9.9999	1,500	750

58851400 Count Frequency

Scal Factor	Count Speed (Pulses per Second)			
	Function 61 value = "0"		Function 61 value = "1"	
	Nominal Count	Quadrature and/or Doubled Count	Nominal Count	Quadrature and/or Doubled Count
<1.0000	5,000	2,500	3,500	1,750
1.0000	7,500	3,750	4,500	2,250
1.9999	4,000	2,000	2,400	1,200
2.0000	6,000	3,000	3,600	1,800
9.0000	2,000	1,000	1,100	550
9.9999	1,500	750	1,000	500

58827400 Count Frequency

Scale Factor	Count Speed (Pulses per Second)		
	Count Up	Count Down	Quadrature
0.999	4,000	2,250	2,000
1.000	5,000	3,500	3,500
1.999	3,500	2,000	1,250
2.000	4,000	3,000	2,750
9.000	1,500	1,500	1,500
9.999	1,250	1,000	1,000

Note

^① DC power output is only regulated if unit is powered by AC or greater than 18.5 Vdc.

58827410 Count Frequency

Sample Scale Factor	Count Speed (Pulses per Second)				
	Typical Combinations of Features ^①				
	C1 = ON C2 = OFF C3 = OFF RM = OFF	C1 = ON C2 = ON C3 = OFF RM = OFF	C1 = ON C2 = ON C3 = ON RM = OFF	C1 = ON C2 = ON C3 = OFF RM = ON	C1 = ON C2 = ON C3 = ON RM = ON
0.0001–0.9999	6,000	3,000	2,300	2,600	2,000
1.0000	9,000	4,500	3,500	4,000	3,000
5.0000	4,500	2,250	1,000	2,000	750
9.9999	1,500	1,000	500	750	550

Dimensions

Approximate Dimensions in Inches (mm)

President Series Count Control

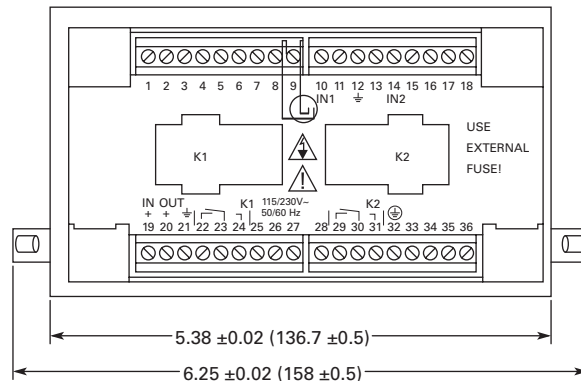
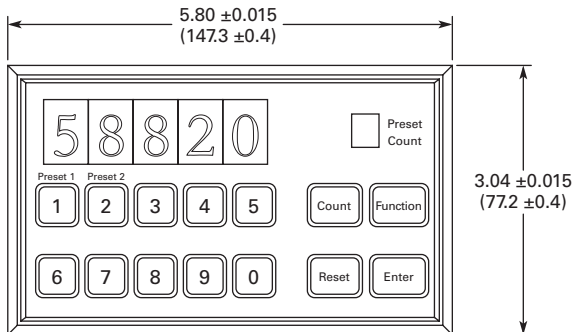
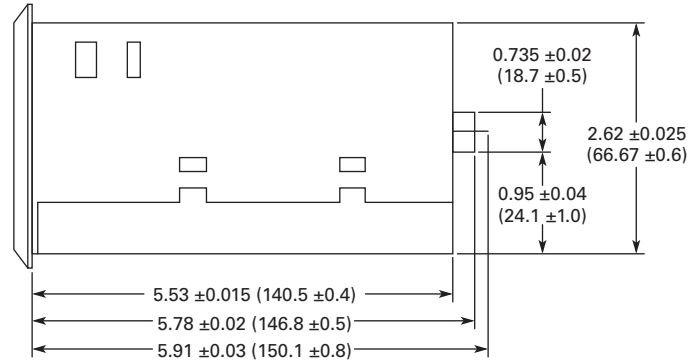
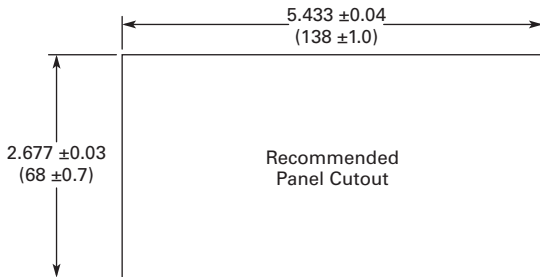

Note

^① C1: Counter #1; C2: Counter #2; C3: Counter #3; RM: Ratemeter.

Ambassador Series (Totalizers)

Product Description

Eaton's Ambassador Series is our most noise-immune totalizer available. Various counting modes can be set by the user.

Features

- AC powered, two-line LCD display
- Eight-digit totalizer
- 1/Tau ratemeter
- Totalizer and ratemeter scaling
- Four user-configurable control inputs
- Two solid-state outputs
- RS-485 serial communications

Standards and Certifications

- UL listed
- CE marked



Product Selection

Ambassador Series Ambassador Series Totalizers



Description	Catalog Number
115 Vac LCD	57601400

Technical Data and Specifications

General Specifications

Description	Specification
Power Input	
AC operation	115 Vac ($\pm 15\%$) std., 50 to 60 Hz, 7 W
DC power output	12 Vdc ($\pm 25\%$), 100 mA maximum (includes all line and load variations)
Environmental	
Operating temperature	32 to 131 °F (0 to 55 °C)
Storage temperature	-4 to 158 °F (-20 to 70 °C)
Operating humidity	85% relative, noncondensing
Rating	NEMA 4 when mounted with gasket provided
Totalizer	
Type	Bi-directional
Digits	Eight
Scaler range	0.00001 to 9.99999
Decimal point	Five positions, programmable
Totalizer Count Speeds ^①	
Maximum speed—solid-state (high speed)	
Mode	Input A/Input B
Add/sub	20 kHz
Add/add	20 kHz
Count/direction	15 kHz
Count x 2/direction	7.5 kHz
Quadrature	6.5 kHz
Quadrature x 2	6.5 kHz
Maximum speed—contact (low speed)	
Mode	Input A/Input B
Add/sub	40 kHz
Add/add	40 kHz
Count/direction	0 kHz

Note

① The maximum count speed depends on the selected count mode. All maximum speeds are shown with square waves (50% duty cycle) input.

General Specifications, continued

Description	Specification
Count Inputs	
Sink	
Impedance	4.6 Kohms to +5 Vdc
Voltage	
High	3.5 to 34.0 Vdc
Low	0.0 to 1.9 Vdc
Source (high)	
Impedance	2.3 Kohms to common
Voltage	
High	3.5 to 17.0 Vdc (100% duty cycle)
Low	0.0 to 1.9 Vdc
Source (low)	
Impedance	2.3 Kohms to common
DC voltage	
High	0.6 to 17.0 Vdc
Low	-17.0 to -0.6 Vdc
AC voltage	17 Vac (48V peak-peak) maximum
Control Inputs	
Impedance	4.7 Kohms to +5 Vdc
Voltage	
High	+3.7 to +24 Vdc
Low	0.0 to 0.9 Vdc
Response	Minimum low 15 ms, minimum high 15 ms
Transistor Outputs (2)	
Type	NPN open collector with transient protection
Maximum voltage (OFF state)	30 Vdc
Maximum current (ON state)	200 mA at 1.3 Vdc
Communication	
Type	RS-485
Format	1 start bit, 7 data bits (ASCII), 1 parity bit, 1 stop bit
Protocol	Opto-22 compatible
Speed	300, 1200, 2400, 4800, 9600 and 19200 baud
Parity	Odd, even, none (space transmitted, ignore received)
Count Accuracy	
Operating within specifications	100% when operated within the specified count speeds and count signal high and low times
Rate Indicator	
Type	1/Tau
Digits	Six
Scaler range	0.00001 to 99999
Decimal point	Five positions, programmable
Accuracy	±0.015% of reading
Update time	1 second, fixed
Zero time	10 seconds, fixed
Connections	
Type	Dual depluggable screw terminal strips
Conductor size	14–22 AWG (2.1–0.38 mm ²), 600V, solid, stranded or fused (preferred)

Dimensions

Approximate Dimensions in Inches (mm)

Ambassador Series Totalizer

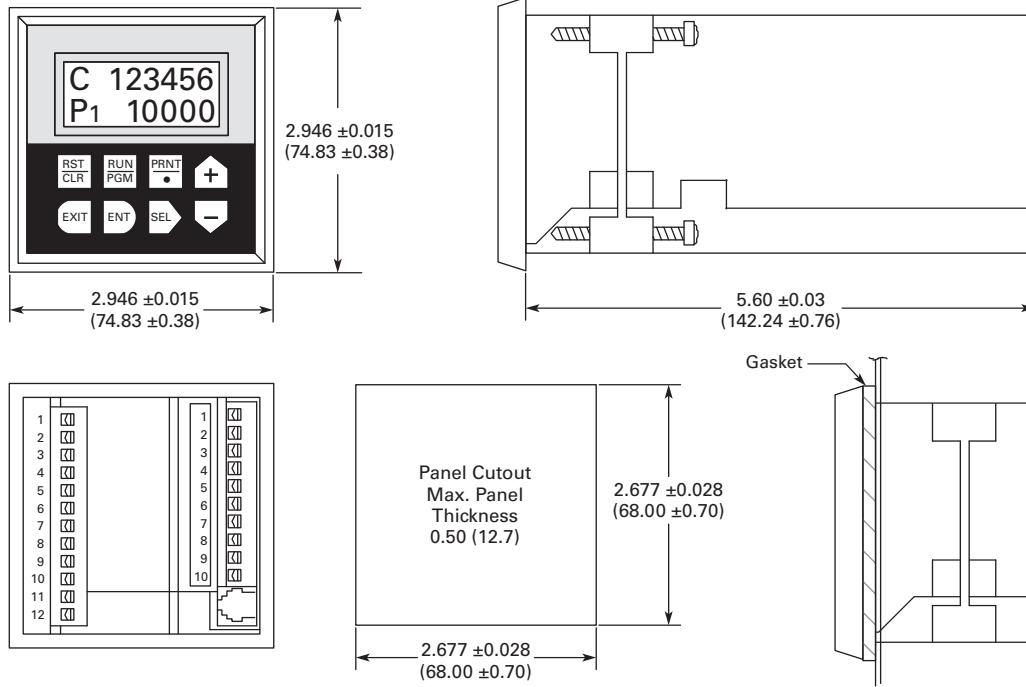

Ambassador Series (Count Control)

Product Description

Eaton's Ambassador Series provides up to four presets in one of the most noise-immune packages available.

Features

- AC powered, two-line LCD display
- Eight-digit totalizer
- 1/Tau ratemeter
- Totalizer and ratemeter scaling
- Four user-configurable control inputs
- Up to two output relays
- Two solid-state outputs
- RS-485 serial communications
- Feet/inches control available

Standards and Certifications

- UL listed
- CE marked



Product Selection

57601401



Ambassador Series Count Control

Description	Catalog Number
Single preset with rate, 115 Vac	57601401
Dual preset with rate, 115 Vac	57601403
Dual preset with rate, batch and totalizer, 115 Vac	57601404
Four preset with rate, batch and totalizer, 115 Vac	57601405
Four preset with rate, batch and totalizer, 230 Vac	57602405

Technical Data and Specifications

General Specifications

Description	Specification
Power Input	
AC operation	115 Vac (±15%) std., 50 to 60 Hz, 7W 230 Vac (±15%) opt., 50 to 60 Hz, 7W
Power Output	
DC operation	12 Vdc (±25%), 100 mA maximum (includes all line and load variations)
Environmental	
Operating temperature	32 to 131 °F (0 to 55 °C)
Storage temperature	-4 to 158 °F (-20 to 70 °C)
Operating humidity	85% relative, noncondensing
NEMA 4 rating	When mounted with gasket provided
Main Counter	
Type	Bi-directional
Digits	Six
Presets	Varies by model
Reset modes	Auto or manual reset to zero or preset
Scaler range	0.00001 to 9.99999
Decimal point	Five positions (six on four-preset models)
Output latency	See table on Page V12-T24-58
Batch Counter	
Type	Increment with main counter recycle or final preset signal
Digits	Six
Presets	One
Output latency	<1 ms

General Specifications, continued

Description	Specification
Totalizer	
Type	Bi-directional, same or opposite of main counter
Digits	Eight
Scaler	Shared with main counter
Decimal point	Tracks main counter
Count Input Speeds	
See tables on Page V12-T24-58	
Count Inputs	
Sink	
Impedance	4.6 Kohms to +5 Vdc
Voltage	
High	3.5 to 34.0 Vdc
Low	0.0 to 1.9 Vdc
Source (high)	
Impedance	2.3 Kohms to common
Voltage	
High	3.5 to 17.0 Vdc (100% duty cycle)
Low	0.0 to 1.9 Vdc
Source (low)	
Impedance	2.3 Kohms to common
DC voltage	
High	0.6 to 17.0 Vdc
Low	-17.0 to -0.6 Vdc
AC voltage	17 Vac (48V peak-peak) maximum
Control Inputs	
Impedance	4.7 Kohms to +5 Vdc
Voltage	
High	+3.7 to +24 Vdc
Low	0.0 to 0.9 Vdc
Response	Minimum low 15 ms, minimum high 15 ms
Relay Outputs	
Type	SPDT contacts
UL ratings	250 Vac, 360 V A pilot duty
Transistor Outputs (2)	
Type	NPN open collector with transient protection
Maximum voltage (OFF state)	30 Vdc
Maximum current (ON state)	200 mA at 1.3 Vdc
Communication	
Type	RS-485
Format	1 start bit, 7 data bits (ASCII), 1 parity bit, 1 stop bit
Protocol	Opto-22 compatible
Speed	300, 1200, 2400, 4800, 9600 and 19200 baud
Parity	Odd, even, none (space transmitted, ignore received)
Rate Indicator (Not available on models 57601-415 and 57601-485)	
Type	1/Tau
Digits	Six
Presets	Two
Scaler range	0.00001 to 99999
Decimal point	Five positions, programmable
Accuracy	±0.015% of reading
Update time	See table on Page V12-T24-58
Zero time	See table on Page V12-T24-58
Connections	
Type	Dual depluggable screw terminal strips
Conductor size	14–22 AWG (2.1–0.38 mm ²), 600V, solid, stranded, or fused (preferred)

Output Latency for Ambassador Control

Style Number	Output Latency
5760X401	0.7 to 2 ms
5760X403	0.7 to 2.7 ms
5760X404	0.7 to 2.7 ms
5760X405	<1 ms

Rate Indicator Specs for Ambassador Control

Style Number	Update Time	Zero Time
5760X401	1 second, fixed	10 seconds, fixed
5760X403	1 second, fixed	10 seconds, fixed
5760X404	1 second, fixed	10 seconds, fixed
5760X405	0.1 to 99.9 seconds, programmable	0.1 to 99.9 seconds, programmable

Ambassador Count Input Speeds—5760X405 ^①

Solid-State	A or B	A and B
A – B	8250/8250	3000/3000
A + B	8250/8250	4000/4000
–A + B	8000/8000	3000/3000
A, B Dir	8000/40	—
2A, B Dir	4500/40	—
A, B Rst	8250	—
Quad x 1	—	3250
Quad x 2	—	3250
Quad x 4	—	2000
Tot A/Cnt B	14000/9000	6500/6500
Tot + Cnt B	16000/8500	6500/6500

Ambassador Count Input Speeds—5760X401, 5760X403, 5760X404

Mode Input A/B	Maximum Speed ^②	
	Solid-State (High Speed)	Contact (Low Speed)
Add/sub	20 kHz	40 kHz
Add/add	20 kHz	40 kHz
Count/direction	15 kHz	40 kHz
Count x 2/direction	7.5 kHz	—
Quadrature	6.5 kHz	—
Quadrature x 2	6.5 kHz	—

Notes

^① Contact inputs = 40 Hz; B direction inputs = 40 Hz and B reset input = 10 μ S min. low. Input A not active on ft/in control.

^② The maximum count speed depends on the selected count mode. All maximum speeds are shown with square waves (50% duty cycle) input.

Dimensions

Approximate Dimensions in Inches (mm)

Ambassador Series

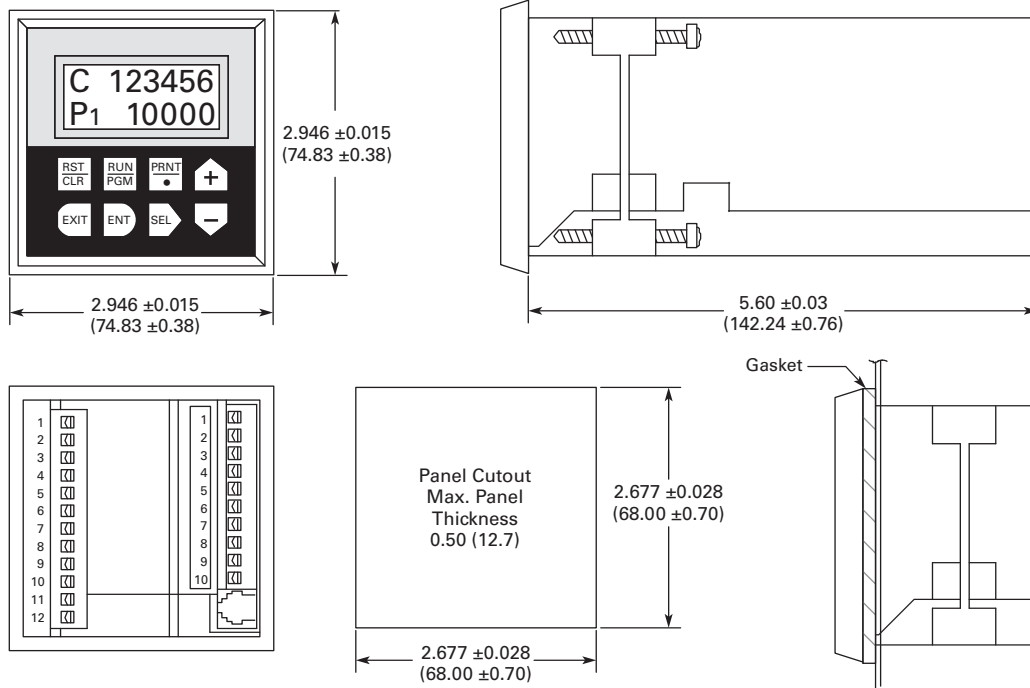

PD-Q and PD-ER Series

Product Description

The PD-Q Series is a five-digit, true subtracting electric predetermined counter that features pushbutton operation of both predetermined count settings and reset. The predetermined count is set by holding the RESET button in and then depressing the easy to operate pushbutton selectors under each digit.

The unit subtracts, one count for each contact closure or impulse and actuates a 4 ampere, 250 Vac switch when zero is reached.

The output signal from this switch can be used to halt or change the flow of items being counted, and/or operate other electrical apparatus. The counter returns to the predetermined number when the RESET button is depressed and it is immediately ready to control the next lot or batch.

The PD-ER Series is identical to the PD-Q Series, except that it has electric reset (ER) for remote operation, allowing either local or remote use.

Features

- Easy setpoint adjustment
- Available in base mount or panel mount configurations

Standards and Certifications

- UL recognized as indicated



Product Selection

When Ordering Specify

When ordering PD-Q and PD-ER Series Predetermined Counters, specify catalog numbers according to the features selected.

Shaded area denotes obsolete or discontinued products and services.

5-Y-41433-*PD-Q



PD-Q and PD-ER Series Predetermined Counters

Voltage	Mounting	Wire Leads	Catalog Number	Order Number
12 Vdc	Panel	Rear	5-Y-41433-401-PD-Q	41433401
24 Vdc	Panel	Rear	5-Y-41433-402-PD-Q	41433402 ①
120 Vac	Panel	Rear	5-Y-41433-406-PD-Q	41433406 ①
240 Vac	Panel	Rear	5-Y-41433-407-PD-Q	41433407
24 Vac	Panel	Rear	5-Y-41433-408-PD-Q	41433408
24 Vdc	Base	Rear	5-Y-41469-402-PD-Q	41469402 ①
120 Vac	Base	Rear	5-Y-41469-406-PD-Q	41469406 ①
240 Vac	Base	Rear	5-Y-41469-407-PD-Q	41469407
24 Vdc	Base	Side	5-Y-41470-402-PD-Q	41470402 ①
120 Vac	Base	Side	5-Y-41470-406-PD-Q	41470406 ①
240 Vac	Base	Side	5-Y-41470-407-PD-Q	41470407
24 Vdc	Panel	Rear	5-Y-41625-402-PD-ER	41625402 ①
120 Vac	Panel	Rear	5-Y-41625-406-PD-ER	41625406 ①
240 Vac	Panel	Rear	5-Y-41625-407-PD-ER	41625407

Note

① UL recognized.

Technical Data and Specifications

General Specifications

Description	Specification
Number of digits	Five
Speed	1000 cpm
Window	Acrylic
Shaft	Stainless steel
Frame	Zinc alloy die cast
Digit size	3/16 in high by 7/64 in wide (4.8 x 2.8 mm)
Weight	
Series PD-Q	0.53 lb (0.24 kg)
Series PD-ER	1.06 lb (0.48 kg)
Finish	Dull Instrument black with red RESET button
Power consumption	
Series PD-Q	9 watts
Series PD-ER	Count coil 9 watts, reset coil 20 watts
Switch rating	SPDT, 4 amperes at 250 Vac

Dimensions

Approximate Dimensions in Inches (mm)

PD-Q and PD-ER Series

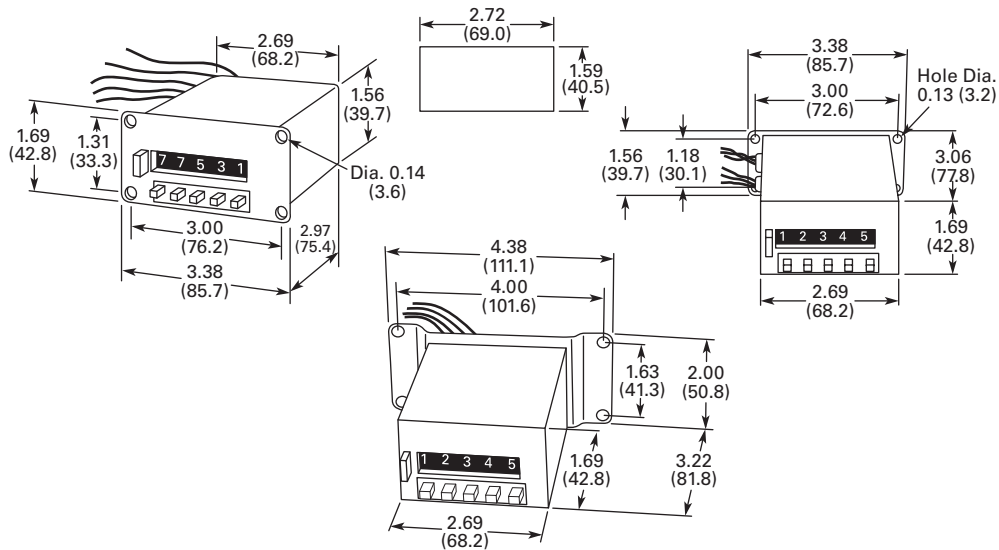

Tachometers/Ratemeters



Contents

Description

Page

Count Controls/Preset Counters

Product Selection Guide	V12-T24-63
Courier Series	V12-T24-64
Eclipse Series	V12-T24-66
Ambassador Series	V12-T24-69



Learn
Online

Product Overview

Ratemeters are used in a variety of applications where it is necessary to monitor the speed of a process. Conveyors, baking ovens, material flow and motor speed are typical uses for ratemeters. Models with alarm outputs can be used to detect high or low rates. Rate indicators are often included as a standard feature on totalizers and count controls.

Typical Application

One of the most common ratemeter applications is a tachometer. A tachometer displays motor or shaft RPM. The inductive proximity sensor detects the key on the shaft and the meter calculates the rate at which the shaft is turning based on a user-defined scaling factor. Signals from encoders, mag pickups, Hall effect sensors, etc. may also be used as inputs.

Application Example

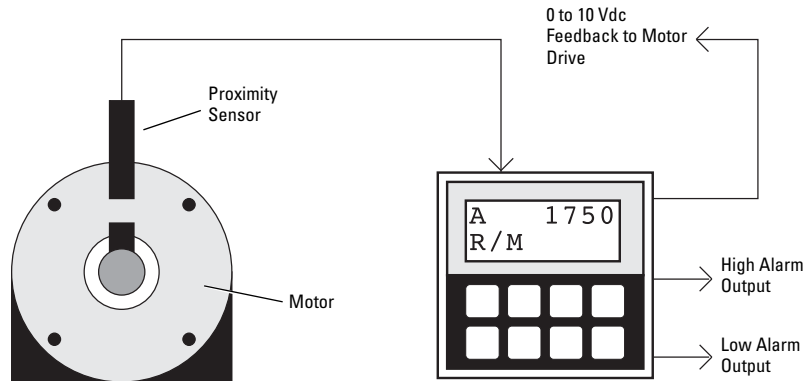

Product Selection Guide

Tachometers/Ratemeters

	Characteristics	Panel Cutout in Inches (mm)	Page
E5-24-E 	Compact device with bright, LED display Multiple functions available: count, time, rate, multifunction, double-function 24 Vdc Power	0.870 x 1.772 (22 x 45)	V12-T24-38
E5-496-E 	Economical, multifunction display Large, LED characters AC or DC power options	1.772 x 3.780 (45 x 96)	V12-T24-42
E5-148-C 	Low cost, simple count control Various power options: battery, AC, DC Easy-to-change preset values Two-line display: input and preset values	1.772 x 1.772 (45 x 45)	V12-T24-46
Courier 	Replaceable lithium battery Eight-digit, high-visibility LCD display Optional backlighting Various input options available	1.299 x 2.677 (33 x 68)	V12-T24-64
Eclipse 	Six-digit, super bright LED display Multiple models available: totalizers, ratemeters, count controls, digital panel meters and flow controls	1.772 x 3.780 (45 x 96)	V12-T24-66
Ambassador 	Six-digit, high-visibility, two-line LCD display User-configurable control inputs Highly flexible control/display	2.667 x 2.667 (68 x 68)	V12-T24-69
Fusion 	Integrated controller combines operator interface, ladder logic and high-speed counting	2.667 x 5.433 (68 x 138)	V12-T24-91

Courier Series**Product Description**

Eaton's Courier Series is powered by a replaceable lithium battery.

Features

- 1/Tau ratemeter
- Scaling capabilities
- Remote reset terminal
- 0.43 in (10.9 mm) display
- Front panel reset
- NEMA 4X

Standards and Certifications

- CE marked

**Product Selection****Courier Series****LCD 1/Tau Ratemeter** ^①

Description	Catalog Number
Battery	53300404
Extended temperature range, battery	53301404
Backlight, battery	53302404

Technical Data and Specifications**General Specifications**

Description	Specification
Power	
Internal battery	3V, Lithium
Life expectancy	5 years +
Replacement part	35367-202
Backlight	
Backlight	10–30 Vdc at 30 mA max. ^②
	Reverse polarity protected
Physical	
Operating temperature	
Model 53300-404	32 to 131 °F (0 to 55 °C)
Model 53301-404	–4 to 158 °F (–20 to 70 °C)
Model 53302-404	32 to 131 °F (0 to 55 °C)
Storage temperature	–4 to 158 °F (–20 to 70 °C)
Operating humidity	60% RH (noncondensing)
Weight	2.2 oz. (62 g) net
Display size	0.43 in (10.9 mm) high
Front panel rating	NEMA 4X when mounted with gasket provided
Case material	Cyclac X-17
Rate Indicator	
Type	1/Tau
Digits	4/5 (four calculated, five displayed with fixed 0 in LSD)
Scaler range	0.001 to 9999
Decimal point	Five positions, programmable
Accuracy	±0.2%
Update time	0.7 seconds
Zero time	10 seconds

Notes

^① For units with rate and total, see Totalizers.

^② Derate operating temperature 1 °C/Volt above 17 Vdc.

General Specifications, continued

Description	Specification
DC Common (Terminal 1) Rate Inputs	
Input B (terminal 2) low speed input designed for contact closures to DC common	
Speed	0 to 20 Hz
Min. low time	10 ms
Min. high time	40 ms
Input impedance	101k ohm
Voltage thresholds	
Low	0–0.4 Vdc
High	2.0–28 Vdc
Max. high	28 Vdc
Input A (terminal 3) high speed input requiring a voltage source such as a current sourcing sensor or a current sinking sensor used with the provided pull up resistors	
Speed	0 to 10 Hz ^①
Min. low time	80 ms ^①
Min. high time	20 ms ^①
Input impedance	2 Kohms above 5 Vdc
Voltage thresholds	
Low	0–1.2 Vdc
High	2.0–28 Vdc
Max. high	28 Vdc
Programmable Enable Input (Terminal 5)	
Operation	Level sensitive (maintained)
Count Accuracy	
Operated within specifications	100%

Dimensions

Approximate Dimensions in Inches (mm)

Courier Series Ratemeter

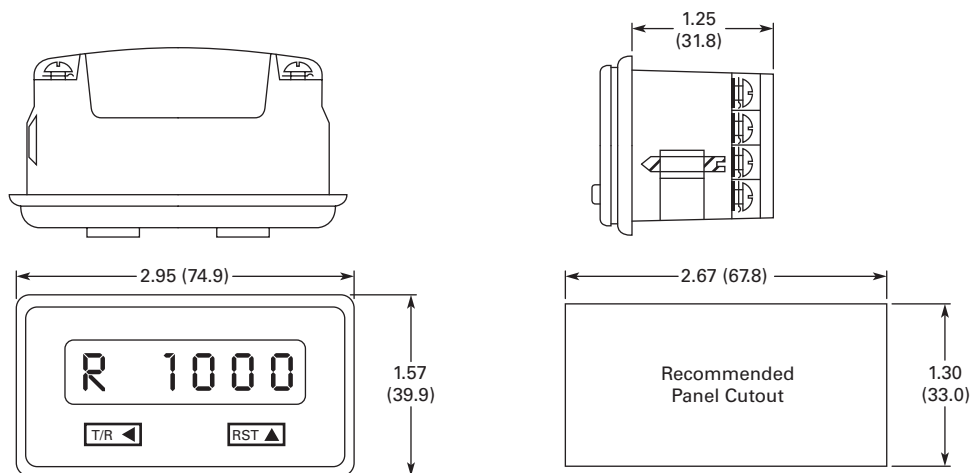
**Note**

① Times are with a 0–5.0V swing.

Eclipse Series

Product Description

Eaton's Eclipse Series offers a high visibility LED and a variety of optional outputs.

Features

- 1/8 DIN cutout
- NEMA 4X front panel
- Universal AC power supply (85–265 Vac)
- Removable screw terminals
- Short depth: 3.6 in (91 mm)
- Front panel programming

Standards and Certifications

- UL and cUL listed
- CE marked



Product Selection

57700470



Eclipse Series Five-Digit LED Ratemeter

Description	Catalog Number
85–265 Vac	57701470
85–265 Vac, alarms	57701471
85–265 Vac, analog out	57701472
85–265 Vac, alarms, analog out	57701473

Technical Data and Specifications

General Specifications

Description	Specification
Input Power	
AC powered models (57701-4XX)	
Input power	85–265 Vac, 47–63 Hz, 20 V A
External fuse	0.2A, 250 Vac, time delay (T200 mA, 250V)
Isolation dielectric strength	2300 Vac
Human Interface	
Display	Five digits
Type	0.56 in high, seven segment, red LED
Indicator	One red LED program/calibration indicator
Update time	0.1 to 99.9 seconds minimum
Data Retention	
Memory type	EEPROM, no batteries required
Duration	100 years
Signal Input	
Rate/process time	Signal in
Sensor type	Sink or source, DIP switch selectable
Input impedance	4.75 Kohms to +5 Vdc or 34.9 Kohms to ground
Thresholds	
High	3.5 to 28 Vdc
Low	0 to 1.9 Vdc, for single ended signals
Magnetic pickup range	200 mV p-p to 65V rms into 34.9 Kohms
Frequency response	200 Hz max. or 10 kHz max. (5V signals), DIP switch selectable
Program Enable Input	
Sensor type	Sink only
Input impedance	4.75 Kohms to +5 Vdc
Thresholds	
High	3.5 to 28 Vdc
Low	0 to 1.9 Vdc
Response	25 ms max. (5V signal)

General Specifications, continued

Description	Specification
Accessory Power Output	
Voltage	12 Vdc \pm 12%
Current	75 mA max.
Protection	Short-circuit protected
Optional Outputs	
Relay board	
Number of relays	Two
Contact type	1 set Form C per relay
Contact rating	5 A, 250 Vac or 30 Vdc
Isolation dielectric strength	2300 Vac
Analog retransmission	
Output signals	4–20 mA (<750 ohms) and 0–10 V (>2500 ohms)
Accuracy	0.13% full scale and 100 PPM/ $^{\circ}$ C (and 0.07% full scale change over 4–20 mA load ranges)
Isolation dielectric strength	2300 Vac to signal inputs, relays and AC power inputs; 500 Vac to RS-485 and DC power inputs
RS-485 serial communications	
Baud rate	1200, 2400, 4800, 9600, or 19,200, programmable
Parity	Even, odd or no parity
Address range	00 to 99 decimal
Protocol	Opto 22 [®] compatible
Isolation dielectric strength	2300 Vac to signal inputs, relays and AC power inputs; 500 Vac to analog outputs and DC power inputs
Environmental	
Operating environment	Indoor use to 2000 meters
Temperature	
Operating	32 to 122 $^{\circ}$ F (0 to 50 $^{\circ}$ C)
Storage	–4 to 158 $^{\circ}$ F (–20 to 70 $^{\circ}$ C)
Humidity	0 to 85% RH, noncondensing
Vibration	2.5 Gs, 30 to 200 Hz
Shock	30 Gs, 11 ms half sinewave
EMC	
	Immunity to EN 50082-2 (heavy industrial)
	Emissions to EN 50081-2 (heavy industrial)
Front panel	NEMA 4X when mounted with gasket provided
CE EMC immunity and emissions requirements	Met using shielded wiring on the RS-485, analog output and pulse input/ power lines. The shields were connected to earth ground at the Eclipse end of the shields.
Pollution degree 2	Overvoltage Category II

Dimensions

Approximate Dimensions in Inches (mm)

Eclipse Series Ratemeter

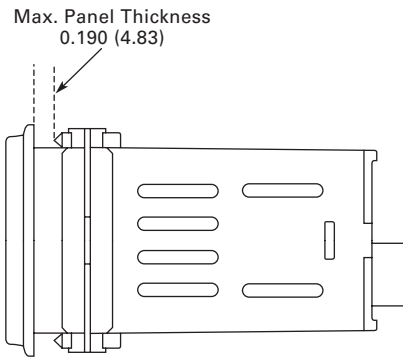
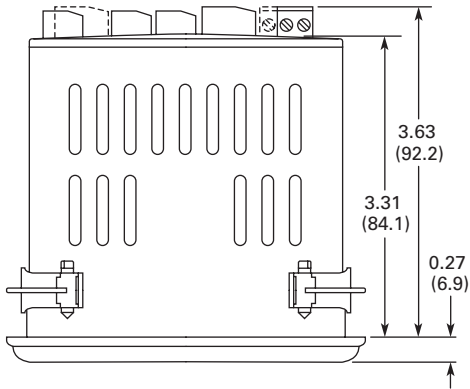
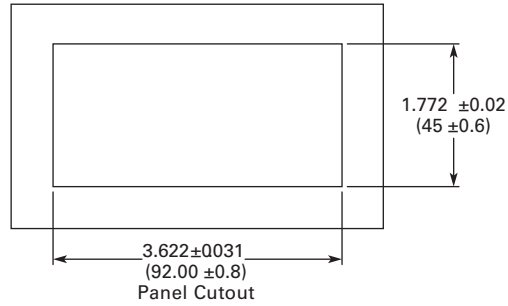
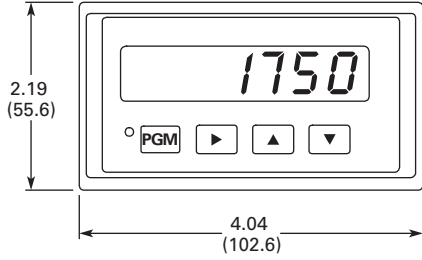

Ambassador Series

Product Description

Eaton's most noise-immune ratemeter with an easy-to-read two-line LCD.

Features

- AC/DC powered, two-line LCD display
- Two-line, five-digit, high visibility, 0.3 in (7.5 mm) characters, backlit display
- One or two rate inputs
- Two rate alarms
- Programmable average and zero times
- Programmable decimal point
- 12 Vdc, 100 mA max. output power
- Removable screw terminals
- RS-485 communications
- NEMA 4 front panel

Standards and Certifications

- UL and cUL listed
- CE marked



Product Selection

57150400

Ambassador Series Ratemeter



Description	Catalog Number
Single Input	
LCD rate indicator, 2 rate alarms, 10–15 Vdc	57150400

Technical Data and Specifications

General Specifications

Description	Specification
Power Input	
Model 57150-40X	10 to 15 Vdc, 300 mA maximum
DC Power Output (AC Models Only)	
Output	12 Vdc ($\pm 25\%$), 100 mA maximum (includes all line and load variations)
Environment	
Operating temperature	32 to 131 °F (0 to 55 °C)
Storage temperature	-4 to 158 °F (-20 to 70 °C)
Operating humidity	85% relative, noncondensing
NEMA 4 rating	When mounted with gasket provided
Ratemeter	
Type	1/Tau
Digits	Five with overrange indication
Scaler range	0.00001 to 99999
Decimal point	Five positions, programmable
Average time	0.1 to 99.9 seconds, programmable
Zero time	0.1 to 99.9 seconds, programmable
Accuracy	$\pm 0.015\%$ of reading
Maximum Rate Input Frequencies	
Maximum frequencies	All maximum frequencies listed are with a square wave input (50-50 duty cycle)
Contact Input	
Contact input	40 Hz

General Specifications, continued

Solid-State Input

Sinking sensor (all DIPs off)	7.3 kHz
Sourcing sensor (push-pull output)	
High threshold (DIPs 1 and 2 on, 3 and 4 off)	0–5V, single input 50 kHz
	0–5V, two inputs 30 kHz (each input)
	0.5–4.5V, single input 40 kHz
	0.5–4.5V, two inputs 30 kHz (each input)
	0–15V, two inputs 22 kHz (each input)
Low threshold (all DIPs on)	–1 to +1V, single input 27 kHz
	–2 to +2V, single input 43 kHz
	≤–3 to ≥+3V, single input 60 kHz
	≤–2 to ≥+2V, two inputs 30 kHz (each input)

Rate Inputs

Sink	
Impedance	4.6 Kohms to +5 Vdc
Voltage	High 3.5 to 34.0, low 0.0 to 1.9 Vdc
Source (high)	
Impedance	2.3 Kohms to common
Voltage	High 3.5 to 17.0 Vdc, low 0.0 to 1.9 Vdc
Source (low)	
Impedance	2.3 Kohms to common
DC voltage	High 0.63 to 17.0 Vdc, low –17.0 to –0.6 Vdc
AC voltage	17 Vac (48V peak-peak) maximum

Control Inputs

Impedance	4.7 Kohms to +5 Vdc
Voltage	High +3.7 to +24 Vdc, low 0.0 to 0.9 Vdc
Response	Min, low 15 ms, min, high 15 ms

Transistor Outputs (x2 for 5715X-401; x4 for 5715X-405)

Type	NPN open collector with transient protection
Max. voltage (OFF state)	30 Vdc
Max. current (ON state)	200 mA at 1.3 Vdc

Communication

Type	RS-485
Format	One start bit, seven data bits (ASCII), one parity bit, one stop bit
Protocol	Opto-22 [®] compatible
Speed	300, 1200, 2400, 4800, 9600, 19200 baud
Parity	Odd, even, none (space transmitted, ignore received)

Analog Output (Models 5715X-401 Only)

Range	0–10 Vdc ± 0.2% at 5 mA
DAC resolution	12 bit

Connections

Type	Dual depluggable screw terminal strips
Conductor size	14–22 AWG (2.1–0.38 mm ²), 600V, solid, stranded or fused (preferred)

Dimensions

Approximate Dimensions in Inches (mm)

Ambassador Series Ratemeters

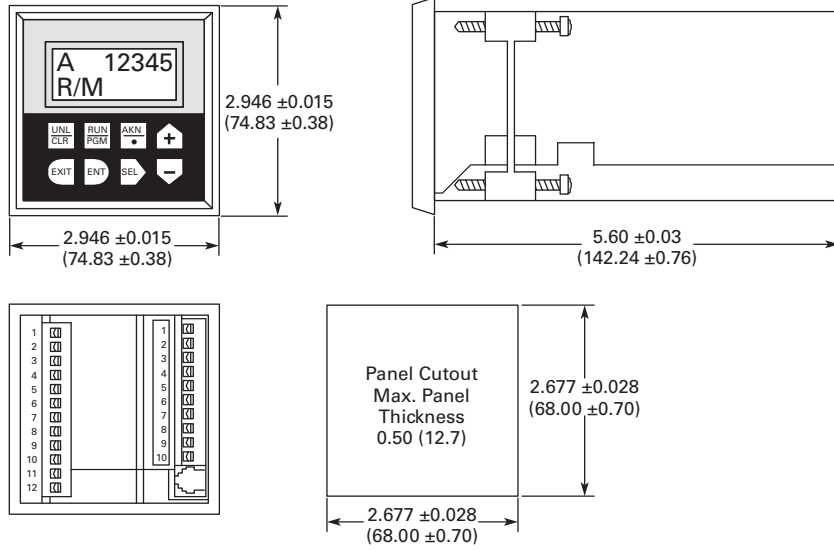

Digital Panel Meters



Contents

Description

Page

Count Controls/Preset Counters

E5-324-E Series **V12-T24-73**

Eclipse Series **V12-T24-75**



Product Overview

Digital Panel Meters are found anywhere a process variable needs to be indicated. Volts, current, pressure, volume, temperature and frequency are typical applications. The product's short depth makes it flexible and accommodating to panel builder needs. A variety of input and output options allows DPMs to be used virtually anywhere.

Typical Application

- Monitor current draw from motor to identify potential failures
- Display pressure reading from transducer with high-pressure alarm
- Display system voltage and detect under voltage or over voltage conditions

Product Selection Guide

Digital Panel Meters

	Characteristics	Panel Cutout in Inches (mm)	Page
E5-324-E	Bright, easy-to-read LED in 1/32 DIN package Programmable scaling of inputs Input for display-hold 24 Vdc power	0.870 x 1.772 (22 x 45)	V12-T24-73
Eclipse	Six-digit, super bright LED display Multiple models available: DC voltage, AC voltage, DC current, AC current, 5 A AC current, 4–20 mA/0–10 V process meter Various output options including relay, analog and RS-485	1.772 x 3.780 (45 x 96)	V12-T24-75



E5-324-E Series**Product Description**

Eaton's most compact panel meter provides an easy-to-read LED in a very small package.

Features

- Galvanic isolation with protection against incorrect polarity
- Automatic MIN/MAX value detection
- Freely programmable characteristic curve end points
- Input Range—
 - Single current measuring input (0/4–20 mA)
 - Single voltage measuring input (0/2–10V)
- Compact display for analog standard signals
- Display range –19.999 to 99.999 with zero blanking
- Modern industrial design
- Input for display-hold

Standards and Certifications

- UL recognized
- CE marked

**Product Selection****E5-324-E0402****E5-324-E0402 Digital Panel Meter**

Description	Catalog Number
LED digital panel meter, 24 x 48 mm	E5-324-E0402

Technical Data and Specifications**General Specifications**

Description	Specification
Supply voltage	10–30 Vdc, galvanically isolated with integrated protection against incorrect polarity
Current consumption	Max. 50 mA
Display	Five-digit display, red seven-segment LEDs; 0.31 in (8 mm) high
Measuring rate	Two measurements/second
Data backup	EEPROM
Housing	Housing for control panel 1.898 x 0.94 in (48 x 24 mm); acc. to DIN 43 700, RAL 7021, dark gray
Ambient temperature	14 to 122 °F (–10 to 50 °C)
EMC	According to EC EMC directive 89/36/EEC
Interference emissions	EN 61 000-6-4/EN 55011 Class B
Interference resistance	EN 61 000-6-2
Protection	IP65 (front)
Input current measurement	0–20 mA, 4–20 mA, voltage drop max. 1.5 Vdc
Input voltage measurement	0–10V, 2–10V
Input resistance approx.	1M ohm
Max. input signal level	30 Vdc
Control inputs	
High	4–30 Vdc
Low	0–2 Vdc
Resolution	14 bits
Error	<0.1% for the whole measuring range at an ambient temperature of 68 °F (20 °C)
Weight: Approx	1.76 oz (50 g)
Connection technique	Screw terminal, pitch 0.2 in (5.08 mm), seven-poles

Dimensions

Approximate Dimensions in Inches (mm)

E5-324-E Series

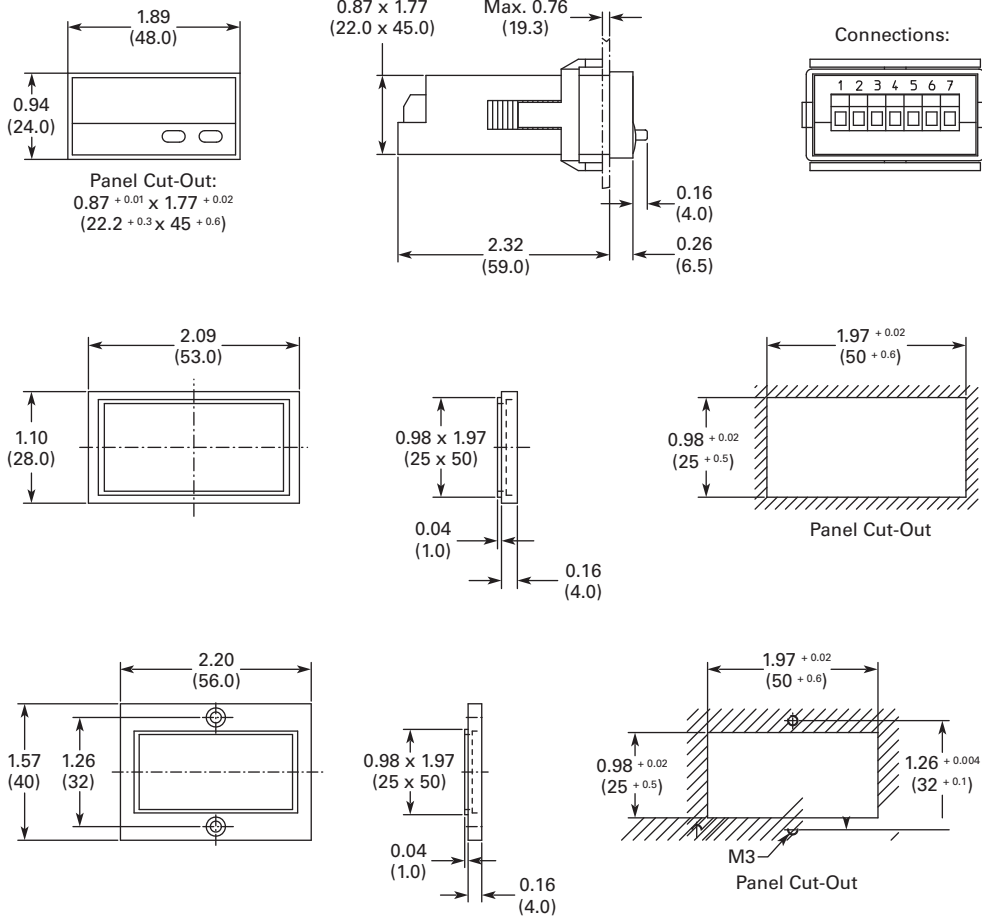

Eclipse Series

Product Description

Eaton's Eclipse Series panel meter features a high-visibility LED and is available with a variety of input and scaling options.

Features

- Four full digits
- 1/8 DIN Size
- Red, LED display
- 0.56 in (14 mm) high characters
- Scalable display
- Flashing alarms
- Maximum/minimum data hold
- Optional analog, relay and RS-485 outputs
- NEMA 4X
- Depluggable terminal blocks

Standards and Certifications

- UL and cUL listed
- CE marked



Catalog Number Selection

Eclipse Series

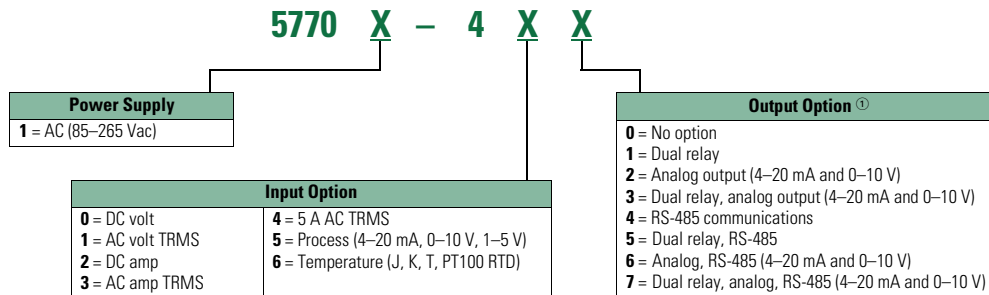

Product Selection

Shaded area denotes obsolete or discontinued products and services.

Eclipse Series Panel Meter



Eclipse Digital Panel Meter

Description	Catalog Number
85–265 Vac, DC volt	57701400
85–265 Vac, DC volt, relay out	57701401
85–265 Vac, DC volt, analog out	57701402
85–265 Vac, AC volt	57701410
85–265 Vac, AC volt, analog out	57701412
85–265 Vac, DC amp	57701420
85–265 Vac, 5 A AC	57701440
85–265 Vac, 5 A AC, relay out	57701441
85–265 Vac, 5 A AC, analog out	57701442
85–265 Vac, 5 A AC, analog out, relay out	57701443

Eclipse Process

Description	Catalog Number
85–265 Vac	57701450
85–265 Vac, relay out	57701451
85–265 Vac, analog out	57701452
85–265 Vac, analog out, relay out	57701453

Note

① Output options 0, 2, 4 are not available for models -41X and -43X.

Technical Data and Specifications

General Specifications

Description	Specification
Input Power	
AC powered models (57751-4XX)	
Input power	85–265 Vac, 47–63 Hz, 20 VA
External fuse	0.2 A, 250 Vac, time delay (T200 mA, 250 V)
Isolation dielectric strength	2300 Vac
Human Interface	
Display	±4 full digits
Type	0.56 in (14 mm) high, seven segment, red LED
Update time	0.4 seconds
Alarm	Flashing display
Indicator	One red LED program/calibration indicator with max./min. capture and hold
Data Retention	
Memory type	EEPROM, no batteries required
Duration	100 years
Signal Input	
DC voltage models (5770X-40X)	
Range	±199.9 m Vdc, ±1.999 Vdc, ±19.99 Vdc, ±199.9 Vdc, DIP switch selectable
Impedance	1M ohm
Overrange	750 Vdc/530 Vac except 220 Vdc/Vac on 199.9 mV range
Accuracy	±0.1% of reading, ±0.03% FS, ±0.5 digit, and ±80 PPM/°C
AC voltage models (5770X-41X)	
Range	199.9 m Vac, 1.999 Vac, 19.99 Vac, 199.9 Vac, DIP switch selectable, all ranges true rms
Frequency	40 to 1000 Hz
Impedance	1M ohm (capacity coupled)
Overrange	750 Vdc/530 Vac except 220 Vdc/Vac on 199.9 mV range
Accuracy	±0.5% of reading, ±0.13% FS, ±0.5 digit, ±180 PPM/°C for crest factor = 1; plus ±0.7% for crest factor = 1 to 3; and ±2.5% for crest factor = 5
DC current models (5770X-42X)	
Range	±199.9 µA DC, ±1.999 mA DC, ±19.99 mA DC, ±199.9 mA DC, DIP switch selectable
Impedance	199.9 mV/selected range
Overrange	30 mA (199.9 µA range), 100 mA (1.999 mA range), 300 mA (19.99 mA range), 1 A (199.9 mA range)
Accuracy	±0.1% of reading, ±0.03% FS, ±0.5 digit, and ±120 PPM/°C
AC current models (5770X-43X)	
Range	199.9 µA AC, 1.999 mA AC, 19.99 mA AC, 199.9 mA AC, DIP switch selectable, all ranges true rms
Frequency	40 to 1000 Hz
Impedance	199.9 mV/selected range (shunt output capacitive coupled)
Overrange	30 mA (1199.9 µA range), 100 mA (1.999 mA range), 300 mA (19.99 mA range), 1 A (199.9 mA range)
Accuracy	±0.5% of reading, ±0.13% FS, ±0.5 digit, and ±200 PPM/°C for crest factor = 1; plus ±0.7% for crest factor = 1 to 3; and ±2.5% for crest factor = 5

General Specifications, continued

Description	Specification
Signal Input, continued	
5 A AC models (5770X-44X)	
Range	5 A AC, true rms
Frequency	40 to 1000 Hz
Impedance	0.02 ohm (shunt output capacitive coupled)
Overrange	10 A maximum
Accuracy	$\pm 0.4\%$ of reading, $\pm 0.13\%$ FS, ± 0.5 digit, and ± 200 PPM/ $^{\circ}$ C for crest factor = 1; plus $\pm 0.7\%$ for crest factor = 1 to 3; and $\pm 2.5\%$ for crest factor = 5
Process models (5770X-45X)	
Range	4–20 mA DC, 0–10 Vdc, 1–5 Vdc; separate input terminals for voltage and current signals
Impedance	100 ohms (current input) and 1.27 Mohms (voltage input)
Overrange	50 mA maximum (current input) and 100 V maximum (voltage input)
Power output	24 Vdc $\pm 10\%$, 90 mA max, short-circuit protected
Accuracy	$\pm 0.1\%$ of reading, $\pm 0.03\%$ FS, ± 0.5 digit, and ± 80 PPM/ $^{\circ}$ C
Optional Outputs	
Relay board	
Dual relay	1 set of Form C contacts each
Contact rating	5 A, 250 Vac or 30 Vdc
Isolation dielectric strength	2300 Vac
Analog retransmission	
Output signals	4–20 mA (<750 ohms) and 0–10 V (>2500 ohms)
Accuracy	0.13% FS, 100 PPM/ $^{\circ}$ C, 0.07% FS change with 4–20 mA load, $\pm 0.3\%$ FS for 4–20 mA output, only after exposure to 85% relative humidity
Isolation dielectric strength	2300 Vac to signal inputs, relays and AC power input; 500 Vac to RS-485 and DC power inputs
RS-485 serial communication	
Baud rate	1200, 2400, 4800, 9600 or 19,200, programmable
Parity	Even, odd or no parity
Address range	00 to 99 decimal
Protocol	Opto 22 [®] compatible
Isolation dielectric strength	2300 Vac to signal inputs, relays, and AC power input; 500 Vac to analog outputs and DC power inputs
Environmental	
Operating environment	Indoor use to 2000 meters
Temperature	
Operating	32 to 122 $^{\circ}$ F (0 to 50 $^{\circ}$ C)
Storage	–4 to 158 $^{\circ}$ F (–20 to 70 $^{\circ}$ C)
Humidity	0 to 85% RH, noncondensing
Vibration	2.5 Gs, 30 to 200 Hz
Shock	30 Gs, 11 ms half sinewave
EMC/EMI	Per EN 61326-1 industrial
Front panel	NEMA 4X when mounted with gasket provided
Agency approval	CE EMC immunity and emissions requirements were met using shielded wiring on the RS-485, analog output and signal input lines. The shields were connected to earth ground at the Eclipse end of the shields. Conducted emissions requirements were met assuming that the AC signal input would not be connected directly to the AC mains. The measurement error during RF immunity testing was less than $\pm 5\%$ of full scale. In addition, models with an AC signal input had measurement error of less than +25% of full scale during RF immunity testing of the RS-485 at frequencies below 1 MHz.
Pollution degree 2	Overvoltage Category II

Dimensions

Approximate Dimensions in Inches (mm)

Eclipse Series

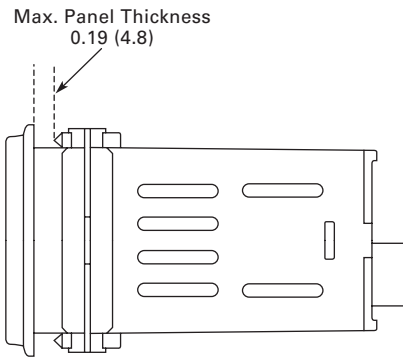
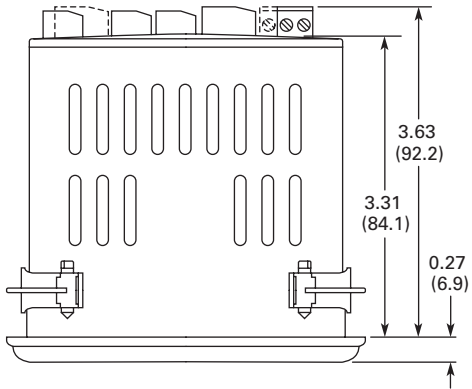
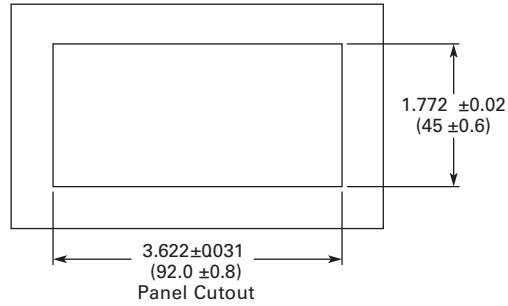
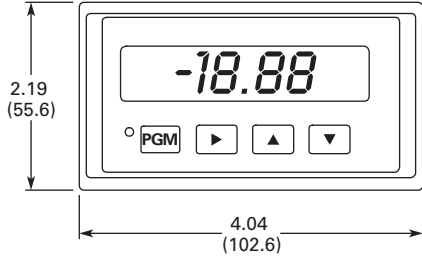

Timers/Hour Meters



Contents

Description**Page**

Timers/Hour Meters

Product Selection Guide **V12-T24-80**Electronic Timers/Hour Meters **V12-T24-81**Electromechanical Timers/Hour Meters **V12-T24-86**Learn
Online**Product Overview**





Timers are used in applications where time itself is the main focus. These include simple knowledge of how long a machine has been running to determine machine maintenance, for example, (elapsed time) to knowing when to change an elevator cable (cable life and safety). Timers generally have the ability to stop and then to continue on from the point at which they stopped. Timer relays are used in applications where an output is required to make something happen at a predetermined point in time (to stop or start the process).

Typical Application

- Elapsed time indication for interval maintenance of construction and agricultural equipment
- Usage metering for determining charges on rental equipment
- Controlled process timing for adhesive application/ curing equipment

Product Selection Guide

Timers/Hour Meters

	Characteristics	Panel Cutout in Inches (mm)	Page
E5-24-E 	Compact device with bright, LED display Multiple functions available: count, time, rate, multifunction, double-function 24 Vdc Power	0.870 x 1.772 (22 x 45)	V12-T24-38
E5-496-E 	Economical, multifunction display Large, LED characters AC or DC power options	1.772 x 3.622 (45 x 92)	V12-T24-42
E5-224-C 	Non-replaceable battery (minimum eight-year life) Compact, low cost and high efficiency Eight-digit LCD timer Manual or electrical reset Various timing modes (Hr/Min/Sec)	0.870 x 1.772 (22 x 45)	V12-T24-82
Hour Meters 	Compact, low-cost LCD and electromechanical elapsed time meters Various power options for almost any power supply	Various	V12-T24-86
Hour Meter/Counter 	Combination counter consists of time meter and adding counter in one Without reset High shock resistance Magnified figures Protection IP52 (front) Data retention if power is lost Long service life UL Approved	1.988 (50.5) dia. or DIN rail	V12-T24-90

Electronic Timers/Hour Meters



Contents

<i>Description</i>	<i>Page</i>
Electronic Timers/Hour Meters	
1/32 DIN LCD—Timers	V12-T24-82
E42D124/E42DIR Series	V12-T24-84
Electromechanical Timers/Hour Meters	V12-T24-86

Electronic Timers/Hour Meters

Product Overview

Eaton’s electronic hour meters are a simple and effective way to monitor equipment on time.

Features

- Reset or non-reset
- Variety of power options
- LCD displays

Standards and Certifications

- UL recognized
- CE



1/32 DIN LCD—Timers

Product Description

Simple battery-powered timers provide an easy-to-read LCD and a variety of timing display options.

Features

- Low price and high efficiency
- Large eight-digit LCD display, height of the figures 0.31 in (8 mm)
- Different time ranges from 0.1 second to 100,000 hours
- 0.1 second synchronization makes it suitable for very short activation times
- High voltage input for 10–260 Vac/Vdc voltage pulses
- IP65
- Screw terminals, RM 5 mm
- Lifetime of the battery approximately eight years
- Locking of the reset key
- Operating temperature 14 to 140 °F (–10 to 60 °C)

Standards and Certifications

- UL recognized
- CE marked



Product Selection

E5-224-C04



1/32 DIN LCD Timers

Description	Catalog Number
Eight-Digit LCD Timer, Battery Power	
Hours/minutes, 0.94 x 1.89 in (24 x 48 mm)	E5-224-C0440
Hours/minutes, 10–260V input, 0.94 x 1.89 in (24 x 48 mm)	E5-224-C0448
Minutes/seconds, 0.94 x 1.89 in (24 x 48 mm)	E5-224-C0450
Minutes/seconds, 10–260V input 0.94 x 1.89 in (24 x 48 mm)	E5-224-C0458

Technical Data and Specifications

General Specifications

Description	Specification
Power supply	Non-replaceable lithium battery (lifetime approximately eight years at 68 °F (20 °C))
Display	LCD, eight-digits
Figure size	0.31 in (8 mm) high
Counting direction	Adding
Display range	
Time range	99999h 59m (134)
Display	99999 - 59
Time range	99999.99h (134)
Display	99999 - 99
Time range	9999h 59m 59s (135)
Display	9999.59.59
Time range	9999999.9s (135)
Display	9999999.9
Reset	Manual and electrical
Timer inputs, DC versions (max. 30 Vdc)	
Timer input	NPN or PNP depending on the type
Switching level	
NPN low	0–0.7V
NPN high	3–30 Vdc
PNP low	0–0.7V
PNP high	4–30 Vdc
Counting start	
NPN	For low signal at the timer input
PNP	For high signal at the timer input

General Specifications, continued

Description	Specification
Timer inputs, high voltage version (10–260 Vdc/Vac)	
Timer input	Optocoupler input max. 30 Hz
Min. pulse time	16 ms
Switching level	
Low	0–2 Vdc/Vac
High	10–260 Vdc/Vac
Counting start	For high signal at the timer input
Time range change (mode)	
Contact input—open collector (switching at 0V)	
NPN low	0–0.7V
NPN high	3–5 Vdc
Time range	Depending on the circuit
Reset Input (only DC and high voltage)	
Minimum pulse time	
DC	50 ms
High voltage	10 ms
Contact input (DC)	
NPN low	0–0.7V
NPN high	3–30 Vdc
High voltage input	10–260 Vdc/Vac
Reset locking input (for DC and AC), electrical reset key locking	
Input not active	Reset key locked
Contact input	Open collector NPN (switching at 0V)
Switching level	
NPN low	0–0.7V
NPN high	3–5 Vdc
Interference emissions	EN 55011 Class B, EN 61 000-6-2, EN 61010 Section 1 (only AC versions)
Housing	Dark gray RAL 7021
Operating temperature	14 to 131 °F (–10 to 55 °C)
Ambient temperature	14 to 140 °F (–10 to 60 °C)
Storage temperature	–4 to 158 °F (–20 to 70 °C)
Protection	IP65 (from front)
Weight	Approx. 1.76 oz (50 g)

Dimensions

Approximate Dimensions in Inches (mm)

1/32 DIN LCD Timers

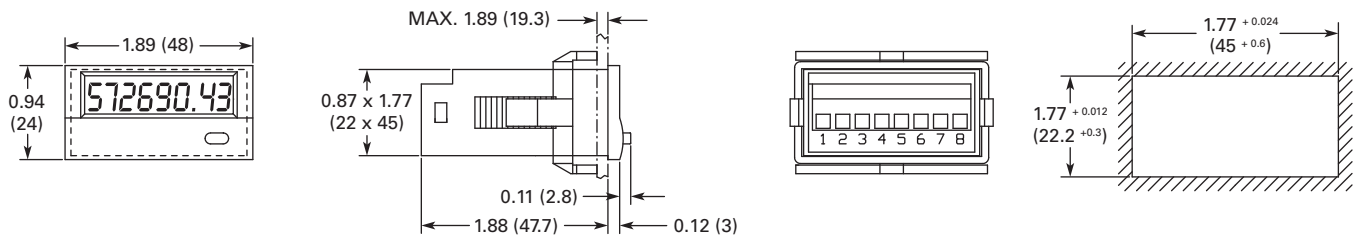

E42DI24/E42DIR Series

Product Description

Simple LCD hour meters with flexible input voltages

Features

- Solid-state hour meters
- Record and display up to 99,999.9 hours, rollover and continue timing
- EEPROM memory can retain data for 25+ years
- Time accumulation indicated by flashing hourglass icon
- Memory will arm only when power has been applied for 5 seconds



Standards and Certifications

- UL recognized
- CE compliant



Product Selection

E42DI24/E42DIR Series Elapsed Time Meters

	Description	Catalog Number
E42DIR 	Round LCD	
	Elapsed hour meter, 48–150 Vdc/100–230 Vac	E42DIR48230
	Elapsed hour meter with reset, 48–150 Vdc/100–230 Vac	E42DIR48230R
	Elapsed hour meter, 12–48 Vdc/20–60 Vac	E42DIR1260
E42DI24 	Rectangular LCD	
	Elapsed hour meter, 48–150 Vdc/100–230 Vac	E42DI2448230
	Elapsed hour meter, with reset, 48–150 Vdc/100–230 Vac	E42DI2448230R
	Elapsed hour meter, 12–48 Vdc/20–60 Vac	E42DI241260

Technical Data and Specifications

General Specifications

Description	Specification
Function	Solid-state hour meter
Power supply	
E42DIX1260X	12–48 Vdc $\pm 25\%$ /20–60 Vac $\pm 25\%$
E42DIX48230X	48–150 Vdc $+23\%$ – 25% /100–230 Vac $+17\%$ – 25%
Frequency range	48–440 Hz
Display	Six-digit LCD, 0.20 in (5 mm)
Accuracy	$\pm 0.1\%$
Recording/display capacity	99,999.9 hours
Resolution	0.1 hour (6 minutes)
Current consumption max. at nominal voltage	
E42DIX1260X	0.8 mA at 12 Vdc 5.0 mA at 48 Vdc 0.5 mA at 20 Vac 2.5 mA at 60 Vac
E42DIX48230X	0.8 mA at 48 Vdc 2.5 mA at 150 Vdc 0.9 mA at 100 Vac 2.0 mA at 230 Vac
Input impedance minimum (pins 3 and 4)	
E42DIX1260X	70 Kohms
E42DIX48230X	480 Kohms
Operating temperature	–40 to 185 °F (–40 to 85 °C)
Storage temperature	–58 to 194 °F (–50 to 90 °C)
Weight	
E42DIRXXXXXX	1.94 oz (55 g)
E42DI24XXXXXX	0.78 oz (22 g)

Dimensions

Approximate Dimensions in Inches (mm)

E42DI24/E42DIR Series

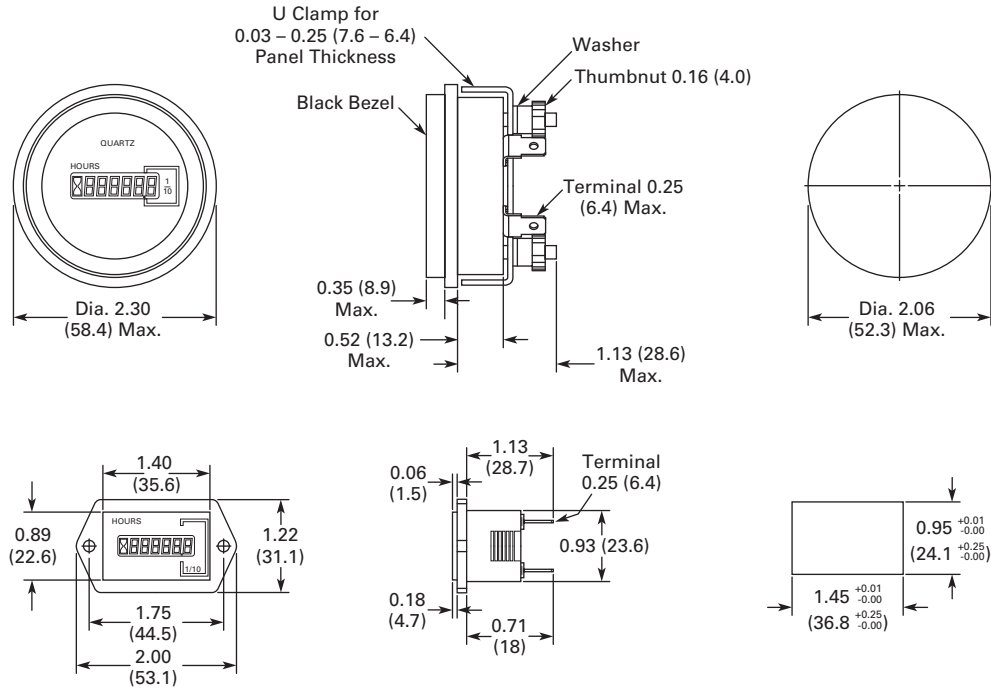

Electromechanical Timers/Hour Meters



Contents

<i>Description</i>	<i>Page</i>
Electronic Timers/Hour Meters	V12-T24-81
Electromechanical Timers/Hour Meters	
1/16 DIN Hour Meters	V12-T24-87
71.1 Round Hour Meters	V12-T24-89
Hour Meter/Counter	V12-T24-90

Electromechanical Timers/Hour Meters

Product Overview

Eaton's electromechanical hour meters are available in a variety of configurations and provide a cost-effective way to monitor equipment on time.

Features

- Non-resettable
- Always readable display

Standards and Certifications

- UL recognized
- CE



1/16 DIN Hour Meters

Product Description

Eaton's most cost-effective elapsed time meter. Features IP65 protection against water intrusion.

Typical Application

- General elapsed time
- Service interval for measurement systems—
 - Respiratory ventilators
 - Oxygen machines
 - Dialysis machines
- Small appliances
- UV lamps
- Display panels in cars

Features

- High shock resistance
- Without reset
- Small dimension
- Magnified figures
- Protection IP65
- Data retention if power is lost
- Long service life
- Optional mounting position

Standards and Certifications

- UL recognized



Product Selection

7-T-65-4848PM-40



1/16 DIN Hour Meters

Description	Catalog Number
10–30 Vdc, 1.89 x 1.89 in (48 x 48 mm)	8-T-65-4848PM-40Z
100–130 Vac, 1.89 x 1.89 in (48 x 48 mm)	7-T-65-4848PM-40E

T4848DINADAPT



DIN Rail Adapter

Description	Catalog Number
DIN rail adapter for DIN electromechanical hour meter	T4848DINADAPT

Technical Data and Specifications

General Specifications

Description	Specification
Electrical connection	Clamp terminal for cable diameter up to 14 AWG (2.5 mm ²), tightening torque max. 0.59 lb-ft (0.8 Nm)
Power consumption	
10–30 Vdc	Approx. 500 mW
100–130 Vdc	Approx. 750 mW
Rated voltages	100–130 Vac, 50 or 60 Hz
	10–30 Vdc
On time	100%
Display	
Seven at AC	99999.99
Eight at DC	999999.99
Accuracy	
AC	Supply frequency + 30 ms
DC	<0.003% (24h)
Count mode	Adding
Figure size	0.16 in (4 mm) high
Color of figures	White and red-on-black
Ambient temperature	5 to 122 °F (–15 to 50 °C)
Mounting position	Any

General Specifications, continued

Description	Specification
Protection	IP65
Housing	Plastic
Weight	1.7 oz (48 g)
Operating indicator of the running time meter	
AC	Fast rotating wheel with red dashes
DC	1/100h display turns continuously by 1-digit in 36 seconds
Test voltage	2000 Vac, 50 Hz for AC counters
Options	Further voltages on request
Color of housing	Gray

Dimensions

Approximate Dimensions in Inches (mm)

1/16 DIN Hour Meters

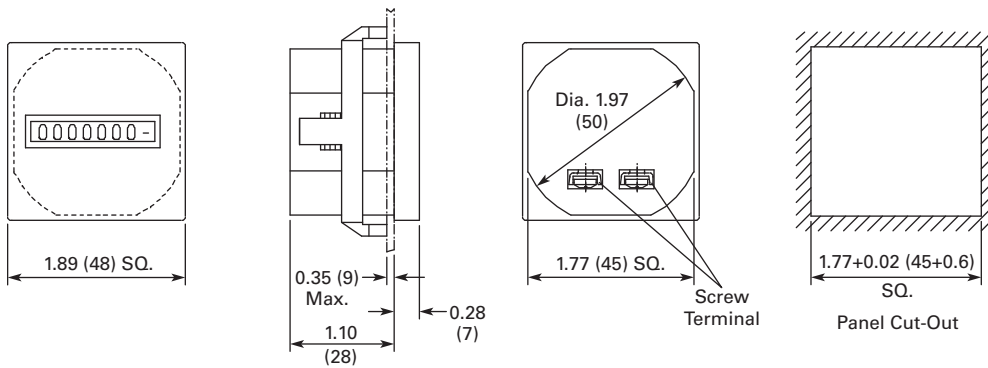

DIN Rail Adapter

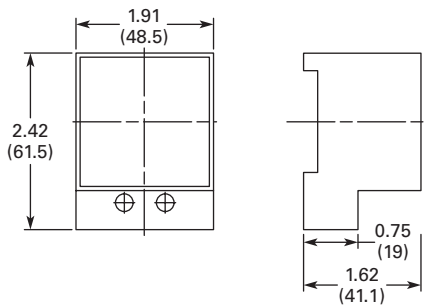

71.1 Round Hour Meters

Product Description

Eaton's 6-T-3H hour meters are heavy-duty elapsed time meters with NEMA 4X protection.

Typical Application

- General elapsed time
- Utility vehicles
- Construction machines
- Generators
- Fork-lift trucks
- Car washes
- Outside areas

Features

- Six-digit hour meter for round panel cut-out
- Low cost
- High shock resistance
- Low power consumption
- Small dimension
- Magnified figures

- Waterproof
- NEMA Type 4X rating
- Data retention if power is lost
- Available in 50 pc. bulk package

Standards and Certifications

- UL recognized



Product Selection

Shaded area denotes obsolete or discontinued products and services.

6-T-3H-508RPM-40

71.1 Round Hour Meters



Description	Catalog Number
115 Vac, 2.80 in (71.1 mm) round	6-T-3H-508RPM-406
10–80 Vdc, 2.80 in (71.1 mm) round	6-T-3H-508RPM-402

Technical Data and Specifications

General Specifications

Description	Specification
Electrical connection	Flat pins 0.8 x 6.3
Power consumption	
AC	Max. 0.4 VA
12 Vdc	Max. 0.08W
48 Vdc	Max. 0.7W
Rated voltages	115 Vac \pm 10%, 50/60 Hz, 10–80 Vdc
On time	100%
Display	Six-digits, 99999.9h
Count mode	Adding
Figure size	0.14 in (3.5 mm) high
Reset	None
Ambient temperature	–22 to 149 °F (–30 to 65 °C)
Mounting position	Any
Protection	IP65
Housing	Plastic
Error	<0.02% over the full range

Dimensions

Approximate Dimensions in Inches (mm)

71.1 Round Hour Meter

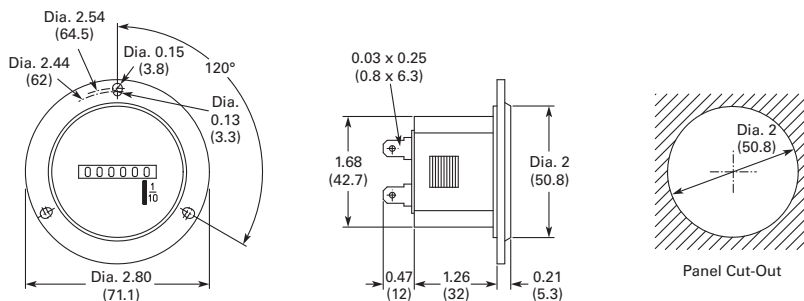

Hour Meter/Counter

Product Description

Eaton's CEC series combination meters provide an event counter and elapsed time meter in one compact unit.

Typical Application

- General counting
- Pump control panels
- Service interval for measurement systems (respiratory ventilators, oxygen machines, dialysis machines)
- Small appliances
- UV lamps
- Display panels in cars

Features

- Combination counter consists of time meter and adding counter in one
- Without reset
- High shock resistance
- Magnified figures
- Protection IP52 (front)
- Data retention if power is lost
- Long service life

Standards and Certifications

- cRU[®]us certified
- CE marked



Product Selection

CEC-...-406

Hour Meter/Counters



Description	Catalog Number
Combination hour meter/counter, 55 mm square front panel mount, 100–130 Vac, 60 Hz	CEC-55PM-406
Combination hour meter/counter, 48 mm DIN rail mount, 100–130 Vac, 60 Hz	CEC-48DR-406

Technical Data and Specifications

General Specifications

Description	Specification
Electrical connection	Flat pin 0.8 x 6.3 mm with screw terminal, tightening torque max. 0.8 Nm
Power consumption	60 Hz, approx. 1.43 VA
Count mode	Adding
Figure size	0.16 x 0.07 in (4 x 1.7 mm)
Color of figures	
Hour	White on black
Decimal	Red on black
Running time meter operating indicator	Fast rotating wheel with red dashes; 99999.99 hour
Accuracy AC	Supply frequency ±30 ms
Reset	None
Ambient temperature	5 to 122 °F (–15 to 50 °C)
Mounting position	Any
Color of housing	Black

Dimensions

Approximate Dimensions in Inches (mm)

DIN Rail Mount

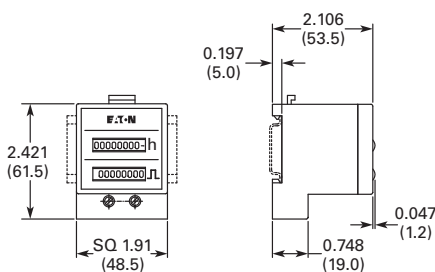

Front Panel Mount

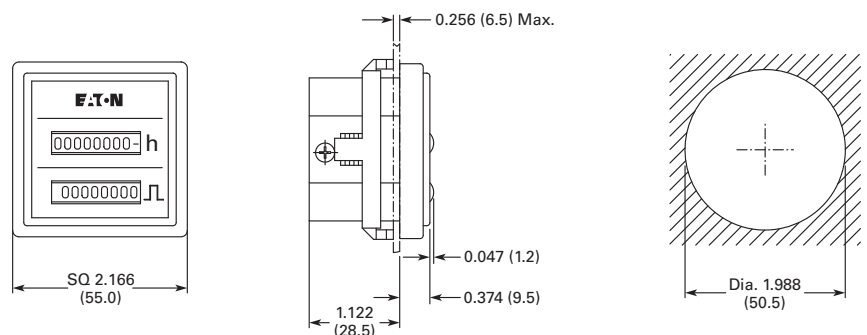

Fusion Integrated Machine Control



Contents

Description

	<i>Page</i>
Fusion Integrated Machine Control	
Standards and Certifications	V12-T24-92
Product Selection	V12-T24-92
Technical Data and Specifications	V12-T24-93
Dimensions	V12-T24-95

Learn
Online

Fusion Integrated Machine Control

Product Description

The Fusion® Integrated Machine Control has advanced features, including a five-preset high speed counter with pre-warn, a totalizer with preset, a batch counter with preset and a ratemeter with high and low setpoints. Unique to the count control world, the Fusion has five output relays (rather than two), along with two transistors and two analog setpoint or follower outputs. Its ten available parameter sets of pre-loaded values are useful as recipes, for job-stacking or for a variety of application-specific purposes.

The Fusion has a multi-line alphanumeric display which can be programmed to show text messages, logic-generated prompts, alarms and machine status. Up to eight screens can be shown or optionally locked out. Count and time presets can be made view-only or editable. Preset entry is achieved with simple 0-9 keys on the front panel rather than complicated scrolling methods. The Fusion's real time clock/calendar may be displayed and/or used to time and date stamp printouts.

With its ladder logic, the Fusion is actually a 26 I/O controller, making it a complete control for many machines and processes, integrating the functions of external timers, pushbuttons, power supplies, indicating lights, control relays and other components in the same box.

Features

- User-configurable operator interface with back-lit LCD display and 18-button tactile feedback keypad
- High speed counter with five presets and pre-warn, totalizer, batch counter and ratemeter
- 10 parameter sets
- 13 digital inputs
- (2) 4–20 mA inputs
- (2) 0–10 V input
- (3) Form C, 2 Form A, 2 NPN transistor, (1) 4–20 mA, and (1) 0–10 V outputs
- RS-232 and RS-485 serial communications
- 100-line ladder logic processor for ultimate flexibility
- Configuration software included
- NEMA 4X enclosure

Features and Benefits

Feature	Customer Benefit
High speed count functions; including scaling, main counter, five presets, pre-warn, totalizer, batch and rate	"Canned" count functions offer flexibility and ease of setup in the desired units of measure.
High speed counting independent of ladder scan time	Precise and repeatable output response for high performance applications.
Flexible display with selectable character sizes (large, medium, small), run screens and ladder triggered messages	Minimizes confusion and operator errors as information can be tailored to what they need and in their language. Maintenance/management data can be separated. Different character sizes allow optimization of information displayed. Machine status information can be displayed allowing operators to take action.
Simple front panel layout and keypad. Four soft keys and six function keys can be used as inputs	Ease of use for operator. Numeric keypad allows for ease of preset and machine parameter entry. Function keys and soft keys allow easy and quick access to information and/or parameters needed by the operator and don't require using additional inputs. Eliminates cost associated with external pushbuttons and inputs.
Parameter sets	Allows for predefined recipes/jobs to be preloaded for the operator. Simplifies operator interaction and minimizes errors.
Programmable relay logic	Well understood programming method that allows flexibility in control functionality. Easy to tailor the control to various applications.
26 I/O (digital and analog)	Provides application flexibility. Analog inputs allow monitoring key process parameters. Analog outputs allow interfacing to drives and other control products.
Integrated solution	Reduced overall control costs, installation and commissioning. More flexible and capable than traditional count/control solutions but less complex than many PLC solutions.
Windows® and front panel programming	Ease of programming and configuration control.
RS-232 and RS-485 serial communication ports	Allow for direct connection to PC for programming, connection to Modbus® networks, interface to serial printer.
Robust type 4X package. DIN cutout and short depth 2.82 in (71.6 mm)	Suited for wet applications. Same cutout as the President Series—easing the migration. Short depth minimizes the cost and size of the machine panel or control enclosure.
Input power: 85–265 Vac 50/60 Hz or 10–30 Vdc models	Greatly reduces models required for different control voltages.
Output power: 12 Vdc at 75 mA, 24 Vdc at 100 mA	Eliminates the need for an external power supply for encoders, analog transducers, etc.
Depluggable screw terminals	Allows for ease of wiring and removal of control. Terminals are different sizes to error-proof installation.
Non-volatile memory and capacitor backed real time clock	Don't have to worry about a battery failing down the road.
Real time clock	Allows for control functions to be performed on day/time and allows for date/time stamping on printouts.
UL, cUL and CE marked	Ease of meeting machine agency requirements and robust EMC performance.

Standards and Certifications

- UL and cUL listed
- CE marked



Product Selection

57550400



Fusion Integrated Machine Control

Description	Catalog Number
Fusion integrated machine control—10–30 Vdc power	57550400
Fusion integrated machine control—85–265 Vac power	57551400
Fusion configuration software	57590400

Technical Data and Specifications**General Specifications**

Description	Specification
Environmental	
Operation	Indoor use to 2000 m
Temperature	32 to 122 °F (0 to 50 °C) operating –4 to 158 °F (–20 to 70 °C) storage
Humidity	0 to 85% RH, noncondensing
Vibration	2.5 Gs, 30–200 Hz
Shock	30 Gs, 11 ms half sinewave
EMC	EN61326:1997 All I/O lines except RS-485 <30 m
Front panel	Type 4X indoor use only, when mounted with gasket provided
Safety	UL and cUL listed, CE compliant
Input Power	
AC model	85–265 Vac, 47–63 Hz, 20 VA; isolation 2300 Vac
DC model	10–30 Vdc, 15 VA
Inputs	
Control	
Number	10
Impedance	4.75 Kohms to +5 Vdc
Thresholds	
High	3.5–30 Vdc
Low	0–1.0 Vdc
Counter	
Number	Three (including reset)
Impedance	4.75 Kohms to +5 Vdc or 26.9 Kohms to ground
Thresholds	
High	3.5–30V
Low	0–1.5V, or 200 mV p-p to 50V rms at 26.9 Kohms (mag pickup)
Response	140 Hz or 14 kHz for sinking, push-pull or mag pickup inputs 60 Hz or 6 kHz for sourcing only inputs All frequencies based on 50-50 duty cycle 6 kHz maximum sustained count speed
Analog	
Number	4
Type	4–20 mA and two 0–10 Vdc
Accuracy	±0.5% FS and ±200 PPM/°C
Impedance	100 ohms (current input), 1.27 Mohms (voltage input)
Overrange	45 mA max. (current input), 20 V max. (voltage input)

General Specifications, continued

Description	Specification
Outputs	
Power (AC input model only)	24 Vdc $\pm 15\%$, 100 mA max., short-circuit protected 12 Vdc $\pm 10\%$, 75 mA max., short-circuit protected
Relays	
Number	3 (Form C), 2 (Form A)
Contacts	5 A, 250 Vac, 30 Vdc
Isolation	2300 Vac
Transistors	
Number	2
Type	NPN Darlington
Ratings	150 mA max. ON current, 30 Vdc max. OFF voltage
Analog	
Number	2, short-circuit protected
Type	4–20 mA (<450 ohms), 0–10 V (>2500 ohms)
Accuracy	$\pm 0.5\%$ FS and ± 200 PPM/ $^{\circ}$ C
Common mode voltage rating	250 Vac
Isolation	2300 Vac
RS-232	
Connector	DB-9S
Polarity	DCE
Baud rate	1200–19200
RS-485	
Connector	Six-wire RJ-12 phonejack
Baud rate	1200–19200
Data Retention	
Program data	
Type	Non-volatile
Duration	100 years, no batteries
Real time clock	
Type	Capacitor
Charge time	Three minutes
Retention	1–5 days
Human Interface	
Display	
Type	128 x 64 pixel graphic LCD with LED backlight
Figure size	0.12 in (3 mm) high, 21 characters per line, 6 lines maximum 0.24 in (6 mm) high, 10 characters per line, 3 lines maximum 0.35 in (9 mm) high, 7 characters per line, 2 lines maximum
Keys	
Number	18
Type	Membrane switches with tactile feedback
Real time clock format	Seconds, minutes, hours, day and date

Dimensions

Approximate Dimensions in Inches (mm)

Fusion Integrated Machine Control ①

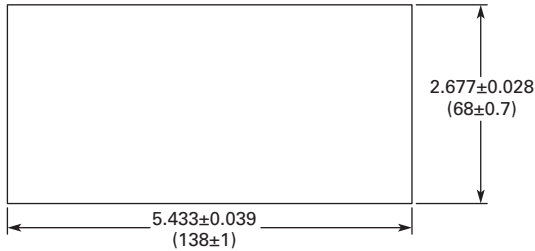
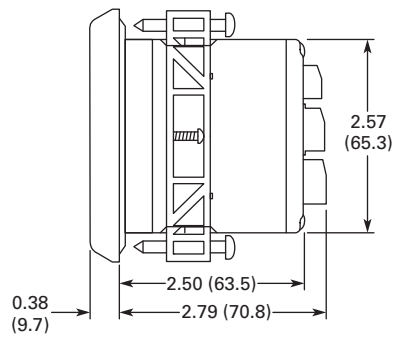
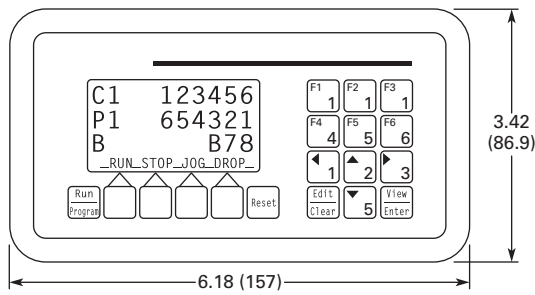
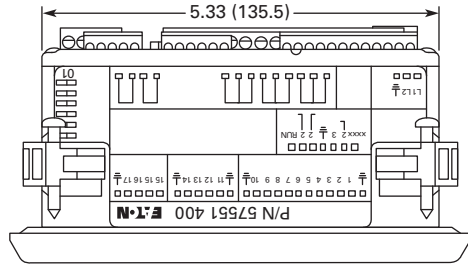

Note

① Recommended panel cutout is 0.375 in (9.5 mm) max. panel thickness.

TC Series



Contents

Description	Page
TC Series	
Product Selection	V12-T24-97
Technical Data and Specifications	V12-T24-97
Special Control Function Inputs	V12-T24-98

TC Series

Product Description

Temperature controllers for a wide range of applications including heat treating, baking, packaging, furnace control, and chillers.

Features and Benefits

- Universal temperature inputs allow user to select from PT100 or J, K, T, E, B, R, S, N, L thermocouples without modification to the unit
- Advanced fuzzy modified PID technology minimizes overshoot/undershoot and allows quick and accurate responses
- Fast sampling rate of up to five times per second ensures accuracy in fast processes
- Standard IP65 front panel (TC48) provides protection in wash-down and other challenging environments

Standards and Certifications

- UL recognized
- CSA certified
- CE marked
- RoHS compliant



Product Selection

TC24411100



TC Series

TC484120001



TC964110100



Description	Normally Stocked Item	Catalog Number
Temperature control, 24 x 48 mm, two relay out, 90–250 Vac	Yes	TC24411100
Temperature control, 24 x 48 mm, SSR driver/relay out, 90–250 Vac	Yes	TC24412100
Temperature control, 48 x 48 mm, one relay out, relay alarm, 90–250 Vac	Yes	TC484110101
Temperature control, 48 x 48 mm, SSR driver out, 90–250 Vac	Yes	TC484120001
Temperature control, 48 x 48 mm, SSR driver out, relay alarm, 90–250 Vac	Yes	TC484120101
Temperature control, 48 x 48 mm, analog out, relay alarm, 90–250 Vac	Yes	TC484130101
Temperature control, 96 x 48 mm, one relay out, relay alarm, 90–250 Vac	Yes	TC964110100
Temperature control, 24 x 48 mm, two relay out, 11–26 Vac/Vdc	—	TC24511100
Temperature control, 48 x 48 mm, one relay out, relay alarm, 11–26 Vac/Vdc	—	TC485110101
Process control, 24 x 48 mm, analog/relay out, 90–250 Vac	—	PC24463100
Temperature control, 48 x 48 mm, analog out, relay alarm, 90–250 Vac	—	TC24413100

Technical Data and Specifications

General Specifications

Description	Specification
Power	
Power	90–250 Vac, 47–63 Hz, 10 VA (TC24), 12 VA (TC48/TC96), 5 W maximum (TCxx4) 11–26 Vac/Vdc, 10 VA (TC24), 12 VA (TC48/TC96), 5 W maximum (TCxx5)
Input	
Resolution	18 bits
Sampling rate	5 times/second
Temperature effect	±1.5 $\mu\text{V}/^\circ\text{C}$ for all inputs except mV input ±3.0 $\mu\text{V}/^\circ\text{C}$ for mV input
Sensor lead resistance effect	
T/C	0.2 $\mu\text{V}/\text{ohm}$
Three-wire RTD	2.6 $^\circ\text{C}/\text{ohm}$ of resistance difference of 2 leads
Two-wire RTD	2.6 $^\circ\text{C}/\text{ohm}$ of resistance sum of 2 leads
Burn-out current	200nA
Common mode rejection ratio (CMRR)	120dB
Normal mode rejection ratio (NMRR)	55dB
Sensor break detection	Sensor open for TC, RTD and mV inputs, sensor short for RTD input, below 1 mA for 4–20 mA, below 0.25 V for 1–5V input
Sensor break response time	Within 4 seconds for TC, RTD, and mV inputs; 0.1 second for 4–20 mA and 1–5 V inputs
Output	
Relay rating	2A/240 Vac; 200,000 life cycles for resistive load
Pulsed voltage	Source voltage 5 V, current limiting resistance of 66 ohms
Linear output	
Resolution	15 bits
Output regulation	0.02% for full load change
Output setting time	0.1 sec. (stable to 99.9%)
Isolation breakdown voltage	1000 Vac
Temperature effect	±0.01% of SPAN/ $^\circ\text{C}$

General Specifications, continued

Description	Specification
Alarm	
Alarm relay	Form C rating; 2 A/240 Vac; 200,000 life cycles for resistive load
Alarm functions	Dwell timer, deviation high/low alarm, deviation band high/low alarm, PV high/low alarm
Alarm mode	Normal, latching, hold, latching/hold
Dwell timer	0.1 to 4553.6 minutes
Environmental and Physical	
Operating temperature	14 to 122 °F (–10 to 50 °C)
Storage temperature	–40 to 140 °F (–40 to 60 °C)
Humidity	0–90% RH (noncondensing)
Altitude	2000 m max.
Pollution	Degree 2
Insulation resistance	20 Mohms min. (at 500 Vdc)
Dielectric strength	2000 Vac, 50/60 Hz for 1 minute
Vibration resistance	10–55 Hz, 10 m/s ² for 1 minute
Moldings	Flame resistant polycarbonate
Dimensions	TC96 = 1.88 in (48 mm) (W) x 3.77 in (96 mm) (H) x 3.15 in (80 mm) (D) TC48 = 1.88 in (48 mm) (W) x 1.88 in (48 mm) (H) x 4.56 in (116 mm) (D) TC24 = 1.96 in (50 mm) (W) x 1.04 in (26.5 mm) (H) x 4.35 (110.5 mm) (D)

Special Control Function Inputs

Input Characteristics

Type	Range	Accuracy at 25 °C	Input Impedance
J	–120 to 1000 °C (–184 to 1832 °F)	±2 °C	2.2 Mohms
K	–200 to 1370 °C (–328 to 2498 °F)	±2 °C	2.2 Mohms
T	–250 to 400 °C (–418 to 752 °F)	±2 °C	2.2 Mohms
E	–100 to 900 °C (–148 to 1652 °F)	±2 °C	2.2 Mohms
B	0 to 1800 °C (32 to 3272 °F)	±2 °C (–200 to 1800 °C)	2.2 Mohms
R	0 to 1767.8 °C (32 to 3214 °F)	±2 °C	2.2 Mohms
S	0 to 1767.8 °C (32 to 3214 °F)	±2 °C	2.2 Mohms
N	–250 to 1300 °C (–418 to 2372 °F)	±2 °C	2.2 Mohms
L	–200 to 900 °C (–328 to 1652 °F)	±2 °C	2.2 Mohms
PT100 (DIN)	–210 to 700 °C (–346 to 1292 °F)	±0.4 °C	1.3 Kohms
PT100 (JIS)	–200 to 600 °C (–328 to 1112 °F)	±0.4 °C	1.3 Kohms
mV	–8 mV to 70 mV	±0.05%	2.2 Mohms
mA	–3 mA to 27 mA	±0.05%	70.5 ohms
V	–1.3 V to 11.5 V	±0.05%	650 Kohms

Accessories and Encoders



Contents

Description	Page
Accessories and Encoders	
DIN Rail Adapter	V12-T24-100
C-Face Ring Tachometer	V12-T24-101
Magnetic Pickup Sensor and Gear	V12-T24-101
Rotary Contactor—ES9513/ES9513RS	V12-T24-102
Measuring Wheels	V12-T24-102
Mounting Bracket	V12-T24-103
Cube Style Shaft Encoders	V12-T24-103
Heavy-Duty Shaft Encoders	V12-T24-106
Right Angle, Size 20 Shaft Encoders	V12-T24-108

Accessories and Encoders

Product Overview

Eaton offers a variety of accessories to complement our counting and control product offering.

Features

- Easy integration with Eaton counters

DIN Rail Adapter

Product Description

Allows mounting of 1/32 DIN front panel mounted products to DIN rail inside panel.

Features

- For panel-mounting all DIN size counters, timers and process indicators 0.94 x 1.89 in (24 x 48 mm) or 1.97 x 0.98 in (50 x 25 mm)
- Cut-out: 0.98 x 1.97 in (25 x 50 mm)
- For snap-on fitting to 35 mm top hat DIN rails
- Construction—
 - Mounting panel for counter: Chrome-plated sheet steel
 - Top hat DIN rail adapter: Glass fiber reinforced polyimide

Product Selection

A2448DINADAPT

DIN Rail Adapter

Description

DIN rail adapter for 1/32 DIN panel mount devices

Catalog Number

A2448DINADAPT



Dimensions

Approximate Dimensions in Inches (mm)

DIN Rail Adapter

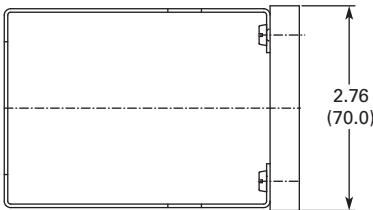
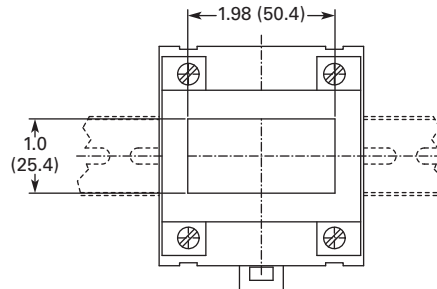
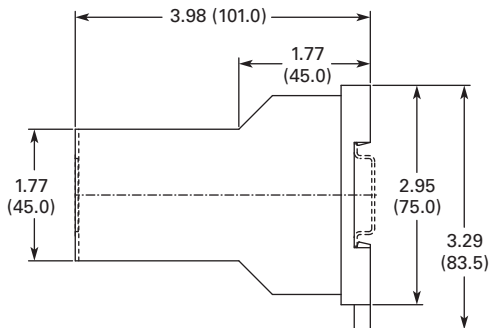

C-Face Ring Tachometer

Product Description

Provides sensing of motor speed when used with ratemeter/tachometer.

Features

- 5–16 Vdc input power
- NPN transistor output, 20 mA sinking capacity
- 60 pulses per resolution
- Zero speed pickup
- Variety of motor C-face sizes: 56, 184, 254, 256
- 39 to 225 °F (4 to 107 °C) operating temperature

Product Selection

47007_

C-Face Sensor



Description	Normally Stocked Item	Catalog Number
Motor size 56C	Yes	47007056
Motor size 143TC, 145TC, 182C, 184C	Yes	47007184
Motor size 184TC, 213C, 215C, 254C	Yes	47007215

Magnetic Pickup Sensor and Gear

Product Description

Sensor ideal for use with a variety of Eaton counters to show motor/shaft speed or measurement.

Features

30-Tooth Gear Accessory

- 1.6 in (41 mm) diameter
- 0.275 in (7 mm) bore diameter
- Mounting set screw included

Product Selection

47004400 and 28433400

Magnetic Pickup Sensor and Gear



Description	Catalog Number
30-tooth gear for magnetic pickup	28433400

Rotary Contactor—ES9513/ES9513RS

Product Description

Simple reed switch circuit to provide a contact closure for counting.

Features

- No power required
- Reed switch output models for electronic counters
- Contact closure output
- Leaf switch output models for electromechanical counters
- 5/16 in (7.9 mm) double shaft, 2400 rpm max. at 1:1 ratio
- 12 in (304.8 mm) wire leads

Product Selection

3910040



Rotary Contactor

Description	Rotary Contactor	Catalog Number
12:1 ratio reed switch output	ES9513RS	39100400
10:1 ratio reed switch output	ES9513RS	39100401
1:1 ratio reed switch output	ES9513RS	41100400
1:3 ratio reed switch output	ES9513RS	41100401
1:3.28 ratio reed switch output	ES9513RS	41100402
1:10 ratio reed switch output	ES9513RS	41100403
1:10 ratio leaf switch output	ES9513	40892400
1:1 ratio leaf switch output	ES9513	40891400
1:3 ratio leaf switch output	ES9513	40892401

Measuring Wheels

Product Description

Measuring wheel mounts to Eaton encoders and rotary contactor to allow for accurate measurement.

Features

- For use with shaft encoders and rotary contactors
- 12 in (304.8 mm) meter circumference
- Urethane, rubber and knurled edges available

Product Selection

Measuring Wheel



1 Ft Circumference Measuring Wheels

Description	Normally Stocked Item	Catalog Number
5/16 in bore, urethane rim	Yes	20144300KIT
3/8 in bore, urethane rim	—	20144303KIT
5/16 in bore, rubber rim	Yes	20154300KIT
3/8 in bore, rubber rim	Yes	20154301KIT
5/16 in bore, knurled rim	Yes	20156300KIT

Mounting Bracket

Product Description

Mounting bracket for Eaton D-Series counters and rotary contactors.

Product Selection

Mounting Bracket



Mounting Bracket

Description	Normally Stocked Item	Catalog Number
Mounting bracket	Yes	40460400

Cube Style Shaft Encoders

Product Description

Provides accurate pulse outputs for use with PLCs and counters.

Features

- 5–28 Vdc input power
- 80 mA current draw
- NPN transistor output, 250 mA sinking capacity
- Square wave output; (50-50 duty cycle)
- Single channel and quadrature models
- Up to 600 pulses per revolution
- 3/8 in (9.5 mm) double ended shaft
- ABEC three double sealed ball bearings
- Tapped holes for face or base mounting
- Military style connector

Product Selection

Cube Shaft Encoder



Cube Shaft Encoders

Description	Normally Stocked Item	Catalog Number
Single Channel		
60 pulses per revolution	—	38150060
100 pulses per revolution	Yes	38150100
120 pulses per revolution	—	38150120
600 pulses per revolution	Yes	38150600
Quadrature		
60 pulses per revolution	—	38151060
100 pulses per revolution	Yes	38151100
120 pulses per revolution	—	38151120
600 pulses per revolution	Yes	38151600

Accessory

Mounting Bracket



Mounting Bracket ^①

Description	Normally Stocked Item	Catalog Number
Mounting bracket	—	40460402

Note

^① 40460400 is shown, 40460402 has additional mounting plate for encoders.

Technical Data and Specifications**General Specifications**

Description	Specification
Electrical	
Input (38150)	
Voltage	9 to 16 Vdc
Current	60 mA max. at 16 Vdc
Ripple	2%
Input (38151)	
Voltage	5 to 28 Vdc
Current	60 mA nom., 100 mA max.
Ripple	≤2%
Output	
Type	Current sinking transistor with 1.5 Kohms pull-up
Sinking current	100 mA max.
Max. voltage at 100 mA	1.3 Vdc
Blocking voltage	40 Vdc max.
Polarity	Positive
Wave shape	Square wave
Pulse rate	
38150	1 to 20,000 pulse per second
38151	1 to 10,000 pulse per second
Rise time	<1 μs
Pulses per rev.	1 to 1270
Accuracy	Within ±0.1°
Environmental	
Operating temperature	32 to 167 °F (0 to 75 °C)
Vibration	3 Gs at 5 to 1000 cps
Shock	20 Gs, 10 ms
Mechanical	
Shaft speed	6000 RPM max.
Shaft rotation	CW or CCW
Bearings	Sealed ball bearings
Starting torque	0.1 oz-in
Moment of inertia	0.0025 ounce in-sec ²
Radial loading	40 pounds operating
Axial loading	30 pounds operating
Shaft	3/8 in (9.5 mm) dia.
Operating life	Up to 100,000 hours, depending on speed
Housing	Aluminum with black anodized finish. Sealed against dust, oil, vapor and moisture.
Mounting	Bottom or front face
Weight	1 lb (0.5 kg) max.
Connector	MS-3102E-14S-6P
Mating connector	MS-3106A-14S-6S with 10 ft (3 m) shielded cable and termination for electronic controls

Dimensions

Approximate Dimensions in Inches (mm)

Cube Shaft Encoders

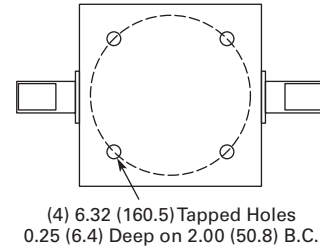
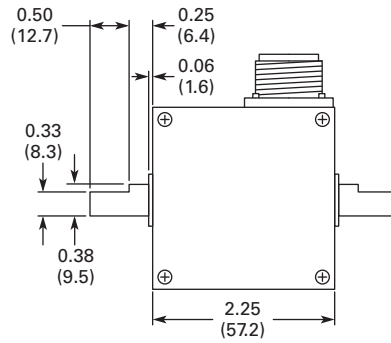
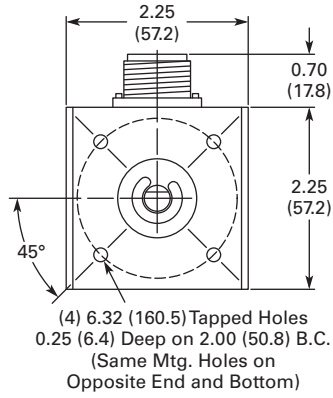

Heavy-Duty Shaft Encoders

Product Description

Provides accurate pulse outputs for use with PLCs and counters.

Features

- 5–28 Vdc input power
- 80 mA current draw
- NPN transistor output, 250 mA sinking capacity
- Square wave output
- Single channel and quadrature models
- 3/8 in (9.5 mm) single ended shaft
- ABEC 3 double sealed ball bearings
- Tapped holes for face or base mounting
- Military style connector

Product Selection

Heavy-Duty Shaft Encoder



Heavy-Duty Encoder

Description	Normally Stocked Item	Catalog Number
Single Channel		
60 pulses per revolution	Yes	48370060
100 pulses per revolution	—	48370100
120 pulses per revolution	Yes	48370120
600 pulses per revolution	Yes	48370600
Quadrature		
60 pulses per revolution	Yes	48371060
100 pulses per revolution	Yes	48371100
100 pulses per revolution	Yes	48371120
600 pulses per revolution	Yes	48371600

Technical Data and Specifications

General Specifications

Description	Specification
Electrical	
Input	
Voltage	5 to 28 Vdc
Current	60 mA nom., 100 mA max.
Ripple	–2%
Output	
Type	Current sinking transistor with 1.5 Kohms pull-up
Sinking current	100 mA max.
Max. voltage at 100 mA	1.3 Vdc
Blocking voltage	40 Vdc max.
Polarity	Positive
Wave shape	Square wave (50-50 duty)
Pulse rate	0 to 20,000 pulse per second
Rise time	<1 μS
Pulses per rev.	1 to 1270
Accuracy	Within ± 0.1° or 6 arc minutes
Environmental	
Operating temperature	32 to 167 °F (0 to 75 °C)
Vibration	3 Gs at 58 to 500 cps
Shock	50 Gs, 11 ms duration

Technical Data and Specifications

General Specifications, continued

Description	Specification
Mechanical	
Shaft speed	6000 RPM max.
Shaft rotation	CW or CCW
Bearings	Sealed ball bearings
Starting torque	1.0 oz-in
Radial loading	50 pounds operating
Axial loading	35 pounds operating
Shaft	3/8 in (9.5 mm) dia.
Housing	Aluminum with black painted finish. Sealed against dust, oil, vapor and moisture.
Mounting	Provisions for bottom or front face
Weight	3.25 lbs (1.47 kg) max.
Connector	MS-3102E-14S-6P
Mating connector	MS-3106A-14S-6S with 10 ft (3 m) shielded cable and termination for electronic controls (Part No. 29665-300) Connector, clamp and bushing only (Part No. 29729-300)

Dimensions

Approximate Dimensions in Inches (mm)

Heavy-Duty Encoder

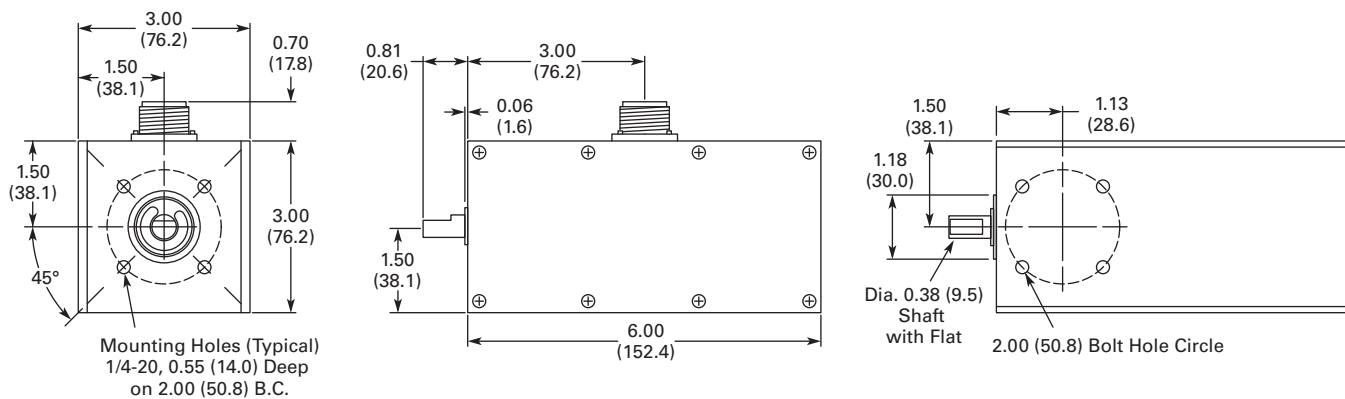

Right Angle, Size 20 Shaft Encoders

Product Description

Provides accurate pulse outputs for use with PLCs and counters.

Features

- 5–28 Vdc input power
- 100 mA current draw
- NPN transistor output, 100 mA sinking capacity
- Quadrature output, two square waves
- Up to 1800 pulses per revolution
- Flange mounting
- 3/8 in (9.5 mm) shaft diameter
- Double shielded ball bearings
- Military style connector

Product Selection

38159_



Right-Angle Shaft Encoder, Size 20

Description	Catalog Number
100 pulses per revolution	38159100
120 pulses per revolution	38159120
600 pulses per revolution	38159600
1000 pulses per revolution	381591000
1800 pulses per revolution	381591800

Encoder Cables

Description	Catalog Number
10 ft encoder cable	29665300
15 ft encoder cable	29665315
20 ft encoder cable	29665320
25 ft encoder cable	29665325
30 ft encoder cable	29665330
35 ft encoder cable	29665335
40 ft encoder cable	29665340
50 ft encoder cable	29665350
75 ft encoder cable	29665375
100 ft encoder cable	29665400

Technical Data and Specifications

General Specifications

Description	Specification
Electrical	
Input	
Voltage	5 to 28 Vdc (4.75 min., 28.0 max.)
Current	100 mA max. with no output load
Ripple	–2% peak to peak at 5 Vdc
Output	
Type	Quadrature current sinking transistors with 2.2 Kohms pull-up
Sinking current	100 mA max.
Max. voltage at 100 mA	1.3 Vdc
Blocking voltage	40 Vdc max.
Polarity	Positive
Wave shape	Square wave (50-50 duty cycle)
Pulse rate	0 to 100,000 pulses per second
Noise immunity	Tested to BS EN6100-4-2; IEC801-3; BS EN61000-4-4; DDENV 50141; DDENV 50204; BS EN55022 (with European compliance option)

General Specifications, continued

Description	Specification
Electrical, continued	
Output, continued	
Symmetry	180 electrical degrees ± 18
Quadrature phasing	90 electrical degrees ± 36
Minimum edge separation	54 electrical degrees
Rise time	$< 1 \mu\text{s}$
Pulses per rev.	1 to 1270
Accuracy	Within $\pm 0.1^\circ$
Environmental	
Operating temperature	32 to 158 °F (0 to 70 °C)
Vibration	20 Gs at 50 to 500 cps
Shock	75 Gs, 11 ms
Mechanical	
Shaft speed	8000 RPM max.
Shaft rotation	CW or CCW
Bearings	Double shielded ball bearings
Starting torque	1.0 oz-in typical
Moment of inertia	5.2×10^4 ounce in-sec ²
Radial and axial loading	(80 lbs max.) 20–40 lbs for bearing life of 1.5×10^9 revolutions
Maximum acceleration	1×10^5 radians/second ²
Shaft	0.375 in (9.5 mm) dia.
Housing	Black non-corrosive finish. Sealed against dust, oil, vapor and moisture.
Mounting	Flange mount
Weight	11 oz (312 g)
Connector	MS-3102E-14S-6P
Mating connector	MS-3106A-14S-6S with 10 ft (3 m) shielded cable and termination for electronic controls (Part No. 29665-300) Connector, clamp and bushing only (Part No. 29729-300)

Dimensions

Approximate Dimensions in Inches (mm)

Right-Angle Shaft Encoder

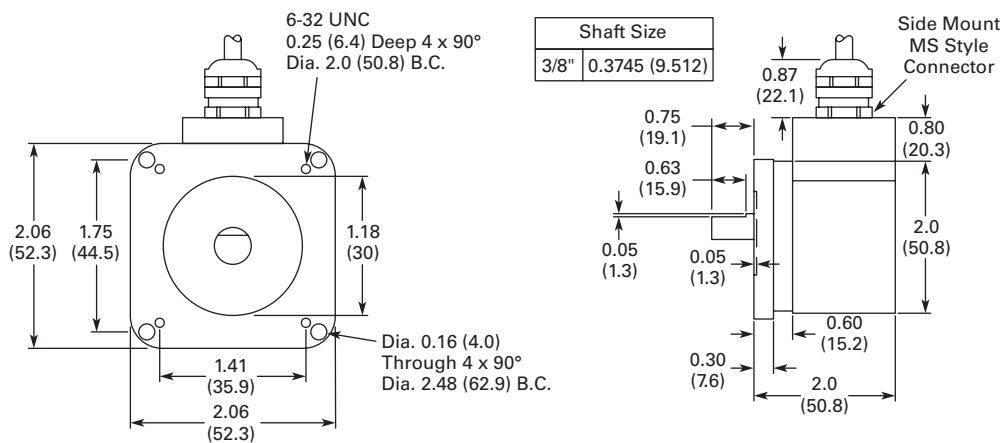

Shaded area denotes obsolete or discontinued products and services.

Spare Parts

Style Number	Description
36172202KIT	Front panel gasket
48369200KIT	Mounting clip
28748200KIT	Screw for mounting clip
48355110KIT	Terminal strip—10 position
48355112KIT	Terminal strip—12 position
58802420	Desk kit for President Series (part numbers 5882–5886 and 5782)
29729300	Accessories connector
56460400	Sequence control
57044200KIT	6460 keypad
57740290KIT	Mounting clip
46066220KIT	Gasket
48720623KIT	Ambassador front keypad
28720400KIT	Kit mounting Ambassador Series
48720614KIT	Label position control
48720280KIT	Label membrane switch, Ambassador

General Accessories

Style Number	Description
48160451	Analog to frequency converter
499904xx(08/16)	Simultaneous input processor (anti-coincidence counting from multiple input devices) 8 inputs/16 inputs
38091400	RC surge suppressor
3605945x(0/1)	Solid-state I/O modules (AC input and output, DC input and output) 0 = DC, 1 = AC
36059201	Plug-in-module, 10–32 Vdc or 15–32 Vac input
36059202	Plug-in-module, 12–140 Vac output

Fusion

Style Number	Description
47590200	Front overlay label

Ambassador Family Accessories

Style Number	Description
48183401	Desk mount kit (enclosure for flat surface mounting)
58801460	RS-485 to RS-232 communications converter
58801461	RS-485 to RS-232 communications converter (Europe)
38145400	RS-485 interconnect kit
38146xxxx	RS-485 cable—xxxx is length in feet, specify with 4 digits (0500 = 500 ft) ^①

President

Style Number	Description
28720302KIT	Mounting kit
28720301KIT	Kit mounting clip and gasket
48720410	5881-0 President replace label
48720420	Label kit
48720430	Kit label replace Lexan to Mylar
48720440	5884 President replace label
48720450	5885 President replace label
48720460	5886 President replace label

Note

^① Call EatonCare.

Alabama**Birmingham (Pelham)**

Tel: (205) 403-3850
Fax: (205) 403-3899

Mobile (Theodore)

Tel: (251) 443-6379
Fax: (251) 443-8845

Alaska**Anchorage**

Tel: (907) 562-8558
Fax: (907) 562-8553

Arizona**Phoenix**

Tel: (480) 449-4200
Fax: (480) 449-4203

Tucson

Tel: (520) 744-9962
Fax: (520) 744-9963

Arkansas**Fayetteville**

Tel: (479) 271-6259
Fax: (479) 271-6241

Jonesboro

Tel: (870) 934-9903
Fax: (870) 934-0824

Little Rock

Tel: (501) 791-2880
Fax: (501) 791-2434

California**Bakersfield**

Tel: (661) 617-1818
Fax: (661) 617-1819

Los Angeles (Pomona)

Tel: (909) 869-8200
Fax: (909) 869-8259

Sacramento (Roseville)

Tel: (916) 780-4100
Fax: (916) 780-4141

San Diego

Tel: (619) 542-7355
Fax: (619) 542-7323

San Francisco (Livermore)

Tel: (925) 454-3700
Fax: (925) 454-3791

Santa Rosa

Tel: (707) 528-9000
Fax: (707) 528-3131

Colorado**Denver (Littleton)**

Tel: (303) 738-2300
Fax: (303) 738-2324

Connecticut**Hartford (Rocky Hill)**

Tel: (860) 298-1300
Fax: (860) 298-1301

Florida**Deerfield Beach**

Tel: (954) 570-3680
Fax: (954) 421-3539

Jacksonville

Tel: (904) 292-5350
Fax: (904) 292-2884

Orlando (Longwood)

Tel: (407) 264-9320
Fax: (407) 264-9330

Miami (Miami Lakes)

Tel: (305) 781-3872

Pensacola

Tel: (850) 479-3264
Fax: (850) 479-3374

Sarasota

Tel: (941) 378-5404
Fax: (941) 378-2798

Tampa

Tel: (813) 287-7000
Fax: (813) 287-7038

Georgia**Atlanta (Smyrna)**

Tel: (678) 309-4201
Fax: (770) 433-1644

Columbus

Tel: (706) 322-7382
Fax: (706) 322-2656

Macon

Tel: (478) 471-0500
Fax: (478) 471-0501

Savannah

Tel: (912) 232-7290
Fax: (912) 232-7965

Hawaii**Honolulu**

Tel: (808) 594-4500
Fax: (808) 593-1115

Idaho**Boise**

Tel: (208) 323-2802
Fax: (208) 376-4863

Illinois**Chicago (Glendale Heights)**

Tel: (630) 260-6301
Fax: (630) 260-6445

Decatur

Tel: (217) 872-1965
Fax: (217) 872-1975

Peoria

Tel: (309) 649-1831
Fax: (309) 649-1833

Rockford

Tel: (815) 398-6585
Fax: (815) 398-2074

Indiana**Evansville**

Tel: (812) 476-7591
Fax: (812) 476-7581

Ft. Wayne

Tel: (260) 420-5500
Fax: (260) 420-5506

Indianapolis

Tel: (317) 334-4500
Fax: (317) 334-4544

South Bend

Tel: (574) 583-0601
Fax: (574) 583-0611

Iowa**Bettendorf**

Tel: (563) 344-7800
Fax: (563) 344-8775

Cedar Rapids

Tel: (319) 378-9554
Fax: (319) 378-9602

Des Moines (Urbandale)

Tel: (515) 334-8950
Fax: (515) 334-8945

Sales & Service Locations

Sales Locations

Kansas

Kansas City (Lenexa)

Tel: (913) 327-3600
Fax: (913) 327-3699

Wichita

Tel: (316) 263-0611
Fax: (316) 267-1084

Kentucky

Lexington

Tel: (859) 278-2115
Fax: (859) 278-6523

Louisville

Tel: (502) 961-5500
Fax: (502) 961-5515

Paducah

Tel: (270) 898-8322
Fax: (270) 898-4079

Louisiana

Baton Rouge

Tel: (225) 295-9060
Fax: (225) 295-9068

New Orleans (Metairie)

Tel: (504) 849-3360
Fax: (504) 834-6086

Shreveport

Tel: (318) 864-9987
Fax: (318) 868-7487

Maine

Augusta (Winthrop)

Tel: (207) 330-7100
Fax: (207) 782-5497

Portland

Tel: (207) 657-7721
Fax: (207) 253-5051

Maryland

Baltimore (Columbia)

Tel: (410) 720-6700
Fax: (410) 720-6740

Massachusetts

Boston (Franklin)

Tel: (774) 235-0200
Fax: (508) 520-1980

Michigan

Detroit (Novi)

Tel: (248) 374-5100
Fax: (248) 374-5177

Grand Rapids

Tel: (616) 559-3535
Fax: (616) 559-3544

Saginaw

Tel: (517) 753-5355
Fax: (517) 753-5928

Minnesota

Duluth

Tel: (218) 722-5300
Fax: (218) 722-5700

Minneapolis (Minnetonka)

Tel: (952) 939-5400
Fax: (952) 939-5457

Mississippi

Jackson

Tel: (601) 919-1102
Fax: (601) 919-1067

Missouri

Springfield

Tel: (417) 882-8880
Fax: (417) 882-8881

St. Louis

Tel: (636) 717-3400
Fax: (636) 717-3546

Montana

Bozeman

Tel: (406) 585-8087
Fax: (406) 585-7994

Nebraska

Omaha

Tel: (402) 339-3208
Fax: (402) 339-0595

Nevada

Las Vegas

Tel: (702) 309-4089
Fax: (702) 222-0771

New Hampshire

Derry

Tel: (603) 458-1751
Fax: (603) 898-0806

New Jersey

Edison

Tel: (732) 767-9600
Fax: (732) 205-2642

New Mexico

Albuquerque

Tel: (505) 828-3800
Fax: (505) 828-3838

New York

Albany (Clifton Park)

Tel: (518) 348-1752
Fax: (518) 348-1758

Buffalo (Amherst)

Tel: (716) 691-4511
Fax: (716) 691-6969

New York

Tel: (212) 319-2100
Fax: (212) 833-0250

Rochester

Tel: (585) 381-0510
Fax: (585) 381-0499

Syracuse (East Syracuse)

Tel: (315) 437-7201
Fax: (315) 437-0924

North Carolina

Asheville (Avery Creek)

Tel: (828) 651-0500
Fax: (828) 651-0980

Charlotte

Tel: (704) 529-3515
Fax: (704) 529-3532

Greensboro

Tel: (336) 852-8849
Fax: (336) 852-8868

Raleigh

Tel: (919) 544-7074
Fax: (919) 206-7339

Wilmington

Tel: (910) 343-1955
Fax: (910) 343-3348

North Dakota

Fargo

Tel: (701) 281-0090
Fax: (701) 281-5772

Ohio

Cincinnati

Tel: (513) 387-2000
Fax: (513) 387-2055

Cleveland (Parma)

Tel: (216) 265-2741
Fax: (216) 265-2770

Columbus (Westerville)

Tel: (614) 899-4104
Fax: (614) 899-5374

Dayton

Tel: (937) 431-3260
Fax: (937) 431-3299

Toledo

Tel: (419) 887-6509

Oklahoma

Oklahoma City

Tel: (405) 947-3729
Fax: (405) 947-3723

Tulsa

Tel: (918) 627-3312
Fax: (918) 622-7618

Oregon**Eugene**

Tel: (541) 451-4634
Fax: (541) 451-4641

Medford

Tel: (541) 776-4849
Fax: (541) 773-9925

Portland (Wilsonville)

Tel: (503) 582-2700
Fax: (503) 570-2918

Pennsylvania**Allentown**

Tel: (610) 336-4080
Fax: (610) 391-8983

Philadelphia (Boothwyn)

Tel: (610) 497-6100
Fax: (610) 497-6187

Pittsburgh (Moon Township)

Tel: (412) 893-3300

York

Tel: (717) 757-1071
Fax: (717) 757-4448

Puerto Rico**Canovanas**

Tel: (787) 257-4422
Fax: (787) 257-4465

South Carolina**Charleston**

Tel: (843) 529-1632
Fax: (843) 529-1634

Columbia

Tel: (803) 799-2684
Fax: (803) 799-1515

Greenville

Tel: (864) 232-5698
Fax: (864) 232-9284

South Dakota**Sioux Falls**

Tel: (605) 271-4100
Fax: (605) 271-4102

Tennessee**Knoxville**

Tel: (865) 980-7200
Fax: (865) 980-7222

Memphis (Cordova)

Tel: (901) 737-0200
Fax: (901) 737-4544

Nashville

Tel: (615) 333-5457
Fax: (615) 333-5485

Texas**Austin**

Tel: (512) 453-5800
Fax: (512) 453-0682

Corpus Christi

Tel: (361) 887-5005
Fax: (361) 887-5023

Dallas (Grapevine)

Tel: (817) 410-1724
Fax: (817) 410-1760

El Paso

Tel: (915) 779-5016
Fax: (915) 779-4655

Houston

Tel: (713) 849-1600
Fax: (713) 849-1675

Lubbock

Tel: (806) 765-0092
Fax: (806) 765-0093

San Antonio

Tel: (210) 366-0093
Fax: (210) 366-0677

Tyler

Tel: (903) 534-1800
Fax: (903) 534-6022

Utah**Salt Lake City**

Tel: (801) 238-4500
Fax: (801) 363-4795

Virginia**Norfolk (Chesapeake)**

Tel: (757) 424-5556
Fax: (757) 424-2938

Richmond (Sandstone)

Tel: (804) 328-6111
Fax: (804) 328-5384

Roanoke

Tel: (540) 345-7809
Fax: (540) 345-1711

Washington**Kennewick**

Tel: (509) 374-8511
Fax: (509) 735-8450

Seattle (Bellevue)

Tel: (425) 644-5800
Fax: (425) 644-6220

Spokane

Tel: (509) 922-4055
Fax: (509) 922-1561

West Virginia**Charleston (Hurricane)**

Tel: (304) 757-9556
Fax: (304) 757-9879

Wisconsin**Appleton**

Tel: (920) 380-2400
Fax: (920) 380-2420

Madison

Tel: (608) 370-6600
Fax: (608) 370-6602

Milwaukee (Brookfield)

Tel: (414) 443-3500
Fax: (414) 257-1844

Sales & Service Locations

Service Locations

Alabama

Birmingham (Pelham)

Tel: (205) 403-3800
Fax: (205) 403-3836

Arizona

Phoenix (Tempe)

Tel: (480) 449-4271
Fax: (480) 449-4285

California

Los Angeles (Diamond Bar)

Tel: (909) 348-0405
Fax: (909) 348-0410

San Diego

Tel: (619) 291-4211
Fax: (619) 692-6291

San Francisco (Livermore)

Tel: (925) 454-3650
Fax: (925) 454-3655

Colorado

Denver (Littleton)

Tel: (303) 738-2360
Fax: (303) 762-0419

Connecticut

Hartford

Tel: (860) 298-1300
Fax: (860) 298-1301

Florida

Jacksonville

Tel: (904) 292-5351
Fax: (904) 292-2884

Miami (Deerfield Beach)

Tel: (954) 571-8282
Fax: (954) 419-9881

Georgia

Atlanta (Smyrna)

Tel: (678) 309-4242
Fax: (770) 433-0627

Illinois

Chicago (Glendale Heights)

Tel: (630) 260-6302
Fax: (630) 690-7407

Iowa

Des Moines

Tel: (515) 334-8958
Fax: (515) 334-8945

Indiana

Indianapolis

Tel: (502) 961-5500
Fax: (502) 961-5520

Kansas

Kansas City

Tel: (913) 327-3650
Fax: (913) 327-3670

Kentucky

Louisville

Tel: (502) 961-5500
Fax: (502) 961-5520

Louisiana

Baton Rouge

Tel: (225) 756-1541
Fax: (225) 756-0178

Maine

Augusta (Winthrop)

Tel: (207) 330-7100
Fax: (207) 330-7199

Maryland

Baltimore (Columbia)

Tel: (410) 720-6700
Fax: (410) 720-6740

Massachusetts

Boston (Franklin)

Tel: (774) 235-0255
Fax: (774) 235-0276

Minnesota

Duluth

Tel: (218) 722-5300
Fax: (218) 722-5700

Minneapolis (Minnetonka)

Tel: (952) 912-1320
Fax: (952) 912-1355

Missouri

St. Louis

Tel: (636) 717-3403
Fax: (636) 717-3450

New York

New York City (Union, NJ)

Tel: (908) 624-2370
Fax: (908) 624-2341

Syracuse (East Syracuse)

Tel: (315) 437-7204
Fax: (315) 437-0924

North Carolina

Raleigh (Durham)

Tel: (919) 741-4378
Fax: (919) 882-1488

Ohio

Cleveland (Independence)

Tel: (216) 642-5251
Fax: (216) 642-5238

Oklahoma

Oklahoma City

Tel: (405) 947-3729
Fax: (405) 947-3723

Oregon

Portland (Wilsonville)

Tel: (425) 644-6280

Pennsylvania

Philadelphia (Boothwyn)

Tel: (610) 364-2608
Fax: (610) 364-1739

Pittsburgh (Warrendale)

Tel: (724) 779-5811
Fax: (724) 779-5828

Texas

Austin

Tel: (512) 302-4011
Fax: (512) 302-4150

Dallas (Grapevine)

Tel: (817) 410-1625
Fax: (817) 410-1640

Houston

Tel: (713) 948-8240
Fax: (713) 948-8245

San Antonio

Tel: (210) 366-0093
Fax: (210) 366-0677

Washington

Seattle (Bellevue)

Tel: (425) 644-6260
Fax: (425) 644-6255

West Virginia

Skelton

Tel: (304) 256-3918
Fax: (304) 256-3920

Wisconsin

Appleton

Tel: (920) 380-2430
Fax: (920) 380-2420

Canada

Toronto, Ontario

Tel: (416) 798-0112
Fax: (416) 798-0063

Montreal, Quebec (Laval)

Tel: (450) 668-0853
Fax: (450) 663-5858

Ottawa, Ontario

Tel: (613) 739-1115
Fax: (613) 739-7339

Kitchener, Ontario

Tel: (519) 893-4848
Fax: (519) 893-2992

Calgary, Alberta

Tel: (403) 717-4931
Fax: (403) 717-3962

Satellite Plants

Arizona

Phoenix

Tel: (480) 449-4222

California

Los Angeles

Tel: (951) 685-5788

San Francisco

Tel: (510) 784-8981

Colorado

Denver

Tel: (303) 366-2080

Connecticut

Hartford

Tel: (860) 298-1305
Fax: (860) 298-1306

Florida

Orlando

Tel: (407) 264-9300

Georgia

Atlanta

Tel: (678) 309-4260

Illinois

Chicago

Tel: (630) 260-6303

Maryland

Baltimore

Tel: (410) 796-7777

Missouri

St. Louis

Tel: (636) 717-3500

New Jersey

West Hampton

Tel: (609) 835-4230

North Carolina

Raleigh

Tel: (919) 544-7074

Ohio

Cleveland

Tel: (216) 433-0616

Texas

Dallas

Tel: (817) 251-6733

Houston

Tel: (713) 688-8430

Washington

Seattle

Tel: (253) 833-5021

Service Centers

California

Los Angeles

Tel: (562) 944-6413

Colorado

Denver

Tel: (303) 366-9949

Connecticut

Hartford

Tel: (860) 683-4221

Georgia

Atlanta

Tel: (678) 309-4270

Illinois

Chicago

Tel: (630) 260-6304

Ohio

Cincinnati

Tel: (513) 682-4000

Texas

Houston

Tel: (713) 939-9690

Eaton Terms & Conditions



Terms & Conditions



Contents

<i>Description</i>	<i>Page</i>
Terms and Conditions of Sale	V12-A1-1
Terms of Payment	V12-A1-2
Freight	V12-A1-3
Warranty	V12-A1-3

Selling Policy (Supersedes Selling Policy 25-000, dated November 1, 2008)

Terms and Conditions of Sale

The Terms and Conditions of Sale set forth herein, and any supplements which may be attached hereto, constitute the full and final expression of the contract for the sale of products or services (hereinafter referred to as Product(s) or Services by Eaton Corporation (hereinafter referred to as Seller) to the Buyer, and supersedes all prior quotations, purchase orders, correspondence or communications whether written or oral between the Seller and the Buyer. Notwithstanding any contrary language in the Buyer's purchase order, correspondence or other form of acknowledgment, Buyer shall be bound by these Terms and Conditions of Sale when it sends a purchase order or otherwise indicates acceptance of this contract, or when it accepts delivery from Seller of the Products or Services.

THE CONTRACT FOR SALE OF THE PRODUCTS OR SERVICES IS EXPRESSLY LIMITED TO THE TERMS AND CONDITIONS OF SALE STATED HEREIN. ANY ADDITIONAL OR DIFFERENT TERMS PROPOSED BY BUYER ARE REJECTED UNLESS EXPRESSLY AGREED TO IN WRITING BY SELLER. No contract shall exist except as herein provided.

Complete Agreement

No amendment or modification hereto nor any statement, representation or warranty not contained herein shall be binding on the Seller unless made in writing by an authorized representative of the Seller. Prior dealings, usage of the trade or a course of performance shall not be relevant to determine the meaning of this contract even though the accepting or acquiescing party had knowledge of the nature of the performance and opportunity for objection.

Quotations

Written quotations are valid for 30 days from its date unless otherwise stated in the quotation or terminated sooner by notice.

Verbal quotations, unless accepted, expire the same day they are made.

A complete signed order must be received by Seller within 20 calendar days of notification of award, otherwise the price and shipment will be subject to re-negotiation.

Termination and Cancellation

Products

Any order may be terminated by the Buyer only by written notice and upon payment of reasonable termination charges, including all progress billings and all incurred direct manufacturing costs.

Services

Any order may be terminated by the Buyer only by written notice and upon payment of reasonable termination charges including all costs plus profit.

Seller shall have the right to cancel any order at any time by written notice if Buyer breaches any of the terms hereof, becomes the subject of any proceeding under state or federal law for the relief of debtors, or otherwise becomes insolvent or bankrupt, generally does not pay its debts as they become due or makes an assignment for the benefit of creditors.

Appendix 1—General Terms and Conditions of Sale

Effective Date: November 1, 2017

Prices

All prices are subject to change without notice. In the event of a price change, the effective date of the change will be the date of the new price or discount sheet, letter or telegram. All quotations made or orders accepted after the effective date will be on the new basis. For existing orders, the price of the unshipped portion of an order will be the price in effect at time of shipment.

Price Policy—Products and Services

When prices are quoted as firm for quoted shipment, they are firm provided the following conditions are met:

1. The order is released with complete engineering details.
2. Shipment of Products are made, and Services purchased are provided within the quoted lead time.
3. When drawings for approval are required for any Products, the drawings applicable to those Products must be returned within 30* calendar days from the date of the original mailing of the drawings by Seller. The return drawings must be released for manufacture and shipment and must be marked "APPROVED" or "APPROVED AS NOTED." Drawing re-submittals which are required for any other reason than to correct Seller errors will not extend the 30-day period.

* 60 days for orders through contractors to allow time for their review and approval before and after transmitting them to their customers.

If the Buyer initiates or in any way causes delays in shipment, provision of Services or return of approval drawings beyond the periods stated above, the price of the Products or Services will be increased 1% per month or fraction thereof up to a maximum of 18 months from the date of the Buyer's order. For delays resulting in shipment or provision of Services beyond 18 months from the date of the Buyer's order, the price must be renegotiated.

Price Policy—BLS

Refer to Price Policy 25-050.

Minimum Billing

Orders less than \$1,000 will be assessed a shipping and handling charge of 5% of the price of the order, with a minimum charge of \$25.00 unless noted differently on Product discount sheets.

Taxes

The price does not include any taxes. Buyer shall be responsible for the payment of all taxes applicable to, or arising from the transaction, the Products, its sale, value, or use, or any Services performed in connection therewith regardless of the person or entity actually taxed.

Terms of Payment

Products

Acceptance of all orders is subject to the Buyer meeting Seller's credit requirements. Terms of payment are subject to change for failure to meet such requirements. Seller reserves the right at any time to demand full or partial payment before proceeding with a contract of sale as a result of changes in the financial condition of the Buyer. Terms of Payment are either Net 30 days from the date of invoice of each shipment or carry a cash discount based on Product type. Specific payment terms for Products are outlined in the applicable Product discount schedules.

Services

Terms of payment are net within 30 days from date of invoice for orders amounting to less than \$50,000.00.

Terms of payment for orders exceeding \$50,000.00 shall be made according to the following:

1. Twenty percent (20%) of order value with the purchase order payable 30 days from date of invoice.
2. Eighty percent (80%) of order value in equal monthly payments over the performance period payable 30 days from date of invoice.

Except for work performed (i) under a firm fixed price basis or (ii) pursuant to terms of a previously priced existing contract between Seller and Buyer, invoices for work performed by Seller shall have added and noted on each invoice a charge of 3% (over and above the price of the work) which is related to Seller compliance with present and proposed environmental, health, and safety regulations associated with prescribed requirements covering hazardous materials management and employee training, communications, personal protective equipment, documentation and record keeping associated therewith.

Adequate Assurances

If, in the judgment of Seller, the financial condition of the Buyer, at any time during the period of the contract, does not justify the terms of payment specified, Seller may require full or partial payment in advance.

Delayed Payment

If payments are not made in accordance with these terms, a service charge will, without prejudice to the right of Seller to immediate payment, be added in an amount equal to the lower of 1.5% per month or fraction thereof or the highest legal rate on the unpaid balance.

Freight

Freight policy will be listed on the Product discount sheets, or at option of Seller one of the following freight terms will be quoted.

F.O.B.—P/S—Frt./Ppd. and Invoiced

Products are sold F.O.B. point of shipment freight prepaid and invoiced to the Buyer.

F.O.B.—P/S—Frt./Ppd. and Allowed

Products sold are delivered F.O.B. point of shipment, freight prepaid and included in the price.

F.O.B. Destination—Frt./Ppd. and Allowed

At Buyer's option, Seller will deliver the Products F.O.B. destination freight prepaid and 2% will be added to the net price.

The term "freight prepaid" means that freight charges will be prepaid to the accessible common carrier delivery point nearest the destination for shipments within the United States and Puerto Rico unless noted differently on the Product discount sheets. For any other destination, contact Seller's representative.

Shipment and Routing

Seller shall select the point of origin of shipment, the method of transportation, the type of carrier equipment and the routing of the shipment.

If the Buyer specifies a special method of transportation, type of carrier equipment, routing, or delivery requirement, Buyer shall pay all special freight and handling charges.

When freight is included in the price, no allowance will be made in lieu of transportation if the Buyer accepts shipment at factory, warehouse, or freight station or otherwise supplies its own transportation.

Risk of Loss

Risk of loss or damage to the Products shall pass to Buyer at the F.O.B. point.

Concealed Damage

Except in the event of F.O.B. destination shipments, Seller will not participate in any settlement of claims for concealed damage.

When shipment has been made on an F.O.B. destination basis, the Buyer must unpack immediately and, if damage is discovered, must:

1. Not move the Products from the point of examination.
2. Retain shipping container and packing material.
3. Notify the carrier in writing of any apparent damage.
4. Notify Seller representative within 72 hours of delivery.
5. Send Seller a copy of the carrier's inspection report.

Witness Tests/Customer Inspection

Standard factory tests may be witnessed by the Buyer at Seller's factory for an additional charge calculated at the rate of \$2,500 per day (not to exceed eight (8) hours) per Product type. Buyer may final inspect Products at the Seller's factory for \$500 per day per Product type.

Witness tests will add one (1) week to the scheduled shipping date. Seller will notify Buyer fourteen (14) calendar days prior to scheduled witness testing or inspection. In the event Buyer is unable to attend, the Parties shall mutually agree on a rescheduled date. However, Seller reserves the right to deem the witness tests waived with the right to ship and invoice Products.

Held Orders

For any order held, delayed or rescheduled at the request of the Buyer, Seller may, at its sole option (1) require payment to be based on any reasonable basis, including but not limited to the contract price, and any additional expenses, or cost resulting from such a delay; (2) store Products at the sole cost and risk of loss of the Buyer; and/or (3) charge to the Buyer those prices under the applicable price policy. Payment for such price, expenses and costs, in any such event, shall be due by Buyer within thirty (30) days from date of Seller's invoice. Any order so held delayed or rescheduled beyond six (6) months will be treated as a Buyer termination.

Drawing Approval

Seller will design the Products in line with, in Seller's judgment, good commercial practice. If at drawing approval Buyer makes changes outside of the design as covered in their specifications, Seller will then be paid reasonable charges and allowed a commensurate delay in shipping date based on the changes made.

Drawing Re-Submittal

When Seller agrees to do so in its quotation, Seller shall provide Buyer with the first set of factory customer approval drawing(s) at Seller's expense. The customer approval drawing(s) will be delivered at the quoted delivery date. If Buyer requests drawing changes or additions after the initial factory customer approval drawing(s) have been submitted by Seller, the Seller, at its option, may assess Buyer drawing charges. Factory customer approval drawing changes required due to misinterpretation by Seller will be at Seller's expense. Approval drawings generated by Bid Manager are excluded from this provision.

Warranty

Warranty for Products

Seller warrants that the Products manufactured by it will conform to Seller's applicable specifications and be free from failure due to defects in workmanship and material for one (1) year from the date of installation of the Product or eighteen (18) months from the date of shipment of the Product, whichever occurs first.

In the event any Product fails to comply with the foregoing warranty, Seller will, at its option, either (a) repair or replace the defective Product, or defective part or component thereof, F.O.B. Seller's facility freight prepaid, or (b) credit Buyer for the purchase price of the Product. All warranty claims shall be made in writing.

Seller requires all non-conforming Products be returned at Seller's expense for evaluation unless specifically stated otherwise in writing by Seller.

This warranty does not cover failure or damage due to storage, installation, operation or maintenance not in conformance with Seller's recommendations and industry standard practice or due to accident, misuse, abuse or negligence. This warranty does not cover reimbursement for labor, gaining access, removal, installation, temporary power or any other expenses, which may be incurred in connection with repair or replacement.

This warranty does not apply to equipment not manufactured by Seller. Seller limits itself to extending the same warranty it receives from the supplier.

Appendix 1—General Terms and Conditions of Sale

Effective Date: November 1, 2017

Extended Warranty for Products

If requested by the Buyer and specifically accepted in writing by Seller, the foregoing standard warranty for Products will be extended from the date of shipment for the period and price indicated below:

- 24 months—2% of Contract Price
- 30 months—3% of Contract Price
- 36 months—4% of Contract Price

Special Warranty (In and Out) for Products

If requested by the Buyer and specifically accepted in writing by Seller, Seller will, during the warranty period for Products, at an additional cost of 2% of the contract price, be responsible for the direct cost of:

1. Removing the Product from the installed location.
2. Transportation to the repair facility and return to the site.
3. Reinstallation on site.

The total liability of Seller for this Special Warranty for Products is limited to 50% of the contract price of the particular Product being repaired and excludes expenses for removing adjacent apparatus, walls, piping, structures, temporary service, etc.

Warranty for Services

Seller warrants that the Services performed by it hereunder will be performed in accordance with generally accepted professional standards.

The Services, which do not so conform, shall be corrected by Seller upon notification in writing by the Buyer within one (1) year after completion of the Services.

Unless otherwise agreed to in writing by Seller, Seller assumes no responsibility with respect to the suitability of the Buyer's, or its customer's, equipment or with respect to any latent defects in equipment not supplied by Seller. This warranty does not cover damage to Buyer's, or its customer's, equipment, components or parts resulting in whole or in part from improper maintenance or operation or from their deteriorated condition. Buyer will, at its cost, provide Seller with unobstructed access to the defective Services, as well as adequate free working space in the immediate vicinity of the defective Services and such facilities and systems, including, without limitation, docks, cranes and utility disconnects and connects, as may be necessary in order that Seller may perform its warranty obligations. The conducting of any tests shall be mutually agreed upon and Seller shall be notified of, and may be present at, all tests that may be made.

Warranty for Power Systems Studies

Seller warrants that any power systems studies performed by it will conform to generally accepted professional standards. Any portion of the study, which does not so conform, shall be corrected by Seller upon notification in writing by the Buyer within six (6) months after completion of the study. All warranty work shall be performed in a single shift straight time basis Monday through Friday. In the event that the study requires correction of warranty items on an overtime schedule, the premium portion of such overtime shall be for the Buyer's account.

Limitation on Warranties for Products, Services and Power Systems Studies

THE FOREGOING WARRANTIES ARE EXCLUSIVE EXCEPT FOR WARRANTY OF TITLE. SELLER DISCLAIMS ALL OTHER WARRANTIES INCLUDING ANY IMPLIED WARRANTIES OF MERCHANTABILITY AND FITNESS FOR A PARTICULAR PURPOSE.

CORRECTION OF NON-CONFORMITIES IN THE MANNER AND FOR THE PERIOD OF TIME PROVIDED ABOVE SHALL CONSTITUTE SELLER'S SOLE LIABILITY AND BUYER'S EXCLUSIVE REMEDY FOR FAILURE OF SELLER TO MEET ITS WARRANTY OBLIGATIONS, WHETHER CLAIMS OF THE BUYER ARE BASED IN CONTRACT, IN TORT (INCLUDING NEGLIGENCE OR STRICT LIABILITY), OR OTHERWISE.

Asbestos

Federal Law requires that building or facility owners identify the presence, location and quantity of asbestos containing material (hereinafter "ACM") at work sites. Seller is not licensed to abate ACM. Accordingly, for any contract which includes the provision of Services, prior to (i) commencement of work at any site under a specific Purchase Order, (ii) a change in the work scope of any Purchase Order, the Buyer will certify that the work area associated with the Seller's scope of work includes the handling of Class II ACM, including but not limited to generator wedges and high temperature gaskets which include asbestos materials. The Buyer shall, at its expense, conduct abatement should the removal, handling, modification or reinstallation, or some or all of them, of said Class II ACM be likely to generate airborne asbestos fibers; and should such abatement affect the cost of or time of performance of the work, then Seller shall be entitled to an equitable adjustment in the schedule, price and other pertinent affected provisions of the contract.

Compliance with Nuclear Regulation

Seller's Products are sold as commercial grade Products not intended for application in facilities or activities licensed by the United States Nuclear Regulatory Commission for atomic purposes. Further certification will be required for use of the Products in any safety-related application in any nuclear facility licensed by the U.S. Nuclear Regulatory Commission.

Returning Products

Authorization and shipping instructions for the return of any Products must be obtained from Seller before returning the Products.

When return is occasioned due to Seller error, full credit including all transportation charges will be allowed.

Product Notices

Buyer shall provide the user (including its employees) of the Products with all Seller supplied Product notices, warnings, instructions, recommendations, and similar materials.

Force Majeure

Seller shall not be liable for failure to perform or delay in performance due to fire, flood, strike or other labor difficulty, act of God, act of any governmental authority or of the Buyer, riot, embargo, fuel or energy shortage, car shortage, wrecks or delays in transportation, or due to any other cause beyond Seller's reasonable control. In the event of delay in performance due to any such cause, the date of delivery or time for completion will be extended by a period of time reasonably necessary to overcome the effect of such delay.

Liquidated Damages

Contracts which include liquidated damage clauses for failure to meet shipping or job completion promises are not acceptable or binding on Seller, unless such clauses are specifically accepted in writing by an authorized representative of the Seller at its headquarters office.

Patent Infringement

Seller will defend or, at its option, settle any suit or proceeding brought against Buyer, or Buyer's customers, to the extent it is based upon a claim that any Product or part thereof, manufactured by Seller or its subsidiaries and furnished hereunder, infringes any United States patent, other than a claim of infringement based upon use of a Product or part thereof in a process, provided Seller is notified in reasonable time and given authority, information and assistance (at Seller's expense) for the defense of same. Seller shall pay all legal and court costs and expenses and court-assessed damages awarded therein against Buyer resulting from or incident to such suit or proceeding. In addition to the foregoing, if at any time Seller determines there is a substantial question of infringement of any United States patent, and the use of such Product is or may be enjoined, Seller may, at its option and expense: either (a) procure for Buyer the right to continue using and selling the Product; (b) replace the Product with non-infringing apparatus; (c) modify the Product so it becomes non-infringing; or (d) as a last resort, remove the Product and refund the purchase price, equitably adjusted for use and obsolescence. In no case does Seller agree to pay any recovery based upon its Buyer's savings or profit through use of Seller's Products whether the use be special or ordinary. The foregoing states the entire liability of Seller for patent infringement.

The preceding paragraph does not apply to any claim of infringement based upon: (a) any modification made to a Product other than by Seller; (b) any design and/or specifications of Buyer to which a Product was manufactured; or (c) the use or combination of Product with other products where the Product does not itself infringe. As to the above-identified claim situations where the preceding paragraph does not apply, Buyer shall defend and hold Seller harmless in the same manner and to the extent as Seller's obligations described in the preceding paragraph. Buyer shall be responsible for obtaining (at Buyer's expense) all license rights required for Seller to be able to use software products in the possession of Buyer where such use is required in order to perform any Service for Buyer.

With respect to a Product or part thereof not manufactured by Seller or its subsidiaries, Seller will attempt to obtain for Buyer, from the supplier(s), the patent indemnification protection normally provided by the supplier(s) to customers.

Compliance with OSHA

Seller offers no warranty and makes no representation that its Products comply with the provisions or standards of the Occupational Safety and Health Act of 1970, or any regulation issued thereunder. In no event shall Seller be liable for any loss, damage, fines, penalty or expenses arising under said Act.

Limitation of Liability

THE REMEDIES OF THE BUYER SET FORTH IN THIS CONTRACT ARE EXCLUSIVE AND ARE ITS SOLE REMEDIES FOR ANY FAILURE OF SELLER TO COMPLY WITH ITS OBLIGATIONS HEREUNDER.

NOTWITHSTANDING ANY PROVISION IN THIS CONTRACT TO THE CONTRARY, IN NO EVENT SHALL SELLER BE LIABLE IN CONTRACT, IN TORT (INCLUDING NEGLIGENCE OR STRICT LIABILITY) OR OTHERWISE FOR DAMAGE TO PROPERTY OR EQUIPMENT OTHER THAN PRODUCTS SOLD HEREUNDER, LOSS OF PROFITS OR REVENUE, LOSS OF USE OF PRODUCTS, COST OF CAPITAL, CLAIMS OF CUSTOMERS OF THE BUYER OR ANY SPECIAL, INDIRECT, INCIDENTAL OR CONSEQUENTIAL DAMAGES WHATSOEVER, REGARDLESS OF WHETHER SUCH POTENTIAL DAMAGES ARE FORESEEABLE OR IF SELLER HAS BEEN ADVISED OF THE POSSIBILITY OF SUCH DAMAGES.

THE TOTAL CUMULATIVE LIABILITY OF SELLER ARISING FROM OR RELATED TO THIS CONTRACT WHETHER THE CLAIMS ARE BASED IN CONTRACT, IN TORT (INCLUDING NEGLIGENCE OR STRICT LIABILITY) OR OTHERWISE, SHALL NOT EXCEED THE PRICE OF THE PRODUCT OR SERVICES ON WHICH SUCH LIABILITY IS BASED.

Appendix 2—Alphabetical Product Index

A

A (Type)	V12-T13-56	A40 Contactors and Starters	V12-T13-6
A.B.B. Breaker—Retrofit Kits	V12-T17-51	A41 Contactors and Starters	V12-T13-6
A10 Contactors and Starters	V12-T13-6	A415/A445/A485	V12-T13-71
A11 Contactors and Starters	V12-T13-6	A50 Contactors and Starters	V12-T13-6
A13 Contactors and Starters	V12-T13-6	A51 Contactors and Starters	V12-T13-6
A200 Contactors and Starters	V12-T13-23	A515/A545 Model A	V12-T13-71
A200 Starter Replacement Capabilities		A515/A545 Model B	V12-T13-71
Arc Box	V12-T13-23–V12-T13-25	A600 Contactors and Starters	V12-T13-23
Arc Cup Kit	V12-T13-25	A603 Contactors and Starters	V12-T13-23
Auxiliary Electrical Interlock	V12-T13-26	A604 Contactors and Starters	V12-T13-23
Coils	V12-T13-23–V12-T13-26	A606 Contactors and Starters	V12-T13-23
Contact Kits	V12-T13-23–V12-T13-25	A70 Contactors and Starters	V12-T13-6
Cross Bar	V12-T13-23–V12-T13-25	A700 Contactors and Starters	V12-T13-23
Current Transformers	V12-T13-25	A703 Contactors and Starters	V12-T13-23
Heaters	V12-T13-30–V12-T13-32	A704 Contactors and Starters	V12-T13-23
KO Spring	V12-T13-23–V12-T13-25	A706 Contactors and Starters	V12-T13-23
Line Connection Kit	V12-T13-25	A71 Contactors and Starters	V12-T13-6
Load Connection Kit	V12-T13-25	A80 Contactors and Starters	V12-T13-6
Lower Base	V12-T13-23, V12-T13-24	A800 Contactors and Starters	V12-T13-23
Magnet Assembly	V12-T13-25	A804 Contactors and Starters	V12-T13-23
Magnet Spacing Kit	V12-T13-25	A806 Contactors and Starters	V12-T13-23
Overload Relay	V12-T13-27, V12-T13-28	A81 Contactors and Starters	V12-T13-6
Phase Barrier	V12-T13-25	AA	V12-T13-28
Shunt	V12-T13-25	ABH	V12-T4-7
Terminals	V12-T13-23, V12-T13-24	ABH Panelboard	V12-T4-7
Upper Base	V12-T13-23, V12-T13-24	ABH Panelboard, Replacement Breaker	V12-T4-7
A201 Contactors and Starters	V12-T13-23	AC Coils Electrically Held	V12-T13-34
A202 Contactors and Starters	V12-T13-33	AC Coils Magnetically Latched	V12-T13-35
A202 Lighting Contactor (Electrically Held Magnetically Latched)		AC Drives	V12-T13-72–V12-T13-75
Replacement Capabilities	V12-T13-33	Accessories	
A203 Contactors and Starters	V12-T13-23	Counters, Panel Meters, Tachometers and Timers	V12-T24-99–V12-T24-109
A204 Contactors and Starters	V12-T13-23	Encoders	V12-T24-103–V12-T24-109
A206 Contactors and Starters	V12-T13-23	Measuring Wheels	V12-T24-102
A210 Contactors and Starters	V12-T13-23	Metering Devices, IQ 130/140/150 Series	
A211 Contactors and Starters	V12-T13-23	Panel Mounting Adapter	V12-T10-20
A213 Contactors and Starters	V12-T13-23	Metering Devices, Power Xpert Meter 4000/6000/8000	
A214 Contactors and Starters	V12-T13-23	Communication Expansion Card	V12-T10-15
A216 Contactors and Starters	V12-T13-23	Digital I/O Card	V12-T10-15
A220 Contactors and Starters	V12-T13-23	Graphic Display Module	V12-T10-15
A223 Contactors and Starters	V12-T13-23	Panel Mounting Bracket	V12-T10-15
A224 Contactors and Starters	V12-T13-23	Power Xpert Meter 4000 to 6000 License Upgrade Key	V12-T10-15
A226 Contactors and Starters	V12-T13-23	Type BR Loadcenters and Circuit Breakers	
A25	V12-T13-53	Filler Plates	V12-T5-14, V12-T5-15
A250 Contactors and Starters	V12-T13-23	Handle Lockoffs	V12-T5-16, V12-T5-17
A251 Contactors and Starters	V12-T13-23	Handle Ties	V12-T5-16
A2B Panelboard	V12-T4-7	Hold-Down Kits	V12-T5-18
A30 Contactors and Starters	V12-T13-6	Main and Subfeed Lug Blocks	V12-T5-14
A31 Contactors and Starters	V12-T13-6	Main Breaker Lug Kits	V12-T5-18
		Main Lugs	V12-T5-14
		Mechanical Interlock Covers	V12-T5-16

Appendix 2—Alphabetical Product Index

Accessories, continued

Type CH Loadcenters and Circuit Breakers	
Handle Lockdogs	V12-T5-7
Handle Lockoffs	V12-T5-7
Handle Ties	V12-T5-7
Hold-Down Kits	V12-T5-7
Main Breaker Lug Kits	V12-T5-8
Mechanical Interlocks	V12-T5-8
Mounting Bases	V12-T5-8
Accessories and Modifications	V12-T3-3, V12-T3-17–V12-T3-48, V12-T3-51, V12-T3-53, V12-T3-55, V12-T3-57, V12-T3-59, V12-T3-63–V12-T3-79
Accessories and Renewal Parts for	
Magnum DS Breakers	V12-T17-8
Accessories for Low Voltage Breakers	V12-T17-9
Accessories for Trip Unit Retrofit Kits	V12-T17-28
Accuflow	V12-T13-72–V12-T13-75
Accuflow 110	V12-T13-72
Accuflow Jr.	V12-T13-72–V12-T13-75
Accutrol 100	V12-T13-72–V12-T13-75
Accutrol 110	V12-T13-72–V12-T13-75
Accutrol 150	V12-T13-72–V12-T13-75
Accutrol 200	V12-T13-72–V12-T13-75
Accutrol 300	V12-T13-72–V12-T13-75
Accutrol 400	V12-T13-72–V12-T13-75
Accutrol 700	V12-T13-72–V12-T13-75
ACM and Metering Module for Advantage Unit	V12-T14-11
Active Harmonic Filter	V12-T21-4
Adapters—DS Breaker Test Kit	V12-T17-9
Adding C-HRG to a Wye System	V12-T16-2
Adding High Resistance to a Wye or Delta System	V12-T16-6
Additional Information for Medium Voltage Switchgear	V12-T17-64
Addressable Relay II	V12-T10-32, V12-T11-11, V12-T11-25
Adjustable Frequency AC Drives	V12-T13-72–V12-T13-75
Advanced Technology Services	V12-T13-75
Advantage	V12-T11-11, V12-T14-11
Device Panel Upgrade	V12-T14-11
Feeder Breaker Units	V12-T14-11
Handle Mechanism	V12-T14-4
MCC Product Description	V12-T14-11
MCC Replacement Capabilities	V12-T14-11
Motor Control Center	V12-T14-3
Replacement Capabilities	V12-T13-51
Replacement Starter Units	V12-T14-11
Starter	V12-T13-51
AE-1 General Electric Breaker	V12-T17-40
AF	V12-T13-56
AF Adjustable Frequency AC Drives	V12-T13-72–V12-T13-75
AF-1000	V12-T13-72–V12-T13-75
AF-1500	V12-T13-72–V12-T13-75
AF-1600	V12-T13-72–V12-T13-75
AF-2000	V12-T13-72–V12-T13-75
AF-300	V12-T13-72, V12-T13-73
AF-300 (Responder)	V12-T13-72, V12-T13-74, V12-T13-75
AF-3000	V12-T13-72–V12-T13-75
AF-5000	V12-T13-72–V12-T13-75
AF-5000+	V12-T13-72–V12-T13-75
AF-6000	V12-T13-72–V12-T13-75
AF-7000	V12-T13-72–V12-T13-75
AF-8000	V12-T13-72–V12-T13-75
AF91	V12-T13-72–V12-T13-74
AF93	V12-T13-72–V12-T13-75
AF95	V12-T13-72–V12-T13-75
AF97	V12-T13-72–V12-T13-75
AH—AMPGARD	V12-T13-99
Air Magnetic Breaker MOC Closing Times	V12-T17-62
Air Replacement Breakers	V12-T17-11, V12-T22-6
Air Replacement Breakers—Type DB	V12-T17-3
Air-to-Vacuum Conversion Kit	V12-T13-93
Air-to-Vacuum Starter Cell Kit	V12-T13-92
AK-1 General Electric Breaker	V12-T17-38
AK-2/2A General Electric Breaker	V12-T17-38
AK-3/3A General Electric Breaker	V12-T17-38
AKR(U)-6D/7D General Electric Breaker	V12-T17-38
AKR-4A/5A General Electric Breaker	V12-T17-38
AKR-6D/7D General Electric Breaker	V12-T17-38
AKRT-4A/5A General Electric Breaker	V12-T17-38
AL-2 General Electric Breaker	V12-T17-39
Alarm Lockout Switch	V12-T3-3
Alarm Switch	V12-T3-76
Allis-Chalmers	
AM Vacuum Replacement Breaker	V12-T17-60
FA Vacuum Replacement Breaker	V12-T17-60
FB Vacuum Replacement Breaker	V12-T17-60
FC Vacuum Replacement Breaker	V12-T17-60
MA Vacuum Replacement Breaker	V12-T17-60
RUPTAIR Vacuum Replacement Breaker	V12-T17-60
Allis-Chalmers AR-Series Replacement Breakers	V12-T17-11, V12-T22-6
Allis-Chalmers G Breaker	V12-T17-42
Allis-Chalmers LA Breaker	V12-T17-42
Allis-Chalmers LA Breakers Replacement and Upgrade Capabilities	V12-T17-41
Allis-Chalmers LA Breakers with Digitrip RMS Retrofit Kits	V12-T17-42
Allis-Chalmers LG Breaker	V12-T17-42
Ambient Compensating	V12-T3-33
Ambient Compensating Breakers	V12-T3-17, V12-T3-41, V12-T3-42
AMI AMPGARD	V12-T13-76, V12-T13-87, V12-T13-91, V12-T13-99
AMPGARD	V12-T13-87, V12-T13-95
AMPGARD 25/50 L4	V12-T13-99
AMPGARD 25/50 L7	V12-T13-99

Appendix 2—Alphabetical Product Index

AMPGARD 25L2	V12-T13-99	Automation Services	V12-T22-7
AMPGARD 50L2	V12-T13-99	Demand Management Systems	V12-T22-7
AMPGARD 50V4	V12-T13-99	PLC Systems	V12-T22-7
AMPGARD AH	V12-T13-88, V12-T13-99	Power Management Systems	V12-T22-7
AMPGARD AMI	V12-T13-76, V12-T13-87, V12-T13-91, V12-T13-99	Systems Integration	V12-T22-7
AMPGARD IT	V12-T13-97	AUTOVAR Filter	V12-T21-4
AMPGARD IT Soft Start	V12-T13-97	AUTOVAR MV	V12-T21-4
AMPGARD MV Motor Control	V12-T13-87	Auxiliary Contact Kits Definite Purpose	V12-T13-65–V12-T13-69
AMPGARD OIL	V12-T13-88, V12-T13-99	Auxiliary Switch	V12-T3-3, V12-T3-76
AMPGARD S202 (SJ)	V12-T13-99	AVD-Contactor	V12-T13-66
AMPGARD Solutions Overview	V12-T13-99	B	
AMPGARD Starters	V12-T13-76	B.B.C. Breaker—Retrofit Kits	V12-T17-51
AMPGARD V202 (SJ)	V12-T13-99	B10 Contactors and Starters	V12-T13-6
AMT Fixed Width Handle Mechanism	V12-T3-96	B10B Panelboard	V12-T4-7
AMT Vari-Depth Handle Mechanisms	V12-T3-95, V12-T3-96, V12-T3-104–V12-T3-106	B10B Panelboard, Replacement Breaker	V12-T4-7
AN—A200 Overload Relay	V12-T13-28	B10B-LX Panelboard	V12-T4-7
ANSI and IEC Rating Table for VCP-W Breakers	V12-T17-58	B10B-LX Panelboard, Replacement Breaker	V12-T4-7
Application Guide for Medium Voltage Fuses	V12-T18-3	B10B-LXX Panelboard	V12-T4-7
Application Notes for		B10B-LXX Panelboard, Replacement Breaker	V12-T4-7
Allis-Chalmers LA Power Circuit Breakers	V12-T17-41	B11 Contactors and Starters	V12-T13-6
Federal Pacific Circuit Breakers	V12-T17-49	B25	V12-T13-53
ITE K-Line Power Circuit Breakers	V12-T17-43	B3NO	V12-T13-27
Other ITE Power Circuit Breakers	V12-T17-45	B50 Contactors and Starters	V12-T13-6
Siemens-Allis Circuit Breakers	V12-T17-47	B51 Contactors and Starters	V12-T13-6
Westinghouse DB and DBL Power Circuit Breakers	V12-T17-31, V12-T17-37	B52 Contactors and Starters	V12-T13-6
Westinghouse DS and DSL Power Circuit Breakers	V12-T17-33	B65B Panelboard	V12-T4-7
Westinghouse SPB Power Circuit Breakers	V12-T17-35	B65B Panelboard, Replacement Breaker	V12-T4-7
Application of Trip Unit Retrofit Kits	V12-T17-17	BA — Medium Voltage Fuses	V12-T18-2
Arcflash Reduction Maintenance System	V12-T17-19, V12-T17-28	BA—A200 Overload Relay	V12-T13-27
ARII	V12-T10-32, V12-T11-25	BAB	V12-T3-7
ARMS	V12-T17-28	Back-up Power Switches — see Automatic Transfer Switches	V12-T20-1
AR-Series Replacement Breakers		BAL	V12-T18-2
Allis-Chalmers	V12-T17-11, V12-T22-6	BAL-R	V12-T18-2
Federal Pacific Electric	V12-T17-11, V12-T22-6	Base Mounting Hardware	V12-T3-70
General Electric	V12-T17-11, V12-T22-6	BCLS	V12-T18-3
ITE	V12-T17-11, V12-T22-6	BHLE	V12-T18-3
Westinghouse	V12-T17-11, V12-T22-6	BIM	V12-T11-11
ASCII	V12-T12-2	BN—A200 Overload Relay	V12-T13-27
ASR Relay, Synchronous Motor Control	V12-T13-76–V12-T13-79	Bolt-on Units—Busway	V12-T9-11
AST	V12-T9-7	BP	V12-T9-5, V12-T9-8, V12-T9-11
ATS	V12-T20-1–V12-T20-3	BP9000	V12-T13-72
ATS Inc.	V12-T12-4	BPONI	V12-T11-25
Auto/Manual Reset, Class 20, Thermal Type A Overload Relay	V12-T13-28	BR Loadcenters	V12-T5-14–V12-T5-23
Automatic Field Application Control	V12-T13-85	Brakes—511 Type	V12-T13-63
Automatic Synchronization	V12-T13-85	Breaker	
Automatic Transfer Switches	V12-T20-1–V12-T20-3	Molded-Case Current Limiting	V12-T3-13, V12-T3-14
		Rating Plugs	V12-T3-60

Appendix 2—Alphabetical Product Index

- Breaker Accessories V12-**T5**-7, V12-**T5**-8, V12-**T17**-9
- Breaker Cell Provisions for SPB Breakers V12-**T15**-4
- Breaker Guide
 - Panelboard Replacement Breakers V12-**T3**-80–V12-**T3**-82
- Breaker Identification V12-**T3**-3
- Breaker Plug-in Units V12-**T9**-5
 - Pow-R-Way V12-**T9**-5
 - Standard Plug-in and Low Impedance Busway V12-**T9**-5
- Breaker Reconditioning and Trip System Upgrades V12-**T2**-2
- Breaker Renewal Parts
 - DB Breakers V12-**T17**-3
 - DH Breakers V12-**T17**-55
 - DHP Breakers V12-**T17**-56
 - DS Breakers V12-**T17**-5
 - DSII Breakers V12-**T17**-7
 - Magnum DS Breakers V12-**T17**-8
 - VCP Breakers V12-**T17**-57
 - VCP-W Breakers V12-**T17**-58
- Breaker Replacement Chart, Panelboards V12-**T4**-4–V12-**T4**-8
- Breaker Retrofit Kits
 - 5 Star MCCs V12-**T14**-15
 - F10 MCCs V12-**T14**-16
 - Type W MCCs V12-**T14**-16
- Breaker Service Center V12-**T3**-112
- Breaker Test Cabinet V12-**T17**-9
- Breaker Test Kit Adapters V12-**T17**-9
- Breaker Test Kits V12-**T17**-9
- Breakers
 - Accessories, Molded-Case V12-**T3**-3, V12-**T3**-17, V12-**T3**-48, V12-**T3**-51, V12-**T3**-53, V12-**T3**-55, V12-**T3**-57, V12-**T3**-59, V12-**T3**-63
 - Current Limiting V12-**T3**-13, V12-**T3**-14
 - Medium Voltage
 - Vacuum Replacement V12-**T2**-2
 - Miniature, QUICKLAG V12-**T3**-6, V12-**T3**-7
 - Molded-Case V12-**T3**-1–V12-**T3**-168
 - Molded-Case Circuit
 - Handle Extension V12-**T3**-112
 - Handle Mechanisms V12-**T3**-95–V12-**T3**-112
 - Motor Circuit Protectors V12-**T3**-63
 - Motor Control Center Replacement V12-**T3**-88
 - Nameplate Data V12-**T3**-3
 - Panelboard Replacement V12-**T3**-80–V12-**T3**-82, V12-**T3**-84–V12-**T3**-87
 - Rating Plugs V12-**T3**-60
 - Replacement Capabilities V12-**T3**-15–V12-**T3**-167
 - Replacement Circuit V12-**T3**-15–V12-**T3**-60
 - Replacement Cross-Reference V12-**T3**-113–V12-**T3**-167

- Breakers, continued
 - Replacement Guide V12-**T3**-10–V12-**T3**-14
 - Replacement, SELTRONIC V12-**T3**-12
 - Vacuum Replacement
 - Medium Voltage V12-**T2**-2
- Brush Type Mark V V12-**T13**-76, V12-**T13**-80, V12-**T13**-81
- Brush Type Mark V Solid-State Slipsyn
 - Class 14-100 Field Application Panel V12-**T13**-80
- Brush Type Relay Slipsyn
 - Class 14-100 Application Field Panel V12-**T13**-80
 - Class 14-100 Application Panel V12-**T13**-78
- Brushless Motor Control V12-**T13**-77
- Brushless Synchronous Control V12-**T13**-83
- Brushless Type Mark V Solid-State Slipsyn
 - Class 14-100 Field Application Panel V12-**T13**-85
- Brushless Type Relay Slipsyn
 - Class 14-100 Field Application Panel V12-**T13**-83
- Brushless-Type Relay-Panel Slipsyn (Class 14-100) V12-**T13**-84
- Bryant V12-**T3**-114
- Buck-Boost Transformers V12-**T8**-2
- Bucket Retrofits—Motor Control Center V12-**T2**-2
- Bulletin 9950 MV Motor Control V12-**T13**-87
- Bus Plugs—see Low Voltage Bus Plugs
- Bus, Fluidized Switchgear V12-**T2**-2
- Busbar Connectors V12-**T3**-48, V12-**T3**-59
- Bus—Fluidized
 - Switchgear V12-**T2**-2
- Bussed End Caps V12-**T6**-2
- Busway (Low Voltage)
 - Bolt-on Units V12-**T9**-11
 - Busway TVSS Protection V12-**T9**-14
 - Clipper Power Systems V12-**T9**-14
 - Current Limiting V12-**T9**-2
 - Electric Utility (DC) V12-**T9**-2
 - H5000 Feeder V12-**T9**-2, V12-**T9**-4, V12-**T9**-8
 - H5000 Plug-in 225–1000A V12-**T9**-2
 - High Frequency V12-**T9**-2
 - IQ Energy Sentinels V12-**T9**-15
 - Low Impedance Feeder V12-**T9**-2
 - Low Impedance Plug-in V12-**T9**-2
 - Plug-in Units V12-**T9**-12
 - CP2 V12-**T9**-3, V12-**T9**-12–V12-**T9**-14
 - CP3 V12-**T9**-3, V12-**T9**-12–V12-**T9**-14
 - CP4 V12-**T9**-3, V12-**T9**-12–V12-**T9**-14
 - Pow-R-Way II Plug-in Straight Length V12-**T9**-2
 - Pow-R-Way Plug-in Straight Length V12-**T9**-2
 - Standard Plug-in V12-**T9**-2, V12-**T9**-9
- Busway—see Low Voltage Busway
- BV Bus V12-**T9**-3
- Bypass Isolation Switches —
 - see Automatic Transfer Switches V12-**T20**-1

Appendix 2—Alphabetical Product Index

C

- C10 Contactors and Starters V12-T13-6
- C25 V12-T13-53
- C30 Contactors and Starters V12-T13-6
- C306 V12-T13-40–V12-T13-44
- C316 Overload Relays V12-T13-46
- C32 V12-T13-53
- C321 V12-T13-8
- C371 Handle Mechanisms V12-T3-108
- C50 Contactors and Starters V12-T13-6
- C514 V12-T13-71
- C80 DC Contactors V12-T13-61
- C80 Mill Type DC Contactors
 - Replacement Capabilities V12-T13-62
- CA Molded-Case Circuit Breakers V12-T3-10
- CA Molded-Case Switch V12-T3-62
- CA Replacement Breaker V12-T3-10
- CAH Molded-Case Circuit Breakers V12-T3-10
- CAH Replacement Breaker V12-T3-10
- Calibration, 50°C V12-T3-17, V12-T3-20, V12-T3-22,
 - V12-T3-24, V12-T3-26, V12-T3-28, V12-T3-30,
 - V12-T3-31, V12-T3-33, V12-T3-36, V12-T3-38,
 - V12-T3-39, V12-T3-41, V12-T3-44, V12-T3-45,
 - V12-T3-48, V12-T3-83, V12-T3-87
- Cantilever Hangers V12-T9-7
- Capacitor Cells V12-T21-3
- Capacitors V12-T21-3
- Catalog Numbering System
 - Type C-HRG (Low Voltage) V12-T16-4
 - Type C-HRG (Medium Voltage) V12-T16-7
- Catalog Numbering Systems
 - AMPGARD Contactors and Starters V12-T13-88–V12-T13-90
 - Series C Retrofit Kits for MCCs V12-T14-17
- CDP Panelboard V12-T4-2, V12-T4-4, V12-T4-9
- CDP Panelboard (Cutler-Hammer) V12-T4-4
- CDP Panelboard (Westinghouse) V12-T4-2, V12-T4-7
- CDP Panelboard, Replacement
 - Breaker V12-T4-2, V12-T4-4, V12-T4-9
- CDP/HCDP Panelboard V12-T4-7
- CDP/HCDP Panelboard, Replacement Breaker V12-T4-7
- Cell Provisions for DS Circuit Breakers V12-T17-5
- Cell Provisions, Low Voltage
 - Switchgear V12-T17-5, V12-T17-7, V12-T17-8
- Cell-Retrofit, MV Motor Starter V12-T13-91
- Center Studs V12-T3-77
- CG11 V12-T6-2
- CG2 V12-T6-2
- CG2, 4 V12-T6-2
- CG3 V12-T6-2
- CG3, 5, 7, 9, 11 V12-T6-2
- CG4 V12-T6-2
- CG5 V12-T6-2
- CG7 V12-T6-2
- CG9 V12-T6-2
- CH Loadcenters V12-T5-4, V12-T5-5, V12-T5-6
- Challenger—Breaker Cross-Reference V12-T3-113
- CHB Miniature Circuit Breakers V12-T3-9, V12-T4-4
- CHB Panelboard V12-T4-2, V12-T4-4
- CHB Panelboard, Replacement Breaker V12-T4-4
- CHP Panelboard V12-T4-4
- CHP Panelboard, Replacement Breaker V12-T4-4
- C-HRG (Low Voltage) High
 - Resistance Grounding Systems V12-T16-2–V12-T16-4
- C-HRG (Medium Voltage) High
 - Resistance Grounding Systems V12-T16-5–V12-T16-7
- Circuit Breaker Cell Provisions V12-T15-3
- Circuit Breaker Plug-in Unit (Closed) V12-T9-8
- Circuit Breaker Plug-in Unit (Open) V12-T9-8
- Circuit Breaker Provisions for
 - WF/WRP, ES and Pow-R-Line C
 - Distribution Switchboards V12-T15-5
- Circuit Breaker Repair V12-T3-112
- Circuit Breaker Test Kits for DS Breakers V12-T17-9
- Circuit Breaker, DB V12-T17-2, V12-T17-3
- Circuit Breaker, DS V12-T17-2, V12-T17-4, V12-T17-5
- Circuit Breaker, DSII V12-T17-2, V12-T17-6, V12-T17-7
- Circuit Breaker, Low Voltage
 - Power Air Circuit Breakers (LVPACB) V12-T17-5, V12-T17-6
- Circuit Breaker, Magnum DS V12-T17-2, V12-T17-8
- Circuit Breakers
 - Molded-Case V12-T3-1–V12-T3-168
 - Current Limiting V12-T3-13, V12-T3-14
 - Miniature, QUICKLAG V12-T3-6, V12-T3-7
 - Replacements V12-T2-3
- Citation Adapter Plates V12-T13-8
- Citation Starter Replacement Capabilities
 - Coils V12-T13-7
 - Contacts V12-T13-7
 - Current Transformers V12-T13-8
 - Heaters V12-T13-9–V12-T13-21
- Clamp-On CTs V12-T10-35
- Clamp-On Current Transformers
 - Metering Devices V12-T10-35
- Class 1 Reconditioning
 - Aftermarket Centers of Excellence (ACE) V12-T22-7
 - DB Breakers V12-T17-3
 - DHP Breakers V12-T17-56
 - DS Breakers V12-T15-3, V12-T17-5
 - DSII Breakers V12-T17-7
 - Magnum DS Breakers V12-T17-8
 - Renewal Parts V12-T22-7
- Class 1, Division 2, Hazardous Location Transformer V12-T8-4
- Class 10—A200 Overload Relay V12-T13-29
- Class 20—A200 Overload Relay V12-T13-27, V12-T13-28
- Classic AMPGARD V12-T13-94

Appendix 2—Alphabetical Product Index

CLE V12-**T18**-2–V12-**T18**-4

CLH V12-**T9**-7

Clipper Power Systems—Visor Series

 Low Voltage Busway V12-**T9**-14

CLPT V12-**T18**-2–V12-**T18**-4

CLS V12-**T18**-2–V12-**T18**-4

CLT V12-**T18**-2–V12-**T18**-4

CM V12-**T19**-2–V12-**T19**-4

CM-1 V12-**T19**-2

CM-2 V12-**T19**-2

CM-22 V12-**T19**-2–V12-**T19**-4

CM52 V12-**T19**-2–V12-**T19**-4

CMCU V12-**T3**-103

CMD V12-**T19**-2–V12-**T19**-4

CMR-8 V12-**T19**-2–V12-**T19**-4

CN-33 V12-**T19**-2

CNJ V12-**T19**-2

Coils

 A202 Lighting Contactor V12-**T13**-33, V12-**T13**-34

 AVD V12-**T13**-66

 Citation V12-**T13**-7

 D V12-**T13**-67

 Definite Purpose V12-**T13**-53

 DPM V12-**T13**-65

 Freedom (IEC) V12-**T13**-42

 Freedom (NEMA) V12-**T13**-38

 JF Autostarter V12-**T13**-56

 Reversing/Assignment V12-**T13**-68

 Type N V12-**T13**-22

 V200/V201 V12-**T13**-36

Communication Expansion Card

 Metering Devices, Power Xpert Meter 4000/6000/8000

 Accessories V12-**T10**-15

Communication Network Devices V12-**T11**-12–V12-**T11**-26

Communication Ports — PLCs V12-**T12**-2

Communication Systems V12-**T11**-1–V12-**T11**-26

 PowerNet V12-**T2**-3

Communications via the PowerNet System—

 Retrofit Kits V12-**T17**-18

Consulting and Advisory Support V12-**T22**-8

Contact Blocks V12-**T23**-9–V12-**T23**-10

Contact Kits

 A200 V12-**T13**-23–V12-**T13**-25

 Advantage V12-**T13**-51

 AVD V12-**T13**-66

 Citation V12-**T13**-7

 Contactors and Starters V12-**T2**-3

 D V12-**T13**-67

 DPM V12-**T13**-65

 Freedom (IEC) V12-**T13**-42

 Freedom (NEMA) V12-**T13**-38

 Reversing/Assignment V12-**T13**-68

Contactor

 25L2 Medium Voltage V12-**T13**-88, V12-**T13**-92, V12-**T13**-93

 25L4 Medium Voltage V12-**T13**-88, V12-**T13**-92, V12-**T13**-93

 25L7 Medium Voltage V12-**T13**-88, V12-**T13**-92, V12-**T13**-93

 50L2 Medium Voltage V12-**T13**-88, V12-**T13**-92, V12-**T13**-93

 50L4 Medium Voltage V12-**T13**-88, V12-**T13**-92, V12-**T13**-93

 50L7 Medium Voltage V12-**T13**-88, V12-**T13**-92, V12-**T13**-93

 LF Air-Break Medium Voltage V12-**T13**-87, V12-**T13**-92, V12-**T13**-93

 Medium Voltage V12-**T13**-87, V12-**T13**-92–V12-**T13**-97

 SJ Vacuum Medium Voltage V12-**T13**-87, V12-**T13**-94

 SL Vacuum Medium Voltage V12-**T13**-87, V12-**T13**-90, V12-**T13**-94

Contactors and Starters—Parts, Contact Kit V12-**T2**-3

Contactors, Starters and Brakes V12-**T13**-2–V12-**T13**-69

Control and Overload

 Advantage V12-**T13**-51

Coordination Study V12-**T22**-4

Counters

 Count Controls/Preset Counters V12-**T24**-44–V12-**T24**-61

 Totalizers V12-**T24**-2–V12-**T24**-55

Counters, Panel Meters, Tachometers and Timers

 Special Control Functions V12-**T24**-98

Covers — Loadcenters V12-**T5**-4

CP V12-**T9**-12

CP2 V12-**T9**-2, V12-**T9**-12–V12-**T9**-14

CP2 Plug-in V12-**T9**-14

CP2 SAFETYBUS V12-**T9**-2

CP3 V12-**T9**-3, V12-**T9**-12–V12-**T9**-14

CP3 Plug-in V12-**T9**-14

CP3 SAFETYBUS V12-**T9**-3

CP4 V12-**T9**-3, V12-**T9**-12–V12-**T9**-14

CP4 Plug-in V12-**T9**-14

CP4 SAFETYBUS V12-**T9**-3

Cross-Reference

 Industrial MCB/MCCBs, Residential

 MCBs, Mining Breakers V12-**T3**-113–V12-**T3**-167

CTK V12-**T9**-9

Current Limiter Attachment V12-**T3**-63

Current Limiting Breakers

 Replacement Guide V12-**T3**-13, V12-**T3**-14

Current Limiting Bus V12-**T9**-3

Current Limiting Circuit Breakers V12-**T3**-13, V12-**T3**-14

Current Limit-R Circuit Breakers V12-**T3**-2, V12-**T3**-13

Appendix 2—Alphabetical Product Index

Current Transformers	V12-T10-43	DBS	V12-T18-2
Current Transformers (CTs).	V12-T10-33	DBU	V12-T18-2, V12-T18-3, V12-T18-5
Metering Devices	V12-T10-33	DC Busway	V12-T9-3
Current-Limiting Fuses	V12-T18-4	DC Coils for Contactors and Starters	V12-T13-65
Customer Required Information for Trip Unit Retrofit Kits	V12-T17-28	DC Contactors	
Cutler-Hammer PowerNet and Zone Interlock Kits (OPTIM 550 only)	V12-T3-94	ME and MD	V12-T13-57
CX/CXN	V12-T18-2–V12-T18-4	D-Contactor	V12-T13-67
D		Definitions of Replacement and Upgrade Capabilities for Trip Unit Retrofit Kits	V12-T17-19
D100	V12-T12-2	DeviceNet Interface Module Upgrade (DN65)	V12-T14-14
D120	V12-T12-2, V12-T12-4	DH Breaker Renewal Parts	V12-T17-55
D200	V12-T12-3	DH Medium Voltage Switchgear Assemblies and Power Circuit Breakers	V12-T17-55
D300	V12-T12-3	DHP Breaker	
D320	V12-T12-2, V12-T12-3	Class 1 Reconditioning	V12-T17-56
D32LT	V12-T12-2, V12-T12-3	Renewal Parts	V12-T17-56
D50	V12-T12-2, V12-T12-3	DHP Medium Voltage Switchgear Assemblies and Power Circuit Breakers	V12-T17-56
D500	V12-T12-3, V12-T12-4	DHP Switchgear Fluidized Switchgear Bus	V12-T17-56
DA Molded-Case Circuit Breakers	V12-T3-11, V12-T3-31, V12-T3-116	DHP, VCP, VCP-W Front Panel Retrofits with IQ Devices and PowerNet	V12-T17-59
DA Molded-Case Switch	V12-T3-61	DHP, VCP, VCP-W MVA Upgrades for Medium Voltage Switchgear	V12-T17-59
DA Replacement Breaker	V12-T3-11	DHP-VR Ratings	V12-T17-56
DA-50-1600 Westinghouse Breaker	V12-T17-30	DHP-VR Replacement Breakers	V12-T17-56
DA-50-800 Westinghouse Breaker	V12-T17-30	Digital I/O Card	
DA-75 Westinghouse Breaker	V12-T17-30	Metering Devices, Power Xpert Meter 4000/6000/8000	V12-T10-15
Damper Winding Protective Relay, Synchronous	V12-T13-79, V12-T13-83, V12-T13-84	Accessories	V12-T10-15
DB Breaker		Digital Panel Meters	V12-T24-72–V12-T24-78
Class 1 Reconditioning	V12-T17-3	Digitrip 1150	V12-T11-11
Digitrip Trip Unit Retrofit Kits	V12-T17-3	Digitrip 3000	V12-T10-29, V12-T10-30, V12-T11-11
Parts	V12-T17-3	Digitrip 3000 Optional Drawout Case	V12-T10-43
Technology Upgrades	V12-T17-3	Digitrip 3000 Overcurrent Relay	V12-T10-43
DB Low Voltage Switchgear Assemblies and Power Circuit Breakers	V12-T17-3	Digitrip 3000 Trip Unit	V12-T10-30
DB Power Circuit Breaker	V12-T17-2, V12-T17-3	Digitrip 550	V12-T3-94
DB Retrofit Kits Upgrades from Amptector	V12-T17-32	Digitrip MV	V12-T10-29
DB Switchgear	V12-T17-2	Digitrip OPTIM 1050	V12-T11-11
DB VSR	V12-T17-3	Digitrip OPTIM 750	V12-T11-11
DB-100 Westinghouse Breaker	V12-T17-32	Digitrip Retrofit Kits	V12-T17-17–V12-T17-52
DB-15 Westinghouse Breaker	V12-T17-32	Accessories	V12-T17-28
DB-25 Westinghouse Breaker	V12-T17-32	Rating Plugs	V12-T17-24–V12-T17-27
DB25-AR600NM	V12-T17-3, V12-T17-11, V12-T22-6	Retrofit Kits	
DB25-LV-VSR Vacuum Starter Retrofit	V12-T17-3	Allis-Chalmers LA Breakers	V12-T17-41, V12-T17-42
DB-50 Westinghouse Breaker	V12-T17-32	Federal Pacific Breakers	V12-T17-49, V12-T17-50
DB50-AR1600M	V12-T17-11, V12-T22-6	General Electric Breakers	V12-T17-37–V12-T17-40
DB-75 Westinghouse Breaker	V12-T17-32	ITE Breakers	V12-T17-43–V12-T17-46
DB75-AR3000M	V12-T17-11, V12-T22-6	Other Manufacturers	V12-T17-51
DBA	V12-T18-2	Siemens and Siemens-Allis Breakers	V12-T17-47, V12-T17-48
DB-AR Replacement Breakers	V12-T17-3	Westinghouse Breakers	V12-T17-29–V12-T17-36
DBL-25 Westinghouse Breaker	V12-T17-32	Digitrip Retrofit Kits for Pow-R-Gear, Pow-R-M-S and SPB	V12-T15-4
DBL-50 Westinghouse Breaker	V12-T17-32	Digitrip Retrofit Kits for WRI, Pow-R-I, Pow-R-M-S/F and Pow-R-Line <i>i</i>	V12-T15-3

Appendix 2—Alphabetical Product Index

Digitrip Retrofit Kits Further Information	V12- T17 -52
Digitrip Retrofit Kits Pricing Information	V12- T17 -52
Digitrip RMS 810	V12- T11 -11
Digitrip RMS 910	V12- T11 -11
Digitrip RMS Retrofit Kit Catalog Numbering System	
Allis-Chalmers LA Breakers	V12- T17 -42
Federal Pacific Breakers	V12- T17 -50
General Electric AK Breakers	V12- T17 -38
General Electric AL Breakers	V12- T17 -39
ITE K-Line Breakers	V12- T17 -44
Other Breakers	V12- T17 -51
Other ITE Breakers	V12- T17 -46
Siemens and Siemens-Allis Breakers	V12- T17 -48
Westinghouse DA/DK Breakers	V12- T17 -30
Westinghouse DB Breakers	V12- T17 -32
Westinghouse DS Breakers	V12- T17 -34
Westinghouse SPB Breakers	V12- T17 -36
Digitrip RMS Retrofit Kits	
Allis-Chalmers LA Breakers	V12- T17 -42
Federal Pacific Breakers	V12- T17 -50
General Electric AK Breakers	V12- T17 -38
General Electric AL Breakers	V12- T17 -39
ITE K-Line Breakers	V12- T17 -44
Other Breakers	V12- T17 -51
Other General Electric Breakers	V12- T17 -40
Other ITE Breakers	V12- T17 -46
Siemens and Siemens-Allis Breakers	V12- T17 -48
Westinghouse DA and DK Breakers	V12- T17 -30
Westinghouse DB Breakers	V12- T17 -32
Westinghouse DS Breakers	V12- T17 -34
Westinghouse SPB Breakers	V12- T17 -36
Digitrip RMS Trip Unit Replacement	V12- T17 -21, V12- T17 -22
Digitrip Trip Unit Retrofit Kit	
DB Breakers	V12- T17 -3
DS Breakers	V12- T17 -5
DSII Breakers	V12- T17 -7
Digitrip Trip Unit Retrofit Kits for SPB and DS Breakers	V12- T15 -6
Digitrip Trip Unit Upgrade Table	V12- T17 -19
Dimensions for MCC Buckets and Doors	V12- T14 -3
Direct (Close-Coupled) Handle Mechanisms	V12- T3 -111
Discharge Resistor, Starting and Field	V12- T13 -79, V12- T13 -80, V12- T13 -82
Distribution Switchboards (Low Voltage)	V12- T15 -1–V12- T15 -6
ES	V12- T15 -5
IQ and PowerNet Communications Retrofits	V12- T15 -6
Pow-R-Gear	V12- T15 -4
Pow-R-I	V12- T15 -3
Pow-R-Line C	V12- T15 -5
Pow-R-Line <i>i</i>	V12- T15 -3
Pow-R-M-S	V12- T15 -4
Pow-R-M-S/F	V12- T15 -3

Distribution Switchboards (Low Voltage), continued	
Product Description	V12- T15 -2
Product History	V12- T15 -2
Product History Time Line	V12- T15 -2
WF/WRP	V12- T15 -5
WRI	V12- T15 -3
Distribution System Overview	V12- T2 -2–V12- T2 -4
DK Molded-Case Circuit Breakers	V12- T3 -116
DK Series C Breaker	V12- T3 -11
DK-15 Westinghouse Breaker	V12- T17 -30
DK-25 Westinghouse Breaker	V12- T17 -30
DN	V12- T13 -3
DN65 DeviceNet Interface Module for MCC Upgrades	V12- T14 -14
DP-4000	V12- T10 -36, V12- T13 -93, V12- T13 -95
DPM Definite Purpose Contactor	V12- T13 -65
Drawout Mounting Breakers	V12- T3 -57
Drip Hoods — Meter Centers	V12- T6 -2
Drives — see Adjustable Frequency Drives	
Dry-Type Distribution Transformers	V12- T8 -2
DS-3	V12- T8 -2
DT-3	V12- T8 -2
EP	V12- T8 -2
EPT	V12- T8 -2
KT	V12- T8 -2
MD	V12- T8 -2
MPC	V12- T8 -2
MTA	V12- T8 -2
MTC	V12- T8 -2
NEMA TP-1	V12- T8 -2
DS and DSL-206 Westinghouse Breaker	V12- T17 -34
DS and DSL-416 Westinghouse Breaker	V12- T17 -34
DS Breaker Class 1 Reconditioning	V12- T15 -3
DS Breaker Parts	V12- T17 -5
DS Breaker Standard Retrofit RMS Replacement Trip Units	V12- T17 -21
DS Breakers	V12- T17 -5
DS Breakers Class 1 Reconditioning	V12- T17 -5
DS Breakers with Digitrip Trip Unit Retrofit Kits	V12- T17 -5
DS Breakers with IQ and PowerNet Communications	V12- T17 -5
DS Circuit Breaker Cell Provisions	V12- T17 -5
DS Low Voltage Switchgear Assemblies and Power Circuit Breakers	V12- T17 -4–V12- T17 -5
DS Parts	V12- T15 -3, V12- T15 -5
DS Power Circuit Breaker	V12- T17 -2, V12- T17 -4, V12- T17 -5
DS Rating Plugs	V12- T17 -24, V12- T17 -25
DS Switchgear Structure Parts	V12- T17 -5
DS-3	V12- T8 -2
DS-420 Westinghouse Breaker	V12- T17 -34
DS-632 Westinghouse Breaker	V12- T17 -34
DS-840 Westinghouse Breaker	V12- T17 -34

Appendix 2—Alphabetical Product Index

DSII	
Breaker Parts	V12-T17-7
Breakers	V12-T17-7
Breakers Class 1 Reconditioning	V12-T17-7
Breakers with Digitrip Trip Unit Retrofit Kits	V12-T17-7
Circuit Breaker Provisions	V12-T17-7
DSII Low Voltage Switchgear Assemblies and Power Circuit Breakers	V12-T17-2, V12-T17-6, V12-T17-7
DSII Switchgear Structure Parts	V12-T17-7
DSII VSR	V12-T17-7
DT	V12-T10-30
DT-3	V12-T8-2
DT-3000	V12-T10-12–V12-T10-14, V12-T10-30
Dual-Source Power Supply	V12-T10-43
Dynamatic Adjustable Frequency AC Drives	V12-T13-72
Dynamic Data Exchange	V12-T11-8, V12-T11-9
E	
E Out-of-Production Circuit Breaker	V12-T3-10, V12-T3-81
E2F Mining Breakers	V12-T3-164
E2FM Mining Breakers	V12-T3-162, V12-T3-166, V12-T3-167
E2K Mining Breakers	V12-T3-164, V12-T3-166, V12-T3-167
E2KE Mining Breakers	V12-T3-162–V12-T3-164
E2KEM Mining Breakers	V12-T3-163, V12-T3-164, V12-T3-167
E2LE Mining Breakers	V12-T3-163, V12-T3-166, V12-T3-167
E2LEM Mining Breakers	V12-T3-163, V12-T3-167
E2N Mining Breakers	V12-T3-162–V12-T3-164, V12-T3-166, V12-T3-167
E2NM Mining Breakers	V12-T3-162, V12-T3-164, V12-T3-166, V12-T3-167
EA	V12-T13-71
EA Out-of-Production Circuit Breaker	V12-T3-10, V12-T3-81
Easy-Start	
100	V12-T13-71
120	V12-T13-71
EA	V12-T13-71
EC	V12-T13-71
EJ	V12-T13-71
ES	V12-T13-71
Jr.	V12-T13-71
Eaton Terms & Conditions	V12-A1-1
Freight	V12-A1-3
Limitation of Liability	V12-A1-5
Terms and Conditions of Sale	V12-A1-1
Terms of Payment	V12-A1-2
Warranty	V12-A1-3
Eaton's Electrical Services & Systems	V12-T11-3
EB Molded-Case Circuit Breakers	V12-T3-10, V12-T3-15, V12-T3-116, V12-T3-117
EB Molded-Case Switch	V12-T3-61
EB Replacement Breaker	V12-T3-10
EC Out-of-Production Cutler-Hammer Breaker	V12-T3-10
ECN42–ECN44	V12-T13-56
ED Series C Breaker	V12-T3-10
EDC Series C Breaker	V12-T3-10
EDH Series C Breaker	V12-T3-10
EE Panelboard	V12-T4-2, V12-T4-6, V12-T4-13
EE Panelboard, Replacement Breaker	V12-T4-2, V12-T4-6, V12-T4-13
EESS (Eaton's Electrical Services & Systems)	V12-T22-2
EG Series C Breaker	V12-T3-10
EH Out-of-Production Circuit Breaker	V12-T3-10, V12-T3-81
EHB Molded-Case Circuit Breakers	V12-T3-10, V12-T3-15, V12-T3-117
EHB Molded-Case Switch	V12-T3-61
EHB Replacement Breaker	V12-T3-10
EHC Out-of-Production Cutler-Hammer Breaker	V12-T3-10
EHD Molded-Case Circuit Breakers	V12-T3-116, V12-T3-117
EHD Series C Breaker	V12-T3-10
EJ	V12-T13-71
Electric Utility Bus	V12-T9-3
Electrical Power System Protection	V12-T10-30
Electronic Metering — see IQ Products	
Electronic Metering and Protection	V12-T10-2
Electronic Motor Protective Relay	V12-T10-36
Electronic Power Meters	
IQ 250 and IQ 260	V12-T10-19
Electronic Self-Enclosed Meters	
IQ 150S/250S	V12-T10-21
Enclosed Meters	
Metering Devices	V12-T10-23
Energy Saver	V12-T13-71
Energy Sentinel	V12-T11-11
EP Panelboard	V12-T4-6, V12-T4-14, V12-T8-2
EP Panelboard, Replacement Breaker	V12-T4-6, V12-T4-14, V12-T8-2
EPONI	V12-T10-24
Equipment Services and Upgrades	V12-T22-8
ES	V12-T13-71
ES Distribution Switchboard Rating Table	V12-T15-5
Ethernet	
Adapter	V12-T12-2
Euro IEC Direct Handle Mechanism	V12-T3-95, V12-T3-111
Eutectic Alloy Overloads	V12-T13-3
Excitation Control	V12-T13-79
Exciter/Excitation Control, Synchronous Motor Control	V12-T13-76–V12-T13-86
Expulsion Fuses	V12-T18-5
Extended Line Terminal Shields	V12-T3-70
Extension Handle	V12-T3-112

Appendix 2—Alphabetical Product Index

F

F Out-of-Production Circuit Breaker	V12-T3-10, V12-T3-81, V12-T3-88
F TRI-PAC Out-of-Production Circuit Breaker	V12-T3-13
F10 Motor Control Center	
Add-on Structures	V12-T14-8
Feeder Breaker Units	V12-T14-8
Handle Mechanism	V12-T14-4
MCC Product Description	V12-T14-8
MCC Replacement Capabilities	V12-T14-8
MCCs with Series C Retrofit Kits	V12-T14-16
Replacement Starter Units	V12-T14-8
Series C Retrofit Kit	V12-T3-92
F2100 Motor Control Center	
Feeder Breaker Units	V12-T14-12
Handle Mechanism	V12-T14-4
MCC Product Description	V12-T14-12
MCC Replacement Capabilities	V12-T14-12
Replacement Starter Units	V12-T14-12
FA Out-of-Production Circuit Breaker	V12-T3-10, V12-T3-11, V12-T3-81, V12-T3-88
FA TRI-PAC Out-of-Production Circuit Breaker	V12-T3-13
Factory Original—Identification for MCCBs	V12-T3-4
Factory Repair Services for SPB Breakers	V12-T15-4, V12-T15-5
Factory Retrofits for Competitive MCCs	V12-T14-18
FB Current Limiting Breaker	V12-T3-13
FB Molded-Case Circuit Breakers	V12-T3-10, V12-T3-16, V12-T3-119, V12-T3-120
FB Molded-Case Switch	V12-T3-61
FB Replacement Breaker	V12-T3-10, V12-T3-11
FC Out-of-Production Circuit Breaker	V12-T3-11
FC Out-of-Production Cutler-Hammer Breaker	V12-T3-10
FCL Current Limiting Breaker	V12-T3-13
FD Series C Breaker	V12-T3-10, V12-T3-11
FDB Series C Breaker	V12-T3-10, V12-T3-11
FDC	V12-T14-16
FDC Series C Breaker	V12-T3-10, V12-T3-11
FDP Panelboard	V12-T4-2, V12-T4-7, V12-T4-10
FDP Panelboard, Replacement Breaker	V12-T4-2, V12-T4-7
Features of PowerNet Communications	V12-T17-20
Federal Pacific	
100HF Breaker	V12-T17-50
FP-25 Breaker	V12-T17-50
FP-50 Breaker	V12-T17-50
FPS-50 Breaker	V12-T17-50
FPS-75 Breaker	V12-T17-50
Federal Pacific Breakers Replacement and Upgrade Capabilities	V12-T17-49
Federal Pacific Breakers with Digitrip RMS Retrofit Kits	V12-T17-50
Federal Pacific Electric	
DST Vacuum Replacement Breaker	V12-T17-60
DST-2 Vacuum Replacement Breaker	V12-T17-60

Federal Pacific Electric AR-Series Replacement Breakers	V12-T17-11, V12-T22-6
Federal Pioneer Breaker	V12-T17-51
Federal Specification Classifications	V12-T3-17
Feeder Breaker Units	
11-300	V12-T14-5
5 Star/Series 2100	V12-T14-10
Advantage	V12-T14-11
F10	V12-T14-8
F2100	V12-T14-12
Freedom Unitrol	V12-T14-9
Type W	V12-T14-7
FH	V12-T13-30, V12-T13-32, V12-T13-36
FH Out-of-Production Circuit Breaker	V12-T3-10, V12-T3-11
Field Control Panel, Synchronous	V12-T13-76–V12-T13-86
Field-Mountable Attachments—MCCBs	V12-T3-51, V12-T3-53, V12-T3-55, V12-T3-59
Filler Plates	
Type BR Loadcenters and Circuit Breakers Accessories	V12-T5-14, V12-T5-15
FL Out-of-Production Circuit Breaker	V12-T3-10
Flex Shaft Handle Mechanisms	V12-T3-95, V12-T3-107
Fluidized Switchgear Bus	V12-T2-2, V12-T17-59
DHP Switchgear	V12-T17-56
VCP Switchgear	V12-T17-57
VCP-W Switchgear	V12-T17-58
FP	V12-T17-11
FP-25 Federal Pacific Breaker	V12-T17-50
FP25-AR600NM	V12-T17-11, V12-T22-6
FP-50 Federal Pacific Breaker	V12-T17-50
FP-5000	V12-T10-12–V12-T10-14, V12-T10-29, V12-T11-11
FP-5000 Feeder Protection	V12-T10-29
FP-5000 Feeder Relay	V12-T10-43
FP50-AR1600M	V12-T17-11, V12-T22-6
FP75-AR3000B	V12-T17-11, V12-T22-6
FPE	V12-T22-6
FPS-50 Federal Pacific Breaker	V12-T17-50
FPS-75 Federal Pacific Breaker	V12-T17-50
Freedom Starter—IEC—Replacement Capabilities	
Coils	V12-T13-42–V12-T13-46
Contact Kits	V12-T13-42–V12-T13-46
Current Transformer	V12-T13-42–V12-T13-45
Magnet Frame Armature	V12-T13-42–V12-T13-46
Overload Relays	V12-T13-42–V12-T13-46
Freedom Starter—NEMA—Replacement Capabilities	
Coils	V12-T13-38–V12-T13-41
Contact Kits	V12-T13-38–V12-T13-41
Current Transformer	V12-T13-40
Magnet Frame Armature	V12-T13-38–V12-T13-41
Overload Relays	V12-T13-40, V12-T13-41

Freedom Unitrol	V12-T14-3, V12-T14-9
Add-on Structures	V12-T14-9
Feeder Breaker Units	V12-T14-9
Handle Mechanism	V12-T14-4
MCC Product Description	V12-T14-9
MCC Replacement Capabilities	V12-T14-9
Replacement Starter Units	V12-T14-9
Front Panel Retrofits with IQ Devices and PowerNet for DHP, VCP, VCP-W	V12-T17-59
FS Out-of-Production Circuit Breaker	V12-T3-10, V12-T3-11
FT	V12-T13-29
Fuse Base	V12-T7-2
Fuse Block	V12-T7-2
Fused WLI Switch	V12-T17-65
Fuses	V12-T18-1–V12-T18-8
Fusible Bolt-on Units	V12-T9-11
Fusible Plug-in Units	V12-T9-5, V12-T9-9
Pow-R-Way	V12-T9-5
Standard Plug-in and Low Impedance Busway	V12-T9-5
Fusible Switch Plug-in Units	V12-T9-12
Fusion Integrated Machine Control	V12-T24-91–V12-T24-95
FV Multispeed	V12-T13-88

G

G Allis-Chalmers Breaker	V12-T17-42
G Direct Handle Mechanism	V12-T3-95, V12-T3-111
G Out-of-Production Circuit Breaker	V12-T3-10
Gate Turn-off Thyristor	V12-T13-73
GCA	V12-T13-3, V12-T13-25
GCA 530/630, Sizes 5–9	V12-T13-25
GCA/GPD	V12-T13-25
GCD	V12-T13-3
GD Series C Breaker	V12-T3-10
GE AKR4A30-AR800NM	V12-T17-11, V12-T22-6
GE MG-8	V12-T19-2–V12-T19-4
GE MG-9	V12-T19-2–V12-T19-4
GE—AK	V12-T17-11, V12-T22-6
GE-AK2A50-AR1600M	V12-T17-11, V12-T22-6
GE—AKR	V12-T17-11, V12-T22-6
General Electric	
AK-1 Breaker	V12-T17-38
AK-2/2A Breaker	V12-T17-38
AK-3/3A Breaker	V12-T17-38
AKR(U)-6D/7D Breaker	V12-T17-38
AKR-4A/5A Breaker	V12-T17-38
AKR-6D/7D Breaker	V12-T17-38
AKRT-4A/5A Breaker	V12-T17-38
AM13.8 Vacuum Replacement Breaker	V12-T17-60
AM15 Vacuum Replacement Breaker	V12-T17-60
AM4.16 Vacuum Replacement Breaker	V12-T17-60

General Electric, continued	
AM5 Vacuum Replacement Breaker	V12-T17-60
AM7.2 Vacuum Replacement Breaker	V12-T17-60
AM7.5 Vacuum Replacement Breaker	V12-T17-60
MagneBlast Vacuum Replacement Breaker	V12-T17-60
General Electric AE-1 Breaker	V12-T17-40
General Electric AK Breakers with Digitrip RMS Retrofit Kits	V12-T17-38
General Electric AL Breakers with Digitrip RMS Retrofit Kits	V12-T17-39
General Electric AL-2 Breaker	V12-T17-39
General Electric AR-Series Replacement Breakers	V12-T17-11, V12-T22-6
Genuine Breakers—Identification for MCCBs	V12-T3-4
G-Frame Vari-Depth Handle Mechanism	V12-T3-95
GHC Series C Breaker	V12-T3-10
GND36	V12-T9-9
GPD Sizes 7–9	V12-T13-25
Graphic Display Module	
Metering Devices, Power Xpert Meter 4000/6000/8000	
Accessories	V12-T10-15
Ground Bars — Loadcenters	V12-T5-4
Ground Fault	V12-T17-18
Ground Fault Detection with High Resistance Grounding (C-HRG)	V12-T16-6
GS104	V12-T9-8, V12-T9-9
GTE-Sylvania SSPB Breaker	V12-T17-51

H

H1	V12-T13-10–V12-T13-21
H1000 Series Starters and Brakes	V12-T13-18
H10B Panelboard	V12-T4-7
H10B Panelboard, Replacement Breaker	V12-T4-7
H10P Panelboard	V12-T4-7
H10P Panelboard, Replacement Breaker	V12-T4-7
H1100 Series Starters and Brakes	V12-T13-18
H5000 Feeder	V12-T9-3
H5000 Plug-in	V12-T9-3, V12-T9-14
Handle Extensions Series C	V12-T3-112
Handle Lockdogs	
Type CH Loadcenters and Circuit Breakers	
Accessories	V12-T5-7
Handle Lockoffs	
Type BR Loadcenters and Circuit Breakers	
Accessories	V12-T5-16, V12-T5-17
Type CH Loadcenters and Circuit Breakers	
Accessories	V12-T5-7

Appendix 2—Alphabetical Product Index

Handle Mechanism for Motor Control Center Buckets	
11-300	V12- T14 -4
5 Star/Series 2100	V12- T14 -4
9800	V12- T14 -4
F10	V12- T14 -4
Freedom Unitrol	V12- T14 -4
Type W	V12- T14 -4
Handle Mechanisms	V12- T3 -95–V12- T3 -111
AMT Vari-Depth	V12- T3 -95
Direct (Close-Coupled)	V12- T3 -111
Euro IEC Direct	V12- T3 -95, V12- T3 -111
Extensions	V12- T3 -112
Flex-Shaft Type	V12- T3 -95
G Direct	V12- T3 -95, V12- T3 -111
G-Frame Vari-Depth	V12- T3 -95
Series C Rotary and Universal Rotary	V12- T3 -95, V12- T3 -109
Slide Plate Type	V12- T3 -95
Type AMT Vari-Depth	V12- T3 -95
Type MC Motor Control	V12- T3 -95, V12- T3 -103
Type SM Safety Handle	V12- T3 -95
Universal Direct	V12- T3 -95, V12- T3 -111
Universal Rotary Type	V12- T3 -95, V12- T3 -109
Vari-Depth Type	V12- T3 -95
Handle Ties	
Accessories	
Type CH Loadcenters and Circuit Breakers	V12- T5 -7
Type BR Loadcenters and Circuit Breakers	
Accessories	V12- T5 -16, V12- T5 -18
Harmonic Correction Unit	V12- T21 -4
Hazardous Location — Dry-Type Transformers	V12- T8 -2
HBAW	V12- T3 -7
HBAX	V12- T3 -7
HCA Molded-Case Circuit Breakers	V12- T3 -10
HCA Replacement Breaker	V12- T3 -10
HCDP Panelboard	V12- T4 -7, V12- T4 -9
HCL	V12- T18 -3
Heater Selection for Types A and B Overload Relays	
Sizes 00, 0, 1 and 2 Starters	V12- T13 -30, V12- T13 -31
Sizes 3 and 4 Starters	V12- T13 -32
Sizes 5 and 6 Starters	V12- T13 -32
Heaters, A200	V12- T13 -30–V12- T13 -32
Heaters, Citation	V12- T13 -9–V12- T13 -21
Heaters, V201	V12- T13 -36
HF Out-of-Production Circuit Breaker	V12- T3 -10, V12- T3 -81, V12- T3 -88
HFA Out-of-Production Circuit Breaker	V12- T3 -10, V12- T3 -11, V12- T3 -81, V12- T3 -88
HFB Molded-Case Circuit Breakers	V12- T3 -10, V12- T3 -16, V12- T3 -117, V12- T3 -120
HFB Replacement Breaker	V12- T3 -10, V12- T3 -11, V12- T3 -119
HFC Out-of-Production Circuit Breaker	V12- T3 -11
HFC Out-of-Production Cutler-Hammer Breaker	V12- T3 -10
HFD	V12- T14 -16
HFD Series C Breaker	V12- T3 -10, V12- T3 -11
High Frequency Bus	V12- T9 -3
High Resistance Grounding System—Low Voltage	V12- T2 -3
HJD	V12- T14 -16
HJD Series C Breaker	V12- T3 -11
HK Out-of-Production Circuit Breaker	V12- T3 -11, V12- T3 -82
HKA Molded-Case Circuit Breakers	V12- T3 -11, V12- T3 -25, V12- T3 -122
HKA Replacement Breaker	V12- T3 -11
HKB Molded-Case Circuit Breakers	V12- T3 -11, V12- T3 -21, V12- T3 -123
HKB Replacement Breaker	V12- T3 -11
HKD	V12- T14 -16
HKD Series C Breaker	V12- T3 -11
HKL Out-of-Production Circuit Breaker	V12- T3 -11, V12- T3 -82
HLA Molded-Case Circuit Breakers	V12- T3 -11, V12- T3 -34– V12- T3 -39, V12- T3 -124–V12- T3 -126
HLA Replacement Breaker	V12- T3 -11, V12- T3 -80, V12- T3 -124–V12- T3 -126
HLB Molded-Case Circuit Breakers	V12- T3 -11, V12- T3 -29, V12- T3 -126
HLB Replacement Breaker	V12- T3 -11, V12- T3 -126–V12- T3 -128
HLC Molded-Case Circuit Breakers	V12- T3 -11, V12- T3 -49, V12- T3 -128
HLC Replacement Breaker	V12- T3 -11, V12- T3 -128
HLCA Molded-Case Circuit Breakers	V12- T3 -49, V12- T3 -128
HLCA Replacement Breaker	V12- T3 -128
HLCC Molded-Case Circuit Breakers	V12- T3 -49, V12- T3 -128
HLCC Replacement Breaker	V12- T3 -128
HLCCA Molded-Case Circuit Breakers	V12- T3 -49, V12- T3 -128
HLCCG Molded-Case Circuit Breakers	V12- T3 -50, V12- T3 -128
HLCCGA Molded-Case Circuit Breakers	V12- T3 -50, V12- T3 -128
HLCG Molded-Case Circuit Breakers	V12- T3 -50, V12- T3 -128
HLCGA Molded-Case Circuit Breakers	V12- T3 -50, V12- T3 -129
HLD Series C Breaker	V12- T3 -11
HLE	V12- T18 -2–V12- T18 -4
HLE/HCL	V12- T18 -3
HLM Out-of-Production Circuit Breaker	V12- T3 -11, V12- T3 -12, V12- T3 -82
HMA Molded-Case Circuit Breakers	V12- T3 -12, V12- T3 -40, V12- T3 -42, V12- T3 -129
HMA Replacement Breaker	V12- T3 -12, V12- T3 -129
HMC Molded-Case Circuit Breakers	V12- T3 -52, V12- T3 -131
HMC Replacement Breaker	V12- T3 -131
HMCA Molded-Case Circuit Breakers	V12- T3 -52, V12- T3 -131
HMCC Molded-Case Circuit Breakers	V12- T3 -52, V12- T3 -131
HMCCA Molded-Case Circuit Breakers	V12- T3 -52, V12- T3 -131
HMCCG Molded-Case Circuit Breakers	V12- T3 -53, V12- T3 -131
HMCCGA Molded-Case Circuit Breakers	V12- T3 -53, V12- T3 -131
HMCG Molded-Case Circuit Breakers	V12- T3 -53, V12- T3 -131
HMCGA Molded-Case Circuit Breakers	V12- T3 -53, V12- T3 -131

Appendix 2—Alphabetical Product Index

HMCP	V12-T14-17	Interrupting Rating, Magnum DS without Current Limiters	V12-T17-8
HMDL Series C Breaker	V12-T3-12	Introduction	V1-T1-i, V1-T1-ii, V12-T1-1–V12-T1-3
HNB Molded-Case Circuit Breakers	V12-T3-12, V12-T3-43, V12-T3-45, V12-T3-131	IPONI	V12-T10-24, V12-T11-11, V12-T11-25
HNB Replacement Breaker	V12-T3-12, V12-T3-131	IQ	V12-T10-26, V12-T10-31, V12-T10-39, V12-T11-11
HNC Molded Case Circuit Breakers	V12-T3-54	IQ 1000	V12-T10-36, V12-T10-37
HNC Molded-Case Circuit Breakers	V12-T3-12, V12-T3-55, V12-T3-131	IQ 1000 II	V12-T10-36, V12-T10-37
HNC Replacement Breaker	V12-T3-12, V12-T3-131	IQ 110 Electronic Power Meter	V12-T10-40
HNCA Molded-Case Circuit Breakers	V12-T3-54, V12-T3-55, V12-T3-132	IQ 110/115	V12-T10-43
HNCG Molded-Case Circuit Breakers	V12-T3-54, V12-T3-55, V12-T3-132	IQ 110/115 Electronic Power Meters	V12-T10-40
HNCGA Molded-Case Circuit Breakers	V12-T3-54, V12-T3-55, V12-T3-132	IQ 130/140/150	V12-T10-43
HND Series C Breaker	V12-T3-12	IQ 130/140/150 Series Electronic Power Meters Metering Devices	V12-T10-20
HNDP Panelboard	V12-T4-4	IQ 150S/250S	V12-T10-43
HNDP Panelboard, Replacement Breaker	V12-T4-4	IQ 200	V12-T10-43, V12-T11-11
Hold-Down Kits		IQ 200/IQ 300	V12-T11-11
Type BR Loadcenters and Circuit Breakers		IQ 2000	V12-T10-36
Accessories	V12-T5-18	IQ 210/220	V12-T10-39
Hour Meters and Timers	V12-T24-79–V12-T24-90	IQ 230	V12-T10-8, V12-T10-9, V12-T10-27
How to Generate a Trip Unit Retrofit Kit Catalog Number	V12-T17-28	IQ 250 and IQ 260 Electronic Power Meters	V12-T10-19
How to Identify Motor Control Center Buckets	V12-T14-3	IQ 250/260	V12-T10-19
How to Order a Series C Retrofit Kit for MCCs	V12-T14-17	IQ 300	V12-T10-38, V12-T10-43, V12-T11-11
How to Price a Trip Unit Retrofit Kit	V12-T17-28	IQ 320 for MCCs	V12-T14-14
How to Select a Retrofit Kit	V12-T17-28	IQ 35M	V12-T10-43
HQP Miniature Circuit Breaker	V12-T3-7	Metering Devices	V12-T10-22
Hubs — Loadcenters	V12-T5-4	IQ 500	V12-T11-11
HVX9000	V12-T13-74	IQ Analyzer	V12-T10-24, V12-T10-36, V12-T10-43, V12-T11-11
HWT-500	V12-T19-4	IQ Analyzer 6000/6200	V12-T10-36
I		IQ Analyzer 6400/6600	V12-T10-24
I/O Modules	V12-T12-2	IQ Analyzer 6400/6600 Series	V12-T10-8, V12-T10-9
I/O Plus	V12-T12-3	IQ Analyzer for MCCs	V12-T14-14
IBP	V12-T9-5	IQ and PowerNet Communications for DS Breakers	V12-T17-5
ICS Inc.	V12-T12-4	IQ and PowerNet Communications Retrofits for Distribution Switchboards	V12-T15-6
Identifying Genuine Factory Original MCCBs	V12-T3-4	IQ and PowerNet Communications Retrofits for Pow-R-Gear, Pow-R-M-S and SPB	V12-T15-4
Identifying Renewal Parts for MCCs	V12-T14-18	IQ and PowerNet Communications Retrofits for WRI, Pow-R-I, Pow-R-M-S/F and Pow-R-Line <i>i</i>	V12-T15-3
IMPCABLE	V12-T11-25, V12-T11-26	IQ Cable	V12-T10-31
INCOM Network	V12-T11-8, V12-T11-11, V12-T11-25	IQ Data	V12-T10-37, V12-T13-95
Indicating Lights	V12-T23-6–V12-T23-7	IQ Data Only	V12-T13-95
Industrial Control Transformer	V12-T8-4	IQ Data Plus	V12-T10-37
Installation and Startup Services	V12-T2-3	IQ Data Plus II	V12-T10-37
Installation/Startup	V12-T22-2	IQ DC Power Supply	V12-T10-31, V12-T10-43
Instant Response Center	V12-T22-8	IQ DP-4000	V12-T10-8, V12-T10-9, V12-T10-25, V12-T10-36, V12-T10-43, V12-T11-11
Instrument Specialties, Inc.	V12-T12-3	IQ DP-4000 Auxiliary Power Supply	V12-T10-43
Integrated Project Solutions	V12-T22-7	IQ DP-4000 I/O Module	V12-T10-43
Design	V12-T22-7	IQ DP-4000/4100	V12-T10-25
Speed of Response	V12-T22-7	IQ DP-4000/IQ DP-4100	V12-T11-11

Appendix 2—Alphabetical Product Index

IQ DP-4100	V12-T10-25, V12-T11-11
IQ Energy Sentinel	V12-T2-3, V12-T10-10, V12-T10-11
IQ Energy Sentinel (Universal Mount)	V12-T10-26
IQ Energy Sentinel for Bus Plugs	V12-T9-15
IQ Energy Sentinels	V12-T10-26
IQ Energy/Power Sentinel	V12-T10-10, V12-T10-11
IQ Flange	V12-T10-31
IQ Floor-Mounted Enclosure	V12-T10-32, V12-T13-93
IQ Generator	V12-T10-38
IQ Metering and Protection	V12-T10-36
IQ Multipoint Energy Submeter II	V12-T10-43
Metering Devices	V12-T10-42
IQ Power Sentinel	V12-T10-41
IQ Power Sentinel	
Metering Devices	V12-T10-41
IQ Products	V12-T2-3, V12-T10-1–V12-T10-43
Addressable Relay	V12-T11-11
Addressable Relay (AR and ARII)	V12-T10-3, V12-T10-32
AEM	V12-T10-3
AEM II	V12-T10-3
CED	V12-T10-3
Current Transformers	V12-T10-43
Digitrip 3000 (DT-3000)	V12-T10-30
Digitrip 3000 Optional Drawout Case	V12-T10-43
Digitrip 3000 Overcurrent Relay	V12-T10-43
Digitrip MV	V12-T10-3
DT-3000	V12-T10-3, V12-T10-12–V12-T10-14, V12-T11-11
Dual-Source Power Supply	V12-T10-43
Energy Sentinel	V12-T10-26
FP-5000	V12-T10-3, V12-T10-12–V12-T10-14, V12-T10-29
FP-5000 Feeder Relay	V12-T10-43
IQ 1000	V12-T10-3, V12-T10-36, V12-T10-37
IQ 1000 II	V12-T10-3, V12-T10-36, V12-T10-37
IQ 110/115	V12-T10-43
IQ 110/115 Electronic Power Meters	V12-T10-40
IQ 130/140/150	V12-T10-43
IQ 150S/250S	V12-T10-43
IQ 200	V12-T10-3, V12-T10-43, V12-T11-11
IQ 2000	V12-T10-3, V12-T10-36
IQ 210/220	V12-T10-39
IQ 230	V12-T10-8, V12-T10-9, V12-T10-27
IQ 250/260	V12-T10-43
IQ 300	V12-T10-3, V12-T10-38, V12-T10-43, V12-T11-11
IQ 35M	V12-T10-43
IQ 500	V12-T10-3, V12-T11-11
IQ Analyzer	V12-T10-3, V12-T10-24, V12-T10-43, V12-T11-11
IQ Analyzer 6400/6600Series	V12-T10-8, V12-T10-9
IQ Cable	V12-T10-31

IQ Products, continued

IQ Data	V12-T10-3, V12-T10-37
IQ Data Plus	V12-T10-3, V12-T10-37
IQ Data Plus II	V12-T10-3, V12-T10-37
IQ DC Power Supply	V12-T10-31, V12-T10-43
IQ DP-4000	V12-T10-3, V12-T10-8, V12-T10-9, V12-T10-25, V12-T10-36, V12-T10-43, V12-T11-11
IQ DP-4000 Auxiliary Power Supply	V12-T10-43
IQ DP-4000 I/O Module	V12-T10-43
IQ DP-4100	V12-T10-25
IQ Energy Sentinel	V12-T10-3, V12-T10-10, V12-T10-11, V12-T10-26
IQ Flange	V12-T10-31
IQ Generator	V12-T10-3, V12-T10-38
IQ Multipoint Energy Submeter II	V12-T10-43
IQ Power Sentinel	V12-T11-11
IQ Sentinels	V12-T10-43
MP-3000	V12-T10-3, V12-T10-12–V12-T10-14, V12-T10-28, V12-T11-11
MP-3000 Motor Protection Relay	V12-T10-43
Optional Clamp-on CTs	V12-T10-43
Panel Mounting Adapter Kit for IQ	
100/200 Series and PXM 2000 Meters	V12-T10-31
Portable IQ Analyzer	V12-T10-43
Power Xpert 2000	V12-T10-43
Power Xpert 4000/6000/8000	V12-T10-43
Power Xpert Multi-Point Meter	V12-T10-43
Universal RTD Module	V12-T10-43
URTD	V12-T10-36, V12-T11-11
IQ Retrofit Kits for MCC Unit Upgrades	V12-T14-14
IQ Sentinels	V12-T10-43
IQ Transfer Switch	V12-T11-11
IQDATA	V12-T10-37
IQGEN	V12-T10-38
IS-5000+	V12-T13-72, V12-T13-74, V12-T13-75
IS-7000	V12-T13-72, V12-T13-74, V12-T13-75
ISO-Switch (AMPGARD Isolation Switch)	V12-T13-87, V12-T13-92
IT	V12-T13-56, V12-T13-71
IT Soft Start	V12-T13-97, V12-T14-14
IT Starter	V12-T13-71
ITAP	V12-T9-5
ITE	
15HK Vacuum Replacement Breaker	V12-T17-60
5HK Vacuum Replacement Breaker	V12-T17-60
5HV Vacuum Replacement Breaker	V12-T17-60
KB Breaker	V12-T17-46
KC Breaker	V12-T17-46
KD Breaker	V12-T17-46
KDON Breaker	V12-T17-44
KE Breaker	V12-T17-46
Vacuum Replacement Breaker	V12-T17-60

Appendix 2—Alphabetical Product Index

ITE AR-Series Replacement Breakers V12-**T17**-11, V12-**T22**-6
 ITE K-Line Breaker V12-**T17**-44
 ITE K-Line Breakers Replacement and
 Upgrade Capabilities V12-**T17**-43
 ITE K-Line Breakers with Digitrip RMS Retrofit Kits V12-**T17**-44

J

J Out-of-Production Circuit Breaker V12-**T3**-11, V12-**T3**-82
 J02 V12-**T13**-26
 J11 V12-**T13**-26
 J1C V12-**T13**-26
 J20 V12-**T13**-26
 JA Molded-Case Circuit Breakers V12-**T3**-11, V12-**T3**-23,
 V12-**T3**-132, V12-**T3**-133
 JA Molded-Case Switch V12-**T3**-61
 JA Replacement Breaker V12-**T3**-11
 Jaws V12-**T6**-2
 JB Molded-Case Circuit Breakers V12-**T3**-11, V12-**T3**-19,
 V12-**T3**-134–V12-**T3**-136
 JB Molded-Case Switch V12-**T3**-61
 JB Replacement Breaker V12-**T3**-11, V12-**T3**-134–V12-**T3**-136
 JD Series C Breaker V12-**T3**-11
 JDB Series C Breaker V12-**T3**-11
 JDC V12-**T14**-16
 JDC Series C Breaker V12-**T3**-11
 JF Autostarter
 Replacement Capabilities V12-**T13**-56
 JH Out-of-Production Circuit Breaker V12-**T3**-11
 JK Out-of-Production Circuit Breaker V12-**T3**-11
 JKL Out-of-Production Circuit Breaker V12-**T3**-11
 JL Out-of-Production Circuit Breaker V12-**T3**-11
 JMI V12-**T11**-10
 JS Out-of-Production Circuit Breaker V12-**T3**-11

K

K Out-of-Production Circuit Breaker V12-**T3**-11, V12-**T3**-82
 K TRI-PAC Out-of-Production Circuit Breaker V12-**T3**-13
 KA Molded-Case Circuit Breakers V12-**T3**-11, V12-**T3**-25,
 V12-**T3**-136, V12-**T3**-137
 KA Molded-Case Switch V12-**T3**-61
 KA Replacement Breaker V12-**T3**-11, V12-**T3**-136, V12-**T3**-137
 KB ITE Breaker V12-**T17**-46
 KB Molded-Case Circuit Breakers V12-**T3**-11, V12-**T3**-21,
 V12-**T3**-137
 KB Molded-Case Switch V12-**T3**-61
 KB Replacement Breaker V12-**T3**-11, V12-**T3**-137
 KC ITE Breaker V12-**T17**-46
 KD ITE Breaker V12-**T17**-46
 KD Replacement Breaker V12-**T3**-128
 KD Series C Breaker V12-**T3**-11, V12-**T3**-128
 KDB Series C Breaker V12-**T3**-11
 KDC V12-**T14**-16

KDC Series C Breaker V12-**T3**-11
 KDON ITE Breaker V12-**T17**-44
 KE ITE Breaker V12-**T17**-46
 KES Series C Breaker V12-**T3**-128
 K-Factor Dry-Type Distribution V12-**T8**-4
 KH Out-of-Production Circuit Breaker V12-**T3**-11
 KH-D Out-of-Production Circuit Breaker V12-**T3**-11
 KL Out-of-Production Circuit Breaker V12-**T3**-11, V12-**T3**-82
 KL TRI-PAC Out-of-Production Circuit Breaker V12-**T3**-14
 K-Line ITE Breaker V12-**T17**-44
 KS Out-of-Production Circuit Breaker V12-**T3**-11
 KS-D Out-of-Production Circuit Breaker V12-**T3**-11
 K-Series Safety Switches V12-**T7**-2

L

L Out-of-Production Circuit Breaker V12-**T3**-11
 L TRI-PAC Out-of-Production Circuit Breaker V12-**T3**-14
 L-56 V12-**T13**-26
 L-56B V12-**T13**-26
 L-56C V12-**T13**-26
 L-56D V12-**T13**-26
 L-56E V12-**T13**-26
 L-56F V12-**T13**-26
 L-56G V12-**T13**-26
 L-56H V12-**T13**-26
 L-56J V12-**T13**-26
 L-56M V12-**T13**-26
 L-56P V12-**T13**-26
 L-56R V12-**T13**-26
 L-56S V12-**T13**-26
 L63 V12-**T13**-26
 L64 V12-**T13**-26
 LA Allis-Chalmers Breaker V12-**T17**-42
 LA Current Limiting Breaker V12-**T3**-13, V12-**T3**-14
 LA Molded-Case Circuit Breakers V12-**T3**-11, V12-**T3**-34,
 V12-**T3**-36, V12-**T3**-37,
 V12-**T3**-137, V12-**T3**-139
 LA Molded-Case Switch V12-**T3**-62
 LA Replacement Breaker V12-**T3**-11, V12-**T3**-138, V12-**T3**-139
 LA600-AR600NM V12-**T17**-11, V12-**T22**-6
 LAB Molded-Case Circuit Breakers V12-**T3**-11, V12-**T3**-32,
 V12-**T3**-139–V12-**T3**-141
 LAB Molded-Case Switch V12-**T3**-62
 LAB Replacement Breaker V12-**T3**-11
 LAF Siemens Breaker V12-**T17**-48
 LAY Molded-Case Circuit Breakers V12-**T3**-39, V12-**T3**-141,
 V12-**T3**-142
 LB and HLB V12-**T3**-29
 LB Molded-Case Circuit Breakers V12-**T3**-11, V12-**T3**-29,
 V12-**T3**-142, V12-**T3**-143
 LB Molded-Case Switch V12-**T3**-61

Appendix 2—Alphabetical Product Index

LB Replacement Breaker	V12-T3-11
LBB Molded-Case Circuit Breakers	V12-T3-11, V12-T3-27, V12-T3-143–V12-T3-146
LBB Molded-Case Switch	V12-T3-61
LBB Replacement Breaker	V12-T3-11
LBF Load Break Switch	V12-T17-66
LBF/WLI/MVS Load Interrupter Switchgear	V12-T17-66
LC Molded-Case Circuit Breakers	V12-T3-11, V12-T3-49, V12-T3-146
LC Molded-Case Switch	V12-T3-62
LC Replacement Breaker	V12-T3-11
LCA Molded-Case Circuit Breakers	V12-T3-49, V12-T3-146
LCC Molded-Case Circuit Breakers	V12-T3-49, V12-T3-146, V12-T3-147
LCC Molded-Case Switch	V12-T3-62
LCCA Molded-Case Circuit Breakers	V12-T3-49, V12-T3-147
LCCG Molded-Case Circuit Breakers	V12-T3-50, V12-T3-147
LCCGA Molded-Case Circuit Breakers	V12-T3-50, V12-T3-147
LCG Molded-Case Circuit Breakers	V12-T3-50, V12-T3-147
LCGA Molded-Case Circuit Breakers	V12-T3-50, V12-T3-147
LCL Current Limiting Breaker	V12-T3-13
LCY Molded-Case Circuit Breakers	V12-T3-147
LCYA Molded-Case Circuit Breakers	V12-T3-147
LCYG Molded-Case Circuit Breakers	V12-T3-147
LCYGA Molded-Case Circuit Breakers	V12-T3-147
LD Series C Breaker	V12-T3-11, V12-T3-128
LDB Series C Breaker	V12-T3-11
LES Series C Breaker	V12-T3-128
LF Air AMPGARD	V12-T13-87, V12-T13-92, V12-T13-93
LF Air-Break Contactor	V12-T13-92
LF Air-Break Design Starter	V12-T13-92
LF AMPGARD	V12-T13-76
LFB Current Limiter Attachment	V12-T3-17
LG Allis-Chalmers Breaker	V12-T17-42
LH(A) Out-of-Production Circuit Breaker	V12-T3-11
LH(E) Out-of-Production Circuit Breaker	V12-T3-11
Life Extension	V12-T22-2, V12-T22-8
Life Line Unibus	V12-T9-3
Light Units	V12-T23-9–V12-T23-10
Lighting Control System, Pow-R-Command	V12-T4-20
Line Shield	V12-T7-2
LM Out-of-Production Circuit Breaker	V12-T3-11, V12-T3-12, V12-T3-82
Load Break Switch	V12-T17-66
Load Interrupter	V12-T17-65
Load Interrupter—Replacement Parts	V12-T17-67–V12-T17-69
Loadcenter History	V12-T5-4
Loadcenters	
BR Family	V12-T5-2
CH Family	V12-T5-2

Loadcenters and Circuit Breakers	
Type CH	
Renovation Loadcenter	V12-T5-25
Retrofit Interior Kits	V12-T5-27
Surge Panel	V12-T5-29
Local Monitoring—Retrofit Kits	V12-T17-18
Low Impedance Busway	V12-T9-8
Low Impedance Plug-in Bus	V12-T9-3
Low Voltage Adjustable Frequency Drives	V12-T13-72–V12-T13-75
Low Voltage Breaker Drawout Vacuum Starter Replacement	
Retrofit Services	V12-T17-12, V12-T17-13
Low Voltage Breaker Test Kit	V12-T17-9
Low Voltage Bus Plugs	
Bolt-on Units	V12-T9-11
Circuit Breaker	V12-T9-6, V12-T9-8, V12-T9-10, V12-T9-11
Fusible	V12-T9-6, V12-T9-9–V12-T9-13
Renewal Parts	V12-T9-4
Low Voltage Busway	V12-T9-1–V12-T9-15
Bolt-on Units	V12-T9-11
Clipper Power Systems	V12-T9-14
CP2	V12-T9-2, V12-T9-4, V12-T9-12–V12-T9-14
CP3	V12-T9-3, V12-T9-4, V12-T9-12–V12-T9-14
CP4	V12-T9-3, V12-T9-4, V12-T9-12–V12-T9-14
H5000	V12-T9-2–V12-T9-4, V12-T9-8
Low Impedance	V12-T9-2–V12-T9-5, V12-T9-8, V12-T9-9, V12-T9-11
Standard Plug-in	V12-T9-2–V12-T9-9
Low Voltage DB Switchgear Assemblies	
and Power Circuit Breakers	V12-T17-3
Low Voltage Distribution Switchboards	V12-T15-2–V12-T15-6
Low Voltage DS Switchgear Assemblies	
and Power Circuit Breakers	V12-T17-4–V12-T17-5, V12-T17-8
Low Voltage DSII Switchgear Assemblies	
and Power Circuit Breakers	V12-T17-6, V12-T17-7
Low Voltage High Resistance Grounding Systems	V12-T2-3
Low Voltage Magnum DS Switchgear	
Assemblies and Power Circuit Breakers	V12-T17-8
Low Voltage MCC Support Services	V12-T14-19
Low Voltage MCCs	V12-T14-2
Low Voltage Power Air Circuit	
Breakers (LVPACB)	V12-T17-5, V12-T17-6
Low Voltage Power Air Replacement	
Breakers	V12-T17-11, V12-T22-6
Low Voltage Power Breakers	
DB Power Circuit Breaker	V12-T2-2
DS Power Circuit Breaker	V12-T2-2
DSII Power Circuit Breaker	V12-T2-2
Magnum DS Power Circuit Breaker	V12-T2-2
Replacement	V12-T2-2
SPB Power Circuit Breaker	V12-T2-2
Low Voltage Power Factor Correction	V12-T21-5
Low Voltage Soft Starters	V12-T13-70

Low Voltage Starters V12-T14-5

Low Voltage Switchgear V12-T17-2–V12-T17-11, V12-T22-6

Low Voltage Switchgear Assemblies and Power Circuit Breakers V12-T17-2

Low Voltage Switchgear Cell Provisions V12-T17-5, V12-T17-7, V12-T17-8

Low Voltage Switchgear Competitive Upgrades V12-T17-11, V12-T22-6

Low Voltage Switchgear Procedure for Identifying Renewal Parts V12-T17-10

Low Voltage Synchronous Starters V12-T13-77

Low Voltage Vacuum Starters V12-T13-36

Lower Base V12-T13-24

LS(A) Out-of-Production Circuit Breaker V12-T3-11

LS(E) Out-of-Production Circuit Breaker V12-T3-11

LV MCC Technology Upgrades V12-T14-14, V12-T14-15

LWT-450 V12-T19-4

M

M (Type) V12-T13-57, V12-T13-60

M Out-of-Production Circuit Breaker V12-T3-12

MA Molded-Case Circuit Breakers V12-T3-12, V12-T3-40, V12-T3-147, V12-T3-148

MA Molded-Case Switches V12-T3-62

MA Out-of-Production Circuit Breaker V12-T3-12

MA Replacement Breaker V12-T3-12

MA TRI-PAC Out-of-Production Circuit Breaker V12-T3-14

Machine Control Fusion Integrated V12-T24-91–V12-T24-95

Magnetic Only and Ambient Compensating Breakers V12-T3-24, V12-T3-42

Magnetic Only Breakers V12-T3-16, V12-T3-20–V12-T3-26, V12-T3-28, V12-T3-30, V12-T3-33, V12-T3-35–V12-T3-38, V12-T3-41–V12-T3-44, V12-T3-48

Magnum DS Breaker Parts V12-T17-8

Magnum DS Breakers V12-T17-2, V12-T17-8

Magnum DS Breakers Class 1 Reconditioning V12-T17-8

Magnum DS Breakers Renewal Parts and Accessories V12-T17-8

Magnum DS Circuit Breaker Provisions V12-T17-8

Magnum DS Interrupting Rating without Current Limiters V12-T17-8

Magnum DS Low Voltage Switchgear Assemblies and Power Circuit Breakers V12-T17-8

Magnum DS Switchgear Structure Parts V12-T17-8

Main and Subfeed Lug Blocks Type BR Loadcenters and Circuit Breakers Accessories V12-T5-14

Main Breaker Lug Kits Type BR Loadcenters and Circuit Breakers Accessories V12-T5-18

Type CH Loadcenters and Circuit Breakers Accessories V12-T5-10

Main Lugs Type BR Loadcenters and Circuit Breakers Accessories V12-T5-14

Maintenance, Predictive V12-T22-5

Manual Reset, Class 20, Thermal Type B Overload Relay V12-T13-27

Mark V12-T13-81, V12-T13-82

MARK 75 Molded-Case Circuit Breakers V12-T3-16, V12-T3-21, V12-T3-22, V12-T3-25, V12-T3-29, V12-T3-34, V12-T3-37, V12-T3-40, V12-T3-41, V12-T3-43, V12-T3-49–V12-T3-55

Mark I and Mark II Static Slipsyn V12-T13-76

Mark I Static Slipsyn (Brush Type) V12-T13-77

Mark II Static Slipsyn (Brush Type) V12-T13-77

Mark V Brushless Field Controller V12-T13-76, V12-T13-77, V12-T13-80–V12-T13-82, V12-T13-85, V12-T13-86

Mark V Solid-State Field Panel V12-T13-82, V12-T13-85

Mark V Solid-State Slipsyn V12-T13-76, V12-T13-80–V12-T13-82, V12-T13-85, V12-T13-86

Master INCOM Network Translator II V12-T11-8

Match and Lineup Cubicles for Pow-R-Line C Distribution Switchboards V12-T15-5

Match and Lineup Cubicles for VCP-W V12-T17-58

MAY Molded-Case Circuit Breakers V12-T3-42, V12-T3-148

MB V12-T13-56

MC Handle Mechanism V12-T3-96

MC Molded-Case Circuit Breakers V12-T3-12, V12-T3-52, V12-T3-148

MC Molded-Case Switches V12-T3-62

MC Replacement Breaker V12-T3-12

MC Type Motor Control Handle Mechanism V12-T3-103

MCA Molded-Case Circuit Breakers V12-T3-52, V12-T3-148

MCC Competitive Retrofit Upgrades V12-T14-18

MCC Molded-Case Circuit Breakers V12-T3-52, V12-T3-148

MCC Molded-Case Switch V12-T3-62

MCC Regional Manufacturing Locations V12-T14-19

MCC Replacement Breaker V12-T3-12

MCC Replacement Parts V12-T14-13

MCC Service Centers V12-T14-19

MCC Support Services V12-T14-19

MCC Units with **IT** Soft Start Upgrades V12-T14-15

MCC Units with SPD V12-T14-15

MCC Upgrade with SV9000 Adjustable Frequency Drives V12-T14-15

MCCA Molded-Case Circuit Breakers V12-T3-52, V12-T3-148

MCCG Molded-Case Circuit Breakers V12-T3-53, V12-T3-148

MCCGA Molded-Case Circuit Breakers V12-T3-53, V12-T3-148

MCG Molded-Case Circuit Breakers V12-T3-53, V12-T3-149

MCGA Molded-Case Circuit Breakers V12-T3-53, V12-T3-149

Appendix 2—Alphabetical Product Index

McGraw & Edison	
PSD-15 Vacuum Replacement Breaker	V12-T17-61
WSA-15 Vacuum Replacement Breaker	V12-T17-61
WSA-5 Vacuum Replacement Breaker	V12-T17-61
MCP Motor Circuit Protectors	V12-T3-63
MD	V12-T8-2, V12-T13-57, V12-T13-59
MD 810R	V12-T13-60
MD Replacement Breaker	V12-T3-12
MDL Series C Breaker	V12-T3-12, V12-T3-129
MDS Breaker	V12-T17-2, V12-T17-8
MDS Replacement Breaker	V12-T3-12
ME and MD DC Contactors	V12-T13-57
Replacement Capabilities	V12-T13-58
MEB	V12-T17-65
Mechanical Interlock Covers	
Type BR Loadcenters and Circuit Breakers	
Accessories	V12-T5-16
Mechanical Interlocks	
Kirk Key Interlock	V12-T3-77
Sliding Bar Type	V12-T3-77
Type CH Loadcenters and Circuit Breakers	
Accessories	V12-T5-8
Medium Voltage (AMPGARD) Starters	V12-T13-76
Medium Voltage AUTOVAR	V12-T21-4
Medium Voltage DH Switchgear Assemblies and Power Circuit Breakers	V12-T17-55
Medium Voltage DHP Switchgear Assemblies and Power Circuit Breakers	V12-T17-56
Medium Voltage Fuses	V12-T18-1–V12-T18-8
Medium Voltage Load Interrupter	V12-T17-65
Medium Voltage Motor Control (2300–7200V)	V12-T13-76
Medium Voltage Power Factor Correction	V12-T21-4
Medium Voltage Starter	V12-T13-87
Medium Voltage Starter Upgrades	V12-T2-2
Medium Voltage Switchgear	V12-T17-53–V12-T17-64
Medium Voltage Switchgear Assemblies and Power Circuit Breakers	V12-T17-53–V12-T17-58
Medium Voltage Switchgear Competitive Upgrades	V12-T17-60
Medium Voltage Switchgear Fluidized Bus	V12-T17-59
Medium Voltage Vacuum Replacement	
SURE CLOSE	V12-T22-6
VR-Series	V12-T22-6
Medium Voltage Vacuum Replacement Breakers	V12-T2-2, V12-T17-60
Medium Voltage VCP Switchgear Assemblies and Power Circuit Breakers	V12-T17-57
Medium Voltage VCP-W Switchgear Assemblies and Power Circuit Breakers	V12-T17-58
Metal-Enclosed Switchgear	V12-T17-65–V12-T17-69
Meter Centers	V12-T6-1–V12-T6-9
Meter Main Devices	V12-T6-4
Meter Packs	V12-T6-2, V12-T6-3
Meter Sockets	V12-T6-2
Metering	V12-T2-3
Metering Devices	
Clamp-On Current Transformers	V12-T10-35
Current Transformers (CTs)	V12-T10-33
Enclosed Meters	V12-T10-23
IQ 130/140/150 Series Electronic Power Meters	V12-T10-20
IQ 150S/250S	V12-T10-21
IQ 250/260	V12-T10-4, V12-T10-5, V12-T10-19
IQ 35M	V12-T10-22, V12-T10-23
IQ Multipoint Energy Submeter II	V12-T10-42
Power Xpert Multi-Point Meter	V12-T10-10, V12-T10-11, V12-T10-18
PXM 2000	V12-T10-4, V12-T10-5, V12-T10-17
Metering Selection Chart	V12-T10-4–V12-T10-11
Metering, Protection and Control Devices	
IQ 250/260	V12-T10-4, V12-T10-5, V12-T10-19
Modbus Master INCOM Network Translator (mMINT)	V12-T11-12
PXM 2000	V12-T10-4, V12-T10-5
MG	V12-T19-3, V12-T19-4
MG-8	V12-T19-2–V12-T19-4
MG-9	V12-T19-2–V12-T19-4
MH Out-of-Production Circuit Breaker	V12-T3-12
Microprocessor-Based Overcurrent Trip	V12-T10-30
Microprocessor-Based Protection	V12-T10-29
Miniature	
CHB	V12-T3-9
QUICKLAG	V12-T3-6, V12-T3-7
Mining Breaker Repair	V12-T3-112
Mining Breakers	V12-T3-162–V12-T3-167
Mini-Power Center	V12-T8-4
MINT II	V12-T11-8, V12-T11-10, V12-T11-25
MME	V12-T13-57
MOC Closing Times	
Air Magnetic Breakers	V12-T17-62
Vacuum Replacement Breakers with SURE CLOSE	V12-T17-62
Vacuum Replacement Breakers without SURE CLOSE	V12-T17-62
MOC Operators and Vacuum Replacement Breakers	V12-T17-55, V12-T17-56, V12-T17-60–V12-T17-62
Modbus	V12-T11-10
Modbus Gateway	V12-T11-10
Modbus MINT (mMINT)	V12-T11-12
Modbus RTU	V12-T12-2
Modular Metering	V12-T6-2
Moisture-Fungus-Corrosion Treatment	V12-T3-77
Molded-Case Circuit Breakers	V12-T3-1–V12-T3-168
Accessories	V12-T3-3, V12-T3-17–V12-T3-48, V12-T3-51, V12-T3-53, V12-T3-55, V12-T3-57, V12-T3-59, V12-T3-63–V12-T3-79

Appendix 2—Alphabetical Product Index

Molded-Case Circuit Breakers, continued

Auxiliary Switch	V12-T3-3, V12-T3-76
Base Mounting Hardware	V12-T3-70
Center Studs	V12-T3-77
Extended Line Terminal Shields	V12-T3-70
Fuse Mounting Base for PB Breakers	V12-T3-70
Handle Locks	V12-T3-70
Mechanical Interlocks, Kirk Key Interlock	V12-T3-77
Mechanical Interlocks, Sliding Bar Type	V12-T3-77
Mechanical Interlocks, Walking Beam Type	V12-T3-77
Moisture-Fungus-Corrosion Treatment	V12-T3-77
Molded Type Handle Extension	V12-T3-71
Motor Operators	V12-T3-78
Panelboard Connecting Straps	V12-T3-68
Plug-In Adapter Kits	V12-T3-69
Rear-Connected Studs	V12-T3-66
Shunt Trip	V12-T3-71
Standard Undervoltage Release	V12-T3-74
Cross-Reference	V12-T3-113–V12-T3-167
Current Limiting	V12-T3-13, V12-T3-14
Factory Original	V12-T3-4
Genuine	V12-T3-4
Handle Mechanisms	V12-T3-95–V12-T3-112
Identifying Genuine	V12-T3-4
Miniature, CHB	V12-T3-9
Miniature, QUICKLAG	V12-T3-6, V12-T3-7
Mining Replacement Breakers	V12-T3-162–V12-T3-167
Modifications	V12-T3-17, V12-T3-48, V12-T3-51, V12-T3-53, V12-T3-55, V12-T3-57, V12-T3-59, V12-T3-87
Motor Circuit Protectors	V12-T3-63
Motor Control Center	
Series C	V12-T3-91
Motor Control Center Replacement	
Breakers	V12-T3-88–V12-T3-90
Nameplate Data	V12-T3-3
Catalog Number	V12-T3-3
Shop Order Number	V12-T3-3
OPTIM 550 Trip Unit Upgrades	V12-T3-94
Panelboard Replacement	V12-T3-80
Panelboard Replacement Breakers	V12-T3-80–V12-T3-82
Rating Plug Selection Data	V12-T3-60
Replacement	
DA	V12-T3-31
EB and EHB	V12-T3-15
FB and HFB	V12-T3-16
JA	V12-T3-23
JB	V12-T3-19
KA and HKA	V12-T3-25
KB and HKB	V12-T3-21
LA and HLA	V12-T3-34, V12-T3-37
LAB	V12-T3-32
LAY	V12-T3-39
LB and HLB	V12-T3-29
LBB	V12-T3-27
MA and HMA	V12-T3-40
NB and HNB	V12-T3-43
NBY	V12-T3-45

Molded-Case Circuit Breakers, continued

Replacement, continued	
PB	V12-T3-46
PBF	V12-T3-47
Types LA and HLA	V12-T3-34, V12-T3-37
Replacement Capabilities	V12-T3-5
Current Production	V12-T3-5
MCC Replacement	V12-T3-5
Panelboard Replacement	V12-T3-5
Series C	V12-T3-5
Replacement Circuit Breakers	V12-T3-15–V12-T3-60
Replacement Cross-Reference	V12-T3-113–V12-T3-167
Replacement Guide	V12-T3-10–V12-T3-14
Replacement, SELTRONIC	V12-T3-49–V12-T3-59
Series C	V12-T3-3, V12-T3-5, V12-T3-10–V12-T3-12, V12-T3-91–V12-T3-96, V12-T3-109, V12-T3-110
Molded-Case Circuit Breakers—Replacement	V12-T2-3
Molded-Case Switches	V12-T3-61
Molded-Type Handle Extension	V12-T3-71
Monitoring and Testing	V12-T22-2–V12-T22-7
Monitoring Systems (Power Xpert)	V12-T11-4–V12-T11-7
Motor Circuit Protector Catalog Numbers	V12-T14-17
Motor Circuit Protectors	V12-T3-63
Motor Circuit Protectors, Replacement	V12-T3-63, V12-T3-102
Motor Control Center	
Bucket Dimensions	V12-T14-3
Bucket Handle Mechanism	V12-T14-4
Bucket Identification	V12-T14-3
Bucket Retrofits	V12-T2-2
Motor Control Center Replacement Circuit Breakers	V12-T14-16
Motor Control Center Types of Handle Mechanism	V12-T14-4
Motor Control Centers	V12-T14-1–V12-T14-19
Competitive Factory Retrofit	V12-T14-18
Series C Circuit Breaker Retrofit Kits	
5 Star	V12-T3-91, V12-T14-15
F10 Series C Retrofit Kit	V12-T3-92, V12-T14-16
Type W	V12-T3-91, V12-T14-16
Motor Protection Relay	V12-T10-28
Motor Starters	
Medium Voltage (2300–7200V)	V12-T13-76
Synchronous	V12-T13-76
Mounting Bases	
Type CH Loadcenters and Circuit Breakers	
Accessories	V12-T5-8
MP100 Panelboard	V12-T4-5
MP100 Panelboard, Replacement Breaker	V12-T4-5
MP-3000 Motor Protection Relay	V12-T10-12–V12-T10-14, V12-T10-28, V12-T10-36, V12-T10-43, V12-T11-11, V12-T13-91, V12-T13-93, V12-T13-95
MP40 Panelboard	V12-T4-2, V12-T4-5, V12-T4-12
MP40 Panelboard, Replacement	
Breaker	V12-T4-2, V12-T4-5, V12-T4-12

Appendix 2—Alphabetical Product Index

MPC	V12-T8-2
MPC1	V12-T12-3, V12-T12-4
MPC1 Series	V12-T12-4
MPCR	V12-T19-2, V12-T19-4
MPCR Relay	V12-T19-2, V12-T19-4
MPCV	V12-T19-2, V12-T19-4
MPCV Relay	V12-T19-3, V12-T19-4
MPONI	V12-T10-24, V12-T11-25
MR	V12-T13-57, V12-T13-59
MS Out-of-Production Circuit Breaker	V12-T3-12
MSB	V12-T17-65
MTA	V12-T8-2
MTC	V12-T8-2
MTK	V12-T9-9
Multiple Metering	V12-T6-2
MV Motor Control	V12-T13-87–V12-T13-99
MV801 Control Module	V12-T13-97
MVA Upgrades for DHP, VCP, VCP-W	V12-T17-59
MVVR (Medium Voltage Vacuum Replacement)	V12-T22-6
MVX9000	V12-T13-74

N

N (Contactor)	V12-T13-2
N110	V12-T9-8, V12-T9-9
N250KB	V12-T9-8, V12-T9-9
N400	V12-T9-8, V12-T9-9
NA1B Panelboard (Cutler-Hammer)	V12-T4-4
NA1B Panelboard (Westinghouse)	V12-T4-7
NA1B Panelboard, Replacement Breaker	V12-T4-4, V12-T4-7
NAB Panelboard	V12-T4-7
NAB Panelboard, Replacement Breaker	V12-T4-7
Narrow AMI	
Vacuum Starter Cell-Retrofit	V12-T13-91
NB Current Limiting Breaker	V12-T3-14
NB Molded-Case Circuit Breakers	V12-T3-12, V12-T3-43, V12-T3-149
NB Molded-Case Switch	V12-T3-62
NB Replacement Breaker	V12-T3-12
NBY Molded-Case Circuit Breakers	V12-T3-45, V12-T3-150
NC Molded-Case Circuit Breakers	V12-T3-12, V12-T3-54, V12-T3-55, V12-T3-150
NC Molded-Case Switch	V12-T3-62
NC Replacement Breaker	V12-T3-12
NCA Molded-Case Circuit Breakers	V12-T3-54, V12-T3-55, V12-T3-150
NCG Molded-Case Circuit Breakers	V12-T3-54, V12-T3-55, V12-T3-150
NCGA Molded-Case Circuit Breakers	V12-T3-54, V12-T3-55, V12-T3-150
ND Series C Breaker	V12-T3-12
NDC Series C Breaker	V12-T3-12
NDP Panelboard (Cutler-Hammer)	V12-T4-4

NDP Panelboard (Westinghouse)	V12-T4-7
NDP Panelboard, Replacement Breaker	V12-T4-4, V12-T4-7
NEB Panelboard	V12-T4-7
NEB Panelboard, Replacement Breaker	V12-T4-7
Network Protector Relays — Communications	V12-T11-11
Network Protectors	V12-T19-1–V12-T19-6
Retro-Build	V12-T19-3
Neutral Bars — Loadcenters	V12-T5-4
New Circuit Breakers for WF/WRP, ES and Pow-R-Line C Distribution Switchboards	
DS Molded-Case Circuit Breakers	V12-T15-5
RD Molded-Case Circuit Breakers	V12-T15-5
SPB Molded-Case Circuit Breakers	V12-T15-5
New DB Breakers	V12-T17-3
New DS Breakers	V12-T17-5
New DSII Breakers	V12-T17-7
New Magnum DS Breakers	V12-T17-8
New Units for Competitive MCCs	V12-T14-18, V12-T14-19
New VCP-W Switchgear Assemblies	V12-T17-58
New VCP-W Vacuum Breakers	V12-T17-58
Next Generation AMPGARD	V12-T13-96
NFB Panelboard	V12-T4-2, V12-T4-4
NFB Panelboard, Replacement Breaker	V12-T4-2, V12-T4-4
NH Out-of-Production Circuit Breaker	V12-T3-12
NH1B Panelboard (Cutler-Hammer)	V12-T4-4
NH1B Panelboard (Westinghouse)	V12-T4-7
NH1B Panelboard, Replacement Breaker	V12-T4-4, V12-T4-7
NHB Molded-Case Circuit Breakers	V12-T3-43
NHDP Panelboard	V12-T4-7
NHDP Panelboard, Replacement Breaker	V12-T4-7
NHEB Panelboard	V12-T4-7
NHEB Panelboard, Replacement Breaker	V12-T4-7
NL-3XX	V12-T12-3
NLAB Panelboard (Cutler-Hammer)	V12-T4-4
NLAB Panelboard (Westinghouse)	V12-T4-7
NLAB Panelboard, Replacement Breaker	V12-T4-4, V12-T4-7
NLAB-AB Panelboard	V12-T4-7
NLAB-AB Panelboard, Replacement Breaker	V12-T4-7
NLAB-ABH Panelboard	V12-T4-7
NLAB-ABH Panelboard, Replacement Breaker	V12-T4-7
NLAB-LX Panelboard	V12-T4-7
NLAB-LX Panelboard, Replacement Breaker	V12-T4-7
NPCOREMOD	V12-T11-10
NPLAB Panelboard (Cutler-Hammer)	V12-T4-4
NPLAB Panelboard (Westinghouse)	V12-T4-7
NPLAB Panelboard, Replacement Breaker	V12-T4-4, V12-T4-7
NPLAPQ Panelboard	V12-T4-7
NPLAPQ Panelboard, Replacement Breaker	V12-T4-7
NPMODBUS	V12-T11-10
NQB Panelboard	V12-T4-7
NQB Panelboard, Replacement Breaker	V12-T4-7
NQC Panelboard	V12-T4-7

Appendix 2—Alphabetical Product Index

NQC Panelboard, Replacement Breaker	V12- T4 -7
NQP Panelboard	V12- T4 -7
NQP Panelboard, Replacement Breaker	V12- T4 -7
NS Out-of-Production Circuit Breaker	V12- T3 -12
Numa-Logic	V12- T12 -2, V12- T12 -3
Numa-Logic 300 Series	V12- T12 -3
Numa-Logic 400 Series	V12- T12 -4
Numa-Logic 700 Series	V12- T12 -4

O

OIL	V12- T13 -99
Operating Handle — Safety Switches	V12- T7 -2
Operating Mechanism — Safety Switches	V12- T7 -2
OPTIM 550 Trip Unit Upgrades	V12- T3 -94
OPTIM Trip Unit Upgrades	V12- T3 -94
Optional Clamp-on CTs	V12- T10 -43
Ordering Process for Series C Retrofit Kits for MCC Units	V12- T14 -17
Other Breakers Rating Plugs	V12- T17 -27
Other Breakers with Digitrip RMS Retrofit Kits	V12- T17 -51
Other Breakers—Horizontal Retrofit RMS Replacement Trip Units	V12- T17 -22
Other Breakers—Vertical Retrofit RMS Replacement Trip Units	V12- T17 -23
Other General Electric Breakers with Digitrip RMS Retrofit Kits	V12- T17 -40
Other ITE Breakers Replacement and Upgrade Capabilities	V12- T17 -45
Other ITE Breakers with Digitrip RMS Retrofit Kits	V12- T17 -46
Overcurrent Trip Unit	V12- T10 -30
Overload	V12- T13 -28
Overload Relay Selection Table	V12- T13 -27–V12- T13 -29
Overload Relays Type FT Fast Trip	V12- T13 -29
Overview of High Resistance Grounding C-HRG (Medium Voltage)	V12- T16 -5

P

P- and S-Contactors	V12- T13 -69
PA Out-of-Production Circuit Breaker	V12- T3 -12
PA TRI-PAC Out-of-Production Circuit Breaker	V12- T3 -14
Panel Mounting Adapter Metering Devices, IQ 130/140/150 Series Accessories	V12- T10 -20
Panel Mounting Adapter Kit	V12- T10 -31
Panel Mounting Bracket Metering Devices, Power Xpert Meter 4000/6000/8000 Accessories	V12- T10 -15
Panelboard Breaker Replacement Chart	V12- T4 -4–V12- T4 -8
Panelboard Connecting Straps	V12- T3 -68

Panelboard Replacement Breakers Selection Guide	V12- T3 -80–V12- T3 -82
Types RFA, RF, RHFA and RHF	V12- T3 -84–V12- T3 -87
Panelboards	V12- T4 -1–V12- T4 -22
A2B	V12- T4 -7
ABH	V12- T4 -7
B10B	V12- T4 -7
B10B-LX	V12- T4 -7
B10B-LXX	V12- T4 -7
B65B	V12- T4 -7
Breaker Replacement Chart	V12- T4 -4–V12- T4 -8
CDP	V12- T4 -2, V12- T4 -4, V12- T4 -9
CDP/HCDP	V12- T4 -7
CHB	V12- T4 -2, V12- T4 -4
EE	V12- T4 -2, V12- T4 -6, V12- T4 -13
EP	V12- T4 -14
FDP	V12- T4 -2, V12- T4 -7, V12- T4 -10
H10B	V12- T4 -7
H10P	V12- T4 -7
MP40	V12- T4 -2, V12- T4 -5, V12- T4 -12
NA1B	V12- T4 -7
NAB	V12- T4 -7
NDP	V12- T4 -7
NEB	V12- T4 -7
NFB	V12- T4 -2, V12- T4 -4
NH1B	V12- T4 -7
NHDP	V12- T4 -7
NHEB	V12- T4 -7
NLAB	V12- T4 -7
NLAB-AB	V12- T4 -7
NLAB-ABH	V12- T4 -7
NLAB-LX	V12- T4 -7
NPLAB	V12- T4 -7
NPLAPQ	V12- T4 -7
NQB	V12- T4 -7
NQC	V12- T4 -7
NQP	V12- T4 -7
PB	V12- T4 -5, V12- T4 -11
PB/PH/PH-L	V12- T4 -11
PH	V12- T4 -5, V12- T4 -11
PH-L	V12- T4 -11
Pow-R-Line 3	V12- T4 -2
PRL1 and PRL2	V12- T4 -15
PRL3	V12- T4 -16
PRL3a	V12- T4 -17
PRL4B	V12- T4 -18
PRL4F	V12- T4 -19
Q10P	V12- T4 -7
Q22B	V12- T4 -7
Q22P	V12- T4 -7
Q65P	V12- T4 -7
Retrofits	V12- T4 -21
Satellite Plants	V12- T4 -22

Appendix 2—Alphabetical Product Index

Panelboards, continued

Technology Upgrades	
Pow-R-Command	V12-T4-20
Surge Protection Devices—SPD Series	V12-T4-20
W10B	V12-T4-7
W10P	V12-T4-7
W22B	V12-T4-7
W22P	V12-T4-7
WCA	V12-T4-7
WEB	V12-T4-2, V12-T4-7
WEHB	V12-T4-7
WFB	V12-T4-7
WGB	V12-T4-7
WGHB	V12-T4-7

Panel Meters

Digital	V12-T24-72–V12-T24-78
-------------------	-----------------------

Parts for SPB, DS and RD	V12-T15-3–V12-T15-5
------------------------------------	---------------------

Past Technology for Trip Unit Retrofit Kits	V12-T17-20
---	------------

PB Current Limiting Breaker	V12-T3-14
---------------------------------------	-----------

PB Molded-Case Circuit Breakers	V12-T3-12, V12-T3-46, V12-T3-48, V12-T3-150, V12-T3-151
---	--

PB Molded-Case Switch	V12-T3-62
---------------------------------	-----------

PB Panelboard	V12-T4-5, V12-T4-11
-------------------------	---------------------

PB Panelboard, Replacement Breaker	V12-T4-5
--	----------

PB Replacement Breaker	V12-T3-12, V12-T3-151
----------------------------------	-----------------------

PB/PH/PH-L, Panelboards	V12-T4-11
-----------------------------------	-----------

PBF Molded-Case Circuit Breakers	V12-T3-47, V12-T3-48, V12-T3-151
--	-------------------------------------

PBF Molded-Case Switch	V12-T3-62
----------------------------------	-----------

PBF Replacement Breaker	V12-T3-151
-----------------------------------	------------

PC Molded-Case Circuit Breakers	V12-T3-12, V12-T3-56, V12-T3-59, V12-T3-151, V12-T3-152
---	--

PC Molded-Case Switch	V12-T3-62
---------------------------------	-----------

PC Replacement Breaker	V12-T3-12, V12-T3-151, V12-T3-152
----------------------------------	-----------------------------------

PC-100	V12-T12-3
------------------	-----------

PC-110	V12-T12-3
------------------	-----------

PCA Molded-Case Circuit Breakers	V12-T3-56, V12-T3-152
--	-----------------------

PCA Replacement Breaker	V12-T3-152
-----------------------------------	------------

PCC Molded-Case Circuit Breakers	V12-T3-12, V12-T3-56, V12-T3-152
--	-------------------------------------

PCC Molded-Case Switch	V12-T3-62
----------------------------------	-----------

PCC Replacement Breaker	V12-T3-12, V12-T3-152
-----------------------------------	-----------------------

PCCA Molded-Case Circuit Breakers	V12-T3-56, V12-T3-152
---	-----------------------

PCCA Replacement Breaker	V12-T3-152
------------------------------------	------------

PCCF Molded-Case Circuit Breakers	V12-T3-152
---	------------

PCCFA Molded-Case Circuit Breakers	V12-T3-152
--	------------

PCCFA Replacement Breaker	V12-T3-152
-------------------------------------	------------

PCCFG Molded-Case Circuit Breakers	V12-T3-58
--	-----------

PCCFG Replacement Breaker	V12-T3-153
-------------------------------------	------------

PCCFGA Molded-Case Circuit Breakers	V12-T3-153
---	------------

PCCG Molded-Case Circuit Breakers	V12-T3-58, V12-T3-153
---	-----------------------

PCCGA Molded-Case Circuit Breakers	V12-T3-153
--	------------

PCF Molded-Case Circuit Breakers	V12-T3-56, V12-T3-58, V12-T3-153
PCF Molded-Case Switch	V12-T3-62
PCF Replacement Breaker	V12-T3-153
PCFA Molded-Case Circuit Breakers	V12-T3-153
PCFA Replacement Breaker	V12-T3-153
PCFG Molded-Case Circuit Breakers	V12-T3-153
PCFG Replacement Breaker	V12-T3-153
PCFGA Molded-Case Circuit Breakers	V12-T3-153
PCFGA Replacement Breaker	V12-T3-153
PCG Molded-Case Circuit Breakers	V12-T3-58, V12-T3-153
PCGA Molded-Case Circuit Breakers	V12-T3-58, V12-T3-153
Personal Protective Equipment (PPE)	V12-T17-19, V12-T17-61
PFC	V12-T13-89
PH Panelboard	V12-T4-5, V12-T4-11
PH Panelboard, Replacement Breaker	V12-T4-5
PH-L Panelboard	V12-T4-11
PH-L Panelboard, Replacement Breaker	V12-T4-11
PLCs	V12-T12-1–V12-T12-4
Plug-In Adapter Kits	V12-T3-69
Plug-in Cable Tap Boxes	V12-T9-12
PONI	V12-T11-25
PONI Communication Modules	V12-T11-25
Portable IQ Analyzer	V12-T10-43
Portable Test Kit	V12-T3-65
Power Air Circuit Breaker, Low Voltage	V12-T17-5, V12-T17-6
Power Air Replacement Breakers	V12-T17-11, V12-T22-6
Power Breaker Replacement	V12-T2-2
Power Breaker Replacement, Low Voltage	V12-T2-2
Power Distribution Bus	V12-T9-3
Power Equipment Services	V12-T22-2
Installation/Startup	V12-T22-2
Routine/Emergency Service	V12-T22-2
Strategic Alliances	V12-T22-2
Warranty Service	V12-T22-2
Power Factor Correction Capacitors	V12-T21-1–V12-T21-4
Power Fuses	V12-T18-2
Power Management Products	V12-T2-3, V12-T10-1, V12-T10-2
Power Management Systems	V12-T22-7
Power Manager	V12-T11-11
Power Miser 2	V12-T13-71
Power Modules	V12-T10-32
Power Quality and Energy Management Studies	V12-T22-4
Power Racking	V12-T17-61
Power Sentinel	V12-T11-11
Power Systems Engineering	V12-T22-4
Energy Management	V12-T22-4
Power Quality	V12-T22-4
Power Xpert 2000	V12-T10-43
Power Xpert 2000 Series	V12-T10-17
Power Xpert 4000/6000/8000	V12-T10-43

Appendix 2—Alphabetical Product Index

Power Xpert Meter 4000 to 6000 License Upgrade Key	
Metering Devices, Power Xpert Meter 4000/6000/8000	
Accessories	V12-T10-15
Power Xpert Multi-Point Meter	V12-T10-3, V12-T10-10, V12-T10-11, V12-T10-18, V12-T10-43
PowerChain Audit	V12-T22-4
PowerChain Benefits	V12-T22-2
PowerChain End-to-End Capabilities	V12-T22-3
PowerChain Life-Cycle Approach	V12-T22-3
PowerChain Management Solutions	V12-T22-2
PowerNet	V12-T2-3, V12-T10-2
PowerNet Communication Devices	
IQ 250/260	V12-T10-4, V12-T10-5
PXM 2000	V12-T10-4, V12-T10-5
PowerNet Communication Features—Retrofit Kits	V12-T17-20
PowerNet Communications	V12-T2-3
PowerNet Device Selection Chart	V12-T11-11
PowerNet Kits	V12-T3-94
Powerstat	V12-T13-84
POW-R Trip	V12-T17-18
Pow-R-Command, Lighting Control System	V12-T4-20
Pow-R-Gear Distribution Switchboard Rating Table	V12-T15-4
Pow-R-Gear Switchboard	V12-T15-4
Pow-R-Gear, Pow-R-M-S and SPB Replacement Breakers	V12-T15-4
Pow-R-Gear, Pow-R-M-S and SPB Technology Upgrades	
Digitrip Trip Unit Retrofit Kits	V12-T15-4
IQ and PowerNet Communications Retrofits	V12-T15-4
Pow-R-Trip Unit Upgrades	V12-T15-4
SPD Series Surge Protective Devices	V12-T15-4
Pow-R-I Switchboard	V12-T15-2, V12-T15-3
Pow-R-Line 1R	V12-T4-21
Pow-R-Line 2R	V12-T4-21
Pow-R-Line 3	V12-T4-2
Pow-R-Line 3 Panelboard, Replacement Breaker	V12-T4-2
Pow-R-Line C Distribution Switchboards Match and Lineup Cubicles	V12-T15-5
Pow-R-Line C Switchboard	V12-T15-2, V12-T15-5
Pow-R-Line / Switchboard	V12-T15-2, V12-T15-3
Pow-R-M-S Distribution Switchboard Rating Table	V12-T15-4
Pow-R-M-S Switchboard	V12-T15-2, V12-T15-4
Pow-R-M-S/F Switchboard	V12-T15-2, V12-T15-3
Pow-R-Way Bus	V12-T9-3, V12-T9-5, V12-T9-14
Pow-R-Way II Bus	V12-T9-3, V12-T9-14
Pow-R-Way III Bus	V12-T9-3, V12-T9-14
PPE	V12-T17-19, V12-T17-61
Pre 3-Star Control	V12-T13-4
Predictive Maintenance	V12-T22-5
Online Assessment	V12-T22-5
Partial Discharge	V12-T22-5
PRL1 Panelboard	V12-T4-8, V12-T4-15
PRL1 Panelboard, Replacement Breaker	V12-T4-8, V12-T4-15
PRL2 Panelboard	V12-T4-8, V12-T4-15
PRL2 Panelboard, Replacement Breaker	V12-T4-8, V12-T4-15
PRL3 Panelboard	V12-T4-8, V12-T4-16
PRL3 Panelboard, Replacement Breaker	V12-T4-8, V12-T4-16
PRL3a Panelboard	V12-T4-17
PRL3a Panelboard, Replacement Breaker	V12-T4-17
PRL4B Panelboard	V12-T4-8, V12-T4-18
PRL4B Panelboard, Replacement Breaker	V12-T4-8, V12-T4-18
PRL4F Panelboard	V12-T4-8, V12-T4-19
PRL4F Panelboard, Replacement Breaker	V12-T4-8, V12-T4-19
Procedure for Identifying Renewal Parts for Power Breakers	V12-T17-10
Product Operated Network Interface	V12-T11-25
Programmable Logic Control Functions	V12-T10-29
Programmable Logic Controllers	V12-T12-1–V12-T12-4
Protection and Coordination Study	V12-T22-4
Protective Relay Selection Chart	V12-T10-12–V12-T10-14
Protective Relaying	V12-T2-3
Provisions for DSII Circuit Breakers	V12-T17-7
Provisions for Magnum DS Circuit Breakers	V12-T17-8
Provisions, LV Switchgear Cell	V12-T17-8
Pullout Relay/Protection, Synchronous Motor Control	V12-T13-79–V12-T13-85
Pullout/Power Factor Relay	V12-T13-84
Pushbuttons	V12-T23-2–V12-T23-7
Pushbuttons and Pilot Devices (22 mm)	V12-T23-1–V12-T23-10
Accessories	V12-T23-11–V12-T23-13
PWA	V12-T13-89
PWB	V12-T13-89
Q	
Q10P Panelboard	V12-T4-7
Q10P Panelboard, Replacement Breaker	V12-T4-7
Q22B Panelboard	V12-T4-7
Q22B Panelboard, Replacement Breaker	V12-T4-7
Q22P Panelboard	V12-T4-7
Q22P Panelboard, Replacement Breaker	V12-T4-7
Q65P Panelboard	V12-T4-7
Q65P Panelboard, Replacement Breaker	V12-T4-7
QBGF	V12-T3-7
QBGFEP	V12-T3-8
QBHGF	V12-T3-8
QBHGFEP	V12-T3-8
QBHW	V12-T3-7
QBHW QUICKLAG Miniature Circuit Breaker	V12-T3-6
QC QUICKLAG Miniature Circuit Breaker	V12-T3-6, V12-T3-9
QCC Out-of-Production Circuit Breaker	V12-T3-10
QCF QUICKLAG Miniature Circuit Breaker	V12-T3-6
QCGF	V12-T3-8
QCGFEP	V12-T3-8

Appendix 2—Alphabetical Product Index

QCHGF	V12-T3-8
QCHGFEP	V12-T3-8
QCHW QUICKLAG Miniature Circuit Breaker	V12-T3-6
QCR QUICKLAG Miniature Circuit Breaker	V12-T3-6, V12-T3-9
QHCW QUICKLAG Miniature Circuit Breaker	V12-T3-6
QHCX QUICKLAG Miniature Circuit Breaker	V12-T3-6
QHPW QUICKLAG Miniature Circuit Breaker	V12-T3-6
QHPX Miniature Circuit Breaker	V12-T3-6
QP	V12-T6-2
QPGF	V12-T3-7
QPGFEP	V12-T3-7
QPHGF	V12-T3-7
QPHGFEP	V12-T3-7
QPHW Miniature Circuit Breaker	V12-T3-6
QS, QP	V12-T6-2
Quad XYZ	V12-T11-11
Quick-Assembled Plugs	V12-T9-10
QUICKLAG Breakers	V12-T3-6, V12-T3-7
BAB	V12-T3-6
FAZ	V12-T3-6
HBAW	V12-T3-6
HBAX	V12-T3-6
HQP	V12-T3-6
QBHW	V12-T3-6
QC	V12-T3-6, V12-T3-9
QCF	V12-T3-6, V12-T3-9
QCHW	V12-T3-6
QCR	V12-T3-6, V12-T3-9
QHCW	V12-T3-6
QHCX	V12-T3-6
QHPW	V12-T3-6
QHPX	V12-T3-6
QPHW	V12-T3-6
WMT	V12-T3-6
WMZ	V12-T3-6

R

Racking Crank	V12-T3-59
Ratemeters and Tachometers	V12-T24-62–V12-T24-71
Rating Plug Replacement	V12-T17-21
Rating Plug Selection Data	V12-T3-60
Rating Plugs for DS Breakers	V12-T17-24, V12-T17-25
Rating Plugs for Molded-Case Circuit Breakers	V12-T3-60
Rating Plugs for Other Breakers	V12-T17-27
Rating Plugs for SPB Breakers	V12-T17-24, V12-T17-26
Rating Table for ES Distribution Switchboards	V12-T15-5
Rating Table for Pow-R-Gear Distribution Switchboards	V12-T15-4
Rating Table for WF/WRP Distribution Switchboards	V12-T15-5
Ratings for DHP-VR	V12-T17-56
Ratings for DH-VR	V12-T17-55
Ratings of Trip Unit Retrofit Kits	V12-T17-17

RBA/RDB	V12-T18-2, V12-T18-3, V12-T18-5
RD Parts	V12-T15-3, V12-T15-5
RD Series C Breaker	V12-T3-12
RE Molded-Case Circuit Breakers	V12-T3-153, V12-T3-154
RE Panelboard Replacement Breakers	V12-T3-80, V12-T3-81, V12-T3-83
RE Replacement Breaker	V12-T3-153, V12-T3-154
REA Molded-Case Circuit Breakers	V12-T3-154, V12-T3-155
REA Panelboard Replacement Breakers	V12-T3-80, V12-T3-81, V12-T3-83
REA Replacement Breaker	V12-T3-154, V12-T3-155
Rear-Connected Studs	V12-T3-66
Reconditioning, Class 1	V12-T17-3, V12-T17-5, V12-T17-7
Rectifier	V12-T13-84
Regional Manufacturing Locations for MCCs	V12-T14-19
REH Molded-Case Circuit Breakers	V12-T3-155
REH Panelboard Replacement Breakers	V12-T3-80, V12-T3-81, V12-T3-83
REH Replacement Breaker	V12-T3-155
Relay and Solid-State Slipsyn Control	V12-T13-86
Relay Field Panel, Synchronous Motor Control	V12-T13-78
Relay Slipsyn, Synchronous Motor Control	V12-T13-76, V12-T13-78, V12-T13-83, V12-T13-84
Relay, Motor Protection	V12-T10-28
Remanufactured VCP Breakers	V12-T17-57
Remote Ground Fault Trip Indicator	V12-T3-65
Remote Power Racking	V12-T17-61
Renewal Parts	
Definite Purpose Contactors and Starters	
NEMA Type 1 Enclosed	V12-T13-54
Renewal Parts and Accessories for	
Magnum DS Breakers	V12-T17-8
Renovation Loadcenter	
Type CH	
Loadcenters and Circuit Breakers	V12-T5-25
Renovation Panel	V12-T4-21
Repair Services for SPB Breakers	V12-T15-3
Replacement	V12-T13-47
Breakers, Motor Control Center	V12-T3-88
Breakers, Panelboard	V12-T3-80
Capabilities, Molded-Case Circuit Breakers	V12-T3-5
Circuit Breakers	V12-T3-10–V12-T3-14
Mining Breakers	V12-T3-162–V12-T3-167
Molded-Case Switches	V12-T3-61
Motor Circuit Protectors	V12-T3-63
SELTRONIC	V12-T3-12
Replacement and Upgrading	V12-T22-8
Replacement Breakers	
Type DB-AR	V12-T17-3
Type DHP-VR	V12-T17-56
Type DH-VR	V12-T17-55
Type DS-AR	V12-T17-5
Replacement Circuit Breakers for MCCs	V12-T14-15

Appendix 2—Alphabetical Product Index

- Replacement Digitrip RMS Trip Units V12-**T17**-21, V12-**T17**-22
- Replacement Feeder Breaker Units
 - 11-300 V12-**T14**-5
 - 5 Star/Series 2100 V12-**T14**-10
 - 9800 V12-**T14**-6
 - Advantage V12-**T14**-11
 - F10 V12-**T14**-8
 - F2100 V12-**T14**-12
 - Freedom Unitrol V12-**T14**-9
 - Type W V12-**T14**-7
- Replacement Fuse Base V12-**T9**-5
- Replacement Guide
 - Current Limiting V12-**T3**-13, V12-**T3**-14
 - Series C V12-**T3**-10–V12-**T3**-12
- Replacement Molded-Case Circuit Breakers and Parts V12-**T2**-3
- Replacement Parts for MCCs V12-**T14**-13
- Replacement Power Breakers V12-**T2**-2
- Replacement Starter Units
 - 11-300 MCCs V12-**T14**-5
 - 5 Star/Series 2100 MCCs V12-**T14**-10
 - 9800 MCCs V12-**T14**-6
 - Advantage MCCs V12-**T14**-11
 - F10 MCCs V12-**T14**-8
 - F2100 MCCs V12-**T14**-12
 - Freedom Unitrol MCCs V12-**T14**-9
 - Type W MCCs V12-**T14**-7
- Replacement Vacuum Breakers V12-**T2**-2
- Replacement Vacuum Contactors V12-**T13**-94
- Residential Meter Stacks
 - Ring V12-**T6**-7
- Resistor, Starting and Field Discharge for Synchronous V12-**T13**-79, V12-**T13**-80, V12-**T13**-82
- Retro-build — see Network Protectors
- Retrofit Interior Kits
 - Type CH
 - Loadcenters and Circuit Breakers V12-**T5**-27
- Retrofit Kits
 - Trip Units V12-**T2**-2
- Retrofit Kits, Series C for Motor Control Centers V12-**T3**-91
- Retrofit Services
 - Low Voltage Breaker Drawout
 - Vacuum Starter Replacement V12-**T17**-12, V12-**T17**-13
- Retrofits
 - Motor Control Center V12-**T2**-2
 - Motor Control Center Buckets V12-**T2**-2
 - Panelboards V12-**T4**-21
 - Power Breaker Trip Units V12-**T17**-21, V12-**T17**-22
 - SPD V12-**T2**-3
 - Submetering V12-**T2**-3
- Retrofit—Trip System V12-**T2**-2
- Reversing/Assignment Contactor V12-**T13**-68
- RF Molded-Case Circuit Breakers V12-**T3**-155, V12-**T3**-156
- RF Panelboard Replacement Breakers V12-**T3**-80, V12-**T3**-81, V12-**T3**-84
- RF Replacement Breaker V12-**T3**-156
- RFA Molded-Case Circuit Breakers V12-**T3**-156
- RFA Panelboard Replacement Breakers V12-**T3**-80, V12-**T3**-81, V12-**T3**-84
- RFK V12-**T9**-9
- RH V12-**T17**-22
- RHF Molded-Case Circuit Breakers V12-**T3**-156, V12-**T3**-157
- RHF Panelboard Replacement Breakers V12-**T3**-80, V12-**T3**-81, V12-**T3**-85
- RHFA Molded-Case Circuit Breakers V12-**T3**-157
- RHFA Panelboard Replacement Breakers V12-**T3**-80, V12-**T3**-81, V12-**T3**-84
- RHK Molded-Case Circuit Breakers V12-**T3**-157, V12-**T3**-158
- RHK Panelboard Replacement Breakers V12-**T3**-80, V12-**T3**-82, V12-**T3**-86
- RHKL Molded-Case Circuit Breakers V12-**T3**-158
- RHKL Panelboard Replacement Breakers V12-**T3**-80, V12-**T3**-82, V12-**T3**-86
- RHLM Molded-Case Circuit Breakers V12-**T3**-158, V12-**T3**-159
- RHLM Panelboard Replacement Breakers V12-**T3**-80, V12-**T3**-82, V12-**T3**-87
- RJ Molded-Case Circuit Breakers V12-**T3**-159
- RJ Panelboard Replacement Breakers V12-**T3**-80, V12-**T3**-82, V12-**T3**-85
- RK Molded-Case Circuit Breakers V12-**T3**-159, V12-**T3**-160
- RK Panelboard Replacement Breakers V12-**T3**-80, V12-**T3**-82, V12-**T3**-85
- RKL Molded-Case Circuit Breakers V12-**T3**-160
- RKL Panelboard Replacement Breakers V12-**T3**-80, V12-**T3**-82, V12-**T3**-85
- RL Siemens Breaker V12-**T17**-48
- RLM Molded-Case Circuit Breakers V12-**T3**-160, V12-**T3**-161
- RLM Panelboard Replacement Breakers V12-**T3**-80, V12-**T3**-82, V12-**T3**-86
- RLX Siemens-Allis Breaker V12-**T17**-48
- RMCF Motor Control Center Replacement Breakers V12-**T3**-88, V12-**T3**-89
- RMCF Motor Control Center Replacement Breakers V12-**T3**-88, V12-**T3**-89
- RMCHF Motor Control Center Replacement Breakers V12-**T3**-88, V12-**T3**-90
- RMCHFA Motor Control Center Replacement Breakers V12-**T3**-88, V12-**T3**-90
- RMS 500 V12-**T17**-21, V12-**T17**-23, V12-**T17**-25–V12-**T17**-28
- RMS 510 V12-**T17**-21, V12-**T17**-23, V12-**T17**-25–V12-**T17**-28
- RMS 600 V12-**T17**-21, V12-**T17**-23, V12-**T17**-25–V12-**T17**-28
- RMS 610 V12-**T17**-21, V12-**T17**-23, V12-**T17**-25–V12-**T17**-28
- RMS 700 V12-**T17**-21, V12-**T17**-23, V12-**T17**-25–V12-**T17**-28
- RMS 800 V12-**T17**-21, V12-**T17**-23, V12-**T17**-25–V12-**T17**-28
- RMS 810 V12-**T17**-21, V12-**T17**-23, V12-**T17**-25–V12-**T17**-28
- RMS 910 V12-**T17**-21, V12-**T17**-23, V12-**T17**-25–V12-**T17**-28
- RNA V12-**T13**-89

Appendix 2—Alphabetical Product Index

RNR V12-**T13**-89

Roller-Smith RS-25A Breaker V12-**T17**-51

Roll-out with SJ V12-**T13**-95

Routine/Emergency Service V12-**T22**-2

RPR-2 (Remote Power Racking) V12-**T17**-61

RS-232. V12-**T11**-10, V12-**T12**-2

RS-25A Roller-Smith Breaker V12-**T17**-51

RTD Module V12-**T11**-11

RTD Modules V12-**T10**-36

RV Autotransformer V12-**T13**-88

RV Part Winding V12-**T13**-88

RV Wye-Delta V12-**T13**-88

RVS V12-**T13**-89

S

S202 V12-**T13**-89

S801+ and S811+ soft starter. V12-**T13**-71

S811+ Soft Starter V12-**T13**-71

Safety Switches V12-**T7**-2

Saf-T-Vue Breakers V12-**T3**-15, V12-**T3**-16,
V12-**T3**-19–V12-**T3**-29, V12-**T3**-32–V12-**T3**-34,
V12-**T3**-37, V12-**T3**-40–V12-**T3**-43

Sales Locations V12-**A**-2–V12-**A**-4

Satellite Locations V12-**T4**-22

Satellite Plants, Panelboards V12-**T4**-22

SCB 1200A Out-of-Production Circuit Breaker V12-**T3**-12

SCB 2000–3000A Out-of-Production
Circuit Breaker V12-**T3**-12

SCB 600A Out-of-Production Circuit Breaker V12-**T3**-11

SCR V12-**T13**-73

SCR Truck Cell V12-**T13**-97

Selecting a Retrofit Kit V12-**T17**-28

Selection V12-**T13**-31

Selection Guide V12-**T3**-80–V12-**T3**-82

Selector Switches V12-**T23**-8–V12-**T23**-9

Self-Enclosed Electronic Meters
IQ 150S/250S V12-**T10**-21

SELTRONIC Breakers V12-**T3**-49–V12-**T3**-60, V12-**T3**-65,
V12-**T3**-73

SELTRONIC Ground Fault Trip Indicator V12-**T3**-65

SELTRONIC Replacement Breaker V12-**T3**-12

Sensing and Measurement
IQ 250/260 V12-**T10**-4, V12-**T10**-5
PXM 2000 V12-**T10**-4, V12-**T10**-5

Sequence of Operation for C-HRG
(Low Voltage) High Resistance Ground V12-**T16**-3
(Medium Voltage) High Resistance Ground V12-**T16**-6

Series 2100 Motor Control Centers V12-**T14**-3, V12-**T14**-10
Add-on Structures V12-**T14**-10
Feeder Breaker Units V12-**T14**-10
Handle Mechanism V12-**T14**-4
Replacement Starter Units V12-**T14**-10

Series C
Molded-Case Circuit Breakers
Interrupting V12-**T14**-16
Motor Circuit Protectors
Magnetic V12-**T14**-17

Series C Circuit Breakers V12-**T3**-10–V12-**T3**-12
Breaker Replacement Guide V12-**T3**-10
Flex Shaft Handle Mechanism V12-**T3**-96
Handle Extensions V12-**T3**-112
Replacement Capabilities V12-**T3**-5
Retrofit Kits V12-**T3**-91
Rotary Accessories V12-**T3**-110
Rotary and Universal Rotary
Handle Mechanisms V12-**T3**-109, V12-**T3**-110
Rotary Handle Mechanism V12-**T3**-95, V12-**T3**-96,
V12-**T3**-109

Series C MCC Retrofit Kit Ordering Process V12-**T14**-17

Series C MCP Catalog Numbers V12-**T14**-17

Series C Retrofit Kits V12-**T14**-15

Series C Retrofit Kits Catalog Numbering System V12-**T14**-17

Series C Retrofit Kits for 5 Star MCCs V12-**T14**-15

Series C Retrofit Kits for F10 MCCs V12-**T14**-16

Series C Retrofit Kits for Motor Control Centers V12-**T14**-15

Series C Retrofit Kits for Type W MCCs V12-**T14**-16

Series Programmable Logic Controllers V12-**T12**-2

Service
Installation and Startup V12-**T2**-3

Service Locations V12-**A**-5

Service Solutions V12-**T22**-8

Shielded Isolation V12-**T8**-2

Shunt Trip V12-**T3**-3

Siemens and Siemens-Allis Breakers
with Digitrip RMS Retrofit Kits V12-**T17**-48

Siemens LAF Breaker V12-**T17**-48

Siemens RL Breaker V12-**T17**-48

Siemens-Allis Breakers Replacement
and Upgrade Capabilities V12-**T17**-47

Siemens-Allis RLX Breaker V12-**T17**-48

SJ V12-**T13**-91, V12-**T13**-93, V12-**T13**-94

SJ AMPGARD V12-**T13**-77

SJ Vacuum-Break Contactor V12-**T13**-87, V12-**T13**-94

SL V12-**T13**-91, V12-**T13**-92, V12-**T13**-94

SL and SJ Vacuum AMPGARD V12-**T13**-94

SL Vacuum-Break Contactor V12-**T13**-87, V12-**T13**-90, V12-**T13**-94

SL50 V12-**T13**-90

Appendix 2—Alphabetical Product Index

SLB and SLS Contactors AMPGARD	V12-T13-96	Standard AMI	
Slide Plate Type Handle Mechanisms	V12-T3-95, V12-T3-96, V12-T3-99	Vacuum Starter Cell-Retrofit	V12-T13-91
Slide-out with SJ	V12-T13-95	Standard Plug-in	V12-T9-3, V12-T9-8
Slipsyn	V12-T13-82	Standard Plug-in Straight Length	V12-T9-7
Slipsyn Automatic Field Application Panel		Standard Retrofit RMS Replacement	
Static Exciter	V12-T13-80, V12-T13-85	Trip Units for DS Breakers	V12-T17-21
Slipsyn Class 14-200 Low Voltage Motor Starters	V12-T13-82	Standard Retrofit RMS Replacement	
Slipsyn, Synchronous Motor Control	V12-T13-76	Trip Units for SPB Breakers	V12-T17-21
SLS	V12-T13-89	Starter Units	
SLW	V12-T13-89	11-300	V12-T14-5
SM Type Safety Handle Mechanism	V12-T3-95, V12-T3-96, V12-T3-101, V12-T3-102	5 Star/Series 2100	V12-T14-10
SMCU	V12-T3-103	9800	V12-T14-6
Socket Replacement	V12-T6-2	Advantage	V12-T14-11
Soft Starter	V12-T13-71, V12-T13-97, V12-T14-14	F10	V12-T14-8
Soft Starters	V12-T13-70	F2100	V12-T14-12
Soft starters	V12-T13-70	Freedom Unitrol	V12-T14-9
Solid-State Low Voltage Motor Control		Type W	V12-T14-7
Adjustable Frequency AC Drives	V12-T13-72–V12-T13-75	Starting and Field Discharge Resistor,	
Reduced Voltage Motor Starters	V12-T13-70	Synchronous	V12-T13-79, V12-T13-80, V12-T13-82
Solid-State—Mark V	V12-T13-76	Startup Services and Commissioning	V12-T2-3, V12-T22-8
SPB and DS Breaker Digitrip Trip Unit Retrofit Kits	V12-T15-6	State-of-the-Art Features of Trip Unit Retrofit Kits	V12-T17-18
SPB Breaker Cell Provisions	V12-T15-4	Static Excitation Power Supply Panel	V12-T13-79
SPB Breaker Standard Retrofit RMS		Static Exciter	V12-T13-81
Replacement Trip Units	V12-T17-21	Static Exciter, Synchronous Motor Control	V12-T13-76, V12-T13-79–V12-T13-82, V12-T13-84, V12-T13-85
SPB Factory Repair Service	V12-T15-4, V12-T15-5, V12-T17-15	Strategic Alliances	V12-T22-2
SPB Parts	V12-T15-3, V12-T15-4, V12-T15-5, V12-T17-15	Structure Parts for DS Switchgear	V12-T17-5
SPB Rating Plugs	V12-T17-24, V12-T17-26	Structure Parts for DSII Switchgear	V12-T17-7
SPB Repair Services	V12-T15-3, V12-T17-15	Structure Parts for Magnum DS Switchgear	V12-T17-8
SPB-100 Westinghouse Breaker	V12-T17-36	Structure Parts for WF/WRP, ES and Pow-R-Line C Distribution Switchboards	V12-T15-5
SPB-150 Westinghouse Breaker	V12-T17-14, V12-T17-36	Submetering Retrofits—IQ Energy Sentinel	V12-T2-3
SPB-50 Westinghouse Breaker	V12-T17-36	Support Services for MCCs	V12-T14-19
SPB-65 Westinghouse Breaker	V12-T17-14, V12-T17-36	<i>SURE CLOSE</i>	V12-T17-55, V12-T17-56, V12-T17-60, V12-T17-61, V12-T17-62
SPCB 1200A Out-of-Production Circuit Breaker	V12-T3-12	<i>SURE CLOSE MOC</i>	V12-T22-6
SPCB 2000–3000A Out-of-Production Circuit Breaker	V12-T3-12	Surge Panel	
SPCB 600A Out-of-Production Circuit Breaker	V12-T3-11	Type CH	
SPD Series Surge Protective Devices	V12-T15-6	Loadcenters and Circuit Breakers	V12-T5-29
SPD System Retrofits	V12-T2-3	Surge Protection Devices—SPD Series	V12-T4-20
SPD Upgrade for MCC Units	V12-T14-15	Surge Protective Device—MCC	V12-T14-15
Special Calibrations	V12-T3-17–V12-T3-36, V12-T3-38, V12-T3-39, V12-T3-41, V12-T3-44, V12-T3-45, V12-T3-48	SV9000	V12-T13-74
Specified Circuit Breaker	V12-T5-24	SV9000 Adjustable Frequency Drives for MCC Upgrades	V12-T14-15
SRH	V12-T17-22	SVX9000	V12-T13-74
SSPB GTE-Sylvania Breaker	V12-T17-51	Switchboards, Distribution	V12-T15-1–V12-T15-6
ST	V12-T9-7		
Stab Base Assembly	V12-T9-5		

Appendix 2—Alphabetical Product Index

Switches

Molded-Case	V12-T3-61
CA	V12-T3-62
DA	V12-T3-61
EB	V12-T3-61
EHB	V12-T3-61
FB	V12-T3-61
JA	V12-T3-61
JB	V12-T3-61
KA	V12-T3-61
KB	V12-T3-61
LA	V12-T3-62
LAB	V12-T3-62
LB	V12-T3-61
LBB	V12-T3-61
LC	V12-T3-62
LCC	V12-T3-62
MA	V12-T3-62
MC	V12-T3-62
MCC	V12-T3-62
NB	V12-T3-62
NC	V12-T3-62
PB	V12-T3-62
PBF	V12-T3-62
PC	V12-T3-62
PCC	V12-T3-62
PCF	V12-T3-62

Switches — see Automatic Transfer Switches

Switchgear

DB	V12-T17-2, V12-T17-3
DHP	V12-T17-56
DS	V12-T17-2, V12-T17-4–V12-T17-6
DSII	V12-T17-2, V12-T17-6, V12-T17-7
Magnum DS	V12-T17-2, V12-T17-8, V12-T17-10
WPA	V12-T17-2
Switchgear — Low Voltage Competitive Upgrades	V12-T22-6
Switchgear Assemblies and Power	
Circuit Breakers—Low Voltage	V12-T17-2
Switchgear Assemblies and Power	
Circuit Breakers—Medium Voltage	V12-T17-53–V12-T17-58
Switchgear Fluidized Epoxy Bus	V12-T2-2
Switchgear Trip Unit Retrofit Kits	V12-T17-17–V12-T17-52
Switchgear—Low Voltage	V12-T17-10
Switchgear—Low Voltage Competitive Upgrades	V12-T17-11
Switchgear—Medium Voltage Competitive Upgrades	V12-T17-60
Switching Base	V12-T7-2
Synchronous Motor Control	V12-T13-76–V12-T13-99
Systems Pow-R Breaker (SPB)	V12-T17-14–V12-T17-16
Systems—Distribution	V12-T2-4

T

T-56A	V12-T13-26
T-56B	V12-T13-26
TA225	V12-T3-24
Tachometers and Ratemeters	V12-T24-62–V12-T24-71
TAP	V12-T9-5, V12-T9-9, V12-T9-11

TCP/IP Ethernet network	V12-T11-3
Technical Resource Center	V12-T12-4
Temperature Controls	V12-T24-96–V12-T24-98
Special Control Functions	V12-T24-98
Terminals	V12-T3-17–V12-T3-40, V12-T3-42–V12-T3-45, V12-T3-51, V12-T3-53, V12-T3-55, V12-T3-61–V12-T3-63, V12-T3-83, V12-T3-87
Test Kit Adapters	V12-T17-9
Test Kit Unit	V12-T17-9
Testing	V12-T22-5, V12-T22-7
Test-Kit, DS/DSII (Amptector-Digitrip)	V12-T17-9
Thermographic Survey	V12-T22-5
Timers and Hour Meters	V12-T24-79–V12-T24-90
Electromechanical	V12-T24-86–V12-T24-90
Electronic	V12-T24-81–V12-T24-85
Totalizers	V12-T24-2–V12-T24-55
Electromechanical	V12-T24-25–V12-T24-34
Electronic	V12-T24-35–V12-T24-55
Mechanical	V12-T24-4–V12-T24-24
Revolution	V12-T24-11–V12-T24-24
Stroke	V12-T24-4–V12-T24-10
TP-1	V12-T8-2
Transfer Switches —	
see Automatic Transfer Switches	V12-T20-1
Transformers	
Accessories	V12-T8-3
Case Parts, Ventilated Units	V12-T8-4
Rodent Screen	V12-T8-3
Terminal Lug	V12-T8-3
Buck-Boost	V12-T8-2
Class 1, Division 2	V12-T8-4
Dry-Type	V12-T8-4
DS-3	V12-T8-2
DT-3	V12-T8-2
EP	V12-T8-2
EPT	V12-T8-2
KT	V12-T8-2
MD	V12-T8-2
MPC	V12-T8-2
MTA	V12-T8-2
MTC	V12-T8-2
NEMA TP-1	V12-T8-2
Hazardous Location	V12-T8-2
Industrial Control (MTA and MTC)	V12-T8-2
Mini-Power Center (MPC)	V12-T8-2
Motor Drive Isolation (MD)	V12-T8-2
Nonlinear (KT)	V12-T8-2
Shielded Isolation	V12-T8-2
TP-1	V12-T8-2
Transient voltage surge suppression (TVSS)	V12-T9-14
Trip System Upgrades	V12-T2-2
Trip Unit Features for Trip Unit Retrofit Kits	V12-T17-20
Trip Unit Retrofit Kit Applications	V12-T17-17
Trip Unit Retrofit Kit Catalog Number Development	V12-T17-28

Appendix 2—Alphabetical Product Index

Trip Unit Retrofit Kit Ratings	V12-T17-17	Types LC, LCC, LCA, LCCA, MARK 75 Types HLC, HLCC, HLCA, HLCCA SELTRONIC	V12-T3-49
Trip Unit Retrofit Kits	V12-T17-17–V12-T17-52	Types LCG, LCCG, LCGA, LCCGA, MARK 75 Types HLCG, HLCCG, HLCGA, HLCCGA SELTRONIC	V12-T3-50, V12-T3-51
Accessories	V12-T17-28	Types MC, MCC, MCA, MCCA, MARK 75 Types HMC, HMCC, HMCA, HMCCA SELTRONIC	V12-T3-52
Rating Plugs	V12-T17-24–V12-T17-27	Types MCG, MCCG, MCGA, MCCGA and MARK 75 Types HMCG, HMCCG, HMCGA, HMCCGA SELTRONIC	V12-T3-53
Retrofit Kits		Types NC, NCA, NCG, NCGA, MARK 75 Type HNC, HNCA, HNCG, HNCGA SELTRONIC	V12-T3-54, V12-T3-55
Allis-Chalmers LA Breakers	V12-T17-41, V12-T17-42	Types PC, PCA, PCC, PCCA SELTRONIC	V12-T3-56
Federal Pacific Breakers	V12-T17-49, V12-T17-50	Types PCG, PCGA, PCCG, PCCGA SELTRONIC	V12-T3-58
General Electric Breakers	V12-T17-37–V12-T17-40		
ITE Breakers	V12-T17-43–V12-T17-46		
Other Manufacturers	V12-T17-51		
Siemens and Siemens-Allis Breakers	V12-T17-47, V12-T17-48		
Westinghouse Breakers	V12-T17-30–V12-T17-36		
Trip Units	V12-T17-21, V12-T17-22		
Trip Unit Retrofit Kits Accessories	V12-T17-28		
Trip Unit Retrofit Kits Definitions for Replacement and Upgrade Capabilities	V12-T17-19		
Trip Unit Retrofit Kits Past Technology	V12-T17-20		
Trip Unit Retrofit Kits Trip Unit Features	V12-T17-20		
Trip Unit Retrofit Kits with Digitrip RMS Trip Units	V12-T17-21–V12-T17-27		
Trip Unit Retrofits	V12-T2-2		
Trip, Microprocessor-Based	V12-T10-30		
TRI-PAC Breakers	V12-T3-13		
Troubleshooting	V12-T22-5		
Truck Cell, SCR	V12-T13-97		
True rms	V12-T17-18		
Type A Overload Relay	V12-T13-28		
Type B Overload Relay	V12-T13-27		
Type CH			
Loadcenters and Circuit Breakers			
Renovation Loadcenter	V12-T5-25		
Retrofit Interior Kits	V12-T5-27		
Surge Panel	V12-T5-29		
Type F Magnetic Contactor	V12-T13-3		
Type FT Fast Trip, Class 10 Overload Relay	V12-T13-29		
Type H, Medium Voltage Contactor	V12-T13-91		
Type K, Medium Voltage Contactor	V12-T13-91		
Type MC Motor Control Handle Mechanisms	V12-T3-95, V12-T3-103		
Type N Control	V12-T13-3		
Type N Starter Replacement Capabilities			
Coils	V12-T13-22		
Contact Kits	V12-T13-22		
Type S 511 AC and DC Brakes	V12-T13-63		
Type SM Safety Handle Mechanisms	V12-T3-101		
Type W Motor Control Centers			
Add-on Structures	V12-T14-7		
Feeder Breaker Units	V12-T14-7		
Handle Mechanism	V12-T14-4		
MCCs with Series C Retrofit Kits	V12-T3-91, V12-T14-16		
		UCTB	V12-T9-7
		UEC	V12-T9-7
		Undervoltage Release (UVR)	V12-T3-3
		Unibus	V12-T9-3
		UNIPAK	V12-T21-4
		UNIPUMP	V12-T21-4
		UNIVAR and Filter	V12-T21-4
		Universal Cable Tap Box	V12-T9-7
		Universal Direct Handle Mechanisms	V12-T3-111
		Universal Module	V12-T10-36
		Universal Mount IQ Energy Sentinel	V12-T10-26
		Universal Remote Power Racking	V12-T17-61
		Universal Rotary Type Handle Mechanisms	V12-T3-95, V12-T3-109
		Universal RTD Module	V12-T10-36, V12-T10-43
		Upgrades	
		Medium Voltage Starter	V12-T2-2
		URTD	V12-T10-36
		V	
		V201 and V200 Vacuum Contactors and Starters	
		Heaters	V12-T13-36
		vacuum	V12-T13-93
		Vacuum Break Roll-out	V12-T13-89
		Vacuum Break Slide-out	V12-T13-89
		Vacuum Contactor Replacement Coils	V12-T13-36
		Vacuum Replacement Breakers	V12-T2-2, V12-T17-60
		Allis-Chalmers AM	V12-T17-60
		Allis-Chalmers FA	V12-T17-60
		Allis-Chalmers FB	V12-T17-60
		Allis-Chalmers FC	V12-T17-60
		Allis-Chalmers MA	V12-T17-60
		Allis-Chalmers RUPTAIR	V12-T17-60
		Federal Pacific DST	V12-T17-60
		Federal Pacific DST-2	V12-T17-60
		General Electric AM13.8	V12-T17-60

Appendix 2—Alphabetical Product Index

Vacuum Replacement Breakers, continued

General Electric AM15	V12- T17-60
General Electric AM4.16	V12- T17-60
General Electric AM5	V12- T17-60
General Electric AM7.2	V12- T17-60
General Electric AM7.5	V12- T17-60
General Electric MagneBlast	V12- T17-60
ITE	V12- T17-60
ITE 15HK	V12- T17-60
ITE 5HK	V12- T17-60
ITE 5HV	V12- T17-60
McGraw & Edison PSD-15	V12- T17-61
McGraw & Edison WSA-15	V12- T17-61
McGraw & Edison WSA-5	V12- T17-61
Vacuum Replacement Breakers with MOC Operators	V12- T17-55 , V12- T17-56 , V12- T17-60 –V12- T17-62
Vacuum Replacement Breakers with <i>SURE CLOSE</i>	V12- T17-62
Vacuum Starter Replacement for DB Breakers	V12- T17-3
Vacuum Starter Replacement for DSII Breakers	V12- T17-7
Vacuum Starter Retrofit—DB25-LV-VSR	V12- T17-3
Vacuum Starter Structures	V12- T13-94
Vacuum Starters	V12- T13-36
Vacuum, Roll-out (standard)	V12- T13-89
Vacuum, Slide-out (standard)	V12- T13-89
Vari-Depth Handle Mechanism	V12- T3-95 –V12- T3-98
VCP Breaker Renewal Parts	V12- T17-57
VCP Medium Voltage Switchgear Assemblies and Power Circuit Breakers	V12- T17-57
VCP Remanufactured Breakers	V12- T17-57
VCP Switchgear Fluidized Switchgear Bus	V12- T17-57
VCP-W ANSI and IEC Rating Table	V12- T17-58
VCP-W Breaker Renewal Parts	V12- T17-58
VCP-W Match and Lineup Cubicles	V12- T17-58
VCP-W Medium Voltage Switchgear Assemblies and Power Circuit Breakers	V12- T17-58
VCP-W Switchgear Fluidized Switchgear Bus	V12- T17-58
VCP-W Vacuum Breakers	V12- T17-58
Vectrol Energy Saver	V12- T13-71
Vectrol Startrol	V12- T13-71
Vectrol Startrol Power Miser	V12- T13-71
Vectrol VMS	V12- T13-71
Vertical Retrofit RMS Replacement Trip Units for Other Breakers	V12- T17-23
Victory Bus Duct	V12- T9-3
VLT-5	V12- T13-72 –V12- T13-75
VMAN	V12- T13-89
VMS	V12- T13-71
Volt Trap	V12- T13-84
VR-Series Medium Voltage Vacuum Replacement (MVVR) Breakers	V12- T22-6
VSR, DB	V12- T17-3
VSR, DSII	V12- T17-7

W

W10B Panelboard	V12- T4-7
W10B Panelboard, Replacement Breaker	V12- T4-7
W10P Panelboard	V12- T4-7
W10P Panelboard, Replacement Breaker	V12- T4-7
W210	V12- T13-90
W22B Panelboard	V12- T4-7
W22B Panelboard, Replacement Breaker	V12- T4-7
W22P Panelboard	V12- T4-7
W22P Panelboard, Replacement Breaker	V12- T4-7
Warranty Service, Power Equipment Services	V12- T22-2
WCA Panelboard	V12- T4-7
WCA Panelboard, Replacement Breaker	V12- T4-7
WCG3, 5, 7, 9, 11	V12- T6-2
WCK	V12- T13-51
WCOIL	V12- T13-51
WEB Panelboard	V12- T4-2 , V12- T4-7
WEB Panelboard, Replacement Breaker	V12- T4-2 , V12- T4-7
WEHB Panelboard	V12- T4-7
WEHB Panelboard, Replacement Breaker	V12- T4-7
Westinghouse 50/55, 100/110, 300, 400, 500, 700, 900, 1100, 1200/1250, 1500/1700, 2000	V12- T12-3
Westinghouse AR-Series Replacement Breakers	V12- T17-11 , V12- T22-6
Westinghouse Breaker Type DA-50-1600	V12- T17-30
Type DA-50-800	V12- T17-30
Type DA-75	V12- T17-30
Type DB-100	V12- T17-32
Type DB-25	V12- T17-32
Type DB-50	V12- T17-32
Type DB-75	V12- T17-32
Type DBL-25	V12- T17-32
Type DBL-50	V12- T17-32
Type DK-15	V12- T17-30
Type DK-25	V12- T17-30
Type DS and DSL-206	V12- T17-34
Type DS and DSL-416	V12- T17-34
Type DS-420	V12- T17-34
Type DS-632	V12- T17-34
Type DS-840	V12- T17-34
Type SPB-100	V12- T17-36
Type SPB-150	V12- T17-36
Type SPB-50	V12- T17-36
Type SPB-65	V12- T17-36
Westinghouse DA and DK Breakers with Digitrip RMS Retrofit Kits	V12- T17-30
Westinghouse DB Breakers with Digitrip RMS Retrofit Kits	V12- T17-32
Westinghouse DS Breakers with Digitrip RMS Retrofit Kits	V12- T17-34

Westinghouse SPB Breakers with Digitrip RMS Retrofit Kits	V12-T17-36
Westinghouse, Challenger and Bryant Cross-Reference	V12-T3-113
WF/WRP Switchboards	V12-T15-5
WFB Panelboard	V12-T4-7
WFB Panelboard, Replacement Breaker	V12-T4-7
WGB Panelboard	V12-T4-7
WGB Panelboard, Replacement Breaker	V12-T4-7
WGHB Panelboard	V12-T4-7
WGHB Panelboard, Replacement Breaker	V12-T4-7
WLI Load Interrupter	V12-T17-65
WM	V12-T6-2
WM, WP	V12-T6-2
Works-in-a-Drawer, MV Motor Control Device Panel	V12-T13-93, V12-T13-95
WP	V12-T6-2
WPA Switchgear	V12-T17-4
WRI Switchboards	V12-T15-2, V12-T15-3
Digitrip Trip Unit Retrofit Kits	V12-T15-3
IQ and PowerNet Communications Retrofits	V12-T15-3
SPD Series Surge Protective Devices	V12-T15-3
WVB	V12-T17-65
Wye or Delta Systems with High Resistance Grounding Addition (C-HRG)	V12-T16-6

X

XT IEC Contactors and Starters	V12-T13-49
XT IEC Power Control	V12-T13-49
XT	V12-T13-3

Z

ZN110	V12-T9-8, V12-T9-9
ZN250KB	V12-T9-8, V12-T9-9
ZN400	V12-T9-8, V12-T9-9
Zone Interlock Kits	V12-T3-94
Zone Interlocking	V12-T17-18

Numerics

100 Ampere Busway	V12-T9-3, V12-T9-6
100/110	V12-T12-3
100/110 Series	V12-T12-3
100HF Federal Pacific Breaker	V12-T17-50
11–202	V12-T13-88
11-300 Motor Control Centers	V12-T14-4
Add-on Structures	V12-T14-5
Feeder Breaker Units	V12-T14-5
Handle Mechanism	V12-T14-5
Replacement Starter Units	V12-T14-5
1MM	V12-T6-2
1MM, 3MM, 35MM, 37MM, 35SS, 37SS	V12-T6-2

202	V12-T13-89
2100 Series Motor Control Centers	V12-T14-3, V12-T14-10
Add-on Structures	V12-T14-10
Feeder Breaker Units	V12-T14-10
Handle Mechanism	V12-T14-4
Replacement Starter Units	V12-T14-10
212	V12-T13-89
2225TA	V12-T3-125
25/50L4	V12-T13-92, V12-T13-99
25/50L7	V12-T13-92, V12-T13-99
25L2	V12-T13-92, V12-T13-99
25L2 Vacuum Replacement Contactor	V12-T13-93
300 Series	V12-T12-3
35MM	V12-T6-2
35SS	V12-T6-2
37MM	V12-T6-2
37SS	V12-T6-2
3MM	V12-T6-2
3-Star Contactors and Starters	V12-T13-5
400 Series	V12-T12-4
400A Air-to-Vacuum Contactor Replacement	V12-T13-92
400A SL Roll-out Replacement	V12-T13-94
400A SL Slide-out Replacement	V12-T13-94
400A Vacuum Starter Cell Kit	V12-T13-95
5 Star Motor Control Centers	V12-T14-3, V12-T14-10, V12-T14-15
Series C Retrofit Kits	V12-T3-91, V12-T14-15
50°C Calibration	V12-T3-17, V12-T3-20, V12-T3-22, V12-T3-24, V12-T3-26, V12-T3-28, V12-T3-30, V12-T3-31, V12-T3-33, V12-T3-36, V12-T3-38, V12-T3-39, V12-T3-41, V12-T3-44, V12-T3-45, V12-T3-48, V12-T3-83, V12-T3-87
502	V12-T13-89
50L2	V12-T13-92, V12-T13-99
50L2 Air-to-Vacuum Retrofit Kit	V12-T13-93
50L2 Vacuum Retrofit	V12-T13-89
50L4	V12-T13-92
50V4	V12-T13-99
511 AC and DC Brakes Replacement Capabilities	V12-T13-64
602	V12-T13-89
700 Series	V12-T12-4
700A Air-to-Vacuum Conversion Kits	V12-T13-93
702	V12-T13-89
7200V	V12-T13-87
802	V12-T13-89
9000 Series	V12-T13-73
902	V12-T13-89

Appendix 2—Alphabetical Product Index

9556 Contactors and Starters	V12- T13 -5
9560 Contactors and Starters	V12- T13 -5, V12- T13 -53
9584 Contactors and Starters	V12- T13 -53
9586 Contactors and Starters	V12- T13 -5, V12- T13 -53
9589 Contactors and Starters	V12- T13 -5
9591 Contactors and Starters	V12- T13 -5
9658 Contactors and Starters	V12- T13 -5
9736 Contactors and Starters	V12- T13 -5
9739 Contactors and Starters	V12- T13 -5
9800 Motor Control Centers	V12- T14 -6
Add-on Structures	V12- T14 -6
Feeder Breaker Units	V12- T14 -6
Handle Mechanism	V12- T14 -4
Replacement Starter Units	V12- T14 -6