

THE FUTURE IS ON



L-101

The Industry's Premier Line of Wiring Devices

Including Power Delivery and Data Connection Devices for Construction & Maintenance



THE FUTURE IS ON



The Largest Selection for Industrial, Commercial and Residential Construction





TABLE OF CONTENTS with Quick Reference Index

ABOUT LEVITON—vi–ix; HOW TO USE THIS CATALOG—x, A8, C36, D28, G18, H8, J36, K18, T6, U6
 CATALOG NUMBER ALPHANUMERIC INDEX (last section)—Index pages 1–16

SECTION **A**
Acenti Collection

Acenti® Collection
 Overview A2
Acenti Lighting Controls
 Dimmers and Fan Speed Control A3
Acenti Switches
 15A and 20A Switches A4
 Electronic Timer Switch A4
 Manual-ON Occupancy Sensor A4

Acenti Receptacles
 Triplex and Duplex A5
 Sixplex and Duplex Surge Protective Receptacles A5
Acenti Wallplates and QuickPort® Connectors
 Wallplates A6
 QuickPort Snap-In Connectors A7
 QuickPort Wallplate Inserts A7

SECTION **B**
Decora Devices

General Overview B2
 Decora Switch Overview B3
Commercial Grade Switches
 Decora *Plus* AC Quiet Rocker Switches B4
 Decora *Plus* Momentary and Maintained Switches B5
 Decora *Plus* Illuminated and Pilot Light Switches B6
Residential Grade Switches
 Decora AC Quiet Rocker Switches B7, B8
 Illuminated, Pilot Light B8
 Decora 911 Emergency Flasher B8
Industrial and Commercial Grade Receptacles
 Decora Receptacles Overview B9
 Decora *Plus* Receptacles B10, B11
Residential Grade Receptacles
 Decora Quickwire and Side Wired B12
Hospital and Industrial Grade Surge Protective Receptacles
 Decora Back and Side Wired B13
SmartLockPRO® GFCI Receptacles
 SmartLockPRO® Overview B14

GFCI Receptacles B15
 Combination Switch/GFCI Outlet B15
 Blank Face B15
Commercial Grade Devices
 Decora Combination Devices B16, B17
 Decora Voice/Data/Video Devices B18
 Decora *Plus* Canadian 347V AC
 Quiet Rocker Switches B19
 Canadian 347V Midway Nylon Wallplates B19
Wallplates
 Decora *Plus* Screwless Snap-On B20
 Decora Thermoset, Thermoplastic and Metal B21–B23
 Adapters B24
 Replacement Screws B24
Decora-Style Recessed Receptacles
 Overview B25
 Recessed Entertainment Box B26
 Duplex Recessed Receptacles B26

SECTION **C**
Lighting and Fan Speed Controls

Architectural Lighting Control Systems
 Dimensions® D3200 C2-C4
 Dimensions® D4000 C5, C6
 Power Extenders C7
 a-2000 Modular Dimming Cabinets C8, C9
Architectural Specification
 Overview C10
 Monet® Controls C11, C12
 Monet® Multi-Gang Wallplates C13
 Renoir® Preset Slide Controls C14, C15
 Van Gogh® Rotary Dimmers C16
Ganging and Derating Lighting Controls
Designer Controls
 Overview C18
 Vizia™ Digital Controls C19
 Vizia™ Remotes C20
 Vizia-RF™ Scene Capable Dimmers C21
 Vizia-RF™ Remotes C22
 Mural® Digital Controls C23

Mural® Scene Controls C24, C25
Touch Lighting Controls
 Overview C26
 True Touch™ Digital Touch Dimmer C27
 ToggleTouch™ Digital Dimmer C28
Traditional Controls
 Overview C29
 IllumaTech™ Preset Slide Controls C30
 IllumaTech™ Rotary Controls C31
 SureSlide™ Slide Controls C32
 Trimatron™ Deluxe Rotary Controls C33
Incandescent Lighting Controls
 Toggle Dimmers C34
 Decora 911 Flasher Switch C34
 4-Level Step Dimmer C35
 Feed-Through Lamp-Cord Dimmers C35
 Tabletop Dimmer C35
 Full-Range Dimmer Socket C35

SECTION **D**
Energy Management Products

Occupancy Sensor Lighting Controls
 Overview D2
 Decora Wall Switch Infrared Occupancy Sensors D3-D6
 Decora Dual-Relay Wall Switch
 Infrared Occupancy Sensors D4
 Decora Wall Switch Multi-Tech Occupancy Sensor D4
 Manual-ON Wall Switch Occupancy Sensor D6
 Self-Contained Fixture Mount Occupancy Sensor D7
 Power Base Adaptor D8
 Self-Contained Infrared Ceiling Mount
 Occupancy Sensor D9
 Multi-Tech Ceiling Mount Occupancy Sensor D10
 Ultrasonic Ceiling Mount Occupancy Sensor D11
 Infrared Ceiling Mount Occupancy Sensor D12
 Multi-Tech Wall Mount Occupancy Sensor D13
 Infrared Wide-View Wall Mount Occupancy Sensor D14
 Infrared High-Bay Wall Mount Occupancy Sensor D14

Infrared Long-Range Wall Mount Occupancy Sensor D14
 Power Packs for Occupancy Sensors D15
 Infrared Outdoor Motion Sensors D16
Centura System
 Centura® Fluorescent Energy
 Management System D17, D18
Timed Lighting Controls
 Decora *Plus* Electronic Timer Switches D19
 Decora Programmable Electronic Timer Switches D20
 Variable Countdown Timer Switch D20
 Z-MAX Relay Lighting Control Systems D21-D27
 Z-MAX Relay Cabinets D22, D23
 RRP-Remote 4-Relay Panel D24
 EZ-MAX Relay Cabinets D25
 Z-MAX Digital and Low Voltage Switch Stations D26
 miniZ™ Intelligent Daylight Management System D27

SECTION **E**
Wallplates

Decora® *Plus* Screwless Snap-On E2, E4, E5
 Decora® E3, E4, E5
 Wallplate Overview E6
 Toggle E7–E9
 Duplex Receptacle E10, E11
 Single Receptacle E12
 Telephone or Cable Outlet, Box Mount E13, E14
 Telephone or Cable Outlet, Strap Mount E14, E15
 Blank, Box Mount E16, E17
 Blank, Strap Mount E17, E18
 Power Outlet Receptacles E19, E20
 Two-Gang with Centered Opening E21
 Louvre Plates E22
 Combination Wallplates
 Toggle and Single Receptacle E23
 Toggle and Duplex Receptacle E23, E24

Toggle and Decora/GFCI E25
 Toggle and Blank E26
 Standard Combinations—2-Gang E26–E28
 Standard Combinations—3-Gang/4-Gang E28
 Sectional for Multi-Gang Installations E29
 Hot Stamped and Engraved E29, E30
 Voice/Data/CATV E31
 Weather Resistant Covers
 Raintight While-In-Use E32
 Industrial Grade E33
 Die-cast Zinc E34
 Thermoplastic E35
 Stainless Steel Lockout E34, E35
 Accessories E36
 Custom Wallplates E37–E40

TABLE OF CONTENTS with Quick Reference Index

SECTION F
AC Switches

Industrial Grade Switches		
Overview	F2	
Back and Side Wired	F3	
Toggle	F3	
Locking	F3	
Wire Lead Toggle	F3	
Canadian 347V AC	F3	
Pilot Light	F4	
Lighted Handle	F4	
Maintained Contact	F5	
Momentary Contact	F5	
Side Wired	F6	
Toggle	F6	
Locking	F6	
AC Manual Motor and Welder Starting	F7	
Safety Disconnect Switches	F8, F9	
		Key Lock Power F10
		Commercial Grade Switches
		Overview F11
		Back and Side Wired F12
		Toggle F12
		Side Wired F12
		Toggle F12
		Hospital Call F12
		Canadian 120/277V AC F12
		Lighted Toggle F13
		Canadian 347V AC F13
		Framed Toggle F13
		Residential Grade Switches
		Quickwire and Sidewire F14
		Illuminated Toggle F14
		CO/ALR F14

SECTION G
Straight Blade Receptacles

Overview	G2	
Hospital Grade		
Back and Side Wired with		
Wire Leads	G3	
Isolated Ground	G3	
Four-In-One	G5	
Industrial Grade		
Back and Side Wired with Wire Leads	G4	
Side Wired	G4	
Isolated Ground	G4	
Dual Voltage	G4	
Clock Hanger	G4	
Four-In-One	G5	
		Power Devices G6-G11
		Commercial Grade
		Overview G12
		Back and Side Wired G13, G15
		Dual Voltage G13
		Side Wired G14, G15
		Brass Floorbox Assembly G14
		QuickPort® Snap-In Jacks with Brass Floorplate G15
		Residential Grade
		Quickwire Push-In G16
		Quickwire Push-In and Side Wired G16
		Side Wired G16, G17
		CO/ALR G16
		Clock Hanger G17
		Snap-In Devices G17
		Shallow Wallbox Extender for GFCI H5
		GFCI Cordsets and Extension Cords H6
		GFCI Accessories H7
		Flush Cover Wallplates H7
		Raintight While-In-Use Covers H7
		Temporary Portable Power H7
		Distribution Center/GFCI (The Box) H7
		Power Cords for The Box H7

SECTION H
GFCI Personnel Protection Devices

GFCI Personnel Protection Devices		
SmartLock ^{Pro} ® GFCI Devices	H2-H4	
Overview	H2-H3	
Hospital Grade Receptacles	H4	
Commercial Grade Receptacles	H4	
Switch-Rated Blank Face	H4	
Combination Switch/GFCI Outlet	H4	
High-Current	H5	
Right-Angle GFCI Plug	H5	

SECTION I
Combination Devices

Commercial Grade AC Combination Devices		
15A Devices	I2	
15A Switch/Receptacle	I2	
15A Switches	I2	
15A S.P. Switch/Neon Pilot Light	I2	
		20A Devices I2
		20A S.P. Switches I2
		20A S.P. Switch/Receptacle I2
		20A S.P. Switch/Neon Pilot Light I2
		Decora® Combination Devices I3
		Decora® Multi Switches I4
		SmartLock ^{PRO} ® GFCI/Switch I4

SECTION J
Structured Media Components

Structured Media™ Components		
Overview	J2	
Enclosures	J3-J5	
Media Versatile™ Panel	J5	
Enclosure for Multiple Dwelling Units (MDUs)	J6	
Cabling Panels	J7-J10	
Stand-Alone Modules and Boards	J10, J11	
Mounting Brackets	J11, J12	
Power and Surge Protective	J13, J14	
Networking and Internet Sharing	J15	
Video Distribution	J16-J18	
Home Video Monitoring System	J19-J21	
Residential Intercom System	J22	
Home Entertainment Components		
Leviton/JBL Products and Systems		
Indoor Speakers	J23	
		Outdoor Speakers J24
		Home Theater Speakers J24-J25
		Harman/Kardon Entertainment Center J26
		Components and Accessories J26
		Leviton Architectural Edition™ Products
		Multi-Room Audio Amplifiers and J27
		Keypad System Accessories J27
		Audio Volume Controls J28-J30
		Audio Distribution Products J31-J32
		SpecGrade Sound™ Products
		Indoor Speakers J33
		Outdoor Speakers J33
		Other Home Entertainment Products
		Decora Media System J34
		Multi-Room IR Repeater System J35
		Decora Recessed Receptacles J35

SECTION K
DHC Powerline Carrier Components

Overview	K2	
Controllers—Green Line		
Toscana™ Deluxe Programmer	K3	
Wall Switch Controllers with		
2-Way Communication	K4, K5	
Wall Switch Controllers with Scene Capability	K5	
RF Products	K6	
Controllers—Red Line		
Basic Programmer	K7	
Table Top Controller	K7	
Dry Contact Controllers	K7	
Receivers—Green Line		
Wall Switches with 2-Way		
Communication	K8	
Wall Switches with Scene Capability	K8, K9	
Plug-In Modules with Scene Capability	K10	
		Receivers—Red Line
		Wall Switches K11
		Remote Switches K12
		Double-Pole 20A Wall Switch K12
		Receptacles K13
		Universal Low-Voltage Module K14
		Fixture Modules K14
		DHC Network Integrity Products
		Panel-Mounted Surge K15
		Protective Devices K15
		System Amplifier/Coupler/Repeater K16
		Couplers and Attenuators K16
		Filters K17
		Signal Strength Indicator K17

TABLE OF CONTENTS with Quick Reference Index

SECTION L
**Multimedia
Structured
Cabling Systems**

Quick Reference Guide	L2	Accessories	L47-L49
Connectors		Enclosures	
QuickPort®	L3-L5	Telecommunications	L50, L51
Fiber Optic	L6, L7	Wireless Access Point	L52
Wallplates and Housings		Cable Management and Rack Accessories	
QuickPort	L8-L16	Versi-Duct®	L53
Acentii®	L17	Rack and Frame	L54-L57
Standard Telephone/Media Jacks	L18-L22	Hook and Loop	L58
Workstation Accessories	L23	Labeling Products	L59, L60
Copper Components		Tools and Accessories	
Patch Panels	L24-L30	Punchdown/Termination	L61
Industrial Connectivity	L31	Fiber L62-L64 Tone Test	L65
Patch Cords	L32	Crimping/Stripping	L65
110-Style	L33-L38	Craftsperson's Handset	L66
66-Block	L39-L40	Modular Plug Breakout Adapter	L66
Fiber Components			
Enclosures	L41-L45		
Fiber Optic Cable Assemblies	L46		

SECTION M
**Straight Blade
Plugs and
Connectors**

Industrial Grade Plugs & Connectors		Python™	M6
Overview	M2	Integrated Inlets and Outlets with Weather-Resistant Covers	M7
15A 125V & 250V		Weather-Resistant Boots	M4
Hospital Grade	M3	20 AMP Power Plugs	M8
Industrial Grade	M3	30 AMP Nylon Angle Plugs	M8
Flanged Inlets and Outlets	M3	50 AMP Nylon Angle Plugs	M9
Wetguard®	M5	60 AMP Nylon Angle Plugs	M10
Dustguard®	M5	Commercial Grade Plugs & Connectors	
Python™	M6	Overview	M11
Integrated Inlets and Outlets with Weather-Resistant Covers	M7	15A 125V & 250V	M12
20A 125V & 250V		20A 125V & 250V	M13
Hospital Grade	M4	30 Amp and 50 Amp Dual Power Attachment Plugs	M14
Industrial Grade	M4	Residential Grade Plugs & Connectors	
Flanged Inlets and Outlets	M4	Parallel, Polarized and Non-Polarized	M15
Wetguard®	M5	Grounding	M16
Dustguard®	M5		

SECTION N
**Locking and
Corrosion Resistant
Devices**

Industrial Specification Grade Locking Devices		Non-NEMA Devices	
Overview	N2-N4	15 Amp	N24
15 Amp Devices	N5, N6	20 Amp	N24
20 Amp Devices	N7-N11	30 Amp	N25
30 Amp Devices	N12-N16	50 Amp	N25
Wetguard® Devices		50 Amp "California Style"	N26
15 Amp	N17	Weather Resistant Boots	N27
20 Amp	N17, N18	Power Interrupting Devices	N28
30 Amp	N19	Midget Straight Blade and Locking Devices	N29
Corrosion Resistant Devices		Combination Locking and Straight Blade Devices	N30
15 Amp	N20	Integrated Inlets and Outlets with Weather Resistant Covers	N30
20 Amp	N21		
30 Amp	N22		
50 Amp	N23		

SECTION O
**Pin &
Sleeve Devices**

North American Watertight Pin & Sleeve Devices		Pin & Sleeve Products	
Overview	O2, O3	Back Boxes	O21
20 & 30 Amp Devices	O4	Accessories	O22
60 & 100 Amp Devices	O5	Making the Right Connection	
Dimensions	O6, O7	Color Code and Clock Position	O23
Specifications	O8, O9	Leviton Catalog Numbering System	O23
PowerSwitch® by Leviton		PowerSwitch® by Leviton	
North American Watertight Mechanical Interlocks		Watertight Safety Disconnect Switches	
Overview	O10, O11	Overview	O24
20 & 30 Amp Devices	O12	30, 60 & 100 Amp Devices	O25
60 & 100 Amp Devices	O13	Specifications	O26
Dimensions	O14	Dimensions	O27, O28
Specifications	O15	Accessories	O28
International-Rated Pin & Sleeve Devices			
16, 32, 63 & 125 Amp Devices	O16		
Specifications	O17		
Dimensions	O18-O20		

SECTION P
**Single Pole Cam-Type
Connectors and Stage
Pin Devices**

Cam Connectors and Stage Pin Devices for Commercial and Industrial Applications		Up to 400 AMP	
Stage Pin Devices—Overview, and Benefits	P2	16 Series—Taper Nose	P9, P10
20, 60 and 100 AMP Stage Pin Devices	P3	18 Series—Ball Nose	P12-P13
Cam Connectors—Overview, and Benefits	P4, P5	Up to 690 AMP	
Ampacity Chart	P6	17 Series—Taper Nose	P14
Up to 140 AMP		19 Series—Ball Nose	P15
15 Series—Taper Nose	P7	22 Series—Latching Ball Nose	P16
Up to 300 AMP		23 Series—Latching Taper Nose	P17
16 Series—Taper Nose	P8	Product Accessories	P18
18 Series—Ball Nose	P11	Stage Pin Dimensional Drawings	P19-20
		Cam Connector Dimensional Drawings	P21-26

TABLE OF CONTENTS with Quick Reference Index

<p>SECTION Q</p> <p>Wire Mesh Safety Grips</p>	<p>Wire Mesh Safety Grips</p> <p>Overview 02</p> <p>Technical Reference 03</p> <p>Selecting Pulling and Support Grips 04–06</p> <p>Pulling Grips 07–014</p> <p>Strain-Relief Grips 015–018</p> <p>Support Grips 019–026</p>
<p>SECTION R</p> <p>Surge Protective Devices</p>	<p>Industrial Surge Protective Devices</p> <p>Overview R2</p> <p>Four-Outlet Plug-Ins R3</p> <p>5100 Series R3</p> <p>Surge Strips R4</p> <p>Surge Protection Modules R5</p> <p>Surge Protection Panels R6, R7</p> <p>74000 Series R6</p> <p>57000 Series R7</p> <p>52000 Series R8</p> <p>47000 and 52000-7M3 Series R9</p> <p>42000 and 32000 Series R10</p> <p>Low Voltage Communications SPD's</p> <p>3400 and 3800 Series R11</p> <p>Surge Counter: 51000 SMC R11</p> <p>Equipment Cabinet SPD's</p> <p>3800 Series R12</p> <p>Surge Protection Receptacles R13</p> <p>Decora Series Four-In-One Series R14</p> <p>Commercial Surge Protection Devices</p> <p>S1000 and S2000 Series Surge Strips R15</p> <p>4950 Series Surge Strips R15</p> <p>5500 and 5505 Series PDU's with Surge Protection R16</p> <p>Rack-mounted Power Distribution Devices</p> <p>4505 Series 19" Rack Mount PDUs R17</p> <p>P1000 Series PDUs R17</p> <p>Metered Series PDUs R18</p> <p>Switched Series PDUs R19</p> <p>Residential Surge Protection Devices</p> <p>Meter Socket Surge Adapter R20</p> <p>Secondary Surge Arrestors R20</p> <p>General Purpose Plug-Ins R21</p> <p>51000 Series Surge Protection Panels R21</p> <p>3950 Series Module Bracket R22</p> <p>5950 Series Surge Modules R22</p> <p>Uninterruptible Power Supplies</p> <p>Sine and Online Series UPS Systems R23</p> <p>Pro, Slim and Strip Series UPS Systems R23, R24</p>
<p>SECTION S</p> <p>Lampholders</p>	<p>Overview S2</p> <p>Incandescent Lampholders</p> <p>Outlet Box, Keyless and Pull Chain S3, S4</p> <p>Metal Shell and Interiors S5</p> <p>Phenolic Cap and Shell S5</p> <p>Multi-Lampholder Clusters S6</p> <p>Porcelain Par Connectors S6</p> <p>Bayonet Socket–Single Contact S6</p> <p>Porcelain Mogul Base S7</p> <p>Socket Extensions S8</p> <p>Appliance Heating Receptacle S8</p> <p>Porcelain and Phenolic S8</p> <p>Porcelain Snap-In S9</p> <p>Porcelain Keyless–Commercial Units S9</p> <p>Porcelain Keyless Fixture Single Circuit-Medium Base S9</p> <p>Porcelain Keyless Medium Base–Side Angle Mounted S10</p> <p>Phenolic Keyless Fixture–Medium Base S10</p> <p>Lampholders for Recessed Single Contact Lamps S10</p> <p>Lampholders for Metal Halide and Quartz Halogen Lamps S10</p> <p>Candle Sockets S10–S12</p> <p>Fluorescent Lampholders</p> <p>Compact Fluorescent Ceiling Lampholder S4</p> <p>Linear Fluorescent S13–S17</p> <p>Medium Bi-Pin S13–S15</p> <p>High Output S13, S14</p> <p>Slimline S13, S14</p> <p>Miniature S16</p> <p>T-8 to T-5 Adapter S16</p> <p>4-Pin Long Twin Tube with 2G11 Base S17</p> <p>Lamp Support Clips for Long Twin Tube S18</p> <p>Compact Fluorescent Lampholders (CFL's) S19–S22</p> <p><i>For a complete listing of OEM products, see the OEM-100 Catalog.</i></p>
<p>SECTION T</p> <p>Appliance Switches</p>	<p>Appliance Switches</p> <p>Single Pole Pull Chain T2</p> <p>Single Pole Rotary T2</p> <p>Two Circuit Rotary T3</p> <p>Single Pole Pushbutton T3</p> <p>Door Jamb Switch T3</p> <p>Fluorescent Starter Pushbutton T4</p> <p>Single Pole Toggle T4</p> <p>Feed-Through Cord Switch T5</p> <p>Miniature Feed-Through Cord Switch T5</p>
<p>SECTION U</p> <p>Electrical Accessories & Decorative Devices</p>	<p>Residential Grade Electrical Accessories and Decorative Devices</p> <p>Taps and Adapters U2</p> <p>Night Lights U3</p> <p>Guide Lights U4</p> <p>Fluorescent Utility Lights U4</p> <p>Child Protection Devices U4</p> <p>Accessories U4</p> <p>Wallplates U5</p>
<p>SECTION V</p> <p>Technical Information</p>	<p>Abbreviations V2</p> <p>National Electrical Code Requirements V3</p> <p>Associations, Organizations and Standards V4, V5</p> <p>Certification Agencies and Markings V5</p> <p>UL, CSA and NEMA Standards Pertaining to Leviton V6</p> <p>High-Abuse, UL Listed Hospital Grade Wiring Devices V7</p> <p>Glossary of Electrical Wiring Device Terms V8–V10</p> <p>Switches V11</p> <p>Dimmers V11</p> <p>Receptacles V11, V12</p> <p>Ground Fault Circuit Interrupters (GFCI's) V12</p> <p>Enclosure Classifications V13–V15</p> <p>Materials Used in Wiring Devices V15, V16</p> <p>ANSI Architectural Symbols V17</p> <p>NEMA Straight Blade Configurations V18</p> <p>NEMA Locking Configurations V18</p> <p>Horsepower Ratings for NEMA Configurations V20</p> <p>Circuit Wiring Diagrams V21–V23</p> <p>Switch Wiring Diagrams V24</p> <p>Diameter Ranges of Jacketed Cord V25</p> <p>Wallplate Dimensions V26</p> <p>Telephone Wiring Devices — Codes and Standards V27</p> <p>Wire Color Codes & Jack Pin Designations V28</p>

THE FUTURE IS ON

2007	Don Hendler named CEO; Steve Sokolow named Chairman. New branding launched.
2005	Don Hendler becomes President.
2003	Opening of manufacturing facility in China.
1986	Leviton begins operations in Mexico
1979	Leviton devices used in refurbishing Statue of Liberty and Ellis Island.
1975	Company moves corporate headquarters to Little Neck, NY.
1973	Decora® designer-style devices introduced.
1965	Harold Leviton becomes President and CEO.
1961	Leviton devices installed in the White House.
1953	Acquires Hale Brothers Companies, now known as Leviton Canada.
1939	Leviton devices featured at the World's Fair.
1932	Leviton devices used in Empire State Building.
1929	Leviton relocates to Greenpoint, Brooklyn.
1910	Leviton makes pullchain lampholders for Edison's new light bulbs.
1906	Isidor Leviton opens a small shop in New York making gas mantle tips.

Rooted in a Rich Tradition of Excellence



Isidor Leviton

The Leviton Manufacturing Company

offers our customers the most comprehensive

selection of wiring devices for virtually every conceivable residential, commercial, industrial and OEM wiring application. From our simple roots at the dawn of the electrical age, our product offering has branched out to include more than 25,000 wiring devices, systems and components which meet the needs of today's rapidly changing global marketplace. And while times have changed, the core principles upon which the Leviton family business was formed remain the same. Quality, innovation and a rich heritage of unparalleled customer service and support are hallmarks of the Leviton name.

From Modest Beginnings to Industry Leader

Like many large companies today, Leviton didn't start out that way. Our founding father Isidor Leviton opened up a small tinsmithing operation in Manhattan in 1906, after emigrating from Russia. The small startup company produced mantle tips for the gas lighting industry. As electricity quickly grew to become the dominant infrastructure for powering the lights and



Harold Leviton

the appliances of the day, the business retooled to produce a single electrical product — the pull-chain lampholder. Envisioning the widespread use of electricity in homes, businesses and factories at the turn of the century, the Leviton Company continued to anticipate marketplace needs. As times changed, so did we, and over ten decades, from simple beginnings, we evolved to become an industry leader with operations throughout North America and around the globe.

Leading the Way through a Rich Family Heritage

Today, standing on the horizon of our second century in business, we're committed to remaining that rarity in the contemporary American business landscape — a third generation family-owned company dedicated to our core vision, philosophy and family culture. From the early days of Isidor Leviton, to the global expansion engineered by the "big-picture" thinking of our late CEO and Chairman, Harold Leviton, to our latest branding and strategic programs under his successor Don Hendler, Leviton's legacy and family tradition live on. Now in our second century, we continue to lead the industry with the most complete selection of products, programs and services.



Don Hendler

No matter what markets you serve...

Your Future Is On with Leviton

There's a good reason Leviton is the number one choice of builders,



architects, electrical contractors, specifying engineers and other electrical professionals we serve. We've set the highest levels of quality and efficiency as our benchmarks. Our products are backed by superior technical service, quality assurance, engineering, research and development, testing and the highest manufacturing standards. This combination of expertise and personal commitment has earned us a worldwide reputation for quality, precision and reliability.

Pioneering Advances

Leviton engineers, designers and researchers apply leading-edge technology in the design of our products. Equipped with the latest



CAD/CAM tools, direct model-making capability and industry-leading R & D and testing facilities, our design staff is able to quickly develop products for every industrial and commercial grade wiring device application, as well as the latest offerings in lighting controls, lighting and energy management systems, structured media components, home automation and a host of other emerging new areas.

Advanced Technologies

Through vertical integration of our manufacturing capabilities,



we fabricate all parts for the devices we produce. This assures unmatched quality, not only in finished products, but also in components and sub-assemblies. Industrial robotics and automated assembly improve our manufacturing process dramatically, so that we are able to measure production times in minutes, and often in seconds. And, our ability to make quick product changeovers enables us to operate at the cutting edge of responsiveness.



Setting the Standard for Service

The true mark of leadership is customer satisfaction.

A centralized customer service department lets us service your needs with quick turnaround and maximum efficiency.

Strategically located warehouses throughout North America, equipped with state-of-the-art material handling technologies are interlinked by a computerized network that provides outstanding turnaround and order fill for our customers. Our electronic data interchange (EDI) and vendor managed inventory (VMI) satisfy a broad array of customer needs.



World-Class Quality

Leviton's state-of-the-art manufacturing processes facilitate zero-defect factory output as well as lower production costs. Our quality assurance team has instituted an innovative inspection program that applies statistical process controls to improve product quality. Component parts are checked at every step to ensure that finished devices are perfect. In addition, we use UL as a registrar to secure ISO registration for our manufacturing plants, warehouses and office facilities.



All Leviton manufacturing facilities are ISO 9001 Certified. We are also committed to Six Sigma quality standards as an integral part of our operations. This leads to measurable quality enhancements in all phases of manufacturing, with the goal of achieving a performance standard of 99.9997%, or 3.4 defects per 1 million opportunities.



Powerful Marketing Maximizes Opportunity

Leviton goes to market in the Retail, Distribution and OEM channels. Each has a dedicated Marketing Division applying its depth of expertise to identify opportunities for creating strong sales volume, increased share of market and sustained profitable growth for our customers. In addition, Leviton offers comprehensive marketing and merchandising support that includes advertising, collateral materials, sales aids, incentive programs, award-winning merchandising systems, promotions and in-depth training.



Leading the Industry

Leviton has led the industry at the forefront of progress and innovation for over a century. We sustain this legacy with a continuing commitment to

pioneering new technologies, implementing enlightened business policies and providing outstanding responsiveness. The net result is that no matter what markets you serve, it's our pledge to serve you well.

Our Most Comprehensive Catalog to Date

The L-101 Catalog reflects our commitment to support traditional as well as emerging new markets. We expanded this catalog with an extensive line of rugged, high-performance



Industrial Grade devices to satisfy the exacting needs of industrial and institutional users. Also included is a larger offering of devices for commercial and residential applications, including the latest structured wiring and multimedia solutions. Our most comprehensive catalog to date, the L-101 represents our dedicated commitment to serving your complete electrical wiring device needs.

...Leviton will serve you well.

TABLE OF CONTENTS with Quick Reference Index

The L-101 Leviton Wiring Device Catalog is designed to help you find the device you're seeking in the quickest and easiest way possible. Most product sections are divided into three distinct categories in the following sequence—Industrial Grade, Commercial Grade and Residential Grade—and grouped according to amperage and voltage, lowest to highest. For example, if you need to order 15 Amp, 125 Volt Industrial Grade straight-blade duplex receptacles, begin your search with the main Table of Contents at the front of the book. Here you'll see that all straight blade receptacles are listed in Section G. Turn to Section G for a more detailed Table of Contents on the first page. Each section page contains product descriptions, ratings and catalog numbers. There are also helpful highlights including Specifications and Features, Testing and Code Compliance, Color listing, Material Characteristics and dimensioned color product photos. Any product page in the L-101 Catalog can be clearly copied or faxed to customers and prospects for use as a specifier sheet or as part of a presentation.

The Quick Reference Guide follows the main Table of Contents to help you pinpoint and locate specific products. Technical Section V provides general product and test data, industry standards, NEMA configuration charts, a glossary of wiring device terms, ANSI architectural symbols and other related information. Specific catalog numbers are listed in the exhaustive index at the back of the catalog.

A
B
D

15 AMP 125 and 250V • 20 AMP 125 and 250V

Industrial Grade Straight Blade Receptacles

4.06 (103.2)
3.28 (83.3)
2.77 (70.4)
1.53 (38.9)
0.87 (22.1)

Back and Side Wired (Basic Cat. No. Denotes Brown Device*)

DESCRIPTION	CAT. NO./COLOR 15A/125V	CAT. NO./COLOR 15A/250V	CAT. NO./COLOR 20A/125V	CAT. NO./COLOR 20A/250V
LEVSPEC® Duplex Receptacle, Brass Strap	5262 I, W, GY, R, E	5662 I	5362 I, W, GY, R, E	5462 I, GY
Single Receptacle	5261 I, W, GY	5661 I	5361 I, W, A, T, GY	5461 I, A, T, GY
Narrow Body Duplex Receptacle	5252 I, W, A, T, GY, R, E, BU		5352 I, W, A, T, GY, R,	

0.85 (21.6)

MICROWAVE SAFE

80703-IG 80703-I 80704-GY 80716-R 84003-40 84004-40 84016-40

For complete wallplate selection, see Section E.

LESS STEEL

4.06 (103.2)
3.28 (83.3)
2.80 (71.0)
1.56 (39.6)
0.85 (21.6)

SPECIFICATIONS AND FEATURES

Back & Side Wired Duplex

- Impact-resistant thermoplastic nylon cover and body
- Smooth face does not collect dirt
- Four corner latches securely fasten face
- Single-piece brass mounting strap on LEVSPEC devices, multi-piece steel strap on other devices
- Large, triple-wipe, brass "T" contacts for superior contact and conductivity
- Back and side-wiring options
- Brass terminal screws to reduce conductor oxidation
- Break-off tabs for easy two-circuit conversion
- Apron barrier to prevent accidental contact between terminal screw heads and metal box
- Exclusive V-shaped, serrated back-wiring clips for superior contact and conductivity

TESTING AND CODE COMPLIANCE

- UL Listed 498 (UL File #13399); UL Federal Specification WC-596

- Meets NEMA WD-1 & 6, and ANSI standards
- Backed by a Limited 10-Year Warranty
- SPECLASS devices backed by a Limited 2-Year Warranty

*COLOR

Basic Cat. Nos. shown above denote Brown device, except for Isolated Ground (-IG) devices Basic Cat. No. denotes Orange. Isolated Ground Receptacle is distinguished by an orange triangle on its face. For other color selections, add suffix to the catalog number as follows: Ivory (-I), White (-W), Brown (For IG devices only, add -B), Almond (-A), Light Almond (-T), Gray (-G or -GY), Black (-E), Red (-R) and Blue (-BU; for IG devices only, add -BIG)

MATERIAL CHARACTERISTICS

Environmental: Flammability, Rated V2
Operating Temperature: From -40° C (without impact) to 60° C maximum continuous

<p>A RATING</p> <p>B Choose GRADE, if appropriate</p> <p>C DIMENSIONED PHOTOGRAPH</p> <p>D WIRING/CERTIFICATIONS</p>	<p>E CATALOG NUMBER</p> <p>F DESCRIPTION</p> <p>G Check for NEMA CONFIGURATION</p> <p>H WALLPLATE REFERENCE, if appropriate</p>	<p>I SPECIFICATIONS & FEATURES</p> <p>J TESTING AND CODE COMPLIANCE</p> <p>K COLOR LISTING</p> <p>L MATERIAL CHARACTERISTICS</p>
--	---	--

10 Courtesy of Steven Engineering, Inc. • 230 Ryan Way, South San Francisco, CA 94080-6370 • General Inquiries: (800) 670-4183 • www.stevenengineering.com

Acenti Collection

Premium Grade

INDEX

Acenti® Collection	
Overview	.A2
Acenti Lighting Controls	
Dimmers and Fan Speed Control	.A3
Acenti Switches	
15A and 20A Switches	.A4
Electronic Timer Switch	.A4
Manual-ON Occupancy Sensor	.A4
Acenti Receptacles	
Triplex and Duplex	.A5
Sixplex and Duplex Surge Protective Receptacles	.A5
Acenti Wallplates and QuickPort® Connectors	
Wallplates	.A6
QuickPort Snap-In Connectors	.A7
QuickPort Wallplate Inserts	.A7



ACENTI® COLLECTION FEATURES

Premium Grade Lighting Controls and Devices

THE ACENTI COLLECTION OFFERS A FULL PORTFOLIO OF TECHNICALLY AND AESTHETICALLY SUPERIOR DEVICES FOR RESIDENTIAL APPLICATIONS.

Acenti lighting controls and switches respond alike; their push pads remain permanently graded. No line breaks or irregular shadow patterns detract from their pleasing, symmetrical appearance. The Collection includes the industry's first triplex receptacle, duplex and sixplex surge protective receptacles, GFCIs, screwless snap-on wallplates, and QuickPort® multimedia inserts and snap-in connectors.

Acenti Lighting Controls

Lighting and fan speed controls feature a patent-pending return to neutral push pad, multi-location control with either matching or coordinating remotes, soothing blue LEDs and Acenti's unique surface alignment system.

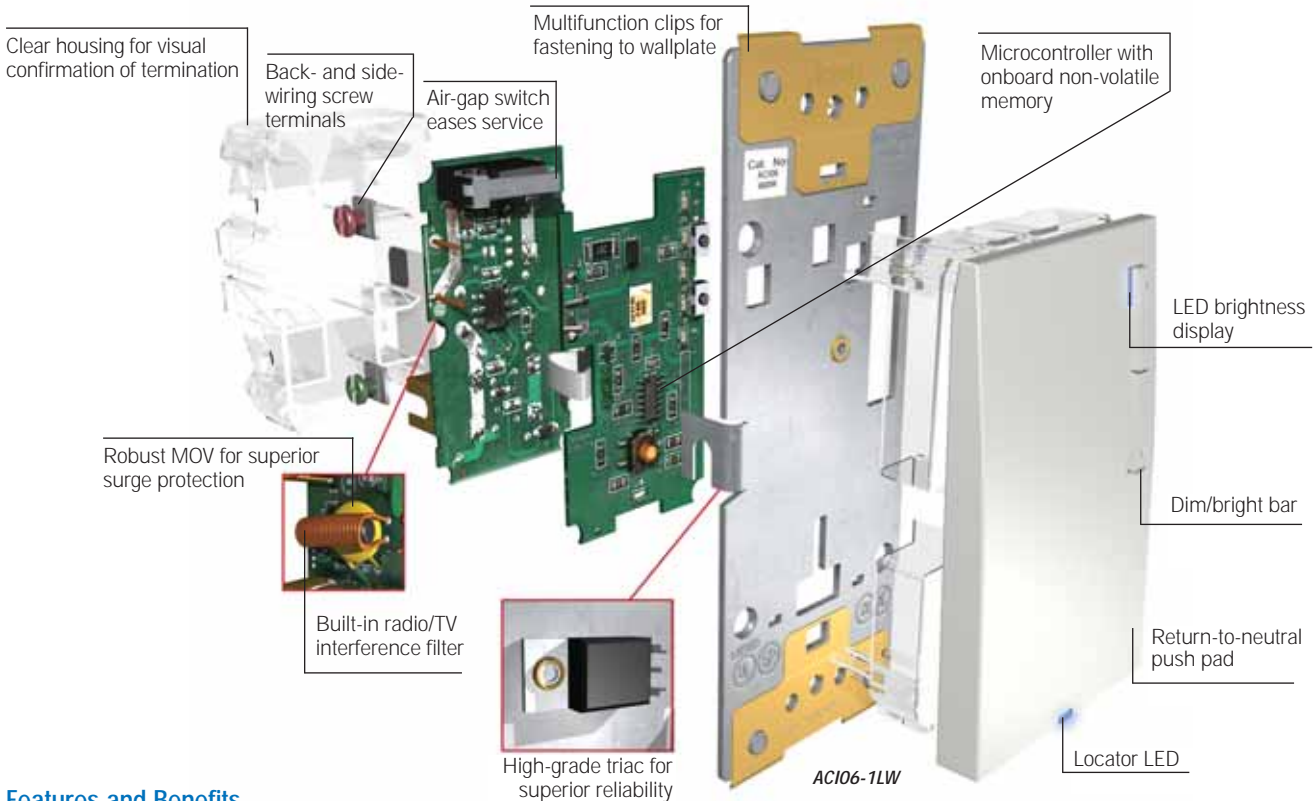

Features and Benefits

- Efficient construction with consistent form factor, excellent ergonomic traits and precision feel
- Innovative contoured geometry* offers an exclusive aesthetic design
- Clean multi-gang installation with no dividers between devices
- Devices and wallplates molded from engineering-grade polymer with subtle matte finish and flawless color match
- Screwless wallplates snap onto device's TOX®-fastened multifunction clips
- Brushed and polished metal finish wallplates available to coordinate with premium grade appliances
- Meet all applicable UL, CSA, NOM and FCC requirements
- Backed by a Five-Year Limited Warranty

* U. S. and Foreign Patents Pending.
TOX® is a registered trademark of TOX PRESSOTECHNIK, LLC.

ACENTI BY LEVITON...DOWN TO THE LAST DETAIL



Switches

Return-to-neutral push pad with blue LED locator. 15A electronic (single-pole or multi-location) and 20A electromechanical models (120 & 277V in SP, 3W, 4W).
AC315-1LW shown



Triplex & Duplex Receptacles

Exclusive space-saving Triplex Receptacle in NEMA 5-15R and 5-20R configurations. Duplex models also available.
AC315-W shown

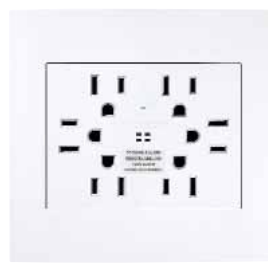

GFCI, Sixplex & Duplex Surge Protective Receptacles

GFCIs feature lockout action for added safety. Exclusive Sixplex Surge Receptacle saves space and helps protect sensitive electronic equipment.
ACSR6-W shown



Wallplates

Screwless snap-on design provides smooth, clean look exclusively for all Acenti devices. Brushed stainless steel versions available.
ACWP1-W shown



Acenti Lighting Controls

All Acenti lighting controls provide single-pole (one location) and 3-way (multi-location) control when used with Remote unit.

Acenti Controls with LED Locator and Brightness Display 120V AC 60Hz Only

DESCRIPTION	CAT. NO.	RATING	COLOR*
Acenti Incandescent Dimmer	ACI06-1L	600W	W, Q, A, S, D, C, G, E
Acenti Magnetic Low-Voltage Dimmer	ACM06-1L	600VA (450W)	W, Q, A, S, D, C, G, E
Acenti Incandescent/ Magnetic Low-Voltage Dimmer	ACM10-1L	1000W/ 1000VA (800W)	W, Q, A, S, D, C, G, E
Acenti Electronic Low-Voltage Dimmer; Neutral required	ACE04-1L	400W	W, Q, A, S, D, C, G, E
Acenti Electronic Low-Voltage Dimmer; Neutral required	ACE06-1L	600W	W, Q, A, S, D, C, G, E
Acenti Advance Mark 10™ <i>Powerline</i> or Tu-Wire™ Fluorescent Dimmer; Neutral required	ACX10-1L	1000VA	W, Q, A, S, D, C, G, E
Acenti Hi-lume® or Eco-10™ (Eco-Series) Fluorescent Dimmer; Neutral required	ACH08-1L	8 Amps	W, Q, A, S, D, C, G, E
Acenti Quiet Fan Speed Control (LED Display denotes speed); Neutral required	ACF01-1L	1.5 Amps	W, Q, A, S, D, C, G, E
Matching Remote Unit to 120V Dimmers/Fan Speed Control for 3-Way or up to 5 locations; Neutral required	AC00R-1L	No load rating	W, Q, A, S, D, C, G, E
Coordinating Remote Unit to 120V Dimmers/Fan Speed Control for 3-Way or up to 10 locations, no LED; Neutral required†	AC00R-10	No load rating	W, Q, A, S, D, C, G, E

† Except when used with incandescent or magnetic low-voltage dimmers.

CAUTION ON RETROFITS: When retrofitting Mark 10™ *Powerline* dimming ballasts into fixtures that originally had Instant Start ballasts, the sockets MUST be replaced with Rapid Start sockets to allow proper dimmer operation and prevent damage to the dimming ballast. Refer to the instructions provided with the ballast and the Leviton dimmer.

Acenti Colors

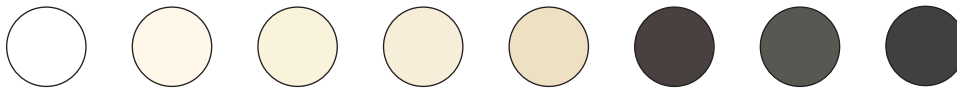

Note: Wallplates are also available in Brushed Stainless Steel, Polished Chrome and 24K Gold finishes.
Custom premium colors available.

Maximum Load per Acenti Device

CAT. NO.	SINGLE	2-GANG	MORE THAN 2-GANG
ACE04-1L	400W	350W	250W
ACE06-1L	600W	500W	400W
ACF01-1L	1.5A	1.5A	1.5A
ACH08-1L	8A	8A	8A
ACI06-1L	600W	600W	500W
ACM06-1L	600VA (450W)	600VA (450W)	500VA (375W)
ACM10-1L	1000W/ 1000VA (800W)	800W/ 800VA (640W)	650W/ 650VA (520W)
ACX10-1L	1000VA	800VA	650VA

SPECIFICATIONS AND FEATURES

- Universal design provides crisp actuation with minimal travel
- Push pad always returns to neutral position regardless of load status
- Minimum brightness can be adjusted to comfortable level
- Dim-lock feature allows lights to turn on to a user-configured level every time
- Soothing blue LED Locator for easy location in the dark
- Subtle blue LED brightness level display
- Digital circuitry provides eye-pleasing soft-ON/fade-OFF and extended lamp life; fade rates are selectable

- Protected memory and voltage compensation maintain light levels after power outages
- Single-pole (one-location) and 3-way (multi-location) switching with Acenti Remote Units
- Built-in radio/TV interference filter
- Terminal screws (back- and side-wire) on select models ease installation
- Multifunction self-grounding clip snaps onto wallplate and ensures proper device alignment
- Screwless, snap-on wallplates in matching and coordinating colors

TESTING AND CODE COMPLIANCE

- UL Listed (File #E-31373)
- CSA Certified (File #LR-3413)

- NOM Certified (#057)
- Meets FCC Part 15
- Backed by a Limited Five-Year Warranty

*COLOR

For color selection, add suffix to catalog number as follows: Alabaster (-W), Quartz (-Q), Natural (-A), Sand (-S), Driftwood (-D), Cocoa (-C), Slate (-G), Onyx (-E).

MATERIAL CHARACTERISTICS

Environmental: Flammability UL-94, V2 Rating
Operating Temperature: 32°F to 130°F

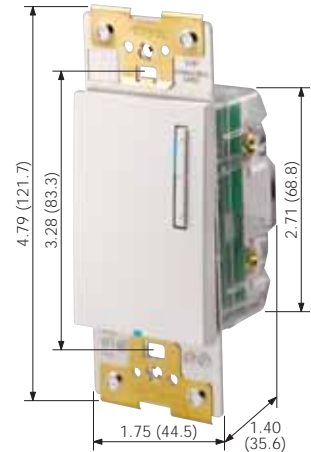

ACI06-1LW

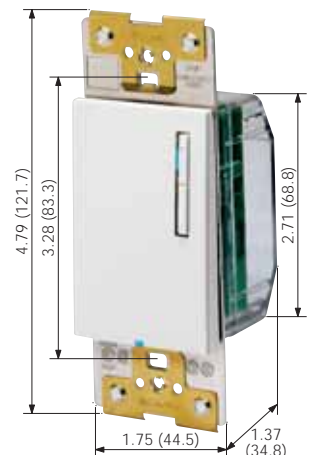

ACE06-1LW

Use Leviton Power Extenders to extend the load capacity of box-mounted dimmers. Leviton Power Extenders are available for incandescent, magnetic low-voltage, electronic low-voltage, Advance Mark 10™ *Powerline* fluorescent dimming ballasts or equivalents, and 0-10 VDC dimmable fluorescent ballasts such as Advance Mark 7™, OSRAM Sylvania Quicktronic Helios or equivalent ballasts.

See Section C for more information.



ACENTI® SWITCHES AND ADAPTIVE DEVICES • 120 AND 277V AC

Premium Grade Switches and Adaptive Devices

Acenti Collection

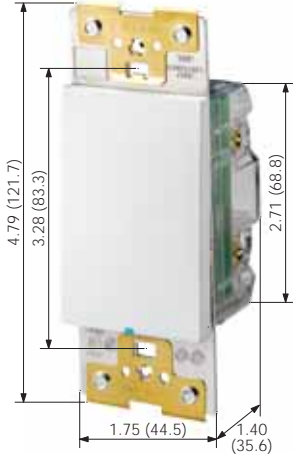

ACS15-1LW

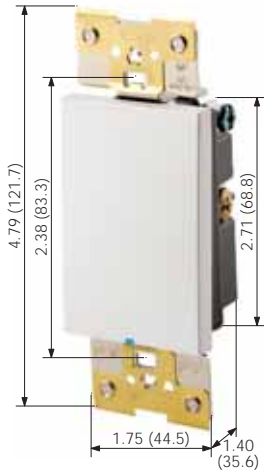

AC201-1LW



ACP15-CBW

Acenti Switches

Acenti Switches 120V AC

DESCRIPTION	CAT. NO.	RATING	COLOR*
Acenti 15-Amp Non-Dimming Electronic Switch for Single-Pole, 3-Way or More Applications, with LED Locator; Neutral required	ACS15-1L	15 Amp	W, Q, A, S, D, C, G, E
Matching Remote Unit to ACS15-1L Switch for 3-Way or up to 5 locations, with LED Locator; Neutral required	ACOSR-1L	No load rating	W, Q, A, S, D, C, G, E
Coordinating Remote Unit to ACS15-1L Switch for 3-Way or up to 10 locations, no LED; Neutral required	ACOSR-10	No load rating	W, Q, A, S, D, C, G, E
Acenti 20-Amp Non-Dimming Electromechanical Switch for Single-Pole and Motor Loads, with LED Locator	AC201-1L	20 Amp	W, Q, A, S, D, C, G, E
Acenti 20-Amp Non-Dimming Electromechanical Switch for 3-Way Applications, with LED Locator	AC203-1L	20 Amp	W, Q, A, S, D, C, G, E
Acenti 20-Amp Non-Dimming Electromechanical Switch for 4-Way Applications, with LED Locator	AC204-1L	20 Amp	W, Q, A, S, D, C, G, E

Acenti Switches 277V AC

DESCRIPTION	CAT. NO.	RATING	COLOR*
Acenti 20-Amp Non-Dimming Electromechanical Switch for Single-Pole Applications, with LED Locator	AC201-7L	20 Amp	W, Q, A, S, D, C, G, E
Acenti 20-Amp Non-Dimming Electromechanical Switch for 3-Way Applications, with LED Locator	AC203-7L	20 Amp	W, Q, A, S, D, C, G, E
Acenti 20-Amp Non-Dimming Electromechanical Switch for 4-Way Applications, with LED Locator	AC204-7L	20 Amp	W, Q, A, S, D, C, G, E

Acenti Adapted Devices

Acenti Electronic Timer Switch 120V AC 60Hz Only

DESCRIPTION	CAT. NO.	INTERVAL	COLOR*
Acenti Timer Switch with Four Preset Buttons and OFF, LED Locator; Neutral required. 3-Wire, Single-Pole, 1000W Incandescent, 20A Inductive, 1 HP @ 120V	ACT60-L	10-20-30-60 Minutes	W, A

Acenti Manual-ON Occupancy Sensor 120V AC 60Hz Only

DESCRIPTION	CAT. NO.	RATING	COLOR*
Manual-ON Occupancy Sensor, CEC Title 24 Compliant, Single-Pole, 3-Way or more when used with ACPOR Remote or Acenti Switch Remotes ACOSR-1L and ACOSR-10; Neutral required. With LED locator, 180° field of view, 900 sq. ft. coverage.	ACP15-CB	Incandescent: 1800VA, Fluorescent: 1800W at 120V AC, Motor: 1/2 HP @ 120V AC	W, A, E
Manual-ON Occupancy Sensor Remote Unit, 3-Way or more when used with ACP15 Occupancy Sensor or any Acenti Dimmer; Neutral required. With LED locator, 180° field of view, 900 sq. ft. coverage.	ACPOR-CB	No load rating	W, A, E

SPECIFICATIONS AND FEATURES

Acenti Switches

- Universal design provides crisp actuation with minimal travel
- Push pad always returns to neutral position regardless of load status
- Soothing blue Locator LED for easy location in the dark
- ACS15-1L provides single-pole (one-location) and multi-location switching with Acenti Remote Units
- Terminal screws (back- and side-wire) ease installation
- Multifunction self-grounding clip snaps onto wallplate and ensures proper device alignment
- Screwless, snap-on wallplates in matching and coordinating colors

Acenti Electronic Timer Switch

- Four preset buttons plus OFF for timed control of lights and appliances
- LEDs indicate time elapsed and last LED flashes two-minutes-until-OFF warning

Acenti Occupancy Sensor

- Manual-ON/Automatic OFF operation in accordance with California Title 24 2005 requirements
- ACP15 provides true 3-way control when used with ACPOR Remote – ideal for L-shaped room or any large rooms
- ACP15 can be used with Acenti Switch Remotes for true 3-way control where a single sensor provides

complete room coverage – ideal for rooms with more than one entrance

- ACPOR Remote can be used with any Acenti dimmer for true 3-way control with combined occupancy sensor/dimmer functionality – ideal for Jack and Jill bathrooms

TESTING AND CODE COMPLIANCE

- Switches:** • UL Listed (File #E-7458)
• CSA Certified (File #LR-152105)
• Meets NEMA WD-1 & WD-6 requirements
- Timer:** • UL Listed (File #E-66800)
• CSA Certified (File #LR-68679)
- Occupancy Sensor:** • UL Listed (File #E-118904)
• CSA Certified (File #LR-152105)
• Conforms to California Title 24 Energy code and FCC regulations
- All Devices:** • NOM Certified (#057)
• Backed by a Limited Five-Year Warranty

*COLOR

For color selection, add suffix to catalog number as follows:
Alabaster (-W), Quartz (-Q), Natural (-A), Sand (-S),
Driftwood (-D), Cocoa (-C), Slate (-G), Onyx (-E).

MATERIAL CHARACTERISTICS

Environmental: Flammability UL-94, V2 Rating
Operating Temperature: 32°F to 130°F



To learn more about Leviton's outstanding offering of devices visit our Website at: www.leviton.com



Premium Grade Receptacles

Acenti Receptacles

Acenti Triplex and Duplex Receptacles 125V

DESCRIPTION	CAT. NO./COLOR* 15A/125V	CAT. NO./COLOR* 20A/125V
	5-15R	5-20R
Acenti Triplex Receptacle	AC315 W, Q, A, S, D, C, G, E	AC320 W, Q, A, S, D, C, G, E
Acenti Duplex Receptacle	AC215 W, Q, A, S, D, C, G, E	AC220 W, Q, A, S, D, C, G, E

Acenti GFCI, Sixplex and Duplex Surge Protective Receptacles 125V

DESCRIPTION	CAT. NO./COLOR* 15A/125V	CAT. NO./COLOR* 20A/125V
	5-15R	5-20R
Acenti GFCI Receptacle, 20A/125V Feed-Through	ACGF1 W, Q, A, S, D, C, G, E	ACGF2 W, Q, A, S, D, C, G, E
Acenti Sixplex Surge Protective Receptacle, 2-Gang with 6" Leads, Indicator Light and Audible Alarm	ACSR6 W, Q, A, S, D, C, G, E	—
Acenti Duplex Surge Protective Receptacle with Indicator Light and Audible Alarm	ACSSR W, Q, A, S, D, C, G, E	—

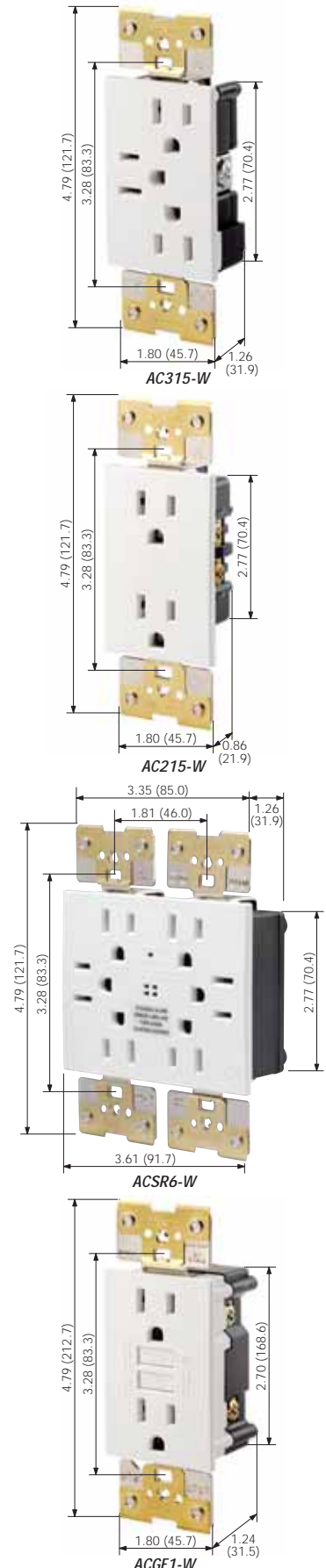

Acenti Collection

SPECIFICATIONS AND FEATURES

All Triplex and Duplex Receptacles

- Fit into a standard size wallbox
- Exclusive space-saving Triplex Receptacle accommodates 3 NEMA grounding plugs
- Neat multi-gang installation with no dividers between devices
- Terminal screws (back and side wire) available for easier installation
- Multifunction self-grounding clip snaps onto wallplate and ensures proper device alignment
- Subtle, matte finish complements fine décors
- Molded from engineering-grade polymer for uniformity and flawless color match
- Screwless, snap-on wallplates in matching and coordinating colors

GFCI Receptacles

- Patented bridge contact provides individual set of contacts for GFCI receptacle face and downstream receptacles
- Patented, advanced technology "dead-face" safety feature: no power to receptacle face if improperly wired (line-load reversal)
- Lockout feature for added safety
- Matching TEST and RESET buttons

Surge Protective Receptacles

- Exclusive space-saving Sixplex Surge Protective Receptacle provides six outlets
- Protect sensitive electronic equipment against transient voltage surges
- UL 1449 clamping level: 400V
- Audible alarm for protection status
- Soothing blue LED Monitor/Indicator

TESTING AND CODE COMPLIANCE

- UL Listed (Triplex/Duplex/Surge: File #E-13399, GFCI: File #E-48380)
- CSA Certified (Triplex/Duplex: File #LR-152105, GFCI: File #LR-57811, Surge: File #MC152105/LR-406)
- NOM Certified (#057)
- Meets NEMA WD-1 & WD-6 requirements
- Backed by a Limited Five-Year Warranty

*COLOR

For color selection, add suffix to catalog number as follows: Alabaster (-W), Quartz (-Q), Natural (-A), Sand (-S), Driftwood (-D), Cocoa (-C), Slate (-G), Onyx (-E).

MATERIAL CHARACTERISTICS

Environmental: Flammability UL-94, V2 Rating
Operating Temperature: 32°F to 130°F



ACENTI® WALLPLATES

Premium Grade Wallplates

Acenti Screwless Snap-On Wallplates

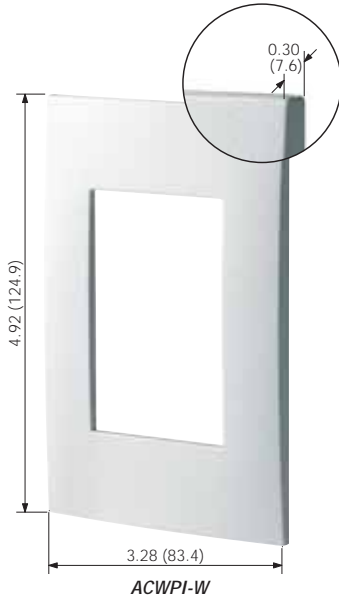

DESCRIPTION	COLOR*	ENGINEERING GRADE POLYMER CAT. NO.	BRUSHED STAINLESS STEEL CAT. NO.**	POLISHED CHROME CAT. NO.**	24K GOLD CAT. NO.**
1-Gang 1 Acenti	W, Q, A, S, D, C, G, E	ACWP1	ACWM1-STS	ACWM1-PCH	ACWM1-24K
2-Gang 2 Acenti	W, Q, A, S, D, C, G, E	ACWP2	ACWM2-STS	ACWM2-PCH	ACWM2-24K
3-Gang 3 Acenti	W, Q, A, S, D, C, G, E	ACWP3	ACWM3-STS	ACWM3-PCH	ACWM3-24K
4-Gang 4 Acenti	W, Q, A, S, D, C, G, E	ACWP4	ACWM4-STS	ACWM4-PCH	ACWM4-24K
5-Gang 5 Acenti	W, Q, A, S, D, C, G, E	ACWP5	ACWM5-STS	ACWM5-PCH	ACWM5-24K
6-Gang 6 Acenti	W, Q, A, S, D, C, G, E	ACWP6	ACWM6-STS	ACWM6-PCH	ACWM6-24K
Blank Wallplate Insert	W, Q, A, S, D, C, G, E	ACW14	—	—	—



ACWM1-STS



ACWM1-PCH



ACWM1-24K

SPECIFICATIONS AND FEATURES

- Exclusively for all Acenti devices
- Screwless snap-on design provides smooth, clean look
- Subtle, matte finish complements fine décor
- Available in engineering-grade polymer, brushed stainless steel, polished chrome and 24K Gold metal finishes
- Unique, screwless metal finish wallplates coordinate with premium-grade appliances
- Single-opening design of multi-gang wallplates means device frames rest side by side, without extra webbing between them to disrupt clean appearance
- Alignment plate with positioning pins ensures alignment of device and wallplate
- Snaps easily and directly onto device's multifunction, Tox®+fastened clips, which also provides self-grounding of device and metal wallplate (when used with a properly grounded metal wallbox)
- Custom premium colors and QuickPort® jack inserts available

TESTING AND CODE COMPLIANCE

- UL Listed and CSA Certified
- NOM Certified (#057)
- Meet NEMA Standards WD-1, WD-6 (plastic); Meet NEMA and ANSI standards (metal)
- Backed by a Limited Five-Year Warranty

*COLOR

For color selection, add suffix to catalog number as follows: Alabaster (-W), Quartz (-Q), Natural (-A), Sand (-S), Driftwood (-D), Cocoa (-C), Slate (-G), Onyx (-E). **STS denotes Stainless Steel, PCH denotes Polished Chrome and 24K denotes 24K Gold finishes.

†TOX® is a registered trademark of TOX PRESSOTECHNIK, LLC.



Acenti® QuickPort Snap-In Connectors and Wallplate Inserts

Acenti QuickPort® Snap-In Connectors

DESCRIPTION	CAT. NO.
Cat 5e Jack	AC108-R*5
RCA Jack w/Red Stripe	AC830-B*R
RCA Jack w/Black Stripe	AC830-B*E
RCA Jack w/Yellow Stripe	AC830-B*Y
RCA 110 Termination, Orange Barrel	AC735-RO*
RCA 110 Termination, Red Barrel	AC735-RR*
RCA 110 Termination, White Barrel	AC735-RW*
RCA 110 Termination, Yellow Barrel	AC735-RY*
Banana Jack w/Red Stripe	AC837-B*R
Banana Jack w/Black Stripe	AC837-B*E
Binding Post w/Red Stripe	AC833-B*R
Binding Post w/Black Stripe	AC833-B*E
BNC Adapter, Nickel-Plated	AC084-B*F
BNC Adapter, Gold-Plated	AC832-OB*
F-Type Adapter, Nickel-Plated	AC084-F*F
F-Type Adapter, Gold-Plated	AC831-OB*
Blank Insert	AC084-B*B
S-Video Module, 110 Termination	AC734-SV*

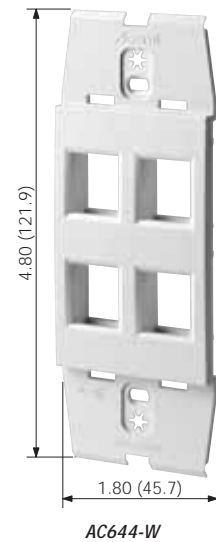

Acenti QuickPort® Multimedia Wallplate Inserts

DESCRIPTION	CAT. NO.	COLOR*
2-Port QuickPort Insert	AC642	W, Q, A, S, D, C, G, E
3-Port QuickPort Insert	AC643	W, Q, A, S, D, C, G, E
4-Port QuickPort Insert	AC644	W, Q, A, S, D, C, G, E
6-Port QuickPort Insert	AC646	W, Q, A, S, D, C, G, E



SPECIFICATIONS AND FEATURES

- Complements complete line of premium grade Acenti devices
- Provides voice, data, audio and video
- Compatible with the complete collection of Acenti screwless, snap-on wallplates

TESTING AND CODE COMPLIANCE

QuickPort Wallplate Inserts

- UL Listed and CSA Certified
- Meets NEMA Standards WD-1, WD-6

QuickPort Snap-In Connectors and Wallplate Inserts

- Backed by a Limited Five-Year Warranty

*COLOR

When ordering Acenti QuickPort Snap-In Connectors, insert color description where (*) is indicated. Alabaster (W), Quartz (Q), Natural (A), Sand (S), Driftwood (D), Cocoa (C), Slate (G) and Onyx (E).
 When ordering Acenti QuickPort Wallplate Inserts, add suffix to catalog number as follows: Alabaster (-W), Quartz (-Q), Natural (-A), Sand (-S), Driftwood (-D), Cocoa (-C), Slate (-G) and Onyx (E).

HOW TO USE THIS CATALOG

The L-101 Leviton Wiring Device Catalog is designed to help you find the device you're seeking in the quickest and easiest way possible. Most product sections are divided into three distinct categories in the following sequence—Industrial Grade, Commercial Grade and Residential Grade—and grouped according to amperage and voltage, lowest to highest. For example, if you need to order 15 Amp, 125 Volt Industrial Grade straight-blade duplex receptacles, begin your search with the main Table of Contents at the front of the book. Here you'll see that all straight blade receptacles are listed in Section G. Turn to Section G for a more detailed Table of Contents on the first page. Each section page contains product descriptions, ratings and catalog numbers. There are also helpful highlights including Specifications and Features, Testing and Code Compliance, Color listing, Material Characteristics and dimensioned color product photos. Any product page in the L-101 Catalog can be clearly copied or faxed to customers and prospects for use as a specifier sheet or as part of a presentation.

The Quick Reference Guide follows the main Table of Contents to help you pinpoint and locate specific products. Technical Section V provides general product and test data, industry standards, NEMA configuration charts, a glossary of wiring device terms, ANSI architectural symbols and other related information. Specific catalog numbers are listed in the exhaustive index at the back of the catalog.

15 AMP 125 and 250V • 20 AMP 125 and 250V

Industrial Grade Straight Blade Receptacles

Back and Side Wired (Basic Cat. No. Denotes Brown Device*)

DESCRIPTION	CAT. NO./COLOR 15A/125V	CAT. NO./COLOR 15A/250V	CAT. NO./COLOR 20A/125V	CAT. NO./COLOR 20A/250V
LEVSPEC® Duplex Receptacle, Brass Strap	5262 I, W, GY, R, E	5662 I	5362 I, W, GY, R, E	5462 I, GY
Single Receptacle	5261 I, W, GY	5661 I	5361 I, W, A, T, GY	5461 I, A, T, GY
Narrow Body Duplex Receptacle	5252 I, W, A, T, GY, R, BU		5352 I, W, A, T, GY, R,	

80703-IG 80703-I 80704-GY 80716-R

84003-40 84004-40 84016-40

For complete wallplate selection, see Section E.

SPECIFICATIONS AND FEATURES

Back & Side Wired Duplex

- Impact-resistant thermoplastic nylon cover and body
- Smooth face does not collect dirt
- Four corner latches securely fasten face
- Single-piece brass mounting strap on LEVSPEC devices, multi-piece steel strap on other devices
- Large, triple-wipe, brass "T" contacts for superior contact and conductivity
- Back and side-wiring options
- Brass terminal screws to reduce conductor oxidation
- Break-off tabs for easy two-circuit conversion
- Apron barrier to prevent accidental contact between terminal screw heads and metal box
- Exclusive V-shaped, serrated back-wiring clamp for superior contact and conductivity

TESTING AND CODE COMPLIANCE

- UL Listed 498 (UL File #13399); UL Federal Specification WC-596

COLOR

Basic Cat. Nos. shown above denote Brown device, except for Isolated Ground (-IG) devices Basic Cat. No. denotes Orange. Isolated Ground Receptacle is distinguished by an orange triangle on its face. For other color selections, add suffix to the catalog number as follows: Ivory (-I), White (-W), Brown (For IG devices only, add -A), Almond (-A), Light Almond (-T), Gray (-G or -GY), Black (-E), Red (-R) and Blue (-BU); for IG devices only, add -BIG)

MATERIAL CHARACTERISTICS

Environmental: Flammability, Rated V2
Operating Temperature: From -40° C (without impact) to 60°C maximum continuous

A RATING	E CATALOG NUMBER	I SPECIFICATIONS & FEATURES
B Choose GRADE, if appropriate	F DESCRIPTION	J TESTING AND CODE COMPLIANCE
C DIMENSIONED PHOTOGRAPH	G Check for NEMA CONFIGURATION	K COLOR LISTING
D WIRING/CERTIFICATIONS	H WALLPLATE REFERENCE, if appropriate	L MATERIAL CHARACTERISTICS

A

8 Courtesy of Steven Engineering, Inc. • 230 Ryan Way, South San Francisco, CA 94080-6370 • General Inquiries: (800) 670-4183 • www.stevenengineering.com

Decora® Devices

General Overview	B2
Decora Switch Overview	B3
Commercial Grade Switches	
Decora <i>Plus</i> AC Quiet Rocker Switches	B4
Decora <i>Plus</i> Momentary and Maintained Switches	B5
Decora <i>Plus</i> Illuminated and Pilot Light Switches	B6
Residential Grade Switches	
Decora AC Quiet Rocker Switches	B7, B8
Illuminated, Pilot Light	B8
Decora 911 Emergency Flasher	B8
Industrial and Commercial Grade Receptacles	
Decora Receptacles Overview	B9
Decora <i>Plus</i> Receptacles	B10, B11
Residential Grade Receptacles	
Decora Quickwire and Side Wired	B12
Hospital and Industrial Grade Surge Protective Receptacles	
Decora Back and Side Wired	B13
SmartLockPRO® GFCI Receptacles	
SmartLockPRO® Overview	B14
GFCI Receptacles	B15
Combination Switch/GFCI Outlet	B15
Blank Face	B15
Commercial Grade Devices	
Decora Combination Devices	B16, B17
Decora Voice/Data/Video Devices	B18
Decora <i>Plus</i> Canadian 347V AC Quiet Rocker Switches	B19
Canadian 347V Midway Nylon Wallplates	B19
Wallplates	
Decora <i>Plus</i> Screwless Snap-On	B20
Decora Thermoset, Thermoplastic and Metal	B21–B23
Adapters	B24
Replacement Screws	B24
Decora-Style Recessed Receptacles	
Overview	B25
Recessed Entertainment Box	B26
Duplex Recessed Receptacles	B26



DECORA® DEVICE FEATURES

Commercial Grade Wiring devices

LEVITON'S DECORA DESIGNER LINE OF WIRING DEVICES ADDS CONTEMPORARY STYLING TO ANY RESIDENTIAL OR COMMERCIAL APPLICATION.

Decora Devices are built to the highest performance standards to provide a long, trouble-free service life. The Decora Devices line represents a broad selection of switches, receptacles, surge suppressor receptacles, SmartLock® GFCI receptacles, combination devices, wall jacks and wallplates.

Features and Benefits

- Decora Devices are engineered for beauty, versatility and durability
- All Decora Plus Commercial Grade devices feature heavy-duty construction
- All Decora devices meet or exceed applicable UL, CSA and NOM testing standards
- Backed by a Limited 10-Year Warranty

DECORA COLORS

Decora devices are offered in a wide range of colors and finishes, which includes Almond, Light Almond, White, Ivory, Gray, Red, Ebony (Black) and Mahogany Brown. A selection of metal Decora wallplates comes in Brushed Brass, Polished Brass, Stainless Steel and Aluminum.



Decora Switches

A complete range of single pole, double pole, 3 and 4-way switches in both residential and commercial grades. **5691-2E, 5621-2W shown**

Decora Receptacles

A broad selection of amperages and NEMA configurations in Industrial, Commercial and Residential grades with an array of colors from which to choose. **16352-GY shown**

Decora Illuminated Switches

Pilot Light, Illuminated Rocker, Maintained and Momentary Contact versions. **5631-2I, 5628-2A shown**



Decora Hospital Grade Receptacles
Leviton's selection includes Isolated Ground, Tamper Resistant, Surge Protected, GFCI and Power Indication versions. **16262-IGR shown**



Decora Combo Devices
Compact design fits dual or triple switch, switch/receptacle, or switch/GFCI receptacle into standard wallboxes. **7299-1 shown**



Decora Communications Wiring Devices
Pre-configured and field-configurable jacks accommodate Decora wallplates, complementing other Decora wiring devices, and fit in standard NEMA wallboxes. **41658-W shown**

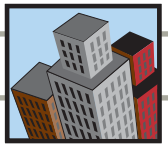

DECORA PLUS SWITCHES ENHANCE EVERY INTERIOR

Leviton's Decora line of designer-style switches are available in a complete range of single pole, double pole, 3 and 4-way switches in both residential and commercial grades. They come in a cascade of contemporary shades and add an air of distinction and value to contemporary commercial and residential design schemes.

Features and Benefits

- Engineered for fine tolerances and top performance
- Decora Plus Switches feature impact resistant thermoplastic construction for long service life
- All Decora devices meet or exceed applicable UL, CSA and NOM testing standards

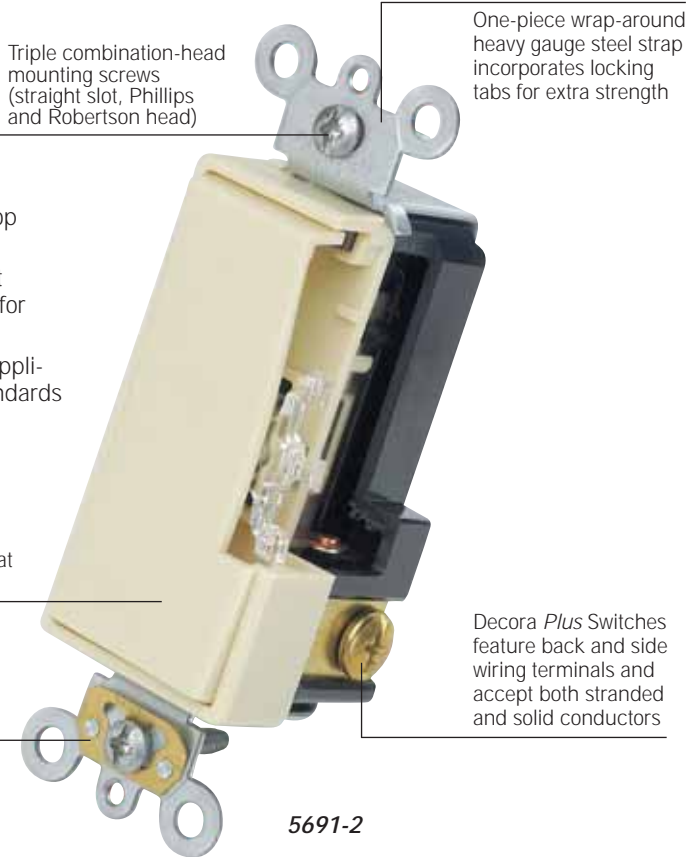

Triple combination-head mounting screws (straight slot, Phillips and Robertson head)

One-piece wrap-around heavy gauge steel strap incorporates locking tabs for extra strength

Decora Plus Switches have patented concave rockers that present a low profile

Self-grounding clip

Decora Plus Switches feature back and side wiring terminals and accept both stranded and solid conductors

5691-2



Decora Plus Switches

A complete range of rugged Commercial Specification Grade single pole, double pole, 3 and 4-way switches.
5691-2E, 5621-2W shown



Illuminated Switches

Rocker lens is illuminated when load is OFF.
5631-2I shown



Pilot Light Switches

Rocker lens is illuminated when load is ON.
5628-2A shown



Momentary Contact Switches

Combines Decora styling and rugged construction for momentary contact closure (single-pole, double-throw, center OFF switching).
5657-2A shown



Maintained Contact Switches

Rugged Decora styling for maintained contact closure (single-pole, double-throw, center OFF switching).
5685-2E shown



Residential Grade Switches

Engineered for smooth, quiet operation and a long trouble-free service in fine residential interiors.
5601-2I shown



DECORA® PLUS SWITCHES 15 and 20 AMP 120/277V

Commercial Grade Switches

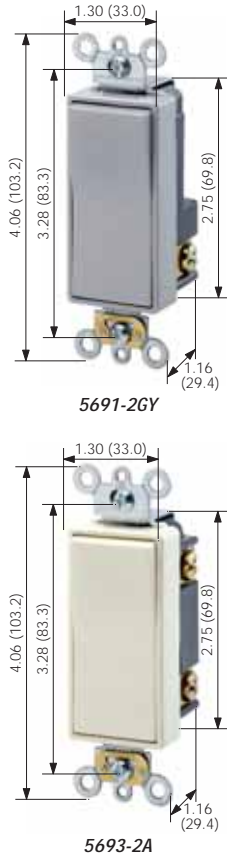

Decora Plus AC Quiet Rocker Switches

Back and Side Wired 120/277V AC

DESCRIPTION	15 AMP	20 AMP	ROCKER & FRAME COLOR* <i>Basic Cat. No. Denotes Mahogany</i>
Single-Pole	5691-2	5621-2†	I, W, A, T, GY, E
Three-way	5693-2	5623-2†	I, W, A, T, GY, E
Four-way	—	5624-2	I, W, A, T, GY

†Available in Red (-R)

Wallplates

THERMOPLASTIC		POLYCARBONATE SCREWLESS SNAP-ON		302 STAINLESS STEEL	
80401-NT	80409-NT	80301-SGY	80309-SGY	84401-40	84409-40

For complete Decora wallplate selection, see pages B20–B24.

SPECIFICATIONS AND FEATURES

Back and Side Wired

- Full rated current capacity with tungsten, fluorescent or resistive loads. Motor capacity is 80% of switch rating
- Back and side-wiring terminals accept both solid and stranded wire to ease installation
- New architecturally-styled smooth-action concave rocker
- Heavy-duty impact-resistant thermoplastic construction for long service life in commercial applications
- Two ground connection options: a green grounding screw and a self-grounding clip
- For Canadian 347V Decora Plus Switches, see page B19

TESTING AND CODE COMPLIANCE

- UL Listed (File #E-7458)
- CSA Certified (File #LR-3413)
- NOM Certified (#057)
- Compliance with the latest Federal Specification WS-896
- Backed by a Limited 10-Year Warranty

*COLOR

Colors available as listed. For other color selections, add suffix to catalog numbers as follows: Ivory (-I), White (-W), Almond (-A), Light Almond (-T), Gray (-GY), Black (-E), Red (-R).

Imprinted Decora Switches

Custom orders available in Ivory (-I), White (-W).

HORSEPOWER

15A	20A
1/2 @ 120V	1 @ 120V
2 @ 240V	2 @ 240V

MATERIAL CHARACTERISTICS

Environmental: Flammability UL-94, V2 Rating
Operating Temperature: -40°C to 120°C

DECORA® PLUS SWITCHES 15 AMP 120/277V

Commercial Grade Switches

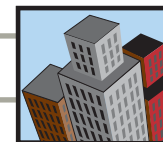

Decora Plus Momentary and Maintained Switches







Back and Side Wired Momentary Contact 15 AMP 120/277V AC

DESCRIPTION	CAT. NO.	COLOR*
Single-Pole, Double Throw, Center OFF	5657-2	I, W, A, T, GY, E <i>Basic Cat. No. Denotes Mahogany</i>

Back and Side Wired Maintained Contact 15 AMP 120/277V AC

DESCRIPTION	CAT. NO.	COLOR*
Single-Pole, Double-Throw, Center OFF	5685-2	I, W, A, T, GY, E
Double-Pole, Double-Throw, Center OFF	5686-2	I, W, A, T (No Mahogany)

Wallplates

THERMOSET		THERMOPLASTIC		POLISHED BRASS	
					
80401-W	80601-W Midway Size	80401-NW	80409-NW	81401-PB	81409-PB

For complete Decora wallplate selection, see pages B20–B24.

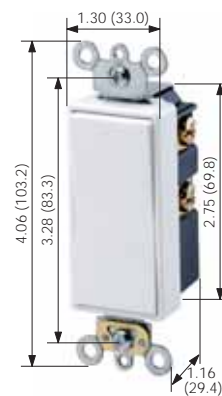

5657-2W

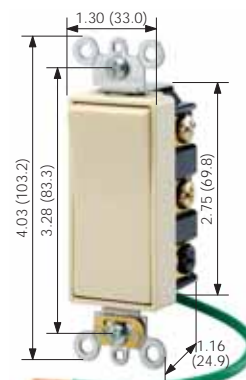

5686-2I

SPECIFICATIONS AND FEATURES

- Full rated current capacity with tungsten, fluorescent or resistive loads. Motor capacity is 80% of switch rating
- Wrap-around heavy-gauge strap with locking tabs for added strength
- Back and side-wiring terminals accept both solid and stranded wire to ease installation

TESTING AND CODE COMPLIANCE

- UL Listed (File #E-7458)
- CSA Certified (File #LR-3413)
- NOM Certified (#057)
- Meets requirements of latest Federal Specification WS-896
- Backed by a Limited 10-Year Warranty

*COLOR

Colors available as listed. For other color selections, add suffix to catalog numbers as follows: Ivory (-I), White (-W), Almond (-A), Light Almond (-T), Gray (-GY), Black (-E).

HORSEPOWER

15A
1/2 @ 120V
2 @ 240V

MATERIAL CHARACTERISTICS

Environmental: Flammability UL-94, V2 Rating
Operating Temperature: -40°C to 120°C



DECORA® PLUS SWITCHES 20 AMP 120 and 277V

Commercial Grade Switches

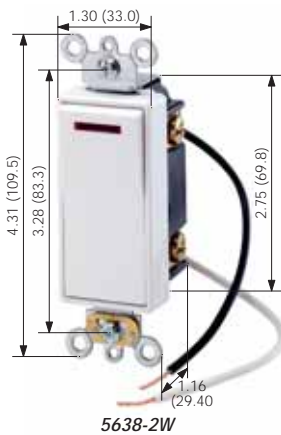
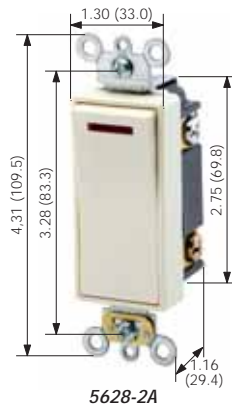

Decora Plus Illuminated and Pilot Light Switches

20 AMP Back and Side Wired Illuminated
(Illuminated when load is OFF—Does not require a neutral wire)

DESCRIPTION	CAT. NO.	COLOR*
Single-Pole, 120V AC	5631-2	I, W, A, T, E
Three-way, 120V AC	5633-2	I, W, A, T
Single-Pole, 277V AC	5649-2	I, W
Three-way, 277V AC	5659-2	W

20 AMP Back and Side Wired Pilot Light
(Illuminated when load is ON—Requires a neutral wire)

DESCRIPTION	CAT. NO.	COLOR*
Single-Pole, 120V AC	5628-2	I, W, A, T
Three-way, 120V AC	5638-2	I, W, A
Three-way, 277V AC	5639-2	W

Wallplates

THERMOSET		THERMOPLASTIC		ALUMINUM	
80601-A Midway Size	80609-A Midway Size	80401-NW	80409-NW	83401	83409

For complete Decora wallplate selection, see pages B20–B24.

SPECIFICATIONS AND FEATURES

- 20A, 120 and 277V single-pole and 3-way versions
- Pilot Light rocker visible when ON even in bright light
- Back and side-wiring terminals accept both solid and stranded wire to ease installation
- Two ground connection options: a green grounding screw and a self-grounding clip

TESTING AND CODE COMPLIANCE

- UL Listed (File #E-7458)
- CSA Certified (File #LR-3413)
- NOM Certified (#057)
- Compliance with the latest Federal Specification WS-896
- Backed by a Limited 10-Year Warranty

*COLOR

Colors available as listed. For other color selections, add suffix to catalog numbers as follows: Ivory (-I), White (-W), Almond (-A), Light Almond (-T), Black (E).

HORSEPOWER

20A
1 @120V
2 @ 240V

MATERIAL CHARACTERISTICS

Environmental: Flammability UL-94, V2 Rating
Operating Temperature: -40°C to 120°C



Decora AC Quiet Rocker Switches

15 AMP Quickwire Push-In and Side Wired 120/277V AC

DESCRIPTION	CAT. NO.	ROCKER/FRAME COLOR*
Single-Pole	5601	Mahogany
	5601-I	Ivory
	5601-W	White
	5601-2	Mahogany
	5601-2I	Ivory
	5601-2W	White
	5601-2A	Almond
	5601-2T	Light Almond
	5601-2E	Ebony
	5601-2GY	Gray
	5601-S2I†	Ivory
5601-S2W†	White	
5601-S2A†	Almond	
Double-Pole	5602-2	Mahogany
	5602-2I	Ivory
	5602-2W	White
	5602-2GY	Gray
	5602-2A	Almond
	5602-2T	Light Almond
	5602-2E	Ebony
Three-Way	5603	Mahogany
	5603-I	Ivory
	5603-W	White
	5603-2	Mahogany
	5603-2I	Ivory
	5603-2W	White
	5603-2A	Almond
	5603-2T	Light Almond
	5603-2E	Ebony
	5603-2GY	Gray
	5603-S2I†	Ivory
5603-S2W†	White	
5603-S2A†	Almond	
Four-Way	5604-2	Mahogany
	5604-2I	Ivory
	5604-2W	White
	5604-2A	Almond
	5604-2T	Light Almond
	5604-2E	Ebony
	5604-2GY	Gray

Note: To order Decora rocker switches with grounding screw add suffix -2 (e.g. 5601-2I)

† Self-grounding when installed in a properly grounded metal wallbox.

Wallplates

THERMOSET		POLYCARBONATE SCREWLESS SNAP-ON		302 STAINLESS STEEL	
80401-GY	80409-GY	80301-SI	80309-SI	84401-40	84409-40

For complete Decora wallplate selection, see pages B20-B24.

SPECIFICATIONS AND FEATURES

- Switch frame shields against dust and fits in wallplate to prevent rocker binding
- Side Wire and Quickwire (No.12 or No.14 copper or copper-clad wire) push-in terminal wiring options
- Sturdy construction for long service life
- Full rated current capacity with tungsten, fluorescent or resistive loads. Motor capacity is 80% of switch rating
- Conform to all NEMA standard specifications

TESTING AND CODE COMPLIANCE

- UL Listed (File #E-7458)
- CSA Certified (File #LR-3413)
- NOM Certified (#057)
- Backed by a Limited Two-Year Warranty

*COLOR

Rocker/Frame colors available as listed.

HORSEPOWER

15A
1/2 @120V
2 @ 240V

MATERIAL CHARACTERISTICS

Environmental: Flammability UL-94, V2 Rating
Operating Temperature: -40°C to 120°C

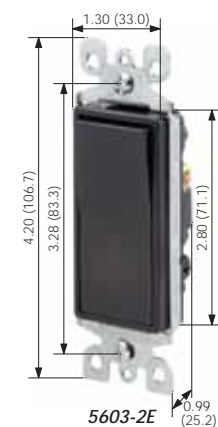
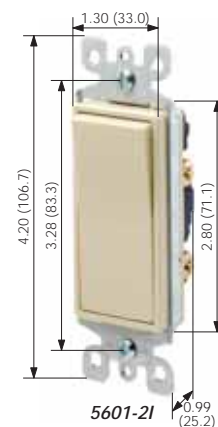



DECORA® SWITCHES 15 AMP 120 and 120/277V

Residential Grade Switches

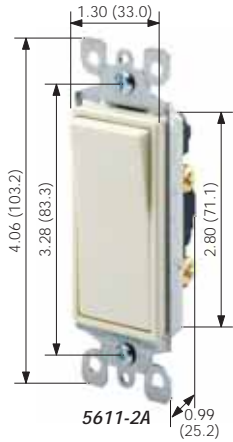

Decora AC Quiet Rocker Switches

Quickwire® and Side Wired Illuminated 15 AMP 120/277V AC
(Illuminated when load is OFF—Does not require a neutral wire)

DESCRIPTION	CAT. NO.	COLOR*
Single-Pole	5611-I	Ivory
	5611-W	White
	5611-2A	Almond
	5611-2T	Light Almond
Three-Way	5613-I	Ivory
	5613-W	White
	5613-2A	Almond
	5613-2T	Light Almond
Four-Way	5614-2I	Ivory
	5614-2W	White
	5614-2A	Almond
	5614-2T	Light Almond

Note: To order Decora rocker switches with grounding screw add suffix -2 (e.g. - 5611-2I)

Quickwire and Side Wired Pilot Light 15 AMP 120V AC
(Illuminated when load is ON—Requires a neutral wire)

DESCRIPTION	CAT. NO.	COLOR*
Single-Pole	5618-2	I, W, A, T

Quickwire and Side Wired Imprinted 15 AMP 120/277V AC

DESCRIPTION	STOCK MESSAGES AVAILABLE	CAT. NO.	COLOR*
Single-Pole, Stock or Custom Imprinted	FAN, DISPOSAL, OIL BURNER	5601-Z2	I, W

Quickwire and Side Wired Molded 15 AMP 120/277V AC

DESCRIPTION	CAT. NO.	COLOR*
Single-Pole ON/OFF Molded in Rocker	5601-X2	I, W, A, T, E

911 Flasher Switch

500 WATTS 120V

DESCRIPTION	CAT. NO.	COLOR*
3-Position Emergency Flasher Rocker Switch	911	I, W, A

Wallplates

THERMOSET				ALUMINUM	
80401-W	80409-W	80601-I Midway Size	80609-I Midway Size	83401	83409

For complete Decora wallplate selection, see pages B20–B24.

SPECIFICATIONS AND FEATURES

- Illuminated Switch rocker illuminated when load is OFF
- Pilot Light switch rocker visible when ON even in bright light
- Switch border shields against dust and fits in wallplate to prevent rocker binding
- Side-wiring terminals accept both solid and stranded wire to ease installation
- Full rated current capacity with tungsten, fluorescent or resistive loads. Motor capacity is 80% of switch rating
- Conform to all NEMA standard specifications

Imprinted Decora Switches

- Stock Decora switches available with choice of three imprints on rocker: FAN, DISPOSAL, OIL BURNER

911 Switch

- 911 Switch provides standard ON/OFF control plus a special illuminated FLASH function will flash controlled lighting ON and OFF at one-second intervals
- Replaces standard single-pole switch—flash function alerts neighbors and helps emergency personnel locate a house quickly

TESTING AND CODE COMPLIANCE

- UL Listed (File #E-7458)
- CSA Certified (File #LR-3413)
- NOM Certified (#057)
- Backed by a Limited Two-Year Warranty

*COLOR

For color choice add suffix as follows: Ivory (-I), White (-W), Almond (-A), Light Almond (-T).

HORSEPOWER

15A
1/2 @120V
2 @ 240V

MATERIAL CHARACTERISTICS

Environmental: Flammability UL-94, V2 Rating
Operating Temperature: -40°C to 120°C

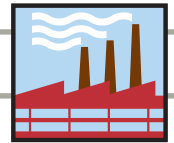

THE BEAUTY, DURABILITY AND VERSATILITY OF DECORA RECEPTACLES

Leviton's Decora line of designer-style receptacles are available in Industrial Grade (including Hospital Grade), Commercial Grade and Residential Grade, with a number of wiring options and features. They come in a variety of contemporary shades and add contemporary style to fine interiors everywhere.

Features and Benefits

- Engineered for fine appearance and top performance in demanding commercial and institutional applications using a durable, thermoplastic face and impact-resistant construction
- Shallow design for maximum wiring room in wallbox
- Back Wire and Side Wire terminal wiring options for ease of installation
- Heavy-gauge zinc-plated steel locked-in wrap-around strap
- Triple-wipe brass contacts for long service life
- Exclusive V-shaped, serrated back wiring clamps for superior contact and conductivity
- Available in an array of colors to coordinate with any interior
- Backed by a Limited 10-Year Warranty

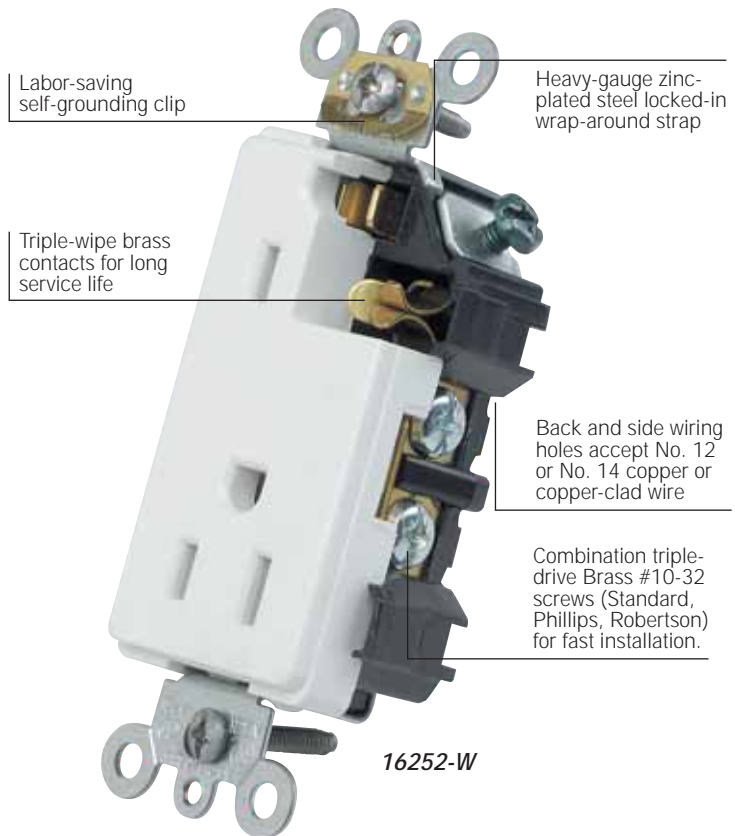

Hospital Grade Tamper Resistant Receptacles
These Hospital Grade receptacles incorporate a unique shutter mechanism that opens easily for insertion of 2 or 3-prong plugs, but prevents the insertion of small objects into either slot.
16262-SGI shown



Dual Voltage Receptacles
Maintain the consistent look of Decora style receptacles throughout commercial settings even when the need arises for Dual Voltage 15A 125 and 15A 250V duplex receptacles.
16292-I shown



Surge Suppressor Receptacles
Decora-style single and duplex surge-protective receptacles, including versions with audible alarm, LED indicator light and Isolated Ground.
8280-IGB shown



Hospital Grade Power Indication™ Receptacles
Power Indication meets UL 498 Hospital Grade identification requirements and provides visual confirmation that the device is energized.
16362-PLR shown



SmartLockPRO® GFCI Receptacles
SmartLockPRO GFCI meets or exceeds UL 2006 requirements and features a patented lockout action that blocks RESET if GFCI protection has been compromised.
7599-W shown



Residential Grade Receptacles
Receptacles engineered for elegant appearance, speedy installation and a long trouble-free service life for fine residential applications.
5325-I shown

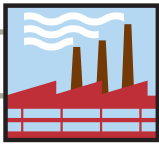

DECORA® PLUS RECEPTACLES 15 and 20 AMP 125V • 20 AMP 250V

Industrial Grade Receptacles

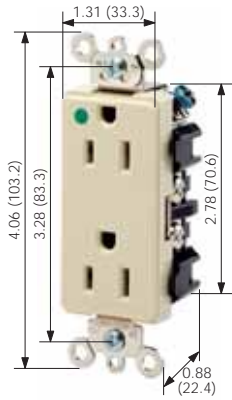

16262-HGI

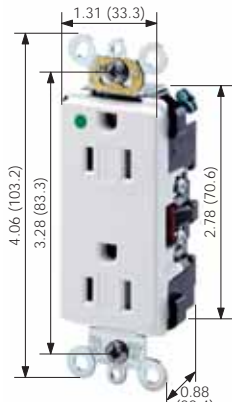

16262-SGW

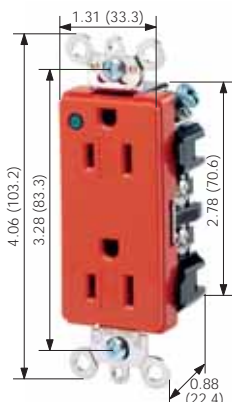

16262-PLR

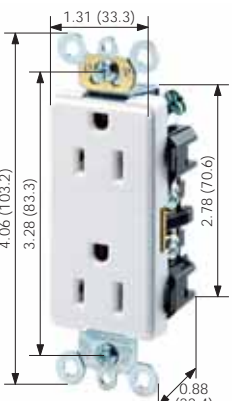



16262-W

Decora Plus Receptacles

Back and Side Wired NEMA 5-15R & 5-20R

(Basic Cat. No. denotes Mahogany device except where noted)

DESCRIPTION	CAT. NO./COLOR* 15A-125V	CAT. NO./COLOR* 20A-125V
	5-15R 	5-20R 
Hospital Grade, Duplex	16262-HG I, W, G, R (No Mahogany)	16362-HG I, W, A, G, R (No Mahogany)
Hospital Grade, Tamper Resistant Duplex	16262-SG I, W, A, R	
Hospital Grade, Isolated Ground Duplex (Not Self-Grounding)	16262-IG (Basic Cat. No. Orange) B, I, W, G, R, E	16362-IG (Basic Cat. No. Orange) B, I, W, G, R
Hospital Grade, Power Indication Duplex	16262-PL I, W, R (No Mahogany)	16362-PL I, W, R (No Mahogany)
Industrial Grade, Duplex	16262 I, W, GY, E	16362 I, W, A, T, GY, E









Back and Side Wired NEMA 6-20R

DESCRIPTION	CAT. NO./COLOR* 20A-250V
	6-20R 
Hospital Grade, Duplex	16462-HG I, W (No Mahogany)

Wallplates for Isolated Ground Devices Engraved with "Isolated Ground"

DESCRIPTION	CAT. NO.	COLOR*
Decora Receptacle Wallplate	80401-IG	Orange only

Wallplates

THERMOPLASTIC				POLYCARBONATE SCREWLESS SNAP-ON		302 STAINLESS STEEL	
							
80401-NI	80409-NI	PJ26-I Midway Size	80409-NR	80301-SW	80309-SW	84401-40	84409-40

For complete Decora wallplate selection, see pages B20-B24.

SPECIFICATIONS AND FEATURES

- Durable thermoplastic face in an array of contemporary colors
- Receptacles have a locked-in mounting strap with a self-grounding clip riveted to the strap (Except Isolated Ground devices)
- Hospital Grade Tamper-resistant receptacles include a unique shutter mechanism that opens easily for the insertion of 2 or 3-prong plugs while preventing entry by other small objects into either outlet slot
- Hospital Grade Isolated Ground receptacles (identified by an orange face or triangle on the face) protect sensitive electronic equipment and eliminate electromagnetic interference by providing a separate path to ground
- Power Indication meets UL 498 Hospital Grade identification requirements and provides visual confirmation that the device is energized.
- Back and side wiring terminals permit fast installation of up to No. 10 solid or stranded conductors
- Triple-wipe copper alloy contacts ensure maximum conductivity

TESTING AND CODE COMPLIANCE

- UL Listed (File #E-13399)
- CSA Certified (File #LR-406)
- NOM Certified (#057)
- Backed by a Limited 10-Year Warranty

*COLOR

Basic Cat. Nos. denote Mahogany device (unless indicated) and Orange for Isolated Ground (-IG) Devices. Isolated Ground Receptacle is distinguished by an orange triangle on its face. For other color selections, add suffix to the catalog number as follows: Ivory (-I), White (-W), Almond (-A), Light Almond (-T), Mahogany (for IG devices only, add -B), Red (-R), Gray (-G or -GY) and Black (-E).

MATERIAL CHARACTERISTICS

Environmental: Flammability UL-94, V2 Rating
Operating Temperature: -40°C to 60°C Maximum Continuous

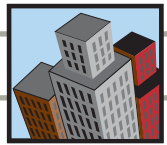

Decora Plus Receptacles

Back and Side Wired, Self-Grounding† NEMA 5-15R, 6-15R, 5-20R & 6-20R

(Basic Cat. No. denotes Mahogany device)*

DESCRIPTION	CAT. NO./COLOR 15A/125V	CAT. NO./COLOR 15A/250V	CAT. NO./COLOR 20A/125V	CAT. NO./COLOR 20A/250V
	5-15R	6-15R	5-20R	6-20R
Duplex	16252 I, W, A, T, GY, E	16662 I, W (No Mahogany)	16352 I, W, A, T, GY, E	16462 I, W (No Mahogany)
Single	16251 I, W	16651 I, W (No Mahogany)	16351 I, W	16451 I, W (No Mahogany)
Tamper Resistant Duplex	DR15S-G I, W, A (No Mahogany)			

†Self-grounding when installed in a properly grounded metal wallbox

Side Wired, Self-Grounding† NEMA 5-15R, 6-15R, 5-20R & 6-20R

(Basic Cat. No. denotes Mahogany device)*

DESCRIPTION	CAT. NO./COLOR 15A/125V	CAT. NO./COLOR 15A/250V	CAT. NO./COLOR 20A/125V	CAT. NO./COLOR 20A/250V
	5-15R	6-15R	5-20R	6-20R
Duplex	16242 I, W, E		16342 I, W, GY, E	
Single	16241 I, W (No Mahogany)	16641 I, W (No Mahogany)	16341 I, W, A, T, GY, E	16441 I, W, A, T (No Mahogany)

†Self-grounding when installed in a properly grounded metal wallbox

Back and Side Wired, Self-Grounding† 125V/250V Dual Voltage
NEMA 5-15R & 6-15R

DESCRIPTION	CAT. NO.	COLOR*
Duplex, Dual Voltage	16292	I, W

†Self-grounding when installed in a properly grounded metal wallbox

Wallplates

THERMOSET		POLYCARBONATE SCREWLESS SNAP-ON		THERMOPLASTIC	
80401	80609-A Midway Size	SJ26-SA Midway Size	SJ262-SA Midway Size	80401-NGY	80409-NGY

For complete Decora wallplate selection, see pages B20-B24.

SPECIFICATIONS AND FEATURES

- Back Wire and Side Wire terminal options
- Heavy-gauge zinc-plated steel locked-in wrap-around strap
- Terminal screws accept up to No. 10 copper or copper-clad wire, solid or stranded
- Back wire terminals accept up to No. 10 copper or copper-clad wire, solid or stranded
- Labor-saving self-grounding clip
- Heavy-duty triple-wipe brass contacts for long service life
- Impact-resistant thermoplastic construction

TESTING AND CODE COMPLIANCE

- UL Listed (File #E-13399)
- CSA Certified (File #LR-406)
- NOM Certified (#057)
- Backed by a Limited 10-Year Warranty

***COLOR**

Basic Cat. No. denotes Mahogany device (unless indicated). For other color selections, add suffix to the catalog number as follows: Ivory (-I), White (-W), Almond (-A), Light Almond (-T), Gray (-GY) and Black (-E).

MATERIAL CHARACTERISTICS

Environmental: Flammability UL-94, V2 Rating
Operating Temperature: -40°C to 60°C Maximum Continuous

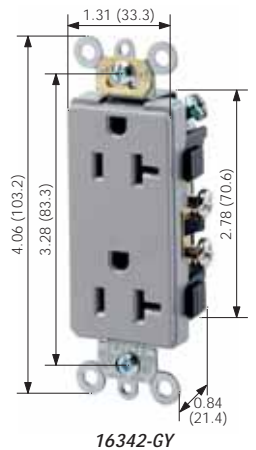
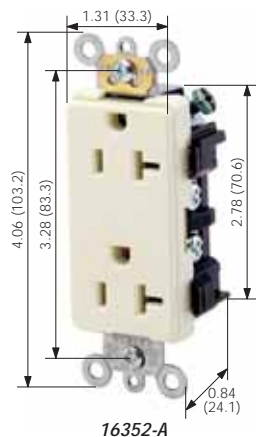
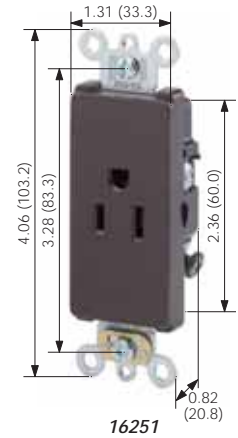



DECORA® RECEPTACLES 15 AMP 125V

Residential Grade Receptacles

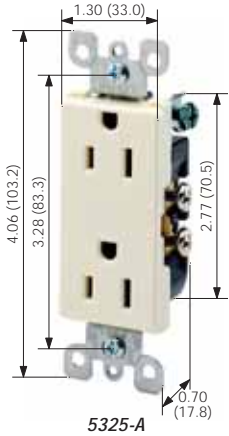

5325-A

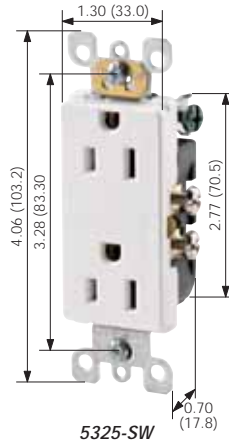

5325-SW



5328-W

Decora AC Receptacles

Side Wire and Quickwire NEMA 5-15R

DESCRIPTION	CAT. NO.	COLOR*
	5-15R	<i>Basic Cat. No. Denotes Mahogany</i>
Duplex	5325	I, W, A, T, GY, E
Duplex, Self-Grounding Clip	5325-S†	I, W, A, T (No Mahogany)
Duplex, 8-Hole Quickwire	5328	I, W, A (No Mahogany)

†Self-grounding when installed in a properly grounded metal wallbox

Wallplates

THERMOSET			THERMOPLASTIC		POLISHED BRASS	302 STAINLESS STEEL	
80401-A	80409-E	80411-E	80401-NT	80409-NT	81401-PB	84401-40	84409-40

For complete Decora wallplate selection, see pages B20–B24.

SPECIFICATIONS AND FEATURES

- Side Wire and Quickwire™ holes accept No. 14 AWG copper wire for Cat. No. 5325
- Heavy-gauge zinc-plated steel mounting strap
- Heavy duty double-wipe brass contacts for long service life

TESTING AND CODE COMPLIANCE

- UL Listed (File #E-13399)
- CSA Certified (File #LR-406)
- NOM Certified (#057)
- Backed by a Limited One-Year Warranty

*COLOR

Basic Cat. No. denotes Mahogany (Brown) device unless indicated. For other color selections, add suffix to the catalog number as follows: Ivory (-I), White (-W), Almond (-A), Light Almond (-T), Gray (-GY), and Black (-E).

MATERIAL CHARACTERISTICS

Environmental: Flammability UL-94, V2 Rating
Operating Temperature: -40°C to 60°C Maximum Continuous

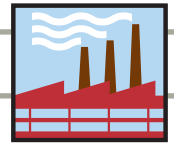

Decora Surge Protective Receptacles

Back and Side Wired NEMA 5-15R & 5-20R

(Basic Cat. No. denotes Mahogany device except where noted)

DESCRIPTION	CAT. NO./COLOR* 15A-125V	CAT. NO./COLOR* 20A-125V
	5-15R	5-20R
Hospital Grade, Surge Duplex with Indicator Light and Audible Alarm	8280 I, W, A, T, R, B	8380 I, W, GY, R, B
Hospital Grade, Surge Single with Indicator Light and Audible Alarm	—	8381 I (No Mahogany)
Hospital Grade, Isolated Ground, Surge Duplex with Indicator Light and Audible Alarm	8280-IG I, W, A, G, B, O (No Mahogany)	8380-IG I, W, G, B, O (No Mahogany)
Hospital Grade, Isolated Ground, Surge Single with Indicator Light and Audible Alarm	8281-IG I, O (No Mahogany)	8381-IG I, W, B (No Mahogany)
Industrial Grade, Surge Duplex with Indicator Light and Audible Alarm	7280 I, W, A, GY, B	7380 I, W, GY, B
Industrial Grade, Surge Duplex with Indicator Light	5280 I, W, A, T, GY, B	5380 I, W, GY, B
Industrial Grade, Isolated Ground, Surge Duplex with Indicator Light	5280-IG I, W, A, G, B, O	5380-IG I, W, G, B, O

For more information regarding Surge Protective Devices, refer to Section R.

Wallplates

THERMOSET	POLYCARBONATE SCREWLESS SNAP-ON	BRASS	302 STAINLESS STEEL
 80401-NB	 80309-SA	 81401	 84401-40
 PJ26-BU Midway Size	 SJ262-SA Midway Size	 81409	 84409-40

For complete Decora wallplate selection, see pages B20–B24.

SPECIFICATIONS AND FEATURES

- Decora-styled TVSS receptacles protect sensitive electronic equipment against transient voltage surges
- UL 1449 Suppressed Voltage Ratings: 400V for all 3 modes (line-neutral, line-ground, neutral ground)
- Hospital Grade versions (indicated by green dot on receptacle face) are suitable for high-abuse health care, industrial and commercial applications
- Isolated Ground versions (indicated by orange color or orange triangle on receptacle face) provide a pure ground path for use with isolated grounding systems
- Monitor/Indicator LED is ON continuously when protection is active and OFF when protection circuit is deactivated due to excessive transients
- All Hospital Grade devices and Cat. Nos. 7280 and 7380 Industrial devices also provide an audible tone alert that sounds if protection is lost
- Maximum Continuous Operating Voltage: 150V
- Maximum single-pulse transient current (8 x 20µs Amps peak) 24,000A (L-N), 12,000A (L-G), 12,000 (N-G)
- Rated single pulse transient energy (10 x 1000µs, impulse) 320 Joules
- RFI and EMI noise filtration (-35db, @5KHz-5MHz)

TESTING AND CODE COMPLIANCE

- UL Listed (File #E-13399)
- CSA Certified (File #LR-406)
- NOM Certified (#057)
- UL Standard 1449-2nd ED
- Backed by a Limited 10-Year Warranty

***COLOR**

Basic Cat. Nos. denote Mahogany device, unless indicated. Isolated Ground Receptacle is distinguished by an orange triangle on its face. For other color selections, add suffix to the catalog number as follows: Ivory (-I), White (-W), Almond (-A), Light Almond (-T), Red (-R), Gray (-G or -GY), Blue (-B) and Orange (-O).

MATERIAL CHARACTERISTICS

Environmental: Flammability UL-94, V2 Rating
Operating Temperature: -40°C to 120°C

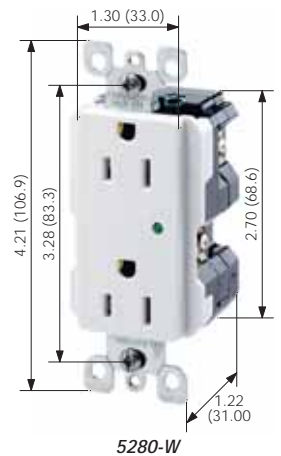
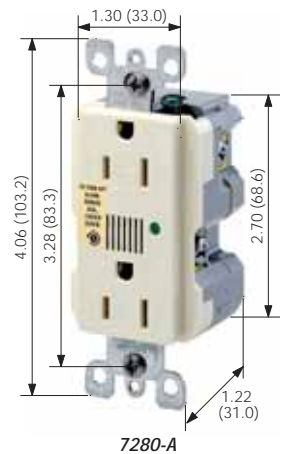
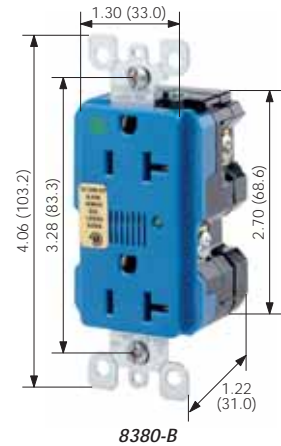



DECORA® SMARTLOCKPRO® GFCI PERSONNEL PROTECTION DEVICE FEATURES

Commercial Grade Decora Devices



SmartLockPRO® GFCI with Professional Grade Lockout Action

Meets or exceeds Underwriters Laboratories (UL) 2006 UL943 GFCI Safety Standards

- Patented professional grade lockout action as end-of-life indication
- Prevents power from being connected to face and feed-through terminals when miswired (line-load reversal)
- Improved immunity to electrical noise to reduce false tripping
- Advanced electronics provide superior surge immunity
- Trip threshold meets or exceeds UL requirements for tripping time

THE SMARTLOCKPRO® PROTECTION ADVANTAGE

While other GFCI manufacturers may have taken the alternate route in the 2006 UL Standard by providing an indicator light for end-of-life indication, allowing reset and continued use of a GFCI with unprotected power to the GFCI face and downstream receptacles, the SmartLockPRO's reset button will not engage if protection has been compromised. The SmartLockPRO's unique patented professional grade end-of-life lockout action, reduces the possibility of end-users incorrectly assuming that a reset GFCI outlet is providing ground fault protection when it actually is not.

Ideal for a Wide Range of GFCI Applications

- **Residential** – Kitchens, bathrooms, garages, basements and other wet locations
- **Outdoors** – Outdoor receptacles by pools, cabanas, patios, decks and lanais
- **Hospital and Healthcare Facilities** – Scrub rooms, lavatories kitchenettes and other potentially wet locations
- **Educational Facilities** – Classrooms, restrooms, laboratories, dormitories and kitchens
- **Airports** – Bathrooms, general use areas and maintenance areas
- **Restaurants, Lodging and Retail Malls** – Bathrooms, general use areas and maintenance areas
- **Commercial Offices** – Bathrooms, basement areas, hallways and kitchens
- **Public Areas** – Near wet and damp locations



Professional Grade Protection

SPECIFICATIONS AND FEATURES

- Meets or exceeds UL 2006 Requirements
 - TEST and RESET functions work together so that a tripped GFCI cannot be reset if GFCI circuit no longer provides ground fault protection
 - RESET button is blocked if GFCI protection has been compromised, reducing the possibility of end-users incorrectly assuming that a reset GFCI is providing ground fault protection when it actually is not
 - Line-load diagnostic feature prevents GFCI from being reset and stops power from being fed to the GFCI receptacle face or through to downstream devices. This alerts installer to a line-load reversal. Indicator light will be ON to indicate line-load reversal.
 - The SmartLockPRO® GFCI with lockout action is designed and patented by Leviton
 - Trip threshold meets or exceeds UL requirements for tripping time
 - Impact-resistant thermoplastic cover and body
 - Silver-alloy contacts
 - Compatible with all Decora devices: available in selected Decora colors
- Combination Switch/SmartLockPRO® GFCI Outlet**
- Ideal for kitchens, bathrooms, modular kitchen units, bathroom cabinet fixtures, lamp cabinet fixtures and applications where combination devices are used.

TESTING AND CODE COMPLIANCE

- UL Standard 943 Class A (GFCI) and 498 (Receptacles)
- UL Listed (File # 48380)
- CSA Certified (File #LR-57811)
- NOM Certified (#057)
- Backed by a Limited Two-Year Warranty

*COLOR

Basic Cat. Nos. denote Brown color unless indicated. For other color selections, add suffix to catalog number as follows: Ivory (-I), White (-W), Almond (-A), Light Almond (-T), Gray (-G or GY), Red (-R), Black (-E).

MATERIAL CHARACTERISTICS

Flammability: Rated V2
Operating Temperature: -30°F (-35°C) to 151°F (66°C)



SMARTLOCK^{PRO}® GFCI RECEPTACLES 15 AMP 125V • 20 AMP 125V

Commercial and Hospital Grade GFCI Personnel Protection Devices



Hospital Grade SmartLock^{PRO}® GFCI Receptacles

Back and Side Wired 15 AMP 125V at Receptacle, 20 AMP Feed-Through



DESCRIPTION	CAT. NO.	COLOR*	NEMA CONFIG.
Duplex with LED Indicator Light, buttons match face color	7599-HG	I, W, A, T, G, R <small>Basic Cat. No. Denotes Brown</small>	
Duplex with LED Indicator Light, buttons match face color. DIN-Rail mounting with terminal wiring block. UL Recognized Component	7599-DIN	Black Only	5-15R 

Back and Side Wired 20 AMP 125V at Receptacle and Feed-Through



DESCRIPTION	CAT. NO.	COLOR*	NEMA CONFIG.
Duplex with LED Indicator Light, buttons match face color	7899-HG	I, W, A, T, G, R	5-20R 

Commercial Grade SmartLock^{PRO}® GFCI Receptacles

Back and Side Wired 15 AMP 125V at Receptacle, 20 AMP Feed-Through

DESCRIPTION	CAT. NO.	COLOR*	NEMA CONFIG.
Duplex with Indicator Light, buttons match face color	7599	I, W, A, T, GY, R, E <small>Basic Cat. No. Denotes Brown</small>	5-15R 
Duplex with LED Indicator Light, Black & Red buttons. With 6" leads	7599-L	I, W (No Brown)	5-15R 

Back and Side Wired 20 AMP 125V at Receptacle and Feed-Through

DESCRIPTION	CAT. NO.	COLOR*	NEMA CONFIG.
Duplex with LED Indicator Light, buttons match face color	7899	I, W, A, T, GY, E <small>Basic Cat. No. Denotes Brown</small>	5-20R 
Duplex with LED Indicator Light, Black & Red buttons. With 6" leads	7899-L	I, W (No Brown)	5-20R 

Combination Switch/SmartLock^{PRO}® GFCI Outlet

15 AMP @ 125V Side Wired AC Switch Rating, 15 AMP 125V at Receptacle, 20 AMP Feed-Through

DESCRIPTION	CAT. NO.	COLOR*	NEMA CONFIG.
Single-Pole Switch and SmartLock GFCI-Protected Outlet, buttons match face color	7299	I, W, A	5-15R 

Blank Face SmartLock^{PRO}® GFCI





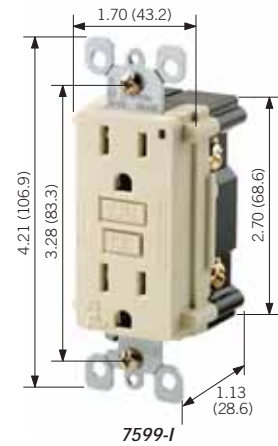
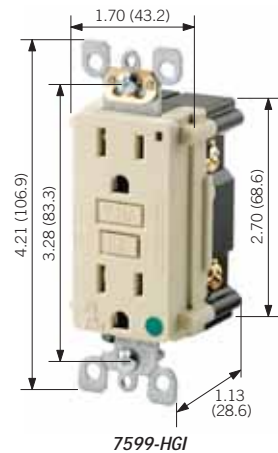



Back and Side Wired 20 AMP 125V Feed-Through

DESCRIPTION	CAT. NO.	COLOR*
Blank Face, No Indicator Light, buttons match face color	8590	I, W, A, T, E



Decora Devices

Wallplates

THERMOSET	POLYCARBONATE SCREWLESS SNAP-ON	POLISHED BRASS	302 STAINLESS STEEL
 	 	 	 
80401-NT 80409-NT	80301-SW 80309-SW	81401-PB 81409-PB	84401-40 84409-40

For complete Decora wallplate selection, see pages B20-B24.



DECORA® COMBINATION DEVICES 15 and 20 AMP • 120 and 120/277V

Commercial Grade Combination Devices

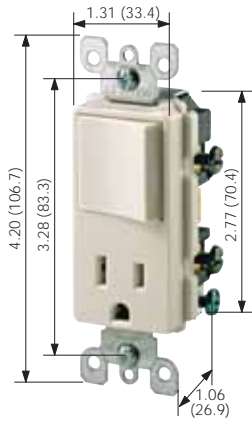

5625-T

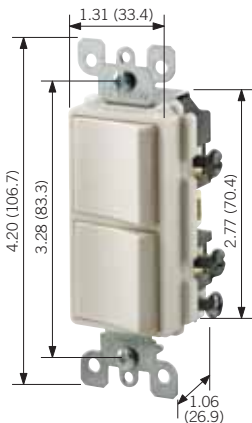

5634-T

Decora Combination Devices





15 AMP

DESCRIPTION	RATING	CAT. NO.	COLOR*
Single-Pole Switch/Receptacle	Switch: 15A-120V AC Receptacle: 15A-125V	5625	I, W, A, T, GY, E
Single-Pole Switch/Pilot Light	Switch: 15A-120V AC Pilot: 1/25W-125V AC	5626	I, W, A
Two Single-Pole Switches	15A-120/277V AC	5634	I, W, A, T, GY, E
3-Way Switch/Single-Pole Switch	15A-120/277V AC	5641	I, W, A, T, E
Two 3-Way Switches	15A-120/277V AC	5643	I, W, A, T
3-Way Switch/Receptacle	Switch: 15A-120V AC Receptacle: 15A-125V	5645	I, W, A, E
3-Way Switch/Pilot Light	Switch: 15A-120V AC Pilot: 1/25W-125V	5646	I, W, A

20 AMP

DESCRIPTION	RATING	CAT. NO.	COLOR*
Two Single-Pole Switches	20A-120/277V AC	5627	I, W, A, T
Single-Pole Switch/Receptacle	Switch: 20A-120V AC Receptacle: 20A-125V	5636	I, W, A
Single-Pole Switch/Pilot Light	Switch: 20A-120V AC Pilot: 1/25W-125V AC	5637	I, W, A
Two 3-Way Switches	20A-120/277V AC	5640	I, W, A, T

Wallplates

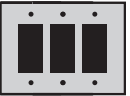
THERMOSET		THERMOPLASTIC	POLYCARBONATE SCREWLESS SNAP-ON		302 STAINLESS STEEL
					
80401-W	80409-W	80409-NI	80309-SI	80311-SI	84411-40

For complete Decora wallplate selection, see pages B20-B24.

SPECIFICATIONS AND FEATURES

- Elegant Decora styling provides multiple control in a single-gang wallbox
- All devices have grounding screw
- Fit standard wall boxes

TESTING AND CODE COMPLIANCE

- UL Listed (File #E-7458)
- CSA Certified (File #LR-3413)
- NOM Certified (#057)
- Backed by a Limited Two-Year Warranty

*COLOR

Colors available as listed. For other color selections, add suffix to catalog numbers as follows: Ivory (-I), White (-W), Almond (-A), Light Almond (-T), Gray (-GY) and Black (-E).

HORSEPOWER

15A	20A
1/2 @ 120V	1 @ 120V
2 @ 240V	2 @ 240V

MATERIAL CHARACTERISTICS

Environmental: Flammability UL-94, V2 Rating
Operating Temperature: -40°C to 120°C

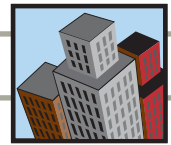

Decora Combination Switches

Individual Switches: 15 AMP 120V/Device Total: 20 AMP-120V†

DESCRIPTION	CAT. NO.	COLOR*
Dual Rocker Switches	1754	I, W, A, T
Dual Rocker Switches with Ground Screw	1754-2	W
Illuminated Dual Rocker Switches light is ON when top rocker is off	1754-IL	I, W, A
Three Rocker Switches	1755	I, W, A, T
Three Rocker Switches with Ground Screw	1755-2	I, W
Three Rocker Switches (Double Pole ON-OFF-ON Top Switch; Two Single-Pole Switches)	1759	I, W

†WARNING: Although each individual rocker switch is rated up to 15A 120V, the total combined load for both duplex or all three triplex switches MUST NOT EXCEED 20 AMPS.

Decora Combination Switch/SmartLockPRO® GFCI Outlet

Receptacle: 15 AMP 125V/Feed-through: 20 AMP 125V

DESCRIPTION	CAT. NO.	COLOR*
Single-Pole Switch and SmartLockPRO GFCI-Protected Outlet with Indicator Light	7299	I, W, A

Wallplates

THERMOSET		POLYCARBONATE SCREWLESS SNAP-ON			BRASS
80401-I	80409-I	80301-SW	80309-SW	80311-SW	81401

For complete Decora wallplate selection, see pages B20–B24.

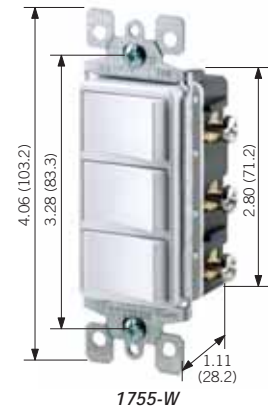

1754-W

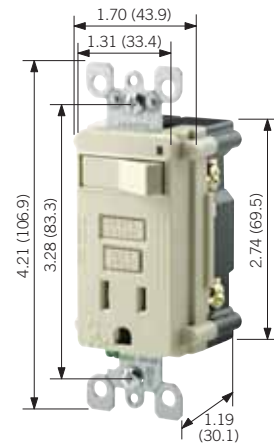

7299-I

SPECIFICATIONS AND FEATURES

- Multi-switch combination devices save space and add convenience
- Common shunted internally to all switches
- Elegant Decora styling permits ganging with other Decora devices
- Switch/SmartLockPRO® GFCI Receptacle replaces standard switch/outlet combination devices in commercial or residential installations
- Space-saving SmartLockPRO® GFCI protection in new or retrofit construction
- Switch/SmartLockPRO® GFCI Receptacle permits multiple wiring options that allow six different applications

SmartLockPRO® GFCI

- Meets or exceeds UL 2006 Code Requirements for line-load reversal indication during installation and end-of-life indication
- Exclusive, patented lockout-action: RESET button is blocked if GFCI protection has been compromised, eliminating the risk of end-users incorrectly assuming that a reset GFCI is providing ground fault protection when it actually is not

TESTING AND CODE COMPLIANCE

Decora Switches

- UL Listed (File #7458)
- CSA (File #LR-3413)
- NOM Certified (#057)
- Backed by a Limited Two-Year Warranty

Switch/SmartLockPRO® GFCI Receptacle

- UL Listed (File #48380)
- Listed UL Standard 943, Class A
- CSA Certified (File #LR-57811)
- NOM Certified (#057)
- Backed by a Limited Two-Year Warranty

***COLOR**

Colors available as listed. For other color selections, add suffix to catalog numbers as follows: Ivory (-I), White (-W), Almond (-A), Light Almond (-T).

MATERIAL CHARACTERISTICS

Environmental: Flammability UL-94, V2 Rating
Operating Temperature: -40°C to 120°C



DECORA® VOICE, DATA and VIDEO DEVICES

Commercial Grade Wall Jacks

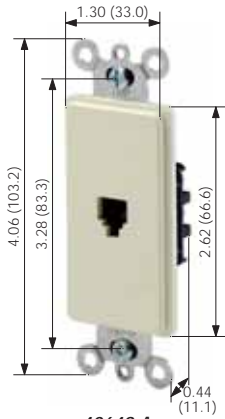

40649-A

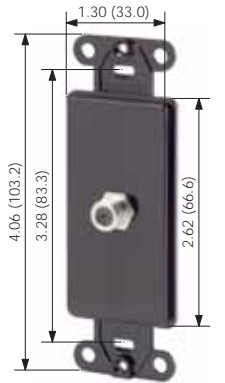

40681

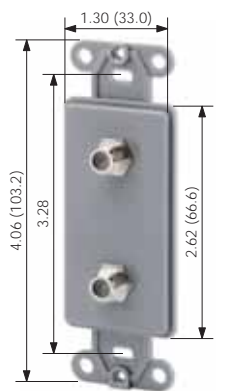

40682-GY

Wall Jacks

Type 625 Single Telephone Wall Jacks

DESCRIPTION	CAT. NO.	COLOR*
4-Conductor	40649	I, W, A, GY, E <small>Basic Cat. No. Denotes Mahogany</small>
6-Conductor	40638	I, W, A, T, GY, E
8-Conductor	40680	I, W

F Connector Wall Jacks*

DESCRIPTION	CAT. NO.	COLOR*
Single F Connector	40681	I, W, A, T, GY
Duplex F Connector	40682	I, W, A, T, GY
Single F Connector (includes Snap-On Decora Plus Wallplate)	80381	I, W, A, T, GY

*Standard bulkhead F connector for CATV or other video applications. These jacks are not rated UL94V-O.

Decora® Plus Voice/Data Jacks with QuickPort® Snap-in Modules

DESCRIPTION	CAT. NO.	COLOR*
Empty, 2-Port Platform, No Jacks	41642	I, W, A, T, GY, B
Platform with Two 6-Conductor Jacks	41666	I, W
Platform with Two 8-Conductor Jacks	41688	I, W, T
Platform with One 6-Conductor Jack and One F Connector	41658	I, W
Platform with One 6-Conductor Jack and One 8-Conductor Jack	41668	I, W

Wallplates

THERMOSET	THERMOPLASTIC	POLYCARBONATE SCREWLESS SNAP-ON
<p>80401-A 80601-A Midway Size</p>	<p>PJ26-GY Midway Size 80409-NGY</p>	<p>80301-S SJ262-S Midway Size</p>

For complete Decora wallplate selection, see pages B20-B24.

SPECIFICATIONS AND FEATURES

- All wall jacks are compatible with Decora Plus snap-on wallplates and Decora standard wallplates
- All wall jacks can be used with single or multiple-gang wall boxes
- Modular Jacks have 50 micro-inches hard gold-plated phosphor bronze spring wire contacts.
- Jacks can be used for 75-OHM cable connections for televisions, VCR's and receivers
- Decora Plus Duplex Jack uses snap-in modules with quick-connect insulation displacement terminals for 22 or 24 AWG wire

TESTING AND CODE COMPLIANCE

- UL Listed (File #109712) in accordance with NEC Article 800-51(-1)
- CSA Certified (File #80287 for all cat. nos. except 80381, which is File #LR-20064)
- NOM Certified (#057)

- Decora F-Connector Wall Jacks meet specs. for UL 1863
- Meet FCC Part 68 requirements
- All Decora Plus Voice/Data Jack Snap-in QuickPort modules meet TIA-568A electrical, mechanical and transmission requirements
- Wall Jacks' housings of high-impact, self-extinguishing plastic, rated UL 94 V-O
- Backed by a Limited Two-Year Warranty

*COLOR

Basic Cat. No. denotes Mahogany device (unless indicated). For other color selections, add suffix to catalog numbers as follows: Ivory (-I), White (-W), Almond (-A), Light Almond (-T), Gray (-GY), Black (-E), Brown (-B).

MATERIAL CHARACTERISTICS

Environmental Flammability: Meet specs for UL1863

For QuickPort® Snap-in Modules, see section "S"

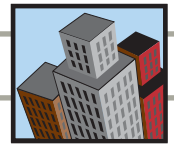

Canadian 347V AC Quiet Rocker Switches

Back and Side Wired 15 AMP 347V AC

DESCRIPTION	CAT. NO.	COLOR*
Single-Pole Rocker Switch	5691-C	I, W, A, G, E
3-Way Rocker Switch	5693-C	I, W, A, E
4-Way Rocker Switch	5694-C	W

Back and Side Wired 20 AMP 347V AC

DESCRIPTION	CAT. NO.	COLOR*
Single-Pole Rocker Switch	5621-C	I, W, G
3-Way Rocker Switch	5623-C	W, G
4-Way Rocker Switch	5624-C	W

Midway Nylon Wallplates

For Canadian 347V Decora Devices

DESCRIPTION	CAT. NO.	COLOR*
1-Gang 1-Decora	80401-CN	I, W, A, G, E
2-Gang 2-Decora	80409-CN	I, W, A, G, E
3-Gang 3-Decora	80411-CN	I, W, G, E
4-Gang 4-Decora	80412-CN	I, W, G

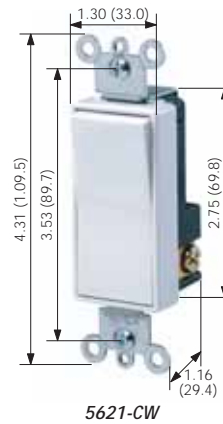
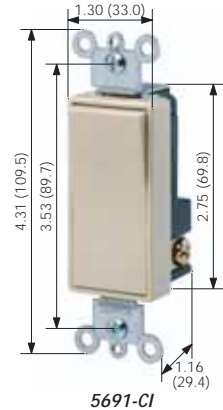

SPECIFICATIONS AND FEATURES

- New architecturally-styled smooth-action concave rocker
- Heavy-duty impact-resistant thermoplastic construction for long service life in commercial applications
- Full rated current capacity with tungsten, fluorescent or resistive loads. Motor capacity is 80% of switch rating
- Wrap-around heavy-gauge strap with locking tabs for added strength
- Back and side-wiring terminals accept both solid and stranded wire to ease installation
- Green grounding screw
- Canadian 347V Decora wallplates available in a number of colors
- **Note:** Decora Plus Canadian 347V switches fit only those wallplates designated for 347V AC devices
- **Note:** Canadian 347V Decora wallplates fit "Commander Type" boxes

TESTING AND CODE COMPLIANCE

- Switches**
- UL Listed (File #E-7458)
 - CSA Certified (File #LR-3413)
- Wallplates**
- UL Listed (File #E-13397)
 - CSA (File #LR-16347)
 - NOM Certified (#057)
 - Fully compliant with NEMA Standards WD-1
 - Backed by a Limited 10-Year Warranty

***COLOR**

For color selection, add suffix to catalog number as follows: Ivory (-I), White (-W), Almond (-A), Gray (-G), Black (-E) and Red (-R).

MATERIAL CHARACTERISTICS

Environmental: Flammability UL-94, V2 Rating
 Operating Temperature: -40°C to 120°C





DECORA® PLUS SCREWLESS SNAP-ON WALLPLATES

Commercial Grade Wallplates

Decora Plus Screwless Snap-On Wallplates

- Sleek, smooth contemporary architectural styling enhances fine décor
- Exclusive new design eliminates subplate screws
- "Hook and Snap" subplate and wallplate mounting provides easy, time saving installation
- Decora-compatible two-piece kit allows easy retrofit to any Decora installation
- Tough, unbreakable polycarbonate construction
- Now available in standard and midway sizes that can be mounted onto larger-volume wallboxes and/or used to hide wall irregularities.



80301-SW
Standard Size



SJ26-SW
Midway Size

Standard Size
Single-Gang Screwless Snap-On Wallplate

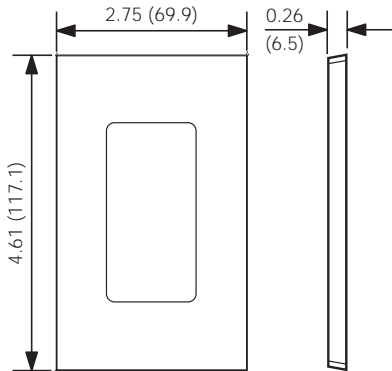

80301-S

Midway Size
Single-Gang Screwless Snap-On Wallplate

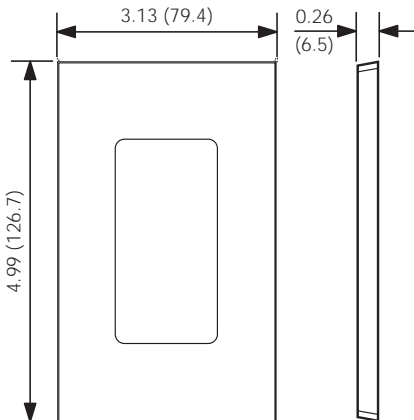

SJ26-S

Midway wallplates can be mounted onto larger-volume outlet boxes and/or used to hide wall irregularities. Midway wallplates are a full 0.375" higher and wider than standard size wallplates.

NOTE: Add 1.81" (46.0mm) for each additional gang.

Decora Plus Screwless Snap-On Wallplates

DESCRIPTION	COLOR	STANDARD	MIDWAY
1-Gang 1-Decora	Ivory	80301-SI	SJ26-SI
	Ebony/Black	80301-SE	SJ26-SE
	Gray	80301-SGY	SJ26-SGY
	White	80301-SW	SJ26-SW
	Mahogany/Brown	80301-S	SJ26-S
	Almond	80301-SA	SJ26-SA
	Light Almond	80301-ST	SJ26-ST
2-Gang 2-Decora	Ivory	80309-SI	SJ262-SI
	Ebony/Black	80309-SE	SJ262-SE
	Gray	80309-SGY	SJ262-SGY
	White	80309-SW	SJ262-SW
	Mahogany/Brown	80309-S	SJ262-S
	Almond	80309-SA	SJ262-SA
	Light Almond	80309-ST	SJ262-ST
3-Gang 3-Decora	Ivory	80311-SI	SJ263-SI
	Ebony/Black	80311-SE	SJ263-SE
	White	80311-SW	SJ263-SW
	Almond	80311-SA	SJ263-SA
	Light Almond	80311-ST	SJ263-ST
4-Gang 4-Decora	Ivory	80312-SI	SJ264-SI
	White	80312-SW	SJ264-SW
	Almond	80312-SA	SJ264-SA
	Light Almond	80312-ST	SJ264-ST
5-Gang 5-Decora	Ivory	80321-SI	SJ265-SI
	White	80321-SW	SJ265-SW
	Almond	80321-SA	SJ265-SA
	Light Almond	80321-ST	SJ265-ST
6-Gang 6-Decora	Ivory	80326-SI	SJ266-SI
	White	80326-SW	SJ266-SW
	Almond	80326-SA	SJ266-SA
	Light Almond	80326-ST	SJ266-ST

TESTING AND CODE COMPLIANCE

- UL Listed (File #E-13397)
- Meets NEMA Standards WD-1, WD-6
- CSA Certified (File #LR-16347)
- NOM Certified (File #057)
- Backed by a Limited Ten-Year Warranty

MATERIAL CHARACTERISTICS

Environmental: Flammability UL-94, V2 Rating
Operating Temperature: -40°C to 120°C

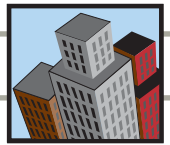

Residential and Commercial Grade Decora Wallplates

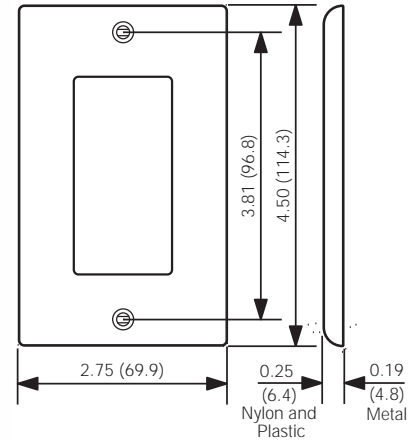

Standard Size Single-Gang

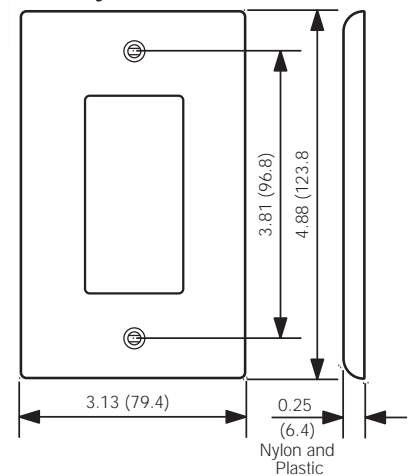

Midway Size Single-Gang

Midway wallplates can be mounted onto larger-volume outlet boxes and/or used to hide wall irregularities. Midway wallplates are a full 0.375" higher and wider than standard size wallplates.

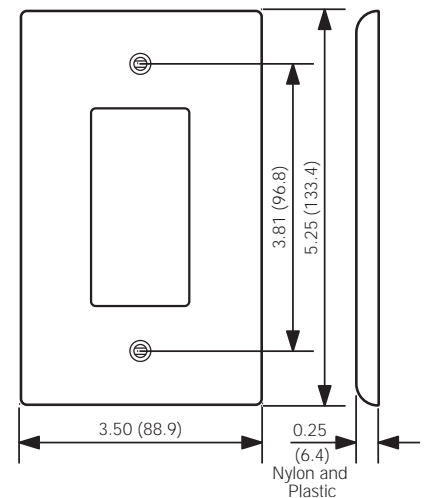

Oversized Single-Gang

Oversized wallplates are used to conceal greater wall irregularities than those hidden by Midway wallplates. Oversized wallplates are a full 0.75" higher and wider than standard size wallplates.

NOTE: Add 1.81" (46.0mm) for each additional gang.

All Decora Wallplates

- Accent any wall covering with a wide selection of colors and finishes
- Smooth face and rounded edges resist dust accumulation
- Individual plastic wrapping to protect wallplate's surface
- Color-matched metal mounting screws supplied

Residential Grade Thermoset Wallplates

- Photoelectrically color-matched to Leviton Decora devices
- Designed for high dielectric strength and arc resistance
- Meet or surpass UL 514 testing requirements
- Resistant to fading, discoloration, grease, oils, organic solvents and moisture scratches
- Backed by a Limited Two-Year Warranty

Commercial Grade Thermoplastic Wallplates

- Molded thermoplastic for maximum resistance to impact, abrasion, fading and discoloration
- Resistant to mechanical stress associated with high abuse applications
- Backed by a Limited Ten-Year Warranty

Commercial Grade Metal Wallplates

- Rounded edges to prevent injury and wall damage
- Deluxe stainless steel is non-magnetic Type 302, .032" thick
- Standard magnetic stainless steel Type 430, .032" thick, also available
- Brass is 70/30 alloy 260, .040" thick
- Aluminum is 3004 alloy, .040" thick
- Backed by a Limited Ten-Year Warranty

TESTING AND CODE COMPLIANCE

- Thermoplastic and Thermoset: UL Listed (File #E-13397)
- Metal: UL Listed (File #E-16347)
- Meets NEMA Standards WD-1, WD-6
- CSA Certified (File #LR-16347)
- NOM Certified (File #057)

MATERIAL CHARACTERISTICS

Environmental: Flammability UL-94, V2 Rating
Operating Temperature: -40°C to 120°C





DECORA® WALLPLATES

Residential and Commercial Grade Decora Wallplates

Thermoset			Thermoplastic		Screwless Snap-On Polycarbonate		Assorted Metals		
-----------	--	--	---------------	--	---------------------------------	--	-----------------	--	--

DESCRIPTION 1-Gang 1-Decora										
	COLOR	STANDARD P26	MIDWAY SPJ26	OVERSIZE P026	STANDARD N26	MIDWAY PJ26	STANDARD	MIDWAY	MATERIAL	STANDARD
Ivory	80401-I	80601-I	86601	80401-NI	PJ26-I	80301-SI	SJ26-SI	Chrome	*	—
Black	80401-E	—	—	80401-NE	PJ26-E	80301-SE	SJ26-SE	Aluminum	A26 83401	—
Gray	80401-GY	—	—	80401-NGY	PJ26-GY	80301-SGY	SJ26-SGY	Brass	B26 81401	—
White	80401-W	80601-W	88601	80401-NW	PJ26-W	80301-SW	SJ26-SW	Polished Brass	81401-PB	—
Brown	80401	80601	—	80401-N	PJ26	80301-S	SJ26-S	430 S/S	*	*
Almond	80401-A	80601-A	82601	80401-NA	PJ26-A	80301-SA	SJ26-SA	302 S/S	SN26-N 84401-40	S026 SO26
Light Almond	80401-T	80601-T	—	80401-NT	PJ26-T	80301-ST	SJ26-ST			
Red	—	—	—	80401-NR	PJ26-R	—	—			
Blue	—	—	—	80401-NB	PJ26-BU	—	—			

DESCRIPTION 2-Gang 2-Decora										
	COLOR	STANDARD P262	MIDWAY SPJ262	OVERSIZE P0262	STANDARD N262	MIDWAY PJ262	STANDARD	MIDWAY	MATERIAL	STANDARD
Ivory	80409-I	80609-I	86602	80409-NI	PJ262-I	80309-SI	SJ262-SI	Chrome	*	—
Black	80409-E	—	—	80409-NE	PJ262-E	80309-SE	SJ262-SE	Aluminum	A262 83409	—
Gray	80409-GY	—	—	80409-NGY	PJ262-GY	80309-SGY	SJ262-SGY	Brass	B262 81409	—
White	80409-W	80609-W	88602	80409-NW	PJ262-W	80309-SW	SJ262-SW	Polished Brass	81409-PB	—
Brown	80409	80609	—	80409-N	—	80309-S	SJ262-S	430 S/S	*	*
Almond	80409-A	80609-A	82602	80409-NA	PJ262-A	80309-SA	SJ262-SA	302 S/S	S262-N 84409-40	S0262 SO262
Light Almond	80409-T	80609-T	—	80409-NT	PJ262-T	80309-ST	SJ262-ST			
Red	—	—	—	80409-NR	—	—	—			
Blue	—	—	—	80409-NB	—	—	—			

DESCRIPTION 3-Gang 3-Decora										
	COLOR	STANDARD P263	MIDWAY SPJ263	OVERSIZE	STANDARD N263	MIDWAY PJ263	STANDARD	MIDWAY	MATERIAL	STANDARD
Ivory	80411-I	80611-I	—	80411-NI	PJ263-I	80311-SI	SJ263-SI	Chrome	*	—
Black	80411-E	—	—	80611-E	—	80311-SE	SJ263-SE	Aluminum	A263 83411	—
Gray	80411-GY	—	—	80411-NGY	PJ263-GY	—	—	Brass	B263 81411	—
White	80411-W	80611-W	—	80411-NW	PJ263-W	80311-SW	SJ263-SW	Polished Brass	81411-PB	—
Brown	80411	80611	—	80411-N	—	—	—	430 S/S	*	*
Almond	80411-A	80611-A	—	80411-NA	PJ263-A	80311-SA	SJ263-SA	302 S/S	S263-N 84411-40	S0263 SO263
Light Almond	80411-T	80611-T	—	80411-NT	PJ263-T	80311-ST	SJ263-ST			

*Consult your Leviton representative for ordering details: allow 3-4 weeks for delivery.
For Decora Combination Wallplates, see Section E.

NOTE: Where applicable, Industry Number indicated in BOLD FACE. For some wallplates, Industry Number and Leviton Catalog Number are identical.

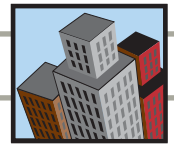

Residential and Commercial Grade Decora Wallplates

	Thermoset			Thermoplastic		Screwless Snap-On Polycarbonate		Assorted Metals		
DESCRIPTION 4-Gang 4-Decora										
COLOR	STANDARD P264	MIDWAY SPJ264	OVERSIZE	STANDARD N264	MIDWAY PJ264	STANDARD	MIDWAY	MATERIAL	STANDARD	OVERSIZE
Ivory	80412-I	80612-I	—	80412-NI	PJ264-I	80312-SI	SJ264-SI	Chrome	*	—
Black	80412-E	—	—	—	—	80312-SE	SJ264-SE	Brass	B264 81412	—
Gray	80412-GY	—	—	—	PJ264-GY	—	—	430 S/S	*	—
White	80412-W	80612-W	—	80412-NW	PJ264-W	80312-SW	SJ264-SW	302 S/S	S264-N 84412-40	—
Brown	80412	80612	—	80412-N	—	80312	—			
Almond	80412-A	80612-A	—	80412-NA	PJ264-A	80312-SA	SJ264-SA			
Light Almond	80412-T	80612-T	—	80412-NT	PJ264-T	80312-ST	SJ264-ST			
DESCRIPTION 5-Gang 5-Decora										
COLOR	STANDARD P265	MIDWAY	OVERSIZE	STANDARD N265	MIDWAY	STANDARD	MIDWAY	MATERIAL	STANDARD	OVERSIZE
Ivory	80423-I	—	—	—	—	80321-SI	SJ265-SI	Brass	B265 81423	—
Black	80423-E	—	—	—	—	—	—	430 S/S	*	—
Gray	80423-GY	—	—	—	—	—	—	302 S/S	S265 84423-40	—
White	80423-W	—	—	—	—	80321-SW	SJ265-SW			
Brown	80423	—	—	—	—	—	—			
Almond	80423-A	—	—	—	—	80321-SA	SJ265-SA			
Light Almond	80423-T	—	—	80423-NT	—	80321-ST	SJ265-ST			
DESCRIPTION 6-Gang 6-Decora										
COLOR	STANDARD P266	MIDWAY	OVERSIZE	STANDARD N266	MIDWAY	STANDARD	MIDWAY	MATERIAL	STANDARD	OVERSIZE
Ivory	80436-I	—	—	—	—	80326-SI	SJ266-SI	Brass	B266 *	—
Black	80436-E	—	—	—	—	—	—	430 S/S	—	—
Gray	80436-GY	—	—	—	—	—	—	302 S/S	S266-N 84436-40	—
White	80436-W	—	—	—	—	80326-SW	SJ266-SW			
Brown	80436	—	—	—	—	—	—			
Almond	80436-A	—	—	80436-NA	—	80326-SA	SJ266-SA			
Light Almond	80436-T	—	—	—	—	80326-ST	SJ266-ST			
DESCRIPTION 7-Gang 7-Decora										
COLOR	STANDARD S607	MIDWAY	OVERSIZE	STANDARD	MIDWAY	STANDARD	MIDWAY	MATERIAL	STANDARD	OVERSIZE
Ivory	80407-I†	—	—	—	—	—	—	Brass	B607 *	—
White	80407-W†	—	—	—	—	—	—	430 S/S	*	—
								302 S/S	S607-N *	—
DESCRIPTION 8-Gang 8-Decora										
COLOR	STANDARD S609	MIDWAY	OVERSIZE	STANDARD	MIDWAY	STANDARD	MIDWAY	MATERIAL	STANDARD	OVERSIZE
Ivory	—	—	—	—	—	—	—	Brass	B609 *	—
White	80408-W†	—	—	—	—	—	—	430 S/S	*	—
								302 S/S	S609-N *	—

*Consult your Leviton representative for ordering details: allow 3-4 weeks for delivery. †Painted metal

NOTE: Where applicable, Industry Number indicated in BOLD FACE. For some wallplates, Industry Number and Leviton Catalog Number are identical.

For answers to technical questions, call Leviton's Techline at 1-800-824-3005





DECORA® WALLPLATE ACCESSORIES

Residential Grade







DECORA REPLACEMENT SCREWS

Wallplate Replacement Screws (5/16" – 6x32 threads)

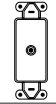
DESCRIPTION	CAT. NO.	DESCRIPTION	CAT. NO.
Almond 100 per box	82400	Ivory 100 per box	86400
Stainless Steel 100 per box	84400	Gray 100 per box	87400
Brown 100 per box	85400	White 100 per box	88400

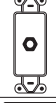
Standard Size Plastic Adapters

DESCRIPTION	CAT. NO.	COLOR*
		<i>Basic Cat. No. Denotes Mahogany</i>
 Dimmer Shaft (.406" hole)	80400	I, W, A, T, GY, E
 Blank (no hole)	80414	I, W, A, T, GY, E
 CATV Jack	40681-I	I, W, A, T, GY, E
 Wallbox Adapter Extends shallow wallbox to fit GFCI/Decora devices	6197	I, W



80400-I



80414-W

Decora® Plus Standard Size Plastic Adapters

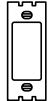
DESCRIPTION	CAT. NO.	COLOR*
 CATV Jack	80381	I, W, A, T, GY, E
 Blank (no hole)	80314	I, W, A, T, GY, E



6197-W

TESTING AND CODE COMPLIANCE

- Backed by a Limited Two-Year Warranty

*COLOR

Colors available as listed. For other color selections, add suffix to catalog numbers as follows: Ivory (-I), White (-W), Almond (-A), Light Almond (-T), Gray (-GY), Black (-E).

MATERIAL CHARACTERISTICS

Environmental: Flammability UL-94, V2 Rating
Operating Temperature: -40°C to 120°C



GET A FLAWLESS FLUSH-MOUNTED INSTALLATION WITH LEVITON'S LINE OF RECESSED DEVICES

For an almost invisible installation behind wall-mounted TVs, entertainment centers, monitors and more, connect with Leviton Recessed Devices. The Recessed Entertainment Box (REB) centralizes AC power and low-voltage connection points for audio, video, data and phones. For smaller applications, choose the Two-Gang Recessed Duplex Receptacle with openings for 6 installer-selected QuickPort® connectors or the One-Gang Recessed Duplex Receptacle.

Features and Benefits

- Recessed Entertainment Box (REB) centralizes points for AC power, audio, video, home theater, data and phone connections
- Recessed two-gang duplex receptacle with openings for 6 QuickPort® Connectors installs invisibly behind wall units and wall-mounted flat-panel TVs
- Two-gang duplex receptacle is fully compatible with Leviton's QuickPort snap-in modules, including component video and S-Video signal connectors (not included)
- Recessed One-Gang Duplex Receptacle supplies AC power for two components (flat panel TVs and video receiver)
- Meet all applicable UL and CSA requirements
- Backed by a Limited Two-Year Warranty

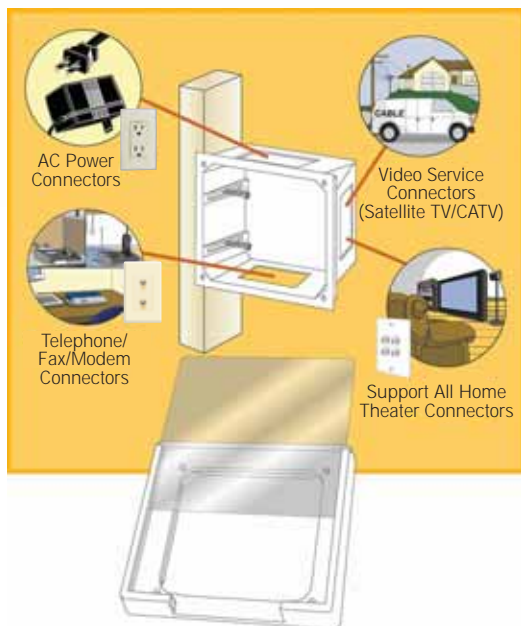

The Recessed Entertainment Box
Centralizes home theater electronics in a single location. Ideal for new construction and retrofit applications. (QuickPort® connectors not included)
47617-REB shown



Recessed Duplex Receptacle with Connector Openings
Flush mounts to install invisibly behind wall units and flat panel TVs. Provides openings for 6 installer-selected QuickPort connectors.
690-W shown



Recessed One-Gang Duplex Receptacle
Supplies AC power for two components and provides sleek installation for signature artwork and flat panel TVs.
689-W shown



DECORA®-STYLE RECESSED DEVICES

Residential Grade Recessed Devices

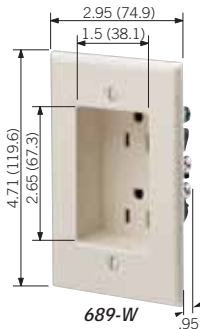
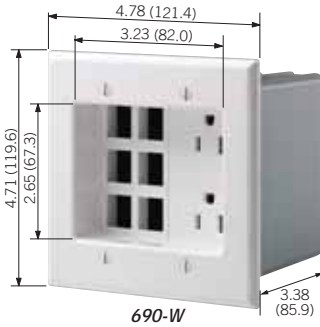

Recessed Entertainment Box

DESCRIPTION	CAT. NO.	COLOR*
REB Box with Low-Profile Frame	47617-REB	White
High-Profile Cover	47617-HPC	White
Low-Profile Frame	47617-LPF	White
Replacement Snap-In Plates (2/Bag)	47617-PLT	White
REB Box with High-Profile Cover	47617-RBH	White

Decora Recessed Receptacles

Duplex Recessed Receptacles

15A-125V AC, 2-Pole, 3-Wire, NEMA 5-15R

DESCRIPTION	CAT. NO.	COLOR*	NEMA CONFIG.
Two-Gang Duplex Receptacle with Openings for 6 QuickPort Connectors (4 blank inserts included)†	690	I, W, T, E	5-15R
One-Gang Duplex Receptacle	689	I, W, T, E	

† QuickPort Connectors not included.

Single Recessed Receptacles

Side-Wired 15A-125V AC, 2-Pole, 3-Wire, NEMA 5-15R

DESCRIPTION	CAT. NO.	COLOR*	NEMA CONFIG.
One-Gang Single Receptacle with Clock Hanger Hook	688	I, W	5-15R
One-Gang Single Receptacle with Clock Hanger Hook	5261-CH	Stainless Steel	

Side-Wired 20A-125V AC, 2-Pole, 3-Wire, NEMA 5-20R

DESCRIPTION	CAT. NO.	COLOR*	NEMA CONFIG.
One-Gang Single Receptacle with Clock Hanger Hook	5361-CH	Stainless Steel	5-20R

SPECIFICATIONS AND FEATURES

Recessed Entertainment Box

- Manages home theater, satellite TV, Internet, whole-house audio/video and home-networking electronics from a single location
- Ideal for new construction (stud-mounted) and retrofit (wall-mounted) applications
- Low-profile frame provides neat, clean recessed installation
- Optional high-profile cover includes sliding plastic front panel and channels all wires through the bottom of the REB
- Any combination of line and low-voltage products can be configured in the three device opening
- Paintable white ABS molded plastic for structural integrity

Recessed Two-Gang Duplex Receptacle with QuickPort Openings

- Provides 2 15A/125V AC NEMA 5-15R power outlets and openings for 6 installer-selected QuickPort connectors or blank inserts (4 inserts included)
- Fully compatible with Leviton's QuickPort Snap-In modules, including component video and S-video signal connectors (not included)
- Includes plastic electrical box designed for use in new and retrofit construction and a barrier to separate line and low-voltage conductors
- Wallplate built into device

Recessed One-Gang Duplex Receptacle

- Installs invisibly behind wall units, signature artwork and wall-mounted flat-panel TVs
- Supplies AC power for two components (flat panel TVs and video receiver)
- Fits most common electrical boxes available (electrical box not included)

Recessed One-Gang Single Receptacles

- Includes clock-hanger hook
- Flush mount with square recess

TESTING AND CODE COMPLIANCE

Recessed Receptacles

- cULus Listed
- NOM Certified (#057)

All Recessed Devices

- Backed by a Limited Two-Year Warranty

*COLOR

For color selection, add suffix to catalog number as follows: Ivory (-I), White (-W), Light Almond (-T) and Black (-E).

MATERIAL CHARACTERISTICS

Environmental: Flammability UL-94, V2 Rating
Operating Temperature: -40° to 120°C

Lighting and Fan Speed Controls

INDEX

Architectural Lighting Control Systems

Dimensions® D3200.....	C2-C4
Dimensions® D4000.....	C5, C6
Power Extenders.....	C7
a-2000 Modular Dimming Cabinets.....	C8, C9

Architectural Specification

Overview.....	C10
Monet® Controls.....	C11, C12
Monet® Multi-Gang Wallplates.....	C13
Renoir® Preset Slide Controls.....	C14, C15
Van Gogh® Rotary Dimmers.....	C16
Ganging and Derating Lighting Controls.....	C17

Designer Controls

Overview.....	C18
Vizia™ Digital Controls.....	C19
Vizia™ Remotes.....	C20
Vizia-RF™ Scene Capable Dimmers.....	C21
Vizia-RF™ Remotes.....	C22
Mural® Digital Controls.....	C23
Mural® Scene Controls.....	C24, C25

Touch Lighting Controls

Overview.....	C26
True Touch™ Digital Touch Dimmer.....	C27
ToggleTouch™ Digital Dimmer.....	C28

Traditional Controls

Overview.....	C29
IllumaTech™ Preset Slide Controls.....	C30
IllumaTech™ Rotary Controls.....	C31
SureSlide™ Slide Controls.....	C32
Trimatron™ Deluxe Rotary Controls.....	C33

Incandescent Lighting Controls

Toggle Dimmers.....	C34
Decora 911 Flasher Switch.....	C34
4-Level Step Dimmer.....	C35
Feed-Through Lamp-Cord Dimmers.....	C35
Tabletop Dimmer.....	C35
Full-Range Dimmer Socket.....	C35





DIMENSIONS® ARCHITECTURAL LIGHTING CONTROL SYSTEM FEATURES

Commercial Grade Lighting Controls

WHETHER IT'S ADVANCED ARCHITECTURAL LIGHTING CONTROL SYSTEMS THAT CAN BE CUSTOM-MANUFACTURED FOR ANY SITE-SPECIFIC REQUIREMENT OR INNOVATIVE BOX-MOUNTED CONTROLS FOR INCANDESCENT, LOW-VOLTAGE AND FLUORESCENT LIGHTING, LEVITON HAS THE PRODUCTS YOU CAN DEPEND ON.

Our designer preset systems and distributed programmable computer-controlled systems are ideal for large-scale, multi-use environments. Leviton's innovative line of box-mounted controls includes digital multi-location devices that provide maximum performance in architectural, commercial and residential settings.

Dimensions Architectural Lighting Control Systems

Each Dimensions® System combines ease of operation with a wide range of entry stations and accessories to provide a powerful and flexible control solution. The bright LCD readout displays functions and scene information in plain English, and guides you step-by-step through setup and operation. They enable the optimal mix of lighting to be selected—to evoke the right mood—without the guesswork.

Triac with generous 1000W zone capacity

LCD with intuitive, menu-driven Wizard interface guides setup and operation

Zone information buttons display zone name and brightness level

Interchangeable covers

Features and Benefits

- Astronomical clock for event scheduling
- Programmable scene and zone names, fade rates and much more
- Join/separate functionality (D3208 and D4200)
- Optional setup software and handheld remote control
- Meets ASHRAE Standard 90.1 requirements
- Backed by a Limited Two-Year Warranty

NOTE: The Dimensions product line also includes the highly advanced D8000 system. Consult your Leviton representative for more information.

DIMENSIONS D3200 SYSTEM



D3200 Multizone Controller/Dimmer

Advanced, multipoint scene control and dimming with 4 to 6 dimming loads and 8 scene buttons. D3208 features join/separate for partitioning and the addition of two auxiliary zones via network power extenders. D3206-ILS shown



D3200 Scene Controller

Four-scene Decora® wall controller with Off switch. Ideal for secondary entranceways and residential applications. NE505 shown



D3200 LCnet SmartJack (with Software)

PC/laptop-to-network jack that enables D3200 Data Manager software. NE100-00C shown



D3200 Infrared Remote Control

Handheld remote control for use with any IR-receiving D3200 controller. NE210 shown

DIMENSIONS D4000 SYSTEM



D4000 Series Multizone Controller

32-zone digital lighting controller and entry station used with dimming cabinets, relay cabinets remote receivers, and accessory stations. D4200-00W shown



D4000 Series Remote Station

Decora-style wall controllers in 15 versions, each with unique range of D4000 functionality. D42PB-00W shown

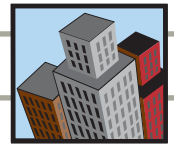

Dimensions D3200 Architectural Lighting Control System

The Dimensions D3200 is a component-based lighting system flexible enough for a wide range of commercial and high-end residential lighting applications. The essential component is the Multizone Controller/Dimmer, a self-contained programmable dimmer and scene controller that will control up to eight zones of lighting. The unit will also function as a control unit for other devices attached to the Leviton Control Network (LCnet). By adding wall mounted scene controllers, a hand-held remote and a SmartJack for PC-based programming, the D3200 offers a comprehensive lighting control solution that can be expanded at any time.

Dimensions D3200 Multizone Controller/Dimmers

DESCRIPTION	CAT. NO.	LOAD RATING	COLOR*
D3204 Multizone Controller/ Dimmer—Self-contained dimmer with learning IR receiver. Controls up to 4 local zones and a maximum of 248 remote zones. Features 8 scene buttons and 32-scene capability. LCD with wizard menus. Supplies 24VDC @ 150mA power to hardwired control devices.	D3204-1LW	120V AC 60Hz: 1920W/VA total output, 1000W/VA max. per zone, 1200W/VA max. per side. For use with Incandescent, Tungsten, Magnetic Low Voltage Transformer, Advance Mark 10™ Powerline Electronic Fluorescent Dimming Ballast, Neon, Cold Cathode and non-dimming loads. Electronic Low Voltage and 0-10V DC Fluorescent Hi-Lume and Eco-10 controlled with optional power extenders.	W
Dimensions D3206 Multizone Controller/Dimmer—Self-contained dimmer with learning IR receiver. Controls up to 6 local zones and a maximum of 186 remote zones. Features 8 scene buttons and 32-scene capability. LCD with wizard menus. Supplies 24VDC @ 150mA power to hardwired control devices.	D3206-1LW	Same as D3204-1LW	W
Dimensions D3208 Multizone Controller/Dimmer—All features of the D3206 plus: Combine/separate functionality for 8 partitioned spaces in up to 256 configurations. Up to 64 scheduled scene changes. Easy access to 2 auxiliary loads from front panel. Controls 62 additional remote zones (248 max).	D3208-1LW	Same as D3204-1LW	W
D3204 Multizone Controller/Dimmer—same as D3204-1L except rated for 230V loads.	D3204-2LW	230V AC 50–60Hz: 2400W/VA total output, 800W/VA max. per zone. For use with Incandescent, Tungsten, Magnetic Low Voltage Transformer, Advance Mark 10™ Powerline Electronic Fluorescent Dimming Ballast, Neon, Cold Cathode and non-dimming loads.	W
D3206 Multizone Controller/Dimmer—same as D3206-1L except rated for 230V loads.	D3206-2LW	Same as D3204-2LW	W
Dimensions D320x Color Change Kits	D32CK	—	II, WW, AA, GG, EE, SW



D3208



***COLOR/CONTROLLERS**

Available with White Frame/White Cover (-1LW) or (-2LW). For other colors, order Cat. No. D32CK Color Change Kit and add suffix as follows: Ivory Frame/Ivory Cover (-II), White Frame/White Cover (-WW), Almond Frame/Almond Cover (-AA), Gray Frame/Gray Cover (-GG), Black Frame/Black Cover (-EE), White Frame/Smoke Cover (-SW).



DIMENSIONS® ARCHITECTURAL LIGHTING CONTROL SYSTEM FEATURES

Commercial Grade Lighting Controls

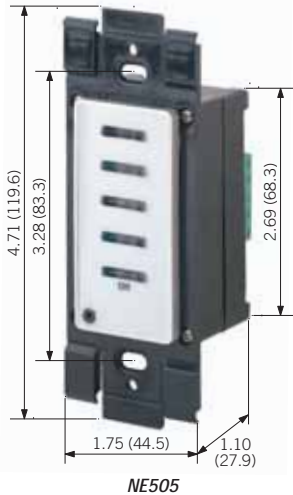

NE505



NE210

Dimensions D3200 Architectural Lighting Control System

Dimensions D3200 System Components

DESCRIPTION	CAT. NO.	LOAD RATING	COLOR*
Scene Controller—Decora-style 5-button wall controller with 4 scene recall buttons plus OFF. Features learning IR receiver.	NE505	Input Voltage: 24VDC Input Current: 24mA	White with Ivory Color option*
NE505 Color Change Kit with Customizable Labels (wallplates sold separately)	DCK05-0C	—	I, W, A, G, E
Decora Partition Controller—with 5 buttons (4 walls and Reset). For use in D3208 system.	NE515	Input Voltage: 24VDC Input Current: 24mA	White with Ivory Color option*
Infrared Remote Control—Handheld remote for use with any IR-receiving D3200 Controller. Provides 8 scene selections, group DIM/BRIGHT, Max and OFF buttons.	NE210	No load rating— for use with any IR-receiving D3200 Controller	Black
Terminator Block—For use with LCnets not terminated with D3200s and with total wire length greater than 10 ft.	NE600	No load rating	White
SmartJack—Decora-style jack enables D3200 Setup Software to be run from PC or laptop. Includes PC cable and Software CD. Essential for any LCnet system where PC interface is desired.†	NE100-00C	No load rating	White with Ivory Color option*
Power Extenders—Extend the power handling capacity of any D3206/D3208 dimming zone or activates auxiliary zones.	See page C7 for complete listing	Models available for incandescent, magnetic-low voltage, electronic low-voltage, Advance Mark 7™ 0-10V or equivalent and 0-10VDC dimmable electronic fluorescent ballasts. See page C8 for ratings.	See page C7

†Software can be downloaded from www.leviton.com/D3200

Dimensions D3200

SPECIFICATIONS AND FEATURES

- D3204 and D3206**
- 41 internally-driven dimming loads (D3206); 4 for D3204
 - Controls up to 186 remote zones via Leviton Control Network (LCnet) bus (D3206); D3204 controls up to 248
 - 6 (D3206) and 4 (D3204) Scene buttons and 32-scene capability
 - 2-line, 32-character LCD with Wizards for easy setup
 - LED Light-level indicators
 - Group raise/lower buttons for changing all zone light levels at same time
 - Learning IR Receiver
 - Powers LCnet controllers and Leviton SmartJack
 - Mounts in 4-gang box with 4-gang device cover
 - UL Listed, CSA Certified
 - California Title 24 compliant and meets ASHRAE Standard 90.1 requirements
 - Backed by a Limited Two-Year Warranty
- D3208 Additional Features**
- Up to 64 scheduled scene changes based on time of day or astronomical clock
 - Combine/Separate functionality for 8 partitions in up to 256 different configurations
 - Controls up to 248 remote zones
 - Easy front panel access to 2 auxiliary LCnet dimming zones or switching loads

APPLICATIONS

- Home Theaters
- Great Rooms
- Ballrooms
- Conference Rooms
- Restaurants
- Executive Offices
- Surgical Suites
- Houses of Worship
- Light Commercial Applications

D3200 System Components

*COLOR/COMPONENTS

Cat Nos. NE505, NE515 and NE100 come in White with matching wallplate. Include snap-on Ivory Color Change Kit. (Ivory wallplate sold separately). With DCK05-0C Color Change Kits add to suffix as follows: Ivory (I), White (W), Almond (A), Gray (G), and Black (E).

TESTING AND CODE COMPLIANCE

- UL Listed, CSA Certified, FCC Part 15 (where applicable)
- Backed by a Limited Two-Year Warranty



Dimensions D4000 Series Architectural Lighting Control System

The Dimensions D4000 Series offers a wide range of entry stations and accessories for a powerful and flexible lighting control solution. Easy to install, configure and operate, D4000 Series products are scalable for every application from stand-alone systems to a complete network environment.

Product Compatibility Chart

D4000 Series Controllers	PRODUCTS BEING CONTROLLED										
	D4200 Entrance Stations	D4200 Partition Stations	iSeries e a-2000 MDS	Z-MAX Network Panels	NPC	D4104/D4106	D4200	D4206	D4006	Closure Input/Output	AV
D4104/D4106	Yes	Yes	—	—	—	—	—	—	—	—	—
D4200	Yes	Yes	Yes	Yes	Yes	—	Yes	Yes	Yes	Yes	Yes
D4206	Yes	Yes	Yes	Yes	Yes	—	Yes	Yes	Yes	Yes	Yes
D8000	—	—	Yes	Yes	Yes	—	—	Yes	Yes	Yes	Yes



D4200



D42P8-00W

SPECIFICATIONS AND FEATURES

- Up to 32 zones/channels of control
- Up to 6 Internal Network Dimmers
- Scene memory 16 + 2
- Fade times for each scene
- Room partition control
- Remote dimmer configuration
- Includes Lockout and Sequencer
- Complete multi-event scheduler
- Integrated astronomical time clock
- Dimmer Rating for Incandescent, Advance Mark 10®, Lutron Tu-Wire® and Magnetic Low Voltage load types:
 - 120V: Max 1,000W per Dimmer; Max 1,920W per unit (continuous); Max 1,200W per side
 - 230V: Max 800W per Dimmer; Max 2,420W per unit (continuous); Max 1,200W per side

D4104/D4106 Stand-Alone Systems

- Compatible with Entry and Room Combine Stations
- Used when integration with other product or rooms is not required.
- 4 or 6 channels and dimmers

D4200 Network Controller

- Full network compatibility
- 32 control channels
- Used to control other dimmers or relays on the Luma-Net network

D4206 Network Controller w/Dimmers

- Full network and device compatibility
- 32 control channels
- Used to control other dimmers or relays on the Luma-Net network
- 6 internal dimmers

D4006 Remote Dimmer

- Full network compatibility
- Controllable by any network controller
- Start channel and Network ID (address) set from front panel
- Full configuration from any connected D4200 or D4206
- 6 internal dimmers

Entrance Stations

- Connect to controller via Luma-Net network
- Used to remotely control scenes and zones on a master station

Command Stations

- Connect to controller via Luma-Net network
- Used to execute commands on a master station

Room Combine Stations

- Connect to controller via Luma-Net network
- Requires 1 Master station in each room, addressed 10 for room 1, 20 for room 2, etc.
- Other room-combine options available, contact your local sales agent for more information

APPLICATIONS

- Ballrooms
- Cafeterias
- Auditoriums
- Lecture Halls
- Conference Rooms
- Hotel Suites
- Restaurants
- Museums
- Houses of Worship

* Mark 10® is a registered trademark of Advance Transformer Company.
Lutron Tu-Wire® is a registered trademark of Lutron Electronics Co., Inc.



DIMENSIONS® ARCHITECTURAL LIGHTING CONTROL SYSTEMS

Commercial Grade Lighting Controls

Dimensions D4000 Series Architectural Lighting Controls

Dimensions D4000 Series Lighting Controller



D42P8-00W

DESCRIPTION	CAT. NO.
120V, 4 Channels/Dimmers, Stand-Alone System	D4104-1LW
230V, 4 Channels/Dimmers, Stand-Alone System	D4104-2LW
120V, 6 Channels/Dimmers, Stand-Alone System	D4106-1LW
230V, 6 Channels/Dimmers, Stand-Alone System	D4106-2LW
Network Controller	D4200-00W
120V, 6 Channels/Dimmers, Network Controller w/Dimmers	D4206-1LW
230V, 6 Channels/Dimmers, Network Controller w/Dimmers	D4206-2LW
120V, 6 Channels/Dimmers, Remote Dimmer	D4006-1LW
230V, 6 Channels/Dimmers, Remote Dimmer	D4006-2LW

Dimensions D4000 Series Wall-Mounted Remote Stations

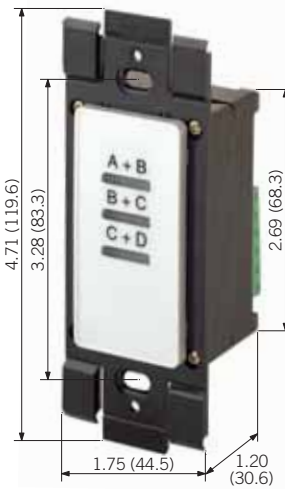

D42CS-03W

One-button Start/Stop Sequencer	D42SQ-00W
One-button Start/Stop Event Timer	D42ET-00W
One-button Join/Separate Link	D42LI-NKW
One-button Lock/Unlock	D42LO-CKW
Two-button: Preset Scene 1 and OFF, built-in IR receiver	D42P1-00W
Two-button: Master Raise and Lower, built-in IR receiver	D42RL-00W
Two-button: Preset Scene Max and OFF, built-in IR receiver	D42MO-00W
Three-button: Preset Scene 1, Max and OFF, built-in IR receiver	D42P1-MOW
Four-button: Max, OFF, Master Raise and Lower, built-in IR receiver	D42MO-RLW
Five-button: Preset Scenes 1-4 and OFF, built-in IR receiver	D42P4-00W
Five-button: Preset Scene 1, Max, OFF, Master Raise and Lower, built-in IR receiver	D42P1-RLW
Eight-button: Preset Scenes 1-4, Max, OFF, Raise and Lower, built-in IR receiver	D42P4-RLW
Eight-button: Preset Scenes 9-16	D42P9-16W
Ten-button: Preset Scenes 1-8, Max and OFF, built-in IR receiver	D42P8-00W
Ten-button: Preset Scenes 9-16, Raise and Lower, built-in receiver	D42P9-RLW

Dimensions D4000 Series Room-Combine Stations

One-button: Combines 2 rooms with 1 partition	D42CS-01W
Three-button: Combines 3 rooms with 3 partitions	D42CS-3AW
Four-button: Combines 4 rooms with 4 partitions	D42CS-04W
Two-button: Combines 3 rooms with 2 partitions	D42CS-02W
Three-button: Combines 4 rooms with 3 partitions	D42CS-03W

Dimensions D4000 Series IR Handheld Controls†

Four Preset Scenes	D42IR-04L
Eight Preset Scenes	D42IR-08L
Sixteen Preset Scenes	D42IR-16L

†Remote IR Ceiling-Mount Receivers available in single-gang and 2-gang models. Consult your Leviton representative for more information.

See page C5 For Dimensions D4000 Series Specifications and Features



D42IR-16L

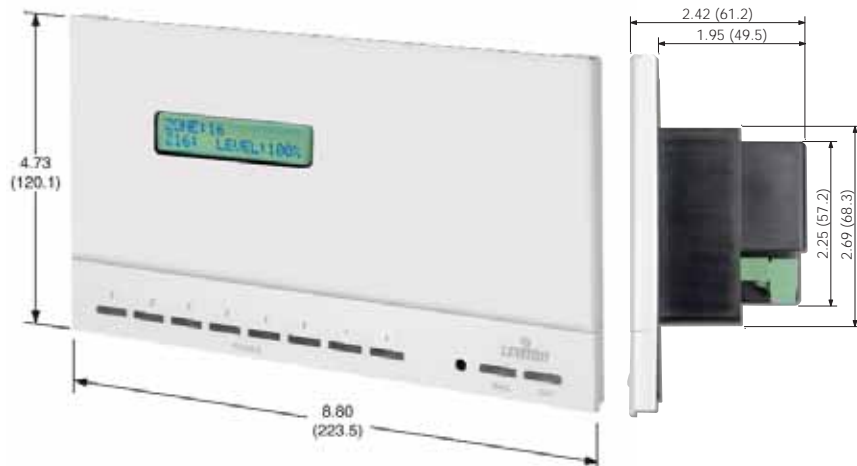

To learn more about Leviton's outstanding offering of devices visit our Website at: www.leviton.com

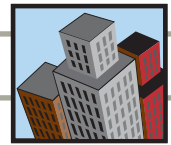

Standard Power Extenders

Power Extenders—PE100, PE200, PE300, PE400

DESCRIPTION	CAT. NO.	RATING
Extends dimming zone capacity to full 1920W/VA @ 120V for incandescent, magnetic low-voltage, halogen or neon/cold cathode lighting. Aluminum heat sink with snap-on white cover	PE100-10W	Input Voltage: 120V 50/60Hz Load Rating: 1920W/VA Load Output Power: phase independent of control device Dimmer Input: 120V 50/60Hz
Extends dimming zone capacity to full 1920VA @ 120V for Mark 10™ Powerline, Hi-Lume®, or equivalent dimmable fluorescent ballast. Aluminum heat sink with snap-on white cover	PE200-10W	Input Voltage: 120V 50/60Hz Load Rating: 1920VA Load Output Power: phase independent of control device Dimmer Input: 120V 50/60Hz
Extends dimming zone capacity to full 3000VA @ 277V for Mark 10™ Powerline, Hi-Lume®, or equivalent dimmable fluorescent ballast. Aluminum heat sink with snap-on white cover	PE200-70W	Input Voltage: 277V 50/60Hz Load Rating: 3000VA Load Output Power: phase independent of control device Dimmer Input: 120V 50/60Hz
Extends dimming zone capacity to full control of a 20A circuit with 0–10 V DC Mark 7® 0–10V, Lutron 0–10V, OSRAM Sylvania Quicktronic® Helios™ or equivalent ballast. Metallic silver color.	PE300-D0W	Input Voltage: 120V AC to 277V AC, 60Hz Load Rating: 20A–2400VA @ 120V AC, 5500VA @ 277V AC Power Consumption: 6W @ 120V AC, 18W @ 277V AC Output Ballast Control: 0–10V DC Dimmer Input: 120V 60Hz
Extends dimming zone capacity to full control of a 1000W/VA @ 120V AC for electronic low voltage or incandescent lighting. Aluminum heat sink with snap-on white cover	PE400-10W	Input Voltage: 120V AC 50/60Hz Load Rating: 1000W/VA Load Output Power: phase independent of control device Dimmer Input: 120V 60Hz

Mark 10™ and Mark 7™ are trademarks of Advance Transformer Company.
Hi-Lume® is a registered trademark of Lutron Electronics Co., Inc.

Auxiliary-Zone Network Power Extenders (for D3200 Systems only)

DESCRIPTION	CAT. NO.	RATING
Enables 2 auxiliary zones on a D3200 Controller/Dimmer for full control over incandescent, magnetic low-voltage, or neon/cold cathode lighting. Aluminum heat sink with snap-on white cover	PEAUX-12W	Input Voltage: 120V AC 50/60Hz Load Rating: 1920W/VA total, or 1000W/VA max. per zone Load Output Power: phase independent of control device Dimmer Input: D3200
Enables 1 auxiliary zone on a D3200 Controller/Dimmer for full control over incandescent, magnetic low-voltage, or neon/cold cathode lighting Aluminum heat sink with snap-on white cover	PEAUX-AUW	Input Voltage: 230V AC 50/60Hz Load Rating: 2400 W/VA total Load Output Power: phase independent of control device Dimmer Input: D3200
Enables 1 auxiliary zone on a D3200 Controller/Dimmer for full control over Mark 7™ 0–10V, OSRAM Sylvania Quicktronic Helios, Lutron 0–10V, or equivalent ballasts. Aluminum heat sink with snap-on white cover	PEAU7-M1W	Input Voltage: 120–230V 50–60Hz Output Ballast Control: 0–10V DC Load Rating: 20A–120V & 10A–230V Load Output Power: phase independent of control device Dimmer Input: D3200

Power Extender Compatibility

Standard Power Extenders work with any Dimensions Multizone Controller/Dimmer and all Architectural Systems. Refer to the chart below for compatibility with Leviton Box-Mounted Dimmers.

POWER EXTENDER	BOX-MOUNTING DIMMER COMPATIBILITY
PE100-10W	Must use 120V 600W Incandescent version of Acenti, IllumaTech, Mural, True Touch, ToggleTouch, Sure Slide and Home Controls. (or 600VA version of Acenti). For Monet, use 120V 600VA Magnetic Low-Voltage version (requires Neutral wire). For dimmers that include a Neutral wire, the dimmer Neutral wire must be connected.
PE200-10W PE200-70W	Must use 120V 600VA Mark 10 version Acenti, of Monet, IllumaTech, and Mural. For dimmers that include a Neutral wire, the dimmer Neutral wire must be connected. For Hi-Lume ballasts, use incandescent dimmers. PE200-70W is compatible with all 600VA-220V box-mounted dimmers.
PE300-D0W	Must use 120V 600W Incandescent version of Acenti, IllumaTech, Mural, True Touch, ToggleTouch, Sure Slide and Home Controls. For Monet, use 120V 600VA Magnetic Low-Voltage version (requires Neutral wire). For dimmers that include a Neutral wire, the dimmer Neutral wire must be connected.
PE400-D0W	Must use 120V 600W Incandescent version of Acenti, IllumaTech, Mural, True Touch, Trimatron and Sure Slide Home Controls. For Monet, use 120V 600VA Magnetic Low-Voltage version (requires Neutral wire). For dimmers that include a Neutral wire, the dimmer Neutral wire must be connected.

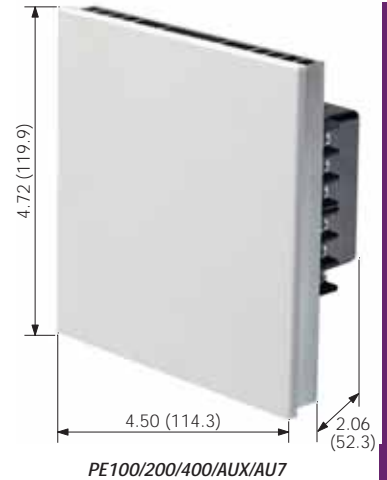

PE100/200/400/AUX/AU7

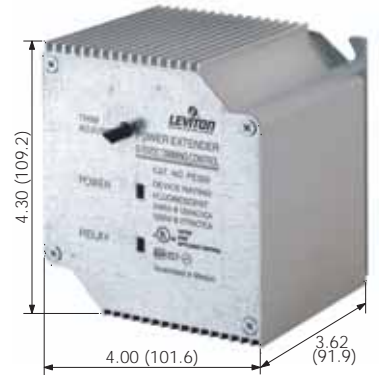

PE300-D0W

SPECIFICATIONS AND FEATURES

Standard Power Extenders

- Emulates characteristics of dimmer it is connected to in terms of dimming range and resolution
- Low-end trim available for setting minimum brightness level (PE100, PE200, PE300)
- PE100, PE200 and PE400 can be surface or flush mounted using 1900 Box and 2-gang raised cover
- PE300 mounts in 4" square box

APPLICATIONS

Standard Power Extenders

- Works with any D3200 Multizone Controller/Dimmer to extend load capacity of any zone
- Extends load capacity of box-mounted dimmers (see compatibility chart)
- Works with all families of Leviton Architectural Systems

Network Power Extenders

- Enables a D3200 Multizone Controller/Dimmer to accommodate extra loads
- Works with any D3200 Multizone Controller/Dimmer to extend load capacity of any zone

TESTING AND CODE COMPLIANCE

- UL Listed (except PEAUX-AUW), CSA Certified and NOM Certified
- Backed by a Limited Two-Year Warranty



ARCHITECTURAL DIMMING CABINETS

Commercial Grade Lighting Controls

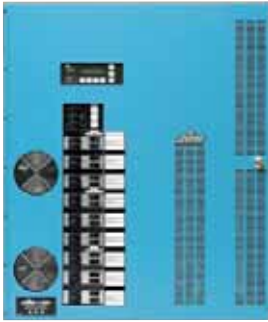

a-2000-24

a-2000® Modular Dimming Cabinets

The a-2000® is a compact, high-performance dimming cabinet that combines theatrical grade performance with the ability to control a wide variety of architectural load types. Its modular design enables rapid servicing of both dimming modules and control electronics. The a-2000 digital module cabinets are easy to install and work with virtually all types of lighting, including 120 and 277VAC dimming fluorescent lamps. This state-of-the-art cabinet integrates seamlessly with preset or manual controls, building automation, daylight harvesting and time clock systems. The a-2000 is a highly versatile dimming platform supporting a broad array of control requirements.

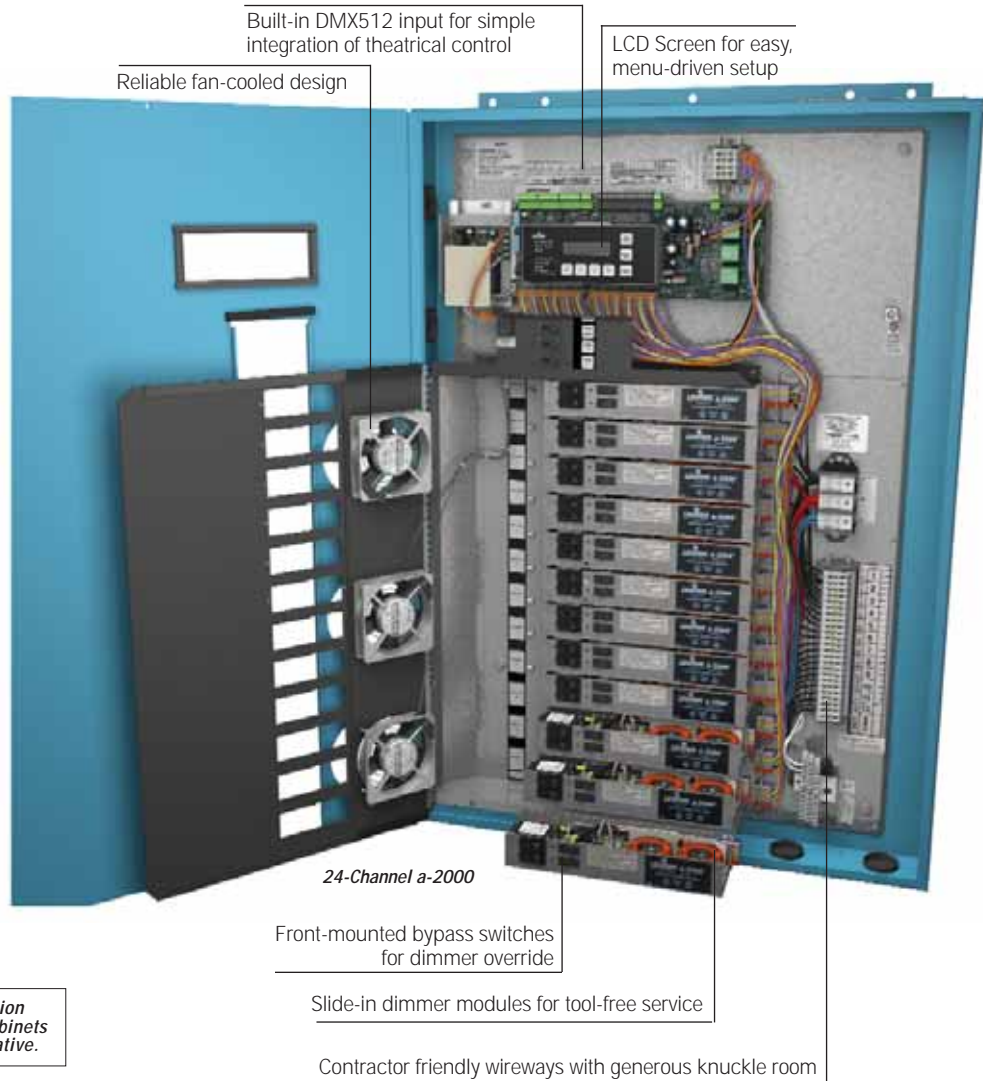

Built-in DMX512 input for simple integration of theatrical control

LCD Screen for easy, menu-driven setup

Reliable fan-cooled design

24-Channel a-2000

Front-mounted bypass switches for dimmer override

Slide-in dimmer modules for tool-free service

Contractor friendly wireways with generous knuckle room

For complete ordering information on Leviton a-2000 Dimming Cabinets consult your Leviton representative.

SPECIFICATIONS AND FEATURES

- Fully programmable from front panel
- Plug-in dimmer modules for easy maintenance
- Communication inputs: DMX512, Luma-Net III, RS485, full bright, emergency, and +0-10VDC analog
- Capacity of up to 48 dimmer circuits
- Each dimmer channel rated to 20A continuous (20A modules only)
- All load types supported
- Rugged dual-SCR dimmer circuitry for superior dimming performance and reliability over triac dimmers
- Individual bypass per-dimmer provides work-light function

- Restoration feature restores the last lighting look in the event of power failures
- Lifetime non-volatile memory
- Super-quiet, redundant ball-bearing fan design for added reliability
- Contractor-friendly design for easy installation with a large wiring space
- Compact 30-3/8 inch cabinet width holds up to 24 dimmer CCTS and fits between two stud widths
- Surface or recessed mounting
- Top, bottom or side feed

APPLICATIONS

- Office spaces
- Daylight harvesting
- Cafeterias
- Ballrooms
- Auditoriums
- Houses of worship
- Lecture halls
- Conference rooms
- Restaurants
- Multi-purpose rooms
- Office spaces
- Spaces requiring a single dimming source for a broad range of loads

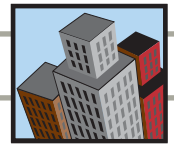

a-2000® Dimmer Modules

The a-2000 uses a modular dimmer, allowing for ease of replacement and custom tailoring of module type to each project's specific needs. Leviton's a-2000 dimmer modules employ proven dual SCR dimming technology, inherited from Leviton's line of theatrical equipment.

SUPPORTED LOAD TYPE	UNIVERSAL	240V	STANDARD
Incandescent	X	X	X
Tungsten	X	X	X
Neon	X	X	X
Cold-Cathode	X	X	X
Magnetic Low Voltage	X	X	X
Electronic Low Voltage*	X	X	X
Fluorescent Dimming Ballasts	X	X	X
0-10V Fluorescent Ballast Example†: Advance Mark 7®	X	X	X
2-Wire Fluorescent Ballast Example†: Advance Mark 10®	X	—	X
3-Wire Fluorescent Ballast Examples†: Lutron Hi-lume® & Eco-10™	X**	—	—

* Electronic Low Voltage transformers are supported upon the manufacturer's approval for use with forward phase dimmers. When the use of Electronic Low Voltage is required that does not meet this requirement, Leviton's PE400 power extender may be used. Contact your local Leviton LMS representative for more information.

** Supports all standard load types as well as 2 circuits of Hi-lume and other 3-wire fluorescent dimming ballasts.

† Mark 7® and 10® are registered trademarks of Advance Transformer Company. Eco-10™ is a trademark and Hi-lume® is a registered trademark of Lutron Electronics Co., Inc

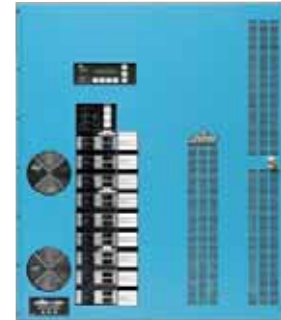

a-2000-24 with Relay Cabinet

SPECIFICATIONS AND FEATURES

- 20A continuous duty rating (120V modules only)
- Voltage regulation: compensates for incoming line voltage variations
- 97% efficiency
- 350 μS rise time standard
- Ratings are for continuous use at 100% load

Universal Modules:

- Bypass switch has two modes: Normal and Bypass. When the switch is set to Bypass (red LED illuminated), the SCRs and relays are forced to turn on independent of the control module

- 277V Universal modules may be used in 120V cabinets.
- 120V Universal modules may be used only in 120V cabinets.

240V Modules:

- Built-in bypass switches (240V): Bypasses control electronics permitting the cabinet to be used for work lights during construction.

Standard Modules:

- Built-in bypass switches (120V) or shunts (277V): Bypasses control electronics, permitting the cabinet to be used for work lights during construction.



ARCHITECTURAL SPECIFICATIONS LIGHTING CONTROLS FEATURES

Commercial Grade Lighting Controls

Architectural Specification Lighting Controls

Inspired by the great painters, Leviton's Monet®, Renoir® and Van Gogh® dimmers and fan speed controls accent today's most beautiful interiors. Leviton's premier line of architectural lighting controls can accommodate high wattage loads and mate with screwless narrow- and wide-fin wallplates—for the ultimate flexibility in design.

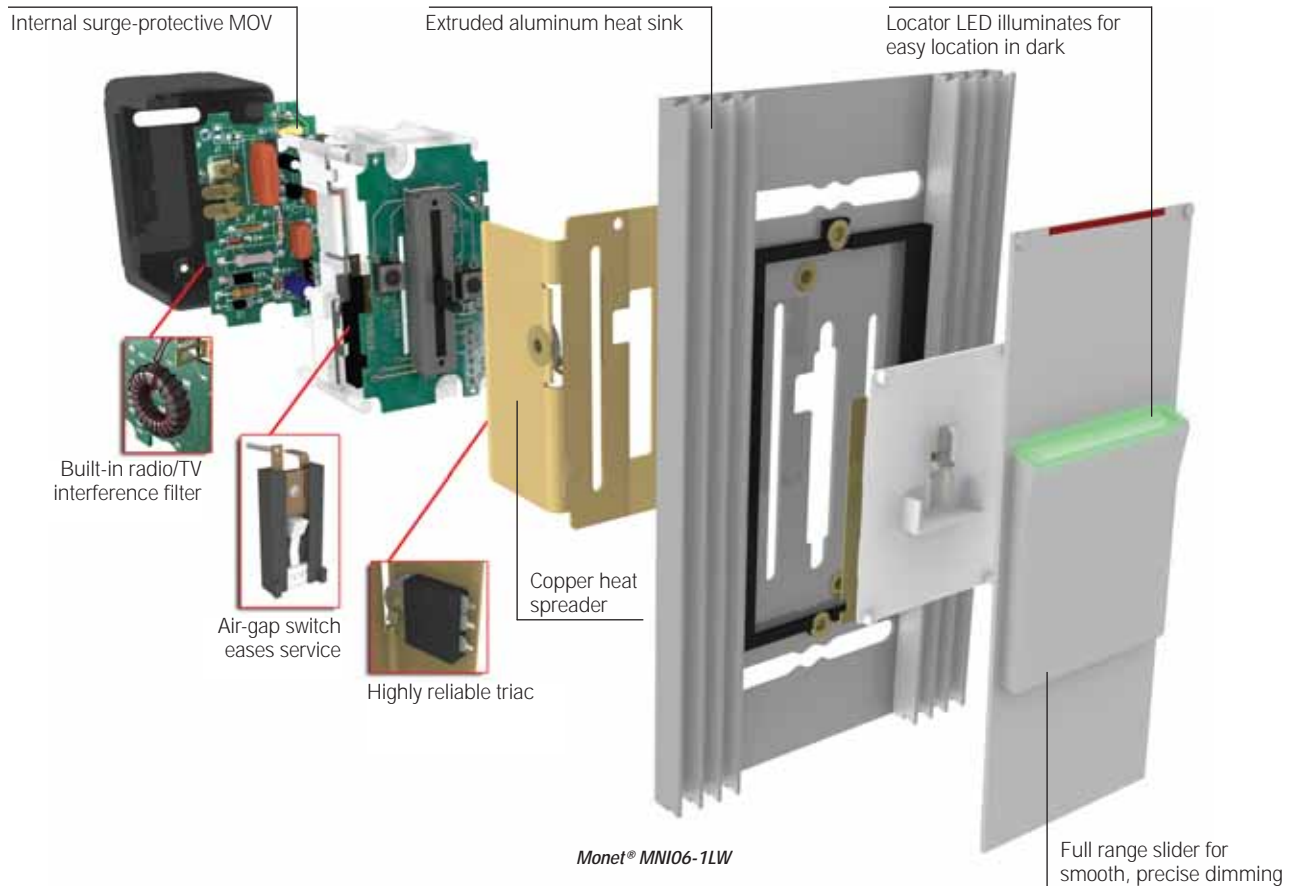

Features and Benefits

- Full-range dimming for both single-pole and multi-location control
- Accommodates high-power loads
- Low profile, designer styling; mates with narrow- and wide-fin screwless wallplates
- Wide range of colors available through convenient color change kits
- UL and CSA Listed
- Backed by a Limited Five-Year Warranty

ARCHITECTURAL SPECIFICATION DIMMING AND FAN SPEED CONTROLS



Monet® Slide Dimmer
Low-profile architectural controls with advanced features. With narrow or wide fin. Matte finish. Custom-engraved wallplates available. *MNI06-1LW shown*



Renoir® Slide Dimmer
Rugged, full-range preset slide dimmer for high-power loads. With narrow or wide fin. *81000-W shown*



Van Gogh® Rotary Dimmer
Architectural yet classic full-range rotary dimmer for high-power incandescent loads. Rugged design. *60800-W shown*

Architectural Specifications Lighting Controls



To learn more about Leviton's outstanding offering of devices visit our Website at: www.leviton.com

Courtesy of Steven Engineering, Inc. • 230 Ryan Way, South San Francisco, CA 94080-6370 • General Inquiries: (800) 670-4183 • www.stevenengineering.com

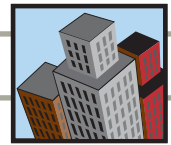

Monet Architectural Specification Grade Preset Controls
120V and 277V AC 60Hz

Low-profile Architectural Decora Digital Preset Slide Dimmers with LED locator light. Most Monet dimmers provide single-pole (1 location) and 3-way (multi-location) control with Switching Remote.

Incandescent 120V AC

DESCRIPTION	CAT. NO.	RATING	COLOR CHANGE KIT
Monet Dimmer (narrow fin)	MNIO6-1LW	600W	I, W, A, G, E, B
Monet Dimmer (narrow fin)	MNI10-1LW	1000W	I, W, A, G, E, B
Monet Dimmer (wide fin)	MNI15-1LW	1500W	I, W, A, G, E, B
Monet Incandescent Dimmer, Single-Pole, Unlighted (narrow fin)	MNIO6-10W	600W	I, W, A, G, E
Monet Incandescent Dimmer, Single-Pole, Unlighted (narrow fin)	MNI10-10W	1000W	I, W, A, G, E

Low-Voltage 120V AC

DESCRIPTION	CAT. NO.	RATING	COLOR CHANGE KIT
Monet Dimmer (narrow fin) Electronic	MNEO4-1LW	400VA (320W)	I, W, A, G, E, B
Monet Dimmer (narrow fin) Magnetic	MNMO6-1LW	600VA (450W)	I, W, A, G, E, B
Monet Dimmer (narrow fin) Magnetic	MNM10-1LW	1000VA (800W)	I, W, A, G, E, B
Monet Dimmer (wide fin) Magnetic	MNM15-1LW	1500VA (1200W)	I, W, A, G, E, B

Mark 10™ Fluorescent Ballast 120 and 277V AC

For Advance Mark 10™ Powerline fluorescent dimming ballasts.

DESCRIPTION	CAT. NO.	RATING	COLOR CHANGE KIT
Monet Mark 10 Fluorescent Dimmer (narrow fin)	MXN10-1LW	1000VA 120V AC	I, W, A, G, E, B
Monet Mark 10 Fluorescent Dimmer (wide fin)	MXN15-1LW	1500VA 120V AC	I, W, A, G, E, B
Monet Mark 10 277V Fluorescent Dimmer (narrow fin)	MXN20-7LW	2000VA 277V AC	I, W, A, G, E, B
Monet Mark 10 277V Fluorescent Dimmer (wide fin)	MXN30-7LW	3000VA 277V AC	I, W, A, G, E, B

Fan Speed Controls 120V AC

DESCRIPTION	CAT. NO.	RATING	COLOR CHANGE KIT
Monet Fan Speed Control (narrow fin)	MNF07-1LW	7.5A 120V AC	I, W, A, G, E, B
Monet Fan Speed Control (wide fin)	MNF10-1LW	10A 120V AC	I, W, A, G, E, B

Monet Accessory Products

DESCRIPTION	CAT. NO.	RATING	COLOR CHANGE KIT
Monet Remote Non-Dimming Switching Unit for 3-Way Applications (Unlighted)	MNOOR-DOW	No load rating, use with 120V & 277V Monet dimmers only	I, W, G, E, A
Color Change Kits for MNOOR-DOW Monet 3-Way Switching Unit	MNKOR-00	—	I, W, G, E, A
Color Change Kit for Narrow Fin Monet Lighted Controls	MNKIT-SL	—	I, W, A, G, E, B
Color Change Kit for Wide Fin Monet Lighted Controls	MNKIT-1L	—	I, W, A, G, E, B
Color Change Kit for Monet Unlighted Dimmers	MNKIT-SO	—	I, W, A, G, E
Monet Adapter Plate: Allows any Decora strap-mount device to be ganged with either small or large-size Monet controls. In multi-gang installations, must use on ends	MNOLA-000 (large) MNOSA-000 (small)	—	Metal Heat Sink

Note: Mark 10® is a trademark of the Advance Transformer Company.

NOTE: Multi-gang wallplates are available for combining narrow and wide dimmers, with or without fins removed. Refer to page C13.

Note: Sharing a neutral wire may cause flickering. Connect all dimmers to the same phase or run a separate neutral to each phase. Consult Leviton Techline if problems persist.
 Digital Lighting and Fan Speed Controls are polarity sensitive devices. Always follow the wiring instructions included with each device. They can be used in conventional 3-way and 4-way wiring circuits only when the Control is properly connected to the load as indicated by the device's wiring instructions.

See page C12 for Monet Specifications and Features

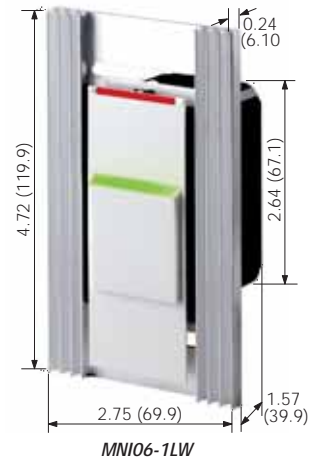

MNIO6-1LW

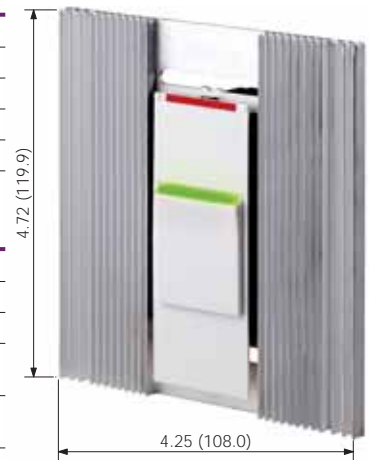

MNI15-1LW

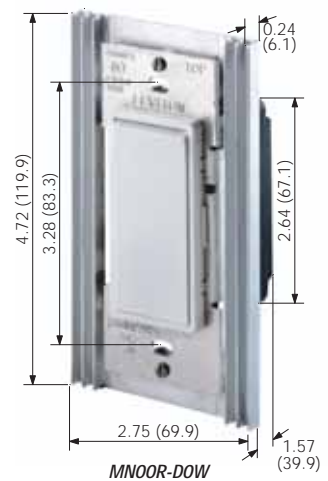

MNOOR-DOW

Monet Architectural Fin Width
 Narrow: 2.75" (69.9 mm)
 Wide: 4.25" (108.0 mm)

CAUTION ON RETROFITS: When retrofitting Mark 10® Powerline dimming ballasts into fixtures that originally had Instant Start ballasts, the sockets MUST be replaced with Rapid Start sockets to allow proper dimmer operation and prevent damage to the dimming ballast. Refer to the instructions provided with the ballast and the Leviton dimmer.



MNS20-1LW

Monet Architectural Specification Grade Controls

Monet Switches

DESCRIPTION	CAT. NO.	RATING	COLOR*
Monet Single-Pole Rocker Switch with Screw Terminals, Lighted (narrow fin)	MNS20-1L	20A 120V AC	I, W, A, G, E
Monet 3-Way Rocker Switch with Screw Terminals, Unlighted (narrow fin)	MNS20-D3	20A 120/277V AC	I, W, A, G, E
Monet 4-Way Rocker Switch with Screw Terminals, Unlighted (narrow fin)	MNS20-D4	20A 120/277V AC	I, W, A, G, E

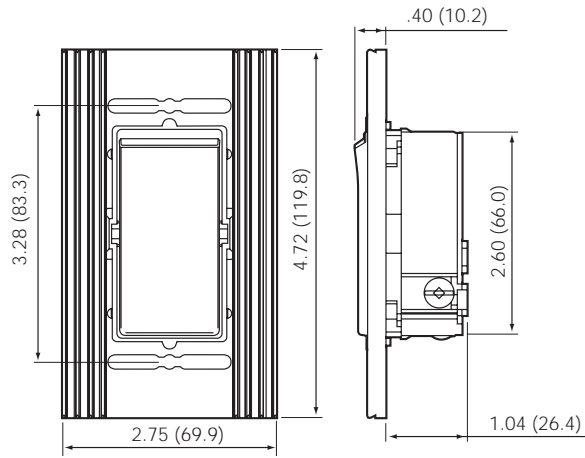

MNS20 shown

SPECIFICATIONS AND FEATURES

- Premier Architectural Specification Grade dimmer combines high load capability, esthetic appearance, digital circuitry and Scene Lighting capabilities
- Provides single-pole and 3-way switching with Monet Non-Dimming Remote Unit
- Low-profile architectural fins, even on wide-fin models, for a flush fit appearance
- Smooth slide-dimming operation. Push slider for ON/OFF preset
- Digital circuit provides Soft-ON/Fade-OFF for eye-pleasing effect and prolonged bulb life
- Specially designed to minimize shadows with non-reflective, easy-to-clean matte finish. Ideal for museums, art galleries, showrooms
- Soft, green locator LED discretely positioned on slider
- Square Law Dimming ensures linear slide control across entire dim and bright output range
- Hidden air-gap switch; slider moves into hidden key-way to access air-gap switch for servicing needs. When air gap switch is open, red line appears at top
- Small and large size adapter plates fit all Leviton Decora straps to make them compatible with Monet wallplates

- Screwless, designer Monet wallplates with matte finish included. Multi-gang wallplates also available for combining narrow and wide dimmers, with or without fins removed (see page C13)
- Customized wallplate engravings available—See your Leviton representative for more information
- Built-in radio/TV interference filter
- Protected memory during temporary power failures
- Internal MOV for surge protection

TESTING AND CODE COMPLIANCE

- UL Listed (File #E-31373)
- CSA Certified (File #LR-3413)
- Backed by a Limited Two-Year Warranty

*COLOR

Cat. No. denotes White device. For other colors, order Color Change Kits and add suffix as follows: Ivory (-I), White (-W), Gray (-G), Black (-E), Brown (-B) and Almond (-A). Monet Rocker Switches listed above do not use Color Change Kits—Add suffix to basic Cat. No. for color selection.

MATERIAL CHARACTERISTICS

Environmental: Flammability UL-94, V2 Rating
Operating Temperature: 32°F to 130°F

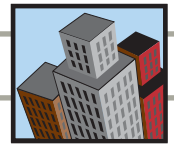

Monet Multi-Gang Wallplates

TABLE 1 — FOR INSTALLATIONS WITH NO FINNS BROKEN OFF

Wallplate Cat. No.	Number of Narrow Fin/Wide Fin Controls	Wallbox Requirements
MNW10-00	1 Narrow	1-Gang
MNW20-00	2 Narrow	3-Gang
MNW30-00	3 Narrow	5-Gang
MNW40-00	4 Narrow	6-Gang
MNW50-00	5 Narrow	9-Gang
MNW60-00	6 Narrow	10-Gang
MNW01-00	1 Wide	1-Gang
MNW02-00	2 Wide	4-Gang
MNW03-00	3 Wide	7-Gang
MNW04-00	4 Wide	9-Gang
MNW11-00	1 Narrow/1 Wide	4-Gang
MNW21-00	2 Narrow/1 Wide	5-Gang
MNW31-00	3 Narrow/1 Wide	7-Gang
MNW41-00	4 Narrow/1 Wide	8-Gang
MNW51-00	5 Narrow/1 Wide	10-Gang
MNW12-00	1 Narrow/2 Wide	6-Gang
MNW22-00	2 Narrow/2 Wide	8-Gang
MNW32-00	3 Narrow/2 Wide	9-Gang
MNW13-00	1 Narrow/3 Wide	9-Gang
MNW23-00	2 Narrow/3 Wide	10-Gang

TABLE 2 — FOR INSTALLATIONS WITH FINNS BROKEN OFF

Wallplate Cat. No.	Number of Narrow Fin/Wide Fin Controls	Wallbox Requirements
MNW20-FB	2 Narrow	2-Gang
MNW30-FB	3 Narrow	3-Gang
MNW40-FB	4 Narrow	4-Gang
MNW50-FB	5 Narrow	5-Gang
MNW60-FB	6 Narrow	6-Gang
MNW70-FB	7 Narrow	7-Gang
MNW80-FB	8 Narrow	8-Gang
MNW90-FB	9 Narrow	9-Gang
MNW02-FB	2 Wide	3-Gang
MNW03-FB	3 Wide	5-Gang
MNW04-FB	4 Wide	7-Gang
MNW05-FB	5 Wide	9-Gang
MNW11-FB	1 Narrow/1 Wide	3-Gang
MNW21-FB	2 Narrow/1 Wide	4-Gang
MNW31-FB	3 Narrow/1 Wide	5-Gang
MNW41-FB	4 Narrow/1 Wide	6-Gang
MNW51-FB	5 Narrow/1 Wide	7-Gang
MNW61-FB	6 Narrow/1 Wide	8-Gang
MNW71-FB	7 Narrow/1 Wide	9-Gang
MNW81-FB	8 Narrow/1 Wide	10-Gang
MNW12-FB	1 Narrow/2 Wide	5-Gang
MNW22-FB	2 Narrow/2 Wide	6-Gang
MNW32-FB	3 Narrow/2 Wide	7-Gang
MNW42-FB	4 Narrow/2 Wide	8-Gang
MNW52-FB	5 Narrow/2 Wide	9-Gang
MNW62-FB	6 Narrow/2 Wide	10-Gang
MNW13-FB	1 Narrow/3 Wide	7-Gang
MNW23-FB	2 Narrow/3 Wide	8-Gang
MNW33-FB	3 Narrow/3 Wide	9-Gang
MNW43-FB	4 Narrow/3 Wide	10-Gang
MNW14-FB	1 Narrow/4 Wide	9-Gang
MNW24-FB	2 Narrow/4 Wide	10-Gang

Monet multi-gang wallplates are available for every permissible combination of small fin and large fin dimmers. Tables 1 and 2 can be used to determine if a specific combination of devices is possible. When small and large fin devices are combined, all the large fin devices must be placed to one side and all the small fin devices must be placed to the other side. In an installation where all the fins are broken off, do not remove the fins from the dimmers at each of the extreme ends of the installation.

MONET MULTI-GANG WALLPLATE CATALOG NUMBER SYSTEM

Example: **MNW31-00W**

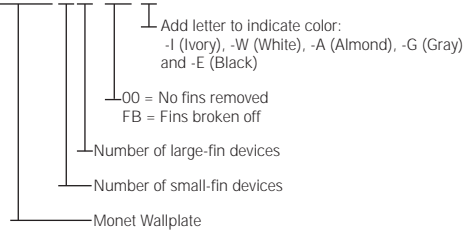

Maximum Load per Monet Dimmer Multi-Gang with Fins Broken Off

Cat. No.	Single	2-Gang	More Than 2-Gang
MNE04	400VA (320W)	300VA (240W)	250VA (200W)
MNF07	7.5A	6A	5.3A
MNF10	10A	8A	7A
MNI06	600W	500W	400W
MNI10	1000W	800W	700W
MNI15	1500W	1250W	1000W
MNM06	600VA (450W)	500VA (375W)	400VA (300W)
MNM10	1000VA (800W)	800VA (640W)	700VA (560W)
MNM15	1500VA (1200W)	1250VA (1000W)	1000VA (800W)
MNX10	1000VA (980W)	800VA (784W)	700VA (686W)
MNX15	1500VA (1470W)	1250VA (1225W)	1000VA (980W)
MNX20-7	2000VA (1960W)	1600VA (1568W)	1400VA (1372W)
MNX30-7	3000VA (2940W)	2500VA (2450W)	2000VA (1960W)

Note: For more information on Fin Removal, refer to the instruction sheet provided with each Monet device.

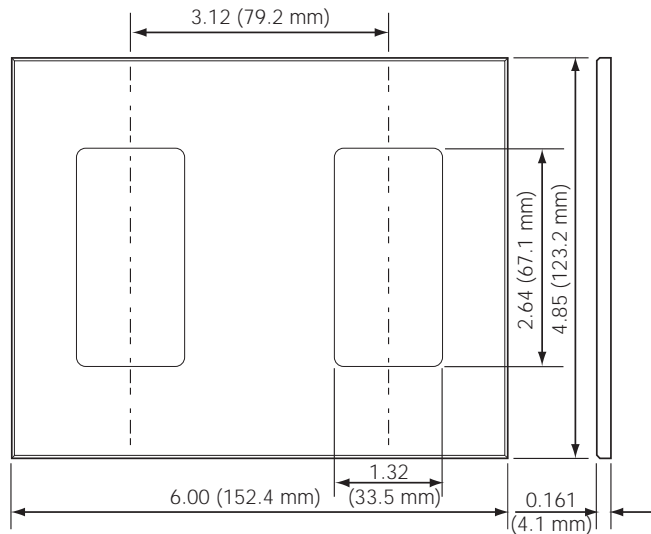

MNW20-00



Commercial Grade Lighting Controls

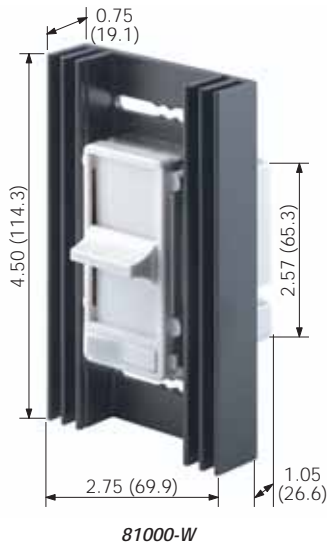

81000-W



82000-W

Renoir Architectural Fin Width
Narrow: 2.75" (69.9 mm)
Wide: 4.50" (108.0 mm)

CAUTION ON RETROFITS: When retrofitting Mark 10® Powerline dimming ballasts into fixtures that originally had Instant Start ballasts, the sockets MUST be replaced with Rapid Start sockets to allow proper dimmer operation and prevent damage to the dimming ballast. Refer to the instructions provided with the ballast and the Leviton dimmer.

Renoir Architectural Specification Preset Slide Dimmers

Renoir Incandescent 120V AC 60Hz Only

DESCRIPTION	CAT. NO.	RATING	COLOR*
Renoir Single-Pole (narrow fin)	80800	800W	I, W, GY, B
Renoir 3-Way (narrow fin)	80800-3	800W	I, W, GY, B
Renoir Single-Pole (narrow fin)	81000	1000W	I, W, A, GY, B
Renoir Single-Pole, Illuminated (narrow fin)	81000-L	1000W	I, W
Renoir 3-Way (narrow fin)	81000-3	1000W	I, W, A, GY, B
Renoir 3-Way, Illuminated (narrow fin)	81000-L3	1000W	I, W
Renoir Single-Pole (wide fin)	81500	1500W	I, W, A, GY, B
Renoir 3-Way (wide fin)	81500-3	1500W	I, W, A, GY, B
Renoir Single-Pole (wide fin)	82000	2000W	I, W, A, GY, B
Renoir Single-Pole, Illuminated (wide fin)	82000-L	2000W	I, W
Renoir 3-Way (wide fin)	82000-3	2000W	I, W, A, GY
Renoir 3-Way, Illuminated (wide fin)	82000-L3	2000W	I, W

Renoir Magnetic Low-Voltage 120V AC 60Hz Only

DESCRIPTION	CAT. NO.	RATING	COLOR*
Renoir Single Pole (narrow fin)	71111	1000VA (800W)	I, W, GY, B
Renoir 3-Way (narrow fin)	71113	1000VA (800W)	I, W, B
Renoir Single Pole (wide fin)	71511	1500VA (1200W)	I, W
Renoir 3-Way (wide fin)	71513	1500VA (1200W)	I

Renoir Fluorescent Dimming Ballasts 120V and 277V AC 60Hz Only

DESCRIPTION	CAT. NO.	RATING	COLOR*
Renoir Fluorescent Dimmer, Single-Pole and 3-Way (wide-fin)	26666-31	1200VA (900W) 120V AC Advance Mark 10™ Powerline fluorescent dimming ballast	White
Renoir Fluorescent Dimmer, Single-Pole and 3-Way (wide-fin)	26666-37	1200VA (900W) 277V AC Advance Mark 10™ Powerline fluorescent dimming ballast	White

Note: For complete information on installation, ganging and derating of High Wattage Dimmers, consult Leviton's Lighting Controls Product Selection Guide or the Dimmer Instruction Sheet provided with the device.

When ganging these units, no derating is necessary except on those units which have had both sets of snap-off, fins removed. These shall be derated as follows:

Maximum Load per Renoir Dimmer Multi-Gang with Fins Broken Off			
Cat. No.	Single	2-Gang	More Than 2-Gang
26666-31	1200VA	1100VA	1050VA
26666-37	1200VA	1200VA	1200VA
71111/3	1000VA (800W)	800VA (800W)	700VA (640W)
71511/3	1500VA (1200W)	1300VA (1200W)	1100VA (1040W)
80800	800W	700W	600W
81000	1000W	800W	700W
81500	1500W	1300W	1000W
82000	2000W	1800W	1500W

NOTE: For fin removal and switchbox requirements for ganging Leviton Renoir dimmers, refer to page C17.

Note: Sharing a neutral wire may cause flickering. Connect all dimmers to the same phase or run a separate neutral to each phase. Consult Leviton Techline if problems persist.

SPECIFICATIONS AND FEATURES

- ON/OFF rocker switch turns lights ON at last selected brightness level
- Smooth-action, linear slide control for easy, precise operation
- Available in single-pole (one location) and 3-way (multi-location) versions. 3-way dimmer is used with standard 3-way ON/OFF switch
- Decora-styling coordinates with Leviton's extensive line of Decora devices
- Decora-style screwless snap-on wallplates present an attractive appearance in any application
- Slim, compact housing easily fits in standard wall boxes
- Fins are easily removed for multi-gang applications
- Large radio/TV interference filter
- Illuminated versions available

TESTING AND CODE COMPLIANCE

- UL Listed (File #E-31373)
- CSA Certified (File #LR-3413)
- Backed by a Limited Five-Year Warranty

***COLOR**

Add suffix to catalog numbers as follows for color selection: Ivory (-I) White (-W), Almond (A), Gray (-GY), Brown (-B)

MATERIAL CHARACTERISTICS

Environmental: Flammability UL-94, V2 Rating
Operating Temperature: 32°F to 130°F

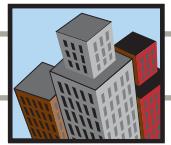

Renoir Architectural Specification Preset Slide Fan Speed Controls

Renoir Fan Speed Controls 120V AC 60Hz Only

DESCRIPTION	CAT. NO.	RATING	COLOR*
Renoir Single-Pole (narrow-fin)	80827	7.5 Amps	I, W
Renoir Single-Pole (wide-fin)	81127	10 Amps	I, W
Renoir Single-Pole (wide-fin)	81527	15 Amps	I, W

NOTE: For fin removal and switchbox requirements for ganging Leviton Renoir fan speed controls, refer to page C17.

Note: Sharing a neutral wire may cause flickering. Connect all dimmers to the same phase or run a separate neutral to each phase. Consult Leviton Techline if problems persist.

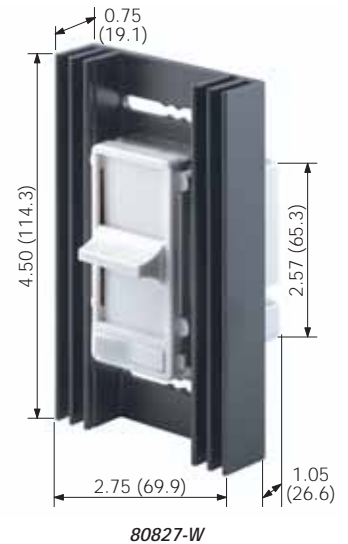

Renoir Architectural Fin Width
 Narrow: 2.88" (73.2 mm)
 Wide: 4.69" (119.1 mm)

SPECIFICATIONS AND FEATURES

- Smooth-action, linear slide control for easy, precise operation
- Manual low-end trim adjustment feature on fan speed controls allows precise adjustment of low-end fan settings when installing device
- Decora-styling coordinates with Leviton's extensive line of Decora devices
- Decora-style screwless snap-on wallplate present an attractive appearance in any application
- Slim, compact housing easily fits in standard wall boxes
- Fins are easily removed for multi-gang applications

TESTING AND CODE COMPLIANCE

- UL Listed (File # E-31373)
- CSA Certified (File #LR-3413)
- Backed by a Limited Five-Year Warranty

***COLOR**

Add suffix to catalog numbers as follows for color selection: Ivory (-I) White (-W).

MATERIAL CHARACTERISTICS

Environmental: Flammability UL-94, V2 Rating
 Operating Temperature: 32°F to 130°F



Van Gogh Architectural Specification Rotary Dimmers

Van Gogh Incandescent 120V AC 60Hz Only

DESCRIPTION	CAT. NO.	RATING	COLOR*
Van Gogh Single-Pole Rotary (narrow fin)	60800	800W	I, W
Van Gogh 3-Way Push ON/Push OFF (narrow fin)	60800-3	800W	I, W
Van Gogh Single-Pole Rotary (narrow fin)	61000	1000W	I, W
Van Gogh 3-Way Push ON/Push OFF (narrow fin)	61000-3	1000W	I, W
Van Gogh Single-Pole Rotary (wide fin)	61500	1500W	I, W
Van Gogh Single-Pole Rotary (wide fin)	62000	2000W	I, W

Note: Sharing a neutral wire may cause flickering. Connect all dimmers to the same phase or run a separate neutral to each phase. Consult Leviton Techline if problems persist.

When ganging these units, no derating is necessary except on those units which have had both sets of snap-off, fins removed. These shall be derated as follows:

Maximum Load per Van Gogh Dimmer Multi-Gang with Fins Broken Off			
Cat. No.	Single	2-Gang	More Than 2-Gang
60800	800W	700W	600W
61000	1000W	800W	700W
61500	1500W	1300W	1100W
62000	2000W	1800W	1500W

NOTE: For fin removal and switchbox requirements for ganging Leviton Van Gogh dimmers, refer to page C17.

Color Change Kits for 60800, 61000 Dimmer Units

DESCRIPTION	CAT. NO.
Brown Cover and Matching Knob w/Gold Insert	60001
Ivory Cover and Matching Knob w/Gold Insert	60001-I
White Cover and Matching Knob w/ Silver Insert	60001-W

Color Change Kits for 61500, 62000 Dimmer Units

DESCRIPTION	CAT. NO.
Brown Cover and Matching Knob w/Gold Insert	60002
Ivory Cover and Matching Knob w/Gold Insert	60002-I
White Cover and Matching Knob w/ Silver Insert	60002-W

Van Gogh™ Architectural Rotary Fan Speed Control 120V AC 60Hz Only

DESCRIPTION	CAT. NO.	RATING	COLOR*
Van Gogh Single-Pole (wide fin)	61027	10 Amps	I, W

Note: When more than one ceiling fan is controlled, make sure the blades are rotating on all fans.



61000-W



62000-W

Van Gogh Architectural Fin Width
Narrow: 2.75" (69.9 mm)
Wide: 4.56" (115.8 mm)

SPECIFICATIONS AND FEATURES

- Classic rotary architectural-style dimmer is a popular choice in many installations
- Available in Rotary ON/OFF (single pole only) and Push-ON/Push-OFF (3-way).
- 3-way version is used with a standard 3-way ON/OFF switch
- Snap-on cover conceals heat fins
- Color-matched dimmer control knob with gold insert for an attractive appearance in any installation
- Snap-off fins permit easy ganging with other devices
- Slim, compact housing easily fits in standard wall box
- Large radio/TV interference filter

TESTING AND CODE COMPLIANCE

- UL Listed (File #E-31373, 62000 File #E-66800)
- CSA Certified (File #LR-3413)
- Backed by a Limited Five-Year Warranty

*COLOR

Add suffix to catalog number as follows for colors: Ivory cover with Gold insert (-I), White cover with Silver insert (-W).

MATERIAL CHARACTERISTICS

Environmental: Flammability UL-94, V2 Rating
Operating Temperature: 32°F to 130°F



Ganging and Derating Box-Mounted Lighting Controls

Ganging is an installation practice where two or more lighting controls are mounted side-by-side using the required number of connected wallboxes. Ganging may require the removal of part of the fins on Architectural Dimmers or part of the mounting strap on strap-mounted devices. In Architectural Dimmers, the metallic fins help dissipate heat from within the device. Strap mounted dimmers use the mounting strap for the same purpose. Therefore, removing a portion of the fins or strap for ganging purposes will require derating the dimmers to prevent them from overheating.

Ganging and Derating Leviton Lighting Controls

When ganging Mural, True Touch, ToggleTouch and IllumaTech controls, the side sections of the mounting strap must be removed. Use pliers to carefully bend side sections back and forth until they break off. The side sections of the strap dissipate heat, so removing them requires derating the dimmer's capacity. See Chart 1.

Note that Leviton SureSlide and Trimatron lighting controls can be ganged without removing any sections of their mounting straps. However, SureSlide and Trimatron controls must also be derated when they're ganged.

Maximum Load Per Dimmer for Multi-Ganging All Strap-Mounted Dimmers

Dimmer Rating	Single	2-Gang	More Than 2-Gang
500W	500W	400W	300W
600W	600W	500W	400W
1000W	1000W	800W	700W
400VA	400VA	350VA	250VA
600VA*	600VA	500VA	400VA
1000VA	1000VA	800VA	700VA

*Except IPX06-7, which requires no derating

Maximum Bulb Wattage for Magnetic Low-Voltage Lighting

The capacity of a magnetic low-voltage dimmer is its VA rating. If a wattage rating is also listed (as in this book), it is merely an estimate of the lamp wattage that can be placed on a UL-approved magnetic low-voltage transformer without exceeding the dimmer's VA rating. (This is, in turn, based on an estimate of transformer efficiency.)

Power To Transformer	Transformer Efficiency	Lamp Load
1000VA	X 80%	= 800W
600VA	X 75%	= 450W

Ganging and Leviton Renoir® and Van Gogh® Architectural Lighting Controls

When fins are broken off on wide and narrow controls for ganging purposes, the number of switch boxes required can be quickly determined by referring to the two charts below.

Ganging

Switch boxes required for ganging Leviton architectural controls when no fins are removed:

Number of Wide Controls	Number of Narrow Controls*				
	0	1	2	3	4
0	•	•	•	•	•
1	1	3	5	7	8
2	4	6	7	9	11
3	7	9	10	11	13
4	9	11	12	14	16

Switch boxes required for ganging Leviton architectural controls when all inside fins are removed:

Number of Wide Controls	Number of Narrow Controls						
	0	1	2	3	4	5	6
0	0	1	2	3	4	5	6
1	1	3	4	5	6	7	8
2	3	5	6	7	8	9	10
3	5	7	8	9	10	11	12
4	7	9	10	11	12	13	14
5	9	11	12	13	14	15	16
6	11	13	14	15	16	17	18

*Narrow controls must have fins broken off to be ganged.



DESIGNER CONTROL FEATURES

Commercial Grade Controls

Designer Lighting Controls

Brilliant inside and out — the Vizia® collection includes dimmers, fan speed controls and radio frequency (RF) products integrated into a stylish form factor. With Vizia RF, homeowners can automate lighting as well as select appliances and electronics. The Mural® line encompasses scene-capable enhancement products. These designer-style devices provide full-range dimming in a sleek, Decora body that will enhance any décor.

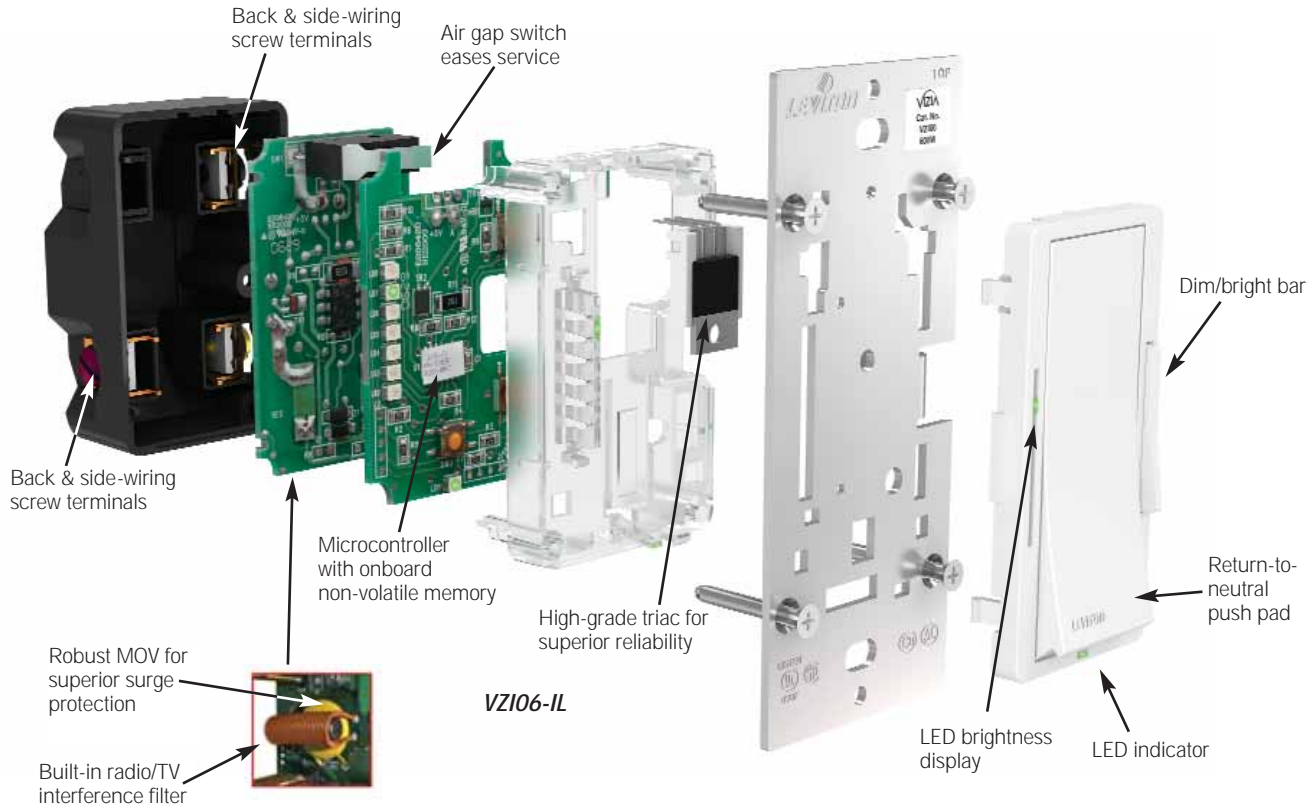

Features and Benefits

- Easy to operate for people of all ages and abilities
- Digital circuitry provides eye-pleasing soft-ON/fade-OFF that extends lamp life
- Compatible with Decora® screwless and Decora standard designer wallplates
- Wide range of colors available through convenient color change kits
- UL and CSA Listed
- Backed by a Limited Five-Year Warranty

LEVITON DESIGNER DIMMERS FOR FULL-RANGE DIMMING



Vizia Controls
Vizia digital dimmer with LED brightness level indicators, intuitive Dim/Bright bar and return-to-neutral pushpad. Color-change kits available.
VZ106-1L shown



Vizia Remote Controls
Enables multi-location dimming or fan control when used in conjunction with Vizia Dimmer/Fan Speed Controls.
VZ00R-1L shown



Mural 7-Scene Controller
Decora style controller sends commands for up to 7 distinct scenes to individual Mural Scene-Capable Controllers.
MN00C-1LW shown

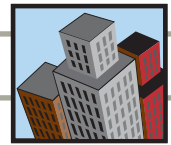

Vizia Digital Controls

All Vizia Preset Dimmers and Fan Speed Controls provide single-pole (one location) or 3-way (multi-location) control when used with a Vizia remote unit.

Vizia Digital Controls with LED Locator and Brightness Display

Single-Pole, 3-Way or more applications

DESCRIPTION	CAT. NO.	RATING	COLOR*
Vizia Incandescent Dimmer†	VZIO6-1L	600W 120V AC 60Hz	X, Z, W
Vizia Magnetic Low Voltage Dimmer†	VZM06-1L	600VA (450W) 120V AC 60Hz	X, Z
Vizia Incandescent/Magnetic Low Voltage Dimmer†	VZM10-1L	1000W Incandescent, 1000VA Magnetic Low Voltage 120V AC 60Hz	X, Z
Vizia Electronic Low Voltage Dimmer; neutral required†	VZE04-1L	400W 120V AC 60Hz	X, Z
Vizia Electronic Low Voltage Dimmer; neutral required†	VZE06-1L	600W 120V AC 60Hz	X, Z
Vizia Fluorescent Dimmer for Advance Mark 10® Powerline or Tu-Wire® Ballasts; neutral required	VZX10-1L	1000VA 120V AC 60Hz	X, Z
Vizia Fluorescent Dimmer for Advance Mark 10® Powerline Ballasts; neutral required	VZX12-7L	1200VA 277V AC 60Hz	X, Z
Vizia Fluorescent Dimmer for Hi-Lume® or Eco-10® (Eco Series) Ballasts; neutral required	VZH08-1L	8A 120V AC 60Hz	X, Z
Vizia Fluorescent Dimmer for Hi-Lume® or Eco-10® (Eco Series) Ballasts; neutral required	VZH06-7L	6A 277V AC 60Hz	X, Z
Vizia Quiet Fan Speed Control; neutral required	VZF01-1L	1.5A 120V AC 60Hz	X, Z
Vizia Switch with LED Locator; neutral required	VZS15-1L	15A 120V AC 60Hz	X, Z
Vizia Matching Dimmer/Fan Speed Color Change Kit	VZKIT-MD	—	I, W, A, T, G, E, R, B
Vizia Coordinating Dimmer/Fan Speed Color Change Kit; no LED	VZKIT-CD	—	I, W, A, T, G, E, R, B
Vizia Matching Switch Color Change Kit with LED Locator	VZKIT-MS	—	I, W, A, T, G, E, R, B
Vizia Coordinating Switch Color Change Kit, no LED	VZKIT-CS	—	I, W, A, T, G, E, R, B



VZIO6-1LX

Use Leviton Power Extenders to extend the load capacity of box-mounted dimmers. Leviton Power Extenders are available for incandescent, magnetic low-voltage, electronic low-voltage, Advance Mark 10® Powerline fluorescent dimming ballasts or equivalents, and 0–10 VDC dimmable fluorescent ballasts such as Advance Mark 7® 0-10V, OSRAM Sylvania Quicktron Helios or equivalent ballasts.

† Contractor Packs are available in White (-W), Almond (-A) or Light Almond (-T), packaged 10 pieces/box. To order, add suffix -ML to catalog number followed by color designation. Ex.: VZIO6-ML*

Eco-10® (Eco-Series) Tu-Wire® and Hi-Lume® are trademarks of Lutron Electronics Co., Inc.

See Page C7 for more information on Leviton Power Extenders

Note: Sharing a neutral wire may cause flickering. Connect all dimmers to the same phase or run a separate neutral to each phase. Consult Leviton Techline if problems persist. Digital Lighting and Fan Speed Controls are polarity sensitive devices. Always follow the wiring instructions included with each device.

CAUTION ON RETROFITS: When retrofitting Mark 10® Powerline dimming ballasts into fixtures that originally had Instant Start ballasts, the sockets MUST be replaced with Rapid Start sockets to allow proper dimmer operation and prevent damage to the dimming ballast. Refer to the instructions provided with the ballast and the Leviton dimmer.

SPECIFICATIONS AND FEATURES

- Streamlined Decora styling complements any interior, adds a “family look” when ganged with any Decora device
- Push pad always returns to neutral regardless of load status
- Digital circuitry provides Soft-ON/Fade-OFF lighting and prolonged lamp life or an option via simple programming for classic ON/OFF
- Green LED locator light illuminates when lights are OFF
- Air-gap switch completely disconnects power to unit for bulb changing or removal from service
- Provides single pole (one-location) or multi-location full range dimming when used with Vizia Dimmer Remotes (see P. C20 for Vizia Remotes)
- Vizia Six-Pack: Three color choices along with single pole or 3-way control provide 6 different options in each box, eliminating the need to stock a large variety of devices
- Color Change Kits are available in a wide range of colors, making it easy and economical to change decorating schemes
- Power failure recovery assures retention of lighting levels during long-term power interruptions
- Built-in radio/TV interference filter
- Quiet 1.5Amp Fan Speed Controls are perfect for libraries, study rooms and any areas where ceiling fan noise could become distracting
- Fits in standard wallbox – units may be ganged
- LED display alongside push pad indicates selected brightness /fan speed level
- Dim/Bright Bar allows user to set brightness level when lights are ON or OFF
- Minimum brightness level can be easily programmed from 1 to 50% of full brightness
- Dim Lock level feature determines preset light level regardless of last setting
- Selectable Fade Rate is easily programmable for desired Fade ON/OFF
- Press and hold push pad to turn lights on to full bright from any preset light level
- To use the Delayed OFF feature while lights are ON (10 seconds to OFF), press and hold the push pad
- Compatible with Decora PLUS screwless wallplates and Decora wallplates

TESTING AND CODE COMPLIANCE

- UL Listed (File #E-31373)
- CSA Certified (File #M/C 152105)
- Backed by a Limited Five-Year warranty

MATERIAL CHARACTERISTICS

Environmental: Flammability UL-94, V2 Rating
Operating Temperature: 32°F to 130°F

*COLOR

Vizia Controls come packaged with three colors. Controls with suffix (-X) include White, Ivory and Almond. Controls with suffix (-Z) include White, Ivory and Light Almond. Color Change Kits available in the following colors: Ivory (I), White (-W), Almond (-A), Light Almond (-T), Gray (-G), Black (-E), Red (-R) and Brown (-B).



Vizia Remotes

Vizia Remotes — No Load Rating
 For Use with Vizia Dimmers, Switches and Fan Speed Controls  

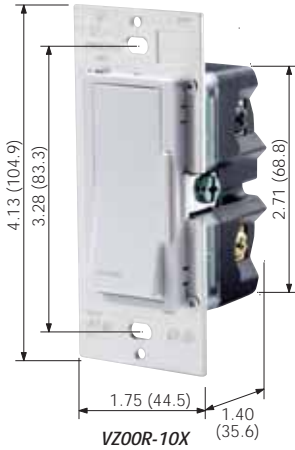

VZ00R-10X

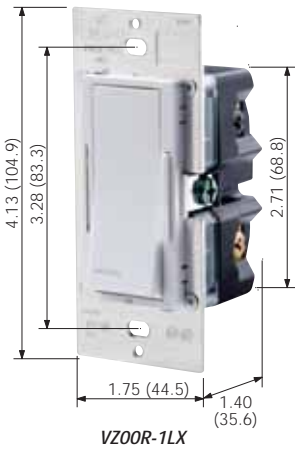

VZ00R-1LX

DESCRIPTION	CAT. NO.	RATING	COLOR* X=I+W+A Z=I+W+T
Vizia Matching Remote Unit to 120V Dimmers/Fan Speed Control for 3-way or up to 5 locations, with LED Locator and Brightness/Fan Speed Display; neutral required†	VZ00R-1L	120V AC 60Hz	X, Z, W
Vizia Matching Remote Unit to 277V Dimmers for 3-way or up to 5 locations, with LED Locator and Brightness Display; neutral required	VZ00R-7L	277V AC 60Hz	X, Z
Vizia Coordinating Remote Unit to 120V Dimmers/Fan Speed Control for 3-way or up to 10 locations, no LED; neutral required when used with a device that requires a neutral wire†	VZ00R-10	120V AC 60Hz	X, Z
Vizia Matching Switch Remote Unit to 120V Dimmers/Fan Speed Control and VZS15-1L Switch for 3-way or up to 5 locations, with LED Locator; neutral required	VZ0SR-1L	120V AC 60Hz	X, Z
Vizia Coordinating Switch Remote Unit to 120V Dimmers/Fan Speed Control and VZS15-1L Switch for 3-way or up to 10 locations, no LED; neutral required when used with a device that requires a neutral wire	VZ0SR-10	120V AC 60Hz	X, Z
Vizia Matching Dimmer/Fan Speed Remote Color Change Kit with LED Locator and Brightness Display	VZKIT-MD	—	I, W, A, T, G, E, R, B
Vizia Coordinating Dimmer/Fan Speed Remote Color Change Kit, no LED	VZKIT-CD	—	I, W, A, T, G, E, R, B
Vizia Matching Switch Remote Color Change Kit with LED Locator	VZKIT-MS	—	I, W, A, T, G, E, R, B
Vizia Coordinating Switch Remote Color Change Kit, no LED	VZKIT-CS	—	I, W, A, T, G, E, R, B

† Contractor Packs are available in White (-W), Almond (-A) or Light Almond (-T), packaged 10 pieces/box. To order, add suffix -ML to catalog number followed by color designation. Ex.: VZ00R-ML*

Note: Sharing a neutral wire may cause flickering. Connect all dimmers to the same phase or run a separate neutral to each phase. Consult Leviton Techline if problems persist. Digital Lighting and Fan Speed Controls are polarity sensitive devices. Always follow the wiring instructions included with each device.

SPECIFICATIONS AND FEATURES

- Can be used with all Vizia Dimmers, Switches and Fan Speed controls
- Streamlined Decora styling complements any interior, adds a "family look" when ganged with any Decora device
- Push pad returns to neutral regardless of load status
- Green LED locator light illuminates when lights are OFF (matching remotes only)
- Provides multi-location full range control when used with Vizia Dimmers/Fan Speed Controls
- Three color options in each box eliminates the need to stock a large variety of devices
- Color Change Kits are available in a wide range of colors, making it easy and economical to change decorating schemes
- Fits in standard wallbox – units may be ganged
- Matching Remotes have LEDs and provide control from up to 5 different locations (neutral wire required)
- Coordinating Remotes provide control from up to 10 different locations

TESTING AND CODE COMPLIANCE

- UL Listed (File #E-31373)
- CSA Certified (File #M/C 152105)
- Backed by a Limited Five-Year Warranty

MATERIAL CHARACTERISTICS

Environmental: Flammability UL-94, V2 Rating
 Operating Temperature: 32°F to 130°F

*COLOR

Vizia Remotes come packaged with three colors. Controls with suffix (-X) include White, Ivory and Almond. Controls with suffix (-Z) include White, Ivory and Light Almond. Color Change Kits available in the following colors: Ivory (I), White (-W), Almond (-A), Light Almond (-T), Gray (-G), Black (-E), Red (-R) and Brown (-B).

Use Leviton Power Extenders to extend the load capacity of box-mounted dimmers. Leviton Power Extenders are available for incandescent, magnetic low-voltage, electronic low-voltage, Advance Mark 10® Powerline fluorescent dimming ballasts or equivalents, and 0-10 VDC dimmable fluorescent ballasts such as Advance Mark 7® 0-10V, OSRAM Sylvania Quicktronic Helios or equivalent ballasts.



Vizia RF Scene Capable Dimmers

All Vizia RF dimmers provide single-pole (one-location) and 3-way (multi-location) control when used with a Vizia coordinating (no LED) remote unit.

DESCRIPTION	CAT. NO.	RATING	COLOR* X=I+W+A
Vizia RF Incandescent Scene Capable Dimmer with LED Locator and Brightness Display	RZI06-1L	600W	X
Vizia RF Incandescent Scene Capable Dimmer with LED Locator and Brightness Display	RZI10-1L	1000W	X
Vizia RF Magnetic Low-Voltage Scene Capable Dimmer with LED Locator and Brightness Display	RZM10-1L	1000VA	X
Vizia RF ON/OFF Scene Capable Switch with LED Locator	RZS15-1L	15A 1800W Resistive 1800W Incandescent 1800VA Fluorescent 1800VA Inductive 1/2 HP Motor (9.8A)	X
Vizia RF Matching Dimmer Color Change Kit	VZKIT-MD		I, W, A, T, G, E, R, B
Vizia RF Matching Switch Color Change Kit with LED Locator and Brightness Display	VZKIT-MS		I, W, A, T, G, E, R, B

See Page C20 for Vizia Non-RF remotes. See Page C22 for Vizia RF remotes.

Vizia RF Plug-In Modules

DESCRIPTION	CAT. NO.	RATING	COLOR*
Vizia RF Scene Capable Plug-In Lamp Dimming Module	RZP03-1L	300W	White
Vizia RF Scene Capable Plug-In Appliance Module	RZP15-1L	15A 1800W Resistive 1800W Incandescent 1800VA Fluorescent 1800VA Inductive 1/2 HP motor loads @ 120V AC, 60Hz	White
Vizia RF Plug-In Serial Interface Module ASCII to Z-Wave Interface	RZCOP-1L	—	White

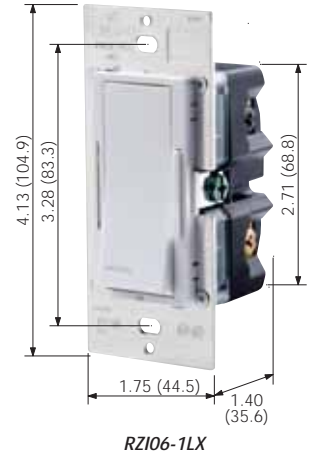

RZI06-1LX

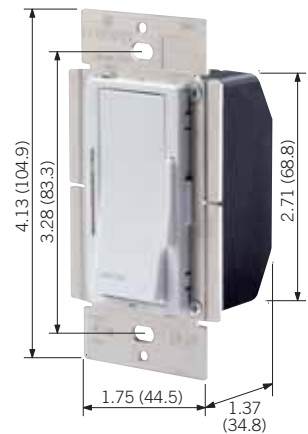

RZM10-1LX

SPECIFICATIONS AND FEATURES

Vizia RF Scene Capable Dimmers

- Scene capable, wireless control via RF (Z-Wave® technology)
- Digital circuitry provides soft ON/fade OFF light switching and smooth full-range changes in brightness level for extended bulb life
- Push pad always returns to neutral position regardless of load status
- Compatible with Decora Plus screwless wallplates and Decora wallplates
- Complements Vizia Lighting Controls (see page C19 for more information)
- Color change kits are available to allow fast color changeover and simplify stocking inventory
- Vizia Six-Pack: Three color choices along with single pole or 3-way control provide 6 different options in each box, eliminating the need to stock a large variety of devices
- Easy adjustments for minimum brightness level, Dim-Lock and selectable fade rates
- Lights turn ON at the last selected brightness level or at user-programmable Dim-Lock setting
- Manual and remote ON/OFF/DIM/BRIGHT control of connected Dimmer
- ON/OFF/DIM/BRIGHT scene and zone control capability
- Responds to Vizia RF Controllers as well as selected Z-Wave certified controllers from other manufacturers
- Works with the Vizia RF 1-Zone Controller/Matching Dimmer Remote (RZCZ1-1L) for RF virtual 3-way control without the need for traditional 3-way wiring or for a dedicated traveler wire
- Works with Vizia™ (non-RF) Coordinating Remotes (VZ00R-10) for hardwired 3-way or up to 10-location control

- Enhanced 2-way communication
- Easy to clean, high gloss finish complements a wide range of décors
- DIM/BRIGHT bar allows user to select brightness level when lights are ON or OFF— green LED displays brightness level
- Power-failure memory allows light levels to return to the same levels set prior to power interruption
- RFI filtering for radio, audio and video equipment
- UL required air gap switch disconnects power from load locally. It is concealed during normal operation and is accessible without removing the wallplate

Vizia RF Scene Capable Plug-in Appliance Module (RZP15)

- Provides 15A-120VAC NEMA 5-15R grounding receptacle for use with a wide variety of lamps and appliances
- Provides Manual ON/OFF switching of plug-in load and remote scene and zone control compatibility

- Enhanced 2-way communication

Vizia RF Scene Capable Plug-in Lamp Dimming Module (RZP03)

- Provides NEMA polarized 1-15R 2-blade receptacle for use with incandescent lamps
- Load Sensing feature allows lamp to be turned ON manually using the lamp's switch or the integrated ON/OFF button
- Provides manual and remote ON/OFF/DIM/BRIGHT control of plug-in lamps
- Enhanced 2-way communication
- Provides ON/OFF/DIM/BRIGHT scene and zone control capability

TESTING AND CODE COMPLIANCE

- UL Listed (File #E-66800)
- CSA Certified (File #152105)
- NOM Certified (#057)
- Complies with FCC Part 15, Class B
- Z-Wave Certified
- Backed by a Limited Five-Year Warranty

*COLOR

Vizia-RF Lighting Controls come packaged with three colors. Controls with suffix (-X) include White, Ivory and Almond. Color Change Kits available in the following colors: Ivory (-I), White (-W), Almond (-A), Light Almond (-T), Gray (-G), Black (-E), Red (-R) and Brown (-B).

MATERIAL CHARACTERISTICS

Environmental: Flammability UL-94, V2 Rating
Operating Temperature: 32°F to 130°F



Vizia RF™ Remotes for Use with Vizia RF Scene-Capable Dimmers and Switches

Vizia RF™ Remotes

DESCRIPTION	CAT. NO.	RATING	COLOR* X=I+W+A Z=I+W+T
Vizia RF 1-Button Zone Dimming Controller	RZCZ1-1L	No load rating – 120V AC 60Hz	X
Vizia RF 4-Button Zone Controller	RZCZ4-1L	No load rating – 120V AC 60Hz	X
Vizia RF 1-Button Scene Controller	RZCS1-1L	No load rating – 120V AC 60Hz	X
Vizia RF 4-Button Scene Controller	RZCS4-1L	No load rating – 120V AC 60Hz	X
Vizia RF Handheld Remote Controller Programmer/Timer (Internal Astronomical Clock)	RZCPG-OSG	2 AA batteries (Included)	Silver
Vizia RF Handheld Remote Controller Programmer (Basic)	RZCPG-BSG	2 AA batteries (Included)	Silver
Vizia RF IR Handheld Remote Controller	RZMR1-OSG	2 AA batteries (Included)	Silver
4-Button Scene Controller Color Change Kit with LED Locator	VZKIT-S4	—	I, W, A
4-Button Zone Controller Color Change Kit with LED Locator	VZKIT-Z4	—	I, W, A
Matching Dimmer Color Change Kit with LED Locator and Brightness Display for RZCZ1	VZKIT-MD	—	I, W, A
Matching Switch Color Change Kit with LED Locator for RZCS1	VZKIT-MS	—	I, W, A
Coordinating Dimmer Remote for up to 10 location applications; neutral required	VZ00R-10	No load rating – 120V AC 60Hz	X, Z

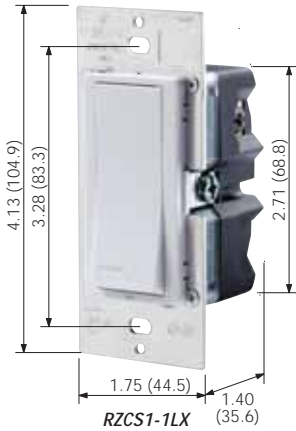

RZCS1-1LX



RZCS4-1LX



RZCPG-OSG

SPECIFICATIONS AND FEATURES

Vizia RF Controllers

- Compatible with Decora Plus screwless wallplates and Decora wallplates
- Enhanced 2-way communication
- Popular Vizia-style push pad on 1-button controllers blend seamlessly with other devices in the Vizia collection

Vizia RF 1-Button Scene Controller (RZCS1-1L)

- Provides remote ON/OFF control of one scene
- Virtual 3-way and multi-location remote ON/OFF control of selected Vizia RF switches without the need for traditional 3-way wiring or a dedicated traveler wire
- Controller fits in standard wall box and utilizes household 120VAC 60Hz wiring (when neutral wire is present) for easy "no-new-wires" installation
- Green LED illuminates to indicate controlled scene. When acting as a matching remote, LED will illuminate when the load is OFF

Vizia RF 1-Button Zone Dimming Controller (RZCZ1-1L)

- Provides remote ON/OFF/DIM/BRIGHT control of one Vizia RF Dimmer
- Virtual 3-way remote dimming control of selected Vizia RF dimmers without the need for traditional 3-way wiring or a dedicated traveler wire
- Controller fits in standard wall box and utilizes existing 120VAC 60Hz wiring to replace a regular switch (when neutral wire is present) for easy "no-new-wires" installation
- Green LED locator illuminates to indicate controlled zone or load is OFF

Vizia RF 4-Button Scene (RZCS4-1L) or Zone (RZCZ4-1L) Controllers

- Provides remote ON/OFF/DIM/BRIGHT control of four scenes (RZCS4-1L) or zones/areas (RZCZ4-1L) of selected Vizia RF devices
- Integrated infrared (IR) port
- Controller fits in standard wall box and utilizes existing 120VAC 60Hz wiring to replace a regular switch (when neutral wire is present) for easy "no-new-wires" installation
- Green LED illuminates when the assigned scene (RZCS4-1L) or zone/area (RZCZ4-1L) is ACTIVE

Vizia RF Handheld Remotes

RZCPG

- Primary device for creating and programming a Vizia RF system
- Provides user level control of up to 128 devices
- Can operate as a secondary remote control
- Provides remote control (ON/OFF/DIM/BRIGHT/SCENE/ZONE) of all devices in the Vizia RF network

RZMR1

- Works with Vizia RF IR compatible controllers
- Controls four scenes and four zones

TESTING AND CODE COMPLIANCE

- UL Listed (File #-E-66800)
- CSA Certified (File #152105)
- NOM Certified (#057)
- Complies with FCC Part 15, Class B
- Z-Wave Certified
- Backed by a Limited Five-Year Warranty

Handheld Remotes

- Complies with FCC Part 15, Class B
- Z-Wave Certified

*COLOR

Vizia-RF Home Controls come packaged with three colors. Controls with suffix (-X) include White, Ivory and Almond. Controls with suffix (-Z) include White, Ivory and Light Almond. Color Change Kits available in the following colors: Ivory (I), White (-W), Almond (-A).

MATERIAL CHARACTERISTICS

Environmental: Flammability UL-94, V2 Rating
Operating Temperature: 32°F to 131°F

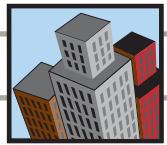

Mural Digital Controls

All Mural controls provide single-pole (one location) or 3-way (multi-location) control when used with Multi-Remote unit.

Mural Digital Controls 120V AC 60Hz Only

DESCRIPTION	CAT. NO.	RATING	COLOR*
Mural Incandescent Dimmer with LED Locator and Brightness Display	MDI06-1L	600W	I, W, A (G, E, B with Kit)
Mural Incandescent Dimmer with LED Locator and Brightness Display	MDI10-1L	1000W	I, W, A (G, E, B with Kit)
Mural Magnetic Low-Voltage Dimmer with LED Locator and Brightness Display	MDM06-1L	600VA (450W)	I, W, A (G, E, B with Kit)
Mural Magnetic Low-Voltage Dimmer with LED Locator and Brightness Display	MDM10-1L	1000VA (800W)	I, W, A (G, E, B with Kit)
Mural Electronic Low-Voltage Dimmer with LED Locator and Brightness Display	MDE03-1L	350VA (280W)	W (I, A, G, E, B with Kit)
Mural Quiet Fan Speed Control with LED Locator and Brightness Display; neutral required	MDF01-1L	1.5A	I, W, A (G, E, B with Kit)
Coordinating Remote Unit to Dimmers/ Fan Speed Controls for 3-way or up to 10 locations, no LED	MS00R-10	No load rating	I, W, A (G, E with Kit)
Coordinating Remote Unit to Electronic Low-Voltage Dimmer for 3-way or up to 10 locations, no LED; neutral required	MSE0R-10	No load rating	W (I, A, G, E with Kit)

Color Change Kits for Mural Controls

DESCRIPTION	CAT. NO.	COLOR*
Mural Dimmer Color Change Kit with LED Locator and Brightness Display	DRKDD-1L	I, W, A, G, E, B
Remote Color Change Kit, no LED Locator or Display	DRKOR-00	I, W, A, G, E, B

Digital Lighting and Fan Speed Controls are polarity sensitive devices. Always follow the wiring instructions included with each device.

See Page C7 for more information on Leviton Power Extenders

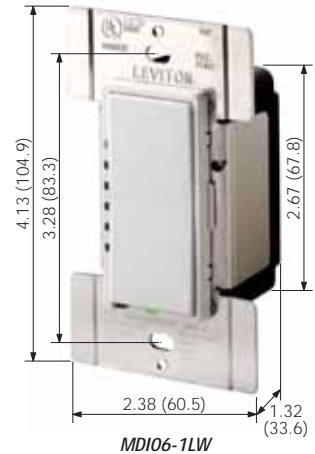

SPECIFICATIONS AND FEATURES

- Provides single-pole (one-location) or multi-location full range dimming when used with MS00R remote unit
- Streamlined popular Decora styling enhances any interior and adds a family look when ganged with other Decora devices
- Smooth ON/OFF and DIM/BRIGHT Decora rocker action provides ease of operation for people of all ages and abilities
- Digital circuitry provides Soft-ON/Fade-OFF switching for an eye-pleasing effect and extended lamp life
- Compatible with DecoraPLUS screwless and Decora wallplates
- Locator LED illuminated when lights are OFF
- Color change kits available in a wide range of choices, making it easy and economical to change decorating schemes
- Color change kits simplify inventory for distributors and contractors who can offer a complete range of colors without stocking a different device for each one
- Protected memory and voltage compensation maintain light levels after short-term power outages and during minor power fluctuations

- Coordinates with Leviton's DHC line of products
- Green LED display alongside rocker indicates selected brightness level on MD models
- Built-in radio/TV interference filter
- Air gap switch completely disconnects power to unit for bulb changing or removal from service

TESTING AND CODE COMPLIANCE

- UL Listed (File #E-31373)
- CSA Certified (File #LR-3413)
- Backed by a Limited Five-Year Warranty

*COLOR

To order colors, add suffix to basic catalog number. Colors in parentheses must be ordered as Color Change Kits. Color suffixes are: Ivory (-I), White (-W), Almond (-A), Gray (-G), Black (-E) and Brown (-B).

MATERIAL CHARACTERISTICS

Environmental: Flammability UL-94, V2 Rating
Operating Temperature: 32°F to 130°F

Use Leviton Power Extenders to extend the load capacity of box-mounted dimmers. Leviton Power Extenders are available for incandescent, magnetic low-voltage, electronic low-voltage, Advance Mark 10® Powerline fluorescent dimming ballasts or equivalents, and 0–10 VDC dimmable fluorescent ballasts such as Advance Mark 7® 0–10V, OSRAM Sylvania Quicktronic Helios or equivalent ballasts.



Commercial Grade Lighting Controls

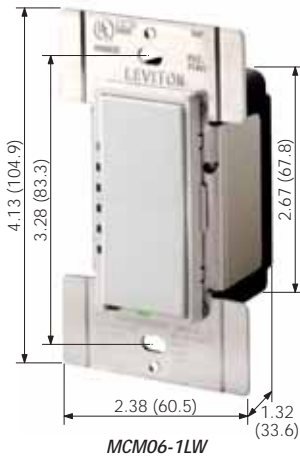

MCM06-1LW

Mural Scene Capable Digital Dimmers

Compatible with Scene Controller and Scene Enhancement Products — See page C25.

Mural Scene Capable Digital Dimmer 120V AC 60Hz Only

DESCRIPTION	CAT. NO.	RATING	COLOR*
Mural Scene Capable Incandescent/Magnetic Low-Voltage Dimmer with LED Locator and Brightness Display	MCM06-1L	600W Incandescent 600VA Magnetic Low Voltage	I, W, A (G, E, B with Kit)
Mural Scene Capable Incandescent/Magnetic Low-Voltage Dimmer with LED Locator and Brightness Display	MCM10-1L	1000W Incandescent 1000VA Magnetic Low Voltage	I, W, A (G, E, B with Kit)
Mural Scene Capable Preset Fluorescent Dimmer for Mark 10® Powerline Ballast with LED Locator and Brightness Display; neutral required	MCX10-1L	1000VA	W (I, A, G, E, B with Kit)
Color Change Kits for Mural MC Scene Capable Dimmer	DRKDD-1L	—	I, W, A, G, E, B

See Page C7 for more information on Leviton Power Extenders

Note: Sharing a neutral wire may cause flickering. Connect all dimmers to the same phase or run a separate neutral to each phase. Consult Leviton Techline if problems persist. Digital Lighting and Fan Speed Controls are polarity sensitive devices. Always follow the wiring instructions included with each device.

CAUTION ON RETROFITS: When retrofitting Mark 10® Powerline dimming ballasts into fixtures that originally had Instant Start ballasts, the sockets MUST be replaced with Rapid Start sockets to allow proper dimmer operation and prevent damage to the dimming ballast. Refer to the instructions provided with the ballast and the Leviton dimmer.

SPECIFICATIONS AND FEATURES

- Responds to lighting level commands sent by the Cat. No. MN00C-1L Scene Controller (See Page C25). Users can program the desired lighting level for individual Mural Scene Dimmers in up to seven distinct lighting scenes, which are easily accessed by one or more Scene Controllers
- Smooth ON/OFF and DIM/BRIGHT Decora rocker action provides ease of operation for people of all ages and abilities
- Local DIM/BRIGHT adjustment on individual scene dimmers will not affect programmed scene lighting settings
- Compatible with Scene Enhancement Products including Contact Closure Interface, Infrared Hand-Held Remote and Infrared Receiver, and one-way and two-way Signal Repeater
- Streamlined, popular Decora styling enhances any interior and adds a “family look” when ganged with any Decora device
- Digital circuitry provides Soft-ON/Fade-OFF operation for an eye-pleasing effect and prolonged lamp life
- Green LED display alongside rocker indicates selected brightness level
- Locator LED illuminates when lights are OFF
- Color change kits available in a wide range of choices, making it easy and economical to change decorating schemes

- Color change kits simplify inventory for distributors and contractors who can offer a complete range of colors without stocking a different device for each one
- Minimum Brightness Adjustment sets comfortable minimum light level
- Protected memory and voltage compensation maintain light levels after power outages and during minor power fluctuations
- Built-in radio/TV interference filter
- Air-gap switch completely disconnects power to unit for bulb changing or removal from service

TESTING AND CODE COMPLIANCE

- UL Listed (File #E-31373)
- CSA Certified (File #LR-3413)
- Backed by a Limited Five-Year warranty

*COLOR

To order colors, add suffix to basic catalog number. Colors in parentheses must be ordered as Color Change Kits. Color suffixes are: Ivory (-I), White (-W), Almond (-A), Gray (-G), Black (-E) and Brown (-B).

MATERIAL CHARACTERISTICS

Environmental: Flammability UL-94, V2 Rating
Operating Temperature: 32°F to 130°F

Use Leviton Power Extenders to extend the load capacity of box-mounted dimmers. Leviton Power Extenders are available for incandescent, magnetic low-voltage, electronic low-voltage, Advance Mark 10® Powerline fluorescent dimming ballasts or equivalents, and 0–10 VDC dimmable fluorescent ballasts such as Advance Mark 7® 0–10V, OSRAM Sylvania Quicktronic Helios or equivalent ballasts.

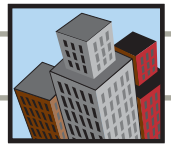



Mural Scene Controller and Accessories

Scene Controller for Mural Scene Capable Lighting Controls  

DESCRIPTION	CAT. NO.	RATING	COLOR*
Mural Scene Controller: 7 Lighting-Scene Buttons plus OFF and Group DIM/BRIGHT Buttons	MN00C-1L	No load rating, use with 120V Mural Scene Dimmers only	White, for other colors use Color Change Kits
Color Change Kits with Text for Mural MN00C-1L Scene Controller	DCKS7-00	—	I, W, A, G, E
Color Change Kit with Customizable Labels for Mural Scene Controller	DCKS7-0C	—	I, W, A, G, E

Scene Enhancement Products—

Compatible with Mural Scene Capable Lighting Controls  

DESCRIPTION	CAT. NO.	RATING	COLOR*
Signal Repeater—Must be used if controlling lighting on more than one circuit. One-Way and Two-Way versions available	17100-1WY, 17100-2WY	No load rating 120V AC	—
Contact Closure Interface—Allows control of Mural Scene Capable devices from home theater and building control systems via momentary contact inputs	177BI	No load rating 120V AC	(Non-color item)
Infrared Receiver available with Wall Mount and Ceiling Fan Bezels	177IR-IWA	No load rating 120V AC	Supplied with Ivory, White and Almond bezels
Hand-Held Infrared Remote Control: with 4 Scene Buttons plus OFF	177RC	No load rating 120V AC	E

Note: A Repeater must be used on any installation that uses more than one circuit.



SPECIFICATIONS AND FEATURES

Scene Controller

- Sends commands for up to seven distinct scenes to individual Mural Scene Capable Dimmers
- Multiple Scene Controllers can be used for multi-point access to scenes.
- Provides OFF button and two arrow-shaped buttons for group Dim and Bright control
- Local DIM/BRIGHT adjustment on individual scene dimmers will not affect programmed scene settings
- Green LED display for each scene button indicates selected scene
- Fast, easy scene programming: Press scene button on MN00C, adjust individual level on Mural Scene Capable dimmer, press program button on dimmer
- Controls up to 20 scene dimmers per circuit
- Streamlined, popular Decora styling enhances any interior and adds a “family look” when ganged with any Decora device
- Use Decora Plus or any standard Decora wallplate
- Color change kits are available in a wide range of colors making it easy and economical to change decorating schemes
- Internal MOV for surge protection

- Customized lettering for each scene button available (maximum of 8 characters and spaces) — see your Leviton representative for ordering information

Scene Enhancement Products

- Two-Way Repeater provides scene control communication link between branch circuits. One-Way Repeater allows the creation of separate scene control zones

TESTING AND CODE COMPLIANCE

- UL Listed (File #E-31373 – Cat. Nos. MN00C and 177IR; File #E-66800 – Cat. Nos. 17100-1WY and 17100-2WY; File #E-600800 – Cat. No. 177BI)
- CSA Certified (File #LR-3413)
- Backed by a Limited Five-Year Warranty

***COLOR**

Basic Cat. No. denotes White device. For other colors, order Color Change Kits and add suffix as follows: Ivory (-I), White (-W), Almond (-A), Gray (-G) and Black (-E) .

MATERIAL CHARACTERISTICS

Environmental: Flammability UL-94, V2 Rating
Operating Temperature: 32°F to 130°F



TOUCH LIGHTING CONTROL FEATURES

Commercial Grade Lighting Controls

Touch Lighting Controls

The Leviton Touch series includes two full-range dimming lines that use digital touch pad technology to enable dimming and switching with a touch of a finger: True Touch™ and ToggleTouch™.

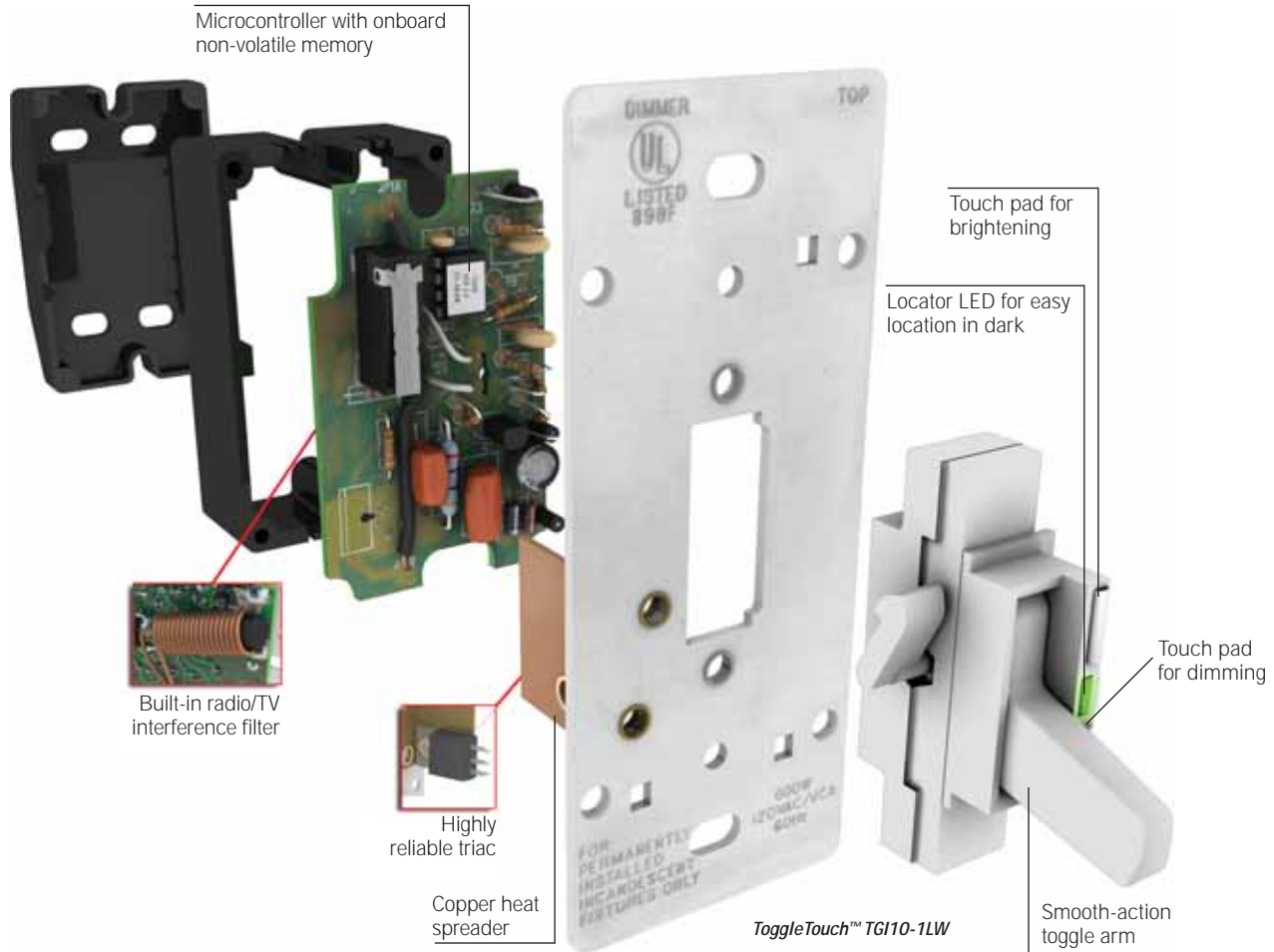

Features and Benefits

- Preset dimmers incorporate touchpad technology
- Digital circuitry provides eye-pleasing Soft-ON/ Fade-OFF that extends lamp life (most models)
- Single- and multi-location control available
- Wide range of colors coordinates with any décor
- UL and CSA Listed
- Backed by a Limited Five-Year Warranty

LEVITON TOUCH DIMMERS FOR FULL-RANGE DIMMING



True Touch™ Dimmer
Decora-style digital touch dimmer. Provides fingertip full-range single-pole and multi-location dimming. Color change kits available. **T110-1LX shown**



ToggleTouch™ Dimmer
Unique design features toggle-style ON/OFF switch with bright and dim digital touch pads alongside toggle and LED locator light. **TGI10-1LW shown**

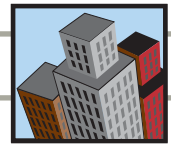

True Touch Digital Dimmers

All True Touch dimmers provide single-pole (one location) or 3-way (multi-location) control when used with TrueTouch Remote.

True Touch Digital Dimmer 120V AC 60Hz

DESCRIPTION	CAT. NO.	RATING	COLOR*
True Touch Incandescent Dimmer with LED Locator	TTI06-1L	600W	X, Z, GS X=I+W+A Z=I+W+T
True Touch Incandescent Dimmer with LED Locator	TTI10-1L	1000W	X, Z, GS
True Touch Magnetic Low-Voltage Dimmer with LED Locator	TTM10-1L	1000VA (800W)	X, Z, GS
Coordinating Remote Unit to True Touch Dimmers for 3-way or up to 10 locations, no LED	TT00R-1	No load rating	X, Z, GS
True Touch Dimmer Color Change Kit	TTKIT	—	I, W, A, T, GY, E, WS, GI, BG
True Touch Remote Dimmer Color Change Kit	TTKTR	—	I, W, A, T, GY, E, WS, GI, BG

See Page C7 for more information on Leviton Power Extenders

Digital Lighting and Fan Speed Controls are polarity sensitive devices. Always follow the wiring instructions included with each device. They can be used in conventional 3-way and 4-way wiring circuits only when the Control is properly connected to the load as indicated by the device's wiring instructions.



- SPECIFICATIONS AND FEATURES**
- Provides fingertip ease of use and precise adjustment of lighting levels. Simple one-touch for ON at preset level, or again for OFF. Touch and hold for BRIGHT/DIM lighting control
 - Provides single-pole (one-location) and multi-location full range dimming when used with TT00R remote dimmer
 - Attractive Decora styling blends with any interior
 - Digital circuitry provides Soft-ON/Fade-OFF switching for an eye-pleasing effect and extended lamp life
 - Compatible with DecoraPLUS screwless and Decora wallplates
 - Locator LED is illuminated when lights are OFF (no LED on Remote Unit)
 - Color change kits offered in a wide range of colors, making it easy and economical to change decorating schemes
 - Protected memory maintains light levels after short-term power outages and during minor power fluctuations
 - Built-in radio/TV interference filter
 - Air gap switch completely disconnects power to unit for bulb changing or removal from service

- TESTING AND CODE COMPLIANCE**
- UL Listed (File #E-31373)
 - CSA Certified (File #LR-3413)
 - Backed by a Limited Five-Year Warranty

***COLOR**

TTI06, TTI10 and TTM10 products come packaged with three colors. Products with suffix (-X) include White, Ivory and Almond; products with suffix (-Z) include White, Ivory and Light Almond; products with suffix (-GS) include White, Gold and Silver. Color change kits available in the following colors: White (-W), Ivory (-I), Almond (-A), Light Almond (-T), Gray (-G), Black (-E), White Frame/Silver Touch (-WS), Ivory Frame/Gold Touch (-GI) and Brown Frame/Gold Touch (-BG).

MATERIAL CHARACTERISTICS

Environmental: Flammability UL-94, V2 Rating
Operating Temperature: 32°F to 130°F

Use Leviton Power Extenders to extend the load capacity of box-mounted dimmers. Leviton Power Extenders are available for incandescent, magnetic low-voltage, electronic low-voltage, Advance Mark 10® Powerline fluorescent dimming ballasts or equivalents, and 0–10 VDC dimmable fluorescent ballasts such as Advance Mark 7® 0–10V, OSRAM Sylvania Quicktronic Helios or equivalent ballasts.



Commercial Grade Lighting Controls

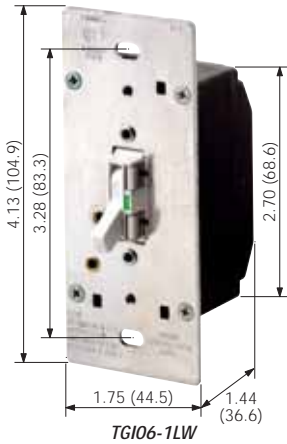

ToggleTouch Digital Dimmers

All ToggleTouch Preset Dimmers provide single-pole (one-location) or 3-way (multi-location) control when used with a 3-way switch, except where noted.

ToggleTouch Digital Touch Dimmer with LED Locator 120V AC 60Hz  

DESCRIPTION	CAT. NO.	RATING	COLOR*
ToggleTouch Incandescent Dimmer	TGI06-1L	600W	W, I, A, T, B
ToggleTouch Incandescent Dimmer	TGI10-1L	1000W	W, I, A, T, G
ToggleTouch Magnetic Low-Voltage Dimmer	TGM10-1L	1000VA (800W)	W, I, A, T, G

Note: Leviton does not recommend using the ToggleTouch Dimmer with metal wallplates.
See Page C7 for more information on Leviton Power Extenders

Digital Lighting and Fan Speed Controls are polarity sensitive devices. Always follow the wiring instructions included with each device. They can be used in conventional 3-way and 4-way wiring circuits only when the Control is properly connected to the load as indicated by the device's wiring instructions.

SPECIFICATIONS AND FEATURES

- Provides a unique combination of toggle-style ON/OFF switching and digital touch pad technology
- Designed for smooth ON/OFF toggle action and fingertip touch dimming control that's easy to operate
- Provides single-pole (one-location) and 3-way (multi-location) control when used with a 3-way switch
- Touch pads match color of toggle switch
- Fits and gangs perfectly with Leviton standard toggle wallplates and all Leviton toggle switches
- Provides preset dimming with Soft-ON feature (does not provide Fade-OFF)
- Locator LED is illuminated when lights are OFF
- Protected memory during temporary power failures ensures that ToggleTouch will retain last setting before power interruption
- Built-in radio/TV interference filter

TESTING AND CODE COMPLIANCE

- UL Listed (File #E-31373)
- CSA Certified (File #LR-3413)
- Backed by a Limited Five-Year Warranty

*COLOR

To order colors, add suffix to catalog number as follows: Ivory (-I), White (-W), Almond (-A), Light Almond (-T), Gray (-G) and Brown (-B).

MATERIAL CHARACTERISTICS

Environmental: Flammability UL-94, V2 Rating
Operating Temperature: 32°F to 130°F

Use Leviton Power Extenders to extend the load capacity of box-mounted dimmers. Leviton Power Extenders are available for incandescent, magnetic low-voltage, electronic low-voltage, Advance Mark 10® Powerline fluorescent dimming ballasts or equivalents, and 0–10 VDC dimmable fluorescent ballasts such as Advance Mark 7® 0–10V, OSRAM Sylvania Quicktronic Helios or equivalent ballasts.

TRADITIONAL CONTROL FEATURES

Commercial and Residential Grade Controls

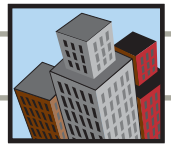

Traditional Controls

Leviton offers a full line of slide, rotary and toggle dimmers and fan speed controls ideally suited to traditional interiors. The line includes IllumaTech™, SureSlide™, and Trimatron® brand devices as well as a number of specialty lighting devices. Leviton traditional controls are offered in a variety of colors.

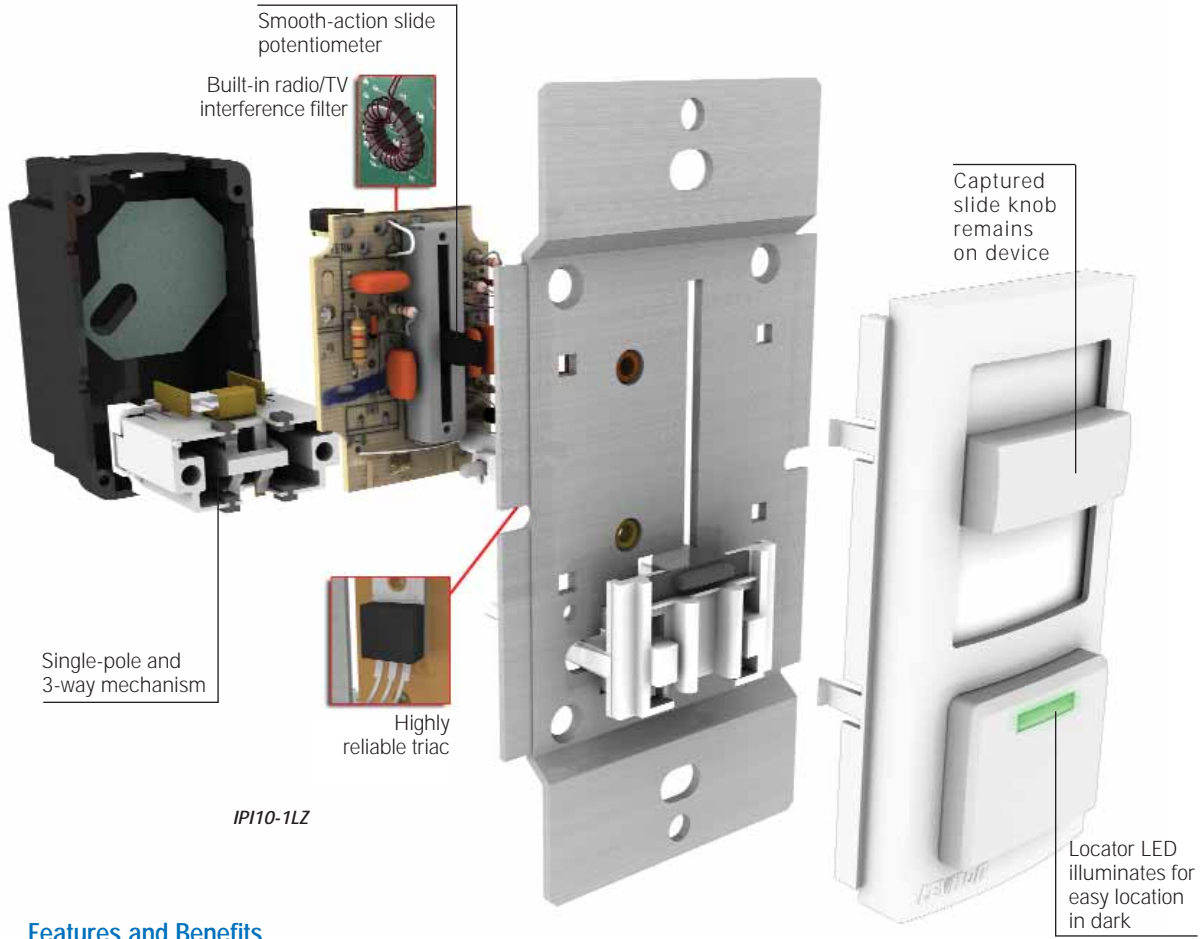

IPI10-1LZ

Features and Benefits

- Features slide, rotary and toggle style dimmers
- Most with full-range dimming and built-in radio/TV interference filter
- Single- and multi-location control available
- UL and CSA Listed
- Backed by a Limited Five-Year Warranty

TRADITIONAL STYLE SLIDE AND ROTARY LIGHTING CONTROLS



IllumaTech™ Slide and Rotary Dimmers
Decora-style dimmer with full-range slide or rotary dimming for single- or multi-location dimming control. Color change kits available.
IPI06-1LZ and RPI06-1LZ shown



SureSlide™ Slide Controls
Smooth-action slide control for easy, precise operation. Slim design ideal for multi-gang installations. Preset and slide-to-off versions.
6633-PLW shown



Trimatron® Rotary Controls
Ultra-compact, full-range rotary dimmers.
6681-W shown



Specialty Lighting Controls
Specialty dimmers, sockets and switches. Emergency switch flashes lights on and off. Lamp-cord and 4-step dimmers also available.
911-W shown



Commercial Grade Controls

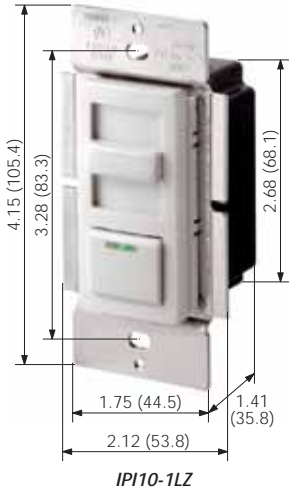

IPI10-1LZ

IllumaTech Preset Slide Controls

All IllumaTech Preset Dimmers provide single-pole (one-location) or 3-way (multi-location) control when used with a 3-way switch.

IllumaTech Slide Controls—Single Pole and 3-Way  

DESCRIPTION	CAT. NO.	RATING	COLOR*
IllumaTech Incandescent Dimmer with LED Locator	IPI06-1L	600W 120V AC 60Hz	X, Z
IllumaTech Incandescent Dimmer with LED Locator	IPI10-1L	1000W 120V AC 60Hz	X, Z
IllumaTech Electronic Low-Voltage Dimmer with LED Locator; neutral required	IPE04-1L	400VA (320W) 120V AC 60Hz	X, Z
IllumaTech Magnetic Low-Voltage Dimmer with LED Locator	IPM06-1L	600VA (450W) 120V AC 60Hz	X, Z
IllumaTech Magnetic Low-Voltage Dimmer with LED Locator	IPM10-1L	1000VA (800W) 120V AC 60Hz	X, Z
IllumaTech Fluorescent Dimmer for Advance Mark 7® 0-10V Ballast with LED Locator; neutral required	IP710-DL	1200VA @ 120V AC 60Hz, 1500VA @ 277V AC 60Hz	X, Z
IllumaTech Fluorescent Dimmer for Advance Mark 10® Powerline Ballasts, no LED; neutral required	IPX06-10	600VA 120V AC 60Hz	X, Z
IllumaTech Fluorescent Dimmer for Advance Mark 10® Powerline Ballasts, no LED; neutral required	IPX10-10	1000VA 120V AC 60Hz	X, Z
IllumaTech Fluorescent Dimmer for Advance Mark 10® Powerline Ballasts, no LED; neutral required	IPX06-70	600VA 277V AC 60Hz	X, Z
IllumaTech Fluorescent Dimmer for Advance Mark 10® Powerline Ballasts, no LED; neutral required	IPX12-70	1200VA 277V AC 60Hz	X, Z
IllumaTech Quiet Fan Speed Control with LED Locator; neutral required	IPF01-1L	1.5 Amps 120V AC 60Hz	X, Z
IllumaTech Fully variable Fan Speed Control with LED Locator; neutral required	IPF05-1L	5 Amps 120V AC 60Hz	X, Z
IllumaTech Color Change Kit with LED Locator	IPKIT-00	—	I, W, A, T, G, E, R, B
IllumaTech Color Change Kit, no LED	IPKIT-0N	—	I, W, A, T, G, E, R, B
IllumaTech Color Change Kit for Fan Speed Control	IPOFK-00	—	I, W, A, T, G, E, R, B

See Page C7 for more information on Leviton Power Extenders

Note: Sharing a neutral wire may cause flickering. Connect all dimmers to the same phase or run a separate neutral to each phase. Consult Leviton Techline if problems persist.

CAUTION ON RETROFITS: When retrofitting Mark 10® Powerline dimming ballasts into fixtures that originally had Instant Start ballasts, the sockets MUST be replaced with Rapid Start sockets to allow proper dimmer operation and prevent damage to the dimming ballast. Refer to the instructions provided with the ballast and the Leviton dimmer.

SPECIFICATIONS AND FEATURES

- Fluid slide movement allows fine adjustment of light level with minimum effort
- Captured, wrap-around slide bar stays in place and cannot fall off during use
- Easy-to-use pushbutton switch with conveniently positioned locator LED. Makes the pushbutton easier to find in the dark
- Provide single-pole (one-location) and multi-location lighting control when used with a 3-way switch
- IllumaTech Six-Pack: Three color choices, along with single- or multi-location control provide six different options in each box, eliminating the need to stock a large variety of devices
- Attractive Decora styling blends with any interior
- Compatible with Decora screwless and Decora standard designer wallplates
- Power failure recovery ensures retention of last setting before power interruption
- Built-in radio/TV interference filter
- Quiet 1.5 Amp Fan Speed Controls are ideal for libraries, study rooms and any area where ceiling fan noise could become distracting. Full range 5-amp fan speed controls also available

- Color change kits feature a self-aligning mechanism that automatically connects it to internal slider
- Snap-On Color Change Kits allow color changes on any device, eliminating the need to stock a separate device for every available color

TESTING AND CODE COMPLIANCE

- UL Listed (File #E-31373)
- CSA Certified (File #LR-3413)
- Backed by a Limited Five-Year Warranty

*COLOR

IllumaTech Preset Controls come packaged with three colors. Controls with suffix (-X) include Ivory, White and Almond; controls with suffix (-Z) include Ivory, White and Light Almond. Color Change Kits available in the following colors: Ivory (-I), White (-W), Almond (-A), Light Almond (-T), Gray (-G), Black (-E), Brown (-B) and Red (-R).

MATERIAL CHARACTERISTICS

Environmental: Flammability UL-94, V2 Rating
Operating Temperature: 32°F to 130°F

Use Leviton Power Extenders to extend the load capacity of box-mounted dimmers. Leviton Power Extenders are available for incandescent, magnetic low-voltage, electronic low-voltage, Advance Mark 10® Powerline fluorescent dimming ballasts or equivalents, and 0–10 VDC dimmable fluorescent ballasts such as Advance Mark 7® 0–10V, OSRAM Sylvania Quicktronic Helios or equivalent ballasts.



Residential Grade Controls

IllumaTech Rotary Controls

All IllumaTech Rotary Controls combine the ease of a traditional rotary dial with the contemporary look of Leviton Decora®.

IllumaTech Rotary Controls 120V AC 60Hz

DESCRIPTION	CAT. NO.	RATING	COLOR* X=I+W+A Z=I+W+T
IllumaTech Rotary Incandescent Dimmer, Single-Pole or 3-way, with LED Locator	RPI06-1L	600W	X, Z
IllumaTech Rotary Incandescent Dimmer, Single-Pole or 3-way, no LED	RPI06-10	600W	X, Z
IllumaTech Rotary Quiet Fan Speed Control, Single-Pole, no LED	RTF01-1L	1.5A	X, Z
IllumaTech Rotary Quiet Fan Speed Control and Dimmer, Single-Pole, no LED	RTD01-10	1.5A Fan Control/ 300W Dimmer	X, Z

See Page C7 for more information on Leviton Power Extenders



RPI06-1LX

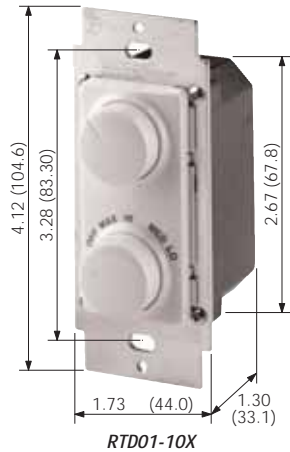

RTD01-10X

SPECIFICATIONS AND FEATURES

- Combines traditional rotary dial with contemporary Decora styling
- Dimmers provide single-pole (one-location) and 3-way (multi-location) control when used with a 3-way switch
- IllumaTech Six-Pack: Three color choices, along with single- or 3-way control provide six different options in each box, eliminating the need to stock a large variety of devices
- Dimmers available in illuminated and non-illuminated versions
- Quiet 1.5 Amp Fan Speed Controls are perfect for libraries, study rooms and any area where ceiling fan noise could become distracting
- Dual fan speed control and dimmer is ideal for ceiling fans with built-in light fixtures
- Attractive Decora styling coordinates perfectly with Leviton's complete line of Decora wiring devices
- Compatible with Decora Plus screwless and Decora standard designer wallplates
- Built-in radio/TV interference filter
- Slim, compact housing fits easily into a standard wallbox and is suitable for multi-gang installations

TESTING AND CODE COMPLIANCE

- UL Listed (File #E-31373)
- CSA Certified (File #LR-3413)
- Backed by a Limited Five-Year Warranty

***COLOR**

IllumaTech Rotary Controls come packaged with three colors. Controls with suffix (-X) include White, Ivory and Almond; controls with suffix (-Z) include Ivory, White and Light Almond.

MATERIAL CHARACTERISTICS

Environmental: Flammability UL-94, V2 Rating
Operating Temperature: 32°F to 130°F

Use Leviton Power Extenders to extend the load capacity of box-mounted dimmers. Leviton Power Extenders are available for incandescent, magnetic low-voltage, electronic low-voltage, Advance Mark 10® Powerline fluorescent dimming ballasts or equivalents, and 0-10 VDC dimmable fluorescent ballasts such as Advance Mark 7® 0-10V, OSRAM Sylvania Quicktronic Helios or equivalent ballasts.



Residential Grade Controls

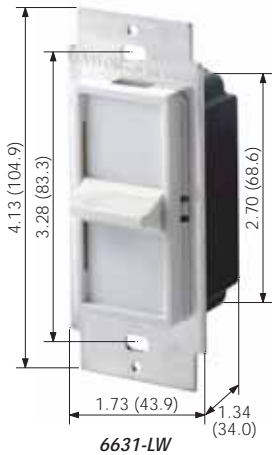

6631-LW

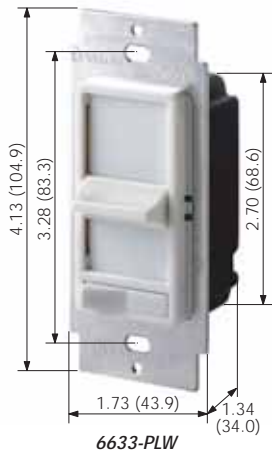

6633-PLW

SureSlide™ Full Range Slide Controls 120V AC 60Hz Only

Incandescent

DESCRIPTION	CAT. NO.	RATING	COLOR*
SureSlide Single-Pole Slide-To-Off Dimmer, with optional use LED	6631-L	600W	I, W, A, T
SureSlide Single-Pole or 3-Way Dimmer with Preset On/Off Switch, with optional use LED	6633-PL	600W	I, W, A, T
SureSlide Incandescent or Magnetic Low-Voltage Dual Slide-To-Off Dimmer—two Single-Pole Loads	6628	300W or 300VA per circuit; 600W/600VA Total	I, W, A

Low Voltage

DESCRIPTION	CAT. NO.	RATING	COLOR*
SureSlide Magnetic Low-Voltage Dimmer, Single-Pole or 3-Way with Preset On/OFF Switch, with optional use LED	6613-PL	600VA (450W)	I, W, A, T
SureSlide Electronic Low-Voltage Dimmer, Single-Pole or 3-Way with Preset On/OFF Switch	6615-P	300W	W, T

Advance Mark 10® Powerline/Philips Marathon™

DESCRIPTION	CAT. NO.	RATING	COLOR*
SureSlide Dimmer for Mark 10 PowerLine/Phillips Marathon Ballasts, Single-Pole	6668	Mark 10 500W-120V, Philips Dimmable Marathon—350W-120V	I, W

Full-Range Fan Speed Control

DESCRIPTION	CAT. NO.	RATING	COLOR*
SureSlide Single-Pole	6627-1	5A	I, W (Also available in Brown)
SureSlide Single-Pole or 3-Way with Preset ON/OFF	6637-P	5A	I, W, A

Quiet Step Fan Speed Controls

DESCRIPTION	CAT. NO.	RATING	COLOR* (Brown not available)
SureSlide Single-Pole or 3-way Quiet Step with Preset ON/OFF	6629-3	1.5A	I, W, A, GY
SureSlide Dual Quiet Fan Speed Control and Dimmer	6630	1.5A Fan Control/ 300W Dimmer	I, W, A, T, GY

See Page C7 for more information on Leviton Power Extenders

CAUTION ON RETROFITS: When retrofitting Mark 10™ Powerline dimming ballasts into fixtures that originally had Instant Start ballasts, the sockets MUST be replaced with Rapid Start sockets to allow proper dimmer operation and prevent damage to the dimming ballast. Refer to the instructions provided with the ballast and the Leviton dimmer.

Use Leviton Power Extenders to extend the load capacity of box-mounted dimmers. Leviton Power Extenders are available for incandescent, magnetic low-voltage, electronic low-voltage, Advance Mark 10® Powerline fluorescent dimming ballasts or equivalents, and 0-10 VDC dimmable fluorescent ballasts such as Advance Mark 7® 0-10V, OSRAM Sylvania Quicktronic Helios or equivalent ballasts.

SPECIFICATIONS AND FEATURES

- All SureSlide devices have a permanently mounted smooth-action integrated linear slide control for easy, precise operation
- SureSlide features a slim, compact housing that fits easily into a standard wallbox and is suitable for multi-gang installations
- Preset versions provide single-pole (one-location) and 3-way (multi-location) lighting control when used with a 3-way switch
- Illuminated versions feature optional-use Locator LED
- SureSlide's attractive Decora styling coordinates perfectly with Leviton's complete line of Decora wiring devices
- Compatible with Decora screwless and Decora standard designer wallplates
- Built-in radio/TV interference filter
- Quiet 1.5 Amp Fan Speed Controls are ideal for libraries, study rooms and any area where ceiling fan noise could become distracting. Full range 5-amp fan speed controls also available
- SureSlide Cat. No. 6668 is specially designed to work with the Philips Dimmable Marathon™

TESTING AND CODE COMPLIANCE

- UL Listed (File #E-31373)
- CSA Certified (File #LR-3413)
- Limited Five-Year Warranty

*COLOR

To order colors, add suffix to catalog number as follows: Ivory (-I), White (-W), Almond (-A), Light Almond (-T), Gray (-GY) and Black (-E). Basic Cat. No. denotes Brown where Brown is available.

MATERIAL CHARACTERISTICS

Environmental: Flammability UL-94, V2 Rating
Operating Temperature: 32°F to 130°F



Trimatron™ Deluxe Full Range Rotary Controls

Trimatron Incandescent Rotary Dimmers 600 Watts

DESCRIPTION	CAT. NO.	RATING	COLOR*
Trimatron Incandescent Dimmer, push-ON/ push-OFF, Single-Pole	6681	600W-120V AC	I, W, A
Trimatron Incandescent Dimmer, push-ON/ push-OFF 3-Way	6683	600W-120V AC	I, W, A
Trimatron Incandescent Dimmer, Single-Pole	6602	600W-120V AC	I, W
Trimatron Incandescent Dimmer Single-Pole (Not UL Listed or CSA Certified)	6602-220	600W-220V 50Hz	W
Decora Plastic Adapter for Rotary Dimmers — plastic, standard size; fits over .406" dimmer shaft	80400	—	I, W, A, E (Basic Cat. No. denotes Brown)
Dimmer Knobs with metal insert (packed 25 per box)	26115	—	I, W, A, T, E (Basic Cat. No. denotes Brown)

Note: All dimmers have a ground wire.

Trimatron Fan Speed Controls 120V AC 60Hz Only

DESCRIPTION	CAT. NO.	RATING	COLOR*
Trimatron Full-Range Fan Speed Control	6616-X	5A-120V AC	I, W
Trimatron Quiet Fan Speed Control	6639	1.5A-120V AC	I, W

See Page C7 for more information on Leviton Power Extenders

Use Leviton Power Extenders to extend the load capacity of box-mounted dimmers. Leviton Power Extenders are available for incandescent, magnetic low-voltage, electronic low-voltage, Advance Mark 10® Powerline fluorescent dimming ballasts or equivalents, and 0–10 VDC dimmable fluorescent ballasts such as Advance Mark 7® 0–10V, OSRAM Sylvania Quicktronic Helios or equivalent ballasts.

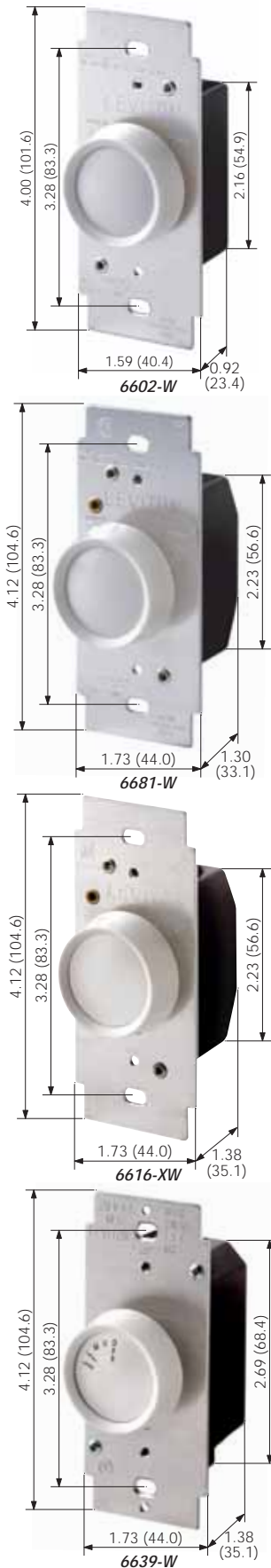

SPECIFICATIONS AND FEATURES

- Leviton Trimatron lighting controls are traditional rotary-style dimmers featuring an ultra-compact design that fits in even the tightest single-gang wallboxes and is suitable for multi-gang installations
- Built-in radio/TV interference filter
- Quiet 1.5 Amp Trimatron Fan Speed Controls are ideal for libraries, study rooms and any area where ceiling fan noise could become distracting. Full range 5-Amp fan speed controls also available
- Wire leads provided for fast, easy assembly and wiring

TESTING AND CODE COMPLIANCE

- UL Listed (File #E-31373)
- CSA Certified (File #LR-3413)
- Backed by a Limited Five-Year Warranty

*COLOR

Add suffix to catalog numbers as follows to select colors: Ivory (-I), White (-W), Almond (-A), Light Almond (-T) and Black (-E). Cat. Nos. 80400 and 26115 also available in Brown (no suffix).

MATERIAL CHARACTERISTICS

Environmental: Flammability UL-94, V2 Rating
Operating Temperature: 32°F to 130°F



Residential Grade Lighting Controls

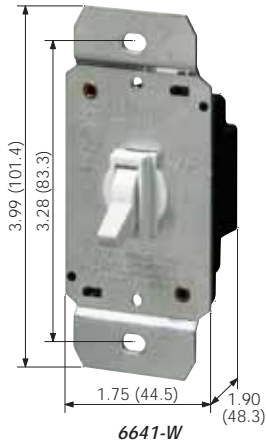

Incandescent Lighting Controls

Toggle Dimmers 600 Watts 120V AC 60Hz Only

DESCRIPTION	CAT. NO.	RATING	COLOR* (Basic Cat. No. Denotes Brown)
Incandescent Dimmer, Single-Pole	6641	600W-120V AC	I, W,
Incandescent Dimmer for Single-Pole or 3-Way	6643	600W-120V AC	I, W
Incandescent Dimmer, Single-Pole, Illuminated	6691	600W-120V AC	Clear
Incandescent Dimmer, Single-Pole or 3-way, Illuminated	6693	600W-120V AC	Clear

Decora® 911 Flasher 500 Watts 120V AC 60Hz Only

DESCRIPTION	CAT. NO.	RATING	COLOR*
Decora 3-Position Emergency Flasher Rocker Switch, Incandescent only	911	500W-120V AC	I, W, A



SPECIFICATIONS AND FEATURES

Toggle Dimmers

- Easy-to-install shallow design replaces standard switch in single wallbox
- Built-in radio/TV interference filter
- Positive ON/OFF action with smooth, full-range brightness control

911 Switch

- 911 replaces standard single-pole switch and alerts neighbors and helps emergency personnel locate a house quickly
- 911 Switch has standard ON/OFF operation plus a special illuminated "FLASH" position that causes controlled lighting to flash ON and OFF at one second intervals

TESTING AND CODE COMPLIANCE

- UL Listed (File #E-31373)
- CSA Certified (File #LR-3413)
- Backed by a Limited Five-Year Warranty

***COLOR**

Basic Cat. No. denotes Brown where indicated. Add suffix to catalog number as follows for other colors: Ivory (-I), White (-W), and Almond (-A).



MATERIAL CHARACTERISTICS

Environmental: Flammability UL-94, V2 Rating
Operating Temperature: 32°F to 130°F



Residential Grade Lighting Controls

Specialty Dimmers and Sockets

Incandescent Dimmers 120V AC 60Hz Only  

DESCRIPTION	CAT. NO.	RATING	COLOR*
Decora 4-Level Step Dimmer Incandescent only	6161	500W	W, I, A
HI-LO Feed-through Lamp-Cord Dimmer	1420	200W	W <i>(Basic Cat. No. Denotes Brown)</i>
Full-Range Feed-through Lamp-Cord Dimmer (Individually boxed) (not UL Listed or CSA Certified)	6250-3	200W	I <i>(Basic Cat. No. Denotes Brown)</i>
Tabletop Dimmer for plug-in lamps	TBI03	300W	W, E

Dimmer Socket 120V AC 60Hz Only  

DESCRIPTION	CAT. NO.	RATING	COLOR*
Full-Range Compact Dimmer Socket (1/8 I.P.S Thread and Set Screw)	6151	150W	(Non-color item)

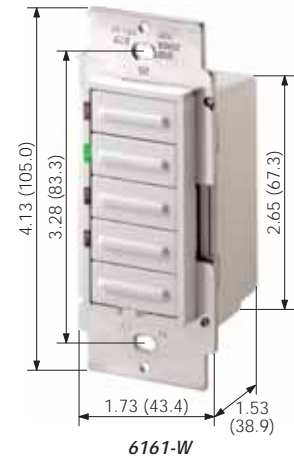

6161-W



6151

SPECIFICATIONS AND FEATURES

Four-Level Step Dimmer

- Eliminates guesswork — user selects one of four preset lighting levels (25%, 50%, 75%, 100%)
- Easily installs in place of single-pole switch
- LED indicates selected level of brightness
- Sleek designer styling; can be ganged with other Decora devices

Lamp Cord and Socket Dimmers

- Compact Dimmer Socket interchangeable with standard lampholder for dimmer conversion (eliminates need for expensive 3-way bulbs)
- Full-Range Feed-Through Lamp Cord Dimmer provides full-range dimming with positive ON/OFF action in a completely insulated plastic housing

TESTING AND CODE COMPLIANCE

- UL Listed (File #E-3810) – 6151; (File #E-7458) – 1420; (File #E-7442) – 6250-3
- CSA Certified (File #LR-1863) – 6151; (File #LR-3413) – 1420
- Backed by a Limited Five-Year Warranty

*COLOR

Basic Cat. No. denotes Brown where indicated. Add suffix to catalog number as follows for other colors: Ivory (-I), White (-W).

MATERIAL CHARACTERISTICS

Environmental: Flammability UL-94, V2 Rating
Operating Temperature: 32°F to 130°F

HOW TO USE THIS CATALOG

The L-101 Leviton Wiring Device Catalog is designed to help you find the device you're seeking in the quickest and easiest way possible. Most product sections are divided into three distinct categories in the following sequence—Industrial Grade, Commercial Grade and Residential Grade—and grouped according to amperage and voltage, lowest to highest. For example, if you need to order 15 Amp, 125 Volt Industrial Grade straight-blade duplex receptacles, begin your search with the main Table of Contents at the front of the book. Here you'll see that all straight blade receptacles are listed in Section G. Turn to Section G for a more detailed Table of Contents on the first page. Each section page contains product descriptions, ratings and catalog numbers. There are also helpful highlights including Specifications and Features, Testing and Code Compliance, Color listing, Material Characteristics and dimensioned color product photos. Any product page in the L-101 Catalog can be clearly copied or faxed to customers and prospects for use as a specifier sheet or as part of a presentation.

The Quick Reference Guide follows the main Table of Contents to help you pinpoint and locate specific products. Technical Section V provides general product and test data, industry standards, NEMA configuration charts, a glossary of wiring device terms, ANSI architectural symbols and other related information. Specific catalog numbers are listed in the exhaustive index at the back of the catalog.

15 AMP 125 and 250V • 20 AMP 125 and 250V

Industrial Grade Straight Blade Receptacles

Back and Side Wired (Basic Cat. No. Denotes Brown Device*)

DESCRIPTION	CAT. NO./COLOR 15A/125V	CAT. NO./COLOR 15A/250V	CAT. NO./COLOR 20A/125V	CAT. NO./COLOR 20A/250V
LEVSPEC® Duplex Receptacle, Brass Strap	5262 I, W, GY, R, E	5662 I	5362 I, W, GY, R, E	5462 I, GY
Single Receptacle	5261 I, W, GY	5661 I	5361 I, W, A, T, GY	5461 I, A, T, GY
Narrow Body Duplex Receptacle	5252 I, W, A, T, GY, R, BU		5352 I, W, A, T, GY, R,	

For complete wallplate selection, see Section E.

80703-IG 80703-I 80704-GY 80716-R

84003-40 84004-40 84016-40

SPECIFICATIONS AND FEATURES

Back & Side Wired Duplex

- Impact-resistant thermoplastic nylon cover and body
- Smooth face does not collect dirt
- Four corner latches securely fasten face
- Single-piece brass mounting strap on LEVSPEC devices, multi-piece steel strap on other devices
- Large, triple-wipe, brass "T" contacts for superior contact and conductivity
- Back and side-wiring options
- Brass terminal screws to reduce conductor oxidation
- Break-off tabs for easy two-circuit conversion
- Apron barrier to prevent accidental contact between terminal screw heads and metal box
- Exclusive V-shaped, serrated back-wiring clamp for superior contact and conductivity

TESTING AND CODE COMPLIANCE

- UL Listed 498 (UL File #13399); UL Federal Specification WC-596

***COLOR**

Basic Cat. Nos. shown above denote Brown device, except for Isolated Ground (-IG) devices Basic Cat. No. denotes Orange. Isolated Ground Receptacle is distinguished by an orange triangle on its face. For other color selections, add suffix to the catalog number as follows: Ivory (-I), White (-W), Brown (For IG devices only, add -A), Almond (-A), Light Almond (-T), Gray (-G or -GY), Black (-E), Red (-R) and Blue (-BU); for IG devices only, add -BIG)

MATERIAL CHARACTERISTICS

Environmental: Flammability, Rated V2
Operating Temperature: From -40° C (without impact) to 60°C maximum continuous

- | | | |
|---------------------------------------|--|--------------------------------------|
| A RATING | E CATALOG NUMBER | I SPECIFICATIONS & FEATURES |
| B Choose GRADE, if appropriate | F DESCRIPTION | J TESTING AND CODE COMPLIANCE |
| C DIMENSIONED PHOTOGRAPH | G Check for NEMA CONFIGURATION | K COLOR LISTING |
| D WIRING/CERTIFICATIONS | H WALLPLATE REFERENCE, if appropriate | L MATERIAL CHARACTERISTICS |

Energy Management Products

INDEX

Occupancy Sensor Lighting Controls	
Overview	D2
Decora Wall Switch Infrared Occupancy Sensors	D3-D6
Decora Dual-Relay Wall Switch Infrared Occupancy Sensors	D4
Decora Wall Switch Multi-Tech Occupancy Sensor	D4
Manual-ON Wall Switch Occupancy Sensor	D6
Self-Contained Fixture Mount Occupancy Sensor	D7
Power Base Adaptor	D8
Self-Contained Infrared Ceiling Mount Occupancy Sensor	D9
Multi-Tech Ceiling Mount Occupancy Sensor	D10
Ultrasonic Ceiling Mount Occupancy Sensor	D11
Infrared Ceiling Mount Occupancy Sensor	D12
Multi-Tech Wall Mount Occupancy Sensor	D13
Infrared Wide-View Wall Mount Occupancy Sensor	D14
Infrared High-Bay Wall Mount Occupancy Sensor	D14
Infrared Long-Range Wall Mount Occupancy Sensor	D14
Power Packs for Occupancy Sensors	D15
Infrared Outdoor Motion Sensors	D16
Centura System	
Centura® Fluorescent Energy Management System	D17, D18
Timed Lighting Controls	
DecoraPlus Electronic Timer Switches	D19
Decora Programmable Electronic Timer Switches	D20
Variable Countdown Timer Switch	D20
Z-MAX Relay Lighting Control Systems	D21-D27
Z-MAX Relay Cabinets	D22, D23
RRP-Remote 4-Relay Panel	D24
EZ-MAX Relay Cabinets	D25
Z-MAX Digital and Low Voltage Switch Stations	D26
miniZ™ Intelligent Daylight Management System	D27



OCCUPANCY SENSOR LIGHTING CONTROL FEATURES

Commercial and Residential Grade Energy Management Products

LEVITON OFFERS A RANGE OF PRODUCTS THAT REDUCE ENERGY COSTS WHILE INCREASING COMFORT AND SECURITY.

The modular Centura® Fluorescent Energy Management system offers "daylight harvesting" in commercial buildings through the use of photo sensors, occupancy sensors, dimmers and a PC-based lighting control interface. Occupancy Sensors provide convenient, hands-free lights-ON/lights-OFF switching either independently or as part of the Centura system. Leviton's residential and commercial grade Electronic Timers reduce energy bills and can provide a "lived-in look" for added home security. Z-MAX™ timed relay lighting control panels combine time clock and switching contactor functions with innovative technology for advanced scheduling of lighting and other loads in commercial, educational and outdoor areas.

Occupancy Sensor Lighting Controls

Leviton offers a variety of space-monitoring Occupancy Sensor Lighting Controls for virtually any room, facility, home or office. Wall or ceiling mount, with passive infrared, ultrasonic or multi-technology sensing; end-users will benefit from the energy savings, convenience and security provided by Leviton Occupancy Sensors.

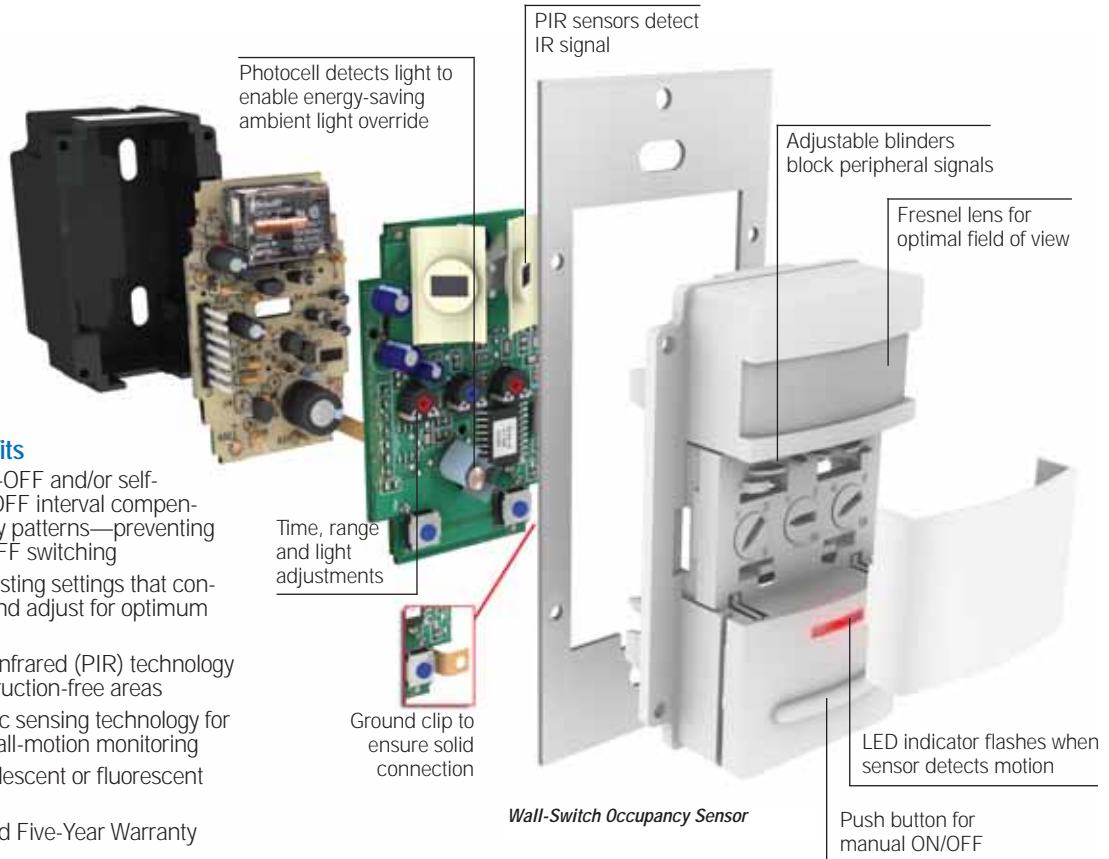

Features and Benefits

- Adjustable delayed-OFF and/or self-adjusting delayed-OFF interval compensates for occupancy patterns—preventing unnecessary ON/OFF switching
- Many with self-adjusting settings that continuously analyze and adjust for optimum performance
- Advanced passive infrared (PIR) technology for monitoring obstruction-free areas
- Advanced ultrasonic sensing technology for highly accurate small-motion monitoring
- For use with incandescent or fluorescent lighting
- Backed by a Limited Five-Year Warranty

OCCUPANCY SENSOR LIGHTING CONTROLS FOR COMMERCIAL AND RESIDENTIAL APPLICATIONS



Decora® Wall-Switch Infrared Occupancy Sensor
Features automatic "walk-through" sensing and self-adjusting delayed-OFF. Dual relay versions available.
ODS15-IDW shown

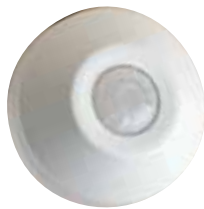

Self-Contained Infrared Ceiling-Mount Occupancy Sensor
Features built-in relay and 360° coverage. For small spaces.
ODC05-11W shown



Multi-tech Ceiling-Mount Occupancy Sensor
IR and ultrasonic combine for accurate monitoring while minimizing false triggers. For larger, open areas. Self adjusting.
OSC20-MOW shown



Ultrasonic Ceiling-Mount Occupancy Sensor
Highly accurate small-motion detection. Self-adjusting sensitivity and time off.
OSC05-UOW shown



Wall-Mount Occupancy Sensor
Available with multi-technology sensing or IR wide-view, high-bay and long-range versions. Fits in corner.
OSW12-MOW shown



Infrared Outdoor Motion Sensor
Adjustable delayed-OFF plus sensitivity to reduce false triggers. For commercial and residential applications.
PS200 shown

Energy Management Products

D



To learn more about Leviton's outstanding offering of devices visit our Website at: www.leviton.com

Courtesy of Steven Engineering, Inc. • 230 Ryan Way, South San Francisco, CA 94080-6370 • General Inquiries: (800) 670-4183 • www.stevenengineering.com

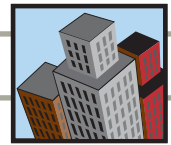

Wall Switch Occupancy Sensor Lighting Controls

Decora Wall Switch Infrared Occupancy Sensor (Incandescent or Fluorescent)

DESCRIPTION	CAT. NO.	RATING	COLOR*
Decora Wall Switch PIR Occupancy Sensor, 180° field of view, 2100 sq. ft	ODS10-ID	Incandescent: 800W @ 120V, Fluorescent: 1200VA @ 120V, 2700VA @ 277V. For 60 Hz AC only. Motor: 1/4 HP @ 120V	I, W, A, T, G
Decora Wall Switch PIR Occupancy Sensor with Self-Adaptive Technology, 180° field of view, 2100 sq. ft	ODS15-ID	Incandescent: 1800W @ 120V. Fluorescent: 1800VA @ 120V, 4000VA @ 277V. Motor: 1/4 HP @ 120V	I, W, A, T, G
Decora Wall Switch PIR Occupancy Sensor with LED Night Light, 180° field of view, 1200 sq. ft (neutral required)	OSSNL-ID	Incandescent: 800W @ 120V Fluorescent: 1200VA @ 120V 2700VA @ 277V Motor: 1/8HP @ 120V	I, W, A, T, G
CEC Title 24 Compliant Decora Wall Switch PIR Manual-ON Sensor with LED Night Light, 180° field of view, 1200 sq. ft (neutral required)	OSS10-ID	Incandescent: 800W @ 120V Fluorescent: 1200VA @ 120V 2700VA @ 277V Motor: 1/8HP @ 120V	I, W, A, T, G

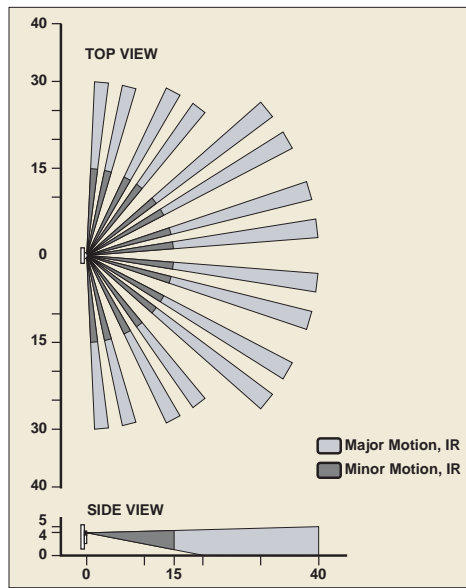

ODSXX-ID/OSSXX-ID Field of View (in feet)

SPECIFICATIONS AND FEATURES

All ODS Wall Switch Sensors

- Ambient light override prevents these devices from switching lights ON when there is ample natural sunlight
- Push-button manual override is used to turn lights ON at any time, regardless of the override setting
- 180° field of view, 2100 sq. ft. of coverage
- One unit can be used for 120V or 277VAC 60Hz incandescent, low voltage and fluorescent lighting with either magnetic or electronic ballasts, and motor loads
- Fits in standard wallbox; gangable
- Elegant Decora styling; uses Decora wallplate

ODS15-ID PIR Occupancy Sensor

- For use in small offices, conference rooms, classrooms, stockrooms, lounges, restrooms, warehouses and commercial areas
- Exclusive automatic "Walk-Through" sensing increases energy savings by shutting lights within 2 1/2 minutes after momentary occupancy

- Delayed-OFF time interval (5, 10 and 20 minutes) compensates for real-time occupancy patterns, preventing unnecessary ON/OFF switching—with 30-second test mode

ODS10-ID PIR Occupancy Sensor

- For use in enclosed offices, storage rooms, copier rooms and closets
- Delayed-OFF time settings: 10, 20 and 30 minutes with 30-second test mode

All Night Light Wall Switch Sensors

- For use in conference rooms, classrooms, small offices, lounges, hotel/hospital/office restrooms
- 180° field of view, 1200 sq. ft. of coverage
- Night light with dim feature

OSSNL-ID PIR Occupancy Sensor

- Manual delayed-OFF time settings: 30 seconds, 30 minutes, 1 hour, 2 hours

OSS10-ID PIR Occupancy Sensor

- Manual delayed-OFF time settings: 30 seconds to 30 minutes

- Manual ON/Auto OFF operation for CEC Title 24 Compliance

TESTING AND CODE COMPLIANCE

- UL Listed (File #E-118904)
- CSA Certified (File #LR-91148M)
- NOM Certified (#057)
- Conforms to California Title 24 Energy Code
- Backed by a Limited Five-Year Warranty

***COLOR**

Colors available as listed, add suffix to catalog number as follows: Ivory (-I), White (-W), Almond (-A), Light Almond (-T), Gray (-G).

MATERIAL CHARACTERISTICS

Operating Temperature: 0°C to 50°C
Storage Temperature: -10°C to 85°C
Relative Humidity: 20% to 90% non-condensing





DECORA® OCCUPANCY SENSOR LIGHTING CONTROLS • WALL SWITCH

Commercial Grade Energy Management Products

Wall Switch Occupancy Sensor Lighting Controls

Dual-Relay Decora Wall Switch Infrared Occupancy Sensor

DESCRIPTION	CAT. NO.	PHOTOCELL CONTROL OPTIONS PER RELAY	RATING	COLOR*
Dual-Relay Decora Wall Switch PIR Occupancy Sensor with Self-Adaptive Technology, 180° field of view, 2100 sq. feet	ODSOD-ID	Default Setting: Conference Room Mode (Both Primary and Secondary Relays respond to Ambient Light Override.) Alternate Setting: Classroom Mode (Primary Relay only responds to Ambient Light Override.)	Primary Relay: Fluorescent: 1200VA @ 120V, 2700VA @ 277V. Incandescent: 800W @ 120V. Secondary Relay: Fluorescent: 800VA @ 120V, 1200VA @ 277V. Incandescent: 800W @ 120V	I, W, A, T, G
Dual-Relay Decora Wall Switch PIR Occupancy Sensor with Self-Adaptive Technology. Secondary relay provides Manual-ON only for CEC Title 24 compliance, 180° field of view, 2100 sq. ft	ODSOD-TD	Primary Relay provides Automatic ON switching and responds to Ambient Light Override. Secondary Relay provides Manual-ON switching only	Primary Relay: Fluorescent: 1200VA @120V, 2700VA @ 277V. Incandescent: 800W @ 120V. Secondary Relay: Fluorescent: 800VA @ 120V, 1200VA @ 277V. Incandescent: 800W @ 120V	I, W, A, T, G

Decora Wall Switch Multi-Tech (PIR & US) Occupancy Sensors

DESCRIPTION	CAT. NO.	RATING	COLOR*
Decora Wall Switch Multi-Tech Occupancy Sensor with Self-Adaptive Technology, 180° field of view, 1200 sq. ft	OSSMT-MD	Incandescent/Tungsten: 800W @ 120V Fluorescent: 1200VA @ 120V, 2700VA @ 277V Motor: 1/4HP @ 120V	I, W, A, T, G

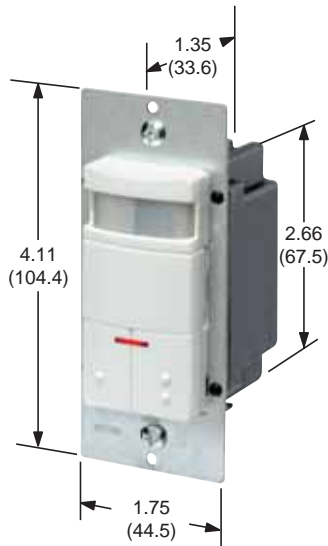

ODSOD-IDW/ODSOD-TDW

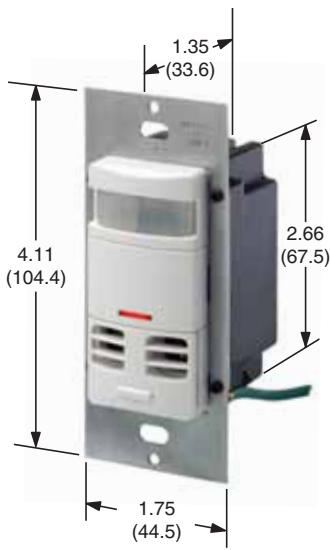

OSSMT-MD Multi-Tech Sensor

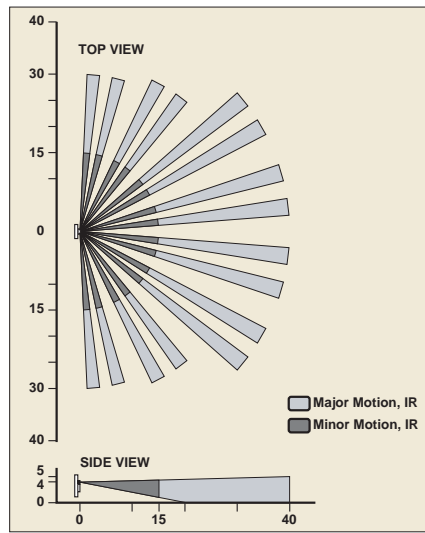

ODSOD-ID, -TD Field of View (in feet)

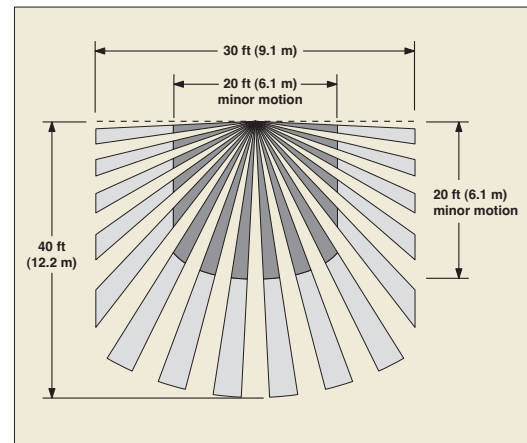

OSSMT-MD Field of View (in feet)

SPECIFICATIONS AND FEATURES

Dual-Relay PIR Occupancy Sensors

- Ideal for classrooms, multimedia and conference rooms, day care centers, office, and lounges
- Exclusive automatic "Walk-Through" sensing
- Provides automatic switching for 2 separate banks of fluorescent, incandescent, or low-voltage lighting from a single unit
- Delayed-OFF time interval (5, 10 and 20 minutes) compensates for real-time occupancy patterns, preventing unnecessary ON/OFF switching—with 30-second test mode
- ODSOD-TD provides Manual-ON/Auto-OFF operation for CEC Title 24 compliance

OSSMT-MD Multi-Tech Occupancy Sensor

- Ideal in offices, conference rooms, storage areas, restrooms, classrooms and lounges

- Combines passive infrared and ultrasonic technologies to provide maximum sensitivity with immunity to false triggering
- Ambient light override prevents lights from turning ON when there is ample natural light
- Exclusive automatic "Walk-Through" sensing
- Manual delayed-OFF time settings (30 seconds to 30 minutes)
- Manual-ON/Auto-OFF setting for CEC Title 24 compliance

TESTING AND CODE COMPLIANCE

- UL Listed (File #E-118904)
- Cat. No. ODSOD-ID is CUL/US Certified
- CSA Certified (File #LR-91148M)
- NOM Certified (#057)
- Conforms to California Title 24 Energy Code
- Backed by a Limited Five-Year Warranty

*COLOR

Colors available as listed, add suffix to catalog number as follows: Ivory (-I), White (-W), Almond (-A), Light Almond (-T), Gray (-G).

MATERIAL CHARACTERISTICS

Operating Temperature: 0°C to 50°C
Storage Temperature: -10°C to 85°C
Relative Humidity: 20% to 90% non-condensing



Wall Switch Occupancy Sensor Lighting Controls

Decora Wall Switch Infrared Occupancy Sensor

DESCRIPTION	CAT. NO.	RATING	COLOR*
Decora Wall Switch PIR Occupancy Sensor, Single-Pole & 3-Way, 180° field of view, 400 sq. ft	PR180-1L	Incandescent: 500W, Rapid Start Magnetic Fluorescent only: 400VA @ 120V AC,	I, W, A
Decora Wall Switch PIR Occupancy Sensor, Single-Pole, 150° field of view, 350 sq. ft	PR150-1L	Incandescent: 500W, Rapid Start Magnetic Fluorescent only: 400VA @ 120V AC,	I, W, A

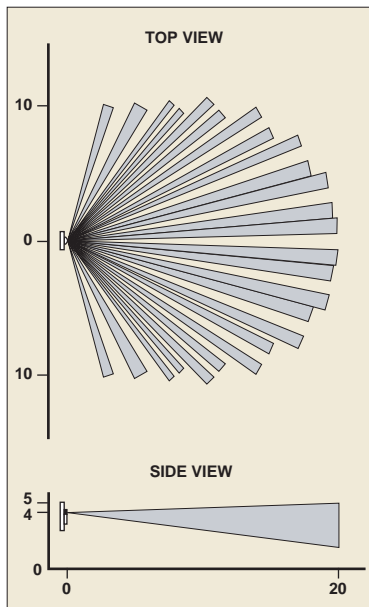

PR150-1L Field of View (in feet)

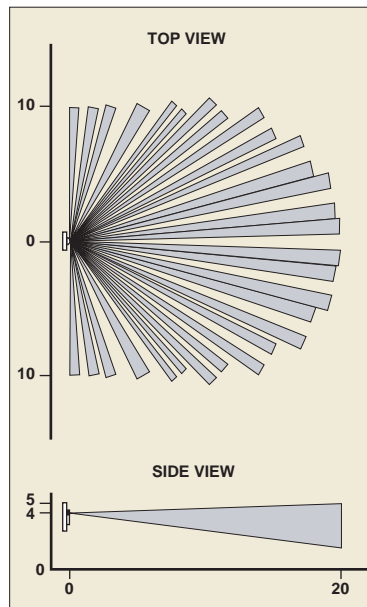

PR180-1L Field of View (in feet)

SPECIFICATIONS AND FEATURES

- PR180 with 180° field of view, 400 sq. ft. of coverage: For use in large rooms, home offices, and a variety of light commercial and residential applications
- PR150 with 150° field of view, 350 sq. ft. of coverage: For use in residential applications
- Ambient light override prevents these devices from switching lights ON when there is ample natural sunlight
- Manual override for use as a standard ON/OFF switch
- Adjustable delayed-OFF time interval (15 seconds to 15 minutes)
- Fits in standard wallbox; gangable
- Elegant Decora styling; uses Decora wallplate

TESTING AND CODE COMPLIANCE

- UL Listed (File #E-118904)
- CSA Certified (File #LR-91148M)
- Backed by a Limited Two-Year Warranty

*COLOR

Colors available as listed; add suffix to catalog number as follows: Ivory (-I), White (-W), Almond (-A).

MATERIAL CHARACTERISTICS

Operating Temperature: 0°C to 50°C
 Storage Temperature: -10°C to 85°C
 Relative Humidity: 20% to 90% non-condensing



DECORA® OCCUPANCY SENSOR LIGHTING CONTROLS • WALL SWITCH

Residential Grade Energy Management Products



Manual-ON Wall Switch Occupancy Sensor Lighting Controls

Decora Manual-ON Wall Switch Infrared Occupancy Sensor

DESCRIPTION	CAT. NO.	RATING	COLOR*
Decora Manual-ON Wall Switch PIR Occupancy Sensor, CEC Title 24 Compliant, Single-Pole, 3-Way or more when used with IPPOR Sensor Remote or Vizia Switch Remote, 180° field of view, 900 sq. ft (neutral required)	IPP15-1L	Incandescent: 1800W, Fluorescent: 1800VA at 120V AC, Motor: 1/2 HP @ 120V AC	I, W, A, T, E
Decora Manual-ON Occupancy Sensor Remote, 180° field of view, 900 sq. ft (neutral required)	IPPOR-1L	120V AC—No load rating, For use with IPP15 Sensor or Vizia Dimmers	I, W, A, T
Vizia™ Matching Switch Remote, lighted (neutral required)	VZOSR-1L	120V AC—No load rating	X (I, W & A), Z (I, W & T)
Vizia™ Coordinating Switch Remote, unlighted (neutral required)	VZOSR-10	120V AC—No load rating	X (I, W & A), Z (I, W & T)

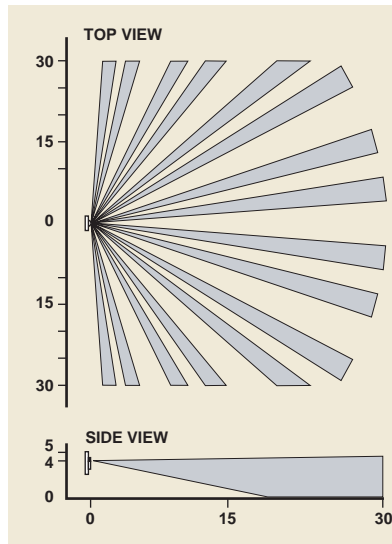

IPP15-IL Field of View (in feet)

SPECIFICATIONS AND FEATURES

- Manual-ON/Automatic OFF operation in accordance with California Title 24 2005 requirements
- 180° field-of-view provides approximately 900 sq. ft. of coverage suitable for bathrooms, basements, garages, utility rooms, and a variety of other residential areas
- Low-profile design eliminates an obtrusive “scanning-device” look
- Elegant Decora styling complements any interior and coordinates with Leviton’s popular line of Decora wiring devices and Vizia lighting controls
- IPP15 provides a true 3-Way feature when used with the IPPOR Manual-ON Occupancy Sensor Remote or the VZOSR Vizia Switch Remote
- Convenient push-button provides Manual ON/OFF light switching at any time

- Segmented Fresnel lens provides optimum sensitivity and performance
- Horizontal field of view may be adjusted between 180° and 32° of arc by using integral blinders located on either side of the lens
- Four optional manual adjustments for delayed-OFF time settings maximize energy savings: 30 seconds (for walk test), 5 minutes, 15 minutes and 30 minutes
- LED indicator light flashes when sensor detects motion to verify detection is active
- Fits in standard wallbox
- Requires a neutral (white) wire connection

- Conforms to California Title 24 Energy Code and FCC regulations
- Backed by a Limited Five-Year Warranty

*COLOR

Colors available as listed, add suffix to catalog number as follows: Ivory (-I), White (-W), Almond (-A), Light Almond (-T) and Black (-E). Vizia Switch Remotes come packaged with three colors. Controls with suffix (-X) include White, Ivory and Almond. Controls with suffix (-Z) include White, Ivory and Light Almond.

MATERIAL CHARACTERISTICS

Operating Temperature: 0°C to 50°C
Storage Temperature: -10°C to 85°C
Relative Humidity: 20% to 90% non-condensing

TESTING AND CODE COMPLIANCE

- UL Listed (File #E-118904)
- CSA Certified (File #LR-152105)

Energy Management Products

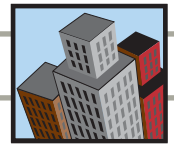

Self-Contained Infrared Fixture-Mount Occupancy Sensor

DESCRIPTION	CAT. NO.	RATING	MOUNTING HEIGHT	COLOR
Self-Contained Fixture-Mount High Bay Occupancy Sensor with 360° open area lens and 60 x 20 ft. aisle pattern lens	OSFHU-ITW	Fluorescent: 800VA @ 120V, 1200VA @ 277V, 1500VA @ 347V Motor: 1/4HP @ 120V	360° lens: 40 ft with 60 ft dia. 30 ft with 50 ft dia. 20 ft with 50 ft dia. Aisle lens: 40 ft with 60 ft (length) x 20 ft (width)	White
Offset Adapter Accessory for High Bay Fixture-Mount Occupancy Sensor	OSFOA-00W	---	---	White

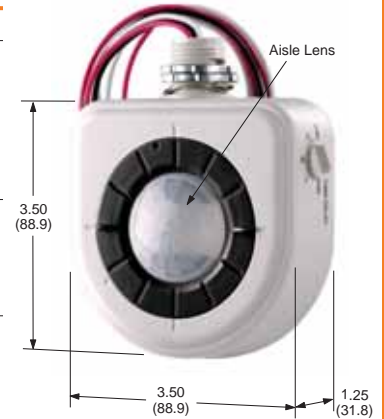

OSFHU-ITW



360° Lens



OSFOA

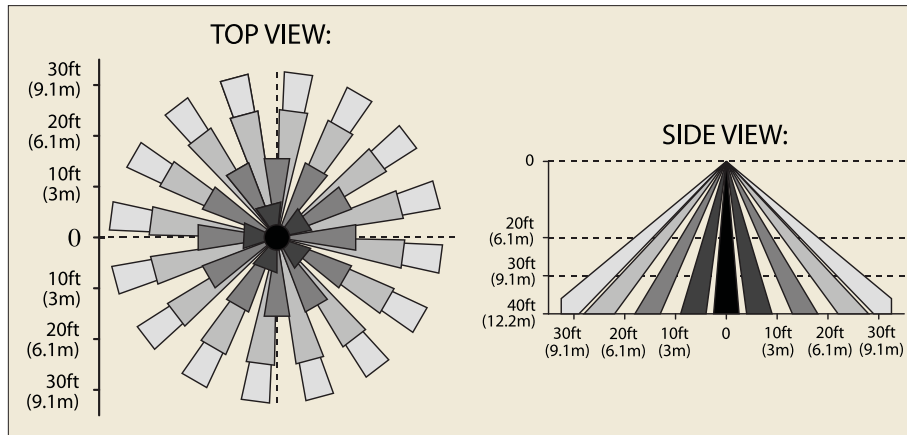

OSFHU-ITW 360° Field of View (in feet)

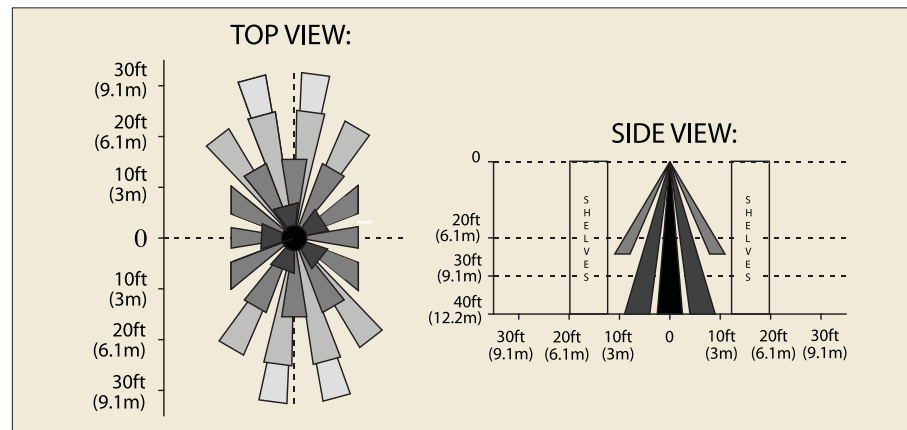

OSFHU-ITW Aisle Field of View (in feet)

SPECIFICATIONS AND FEATURES

- Ideal in commercial facilities with high ceilings, including warehouses, manufacturing and others
- Mounts directly to industrial-style fluorescent luminaires or electrical junction box
- Provided with an open area 360° lens installed in the sensor and an interchangeable 60 x 20 ft. aisle-pattern lens
- Self-contained PIR sensor and relay turn individual fixtures ON/OFF based on occupancy
- Accommodates high-bay 20-40 ft. mounting heights
- Relay uses zero-crossing circuitry for enhanced reliability and long-life operation

- Delayed-OFF time adjustment from 30 seconds to 20 minutes
- Two-piece accessory offset adapter (Cat. No. OSFOA-00W) that snaps into a 1/2" knockout on the end of an industrial fixture is also available
- Adapter allows positioning of the sensor below the fixture body to improve field of view for deep body fixtures

TESTING AND CODE COMPLIANCE

- UL and cUL Listed
- California Title 24 Compliant
- FCC Compliant
- Backed by a Limited Five-Year Warranty



OPB15-ODW

Self-Contained Power Base Adaptor

Power Base Adaptor

Converts any Leviton low voltage ceiling or wall-mount occupancy sensor to a self-contained, line voltage unit with 15A, 120/277V load capacity

Power Base Adaptor

DESCRIPTION	CAT. NO.	POWER INPUT/OUTPUT	RATING	COLOR
Power Base Adaptor	OPB15-ODW	Power Input: 120/277VAC Control Output: 24VDC, 40mA	15A Incandescent, Electronic or Magnetic Fluorescent Ballast	White

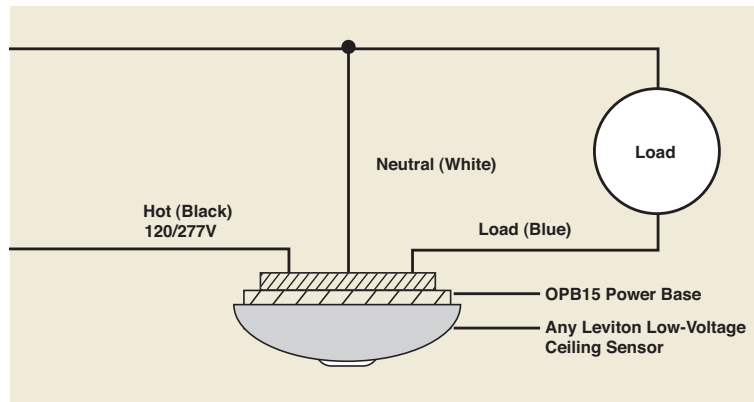

OPB15-ODW Power Base Adaptor Wiring Diagram

SPECIFICATIONS AND FEATURES

- Ideal for use in lavatories, remodels, hard ceiling spaces, energy conservation retrofits and any installation with limited access for low-voltage wiring
- Patent-pending design converts Leviton low-voltage ceiling sensors to line voltage
- Ideal for both existing buildings with limited access to low-voltage wiring and new construction with line-voltage circuiting only
- Mounts easily in a standard 2.125" deep x 4" octagon or 2.125" deep x 4" square electrical box with a 2-gang mud ring; flying leads provide fast line voltage connections

- Two-piece terminal block provides fast, easy low-voltage connections to the sensor
- Relay uses zero-crossing circuitry for enhanced reliability and long-life operation

TESTING AND CODE COMPLIANCE

- UL and cUL Listed
- NOM Certified
- California Title 24 Compliant
- Backed by a Limited Five-Year Warranty

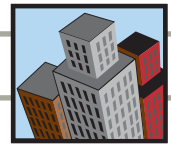

Ceiling-Mount Occupancy Sensor Lighting Controls

PIR Occupancy Sensor with built-in relay—Separate Power Pack not required

Self-Contained Infrared Ceiling-Mount Occupancy Sensor

DESCRIPTION	CAT. NO.	RATING	COVERAGE	COLOR
Self-Contained Ceiling-Mount Infrared Occupancy Sensor and Switching Relay	ODCOS-11W	Incandescent: 1000W @ 120V. Fluorescent: 1000VA @ 120V. 1 HP @ 120V For 60Hz AC only	360°, 530 sq. ft	White
Self-Contained Ceiling-Mount Infrared Occupancy Sensor and Switching Relay	ODCOS-12W	Incandescent: 1000W @ 220V. Fluorescent: 500VA @ 220V. For 50Hz AC only	360°, 530 sq. ft	White
Self-Contained Ceiling-Mount Infrared Occupancy Sensor and Switching Relay	ODCOS-17W	Fluorescent: 2700VA @ 277V. For 60Hz AC only	360°, 530 sq. ft	White
Protective Cage	ODCCG	—	—	White

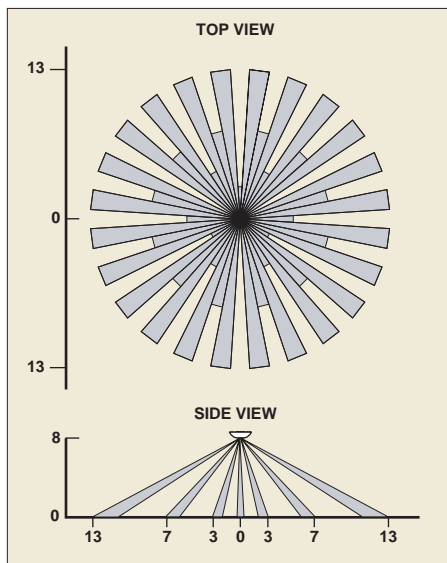
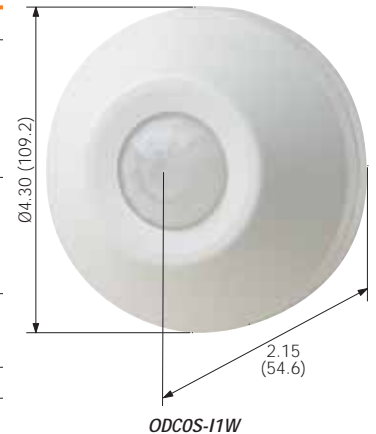

ODCOS-I Field of View (in feet)

SPECIFICATIONS AND FEATURES

- Ideal for use in storage areas, small bathrooms, copy rooms and a variety of small spaces without wall switches
- Full 360° view of a 530 sq. ft. area when surface mounted on standard, 8-foot ceiling
- Sensor and switching relay combined in a single self-contained unit—No control unit required
- Ambient light override option prevents lights from turning ON when there is ample natural light
- Adjustable Delayed-OFF time settings from 20 seconds (for test mode) to 15 minutes
- Small, unobtrusive self-contained unit: 4.3" (109.2 mm) diameter

TESTING & CODE COMPLIANCE

- UL Listed and CSA Certified
- California Title 24 compliant and meets ASHRAE Standard 90.1 requirements
- Backed by a Limited Five-Year Warranty



OCCUPANCY SENSOR LIGHTING CONTROLS • CEILING MOUNT

Commercial Grade Energy Management Products

Ceiling-Mount Occupancy Sensor Lighting Controls

Multi-Technology Ceiling-Mount Occupancy Sensor (UL, CE) (For use with Leviton Power Pack)*
 Advanced motion sensors combine infrared and ultrasonic technology for highly accurate monitoring without false triggering. All-digital self-adjusting technology provides "Install and Forget" solution for automatic lighting control.



OSC05-MOW



OSC20-MOW

DESCRIPTION	CAT. NO.	COVERAGE	OPERATING FREQUENCY	COLOR
Multi-Tech Ceiling-Mount Occupancy Sensor	OSC05-MOW	180°, 500 sq. ft	40kHz	White
Multi-Tech Ceiling-Mount Occupancy Sensor	OSC10-MOW	360°, 1000 sq. ft	40kHz	White
Multi-Tech Ceiling-Mount Occupancy Sensor	OSC20-MOW	360°, 2000 sq. ft	32kHz	White
Protective Cage for Ceiling-Mount Occupancy Sensors	ODCCG-000	—	—	White

*Low-voltage wiring is used to connect Leviton Occupancy Sensors to Cat. No. OSP20 Power Pack or a Centura CN100 Power Pack (purchased separately). See page D15 for information on OSP20.

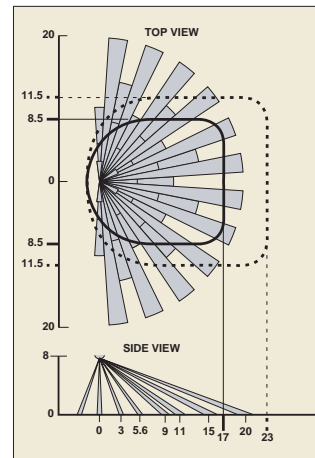
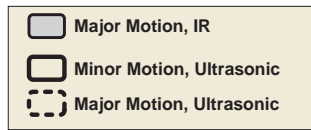

OSC05-MOW Field of View (in feet)

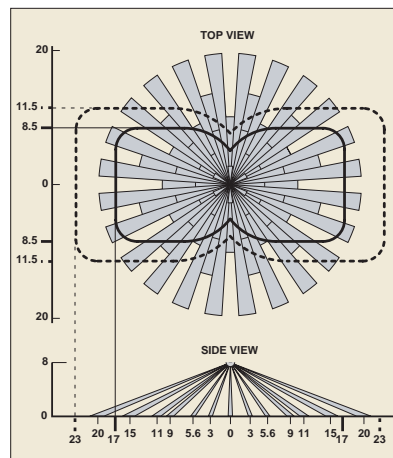

OSC10-MOW Field of View

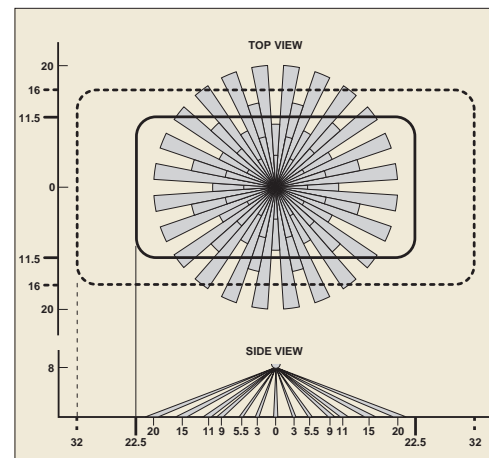

OSC20-MOW Field of View

SPECIFICATIONS AND FEATURES

- Ideal for office areas with cubicles, general work space, classrooms, cafeterias and public areas in commercial facilities
- Ultrasonic sensing for maximum sensitivity combined with Passive Infrared (PIR) sensing to prevent false triggering from air conditioning and corridor activity
- Self-adjusting settings continuously analyze and adjust for optimum performance
- Ambient light override prevents lights from turning ON when there is ample natural light
- Manual Delayed-OFF time settings of 30 seconds to 30 minutes
- Self-Adjusting Delayed-OFF time interval settings for 30 seconds to 30 minutes — Compensates for real-time occupancy patterns, preventing unnecessary ON/OFF switching

- Non-volatile memory preserves all automatic and manual settings during power outages
- Choice of coverage patterns to suit a variety of applications
- Small, unobtrusive size blends in with any décor
- Fast, simple installation using 4 color-coded low-voltage wires and a single mounting post
- Compatible with Wiremold® surface raceways for mounting to hard ceilings

TESTING AND CODE COMPLIANCE

- CUL/US, FCC and NOM Certified
- California Title 24 compliant and meets ASHRAE Standard 90.1 requirements
- Backed by a Limited Five-Year Warranty

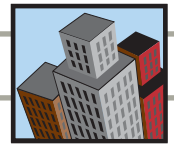

Ceiling-Mount Occupancy Sensor Lighting Controls

Ultrasonic Ceiling-Mount Occupancy Sensor (UL) (For use with Leviton Power Pack)*

Advanced Ultrasonic sensing technology for highly accurate monitoring with excellent immunity to air currents and other interference. All-digital self-adjusting technology provides "Install and Forget" solution for automatic lighting control.

DESCRIPTION	CAT. NO.	COVERAGE	OPERATING FREQUENCY	COLOR
Ultrasonic Ceiling-Mount Occupancy Sensor	OSC05-UOW	180°, 500 sq. ft	40kHz	White
Ultrasonic Ceiling-Mount Occupancy Sensor	OSC10-UOW	360°, 1000 sq. ft	40kHz	White
Ultrasonic Ceiling-Mount Occupancy Sensor	OSC20-UOW	360°, 2000 sq. ft	32kHz	White
Protective Cage for Ceiling-Mount Occupancy Sensors	ODCCG-000	—	—	White

*Low-voltage wiring is used to connect Leviton Occupancy Sensors to Cat. No. OSP20 Power Pack or a Centura CN100 Power Pack (purchased separately). See page D15 for information on OSP20.



OSC05-UOW

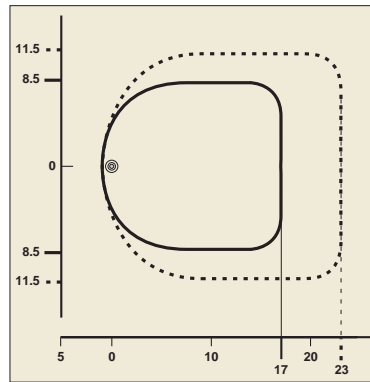
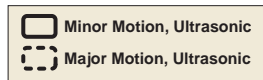

OSC05-UOW Field of View (in feet)

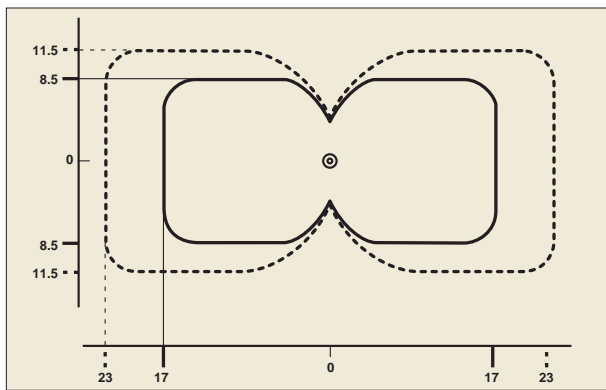

OSC10-UOW Field of View

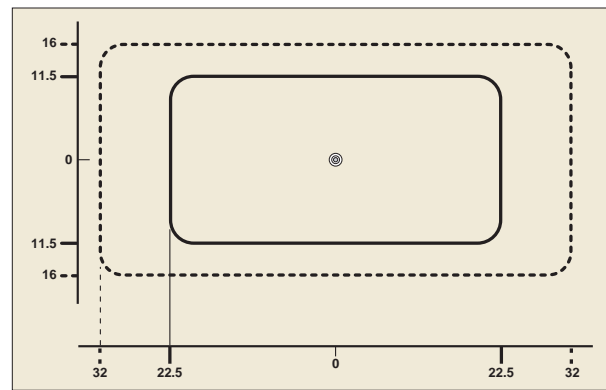

OSC20-UOW Field of View

SPECIFICATIONS AND FEATURES

- Ideal for restrooms, office areas with cubicles, general work space, warehouse and storage facilities, cafeterias and public areas in commercial facilities
- Ultrasonic sensing for maximum range and sensitivity combined with high immunity to false triggering from air currents and other interference
- Self-adjusting settings continuously analyze and adjust for optimum performance
- Ambient light override prevents lights from turning ON when there is ample natural light
- Manual Delayed-OFF time settings of 30 seconds to 30 minutes
- Self-Adjusting Delayed-OFF time interval settings for 30 seconds to 30 minutes — Compensates for real-time occupancy patterns, preventing unnecessary ON/OFF switching

- Non-volatile memory preserves all automatic and manual settings during power outages
- Choice of coverage patterns to suit a variety of applications
- Small, unobtrusive size blends in with any décor
- Fast, simple installation using 4 color-coded low-voltage wires and a single mounting post

TESTING AND CODE COMPLIANCE

- CUL/US Certified
- Meets ASHRAE Standard 90.1 requirements
- Backed by a Limited Five-Year Warranty



OCCUPANCY SENSOR LIGHTING CONTROLS • CEILING MOUNT

Commercial Grade Energy Management Products

Ceiling-Mount Occupancy Sensor Lighting Controls

Infrared Ceiling-Mount Occupancy Sensor ^{UL} ^{CS} (For use with Leviton Power Pack)*

Advanced Passive Infrared technology for highly accurate monitoring in a variety of commercial applications. All-digital self-adjusting technology provides "Install and Forget" solution for automatic lighting control.



OSC04-IOW

DESCRIPTION	CAT. NO.	COVERAGE	COLOR
Infrared Ceiling-Mount Occupancy Sensor	OSC04-IOW	360°, 450 sq. ft	White
Infrared Ceiling-Mount Occupancy Sensor with Ambient Light Override and Secondary Relay	OSC15-IOW	360°, 1500 sq. ft	White
Protective Cage for Ceiling-Mount Occupancy Sensors	ODCCG-000	—	White

*Low-voltage wiring is used to connect Leviton Occupancy Sensors to Cat. No. OSP20 Power Pack or a Centura CN100 Power Pack (purchased separately). See page D15 for information on OSP20.

- Minor Motion, IR
- Major Motion, IR

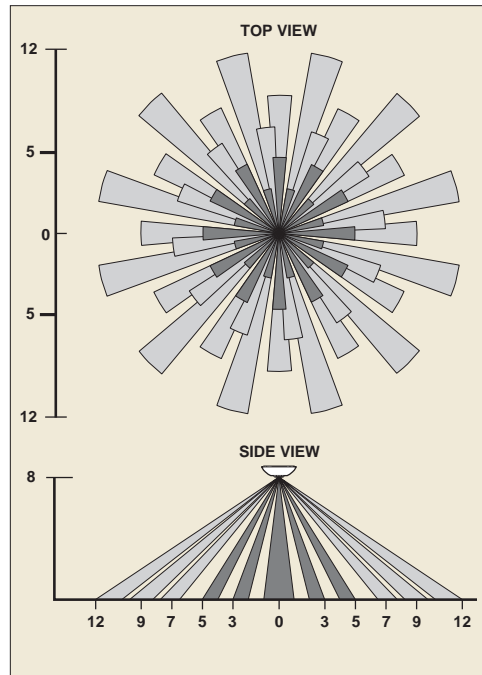

OSC04-IOW Field of View (in feet)

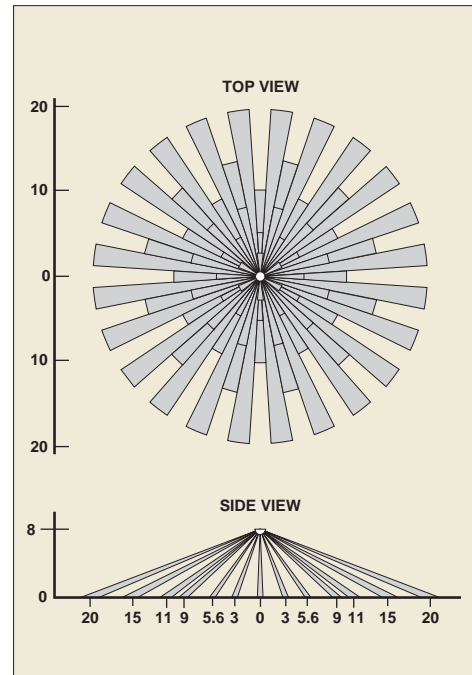

OSC15-IOW Field of View

SPECIFICATIONS AND FEATURES

- Ideal for use in small offices, closets, open offices, and other areas in commercial facilities with unobstructed view of the sensor
- Self-adjusting settings continuously analyze and adjust for optimum performance
- Ambient light override prevents lights from turning ON when there is ample natural light
- Manual Delayed-OFF time settings of 30 seconds to 30 minutes
- Self-Adjusting Delayed-OFF time interval settings for 30 seconds to 30 minutes — Compensates for real-time occupancy patterns, preventing unnecessary ON/OFF switching

- Non-volatile memory preserves all automatic and manual settings during power outages
- Small, unobtrusive size blends in with any décor
- Fast, simple installation using 4 color-coded low-voltage wires and a single mounting post

TESTING AND CODE COMPLIANCE

- Meets ASHRAE Standard 90.1 requirements
- Backed by a Limited Five-Year Warranty

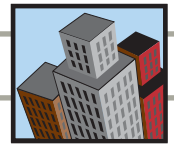

Wall-Mount Occupancy Sensor Lighting Controls

Multi-Technology Wall-Mount Occupancy Sensor (For use with Leviton Power Pack or Power Base Adaptor)*

Advanced motion sensors combine infrared and ultrasonic technology for highly accurate monitoring without false triggering. All-digital self-adjusting technology provides “Install and Forget” solution for automatic lighting control.

DESCRIPTION	CAT. NO.	COVERAGE	OPERATING FREQUENCY	COLOR
Multi-Tech Wall-Mount Occupancy Sensor	OSW12-MOW	115°, 1200 sq. ft	32kHz	White

*Low-voltage wiring is used to connect Leviton Occupancy Sensors to Cat. No. OSP20 Power Pack, OPB15 Power Base Adaptor or a Centura CN100 Power Pack (purchased separately). See page D15 for information on OSP20 and page D8 for information on OPB15.

Note: Canopy and neck allow the Wall-Mount Occupancy Sensor to be installed on the ceiling as well.



OSW12-MOW
Wall Mount



OSW12-MOW
Ceiling Mount

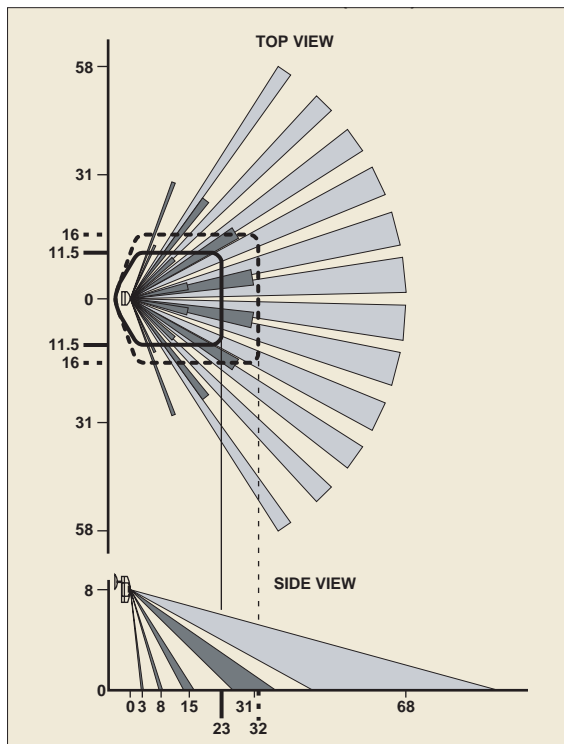

OSW12-MOW Field of View (in feet)

SPECIFICATIONS AND FEATURES

- Ideal for conference rooms, stairwells, high-ceiling rooms, open areas, storage rooms and classrooms. Also ideal for corner mounting in a variety of applications.
- Ultrasonic sensing for maximum sensitivity combined with Passive Infrared (PIR) sensing to prevent false triggering from air conditioning and corridor activity
- Adjustable swivel neck rotates 85° vertically and 60° horizontally— Can be used for ceiling or wall mounting
- Self-adjusting settings continuously analyze and adjust for optimum performance
- Ambient light override prevents lights from turning ON when there is ample natural light

- Manual Delayed-OFF time settings of 30 seconds to 30 minutes
- Self-Adjusting Delayed-OFF time interval settings for 30 seconds to 30 minutes — Compensates for real-time occupancy patterns, preventing unnecessary ON/OFF switching
- Non-volatile memory preserves all automatic and manual settings during power outages
- Fast, simple installation using 3 color-coded low-voltage wires and a single mounting post

TESTING AND CODE COMPLIANCE

- Meets ASHRAE Standard 90.1 requirements
- Backed by a Limited Five-Year Warranty
- California Title 24 Compliant



OCCUPANCY SENSOR LIGHTING CONTROLS • WALL MOUNT

Commercial Grade Energy Management Products

Wall-Mount Occupancy Sensor Lighting Controls

Infrared Wide View, High-Bay and Long-Range Wall-Mount Occupancy Sensor ^{UL} ^{CE}

(For use with Leviton Power Pack or Power Base Adaptor)*

Advanced Passive Infrared technology for highly accurate monitoring in a variety of commercial applications. All-digital self-adjusting technology provides "Install and Forget" solution for automatic lighting control.



OSWHB-IOW

DESCRIPTION	CAT. NO.	COVERAGE	COLOR
Infrared Wide-View Wall-Mount Occupancy Sensor	OSWWW-IOW	115°, 2500 sq. ft	White
Infrared High-Bay Wall-Mount Occupancy Sensor	OSWHB-IOW	55 ft., 7 ft. wide @ 30 ft. high	White
Infrared Long-Range Wall-Mount Occupancy Sensor	OSWLR-IOW	100 ft., 110° @ 10 ft. high	White

*Low-voltage wiring is used to connect Leviton Occupancy Sensors to Cat. No. OSP20 Power Pack, OPB15 Power Base Adaptor or a Centura CN100 Power Pack (purchased separately). See page D15 for information on OSP20 and page D8 for information on OPB15.

Note: Canopy and neck allow the Wall-Mount Occupancy Sensor to be installed on the ceiling as well.

Energy Management Products

SPECIFICATIONS AND FEATURES

- OSWWW-I: Ideal for conference rooms, stairwells, high-ceiling rooms, large open areas, parking garages, storage rooms and rooms with pendant fixtures. Also ideal for corner mounting in a variety of applications.
- OSWHB-I and OSWLR-I: Ideal for monitoring long, narrow spaces such as warehouse aisles, hallways, stairways, any narrow room, closets and storage areas. Also ideal for corner mounting in a variety of applications.
- Self-adjusting settings continuously analyze and adjust for optimum performance
- Ambient light override prevents lights from turning ON when there is ample natural light
- Adjustable swivel neck rotates 85° vertically and 60° horizontally—Can be used for ceiling or wall mounting
- Manual Delayed-OFF time settings of 30 seconds to 30 minutes
- Self-Adjusting Delayed-OFF time interval settings for 30 seconds to 30 minutes — Compensates for real-time occupancy patterns, preventing unnecessary ON/OFF switching
- Non-volatile memory preserves all automatic and manual settings during power outages
- Fast, simple installation using 3 color-coded low-voltage wires and a single mounting post

TESTING AND CODE COMPLIANCE

- Meets ASHRAE Standard 90.1 requirements
- Backed by a Limited Five-Year Warranty
- California Title 24 Compliant

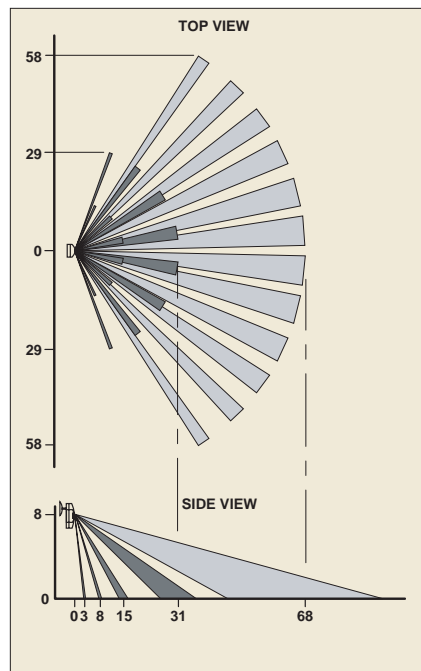

OSWWW Field of View (in feet)

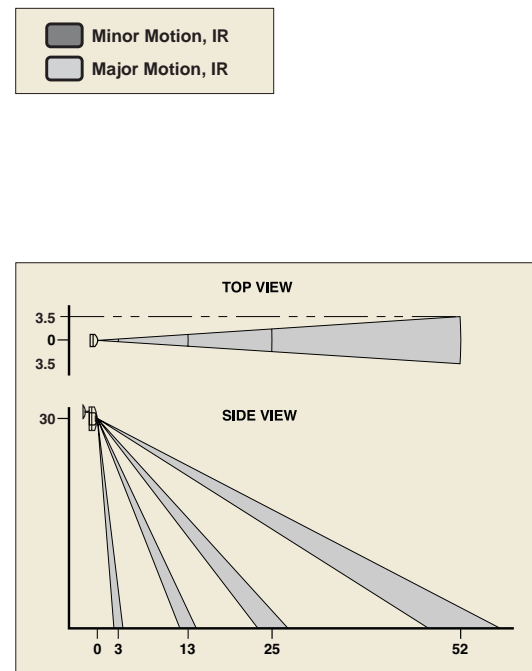

OSWHB Field of View

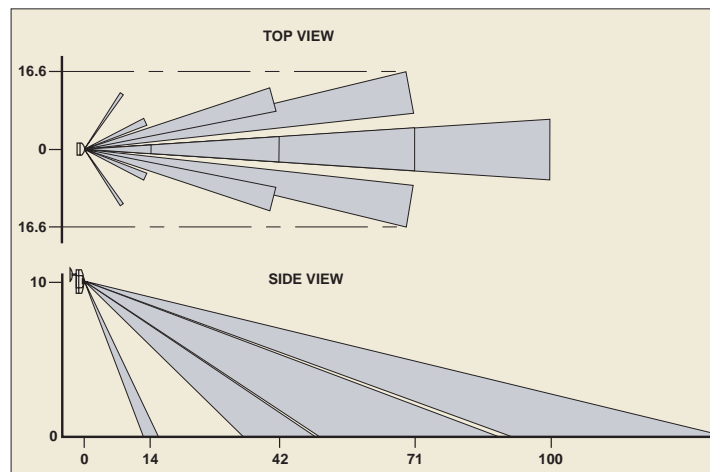

OSWLR Field of View

OCCUPANCY SENSOR POWER PACKS

Commercial Grade Energy Management Products



Occupancy Sensor Power Packs

Power packs provide power for occupancy sensors as well as load switching circuitry. A Leviton Power Pack is required with any low voltage occupancy sensor. Add-A-Relay units can be used to expand control capability.

Power Packs and Accessories (For use with Leviton Occupancy Sensors on pages D10-D14)

DESCRIPTION	CAT. NO.	POWER INPUT	RELAY RATING	CONTROL INPUT	POWER SUPPLY OUTPUT
Power Pack	OSP20-0D0	120/220/ 277VAC, 60Hz	20A fluorescent/ incandescent @ 120V, 20A fluor. @ 277V; 1HP @120V, 2HP @ 240V	5mA, 24VDC	150mA, 24VDC
Power Pack with HVAC relay	OSP20-RD0	120/220/ 277VAC, 60Hz	20A fluorescent/ incandescent @ 120V, 20A fluor. @ 277V; 1HP @ 120V, 2HP @ 240V; HVAC: 0.5A @ 125VAC, 1A @ 30VDC	5mA, 24VDC	150mA, 24VDC
Power Pack with HVAC relay	OSP15-R30	347VAC, 60Hz	15A fluorescent @ 347V; 1HP @ 120V, 2HP @ 240V; HVAC: 0.5A @ 125VAC, 1A @ 30VDC	5mA, 24VDC	120mA, 24VDC
Add-A-Relay Unit with HVAC relay	OSA20-R00	—	15A incandescent @120V, 20A fluorescent @120V, 20A fluor. @ 277V, 15A fluor. @ 347V; HVAC: 0.5A @ 125VAC, 1A @ 30VDC	5mA, 24VDC	—
Low-Voltage Nipple Adapter with 1/2" Lock Nut for Power Pack and Add-A-Relay units	OSPNA-000	—	—	—	—



Power Pack Capacity Formula

Leviton power packs can be used to provide power to one or more occupancy sensors. Since current consumptions of occupancy sensors may vary, the best way to ensure you order the correct number of power packs and Add-A-Relays is by using this formula:

$$\begin{array}{|c|} \hline \text{Number of} \\ \text{Model A sensors} \\ \hline \times \\ \hline \text{Sensor A current} \\ \text{consumption rating} \\ \hline \end{array} + \begin{array}{|c|} \hline \text{Number of} \\ \text{Model B sensors} \\ \hline \times \\ \hline \text{Sensor B current} \\ \text{consumption rating...} \\ \hline \end{array} + \begin{array}{|c|} \hline \text{Number of} \\ \text{Add-A-Relays} \\ \hline \times \\ \hline 50\text{mA} \\ \hline \end{array} \leq 150\text{mA per power pack}$$

SENSOR	CURRENT CONSUMPTION
OSC04-I, OSC15-I, OSWHB-I, OSWLR-I, OSWWW-I	20mA
OSC05-M, OSC05-U, OSW12-M	30mA
OSC20-M, OSC20-U	32mA
OSC10-M, OSC10-U	40mA
OSA20-R00 Add-A-Relay	50mA

SPECIFICATIONS AND FEATURES

Power Pack

- For use with all OS Series occupancy sensors
- Power supply for OS Series occupancy sensors
- Switches incandescent, magnetic and electronic fluorescent, magnetic and electronic low voltage, and motor loads
- Compact size and light weight allows easy mounting through knockout in junction box (from either inside or outside the box) with a simple twist-on nut

Add-A-Relay

- Expands power pack load capacity by functioning as a supplementary relay
- Provides ability to switch loads in different voltage systems

- Compatible with electronic ballasts
- Same compact size and mounting features as Power Pack

Nipple Adapter

- Simplifies the connection of occupancy sensor to the low-voltage side of a power pack mounted inside a fluorescent ballast cavity
- 1/2" conduit lock nut included

TESTING AND CODE COMPLIANCE

- cULus, FCC and NOM Certified
- Meets ASHRAE Standard 90.1 requirements
- Backed by a Limited Five-Year Warranty



OCCUPANCY SENSOR LIGHTING CONTROLS • OUTDOOR

Commercial and Residential Grade Energy Management Products



PS200

Outdoor Motion Sensors

Passive Infrared (PIR) outdoor motion sensors provide outstanding value in security lighting, convenience, safety and energy savings for a wide range of commercial and residential applications.

COMMERCIAL GRADE

Professional Series Infrared Outdoor Occupancy Sensor

DESCRIPTION	CAT. NO.	RATING	COVERAGE	COLOR
Professional Series Outdoor PIR Motion Sensor	PS200-10	Incandescent: 1000W @ 120V. For 60Hz AC only	200°	White
Professional Series Outdoor PIR Motion Sensor with Dual Floodlights	PS200-1F	Incandescent: 1000W @ 120V. For 60Hz AC only	200°	White
Professional Series Outdoor PIR Motion Sensor	PS110-10	Incandescent: 1000W @ 120V. For 60Hz AC only	110°	White
Professional Series Outdoor PIR Motion Sensor with Dual Floodlights	PS110-1F	Incandescent: 1000W @ 120V. For 60Hz AC only	110°	White

RESIDENTIAL GRADE

Residential Series Infrared Outdoor Occupancy Sensor

DESCRIPTION	CAT. NO.	RATING	COVERAGE	COLOR
Residential Series Outdoor PIR Motion Sensor	RS110-10	Incandescent: 500W @ 120V. For 60Hz AC only	110°	White
Residential Series Outdoor PIR Motion Sensor with Dual Floodlights	RS110-1F	Incandescent: 500W @ 120V. For 60Hz AC only.	110°	White

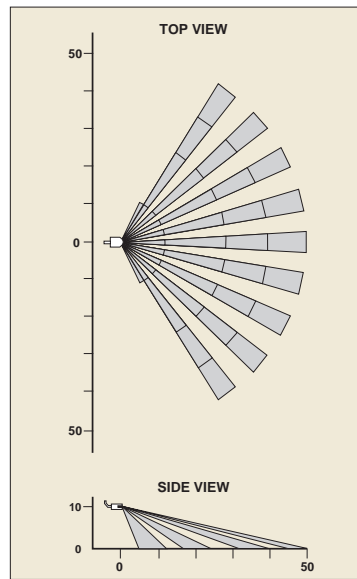

PS110/RS110 Field of View (in feet)

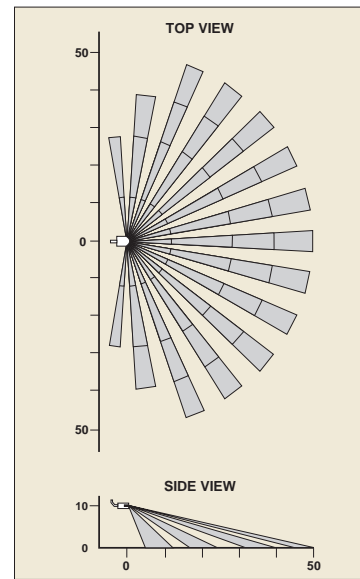

PS200 Field of View

SPECIFICATIONS AND FEATURES

Professional Series

- Ideal for a wide range of commercial/industrial settings including parking areas, storage facilities, warehouses, loading docks, marina, garages, walkways, campus grounds, meat lockers, walk-in refrigerators/freezers and outbuildings
- Adjustable Delayed-OFF time settings from 20 seconds (for test mode) to 15 minutes
- Adjustable sensitivity and immunity to RFI signals reduces false triggers
- Ambient light override prevents lights from turning ON when there is ample natural light
- Provides Automatic, Test and Continuous Modes—Test mode simulates automatic operation with short delayed-OFF time for ease of making adjustments. Continuous mode enables manual override for

- constant "lights ON" operation (when used with standard ON/OFF switch)
- Surge suppression minimizes likelihood of damage due to electrical surges
- Temperature compensation feature ensures uniform performance in extreme hot or cold weather and during temperature fluctuations
- Sensor neck adjustment allows accurate area monitoring: 110° vertical, 180° horizontal, 110° rotational

Residential Series

- Ideal for a wide range of residential settings including backyards, garages, entranceways, porches, swimming pool areas, doorways and private docks
- Sensor neck adjustment allows accurate area monitoring: 110° vertical, 180° horizontal, 110° rotational
- Adjustable Delayed-OFF time settings from 20 seconds (for test mode) to 15 minutes

- Adjustable sensitivity reduces false triggers
- Provides Automatic, Test and Continuous Modes—Test mode simulates automatic operation with short Delayed-OFF time for ease of making adjustments. Continuous mode enables manual override for constant "lights ON" operation (when used with standard ON/OFF switch)

TESTING AND CODE COMPLIANCE

- UL Listed
- CSA Certified

MATERIAL CHARACTERISTICS

- Meets ASHRAE Standard 90.1 requirements
- Backed by a Limited Five-Year Warranty

FLUORESCENT ENERGY MANAGEMENT SYSTEMS

Commercial Grade Energy Management Products

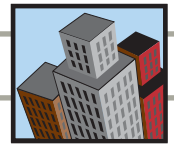

Centura® Fluorescent Energy Management System

Centura combines the technology of “daylight harvesting” with a host of innovative energy-efficient modular lighting controls, including dimmers, timers, occupancy sensors and photo-sensors that dim or turn off fluorescent lighting when a space is not being used. Centura incorporates the ability to interface with Leviton occupancy sensors to provide even greater energy savings. When single or multiple occupancy sensors are installed, programmed interior lighting is automatically turned OFF when the room is vacant and back ON to the programmed level when occupancy is detected. The use of movement sensors means energy savings up to a proven 50%.



Leviton Occupancy Sensors Compatible with Centura System

DESCRIPTION	CAT. NO.	COVERAGE	PAGE NO.
Multi-tech Ceiling Sensor	OSC05-M0W	180°, 500 sq. ft.	D10
Multi-tech Ceiling Sensor	OSC10-M0W	360°, 1000 sq. ft.	D10
Multi-tech Ceiling Sensor	OSC20-M0W	360°, 2000 sq. ft.	D10
Ultrasonic Ceiling Sensor	OSC05-U0W	180°, 500 sq. ft.	D11
Ultrasonic Ceiling Sensor	OSC10-U0W	360°, 1000 sq. ft.	D11
Ultrasonic Ceiling Sensor	OSC20-U0W	360°, 2000 sq. ft.	D11
PIR Ceiling Sensor	OSC04-I0W	360°, 450 sq. ft.	D12
PIR Ceiling Sensor	OSC15-I0W	360°, 1500 sq. ft.	D12
Multi-tech Wall Sensor	OSW12-M0W	115°, 1200 sq. ft.	D13
PIR Wide-View Sensor	OSWWV-I0W	115°, 2500 sq. ft.	D14
PIR Long Range Sensor	OSWLR-I0W	100 ft. @ 10 ft. high	D14
PIR High-Bay Sensor	OSWHB-I0W	55 ft., 7 ft. wide @ 30 ft. high	D14

Note: The Leviton Occupancy Sensors listed can be powered by the Centura Dimming Power Pack—Use of a separate Occupancy Sensor Power Pack is not required.

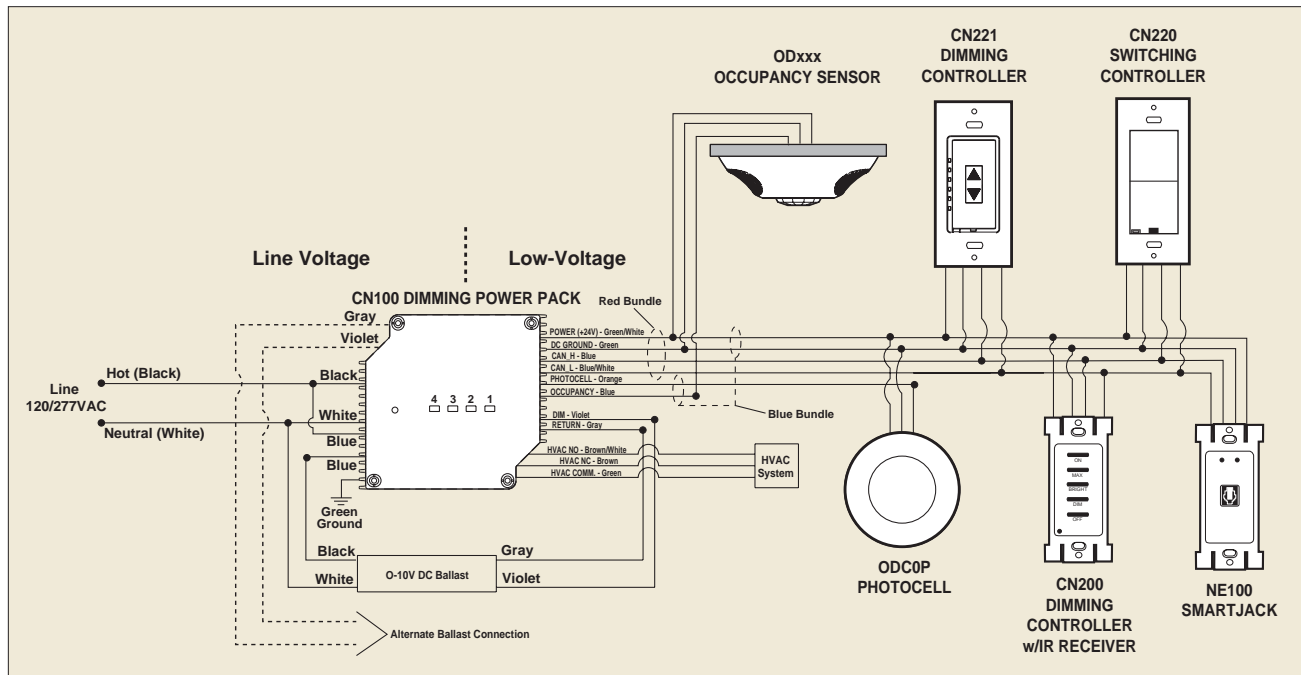

System Wiring Diagram

For more information on Commercial Fluorescent Energy Management Systems, visit Leviton's website at www.leviton.com



FLUORESCENT ENERGY MANAGEMENT SYSTEMS

Commercial Grade Energy Management Products

Energy Management Products

Centura® Fluorescent Energy Management System

Leviton's Centura, a modular lighting control system for dimming fluorescent ballasts (Advance Mark 7™, OSRAM Sylvania Quicktronic® Helios™ and Energy Savings SuperDim™), brings increased energy savings to commercial spaces. Using a technique known as "daylight harvesting," Centura factors in the available daylight for the precise control of fluorescent light levels to achieve optimum comfort and energy efficiency.

Centura Fluorescent Energy Management System

DESCRIPTION	CAT. NO.	RATING	COLOR
Centura Dimming Power Pack—ON/OFF and DIM/BRIGHT control of 0-10VDC dimming fluorescent ballasts. Responds to Wall Controller, Occupancy Sensor and Photocell input and provides +24 VDC power supply for these devices. Programmed via Wall Controller or via Leviton Personal Dimmer software from a PC. Secondary relay sends control signals to HVAC system. LEDs indicate operation mode	CN100-000	2400VA @ 120V AC 60Hz, 5500VA @ 277V AC 60Hz. For use with Advance Mark 7™ 0-10VDC, OSRAM Sylvania Quicktronic® Helios™, Energy Savings SuperDim™ and comparable ballasts only	Gray Metallic
Centura Dimming Controller with Infrared Receiver—Decora-style 5-button unit for ON/OFF, DIM/BRIGHT and MAX override. Built-in IR receiver for use with Centura NE200-00E Hand-Held Remote. Programs energy management functions	CN200-00C	No load rating, for use with Centura Dimming Power Pack only	White (Ivory color change kit included)
Centura Hand-Held Remote Controller Infrared—Remote provides convenient ON/OFF, DIM/BRIGHT control presets and programming. Designed for use with Centura CN200	NE200-00E	No load rating, for use with Centura CN200 Controller only	Black
Centura Switching Controller—Decora-style rocker for ON/OFF switching	CN220-00C	No load rating	White (Ivory color change kit included)
Centura Dimming Controller—Decora-style rocker for ON/OFF switching with built-in arrow-shaped rocker for DIM/BRIGHT control. LED display indicates selected brightness level. Programs energy management functions—back of wallplate provides instruction label that lines up with LEDs to facilitate programming	CN221-00C	No load rating, for use with Centura Dimming Power Pack only	White (Ivory color change kit included)
Centura Photocell—Detects available light levels for "Daylight Harvesting." Allows Centura system to maintain a programmed light level by constantly adjusting fluorescent light output to compensate for changes in available daylight	ODCOP	No load rating, for use with Centura Dimming Power Pack only. 0-70 foot candles	White
Centura Lcnet SmartJack—Includes a cable for connecting the SmartJack to a PC and a mini-CD containing server, administrator and user software. For the latest software upgrades, check Leviton's website at leviton.com/centura	NE100-00C	No load rating, for use with Centura Power Pack	White (Ivory color change kits included)

For more information on Commercial Fluorescent Energy Management Systems, visit Leviton's website at www.leviton.com

SPECIFICATIONS AND FEATURES

- Ideal for commercial spaces and individual offices
- Reduces eyestrain and fatigue from glare, increasing comfort and productivity
- All functions conveniently accessed through Controllers or via Leviton Personal Dimmer software from a PC
- Dimming Power Pack provides low-voltage power supply for Controllers, Photocell and Occupancy Sensors
- Photocell provides energy savings through Daylight Harvesting technology
- Use with Leviton Occupancy Sensors for increased energy savings: Lights turn ON automatically to programmed levels when personnel enter area; OFF automatically when area becomes vacant

- Modular system design expands energy saving options with an interface for building emergency systems, load shedding programs and time clock systems
- Dimming Power Pack mounts in standard 4" square back box. Dimming and Switching Controllers mount in standard single-gang switch box

TESTING AND CODE COMPLIANCE

- Agency approvals for all Centura components are UL, CSA, NOM, FCC, and California Title 24 (where applicable) except for the hand-held remote controller
- Meets ASHRAE Standard 90.1 requirements
- Backed by a Limited Two-Year Warranty (except photocell: Backed by a Limited Five-Year Warranty)

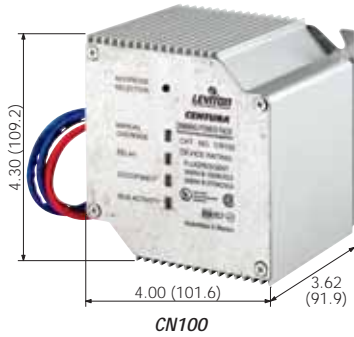

CN100



CN200

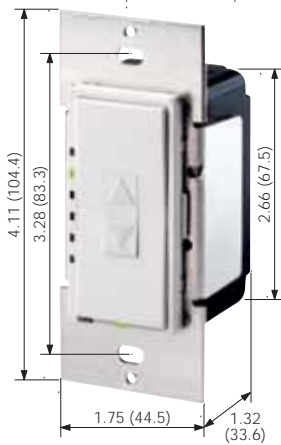

CN221

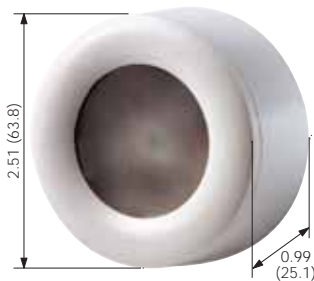

ODCOP



To learn more about Leviton's outstanding offering of devices visit our Website at: www.leviton.com

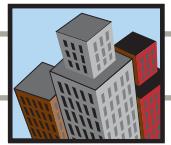

Decora Plus Electronic Timer Switches

Leviton Timers add contemporary styling to any commercial or residential application. Built to the highest performance standards, Decora Electronic Timers provide long-lasting trouble-free service life.

Four Preset buttons plus an OFF button permit timed control of lights and appliances. Decora Plus Timers are ideal for heat lamps, foyer and outdoor lights, hot tubs, spas, attic and exhaust fans. LEDs indicate elapsed time and flash “Two Minutes Until OFF” warning.

COMMERCIAL GRADE

Electronic Timer Switches 120V AC 60Hz

DESCRIPTION	CAT. NO.	INTERVAL	COLOR*
Four Preset Buttons and OFF	6215M	2-5-10-15 Minutes	I, W, A, T
3-Wire, Single-Pole (Neutral Required)	6230M	5-10-15-30 Minutes	I, W, A, T
1000W Incandescent, 20A Inductive	6260M	10-20-30-60 Minutes	I, W, A, T
1 HP @ 120V. Compatible with electronic ballasts	6212H	2-4-8-12 Hours	I, W, A

RESIDENTIAL GRADE

Electronic Timer Switches 120V AC 60Hz

DESCRIPTION	CAT. NO.	INTERVAL	COLOR*
Four Preset Buttons and OFF	6515M	2-5-10-15 Minutes	I, W, A
2-Wire, Single-Pole, 120V	6560M	10-20-30-60 Minutes	I, W, A
500W Incandescent Only	6512H	2-4-8-12 Hours	I, W, A



SPECIFICATIONS AND FEATURES

- Electronic Timer Switch has four preset buttons plus OFF for timed control of lights and appliances
- Electronic Timer Switch LEDs indicate time elapsed and last LED flashes two minutes until OFF warning
- All install easily in single gang wallbox in place of standard switch
- Electronic keypad control
- Matching Decora wallplate included

TESTING AND CODE COMPLIANCE

- UL Listed (File #E-66800)
- CSA Certified (File #LR-68679)
- NOM Certified (#057)
- Meets ASHRAE Standard 90.1 requirements
- NOM Certified (#057)
- Backed by a Limited Two-Year Warranty

*COLOR

Colors available as listed. For color selections, add suffix to catalog numbers as follows: Ivory (-I), White (-W), Almond (-A), Light Almond (-T).

MATERIAL CHARACTERISTICS

Environmental: Flammability UL-94, V2 Rating
Operating Temperature: 32°F to 130°F

For more information regarding matching wallplates, colors, materials, single and multi-gang, refer to Wallplates, section E.



DECORA® ELECTRONIC TIMER SWITCHES

Commercial and Residential Grade Energy Management Products

Energy Management Products



6124H-W

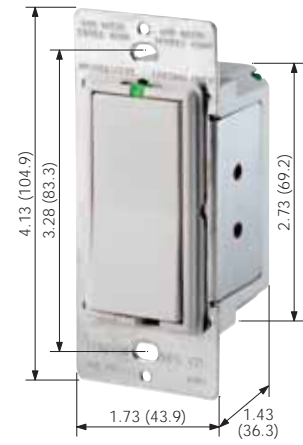

6651-W

Decora Programmable Electronic Timer Switches

COMMERCIAL GRADE

24-Hour Programmable Electronic Timer Switch 120V AC 60Hz

DESCRIPTION	CAT. NO.	INTERVAL	COLOR*
24-Hour LCD Programmable Timer Switch-1200W Incandescent, 1200VA Inductive @ 120V AC 60Hz Motor: 1 HP @ 120V AC 60Hz UL, 3/4 HP @ 120V AC 60Hz CSA Neutral Connection Required Compatible with electronic ballasts	6124H	24-Hour ON/OFF scheduling in 30 minute intervals	I, W, A, T

RESIDENTIAL GRADE

14-Hour Programmable Electronic Timer Switch 120V AC 60Hz

DESCRIPTION	CAT. NO.	INTERVAL	COLOR
14-Hour Segment Programmable Timer Switch-40W min, 500W max. @ 120V AC 60Hz, Incandescent only	6651	14-Hour ON/OFF scheduling in hourly intervals	I, W, A

Variable Countdown Timer Switch 120V AC 60Hz

DESCRIPTION	CAT. NO.	INTERVAL	COLOR
Decora Style Rotary-Dial Variable Countdown Timer Switch-600W Incandescent, 20A Inductive Motor: 1 HP @ 120V AC 60Hz Neutral Connection Required	6652	1 minute to 18 hours	I, W, A

SPECIFICATIONS AND FEATURES

24-Hour Programmable Timer

- Ideal for a wide variety of commercial and residential applications including outdoor lighting, pools, motors, sprinklers, exhaust and attic fans, bathroom heat lamps, hot tubs and spas, whole-house exhaust fan scheduling, office lights, janitor closets, landscape and security lighting
- Permits separate ON or OFF scheduling for half-hour periods of the day; ON/OFF manual control available by using button below display panel
- Decora styling enhances any interior (NOTE: 6124H cannot be used with Decora Plus Screwless Snap-On Wallplates)

14-Hour Programmable Timer

- Ideal for residential incandescent lighting control including indoor, outdoor and seasonal lighting
- "Set-it-and-forget convenience" provides automatic daily control with manual override
- Automates daily switching program (up to 14 hours) by responding to DIP switch ON or OFF position for each hour; repeats until function switch is moved to Manual or OFF mode

Countdown Timer Switch

- For residential and light commercial applications including indoor and outdoor lighting, office lights and ceiling paddle fans
- Simple rotary-dial time selection of settings from 1 minute to 18 hours: ON/OFF manual control available
- An illuminated LED indicates load is ON. Blinking LED accompanied by annunciator sound indicates end of time cycle

TESTING AND CODE COMPLIANCE

- UL Listed (File #E-66800)
- CSA Certified (File #LR-68679)
- Backed by a Limited Two-Year warranty

*COLOR

Colors available as listed. For color selections, add suffix to catalog numbers as follows: Ivory (-I), White (-W), and Almond (-A).

MATERIAL CHARACTERISTICS

Environmental: Flammability UL-94, V2 Rating
Operating Temperature: 32°F to 130°F



To learn more about Leviton's outstanding offering of devices visit our Website at: www.leviton.com



Z-MAX Relay Overview

Z-MAX Lighting Control Relay Systems

The Leviton Z-MAX™ line of timed lighting controls and relays provides advanced scheduling of lighting and other loads in applications where a time clock is typically used in conjunction with switching contactors. All Z-MAX models feature easy-to-use menu-driven programming and configuration, a programmable time clock and output relays in a compact cabinet, and several optional accessories for remote control. Z-MAX relay panels are ideal for cafeterias, auditoriums, offices, parking facilities, gymnasiums, pools, educational facilities, and landscape and security lighting. A number of wall stations, flush trim kits and other accessories are available.

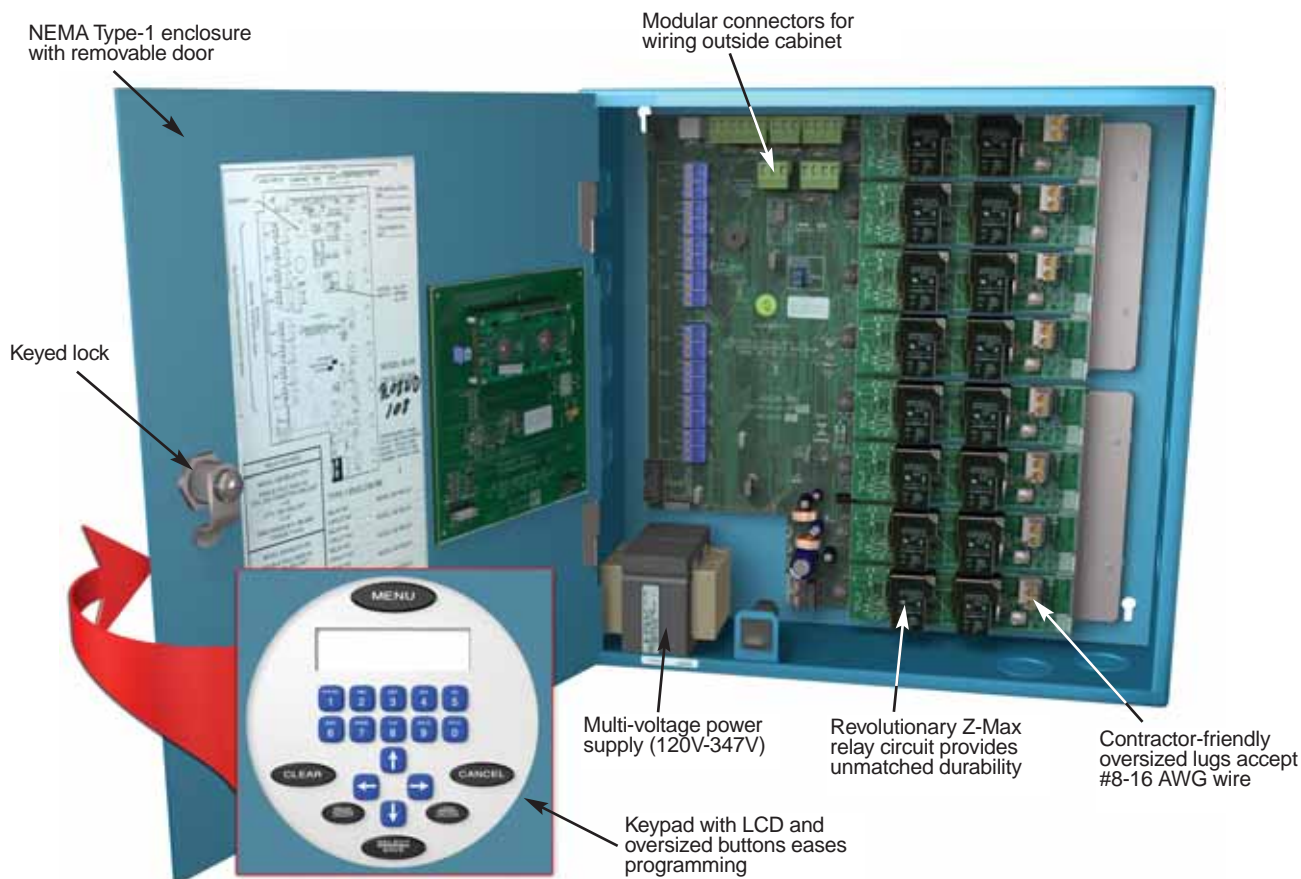

- In four versions: 8-relay non-networked and 8-relay, 24-relay, 48-relay networked
- Single-circuit relay cards simplify maintenance and expansion
- Integrated astronomical time clock
- Individually replaceable relays rated for all light sources as well as motors
- Single-pole and two-pole relays fit in the same location
- Normal or emergency panel capability
- Compatible with occupancy sensors, photocells, digital and low-voltage wall stations and more

Available Color



Blue



TIMED LIGHTING CONTROL PANELS

Commercial Grade Energy Management & Dimming Products

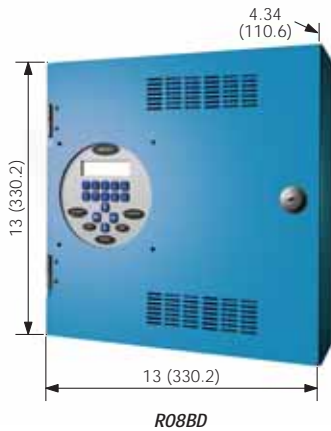

Z-MAX™ Relay Cabinets

Z-MAX Relay Cabinets provide complex scheduling of lighting and other loads in commercial and residential applications where a time clock would typically be used in conjunction with switching contactors. Z-MAX relay cabinets are ideal for cafeterias, auditoriums, offices, parking facilities, gymnasiums, pools, educational facilities, and landscape and security lighting. Unique to Z-MAX is the standard relay card's proprietary circuitry that eliminates arc shower pitting at the contacts for extended relay life. The stand-alone cabinets presented here are best suited to advanced scheduling of a single area (networked 8-relay cabinets are also available). The Z-MAX line features a wide range of accessories, including digital and low-voltage switch stations.

8-Relay Stand-Alone Z-MAX Cabinets

With 8 switch inputs and 20A output relays

DESCRIPTION	CAT. NO.	INPUT POWER	COLOR
Standard 8-Relay Cabinet (no relays)	R08BD-000	120, 277, 347V	Blue
8-Relay Cabinet with 4 Standard Relays	R08BD-104	120, 277, 347V	Blue
8-Relay Cabinet with 8 Standard Relays	R08BD-108	120, 277, 347V	Blue
8-Relay Cabinet with 4 2-Pole Relays	R08BD-204	120, 277, 347V	Blue
8-Relay Cabinet with 8 2-Pole Relays	R08BD-208	120, 277, 347V	Blue
8-Relay Cabinet with 4 347V Relays	R08BD-C04	120, 277, 347V	Blue
8-Relay Cabinet with 8 347V Relays	R08BD-C08	120, 277, 347V	Blue

For network versions replace B in middle of catalog number with N for network. 24-relay and 48-relay cabinets with 12 switch inputs (in master and slave versions) are also available. For digital and low-voltage switch stations, see page D26.

Z-MAX Relay Cards

For incandescent, electronic fluorescent, magnetic fluorescent, electronic low voltage, neon cold cathode, high intensity discharge and motor loads

DESCRIPTION	CAT. NO.	INPUT POWER
Standard 20A Single-Pole Relay Card*	RELAY-STD	120-277V
2-Pole 20A Relay Card	RELAY-2PL	240/480V
347V Single-Pole 20A Relay Card	RELAY-347	120-347V
Normally Closed Relay Card	RELAY-NCL	120-347V

*NOTE: Relay cabinets ship with RELAY-STD modules unless otherwise specified.

For the complete line of Z-MAX components, visit Leviton's website at www.leviton.com.

SPECIFICATIONS AND FEATURES

- Easy-to-program keypad control module with LCD screen and straightforward menus—in plain English (not code)
- Internal time clock with astronomical clock, daylight savings time, and holiday scheduling features
- Generous wiring space and easy-to-wire terminals
- Switch inputs with override capability for each relay
- Hinged, removable door with keyed lock
- Works with analog controllers, low voltage switches, discrete and analog photocells, and occupancy sensors
- Accessories include: Z-MAX Switch Stations, telephone and modem interface modules, additional

switch input board, Ethernet module, photocell, flush trim kits, voltage barriers, and PC-based programming software

- Enclosure Dimensions: 13.00 (330.2) x 13.00 (330.2) x 4.34 (110.6)

TESTING AND CODE COMPLIANCE

- UL Listed (for individual load types) and CUL Listed under both Industrial Control Equipment and Energy Management Equipment
- California Title 24 compliant and meets ASHRAE Standard 90.1 requirements
- NOM certified
- Limited Two-Year Warranty on cabinets



Z-MAX Relay Product Listing

Z-MAX Relay Cabinets with Integrated Electrical Distribution

Z-MAX Relay Panels with an integrated electrical distribution system offer the convenience of a single feed with the flexibility of our popular Z-MAX relay system. Each includes all the award winning features of the Z-MAX product line, integrated with a standard system of electrical distribution and over current protection. These integrated systems use commonly available Cutler Hammer breakers.



Z-MAX Relay Cabinets with Integrated Electrical Distribution

120V Systems Stock Configurations

CAT. NO.	VOLTS	PHASE	POWER FEED	NO. OF CIRCUIT BREAKERS (20A SINGLE POLE)	NO. OF Z-MAX RELAY MODULES (STANDARD SINGLE POLE)
RB423-L11	120/208	3Ø	Main Lug	42	42
RB423-B11	120/208	3Ø	225A Main Breaker	42	42
RB421-L11	120/240	1Ø	Main Lug	42	42
RB421-B11	120/240	1Ø	225A Main Breaker	42	42
RB243-L11	120/208	3Ø	Main Lug	24	24
RB243-L11	120/208	3Ø	225A Main Breaker	24	24
RB241-L11	120/240	1Ø	Main Lug	24	24
RB241-B11	120/240	1Ø	225A Main Breaker	24	24

277V Systems Stock Configurations

CAT. NO.	VOLTS	PHASE	POWER FEED	NO. OF CIRCUIT BREAKERS (20A SINGLE POLE)	NO. OF Z-MAX RELAY MODULES (STANDARD SINGLE POLE)
RB423-L21	277/480	3Ø	Main Lug	42	42
RB423-B21	277/480	3Ø	200A Main Breaker	42	42
RB243-L21	277/480	3Ø	Main Lug	24	24
RB243-B21	277/480	3Ø	200A Main Breaker	24	24

Custom configurations are available upon request.

Contact your local Leviton LMS representative for additional information or visit www.leviton.com/LMS.

SPECIFICATIONS AND FEATURES

- Single or Three Phase configurations
- 120V, 277V or 347V systems
- Main lugs or main breaker
- Custom load center configuration
- Field replaceable standard breakers
- All standard Z-MAX operational features
- Uses Cutler-Hammer CH, GHQ and GBH frame snap-in breakers, locked in place by the enclosure
- Ships as one complete pre-wired assembly

- Up to 100,000A AIC, short Circuit Current Rating, available on all panelboards (Consult factory for details)
- 277/480V panelboards, main lugs, 65k AIC @ 120/208V, 14k AIC @ 277/480V standard
- 277/480V panelboard, main breaker, 35k AIC standard
- 120/208V or 120/240V panelboards, main lugs, 10k AIC standard
- 120/208V or 120/240V panelboards, main breaker, 25k AIC standard depending on main breaker

- 347/600V panelboards, main lugs, 10k AIC standard
- 347/600V panelboards, main breaker, 19k AIC standard

TESTING AND CODE COMPLIANCE

- UL and cUL Listed



TIMED LIGHTING CONTROL PANELS

Commercial Grade Energy Management & Dimming Products

Z-MAX Relay Product Listing

RRP—Remote 4-Relay Panel (Controlled by Z-MAX Master Cabinet)

The RRP (Remote Relay Panel) provides distributed switching of up to four 20 amp lighting circuits, enabling multiple units to be networked and controlled from a Z-MAX Master Relay Panel. With photocell, occupancy sensor and local switch inputs, the RRP is an ideal solution for applications such as school classrooms where daylight harvesting, occupancy sensor control, local switching and central control scheduling are desired. Revolutionary Z-MAX switching circuit with 10,000,000 cycle life employed in the 120-277V standard relay model.

RRP—Remote 4-Relay Panel

DESCRIPTION	CAT. NO.	RATING
Remote Relay Panel with 4, Single Pole 20 Amp Relays for use with Z-MAX. 120/277V	RE4SD-104	20A per relay
Remote Relay Panel with 4, Double Pole 20 Amp Relays for use with Z-MAX. 120/277V	RE4SD-204	20A per relay
Remote Relay Panel with 4, Single Pole 20 Amp Relays for use with Z-MAX. 347V	RE4SD-304	20A per relay

Dimensions: 10.0 (254.0) H x 10.0 (254.0) W x 4.0 (101.6) D



RRP – Remote 4-Relay Panel

For more information on Z-MAX Remote Relay Panels and Accessories, refer to Z-MAX data sheets.

SPECIFICATIONS AND FEATURES

- Network ready for up to 96 total relays
- USB port for software updates and network configuration
- 120/277V dual voltage standard
- 347V available
- Removable interior allows rough-in without risk of damage to components
- Rated for 100% load capacity
- Handles in-rush currents in excess of 50 times load current
- Low-voltage switch inputs support Leviton low voltage switches and GE-style, ON/OFF switches with optional LED output

ACCESSORIES

- Low-voltage switch adapter (reduces required wire count of GE style switch by 1)
- 1-10 Button low voltage switches
- Indoor and outdoor 0-10V photocells
- Atrium and skylight 0-10V photocells

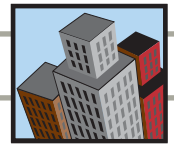

EZ-MAX Relay Product Listing

EZ-MAX Relay Cabinets

EZ-MAX relay lighting control panels combine the power and performance of the larger Z-MAX relay cabinets in a cost-effective four-circuit package that's housed in a compact 10" X 10" standard electrical enclosure. It is the ideal contractor friendly, quick-to-install solution for smaller, stand-alone applications that do not require the field configuration or advanced networking features of the larger Z-MAX cabinets. It serves as a smart replacement for time clock/contactor installations for any application requiring reliable and cost-effective automatic lighting control.



EZ-MAX Relay Cabinet

EZ-MAX Relay Cabinets

DESCRIPTION	CAT. NO.	RATING
EZ-MAX with 4 120-277V relays	RE4BD-104	20A per relay
EZ-MAX with 4 208-480V 2-pole relays	RE4BD-204	20A per relay
EZ-MAX with 4 120-347V relays	RE4BD-C04	20A per relay

For more information on EZ-MAX Relay Cabinets, refer to EZ-MAX data sheets.

Dimensions: 10.0 (254.0) H x 10.0 (254.0) W x 4.0 (101.6) D

See pages D10-D15 for information on compatible Leviton Occupancy Sensors.

For digital and low-voltage switch stations, see page D26.

SPECIFICATIONS AND FEATURES

Relay Cabinets

- 120-277V standard relay model features revolutionary, patent-pending Z-MAX switching circuit with an unprecedented 10,000,000 cycle life
- 347V available
- Low-voltage inputs allow connection of photocells, occupancy sensors and low-voltage switches for a comprehensive, easy-to-install energy management solution
- Refer to pages D21-D22 for Z-MAX general features

Accessories

- Modem module for touch tone control or remote configuration

- Low-voltage switch adapter (reduces required wire count of GE style switch by 1)
- 1-4 Button low voltage switches
- Indoor and outdoor 0-10V photocells
- Atrium and skylight 0-10V photocells

TESTING AND CODE COMPLIANCE

- ASHRAE 90.1 compliant
- CEC Title 24 compliant
- Limited Ten-Year Warranty



TIMED LIGHTING CONTROL PANELS

Commercial and Residential Grade Energy Management Products

Z-MAX Relay Product Listing

Z-MAX Digital and Low Voltage Switch Stations

The Z-MAX system can incorporate either digital or low-voltage stations. Although they look identical, there are a few differences in how they operate. Both contain buttons that are programmable to a variety of functions and custom labels are available.



ZMDSW-03W

Z-MAX Switch Stations

DESCRIPTION	DIGITAL SWITCH CAT. NO.*	LOW-VOLTAGE SWITCH CAT. NO.**	COLOR
On/Off switch	ZMDSW-01W	LVS-01W	White
Zones 1 and 2	ZMDSW-02W	LVS-02W	White
Zones 1 to 3	ZMDSW-03W	LVS-03W	White
Zones 1 to 4	ZMDSW-04W	LVS-04W	White
Zones 1 to 5	ZMDSW-05W	LVS-05W	White
Zones 1 to 6	ZMDSW-06W	LVS-06W	White
Zones 1 to 8	ZMDSW-08W	LVS-08W	White
Zones 1 to 10	ZMDSW-10W	LVS-10W	White

Note: Wallplate sold separately

*Support network and master Z-MAX versions only

**Support EZ-MAX and Z-MAX stand-alone and slave versions only

miniZ™ Low-Voltage Switch Stations

DESCRIPTION	CAT. NO.	COLOR
5-Button dimming controller with On/Off, for use with miniZ only.	LV200-00W	White
On/Off switch controller for use with miniZ, Z-MAX and EZ-MAX	LV240-00W	White

Dimensions: 4.71 (119.7) H x 1.76 (44.7) W x 1.26 (32.0) D for Switch Stations



LVS-08W

SPECIFICATIONS AND FEATURES

Common Features

- Available in 8 configurations
- Programmable functions include: on, off, and group and scene select
- Compatible with standard and midway size Decora® wallplates
- Custom labeling available; contact a factory representative

Digital Station

- Wired via Luma-Net® to compatible products including D4200, D8000, a-2000, i Series e, i Series Quad, and Z-MAX Relay Cabinets
- Networks with up to 127 devices
- Compatible with handheld IR remote control

Low-Voltage Station

- Compatible with EZ-MAX and Z-MAX Relay Cabinets, MDS cabinets, a-2000 cabinets (with analog card), network protocol converter, and other low-voltage devices
- Cat. No. LV240 for use with miniZ Intelligent Daylight Management System, Z-MAX and EZ-MAX
- Cat. No. LV200 for use with miniZ Intelligent Daylight Management System only

WARRANTY

- Limited Two-Year Warranty



miniZ™ Product Listing

miniZ™ Intelligent Daylight Management System

miniZ combines occupancy sensing, daylight harvesting and flexible lighting control functions into a single, easily installed package. miniZ features several methods of ladderless commissioning, including the AutoCal™ feature, the world's first 100% self-configuring daylight harvesting system. Installation requires little more than any other power-pack type product. The performance features and capabilities of the miniZ product provide a package that surpasses all others in the industry at a price anyone can afford.

miniZ™ Intelligent Daylight Management System

20A output relays (120/277V); 15A output relays (347V); Fluorescent, non-dimmed and 1-10V dimmed (0,2 or 3 zones); 120mA/24V output for operation of occupancy sensors, etc.

CAT. NO.	20A POWER CIRCUITS	0-10V DIMMING CIRCUITS	CONTROL INPUT VOLTAGE	NETWORK FUNCTIONALITY
MZB00-102	2	0	120/277VAC	No
MZD20-102	2	2	120/277VAC	No
MZD30-101	1	3	120/277VAC	No
MZN20-102*	2	2	120/277VAC	Yes
MZN30-101*	1	3	120/277VAC	Yes
MZB00-C02	2	0	220/347VAC	No
MZD20-C02	2	2	220/347VAC	No
MZD30-C01	1	3	220/347VAC	No
MZN20-C02*	2	2	220/347VAC	Yes
MZN30-C01*	1	3	220/347VAC	Yes

*Consult with factory for availability.

Dual Room miniZ™ Intelligent Daylight Management System

The dual room miniZ offers the same performance features as the miniZ, but instead of working in one room using one photocell to control three zones, it provides dual room/ one zone per room daylight harvest control using a separate photocell and occupancy sensor for each room.

CAT. NO.	20A POWER CIRCUITS	0-10V DIMMING CIRCUITS	CONTROL INPUT VOLTAGE	NETWORK FUNCTIONALITY
MZB02-102	2	0	120/277VAC	No
MZD22-102	2	2	120/277VAC	No
MZN22-102*	2	2	120/277VAC	Yes
MZB02-C02	2	0	220/347VAC	No
MZD22-C02	2	2	220/347VAC	No
MZN22-C02*	2	2	220/347VAC	Yes

*Consult with factory for availability.

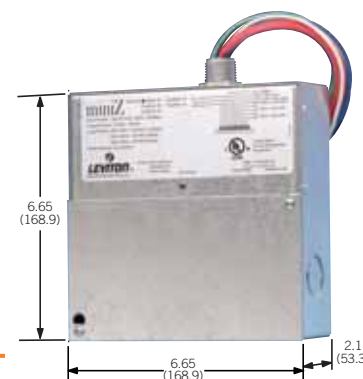

miniZ/ Dual Room miniZ

SPECIFICATIONS AND FEATURES

- Automatic Correction setting for Light Loss Factor (LLF) recognizes and corrects for lumen maintenance issues
- Cost-effective energy code compliance
- Ladderless Commissioning™ provides install-and-forget convenience
- Automatic closed-loop, multi-zone daylight control
- Convenient occupancy sensor and photocell integration
- Simplified daylight harvesting with 3% to 100% dimming capabilities (0-10V fluorescent dimming ballasts required)
- Autocal™ (patent pending) automatic photocell calibration
- Accepts external time clock inputs

- Simplified integration with emergency and building automation systems
- Automatic Daylight Harvest Mode provides optimum lighting output for additional energy savings potential
- Daylight switching full range 0-10V dimming and network models available
- Cost effective energy code compliance
- Accepts external time clock inputs
- Closed loop or open loop daylight control
- Isolated contacts for HVAC relay
- miniZ works in one room using one photocell and occupancy sensor to control three zones
- Dual Room miniZ controls one zone per room using a separate photocell and occupancy sensor for each room

NETWORK FEATURES

- Luma-CAN® Network support
- Network digital switch support
- Z-MAX master/slave network participation
- Remote shared network inputs
- Scalable system expansion

TESTING AND CODE COMPLIANCE

- UL and cUL Listed
- CEC Title-24 Listed
- Limited Two-Year Warranty

HOW TO USE THIS CATALOG

The L-101 Leviton Wiring Device Catalog is designed to help you find the device you're seeking in the quickest and easiest way possible. Most product sections are divided into three distinct categories in the following sequence—Industrial Grade, Commercial Grade and Residential Grade—and grouped according to amperage and voltage, lowest to highest. For example, if you need to order 15 Amp, 125 Volt Industrial Grade straight-blade duplex receptacles, begin your search with the main Table of Contents at the front of the book. Here you'll see that all straight blade receptacles are listed in Section G. Turn to Section G for a more detailed Table of Contents on the first page. Each section page contains product descriptions, ratings and catalog numbers. There are also helpful highlights including Specifications and Features, Testing and Code Compliance, Color listing, Material Characteristics and dimensioned color product photos. Any product page in the L-101 Catalog can be clearly copied or faxed to customers and prospects for use as a specifier sheet or as part of a presentation.

The Quick Reference Guide follows the main Table of Contents to help you pinpoint and locate specific products. Technical Section V provides general product and test data, industry standards, NEMA configuration charts, a glossary of wiring device terms, ANSI architectural symbols and other related information. Specific catalog numbers are listed in the exhaustive index at the back of the catalog.

15 AMP 125 and 250V • 20 AMP 125 and 250V

Industrial Grade Straight Blade Receptacles

Back and Side Wired (Basic Cat. No. Denotes Brown Device*)

DESCRIPTION	CAT. NO./COLOR 15A/125V	CAT. NO./COLOR 15A/250V	CAT. NO./COLOR 20A/125V	CAT. NO./COLOR 20A/250V
LEVSPEC® Duplex Receptacle, Brass Strap	5262 I, W, GY, R, E	5662 I	5362 I, W, GY, R, E	5462 I, GY
Single Receptacle	5261 I, W, GY	5661 I	5361 I, W, A, T, GY	5461 I, A, T, GY
Narrow Body Duplex Receptacle	5252 I, W, A, T, GY, R, BU		5352 I, W, A, T, GY, R,	

For complete wallplate selection, see Section E.

80703-IG 80703-I 80704-GY 80716-R

84003-40 84004-40 84016-40

SPECIFICATIONS AND FEATURES

Back & Side Wired Duplex

- Impact-resistant thermoplastic nylon cover and body
- Smooth face does not collect dirt
- Four corner latches securely fasten face
- Single-piece brass mounting strap on LEVSPEC devices, multi-piece steel strap on other devices
- Large, triple-wipe, brass "T" contacts for superior contact and conductivity
- Back and side-wiring options
- Brass terminal screws to reduce conductor oxidation
- Break-off tabs for easy two-circuit conversion
- Apron barrier to prevent accidental contact between terminal screw heads and metal box
- Exclusive V-shaped, serrated back-wiring clamp for superior contact and conductivity

TESTING AND CODE COMPLIANCE

- UL Listed 498 (UL File #13399); UL Federal Specification WC-596

***COLOR**

Basic Cat. Nos. shown above denote Brown device, except for Isolated Ground (-IG) devices Basic Cat. No. denotes Orange. Isolated Ground Receptacle is distinguished by an orange triangle on its face. For other color selections, add suffix to the catalog number as follows: Ivory (-I), White (-W), Brown (For IG devices only, add -A), Almond (-A), Light Almond (-T), Gray (-G or -GY), Black (-E), Red (-R) and Blue (-BU); for IG devices only, add -BIG)

MATERIAL CHARACTERISTICS

Environmental: Flammability, Rated V2
Operating Temperature: From -40° C (without impact) to 60°C maximum continuous

- | | | |
|--|---|--|
| <p>A RATING</p> <p>B Choose GRADE, if appropriate</p> <p>C DIMENSIONED PHOTOGRAPH</p> <p>D WIRING/CERTIFICATIONS</p> | <p>E CATALOG NUMBER</p> <p>F DESCRIPTION</p> <p>G Check for NEMA CONFIGURATION</p> <p>H WALLPLATE REFERENCE, if appropriate</p> | <p>I SPECIFICATIONS & FEATURES</p> <p>J TESTING AND CODE COMPLIANCE</p> <p>K COLOR LISTING</p> <p>L MATERIAL CHARACTERISTICS</p> |
|--|---|--|

Wallplates

INDEX

Decora® Plus Screwless Snap-On	E2, E4, E5
Decora®	E3, E4, E5
Wallplate Overview	E6
Toggle	E7-E9
Duplex Receptacle	E10, E11
Single Receptacle	E12
Telephone or Cable Outlet, Box Mount	E13, E14
Telephone or Cable Outlet, Strap Mount	E14, E15
Blank, Box Mount	E16, E17
Blank, Strap Mount	E17, E18
Power Outlet Receptacles	E19, E20
Two-Gang with Centered Opening	E21
Louvre Plates	E22
Combination Wallplates	
Toggle and Single Receptacle	E23
Toggle and Duplex Receptacle	E23, E24
Toggle and Decora/GFCI	E25
Toggle and Blank	E26
Standard Combinations-2-Gang	E26-E28
Standard Combinations-3-Gang/4-Gang	E28
Sectional for Multi-Gang Installations	E29
Hot Stamped and Engraved	E29, E30
Voice/Data/CATV	E31
Weather Resistant Covers	
Raintight While-In-Use	E32
Industrial Grade	E33
Die-cast Zinc	E34
Thermoplastic	E35
Stainless Steel Lockout	E34, E35
Accessories	E36
Custom Wallplates	E37-E40



DECORA® PLUS SCREWLESS SNAP-ON WALLPLATES

Residential and Commercial Grade Wallplates

Decora Plus Screwless Snap-On Wallplates

- Sleek, smooth contemporary architectural styling enhances fine décor
- Exclusive new design eliminates subplate screws
- "Hook and Snap" subplate and wallplate mounting provides easy, time saving installation
- Decora-compatible two-piece kit allows easy retrofit to any Decora installation
- Tough, unbreakable polycarbonate construction
- Now available in standard and midway sizes that can be mounted onto larger-volume wallboxes and/or used to hide wall irregularities.



80301-SW
Standard Size



SJ26-SW
Midway Size

Standard Size
Single-Gang Screwless Snap-On Wallplate

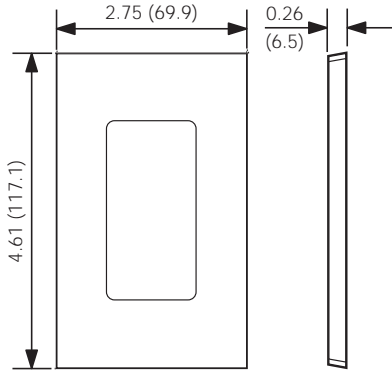

80301-S

Midway Size
Single-Gang Screwless Snap-On Wallplate

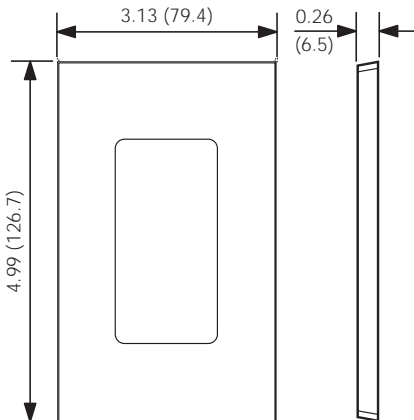

SJ26-S

Midway wallplates can be mounted onto larger-volume outlet boxes and/or used to hide wall irregularities. Midway wallplates are a full 0.375" higher and wider than standard size wallplates.

NOTE: Add 1.81" (46.0mm) for each additional gang.

Decora Plus Screwless Snap-On Wallplates

DESCRIPTION	COLOR	STANDARD	MIDWAY
1-Gang 1-Decora	Ivory	80301-SI	SJ26-SI
	Ebony/Black	80301-SE	SJ26-SE
	Gray	80301-SGY	SJ26-SGY
	White	80301-SW	SJ26-SW
	Mahogany/Brown	80301-S	SJ26-S
	Almond	80301-SA	SJ26-SA
	Light Almond	80301-ST	SJ26-ST
2-Gang 2-Decora	Ivory	80309-SI	SJ262-SI
	Ebony/Black	80309-SE	SJ262-SE
	Gray	80309-SGY	SJ262-SGY
	White	80309-SW	SJ262-SW
	Mahogany/Brown	80309-S	SJ262-S
	Almond	80309-SA	SJ262-SA
	Light Almond	80309-ST	SJ262-ST
3-Gang 3-Decora	Ivory	80311-SI	SJ263-SI
	Ebony/Black	80311-SE	SJ263-SE
	White	80311-SW	SJ263-SW
	Almond	80311-SA	SJ263-SA
	Light Almond	80311-ST	SJ263-ST
4-Gang 4-Decora	Ivory	80312-SI	SJ264-SI
	White	80312-SW	SJ264-SW
	Almond	80312-SA	SJ264-SA
	Light Almond	80312-ST	SJ264-ST
5-Gang 5-Decora	Ivory	80321-SI	SJ265-SI
	White	80321-SW	SJ265-SW
	Almond	80321-SA	SJ265-SA
	Light Almond	80321-ST	SJ265-ST
6-Gang 6-Decora	Ivory	80326-SI	SJ266-SI
	White	80326-SW	SJ266-SW
	Almond	80326-SA	SJ266-SA
	Light Almond	80326-ST	SJ266-ST

TESTING AND CODE COMPLIANCE

- UL Listed (File #E-13397)
- Meets NEMA Standards WD-1, WD-6
- CSA Certified (File #LR-16347)
- NOM Certified (File #057)
- Backed by a Limited Ten-Year Warranty

MATERIAL CHARACTERISTICS

Environmental: Flammability UL-94, V2 Rating
Operating Temperature: -40°C to 120°C

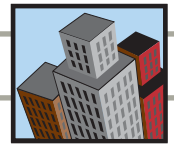

Residential and Commercial Grade Decora Wallplates

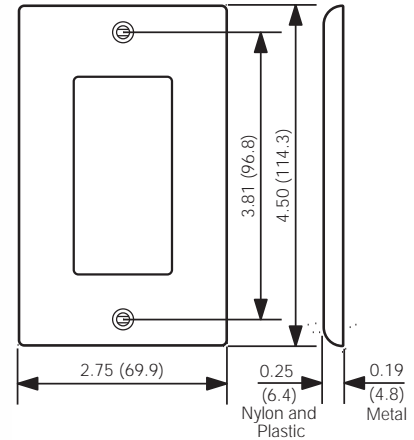

Standard Size Single-Gang

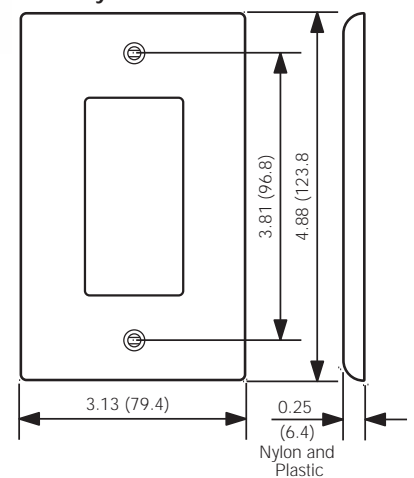

Midway Size Single-Gang

Midway wallplates can be mounted onto larger-volume outlet boxes and/or used to hide wall irregularities. Midway wallplates are a full 0.375" higher and wider than standard size wallplates.

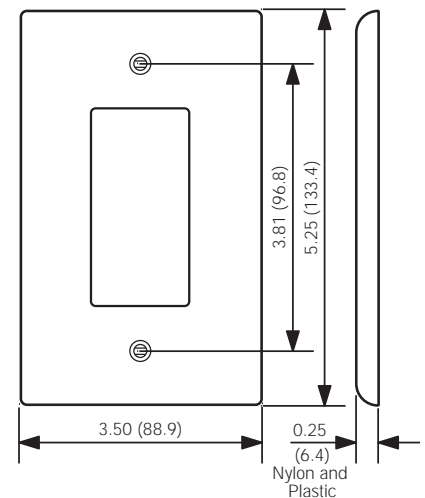

Oversized Single-Gang

Oversized wallplates are used to conceal greater wall irregularities than those hidden by Midway wallplates. Oversized wallplates are a full 0.75" higher and wider than standard size wallplates.

NOTE: Add 1.81" (46.0mm) for each additional gang.

All Decora Wallplates

- Accent any wall covering with a wide selection of colors and finishes
- Smooth face and rounded edges resist dust accumulation
- Individual plastic wrapping to protect wallplate's surface
- Color-matched metal mounting screws supplied

Residential Grade Thermoset Wallplates

- Photoelectrically color-matched to Leviton Decora devices
- Designed for high dielectric strength and arc resistance
- Meet or surpass UL 514 testing requirements
- Resistant to fading, discoloration, grease, oils, organic solvents and moisture scratches
- Backed by a Limited Two-Year Warranty

Commercial Grade Thermoplastic Wallplates

- Molded thermoplastic for maximum resistance to impact, abrasion, fading and discoloration
- Resistant to mechanical stress associated with high abuse applications
- Backed by a Limited Ten-Year Warranty

Commercial Grade Metal Wallplates

- Rounded edges to prevent injury and wall damage
- Deluxe stainless steel is non-magnetic Type 302, .032" thick
- Standard magnetic stainless steel Type 430, .032" thick, also available
- Brass is 70/30 alloy 260, .040" thick
- Aluminum is 3004 alloy, .040" thick
- Backed by a Limited Ten-Year Warranty

TESTING AND CODE COMPLIANCE

- Thermoplastic and Thermoset: UL Listed (File #E-13397)
- Metal: UL Listed (File #E-16347)
- Meets NEMA Standards WD-1, WD-6
- CSA Certified (File #LR-16347)
- NOM Certified (File #057)

MATERIAL CHARACTERISTICS

Environmental: Flammability UL-94, V2 Rating
Operating Temperature: -40°C to 120°C

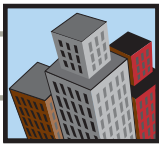

WALLPLATES

Residential and Commercial Grade Decora Wallplates

Decora

DESCRIPTION 1-Gang 1-Decor	Thermoset			Thermoplastic		Screwless Snap-On Polycarbonate		Assorted Metals		
	STANDARD P26	MIDWAY SPJ26	OVERSIZE PO26	STANDARD N26	MIDWAY PJ26	STANDARD	MIDWAY	MATERIAL	STANDARD	OVERSIZE
Ivory	80401-I	80601-I	86601	80401-NI	PJ26-I	80301-SI	SJ26-SI	Chrome	*	---
Black	80401-E	---	---	80401-NE	PJ26-E	80301-SE	SJ26-SE	Aluminum	A26 83401	---
Gray	80401-GY	---	---	80401-NGY	PJ26-GY	80301-SGY	SJ26-SGY	Brass	B26 81401	---
White	80401-W	80601-W	88601	80401-NW	PJ26-W	80301-SW	SJ26-SW	Polished Brass	81401-PB	---
Brown	80401	80601	---	80401-N	PJ26	80301-S	SJ26-S	430 S/S	*	*
Almond	80401-A	80601-A	82601	80401-NA	PJ26-A	80301-SA	SJ26-SA	302 S/S	SN26-N 84401-40	S026 S026
Light Almond	80401-T	80601-T	---	80401-NT	PJ26-T	80301-ST	SJ26-ST			
Red	---	---	---	80401-NR	---	---	---			
Blue	---	---	---	80401-NB	PJ26-BU	---	---			

DESCRIPTION 2-Gang 2-Decor	Thermoset			Thermoplastic		Screwless Snap-On Polycarbonate		Assorted Metals		
	STANDARD P262	MIDWAY SPJ262	OVERSIZE PO262	STANDARD N262	MIDWAY PJ262	STANDARD	MIDWAY	MATERIAL	STANDARD	OVERSIZE
Ivory	80409-I	80609-I	86602	80409-NI	PJ262-I	80309-SI	SJ262-SI	Chrome	*	---
Black	80409-E	---	---	80409-NE	PJ262-E	80309-SE	SJ262-SE	Aluminum	A262 83409	---
Gray	80409-GY	---	---	80409-NGY	PJ262-GY	80309-SGY	SJ262-SGY	Brass	B262 81409	---
White	80409-W	80609-W	88602	80409-NW	PJ262-W	80309-SW	SJ262-SW	Polished Brass	81409-PB	---
Brown	80409	80609	---	80409-N	PJ262	80309-S	SJ262-S	430 S/S	*	*
Almond	80409-A	80609-A	82602	80409-NA	PJ262-A	80309-SA	SJ262-SA	302 S/S	S262-N 84409-40	S0262 S0262
Light Almond	80409-T	80609-T	---	80409-NT	PJ262-T	80309-ST	SJ262-ST			
Red	---	---	---	80409-NR	---	---	---			
Blue	---	---	---	80409-NB	---	---	---			

DESCRIPTION 3-Gang 3-Decor	Thermoset			Thermoplastic		Screwless Snap-On Polycarbonate		Assorted Metals		
	STANDARD P263	MIDWAY SPJ263	OVERSIZE	STANDARD N263	MIDWAY PJ263	STANDARD	MIDWAY	MATERIAL	STANDARD	OVERSIZE
Ivory	80411-I	80611-I	---	80411-NI	PJ263-I	80311-SI	SJ263-SI	Chrome	*	---
Black	80411-E	---	---	---	---	80311-SE	SJ263-SE	Aluminum	A263 83411	---
Gray	80411-GY	---	---	80411-NGY	PJ263-GY	---	---	Brass	B263 81411	---
White	80411-W	80611-W	---	80411-NW	PJ263-W	80311-SW	SJ263-SW	Polished Brass	81411-PB	---
Brown	80411	80611	---	80411-N	---	---	---	430 S/S	*	*
Almond	80411-A	80611-A	---	80411-NA	PJ263-A	80311-SA	SJ263-SA	302 S/S	S263-N 84411-40	S0263 S0263
Light Almond	80411-T	80611-T	---	80411-NT	PJ263-T	80311-ST	SJ263-ST			

*Consult your Leviton representative for ordering details: allow 3-4 weeks for delivery.

NOTE: Where applicable, Industry Number indicated in BOLD FACE. For some wallplates, Industry Number and Leviton Catalog Number are identical.

Decorate Wallplates

E
4

Residential and Commercial Grade Decora Wallplates



Decora

	Thermoset			Thermoplastic		Screwless Snap-On Polycarbonate		Assorted Metals		
DESCRIPTION 4-Gang 4-Decora										
COLOR	STANDARD P264	MIDWAY SPJ264	OVERSIZE	STANDARD N264	MIDWAY PJ264	STANDARD	MIDWAY	MATERIAL	STANDARD	OVERSIZE
Ivory	80412-I	80612-I	—	80412-NI	PJ264-I	80312-SI	SJ264-SI	Chrome	*	—
Black	80412-E	—	—	—	—	80312-SE	SJ264-SE	Brass	B264 81412	—
Gray	80412-GY	—	—	—	PJ264-GY	—	—	430 S/S	*	—
White	80412-W	80612-W	—	80412-NW	PJ264-W	80312-SW	SJ264-SW	302 S/S	S264-N 84412-40	—
Brown	80412	—	—	80412-N	—	—	—			
Almond	80412-A	80612-A	—	80412-NA	PJ264-A	80312-SA	SJ264-SA			
Light Almond	80412-T	80612-T	—	80412-NT	PJ264-T	80312-ST	SJ264-ST			
DESCRIPTION 5-Gang 5-Decora										
COLOR	STANDARD P265	MIDWAY	OVERSIZE	STANDARD N265	MIDWAY	STANDARD	MIDWAY	MATERIAL	STANDARD	OVERSIZE
Ivory	80423-I	—	—	—	—	80321-SI	SJ265-SI	Brass	B265 81423	—
Black	80423-E	—	—	—	—	—	—	430 S/S	*	—
Gray	80423-GY	—	—	—	—	—	—	302 S/S	S265 84423-40	—
White	80423-W	—	—	—	—	80321-SW	SJ265-SW			
Brown	80423	—	—	—	—	—	—			
Almond	80423-A	—	—	—	—	80321-SA	SJ265-SA			
Light Almond	80423-T	—	—	80423-NT	—	80321-ST	SJ265-ST			
DESCRIPTION 6-Gang 6-Decora										
COLOR	STANDARD P266	MIDWAY	OVERSIZE	STANDARD N266	MIDWAY	STANDARD	MIDWAY	MATERIAL	STANDARD	OVERSIZE
Ivory	80436-I	—	—	—	—	80326-SI	SJ266-SI	Brass	B266 *	—
Black	80436-E	—	—	—	—	—	—	430 S/S	—	—
Gray	80436-GY	—	—	—	—	—	—	302 S/S	S266-N 84436-40	—
White	80436-W	—	—	—	—	80326-SW	SJ266-SW			
Brown	80436	—	—	—	—	—	—			
Almond	80436-A	—	—	80436-NA	—	80326-SA	SJ266-SA			
Light Almond	80436-T	—	—	—	—	80326-ST	SJ266-ST			
DESCRIPTION 7-Gang 7-Decora										
COLOR	STANDARD S607	MIDWAY	OVERSIZE	STANDARD	MIDWAY	STANDARD	MIDWAY	MATERIAL	STANDARD	OVERSIZE
Ivory	80407-I†	—	—	—	—	—	—	Brass	B607 *	—
White	80407-W†	—	—	—	—	—	—	430 S/S	*	—
								302 S/S	S607-N *	—
DESCRIPTION 8-Gang 8-Decora										
COLOR	STANDARD S609	MIDWAY	OVERSIZE	STANDARD	MIDWAY	STANDARD	MIDWAY	MATERIAL	STANDARD	OVERSIZE
Ivory	80408-I†	—	—	—	—	—	—	Brass	B609 *	—
White	80408-W†	—	—	—	—	—	—	430 S/S	*	—
								302 S/S	S609-N *	—

*Consult your Leviton representative for ordering details: allow 3-4 weeks for delivery. †Painted metal





LARGER SIZE WALLPLATES

Residential and Commercial Grade Wallplates

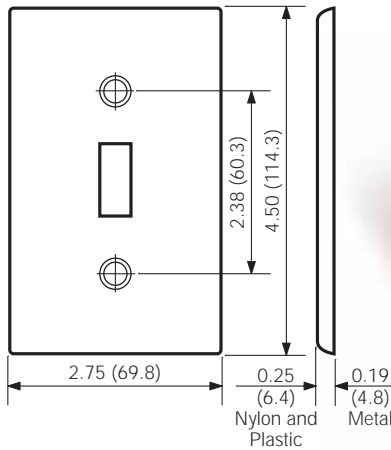

Standard Size Single-Gang

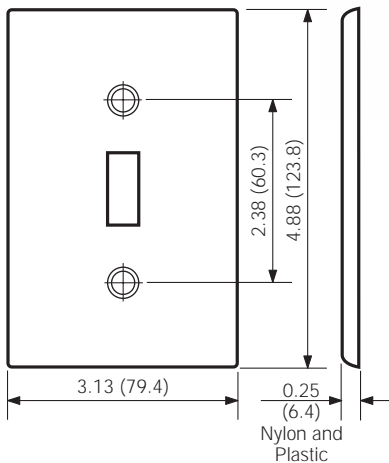

Midway Size Single-Gang

Midway wallplates can be mounted onto larger-volume outlet boxes and/or used to hide wall irregularities. Midway wallplates are a full 0.375" higher and wider than standard size wallplates.

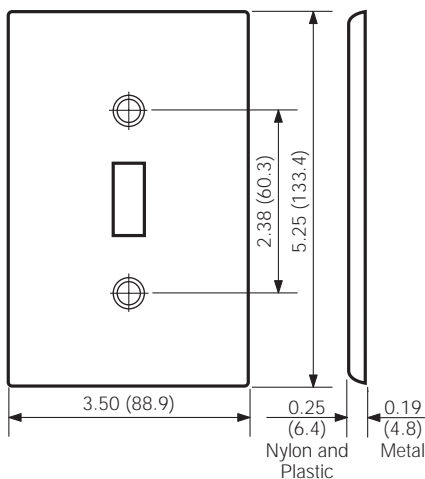

Oversized Single-Gang

Oversized wallplates are used to conceal greater wall irregularities than those hidden by Midway wallplates. Oversized wallplates are a full 0.75" higher and wider than standard size wallplates.

NOTE: Add 1.81" (46.0mm) for each additional gang.

A COMPLETE SELECTION OF WALLPLATES FOR INDUSTRIAL, COMMERCIAL AND RESIDENTIAL APPLICATIONS



Features and Benefits of All Leviton Wallplates

- Easy to Clean, smooth finish
- Noncombustible
- Individual plastic wrapping to protect wallplate surface
- Color-matched metal mounting screws supplied in an envelope to protect plate from scratches
- UL Listed and CSA Certified
- Conform to NEMA and ANSI Standards

Residential Grade Thermoset (Plastic) Wallplates

- Photoelectrically color-matched to Leviton Decora devices
- Designed for high dielectric strength and arc resistance
- Meet or surpass UL 514 testing requirements
- Resistant to fading, discoloration, grease, oils, organic solvents and moisture scratches
- Backed by a Limited Two-Year Warranty

Commercial Grade Thermoplastic (Nylon) Wallplates

- Molded thermoplastic for maximum resistance to impact, abrasion, fading and discoloration
- Resistant to mechanical stress associated with high abuse applications
- Backed by a Limited Ten-Year Warranty

Commercial Grade Metal Wallplates

- Rounded edges to prevent injury and wall damage
- Deluxe stainless steel is non-magnetic Type 302, .032" thick
- Standard magnetic stainless steel Type 430, .032" thick, also available
- Brass is 70/30 alloy 260, .040" thick
- Aluminum is 3004 alloy, .040" thick
- Backed by a Limited Ten-Year Warranty

TESTING AND CODE COMPLIANCE

- UL Listed
- Meets NEMA Standards WD-1, WD-6
- CSA Certified

MATERIAL CHARACTERISTICS

Environmental: Flammability UL-94, V2 Rating
Operating Temperature: -40°C to 120°C

Residential and Commercial Grade Wallplates

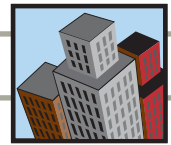

Toggle

Thermoset (Plastic)	Thermoplastic (Nylon)	Assorted Metals
---------------------	-----------------------	-----------------

DESCRIPTION 1-Gang 1-Toggle	Thermoset (Plastic)			Thermoplastic (Nylon)		Assorted Metals		
COLOR	STANDARD P1	MIDWAY SPJ1	OVERSIZE PO1	STANDARD N1	MIDWAY PJ1	MATERIAL	STANDARD	OVERSIZE
Ivory	86001	80501-I	86101	80701-I	PJ1-I	Chrome	C1 1901	—
Black	—	—	—	80701-E	PJ1-E	Aluminum	A1 83001	—
Gray	87001	—	—	80701-GY	PJ1-GY	Brass	B1 81001	—
Red	—	—	—	80701-R	—	Polished Brass	81001-PB	—
White	88001	80501-W	88101	80701-W	PJ1-W	430 S/S	S1 84001	S01 84101
Brown	85001	80501	85101	80701	PJ1	302 S/S	S1-N 84001-40	S01-N 84101-40
Almond	82001	80501-A	—	80701-A	PJ1-A			
Light Almond	78001	80501-T	—	80701-T	PJ1-T			

DESCRIPTION 2-Gang 2-Toggles	Thermoset (Plastic)			Thermoplastic (Nylon)		Assorted Metals		
COLOR	STANDARD P2	MIDWAY SPJ2	OVERSIZE PO2	STANDARD N2	MIDWAY PJ2	MATERIAL	STANDARD	OVERSIZE
Ivory	86009	80509-I	86109	80709-I	PJ2-I	Chrome	1909	—
Black	—	—	—	80709-E	PJ2-E	Aluminum	A2 83009	—
Gray	87009	—	—	80709-GY	PJ2-GY	Brass	B2 81009	—
Red	—	—	—	80709-R	—	Polished Brass	81009-PB	—
White	88009	80509-W	88109	80709-W	PJ2-W	430 S/S	S2 84009	—
Brown	85009	80509	85109	80709	—	302 S/S	S2-N 84009-40	S02-N 84109-40
Almond	82009	80509-A	—	80709-A	PJ2-A			
Light Almond	78009	80509-T	—	80709-T	PJ2-T			

DESCRIPTION 3-Gang 3-Toggles	Thermoset (Plastic)			Thermoplastic (Nylon)		Assorted Metals		
COLOR	STANDARD P3	MIDWAY SPJ3	OVERSIZE PO3	STANDARD N3	MIDWAY PJ3	MATERIAL	STANDARD	OVERSIZE
Ivory	86011	80511-I	86111	80711-I	PJ3-I	Chrome	*	—
Black	—	—	—	80711-E	PJ3-E	Aluminum	A3 83011	—
Gray	87011	—	—	80711-GY	—	Brass	B3 81011	—
Red	—	—	—	80711-R	—	Polished Brass	81011-PB	—
White	88011	80511-W	88111	80711-W	PJ3-W	430 S/S	S3 84011	—
Brown	85011	80511	—	80711	PJ3	302 S/S	S3-N 84011-40	S03-N 84111-40
Almond	82011	80511-A	—	80711-A	PJ3-A			
Light Almond	78011	80511-T	—	80711-T	PJ3-T			

*Consult your Leviton representative for ordering details: allow 3-4 weeks for delivery.

NOTE: Where applicable, Industry Number indicated in BOLD FACE. For some wallplates, Industry Number and Leviton Catalog Number are identical.



WALLPLATES

Residential and Commercial Grade Wallplates

Toggle

	Thermoset (Plastic)			Thermoplastic (Nylon)		Assorted Metals		
DESCRIPTION 4-Gang 4-Toggles								
COLOR	STANDARD P4	MIDWAY SPJ4	OVERSIZE	STANDARD N4	MIDWAY PJ4	MATERIAL	STANDARD	OVERSIZE
Ivory	86012	80512-I	—	80712-I	PJ4-I	Chrome	*	—
Black	—	—	—	80712-E	—	Aluminum	A4 83012	—
Gray	87012	—	—	—	—	Brass	B4 81012	—
						Polished Brass	81012-PB	—
White	88012	80512-W	—	80712-W	PJ4-W	430 S/S	S4 84012	*
Brown	85012	80512	—	—	—	302 S/S	S4-N 84012-40	S04-N 84112-40
Almond	82012	80512-A	—	80712-A	PJ4-A			
Light Almond	78012	80512-T	—	80712-T	PJ4-T			
DESCRIPTION 5-Gang 5-Toggles								
COLOR	STANDARD P5	MIDWAY	OVERSIZE	STANDARD N5	MIDWAY	MATERIAL	STANDARD	OVERSIZE
Ivory	86023	—	—	80723-I	—	Chrome	*	—
White	88023	—	—	80723-W	—	Aluminum	A5 *	—
Brown	85023	—	—	—	—	Brass	B5 81023	—
Almond	82023	—	—	—	—	Polished Brass	81023-PB	—
Light Almond	78023	—	—	—	—	430 S/S	S5 *	—
						302 S/S	S5-N 84023-40	—
DESCRIPTION 6-Gang 6-Toggles								
COLOR	STANDARD P6	MIDWAY	OVERSIZE	STANDARD N6	MIDWAY	MATERIAL	STANDARD	OVERSIZE
Ivory	86036	—	—	80736-I	—	Chrome	*	—
White	88036	—	—	80736-W	—	Aluminum	A6 *	—
Brown	85036	—	—	—	—	Brass	B6 81036	—
Almond	82036	—	—	—	—	430 S/S	S6 *	—
Light Almond	78036	—	—	—	—	302 S/S	S6-N 84036-40	—

*Consult your Leviton representative for ordering details: allow 3-4 weeks for delivery.

NOTE: Where applicable, Industry Number indicated in BOLD FACE. For some wallplates, Industry Number and Leviton Catalog Number are identical.

Residential and Commercial Grade Wallplates

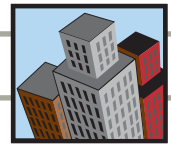

Toggle

	Thermoset (Plastic)			Thermoplastic (Nylon)		Assorted Metals		
DESCRIPTION 7-Gang 7-Toggles								
COLOR	STANDARD S601	MIDWAY	OVERSIZE	STANDARD	MIDWAY	MATERIAL	STANDARD	OVERSIZE
Ivory	S601-I†	—	—	—	—	Chrome	*	—
White	S601-W†	—	—	—	—	Brass	B601 *	—
						430 S/S	*	—
						302 S/S	S601-N 84070-40	—

†Painted metal wallplate.

DESCRIPTION 8-Gang 8-Toggles								
COLOR	STANDARD S602	MIDWAY	OVERSIZE	STANDARD N6	MIDWAY	MATERIAL	STANDARD	OVERSIZE
Ivory	S602-I†	—	—	—	—	Chrome	*	—
White	S602-W†	—	—	—	—	Brass	B602 *	—
						430 S/S	*	—
						302 S/S	S602-N 84048-40	—

†Painted metal wallplate.

DESCRIPTION 9-Gang 9-Toggles								
COLOR	STANDARD S603	MIDWAY	OVERSIZE	STANDARD	MIDWAY	MATERIAL	STANDARD	OVERSIZE
Ivory	S603-I†	—	—	—	—	Chrome	*	—
White	S603-W†	—	—	—	—	Brass	B603 *	—
						430 S/S	*	—
						302 S/S	S603-N 84049-40	—

†Painted metal wallplate.

DESCRIPTION 10-Gang 10-Toggles								
COLOR	STANDARD S604	MIDWAY	OVERSIZE	STANDARD	MIDWAY	MATERIAL	STANDARD	OVERSIZE
Ivory	S604-I†	—	—	—	—	Chrome	*	—
White	S604-W†	—	—	—	—	Brass	B604 *	—
						302 S/S	S604-N 84050-40	—

†Painted metal wallplate.

*Consult your Leviton representative for ordering details: allow 3-4 weeks for delivery.

NOTE: Where applicable, Industry Number indicated in BOLD FACE. For some wallplates, Industry Number and Leviton Catalog Number are identical.



WALLPLATES

Residential and Commercial Grade Wallplates

Receptacle

	Thermoset (Plastic)			Thermoplastic (Nylon)		Assorted Metals		
--	---------------------	--	--	-----------------------	--	-----------------	--	--

DESCRIPTION
1-Gang
1-Duplex



COLOR	STANDARD P8	MIDWAY SPJ8	OVERSIZE	STANDARD N8	MIDWAY PJ8	MATERIAL	STANDARD	OVERSIZE
Ivory	86003	80503-I	86103	80703-I	PJ8-I	Chrome	C8 1903	—
Black	—	—	—	80703-E	PJ8-E	Aluminum	A8 83003	—
Gray	87003	—	—	80703-GY	PJ8-GY	Brass	B8 81003	—
Red	—	—	—	80703-R	PJ8-R	Polished Brass	81003-PB	—
White	88003	80503-W	88103	80703-W	PJ8-W	430 S/S	S8 84003	S08 84103
Brown	85003	80503	85103	80703	PJ8	302 S/S	S8-N 84003-40	S08-N 84103-40
Blue	—	—	—	80703-BU	PJ8-BU			
Almond	82003	80503-A	—	80703-A	PJ8-A			
Light Almond	78003	80503-T	—	80703-T	PJ8-T			

DESCRIPTION
2-Gang
2-Duplex



COLOR	STANDARD P82	MIDWAY SPJ82	OVERSIZE	STANDARD N82	MIDWAY PJ82	MATERIAL	STANDARD	OVERSIZE
Ivory	86016	80516-I	86116	80716-I	PJ82-I	Chrome	C82 *	—
Black	—	—	—	80716-E	PJ82-E	Aluminum	A82 83016	—
Gray	87016	—	—	80716-GY	PJ82-GY	Brass	B82 81016	—
Red	—	—	—	80716-R	PJ82-R	Polished Brass	*	—
White	88016	80516-W	88116	80716-W	PJ82-W	430 S/S	S82 84016	S082 84116
Brown	85016	80516	85116	80716	PJ82	302 S/S	S82-N 84016-40	S082-N 84116-40
Orange	—	—	—	80716-ORG	—			
Blue	—	—	—	80716-BU	—			
Almond	82016	80516-A	—	80716-A	PJ82-A			
Light Almond	78016	80516-T	—	80716-T	PJ82-T			

DESCRIPTION
3-Gang
3-Duplex

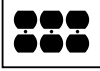

COLOR	STANDARD P83	MIDWAY	OVERSIZE	STANDARD	MIDWAY	MATERIAL	STANDARD	OVERSIZE
Ivory	86030	—	—	80730-I	—	Chrome	*	—
						Aluminum	*	—
Gray	—	—	—	80730-GY	—	Brass	*	—
Red	—	—	—	80730-R	—	430 S/S	S83 *	—
White	88030	—	—	80730-W	—	302 S/S	S83-N 84030-40	S083-N 84130-40
Brown	85030	—	—	—	—			
Light Almond	—	—	—	78030	—			

*Consult your Leviton representative for ordering details: allow 3-4 weeks for delivery.

NOTE: Where applicable, Industry Number indicated in BOLD FACE. For some wallplates, Industry Number and Leviton Catalog Number are identical.

Residential and Commercial Grade Wallplates

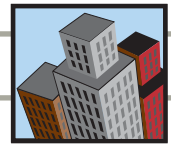

Duplex Receptacle

	Thermoset (Plastic)			Thermoplastic (Nylon)		Assorted Metals		
--	---------------------	--	--	-----------------------	--	-----------------	--	--

DESCRIPTION 4-Gang 4-Duplex								
COLOR	STANDARD	MIDWAY	OVERSIZE	STANDARD	MIDWAY	MATERIAL	STANDARD	OVERSIZE
Ivory	86041	—	—	—	—	Chrome	*	—
White	88041	—	—	—	—	Aluminum	*	—
Brown	85041	—	—	—	—	Brass	*	—
						430 S/S	S84 84041	*
						302 S/S	S84-N *	*

DESCRIPTION 5-Gang 5-Duplex								
COLOR	STANDARD	MIDWAY	OVERSIZE	STANDARD	MIDWAY	MATERIAL	STANDARD	OVERSIZE
						Chrome	*	—
						Brass	B85 *	—
						302 S/S	S85-N 84055-40	—

DESCRIPTION 6-Gang 6-Duplex								
COLOR	STANDARD	MIDWAY	OVERSIZE	STANDARD	MIDWAY	MATERIAL	STANDARD	OVERSIZE
						Chrome	*	—
						Brass	B86 *	—
						302 S/S	S86-N 84056-40	—

DESCRIPTION 7-Gang 7-Duplex								
COLOR	STANDARD	MIDWAY	OVERSIZE	STANDARD	MIDWAY	MATERIAL	STANDARD	OVERSIZE
						Chrome	*	—
						Brass	B608 *	—
						430 S/S	S608 *	—
						302 S/S	*	—

DESCRIPTION 8-Gang 8-Duplex								
COLOR	STANDARD	MIDWAY	OVERSIZE	STANDARD	MIDWAY	MATERIAL	STANDARD	OVERSIZE
						Chrome	*	—
						Brass	B6082 *	—
						430 S/S	S6082 *	—
						302 S/S	*	—

*Consult your Leviton representative for ordering details: allow 3-4 weeks for delivery.

NOTE: Where applicable, Industry Number indicated in BOLD FACE. For some wallplates, Industry Number and Leviton Catalog Number are identical.



WALLPLATES

Residential and Commercial Grade Wallplates

Single Receptacle—15 Amp and 20 Amp Straight Blade and 15 Amp Locking
 Thermoset (Plastic) Thermoplastic (Nylon)

Assorted Metals

DESCRIPTION

1-Gang
 1-Single 1.406" dia. Hole



COLOR	STANDARD P7	MIDWAY SPJ7	OVERSIZE	STANDARD N7	MIDWAY PJ7	MATERIAL	STANDARD	OVERSIZE
Ivory	86004	80504-I	—	80704-I	PJ7-I	Chrome	*	—
Black	—	—	—	80704-E	—	Aluminum	A7 83004	—
Gray	—	—	—	80704-GY	—	Brass	B7 81004	—
Red	—	—	—	80704-R	PJ7-R	430 S/S	S7 *	*
White	88004	80504-W	—	80704-W	PJ7-W	302 S/S	S7-N 84004-40	S07-N 84104-40
Brown	85004	80504	—	80704	—			
Orange	—	—	—	80704-ORG	—			
Almond	82004	80504-A	—	80704-A	PJ7-A			
Light Almond	78004	80504-T	—	80704-T	PJ7-T			

DESCRIPTION

2-Gang
 2-Singles 1.406" dia. Holes



COLOR	STANDARD P72	MIDWAY SPJ82	OVERSIZE	STANDARD N82	MIDWAY PJ82	MATERIAL	STANDARD	OVERSIZE
Ivory	86052	—	—	—	—	Chrome	*	—
White	88052	—	—	—	—	Aluminum	*	—
Brown	85052	—	—	—	—	Brass	*	—
						430 S/S	S72 *	—
						302 S/S	S72-N 84052-40	—

DESCRIPTION

3-Gang
 3-Singles 1.406" dia. Holes

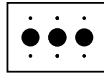

COLOR	STANDARD	MIDWAY	OVERSIZE	STANDARD	MIDWAY	MATERIAL	STANDARD	OVERSIZE
						Brass	*	—
						430 S/S	S73 *	—
						302 S/S	S73-N S73-N	—

DESCRIPTION

4-Gang
 4-Singles 1.406" dia. Holes

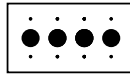

COLOR	STANDARD	MIDWAY	OVERSIZE	STANDARD	MIDWAY	MATERIAL	STANDARD	OVERSIZE
						Brass	*	—
						430 S/S	S74 *	—
						302 S/S	S74-N	—

DESCRIPTION

5-Gang
 5-Singles 1.406" dia. Holes

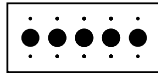

COLOR	STANDARD	MIDWAY	OVERSIZE	STANDARD	MIDWAY	MATERIAL	STANDARD	OVERSIZE
						Brass	*	—
						430 S/S	S75 *	—
						302 S/S	S75-N	—

DESCRIPTION

6-Gang
 6-Singles 1.406" dia. Holes

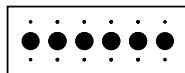

COLOR	STANDARD	MIDWAY	OVERSIZE	STANDARD	MIDWAY	MATERIAL	STANDARD	OVERSIZE
						Brass	*	—
						430 S/S	S76 *	—
						302 S/S	S76-N	—

*Consult your Leviton representative for ordering details: allow 3-4 weeks for delivery.

NOTE: Where applicable, Industry Number indicated in BOLD FACE. For some wallplates, Industry Number and Leviton Catalog Number are identical.



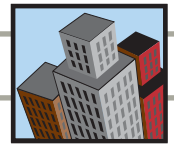

Residential and Commercial Grade Wallplates

Telephone or Cable Outlet Wallplates—Box Mounted

Thermoset (Plastic)	Thermoplastic (Nylon)	Assorted Metals
---------------------	-----------------------	-----------------

DESCRIPTION
1-Gang
Phone/Cable .312" dia. Hole, Box Mount



COLOR	STANDARD	MIDWAY SPJ738	OVERSIZE	STANDARD	MIDWAY	MATERIAL	STANDARD	OVERSIZE
Ivory	—	80513-I	—	—	—	Aluminum	A738 83013	—
White	—	80513-W	—	—	—	Brass	B738 81013	—
Almond	—	80513-A	—	—	—	Polished Brass	81013-PB	—
Light Almond	—	80513-T	—	—	—	430 S/S	S738 84013	—
						302 S/S	S7-N 84013-40	—

DESCRIPTION
1-Gang
Phone/Cable .406" dia. Hole, Box Mount



COLOR	STANDARD P11	MIDWAY	OVERSIZE	STANDARD	MIDWAY PJ11	MATERIAL	STANDARD	OVERSIZE
Ivory	86013	—	—	—	PJ11-I	Aluminum	*	—
Black	—	—	—	—	PJ11-E	Brass	*	—
Gray	—	—	—	—	PJ11-GY	430 S/S	*	—
White	88013	—	—	—	PJ11-W	302 S/S	S11-N 84061-40	*
						—	—	—
Almond	82013	—	—	—	PJ11-A	—	—	—
Light Almond	78013	—	—	—	PJ11-T	—	—	—

DESCRIPTION
1-Gang
Phone/Cable .625" dia. Hole, Box Mount



COLOR	STANDARD P737	MIDWAY	OVERSIZE	STANDARD	MIDWAY	MATERIAL	STANDARD	OVERSIZE
Ivory	86017	—	—	—	—	Aluminum	A737 *	—
White	88017	—	—	—	—	Brass	B737 81017	—
						430 S/S	S737 *	—
						302 S/S	S737-N 84017-40	—

DESCRIPTION
2-Gang
Phone/Cable .406" dia. Hole, Box Mount



COLOR	STANDARD P21	MIDWAY	OVERSIZE	STANDARD	MIDWAY	MATERIAL	STANDARD	OVERSIZE
Ivory	86062	—	—	—	—	Brass	*	—
White	88062	—	—	—	—	430 S/S	*	—
						302 S/S	S21-N 84062-40	—

DESCRIPTION
3-Gang
Phone/Cable .406" dia. Hole, Box Mount



COLOR	STANDARD	MIDWAY	OVERSIZE	STANDARD	MIDWAY	MATERIAL	STANDARD	OVERSIZE
						Brass	*	—
						430 S/S	*	—
						302 S/S	S31-N	—

*Consult your Leviton representative for ordering details: allow 3-4 weeks for delivery.

NOTE: Where applicable, Industry Number indicated in BOLD FACE. For some wallplates, Industry Number and Leviton Catalog Number are identical.





WALLPLATES

Residential and Commercial Grade Wallplates

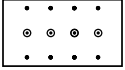
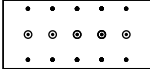
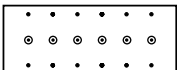
Telephone or Cable Outlet Wallplates—Box Mounted

Thermoset (Plastic)			Thermoplastic (Nylon)			Assorted Metals		
DESCRIPTION 4-Gang Phone/Cable .406" dia. Hole, Box Mount 								
COLOR	STANDARD	MIDWAY	OVERSIZE	STANDARD	MIDWAY	MATERIAL	STANDARD	OVERSIZE
						Brass	*	—
						430 S/S	*	—
						302 S/S	S41-N *	—
DESCRIPTION 5-Gang Phone/Cable .406" dia. Hole, Box Mount 								
COLOR	STANDARD	MIDWAY	OVERSIZE	STANDARD	MIDWAY	MATERIAL	STANDARD	OVERSIZE
						Brass	*	—
						430 S/S	*	—
						302 S/S	S51-N *	—
DESCRIPTION 6-Gang Phone/Cable .406" dia. Hole, Box Mount 								
COLOR	STANDARD	MIDWAY	OVERSIZE	STANDARD	MIDWAY	MATERIAL	STANDARD	OVERSIZE
						Brass	*	—
						430 S/S	*	—
						302 S/S	S61-N *	—

Telephone or Cable Outlet Wallplates—Strap Mounted

Thermoset (Plastic)			Thermoplastic (Nylon)			Assorted Metals		
DESCRIPTION 1-Gang Phone/Cable .406" dia. Hole, Strap Mount With knockout to enlarge hole to .625" 								
COLOR	STANDARD P12	MIDWAY	OVERSIZE	STANDARD	MIDWAY	MATERIAL	STANDARD	OVERSIZE
Ivory	86018	—	—	—	—	Aluminum	*	—
White	88018	—	—	—	—	Brass	*	—
Brown	85018	—	—	—	—	430 S/S	S12 *	—
						302 S/S	S12-N 84018-40	—
DESCRIPTION 1-Gang Phone/Cable .406" dia. Hole, Strap Mount 								
COLOR	STANDARD	MIDWAY	OVERSIZE PO12	STANDARD N12	MIDWAY	MATERIAL	STANDARD	OVERSIZE
Ivory	—	—	86113	80718-I	—	Brass	*	—
Black	—	—	—	80718-E	—	430 S/S	*	—
Gray	—	—	—	80718-GY	—	302 S/S	*	—
White	—	—	88113	80718-W	—			
Brown	—	—	—	80718	—			
DESCRIPTION 1-Gang Phone/Cable .625" dia. Hole, Strap Mount 								
COLOR	STANDARD P730	MIDWAY	OVERSIZE	STANDARD	MIDWAY	MATERIAL	STANDARD	OVERSIZE
White	88037	—	—	—	—	Brass	*	—
						430 S/S	*	S0730 *
						302 S/S	S730-N 84037-40	S0730-N 84137-40

*Consult your Leviton representative for ordering details: allow 3-4 weeks for delivery.

NOTE: Where applicable, Industry Number indicated in BOLD FACE. For some wallplates, Industry Number and Leviton Catalog Number are identical.

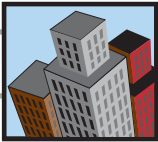

Residential and Commercial Grade Wallplates

Telephone or Cable Outlet Wallplates—Strap Mounted

Thermoset (Plastic) Thermoplastic (Nylon) Assorted Metals

DESCRIPTION 2-Gang Phone/Cable .406" dia. Hole, Strap Mount	Thermoset (Plastic)			Thermoplastic (Nylon)		Assorted Metals		
	STANDARD	MIDWAY	OVERSIZE	STANDARD	MIDWAY	MATERIAL	STANDARD	OVERSIZE
Ivory	P22-1†	—	—	—	—	Brass	—	—
						430 S/S	*	—
						302 S/S	S22-N	*

†Painted metal wallplate.

DESCRIPTION 3-Gang Phone/Cable .406" dia. Hole, Strap Mount	Thermoset (Plastic)			Thermoplastic (Nylon)		Assorted Metals		
	STANDARD	MIDWAY	OVERSIZE	STANDARD	MIDWAY	MATERIAL	STANDARD	OVERSIZE
	P32	—	—	—	—	Brass	—	—
						430 S/S	*	—
						302 S/S	S32-N	*

†Painted metal wallplate.

DESCRIPTION 4-Gang Phone/Cable .406" dia. Hole, Strap Mount	Thermoset (Plastic)			Thermoplastic (Nylon)		Assorted Metals		
	STANDARD	MIDWAY	OVERSIZE	STANDARD	MIDWAY	MATERIAL	STANDARD	OVERSIZE
	P32	—	—	—	—	Brass	*	—
						430 S/S	*	—
						302 S/S	S42-N	*

†Painted metal wallplate.

DESCRIPTION 5-Gang Phone/Cable .406" dia. Hole, Strap Mount	Thermoset (Plastic)			Thermoplastic (Nylon)		Assorted Metals		
	STANDARD	MIDWAY	OVERSIZE	STANDARD	MIDWAY	MATERIAL	STANDARD	OVERSIZE
	P32	—	—	—	—	Brass	*	—
						430 S/S	*	—
						302 S/S	S52-N	*

†Painted metal wallplate.

DESCRIPTION 6-Gang Phone/Cable .406" dia. Hole, Strap Mount	Thermoset (Plastic)			Thermoplastic (Nylon)		Assorted Metals		
	STANDARD	MIDWAY	OVERSIZE	STANDARD	MIDWAY	MATERIAL	STANDARD	OVERSIZE
	P32	—	—	—	—	Brass	*	—
						430 S/S	*	—
						302 S/S	S62-N	*

†Painted metal wallplate.

*Consult your Leviton representative for ordering details: allow 3-4 weeks for delivery.

NOTE: Where applicable, Industry Number indicated in BOLD FACE. For some wallplates, Industry Number and Leviton Catalog Number are identical.







WALLPLATES

Residential and Commercial Grade Wallplates

Blank Wallplates—Box Mounted

Thermoset (Plastic)			Thermoplastic (Nylon)			Assorted Metals		
DESCRIPTION 1-Gang 1-Blank, Box Mounted 								
COLOR	STANDARD P13	MIDWAY SPJ13	OVERSIZE P013	STANDARD N13	MIDWAY PJ13	MATERIAL	STANDARD	OVERSIZE
Ivory	86014	80514-I	86114	80714-I	PJ13-I	Chrome	*	—
Black	—	—	—	80714-E	PJ13-E	Aluminum	A13 83014	—
Gray	87014	—	—	80714-GY	PJ13-GY	Brass	B13 81014	—
Red	—	—	—	80714-R	PJ13-R	430 S/S	S13 84014	S013 84114
White	88014	80514-W	88114	80714-W	PJ13-W	302 S/S	S13-N 84014-40	S013-N 84114-40
Brown	85014	80514	85114	80714	PJ13			
Almond	82014	80514-A	—	80714-A	PJ13-A			
Light Almond	78014	80514-T	—	80714-T	PJ13-T			

DESCRIPTION 2-Gang 2-Blanks, Box Mounted 								
COLOR	STANDARD P23	MIDWAY SPJ23	OVERSIZE	STANDARD N24	MIDWAY PJ23	MATERIAL	STANDARD	OVERSIZE
Ivory	86025	80525-I	—	80725-I	PJ23-I	Aluminum	83025	—
Black	—	—	—	80725-E	—	Brass	B23 81025	—
Gray	87025	—	—	80725-GY	PJ23-GY	Polished Brass	81025-PB	—
White	88025	80525-W	—	80725-W	PJ23-W	430 S/S	S23 84025	—
Brown	85025	80525	—	80725	—	302 S/S	S23-N 84025-40	S023-N 84125-40
Almond	82025	80525-A	—	80725-A	PJ23-A			
Light Almond	78025	80525-T	—	80725-T	PJ23-T			

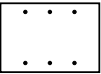
DESCRIPTION 3-Gang 3-Blanks, Box Mounted 								
COLOR	STANDARD P33	MIDWAY	OVERSIZE	STANDARD	MIDWAY	MATERIAL	STANDARD	OVERSIZE
Ivory	86033	80533-I	—	80735-I	—	Aluminum	*	—
Black	—	—	—	80735-E	—	Brass	*	—
Gray	—	—	—	80735-GY	—	430 S/S	*	—
White	88033	80533-W	—	80735-W	—	302 S/S	S33-N 84033-40	S033-N 84133-40
Brown	85033	—	—	—	—			
Almond	—	—	—	80735-A	—			

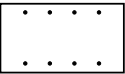
DESCRIPTION 4-Gang 4-Blanks, Box Mounted 								
COLOR	STANDARD P43	MIDWAY	OVERSIZE	STANDARD	MIDWAY	MATERIAL	STANDARD	OVERSIZE
Ivory	86064	—	—	—	—	Aluminum	*	—
White	88064	—	—	—	—	Brass	*	—
Brown	85064	—	—	—	—	430 S/S	S43 84064	*
						302 S/S	S43-N 84064-40	*

DESCRIPTION 5-Gang 5-Blanks, Box Mounted 								
COLOR	STANDARD	MIDWAY	OVERSIZE	STANDARD	MIDWAY	MATERIAL	STANDARD	OVERSIZE
						Brass	*	—
						302 S/S	S53-N 84065-40	—

*Consult your Leviton representative for ordering details: allow 3-4 weeks for delivery.

NOTE: Where applicable, Industry Number indicated in BOLD FACE. For some wallplates, Industry Number and Leviton Catalog Number are identical.



Residential and Commercial Grade Wallplates

Blank Wallplates—Box Mounted

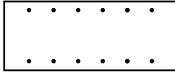
Thermoset (Plastic)			Thermoplastic (Nylon)			Assorted Metals		
DESCRIPTION 6-Gang 6-Blanks, Box Mounted 								
COLOR	STANDARD	MIDWAY	OVERSIZE	STANDARD	MIDWAY	MATERIAL	STANDARD	OVERSIZE
						Brass	*	—
						302 S/S	S63-N 84066-40	—

DESCRIPTION 7-Gang 7-Blanks, Box Mounted 								
COLOR	STANDARD	MIDWAY	OVERSIZE	STANDARD	MIDWAY	MATERIAL	STANDARD	OVERSIZE
						Brass	*	—
						302 S/S	S6013-N 84067-40	—

DESCRIPTION 8-Gang 8-Blanks, Box Mounted 								
COLOR	STANDARD	MIDWAY	OVERSIZE	STANDARD	MIDWAY	MATERIAL	STANDARD	OVERSIZE
						Brass	*	—
						302 S/S	S6023-N 84068-40	—

Blank Wallplates—Strap Mounted

Thermoset (Plastic)			Thermoplastic (Nylon)			Assorted Metals		
DESCRIPTION 1-Gang 1-Blank, Strap Mounted 								
COLOR	STANDARD	MIDWAY	OVERSIZE	STANDARD	MIDWAY	MATERIAL	STANDARD	OVERSIZE
Ivory	86019	—	—	80719-I	—	Aluminum	*	—
Black	—	—	—	80719-E	—	Brass	*	—
Gray	—	—	—	80719-GY	—	430 S/S	S14 84019	*
Red	—	—	—	80719-R	—	302 S/S	S14-N 84019-40	S014-N 84119-40
White	88019	—	—	80719-W	—			
Brown	85019	—	—	80719	—			

DESCRIPTION 2-Gang 2-Blank, Strap Mounted 								
COLOR	STANDARD	MIDWAY	OVERSIZE	STANDARD	MIDWAY	MATERIAL	STANDARD	OVERSIZE
Ivory	86034	—	—	80734-I	—	430 S/S	*	—
Black	—	—	—	80734-E	—	302 S/S	S24-N 84034-40	S024-N 84134-40
Red	—	—	—	80734-R	—			
White	88034	—	—	80734-W	—			

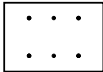
DESCRIPTION 3-Gang 3-Blank, Strap Mounted 								
COLOR	STANDARD	MIDWAY	OVERSIZE	STANDARD	MIDWAY	MATERIAL	STANDARD	OVERSIZE
Ivory	86035	—	—	—	—	Brass	*	—
White	88035	—	—	—	—	430 S/S	*	*
						302 S/S	S34-N 84035-40	—

*Consult your Leviton representative for ordering details: allow 3–4 weeks for delivery.

NOTE: Where applicable, Industry Number indicated in BOLD FACE. For some wallplates, Industry Number and Leviton Catalog Number are identical.



WALLPLATES

Residential and Commercial Grade Wallplates

Blank Wallplates—Strap Mounted

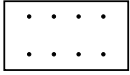
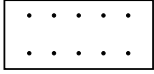
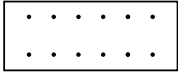
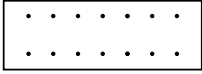
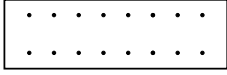
Thermoset			Thermoplastic			Assorted Metals		
DESCRIPTION 4-Gang 4-Blank, Strap Mounted 								
COLOR	STANDARD	MIDWAY	OVERSIZE	STANDARD	MIDWAY	MATERIAL	STANDARD	OVERSIZE
Ivory	86057	—	—	—	—	Brass	*	—
White	88057	—	—	—	—	430 S/S	*	*
						302 S/S	S44-N 84057-40	—
DESCRIPTION 5-Gang 5-Blank, Strap Mounted 								
COLOR	STANDARD	MIDWAY	OVERSIZE	STANDARD	MIDWAY	MATERIAL	STANDARD	OVERSIZE
						Brass	*	—
						430 S/S	*	—
						302 S/S	S54-N S54-N	—
DESCRIPTION 6-Gang 6-Blank, Strap Mounted 								
COLOR	STANDARD	MIDWAY	OVERSIZE	STANDARD	MIDWAY	MATERIAL	STANDARD	OVERSIZE
						Brass	*	—
						430 S/S	*	—
						302 S/S	S64-N *	—
DESCRIPTION 7-Gang 7-Blank, Strap Mounted 								
COLOR	STANDARD	MIDWAY	OVERSIZE	STANDARD	MIDWAY	MATERIAL	STANDARD	OVERSIZE
						Brass	*	—
						430 S/S	*	—
						302 S/S	S6014-N *	—
DESCRIPTION 8-Gang 8-Blank, Strap Mounted 								
COLOR	STANDARD	MIDWAY	OVERSIZE	STANDARD	MIDWAY	MATERIAL	STANDARD	OVERSIZE
						Brass	*	—
						430 S/S	*	—
						302 S/S	S6024-N *	—

*Consult your Leviton representative for ordering details: allow 3-4 weeks for delivery.

NOTE: Where applicable, Industry Number indicated in BOLD FACE. For some wallplates, Industry Number and Leviton Catalog Number are identical.

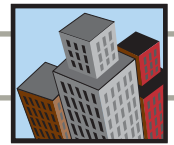

Residential and Commercial Grade Wallplates

Power Outlet Receptacle – One Gang
Thermoset (Plastic)

Thermoplastic (Nylon)

Assorted Metals

DESCRIPTION
20A & 30A Locking Receptacles
1-Gang 1.60" dia. Hole



COLOR	STANDARD	MIDWAY	OVERSIZE	STANDARD N726	MIDWAY	MATERIAL	STANDARD	OVERSIZE
Ivory	—	—	—	80720-I	—	Brass	*	—
Black	—	—	—	80720-E	—	430 S/S	*	—
Gray	—	—	—	80720-GY	—	302 S/S	S720-N 84020-40	—
Red	—	—	—	80720-R	—			
White	—	—	—	80720-W	—			
Brown	—	—	—	80720	—			

DESCRIPTION
30A & 50A Power Receptacle
1-Gang 2.15" dia. Hole
Use with 278, 279, 5206, 5207, 5371, 5372, 5373, 5374



COLOR	STANDARD	MIDWAY P724	OVERSIZE	STANDARD	MIDWAY N724	MATERIAL	STANDARD	OVERSIZE
Ivory	—	80528-I	—	—	80728-I	Aluminum	A724 83028	—
Black	—	80528-BLK	—	—	80728-E	Steel, Brass Finish	B724 4928	—
Gray	—	—	—	—	80728-GY	Steel, Aluminum Finish	S724-GY 4927	—
White	—	80528-W	—	—	80728-W	430 S/S	S724 84028	—
Brown	—	—	—	—	80728			

Power Outlet Receptacle—Two Gang
Thermoset (Plastic)

Thermoplastic (Nylon)

Assorted Metals

DESCRIPTION
30A & 50A Power Receptacle
2-Gang 2.15" dia. Hole
For use with 278,279, 5206, 5207, 5371, 5372, 5373, 5374



COLOR	STANDARD	MIDWAY PJ 703	OVERSIZE	STANDARD	MIDWAY N703	MATERIAL	STANDARD	OVERSIZE
Ivory	—	80526-I	—	—	80726-I	Brass	B703 *	—
Black	—	80526-BLK	—	—	—	Alum	A703 83026	—
White	—	80526-W	—	—	80726-W	Steel, Alum Fin.	S703-GY 4934	—
Brown	—	—	—	—	80726	430 S/S	S703 84026	—

*Consult your Leviton representative for ordering details: allow 3-4 weeks for delivery.

NOTE: Where applicable, Industry Number indicated in BOLD FACE. For some wallplates, Industry Number and Leviton Catalog Number are identical.

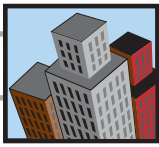

WALLPLATES

Residential and Commercial Grade Wallplates

Power Outlet Receptacle – Two Gang

Thermoset (Plastic)

Thermoplastic (Nylon)

Assorted Metals

DESCRIPTION

2-Gang
2.15" dia. Hole Offset



COLOR	STANDARD	MIDWAY	OVERSIZE	STANDARD	MIDWAY	MATERIAL	STANDARD	OVERSIZE
						430 S/S	S705 84022	—

DESCRIPTION

30A & 50A Power Receptacle
2-Gang 2.465" dia. Hole



COLOR	STANDARD	MIDWAY	OVERSIZE	STANDARD	MIDWAY	MATERIAL	STANDARD	OVERSIZE
Ivory	—	80530-I	—	—	—	Steel, Alum Fin	S701-GY S701-GY	—
Black	—	80530-BLK	—	—	—	430 S/S	S701 *	—
White	—	80530-W	—	—	—	302 S/S	S701-40	—
Almond	—	80530-A	—	—	—			
Light Almond	—	80530-T	—	—	—			

*Consult your Leviton representative for ordering details: allow 3–4 weeks for delivery.

NOTE: Where applicable, Industry Number indicated in **BOLD FACE**. For some wallplates, Industry Number and Leviton Catalog Number are identical.

Residential and Commercial Grade Wallplates

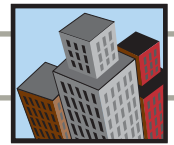

Two Gang with Centered Opening
Thermoset (Plastic)

DESCRIPTION 2-Gang 1-Toggle	Thermoset (Plastic)			Thermoplastic (Nylon)		Assorted Metals			
	COLOR	STANDARD	MIDWAY	OVERSIZE	STANDARD	MIDWAY	MATERIAL	STANDARD	OVERSIZE
							Brass	81040	—
							430 S/S	—	—
							302 S/S	S740-N 84040-40	—

DESCRIPTION 2-Gang 1-Phone/Cable .406" Hole, Box Mount	Thermoset (Plastic)			Thermoplastic (Nylon)		Assorted Metals			
	COLOR	STANDARD	MIDWAY	OVERSIZE	STANDARD	MIDWAY	MATERIAL	STANDARD	OVERSIZE
							Brass	*	—
							430 S/S	*	—
							302 S/S	*	—

DESCRIPTION 2-Gang 1-Phone/Cable .406" Hole, Strap Mount	Thermoset (Plastic)			Thermoplastic (Nylon)		Assorted Metals			
	COLOR	STANDARD	MIDWAY	OVERSIZE	STANDARD	MIDWAY	MATERIAL	STANDARD	OVERSIZE
							Brass	*	—
							430 S/S	*	—
							302 S/S	*	—

DESCRIPTION 2-Gang Blank Box Mount	Thermoset (Plastic)			Thermoplastic (Nylon)		Assorted Metals			
	COLOR	STANDARD	MIDWAY	OVERSIZE	STANDARD	MIDWAY	MATERIAL	STANDARD	OVERSIZE
							Brass	*	—
							430 S/S	*	—
							302 S/S	*	—

DESCRIPTION 2-Gang Blank Strap Mount	Thermoset (Plastic)			Thermoplastic (Nylon)		Assorted Metals			
	COLOR	STANDARD	MIDWAY	OVERSIZE	STANDARD	MIDWAY	MATERIAL	STANDARD	OVERSIZE
							Brass	—	—
							430 S/S	—	—
							302 S/S	*	—

DESCRIPTION 2-Gang 1-Decora	Thermoset (Plastic)			Thermoplastic (Nylon)		Assorted Metals			
	COLOR	STANDARD	MIDWAY	OVERSIZE	STANDARD	MIDWAY	MATERIAL	STANDARD	OVERSIZE
							Brass	—	—
							430 S/S	*	—
							302 S/S	S746-N S746-N	—

DESCRIPTION 2-Gang 1 Single Outlet 1.406" dia. Hole	Thermoset (Plastic)			Thermoplastic (Nylon)		Assorted Metals			
	COLOR	STANDARD	MIDWAY	OVERSIZE	STANDARD	MIDWAY	MATERIAL	STANDARD	OVERSIZE
							Brass	—	—
							430 S/S	*	—
							302 S/S	S747-N 84092-40	—

DESCRIPTION 2-Gang 1-Duplex	Thermoset (Plastic)			Thermoplastic (Nylon)		Assorted Metals			
	COLOR	STANDARD	MIDWAY	OVERSIZE	STANDARD	MIDWAY	MATERIAL	STANDARD	OVERSIZE
							302 S/S	S748-N 84039-40	—

*Consult your Leviton representative for ordering details: allow 3-4 weeks for delivery.

NOTE: Where applicable, Industry Number indicated in BOLD FACE. For some wallplates, Industry Number and Leviton Catalog Number are identical.

For answers to technical questions, call Leviton's Techline at 1-800-824-3005





WALLPLATES

Residential and Commercial Grade Wallplates

Louvre Plates

Thermoset (Plastic)

Thermoplastic (Nylon)

Assorted Metals

DESCRIPTION
1-Gang Center
1-Louvre Plate
Horizontal Box Mount



COLOR	STANDARD	MIDWAY	OVERSIZE	STANDARD	MIDWAY	MATERIAL	STANDARD	OVERSIZE
	P760							
Ivory	86079†	—	—	—	—	Brass	B760 81079	—
White	88079†	—	—	—	—	430 S/S	*	—
						302 S/S	S760-N 84079-40	—

DESCRIPTION
1-Gang
1-Louvre Plate
Strap Mount



COLOR	STANDARD	MIDWAY	OVERSIZE	STANDARD	MIDWAY	MATERIAL	STANDARD	OVERSIZE
	P771							
Ivory	86080†	—	—	—	—	Brass	B771 81080	—
White	88080†	—	—	—	—	430 S/S	*	—
Almond	82080†	—	—	—	—	302 S/S	S771-N 84080-40	—

DESCRIPTION
2-Gang
2-Louvre Plate
Strap Mount



COLOR	STANDARD	MIDWAY	OVERSIZE	STANDARD	MIDWAY	MATERIAL	STANDARD	OVERSIZE
						Brass	*	—
						430 S/S	*	—
						302 S/S	S772-N 84081-40	—

DESCRIPTION
3-Gang
3-Louvre Plate
Strap Mount



COLOR	STANDARD	MIDWAY	OVERSIZE	STANDARD	MIDWAY	MATERIAL	STANDARD	OVERSIZE
						Brass	*	—
						430 S/S	*	—
						302 S/S	*	—

†Painted metal wallplate.

*Consult your Leviton representative for ordering details: allow 3–4 weeks for delivery.

NOTE: Where applicable, Industry Number indicated in BOLD FACE. For some wallplates, Industry Number and Leviton Catalog Number are identical.

Residential and Commercial Grade Wallplates

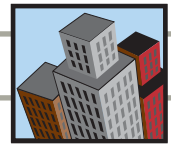

Combination Wallplates
Toggle Switch and Single Receptacle
Thermoset (Plastic)

Thermoplastic (Nylon)

Assorted Metals

DESCRIPTION

2-Gang
1-Toggle 1-Single 1.406" dia. Hole



COLOR	STANDARD P17	MIDWAY	OVERSIZE	STANDARD	MIDWAY	MATERIAL	STANDARD	OVERSIZE
Ivory	86007	---	---	---	---	Aluminum	*	---
White	88007	---	---	---	---	Brass	*	---
						430 S/S	S17 84007	---
						302 S/S	S17-N 84007-40	---

DESCRIPTION

3-Gang
2-Toggles 1-Single 1.406" dia. Hole



COLOR	STANDARD	MIDWAY	OVERSIZE	STANDARD	MIDWAY	MATERIAL	STANDARD	OVERSIZE
						Aluminum	*	---
						Brass	*	---
						430 S/S	*	---
						302 S/S	S27-N 84088-40	---

DESCRIPTION

4-Gang
3-Toggles 1-Single 1.406" dia. Hole



COLOR	STANDARD	MIDWAY	OVERSIZE	STANDARD	MIDWAY	MATERIAL	STANDARD	OVERSIZE
						Aluminum	*	---
						Brass	*	---
						430 S/S	*	---
						302 S/S	S37-N 84042-40	---

Combination Wallplates
Toggle Switch and Duplex Receptacle
Thermoset (Plastic)

Thermoplastic (Nylon)

Assorted Metals

DESCRIPTION

2-Gang
1-Toggle 1-Duplex



COLOR	STANDARD P18	MIDWAY SPJ18	OVERSIZE P018	STANDARD N18	MIDWAY	MATERIAL	STANDARD	OVERSIZE
Ivory	86005	80505-I	86105	80705-I	PJ18-I	Aluminum	A18 83005	---
Black	---	---	---	80705-E	PJ18-E	Brass	B18 81005	---
Gray	87005	---	---	80705-GY	---	430 S/S	S18 84005	*
Red	---	---	---	80705-R	---	302 S/S	S18-N 84005-40	S018-N 84105-40
White	88005	80505-W	88105	80705-W	PJ18-W			
Brown	85005	80505	---	80705	----			
Almond	82005	80505-A	---	80705-A	PJ18-A			
Light Almond	78005	80505-T	---	80705-T	PJ18-T			

*Consult your Leviton representative for ordering details: allow 3-4 weeks for delivery.

NOTE: Where applicable, Industry Number indicated in BOLD FACE. For some wallplates, Industry Number and Leviton Catalog Number are identical.



WALLPLATES

Residential and Commercial Grade Wallplates

Combination Wallplates Toggle Switch and Duplex Receptacle

Thermoset (Plastic)			Thermoplastic (Nylon)			Assorted Metals		
DESCRIPTION 3-Gang 2-Toggles 1-Duplex 								
COLOR	STANDARD P28	MIDWAY SPJ28	OVERSIZE	STANDARD N28	MIDWAY	MATERIAL	STANDARD	OVERSIZE
Ivory	86021	80521-I	—	80721-I	—	Aluminum	*	—
Black	—	—	—	80721-E	—	Brass	B28 81021	—
						430 S/S	*	*
White	88021	80521-W	—	80721-W	—	302 S/S	S28-N 84021-40	S028-N 84121-40
Brown	85021	80521	—	—	—			
Almond	82021	80521-A	—	—	—			
Light Almond	78021	80521-T	—	—	—			

DESCRIPTION 4-Gang 3-Toggles 1-Duplex 								
COLOR	STANDARD P38	MIDWAY	OVERSIZE	STANDARD	MIDWAY	MATERIAL	STANDARD	OVERSIZE
Ivory	P38-I	—	—	80743-I	—	Aluminum	*	—
White	P38-W	—	—	80743-W	—	Brass	*	—
Brown	P38	—	—	—	—	430 S/S	84043	*
Almond	P38-A	—	—	—	—	302 S/S	*	—
Light Almond	P38-T	—	—	—	—			

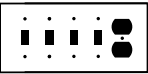
DESCRIPTION 5-Gang 4-Toggles 1-Duplex 								
COLOR	STANDARD P48	MIDWAY	OVERSIZE	STANDARD	MIDWAY	MATERIAL	STANDARD	OVERSIZE
Ivory	P48-I†	—	—	—	—	Brass	*	—
White	P48-W†	—	—	—	—	430 S/S	*	—
						302 S/S	S48-N S48-N	—

†Painted Metal Wallplate

*Consult your Leviton representative for ordering details: allow 3–4 weeks for delivery.

NOTE: Where applicable, Industry Number indicated in **BOLD FACE**. For some wallplates, Industry Number and Leviton Catalog Number are identical.

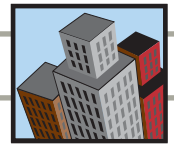

Residential and Commercial Grade Wallplates

Combination Wallplates
Toggle Switch and Decora/GFCI
Thermoset (Plastic)

Thermoplastic (Nylon)

Assorted Metals

DESCRIPTION

2-Gang 1-Toggle 1-Decora/GFCI



COLOR	STANDARD P126	MIDWAY SPJ126	OVERSIZE P0126	STANDARD	MIDWAY PJ126	MATERIAL	STANDARD	OVERSIZE
Ivory	80405-I	80605-I	86605	80707-I	PJ126-I	Brass	*	—
Black	80405-E	—	—	80707-E	—	430 S/S	S126 S126	—
Gray	80405-GY	—	—	80707-GY	—	302 S/S	*	—
Red	—	—	—	80707-R	—			
White	80405-W	80605-W	88605	80707-W	PJ126-W			
Brown	80405	80605	—	80707	PJ126			
Almond	80405-A	80605-A	82605	80707-A	PJ126-A			
Light Almond	80405-T	80605-T	—	80707-T	PJ126-T			

DESCRIPTION

3-Gang 2-Toggles 1-Decora/GFCI



COLOR	STANDARD P226	MIDWAY SPJ226	OVERSIZE	STANDARD	MIDWAY SPJ226	MATERIAL	STANDARD	OVERSIZE
Ivory	80421-I	—	—	80745-I	PJ226-I	Brass	*	—
Black	80421-E	—	—	—	—	430 S/S	*	—
White	80421-W	—	—	80745-W	PJ226-W	302 S/S	S226-N 84421-40	—
Brown	80421	—	—	—	PJ226			
Almond	80421-A	—	—	80745-A	PJ226-A			
Light Almond	80421-T	—	—	—	PJ226-T			

DESCRIPTION

3-Gang 2-Decora/GFCI 1 - Toggle



COLOR	STANDARD P1262	MIDWAY	OVERSIZE	STANDARD	MIDWAY	MATERIAL	STANDARD	OVERSIZE
Ivory	80431-I	—	—	80731-I	—	Brass	*	—
Black	—	—	—	80731-E	—	430 S/S	*	—
Gray	80431-GY	—	—	80731-GY	—	302 S/S	*	—
White	80431-W	—	—	80731-W	—			
Brown	80431	—	—	—	—			
Almond	80431-A	—	—	—	—			
Light Almond	80431-T	—	—	—	—			

DESCRIPTION

4-Gang 2-Toggles 2-Decora/GFCI



COLOR	STANDARD P326	MIDWAY	OVERSIZE	STANDARD	MIDWAY	MATERIAL	STANDARD	OVERSIZE
Ivory	P326-I	—	—	80732-I	—	Brass	*	—
White	P326-W	—	—	80732-W	—	430 S/S	*	—
Brown	P326	—	—	—	—	302 S/S	*	—
Almond	P326-A	—	—	—	—			
Light Almond	P326-T	—	—	—	—			

DESCRIPTION

4-Gang 3-Toggles 1-Decora/GFCI



COLOR	STANDARD P2262	MIDWAY	OVERSIZE	STANDARD	MIDWAY SPJ826	MATERIAL	STANDARD	OVERSIZE
Ivory	P2262-I†	—	—	—	—	Brass	*	—
White	P2262-W†	—	—	—	—	430 S/S	*	—
						302 S/S	*	—

DESCRIPTION

5-Gang 4-Toggles 1-Decora/GFCI

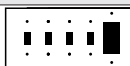

COLOR	STANDARD	MIDWAY	OVERSIZE	STANDARD	MIDWAY SPJ826	MATERIAL	STANDARD	OVERSIZE
						Brass	*	—
						430 S/S	*	—
						302 S/S	S426-N S426-N	—

†Painted metal wallplate.

*Consult your Leviton representative for ordering details: allow 3-4 weeks for delivery.





WALLPLATES

Residential and Commercial Grade Wallplates

Combination Wallplates Toggle Switch and Blank—Box Mount and Strap Mount

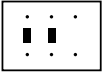
Thermoset (Plastic)			Thermoplastic (Nylon)		Assorted Metals			
DESCRIPTION 2-Gang 1-Toggle 1-Blank, Strap Mount 								
COLOR	STANDARD	MIDWAY	OVERSIZE	STANDARD	MIDWAY	MATERIAL	STANDARD	OVERSIZE
Ivory	—	—	—	80706-I	—	Aluminum	*	—
						Brass	*	—
Gray	—	—	—	80706-GY	—	430 S/S	*	—
Red	—	—	—	80706-R	—	302 S/S	S114-N 84077-40	—
White	—	—	—	80706-W	—			
Almond	—	—	—	80706-A	—			
Light Almond	—	—	—	80706-T	—			

DESCRIPTION 3-Gang 2-Toggles 1-Blank, Strap Mount 								
COLOR	STANDARD	MIDWAY	OVERSIZE	STANDARD	MIDWAY	MATERIAL	STANDARD	OVERSIZE
						Brass	*	—
						430 S/S	*	—
						302 S/S	S214-N S214-N	—

DESCRIPTION 2-Gang 1-Toggle 1-Blank, Box Mount 								
COLOR	STANDARD	MIDWAY	OVERSIZE	STANDARD	MIDWAY	MATERIAL	STANDARD	OVERSIZE
	P113	SPJ113	P0113					
Ivory	86006	80506-I	86106	—	—	Brass	*	—
White	88006	80506-W	88106	—	—	430 S/S	*	—
Brown	85006	80506	—	—	—	302 S/S	S113-N 84006-40	—

Combination Wallplates Standard Combinations—Two Gang

Thermoset (Plastic)			Thermoplastic (Nylon)		Assorted Metals			
DESCRIPTION 2-Gang 1-Single 1.406" dia. hole 1-Duplex 								
COLOR	STANDARD	MIDWAY	OVERSIZE	STANDARD	MIDWAY	MATERIAL	STANDARD	OVERSIZE
	P78							
Ivory	86046†	—	—	—	—	Aluminum	*	—
White	88046†	—	—	—	—	Brass	*	—
						430 S/S	*	*
						302 S/S	S78-N 84046-40	S078-N 84146-40

†Painted metal wallplate.

*Consult your Leviton representative for ordering details: allow 3–4 weeks for delivery.

NOTE: Where applicable, Industry Number indicated in BOLD FACE. For some wallplates, Industry Number and Leviton Catalog Number are identical.

Residential and Commercial Grade Wallplates



Combination Wallplates
Standard Combinations—Two Gang
Thermoset (Plastic)

Thermoplastic (Nylon)

Assorted Metals

DESCRIPTION

2-Gang
1-Duplex 1-Decora/GFCI



COLOR	STANDARD P826	MIDWAY	OVERSIZE	STANDARD	MIDWAY PJ826	MATERIAL	STANDARD	OVERSIZE
Ivory	80455-I	—	—	80746-I	—	Aluminum	*	—
Black	—	—	—	80746-E	—	Brass	*	—
Gray	—	—	—	80746-GY	—	430 S/S	*	—
Red	—	—	—	80746-R	—	302 S/S	S826-N 84455-40	—
White	80455-W	—	—	80746-W	—			
Brown	80455	—	—	80746	—			
Almond	80455-A	—	—	80746-A	—			
Light Almond	80455-T	—	—	80746-T	—			

DESCRIPTION

2-Gang
1-Toggle 1-Phone/Cable .406" dia. hole, Strap Mount



COLOR	STANDARD P112	MIDWAY	OVERSIZE	STANDARD	MIDWAY	MATERIAL	STANDARD	OVERSIZE
Ivory	86077	—	—	—	—	Brass	*	—
White	88077	—	—	—	—	430 S/S	*	—
						302 S/S	S112-N S112-N	—

DESCRIPTION

2-Gang
1-Phone/Cable .406" dia. hole, Strap Mount 1 – Duplex



COLOR	STANDARD	MIDWAY	OVERSIZE	STANDARD	MIDWAY	MATERIAL	STANDARD	OVERSIZE
Ivory	86078	—	—	—	—	Brass	*	—
White	88078	—	—	—	—	430 S/S	*	—
						302 S/S	S128-N 84078-40	—

DESCRIPTION

2-Gang
1-Phone/Cable .406" dia. hole 1 – Blank, Strap Mount



COLOR	STANDARD	MIDWAY	OVERSIZE	STANDARD	MIDWAY	MATERIAL	STANDARD	OVERSIZE
						Brass	*	—
						430 S/S	*	—
						302 S/S	*	—

DESCRIPTION

2-Gang
1-Phone/Cable .406" dia. hole 1 – Blank, Strap Mount



COLOR	STANDARD P1226	MIDWAY	OVERSIZE	STANDARD	MIDWAY	MATERIAL	STANDARD	OVERSIZE
Ivory	80479-I	—	—	—	—	Brass	*	—
White	80479-W	—	—	—	—	430 S/S	*	—
						302 S/S	*	—

DESCRIPTION

2-Gang
1-Blank 1- Duplex, Box Mount



COLOR	STANDARD P138	MIDWAY SPJ138	OVERSIZE P0138	STANDARD N138	MIDWAY	MATERIAL	STANDARD	OVERSIZE
Ivory	86008	80508-I	86108	N138-I	—	Brass	*	—
White	88008	80508-W	—	—	—	430 S/S	*	—
Brown	85008	—	—	—	—	302 S/S	S138-N 84008-40	—

*Consult your Leviton representative for ordering details: allow 3-4 weeks for delivery.

NOTE: Where applicable, Industry Number indicated in BOLD FACE. For some wallplates, Industry Number and Leviton Catalog Number are identical.



WALLPLATES

Residential and Commercial Grade Wallplates

Combination Wallplates Standard Combinations—Two Gang Thermoset (Plastic)

DESCRIPTION	Thermoset (Plastic)			Thermoplastic (Nylon)		Assorted Metals		
	STANDARD	MIDWAY	OVERSIZE	STANDARD	MIDWAY	MATERIAL	STANDARD	OVERSIZE
2-Gang 1-Blank 1- Duplex, Strap Mount	P148			PJ826				
Ivory	86087†	—	—	—	—	Brass	*	—
White	88087†	—	—	—	—	430 S/S	*	—
						302 S/S	S148-N 84087-40	—

DESCRIPTION 2-Gang 1-Blank 1-Single 1.406" dia. hole, Strap Mount

DESCRIPTION	Thermoset (Plastic)			Thermoplastic (Nylon)		Assorted Metals		
	STANDARD	MIDWAY	OVERSIZE	STANDARD	MIDWAY	MATERIAL	STANDARD	OVERSIZE
2-Gang 1-Blank 1-Single 1.406" dia. hole, Strap Mount	P147-I							
Ivory	86085†	—	—	—	—	Aluminum	*	—
White	88085†	—	—	—	—	Brass	*	—
						430 S/S	*	—
						302 S/S	S147-N 84085-40	—

DESCRIPTION 2-Gang 1-Blank 1-Decora/GFCI, Strap Mount

DESCRIPTION	Thermoset (Plastic)			Thermoplastic (Nylon)		Assorted Metals		
	STANDARD	MIDWAY	OVERSIZE	STANDARD	MIDWAY	MATERIAL	STANDARD	OVERSIZE
2-Gang 1-Blank 1-Decora/GFCI, Strap Mount	P1426	SPJ1326						
Ivory	P1426-I†	80608-I	—	80708-I	—	Brass	*	—
Black	—	—	—	80708-E	—	430 S/S	*	*
Gray	—	—	—	80708-GY	—	302 S/S	S1426-N S1426-N	*
White	P1426-W†	80608-W	—	80708-W	—			
Brown	—	80608	—	80708	—			
Almond	—	80608-A	—	80708-A	—			
Light Almond	—	80608-T	—	80708-T	—			

STANDARD COMBINATIONS—THREE GANG

DESCRIPTION 3-Gang 1-Toggle 2-Duplex

DESCRIPTION	Thermoset (Plastic)			Thermoplastic (Nylon)		Assorted Metals		
	STANDARD	MIDWAY	OVERSIZE	STANDARD	MIDWAY	MATERIAL	STANDARD	OVERSIZE
3-Gang 1-Toggle 2-Duplex	P182							
Ivory	86047	—	—	80747-I	—	Brass	*	—
White	88047	—	—	80747-W	—	430 S/S	*	*
Brown	85047	—	—	—	—	302 S/S	S182-N 84047-40	S0182-N 84147-40

STANDARD COMBINATIONS—FOUR GANG

DESCRIPTION 4-Gang 2-Toggle 2-Duplex

DESCRIPTION	Thermoset (Plastic)			Thermoplastic (Nylon)		Assorted Metals		
	STANDARD	MIDWAY	OVERSIZE	STANDARD	MIDWAY	MATERIAL	STANDARD	OVERSIZE
4-Gang 2-Toggle 2-Duplex	P1226							
						Aluminum	*	—
						Brass	B282 81045	—
						430 S/S	*	—
						302 S/S	S282-N 84045-40	—

†Painted metal wallplate.

*Consult your Leviton representative for ordering details: allow 3–4 weeks for delivery.

NOTE: Where applicable, Industry Number indicated in BOLD FACE. For some wallplates, Industry Number and Leviton Catalog Number are identical.

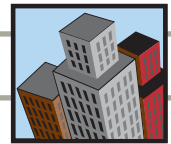

Sectional Wallplates for Multi-Gang Installations† Thermoplastic Construction

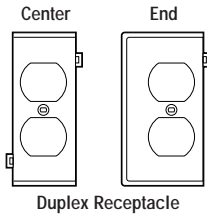

DESCRIPTION	COLOR	CENTER PANELS CAT. NO.	END PANELS CAT. NO.
Duplex Receptacle	White Ivory	PSC 8-W PSC 8-I	PSE 8-W PSE 8-I
Toggle Switch	White Ivory	PSC 1-W PSC 1-I	PSE 1-W PSE 1-I
Single Receptacle, 1.406" dia. hole	White Ivory	PSC 7-W PSC 7-I	PSE 7-W PSE 7-I
Blank, Strap-Mount	White Ivory	PSC 14 PSC14-I	PSE 14-W PSE 14-I
Decora	White Ivory	PSC 26-W PSC 26-I	PSE 26-W PSE 26-I

† Outer dimensions of wallplates created from two or more sectional panels will be the same as standard multi-gang plates.

Horizontal Split Plate for Terminated Cable

DESCRIPTION
Horizontal Split Plate for Terminated Cable
1-Gang .625" dia. Hole w/Grommet .406" inner dia.



COLOR	CAT. NO.	IND. NO.	METAL	CAT. NO.	IND. NO.
Ivory	N751-I	N751-I	BRASS	*	—
White	N751-W	N751-W	430 S/S	*	—
			302 S/S	S751-N	S751-N

Hot Stamped And Engraved Plates Thermoset (Plastic)

Thermoplastic (Nylon)

Assorted Metals (Engraved)

DESCRIPTION
1-Gang 1-Duplex
Stamped And Engraved
"EMERGENCY"



COLOR	STANDARD	MIDWAY	OVERSIZE	STANDARD	MIDWAY	MATERIAL	STANDARD	OVERSIZE
Red	—	—	—	80703-RE	PJ8-RE	302 S/S	84003-E40	—

2-Gang 2-Duplex
Stamped And Engraved
"EMERGENCY"



COLOR	STANDARD	MIDWAY	OVERSIZE	STANDARD	MIDWAY	MATERIAL	STANDARD	OVERSIZE
Red	—	—	—	80716-RE	PJ82-RE	302 S/S	84016-E40	—

1-Gang 1-Duplex
Stamped And Engraved
"ISOLATED GROUND"



COLOR	STANDARD	MIDWAY	OVERSIZE	STANDARD	MIDWAY	MATERIAL	STANDARD	OVERSIZE
Orange	—	—	—	80703-IG	PJ8-IG	302 S/S	84003-IG	—
White	—	—	—	80703-IGW	—			

2-Gang 2-Duplex
Stamped And Engraved
"ISOLATED GROUND"



COLOR	STANDARD	MIDWAY	OVERSIZE	STANDARD	MIDWAY	MATERIAL	STANDARD	OVERSIZE
Orange	—	—	—	80716-IG	—	302 S/S	*	—

1-Gang 1-Single, 1.406" Dia. Hole
Stamped And Engraved
"ISOLATED GROUND"



COLOR	STANDARD	MIDWAY	OVERSIZE	STANDARD	MIDWAY	MATERIAL	STANDARD	OVERSIZE
Orange	—	—	—	80704-IG	—	302 S/S	*	—









*Consult The End Of This Wallplate Section For Ordering Details: Allow 3-4 Weeks For Delivery.



ENGRAVED WALLPLATES

Residential and Commercial Grade Wallplates

Hot Stamped and Engraved Plates

Thermoset (Plastic)			Thermoplastic (Nylon)			Assorted Metals (Engraved)		
DESCRIPTION 1-Gang 1-Single, 1.60" Dia. Hole Stamped And Engraved "ISOLATED GROUND" For Use With 20A & 30A Single Locking Receptacles								
COLOR	STANDARD	MIDWAY	OVERSIZE	STANDARD	MIDWAY	MATERIAL	STANDARD	OVERSIZE
Orange	_____	_____	_____	80720-IG	_____	302 S/S	*	_____
								
DESCRIPTION 1-Gang 1-Toggle Stamped And Engraved "EMERGENCY"								
COLOR	STANDARD	MIDWAY	OVERSIZE	STANDARD	MIDWAY	MATERIAL	STANDARD	OVERSIZE
Red	_____	_____	_____	80701-RE	_____	302 S/S	84001-E40	_____
								
DESCRIPTION 1-Gang 1-Duplex No Stamp								
COLOR	STANDARD	MIDWAY	OVERSIZE	STANDARD	MIDWAY	MATERIAL	STANDARD	OVERSIZE
Orange	_____	_____	_____	80703-ORG	_____	_____	_____	_____
								
DESCRIPTION 1-Gang 1-Duplex Stamped "GFCI PROTECTED"								
COLOR	STANDARD	MIDWAY	OVERSIZE	STANDARD	MIDWAY	MATERIAL	STANDARD	OVERSIZE
Ivory	_____	_____	_____	80703-GFI	_____	302 S/S	*	_____
White	_____	_____	_____	80703-GRW	_____	302 S/S	*	_____
								
DESCRIPTION 1-Gang 1-Duplex Stamped "COMPUTER ONLY"								
COLOR	STANDARD	MIDWAY	OVERSIZE	STANDARD	MIDWAY	MATERIAL	STANDARD	OVERSIZE
Ivory	_____	_____	_____	80703-COI	_____	302 S/S	*	_____
White	_____	_____	_____	80703-COW	_____	302 S/S	*	_____
Orange	_____	_____	_____	80703-COO	_____	_____	_____	_____
								
DESCRIPTION 1-Gang 1-Decora Stamped "SURGE PROTECTED"								
COLOR	STANDARD	MIDWAY	OVERSIZE	STANDARD	MIDWAY	MATERIAL	STANDARD	OVERSIZE
_____	_____	_____	_____	*	_____	302 S/S	*	_____
								
DESCRIPTION 1-Gang 1-Decora Stamped "ISOLATED GROUND"								
COLOR	STANDARD	MIDWAY	OVERSIZE	STANDARD	MIDWAY	MATERIAL	STANDARD	OVERSIZE
Orange	_____	_____	_____	80401-IG	_____	302 S/S	*	_____
								
DESCRIPTION 1-Gang 1-Decora Stamped "GFCI"								
COLOR	STANDARD	MIDWAY	OVERSIZE	STANDARD	MIDWAY	MATERIAL	STANDARD	OVERSIZE
Ivory	_____	_____	_____	80401-GFI	_____	302 S/S	*	_____
White	_____	_____	_____	80401-GFW	_____	302 S/S	*	_____
								
DESCRIPTION 1-Gang 1-Decora Stamped "COMPUTER ONLY"								
COLOR	STANDARD	MIDWAY	OVERSIZE	STANDARD	MIDWAY	MATERIAL	STANDARD	OVERSIZE
Ivory	_____	_____	_____	80401-COI	_____	302 S/S	*	_____
White	_____	_____	_____	80401-COW	_____	302 S/S	*	_____
								

*Consult The End Of This Wallplate Section For Ordering Details: Allow 3-4 Weeks For Delivery.



Voice/Data/CATV Wallplates

These sturdy, high-impact wallplates for the 46000 series voice/data devices are available for single-gang applications with standard or Decora-compatible styling.



**Standard Size
Voice/Data/Catv Wallplates***

DESCRIPTION		COLOR (NYLON)	METAL	CAT. NO.
1-Gang Type "F" Connector		Ivory	—	80781-I
		White	—	80781-W
		Almond	—	80781-A
		Light Almond	—	80781-T
1-Gang Duplex Type "F" Connector		Ivory	—	80782-I
		White	—	80782-W
		Almond	—	80782-A
		Light Almond	—	80782-T
1-Gang* Db9 Data Connector Db15 Data Connector		—	302 S/S	84441-40
		—	302 S/S	84442-40
1-Gang* Bnc/Tnc "D" Connector		—	302 S/S	84444-40

For more information regarding Voice/Data/CATV Wallplates, refer to Section L.

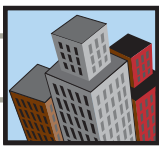

WEATHER-RESISTANT COVERS

Commercial Grade

Features and Benefits

Plastic

- Impact resistant thermoplastic construction
- Pre-installed gasket for easy, reliable installation
- Tongue and groove plate-to-cover construction
- Offset device opening (horizontal only) for easier cord exit
- Thermoplastic inserts prevent insect and debris accumulation

Plastic and Metal

- Self-closing
- Vertical and horizontal mounting
- Die cast aluminum or impact-resistant thermoplastic covers and bases
- Weather-resistant gaskets
- Stainless steel springs
- Gray or clear finish



Raintight While-In-Use Covers

DESCRIPTION	MOUNTING	CAT. NO.
Telescoping While-In-Use Smoked Cover	Vertical	T5979-W
With Colored Base And Matching Duplex,	Vertical	T5979-T
Decora And Single Receptacle Wallplates	Vertical	T5979-GY
	Vertical	T5979
Duplex Receptacle, Gray, Standard	Vertical	5976-GY
Duplex Receptacle, Gray, Extra Deep	Vertical	5976-DGY
Duplex Receptacle, Clear, Standard	Vertical	5976-CL
Duplex Receptacle, Clear, Extra Deep	Vertical	5976-DCL
Decora/GFCI, Clear, Standard	Vertical	5977-CL
Decora/GFCI, Clear, Extra Deep	Vertical	5977-DCL
Single Receptacle, Gray, Standard	Vertical	5978-GY
Single Receptacle, Clear, Standard	Vertical	5978-CL
Single Receptacle, Gray, Extra Deep	Vertical	5978-DGY
Single Receptacle, Clear, Extra Deep	Vertical	5978-DCL
Duplex Receptacle, Gray, Standard	Horizontal	5996-GY
Duplex Receptacle, Gray, Extra Deep	Horizontal	5996-DGY
Duplex Receptacle, Clear, Standard	Horizontal	5996-CL
Decora/GFCI, Gray, Standard	Horizontal	5997-GY
Decora/GFCI, Gray, Extra Deep	Horizontal	5997-DGY
Decora/GFCI, Clear, Standard	Horizontal	5997-CL
Decora/GFCI, Clear, Extra Deep	Horizontal	5997-DCL
Single Receptacle, Gray, Standard	Horizontal	5998-GY
Single Receptacle, Gray, Extra Deep	Horizontal	5998-DGY
Single Receptacle, Clear, Standard	Horizontal	5998-CL

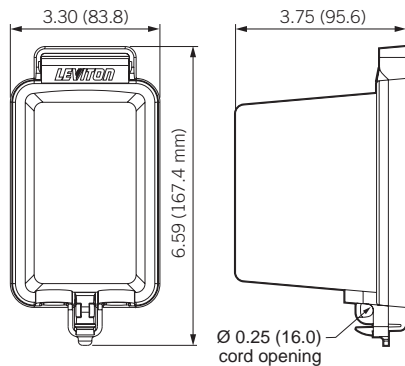
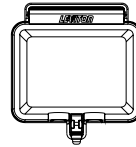
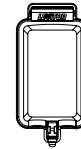

VERTICAL MOUNT, EXTRA DEEP
5976-D

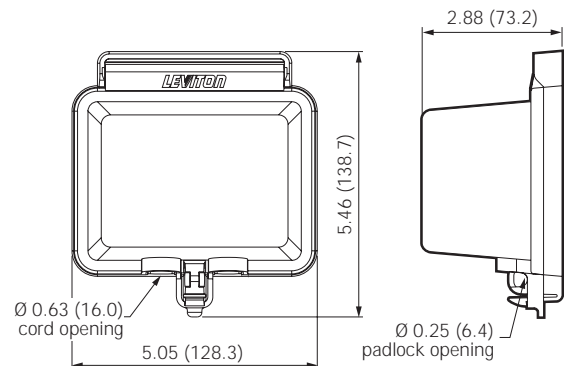

HORIZONTAL MOUNT, STANDARD
5997

SPECIFICATIONS & FEATURES

- Mounting Screws and rubber gasket included for fast, easy installation onto surface-mounted outdoor-type boxes or flush-mounted wall boxes
- Easy-grip self-closing covers with durable, non-corrosive stainless steel screws
- acked by a Limited Two-Year Warranty

TESTING AND CODE COMPLIANCE

- Full compliance with UL, CSA and NEC Section 410-57 requirements for damp and wet locations with cover closed
- Raintight while-in-use covers are NEMA 3R rated for use with unattended plugs engaged in "live" receptacles in wet or damp locations

*COLOR

Basic Cat. No. denotes Brown. For other color selections, add suffix to catalog numbers as follows: White (-W), Light Almond (-T), Gray (-GY).

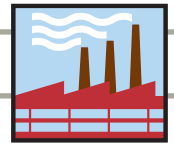

Features and Benefits

- Glass-filled thermoplastic cover and plate for outstanding impact resistance and durability
- UL 94-VO Flammability Rating
- Superior IP 54 Suitability rating protects against dust particles and splashing water
- NEMA Type 3R enclosure rating ensures protection against rain, sleet and damage from external ice formation
- Dual gaskets, one under plate and one under lid, for weather-resistant fit
- Stainless steel hinge-pin, spring and mounting screws for excellent corrosion resistance
- Triple-combination screws accept Phillips, straight-blade or Robertson-head screwdrivers
- Oversized cover tab for easier opening with gloved hands
- Mounts to panel or FS/FD boxes
- UL Listed and CSA certified for wet locations with cover closed



Industrial Weather-Resistant Covers

DESCRIPTION	COLOR	CAT. NO.
For use with 15-amp locking, 15-amp and 20-amp straight-blade flanged inlets and outlets	GRAY	WP1
For use with 20-amp and 30-amp 3-, 4-, and 5-wire locking flanged inlets and outlets; 30-amp and 50-amp 3-wire power receptacles	GRAY	WP2
For use with 20-amp and 30-amp and FS/FD boxes single locking receptacles	YELLOW	7420-CR

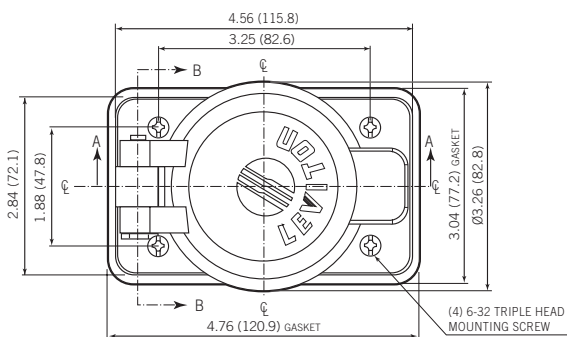

WATER RESISTANT COVER
WP1 and 7420-CR

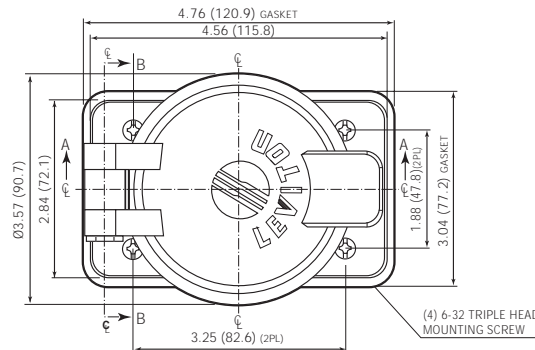

WATER RESISTANT COVER
WP2

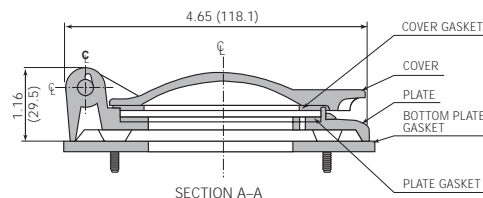
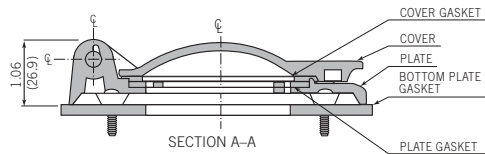

TESTING AND CODE COMPLIANCE

- UL Listed (File # E-13397)
- CSA Certified (File # LR-16347)
- NOM Certified (# 057)
- IP 54 Suitability rating (protected against dust and splashing water)
- NEMA Type 3R enclosure rating
- Backed by a Limited 10-Year Warranty

MATERIAL CHARACTERISTICS



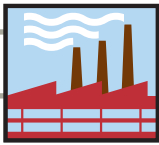



Environmental: VO Flammability Rating per UL 94
Operating Temperature: -40°C to 75°C

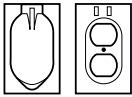
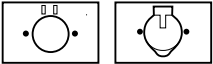
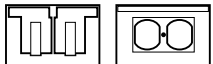
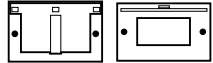
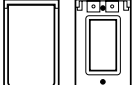

WEATHER-RESISTANT COVERS

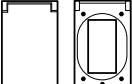
Industrial Grade

Die-Cast Zinc Weather-Resistant Covers

DESCRIPTION		MOUNTING	CAT. NO.
Duplex Receptacle 1-GANG		Vertical	4926
Single Receptacle 1-GANG Self-Closing Lid 1.406 Dia. Hole		Horizontal	4925-2
Duplex Receptacle or Combination Device 1-GANG Two Independent Self-Closing Lids★		Horizontal	4970
Decora/GFCI 1-GANG Self-Closing Lid		Horizontal	4990
Decora/GFCI 1-GANG Self-Closing Lid★		Vertical	4992
Decora/GFCI 1-GANG Self-Closing Lid for mounting on FS type box		Horizontal	6196-FS
Decora/GFCI 1-GANG Self-Closing Lid for mounting on FS type box		Vertical	6196-VFS
Weatherproof Wallplate & Switch 15A 120V AC		Horizontal or Vertical	1432
NEMA 1 Steel Enclosure without Switch		Vertical	N13NC
DESCRIPTION		COLOR	CAT. NO.
Lockout Wallplate (lock sold separately)		S/S	84001-LOK

All devices are UL Listed . Also CSA Certified except where indicated by★

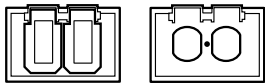
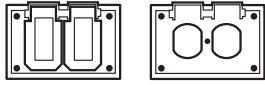
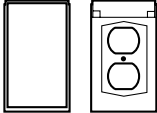
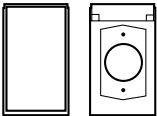
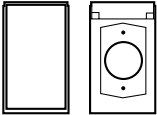
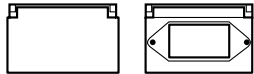
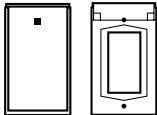
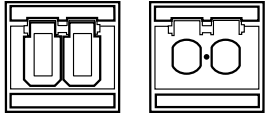

Thermoplastic Weather-Resistant Covers

DESCRIPTION		MOUNTING	CAT. NO.
Duplex Receptacle or Combination Device 1-GANG Two Independent Self-Closing Lids		Horizontal	4976-GY 4976-W
Duplex Receptacle or Combination Device 1-GANG for mounting on FS type box Two Independent Lids		Horizontal	4976-FS
Duplex Receptacle or Combination Device 1-GANG Self-Closing Lid		Vertical	4978-GY 4978-W
Single Receptacle 1-GANG Self-Closing Lid 1.406" Dia. Hole		Vertical	4979-GY
Single 20A or 30A Locking Receptacle 1-GANG Self-Closing Lid 1.60" Dia. Hole		Vertical	4980-GY
Decora/GFCI 1-GANG Self-Closing Lid		Horizontal	4996-GY 4996-W
Decora/GFCI 1-GANG Self-Closing Lid		Vertical	4998-GY 4998-W
Oversized Duplex 1-GANG Two Independent Self-Closing Lids		Horizontal	4986-GY

Blank Box Mounted Wallplates with Gasket

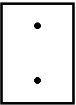
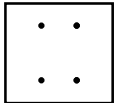
DESCRIPTION		MOUNTING	CAT. NO.
1-GANG Aluminum, Box Mount		N/A	83014-EXT
2-GANG Aluminum, Box Mount		N/A	83025-EXT

Type 302 Stainless Steel Wallplate—Box Mount

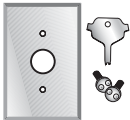
DESCRIPTION		COLOR	CAT. NO.
Type 302 Stainless Steel Wallplate w/Tamper-Resistant Screws and Spanner Tool		S/S	84071-40

All devices are UL Listed and CSA Certified.



WALLPLATE ACCESSORIES

Commercial Grade

Wallplate Screws

DESCRIPTION	COLOR	CAT. NO.
Oval Head Milled Slot 5/16" long—6-32 thread 100 per box	Ivory Gray White Brown Almond S/S	86400-PRT 87400-PRT 88400-PRT 85400-PRT 82400-PRT 84400-PRT
Oval Head Milled Slot 1/2" long—6-32 thread 100 per box	Ivory Black Gray White Brown S/S	86000-PRT 83000-PRT 87000-PRT 88000-PRT 85000-PRT 84000-PRT
Oval Head Milled Slot 7/8" long—6-32 thread 50 per box	Ivory Red White Brown S/S	86500-PRT 89500-PRT 88500-PRT 85500-PRT 84500-PRT

Pilot Light Jewels

DESCRIPTION	COLOR	CAT. NO.
Round Fits single receptacle hole 1.375–1.406" dia.	Green Red	405 GR 405 R
Rectangular Fits toggle switch hole .406 x .942"	Green Red	406 GR 406 R
Lampholder Assembly for use with jewels or louvre plates—use with standard 2.5" box and 4 watt bulb (bulb included)		2152

Mounting Screws

DESCRIPTION	COLOR	CAT. NO.
Phillips/Standard 7/8" long—6-32 thread 50 per bag	S/S	84440

Decora Plus Standard Size Plastic Adapters

DESCRIPTION	COLOR	CAT. NO.
CATV Jack	Ivory Black Gray White Almond Light Almond	80381-I 80381-E 80381-GY 80381-W 80381-A 80381-T
Blank No Hole	Ivory Black Gray White Almond Light Almond	80314-I 80314-E 80314-GY 80314-W 80314-A 80314-T

All devices are UL Listed and CSA Certified.

Tamper-Resistant Spanner Head Screws

DESCRIPTION	COLOR	CAT. NO.
Spanner Head 1/2" long—6-32 thread, 100 per box	S/S	84000-T
Screwdriver for Spanner head or Tamper-Resistant screws	Black	84000-TSD

Plastic Wallplate Adapters

DESCRIPTION	COLOR	CAT. NO.
These adapters permit the use of rotary dimmers in multi-gang Decora installations or fill blank holes in multi-device Decora or toggle wallplates.		
Dimmer Shaft .406" dia. Hole	Ivory Black Gray Brown White Almond Light Almond	80400-I 80400-E 80400-GY 80400 80400-W 80400-A 80400-T
Blank Decora No Hole	Ivory Black Gray Brown White Almond Light Almond	80414-I 80414-E 80414-GY 80414 80414-W 80414-A 80414-T
Blank Toggle No Hole	Ivory Gray Brown White Almond Light Almond	80700-I 80700-GY 80700 80700-W 80700-A 80700-T
Wallbox Adapter Extends shallow wallbox to fit GFCI/Decora devices	Ivory Brown White	6197-I 6197 6197-W

Snap in Grommet reduces 1.406" to 1.00" for use with single receptacle wallplates	Black	403-E
--	-------	-------

Thermoplastic Yoke/Mounting Strap w/screws Custom wallplate configurations 11, 23, 27 and 31 are supplied with strap kits. See page G42		404
---	--	-----

Special Wallplates

The Order Form and instructions requesting custom wallplate configurations are found on the following pages. Custom wallplates are available in a variety of metals and can be requested from Leviton through special order, beginning on the next page.

All devices are UL Listed and CSA Certified.



How to Order Custom Wallplates



General Information

Custom wallplates, up to twelve gangs in size, made of brass, stainless steel, painted steel, aluminum or chrome, can be special ordered from Leviton. Any combination of the configurations shown can be specified to meet your needs. In addition, standard and custom metal wallplates can be engraved, and standard nylon wallplates can be hot stamped, with the message of your choice. Follow the steps below to fill out the Custom Wallplate Order Form completely and accurately. The finished order form must include:

1. The wallplate catalog number
2. The type of wallplate material desired (from the Material Code Chart)
3. The quantity of wallplates desired
4. The wallplate configurations in proper order (from the Configuration Code Chart)
5. The wallplate color, selected from the Wallplate Color Code Chart
6. Engraved or hot stamped message, if desired, with message location and letter size
7. Engraved or hot stamped message filler color, selected from the Fill-In Color Chart

Photocopy the blank Custom Wallplate Order Form at the back of this section and refer to the completed sample Custom Wallplate Order Form shown when filling out your order. Your Leviton representative can provide you with additional forms if needed. The sample order grid below shows the custom wallplate pictured at right:

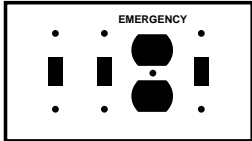

Sample Grid

CAT. NO. 90004 MATERIAL CODE S3 QTY. 1

(1) (2) (3) (4) (5) (6) (7) (8) (9) (10) (11) (12)

01	01	EMERGENCY 03	01								
----	----	-----------------	----	--	--	--	--	--	--	--	--

COLOR CODE ENGRAVED HOT STAMPED LETTER SIZE 3/8"

FILLER CODE XR PRICE



WALLPLATES

How to Order Custom Wallplates

How to Fill Out the Custom Wallplate Order Form

STEP 1: DETERMINE THE WALLPLATE CATALOG NUMBER

The catalog number for a custom wallplate is determined as follows: a single-gang custom wallplate is Cat. No. 90001, a double-gang custom wallplate is Cat.No. 90002, a three-gang custom wallplate is Cat. No. 90003, and so on through the sequence to Cat. No. 90010 for the ten-gang custom wallplate. Enter the number in the space on the Order Form marked "CAT. NO." If you are ordering a standard metal wallplate for custom engraving, use the 90000 series number. If you are ordering a standard nylon wallplate for custom hot stamping, enter that wallplate's catalog number in the space on the Order Form marked "CAT. NO."

STEP 2: SELECT THE WALLPLATE MATERIAL

Choose the custom wallplate material desired from the Wallplate Material Chart below. Enter the Material Code for the material selected in the space marked "MATERIAL CODE" on the Order Form. When ordering Custom Hot Stamped wallplates, enter NYLON.

MATERIAL	MATERIAL CODE
Aluminum [†]	AL
Brass (Satin) Polished Brass	BR PB
Non-Magnetic Stainless Steel-Type 302/304	S3
Oversize Non-Magnetic Stainless Steel-Type 302/304*	S30
Painted Steel	S5
Oversize Painted Steel*	S50
Chrome	CRM
Raw Steel	RAW























[†]6-Gang maximum size, standard size only
*4-Gang maximum size

STEP 3: DETERMINE THE QUANTITY OF THE WALLPLATE ORDER

Enter the quantity of wallplates needed in the space marked "QUANTITY" on the Order Form.

STEP 4: DETERMINE THE CUSTOM WALLPLATE CONFIGURATION

The Wallplate Configuration Chart below shows all the configurations that can be specified for Leviton custom metal wallplates. Each configuration has a specific Configuration Code number in the lower right-hand corner of its corresponding space on the chart. Enter this configuration code in the center of the corresponding square on the Order Form Grid to match its desired position on the finished custom wallplate. Refer to the Sample Order Form Grid for clarification on configurations and their placement, if necessary (page G43).

 Toggle Switch 01	 Duplex Receptacle 03	 Louvre Horizontal Mount 05	 Louvre Vertical Mount* 07	 Blank Box Mount 09	 Blank Strap Mount 11
 Decora/ GFCI 13	 Single 1.406" dia. Receptacle 15	 1.60" dia. Hole 17	 2.15" dia. Hole** 19	 2.647" dia. Hole** 21	 .312" dia. Hole Strap Mount 23
 .312" dia. Hole Box Mount 25	 .406" dia. Hole Strap Mount 27	 .406" dia. Hole Box Mount 29	 .625" dia. Hole Strap Mount 31	 .625" dia. Hole Box Mount 33	 Interchangeable 1-Device Vertical 35
 Interchangeable 1-Device Horizontal 37	 Interchangeable 2-Device 39	 Interchangeable 3-Device 41	 2.460" dia. Hole 2-Gang Only** 47	0.880" dia. Hole for Key Lock Power Switch**. Tamper-resistant screws and screwdriver included w/Key Lock configurations. Device mount unless specified otherwise. For 1-gang, order 84071-40.	
 49					

Enter the code number for the configurations you select in the center box on each desired wallplate position on the Custom Wallplate Order Form.

*3-Gang minimum
**2-Gang minimum



How to Fill Out the Custom Wallplate Order Form (continued)

STEP 5: SELECT THE WALLPLATE COLOR

For painted metal, select one of the following colors and enter its color code in the space marked "COLOR CODE" on the order form:

COLOR	WALLPLATE COLOR CODE
Almond	PA
Black	PE
Brown	PB
Gray	PG
Ivory	PI
Orange	PO
Red	PR
White	PW

STEP 6: ENTER ENGRAVING INFORMATION

NOTE: WE CAN ENGRAVE NYLON AND PAINTED AND UNPAINTED METAL WALLPLATES. After completing steps 1-5:

6A) Type or clearly print the message(s) (i.e., TURN OFF) as you wish it to appear on the lines provided in the appropriate Grid box(es). **6B)** Select the size of the letters you desire for the wallplate message from the dimensions shown below and enter that size in the space marked "LETTER SIZE" on the Order Form. **6C)** Select the fill-in color for the message letter from the chart below and enter the code for the color chosen in the space marked "FILLER CODE."

FILLER COLOR CODES for Engraved Wallplates

COLOR	CODE
Black	XE
White	XW
Red	XR
No Filler	XX

LETTER SIZE GAUGE for Engraved Wallplates

1/8"	3/16"	1/4"	5/16"	3/8"
E	E	E	E	E

STEP 7: ENTER HOT STAMPING INFORMATION

7A) Select the message(s) desired from the Message Library below. Enter the message on the lines provided in the appropriate Grid box(es) where they should appear. The message will be stamped in 3/16"-high text.

HOT STAMPING MESSAGE LIBRARY FOR CUSTOM NYLON WALLPLATES

1. SHOWER	7. HEAT	13. ON	19. ISOLATED	25. EQUIP
2. VANITY	8. DATA	14. PROTECTED	20. GROUND	26. FLUORESCENT
3. VOICE	9. COMPUTER	15. OFF	21. CONDITIONED	27. OIL
4. ONLY	10. GFCI	16. OIL BURNER	22. CONDITIONED POWER	28. POWER
5. ISOLATED GROUND	11. SURGE	17. PC	23. CRITICAL	29. UPS
6. EMERGENCY	12. FAN	18. DEDICATED	24. ELEC.	

7B) Select the fill-in color for the message letter from the chart below and enter the code for the color chosen in the space marked "FILLER CODE."

COLOR	CODE
Black	XE
White	XW
Red	XR
No Filler	XX

To order nylon wallplates with custom hot stamped message, contact your Leviton salesman or customer service representative.

8) NOTE: Sequential engraving is available. Consult factory for ordering instructions.

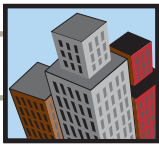

WALLPLATES

How to Order Custom Wallplates

Custom Wallplate Order Form

BILL TO:

SHIP TO:

CAT. NO. _____ MATERIAL CODE _____ QTY. _____

(1) (2) (3) (4) (5) (6) (7) (8) (9) (10) (11) (12)

<input type="checkbox"/>	<input type="checkbox"/>	<input type="checkbox"/>	<input type="checkbox"/>	<input type="checkbox"/>	<input type="checkbox"/>	<input type="checkbox"/>	<input type="checkbox"/>	<input type="checkbox"/>	<input type="checkbox"/>	<input type="checkbox"/>	<input type="checkbox"/>
--------------------------	--------------------------	--------------------------	--------------------------	--------------------------	--------------------------	--------------------------	--------------------------	--------------------------	--------------------------	--------------------------	--------------------------

COLOR CODE _____ ENGRAVED _____ HOT STAMPED _____ LETTER SIZE _____

FILLER CODE _____ PRICE _____

ENGRAVING INFORMATION (Please print per corresponding gang number.)

(1)

(2)

(3)

(4)

(5)

(6)

(7)

(8)

(9)

(10)

(11)

(12)

DESCRIPTION

(Use this space to add additional information that may be helpful.)

TERMS

- Please take care to complete your order carefully. Custom wallplates cannot be returned
- Custom orders are shipped in three to four weeks
- All engraving shall be centered within its corresponding gang unless specifically instructed to span across multiple gangs
- All engravings on toggle configurations shall appear above the mounting screw holes unless specifically instructed otherwise
- All engravings on GFCI/Decora configurations shall appear below the mounting screw hole unless specifically instructed otherwise



AC Switches

INDEX

Industrial Grade Switches	
Overview	F2
Back and Side Wired	F3
Toggle	F3
Locking	F3
Wire Lead Toggle	F3
Canadian 347V AC	F3
Pilot Light	F4
Lighted Handle	F4
Maintained Contact	F5
Momentary Contact	F5
Side Wired	F6
Toggle	F6
Locking	F6
AC Manual Motor and Welder Starting	F7
Safety Disconnect Switches	F8, F9
Key Lock Power	F10
Commercial Grade Switches	
Overview	F11
Back and Side Wired	F12
Toggle	F12
Side Wired	F12
Toggle	F12
Hospital Call	F12
Canadian 120/277V AC	F12
Lighted Toggle	F13
Canadian 347V AC	F13
Framed Toggle	F13
Residential Grade Switches	
Quickwire and Sidewire	F14
Illuminated Toggle	F14
CO/ALR	F14

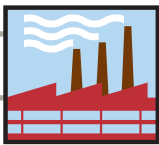

AC SWITCH FEATURES

Industrial Grade AC Switches

LEVITON OFFERS A FULL LINE OF 15, 20 AND 30 AMP AC SWITCHES, AVAILABLE IN INDUSTRIAL, COMMERCIAL AND RESIDENTIAL GRADE, WITH A WIDE VARIETY OF COLORS, WIRING OPTIONS AND OTHER FEATURES.

Leviton's AC switches are for control of resistive and inductive loads and motors. A full selection of ratings is available in Industrial Grade, Commercial Grade and Residential Grade.

The following pages provide a comprehensive overview of the complete Leviton AC Quiet Switch product line. Ordering information will help you select the switches best suited to meet your application requirements.

Leviton's Industrial Grade AC switches for heavy-duty applications represent top-of-the-line quality and peak performance. Leviton uses the finest materials available and the highest production standards to produce industrial switches of unmatched versatility and reliability.

Features and Benefits—**LEVSPEC** Industrial Grade Switches

- Top-of-the-line industrial-grade quality for peak performance and rugged, long-lasting service
- All screws are triple-drive and accept Standard, Phillips and Robertson screwdrivers
- External clamp-type wiring terminals provides secure connection of solid or stranded wire for back or side wiring
- Back or side-wired grounding terminal offers wiring flexibility
- Sturdy, long-lasting thermoplastic toggles provide smooth switching action and long life
- UL 20 Listed; meets latest Federal Specifications WS-896, CSA Specification C22.2.2 No. 11 Certified; NOM Certified; complies with NEMA and ANSI requirements
- Backed by a Limited 10-Year Warranty



Back and Side Wired
External clamp-type terminals for maximum wiring versatility.
1203-21 shown



Pilot Light
Toggle is illuminated when load is on for visual confirmation.
1201-PLC shown



Locking
Designed to prevent tampering and unauthorized switching.
1121-2L shown



Maintained and Momentary Contact
Positive switching action with center-off position.
1285 shown

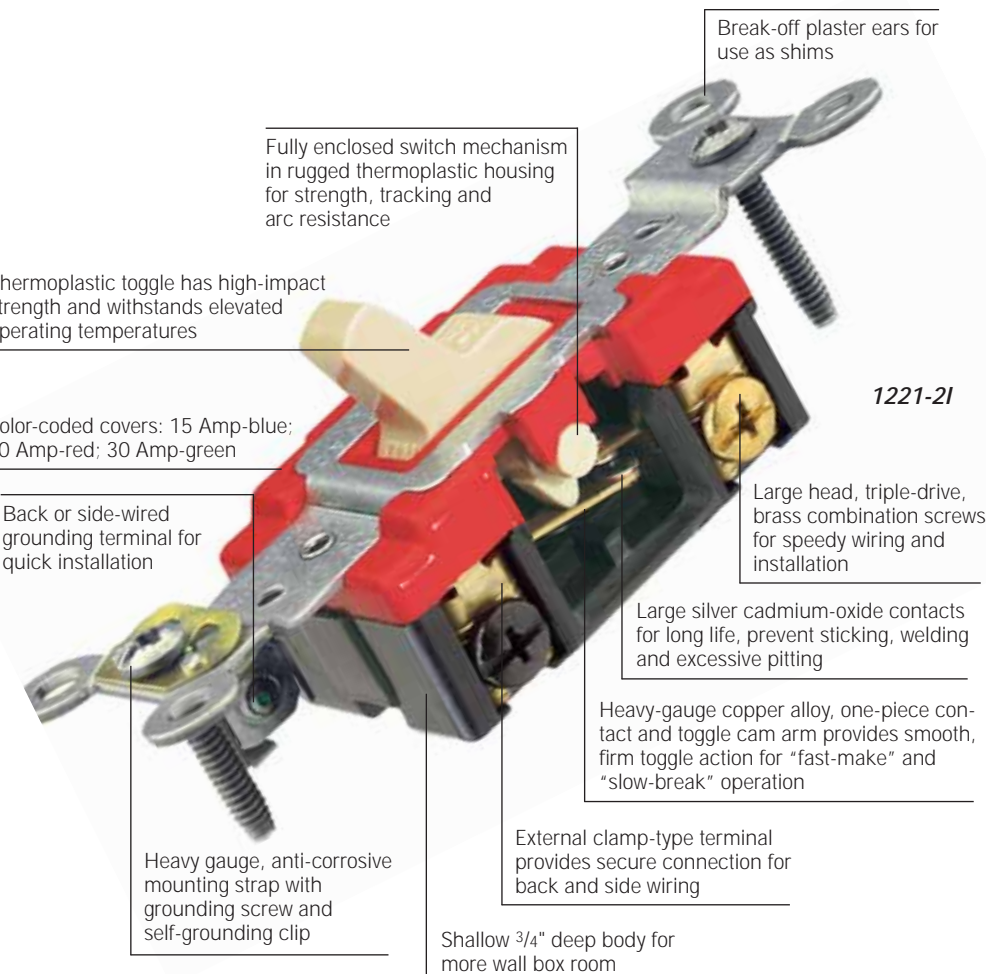

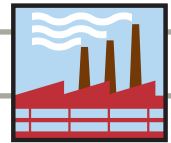

Industrial Grade AC Quiet Switches

Back and Side Wired 120/277V AC Quiet Switches

DESCRIPTION LEVSPEC®	15 AMP	20 AMP	30 AMP	COLOR*
Single-Pole Toggle	1201-2	1221-2	3031-2	15A: I, W, GY, R 20A: I, W, A, T, GY, R, E 30A: I, W
Single-Pole Locking†	1201-2L	1221-2L	3031-2L	15A: I; 20A: I, W, G, R
Double-Pole Toggle	1202-2	1222-2	3032-2	15A: I, W, GY 20A: I, W, GY, R, E 30A: I, W, E, R
Double-Pole Locking†	1202-2L	1222-2L	3032-2L	20A: I
3-Way Toggle	1203-2	1223-2	3033-2	15A: I, W, GY, R 20A: I, W, GY, R, E, A, T 30A: I, W
3-Way Locking†	1203-2L	1223-2L	3033-2L	15A: I; 20A: I, W, G
4-Way Toggle	1204-2	1224-2	—	15A: I, W, GY 20A: I, W, GY, R, E, T
4-Way Locking†	1204-2L	1224-2L	—	20A: I, G, W

SPECCASS® General Duty Switches

Single Pole Toggle	—	1221-S	—	20A: I, W, R, GY
Double Pole Toggle	—	1222-S	—	20A: I, W, GY
3-Way Toggle	—	1223-S	—	20A: I, W, R, GY
4-Way Toggle	—	1224-S	—	20A: I, W, GY

†Key for Locking Switch: Cat. No. 55500-PRT.

Wire Lead 120/277V AC Quiet Switches

DESCRIPTION	15 AMP	20 AMP	COLOR
SPECCASS® General Duty Switches			
Single-Pole Toggle	1241	1243	15A & 20A: I, W
3-Way Toggle	1242	1244	15A & 20A: I, W

Back and Side Wired Canadian 347V AC Quiet Switches

DESCRIPTION	15 AMP	20 AMP	COLOR**
See Canadian Color			
Single-Pole Toggle	18201	18221	15A & 20A: I, W, B, R, G
Double-Pole Toggle	18202	18222	15A: I only 20A: I, B
3-Way Toggle	18203	18223	15A & 20A: I, W, B, R, G
4-Way Toggle	18204	18224	15A: I, B, R, G 20A: I, B

NOTE: Cat. Nos. 1201, 1221, 18201, 18221, 1203, 1223, 18203 and 18223 feature external clamp-type wiring termination for back and side wiring

Wallplates

THERMOPLASTIC			302 STAINLESS STEEL			
80701-I	80709-E	80711-W	84001-40	84001-E40	84009-40	84011-40

For complete wallplate selection, see Section E.

- SPECIFICATIONS AND FEATURES**
- Top-of-the-line industrial quality
 - Heavy gauge copper alloy one-piece arm for top performance
 - Large silver cadmium-oxide contacts for long life, prevent sticking, welding and excessive pitting
 - Color-coded covers: 15 Amp-blue; 20 Amp-red; 30 Amp-green
 - Fully enclosed switch mechanism in rugged housing for strength, tracking and arc resistance
 - Brass combination-head terminal screws on LEVSPEC devices, steel combination head terminal screws on other devices
 - Self-grounding clip on LEVSPEC devices (self-grounding when used with a grounded metal wallbox)
 - Wire lead switches for fast and easy installation

- TESTING AND CODE COMPLIANCE**
- Meets all NEMA WD 1 & 6, and ANSI requirements
 - Meets Federal Specification WS-896
 - UL Listed (File #E-7458)
 - CSA Certified (File #152105)
 - NOM Certified (#057)
 - Backed by a Limited 10-Year Warranty
 - SPECCASS devices backed by a Limited 2-Year Warranty

***COLOR**

Basic Cat. Nos. shown above denote Brown color. Other color available as listed, add suffix to catalog number as follows: Ivory (-I), White (-W), Gray (-GY or -G), Red (-R), Black/Ebony (-E), Almond (-A) and Light Almond (-T). For locking switch colors, use the following suffixes: Ivory (-2IL), White (-2WL), Gray (-2GL), Red (-2RL).

**** CANADIAN COLOR**

For color selection, add suffix to catalog number as follows: Ivory (-I), White (-W), Brown (-B), Red (-R), and Gray (-G).

HORSEPOWER

15A	20A	30A
1/2 @ 120V	1 @ 120V	2 @ 120V
2 @ 240V	2 @ 240V	2 @ 240V

MATERIAL CHARACTERISTICS

Environmental: Flammability, Rated V2
Operating Temperature: -40°C to 65°C.

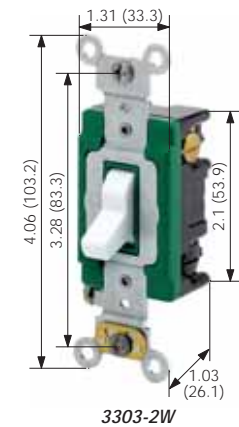
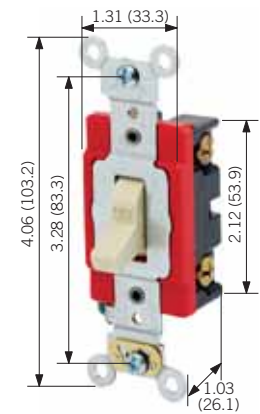
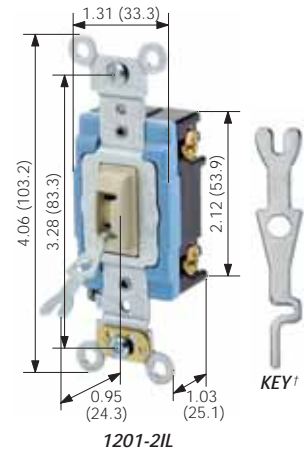

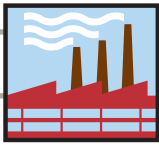

15, 20 and 30 AMP 120V and 20 AMP 277V

Industrial Grade AC Switches

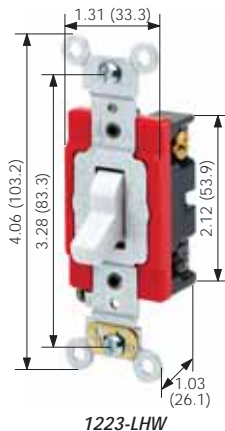
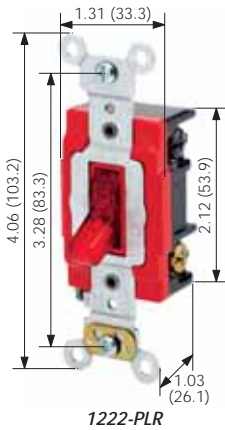
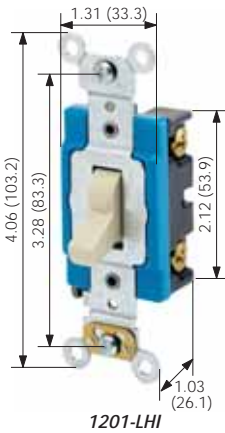
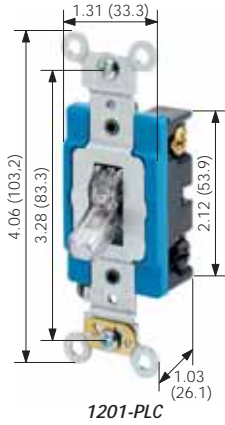

Pilot Light and Lighted Handle

Back and Side Wired Pilot Light

DESCRIPTION*	15 AMP 120V	20 AMP 120V	30 AMP 120V	20 AMP 277V
Single-Pole	1201-PL	1221-PL	3031-PL✓	1221-7P✓
Double-Pole	1202-PL+	1222-PL	3032-PL✓	1222-7P+
3-Way	1203-PL	1223-PL	—	1223-7P+

Note: Pilot light switches require a neutral wire; lighted handle switches do not require a neutral wire.

*Available toggles for these devices: Clear (-PLC), Red (-PLR), Green (-PLG).

+Available in red toggle only.

✓ Available in clear or red toggle only.

Back and Side Wired Lighted Handle

DESCRIPTION†	15 AMP 120V	20 AMP 120V	30 AMP 120V	20 AMP 277V
Single-Pole	1201-LH	1221-LH	3031-LH*	1221-7L
3-Way	1203-LH	1223-LH	—	1223-7L

Note: Pilot light switches require a neutral wire; lighted handle switches do not require a neutral wire.

†Available toggles for these devices: Clear (-LHC), Ivory (-LHI), White (-LHW).

*Available in ivory toggle only.

Wallplates

THERMOPLASTIC			302 STAINLESS STEEL			
80701-I	80709-I	80711-W	84001-40	84001-E40	84009-40	84011-40

For complete wallplate selection, see Section E.

SPECIFICATIONS AND FEATURES

- Pilot light and lighted handle switches provide top performance in punishing industrial applications
- Lighted handle illuminated when load is OFF. Pilot light toggle illuminated when load is ON.
- 120 and 277V versions in single pole and 3-way
- Fully enclosed switch mechanism in rugged housing for strength, track and arc resistance
- Self-grounding clip (self-grounding when used with a grounded metal wallbox)

TESTING AND CODE COMPLIANCE

- Meets all NEMA WD 1 & 6, and ANSI requirements
- Meets Federal Specification WS-896
- UL Listed (File #E-7458)
- CSA Certified (File #152105)
- NOM Certified (#057)
- Backed by a Limited 10-Year Warranty

HORSEPOWER

15A	20A	30A
1/2 @ 120V	1 @ 120V	2 @ 120V

MATERIAL CHARACTERISTICS

Environmental: Flammability, Rated V2
Operating Temperature: -40°C to 65°C.

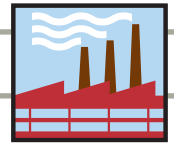

Maintained and Momentary Contact

Back and Side Wired Maintained Contact 120/277V AC

DESCRIPTION	15 AMP	20 AMP	30 AMP	COLOR*
Single-Pole, Double Throw, Center Off	1281	1285	1287	15A: I, W 20A: I, W, GY 30A: I
Single-Pole, Double Throw, Center Off, Locking†	1281-L	1285-L	1287-L	15, 20 & 30A: Black only
Double-Pole, Double Throw, Center Off	1282	1286	1288	15A: I, W 20A: I, W 30A: I, W
Double-Pole, Double Throw, Center Off, Locking†	—	—	1288-L	30A: Black only

†Key for Locking Switch: Cat. No. 55500-PRT

Back and Side Wired Momentary Contact 120/277V AC

DESCRIPTION	15 AMP	20 AMP	30 AMP	COLOR*
Single-Pole, Double-Throw, Center Off	1256	1257	1260★	15: I, W, GY 20A: I, W, GY 30A: Brown only
Single-Pole, Double-Throw, Center Off, Locking†	—	1257-L★	—	20A: Black only
Double-Pole, Double-Throw, Center Off	—	—	1262★	30A: Brown only

†Key for Locking Switch: Cat. No. 55500-PRT.

CSA Certified except where indicated by ★

Wallplates

THERMOPLASTIC			302 STAINLESS STEEL			
80701-I	80709-E	80711-W	84001-40	84001-E40	84009-40	84011-40

For complete wallplate selection, see Section E.

SPECIFICATIONS AND FEATURES

- Single-Pole and Double-Pole versions, toggle or locking
- Positive switching action with center-off position
- Large silver cadmium-oxide contacts for long life, prevent sticking, welding and excessive pitting
- Clamp-type terminals accept up to #10 CU wire
- Full rated current capacity on fluorescent, tungsten and resistive loads; motor load capacity up to 80% switch current rating

TESTING AND CODE COMPLIANCE

- Meets all NEMA WD 1 & 6, and ANSI requirements
- UL Listed (File #E-7458)
- CUL (File #E-63969)
- NOM Certified (#057)
- Backed by a Limited 10-Year Warranty

*COLOR

Basic Cat. Nos. shown above denote Brown color except for Locking Devices (Black). Other colors available as listed, add suffix to catalog number as follows: Ivory (-I), White (-W) and Gray (-GY).

HORSEPOWER

15A	20A	30A
1/2 @ 120V	1 @ 120V	2 @ 120V
2 @ 240V	2 @ 240V	2 @ 240V

MATERIAL CHARACTERISTICS

Environmental: Flammability, Rated V2
Operating Temperature: -40°C to 65°C.

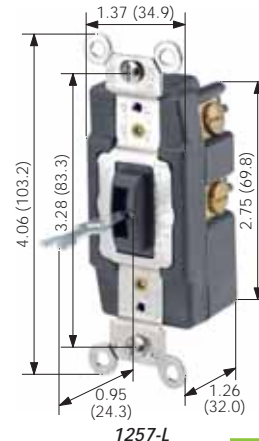
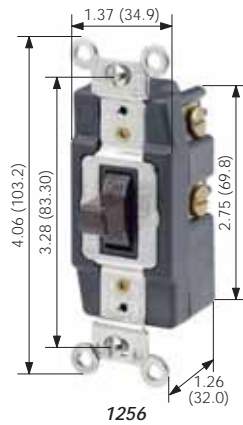
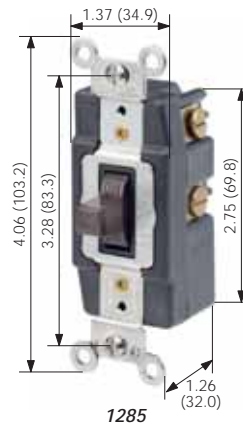
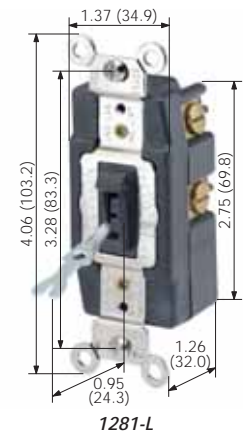

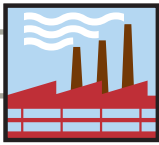

15 and 20 AMP 120/277V

Industrial Grade AC Quiet Switches

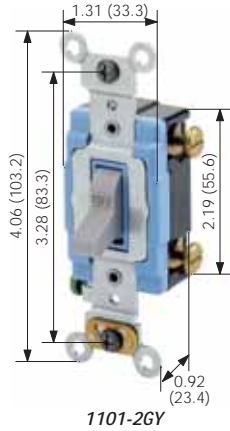

1101-2GY

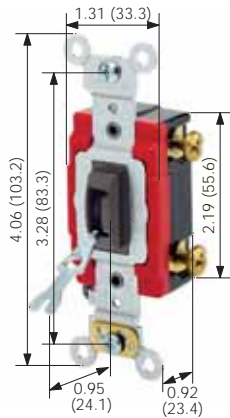

1121-2L

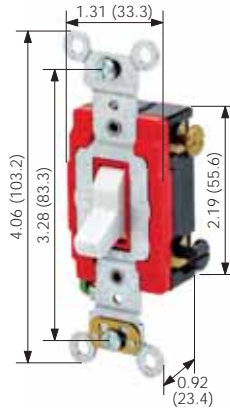

1123-2W

Side Wired 120/277V AC Quiet Switches

DESCRIPTION	15 AMP	20 AMP	COLOR*
Single-Pole Toggle	1101-2	1121-2	15A: I, W, GY 20A: I, W, GY, R
Single-Pole Locking†	1101-2L	1121-2L	15A & 20A: Brown Only
Double-Pole Toggle	1102-2	1122-2	15A: I 20A: I, W, GY
Double-Pole Locking	1102-2L	1122-2L	15A & 20A: Brown Only
3-Way Toggle	1103-2	1123-2	15A: I, W, GY 20A: I, W, GY, R
3-Way Locking†	1103-2L	1123-2L	15A & 20A: Brown Only
4-Way Toggle	1104-2	1124-2	15A: Ivory only 20A: I, W, GY, R
4-Way Locking†	1104-2L	1124-2L	15A & 20A: Brown Only

†Key for Locking Switch: Cat. No. 55500-PRT.

Wallplates

THERMOPLASTIC			302 STAINLESS STEEL			
80701	80709-1	80711-W	84001-40	84001-E40	84009-40	84011-40

For complete wallplate selection, see Section E.

SPECIFICATIONS AND FEATURES

- Rugged construction for trouble-free service in industrial environments
- Heavy-gauge copper alloy one-piece arm for smooth, quiet, firm toggle action
- Large silver cadmium-oxide contacts for long life, prevent sticking, welding and excessive pitting
- Large head, deep-slotted terminal screws for fast, easy wiring; accept up to #10 copper and copper-clad wire
- Self-grounding clip (self-grounding when used with a metal wallbox)

TESTING AND CODE COMPLIANCE

- Meets all NEMA WD 1 & 6, and ANSI requirements
- UL Listed (File #E-7458) to meet the latest Federal Specification, WS-896
- CSA Certified (File #152105)
- NOM Certified (#057)
- Backed by a Limited 10-Year Warranty

*COLOR

Basic Cat. Nos. shown above denote Brown color. Other colors available as listed, add suffix to catalog number as follows: Ivory (-I), White (-W), Gray (-GY), Red (-R), Black/Ebony (-E).

HORSEPOWER

15A	20A
1/2 @ 120V	1 @ 120V
2 @ 240V	2 @ 240V

MATERIAL CHARACTERISTICS

Environmental: Flammability, Rated V2
Operating Temperature: -40°C to 65°C.

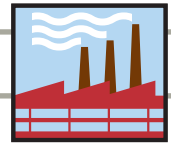

Industrial Grade AC Manual Motor and Welder Starting Switches

Back and Side Wired AC Manual Motor Starting Switches 30 AMP 600V AC

DESCRIPTION	MAX. HP RATING	IN TYPE 1 ENCL.	IN TYPE 3R ENCL.	SWITCH ONLY
Double-pole, single-throw AC manual motor starting switch, without overload protection. Color: Black	2HP 120V AC 5HP 240V AC 10HP 480V AC 15HP 600V AC	N1302	N3302	MS302
Same as above – Short Toggle				MS302-S
Three-pole, single-throw AC manual motor starting switch, without overload protection. Color: Black	3HP 120V AC 7.5HP 240V AC 15HP 480V AC 20HP 600V AC	N1303	N3303	MS303
Same as above – Short Toggle				MS303-S



Back and Side Wired AC Manual Motor Starting Switches 40 AMP 600V AC

DESCRIPTION	MAX HP RATING	CAT. NO.
Double-pole, single-throw AC manual motor starting switch, without overload protection. Color: Black	2HP 120V AC 5HP 240V AC 10HP 480V AC 15HP 600V AC	MS402
Three-pole, single-throw AC manual motor starting switch, without overload protection. Color: Black	3HP 120V AC 7.5HP 240V AC 15HP 480V AC 20HP 600V AC	MS403



Back or Front Wired AC Manual Motor Starting Switches 60 AMP 600V AC

DESCRIPTION	MAX. HP RATING	IN NEMA 3R ENCL.	SWITCH ONLY
Double-pole, single-throw AC manual motor starting switch, without overload protection. Back Wired. Color: Black	10HP 240V AC 15HP 480V AC 20HP 600V AC	N3602	MS602-BW
Same as above except Front Wired			MS602-FW
Three-pole, single-throw AC manual motor starting switch, without overload protection. Back Wired. Color: Black	10HP 240V AC 25HP 480V AC 30HP 600V AC	N3603	MS603-BW
Same as above except Front Wired			MS603-FW

Side Wired AC Manual Welder Starting Switches 40 AMP 600V AC

DESCRIPTION	MAX. HP RATING	CAT. NO.
Double-pole, single-throw AC manual welder starting switch. Color: Black	5HP 250V AC	WS402

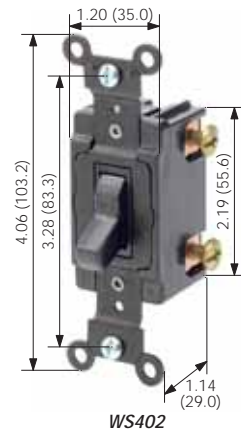

Enclosures and Wallplates

TYPE 1 STEEL ENCLOSURE WITHOUT SWITCH For 30A MS Switches	TYPE 3R ENCLOSURE WITHOUT SWITCH For 30A MS Switches	302 STAINLESS STEEL LOCKOUT WALLPLATE w/TAMPER-RESISTANT SCREWS and SPANNER TOOL	TYPE 1 ENCLOSURES w/THERMOPLASTIC COVER and w/30A 2-P (N1302-T) or 30A 3-P (N1303-T) Switch	TYPE 3R ENCLOSURE WITHOUT SWITCH For 40 or 60A MS Switches
2 Knockouts 1/2" and 3/4" Top and Bottom	2 Bottom Knockouts #1 Allows: 1/2", 3/4" #2 Allows: 1", 1 1/4"	84001-LOK (Lock purchased separately)	N1303-T (w/30A Switch) N13NC-T (Cover Only)	2 Bottom Knockouts both allow: 1/2", 3/4", 1", 1 1/4"
 N13NC	 N33NC		 	 N36NC

Note: For Type 3R Enclosure lockout, padlock with 5/16" or equivalent shackle recommended (min. 1/4" Dia.). For complete wallplate selection, see Section E.

SPECIFICATIONS AND FEATURES

MS Switches

- All molded parts are thermoplastic to resist impacts, chemicals, temperature, tracking and arcing
- Positive-contact design enhances fast-make/ slow-break
- Silver-alloy contacts for maximum conductivity and service life
- Back and side wire terminals accept up to #10 AWG solid copper wire. For stranded #8 AWG wire, remove terminal clamp and use ring terminal
- Oversized #10 triple-combination terminal screws are vibration resistant
- Insulating barrier between terminals provide isolation from each phase

- Nickel-plated brass mounting yoke for superior corrosion resistance
- Large toggle provides positive actuation, even with gloved hand

WS Switches

- Capable of accommodating bus bar termination in multi-gang applications
- Hole for mounting hardware supports panel mounting with self-threading fasteners or pop rivets
- Terminal screws accept up to # 10 AWG solid copper wire. For stranded # 8 AWG wire, remove terminal clamp and use ring terminal
- Fast-threading, corrosion-resistant brass triple-combination screws for fast, easy installation

TESTING AND CODE COMPLIANCE

- MS devices: UL & CUL Listed (File #E-63969)
- WS devices: UL Recognized Component (File #E-63969)
- MS & WS devices comply with UL 508
- Backed by a Limited Ten-Year Warranty

MATERIAL CHARACTERISTICS

UL94 V0 Flammability Rating
Operating Temperature: -40°C to 65°C

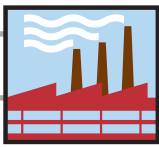

SAFETY DISCONNECT SWITCH FEATURES

Industrial Grade Watertight Safety Disconnect Switches UL 98 & UL 508 Listed, CUL per CSA Specification, C22.2 No. 14 Certified

**2 YEAR LIMITED
WARRANTY**

Liquid-tight conduit fitting can be installed for top or bottom feed

- One fitting supplied:
- 30 Amp – 1"
 - 60 Amp – 1 1/4"
 - 100 Amp – 1 1/2"

Stainless steel screws are captive and will not fall out when cover is opened

- Impact UV and chemical-resistant Valox enclosure rated to UL and IEC watertight standards
- Type 3R, 4X & 12K
 - IP67

**Fused Models Accept
"Class J" Time-Delay Fuses**

Pre-wired grounding plates (top and bottom of enclosure) connect to metal conduit grounding system

Brass threaded inserts will not strip, provide higher torque, and form tighter seal between back box and cover

Rugged hinge mechanism pivots 180° for easy access during installation and maintenance

Red "pistol grip" handle provides visual confirmation of switch's status

Integrated lockout handle meets OSHA safety regulations

**Watertight Safety Disconnect Switches Include —
30 Amp Fused, 60 & 100 Amp
(Fused & Non-Fused)**

**Meets 2002 NEC® Requirements
430.102 (A) and 430.102 (B)**

Circuit identification pad for means of identifying specific equipment loads

DS60-FAX



Handle with padlock installed

Generous wiring space for top to bottom wiring

- Disconnect switch with integrated fuse holder offers proven performance in a compact package
- Fused cartridges accept "Class J" fuses (not included)
 - 1 Factory installed Auxiliary Contact (Normally Open – 10 Amp)
 - Additional Auxiliary Contact Available (Normally Closed – 10 Amp)
 - Easily accessible neutral and ground terminal blocks



Cover Screws: 1 1/8" deep slotted. LG stainless steel.
Mounting Screws: 10-24 x 1/2" deep slotted. LG stainless steel.

DS60-FAX



STANDARDS & CERTIFICATIONS

Safety Disconnect Switches

UL 98 Fused (Including 100A Non-Fused - DS)	UL 508 Non-Fused	CSA C22.2 No. 14	NOM	CE	IEC 947-3
E63969		✓	✓	✓*	✓

* Not available on DS30-AX

Watertight Safety Disconnect Switches

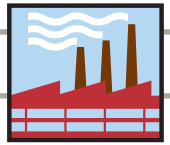

Industrial Grade Watertight Safety Disconnect Switches



Engineered to UL & IEC Watertight Standards

Meets 2002 NEC® Requirements 430.102 (A) and 430.102 (B)



DS30-AX (Non-Fused)



DS60-FAX (Fused)



DS100-AX (Non-Fused)

2 YEAR LIMITED WARRANTY

Ordering Information for Watertight Safety Disconnect Switches

AMPS	MAX VOLTAGE	INTERRUPTED RATINGS — RMS SYMMETRICAL AMPERES	
		Non-Fused are suitable for use on circuits capable of delivering not more than (see chart below for catalog no. and value) RMS symmetrical amperes.	
		Fused, when protected by Class J fuses, 600V AC maximum, are suitable for use on circuits capable of delivering not more than (see chart below for catalog no. and value) RMS symmetrical amperes.	
		CATALOG NO. NON-FUSED	CATALOG NO. FUSED
30 60 100	600V AC 600V AC 600V AC	DS30-AX DS60-AX DS100-AX	DS30-FAX DS60-FAX

ELECTRICAL			
	Device	Current Applied	Duration
Ground Path Integrity	30 A	60 A	2 min
	60 A	120 A	4 min
	100 A	200 A	6 min
Current Interrupting	Certified for current interrupting at full-rated current and voltage		
Endurance	6000 operations at rated current and voltage (Power factor 0.75 – 0.80)		
Dielectric	1000 V plus twice rated voltage for 1 minute		

MECHANICAL	
Mold Stress Relief	70°C for 7 hours
Knockout Test	Remains in place with 20 lb push
Crush	100 lb
Impact	1.2 lb steel ball dropped from 5 ft
Cold Impact	Same as above, after conditioning to -35°C
Strength of Insulating Base and Support	110% of specified tightening torque on terminal screws
Pullout	18 lb pull on internal wires

ENVIRONMENTAL	
Flammability	V2 or better per UL 94 or CSA 22-2 No 0.6; V-0 for watertight enclosure
Rain (3R) per UL 50	Water spray @ 5 psi from all sides for 1 hr
Hosedown (4X) per UL 50	Water spray @ 65 gal/min for 5 minutes
Dust (12K) per UL 50	Cement Dust Circulated @ 1000 ft/minute for 5 minutes
Gasket Aging	70°C for 168 hours
UV Resistance	Exposed plastic materials are UV stabilized
Operating Temperature	-40°C to +60°C (-40°F to +140°F)

VOLTS	MAX. HP RATINGS PER UL508 NON-FUSED SAFETY DISCONNECT SWITCHES		
	DS30-AX	DS60-AX	DS100-AX
120V AC	1	2	5
208V AC	5	20	25
240V AC	2.5	10	15
480V AC	5	20	25
600V AC	NA	20	20
3Ø Y 120/208V AC	5	20	25
3Ø 240V AC	5	20	30
3Ø 480V AC	15	40	50
3Ø 600V AC	15	40	50

VOLTS	MAX. HP RATINGS PER UL508 FUSED SAFETY DISCONNECT SWITCHES	
	DS30-FAX	DS60-FAX
120V AC	2	NR
208V AC	7.5	15
240V AC	3	NR
480V AC	15	NR
600V AC	20	NR
3Ø Y 120/208V AC	7.5	15
3Ø 240V AC	7.5	15
3Ø 480V AC	15	30
3Ø 600V AC	20	50

NR = Not Rated

Watertight Safety Disconnect Switches

F o

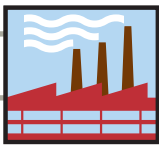

20 AMP 120/277V

Industrial Grade AC Key Lock Power Switches

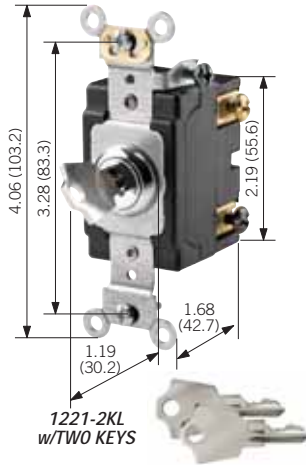

Back and Side Wired Key Lock Power Switches 20 AMP 120/277V AC

DESCRIPTION	CAT. NO.
Single-Pole Key Lock Power Switch, 2 keys provided	1221-2KL
Double-Pole Key Lock Power Switch, 2 keys provided	1222-2KL
3-Way Key Lock Power Switch, 2 keys provided	1223-2KL
4-Way Key Lock Power Switch, 2 keys provided	1224-2KL
Replacement Keys, 2 per pack	2KL

Wallplates and Wallboxes

302 STAINLESS STEEL COMES WITH TAMPER-RESISTANT SCREWS and SPANNER TOOL	FD or DEEP WALLBOX RECOMMENDED MINIMUM INTERNAL DEPTH 2 ³ / ₄ " SINGLE COVER/GANG	ADAPTER EXTENDS SHALLOW WALLBOX, USE WITH STAINLESS WALLPLATE—CAT. NO. 84071-40
 84701-40		 COLOR Brown Ivory White CAT. NO. 6197 6197-I 6197-W
2-GANG STAINLESS STEEL WALLPLATE	3-GANG STAINLESS STEEL WALLPLATE	
 84072-40	 84073-40	

For complete wallplate selection, see Section E.

Key Lock Power Switches are not recommended for use on Master or Emergency Power Systems.

SPECIFICATIONS AND FEATURES

- Key-operated locking mechanism for maximum tamper-proof operation in schools, institutions, public housing, trailer parks, loading docks, freight yards and other areas
- Chrome lock dome with 2 keys provided per switch
- Back and side wire terminals accept up to #14 – #10 AWG copper or copper clad wire
- Large, combination head terminal screws with external clamps
- 4-Way switch has internal, back-wire clamps
- Triple-combination mounting screws for fast, easy installation
- Heavy-gauge rust-resistant mounting strap with steel grounding screw and self-grounding clip (self grounding when used in a properly grounded metal wallbox)
- Key removable in ON or OFF positions

TESTING AND CODE COMPLIANCE

- Meets NEMA WD-1, WD-6 & ANSI requirements
- Meets Federal Specifications WS-896
- UL Listed (File #E-7458)
- CSA Certified (File #152105)
- NOM Certified (#057)
- Backed by a Limited Ten-Year Warranty

HORSEPOWER

20A
 1 @ 120V
 2 @ 240V
 16 Amp Max.

MATERIAL CHARACTERISTICS

Environmental: Flammability, Rated V2
 Operating Temperature: -40°C to 65°C.

AC QUIET SWITCH FEATURES

Commercial Grade AC Quiet Switches



LEVITON OFFERS A LARGE SELECTION OF 15 AND 20 AMP COMMERCIAL SWITCHES, AVAILABLE IN A WIDE VARIETY OF COLORS, WIRING OPTIONS AND OTHER FEATURES.

Leviton's Commercial Grade switches are designed to offer outstanding reliability and top performance in commercial settings. Ideal applications include municipal facilities, government buildings, malls, department stores, hospital and health care facilities, office buildings, schools, colleges, universities, houses of worship and cultural institutions.

Features and Benefits

- Listed UL Federal Specification, WS-896
- External clamp-type wiring terminals provides secure connection of solid or stranded wire for back or side wiring (CSB1 and CSB3)
- Heavy-duty pre-plated steel mounting strap for maximum strength
- All screws are brass combination-head for fast installation with Standard, Phillips and Robertson head screwdrivers
- Backed by a Limited 10-Year Warranty

Back and Side Wired
External clamp-type terminals for maximum wiring versatility.
CSB1-20 shown

Side Wired
Sturdy, rugged, cost effective.
CS120-2W shown

Framed Toggle
For neater finished appearance.
54501-2I shown

Lighted Toggle
Lights up, when power is off, easy to locate in darkened rooms.
5501-LHI shown

Hospital Call Switch
Turns on when toggle is pulled down with cord (included).
5501-8 shown

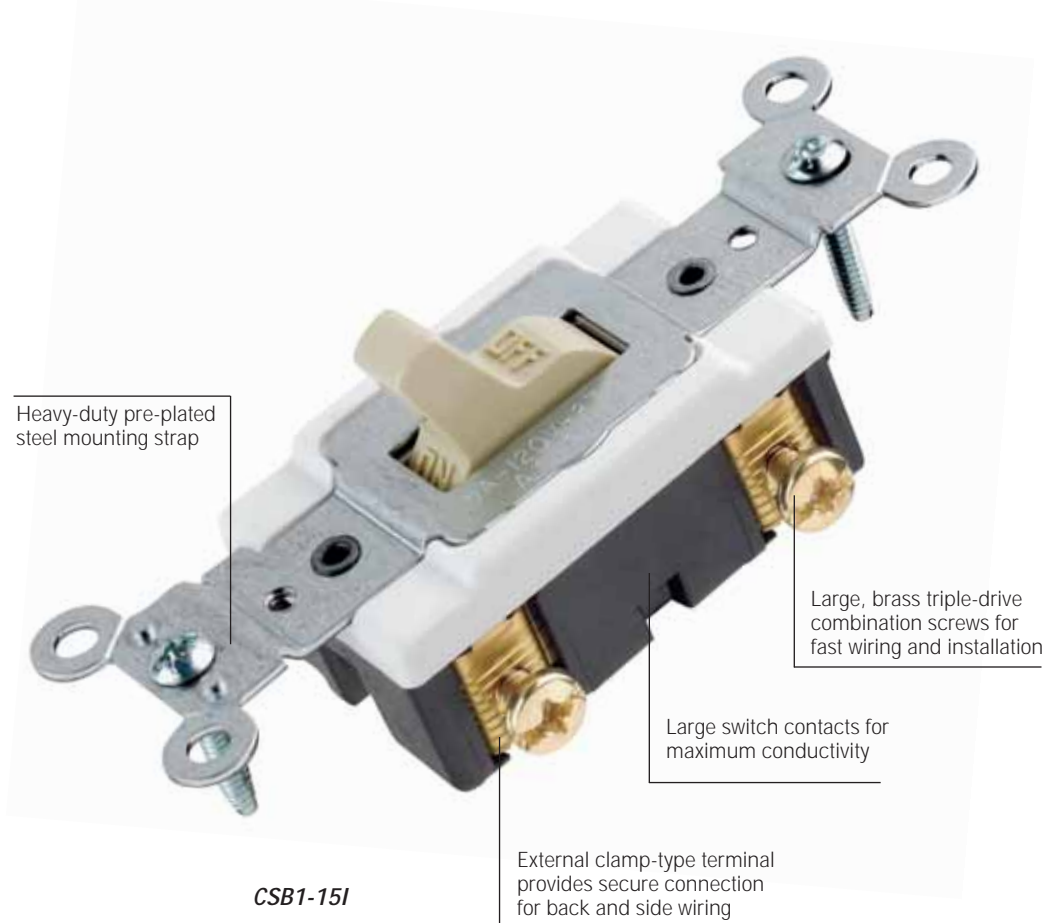

Heavy-duty pre-plated steel mounting strap

Large, brass triple-drive combination screws for fast wiring and installation

Large switch contacts for maximum conductivity

External clamp-type terminal provides secure connection for back and side wiring

CSB1-151



15 and 20 AMP 120/277V • 15 and 20 AMP CANADIAN 120/277V

Commercial Grade AC Quiet Switches

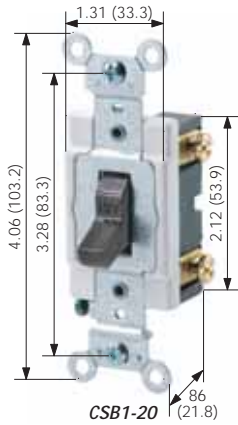

CSB1-20

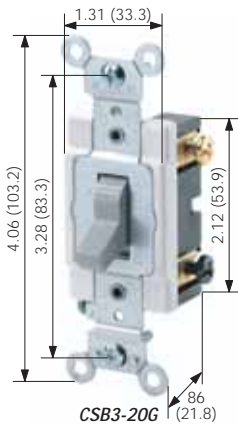

CSB3-20G

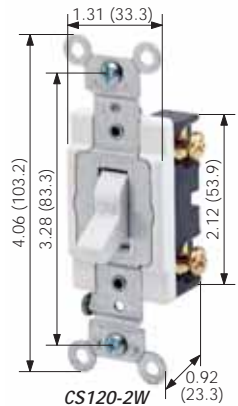

CS120-2W

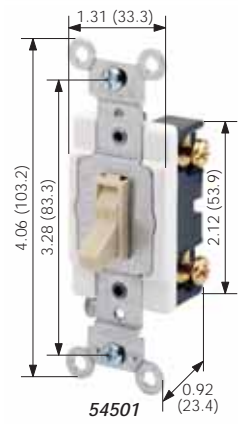

54501

Back and Side Wired 120/277V AC Quiet Switches

DESCRIPTION	15 AMP	20 AMP	COLOR*
Single-Pole Toggle	CSB1-15	CSB1-20	15A & 20A: I, W, A, T, G
Double-Pole Toggle	CSB2-15	CSB2-20	15A: I, W, A, T 20A: I, W, A, T, G
3-Way Toggle	CSB3-15	CSB3-20	15A: I, W, A, T 20A: I, W, A, T, G
4-Way Toggle	CSB4-15	CSB4-20	15A: I, W, A 20A: I, W, A, G

Side Wired 120/277V AC Quiet Switches

DESCRIPTION	15 AMP	20 AMP	COLOR*
Single-Pole Toggle	CS115-2	CS120-2	15A & 20A: I, W, A, T, GY, E
Single-Pole Hospital Call Switch†	5501-8	—	15A: I
Double-Pole Toggle	CS215-2	CS220-2	15A: I, W, GY 20A: I, W, A, T, GY, E
Double-Pole Hospital Call Switch†	5502-8	—	15A: Ivory Only
3-Way Toggle	CS315-2	CS320-2	15A: I, W, A, T, GY 20A: I, W, A, T, GY, E
4-Way Toggle	CS415-2	CS420-2	15A: I, W, A, T, GY 20A: I, W, A, T, GY, E
Single-Pole, Framed Toggle	54501-2	54521-2	15A & 20A: I, W, GY
Double-Pole, Framed Toggle	54502-2	54522-2	15A: I, W 20A: I, W
3-Way, Framed Toggle	54503-2	54523-2	15A & 20A: I, W, GY
4-Way, Framed Toggle	54504-2	54524-2	15A: I, W, A, T, GY 20A: I, W, GY

†Hospital Call Switch turns on when toggle is pulled down with cord (3-ft braided cord included)

NOTE: Cat. Nos. CSB1 and CSB3 feature external clamp-type wiring termination for back and side wiring

Side Wired Canadian 120/277V AC Quiet Switches

Note: Cat. No. 54501-2 series is identified in Canada by the following catalog numbers:

DESCRIPTION	15 AMP	20 AMP	COLOR**
Single-Pole, Framed Toggle	1101-C	54521-2	15A: I, W, B, G, E 20A: I, W, B, G
Double-Pole, Framed Toggle	1102-C	54522-2	15A & 20A: I, W, B, G
3-Way, Framed Toggle	1103-C	54523-2	15A: I, W, B, E 20A: I, W, B, G
4-Way, Framed Toggle	1104-C	54524-2	15A: I, W, B, E 20A: I, W, B, G

Wallplates

THERMOPLASTIC			302 STAINLESS STEEL			
80701-I	80709	80711-W	84001-40	84001-E40	84009-40	84011-40

For complete wallplate selection, see Section E.

SPECIFICATIONS AND FEATURES

- Large head triple-drive combination screws (Standard, Phillips and Robertson) for fast wiring
- Heavy-gauge, rust-resistant steel mounting strap
- Accepts #14-#12 AWG copper or copper-clad wire
- Convenient break-off plaster ears for best alignment
- Large switch contacts for maximum conductivity

TESTING AND CODE COMPLIANCE

- UL Listed to meet the latest Federal Specification, WS-896 (File #E-748)
- Meets all NEMA WD 1 & 6, and ANSI requirements
- CSA Certified (File #LR-3413)
- NOM Certified (#057)
- Backed by a Limited 10-Year Warranty

*COLOR

Basic Cat. Nos. shown above denote Brown color. Other colors available as listed, add suffix to catalog number as follows: Ivory (-I), White (-W), Almond (-A), Light Almond (T), Gray (-GY), Black (-E).

** CANADIAN COLOR

For color selection, add suffix to catalog number as follows: Ivory (-I), White (-W), Brown (-B), and Gray (-G).

HORSEPOWER

15A	20A
1/2 @ 120V	1 @ 120V
2 @ 240V	2 @ 240V

MATERIAL CHARACTERISTICS

Environmental: Flammability, Rated V2
Operating Temperature: -40°C to 65°C.

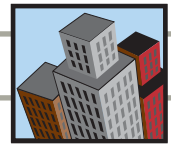

Side Wired Lighted Toggle 15 AMP 120V AC Only

DESCRIPTION	CAT. NO.	COLOR*
Single-Pole Lighted Toggle	5501-LH	15A: I, W
3-Way Lighted Toggle	5503-LH	15A: I, W

Side Wired Canadian 15 AMP 347V AC

DESCRIPTION	CAT. NO.	COLOR** <i>See Canadian Color</i>
Single-Pole, Framed Toggle	18201-C	15A: I, W, B, G
Double-Pole, Framed Toggle	18202-C	15A: I, W
3-Way, Framed Toggle	18203-C	15A: I, W, B, G
4-Way, Framed Toggle	18204-C	15A: I, W, G

Wallplates

THERMOPLASTIC			302 STAINLESS STEEL			
80701-I	80709-I	80711-W	84001-40	84001-E40	84009-40	84011-40

For complete wallplate selection, see Section E.

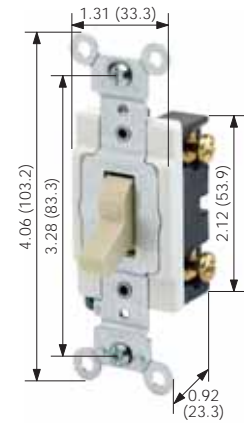

5501-LH1

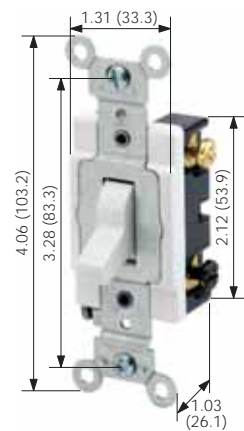

5503-LHW

SPECIFICATIONS AND FEATURES

- Quiet, reliable mechanical action
- Large head triple-drive combination screws (Standard, Phillips and Robertson) for fast wiring installation
- Accepts #14–#12 AWG copper or copper-clad wire
- Large switch contacts for maximum conductivity

TESTING AND CODE COMPLIANCE

- UL listed to meet the latest Federal Specification, WS-896 (File #E-748)
- Meets all NEMA WD 1 & 6, and ANSI requirements
- CSA Certified (File #LR-3413)
- NOM Certified (#057)
- Backed by a Limited 10-Year Warranty

*** COLOR**

Basic Cat. Nos. shown above denote Brown color except for Lighted Toggle Switches. Other colors available as listed, add suffix to catalog number as follows: Ivory (-I), White (-W).

**** CANADIAN COLOR**

For color selection, add suffix to catalog number as follows: Ivory (-I), White (-W), Brown (-B), and Gray (-G)

HORSEPOWER

15A
1/2 @120V

MATERIAL CHARACTERISTICS

Environmental: Flammability, Rated V2
Operating Temperature: -40°C to 65°C.





15 AMP 120V

Residential Grade AC Quiet Switches

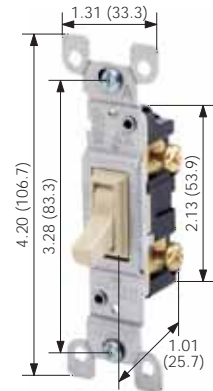

1451

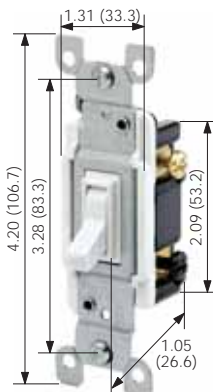

1453

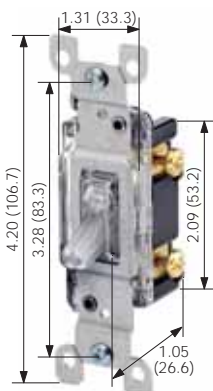

1461-LHC

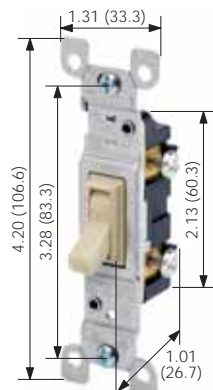

2651-2

Quickwire and Side Wired Framed Toggle 15 AMP 120V AC Quiet Switches

DESCRIPTION	CAT. NO.	COLOR*
Single-Pole	1451	I, W
3-Way	1453	I, W, A, T
Single-Pole with grounding screw	1451-2	I, W, A, T, E
3-Way with grounding screw	1453-2	I, W, A, T, E
4-Way with grounding screw	54504-2	I, W, A, GY, T
Single-Pole, less ears with grounding screw	1451-4	I, W
3-Way, less ears with grounding screw	1453-4	I, W

Note: Available in Convenience Packs.

Quickwire and Side Wired Illuminated Toggle 15 AMP 120V AC

DESCRIPTION	CAT. NO.	COLOR (Toggle & Frame)*
Single-Pole (Amber Illumination)	1461-LH	C
3-Way (Amber Illumination)	1463-LH	C
Single-Pole (Green Illumination)	1461-GH	I, W, A, T, E
3-Way (Green Illumination)	1461-GH	I, W, A, T, E

Note: Illuminated switches do not require a neutral wire.

CO/ALR Side Wired Framed Toggle

15 AMP 120V AC

DESCRIPTION	CAT. NO.	COLOR*
Single-Pole with grounding screw	2651-2	I, W
3-Way with grounding screw	2653-2	I, W



Note: CO/ALR devices are for connection to 12 or 10 AWG aluminum conductors.

Wallplates

THERMOPLASTIC			302 STAINLESS STEEL			
80701-I	80709	80711-W	84001-40	84001-E40	84009-40	84011-40

For complete wallplate selection, see Section E.

SPECIFICATIONS AND FEATURES

- Faster installation with combination of side wiring and Quickwire push-in wiring
- Quickwire accepts conductors up to #12 AWG; #14 AWG in Canada
- Side wire accepts conductors up to #12 AWG
- Large head triple-drive combination screws (Standard, Phillips, Robertson) for fast wiring installation
- Impact-resistant, durable thermoplastic toggle and frame

TESTING AND CODE COMPLIANCE

- UL Listed (File # E-7458)
- CSA Certified (File #LR-3413)
- NOM Certified (#057)
- Backed by a Limited Two-Year Warranty

*COLOR

Basic Cat. Nos. shown above denote Brown color. Other colors available as listed, add suffix to catalog number as follows: Ivory (-I), White (-W), Almond (-A), light Almond (T), Black/Ebony (-E), Clear (-C), Grey (-GY)

HORSEPOWER

15A
1/2 @120V

MATERIAL CHARACTERISTICS

Environmental: Flammability, Rated V2
Operating Temperature: -40°C to 65°C.

Straight Blade Receptacles

INDEX

Overview	.G2
Hospital Grade	
Back and Side Wired with Wire Leads	.G3
Isolated Ground	.G3
Four-In-One	.G5
Industrial Grade	
Back and Side Wired with Wire Leads	.G4
Side Wired	.G4
Isolated Ground	.G4
Dual Voltage	.G4
Clock Hanger	.G4
Four-In-One	.G5
Power Devices	.G6-G11
Commercial Grade	
Overview	.G12
Back and Side Wired	.G13, G15
Dual Voltage	.G13
Side Wired	.G14, G15
Brass Floorbox Assembly	.G14
QuickPort® Snap-In Jacks with Brass Floorplate	.G15
Residential Grade	
Quickwire Push-In	.G16
Quickwire Push-In and Side Wired	.G16
Side Wired	.G16, G17
CO/ALR	.G16
Clock Hanger	.G17
Snap-In Devices	.G17



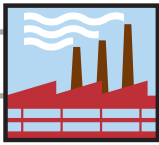

STRAIGHT BLADE RECEPTACLE FEATURES

Industrial Grade Straight Blade Receptacles

LEVITON'S INDUSTRIAL GRADE STRAIGHT BLADE RECEPTACLES ARE BUILT TO THE MOST DEMANDING STANDARDS FOR PERFORMANCE AND RELIABILITY. THEY'RE DESIGNED TO WITHSTAND THE HIGHEST ABUSE AND RESIST IMPACT, CRACKING AND HARSH CHEMICALS.



Hospital Grade, Tamper Resistant
Approved for emergency circuits and pediatric/psychiatric care areas.
8300-SGW shown



Hospital Grade, Isolated Ground
Provides a pure ground path to a building's isolated ground system.
8200-IG shown



Industrial Grade Back & Side Wired
Features interlocking thermoplastic body and cover with one-piece brass strap.
5262-W shown



Four-In-One
Hardwire device converts a duplex receptacle installation into four receptacles without multiple installation labor and material costs.
5490-BU shown

All Leviton Hospital Grade Receptacles undergo the most stringent UL testing to assure continuous, safe operation in any application requiring high-abuse tolerance, including health care facilities, manufacturing plants and schools.

Features and Benefits

- UL 498 for Hospital Grade (UL File #E-13399); UL Federal Specification WC-596 Listing
- CSA Certified where applicable (CSA File #LR-406)
- NOM Certified
- Meets NEMA WD-1 and 6 and ANSI standards
- All industrial back and side wired receptacles have #10-32 triple combination head terminal screws; straight, Phillips and Robertson.
- Back and side wiring options accept #14-#10 AWG stranded or solid wire
- Power Indication™ circuit board integrates 100,000 hour LED and components in a compact fail-safe assembly
- Apron barrier to prevent accidental contact between terminal screw heads and metal box
- Exclusive V-shaped, serrated back-wiring clamps for superior contact and conductivity
- Backed by a Limited 10-Year Warranty
- Hospital Grade Receptacles also available with Decora® designer-styling (See Decora® Plus devices, Section B)

POWER INDICATION™

Face and body locked together with exclusive four-corner latch construction, remains securely fastened

Power Indication™ meets UL498 Hospital Grade identification requirements and offers visual confirmation that the device is energized

Large, triple-wipe, nickel plated brass "T" contacts for superior contact and conductivity

Nickel-plated brass bushing for additional assembly security

Thick-walled impact-resistant thermoplastic nylon cover and body withstands abuse

Smooth face, easy to clean and soil resistant

Exclusive nickel-plated brass, staked on, self-grounding clip will never fall off

Nickel-plated brass, one piece mounting strap with integral ground contact, for superior ground path

Back and side-wire grounding terminal for quick ground installation

Exclusive V-shaped, serrated back-wiring clamps for superior contact and conductivity

Back and side-wiring options

Exclusive triple combination #10-32 nickel-plated brass terminal screws, straight slot, Phillips #2, Robertson #1, for excellent torque

Apron barrier to prevent accidental contact of terminal screw heads with metal box

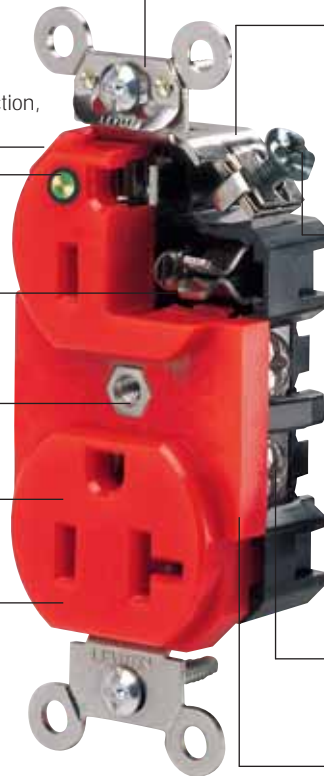

8300-PLR shown

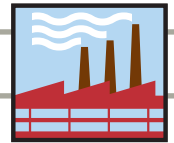

Hospital Grade

Back and Side Wired/Wire Lead (Basic Cat. No. Denotes Brown Device*)

DESCRIPTION	CAT. NO./COLOR 15A/125V	CAT. NO./COLOR 15A/250V	CAT. NO./COLOR 20A/125V	CAT. NO./COLOR 20A/250V
	5-15R	6-15R	5-20R	6-20R
Duplex Receptacle	8200 I, W, GY, R	8600 I	8300 I, W, A, T, GY, R, E	8400 I
Single Receptacle	8210 I, W, R	—	8310 I, W, GY, R	—
Slim Design Receptacle	8200-H I, W, GY, R	—	8300-H I, W, GY, R	—
Duplex Receptacle, Tamper-Resistant	8200-SG I, W, G, R	—	8300-SG I, W, A, T, G, R	—
Illuminated Duplex Receptacle	8200-HL I, W, G, R, (No Brown)	—	8300-HL I, W, R (No Brown)	—
Power Indication™ Duplex Receptacle	8200-PL I, W, R, (No Brown)	—	8300-PL I, W, R (No Brown)	—
Duplex Receptacle, w/6" Wire Leads	8200-L I, W, GY, R	—	8300-L I, W, A, GY, R, E	—

Note: Single, Slim Design, Illuminated, Power Indication and Tamper-Resistant Receptacles meet specifications for UL Hospital Grade listing but have a different construction and design from standard Hospital Grade Duplex Receptacles listed above. There are dimensional differences between 8200-SG and 8300-SG devices. 8200-SG contains a nickel-plated steel yoke with riveted ground contacts. 8300-SG contains a one-piece, nickel-plated brass yoke.

Isolated Ground Receptacles (Basic Cat. No. Denotes Orange Device*)

DESCRIPTION	CAT. NO./COLOR 15A/125V	CAT. NO./COLOR 15A/250V	CAT. NO./COLOR 20A/125V	CAT. NO./COLOR 20A/250V
Duplex Receptacle	8200-IG B, I, W, G, R	—	8300-IG B, I, W, G, R	—
Duplex Receptacle w/6" Ground Lead	8200-LIG Orange Only	—	8300-LIG Orange Only	—
Single Receptacle w/6" Ground Lead	8210-IG Orange Only	—	8310-IG Orange Only	—

Wallplates

THERMOPLASTIC					302 STAINLESS STEEL		
80703-IG	80704-IG	80703-I	80704-GY	80716-R	84003-40	84004-40	84016-40

For complete wallplate selection, see Section E.

See Page G4 for Leviton's full line of Four-In-One Receptacles.
See Section R for Leviton's full line of Surge Protective Devices.

SPECIFICATIONS AND FEATURES

Duplex Receptacles

- Impact-resistant thermoplastic nylon cover and body
- Smooth face does not collect dirt
- Four corner latches securely fasten face
- Large, triple-wipe, brass "T" contacts for superior contact and conductivity
- High-performance brass #10-32 terminal screws to reduce conductor oxidation
- Back and side-wire ground termination brass strap version
- Back and side-wiring options
- Break-off tabs for easy two-circuit conversion
- Apron barrier to prevent accidental contact between terminal screw heads and metal box
- Exclusive V-shaped, serrated back-wiring clamps for superior contact
- Power Indication™ provides permanent "green dot" lens with 100,000 hour LED status indicator
- Wire lead receptacles for fast and easy installation

Note: Cat. Nos. 8200-HL and 8300-HL construction features differ from those listed above.

TESTING AND CODE COMPLIANCE

- UL Listed 498 for Hospital Grade (UL File #13399); UL Federal Specification WC-596
- CSA Certified (CSA File #152105)
- NOM Certified (#057)
- Meets NEMA WD-1 & 6, and ANSI standards
- Backed by a Limited 10-Year Warranty

***COLOR**

Basic Cat. Nos. shown above denote Brown for Hospital Grade and Orange for Isolated Ground (-IG) Devices. Isolated Ground Receptacle is distinguished by an orange triangle on its face. For other color selections, add suffix to the catalog number as follows: Ivory (-I), White (-W), Almond (-A), Brown (IG devices only, add -B), Red (-R), Gray (-G or -GY) and Black (-E).

MATERIAL CHARACTERISTICS

Environmental: Flammability, Rated V2
Operating Temperature: From -40° C (without impact) to 60°C maximum continuous

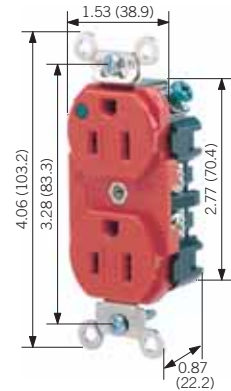

8200-PLR

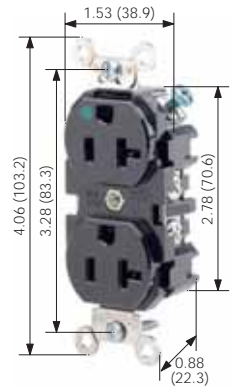

8300-E

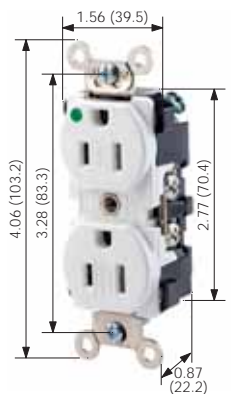

8200-SGW

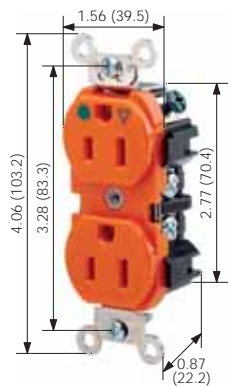

8200-IG

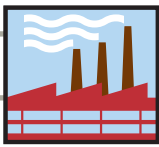

15 AMP 125 and 250V • 20 AMP 125 and 250V

Industrial Grade Straight Blade Receptacles

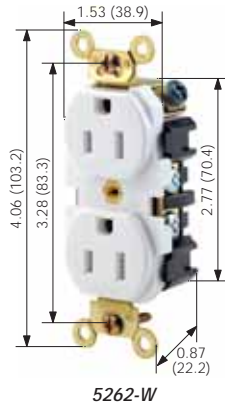

5262-W

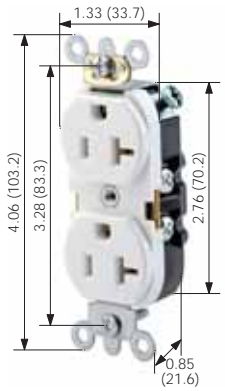

5362-SW

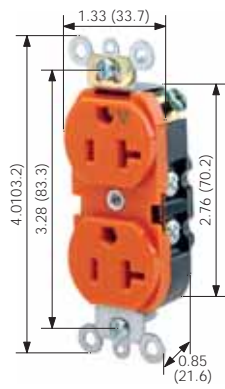

5362-IG

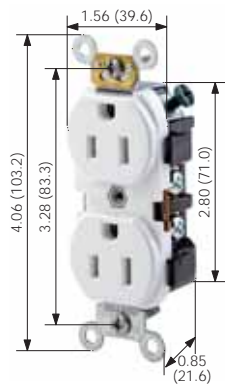

5242-W

Back and Side Wired/Wire Lead (Basic Cat. No. Denotes Brown Device*)

DESCRIPTION	CAT. NO./COLOR 15A/125V	CAT. NO./COLOR 15A/250V	CAT. NO./COLOR 20A/125V	CAT. NO./COLOR 20A/250V
	5-15R	6-15R	5-20R	6-20R
LEVSPEC® Duplex Receptacle, Brass Strap	5262 I, W, GY, R, E	5662 I	5362 I, W, GY, R, E	5462 I, GY
Single Receptacle	5261 I, W, GY	5661 I	5361 I, W, A, T, GY, E	5461 I, A, T, GY
Narrow Body Duplex Receptacle	5252 I, W, A, T, GY, R, E, BU	—	5352 I, W, A, T, GY, R, E, BU	—
Single Receptacle, Clockhanger	5261-CH Stainless Steel	—	5361-CH Stainless Steel	—
SPECCCLASS® General Duty Duplex Receptacle	5262-S I, W, A, T, GY, R, E, BU	—	5362-S I, W, A, T, GY, R, E, BU	—
SPECCCLASS® General Duty Duplex Receptacle w/6" Wire Leads	5262-L I, W, A, GY, R, E	—	5362-L I, W, A, GY, R, E	—

Note: Single Receptacles meet Federal Specifications WC-596 but have a different construction and design than Duplex Receptacles listed above.

Back and Side Wired — Isolated Ground Receptacles (-IG) (Basic Cat. No. Denotes Orange Device*)

DESCRIPTION	CAT. NO./COLOR 15A/125V	CAT. NO./COLOR 15A/250V	CAT. NO./COLOR 20A/125V	CAT. NO./COLOR 20A/250V
Slim Design Duplex Receptacle	5262-IG B, I, W, G, R, BIG	5662-IG	5362-IG B, I, W, A, T, G, R, BIG	5462-IG

Side Wired (Basic Cat. No. Denotes Brown Device*)

DESCRIPTION	CAT. NO./COLOR 15A/125V	CAT. NO./COLOR 15A/250V	CAT. NO./COLOR 20A/125V	CAT. NO./COLOR 20A/250V
Duplex Receptacle	5242 I, W, GY, R	—	5342 I, W, GY, R	—
Single Receptacle	5251 I	5651 I, W	5351 I	—

Back and Side Wired Dual Voltage (Basic Cat. No. Denotes Brown Device*)

DESCRIPTION	RATING	CAT. NO.	COLOR
Duplex Receptacle	15A 125V/15A 250V	5292	I

Wallplates

THERMOPLASTIC				302 STAINLESS STEEL		
80703-IG	80703-I	80704-GY	80716-R	84003-40	84004-40	84016-40

For complete wallplate selection, see Section E.

SPECIFICATIONS AND FEATURES

- Back & Side Wired Duplex
- Impact-resistant thermoplastic nylon cover and body
- Smooth face does not collect dirt
- Four corner latches securely fasten face
- Single-piece brass mounting strap on LEVSPEC devices, multi-piece steel strap on other devices
- Large, triple-wipe, brass "T" contacts for superior contact and conductivity
- Back and side-wiring options
- Brass terminal screws to reduce conductor oxidation
- Break-off tabs for easy two-circuit conversion
- Apron barrier to prevent accidental contact between terminal screw heads and metal box
- Exclusive V-shaped, serrated back-wiring clamps for superior contact and conductivity
- Wire lead receptacles for fast and easy installation

TESTING AND CODE COMPLIANCE

- UL Listed 498 (UL File #13399); UL Federal Specification WC-596

- CSA Certified where applicable (CSA File #LR-406)
- NOM Certified (#057)
- Meets NEMA WD-1 & 6, and ANSI standards
- Backed by a Limited 10-Year Warranty
- SPECCCLASS devices backed by a Limited 2-Year Warranty

*COLOR

Basic Cat. Nos. shown above denote Brown device, except for Isolated Ground (-IG) devices Basic Cat. No. denotes Orange. Isolated Ground Receptacle is distinguished by an orange triangle on its face. For other color selections, add suffix to the catalog number as follows: Ivory (-I), White (-W), Brown (For IG devices only, add -B), Almond (-A), Light Almond (-T), Gray (-G or -GY), Black (-E), Red (-R) and Blue (-BU; for IG devices only, add -BIG)

MATERIAL CHARACTERISTICS

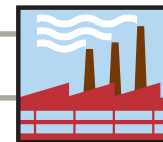

Environmental: Flammability, Rated V2
Operating Temperature: From -40° C (without impact) to 60°C maximum continuous



Industrial Grade Straight Blade Receptacles

Four-In-One 2-Pole 3-Wire Grounding

(Basic Cat. No. denotes Brown device, except Isolated Ground devices—Basic Cat. No. denotes Orange device)

DESCRIPTION	CAT. NO./COLOR* 15A-125V	CAT. NO./COLOR* 20A-125V
	5-15R 	5-20R 
Industrial Grade	1254 I, W, GY, R, E	21254 I, W, GY, R, E, Y
Hospital Grade	1254-H I, W, R	21254-H I, W, GY, R
Hospital Grade, Isolated Ground	1254-IG	21254-IG I, W
Industrial Grade, Surge Protective	5480 I, W, GY, R, BU (No Brown)	5490 I, W, GY, BU (No Brown)
Industrial Grade, Surge Protective/ Isolated Ground	5480-IG Orange only	5490-IG Orange, I, B
Hospital Grade, Surge Protective/ Isolated Ground	8480-IG I, W, B	8490-IG I, B
Hospital Grade, Surge Protective	8480 I, W, R (No Brown)	8490 I, W, R (No Brown)

For surge protective performance data, see page R14.

Four-In-One Adapter Plates

CAT. NO.	COLOR*
3254	I, W, GY, R, E, OR, BLU

Four-In-One Portable Boxes

CAT. NO.	COLOR*
4254	I, GY, E, OR, Y (No Brown)

Portable boxes are not UL Listed. UL Listing does not apply when Four-in-One Receptacles are used with portable boxes for extension cord applications.

Four-In-One Receptacle Wallbox Mounting

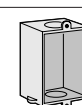
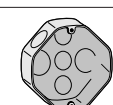
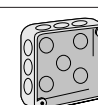
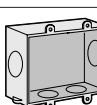
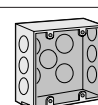
MOUNTS DIRECTLY			MOUNTS WITH ADAPTER PLATE	
				
Single-Gang	4" Octagonal	4" Square	2-Gang	4 1/16" Square

SPECIFICATIONS AND FEATURES

- Terminal wiring screws fit inside a standard single-gang wallbox; adapter plate not required (optional)
- Heavy-impact nylon cover and base for strength and resistance to chemicals and corrosives
- Smooth face; easy to clean surface
- Easy-to-read voltage and amperage rating molded onto face
- Heavy-duty, T-type triple-wipe bronze contacts for maximum performance
- Ground holes configured up or down to be outside the device, accommodating up to 4 Fed Spec size straight or angle plugs
- No. 8 terminal screws accept up to No. 12 solid or stranded copper wire
- Termination anchor holes for easy conductor wiring
- Deep cut mill-slotted screws resist slippage
- Exclusive shield-wall design protects ground connection from contact with live circuit conductors
- *"A" and "B" molded on face and back for easy identification of receptacle pairs for split-circuit conversion. (Note: Split circuit not available on surge models).
- Convenient built-in strip-gauge

TESTING AND CODE COMPLIANCE

- UL Listed 498 for Hospital Grade (UL File #13399); UL Federal Specification WC-596; UL Listed Adapter Plates (File #E-13397)
- CSA Certified where applicable (CSA File #152105); CSA Certified Adapter Plates (File #LR-16347)
- NOM Certified (#057)
- Complies with NEMA WD-1 & 6, and ANSI standards
- Backed by a Limited 10-Year Warranty

*COLOR

Basic Cat. Nos. denote Brown device, except for Isolated Ground (-IG) devices-Basic Cat. No. denotes Orange. Isolated Ground receptacle distinguished by orange triangle on its face. For other color selections, add suffix to the catalog number as follows: Ivory (-I), White (-W), Red (-R), Gray (-G or -GY), Black (-E), Orange (For adapter plates and portable boxes only, -OR), Blue (-BU, -BLU, -B) and Yellow (-Y).

MATERIAL CHARACTERISTICS

Environmental: Flammability, Rated V2
Operating Temperature: From -40° C (without impact) to 60° C maximum continuous

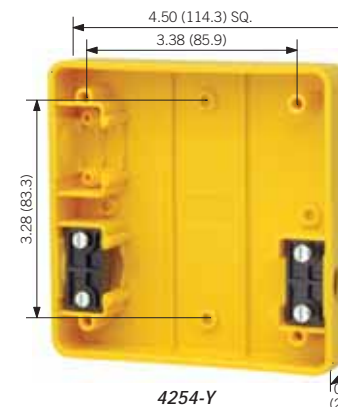
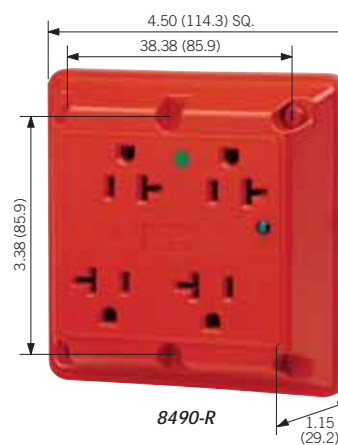
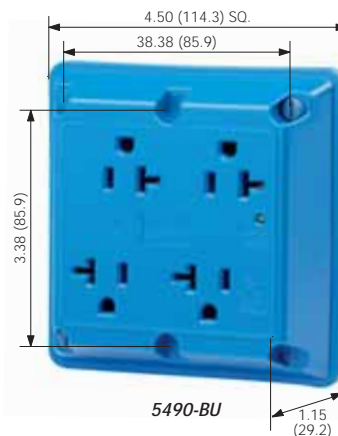

Straight Blade Receptacles

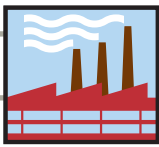

20 AMP 120/208V • 30 AMP 125V

Industrial Grade Straight Blade Receptacles

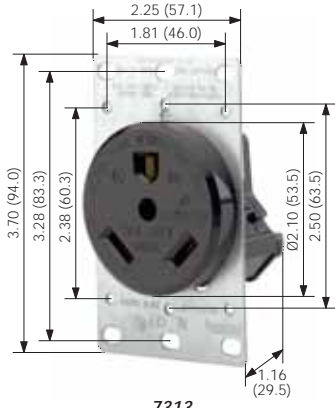

7313

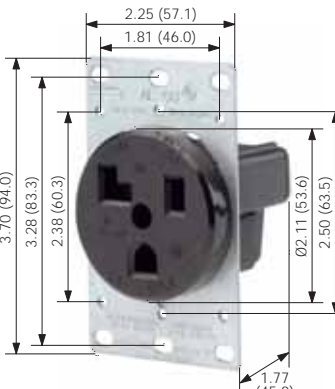

5371

Power Devices

20 AMP 120/208V 3ØY 4-Pole 4-Wire Non-Grounding

DESCRIPTION	CAT. NO.	WALLPLATE INFORMATION
Flush Mount Receptacle	7250-FR	Fits any standard single gang receptacle plate with 1.41" diameter center hole. See Section E for more information
	18-20R	
Matching Plug	7251-C	
	18-20P	

30 AMP 125V 2-Pole 3-Wire Grounding

DESCRIPTION	CAT. NO.	WALLPLATE INFORMATION
Flush Mount Receptacle	5371	Fits all wallplates with 2.15" diameter center hole. See Section E for more information
	5-30R	
Flush Mount Receptacle Isolated Ground	5371-IG	As above
Matching Angle Plug	9530-P	
	5-30P	

30 AMP 125V 2-Pole 3-Wire Grounding

DESCRIPTION	CAT. NO.
Flush Mount Receptacle for Recreational Vehicles	7313
	TT-30R
Matching Angle Plug	830-T
	TT-30P ANSI STD. C73.13

Wallplates

THERMOPLASTIC	430 STAINLESS STEEL		ALUMINUM	WEATHER-RESISTANT COVER
2.15" Dia. Opening	2.15" Dia. Opening		2.15" Dia. Opening	IP64 Rated
80728-E	80726-I	84028 84026	84004	83028

For complete wallplate selection, see Section E.

SPECIFICATIONS AND FEATURES

- Heavy-gauge, double-wipe copper alloy contacts
- Easy-to-wire terminals accept up to No. 4 AWG conductors
- Terminals marked for easy identification and fast wiring
- All mounting hardware included
- Flush-mount devices fit single or two-gang outlet boxes

TESTING AND CODE COMPLIANCE

- UL Listed for copper or aluminum conductors—except Cat. Nos. 7250, 7313, 830-T (File #E-13399); Angle Plugs (File #E-13393)

- UL Test 498
- CSA Certified for copper or aluminum conductors (File #152105); Receptacle for Recreational Vehicles (File #2781); CSA Test 42
- NOM Certified (#057)
- Meets NEMA and ANSI standards
- Backed by a Limited 10-Year Warranty

MATERIAL CHARACTERISTICS

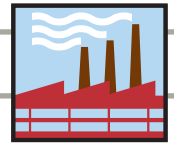

Environmental: Flammability, Rated V2
Operating Temperature: From -40° C (without impact) to 60°C maximum continuous



Industrial Grade Straight Blade Receptacles

Power Devices

30 AMP 250V 2-Pole 3-Wire Grounding

DESCRIPTION	CAT. NO.	WALLPLATE INFORMATION
Flush Mount Receptacle	5372	Fits all wallplates with 2.15" diameter center hole. See Section E for more information.
	6-30R 	
Flush Mount Receptacle Isolated Ground	5372-IG	As above
Surface Mount Receptacle	5376	
Matching Angle Plug	9630-P	
	6-30P 	

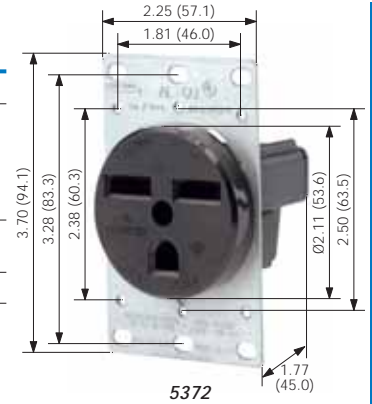



30 AMP 277V 2-Pole 3-Wire Grounding

DESCRIPTION	CAT. NO.	WALLPLATE INFORMATION
Flush Mount Receptacle	9730-A	Fits all wallplates with 2.15" diameter center hole. See Section E for more information.
	7-30R 	



30 AMP 125/250V 3-Pole 3-Wire Non-Grounding

DESCRIPTION	CAT. NO.	WALLPLATE INFORMATION
Flush Mount Receptacle	5207	Fits all wallplates with 2.15" diameter center hole. See Section E for more information.
	10-30R 	
Surface Mount Receptacle	5054	
Matching Angle Plug	9332-P	
	10-30P 	

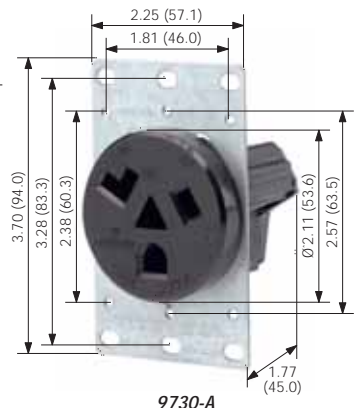

Wallplates

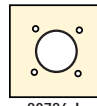
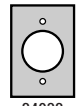
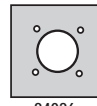
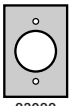
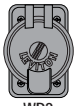
THERMOPLASTIC	430 STAINLESS STEEL	ALUMINUM	WEATHER-RESISTANT COVER
2.15" Dia. Opening	2.15" Dia. Opening	2.15" Dia. Opening	IP64 Rated
 80728-E	 80726-I	 84028	 84026
		 83028	 WP2

For complete wallplate selection, see Section E.

SPECIFICATIONS AND FEATURES

- Made of durable thermoplastic
- Heavy-gauge, double-wipe copper alloy contacts
- Easy-to-wire terminals accept up to No. 4 AWG conductors
- Terminals marked for easy identification and fast wiring
- All mounting hardware included
- Flush-mount devices fit single or two-gang outlet boxes
- Surface-mount devices are COMMERCIAL GRADE and have concentric knockouts for 3/4" and 1" conduit and adjustable cord clamp for back and bottom entrance of cable

TESTING AND CODE COMPLIANCE

- UL Listed for copper or aluminum conductors (File #E-13399); Angle Plugs (File #E-13393, File #E-3810)
- UL Test 498
- CSA Certified for copper or aluminum conductors (File #152105); CSA Test 42
- NOM Certified (#057)
- Meets NEMA and ANSI standards
- Backed by a Limited 10-Year Warranty

MATERIAL CHARACTERISTICS

Environmental: Flammability, Rated V2
Operating Temperature: From -40° C (without impact) to 75°C maximum continuous



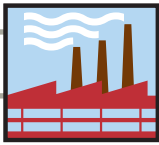

30 AMP 125/250V • 30 AMP 250V 3Ø • 30 AMP 120/208V 3ØY

Industrial Grade Straight Blade Receptacles

Straight Blade Receptacles

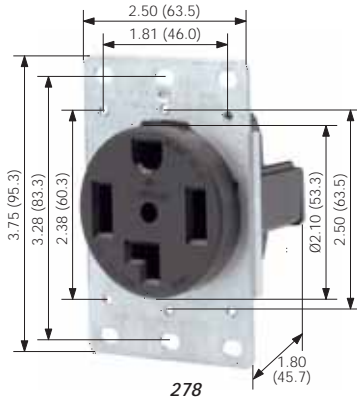

278



55054

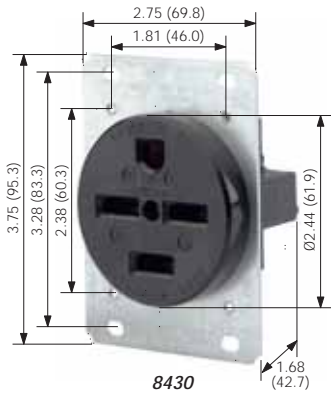

8430

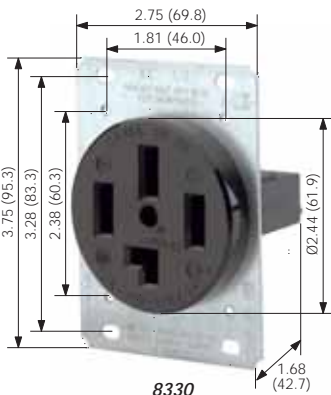

8330

Power Devices

30 AMP 125/250V 3-Pole 4-Wire Grounding

DESCRIPTION	CAT. NO.	WALLPLATE INFORMATION
Flush Mount Receptacle	278	Fits all wallplates with 2.15" diameter center hole, (shown on page G9). See Section E for more information.
	14-30R	
Panel Mount Receptacle	278-PM	Same dimensions as Cat. No. 279-PM (except for NEMA config.) shown on page G10.
Surface Mount Receptacles	55054	
Matching Angle Plug	9432-P	
	14-30R	

30 AMP 250V 3Ø 3-Pole 4-Wire Grounding

DESCRIPTION	CAT. NO.	WALLPLATE INFORMATION
Flush Mount Receptacle	8430	Fits 2-gang wallplates w/2.465" diameter center hole. See Section E for more information.
	15-30R	
Matching Angle Plug	8432-P	
	15-30P	

30 AMP 120/208V 3ØY 4-Pole 4-Wire Non-Grounding

DESCRIPTION	CAT. NO.	WALLPLATE INFORMATION
Flush Mount Receptacle	8330	Fits 2-gang wallplates w/2.465" diameter center hole. See Section E for more information.
	18-30R	
Matching Angle Plug	8332-P	
	18-30R	

Wallplates

302 STAINLESS STEEL	430 STAINLESS STEEL	STEEL-ALUMINUM FINISH
2.465" Dia. Opening	2.465" Dia. Opening	2.465" Dia. Opening
S701-40	S701	S701-GY

For Cat. No. 278, see recommended wallplates (with 2.15" Dia. Opening) on page G9
For complete wallplate selection, see Section E.

SPECIFICATIONS AND FEATURES

- Made of durable thermoplastic
- Heavy-gauge, double-wipe copper alloy contacts
- Easy-to-wire terminals accept up to No. 4 AWG conductors
- Terminal marked for easy identification and fast wiring
- All mounting hardware included
- Flush-mount devices fit single or two-gang outlet boxes
- Surface mount devices are COMMERCIAL GRADE and have concentric knockouts for 3/4" and 1" conduit and adjustable cord clamp and back and bottom entrance of cable

TESTING AND CODE COMPLIANCE

- UL Listed for copper or aluminum conductors (File #E-13399); Angle Plugs (File #E-13393, File #E-3810)
- UL Test 498
- CSA Certified for copper or aluminum conductors (File #152105); CSA Test 42
- NOM Certified (#057)
- Meets NEMA and ANSI standards
- Backed by a Limited 10-Year Warranty

MATERIAL CHARACTERISTICS

Environmental: Flammability, Rated V2
Operating Temperature: From -40° C (without impact) to 75°C maximum continuous



To learn more about Leviton's outstanding offering of devices visit our Website at: www.leviton.com

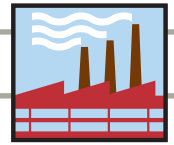

Industrial Grade Straight Blade Receptacles

Power Devices

50 AMP 125V 2-Pole 3-Wire Grounding

DESCRIPTION	CAT. NO.	WALLPLATE INFORMATION
Flush Mount Receptacle	5373	Fits all wallplates with 2.15" diameter center hole. See Section E for more information.
	5-50R	
Matching Angle Plug	9550-P	
	5-50P	

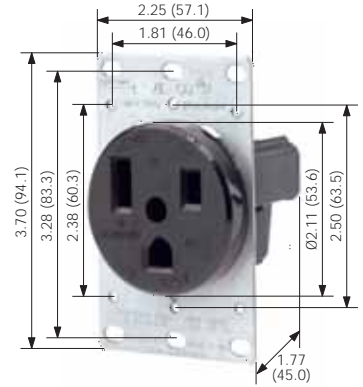

5373

50 AMP 250V 2-Pole 3-Wire Grounding

DESCRIPTION	CAT. NO.	WALLPLATE INFORMATION
Flush Mount Receptacle	5374	Fits all wallplates with 2.15" diameter center hole. See Section E for more information.
	6-50R	
Flush Mount Receptacle Isolated Ground	5374-IG	As above
Surface Mount Receptacle	5378	
Matching Angle Plug	9650-P	
	6-50P	



5378

50 AMP 277V 2-Pole 3-Wire Grounding

DESCRIPTION	CAT. NO.	WALLPLATE INFORMATION
Flush Mount Receptacle	9750-A	Fits all wallplates with 2.15" diameter center hole. See Section E for more information.
	7-50R	
Matching Angle Plug	9750-P	
	7-50P	

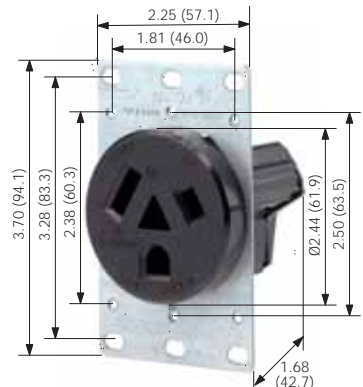

9750-A

Wallplates

THERMOPLASTIC	430 STAINLESS STEEL	ALUMINUM	WEATHER-RESISTANT COVER
2.15" Dia. Opening	2.15" Dia. Opening	2.15" Dia. Opening	IP64 Rated
80728-E	80726-I	84026	83028

For complete wallplate selection, see Section E.

- SPECIFICATIONS AND FEATURES**
- Made of durable thermoplastic
 - Heavy-gauge, double-wipe copper alloy contacts
 - Easy-to-wire terminals accept up to No. 4 AWG conductors
 - Terminal marked for easy identification and fast wiring
 - All mounting hardware included
 - Flush-mount devices fit single or two-gang outlet boxes
 - Surface-mount devices are COMMERCIAL GRADE and have concentric knockouts for 3/4" and 1" conduit and adjustable cord clamp and back and bottom entrance of cable

- TESTING AND CODE COMPLIANCE**
- UL Listed for copper or aluminum conductors (File #E-13399); Angle Plugs (File #E-13393, File #E-3810)
 - UL Test 498
 - CSA Certified for copper or aluminum conductors (File #152105); CSA Test 42
 - NOM Certified (#057)
 - Meets NEMA and ANSI standards
 - Backed by a Limited 10-Year Warranty

MATERIAL CHARACTERISTICS

Environmental: Flammability, Rated V2
 Operating Temperature: From -40° C (without impact) to 75° C maximum continuous

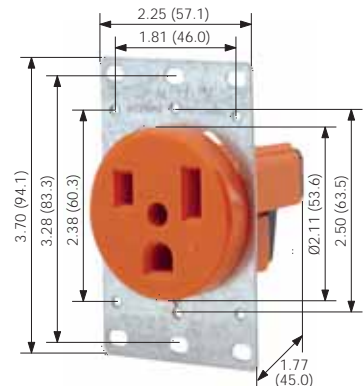

5374-IG

Straight Blade Receptacles

G



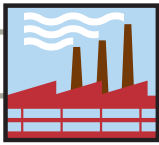

50 AMP 125/250 and 250V 3Ø

Industrial Grade Straight Blade Receptacles

Straight Blade Receptacles

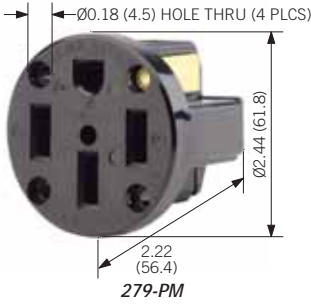

279-PM

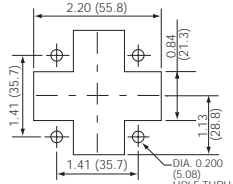

279-PM Recommended Panel Cutout

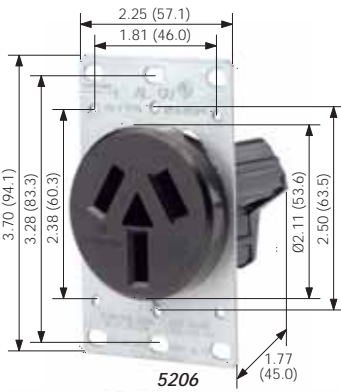

5206



55050

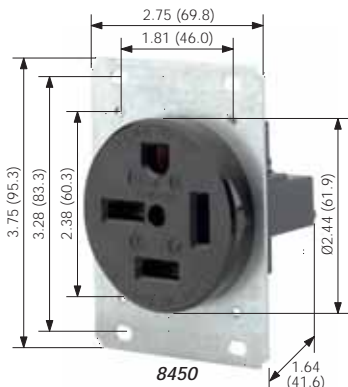

8450

Power Devices

50 AMP 125/250V 3-Pole 3-Wire Non-Grounding

DESCRIPTION	CAT. NO.	WALLPLATE INFORMATION
Flush Mount Receptacle	5206 10-50R	Fits all wallplates with 2.15" diameter center hole. See Section E for more information.
Surface Mount Receptacle	5050	
Matching Angle Plug	9450-P 10-50P	

50 AMP 125/250V 3-Pole 4-Wire Grounding

DESCRIPTION	CAT. NO.	WALLPLATE INFORMATION
Flush Mount Receptacle	279 14-50R	Same dimensions as Cat. No. 278 (except for NEMA config.) shown on page G8. Fits all wallplates with .215" diameter hole. See Section E for more information.
Panel Mount Receptacle	279-PM	Same dimensions (except for NEMA config.) and recommended panel cutout as Cat. No. 278-PM listed on page G8.
Surface Mount Receptacle	55050	
Matching Angle Plug	9452-P 14-50P	

50 AMP 250V 3Ø 3-Pole 4-Wire Grounding

DESCRIPTION	CAT. NO.	WALLPLATE INFORMATION
Flush Mount Receptacle	8450 15-50R	Fits wallplates with 2.465" diameter center hole. See Section E for more information.
Flush Mount Receptacle Isolated Ground	8450-IG	As above
Matching Angle Plug	8452-P 15-50P	

Wallplates

430 STAINLESS STEEL	302 STAINLESS STEEL	WEATHER-RESISTANT COVER
2.15" Dia. Opening—For use with 279 & 5206	2.465" Dia. Opening—For use with 8450-A	IP64 Rated
 84028	 84026	 WIP2
 84028	 S701-40	

For complete wallplate selection, see Section E.

SPECIFICATIONS AND FEATURES

- Made of durable thermoplastic
- Heavy-gauge, double-wipe copper alloy contacts
- Easy-to-wire terminals accept up to No. 4 AWG conductors
- Terminal marked for easy identification and fast wiring
- All mounting hardware included
- Flush-mount devices fit single or two-gang outlet boxes
- Surface-mount devices are COMMERCIAL GRADE and have concentric knockouts for 3/4" and 1" conduit and adjustable cord clamp and back and bottom entrance of cable

TESTING AND CODE COMPLIANCE

- UL Listed for copper or aluminum conductors (File #E-13399); Angle Plugs (File #E-13393, File #E-3810)
- UL Test 498
- CSA Certified for copper or aluminum conductors (File #152105); CSA Test 42
- NOM Certified (#057)
- Meets NEMA and ANSI standards
- Backed by a Limited 10-Year Warranty

MATERIAL CHARACTERISTICS

Environmental: Flammability, Rated V2
Operating Temperature: From -40° C (without impact) to 75° C maximum continuous



To learn more about Leviton's outstanding offering of devices visit our Website at: www.leviton.com

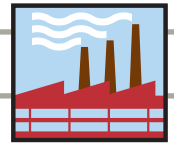

Industrial Grade Straight Blade Receptacles

Power Devices

50 AMP 120/208V 3ØY 4-Pole 4-Wire Non-Grounding

DESCRIPTION	CAT. NO.	WALLPLATE INFORMATION
Flush Mount Receptacle	8350 18-50R	Fits wallplates with 2.465" diameter center hole.
Matching Angle Plug	8352-P 18-50P	

60 AMP 125/250V 3-Pole 4-Wire Grounding

DESCRIPTION	CAT. NO.	WALLPLATE INFORMATION
Flush Mount Receptacle	9460 14-60R	Fits wallplates with 2.465" diameter hole.
Flush Mount Receptacle Isolated Ground	9460-IG	As above
Matching Angle Plug	9462-P 14-60P	



60 AMP 250V 3Ø 3-Pole 4-Wire Grounding

DESCRIPTION	CAT. NO.	WALLPLATE INFORMATION
Flush Mount Receptacle	8460 15-60R	Fits wallplates with 2.465" diameter hole.
Matching Angle Plug	8462-P 15-60P	

60 AMP 120/208V 3ØY 4-Pole 4-Wire Non-Grounding

DESCRIPTION	CAT. NO.	WALLPLATE INFORMATION
Flush Mount Receptacle	8360 18-60R	Fits wallplates with 2.465" diameter hole.
Matching Angle Plug	8362-P 18-60P	

Wallplates

302 STAINLESS STEEL	430 STAINLESS STEEL	STEEL-ALUMINUM FINISH
2.465" Dia. Opening	2.465" Dia. Opening	2.465" Dia. Opening
 S701-40	 S701	 S701-GY

For complete wallplate selection, see Section E.

SPECIFICATIONS AND FEATURES

- Made of durable thermoplastic
- Heavy-gauge, double-wipe copper alloy contacts
- Easy-to-wire terminals accept up to No. 4 AWG conductors
- Terminal marked for easy identification and fast wiring
- All mounting hardware included
- Flush-mount devices fit single or two-gang outlet boxes

TESTING AND CODE COMPLIANCE

- UL Listed for copper or aluminum conductors (File #E-13399); Angle Plugs (File #E-13393, File #E-3810)
- UL Test 498
- CSA Certified for copper or aluminum conductors (File #152105); CSA Test 42
- NOM Certified (#057)
- Meets NEMA and ANSI standards
- Backed by a Limited 10-Year Warranty

MATERIAL CHARACTERISTICS

Environmental: Flammability, Rated V2
Operating Temperature: From -40° C (without impact) to 75°C maximum continuous

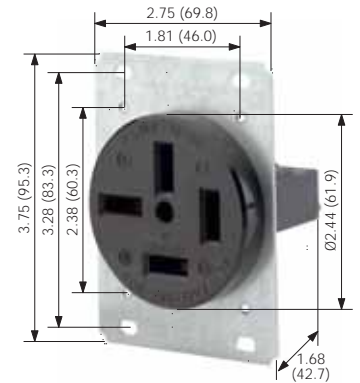

8350

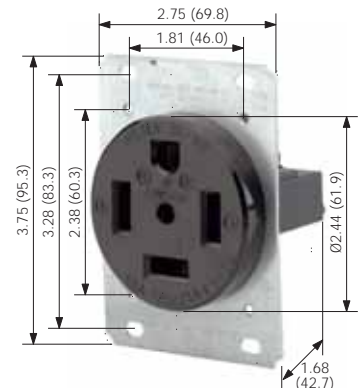

9460

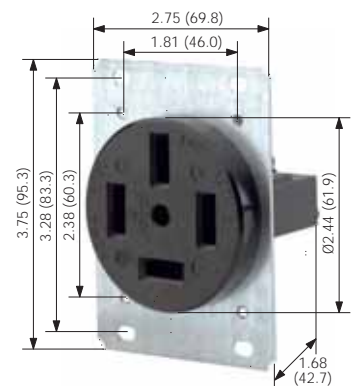

8360

Straight Blade Receptacles



STRAIGHT BLADE RECEPTACLE FEATURES

Commercial Grade Straight Blade Receptacles

LEVITON OFFERS A LARGE SELECTION OF 15 AND 20 AMP COMMERCIAL GRADE RECEPTACLES, AVAILABLE IN A WIDE VARIETY OF COLORS, WIRING OPTIONS AND OTHER FEATURES.



Back & Side Wired
Constructed of high impact resistant thermoplastic, power contacts are triple wipe for good conductivity.
BR15-W shown



Side Wired
Available with back and side-wired options, it can operate at either 125 or 250V volts.
CR15-W shown



Dual Voltage
Smooth face, self-grounding clip, easily accessible break-off tabs for split-circuit wiring.
5844 shown



Brass Floor Box Assembly
Complete with brass plate, receptacle, brass screw-in cap and O-ring.
5249-FBA shown

Leviton's Commercial Receptacles are manufactured to withstand the demands of commercial and institutional applications. These commercial receptacles provide long-lasting service life and are a cost-saving alternative to the industrial devices.

Features and Benefits

- Cost-efficient alternative to industrial receptacles
- Manufactured to withstand the demands of commercial and institutional applications
- Power contacts available in triple and double wipe for maximum conductivity and plug retention
- Shallow design for maximum wiring room in box
- UL Listed 498 (UL File #E-13399)
- CSA Certified where applicable (CSA File #LR-406)
- NOM Certified (#057)
- Meets NEMA WD-1 & 6, and ANSI standards
- Backed by a Limited 10-Year Warranty
- All commercial side-wired receptacles have #8-32 triple combination head terminal screws
- All commercial back and side-wired receptacles have #10-32 triple combination head terminal screws

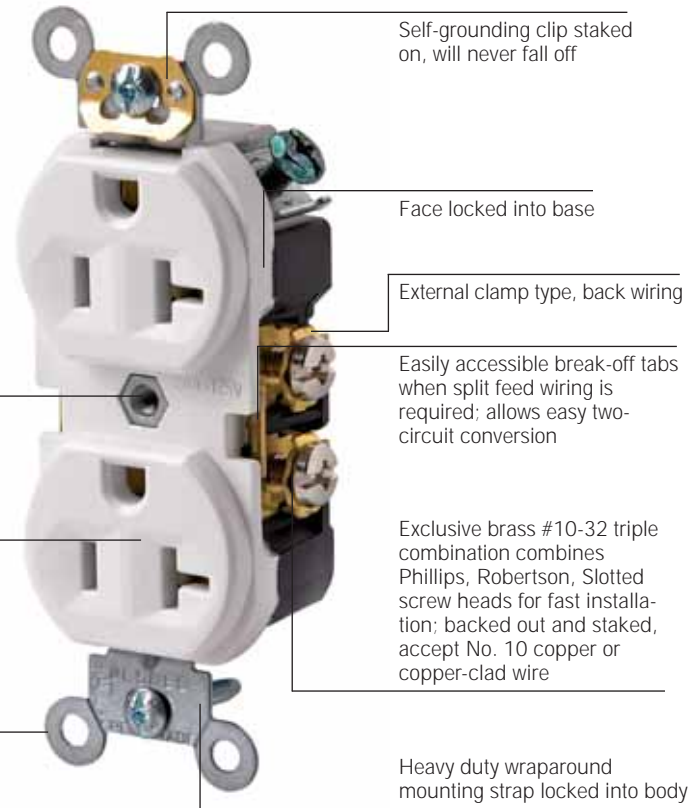

BR20 shown





- Back-wiring clamps accept up to No. 10 solid or stranded copper wire
- Exclusive V-shaped, serrated back-wiring clamps for superior contact and conductivity

15 AMP 125 and 250V • 20 AMP 125 and 250V Commercial Grade Straight Blade Receptacles





Back and Side Wired 15 AMP 125V & 250V 20 AMP 125V & 250V Grounding

(Basic Cat. No. Denotes Brown Device*)



DESCRIPTION	CAT. NO./COLOR 15A/125V	CAT. NO./COLOR 15A/250V	CAT. NO./COLOR 20A/125V	CAT. NO./COLOR 20A/250V
	5-15R 	6-15R 	5-20R 	6-20R 
Duplex Receptacle	BR15 I, W, GY, E, A, T		BR20 I, W, GY, E, A, T	5824 I
Single Receptacle	5088 I, A	5089 I (No Brown)	5891 W	5823 I

Dual Voltage Back and Side Wired 20 AMP 125V & 20 AMP 250V Grounding



(Basic Cat. No. Denotes Brown Device*)

DESCRIPTION	CAT. NO. 20A/125V	CAT. NO. 20A/250V	COLOR* Basic Cat. No. Denotes Brown
	5-20R 	6-20R 	
Duplex Receptacle, Dual Voltage	5844	5844	I







Dual Voltage Side Wired 15 AMP 125V & 15 AMP 250V Grounding

DESCRIPTION	CAT. NO. 15A/125V	CAT. NO. 15A/250V	COLOR* Basic Cat. No. Denotes Brown
	5-15R 	6-15R 	
Duplex, Grounding, Dual Voltage (Triple Wipe)	5031	5031	I, W

Dual Voltage Side Wired 20 AMP 125V & 20 AMP 250V Grounding

DESCRIPTION	CAT. NO. 20A/125V	CAT. NO. 20A/250V	COLOR* Basic Cat. No. Denotes Brown
	5-20R 	6-20R 	
Duplex Receptacle, Dual Voltage (Triple Wipe)	5842	5842	I

Wallplates

THERMOPLASTIC			302 STAINLESS STEEL		
					
80703-I	80704-W	80716-I	84003-40	84004-40	84016-40

For complete wallplate selection, see Section E.

SPECIFICATIONS AND FEATURES

- Large-head, triple-drive terminal screws, backed out and staked, accept No. 10 copper or copper-clad wire
- Back-wiring clamps accept up to No. 10 copper or copper-clad wire
- All power contacts are triple wipe for maximum conductivity and plug retention
- Heavy-gauge, rust-resistant steel mounting strap
- Shallow design for maximum wiring room in box
- Convenient washer-type break-off plaster ears for best flush alignment
- Captive mounting screws for fast installation
- Break-off tabs on duplex receptacles for easy two-circuit conversion

TESTING AND CODE COMPLIANCE

- UL Listed 498
- CSA Certified where applicable (File #LR-406)
- NOM Certified (#057)
- Meets or exceeds NEMA WD-1, & 6, and ANSI standards
- Backed by a Limited 10-Year Warranty

*COLOR

Basic Cat. Nos. shown above denote Brown color. For other color selections, add the suffix to catalog number as follows: Ivory (-I), White (-W), Black (-E), Almond (-A), Light Almond (-T), Gray (-GY).

MATERIAL CHARACTERISTICS

Environmental: Flammability, Rated V2
Operating Temperature: From -40° C (without impact) to 60° C maximum continuous

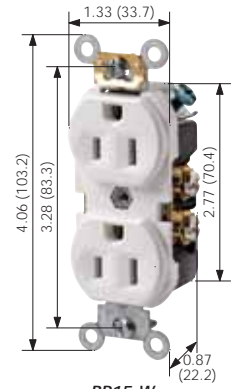

BR15-W

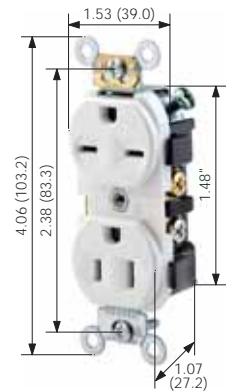

5031-W

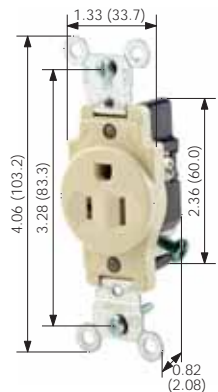

5088-I

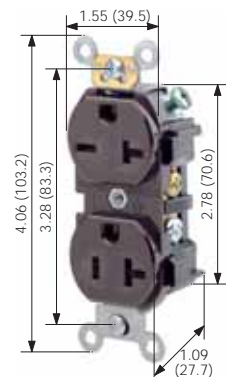

5844

Straight Blade Receptacles



15 AMP 125 and 250V • 20 AMP 125 and 250V

Commercial Grade Straight Blade Receptacles

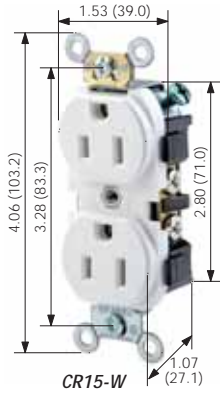

CR15-W

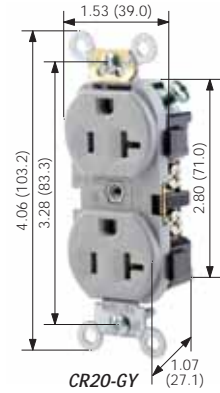

CR20-GY

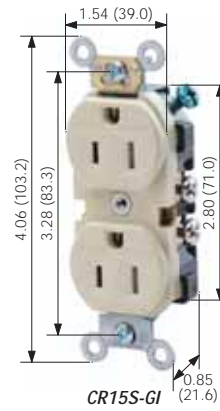

CR15S-GI

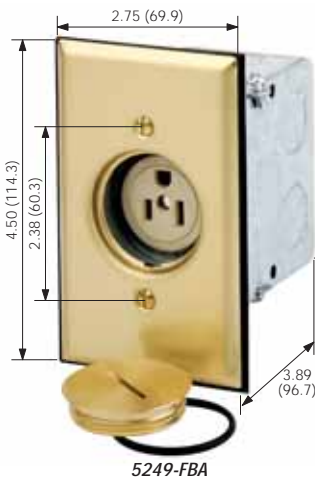

5249-FBA

Side Wired 15 AMP 125 and 250V 20 AMP 125 and 250V

(Basic Cat. No. Denotes Brown Device*)

DESCRIPTION	CAT. NO./COLOR 15A/125V	CAT. NO./COLOR 15A/250V	CAT. NO./COLOR 20A/125V	CAT. NO./COLOR 20A/250V
	5-15R	6-15R	5-20R	6-20R
Duplex Receptacle	CR15 I, W, A, T, GY, E	5028* I	CR20 I, W, A, T, GY, E	5822* I, W
Duplex Receptacle, Smooth Face	CR15 I, W, GY	—	CR20 I, W, GY	—
Duplex Receptacle, on 4" Cover★	5042 Zinc plated steel	—	—	—
Single Receptacle	5015 I, W, A, T	5029 I	5801 I, W, A, T	5821 I, W, A, T
Single Receptacle on 4" Cover	5059 Zinc plated steel	—	—	—
Duplex Receptacle with Pigtail Leads★	5040 I, W (No Brown)	—	5340 I, W, GY, A	—
Single Receptacle, Short Strap, 8-32 Tapped Mounting Holes on 1 3/4" Centers	5258-SS E Only	5658-SS E Only	—	5458-SS E Only
Tamper Resistant Duplex Receptacle	CR15S-G I, W, T (No Brown)	—	—	—
Single Display Receptacle w/Solid Brass Plate.	5250 Brass	—	—	—
Single Brass Floorbox Assembly.	5249-FBA Brass	—	5349-FBA Brass	—
Duplex Brass Floorbox Assembly	25249-FBA Brass	—	25349-FBA Brass	—
Duplex Nickel-Plated Floorbox Assembly	25249-SBA	—	—	—

Floorbox Replacement Screw Cap with O-Ring—Single, Brass—5249-CAP; Duplex, Brass—25249-CAP

CSA Certified except where indicated by ★

Wallplates

THERMOPLASTIC			302 STAINLESS STEEL		
80703-I	80704-W	80716-I	84003-40	84004-40	84016-40

For complete wallplate selection, see Section E.

SPECIFICATIONS AND FEATURES

Side Wired Duplex Receptacles

- Large-head terminal screws, backed out and staked, accept No. 10 copper or copper-clad wire
- All power contacts are triple wipe for maximum conductivity and plug retention — except CR series
- Heavy-gauge, rust-resistant steel mounting strap
- Shallow design for maximum wiring room in box
- Convenient washer-type break-off plaster ears for best flush alignment
- Captive mounting screws for fast installation where applicable

Brass Floorbox Assembly

- Complies with NEC 370-27(b)
- All-in-one, ready-to-wire unit provides quick, easy installation
- Plate gasket and O-ring combine to seal out moisture and contaminants
- Thick brass plate and screw cap resist abuse and prevent contaminant from entering device
- Durable nylon receptacle face and body resist breakage
- Brass screw cap threaded to fit flush to plate
- Green grounding screw

TESTING AND CODE COMPLIANCE

- UL Listed 498 (File #E-13399)
- CSA Certified where applicable (File #LR-406)
- NOM Certified (#057)
- Meets or exceeds NEMA WD-1, and -6, and ANSI standards
- Backed by a Limited 10-Year Warranty

*COLOR

Basic Cat. Nos. shown above denote Brown color device. For other color selections, add suffix to the catalog number as follows: Ivory (-I), White (-W), Almond (-A), Light Almond (-T), Gray (-GY) and Black (-E).

MATERIAL CHARACTERISTICS

Environmental: Flammability, Rated V2
Operating Temperature: From -40° C (without impact) to 60°C maximum continuous

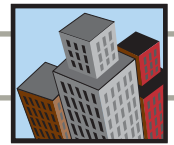

Commercial Grade QuickPort® Jacks w/Brass Floorplate • Straight Blade Receptacles

QuickPort® Snap-In Jacks and Modules with Brass Floorplate

DESCRIPTION	CAT. NO.	COLOR*
Floor Jack Housing with Brass Plate and 6-Conductor Jack	41650-6	Brass
Floor Jack Housing with Brass Plate and Coaxial F-Connector	41650-F	Brass
Duplex Floor Jack Housing with Brass Plate and Two 6-Conductor Jacks	41652-6	Brass
Duplex Floor Jack Housing with Brass Plate, 6-Conductor Jack and Coaxial F-Connector	41652-6F	Brass
Duplex Floor Jack Housing only; 1 Blank Filler Provided	41652-000	Brass

Back and Side Wired 15 AMP 277V AC Grounding

DESCRIPTION	CAT. NO.	COLOR*
Duplex Receptacle (Double Wipe)	5585	Brown Only



Side Wired 20 AMP 125/250V Non-Grounding

DESCRIPTION	CAT. NO.	COLOR*
Single Receptacle (Double Wipe) (9151-N matching plug on page M4)	5032	I

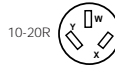

SPECIFICATIONS AND FEATURES

Receptacles

- Terminal screws, backed out and staked, accept No. 10 copper or copper-clad wire
- Power contacts are double wipe for maximum conductivity and plug retention
- Heavy gauge, rust-resistant steel mounting strap
- Shallow design for maximum wiring room in box
- Convenient washer-type break-off plaster ears for best flush alignment
- Captive mounting screws for fast installation

TESTING AND CODE COMPLIANCE

- UL Listed 498
- CSA Certified where applicable (File #LR-406)
- NOM Certified (#057)
- Meets or exceeds NEMA WD-1 and -6, and ANSI standards
- Backed by a Limited 10-Year Warranty

*COLOR

Basic Cat. Nos. shown above denote Brown color. For other color selections, add the suffix to catalog number as follows: Ivory (-I).

MATERIAL CHARACTERISTICS

Environmental: Flammability, Rated V2
Operating Temperature: From -40° C (without impact) to 60° C maximum continuous



41650-F



41652-6F

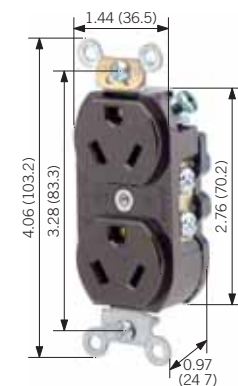

5585

Straight Blade Receptacles



15 AMP 125V • 15 AMP 125V CO/ALR

Residential Grade Straight Blade Receptacles

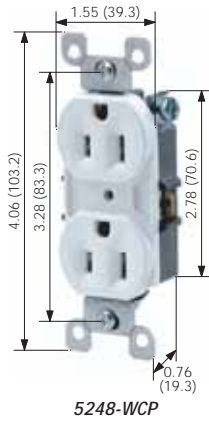

5248-WCP

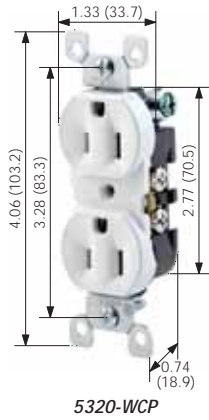

5320-WCP

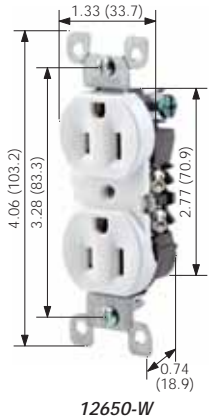

12650-W

8-Hole Quickwire Push-In 15 AMP 125V Grounding

DESCRIPTION	CAT. NO.	COLOR* <small>Basic Cat. No. Denotes Brown</small>
Duplex Receptacle, CONTRACTOR PACK (10 BULK)	5248-CP	I, W
	5-15R	
Duplex Receptacle, Less Plaster Ears (200 BULK)	5248-4	I, W

Quickwire Push-In and Side Wired 15 AMP 125V Grounding

DESCRIPTION	CAT. NO.	COLOR* <small>Basic Cat. No. Denotes Brown</small>
Duplex Receptacle, All Screws Backed Out, CONTRACTOR PACK (10 BULK)	5320-CP	I, W, A, T
	5-15R	
Duplex Receptacle, Self-Grounding	5320-S	I, W, A, T
Duplex Receptacle, Less Plaster Ears★, All Screws Backed Out	5320-4	I, W

Side Wired 15 AMP 125V Grounding

DESCRIPTION	CAT. NO.	COLOR* <small>Basic Cat. No. Denotes Brown</small>
Duplex Receptacle, on 4" Cover	1228	Brown Only
	5-15R	

CONTRACTOR PACK is a box of 10 bulk-packed devices (no individual packaging) for speedy on-the-job installation.

Side Wired CO/ALR 15 AMP 125V Grounding

DESCRIPTION	CAT. NO.	COLOR* <small>No Brown</small>
Duplex Receptacle, UL Listed for direct connection to No. 12 or No. 10 aluminum conductors	12650	I, W
	5-15R	



CSA Certified except where indicated by ★

Wallplates

THERMOSET		THERMOPLASTIC		302 STAINLESS STEEL	
85003	86016	80703-I	80716-I	84003-40	84016-40

For complete wallplate selection, see Section E.

SPECIFICATIONS AND FEATURES

- Terminal screws accept up to No. 12 copper or copper-clad wire
- Quickwire push-in terminals accept No. 14 solid copper wire only
- Double-wipe power contacts for maximum conductivity and plug retention
- Thermoplastic construction
- Heavy-gauge, rust-resistant steel mounting strap
- Shallow design for maximum wiring room
- Break-off plaster ears for best flush alignment
- Captive mounting screws
- Break-off tabs allow easy two-circuit conversion

TESTING AND CODE COMPLIANCE

- UL Listed 498
- CSA Certified where applicable (File #LR-406)
- NOM Certified (#057)
- Meets or exceeds NEMA standards
- Backed by a Limited Two Year Warranty
- CO/ALR UL Listed 1561

*COLOR

Basic Cat. Nos. shown above denote Brown color. For other color selections, add the suffix to catalog number as follows: Ivory (-I), White (-W), Almond (-A), Light Almond (-T).

MATERIAL CHARACTERISTICS

Environmental: Flammability, Rated V2
Operating Temperature: From -40° C (without impact) to 60° C maximum continuous



Residential Grade Straight Blade Receptacles

Side Wired 15 AMP/125V Non-Grounding

DESCRIPTION	CAT. NO.	COLOR*
Duplex Receptacle, ★ Plaster Ears	223	I, W <i>Basic Cat. No. Denotes Brown</i>
	1-15R	
Duplex Receptacle ★ T-SLOT, Not UL Listed; for replacement use only	5000	I <i>(No Brown)</i>

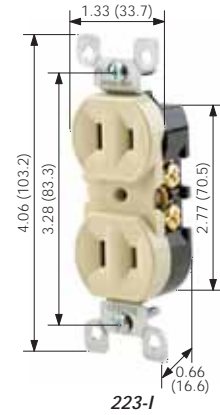

Snap-In Devices 15 AMP/125V

DESCRIPTION	CAT. NO.	PANEL THICKNESS (inches)	PANEL OPENING (inches)	COLOR*
2-Wire Polarized Outlet. Leads No. 14 AWG, 105°C Plastic, 6" Long, Stripped 1/2"	1306	.028 -.060	.97 x .52	E, W
	1-15R			
2-Wire Polarized Outlet. Back Strap Mounting, Leads No. 14 AWG, 105°C Plastic, 6" Long, Stripped 1/2"	306	.015 -.093	.97 x .52	E, W
	1-15R			
3-Wire Grounding Outlet. Leads No. 14 AWG, 105°C Plastic, 6" Long, Stripped 1/2". Grounding Wire No. 16 AWG	1374	.031 -.080*	.95 x .95	E, W
	5-15R			
3-Wire Grounding Power Plug. Leads No. 14 AWG, 105°C Plastic, 6" Long, Stripped 1/2". Grounding Wire No. 16 AWG	1373	.031 -.080	.95 x .95	E
	5-15P			

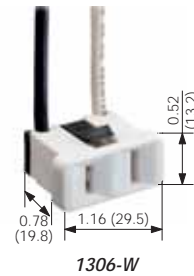

*Other panel thicknesses available.

Side Wired Clock Hanger 15 AMP/125V Grounding

DESCRIPTION	CAT. NO.	COLOR*
Flush Mount with Square Recess	688	I, W <i>No Brown</i>
	5-15R	

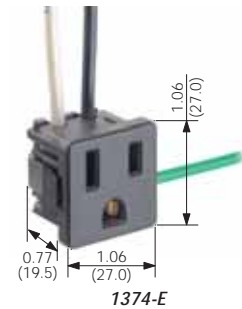

CSA Certified except where indicated by ★

SPECIFICATIONS AND FEATURES

223-I & 5000

- Terminal screws accept up to No. 12 copper or copper-clad wire for side wiring
- Double-wipe power contacts for maximum conductivity and plug retention
- Heavy-gauge, rust-resistant steel mounting strap
- Shallow design for maximum wiring room
- Break-off plaster ears for best flush alignment
- Captive mounting screws
- Break-off tabs allow easy two-circuit conversion

Snap-In Devices

- All 1306 product come with dual exiting capabilities
- Snap-in devices with other mounting clips and terminations available upon request

TESTING AND CODE COMPLIANCE

- UL Listed 498
- CSA Certified where applicable (File #LR-406)
- NOM Certified (#057)
- Meets or exceeds NEMA standards
- Backed by a Limited Two-Year Warranty

*COLOR

Basic Cat. Nos. shown above denote Brown color. For other color selections, add the suffix to catalog number as follows: Ivory (-I), White (-W), Black (-E).

MATERIAL CHARACTERISTICS

Environmental: Flammability, Rated V2
Operating Temperature: From -40° C (without impact) to 60°C maximum continuous

Snap-In Devices

Environmental: Flammability, Rated V2
Operating Temperature: From -40° C (without impact) to 65°C maximum continuous



Straight Blade Receptacles

HOW TO USE THIS CATALOG

The L-101 Leviton Wiring Device Catalog is designed to help you find the device you're seeking in the quickest and easiest way possible. Most product sections are divided into three distinct categories in the following sequence—Industrial Grade, Commercial Grade and Residential Grade—and grouped according to amperage and voltage, lowest to highest. For example, if you need to order 15 Amp, 125 Volt Industrial Grade straight-blade duplex receptacles, begin your search with the main Table of Contents at the front of the book. Here you'll see that all straight blade receptacles are listed in Section G. Turn to Section G for a more detailed Table of Contents on the first page. Each section page contains product descriptions, ratings and catalog numbers. There are also helpful highlights including Specifications and Features, Testing and Code Compliance, Color listing, Material Characteristics and dimensioned color product photos. Any product page in the L-101 Catalog can be clearly copied or faxed to customers and prospects for use as a specifier sheet or as part of a presentation.

The Quick Reference Guide follows the main Table of Contents to help you pinpoint and locate specific products. Technical Section V provides general product and test data, industry standards, NEMA configuration charts, a glossary of wiring device terms, ANSI architectural symbols and other related information. Specific catalog numbers are listed in the exhaustive index at the back of the catalog.

15 AMP 125 and 250V • 20 AMP 125 and 250V

Industrial Grade Straight Blade Receptacles

5362-IG

DESCRIPTION	CAT. NO./COLOR 15A/125V	CAT. NO./COLOR 15A/250V	CAT. NO./COLOR 20A/125V	CAT. NO./COLOR 20A/250V
LEVSPEC® Duplex Receptacle, Brass Strap	5262 I, W, GY, R, E	5662 I	5362 I, W, GY, R, E	5462 I, GY
Single Receptacle	5261 I, W, GY	5661 I	5361 I, W, A, T, GY	5461 I, A, T, GY
Narrow Body Duplex Receptacle	5252 I, W, A, T, GY, R, BU		5352 I, W, A, T, GY, R,	

80703-IG 80703-I 80704-GY 80716-R

84003-40 84004-40 84016-40

For complete wallplate selection, see Section E.

SPECIFICATIONS AND FEATURES

Back & Side Wired Duplex

- Impact-resistant thermoplastic nylon cover and body
- Smooth face does not collect dirt
- Four corner latches securely fasten face
- Single-piece brass mounting strap on LEVSPEC devices, multi-piece steel strap on other devices
- Large, triple-wipe, brass "T" contacts for superior contact and conductivity
- Back and side-wiring options
- Brass terminal screws to reduce conductor oxidation
- Break-off tabs for easy two-circuit conversion
- Apron barrier to prevent accidental contact between terminal screw heads and metal box
- Exclusive V-shaped, serrated back-wiring clamp for superior contact and conductivity

TESTING AND CODE COMPLIANCE

- UL Listed 498 (UL File #13399); UL Federal Specification WC-596

- Meets NEMA WD-1 & 6, and ANSI standards
- Backed by a Limited 10-Year Warranty
- SPECCLASS devices backed by a Limited 2-Year Warranty

***COLOR**

Basic Cat. Nos. shown above denote Brown device, except for Isolated Ground (-IG) devices Basic Cat. No. denotes Orange. Isolated Ground Receptacle is distinguished by an orange triangle on its face. For other color selections, add suffix to the catalog number as follows: Ivory (-I), White (-W), Brown (For IG devices only, add -A), Almond (-A), Light Almond (-T), Gray (-G or -GY), Black (-E), Red (-R) and Blue (-BU); for IG devices only, add -BIG)

MATERIAL CHARACTERISTICS

Environmental: Flammability, Rated V2
Operating Temperature: From -40° C (without impact) to 60°C maximum continuous

- | | | |
|---------------------------------------|--|--------------------------------------|
| A RATING | E CATALOG NUMBER | I SPECIFICATIONS & FEATURES |
| B Choose GRADE, if appropriate | F DESCRIPTION | J TESTING AND CODE COMPLIANCE |
| C DIMENSIONED PHOTOGRAPH | G Check for NEMA CONFIGURATION | K COLOR LISTING |
| D WIRING/CERTIFICATIONS | H WALLPLATE REFERENCE, if appropriate | L MATERIAL CHARACTERISTICS |

GFCI Personnel Protection Devices

INDEX

GFCI Personnel Protection Devices	
SmartLockPro® GFCI Devices	H2-H4
Overview	H2-H3
Hospital Grade Receptacles	H4
Commercial Grade Receptacles	H4
Switch-Rated Blank Face	H4
Combination Switch/GFCI Outlet	H4
High-Current	H5
Right-Angle GFCI Plug	H5
Shallow Wallbox Extender for GFCI	H5
GFCI Cordsets and Extension Cords	H6
GFCI Accessories	H7
Flush Cover Wallplates	H7
Raintight While-In-Use Covers	H7
Temporary Portable Power Distribution Center/GFCI (The Box)	H7
Power Cords for The Box	H7





SMARTLOCKPRO® GFCI PERSONNEL PROTECTION DEVICE FEATURES

Commercial Grade GFCI Personnel Protection Devices

LEVITON IS THE LEADING DESIGNER AND MANUFACTURER OF GROUND FAULT CIRCUIT INTERRUPTERS (GFCIs) IN THE ELECTRICAL INDUSTRY. FOR MORE THAN A QUARTER OF A CENTURY, LEVITON HAS DEVELOPED — AND CONTINUES TO DEVELOP — GFCI RECEPTACLES AND OTHER PRODUCTS TO HELP REDUCE THE HAZARD OF SERIOUS ELECTRICAL SHOCK.

The National Electric Code requires GFCI protection in specific locations within residential, commercial and industrial installations. New and revised GFCI applications appear with each new edition of the code. Leviton offers the largest and most diverse line of high quality, reliable devices to meet the demand for ground fault protection. Following is a complete listing of Leviton's GFCI product line.



SmartLockPRO® GFCI with Professional Grade Lockout Action

Meets or exceeds Underwriters Laboratories (UL) 2006 UL943 GFCI Safety Standards

- Patented professional grade lockout action as end-of-life indication
- Prevents power from being connected to face and feed-through terminals when miswired (Line-load reversal)
- Improved immunity to electrical noise to reduce false tripping
- Advanced electronics provide superior surge immunity
- Trip threshold meets or exceeds UL requirements for tripping time

THE SMARTLOCKPRO® PROTECTION ADVANTAGE

While other GFCI manufacturers may have taken the alternate route in the 2006 UL Standard by providing an indicator light for end-of-life indication, allowing reset and continued use of a GFCI with unprotected power to the GFCI face and downstream receptacles, the SmartLockPRO's reset button will not engage if protection has been compromised. The SmartLockPRO's unique patented professional grade end-of-life lock-out action, reduces the possibility of end-users incorrectly assuming that a reset GFCI outlet is providing ground fault protection when it actually is not

Ideal for a Wide Range of GFCI Applications

- Residential – Kitchens, bathrooms, garages, basements and other wet locations
- Outdoors – Outdoor receptacles by pools, cabanas, patios, decks and lanais
- Hospital and Healthcare Facilities – Scrub rooms, lavatories kitchenettes and other potentially wet locations
- Airports – Bathrooms, general use areas and maintenance areas
- Educational Facilities – Classrooms, restrooms, laboratories, dormitories and kitchens
- Restaurants, Lodging and Retail Malls – Bathrooms, general use areas and maintenance areas
- Commercial offices – Bathrooms, basement areas, hallways and kitchens
- Public Areas – Near wet and damp locations



Professional Grade Protection

SPECIFICATIONS AND FEATURES

- Meets or exceeds UL 2006 Requirements
 - TEST and RESET functions work together so that a tripped GFCI cannot be reset if GFCI circuit no longer provides ground fault protection
 - RESET button is blocked if GFCI protection has been compromised, providing a true "dead-face" design that ensures no power at GFCI receptacle face or downstream-fed receptacles
 - Line-load diagnostic feature prevents GFCI from being reset and stops power from being fed to the GFCI receptacle face or through to downstream devices. This alerts installer to a line-load reversal. Indicator light will be ON to indicate line/load reversal.
 - The SmartLockPRO GFCI with lockout action is designed and patented by Leviton
 - Trip threshold meets or exceeds UL requirements for tripping time
 - Impact-resistant thermoplastic cover and body
 - Silver-alloy contacts
 - Compatible with all Decora devices: available in selected Decora colors
- Combination Switch/SmartLockPRO® GFCI Outlet**
- Ideal for kitchens, bathrooms, modular kitchen units, bathroom cabinet fixtures, lamp cabinet fixtures and applications where combination devices are used.

TESTING AND CODE COMPLIANCE

- UL Standard 943 Class A (GFCI) and 498 (Receptacles)
- UL Listed (File # 48380)
- CSA (#LR-57811)
- NOM Certified (#057)
- Backed by a Limited Two-Year Warranty

COLOR

Basic Cat. Nos. denote Brown color unless indicated. For other color selections, add suffix to catalog number as follows: Ivory (-I), White (-W), Almond (-A), Light Almond (-T), Gray (-G or GY), Red (-R), Black (-E).

MATERIAL CHARACTERISTICS

Flammability: Rated V2

Operating Temperature: -30°F (-35°C) to 151°F (66°C)



SMARTLOCKPRO® GFCI PERSONNEL PROTECTION DEVICE FEATURES

Commercial Grade GFCI Personnel Protection Devices



UL Standard 943 Class A (GFCI) & 498 (Receptacles)
CSA Certified (File #057)
Meets July 28, 2006 UL Requirements



Thick-walled, impact-resistant thermoplastic nylon cover and body withstands abuse

"Surge hardened" electronics offer superior resistance to surges and overvoltages.

Silver alloy contacts for reliable make/break switching.

Triple drive combination terminal screws.



Eight back-wire holes (two per terminal) and back-wire ground.

Provisions for back- or side-wiring.

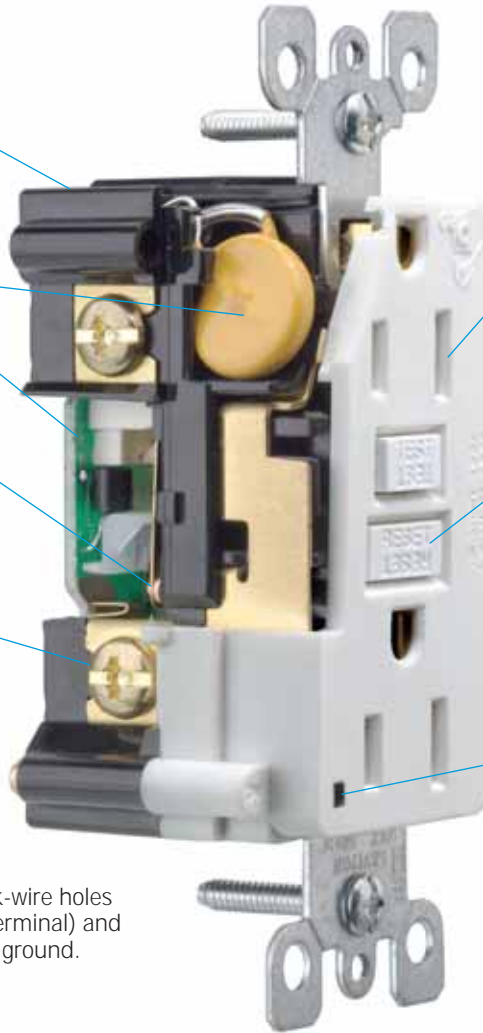

7599-W

Heavy duty double wipe for 15 Amp contacts and triple wipe for 20 Amp contacts

Patented lockout feature prevents "RESET" if GFCI is not functioning properly or miswired due to reversal of line and load leads.

Dual function LED offers indication of line/load reversal & power availability.



Leviton SmartLockPRO® icon ensures improved GFCI product design.



Lockout action blocks the "RESET" button if GFCI protection has been compromised.



Dual function LED offers indication of line/load reversal & power availability.

GFCI Personnel Protection Devices



15 AMP 125V • 20 AMP 125V

Commercial Grade GFCI Personnel Protection Devices



7599-HGI

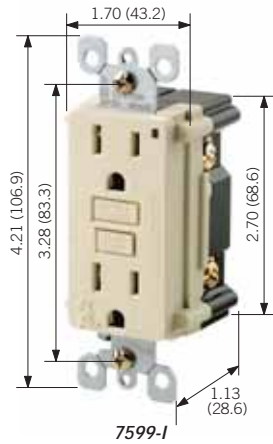

7599-I

Hospital Grade SmartLock^{PRO}® GFCI Receptacles — Back and Side Wired

15 AMP 125V at Receptacle, 20 AMP Feed-Through

DESCRIPTION	CAT. NO.	COLOR* <i>Basic Cat. No. Denotes Brown</i>	NEMA CONFIG.
Duplex with LED Indicator Light, buttons match face color	7599-HG	I, W, A, G, R, T	
Duplex with LED Indicator Light, buttons match face color. DIN-Rail mounting with terminal wiring block. UL Recognized Component	7599-DIN	Black Only	

20 AMP 125V at Receptacle and Feed-Through

DESCRIPTION	CAT. NO.	COLOR* <i>Basic Cat. No. Denotes Brown</i>	NEMA CONFIG.
Duplex with LED Indicator Light, buttons match face color	7899-HG	I, W, A, G, R, T	

Commercial Grade SmartLock^{PRO}® GFCI Receptacles — Back & Side Wired

15 AMP 125V at Receptacle, 20 AMP Feed-Through

DESCRIPTION	CAT. NO.	COLOR* <i>Basic Cat. No. Denotes Brown</i>	NEMA CONFIG.
Duplex, with Indicator Light, buttons match face color	7599	I, W, A, T, GY, E, R	
Duplex, with LED Indicator Light, Black & Red buttons. With 6" leads	7599-L	I, W (No Brown)	

20 AMP 125V at Receptacle and Feed-Through

DESCRIPTION	CAT. NO.	COLOR* <i>Basic Cat. No. Denotes Brown</i>	NEMA CONFIG.
Duplex, with Indicator Light, buttons match face color	7899	I, W, A, T, GY, E, R	
Duplex with LED Indicator Light, Black & Red buttons. With 6" leads	7899-L	I, W	

Combination Switch/ SmartLock^{PRO}® GFCI Outlet — Side Wired

15 AMP @ 125V AC Switch Rating, 15 AMP 125V at Receptacle, 20 AMP Feed-Through

DESCRIPTION	CAT. NO.	COLOR* <i>No Brown</i>	NEMA CONFIG.
Single-Pole Switch and SmartLock GFCI-Protected Outlet, buttons match face color	7299	I, W, A	

Switch-Rated SmartLock^{PRO}® GFCI — Back and Side Wired

20 AMP 125V Feed-Through

DESCRIPTION	CAT. NO.	COLOR* <i>No Brown</i>
Blank Face, No Indicator Light, buttons match face color	8590	I, W, A, T, E

GFCI Wallbox Extender

DESCRIPTION	CAT. NO.	COLOR* <i>Basic Cat. No. Denotes Brown</i>
Shallow Wallbox extender for GFCI	6197	I, W

Wallplates

THERMOSET	POLYCARBONATE SCREWLESS SNAP-ON	POLISHED BRASS	302 STAINLESS STEEL
 80401-NT	 80301-SW	 81401-PB	 84401-40
 80409-NT	 80309-SW	 81409-PB	 84409-40

For complete Decora wallplate selection, see pages B20–B24.

TESTING AND CODE COMPLIANCE

- UL Standard 943 Class A (GFCI) and 498 (Receptacles)
- UL Listed (File # 48380)
- CSA (#LR-57811)
- NOM Certified (#057)
- Backed by a Limited Two-Year Warranty

*COLOR

Basic Cat. Nos. listed on page denote Brown color unless indicated. For other color selections, add suffix to catalog number as follows: Ivory (-I), White (-W), Almond (-A), Light Almond (-T), Gray (-G or GY), Red (-R), Black (-E).

MATERIAL CHARACTERISTICS

Flammability: Rated V2
Operating Temperature: -30°F (-35°C) to 151°F (66°C)



High Current SmartLock® GFCI — Back and Side Wired

DESCRIPTION	CAT. NO.	COLOR*
High Current GFCI Contact rating at GFCI: 20A 125V, load capability with 125V control relay: 80A @ 240V max. <i>Note: The 8895 is wired in conjunction with a switching contactor or relay supplied by the customer. Each 8895 and contactor combination MUST be reviewed and approved by UL. Consult Leviton, Little Neck, for a list of combinations approved to date.</i>	8895	No Brown I, W, E

Right Angle GFCI Plug

DESCRIPTION	CAT. NO.	COLOR	NEMA CONFIG.
Rated 15A-125V, Automatic Reset	16592†	Black	1-15P
Rated 15A-125V, Automatic Reset	16593†	Black	5-15P
Rated 20A-125V, Automatic Reset	16893†	Black	5-20P

† Wiring module accepts No. 18 (.300") thru No. 12 (.432") cord sizes

Waterproof Cover for Right Angle GFCI Plugs

DESCRIPTION	CAT. NO.	COLOR	NEMA CONFIG.
Waterproof Cover for Right Angle GFCI Plugs with ground pin up orientation	86593	Clear	

Heavy Duty Right Angle GFCI Plug

DESCRIPTION	CAT. NO.	COLOR	NEMA CONFIG.
Rated 15A-125V, Automatic Reset	6593††	Black	5-15P
Rated 15A-125V, Manual Reset	6594††	Yellow	5-15P
Rated 20A-125V, Manual Reset	6893††	Black	5-20P
Rated 20A-125V, Automatic Reset	6894††	Yellow	5-20P

†† Wiring module accepts No. 18 (.300") thru No. 12 (.607") cord sizes



SPECIFICATIONS AND FEATURES

- High Current GFCI**
- Adds ground fault protection to heavy equipment powered through 3-and 4-wire circuits grounded with neutral
 - Meets or exceeds UL 2003 Code Requirements for increased surge immunity, corrosion resistance, resistance to false tripping and diagnostic indication for line-load wiring reversal
 - Exclusive, patented lockout-action: RESET button is blocked if GFCI protection has been compromised, eliminating the risk of end-users incorrectly assuming that a reset GFCI is providing ground fault protection when it actually is not
 - Test and Reset buttons confirm proper operation
 - Ideal for use with spas, heater packs, high pressure washers, industrial mixers and other equipment
- Right Angle GFCI Plug**
- UL 943 Class A GFCI operation with open-neutral protection
 - May be pre-wired to cable of any specified length
 - Power indicator light goes off if GFCI trips or unit is unplugged

TESTING AND CODE COMPLIANCE

- Right Angle GFCI Plug**
- UL Standard 943 Class A (GFCI) and 498 (receptacles)
 - UL Recognized Component (File #48380)
 - CSA Certified (LR-57811)
 - Backed by a Limited One-Year Warranty

*** COLOR**

Basic Cat. Nos. shown above denote color as indicated. For other color selections, add the suffix to catalog number as follows: Ivory (-I), White (-W), Black (-E).

MATERIAL CHARACTERISTICS

Flammability: Rated V2
Operating Temperature: -30°F (-35°C) to 151°F (66°C)

GFCI Personnel Protection Devices





15 and 20 AMP 125V • 15 and 20 AMP 240V

Commercial Grade GFCI Personnel Protection Devices



Automatic Reset GFCI Cord Sets and Extension Cord — Black Body

DESCRIPTION	CAT. NO.	LENGTH	NEMA CONFIG.	
15A-125V GFCI Cord Set	66591-2C	2 feet		
15A-125V GFCI Cord Set	66591-6C	6 feet		
15A-125V GFCI Cord Set	66591-25C	25 feet	5-15P	5-15R
15A-125V GFCI Cord Set, with Fluorescent Light	66591-WL	20 feet		
15A-125V GFCI Cord Set, Triple Outlet	66593-3	3 feet		
15A-125V Locking GFCI Cord Set	66597-3	3 feet	L5-15P	L5-15R
20A-125V GFCI Cord Set	66891-3	3 feet	5-20P	5-20R
20A-125V Locking GFCI Cord Set	66897-3	3 feet	L5-20P	L5-20R
15A-125V GFCI Extension Cord*	26591-37C	37 feet	5-15P	No Connector
15A-125V GFCI Cord Set	66591-2C	2 feet	5-15P	5-15R
15A-240V GFCI Extension Cord*	26592-E	35 feet	6-15P	No Connector
20A-240V GFCI Extension Cord*	36592-E	35 feet	6-20P	No Connector

Manual Reset GFCI Cord Sets — High Visibility Yellow Body

DESCRIPTION	CAT. NO.	LENGTH	NEMA CONFIG.	
15A-125V	69591-3	3 feet		
15A-125V	69591-25	25 feet	5-15P	5-15R
Triple-tap, 15A-125V	69593-3	3 feet		
20A-125V	69891-3	3 feet	5-20P	5-20R
15A-125V, w/Wetguard® Plugs and Connectors	69591-W3	3 feet	5-15P	5-15R
15A-125V, w/Wetguard® Plugs and Connectors	69591-W25	25 feet	5-15P	5-15R
20A-125V, w/Wetguard® Plugs and Connectors★	69891-W3	3 feet	5-20P	5-20R

*UL recognized component
CSA Certified except where indicated by ★



SPECIFICATIONS AND FEATURES

- UL 943 Class A GFCI operation with open-neutral protection
- Automatic Reset Cord Sets (black body) will automatically reset ON when power is restored after a power interruption
- Manual Reset Cord Sets (yellow body) will not automatically reset ON when power is restored after a power interruption—Reset button must be pushed in
- Trip threshold meets or exceeds UL requirements for tripping time
- Impact-resistant thermoplastic cover and body
- Silver alloy contacts
- Water-resistant enclosure is sealed by ultrasonic welding
- Power indicator light goes off if GFCI trips or unit is unplugged

TESTING AND CODE COMPLIANCE

- UL Standard 943 Class A (GFCI)
- UL Listed (File #48380)
- Backed by a Limited One-Year Warranty

MATERIAL CHARACTERISTICS

Flammability: Rated V2
Operating Temperature: -30°F (-35°C) to 151°F (66°C)

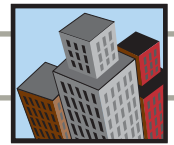

Commercial Grade GFCI Personnel Protection Devices

Single Gang Flush Cover Wallplates — Gray Finish

MOUNTING POSITION & DESCRIPTION	CAT. NO.	FITS TYPE OF BOX
Vertical — Die-Cast Zinc	6196-V	Standard
Horizontal — Die-Cast Zinc	6196	Standard
Vertical — Die-Cast Zinc	6196-VFS	FS (Four Screws)
Horizontal — Die-Cast Zinc	6196-FS	FS (Four Screws)
Horizontal — Die-Cast Zinc	4990	Standard
Vertical — Die-Cast Zinc	4992	Standard
Horizontal — Plastic	4996	Standard
Vertical — Plastic	4998	Standard



Raintight While-In-Use Covers

DESCRIPTION	CAT. NO.	COLOR
GFCI, Vertical Mount	5977-GY	Gray
GFCI, Vertical Mount w/Extra Deep Cover	5977-DGY	Gray
GFCI, Vertical Mount	5977-CL	Clear
GFCI, Vertical Mount w/Extra Deep Cover	5977-DCL	Clear
GFCI, Horizontal Mount	5997-GY	Gray
GFCI, Horizontal Mount w/Extra Deep Cover	5997-DGY	Gray
GFCI, Horizontal Mount	5997-CL	Clear
GFCI, Horizontal Mount w/Extra Deep Cover	5997-DCL	Clear

Temporary Portable Power Distribution Center/GFCI (The Box)

DESCRIPTION	CAT. NO.	INLET Non-NEMA California Style	OUTLET Non-NEMA California Style	NEMA CONFIG.
Power Distribution Box. GFCI-Protected Receptacles: (6) 20A/125V Locking, GFCI Protected (1) 30A/250V Locking, GFCI Protected	PB101-SGF	50A, 125/250V	50A, 125/250V	
Power Distribution Box GFCI Protected Receptacles: (6) 20A/125V Locking, GFCI Protected (1) 30A/250V Locking, Non-GFCI Protected	PB101-000	50A 125/250V	50A 125/250V	6: L5-20R 1:L 6-30R
Power Distribution Box, GFCI-Protected Receptacles: (6) 20A/125V Straight Blade, GFCI Protected (1) 30A/250V Locking, GFCI Protected	PB103-SGF	50A, 125/250V	50A, 125/250V	
Power Distribution Box GFCI Protected Receptacles: (6) 20A/125V Straight Blade, GFCI Protected (1) 30A/250V Locking, Non-GFCI Protected	PB103-000	50A 125/250V	50A 125/250V	6: 5-20R 1: L6-30R

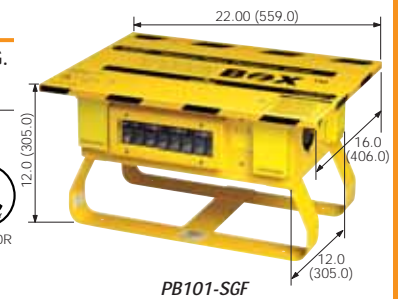

Power Cords

DESCRIPTION	CAT. NO.	NON-NEMA CONFIG.
50 ft. Temporary Power Cord w/Weather-Resistant 50A, 125/250 Plug & Connector	KRS-A9519	
100 ft. Temporary Power Cord w/Weather-Resistant 50A, 125/250 Plug & Connector	KUS-A9519	 NON-NEMA



SPECIFICATIONS AND FEATURES

- The Box**
- For temporary use in industrial & commercial maintenance & repair stations (construction, entertainment, amusement sites, trade shows, convention halls) where portable power is needed
 - Weatherproof covers prevent nuisance tripping; prevent moisture from entering contacts
 - Clear port hole panel for circuit breaker viewing
 - Reinforced metal housing & legs withstand abuse
- Power Cords**
- Flexible, abrasion-resistant construction for reliable performance to -31°F

TESTING AND CODE COMPLIANCE

- Raintight covers satisfy NEC Article 410-57(b) requirements
 - Raintight covers are rated NEMA 3R
- The Box**
- Meets OSHA Regulation 20, Part 1926, Subpart K for open-neutral GFCI & circuit overload protection
 - UL Listed for outdoor use
 - Backed by a Limited One-Year Warranty
- Power Cords**
- UL Listed (File #E-48380)

GFCI Personnel Protection Devices

HOW TO USE THIS CATALOG

The L-101 Leviton Wiring Device Catalog is designed to help you find the device you're seeking in the quickest and easiest way possible. Most product sections are divided into three distinct categories in the following sequence—Industrial Grade, Commercial Grade and Residential Grade—and grouped according to amperage and voltage, lowest to highest. For example, if you need to order 15 Amp, 125 Volt Industrial Grade straight-blade duplex receptacles, begin your search with the main Table of Contents at the front of the book. Here you'll see that all straight blade receptacles are listed in Section G. Turn to Section G for a more detailed Table of Contents on the first page. Each section page contains product descriptions, ratings and catalog numbers. There are also helpful highlights including Specifications and Features, Testing and Code Compliance, Color listing, Material Characteristics and dimensioned color product photos. Any product page in the L-101 Catalog can be clearly copied or faxed to customers and prospects for use as a specifier sheet or as part of a presentation.

The Quick Reference Guide follows the main Table of Contents to help you pinpoint and locate specific products. Technical Section V provides general product and test data, industry standards, NEMA configuration charts, a glossary of wiring device terms, ANSI architectural symbols and other related information. Specific catalog numbers are listed in the exhaustive index at the back of the catalog.

15 AMP 125 and 250V • 20 AMP 125 and 250V

Industrial Grade Straight Blade Receptacles

Back and Side Wired (Basic Cat. No. Denotes Brown Device*)

DESCRIPTION	CAT. NO./COLOR 15A/125V	CAT. NO./COLOR 15A/250V	CAT. NO./COLOR 20A/125V	CAT. NO./COLOR 20A/250V
LEVSPEC® Duplex Receptacle, Brass Strap	5262 I, W, GY, R, E	5662 I	5362 I, W, GY, R, E	5462 I, GY
Single Receptacle	5261 I, W, GY	5661 I	5361 I, W, A, T, GY	5461 I, A, T, GY
Narrow Body Duplex Receptacle	5252 I, W, A, T, GY, R, BU		5352 I, W, A, T, GY, R,	

For complete wallplate selection, see Section E.

80703-IG 80703-I 80704-GY 80716-R

84003-40 84004-40 84016-40

SPECIFICATIONS AND FEATURES

Back & Side Wired Duplex

- Impact-resistant thermoplastic nylon cover and body
- Smooth face does not collect dirt
- Four corner latches securely fasten face
- Single-piece brass mounting strap on LEVSPEC devices, multi-piece steel strap on other devices
- Large, triple-wipe, brass "T" contacts for superior contact and conductivity
- Back and side-wiring options
- Brass terminal screws to reduce conductor oxidation
- Break-off tabs for easy two-circuit conversion
- Apron barrier to prevent accidental contact between terminal screw heads and metal box
- Exclusive V-shaped, serrated back-wiring clamp for superior contact and conductivity

TESTING AND CODE COMPLIANCE

- UL Listed 498 (UL File #13399); UL Federal Specification WC-596

COLOR

Basic Cat. Nos. shown above denote Brown device, except for Isolated Ground (-IG) devices Basic Cat. No. denotes Orange. Isolated Ground Receptacle is distinguished by an orange triangle on its face. For other color selections, add suffix to the catalog number as follows: Ivory (-I), White (-W), Brown (For IG devices only, add -A), Almond (-A), Light Almond (-T), Gray (-G or -GY), Black (-E), Red (-R) and Blue (-BU); for IG devices only, add -BIG)

MATERIAL CHARACTERISTICS

Environmental: Flammability, Rated V2
Operating Temperature: From -40° C (without impact) to 60°C maximum continuous

- | | | |
|---------------------------------------|--|--------------------------------------|
| A RATING | E CATALOG NUMBER | I SPECIFICATIONS & FEATURES |
| B Choose GRADE, if appropriate | F DESCRIPTION | J TESTING AND CODE COMPLIANCE |
| C DIMENSIONED PHOTOGRAPH | G Check for NEMA CONFIGURATION | K COLOR LISTING |
| D WIRING/CERTIFICATIONS | H WALLPLATE REFERENCE, if appropriate | L MATERIAL CHARACTERISTICS |

Combination Devices

INDEX

Commercial Grade
AC Combination Devices

15A Devices	.I2
15A Switch/Receptacle	.I2
15A Switches	.I2
15A S.P. Switch/Neon Pilot Light	.I2
20A Devices	.I2
20A S.P. Switches	.I2
20A S.P. Switch/Receptacle	.I2
20A S.P. Switch/Neon Pilot Light	.I2
Decora® Combination Devices	.I3
Decora® Multi Switches	.I4
SmartLockPRO® GFCI/Switch	.I4





15 and 20 AMP 120V and 120/277V

Commercial Grade AC Combination Devices

LEVITON OFFERS THE MOST COMPREHENSIVE LINE OF DURABLE COMBINATION DEVICES ON THE MARKET TODAY.

Combination devices permit installation of two devices in a space normally occupied by only one, resulting in reduced installation time and increased convenience.

The following pages provide a detailed listing of the complete line of Leviton combination devices.



5225-W



5224-2W

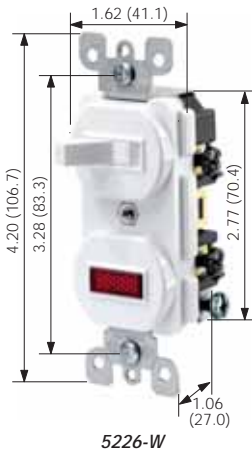

5226-W

Combination Devices†

15 AMP

DESCRIPTION	RATING	CAT. NO.	COLOR* <small>Basic Cat. No. Denotes Brown</small>
Two Single-Pole Switches (Non-Grounding)	15A-120/277V AC	5224	I, W
Two Single-Pole Switches	15A-120/277V AC	5224-2	I, W, A, T
Single-Pole Switch/Receptacle	Switch: 15A-120V AC Receptacle: 15A-125V	5225	I, W, A, T
Single-Pole Switch/Pilot Light	Switch: 15A-120V AC Pilot Light: 1/25W-125V AC	5226	I, W, A, T
3-Way Switch/ Single-Pole Switch	15A-120/277V AC	5241	I, W, A, T
Two 3-Way Switches	15A-120/277V AC	5243	I, W, A, T
3-Way Switch/Receptacle	Switch: 15A-120V AC Receptacle: 15A-125V	5245	I, W
3-Way Switch/Pilot Light	Switch: 15A-120V AC Pilot light: 1/25W-125V AC	5246	I, W

20 AMP

DESCRIPTION	RATING	CAT. NO.	COLOR* <small>Basic Cat. No. Denotes Brown</small>
Two Single-Pole Switches	20A-120/277V AC	5334	I, W
Single-Pole Switch/Receptacle	Switch: 20A-120V AC Receptacle: 20A-125V	5335	I, W, E
Single-Pole Switch/Pilot Light	Switch: 20A-120V AC Pilot Light: 1/25W-125V AC	5336	I

† All devices are grounded except where noted.

Wallplates

THERMOSET	THERMOPLASTIC	302 STAINLESS STEEL
 88003	 80703-W	 84003-40

For complete wallplate selection, see Section E.

SPECIFICATIONS AND FEATURES

- AC quiet switches have silver-cadmium oxide contacts and receptacles have double-wipe contacts for maximum conductivity
- All devices have grounding screw, except where noted
- Side wired with terminal screws that accept up to #12 copper or copper-clad wire
- Fit standard wallboxes
- Break-off tabs on devices with AC quiet switches permit conversion to separate feeds

TESTING AND CODE COMPLIANCE

- UL Listed (File #7458)
- CSA (File #LR-3413)
- NOM Certified (#057)
- Backed by a Limited Two-Year Warranty

*COLOR

Basic Cat. Nos. shown above denote Brown color. For other color selections, add suffix to the catalog number as follows: Ivory (-I), White (-W), Almond (-A), Light Almond (-T), Black (-E).

HORSEPOWER

15A	20A
1/2 @ 120V	1 @ 120V
2 @ 240V	2 @ 240V

MATERIAL CHARACTERISTICS

Environmental: Flammability UL-94, V2 Rating
Operating Temperature: -40°C to 120°C

15 and 20 AMP 120V and 120/277V Commercial Grade AC Combination Devices

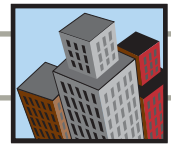

Decora® Combination Devices





15 AMP

DESCRIPTION	RATING	CAT. NO.	COLOR*
Two Single-Pole Switches	15A-120/277V AC	5634	I, W, A, T, GY, E
Single-Pole Switch/Receptacle	Switch: 15A-120V AC Receptacle: 15A-125V	5625	I, W, A, T, GY, E
Single-Pole Switch/Pilot Light	Switch: 15A-120V AC Pilot: 1/25W-125V AC	5626	I, W, A
3-Way Switch/Single-Pole Switch	15A-120/277V AC	5641	I, W, A, T, E
Two 3-Way Switches	15A-120/277V AC	5643	I, W, A, T
3-Way Switch/Receptacle	Switch: 15A-120V AC Receptacle: 15A-125V	5645	I, W, A, E
3-Way Switch/Pilot Light	Switch: 15A-120V AC Pilot: 1/25W-125V AC	5646	I, W, A

20 AMP

DESCRIPTION	RATING	CAT. NO.	COLOR*
Two Single-Pole Switches	20A-120/277V AC	5627	I, W, A, T
Single-Pole Switch/Receptacle	Switch: 20A-120V AC Receptacle: 20A-125V	5636	I, W, A
Single-Pole Switch/Pilot Light	Switch: 20A-120V AC Pilot: 1/25W-125V AC	5637	I, W, A
Two 3-Way Switches	20A-120/277V AC	5640	I, W, A, T

Wallplates

THERMOSET	THERMOPLASTIC	POLYCARBONATE SCREWLESS SNAP-ON		302 STAINLESS STEEL
 80401-I	 80401-NW	 80301-ST	 80301-SW	 84401-40

For complete Decora wallplate selection, see pages B20–B24.

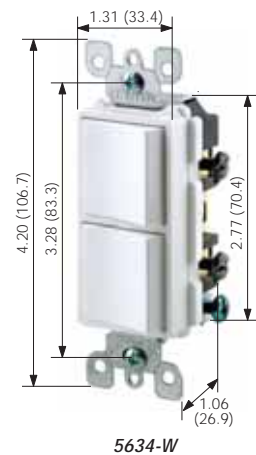
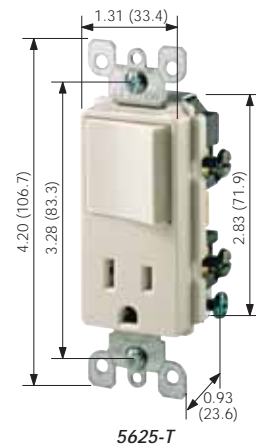

AC Combination Devices

SPECIFICATIONS AND FEATURES

- Elegant Decora styling provides multiple control in a single-gang wallbox
- All devices have grounding screw
- Fit standard wall boxes

TESTING AND CODE COMPLIANCE

- UL Listed (File #E-7458)
- CSA Certified (File #LR-3413)
- NOM Certified (#057)
- Backed by a Limited Two-Year Warranty

*COLOR

Colors available as listed. For other color selections, add suffix to catalog numbers as follows: Ivory (-I), White (-W), Almond (-A), Light Almond (-T), Gray (-GY) and Black (-E).

HORSEPOWER

15A	20A
1/2 @ 120V	1 @ 120V
2 @ 240V	2 @ 240V

MATERIAL CHARACTERISTICS

Environmental: Flammability UL-94, V2 Rating
Operating Temperature: -40°C to 120°C



15 AMP 120V

Commercial Grade AC Combination Devices

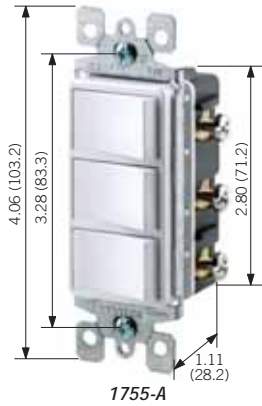

1755-A



7299-NI

Decora® Combination Switches

Individual Switches: 15 AMP 120V/Device Total: 20 AMP-120V †

DESCRIPTION	CAT. NO.	COLOR*
Dual Rocker Switches with Ground Screw	1754-2	I, W, A, T
Illuminated Dual Rocker Switches light is ON when top rocker is OFF	1754-IL	I, W, A
Three Rocker Switches with Ground Screw	1755-2	I, W, A, T
Three Rocker Switches (Double Pole ON-OFF-ON Top Switch; Two Single-Pole Switches)	1759	I, W

†Warning: Although each individual rocker switch is rated up to 15A 120V, the total combined load for both duplex or all three triplex switches **must not exceed 20 AMPS.**

Decora® Combination Switch/SmartLockPRO® GFCI Outlet

Receptacle: 15 AMP 125V/Feed-through: 20 AMP 125V
Switch Rating: 15 AMP, 1800 WATTS @ 120V AC

DESCRIPTION	CAT. NO.	COLOR*
Single-Pole Switch and SmartLockPRO® GFCI-Protected Outlet with Indicator Light	7299	NI, NW, NA

Wallplates

THERMOSET	THERMOPLASTIC	POLYCARBONATE SCREWLESS SNAP-ON		BRASS
80401-I	80401-NW	80301-ST	80301-SW	81401

For complete Decora wallplate selection, see pages B20–B24.

SPECIFICATIONS AND FEATURES

- Multi-switch combination devices save space and add convenience
- Common shunted internally to all switches
- Elegant Decora styling permits ganging with other Decora devices
- Switch/SmartLockPRO® GFCI Receptacle replaces standard switch/outlet combination devices in commercial or residential installations
- Space-saving SmartLockPRO® GFCI protection in new or retrofit construction
- Switch/SmartLockPRO® GFCI Receptacle permits multiple wiring options that allow six different applications

SmartLockPRO® GFCI

- Meets or exceeds UL 2006 Code Requirements for increased surge immunity, corrosion resistance, resistance to false tripping and diagnostic indication for line-load wiring reversal
- Exclusive, patented lockout-action: RESET button is blocked if GFCI protection has been compromised, eliminating the risk of end-users incorrectly assuming that a reset GFCI is providing ground fault protection when it actually is not

TESTING AND CODE COMPLIANCE

Decora Switches

- UL Listed (File #7458)
- CSA (File #LR-3413)
- NOM Certified (#057)
- Backed by a Limited Two-Year Warranty

Switch/SmartLockPRO® GFCI Receptacle

- UL Listed (File #48380)
- Listed UL Standard 943, Class A
- CSA Certified (File #LR-57811)
- NOM Certified (#057)
- Backed by a Limited Two-Year Warranty

*COLOR

Colors available as listed. For other color selections, add suffix to catalog numbers as follows: Ivory (-I), White (-W), Almond (-A), Light Almond (-T).

MATERIAL CHARACTERISTICS

Environmental: Flammability UL-94, V2 Rating
Operating Temperature: -40°C to 120°C

Structured Media Components

Leviton Integrated Networks™

INDEX

Structured Media™ Components

Overview	J2
Enclosures	J3-J5
Media Versatile™ Panel	J5
Enclosure for Multiple Dwelling Units (MDUs)	J6
Cabling Panels	J7-J10
Stand-Alone Modules and Boards	J10, J11
Mounting Brackets	J11, J12
Power and Surge Protective	J13, J14
Networking and Internet Sharing	J15
Video Distribution	J16-J18
Home Video Monitoring System	J19-J21
Residential Intercom System	J22

Home Entertainment Components

Leviton/JBL Products and Systems

Indoor Speakers	J23
Outdoor Speakers	J24
Home Theater Speakers	J24-J25
Harman/Kardon Entertainment Center Components and Accessories	J26

Leviton Architectural Edition™ Products

Multi-Room Audio Amplifiers and Keypad System Accessories	J27
Audio Volume Controls	J28-J30
Audio Distribution Products	J31-J32

SpecGrade Sound™ Products

Indoor Speakers	J33
Outdoor Speakers	J33

Other Home Entertainment Products

Decora Media System	J34
Multi-Room IR Repeater System	J35
Decora Recessed Receptacles	J35





STRUCTURED MEDIA COMPONENTS

STRUCTURED MEDIA™ COMPONENTS—LEVITON INTEGRATED NETWORKS™

The information and communication revolution will have as much impact on America's homes and businesses as did the electrical revolution of the 20th Century. To fully enable the modern home, Leviton has developed Leviton Integrated Networks as the upgrade path to the future. Leviton Integrated Network's Structured Media components and systems deliver the capacity, bandwidth and speed that today's and tomorrow's information and entertainment technologies will demand.

Innovative Technology Blends Multiple Options Into One System

Leviton Integrated Networks takes the concept of structured cabling, as practiced in demanding commercial applications, and combines it with multimedia. This blending accommodates the convergence of telephone communications, computer and Internet services and much more. An innovative series of modules and media centers—configured for either essential platforms or more customized enhanced platforms—manage and distribute voice, data, audio and video in flexible configurations that best suit each homeowner's individual requirements. These requirements can range from something as simple as cable TV and telephone in several rooms, to a local area network (LAN) for a small office or home-based business.

Entertainment products built into the home should have no compromises — in quality, performance, reliability or value. That's why Leviton offers a wide variety of state-of-the-art residential entertainment products that represent today's most advanced audio/video technologies, including indoor and outdoor speakers, on-wall home theater systems, A/V entertainment center products, controls and distribution components.

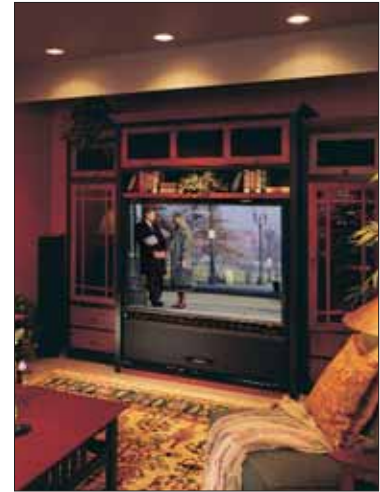



47605-140 Panel Enclosure with Cover



Series 140 Panel Premium Hinged Cover

Series 140 Structured Media Enclosure

This 14" professional-grade whole-house media enclosure creates one distribution point in the home for all low voltage cables. It will accommodate two Pre-Configured Structured Cabling Panels. The sturdy design and functionality facilitate installation, reducing job-site labor costs, and making it ideal for essential home networking.

SPECIFICATIONS

Dimensions:	
Enclosure:	14.38"H x 14.38"W x 3.60"D
Cover:	16.10"H x 16.10"W
Materials: White, powder-coated enclosure (20 gauge steel), cover (18 gauge steel)	
Standards Compliance: ACA and cULus Listed. UL Listed for fire and burglary	

Series 140 Structured Media Enclosures and Covers

DESCRIPTION	CAT. NO.
Series140 Enclosure and Flush-Mount Cover, empty	47605-140
Series140 Enclosure only	47605-14E
Series 140 Flush Mount Cover	47605-14C
Series 140 Hinged Cover–Economy	47605-14D
Series 140 Hinged Cover–Premium	47605-14P
Series140 Enclosure only (6 per pack)	47605-14G
Series 140 Flush Mount Cover (6 per pack)	47605-14B

SPECIFICATIONS AND FEATURES

- Accommodates up to two full-width Pre-Configured Structured Cabling Panels—delivering audio/ video, voice and data to any room of the home or office.
- Positive “stops” on housing sidewalls prevent the enclosure from falling through studs during installation.
- One piece white steel unit holds full and half-width expansion modules.
- Can be surface-mounted or recessed. Ideal for new installations or retrofits.
- Mounting guides on the cover align screw-holes and reduce the chances of dropping during attachment.
- Powder-coated white cover features a 3/4" overlap to hide irregular drywall cuts.
- Combine two or more enclosures for larger installations or future expansion.
- Multiple knock-outs on top and bottom including two new 2" knockouts on top, facilitate cable entry and routing.
- Cut-out in base of enclosure for mounting single gang J-Box kit
- Six 3" square self-healing foam grommets accommodate cable bundles



STRUCTURED MEDIA™ CENTERS

Series 280 and 420 Structured Media Enclosures

Command central for home media convergence, Leviton's SMC-280 and SMC-420 home technology enclosures put the home or small office on the cutting edge of the Information Age. By bringing every conceivable technology distribution point together in one place, they make running cable and managing media both simple and more cost-effective. Designed to incorporate a hospital-grade power quality module for maximum protection from line surges, the 28" and 42" high units accommodate all the latest in functions such as home networking, fax, internet (including high speed services such as DSL, cable modems and ISDN), multi-line telephones, security camera, coaxial cable and satellite video distribution, and speaker and volume controls, when equipped with the correct accessories.

The Series 280 enclosure can comfortably accommodate up to 8 different Distribution Modules, depending on selection and density, and the 420 enclosure, with its generous size and capacity for up to 12 modules, can simultaneously manage many diverse functions. Perfect for home office and home entertainment. Make sure you plan all modules before starting the project, and specify the correct size media center.

Note: Module count will depend on the type used; some are larger than others.



Series 280 Panel enclosure with cover

SPECIFICATIONS

Dimensions:

SMC-280 Enclosure:	28"H x 14.38"W x 3.00"D
SMC-280 Cover:	29.25"H x 15.62"W
SMC-420 Enclosure:	42"H x 14.38"W x 3.60"D
SMC-420 Cover:	43.25"H x 15.62"W

Materials: White, powder-coated enclosure (20 gauge steel), cover (18 gauge steel)

Standards Compliance: ACA and CULUS Listed. UL Listed for fire and burglary



Series 280 Premium Hinged Cover

Series 280 and 420 Structured Media Enclosures and Covers

DESCRIPTION	CAT. NO.
Series 280 Enclosure and Flush-Mount Cover, empty	47605-28W
Series 280 Enclosure, only	47605-28N
Series 280 Flush-Mount Cover	47605-F28
Series 280 Hinged Cover—Economy	47605-28D
Series 280 Hinged Cover—Premium	47605-28P
Series 280 Enclosure, only (3 per pack)	47605-28G
Series 280 Flush-Mount Cover (3 per pack)	47605-28B
Series 420 Enclosure and Flush-Mount Cover, empty	47605-42W
Series 420 Enclosure, only	47605-42N
Series 420 Flush-Mount Cover	47605-F42
Series 420 Hinged Cover—Economy	47605-42D
Series 420 Hinged Cover—Premium	47605-42P
Lock and Key for Structured Media Centers	5L000-LOK



Series 420 Premium Hinged Cover

SPECIFICATIONS AND FEATURES

- Multiple knock-outs (up to 2") on top, bottom, sides and back, including two new 2" knock-outs on top, facilitate cable entry and routing from every desired room.
- Six 3" square self-healing foam grommets accommodate cable bundles and protect them from being cut
- Sturdy, one-piece white steel construction.
- Combine two or more enclosures for larger installations or future expansions.
- Holds 1/4, 1/2 and full-width expansion modules with the ability to mount most modules vertically or horizontally.
- Large capacity provides multiple functionality for "wired" homes.
- Powder-coated white cover features a 3/4" overlap to hide irregular drywall cuts.

- Mounting hooks on the cover align screw-holes and reduce the chances of dropping during attachment.
- Holds a broad range of current and future distribution modules, delivering audio, video, voice, data, security, and more to any room of the home or office.
- Threaded inserts added to enclosure to ensure accurate threading of screws when mounting cover
- Can be surface-mounted or recessed. Ideal for new installations or retrofits.
- Knock-out in base of enclosure for mounting of either a single gang J-Box kit or an AC power module
- Designed to accommodate safe, high-quality hospital-grade power module with surge suppression.



Extender Brackets for Leviton Series 280 and 420 Structured Media Centers

The Extender Brackets provide an additional 2" of depth and enhanced ventilation with Leviton's Series 280 and 420 Structured Media Centers (SMCs). The Extender Brackets, which are attached between the enclosure and the cover, form a frame assembled from four 2"-deep sheet metal rails with louvers on each side. The greater depth allows for better cable management and for larger modules, such as audio amplifiers, to be mounted within the Structured Media Centers.

Series 280 and 420 Structured Media Enclosures

DESCRIPTION	CAT. NO.
Extender Bracket 2" depth extension package for Series 280 Structured Media Centers	47612-28B
Extender Bracket 2" depth extension package for Series 420 Structured Media Centers	47612-42B

SPECIFICATIONS AND FEATURES

Extender Brackets

- Made of sturdy white powder-coated 18-gauge sheet metal
- Louvers in the Extender Brackets enhance ventilation for added protection against heat build-up from installed modules
- Two-Year Product Warranty



Media Versatile Panel— For Custom Retrofits and Remodeling

Ideal for custom retrofits and remodeling applications, the Media Versatile™ Panel with 3/8" plywood backing allows an open architecture for consolidating low voltage electronics and distribution components for phone, fax/modem, data, home networking, audio, video and home control. The 24" high cold-rolled steel panel with securable door will accommodate a wide variety of Structured Media Distribution Modules by simply removing the Push-Lock Pins and attaching directly to the plywood backing. The sturdy construction is built to industrial-grade standards, and the panel can be surface mounted or recessed in the wall. (Optional mounting brackets may be used for non-standard stud spacing). Ideal for custom retrofits and remodeling applications. Available in black powder coat finish. UL Listed.

SPECIFICATIONS

Dimensions:	24"H x 14"W x 6"D
Materials:	Powder-coated 18 gauge steel with 3/8" plywood backing
Standards Compliance:	UL Listed.

Media Versatile Panel

DESCRIPTION	CAT. NO.
Media Versatile Panel	47602-24E
Mounting Brackets—(set of 4)	47602-BKE

SPECIFICATIONS AND FEATURES

- Eight 1" or 1.5" conduit fittings on top and bottom facilitate cable entry and routing
- Wall-mount or recess. Ideal for new installations or retrofits
- Securable door provides maximum protection from dust and abuse
- Plywood backing allows open architecture for customizing layout and can accommodate a wide variety of Structured Media Distribution Modules.



STRUCTURED MEDIA™ CENTERS



Compact Structured Media Enclosure—For Multi-Dwelling Units (MDU's)

Leviton's new Compact Structured Media Enclosure for Multi-Dwelling Units offers a compact, cost-effective distribution point for basic telephone and video to owners/managers of multi-unit buildings. The unit accommodates a variety of telephone/video distribution configurations by hosting up to three Telephone Expansion Boards and one Passive Video Splitter.

SPECIFICATIONS

Dimensions: (Enclosure)	8.03"(204.0) H x 14.40"(365.6) W x 3.71"(94.2) D
(Cover)	9.01"(228.9) H x 15.39"(390.8) L
Materials:	ABS molded plastic
Standards Compliance:	UL94 VO flame-retardant fire rating

Compact Structured Media Enclosure for MDU's

DESCRIPTION	CAT. NO.
Compact Structured Media Enclosure and Cover, empty	47605-MDU
MDU Kit (Compact Structured Media Enclosure & Cover plus 1x6 Telephone Expansion Board)	47604-F6
MDU Kit (Compact Structured Media Enclosure & Cover plus 1x6 Telephone Expansion Board and 6-Way Splitter)	47604-F6S

SPECIFICATIONS AND FEATURES

- Unique modular design has fewer parts and is made exclusively from ABS molded plastic to provide customers with cost savings in installation time
- Flexibility to accommodate a variety of telephone/video distribution configurations
- Snap-on cover requires no tools or fasteners
- Molded-in brackets provide quick snap-in convenience for Telephone Expansion Boards
- Angled video splitter shelf for easy installation
- Hosts up to three Telephone Expansion Boards and one Passive Video Splitter
- Available empty with cover or in two kitted versions with a 1x6 Telephone Expansion Board or with a 1x6 Telephone Expansion Board and a 6-Way Splitter













Pre-Configured Structured Cabling Panels

Route telephone, data and video services throughout your home or office with one simple panel. Leviton's Pre-configured Structured Cabling Panels combine some of our most popular voice, data and RF modules to create an economical one-stop home and office media distribution point. See the following pages for available configurations. Some modules are available in expansion styles to fill unused panel slots (see this page). Choose the pre-configured combination that best meets your needs, and enhance with expansion boards or stand-alone brackets.

Panel Components and Expansion Boards

Pre-configured Panels are assembled at the factory and will contain one or more of the following distribution modules.

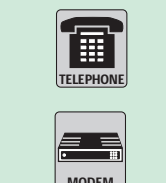



COMPONENTS	APPLICATION	FEATURES	AVAILABLE AS
 <p>1x9 Bridged Telephone Board</p> <p>Basic telephone distribution</p>		<ul style="list-style-type: none"> Bridge up to 4 telephone lines to 9 locations Connect up to 9 separate telephones per line Printed circuit board module 4-pair 110-type IDC punchdowns 	<ul style="list-style-type: none"> Part of a Pre-configured Panel Stand-alone module with bracket Expansion board without bracket
 <p>Category 5e Voice & Data Board</p> <p>Basic home networking</p>		<ul style="list-style-type: none"> Patch phone or data connections to 6 locations Combine with a TLDM, key system, or network hubs for additional applications Printed circuit board module 4-pair 110-type IDC punchdowns and 6 CAT 5e RJ-45 ports 	<ul style="list-style-type: none"> Part of a Pre-configured Panel Stand-alone module with bracket Expansion board without bracket
 <p>Category 6 Voice & Data Board</p> <p>Basic home networking</p>		<ul style="list-style-type: none"> Patch phone or data connections to 6 locations Combine with a TLDM, key system, or network hubs for additional applications Printed circuit board module 4-pair 110-type IDC punchdowns and 6 CAT 6 RJ-45 ports 	<ul style="list-style-type: none"> Part of a Pre-configured Panel Stand-alone module with bracket Expansion board without bracket
 <p>Telephone Patching Board</p> <p>Expanded 4-line telephone distribution</p>		<ul style="list-style-type: none"> Bridge up to 4 telephone lines to 7 locations Printed circuit board module One incoming 4-pair 110-type IDC punchdown and 7 outgoing RJ-45 jack connections Combine with a Category 5e Board to route telephone to remote locations 	<ul style="list-style-type: none"> Part of a Pre-configured Panel Expansion board without bracket
 <p>Telephone Security Board</p> <p>Route simple telephone with security interface</p>		<ul style="list-style-type: none"> Bridge up to 4 telephone lines to 6 locations Connect up to 6 separate telephones per line Connect to security system Printed circuit board module 4-pair 110-type IDC punchdowns 	<ul style="list-style-type: none"> Stand-alone module with bracket
 <p>DSL Filter Board</p> <p>Filters DSL signal from telephone line</p>		<ul style="list-style-type: none"> Filters DSL signal from phone line before distribution throughout a home or office. Eliminates need for individual filters at each wallplate. Use with any phone distribution module. Printed circuit board module with RJ-45 jack and 110 punchdowns 	<ul style="list-style-type: none"> Stand-alone module with bracket Expansion board without bracket



STRUCTURED MEDIA™ PANELS/MODULES

Panel Components and Expansion Boards (continued)

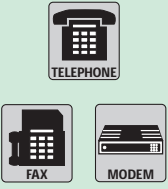
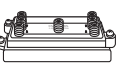
Pre-configured Panels are assembled at the factory and will contain one or more of the following distribution modules.

COMPONENTS	APPLICATION	FEATURES	AVAILABLE AS
 <p>Telephone Line Distribution Board (TLDM)</p> <p>Enhanced telephone distribution</p>		<ul style="list-style-type: none"> • 19 multi-line telephone connections in combinations of 2 or 4 lines • Bridge "Line 1" service to 12 locations and 4-line service to 8 locations • Connect to CAT 5e Voice & Data Board(s) or additional panels for more connections and easier adds/moves/changes • Independent RJ-45 jack and punchdown security interface to accommodate alarm systems 	<ul style="list-style-type: none"> • Part of a Pre-configured Panel ONLY • Expansion board with bracket
 <p>4x12 Telephone Distribution Board</p>		<ul style="list-style-type: none"> • Fits easily into any Leviton Structured Media enclosure, or can be used as a stand-alone unit. • Distribute up to 4 telephone lines through 12 telephone connections • Links with other distribution boards, modules, or panels to expand the system • 12 modular RJ-45 jack outputs. • 4-pair 110 type IDC inputs. 	<ul style="list-style-type: none"> • Part of a Pre-configured Panel ONLY
 <p>Video Splitters</p> <p>Basic video distribution</p>		<ul style="list-style-type: none"> • Cable TV or off-air antenna signals • 4-way or 6-way RF Splitter • Die-cast housing • Available in 1GHz and 2GHz models 	<ul style="list-style-type: none"> • Part of a Pre-configured Panel • Stand-alone module with bracket



47606-BTV



47606-BNP

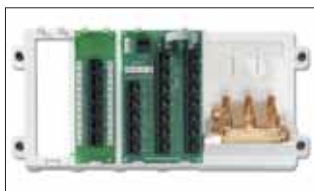

47606-AHT

Pre-configured Structured Cabling Panels—Full Width

Leviton has a Pre-Configured Structured Cabling Panel to fit any application. See opposite for explanations of individual boards. Use the Panels as they are, expand with easy snap-in Expansion Boards, or combine with other Panels or Stand-alone Modules to create a Structured Media solution tailored to your specific needs. Ideal for all installations, from basic to high-end. The new non-conductive synthetic bracket features a rugged construction and a "shelf-style" design with enhanced cable management and easier installation. Boards quickly snap on and off for easy adds/moves/changes.

DESCRIPTION	CAT. NO.	CONSISTS OF
Basic Telephone and Video Panel (BTVP)	47606-BTV	<ul style="list-style-type: none"> • (1) 1x9 Bridged Telephone Board • (1) 6-way 2GHz Video Splitter • Bridge up to 4 telephone lines to 9 locations • Route video to 6 locations
Basic Home Networking Plus Panel (BNP)	47606-BNP	<ul style="list-style-type: none"> • (1) Telephone Patching Board • (1) Category 5e Voice & Data Module • (1) 6-way 2GHz Video Splitter • 6 4-line telephone connections • Route video to 6 locations • Patch data or telephone service to 6 remote locations • Comes with 6 8-inch 8p8c Flat Patch Cords
Advanced Home Telephone & Video Panel (AHT)	47606-AHT	<ul style="list-style-type: none"> • (1) Telephone Line Distribution Module • (1) Category 5e Voice & Data Board • (1) 6-way 2GHz Video Splitter • 19 multi-line telephone connections (in various combinations of 2 or 4 lines) • Route video to 6 locations • Patch data or telephone service to 6 remote locations • Comes with 6 8-inch 8p8c Flat Patch Cords

Full-width panel dimensions: 6.25"H x 13.06"W x 2.50"D

For detailed features and dimensions, please consult individual specification sheets at www.leviton.com



DESCRIPTION	CAT. NO.	CONSISTS OF
Advanced Home Office Panel	47606-ASO	<ul style="list-style-type: none"> • (1) Telephone Line Distribution Module • (2) Category 5e Voice & Data Boards • (1) 6-Way 2GHz Video Splitter • (1) 19 multi-line telephone connections (in various combinations of 2 or 4 lines) • Route video to 6 locations • Patch data or telephone service to 6 remote locations • Comes with (6) 8-inch 8p8c Flat Patch Cords
12-Port Structured Media Panel (12P)	47603-12P	<ul style="list-style-type: none"> • (1) Telephone Line Distribution Module • (2) Category 5e Voice & Data Boards • 19 multi-line telephone connections (in various combinations of 2 or 4 lines) • Patch data or telephone service to 12 remote locations • Comes with 12 8-inch 8p8c Flat Patch Cords
18-Port Structured Media	47603-18P	<ul style="list-style-type: none"> • (1) Telephone Line Panel (18P) Distribution Module • (3) Category 5e Voice & Data Boards • 19 multi-line telephone connections (in various combinations of 2 or 4 lines) • Patch data or telephone service to 18 remote locations • Comes with 18 8-inch 8p8c Flat Patch Cords
24-Port Structured Media Panel (24P)	47603-24P	<ul style="list-style-type: none"> • (1) Telephone Line Distribution Module • (4) Category 5e Voice & Data Boards • 19 multi-line telephone connections (in various combinations of 2 or 4 lines) • Patch data or telephone service to 24 remote locations • Comes with 24 8-inch 8p8c Flat Patch Cords
4 x 12 Telephone Distribution Panel	47603-12M	<ul style="list-style-type: none"> • (1) 4 x 12 Telephone Dist. Board • Handles up to 4 telephone lines through 12 connections
4 x 12 Telephone Distribution Panel w/ Splitter	47603-412	<ul style="list-style-type: none"> • (1) 4 x 12 Telephone Dist. Board • (1) 8-way 2GHz Video Splitter • Handles up to 4 telephone lines through 12 connections • Features output for up to 8 video connections
4 x 18 Telephone Distribution Panel	47603-18M	<ul style="list-style-type: none"> • (1) 4 x 18 Telephone Dist. Board • Handles up to 4 telephone lines through 18 connections
4 x 18 Telephone Distribution Panel w/CAT 5e Board	47603-8C1	<ul style="list-style-type: none"> • (1) 4 x 18 Telephone Dist. Board • (1) Category 5e Voice & Data Module • Handles up to 4 telephone lines through 18 connections • Provides voice and data service to 6 remote locations via CAT 5e voice and data boards

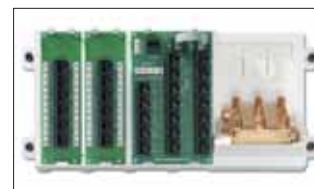

47606-ASO

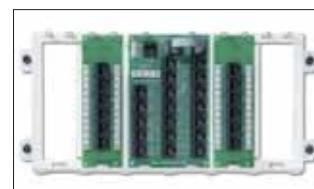

47603-12P

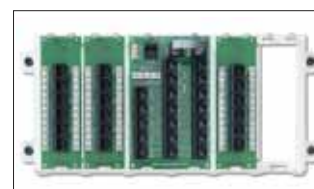

47603-18P

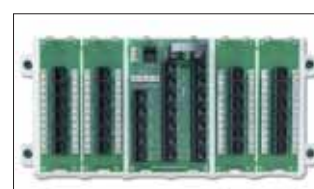

47603-24P

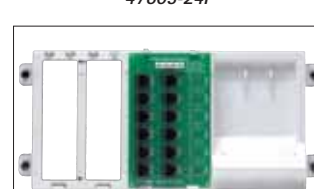

47603-12M

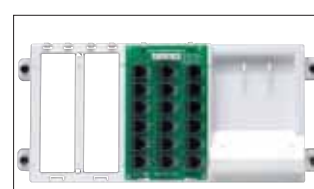

47603-18M

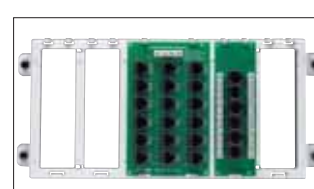

47603-8C1

Full-width panel dimensions: 6.25"H x 13.06"W x 2.50"D

For detailed features and dimensions, please consult individual specification sheets at www.leviton.com



STRUCTURED MEDIA™ PANELS and BOARDS



47603-1G4



47603-1G6



47603-TSV



47603-1G8

Pre-Configured Structured Cabling Panels—Compact Series

Leviton's simple solution for basic telephone and video distribution. These compact panels, with their space-saving profile provide simple bridged telephone to 9 locations and 1GHz video to four or six locations, respectively. Compact Series Panels are ideal for MDUs and apartments, installations with space constraints and/or installations where budget is the driving concern.

DESCRIPTION	CAT. NO.	CONSISTS OF
Telephone & 4-Way Video	47603-1G4	<ul style="list-style-type: none"> • (1) 1x9 Bridged Telephone Board • (1) 4-way 1GHz Video Splitter • Bridge up to 4 telephone lines to 9 locations • Route video to 4 locations
Telephone & 6-Way Video	47603-1G6	<ul style="list-style-type: none"> • (1) 1x9 Bridged Telephone Board • (1) 6-way 1GHz Video Splitter • Bridge up to 4 telephone lines to 9 locations • Route video to 6 locations
Telephone Security & 6-Way Video	47603-TSV	<ul style="list-style-type: none"> • (1) Telephone Security Board • (1) 6-way 1GHz Video Splitter • Bridge up to 4 telephone lines to 6 locations • RJ-45 Port for Security Interface • Route video to 6 locations
Telephone & 8-Way Video	47603-1G8	<ul style="list-style-type: none"> • (1) 1x9 Bridged Telephone Board • (1) 8-way 1GHz Video Splitter • Bridge up to 4 telephone lines to 9 locations • Route video to 8 locations

Compact panel dimensions: 6.5"H x 6.5"W

For detailed features and dimensions, please consult individual specification sheets at www.levitonvoicedata.com

Stand-Alone Modules and Expansion Boards

Stand-Alone Modules

DESCRIPTION—MODULE with BRACKET	CAT. NO.
A—1x9 Bridged Telephone Module	47689-00B
B—Category 5e Voice and Data Module	47605-C5B
C—Telephone Security Module	47609-TSV
D—DSL Filter Module	47616-DSB
Category 6 Voice and Data Module	47616-C6B

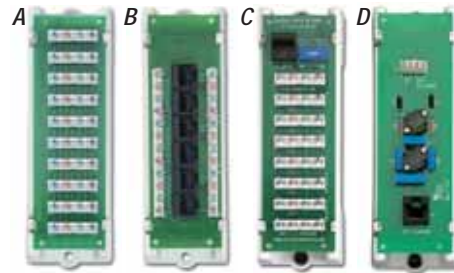

Expansion Boards

DESCRIPTION	CAT. NO.
E—1x9 4-Line Bridged Telephone Board	47603-110
F—1 x 6 4-Line Bridged Telephone Expansion Board	47609-F6
G—1 x 4 6-Line Bridged telephone Expansion Board	47609-S4
H—1 x 10 6-Line Bridged Telephone Security Expansion Board	47609-S10
I—1x5 4-Line Bridged Phone w/Data Pass Through Expansion Board	47609-D5P
J—1x4 4-Line Bridged Phone and 4-Port CAT 5e Expansion Board	47609-4DP
K—1x4 Bridged Phone Board	47609-004
L—Category 5e Voice and Data Expansion Board	47603-C5
Category 6 Voice and Data Expansion Board	47611-C6

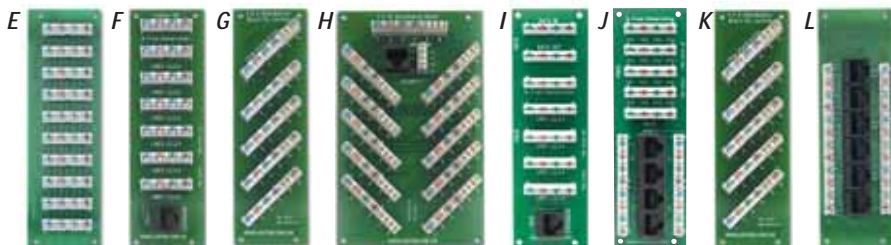



Expansion Boards

DESCRIPTION	CAT. NO.
M-Telephone Patching Expansion Board	47609-EMP
N-DSL Filter Board	47616-DSF
O-Telephone Line Distribution Module and 19 Multi-Line Connections (in various combinations of 2 or 4 lines) Board	47603-TDM
P-4x12 Telephone Distribution Board	47603-12B
Q-4x18 Telephone Distribution Board	47603-18B

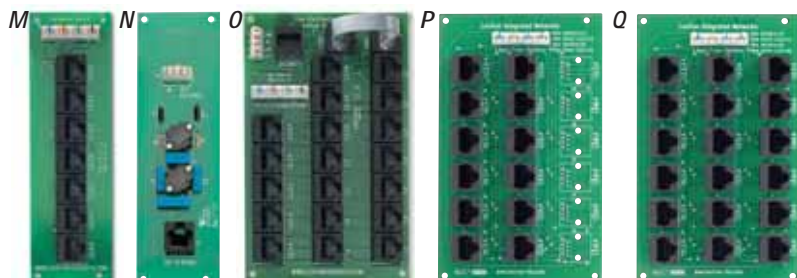

Plastic Mounting Brackets for Leviton Structured Media Centers

The Single Plastic Bracket accepts mounting of any single Leviton phone, data, security or DSL Filter Board within the Structured Media Center to enhance an existing system, for use as a stand-alone solution for voice (with or without security), data and DSL filtering services. The Expansion Plastic Bracket is a full-width bracket that can be populated with up to five Leviton phone, data, security or DSL Filter Expansion Boards in a Leviton Series 140, 280 or 420 Structured Media Center. This unit offers a universal design that accommodates installation of a variety of manufacturers' products.

DESCRIPTION	CAT. NO.
A-Single Plastic Bracket for mounting a single Leviton phone, data, security or DSL Filter Expansion Board in a Leviton Series 140, 280 or 420 Structured Media Center	47612-SBK
B-Expansion Plastic Bracket for mounting up to five Leviton phone, data, security or DSL Filter Expansion Boards in a Leviton Series 140, 280 or 420 Structured Media Center	47612-EBK
C-Half Plastic Bracket for mounting up to 3 Leviton Phone, Data, Security or DSL Filter Expansion Boards in Series 140, 280 or 420 SMC	47612-HBK
D-Data Plastic Bracket for mounting switches, routers, and modems within a Leviton Series 140, 280 or 420 Structured Media Center	47612-DBK

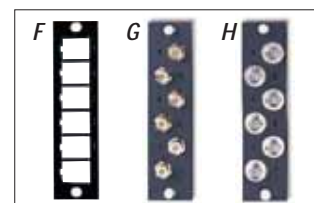
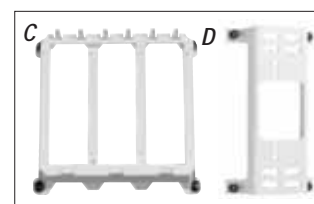
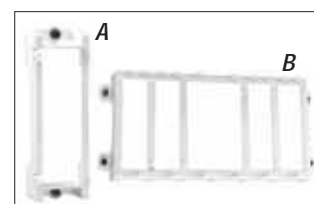

Multimedia Adapter Bracket and Mounting Plates

Create a custom audio/video, copper or fiber mini-panel in your Structured Media Center with the Multi-Media Adapter Bracket. The bracket supports your choice of two 6-pack mounting plates, and snaps easily into any of Leviton's Structured Media Centers with push-pins. Pre-loaded mounting plates are available for BNC and F-connectors, or create a custom configuration with unloaded 6-pack QuickPort® plates. QuickPort plates accept any combination of the following QuickPort adapters or connectors: BNC, F-Connector, ST, FC, SC and MT-RJ Fiber Optics, Banana Jacks, Speaker Binding Posts, RCA, S-Video, Voice Grade, and Category 5, 5e or 6. Bracket mounts vertically or horizontally.

DESCRIPTION	CAT. NO.
E-Multimedia Bracket	47612-MMA
F-BNC Mounting plate, 6-pack, loaded	5F100-BNC
G-F-Connector Mounting plate, 6-pack, loaded	5F100-6VF
H-QuickPort Mounting plate, 6-pack, unloaded	5F100-6QP

Accessories

DESCRIPTION	CAT. NO.
8-Conductor Flat Telephone Patch Cord, 8" long ((1 each)	42400-8FG

SPECIFICATIONS AND FEATURES

All Plastic Brackets

- Made of sturdy white ABS plastic
- Come with push-lock pins
- Snap-in installation in any Leviton series 140, 280 or 420 Structured Media Center
- Allow for cable management via routing under bracket



STRUCTURED MEDIA™ BRACKETS

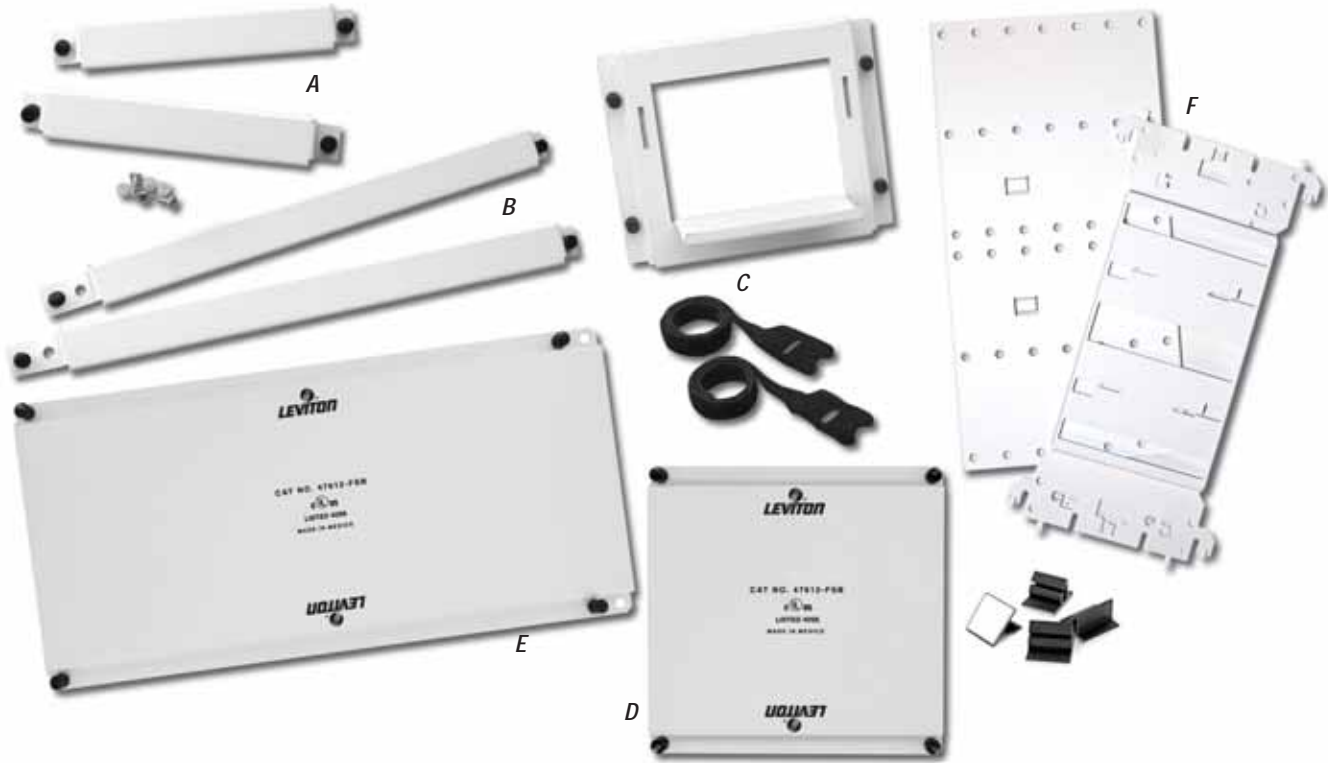

Universal Security & Shelf Brackets for Leviton Structured Media Centers

The Universal Security Brackets allow for consolidation and integration of security products into any of Leviton's Series 140, 280 or 420 Structured Media Center enclosures. The 6" and 12" Universal Security Brackets accommodate the widest variety of security alarm panels. These 1"-wide brackets are sold in pairs with self-tapping screws and insulating spacers for easy attachment to the panels. The Universal Shelf Bracket provides space for security batteries of various sizes as well as other products to be mounted within Leviton's Series 140, 280 or 420 Structured Media Centers. The bracket comes with four 8" long Velcro® strips to strap down products to the shelf, ensuring both vertical and horizontal stability.

Universal Security & Shelf Brackets for Leviton 140, 280 or 420 Structured Media Centers

DESCRIPTION	CAT. NO.
A-6" Universal Security Bracket. Comes a set of two 6"-long, 1"-wide brackets with self-tapping screws and spacers for mounting within Leviton's Series 140, 280 or 420 Structured Media Centers	47612-6SB
B-12" Universal Security Bracket. Comes a set of two 12"-long, 1"-wide brackets with self-tapping screws and spacers for mounting within Leviton's Series 140, 280 or 420 Structured Media Centers	47612-1SB
C-Universal Shelf Bracket. Comes with four 8"-long Velcro strips to strap down security batteries of various sizes as well as other products to be mounted within Leviton's Series 140, 280 or 420 Structured Media Centers	47612-UBK
D-Half-Width Universal Security Plate. Comes with a 6" long plate with four adhesive clips for mounting with Leviton's Series 140, 280 or 420 Structured Media Centers	47612-HSB
E-Full-Width Universal Security Plate. Comes with a 12" long plate with four adhesive clips for mounting with Leviton's Series 140, 280 or 420 Structured Media Centers	47612-FSB
F-Combo Bracket is designed to accommodate Leviton products to be installed in most structured wiring enclosures on the market	47612-CBK

SPECIFICATIONS AND FEATURES

All Brackets

- Made of white powder-coated 18 gauge sheet metal
- Come with push-lock pins

Universal Security Brackets

- Allow an unlimited number of upgrades (limited only by the enclosure's size) to be added to an existing security system terminated within any Leviton Structured Media Center
- Sold in pairs with self-tapping screws and spacers to easily connect the largest number of security alarm manufacturers' panels

Universal Shelf Bracket

- Allows security batteries and other products to be mounted inside any Leviton Structured Media Center
- Vertical and horizontal slots on bracket to accommodate Velcro strips, ensuring vertical and horizontal stability

Combo Bracket

- Allows Leviton products to be installed in most non-Levton structured wiring enclosures



To learn more about Leviton's outstanding offering of devices visit our Website at: www.leviton.com



Surge-Protective and Standard AC Power Modules and J-Box Kits

Surge AC Power Module or J-Box kit models add clean, safe power to the Series 280 or 420 Structured Media Enclosures (Series 140 enclosure only accepts J-Box kits). Two non-surge protected AC Power Module or J-Box kit units offer an economical method of providing power to distribution modules and, except for built-in surge suppression, offer the same features as the respective surge-protected units. In extremely excessive surge conditions, an alarm will sound to warn the user that power is unprotected. Consists of one (J-Box kit) or two (AC Power Module) 15 Amp Hospital Grade duplex receptacles housed in a powder-coated steel enclosure. They feature EMI/RFI filtering and meet UL 1449 standards.

AC Power Modules for 280 and 420 Series Structured Media Enclosures

SPECIFICATIONS

Dimensions:	10"H x 2.8"W x 2.3"D
Standards Compliance (Surge model only):	UL 1449
Input:	2 @ 15A 120V AC

AC Power Modules for 280 and 420 Series Structured Media Enclosures

DESCRIPTION	CAT. NO.
Surge AC Power Module, Two Duplex Receptacle	47605-DP
Non-Surge AC Power Module, Two Duplex Receptacles	47605-NDP

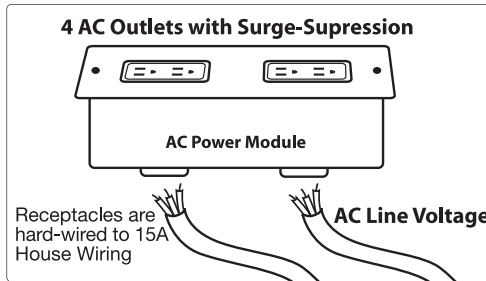

J-Box Kits for 140, 280 and 420 Series Structured Media Enclosures

SPECIFICATIONS

Dimensions:	3"H.x 2"W.x 2.5"D.
Standards Compliance (Surge model only):	UL 1449
Input:	1 @ 15A 120V AC

J-Box Kits for 140, 280 and 420 Series Structured Media Enclosures

DESCRIPTION	CAT. NO.
Surge J-Box Kit, One Duplex Receptacle	47605-ACS
Non-Surge J-Box Kit, One Duplex Receptacle	47605-ACN

Universal Mini DC Power Supplies

These compact units are designed specifically to fit into Leviton's Series 140, 280 and 420 Structured Media enclosures. They are compatible with any incoming AC voltage in the range of 90 to 264V. The 47605-PSA's 9 12VDC connectors provide up to 40 watts of power and the 47605-PSB's 3 12VDC connectors provide up to 10 watts of power while providing short circuit overload and surge protection as well as EMI/RFI filtering to connected equipment.

DESCRIPTION	CAT. NO.
Universal DC Power Supply, 9 12VDC connectors	47605-PSA
Universal Mini DC Power Supply, 3 12VDC connectors	47605-PSB



47605-ACN Non-Surge J-Box Kit



47605-PSB, 47605-PSA
Universal Mini DC Power Supplies

SPECIFICATIONS AND FEATURES

- Hospital grade surge-protected units provide greater protection for line-voltage modules, including multi-stage defense (L-N, L-G, N-G)
- Non-surge suppressor units provide an economical method of providing power to active components
- Available with one (J-Box kits) or two (AC Power Modules) 15 Amp duplex receptacles
- Safety clips protect outlets against dust, dirt and debris
- One (J-Box kits) or two (AC Power Modules) cable knock-outs on bottom for power service connection
- Saves valuable real estate by mounting on outside of Structured Media Enclosures
- Meets UL 1449 standards



MEDIA CENTER POWER



Snap-In Surge Protection Modules

SPECIFICATIONS AND FEATURES

- Interchangeable modules accommodate changing surge protection needs
- All modules easily snap in to the Cat. No. 3950 Surge Module Bracket
- User-friendly design—no wiring required
- Telephone/Fax/Modem Module acts as a splitter, allowing the connection of two devices



3950-BKT



SPECIFICATIONS AND FEATURES

- Contains six removable double screw terminal jacks.
- Each jack utilizes slot-drive screws.
- Shipped with 6 wires containing 18 gauge connectors and 2.1 mm power plugs.
- Fully regulated (12 volt DC regulated output).

Snap-In Modules for Structured Media Enclosure Surge Module Bracket

Leviton's snap-in surge protective modules provide customized surge protection for all low-voltage communication and data lines in the Structured Media Enclosure. All Series 5950 modules can snap-in to the Cat. No. 3950-BKT Surge Module Bracket. The bracket, allows you to add and change modules to fit specific protection needs. Choose from a selection of protection modules for Digital Satellite Systems, Ethernet systems, Cable TV, Telephone/Fax/Modem and DSL/ADSL equipment. All devices attached to the modules are covered under the Leviton \$50,000 Connected Equipment Warranty.

DESCRIPTION	CAT. NO.
Satellite System/Cable TV Protection Module—4 Standard F-connectors. 3-Amp fuse for over-current. Max. line voltage: 75V DC. Breakdown Voltage Range: 70.4-110 Volts/Sec	Beige—5951-SA Gray—5951-SAT Ice—5951-SAC
Ethernet Protection Module (10 Base-T Applications)—Two RJ45 connectors to protect two pair of transmit/receive lines. 10-Amp automatic Resettable PTC fuses. Max. operating voltage: 16.6V DC. Breakdown Voltage Range: 2.62-19.2 Volts/Sec	Beige—5952-ET Gray—5952-ETH
Cable TV System Protection Module—Two Standard F-type connectors. 3-Amp fuse for over-current. Max. line voltage: 75V DC. Breakdown Voltage Range: 70.4-110 Volts/Sec	Beige—5953-PC Gray—5953-PCG Ice—5953-PCC
Telephone/Fax/Modem Protection Module—Three RJ11, 4-wire/2-pair connectors. 3-Position splitter allows for connection to a common line. 3-Amp fuse for over-current protection. Max. operating voltage: 150V rms (including ring voltage). Breakdown Voltage Range: 162-331 Volts/Sec	Beige—5954-AT4 Gray—5954-PT4 Ice—5954-CT4
DSL/ADSL Subscriber Equipment Protection Module—Three RJ11, 4-wire/2pair connectors. 3-Amp fuse for over-current protection. Max. operating voltage: 150V rms (including ring voltage). Breakdown Voltage Range: 162-331 Volts/Sec	Beige—5955-DT Gray—5955-DTG
Cat. 5 Ethernet Module Two RJ45 Connectors with Ground Pin for Ethernet - Cat. 5	Beige—5957-OCS Gray—5957-C5G
Two Line Telephone Module One Input, One Output RJ11 Connector for 4-Wire POTS	Beige—5958-AT4 Gray—5958-PT4
Four Line Telephone Module One Input, One Output RJ45 Connector for 8-Wire POTS	Beige—5959-BT8 Gray—5959-GT8
Surge Module Bracket	3950-BKT

TESTING AND CODE COMPLIANCE

CAT. NO.	MCOV (VDC)	CLAMPING VOLTAGE (VDC)	TESTED TO	MEET STANDARDS
5951	60	388	UL 452	ANSI/IEEE
5952	16.6	23	UL497B	C-62.36
5953	60	388	UL452	
5954	288	715	UL497A	CSA
5955	205	210	UL497A	(#LR-94773)
5957	16.6	23	UL497B	
5958	288	715	UL497A	
5959	288	715	UL497A	

DC Power Distribution Module

The DC Power Distribution Module is a unique solution to the need for high quality electrical power for the separate DC-powered components in the Structured Media Enclosure. This module reduces clutter and opens-up space in the Structured Media Enclosure by eliminating the need for multiple DC transformers. Powered by a single DC power supply, the Power Distribution module provides fully-regulated 12 VDC power for up to 6 devices.

SPECIFICATIONS

Input:	110V AC
Output:	Provides 13V DC power for up to 6 devices 1500mA
Compliance (Surge model only):	UL 1449
Dimensions:	6.58"H x 2.5"W x 1.5"D
Wire Gauge:	Up to 12 gauge

DC Power Distribution Module

DESCRIPTION	CAT. NO.
DC Power Distribution Module	48212-ODC



Structured Media™ Modules—Internet Connection Sharing and Multi-Location Networking

10/100 Internet Gateway Cable/DSL Broadband Router*

Leviton's 10/100Mbps Internet Gateway (a.k.a router) allows multiple users to securely share a single, protected high-speed Internet connection.

10/100 base-t switches*

At 10/100Mbps speeds, these units are excellent choices for networking PC's to meet a wide range of residential needs such as sharing files, printers and other peripherals.

*Networked PC's and peripherals require compatible networking cards or adapters and associated software.



Cat No. 47611-GT4
10/100Mbps Internet Gateway Router

10/100 Base-T Switches and 10/100 Base-T Internet Gateway Router

SPECIFICATIONS	10/100BASE-T 5-PORT (OR 8-PORT) SWITCHES	10/100 BASE-T INTERNET GATEWAY ROUTER
Data Transfer Rate	10/100 Mbps	
Connectors	5 (or 8) ports, 1 AC Power Adapter Jack	4 LAN ports, 1 WAN port, 1 Uplink port, 1 AC Power Adapter Jack
Cabling Requirements	Standard Cat 5/5e UTP	
LED Indicators	One Power Indicator, 5 (or 8) Link/Activity and 5 (or 8) 100Mbps	One Power Indicator, one Diagnostic Indicator, five Link/Activity, five FDX/Col and five 10/100Mbps
Power Supply	12VDC, 1000mA	
Dimensions	5.85" x 3.2" x 1.03"	5.54" x 3.92" x 1.05"
Standards Compliance	IEEE 802.3 10 Base-T Ethernet IEEE 802.3u 100 Base-TX Fast Ethernet, and FCC Class B	

10/100 Base-T Switches and 10/100 Base-T Internet Gateway Router

DESCRIPTION	CAT. NO.
10/100 Base-T 5-Port Ethernet Switch, with Power Adapter	47611-5PT
10/100 Base-T 8-Port Ethernet Switch, with Power Adapter	47611-8PT
10/100 Base-T Internet Gateway Router, with Power Adapter	47611-GT4

Cable Distribution—Modem Outside the Structured Media Center

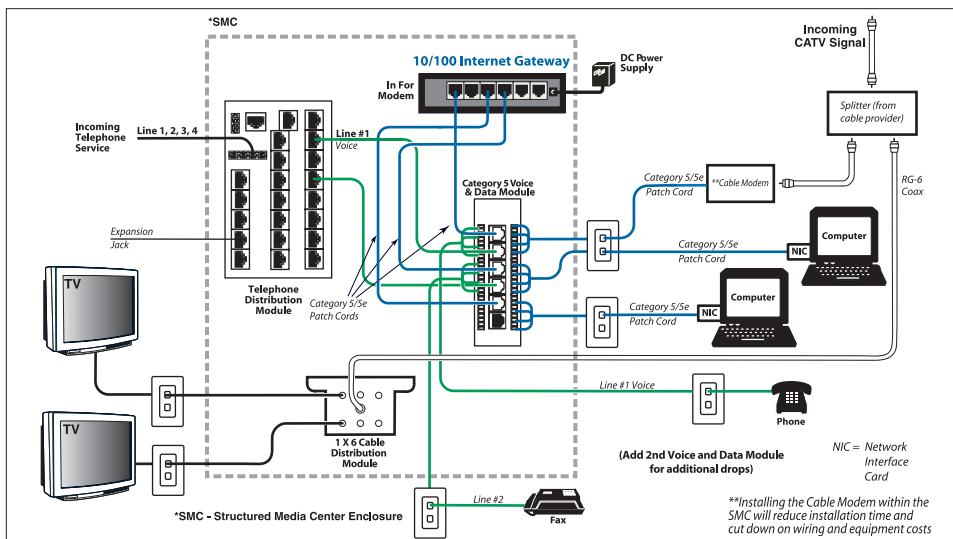

47611-5PT



47611-8PT

SPECIFICATIONS AND FEATURES

- Connects up to 4 devices directly (up to 253 computers via a series of cascaded devices) to the Internet using a single shared high-speed DSL, cable modem, or Satellite connection
- Allows fast Internet access at up to 100 Mbps
- Permits creation of a private high-speed home area network (HAN) or local area network (LAN) in small office/home office (SOHO) environments for all connected computers with its fast, integral 10/100Mbps auto-sensing Ethernet ports
- High performance suitable for demanding home office and telecommuting applications, including sharing of high-speed and high-capacity devices such as storage devices and back-up systems.
- Network Address Translation technology (NAT) creates a firewall that securely cloaks the private network from outside access

- Pass-through IPSEC and ISAKMP protocols allow attached LAN users to implement secure Virtual Private Network (VPN) communication applications on their PC's.
- Built-in DHCP server for easy setup and allocation of IP addresses on the LAN.
- Connections are made by running cable from desired locations to a Category 5e Voice and Data Module (either a stand-alone module page J10, or one of the units in the Pre-Configured Structured Cabling Panels page J9). From there, Category 5 or 5e patch cord can be used to connect the Gateway to the Category 5e Module.
- Network protocols: TCP/IP, DHCP, DNS, NAT, TFTP, HTTP, PPOE. Not PPOA
- Auto detect uplink: Use any port to cascade additional switches, hubs or routers

**Installing the Cable Modem within the SMC will reduce installation time and cut down on wiring and equipment costs



47693-ESM



47693-GSM



47693-3BY



47693-G3Y

CATV 1GHz Video Distribution Modules

Cable service providers are converting to digital systems. These new systems will squeeze hundreds of channels plus Internet service onto the coax line. Leviton's high-performance CATV modules can support these new systems while limiting noise and other artifacts. Modules can distribute standard inputs such as CATV and antennas, and modulated inputs such as VCR's, DVD's and security camera/CCTV on coaxial cable throughout the house. Signals can be precisely controlled through the modules' built-in amplifier/attenuator (-5 to +15db) to compensate for variations in incoming signal strength for the clearest possible reception*.

Incorporates state-of-the-art bi-directional signal paths to support cable modem or cable box communications throughout a home or office. Choose from one or three-input models; both come with 8 outputs. One and three-input models come in both nickel-plated and gold-plated connector versions.

Dimensions: 3.50"H x 6.50"W x 3.20"D, Connector: F-Type, Impedance: 75 Ohm, Power Input: 12 VDC, 500 mA (1x8 & 3x8).

*Not for use in-line between 1 satellite dish (LNB) and DBS satellite TV receiver.

1x8 CATV Distribution Modules (1GHz)

Parameter	Bandwidth	Forward Path	Return Path
Band	--	52-1000MHz	5-42MHz
Gain (Loss)	--	4dB	(-0.5dB)
Flatness	--	±0.75dB	±1.5dB
Return Loss – Input	--	22.0dB	21.0dB
Return Loss – Output	--	22.0dB	21.0dB
Port Isolation – Output	--	25.0dB	27.0dB
Group Delay (span 3.58MHz)	54-60MHz	15ns	--
	61-1000MHz	7ns	--
Group Delay (span 1MHz)	5-42 MHz	--	17ns
	10-40 MHz	--	10ns
Power to RF Input Isolation	5-1000 MHz	100dB (min)	
RFI Isolation	5-1000 MHz	-110dBc	
Noise Figure	5-1000 MHz	3.5dB	
Distortions*	CSO	-65dBc	
	CTB	-74dBc	
	Xmod	-75dBc	

* Input level at +10dBmV flat 77 channels & 200MHz noise for QAM test from 550 to 790MHz
Operating Temperature: -40°C to +60 °C

3x8 CATV Distribution Modules (1GHz)

Parameter	Bandwidth	Forward Path	Return Path
Band	--	52-1000MHz	5-42MHz
Gain (Loss)	--	3.5dB	(-11.0dB)
Flatness	--	±1.0dB	±1.5dB
Return Loss – Input	--	22.0dB	21.0dB
Return Loss – Output	--	20.0dB	21.0dB
Port Isolation – Output	--	25.0dB	25.0dB
Group Delay (span 3.58MHz)	54-60MHz	15ns	--
	61-1000MHz	7ns	--
Group Delay (span 1MHz)	5-42 MHz	--	17ns
	10-40 MHz	--	10ns
Power to RF Input Isolation	5-1000 MHz	100dB (min)	
RFI Isolation	5-1000 MHz	-110dBc	
Noise Figure	5-1000 MHz	6.5dB	
Distortions*	CSO	-65dBc	
	CTB	-74dBc	
	Xmod	-75dBc	

* Input level at +10dBmV flat 77 channels & 200MHz noise for QAM test from 550 to 790MHz
Operating Temperature: -40°C to +60 °C

CATV Distribution Modules

DESCRIPTION	CAT. NO.
1x8 CATV Module, 1 GHz, Nickel-plated Connectors	47693-ESM
1x8 CATV Module, 1 GHz, Gold-plated Connectors	47693-GSM
3x8 CATV Module, 1 GHz, Nickel-plated Connectors	47693-3BY
3x8 CATV Module, 1 GHz, Gold-plated Connectors	47693-G3Y



Video Amplifier

Run cable TV and other video service signals, such as antenna or other modulated input through this Video Amplifier Module and boost video signal strength up to 25 dB. Features a variable attenuator for signal amplification level setting, and an FM trap to eliminate unwanted FM interference.

SPECIFICATIONS

Dimensions:	6.58"H x 3.67"W x 4.4"D
Frequency Range MHz:	50-1000
Gain Control Range dB:	10-25dB
FM Trap dB:	25
Impedance:	75 Ohm
Connector Type:	F-type
Power Source:	12 VDC 500 mA

Video Amplifier

DESCRIPTION	CAT. NO.
Video Amplifier Module	48210-VA



48210-VA

SPECIFICATIONS AND FEATURES

- Run cable TV or other video signals through the Video Amplifier before splitting and distributing throughout the home or office.
- Boost signal strength by up to 25 dB.

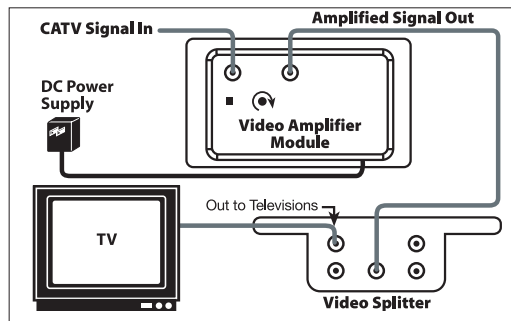



VIDEO DISTRIBUTION



1 GHz Modules



1 GHz Video Splitters

SPECIFICATIONS AND FEATURES

- Splits video signals. Outputs for up to 4, 6 or 8 televisions.
- Provide digital cable, cable TV and other video services, via coaxial cable, to any room in the house.
- Die-cast housing and printed circuit board.
- Use with the Video Amplifier for increased signal strength.
- Units for SMC 140, 280, 420 come with mounting bracket.
- Gold-flashed contacts on 2 GHz units provide lowest conductive resistance.



47691-3MS



47691-5MS

SPECIFICATIONS AND FEATURES

- Distributes digital satellite signals to up to 4 TVs (47691-3MS) or 8 TVs (47691-5MS).
- Combines signals from digital satellite with off-air antenna onto single coax cable.
- DSS 75 Ohm and 2.0 GHz Combiner/Diplexer with DC Blocking, Cat. No. 40856-DSS, is available to separate antenna and cable signals.

Passive Components

Use 4-, 6- and 8-way Passive Video Splitters to split digital cable, quality cable TV and off-air antenna signals to 4, 6, or 8 televisions throughout the home or office. They feature die-cast housing and printed circuit board construction. Use with the Video Amplifier for increased signal strength.

1x4, 1x6, 1x8 Passive Video Splitters

ITEM	CAT NO.	DIMENSION	RANGE
1x4	47690-4C	2.14"H x 6.58"W x 1.40"D	1 GHz
	47690-004	1.65"H x 3.34"W x 1.14"D	1 GHz
	47690-4C2	2.14"H x 6.58"W x 1.40"D	2 GHz
	47690-G4	1.65"H x 3.34"W x 1.14"D	2 GHz
1x6	47690-6C	3.00"H x 6.58"W x 1.40"D	1 GHz
	47690-006	2.64"H x 3.34"W x 1.14"D	1 GHz
	47690-6C2	3.00"H x 6.58"W x 1.40"D	2 GHz
	47690-G6	2.64"H x 3.34"W x 1.14"D	2 GHz
1x8	47690-8C	3.00"H x 6.58"W x 1.40"D	1 GHz
	47690-008	2.64"H x 3.34"W x 1.14"D	1 GHz
	47690-8C2	3.00"H x 6.58"W x 1.40"D	2 GHz
	47690-G8	2.64"H x 3.34"W x 1.14"D	2 GHz

1x4, 1x6, 1x8 Passive Video Splitters

1x4 Passive Video Splitter Module for SMC 140, 280, 420 (1 GHz)	47690-4C
1x4 Passive Video Splitter For Compact Structured Media Enclosure	47690-004
1x6 Passive Video Splitter Module for SMC 140, 280, 420 (1 GHz)	47690-6C
1x6 Passive Video Splitter For Compact Structured Media Enclosure	47690-006
1x8 Passive Video Splitter Module for SMC 140, 280, 420 (1 GHz)	47690-8C
1x8 Passive Video Splitter For Compact Structured Media Enclosure	47690-008
1x4 Passive Video Splitter Module for SMC 140, 280, 420 (2 GHz)	47690-4C2
1x4 Passive Video Splitter For Compact Structured Media Enclosure (2GHz)	47690-G4
1x6 Passive Video Splitter Module for SMC 140, 280, 420 (2 GHz)	47690-6C2
1x6 Passive Video Splitter For Compact Structured Media Enclosure (2GHz)	47690-G6
1x8 Passive Video Splitter Module for SMC 140, 280, 420 (2 GHz)	47690-8C2
1x8 Passive Video Splitter For Compact Structured Media Enclosure (2GHz)	47690-G8

Satellite Distribution Components

3x4 Multi-Switch—Passive module combines signals from dual incoming LNB digital satellite systems with off-air antenna signals on a single coaxial cable, enabling distribution to up to 4 TV's. Module incorporates a separate input for TV antenna signals (best used in combination with a video amplifier).

5x8 Multi-Switch—Active module combines signals from two dual incoming LNB digital satellite systems with an off-air antenna or cable signals on a single coaxial cable, enabling distribution to up to 8 TV's. Works with HDTV or standard receivers and with integrated multi-switches at the satellite dish; also works with DirecTV® systems. Equipped with built-in low noise amplifier and 24VDC power supply.

SPECIFICATIONS	CAT. NO. 47691-3MS
3x4 Multi-Switch	
Dimensions:	4.77"H x 6.58"W x 2.37"D
Frequency:	Terrestrial: 40-860 MHz Satellite: 950-2150 MHz Receiver Output: 40-2150 MHz
Connectors:	F-type, 75 Ohms
LNB Input Selection:	LNBA: 13/14VDC LNBB: 17/18VDC
Insertion Loss (typical):	Terrestrial: -7dB Satellite: -3dB
Return Loss (typical):	Terrestrial: -10dB Satellite: -10dB
Isolation (typical):	Output to Opposite Input -22dB
DC Power Passing:	500ma (max.)

SPECIFICATIONS	CAT. NO. 47691-5MS
5x8 Multi-Switch	
Dimensions:	7.14"H x 13.25"W x 2.33"D
Frequency:	Terrestrial: 54-806 MHz Satellite: 950-2150 MHz Receiver Output: 54-2150 MHz
Connectors:	F-type, 75 Ohms
LNB Input Selection:	13/18VDC or 22kHz tone
Insertion Loss (typical):	Terrestrial: -2dB Satellite: -5dB
Rejection:	Satellite-Terrestrial: 30dB Terrestrial-Satellite: 20dB Receiver-Receiver: 30dB
Switching Isolation:	Terrestrial: N/A Satellite: 30dB
Noise Figure:	Terrestrial: 5dB Satellite: 4.8dB
Max. Current to LNBS:	500mA
DC Power:	24VDC, 600mA

DESCRIPTION	CAT. NO.
3x4 Multi-Switch	47691-3MS
5x8 Multi-Switch	47691-5MS



Leviton Video Monitoring System

Leviton's easy-to-install, high-resolution color video cameras only require one CAT 5e cable for video and power connections, both of which are supplied by a Camera Hub in the SMC. The Camera Hub installs in a single Leviton bracket space in the SMC and the cameras mount with only two screws on a low voltage ring (Indoor Camera) or outdoor electrical box (Outdoor Camera). Standard 110 IDC terminations and 8P8C jacks make the UTP cable connections quick, simple and reliable. Indoor Camera fits in a Decora style wallplate and comes with clear and tinted lens covers. The Outdoor Camera provides 0 Lux operation with IR illumination.

The Leviton IP/Quad Module enables users to view a full-screen single Indoor or Outdoor camera view or multiple cameras, up to four at once in the same "quad" view, on one or more TV sets in the home, or via the Internet from any location using an Internet browser on a PC. Mount s directly in SMC with integral mounting bracket.

Video Monitoring System Components

DESCRIPTION	CAT. NO.
Indoor Color Camera	VSIND-OSC
Outdoor Color Camera	VSOUT-00W
Camera Hub	VSHUB-000
IP/Quad Module	VSQIP-000



VSIND-OSC



VSOUT-00W



VSHUB-000



VSQIP-000

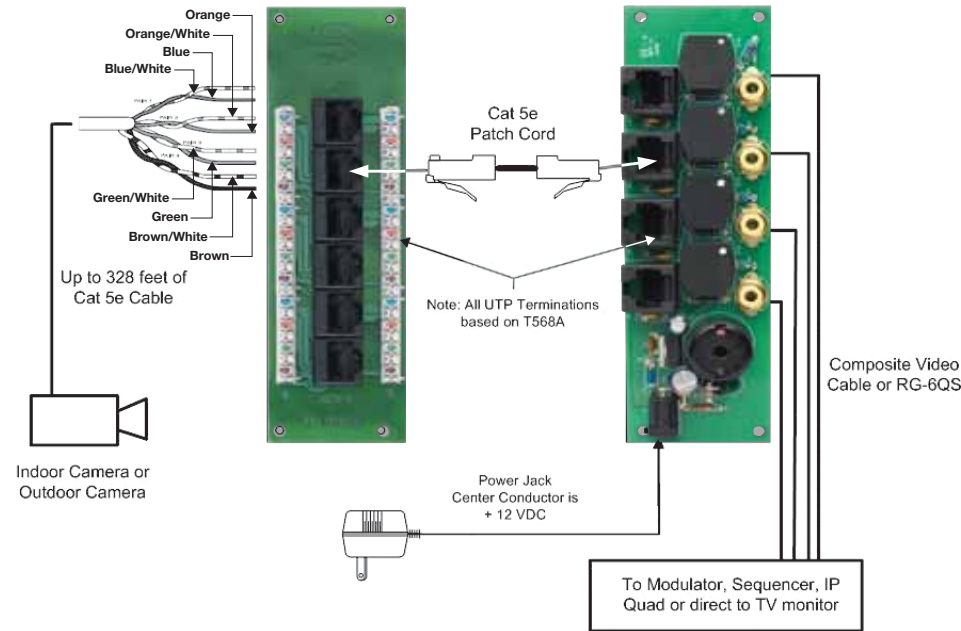

SPECIFICATIONS AND FEATURES

Camera Hub

- Powers camera engines over UTP connection up to 100 meters

Indoor Camera

- Includes balun for clear video over UTP cable
- Includes 15VDC input power terminals for separate power cable where UTP run exceeds 100 meter limit
- Internal strap allows viewing angle adjustment
- Fits standard Decora plate with snap-in clear or smoked inserts

Outdoor camera

- Auto-on infrared LEDs for B&W video images in zero Lux conditions
- Includes balun for clear video over UTP cable

- Includes 15VDC input power terminals for separate power cable where UTP run exceeds 100 meter limit
- Mounts via special single-gang wallplate.
- Ball-joint strut allows 360° rotation and +/- 90° tilt viewing angle adjustment

IP/Quad Module

- Mounts directly to the SMC with integral mounting bracket
- Enables user to view Indoor and Outdoor Cameras on one or more TV sets in the home or via the Internet from any location using an Internet browser on a PC
- Easy browser setup and control of all cameras, including camera name, sensitivity, brightness, contrast, saturation, hue, and single or multiple camera display mode



HOME VIDEO MONITORING SYSTEM



Media Center Modulator

The Media Center Modulator takes the signal from a video device such as a security camera (or multiple cameras using the Video Sequencer) and modulates the signal to one unused cable TV channel, which can then be combined with the CATV signal to multiple locations anywhere in the home, effectively providing a whole-house security channel.

Select the broadcast channel to be programmed via dip-switch button programming. The modulator provides 0, 10, 20 or 30 dBmV RF output.

Note: Modulator broadcasts mono audio only. In a Structured Media System, when used with Structured Media Video Distribution modules, the Modulator must be used with a Leviton Notch Filter (PN 47690-NFA) to clear the target cable channel and avoid interference.



48213-VMA

SPECIFICATIONS AND FEATURES

- RCA video and audio inputs.
- F-Connector output: 14-69 UHF; 70-94, 100-125 CATV.
- DC power supply.

SPECIFICATIONS

Dimensions:	3.2"H x 2.25"W x 1"D
Inputs:	RCA video, RCA audio inputs
Outputs:	1 F-connector for RF signal
Operational channels:	14-69 UHF; 70-94, 100-125 CATV
Bandwidth:	50MHZ-860MHZ
Power:	12V DC 400mA

Media Center Modulator

DESCRIPTION	CAT. NO.
Media Center Modulator	48213-VMA



48213-CVS

SPECIFICATIONS AND FEATURES

- Inputs for up to four video cameras and audio sources.
- Automatic switching between cameras.
- 1-30 second variable time setting between cameras.
- RCA composite audio/video inputs and outputs.

Video Sequencer

The Structured Media Video Sequencer, which automatically switches between video cameras, is a security product engineered for long-term home use. With the Video Sequencer, up to four Decora Cameras* may be monitored sequentially. The Sequencer allows a variable time-interval setting from 1-30 seconds on each camera to allow thorough surveillance of any perimeter or interior. The Video Sequencer has four composite RCA audio/video inputs and two sets of RCA outputs to connect with a monitor or modulator. It snaps into a 280 or 420 Structured Media Center.

SPECIFICATIONS

Dimensions:	7.4"H x 4.75"W x 2"D
Power:	12 VDC @ 300mA
Inputs:	Four RCA video; Eight RCA left/right audio
Outputs:	2 RCA video and 4 RCA left/right audio
Time interval:	1-30 seconds, variable/adjustable
Signal to Noise Ratio:	<1.2dB
Bandwidth:	5MHz

Video Sequencer

DESCRIPTION	CAT. NO.
Video Sequencer	48213-CVS

**Not for use with Indoor/Outdoor B&W Camera with built-in modulator (Cat. No. 48213-BMC).*



Indoor/Outdoor B&W Camera with Built-in Modulator

The Indoor/Outdoor B&W Camera allows monitoring of front doors, back yards, and anywhere an extra eye is desirable. It is designed to withstand temperature and environmental extremes when mounted in a suitable location.* The camera uses a single wire for power and video making installation easy. Output is controlled by a dip-switch inside the camera housing. Permits 360° horizontal adjustment and 180° vertical adjustment.

**Recommended mounting is in a sheltered location such as under an eave or overhang and away from direct exposure to rain and snow.*

Not for use with video sequencer

SPECIFICATIONS

Dimensions:	Base 5.5" x 4.5"
Power:	12 VDC, 300mA
Output Connection:	F-Connector, 75 Ohm
Camera Lens:	3.6 mm
Resolution:	350+ lines
Minimum Illumination:	0.7 lux
Output Level:	27 dBmV
Output Frequency:	UHF 14-69, CATV 70-94, 100-125
Cable Type:	RG 59, RG6 or better



48213-BMC

Indoor/Outdoor B&W Camera with Built-in Modulator

DESCRIPTION	CAT. NO.
Indoor/Outdoor B&W Camera with Built-in Modulator	48213-BMC

RF Notch Filter

The RF Notch Filter is an essential element of Home Security Monitoring and Multi-Room Video. It blocks incoming cable TV channels 75-80, allowing the Media Center Modulator or Component Modulator to broadcast an in-house "security" or "entertainment" channel over the coaxial cable system without interference. The Notch Filter simply couples to the coaxial cable TV input on either a splitter or an active video distribution device. Once installed, it filters out six cable channels to make room for any home security or entertainment video application. It also blocks outgoing signals, such as cameras, from being broadcast outside the home.

SPECIFICATIONS

Dimensions/Weight:	3"L x .9"W – 2lbs
Type:	Passive RF filter
Bandwidth:	CATV channels 75-80
Input:	Female F-connector
Output:	Male F-connector



47690-NFA

RF Notch Filter

DESCRIPTION	CAT. NO.
RF Notch Filter	47690-NFA



RESIDENTIAL INTERCOM SYSTEM



A



C, D, E

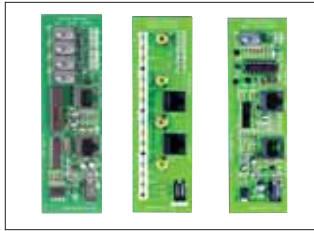

F, G, H

RESIDENTIAL INTERCOM SYSTEM

Leviton brings the home intercom into the 21st century with the introduction of its new Residential Intercom system for Structured Media™ installations. Available as a series of easy-to-install components, the Residential Intercom system is designed to incorporate easily into the category 5-based modular structured wiring systems that have become a standard feature of today's high-tech homes.

DESCRIPTION	CAT. NO.
A-Intercom Kit (includes Main Controller Board, 1 Interface Board on a bracket with 1 Outdoor station)	47000-MKB
B-Main Controller Board	47000-00M
C-Outdoor Station (Brushed nickel finish)	47000-OD1
D-Indoor Station (White)	47000-OW1
E-Indoor Station (Black)	47000-OE1
F-Door Strike Module	47000-STR
G-Interface Board with 4 additional ports	47000-PRT
H-Door Chime Module	47000-CHM

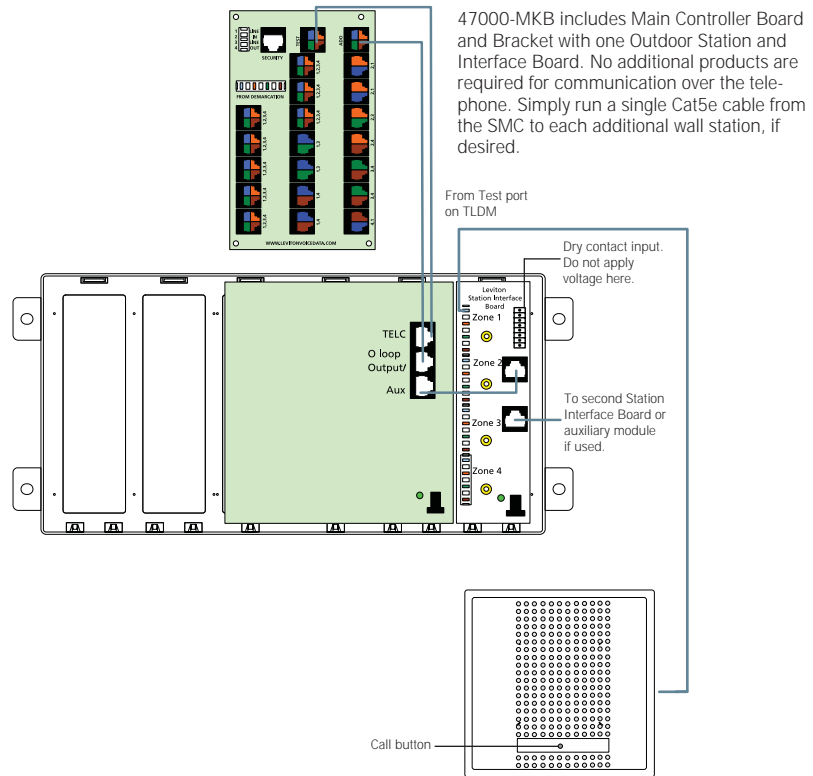

47000-MKB includes Main Controller Board and Bracket with one Outdoor Station and Interface Board. No additional products are required for communication over the telephone. Simply run a single Cat5e cable from the SMC to each additional wall station, if desired.

SPECIFICATIONS AND FEATURES

- Main controller board installs easily in SMC
- System integrates with other services in SMC (phone system, door strike, lighting controls, door bell, dry contact security devices and Indoor and Outdoor Stations)
- Supports up to 12 wall station locations in four zones
- Onboard firmware for music-on-hold
- Answering machine function for message and message taking for intercom activations
- Allows call-on-hold for hang-up at one location and pick-up at another
- Allows whole-house paging, including phone-to-phone paging
- CCTV capability integrated in Interface Board



Leviton Architectural Edition™ powered by JBL Products and Systems

When music and film professionals who create and record sound for a living have to “get it right,” they insist on JBL. Because they know JBL systems will faithfully deliver all the clarity, accuracy and impact of the original performance. When it comes to entertaining at home, why settle for less than the recording industry’s best? Especially when Leviton makes it easy to build premium JBL sound right into the home and enjoy music, movies and more with the same legendary quality heard in concerts, clubs, recording studios, and from behind the screens of the best theaters in the world.

The Leviton Architectural Edition powered by JBL program transforms a living room into a cinema, a deck into an outdoor concert, a kitchen into an elegant bistro, a dining room into a dance hall. Even a master bath turns into a luxurious private retreat. Most important, Leviton/JBL systems are the product of precision engineering, advanced audio technology, painstaking craftsmanship and the latest advances in materials— the same technologies, features and performance that make JBL the first choice of professionals. And they are offered through a select network of quality homebuilders and trained installation professionals working with Leviton, the leader in residential connectivity and home networking systems.

Leviton Architectural Edition™ powered by JBL Indoor In-Wall and In-Ceiling Speakers

Leviton/JBL multi-room In-Wall and In-Ceiling Speakers can deliver a professional listening experience in the home because they incorporate the same features and technologies found in JBL’s renowned family of professional studio monitors, including an Elliptical Oblate Spheroidal™ (EOS) Waveguide for improved high-frequency dispersion throughout a listening area, Titanium-laminate drivers to ensure musical accuracy and clarity, and HeatScape™ magnetic structures for impact and bass realism.

6.5-Inch (170mm) Two-Way In-Wall Loudspeaker

Acoustically transparent paintable baffles and grilles. 1” (25mm) Titanium laminate dome tweeter and 6.5” (170mm) Titanium-laminate woofer, Frequency Response (-10dB): 38 Hz-20 kHz, Sensitivity (2.83V/1m): 88 dB, Power Handling: 80 Watts, Impedance: Nominal 8 Ohms, Dimensions: 11” (279mm) H x 8.5” (226mm) W x 3.87” (98mm) D. Weight: 5 lb/2.3 kg per speaker. Sold in pairs.

DESCRIPTION	CAT NO.
6.5-Inch Two-Way In-Wall Loudspeaker	AEI65

8-Inch (200mm) Two-Way In-Wall Loudspeaker

Acoustically transparent paintable baffles and grilles. 1” (25mm) Titanium laminate dome tweeter and 8” (200mm) Titanium-laminate woofer, Frequency Response (-10dB): 30 Hz-20 kHz, Sensitivity (2.83V/1m): 89 dB, Power Handling: 100 Watts, Impedance: Nominal 8 Ohms, Dimensions: 13.12” (333mm) H x 10.12” (257mm) W x 4” (102mm) D. Weight: 7.8 lb/3.5kg per speaker. Sold in pairs.

DESCRIPTION	CAT NO.
8-Inch Two-Way In-Wall Loudspeaker	AEI80

6.5-Inch (170mm) Two-Way In-Ceiling Loudspeaker

Acoustically transparent paintable baffles and grilles. 1” (25mm) Titanium laminate dome tweeter and 6.5” (170mm) Titanium-laminate woofer, Frequency Response (-10dB): 40 Hz-20 kHz, Sensitivity (2.83V/1m): 88dB, Power Handling: 80 Watts, Impedance: Nominal 8 Ohms, Dimensions: 9.18” (233mm) Diameter x 4.25” (108mm) Depth. Weight: 4.5 lb/2.0 kg per speaker. Sold in pairs.

DESCRIPTION	CAT NO.
6.5-Inch Two-Way In-Ceiling Loudspeaker	AEC65

8-Inch (200mm) Two-Way In-Ceiling Loudspeaker

Acoustically transparent paintable baffles and grilles. 1” (25mm) Titanium laminate dome tweeter and 8” (200mm) Titanium-laminate woofer, Frequency Response (-10dB): 32 Hz-20 kHz, Sensitivity (2.83V/1m): 89 dB, Power Handling: 100 Watts, Impedance: Nominal 8 Ohms, Dimensions: 10.87” (275mm) Diameter x 4.25” (108mm) Depth. Weight: 5.3 lb/2.5 kg per speaker. Sold in pairs.

DESCRIPTION	CAT NO.
8-Inch Two-Way In-Ceiling Loudspeaker	AEC80

6.5-Inch (170mm) Two-Channel/Single Location Two-Way In-Ceiling Loudspeaker

Acoustically transparent paintable baffles and grilles. Reproduces two channels of stereo from one location. Dual .75” (19mm) Titanium laminate dome tweeters and 6.5” (170mm) Dual voice-coil Titanium-laminate woofer, Frequency Response (-10dB): 40 Hz-20 kHz, Sensitivity (2.83V/1m): 88 dB with both channels driven, Power Handling: 100 Watts total, Impedance: Nominal 8 Ohms, Dimensions: 9.8” (233mm) Diameter x 4.25” (108mm) Depth. Weight: 4 lb/1.8kg per speaker. Sold individually.

DESCRIPTION	CAT NO.
6.5-Inch Two-Channel/Single Location Two-Way In-Ceiling Loudspeaker	AEM65

Note: See page J24 for In-Wall and In-Ceiling Preconstruction Kits



AEI65



AEI80



AEC65



AEC80



AEM65



AEN24



AES36



AEI55



AECCS



AESUB

Pre-Construction Kits for Leviton/JBL In-Wall and In-Ceiling Speakers

DESCRIPTION	CAT NO.
Pre-Construction Kit - 6.5" In-Ceiling Speakers	PCC55-KIT
Pre-Construction Kit - 8" In-Ceiling Speakers	AEPC8-KIT
Pre-Construction Kit - 6.5" In-Wall Speakers	AEPI6-KIT
Pre-Construction Kit - 8" In-Wall Speakers	AEPI8-KIT
In-Wall Shelf Pre-Construction (for use with AAEI55)	AEPI8-KIT

Leviton Architectural Edition™ powered by JBL Outdoor/All-Weather Speakers

As the brand delivering sound in more concert venues than any other (including all three Woodstock festivals) JBL is extremely qualified to bring premium sound outdoors. These outdoor speakers are engineered to withstand long-term exposure to the elements right down to their weatherized grilles and input connectors. They are also ideal for indoor pools, atriums and other large open spaces where enclosure speakers with large-area coverage are desired.

Outdoor/All-Weather Two-Way Loudspeaker

Professional-grade injection-molded weather-resistant ported base-reflex enclosure with metal-mesh grille, .75" (19mm) Titanium laminate dome tweeter and 4" (100mm) WeatherPlas™ (polymer-coated cellulose fiber cone) woofer with rubber surround, high-temperature/oversized Kapton® voice coil and HeatScape™ motor structure, Frequency Response (-3dB): 75 Hz-20 kHz, Sensitivity (2.83V/1m): 86 dB, Power Handling: 100 Watts, Impedance: Nominal 8 Ohms, Dimensions: 9.5" (241mm) H x 6.25" (159mm) W x 4.75" (121mm) D. Weight: 4.5 lb/2.1 kg per speaker. Sold in pairs.

DESCRIPTION	CAT NO.
Outdoor/All-Weather Two-Way Loudspeaker	AEN24

Outdoor/All-Weather Three-Way Loudspeaker

"Extreme performance" three-way professional-grade sealed enclosure speaker with all-metal, gold-plated binding posts for outdoor applications and for music and home theater installations (as a satellite with a subwoofer system). 1" (25mm) Pure Titanium laminate dome tweeter, 4" (100mm) WeatherPlas™ shielded midrange with Linear Field Proximity (LFP) bezel and 6" (150mm) WeatherPlas™ (polymer-coated cellulose fiber cone) woofer with rubber surround, high-temperature/oversized Kapton® voice coil, Frequency Response (-3dB): 60 Hz-20 kHz, Sensitivity (2.83V/1m): 90 dB, Power Handling: 150 Watts, Impedance: Nominal 8 Ohms, Dimensions: 10.25" (260mm) H x 14.62" (371mm) W x 5" (127mm) D. Weight: 11 lb/5 kg per speaker. Sold in pairs

DESCRIPTION	CAT NO.
Outdoor/All-Weather Three-Way Loudspeaker	AES36*

* See Leviton.com for current Leviton part number.

Leviton Architectural Edition™ powered by JBL Home Theater Speaker Components

JBL systems measure-up to higher standards than "home" theater, because more JBL speakers are found in film recording studios and behind the screens of the worlds best movie theaters than any other brand. This select group of installed and enclosed speakers for residential home-theater applications can bring cinema realism to any living room.

Two-Way In-Wall Center Channel Speaker

Can be used in front-speaker home theater applications either singly with Leviton/JBL In-Wall left and right speakers or in a matched set of three left/right/center speaker in ultra-premium installations. Acoustically-transparent paintable baffle and grille. 1" (25mm) Pure Titanium dome tweeter and two 5" (125mm) Polymer-coated aluminum woofers, Frequency Response (-10dB): 40 Hz-20 kHz, Sensitivity (2.83V/1m): 88 dB, Power Handling: 120 Watts, Impedance: Nominal 8 Ohms, Dimensions: 7.5" (191mm) H x 15.37" (391mm) W x 3.87" (98mm) D. Weight: 5.7 lb/2.5 kg per speaker. Sold individually

DESCRIPTION	CAT NO.
Two-Way In-Wall Center Channel Speaker	AEI55

Dual 5-Inch (125mm) Two-Way Shelf-Mount Center Channel Loudspeaker

Enclosed free-standing, shelf-mounted center-channel speaker to accompany in-wall installed left and right speakers like the Leviton/JBL AEI65, AEI80 and AEI55. .75" (19mm) Titanium laminate dome shielded tweeter and two 5" (130mm) PolyPlas™ shielded woofers, Frequency response (-3dB): 75 Hz-20 kHz, Sensitivity (2.83V/1m): 90 dB, Power Handling: 75 Watts, Impedance: Nominal 8 Ohms, Dimensions: 6.5" (165mm) H x 20.25" (514mm) W x 9.62" (244mm) D. Weight: 9.6 lb/4.4 kg per speaker. Sold individually..

DESCRIPTION	CAT NO.
Dual 5-Inch (130mm) Two-Way Shelf-Mount Center Channel Loudspeaker	AECCS



Powered 12-Inch Subwoofer

Freestanding front firing, powered (amplified) subwoofer to reinforce in-wall and in-ceiling installed systems in home theater viewing. High-efficiency, high current switched amplifier. Variable low-pass crossover and output level (volume) control. 12" (300mm) PolyPlas™ woofer with heat-resistant voice coil, front-firing enclosure. Amplifier output (RMS): 300 Watts, Dynamic power (peak): 600 Watts, Frequency response (+/- 3dB): 25 Hz low-pass crossover setting (variable), Dimensions: 19.75" (502mm) H x 14.37" (365mm) W x 18" (457mm) D. Weight: 39.5 lb/18 kg. Sold individually.

DESCRIPTION	CAT NO.
Powered 12" Subwoofer	AESUB

Leviton Architectural Edition™ powered by JBL On-Wall Home Cinema Speaker System

An ideal solution for home theater locations where an in-wall/ in-ceiling installed home theater speaker solution is impractical but full performance is desired (such as in room corner installations). This is a 5-channel surround-sound package that is expandable to 6.1 or 7.1 surround-sound operation with the addition of optional matched AESS5 Expansion Satellite Speaker(s). Includes 5 mounting brackets and subwoofer input RCA cable. Available in White or black finish



Home Cinema Speaker System

Speaker Complement: Five 2-way magnetically shielded satellite speakers with high-output 2.5" (63.5mm) woofer and precision .5" (12.7mm) tweeter, and one 8" (200mm) 100 watt powered subwoofer with LFE input, adjustable level control, and built-in crossover network for use with speaker-level outputs. Enclosure: Bass-reflex with FreeFlow™ flared port, Recommended power range: 10-100 Watts, Subwoofer Frequency Response (+/- 3dB): 150 Hz-20kHz, Satellite Speaker Sensitivity (2.83V/1m): 86dB, Satellite Impedance: Nominal 8 Ohms, Dimensions (Subwoofer): 16.25" (413mm) H x 11" (279mm) W x 13.75" (349mm) D, Dimensions (Satellite Speaker): 5" (127mm) H x 3.5" (88mm) W x 3.5" (88mm) D Subwoofer weight: 28 lb/12.7 kg.

Expansion Satellite Speaker

One 2-way magnetically shielded satellite speaker with high-output 2.5" (63.5mm) woofer and precision .5" (12.7mm) tweeter. Recommended power range: 10-100 Watts, Frequency Response (+/- 3dB): 150 Hz-20kHz, Speaker Sensitivity (2.83V/1m): 86dB, Impedance: Nominal 8 Ohms, Dimensions (Satellite Speaker): 5" (127mm) H x 3.5" (88mm) W x 3.5" (88mm) D Weight: 1.8lb/0.8kg per speaker.

DESCRIPTION	CAT NO.
5-Channel Surround-Sound Home Cinema Speaker System with 100 Watt Powered subwoofer and 5 Satellite Speakers - Black	AEH50-BL
5-Channel Surround-Sound Home Cinema Speaker System with 100 Watt Powered subwoofer and 5 Satellite Speakers - White	AEH50-WH
Optional AEH50 System matched satellite Speaker for 6.1 and 7.1 surround-sound operation – Black	AESS5-BL
Optional AEH50 System matched satellite Speaker for 6.1 and 7.1 surround-sound operation – White	AESS5-WH

Rough-In Kit/Adapter Wallplate for JBL Satellite Speaker

Decorative Satellite Speaker Adapter Wallplate. Dimensions: 4.5" (114mm) H x 2.75" (70mm) W x .25" (6mm) D Weight : 1 oz./0.3 kg

DESCRIPTION	CAT NO.
Rough-In Kit/Adapter Wallplate for JBL Satellite Speaker - White	AEPHK-WH
Rough-In Kit/Adapter Wallplate for JBL Satellite Speaker - Black	AEPHK-BL



HKAVR-XXX



HKDVD-038



HKDC-000



HKPOD-000



HKABV-000

Audio/Video Entertainment Center Components and Accessories from Harman/Kardon™

There is no better way to assure the highest performance and value from a state-of-the-art Leviton/JBL than to power it with matched Harman/Kardon Entertainment Center. The Harman/Kardon components available as part of the Leviton/JBL program represent a summary of today's most advanced analog and digital audio and video technologies—and ensure full compatibility with the home entertainment formats and platforms of the future.

Harman/Kardon Audio/Video Receivers

Harman/Kardon 7.1-channel digital audio/video receivers offer a wealth of listening and viewing options, including high-current amplifier design for accurate tracking of musical and audio/video source information, the latest HDMI audio/video input and switching, auto speaker calibration for surround sound perfection, multi-room audio, XM Satellite Radio and I-Pod capability, and much more, all in a elegant package.

DESCRIPTION	CAT NO.
7.1 Channel Surround Sound A/V Receiver, w/HDMI™ Switching and A-BUS®	HKAVR-XXX*
7.1 Channel Surround Sound A/V Receiver, w/HDMI™ Switching	HKAVR-XXX*

High-Performance Single-Disc DVD Player

Advanced video performance requires a maximum resolution source, because the best TV screen is only as good as what's fed into it. The Harman/Kardon progressive-scan DVD Player is equal to the task, with HDMI output, DCDi by Faroudja video processing, and up-scaling to 1080i high-definition playback.

DESCRIPTION	CAT NO.
High-Performance Single-Disc DVD Player with HDMI Output and 1080i Upscaling	HKDVD-038*

High-Definition 5-Disc CD Carousel Changer

The Harman/Kardon Changer compliments your multi-room audio system by delivering hours of music with a wide range of programming options to customize the mix – and advanced digital signal processors and digital output capability to ensure that every musical note is delivered free from distortion.

DESCRIPTION	CAT NO.
High-Definition 5-Disc CD Carousel Changer	HKDC-000*

The Bridge™ iPod Docking Station

The Bridge docking station allows your favorite iPod tracks and playlists to be controlled and heard through an entire home entertainment system when used with a compatible Harman/Kardon A/V Receiver.

DESCRIPTION	CAT NO.
The Bridge™ iPod Docking Station	HKPOD-000*

Infrared Remote Sensor

The low-profile IR remote sensor can be placed conveniently to control audio and video components with a compatible receiver's remote control even when they are in a cabinet or entertainment center. All Harman/Kardon AV products can be connected together so that one IR Sensor can operate them all.

DESCRIPTION	CAT NO.
IR Remote Sensor	HKRMS-000*

Harman/Kardon™ A-BUS® System

Multi-room music is easy with these amplified volume controls and distribution hub. The hub simply plugs into the back of an A-BUS Ready® Harman/Kardon (or other brand) A/V Receiver, and sends a selected sound source to up to four rooms/zones where the amplified volume controls take over. The system is ideal for background and casual indoor audio entertaining applications.

Amplified In-Wall A-BUS Volume Control

A Decora up/down amplified rocker-style volume control for dedicated speakers in a single room/zone for use with any A-BUS Ready Harman/Kardon A/V Receiver. Also accepts control commands to A/V receiver or other compatible components via a built-in IR sensor.

DESCRIPTION	CAT NO.
Amplified In-Wall A-BUS® Volume Control	HKABV-000*

A-BUS® Hub 4-Zone System Expansion

When used with the A-BUS interface on compatible HKAVR A/V Receivers, it allows the A/V Receiver to operate up to four rooms/zones of distributed audio (with HKABV Volume Controls and connected speakers).

DESCRIPTION	CAT NO.
A-BUS® Hub 4-Zone System Expansion	HKABH-000*

* See Leviton.com to confirm current Leviton part number. Check with your Leviton salesperson for product availability.





Leviton Architectural Edition™ Multi-Room Audio Amplifiers

Leviton's AE6MA and AE6MC Architectural Edition Multi-Room Audio Amplifiers combine advanced audio engineering, high-current performance and tremendous value in a single low-profile chassis that delivers superior multi-channel amplification to meet the needs of the most demanding residential multi-zone systems. Combining "audiophile" sound quality with commercial reliability, these amplifiers are a no-compromise solution for large, high-output multi-room listening systems. The amplifiers are designed for long-term use with advanced circuit protection and a thermostatically-controlled cooling fan. The AE6MA is a perfect balance of performance and simplicity, with input source flexibility through a unique "electronic channel link" feature that enables different single sources to be assigned to different rooms/zones. The AE6MC is the ultimate in listening flexibility, with advanced LCD keypads that enable the selection of up to seven different audio sources in any room with full independent control.



AE6MA



AE6MA-back

Single-Source 12 Channel (6 Stereo Pairs) Six-Room/Zone Multi-Channel Power Amplifier

Output power: 50 Watts nominal (40 watts per channel 20Hz to 20kHz @ <0.2% THD, all channels driven into 8 ohms); Peak output power: 100 watts per channel; Inputs: Gold-plated RCA jacks with adjustable input gain; Outputs: 5-way gold-plated binding posts; Total Harmonic Distortion (THD): Less than 0.1% 20 Hz to 20 kHz; Signal-to-noise ratio: Over 105 dB; Fan noise: Quiet 28 dB; Dimensions: 3.5 in (89mm) H x 17 in (432mm) W x 11.5 in (292mm) D

DESCRIPTION	CAT NO.
12 Channel (6 Stereo Pairs) Power Amplifier	AE6MA



AE6MC



AE6MC-back

Seven-Source 12 Channel (6 Stereo Pairs) Six-Room/Zone Multi-Channel Power Controller/Amplifier

Output power: 50 Watts nominal (40 watts per channel 20Hz to 20kHz @ <0.2% THD, all channels driven into 8 ohms); Peak output power: 100 watts per channel; Inputs: 14 gold-plated RCA jacks with adjustable input gain and a fully buffered RCA jack output for each; Outputs: Removable screw terminal, accepts 12-20 gauge wire; Total Harmonic Distortion (THD): Less than 0.1% 20 Hz to 20 kHz; Signal-to-noise ratio: Over 105 dB; Fan noise: Quiet 26 dB; Dimensions: 3.5 in (89mm) H x 17 in (432mm) W x 11.5 in (292mm) D

DESCRIPTION	CAT NO.
Seven-Source, Six-Room Multi-Channel Controller-Amplifier	AE6MC
Keypad Controller for AE6MC	AE6MC-PAD
Remote Control for AE6MC	AE6MC-RMT



AE6MC-PAD

SPECIFICATIONS AND FEATURES

Single-Source 12 Channel (6 Stereo Pairs) Six-Room/Zone Multi-Channel Power Amplifier

- Automatic protection circuitry
- Individual input gain adjustment
- External power ON/OFF through external controllers
- Channel Link allows channels to have individual sources or share a common source
- Cooling fan prevents overheating and maximizes energy efficiency

Single-Source 12 Channel (6 Stereo Pairs) Six-Room/Zone Multi-Channel Power Amplifier

- Seven source input selection for each amplifier

- RS-232 port for use with whole-house and PC-based compatible control systems
- Six internal 80+ position stereo volume controls
- High efficiency/small space.
- Automatic protection circuitry
- Individual bass, treble and balance adjustment of speakers in each room
- External power ON/OFF through external controllers
- All-zone control through use of AE6MC keypad
- Cooling fan prevents overheating and maximizes energy efficiency



An entertainment system is like a chain – it can only be as strong as its weakest link. The Leviton Architectural Edition series of products was developed to make sure that every link in the system—volume controls, distribution and connection components, even multi-room amplifiers—have no weak points and are as “state-of-the-art” in performance as the systems’ speakers. The Leviton Architectural Edition is a complete solution for entertainment system designers and installers. Leviton’s award-winning System Matching module and Strauss™ Transformer-Free volume controls use advanced aerospace technology to deliver ruler-flat frequency response to every zone of a multi-room audio system. The Architectural Edition multi-room audio amplifiers combine advanced audio engineering, high-current performance and tremendous value in a single low-profile chassis that delivers superior multi-channel amplification to meet the needs of the most demanding residential multi-zone systems. The advanced circuit engineering inside Leviton’s home theater and multi-room wallplates means that audiophile-grade connectivity can be easy and quick to install.

Composer Series Volume Controls

Leviton’s Composer Series controls are built to a single quality standard, which means system designers can specify them for any distributed sound application with total confidence. (Leviton’s Strauss and Chopin Digital Volume controls use the same heat-dissipation technology used on the space shuttle and resistive switching to achieve ruler-flat frequency response.) On the Brahms rotary controls, tapped auto-transformer design provides a stable interface between high-current amplification and speakers of virtually any type while resisting contamination from dust and dirt. All audio power ratings are UL referenced. All volume controls feature screw connectors for long-term connection integrity.

Decora® Strauss™ Transformer-Free™ and Impedance Matching Transformer-Free™ Volume Controls

In multi-room distributed audio systems, the source of undesirable speaker coloration (usually perceived as a “muffled” sound) is often the volume control itself, because the audio transformers (AKA: autoformers) used in conventional controls can actually filter the bass and treble frequencies. The Decora Strauss Transformer-Free Volume Controls use audio-grade Cermetile resistors to change volume levels while leaving the audio signal unaffected, resulting in ruler-flat frequency response across the entire audible frequency range. Moreover, Decora Strauss Transformer-Free Volume Controls eliminate the problem of “saturation” associated with conventional volume controls and can handle tremendous amounts of music power. Available in standard and impedance-matched versions.



SGVST-00W

SPECIFICATIONS

Speaker Impedance:	2-16 Ohms (nominal 8 Ohms)
Power Handling:	200W peak/100W RMS
Frequency Response:	20Hz-20KkHz +/- 1dB
Dimensions:	4.06"(103.1) H x 1.32"(33.5) W x 2.5"(63.5) D
Mounting:	Standard single-gang design with a mounting depth of 2.5"
Wire Gauge:	Detachable cable connectors are compatible with all standard speaker wire sizes (14-18 gauge)
Color:	White (Optional color change kits available)

Decora Strauss Transformer-Free Volume Control

DESCRIPTION	CAT NO.—WHITE
Decora Strauss Transformer-Free Impedance-Matched Volume Control	SGVSM-00W
Decora Strauss Transformer-Free Volume Control	SGVST-00W
Color change kit converts to Ivory and Almond	SGVCK-IA
Color change kit converts to Ebony	SGVCK-00E
Color change kit converts to Light Almond	SGVCK-OLA

SPECIFICATIONS AND FEATURES

- Decora slide control with precision 12-position switch (including fully-OFF position)
- Transformer-Free™ volume controls deliver rich, full sound at any volume level in any room
- Aerospace-grade Cermetile resistors replace conventional autoformers to maintain audio signal purity
- Detachable cable connector is compatible with all standard speaker wire (14-18 gauge)



Decora Digital™ Chopin™ Volume Control

Fill a room with high-quality audio at the touch of a button, replacing traditional transformers and rotary controls with this advanced interface module and one-touch Decora Chopin Rocker-Switch Wall Unit. Attractive Decora styling and transformer-less design delivers simplicity and superior sound-quality, and enables “three-way” volume control operation in larger rooms/zones. The Volume Control mounts in a standard wall box or low-voltage mounting bracket and connects via Category 5 cable to the Interface Module.

SPECIFICATIONS

Peak RMS Power Rating:	200 Watts per channel
Continuous Power Rating:	100 Watts RMS per channel
Frequency Response, all rated power levels, +/-0.1 dB:	DC-50,000 Hz
Speaker Impedance:	4-16 Ohms nominal
Speaker/Amplifier Connection:	Removable, snap-in audio monoblock w/screw terminals
Power:	12 Volts DC, 200 mA



48211-WVK



48211-WVC

Decora Digital Volume Control Systems

DESCRIPTION	CAT. NO.
Decora Digital Volume Control Kit (Includes Interface Module and Wall Unit with Power Supply)	48211-WVK
Decora Digital Volume Control Wall Unit	48211-WVC

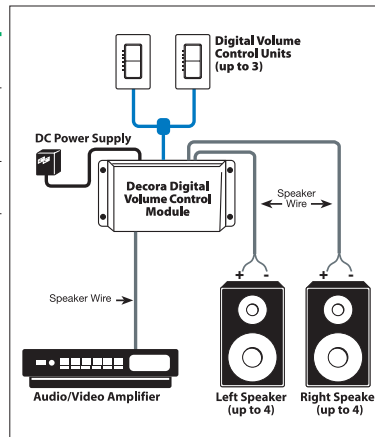

Brahms Autoformer Volume Controls

On the Brahms series of rotary controls, tapped auto-transformer design provides a stable interface between high-current amplification and speakers of virtually any type while resisting contamination from dust and dirt.

Brahms™ Stereo Volume Controls—75 Watt Audio

The 75 Watt Brahms series (25 Watts RMS) of volume controls is designed for low to moderate power installations in the home. The units accommodate 4, 8 or 16 Ohm speakers and amplifiers up to 75 Watts. All controls are impedance matching.

Attenuation: -34 dB in 12 steps. Attenuator Type: Tapped auto transformer. Power Rating: UL Listed @ 75 Watts audio, 25 Watts RMS continuous. Frequency Response: 35 Hz–20 kHz. Screw type connections, 12 position rotary switch.

Decora® Brahms™ Stereo Volume Controls—75 Watt Audio

Control stereo volume from convenient wall-mounted location.

DESCRIPTION	CAT NO.—WHITE
Decora Brahms Stereo Volume Control, 75 Watt, 25 Watt RMS with insert, knob and plate. Boxed unit pack, rack pack carton	40841-ODW



40841-ODW

SPECIFICATIONS AND FEATURES

Decora Digital Chopin Volume Control

- Connects to Interface Module with a single RJ-45 connection. No direct speaker/amplifier connections required at the controller.
- Microprocessor-controlled relays for silent switching.
- Provides impedance matching with speakers from 4–16 Ohms.
- Terminates all amplifier and speaker connections using high-quality audio connection block.
- Digital, transformer-free design uses aerospace-quality cermet resistors for proper heat dissipation and superior performance.
- Each audio zone requires one Digital Volume Control module.
- Each Digital Volume Control module can support up to three volume control units.
- Each Digital Volume Control module can control up to 4 pairs of speakers.
- Tap mute feature activated when center of rocker panel is pressed.



OTHER HOME ENTERTAINMENT PRODUCTS



40905-25W

Decora® Brahms™ Stereo Volume Control with ON/OFF Switch—75 Watt Audio

Control of ON/OFF, as well as volume control.

DESCRIPTION	CAT NO.—WHITE
Decora Brahms Stereo Volume Control, 75 Watt, 25 Watt RMS with insert, knob and plate. Boxed unit pack, rack pack carton	40905-25W

Decora® Brahms™ Stereo Volume Controls—216 Watt Audio

The 216 Watt Audio (72 Watt RMS) Strauss volume control series is designed for higher power installations in the home. Their heavy-duty autoformer construction is designed to resist saturation and degradation even after years of high-volume use. The units accommodate 4, 8 or 16 Ohm speakers and amplifier systems rated up to 216 Watts. All controls are impedance matching.

Attenuation: -34 dB in 12 steps. Attenuator Type: Tapped auto transformer. Power Rating: UL Listed @ 216 Watts Audio, 72 Watts RMS continuous. Frequency Response: 35 Hz–20 kHz. Screw type connectors, 12 position rotary switch.

Decora® Brahms™ Stereo Control with ON/OFF Switch—216 Watt Audio

Convenience of ON/OFF, as well as volume control.

DESCRIPTION	CAT NO.—WHITE
Decora Brahms Stereo Volume Control, 216 Watt, 72 Watt RMS with two-gang plate. Boxed unit pack, rack pack carton	40888-72W



40888-72W



Leviton Architectural Edition System Matching Module with AutoSurge™ Technology

The System Matching Module is used to match the impedance of all speakers and volume controls automatically at a central wiring point. It allows connecting up to six rooms of speakers to a stereo amplifier, and is a cost-effective way to design a passive, impedance-matched multi-room music system.

NOTE: Do not use the System Matching Module with impedance-matched volume controls.

SPECIFICATIONS

Dimensions:	2.57"(68.6) H x 6.38"(161.9) W x 5.38"(136.5) D
Mounting Location:	Mounts in Leviton Structured Media™ Centers
Power Handling:	150W RMS per channel/225W peak
Frequency Response:	10Hz-40kHz, +/- .5dB
Wire Gauge:	Detachable cable connectors are compatible with all standard speaker wire sizes (18-14 AWG)



SGAMP-000

System Matching Module

DESCRIPTION	CAT NO.-WHITE
System Matching Module with AutoSurge Technology	SGAMP-000

1x6 Passive Audio Module

Easy, centralized audio system distribution module connects up to six pairs of speakers from an entertainment center or amplifier. Note: To ensure a correct impedance match with an amplifier, only use the passive audio module with impedance-matched volume controls.

SPECIFICATIONS

Dimensions:	6.58"H x 2.89"W x 1.42"D
Wire Gauge:	18-14 AWG
Requirements:	Product should be used with impedance-matched volume controls



48211-06A

1x6 Passive Audio Module

DESCRIPTION	CAT. NO.
1x6 Passive Audio Module	48211-06A

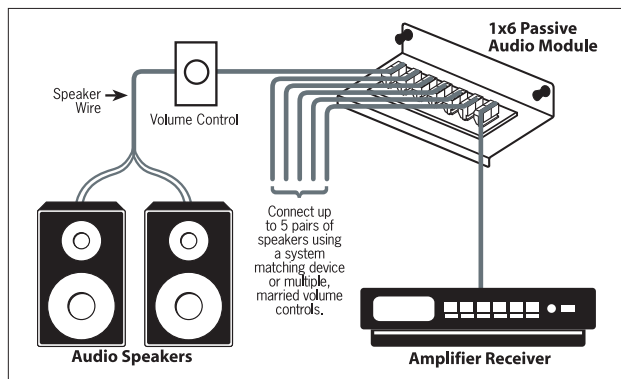

SPECIFICATIONS AND FEATURES

System Matching Module

- Connects up to six rooms/zones
- Convenient single-point connection for all speakers
- Combine with Decora® Strauss™ Transformer-Free-Volume™ Controls or equivalent to control up to six locations of speakers from one amplifier or receiver*
- User-removable connectors facilitate installation
- Transformer-Free impedance-matching design ensures linear frequency response, signal integrity and high power handling capacity

1x6 Passive Audio Module

- Supports up to six pairs of speakers.
- Parallel connection scheme insures the best sound quality.
- User-removable connectors facilitate installation.
- Connects with standard fire-rated speaker wire.



Home Theater and Multi-Room Integrated Wallplates

Both integrated wallplates combine the convenience of a ready-made plate with pre-configured wiring terminations with the performance and connection quality of "audiophile-grade" connectors. These plates are complete and ready-to-use, and make a "custom quality" statement in any installed entertainment system.

Home Theater Interface Wallplate

Connector Type (Front of module): 14 audiophile-grade, gold-plated black and red spring clips, 2 RCA connectors, 2 QuickPort openings; Connector Type (Back of module): 8-pin and 6-pin in-line pluggable screw terminals; Wallplate: High quality impact-resistant white plastic, standard 3-gang with matching painted screws; Mounting Depth: 2.5" (64mm); Wiring: 14-16 gauge speaker wire

DESCRIPTION	CAT NO.
Home Theater Interface Wallplate	AEHTK-000



AEHTK-000

Multi-Room Stereo Speaker Wallplate

Connector Type (Front of module): 4 audiophile-grade, gold-plated black and red spring clips, 2 QuickPort openings; Connector Type (Back of module): Two 2-pin in-line pluggable screw terminals; Wallplate: High quality impact-resistant white plastic, standard single-gang with matching painted screws; Mounting Depth: 2.5" (64mm); Wiring: 14-16 gauge speaker wire

DESCRIPTION	CAT NO.
Multi-Room Stereo Speaker Wallplate	AEMRK-000



AEMRK-000

Specialized Audio/Video Wallplates

These high-value plates are quick to install and intuitive to use when connecting a multi-room entertainment system.

Single Spring Clip Wallplate

Equipped with spade terminals. Mounted on break resistant polymer wallplate.

DESCRIPTION	CAT NO.-WHITE	CAT NO.-IVORY
Single Spring Clip Wallplate. Carded unit pack, rack pack carton	40951-1PW	40951-1PI



40951-1PW

Double Spring Clip Wallplate

Equipped with spade terminals. Mounted on break resistant polymer wallplate.

DESCRIPTION	CAT NO.-WHITE	CAT NO.-IVORY
Double Spring Clip Wallplate. Carded unit pack, rack pack carton	40952-2PW	40952-2PI



40952-2PW

SPECIFICATIONS AND FEATURES

Home Theater Interface Wallplate

- Accommodates from 5.1 to 7.1 channel surround-sound systems
- For use with low voltage rings and standard low voltage junction boxes
- Features RCA connectors for connecting subwoofers
- Two extra openings for additional QuickPort connectors

Multi-Room Stereo Speaker Wallplate

- Integrated wallplate for connecting left and right audio speakers (+/- connections)
- For use with low voltage rings and standard low voltage junction boxes
- Two extra openings for additional QuickPort connectors



SGC65-00W



SGI65-00W



SGI80-00W



SGO99-00W

Spec Grade Sound™ Indoor and Outdoor Speakers

Leviton's award-winning* Spec-Grade Sound™ indoor and outdoor speaker line takes installed home audio to a new level in both technical innovation and value. Leviton's Spec-Grade Sound™ indoor and outdoor speakers can be used with Leviton's innovative, exclusive Decora® Strauss™ Transformer-Free™ Volume Controls and Leviton's System Matching Module and other audio distribution products to form complete systems. All of Leviton Spec Grade Sound™ indoor speakers incorporate exceptionally strong, light and rigid AeroNylon tweeters and Kevlar®-composite woofers for exceptional clarity, detail and impact. They come with built-in AutoSurge protection to help protect the speakers from possible damage due to overdriving. The outdoor/utility speaker is constructed of weather resistant materials inside and out.

*Electronic House Magazine "Product of the Year"

Kevlar is a registered trademark of E.I. du Pont de Nemours and company

6.5-inch Two-Way In-Ceiling Loudspeaker*

Paintable grill and frame. 6.5-inch Composite Kevlar cone low-frequency transducer, .5-inch AeroNylon dome high-frequency transducer, 2-way balanced precision crossover network with AutoSurge circuit protection, Frequency Response: 50-20kHz +/- 3dB, Sensitivity: 87.0 dB SPL @ 1Watt/1 Meter, Power Handling: 120W peak/60W RMS, Impedance: Nominal 8 Ohms/Minimum 6 Ohms, Dimensions: Diameter: 9.03 in (229.4mm); Depth: 4.06 in (103.1mm)

DESCRIPTION	CAT NO.-WHITE ONLY
6.5-inch Two-Way In-Ceiling Loudspeaker	SGC65-00W

6.5-inch Two-Way In-Wall Loudspeaker*

Paintable grill and frame. 6.5-inch Composite Kevlar cone low-frequency transducer, .5-inch AeroNylon dome high-frequency transducer, 2-way balanced precision crossover network with AutoSurge circuit protection, Frequency Response: 50-20kHz +/- 3dB, Sensitivity: 88.0 dB SPL @ 1Watt/1 Meter, Power Handling: 120W peak/60W RMS, Impedance: Nominal 8 Ohms/Minimum 6 Ohms, Dimensions: 12.31 in (312.8mm) H x 9.02 in (229mm) W x 4.06 in (103mm) D

DESCRIPTION	CAT NO.-WHITE ONLY
6.5-inch Two-Way In-Wall Loudspeaker	SGI65-00W

8-inch Two-Way In-Wall Loudspeaker*

Paintable grill and frame. 8-inch Composite Kevlar cone low-frequency transducer, 1-inch AeroNylon dome high-frequency transducer with phase/time alignment guide, 2-way balanced precision crossover network with AutoSurge circuit protection, Frequency Response: 44-20kHz +/- 3dB, Sensitivity: 86.5 dB SPL @ 1Watt/1 Meter, Power Handling: 160W peak/80W RMS, Impedance: Nominal 8 Ohms/Minimum 6 Ohms, Dimensions: 14.25 in (362mm) H x 10.24 in (260mm) W x 4.06 in (103mm) D

DESCRIPTION	CAT NO.-WHITE ONLY
8-Inch Two-Way In-Wall Loudspeaker	SGI80-00W

*Require separate back box for use in fire rated applications

Outdoor/Utility Two-Way Loudspeaker

5.25-inch Silicate-fiber cone low-frequency transducer with butyl surround, .5-inch Polydome high-frequency transducer, 2-way balanced precision crossover network with AutoSurge circuit protection, Element-resistant polypropylene enclosure, gold-plated binding posts, and aluminum mounting, Frequency Response: 50-20kHz +/- 3dB, Sensitivity: 87 dB SPL @ 1Watt/1 Meter, Power Handling: 120W peak/60W RMS, Impedance: Nominal 8 Ohms/Minimum 6 Ohms, Dimension: 8.75 in (222.3mm) H x 6.33 in (161mm) W x 5.5 in (140mm) D (without bracket)

DESCRIPTION	CAT NO.-WHITE ONLY
Outdoor/Utility Two-Way Loudspeaker	SGO99-00W

Spec Grade Sound Pre-Construction Brackets

The Spec Grade Sound Speaker rough in brackets are designed to save time during the rough-in and trim-out phases. The built-in wire management loops ensure that the wire is securely placed and easily located during speaker installation.

DESCRIPTION	CAT NO.-WHITE ONLY
Pre-Construction kit for 6.5" In-Ceiling Speaker	PCC55-KIT
Pre-Construction kit for 6.5" In-Wall Speaker	PCI65-KIT
Pre-Construction kit for 8" In-Wall Speaker	PCI80-KIT

Spec Grade Sound Speaker Grills

DESCRIPTION	CAT NO.-WHITE ONLY
Speaker Grill for Speaker SGC65	SGC65-GRL
Speaker Grill for Speaker SGI65	SGI65-GRL
Speaker Grill for Speaker SGI80	SGI80-GRL



OTHER HOME ENTERTAINMENT PRODUCTS



Decora Media™ System

Send analog audio and video signals through up to 1,000 feet (300 meters) of Category-5 cable with no discernible distortion. The Decora Media System is ideal for connecting source components back to a multi-room audio amplifier located elsewhere in a system. DMS is comprised of: a Send Unit for transmitting audio/video signals, a Receive Unit for receiving signals and a Media Hub. The DMS can operate several ways: in a "hub" configuration with one Send unit sending a single audio/video signal to up to six Receiver units, and point-to-point where Send and Receive units are linked directly together to replace expensive specialized cables or baluns with simple Category-5 cabling..

Send and receive units run on 12VDC, hub runs on 15VDC and can be powered independently or through the Media Hub.

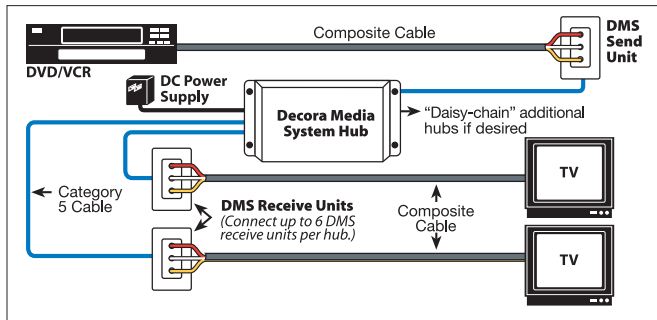

SPECIFICATIONS	SEND UNIT	RECEIVE UNIT	MEDIA HUB
Dimensions:	4.1"H x 1.4"W x 2.0"D	4.1"H x 1.4"W x 2.0"D	6.5"H x 3.4"W x 1.75"D
Video Bandwidth:	50 M Hz @ -3 dB	50 M Hz @ -3 dB	50 M Hz @ -3 dB
Video THD:	75 dBc	-75 dBc	-75 dBc
Video Input:	—	0.5V to 2V composite	0.5V to 2V composite
Video Output:	0.5V to 2V composite	—	—
Slew Rate:	800V/us	800V/us	800V/us
Audio Input Impedance:	—	20k Ohms, max 3Vp-p	20k Ohms, max 3Vp-p
Audio Output Impedance:	51 Ohms, max 2Vp-p	—	—
Audio Freq. Response:	5 Hz-100k Hz, ±3 dB	5 Hz-100k Hz, ±3 dB	5 Hz-100k Hz, ±3 dB
Audio THD:	0.002% 20 Hz-20k Hz	0.004% 20 Hz-20k Hz	0.002% 20 Hz-20k Hz
Audio S/N Ratio:	100 dB typical, 80 dB min 20 Hz-20k Hz	100 dB typical, 80 dB min 20 Hz-20k Hz	100 dB typical, 80 dB min 20 Hz-20k Hz
Input Noise:	4.5nV/(Hz), 1/2 typical @ 1k Hz	6nV/(Hz), 1/2 typical @ 1k Hz	4.5nV/(Hz), 1/2 typical @ 1k Hz
Input and Outputs:	3 RCA input jacks 1 set RJ-45 in/out jacks 1 110 punchdown out 1 DC power input	3 RCA output jacks 1 set RJ-45 in/out jacks 1 110 punchdown out 1 DC power input	3 RCA input jacks 1 RJ-45 input jack 6 RJ-45 output jacks 1 DC power input
Power:	12VDC	12VDC	15VDC

Decora Media System

DESCRIPTION	CAT. NO.
Decora Media System Media Hub with Power Supply	48210-MCH
Decora Media System Send and Receive Unit Pair with Power Supply	48210-SRU
Decora Media System Send Unit with Power Supply	48210-MSU
Decora Media System Receive Unit	48210-MRU

SPECIFICATIONS AND FEATURES

- Cascade hub units to distribute audio/video signals to over 20 locations.
- Send and Receive units are equipped with RJ-45 jacks and 110 punchdown blocks for maximum flexibility in installation.
- Composite RCA inputs for connectivity directly from A/V source.
- Send and Receive units fit standard wallboxes and Decora wallplates.
- Advanced circuitry with automatic equalization streams analog stereo audio and video signals over long distances with less distortion.
- Stereo audio input/output handles Dolby® ProLogic™ surround signals.
- RJ-45 input for Send unit.



Multi-Room Infrared (IR) Repeater System

The IR Repeater System consists of three pieces: an IR Target, IR Emitter and a distribution block for distributing control signals to multiple emitters. The IR Target takes the signal from a remote control for an audio/video component and converts it to a low-voltage electrical signal, sending it back to a component to be controlled by the IR emitter. The flush-mount IR Target easily installs in a ceiling or wall, and connects with Category 5 cable to the IR Emitter. Multiple IR Emitters connect to controlled A/V components through the distribution block in the Structured Media Enclosure. Distribution block (Cat. No. 47689-B) available separately. Dimensions: 2"L x 1"W, Power: 12V DC @200mA, Target Output: 4 signal leads, Target Input: 2 power leads (DC + and -), Emitter Output: Infrared to control source component, Emitter Input: 2 signal leads, Power Supply (included): 12V DC @5mA

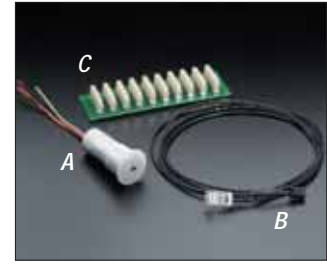

IR Repeater System

DESCRIPTION	CAT. NO.
A-Target	47621-CMS
B-Emitter	47621-MIE
C-1x9 Bridged Telephone Module for IR Repeater, w/o bracket. Individ. boxed unit pack, rack pack carton.	47603-110

Recessed Entertainment Box

DESCRIPTION	CAT. NO.	COLOR*
REB Box with Low-Profile Frame	47617-REB	White
High-Profile Cover	47617-HPC	White
Low-Profile Frame	47617-LPF	White
Replacement Snap-In Plates (2/Bag)	47617-PLT	White
REB Box with High-Profile Cover	47617-RBH	White

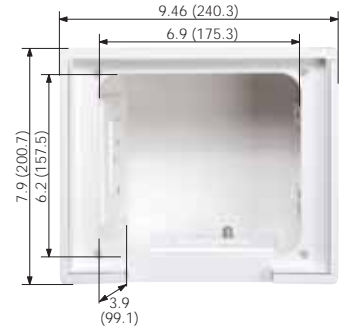

Decora Recessed Receptacles

Duplex Recessed Receptacles 15A-125V AC, 2-Pole, 3-Wire, NEMA 5-15R

DESCRIPTION	CAT. NO.	COLOR*	NEMA CONFIG.
Two-Gang Duplex Receptacle with Openings for 6 QuickPort Connectors (4 blank inserts included) †	690	I, W, T, E	5-15R
One-Gang Duplex Receptacle	689	I, W, T, E	

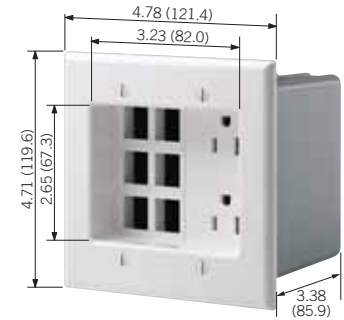

Single Recessed Receptacles

Side-Wired 15A-125V AC, 2-Pole, 3-Wire, NEMA 5-15R

DESCRIPTION	CAT. NO.	COLOR*	NEMA CONFIG.
One-Gang Single Receptacle with Clock Hanger Hook	688	I, W	5-15R
One-Gang Single Receptacle with Clock Hanger Hook	5261-CH	Stainless Steel	

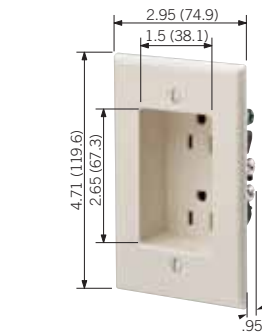

Side-Wired 20A-125V AC, 2-Pole, 3-Wire, NEMA 5-20R

DESCRIPTION	CAT. NO.	COLOR*	NEMA CONFIG.
One-Gang Single Receptacle with Clock Hanger Hook	5361-CH	Stainless Steel	5-20R



† QuickPort Connectors not included.

SPECIFICATIONS AND FEATURES

Recessed Entertainment Box

- Provides single location for line and low-voltage connections
- Stud- and wall-mountable
- Neat, clean recessed installation
- Optional high-profile cover includes sliding plastic front panel and channels all wires through the bottom of the REB
- Paintable white ABS plastic

Recessed Two-Gang Duplex Receptacle with QuickPort Openings

- Provides 2 15A/125V AC NEMA 5-15R power outlets and openings for any 6 installer-selected QuickPort connectors or blank inserts (4 inserts included)
- Includes plastic electrical box and a barrier to separate line and low-voltage conductors
- Wallplate built into device

Recessed One-Gang Duplex Receptacle

- Installs invisibly behind wall units, signature artwork and wall-mounted flat-panel TVs
- Supplies AC power for two components

- Fits most common electrical boxes available (electrical box not included)

Recessed One-Gang Single Receptacles

- Includes clock-hanger hook
- Flush mount with square recess

TESTING AND CODE COMPLIANCE

Recessed Receptacles

- cULus Listed
- NOM Certified (#057)

All Recessed Devices

- Backed by a Limited Two-Year Warranty

*COLOR

For color selection, add suffix to catalog number as follows: Ivory (-I), White (-W), Light Almond (-T) and Black (-E).

MATERIAL CHARACTERISTICS

Environmental: Flammability UL-94, V2 Rating
Operating Temperature: -40° to 120°C

HOW TO USE THIS CATALOG

The L-101 Leviton Wiring Device Catalog is designed to help you find the device you're seeking in the quickest and easiest way possible. Most product sections are divided into three distinct categories in the following sequence—Industrial Grade, Commercial Grade and Residential Grade—and grouped according to amperage and voltage, lowest to highest. For example, if you need to order 15 Amp, 125 Volt Industrial Grade straight-blade duplex receptacles, begin your search with the main Table of Contents at the front of the book. Here you'll see that all straight blade receptacles are listed in Section G. Turn to Section G for a more detailed Table of Contents on the first page. Each section page contains product descriptions, ratings and catalog numbers. There are also helpful highlights including Specifications and Features, Testing and Code Compliance, Color listing, Material Characteristics and dimensioned color product photos. Any product page in the L-101 Catalog can be clearly copied or faxed to customers and prospects for use as a specifier sheet or as part of a presentation.

The Quick Reference Guide follows the main Table of Contents to help you pinpoint and locate specific products. Technical Section V provides general product and test data, industry standards, NEMA configuration charts, a glossary of wiring device terms, ANSI architectural symbols and other related information. Specific catalog numbers are listed in the exhaustive index at the back of the catalog.

15 AMP 125 and 250V • 20 AMP 125 and 250V

Industrial Grade Straight Blade Receptacles

Back and Side Wired (Basic Cat. No. Denotes Brown Device*)

DESCRIPTION	CAT. NO./COLOR 15A/125V	CAT. NO./COLOR 15A/250V	CAT. NO./COLOR 20A/125V	CAT. NO./COLOR 20A/250V
LEVSPEC® Duplex Receptacle, Brass Strap	5262 I, W, GY, R, E	5662 I	5362 I, W, GY, R, E	5462 I, GY
Single Receptacle	5261 I, W, GY	5661 I	5361 I, W, A, T, GY	5461 I, A, T, GY
Narrow Body Duplex Receptacle	5252 I, W, A, T, GY, R, BU		5352 I, W, A, T, GY, R,	

For complete wallplate selection, see Section E.

80703-IG 80703-I 80704-GY 80716-R

84003-40 84004-40 84016-40

SPECIFICATIONS AND FEATURES

Back & Side Wired Duplex

- Impact-resistant thermoplastic nylon cover and body
- Smooth face does not collect dirt
- Four corner latches securely fasten face
- Single-piece brass mounting strap on LEVSPEC devices, multi-piece steel strap on other devices
- Large, triple-wipe, brass "T" contacts for superior contact and conductivity
- Back and side-wiring options
- Brass terminal screws to reduce conductor oxidation
- Break-off tabs for easy two-circuit conversion
- Apron barrier to prevent accidental contact between terminal screw heads and metal box
- Exclusive V-shaped, serrated back-wiring clamp for superior contact and conductivity

TESTING AND CODE COMPLIANCE

- UL Listed 498 (UL File #13399); UL Federal Specification WC-596

***COLOR**

Basic Cat. Nos. shown above denote Brown device, except for Isolated Ground (-IG) devices Basic Cat. No. denotes Orange. Isolated Ground Receptacle is distinguished by an orange triangle on its face. For other color selections, add suffix to the catalog number as follows: Ivory (-I), White (-W), Brown (For IG devices only, add -A), Almond (-A), Light Almond (-T), Gray (-G or -GY), Black (-E), Red (-R) and Blue (-BU); for IG devices only, add -BIG)

MATERIAL CHARACTERISTICS

Environmental: Flammability, Rated V2
Operating Temperature: From -40° C (without impact) to 60°C maximum continuous

- | | | |
|---------------------------------------|--|--------------------------------------|
| A RATING | E CATALOG NUMBER | I SPECIFICATIONS & FEATURES |
| B Choose GRADE, if appropriate | F DESCRIPTION | J TESTING AND CODE COMPLIANCE |
| C DIMENSIONED PHOTOGRAPH | G Check for NEMA CONFIGURATION | K COLOR LISTING |
| D WIRING/CERTIFICATIONS | H WALLPLATE REFERENCE, if appropriate | L MATERIAL CHARACTERISTICS |

DHC Powerline Carrier Components

INDEX

Overview	K2
Controllers—Green Line	
Toscana™ Deluxe Programmer	K3
Wall Switch Controllers with 2-Way Communication	K4, K5
Wall Switch Controllers with Scene Capability	K5
RF Products	K6
Controllers—Red Line	
Basic Programmer	K7
Table Top Controller	K7
Dry Contact Controllers	K7
Receivers—Green Line	
Wall Switches with 2-Way Communication	K8
Wall Switches with Scene Capability	K8, K9
Plug-In Modules with Scene Capability	K10
Receivers—Red Line	
Wall Switches	K11
Remote Switches	K12
Double-Pole 20A Wall Switch	K12
Receptacles	K13
Universal Low-Voltage Module	K14
Fixture Modules	K14
DHC Network Integrity Products	
Panel-Mounted Surge Protective Devices	K15
System Amplifier/Coupler/Repeater	K16
Couplers and Attenuators	K16
Filters	K17
Signal Strength Indicator	K17



DHC POWERLINE CARRIER COMPONENTS FEATURES

Residential Grade Controllers

LEVITON'S DECORA HOME CONTROLS (DHC) RESIDENTIAL POWERLINE CARRIER COMPONENTS PROVIDE HOMEOWNERS WITH EVERYTHING NEEDED FOR PROGRAMMED AND MANUAL CONTROL OF LIGHTING AND APPLIANCES USING THEIR HOME'S EXISTING AC WIRING.

Our current listing of DHC components features new programmers, controllers and receivers with Scene Lighting Capability for coordinated, whole-house lighting control. This includes models offering two-way communication, which enables controllers in remote locations to show the On/Off status of individual lighting loads. Many new DHC components feature Intellisense™, a Leviton exclusive technology. Intellisense reduces noise sensitivity without reducing command signal sensitivity, resulting in the most reliable performance of any powerline carrier home automation system available today.

Features and Benefits

- A network of controllers and DHC switch, dimmer, fixture and receptacle receivers that communicate via unique coded switching signals over a home's AC wiring to automate control of lights and appliances
- DHC components replace switches and outlets, which simplifies installation compared with other automation systems that require dedicated proprietary wiring backbones.
- An effective way to contribute to energy conservation and extend bulb and appliance life
- Offers significant security benefits to today's homeowner, including programmed automatic and manual home security features

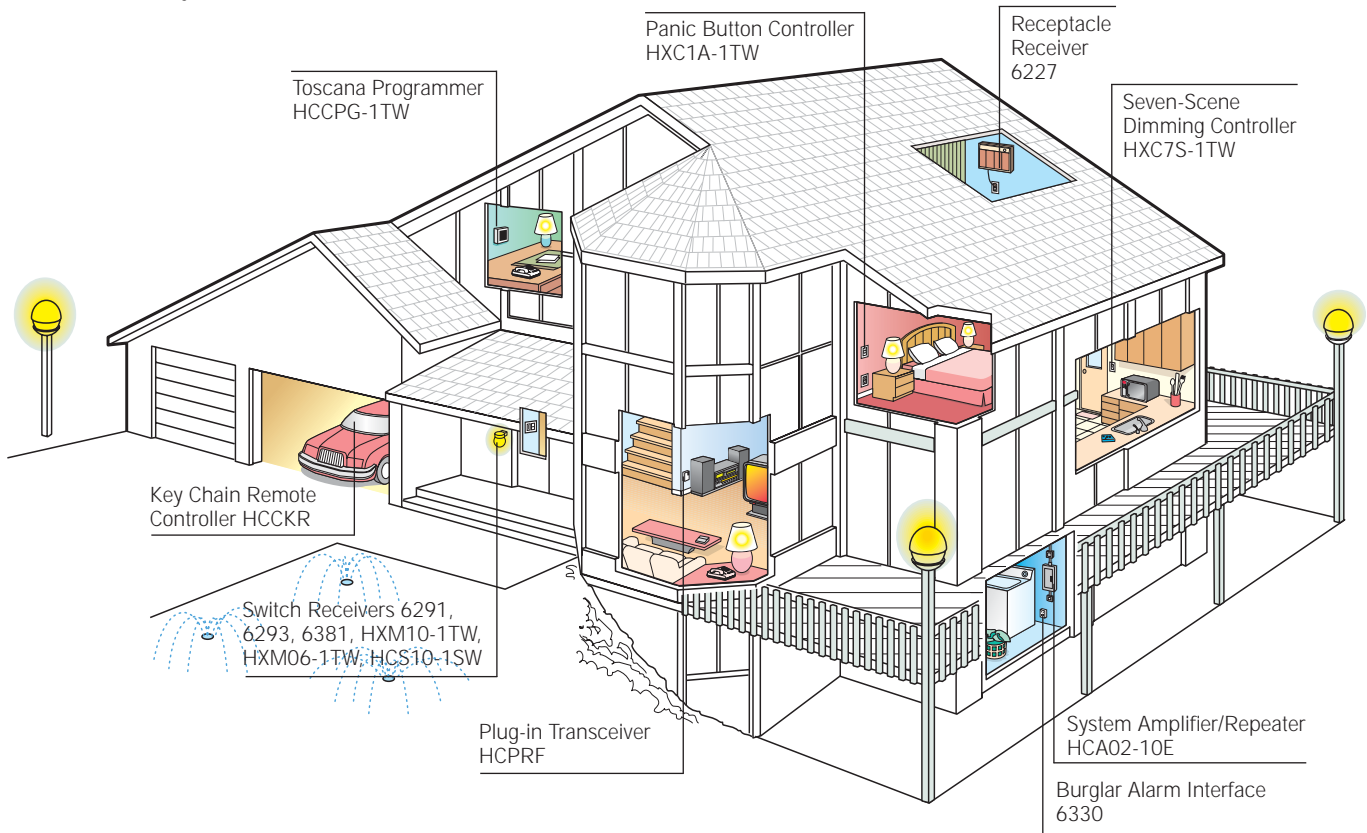

DHC CONTROLLERS, RECEIVERS AND NETWORK INTEGRITY PRODUCTS



DHC Controllers
DHC Controllers send control signals to user-specified DHC address throughout the network. Offering includes wall-mounted programmable, plug-in, tabletop, wireless hand-held, wall switch/dimmer and sensor units, plus models with 2-way communication.
HXC7S-1TW shown



DHC Receivers
DHC Receivers can be set to any of 256 DHC address codes for remote/manual control of incandescent, inductive, fluorescent, or low-voltage loads. They are available as receptacle, plug-in, fixture and multi-location wall switches and dimmer switches.
HXM10-1TW shown



Network Integrity Products
Leviton highly recommends installing these products in every DHC application. The System Coupler/Repeater ensures DHC signal integrity throughout the house. Panel-mount surge devices protect DHC components from transient voltage surges.
51120-1 shown



Toscana™ Deluxe Programmer

Toscana is a simple central access station that expands DHC control capability with easy one-touch access for up to 64 whole-house lighting scenes along with direct remote control of up to 256 devices. Scenes can be accessed by an IR remote or from remote scene lighting control keypads. Toscana provides complex date/time and macro automated programming of lights and appliances.

Timed events or up to 8 groups of timed events can be selected and run on a recurring basis using a highly accurate internal astronomical clock. Toscana registers status changes when DHC receivers with 2-way communication are manually changed.



HCCPG-1TW

Toscana Deluxe Programmer INTELLISENSE™

DESCRIPTION	CAT. NO.
Toscana Deluxe Programmer—Rated: 120V 60Hz AC only. Power consumption: 3 watts. White frame and white cover. Color change kits available for other colors.	HCCPG-1TW

COLOR CHANGE KITS FOR TOSCANA

Cat. No. Ivory Cover/ Ivory Frame	Cat. No. White Cover/ White Frame	Cat. No. Almond Cover/ Almond Frame	Cat. No. Smoke Cover/ White Frame
DCKPG-0II	DCKPG-0WW	DCKPG-0AA	DCKPG-0SW

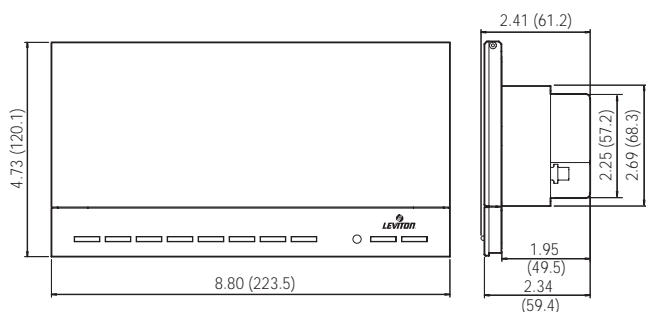

HCCPG-1TW

SPECIFICATIONS AND FEATURES

- Simple central access station for manual control of whole-house system
- No programming experience required—Use simple wizards for setup
- Automatically turn appliances ON/OFF and lights ON/OFF/DIM/BRIGHT
- Controls up to 256 devices in a DHC home system
- Leviton's patented IntelliSense™ Technology virtually eliminates signal problems due to line noise
- 2-Way communication capability registers status changes when receivers with 2-way communication are manually changed
- Permits input of real device names to specify control (such as "wall sconce") rather than cryptic house and device codes (e.g. B5)
- Automatically turns lights ON/OFF at dusk and/or at dawn (astronomical clock)
- Allows creation of up to 64 timed events that can reoccur year annually
- Each timed event can be part of up to 8 "time schedules"
- Create and download complex timed events and macros using a PC with RS-232 port
- Backup and restore all system data; allows cloning of devices using a PC with RS-232 port
- Mounts in standard 4-gang box
- No external wall transformer or powerline interface required
- Rated 120V AC Hz, requires neutral and ground connections

Whole House Lighting Scenes

- Create up to 64 whole-house lighting scenes to create lighting moods
- Access any of the 64 scenes from the Toscana front panel (8 at any one time)
- Access any seven of the scenes remotely using the HXC7S-1TW scene keypads
- Access any of the scenes using 10 learned infrared codes
- Learned infrared codes could be taught using any standard IR remote

TESTING AND CODE COMPLIANCE

- UL Listed (File #E-66800)
- CSA Certified (File #LR-54628)
- NOM Certified (#057)

COLOR

Shipped with White frame and White Cover. See chart for color change kits.

MATERIAL CHARACTERISTICS

Engineering Thermoplastic UL-94, V2 Rating
Operating Temperature: 32°F to 130°F

Note: A Cat. No. HCA02-10E System Amplifier must be installed in all panels in every DHC installation to ensure adequate signal strength.



DECORA® HOME CONTROLS (DHC)



Residential Grade Controllers—Green Line

Wall Switch Controllers with 2-Way Communication INTELLISENSE™

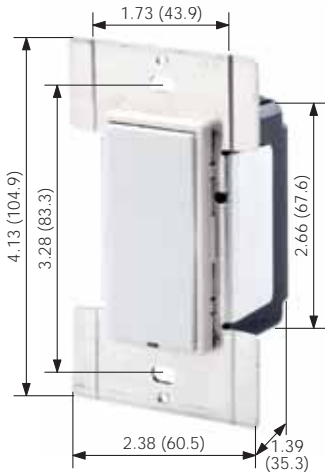

HXC10-1TW

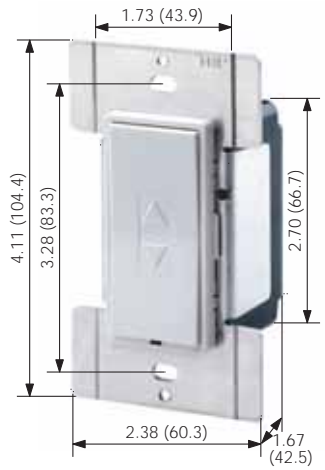

HXC1D-1TW



HXC2D-1TW

DESCRIPTION	CAT. NO.
One Address ON/OFF Controller —One ON/OFF rocker transmits ON/OFF commands to one address. Shipped in White—Color change kits available for other colors.	HXC10-1TW
All Lights ON/All OFF Controller —One ALL LIGHTS ON/ALL OFF rocker transmits commands to all receivers set to the same letter code as this controller. Provides “Panic Button” lighting control for safety and security. NOTE: Receptacle receivers and Universal Low-Voltage Module (6337) do not respond to ALL ON command. Shipped in White—Color change kits available for other colors.	HXC1A-1TW
One-Address Dimming Controller —One ON/OFF rocker transmits ON/OFF commands to one address in the same letter code as this controller. Built-in arrow-shaped rocker transmits DIM/BRIGHT commands to that same address. Shipped in White—Color change kits available for other colors.	HXC1D-1TW
Two-Address Dimming Controller —Two sets of ON/OFF buttons transmit ON/OFF commands to two sequential addresses in the same letter code as this controller. One set of DIM/BRIGHT buttons transmits BRIGHT/DIM commands to the most recently selected address. Shipped in White—Color change kits available for other colors.	HXC2D-1TW

No more than 4 Controllers should be installed on a single branch circuit.

COLOR CHANGE KITS

Controller Cat. No.	Cat. No. Ivory	Cat. No. White	Cat. No. Almond	Cat. No. Gray	Cat. No. Black
HXC10-1TW, HXC1A-1TW	DRK0S-0LI	DRK0S-0LW	DRK0S-0LA	DRK0S-0LG	DRK0S-0LE
HXC1D-1TW	DRK1D-00I	DRK1D-00W	DRK1D-00A	—	—
HXC2D-1TW	DCK2D-00I	DCK2D-00W	DCK2D-00A	—	—
	DCK2D-0CI (w/printable labels)	DCK2D-0CW (w/printable labels)	DCK2D-0CA (w/printable labels)	—	—

SPECIFICATIONS AND FEATURES

- Fit in standard wallboxes and replace regular switches to provide DHC control capability as indicated in “Description”
- 2-Way Communication allows status of receivers changed manually to be reflected in the controller
- Leviton’s patented IntelliSense™ Technology virtually eliminates signal problems due to line noise
- Uses existing 120V AC 60Hz wiring to send command signals
- Compatible with Decora screwless and standard Decora wallplates
- Green LED illuminates to confirm ON command sent or STATUS ON report received
- Decora styling coordinates with Leviton’s popular Decora line; complements any interior
- Backed by a Limited Two-Year Warranty

TESTING AND CODE COMPLIANCE

- UL Listed (File #E-66800)
- CSA Certified (File #LR-54628)
- UL 224A Tested (and others as appropriate)

COLOR

All devices are shipped in White only. See chart for compatible color change kits.

MATERIAL CHARACTERISTICS

Environmental: Flammability (Engineering Thermoplastic) UL-94, V2 Rating
Operating Temperature: 32°F to 130°F

Note: A Cat. No. HCA02-10E System Amplifier must be installed in all panels in every DHC installation to ensure adequate signal strength.



Wall Switch Controllers with 2-Way Communication

DESCRIPTION	CAT. NO.
Three-Address Dimming Controller —Three sets of ON/OFF buttons transmit ON/OFF commands to three sequential addresses in the same letter code group as this controller. One set of DIM/BRIGHT buttons transmits DIM/BRIGHT commands to the most recently selected address. Shipped in White—Color change kits available for other colors.	HXC3D-1TW
Four-Address Dimming Controller —Four sets of ON/OFF buttons transmit ON/OFF commands to four sequential addresses in the same letter code group as this controller. One set of DIM/BRIGHT buttons transmits DIM/BRIGHT commands to the most recently selected. Shipped in White—Color change kits available for other colors.	HXC4D-1TW
Three-Address Dimming, ALL LIGHTS ON/ALL OFF Controller —Three sets of ON/OFF buttons transmit ON/OFF commands to three sequential addresses in the same letter code group as this controller. One set of DIM/BRIGHT buttons transmits DIM/BRIGHT commands to the most recently selected address. One set of ALL LIGHTS ON/ALL OFF buttons transmits commands to all receivers set to the same letter code as this transmitter. Receptacle receivers and Universal Low-Voltage Module (6337) will not respond to ALL ON command. Shipped in White—Color change kits available for other colors.	HXC4A-1TW
Seven-Scene Dimming Controller —Each of seven SCENE buttons transmits ON commands at preset levels to 12 sequential addresses in the same letter code as this controller. (Note: 12-address sequence continues at address 1 if address 16 is reached before all sequential addresses are completed). May be used with all Leviton scene-capable receivers. One set of SCENE DIM/SCENE BRIGHT buttons transmits SCENE DIM/BRIGHT commands to most recently selected scene. One OFF button transmits OFF command to most recently selected scene. Green LEDs illuminate to indicate ON command sent or SCENE ON command detected. Shipped in White—Color change kits available for other colors.	HXC7S-1TW

The HXC7S-1TW utilizes extended code format. This command structure is compatible with Cat. No. HCA02-10E DHC System Amplifier/Coupler /Repeater but is not compatible with the older version of the System Amplifier Cat. No. 6201.



No more than 4 Controllers should be installed on a single branch circuit.

COLOR CHANGE KITS

Controller Cat. No.	Cat. No. Ivory	Cat. No. White	Cat. No. Almond	Cat. No. Gray	Cat. No. Black
HXC3D-1TW	DCK3D-00I	DCK3D-00W	DCK3D-00A	—	—
	DCK3D-0CI (w/printable labels)	DCK3D-0CW (w/printable labels)	DCK3D-0CA (w/printable labels)	—	—
HXC4A-1TW	DCK4A-00I	DCK4A-00W	DCK4A-00A	—	—
	DCK4A-0CI (w/printable labels)	DCK4A-0CW (w/printable labels)	DCK4A-0CA (w/printable labels)	—	—
HXC4D-1TW	DCK4D-00I	DCK4D-00W	DCK4D-00A	—	—
	DCK4D-0CI (w/printable labels)	DCK4D-0CW (w/printable labels)	DCK4D-0CA (w/printable labels)	—	—
HXC7S-1TW	DCKS7-00I	DCKS7-00W	DCKS7-00A	DCKS7-00G	DCKS7-00E
	DCKS7-0CI (w/printable labels)	DCKS7-0CW (w/printable labels)	DCKS7-0CA (w/printable labels)	DCKS7-0CG (w/printable labels)	DCKS7-0CE (w/printable labels)

SPECIFICATIONS AND FEATURES

- Fit in standard wallboxes and replace regular switches to provide DHC control capability as indicated in "Description"
- 2-Way Communication allows status of receivers changed manually to be reflected in the controller
- Leviton's patented IntelliSense™ Technology virtually eliminates signal problems due to line noise
- Uses existing 120V AC 60Hz wiring to send command signals
- Compatible with Decora Plus screwless and standard Decora wallplates
- Green LED illuminates to confirm ON command sent or STATUS ON report received
- Decora styling coordinates with Leviton's popular Decora line; complements any interior
- Backed by a Limited Two-Year Warranty

TESTING AND CODE COMPLIANCE

- UL Listed (File #E-66800)
- CSA Certified (File #LR-54628)
- UL 224A Tested (and others as appropriate)

COLOR

All devices are shipped in White only. See chart for compatible color change kits.

MATERIAL CHARACTERISTICS

Engineering Thermoplastic UL-94, V2 Rating
Operating Temperature: 32°F to 130°F

Note: A Cat. No. HCA02-10E System Amplifier must be installed in all panels in every DHC installation to ensure adequate signal strength.



DECORA® HOME CONTROLS (DHC)



Residential Grade Controllers—Green Line



HCCUR



HCCKR-E

RF Components

DESCRIPTION	CAT. NO.
<p>Universal Remote Control—Hand-held wireless remote control sends RF (radio frequency) command signals to DHC Plug-In Transceiver Cat. No. HCPRF for up to 256 DHC addresses. With an operating range of up to 50 ft. through wall and ceilings, it sends ON/OFF, DIM/BRIGHT and ALL ON/ALL OFF commands for lighting and ON/OFF commands for appliances. The Universal Remote will also control audio and video equipment, including TV's, VCR's, cable boxes, satellite receivers, DVD and CD players and more. Functions as an all-in-one controller for lighting and audio/video systems, making it ideal for home theaters. Universal design also makes it suitable for the elderly and physically challenged. Dual built-in timers can shut off TV and/or DHC devices up to ninety minutes after setting. Uses 2 AAA batteries. Must be used with HCPRF Transceiver. Color: Black.</p>	HCCUR
<p>Plug-In Transceiver—Accepts Radio Frequency DHC commands from the Universal Remote Cat. No. HCCUR for ON/OFF, DIM/BRIGHT and ALL ON/ALL OFF, as well as ON/OFF commands from the Key Chain Remote Cat. No. HCCKR. The Plug-In Transceiver works with all DHC receivers by re-transmitting commands signals onto the home's existing electrical wiring. Plugs into any standard receptacle and provides a built-in outlet for ON/OFF switching of incandescent lamps rated 300W max. @ 120V AC. The lamp can be controlled remotely or locally via the programming button on the face of the Transceiver, which can also be used to change the unit's DHC address. Features IntelliSense™ Technology to ensure optimum system performance. 2-Way communication permits local status of attached lamp to show on all 2-Way capable DHC controllers. Multiple HCPRF Transceivers can be used to increase coverage in large homes. Unit will re-transmit commands for up to 256 DHC addresses. Color: White.</p>	HCPRF-1TW
<p>Key Chain Remote Controller—Designed to fit on a key chain and send RF (radio frequency) command signals to DHC Plug-In Transceiver Cat. No. HCPRF. With an operating range of up to 50 ft. through wall and ceilings, it sends ON/OFF commands for any 2 sequential DHC addresses (addresses are user programmable). Ideal for control of home lighting from a vehicle when entering garage or driveway. Uses long-life 3V CR2032 lithium battery (included). Must be used with HCPRF Transceiver. Color: Black.</p>	HCCKR-E



SPECIFICATIONS AND FEATURES

- Leviton's Universal Remote Control works with DHC-controlled lighting and appliances as well as audio/video system components
- Ultra-compact Key Chain Remote adds to home security by allowing users to turn ON lighting as they approach entranceway, garage or driveway
- Plug-In Transceiver features IntelliSense™ Technology for optimum reliability, 2-way signaling capability, and easy one-button programming. Must be used with Universal Remote and Key Chain Remote.
- Backed by a Limited Two-Year Warranty

TESTING AND CODE COMPLIANCE

- UL Listed (File #E-66800)
- CSA Certified (File #LR-69519)
- NOM Certified (#057)
- UL 224A Tested (and others as appropriate)

COLOR

Colors available as listed.

MATERIAL CHARACTERISTICS

Environmental: Flammability (Engineering Thermoplastic) UL-94, V2 Rating
Operating Temperature: 32°F to 130°F

Note: Cat. No. HCCUR is CSA Certified only. Cat. No. HCPRF-1TW is UL Listed, CSA Certified and NOM Certified. UL and CSA not required for Cat. No. HCCKR-E



Programmer/Controller Products

DESCRIPTION	CAT. NO.
Basic Wall Mounted Programmer —A powerful home automation controller that is easy to install and use. Compact, low-profile unit fits in single-gang wallbox. Accepts up to four addresses; maximum two ON and two OFF commands per address. SECURITY mode randomly selects ON and OFF times to make an empty home appear occupied. ALL LIGHTS ON switch acts as a panic-button lighting system, switching on all DHC switch modules with one touch. DIM/BRIGHTEN command can automatically adjust lighting levels of all fixtures controlled by DHC dimming receivers. LED readout shows time and program status; battery back-up protects clock setting and program status for ten hours during power interruption. Available in Ivory, White, and Almond.	6312
Table Top Controller ★—Provides manual remote control for all 256 DHC addresses. Command functions include ON/OFF, ALL LIGHTS ON/ALL OFF and DIM/BRIGHTEN. The 6320 plugs into any 120 volt AC receptacle to transmit command signals over existing AC wiring.	6320
Dry Contact Controllers ★—Allow monitoring of up to four dry contact closures. No. 6315 Maintained Contact Transmitter sends ON or OFF command signals in response to contact opening or closure. No. 6316 Momentary Contact Transmitter sends ON or OFF command signals in response to contact closure, and no command signal upon contact openings. These units can be used with photocells, infrared sensors, security system, motion sensors, and any other dry-contact-based sensors. Installs in a single-gang wallbox. Color: Ivory.	6315 6316

Power to control side: 125V 60Hz AC Only.

LV LEAD COLOR	TRANSMITS TO
Blue	A1*
Orange	A2*
Yellow	A3*
Brown	A4*

*Or any four sequential address codes within the same Letter Code group as the Transmitter.

CSA Certified except where indicated by★

No more than 4 Controllers should be installed on a single branch circuit.

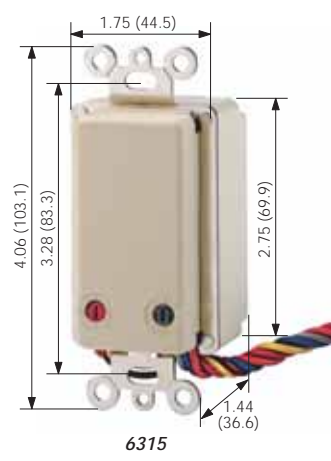
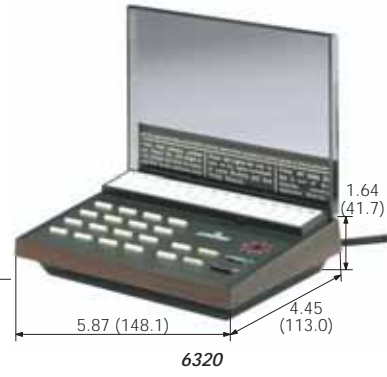
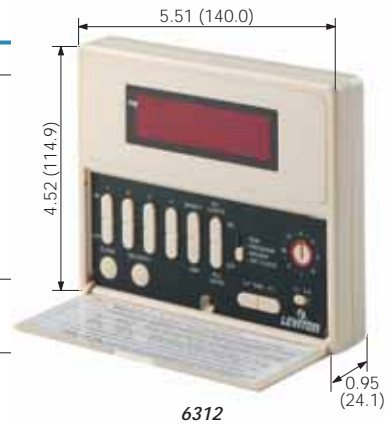

SPECIFICATIONS AND FEATURES

- Programmer adds user-devised scheduling to DHC automated control of lights and appliances for greater convenience, energy savings and security
- Programmer and Controllers send DHC switching commands over existing 60Hz 120V AC house wiring.
- Dry Contact Transmitters link signaling from photocells, infrared sensors, security systems, motion sensors, and other dry contact transmitters to DHC controlled devices
- Backed by a Limited Two-Year Warranty

TESTING AND CODE COMPLIANCE

- UL Listed (File #E-66800)
- CSA Certified (File #LR-54628)
- NOM Certified (#057)

COLOR

Colors available as indicated. Cat. No. 6312 available in Ivory (-I), White (-W) and Almond (-A).

MATERIAL CHARACTERISTICS

Engineering Thermoplastic UL-94, V2 Rating
Operating Temperature: 32°F to 130°F

Note: A Cat. No. HCA02-10E System Amplifier must be installed in all panels in every DHC installation to ensure adequate signal strength.

Home Automation Products





DECORA® HOME CONTROLS (DHC)



Residential Grade Receivers—Green Line

Home Automation Products

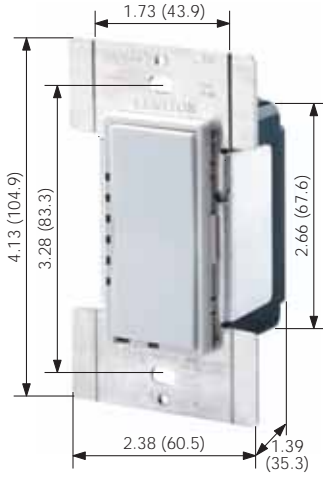

HCM06-1TW

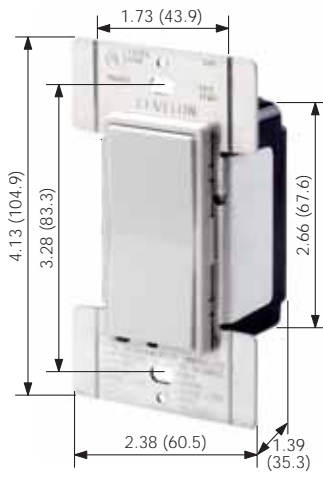

HXM06-1TW

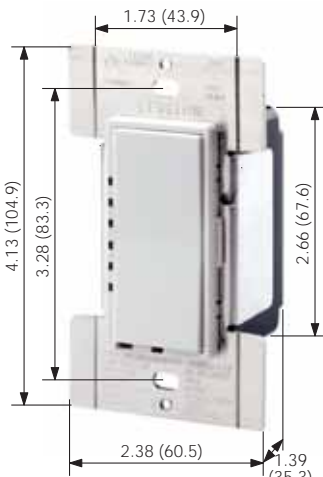

HXS08-1TW

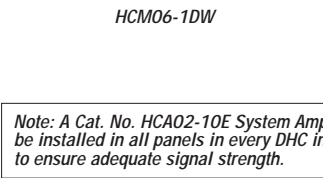

HCM06-1DW

Note: A Cat. No. HCA02-10E System Amplifier must be installed in all panels in every DHC installation to ensure adequate signal strength.

Scene-Capable Wall Dimmers and Switches

The new DHC Scene-Capable Receivers provide one-button programming for scene and address capturing. All feature Leviton's exclusive IntelliSense® to ensure top performance and reliability even when noise is present on the AC powerline.

Dimming Wall Switch Receivers provide manual and remote ON/OFF switching and full-range dimming for incandescent and magnetic low-voltage lighting loads. The new HXS08-1TW Electronic Switch Receiver (non-dimming) provides manual and remote ON/OFF switching for incandescent, magnetic low-voltage, fluorescent and compact fluorescent lighting. All Switch Receivers come with a locator LED. Dimming models feature an LED brightness level display and a preset feature that turns lights ON at the last selected brightness level. Double Tap feature immediately adjusts light to full brightness without affecting the last selected brightness level. All -T Receivers allow 2-way status tracking with the DHC Toscana™ Deluxe Programmer and new 2-way capable controllers when receivers are changed locally.

Typical applications include home theaters, dining rooms, chandeliers, living rooms with multiple high-hats, entranceways, and a wide range of mood lighting applications.

DESCRIPTION	CAT. NO.	RATING @ 120V 60Hz	COLOR
600 Watt Scene-Capable Dimming Wall Switch Receiver with One-Button Programming and LED brightness display. 3-Way capable when used with MS00R-10 Multi-Remote	HCM06-1DW	Incandescent 600W, (450W) Magnetic Low-Voltage Lighting 600VA	White (Ivory kit included)
1000 Watt Scene-Capable Dimming Wall Switch Receiver with One-Button Programming and LED brightness display. 3-Way capable when used with MS00R-10 Multi-Remote	HCM10-1DW	1000W Incandescent, 1000VA (750W) Magnetic Low-Voltage Lighting	White (Ivory kit included)
600 Watt Scene-Capable Dimming Wall Switch Receiver with One-Button Programming, 2-Way Communication and LED brightness display. Neutral connection required	HXM06-1TW	600W Incandescent, 600VA (450W) Magnetic Low-Voltage Lighting	White (Ivory kit included)
1000 Watt Scene-Capable Dimming Wall Switch Receiver with One-Button Programming, 2-Way Communication and LED brightness display. Neutral connection required	HXM10-1TW	1000W, 120V AC 60Hz Incandescent, 1000VA (750W) Magnetic Low-Voltage Lighting	White (Ivory kit included)
8 Amp Scene-Capable Electronic Switch Receiver (non-dimming) with One-Button Programming and 2-Way Communication. Neutral connection required	HXS08-1TW	8 Amp, 1000W Incandescent, 1000VA (750W) Fluorescent & Magnetic Low-Voltage Lighting	White (Ivory kit included)

Special Note: As with any dimmer, derating for multiple gang installations is required for Wall Switch Receivers.

Use Leviton Power Extenders to extend the load capacity of DHC Dimming Wall Switch Receivers.

COLOR CHANGE KITS FOR WALL DIMMERS AND SWITCHES

Receiver Cat. No.	Cat. No. Ivory	Cat. No. White	Cat. No. Almond	Cat. No. Gray	Cat. No. Black
HCM06/10-1DW	DRKDD-1LI	DRKDD-1LW	DRKDD-1LA	DRKDD-1LG	DRKDD-1LE
HXM06/10-1TW	DRKDD-1LI	DRKDD-1LW	DRKDD-1LA	DRKDD-1LG	DRKDD-1LE
HXS08-1TW	DRKOD-1LI	DRKOD-1LW	DRKOD-1LA	DRKOD-1LG	DRKOD-1LE

SPECIFICATIONS AND FEATURES

- New One Button Programming
- Provide Scene Control capability when used with DHC Scene Controller HXCS7-1TW and HCCPG-1TW Toscana Programmer. Also backward compatible with 16400/16450-S and 16400/16450-SD Scene Controllers
- HCM06/10-1DW provides 3-way and multi-location capability when used with MS00R-10 Multi-Remote
- Soft On/Fade Off brightness levels extend bulb life
- Fits in standard wall boxes
- Leviton's patented IntelliSense™ Technology virtually eliminates signal problems due to line noise
- Protected memory during minor power fluctuations
- LED brightness display alongside rocker
- Packed with Ivory and White snap-on rocker/frame kit; optional snap-on rocker/frame color change kits sold separately. See color change kit chart

- Decora-styled to coordinate with Leviton's Decora line of wiring devices
- Backed by a Limited Two-Year Warranty

TESTING AND CODE COMPLIANCE

- UL Listed to File No. E31373
- CSA Certified to File No. LR3413
- NOM Certified #057

COLOR

Colors available as indicated. See chart for Rocker and Frame Kits (must be purchased separately)

MATERIAL CHARACTERISTICS

Engineering Thermoplastic UL-94, V2 Rating
Operating Temperature: 32°F to 130°F



Scene-Capable Wall Dimmers

Dimming Wall Switch Receivers provide manual and remote ON/OFF switching and full range dimming for incandescent and magnetic low-voltage loads. Receivers are scene-capable when used with Leviton's Toscana Programmer HCCPG-1TW and Seven-Scene Controller HXC7S. Receivers will respond to ON, OFF, DIM, BRIGHT, ALL LIGHTS ON/ALL OFF AND SCENE commands. Receivers also provide single-pole and 3-way (multi-location) ON/OFF switching and full range dimming when used with MS00R-10 Multi-Remote. Preset feature turns lights ON at last selected brightness level. Soft ON/Fade OFF feature provides eye-pleasing effect and extended bulb life. Cat. No. HCS10-1SW is a non-dimming ON/OFF Receiver. All receivers feature IntelliSense™ Technology to ensure top performance and reliability even when noise is present on the AC powerline.

Packed with Ivory and White Rocker and Frame Kits. Kits for other colors must be purchased separately.

DESCRIPTION	CAT. NO.	RATING	COLOR
600 Watt Scene-Capable Dimming Switch — Single-pole and 3-way (multi-location) when used with MS00R Multi-Remote. Neutral not required for incandescent loads.	HCM06-1SW	600W Incandescent, 600VA (450W) Magnetic Low-Voltage 120V AC 60Hz	White (Ivory kit included)
1000 Watt Scene-Capable Dimming Switch — Single-pole and 3-way (multi-location) when used with MS00R Multi-Remote. Neutral not required for incandescent loads.	HCM10-1SW	1000W Incandescent, 1000VA (750W) Magnetic Low-Voltage 120V AC 60Hz	White (Ivory kit included)
10 Amp Scene-Capable Switch (Non-Dimming) — Single-pole and 3-way (multi-location) when used with MS00R Multi-Remote. Neutral required. Requires Cat. No. 6287 when used with electronic loads such as compact fluorescent lamps.	HCS10-1SW	1200W Incandescent, 1200VA Fluorescent and Magnetic Low-Voltage Lighting 10A-120V AC 60Hz	White (Ivory kit included)

ROCKER AND FRAME KITS FOR HCM10-1SW AND HCM06-1SW

Cat. No. Ivory	Cat. No. White	Cat. No. Almond	Cat. No. Gray	Cat. No. Black
DRKOD-1LI	DRKOD-1LW	DRKOD-1LA	DRKOD-1LG	DRKOD-1LE

ROCKER AND FRAME KITS FOR HCS10-1SW

Cat. No. Ivory	Cat. No. White	Cat. No. Almond	Cat. No. Gray	Cat. No. Black
DRKOS-0LI	DRKOS-0LW	DRKOS-0LA	DRKOS-0LG	DRKOS-0LE

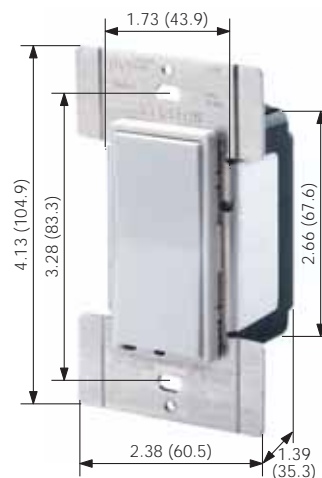

HCM06-1SW

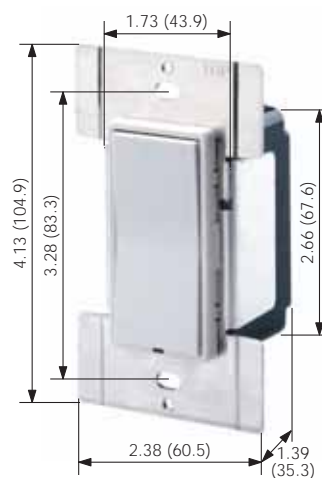

HCS10-1SW

SPECIFICATIONS AND FEATURES

- Provide Scene Control capability when used with DHC Scene Controller HXC7S-1TW and HCCPG-1TW Toscana Programmer. Also backward compatible with 16400/16450-S and 16400/16450-SD Scene Controllers
- Provides 3-way and multi-location capability when used with MS00R-10 Multi-Remote
- Soft On/Fade Off brightness levels allowing extended bulb life
- Fits in standard wall boxes
- Leviton's patented IntelliSense™ Technology virtually eliminates signal problems due to line noise
- Protected memory during minor power fluctuations
- Packed with Ivory and White snap-on rocker/frame kit; optional snap-on rocker/frame color change kits sold separately. See color change kit chart
- Decora-styled to coordinate with Leviton's Decora line of wiring devices
- Backed by a Limited Two-Year Warranty

TESTING AND CODE COMPLIANCE

- UL Listed to File No. E31373
- CSA Certified to File No. LR3413
- NOM Certified #057

COLOR

Colors available as indicated. See chart for Rocker and Frame Kits (must be purchased separately)

MATERIAL CHARACTERISTICS

Engineering Thermoplastic UL-94, V2 Rating
Operating Temperature: 32°F to 130°F





DECORA® HOME CONTROLS (DHC)



Residential Grade Receivers—Green Line



HXP15-1TW



HCP03-10W

Scene-Capable Plug-In Receiver Modules



DESCRIPTION	CAT. NO.
<p>Scene-Capable Plug-In Appliance Module with One-Button Programming and 2-Way Communication—Provides 1-button programming through address capturing. No wiring necessary; plugs into any 15A-125V grounding receptacle and provides NEMA 5-15R grounding receptacle for lights and appliances. Provides manual and remote ON/OFF switching for a variety of free-standing lights and appliances. Provides scene capability (ON/OFF switching) when used with the HXCS7-1TW Seven-Scene Controller and the HCCPG-1TW Toscana Deluxe Programmer. Responds to ON, OFF, ALL LIGHTS ON/ALL OFF and SCENE COMMANDS. Push button allows manual ON/OFF control. Provides status tracking to notify 2-way capable controllers of manual status changes. Features IntelliSense™ Technology for the utmost in reliability even when noise exists on the AC powerline. With LED locator light. Color: White.</p> <p>Rated: 120V AC 60 Hz, 1800W Incandescent, 1800VA Fluorescent, 15A Resistive, 1/2 HP Motor loads @ 120V AC</p>	HXP15-1TW
<p>Scene-Capable Plug-In Lamp Module with One-Button Programming—Provides 1-button programming through address capturing. Provides remote ON/OFF switching, manual ON switching, and remote full-range dimming for plug-in incandescent lamps. No wiring necessary; plugs into 15 Amp AC outlet. Allows local control of any lamp plugged into it. Available in White (-W) only. Provides Scene Control capability when used with DHC Scene Controller HXCS7-1TW and HCCPG-1TW DHC Toscana Deluxe Programmer. Also backward compatible with 16400/16450-S and 16400/16450-SD DHC Scene Controllers. Equipped with Leviton's IntelliSense® advanced circuitry for the utmost in reliability, even where electrical "noise" exists on the power line. Responds to ON, OFF, DIM, BRIGHT, ALL LIGHTS ON/ALL OFF and SCENE LIGHTING commands.</p> <p>Rated: 120V 60Hz, 300W Incandescent</p>	HCP03-10W

Home Automation Products

SPECIFICATIONS AND FEATURES

- Plug-in design requires no wiring
- HXP15-1TW provides manual and remote ON/OFF switching of plug-in lamps and appliances
- HCP03-10W provides manual and remote ON/OFF switching and full-range dimming for plug-in incandescent lamps
- One-button programming through address capturing
- Scene-capable when used with when used with the HXCS7-1TW Seven-Scene Controller and the HCCPG-1TW Toscana Deluxe Programmer.
- Protected memory maintains status of plug-in loads and address programming during minor power fluctuations
- HXP15-1TW provides status tracking to notify 2-way capable controllers of manual status changes
- Leviton's patented IntelliSense™ Technology virtually eliminates signal problems due to line noise
- Backed by a Limited Two-Year Warranty

TESTING AND CODE COMPLIANCE

- UL Listed (File #E-66800)
- CSA Certified (File #LR-54628)
- NOM Certified (#057)

MATERIAL CHARACTERISTICS

Engineering Thermoplastic UL-94, V2 Rating
Operating Temperature: 32°F to 130°F

K
19



To learn more about Leviton's outstanding offering of devices visit our Website at: www.leviton.com



Wall Switch Receivers

DESCRIPTION

CAT. NO.

Single-Pole (One Location) Switch—Equipped with Intellisense (gated automatic gain control) and provides manual and remote ON/OFF control. Can be set to any of 256 DHC address codes to switch incandescent, inductive or resistive loads where dimming is not required. Responds to ON, OFF, ALL LIGHTS ON/ALL OFF commands. Wires easily into standard wall box using terminal screws. Neutral Connection Required. Pilot light is ON when switch is ON. Code wheels are located beneath rocker plate. Packed with Ivory and White Rocker and Frame. Kits for other colors must be purchased separately (See Chart). Requires Cat. No. 6287 when used with electronic loads such as compact fluorescent lamps.

6291-WI

Rated: 15A 120V AC 60Hz Incandescent, Inductive or Resistive

3-Way (Multi-Location) Switch—Equipped with Intellisense (gated automatic gain control). Provides manual and remote ON/OFF control in multi-station switching circuits when used in conjunction with one or more Cat. No. 6294 Remote Switches. The 6293 can be set to any of 256 DHC address codes to switch incandescent, inductive or resistive loads where dimming is not required. Responds to ON, OFF, ALL LIGHTS ON/ALL OFF commands. Wires easily into standard wall box using terminal screws. Neutral Connection Required. Pilot light is ON when switch is ON. Code wheels are located beneath rocker plate. For proper operation, the total length of traveler wire between Multi-Location Switch and Remote should not exceed 90 feet. Packed with Ivory and White Rocker and Frame. Kits for other colors must be purchased separately (See Chart).

6293-WI

Rated: 15A 120V AC 60Hz Incandescent, Inductive or Resistive



ROCKER AND FRAME KITS FOR 6383 SWITCH

Cat. No. Ivory	Cat. No. White
6081-I	6081-W

ROCKER AND FRAME KITS FOR 6291 AND 6293 SWITCH

Cat. No. Ivory
6091-I

SPECIFICATIONS AND FEATURES

- Fit in standard wallboxes and replace regular switches to provide manual and remote ON/OFF switching of lighting and appliances. 6381-WI dimming switch rated for incandescent lighting only
- Leviton's patented Intellisense™ Technology virtually eliminates signal problems due to line noise
- Use existing 60Hz 120V AC house wiring to add multi-location switching without resorting to complicated and costly conventional wiring means
- Decora styled to coordinate with Leviton's Decora line of wiring devices
- Backed by a Limited Two-Year Warranty

TESTING AND CODE COMPLIANCE

- UL Listed (File #E-66800)
- CSA Certified (File #LR-54628)

MATERIAL CHARACTERISTICS

Engineering Thermoplastic UL-94, V2 Rating
Operating Temperature: 32°F to 130°F



DECORA® HOME CONTROLS (DHC)



Residential Grade Receivers—Red Line

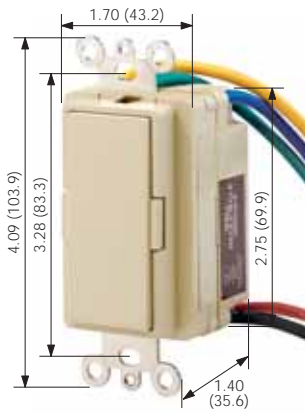

6371-I

Wall Switch Remotes and Receivers

DESCRIPTION	CAT. NO.
<p>3-Way and 4-Way (Multi-Location) Remote Switch—For use with DHC Cat. Nos. 6383 and 6293 Multi-Location Switches as a remote switch. The 6294 provides 3-Way, 4-Way and higher-level control in conjunction with these units. It cannot be used for any other purpose in the DHC network. The unit wires easily into standard wall box using terminal screws. For proper operation, the total length of traveler wire between Multi-Location Switch and Remote should not exceed 90 feet. Available in Ivory (-I), White (-W) and Almond (-A). Specify color(s) when ordering, as snap-on cover and frame kits cannot be used with the 6294.</p> <p>No Load Rating—For use with 6293 and 6383 units only</p>	6294
<p>Double Pole Wall Switch—Equipped with Intellisense (gated automatic gain control). Provides local and remote ON/OFF control. Responds to ON/OFF and ALL OFF commands from controllers. Can be set to any of the 256 DHC address codes. Intended for control of pool pumps, air conditioning units, spa heaters and pumps, and other large residential loads. Wire easily into any standard wall box by means of six-inch leads. Available in Ivory only.</p> <p>Rated: 20A 2 HP 250V AC 60Hz</p>	6371-I



ROCKER AND FRAME KITS FOR MSOOR-10 REMOTE SWITCH

Cat. No. Ivory	Cat. No. White	Cat. No. Almond	Cat. No. Gray	Cat. No. Black
DRKOR-00I	DRKOR-00W	DRKOR-00A	DRKOR-00G	DRKOR-00E

Home Automation Products

SPECIFICATIONS AND FEATURES

- Remote Units add multi-location capability to dimmer and switch receivers
- Fit in standard wallboxes to replace regular switches
- Leviton's patented Intellisense™ Technology virtually eliminates signal problems due to line noise (Cat. No. 6371-I)
- 6371-I Heavy-duty appliance switch available for automated control of heavy-duty loads such as air conditioning and pool pumps
- Decora styled to coordinate with Leviton's Decora line of wiring devices
- Backed by a Limited Two-Year Warranty

TESTING AND CODE COMPLIANCE

- UL Listed (File #E-66800)
- CSA Certified (File # LR-54628)

COLOR

Colors available as indicated.

HORSEPOWER

Cat. No 6371-I: 2 HP @ 250V 20A

MATERIAL CHARACTERISTICS

Engineering Thermoplastic UL-94, V2 Rating
Operating Temperature: 32°F to 130°F





RECEPTACLE Receivers

DESCRIPTION

Split Duplex Wall Receptacle—Equipped with Intellisense (gated automatic gain control). Top outlet provides remote ON/OFF load control in response to controller command signals. Bottom outlet is continuously live. Local control of any light or appliance plugged into the controlled outlet can be achieved by switching the load ON/OFF switch once or twice. Will not respond to ALL LIGHTS ON command. Fits standard wall boxes and supplied with leads for easy installation.

Rated: 15A 120V 60Hz AC only. NEMA 5-15R.

CAT. NO.

6227-I
6227-W
6227-A



Duplex Wall Receptacle—Equipped with Intellisense (gated automatic gain control). Same as 6227, but with both top and bottom outlets providing ON/OFF control in response to controller command signals. Feed-through load allows control of receptacles downstream. Will not respond to ALL LIGHTS ON command. No local control available.

Rated: 15A 120V 60Hz AC only. NEMA 5-15R

6280-W



Single Wall Receptacle★—Equipped with Intellisense (gated automatic gain control). Provides ON/OFF control. No local control available. Wires easily into standard wallbox using supplied six-inch leads. Will not respond to ALL LIGHTS ON command.

Rated: 20A 120V 60Hz AC only. NEMA 5-20R

6296-I
6296-W



Single Wall Receptacle★—Equipped with Intellisense (gated automatic gain control). Provides ON/OFF control. No local control available. Wires easily into standard wallbox using supplied six-inch leads. Will not respond to ALL LIGHTS ON command.

Rated: 20A 250V 60Hz AC only. NEMA 6-20R

6298-W



CSA Certified except where indicated by★

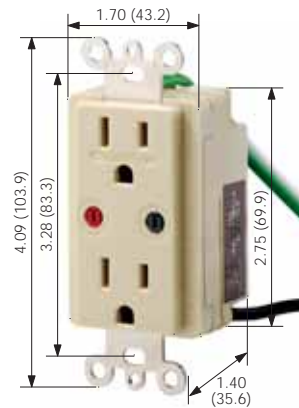

6227-I

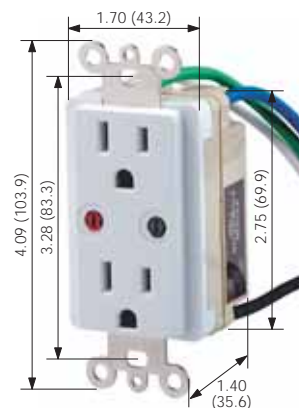

6280-W

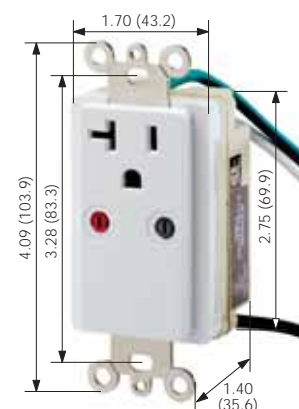

6296-W

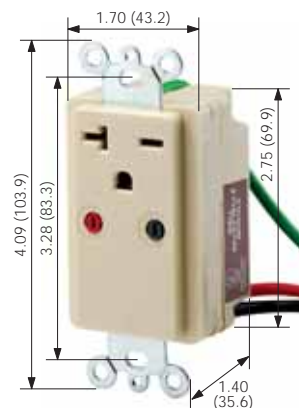

6298-I

SPECIFICATIONS AND FEATURES

- Available in commonly used NEMA configurations
- Fit in standard wallboxes and replace standard receptacles
- Leviton's patented Intellisense™ Technology virtually eliminates signal problems due to line noise
- Decora styled to coordinate with Leviton's Decora line of wiring devices
- Backed by a Limited Two-Year Warranty

TESTING AND CODE COMPLIANCE

- UL Listed (File #E-66800)
- CSA Certified (File # LR-54628)
- NOM Certified (#057)

COLOR

Colors available as indicated in Ivory (-I), White (-W) and Almond (-A).

MATERIAL CHARACTERISTICS

Engineering Thermoplastic UL-94, V2 Rating
Operating Temperature: 32°F to 130°F





DECORA® HOME CONTROLS (DHC)



Residential Grade Receivers—Red Line



6337



6375

Receiver Modules

DESCRIPTION	CAT. NO.
<p>Universal Low Voltage Module—Almost any device operated at low voltages can now be automated using the 6337. This receiver interfaces between the low voltage device and the 120V AC wiring network. It receives an ON or OFF command from DHC Transmitters and can operate sprinkler systems, designated lighting, skylight closures, heating systems, garage door openers and other lighting and motor loads. Simply connect LV wiring to the screw terminal on the module and plug it into any 120V wall outlet.</p> <p>In addition to switching contacts, the 6337 has a built-in alarm that can be set to sound whenever the switch contacts are closed. The 6337 can be set to operate the relay only, the alarm only, or both the relay and the alarm.</p> <p>The 6337 can also be set for momentary operation so that the relay and/or the alarm will be turned on for approximately two seconds in response to any ON command. Does not respond to ALL LIGHTS ON or DIM/BRIGHT commands.</p> <p>Rated: 120V 60Hz AC only. Contacts: 5A 12V DC, 100VA 30V DC Inductive</p>	6337
<p>Fixture Relay Module—Can be mounted at either an incandescent or fluorescent fixture by means of adhesive strips. Responds to ON/OFF and ALL LIGHTS ON/ALL OFF commands from controllers. Equipped with leads for easy installation.</p> <p>Rated: 15A 120V 60Hz AC only, incandescent, inductive, or resistive.</p>	6375
<p>Dimming Fixture Module—Can be mounted at an incandescent fixture by means of adhesive strips. Responds to ON/OFF, DIM/BRIGHTEN and ALL LIGHTS ON/ALL OFF commands from controllers. Equipped with leads for easy installation.</p> <p>Rated: 300W incandescent 120V 60Hz AC only.</p>	6376

See Lighting Controls Section C for more information on Leviton Power Extenders.

Use Leviton Power Extenders to extend the load capacity of DHC Dimming Wall Switch Receivers.

SPECIFICATIONS AND FEATURES

- Universal Low Voltage Module can automate devices operated at low voltages such as sprinklers, skylights, and heating/AC systems
- Fixture modules provide direct control for fixtures where only remote control is necessary
- Backed by a Limited Two-Year Warranty

TESTING AND CODE COMPLIANCE

- UL Listed (File #E-66800)
- CSA Certified (File #LR-54628)
- NOM Certified (#057)

MATERIAL CHARACTERISTICS

Engineering Thermoplastic UL-94, V2 Rating
Operating Temperature: 32°F to 130°F



DHC Network Integrity Products

Panel Mounted Surge Protective Devices (SPD)—Provides homes with protection from high-energy transient voltage surges that can damage sensitive electronic circuits in computers, audio and video components and electronic appliances. DHC components incorporate micro circuitry and Leviton highly recommends protecting the DHC network from powerline surges. Leviton Panel Mount devices feature unique hybrid suppression circuitry for outstanding surge protection. The following devices are compatible with all DHC components.

DESCRIPTION	CAT. NO.	MAX. SURGE CURRENT (8 X 20µs wave) L-N	UL 1449 RATING L-N
120/240V AC, Single-Phase —Standard J-box metal enclosure with pre-punched standard knockouts.	51120-1	50kA	500V
120/208V AC, 3-Phase WYE —Standard J-box metal enclosure with pre-punched standard knockouts.	51120-3	50kA	500V
120/240V AC, Single-Phase —NEMA 3R enclosure suitable for outdoor use	51120-3R	50kA	800V
120/240V AC, Single-Phase —Features sine wave tracking, redundant protection and replaceable/surge modules. NEMA 12 enclosure with hinged cover.	52120-M2H	100kA	400V
120/240V AC, Single-Phase Multimedia Panel —Provides surge protection for AC powerline, 2-pairs of phone/fax/modem connections, and dual CATV/Satellite feeds using F connectors. Painted steel NEMA 1 enclosure with four perforated 7/8" knockouts.	51110-PTC	AC: 48kA Tel: 1.9kA @ 3.8kV CATV: 2kA	AC: 400V Tel: 220V CATV: 25V



51110-PTC



51120-1

Note: A Panel Mount Surge Protective Device should be installed at the service panel in every DHC installation.

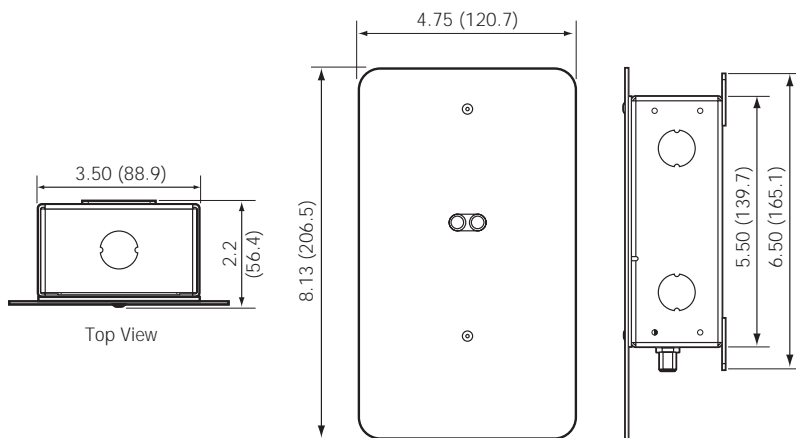

Multimedia Panel Surge Protective Device
Cat. No. 51110-PTC

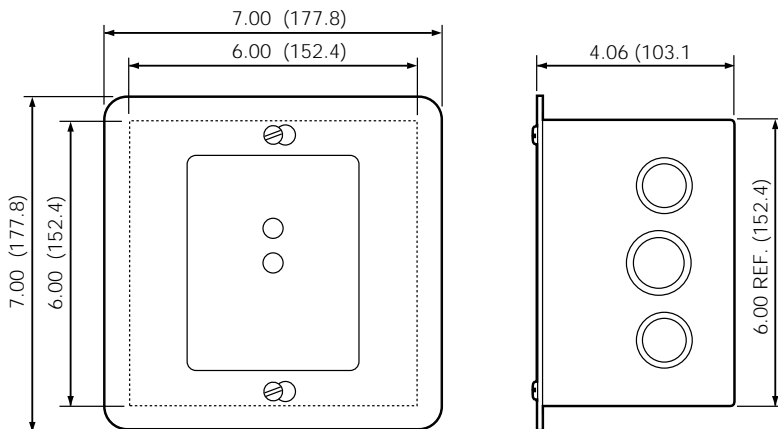

PANEL MOUNTED SURGE PROTECTIVE DEVICE
Cat. No. 51120-1,-3

SPECIFICATIONS AND FEATURES

- Real-time diagnostic visual indicator shows power and suppression status for each (protected) phase
- Cat. No. 51110-PTC Multimedia Panel protects AC, phone/fax/modem, and CATV/Satellite lines from transient voltage surges
- Cat. No. 52120-M2H features user-replaceable surge modules
- Backed by a Limited 10-Year Warranty

TESTING AND CODE COMPLIANCE

- Listed to UL 1449 (2nd edition) Standards
- UL Listed (File #E-146315)
- CSA Certified (File #LR94773)

MATERIAL CHARACTERISTICS

Engineering Thermoplastic UL-94, V2 Rating
Operating Temperature: -10°C to 60°C



HCA02-10E

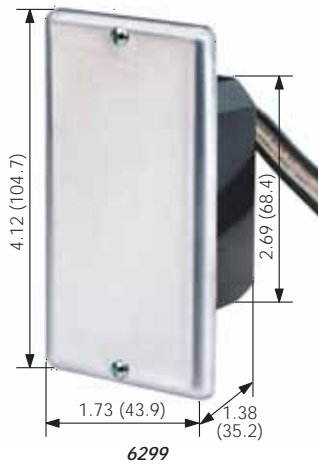

6299

DHC Network Integrity Products

DESCRIPTION	CAT. NO.
<p>System Amplifier/Coupler/Repeater with Built-in Test Signal Generator—Performs a variety of functions to ensure outstanding DHC system performance and reliability. Couples transmitter (programmer and controller) signals generated on the 120V leg where the transmitter draws power onto the other leg in a 120/240V single-phase 3-wire residential wiring system. The HCA02-10E also amplifies and repeats command signals to maintain proper signal strength through the DHC system. Green pilot light indicates unit has power. Lamp will indicate when signal is being transmitted. Features IntelliSense™ Technology to help ensure top performance even when noise is present on the AC powerline. The error lamp indicates the IntelliSense feature is activated. The unit provides convenient test signal transmission for easy signal strength verification at individual DHC module locations using Leviton's Cat. No. 6386 Signal Strength Indicator.</p> <p>The HCA02-10E should be installed at the main panel on its own dedicated 15A breaker in accordance with NEC requirements. The HCA02-10E cannot be used in a 3-phase system.</p> <p><i>Note: A Cat. No. HCA02-10E System Amplifier must be installed in all panels in every DHC installation to ensure adequate signal strength.</i></p>	HCA02-10E
<p>Signal Bridge/Passive System Coupler—Couples the DHC command signal onto the 120V legs of the power system to ensure sufficient command signal strength throughout the DHC network. (NOTE: 6299 should NOT be installed in the same panel as HCA02-10E). Rated: 120/240V 60Hz AC only.</p>	6299
<p>Signal Attenuator, 2-Phase—Attenuates “(knocks down”) external noise and signal levels entering the DHC network. The 6285 can be used to block interference from appliances, electronic ballasts and home electronics to ensure top performance from DHC network. Also used to block signal leakage (attenuation) caused by capacitive filters and electronic power supplies. Rated: 2-Phase 120/240V & 120/208V 60Hz AC only.</p>	6285
<p>Multi-Phase Blocking Coupler—The 6284 is installed between the incoming electrical service and the service panel in apartment buildings, condominiums, attached-unit dwellings and homes sharing the same side of the electrical transformer. Keeps extraneous electronic noise and signals from entering or leaving the DHC network. Rated: 120V, 120/240V & 120/208V 60Hz AC—Max. 200 Amp panel.</p>	6284



SPECIFICATIONS AND FEATURES

- Cat. No. HCA02-10E System Amplifier/Coupler/Repeater must be installed in all DHC installations to ensure adequate signal strength.
- Cat. Nos. 6284 and 6285 are used to stop extraneous noise and signals from degrading DHC network operation
- Backed by a Limited Two-Year Warranty

TESTING AND CODE COMPLIANCE

- UL Listed (File #E-66800)
- CSA Certified (File #LR3413)
- UL 244A Tested (and others where applicable)

MATERIAL CHARACTERISTICS

Engineering Thermoplasti UL-94, V2 Rating
Operating Temperature: 32°F to 130°F



DHC Network Integrity Products

DESCRIPTION	CAT. NO.
<p>Noise Block—The 6287 is designed for use with DHC switch modules that include a means for connection to neutral. This device may be wired on the LOAD side of a DHC switch module (except 6383), or on the LINE side of any fixture using an electronic ballast, a low-voltage ballast, or any noise-generating source that does not require more than 5A 120V AC. The 6287 prevents interference generated by fixture components from interfering with DHC signals.</p> <p>Rated: 5A 120V 60Hz AC only.</p>	6287
<p>Plug-in Noise Filter—electrical appliances may generate “noise” that could interfere with proper signal transmission. When the offending appliance is isolated and plugged into the 6288 Noise Filter, which is in turn plugged into a receptacle, stray noise is filtered out, ensuring a clear signal. Color: Brown.</p> <p>Rated: 5A 120V 60Hz AC only.</p>	6288
<p>In-Line Noise Reducer—the 6289 Noise Reducer filters electrical “noise” and signals with frequencies above and below the 121 kHz signal. The 6289 may be installed at the “noise” or signal source or at the module affected by the interference. Depending on the source of the interference, the 6289 may be wired phase to neutral or phase to phase.</p>	6289

DHC Powerline Carrier Test Equipment

<p>Signal Strength Indicator—Measures command signal strength at individual module locations. Minimum signal strength required for proper DHC Powerline Carrier component operation is 100mV.</p>	6386
--	------

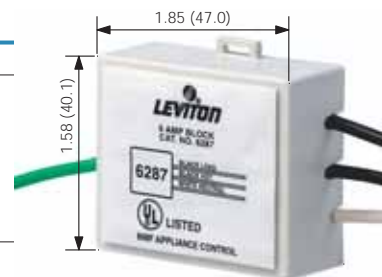

6287



6288



6289



6386

SPECIFICATIONS AND FEATURES

- These devices are designed to eliminate interference from appliances, electronic ballasts and home electronics in order to insure top performance from DHC systems
- Backed by a Limited Two-Year Warranty
- **Signal Strength Indicator**
- Signal strength testing equipment used to ensure proper operation of DHC system
- Backed by a Limited Two-Year Warranty

TESTING AND CODE COMPLIANCE

- NOM Certified (#057)
- UL Listed (E-66800)
- **Signal Strength Indicator**
- UL Listed (File #E-66800)
- NOM Certified (#057)

MATERIAL CHARACTERISTICS

Engineering Thermoplastic UL-94, V2 Rating
Operating Temperature: 32°F to 130°F

HOW TO USE THIS CATALOG

The L-101 Leviton Wiring Device Catalog is designed to help you find the device you're seeking in the quickest and easiest way possible. Most product sections are divided into three distinct categories in the following sequence—Industrial Grade, Commercial Grade and Residential Grade—and grouped according to amperage and voltage, lowest to highest. For example, if you need to order 15 Amp, 125 Volt Industrial Grade straight-blade duplex receptacles, begin your search with the main Table of Contents at the front of the book. Here you'll see that all straight blade receptacles are listed in Section G. Turn to Section G for a more detailed Table of Contents on the first page. Each section page contains product descriptions, ratings and catalog numbers. There are also helpful highlights including Specifications and Features, Testing and Code Compliance, Color listing, Material Characteristics and dimensioned color product photos. Any product page in the L-101 Catalog can be clearly copied or faxed to customers and prospects for use as a specifier sheet or as part of a presentation.

The Quick Reference Guide follows the main Table of Contents to help you pinpoint and locate specific products. Technical Section V provides general product and test data, industry standards, NEMA configuration charts, a glossary of wiring device terms, ANSI architectural symbols and other related information. Specific catalog numbers are listed in the exhaustive index at the back of the catalog.

15 AMP 125 and 250V • 20 AMP 125 and 250V

Industrial Grade Straight Blade Receptacles

Back and Side Wired (Basic Cat. No. Denotes Brown Device*)

DESCRIPTION	CAT. NO./COLOR 15A/125V	CAT. NO./COLOR 15A/250V	CAT. NO./COLOR 20A/125V	CAT. NO./COLOR 20A/250V
LEVSPEC® Duplex Receptacle, Brass Strap	5262 I, W, GY, R, E	5662 I	5362 I, W, GY, R, E	5462 I, GY
Single Receptacle	5261 I, W, GY	5661 I	5361 I, W, A, T, GY	5461 I, A, T, GY
Narrow Body Duplex Receptacle	5252 I, W, A, T, GY, R, # BU		5352 I, W, A, T, GY, R,	

5362-IG

For complete wallplate selection, see Section E.

80703-IG

80703-I

80704-GY

80716-R

84003-40

84004-40

84016-40

SPECIFICATIONS AND FEATURES

Back & Side Wired Duplex

- Impact-resistant thermoplastic nylon cover and body
- Smooth face does not collect dirt
- Four corner latches securely fasten face
- Single-piece brass mounting strap on LEVSPEC devices, multi-piece steel strap on other devices
- Large, triple-wipe, brass "T" contacts for superior contact and conductivity
- Back and side-wiring options
- Brass terminal screws to reduce conductor oxidation
- Break-off tabs for easy two-circuit conversion
- Apron barrier to prevent accidental contact between terminal screw heads and metal box
- Exclusive V-shaped, serrated back-wiring clamp for superior contact and conductivity

TESTING AND CODE COMPLIANCE

- UL Listed 498 (UL File #13399); UL Federal Specification WC-596

***COLOR**

Basic Cat. Nos. shown above denote Brown device, except for Isolated Ground (-IG) devices Basic Cat. No. denotes Orange. Isolated Ground Receptacle is distinguished by an orange triangle on its face. For other color selections, add suffix to the catalog number as follows: Ivory (-I), White (-W), Brown (For IG devices only, add -A), Almond (-A), Light Almond (-T), Gray (-G or -GY), Black (-E), Red (-R) and Blue (-BU); for IG devices only, add -BIG)

MATERIAL CHARACTERISTICS

Environmental: Flammability, Rated V2
Operating Temperature: From -40° C (without impact) to 60°C maximum continuous

- | | | |
|---------------------------------------|--|--------------------------------------|
| A RATING | E CATALOG NUMBER | I SPECIFICATIONS & FEATURES |
| B Choose GRADE, if appropriate | F DESCRIPTION | J TESTING AND CODE COMPLIANCE |
| C DIMENSIONED PHOTOGRAPH | G Check for NEMA CONFIGURATION | K COLOR LISTING |
| D WIRING/CERTIFICATIONS | H WALLPLATE REFERENCE, if appropriate | L MATERIAL CHARACTERISTICS |

Structured Cabling Systems

INDEX

Quick Reference Guide	L2
Connectors	
QuickPort®	L3-L5
Fiber Optic	L6, L7
Wallplates and Housings	
QuickPort	L8-L16
Acenti®	L17
Standard Telephone/Video Jacks	L18-L22
Workstation Accessories	L23
Copper Components	
Patch Panels	L24-L30
Industrial Connectivity	L31
Patch Cords	L32
110-Style	L33-L38
66-Block	L39-L40
Fiber Components	
Enclosures	L41-L45
Fiber Optic Cable Assemblies	L46
Accessories	L47-L49
Enclosures	
Telecommunications	L50, L51
Wireless Access Point	L52
Cable Management and Rack Accessories	
Versi-Duct®	L53
Rack and Frame	L54-L57
Hook and Loop	L58
Labeling Products	L59, L60
Tools and Accessories	
Punchdown/Termination	L61
Fiber	L62-L64
Tone Test	L65
Crimping/Stripping	L65
Craftsman's Handset	L66
Modular Plug Breakout Adapter	L66



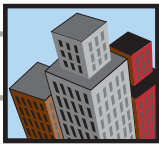

STRUCTURED CABLING DEVICE FEATURES

Quick Reference Guide

The following terms are used throughout this section to help users quickly identify special product features.

eXtreme® 10G

Our Category 6A solution enables advanced technologies, including new 10G and IP-based services. eXtreme 10G connectors feature patent-pending Cone of Silence and patented Retention Force Technology® (RFT) for unparalleled signal integrity.

eXtreme® 6+

Leviton's Category 6 solution with patented Retention Force Technology. Includes connectors, patch cords and a variety of patch panels. Exceeds TIA specifications for channel, permanent link and component-rated Category 6 systems.

GigaMax® 5e

Leviton's Category 5e channel and component rated solution. Includes connectors, patch cords and a variety of universal and pre-configured panels. Exceeds TIA specifications for channel-and component-rated Category 5e systems.

Category 5

Leviton's Category 5 solution for fast reliable voice and data applications from frame to workstation. Includes connectors, patch cords and universal panels. Exceeds TIA specifications for channel and category-rated Category 5 systems.

Opt-X®

Opt-X is Leviton's full solution Fiber Optic System incorporating a wide range of fiber optic components, including adapters, mounting plates, connectors, enclosures, cable assemblies, tools, consumables and workstation products with features and options to meet all types of customer and application needs.

FastCAM™

Leviton's FastCAM fiber connectors are pre-terminated and factory polished to provide precision termination of single-mode or multimode fiber.

Thread-Lock®

Award-winning Thread-Lock mechanical connectors are part of Leviton's full line of connectors. Ideal for quick installations, the reusable connectors make field-installation simple and cost-effective.

Fast-Cure

Reliable, cost-effective fiber optic connectors with quick, adhesive termination featuring precision pre-radiused zirconia ferrules, high retention strength, and patented non-optical disconnect spacer design.

Versa-Cleave®

The Versa-Cleave tool is your award-winning solution for cleaving fiber perfectly every time.

Versi-Duct®

Leviton's versatile horizontal and vertical slotted duct system for fiber and copper cable organization and management. A high-quality system with a variety of solution-based accessories.

LabelWare™

A TIA/EIA-606-A compliant tool to label and help identify your cabling infrastructure.

110 ChannelMax®

110 channel duct allows extra space for routing cables by increasing the vertical channel depth to 3 or 5 inches.

Retention Force Technology®

Patented features included in eXtreme 6+ and Gigamax 5e+ products, which provide enhanced connection integrity and promote consistent performance over the life of the system. Increased wire retention reduces time contact failure. Improved gas-tight connection prevents corrosion.

QuickPort®

Leviton's extensive line of snap-in modules allows complete field-configurability for the installer. Leviton QuickPort housings, such as wallplates, MOS housings and modular furniture faceplates, can be configured with a custom combination of QuickPort modules which easily snap in or out of ports.

Decora®

The original Decora QuickPort module wallplate is designed to match Decora electrical devices manufactured by Leviton.

Lifetime Performance Warranty

Leviton Voice & Data Division offers a Lifetime Performance Warranty when approved components are installed by a Leviton Certified Installer through the Certified Cabling System (CCS) program.

TIA Guidelines

The TIA, or Telecommunications Industries Association, is the industry regulatory body which defines industry standards, such as the following:

TIA/EIA-568-B: Commercial Building Telecommunications Cabling Standard

TIA/EIA-569-B: Commercial Building Standards for Telecommunications Pathways & Spaces

TIA/EIA-570-B: Residential and Light Commercial Wiring Standard

TIA/EIA-606-A: Administration Standard for the Telecommunications Infrastructure of Commercial Buildings

TIA/EIA-607: Telecommunications Bonding and Grounding Standard

Styles, Features, etc.

These color bars are found throughout this catalog to indicate additional information about a given product. They point out unique features and configurations, or other technical notes to help you in understanding, choosing or using Leviton products.

STYLES

FEATURES

TESTING AND CODE COMPLIANCE

*COLOR

MATERIAL CHARACTERISTICS

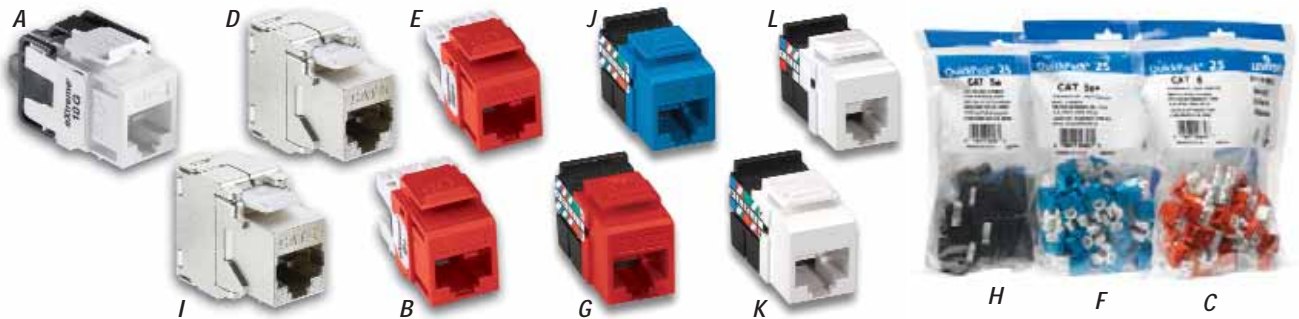
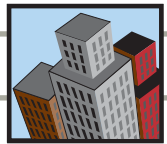

QuickPort Connectors for UTP and STP Copper Cable

A-I Leviton offers a variety of copper connectors from advanced CAT 6A (10G) to CAT 3 solutions. CAT 6A eXtreme® 10G, our highest performing connector featuring the Cone of Silence and Retention Force Technology®, (RFT), resists alien crosstalk (AXT) and offers unparalleled signal integrity. eXtreme 6+ and component rated GigaMAX 5e+ connectors also feature patented RFT for long term performance.

Shielded connectors in CAT 5e and CAT 6 ratings feature a robust, die-cast housing, provide protection from electromagnetic interference, and offer increased data security. Category 5 and Category 3 connectors offer an economical solution for a variety of applications.

All connectors feature standard QuickPort compatibility and universal color coded wiring labels and exceed industry performance standards. Available in 14 colors.



Use a Leviton Field-Termination Coaster to quickly and easily punch down wires on any Leviton Category or Multimedia Connector. For more information, call Sales Support at 1-800-922-6229.

Color Choices



Note: Protect your Category 5e and 6 connectors from damage and debris with Leviton's field installable Shutters and Icons. See Labeling Products Page L60.

Quickport Snap-In Connectors

eXtreme® 10G Snap-In Connectors cULus

DESCRIPTION	CAT. NO.
[A] eXtreme 10G channel-rated connector Cone of Silence™ replacement pack (bag of 13)	6110G-R*6 61C05-B13

eXtreme® 6+ Connectors cULus

DESCRIPTION	CAT. NO.
[B] 8-conductor eXtreme 6+ component-rated connector	61110-R*6
[C] 8-conductor eXtreme 6+ component-rated connectors QuickPack™ (25 per pack)	61110-B*6
[D] eXtreme 6+ shielded channel-rated connector	6S180-SH6

GigaMax® 5e Connectors cULus

DESCRIPTION	CAT. NO.
[E] 8-conductor GigaMax 5e+ component-rated connector	5G110-R*5
[F] 8-conductor GigaMax 5e+ component-rated connectors QuickPack™ (25 per pack)	5G110-B*5
[G] 8-conductor GigaMax 5e channel-rated connector	5G108-R*5
[H] 8-conductor GigaMax 5e channel-rated connectors QuickPack™ (25 per pack)	5G108-B*5
[I] GigaMax 5e shielded channel-rated connector	5S180-SH5

Category 5 Connectors

DESCRIPTION	CAT. NO.
[J] 8-conductor Category 5 connector	41108-R*5

Category 3 Connectors

DESCRIPTION	CAT. NO.
[K] 8-conductor connector	41108-R*3

Voice Grade Connectors

DESCRIPTION	CAT. NO.
[L] 6-conductor USOC connector	41106-R*6
8-conductor USOC connector	41108-R*8

*COLOR/CONNECTORS

For color selection, add suffix to catalog number as follows: Ivory (I), White (W), Gray (G), Black (E), Orange (O), Blue (L), Crimson Red (C), Yellow (Y), Green (V), Purple (P), Almond (A), Light Almond (T), Brown (B), Dark Red (R).

MATERIAL CHARACTERISTICS

- All module bodies are fire-retardant plastic rated UL 94V-0
- Jack spring contacts are the highest quality phosphor bronze, plated with 50 microinches of gold over 100 microinches of nickel for lowest contact resistance, maximum life

TESTING AND CODE COMPLIANCE

- All category-rated connectors comply with TIA-568-A requirements
- UL Listed
- Fully compliant with NEC Article 800
- Meet FCC Part 68



QUICKPORT® for AUDIO/VIDEO

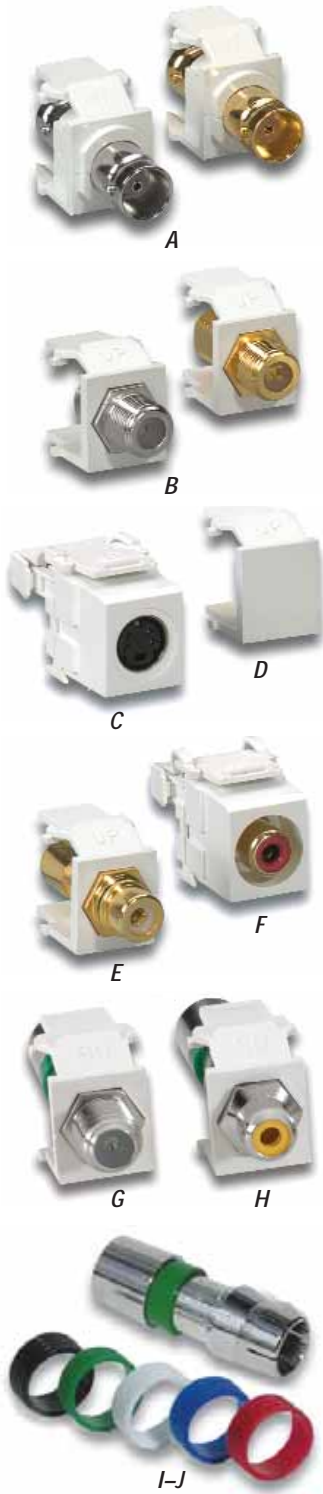

QuickPort Adapters & Connectors for Audio/Video

Mix & match QuickPort Snap-In Audio/Video Adapters and Connectors to create a customized multimedia center. Make connections with standard industry tools. For Compression Connectors, use Leviton's Master Compression Tool.

- A BNC QuickPort Adapter:** Gold-plated female-to-female connector with twist-on front and rear connections using BNC plugs. Applications: high-end video, home theater, CCTV, LAN. Cable: shielded video & data cable.
- B F-Type QuickPort Adapter:** Nickel or gold-plated female-to-female connector with screw-on front and rear connections. Applications: TV, VCR, DVD, satellite, home theater. Cable: coaxial cable terminated with "F" plugs.
- C S-Video QuickPort Connector:** Flush-mount S-Video connector on the front with 110 punchdowns on the rear. Applications: audio/video, conference rooms, classrooms, computers, projectors. Cable: UTP Category 5, 5e or 6 cable.
- D QuickPort Blank Inserts:** Cover up unused QuickPort housing openings. Order in packages of 10.
- E RCA QuickPort Adapters:** Black, yellow or red striped color-coded module for front and rear connections using RCA plugs. Applications: audio/video, home theatre. Cable: shielded audio/video cable with terminated RCA plugs.
- F RCA-110 QuickPort Connector:** Standard RCA connector on the front with 110 punchdowns on the rear. Applications: audio/video, VCR, DVD, computers and gaming consoles. Cable: UTP Category 5, 5e or 6 cable.
- G, H F-Type and RCA QuickPort Compression Connectors:** Time saving solution for robust terminations right at the wall plate. Applications: HDTV, cameras, component video, CATV and satellite signal delivery. Cable: RG6 Quad.
- I, J RCA and F-Type Compression Connectors:** Female style connectors feature radial crimp for increased audio/video signal integrity. Applications: HDTV, cameras, component video, CATV and satellite signal delivery. Cable: RG6 Quad.

All modules meet or exceed industry standards. All QuickPort connectors and modules are UL certified, fully compliant with NEC® Article 800, and meet FCC Part 68.

For product specifications and recommendations, please visit our web resource at www.leviton.com/.

Quickport Modules

Audio/Video Adapters

DESCRIPTION	CAT. NO. IVORY	CAT. NO. WHITE	CAT. NO. ALMOND	CAT. NO. BLACK	CAT. NO. GRAY
[A] BNC Adapter, nickel-plated† BNC Adapter, gold-plated	41084-BIF 40832-OB1	41084-BWF 40832-OBW	41084-BAF 40832-OBA	41084-BEF —	41084-BGF —
[B] F-type Adapter, nickel-plated† F-type Adapter, gold-plated	41084-FIF 40831-OB1	41084-FWF 40831-OBW	41084-FAF 40831-OBA	41084-FEF —	41084-FGF —
[C] S-Video Connector, 110 termination†	40734-SVI	40734-SVW	40734-SVA	40734-SVE	40734-SVG
[D] Blank Insert (pack of 10)†	41084-BIB	41084-BWB	41084-BAB	41084-BEB	41084-BGB
[E] RCA Jack, gold-plated w/black stripe† RCA Jack, gold-plated w/red stripe† RCA Jack, gold-plated w/yellow stripe† RCA Jack, gold-plated w/green stripe† RCA Jack, gold-plated w/blue stripe†	40830-BIE 40830-BIR 40830-BIY 40830-BIV 40830-BIL	40830-BWE 40830-BWR 40830-BWY 40830-BWV 40830-BWL	40830-BAE 40830-BAR 40830-BAY — —	— — — — —	— — — — —
[F] RCA-110 Connector†	40735-R*I	40735-R*W	40735-R*A	40735-R*E	40735-R*G

Part numbers shown are for individual polybag packages in standard cartons. Some carded and contractor packs also available. Call customer service at 1-800-722-2082.

† Note: Also available in Light Almond (*T*)

*COLOR/CONNECTORS

For color selection, add suffix to catalog number as follows: [F] RCA-110 Connector Inner Barrel Color—Orange (O), Red (R), White (W), Yellow (Y). [G-H] Insert Color—Red (R), Black (E), Yellow (Y), Blue (L), Green (V).

MATERIAL CHARACTERISTICS

- All module bodies are fire-retardant plastic rated UL 94V-0

Compression Connectors and Adapters

DESCRIPTION	CAT. NO. F-STYLE	CAT. NO. RCA
[G-H] QuickPort Compression Connectors	40782-CPF	40782-R*W
[I-J] Compression Connectors	40985-CPF	40985-CRU

Note: See Tools & Accessories Page L59 for Master Compression Tool.

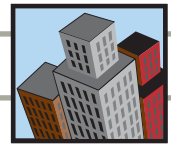

QuickPort Snap-In Adapters & Connectors for Audio

- A, B Banana Jack Adapters:** One black striped or one red striped color-coded module per unit pack. Screw-on rear-side connections. Front-side connections use standard banana plugs. Applications: speaker connections. Cable: speaker wire terminated with banana plugs.
- C, D Binding Post Adapters:** One black striped or one red striped color-coded module per unit pack. Screw-on rear-side connections. Optional front-side connections—either screw-on or push-in—for banana plugs, speaker tip, spade tip, or bare wire. Applications: audio speaker connections. Cable: speaker wire.

All modules meet or exceed industry standards. All QuickPort connectors and modules are UL certified, fully compliant with NEC® Article 800, and meet FCC Part 68.

QuickPort Snap-In Modules

Audio Adapters

DESCRIPTION	CAT. NO. IVORY	CAT. NO. WHITE	CAT. NO. ALMOND	CAT. NO. LIGHT ALMOND
[A] Banana Jack Adapter, gold-plated w/black stripe	40837-BIE	40837-BWE	40837-BAE	40837-BTE
[B] Banana Jack Adapter, gold-plated w/red stripe	40837-BIR	40837-BWR	40837-BAR	40837-BTR
[C] Binding Post Adapter gold-plated w/black stripe	40833-BIE	40833-BWE	40833-BAE	40833-BTE
[D] Binding Post Adapter gold-plated w/red stripe	40833-BIR	40833-BWR	40833-BAR	40833-BTR

Part numbers shown are for individual polybag packages in standard cartons. Some carded and contractor packs also available. Call customer service at 1-800-722-2082.

Push-On, Twist-On & Crimp-On F Connectors

- E, F Push-On F-Connectors:** Quick, cost-effective 75 Ohm coaxial cable terminations, require no crimping tools. Quick and Universal versions accommodate RG-59, RG-6, and RG-6 Quad coax diameters.
- G-K 1-Piece and 2-Piece Crimp-On F-Connectors:** Terminates 75 Ohm coaxial cable with a crimp-on male F-Connector. 2-piece version with separate crimp ring, or one-piece version with crimp ring attached. Both RG-59 and RG-6 versions available. Crimping tool required.
- L, M Twist-On F-Connectors:** Twist-on male F-Connector for 75 Ohm coaxial cable. No crimping required. RG-59 and RG-6 versions.

Push-On, Crimp-On and Twist-On Connectors

DESCRIPTION	CAT. NO.
[E] Universal F-Connector (bag of 100 with installation tool)	40985-HPC
[F] Quick F-Connector (bag of 20 with installation tool)	40985-HPM
[G] One-piece Crimp-on for RG-6 quad shield (bag of 100)	40985-0Q6
[H] One-piece Crimp-on for RG-59 (bag of 100)	40985-1P9
[I] One-piece Crimp-on for RG-6 (bag of 100)	40985-1P6
[J] Two-piece Crimp-on for RG-59 (bag of 100)	40985-2P9
[K] Two-piece Crimp-on for RG-6 (bag of 100)	40985-2P6
[L] Twist-On Connector for RG-59 (bag of 100)	40985-TW9
[M] Twist-On Connector for RG-6 (bag of 100)	40985-TW6

Note: See Tools & Accessories Section Page L63 for Crimping Tool.

HDMI and DVI Connectors

DESCRIPTION	CAT. NO. WHITE	CAT. NO. IVORY
3.5mm Stereo Connector	40839-SWS	40839-SIS
[N] HDMI Feed Through-Decora Style	41647-00W	41647-00I
[O] DVI Feed Through	41648-00W	41648-00I

MATERIAL CHARACTERISTICS

- All module bodies are fire-retardant plastic rated UL 94V-0





FIBER OPTIC CONNECTORS



A B C



D E F



G H



I J



K



M

L

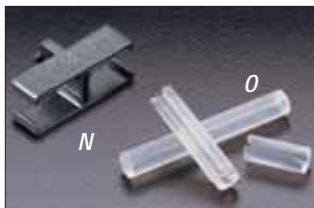

N

O

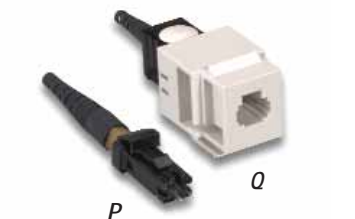

P

Q

FastCAM™ Factory Polished Fiber Connectors

Pre-terminated and factory polished to provide precision termination of single-mode and multimode fiber. Available in LC, ST and SC styles to fit 250µm and 900µm cables with standard single-mode and standard multimode or laser-optimized multimode fiber options

FastCAM Fiber Connectors

DESCRIPTION	CAT. NO.
[A] FastCAM ST Multimode 62.5µm Connector	49991-MST
[B] FastCAM ST Multimode 50µm Connector	49991-5ST
[C] FastCAM ST Single-mode Connector	49991-SST
FastCAM Laser Optimized ST Multimode Connector	49991-LST
[D] FastCAM SC Multimode 62.5µm Connector	49991-MSC
[E] FastCAM SC Multimode 50µm Connector	49991-5SC
[F] FastCAM SC Single-mode Connector	49991-SSC
FastCAM Laser Optimized SC Multimode Connector	49991-LSC
[G] FastCAM LC Multimode 62.5µm Connector	49991-MLC
[H] FastCAM LC Multimode 50µm Connector	49991-5LC
[I] FastCAM LC Single-mode Connector	49991-SLC
[J] FastCAM Laser Optimized LC Multimode Connector	49991-LLC

Thread-Lock® Reusable Fiber Connectors, Multimode And Single-mode

K-M Award-winning Thread-Lock Connectors, available in SC, FC and ST® styles, are reusable, field-terminable fiber optic connectors with a simple, craft-friendly installation. Available in 62.5/125 and 50/125 multimode or single-mode versions. Each box of 50 connectors includes one tightening tool.

Thread-Lock Fiber Connectors

DESCRIPTION	CAT. NO. SINGLEMODE	CAT. NO. MULTIMODE
[K] SC Thread-Lock Connector	49884-SSC (blue)	49884-MSC (beige)
[L] FC Thread-Lock Connector	49883-SFC	49883-MFC
[M] ST Thread-Lock Connector	49882-SST	49882-MST

Thread-Lock Accessories

DESCRIPTION	CAT. NO.
[N] SC Duplex Clip for Thread-Lock Connector, black (bag of 25)	49884-DPC
[O] Silicon Build-up Sleeve Kit, includes one of each type (bag of 10)	49885-SBS
Nylon Retention Sleeve (bag of 10)	49855-SLV

MT-RJ Fiber Connectors, Multimode

P, Q Leviton MT-RJ Workstation connectors offer innovative push-button fiber termination, and plug directly into our MOS adapters (see page L14). Frame-Station connectors use a cam technology to lock the fiber into a terminated position for use in frame or, with adapters, in the workstation. Both feature a pre-polished ribbon fiber ferrule that eliminates polishing.

MT-RJ Fiber Connectors

DESCRIPTION	CAT. NO.
[P] High-Density MT-RJ Frame-Station Connector, multimode, 62.5 µm	49888-6SF
High-Density MT-RJ Frame-Station Connector, multimode, 50.0 µm	49888-5SF
[Q] High-Density MT-RJ Workstation Connector, multimode, 62.5 µm	49888-6SW
High-Density MT-RJ Workstation Connector, multimode, 50.0 µm	49888-5SW

Note: For a complete listing of Fiber Optic Tools, see the Tools section, Pages L62–L64.



Fast Cure Adhesive Connectors

A-D Leviton Fast-Cure adhesive connectors, available in ST, SC, FC, and LC styles, are reliable, cost-effective fiber optic connectors with quick, adhesive termination. Feature precision pre-radiused zirconia ferrules, high cable retention crimp, and patented non-optical disconnect spacer design. Available in multimode or singlemode versions.

Adhesive Connectors

DESCRIPTION	CAT. NO. SINGLE-MODE	CAT. NO. MULTIMODE
[A] ST Fast Cure Connector	49990-SST	49990-MST
[B] SC Fast Cure Connector	49990-SSC	49990-MSC
[C] FC Fast Cure Connector	49990-SFC	49990-MFC
[D] LC Fast Cure Connector with 3mm boot LC Fast Cure Connector with .9mm boot	49990-SL2 49990-SDL	49990-ML2 49990-MDL

Fast Cure Accessories

DESCRIPTION	CAT. NO. SINGLE-MODE	CAT. NO. MULTIMODE
[E] SC Duplex Clip for Fast Cure Connector, black (bag of 25)		49886-DSC
[F] LC Duplex Clip for Fast Cure Connector, blue (bag of 25)	49886-DLS	
[G] LC Duplex Clip for Fast Cure Connector, beige (bag of 25)		49886-DLM

QuickPort® Snap-In Fiber Adapters

H-L Leviton offers QuickPort adapters to bring Thread-Lock and Fast-Cure fiber to any QuickPort wallplate or housing. FC, SC, ST, LC and MT-RJ adapters, in various colors.

Fiber Adapters

DESCRIPTION	CAT. NO.
[H] QuickPort MT-RJ Adapter, for Frame-Station Connector	49889-QF*
[I] QuickPort ST Fiber Optic Adapter, SM/MM, Phos. Bronze Sleeve† QuickPort ST Fiber Optic Adapter, SM/MM, Zirconia Sleeve	41084-S*F 41084-S*Z
[J] QuickPort Simplex FC Fiber Optic Adapter, SM/MM, Phos. Bronze Sleeve QuickPort Simplex FC Fiber Optic Adapter, SM/MM, Zirconia Sleeve	41084-F*P 41084-F*Z
[K] QuickPort Multimode Simplex SC Adapter Module, Phos Bronze QuickPort Singlemode Simplex SC Adapter Module, Zirconia Ceramic	41085-M*C 41085-S*C
[L] QuickPort Duplex LC Adapter, SM/MM, Phos. Bronze Sleeve QuickPort Duplex LC Adapter, SM/MM, Zirconia Ceramic Sleeve	41085-ML* 41085-SL*

[H-M] Use with MOS 1 Port Adapter 41291-1M* Page L15

† Note: Cat. No. 41084 also available in Light Almond (-STF)

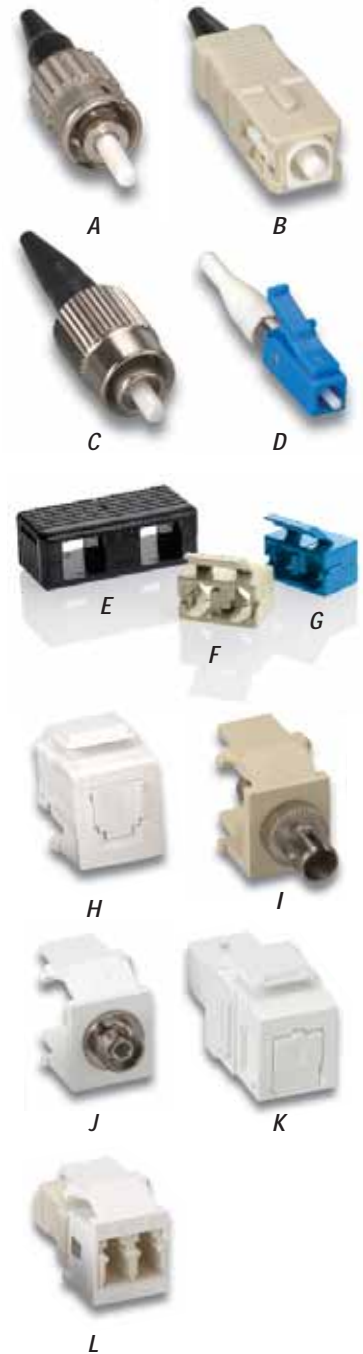

Connectors

*COLOR/FIBER ADAPTERS

[H-M] For color selection, add suffix to catalog number as follows: Ivory (I), White (W), Gray (G), Black (E).



Leviton QuickPort fiber adapters fit into any Leviton QuickPort wallplate or housing, providing a high-density fiber-to-the-workstation solution, see pages L8-L17 for workstation options.



Leviton's Fiber Optic Consumables Kits provide the products you need to quickly and efficiently polish, clean and terminate all our fiber connectors. See Page L63.



QUICKPORT® FLUSH MOUNT WALLPLATES and INSERTS

QuickPort Flush Mount Wallplates and Inserts

Leviton offers one of the largest selections of field-configurable, flush mount wallplates and inserts available on today's market. They provide the adaptability and performance required in a voice/data wiring interface in a sleek low-profile wallplate.

Choose from a full range of materials and styles, including: nylon, urea and stainless steel; standard and midsize; single- and dual-gang; and Decora® designer styling. All Leviton flush mount devices fit standard NEMA openings for easy installation on new or existing wallboxes.



Styles

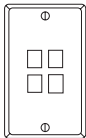

QuickPort

Wallplates with standard-sized openings designed to accommodate QuickPort connectors or adapters.

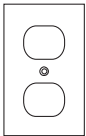

Flush Mount

Wallplates designed to fit smoothly against a wall, with a minimum profile.

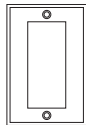

Decora®

Wallplates with standard-sized openings designed to accommodate Decora Inserts.

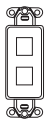

Decora Insert

Standard, Decora-sized inserts designed to adapt high and low voltage applications to a single wallplate profile.

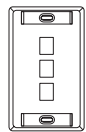

Single-gang

The standard wallplate width of 2.75" W x 4.53" H.

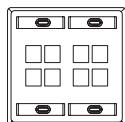

Dual-Gang

The standard double wallplate width of 4.625" W x 4.53" H.

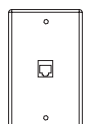

Wall Jack

A wallplate preconfigured with some kind of connector or adapter.

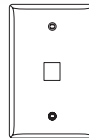

Midsize

A wider (3.12" W x 4.87" H) single-gang wallplate designed to disguise flaws in drywall or provide a designer silhouette.

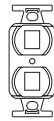

Type 106 (Duplex)

The Standard NEMA-style form, with two openings, which is most common among electrical outlets.



Type 105 (Single)

The Standard NEMA-style form with one opening—less common than the Type 106.

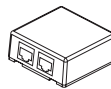

Type 104 (Duplex)

A NEMA-style of surface-mount box, with two outlets or openings, common for use with telephone jacks on walls or along baseboards.

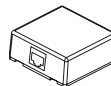

Type 103 (Single)

Identical to the type 104 box, but featuring only one outlet.



Acenti™ Insert

QuickPort inserts designed to snap into Acenti wallplates.

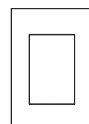

Acenti Wallplate

Sleek, low-profile plates available in 1–6 gang styles accept a variety of QuickPort and other inserts for voice, data, electro-mechanical, lighting control, GFCI and more.

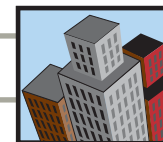

QuickPort Decora Multimedia Inserts

Combine voice, data, audio and video in one compact, attractive Decora wallplate. QuickPort Decora Wallplate Inserts offer designer style to match Leviton Decora electrical switches and outlets, with the capacity and flexibility to support high-tech communications for boardrooms or workstations. QuickPort snap-in modules fit neatly into a single gang Decora wallplate and can be combined with Decora electrical devices (with a barrier box) in a multi-gang wallplate. Simply snap in the QuickPort connectors of your choice to customize multimedia options. Compatible with all standard Decora wallplates and Decora Plus snap-on wallplates with hidden mounting screws and standard NEMA openings. UL Listed and CSA Certified.



For Decora-style F-connector and Telephone Wall Jack Inserts, see page L19.

QuickPort Decora Multimedia Inserts

DESCRIPTION	CAT. NO. IVORY	CAT. NO. WHITE	CAT. NO. GRAY	CAT. NO. BLACK	CAT. NO. ALMOND	CAT. NO. BROWN
2-Port Insert†	41642-00I	41642-00W	41642-0GY	41642-0OE	41642-00A	41642-00B
3-Port Insert†	41643-00I	41643-00W	41643-0GY	41643-0OE	41643-00A	41643-00B
4-Port Insert†	41644-00I	41644-00W	41644-0GY	41644-0OE	41644-00A	41644-00B
6-Port Insert†	41646-00I	41646-00W	41646-0GY	41646-0OE	41646-00A	41646-00B
Blank Insert†	80414-00I	80414-00W	80414-0GY	80414-0OE	80414-00A	

QuickPort 2-Port Insert/Connector Kits

DESCRIPTION	CAT. NO. IVORY	CAT. NO. WHITE
2-Port Insert w/two 6-conductor connectors	41666-00I	41666-00W
2-Port Insert w/two 8-conductor connectors†	41688-00I	41688-00W

Decora Plus Voice/Data Connectors with QuickPort Snap-In Modules

DESCRIPTION	CAT. NO. IVORY	CAT. NO. WHITE
Insert with one 6-conductor jack and one F-connector	41658-00I	41658-00W
Insert with one 6-conductor jack and one 8-conductor jack	41668-00I	41668-00W

Note: Order QuickPort Snap-In Modules on pages L3-L7. Configured versions also meet FCC Part 68.

† Note: Also available in Light Almond (00T)

Decora Wallplates

DESCRIPTION	CAT. NO. UREA	CAT. NO. NYLON	CAT. NO. DECORA PLUS SNAP-ON
Single-Gang Decora Wallplate	80401-00*	80401-0N*	80301-0S*
Dual-Gang Decora Wallplate	80409-00*	80409-0N*	80309-0S*
Three-Gang Decora Wallplate	80411-00*	80411-0N*	80311-0S*
Four-Gang Decora Wallplate	80412-00*	80412-0N*	80312-0S*

Note: Additional Decora Wallplate ordering information can be found on page L9.

*COLOR/WALLPLATES

For color selection, add suffix to catalog number as follows: 1- and 2-Gang-Ivory (I), White (W), Gray (G), Black (E), Almond (A), Light Almond (T) and Brown (no additional suffix indicates Brown), 3-Gang-Ivory (I), White (W), Black (E), Almond (A) and Light Almond (T). 4-Gang-Ivory (I), White (W), Almond (A) and Light Almond (T).



QUICKPORT® SINGLE- and DUAL-GANG WALLPLATES



Leviton's LabelWare® System is TIA/EIA-606-A compliant and designed to help you label all our copper and fiber products. User-friendly software makes it quick, easy, and completely configurable or use pre-printed labels. See pages L59-L60.

QuickPort Single- and Dual-Gang Wallplates

QUICKPORT SINGLE-GANG MULTI-PORT WALLPLATES WITH OR WITHOUT DESIGNATION WINDOWS

A, B Single-gang flush mount wallplates offer field-configurable flexibility in an attractive single-piece housing. Fully compatible with all QuickPort Snap-in Modules including connectors or blank fillers. Options for port identification include LabelWare® wallplate and housing labels, typed or handwritten labels for designation windows, or the use of different color QuickPort modules. All windows are field-label compatible, and cover the wallplate security screw. UL Listed, CSA Certified, NEC Article 800 compliant.

QuickPort Single-Gang Inserts

DESCRIPTION	CAT. NO. IVORY	CAT. NO. WHITE	CAT. NO. GRAY	CAT. NO. BLACK	CAT. NO. ALMOND	CAT. NO. BROWN
6-Port Wallplate*	41080-6IP	41080-6WP	41080-6GP	41080-6EP	41080-6AP	41080-6BP
4-Port Wallplate*	41080-4IP	41080-4WP	41080-4GP	41080-4EP	41080-4AP	41080-4BP
3-Port Wallplate*	41080-3IP	41080-3WP	41080-3GP	41080-3EP	41080-3AP	41080-3BP
2-Port Wallplate*	41080-2IP	41080-2WP	41080-2GP	41080-2EP	41080-2AP	41080-2BP
1-Port Wallplate*	41080-1IP	41080-1WP	41080-1GP	41080-1EP	41080-1AP	41080-1BP

* Note: Cat. No. 41080 also available in Light Almond (41080-TP)

QuickPort Single-Gang Wallplates with Designation ID Windows

DESCRIPTION	NO. OF WINDOWS	CAT. NO. IVORY	CAT. NO. WHITE	CAT. NO. GRAY	CAT. NO. BLACK
6-Port Wallplate	2	42080-6IS	42080-6WS	42080-6GS	42080-6ES
4-Port Wallplate	2	42080-4IS	42080-4WS	42080-4GS	42080-4ES
3-Port Wallplate	2	42080-3IS	42080-3WS	42080-3GS	42080-3ES
2-Port Wallplate	2	42080-2IS	42080-2WS	42080-2GS	42080-2ES
1-Port Wallplate	1	42080-1IS	42080-1WS	42080-1GS	42080-1ES

Note: Housings are sold empty. Snap-in Connectors must be ordered separately. (See pages L3-L7.)

QUICKPORT DUAL-GANG MULTI-PORT WALLPLATES WITH DESIGNATION WINDOWS

C Dual-gang flush mount wallplates with designation windows are designed in a single-piece housing and a wide choice of port counts for maximum density. Field configure with any combination of QuickPort Snap-in Modules. Use different color QuickPort modules for port identification, or type or hand-write labels for designation windows. All windows are field-label compatible, and cover the wallplate security screw. QuickPort wallplates are UL Listed, CSA Certified, and listed in compliance with NEC Article 800.

QuickPort Dual-Gang Wallplates with Designation ID Windows

DESCRIPTION	NO. OF WINDOWS	CAT. NO. IVORY	CAT. NO. WHITE	CAT. NO. GRAY	CAT. NO. BLACK
12-Port Wallplate	4	42080-12I	42080-12W	42080-12G	42080-12E
8-Port Wallplate	4	42080-8IP	42080-8WP	42080-8GP	42080-8EP
6-Port Wallplate	4	42080-6IP	42080-6WP	42080-6GP	42080-6EP
4-Port Wallplate	4	42080-4IP	42080-4WP	42080-4GP	42080-4EP
3-Port Wallplate	2	42080-3IP	42080-3WP	42080-3GP	42080-3EP
2-Port Wallplate	2	42080-2IP	42080-2WP	42080-2GP	42080-2EP
1-Port Wallplate	2	42080-1IP	42080-1WP	42080-1GP	42080-1EP

Note: Housings are sold empty. Snap-in Connectors must be ordered separately. (See pages L3-L7.)

QUICKPORT MIDWAY WALLPLATES

D Midway wallplates provide QuickPort modularity with .375" more coverage than standard wallplates. Expanded silhouette provides designer look and easily hides irregular drywall cuts or flaws around outlets. The 4.875" x 3.125" plate is .375" wider and taller, and matches Leviton's Midway Wallplates for electrical devices and lighting controls, .25" depth ensures a clean fit with various devices. Crafted from durable, smooth-finish nylon, wallplates fit a single-gang electrical box. UL listed and CSA certified.

QuickPort Midway Single-Gang Wallplates, Nylon

DESCRIPTION	CAT. NO. IVORY	CAT. NO. WHITE	CAT. NO. ALMOND	CAT. NO. BROWN	CAT. NO. LT ALMOND
6-Port Midway QuickPort Wallplate	41091-6IN	41091-6WN	41091-6AN	41091-6BN	41091-6TN
4-Port Midway QuickPort Wallplate	41091-4IN	41091-4WN	41091-4AN	41091-4BN	41091-4TN
3-Port Midway QuickPort Wallplate	41091-3IN	41091-3WN	41091-3AN	41091-3BN	41091-3TN
2-Port Midway QuickPort Wallplate	41091-2IN	41091-2WN	41091-2AN	41091-2BN	41091-2TN
1-Port Midway QuickPort Wallplate	41091-1IN	41091-1WN	41091-1AN	41091-1BN	41091-1TN

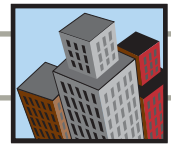

QuickPort Stainless Steel Wallplates

QUICKPORT STAINLESS STEEL SINGLE-GANG AND DUAL-GANG WALLPLATES

A, B Leviton's single-gang and dual-gang QuickPort Stainless Steel Wallplates provide elegant designer styling, and accept any QuickPort connector or adapter. Ideal in environments that demand durable, easy-to-clean solution. Use different color QuickPort modules or the LabelWare System for port identification. Fit standard NEMA electrical boxes. cULus Listed, meet FCC Part 68, and are listed in compliance with TIA/EIA-568-B.

QuickPort Stainless Steel Wallplates

DESCRIPTION	CAT. NO. 1-PORT	CAT. NO. 2-PORT	CAT. NO. 3-PORT	CAT. NO. 4-PORT	CAT. NO. 6-PORT	CAT. NO. 8-PORT	CAT. NO. 12-PORT
Single-Gang	43080-1S1	43080-1S2	43080-1S3	43080-1S4	43080-1S6	—	—
Dual-Gang	—	43080-2S2	—	43080-2S4	43080-2S6	43080-2S8	43080-S12

Note: Housings are sold empty. Snap-in Connectors must be ordered separately. (See pages L3-L7.)

QUICKPORT STAINLESS STEEL WALLPHONE WALLPLATES

C Bring Stainless Steel elegance to your wallphone. Easily mount any standard wallphone on this sturdy, standard-sized wallplate with durable rivets. Single port accepts any Leviton QuickPort Connector. Recessed design fits cleanly with slide-rail mechanisms.

QuickPort Stainless Steel Wallphone Wallplates

DESCRIPTION	CAT. NO.
Stainless Steel Wallphone Wallplate, recessed	4108W-1SP
Stainless Steel Wallphone Wallplate	4108W-OSP

Note: Leviton also offers Voice-Grade Wall Phone Jacks. (See pages L3-L7.)

QuickPort Wallplate Inserts

QUICKPORT DUPLEX/QUAD 106 INSERTS

D, E The QuickPort Duplex and Quad 106 Units are ideal for applications where two or four individual modular ports are desired, within the standard '106/NEMA-style' outline that prevails among electrical outlets. Accepts all QuickPort Snap-in Modules and fits standard NEMA wallboxes and most floor boxes and monuments. A recess above each module port on the Duplex 106 Unit accommodates Leviton Designation Labels (page L60) or hand-written port ID. Uses standard duplex wallplates (sold separately, see Section E). UL & CSA listed and NEC Article 800 compliant.

QuickPort Duplex 106 Insert

DESCRIPTION	CAT. NO. LT. ALMOND	CAT. NO. IVORY	CAT. NO. WHITE	CAT. NO. GRAY	CAT. NO. BLACK
QuickPort Duplex 106 Insert only	41087-2TP	41087-2IP	41087-2WP	41087-2GP	41087-2EP
QuickPort Quad 106 Insert only	41087-QTP	41087-QIP	41087-QWP	41087-QGP	41087-QEP

Note: Inserts are sold empty. Snap-in Connectors must be ordered separately. (See pages L3-L7.)

QUICKPORT FLOOR JACK INSERTS

F Rugged and fully field-configurable, this device provides point-of-use connectivity for a broad range of applications where convenience or building requirements dictate the use of a floor-mounted communications outlet. Each floorplate is made of .06" thick solid brass to hold up under heavy furniture or foot traffic. When not in use, a flush-fitting brass screw cap keeps internal components free from dirt and dust.

The two individual ports are configured easily with any combination of QuickPort. QuickPort floor jacks will fit standard metal boxes 3" x 2", 3" x 2 1/8" and larger.

QuickPort Duplex Floor Jack Insert with Brass Plate and Screw Cap

DESCRIPTION	CAT. NO.
Insert with one F-connector, one blank module, and brass plate w/cap	41650-00F
Insert with one 6-conductor connector, one blank module, and brass plate w/cap	41650-006
Insert with one blank module and brass plate w/cap	41652-000
Insert with two 6-conductor jacks and brass plate w/cap	41652-006
Insert with one 6-conductor connector, one F-connector, and brass plate w/cap	41652-06F

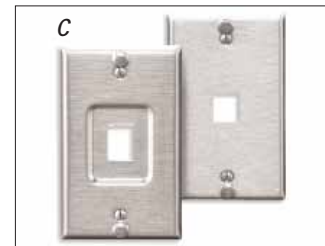
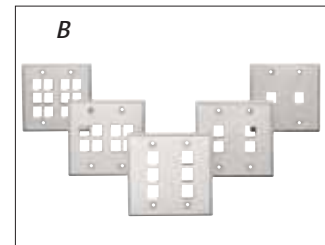
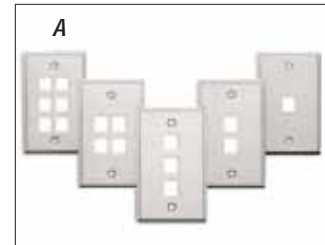

NOTE: Wallplate included with each QuickPort Floor Jack Insert.



QUICKPORT® MODULAR FURNITURE FACEPLATES



Steelcase Series



Herman Miller® series (shown with 49910-SE4 and Herman Miller's "Reducer" G1189A)



Haworth® Panels

QuickPort Modular Furniture Faceplates

Bring a simple snap-in installation, attractive streamlined appearance and easy identification to your modular furniture environments. QuickPort Modular Furniture Faceplates accept all QuickPort Snap-In Modules—supporting virtually any application—and snap easily and snugly into standard modular furniture. Features faceplate windows with clear plastic covers that allow easy insertion of ID labels. Labor-saving QuickPort jack design and tool-less plate installation simplifies installations, adds, moves and changes, and allows access to the connectors without removing the furniture channel cover. Available in 2- and 4-port versions, and in four colors: ivory, white, gray and black. cULus Listed and A-Tick Certified.



QuickPort furniture faceplates come in many styles to fit all major modular furniture brands.

Standard Modular Furniture Faceplates with ID Windows

DESCRIPTION	CAT. NO.	HERMAN MILLER®	STEELCASE	HAWORTH®	HON	OTHERS
2-Port	49910-S*2	●	●	●	●	●
4-Port (w/1 blank)	49910-S*4	●	●	●	●	●
4-Port Extended-depth† (w/1 blank)	49910-E*4	●	●	●	●	●

Note: Standard modular furniture faceplates above fit openings of approximately 1.38" x 2.63".

†4-port extended plate provides 1/2" added depth (3/4" total) for installation into shallow raceway channels, e.g., some powered channels.

● Compatible when used with Herman Miller G1189A Reducer available from Herman Miller dealers.

Herman Miller Modular Furniture Faceplates

DESCRIPTION	CAT. NO.	HERMAN MILLER®	STEELCASE	HAWORTH®	HON	OTHERS
2-Port HM Faceplate†	49910-H*2	●	—	—	—	—
4-Port HM Faceplate (with 1 Blank)	49910-H*4	●	—	—	—	—

Note: Herman Miller faceplates above fit openings of approximately 1.88" x 2.98".

†Fits most Herman Miller furniture. To ensure compatibility with specific models call Applications Engineering.

*COLOR/FACEPLATES

For color selection, add suffix to catalog number as follows: Ivory (I), White (W), Gray (G), Black (E).

MATERIAL CHARACTERISTICS

High-impact, fire-retardant, plastic rated UL 94V-0.

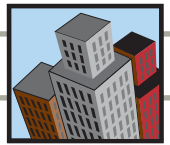

QuickPort Multimedia Outlet System (MOS)

The innovative QuickPort Multimedia Outlet System is designed to provide the highest level of application and installation flexibility for fiber optic and twisted-pair connectivity. It consists of a surface mount box and single- and dual-gang wallplates, which accept a variety of copper, fiber, and A/V QuickPort snap-in modules.

The MOS line is distinguished from other QuickPort housings by several features: front-load installation capability so that changes can be made without dismantling the entire device; duplex modules and fiber coupling types for SC, ST, MT-RJ and other applications; the addition of S-video and RCA adapters for high-definition audio/video; and design elements for enhanced routing, storage and bend radius protection of fiber and copper cabling. See individual product descriptions for more features.

For product specifications and recommendations, please visit our web resource at www.leviton.com.



Features and Benefits

- A** Multiple connector termination stations provide stabilized punchdown support.
- B** Leviton's exclusive dual rings store the fiber loop and provide multiple straight paths to each port.
- C** Single latch cover with security option restricts access if desired.
- D** Multi-directional mounting and raceway access allow complete installation flexibility.
- E** Front-loading inserts simplify configuration, while strong latches keep them in place during use.
- F** Fiber storage/spacer ring fits between wallbox/mud ring and MOS dual-gang plate for fiber loop storage and management.
- G** 45° angled jack insert optimizes bend radius compliance of cable exiting QuickPort® snap-in connectors.
- H** Load up to 12 devices in a dual-gang wallplate.

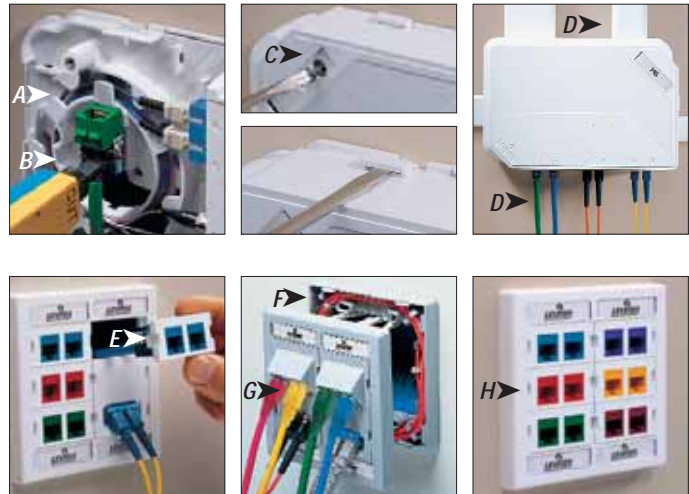



QUICKPORT® MULTIMEDIA OUTLET SYSTEM (MOS)

Styles

Configurations for MOS Wallplates

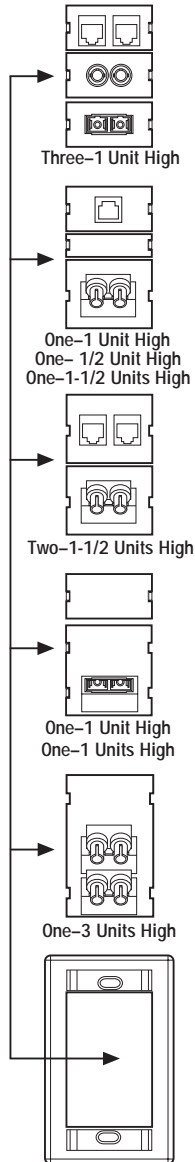

COLOR/INSERTS and WALLPLATES

For color selection, add suffix to catalog number as follows:

- * Ivory (I), White (W), Gray (G), Black (e)
- ° Light Almond (T), Ivory (I), White (W), Gray (G), Black (E)
- Ivory (I), White (W)

MATERIAL CHARACTERISTICS

High-impact, fire-retardant, plastic rated UL 94V-0.

QuickPort Multimedia Outlet System (MOS)

MOS Surface Mount Boxes and Wallplates

	6-Port Surface Mount Box	41296-MM ⁰
	Single-Gang Wallplate	41290-SM ⁰
	Dual-Gang Wallplate	41290-DM ⁰
	Fiber Storage/Spacer Ring	41290-DR*

MOS Inserts for Surface Mount Boxes and Wallplates

	2-Port QuickPort Adapter, flush, (1 unit high)	41291-2Q ⁰
	1-Port QuickPort Adapter, flush, (1 unit high)	41291-1M ⁰
	1 S-video Insert Module, (1 unit high)	41291-1V ⁰
	1 RCA Insert Module, 2-port, screw terminal (1 unit high) (red and white stripe)	41291-1R ⁰
	1 RCA Insert Module, 3-port, female-to-female adapters (1 unit high) (yellow and white stripe)	41292-3R ⁰
	1 HD-15 Insert Module, female-to-female (1 unit high)	41293-HD ⁰
	1 HD-15 Screw Terminal	41295-HD*
	1 Duplex ST® Adapter, (1 unit high) (phos. bronze sleeve)	41291-2T*
	1 Duplex ST® Adapter, (1 unit high) (zirconia ceramic sleeve)	41291-2T*
	1 Duplex FC Adapter (1 unit high) (phos. bronze sleeve)	41291-PF*
	1 Duplex FC Adapter (1 unit high) (zirconia ceramic sleeve)	41291-ZF*
	1 Duplex SC Adapter (1 unit high) (phos. bronze sleeve)	41291-PC*
	1 Duplex SC Adapter (1 unit high) (zirconia ceramic sleeve)	41291-2C*
	Blank Module (1 unit high)	41291-1B*
	Blank Module HD-15 Insert Module	41291-DB ⁰
	1 RCA Component (Y, W, R) 110	41292-AV*
	1 RCA Component (R, G, B) 110	41292-DV*
	1 Decora Converter Strap	41649-00*

MOS Inserts for use with MOS Wallplates

	2-Port QuickPort Adapter, 45° exit (1.5 units high)	41294-2Q ⁰
	Blank Module (0.5 unit high)	41295-5B ⁰
	Blank Module (1.5 units high)	41294-2B ⁰
	Blank Module (2 units high)	41292-2B ⁰
	1 Duplex ST® Adapter 45° exit, SM/MM (1.5 units high) (phos. bronze sleeve)	41294-2T*
	1 Duplex ST® Adapter 45° exit, SM/MM (1.5 units high) (zirconia ceramic sleeve)	41294-2T*
	1 Duplex FC Adapter 45° exit, SM/MM (1.5 units high) (phos. bronze sleeve)	41294-PF*
	1 Duplex FC Adapter 45° exit, SM/MM (1.5 units high) (zirconia ceramic sleeve)	41294-ZF*
	1 Duplex SC® Adapter 45° exit, SM/MM (1.5 units high) (phos. bronze sleeve)	41294-PC*
	1 Duplex SC® Adapter 45° exit, SM/MM (1.5 units high) (zirconia ceramic sleeve)	41294-2C*
	1 Duplex ST® Adapter 45° exit, SM/MM (2 units high) (phos. bronze sleeve)	41292-2T*
	1 Duplex ST® Adapter 45° exit, SM/MM (2 units high) (zirconia ceramic sleeve)	41292-2T*
	1 Duplex FC Adapter 45° exit, SM/MM (2 units high) (phos. bronze sleeve)	41292-PF*
	1 Duplex FC Adapter 45° exit, SM/MM (2 units high) (zirconia ceramic sleeve)	41292-ZF*
	2 Duplex SC® Adapter 45° exit, SM/MM (2 units high) (phos. bronze sleeve)	41292-2C*
	2 Duplex SC® Adapter 45° exit, SM/MM (2 units high) (zirconia ceramic sleeve)	41292-2C*
	2 Duplex ST® Adapter 45° exit, SM/MM (3 units high) (phos. bronze sleeve)	41293-4T*
	2 Duplex ST® Adapter 45° exit, SM/MM (3 units high) (zirconia ceramic sleeve)	41293-4T*
	2 Duplex FC Adapter 45° exit, SM/MM (3 units high) (phos. bronze sleeve)	41293-PF*
	2 Duplex FC Adapter 45° exit, SM/MM (3 units high) (zirconia ceramic sleeve)	41293-ZF*
	2 Duplex SC® Adapter 45° exit, SM/MM (3 units high) (phos. bronze sleeve)	41293-PC*
	2 Duplex SC® Adapter 45° exit, SM/MM (3 units high) (zirconia ceramic sleeve)	41293-4C*



QuickPort Surface Mount Housings

Leviton's surface mount housings offer fast, economical installation and field configuration for applications where it may not be practical to add a wallbox, such as modular furniture environments or retrofit situations. As with all QuickPort field-configurable products, you configure the housing to your specific needs using Snap-In Modules—easily rearranged if applications change. These housings can be adapted for mounting on all types of surfaces, including walls and furniture with tape or screws (both included) modular furniture with a modular furniture bracket (page L23) or to metal surfaces with magnets (page L23).

Note: Identify all your connections with Leviton LabelWare System wallplate and housing labels (See page L60.)

Designation window accepts hand-written indications, field-printed labeling systems, Leviton LabelWare™ or pre-printed port ID labels (see page L59).



4-, 6- and 12-port housing feature raceway knockouts on all non-ported sides which are compatible with major raceway brands.

For large installations, silkscreen the cover with words, numbers, icons or company logos. Call Applications Engineering for advice on artwork and minimum quantity requirements.

Port identification areas reside next to numbered ports.



4-, 6- and 12-port surface-mount housings are compatible with Leviton's modular furniture mounting brackets and magnets (see page L24).

In-port connector termination stations provide stability during punchdown.



QUICKPORT® SURFACE MOUNT HOUSINGS



QuickPort 1-, 2-, 4-, 6-, and 12-Port Surface Mount Housings

A-E Leviton has a surface mount housing to suit your need. 1-, 2-, 4-, 6- and 12-Port housings are easily field configured with QuickPort Connectors (sold separately, pages L3-L7). The 2-port version comes with a blank filler to cover and protect one unused opening. The 4- and 6-port housings are sized to completely cover a single-gang NEMA wallbox opening, while the 12-port fits over a single- or dual-gang NEMA box opening. Housings contain knockouts to accommodate raceway and cable entry, with built-in strain relief to assure undisturbed connections, and easy cover latches allow easy adds, moves and changes.

All housings can be mounted with screws or adhesive mounting tape (both provided), or with magnets or modular furniture brackets (sold separately on page L24). Identify ports and stations by using ample space next to each port or the designation window. All housings are UL Listed and compliant with NEC Article 800.

QuickPort Surface Mount Housings

DESCRIPTION	CAT. NO.
[A] 1-Port Surface Mount Housing	41089-1*P
[B] 2-Port Surface Mount Housing (includes 1 blank module)	41089-2*P
[C] 4-Port Surface Mount Housing	41089-4*P
[D] 6-Port Surface Mount Housing	41089-6*P
[E] 12-Port Surface Mount Housing	41089-12*

Note: Connectors must be ordered separately. (See pages L3-L7)

Leviton also offers Pre-configured Voice-Grade Surface Mount Jacks. (See page L23)

*COLOR/INSERTS and WALLPLATES

For color selection, add suffix to catalog number as follows: Ivory (I), White (W), Gray (G), Black (E).

MATERIAL CHARACTERISTICS

High-impact, fire-retardant, plastic rated UL 94V-0.

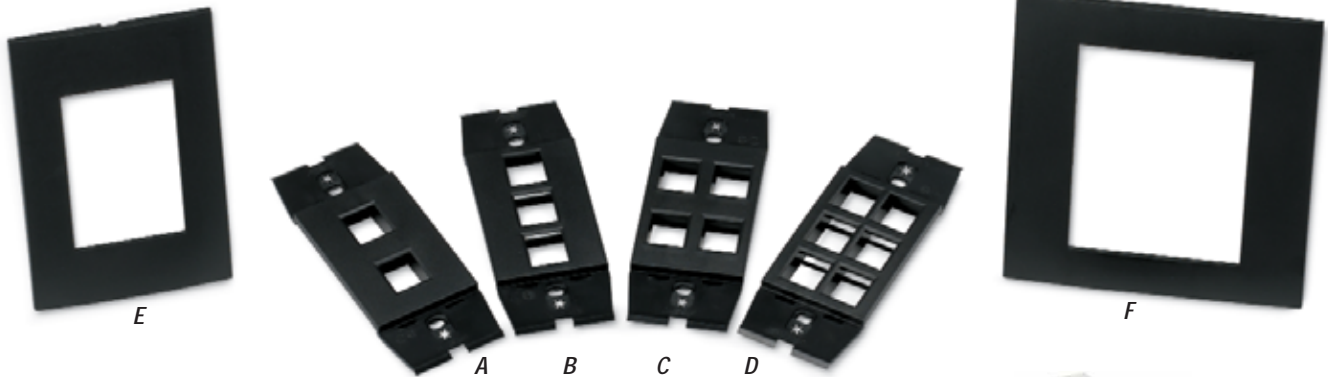

Acenti Wallplates, QuickPort® Inserts and Connectors

Leviton's new Acenti wallplates are sleek and smooth and come in 7 soft neutral colors to perfectly complement any home or office environment. The soft radius design with low-profile corners adds personality with clean simple lines. Available in 1-, 2-, 3-, 4-, 5- and 6-gang styles. Choose from a wide variety of inserts for voice, data, electro-mechanical, lighting control, GFCI, and more. QuickPort inserts give all your voice, data, audio/visual and even fiber connections a sleek new look. See all the options at Leviton.com/acenti or call Leviton Customer Service at 1(800) 323-8920.

Acenti QuickPort Multimedia Inserts

DESCRIPTION	CAT. NO.
[A] 2-Port Acenti QuickPort Insert	AC642
[B] 3-Port Acenti QuickPort Insert	AC643
[C] 4-Port Acenti QuickPort Insert	AC644
[D] 6-Port Acenti QuickPort Insert	AC646

Acenti Wallplates

DESCRIPTION	CAT. NO.
[E] Single-Gang Acenti Wallplate	ACWP1
[F] Dual-Gang Acenti Wallplate	ACWP2
Three-Gang Acenti Wallplate	ACWP3
Four-Gang Acenti Wallplate	ACWP4
Five-Gang Acenti Wallplate	ACWP5
Six-Gang Acenti Wallplate	ACWP6

Note: Order QuickPort Snap-In Connectors on page L3-L7. Configured versions also meet FCC Part 68

Acenti® QuickPort® Snap-In Connectors

DESCRIPTION	CAT. NO.
GigaMax® Cat 5e Channel-Rated Connector	AC108-R*5
[G] BNC Adapter, Nickel-Plated	AC084-B*F
BNC Adapter, Gold-Plated	AC832-OB*
F-Type Adapter, Nickel-Plated	AC084-F*F
[H] F-Type Adapter, Gold-Plated	AC831-OB*
[I] S-Video Module, 110 Termination	AC734-SV*
[J] Blank Insert (Pack of 10)	AC084-B*B
RCA Jack, Gold-Plated w/Red Stripe	AC830-B*R
[K] RCA Jack, Gold-Plated w/Black Stripe	AC830-B*E
RCA Jack, Gold-Plated w/Yellow Stripe	AC830-B*Y
[L] Banana Jack, Gold-Plated w/Red Stripe	AC837-B*R
Banana Jack, Gold-Plated w/Black Stripe	AC837-B*E
Binding Post Adapter, Gold-Plated w/Red Stripe	AC833-B*R
[M] Binding Post Adapter, Gold-Plated w/Black Stripe	AC833-B*E
RCA 110 Termination Connector, Orange Inner Barrel	AC735-R0*
RCA 110 Termination Connector, Red Inner Barrel	AC735-RR*
RCA 110 Termination Connector, White Inner Barrel	AC735-RW*
RCA 110 Termination Connector, Yellow Inner Barrel	AC735-RY*



***COLOR/ACENTI**

For color selection, add suffix to catalog number as follows: Neutral Colors—Alabaster (ALA), Onyx (ONX) and Slate (SLT). Off-White Colors—Quartz (QTZ), Sand (SND), Driftwood (DFT) and Natural (NTL).



STANDARD TELEPHONE/VIDEO WALL JACKS

A



Standard Telephone/Video Wall Jacks

TYPE 625B4 MODULAR WALL JACK

Includes jack, plate, and mounting hardware. Fits standard NEMA wallboxes. Screw terminals. UL Listed and CSA Certified or cULus Listed. Standard 6P4C (item A) 625B4 Modular Wall Jacks feature lead-frame design for reliability and ease of installation.

Type 625B4 Modular Wall Jack—Smooth Finish cULus, Standard Plate

DESCRIPTION	CAT. NO. BROWN	CAT. NO. IVORY	CAT. NO. WHITE	CAT. NO. ALMOND	CAT. NO. LT ALMOND
[A] 6-Position, 4-Conductor	40249-000†	40249-001†	40249-00W†	40249-00A†	40249-00T†
6-Position, 6-Conductor	—	40238-00I	40238-00W	—	40238-00T
8-Position, 8-Conductor	—	40280-00I	40280-00W	—	40280-00T

B



Type 625B4 Modular Wall Jack—Smooth Finish , Midway Plate

DESCRIPTION	CAT. NO. BROWN	CAT. NO. IVORY	CAT. NO. WHITE	CAT. NO. LT ALMOND
6-Position, 4-Conductor	40549-000	40549-00I	40549-00W	40549-00T
[B] 8-Position, 8-Conductor	40580-00I	40580-00W	—	—

Type 625B4 Modular Wall Jack—Smooth Finish , alternate construction (not shown)

DESCRIPTION	CAT. NO. IVORY	CAT. NO. WHITE	CAT. NO. GRAY	CAT. NO. ALMOND	CAT. NO. BROWN
6-Position, 4-Conductor	4625B-44I	4625B-44W	4625B-44G	4625B-44A	4625B-044
6-Position, 6-Conductor	4625B-46I	4625B-46W	4625B-46G	—	—
8-Position, 8-Conductor	4625B-48I	4625B-48W	—	—	—

Note: Robertson/Slot Drive screws available for 4625B series, call customer service for ordering information.
†These products are cULus Listed.

C



TYPE 625D F-CONNECTOR WALLPLATES

C F-Connector wallplates have one or two F-Connectors. Wallplates have a smooth finish. UL Listed and CSA certified.

F-Connector Wallplate

DESCRIPTION	CAT. NO. IVORY	CAT. NO. WHITE	CAT. NO. ALMOND	CAT. NO. LT ALMOND
[B] Flush-Mount Single F-Connector	80781-00I	80781-00W	80781-00A	80781-00T
Flush-Mount Duplex F-Connector	80782-00I	80782-00W	80782-00A	80782-00T

D



TYPE 625D COMBINATION WALL JACKS AND F-CONNECTOR WALLPLATES

D The Type 625D jacks include one modular jack (with screw terminals) for voice, and one F-connector for cable TV or other video applications using RG6 or RG59 coax. UL Listed and CSA Certified.

Type 625D Combination Wall Jacks and F-Connector Wallplates

DESCRIPTION	CAT. NO. IVORY	CAT. NO. WHITE	CAT. NO. GRAY	CAT. NO. ALMOND	CAT. NO. LT ALMOND
[C] 6-Position, 4-Conductor and F-Connector	40259-00I	40259-00W	40259-00G	40259-00A	40259-00T
6-Position, 6-Conductor and F-Connector	40258-00I	40258-00W	—	—	40258-00T

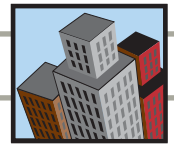

Decora® Telephone Wall Jack Inserts

DECORA MODULAR SINGLE OR DUPLEX WALL JACK INSERTS

A These single or duplex flush-mount voice-grade connectors fit in Leviton's popular Decora line of devices. Screw terminals. Includes matching Decora wallplate.

Decora Modular Wall Jack

DESCRIPTION	CAT. NO. IVORY	CAT. NO. WHITE	CAT. NO. LT ALMOND
Decora Single Modular Wall Jack, 6-position 4-conductor	40949-0ID	40949-0WD	40949-0TD
Decora Duplex Modular Wall Jack, 6-position 4-conductor	40944-0ID	40944-0WD	40944-0TD

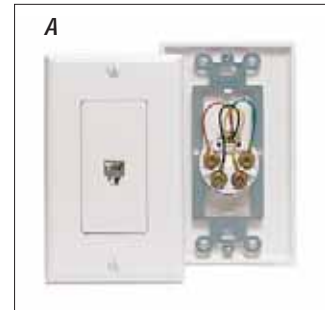

TYPE 625 DECORA MODULAR WALL JACKS

B Single flush mount jack for use with Decora or Decora Plus wallplates. Mount in standard or multi-gang electrical box. Screw terminals. UL Listed and CSA Certified.

Type 625 Decora Modular Wall Jack

DESCRIPTION	CAT. NO. IVORY	CAT. NO. WHITE	CAT. NO. GRAY	CAT. NO. BLACK	CAT. NO. ALMOND	CAT. NO. BROWN
6-position 4-conductor	40649-00I	40649-00W	40649-0GY	40649-00E	40649-00A	40649-000
6-position 6-conductor†	40638-00I	40638-00W	40638-0GY	40638-00E	40638-00A	40638-000
8-position 8-conductor	40680-00I	40680-00W	40680-0GY	—	—	—

† Note: Cat. No. 40680 also available in Light Almond (40680-00T)

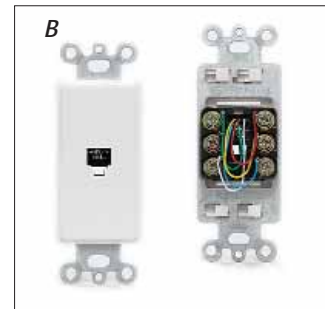

DECORA TV/PHONE COMBINATION JACK

C Combination jack with 4-Conductor modular jack for UTP telephone connections and F-Connector for video (coaxial cable) connections. Includes matching Decora wallplate.

Decora TV/Phone Combination Jack

DESCRIPTION	CAT. NO. IVORY	CAT. NO. WHITE	CAT. NO. LT ALMOND
Decora TV/Phone Combination Jack, 6-position 4-conductor	40959-0ID	40959-0WD	40959-0TD

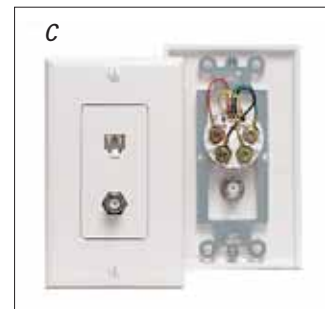

Midway Telephone and Telephone/F-Connector Wall Jacks

MIDWAY WALL JACKS

D, E Midway wall jacks provide a larger silhouette for a more designer look, and to easily hide irregular drywall cuts. Choose a voice grade connector for UTP cable or an F-connector (filled or empty) for coaxial cable. Crafted from durable, UV-resistant nylon.

QuickPort® Midway Wallplates

DESCRIPTION	CAT. NO.
[D] Midway Video Wallplate with F-Connector†	40539-0M*
[E] Midway Video Wallplate without F-Connector (hexagonal opening only)	40539-HM*
Midway Phone Wallplate with 6P4C Voice Grade Connector	40539-PM*
Midway Wallplate with 6P4C Voice Grade Connector & F-Connector	40539-CM*

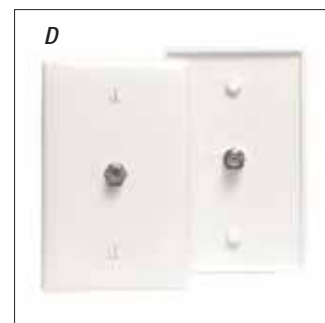

TYPE 625B MIDWAY DUPLEX WALL JACKS

These smooth finish midway units include 2 jacks, wallplate and mounting hardware. Wire to provide the same dial tone on both jacks or separate lines. Screw terminals. UL Listed & CSA Certified.

Type 625B Duplex Wall Jack

DESCRIPTION	CAT. NO. IVORY	CAT. NO. WHITE
Type 625B Duplex Wall Jack, 6-position 4-conductor, Midway Plate†	40544-00I	40544-00W
Type 625B Duplex Wall Jack, 6-position 6-conductor, Midway Plate	40566-00I	—
Type 625B Duplex Wall Jack, 8-position 8-conductor, Midway Plate†	40588-00I	40588-00W

Note: Part Numbers 40544 and 40588 are also available in Light Almond (40544-00T and 40588-00T)

*COLOR/MIDWAY WALLPLATES

For color selection, add suffix to catalog number as follows: Ivory (I), White (W), Almond (A), Brown (B), Light Almond (T)



TELEPHONE WALL PHONE JACKS

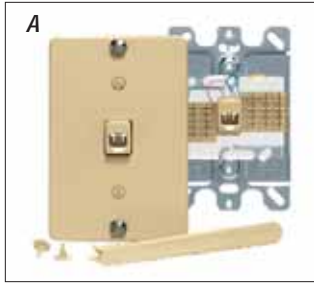

Telephone Wall Phone Jacks

TYPE 630A QUICK-CONNECT WALL PHONE JACK WITH PLASTIC WALL PLATE

A Features quick-connect terminals, screw-on wallplate, metal bracket, mounting lugs, and installation tool. Removable lugs and color-matched plastic inserts (included) permit conversion from wall phone jack to flush mount jack. UL Listed and CSA Certified.

Type 630A Quick-Connect Jack with Plastic Wallplate

DESCRIPTION	CAT. NO. IVORY	CAT. NO. WHITE	CAT. NO. GRAY	CAT. NO. ALMOND	CAT. NO. LT ALMOND
6-Position, 4-Conductor	40253-00I	40253-00W	40253-0GY	40253-00A	40253-00T
6-Position, 6-Conductor	40263-00I	40263-00W	—	—	40263-00T



TYPE 630A QUICK-CONNECT WALL PHONE JACK WITH STAINLESS STEEL WALLPLATE

B Includes 4- or 6-conductor jack with screw terminals, stainless steel screw-on wallplate, mounting screws and installation tool.

Type 630A Quick-Connect Jack with Stainless Steel Wallplate

DESCRIPTION	CAT. NO.
6-Position, 4-Conductor w/ QuickPort terminations	40223-00S
6-Position, 6-Conductor w/ screw terminations	40226-00S



WALL PHONE JACK

C Single phone jack for standard wall phone. Four color-coded screw-down connections.

Wall Phone Jack

DESCRIPTION	CAT. NO. IVORY	CAT. NO. WHITE	CAT. NO. ALMOND	CAT. NO. LT ALMOND
Wall Phone Jack	40914-00I	40914-00W	40914-00A	40914-00T



TYPE 625B3 DUPLEX WALL JACK

D These smooth finish units include 2 jacks, wallplate and mounting hardware. Wire to provide the same dialtone on both jacks or separate lines. Screw terminals. UL Listed & CSA Certified.

Type 625B3 Duplex Wall Jack

DESCRIPTION	CAT. NO. IVORY	CAT. NO. WHITE
Type 625B3 Duplex Wall Jack, 6-position 4-conductor, Standard Plate*	40244-00I	40244-00W
Type 625B3 Duplex Wall Jack, 6-position 6-conductor, Standard Plate†	40266-00I	40266-00W

* NOTE: Part Number 40244 is also available in Almond (40244-00A), Light Almond (40244-00T) and Brown (40244-000) versions.

† NOTE: Part Number 40266 is also available in Light Almond (40266-00T)



TYPE 630A SCREW TERMINAL WALL JACK WITH PLASTIC WALLPLATE

E Features 4-conductor jack, screw terminals, screw-on wallplate and removable mounting lugs can be converted to a flush-mount jack by replacing lugs with color-keyed plastic inserts (included). UL Listed and CSA Certified.

Type 630A Screw Terminal Wall Jack with Plastic Wallplate

DESCRIPTION	CAT. NO. IVORY	CAT. NO. WHITE	CAT. NO. LT ALMOND
6-position, 4-conductor	40257-00I	40257-00W	40257-00T



TYPE 630A SCREW TERMINAL WALL JACK WITH SNAP-ON PLASTIC WALLPLATE

F Includes snap-on wallplate, mounting screws, and factory installed legs. UL Listed and CSA Certified.

Type 630A Screw Terminal Wall Jack with Snap-On Plastic Wallplate

DESCRIPTION	CAT. NO. IVORY	CAT. NO. WHITE	CAT. NO. ALMOND	CAT. NO. LT ALMOND
6-position, 4-conductor	40214-00I	40214-00W	40214-00A	40214-00T
6-position, 6-conductor	40216-00I	40216-00W	—	40216-00T

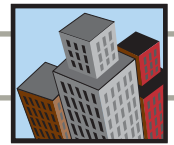



Telephone Wall Jack Inserts

TYPE 106 DUPLEX FLUSH MOUNT MODULAR JACK WITH 110-TYPE TERMINATION

A The Type 106 duplex jack accommodates two voice and/or data terminals in the same jack location, using standard duplex electrical wallplates. Jack choices include 4-, 6-, and 8-conductor modular jacks for voice or data, with 8-conductor keyed versions typically used for data. Mounts easily in standard electrical boxes, most floor monuments, raceways, and many cellular or raised floor boxes without adapters. May be ganged for multiple-port applications. Installation is fast and easy with 110-type insulation displacement connectors for 22-26 AWG inside wiring. UL Listed, CSA Certified, and meets FCC Part 68 requirements.

Type 106 Flush Mount Modular Jack  

DESCRIPTION	PORT DESIGNATIONS		CAT. NO. IVORY	CAT. NO. WHITE	CAT. NO. GRAY
Two 4-Conductor USOC Jacks†	Line 1	Line 2	41364-IDI	41364-IDW	41364-IDG
Two 6-Conductor USOC Jacks	Line 1	Line 2	41366-IDI	41366-IDW	41366-IDG
One 6-Conductor USOC Jack and one 8-conductor T568B CAT 3 jack	Voice	Data	41365-IDI	41365-IDW	—
Two 8-Conductor USOC Jacks	Line 1	Line 2	41368-IDI	—	—
Two 8-Conductor T568B CAT 3 Jacks	Line 1	Line 2	41367-IDI	41367-IDW	—
Two 8-Conductor T568B Jacks 	Voice	Data	41361-IDI	—	—
One 8-Conductor T568B Jack, and one 8-conductor keyed T568B jack 	Voice	Data	41360-IDI	—	—

† Note: Part Numbers 41364 and 41361 are also available in Light Almond (41364-00T and 41361-00T)
 Note: Wallplate ordering information can be found on pages L8-L12.

TYPE 105 FLUSH MOUNT MODULAR JACK WITH 110-TYPE TERMINATION

B The 105 single-port flush mount jack fits a standard single opening (1.406" diameter) electrical wallplate. It is available in 4-, 6-, or 8-conductor configurations for voice and data, with the 8-conductor keyed version typically used for data. Mounts easily in standard single-, double-, or multi-gang electrical boxes, most floor monuments, and many cellular or raised floor boxes. Installs quickly using industry standard 110-type insulation displacement connectors for 22-26 AWG inside wiring. UL Listed, CSA Certified, and meets FCC Part 68 requirements.

Type 105 Flush Mount Modular Jack  

DESCRIPTION	CAT. NO. IVORY	CAT. NO. WHITE	CAT. NO. LT ALMOND
One 6-Position, 4-Conductor Jack	41054-IDD	—	41054-TDD
One 8-Position, 8-Conductor Jack, T568B 	41058-IDA	41058-WDA	—

Note: Wallplate ordering information can be found on pages L8-L11.

TYPE 625B ROUND MODULAR JACK WALLPLATE INSERT

C A 4-conductor jack with Type 43A mounting bracket attached. Mounts in any standard electrical box. Slotted holes facilitate alignment. Can be used indoors or outdoors with corresponding Leviton wallplate. For use with 4-conductor modular line cord. Screw terminals. UL Listed & CSA Certified.

Type 625B Round Modular Jack Wallplate Insert and Wallplate  

DESCRIPTION	CAT. NO. IVORY	CAT. NO. LT ALMOND
Type 625B Round Modular Jack	40201-00I	40201-00T
Round Modular Jack Wallplate	80704-00I	80704-00T

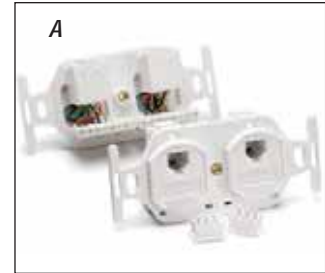

MATERIAL CHARACTERISTICS

Flush Mount Modular Jacks

- Housing: High-impact, fire-retardant plastic rated UL 94V0.
- Spring wire contacts: Phosphor bronze, plated with 50 microinches hard gold over 100 microinches nickel.
- Wire leads: PVC-insulated, tinned solid copper.
- Mounting screws: Combination Phillips/Straight blade head.

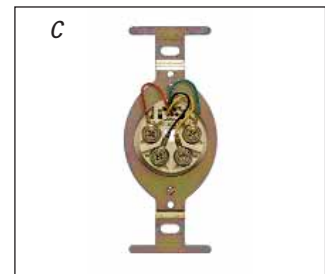
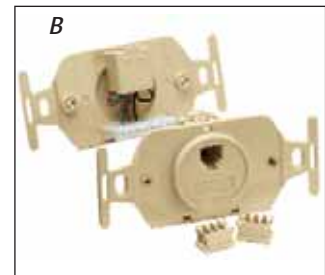



SURFACE MOUNT TELEPHONE JACKS

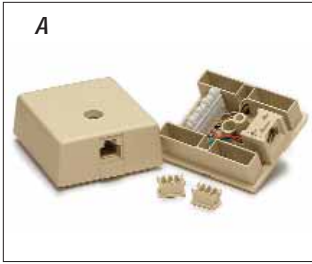

MATERIAL CHARACTERISTICS

- 103 Jacks**
- Housings: High-impact, fire-retardant plastic rated UL 94V0.
 - Spring wire contacts: Phosphor bronze, plated with 50 microinches gold over 100 microinches nickel.
 - 110 clips: Solder-plated phosphor bronze.



MATERIAL CHARACTERISTICS

- 104 Jacks**
- Housings: High-impact, fire-retardant plastic rated UL 94V0.
 - Spring wire contacts: Phosphor bronze, plated with 50 microinches gold over 100 microinches nickel.
 - 110 clips: Solderplated phosphor bronze.

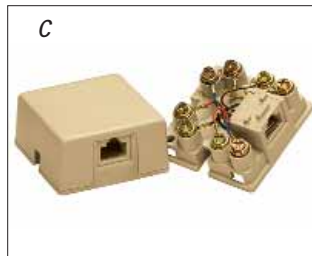

Surface Mount Telephone Jacks

TYPE 103 SURFACE MOUNT MODULAR JACK WITH 110-TYPE TERMINATION

A The 103 single-port surface mount jack is available in 4-, 6-, or 8-conductor configurations for voice and data. Mounts using screws or doublesided tape (both included), or optional magnets (see page L24). UL Listed and CSA Certified.

Type 103 Single-Port Surface Mount Modular Jack

DESCRIPTION	CAT. NO. IVORY	CAT. NO. WHITE	CAT. NO. LT ALMOND
6-Position, 4-conductor Jack	41034-IDA	—	41034-TDA
6-Position, 6-conductor Jack	41036-IDA	—	41036-TDA
8-Position, 8-conductor USOC Jack	41038-IDA	—	41038-TDA
8-Position, 8-conductor T568B Category 3 compliant Jack	41038-IDB	41038-WDB	41038-TDB

TYPE 104 DUPLEX SURFACE MOUNT MODULAR JACK WITH 110-TYPE TERMINATION

B The 104 Duplex Surface Mount Jack accommodates two voice and/or data ports. Available in 4-, 6-, or 8-conductor configurations for voice and data. Mounts easily using screws or doublesided tape (both included), or optional magnets (see page L23). UL Listed and CSA Certified.

Type 104 Duplex Surface Mount Modular Jack

DESCRIPTION	PORT DESIGNATIONS		CAT. NO. IVORY	CAT. NO. LT ALMOND
Two 4-Conductor Jacks	Line 1	Line 2	41044-IDA	41044-TDA
Two 6-Conductor Jacks	Line 1	Line 2	41046-IDA	41046-TDA
One 6-Conductor Jack and one 8-conductor T568B Category 3 compliant jack	Voice	Data	41086-IDB	—
Two 8-Conductor USOC Jacks	Line 1	Line 2	41048-IDA	—
Two 8-Conductor T568B Category 3 compliant Jacks	Line 1	Line 2	41048-IDB	41048-TDB
Two 8-Conductor T568B Category 3 compliant Jacks, one keyed and one non-keyed	Data	Data	41088-IDB	—

TYPE 625A2 SURFACE MOUNT JACK

C The compact design of this “biscuit block” jack offers improved appearance and space savings for surface-mount applications, and includes many features to facilitate installation. Unit comes with your choice of modular jacks prewired to combo-head screw terminals. High-reliability features include retainer comb to assure proper contact between jack and plug. Self-tapping screws and adhesive pad are included. UL Listed and CSA Certified.

Type 625A2 Surface Mount Jack

DESCRIPTION	CAT. NO. IVORY	CAT. NO. WHITE	CAT. NO. GRAY	CAT. NO. LT ALMOND
6-Position 4-Conductor	4625A-24I	4625A-24W	—	4625A-24T
6-Position 6-Conductor	4625A-26I	4625A-26W	—	4625A-26T
8-Position 8-Conductor	40278-00I	40278-00W	40278-00G	40278-00T
8-Position 8-Conductor (with shorting bar, RJ31X)	40278-SBI	—	—	40278-SBT
8-Position 4-Conductor (with shorting bar, RJ31X)	40274-SBI	—	—	—



Workstation Accessories

SINGLE- AND DUAL-GANG SURFACE MOUNT BACKBOXES

These two-piece Surface Mount Backboxes snap snugly together to adapt Leviton flush mount products for surface mounting. Available in two sizes with knockouts on all sides for cable entry. Mounting options include screws and double-sided tape (installer-supplied); modular furniture brackets (F, G, H below) or magnet mounting (E below).

Single- and Dual-Gang Surface Mount Backboxes

DESCRIPTION	CAT. NO. IVORY	CAT. NO. WHITE	CAT. NO. GRAY	CAT. NO. BLACK
[A] Single-Gang 1.89" deep	42777-1IA	42777-1WA	42777-1GA	42777-1EA
[B] Single-Gang 1.45" deep	42777-1IB	42777-1WB	42777-1GB	42777-1EB
[C] Dual-Gang 1.89" deep	42777-2IA	42777-2WA	42777-2GA	42777-2EA
[D] Dual-Gang 1.45" deep	42777-2IB	42777-2WB	42777-2GB	42777-2EB

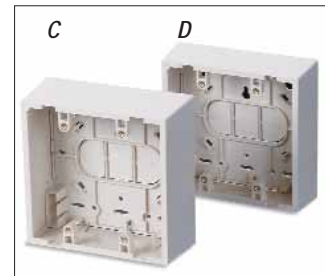
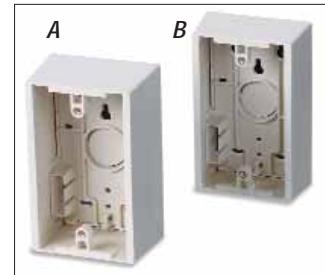

MAGNETS

Mount surface mount products on desks and other metal surfaces.

Magnets

DESCRIPTION	CAT. NO.
[E] Magnets (4 per pack)	41030-SMJ

Use 1 Magnet for 2-port Surface Mount Housing. Use 2 Magnets for 4-, 6-, and 12-port Surface Mount Housings, Single & Dual-Gang Surface Mount Backboxes, 103 & 104 type Modular Jacks.



MODULAR FURNITURE BRACKETS

Use to install Leviton surface mount outlets (or flush mount devices with backbox) in many types of modular offices. Can also be used with Leviton backboxes and surface mount 4-, 6- and 12- port housings. Cold-rolled steel units snap securely into modular partitions. A cutout allows rear cable entry for a clean, uncluttered look and tangle-free installation. Available in black.

Modular Furniture Brackets

DESCRIPTION	CAT. NO.
[F] For Steelcase 9000®, Haworth®, Knoll Morrison®, Allsteel®, Teknion® and Westinghouse®	49222-BLK
[G] For Herman Miller Ethospace® and Steelcase Avenir®	49222-ESP
[H] For Herman Miller Action Office®	49222-HAO

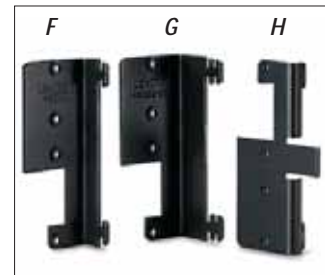



PATCH PANELS



24-Port [1.75" H x 19.0" W]

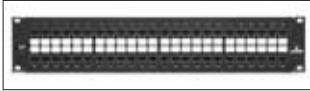

48-Port [3.5" H x 19.0" W]



Recessed Angled 48-Port
[3.5" H x 19.0" W x 4.8" D]

Category 6A (10G) Performance System

Leviton's eXtreme® 10G System, featuring Cone of Silence™ and Retention Force Technology®, supports backwards compatibility for 1G and 10/100 Ethernet, as well as advanced new 10G Base-T applications. Patent pending Cone of Silence blocks alien crosstalk (AXT) between neighboring connectors. Retention Force Technology ensures error-free performance over the life of the system by reinforcing time contacts even when 4- or 6-pin plugs have been used.

EXTREME 10G QUICKPORT® PATCH PANELS

Preloaded with black eXtreme 10G connectors, panels offer universal T568A/B wiring compatibility, 110-style IDC termination field, and labeling surfaces. Available in standard and angled styles.

CAT 6A Performance QuickPort® Patch Panels

DESCRIPTION	CAT. NO.
24-Port QuickPort Patch Panel preloaded with eXtreme® 10G Connectors, 1RU	6910G-U24
48-Port QuickPort Patch Panel preloaded with eXtreme 10G Connectors, 2RU	6910G-U48
48-Port High-Density QuickPort Patch Panel kitted with 48 eXtreme 10G connectors and cable management bar, 1RU	6910G-D48

SPECIFICATIONS AND FEATURES

- Guaranteed to exceed the current TIA CAT 6A specifications for all AXT, NEXT, FEXT, PSNEXT, PSELFEXT, PSACR Insertion Loss and Return Loss, with tested transmission performance
- Exceeds TIA 568 B.2-10 channel performance when installed with Leviton approved 10G cable
- ETL verified to comply with and guaranteed to meet IEEE 802.3an 10GBASE-T and TIA Cat 6A standards
- Proprietary technology allows the channel to surpass proposed *6 around 1" Alien Crosstalk (AXT) test requirements



eXtreme® 6+ Universal Patch Panels

Craft-friendly eXtreme 6+ Universal Patch Panels exceed published Category 6 standards and feature patented Retention Force Technology™ for robust long-term performance and mechanical integrity.

These 12-, 24-, 48- and 96-port panels (and 12-port patch block) come pre-configured with craft-friendly 110-style punchdowns on the rear and six-port RJ-45 front modules. Rear designation labels are reversible, with color-coded diagrams for T568A, T568B and 25-pair wiring configurations.

Patch panels feature advanced cable management and accommodate top, bottom or side cable entry.

All eXtreme 6+ panels mount in standard 19" equipment racks, are cULus Listed and A-tick compliant.

eXtreme 6+ Universal Patch Panels

DESCRIPTION	CAT. NO. 12-PORT PATCH BLOCK*	CAT. NO. 12-PORT PANEL	CAT. NO. 24-PORT PANEL	CAT. NO. 48-PORT PANEL	CAT. NO. CENTRAL LABEL 48-PORT PANEL	CAT. NO. 96-PORT PANEL
High-density, Pre-Configured Patch Panel with wire management bar	69586-U89	69586-U12	69586-U24	69586-U48	69586-C48	69586-U96
<i>Dimensions:</i>	10.0"H x 2.30"W	1.75"H x 19.0"W	1.75"H x 19.0"W	3.5"H x 19.0"W	3.5"H x 19.0"W	7"H x 19.0"W

*12-Port Patch Block does not include wire management bar.

eXtreme 6+ QuickPort® Patch Panels

QuickPort Category 6 Patch Panels are provided in a kit with black eXtreme 6+ connectors and are available in 24- and 48-port versions. IRU 48-port panel provides extra density in minimal space. Connector rear-termination field ensures easy accessibility and accommodates T568A or T568B wiring configurations. cULus listed.

QuickPort Category 6 Patch Panels

DESCRIPTION	DIMENSIONS	CAT. NO.
24-Port, IRU Patch Panel with eXtreme 6+ Connectors	1.75"H x 19"W	69270-U24
48-Port, 2RU Patch Panel with eXtreme 6+ Connectors	3.5"H x 19"W	69270-U48
48-port, IRU QuickPort High Density Patch Panel with eXtreme 6+ Connectors with cable mgmt bar		69270-D48



MATERIAL CHARACTERISTICS

- Panels and blocks are 16 gauge steel, black painted finish with white write-on areas silkscreened beside the connectors. Printed circuit boards and plastic components are fire-retardant materials rated UL 94V-0.

12-Port Patch Block

STYLES



12-Port Panel



24-Port Panel



48-Port Panel



48-Port Panel with Centralized Labels



96-Port Panel

FEATURES



Universal printed circuit-board modules— with 110 connections and rear termination field for easy-field configurability— can be used for T568A, T568B or 25-pair wiring schemes.

- Patch panel labeling kit features colored slide-in front port identification labels.
- Reversible rear label slides easily into redesigned slot and shows color-coded diagrams for T568A, T568B and 25-pair wiring.



PATCH PANELS and BLOCKS

UNIVERSAL T568A & T568B



GigaMax® 5e and Category 5 Universal Patch Panels and Patch Blocks

GigaMax 5e and Category 5 Universal Patch Panels and Patch Blocks come in a variety of port densities. Both the blocks and panels come pre-configured with 110-punchdowns on the back and either Category 5 or GigaMax 5e six-port modules on the front. Both versions can be used for T568A or T568B wiring configurations. The panels, available with 12 to 96 pre-configured ports, mount in standard 19" equipment racks and accommodate top, bottom or side cable entry. For smaller, wall-mount installations, the 12-port patch blocks are an ideal low-profile solution.

GigaMax 5e panels are rated for both component and channel-level performance.

All panels and blocks are cULus Listed and meet all requirements of the latest published TIA guidelines.

Universal GigaMax 5e Patch Panels

DESCRIPTION	CAT. NO. 12-PORT	CAT. NO. 24-PORT	CAT. NO. 48-PORT	CAT. NO. CENTRAL LABEL 48-PORT	CAT. NO. 96-PORT
T568B/T568A	5G596-U12	5G596-U24	5G596-U48	5G596-C48	5G596-U96
Dimensions:	1.75"H x 19.0"W	1.75"H x 19.0"W	3.5"H x 19.0"W	3.5"H x 19.0"W	7.0" H x 19.0" W

Universal Category 5 Patch Panels

DESCRIPTION	CAT. NO. 12-PORT	CAT. NO. 24-PORT	CAT. NO. 48-PORT	CAT. NO. 96-PORT
T568B/T568A	59596-U12	59596-U24	59596-U48	59596-U96
Dimensions:	1.75"H x 19.0"W	1.75"H x 19.0" W	3.5"H x 19.0"W	7.0"H x 19.0"W

Universal Category 5 and GigaMax 5e Patch Blocks (including Mounting Brackets)

DESCRIPTION	CAT. NO. 12-PORT CATEGORY 5	CAT. NO. 12-PORT GigaMax 5e
T568B/T568A	59596-U89	5G596-U89
Dimensions:	10.0"H x 2.30"W	10.0"H x 2.30"W

GigaMax 5e QuickPort® Patch Panels

QuickPort Category 5e Patch Panels are provided in a kit with with black GigaMax 5e+ connectors and are available in 24- and 48-port versions. Connector rear-termination field ensures easy accessibility and accommodates T568A or T568B wiring configurations. UL listed.

QuickPort Category 5e Patch Panels

DESCRIPTION	DIMENSIONS	CAT. NO.
24-Port, 1RU Patch Panel with GigaMax 5e+ Connectors	1.75"H x 19"W	5G270-U24
48-Port, 2RU Patch Panel with GigaMax 5e+ Connectors	3.5"H x 19"W	5G270-U48
48-port, 1RU Patch Panel with GigaMax 5e+ Connectors, cable mgmt bar		5G270-D48

Note: Use Leviton's LabelWare™ System to quickly label your QuickPort panels. See Page L57.

STYLES



12-Port



24-Port



48-Port



48-Port

with Centralized Labels



96-Port

FEATURES

- Connector spring wire contacts are highest quality phosphor bronze, plated with 50 microinches gold over 100 microinches of nickel.
- Universal printed circuit-board modules with 110 IDC punchdowns can be used for T568A, T568B and 25-pair wiring configurations.



MATERIAL CHARACTERISTICS

- Panels and blocks are 16 gauge steel, black painted finish with white write-on areas silkscreened beside the connectors. Printed circuit boards and plastic components are fire-retardant materials rated UL 94V-0.

Copper Components



extreme® 6+, GigaMax™ 5e and QuickPort® Angled Patch Panels

Simplify cable management, ease patch cord access, and increase rack density with Angled Patch Panels from Leviton.

Panels are available in eXtreme 6+ or GigaMax 5e Universal/110-style Angled versions. Field-configurable QuickPort versions accommodate any style of QuickPort connector, and are available empty, or as kits with either Gigamax 5e+ or extreme 6+ QuickPort connectors.

All Universal panels feature 110-style punchdowns and reversible rear designation labels with color-coded wiring diagrams for T568A, T568B and 25-pair configurations.

An array of accessories, including Horizontal Ring, 1RU and 2RU Angled Blank Panel Inserts, Transitional Cover and Angled Cable Management Bar improves rack management.

All panels mount in standard 19" equipment racks and accommodate side cable entry. All panels are cULus Listed and meet or exceed all requirements of applicable Category ratings.

Angled Universal/110 Patch Panels

DESCRIPTION	DIMENSIONS	CAT. NO.
eXtreme 6+ Angled Patch Panel, 48-Port, 2RU	3.5" x 19.0" x 4.8"	69587-U48
GigaMax 5e Angled Patch Panel, 48-Port, 2RU	3.5" x 19.0" x 4.8"	56597-U48

Angled QuickPort Panels

DESCRIPTION	DIMENSIONS	CAT. NO.
eXtreme 6+ Angled Pre-configured Patch Panel, 48-Port	3.5" x 19.0" x 4.8"	69271-U48
GigaMax 5e Angled Pre-configured Patch Panel, 48-Port	3.5" x 19.0" x 4.8"	56271-U48
High Density Angled Patch Panel, 72-Port, 2RU, w/cable mgmt bar, sold empty		49256-D72
QuickPort Angled Patch Panel, 1RU, sold empty		49256-H24
QuickPort Angled Patch Panel, 48-Port, sold empty	3.5" x 19.0" x 4.8"	49256-H48

Note: See Section L3-L5 for QuickPort connector options.

Angled Panel Accessories

DESCRIPTION	CAT. NO.
[A] Angled Cable Management Bar, rear (4 Hook and Loop fasteners included)	49006-AMB
[B] Vertical Transition Ring (Horizontal Cable Ring), 2/box	49262-HR1
[C] Front Blank Angled Panel, 2RU	49254-BA2
[D] Front Blank Angled Panel, 1RU	49254-BA1
[E] Transitional Cover	49254-BC1
Angled Horizontal Patch Cord Organizer, 1RU	49254-LPM
Angled Horizontal Patch Cord Organizer, 2RU	49254-BCM

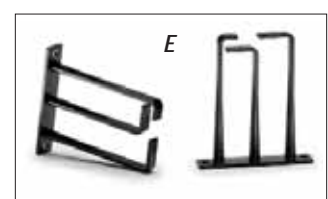
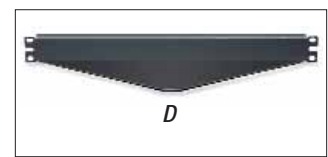
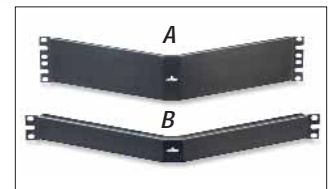



MULTIMEDIA PATCH PANELS AND PATCH BLOCKS



STYLES



A 24-Port



B 32-Port



C 24-Port High Density



D 48-Port High Density

FEATURES

- Cable-tie down slots accommodate Hook and Loop Cable Management tie-wraps and plastic cable ties. Built-in cable management organizes cable and helps maintain optimum bend radii.
- Exclusive Quick Termination Stations can be used to temporarily hold connectors for more convenient termination and cable dressing on 24- and 32-port standard QuickPort panels.
- QuickPort panels accept all Leviton QuickPort snap-in connectors, modules and blanks. Use with Category 6, 5e or 5 connectors for outstanding performance.
- Rugged dual-wall reinforced construction provides secure, flush mount module retention.

QuickPort® Multimedia Patch Panels and Patch Blocks

Create a Category 5, 5e, 6 or multimedia panel instantly by matching Leviton Performance connectors with versatile QuickPort patch panels and patch blocks. Field-configure with any QuickPort Snap-in Modules for voice, data, audio and video, including: Category 5, GigaMax® 5e, and eXtreme® 6+ (sold separately), to configure the panel to your exact needs.

Configure patch blocks with up to 12 QuickPort modules. Patch panels range in port density from 24 to 48 ports. 24- and 32-port panels incorporate Leviton's exclusive 'Quick Termination Station', and a cable management tray. The high-density panels include a wire management bar. An 89D mounting bracket is sold separately for patch blocks.

QuickPort Multimedia Patch Panels with Cable Tray

DESCRIPTION	DIMENSIONS	CAT. NO.
[A] 24-Port Patch Panel with Cable Tray (Order 1 Port identification kit)	(3.5"H x 19"W)	49255-Q24 49257-QID
[B] 32-Port Patch Panel with Cable Tray (Order 2 Port identification kits)	(3.5"H x 19"W)	49255-Q32 49257-QID

QuickPort High Density Multimedia Patch Panels with Wire Management Bar

DESCRIPTION	DIMENSIONS	CAT. NO.
[C] High Density 24-Port Patch Panel w/Wire Management Bar (Order 1-Port identification kit)	(1.75"H x 19"W)	49255-H24 49257-QHD
[D] High Density 48-Port Patch Panel w/Wire Management Bar. (Order 2-Port identification kits)	(3.5"H x 19"W)	49255-H48 49257-QHD

QuickPort High Multimedia Patch Blocks

DESCRIPTION	DIMENSIONS	CAT. NO.
QuickPort 12-Port Patch Block, (mounting bracket sold separately)	(10"H x 2.375" W)	49255-Q89
QuickPort Patch Block mounting bracket, shown above (89D)		40089-00D
QuickPort 12-Port Multimedia Patch Block, (extra deep) (mounting bracket included)	(10"H x 2.375"W)	47689-00P

Note: The above QuickPort Multimedia Patch Panels and Blocks are sold empty. See pages L3-L7 for our full line of QuickPort Connectors.

Note: Use Leviton's LabelWare™ System to quickly label your QuickPort panels. See Page L59.

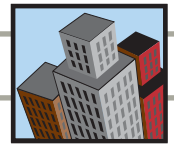

High Density Patch Panels

Leviton's high density 1RU 48-port and 2RU 72-port style patch panels provide the extra density you need along with robust performance. The 1RU 48-port patch panels feature industry-first, die-cast aluminum construction for high-strength and low weight and include a heavy-duty cable management bar to support the terminated cables. They are sold empty or kitted with 48 category-rated QuickPort connectors. The 72-port super-high density panels are sold empty in flat, angled and recessed-angle configurations.

High Density Patch Panels

DESCRIPTION	CAT. NO.
High-Density 48-Port Patch Panel w/ CAT 6A connectors, cable management bar	6910G-D48
High-Density 48-Port Patch Panel w/CAT 6 connectors, cable management bar	69270-D48
High-Density 48-Port Patch Panel w/CAT 5e connectors, cable management bar	5G270-D48
[A] High-Density 48-Port Patch Panel, empty, w/cable management bar	49255-D48
High-Density Cable Management Bar, sold separately	49005-DMB
[B] High-Density 72-Port Patch Panel	49255-D72
High-Density 72-Port Angled Patch Panel	49256-D72
High-Density 72-Port Recessed Angled Patch Panel	4W256-D72

VertiGO™ Zero-U Patch Panels

Leviton's new VertiGO Zero-U Patch Panels with Opt-X® and QuickPort Adapter Plate compatibility (sold separately) provide the ideal solution for copper and fiber connectivity in limited space without taking up any horizontal rack space.

VertiGO Zero-U Panels

DESCRIPTION	CAT. NO.
[C] QuickPort 12-Port Zero-U Patch Panels, panel only	49280-QP0
QuickPort 12-Port Zero-U Patch Panel, panel w/ 3" wire channel	49280-QP3
QuickPort 12-Port Zero-U Patch Panel, panel w/ 6" wire channel	49280-QP6
[D] Opt-X Adapter Plate Zero-U Patch Panel, panel only	49280-AP0
Opt-X Adapter Plate Zero-U Patch Panel, panel w/ 3" wire channel	49280-AP3
Opt-X Adapter Plate Zero-U Patch Panel, panel w/ 6" wire channel	49280-AP6

QuickPort & Opt-X Adapter Plates

DESCRIPTION	CAT. NO.
[E] Opt-X Adapter Plate, 6-Pack QuickPort, sold empty	5F100-QP6
[F] Opt-X Adapter Plate, Blank	5F100-BLK
[G] Opt-X Adapter Plate, 6-Pack Duplex LC MM, (12-fiber) beige, phos. bronze sleeve	5F100-12P
[H] Opt-X Adapter Plate, 6-Pack Duplex LC MM, (12-fiber) aqua, zirconia ceramic sleeve	5F100-12A

Shielded Patch Panel

Shielded patch panel provides both EMI protection and data security. Panel accepts Leviton's QuickPort Shutter Kit for labeling options and includes grounding wire and nickel-plating for improved grounding, cable management bar and cable ties

QuickPort Shielded Patch Panel

DESCRIPTION	CAT. NO.
[I] QuickPort Shielded Patch Panel, 24-Port, 1RU	4S255-S24

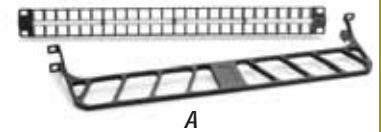

A

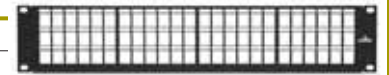

B



C



D



E



F



G



H

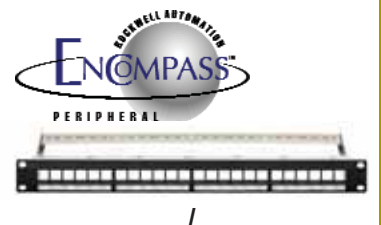

I

VERTIGO FEATURES

- Ideal for data center cabinets and other high-density network spaces.
- Mounts on the back rail of cabinets utilizing industry standard RU fastener spacing.
- Can be installed on the right or left of the cabinet.
- Can share mounting hardware with servers or other existing equipment.





HIGH DENSITY AND ZERO-U PATCH PANELS



STYLES



24-Port



48-Port

FEATURES



Cable management bar available separately to facilitate dressing and organization of cable.

- Printed circuit-board modules with 110 IDC-style punchdowns or industry standard RJ21X connector termination.
- Connector spring wire contacts are highest quality phosphor bronze, plated with 50 microinches gold over 100 microinches of nickel.

Voice Grade Patch Panels

Leviton's Voice Grade Patch Panels are the perfect solution for bringing voice to your cable rack. Pre-configured in 24- and 48-Port densities, and designed specifically for voice grade applications, these low-cost panels are available in pre-connectorized and 110-IDC versions. A unique rear label is provided for the 110-IDC style patch panels that delineates 1-pair, 2-pair and 4-pair termination, in addition to showing 25-pair color coded termination.

Voice Grade Patch Panels, 110-Style

DESCRIPTION	CAT. NO. 24-PORT	CAT. NO. 48-PORT
Voice 8P4C Jacks, 110 termination	49013-P24	49013-P48
Dimensions:	1.75"H x 19.0"W	3.5"H x 19.0"W
Cable Management Bar	49005-CMB	49005-CMB

Voice Grade Patch Panels, Pre-Connected

DESCRIPTION	CAT. NO. 24-PORT	CAT. NO. 48-PORT
Voice 8P2C Jacks, 25-pair connector	49012-J24	49012-J48
Voice 8P4C Jacks, 25-pair connector	49014-J24	49014-J48
Voice 8P8C Jacks, 25-pair connector	49018-J24	49018-J48
Dimensions:	1.75"H x 19.0"W	3.5"H x 19.0"W
Cable Management Bar	49005-CMB	49005-CMB

Note: 49004 comes without label holders, and is available only in black painted finish with white write-on areas next to the connectors.

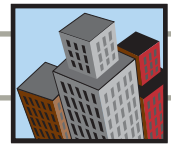

DuraPort™ Industrial Connectivity

Moisture, dust, corrosion, acids, detergents, oils, and vibration – each presents a serious threat to network connectivity, especially with repeated exposure. Defeat these threats with patent pending DuraPort Industrial Connectivity products, Leviton's IP67-rated line of connector housings, patch cords, and wallplates.

DuraPort™ Industrial Connector Housings

DESCRIPTION	CAT. NO.
[A] CAT 6 Industrial Connector Housing w/Connector Cap	D6706-00E
" CAT 5e+ Industrial Connector Housing w/Connector Cap	D675E-00E
" Connector Cap	D6701-00E



A Connector Housings

DuraPort™ Industrial Stainless Steel Wallplates

DESCRIPTION	CAT. NO.
[B] Industrial Wallplate, S/S, 1-Port, Single-Gang	D6710-1S1
" Industrial Wallplate, S/S, 2-Port, Single-Gang	D6710-1S2
" Industrial Wallplate, S/S, 2-Port, Dual-Gang	D6710-2S2
" Industrial Wallplate, S/S, 4-Port, Dual-Gang	D6710-2S4

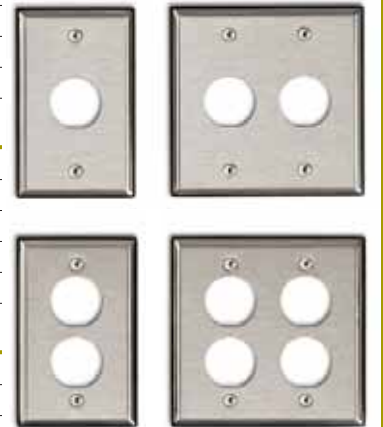

B Stainless Steel Wallplates

DuraPort™ Industrial Patch Cords, CAT 6

DESCRIPTION	CAT. NO.
[C] Industrial Plug-to-Industrial Plug, 3-ft	D6720-03E
" Industrial Plug-to-Industrial Plug, 5-ft	D6720-05E
" Industrial Plug-to-Industrial Plug, 7-ft	D6720-07E
" Industrial Plug-to-Industrial Plug, 10-ft	D6720-10E
" Industrial Plug-to-Industrial Plug, 15-ft	D6720-15E
" Industrial Plug-to-Industrial Plug, 20-ft	D6720-20E
[D] Industrial Plug-to-RJ45 Plug, 3-ft	D6721-03E
" Industrial Plug-to-RJ45 Plug, 5-ft	D6721-05E
" Industrial Plug-to-RJ45 Plug, 7-ft	D6721-07E
" Industrial Plug-to-RJ45 Plug, 10-ft	D6721-10E
" Industrial Plug-to-RJ45 Plug, 15-ft	D6721-15E
" Industrial Plug-to-RJ45 Plug, 20-ft	D6721-20E



C Plug-to-Industrial Plug

Duraport™ Industrial Outlet Kits

DESCRIPTION	CAT. NO.
[E] Industrial Outlet Kit, S/S, 1-Port, Single-Gang	D670K-1S1
Industrial Outlet Kit, S/S, 2-Port, Single-Gang	D670K-1S2
Industrial Outlet Kit, S/S, 2-Port, Dual-Gang	D670K-2S2
Industrial Outlet Kit, S/S, 4-Port, Dual-Gang	D670K-2S4



D Industrial Plug-to-RJ45



E Outlet Kits

SPECIFICATIONS AND FEATURES

DuraPort™ Industrial Connector Housings

- Made of Polybutylene Terephthalate (PBT) for strength and chemical resistance.

DuraPort™ Industrial Wallplates

- Molded gasket with embedded sealing feature for wallplate mounting holes, ensures a watertight fit.

DuraPort™ Industrial Patch Cords

- Sheathed in Thermoplastic Elastomer to resist heat, abrasion, and tearing.

DuraPort™ Industrial Outlet Kits

- Pre-assembled stainless steel wallplate with an appropriate number of connector housings and connector caps.



PATCH CORDS

Copper Components



Performance Patch Cords

A Leviton's eXtreme 10G, eXtreme 6+, GigaMax 5e and Category 5 patch cords meet or exceed industry standard specifications and use compliant stranded wiring as specified by the latest TIA guidelines, to ensure adequate "flex life". All have quality construction to maintain the integrity of signal transmission at the cross-connect, which is critical to the performance of the entire cabling system. Available in lengths of 3', 5', 7', 10', 15' and 20', in seven colors.

NOTE: Leviton Performance Patch Cords are required to qualify for the Leviton Lifetime Warranty on Certified installations.

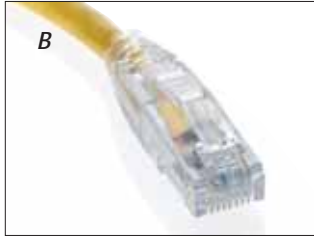

Standard Patch Cords

DESCRIPTION	CAT. NO. eXtreme 10G	CAT. NO. eXtreme 6+	CAT. NO. GigaMax 5e	CAT. NO. CATEGORY 5
3-foot length (.91 m)	6210G-03*	62460-03*	5G460-03*	52455-03*
5-foot length (1.52 m)	6210G-05*	62460-05*	5G460-05*	52455-05*
7-foot length (2.13 m)	6210G-07	62460-07*	5G460-07*	52455-07*
10-foot length (3.05 m)	6210G-10	62460-10*	5G460-10*	52455-10*
15-foot length (4.57 m)	6210G-15	62460-15*	5G460-15*	52455-15*
20-foot length (6.10 m)	6210G-20	62460-20*	5G460-20*	52455-20*

* = Colors: White(W), Yellow(Y), Red(R), Blue(B), Green(G), Grey(S), Black(E)

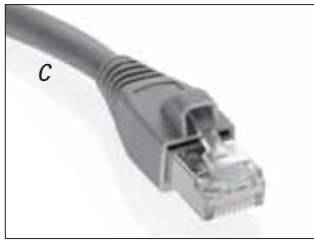

Slimline Patch Cords

SlimLine Patch Cords make it easy to get connected in both traditional and high-density applications. Bootless design and narrow Slimline profile are ideal in environments where rack space is especially tight. The snagless design prevents plugs from becoming entangled in nearby cables and the easy-access quick-release tab makes connections and disconnections easier. Flexible two-piece strain relief boot ensures excellent connectivity. Available in Category 5e and 6 ratings.

SlimLine Patch Cords

DESCRIPTION	CAT. NO.	CAT. NO.
3-foot length (.91 m)	5D460-03*	6D460-03*
5-foot length (1.52 m)	5D460-05*	6D460-05*
7-foot length (2.13 m)	5D460-07*	6D460-07*
10-foot length (3.05 m)	5D460-10*	6D460-10*
15-foot length (4.57 m)	5D460-15*	6D460-15*
20-foot length (6.10 m)	5D460-20*	6D460-20*

* = Colors: White(W), Yellow(Y), Red(R), Blue(B), Green(G), Grey(S), Black(E)

Shielded Patch Cords

Shielded Patch Cords, part of Leviton's full line of shielded products, provide enhanced EMI/RFI protection and increased data security for government, financial, and other critical applications. These Category 5e and Category 6 patch cords are available in 6 lengths. Grey only.

SlimLine Patch Cords

DESCRIPTION	CAT. NO.	CAT. NO.
3-foot length (.91 m)	5S460-03S	6S460-03S
5-foot length (1.52 m)	5S460-05S	6S460-05S
7-foot length (2.13 m)	5S460-07S	6S460-07S
10-foot length (3.05 m)	5S460-10S	6S460-10S
15-foot length (4.57 m)	5S460-15S	6S460-15S
20-foot length (6.10 m)	5S460-20S	6S460-20S

NOTE: Leviton Patch Cords (Standard, SlimLine or Shielded) are required to qualify for the Leviton Lifetime Warranty on Certified installations.

* COLOR/PATCH CORDS

For color selection, add suffix to catalog number as follows: Ivory (I), White (W), Gray (G), Black (E), Blue (L), Red (R), Green (G), Yellow (Y).

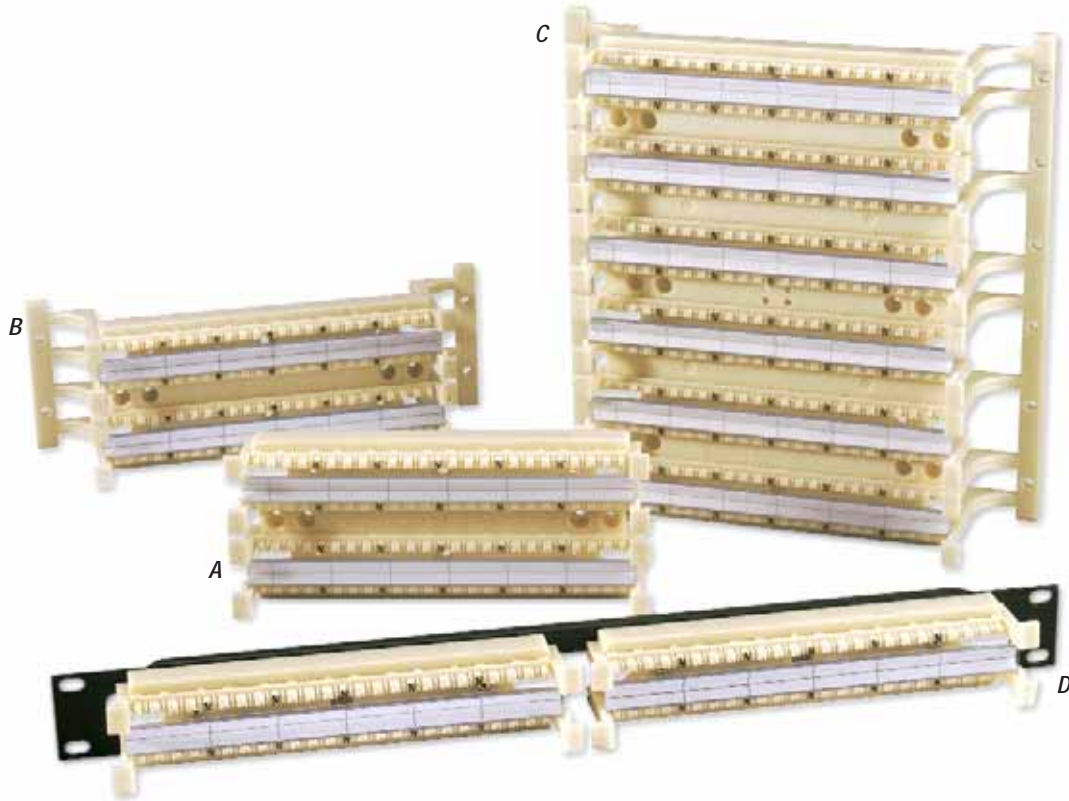
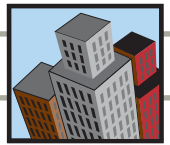

eXtreme 6+ 110-Style Wiring Products

Leviton's 110-Style Wiring Products are perfect for quick and easy cross connects in a minimum of space. Achieve top performance and network integrity at consolidation points, even at Category 6 levels. Building a cross-connect system for voice and data is effortless.

eXtreme 6+ 110-Style Wiring Blocks are available in 96- and 288-Pair units, with or without legs for wall mount applications. We also offer 96-, 192- and 288-pair rack-mount units. All kits include C-4 clips.

A full selection of patch cords is available for easy connection to network equipment. All units meet or exceed Category 6 transmission requirements.

eXtreme 6+ Cat 6 110-Style Wiring Block – Kitted Versions

DESCRIPTION	CAT. NO.
[A] eXtreme 6+ 110-Style Wiring Block, Wall-Mount w/o legs, CAT 6, 96-Pair	41NB6-1F4
[B] eXtreme 6+ 110-Style Wiring Block, Wall-Mount w/legs, CAT 6, 96-Pair	41AB6-1F4
[C] eXtreme 6+ 110-Style Wiring Block, Wall-Mount w/legs, CAT 6, 288-Pair	41AB6-3F4
[D] eXtreme 6+ 110-Style Wiring Block, Rack-Mount, CAT 6, 96-Pair	41DR6-1F4
eXtreme 6+ 110-Style Wiring Block, Rack-Mount, CAT 6, 192-Pair	41DR6-2F4
eXtreme 6+ 110-Style Wiring Block, Rack-Mount, CAT 6, 288-Pair	41DR6-3F4

Note: Category 5e and 6 110 wiring block legs are non-removable.

Note: Identify all of your 110 products with LabelWare™ 110 wiring product labels. See page L59.

Note: All kits include C-4 clips.

MATERIAL CHARACTERISTICS

- C-4 connector clips (sold separately or included in kitted versions) are fire-retardant UL 94V-0 plastic with solder-plated IDC's.



EXTREME® 6+ 110-STYLE PATCH CORDS and CONNECTOR CLIPS



eXtreme 6+ 110-Style Patch Cords

A, B Make your network connections with eXtreme 6+ 110-style Patch Cords, a quick solution for 110 to 110 and 110 to RJ45 applications (in both T568A and T568B wiring configurations). Cords are gray with gray boots and are offered in 1', 2', 3', 5', 7' and 10' lengths. All cords meet or exceed all Category 6 transmission requirements.

eXtreme 6+ Cat 6 110-Style Patch Cords

DESCRIPTION	CAT. NO. 1-FOOT	CAT. NO. 2-FOOT	CAT. NO. 3-FOOT	CAT. NO. 5-FOOT	CAT. NO. 7-FOOT	CAT. NO. 10-FOOT
[A] CAT 6 110 to 110-Style Patch Cord, 4 pair	62240-01S	62240-02S	62240-03S	62240-05S	62240-07S	62240-10S
[B] CAT 6 110 to T568A Patch Cord, 4 pair	6234A-01S	6234A-02S	6234A-03S	6234A-05S	6234A-07S	6234A-10S
CAT 6 110 to T568B Patch Cord, 4 pair	6234B-01S	6234B-02S	6234B-03S	6234B-05S	6234B-07S	6234B-10S

eXtreme 6+ 110-Style Connector Clips

C Choose these connector clips for a high-quality, gas-tight connection to ensure signal integrity in your Category 6 applications. Clips withstand 200 re-terminations and are made of fire-retardant plastic rated UL 94V-0 with solder-plated IDCs.

eXtreme 6+ Cat 6 110-Style C-4 Clip

DESCRIPTION	CAT. NO.
[C] eXtreme 6+ C-4 Clip, CAT 6 (bag of 10)	69104-IDC

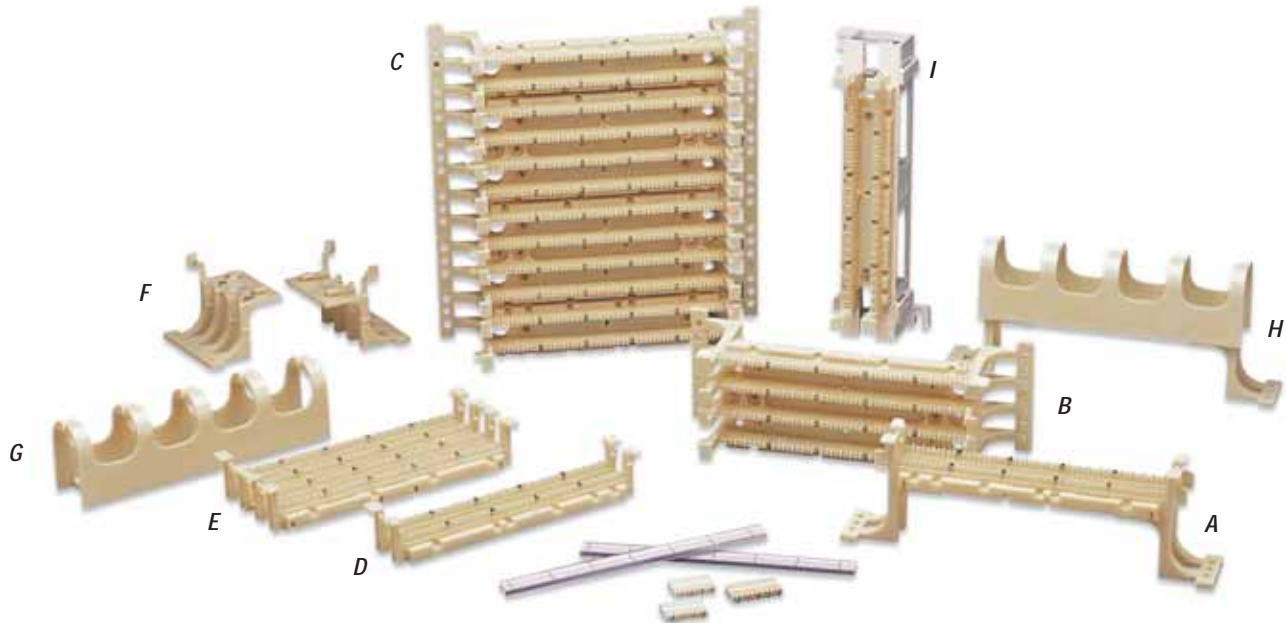

GigaMax 5e 110-Style Wiring Products

WALL-MOUNT 110-STYLE WIRING PRODUCTS

Create compact, adaptable 110 termination fields for voice and data by mounting 110 wiring bases to the wall or a backboard. Bases come in 50-, 100- or 300-pair densities. The 50- and 100-pair bases may be ordered with or without standoff legs. All 300-pair bases include stand-off legs, label strip holders and white paper labels. A 50-pair 89D bracket configuration is also available (89D bracket sold separately, page L39).

Complete kits are available for 100- and 300-pair wall-mount units and 89D wiring base, and include bases, C-4 or C-5 connecting blocks, label holders and white paper labels.

All components are UL listed and exceed the latest TIA-568-B standards and Category 5e transmission requirements. Verified by independent testing.

GigaMax 5e 110-Style Wall-Mount Wiring Products

DESCRIPTION	CAT. NO.
[A] GigaMax 5e 110-Style Wiring Block, Wall-Mount w/legs, Cat 5e, 50-Pair	41AW1-050
[B] GigaMax 5e 110-Style Wiring Block, Wall-Mount w/legs, Cat 5e, 100-Pair	41AW2-100
[C] GigaMax 5e 110-Style Wiring Block, Wall-Mount w/legs, Cat 5e, 300-Pair	41AW2-300
[D] GigaMax 5e 110-Style Wiring Block, Wall-Mount w/o legs, Cat 5e, 50-Pair	41DW1-050
[E] GigaMax 5e 110-Style Wiring Block, Wall-Mount w/o legs, Cat 5e, 100-Pair	41DW2-100
GigaMax 5e 110-Style legs (2 ea) for use with 41DW1	410L2-050
[F] GigaMax 5e 110-Style legs (2 ea) for use with 41DW2	410L2-100
[G] GigaMax 5e 110-Style Horizontal Cord Manager w/o legs	41D10-HCM
[H] GigaMax 5e 110-Style Horizontal Cord Manager w/ legs	41A10-HCM
[I] GigaMax 5e 110-Style 50-Pair 89-D Base	41DW1-589

GigaMax 5e 110-Style Wall-Mount Wiring Products – Kitted Versions

DESCRIPTION	CAT. NO. C-4 CLIPS	CAT. NO. C-5 CLIPS
[J] Wiring Block, Wall-Mount w/legs kit, Cat 5e, 100-Pair	41AB2-1F4	41AB2-1F5
Wiring Block, Wall-Mount w/o legs kit, Cat 5e, 100-Pair	41NB2-1F4	41NB2-1F5
Wiring Block, Wall-Mount w/legs kit, Cat 5e, 300-Pair	41AB2-3F4	41AB2-3F5

Note: Category 5e and 6 110 wiring block legs are non-removable.

MATERIAL CHARACTERISTICS

- Horizontal cord managers and 110 wiring bases feature sturdy construction of fire-retardant plastic rated UL 94V-0. C-4 and C-5 connector blocks (sold separately or included in kitted versions) are fire-retardant UL 94V-0 plastic with solder-plated IDC's.



RACK-MOUNT 110-STYLE WIRING PRODUCTS

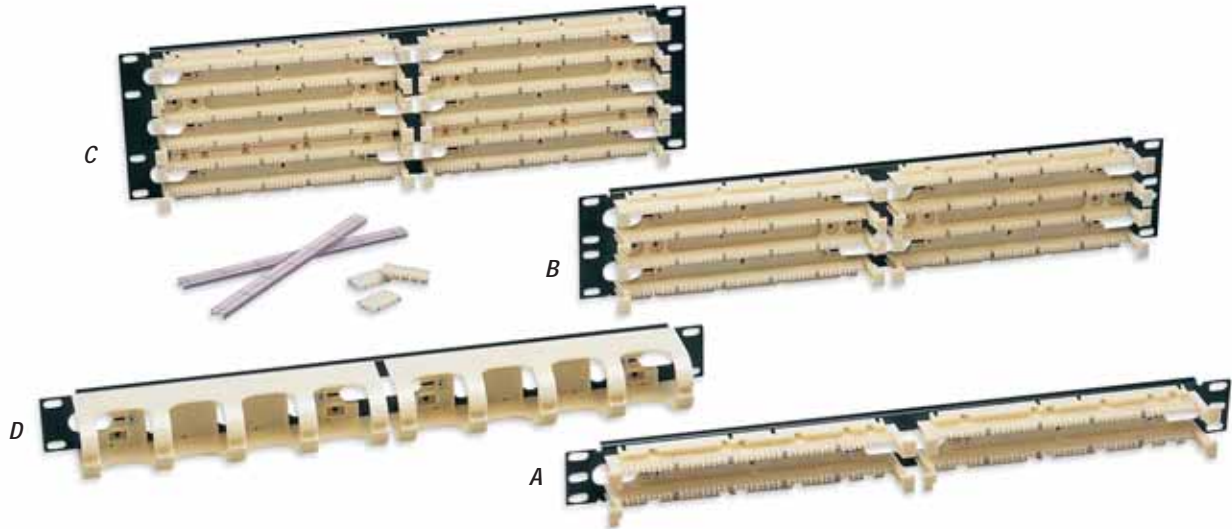

Rack-Mount 110-Style Wiring Products

Rack-Mount 110 Wiring Products attach to standard 19" wide racks to create compact, adaptable 110 termination fields for voice and data. Panels come in 100-, 200- or 300-pair densities and terminate 22-26 AWG solid copper wire. Cord management is provided by horizontal cord managers (sold separately).

Kits for 100-, 200- and 300-pair rack-mount panels include the panel, C-4 and C-5 connecting blocks, label strip holders and white paper labels.

Horizontal cord managers and 110 wiring bases feature sturdy single-piece construction of fire-retardant plastic rated UL 94V-0. Wiring bases are attached to 19" wide steel rack-mount panels, painted black. Screws are included for mounting the panels onto 19" racks. C-4 and C-5 connector blocks are fire-retardant UL 94V-0 plastic with solder-plated IDC's.

All components are UL Listed, and exceed Category 5e transmission requirements. Verified by independent testing.

GigaMax® 5e 110-Style Rack-Mount Wiring Blocks

DESCRIPTION	CAT. NO.
[A] GigaMax 5e 110-Style Wiring Block, Rack-Mount, Cat 5e, 100 Pair	41DR2-100
[B] GigaMax 5e 110-Style Wiring Block, Rack-Mount, Cat 5e, 200 Pair	41DR2-200
[C] GigaMax 5e 110-Style Wiring Block, Rack-Mount, Cat 5e, 300 Pair	41DR2-300
[D] Rack-Mount Horizontal Cord Manager (for part numbers listed above and below).	41D1R-HCM

GigaMax 5e 110-Style Rack-Mount Wiring Products – Kitted Versions

DESCRIPTION	CAT. NO. C-4 CLIPS	CAT. NO. C-5 CLIPS
GigaMax 5e 110-Style Wiring Block, Rack-Mount kit, Cat 5e, 100-Pair	41DBR-1F4	41DBR-1F5
[E] GigaMax 5e 110-Style Wiring Block, Rack-Mount kit, Cat 5e, 200-Pair	41DBR-2F4	41DBR-2F5
GigaMax 5e 110-Style Wiring Block, Rack-Mount kit, Cat 5e, 300-Pair	41DBR-3F4	41DBR-3F5

Note: Leviton's Label Holders and Strips are ideal for identification of all your key 110 connections. See page L60.

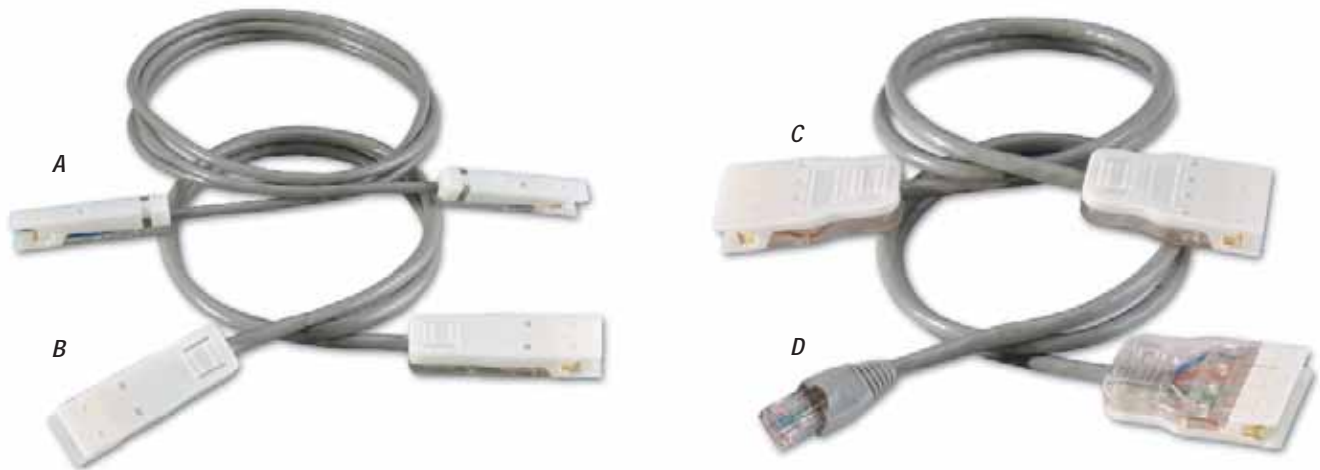
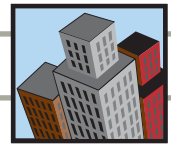

GigaMax 5e 110-Style Patch Cords

A–D Make quick connections with GigaMax 110-Style Patch Cords. Available in 110 to 110 for cross connects and 110 to RJ45 (in both T568A and T568B wiring configurations) to connect to a panel or nearby workstation. The cords are offered in 1', 2', 3', 5', and 10' lengths, in gray with gray boots.

GigaMax 5e 110-Style Patch Cords A-Tick

DESCRIPTION	CAT. NO. 1-FOOT	CAT. NO. 2-FOOT	CAT. NO. 3-FOOT	CAT. NO. 5-FOOT	CAT. NO. 7-FOOT	CAT. NO. 10-FOOT
[A] 110 to 110 Patch Cord, 1 pair	5G210-01S	5G210-02S	5G210-03S	5G210-05S	5G210-07S	5G210-10S
[B] 110 to 110 Patch Cord, 2 pair	5G220-01S	5G220-02S	5G220-03S	5G220-05S	5G220-07S	5G220-10S
[C] CAT 5e, 110 to 110 Patch Cord, 4 pair	5G240-01S	5G240-02S	5G240-03S	5G240-05S	5G240-07S	5G240-10S
[D] CAT 5e, 110 to 568A Patch Cord, 4 pair	5G34A-01S	5G34A-02S	5G34A-03S	5G34A-05S	5G34A-07S	5G34A-10S
CAT 5e, 110 to 568B Patch Cord, 4 pair	5G34B-01S	5G34B-02S	5G34B-03S	5G34B-05S	5G34B-07S	5G34B-10S



GigaMax 5e 110-Style Connector Clips

E These high-quality connector clips securely seat the wires on 110 wiring bases, providing a gas-tight IDC connection that maintains signal integrity for high performance applications. Available in three Category 5/5e pair-count sizes: C-3, C-4 and C-5. These clips withstand 200 reterminations, and are made of fire-retardant plastic rated UL 94V-0 with solder-plated insulation displacement connectors.

GigaMax 5e 110-Style Connector Clip

DESCRIPTION	CAT. NO.
GigaMax 5e 110-Style C-3 Connector Clips (bag of 10)	49103-IDC
GigaMax 5e 110-Style C-4 Connector Clips (bag of 10)	49104-IDC
GigaMax 5e 110-Style C-4 Connector Clips (bag of 50)	49104-I50
GigaMax 5e 110-Style C-5 Connector Clips (bag of 10)	49105-IDC



110-STYLE WALL-MOUNT FRAMES



110-Style Wall-Mount Frames

A–D For 110 wall-mount applications, mounting frames provide additional options for cord/cable management, access, and density via a rear cable channel, side slots, horizontal cord managers and a bottom cable tray. Components are offered individually or in kits (see ordering information below for description of included parts).

Begin with the basic mounting frames and vertical cord managers. Each has a 300-pair capacity—room for three 100-pair wiring bases, with 100-pair horizontal cord managers in between. The capacity for each mounting frame or vertical manager may be increased to 600 or 900 pairs with the addition of up to two 300-pair extension units.

Frames, trays and vertical cord managers are composed of sturdy steel, painted black; wiring bases, connector blocks and horizontal cord managers are fire-retardant plastic rated UL 94V-0. Kits include screws for attaching wiring bases and cord managers to the mounting frame. All components are UL Listed and exceed Category 5e transmission requirements. Verified by independent testing.



Wall-Mounting Frame 110-Style Wiring Products

DESCRIPTION	CAT. NO.
[A] 300-pair Basic Mounting-Frame Unit (sheet metal frame and bottom cable tray only).	41MB2-SMF
[B] 300-pair Extension Mounting-Frame Unit (sheet metal frame only).	41MB2-SME
Basic Mounting Frame Kit with three 100-pair bases; mounting frame; cable tray; C-4 connector blocks; three horizontal cord managers; label strip holders and white label strips.	41MB2-3FT
Extension Mounting Frame Kit with three 100-pair bases; mounting frame; C-4 connector blocks; three horizontal cord managers; label strip holders and white label strips.	41MB2-EXT
[C] 300-pair Vertical Cord Manager, Basic unit; includes bottom cable tray.	41880-300
[D] 300-pair Vertical Cord Manager, Extension unit.	41880-EXT
Rack-Mount Horizontal Cord Manager (Not Shown)	41D1R-HCM

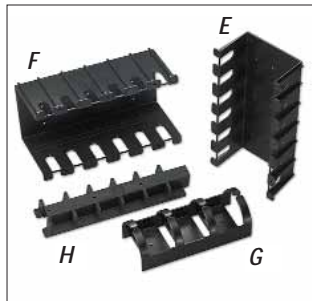

110-Style ChannelMax™ System

E–H Manage your cable with the 110 ChannelMax System, perfect to maximize control in minimum space. Cable channel provides extra room in the rear, cable trough allows a clean connection at the CP/frame, and vertical spool manager helps to dress cross-connect cables.

110-Style Channel System

DESCRIPTION	CAT. NO.
[E] 3" Deep Vertical Cable Channel	41CMS-300
[F] 5" Deep Vertical Cable Channel	41CMS-500
[G] Horizontal Cable Management Trough	41CMS-HCM
[H] Vertical Spool Manager Mounting Bracket	41CMS-VSM



66-Clip Connecting Blocks

A variety of M Blocks, including 25-pair and split 50-pair styles, provide versatile cross connect points in equipment and telecommunications rooms. Install individually or in pairs. Constructed of high-impact, fire-retardant UL 94V-0 plastic with phosphor bronze quick-connect insulation displacement 66-clips. Install individually or in pairs in a cross-connect system using jumper wires or bridging clips.

66-Clip Connecting Blocks

DESCRIPTION	CAT. NO.
[A] M Block: 25-pair (66M1-25) 10"H x 3 ⁵ / ₁₆ "W x 1 ³ / ₁₆ "D	40066-M25
Split M Block: 50-pair (66M1-50) 10"H x 3 ⁵ / ₁₆ "W x 1 ³ / ₁₆ "D	40066-M50
M Block with female connector (66M1-50W) 10"H x 3 ⁵ / ₁₆ "W x 1 ³ / ₁₆ "D	40066-0MW
[B] M Block with female and male connectors (66M1-50W2) 10"H x 3 ⁵ / ₁₆ "W x 1 ³ / ₁₆ "D	40066-MW2
[C] Connectorized Demarc Block (66M1-50R) 10"H x 3 ¹³ / ₃₂ "W x 2 ³ / ₄ "D female amphenol	40066-0MR

66-Clip Connecting Block Accessories

Accessories include Covers for M Blocks and Demarc Blocks, M-Block Brackets for Jack/Connector Mounting, Wire Distribution Spools, Modular Adapters and Bridging Clips.

Bridging Clips

DESCRIPTION	CAT. NO.
[D] Bridging Clips (SA-1), bag of 50	40067-0BC

Hinged Covers and Snap-On Covers

DESCRIPTION	CAT. NO.
Snap-on Cover for M blocks (66MC-4) 9-15/16" H x 2-5/16" W x 5/16" D	40050-MCV
Hinged Cover for Demarc blocks: orange (66MC4LH-O) 10" H x 2-7/16" W x 3/4" D	40050-MHO
Hinged Cover for M blocks: grey (66MC4LH-G) 10" H x 2-7/16" W x 3/4" D	40050-MHG

Bracket for M Blocks and Connector Mounting

DESCRIPTION	CAT. NO.
[E] M-block Bracket for connector mounting (89-D/QuickPort Blocks) 10" H x 3-13/32" W x 1-1/2" D	40089-00D

Note: Numbers in parentheses refer to industry product designation.

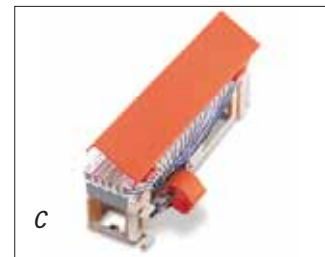
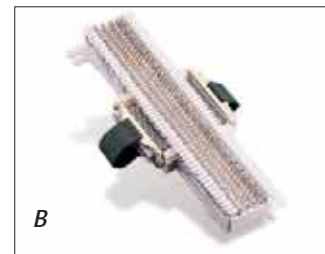
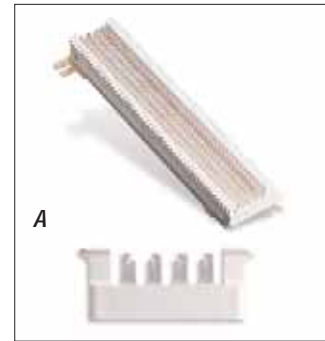



66-CONNECTING BLOCK ACCESSORIES



66-Clip Connecting Block Accessories (continued)

Modular Adapters

DESCRIPTION	CAT. NO.
[F] Position Modular Adapter (Tap™-2) - Converts two 66-clip contacts into a 6P2C modular jack	40072-0T2
4-Position Modular Adapter (Tap™-4) - Converts four contacts into a 6P4C modular jack	40072-0T4
6-Position Modular Adapter (Tap™-6) - Converts six contacts into a 6P6C modular jack	40072-0T6
8-Position Modular Adapter, T568B wiring (Tap™-008) - Converts eight contacts 8P8C non-keyed modular jack	40072-0T8



Wire Distribution Spools

DESCRIPTION	CAT. NO.
[G] Wire Distribution Spool (20-A) 1-3/4" Dia. x 3" H	40054-0DS
[H] Wire Distribution Spool with screw (20-B) 1-3/4" Dia. x 3" H	40054-DSS

Note: Number in parentheses refers to industry product designation.

Surface-Mount Mini Patch Panels

For applications with space limitations or simple breakout patching, the Mini Patch Panel with modular connectors can be mounted almost anywhere. Combine two or more panels in-line and use patch cords to make and change connections.

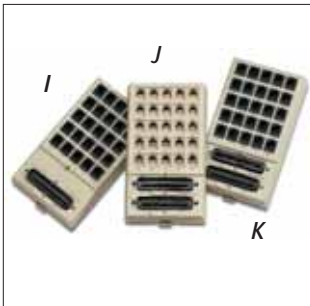

Surface-Mount Mini Patch Panels

DESCRIPTION	CAT. NO.
[I] 25 6-position 2-conductor (RJ11) FCC Spec Jacks connected to a circuit board with one male 25-pair connector in surface-mount housing. Wired in standard T-R sequence (26-1, 27-2, 28-3, etc).	41600-00I
[J] 25 6-position 4-conductor (RJ14) FCC Spec Jacks wired into two male 25-pair connectors in standard T-R sequence.	41610-00I
[K] 25 6-position 2-conductor (RJ11) FCC Spec Jacks connected to a circuit board with two bridged 25-pair connectors (one male and one female) in standard T-R sequence for series connection.	41620-00I
Mounting Magnets (20 Per Package)	49200-00M

OPT-X® 1000 1RU FIBER OPTIC ENCLOSURES

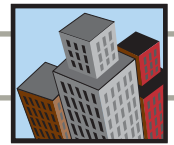

SEE FIBER DENSITY CHART, PAGE L48

Front and rear tilt-up lids that provide unobstructed access to adapters and mounting plates.

Slide rail option allows easy installation and re-entry regardless of equipment or enclosures above.

Mounting brackets are reversible for mid- or flush-mounting in 19" racks.



High-density adapter enclosure houses up to 24 ST® or 12 duplex SC adapters. Another version accepts three six-fiber mounting plates; configure with ST, FC, SC, LC and MT-RJ or add a QuickPort plate to create a multimedia enclosure.

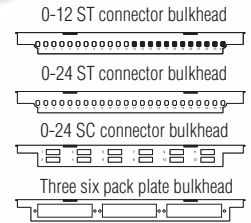

Opt-X 1000 Low-Profile Rack-Mount Enclosures (1RU) 1.75"H x 19.0"W x 12.0"D

DESCRIPTION	CAT. NO. W/O RAILS	CAT. NO. W/RAILS
24 Fiber w/6 ST adapters	5R030-OAB	5P030-OAB
24 Fiber w/3 duplex SC adapters	5R030-OHB	5P030-OHB
72 Fiber, empty (accepts 3 adapter plates, sold sep.)	5R130-00N	5P130-00N
24 Fiber, loaded w/12 ST adapters	5R230-OAB	5P230-OAB
24 Fiber, loaded w/6 duplex SC adapters	5R230-OHB	5P230-OHB
24 Fiber, unloaded, punched for ST adapters	5R330-OAA	5P330-OAA
24 Fiber, unloaded, punched for duplex SC adapters	5R330-OHA	5P330-OHA
24 Fiber loaded w/24 ST adapters	5R330-OAB	5P330-OAB
24 Fiber loaded w/12 duplex SC adapters	5R330-OHB	5P330-OHB

Add-On Slide Rail Kit

DESCRIPTION	CAT. NO.
Slide Rail Kit for IRU enclosures only	5S100-SLM

Replacement Door

DESCRIPTION	CAT. NO.
24 Fiber Rack-Mount Metal 1RU Replacement Door	5D000-1RM

LOADED = The enclosure's bulkhead contains the specified couplings.

UNLOADED = The enclosure includes a bulkhead which has openings for, but does not include, the specified couplings.

EMPTY = No bulkhead coupling plates are included.

Note: For mounting plates and accessories, see pages L47-49.

Note: Custom lengths and configurations on pigtails available; call customer service for more information: 1-800-722-2082



Opt-X 1000 Low-Profile Rack-Mount shown in open view.



OPT-X® 1000 2RU FIBER OPTIC ENCLOSURES

Horizontal entry ports in the front and back and vertical entry ports in the rear offer egress/ ingress for distribution of patch cables.

SEE FIBER DENSITY CHART, PAGE L48



Front and rear tilt-up lids that provide unobstructed access to adapters and mounting plates.

Room for up to 6 Mounting Plates, housing a wide variety of SC, FC, ST, LC and MT-RJ adapters. See Fiber Density Chart on page L47.

Metal or smoked polycarbonate doors. Metal doors are available with or without a lock.

Fiber Components



Opt-X 1000 Fiber Optic Enclosures (2RU) 3.5"H x 19.0"W x 12.0"D ^{UL}

DESCRIPTION	CAT. NO.
2RU Enclosure with Metal Door (no lock)	5R430-00N
2RU Enclosure with Metal Door and one Lock/key	5R440-00N
2RU Enclosure with Poly Door (No Lock)	5R460-00N

Replacement Doors

DESCRIPTION	CAT. NO.
2RU Replacement Metal Door	5D000-2RM
2RU Replacement Poly Door	5D000-2RP

Accessories

DESCRIPTION	CAT. NO.
12 Splice Tray	5T000-00T
3M Fibrlock™ Splice Holder	5T000-3MT
AT&T Rotary Splice Holder	5T000-ATT
Lock and Key	5L000-LOK
Slide mounts (kit)	5S100-SLM
Fiber rings, 2 per pack, 2.5" diameter	5R100-0FR

PLEASE NOTE: All STOCK configurations of this rack-mount enclosure are sold 'empty,' or without any mounting plates installed. Capacity is dependent upon configuration of mounting plates as shown in note. Rack-mount enclosures DO include grounding/strain relief, grommets, labels, and the appropriate number of cable management rings.

Note: For mounting plates and accessories. See pages L47-L49.

Note: Custom lengths and configurations on pigtailed available; call customer service for more information: 1-800-722-2082



Wall mount or rack mount for maximum flexibility. Mid- or flush-mount the 2RU in any space on a standard 19" or 23" rack, or use the universal mounting brackets to flush mount on a wall.

OPT-X® 1000 3RU and 6RU FIBER OPTIC ENCLOSURES

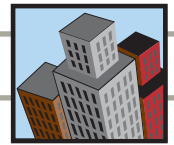

Tilt-up rear door provides unobstructed access to the fiber loop.

SEE FIBER DENSITY CHART, PAGE L48

Front and rear doors drop down flat to act as a workshelf, or can be removed completely. Available in metal or smoked polycarbonate.

Reversible mounting brackets allow mounting on 19" or 23" industry standard equipment frames; move forward for flush mount positioning in NEMA enclosures.

Opt-X 1000 Rack-Mount Enclosures, 3 Rack Units High (3RU) 5.25"H x 19.0"W x 12.0"D ^{UL}

DESCRIPTION	CAT. NO.
3RU, Empty with metal door, no lock	5R730-00N
3RU, Empty with metal door and one lock/key	5R740-00N
3RU, Empty with smoked polycarbonate door, no lock	5R760-00N

Opt-X 1000 Rack-Mount Enclosures, 6 Rack Units High (6RU) 10.25"H x 19.0"W x 12.0"D ^{UL}

DESCRIPTION	CAT. NO.
6RU, Empty with metal door, no lock	5R930-00N
6RU, Empty with metal door and one lock/key	5R940-00N
6RU, Empty with smoked polycarbonate door, no lock	5R960-00N

Add-On Slide Rail Kit

DESCRIPTION	CAT. NO.
Slide rail kit for 3RU or 6RU fiber Rack-Mount enclosures only	5S100-SLM

Replacement Doors

DESCRIPTION	CAT. NO.
3RU Rack-Mount replacement metal door	5D000-3RM
3RU Rack-Mount replacement smoked poly door	5D000-3RP

Add-On Lock and Key

DESCRIPTION	CAT. NO.
Add security to an existing door for this enclosure—simply remove the black plastic plug on the door front, and replace with lock mechanism. Lock and Key	5L000-LOK

PLEASE NOTE: All STOCK configurations of this rack-mount enclosure are sold 'empty,' or without any mounting plates installed. Capacity is dependent upon configuration of mounting plates as shown in note. Rack-mount enclosures DO include grounding/strain relief, grommets, labels, 8 or 16 blank plastic mounting plates, and the appropriate number of cable management rings.

Note: For mounting plates and accessories. See pages L47-49.



FEATURES

- Includes 8 (3RU) or 16 (6RU) plastic blank mounting plates to inexpensively fill up any unused locations.
- Houses up to 12 (3RU) or 24 (6RU) mounting plates for assorted fiber or multimedia applications. See chart on page L48.



OPT-X® 1000 WALL-MOUNT FIBER OPTIC ENCLOSURES

Doors are L-shaped for maximum access to couplings through the open sidewall.

Door options:

- Split with single lock
- Split with two locks (custom option)
- Solid with single lock
- Solid without lock

Houses 2 (small), 4 (medium) or 12 mounting plates for assorted fiber or multimedia applications. See chart on page L47.

SEE FIBER DENSITY CHART, PAGE L48



Unique cable management ring is adjustable and stackable to simplify fiber loop installation, bend radius compliance, and future maintenance/additions. Stores 3 meters of 900 micron fiber per adapter.

Sidewall cutout gives completely unobstructed access to the mounting plates when door is open (covered when door is closed).



Opt-X 1000 Small Wall-Mount Enclosures 8.0"H x 13.0"W x 3.5"D ^{UL}

DESCRIPTION	CAT. NO.
Small, Empty with solid metal door, no lock, holds no splice trays	5W110-00N
Small, Empty with split metal door and one lock/key, holds no splice trays	5W120-00N
Small, Empty with solid metal door and lock/key, holds no splice trays	5W170-00N

Opt-X 1000 Medium Wall-Mount Enclosures 14.0"H x 12.0"W x 5.25"D ^{UL}

DESCRIPTION	CAT. NO.
Medium, Empty with solid metal door, no lock, holds 6 splice trays	5W310-00N
Medium, Empty with split metal door and one lock/key, holds 6 splice trays	5W320-00N
Medium, Empty with solid metal door and one lock/key, holds 6 splice trays	5W370-00N



Opt-X 1000 Large Wall-Mount Enclosures 17.0"H x 15.0"W x 5.25"D ^{UL}

DESCRIPTION	CAT. NO.
Large, Empty with solid metal door, no lock, holds 6 splice trays	5W710-00N
Large, Empty with split metal door and one lock/key, holds 6 splice trays	5W720-00N
Large, Empty with solid metal door and lock/key, holds 6 splice trays	5W770-00N

Add-On Lock and Key

DESCRIPTION	CAT. NO.
Add security to an existing metal enclosure door. Simply remove the black plastic plug on the door front, and replace with lock mechanism. Lock and Key	5L000-LOK

PLEASE NOTE: All STOCK configurations of this wall-mount enclosure are sold 'empty,' or without any mounting plates installed. Capacity is dependent upon configuration of mounting plates shown on page L48. The wall-mount enclosures DO include grounding/strain relief, grommets, labels, and the appropriate number of cable management rings. Large Wall-Mount Enclosure includes 8 blank plastic mounting plates.

Note: For mounting plates and accessories. See page L48.



Opt-X 500 1RU, 2RU and 3RU Fiber Optic Enclosures

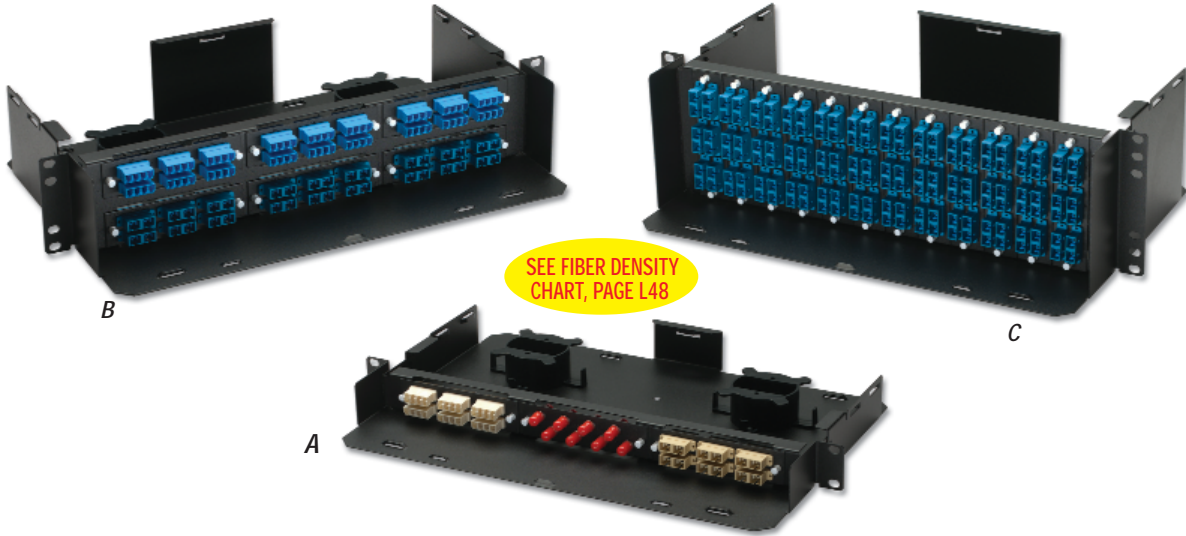

Opt-X 500 Fiber Enclosures, 3 Rack Units High (3RU) 5.25"H x 19.0"W x 12.0"D

DESCRIPTION	CAT. NO.
[A] 1RU, empty with metal cover, no lock	5R1UA-A03
[B] 2RU, empty with metal cover, no lock	5R2UA-A06
[C] 3RU, empty with metal cover, no lock	5R3UA-A12



1RU with cover



2RU with cover



3RU with cover

Opt-X 250 1RU Fiber Optic Panel



Opt-X 250 Fiber Panel 1.75"H x 19.0"W x 7.7"D

DESCRIPTION	CAT. NO.
1RU, empty with no metal cover, no lock	5R1UE-A03

SPECIFICATIONS AND FEATURES

Opt-X 500 Fiber Enclosure

- One-piece removable cover protects and conceals patch cords and allows for complete accessibility to the back of the enclosure.
- Mounting brackets allow for installation on any rack space.
- Stores 3 meters of 900 micron tight buffered fiber per adapter.
- Multiple bend radius and cable management features including 2 cable tie down features in front, and 4 in back, protect and organize cables.

Opt-X 250 Fiber Panel

- Perfect for small to medium installations with excellent flexibility at a competitive price.
- Utilizes minimum rack space while providing space for up to three (3) adapter plates or splice trays (more splice trays if no obstructions).
- Two fiber management rings easily attach to low profile mounting clips for customized positioning. Includes multiple bend radius and cable management features.
- Open back allows easy access and management in all directions.
- Mounting brackets allow panel to be installed on any rack space.



FIBER OPTIC CABLE ASSEMBLIES

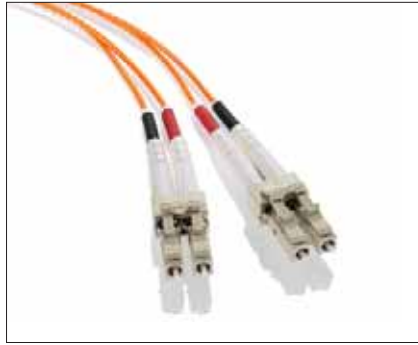
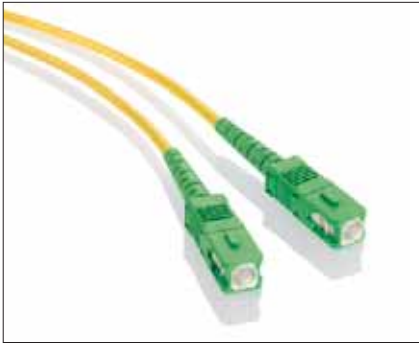

Fiber Optic Cable Assemblies

Leviton offers an extensive line of high quality fiber optic cable assemblies, including laser optimized versions as well as pigtails for frame and workstation. Strenuously tested for return and insertion loss, and held to strict internal quality standards, these cable assemblies are developed to exceed TIA 568-B.3 standards.

Choose from standard & hybrid combinations of connectors, in single-mode and multimode, for cable assemblies and pigtails in ST, SC, FC, LC and MT-RJ styles. Laser optimized assemblies are available in a 50µm core style with a variety of connection configurations including combinations of MT-RJ, ST, SC and LC connectors and provide 10-gig performance for higher bandwidth requirements at greater distances.

We also provide custom lengths and configurations manufactured to your exact specifications—simply call customer service for more information. PLEASE NOTE: CUSTOM LENGTHS MAY REQUIRE A WAITING PERIOD. All cables are OFNR* rated and meet all applicable TIA/EIA and industry standards.

*OFNP-rated cables are available as a special order. See below.

Configure Your Catalog Number

Fiber Optic Cable Assemblies, OFNR Rated — Configure your Catalog Number by following the key below



Examples: 50DSC-M05 = 50 micron Duplex SC-SC multimode connector – 5 meters

Step 1		Step 2		Step 3				Step 4		Step 5		
CORE STYLE/POLISH TYPE (AA)		CABLE TYPE (B)		CONNECTOR COMBINATIONS (CC)				MODE (D)		CABLE LENGTH (EE)		
Multimode Core	Code	Cable Type	Code	Standard & Pigtail	Code	Hybrid	Code	Mode Type	Code	Length/m	Length/ft	Code
50µm size	50	Simplex	S	MT-RJ-to-MT-RJ	MJ	SC-to-ST	CT	Single-mode	S	1 meter	3.3'	01
62.5µm size	62	Duplex	D	ST-to-ST	ST	SC-to-FC	CF	Multimode	M	2 meters	6.6'	02
50µm laser optimized	5L	Pigtail	P	SC-to-MT-RJ	CM	ST-to-MT-RJ	TM	<i>Note: This will depend on selected Core Size/Polish as indicated in Step 1.</i>				
Singlemode Core		<i>Note: MT-RJ is always duplex. Simplex and duplex cannot be combined.</i>		SC-to-SC	SC	ST-to-FC	TF	3 meters		9.8'		03
UPC polish (ultra physical contact)	UP			FC-to-FC	FC	ST-to-LC	TL	5 meters		16.4'		05
APC polish (angle physical contact)	AP			LC-to-LC	LC	FC-to-LC	FL	10 meters		32.8'		10
						LC-to-MT-RJ	ML	<i>Note: Custom lengths available upon request. Call Customer Service at 1(800) 722-2082 for more information.</i>				

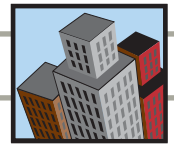

OPT-X® Fiber Adapter Plates*

DESCRIPTION	CAT. NO.
[A] 6-Pack ST MM, (6-fiber) phos. bronze sleeve	5F100-1ST
6-Pack ST SM, (6-fiber) zirconia ceramic sleeve	5F100-6ZT
[B] 8-Pack ST MM, (8-fiber) phos. bronze sleeve	5F100-8ST
8-Pack ST SM, (8-fiber) zirconia ceramic sleeve	5F100-8ZT
6-Pack FC MM, (6-fiber) phos. bronze sleeve	5F100-6PF
6-Pack FC SM, (6-fiber) zirconia ceramic sleeve	5F100-6ZF
8-Pack FC MM, (8-fiber) phos. bronze sleeve	5F100-8PF
8-Pack FC SM, (8-fiber) zirconia ceramic sleeve	5F100-8ZF
[C] 3-Pack Duplex SC MM, (6-fiber) beige, phos. bronze sleeve	5F100-3BC
[D] 3-Pack Duplex SC SM, (6-fiber) blue, phos. bronze sleeve	5F100-3SC
[E] 3-Pack Duplex SC SM, (6-fiber) green, zirconia ceramic sleeve	5F100-3CA
3-Pack Duplex SC SM, (6-fiber) blue, zirconia ceramic sleeve	5F100-3ZC
3-Pack Duplex SC MM Laser Optimized, (6-fiber) aqua, zirconia ceramic sleeve	5F100-3AC
[F] 6-Pack Duplex SC MM, (12-fiber) beige, phos. bronze sleeve	5F100-6BC
[G] 6-Pack Duplex SC SM, (12-fiber) blue, phos. bronze sleeve	5F100-CSC
[H] 6-Pack Duplex SC MM laser optimized, (12-fiber) aqua, zirconia ceramic sleeve	5F100-6AC
6-Pack Duplex SC SM, (12-fiber) blue, zirconia ceramic sleeve	5F100-6ZC
6-Pack Duplex SC SM, (12-fiber) green, zirconia ceramic sleeve	5F100-6CA
[I] 6-Pack MT-RJ MM, (12-fiber) beige, dual polarity	5F100-6MC
[J] 12-Pack MT-RJ MM, (24-fiber) beige, dual polarity	5F100-12M
[K] 6-Pack Duplex LC MM, (12-fiber) beige, phos. bronze sleeve	5F100-12P
[L] 6-Pack Duplex LC SM, (12-fiber) blue, zirconia ceramic sleeve	5F100-12Z
6-Pack Duplex LC SM, (12-fiber) green, zirconia ceramic sleeve	5F100-12V
[M] 6-Pack Duplex LC MM laser optimized, (12-fiber) aqua, zirconia ceramic sleeve	5F100-12A
[N] 6-Pack Quad LC MM, (24-fiber) beige, phos. bronze sleeve	5F100-24P
[O] 6-Pack Quad LC SM, (24-fiber) blue, zirconia ceramic sleeve	5F100-24Z
[P] 6-Pack Quad LC MM, (24-fiber) laser optimized aqua, zirconia ceramic sleeve	5F100-24A
[Q] Blank, metal	5F100-BLK
Blank, plastic	5F100-BPP

*NOTE: Not for use with LightSpace™ Enclosures.

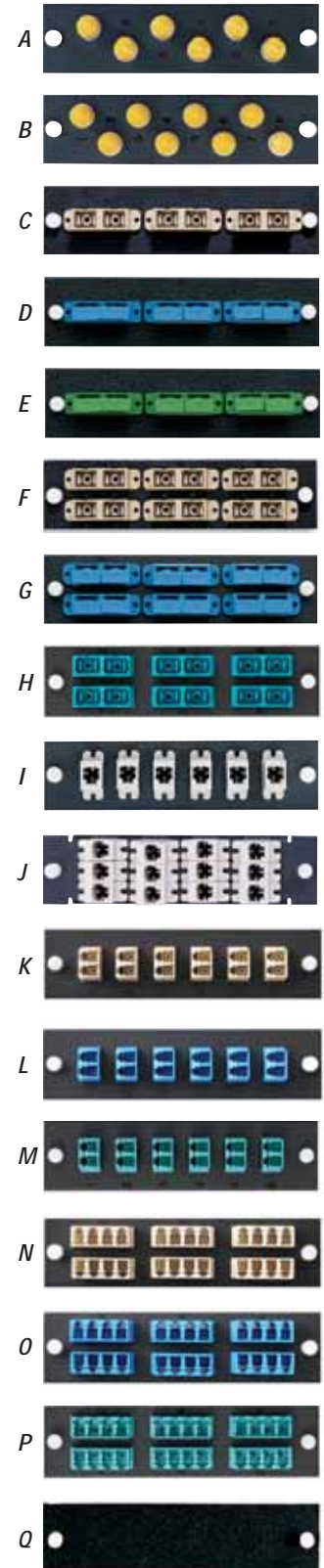

3-pack, 6-pack, 8-pack, 12-pack = capacity of up to 3, 6, 8 or 12 connectors, respectively.



Fiber Density Chart

Styles

RACK MOUNT DENSITY

Low Profile 1RU

Holds 1 Bulkhead w/or w/o 3 Mounting Plates

- 6-pack ST = up to 18 Fibers
- 8-pack ST = up to 24 Fibers
- 6-pack FC = up to 18 Fibers
- 8-pack FC = up to 24 Fibers
- 3-pack Duplex SC = up to 18 Fibers
- 6-pack Duplex SC = up to 24 Fibers
- 6-pack MT-RJ = up to 36 Fibers
- 12-pack MT-RJ = up to 72 Fibers

2RU Holds up to 6 Mounting Plates

- 6-pack ST = up to 36 Fibers
- 8-pack ST = up to 48 Fibers
- 6-pack FC = up to 36 Fibers
- 8-pack FC = up to 48 Fibers
- 3-pack Duplex SC = up to 36 Fibers
- 6-pack Duplex SC = up to 72 Fibers
- 6-pack MT-RJ = up to 72 Fibers
- 12-pack MT-RJ = up to 144 Fibers

3RU Holds up to 12 Mounting Plates

- 6-pack ST = up to 72 Fibers
- 8-pack ST = up to 96 Fibers
- 6-pack FC = up to 72 Fibers
- 8-pack FC = up to 96 Fibers
- 3-pack Duplex SC = up to 72 Fibers
- 6-pack Duplex SC = up to 144 Fibers
- 6-pack MT-RJ = up to 144 Fibers
- 12-pack MT-RJ = up to 288 Fibers

6RU Holds up to 24 Mounting Plates

- 6-pack ST = up to 144 Fibers
- 8-pack ST = up to 192 Fibers
- 6-pack FC = up to 144 Fibers
- 8-pack FC = up to 192 Fibers
- 3-pack Duplex SC = up to 144 Fibers
- 6-pack Duplex SC = up to 288 Fibers
- 6-pack MT-RJ = up to 288 Fibers
- 12-pack MT-RJ = up to 576 Fibers

WALL MOUNT DENSITY

Small Holds up to 2 Mounting Plates

- 6-pack ST = up to 12 Fibers
- 8-pack ST = up to 16 Fibers
- 6-pack FC = up to 12 Fibers
- 8-pack FC = up to 16 Fibers
- 3-pack Duplex SC = up to 12 Fibers
- 6-pack Duplex SC = up to 24 Fibers
- 6-pack MT-RJ = up to 24 Fibers
- 12-pack MT-RJ = up to 48 Fibers

Medium Holds up to 4 Mounting Plates

- 6-pack ST = up to 24 Fibers
- 8-pack ST = up to 32 Fibers
- 6-pack FC = up to 24 Fibers
- 8-pack FC = up to 32 Fibers
- 3-pack Duplex SC = up to 24 Fibers
- 6-pack Duplex SC = up to 48 Fibers
- 6-pack MT-RJ = up to 48 Fibers
- 12-pack MT-RJ = up to 96 Fibers

Large Holds up to 12 Mounting Plates

- 6-pack ST = up to 72 Fibers
- 8-pack ST = up to 96 Fibers
- 6-pack FC = up to 72 Fibers
- 8-pack FC = up to 96 Fibers
- 3-pack Duplex SC = up to 72 Fibers
- 6-pack Duplex SC = up to 144 Fibers
- 6-pack MT-RJ = up to 144 Fibers
- 12-pack MT-RJ = up to 288 Fibers



Fiber Adapters

DESCRIPTION	CAT. NO.
[A] ST® Adapter MM w/Phosphor Bronze Sleeve	49882-SAD
[B] ST Adapter SM w/Zirconia Sleeve	49882-ZAD
[C] FC Adapter SM w/Phosphor Bronze Sleeve	49883-SAD
[D] FC Adapter MM w/Zirconia Sleeve	49883-MAD
[E] SC Duplex Adapter SM (blue) w/Zirconia Sleeve	49884-SAD
SC Duplex Adapter SM (blue) w/Phosphor Bronze Sleeve	49884-MAD
[F] SC Duplex Adapter MM (beige) w/Phosphor Bronze Sleeve	49884-BAD
[G] SC Duplex Adapter MM aqua, zirconia ceramic sleeve	49884-AAD
[H] SC Simplex Adapter SM blue, zirconia ceramic sleeve	49884-SAS
[I] SC Simplex Adapter MM beige, phos. Bronze sleeve	49884-MAS
[J] SC Simplex Adapter SM APC green, zirconia ceramic sleeve	49884-VAS
[K] MT-RJ Adapter MM (beige)	49889-MAD
[L] Quad LC Adapter MM (aqua)	5F100-QLA
[M] Quad LC Adapter MM (beige)	5F100-QLC
[N] Quad LC Adapter SM (blue)	5F100-QLZ
[O] Duplex LC Adapter MM (beige)	5F100-DLC
[P] Duplex LC Adapter SM (blue)	5F100-DLZ
[Q] LC Duplex Adapter MM aqua, zirconia ceramic sleeve	5F100-DLA
LC Simplex Adapter MM green, zirconia ceramic sleeve	5F100-DLV

FIBER OPTIC FAN-OUT KIT

R Protect your bare fiber and prepare loose-tube cable for direct termination to connectors with these simple 6- or 12-strand kits. Available in 24" or 36" lengths. Kits separate 250 µm fibers and route them into color-coded 900 µm buffer tubes. No proprietary tools required. Can be used with any manufacturers loose-tube cabling, and any industry standard connectors.

Fiber Optic Fan-Out Kit

DESCRIPTION	CAT. NO.
[R] 24" Fiber Optic Fan-Out Kit, 6-fiber	49887-06S
24" Fiber Optic Fan-Out Kit, 12-fiber	49887-12S
36" Fiber Optic Fan-Out Kit, 6-fiber	49887-06L
36" Fiber Optic Fan-Out Kit, 12-fiber	49887-12L

FIBER OPTIC FAN-OUT CONSUMABLES KIT

S Leviton's Fan-Out Consumables Kit contains everything to properly terminate at least 10 Fiber Optic Fan-Out Kits, including lint-free wipes, alcohol pads, d'Gel™ packets, sealant, and talc powder

Fiber Optic Fan-Out Consumables Kit

DESCRIPTION	CAT. NO.
[S] Fan-Out Consumables Kit	49800-FAN

SPLICE TRAY KITS

Splice Tray Kits

DESCRIPTION	CAT. NO.
12-splice Splice Tray Kit (Comes standard with Fusion/Heatshrink splice holders)	5T000-00T

EXTRA CABLE MANAGEMENT RINGS

Extra Cable Management Rings

DESCRIPTION	CAT. NO.
Additional Fiber Cable Management Rings (package of 2)— Can be stacked on top of existing rings for additional cable storage or management.	5R100-0FR



A-D



E-J



K-Q



R



S

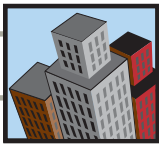

ACTIVE ZONE CABLING



Telecommunications Enclosures for Active Zone Cabling

Leviton's telecommunications enclosures add flexibility and manageability to cabling infrastructure. Active ceiling enclosures install flush with the drop ceiling for a clean, unobtrusive look. Recessed panels in doors may be fitted with a ceiling tile. Fully hinged, drop down doors support installed equipment and open to face the technician for safe, easy access. Manufactured of aluminum, all ceiling enclosures are plenum rated and include two edge-protected cable access ports with fire rated foam sealing kits.



2' x 2' Active Ceiling Enclosure

A Accommodates one removable assembly with total 2RU of active electronics and up to 5RU (2U+1U+2U) of 19" rack-mount patch panels and wire management. Units are AC Power ready and include a 9 CFM fan with transformer capable of providing more than 100 air changes per hour. UL Listed.

2' x 2' Active Ceiling Enclosure 12.0"H x 24.0"W x 24.0"L

DESCRIPTION	CAT. NO.
[A] Active Ceiling Enclosure, 2' x 2'	Z1000-AC2



2' x 4' Active Ceiling Enclosure

B For hubs, switches and patch panels in high density areas, these enclosures house two removable rack-mount assemblies each with 4RU (total 8RU) of mounting space for active components and up to 10RU divided (2U+1U+2U) of 19" rack-mount patch panels and wire management. Units are AC Power ready and include a 9 CFM fan with transformer capable of providing more than 100 air changes per hour. UL listed.

2' x 4' Active Ceiling Enclosure 12.0"H x 24.0"W x 48.0"L

DESCRIPTION	CAT. NO.
[B] Active Ceiling Enclosure, 2' x 4'	Z1000-AC4



Accessories

Enclosure Accessories

DESCRIPTION	CAT. NO.
[C] Foam kit for zone ceiling enclosures	Z1000-FM1
Chrome Lock Kit	Z1000-LOK
Replacement Keys (2)	Z1000-KEY



Telecommunications Enclosures for Passive Zone Cabling

These easy-to-install enclosures provide flexible consolidation point placement in the floor or ceiling. Manufactured of aluminum, enclosures are plenum rated and include fire-rated foam sealing kits.

2' x 2' Passive Ceiling Enclosure

A For consolidation points within the ceiling, these enclosures accommodate up to 5RU (2U+1U+2U) of 19" rack-mount patch panels and or wire management. Enclosures install flush with the drop ceiling and recessed panels in doors may be fitted with a ceiling tile for a clean, unobtrusive look. Fully hinged, drop down doors support installed equipment and open to face the technician for safe, easy access. UL listed.

2' x 2' Passive Ceiling Enclosure

DESCRIPTION	CAT. NO.
[A] Passive Ceiling Enclosure, 2' x 2'	Z1000-PC2



2' x 2' Passive Raised Floor Enclosure

For consolidation points in air handling spaces under 8" deep raised floors, this enclosure holds two 4RU (8U total) racks to accommodate any combination of standard 19" rack-mountable patch panels or wire management. Rotating patch panel mounting locations provide easy access to rear of patch panels for easy terminations. UL listed.

2' x 2' Passive Raised Floor Enclosure

DESCRIPTION	CAT. NO.
Passive Raised Floor Enclosure, 8" depth	Z1000-PF2



WIRELESS ACCESS POINT ENCLOSURES

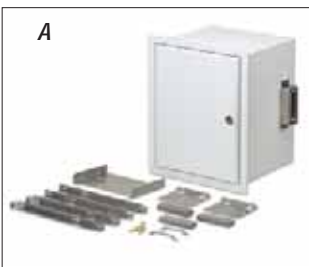

Wireless Access Point Enclosures

WIRELESS ACCESS POINT CEILING ENCLOSURES, 10" AND 5"

A-B Mount these enclosures into standard 2' x 2' ceiling tiles for a clean look and easy access. Each unit is designed to house a variety of wireless access points. Single edge-protected access port includes a fire-rated foam sealing kit, making it suitable for air handling spaces. Doors are fully hinged and lockable. The enclosure is painted white to blend with ceiling tiles. Multiple door faceplates, including a blank one, are sold separately to accommodate a variety of wireless equipment. UL listed.



WIRELESS ACCESS POINT CEILING ENCLOSURE, 4" DEEP

C This ceiling mount enclosure accommodates one wireless access point or bridge. The removable door mounted bracket supports equipment up to 10¹/₂" wide by 5¹/₂" deep by 1⁷/₈" high. Fully hinged door is lockable for security and is stamped with two obround holes centered 5" apart allowing antennas to extend below the drop ceiling. UL listed.

Wireless Access Point Ceiling Enclosures

DESCRIPTION	CAT. NO.
[A] Wireless Access Point Ceiling Enclosure, 10" Depth, w/o Faceplate	W1000-WCE
[B] Wireless Access Point Ceiling Enclosure, 5" Depth, w/o Faceplate	W1000-WC5
[C] Wireless Access Point Ceiling Enclosure, 4" Depth	W1000-WC0



Faceplates

Wireless Access Point Ceiling Enclosure Faceplates

DESCRIPTION	CAT. NO.
Blank Faceplate (Fits 10" Wireless Access Point Enclosure)	W1000-F01
Faceplate for Cisco Aironet™ 350 (Fits 5" and 10" Wireless Access Point Enclosure)	W1000-F02
Faceplate for Cisco Aironet 1100 (Fits 5" and 10" Wireless Access Point Enclosure)	W1000-F03
Faceplate for Cisco Aironet 1200 (Fits 5" and 10" Wireless Access Point Enclosure)	W1000-F04
[D] Faceplate for Leviton AP200 Wireless Access Point w/mounting bracket	W1000-WC5

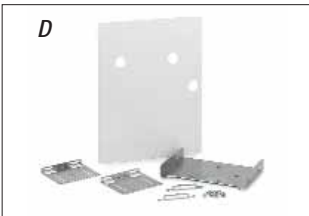

WIRELESS ACCESS POINT WALL-MOUNT ENCLOSURE

E Constructed of rugged steel with a lock assembly these enclosures are perfect for areas where there is limited floor or ceiling space and a need for security. Inside space accommodates a Cisco® Aironet® 350 or equivalent equipment sized 9" wide by 6¹/₂" high by 2³/₄" deep. UL listed.

Wireless Access Point Wall-Mount Enclosure

DESCRIPTION	CAT. NO.
[E] Wireless Access Point Wall-Mount Enclosure	W1000-WWO



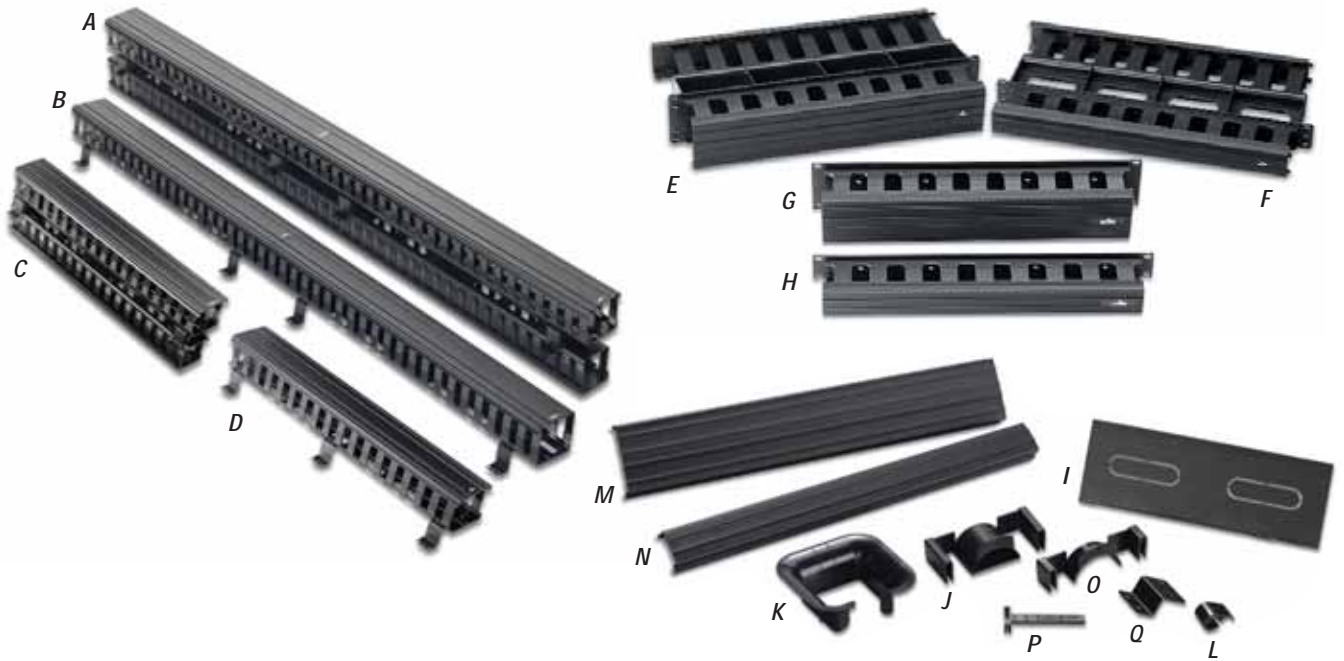
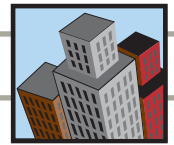

Versi-Duct Slotted Duct Cable Management System

Leviton's unique Versi-Duct Slotted Duct System provides a versatile simple solution for fiber and copper cable organization and management. The horizontal duct is available in both one rack (1RU-1.75") or two-rack (2RU-3.5") unit sizes to accommodate both small and large cable systems. Vertical slotted ducts come in a 35" half or 80" full rack height version. Both the horizontal and vertical slotted ducts come in a Front Only or Front & Back configurations with cable-concealing covers and an assortment of accessories. Versi-Duct is the ideal system for efficient, adaptable rack and frame cable management.

Versi-Duct Slotted Duct Cable Management Systems

DESCRIPTION	CAT. NO.
[A] Vertical Front & Rear Duct, 80" high	4980L-VFR
[B] Vertical Front-only Duct, 80" high	4980L-VFO
[C] Vertical Front & Rear Duct, 35" high	4935L-VFR
[D] Vertical Front-only Duct, 35" high	4935L-VFO
[E] Horizontal Front & Rear Duct, 2RU	492RU-HFR
[F] Horizontal Front & Rear Duct, 1RU	491RU-HFR
[G] Horizontal Front-only Duct, 2RU	492RU-HFO
[H] Horizontal Front-only Duct, 1RU	491RU-HFO
[I] Vertical Channel Divider	49265-DV1
[J] Slack Loop Storage Organizer, extended (2")	49265-SL2
[K] Bend-radius Compliant Funnel, rear only	49265-FN4
[L] Duct Cover Hinge, 4 per package	49265-HNG
[M] Extended Cover, Front-only 2RU	49265-EX3
[N] Extended Cover, Front-only 1RU	49265-EX1
[O] Slack Loop Storage Organizer	49265-SL1
[P] Cable Retainer	49265-WR1
[Q] Mounting Bracket, 2 per package	49265-BRK

FEATURES

Versi-Duct

- Versatile accessories solve a variety of cable management challenges
- Suitable for copper and fiber applications
- Slack loop control feature
- Helps maintain proper cable bend radii
- Offered in Front & Back and Front Only versions (for both vertical and horizontal ducts)
- Horizontal Duct offered in 1RU (1.75") and 2RU (3.50") sizes
- Horizontal Duct offered in 35" and 80" lengths
- Cable concealing covers with optional hinges



RACK AND FRAME CABLE MANAGEMENT

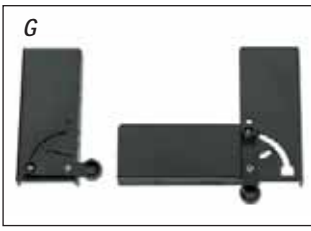

Horizontal Cable Management

Create a first class cabling infrastructure and reduce network administration time using Leviton's Horizontal Cable Management System. Options include cable management bars, patch cord organizers, slack organizers, and the patent-pending Front Hinge Bracket.

Cable Management Bars

DESCRIPTION	HEIGHT	RINGS	CAT NO.
[A] Rear Cable Manager for Active Equipment	2RU		41188-SM2
[B] Extended Cable Management Bar			49005-EMB
[C] Cable Management Bar			49005-CMB
[D] High Density Cable Management Bar			49005-DMB

Horizontal Patch Cord Organizers

DESCRIPTION	HEIGHT	RINGS	CAT NO.
[E] Horizontal Patch Cord Organizer	2RU	2"	49253-2CM
Horizontal Patch Cord Organizer	2RU	4"	49253-BCM
Horizontal Patch Cord Organizer	1RU	4"	49253-LPM
[F] Horizontal Patch Cord Organizer	4RU	5"	49253-4CM
Horizontal Patch Cord Organizer	4RU	7"	49253-6CM
Horizontal Patch Cord Organizer (Angled)	1RU	2"	4W254-LPM
Horizontal Patch Cord Organizer (Angled)	2RU	2"	4W254-BCM
Horizontal Patch Cord Organizer (w/ metal cover)	1RU	4"	4925C-LPM
[G] Horizontal Patch Cord Organizer (w/ metal cover)	2RU	4"	4925C-BCM
Horizontal Patch Cord Organizer (w/ metal cover)	4RU	5"	4925C-4CM
Horizontal Patch Cord Organizer (w/ metal cover)	4RU	7"	4925C-6CM

Front Hinge Bracket

DESCRIPTION	HEIGHT	RINGS	CAT NO.
[H] Front Hinge Bracket	3RU		49400-FHB



Rack Cable Management and Accessories

CORD ORGANIZERS

Two-Position Cord Organizer combines horizontal and vertical distribution rings with individual routing clips for patch cord organization between patch panels. One-Position Cord Organizer is 1RU with vertical distribution rings and individual routing clips.

Cord Organizers

DESCRIPTION	CAT. NO.
[A] Two-Position Organizer Panel (19" wide, 2RU)	49252-P02
[B] One-Position Organizer Panel (19" wide, 1RU)	49252-P01

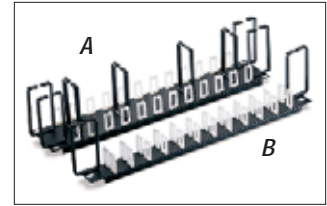

COMBO FRONT/REAR MANAGEMENT

Manage front and rear cables/cords in a 2RU standard rack space. Oversized front rings meet larger-capacity requirements for patch cords. Rear management maintains bend radius of cables routed from vertical channels. Retention rings and fixed anchor points for 'loose-fit' or tie-wrapped bundles.

Combo Front/Rear Management

DESCRIPTION	CAT. NO.
[C] Combo Front/Rear Manager (19" wide, 2RU)	49252-PCM



RECLOSEABLE CABLE BARS

Manage cable vertically and horizontally on relay racks and cabinets. 19" metal-clad horizontal bar with attached loops (Hook and Loop-Style) screws into rack to manage cables horizontally.

Recloseable Cable Bars

DESCRIPTION	CAT. NO. 3RU
[D] Metal Clad Horizontal Bar (for 19" Racks, 1RU)	41150-019



THE WRAP BAR

Mounts to the rear of standard TIA/EIA racks to support cable bundles and help maintain bend radius near cable terminations. Fixed anchor points for 'loose-fit' tie wrapped cables.

The Wrap Bar

DESCRIPTION	CAT. NO.
[E] Tie Wrap Bar (19" wide, 1.0" high, 1.5" deep)	49258-TWB



SPACEMAKER CABLE MANAGER

Mounts to front or rear of standard TIA/EIA racks to support cable bundles and help maintain bend radius. Allows retrofit of current configurations without the need to move existing patch panels. Using existing panel screws, simply loosen screws, slide in SpaceMaker, and re-tighten screws.

Spacemaker Cable Manager

DESCRIPTION	CAT. NO.
[F] SpaceMaker Cable Manager (19" wide, 1RU, 2RU, 3RU)	41188-SM1



VERTICAL MANAGEMENT COMPONENTS

Flexible front and rear vertical management. "Open-ring" system can be changed as needed for total customization and on-site adaptability. An optional tie bracket and divider panel can be added to provide cord and cable separation between racks.

Vertical Management Components

DESCRIPTION	CAT. NO.
[G] 3" Vertical Manager Ring (4-pair cable capacity: 180 rear, 250 front)	49260-MR3
[H] 6" Vertical Manager Ring (4-pair cable capacity: 360 rear, 500 front)	49260-MR6
[I] Tie Bracket to secure vertical manager ring to adjacent rack	49261-BKT

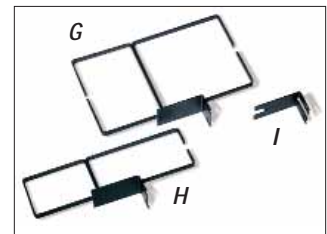



RACK AND FRAME CABLE MANAGEMENT

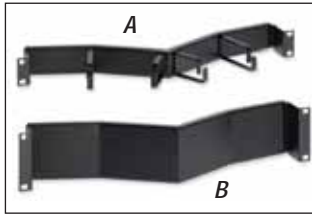

Angled Panel Cable Management

Angled panels and accessories provide improved access to 110 punch down fields and allow the option to increase rack density. Angled Cable Management Accessories, suitable for Category 5e, 6, or 10G Angled Patch Panels, provide enhanced cable management and organization via the Angled Cable Management Bar, Vertical Transition Rings, 1RU and 2RU Angled Blank Panel Inserts, and Transitional Covers. Recessed Angled and Angled styles available.

RECLOSABLE TIE-WRAPS

A Hook & Loop tie-wrap that easily reopens for moves, adds and changes, this general purpose Hook & Loop strap is available in 5", 8" and 12" lengths 1/2" wide.

Recessed Angled Panel Cable Management Accessories

DESCRIPTION	CAT. NO.
[A] Recessed Angled Horizontal Patch Cord Organizer, 1RU	4W254-LPM
Recessed Angled Horizontal Patch Cord Organizer, 2RU	4W254-BCM
1RU Recessed Angled Blank Panel Inserts	4W254-BA1
[B] 2RU Recessed Angled Blank Panel Inserts	4W254-BA2
[C] Recessed Angled Cable Management Bar, rear (4 hook and loop fasteners included)	4W006-AMB
[D] Recessed Angled Transitional Cover	4W254-BC1
Vertical Transition Rings (Horizontal Cable Ring), 2/box	49262-HR1

Angled Panel Cable Management Accessories

DESCRIPTION	CAT. NO.
Angled Horizontal Patch Cord Organizer, 1RU	49254-LPM
Angled Horizontal Patch Cord Organizer, 2RU	49254-BCM
[E] 1RU Angled Blank Panel Inserts	49254-BA1
[F] 2RU Angled Blank Panel Inserts	49254-BA2
[G] Angled Cable Management Bar, rear (4 hook and loop fasteners included)	49006-AMB
[H] Angled Transitional Cover	49254-BC1
Vertical Transition Ring (Horizontal Cable Ring), 2/box	49262-HR1

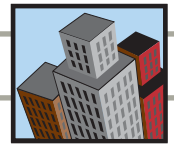

Rack Cable Management and Accessories

RACK AND PANEL ACCESSORIES

The Hinged Wall-Mount Bracket is designed for use in installations where space is constrained or racks are not used. Available in 2RU, 3RU, and 4RU sizes.

Blank Panels provide a seamless look until additional rack space is needed for future expansion.

Rack and Panel Accessories

DESCRIPTION	CAT. NO.
[A] Hinged Wall-Mount Bracket, 2RU	49251-W62
Hinged Wall-Mount Bracket, 3RU	49251-W63
Hinged Wall-Mount Bracket, 4RU	49251-W64
[B] Front Blank Panel, Standard, 4RU	49254-BP4
[C] Front Blank Panel, Standard, 2RU	49254-BP2
[D] Front Blank Panel, Standard, 1RU	49254-BP1

110 CHANNELMAX® SYSTEM

Route and manage cables and cross connect wires in 110-style installations with the 110 ChannelMax System. 3" and 5" Cable Channels, provide two to three times the space of typical 110 blocks with legs, and the non-proprietary design works with all standard 110 blocks. Vertical Spool Managers and Horizontal Cable Management Troughs organize and support cables while allowing easy access for re-configuration. Vertical Spool Manager works with Wire Distribution Spools, PN 40054-DSS, sold separately.

110 ChannelMax® System

DESCRIPTION	CAT. NO.
[E] Horizontal Cable Management Trough	41CMS-HCM
[F] Vertical Spool Manager Mounting Bracket	41CMS-VSM
[G] 5" Deep Vertical Cable Channel	41CMS-500
[H] 3" Deep Vertical Cable Channel	41CMS-300
Wire Management Spools	40054-DSS

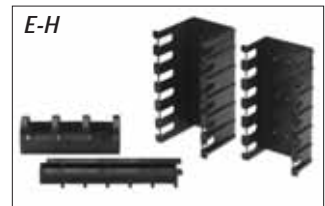



HOOK AND LOOP CABLE MANAGEMENT



General Purpose Hook and Loop Cable Management

Whatever your cable management needs, Leviton has a Hook and Loop product to keep your cable under wraps. These innovative solutions are perfect for the messy cables that accumulate around the workstation.

Recloseable Saddle Ties

DESCRIPTION	CAT NO.
[A] Recloseable Saddle Tie with 10/32 metal rack screw (10 per pack)	41020-SPR
[B] Recloseable Saddle Tie with #8 wood screw (10 per pack)	41010-SPW

Recloseable Compression Strap

DESCRIPTION	CAT NO.
[C] Recloseable Compression Strap	45224-RCS

Recloseable "J" Hook

DESCRIPTION	CAT NO.
[D] Recloseable "J" Hook	46700-SLG

Bulk Hook and Loop Wrap

DESCRIPTION	CAT NO.
[E] Bulk Hook and Loop Wrap, 75 Foot Roll	43115-075
[F] Bulk Hook and Loop Wrap, 15 Foot Roll	43115-015

Recloseable Tie-Wraps

DESCRIPTION	CAT NO.
[G] Tie Wrap, 5" Length (25 per pack)	43105-005
[H] Tie Wrap, 8" Length (25 per pack)	43108-008
[I] Tie Wrap, 12" Length (25 per pack)	43112-012

Hook and Loop Workstation Cable Management

DESCRIPTION	CAT NO.
[J] Individual Loops with Peel-off Adhesive (25 per pack)	41225-SAP

Recloseable Fastener

DESCRIPTION	CAT NO.
[K] Recloseable Fasteners (orange) (10 per pack)	41030-OFT

Recloseable Storage Rings

DESCRIPTION	CAT NO.
[L] Recloseable Storage Ring, Inside Plant (11.75" diameter)	48900-IFR
Recloseable Storage Ring, Outside Plant (24" diameter)	48900-OFR



LableWare

LabelWare is the perfect tool to create TIA/EIA-606-A compliant labels for cabling infrastructure components. Laser print surface on pre-cut, perforated 8.5" x 11" sheets provides simple application with permanent legibility. User-friendly software includes label templates designed specifically for Leviton patch panels, patch cords, 110 wiring products and wallplates. The context sensitive Help Module includes step-by-step instructions to easily create and customize complex label builds in minutes. The Build Editor allows integration of fonts and symbols from your word processing software. Download LabelWare software at www.levitonvoicedata.com/labelware.

Cable and Wallplate Product Labels

DESCRIPTION	CAT. NO.
[A] Cable Wrap-around Labels (8mm), 48 self-adhesive labels per sheet	59260-00W
[B] Wallplate & Housing Labels, 10 sheets, 80 card-stock labels per sheet (white)	59259-C0W
[C] Port Labels, 10 sheets, 324 self-adhesive labels per sheet (clear)	59259-ACL

Patch Panel and 110 Wiring Product Labels

DESCRIPTION	CAT. NO. WHITE	CAT. NO. PUR/YEL	CAT. NO. BLU/GRY	CAT. NO. RED/ORG	CAT. NO. GRE/BRN
[D] 110 Wiring Product Labels, 10 sheets, 16 labels/sheet	59258-00W	59258-0PY	59258-0LG	59258-0RO	59258-0VB
[E] Patch Panel and Block Labels, 10 sheets, 40 labels/sheet	59256-00W	59256-0PY	59256-0LG	59256-0RO	59256-0VB
[F] QuickPort Patch Panel and Block Labels, 10 sheets, 40 labels/sheet	59257-00W	59257-0PY	59257-0LG	59257-0RO	59257-0VB

TIA/EIA-606-A Color Code Chart

TERMINATION TYPE	TYPICAL APPLICATION	COLOR
Demarcation Point	Central office connection	Orange
Network Connections	User side of central office connection	Green
Common Equipment	Connections to PBX, mainframe, LAN, multiplexer	Purple
1st Level Backbone	Terminations of building backbone cable MCs to ICs	White
2nd Level Backbone	Terminations of building backbone cable ICs to HCs	Gray
Horizontal Cabling	Terminations of horizontal cable in TEs	Blue
Campus Backbone	Termination of backbone cable between buildings	Brown
Auxiliary Circuits	Alarms, security, or energy management	Yellow
Key Circuits	Connections to key telephone systems	Red

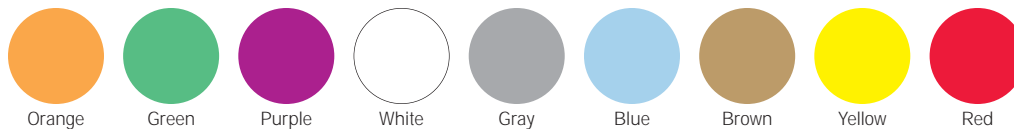



LABELING ACCESSORIES



QuickPort® Shutters and Icons

Leviton's field-installable QuickPort Shutters protect connectors from dust and debris with a unique, one-piece hinged door. Suitable for commercial and residential applications. Shutters feature labels and recessed windows and fit on Leviton Category 6, 5e, 5, and 3 and 8-Position Voice Grade connectors, when used in a QuickPort wallplate or housing. Optional label kits are available. *NOTE: SHUTTERS DO NOT WORK WITH CONNECTOR INTERFACE BEZELS.*

QuickPort Shutters and Icons

DESCRIPTION	CAT. NO.
[A] QuickPort Shutter Kit w/Leviton logo and miscellaneous icons	51084-ICN
Accessory Kit w/pre-printed icons on white paper	51084-XLB
[B] Color Label Kit w/pre-printed icons on colored paper*	51084-CLB



Patch Panel and Port Accessories

Patch Panel Port Identification Kits

DESCRIPTION	CAT. NO.
[C] QuickPort 32-port ID kit (for 24- and 32-port panels)	49257-QID
[C] QuickPort High Density ID kit (for 24- and 48-port high density panels)	49257-QHD



PRE-PRINTED PORT DESIGNATION LABELS

[D] Identify ports on any QuickPort Housings with these attractive and versatile jack designation labels. Printed on clear self-adhesive backing. Commercial or residential labels available.

Port Designation Labels

DESCRIPTION	CAT. NO.	CAT. NO.
	BLACK INK	WHITE INK
Commercial Labels—10 sheets per kit, 94 labels per sheet	41080-LEB	41080-LWB
Residential Labels—10 sheets per kit, 94 labels per sheet	40740-OBE	_____

VOICE 1	VOICE 1	VOICE	VOICE
VOICE 1	VOICE 1	DATA	DATA
VOICE 2	VOICE 2	FAX	FAX
VOICE 2	VOICE 2	PRINTER	PRINTER
VOICE 3	VOICE 3	SPARE	SPARE
VOICE 4	VOICE 4		
DATA 1	DATA 1		
DATA 1	DATA 1		
DATA 2	DATA 2		
DATA 2	DATA 2	1	1
DATA 3	DATA 3	1	1
DATA 3	DATA 3	2	2
DATA 4	DATA 4	2	2
DATA 4	DATA 4	3	3
PHONE	PHONE	4	4
PHONE	PHONE	5	5
PHONE	PHONE	6	6
10BASE-T	10BASE-T	A	A

41080-LEB Shown

110 Product Labeling Holders and Strips

E Identify all your 110 ports quickly and easily with these label holders and slide-in label strips. The clear plastic holders attach to all types of 110 wiring bases including wall, rack and wall-mounting frame styles. Labeling strips are lined for 2-, 3-, 4- or 5-pair spacing and available in white for Cat 6 110 Wiring Products. Cat 5e labeling strips are available in your choice of nine colors.

110 Product Labeling Holders and Strips

DESCRIPTION	CAT. NO.
[E] Clear Label Holders (bag of 6)	41100-HLD
[E] CAT 6 Label Strips lined for 4-pair spacing (bag of 6) (available in white only)	411BL-60W
[E] CAT 5e Label Strips lined for 2-, 3-, 4- or 5-pair spacing (bag of 6) (available in one of 9 colors)	411BL-00*

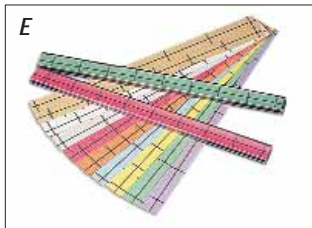

*COLOR/LABELS

QuickPort Shutter Kit
For color selection, add suffix to catalog number as follows: Gray (G), Orange (O), Blue (L), Yellow (Y), Green (V), Purple (P), Brown (B), Red (R).

110 Product Labels
For color selection, add suffix to catalog number as follows: White (W), Gray (G), Orange (O), Blue (L), Yellow (Y), Green (V), Purple (P), Brown (B), Red (R).

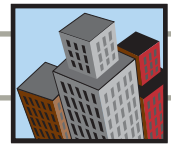

110 Punchdown Tool

WIRE PUNCHDOWN/TERMINATION TOOL

- A** A versatile punchdown/termination tool with changeable blades (sold separately) that enables installers to make reliable connections on a variety of wire termination blocks. Terminate/punch down wire with one simple push on the handle. An adjustable impact setting allows you to terminate wire with less effort than other impact tools. Handle can be fitted with several interchangeable custom blades to cover many termination types: 110 IDC, 66 IDC, Krone, BIX (Northern Telecom BIX system), and an awl (woodscrew starter punch). A spare blade can be kept in a storage chamber in the handle.
- B-E** These special application blades are for use with the Wire Punchdown Tool for terminating 22, 24 or 26 gauge wire. Krone and BIX blades feature scissor-action trim

D814 Wire Puchdown/Termination Tool and D814 Tool Blades

DESCRIPTION	CAT. NO.
[A] Wire Punchdown/Termination Tool (Blade Sold Separately)	49553-814
[B] 110 IDC Blade	49553-110
[C] 66-IDC Blade	49553-066
[D] BIX® Blade	49553-BIX
[E] Krone® Blade	49553-KRN
AWL (Woodscrew starter punch)	49553-AWL

MULTI-PAIR TERMINATION TOOL

- F** The Multi-pair Termination Tool is designed for use with Leviton's Category 6 110-style wiring products. The high-impact, spring-loaded handle, makes it easy to terminate multiple pairs with just one punch. Use "Blade In" and "Blade Out" options for daisy chain or full termination. Category 5e and 6 heads are available separately. Handle works with both Category 5e and 6 heads.

Multi-Pair Termination Tools and Accessories

DESCRIPTION	CAT. NO.
[F] Mass Termination Multi-Pair Tool Handle with CAT 6, 4-Pair Head	49553-TTH
Mass Termination Replacement Head, CAT 6, 4-Pair	49553-64H
Mass Termination Replacement Head, CAT 5e, 5-Pair	49553-55H

MASTER COMPRESSION TOOL

- G** The Multi-pair Termination Tool is designed for use with Leviton's Category 6 110-style wiring products. The high-impact, spring-loaded handle, makes it easy to terminate multiple pairs with just one punch. Use "Blade In" and "Blade Out" options for daisy chain or full termination. Category 5e and 6 heads are available separately. Handle works with both Category 5e and 6 heads.

Master Compression Tool

DESCRIPTION	CAT. NO.
[G] Master Compression Tool	40989-CPT

Compression Connectors are sold on page L4.

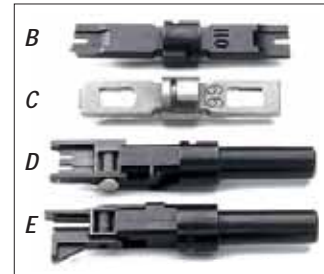



FIBER OPTIC TOOLS



Opt-X Fiber Tool Kits

OPT-X LIGHT TOOL KIT

A All the essential tools for quick field-termination of fiber optic connectors. Includes 100X inspection scope, scribe, polishing fixture, polishing pad, 900µm buffer remover tool, jacket stripper, Thread-Lock® tightening tool, and scissors.

OPT-X PRO TOOL KIT

B Use with any SC, ST, or FC Thread-Lock connectors. Includes Thread-Lock Versa-Cleave® Tool, 200X inspection scope, Thread-Lock tightening tool, one 250µm and one 900µm buffer remover, polishing pad, safety glasses, scissors, jacket stripper, polishing fixture, and music wire.



OPT-X FAST-CURE TOOL KIT

C Use with single-mode or multimode Fast-Cure adhesive connectors - SC, ST, FC, or LC. Includes 200X inspection scope, one 250µm and one 900µm buffer remover, polishing pad, standard 2.5mm and LC 1.25mm polishing fixtures, LC scope adapter, fiber crimp tool, safety glasses, scissors, jacket stripper, music wire and lapping film. Adhesive/Accelerator Kit sold separately on page K5.



OPT-X MT-RJ ACCESSORY KIT

Adds MT-RJ capability to existing tool kits.

Fiber Optic Tool Kits

DESCRIPTION	CAT. NO.
[A] Opt-X Light Tool Kit	49800-MTK
[B] Opt-X Pro Tool Kit (includes Versa-Cleave)	49800-UTP
[C] Opt-X Fast-Cure Tool Kit	49800-FTK
Opt-X MT-RJ Accessory Kit	49800-SLA

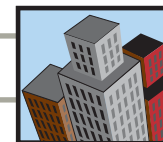

Fiber Optic Tools and Consumables Sold Individually

Individual Components

DESCRIPTION	CAT. NO.
Universal Tools	
[A] 250 µm Buffer Remover	49886-BR2
[B] 900 µm Buffer Remover	49886-BR9
[C] Jacket Stripper	49886-STP
[D] Aramid Strand Scissors	49886-SIS
Marking Pen	49886-SMP
Safety Glasses	49886-GLS
Sapphire Scribe	49886-SCR
2.5mm Polishing Puck	49886-PUC
3" x 6" Polishing Pad	49886-PAD
Opt-X® Tool Kit Carrying Case	49886-CSE
Tightening Tools	
[E] ST/SC Combination Tightening Tool	49886-CTT
[F] FC Tightening Tool	49883-FCT
FastCAM Installation Kits	
[G] Multi/Single-Mode Installation Kit	49800-SMK
[H] Multimode Installation Kit	49800-MMK
MT-RJ Specific Tools	
Strip Length Gauge	49886-SLG
Frame-Station Connector Assembly Tool	49886-FIT
Workstation Connector Lead-in Crimp Tool	49886-SLC
Versa-Cleave® Adapter for MT-RJ Workstation Connectors	49886-VWA
Versa-Cleave Adapter for MT-RJ Frame-Station Connectors	49886-VFA
Opt-X 20/20 Lenses	49886-OTT
MT-RJ Tool Kit Carrying Case	49886-CST
MT-RJ Accessory Kit Carrying Case	49886-CSA
Fast-Cure Specific Tools	
[G] Fiber Optic Crimp Tool with .128, .151, .178 hex die	49886-FCT
LC Scope Adapter	49886-LCS
1.25mm (LC) Polishing Puck	49886-LCP
Fast-Cure Tool Kit Carrying Case	49886-FCC
Consumables	
Music Wire	49886-WRE
Lint Free Dry Wipes 100/pack	49886-DWP
Alcohol Pads 100/pack	49886-APD
12 µm Aluminum Oxide Lapping Film, 100/pack	49886-12F
3 µm Aluminum Oxide Lapping Film, 100/pack	49886-03F
0.3 µm Aluminum Oxide Lapping Film, 100/pack	49886-X3F
Replacement Needles 25/pack	49886-FCN
Replacement Syringes 25/pack	49886-SYR

CONSUMABLES KITS

H-J Leviton's Consumables Kits contain everything you need to clean and polish connectors, such as polyester wipes, alcohol pads, music wire, and 12-, 3- and 0.3 µm lapping film. Fast-Cure kit adds needles and syringes, plus adhesive and accelerator. Adhesive/Accelerator kit is also sold separately. Fan-Out Consumables Kits are also available.

Consumables Kits

DESCRIPTION	CAT. NO.
[H] Universal Consumables Kit	49800-CON
[I] Fast-Cure Consumables Kit	49800-FAC
[J] Adhesive/Accelerator Kit	49800-680
Fan-Out Consumables Kit (shown on page L51)	49800-FAN





Fiber Optic Tools

THREAD-LOCK® VERSA-CLEAVE® TOOL

A-C Diamond blade cleaves fiber perfectly every time, eliminating the need for a craft-sensitive scribe procedure. The ergonomic stop-watch design fits comfortably in the hand, works with any style or brand of mechanical 2.5mm ferrule connector, and cleaves with a simple push of the button. The integrated debris cup catches and retains fiber debris for safe disposal. Versa-Cleave can be ordered separately, or as part of the Opt-X® Pro Tool Kit

Thread-Lock Versa-Cleave

DESCRIPTION	CAT. NO.
[A] Versa-Cleave Tool	49886-TVC
[B] Versa-Cleave Adapter for MT-RJ Workstation Connector	49886-VWA
[C] Versa-Cleave Adapter for MT-RJ Frame-Station Connector	49886-VFA



SAFETY PAD

D Provides a flexible, shatterproof, non-slip surface perfect for terminating all Leviton Fiber Optic Connectors.

Safety Pad

DESCRIPTION	CAT. NO.
[D] Safety Pad	49886-SPD



INSPECTION SCOPES

E, F Leviton's 100x and 200x Inspection Scopes allow techs to view multimode and singlemode end-face polishes safely, and reduce the chances of over-polishing (a side-effect of many coaxial inspection scopes). 200x Scope features oblique viewing technology, ergonomic grip, 200X magnification and full laser eye protection through wavelengths of 850-1550 nanometer. Both scopes feature rugged construction that stands up to jobsite abuse.

Inspection Scopes



DESCRIPTION	CAT. NO.
[E] 100x Inspection Scope	49886-SCP
[F] 200x Inspection Scope	49886-FSP



Tone Test Set

A Use the Leviton Tone Test Set in low voltage wire applications to test for continuity, check for shorts or opens, and provide talk battery for a communication line on a vacant pair. Connect toner across a wire pair and set to transmit either a continuous 1000 Hz or alternating 500/1000 Hz tone. Use with the Speaker Probe (below) to trace pairs and locate broken pairs/cables in walls.

Also identifies Tip and Ring polarity, and line condition for CLEAR LINE with dial tone, BUSY LINE and RINGING LINE. Features "O" ring seals on the case, test leads for water resistance, support leash, tri-color, and nylon-braided tinsel wire test leads. Telco-standard, 6A-type alligator clips with piercing pins securely grip 66-clips, screw heads, screw bodies, and wire-wrapped or threaded terminals. A 6-position, 2-conductor plug lead is also provided for connection to modular jacks.

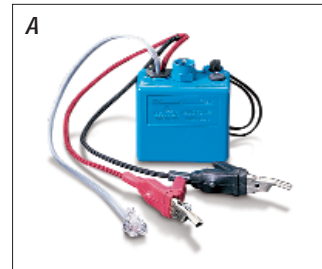

Inductive Speaker Probe

B The streamlined inductive speaker probe detects audible frequency tones quickly for accurate tracing and identification of wires, cables, and metallic circuits. Use with the tone test set (above) to trace and isolate pairs in virtually any type of wire application, without damage to the insulation. Identifies single wires or individual pairs in multiple-pair cables at terminals or closures; identifies station wiring or cables to specific equipment in closets or on distribution frames; and identifies the ends of drop wires. Probe can also be used to locate prewiring, or opens in wires, after wall covering is installed. Features both needlepoint and duckbill tips and a non-locking slide switch.



Tone Test Set, Inductive Speaker Probe — Individual Items and Combinations

DESCRIPTION	CAT. NO.
[A] Tone Test Set (includes 9 volt battery)	49560-TTS
[B] Inductive Speaker Probe only (includes 9 volt battery; one duckbill tip; and one needlepoint tip)	49561-SSP
[C] Leather Belt Holster for Tone Test Set	49560-LCC
[D] Leather Belt Holster for inductive speaker probe	49561-LCC
Spare duckbill and needlepoint tip set	49561-TIP
Kit containing tone test set with belt holster, and inductive speaker probe with belt holster	49562-TSK
Kit containing 5 tone test sets with belt holsters, and 5 inductive speaker probes with belt holsters	49562-KIT

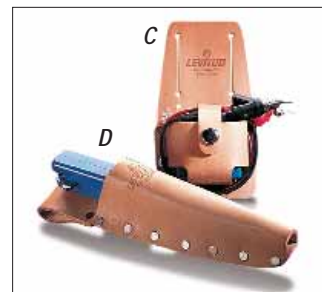

Optional leather belt holsters.

Crimping Tool for Coaxial Connectors

E For use in crimping coaxial connectors onto RG-59 or RG-6 cables. Rugged metal construction with cushioned handles. Carded package for display in merchandising racks.

Crimping Tool for Coaxial Connectors

DESCRIPTION	CAT. NO.
[E] Crimping Tool for Coaxial Connectors	40988-000



UTP Stripping Tool

F Use this versatile tool to strip unshielded twisted pair (UTP) cable. Carded package for display in merchandising racks.

UTP Stripping Tool

DESCRIPTION	CAT. NO.
[F] Stripping Tool	49660-00C

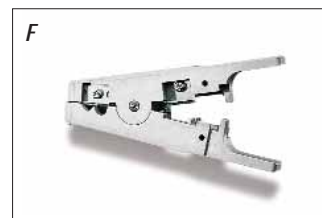



Craftsman's Handset

A This handset is used by installers, repair technicians, and other authorized personnel for basic line testing and essential on-site temporary communications. Line-powered to provide either DTMF (Touch Tone) or dial pulse output. Features all standard 'butset' line tests, including polarity check, line monitoring, and signaling.

Craftsman's Handset

DESCRIPTION	CAT. NO.
[A] Craftsman's Handset	49575-CTS

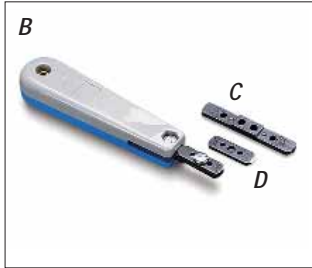

Termination Tool (66-BT)

B This 'pocket friendly' tool quickly punches down 20 through 26 gauge unstripped wire in devices using 66-clip terminals. It adjusts to accommodate variation in wire size and blade sharpness. Replaceable blades reverse to let you terminate and cut wire in a single stroke, or terminate without.

Replacement Stem for Termination Tool (66-BT02)

C The replaceable stem for the termination tool blade.

Replacement Blade for Termination Tool (66-BT01)

D This blade reverses so wires can be terminated and cut, or terminated without cutting. It also adjusts to accommodate variation in wire size or blade sharpness.

Termination Tool, Replacement Stem and Replacement Blade

DESCRIPTION	CAT. NO.
[B] Termination Tool (66-BT)	46666-0BT
[C] Replacement Stem for Termination Tool (66-BT02)	46666-BTS
[D] Replacement Blade for termination Tool (66-BT01)	46666-BTB

Note: Numbers in parentheses refer to industry product designation.

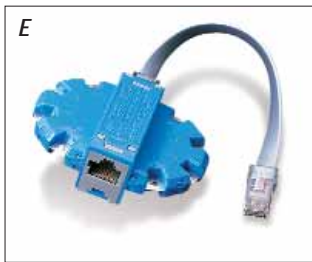

Modular Plug Breakout Adapter

E For testing any 6- or 8-position modular jack with the Tone Test Set or Craftsman's Handset. Includes contacts to connect, via alligator clip leads, to any test apparatus or Lineman's Test Set. Can be used in series with any cable with a 6- or 8-conductor modular plug.

Modular Plug Breakout Adapter

DESCRIPTION	CAT. NO.
[E] Modular Plug Breakout Adapter	40070-MDP

Straight Blade Plugs and Connectors

INDEX

Industrial Grade Plugs & Connectors	
Overview	M2
15A 125V & 250V	
Hospital Grade	M3
Industrial Grade	M3
Flanged Inlets and Outlets	M3
Wetguard®	M5
Dustguard®	M5
Python™	M6
Integrated Inlets and Outlets with Weather-Resistant Covers	M7
20A 125V & 250V	
Hospital Grade	M4
Industrial Grade	M4
Flanged Inlets and Outlets	M4
Wetguard®	M5
Dustguard®	M5
Python™	M6
Integrated Inlets and Outlets with Weather-Resistant Boots	M7
Weather-Resistant Boots	M4
20 AMP Power Plugs	M8
30 AMP Nylon Angle Plugs	M8
50 AMP Nylon Angle Plugs	M9
60 AMP Nylon Angle Plugs	M10
Commercial Grade Plugs & Connectors	
Overview	M11
15A 125V & 250V	M12
20A 125V & 250V	M13
30 Amp and 50 Amp Dual Power Attachment Plugs	M14
Residential Grade Plugs & Connectors	
Parallel, Polarized and Non-Polarized	M15
Grounding	M16

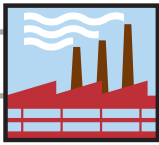

STRAIGHT BLADE PLUG AND CONNECTOR FEATURES

Industrial Grade Straight Blade Plugs and Connectors

A COMPLETE LINE OF PLUGS AND CONNECTORS THAT STANDS UP TO THE HARSHTEST ENVIRONMENTS

The Leviton line of straight blade plugs and connectors includes: Black & White™ Industrial Grade devices that resist impact, corrosion and chemicals; Hospital Grade devices that meet the highest standards for dependable, long-term performance; Wetguard® for water and moisture resistance; Dustguard® to resist dust and dirt; Python™, with an innovative interlocking design; rugged nylon flanged inlets and outlets; and integrated inlets and outlets with weather resistant covers.



Hospital Grade
Superior design, heavy-duty, impact-resistant, all nylon construction for long-lasting performance and reliability in the demanding healthcare environment.
8215-C shown



Angle Plugs and Connectors
For hospital and industry use where power cords must lay close to walls and floors: 8 plug positions.
8215-CAT shown



Wetguard®
Specifically developed for wet or damp locations. EPTR thermoplastic rubber body and rugged design resist water, alkalies, grease, oils and solvents.
14W48 shown



Python™
Hinged design provides speedy, simple wiring and installation, delivers top performance, stands up to rough-duty applications.
5456-VY shown



Flanged Inlets and Outlets
Fit flush on equipment mounting panels and require only 2 mounting screws for easy panel assembly.
5278-C shown



Leviton's 15 and 20 Amp nylon plugs and connectors offer superior performance and long-lasting reliability features; from ergonomic design details to rugged construction that resists impact, punishing application environments, chemicals and corrosives.

Features and Benefits

- UL 498 Listed; meets latest Federal Specifications WC-598; CSA Specification C22.2 No. 42 Certified
- Cord clamp with removable strain relief insert accepts cables rated from 10-3 ST to 18-3 SVT (.245"-.700")
- One-piece, rivetless triple-wipe brass connector contacts offer enlarged contact surface area
- Husk is constructed of ST801 Super Tough Nylon for superior impact resistance in rugged environments
- Beveled back edges prevent body from catching on corners and rough surfaces
- Ergonomic, fluted body design with radial gripping edge is ideal for gripping and pulling

Positive contact plate bundles stranded wire maximizing surface contact resulting in improved termination

NEMA configuration and device rating are molded on front of device to assist with identification

Dead front solid containment barrier prevents accidental contact with internal parts

Wiring module keyed to body for easy assembly and a tight fit

External cord grip utilizes deep triple drive steel screws that are backed out and positioned inside shrouded pockets. External clamps accepts wire mesh grips. Catalog and NEMA numbers printed on cord clamp

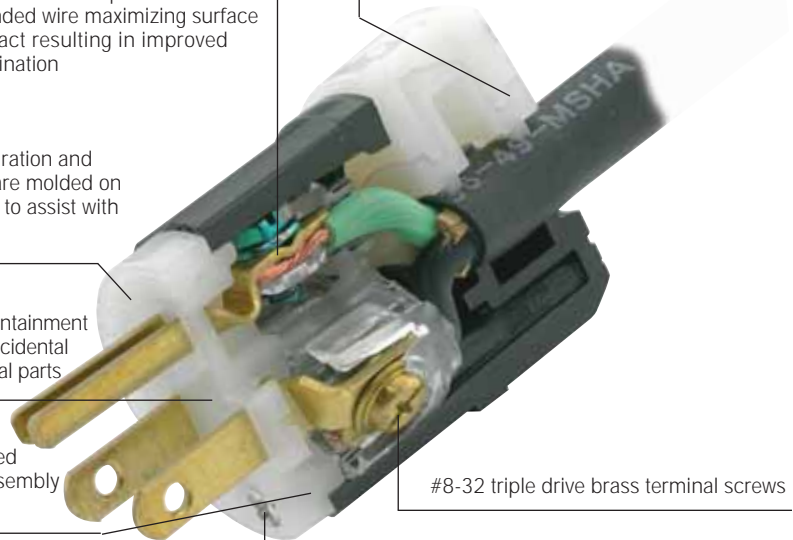

5266-C

#8-32 triple drive brass terminal screws

Three "U" type fast-threading, triple drive, steel screws secure wiring module to body

Wire clamps move in individual chamber — provide positive crimp lock without cutting wire strand

Captive, color-coded brass #8 terminal screws



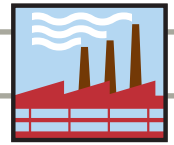

Individual deep-funnelled chamfered wire wells. Clear housing allows inspection of wire termination and provides molded-in wire strip gage



Industrial Grade Straight Blade Plugs and Connectors



Hospital Grade —15 AMP 125V 2-Pole, 3-Wire Grounding

DESCRIPTION	CAT. NO. PLUG NEMA 5-15P 	CAT. NO. CONNECTOR NEMA 5-15R 
Hospital Grade, Black & White Body	8215-C	8219-C
Hospital Grade, Transparent Body	8215-CT	8219-CT
Hospital Grade, Power Indication™ Transparent	8215-PLC	8219-PLC
Hospital Grade Angle, Transparent Body	8215-CAT	—

Industrial Grade —15 AMP 125V 2-Pole, 3-Wire Grounding

Black & White Nylon Body	5266-C	5269-C
High-Visibility Yellow Nylon Body	5266-CY	5269-CY
All-Black Nylon for Stage and Studio	5266-CB	5269-CB
All-Black Nylon, Power Indication™	5266-PLB	5269-PLB
Orange & White Body	5266-CO	5269-CO
Gray Nylon Body	5266-CG	5269-CG
Black & White Nylon Body, Power Indication™	5266-PLC	5269-PLC
Angle, Black & White Nylon Body	5266-CA	5269-CA
Black 2-Piece Nylon Shell	5266-N	5269-N
Flanged Inlet, White Nylon Body	5278-C	—
Flanged Outlet, White Nylon Body	—	5279-C

Industrial Grade —15 AMP 250V 2-Pole, 3-Wire Grounding

DESCRIPTION	CAT. NO. PLUG NEMA 6-15P 	CAT. NO. CONNECTOR NEMA 6-15R 
Black & White Nylon Body	5666-C	5669-C
High-Visibility Yellow Nylon Body	5666-CY	5669-CY
Angle, Black & White Nylon Body	5666-CA	—
Flanged Inlet, White Nylon Body	15678-C	—
Flanged Outlet, White Nylon Body	—	15679-C

For Weather Resistant Plug and Connector Boots, see page M4.

SPECIFICATIONS AND FEATURES

Hospital Grade

- Unmatched quality and performance confirmed by rigorous UL 498 testing
- Clearly identified by green dot

Industrial Grade

- Rugged construction resists impact, sunlight, chemicals and rough use
- All contacts are solid one-piece brass for better conductivity
- Triple-wipe, heavy-duty power contacts set in deep pockets to resist damage
- Captive, color-coded brass #8 terminal screws
- Unique cord clamp accepts wide range of cord sizes (.245"-.700"), providing secure grip without damaging cord jacket: SVT 18-3 to SO 14-3 with strain relief insert, up to ST 10-3 when strain relief insert is removed.
- Power Indication™ devices equipped with green neon bulb rated at 30,000 hours (24/7) for 3.5 years

TESTING AND CODE COMPLIANCE

- Meet NEMA WD 1 & 6, ANSI requirements
- UL Listed & meets UL Fed. Spec. requirements: Industrial Plugs & Connectors (File #13393); Hospital Grade (UL 498, File #E-13393)
- CSA Certified (File #LR-406)
- NOM Certified (#057)
- Backed by a Limited 10-Year Warranty

MATERIAL CHARACTERISTICS

Environmental: Flammability, Rated V2
Operating Temperature: -40°C to 65°C

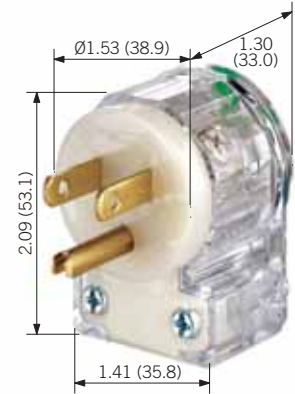

8215-CAT



5266-C



5269-C



5278-C

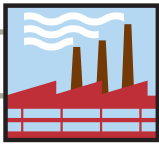

20 AMP 125 and 250V

Industrial Grade Straight Blade Plugs and Connectors



8315-PLC



5366-CA

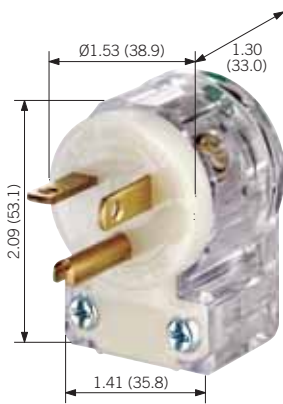



8415-CAT



6017-Y

Hospital Grade — 20 AMP 125V 2-Pole, 3-Wire Grounding





DESCRIPTION	CAT. NO. PLUG	CAT. NO. CONNECTOR
	NEMA 5-20P 	NEMA 5-20R  CSA config. in Canada 
Hospital Grade, Black & White Body	8315-C	8319-C
Hospital Grade, Transparent Body	8315-CT	8319-CT
Hospital Grade, Power Indication™ Transparent	8315-PLC	8319-PLC
Hospital Grade Angle, Transparent Body	8315-CAT	—

Industrial Grade — 20 AMP 125V 2-Pole, 3-Wire Grounding

Black & White Nylon Body	5366-C	5369-C
Black & White Nylon Body, Power Indication™	5366-PLC	5369-PLC
All-Black Nylon, Power Indication™	5366-PLB	5369-PLB
High-Visibility Yellow Nylon Body	5366-CY	5369-CY
Gray Nylon Body	5366-CG	5369-CG
Angle, Black & White Nylon Body	5366-CA	5369-CA
Flanged Inlet, White Nylon Body	15378-C	—
Flanged Outlet, White Nylon Body	—	15379-C

Hospital Grade — 20 AMP 250V 2-Pole, 3-Wire Grounding

DESCRIPTION	CAT. NO. PLUG	CAT. NO. CONNECTOR
	NEMA 6-20P 	NEMA 6-20R  CSA config. in Canada 
Hospital Grade Angle, Transparent Body	8415-CAT	—

Industrial Grade — 20 AMP 250V 2-Pole, 3-Wire Grounding

Black & White Nylon Body	5466-C	5469-C
High-Visibility Yellow Nylon Body	5466-CY	5469-CY
Flanged Inlet, White Nylon Body	5478-C	—
Flanged Outlet, White Nylon Body	—	5479-C

Weather-Resistant Boots

Our outstanding Industrial Grade boots feature a triple-seal design to protect straight blade and locking plugs and connectors against the harmful effects of dirt and moisture in harsh environments. Boots are available in black or high-visibility yellow. The fluted surface and grip-ring design provide a non-slip grip even in wet conditions.

DESCRIPTION	CAT. NO.
Weather-Resistant Straight Blade Plug Boot, Black Rubber. For 15A & 20A Straight Blade Industrial Nylon Plugs	6017
Weather-Resistant Straight Blade Plug Boot, High Visibility Yellow Rubber. For 15A & 20A Straight Blade Industrial Nylon Plugs	6017-Y
Weather-Resistant Straight Blade Connector Boot, Black Rubber. For 15A & 20A Straight Blade Industrial Nylon Connectors	6018
Weather-Resistant Straight Blade Connector Boot, High Visibility Yellow Rubber. For 15A & 20A Straight Blade Industrial Nylon Connectors	6018-Y

SPECIFICATIONS AND FEATURES

Hospital Grade

- Unmatched quality and performance confirmed by rigorous UL 498 testing
- Clearly identified by green dot

Industrial Grade

- Rugged construction resists impact, sunlight, chemicals and rough use
- All connector contacts are solid one-piece brass for superior conductivity
- Triple-wipe, heavy-duty power contacts set in deep pockets to resist damage
- Captive, color-coded brass #8 terminal screws
- Unique cord clamp accepts wide range of cord sizes (.245"–.700"), providing secure grip without damaging cord jacket: SVT 18-3 to SQ 14-3 with strain relief insert, up to ST 10-3 when strain relief insert is removed.

- Power Indication™ devices equipped with green neon bulb rated at 30,000 hours (24/7) for 3.5 years

TESTING AND CODE COMPLIANCE

- Meet NEMA WD 1 & 6, ANSI requirements
- UL Listed & meets Fed. Spec. requirements: Industrial Plugs & Connectors (File #13393); Hospital Grade (UL 498, File #E-13393)
- CSA Certified (File #LR-406)
- NOM Certified (#057)
- Backed by a Limited 10-Year Warranty

MATERIAL CHARACTERISTICS

Environmental: Flammability, Rated V2
Operating Temperature: -40°C to 65°C

15 AMP 125 and 250V • 20 AMP 125 and 250V Industrial Grade Straight Blade Plugs and Connectors

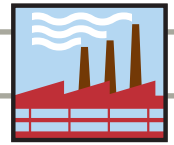

Wetguard® Devices Engineered to IP66 & IP67 Watertight Standards

Wetguard Straight Blade Plugs and Connectors

DESCRIPTION	CAT. NO. PLUG	CAT. NO. CONNECTOR
Rubber Yellow, 15A-125V 2-Pole, 3-Wire	14W47 NEMA 5-15P	15W47 NEMA 5-15R
Black Rubber, 15A-125V 2-Pole, 3-Wire	14W47-B NEMA 5-15P	15W47-B NEMA 5-15R
Yellow Rubber, 15A-250V 2-Pole, 3-Wire	14W49 NEMA 6-15P	15W49 NEMA 6-15R
Yellow Rubber, 15A-277V 2-Pole, 3-Wire	14W34 NEMA 7-15P	15W34 NEMA 7-15R
Yellow Rubber, 20A-125V 2-Pole, 3-Wire	14W33 NEMA 5-20P	15W33 NEMA 5-20R
Yellow Rubber, 20A-250V 2-Pole, 3-Wire	14W48 NEMA 6-20P	15W48 NEMA 6-20R

Replacement Closure Cap

DESCRIPTION	CAT. NO.
Replacement Female Closure Cap for use with 15A & 20A 2-pole, 3-wire devices	50W50



Dustguard® Devices Engineered to IP44 Splashproof and Dust-Tight Standards

Dustguard Straight Blade Plugs and Connectors

DESCRIPTION	CAT. NO. PLUG	CAT. NO. CONNECTOR
High-Visibility Yellow, 15A-125V 2-Pole, 3-Wire	1447 NEMA 5-15P	1547 NEMA 5-15R
High-Visibility Yellow, 15A-250V 2-Pole, 3-Wire	1449 NEMA 6-15P	1549 NEMA 6-15R
High-Visibility Yellow, 20A-125V 2-Pole, 3-Wire	1433 NEMA 5-20P	1533 NEMA 5-20R
High-Visibility Yellow, 20A-250V 2-Pole, 3-Wire	1448 NEMA 6-20P	1548 NEMA 6-20R

For 15 and 20 Amp corrosion resistant straight blade devices, see pages N20–N21.

SPECIFICATIONS AND FEATURES

Wetguard

- IEC IP66 and IP 67 Rated, in accordance with IEC 529 as evaluated by UL and CSA
- NEMA Type 3, 3S, 4, 4X, 6 and 6P Ratings in accordance with UL 50 and CSA 94
- Outstanding resistance to wet and damp environments, extreme temperature variations, acids, alkalis, grease, oils and solvents
- Effective "tongue and groove" construction seals out water, moisture, dirt when plugs are mated with connectors
- Innovative strain-relief grips cables securely, keeps out water and moisture
- Cord clamp range: 18/3–10/3SO (.375" – .655")

- Non-magnetic stainless steel fast-threading assembly screws won't interfere with sensitive equipment
- Connector "hood" closure cap seals device when not in use

Dustguard

- IEC/IP44 Rated
- Developed to withstand dusty and dirty environments, cracking and fading, temperature extremes
- Rugged wiring modules have high performance 1-piece brass triple-wipe contacts, solid brass plug blades
- Self centering cord clamp accepts wide range of conductors, 18-3 SVT–12-3SO (.240"–.655")

TESTING AND CODE COMPLIANCE

- Meet NEMA WD 1 & 6, ANSI requirements
- UL Listed & meets Fed. Spec. requirements: Wetguard (File #13393), Dustguard (File #E-13393)
- CSA Certified (File #LR-406)
- NOM Certified (#057)
- Backed by a Limited 10-Year Warranty

MATERIAL CHARACTERISTICS

Environmental: Flammability, Rated V2
Operating Temperature: -40°C to 65°C



Straight Blade Plugs and Connectors

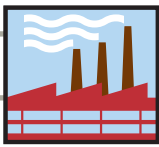



15 AMP 125 and 250V • 20 AMP 125 and 250V

Industrial Grade Straight Blade Plugs and Connectors

PYTHON™ Python™ Plugs and Connectors Feature a Hinged Design for Fast, Easy Installation and Assembly



Hospital Grade — 15 AMP 125V 2-Pole, 3-Wire Grounding

DESCRIPTION	CAT. NO. PLUG NEMA 5-15P 	CAT. NO. CONNECTOR NEMA 5-15R 
White Nylon Body	8256-V	8259-V

Industrial Grade — 15 AMP 125V 2-Pole, 3-Wire Grounding

Black Nylon Body	5256-VB	5259-VB
High-Visibility Yellow Nylon Body	5256-VY	5259-VY
Gray Nylon Body	5256-VG	5259-VG
Angle, High-Visibility Yellow Nylon Body	5256-VA	—



Hospital Grade — 15 AMP 250V 2-Pole, 3-Wire Grounding

DESCRIPTION	CAT. NO. PLUG NEMA 6-15P 	CAT. NO. CONNECTOR NEMA 6-15R 
White Nylon Body	8656-V	8659-V

Industrial Grade — 15 AMP 250V 2-Pole, 3-Wire Grounding

High-Visibility Yellow Nylon Body	15656-VY	15659-VY
Angle, High-Visibility Yellow Nylon Body	15656-VA	—



Hospital Grade — 20 AMP 125V 2-Pole, 3-Wire Grounding

DESCRIPTION	CAT. NO. PLUG NEMA 5-20P 	CAT. NO. CONNECTOR NEMA 5-20R  <small>CSA config. in Canada</small> 
White Nylon Body	8356-V	8359-V

Industrial Grade — 20 AMP 125V 2-Pole, 3-Wire Grounding

Black Nylon Body	5356-VB	5359-VB
High-Visibility Yellow Nylon Body	5356-VY	5359-VY
Angle, High-Visibility Yellow Nylon Body	5356-VA	—

Hospital Grade — 20 AMP 250V 2-Pole, 3-Wire Grounding

DESCRIPTION	CAT. NO. PLUG NEMA 6-20P 	CAT. NO. CONNECTOR NEMA 6-20R  <small>CSA config. in Canada</small> 
White Nylon Body	8456-V	8459-V

Industrial Grade — 20 AMP 250V 2-Pole, 3-Wire Grounding

High-Visibility Yellow Nylon Body	5456-VY	5459-VY
Angle, High-Visibility Yellow Nylon Body	5456-VA	—



5256-VA

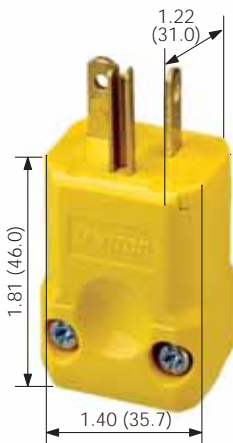

5456-VY

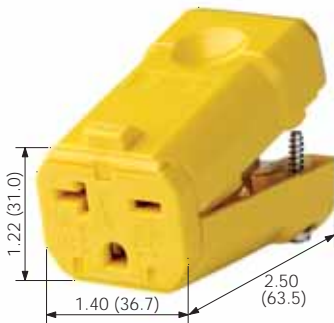

5459-VY

SPECIFICATIONS AND FEATURES

Python

- Tough high-impact body
- Hinged design delivers fast, easy installation and assembly
- Triple-drive screws for easy wiring — Standard, Phillips, Robertson
- Wide Cord Clamp Range, 18-3 SVT–10-3 ST, (.245"–.700")

TESTING AND CODE COMPLIANCE

- Meet NEMA WD 1 & 6, ANSI requirements
- UL Listed & meets Fed. Spec. requirements: Industrial Plugs & Connectors (File #13393); Hospital Grade (UL 498, File #E-13393)
- CSA Certified (File #LR-406)
- NOM Certified (#057)
- Backed by a Limited 10-Year Warranty

MATERIAL CHARACTERISTICS

Environmental: Flammability, Rated V2
Operating Temperature: -40°C to 65°C



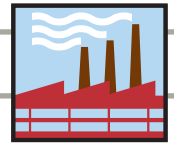









15 AMP 125 and 250V • 20 AMP 125 and 250V Industrial Grade Straight Blade Plugs and Connectors



Integrated Power Inlets and Outlets with Weather-Resistant Covers

- Engineered to IP 64 and NEMA 3R Protection Ratings
- Suitable for Industrial Indoor and Outdoor Use

Integrated Power Inlets and Outlets with Weather-Resistant Covers Gray, Glass-Filled Thermoplastic Cover and White, Nylon Device

DESCRIPTION	CAT. NO. FLANGED INLET	CAT. NO. FLANGED OUTLET
Standard Wire Wells, 15A-125V 2-Pole, 3-Wire	5278-CWP NEMA 5-15P 	5279-CWP NEMA 5-15R 
Slots for Fork Terminals, 15A-125V 2-Pole, 3-Wire	5278-FWP NEMA 5-15P 	5279-FWP NEMA 5-15R 
Standard Wire Wells, 15A-250V 2-Pole, 3-Wire	15678-CWP NEMA 6-15P 	15679-CWP NEMA 6-15R 
Standard Wire Wells, 20A-125V 2-Pole, 3-Wire	15378-CWP NEMA 5-20P 	15379-CWP NEMA 5-20R  
Standard Wire Wells, 20A-250V 2-Pole, 3-Wire	5478-CWP NEMA 6-20P 	5479-CWP NEMA 6-20R  

Note: For locking configurations, please see Section N.



5278-CWP



5278-CWP Shown Open



5279-CWP Shown Open

SPECIFICATIONS AND FEATURES

- Glass-filled thermoplastic cover and plate provide outstanding impact resistance and durability
- UL 94 VO Flammability Rating
- IP 64 Suitability rating protects against dust particles and splashing water
- NEMA Type-3R enclosure Rating ensures protection against rain, sleet and damage from external ice formations
- Available with standard wire wells or with slots that accept fork terminals
- Dual gaskets, one under plate and one under lid, for weather-resistant fit
- Stainless steel external hardware resists corrosive effects of moisture
- Large thumb-tab makes it easy to open cover with gloved hand
- Mounts to panels or FS/FD boxes
- UL Listed and CSA Certified for wet locations with cover closed

TESTING AND CODE COMPLIANCE

- UL Listed (File #-13397)
- CSA Certified (File #LR-16347)
- NOM Certified (#057)
- IP 64 Suitability Rating (protected against dust and splashing water)
- NEMA Type-3R Enclosure Rating when properly installed (protected against rain, sleet and damage from external ice formations)
- Backed by a Limited 2-Year Warranty

MATERIAL CHARACTERISTICS

Environmental: VO Flammability Rating per UL 94
Operating Temperature: -40°C to 75°C

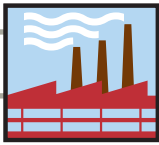

Industrial Grade Straight Blade Plugs and Connectors

20 AMP Power Plugs

20 AMP 125/250V Straight Blade Plugs 3-Pole 3-Wire Non-Grounding

DESCRIPTION	CAT. NO.	MATCHING RECEPTACLE	NEMA CONFIG.
Straight Plug	9151-N	5032 5032-1	10-20P 

20 AMP 120/208V 4-Pole, 4-Wire, 3ØY Non-Grounding

DESCRIPTION	CAT. NO.	MATCHING RECEPTACLE	NEMA CONFIG.
Straight Plug	7251-C	7250-FR	18-20P 

30 AMP Nylon Angle Plugs

30 AMP 125V 2-Pole 3-Wire Grounding

DESCRIPTION	CAT. NO.	MATCHING RECEPTACLE	NEMA CONFIG.
Angle Plug	9530-P	5371 5371-IG	5-30P 

30 AMP 250V 2-Pole 3-Wire Grounding

DESCRIPTION	CAT. NO.	MATCHING RECEPTACLE	NEMA CONFIG.
Angle Plug	9630-P	5372 5372-IG	6-30P 

30 AMP 277V 2-Pole 3-Wire Grounding

DESCRIPTION	CAT. NO.	MATCHING RECEPTACLE	NEMA CONFIG.
Angle Plug	9730-A		7-30P 

30 AMP 125/250V 3-Pole 3-Wire Non-Grounding

DESCRIPTION	CAT. NO.	MATCHING RECEPTACLE	NEMA CONFIG.
Angle Plug	9332-P	5207	10-30P 

30 AMP 125/250V 3-Pole 4-Wire Grounding

DESCRIPTION	CAT. NO.	MATCHING RECEPTACLE	NEMA CONFIG.
Angle Plug	9432-P	278	14-30P 

30 AMP 250V 3-Pole 4-Wire 3-Phase Grounding

DESCRIPTION	CAT. NO.	MATCHING RECEPTACLE	NEMA CONFIG.
Angle Plug	8432-P	8430	15-30P 

30 AMP 120/208V 4-Pole 4-Wire 3ØY Non-Grounding

DESCRIPTION	CAT. NO.	MATCHING RECEPTACLE	NEMA CONFIG.
Angle Plug	8332-P	8330	18-30P 



9530-P



9432-P

For more information regarding matching receptacles, refer to Receptacles, Section G.

SPECIFICATIONS AND FEATURES

- Rugged cord clamp for secure cable grip accommodates cord diameters from .625" to 1.375" and does not tear conductor jacket
- Made of tough, heavy-duty nylon for long service life
- Devices feature heavy-sectioned dead-front right-angle
- Pressure-clamp terminal design
- Terminals accept up to #4AWG stranded conductors
- Four-way positioning front module
- Solid brass blades for maximum conductivity

TESTING AND CODE COMPLIANCE

- UL Listed (File #13393)
- UL Test 498 (CSA 42)
- CSA Certified (File #LR-406)
- NOM Certified (#057)
- Backed by a Limited Two-Year Warranty

MATERIAL CHARACTERISTICS

Environmental: Flammability, Rated V2
Operating Temperature: -40°C to 65°C

50 AMP 125, 250, 277 125/250 and 120/208V Industrial Grade Straight Blade Plugs and Connectors

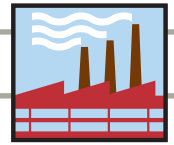

50 AMP Nylon Angle Plugs

50 AMP 125V 2-Pole 3-Wire Grounding

DESCRIPTION	CAT. NO.	MATCHING RECEPTACLE	NEMA CONFIG.
Angle Plug	9550-P	5373	5-50P 

50 AMP 250V 2-Pole 3-Wire Grounding

Angle Plug	9650-P	5374 5374-IG	6-50P 
------------	--------	-----------------	--

50 AMP 277V 2-Pole 3-Wire Grounding

Angle Plug	9750-P	9750-A	7-50P 
------------	--------	--------	--

50 AMP 125/250V 3-Pole 3-Wire Non-Grounding

Angle Plug	9450-P	5206	10-50P 
------------	--------	------	---

50 AMP 125/250V 3-Pole 4-Wire Grounding

Angle Plug	9452-P	279	14-50P 
------------	--------	-----	---

50 AMP 250V 3-Pole 4-Wire 3-Phase Grounding

Angle Plug	8452-P	8450 8450-IG	15-50P 
------------	--------	-----------------	--

50 AMP 120/208V 4-Pole 4-Wire 3ØY Non-Grounding

Angle Plug	8352-P	8350	18-50P 
------------	--------	------	---

For more information regarding matching receptacles, refer to Receptacles, Section G.



SPECIFICATIONS AND FEATURES

- Rugged cord clamp for secure cable grip accommodates cord diameters from .625" to 1.375" and does not tear conductor jacket
- Made of tough, heavy-duty nylon for long service life
- Devices feature heavy-sectioned dead-front right-angle
- Pressure-clamp terminal design
- Terminals accept up to #4AWG stranded conductors
- Four-way positioning front module
- Solid brass blades for maximum conductivity

TESTING AND CODE COMPLIANCE

- UL Listed (File #13393)
- UL Test 498 (CSA 42)
- CSA Certified (File #LR-406)
- NOM Certified (#057)
- Backed by a Limited Two-Year Warranty

MATERIAL CHARACTERISTICS

Environmental: Flammability, Rated V2
Operating Temperature: -40°C to 65°C

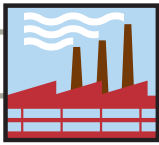

60 AMP 250, 125/250 and 120/208V

Industrial Grade Straight Blade Plugs and Connectors

Straight Blade Plugs and Connectors

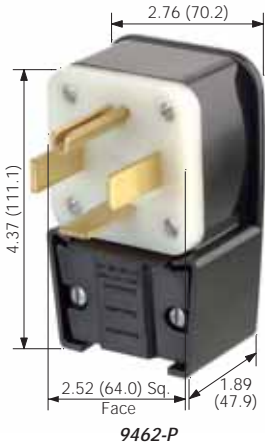

60 AMP Nylon Angle Plugs

60 AMP 125/250V 3-Pole 4-Wire Grounding

DESCRIPTION	CAT. NO.	MATCHING RECEPTACLE	NEMA CONFIG.
Angle Plug	9462-P	9460 9460-IG	14-60P

60 AMP 250V 3-Pole 4-Wire 3-Phase Grounding

Angle Plug	8462-P	8460	15-60P
------------	--------	------	--------

60 AMP 120/208V 4-Pole 4-Wire 3ØY Non-Grounding

Angle Plug	8362-P	8360	18-60P
------------	--------	------	--------

For more information regarding matching receptacles, refer to Receptacles, Section G.



SPECIFICATIONS AND FEATURES

- Rugged cord clamp for secure cable grip accommodates cord diameters from .625" to 1.375" and does not tear conductor jacket
- Made of tough, heavy-duty nylon for long service life
- Devices feature heavy-sectioned dead-front right-angle
- Pressure-clamp terminal design
- Terminals accept up to #4AWG stranded conductors
- Four-way positioning front module
- Solid brass blades for maximum conductivity

TESTING AND CODE COMPLIANCE

- UL Listed (File #13393)
- UL Test 498 (CSA 42)
- CSA Certified (File #LR-406)
- NOM Certified (#057)
- Backed by a Limited Two-Year Warranty

MATERIAL CHARACTERISTICS

Environmental: Flammability, Rated V2
 Operating Temperature: -40°C to 65°C

STRAIGHT BLADE PLUG AND CONNECTOR FEATURES

Commercial Grade Straight Blade Plugs and Connectors

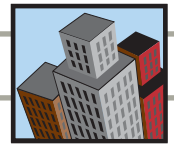

LEVITON OFFERS A LARGE SELECTION OF 15, 20, 30 AND 50 AMP COMMERCIAL GRADE STRAIGHT BLADE PLUGS AND CONNECTORS, AVAILABLE IN A WIDE VARIETY OF FEATURES.

Leviton's Commercial Grade Straight Blade Plugs and Connectors are rugged performers. They are moisture, chemical and abuse-resistant. And they're ideal for indoor and outdoor use.

- EPTR rubber-backed plugs and connectors stand up to rough use, protect against dirt and moisture
- Deep-slotted, backed-out terminal screws draw backwire clamps securely over stripped leads for maximum conductivity

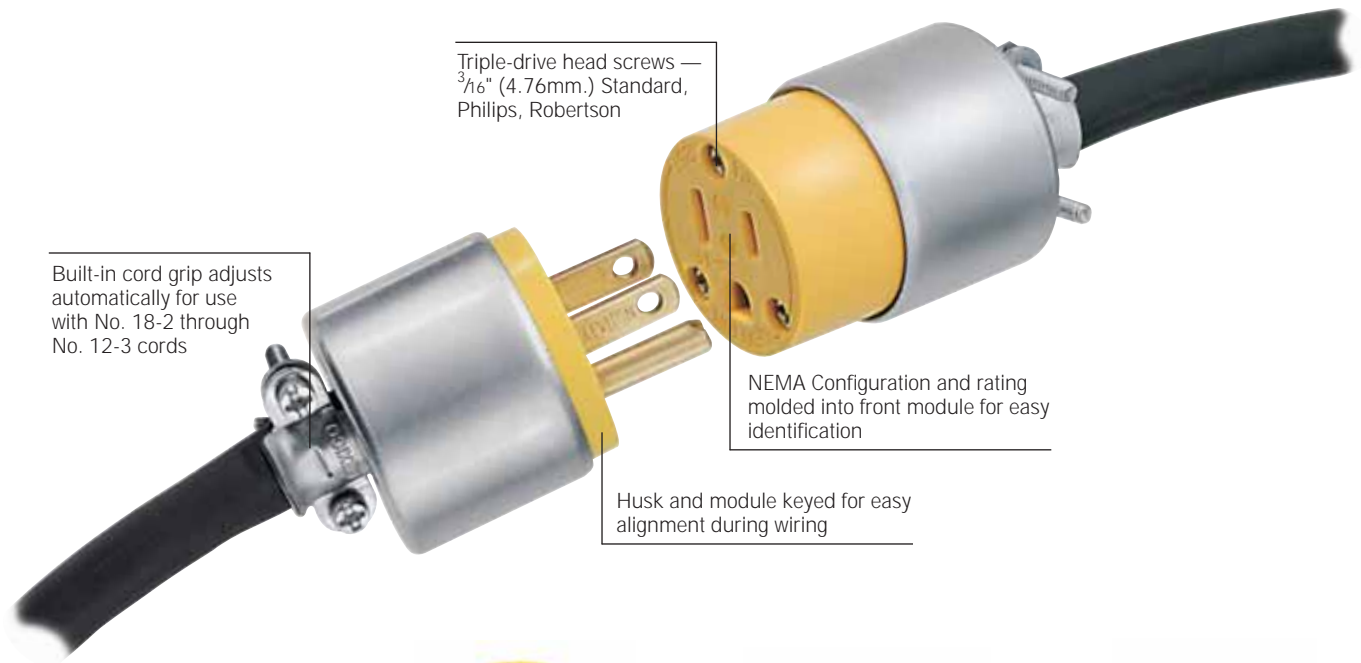

Built-in cord grip adjusts automatically for use with No. 18-2 through No. 12-3 cords

Triple-drive head screws — $\frac{3}{16}$ " (4.76mm.) Standard, Phillips, Robertson

NEMA Configuration and rating molded into front module for easy identification

Husk and module keyed for easy alignment during wiring



PVC Grounding Plug
Resists moisture and chemicals; suited for outdoor cords.
515PV shown



PVC Grounding Connector
Unique dimpled body design provides secure grip; resists abuse.
515CV shown



PVC Angle Grounding Plug
Speed-thread assembly screws tighten with just a few quick turns; impact-resistant.
515AN shown



Armored Grounding Plug
Ideal for shops, garages and rough-duty work with hard floors.
520PA shown



Armored Grounding Connector
Two-piece strain-relief clamp center cord for neat installation; able to take hard punishment.
615CA shown



Rubber Grounding Connector
Provides protection against rough use, dirt, moisture and temperature extremes.
515CR shown



Dual Power Vinyl Angle Plug
Thermoplastic body for long life; interchangeable blade configurations.
930 shown



Motor Base Inlet
Contains heavy gauge brass blades and thermoplastic housing.
5239 shown

Straight Blade Plugs and Connectors





15 AMP 125 and 250V

Commercial Grade Straight Blade Plugs and Connectors



515CV

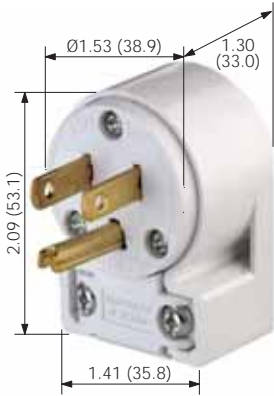



515AN



5239

15 AMP Plugs, Angle Plugs, Armored Plugs and Connectors

15 AMP 125V 2-Pole 3-Wire Grounding

DESCRIPTION	CAT. NO.	COLOR	NEMA CONFIG.
PVC Grounding Plug	515PV	Yellow	
Armored Grounding Plug	515PA	Yellow/Steel Armor	
Rubber Grounding Plug	515PR	Black	
PVC Angle Grounding Plug	515AN	White	
PVC Grounding Connector	515CV	Yellow	5-15P  5-15R 
Armored Grounding Connector	515CA	Yellow/Steel Armor	
Rubber Grounding Connector	515CR	Black	
Motor Base Inlet	5239	Black	

15 AMP 250V 2-Pole 3-Wire Grounding

DESCRIPTION	CAT. NO.	COLOR	NEMA CONFIG.
PVC Grounding Plug	615PV	Yellow	
Armored Grounding Plug	615PA	Yellow/Steel Armor	
Armored Grounding Connector	615CA	Yellow/Steel Armor	
Motor Base Inlet	5240	Black	

Straight Blade Plugs and Connectors

SPECIFICATIONS AND FEATURES

- Triple-drive head screws — Standard, Phillips, Robertson
- NEMA configuration number & rating molded on face of device for easy identification
- Rubber body is dirt and moisture resistant
- Deep-slotted, backed out terminal screws draw backwire clamps securely for maximum conductivity
- Husk & module keyed for easy alignment during wiring
- Built-in cord grip adjusts automatically for use with No. 18-3 through No. 12-3 cords (.245"–.655")
- Motor Base Inlet accepts No. 10 max. copper or copper clad wire

PVC Plugs & Connectors

- Rugged PVC body resists moisture and chemicals; suited for outdoor cords

- Unique dimpled body design provides a secure grip
- Speed-thread assembly screws tighten with just a few quick turns

Armored Plugs & Connectors

- Ideal for shops, garages and rough-duty work with hard floors
- Two piece strain-relief clamp center cord for neat installation

Rubber-Back Plugs & Connectors

- Designed to stand up to rough use
- No internal metal parts exposed
- Elastomeric husk provides added protection against dirt and moisture entry into the back wire port
- Designed to operate in the widest possible temperature range

TESTING AND CODE COMPLIANCE

- Meet NEMA requirements
- UL Listed (File #E-13393)
- CSA Certified (File #LR-406)
- NOM Certified (#057)
- Backed by a Limited 10-Year Warranty

MATERIAL CHARACTERISTICS

Environmental: Flammability, Rated V2 per UL 94
Operating Temperature: -40°C to 65°C.



Commercial Grade Straight Blade Plugs and Connectors

20 AMP Plugs, Angle Plugs, Armored Plugs and Connectors

20 AMP 125V 2-Pole 3-Wire Grounding

DESCRIPTION	CAT. NO.	COLOR	NEMA CONFIG.
PVC Grounding Plug	520PV	Yellow	
Armored Grounding Plug	520PA	Yellow/Steel Armor	
PVC Grounding Connector	520CV	Yellow	5-20P 5-20R
Armored Grounding Connector	520CA	Yellow/Steel Armor	

20 AMP 250V 2-Pole 3-Wire Grounding

DESCRIPTION	CAT. NO.	COLOR	NEMA CONFIG.
PVC Grounding Plug	620PV	Yellow	
Armored Grounding Plug	620PA	Yellow/Steel Armor	
PVC Grounding Connector	620CV	Yellow	6-20P 6-20R
Armored Grounding Connector	620CA	Yellow/Steel Armor	
Rubber Back Grounding Plug	620PR	Black	

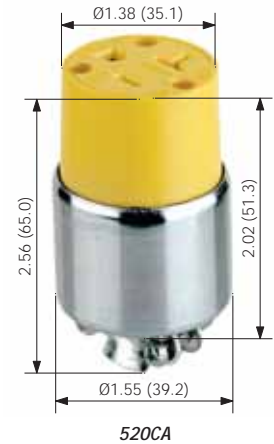

Straight Blade Plugs and Connectors

SPECIFICATIONS AND FEATURES

- Triple-drive head screws — Standard, Phillips, Robertson
- NEMA configuration number & rating molded on device for easy identification
- Dirt and moisture resistant
- Deep-slotted, backed out terminal screws draw backwire clamps securely for maximum conductivity
- Husk & module keyed for easy alignment during wiring
- Built-in cord grip adjusts automatically for use with No. 18-3 through No. 12-3 cords (.245"–.655")

PVC Plugs & Connectors

- Rugged PVC body resists moisture and chemicals; suited for outdoor cords
- Unique dimpled body design provides a secure grip
- Speed-thread assembly screws tighten with just a few quick turns

Armored Plugs & Connectors

- Ideal for shops, garages and rough-duty work with hard floors
- Two piece strain-relief clamp center cord for neat installation

TESTING AND CODE COMPLIANCE

- Meet NEMA requirements
- UL Listed (File #E-13393)
- CSA Certified (File #LR-406)
- NOM Certified (#057)
- Backed by a Limited 10-Year Warranty

MATERIAL CHARACTERISTICS

Environmental: Flammability, Rated V2 per UL 94
Operating Temperature: -40°C to 65°C.



30 AMP—125V/50 AMP 125V, 250V/50 AMP 250V, 125/250V/50 AMP 125/250V, 125V

Commercial Grade Straight Blade Plugs and Connectors



930



931

30 AMP/50 AMP Dual Power Attachment Plugs

30 AMP 125V/50 AMP 125V Grounding

DESCRIPTION	CAT. NO.	COLOR	NEMA CONFIG.
Dual-Power Vinyl Angle Plug, Interchangeable Blades Cord Dia. Range .630"–1.050"	930	Black	5-30P 5-50P

30 AMP 250V/50 AMP 250V Grounding

DESCRIPTION	CAT. NO.	COLOR	NEMA CONFIG.
Dual-Power Vinyl Angle Plug, Interchangeable Blades Cord Dia. Range .630"–1.050"	931	Black	6-30P 6-50P

30 AMP 125/250V/50 AMP 125/250V Non-Grounding

DESCRIPTION	CAT. NO.	COLOR	NEMA CONFIG.
Dual-Power Vinyl Angle Plug, Interchangeable Blades Cord Dia. Range .687"–1.050"	287-T	Black	10-30P 10-50P

30 AMP 125/250V/50 AMP 125/250V Grounding

DESCRIPTION	CAT. NO.	COLOR	NEMA CONFIG.
Dual-Power Vinyl Angle Plug, Interchangeable Blades Cord Dia. Range .750"–1.125"	275-T	Black	14-30P 14-50P

30 AMP 125V 2-Pole 3-Wire Grounding

DESCRIPTION	CAT. NO.	COLOR	NEMA CONFIG.
Travel Trailer Vinyl Angle Plug, for use with 7313 Receptacle Cord Dia. Range .687"–.875"	830-T	Black	ANSI Std. C73.13 TT-30P

SPECIFICATIONS AND FEATURES

- Tough thermoplastic shell for long life
- Shell and bottom are hinged in front for ease of assembly
- Solid brass blades with color-coded terminals simplify wiring
- Each dual combination plug supplied with 30A blades and flat 50A blade
- Dead front right angle construction
- Interchangeable blades eliminate need for stocking different devices
- Built-in rejection feature prevents closure if blades are incorrectly positioned
- Versatile cord clamp suitable for use with Nos. 14, 12, 10, 8 and 6 AWG round cord and Nos. 10/3 SRDT, 8/2-10/1 SRDT and 6/2-8/1 flat wire
- Wiring stripping gauge molded into plug cover

TESTING AND CODE COMPLIANCE

- Meet NEMA requirements
- UL Listed (File #13393)
- CSA Certified (File #LR-406)
- NOM Certified (File #057)
- Backed by a Limited 10-Year Warranty

MATERIAL CHARACTERISTICS

Environmental: Flammability, Rated V2 per UL 94
Operating Temperature: -40°C to 65°C



Residential Grade Straight Blade Plugs and Connectors

10 AMP and 15 AMP Parallel Plugs and Connectors

Easy Wire Plugs

DESCRIPTION	CAT. NO.	COLOR	CORD DIA. (inches)	WIRE GAUGE (stranded) Amperage (Watts)	NEMA CONFIG.
Non-Polarized	321 321-W	Brown White		#16/2 HPN, 15A (1875 Watts) #18/2 HPN, 10A (1250 Watts)	1-15P Non-Polarized
Polarized	321-P* 321-PW*	Brown White		#18/2 SPT-1, 10A (1250 Watts) #18/2 SPT-2, 10A (1250 Watts)	1-15P Polarized
Non-Polarized	123 123-I 123-W	Brown Ivory White		#18/2 SPT-1, 10A (1250 Watts)	1-15P Non-Polarized
Polarized	123-P* 123-PI* 123-PW*	Brown Ivory White		#20/2 XT, 3A (375 Watts)	1-15P Polarized

*Packed 500 Bulk

15 AMP 125V 2-Pole, 2-Wire

DESCRIPTION	CAT. NO.	COLOR	CORD DIA. (inches)	WIRE GAUGE (stranded)	NEMA CONFIG.
Polarized Light Duty Clamptite Plug	101 101-W 101-E	Brown White Black	Up to .250	No. 20, 18, 16 Flat or Rounded	
<i>Note: Consult factory for availability of non-polarized version</i>					
Polarized Light Duty Clamptite Connector	102 102-W 102-E	Brown White Black	Up to .250	No. 20, 18, 16 Flat or Rounded	
Non-Polarized Heavy-Duty PVC Plug	115PV	Yellow			
Non-Polarized Heavy-Duty TPE Rubber Plug	115PR	Black	.245-.655"	AWG 18-2 to 12-2 cable.	
Non-Polarized Short Flat Vinyl Plug★	48643 48643-W 48643-E	Brown White Black	.375 max.	18-14	1-15P Polarized
Polarized Angle Vinyl Plug★	638 638-B 638-W	Black Brown White	.343 max.	16 max.	1-15R Polarized
Non-Polarized Round Vinyl Handle Plug, w/Cord Clamp★	48646	Black	.437 max.	18-14	
Non-Polarized Vinyl Connector, w/Cord Clamp★	612†	Black	.437 max.	14 max.	
Non-Polarized Round Vinyl Handle Plug, w/Spring Blades★	48642	Black	.375 max.	18-14	

†Not UL Listed. For replacement use only.
CSA Certified except where indicated by ★

SPECIFICATIONS AND FEATURES

- Brass plug blades and connector contacts for maximum conductivity
- Armored devices have heavily plated steel shields and cord clamps
- Vinyl devices resist chipping, cracking, oils, grease and acids
- Rubber devices resist cold, abrasion, grease, oils, acids and impact
- Plastic devices resist grease, oils and acids

TESTING AND CODE COMPLIANCE

- Meet NEMA requirements (1-15P)
- UL Listed (File #E-13393)
- CSA Certified
- NOM Certified (#057)
- Backed by a Limited Two-Year Warranty

MATERIAL CHARACTERISTICS

Environmental: Flammability, Rated V2 per UL 94
Operating Temperature: -40°C to 65°C

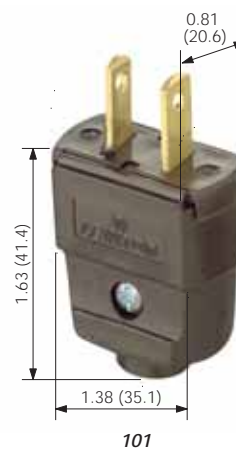
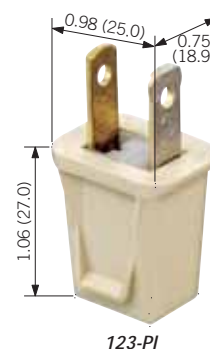
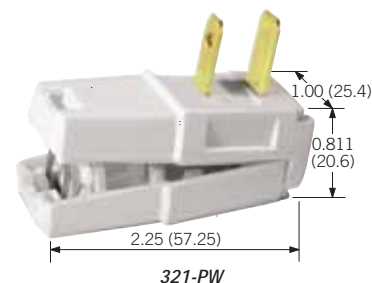

Straight Blade Plugs and Connectors



15 AMP 125V

Residential Grade Straight Blade Plugs and Connectors



113





114



4937

15 AMP Plugs and Connectors

15 AMP 125V 2-Pole, 3-Wire Grounding

DESCRIPTION	CAT. NO.	COLOR	CORD DIA. (inches)	WIRE GAUGE (stranded)	NEMA CONFIG.
Vinyl Handle Plug, w/Cord Clamp★	48648	Black	.437 max.	18-14	
Vinyl Connector, w/ Steel Cord Clamp	617	Black	.437 max.	16 max.	
Rubber Plug w/Vinyl Inner Assembly	113	Black	.396-.562	18-14	
Rubber Connector mates w/No. 113 above	114	Black	.396-.562	18-14	
Weatherproof Inlet on Flush Mount Wallplate with Aluminum Cover	4937			No. 10 max. copper or copper clad	

CSA Certified except where indicated by ★

Straight Blade Plugs and Connectors

SPECIFICATIONS AND FEATURES

- Double wipe brass contacts for maximum conductivity and blade retention

TESTING AND CODE COMPLIANCE

- Meet NEMA requirements
- UL Listed (File #E-13393)
- CSA Certified (File #LR-406)
- NOM Certified (#057)
- Backed by a Limited Two-Year Warranty

MATERIAL CHARACTERISTICS

Environmental: Flammability, Rated V2 per UL 94
 Operating Temperature: -40°C to 65°C

Locking and Corrosion Resistant Devices

INDEX

Industrial Specification Grade Locking Devices

Overview	N2-N4
15 Amp Devices	N5, N6
20 Amp Devices	N7-N11
30 Amp Devices	N12-N16

Wetguard® Devices

15 Amp	N17
20 Amp	N17, N18
30 Amp	N19

Corrosion Resistant Devices

15 Amp	N20
20 Amp	N21
30 Amp	N22
50 Amp	N23

Non-NEMA Devices

15 Amp	N24
20 Amp	N24
30 Amp	N25
50 Amp	N25
50 Amp "California Style"	N26

Weather Resistant Boots N27

Power Interrupting Devices N28

Midget Straight Blade and Locking Devices N29

Combination Locking and
Straight Blade Devices N30

Integrated Inlets and Outlets with
Weather Resistant Covers N30



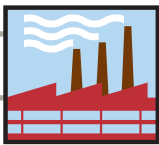

LOCKING DEVICE FEATURES

Industrial Grade Locking Devices

LOCKING DEVICES FOR THE ENTIRE SPECTRUM OF INDUSTRIAL APPLICATIONS

Leviton's Industrial Grade Locking Devices are built to provide unparalleled quality and superior performance in the most severe industrial settings. The Locking Devices line represents a broad selection of plugs and connectors, locking receptacles, flanged inlets and outlets, California-style devices, midget locking devices, power interrupting devices, and non-NEMA devices. Leviton combines the best materials available with superior production standards to produce a broad selection of Locking Devices of unmatched flexibility and dependability.



Internal wiring chambers isolate individual conductors to prevent flashover, arcing, and stray strands of wire

Transparent wiring chambers provide a means of visual inspection of conductors and terminals

Color-coded terminal screws

External cord clamp utilizes deep triple drive steel screws that are backed out and positioned inside shrouded pockets. External clamp accepts wire mesh grips

Cleat on contacts cuts oxidation when plug blades enter contact surfaces

Cable gage identifies maximum cord size allowed with strain relief insert

One-piece, rivetless, .035" thick brass contacts offer enlarged contact surface areas, improved conductivity, low resistance, low heat and long life

Combination #10-32 deep slotted/ Phillips brass screws easily torque to 10-14 in.-lbs.

- UL 498 Listed
- Federal Specification WC-596 Listed
- CSA Specification C22.2 No. 42 Certified

Ergonomically designed fluted body with radial gripping ridge creates an ideal surface for gripping, turning and pulling

Color-coded terminal screws

Deep slotted/ Phillips/Robertson steel screws secure wiring module (12-14 in.-lbs) to body

Molded-in strip gage provides correct measurement for proper strip length of conductor

NEMA configuration, agency certifications and device rating are molded on front of device to assist with identification

Solid brass blades are fitted and held tightly and securely in place

Dead front construction prevents accidental contact with internal parts

Wiring module keyed to body for easy assembly

Super Tough Nylon resists damage from severe impact, abrasion and chemical attack

Speed drive screws for faster assembly

Terminal identification letters on back cover ensure quick and accurate termination



Positive crimp contact plate bundles stranded wire maximizing wire/clamp surface contact



Shrouded pockets in cord clamp prevents slippage of screwdriver blade when tightening clamp screws.



Wire clamps move within individual chambers to provide positive clamp lock without cutting wire strands.



Captive terminal screws eliminate nuisance dropping and searching for missing screws.



Deep-funnelled, large wire wells guide conductors into termination position.

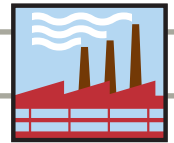

Flanged Inlets and Outlets
Built to endure hard use with rugged nylon flanges that assure a smooth, flush fit and outstanding resistance to cracking and breaking.
2316 shown



Weather-Resistant Boots
Feature triple seal action to protect locking plugs and connectors from the harmful effects of dirt and moisture in harsh operations.
6034 shown



Midget Locking Devices
ML1, ML2 and ML3 Locking devices covering the entire spectrum of industrial applications where restrained space considerations are a factor.
ML1-C shown



Wetguard
Specifically developed for wet or damp locations. EPTR thermoplastic rubber body and rugged design resists water, acids, alkalis, grease, oils and solvents.
24W47 shown

V-MAX® LOCKING FLUSH RECEPTACLES
Engineered for maximum performance with a UL 94 V-0 Flammability Rating.



Color-Coded Voltage Ratings		
125V	250V	277V AC
125/250V	3ø250V	3ø480V

LIFETIME WARRANTY

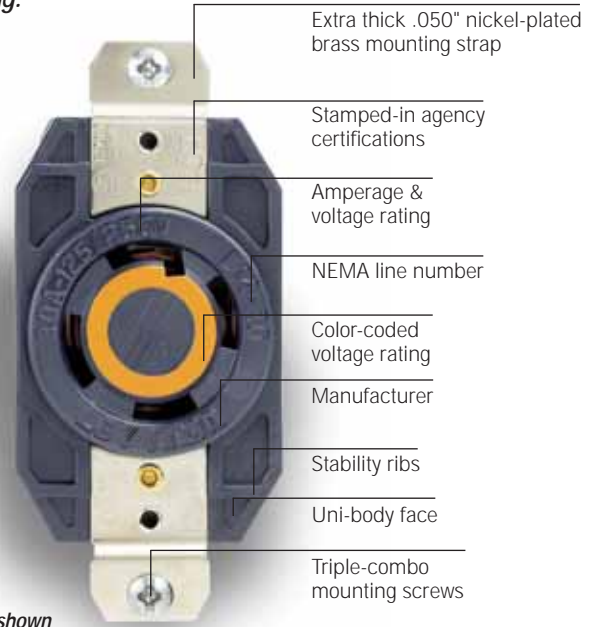

2710 shown

Seam between front cover and back cover is far from contact arcing

Oversized #10 brass Phillips/Robertson/Straight Slot drive terminal screw

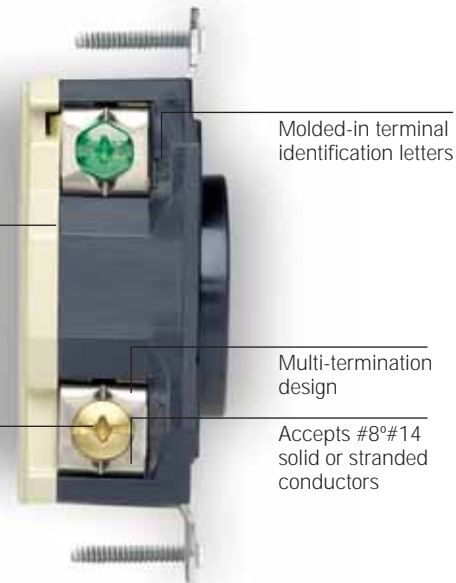

Contacts deeply seated in thick walled faced

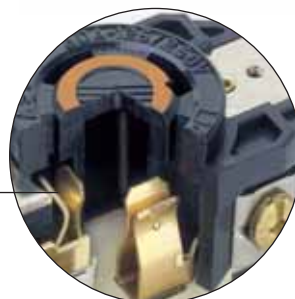

One-piece .040" thick brass, high-copper content contacts with nickel-plated clamp type terminals



Mechanically-secured all-brass ground path

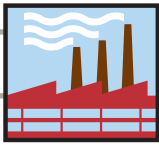

WETGUARD® LOCKING AND CORROSION RESISTANT DEVICE FEATURES

Industrial Grade Locking and Corrosion Resistant Devices



LIFETIME WARRANTY

Clear back cover on wiring module for easy inspection of wired terminals

Rubber body is molded to bondable nylon substrate to maximize sealing capability

Heavy-duty, one-piece nickel-plated brass contacts for maximum conductivity

NEMA configuration number and rating molded onto device face

Cord Ranges
.375" min., 1.125" max.

26W47 shown

Deep-fluted finger grips make for a firm grip when tightening nut

Extra large, deep wiring wells for quick, easy insertion of stranded conductors

Module and husk keyed for alignment

Non-magnetic stainless steel body assembly screws prevent electromagnetic interference

Combination Phillips/standard assembly screws (Robertson/Slotted for Canada)

Nickel-plated brass blades, contacts, wiring screws and lugs resist corrosion

Innovative strain relief system and compression nut provide a watertight seal and prevent cord slippage

EPTB rubber parts resist water and most acids, alkalis, grease, oil, and solvents. Offers UV stability and resists fungal growth



Wetguard Products are Engineered to Meet or Exceed UL and IEC Watertight Standards

- UL 498 Listed
- Federal Specification WC-596 Listed
- CSA Specification C22.2 No. 42 Certified
- Meets IP and NEMA Watertight Standards

Leviton's Corrosion Resistant Devices are specifically designed for extremely damp and corrosive environments. They offer additional corrosive resistance because the metal parts (blades, contacts, terminals and screws) are nickel-plated. They have also passed the ASTM (B117.13) 500 hour Salt Spray (Fog) Test.

Solid brass plug blades held tightly in individual module configurations

Non-magnetic stainless steel assembly screws will not interfere with sensitive navigational equipment

Captive, brass #8 terminal screws are color coded for easy wiring identification

Plug blades avoid contaminants in interior chamber

52CM-69C shown

All current-carrying metal parts (blades, contacts, terminals and screws) are electroless nickel-coated

Heavy-duty, impact-resistant, super tough ST801 all-nylon body construction, with sure grip fluted design

Nylon plug and connector body is distinguished by a bright yellow color for easy identification as corrosion resistant

WEATHER RESISTANT BOOTS AND COVERS FOR CORROSION RESISTANT DEVICES

Weather-resistant boots and covers for plugs and connectors are available for 15A, 20A, 30A and 50A straight and locking plugs and connectors. The tough, rubber triple-seal design protects devices against the harmful effects of dirt and moisture. Thermoplastic covers for 15A, 20A and 30A flush receptacles have close-fitting, spring-loaded lids to protect outlets against the elements in harsh environments. Boots and covers are listed after their appropriate device.

52CM-66C shown

Wiring module keyed to body for easy assembly and tight fit

Wire clamp provides positive crimp lock without cutting wire strands

Mill-slotted, stainless steel cord clamp screws set in deep-funnelled wells

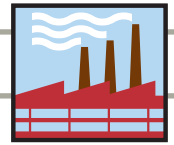

Locking and Corrosion Resistant Devices

N



Industrial Grade Locking Devices

15 AMP 125V 2-Pole 3-Wire Grounding

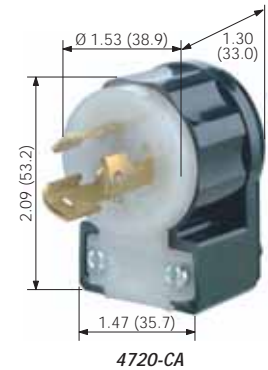

DESCRIPTION	CAT. NO.	NEMA CONFIG.
Dustguard™ Locking Plug, Yellow EPTR Body	2447	
Dustguard™ Locking Connector, Yellow EPTR Body	2547	
Duplex Flush Receptacle, Self Grounding, Back and Side Wired	4700	
Duplex Flush Receptacle w/2 Hot Feeds and 1 Neutral Return, Self Grounding, Back and Side Wired	4702-IIR	
Duplex Flush Receptacle w/Split Feed — 2 Hot Feeds and 2 Neutral Returns, Self Grounding, Back and Side Wired	4703-IIR	
Duplex Flush Receptacle, Isolated Ground, Back and Side Wired	4700-IG	
Single Flush Receptacle	4710	
Single Flush Receptacle, w/Short Strap	4710-SS	
Single Flush Receptacle, Isolated Ground	4710-IG	
Locking Flanged Outlet	4715-C	
Locking Flanged Inlet	4716-C	
Locking Plug, Black & White Nylon Body	4720-C	
Power Indication™ Locking Plug, Black & White Nylon Body	4720-PLC	
Angle Locking Plug, Black & White Nylon Body	4720-CA	
Locking Plug, All Black Nylon for Stage and Studio	4720-CB	
Locking Plug, Yellow Nylon Body	4720-CY	
Locking Connector, Black & White Nylon Body	4729-C	
Power Indication™ Locking Connector, Black Nylon Body	4729-PLC	
Locking Connector, All Black Nylon for Stage and Studio	4729-CB	
Locking Connector, Yellow Nylon Body	4729-CY	



Weather-Resistant Boots for 15A Locking Plugs and Connectors are listed on page N27

Cord Clamp Range—Black & White Plugs and Connectors: .240"–.700" #18–#10 AWG Dustguard Plugs and Connectors: .240"–.655" #18–#12 AWG

Wallplates and Covers

302 STAINLESS STEEL SINGLE RECEPTACLE	302 STAINLESS STEEL DUPLEX RECEPTACLE	WEATHER-RESISTANT FLIP LID COVER FOR INLETS AND OUTLETS
1.41" Dia. Opening		IP64 Rated—Includes Gasket and Screws
		
84004-40	84003-40	WP1

For complete wallplate selection, see Section E.

SPECIFICATIONS AND FEATURES

Locking Flush Receptacles

- Rugged nylon body and cover for outstanding resistance to impact and harsh chemicals
- Double-wipe phosphor-bronze power contacts

Locking Plugs and Connectors

- Super tough Nylon body resists damage from severe impact, abrasion and chemicals
- Ergonomic, fluted body design with radial grip ridge is ideal for gripping, turning and pulling
- Cord clamp does not have to be disassembled from body for wiring—accepts all wire mesh strain reliefs
- One-piece, rivetless .035" thick brass connector contacts and solid brass plug blades provide maximum conductivity and long service life
- Power Indication™ 15A Locking Plugs & Connectors equipped with green neon bulb rated at 30,000 hours (24/7) for 3.5 years

Flanged Inlets and Outlets

- Rugged nylon flange fits flush and won't crack in high-abuse applications
- Individual deep-funneled chamfered wire wells guide each wire into rectangular chambers
- Wire clamps provide positive crimp lock without cutting wire strands

Dustguard Plugs and Connectors

- IEC IP44 Rated
- Developed to withstand dusty and dirty environments, cracking and fading, temperature extremes
- Rugged wiring modules have high performance single-piece brass triple-wipe contacts, solid brass plug blades

TESTING AND CODE COMPLIANCE

- All receptacles, plugs, connectors, inlets and outlets are designed to meet NEMA WD-6, and ANSI C-73, and to meet/exceed UL 498 standards
- UL Fed. Spec. Listed WC-596 – Plugs, Connectors and Flanged Inlets (File #E-13393), Receptacles and Flanged Outlets (File #E-13399)
- CSA Certified (File #LR-406)
- NOM Certified (#057)
- Backed by a Lifetime Warranty

MATERIAL CHARACTERISTICS

Environmental: Flammability Rated V2 per UL94
Operating Temperature: -40°C to 60°C

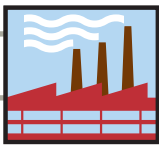

15 AMP 250V, 277V and 3Ø 250V

Industrial Grade Locking Devices



4570-CA

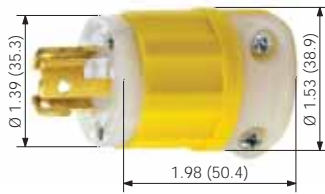

4570-CY

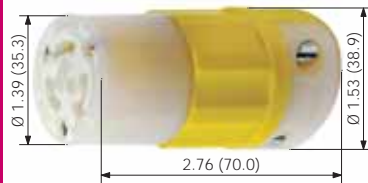

4579-CY

Cord Clamp Range—Black & White Plugs and Connectors: .240"–.700" #18–#10 AWG

15 AMP 250V 2-Pole 3-Wire Grounding

DESCRIPTION	CAT. NO.	NEMA CONFIG.
Duplex Flush Receptacle, Self Grounding, Back and Side Wired	4550	
Duplex Flush Receptacle, Isolated Ground, Back and Side Wired	4550-IG	
Single Flush Receptacle	4560	
Single Flush Receptacle, Isolated Ground	4560-IG	
Locking Plug, Black & White Nylon Body	4570-C	
Power Indication™ Locking Plug, Black & White Nylon Body	4570-PLC	
Angle Locking Plug, Black & White Nylon Body	4570-CA	L6-15P L6-15R
Locking Plug, Yellow Nylon Body	4570-CY	
Locking Connector, Black & White Nylon Body	4579-C	
Power Indication™ Locking Connector, Black & White Nylon Body	4579-PLC	
Locking Connector, Yellow Nylon Body	4579-CY	
Locking Flanged Outlet	4585-C	
Locking Flanged Inlet	4586-C	

15 AMP 277V 2-Pole 3-Wire Grounding

DESCRIPTION	CAT. NO.	NEMA CONFIG.
Duplex Flush Receptacle, Self Grounding, Back and Side Wired	4750	
Duplex Flush Receptacle, Isolated Ground, Back and Side Wired	4570-IG	
Single Flush Receptacle	4760	
Single Flush Receptacle, Isolated Ground	4760-IG	
Locking Plug, Black & White Nylon Body	4770-C	
Power Indication™ Locking Plug, Black & White Nylon Body	4770-PLC	
Angle Locking Plug, Black & White Nylon Body	4770-CA	L7-15P L7-15R
Locking Plug, Yellow Nylon Body	4770-CY	
Locking Connector, Black & White Nylon Body	4779-C	
Locking Connector, Yellow Nylon Body	4779-CY	
Power Indication™ Locking Connector, Black & White Nylon Body	4779-PLC	
Locking Flanged Outlet	4785-C	
Locking Flanged Inlet	4786-C	

15 AMP 3Ø 250V 3-Pole 3-Wire Non-Grounding

DESCRIPTION	CAT. NO.	NEMA CONFIG.
Single Flush Receptacle	4870	
Locking Plug, Black & White Nylon Body	4880-C	L11-15P L11-15R
Locking Connector, Black & White Nylon Body	4889-C	

Weather-Resistant Boots for 15A Locking Plugs and Connectors are listed on page N27

Wallplates and Covers

302 STAINLESS STEEL SINGLE RECEPTACLE	302 STAINLESS STEEL DUPLEX RECEPTACLE	WEATHER-RESISTANT FLIP LID COVER FOR INLETS AND OUTLETS
1.41" Dia. Opening		IP64 Rated—Includes Gasket and Screws
84004-40	84003-40	WP1

For complete wallplate selection, see Section E.

SPECIFICATIONS AND FEATURES

Locking Flush Receptacles

- Rugged nylon body and cover for outstanding resistance to impact and harsh chemicals
- Double-wipe phosphor-bronze power contacts

Locking Plugs and Connectors

- Super tough Nylon body resists damage from severe impact, abrasion and chemicals
- Ergonomic, fluted body design with radial grip ridge is ideal for gripping, turning and pulling
- Cord clamp does not have to be disassembled from body for wiring—accepts all wire mesh strain reliefs

- One-piece, rivetless .035" thick brass connector contacts and solid brass plug blades provide maximum conductivity and long service life
- Power Indication™ 15A Locking Plugs & Connectors equipped with green neon bulb rated at 30,000 hours (24/7) for 3.5 years

Flanged Inlets and Outlets

- Rugged nylon flange fits flush and won't crack in high-abuse applications
- Individual deep-funneled chamfered wire wells guide each wire into rectangular chambers
- Wire clamps provide positive crimp lock without cutting wire strands

TESTING AND CODE COMPLIANCE

- All receptacles, plugs, connectors, inlets and outlets are designed to meet NEMA WD-6, and ANSI C-73, and to meet/exceed UL 498 standards
- UL Fed Spec. Listed WC-596 – Plugs, Connectors and Flanged Inlets (File #E-13393), Receptacles and Flanged Outlets (File #E-13399)
- CSA Certified (File #LR-406)
- NOM Certified (#057)
- Backed by a Lifetime Warranty

MATERIAL CHARACTERISTICS

Environmental: Flammability Rated V2 per UL94
Operating Temperature: -40°C to 60°C

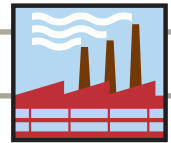

20 AMP 125V 2-Pole 3-Wire Grounding

DESCRIPTION	CAT. NO.	NEMA CONFIG.
V-O-MAX® Single Flush Receptacle	2310	
V-O-MAX® Single Flush Receptacle, Isolated Ground	2310-IG	
Locking Plug, Black & White Nylon Body	2311	
Power Indication™ Locking Plug, Black & White Nylon Body	2311-PLC	
Locking Plug, all Black for Stage and Studio	2311-B	
Power Indication™ Locking Plug, All-Black Nylon Body	2311-PLB	
Locking Plug, Yellow Nylon Body	2311-CY	
Locking Connector, Black & White Nylon Body	2313	
Power Indication™ Locking Connector, Black & White Nylon Body	2313-PLC	
Locking Connector, all Black for Stage and Studio	2313-B	
Power Indication™ Locking Connector, All-Black Nylon Body	2313-PLB	
Locking Connector, Yellow Nylon Body	2313-CY	
Locking Flanged Inlet	2315	
Locking Flanged Outlet	2316	

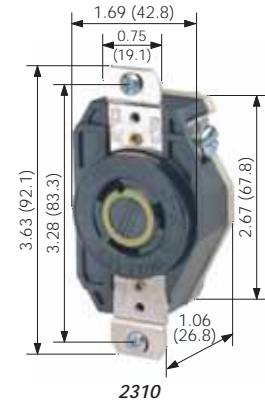

20 AMP 250V 2-Pole 3-Wire Grounding

DESCRIPTION	CAT. NO.	NEMA CONFIG.
V-O-MAX® Single Flush Receptacle	2320	
V-O-MAX® Single Flush Receptacle, Isolated Ground	2320-IG	
Locking Plug, Black & White Nylon Body	2321	
Power Indication™ Locking Plug, Black & White Nylon Body	2321-PLC	
Power Indication™ Locking Plug, All-Black Nylon Body	2321-PLB	
Locking Plug, Yellow Nylon Body	2321-CY	
Locking Connector, Black & White Nylon Body	2323	
Power Indication™ Locking Connector, Black & White Nylon Body	2323-PLC	
Power Indication™ Locking Connector, All-Black Nylon Body	2323-PLB	
Locking Connector, Yellow Nylon Body	2323-CY	
Locking Flanged Inlet	2325	
Locking Flanged Outlet	2326	



20 AMP 277V 2-Pole 3-Wire Grounding

DESCRIPTION	CAT. NO.	NEMA CONFIG.
V-O-MAX® Single Flush Receptacle	2330	
V-O-MAX® Single Flush Receptacle, Isolated Ground	2330-IG	
Locking Plug, Black & White Nylon Body	2331	
Power Indication™ Locking Plug, Black & White Nylon Body	2331-PLC	
Locking Connector, Black Nylon Body	2333	
Power Indication™ Locking Connector, Black & White Nylon Body	2333-PLC	
Locking Flanged Inlet	2335	
Locking Flanged Outlet	2336	



Weather-Resistant Boots for 20A Locking Plugs and Connectors are listed on page N27

For recommended Wallplates and Covers, see page N8.
For complete wallplate selection, see Section E.

Cord Clamp Range—Black & White Plugs and Connectors: .385"–.780" #16–#10 AWG

SPECIFICATIONS AND FEATURES

V-O-Max® Locking Flush Receptacles

- UL 94 V-O Flammability Rating, the best rating of any material used in Industrial Locking Flush Receptacles available today
- Extra-thick .050" nickel-plated brass mounting strap for high-abuse applications
- Designed for maximum durability: One-piece .040" brass, high copper-content contacts with nickel-plated clamp-type terminals
- Color-coded voltage rating on face for easy identification

Locking Plugs and Connectors

- Super tough Nylon body resists damage from severe impact, abrasion and chemicals
- Ergonomic, fluted body design with radial grip ridge is ideal for gripping, turning and pulling

- Cord clamp does not have to be disassembled from body for wiring—accepts all wire mesh strain reliefs
- One-piece, rivetless .035" thick brass connector contacts and solid brass plug blades provide maximum conductivity and long service life
- Power Indication™ 20A Locking Plugs & Connectors equipped with green LED rated at 100,000 hours (24/7) for 11.5 years

Flanged Inlets and Outlets

- Rugged nylon flange fits flush and won't crack in high-abuse applications
- Individual deep-funneled chamfered wire wells guide each wire into rectangular chambers
- Wire clamps provide positive crimp lock without cutting wire strands

TESTING AND CODE COMPLIANCE

- All receptacles, plugs, connectors, inlets and outlets are designed to meet NEMA WD-6, and ANSI C-73, and to meet/exceed UL 498 standards
- UL Fed Spec. Listed WC-596 – Plugs, Connectors and Flanged Inlets (File #E-13393), Receptacles and Flanged Outlets (File #E-13399)
- CSA Certified (File #LR-406)
- NOM Certified (#057)
- Backed by a Lifetime Warranty

MATERIAL CHARACTERISTICS

Environmental: Flammability Rated V2 per UL94, V-O-MAX® Receptacles Rated V0
Operating Temperature: -40°C to 60°C

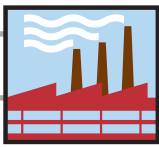

20 AMP 347V, 480V, 600V and 125/250V

Industrial Grade Locking Devices

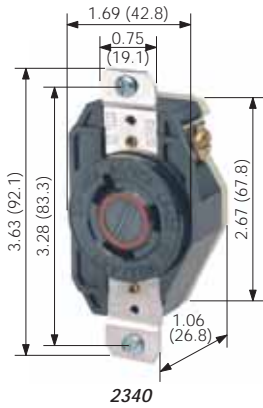

2340



2341



2343



2365

20 AMP 347V 2-Pole 3-Wire Grounding

DESCRIPTION	CAT. NO.	NEMA CONFIG.
V-O-MAX® Single Flush Receptacle	3720	
Locking Plug, Black & White Nylon Body	3721	L24-20P L24-20R
Locking Connector, Black & White Nylon Body	3723	
Locking Flanged Inlet	3755	
Locking Flanged Outlet	3756	

20 AMP 480V 2-Pole 3-Wire Grounding

DESCRIPTION	CAT. NO.	NEMA CONFIG.
V-O-MAX® Single Flush Receptacle	2340	
V-O-MAX® Single Flush Receptacle, Isolated Ground	2340-IG	
Locking Plug, Black & White Nylon Body	2341	L8-20P L8-20R
Locking Connector, Black & White Nylon Body	2343	
Locking Flanged Inlet	2345	
Locking Flanged Outlet	2346	

20 AMP 600V 2-Pole 3-Wire Grounding

DESCRIPTION	CAT. NO.	NEMA CONFIG.
V-O-MAX® Single Flush Receptacle	2350	
V-O-MAX® Single Flush Receptacle, Isolated Ground	2350-IG	
Locking Plug, Black & White Nylon Body	2351	L9-20P L9-20R
Locking Connector, Black & White Nylon Body	2353	
Locking Flanged Inlet	2355	
Locking Flanged Outlet	2356	

20 AMP 125/250V 3-Pole 3-Wire Non-Grounding

DESCRIPTION	CAT. NO.	NEMA CONFIG.
Single Flush Receptacle	2360	
Locking Plug, Black & White Nylon Body	2361	L10-20P L10-20R
Locking Connector, Black & White Nylon Body	2363	
Locking Flanged Inlet	2365	
Locking Flanged Outlet	2366	

Weather-Resistant Boots for 20A Locking Plugs and Connectors are listed on page N27

Cord Clamp Range—Black & White Plugs and Connectors: .385"–.780" #16–#10 AWG

Wallplates and Covers

302 STAINLESS STEEL SINGLE RECEPTACLE	WEATHER-RESISTANT FLIP LID COVER FOR 20A INLETS/OUTLETS AND 20A RECEPTACLES	WEATHER-RESISTANT THERMOPLASTIC COVER FOR RECEPTACLES
1.60" Dia. Opening	IP64 Rated—Includes Gasket and Screws	Self-Closing Lid—Includes Gasket and Screws
84020-40	WP2 for Inlets/Outlets 7420-CR for Receptacles	4980-GY

For complete wallplate selection, see Section E.

SPECIFICATIONS AND FEATURES

V-O-Max® Locking Flush Receptacles

- UL 94 V-O Flammability Rating, the best rating of any material used in Industrial Locking Flush Receptacles available today
- Extra-thick .050" nickel-plated brass mounting strap for high-abuse applications
- Designed for maximum durability: One-piece .040" brass, high copper-content contacts with nickel-plated clamp-type terminals
- Color-coded voltage rating on face for easy identification

Locking Plugs and Connectors

- Super tough Nylon body resists damage from severe impact, abrasion and chemicals

- Ergonomic, fluted body design with radial grip ridge is ideal for gripping, turning and pulling
- Cord clamp does not have to be disassembled from body for wiring—accepts all wire mesh strain reliefs
- One-piece, rivetless .035" thick brass connector contacts and solid brass plug blades provide maximum conductivity and long service life

Flanged Inlets and Outlets

- Rugged nylon flange fits flush and won't crack in high-abuse applications
- Individual deep-funneled chamfered wire wells guide each wire into rectangular chambers
- Wire clamps provide positive crimp lock without cutting wire strands

TESTING AND CODE COMPLIANCE

- All receptacles, plugs, connectors, inlets and outlets are designed to meet NEMA WD-6, and ANSI C-73, and to meet/exceed UL 498 standards
- UL Fed Spec. Listed WC-596 – Plugs, Connectors and Flanged Inlets (File #E-13393), Receptacles and Flanged Outlets (File #E-13399)
- CSA Certified (File #LR-406)
- NOM Certified (#057)
- Backed by a Lifetime Warranty

MATERIAL CHARACTERISTICS

Environmental: Flammability Rated V2 per UL94, V-O-MAX® Receptacles Rated V0
Operating Temperature: -40°C to 60°C

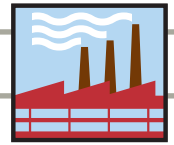



Industrial Grade Locking Devices

20 AMP 3Ø 250V 3-Pole 3-Wire Non-Grounding Ⓛ

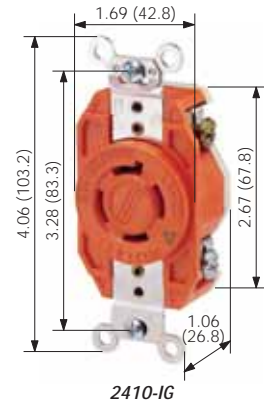
DESCRIPTION	CAT. NO.	NEMA CONFIG.
Single Flush Receptacle	2370	
Locking Plug, Black & White Nylon Body	2371	
Locking Connector, Black & White Nylon Body	2373	L11-20P  L11-20R 
Locking Flanged Inlet	2375	
Locking Flanged Outlet	2376	



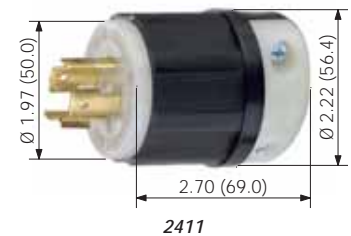

20 AMP 3Ø 480V 3-Pole 3-Wire Non-Grounding Ⓛ

DESCRIPTION	CAT. NO.	NEMA CONFIG.
Single Flush Receptacle	2380	
Locking Plug, Black & White Nylon Body	2381	
Locking Connector, Black & White Nylon Body	2383	L12-20P  L12-20R 
Locking Flanged Inlet	2385	
Locking Flanged Outlet	2386	



20 AMP 125/250V 3-Pole 4-Wire Grounding Ⓛ Ⓢ

DESCRIPTION	CAT. NO.	NEMA CONFIG.
V-O-MAX® Single Flush Receptacle	2410	
V-O-MAX® Single Flush Receptacle, Isolated Ground	2410-IG	
Locking Plug, Black & White Nylon Body	2411	
Locking Connector, Black & White Nylon Body	2413	L14-20P  L14-20R 
Locking Flanged Inlet	2415	
Locking Flanged Outlet	2416	



20 AMP 3Ø 250V 3-Pole 4-Wire Grounding Ⓛ Ⓢ



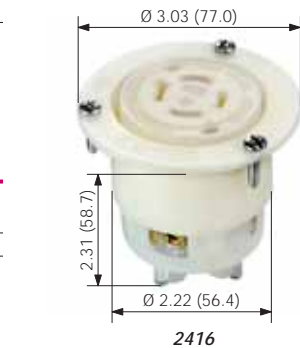

DESCRIPTION	CAT. NO.	NEMA CONFIG.
V-O-MAX® Single Flush Receptacle	2420†	
V-O-MAX® Single Flush Receptacle, Isolated Ground	2420-IG†	
Locking Plug, Black & White Nylon Body	2421	
Locking Connector, Black & White Nylon Body	2423	L15-20P  L15-20R 
Locking Flanged Inlet	2425	
Locking Flanged Outlet	2426	



Weather-Resistant Boots for 20A Locking Plugs and Connectors are listed on page N27

Cord Clamp Range—Black & White Plugs and Connectors 3-Wire: .385"–.780" #16–#10 AWG
4-Wire: .595"–.895" #14–#10 AWG

Wallplates and Covers

302 STAINLESS STEEL SINGLE RECEPTACLE	WEATHER-RESISTANT FLIP LID COVER FOR 20A INLETS/OUTLETS AND 20A RECEPTACLES	WEATHER-RESISTANT THERMOPLASTIC COVER FOR RECEPTACLES
1.60" Dia. Opening	IP64 Rated—Includes Gasket and Screws	Self-Closing Lid—Includes Gasket and Screws
	 	
84020-40	WP2 for Inlets/Outlets 7420-CR for Receptacles	4980-GY

For complete wallplate selection, see Section E.

SPECIFICATIONS AND FEATURES

V-O-Max® Locking Flush Receptacles

- UL 94 V-O Flammability Rating, the best rating of any material used in Industrial Locking Flush Receptacles available today
- Extra-thick .050" nickel-plated brass mounting strap for high-abuse applications
- Designed for maximum durability: One-piece .040" brass, high copper-content contacts with nickel-plated clamp-type terminals
- Color-coded voltage rating on face for easy identification

Locking Plugs and Connectors

- Super tough Nylon body resists damage from severe impact, abrasion and chemicals

- Ergonomic, fluted body design with radial grip ridge is ideal for gripping, turning and pulling
- Cord clamp does not have to be disassembled from body for wiring—accepts all wire mesh strain reliefs
- One-piece, rivetless .035" thick brass connector contacts and solid brass plug blades provide maximum conductivity and long service life

Flanged Inlets and Outlets

- Rugged nylon flange fits flush and won't crack in high-abuse applications
- Individual deep-funneled chamfered wire wells guide each wire into rectangular chambers
- Wire clamps provide positive crimp lock without cutting wire strands

TESTING AND CODE COMPLIANCE

- All receptacles, plugs, connectors, inlets and outlets are designed to meet NEMA WD-6, and ANSI C-73, and to meet/exceed UL 498 standards
- UL Fed Spec. Listed WC-596 – Plugs, Connectors and Flanged Inlets (File #E-13393), Receptacles and Flanged Outlets (File #E-13399)
- CSA Certified (File #LR-406)
- NOM Certified (#057)
- Backed by a Lifetime Warranty

MATERIAL CHARACTERISTICS

Environmental: Flammability Rated V2 per UL94, V-O-MAX® Receptacles Rated V0
Operating Temperature: -40°C to 60°C

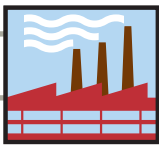

20 AMP 3Ø 480V; 3ØY 120/208V, 277/480V and 347/600V

Industrial Grade Locking Devices

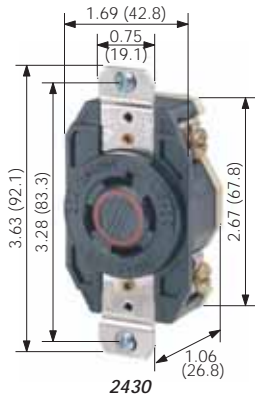

2430



2431



2433



2435

20 AMP 3Ø 480V 3-Pole 4-Wire Grounding

DESCRIPTION	CAT. NO.	NEMA CONFIG.
V-O-MAX® Single Flush Receptacle	2430	
V-O-MAX® Single Flush Receptacle, Isolated Ground	2430-IG	
Locking Plug, Black & White Nylon Body	2431	L16-20P
Locking Connector, Black & White Nylon Body	2433	L16-20R
Locking Flanged Inlet	2435	
Locking Flanged Outlet	2436	

20 AMP 3ØY 120/208V 4-Pole 4-Wire Non-Grounding

DESCRIPTION	CAT. NO.	NEMA CONFIG.
Single Flush Receptacle	2440	
Locking Plug, Black & White Nylon Body	2441	L18-20P
Locking Connector, Black & White Nylon Body	2443	L18-20R
Locking Flanged Inlet	2445	
Locking Flanged Outlet	2446	

20 AMP 3ØY 277/480V 4-Pole 4-Wire Non-Grounding

DESCRIPTION	CAT. NO.	NEMA CONFIG.
Single Flush Receptacle	2450	
Locking Plug, Black & White Nylon Body	2451	L19-20P
Locking Connector, Black & White Nylon Body	2453	L19-20R
Locking Flanged Inlet	2455	
Locking Flanged Outlet	2456	

20 AMP 3ØY 347/600V 4-Pole 4-Wire Non-Grounding

DESCRIPTION	CAT. NO.	NEMA CONFIG.
Single Flush Receptacle	2460	
Locking Plug, Black & White Nylon Body	2461	L20-20P
Locking Connector, Black & White Nylon Body	2463	L20-20R
Locking Flanged Inlet	2465	
Locking Flanged Outlet	2466	

Weather-Resistant Boots for 20A Locking Plugs and Connectors are listed on page N27

Cord Clamp Range—Black & White Plugs and Connectors: .595"-.895" #14-#10 AWG

Wallplates and Covers

302 STAINLESS STEEL SINGLE RECEPTACLE 1.60" Dia. Opening	WEATHER-RESISTANT FLIP LID COVER FOR 20A INLETS/OUTLETS AND 20A RECEPTACLES IP64 Rated—Includes Gasket and Screws	WEATHER-RESISTANT THERMOPLASTIC COVER FOR RECEPTACLES Self-Closing Lid—Includes Gasket and Screws
84020-40	WP2 for Inlets/Outlets	7420-CR for Receptacles
		4980-GY

For complete wallplate selection, see Section E.

SPECIFICATIONS AND FEATURES

V-O-Max® Locking Flush Receptacles

- UL 94 V-O Flammability Rating, the best rating of any material used in Industrial Locking Flush Receptacles available today
- Extra-thick .050" nickel-plated brass mounting strap for high-abuse applications
- Designed for maximum durability: One-piece .040" brass, high copper-content contacts with nickel-plated clamp-type terminals
- Color-coded voltage rating on face for easy identification

Locking Plugs and Connectors

- Super tough Nylon body resists damage from severe impact, abrasion and chemicals

- Ergonomic, fluted body design with radial grip ridge is ideal for gripping, turning and pulling
- Cord clamp does not have to be disassembled from body for wiring—accepts all wire mesh strain reliefs
- One-piece, rivetless .035" thick brass connector contacts and solid brass plug blades provide maximum conductivity and long service life

Flanged Inlets and Outlets

- Rugged nylon flange fits flush and won't crack in high-abuse applications
- Individual deep-funneled chamfered wire wells guide each wire into rectangular chambers
- Wire clamps provide positive crimp lock without cutting wire strands

TESTING AND CODE COMPLIANCE

- All receptacles, plugs, connectors, inlets and outlets are designed to meet NEMA WD-6, and ANSI C-73, and to meet/exceed UL 498 standards
- UL Fed Spec. Listed WC-596 – Plugs, Connectors and Flanged Inlets (File #E-13393), Receptacles and Flanged Outlets (File #E-13399)
- CSA Certified (File #LR-406)
- NOM Certified (#057)
- Backed by a Lifetime Warranty

MATERIAL CHARACTERISTICS

Environmental: Flammability Rated V2 per UL94, V-O-MAX® Receptacles Rated V0
Operating Temperature: -40°C to 60°C

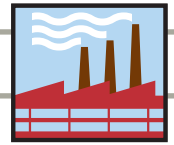

Industrial Grade Locking Devices

20 AMP 3ØY 120/208V 4-Pole 5-Wire Grounding

DESCRIPTION	CAT. NO.	NEMA CONFIG.
V-O-MAX® Single Flush Receptacle	2510	
V-O-MAX® Single Flush Receptacle, Isolated Ground	2510-IG	
Locking Plug, Black & White Nylon Body	2511	L21-20P L21-20R
Locking Connector, Black & White Nylon Body	2513	
Locking Flanged Inlet	2515	
Locking Flanged Outlet	2516	

20 AMP 3ØY 277/480V 4-Pole 5-Wire Grounding

DESCRIPTION	CAT. NO.	NEMA CONFIG.
V-O-MAX® Single Flush Receptacle	2520	
V-O-MAX® Single Flush Receptacle, Isolated Ground	2520-IG	
Locking Plug, Black & White Nylon Body	2521	L22-20P L22-20R
Locking Connector, Black & White Nylon Body	2523	
Locking Flanged Inlet	2525	
Locking Flanged Outlet	2526	

20 AMP 3ØY 347/600V 4-Pole 5-Wire Grounding

DESCRIPTION	CAT. NO.	NEMA CONFIG.
Single Flush Receptacle	2530	
Single Flush Receptacle, Isolated Ground	2530-IG	
Locking Plug, Black & White Nylon Body	2531	L23-20P L23-20R
Locking Connector, Black & White Nylon Body	2533	
Locking Flanged Inlet	2545	
Locking Flanged Outlet	2546	

Weather-Resistant Boots for 20A Locking Plugs and Connectors are listed on page N27

Cord Clamp Range—Black & White Plugs and Connectors: .595"–.895" #14–#10 AWG

Wallplates and Covers

302 STAINLESS STEEL SINGLE RECEPTACLE	WEATHER-RESISTANT FLIP LID COVER FOR 20A INLETS/OUTLETS AND 20A RECEPTACLES	WEATHER-RESISTANT THERMOPLASTIC COVER FOR RECEPTACLES
1.60" Dia. Opening	IP64 Rated—Includes Gasket and Screws	Self-Closing Lid—Includes Gasket and Screws
84020-40	WP2 for Inlets/Outlets 7420-CR for Receptacles	4980-GY

For complete wallplate selection, see Section E.



Locking Devices

SPECIFICATIONS AND FEATURES

Locking Flush Receptacles

- UL 94 V-O Flammability Rating, the best rating of any material used in Industrial Locking Flush Receptacles available today
- Extra-thick .050" nickel-plated brass mounting strap for high-abuse applications
- Designed for maximum durability: One-piece .040" brass, high copper-content contacts with nickel-plated clamp-type terminals
- Color-coded voltage rating on face for easy identification

Locking Plugs and Connectors

- Super tough Nylon body resists damage from severe impact, abrasion and chemicals

- Ergonomic, fluted body design with radial grip ridge is ideal for gripping, turning and pulling
- Cord clamp does not have to be disassembled from body for wiring—accepts all wire mesh strain reliefs
- One-piece, rivetless .035" thick brass connector contacts and solid brass plug blades provide maximum conductivity and long service life

Flanged Inlets and Outlets

- Rugged nylon flange fits flush and won't crack in high-abuse applications
- Individual deep-funneled chamfered wire wells guide each wire into rectangular chambers
- Wire clamps provide positive crimp lock without cutting wire strands

TESTING AND CODE COMPLIANCE

- All receptacles, plugs, connectors, inlets and outlets are designed to meet NEMA WD-6, and ANSI C-73, and to meet/exceed UL 498 standards
- UL Fed Spec. Listed WC-596 – Plugs, Connectors and Flanged Inlets (File #E-13393), Receptacles and Flanged Outlets (File #E-13399)
- CSA Certified (File #LR-406)
- NOM Certified (#057)
- Backed by a Lifetime Warranty

MATERIAL CHARACTERISTICS

Environmental: Flammability Rated V2 per UL94, V-O-MAX® Receptacles Rated V0
Operating Temperature: -40°C to 60°C

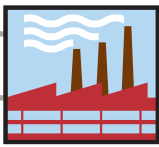

30 AMP 125V, 250V and 277V Industrial Grade Locking Devices

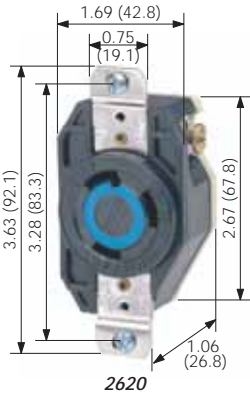

2620





2621-B





2625F

Cord Clamp Range—Black & White Plugs and Connectors: .385"–.860" #16–#8 AWG



30 AMP 125V 2-Pole 3-Wire Grounding

DESCRIPTION	CAT. NO.	NEMA CONFIG.
V-0-MAX® Single Flush Receptacle	2610	
V-0-MAX® Single Flush Receptacle, Isolated Ground	2610-IG	
Locking Plug, Black & White Nylon Body	2611	
Power Indication™ Locking Plug, Black & White Nylon Body	2611-PLC	
Locking Plug, All Black for Stage and Studio	2611-B	
Power Indication™ Locking Plug, All-Black Nylon Body	2611-PLB	
Locking Plug, Yellow Nylon Body	2611-CY	 
Locking Connector, Black & White Nylon Body	2613	
Power Indication™ Locking Connector, Black & White Nylon Body	2613-PLC	
Locking Connector, All Black for Stage and Studio	2613-B	
Power Indication™ Locking Connector, All-Black Nylon Body	2613-PLB	
Locking Connector, Yellow Nylon Body	2613-CY	
Locking Flanged Inlet	2615	
Locking Flanged Outlet	2616	

30 AMP 250V 2-Pole 3-Wire Grounding

DESCRIPTION	CAT. NO.	NEMA CONFIG.
V-0-MAX® Single Flush Receptacle	2620	
V-0-MAX® Single Flush Receptacle, Isolated Ground	2620-IG	
Locking Plug, Black & White Nylon Body	2621	
Power Indication™ Locking Plug, Black & White Nylon Body	2621-PLC	
Locking Plug, All Black for Stage and Studio	2621-B	
Locking Plug, Yellow Nylon Body	2621-CY	
Locking Connector, Black & White Nylon Body	C2623	 
Power Indication™ Locking Connector, Black & White Nylon Body	2623-PLC	
Locking Connector, All Black for Stage and Studio	C2623-B	
Locking Connector, Yellow Nylon Body	C2623-CY	
Locking Flanged Inlet	2625F	
Locking Flanged Outlet	2626F	

30 AMP 277V 2-Pole 3-Wire Grounding

DESCRIPTION	CAT. NO.	NEMA CONFIG.
V-0-MAX® Single Flush Receptacle	2630	
V-0-MAX® Single Flush Receptacle, Isolated Ground	2630-IG	
Locking Plug, Black & White Nylon Body	2631	
Power Indication™ Locking Plug, Black & White Nylon Body	2631-PLC	
Locking Connector, Black & White Nylon Body	2633	 
Power Indication™ Locking Connector, Black & White Nylon Body	2633-PLC	
Locking Flanged Inlet	2635	
Locking Flanged Outlet	2636	

Weather-Resistant Boots for 30A Locking Plugs and Connectors are listed on page N27

*For recommended Wallplates and Covers, see page N13.
For complete wallplate selection, see Section E.*

SPECIFICATIONS AND FEATURES

V-0-Max® Locking Flush Receptacles

- UL 94 V-0 Flammability Rating, the best rating of any material used in Industrial Locking Flush Receptacles available today
- Extra-thick .050" nickel-plated brass mounting strap for high-abuse applications
- Designed for maximum durability: One-piece .040" brass, high copper-content contacts with nickel-plated clamp-type terminals
- Color-coded voltage rating on face for easy identification

Locking Plugs and Connectors

- Super tough Nylon body resists damage from severe impact, abrasion and chemicals

- Ergonomic, fluted body design with radial grip ridge is ideal for gripping, turning and pulling
- Cord clamp does not have to be disassembled from body for wiring—accepts all wire mesh strain reliefs
- One-piece, rivetless .035" thick brass connector contacts and solid brass plug blades provide maximum conductivity and long service life
- Power Indication™ 30A Locking Plugs & Connectors equipped with green LED rated at 100,000 hours (24/7) for 11.5 years

Flanged Inlets and Outlets

- Rugged nylon flange fits flush and won't crack in high-abuse applications
- Individual deep-funneled chamfered wire wells guide each wire into rectangular chambers
- Wire clamps provide positive crimp lock without cutting wire strands

TESTING AND CODE COMPLIANCE

- All receptacles, plugs, connectors, inlets and outlets are designed to meet NEMA WD-6, and ANSI C-73, and to meet/exceed UL 498 standards
- UL Fed Spec. Listed WC-596 – Plugs, Connectors and Flanged Inlets (File #E-13393), Receptacles and Flanged Outlets (File #E-13399)
- CSA Certified (File #LR-406)
- NOM Certified (#057)
- Backed by a Lifetime Warranty

MATERIAL CHARACTERISTICS

Environmental: Flammability Rated V2 per UL94, V-0-MAX® Receptacles Rated V0
Operating Temperature: -40°C to 60°C

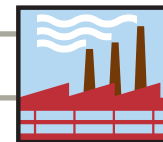

Industrial Grade Locking Devices

30 AMP 480V 2-Pole 3-Wire Grounding

DESCRIPTION	CAT. NO.	NEMA CONFIG.
V-O-MAX® Single Flush Receptacle	2640	
V-O-MAX® Single Flush Receptacle, Isolated Ground	2640-IG	
Locking Plug, Black & White Nylon Body	2641	L8-30P L8-30R
Locking Connector, Black & White Nylon Body	2643	
Locking Flanged Inlet	2645	
Locking Flanged Outlet	2646	

30 AMP 600V 2-Pole 3-Wire Grounding

DESCRIPTION	CAT. NO.	NEMA CONFIG.
V-O-MAX® Single Flush Receptacle	2650	
V-O-MAX® Single Flush Receptacle, Isolated Ground	2650-IG	
Locking Plug, Black & White Nylon Body	C2651	L9-30P L9-30R
Locking Connector, Black & White Nylon Body	C2653	
Locking Flanged Inlet	2655	
Locking Flanged Outlet	2656	

30 AMP 125/250V 3-Pole 3-Wire Non-Grounding

DESCRIPTION	CAT. NO.	NEMA CONFIG.
V-O-MAX® Single Flush Receptacle	2660	
Locking Plug, Black & White Nylon Body	2661	
Locking Connector, Black & White Nylon Body	2663	L10-30P L10-30R
Locking Flanged Inlet	2665	
Locking Flanged Outlet	2666	

30 AMP 3Ø 250V 3-Pole 3-Wire Non-Grounding

DESCRIPTION	CAT. NO.	NEMA CONFIG.
V-O-MAX® Single Flush Receptacle	2670	
Locking Plug, Black & White Nylon Body	2671	
Locking Connector, Black & White Nylon Body	2673	L11-30P L11-30R
Locking Flanged Inlet	2675	
Locking Flanged Outlet	2676	

Weather-Resistant Boots for 30A Locking Plugs and Connectors are listed on page N27

Cord Clamp Range—Black & White Plugs and Connectors: .385"–.860" #16–#8 AWG

Wallplates and Covers

302 STAINLESS STEEL SINGLE RECEPTACLE	WEATHER-RESISTANT FLIP LID COVER FOR 30A INLETS/OUTLETS AND 30A RECEPTACLES	WEATHER-RESISTANT THERMOPLASTIC COVER FOR RECEPTACLES
1.60" Dia. Opening	IP64 Rated—Includes Gasket and Screws	Self-Closing Lid—Includes Gasket and Screws
84020-40	WP2 for Inlets/Outlets 7420-CR for Receptacles	4980-GY

For complete wallplate selection, see Section E.

SPECIFICATIONS AND FEATURES

Locking Flush Receptacles

- UL 94 V-O Flammability Rating, the best rating of any material used in Industrial Locking Flush Receptacles available today
- Extra-thick .050" nickel-plated brass mounting strap for high-abuse applications
- Designed for maximum durability: One-piece .040" brass, high copper-content contacts with nickel-plated clamp-type terminals
- Color-coded voltage rating on face for easy identification

Locking Plugs and Connectors

- Super tough Nylon body resists damage from severe impact, abrasion and chemicals

- Ergonomic, fluted body design with radial grip ridge is ideal for gripping, turning and pulling
- Cord clamp does not have to be disassembled from body for wiring—accepts all wire mesh strain reliefs
- One-piece, rivetless, .035" thick brass connector contacts and solid brass plug blades provide maximum conductivity and long service life

Flanged Inlets and Outlets

- Rugged nylon flange fits flush and won't crack in high-abuse applications
- Individual deep-funneled chamfered wire wells guide each wire into rectangular chambers
- Wire clamps provide positive crimp lock without cutting wire strands

TESTING AND CODE COMPLIANCE

- All receptacles, plugs, connectors, inlets and outlets are designed to meet NEMA WD-6, and ANSI C-73, and to meet/exceed UL 498 standards
- UL Fed Spec. Listed WC-596 – Plugs, Connectors and Flanged Inlets (File #E-13393), Receptacles and Flanged Outlets (File #E-13399)
- CSA Certified (File #LR-406)
- NOM Certified (#057)
- Backed by a Lifetime Warranty

MATERIAL CHARACTERISTICS

Environmental: Flammability Rated V2 per UL94, V-O-MAX® Receptacles Rated V0
Operating Temperature: -40°C to 60°C



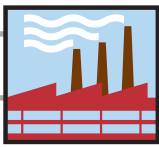

30 AMP 3Ø 480V, 3Ø 600V, 3Ø 250V and 125/250V

Industrial Grade Locking Devices

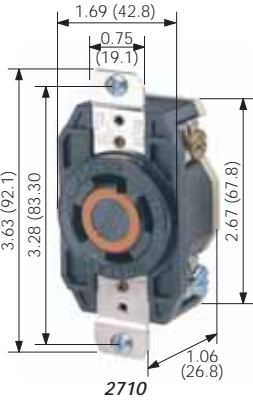

30 AMP 3Ø 480V 3-Pole 3-Wire Non-Grounding

DESCRIPTION	CAT. NO.	NEMA CONFIG.
Single Flush Receptacle	2680	
Locking Plug, Black & White Nylon Body	2681	
Locking Connector, Black & White Nylon Body	2683	L12-30P L12-30R
Locking Flanged Inlet	2685	
Locking Flanged Outlet	2686	

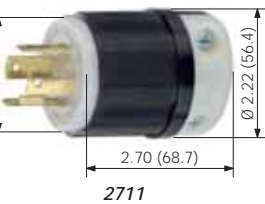

30 AMP 3Ø 600V 3-Pole 3-Wire Non-Grounding

DESCRIPTION	CAT. NO.	NEMA CONFIG.
Single Flush Receptacle	2690	
Locking Plug, Black & White Nylon Body	2691	
Locking Connector, Black & White Nylon Body	2693	L13-30P L13-30R
Locking Flanged Inlet	2695	
Locking Flanged Outlet	2696	



30 AMP 125/250V 3-Pole 4-Wire Grounding

DESCRIPTION	CAT. NO.	NEMA CONFIG.
V-O-MAX® Single Flush Receptacle	2710	
V-O-MAX® Single Flush Receptacle, Isolated Ground	2710-IG	
Locking Plug, Black & White Nylon Body	2711	
Locking Plug, Yellow Nylon Body	2711-CY	
Locking Connector, Black & White Nylon Body	2713	L14-30P L14-30R
Locking Connector, Yellow Nylon Body	2713-CY	
Locking Flanged Inlet	2715	
Locking Flanged Outlet	2716	



30 AMP 3Ø 250V 3-Pole 4-Wire Grounding

DESCRIPTION	CAT. NO.	NEMA CONFIG.
V-O-MAX® Single Flush Receptacle	2720	
V-O-MAX® Single Flush Receptacle, Isolated Ground	2720-IG	
Locking Plug, Black & White Nylon Body	2721	
Locking Connector, Black & White Nylon Body	2723	L15-30P L15-30R
Locking Flanged Inlet	2725	
Locking Flanged Outlet	2726	

Weather-Resistant Boots for 30A Locking Plugs and Connectors are listed on page N27

Cord Clamp Range—Black & White Plugs and Connectors 3-Wire: .385"–.860" #16–#8 AWG
4-Wire: .595"–1.150" #14–#8 AWG

Wallplates and Covers

302 STAINLESS STEEL SINGLE RECEPTACLE	WEATHER-RESISTANT FLIP LID COVER FOR 30A INLETS/OUTLETS AND 30A RECEPTACLES	WEATHER-RESISTANT THERMOPLASTIC COVER FOR RECEPTACLES
1.60" Dia. Opening	IP64 Rated—Includes Gasket and Screws	Self-Closing Lid—Includes Gasket and Screws
	WP2 for Inlets/Outlets 7420-CR for Receptacles	
84020-40		4980-GY

For complete wallplate selection, see Section E.

SPECIFICATIONS AND FEATURES

V-O-Max® Locking Flush Receptacles

- UL 94 V-O Flammability Rating, the best rating of any material used in Industrial Locking Flush Receptacles available today
- Extra-thick .050" nickel-plated brass mounting strap for high-abuse applications
- Designed for maximum durability: One-piece .040" brass, high copper-content contacts with nickel-plated clamp-type terminals
- Color-coded voltage rating on face for easy identification

Locking Plugs and Connectors

- Super tough Nylon body resists damage from severe impact, abrasion and chemicals

- Ergonomic, fluted body design with radial grip ridge is ideal for gripping, turning and pulling
- Cord clamp does not have to be disassembled from body for wiring—accepts all wire mesh strain reliefs
- One-piece, rivetless .035" thick brass connector contacts and solid brass plug blades provide maximum conductivity and long service life

Flanged Inlets and Outlets

- Rugged nylon flange fits flush and won't crack in high-abuse applications
- Individual deep-funneled chamfered wire wells guide each wire into rectangular chambers
- Wire clamps provide positive crimp lock without cutting wire strands

TESTING AND CODE COMPLIANCE

- All receptacles, plugs, connectors, inlets and outlets are designed to meet NEMA WD-6, and ANSI C-73, and to meet/exceed UL 498 standards
- UL Fed Spec. Listed WC-596 – Plugs, Connectors and Flanged Inlets (File #E-13393), Receptacles and Flanged Outlets (File #E-13399)
- CSA Certified (File #LR-406)
- NOM Certified (#057)
- Backed by a Lifetime Warranty

MATERIAL CHARACTERISTICS

Environmental: Flammability Rated V2 per UL94, V-O-MAX® Receptacles Rated V0
Operating Temperature: -40°C to 60°C

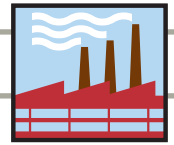

Industrial Grade Locking Devices

30 AMP 3Ø 480V 3-Pole 4-Wire Grounding

DESCRIPTION	CAT. NO.	NEMA CONFIG.
V-O-MAX® Single Flush Receptacle	2730	
V-O-MAX® Single Flush Receptacle, Isolated Ground	2730-IG	
Locking Plug, Black & White Nylon Body	2731	L16-30P L16-30R
Locking Connector, Black & White Nylon Body	2733	
Locking Flanged Inlet	2735	
Locking Flanged Outlet	2736	

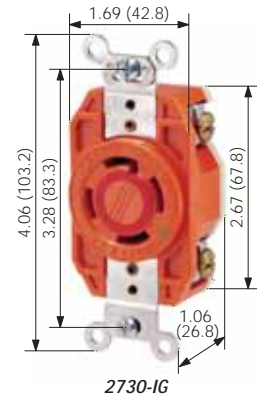

30 AMP 3Ø 600V 3-Pole 4-Wire Grounding

DESCRIPTION	CAT. NO.	NEMA CONFIG.
Single Flush Receptacle	2740	
Single Flush Receptacle, Isolated Ground	2740-IG	
Locking Plug, Black & White Nylon Body	2741	L17-30P L17-30R
Locking Connector, Black & White Nylon Body	2743	
Locking Flanged Inlet	2745	
Locking Flanged Outlet	2746	

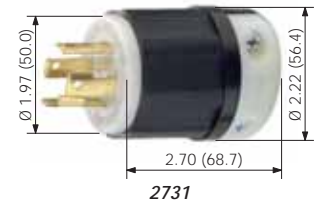

30 AMP 3ØY 120/208V 4-Pole 4-Wire Non-Grounding

DESCRIPTION	CAT. NO.	NEMA CONFIG.
Single Flush Receptacle	2750	
Locking Plug, Black & White Nylon Body	2751	
Locking Connector, Black & White Nylon Body	2753	L18-30P L18-30R
Locking Flanged Inlet	2755	
Locking Flanged Outlet	2756	



30 AMP 3ØY 277/480V 4-Pole 4-Wire Non-Grounding

DESCRIPTION	CAT. NO.	NEMA CONFIG.
Single Flush Receptacle	2760	
Locking Plug, Black & White Nylon Body	2761	
Locking Connector, Black & White Nylon Body	2763	L19-30P L19-30R
Locking Flanged Inlet	2765	
Locking Flanged Outlet	2766	



Weather-Resistant Boots for 30A Locking Plugs and Connectors are listed on page N27

Cord Clamp Range—Black & White Plugs and Connectors: .595"–1.150" #14–#8 AWG

Wallplates and Covers

302 STAINLESS STEEL SINGLE RECEPTACLE	WEATHER-RESISTANT FLIP LID COVER FOR 30A INLETS/OUTLETS AND 30A RECEPTACLES	WEATHER-RESISTANT THERMOPLASTIC COVER FOR RECEPTACLES
1.60" Dia. Opening	IP64 Rated—Includes Gasket and Screws	Self-Closing Lid—Includes Gasket and Screws
	WP2 for Inlets/Outlets	4980-GY
84020-40	7420-CR for Receptacles	

For complete wallplate selection, see Section E.

SPECIFICATIONS AND FEATURES

V-O-Max® Locking Flush Receptacles

- UL 94 V-O Flammability Rating, the best rating of any material used in Industrial Locking Flush Receptacles available today
- Extra-thick .050" nickel-plated brass mounting strap for high-abuse applications
- Designed for maximum durability: One-piece .040" brass, high copper-content contacts with nickel-plated clamp-type terminals
- Color-coded voltage rating on face for easy identification

Locking Plugs and Connectors

- Super tough Nylon body resists damage from severe impact, abrasion and chemicals

- Ergonomic, fluted body design with radial grip ridge is ideal for gripping, turning and pulling
- Cord clamp does not have to be disassembled from body for wiring—accepts all wire mesh strain reliefs
- One-piece, rivetless .035" thick brass connector contacts and solid brass plug blades provide maximum conductivity and long service life

Flanged Inlets and Outlets

- Rugged nylon flange fits flush and won't crack in high-abuse applications
- Individual deep-funneled chamfered wire wells guide each wire into rectangular chambers
- Wire clamps provide positive crimp lock without cutting wire strands

TESTING AND CODE COMPLIANCE

- All receptacles, plugs, connectors, inlets and outlets are designed to meet NEMA WD-6, and ANSI C-73, and to meet/exceed UL 498 standards
- UL Fed Spec. Listed WC-596 – Plugs, Connectors and Flanged Inlets (File #E-13393), Receptacles and Flanged Outlets (File #E-13399)
- CSA Certified (File #LR-406)
- NOM Certified (#057)
- Backed by a Lifetime Warranty

MATERIAL CHARACTERISTICS

Environmental: Flammability Rated V2 per UL94, V-O-MAX® Receptacles Rated V0
Operating Temperature: -40°C to 60°C

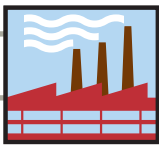

30 AMP 3ØY 347/600V, 3ØY 120/208V and 3ØY 277/480V

Industrial Grade Locking Devices

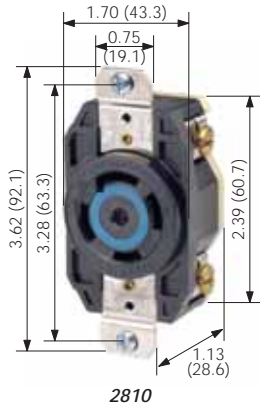

2810

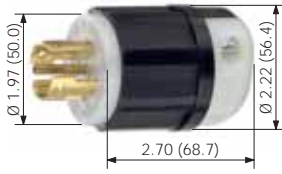

2811



2813



2816

Cord Clamp Range—Black & White Plugs and Connectors: .595"–1.150" #14–#8 AWG

30 AMP 3ØY 347/600V 4-Pole 4-Wire Non-Grounding

DESCRIPTION	CAT. NO.	NEMA CONFIG.
Single Flush Receptacle	2770	
Locking Plug, Black & White Nylon Body	2771	
Locking Connector, Black & White Nylon Body	2773	L20-30P L20-30R
Locking Flanged Inlet	2775	
Locking Flanged Outlet	2776	

30 AMP 3ØY 120/208V 4-Pole 5-Wire Grounding

DESCRIPTION	CAT. NO.	NEMA CONFIG.
V-O-MAX® Single Flush Receptacle	2810	
V-O-MAX® Single Flush Receptacle, Isolated Ground	2810-IG	
Locking Plug, Black & White Nylon Body	2811	L21-30P L21-30R
Locking Connector, Black & White Nylon Body	2813	
Locking Flanged Inlet	2815	
Locking Flanged Outlet	2816	

30 AMP 3ØY 277/480V 4-Pole 5-Wire Grounding

DESCRIPTION	CAT. NO.	NEMA CONFIG.
Single Flush Receptacle	2820	
Single Flush Receptacle, Isolated Ground	2820-IG	
Locking Plug, Black & White Nylon Body	2821	L22-30P L22-30R
Locking Connector, Black & White Nylon Body	2823	
Locking Flanged Inlet	2825	
Locking Flanged Outlet	2826	

30 AMP 3ØY 347/600V 4-Pole 5-Wire Grounding

DESCRIPTION	CAT. NO.	NEMA CONFIG.
Single Flush Receptacle	2830	
Single Flush Receptacle, Isolated Ground	2830-IG	
Locking Plug, Black & White Nylon Body	2831	L23-30P L23-30R
Locking Connector, Black & White Nylon Body	2833	
Locking Flanged Inlet	2835	
Locking Flanged Outlet	2836	

Weather-Resistant Boots for 30A Locking Plugs and Connectors are listed on page N27

Wallplates and Covers

302 STAINLESS STEEL SINGLE RECEPTACLE	WEATHER-RESISTANT FLIP LID COVER FOR 30A INLETS/OUTLETS AND 30A RECEPTACLES	WEATHER-RESISTANT THERMOPLASTIC COVER FOR RECEPTACLES
1.60" Dia. Opening	IP64 Rated—Includes Gasket and Screws	Self-Closing Lid—Includes Gasket and Screws
84020-40	WP2 for Inlets/Outlets 7420-CR for Receptacles	4980-GY

For complete wallplate selection, see Section E.

SPECIFICATIONS AND FEATURES

Locking Flush Receptacles

- UL 94 V-O Flammability Rating, the best rating of any material used in Industrial Locking Flush Receptacles available today
- Extra-thick .050" nickel-plated brass mounting strap for high-abuse applications
- Designed for maximum durability: One-piece .040" brass, high copper-content contacts with nickel-plated clamp-type terminals
- Color-coded voltage rating on face for easy identification

Locking Plugs and Connectors

- Super tough Nylon body resists damage from severe impact, abrasion and chemicals

- Ergonomic, fluted body design with radial grip ridge is ideal for gripping, turning and pulling
- Cord clamp does not have to be disassembled from body for wiring—accepts all wire mesh strain reliefs
- One-piece, rivetless .035" thick brass connector contacts and solid brass plug blades provide maximum conductivity and long service life

Flanged Inlets and Outlets

- Rugged nylon flange fits flush and won't crack in high-abuse applications
- Individual deep-funneled chamfered wire wells guide each wire into rectangular chambers
- Wire clamps provide positive crimp lock without cutting wire strands

TESTING AND CODE COMPLIANCE

- All receptacles, plugs, connectors, inlets and outlets are designed to meet NEMA WD-6, and ANSI C-73, and to meet/exceed UL 498 standards
- UL Fed Spec. Listed WC-596 – Plugs, Connectors and Flanged Inlets (File #E-13393), Receptacles and Flanged Outlets (File #E-13399)
- CSA Certified (File #LR-406)
- NOM Certified (#057)
- Backed by a Lifetime Warranty

MATERIAL CHARACTERISTICS

Environmental: Flammability Rated V2 per UL94, V-O-MAX® Receptacles Rated V0
Operating Temperature: -40°C to 60°C

15 & 20 AMP 125V, 250V and 277V Industrial Grade Wetguard® Locking Devices

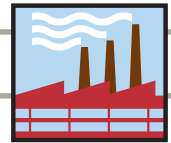

Wetguard® Devices Engineered to IP66 & IP67 Watertight Standards

Wetguard Locking Plugs and Connectors

DESCRIPTION	CAT. NO. PLUG	CAT. NO. CONNECTOR
Yellow EPTR, 15A-125V 2-Pole, 3-Wire Black EPTR	24W47 L5-15P	25W47 L5-15R
Yellow EPTR, 15A-250V 2-Pole, 3-Wire	24W49 L6-15P	25W49 L6-15R
Yellow EPTR, 15A-277V 2-Pole, 3-Wire	24W34 L7-15P	25W34 L7-15R
Yellow EPTR, 20A-125V 2-Pole, 3-Wire Black EPTR	26W47 L5-20P	27W47 L5-20R
Yellow EPTR, 20A-250V 2-Pole, 3-Wire Black EPTR	26W48 L6-20P	27W48 L6-20R
Yellow EPTR, 20A-277V 2-Pole, 3-Wire	26W49 L7-20P	27W49 L7-20R

Replacement Closure Cap

DESCRIPTION	CAT. NO. YELLOW	CAT. NO. BLACK
Connector Cap for 15A devices	50W50	50W50-B
Connector Cap for 20A devices	50W52	50W52-B
Plug Cap for 15A devices	14W	14W-B
Plug Cap for 20A devices	26W	26W-B

Cord Clamp Range—Wetguard® Locking Plugs and Connectors
15A: .375"–.655" #18–#10 AWG
20A: .375"–.875" #18–#10 AWG



24W47



25W47



26W47

Locking Devices

SPECIFICATIONS AND FEATURES

Wetguard

- IEC IP66 and IP 67 Rated, in accordance with IEC 529 as evaluated by UL and CSA
- NEMA Type 4, 4X, 6 and 6P Ratings in accordance with UL 50 and CSA 94
- EPTR rubber parts provide outstanding resistance to wet and damp environments, extreme temperature variations, acids, alkalis, grease, oils and solvents
- Interlocking "tongue and groove" construction seals out water, moisture, dirt when plugs are mated with connectors

- Multi-point sealing system utilizes nut, strain relief washer and rubber bushing to form a watertight cord grip seal
- Non-magnetic stainless steel fast-threading assembly screws won't interfere with sensitive equipment
- Connector "hood" closure cap seals device when not in use

TESTING AND CODE COMPLIANCE

- Meet NEMA WD 1 & 6, ANSI requirements
- UL Listed & meets Fed. Spec. requirements: (File #13393)
- CSA Certified (File #LR-406)
- NOM Certified (#057)
- Backed by a Lifetime Warranty

MATERIAL CHARACTERISTICS

Environmental: Flammability, Rated V2
Operating Temperature: -40°C to 60°C



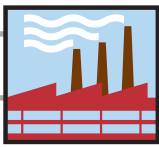

20 AMP 125/250V; 3Ø 250V, 480V, 3ØY 120/208V, 277/480V and 347/600V

Industrial Grade Wetguard® Locking Devices



Wetguard® Devices Engineered to IP66 & IP67 Watertight Standards

Wetguard Locking Plugs and Connectors















26W81







27W81



26W81-B

DESCRIPTION	CAT. NO. PLUG	CAT. NO. CONNECTOR
Yellow EPTR, 20A-125/250V 3-Pole, 4-Wire	26W74 L14-20P 	27W74 L14-20R 
Yellow EPTR, 20A-3Ø 250V 3-Pole, 4-Wire Black EPTR	26W75 L15-20P 	27W75 L15-20R 
Yellow EPTR, 20A-3Ø 480V 3-Pole, 4-Wire Black EPTR	26W76 L16-20P 	27W76 L16-20R 
Yellow EPTR, 20A-3ØY 120/208V 4-Pole, 5-Wire Black EPTR	26W81 L21-20P 	27W81 L21-20R 
Yellow EPTR, 20A-3ØY 277/480V 4-Pole, 5-Wire	26W82 L22-20P 	27W82 L22-20R 
Yellow EPTR, 20A-3ØY 347/600V 4-Pole, 5-Wire	26W83 L23-20P 	27W83 L23-20R 

Wetguard Non-NEMA, Non-Grounding Devices (Not UL Listed—For Replacement Use Only)

DESCRIPTION	CAT. NO. PLUG	CAT. NO. CONNECTOR
Yellow EPTR, 20A-125/250V 3-Pole, 3-Wire	26W08 NON-NEMA 	27W08 NON-NEMA 
Yellow EPTR, 20A-3ØY 120/208V 4-Pole, 4-Wire	26W09 NON-NEMA 	27W09 NON-NEMA 

Replacement Closure Cap

DESCRIPTION	CAT. NO. YELLOW	CAT. NO. BLACK
Connector Cap for 20A devices	50W52	50W52-B
Plug Cap for 20A devices	26W	26W-B

Cord Clamp Range—Wetguard® 20A Locking Plugs and Connectors: .375"–.875" #18–#10 AWG

Locking Devices

SPECIFICATIONS AND FEATURES

Wetguard

- IEC IP66 and IP 67 Rated, in accordance with IEC 529 as evaluated by UL and CSA
- NEMA Type 4, 4X, 6 and 6P Ratings in accordance with UL 50 and CSA 94
- EPTR rubber part provide outstanding resistance to wet and damp environments, extreme temperature variations, acids, alkalis, grease, oils and solvents
- Interlocking "tongue and groove" construction seals out water, moisture, dirt when plugs are mated with connectors

- Multi-point sealing system utilizes nut, strain relief washer and rubber bushing to form a watertight cord grip seal
- Non-magnetic stainless steel fast-threading assembly screws won't interfere with sensitive equipment
- Connector "hood" closure cap seals device when not in use

TESTING AND CODE COMPLIANCE

- Meet NEMA WD 1 & 6, ANSI requirements
- UL Listed & meets Fed. Spec. requirements: (File #13393)
- CSA Certified (File #LR-406)
- NOM Certified (#057)
- Backed by a Lifetime Warranty

MATERIAL CHARACTERISTICS

Environmental: Flammability, Rated V2
Operating Temperature: -40°C to 60°C

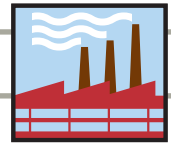





























Industrial Grade Wetguard® Locking Devices







Wetguard® Devices Engineered to IP66 & IP67 Watertight Standards

Wetguard Locking Plugs and Connectors

DESCRIPTION	CAT. NO. PLUG	CAT. NO. CONNECTOR
Yellow EPTR, 30A-125V 2-Pole, 3-Wire Black EPTR	28W47 L5-30P 	29W47 L5-30R 
	28W47-B 	29W47-B 
Yellow EPTR, 30A-250V 2-Pole, 3-Wire	28W48 L6-30P 	29W48 L6-30R 
Yellow EPTR, 30A-277V 2-Pole, 3-Wire	28W49 L7-30P 	29W49 L7-30R 
Yellow EPTR, 30A-125/250V 3-Pole, 4-Wire	28W74 L14-30P 	29W74 L14-30R 
Yellow EPTR, 30A-3Ø 250V 3-Pole, 4-Wire Black EPTR	28W75 L15-30P 	29W75 L15-30R 
	28W75-B 	29W75-B 
Yellow EPTR, 30A-3Ø 480V 3-Pole, 4-Wire Black EPTR	28W76 L16-30P 	29W76 L16-30R 
	28W76-B 	29W76-B 
Yellow EPTR, 30A-3Ø 600V 3-Pole, 4-Wire Black EPTR	28W77 L17-30P 	29W77 L17-30R 
	28W77-B 	29W77-B 
Yellow EPTR, 30A-3ØY 120/208V 4-Pole, 5-Wire	28W81 L21-30P 	29W81 L21-30R 
Yellow EPTR, 30A-3ØY 277/480V 4-Pole, 5-Wire	28W82 L22-30P 	29W82 L22-30R 
Yellow EPTR, 30A-3ØY 347/600V 4-Pole, 5-Wire	28W83 L23-30P 	29W83 L23-30R 

Wetguard Non-NEMA, Non-Grounding Devices (Not UL Listed—For Replacement Use Only)

DESCRIPTION	CAT. NO. PLUG	CAT. NO. CONNECTOR
Yellow EPTR, 30A-125/250V 3-Pole, 3-Wire	28W08 NON-NEMA 	29W08 NON-NEMA 
Yellow EPTR, 30A-3ØY 120/208V 4-Pole, 4-Wire	28W09 NON-NEMA 	29W09 NON-NEMA 

Replacement Closure Cap

DESCRIPTION	CAT. NO. YELLOW	CAT. NO. BLACK
Connector Cap for 30A devices	50W54	50W54-B
Plug Cap for 30A devices	28W	28W-B

Cord Clamp Range—Wetguard® 30A Locking Plugs and Connectors: .625"–1.125" #12–#8 AWG



28W47



29W47



29W47-B

Locking Devices

SPECIFICATIONS AND FEATURES

Wetguard

- IEC IP66 and IP 67 Rated, in accordance with IEC 529 as evaluated by UL and CSA
- NEMA Type 4, 4X, 6 and 6P Ratings in accordance with UL 50 and CSA 94
- EPTR rubber parts provide outstanding resistance to wet and damp environments, extreme temperature variations, acids, alkalis, grease, oils and solvents
- Interlocking "tongue and groove" construction seals out water, moisture, dirt when plugs are mated with connectors

- Multi-point sealing system utilizes nut, strain relief washer and rubber bushing to form a watertight cord grip seal
- Non-magnetic stainless steel fast-threading assembly screws won't interfere with sensitive equipment
- Connector "hood" closure cap seals device when not in use

TESTING AND CODE COMPLIANCE

- Meet NEMA WD 1 & 6, ANSI requirements
- UL Listed & meets Fed. Spec. requirements: (File #13393)
- CSA Certified (File #LR-406)
- NOM Certified (#057)
- Backed by a Lifetime Warranty

MATERIAL CHARACTERISTICS

Environmental: Flammability, Rated V2
Operating Temperature: -40°C to 60°C

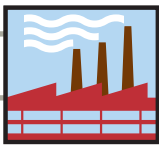

15 AMP 125V, 250V and 277V

Industrial Grade Corrosion Resistant Devices

Corrosion Resistant Devices

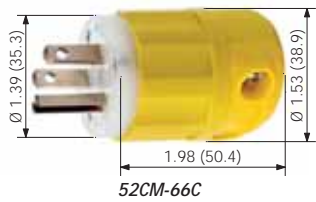

52CM-66C

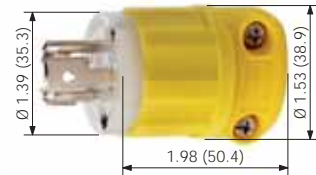

47CM-20C



47CM-29C

Cord Clamp Range—15A St.
Blade/Locking Plugs and Connectors:
.240"-.700" #18-#10 AWG

15 AMP 125V 2-Pole 3-Wire Grounding

DESCRIPTION	CAT. NO.	NEMA CONFIG.
Straight Blade Plug, Yellow Nylon Body and Cord Clamp	52CM-66C	5-15P
Straight Blade Connector, Yellow Nylon Body and Cord Clamp	52CM-69C	5-15R
Duplex Receptacle, Smooth Face. One-Piece Electroless Nickel-Plated Brass Strap	52CM-62	5-15R
Single Receptacle, Smooth Face, Yellow Nylon Body	5261-CR	5-15R
Locking Plug, Yellow Nylon Body and Cord Clamp	47CM-20C	L5-15P
Locking Connector, Yellow Nylon Body and Cord Clamp	47CM-29C	L5-15R
Single Locking Flush Receptacle	47CM-10	L5-15R

15 AMP 250V 2-Pole 3-Wire Grounding







DESCRIPTION	CAT. NO.	NEMA CONFIG.
Single Receptacle, Smooth Face, Yellow Nylon Body	5661-CR	6-15R
Locking Plug, Yellow Nylon Body and Cord Clamp	45CM-70C	L6-15P
Locking Connector, Yellow Nylon Body and Cord Clamp	45CM-79C	L6-15R
Single Locking Flush Receptacle	45CM-60	L6-15R

15 AMP 277V AC 2-Pole 3-Wire Grounding

DESCRIPTION	CAT. NO.	NEMA CONFIG.
Single Locking Flush Receptacle	47CM-60	L7-15R

Weather-Resistant Boots for 15A Locking Plugs and Connectors are listed on page N27

Wallplates and Covers

302 STAINLESS STEEL FOR 15A/20A ST. BLADE/15A SINGLE LOCKING RECEPTACLE	302 STAINLESS STEEL FOR 15A/20A ST. BLADE DUPLEX RECEPTACLE	WEATHER-RESISTANT FLIP LID COVER FOR 15A/20A ST. BLADE/15A LOCKING DEVICES
1.41" Dia. Opening		IP64 Rated—Includes Gasket and Screws
 84004-40	 84003-40	 WP1
WETGUARD COVER AND GASKET FOR 15A/20A ST. BLADE/15A LOCKING DEVICES	BLANK PLATE W/GASKET	FD BOX GLASS-FILLED POLYESTER (2 KO OPENINGS)
IP66 Rated		
 60W03 Yellow, 60W03-B Black	 WP459 Yellow	 452CR Yellow 1/2", 453CR Yellow 3/4", 454CR Yellow 1"

For complete wallplate selection, see Section E.

SPECIFICATIONS AND FEATURES

Plugs and Connectors

- All current-carrying metal parts (blades, contacts, terminals and screws) are electroless nickel-coated
- Captive, brass #8 terminal screws are color coded for easy wiring identification: green (ground), brass (hot) and silver (neutral)
- Super tough nylon plug and connector body is bright yellow for easy corrosion resistant identification
- Connector power contacts are heavy-duty, solid, one-piece brass, triple-wipe, set in deep pockets to resist rough use

- Heavy-duty, impact-resistant, super tough ST801 all-nylon body construction; fluted body design provides sure grip
- Wire clamp moves in individual chamber to provide positive crimp lock without cutting wire strands

TESTING AND CODE COMPLIANCE

- Plugs and connectors pass the ASTM B117-13 five-hundred hour Salt Spray (Fog) Test with no visible corrosion
- Designed to meet or exceed UL Fed Spec. Listing WC-596. UL Listed (File #E-13399 for Receptacles; File #E-13393 for Plugs and Connectors)
- CSA Certified (File #LR-406)
- NOM Certified (#057)
- Meets NEMA WD1 & WD6 requirements
- NEMA configuration and rating molded on front
- Backed by a Limited 10-Year Warranty

MATERIAL CHARACTERISTICS

Environmental: Flammability Rated V2 per UL 94
Operating Temperature: -40°C (without impact) to 60°C maximum continuous

20 AMP 125V, 250V, 277V, 125/250V and 3Ø 250V, 480V

Industrial Grade Corrosion Resistant Devices

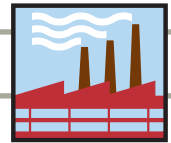

20 AMP 125V 2-Pole 3-Wire Grounding

DESCRIPTION	CAT. NO.	NEMA CONFIG.
Straight Blade Plug, Yellow Nylon Body and Cord Clamp	53CM-66C	5-20P
Straight Blade Connector, Yellow Nylon Body and Cord Clamp	53CM-69C	5-20R
Duplex Receptacle, smooth face. One Piece Electroless Nickel-Plated Brass Strap	53CM-62	5-20R
Single Receptacle, Smooth Face, Yellow Nylon Body	5361-CR	5-20R
Locking Plug, Yellow Nylon Body and Cord Clamp	23CM-11	L5-20P
Locking Connector, Yellow Nylon Body and Cord Clamp	23CM-13	L5-20R
V-0-MAX® Single Locking Flush Receptacle	23CM-10	L5-20R

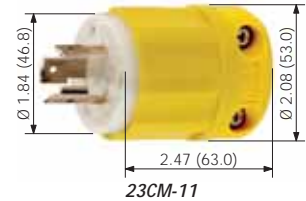

20 AMP 250V 2-Pole 3-Wire Grounding

DESCRIPTION	CAT. NO.	NEMA CONFIG.
Single Receptacle, Smooth Face, Yellow Nylon Body	5461-CR	6-20R
V-0-MAX® Single Locking Flush Receptacle	23CM-20	L6-20R

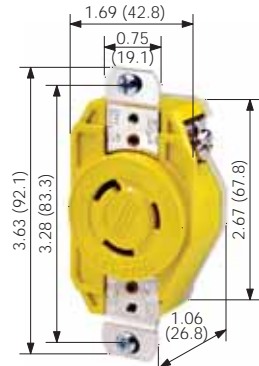

20 AMP 277V AC 2-Pole 3-Wire Grounding

DESCRIPTION	CAT. NO.	NEMA CONFIG.
V-0-MAX® Single Locking Flush Receptacle	23CM-30	L7-20R

20 AMP 125/250V 3-Pole 4-Wire Grounding

DESCRIPTION	CAT. NO.	NEMA CONFIG.
V-0-MAX® Single Locking Flush Receptacle	24CM-10	L14-20R

20 AMP 3Ø 250V 3-Pole 4-Wire Grounding

DESCRIPTION	CAT. NO.	NEMA CONFIG.
V-0-MAX® Single Locking Flush Receptacle	24CM-20	L15-20R

20 AMP 3Ø 480V 3-Pole 4-Wire Grounding

DESCRIPTION	CAT. NO.	NEMA CONFIG.
V-0-MAX® Single Locking Flush Receptacle	24CM-30	L16-20R

Cord Clamp Range—
 20A St. Blade/3-Wire Locking Plugs and Connectors: .240"–.700" #18–#10 AWG
 20A 4-Wire Locking Plugs and Connectors: .595"–.895" #14–#10 AWG

SPECIFICATIONS AND FEATURES

Plugs and Connectors

- All current-carrying metal parts (blades, contacts, terminals and screws) are electroless nickel-coated
- Captive, brass #8 terminal screws are color coded for easy wiring identification: green (ground), brass (hot) and silver (neutral)
- Super tough nylon plug and connector body is bright yellow for easy corrosion resistant identification
- Connector power contacts are heavy-duty, solid, one-piece brass, triple-wipe, set in deep pockets to resist rough use
- Heavy-duty, impact-resistant, all-nylon body construction; fluted body design provides sure grip
- Wire clamp moves in individual chamber to provide positive crimp lock without cutting wire strands

TESTING AND CODE COMPLIANCE







- Plugs and connectors pass the ASTM B117-13 five-hundred hour Salt Spray (Fog) Test with no visible corrosion
- Designed to meet or exceed UL Fed Spec. Listing WC-596. UL Listed (File #E-13399 for Receptacles; File #E-13393 for Plugs and Connectors)
- CSA Certified (File #LR-406)
- NOM Certified (#057)
- Meets NEMA WD1 & WD6 requirements
- NEMA configuration and rating molded on front
- Backed by a Limited 10-Year Warranty

MATERIAL CHARACTERISTICS

Environmental: Flammability Rated V2 per UL94, V-0-MAX® Receptacles Rated V0
 Operating Temperature: -40°C (without impact) to 60°C maximum continuous

Weather-Resistant Boots for 20A Locking Plugs and Connectors are listed on page N27

Wallplates and Covers

302 STAINLESS STEEL 20A SINGLE LOCKING RECEPTACLE	WEATHER-RESISTANT FLIP LID COVER 20A SINGLE LOCKING RECEPTACLE	WETGUARD COVER AND GASKET 20A SINGLE LOCKING RECEPTACLE
1.60" Dia. Opening	IP64 Rated—Includes Gasket and Screws	IP66 Rated
	 	
84020-40	WP2 7420-CR	60W04 Yellow, 60W04-B Black
BLANK PLATE W/GASKET	FD BOX GLASS-FILLED POLYESTER (2 KO OPENINGS)	
		
WP459 Yellow	452CR Yellow 1/2", 453CR Yellow 3/4", 454CR Yellow 1"	

For complete wallplate selection, see Section E.

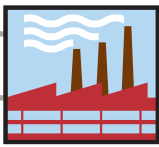

30 AMP 125V, 250V, 125/250V and 3Ø 250V

Industrial Grade Corrosion Resistant Devices

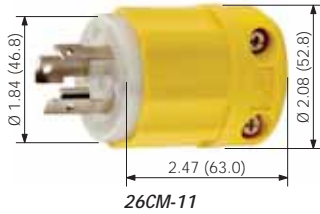

26CM-11

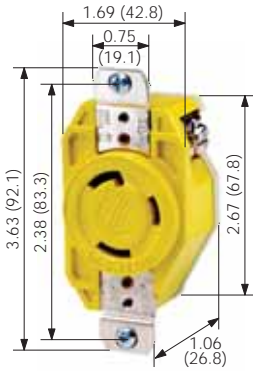

26CM-10

30 AMP 125V 2-Pole 3-Wire Grounding

DESCRIPTION	CAT. NO.	NEMA CONFIG.
Locking Plug, Yellow Nylon Body and Cord Clamp	26CM-11	L5-30P
Locking Connector, Yellow Nylon Body and Cord Clamp	26CM-13	L5-30R
V-O-MAX® Single Locking Flush Receptacle	26CM-10	L5-30R

30 AMP 250V 2-Pole 3-Wire Grounding

DESCRIPTION	CAT. NO.	NEMA CONFIG.
Locking Plug, Yellow Nylon Body and Cord Clamp	26CM-21	L6-30P
Locking Connector, Yellow Nylon Body and Cord Clamp	26CM-23	L6-30R
Single Locking Flush Receptacle	26CM-20	L6-30R

30 AMP 125/250V 3-Pole 4-Wire Grounding

DESCRIPTION	CAT. NO.	NEMA CONFIG.
V-O-MAX® Single Locking Flush Receptacle	27CM-10	L14-30R

30 AMP 3Ø 250V 3-Pole 4-Wire Grounding

DESCRIPTION	CAT. NO.	NEMA CONFIG.
V-O-MAX® Single Locking Flush Receptacle	27CM-20	L15-30R

Weather-Resistant Boots for 30A Locking Plugs and Connectors are listed on page N27

Cord Clamp Range—30A 3-Wire Locking Plugs and Connectors: .385"–.860" #16–#8 AWG
30A 4-Wire Locking Plugs and Connectors: .595"–1.150" #14–#8 AWG

Wallplates and Covers

302 STAINLESS STEEL 30A SINGLE LOCKING RECEPTACLE	WEATHER-RESISTANT FLIP LID COVER 30A SINGLE LOCKING RECEPTACLE	WETGUARD COVER AND GASKET 30A SINGLE LOCKING RECEPTACLE
1.60" Dia. Opening	IP64 Rated—Includes Gasket and Screws	IP66 Rated
84020-40	WP2	7420-CR
BLANK PLATE W/GASKET	FD BOX GLASS-FILLED POLYESTER (2 KO OPENINGS)	
WP459 Yellow	452CR Yellow 1/2", 453CR Yellow 3/4", 454CR Yellow 1"	

For complete wallplate selection, see Section E.

SPECIFICATIONS AND FEATURES

Plugs and Connectors

- All current-carrying metal parts (blades, contacts, terminals and screws) are electroless nickel-coated
- Captive, brass #8 terminal screws are color coded for easy wiring identification: green (ground), brass (hot) and silver (neutral)
- Nylon plug and connector body is bright yellow for easy corrosion resistant identification

- Connector power contacts are heavy-duty, solid, one-piece brass, triple-wipe, set in deep pockets to resist rough use
- Heavy-duty, impact-resistant, all-nylon body construction; fluted body design provides sure grip
- Wire clamp moves in individual chamber to provide positive crimp lock without cutting wire strands

TESTING AND CODE COMPLIANCE

- Plugs and connectors pass the ASTM B117-13 five-hundred hour Salt Spray (Fog) Test with no visible corrosion
- Designed to meet or exceed UL Fed Spec. Listing WC-596. UL Listed (File #E-13399 for Receptacles; File #E-13393 for Plugs and Connectors)
- CSA Certified (File #LR-406)
- NOM Certified (#057)
- Meets NEMA WD1 & WD6 requirements
- NEMA configuration and rating molded on front
- Backed by a Limited 10-Year Warranty

MATERIAL CHARACTERISTICS

Environmental: Flammability Rated V2 per UL94, V-O-MAX® Receptacles Rated V0
Operating Temperature: -40°C (without impact) to 60°C maximum continuous

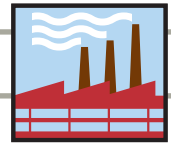

Industrial Grade Corrosion Resistant Devices

50 AMP 125V 2-Pole 3-Wire Grounding

DESCRIPTION	CAT. NO.	NEMA CONFIG.
Locking Plug, Yellow Nylon Body and Cord Clamp	6361-CR	
Locking Connector, Yellow Nylon Body and Cord Clamp	6360-CR	
Single Locking Flush Receptacle	6370-CR	
Power Inlet, 316 Stainless Steel w/Threaded Cap	6372-CR	



50 AMP 125/250V 3-Pole 4-Wire Grounding

DESCRIPTION	CAT. NO.	NEMA CONFIG.
Locking Plug, Yellow Nylon Body and Cord Clamp	6365-CR	
Locking Connector, Yellow Nylon Body and Cord Clamp	6364-CR	
Single Locking Flush Receptacle	6369-CR	
Power Inlet, 316 Stainless Steel w/Threaded Cap	6374-CR	



Boots and Covers for 50 AMP Corrosion Resistant Devices

DESCRIPTION	CAT. NO.
50A Locking Plug Boot, High Visibility Yellow	7715-CRY
50A Locking Plug Boot, Black	7715-CR
50A Locking Connector Boot, High Visibility Yellow	7717-CRY
50A Locking Connector Boot, High Visibility Yellow	7717-CR
Weather-Resistant Receptacle Flip Lid Cover, IP64 rated, Yellow Lexan	7788-CR
Cast Aluminum Grey Flip Lid Cover, IP64 rated	7770

Cord Clamp Range—50A CR Locking Plugs and Connectors: .650"–1.125" #10–#4 AWG

SPECIFICATIONS AND FEATURES

- All current-carrying metal parts (blades, contacts, terminals and screws) are electroless nickel-coated
- Color coded wire entrance holes for simple and easy wiring
- Nylon plug and connector body are bright yellow for easy corrosion resistant identification
- Nylon housing for excellent impact resistance and secure gripping
- Boots are IP55 Rated
- Longer contacts inside connector assure stronger, tighter fitting contact points
- Backed by a lifetime warranty
- External cord clamp with cable insert accommodates from smallest to largest wire size
- Covers are IP64 rated for wet location with cover closed

TESTING AND CODE COMPLIANCE

- NOM Certified (#057)
 - CSA Certified (File# 152105)
- Receptacles**
- UL Listed (File #E-111198)
- Plugs & Connectors and Inlets**
- UL Listed (File #E-57672)

MATERIAL CHARACTERISTICS

Operating Temperature: -40°C to 75°C

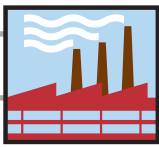

15 AMP 125V/10A-250; 20 AMP 250V, 125/250V and 3ØY 120/208V

Industrial Grade Non-NEMA Locking Devices

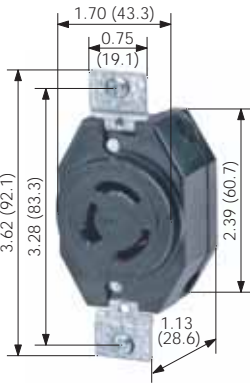

7310-B



7314-C



9965-C

Cord Clamp Range
Non-NEMA Locking Plugs and Connectors—
 15A: .240"-.700" #18-#10 AWG
 20A 3-Wire: .385"-.780" #16-#10 AWG
 20A 4- & 5-Wire: .595"-.895" #14-#10 AWG

15 AMP 125V/10A-250V 3-Pole 3-Wire Non-Grounding Non-NEMA†

DESCRIPTION	CAT. NO.	NON-NEMA CONFIG.
Single Flush Receptacle†	7582	
Locking Plug	7567-C*	
Locking Connector†	7565-C*	NON-NEMA
Locking Flanged Inlet	7556	
Locking Flanged Outlet	7557	

†These devices are no longer UL Listed and are for replacement use only. Add (-G) for grounding version.

*Grounding (-G) version not available. For grounding connector, use Cat. No. 7555-G

**Uses stainless steel wallplate, Cat. No. 84004-40.

20 AMP 250V AC/DC / 10 AMP 600V AC 4-Pole 5-Wire Grounding Non-NEMA

DESCRIPTION	CAT. NO.	NON-NEMA CONFIG.
Single Flush Receptacle	3520	
Locking Plug, Black Nylon Body	3521-C	
Locking Connector, Black Nylon Body	3523-C	NON-NEMA
Locking Flanged Inlet	3524-C	
Locking Flanged Outlet	3525-C	

20 AMP 125V/250V 3-Pole 3-Wire Non-Grounding Non-NEMA††

DESCRIPTION	CAT. NO.	NON-NEMA CONFIG.
Single Flush Receptacle	7310-B	
Locking Plug	9965-C	
Locking Connector	7314-C	NON-NEMA
Locking Flanged Inlet	3325-C	
Locking Flanged Outlet	3326-C	

20 AMP 3ØY 120V/208V 4-Pole 4-Wire Non-Grounding Non-NEMA††

DESCRIPTION	CAT. NO.	NON-NEMA CONFIG.
Single Flush Receptacle	7410-B	
Locking Plug	7411-C	NON-NEMA
Locking Connector	7413-C	
Locking Flanged Inlet	7408-C	
Locking Flanged Outlet	7409-C	NON-NEMA

†† Effective July 1, 1981, rating for non-grounding versions was changed from 20A-250V AC/DC, 10A-600V AC to comply with UL requirements. Add (-G) for grounding devices: (-G) devices are rated 20A-250V AC/DC, 10A-600V AC and are no longer UL Listed — for replacement use only.

Weather-Resistant Boots for 15A and 20A Locking Plugs and Connectors are listed on page N27

Wallplates and Covers

302 STAINLESS STEEL 15A SINGLE RECEPTACLE	302 STAINLESS STEEL 20A SINGLE RECEPTACLE	WEATHER-RESISTANT FLIP LID COVER FOR 20A INLETS/OUTLETS AND 20A RECEPTACLES
1.41" Dia. Opening	1.60" Dia. Opening	IP64 Rated—Includes Gasket and Screws
84004-40	84020-40	WP2 for Inlets/Outlets 7420-CR for Receptacles

For complete wallplate selection, see Section E.

SPECIFICATIONS AND FEATURES

Locking Flush Receptacles

- Rugged nylon body and cover for outstanding resistance to impact and harsh chemicals
- Double-wipe phosphor-bronze power contacts

Locking Plugs and Connectors

- Super tough Nylon body resists damage from severe impact, abrasion and chemicals
- Ergonomic, fluted body design with radial grip ridge is ideal for gripping, turning and pulling
- Cord clamp does not have to be disassembled from body for wiring—accepts all wire mesh strain reliefs
- One-piece, rivetless .035" thick brass connector contacts and solid brass plug blades provide maximum conductivity and long service life

Flanged Inlets and Outlets

- Rugged nylon flange fits flush and won't crack in high-abuse applications
- Individual deep-funneled chamfered wire wells guide each wire into rectangular chambers
- Wire clamps provide positive crimp lock without cutting wire strands

TESTING AND CODE COMPLIANCE

- All receptacles, plugs, connectors, inlets and outlets are designed to meet NEMA WD-6, and ANSI C-73, and to meet/exceed UL 498 standards
- Most non-NEMA locking devices are not UL Listed and are intended for replacement use only. Consult your Leviton representative for more information on UL Listing for Non-NEMA devices
- CSA Certified (File #LR-406)
- NOM Certified (#057)
- Backed by a Lifetime Warranty

MATERIAL CHARACTERISTICS

Environmental: Flammability Rated V2 per UL94
 Operating Temperature: -40°C to 60°C

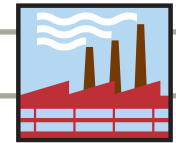

Industrial Grade Non-NEMA Locking Devices

30 AMP 125V/250 3-Pole 3-Wire Non-Grounding Non-NEMA†

DESCRIPTION	CAT. NO.	NON-NEMA CONFIG.
Single Flush Receptacle	3330	
Locking Plug	3331-C	
Locking Connector	3333-C	
Locking Flanged Inlet	3334-C	
Locking Flanged Outlet	3335-C	

†Effective July 1, 1981, rating for non-grounding versions was changed from 30A-250V to comply with UL requirements. Add (-G) for grounding devices: (-G) devices are rated 30A-250V and are no longer UL Listed — for replacement use only.

30 AMP 3ØY 120V/208V 4-Pole 4-Wire Non-Grounding Non-NEMA††

DESCRIPTION	CAT. NO.	NON-NEMA CONFIG.
Single Flush Receptacle	3430	
Locking Plug	3431-C	
Locking Connector	3433-C	
Locking Flanged Inlet	3434-C	
Locking Flanged Outlet	3435-C	

††Effective July 1, 1981, rating for non-grounding versions was changed from 30A-250V AC/DC, 30A-600V AC to comply with UL requirements. Add (-G) for grounding devices: (-G) devices are rated 30A-250V AC/DC, 30A-600V AC and are no longer UL Listed—for replacement use only.

50 AMP 250V DC/600V AC 2-Pole 3-Wire Grounding Non-NEMA

DESCRIPTION	CAT. NO.	NON-NEMA CONFIG.
Single Locking Receptacle	3771	
Locking Plug	3763-C	
Locking Connector	3762-C	
Locking Flanged Inlet	3777	

50 AMP 250V DC/600V AC 3-Pole 4-Wire Grounding Non-NEMA

DESCRIPTION	CAT. NO.	NON-NEMA CONFIG.
Single Locking Receptacle	7379*	
Locking Plug	7765-C*	
Locking Connector	7764-C*	
Locking Flanged Inlet	7958*	

50 AMP 250V DC/600V AC 3-Pole 4-Wire Grounding Non-NEMA

DESCRIPTION	CAT. NO.	NON-NEMA CONFIG.
Single Locking Receptacle	3769	
Locking Plug	3765-C	
Locking Connector	3764-C	
Locking Flanged Inlet	3775	

*Weather Resistant Boots for 30A Locking Plugs and Connectors are listed on page N27.
Weather Resistant Boots for 50A Locking Plugs and Connectors are listed on page N23.*

Wallplates and Covers

WEATHER-RESISTANT FLIP LID COVER FOR 30A INLETS AND OUTLETS AND 30A RECEPTACLES	WEATHER-RESISTANT FLIP LID COVER FOR 50A RECEPTACLES
IP64 Rated—Includes Gasket and Screws	IP64 Rated—Includes Gasket and Screws
WP2 for Inlets/Outlets	7788-CR Yellow Lexan
7420-CR for Receptacles	7770 Gray Metal

*For complete wallplate selection, see Section E.
For replacement use in existing installations only.

SPECIFICATIONS AND FEATURES

30A Locking Flush Receptacles

- Rugged nylon body and cover for outstanding resistance to impact and harsh chemicals
- Double-wipe phosphor-bronze power contacts

30A Locking Plugs and Connectors

- Super tough Nylon body resists damage from severe impact, abrasion and chemicals
- Ergonomic, fluted body design with radial grip ridge is ideal for gripping, turning and pulling
- Cord clamp does not have to be disassembled from body for wiring—accepts all wire mesh strain reliefs
- One-piece, rivetless .035" thick brass connector contacts and solid brass plug blades provide maximum conductivity and long service life

30A Flanged Inlets and Outlets

- Rugged nylon flange fits flush and won't crack in high-abuse applications
- Individual deep-funneled chamfered wire wells guide each wire into rectangular chambers
- Wire clamps provide positive crimp lock without cutting wire strands

50A Locking Plugs and Connectors

- Nylon housing for excellent impact and chemical resistance

50A Locking Receptacles and Flanged Inlets

- Heavy-duty Nylon construction for excellent impact and chemical resistance
- Clamp-type wire terminals

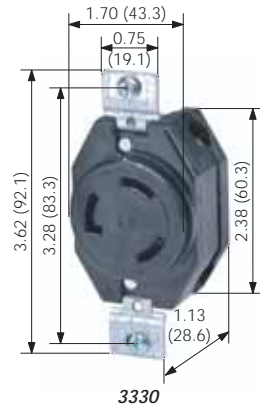

Cord Clamp Range Non-NEMA Locking Plugs and Connectors

- 30A 3-Wire: .385"–.860"
#16–#8 AWG
- 30A 4-Wire: .595"–1.150"
#14–#10 AWG
- 50A 4-Wire: .650"–1.20"
#10–#4 AWG

TESTING AND CODE COMPLIANCE

- All receptacles, plugs, connectors, inlets and outlets are designed to meet NEMA WD-6, and ANSI C-73, and to meet/exceed UL 498 standards
- Most non-NEMA locking devices are not UL Listed and are intended for replacement use only. Consult your Leviton representative for more information on UL Listing for Non-NEMA devices

50A Devices

- UL Listed Plugs, Connectors and Flanged Inlets (File #E-13393), Receptacles (File #E-13399)
- CSA Certified (File #LR-81290)
- NOM certified (#057)

MATERIAL CHARACTERISTICS

Environmental:
Flammability Rated VO per UL94
Operating Temperature:
30A Devices: -40°C to 60°C
50A Devices: -40°C to 75°C

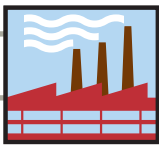

50 AMP 125V, 250V, 125/250V, 480V and 3Ø 480V

Industrial Grade "California Style" CS Non-NEMA Locking Devices



CS63-60C



CS63-77

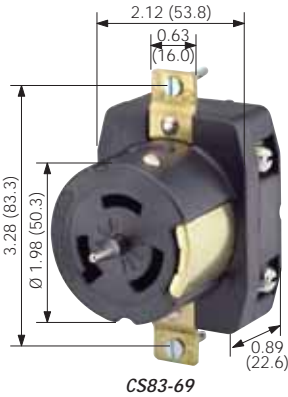

CS83-69

50 AMP 125V 2-Pole 3-Wire Grounding Non-NEMA

DESCRIPTION	CAT. NO.	NON-NEMA CONFIG.
Single Locking Receptacle	CS63-70	
Locking Plug	CS63-61C	
Locking Connector	CS63-60C	
Locking Flanged Inlet	CS63-77	

50 AMP 250V 2-Pole 3-Wire Grounding Non-NEMA

DESCRIPTION	CAT. NO.	NON-NEMA CONFIG.
Single Locking Receptacle	CS82-69	
Locking Plug	CS82-65C	
Locking Connector	CS82-64C	
Locking Flanged Inlet	CS82-75	

50 AMP 125/250V 3-Pole 4-Wire Grounding Non-NEMA

DESCRIPTION	CAT. NO.	NON-NEMA CONFIG.
Single Locking Receptacle	CS63-69	
Locking Plug	CS63-65C	
Locking Connector	CS63-64C	
Locking Flanged Inlet	CS63-75	

50 AMP 3Ø 250V AC 3-Pole 4-Wire Grounding Non-NEMA

DESCRIPTION	CAT. NO.	NON-NEMA CONFIG.
Single Locking Receptacle	CS83-69	
Locking Plug	CS83-65C	
Locking Connector	CS83-64C	
Locking Flanged Inlet	CS83-75	

50 AMP 480V 2-Pole 3-Wire Grounding Non-NEMA

DESCRIPTION	CAT. NO.	NON-NEMA CONFIG.
Single Locking Receptacle	CS84-69	
Locking Plug	CS84-65C	
Locking Connector	CS84-64C	
Locking Flanged Inlet	CS84-75	

50 AMP 3Ø 480V AC 3-Pole 4-Wire Grounding Non-NEMA

DESCRIPTION	CAT. NO.	NON-NEMA CONFIG.
Single Locking Receptacle	CS81-69	
Locking Plug	CS81-65C	
Locking Connector	CS81-64C	
Locking Flanged Inlet	CS8175	

Weather Resistant Boots for 50A Locking Plugs and Connectors are listed on page N23

Cord Clamp Range—50A CS Locking Plugs and Connectors: .680"–1.125" #10–#4 AWG

SPECIFICATIONS AND FEATURES

50A CS Locking Plugs and Connectors

- Nylon housing for excellent impact resistance and secure gripping
- Color-coded wire entrance holes for simple, easy wiring

50A CS Locking Receptacles and Flanged Inlets

- Heavy-duty nylon construction for excellent impact and chemical resistance
- Clamp-type wire terminals

TESTING AND CODE COMPLIANCE

- UL Listed Plugs, Connectors and Flanged Inlets (File #E-13393), Receptacles (File #E-13399)
- CSA Certified (File #LR-15105)
- NOM Certified (#057)

MATERIAL CHARACTERISTICS

Environmental: Flammability Rated VO per UL94
Operating Temperature: -40°C to 75°C

Wallplates and Covers

WEATHER-RESISTANT FLIP LID COVER FOR 50A RECEPTACLES

IP64 Rated—Includes Gasket and Screws



7788-CR Yellow Lexan



7770 Gray Metal

For complete wallplate selection, see Section E.

WEATHER-RESISTANT BOOTS

Industrial Grade Locking Devices

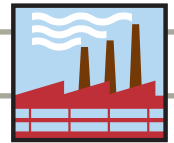

Locking Plug and Connector Boots—Thermoplastic Elastomer Construction

Boots for 15 AMP Industrial Locking Plugs and Connectors

DESCRIPTION	CAT. NO.
Locking Plug Boot, Black	6017-L
Locking Plug Boot, High-Visibility Yellow	6017-LY
Locking Connector Boot, Black	6018-L
Locking Connector Boot, High Visibility Yellow	6018-LY



Boots for 3-Wire 20 AMP & 30 AMP Industrial Locking Plugs and Connectors

DESCRIPTION	CAT. NO.
3-wire Locking Plug Boot, Black	6031
3-wire Locking Plug Boot, High Visibility Yellow	6031-Y
3-wire Locking Connector Boot, Black	6032
3-wire Locking Connector Boot, High Visibility Yellow	6032-Y



Boots for 4 and 5-Wire 20 AMP & 30 AMP Industrial Locking Plugs and Connectors

DESCRIPTION	CAT. NO.
4 & 5-wire Locking Plug Boot, black	6033
4 & 5-wire Locking Plug Boot, High Visibility Yellow	6033-Y
4 & 5-wire Locking Connector Boot, black	6034
4 & 5-wire Locking Connector Boot, High Visibility Yellow	6034-Y



For Weather-Resistant Boots for 50A Locking Plugs and Connectors see page N23



SPECIFICATIONS AND FEATURES

- Feature a triple seal action to protect straight blade and locking plugs and connectors against dirt and moisture in harsh applications
- Plug and connector boots available in black and high-visibility yellow
- Fluted surface and grip-ring design provide a non-slip grip even in wet conditions

WARRANTY

- Backed by a Limited Lifetime Warranty

MATERIAL CHARACTERISTICS

Environmental: Flammability, Rated HB
Operating Temperature: -40°C to 90°C

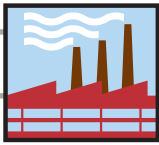

20 AMP 125V and 30A-600VAC / 20 AMP-250V DC

Industrial Grade Locking Power Interrupting Devices—Non-NEMA

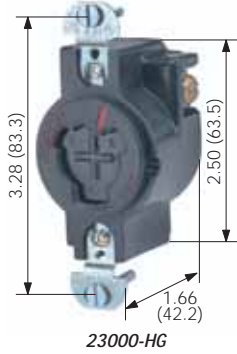

20 AMP 125V 2-Pole 3-Wire Grounding

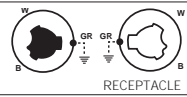
DESCRIPTION	CAT. NO.	NON-NEMA CONFIG.
Single Flush Receptacle with a Thermoset body	23000-HG*	
Locking Connector	23001-HG*	
Locking Plug	23004-HG*	

*UL listed for "HOSPITAL USE ONLY" applications in non-hazardous locations

20 AMP 125V 2-Pole 3-Wire Grounding

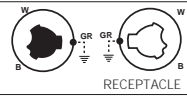
DESCRIPTION	CAT. NO.	NON-NEMA CONFIG.
Single Flush Receptacle	23030	
Locking Connector	23031-A	
Locking Plug	23034-A	

30A-600VAC / 20AMP – 250V DC 3-Pole 4-Wire Grounding

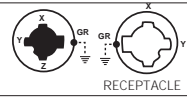
DESCRIPTION	CAT. NO.	NON-NEMA CONFIG.
Single Flush Receptacle	20403	
Locking Connector	21414-B	
Locking Plug	21415-B	

30A-600VAC / 20AMP – 250V DC 4-Pole 5-Wire Grounding

DESCRIPTION	CAT. NO.	NON-NEMA CONFIG.
Single Receptacle with Fiberglass Reinforced Nylon Interior with Cast Iron and Steel Shell. Fits FS or FD boxes	25403	
Locking Connector	25414-B	
Locking Plug	25415-B	

For complete wallplate selection, see Section E.

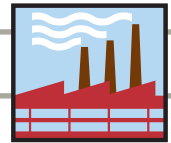

15 AMP 125V 2-Pole 2-Wire Non-Grounding

DESCRIPTION	CAT. NO.	NEMA CONFIG.
Midget Locking Plug	ML1-P	<p>NEMA ML1</p>
Angle Plug	ML1-AP	
Midget Locking Connector	ML1-C	
Angle Connector	ML1-AC	
Plastic Midget Locking Flanged Inlet	ML1-PB	
Plastic Midget Locking Flanged Outlet	ML1-PER	



ML1-P

15 AMP 125V 2-Pole 3-Wire Grounding

DESCRIPTION	CAT. NO.	NEMA CONFIG.
Midget Locking Plug	ML2-P	<p>NEMA ML2</p>
Angle Plug	ML2-AP	
Midget Locking Connector	ML2-C	
Angle Connector	ML2-AC	
Plastic Midget Locking Flanged Inlet	ML2-PB	
Plastic Midget Locking Flanged Outlet	ML2-PER	

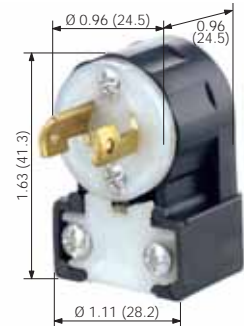

ML1-AP

15 AMP 125/250V 3-Pole 3-Wire Non-Grounding

DESCRIPTION	CAT. NO.	NEMA CONFIG.
Midget Locking Plug	ML3-P	<p>NEMA ML3</p>
Angle Plug	ML3-AP	
Midget Locking Connector	ML3-C	
Angle Connector	ML3-AC	
Plastic Midget Locking Flanged Inlet	ML3-PB	
Plastic Midget Locking Flanged Outlet	ML3-PER	

Straight Blade 15 AMP 125V 2-Pole 2-Wire Non-Grounding

DESCRIPTION	CAT. NO. PLUG	CAT. NO. ANGLE PLUG	NEMA CONFIG.
Midget Straight Blade Plug Black & White Nylon	MS2-P	MS2-AP	<p>NEMA 1-15P</p>

Cord Clamp Range Midget Locking/St. Blade Plugs and Connectors—.218"-.430" #18-#14 AWG

SPECIFICATIONS AND FEATURES

- Offer a smaller form factor for limited-space applications
- Locking Plugs and Connectors feature heavy-duty construction for top performance in the environmental extremes of grueling industrial settings
- Flanged Inlets and Outlets are built to endure hard use with rugged nylon flanges that assure a smooth, flush fit and outstanding resistance to cracking and breaking

TESTING AND CODE COMPLIANCE

- All receptacles, plugs, connectors, inlets and outlets are designed to meet NEMA WD-6, and ANSI C-73, and to meet/exceed UL 498 standards
- UL Fed. Spec. Listed WC-596 – Plugs, Connectors and Flanged Inlets (File #E-13393), Receptacles and Flanged Outlets (File #E-13399)
- CSA Certified (File No. LR-406)
- NOM Certified (#057)
- Backed by a Lifetime Warranty

MATERIAL CHARACTERISTICS

Environmental: Flammability Rated V2 per UL94
 Operating Temperature: -40°C to 60°C

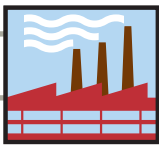

COMBINATION LOCKING & STRAIGHT BLADE • INTEGRATED INLETS & OUTLETS

Industrial Grade Locking Devices

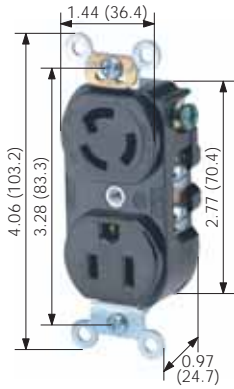

4792

Combination Locking and Straight Blade Duplex Receptacle

15 AMP 125V 2-Pole 3-Wire Grounding Back and Side Wired

DESCRIPTION	CAT. NO.	NEMA CONFIG.
Duplex Combination Locking & Straight Blade Receptacle with Common Feed	4792	L5-15R
Duplex Combination Locking & Straight Blade Receptacle with 2 Hot Feeds, 1 Neutral Return	4794-1R	
Duplex Combination Locking & Straight Blade Receptacle with Split Feed — 2 Hot Feeds, 2 Neutral Returns	4795-2R	5-15R

Integrated Power Inlets and Outlets with Weather-Resistant Covers

- Engineered to IP 64 and NEMA 3R Protection Ratings
- Suitable for Industrial Indoor and Outdoor Use

Integrated Power Inlets and Outlets with Weather-Resistant Covers

Gray, Glass-Filled Thermoplastic Cover and White, Nylon Device

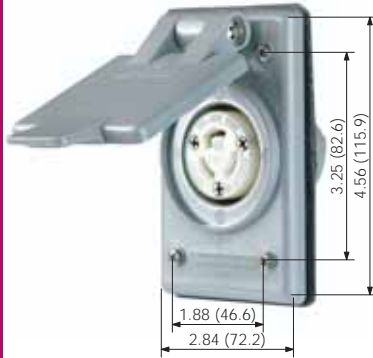

4715-FWP

DESCRIPTION	CAT. NO. FLANGED INLET	CAT. NO. FLANGED OUTLET
Standard Wire Wells, 15A-125V 2-Pole, 3-Wire	4716-CWP <small>NEMA L5-15P</small>	4715-CWP <small>NEMA L5-15R</small>
Slots for Fork Terminals, 15A-125V 2-Pole, 3-Wire	4716-FWP <small>NEMA L5-15P</small>	4715-FWP <small>NEMA L5-15R</small>
Standard Wire Wells, 15A-250V 2-Pole, 3-Wire	4586-CWP <small>NEMA L6-15P</small>	4585-CWP <small>NEMA L6-15R</small>

Note: For straight blade configurations, please see page M7.

Wallplates

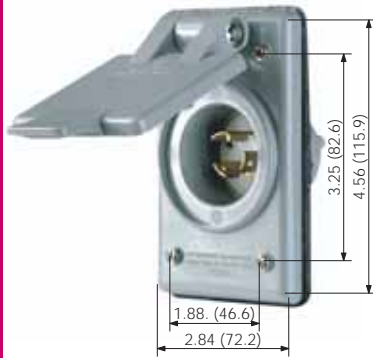

4716-FWP

302 STAINLESS STEEL DUPLEX RECEPTACLE	THERMOPLASTIC DUPLEX RECEPTACLE
 84003-40	 80703-E

For complete wallplate selection, see Section E.

SPECIFICATIONS AND FEATURES

Combination Devices

- Impact-resistant black thermoplastic nylon face and body
- Smooth face does not collect dirt
- Large, triple-wipe brass "T" contacts for superior contact and conductivity
- Triple-combination terminal screws
- Back and side wire options accept #10-#14 AWG stranded or solid wire

Integrated Devices

- Glass-filled thermoplastic cover and plate provide outstanding impact resistance and durability
- Dual gaskets, one under plate and one under lid, for weather-resistant fit
- Stainless steel external hardware resists corrosive effects of moisture
- Large thumb-tab makes it easy to open cover with gloved hand
- Mounts to panels or FS/FD boxes
- UL Listed and CSA Certified for wet locations with cover closed

TESTING AND CODE COMPLIANCE

Combination Devices

- UL Listed (File #E-13393)
- CSA Certified (File #LR-406)
- NOM Certified (#057)
- Backed by a Limited 10-Year Warranty

Integrated Devices

- UL Listed (File #E-13397)
- CSA Certified (File #LR-16347)
- NOM Certified (#057)
- IP 64 Suitability Rating (protected against dust and splashing water)
- NEMA Type 3R Enclosure Rating when properly installed (protected against rain, sleet and damage from external ice formations)
- Backed by a Limited 2-Year Warranty

MATERIAL CHARACTERISTICS

Combination Devices

Environmental: Flammability, Rated V2
Operating Temperature: -40°C (without impact) to 60°C maximum continuous

Integrated Devices

Environmental: VO Flammability Rating per UL 94
Operating Temperature: -40°C to 60°C

Pin & Sleeve Devices

Series 309-1 and 309-2 IEC Configuration

INDEX

North American Watertight Pin & Sleeve Devices

Overview	.02, .03
20 & 30 Amp Devices	.04
60 & 100 Amp Devices	.05
Dimensions	.06, .07
Specifications	.08, .09

PowerSwitch® by Leviton

North American Watertight Mechanical Interlocks

Overview	.010, .011
20 & 30 Amp Devices	.012
60 & 100 Amp Devices	.013
Dimensions	.014
Specifications	.015

International-Rated Pin & Sleeve Devices

16, 32, 63 & 125 Amp Devices	.016
Specifications	.017
Dimensions	.018–.020

Pin & Sleeve Products

Back Boxes	.021
Accessories	.022

Making the Right Connection:

Color Code and Clock Position	.023
Leviton Catalog Numbering System	.023

PowerSwitch® by Leviton

Watertight Safety Disconnect Switches

Overview	.024
30, 60 & 100 Amp Devices	.025
Specifications	.026
Dimensions	.027, .028
Accessories	.028

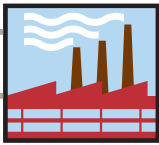

PIN & SLEEVE DEVICE FEATURES

Industrial Grade North American Watertight Pin & Sleeve Devices IEC 309-1 & 309-2

The Watertight Line: North American-Rated Devices

Superior Connection...Superior Protection

Features and Benefits

- Rugged housing, made of superior performance Valox 357, provides maximum corrosion protection and makes the device resistant to impact and abuse; greater resistance to temperature extremes, V-0 flame rated and superior UV stability.
- Contact carrier resists arcing and internal heat build-up; 60 and 100 amp contact/pin carriers are made of reinforced nylon for even greater strength and temperature resistance.
- Solid brass terminal screws on 20A, 30A & 60A devices provide maximum clamping pressure.
- Stainless steel terminal screws and terminals on 100A devices provide corrosion resistance in caustic environments.
- Dependable, clean brass construction for long life, reliable electrical contact, maximum conductivity, and corrosion resistance.
- Watertight Chloroprene onion skin grommet provides a precise, reliable seal at the cable entry point.
- Ground, neutral and phase terminals are clearly identified by color coding or letters and numbering on both front & back side.
- Multiple contact points assure a continuously reliable electrical connection.

UL Rated for both 50 and 60 Hz Applications.

2 YEAR LIMITED
WARRANTY



Accepts liquid-tight conduit with adapter accessory—See page O21



Engineered to IP67
Watertight Standards
North American Rated Devices
20, 30, 60 & 100 Amp

Heavy-Duty
Valox 357 Exterior
Cord Clamp

Reinforced Nylon
Contact Carrier

Clean Brass Pins

Terminal Screws
Stainless Steel (100A)
Solid Brass (20-60A)

5100P7W

Super-Durable
Valox 357 Housing

Watertight Chloroprene
Onion Skin Grommet

5100C7W

Front Terminals,
Raised Lettering,
Identification

Rear Terminals, Raised
Lettering, Identification

Calibrated, Self-Adjusting
Contacts

Valox® is a registered trademark of GE.



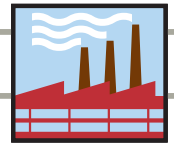

Industrial Grade North American Watertight Pin & Sleeve Devices



Super Tough Housing

- Provides maximum protection from abuse and environment
- Heavy-wall molding of Valox 357 resists impact, heat, flame and chemicals
- Superior performance in low-to-high ambient temperature extremes (-40°C to 60°C)
- Excellent UV stability for superior outdoor performance (UL1682)
- V-0 flammability rating
- Fully insulated
- Color-coded by voltage for easy identification



Pin & Contact Carrier 60 & 100 Amp

- Protects pins & contacts, holding them firmly in place
- Pin Carrier and Contact Carrier constructed of glass fiber reinforced nylon for maximum impact resistance and maximum protection of pins and contacts
- Superior arc-tracking resistance
- Excellent heat-resistance and flame-resistance
- Chamfered wire entry makes wiring easier



External Cord Clamp

- Protects terminals from strain
- Accommodates a wide variety of cord sizes
- Excellent impact strength
- Excellent UV stability for superior outdoor performance (UL1682)
- V-0 flammability rating



Pin & Contact Carrier 20 & 30 Amp

- Pin Carrier and Contact Carrier constructed of nylon for maximum impact resistance and maximum protection of pins and contacts
- Terminal screws are aligned on a single plane for easier access
- Internal hinged cord clamp adds strain-relief and swings aside when wiring terminals
- Large diameter combination head terminal screws



Internal Cord Clamp

- Secondary method for eliminating strain on terminals and conductors
- True IEC 309-1 & 309-2 acceptance
- Constructed of sturdy thermoplastic for tough environments
- Removes easily for user convenience



Pins

- Designed for manageable insertion/withdrawal force
- Clean brass construction resists corrosion, provides superior contact and low electrical resistance
- Rounded tips reduce insertion force and decrease wear on the contact surface area



Spring Loaded Cover, Cover Arm, & Locking Rings

- Rings lock plug to connector
- Spring loaded cover closes automatically
- "Performance grade" Stainless Steel cover spring for superior corrosion-resistance and long life
- Excellent UV stability for outdoor use
- V-0 flammability rating
- Interior arm design in 60 and 100 amp helps eliminate breakage



Sleeves (Contacts)

- Designed for manageable insertion/withdrawal force
- Clean brass construction resists corrosion, provides superior contact and low electrical resistance
- Self-adjusting, machine-calibrated contacts for accurate contact pressure designed for superior wiping and cleaning action
- Made from high performance Swedish Industrial Standard (SIS) Brass 5170-04
- Positioned at sleeve entrance, stainless steel spring enables pin cleaning at earliest point of entry



Gasket/Grommet

- Prevents moisture, dust, and contaminants from entering housing or pin/contact carrier
- Solid Chloroprene for positive seal and excellent chemical/corrosion-resistance
- Onion skin design on grommet provides precise watertight fit, eliminating the need to choose from multiple grommets that may not fit the cable jacket precisely



Terminal Screws

- Engineered to provide maximum holding power and lowest electrical resistance
- Accepts a wide range of conductors
- Double screws ensure secure connection
- Direct bearing pressure terminals for 20, 30 and 60 Amp ratings; pressure clamp termination for 100 Amp devices
- Stainless steel terminal screws and terminals for top performance on 100 Amp

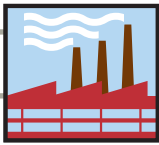

20 AMP • 30 AMP

Industrial Grade North American Watertight Pin & Sleeve Devices

IEC 309-1 & 309-2

20 AMP and 30 AMP Watertight Pin & Sleeve Devices



Engineered to IP67
Watertight Standards

2 YEAR LIMITED
WARRANTY



PLUG — 320P4W

CONNECTOR — 320C4W



RECEPTACLE — 420R9W



INLET — 420B9W



BACK BOX — BX230-V

AMPS	WIRING	VOLTAGE AC	CONNECTOR/ RECEPTACLE	PLUG/ INLET	PLUG	CONNECTOR	RECEPTACLE	INLET	BACK BOX
20	2p3w	125			320P4W	320C4W	320R4W	320B4W	BX230-V
	2p3w	250			320P6W	320C6W	320R6W	320B6W	BX230-V
	2p3w	480			320P7W	320C7W	320R7W	320B7W	BX230-V
	3p4w	125/250			420P12W	420C12W	420R12W	420B12W	BX230-V
	3p4w	30250			420P9W	420C9W	420R9W	420B9W	BX230-V
	3p4w	30480			420P7W	420C7W	420R7W	420B7W	BX230-V
	3p4w	30600			420P5W	420C5W	420R5W	420B5W	BX230-V
	4p5w	30Y120/208			520P9W	520C9W	520R9W	520B9W	BX230-V
	4p5w	30Y277/480			520P7W	520C7W	520R7W	520B7W	BX230-V
	4p5w	30Y347/600			520P5W	520C5W	520R5W	520B5W	BX230-V
30	2p3w	125			330P4W	330C4W	330R4W	330B4W	BX230-V
	2p3w	250			330P6W	330C6W	330R6W	330B6W	BX230-V
	2p3w	480			330P7W	330C7W	330R7W	330B7W	BX230-V
	3p4w	125/250			430P12W	430C12W	430R12W	430B12W	BX230-V
	3p4w	30250			430P9W	430C9W	430R9W	430B9W	BX230-V
	3p4w	30480			430P7W	430C7W	430R7W	430B7W	BX230-V
	3p4w	30600			430P5W	430C5W	430R5W	430B5W	BX230-V
	4p5w	30Y120/208			530P9W	530C9W	530R9W	530B9W	BX230-V
	4p5w	30Y277/480			530P7W	530C7W	530R7W	530B7W	BX230-V
	4p5w	30Y347/600			530P5W	530C5W	530R5W	530B5W	BX230-V

Additional information for Back Boxes and Accessories can be found on pages O21 & O22.

LEVITON To learn more about Leviton's outstanding offering of devices visit our Website at: www.leviton.com

Courtesy of Steven Engineering, Inc. • 230 Ryan Way, South San Francisco, CA 94080-6370 • General Inquiries: (800) 670-4183 • www.stevenengineering.com

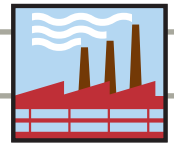

Industrial Grade North American Watertight Pin & Sleeve Devices

IEC 309-1 & 309-2

60 AMP and 100 AMP Watertight Pin & Sleeve Devices



Engineered to IP67
Watertight Standards

2 YEAR LIMITED
WARRANTY



PLUG — 4100P12W

CONNECTOR — 4100C12W

RECEPTACLE — 360R6W

INLET — 360B7W

BACK BOX — BX100-V

AMPS	WIRING	VOLTAGE AC	CONNECTOR/RECEPTACLE	PLUG/INLET	PLUG	CONNECTOR	RECEPTACLE	INLET	BACK BOX
60	2p3w	125			360P4W	360C4W	360R4W	360B4W	BX60-V
	2p3w	250			360P6W	360C6W	360R6W	360B6W	BX60-V
	2p3w	480			360P7W	360C7W	360R7W	360B7W	BX60-V
	3p4w	125/250			460P12W	460C12W	460R12W	460B12W	BX60-V
	3p4w	3Ø250			460P9W	460C9W	460R9W	460B9W	BX60-V
	3p4w	3Ø480			460P7W	460C7W	460R7W	460B7W	BX60-V
	3p4w	3Ø600			460P5W	460C5W	460R5W	460B5W	BX60-V
	4p5w	3ØY120/208			560P9W	560C9W	560R9W	560B9W	BX60-V
	4p5w	3ØY277/480			560P7W	560C7W	560R7W	560B7W	BX60-V
	4p5w	3ØY347/600			560P5W	560C5W	560R5W	560B5W	BX60-V
100	2p3w	125			3100P4W	3100C4W	3100R4W	3100B4W	BX100-V
	2p3w	250			3100P6W	3100C6W	3100R6W	3100B6W	BX100-V
	2p3w	480			3100P7W	3100C7W	3100R7W	3100B7W	BX100-V
	3p4w	125/250			4100P12W	4100C12W	4100R12W	4100B12W	BX100-V
	3p4w	3Ø250			4100P9W	4100C9W	4100R9W	4100B9W	BX100-V
	3p4w	3Ø480			4100P7W	4100C7W	4100R7W	4100B7W	BX100-V
	3p4w	3Ø600			4100P5W	4100C5W	4100R5W	4100B5W	BX100-V
	4p5w	3ØY120/208			5100P9W	5100C9W	5100R9W	5100B9W	BX100-V
	4p5w	3ØY277/480			5100P7W	5100C7W	5100R7W	5100B7W	BX100-V
	4p5w	3ØY347/600			5100P5W	5100C5W	5100R5W	5100B5W	BX100-V

Additional information for Back Boxes and Accessories can be found on pages O21 & O22.

Pin & Sleeve Devices

O
5

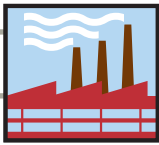

PLUG & CONNECTOR DIMENSIONS

Industrial Grade North American Watertight Pin & Sleeve Devices



Engineered to IP67
Watertight Standards

2 YEAR LIMITED
WARRANTY

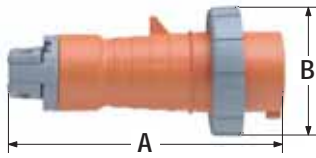

20A, 30A PLUG

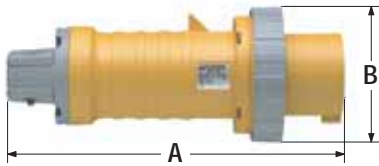

60A, 100A PLUG

Plug Dimensions

CATALOG NO.	AMPS	UNIT	A	B	CORD GRIP RANGE
320P	20	inch	5.83	2.80	.350 –.860
		mm	148	71	9 – 22
420P	20	inch	6.46	3.11	.350 –.860
		mm	164	79	9 – 22
520P	20	inch	6.61	3.43	.437 –1.187
		mm	168	87	11 – 30
330P	30	inch	6.85	3.70	.437 –1.187
		mm	174	94	11 – 30
430P	30	inch	6.85	3.70	.437 –1.187
		mm	174	94	11 – 30
530P	30	inch	7.40	3.98	.437 –1.450
		mm	188	101	11 – 37
360P	60	inch	10.83	4.49	.670 –1.625
		mm	275	114	17 – 41
460P	60	inch	10.83	4.49	.670 –1.625
		mm	275	114	17 – 41
560P	60	inch	10.83	4.49	.670 –1.625
		mm	275	114	17 – 41
3100P	100	inch	12.3	5	.950 –1.875
		mm	312	127	24 – 48
4100P	100	inch	12.3	5	.950 –1.875
		mm	312	127	24 – 48
5100P	100	inch	12.3	5	.950 –1.875
		mm	312	127	24 – 48

Connector Dimensions

CATALOG NO.	AMPS	UNIT	A	B	CORD GRIP RANGE
320C	20	inch	6.73	3.19	.350 –.860
		mm	171	81	9 – 22
420C	20	inch	7.36	3.46	.350 –.860
		mm	187	88	9 – 22
520C	20	inch	7.95	3.82	.437 –1.187
		mm	202	97	11 – 30
330C	30	inch	7.95	4.02	.437 –1.187
		mm	202	102	11 – 30
430C	30	inch	7.95	4.02	.437 –1.187
		mm	202	102	11 – 30
530C	30	inch	8.27	4.29	.437 –1.450
		mm	210	109	11 – 37
360C	60	inch	11.26	4.41	.670 –1.625
		mm	286	112	17 – 41
460C	60	inch	11.26	4.41	.670 –1.625
		mm	286	112	17 – 41
560C	60	inch	11.26	4.41	.670 –1.625
		mm	286	112	17 – 41
3100C	100	inch	12.8	4.84	.950 –1.875
		mm	325	123	24 – 48
4100C	100	inch	12.8	4.84	.950 –1.875
		mm	325	123	24 – 48
5100C	100	inch	12.8	4.84	.950 –1.875
		mm	325	123	24 – 48

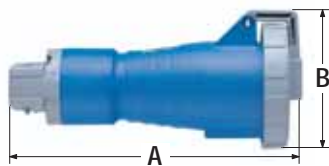

20A, 30A CONNECTOR

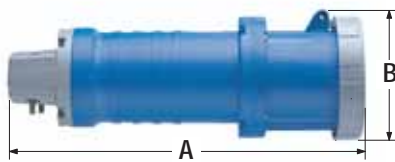

60A, 100A CONNECTOR

INLET & RECEPTACLE DIMENSIONS

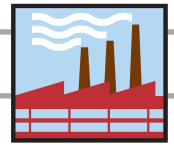

Industrial Grade North American Watertight Pin & Sleeve Devices



Engineered to IP67
Watertight Standards

2 YEAR LIMITED
WARRANTY

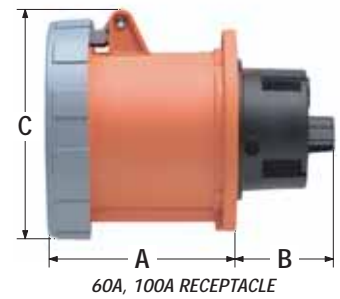
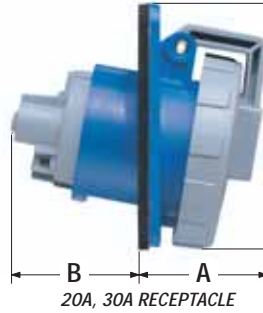
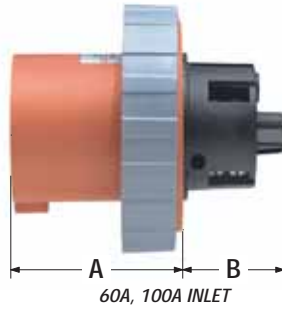
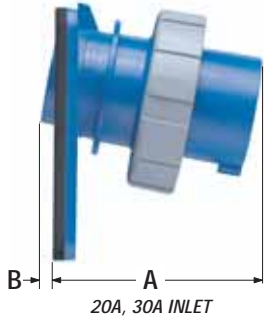

Inlet Dimensions

CATALOG NO.	AMPS	UNIT	A	B
320B	20	inch	1.85	0.39
		mm	47	10
420B	20	inch	2.09	0.39
		mm	53	10
520B	20	inch	2.32	0.39
		mm	59	10
330B	30	inch	2.36	0.47
		mm	60	12
430B	30	inch	2.36	0.47
		mm	60	12
530B	30	inch	2.64	.47
		mm	67	12
360B	60	inch	3.15	1.97
		mm	80	50
460B	60	inch	3.15	1.97
		mm	80	50
560B	60	inch	3.15	1.97
		mm	80	50
3100B	100	inch	3.50	2.21
		mm	89	56
4100B	100	inch	3.50	2.21
		mm	89	56
5100B	100	inch	3.50	2.21
		mm	89	56

Receptacle Dimensions

CATALOG NO.	AMPS	UNIT	A	B	C
320R	20	inch	1.77	2.24	3.74
		mm	45	57	95
420R	20	inch	1.77	2.24	3.74
		mm	45	57	95
520R	20	inch	1.85	2.24	3.90
		mm	47	57	99
330R	30	inch	2.20	2.40	4.10
		mm	56	61	104
430R	30	inch	2.20	2.40	4.10
		mm	56	61	104
530R	30	inch	2.20	2.44	4.37
		mm	56	62	111
360R	60	inch	3.50	1.89	4.37
		mm	89	48	111
460R	60	inch	3.50	1.89	4.37
		mm	89	48	111
560R	60	inch	3.50	1.89	4.37
		mm	89	48	111
3100R	100	inch	3.94	2.28	4.80
		mm	100	58	122
4100R	100	inch	3.94	2.28	4.80
		mm	100	58	122
5100R	100	inch	3.94	2.28	4.80
		mm	100	58	122

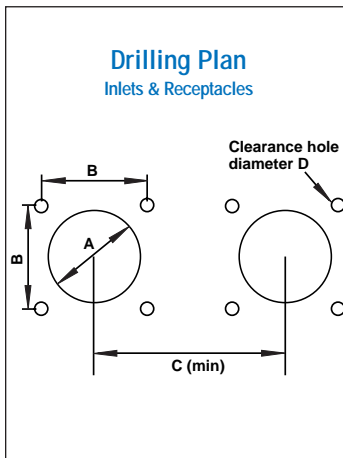

DEVICE SIZE		A		B		C (min)		D	
		inches	mm	inches	mm	inches	mm	inches	mm
20A; 3-wire:	Receptacle	3.26	83	3.12	79.5	3.94	100	0.185	4.7
	Inlet	3.26	83	3.12	79.5	3.94	100	0.185	4.7
20A; 4-wire:	Receptacle	3.26	83	3.12	79.5	4.33	110	0.185	4.7
	Inlet	3.26	83	3.12	79.5	4.33	110	0.185	4.7
20A; 5-wire:	Receptacle	3.26	83	3.12	79.5	4.92	125	0.236	6.0
	Inlet	3.26	83	3.12	79.5	4.92	125	0.185	4.7
30A; 3-wire:	Receptacle	3.26	83	3.12	79.5	5.12	130	0.236	6.0
	Inlet	3.26	83	3.12	79.5	5.12	130	0.185	4.7
30A; 4-wire:	Receptacle	3.26	83	3.12	79.5	5.12	130	0.236	6.0
	Inlet	3.26	83	3.12	79.5	5.12	130	0.185	4.7
30A; 5-wire:	Receptacle	3.26	83	3.12	79.5	5.71	145	0.236	6.0
	Inlet	3.26	83	3.12	79.5	5.71	145	0.185	4.7
60A	All	2.76	70	2.40	61	6.69	170	0.224	5.7
100A	All	3.47	88	2.80	71	7.87	200	0.280	7.1

Pin & Sleeve Devices

0
7

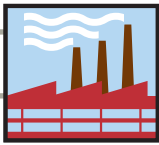

TECHNICAL INFORMATION

Industrial Grade North American Watertight Pin & Sleeve Devices



Engineered to IP67
Watertight Standards

2 YEAR LIMITED
WARRANTY



- Listed to UL 1682 and 1686
- Certified to CSA Standard C22.2 number 182.1
- Classified to IEC Standards 309-1 and 309-2 for both North American-rated and International-rated voltages and services
- CE marking per low-voltage directives 73/23/EEC, 93/68/EEC



4100P12W

4100C12W

Material Specifications

Inlets

PART	MATERIAL
Housing	Valox 357
Locking Ring	Valox 357
Mounting Flange	Valox 357
Contact Carrier	Nylon for 20 and 30 Amp devices; Reinforced nylon for 60 and 100 Amp devices
Phase, Ground Pins	Brass
20, 30, 60A Terminal Screws	Brass
100A Terminal Screws	Stainless Steel
Sealing Gasket	Solid Chloroprene

Connectors

PART	MATERIAL
Housing	Valox 357
Internal Cord Clamp Asmby	Thermoplastic
External Cord Clamp Asmby	Valox 357
Gland Cap	Valox 357
Grommet	Chloroprene Onion Skin
Cover with Arm	Valox 357
Arm Spring	"Performance Grade" Stainless Steel
Cover Eyelet	Nickel-Plated Brass
Sealing Gasket	Solid Chloroprene
Contact Carrier	Nylon for 20 and 30 Amp devices; Reinforced nylon for 60 and 100 Amp devices
Phase, Ground Sleeve	Brass
Sleeve Spring	Stainless Steel
20, 30, 60A Terminal Screws	Brass
100A Terminal Screws	Stainless Steel
Internal Screws	Zinc-plated Steel
External Screws	Acid-proof Stainless Steel

Plugs

PART	MATERIAL
Housing	Valox 357
Locking Ring	Valox 357
Sealing Gasket	Solid Chloroprene
Internal Cord Clamp Asmby	Thermoplastic
External Cord Clamp Asmby	Valox 357
Gland Cap	Valox 357
Grommet	Chloroprene Onion Skin
Contact Carrier	Nylon for 20 and 30 Amp devices; Reinforced nylon for 60 and 100 Amp devices
Ground, Phase Pins	Brass
20, 30, 60A Terminal Screws	Brass
100A Terminal Screws	Stainless Steel
Internal Screws	Zinc-plated Steel
External Screws	Acid-proof Stainless Steel

Receptacles

PART	MATERIAL
Housing	Valox 357
Mounting Flange	Valox 357
Cover with Arm	Valox 357
Arm Spring	"Performance Grade" Stainless Steel
Cover Eyelet	Nickel-Plated Brass
Sealing Gasket	Solid Chloroprene
20, 30, 60A Terminal Screws	Brass
100A Terminal Screws	Stainless Steel
Phase, Ground Sleeves	Brass
Sleeve Spring	Stainless Steel

Valox® is a registered trademark of GE.

STANDARDS & CERTIFICATIONS

Pin & Sleeve: Inlets, Connectors, Plugs, Receptacles

UL 1682 & 1686	CSA C22.2 No. 182.1	NOM	CE	IEC 309-1 & 309-2
E164321 & E164322	LR700925	✓	✓	✓

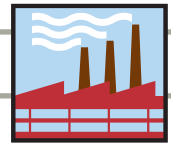

Industrial Grade North American Watertight Pin & Sleeve Devices



Engineered to IP67
Watertight Standards

2 YEAR LIMITED
WARRANTY

Performance Specifications – UL 1682 & 1686

Electrical

Dielectric Voltage	Devices rated ≤ 300V: 2000V for 1 min. Devices rated >300V: 3000V for 1 min.								
Insulation Resistance	500 V for 1 min. Insulation Resistance ≥ 5 megohms								
Ground Path Current	Apply high current for short time (See Table 1) and maintain continuity								
Overload	150% of rated current and 100% of rated voltage for 50 cycles (Power factor 0.75–0.80)								
Current Interrupting	Certified for current interrupting at full-rated current and voltage								
Temperature Rise	Max 30°C rise at full rated current (after overload)								
Resistance to Arcing	Continuation of overload for additional 200 cycles								
Endurance with Load	<table border="1"> <thead> <tr> <th>Device</th> <th># Cycles with Load</th> </tr> </thead> <tbody> <tr> <td>20A</td> <td>5000 Rated Current, Voltage</td> </tr> <tr> <td>30A, 60A</td> <td>1000 Rated Current, Voltage</td> </tr> <tr> <td>100A</td> <td>250 Rated Current, Voltage</td> </tr> </tbody> </table> (Power Factor 0.75 – 0.80)	Device	# Cycles with Load	20A	5000 Rated Current, Voltage	30A, 60A	1000 Rated Current, Voltage	100A	250 Rated Current, Voltage
Device	# Cycles with Load								
20A	5000 Rated Current, Voltage								
30A, 60A	1000 Rated Current, Voltage								
100A	250 Rated Current, Voltage								

Mechanical

Mold Stress Relief	70°C for 7 hrs								
Humidity	32°C, 93% humidity, 168 hrs								
Cable Secureness	Pull force and apply torque for 1 minute (See Table 2)								
Impact	Drop from 30" 8 times after conditioning to -25°C, for 6 hrs								
Crush	250 lbs for 1 min after -25°C for 6 hrs								
Withdrawal Force	Pull for one minute (See Table 3)								
Strength of Insulating Base and Support	110% of specified tightening torque on terminal screws								
Endurance	<table border="1"> <thead> <tr> <th>Device</th> <th>Total # Cycles (connect & disconnect)</th> </tr> </thead> <tbody> <tr> <td>20A</td> <td>5000</td> </tr> <tr> <td>30A, 60A</td> <td>2000</td> </tr> <tr> <td>100A</td> <td>500</td> </tr> </tbody> </table>	Device	Total # Cycles (connect & disconnect)	20A	5000	30A, 60A	2000	100A	500
Device	Total # Cycles (connect & disconnect)								
20A	5000								
30A, 60A	2000								
100A	500								
Polarization Integrity	Matching devices will not mate so that ground is energized even when polarization feature is removed and 40-lb insertion force applied								

Environmental

Flammability	V2 or better on 20 and 30 amp devices per UL 94 or CSA 22.2 No 0.6 ; V-0 on 60 & 100 amp devices
Resistance to Corrosion Moisture Resistance per UL 1682	Ferrous parts immersed in 10% ammonium chloride solution Watertight: Device immersed for 24 hrs in 5 cm of 25°C water Splashproof: 1" dia. water stream at 15 PSI from 10 ft. for 5 minutes
UV Resistance	Exposed plastic materials are UV stabilized



460P7W

460C12W

Short-Time Grounding Test Currents

Device Rating, Amperes	Minimum Size Equipment Grounding Conductor (Copper)		Time, Seconds	Test Current, Amperes
	AWG	(mm ²)		
20	12	(3.3)	4	470
30	10	(5.3)	4	750
60	10	(5.3)	4	750
100	8	(8.4)	4	1180

Ground-path integrity is of critical importance to safe operation of industrial equipment. Leviton pin and sleeve devices are tested by applying a test current through their ground path that far exceeds the device rating. All devices are properly wired and connected to line current at rated values. Then the ground path is subjected to a dramatic, sudden increase in current for 4 seconds. In all cases, the ground pin, sleeve, and terminals of the devices must sustain the test current, continue to function properly, and show no evidence of damage or deterioration in any electrical or mechanical elements of the ground path. Test current values and test parameters are displayed in the above chart.

Cord Secureness Test Values

Device Rating Amperes	Force		Torque		Maximum Displacement	
	lb	N	ft-lb	N • M	inches	mm
20	30	133	0.4	0.54	≤3/32	2.38
30	75	333	0.5	0.68	≤3/32	2.38
60	150	667	1.0	1.4	≤3/32	2.38
100	150	667	2.0	2.7	≤3/32	2.38

Heavy cord stress is typical of industrial applications. To assure you of top performance, Leviton pin and sleeve devices are subjected to a punishing series of tests to confirm they can absorb heavy cord pulls. The cord conductors wired to devices are simultaneously twisted and pulled. Values for the applied twisting torque and force of pull are shown above. In all cases, the cord displacement is less than 3/32 inches.

Minimum Withdrawal Force

Device Rating, Amperes	Minimum Withdrawal Force	
	lb	N
20	5	22
30	6	27
60	15	67
100	20	89

In industrial settings, inadvertent disconnection of power can be troublesome at best, dangerous at worst, and unacceptable in any case. To verify that Leviton pin and sleeve plugs and connectors remain securely connected, they are tested to establish the minimum force required for withdrawal. In establishing these minimum withdrawal forces, the plugs and connectors are properly mated, but not locked with locking rings or other mechanical means. The pins and sleeves provide the only resistance to the force of withdrawal. In all cases, the values in the table above show the minimum force required to separate the plugs and connectors.

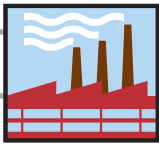

MECHANICAL INTERLOCK FEATURES

Industrial Grade North American Watertight Mechanical Interlocks IEC 309-1 & 309-2

Type 3R, 4X & 12K
IP67



2 YEAR LIMITED
WARRANTY



560MI7W
60 Amp



420MI9W
20 Amp



420MF9W
20 Amp, Fused

Fused Models Accept
"Class J" Time-Delay
Fuses

PowerSwitch® Mechanical Interlocks

- 20 Amp Non-Fused & Fused
- 30 Amp Non-Fused & Fused
- 60 Amp Non-Fused & Fused
- 100 Amp Non-Fused

PowerSwitch Mechanical Interlock devices incorporate a disconnect safety switch and IEC receptacle in a non-metallic watertight enclosure. The interlock mechanism prevents making and breaking of power under load. "The switch cannot be actuated to the *ON* position until an IEC compatible plug is fully inserted, and the plug cannot be removed until the switch is in the *OFF* position."

The complete IEC 309-1 and 309-2 system of plugs, connectors, inlets and mechanical interlock devices can be used for both retrofit and new installations enhancing safety and performance in critical power connections.

Pin & Sleeve Devices

MECHANICAL INTERLOCK FEATURES

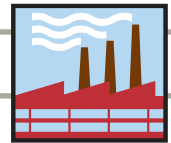

Industrial Grade North American Watertight Mechanical Interlocks

2 YEAR LIMITED WARRANTY

Liquid-tight conduit fitting can be installed for top or bottom feed

One fitting supplied:

- 20-30 Amp – 3/4"
- 60 Amp – 1 1/4"
- 100 Amp – 1 1/2"

Stainless steel screws are captive and will not fall out when cover is opened

Impact, UV and chemical-resistant Valox enclosure rated to UL and IEC watertight standards

- Type 3R, 4X & 12K
- IP67

Fused Models Accept "Class J" Time-Delay Fuses



420MF9W

Red "pistol grip" handle provides visual confirmation of switch's status

Integrated lockout handle meets OSHA safety regulations



Handle with padlock installed

Circuit identification pad for means of identifying specific equipment loads

Color-coded receptacle cover indicates voltage rating of device and seals against water and other contaminants when not in use

Pre-wired grounding plate connects to metal conduit grounding system

Brass threaded inserts will not strip, provide higher torque, and form tighter seal between back box and cover

Rugged hinge mechanism pivots 180° for easy access during installation and maintenance

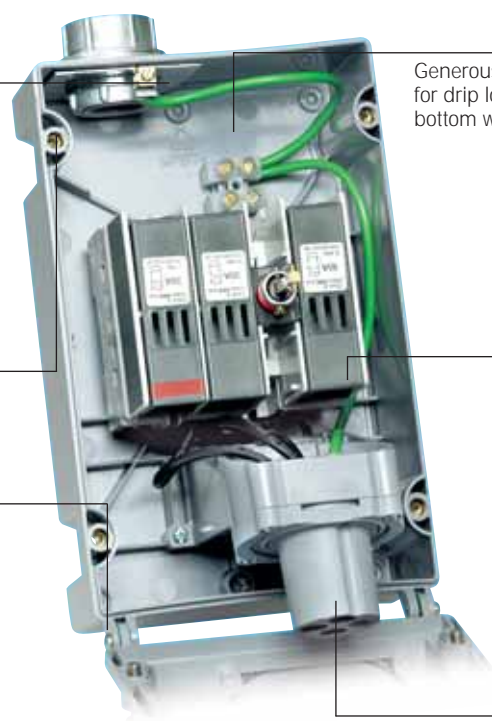

420MF9W

Generous wiring space for drip loop or top to bottom wiring

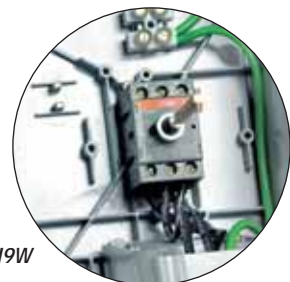

420MI9W

Compact non-fused mechanical interlocks are easy to wire

Disconnect switch with integrated fuse holder offers proven performance in a compact package

- Fused cartridges accept "Class J" fuses (not included)
- One factory installed auxiliary contact (normally opened – 10 Amp). Additional auxiliary contact available (normally closed — 10 Amp)
- Easily accessible neutral and ground terminal blocks

Pre-wired IEC receptacle accepts all manufacturer's IEC 309-2 plugs



STANDARDS & CERTIFICATIONS						
Mechanical Interlocks						
UL 231 & UL1686	UL 98 Fused	UL 508 Non-Fused	CSA C22.2 No. 182.1 & 14	NOM	CE	IEC 309-1 & 309-2
E171391			LR700925	✓	✓	✓

Pin & Sleeve Devices



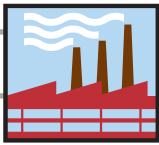

20 AMP • 30 AMP

Industrial Grade North American Watertight Mechanical Interlocks

Non-Fused & Fused



420MF9W



2 YEAR LIMITED WARRANTY



Fused Models Accept "Class J" Time-Delay Fuses

Type 3R, 4X & 12K
IP67

AMPS	WIRING	VOLTAGE AC	RECEPTACLE CONFIG.	PLUG CONFIG.	NON-FUSED		FUSED		USE PLUG CAT. NO.
					MECHANICAL INTERLOCK	HP RATING	MECHANICAL INTERLOCK	HP RATING	
20	2p3w	240			320MI6W	3	—	—	320P6W
	2p3w	480			320MI7W	5	—	—	320P7W
	3p4w	125/250			420MI12W	*	420MF12W	*	420P12W
	3p4w	3Ø240			420MI9W	5	420MF9W	5	420P9W
	3p4w	3Ø480			420MI7W	10	420MF7W	10	420P7W
	3p4w	3Ø600			420MI5W	15	420MF5W	15	420P5W
	4p5w	3ØY120/208			520MI9W	5	—	—	520P9W
	4p5w	3ØY277/480			520MI7W	10	—	—	520P7W
	4p5w	3ØY347/600			520MI5W	15	—	—	520P5W
30	2p3w	240			330MI6W	5	—	—	330P6W
	2p3w	480			330MI7W	10	—	—	330P7W
	3p4w	125/250			430MI12W	*	430MF12W	*	430P12W
	3p4w	3Ø240			430MI9W	10	430MF9W	7.5	430P9W
	3p4w	3Ø480			430MI7W	20	430MF7W	15	430P7W
	3p4w	3Ø600			430MI5W	25	430MF5W	20	430P5W
	4p5w	3ØY120/208			530MI9W	10	—	—	530P9W
	4p5w	3ØY277/480			530MI7W	20	530MF7W	15	530P7W
	4p5w	3ØY347/600			530MI5W	25	530MF5W	20	530P5W

*Consult factory for your specific application.

Pin & Sleeve Devices

0
12

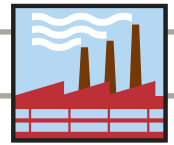

Industrial Grade North American Watertight Mechanical Interlocks
Non-Fused & Fused



Fused Models Accept
"Class J" Time-Delay Fuses



Engineered to IP67
Watertight Standards

2 YEAR LIMITED
WARRANTY

Type 3R, 4X & 12K
IP67

560MI7W

AMPS	WIRING	VOLTAGE AC	RECEPTACLE CONFIG.	PLUG CONFIG.	NON-FUSED		FUSED		USE PLUG CAT. NO.
					MECHANICAL INTERLOCK	HP RATING	MECHANICAL INTERLOCK	HP RATING	
60	2p3w	240			360MI6W	10	360MF6W	*	360P6W
	2p3w	480			360MI7W	20	—	—	360P7W
	3p4w	125/250			460MI12W	*	460MF12W	*	460P12W
	3p4w	3Ø240			460MI9W	20	460MF9W	15	460P9W
	3p4w	3Ø480			460MI7W	40	460MF7W	30	460P7W
	3p4w	3Ø600			460MI5W	40	460MF5W	50	460P5W
	4p5w	3ØY120/208			560MI9W	20	560MF9W	15	560P9W
	4p5w	3ØY277/480			560MI7W	40	—	—	560P7W
	4p5w	3ØY347/600			560MI5W	40	—	—	560P5W

Type 3R, 4X & 12K
IP67

AMPS	WIRING	VOLTAGE AC	RECEPTACLE CONFIG.	PLUG CONFIG.	NON-FUSED		USE PLUG CAT. NO.
					MECHANICAL INTERLOCK	HORSEPOWER RATING	
100	2p3w	125			3100MI4W	5	3100P4W
	2p3w	240			3100MI6W	15	3100P6W
	2p3w	480			3100MI7W	25	3100P7W
	3p4w	125/250			4100MI12W	*	4100P12W
	3p4w	3Ø240			4100MI9W	30	4100P9W
	3p4w	3Ø480			4100MI7W	50	4100P7W
	3p4w	3Ø600			4100MI5W	50	4100P5W
	4p5w	3ØY120/208			5100MI9W	25	5100P9W
	4p5w	3ØY277/480			5100MI7W	50	5100P7W
	4p5w	3ØY347/600			5100MI5W	50	5100P5W

*Consult factory for your specific application.

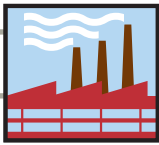

MECHANICAL INTERLOCK DIMENSIONS

Industrial Grade North American Watertight Mechanical Interlocks Non-Fused & Fused

2 YEAR LIMITED
WARRANTY

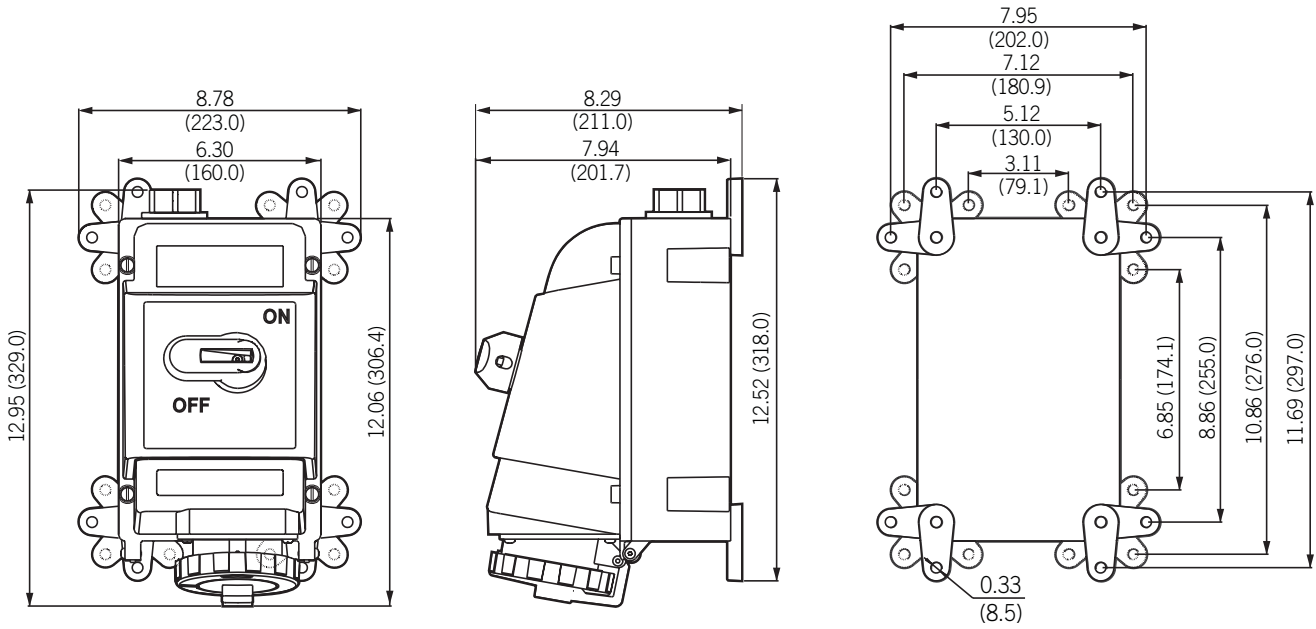

20 AMP & 30 AMP FUSED AND NON-FUSED

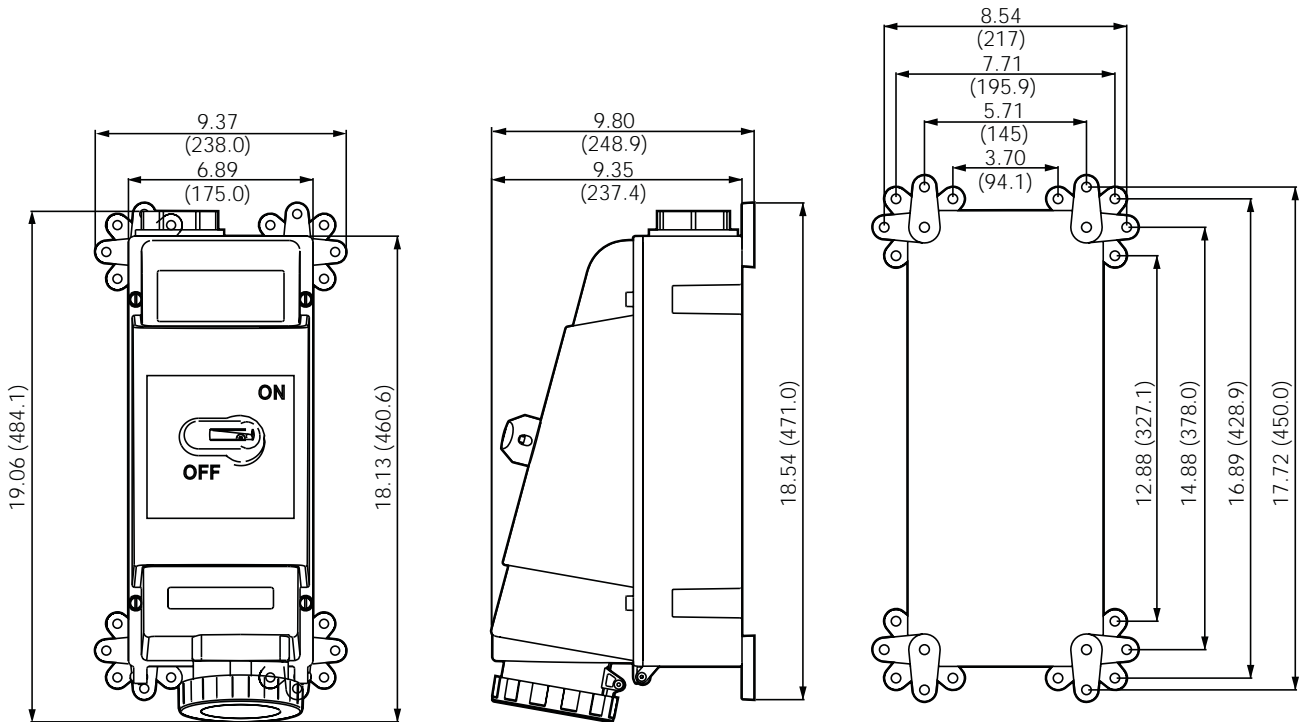

60 AMP FUSED & NON-FUSED & 100 AMP NON-FUSED

Pin & Sleeve Devices

0
14



To learn more about Leviton's outstanding offering of devices visit our Website at: www.leviton.com

Courtesy of Steven Engineering, Inc. • 230 Ryan Way, South San Francisco, CA 94080-6370 • General Inquiries: (800) 670-4183 • www.stevenengineering.com

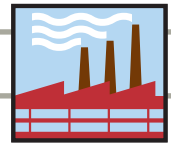

Industrial Grade North American Watertight Mechanical Interlocks

20, 30, 60 and 100 AMP



Engineered to IP67
Watertight Standards

2 YEAR LIMITED
WARRANTY

- Enclosures are rated Type 3R, 4X & 12K, IP67
- Listed to UL 231 and 1686
- Certified to CSA Standard C22.2 number 182.1 & 14
- Classified to IEC Standards 309-1 and 309-2 for both North American-rated voltages and services
- CE marking per low-voltage directives 73/23/EEC, 93/68/EEC
- Switches are listed to UL 508 for Non-Fused and UL98 for Fused models (including 100 Amp Non-Fused)

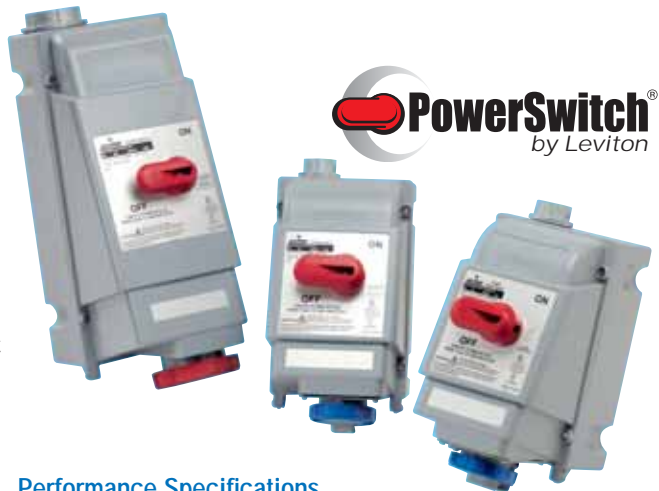

Material Specifications

20 and 30 Amp Devices

PART	MATERIAL
Housing Cover	Valox 357
Housing Base	Valox 357
Cover with Arm	Valox 357
Locking Ring	Valox 357
Cover Arm Eyelet	Nickel-Plated Brass
Housing Gasket	Solid Chloroprene
Sealing Gasket	Solid Chloroprene
Handle	Valox 357
Actuator Shaft	Valox 357
Locking Mechanism	Zinc-Coated Steel
Contact Carrier	Nylon
Phase and Ground Sleeves	Brass
Ground Contact	Brass
Conduit Grounding Plate	Zinc-Coated Steel
Conduit Hub (1")	Die-Cast Zinc
Switch	Reinforced Nylon
Switch Terminal Contacts	Brass
Internal Screws	Zinc-Coated Steel
Housing Screws	Stainless Steel

Additional Components for 60 Amp Devices

PART	MATERIAL
Ground Bus	Brass
Neutral Bus	Brass
Actuator Shaft	Zinc-Coated Steel
Contact Carrier	Reinforced Nylon
Conduit Hub (1 1/2")	Die-Cast Zinc
Locking Mechanism	Valox 357

Additional Components for 100 Amp Devices

PART	MATERIAL
Ground Terminal	Plated Brass/Steel
Ground Terminal Block	Nylon
Neutral Terminal	Plated Brass/Steel
Neutral Terminal Block	Nylon
Terminal Shaft Key	Die-Cast Aluminum
Actuator Shaft	Zinc-Coated Steel
Contact Carrier	Reinforced Nylon
Conduit Hub (2")	Die-Cast Zinc
Switch	Reinforced Nylon
Locking Mechanism	Valox 357

Valox® is a registered trademark of GE.

Performance Specifications

ELECTRICAL			
Ground Path Integrity	Device 20 A 30 A	Current Applied 40 A 60 A	Duration 2 min 2 min
	60 A 100 A	120 A 200 A	4 min 6 min
Current Interrupting	Certified for current interrupting at full-rated current and voltage		
Endurance	6000 operations at rated current and voltage (Power factor 0.75 – 0.80)		
Dielectric	1000 V plus twice rated voltage for 1 minute		

MECHANICAL	
Mold Stress Relief	70°C for 7 hours
Knockout Test	Remains in place with 20 lb push
Crush	100 lb
Impact	1.2 lb steel ball dropped from 5 ft
Cold Impact	Same as above, after conditioning to -35°C
Strength of Insulating Base and Support	110% of specified tightening torque on terminal screws
Pullout	18 lb pull on internal wires

ENVIRONMENTAL	
Flammability	No 0.6; V-0 for watertight enclosure
Rain (3R) per UL 50	Water spray @ 5 psi from all sides for 1 hr
Hosedown (4X) per UL 50	Water spray @ 65 gal/min for 5 min.
Dust (12K) per UL 50	Cement Dust Circulated @ 1000 ft/minute for 5 minutes
Gasket Aging	70°C for 168 hours
UV Resistance	Exposed plastic materials are UV stabilized
Operating Temperature	-40°C to +60°C (-40°F to +140°F)

STANDARDS & CERTIFICATIONS						
Mechanical Interlocks						
UL231 & UL1686	UL 98 Fused	UL 508 Non-Fused	CSA C22.2	NOM	CE	IEC 309-1 & 309-2
✓	✓	✓	✓	✓	✓	✓

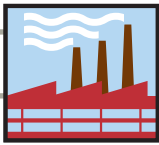

16 AMP • 32 AMP • 63 AMP • 125 AMP

Industrial Grade International-Rated Pin & Sleeve Devices



2 YEAR LIMITED WARRANTY

432P3WL, 432C3WL & All 125A Devices listed on this page have North American Rated Construction



SP516P6



SP516C6



SP516R6



SP516B6

International-Rated Devices

Leviton offers international-rated pin and sleeve devices available in 16, 32, 63 and 125 Amps. These IEC 309-1 and 309-2 compliant devices are ideal for use overseas where voltage and amperage requirements differ from North American standards, but where rigorous performance, quality, and reliability criteria need to be met.

16, 32 and 63 Amp devices have an environmental classification of splashproof (IP44), and 125 Amp devices are classified as watertight (IP67).

Ordering Information*

AMPS	WIRING	VOLTAGE AC	CONNECTOR/RECEPTACLE	PLUG/INLET	PLUG	CONNECTOR	RECEPTACLE	INLET
16	2p3w	100 – 130			SP316P4	SP316C4	SP316R4	SP316B4
	2p3w	250			SP316P6	SP316C6	SP316R6	SP316B6
	3p4w	380 – 415			SP416P6	SP416C6	SP416R6	SP416B6
	4p5w	200/346 – 240/415			SP516P6	SP516C6	SP516R6	SP516B6
32	2p3w	100 – 130			SP332P4	SP332C4	SP332R4	SP332B4
	2p3w	250			SP332P6	SP332C6	SP332R6	SP332B6
	3p4w	380 – 415			SP432P6	SP432C6	SP432R6	SP432B6
	3p4w	30380 – 30440			432P3WL†	432C3WL†	—	—
	4p5w	200/346 – 240/415			SP532P6	SP532C6	SP532R6	SP532B6
63	2p3w	250			SP363P6	SP363C6	SP363R6	SP363B6
	3p4w	380 – 415			SP463P6	SP463C6	SP463R6	SP463B6
	4p5w	200/346 – 240/415			SP563P6	SP563C6	SP563R6	SP563B6
125	2p3w	250			3125P6W	3125C6W	3125R6W	3125B6W
	3p4w	380 – 415			4125P6W	4125C6W	4125R6W	4125B6W
	4p5w	200/346 – 240/415			5125P6W	5125C6W	5125R6W	5125B6W

*Consult the factory for availability before placing your order. These are specialty order items and are not regularly stocked.

†This device has North American 30 Amp construction and is used in refrigerated container applications.



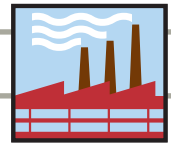

Industrial Grade International-Rated Pin & Sleeve Devices

- Classified to IEC Standards 309-1 and 309-2
- CE marking per low-voltage directives 73/23/EEC, 93/68/EEC



Material Specifications

Inlets

PART	MATERIAL FOR 16A, 32A INLETS	MATERIAL FOR 63A, 125A INLETS
Housing	Nylon	Valox 357
Mounting Flange	Nylon	_____
Locking Ring (125A)	_____	Valox 357
Contact Carrier	Nylon	Reinforced Nylon
Terminal Screws – Stainless Steel (125A)	Brass	Brass (63A)
Phase, Ground Pins	Brass	Brass

Connectors

PART	MATERIAL FOR 16A, 32A CONNECTORS	MATERIAL FOR 63A, 125A CONNECTORS
Housing	Nylon	Valox 357
Cover	Nylon	Valox 357
Arm Spring	Stainless Steel	Stainless Steel
Contact Carrier	Nylon	Reinforced Nylon
Internal Cord Clamp	Nylon	Nylon
External Cord Clamp	_____	Valox 357
Grommet	EPDM Rubber	EPDM Rubber (63A), Chloroprene Onion Skin (125A)
Sealing Gasket (125A)	_____	Solid Chloroprene
Cover Eyelet	Nickel Plated Brass	Nickel Plated Brass
External Screws	_____	Acid-Proof Stainless Steel
Terminal Screws	Brass	Brass (63A), Stainless Steel (125A)
Phase, Ground Sleeve	Brass	Brass
Sleeve Spring	Stainless Steel	Stainless Steel
Internal Screws	Zinc-Plated Steel	Zinc-Plated Steel

Plugs

PART	MATERIAL FOR 16A, 32A PLUGS	MATERIAL FOR 63A, 125A PLUGS
Housing	Nylon	Valox 357
Contact Carrier	Nylon	Reinforced Nylon
Internal Cord Clamp	Nylon	Nylon
External Cord Clamp	_____	Valox 357
Grommet	EPDM Rubber	EPDM Rubber (63A), Chloroprene Rubber (125A)
Sealing Gasket (125A)	_____	Solid Chloroprene
External Screws	_____	Acid-Proof Stainless Steel
Terminal Screws	Brass	Brass (63A), Stainless Steel (125A)
Phase, Ground Pins	Brass	Brass
Sleeve Spring	Stainless Steel	Stainless Steel
Internal Screws	Zinc-Plated Steel	Zinc-Plated Steel

Receptacles

PART	MATERIAL FOR 16A, 32A PLUGS	MATERIAL FOR 63A, 125A PLUGS
Housing	Nylon	Valox 357
Cover	Nylon	Valox 357
Mounting Flange	Nylon	_____
Arm Spring	_____	Stainless Steel
Contact Carrier	Nylon	Reinforced Nylon
Sealing Gasket (125A)	_____	Solid Chloroprene
Cover Eyelet	Nickel Plated Brass	Nickel Plated Brass
Terminal Screws	Brass	Brass (63A), Stainless Steel (125A)
Phase, Ground Sleeve	Brass	Brass
Sleeve Spring	Stainless Steel	Stainless Steel

Valox® is a registered trademark of GE.

STANDARDS & CERTIFICATIONS	
Pin & Sleeve: Inlets, Connectors, Plugs, Receptacles	
CE ✓	IEC 309-1 & 309-2 ✓

International-Rated Pin & Sleeve Devices

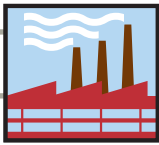

PLUG & CONNECTOR DIMENSIONS

Industrial Grade International-Rated Pin & Sleeve Devices

2 YEAR LIMITED
WARRANTY

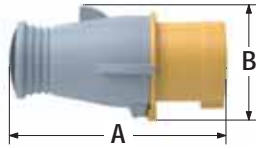

16A, 32A PLUG

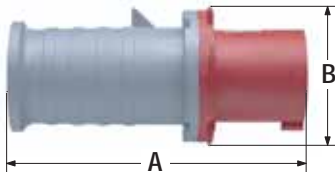

63A PLUG

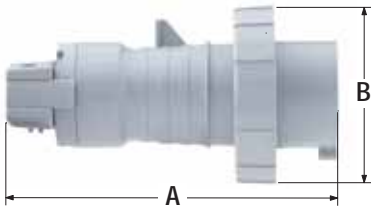

32A PLUG

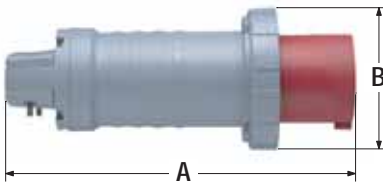

125A PLUG

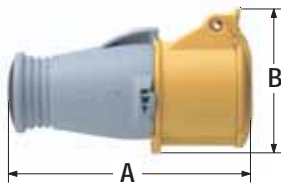

16A, 32A CONNECTOR

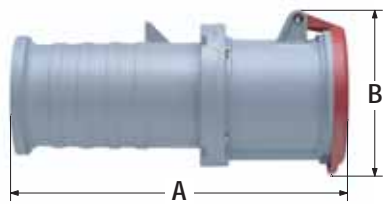

63A CONNECTOR

Plug Dimensions

CATALOG NO.	AMPS	UNIT	A	B	CORD GRIP RANGE (DIA.)
SP316P	16	inch	4.53	2.48	.350 – .860
		mm	115	63	9 – 22
SP416P	16	inch	5.51	2.83	.350 – .860
		mm	140	72	9 – 22
SP516P	16	inch	5.51	2.99	.437 – 1.187
		mm	140	76	11 – 30
SP332P	32	inch	6.14	3.27	.437 – 1.187
		mm	156	83	11 – 30
SP432P	32	inch	6.14	3.27	.437 – 1.187
		mm	156	83	11 – 30
SP532P	32	inch	6.14	3.46	.437 – 1.450
		mm	156	88	11 – 37
SP363P	63	inch	8.46	4.06	.670 – 1.625
		mm	215	103	17 – 41
SP463P	63	inch	8.46	4.06	.670 – 1.625
		mm	215	103	17 – 41
SP563P	63	inch	8.46	4.06	.670 – 1.625
		mm	215	103	17 – 41

Plug Dimensions

CATALOG NO.	AMPS	UNIT	A	B	CORD GRIP RANGE (DIA.)
432P3WL	32	inch	5.79	3.70	.437 – 1.450
		mm	147	94	11 – 37
3125P	125	inch	12.32	5.12	.950 – 1.875
		mm	313	130	24 – 48
4125P	125	inch	12.32	5.12	.950 – 1.875
		mm	313	130	24 – 48
5125P	125	inch	12.32	5.12	.950 – 1.875
		mm	313	130	24 – 48

Connector Dimensions

CATALOG NO.	AMPS	UNIT	A	B	CORD GRIP RANGE (DIA.)
SP316C	16	inch	4.88	2.95	.350 – .860
		mm	124	75	9 – 22
SP416C	16	inch	5.91	3.45	.350 – .860
		mm	150	85	9 – 22
SP516C	16	inch	5.98	3.50	.437 – 1.187
		mm	152	89	11 – 30
SP332C	32	inch	6.73	3.66	.437 – 1.187
		mm	171	93	11 – 30
SP432C	32	inch	6.73	3.66	.437 – 1.187
		mm	171	93	11 – 30
SP532C	32	inch	6.73	3.89	.437 – 1.450
		mm	171	99	11 – 37
SP363C	63	inch	8.82	4.41	.670 – 1.625
		mm	224	112	17 – 41
SP463C	63	inch	8.82	4.41	.670 – 1.625
		mm	224	112	17 – 41
SP563C	63	inch	8.82	4.41	.670 – 1.625
		mm	224	112	17 – 41

INLET & RECEPTACLE DIMENSIONS

Industrial Grade International-Rated Pin & Sleeve Devices

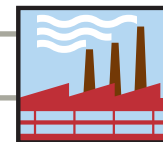

2 YEAR LIMITED
WARRANTY

Connector Dimensions

CATALOG NO.	AMPS	UNIT	A	B	CORD GRIP RANGE (DIA.)
432C3WL	32	inch	6.97	4.02	.437 – 1.187
		mm	177	102	11 – 30
3125CW	125	inch	12.80	4.80	.950 – 1.875
		mm	325	122	28 – 48
4125CW	125	inch	12.80	4.80	.950 – 1.875
		mm	325	122	28 – 48
5125CW	125	inch	12.80	4.80	.950 – 1.875
		mm	325	122	28 – 48



Receptacle Dimensions

CATALOG NO.	AMPS	UNIT	A	B	C
SP316R	16	inch	2.20	1.14	2.87
		mm	56	29	73
SP416R	16	inch	2.28	1.18	3.43
		mm	58	30	87
SP516R	16	inch	2.36	1.22	3.50
		mm	60	31	89
SP332R	32	inch	2.76	1.34	3.66
		mm	70	34	93
SP432R	32	inch	2.76	1.34	3.66
		mm	70	34	93
SP532R	32	inch	2.76	1.34	3.90
		mm	71	34	99
SP363R	63	inch	3.43	1.89	4.41
		mm	87	48	112
SP463R	63	inch	3.43	1.89	4.41
		mm	87	48	112
SP563R	63	inch	3.43	1.89	4.41
		mm	87	48	112

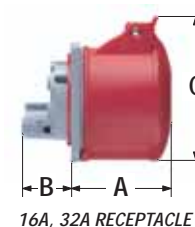

Receptacle Dimensions

CATALOG NO.	AMPS	UNIT	A	B	C
3125R	125	inch	3.94	2.28	4.80
		mm	100	58	122
4125R	125	inch	3.94	2.28	4.80
		mm	100	58	122
5125R	125	inch	3.94	2.28	4.80
		mm	100	58	122



Inlet Dimensions for International-Rated Watertight devices

CATALOG NO.	AMPS	UNIT	A	B
3125B6W	125	inch	3.50	2.21
		mm	89	56
4125B6W	125	inch	3.50	2.21
		mm	89	56
5125B6W	125	inch	3.50	2.21
		mm	89	56



International-Rated Pin & Sleeve Devices

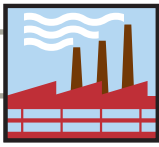

INLET & RECEPTACLE DIMENSIONS

Industrial Grade International-Rated Pin & Sleeve Devices

2 YEAR LIMITED
WARRANTY

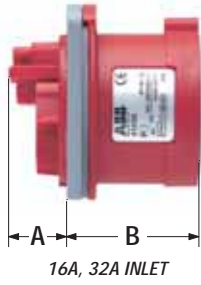

Inlet Dimensions

CATALOG NO.	AMPS	UNIT	A	B
SP316B	16	inch	.85	1.83
		mm	21.5	46.5
SP416B	16	inch	.83	1.85
		mm	21	47
SP516B	16	inch	.83	1.83
		mm	21	46.5
SP332B	32	inch	.95	2.19
		mm	24.5	55.5
SP432B	32	inch	.95	2.19
		mm	24.5	55.5
SP532B	32	inch	.98	2.19
		mm	25	55.5
SP363B	63	inch	1.97	3.0
		mm	50	78
SP463B	63	inch	1.97	3.0
		mm	50	78
SP563B	63	inch	1.97	3.0
		mm	50	78

International-Rated Pin & Sleeve Devices

Inlet Panel Mounting Dimensions

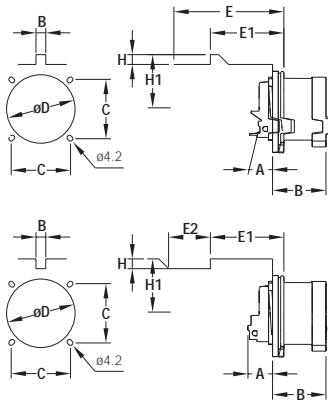

DEVICE SIZE		C	D	E	E1	E2	G	H	H1
SP316B	in	1.73-1.85	1.93	2.95	1.59	0.31	0.35	0.16	1.18
	mm	44-47	49	75	40.5	8	9	4	30
SP416B	in	1.97-2.05	2.32	3.15	1.83	0.31	0.35	0.2	1.34
	mm	50-52	59	80	46.5	8	9	5	34
SP516B	in	1.97-2.05	2.32	3.54	2.07	0.31	0.35	0.27	1.5
	mm	50-52	59	90	52.5	8	9	7	38
SP332B	in	2.36-2.40	2.6	3.54	2.11	0.31	0.35	0.27	1.57
	mm	60-61	66	90	53.5	8	9	7	40
SP432B	in	2.36-2.40	2.6	3.54	2.11	0.31	0.35	0.27	1.57
	mm	60-61	66	90	53.5	8	9	7	40
SP532B	in	2.36-2.40	2.6	4.13	2.34	0.35	0.35	0.31	1.77
	mm	60-61	66	105	59.5	9	9	8	45
SP363B	in	2.40	2.76	4.13	2.32	0.39	0.43	0.35	1.95
	mm	61	70	105	59	10	11	9	49.5
SP463B	in	2.40	2.76	4.13	2.32	0.39	0.43	0.35	1.95
	mm	61	70	105	59	10	11	9	49.5
SP563B	in	2.40	2.76	4.13	2.32	0.39	0.43	0.35	1.95
	mm	61	70	105	59	10	11	9	49.5

Drilling Plan Inlets & Receptacles

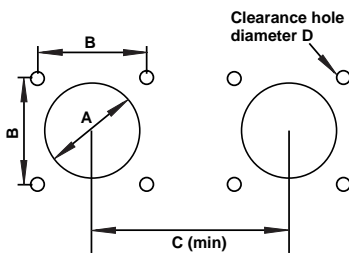

DEVICE SIZE		A		B		C (min)		D	
		inches	mm	inches	mm	inches	mm	inches	mm
16A; 3-wire:	Receptacle	1.93	49	1.73	44	3.35	85	.185	4.7
	Inlet	1.93	49	1.73	44	3.35	85	.185	4.7
16A; 4-wire:	Receptacle	2.32	59	2.05	52	3.94	100	.185	4.7
	Inlet	2.32	59	2.05	52	3.94	100	.185	4.7
16A; 5-wire:	Receptacle	2.32	59	2.05	52	3.94	100	.185	4.7
	Inlet	2.32	59	2.05	52	3.94	100	.185	4.7
32A; 3-wire:	Receptacle	2.60	66	2.40	61	4.53	115	.185	4.7
	Inlet	2.60	66	2.40	61	4.53	115	.185	4.7
32A; 4-wire:	Receptacle	2.60	66	2.40	61	4.53	115	.185	4.7
	Inlet	2.60	66	2.40	61	4.53	115	.185	4.7
32A; 5-wire:	Receptacle	2.60	66	2.40	61	4.53	115	.185	4.7
	Inlet	2.60	66	2.40	61	4.53	115	.185	4.7
63A	All	2.76	70	2.40	61	6.69	170	.185	4.7
125A	All	3.47	88	2.80	71	7.87	200	.280	7.1

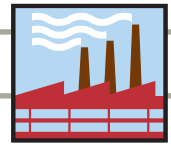

2 YEAR LIMITED WARRANTY

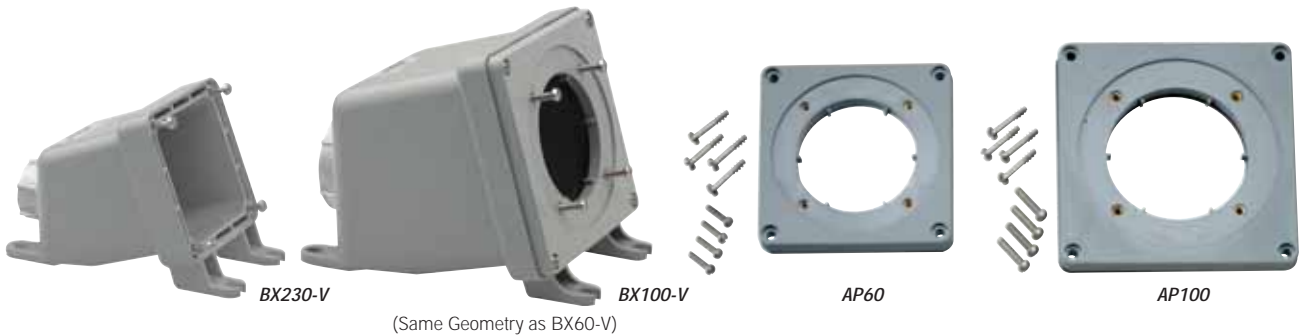

(Same Geometry as BX60-V)

Valox® Back Boxes for Watertight Inlets & Receptacles

APPLICATION	CATALOG NO.
20 & 30 Amp No Adapter Plate Required	BX230-V
60 Amp Adapter Plate Included	BX60-V
100 Amp Adapter Plate Included	BX100-V

Replacement Valox® Adapter Plates for Leviton & Hubbell Back Boxes

APPLICATION	CATALOG NO.
60 Amp Watertight Inlets & Receptacles	AP60
100 Amp Watertight Inlets & Receptacles	AP100

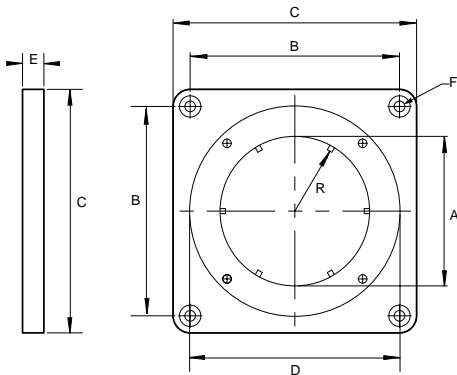

Dimensions for Valox® Adapter Plates

UNIT	A	B	C	D	E	F	R
60 Amp							
inch	2.78	3.86	4.50	3.88	.40	.20	1.28
mm	70	98	114	98.5	10	5	32.5
100 Amp							
inch	3.23	4.88	5.50	4.60	.40	.22	1.50
mm	82	124	140	117	10	5.5	38

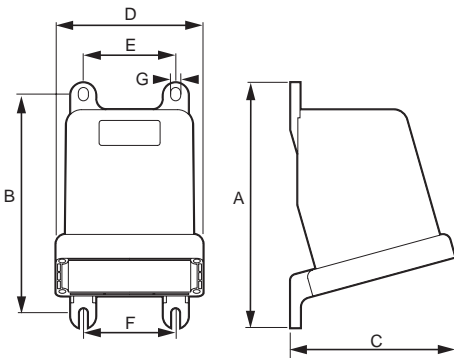

Dimensions for Valox® Back Boxes

UNIT	A	B	C	D	E	F	G
20 Amp & 30 Amp – 1" Hub							
inch	6.69	5.91	4.53	3.90	2.35	2.35	0.25
mm	170.0	150.0	115.0	99.0	60.0	60.0	6.5
60 Amp – 1 1/2" Hub							
inch	7.68	6.92	5.20	4.65	2.99	2.99	0.31
mm	195.0	176.0	132.0	118.0	76.0	76.0	8.0
100 Amp – 2" Hub							
inch	8.23	7.39	6.30	5.71	3.99	3.33	0.33
mm	209.0	188.0	160.0	145.0	101.0	84.5	8.5

Valox® is a registered trademark of GE.

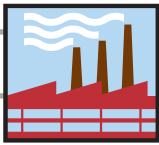

PIN & SLEEVE ACCESSORIES

Industrial Grade Pin & Sleeve Devices



PC420

PC60

PC100

PROTECTIVE CLOSURE CAPS

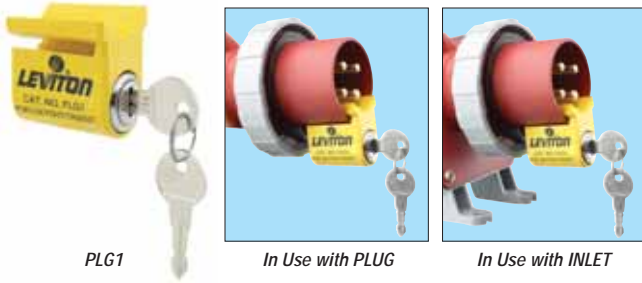

PLG1

In Use with PLUG

In Use with INLET

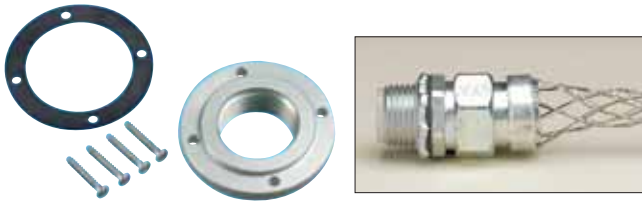

SAD125

L7902 STRAIGHT MALE
LIQUID-TIGHT GRIP
For use with flexible metal conduit.



CA520

CA100

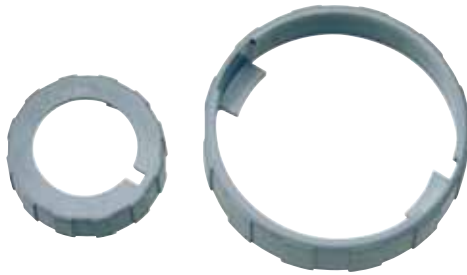

RA420

RA100



Mount-Kit

Protective Closure Caps for Plugs and Inlets

APPLICATION NORTH AMERICAN	APPLICATION INTERNATIONAL	WATERTIGHT CATALOG NO.
20 Amp, 3-Wire	16 Amp, 3-Wire	PC320
20 Amp, 4-Wire	16 Amp, 4-Wire	PC420
20 Amp, 5-Wire	16 Amp, 5-Wire	PC520
30 Amp, 3-, 4-Wire	32 Amp, 3-, 4-Wire	PC3430
30 Amp, 5-Wire	32 Amp, 5-Wire	PC530
All 60 Amp	All 63 Amp	PC60
All 100 Amp	All 125 Amp	PC100

Lockout / Tagout for Pin and Sleeve Devices

APPLICATION	CATALOG NUMBER WATERTIGHT & SPLASHPROOF
Can be used for any IEC 309-1 and 309-2 pin and sleeve plugs or inlets	PLG1

Liquid-Tight Adapters

APPLICATION	NPT SIZE	ADAPTER CATALOG NO.	STRAIGHT MALE FITTING CATALOG NO.
20 Amp, 3-, 4-Wire	1/2" NPT	SAA12	L7902
20 Amp, 5 Wire	1/2" NPT	SAB12	L7902
30 Amp, 3-, 4-Wire	3/4" NPT	SAB34	L7903
30 Amp, 5 Wire	3/4" NPT	SAC34	L7903
30 Amp, 5 Wire	1" NPT	SAC100	L7904
60 Amp, All	1 1/4" NPT	SAC125	L7905
100 Amp, All	1 1/4" NPT	SAD125	L7905

Replacement Watertight Closure Cover Kit for Connectors and Receptacles

APPLICATION	CATALOG NUMBER
20 Amp, 3-Wire	CA320
20 Amp, 4-Wire	CA420
20 Amp, 5-Wire	CA520
30 Amp, 3-, 4-Wire	CA343
30 Amp, 5-Wire	CA530
All 60 Amp	CA060
All 100 Amp	CA100

Replacement Watertight Locking Ring for Plugs and Inlets

APPLICATION	CATALOG NUMBER
20 Amp, 3-wire	RA320
20 Amp, 4-wire	RA420
20 Amp, 5-wire	RA520
30 Amp, 3-, 4-wire	RA343
30 Amp, 5-wire	RA530
All 60 Amp	RA060
All 100 Amp	RA100

Replacement Grommets for Plugs and Connectors

APPLICATION	CATALOG NUMBER
20A 3,4-Wire	GROMT-020
20A 5-Wire 30A 3,4-Wire	GROMT-023
30A 5-Wire	GROMT-030
All 60A	GROMT-060
All 100A	GROMT-100

Replacement Mounting Feet

APPLICATION	CATALOG NUMBER
For all Disconnects and Mechanical Interlocks. Includes 4 feet and 4 mounting screws	MOUNT-KIT

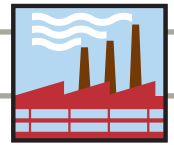

Making the Right Connection is as Easy as Matching Colors and Telling Time!

Leviton's pin and sleeve devices are easy to use. Matching amperage and voltage requirements is literally as easy as matching colors and telling time.

The amperage rating is related to the size of the device; devices of the same amperage are the same size.

The voltage rating is related to the location of the ground sleeve on the female device and the number of conductors. This location is based on a clock face with the key-way at the 6 o'clock position.

The ground sleeve is positioned at a specific hour location, depending on the device's voltage rating.

The clock position for plugs and inlets is a mirror image of the position for matching connectors and receptacles.

For quick visual identification, voltage ratings are also color-coded and the housings of interconnecting units are always the same color. All 125VAC devices are yellow; 250VAC are blue, etc. Matching up interconnecting devices is as easy as matching colors.

North American

Green Dot • Represents the Ground Sleeve of Female Devices (Connectors & Receptacles)

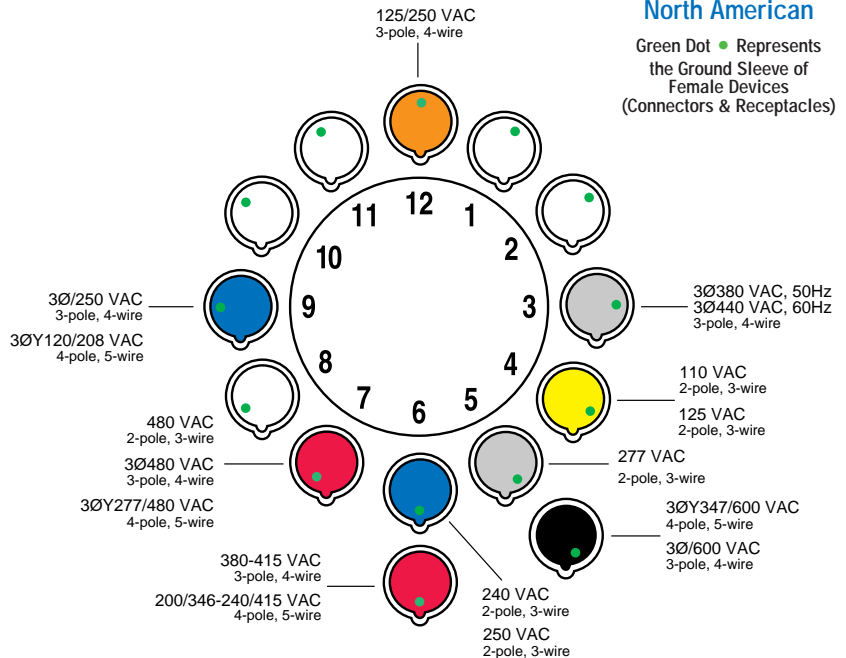

Rated Voltage	Color
110V-130V	Yellow
125V-250V	Orange
200V-250V	Blue
277V, 380V, 440V	Grey
346V-480V	Red
500V and above	Black

Catalog Numbering System

Leviton's catalog numbering system is easy to use. Each letter or number provides a description of the product. Simply follow the six-part code below, made up of letters and numbers. Each catalog number contains the number of conductors, amperage rating, device type, clock position of the ground sleeve, and environmental rating. For example, the catalog number below refers to a 3-wire, 20 amp receptacle with a grounding sleeve located at the 6 o'clock position and an environmental classification of watertight.

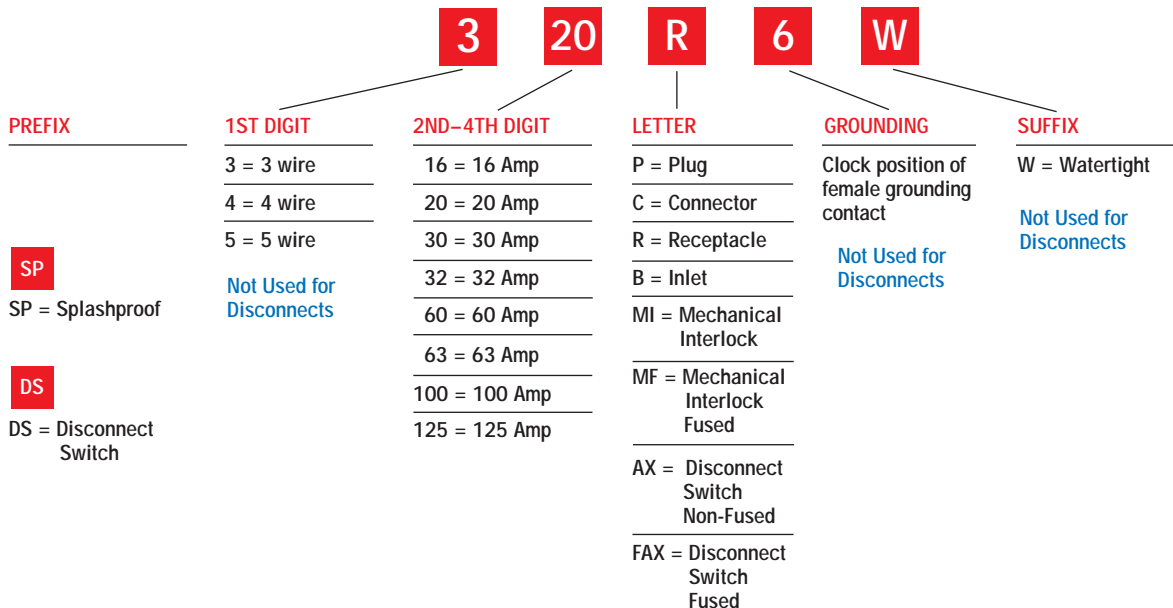

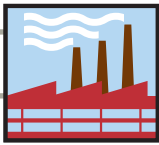

SAFETY DISCONNECT SWITCH FEATURES

Industrial Grade Watertight Safety Disconnect Switches UL 98 & UL 508 Listed, CUL per CSA Specification, C22.2 No. 14 Certified

2 YEAR LIMITED
WARRANTY

Liquid-tight conduit fitting can be installed for top or bottom feed

- One fitting supplied:
- 30 Amp – 3/4"
 - 60 Amp – 1 1/4"
 - 100 Amp – 1 1/2"

Stainless steel screws are captive and will not fall out when cover is opened

- Impact UV and chemical-resistant Valox enclosure rated to UL and IEC watertight standards
- Type 3R, 4X & 12K
 - IP67

Fused Models Accept
"Class J" Time-Delay Fuses

Pre-wired grounding plates (top and bottom of enclosure) connect to metal conduit grounding system

Brass threaded inserts will not strip, provide higher torque, and form tighter seal between back box and cover

Rugged hinge mechanism pivots 180° for easy access during installation and maintenance

Red "pistol grip" handle provides visual confirmation of switch's status

Integrated lockout handle meets OSHA safety regulations

Watertight Safety Disconnect Switches Include —
30 Amp Fused, 60 & 100 Amp (Fused & Non-Fused)

Meets 2002 NEC® Requirements
430.102 (A) and 430.102 (B)

Circuit identification pad for means of identifying specific equipment loads

DS60-FAX



Handle with padlock installed

Generous wiring space for top to bottom wiring

- Disconnect switch with integrated fuse holder offers proven performance in a compact package
- Fused cartridges accept "Class J" fuses (not included)
 - 1 Factory installed Auxiliary Contact (Normally Open – 10 Amp)
 - Additional Auxiliary Contact Available (Normally Closed – 10 Amp)
 - Easily accessible neutral and ground terminal blocks

DS60-FAX



STANDARDS & CERTIFICATIONS

Safety Disconnect Switches

UL 98 Fused (Including 100A Non-Fused - DS)	UL 508 Non-Fused	CSA C22.2 No. 14	NOM	CE	IEC 947-3
E63969		✓	✓	*	✓

*Not available on DS30-AX

LEVITON To learn more about Leviton's outstanding offering of devices visit our Website at: www.leviton.com

30 AMP • 60 AMP • 100 AMP

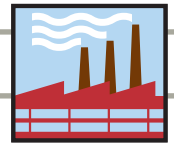

Industrial Grade Watertight Safety Disconnect Switches



Engineered to UL & IEC
Watertight Standards



DS30-AX
(Non-Fused)



DS60-FAX
(Fused)



DS100-AX
(Non-Fused)

2 YEAR LIMITED
WARRANTY

Ordering Information

AMPS	MAX VOLTAGE	CATALOG NO.	
		NON-FUSED	FUSED
30	600V AC	DS30-AX	DS30-FAX
60	600V AC	DS60-AX	DS60-FAX
100	600V AC	DS100-AX	

ELECTRICAL				MECHANICAL		ENVIRONMENTAL		
Ground Path Integrity	Device	Current Applied	Duration	Mold Stress Relief	70°C for 7 hours	Flammability	V2 or better per UL 94 or CSA 22.2 No 0.6; V-0 for watertight enclosure	
	30 A	60 A	2 min	Knockout Test	Remains in place with 20 lb push		Rain (3R) per UL 50	Water spray @ 5 psi from all sides for 1 hr
	60 A	120 A	4 min					
100 A	200 A	6 min	Crush	100 lb	Hosedown (4X) per UL 50	Water spray @ 65 gal/min for 5 minutes		
Current Interrupting	Certified for current interrupting at full-rated current and voltage			Impact	1.2 lb steel ball dropped from 5 ft	Dust (12K) per UL 50	Cement Dust Circulated @ 1000 ft/minute for 5 minutes	
Endurance	6000 operations at rated current and voltage (Power factor 0.75 – 0.80)			Cold Impact	Same as above, after conditioning to -35°C	Gasket Aging	70°C for 168 hours	
Dielectric	1000 V plus twice rated voltage for 1 minute			Strength of Insulating Base and Support	110% of specified tightening torque on terminal screws	UV Resistance	Exposed plastic materials are UV stabilized	
				Pullout	18 lb pull on internal wires	Operating Temperature	-40°C to +60°C (-40°F to +140°F)	

VOLTS	MAX. HP RATINGS PER UL508 NON-FUSED SAFETY DISCONNECT SWITCHES			VOLTS	MAX. HP RATINGS PER UL508 FUSED SAFETY DISCONNECT SWITCHES	
	DS30-AX	DS60-AX	DS100-AX		DS30-FAX	DS60-FAX
120V AC	1	2	5	120V AC	2	NR
208V AC	5	20	25	208V AC	7.5	15
240V AC	2.5	10	15	240V AC	3	NR
480V AC	5	20	25	480V AC	15	NR
600V AC	NA	20	20	600V AC	20	NR
3Ø Y 120/208V AC	5	20	25	3Ø Y 120/208V AC	7.5	15
3Ø 240V AC	5	20	30	3Ø 240V AC	7.5	15
3Ø 480V AC	15	40	50	3Ø 480V AC	15	30
3Ø 600V AC	15	40	50	3Ø 600V AC	20	50

NR = Not Rated

Watertight Safety Disconnect Switches

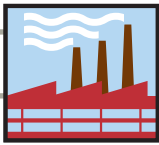

TECHNICAL INFORMATION

Industrial Grade Watertight Safety Disconnect Switches UL 98 & UL 508 Listed, CUL per CSA Specification, C22.2 No. 14 Certified



Engineered to IP67
Watertight Standards

2 YEAR LIMITED
WARRANTY



Watertight Safety Disconnect Switches

- Heavy Duty Safety Disconnects
- Enclosures are TYPE 3R, 4X & 12K, IP67
- Listed to UL 508 for Non-Fused and UL 98 for Fused
- Certified to CSA Standard C22.2 number 14
- Classified to IEC Standard 947-3
- CE marking per low-voltage directives 73/23/EEC, 93/68/EEC

Material Specifications

30 Amp Switch, Non-Fused

PART	MATERIAL
Housing Cover	Valox 357
Housing Base	Valox 357
Housing Gasket	Solid Chloroprene
Handle	Valox 357
Screw handle	Stainless Steel
Conduit Grounding Plate	Zinc-Coated Steel
Conduit Hub	Die-Cast Zinc
Switch	Nylon
Switch Terminal Contacts	Brass
Switch Contacts	Cadmium-Free Silver Alloy
Internal Screws	Zinc-Coated Steel
Housing Screws	Stainless Steel
Mounting Feet	Valox 357
Ground Terminal	Plated Brass/Steel
Ground Terminal Block	Nylon
Neutral Terminal	Plated Brass/Steel
Neutral Terminal Block	Nylon

60 & 100 Amp Switch, Non-Fused

PART	MATERIAL
Housing Cover	Valox 357
Housing Base	Valox 357
Housing Gasket	Solid Chloroprene
Handle	Valox 357
Screw handle	Stainless Steel
Conduit Grounding Plate	Zinc-Coated Steel
Conduit Hub	Die-Cast Zinc
Switch	Reinforced Nylon
Switch Terminal Contacts	Brass
Switch Contacts	Cadmium-Free Silver Alloy
Internal Screws	Zinc-Coated Steel
Housing Screws	Stainless Steel
Hinge Screws	Stainless Steel
Mounting Feet	Valox 357
Ground Terminal	Plated Brass/Steel
Ground Terminal Block	Nylon
Neutral Terminal	Plated Brass/Steel
Neutral Terminal Block	Nylon

30 & 60 Amp Switch, Fused

PART	MATERIAL
Housing Cover	Valox 357
Housing Base	Valox 357
Housing Gasket	Solid Chloroprene
Handle	Valox 357
Screw handle	Stainless Steel
Conduit Grounding Plate	Zinc-Coated Steel
Conduit Hub	Die-Cast Zinc
Switch	Reinforced Nylon
Switch Terminal Contacts	Brass
Internal Screws	Zinc-Coated Steel
Housing Screws	Stainless Steel
Hinge Screws	Stainless Steel
Fuse Holder	Reinforced Nylon
Mounting Feet	Valox 357
Ground Terminal	Plated Brass/Steel
Ground Terminal Block	Nylon
Neutral Terminal	Plated Brass/Steel
Neutral Terminal Block	Nylon

Valox® is a registered trademark of GE.

STANDARDS & CERTIFICATIONS

Safety Disconnect Switches

UL 98 Fused	UL 508 Non-Fused	CSA C22.2 No.14	NOM	CE	IEC 947-3
✓	✓	✓	✓	*	✓

*Not available on DS30-AX

IP Ratings & UL Standards

CATALOG NO.	IP RATING	UL STANDARD
DS30-AX	IP67	UL508
DS60-AX	IP67	UL508
DS100-AX	IP67	UL98
DS30-FAX	IP67	UL98
DS60-FAX	IP67	UL98

SWITCHING MECHANISM TYPE

NON-FUSED	SWITCHING	FUSED	SWITCHING
DS30-AX	Rotary	DS30-FAX	Knife
DS60-AX	Rotary	DS60-FAX	Knife
DS100-AX	Knife	—	—



To learn more about Leviton's outstanding offering of devices visit our Website at: www.leviton.com

SAFETY DISCONNECT SWITCH DIMENSIONS

Industrial Grade Watertight Safety Disconnect Switches

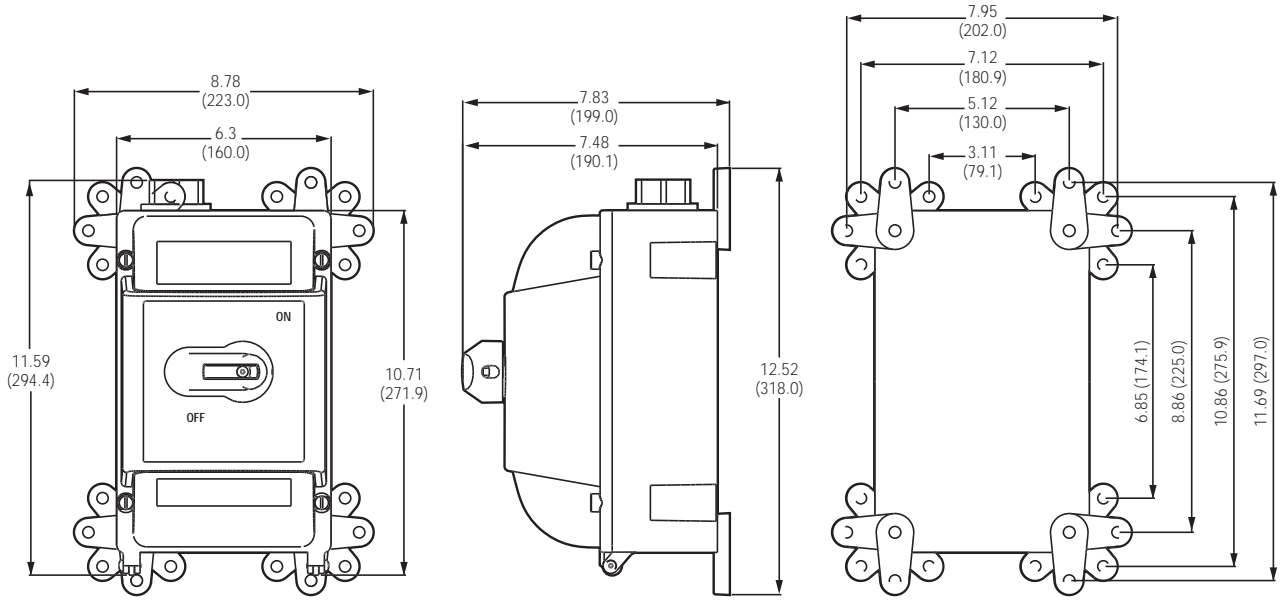
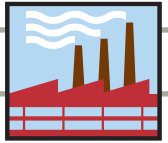

30 AMP FUSED & 60 AMP NON-FUSED

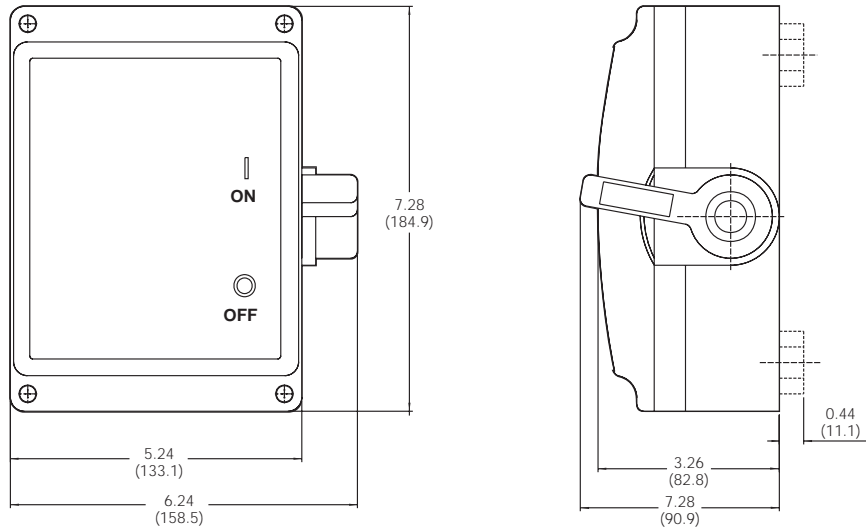

30 AMP NON-FUSED

Watertight Safety Disconnect Switches

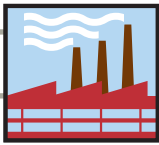

SAFETY DISCONNECT SWITCH DIMENSIONS

Industrial Grade Watertight Safety Disconnect Switches

2 YEAR LIMITED
WARRANTY

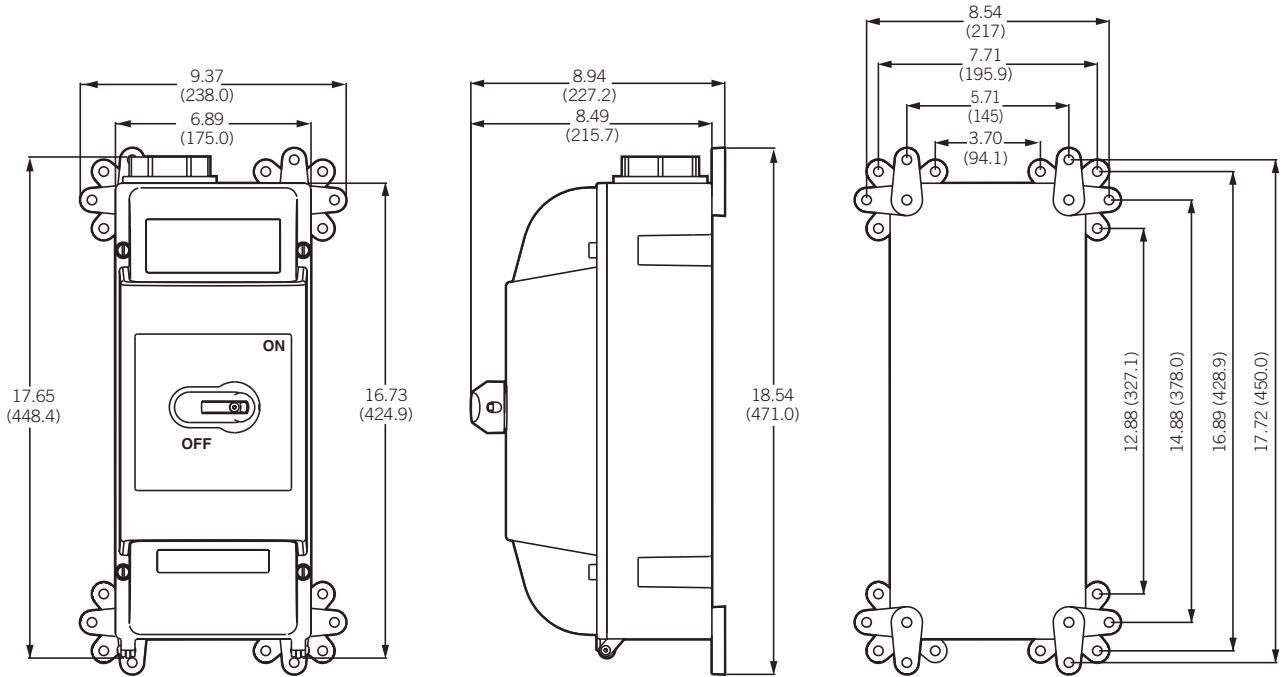

60 AMP FUSED & 100 AMP NON-FUSED

Auxiliary Contacts for Safety Disconnect Switches

- Leviton Disconnect Switches automatically ship with one factory installed auxiliary contact, normally open.
- A second auxiliary contact may be added. Select from the table below.



DEVICE	CATALOG NO.	DESCRIPTION
For ALL non-fused and fused disconnect switches	AUXNO	Normally open contact, 10 Amp, early break type
	AUXNC-NF	Normally closed contact, 10 Amp, early break type
For ALL fused disconnect switches	AUXNC-F	Normally closed contact, 10 Amp, early break type

Watertight Safety Disconnect Switches

Single Pole Cam-Type Connectors and Stage Pin Devices

INDEX

Cam Connectors and Stage Pin Devices for Commercial and Industrial Applications

Stage Pin Devices—Overview, and Benefits	P2
20, 60 and 100 AMP Stage Pin Devices	P3
Cam Connectors—Overview, and Benefits	P4, P5
Ampacity Chart	P6
Up to 140 AMP	
15 Series—Taper Nose	P7
Up to 300 AMP	
16 Series—Taper Nose	P8
18 Series—Ball Nose	P11
Up to 400 AMP	
16 Series—Taper Nose	P9, P10
18 Series—Ball Nose	P12–P13
Up to 690 AMP	
17 Series—Taper Nose	P14
19 Series—Ball Nose	P15
22 Series—Latching Ball Nose	P16
23 Series—Latching Taper Nose	P17
Product Accessories	P18
Stage Pin Dimensional Drawings	P19–20
Cam Connector Dimensional Drawings	P21–26



STAGE PIN DEVICE FEATURES

Commercial Grade Stage Pin Devices

Stage Pin Devices — Conforms to USITT (United States Institute for Theater Technology) S3 Standard for Stage Pin Connectors



Male pins and female contacts have a one-piece solid brass design for superior current flow and resistance from abuse
Male pins and female contacts float to ensure compatibility with all competitive products and improved electrical connections

Terminal identification letters on device ensure quick and accurate termination

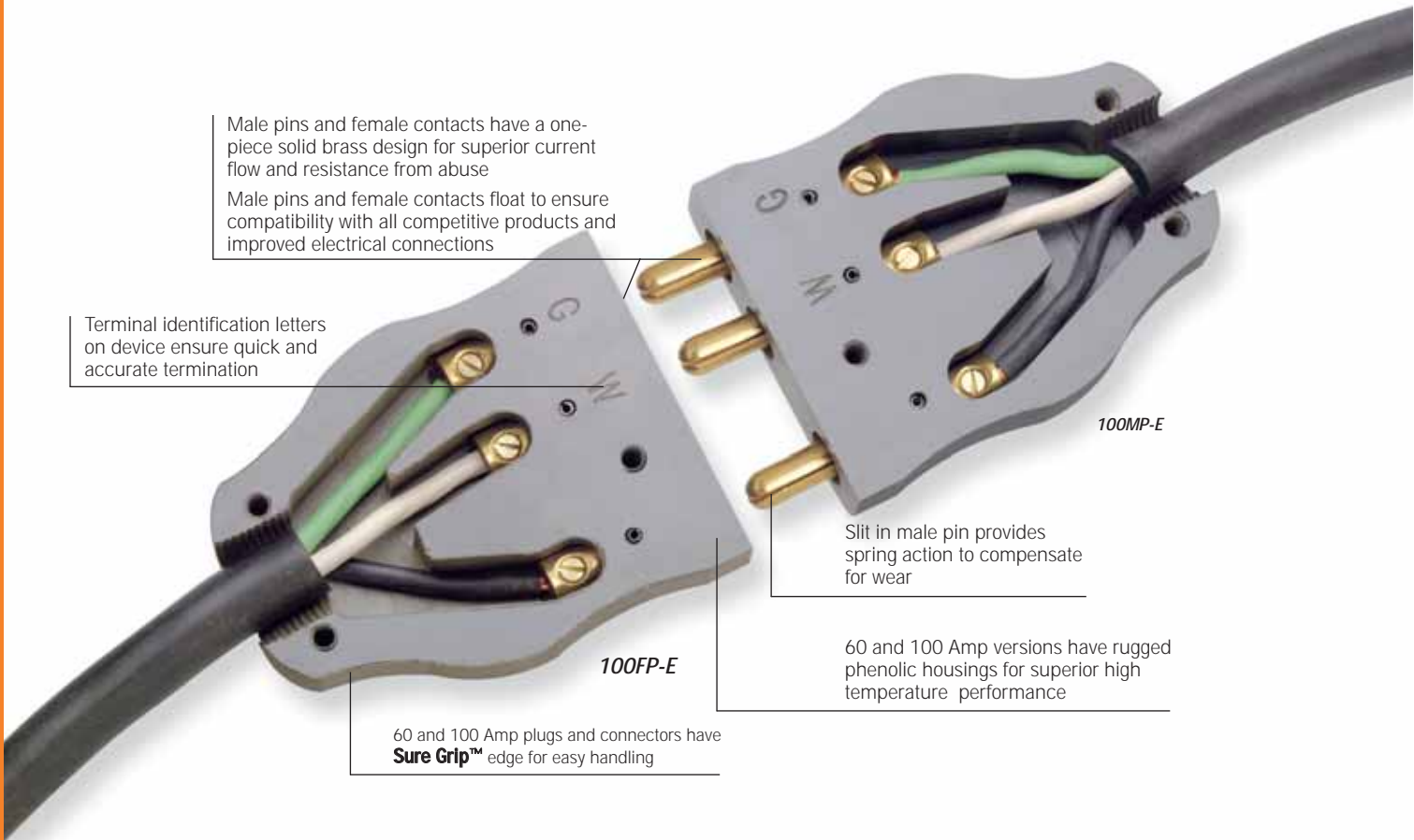

100MP-E

Slit in male pin provides spring action to compensate for wear

60 and 100 Amp versions have rugged phenolic housings for superior high temperature performance

100FP-E

60 and 100 Amp plugs and connectors have **Sure Grip™** edge for easy handling

20MP-CL



20 Amp version is available with a clear cover to allow for visual inspection of proper termination of conductors. Other colors available include white, blue, green, yellow, red and orange. Consult factory for availability.

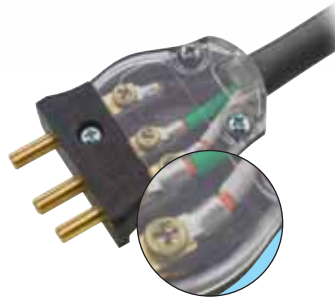

Male Plug, Crimp Terminal



Male Plug, Pressure Plate Terminal



20, 60 and 100 AMP 125V Stage Pin Devices

20A 125V, 2-P 3-W, Grounding

DESCRIPTION	CATALOG NO.	COLOR*
Male Plug-Pressure Plate Terminal	20MP-E	Black
Male Plug-Pressure Plate Terminal	20MP-CL	Black w/ Clear Cover
Male Plug-Crimp Terminal	20MC-E	Black
Male Plug-Crimp Terminal	20MC-CL	Black w/ Clear Cover
Female Connector-Pressure Plate Terminal	20FP-E	Black
Female Connector-Pressure Plate Terminal	20FP-CL	Black w/ Clear Cover
Female Connector-Crimp Terminal	20FC-E	Black
Female Connector-Crimp Terminal	20FC-CL	Black w/ Clear Cover
Panel Mount Male Inlet-Set Screw Terminal, Snap-In Mounting†	20IS-E	Black
Panel Mount Female Receptacle-Screw Terminal, Snap-In Mounting†	20RS-E	Black



20MP-CL



20FP-CL

60A 125V, 2-P 3-W, Grounding

Male Plug-Set Screw Terminal	60MP-E	Black
Female Connector-Set Screw Terminal	60FP-E	Black
Panel Mount Female Receptacle-Set Screw Terminal, Snap-In Mounting†	60RS-E	Black
Panel Mount Female Receptacle-Set Screw Terminal, Bolt-On Mounting†	60RB-E	Black
Panel Mount Male Inlet-Set Screw Terminal, Snap-In Mounting†	60IS-E	Black
Panel Mount Male Inlet-Set Screw Terminal, Bolt-On Mounting†	60IB-E	Black



60MP-E



60FP-E

100A 125V, 2-P 3-W, Grounding

Male Plug-Set Screw Terminal	100MP-E	Black
Female Connector-Set Screw Terminal	100FP-E	Black
Panel Mount Female Receptacle-Set Screw Terminal, Bolt-On Mounting†	100RB-E	Black
Panel Mount Male Inlet-Set Screw Terminal, Bolt-On Mounting†	100IB-E	Black

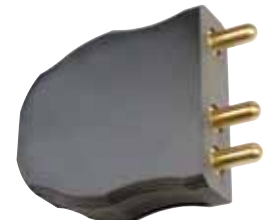

100MP-E



100FP-E

*For 20 Amp male plugs and female connectors, other cover colors are available in white, blue, green, yellow, red and orange. Consult factory for availability.

†SEE PAGE P19 and P20 FOR DIMENSIONAL DRAWINGS



Male Panel Mount, Bolt-On



Female Panel Mount, Snap-In

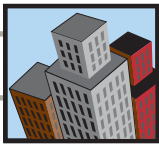

SINGLE POLE CAM-TYPE CONNECTOR FEATURES

Commercial & Industrial Grade Single Pole Cam-Type Connectors

Cam Connectors for Commercial and Industrial Use

Leviton offers a wide variety of single pin cam-type cable connectors and panel mount receptacles that supply temporary electrical power distribution for multiple indoor and outdoor applications. The heavy-duty connectors are the standard for the following markets:

- Entertainment and Movie Industry
- Concerts and Theme Parks
- Carnival Equipment
- Conventions.

Other applications include:

- Motor and Generator Splices
- Mining and Construction Sites
- Commercial and Navy Shipbuilding & Repair
- Other temporary power applications.

Leviton manufactures the highest quality single pin connectors available. Our connectors are completely compatible with competitive cam-type products and can be retrofitted to existing locations and power distribution systems. We offer a variety of quick connect/disconnect connectors for various amperage ratings in a multitude of cable sizes. Connectors are available in two styles:

- Field detachable
- Vulcanized

We also offer ball nose and taper nose configurations.

Quality Product and Diversification

In addition to high product quality comes diversity when doing business with Leviton. Leviton offers many varieties of entertainment cable and the ability to produce specialty cord sets for the entertainment/power distribution marketplace.

Leviton Cam-Type Connectors

Features and Benefits

- Intermateable and compatible with competitive cam-type products—can be retrofitted to existing locations and power distribution systems
- Locking and reinforcing ring won't melt, break or crack
- Shatter and crack proof—high durometer thermoplastic elastomer (TPE) or neoprene rubber
- Color-coded insulating sleeves—fast and easy phase identification
- Prevents arcing or burning—no movement of contact surfaces
- Self compensating for wear—slit and cam in male contact provides spring action for longer usage
- Quick connect/disconnect—twist and pull provided by double cam male and cam button in female
- High conductivity—positive, vibration-proof connection provided by double cam design
- Wide range of applications—usable with a wide range of cable and amperage ratings
- Meets NEC Code, UL Listed and CSA Certified. NEMA 3R-Rated for use in outside locations

Experience the Difference

Our cam-type connectors are designed for easy assembly and disassembly without special tools. An insulated screw is used to tightly secure the contact inside the insulating sleeve, making assembly, disassembly and field repairs effortless. The connectors use plastic locking and reinforcement rings molded into insulating sleeves and receptacles. Under severe stress and load conditions, plastic locking and reinforcement rings will not melt, break or crack. Other quality differences include:

- Reusable sleeves and contacts
- Preservation of cable length
- Snug fit due to Helox shape of connection as well as cable cutoffs that accommodate a wide range of cable sizes
- Hard thermoplastic elastomer screw head provides strength and durability
- Collar around port provides protection for insulated screw
- Quick check for cable-to-contact connection

SINGLE POLE CAM-TYPE CONNECTOR FEATURES

Commercial Grade Single Pole Cam-Type Connectors

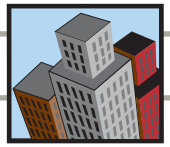

16/18 Series double-set screw with copper wire strain relief

High conductivity—positive, vibration-proof connection provided by double cam design

Collar around port provides protection for insulated screw

Shatter and crack proof—high durometer thermoplastic elastomer (TPE)

Self compensating for wear—slit and cam in male contact provides spring action for longer usage

Hard thermoplastic screw head provides strength and durability

Intermateable and compatible with competitive cam-type products—can be retrofitted to existing locations and power distribution systems

Color-coded insulating sleeves for easy phase identification

16D26-R

16D35-E

16D26-E

15, 16, 18 Series Connectors

COMPONENT	DESCRIPTION
Sleeve	Santoprene
Contact	Brass
Strain Relief	Copper Wire

Single Pole Cam-Type Connectors





SINGLE POLE CAM-TYPE AMPACITY CHART

Commercial & Industrial Grade Single Pole Cam-Type Connectors

Ampacity Chart

CABLE SIZE	MAXIMUM ALLOWABLE AMPACITIES		
	60°C (140°F) CABLE	75°C (167°F) CABLE	90°C (194°F) CABLE
#8	60	70	80
#6	80	95	105
#4	105	125	140
#3	120	145	165
#2	140	170	190
#1	165	195	220
1/0	195	230	260
2/0	225	265	300
3/0	260	310	350
4/0	300	360	400
250MCM	340	405	455
300MCM	375	445	505
350MCM	420	505	570
400MCM	455	545	615
500MCM	515	620	690

15 SERIES—TAPER NOSE—UP TO 140 AMP

Commercial Grade Single Pole Cam-Type Connectors

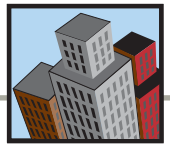

15 Series—Taper Nose—Up to 140 AMP, 600V

Refer to Ampacity Chart for all cable sizes on page P6

Male Detachable Plug

CABLE SIZE	COMPLETE CAT NO.	CONTACT CAT NO.	INSULATOR CAT NO.	TERMINATION TYPE
#6-#4	15D21*	15D21-C	15SDM*	Single Set Screw
#6-#4	15D23*†	15D23-C	15SDM*	Crimped★

Female Detachable Plug

CABLE SIZE	COMPLETE CAT NO.	CONTACT CAT NO.	INSULATOR CAT NO.	TERMINATION TYPE
#6-#4	15D22*	15D22-C	15SDF*	Single Set Screw
#6-#4	15D24*†	15D24-C	15SDF*	Crimped★

Male Detachable Plug

CABLE SIZE	COMPLETE CAT NO.	CONTACT CAT NO.	INSULATOR CAT NO.	TERMINATION TYPE
#8	15D25*	15D26-C	15SDM*	Crimped

Female Detachable Plug

CABLE SIZE	COMPLETE CAT NO.	CONTACT CAT NO.	INSULATOR CAT NO.	TERMINATION TYPE
#8	15D26*	15D26-C	15SDF-*	Crimped

Protective Caps for All 15 Series Insulators

STYLE	CAT NO.	STYLE	CAT NO.
Male	15P21-E	Female	15P22-E

Multi-Way Connectors★

STYLE	DESCRIPTION	CAT NO.
Paralleling Tee	Female-Male-Male	15A21††
Tapping Tee	Female-Female-Male	15A22††
Double Female	Female-Female	15A23††

SEE PAGE P21 FOR DIMENSIONAL DRAWINGS



15D21



15D22



15P21-E



15P22-E



15A21-G

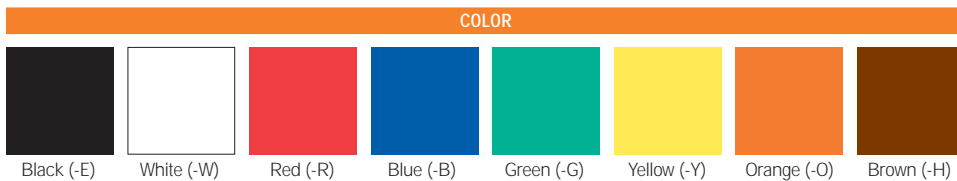

* For color selections, add suffix to catalog number as follows: Black (-E), White (-W), Red (-R), Blue (-B), Green (-G), Yellow (-Y), Orange (-O) and Brown (-H).

† Available in Tour Grade (-T), Green (-G). Nickel Plated contact.

†† For color selections, add suffix to catalog number as follows: Black (-E), White (-W), Red (-R), Blue (-B) and Green (-G).

★ Contact Factory for Color Availability.

SPECIFICATIONS AND FEATURES

- The 15 Series Taper Nose mini-cam plugs, receptacles and connectors are tough and reliable. Primary applications include carnivals and theme parks, as well as the entertainment industry

TESTING AND CODE COMPLIANCE

- UL Listed E-13399
- NEMA 3R-Rated for use in outside locations
- CSA Certified 152105

Single Pole Cam-Type Connectors



16 SERIES—TAPER NOSE—UP TO 300 AMP

Commercial Grade Single Pole Cam-Type Connectors

Single Pole Cam-Type Connectors



16D22-E



16D25-R



16D31-O



16D35-Y



16V22-B



16V27-G

16 Series—Taper Nose—Up to 300 AMP, 600V

Refer to Ampacity Chart for all cable sizes on page P6

Male Detachable Plug

CABLE SIZE	COMPLETE CAT NO.	CONTACT CAT NO.	INSULATOR CAT NO.	TERMINATION TYPE
#2-2/0	16D21*	-	16SDM-22*★	Single Set Screw
#2-2/0	16D22*	16D22-C	16SDM-22*★	Double Set Screw
#2-#1	16D25*	-	16SDM-22*★	Crimped★
1/0-2/0	16D26*	-	16SDM-22*★	Crimped★
1/0-2/0 HeavyDuty	16D27*	-	-	Crimped★

Female Detachable Plug

CABLE SIZE	COMPLETE CAT NO.	CONTACT CAT NO.	INSULATOR CAT NO.	TERMINATION TYPE
#2-2/0	16D29*	-	16SDF-22*★	Single Set Screw
#2-2/0	16D31*	16D31-C	16SDF-22*★	Double Set Screw
#2-#1	16D34*	-	16SDF-22*★	Crimped★
1/0-2/0	16D35*	-	16SDF-22*★	Crimped★
1/0-2/0 Heavy Duty	16D36*	-	-	Crimped★

Male Vulcanized Plug

CABLE SIZE	COMPLETE CAT NO.	CONTACT CAT NO.	INSULATOR CAT NO.	TERMINATION TYPE
1/0-2/0	16V22*†	-	-	Crimped★

Female Vulcanized Plug

CABLE SIZE	COMPLETE CAT NO.	CONTACT CAT NO.	INSULATOR CAT NO.	TERMINATION TYPE
1/0-2/0	16V26*†	-	-	Crimped★

SEE PAGE P21 and P22 FOR DIMENSIONAL DRAWINGS

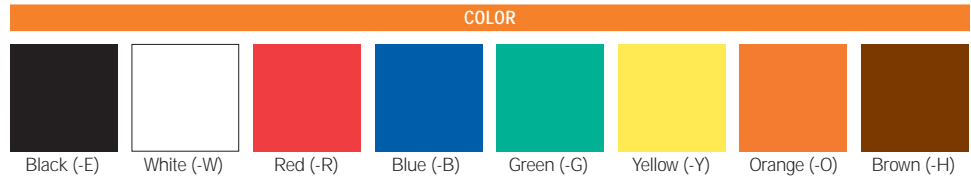

*For color selections, add suffix to catalog number as follows: Black (-E), White (-W), Red (-R), Blue (-B), Green (-G), Yellow (-Y), Orange (-O) and Brown (-H).

†Available in Tour Grade (-T), Green (-G). Nickel Plated contact.

★Contact Factory for Color Availability.

SPECIFICATIONS AND FEATURES

- Leviton 16 Series Taper Nose products are the connectors of choice for concerts, sound stages, movie making, television production, sporting events and conventions.
- UL Listed E-13399
- CSA Certified 152105, all detachable plugs except single set screws.

16 SERIES—TAPER NOSE—UP TO 400 AMP

Commercial Grade Single Pole Cam-Type Connectors

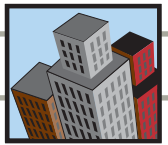

16 Series—Taper Nose—Up to 400 AMP, 600V

Refer to Ampacity Chart for all cable sizes on page P6

Male Detachable Plug

CABLE SIZE	COMPLETE CAT NO.	CONTACT CAT NO.	INSULATOR CAT NO.	TERMINATION TYPE
1/0–4/0	16D23*	-	16SDM-14**★	Single Set Screw
1/0–4/0	16D24*	16D24-C	16SDM-14**★	Double Set Screw
3/0–4/0	16D28*	-	16SDM-14**★	Crimped

Female Detachable Plug

CABLE SIZE	COMPLETE CAT NO.	CONTACT CAT NO.	INSULATOR CAT NO.	TERMINATION TYPE
1/0–4/0	16D32*	-	16SDF-14**★	Single Set Screw
1/0–4/0	16D33*	16D33-C	16SDF-14**★	Double Set Screw
3/0–4/0	16D37*	16D37-C	16SDF-14**★	Crimped

Male Vulcanized Plug

CABLE SIZE	COMPLETE CAT NO.	CONTACT CAT NO.	INSULATOR CAT NO.	TERMINATION TYPE
3/0–4/0	16V24*†	-	-	Crimped★

Female Vulcanized Plug

CABLE SIZE	COMPLETE CAT NO.	CONTACT CAT NO.	INSULATOR CAT NO.	TERMINATION TYPE
3/0–4/0	16V28*†	16V28-C	-	Crimped★

Protective Caps for All 16 Series Insulators

STYLE	CAT NO.	STYLE	CAT NO.
Male	16P21*	Female	16P22*

SEE PAGE P21 and P22 FOR DIMENSIONAL DRAWINGS



16D23-B



16D24-Y



16D32-W



16D33-O



16V24-Y



16V28-E



16P22-E

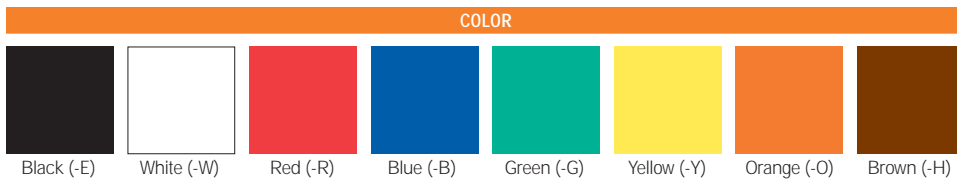

*For color selections, add suffix to catalog number as follows: Black (-E), White (-W), Red (-R), Blue (-B), Green (-G), Yellow (-Y), Orange (-O) and Brown (-H).

†Available in Tour Grade (-T), Black (-E), White (-W), Red (-R) and Blue (-B). Nickel Plated contact.

★Contact factory for color availability

SPECIFICATIONS AND FEATURES

- Leviton 16 Series Taper Nose products are the connectors of choice for concerts, sound stages, movie making, television production, sporting events and conventions.
- UL Listed E-13399
- CSA Certified 152105, all detachable plugs except single set screws.

Single Pole Cam-Type Connectors



16 SERIES—TAPER NOSE—UP TO 400 AMP

Commercial Grade Single Pole Cam-Type Connectors

16 Series—Taper Nose—Up to 400 AMP, 600V

Refer to Ampacity Chart for all cable sizes on page P6

Male Panel Receptacles

CABLE SIZE	CAT NO.	TERMINATION TYPE
1/0–4/0	16R21*	Double Set Screw
#2–4/0	16R23*†	Threaded Stud**

Female Panel Receptacles

CABLE SIZE	CAT NO.	TERMINATION TYPE
1/0–4/0	16R22*	Double Set Screw
#2–4/0	16R24*†	Threaded Stud**

Female Panel Receptacles – with Micro Switch

CABLE SIZE	CAT NO.	TERMINATION TYPE
#2–4/0	16RSW††	Threaded Stud★

Snap Back Cover for Male and Female Panel Receptacle

CAT NO.
16S21*

Female Terminal Connector

CABLE SIZE	CAT NO.	TERMINATION TYPE
#2–4/0	16F21*	Angled
#2–4/0	16F22*	Offset

Multi-Way Connectors

STYLE	DESCRIPTION	CAT NO.
Paralleling Tee	Female-Male-Male	16A21*★
Tapping Tee	Female-Female-Male	16A22*★
3-Fer	Male-Female-Female-Female	16A23*★
Reverse 3-Fer	Female-Male-Male-Male	16A26*★
Double Female	Female-Female	16A24*★
Double Male	Male-Male	16A25*★

SEE PAGE P21 and P22 FOR DIMENSIONAL DRAWINGS

**Threaded stud panel receptacles available in various lengths: Standard stud length is 3/4" – 1" stud length specify – 10 suffix; 1.125" stud length specify – 11 suffix; 1.25" stud length specify – 12 suffix; 1.50" stud length specify – 14 suffix; 2.00" stud length specify – 20 suffix (16R24 only). Other stud lengths available.

COLOR



Black (-E) White (-W) Red (-R) Blue (-B) Green (-G) Yellow (-Y) Orange (-O) Brown (-H)
 *For color selections, add suffix to catalog number as follows: Black (-E), White (-W), Red (-R), Blue (-B), Green (-G), Yellow (-Y), Orange (-O) and Brown (-H).

†Available in Tour Grade (-T), Black (-E), White (-W), Red (-R), Blue (-B) and Green (-G). Nickel Plated contact.

††For color selections, add suffix to catalog number as follows: Black (-E), White (-W), Red (-R), Blue (-B) and Green (-G).

★Contact factory for color availability

SPECIFICATIONS AND FEATURES

- Leviton 16 Series Taper Nose products are the connectors of choice for concerts, sound stages, movie making, television production, sporting events and conventions.

TESTING AND CODE COMPLIANCE

- UL Listed E-13399
- CSA Certified 152105
- NEMA 3R-Rated for use in outside locations

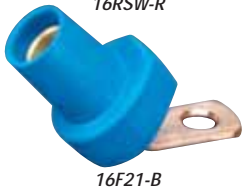
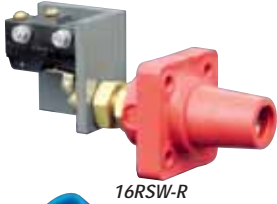
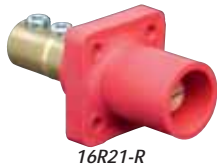

18 SERIES—BALL NOSE—UP TO 300 AMP

Commercial Grade Single Pole Cam-Type Connectors

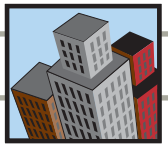

18 Series—Ball Nose—Up to 300 AMP, 600V

Refer to Ampacity Chart for all cable sizes on page P6

Male Detachable Plug

CABLE SIZE	COMPLETE CAT NO.	CONTACT CAT NO.	INSULATOR CAT NO.	TERMINATION TYPE
#2-2/0	18D21*	-	-	Single Set Screw★
#2-2/0	18D22*	-	-	Double Set Screw★
#2-#1	18D25*	-	-	Crimped★

Female Detachable Plug

CABLE SIZE	COMPLETE CAT NO.	CONTACT CAT NO.	INSULATOR CAT NO.	TERMINATION TYPE
#2-2/0	18D29*	-	-	Single Set Screw★
#2-2/0	18D31*	-	-	Double Set Screw★

SEE PAGE P22 and P23 FOR DIMENSIONAL DRAWINGS



18D21-B



18D22-G

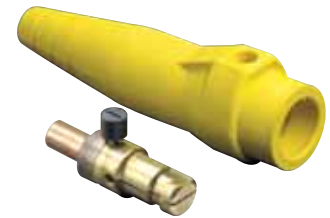

18D25-Y



18D29-O



18D31-W

COLOR



Black (-E) White (-W) Red (-R) Blue (-B) Green (-G) Yellow (-Y) Orange (-O) Brown (-H)
 * For color selections, add suffix to catalog number as follows: Black (-E), White (-W), Red (-R), Blue (-B), Green (-G), Yellow (-Y), Orange (-O) and Brown (-H).

★ Contact factory for color availability

SPECIFICATIONS AND FEATURES

- The 18 Series Ball Nose pin and sleeve type plugs, receptacles and connectors are used by the broadcast industry in Canada, as well as the welding industry in the United States

TESTING AND CODE COMPLIANCE

- UL Listed E-13399
- CSA Certified 152105, all detachable plugs except single set screws.



18 SERIES—BALL NOSE—UP TO 400 AMP

Commercial Grade Single Pole Cam-Type Connectors

Single Pole Cam-Type Connectors

18 Series—Ball Nose—Up to 400 AMP, 600V

Refer to Ampacity Chart for all cable sizes on page P6

Male Detachable Plug

CABLE SIZE	COMPLETE CAT NO.	CONTACT CAT NO.	INSULATOR CAT NO.	TERMINATION TYPE
1/0–4/0	18D23*	-	-	Single Set Screw★
1/0–4/0	18D24*	-	-	Double Set Screw

Female Detachable Plug

CABLE SIZE	COMPLETE CAT NO.	CONTACT CAT NO.	INSULATOR CAT NO.	TERMINATION TYPE
1/0–4/0	18D33*	-	-	Double Set Screw

Protective Caps for All 18 Series Insulators★

STYLE	CAT NO.	STYLE	CAT NO.
Male	18P21**	Female	18P22**

SEE PAGE P22 and P23 FOR DIMENSIONAL DRAWINGS



18D23-Y



18D24-E

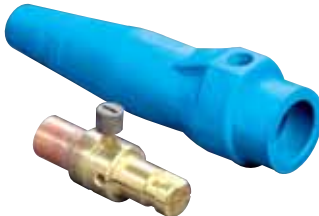

18D28-B



18D32-H



18D37-R

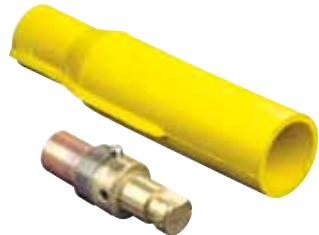

18V24-Y

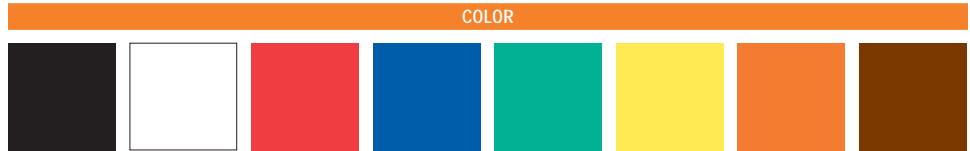

Black (-E) White (-W) Red (-R) Blue (-B) Green (-G) Yellow (-Y) Orange (-O) Brown (-H)
 * For color selections, add suffix to catalog number as follows: Black (-E), White (-W), Red (-R), Blue (-B), Green (-G), Yellow (-Y), Orange (-O) and Brown (-H).

★ Contact factory for color availability

SPECIFICATIONS AND FEATURES

- Leviton ECT 18 Series Taper Nose products are the connectors of choice for concerts, sound stages, movie making, television production, sporting events and conventions.

TESTING AND CODE COMPLIANCE

- UL Listed E-13399
- CSA Certified 152105, all detachable plugs except single set screws.

18 SERIES—BALL NOSE—UP TO 400 AMP

Commercial Grade Single Pole Cam-Type Connectors

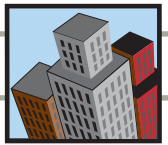

18 Series—Ball Nose—Up to 400 AMP, 600V

Refer to Ampacity Chart for all cable sizes on page P6

Male Panel Receptacles

CABLE SIZE	CAT NO.	TERMINATION TYPE
#2-4/0	18R21*	Threaded Stud**★
1/0-4/0	18R23*	Double Set Screw★

Female Panel Receptacles

CABLE SIZE	CAT NO.	TERMINATION TYPE
#2-4/0	18R22*	Threaded Stud**★
1/0-4/0	18R24*	Double Set Screw

Female Terminal Connector

CABLE SIZE	CAT NO.	TERMINATION TYPE
#2-4/0	18F21*	Angled★

Multi-Way Connectors

STYLE	DESCRIPTION	CAT NO.
Tapping Tee	Female-Female-Male	18A22★
Double Male	Male-Male	18A25★

SEE PAGE P22 and P23 FOR DIMENSIONAL DRAWINGS

**Threaded stud panel receptacles available in various lengths: Standard stud length is 3/4" – 1.25" stud length specify – 12 suffix. Other stud lengths available.



18R22-G



18A22-E



18A25-E

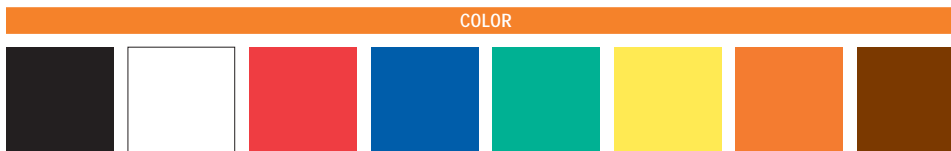

* For color selections, add suffix to catalog number as follows: Black (-E), White (-W), Red (-R), Blue (-B), Green (-G), Yellow (-Y), Orange (-O) and Brown (-H).

★ Contact factory for color availability

SPECIFICATIONS AND FEATURES

- Leviton 18 Series Taper Nose products are the connectors of choice for concerts, sound stages, movie making, television production, sporting events and conventions.

TESTING AND CODE COMPLIANCE

- UL Listed E-13399
- CSA Certified 152105

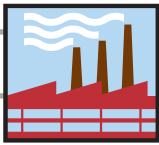

17 SERIES—TAPER NOSE—UP TO 690 AMP

Industrial Grade Single Pole Cam-Type Connectors

Single Pole Cam-Type Connectors

17 Series—Taper Nose—Up to 690 AMP, 600V

Refer to Ampacity Chart for all cable sizes on page P6

Male Detachable Plug

CABLE SIZE	COMPLETE CAT NO.	CONTACT CAT NO.	INSULATOR CAT NO.	TERMINATION TYPE
250–350 MCM	17D21*	-	17SDM*★	Double Set Screw
350–500 MCM	17D22*	-	17SDM*★	Double Set Screw

Female Detachable Plug

CABLE SIZE	COMPLETE CAT NO.	CONTACT CAT NO.	INSULATOR CAT NO.	TERMINATION TYPE
250–350 MCM	17D23*	-	-	Double Set Screw
350–500 MCM	17D24*	-	-	Double Set Screw

Male Vulcanized Plug

CABLE SIZE	COMPLETE CAT NO.	CONTACT CAT NO.	INSULATOR CAT NO.	TERMINATION TYPE
350–500 MCM	17V22*	-	-	Crimped★
500–750 MCM	17V23*	-	-	Crimped★

Female Vulcanized Plug

CABLE SIZE	COMPLETE CAT NO.	CONTACT CAT NO.	INSULATOR CAT NO.	TERMINATION TYPE
500–750 MCM	17V26-E	-	-	Crimped★

Protective Caps for All 17 Series Insulators

STYLE	CAT NO.	STYLE	CAT NO.
Male	17P21*	Female	17P22*

Male Panel Receptacles

CABLE SIZE	CAT NO.	TERMINATION TYPE	STYLE
250–750 MCM	17R21*	Threaded Stud	90 Degree
250–750 MCM	17R23*	Threaded Stud	30 Degree★

Female Panel Receptacles

CABLE SIZE	CAT NO.	TERMINATION TYPE	STYLE
250–750 MCM	17R22*	Threaded Stud	90 Degree
250–750 MCM	17R24*	Threaded Stud	30 Degree★

SEE PAGE P24 FOR DIMENSIONAL DRAWINGS



17D21-W



17D23-E



17V26-G



17R23-E



17P21-E

COLOR



Black (-E) White (-W) Red (-R) Blue (-B) Green (-G) Yellow (-Y) Orange (-O) Brown (-H)

* For color selections, add suffix to catalog number as follows: Black (-E), White (-W), Red (-R), Blue (-B), Green (-G), Yellow (-Y), Orange (-O) and Brown (-H).

★ Contact factory for color availability

SPECIFICATIONS AND FEATURES

- The 17 Series Taper Nose connectors withstand grueling, heavy-duty industrial use. Applications include generator test stations, water purification plants, electro-chemical machining equipment and other general industrial uses.

19 SERIES—BALL NOSE—UP TO 600 AMP

Industrial Grade Single Pole Cam-Type Connectors

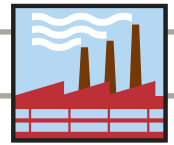

19 Series—Ball Nose—Up to 690 AMP, 600V

Refer to Ampacity Chart for all cable sizes on page P6

Male Detachable Plug

CABLE SIZE	COMPLETE CAT NO.	CONTACT CAT NO.	INSULATOR CAT NO.	TERMINATION TYPE
250–350 MCM	19D21*	-	-	Double Set Screw★
350–500 MCM	19D22*	-	-	Double Set Screw

Female Detachable Plug

CABLE SIZE	COMPLETE CAT NO.	CONTACT CAT NO.	INSULATOR CAT NO.	TERMINATION TYPE
250–350 MCM	19D23*	-	-	Double Set Screw★
350–500 MCM	19D24*	-	-	Double Set Screw★

Male Vulcanized Plug

CABLE SIZE	COMPLETE CAT NO.	CONTACT CAT NO.	INSULATOR CAT NO.	TERMINATION TYPE
500–750 MCM	19V23*	-	-	Crimped★

Protective Caps for All 19 Series Insulators

STYLE	CAT NO.	STYLE	CAT NO.
Male	19P21*★	Female	19P22

Male Panel Receptacles

CABLE SIZE	CAT NO.	TERMINATION TYPE	STYLE
250–750 MCM	19R21*	Threaded Stud	90 Degree

Female Panel Receptacles

CABLE SIZE	CAT NO.	TERMINATION TYPE	STYLE
250–750 MCM	19R22*	-	90 Degree
250–750 MCM	19R24*	Threaded Stud	30 Degree★

SEE PAGE P24 and P25 FOR DIMENSIONAL DRAWINGS



Single Pole Cam-Type Connectors

COLOR



* For color selections, add suffix to catalog number as follows: Black (-E), White (-W), Red (-R), Blue (-B), Green (-G), Yellow (-Y), Orange (-O) and Brown (-H).

★ Contact factory for color availability

SPECIFICATIONS AND FEATURES

- The 19 Series Ball Nose connectors are designed for general industrial applications

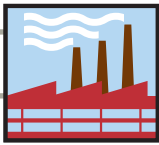

22 SERIES—LATCHING BALL NOSE—UP TO 690 AMP

Industrial Grade Single Pole Cam-Type Connectors

22 Series—Latching Ball Nose—Up to 690 Amp, 600V

Refer to Ampacity Chart for all cable sizes on page P6

Male Latching Plug

CABLE SIZE	COMPLETE CAT NO.	CONTACT CAT NO.	INSULATOR CAT NO.	TERMINATION TYPE
250–350 MCM	22L21 ¹	-	22SVM ³	Crimped
350–500 MCM	22L22 ²	22L22-C	22SVM ³	Crimped
350–500 MCM	22L22-S ^{3†}	-	-	-
500–750 MCM	22L23 ³	22L23-C	22SVM ³	Crimped

Female Latching Plug

CABLE SIZE	COMPLETE CAT NO.	CONTACT CAT NO.	INSULATOR CAT NO.	TERMINATION TYPE
250–350 MCM	22L24 ¹	-	22SVF ³	Crimped
350–500 MCM	22L25 ²	22L25-C	22SVF ³	Crimped
350–500 MCM	22L25-S ^{3†}	-	-	-
500–750 MCM	22L26 ³	-	22SVF ³	Crimped

Protective Caps for All 22 Series Insulators

STYLE	CAT NO.	STYLE	CAT NO.
Male	19P21★	Female	19P22★

Male Panel Receptacles

CABLE SIZE	CAT NO.	TERMINATION TYPE	STYLE
250–750 MCM	22R21 ³	Threaded Stud	90 Degree
250–750 MCM	22R23 ³	Threaded Stud	30 Degree

Female Panel Receptacles

CABLE SIZE	CAT NO.	TERMINATION TYPE	STYLE
250–750 MCM	22R22 ³	Threaded Stud	90 Degree
250–750 MCM	22R24 ⁴	Threaded Stud	30 Degree
250–750 MCM	22R26 ³	Threaded Stud	15 Degree

Female Panel Receptacles—with Micro Switch

CABLE SIZE	CAT NO.	TERMINATION TYPE	STYLE
250–750 MCM	22R28 ³	Threaded Stud	15 Degree

SEE PAGE P25 and P26 FOR DIMENSIONAL DRAWINGS

†Detachable

★Contact factory for color availability

COLOR

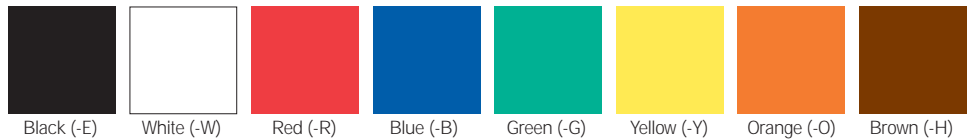

For color selections, add suffix to catalog number as follows:

¹ Black (-E), White (-W), Red (-R), Green (-G)

² Black (-E), White (-W), Red (-R), Yellow (-Y), Orange (-O), Brown (-H)

³ Black (-E), White (-W), Red (-R)

⁴ Black (-E), White (-W), Red (-R), Green (-G), Yellow (-Y), Orange (-O), Brown (-H)

SPECIFICATIONS AND FEATURES

- The Leviton 22 series Cam-Type connectors are specified in the United Facility Guide Specification (4FGS-16145).
- Leviton's Cam-Type positive latching connectors and receptacles are the standard used by Navy bases and shipyards in supplying 480 volts AC 3-phase power to ships at dockside. Our latching connector series has been thoroughly and successfully tested by ETL Laboratories to meet Navy specifications, including intermateability with competition. Our latching connector series provides heavy duty, completely insulated connectors that are vibration-resistant and positively lock into place. Leviton latching connectors will not vibrate, twist or turn

loose, ensuring high conductivity and maximum efficiency. Leviton contacts can be retrofitted to existing locations and power distribution systems. Our male contacts are designed to provide 40% more surface contact with the female vs. competitive products. The additional efficiency will help ensure greater conductivity while preventing burnout.

- The connectors and all components are completely interchangeable with competitive cam-type products.

TESTING AND CODE COMPLIANCE

- ETL Tested, Report #521300
- Waterproof (when vulcanized) and fire-resistant for outside usage



22L21-R



22L22-E



22L25-E



22L22-S



22R23-E



22R24-E



22L25-E



22R28-W

23 SERIES—LATCHING TAPER NOSE—UP TO 690 AMP

Industrial Grade Single Pole Cam-Type Connectors

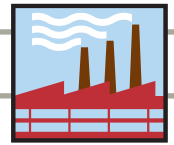

23 Series—Latching Taper Nose—Up to 690 Amp, 600V

Refer to Ampacity Chart for all cable sizes on page P6

Male Latching Plug

CABLE SIZE	COMPLETE CAT NO.	CONTACT CAT NO.	INSULATOR CAT NO.	TERMINATION TYPE
350–500 MCM	23L22 ¹	-	-	Crimped
500–750 MCM	23L23 ²	-	-	Crimped

Female Latching Plug

CABLE SIZE	COMPLETE CAT NO.	CONTACT CAT NO.	INSULATOR CAT NO.	TERMINATION TYPE
350–500 MCM	23L25 ⁴	-	-	Crimped
500–750 MCM	23L26 ⁵	-	-	Crimped

Protective Caps for All 22 Series Insulators

STYLE	CAT NO.	STYLE	CAT NO.
Male	17P21 ⁷	Female	17P22 ⁷

Male Panel Receptacles

CABLE SIZE	CAT NO.	TERMINATION TYPE	STYLE
250–750 MCM	23R21 ⁶	Threaded Stud	90 Degree
250–750 MCM	23R23 ⁴	Threaded Stud	30 Degree

Female Panel Receptacles

CABLE SIZE	CAT NO.	TERMINATION TYPE	STYLE
250–750 MCM	23R22 ⁷	Threaded Stud	90 Degree
250–750 MCM	23R24 ⁷	Threaded Stud	30 Degree

SEE PAGES 25 AND 26 FOR DIMENSIONAL DRAWINGS



23L24-R



23L25-G



23R21-E

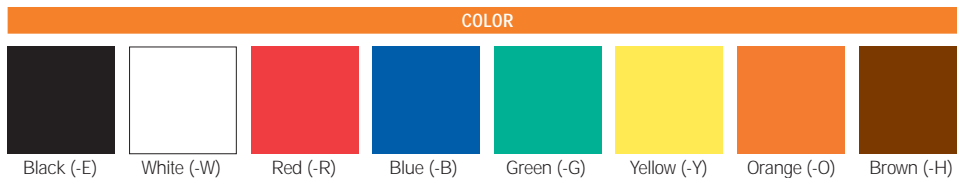

For color selections, add suffix to catalog number as follows:

- 1 White (-W), Blue (-B), Green (-G), Yellow (-Y), Orange (-O), Brown (-H)
- 2 Black (-E), White (-W), Red (-R), Blue (-B), Green (-G)
- 3 Black (-E), White (-W), Red (-R)
- 4 Black (-E), Blue (-B), Green (-G), Yellow (-Y), Orange (-O), Brown (-H)
- 5 Black (-E), White (-W), Red (-R)
- 6 Black (-E), Blue (-B), Green (-G)
- 7 Black (-E), White (-W), Red (-R), Blue (-B), Green (-G), Yellow (-Y), Orange (-O), Brown (-H)

★ Contact factory for color availability

SPECIFICATIONS AND FEATURES

- Leviton's Cam-Type positive latching connectors and receptacles are the standard used by Navy bases and shipyards in supplying 480 volts AC 3-phase power to ships at dockside. Our latching connector series has been thoroughly and successfully tested by ETL Laboratories to meet Navy specifications, including intermateability with competition. Our latching connector series provides heavy duty, completely insulated connectors that are vibration-resistant and positively lock into place. Leviton latching connectors will not vibrate, twist or turn loose, ensuring high conductivity and maximum efficiency. Leviton contacts can be retrofitted to existing

locations and power distribution systems. Our male contacts are designed to provide 40% more surface contact with the female vs. competitive products. The additional efficiency will help ensure greater conductivity while preventing burnout.

- The connectors and all components are completely interchangeable with competitive cam-type products.

TESTING AND CODE COMPLIANCE

- ETL Tested, Report #521300
- Waterproof (when vulcanized) and fire-resistant for outside usage



SINGLE POLE CAM-TYPE CONNECTORS—PRODUCT ACCESSORIES

Industrial Grade Single Pole Cam-Type Connectors

“COM-A-LONG” Assembly Tool

15 Series

DESCRIPTION	CAT. NO.
For Female Plug	15CLM



For Male Plug	15CLF
---------------	-------



16 Series & 18 Series

DESCRIPTION	CAT. NO.
For Female Plug	16CLM



For Male Plug	16CLF
---------------	-------



17 Series, 19 Series & 22/23 Series

DESCRIPTION	CAT. NO.
For Female Plug	17CLM



For Male Plug	17CLF
---------------	-------



Set Screws (10 per package)

DESCRIPTION	CAT. NO.
15 Series	A0001



16 Series & 18 Series	A0002
-----------------------	-------



Copper Shims (10 per package)

DESCRIPTION	CAT. NO.
15 Series	A0006



16 Series & 18 Series	A0004
-----------------------	-------



Strain Relief Wire (10 per package)

DESCRIPTION	CAT. NO.
15 Series	A0007



16 Series & 18 Series	A0003
-----------------------	-------



Insulated Screw (10 per package)

DESCRIPTION	CAT. NO.
16 Series & 18 Series	A0005



Lubricating Spray

DESCRIPTION	CAT. NO.
16 Fluid Ounce Can	C0001



STAGE PIN PANEL MOUNT—DIMENSIONAL DRAWINGS

Commercial Grade Stage Pin Devices



Stage Pin Panel Mount—20 AMP

20A Female Receptacle, Snap-In—page P3

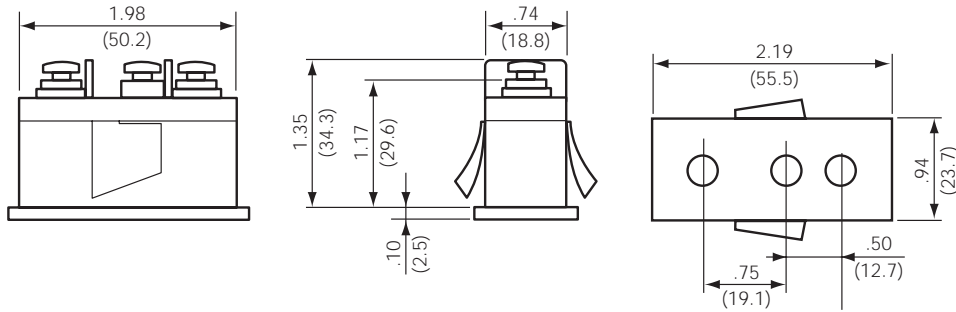

20A Male Inlet, Snap-In—page P3

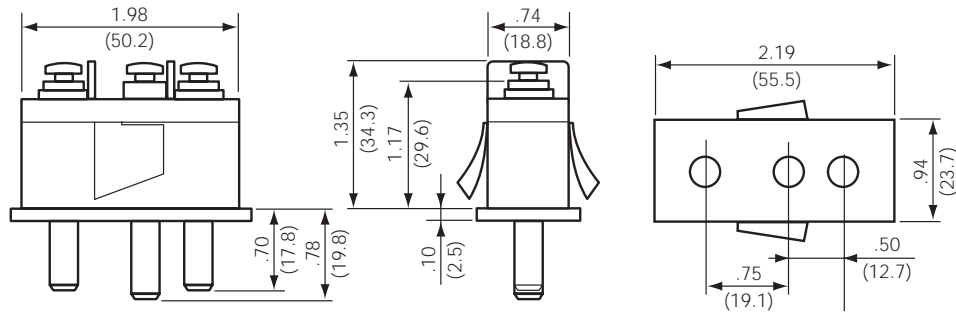

Stage Pin Panel Mount—60 AMP

60A Female Receptacle, Bolt-On—page P3

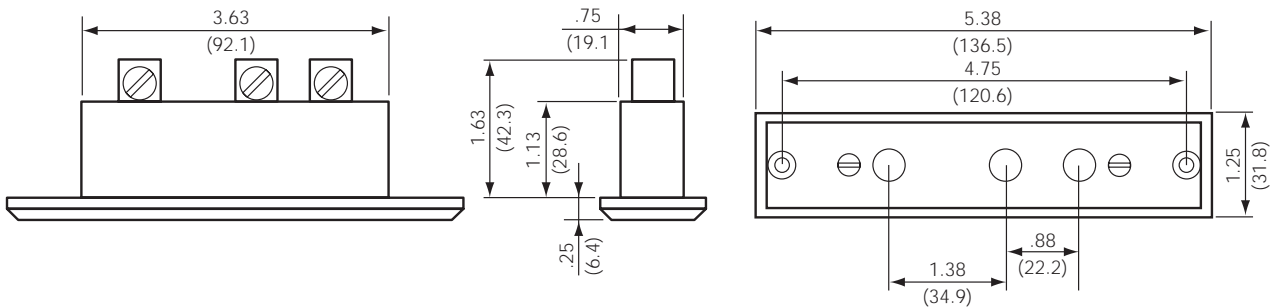

60A Male Inlet, Bolt-On—page P3

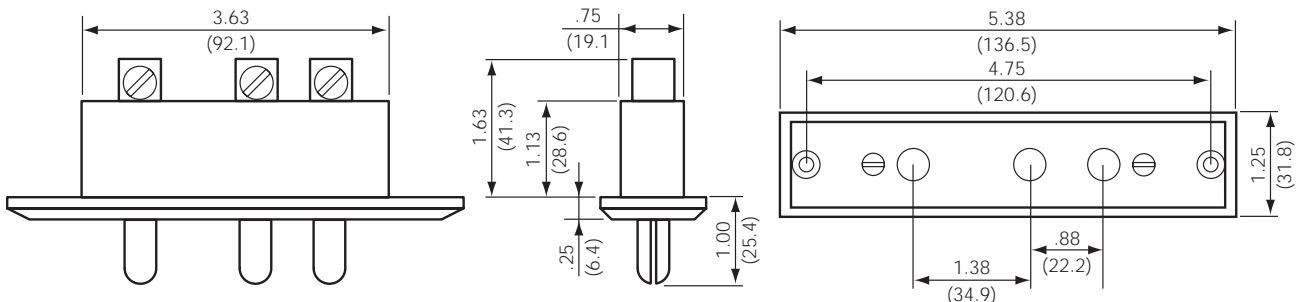

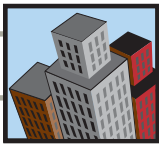

STAGE PIN PANEL MOUNT—DIMENSIONAL DRAWINGS

Commercial Grade Stage Pin Devices

Stage Pin Panel Mount—60 AMP

60A Female Panel Receptacle, Snap-In—page P3

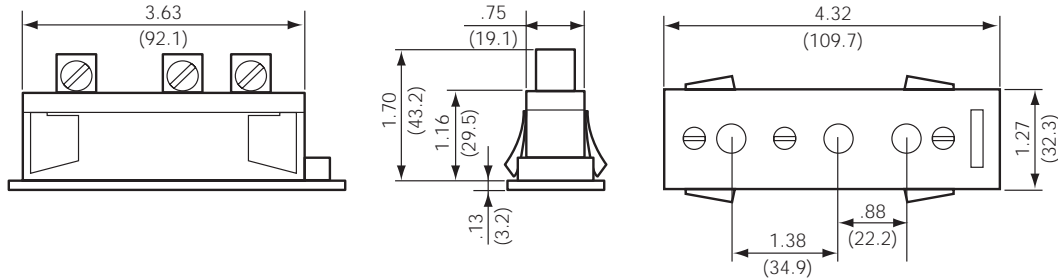

60A Male Panel Receptacle, Snap-In—page P3

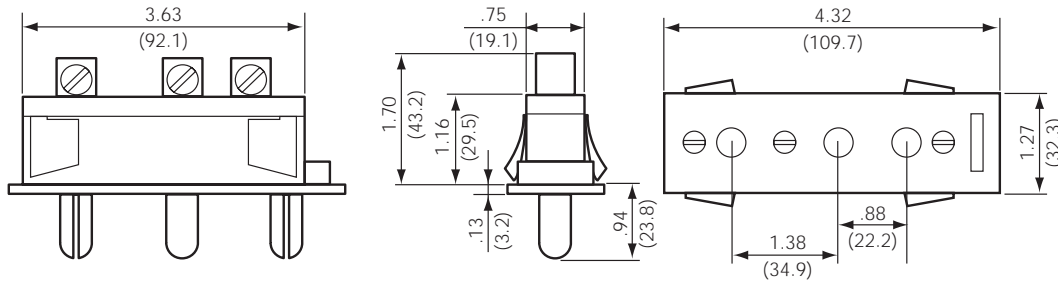

Stage Pin Panel Mount—100 AMP

100A Female Receptacle, Bolt-On—page P3

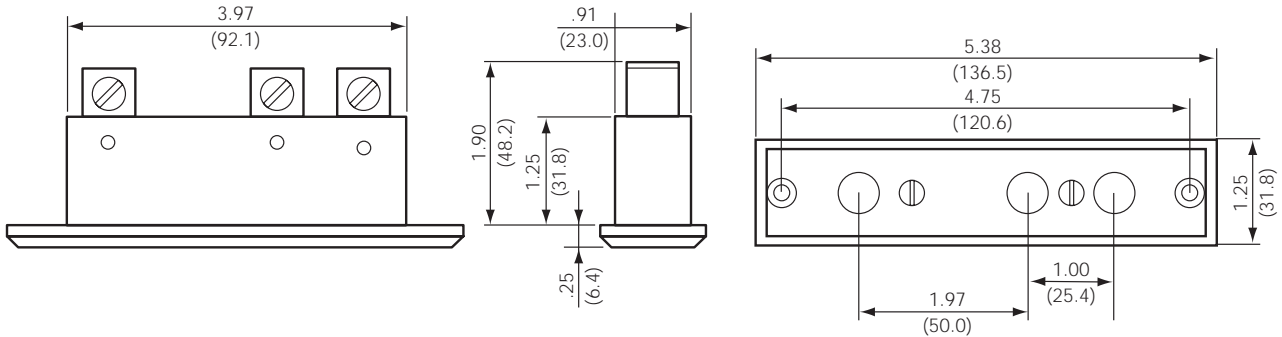

100A Male Inlet, Bolt-On—page P3

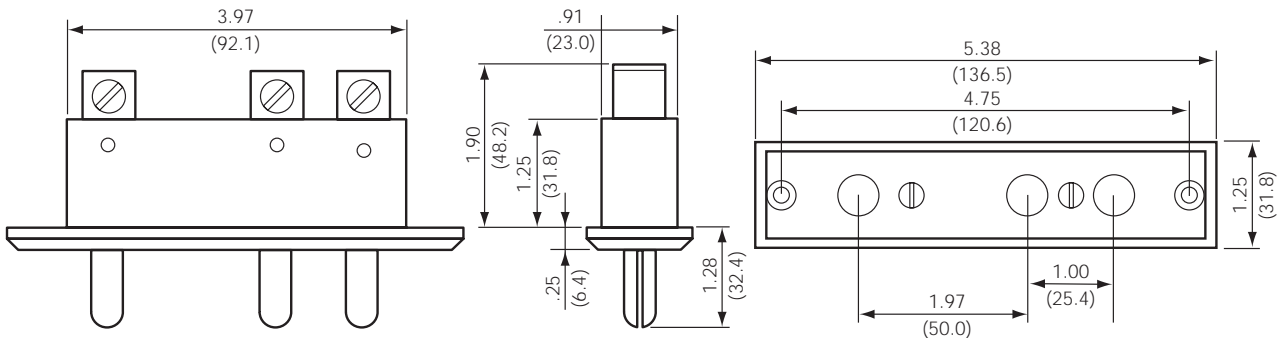

SINGLE POLE CAM-TYPE CONNECTORS—DIMENSIONAL DRAWINGS

Commercial Grade Single Pole Cam-Type Connectors

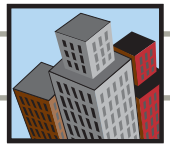

15 Series—Taper Nose

Male and Female Detachable Plugs—page P7

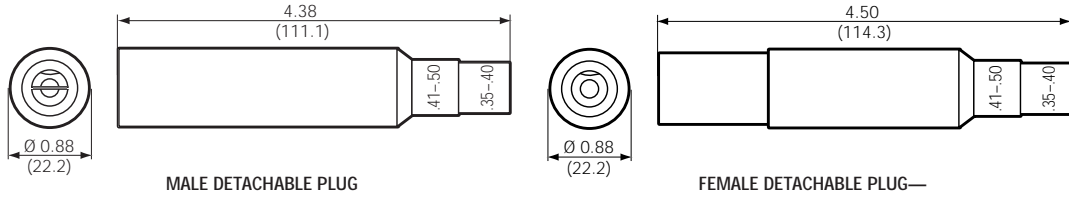

Panel Receptacle Threaded Studs—page P7

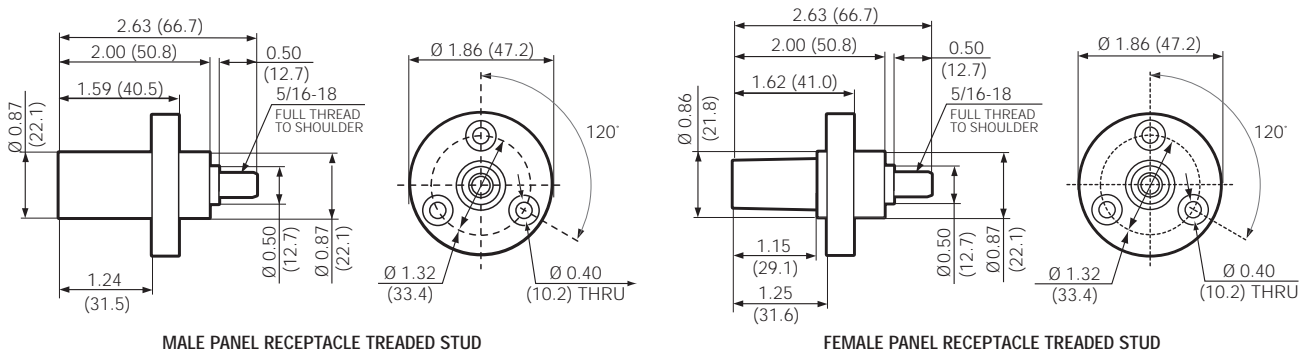

16 Series—Taper Nose

Male and Female Detachable Plugs—pages P8-P10

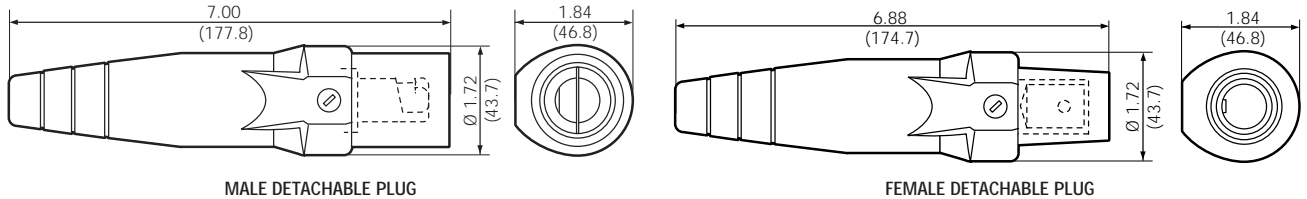

Male and Female Protective Caps—page P13

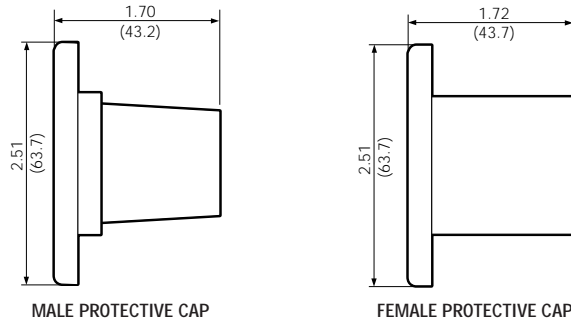

Male and Female Vulcanized Plugs—pages P14, P15

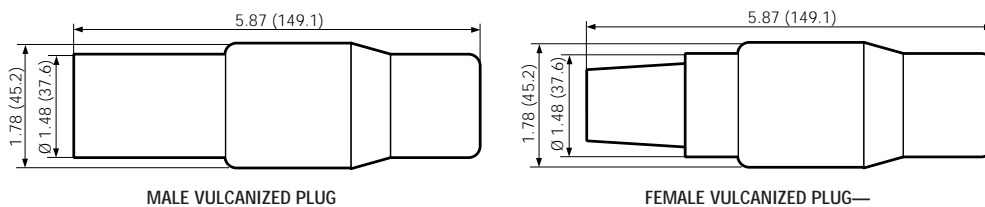



SINGLE POLE CAM-TYPE CONNECTORS—DIMENSIONAL DRAWINGS

Commercial Grade Single Pole Cam-Type Connectors

16 Series—Taper Nose

Double Set Screw and Threaded Panel Receptacle Studs—page P10

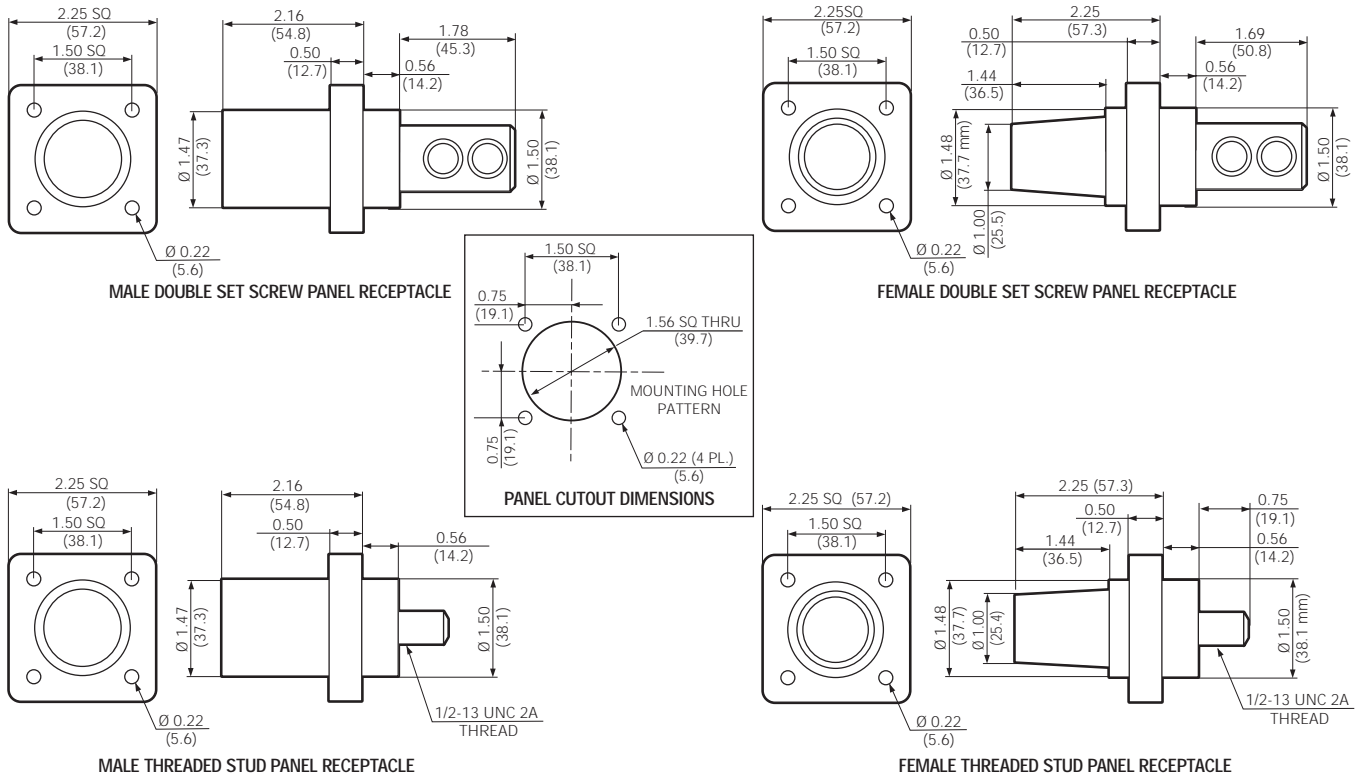

Multi-Way Connectors—page P10

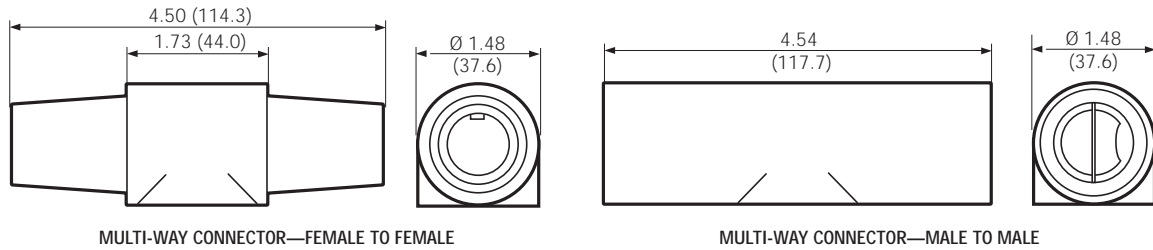

18 Series—Ball Nose

Male and Female Detachable Plugs—pages P11, P12

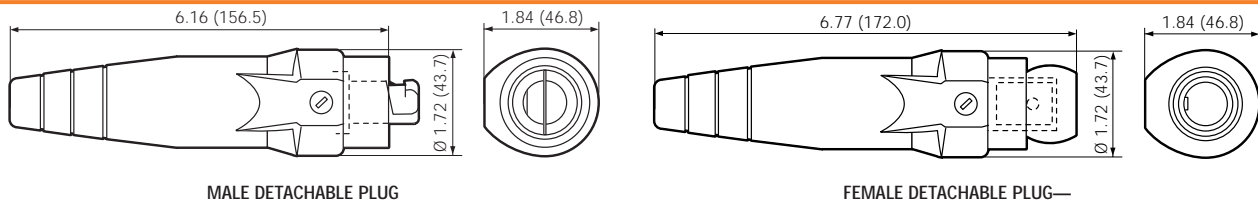

Male and Female Vulcanized Plugs—pages P11, P12

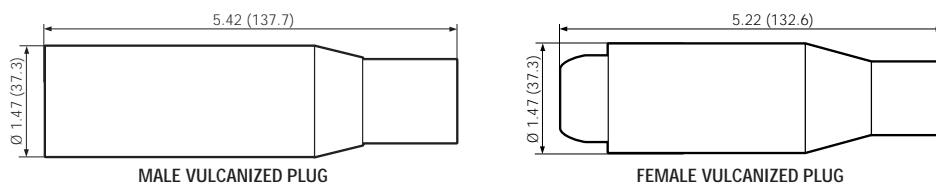

SINGLE POLE CAM-TYPE CONNECTORS—DIMENSIONAL DRAWINGS

Commercial Grade Single Pole Cam-Type Connectors

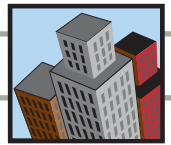

18 Series—Ball Nose

Male and Female Protective Caps—page P12

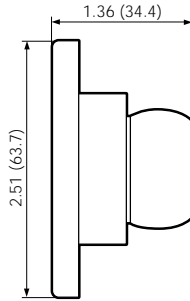

MALE PROTECTIVE CAP

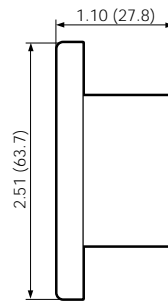

FEMALE PROTECTIVE CAP

Double Set Screw and Threaded Panel Receptacle Studs—page P13

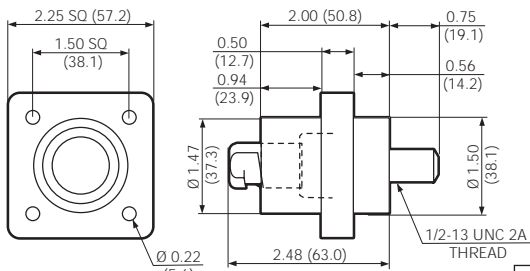

MALE THREADED STUD PANEL RECEPTACLE

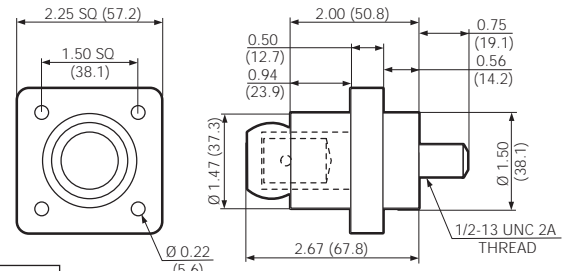

FEMALE THREADED STUD PANEL RECEPTACLE

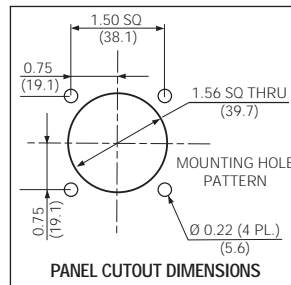

PANEL CUTOUT DIMENSIONS

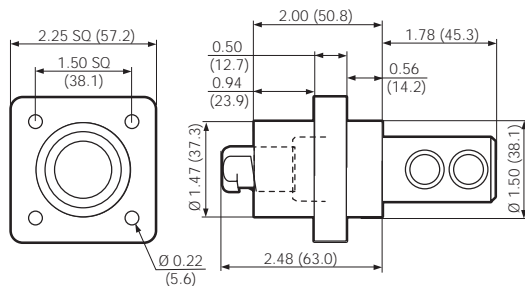

MALE DOUBLE SET SCREW PANEL RECEPTACLE

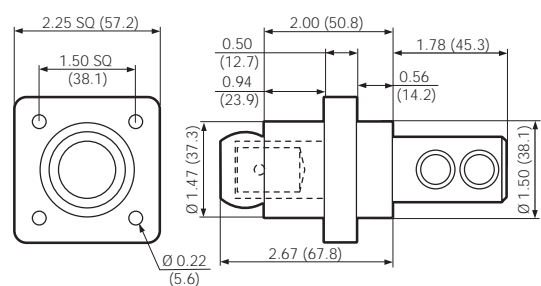

FEMALE DOUBLE SET SCREW PANEL RECEPTACLE

Multi-Way Connectors—page P13

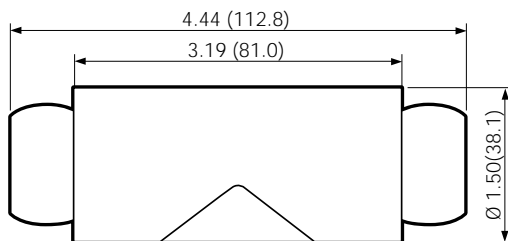

MULTI-WAY CONNECTOR—FEMALE TO FEMALE

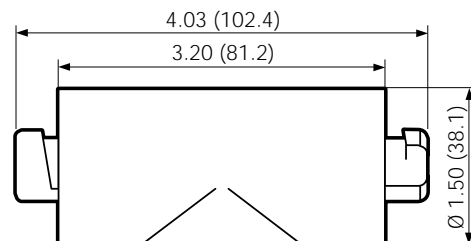

MULTI-WAY CONNECTOR—MALE TO MALE

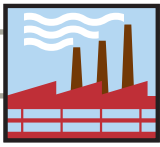

SINGLE POLE CAM-TYPE CONNECTORS—DIMENSIONAL DRAWINGS

Industrial Grade Single Pole Cam-Type Connectors

17 Series—Taper Nose

Male and Female Vulcanized Plugs—pages P14



MALE VULCANIZED PLUG—CRIMPED

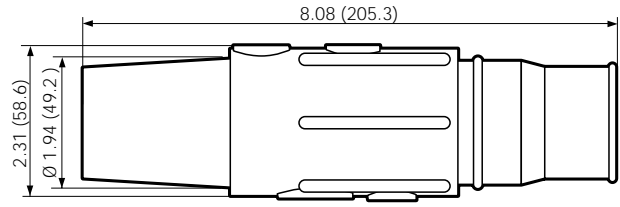

FEMALE VULCANIZED PLUG—CRIMPED

Panel Receptacle Threaded Studs—page P14

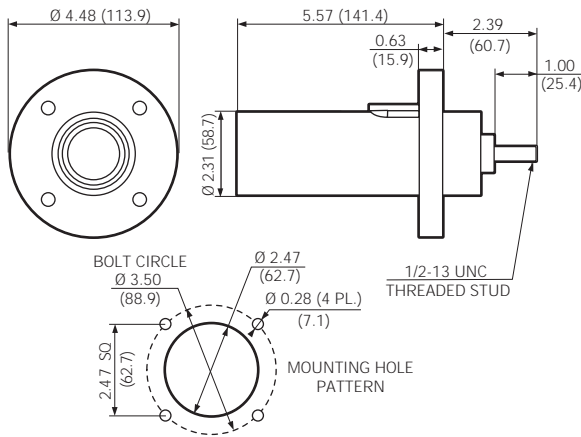

MALE PANEL RECEPTACLE THREADED STUD—90°

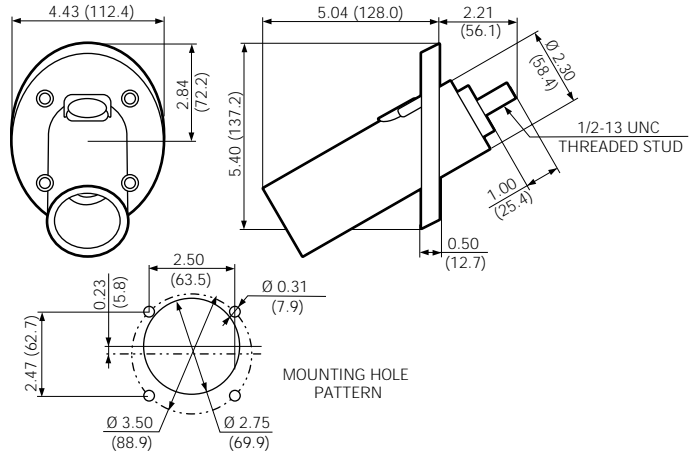

MALE PANEL RECEPTACLE THREADED STUD—30°

19 Series—Ball Nose

Male and Female Detachable Plugs—page P15

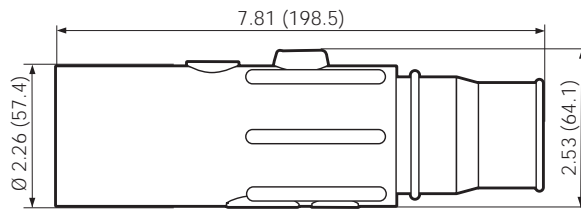

MALE DETACHABLE PLUG—DOUBLE SET SCREW

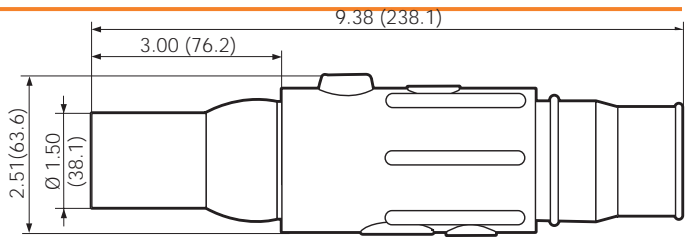

FEMALE DETACHABLE PLUG—DOUBLE SET SCREW

19 Series—Ball Nose

Male and Female Vulcanized Plugs—pages P15

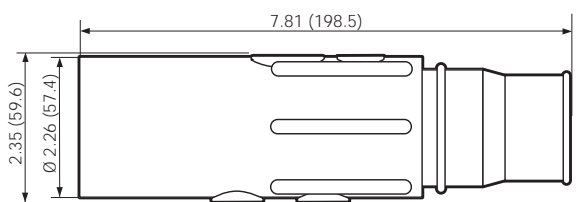

MALE VULCANIZED PLUG—CRIMPED

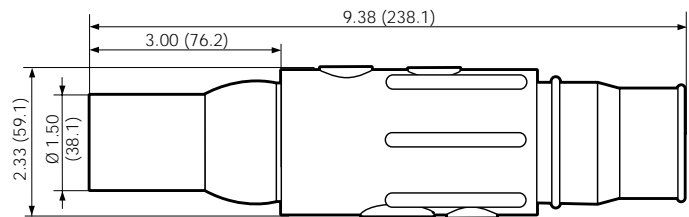

FEMALE VULCANIZED PLUG—CRIMPED

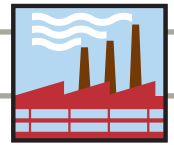

19 Series—Ball Nose

Panel Receptacle Threaded Studs—page P15

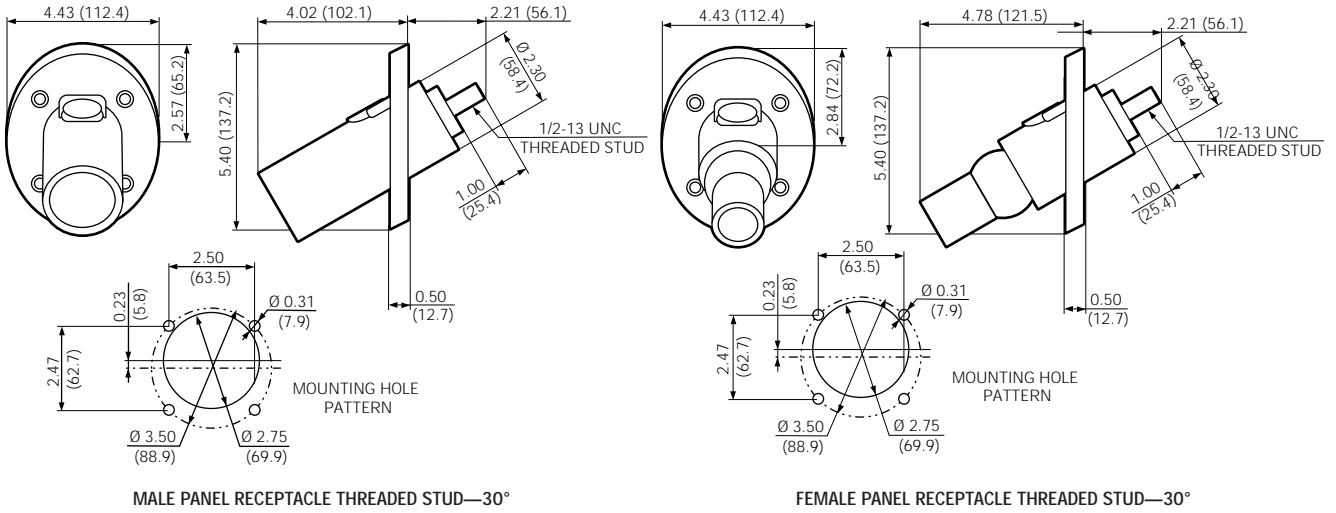

22 Series—Latching Ball Nose

Male and Female Ball Nose Latching Connectors—page P16

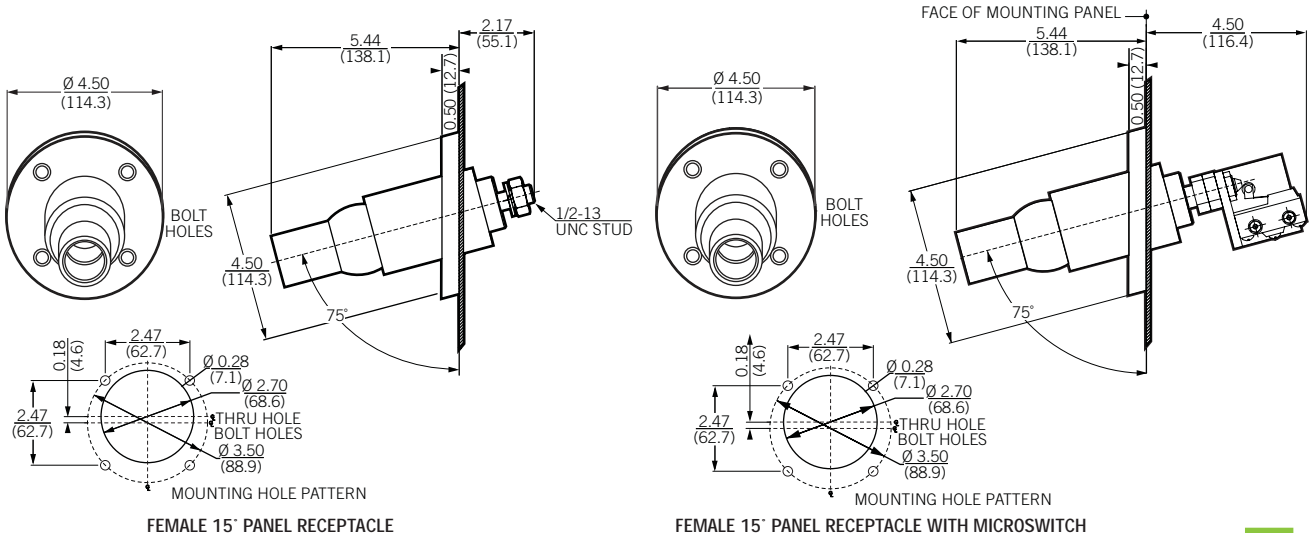
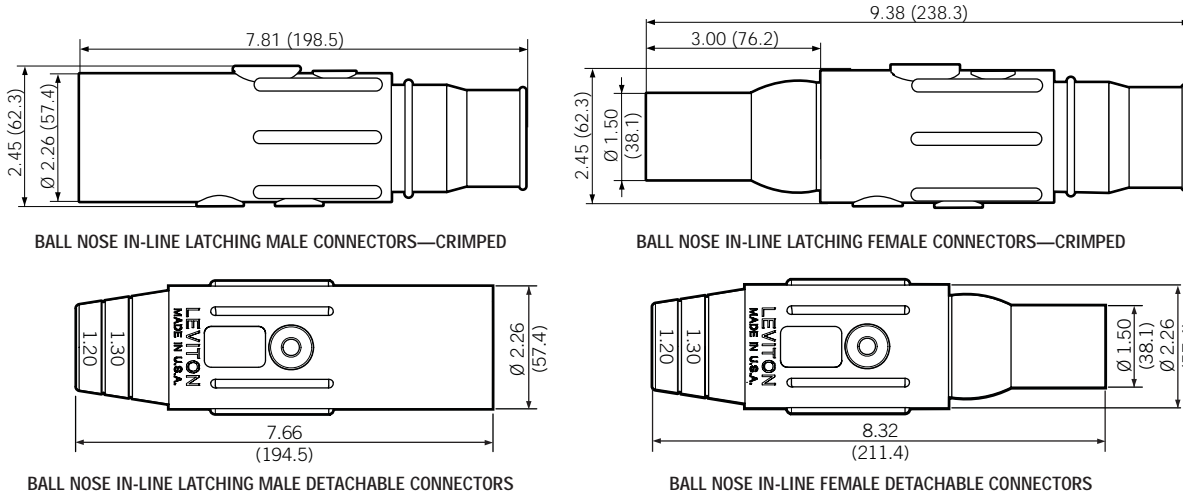

Single Pole Cam-Type Connectors

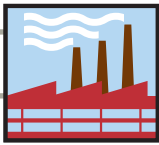

SINGLE POLE CAM-TYPE CONNECTORS—DIMENSIONAL DRAWINGS

Industrial Grade Single Pole Cam-Type Connectors

23 Series—Latching Taper Nose

Male and Female Taper Nose Latching Connectors—pages P17

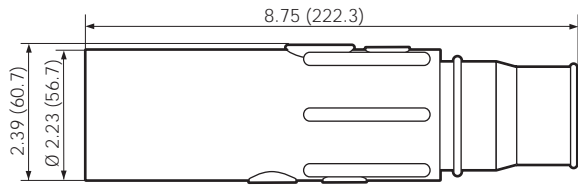

TAPER NOSE IN-LINE LATCHING MALE CONNECTORS—CRIMPED

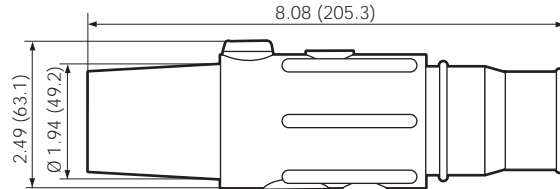

TAPER NOSE IN-LINE LATCHING FEMALE CONNECTORS—CRIMPED

23 Series—Latching Taper Nose

Panel Receptacle Threaded Studs—page P17

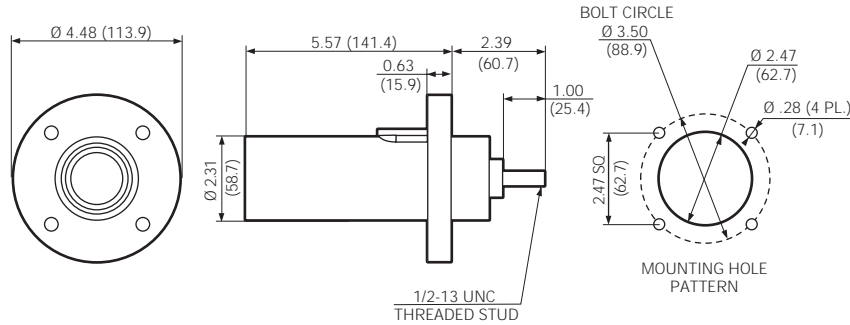

90° MALE PANEL RECEPTACLE THREADED STUD

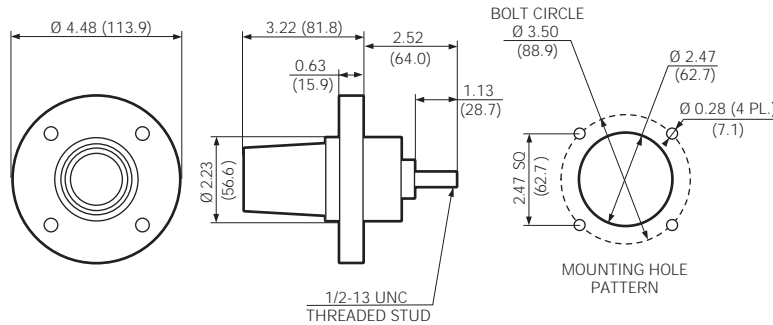

90° FEMALE PANEL RECEPTACLE THREADED STUD

Male and Female Protective Caps—page P17

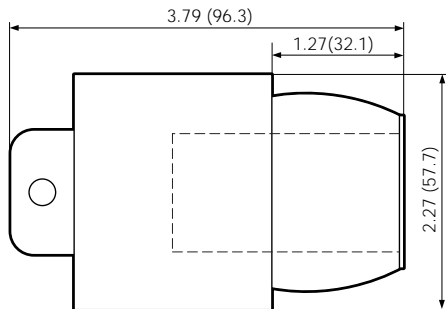

MALE PROTECTIVE CAP

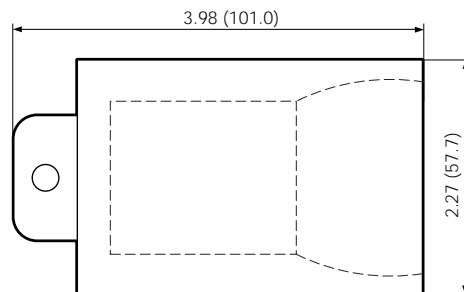

FEMALE PROTECTIVE CAP

Wire Mesh Safety Grips

INDEX

Wire Mesh Safety Grips

Overview	.02
Technical Reference	.03
Selecting Pulling and Support Grips	.04-06
Pulling Grips	.07-014
Strain-Relief Grips	.015-018
Support Grips	.019-026

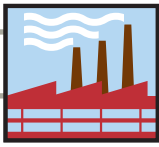

WIRE MESH SAFETY GRIP FEATURES

Industrial Grade Wire Mesh Safety Grips

A LARGE SELECTION OF WIRE MESH PULLING, STRAIN-RELIEF AND SUPPORT GRIPS

Leviton Wire Mesh Safety Grips are built tough to provide the strength, reliability and gripping force required for today's demanding wire management applications. They are designed to distribute stress over a large area so they can securely hold, pull or support the wire, rope, tubing or fiber optic cable to which they are applied.

Leviton Wire Mesh Safety Grip products offer a wide selection of style, weave, attachment and wire options designed to meet the highest standards for strength, flexibility, durability and longevity.

Leviton Wire Mesh Safety Grips are flexible holding devices used to pull cable, rope, or tubing into place; to support it after it has been installed, to prevent cable pullout; or to provide strain-relief that reduces the arc of bend at points of wire connections or terminations.

1. Pulling Grips

Pulling Grips are reusable tools for pulling insulated conductors or bare wires, cable, nylon and wire rope, fiber optic cable etc. Both flexible eye and rotating eye attachments are available.

2. Strain-Relief Grips

Strain-Relief Grips are used to connect cable or flexible conduit to electrical enclosures and equipment. This prevents pullout and bending due to tension at the inner conductors at the point of termination.

3. Support Grips

Support Grips distribute the weight of the vertical or sloping runs of electrical and fiber optic cable, metal rods, tubing or hose over the entire length of the grip so that the cable is not subject to damage. A variety of hangers and bales are available. These grips are also available in stainless steel for additional corrosion-resistance. Consult factory for availability.

Agency Approvals

UL Listings and CSA Certifications are indicated on the appropriate product catalog pages. File numbers, are listed below.

AGENCY	CONTROL NUMBER	FILE NUMBER
Underwriters Laboratories, Inc.	965U 16G5	E-173944 E-176347
Canadian Standards Association	—	LR-702185

Standards

Leviton Wire Mesh Safety Grips meet the following standards:

NEC 300-19—Supporting cables in vertical raceways.

NEC 351-2—Liquid-tight flexible metal conduit installations.

NEC 400-7—Flexible cord installations.

NEC 400-10—Strain-relief at joints and terminals.

JIC H 13.11—Prevention of flexible hose failure.

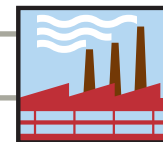

Industrial Grade Wire Mesh Safety Grips

Technical Reference

Hazardous Locations

The following product categories are suitable for use in hazardous locations per Class I, Div. 2; Class II, Div. 1 & 2; and Class III, Div. 1 & 2 requirements.

PRODUCT CATEGORY	TYPE
Deluxe Cord Grips	Aluminum fitting Nylon fitting Non-metallic

Flammability

Non-metallic Deluxe Cord Grips will not support combustion. The ratings are listed below.

COMPONENT	RATING
Wire Mesh Grip	94HB ¹
Fitting	94V ²

¹A test method used by U.L. to determine a rate of burning and/or extent and time of burning of self-supporting plastics in a horizontal position (ASTM D 635-88, IEC 707-1981, ISO/DIS 1210.2).

²A test method used by UL for measuring the comparative extinguishing characteristics of solid plastics in a vertical position (IEC 707-1981, ISO/DIS 1210.2).

Wet Locations

The strain-relief grips listed below are suitable for use in wet locations so long as a listed sealing ring is used between the box and the fitting.

PRODUCT CATEGORY	TYPE
Deluxe Cord Grip	Aluminum fitting Nylon fitting Non-metallic

Types of Wire Mesh Safety Grips

PRODUCT GROUP	DESCRIPTION	MATERIAL
Pulling Grips	Junior Duty	Galvanized steel wire
	Light Duty	Galvanized steel wire
	Medium Duty	Galvanized steel wire
	Heavy Duty	Galvanized steel wire
	Heavy Duty swivel	Galvanized steel wire
	MS Multi-Weave, Rotating Eye	Galvanized steel wire
	MS Multi-Weave, Flexible Eye	Galvanized steel wire
	High Strength	Galvanized steel wire
	Slack, Offset Eye	Galvanized steel wire
	Slack, Offset Eye	Galvanized steel wire
Strain-Relief Grips	Connection Wire	Galvanized steel
	Wide Range (with Gasket)	Galvanized steel wire
	Deluxe Cord Grips	Stainless steel wire
	Liquid-Tight (metallic cond.)	Stainless steel wire
	Liquid-tight (Non-Metallic Cond.)	Stainless steel wire
	Nylon Cord Sealing Grips with Mesh	Nylon
Support Grips	Support Closed	Tinned bronze or stainless steel ¹
	Support Split with Lace	Tinned bronze or stainless steel ¹
	Support Split with Rod	Tinned bronze or stainless steel ¹
	Support Closed, Heavy Duty, Long	Tinned bronze or stainless steel ¹
	Support Split Lace, Heavy Duty, Long	Tinned bronze or stainless steel ¹
	Bus Drop Grips	Galvanized steel wire
	Safety Springs	Spring steel

¹Stainless steel available on request. Contact your Leviton Representative.



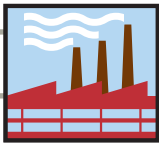

WIRE MESH SAFETY GRIP SELECTION

Industrial Grade Wire Mesh Safety Grips

Selecting Proper Sized Pulling and Support Grips

How to Select Proper Grip Size

Example: For five cables bundled together, each with a diameter of 0.42":

- 1) Locate "5 Cables" column.
- 2) Read down column to range (0.38"-0.48").
- 3) Read across line to Grip Diameter Range (1.00-1.25).

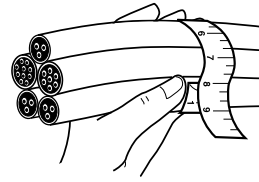

Grip size is based on the outside diameter or circumference of the cable(s). Use Selection Table 1 to determine the Grip Diameter Range for one or more cables of equal diameter. Use Selection Table 2 to determine the Grip Diameter Range for cables of different diameters bundled together. (Note: In this case, the bundle must be measured.) For your convenience, the Reference Tables provide approximate values for flexible cord and AWG or MCM wire.

Grip Selection Table for One or More Cables of Equal Diameter

- 1) Read across top line for number of cables in one grip.
- 2) Read down for diameter of each cable.
- 3) Read across line to Grip Diameter Range column

TABLE 1

Decimal and Fractional Inch Cable Diameters—for One or More Cables of Equal Diameter

1 CABLE	2 CABLES	3 CABLES	4 CABLES	GRIP DIAMETER RANGE
0.25-0.37 1/4-3/8	0.16-0.25 1/64-1/4	0.15-0.22 5/32-7/32	0.12-0.20 1/8-13/64	.250-.375
0.37-0.50 3/8-1/2	0.25-0.36 1/4-23/64	0.22-0.33 7/32-21/64	0.20-0.28 13/64-9/32	.375-0.50
0.50-0.62 1/2-5/8	0.27-0.36 17/64-23/64	0.26-0.33 17/64-21/64	0.24-0.28 15/64-9/32	0.50-0.75
0.62-0.75 5/8-3/4	0.36-0.45 23/64-29/64	0.33-0.36 21/64-23/64	0.28-0.31 9/32-5/16	0.62-0.75
0.75-1.00 3/4-1	0.45-0.60 29/64-39/64	0.36-0.49 23/64-31/64	0.31-0.42 5/16-27/64	0.75-1.00
1.00-1.25 1-1 1/4	0.60-0.76 39/64-49/64	0.49-0.63 33/64-5/8	0.42-0.54 27/64-35/64	1.00-1.25
1.25-1.50 1 1/4-1 1/2	0.76-0.91 49/64-29/32	0.63-0.76 5/8-49/64	0.54-0.65 35/64-21/32	1.25-1.50
1.50-1.75 1 1/2-1 3/4	0.91-1.08 29/32-15/64	0.76-0.89 49/64-57/64	0.65-0.77 21/32-49/64	1.50-1.75
1.75-2.00 1 3/4-2	1.08-1.23 15/64-15/64	0.89-1.02 57/64-11/64	0.77-0.88 49/64-7/8	1.75-2.00
2.00-2.50 2-2 1/2	1.23-1.54 15/64-135/64	1.02-1.28 11/64-19/32	0.88-1.00 7/8-1	2.00-2.50
2.50-3.00 2 1/2-3	1.54-1.84 135/64-127/32	1.28-1.53 19/32-117/32	1.10-1.32 13/32-121/64	2.50-3.00
3.00-3.50 3-3 1/2	1.84-2.15 127/32-25/32	1.53-1.79 117/32-151/64	1.32-1.54 121/64-135/64	3.00-3.50
3.50-4.00 3 1/2-4	2.15-2.45 25/32-229/64	1.79-2.05 151/64-23/64	1.54-1.76 135/64-1-49/64	3.50-4.00

Decimal and Fractional Inch Cable Diameters—for One or More Cables of Equal Diameter

5 CABLES	6 & 7 CABLES	8 CABLES	9 CABLES	GRIP DIAMETER RANGE
0.11-0.14 7/64-9/64	0.10-0.11 3/32-7/64	0.09-0.10 3/32-7/64	0.06-0.09 1/16-3/32	.250-.375
0.14-0.25 9/64-1/4	0.11-0.25 7/64-1/4	0.10-0.20 7/64-13/64	0.09-0.19 3/32-3/16	.375-0.50
0.21-0.25 7/32-1/4	0.19-0.22 3/16-7/32	0.17-0.20 11/64-13/64	0.15-0.19 5/32-3/16	0.50-0.75
0.25-0.29 1/4-19/64	0.22-0.26 7/32-17/64	0.20-0.23 13/64-15/64	0.19-0.22 3/16-7/32	0.62-0.75
0.29-0.38 19/64-3/8	0.26-0.34 17/64-11/32	0.23-0.31 15/64-5/16	0.22-0.31 7/32-5/16	0.75-1.00
0.38-0.48 3/8-31/64	0.34-0.43 11/32-7/16	0.31-0.39 5/16-25/64	0.29-0.36 19/64-23/64	1.00-1.25
0.48-0.58 31/64-37/64	0.43-0.52 7/16-33/64	0.39-0.46 25/64-15/32	0.36-0.43 23/64-7/16	1.25-1.50
0.58-0.67 37/64-43/64	0.52-0.60 33/64-39/64	0.46-0.54 15/32-35/64	0.43-0.49 7/16-31/64	1.50-1.75
0.67-0.77 43/64-49/64	0.60-0.69 39/64-11/16	0.54-0.62 35/64-5/8	0.49-0.57 31/64-37/64	1.75-2.00
0.77-0.96 49/64-31/32	0.69-0.86 11/16-55/64	0.62-0.77 5/8-49/64	0.57-0.72 37/64-23/32	2.00-2.50
0.96-1.16 31/32-15/32	0.86-1.03 55/64-11/32	0.77-0.93 49/64-15/16	0.72-0.86 23/32-55/64	2.50-3.00
1.16-1.35 15/32-123/64	1.03-1.20 11/32-113/64	0.93-1.08 15/16-15/64	0.86-1.00 55/64-1	3.00-3.50
1.35-1.54 123/64-135/64	1.20-1.37 113/64-13/8	1.08-1.24 15/64-115/64	1.00-1.14 1-19/64	3.50-4.00

WIRE MESH SAFETY GRIP SELECTION

Industrial Grade Wire Mesh Safety Grips

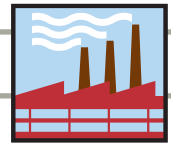

Selecting Proper Sized Pulling and Support Grips

How to Select Proper Grip Size

Example:

For three different diameter cables bundled together with a measured circumference of 6.35".

- 1) Read down Inches (Decimal) column for 6.35" (6.29-7.86 in.).
- 2) Read across line to Grip Diameter Range (2.00-2.50).

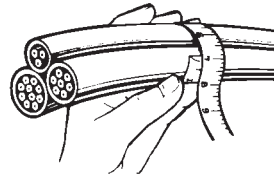

Grip Selection Table for Cables of Different Diameters

Grip Circumference Range refers to the circumference of all cables held together.

- 1) Determine Grip Circumference Range by measuring circumference of bundle of cables to be held (as shown in illustration).
- 2) Read down to locate correct range.
- 3) Read across line to Grip Diameter Range Column.

TABLE 2

Grip Circumference Range—for Cables of Different Diameter

INCHES (FRACTIONAL)	INCHES (DECIMAL)	GRIP DIAMETER RANGE
2 ⁵ / ₃₂ –1 ¹¹ / ₆₄	0.78–1.17	.250–.375
1 ¹¹ / ₆₄ –1 ³⁷ / ₆₄	1.17–1.57	.375–0.50
1 ³⁷ / ₆₄ –1 ¹⁵ / ₁₆	1.57–1.94	0.50–.625
1 ¹⁵ / ₁₆ –2 ³ / ₈	1.94–2.37	0.62–0.75
2 ³ / ₈ –3 ⁵ / ₃₂	2.37–3.15	0.75–1.00
3 ⁵ / ₃₂ –3 ¹⁵ / ₁₆	3.15–3.94	1.00–1.25
3 ¹⁵ / ₁₆ –4 ²³ / ₃₂	3.94–4.72	1.25–1.50
4 ²³ / ₃₂ –5 ³³ / ₆₄	4.72–5.51	1.50–1.75
5 ³³ / ₆₄ –6 ¹⁹ / ₆₄	5.51–6.29	1.75–2.00
6 ¹⁹ / ₆₄ –7 ⁵⁵ / ₆₄	6.29–7.86	2.00–2.50
7 ⁵⁵ / ₆₄ –9 ⁷ / ₁₆	7.86–9.43	2.50–3.00
9 ⁷ / ₁₆ –11 ¹ / ₆₄	9.43–11.01	3.00–3.50
11 ¹ / ₆₄ –12 ³⁷ / ₆₄	11.01–12.58	3.50–4.00

Reference Table Cord Diameters

For your convenience, the following are nominal overall diameters (in inches) for flexible cord.

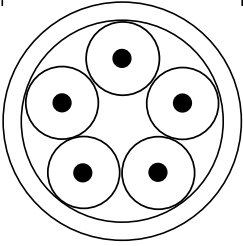
DIAMETER	AT WIRE SIZE AND TYPE	CONDUCTORS			
		2	3	4	5
	18 SO, STO	.36	.38	.41	.49
	18 SJO, SJTO	.30	.32	.35	—
	16 SO, STO	.39	.41	.44	.52
	16 SJO, SJTO	.32	.34	.37	—
	14 SO, STO	.52	.55	.59	.67
	12 SO, STO	.60	.62	.68	.74
	10 SO, STO	.65	.69	.74	.80
	8 SO, STO	.83	.88	.99	1.08
	6 SO, STO	.99	1.04	1.12	1.25

Reference Table AWG or MCM Diameters

This table is to be used as a guide only. Sizes may vary by manufacturer.

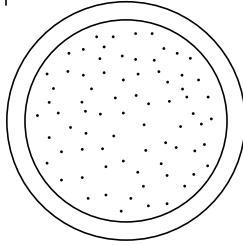
DIAMETER	AWG OR MCM	APPROX. DIA. (INCHES)		AWG OR MCM	APPROX. DIA. (INCHES)	
		THHN	THW		THHN	THW
	14	.105	.162	3/0	.588647	
	12	.122	.179	4/0	.646	.705
	10	.153	.199	250	.716	.788
	8	.201	.259	300	.771	.843
	6	.257	.323	350	.822	.895
	4	.328	.372	400	.869	.942
	3	.356	.401	500	.955	1.03
	2	.388	.433	600	1.06	1.14
	1	.450	.508	700	1.13	1.21
	1/0	.491	.549	750	1.16	1.25
	2/0	.537	.595	1000	1.32	1.40

Wire Mesh Safety Grips



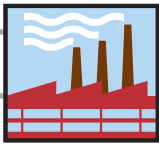

WIRE MESH SAFETY GRIP SELECTION

Industrial Grade Wire Mesh Safety Grips

Selecting Proper Sized Pulling and Support Grips

Strength Information

The approximate breaking strength of any Leviton Wire Mesh Safety Grip is based on working load information established by our engineering laboratories. In making these determinations, it is not possible to cover all applications and operating conditions. Variables such as diameter, gripping surface, number of items gripped, tension, movement, attachments, abrasion, corrosion, prior use and abuse must be assessed by the user. Greater safety factors should be utilized when the conditions of application are vague or unknown.

For specific applications where strength and holding power are important, consult Leviton's Technical Services Department. To determine the recommended working load safety factor for listed cable grips, divide the approximate breaking strength by 5 for pulling grips and by 10 for support grips. Leviton maintains a 6 Sigma Safety Factor for this recommended working load (using average break strengths obtained on new grips under lab test conditions).

Example: For pulling grips— $33,000 \div 5 = 6,600$ lbs. which is the workload factor.

Example: For support grips— $10,080 \div 10 = 1,008$ lbs. which is the workload factor.

All warranties concerning product quality or performance are based on wire mesh safety grips that are properly stored and handled by the user, and grips that are maintained and inspected at a proper frequency in keeping with their use and condition.

Grip Cable Range—Fraction—Decimal—Millimeter Conversion

INCHES (FRACTIONAL)	INCHES (DECIMAL)	METRIC (mm)
$1/4-23/64$	0.25-0.36	6.35-9.13
$3/8-31/64$	0.37-0.49	9.52-12.30
$1/2-39/64$	0.50-0.61	12.70-15.48
$5/8-47/64$	0.62-0.74	15.88-18.65
$3/4-63/64$	0.75-0.99	19.05-25.00
$1-115/64$	1.00-1.24	25.40-31.35
$11/4-131/64$	1.25-1.49	31.75-37.70
$11/2-163/64$	1.50-1.99	38.10-50.40
$2-231/64$	2.00-2.49	50.80-63.10
$21/2-263/64$	2.50-2.99	63.50-75.80
$3-331/64$	3.00-3.49	76.20-88.50
$31/2-363/64$	3.50-3.99	88.90-101.20

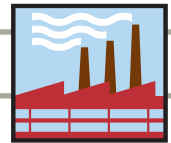





PULLING GRIPS

Leviton Pulling Grips are reusable tools for pulling bare conductors, insulated wires, synthetic rope, wire rope, and fiber optic cable. These grips do not damage the cable, as the tension remains uniform throughout the length of the grip. The mesh responds to fit either a single cable or a bundle of cables.

Leviton Pulling Grips may be used for pulling cable on overhead or underground applications, for stringing service or communication lines into factories, for pulling wire through conduit, and for underground electrical pulls.

Leviton Pulling Grips are woven in galvanized steel for greater strength and longer life. Leviton also offers Pulling Kits that come in a vinyl mat with pockets that can be rolled and tied.

Pulling Grip Eye Options

DESCRIPTION	PAGE NO.	ATTACHMENT INFORMATION
Bale Eye—Medium Duty, Single/Double Weave	Q9	
Bale Eye—Medium and Heavy Duty, Single/Double Weave	Q10	Bale Eye Attachment flexes to follow line of pull with plastic tubing on bale.
Flexible Eye—Junior Duty, Single Weave	Q8	
Flexible Eye—Light Duty, Single Weave	Q8	
Flexible Eye—for Fiber Optic, Multi-Weave	Q9	Flexible Rope Eye Bale has no plastic tubing for better flexibility.
Flexible Eye—High Duty, Multi-Weave	Q13	
Slack Grips, Closed Mesh, Double Weave	Q14	
Slack Grips, Split Lace Mesh, Double Weave	Q14	Offset Flexible Eye For easy attachment of the pulling line.
Slack Grips, Split Rod Mesh, Single Weave	Q14	
Rotating Eye—Heavy Duty, Double Weave	Q11	
Rotating Eye—Heavy Duty, Multi-Weave	Q12	Rotating Eye For use in changing wire rope in large cranes and derricks.

Note: To determine workload safety factor, divide approximate break strength by 5.
See page Q6 for strength information

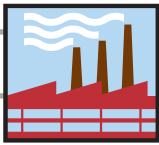

WIRE MESH PULLING GRIPS

Industrial Grade Wire Mesh Safety Grips

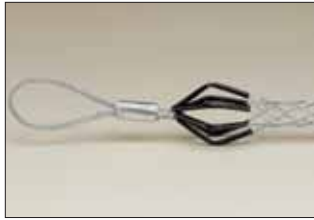

L8503

Junior Duty Series Grips are indispensable tools for electricians with small job requirements. They are used to connect insulated wire bundles to pulling tape or to pull wire rope through conduit.

Pulling Grips

Single Weave, Flexible Eye, Junior Duty

CAT. NO.	CABLE DIA. RANGE (INCHES)	APPROXIMATE BREAK STRENGTH*	MESH LENGTH (INCHES)
L8500	0.25–0.36	1,700	5
L8501	0.37–0.49	1,700	7
L8502	0.50–0.61	1,700	8
L8503	0.62–0.74	2,800	10
L8504	0.75–0.99	4,100	10
L8505	1.00–1.24	4,100	12

Single Weave, Flexible Eye, Junior Duty—Kit

KIT CAT. NO.	KIT INCLUDES ONE EACH OF CAT. NO.
L8510	L8500
	L8501
	L8502
	L8503
	L8504
	L8505



L8511

Light Duty Grips are the most economical pulling grips for many applications, such as industrial plant wiring, rewiring, and underground electrical pulls.

Pulling Grips

Single Weave, Flexible Rope Eye, Light Duty, Short

CAT. NO.	CABLE DIA. RANGE (INCHES)	APPROXIMATE BREAK STRENGTH*	MESH LENGTH (INCHES)
L8511	0.50–0.61	3,400	12
L8512	0.62–0.74	4,100	14
L8513	0.75–0.99	4,100	14
L8514	1.00–1.24	5,800	16.5
L8515	1.25–1.49	5,800	17
L8516	1.50–1.74	7,500	20
L8517	1.75–1.99	10,000	23
L8518	2.00–2.49	10,000	23
L8519	2.50–2.99	13,000	23

Single Weave, Flexible Rope Eye, Light Duty, Medium

CAT. NO.	CABLE DIA. RANGE (INCHES)	APPROXIMATE BREAK STRENGTH*	MESH LENGTH (INCHES)
L8523	0.50–0.61	3,400	16
L8524	0.62–0.74	4,100	16
L8525	0.75–0.99	4,100	20
L8526	1.00–1.24	7,500	20
L8527	1.25–1.49	7,500	22
L8528	1.50–1.99	7,500	25
L8529	2.00–2.49	10,000	26
L8530	2.50–2.9	13,000	28
L8531	3.00–3.49	16,200	30
L8532	3.50–3.99	19,400	32

Single Weave, Flexible Rope Eye, Light Duty, Medium—Kit

KIT CAT. NO.	KIT INCLUDES ONE EACH OF CAT. NO.
L8540	L8525
	L8526
	L8528
	L8529

*To determine workload safety factor, divide approximate break strength by 5. See page Q6 for strength information.

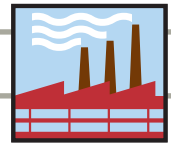

Pulling Grips 

Single/Double Weave, Bale Eye, Medium Duty

CAT. NO.	CABLE DIA. RANGE (INCHES)	APPROXIMATE BREAK STRENGTH*	MESH LENGTH (INCHES)
L8541	0.37-0.49	2,500	12
L8542	0.50-0.74	3,400	14
L8543	0.75-0.99	5,500	18
L8544	1.00-1.24	8,100	22
L8545	1.25-1.49	8,100	24
L8546	1.50-1.99	8,100	26



L8545
Single/Double Weave Pulling Grips are ideal for longer pull applications.

Single/Double Weave, Bale Eye, Medium Duty—Kit

KIT CAT. NO.	KIT INCLUDES ONE EACH OF CAT. NO.
L8550	L8541
	L8542
	L8543
	L8544
	L8545
	L8546

Pulling Grips—Fiber Optic Series 

Fiber Optic Pulling Grips are used for installation of fiber optic communication lines. They easily install on cables and are reusable. Applications include underground, overhead, through-conduit and/or enclosure type pulls.

Leviton fiber optic pulling grips are two-in-one reusable grips: the same tool features both a flexible eye and a swivel eye. The rounded, flexible eye attaches easily to pulling lines, and allows smoother passage through tight spaces than needle-eye designs.

Flexible/Swivel Eye Fiber Optic Grips Multi Weave

CAT. NO.	CABLE DIA. RANGE (INCHES)	APPROX. BREAK STRENGTH*	LENGTH (INCHES)		
			BALE (DIM. A)	MESH (DIM. M)	NOSE DIA.
L8801	.10-.20	1,000	4.75	9	.8
L8802	.21-.35	1,500	4.75	14	.8
L8803	.35-.48	2,200	5.00	18	.9
L8804	.42-.61	2,800	5.00	21	.9
L8805	.53-.74	3,300	5.00	24	1.2
L8806	.64-.87	4,700	5.00	27	1.2

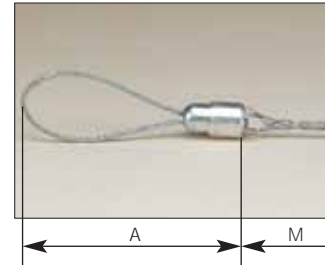

L8801
Fiber Optic Grips are made to pull delicate communication and data lines that have a much smaller cable diameter.

*To determine workload safety factor, divide approximate break strength by 5. See page Q6 for strength information.

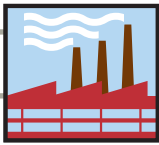

WIRE MESH PULLING GRIPS

Industrial Grade Wire Mesh Safety Grips

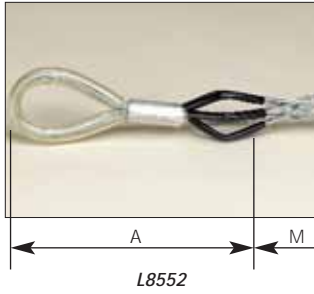

Pulling Grips

This series is recommended for heavy or rugged applications, and is ideally suited for overhead and underground installations. They are offered in short, standard or long mesh lengths.

Single/Double Weave, Bale Eye, Medium Duty, Short

CAT. NO.	CABLE DIA. RANGE (INCHES)	NOMINAL GRIP SIZE	APPROX. BREAK STRENGTH*	LENGTH (INCHES)		EYE SIZE (INCHES)
				BALE (DIM. A)	MESH (DIM. M)	
L8551	0.50-0.61	0.55	4,500	8	21	7/32
L8552	0.62-0.74	0.68	5,600	8	24	1/4
L8553	0.75-0.99	0.87	6,800	8	24	1/4
L8554	1.00-1.49	1.25	9,600	9	24	5/16
L8555	1.50-1.99	1.75	16,400	11	24	7/16
L8556	2.00-2.49	2.25	18,500	12	24	7/16
L8557	2.50-2.99	2.75	24,500	12	24	1/2
L8558	3.00-3.49	3.25	24,500	14	24	1/2
L8559	3.50-3.99	3.75	31,000	14	26	5/8

Single/Double Weave, Bale Eye, Medium Duty, Standard

CAT. NO.	CABLE DIA. RANGE (INCHES)	NOMINAL GRIP SIZE	APPROX. BREAK STRENGTH*	LENGTH (INCHES)		EYE SIZE (INCHES)
				BALE (DIM. A)	MESH (DIM. M)	
L8563	0.75-0.99	0.87	6,800	9	36	1/4
L8564	1.00-1.49	1.25	9,600	9	36	5/16
L8565	1.50-1.99	1.75	16,400	11	36	7/16
L8566	2.00-2.49	2.25	18,500	12	36	7/16
L8567	2.50-2.9	2.75	24,500	12	36	1/2
L8568	3.00-3.49	3.25	24,500	14	36	1/2
L8569	3.50-3.99	3.75	31,000	14	40	5/8

Single/Double Weave, Bale Eye, Medium Duty, Standard—Kit

KIT CAT. NO.	KIT INCLUDES ONE EACH OF CAT. NO.
L8560	L8563
	L8564
	L8565
	L8566

Single/Double Weave, Bale Eye, Heavy Duty, Long

CAT. NO.	CABLE DIA. RANGE (INCHES)	NOMINAL GRIP SIZE	APPROX. BREAK STRENGTH*	MESH DIM. M (INCHES)
L8572	0.75-0.99	0.87	8,100	48
L8573	1.00-1.49	1.25	11,600	48
L8574	1.50-1.99	1.75	19,400	48
L8575	2.00-2.49	2.25	19,400	48
L8576	2.50-2.99	2.75	25,900	48
L8577	3.00-3.49	3.25	25,900	48
L8578	3.50-3.99	3.75	32,400	48

Note: See installation instructions supplied with grip for recommended swivels, links and clamps or accessories listing.
 *To determine workload safety factor, divide approximate break strength by 5. See page Q6 for strength information.

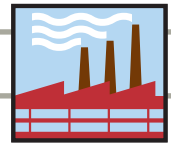

Industrial Grade Wire Mesh Safety Grips

Pulling Grips 

These grips feature a double weave of galvanized steel strands for greater strength and added mesh contact with the cable. Leviton Double Weave Pulling Grips are designed to handle longer or heavier pulling jobs such as installation of underground cables, communication lines, and service lines.

Double Weave Pulling Grips have a forged steel compact rotating eye which can be attached to a swivel.

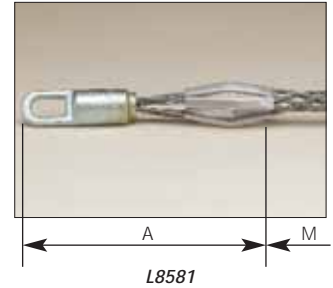

Double Weave, Rotating Eye, Heavy Duty, Short

CAT. NO.	CABLE DIA. RANGE (INCHES)	NOMINAL GRIP SIZE	APPROX. BREAK STRENGTH*	LENGTH (INCHES)		EYE SIZE (INCHES)
				BALE (DIM. A)	MESH (DIM. M)	
L8581	0.50-0.61	0.55	5,600	5	11	7/8
L8582	0.62-0.74	0.68	6,800	5	11	7/8
L8583	0.75-0.99	0.87	9,600	6	20	1
L8584	1.00-1.24	1.12	16,400	7	20	13/8
L8585	1.25-1.49	1.37	16,400	7	21	13/8
L8586	1.50-1.99	1.74	27,200	7	25	15/8
L8587	2.00-2.49	2.24	33,000	8	26	17/8
L8588	2.50-2.99	2.74	41,000	10	28	17/8
L8589	3.00-3.49	3.24	48,000	10	30	17/8
L8591	3.50-3.99	3.74	48,000	10	32	17/8
L8592	4.00-4.49	4.24	48,000	10	33	17/8

Double Weave, Rotating Eye, Heavy Duty, Standard

CAT. NO.	CABLE DIA. RANGE (INCHES)	NOMINAL GRIP SIZE	APPROX. BREAK STRENGTH*	LENGTH (INCHES)		EYE SIZE (INCHES)
				BALE (DIM. A)	MESH (DIM. M)	
L8601	0.50-0.61	0.55	5,600	5	16	7/8
L8602	0.62-0.74	0.68	6,800	5	16	7/8
L8603	0.75-0.99	0.87	9,600	6	32	1
L8604	1.00-1.49	1.12	16,400	7	33	13/8
L8605	1.50-1.99	1.74	16,400	7	34	13/8
L8606	2.00-2.49	2.24	27,200	9	36	15/8
L8607	2.50-2.99	2.74	33,000	10	38	17/8
L8608	3.00-3.49	3.24	41,000	10	39	17/8
L8609	3.50-3.99	3.74	48,000	10	41	17/8
L8611	4.00-4.49	4.24	48,000	10	42	17/8
L8612	4.50-4.99	4.74	48,000	10	58	17/8
L8613	5.00-5.99	5.49	48,000	10	60	17/8
L8614	6.00-6.99	6.49	48,000	10	66	17/8

Double Weave, Rotating Eye, Heavy Duty, Standard—Kit

KIT CAT. NO.	KIT INCLUDES ONE EACH OF CAT. NO.
L8600	L8603
	L8604
	L8605
	L8606

Note: See installation instructions supplied with grip for recommended swivels, links and clamps or accessories listing.
 *To determine workload safety factor, divide approximate break strength by 5. See page Q6 for strength information.

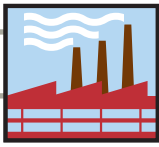

WIRE MESH PULLING GRIPS

Industrial Grade Wire Mesh Safety Grips

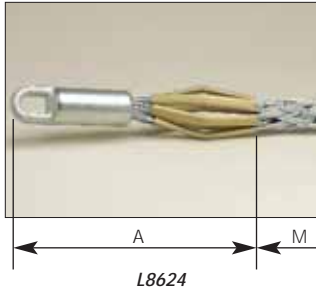

Pulling Grips—Multi-Weave Grips ^{SE}

Leviton Multi-Weave Pulling Grips are constructed of high strength galvanized steel strands and are designed for pulling aluminum or copper bare conductor, wire rope and insulated cables. These grips are used in applications such as distribution line stringing and overhead transmission.

Multi-Weave Pulling Grips are available with a flexible or rotating eye which can be attached to a swivel. The forged steel flexible eye will thread through sheaves and blocks without binding, but is not a swivel and will not turn under tension. The rotating eye can turn to relieve pulling torque when tension is relaxed.

Multi-Weave, Rotating Eye

CAT. NO.	CABLE DIA. RANGE (INCHES)	NOMINAL GRIP SIZE	APPROX. BREAK STRENGTH*	LENGTH (INCHES)		COLOR CODE	EYE SIZE (INCHES)
				BALE (DIM. A)	MESH (DIM. M)		
L8621	0.25–0.49	3/8	6,800	5	26	Dk. Green	7/8
L8622	0.50–0.74	5/8	10,000	6	32	Brown	1
L8623	0.75–0.99	7/8	14,400	6	41	Lt. Blue	1
L8624	1.00–1.24	1 1/8	24,600	8	52	Gold	1 3/8
L8625	1.25–1.49	1 3/8	30,600	8	56	Black	1 5/8
L8626	1.50–1.74	1 5/8	30,600	9	60	Red	1 7/8
L8627	1.75–1.99	2	48,000	10	70	Dk. Blue	1 7/8
L8628	2.00–2.49	2 1/4	48,000	10	50	Yellow	1 7/8
L8629	2.50–2.99	2 3/4	48,000	10	52	Orange	1 7/8
L8631	3.00–3.49	3 1/4	48,000	10	54	Alum.	1 7/8
L8632	3.50–3.99	3 3/4	48,000	10	56	Lt. Green	1 7/8

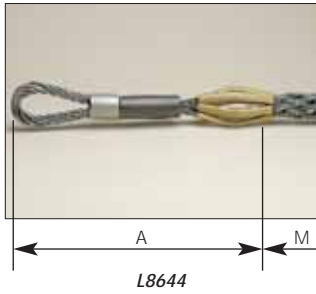

Multi-Weave, Flexible Eye

CAT. NO.	CABLE DIA. RANGE (INCHES)	NOMINAL GRIP SIZE	APPROX. BREAK STRENGTH*	LENGTH (INCHES)		COLOR CODE	EYE SIZE (INCHES)
				BALE (DIM. A)	MESH (DIM. M)		
L8641	0.25–0.49	3/8	6,800	9	26	Dk. Green	1/4
L8642	0.50–0.74	5/8	10,000	9	32	Brown	5/16
L8643	0.75–0.99	7/8	14,400	11	41	Lt. Blue	3/8
L8644	1.00–1.24	1 1/8	24,600	12	52	Gold	1/2
L8645	1.25–1.49	1 3/8	30,600	12	56	Black	1/2
L8646	1.50–1.74	1 5/8	30,600	12	60	Red	1/2
L8647	1.75–1.99	2	48,000	15	70	Dk. Blue	5/8
L8648	2.00–2.49	2 1/4	48,000	18	50	Yellow	5/8
L8649	2.50–2.99	2 3/4	48,000	18	52	Orange	5/8
L8651	3.00–3.49	3 1/4	48,000	18	54	Alum.	5/8
L8652	3.50–3.99	3 3/4	48,000	18	56	Lt. Green	5/8

Note: It is recommended that a swivel be used for release of torque during a pull. Use a connecting link when a swivel is not needed. Do not run grips or swivels over bullwheels while under tension. Do not use Multi-Weave for pulling rope. When higher loads are required, use Leviton's high strength-style pulling grips. See installation instructions supplied with grip for recommended swivels, links and clamps or accessories listing.

**To determine workload safety factor, divide approximate break strength by 5. See page Q6 for strength information.*

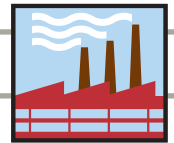

Industrial Grade Wire Mesh Safety Grips

Pulling Grips—High Strength Grips

High Strength Pulling Grips are designed for situations where load and safety considerations require an extra high strength grip. They are most commonly used for attaching pulling lines to conductors, conductors to running boards, and conductor-to-conductor connections. These grips can be used for pulling bare or insulated conductor, wire rope or synthetic rope

A feed tube is used when assembling synthetic rope¹ into the High Strength Pulling Grip and is required on the two largest grip sizes.



Multi-weave Flexible Eye

CAT. NO.	GRIP RANGE O. D. (INCHES)		APPROX. BREAK STRENGTH*	LENGTH (INCHES)		COLOR CODE	FLEXIBLE EYE SIZE (INCHES)
	ROPE ¹	CONDUCTOR		BALE (DIM. A)	MESH (DIM. M)		
L8660	0.25–0.65	0.19–0.37	6,500	10	24	Black	.218
L8661	0.50–0.90	0.38–0.62	14,000	13	26	Dk. Green	.375
L8662	0.75–1.10	0.63–0.87	20,000	14	48	Red	.437
L8663	1.00–1.50	0.88–1.12	30,600	15	60	Dk. Blue	.500
L8664	1.25–1.70	1.13–1.37	46,800	18	76	Yellow	.625
L8665	1.50–2.10	1.38–1.90	66,500	24	89	Aluminum	.750

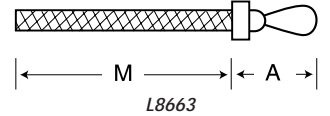

¹For rope, select smallest size grip which meets required workload.

*To determine workload safety factor, divide approximate break strength by 5. See page Q6 for strength information.

Recommended Rope Assembly Using High Strength Feed Tube

- 1) Insert feed tube into High Strength Pulling Grip.
- 2) Insert rope end fully into feed tube.
- 3) Hold rope in feed tube by pinning rope to the ground with end of tube. Pull mesh down onto feed so feed tube nose is protruding through shoulder protectors as shown.
- 4) Push mesh to end of feed tube and pull feed tube through mesh. When tube is pulled, the mesh gripping action will hold rope in place.
- 5) Position rope so that its end is inside the shoulder protectors. Remove slack from mesh by smoothing mesh tight to rope.
- 6) Apply clamps to mesh end.

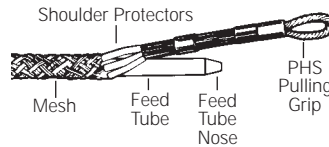

Split-Lace/Split-Rod Attachments (for use where end of cable is not accessible—applies to slack grips only)

Beginning at the end of the grip closest to the bale fitting, thread the lacing through the first two loops of the split, pulling the lace through until the ends are centered evenly. Cross the laces and thread them through the next two loops, and so on down the grip, being careful not to pull the lacing too tight.

Spacing of the laced closure should be approximately the same as the mesh weave. When the end of grip is reached, twist the lacing strands tightly together, wrapping the ends of the lace around the grip, and twisting again to secure. Excess length may be cut off.

Split grips with rod closing are economical, since they are quickly installed, and are reusable. Simply wrap the grip around the cable and thread the rod through the loops, using a corkscrew motion. To remove, pull the rod out, and the grip is ready for re-use.

Split-Lace

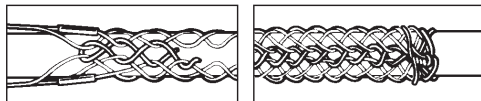

Split-Rod



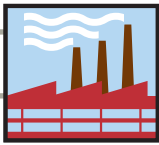

WIRE MESH PULLING GRIPS

Industrial Grade Wire Mesh Safety Grips

PULLING GRIPS—SLACK GRIPS

Slack Grips are reusable grips used for pulling slack in underground cable preparatory to final placement. They may also be used for cable removal. Slack Grips feature an offset eye for easy attachment to the pulling line. See attachment information for split lace and split rod on page Q13.



L8671

Pulling Grips—Slack Grips Series

Closed Mesh, Double Weave, Offset Eye, Heavy Duty, Medium

CAT. NO.	CABLE DIA. RANGE (INCHES)	APPROXIMATE BREAK STRENGTH*	MESH LENGTH (INCHES)
L8671	0.75-0.99	3,000	13
L8672	1.00-1.24	4,200	16
L8673	1.25-1.49	5,500	17
L8674	1.50-1.74	7,400	18
L8675	1.75-1.99	11,000	19
L8676	2.00-2.49	11,000	20
L8677	2.50-2.99	11,000	21
L8678	3.00-3.49	16,000	22
L8679	3.50-3.99	16,000	23

Closed Mesh, Double Weave, Offset Eye, Heavy Duty, Long

L8681	0.75-0.99	3,000	21
L8682	1.00-1.24	5,500	21
L8683	1.25-1.49	5,500	24
L8684	1.50-1.99	7,400	26
L8685	2.00-2.49	11,000	27
L8686	2.50-2.99	11,000	30
L8687	3.00-3.49	16,000	33
L8688	3.50-3.99	16,000	36

Split Lace, Double Weave, Offset Eye, Heavy Duty, Medium

CAT. NO.	CABLE DIA. RANGE (INCHES)	APPROXIMATE BREAK STRENGTH*	MESH LENGTH (INCHES)
L8691	0.75-0.99	3,000	13
L8692	1.00-1.24	4,100	16
L8693	1.25-1.49	4,100	17
L8694	1.50-1.74	5,500	18
L8695	1.75-1.99	7,300	19
L8696	2.00-2.49	7,300	20
L8697	2.50-2.99	7,300	21
L8698	3.00-3.49	9,200	22
L8699	3.50-3.99	11,000	23

Split Lace, Double Weave, Offset Eye, Heavy Duty, Long

L8701	0.75-0.99	3,000	21
L8702	1.00-1.24	4,100	21
L8703	1.25-1.49	4,100	24
L8704	1.50-1.99	5,500	25
L8705	2.00-2.49	7,300	27
L8706	2.50-2.99	7,300	30
L8707	3.00-3.49	9,200	33
L8708	3.50-3.99	11,000	36

Split Rod, Single Weave, Offset Eye, Heavy Duty, Medium

L8711	0.50-0.61	1,800	7
L8712	0.62-0.74	1,900	9
L8713	0.75-0.99	3,000	11
L8714	1.00-1.24	4,100	12
L8715	1.25-1.49	5,700	14
L8716	1.50-1.74	5,800	16
L8717	1.75-1.99	7,700	17
L8718	2.00-2.49	9,300	20
L8719	2.50-2.99	11,300	21
L8721	3.00-3.49	15,100	22
L8722	3.50-3.99	15,100	25

*To determine workload safety factor, divide approximate break strength by 5. See page Q6 for strength information.



L8703



L8711

WIRE MESH STRAIN-RELIEF GRIPS

Industrial Grade Wire Mesh Safety Grips

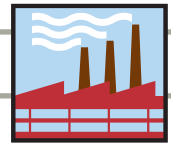

STRAIN-RELIEF GRIPS

Strain-Relief Grips are used to connect cord or cable to electrical enclosures and equipment. These grips prevent pullout due to tension and limit the arc of bend at the point of entry; strain is distributed over the length of mesh rather than concentrated at one point or transferred to the internal termination.

Wide-Range Grips

Wide-Range Grips are recommended for use in wiring of enclosures, power boxes, machine tools, and power centers. They include an insulated bushing (dust-tight).

Single Weave Galvanized Steel Mesh

CAT. NO.	CABLE DIA. RANGE (INCHES)	NPT SIZE (INCHES)	MESH LENGTH @ NOMINAL DIA. (INCHES)	MINIMUM DISTANCE BETWEEN GRIPS (INCHES)
L7501	0.22-0.32	1/2	4	1 1/4
L7502	0.30-0.43	1/2	4 1/2	1 1/4
L7503	0.40-0.54	1/2	5 1/2	1 1/4
L7504	0.52-0.73	3/4	5 1/2	1 1/2
L7505	0.70-0.97	1	8	1 7/8
L7506	0.94-1.25	1 1/4	9	2 3/8
L7507	1.20-1.50	1 1/2	11	2 5/8
L7508	1.40-1.75	2	13	3 1/4
L7509	1.62-2.00	2 1/2	13 1/2	3 5/8
L7511	2.00-2.45	2 1/2	13 1/2	3 5/8



L7504
Galva. Steel mesh

Cord Sealing Grips

Cord Sealing Grips with Mesh are nylon devices used to connect electrical cables to boxes, cabinets, push-buttons, enclosures, etc. They are liquid-tight devices that are highly resistant to impact and corrosion. Non-metallic cord sealing grips will not support combustion. The ratings are: Wire Mesh Grip-94 HB and Fitting-94V-2. Cord Sealing Grip products are suitable for use in wet locations so long as a listed sealing ring is used between the box and the fitting.

Nylon Cord Sealing Grips with Mesh—Straight and 90°

CAT. NOS.	STAINLESS STEEL MESH		NON-METALLIC MESH		CABLE DIA. RANGE (INCHES)	NPT (FORM SIZE)
	STRAIGHT	90°	STRAIGHT	90°		
L7521	—	L7522	L7524	.187-.250		
—	L7527	—	L7528	.250-.312		
—	L7532	—	L7533	.312-.375	1/2"	
—	L7536	—	—	.375-.437	(F2)	
L7538	L7541	L7539	L7542	.437-.500		
L7543 ¹	L7544 ¹	—	—	.500-.562		
L7545 ¹	L7546 ¹	—	—	.562-.625		
L7601	—	L7602	L7604	.187-.250		
L7605	—	—	—	.250-.375		
—	L7612	—	—	.375-.437		
—	L7549	—	L7551	.437-.562	3/4"	
L7552	L7554	L7553	L7555	.500-.625	(F3)	
L7556	L7558	—	L7559	.562-.687		
L7561	L7563	L7562	—	.625-.750		
L7565 ¹	L7566 ¹	—	—	.687-.812		
L7567	—	L7568	L7569	.437-.562		
—	L7573	—	L7574	.500-.625		
—	L7582	—	L7583	.625-.750	1"	
L7584	—	—	L7587	.687-.812	(F4)	
L7588	—	—	L7592	.750-.875		
L7597	—	—	—	.875-1.000		



L7521
Straight—SS mesh



L7527
90°—SS mesh



L7553
Straight—nylon mesh

¹Cable jacket may have to be stripped for clearance. NOTE: F2, F3 and F4 are fitting form sizes.

*Cord Sealing Grips with non-metallic mesh are UL Listed and CSA Certified. Cord Sealing Grips with stainless steel mesh are CSA Certified only.

Wire Mesh Safety Grips

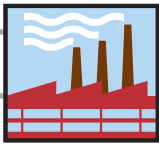

WIRE MESH STRAIN-RELIEF GRIP DIMENSIONS

Industrial Grade Wire Mesh Safety Grips

Strain-Relief Grips—Dimensions

Dimensions for Nylon Cord-Sealing Fittings, Straight Body

FORM	NPT	A	B	C	D	E	F	G	H (REF.)
0	1/4"	.500	.778	.370	.187	.921	.778	.687	1.25
1	3/8"	1.000	1.150	.500	.250	1.250	1.115	1.000	1.85
2	1/2"	1.000	1.300	.500	.300	1.450	1.250	1.100	2.00
3	3/4"	1.000	1.500	.550	.375	1.700	1.578	1.375	2.00
4	1"	1.000	1.850	.687	.375	1.800	1.900	1.650	2.12
5	1 1/4"	1.000	2.050	.687	.375	1.800	2.100	1.850	2.12

Form 0

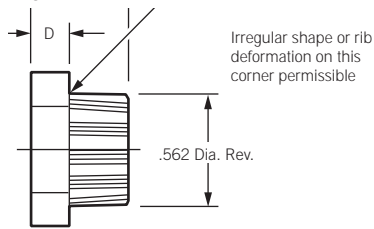

Forms 1-5

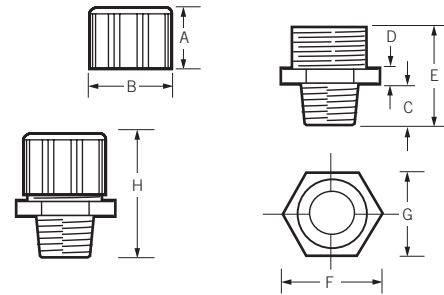

Dimensions for Nylon Cord-Sealing Fittings, 90° Body

FORM	NPT	A	B	C	D	E	F	G	H (REF.)
1	3/8"	1.000	1.150	1.100	.187	1.812	.450	1.687	2.35
2	1/2"	1.000	1.300	1.165	.187	1.900	.578	1.820	2.40
3	3/4"	1.000	1.500	1.600	.187	2.421	.593	2.218	2.75
4	1"	1.000	1.850	1.850	.187	2.656	.800	2.700	3.00
5	1 1/4"	1.000	2.050	1.965	.187	2.859	.750	2.812	3.25

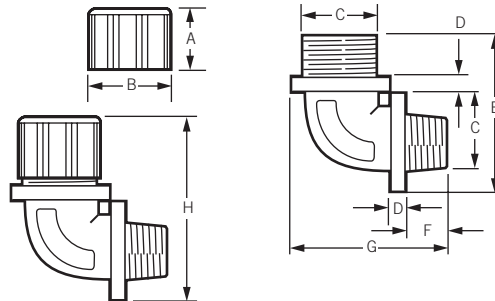

WIRE MESH STRAIN-RELIEF GRIPS

Industrial Grade Wire Mesh Safety Grips

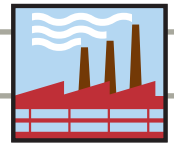

Deluxe Cord Grips

Deluxe Cord Grips are woven of stainless steel mesh with an anodized aluminum body for corrosion resistance. They are offered in Single/Double Weave construction to help absorb direct pull, resist flexing and binding, and eliminate strain. Aluminum fittings are offered in a variety of NPT thread sizes. They are recommended for indoor or outdoor use where moisture may be present in the wiring of pendant stations, processing equipment, hand tools, and extension cord sets. They are UL Listed and CSA Certified. Deluxe Cord Grips are suitable for use in hazardous locations per Class I, Div. 2; Class II, Div. 1 and 2; and Class III, Div. 1 and 2. They are also suitable for use in wet locations as long as a listed sealing ring is used between the box and the fitting.

Single/Double Weave

CAT. NOS. STRAIGHT MALE	90° MALE	45° MALE	STRAIGHT FEMALE	CABLE DIA. RANGE (INCHES)	NPT SIZE
L7701	—	—	—	.187-.250	
L7702	—	—	—	.250-.312	
L7703	—	—	L7822	.312-.375	3/8"
L7704	—	—	—	.375-.437	
L7705	L7761	—	—	.187-.250	
L7706	—	L7802	—	.250-.375	
L7707	L7763	L7803	L7826	.375-.500	1/2"
L7708	L7764	L7804	L7827	.500-.625	
L7709	—	—	—	.625-.750	
L7711	L7765	L7805	—	.250-.375	
L7712	—	L7806	—	.375-.500	
L7700	L7767	L7807	L7831	.500-.625	3/4"
L7713	L7768	L7808	L7832	.625-.750	
L7714	—	—	—	.750-.875	
L7715	L7769	—	—	.437-.562	
L7716	—	—	L7833	.562-.687	
L7717	L7772	—	L7834	.625-.750	1"
L7718	—	—	—	.750-.875	
L7719	—	—	L7836	.875-1.000	
L7721	—	—	—	1.000-1.125	
L7722	—	—	—	1.125-1.250	
L7723	—	—	—	.750-.875	
L7724	—	—	—	.875-1.000	
L7725	—	L7810	—	1.000-1.125	1 1/4"
L7726	L7778	—	—	1.125-1.250	
L7727	—	L7820	—	1.250-1.375	
L7728	L7781	—	—	.750-.875	
L7729	L7782	—	—	.875-1.000	
L7731	—	—	—	1.000-1.125	1 1/2"
L7732	L7784	—	—	1.125-1.250	
L7733	L7785	—	—	1.250-1.375	
L8011	—	—	—	1.312-1.437	
L7770	—	—	—	1.437-1.562	
L7750	—	—	—	1.562-1.687	
L7760	—	—	—	1.687-1.812	
L7780	—	—	—	1.750-1.875	
L7734	—	—	—	1.250-1.375	
L7736	—	—	—	1.500-1.625	2"
L7737	L7789	—	—	1.625-1.750	
—	L7791	—	—	1.750-1.875	
L8012	—	—	—	1.812-1.937	
L8013	—	—	—	1.937-2.062	
L7730	—	—	—	2.187-2.312	
L7739	—	—	—	1.75-1.875	
L7742	—	—	—	1.937-2.062	2-1/2"
L7743	—	—	—	2.062-2.187	
L7744	—	—	—	2.187-2.312	
L7745	—	—	—	1.688-1.812	3"
L7746	—	—	—	1.812-1.937	
L7747	—	—	—	1.937-2.062	
L7748	—	—	—	2.062-2.187	
L7751	—	—	—	2.312-2.437	
L7752	—	—	—	2.437-2.625	
L7754	—	—	—	2.812-3.000	
L7755	—	—	—	3.000-3.250	



L7701
Straight—Male



L7761
90°—Male



L7802
45°—Male



L7822
Straight—Female

Wire Mesh Safety Grips

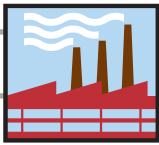

WIRE MESH STRAIN-RELIEF GRIPS

Industrial Grade Wire Mesh Safety Grips

Wire Mesh Safety Grips



L7902
Straight—Male



L7922
90°—Male



L7951
Straight—Female



L7990
90°—Male



L7965
Straight—Male

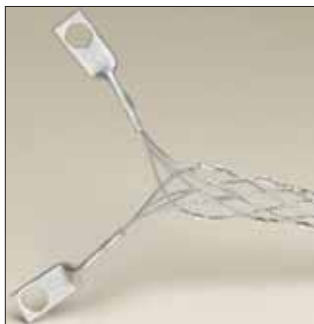

L8003

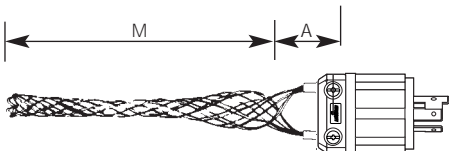

Liquid-Tight Grips

Liquid-Tight Grips are woven stainless steel mesh with an anodized aluminum body for corrosion-resistance. They are used to connect liquid-tight flexible metal conduit to electrical enclosures to prevent conduit pullout. Each fitting is supplied with an insulated throat to ensure conductor insulation and protect against damage caused by flexing, heat expansion or contraction.

Liquid-Tight Grips are recommended in the wiring of motors and any electrical enclosure where liquid-tight conduit is subject to motion or strain. UL Listed and CSA Certified.

Liquid-Tight Grips

CAT. NOS. STRAIGHT MALE	90° MALE	45° MALE	STRAIGHT FEMALE	FITTING SIZE (INCHES)	MESH LENGTH (INCHES)
—	—	L7931	L7951	3/8	2 ⁵ / ₈
L7902	L7916	L7932	—	1/2	3 ⁷ / ₈
L7903	L7917	—	L7953	3/4	4 ³ / ₈
L7904	L7918	—	L7954	1	5 ¹ / ₄
L7905	L7919	—	—	1 ¹ / ₄	5 ⁵ / ₈
L7906	L7921	—	—	1 ¹ / ₂	5 ³ / ₄
L7907	L7922	—	—	2	7 ¹ / ₂
L7908	—	—	—	2 ¹ / ₂	9 ⁵ / ₈
L7911	L7924	L7939	—	3	10 ⁵ / ₈
L7912	—	—	—	4	12

Liquid-Tight Grips for Non-Metallic Type "A" Flexible Conduit

CAT. NOS. STRAIGHT MALE	90° MALE	FITTING SIZE (INCHES)	MESH LENGTH (INCHES)
—	L7999	3/8	9
L7962	L7990	1/2	10
—	L7967	3/4	10 ¹ / ₂
—	L7968	1	12
L7965	L7969	1 ¹ / ₄	17
—	L7971	1 ¹ / ₂	21 ¹ / ₂
L7970	L7972	2	24

Connection Wire Mesh Grips

Connection Wire Mesh Grips provide additional strain-relief for plugs and connectors used on portable equipment in commercial and institutional applications, and industrial plant and construction site areas which incur abnormally high abuse. Grips are made of galvanized steel.

Connection Wire Mesh Grips

CAT NO.	CABLE DIA. RANGE (INCHES)	EYE DIMENSIONS (A) (INCHES)	MESH LENGTH (M) (INCHES)
L8001	.30-.43	1 ¹ / ₁₆	4 ³ / ₄
L8002	.40-.56	1 ¹ / ₁₆	6
L8003	.52-.73	1 ¹ / ₁₆	7
L8004	.70-.85	1 ⁵ / ₁₆	8 ¹ / ₂
L8005	.82-1.00	1 ⁵ / ₁₆	8 ¹ / ₂
L8006	.94-1.25	1 ⁵ / ₁₆	10 ¹ / ₂

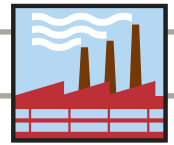

Industrial Grade Wire Mesh Safety Grips

SUPPORT GRIPS

Support Grips are designed to hold the weight of cable on vertical or sloping runs. They may be used indoors or outdoors to support electrical and fiber optic cable, metal rods and tubing.

Leviton Support Grips are woven with tinned bronze wire. For applications requiring a greater degree of corrosion resistance, stainless steel wire is available on special order. For information regarding selection of the proper-sized support grip, see pages Q4 and Q5.

Style

SINGLE "U" EYE

For use when cable is vertical and for applications where cable bends or where a single attachment is more advantageous for positioning.



DOUBLE "U" EYE

For use when cable is vertical and extends through the grip without bending. Eyes may be fastened to open hooks, but should not be more than 15° from the axis of vertical cable. When eyes are supported equally, this attachment offers a fully balanced load.

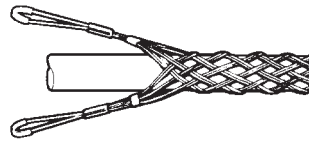

OFFSET EYE

Similar to single eye applications, but for use when offset positioning is required.

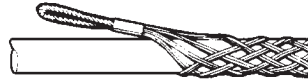

LOCKING (UNIVERSAL) BALE

Adjustable and self-locking, this attachment fits around a beam, pipe or other continuous structural object. The bale wraps around the object and is securely anchored in the bar.



Split Lace/Split Rod

SPLIT LACE

Beginning at the lead end of the grip, thread the lacing through the first two loops of the split, pulling the lace through until the ends are centered evenly. Cross laces and thread through the next two loops, and so on down the grip, being careful not to pull the lacing too tight. The spacing of the lace closure should be approximately the same as that of the mesh weave. When the end of grip is reached, twist the lacing strands tightly together; wrap the ends of the lace around the grip and twist again to secure. Excess length may be cut off.

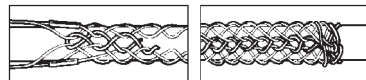

SPLIT ROD

Split grips with rod closing install quickly and they are economical and reusable. Simply wrap the grip around the cable and thread the rod through the loops, using a corkscrew motion. To remove, pull the rod out; and the grip is ready for re-use.

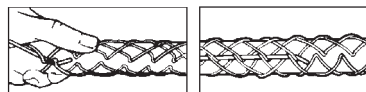

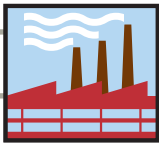

WIRE MESH SUPPORT GRIPS

Industrial Grade Wire Mesh Safety Grips

Support Grips—Standard Closed Mesh

Standard Closed Mesh Support Grips are designed for loads up to 500 lbs. and vertical runs of no more than 100 feet. Heavy-duty closed mesh support grips are designed for loads in excess of 500 lbs. They are available in a variety of eye styles and cable ranges for supporting electrical cable, metal rods and tubing. Closed mesh support grips are used when the end of the cable is accessible. Mesh is made of tinned bronze material.

Single Eye, Closed Mesh, Single Weave

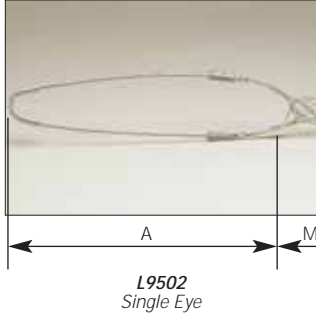

CAT. NO.	CABLE DIA. RANGE (INCHES)	APPROX. BREAK STRENGTH*	LENGTH (INCHES)	
			BALE (DIM. A)	MESH (DIM. M)
L9501	0.50-0.61	770	7	10
L9502	0.62-0.74	960	8	10
L9503	0.75-0.99	1,300	8	12
L9504	1.00-1.24	1,680	9	12
L9505	1.25-1.49	1,680	10	16
L9506	1.50-1.74	1,680	12	17
L9507	1.75-1.99	2,640	14	18
L9508	2.00-2.49	3,760	16	18
L9509	2.50-2.99	3,760	18	21
L9511	3.00-3.49	5,040	21	26
L9512	3.50-3.99	5,040	24	28

Double Eye, Closed Mesh, Single Weave

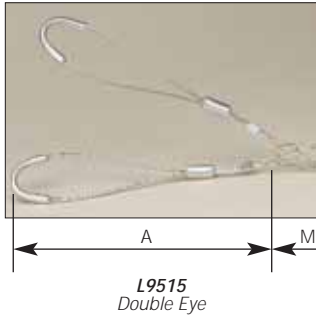

CAT. NO.	CABLE DIA. RANGE (INCHES)	APPROX. BREAK STRENGTH*	LENGTH (INCHES)	
			BALE (DIM. A)	MESH (DIM. M)
L9515	0.50-0.61	770	4	11
L9516	0.62-0.74	1,150	4	11
L9517	0.75-0.99	1,320	4	14
L9518	1.00-1.24	1,920	5	15
L9519	1.25-1.49	1,920	5	16
L9521	1.50-1.74	1,920	6	18
L9523	1.75-1.99	3,360	6	20
L9524	2.00-2.49	3,360	6	22
L9525	2.50-2.99	3,360	6	24
L9526	3.00-3.49	5,280	8	26
L9527	3.50-3.99	5,280	8	28

Offset Eye, Closed Mesh, Single Weave

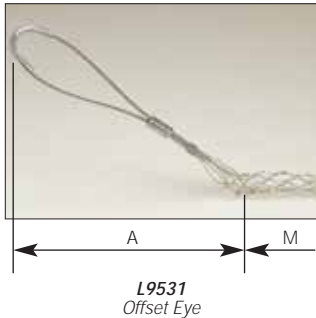

CAT. NO.	CABLE DIA. RANGE (INCHES)	APPROX. BREAK STRENGTH*	LENGTH (INCHES)	
			BALE (DIM. A)	MESH (DIM. M)
L9531	0.50-0.61	770	4	11
L9532	0.62-0.74	960	4	11
L9533	0.75-0.99	960	4	14
L9534	1.00-1.24	1,680	5	15
L9535	1.25-1.49	1,680	5	16
L9536	1.50-1.74	1,680	5	18
L9537	1.75-1.99	2,640	6	20
L9538	2.00-2.49	3,760	6	21
L9539	2.50-2.99	3,760	8	24
L9541	3.00-3.49	5,040	9	26
L9542	3.50-3.99	5,040	9	28

Note: Support grips are also available in stainless steel—contact your Leviton Representative.

*To determine workload safety factor, divide approximate break strength by 10. See page Q6 for strength information.

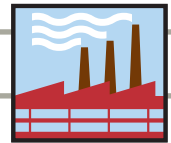

Support Grips—Standard Closed Mesh

Locking Bale, Closed Mesh, Single Weave

CAT. NO.	CABLE DIA. RANGE (INCHES)	APPROX. BREAK STRENGTH*	LENGTH (INCHES)	
			BALE (DIM. A)	MESH (DIM. M)
L9551	0.50–0.61	770	11	10
L9552	0.62–0.74	1,150	11	10
L9553	0.75–0.99	1,320	14	12
L9554	1.00–1.24	1,920	15	12
L9555	1.25–1.49	1,920	16	13
L9556	1.50–1.74	1,920	18	17
L9557	1.75–1.99	3,150	20	18
L9558	2.00–2.49	3,360	21	18
L9559	2.50–2.99	3,360	24	21
L9561	3.00–3.49	5,280	26	23
L9562	3.50–3.99	5,280	28	23.5

*To determine workload safety factor, divide approximate break strength by 10. See page Q6 for strength information.

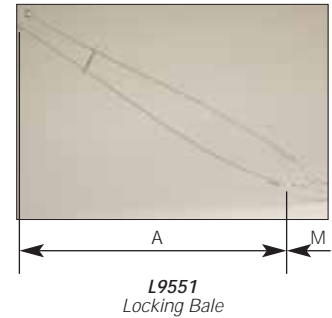

Support Grips—Heavy Duty

Heavy Duty Support Grips handle continuous loads of over 500 lbs. in vertical runs greater than 100 ft. for cable diameters from 3/4" to 4 1/2".

Single Eye, Double Weave, Heavy Long, Closed Mesh

CAT. NO.	CABLE DIA. RANGE (INCHES)	APPROX. BREAK STRENGTH*	LENGTH (INCHES)	
			BALE (DIM. A)	MESH (DIM. M)
L9701	0.75–0.99	2,700	10	26
L9702	1.00–1.24	4,720	10	29
L9703	1.25–1.49	4,720	10	31
L9704	1.50–1.99	4,720	10	35

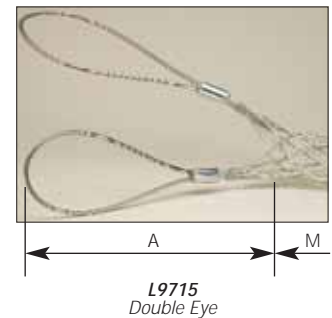

Double Eye, Double Weave, Heavy Long, Closed Mesh

CAT. NO.	CABLE DIA. RANGE (INCHES)	APPROX. BREAK STRENGTH*	LENGTH (INCHES)	
			BALE (DIM. A)	MESH (DIM. M)
L9711	0.75–0.99	2,700	10	26
L9712	1.00–1.25	4,720	10	29
L9713	1.25–1.49	4,720	10	31
L9714	1.50–1.99	4,720	10	35
L9715	2.00–2.49	10,080	10	37
L9716	2.50–2.99	10,080	10	39
L9717	3.00–3.49	10,080	10	41
L9718	3.50–3.99	13,120	10	45
L9719	4.00–4.49	13,120	10	47

*To determine workload safety factor, divide approximate break strength by 10. See page Q6 for strength information.

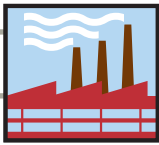

WIRE MESH SUPPORT GRIPS

Industrial Grade Wire Mesh Safety Grips

Support Grips—Standard Split Lace

Split Lace Support Grips are designed for loads up to 500 lbs. and vertical runs of no more than 100 feet. Heavy-duty split lace support grips are available on page Q23. They are available in a variety of eye styles and cable ranges for supporting electrical cable, metal rods and tubing. Split lace grips are utilized when the end of the cable cannot be feasibly accessed and the support grip is intended for permanent installation. Mesh is made of tinned bronze material. For attachment information see page Q19.

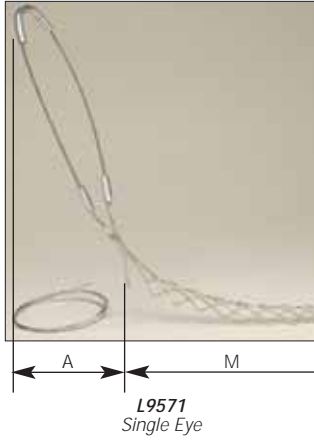

Single Eye, Split Lace, Single Weave

CAT. NO.	CABLE DIA. RANGE (INCHES)	APPROX. BREAK STRENGTH*	LENGTH (INCHES)	
			BALE (DIM. A)	MESH (DIM. M)
L9571	0.50-0.61	770	7	11
L9572	0.62-0.74	960	8	11
L9573	0.75-0.99	1,320	8	14
L9574	1.00-1.24	1,680	9	15
L9575	1.25-1.49	1,680	10	16
L9576	1.50-1.74	1,680	12	18
L9577	1.75-1.99	2,640	14	20
L9578	2.00-2.49	3,760	16	22
L9579	2.50-2.99	3,760	18	24
L9581	3.00-3.49	5,040	21	26
L9582	3.50-3.99	5,040	24	28

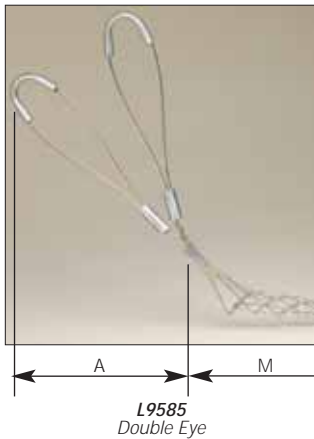

Double Eye, Split Lace, Single Weave

CAT. NO.	CABLE DIA. RANGE (INCHES)	APPROX. BREAK STRENGTH*	LENGTH (INCHES)	
			BALE (DIM. A)	MESH (DIM. M)
L9585	0.50-0.61	770	4	11
L9586	0.62-0.74	1,150	4	11
L9587	0.75-0.99	1,320	4	14
L9588	1.00-1.24	1,920	5	15
L9589	1.25-1.49	1,920	5	16
L9591	1.50-1.74	1,920	5	18
L9592	1.75-1.99	3,150	6	20
L9593	2.00-2.49	3,360	6	22
L9594	2.50-2.99	3,360	6	24
L9595	3.00-3.49	5,280	8	26
L9596	3.50-3.99	5,280	8	28

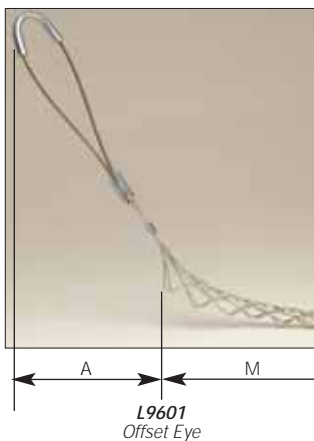

Offset Eye, Split Lace, Single Weave

CAT. NO.	CABLE DIA. RANGE (INCHES)	APPROX. BREAK STRENGTH*	LENGTH (INCHES)	
			BALE (DIM. A)	MESH (DIM. M)
L9601	0.50-0.61	770	4	11
L9602	0.62-0.74	960	4	11
L9603	0.75-0.99	960	4	14
L9604	1.00-1.24	1,680	5	15
L9605	1.25-1.49	1,680	5	16
L9606	1.50-1.74	1,680	5	18
L9607	1.75-1.99	2,640	8	20
L9608	2.00-2.49	3,760	8	22
L9609	2.50-2.99	3,760	8	24
L9611	3.00-3.49	5,040	9	26
L9612	3.50-3.99	5,040	9	28

Note: Support grips are also available in stainless steel—contact your Leviton Representative.

*To determine workload safety factor, divide approximate break strength by 10. See page Q6 for strength information.

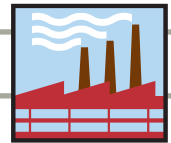

Support Grips—Standard Split Lace

Locking Bale, Split Lace, Single Weave

CAT. NO.	CABLE DIA. RANGE (INCHES)	APPROX. BREAK STRENGTH*	LENGTH (INCHES)	
			BALE (DIM. A)	MESH (DIM. M)
L9621	0.50–0.61	770	18	11
L9622	0.62–0.74	1,150	18	11
L9623	0.75–0.99	1,320	18	14
L9624	1.00–1.24	1,920	18	15
L9625	1.25–1.49	1,920	18	16
L9626	1.50–1.74	1,920	18	18
L9627	1.75–1.99	3,150	18	20
L9628	2.00–2.49	3,360	18	22
L9629	2.50–2.99	3,360	18	24

*To determine workload safety factor, divide approximate break strength by 10. See page Q6 for strength information.



L9621
Locking Bale

Support Grips—Heavy Duty Split Lace

Heavy Duty Support Grips handle continuous loads of over 500 lbs. in vertical runs greater than 100 ft. for cable diameters from 3/4" to 4 1/2".

Single Eye, Double Weave, Heavy Long, Split Lace

CAT. NO.	CABLE DIA. RANGE (INCHES)	APPROX. BREAK STRENGTH*	LENGTH (INCHES)	
			BALE (DIM. A)	MESH (DIM. M)
L9722	0.75–0.99	2,700	10	26
L9723	1.00–1.24	4,720	10	29
L9724	1.25–1.49	4,720	10	31
L9725	1.50–1.99	4,720	10	35

Double Eye, Double Weave, Heavy Long, Split Lace

CAT. NO.	CABLE DIA. RANGE (INCHES)	APPROX. BREAK STRENGTH*	LENGTH (INCHES)	
			BALE (DIM. A)	MESH (DIM. M)
L9731	0.75–0.99	2,700	10	26
L9732	1.00–1.24	4,720	10	29
L9733	1.25–1.49	4,720	10	31
L9734	1.50–1.99	4,720	10	35
L9735	2.00–2.49	10,080	10	37
L9736	2.50–2.99	10,080	10	39
L9737	3.00–3.49	10,080	10	41
L9738	3.50–3.99	13,120	10	45
L9739	4.00–4.49	13,120	10	47

*To determine workload safety factor, divide approximate break strength by 10. See page Q6 for strength information.



L9731
Double Eye

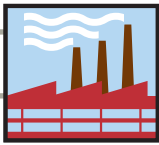

WIRE MESH SUPPORT GRIPS

Industrial Grade Wire Mesh Safety Grips

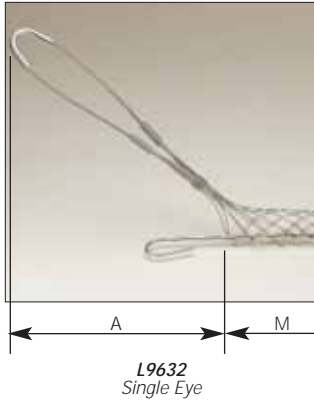

Support Grips—Standard Split Rod ^{SR}

Split Rod Support Grips are designed for loads up to 500 lbs. and vertical runs of no more than 100 feet. They are available in a variety of eye styles and cable ranges for supporting electrical cable, metal rods and tubing. Split rod support grips are utilized when the end of the cable cannot be feasibly accessed and the installation is temporary. For attachment information see page Q19.

Single Eye, Split Rod, Single Weave

CAT. NO.	CABLE DIA. RANGE (INCHES)	APPROX. BREAK STRENGTH*	LENGTH (INCHES)	
			BALE (DIM. A)	MESH (DIM. M)
L9631	0.50-0.61	770	7	9
L9632	0.62-0.74	960	8	9
L9633	0.75-0.99	1,320	8	11
L9634	1.00-1.24	1,680	9	13
L9635	1.25-1.49	1,680	10	15
L9636	1.50-1.74	1,680	12	16
L9637	1.75-1.99	2,640	14	17
L9638	2.00-2.49	3,760	16	20
L9639	2.50-2.99	3,760	18	22
L9641	3.00-3.49	6,560	21	24
L9642	3.50-3.99	6,560	24	26

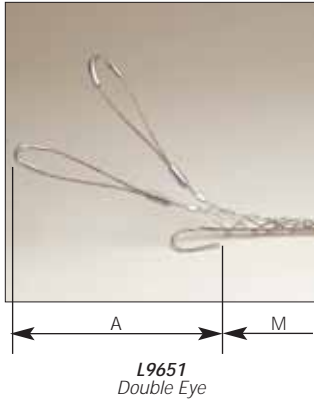

Double Eye, Split Rod, Single Weave

CAT. NO.	CABLE DIA. RANGE (INCHES)	APPROX. BREAK STRENGTH*	LENGTH (INCHES)	
			BALE (DIM. A)	MESH (DIM. M)
L9651	0.50-0.61	770	4	9
L9652	0.62-0.74	1,150	4	9
L9653	0.75-0.99	1,320	4	11
L9654	1.00-1.24	1,920	5	13
L9655	1.25-1.49	1,920	5	15
L9656	1.50-1.74	1,920	5	16
L9657	1.75-1.99	3,150	6	17
L9658	2.00-2.49	3,360	6	20
L9659	2.50-2.99	3,360	6	22
L9661	3.00-3.49	7,520	8	24
L9662	3.50-3.99	7,520	8	26

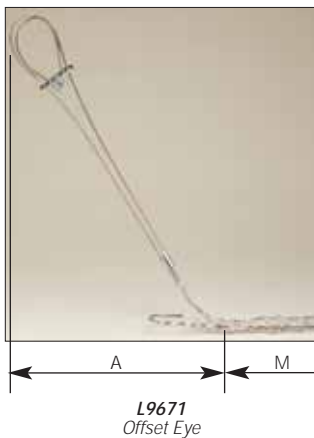

Offset Eye, Split Rod, Single Weave

CAT. NO.	CABLE DIA. RANGE (INCHES)	APPROX. BREAK STRENGTH*	LENGTH (INCHES)	
			BALE (DIM. A)	MESH (DIM. M)
L9671	0.50-0.61	770	4	9
L9672	0.62-0.74	960	4	9
L9673	0.75-0.99	960	4	11
L9674	1.00-1.24	1,680	5	13
L9675	1.25-1.49	1,680	5	15
L9676	1.50-1.74	1,680	5	16
L9677	1.75-1.99	2,640	6	17
L9678	2.00-2.49	3,760	6	20
L9679	2.50-2.99	3,760	6	22
L9681	3.00-3.49	5,040	8	24
L9682	3.50-3.99	5,040	8	26

*To determine workload safety factor, divide approximate break strength by 10. See page Q6 for strength information.

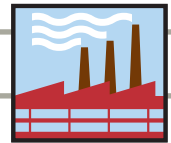

Support Grips—Standard Split Rod

Locking Bale, Split Rod, Single Weave

CAT. NO.	CABLE DIA. RANGE (INCHES)	APPROX. BREAK STRENGTH*	LENGTH (INCHES)	
			BALE (DIM. A)	MESH (DIM. M)
L9688	0.50-0.61	770	10	9
L9689	0.62-0.74	1,150	10	9
L9691	0.75-0.99	1,320	10	11
L9692	1.00-1.24	1,920	14	13
L9693	1.25-1.49	1,920	14	15
L9694	1.50-1.74	1,920	14	16
L9695	1.75-1.99	3,150	14	17
L9696	2.00-2.49	3,360	18	20
L9697	2.50-2.99	3,360	18	22
L9698	3.00-3.49	7,520	18	24
L9699	3.50-3.99	7,520	18	26

*To determine workload safety factor, divide approximate break strength by 10. See page Q6 for strength information.



L9689 Locking Bale

Support Grips—Bus-Drop

Bus-Drop Grips are used as cable support. They relieve any direct tension from the critical connection and absorb vibration and flexing. Bus-Drop Grips are woven of galvanized steel wire. They are offered with either locking bale or single eye attachments.

Locking Bale & Single Eye

CAT. NOS.	LOCKING BALE	CABLE DIA. RANGE (INCHES)	APPROX. BREAK STRENGTH*
L7981	—	.220-.320	1,100
L7982	—	.300-.430	1,100
L7983	L7992	.410-.560	1,100
L7984	L7993	.530-.730	1,100
L7985	L7994	.700-.850	1,900
L7986	L7995	.820-1.00	1,900
L7987	—	.960-1.25	1,900

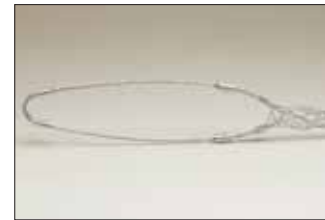

L7984 Single "U" Eye



L7992 Locking Bale

Support Grips—Bus-Drop Accessories

Safety Springs are used with Bus-Drop Grips to relieve sudden strains on the cable system. To use with single eye-type grips, disassemble drawbar from coil, place through the eye and replace the drawbar.

Safety Springs

DESCRIPTION	CAT. NO.	LENGTH (INCHES)
Zinc Plated Max. Load 40 Lbs.	L7997	7.50
Zinc Plated Max. Load 80 Lbs.	L7998	8.50

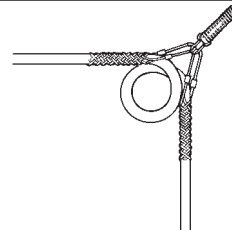

L7998 Safety Spring

Support Hook

DESCRIPTION	CAT. NO.
3/8" Right Hand Wood Screw, Zinc Plated 4 1/2" Long	L7980

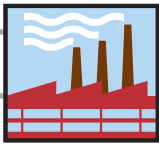

WIRE MESH SUPPORT GRIPS

Industrial Grade Wire Mesh Safety Grips

Support Grips—Fiber Optic Grips

All Leviton Fiber Optic Support Grips are designed to wrap securely around fiber optic cable without damaging it. They are designed to reduce stress on cable in vertical, sloping, or horizontal positions. Single-eye or locking-bale style grips afford lasting support for a wide variety of applications where fiber optic cable is used.

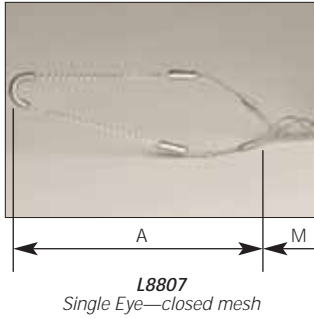

Single Eye, Closed Mesh, Single Weave

CAT. NO.	CABLE DIA. RANGE (INCHES)	APPROX. BREAK STRENGTH*	LENGTH (INCHES)	
			BALE (DIM. A)	MESH (DIM. M)
L8807	.18-.25	300	3	1.7
L8808	.23-.32	300	3	2.5
L8809	.30-.39	300	4	2.5
L8811	.37-.48	300	5	4
L8812	.46-.58	400	6	4
L8813	.56-.71	600	7	5.5
L8814	.69-.88	800	8	6

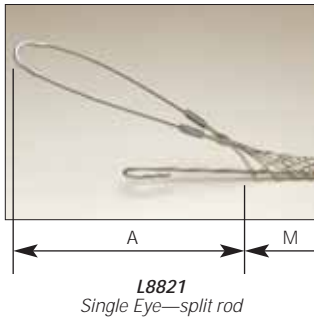

Single Eye, Split Rod, Single Weave

CAT. NO.	CABLE DIA. RANGE (INCHES)	APPROX. BREAK STRENGTH*	LENGTH (INCHES)	
			BALE (DIM. A)	MESH (DIM. M)
L8815	.18-.25	300	3	2.5
L8816	.23-.32	300	3	2.5
L8817	.30-.39	300	4	2.5
L8818	.37-.48	300	5	4
L8819	.46-.58	400	6	5
L8821	.56-.71	600	7	5
L8822	.69-.88	800	8	6

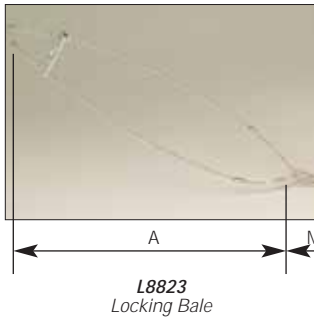

Locking Bale, Closed Mesh, Single Weave

CAT. NO.	CABLE DIA. RANGE (INCHES)	APPROX. BREAK STRENGTH*	LENGTH (INCHES)	
			BALE (DIM. A)	MESH (DIM. M)
L8823	.18-.25	300	9	2.5
L8824	.23-.36	300	9	2
L8825	.30-.39	300	9	2.5
L8826	.37-.48	300	10	4
L8827	.46-.58	400	10	4
L8828	.56-.71	600	10	5.5
L8829	.69-.88	800	10	6

*To determine workload safety factor, divide approximate break strength by 10. See page Q6 for strength information.

Surge Protection, Power Distribution and Uninterruptible Power Supply Devices

INDEX

Industrial Surge Protective Devices	
Overview	R2
Four-Outlet Plug-Ins	R3
5100 Series	R3
Surge Strips	R4
Surge Protection Modules	R5
Surge Protection Panels	R6, R7
74000 Series	R6
57000 Series	R7
52000 Series	R8
47000 and 52000-7M3 Series	R9
42000 and 32000 Series	R10
Low Voltage Communications SPD's	
3400 and 3800 Series	R11
Surge Counter: 51000 SMC	R11
Equipment Cabinet SPD's	R12
3800 Series	R12
Surge Protection Receptacles	R13
Decora Series	
Four-In-One Series	R14
Commercial Surge Protection Devices	
S1000 and S2000 Series Surge Strips	R15
4950 Series Surge Strips	R15
5500 and 5505 Series PDU's with Surge Protection	R16
Rack-mounted Power Distribution Devices	
4505 Series 19" Rack Mount PDU's	R17
P1000 Series PDU's	R17
Metered Series PDU's	R18
Switched Series PDU's	R19
Residential Surge Protection Devices	
Meter Socket Surge Adapter	R20
Secondary Surge Arrestors	R20
General Purpose Plug-Ins	R21
51000 Series Surge Protection Panels	R21
3950 Series Module Bracket	R22
5950 Series Surge Modules	R22
Uninterruptible Power Supplies	
Sine and Online Series UPS Systems	R23
Pro, Slim and Strip Series UPS Systems	R23, R24



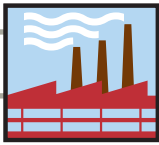

SURGE PROTECTION DEVICE FEATURES

Industrial Grade Surge Protection Devices

LEVITON'S SURGE PROTECTIVE DEVICES (SPD'S) ARE DESIGNED TO REDUCE THE RANDOM ENERGY SURGES OF VOLTAGE TRANSIENTS AND ELECTRICAL NOISE ON THE POWER SUPPLY LINE.

Volatile transients and noise are present in utility power lines, data networks, telephone lines, closed circuit and cable tv feeds, and any other power or control lines connected to electronic equipment.

Leviton's Surge Protection Devices can be used individually or as part of a coordinated application strategy, called Network Protection, to protect sensitive electronic equipment, in industrial, commercial and residential locations, from the stress and degradation inflicted by voltage transients. Leviton Surge Protection Devices are listed to UL 1449 Second Edition Standards.

Leviton's outstanding Surge Protection Devices divert damaging voltage transients, or surges, away from electronic equipment. Transients are diverted away from sensitive microcircuitry, providing protection against catastrophic failure, costly downtime and data disruptions.

Features and Benefits

- Provides seven-mode protection
- User-replaceable modules
- Real-time diagnostics monitor power and suppression status for each mode
- Diagnostic display panel of 74000/75000 units indicates "Fault", "Alert" and "Protection" status
- Provides surge magnitude, time and date of each surge event
- Surge event history downloadable via RS-232 connection



74120-7M3



Panel Mounted
Provides complete protection on all phases even if one module fails; modular design allows easy replacement of modules. NC, NO contacts for remote status indication.
57120-M3 shown



Receptacles
15-20 Amp single, duplex and four-in-one versions with 3-level MOV phase to neutral, phase to ground and neutral to ground protection.
8280-IGB shown



Stand-Alone Low-Voltage SPD
Provides surge protection for low-voltage data and communications lines.
5350-PT8 shown



Plug Strips
Available in a variety of grades, its real time diagnostics monitor power and suppression status.
5300-PS shown



PDUs
Mounts on 19" equipment rack; available with or without rocker-style ON/OFF switch; Resettable circuit breaker protects against overloading and power supply failure.
5500-190 shown



UPSs
New product line offers the latest technology and features available in Uninterruptible Power Supply devices.
U1000-AKP shown



Communication Modules
Provide surge protection for DC-powered low-voltage data network products.
3803-485 shown



Multi-Phase Panel Protector
Provides multiple-phase surge protection; 3-phase units are suitable for WYE and Delta AC systems. NC, NO contacts for remote status indication.
42120-D43 shown



WALL MOUNTED SURGE PROTECTION

Industrial Grade Surge Protection Devices

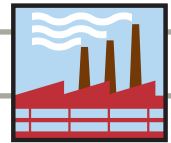

Four-Outlet Plug-In Surge Protection Devices — 15 AMP 120V 50, 60 Hz AC

5100 Series

DESCRIPTION	CAT. NO.	COLOR	APPLICATION
15A Four-Outlet Heavy-Duty DPI	5100-P	Beige	PC's and peripherals, electronic cash registers, digital sound systems, video equipment and microwave ovens

Clamping Performance

SPECIFICATION	5100
Max. single-pulse transient current (8x20µs, Amps peak)	26kA
Rated single-pulse transient energy (10x1000µs, Joules)	320 Joules
EMI/RFI noise rejection @ 50 Ohms 5kHz-100MHz	10-20dB
Cat. A ringwave (6kV, 200A, 100kHz)	370V
Cat. B ringwave (6kV, 500A, 100kHz)	420V
Cat B impulse (6kV, 3kA, 8x20µs)	490
UL 1449 ratings (8x20µs @ 500A) (L-N/L-G, N-G)	330/500/400V
Maximum continuous operating voltage	135V



Surge Protection Devices

SPECIFICATIONS AND FEATURES

- Connect directly to standard NEMA 5-15 wall receptacles
- Diagnostic LED's indicate power & protection status
- Three mode protection for Normal & Common protection: L-N, L-G, N-G
- On-board thermal fusing & overcurrent protection via resettable 15A breaker
- Filtration reduces high frequency noise
- Maximum continuous operating voltage

5100 Series

- Non-inductive design for compatibility with UPS & SPS or transformer systems
- Multi-component suppression circuitry

TESTING AND CODE COMPLIANCE

- UL 1449 Listed (File #E-146315)
- Meets ANSI/IEEE C62.41 standards for both Categories A & B
- CSA Certified (File #LR-94773)
- Lifetime Limited Downline Warranty for device & equipment plugged into it

MATERIAL CHARACTERISTICS

Operating Temperature: -10°C to 60°C
Storage Temperature: -35°C to 60°C

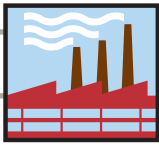

SURGE PROTECTION PLUG STRIPS

Industrial Grade Surge Protection Devices



5300-HTS



5300-PSC



5100-OPS

Plug Strips

DESCRIPTION	CAT. NO.	RATING	APPLICATION
6-Outlet Plug Strip w/ON/OFF Switch	5300-PS	15A-120V AC	Data-sensitive operations
6-Outlet Plug Strip w/ON/OFF Switch w/15 ft. Power Cord	5300-S15	15A-120V AC	Data-sensitive operations
6-Outlet Plug Strip w/ON/OFF Switch	5300-PST	15A-120V AC	Telephone line/modem line protection
6-Outlet Plug Strip w/ON/OFF Switch	5300-PSC	15A-120V AC	CATV line surge protection
6-Outlet Plug Strip Hospital Grade Components	5300-HTS	15A-120V AC	Continues to supply power to load if protection is lost
6-Outlet Plug Strip w/ON/OFF Switch	5300-IPS	15A-120V AC	Rugged metal housing for use in rough environments
Heavy-Duty 6-Outlet Plug Strip w/ON/OFF Switch	5200-PS	15A-120V AC	For microprocessor-based equipment
Heavy-Duty 6-Outlet Plug Strip w/ON/OFF Switch, w/15 ft. Power Cord	5200-S15	15A-120V AC	For microprocessor-based equipment
General-Duty 6-Outlet Plug Strip	5100-PS	15A-120V AC	Compatible with Decora Home Control
General-Duty 6-Outlet Plug Strip, w/15 ft. Power Cord	5100-S15	15A-120V AC	Compatible with UPS and SPS systems
General-Duty 6-Outlet Plug Strip	5100-IPS	15A-120V AC	Rugged metal housing for use in rough environments
General-Duty 6-Outlet Plug Strip	5100-IS2	20A-120V AC	Rugged metal housing for use in rough environments

Clamping Performance

DESCRIPTION	5100-PS	5200-PS	5300-PS GROUP
Max. single-pulse transient current (8x20µs, Amps peak)	26kA	39kA	52kA
Rated single-pulse transient energy (10x1000µs, Joules)	720 Joules	940 Joules	1480 Joules
EMI/RFI noise rejection @ 50 Ohms 5kHz-100MHz	10-30dB	40-50dB	50-60dB
Cat. A ringwave (6kV, 200A, 100kHz)	370V	230V	190V
Cat. B ringwave (6kV, 500A, 100kHz)	420V	270V	210V
Cat B impulse (6kV, 3kA, 8x20µs)	490	370	310
UL 1449 ratings (8x20µs @ 3kA) (L-N/L-G, N-G)	400/400/400	330/400/330	330/330/330 400/400/400 for 5300-HTS only

SPECIFICATIONS AND FEATURES

Plug Strips

- Available in Industrial Specification Grade, Commercial Specification Grade & General Purpose Classifications
- Clamping profile tightly tracks AC sine wave
- Real-time diagnostics monitor power & suppression status
- Six protected outlets
- Resettable circuit breaker & internal fusing
- May be wall-mounted
- Equipped with a 6-foot, 14-3AWG power cord

TESTING AND CODE COMPLIANCE

5300-HPS

- UL Listed 544 (File #118936)
- UL Listed (File Nos. #1449, 1363, 1283)
- CSA Certified (File #LR-94773)
- Meets ANSI/IEEE C62.41 standards for both Categories A & B

Plug Strips

- Lifetime Limited Downline Warranty for device & equipment plugged into it

MATERIAL CHARACTERISTICS

5100-PS, 5200-PS, 5300-PS

Operating Temperature: 0°C to 40°C
Storage Temperature: -35°C to 60°C

5300-HPS

Operating Temperature: 0°C to 60°C
Storage Temperature: -35°C to 60°C

5100-IPS, 5300-IPS, 5100-IS2

Operating Temperature: -10°C to 60°C
Storage Temperature: -35°C to 60°C

WIRED-IN SURGE PROTECTION MODULES

Industrial Grade Surge Protection Devices

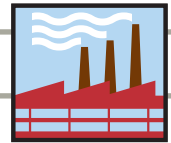

Wired-In Surge Protection Modules NOM CULUS LISTED

DESCRIPTION	CAT. NO.	RATING
Single-Phase, 3-Wire	51005-WM	5A, 120V AC
Single-Phase, 3-Wire	51010-WM	10A, 120V AC
Single-Phase, 3-Wire, DIN-Rail Mounting	51005-DIN	5A, 120V AC
Single-Phase, 3-Wire, DIN-Rail Mounting	51010-DIN	10A, 120V AC
Single-Phase, 3-Wire	51015-WM	15A 120V AC
Single-Phase, 3-Wire	51020-WM	20A 120V AC
Single-Phase, 3-Wire, w/DIN-rail mounting	51020-DIN	20A 120V AC
Single-Phase, 3-wire (For use in parallel connection)	51020-WMT	20A 120V AC
Single-Phase, 4-Wire	51240-WM	20A 240V AC
Single-Phase, w/DIN-rail mounting	51240-DIN	20A 240V AC

Performance Specifications

SPECIFICATION	51005-WM, 51010-WM, 51005-DIN, 51010-DIN	51015-WM, 51020-WM, 51015-DIN, 51020-DIN, 51020-WMT	51240-WM, 51240-DIN
Max. Surge Current (Test w. 8x20µs wave)	L-N: 26kA	L-N: 52kA	L-N: 52kA
Noise Rejection	20-50dB (@ 10K-100MHz)	40-50dB (@ 5kH-100MHz)	40-50dB (@ 5kH-100MHz)
Operating Frequency Range	50, 60Hz	50, 60Hz	50, 60Hz
UL 1449 (2nd Ed.) Rating	L-N: 400V L-G: 400V N-G: 400V	L-N: 330V L-G: 330V N-G: 400V	L-N: 600V L-G: 330V N-G: 600V
MCOV	150V AC	150V AC	270V AC

Note: See your Leviton representative for a complete listing of Low-Voltage Communication Protection modules for factory automation and industrial control applications.



51020-DIN



51020-WMT

SPECIFICATIONS AND FEATURES

Wired-In Surge Protection Module —5100 Series

- For use by OEMs who wish to include 120/240V surge protection as an equipment feature
- Available with DIN-rail mounting
- Provides surge protection to branch circuits
- Staged multi-component surge suppression circuitry provides clamping envelope that follows AC sine-wave contour
- Primary and secondary suppression circuits are automatic resettable fuse protected
- Diagnostic circuitry, with LEDs, to indicate surge protection status & acoustic alert if surge protection is lost
- If surge protection is lost, power is still provided to load until SPD module is replaced

TESTING AND CODE COMPLIANCE

- Recognized to UL Standard 1449, Edition 2.5
- CSA Certified
- Backed by a Limited Five-Year Warranty

MATERIAL CHARACTERISTICS

Operating Temperature: -40°C to 70°C
Storage Temperature: -20°C to 85°C

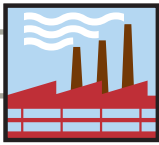

SURGE PROTECTION PANELS

Industrial Grade Surge Protection Devices



74000 Series Panel Mount Devices NOM

DESCRIPTION	CAT. NO.	RATING	MODULE NO.
7-Mode, 3Ø WYE, 4-Wire + Ground	74120-7M3	120/208V AC	(7) HC120-M40
7-Mode, 3Ø WYE, 4-Wire + Ground	74277-7M3	277/480V AC	(7) HC277-M40

Performance Specifications: 74000 Series

CAT. NO.	MCOV	UL 1449 (2nd Ed) IMPULSE (6kV/500A)			MAX. SURGE CURRENT in KA (Test w/8x20µs wave)			NOISE REJECTION
		L-N	L-G	N-G	L-N + L-G = per phase			
74120-7M3	150V AC	400	400	400	200	200	400	-40 dB (@5K-100MHz)
74277-7M3	320V AC	800	800	800	200	200	400	-40 dB (@5K-100MHz)

SPECIFICATIONS AND FEATURES

74000 Series

- Provides seven mode protection
- Uses replaceable modules
- Real-time diagnostics monitor power and suppression status for each mode
- Surge magnitude, time and date is provided for each surge event
- Surge event history downloadable for storage via RS-232 connection
- AC sine wave tracking
- Optically isolated dry contacts

TESTING AND CODE COMPLIANCE

- UL 1449 Edition 2.5 Listed (#E146315)
- CSA Certified (#LR-94773)
- Meets ANSI/IEEE C62.41 & C62.45 Categories A, B & C

MATERIAL CHARACTERISTICS

Operating Temperature: -10°C to 60°C
Storage Temperature: -20°C to 85°C

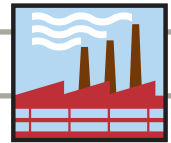

57000 Series Branch Panel Mounts

DESCRIPTION	CAT. NO. W/O SURGE COUNTER	CAT. NO. W/ SURGE COUNTER	VOLTAGE RATING	MODULE
3-Phase WYE, 4-Wire & Ground	57120-M3	57120-CM3	120/208V AC	(3) 120 (1) 8120-GN
3-Phase WYE, 7-Mode, Integral Disconnect, 4-Wire & Ground	57120-M3S	57120-C3S	120/208V AC	(3) 120-M3S (1) 8120-GN
3-Phase WYE, 4-Wire & Ground	57220-IM3	—	220/380V AC	(3) 220 (1) 8250-GN
3-Phase Delta, 3-Wire & Ground	57240-DM3	—	240V AC	(3) 7240
3-Phase WYE, 4-Wire & Ground	57277-M3	57277-CM3	277/480V AC	(3) 7277 (1) 8320-GN
3-Phase WYE, 7-Mode, Integral Disconnect, 4-Wire & Ground	57277-M3S	57277-C3S	277/480V AC	(3) 7277-M3S (1) 8320-GN
3-Phase WYE, 4-Wire & Ground	57346-M3	—	346/600V AC	(3) 7346 (1) 8385-GN
3-Phase WYE, 4-Wire & Ground	57347-M3S	—	347/600V AC	(3) 7347 (1) 8385-GN
3-Phase Delta, 3-Wire & Ground	57480-DM3	—	480V AC	(3) 7480
3-Phase Delta, 3-Wire & Ground	57600-DM3	—	600V AC	(3) 7600

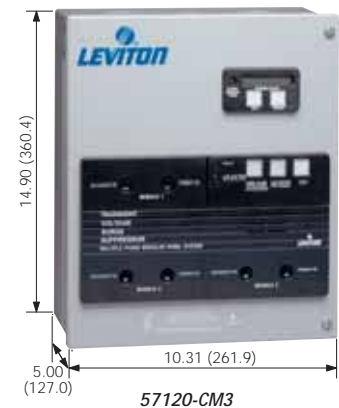

Performance Specifications: 57000 Series

CAT. NO.	MCOV	UL 1449 (2nd Ed) IMPULSE (6kV/500A)				MAX. SURGE CURRENT in KA (Test w/8x20µs wave)			NOISE REJECTION
		L-N	L-G	N-G	L-L	L-N + L-G = per phase			
57120-M3 57120-CM3	150V AC	400	800	400	800	150	—	150	-20 to -40 dB (@5K-10MHz)
57120-M3S 57120-C3S	150V AC	400	500	400	700	100	100	100	-20 to -40 dB (@5K-10MHz)
57220-IM3	250V AC	600	1200	600	1200	150	—	150	-20dB to -40 dB (@5K-10MHz)
57240-DM3	250V AC	—	—	—	700	L-L: 150			-20dB to -40 dB (@5K-10MHz)
57277-M3 57277-MC3	320V AC	800	1800	800	1800	150	—	150	-20dB to -40 dB (@5K-10MHz)
57277-M3S 57277-C3S	320V AC	900	1000	800	1500	100	100	200	-20dB to -40 dB (@5K-10MHz)
57346-M3	385V AC	1000	2000	1000	2000	150	—	150	-20dB to -40 dB (@5K-10MHz)
57480-DM3	550V AC	—	—	—	1500	L-L: 150			-20dB to -40 dB (@5K-10MHz)
57600-DM3	680V AC	—	—	—	1800	L-L: 150			-20dB to -40 dB (@5K-10MHz)
57347-M3S	390V AC	1000	1000	1000	2000	100	100	200	-20dB to -40 dB (@5K-10MHz)

Remote Supervisor

DESCRIPTION	CAT. NO.
Remote Supervisor	52000-RS

SPECIFICATIONS AND FEATURES

57000 Series

- For installation at main distribution panels
- Hybrid suppression circuitry with built-in redundancy provides complete protection on all phases even if one module fails
- Modular design allows easy replacement of modules with the use of tools & without the need to shut down AC system power
- Provides Normal Mode (phase to neutral) & Common Mode (neutral to ground) protection for WYE-configured 3-phase AC systems
- Dry contacts for remote monitoring

57000 Series

- "Series connection" parallel operated (Kelvin/feed-through) rated for 100 Amps maximum continuous line current using #3 AWG conductors
- Optically coupled remote-monitoring port allows use of the optional Remote Supervisor (Cat. No. 52000-RS)

- Dual-stage fuse protection for primary & secondary surge suppression circuits
- Housed in NEMA-12 case with hinged cover, surface or flush mountable
- Noise rejection -20 to -40dB

Remote Supervisor

- For use with any Cat. No. 57000 or 52000 panel-mounted SPD
- Monitors up to 6 (series alarm daisy-chained) panel-mounted SPDs
- Single key-hole surface mounting using just 2 screws
- Annunciator light shows steady GREEN when monitored panel-mounted SPDs are normal, & FLASHING RED in case of protection failure or power interruption
- 75dB acoustic beep tone draws attention to a potential failure
- Jack provided for simple connection to input port via #20 to #22 two-conductor twisted pair, with a wire run up to 5,000 ft. in length

TESTING AND CODE COMPLIANCE

57000 Series

- UL 1449 Listed Edition 2.5 (File #E-146315)
- CSA Certified (File #LR-94773)
- 200 kA rated (M3S versions rated 100kA)
- Meets ANSI/IEEE C62.41 & C62.45 Categories A, B & C
- UL 945-V flame retardant thermoplastic (Front Bezel)
- Backed by a Limited 10-Year Warranty

MATERIAL CHARACTERISTICS

Operating Temperature: -10°C to 60°C
Storage Temperature: -20°C to 85°C

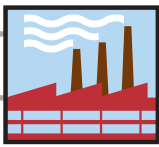

SURGE PROTECTION PANELS

Industrial Grade Surge Protection Devices



52120-M3



52120-CM3

52000 Series Branch Panel Mounts

DESCRIPTION	CAT. NO. W/O SURGE COUNTER	CAT. NO. W/ SURGE COUNTER	VOLTAGE RATING	MODULE
Single-Phase, 2-Wire & Ground	52120-M1	—	120V AC	(1) 2120 (1) 8120-GN
Single-Phase, 3-Wire & Ground (Home Automation Model)	52120-M2 (52120-M2H)	52120-CM2	120/240V AC	(2) 2120 (1) 8120-GN
3-Phase WYE, 4-Wire & Ground (Without Enclosure)	52120-M3 (52120-B3)	52120-CM3	120/208V AC	(3) 2120 (1) 8120-GN
3-Phase WYE (International), 4-Wire & Ground	52220-IM3	—	220/380V AC	(3) 2220 (1) 8250-GN
3-Phase Delta, 3-Wire & Ground	52240-DM3	—	240V AC	(3) 2240
3-Phase WYE, 4-Wire & Ground	52277-M3	52277-CM3	277/480V AC	(3) 2277 (1) 8320-GN
3-Phase WYE, 4-Wire & Ground	52347-M3	—	347/600V AC	3) 2347 (1) 8385-GN
3-Phase Delta, 3-Wire & Ground	52480-DM3	—	480V AC	(3) 2480
Split Phase Delta, 4-Wire & Ground	52412-DS3	—	120/240V AC	(2) 2120 (120V) & (1) 2412 (HI-LEG)

Performance Specifications: 52000 Series

CAT. NO.	MCOV	UL 1449 (2nd Ed) IMPULSE (6kV/500A)				MAX. SURGE CURRENT in KA (Test w/8x20µs wave)	NOISE REJECTION
		L-N	L-G	N-G	L-L		
52120-M1	150V AC	400	800	400	—	100	-20 to -40 dB (@5K-10MHz)
52120-M3 52120-CM2	150V AC	400	800	400	800	100	-20 to -40 dB (@5K-10MHz)
52120-M2H	150V AC	400	800	400	800	100	-20 to -40 dB (@5K-10MHz)
52120-M3 52120-B3 52120-CM3	150V AC	400	800	400	800	100	-20 to -40 dB (@5K-10MHz)
52220-IM3	250V AC	600	1200	600	1200	100	-20 to -40 dB (@5K-10MHz)
52240-DM3	L-L: 250V AC	—	—	—	600	100	-20 to -40 dB (@5K-10MHz)
52277-M3 52277-CM3	320V AC	800	1800	800	1800	100	-20dB to -40 dB (@5K-10MHz)
52347-M3	420V AC L-L: 680	900	—	—	900	100	-20 to -40 dB (@5K-10MHz)
52480-DM3	550V AC	—	—	—	1500	100	-20 to -40 dB (@5K-10MHz)
52412-DS3	L-L: 250V AC	400	800	400	800	100	-20 to -40 dB (@5K-10MHz)

Remote Supervisor

DESCRIPTION	CAT. NO.
Remote Supervisor	52000-RS

SPECIFICATIONS AND FEATURES

52000 Series

- For installation at branch panels for protection in industrial & commercial facilities
- Hybrid suppression circuitry
- Features AC sine wave tracking and redundant protection
- Modular design allows easy replacement of modules without use of tools or the need to shut down the AC system
- Real-time diagnostics monitor power & suppression status for each phase & allow use of optional Remote Supervisor
- Dry contacts for remote monitoring
- Provides Normal Mode (phase to neutral) &

- Common Mode (neutral to ground) protection for WYE-configured 3-phase AC systems
- "Optional Series Connections" (Kelvin/feed-through) rated for 100 Amps maximum continuous line current using #3 AWG conductors
- Fuse protection for each module
- Housed in NEMA-12 case hinged cover, surface or flush mountable

TESTING AND CODE COMPLIANCE

52000 Series

- UL 1449 Listed Edition 2.5 (File #E-146315)
- CSA Certified (File #LR-94773)
- Meets ANSI/IEEE C62.41 and 62.45 requirements for Categories A, B, C
- Backed by a Limited 10-Year Warranty

MATERIAL CHARACTERISTICS

Operating Temperature: -10°C to 60°C
Storage Temperature: -20°C to 85°C

SURGE PROTECTION PANELS

Industrial Grade Surge Protection Devices

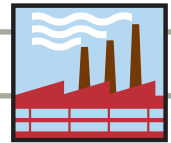

47000 & 52000-7M3 Series Branch Panel Mounts

DESCRIPTION	CAT. NO. W/O SURGE COUNTER	CAT. NO. W/ SURGE COUNTER	VOLTAGE RATING 3Ø WYE (4-Wire & Ground)	MODULE
7-Mode Panel Mount (4-Wired + Ground)	47120-007	—	120/208V AC	—
7-Mode Panel Mount w/NEMA 4X Enclosure (4-Wire + Ground)	47120-4X7	—	120/208V AC	—
7-Mode Panel Mount (4-Wired + Ground)	47277-007	—	277/480V AC	—
7-Mode Panel Mount w/NEMA 4X Enclosure (4-Wire + Ground)	47277-4X7	—	277/480V AC	—
7-Mode Panel Mount (4-Wired + Ground)	47347-007	—	347/600V AC	—
7-Mode Modular Panel Mount (4-Wired + Ground)	52120-7M3	52120-7C3	120/208V AC	(3) 120-7M3 (1) 8120-GN
7-Mode Modular Panel Mount (4-Wired + Ground)	52277-7M3	52277-7C3	277/480V AC	(3) 220-7M3 (1) 8120-GN



47120-007

Performance Specifications: 47000 and 52000-7M3 Series

CAT. NO.	MCOV	UL 1449 (2nd Ed) IMPULSE (6kV/500A)				MAX. SURGE CURRENT in KA (Test w/8x20µs wave)			NOISE REJECTION
		L-N	L-G	N-G	L-L	L-N + L-G = per phase			
47120-007 47120-4X7	140V AC	330	400	330	600	200	200	400	-40 dB (@10K-10MHz)
47277-007 47277-4X7	320V AC	700	800	700	1500	200	200	400	-40 dB (@10K-10MHz)
47347-007	390V AC	1200	1300	1200	2200	200	200	400	-40 dB (@10K-10MHz)
52120-7M3 52120-7C3	150V AC	400	400	400	800	100	100	200	-20 to -40 dB (@5K-10MHz)
52277-7M3 52277-7C3	320V AC	800	800	800	1500	100	100	200	-20 to -40 dB (@5K-10MHz)



47120-4X7

37000, 47000 & 57000-7M3 Series Branch Panel Mounts

DESCRIPTION	CAT. NO. W/O SURGE COUNTER	CAT. NO. W/ SURGE COUNTER	VOLTAGE RATING 3Ø WYE (4-Wire & Ground)
7-Mode Panel Mount Type 1 Enclosure (4-Wired + Ground)	37120-007	—	120/208V AC
7-Mode Panel Mount w/NEMA Type 1 Enclosure (4-Wire + Ground)	37277-4X7	—	277/480V AC

SPECIFICATIONS AND FEATURES

47000 & 52000-7M3 Series

- Provides low-clamping, high surge current capability
- Verifies fail-safe conditions for MOVs under steady-state overvoltage
- 200 kA rated per mode
- Parallel wired to facilitate connection to any service ampacity
- Provides Normal Mode (phase to neutral) & Common Mode (neutral to ground) protection for WYE-configured 3-phase AC systems
- Available with NEMA Type 4X enclosure for outdoor/uncontrolled environments

TESTING AND CODE COMPLIANCE

47000 & 52000-7M3 Series

- UL 1449 Listed Edition 2.5 (File #E-146315)
- CSA Certified (File #LR-94773)
- Meets ANSI/IEEE C62.41 and 62.45 requirements for Categories A, B, C
- Backed by a Limited 10-Year Warranty

MATERIAL CHARACTERISTICS

Operating Temperature: -10°C to 60°C
Storage Temperature: -20°C to 85°C

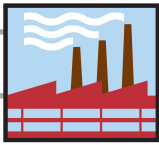

MULTI-PHASE PANEL PROTECTORS

Industrial Grade Surge Protection Devices

Surge Protection Devices



32000 and 42000 Series for Branch Panels

DESCRIPTION	CAT. NO.	VOLTAGE RATING
Single-Phase	32120-1 42120-1	120/240V AC
3-Phase WYE or 220V AC, 3Ø Delta	32120-DY3 42120-DY3	120/208V AC
277/480V or 220/380V AC	32277-DY3	277/480V AC, 220/380V AC
3-Phase WYE or 240, 480V AC 3Ø Delta	42277-DY3	480V AC
3-Phase WYE	32347-DY3 42347-DY3	347/600V AC
Hi-Leg Split Phase Delta	32412-DS3 42412-DS3	120/240V AC
Flush Mount Collar	42001-FMC	—

Performance Specifications: 32000 and 42000 Series

CAT. NO.	MCOV	UL 1449 (2nd Ed) IMPULSE (6kV/500A)			MAX. SURGE CURRENT in KA (Test w/8x20µs wave)	NOISE REJECTION	
		L-N	N-G	L-L		3200 Series	4200 Series
32120-1 42120-1	150V AC	500	500	700	80KA	-20 to -30 dB (@1.5K- 1.2MHz)	-30 to -40 dB (@10K- 10MHz)
32120-DY3 42120-DY3	150V AC	500	500	700			
32277-DY3 42277-DY3	320V AC	900	800	1500			
32347-DY3 42347-DY3	382V AC L-L 660V AC	1200	1000	2000			
32412-DS3 42412-DS3	320V AC L-L 264V AC	400	700 (HiL-N)	800			

SPECIFICATIONS AND FEATURES

32000 & 42000 Series

- 32000 Series compatible with Decora Home Automation devices
- Dry contacts for remote monitoring (NO-C-NC)
- Provide multiple-phase surge protection in commercial & industrial environments
- Compact design permits close installation to panel & provides a short parallel suppression path
- 3-phase units are suitable for WYE & Delta AC systems
- Easily surface-mounted or flush mountable with use of flush collar accessory 42001 FMC
- Real-time diagnostics monitor power & surge suppression status of each phase by means of indicator light & acoustic alarm
- Equipped with normally open/normally closed dry contacts rated 5 Amps 120/240V AC via 3 color-coded AWG leads rated 600V AC for remote monitoring

TESTING AND CODE COMPLIANCE

32000 & 42000 Series

- UL 1449 Listed Edition 2.5 (File #E-146315)
- CSA Certified (File #LR-94773)
- Meets ANSI/IEEE C62.41 and 62.45 requirements for Categories A, B, C
- Backed by a Limited 10-Year Warranty

MATERIAL CHARACTERISTICS

32000 & 42000 Series

Operating Temperature: -10°C to 60°C
Storage Temperature: -20°C to 85°C

LOW VOLTAGE COMMUNICATION MODULES

Industrial Grade Surge Protection Devices

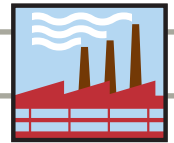

3400 and 3800 Series Low Voltage Communication

Surge Protection Modules



DESCRIPTION	CAT. NO.	RATING	APPLICATION
3-Pin Header Connector, Surface Mount	3803-DHP*	9.6V DC	For programmable logic devices and other computer-related data network products operating on "Blue Hose" networks
6-Pin Header Connector, Surface Mount	3803-485*	9.6C DC	For programmable logic other devices and computer related data network products operating on Allen Bradley DH-485 data networks
5-Pin Header Connector Surface & DIN-Rail Mount	3803-SPX	13.6V DC	For products operating on SERIPLEX control bus networks
DB-9 Connector, Surface & DIN-Rail Mount	3803-CAN	25V DC	For products operating on Honeywell control bus
3-Pin Header Connector, Surface Mount	3803-MOD	9.6V DC	For products operating on Modbus and Modbus Plus networks
3-Pin Header Connector, Surface Mount	3420-009*	9.6V DC	For products operating on 4-20ma Signal Loop networks, 9V DC
3-PIN Header Connector, Surface Mount	3420-035*	38.5V DC	For products operating on 4-20ma Signal Loop networks, 38V DC
4-Position Terminal Block Surface & DIN-rail Mount	3860-GEF	100V DC	For products operating on GE Fanuc Control Bus networks
RJ-45 Connector, Surface & DIN-Rail Mount	3861-ETH	19.8V DC	For products operating on Ethernet PLC ports and CAT 3 networks
BNC Connector, Surface & DIN-Rail Mount	3862-CON	9.18V DC	For ControlNet networks
5-Pin Header Connector Surface & DIN-Rail Mount	3863-DEV	19.8V DC	For DeviceNet networks
Hospital Grade Din-Rail Mountable Surge Protected Duplex Receptacle w/LED & Audible Alarm	3880-DIN	120V	For plug-in surge protection in equipment cabinets

Surge Counter: 51000-SMC

DESCRIPTION	CAT. NO.
Plug-in Surge Counter	51000-SMC

*The Rockwell Automation Encompass Program references complementary products from third party manufacturers committed to providing quality products and services that enhance the Rockwell Automation Solution products and solve the industrial automation needs of mutual customers.



3803-485

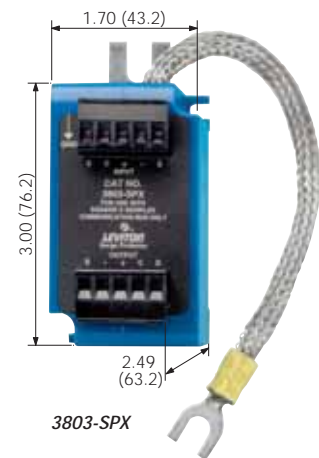

3803-SPX



3880-DIN



51000-SMC

SPECIFICATIONS AND FEATURES

3400 & 3800 Series

- Designed for mounting in standard equipment cabinets
- For use on Allen Bradley & "Blue Hose" devices
- Two options for ground connection
- Low clamping voltage
- Withstands surges at programmable logic devices in harsh electromagnetic or geographic areas
- Provide transient voltage surge suppression for a selection of programmable logic devices & other computer-related data network products

51000-SMC Surge Counter

- Plug-in design provides fast, simple way to determine if surges are present
- 3 settings indicate different sensitivity thresholds based on IEEE C62.41 impulse & ringwave waveforms
- Key operated to prevent tampering
- Excellent tool for determining if you need surge protection in an office environment.

TESTING AND CODE COMPLIANCE

3400 & 3800 Series

- UL 497B Listed (#E175161)
- CSA Certified (#LR-94773)
- Meets ANSI/IEEE C-62.41 requirements
- Backed by a Limited 10-Year Warranty

51000-SMC

- Meets UL Standard 1436

MATERIAL CHARACTERISTICS

Operating Temperature: -40°C to 60°C (3803-DHP, 3803-485, 3803-MOD, 3420-009, 3420-035); -10°C to 85°C (3803-SPX, 3803-CAN, 3860 Series)

Storage Temperature: -40°C to 90°C (3803-DHP, 3803-485, 3803-MOD, 3420-009, 3420-035); -20°C to 85°C (3803-SPX, 3803-CAN, 3860 Series)

Surge Protection Devices

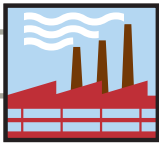

EQUIPMENT CABINET SURGE PROTECTION

Industrial Grade Surge Protection Devices

Surge Protection Devices



3800-DIN



3800-OEM



3840-DIN

Equipment Cabinet Surge Protection Modules 3800 Series

DESCRIPTION	CAT. NO.	RATING
For DIN-Rail Mounting, w/Terminal Block; 120V AC	3800-DIN	120V AC (VRMS)
Terminal Block; 120V AC	3800-OWM	120V AC (VRMS)
Pigtail Wire Leads, 6" long; 120V AC	3800-OEM	120V AC (VRMS)
For DIN-Rail Mounting, w/Terminal Block; 12V DC	3812-DIN	12V DC
Terminal Block; 12V DC	3812-OWM	12V DC
Pigtail Wire Leads; 6" long; 12V DC	3812-OEM	12V DC
For DIN-Rail Mounting, w/Terminal Block; 24V DC	3824-DIN	24V DC
Terminal Block; 24V DC	3824-OWM	24V DC
Pigtail Wire Leads; 6" long; 24V DC	3824-OEM	24V DC
For DIN-Rail Mounting, w/Terminal Block; 240V AC	3840-DIN	240V AC (VRMS)
Terminal Block; 240V AC	3840-OWM	240V AC (VRMS)
Pigtail Wire Leads; 6" long; 240V AC	3840-OEM	240V AC (VRMS)
For DIN-Rail Mounting, w/Terminal Block; 48V DC	3848-DIN	48V DC
Terminal Block; 48V DC	3848-OWM	48V DC
Pigtail Wire Leads; 6" long; 48V DC	3848-OEM	48V DC

Clamping Performance and Performance Specification

CLAMPING PERFORMANCE	CAT. NO. 3800	CAT. NO. 3840
UL Standard 1449 permanently-wired test (8x20μs, 3000A)	L-N: 500V Peak L-G: 500V Peak N-G: 500V Peak	L-N: 330V Peak L-G: 400V Peak N-G: 330V Peak
PERFORMANCE SPECIFICATION	CAT. NO. 3800	CAT. NO. 3840
Max. Single-Pulse	L-N: 1300A	L-N: 1300A
Transient Current (8X20μs, Impulse)	L-G: 6500A N-G: 6500A	L-G: 6500A N-G: 6500A

Consult factory for detailed performance data for other models.

Equipment Cabinet Surge Protection Receptacles

DESCRIPTION	CAT. NO.	RATING
Hospital Grade Duplex Receptacle 60Hz	3880-DIN	15A-120V @ 50,
Single Convenience Outlet 60Hz	3801-DIN	15A-120V @ 50,

Performance Data (3880-DIN, 3801-DIN)

CLAMPING VOLTAGE*	MCOV†	MAX. SINGLE PULSE TRANSIENT CURRENT (8X20μs, Amps peak)	EMI-RFI NOISE REJECTION @50 ohms 5kHz-5MHz
400/400/400V pk	150Vrms	24kA(L-N), 12kA(L-G/N-G)	-35dB

*UL 1449 Suppressed Voltage Ratings (SVR) Assigned at 6" length with 6k/500A per UL1449 (2nd Ed.)
†Maximum Continuous Operating Voltage.

SPECIFICATIONS AND FEATURES

- 3800 Series**
- MOV-based suppression circuitry provides optimum clamping
 - Provides Normal Mode protection for line-to-neutral & common mode; line-to-ground & neutral-to-ground
 - Noise rejection @ 5kHz-5MHz: -35db
 - 3800: 135V (MCOV); 3840: 250V (MCOV)
 - 3800-DIN, 3800-OWM: Terminal block accepts 22 AWG to 12 AWG conductors
 - Consult factory on additional ratings on 3812, 3824 & 3848

- 3880-DIN & 3801-DIN**
- Ideal for mounting in equipment cabinets where convenient plugin surge protection is desired
 - Green LED indicates surge protection loss
 - Audible alarm w/integral disable (quiet) switch
 - Power continues to be provided to loads in the event of protection loss
 - Terminal Block accepts #22-#12 AWG conductors

TESTING AND CODE COMPLIANCE

- UL 1449 Listed Edition 2.5(E146315/DC-E175161)
- CSA Certified (#LR-94773)
- Meets ANSI/IEEE C-62.41 & C-62.45 Categories A, B & C (B & C ONLY for Cat Nos. 3880-DIN & 3801-DIN)
- Backed by a Limited 10-Year Warranty

MATERIAL CHARACTERISTICS

Operating Temperature: -10°C to 60°C
Storage Temperature: -20°C to 85°C

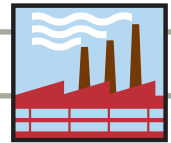

Hospital Grade Surge Protection Receptacles—120V NOM cULUS LISTED

DESCRIPTION	CAT. NO.	COLOR*
15A Duplex—Indicator Light, Audible Alarm	8280	I, W, A, T, R, B <i>Basic Cat. No. Denotes Brown</i>
20A Duplex—Indicator Light, Audible Alarm	8380	I, W, GY, B, R
20A Single—Indicator Light, Audible Alarm	8381	I, (No Brown)

Hospital Grade Isolated Ground Surge Protection Receptacles—120V UL SF

DESCRIPTION	CAT. NO.	COLOR*
15A Duplex—Indicator Light, Audible Alarm	8280-IG	I, W, G, B, O <i>Brown Not Available</i>
15A Single—Indicator Light, Audible Alarm	8281-IG	I, O
20A Duplex—Indicator Light, Audible Alarm	8380-IG	I, W, G, B, O
20A Single—Indicator Light, Audible Alarm	8381-IG	I, W, B

Industrial Grade Surge Protection Receptacles—120V UL SF

DESCRIPTION	CAT. NO.	COLOR*
15A Duplex—Indicator Light	5280	I, W, A, T, GY, B <i>Basic Cat. No. Denotes Brown</i>
15A Duplex—Indicator Light, Audible Alarm	7280	I, W, A, GY, B
20A Duplex—Indicator Light	5380	I, W, GY, B
20A Duplex—Indicator Light, Audible Alarm	7380	I, W, GY, B

Industrial Grade Isolated Ground Surge Protection Receptacles—120V UL SF

DESCRIPTION	CAT. NO.	COLOR*
15A Duplex—Indicator Light	5280-IG	I, W, A, G, B, O <i>Basic Cat. No. Denotes Brown</i>
20A Duplex—Indicator Light	5380-IG	I, W, G, B, O

General Data

SPECIFICATION	DATA APPLICABLE TO ALL
Rated line voltage	120V (VRMS)
Max. continuous operating voltage	150V
Max. single-pulse transient current (8x20µs, Amps peak)	24000A (L-N) 12000A (L-G) 12000A (N-G)
Rated single-pulse transient energy (10x1000µs, impulse)	320 Joules
Noise rejection @ 5kHz-5MHz	-35dB

Clamping Performance

SPECIFICATION	DATA APPLICABLE TO ALL
UL Standard 1449 (2nd Edition) permanently-wired test (8x20µs, 3000A); CSA and NOM Certified	(L-N): 400V Peak (L-G): 400V Peak (N-G): 400V Peak

Note: For Acenti Sixplex and Duplex Surge Protective Receptacles, see page A5

SPECIFICATIONS AND FEATURES

- Provides hard-wired point-of use surge protection for electronic equipment in industrial, commercial and residential applications
- 3-Level surge protection for phase to neutral, phase to ground and neutral to ground
- All receptacles are back and side wired
- Hospital Grade versions (indicated by green dot on receptacle face) are suitable for high-abuse health care, industrial and commercial applications
- Isolated Ground versions (indicated by orange color or orange triangle on receptacle face) provide a pure ground path for use with isolated grounding systems
- Monitor/Indicator LED is ON continuously when protection is active and OFF when protection circuit is deactivated due to excessive transients
- All Hospital Grade devices and Cat. Nos. 7280 and 7380 Industrial devices also provide an audible tone alert that sounds if protection is lost
- EMI/RFI filtering
- Decora styling complements any interior and coordinates with Leviton's popular line of Decora devices

TESTING AND CODE COMPLIANCE

- UL Listed Standard 1449 (Edition 2.5)
- CSA certified
- Meets ANSI/IEEE C62.41 standards for both Categories A & B
- All SPD receptacles are backed by a Limited 10-Year Warranty

*COLOR

Basic Cat. Nos. shown above denote Brown device, except Hospital Grade IG devices not available in Brown. Colors available as listed above, add suffix to basic catalog numbers as follows: Ivory (-I), White (-W), Almond (-A), Light Almond (-T), Gray (-G or -GY), Blue (-B), Orange (-O), Red (-R).

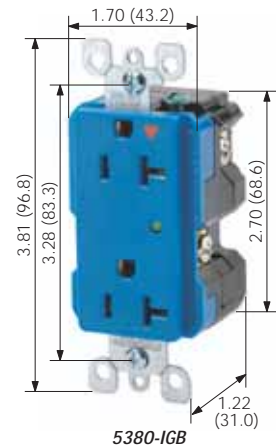
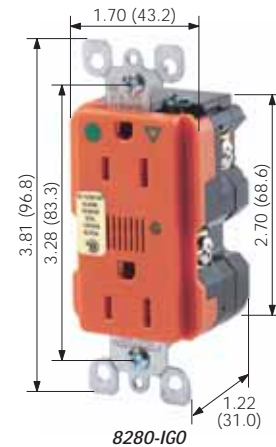

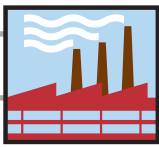

FOUR-IN-ONE SURGE PROTECTION RECEPTACLES

Industrial Grade Surge Protection Devices

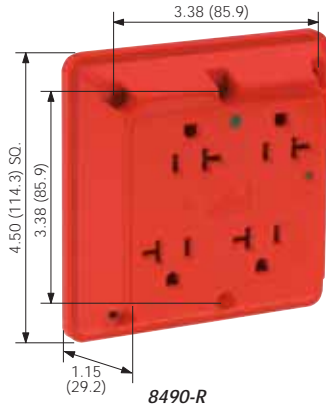

8490-R



3254-E



4254-Y

Four-In-One Surge Protection Receptacles—120V

DESCRIPTION	CAT. NO.	COLOR*
<i>Brown Not Available. For IG Devices, Basic Cat. No. Denotes Orange</i>		
15A Hospital Grade Four-In-One	8480	I, W, R
15A Hospital Grade Four-In-One Isolated Ground	8480-IG	I, W, B
20A Hospital Grade Four-In-One	8490	I, W, R
20A Hospital Grade Four-In-One Isolated Ground	8490-IG	I, W, B
15A Industrial Grade Four-In-One	5480	I, W, GY, BU, R
15A Industrial Grade Four-In-One Isolated Ground	5480-IG	I, B
20A Industrial Grade Four-In-One	5490	I, W, GY, BU
20A Industrial Grade Four-In-One Isolated Ground	5490-IG	I, B

Four-In-One Adapter Plates

CAT. NO.	COLOR*
<i>Basic Cat. No. Denotes Brown</i>	
3254	I, W, GY, R, E, OR, BLU

Four-In-One Portable Boxes†

CAT. NO.	COLOR*
<i>Brown Not Available</i>	
4254	I, GY, E, OR, BLU, Y

General Data

SPECIFICATION	DATA FOR SURGE RECEPTACLES
Rated line voltage	120V (VRMS)
Max. continuous operating voltage	150V
Max. single-pulse transient current (8x20µs, Amps peak)	24000A (L-N) 12000A (L-G) 12000A (N-G)
Rated single-pulse transient energy (10x1000µs, impulse)	320 Joules
Noise rejection @ 5kHz-5MHz	-35dB

Clamping Performance

SPECIFICATION	DATA FOR SURGE RECEPTACLES
UL Standard 1449 (2nd Edition) permanently-wired test (8x20µs, 3000A); CSA and NOM Certified	(L-N): 330V Peak (L-G): 400V Peak (N-G): 400V Peak

†Portable boxes are not UL Listed. UL Listing does not apply when Four-In-One receptacles are used with portable boxes for extension cord applications.

SPECIFICATIONS AND FEATURES

Four-In-One Surge Protection Receptacles

- Replaces standard duplex receptacle with four surge-protected receptacles
- Ideal for locations where surge-protected receptacles are needed and plug-in devices can't be used
- 3-Level surge protection for phase to neutral, phase to ground and neutral to ground
- Hospital Grade versions (indicated by green dot on receptacle face) are suitable for high-abuse health care, industrial and commercial applications
- Isolated Ground versions (indicated by orange color or orange triangle on receptacle face) provide a pure ground path for use with isolated grounding systems

- Monitor/Indicator LED is ON continuously when protection is active and OFF when protection circuit is deactivated due to excessive transients

Four-In-One Adapter Plates & Portable Box

- Adapter plates not required with most standard wallboxes; provides popular "flush fit" look for any installation
- Portable Box designed for all Four-In-One Receptacles (not UL Listed for extension cord applications)
- Four-In-One Portable Box accepts #16/3 AWG Type SJ to #12/3 AWG Type SO COPPER Only

TESTING AND CODE COMPLIANCE

- UL 1449 Edition 2.5
 - Meets ANSI/IEEE C-62.41 & C-62.45 standards for both Categories A & B requirements
 - CSA Certified (#152105)
 - Backed by a Limited 10-Year Warranty
- Four-In-One Adapter Plates**
- UL Listed (File #E-13397 – Cat. No. 3254)

*COLOR

Colors available as listed above. For IG devices, Basic Cat. No. denotes Orange device. Add suffix to basic catalog numbers as follows: Ivory (-I), White (-W), Gray (-GY), Blue (-B, -BU or -BLU), Black (-E), Orange (-OR), Red (-R), Yellow (-Y)

PLUG-IN SURGE PROTECTION DEVICES

Commercial Grade Surge Protection Devices

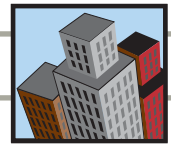

S1000 & S2000 Series Plug Strips

DESCRIPTION	CAT. NO.
S1000 Series Power Surge Strip (6 outlets)	S1000-OPS
S1000 Series TELCO/ CATV/SAT Surge Strip (6 outlets)	S1000-PTC
S2000 Series Power Surge Strip (9 outlets)	S2000-OPS
S2000 Series TELCO/ CATV/SAT Surge Strip (9 outlets)	S2000-PTC

Computer Grade Plug Strips

DESCRIPTION	CAT. NO.	RATING	APPLICATION
7-Outlet (6 switched, 1 continuously live) Strip; beige	4950-PS	15A 125V AC	EMI/RFI noise attenuation for micro-processor-driven electronic equipment
7-Outlet (6 switched, 1 continuously live) Strip w/Two RJ11 Phone Jacks; beige	4950-PST	15A 125V AC	EMI/RFI noise attenuation for micro-processor-driven electronic equipment
7-Outlet (6 switched, 1 continuously live) Strip w/Two F-type Coax Connectors; beige	4950-PSC	15A 125V AC	EMI/RFI noise attenuation for micro-processor-driven electronic equipment

Plug-In Surge Suppressors

DESCRIPTION	CAT. NO.	RATING	APPLICATION
6-Outlet (2 front, 4 side switched) Plug-in; beige	4900-P	15A 125V AC	EMI/RFI noise attenuation for micro-processor-driven electronic equipment
6-Outlet (2 front, 4 side switched) Plug-in w/Two RJ11 Phone Jacks; beige	4900-PT	15A 125V AC	EMI/RFI noise attenuation for micro-processor-driven electronic equipment
6-Outlet (2 front, 4 side switched) Plug-in w/Two F-type Coax Connectors; beige	4900-PC	15A 125V AC	EMI/RFI noise attenuation for micro-processor-driven electronic equipment



S1000



S2000



4950-PSC



4900-P

SPECIFICATIONS AND FEATURES

Plug Strips

- Ground pin to outside for more transformer configurations
- Diagnostic LEDs for surge protection, polarity and ground verification
- Resettable circuit breaker
- Power line carrier compatible
- Audible alarm indicates loss of protection
- Four non-skid rubber feet on the bottom

Computer Grade Plug Strips

- Provides excellent surge suppression & EMI/RFI noise attenuation for microprocessor-driven electronic equipment
- Three-stage protection: line-to-neutral, line-to-ground, neutral-to-ground
- Built-in overload circuit-breaker switch with reset button
- Indicator lights confirm unit is operating & properly grounded
- Clamping voltage: 330V all modes

Plug-Ins

- Provide excellent surge suppression & EMI/RFI noise attenuation for microprocessor-driven electronic equipment
- Indicator lights confirm unit is operating & properly grounded
- Audible alarm indicates protection is no longer active
- Clamping voltage: 330V all modes

TESTING AND CODE COMPLIANCE

Plug Strips

- CSA Certified
- UL Listed 1449 Edition 2.5
- Meets ANSI/IEEE C62.41 Edition 2.5 and C62.45

Computer Grade Plug Strips

- UL Listed 1449
- Limited Lifetime Warranty

Plug-Ins

- UL Listed 1449
- Limited Lifetime Warranty



RACK-MOUNT SURGE PROTECTION DEVICES

Power Distribution Units with Surge Protection



5500-190

19" Rack-Mount PDU's with Surge Protection

DESCRIPTION	CAT. NO.	RATING
With ON/OFF Switch, NEMA 5-15P St. Blade Plug	5500-190	15A 125V
Without ON/OFF Switch, NEMA 5-15P St. Blade Plug	5500-15N	15A 125V
With ON/OFF Switch, NEMA L5-15P Locking Plug	5500-15L	15A 125V
Without ON/OFF Switch, NEMA L5-15P Locking Plug	5500-NL	15A 125V
With ON/OFF Switch, NEMA 5-20P St. Blade Plug	5500-192	20A 125V
With ON/OFF Switch, NEMA 5-15P St. Blade Plug	5505-190	15A 125V
Without ON/OFF Switch, NEMA 5-20P St. Blade Plug	5500-20N	20A 125V
With ON/OFF Switch, NEMA L5-20P Locking Plug	5500-20L	20A 125V
Without ON/OFF Switch, NEMA L5-20P Locking Plug	5500-2NL	20A 125V

General Data

SPECIFICATION	5500-190, 5505-190, 5500-15N, 5500-15L, 5500-NL	5500-192, 5500-20N, 5500-20L, 5500-2NL
Rated line voltage (VRMS)	120V	120V
Load current	15A	20A
Max. continuous operating voltage	135V	135V
Operating frequency range	50, 60Hz	50, 60 Hz

Performance Data

SPECIFICATION	5500 SERIES	5505 SERIES
Max. single-pulse transient current (8x20µs, Amps peak)	52kA	10kA
Rated single-pulse transient energy (10x1000µs, Joules)	1440 Joules	540 Joules
Noise Rejection @ 100kHz – 30MHz	-5 to -40dB	-5 to -40dB
UL 1449 (2nd Ed) Impulse 6kV/500A	330/330/330	400/400/400

SPECIFICATIONS AND FEATURES

19" Rack Mount PDU's with Surge Protection

- Mounts on 19" equipment racks to provide point-of-use surge suppression for electronic equipment
- Clamping profile tightly tracks AC sine wave
- 6 protected duplex receptacles-5 in back, 1 in front
- Available with easy-access ON/OFF rocker-style switch, or without switch to avoid unnecessary equipment switching
- Resettable circuit breaker protects against over-loading & power supply failure
- Provided with 12-ft line cord with either NEMA 5-15P, L5-15P, 5-20P or L5-20P plug

TESTING AND CODE COMPLIANCE

19" Rack Mount PDU's with Surge Protection

- UL Recognized Component tested to UL 1449 standards Edition 2.5
- Covered by a Lifetime Limited Downline Warranty

MATERIAL CHARACTERISTICS

Operating Temperature: -10°C to 60°C
Storage Temperature: -35°C to 60°C

VERTICAL (ZERO-U) AND RACK MOUNT DEVICES

Commercial Grade Power Distribution Units

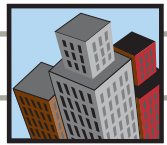

4505 Series 19" Rack Mount Power Distribution Units

DESCRIPTION	CAT. NO.	RATING	INPUT	OUTPUT
[A] 10 Receptacle w/7 ft. power cord	4505-20L	120V 20A	L5-20P	5-20R
10 Receptacle w/10 ft. power cord	4505-20T	120V 20A	L5-20P	5-20R
10 Receptacle w/15 ft. power cord	4505-20F	120V 20A	L5-20P	5-20R

P1000 Series Vertical Power Distribution Units

DESCRIPTION	CAT. NO.	RATING	INPUT	OUTPUT
16 Receptacle w/10 ft. power cord	P1040-10S	120V 15A	5-15P	5-15R
[B] 16 Receptacle w/10 ft. power cord	P1041-10S	120V 20A	5-20P	5-20R
16 Receptacle w/10 ft. power cord	P1042-10L	120V 20A	L5-20P	5-20R
24 Receptacle w/10 ft. power cord	P1043-10S	120V 20A	5-20P	5-20R
[C] 24 Receptacle w/10 ft. power cord	P1044-10L	120V 20A	L5-20P	5-20R
24 Receptacle w/10 ft. power cord	P1045-10L	120V 30A	L5-30P	5-20R
24 Receptacle w/10 ft. power cord	P1046-10L	208V 20A	L6-20P	C13
[D] 24 Receptacle w/10 ft. power cord	P1047-10L	208V 30A	L6-30P	C13

P1000 Series Horizontal Power Distribution Units

DESCRIPTION	CAT. NO.	RATING	INPUT	OUTPUT
10 Receptacle w/12 ft. power cord	P1020-12S	120V 15A	5-15P	5-15R
[E] 10 Receptacle w/12 ft. power cord	P1021-12S	120V 20A	5-20P	5-20R
10 Receptacle w/12 ft. power cord	P1022-12L	120V 20A	L5-20P	5-20R
20 Receptacle w/12 ft. power cord	P1023-12L	120V 30A	L5-30P	5-20R
[F] 12 Receptacle w/12 ft. power cord	P1024-12L	120V 20A	L6-20P	C13
12 Receptacle w/12 ft. power cord	P1025-12L	120V 30A	L6-30P	C13



A (30"L x 1.8"W x 1.75"D)



E (1.75"L x 17.5"W x 4.5"D)



F (30"L x 1.8"W x 1.75"D)

SPECIFICATIONS AND FEATURES

4505 Series PDUs

- Mounts horizontally on 19" racks or cabinets
- 10 receptacles
- Resettable circuit breaker protects against overloading
- Most models available with locking plug
- 3-Year product warranty

P1000 Series

- Available in vertical zero-U or horizontal rack-mount styles
- Available in 120V or 208V options
- LED indicators for power and grounding/polarity
- All models feature circuit breaker protection to prevent current overloads

- 208V PDUs come with 2-pole circuit breakers for added safety
- 18AWG cold-rolled steel enclosure powder coated black
- Included mounting hardware allows attachment to most common cabinets and racks
- 120V/30A PDUs and all 208V PDUs come with DP-rated cords
- 3-Year product warranty

TESTING AND CODE COMPLIANCE

4505 Series

- Meets UL Standard 1363

P1000 Series

- Certified to UL 1363 or UL 60950-1, RoHS compliant



B (30"L x 1.8"W x 1.75"D)
C (48"L x 1.8"W x 1.75"D)
D (48"L x 2.19"W x 2"D)

Surge Protection Devices

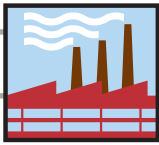

VERTICAL (ZERO-U) AND RACK MOUNT DEVICES

Commercial Grade Power Distribution Units



A

B

A (31.25"L x 1.75"W x 2.25"D
54.0"L x 1.75"W x 2.25"D

B (31.25"L x 1.75"W x 2.25"D
54.0"L x 1.75"W x 2.25"D
45.75"L x 1.75"W x 2.25"D

Metered Series Vertical Power Distribution Units

DESCRIPTION	CAT. NO.	INPUT RATING	INPUT	OUTPUT RATING	OUTPUT
[A] 12 Receptacle w/modular cord*	MV121-1D1	120V 20A		120V	5-20R
12 Receptacle w/10 ft. power cord	MV121-1B1	120V 30A	L5-30P	120V	5-20R
24 Receptacle w/Modular cord*	MV241-1D1	120V 20A		120V	5-20R
[B] 24 Receptacle w/10 ft. power cord	MV241-1B1	120V 30A	L5-30P	120V	5-20R
12 Receptacle w/10 ft. power cord	MV122-1C2	208V 30A	L6-30P	120V	C13
24 Receptacle w/10 ft. power cord	MV242-1C2	208V 30A	L6-30P	120V	C13
21 Receptacle w/10 ft. power cord	MV123-1E2	120/208V			
3-Phase 20A	L21-20P	120V	C13		

* 120V/20A PDUs need a Modular Power cord as shown in the "Accessories" below

Metered Series Horizontal Power Distribution Units

DESCRIPTION	CAT. NO.	INPUT RATING	INPUT	OUTPUT RATING	OUTPUT
[C] 10 Receptacle w/modular cord*	MH101-1D1	120V 20A		120V	5-20R
10 Receptacle w/10 ft. power cord	MH101-1B1	120V 30A	L5-30P	120V	5-20R
[D] 12 Receptacle w/10 ft. power cord	MH122-1C2	208V 30A	L6-30P	208V	C13

* 120V/20A PDUs need a Modular Power cord as shown in the "Accessories" below

Accessories

DESCRIPTION	CAT. NO.
[E] Modular Power Cord, C19 to 5-15P, 10ft.	PCORD-G10
Modular Power Cord, C19 to 5-20P, 10ft	PCORD-A10
Modular Power Cord, C19 to L5-20P, 10ft	PCORD-H10



C

D

C & D (1.75"L x 17.25"W x 5"D)



E

SPECIFICATIONS AND FEATURES

Metered Series PDU

- LED display provides visible warning when current draw is close to maximum capacity thus avoiding circuit overload
- True RMS current monitoring prevents overloads in high-density computing environments
- Included mounting hardware allows attachment to most common cabinets and racks
- Available in vertical zero-u and horizontal rack-mount styles
- Available in 120V and 208V options
- A wide variety of input and output options ensures the flexibility to adapt to varying power requirements

TESTING AND CODE COMPLIANCE

- Meets the UL 60950-1 requirements for branch circuit protection

VERTICAL (ZERO-U) AND RACK MOUNT DEVICES

Commercial Grade Power Distribution Units

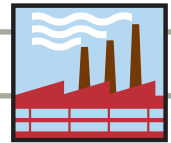

Switched Series Vertical Power Distribution Units

DESCRIPTION	CAT. NO.	INPUT RATING	INPUT	OUTPUT RATING	OUTPUT
[A] 16 Receptacle w/modular cord*	SV161-1D1	120V 20A		120V	5-20R
16 Receptacle w/10 ft. power cord	SV161-1B1	120V 30A	L5-30P	120V	5-20R
[B] 16 Receptacle w/10 ft. power cord	SV162-1C2	208V 30A	L6-30P	208V	C13

* 120V/20A PDUs need a Modular Power cord as shown in the "Accessories" below

Switched Series Horizontal Power Distribution Units

DESCRIPTION	CAT. NO.	INPUT RATING	INPUT	OUTPUT RATING	OUTPUT
[C] 8 Receptacle w/modular cord*	SH081-1D1	120V 20A		120V	5-20R
8 Receptacle w/10 ft. power cord	SH081-1B1	120V 30A	L5-30P	120V	5-20R
[D] 8 Receptacle w/10 ft. power cord	SH082-1C2	208V 30A	L6-30P	208V	C13

* 120V/20A PDUs need a Modular Power cord as shown in the "Accessories" below

Accessories

DESCRIPTION	CAT. NO.
[E] Modular Power Cord, C19 to 5-15P, 10ft.	PCORD-G10
Modular Power Cord, C19 to 5-20P, 10ft	PCORD-A10
Modular Power Cord, C19 to L5-20P, 10ft	PCORD-H10
[F] Temperature & Relative Humidity Probe, 10 ft.	TCORD-010



C & D (1.75"L x 17"W x 7"D)



E



F



A

B

A & B (63.5"L x 1.75"W x 2.25"D)

SPECIFICATIONS AND FEATURES

Switched Series PDUs

- Remote individual outlet management allows shut down of unused outlets and remote rebooting of attached equipment
- Full featured network management provided via Web, SNMP, and Telnet allows remote access, configuration and management
- Power sequencing prevents in-rush current and avoids circuit overload
- Provides SNMP alerts when power or environmental conditions exceed thresholds
- Firmware is easily upgraded via network download to installed units for future product enhancements
- External probe available separately for environmental monitoring

Surge Protection Devices



METER SOCKET SURGE ADAPTER and SECONDARY SURGE ARRESTER

Residential Grade Surge Protection Devices

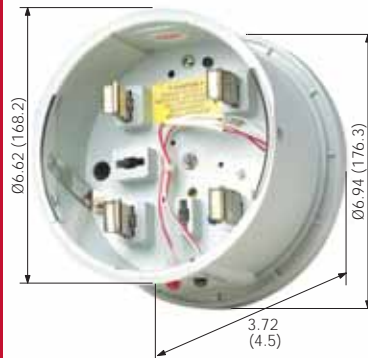

50240-MSA

Meter Socket Surge Adapter

DESCRIPTION	CAT. NO.	RATING
Meter Socket Surge Adapter w/LED's Only	50240-MSA	120/240, 200A-4 Jaw
Meter Socket Surge Adapter w/LED's and Audible Alarm (Switchable)	50240-ASA	120/240, 200A-4 Jaw
Meter Socket Surge Adapter w/LED's and 3Ø, 4-Wire Audible Alarm (Switchable)	50208-ASA	120/208, 200A-7 Jaw,

Secondary Surge Arresters

DESCRIPTION	CAT. NO.	MCOV	RATING
Secondary Surge Arrester	54175-SSA	150V AC*	120/240, 200A
Secondary Surge Arrester w/ LED's and Audible Alarm	55175-ASA	180V AC	120/240, 200A
Secondary Surge Arrester	55175-SSA	180V AC	120/240, 200A
Secondary Surge Arrester W/LEDs and Audible Alarm	55650-ASA	480V AC	277/480V AC, 480V Delta 347/600V AC, 600V Delta

*MOV's rated at 150V. UL assigns a derated MCOV of 132V for surge arrester applications



54175-SSA



55175-ASA

Surge Protection Devices

SPECIFICATIONS AND FEATURES

Meter Socket Surge Adapter

- Single 53mm MOV per line design (Line 1-Neutral, Line 2-Neutral) provides a higher energy capacity than smaller size (20mm) MOV's
- Superior to multiple small MOV configurations where the protection is only as good as the weakest MOV in the chain
- Rated for 65,000 peak amps maximum surge current
- Nominal clamping voltage per line: 800V
- Diagnostic LED's: Green indicates surge protection is active, Red indicates protection is no longer active

- Designed for 120/240 volt single-phase ringless or ring-type meters
- Rugged housing constructed of high-impact, non-conductive fiberglass-reinforced polycarbonate
- Available in popular jaw configurations, featuring spring-loaded, high-pressure copper-plated contacts for maximum conductivity

Secondary Surge Arresters

- Units come with 18" pigtail leads
- Constructed of high-impact, non-conductive, fiberglass-reinforced polycarbonate
- Compact design for easy installation

TESTING AND CODE COMPLIANCE

- Surge arrester performance tested to IEEE C62.11 (10,000 amps/4 x 10 µs), IEEE C62.11, C62.41 & C62.45 Category C Standards
- UL Listed Surge Arrester (465V Discharge voltage @ 1500 amps) (#E146315)
- CSA Certified (#LR94773)
- Backed by a Limited 10-Year Warranty

MATERIAL CHARACTERISTICS

Operating Temperature: -10°C to 60°C
Storage Temperature: -20°C to 85°C



General Purpose Plug-In's

DESCRIPTION	CAT. NO.	RATING
6-Outlet Plug-in w/Power & Circuit Monitor Lights UL 1449 (All Modes) 400V	3500-P	15A 120V
6-Outlet Plug-in w/two RJ11 Phone Jacks, 6 ft. Phone Cord, Power & Circuit Monitor Lights UL 1449 (All Modes) 400V	3500-PT	15A 120V
6-Outlet Plug-in w/two F Coax Cable Connectors, 4 ft. Coax Cable Power & Circuit Monitor Lights UL 1449 (All Modes) 400V	3500-PC	15A 120V

51110 Series Residential Surge Protection Panels

DESCRIPTION	CAT. NO.	RATING
1-Phase, 3-Wire & Ground	51110-1	120/240V AC
Multimedia Panel: 1-Phase, 3-Wire & Ground with two pairs of phone/fax/modem terminals and CATV/Satellite F-Connectors	51110-PTC	120/240V AC
Multimedia Panel: 1-Phase, 3-Wire & Ground with four pairs of phone/fax/modem terminals and CATV/Satellite F-Connectors	51110-CT8	120/240V AC

51120 Series Surge Protection Panels

DESCRIPTION	CAT. NO.	RATING
1-Phase, 3-Wire & Ground	51120-1	120/240V AC
3-Phase WYE, 4-Wire & Ground	51120-3	120/208V AC
1-Phase, 3-Wire & Ground; NEMA 3R Outdoor Enclosure	51120-3R	120/240V AC
1-Phase, 3-Wire & Ground; with RJ11 Telephone and F-Connector CATV/Satellite Modules	51120-PTC	120/240V AC

Surge Protection Panel Performance Specifications

CAT. NO.	MCOV	UL 1449 (2nd Ed) IMPULSE (6kV/500A)		MAX. SURGE CURRENT (Test w/8x20µs wave)
		L-N: 400V	L-L: 800V	
51110-1	150 V AC	L-N: 400V	L-L: 800V	L-N: 80kA
51110-PTC	150V AC	L-N: 400V	L-L: 800V	L-N: 80kA
51110-CT8	150V AC	L-N: 400V	L-L: 800V	L-N: 80kA
51120-1	150V AC	L-N: 500V	L-L: 800V	L-N: 50kA
51120-3	150V AC	L-N: 500V	L-L: 800V	L-N: 50kA
51120-3R	180V AC	L-N: 800V		L-N: 50kA
51120-PTC	150V AC	L-N: 500V	L-L: 800V	L-N: 80kA



3500-PT



51110-PTC



51120-1

SPECIFICATIONS AND FEATURES

General Purpose Plug-Ins

- RFI filtering
- 3-stage protection: hot-to-neutral, hot-to-ground, neutral-to-ground
- Built-in fuse protection
- Monitor lights ON indicates circuit is powered and protected

51110 Series

- 51110-PTC provides protection for 2 telco lines and 2 coax feeds
- 51110-CT8 provides protection for 4 telco lines and 2 coax feeds
- Compatible with Decora Home Controls (see Section B)

51120 Series

- Standard J-Box metal enclosures with pre-punched knockouts; 51120-3R features NEMA 3R enclosure
- Compatible with Decora Home Controls (see Section B)

TESTING AND CODE COMPLIANCE

- UL Listed 1449 Edition 2.5
- Meets ANSI/IEEE C62.41 & C62.45 requirements for Categories A, B & C
- Backed by a Limited 10-Year Warranty
- 51110 Series: CUL/US Certified
- 51120 Series: UL Listed and CSA Certified



MODULAR SURGE PROTECTION STRIPS

Residential Grade Surge Protection Devices



3950-BKT



Snap-In Surge Protection Modules

Snap-In Modules for Structured Media Enclosure Surge Module Bracket

Leviton's snap-in surge protective modules provide customized surge protection for all low-voltage communication and data lines in the Structured Media Enclosure. All Series 5950 modules can snap-in to the Cat. No. 3950-BKT Surge Module Bracket. The bracket, allows you to add and change modules to fit specific protection needs. Choose from a selection of protection modules for Digital Satellite Systems, Ethernet systems, Cable TV, Telephone/Fax/Modem and DSL/ADSL equipment. All devices attached to the modules are covered under the Leviton \$50,000 Connected Equipment Warranty.

Snap-In Modules

SPECIFICATION	CAT. NO.
Satellite System/Cable TV Protection Module—4 Standard F-connectors. 3-Amp fuse for over-current. Max. line voltage: 75V DC. Breakdown Voltage Range: 70.4-110 Volts/Sec	Beige—5951-SA Gray—5951-SAT Ice—5951-SAC
Ethernet Protection Module (10 Base-T Applications)—Two RJ45 connectors to protect two pair of transmit/receive lines. 10-Amp automatic Resettable PTC fuses. Max. operating voltage: 16.6V DC. Breakdown Voltage Range: 2.62-19.2 Volts/Sec	Beige—5952-ET Gray—5952-ETH Ice—5952-ETC
Cable TV System Protection Module—Two Standard F-type connectors. 3-Amp fuse for over-current. Max. line voltage: 75V DC. Breakdown Voltage Range: 70.4-110 Volts/Sec	Beige—5953-PC Gray—5953-PCG Ice—5953-PCC
Telephone/Fax/Modem Protection Module—Three RJ11, 4-wire/2-pair connectors. 3-Position splitter allows for connection to a common line. 3-Amp fuse for over-current protection. Max. operating voltage: 150V rms (including ring voltage). Breakdown Voltage Range: 162-331 Volts/Sec	Beige—5954-AT4 Gray—5954-PT4 Ice—5954-CT4
DSL/ADSL Subscriber Equipment Protection Module—Three RJ11, 4-wire/2pair connectors. 3-Amp fuse for over-current protection. Max. operating voltage: 150V rms (including ring voltage). Breakdown Voltage Range: 162-331 Volts/Sec	Beige—5955-DT Gray—5955-DTG Ice—5955-DTC
Cat. 5 Ethernet Module Two RJ45 Connectors with Ground Pin for Ethernet - Cat. 5	Beige—5957-0CS Grey—5957-C5G
Two Line Telephone Module One Input, One Output RJ11 Connector for 4-Wire POTS	Beige—5958-AT4 Grey—5958-PT4
Four Line Telephone Module One Input, One Output RJ45 Connector for 8-Wire POTS	Beige—5959-BT8 Grey—5959-GT8
Surge Module Bracket	3950-BKT

TESTING AND CODE COMPLIANCE

CAT. NO.	MCOV (VDC)	CLAMPING VOLTAGE (VDC)	TESTED TO	MEET STANDARDS
5951	60	388	UL 452	ANSI/IEEE C-62.36
5952	16.6	23	UL497B	
5953	60	388	UL452	CSA (#LR-94773)
5954	288	715	UL497A	
5955	205	210	UL497A	
5957	16.6	23	UL497B	
5958	288	715	UL497A	
5959	288	715	UL497A	

SPECIFICATIONS AND FEATURES

- Interchangeable modules accommodate changing surge protection needs
- All modules easily snap in to the Cat. No. 3950 Surge Module Bracket
- User-friendly design—no wiring required
- Telephone/Fax/Modem Module acts as a splitter, allowing the connection of two devices



Commercial Grade Uninterruptible Power Supplies (UPS's)

Uninterruptible Power Supplies (UPS's)

Leviton's UPS product line offers the latest technology and features available to help prevent losses and costly downtime associated with outages, sags and blackouts for computers, data and telecom and other sensitive loads.

Sine Series Uninterruptible Power Supply (UPS's)

DESCRIPTION	OUTPUT CAPACITY	FOOTPRINT	OUTLET QTY & TYPE	TYPICAL BACK-UP TIME		CAT. NO.
				FULL LOAD	HALF LOAD	
Line-Interactive, True Sine Wave	800VA/560W	Tower	(4) 5-15R	5 Min	14 Min	U0800-SK
Line-Interactive, True Sine Wave	1000VA/700W	Tower	(4) 5-15R	5 Min	14 Min	U1000-SK
Line-Interactive, True Sine Wave	1500VA/1050W	Tower	(6) 5-15R	5 Min	19 Min	U1500-SK
Line-Interactive, True Sine Wave	2000VA/1400W	Tower	(6) 5-15R	10 Min	47 Min	U2000-SK
Line-Interactive, True Sine Wave	3000VA/2100W	Tower	(6) 5-15R	10 Min	47 Min	U3000-SK
Line-Interactive, True Sine Wave	800VA/560W	Rack-mount, 2U	(4) 5-15R	10 Min	20 Min	U0800-SRM
Line-Interactive, True Sine Wave	1500VA/1050W	Rack-mount, 2U	(4) 5-15R	5 Min	19 Min	U1500-SRM
Line-Interactive, True Sine Wave	3000VA/2100W	Rack-mount, 2U	(6) 5-15R	10 Min	47 Min	U3000-SRM

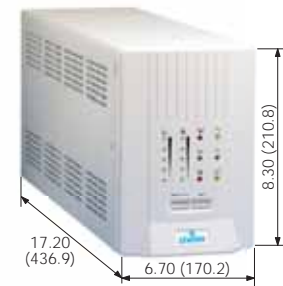

U1500-SK



U3000-VNL



U3000-VRM

On-Line Series Uninterruptible Power Supply (UPS's)

DESCRIPTION	OUTPUT CAPACITY	FOOTPRINT	OUTLET QTY & TYPE	TYPICAL BACK-UP TIME		CAT. NO.
				FULL LOAD	HALF LOAD	
On-Line, Pure Sine Wave	700VA / 490W	Tower	(6) 5-15R	7 Min	15 Min	U0700-VNL
On-Line, Pure Sine Wave	1000VA / 700W	Tower	(6) 5-15R	7 Min	15 Min	U1000-VNL
On-Line, Pure Sine Wave	1500VA / 1050W	Tower	(6) 5-15R	7 Min	11 Min	U1500-VNL
On-Line, Pure Sine Wave	2000VA / 1400W	Tower	(6) 5-15R	7 Min	15 Min	U2000-VNL
On-Line, Pure Sine Wave	3000VA / 2100W	Tower	(6) 5-15R	6 Min	15 Min	U3000-VNL
On-Line, Pure Sine Wave	700VA / 490W	Rack-mount, 2U	(6) 5-15R	7 Min	15 Min	U0700-VRM
On-Line, Pure Sine Wave	1000VA / 700W	Rack-mount, 2U	(6) 5-15R	7 Min	15 Min	U1000-VRM
On-Line, Pure Sine Wave	1500VA / 1050W	Rack-mount, 2U	(6) 5-15R	7 Min	11 Min	U1500-VRM
On-Line, Pure Sine Wave	2000VA / 1400W	Rack-mount, 2U	(6) 5-15R	7 Min	15 Min	U2000-VRM
On-Line, Pure Sine Wave	3000VA / 2100W	Rack-mount, 2U	(6) 5-15R	6 Min	15 Min	U3000-VRM
On-Line, Pure Sine Wave	1000VA / 700W	Rack-mount, 1U	(6) 5-15R	5 Min	11 Min	U1000-DRM

SPECIFICATIONS AND FEATURES

Sine Series Uninterruptible Power Supply

- Line-Interactive technology provides rapid transfer time (<4ms) and voltage regulation for minor sags and swells
- True sine-wave output less than 3% THD
- Selectable output voltage: 100V, 110V, 115V, 120V, or 127V
- Advanced Battery Management (ABM) extends battery life by up to 50%
- Included UPSMON software provides monitoring and control capability
- Energy-saving sleep mode reduces power consumption
- AC Surge Protection and Noise Filtering
- User-replaceable, sealed, maintenance-free lead acid batteries

On-Line Series Uninterruptible Power Supply

- On-Line Double Conversion technology with zero transfer time
- Provides true sine-wave output at less than 3% THD
- LED Display gives "Minutes Remaining" indicator based on actual load
- Selectable output voltage: 100V, 110V, 115V, 120V or 127V
- Advanced Battery Management (ABM) extends battery life by up to 50%
- Optional Extended Battery Packs provide additional back up time
- Included UPSMON software provides monitoring and control capability
- Energy-saving sleep mode reduces power consumption
- AC Surge Protection and Noise Filtering

- User-replaceable, sealed, maintenance-free lead acid batteries
- Includes interface for Emergency Power Off (EPO)

TESTING AND CODE COMPLIANCE

Sine Series Uninterruptible Power Supply

- UL 1778 & cUL Listed
- FCC compliant
- ISO 9001 Certified
- 2-Year Limited Product Warranty (covers parts, labor, and battery)
- 2-Year Limited Connected-Equipment Warranty

On-Line Series Uninterruptible Power Supply

- UL 1778 & cUL Listed
- 2-Year Limited Product Warranty (covers parts, labor, and battery)
- 2-Year Limited Connected-Equipment Warranty



POWER QUALITY

Commercial Grade Uninterruptible Power Supplies (UPS's)



U2200-AKP



U0500-AKP



U0600-AKP Face



U0600-AKP Back



U0625-AKP Face



U0625-AKP Back

Pro, Slim and Strip Series Uninterruptible Power Supplies (UPS's)

DESCRIPTION	OUTPUT CAPACITY	FOOTPRINT	OUTLET QTY & TYPE	TYPICAL BACK-UP TIME		CAT. NO.
				FULL LOAD	HALF LOAD	
Line-Interactive, Simulated Sine Wave	425VA / 297W	Tower	(6) 5-15R	4 Min	17 Min	U0425-AKP
Line-Interactive, Simulated Sine Wave	625VA / 437W	Tower	(6) 5-15R	4 Min	11 Min	U0625-AKP
Line-Interactive, Simulated Sine Wave	825VA / 578W	Tower	(6) 5-15R	6 Min	20 Min	U0825-AKP
Line-Interactive, Simulated Sine Wave	1000VA / 700W	Tower	(5) 5-15R	4 Min	13 Min	U1000-AKP
Line-Interactive, Simulated Sine Wave	1500VA / 1050W	Tower	(6) 5-15R	5 Min	18 Min	U1500-AKP
Line-Interactive, Simulated Sine Wave	2200VA / 1540W	Tower	(6) 5-15R	5 Min	22 Min	U2200-AKP
Line-Interactive, Simulated Sine Wave	500VA / 350W	Desktop	(5) 5-15R	5 Min	20 Min	U0500-AKP
Line-Interactive, Simulated Sine Wave	600VA / 420W	Rack-mount, 1U	(5) 5-15R	7 Min	22 Min	U0600-ARM

SPECIFICATIONS AND FEATURES

- Line-Interactive technology provides rapid transfer time (<4ms) and voltage regulation for minor sags and swells
- Simulated sine-wave output
- Selectable output voltage: 100V, 110V, 115V, 120V or 127V
- Advanced Battery Management (ABM) extends battery life by up to 50%
- Included UPSMON software provides monitoring and control capability
- Energy-saving sleep mode reduces power consumption
- AC Surge Protection and Noise Filtering
- User-replaceable, sealed, maintenance-free lead acid batteries

TESTING AND CODE COMPLIANCE

- UL 1778 & cUL Listed
- FCC compliant
- ISO 9001 Certified
- 2-Year Limited Product Warranty (covers parts, labor, and battery)
- 2-Year Limited Connected-Equipment Warranty

Lampholders

INDEX

Overview	S2
Incandescent Lampholders	
Outlet Box, Keyless and Pull Chain	S3, S4
Metal Shell and Interiors	S5
Phenolic Cap and Shell	S5
Multi-Lampholder Clusters	S6
Porcelain Par Connectors	S6
Bayonet Socket-Single Contact	S6
Porcelain Mogul Base	S7
Socket Extensions	S8
Appliance Heating Receptacle	S8
Porcelain and Phenolic	S8
Porcelain Snap-In	S9
Porcelain Keyless-Commercial Units	S9
Porcelain Keyless Fixture	
Single Circuit-Medium Base	S9
Porcelain Keyless Medium Base-Side Angle Mounted	S10
Phenolic Keyless Fixture-Medium Base	S10
Lampholders for Recessed Single Contact Lamps	S10
Lampholders for Metal Halide and Quartz Halogen Lamps	S10
Candle Sockets	S10-S12
Fluorescent Lampholders	
Compact Fluorescent Ceiling Lampholder	S4
Linear Fluorescent	S13-S17
Medium Bi-Pin	S13-S15
High Output	S13, S14
Slimline	S13, S14
Miniature	S16
T-8 to T-5 Adapter	S16
4-Pin Long Twin Tube with 2G11 Base	S17
Lamp Support Clips for Long Twin Tube	S18
Compact Fluorescent Lampholders (CFL's)	S19-S22

For a complete listing of OEM products, see the OEM-100 Catalog.



LAMP HOLDERS

A VARIETY OF INCANDESCENT AND FLUORESCENT STYLES IN A RANGE OF RATINGS AND MATERIALS

Leviton offers a complete selection of outlet box, incandescent, fluorescent and specialty lampholders, in various ratings and materials. The following pages offer a variety of types and styles.

PORCELAIN MEDIUM BASE LAMP HOLDER

With a choice of mounting and wiring options, these lampholders are ideal for a wide range of commercial and residential incandescent fixtures.

Cat. No. 8101 shown



OUTLET BOX LAMP HOLDER

Available in keyless, pull chain and outlet models, all featuring easy twist-lock mounting.

Cat. No. 8827-CW4 shown



LONG TWIN-TUBE 2G11 BASE LAMP HOLDERS

Choice of mounting and wiring options to reduce fixture assembly time.

Cat. No. 13453 shown



FLUORESCENT LAMP HOLDER FOR MEDIUM BI-PIN LAMPS

Features Lamp-Lock design for quick relamping. Models dedicated for energy-efficient T-8 lamps available.

Cat. No. 13653-WP shown



CANDELABRA BASE LAMP HOLDER

Keyless lampholders for chandeliers and other fixtures, featuring various hickeys or double snap-in spring clips.

Cat. No. 10014-800 shown



PORCELAIN MOGUL BASE LAMP HOLDER

A complete selection of high-quality porcelain moguls with leads or screw terminals.

Pulse-rated models available. Cat. No. 8756 shown

COMPACT FLUORESCENT LAMP HOLDERS

Available for all popular 2-pin and 4-pin lamp bases, with a variety of mounting options. Color-coded for easy wattage identification.

Cat. No. 26725-426 shown



METAL SHELL LAMP HOLDER

Medium base, electrolier lampholders available in a variety of attractive finishes. Cat. No. 9346-PG shown



Outlet Box Lampholders

660 WATT 600V One-Piece Keyless Top Wired

DESCRIPTION/ TERMINALS	WHITE UREA CAT. NO.	OD	FITS BOX SIZE
2 Terminal Screws	8829-CW1	4 1/2"	3 1/4" or 4"
6" Pigtail Leads	8829-CW2	4 1/2"	3 1/4" or 4"
4 Terminal Screws	8829-CW4	4 1/2"	3 1/4" or 4"

660 WATT 250V One-Piece Pull Chain Top Wired

DESCRIPTION/ TERMINALS	WHITE UREA CAT. NO.	OD	FITS BOX SIZE
2 Terminal Screws	8827-CW1	4 1/2"	3 1/4" or 4"
6" Pigtail Leads	8827-CW2	4 1/2"	3 1/4" or 4"
2 Terminal Screws with Captive Clamps	8827-CW4	4 1/2"	3 1/4" or 4"

660 WATT 250V One-Piece Keyless Top Wired

DESCRIPTION/ TERMINALS	PORCELAIN CAT. NO.	OD	FITS BOX SIZE
2 Screws★	9874	3 3/4"	3 1/4"
2 Screws, no cage lip	9875	4 1/2"	3 1/4" or 4"
6" Pigtail Leads, no cage lip	9875-2	4 1/2"	3 1/4" or 4"
4 Screws	49875	4 1/2"	3 1/4" or 4"
4 Quickwire Push-In★	9883	4 1/2"	3 1/4" or 4"

660 WATT 250V One-Piece Pull Chain Top Wired

DESCRIPTION/ TERMINALS	PORCELAIN CAT. NO.	OD	FITS BOX SIZE
2 Screws	29816-C	4 1/2"	3 1/4" or 4"
6" Pigtail Leads	29816-C2	4 1/2"	3 1/4" or 4"
2 Screws w/Captive Clamps for 4-Wire Terminals	49816-C	4 1/2"	3 1/4" or 4"
Interior Mechanism for 2-Piece Outlet Box Lampholders★	29816-CM*		

*When existing stock is depleted, this item will be DISCONTINUED.

CSA Certified except where indicated by★



8827-CW2



9875-2



29816-C

SPECIFICATIONS AND FEATURES

- Twist-lock mounting
- Pull chain models have bell at end of chain on 3 foot cord
- Medium base

TESTING AND CODE COMPLIANCE

- UL Listed (File #E-3810)
- CSA Certified (File #LR-1863)



660W 125V — 15 AMP-125V • 120W 250V

Medium Base Incandescent and GU24 Base Fluorescent Lampholders

Incandescent and Fluorescent Lampholders



9716-C



9726-C



9860

Outlet Box Lampholders

660 WATT 125V Lampholder Outlet 15 AMP-125V One-Piece Pull Chain Side Wired ^{UL}

DESCRIPTION/ TERMINALS	PORCELAIN	OD	FITS BOX SIZE	NEMA CONFIG.
2 Screws★	9716-C	4 1/2"	3 1/4" or 4"	1-15R

660 WATT 125V Lampholder Outlet 15 AMP-125V One-Piece Pull Chain Top Wired ^{UL} ^{CS}

DESCRIPTION/ TERMINALS	PORCELAIN	OD	FITS BOX SIZE	NEMA CONFIG.
2 Screws	9726-C	4 1/2"	3 1/4" or 4"	5-15R

Ball and Chain Accessories

DESCRIPTION	BRASS FINISH	NICKEL FINISH
No. 6 Chain; 1/8" Dia. Balls	18302-1	18302-1N



18302-1N

DESCRIPTION	BRASS FINISH	NICKEL FINISH
Connector for No. 6 Chain	9820	9820-N



9820

DESCRIPTION	BRASS FINISH	NICKEL FINISH
Chain, 3 feet long, End Bell and Connector; use as extension or replacement; 1/25" Dia. Balls	6	6-N



6

DESCRIPTION	BROWN	WHITE
Insulating Link; Thermoplastic 1 3/4" Total Length	9839	9839-I



9839-I

CSA Certified except where indicated by★

GU24 Base Fluorescent Lampholder

Energy-Saving Keyless Bi-Pin Compact Fluorescent Ceiling Lampholder for Closets and Closed Spaces 120 WATT 250V AC ^{cULus}

DESCRIPTION	CAT. NO.
Lampholder with pigtail leads and knockout holes for multiple configurations	9860
Lampholder with pigtail leads and knockout holes for multiple configurations; with 13W Bulb	9860-B
Lampholder with pigtail leads and knockout holes for multiple configurations; with 13W Bulb and Lamp Guard	9860-BL
Lamp Guard	9860-L
13W Replacement Lamp	9865

Note: Not intended for use with incandescent lamps, dimmers or occupancy sensors.

SPECIFICATIONS AND FEATURES

Outlet Box Incandescent Lampholders

- 2-Pole, 2-Wire Outlet; 2-Pole, 3-Wire Outlet
- Twist-lock mounting
- Pull chain models have bell at end of chain on 3 foot cord

Fluorescent Ceiling Lampholder*

- Installs indoors in closets, garages, basements, utility rooms and attics
- Reduces risk of fire in closets and closed spaces
- Built of tough thermoplastic
- Use with a standard wall switch
- Pigtail leads provide easy installation

- Knockout holes on box enable multiple configurations
- * Patent pending

TESTING AND CODE COMPLIANCE

Outlet Box Incandescent Lampholders

- UL Listed (File #E-3810; E-7516)
- CSA Certified (File #LR-1863)

Fluorescent Ceiling Lampholder

- cULus Listed
- Meets NFPA 70, NEC Section 410.8B Requirements and Canadian Electric Code Requirements for use in closets with lamp guard
- Backed by a Limited Two-Year Warranty



To learn more about Leviton's outstanding offering of devices visit our Website at: www.leviton.com



Metal Shell Lampholders

Medium Base, Choice of Finishes*

DESCRIPTION	CAT. NO.	RATING
Key—Electrolier; Single Circuit; 1/8 IPS Tapped Bushing w/Set Screw	9346	250W 250V
Removable Turn Knob—Electrolier; Single Circuit; 1/8 IPS Tapped Bushing w/Set Screw	10083-16	250W 250V
Removable Turn Knob—Electrolier; 2-Circuit; 3 Terminal; 1/8 IPS Tapped Bushing less Set Screw	7070	250W 250V
Removable Turn Knob—Electrolier; 2-Circuit; 1/8 IPS Tapped Bushing	7090	250W 250V
Pull Chain—Electrolier; Single Circuit; 1/8 IPS Tapped Bushing w/Set Screws	19980	660W 250V
Push Through—Electrolier; Single Circuit; 1/8 IPS Tapped Bushing w/Set Screw	7080	660W 250V
Keyless—Electrolier; Single Circuit; 1/8 IPS Tapped Bushing w/Set Screw	8004	660W 250V
Keyless—Short Electrolier; Single Circuit; 1/8 IPS Tapped Bushing w/Set Screw	9347	660W 250V

Metal Shell Lampholders

Interiors — Medium Base, Phenolic Body, Aluminum Screw Shell†

LAMPHOLDER	CAT. NO. INTERIOR
19980	19980-M†
10083-16	10083-M†
7070	7070-M†
7090	7090-M†
9346	9346-M†
6098	7080-M†
8004	8004-M†

Brown Phenolic Cap and Shell Lampholders

Two-Piece, Medium Base Electrolier Interiors

DESCRIPTION	CAT. NO.	RATING	INTERIORS†
Pull Cord (nylon); 2-Circuit, 1/8 IPS Threaded Cap w/Set Screw	97092	250W 250V	7092-2M†
Push-Through; 1/8 IPS Threaded Cap w/Set Screw	95110	660W 250V	7080-M†
Keyless; 1/8 IPS Threaded Cap w/Set Screw	95080	660W 250V	8004-M†

†UL Recognized component.

NOM Certified except where indicated by†.

SPECIFICATIONS AND FEATURES

- Phenolic interior with aluminum screwshell
- 2-Circuit lampholders operate dual-filament lamps in sequence of Low-Medium-High-Off
- Cat. No. 7070 (2-Circuit, 3-Terminal) is wired in series with keyless lampholder

TESTING AND CODE COMPLIANCE

- UL Listed (File #E-3810)
- CSA Certified (File #LR-1863)
- NOM Certified (File #057), except interiors

***FINISH**

A suffix must be added to each basic catalog number to indicate the finish desired. For Polished Gilt/Brass finish, add -PG; for Unfinished Aluminum, add -AL; for Polished Aluminum, add -NI (finishes on aluminum). For bright dip/Brass, add -BR (finish on brass). CONSULT LEVITON REPRESENTATIVE FOR AVAILABILITY OF FINISHES.

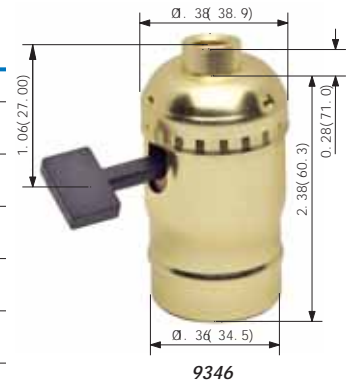

9346



7090

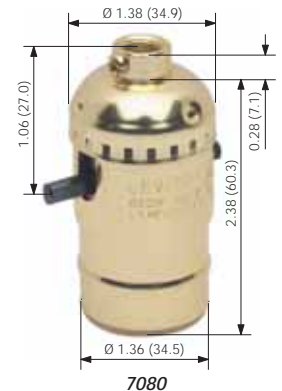

7080



95110



660W 250V

Medium, Candelabra Base, Par Connectors—Incandescent Lampholders

Incandescent Lampholders

Medium Base Multi-Lampholder Clusters

Treated Aluminum Screw Shell

DESCRIPTION	CAT. NO.	RATING	T	TA	B	BA	OAH T+B
2-Light Twin 1/8 IPS Male Top Bracket Only	4020-A3A	660W 250V	1 ⁵ / ₁₆	5 ¹ / ₁₆	—	—	—
2-Light Twin 1/8 IPS Male (top & bottom)	4015-D4F	660W 250V	1 ¹¹ / ₁₆	5 ¹ / ₁₆	1 ¹¹ / ₁₆	7 ¹ / ₁₆	3 ³ / ₈
2-Light Offset 1/8 IPS Male (top & bottom)	4032-E5F	660W 250V	1 ³ / ₄	5 ¹ / ₁₆	1 ³ / ₄	7 ¹ / ₁₆	3 ¹¹ / ₁₆
3-Light 1/8 IPS Male (top & bottom)†	341-D4U	660W 250V	1 ³ / ₄	1 ¹ / ₂	1 ³ / ₄	7 ¹ / ₁₆	3 ¹ / ₂
2-Light Offset 1/8 IPS Male (top); Pullchain Switch (bottom) with 1/2" usable shank★	4034-F5A	660W 250V 1A 125V T	1 ³ / ₄	5 ¹ / ₁₆	1 ¹⁵ / ₁₆	1 ¹ / ₂	3 ³ / ₄ †
2-Light Twin 1/8 IPS Male (top); Pullchain Switch (bottom) 3/8" usable shank★	4017-D2F	660W 250V 1A 125V T	1 ¹ / ₁₆	5 ¹ / ₁₆	1 ¹¹ / ₁₆	3 ³ / ₈	2 ¹³ / ₁₆ †

+Includes nut.

Leads are No. 18 AWG 105°C plastic; 9" long, stripped 3/4"; untinned and pulled through top bracket.

Porcelain Par Connectors

DESCRIPTION	CAT. NO.	RATING
Medium Base for PAR #46 and #38 lamps. Leads are No. 14 AWG 200°C SEW-2 Silicone Rubber Insulated; 18" Long, Stripped 3/4". Others available on inquiry‡	368-1	660W 125V
Mogul Base for PAR #56 and #64 lamps. Leads are No. 14 150°C SEWF-2; 18" Long, Stripped 3/4". Others available upon request	357-8	1000W 125V

Bayonet Socket — Single Contact

Candelabra Base

DESCRIPTION	CAT. NO.	RATING
Flat Bracket. Leads are No. 18 AWG, 105°C Plastic; 6" Long, Stripped 3/4" (one black, one white)★‡	905	Low Voltage

All devices are UL Listed except Cat. No. 905. Also CSA Certified except where indicated by★, and NOM Certified except where indicated by‡.



4034-F5A



341-D4U



4032-E5F

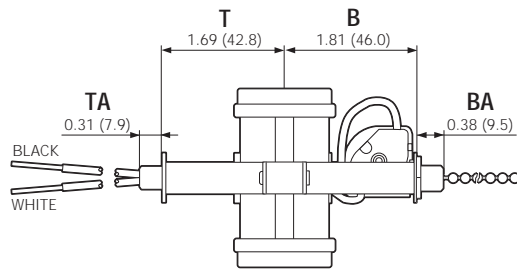

4017-D2F

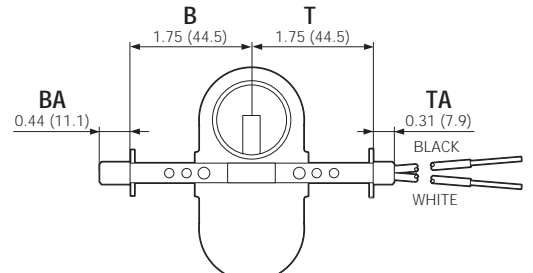

4032-E5F

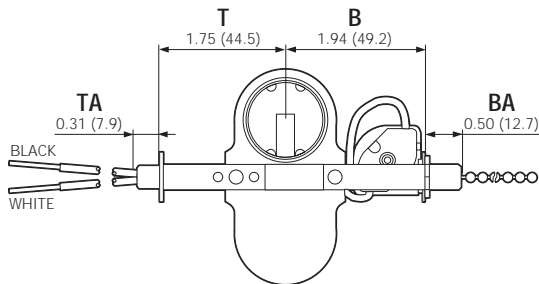

4034-F5A

SPECIFICATIONS AND FEATURES

- Pull chain models have bell at end of chain on 3 foot cord
- Medium and Candelabra bases
- Par connectors have white, unglazed porcelain body

TESTING AND CODE COMPLIANCE

- UL Listed (File #E-13405, E-3810)
- CSA Certified (File #LR-5863, LR-1863)
- NOM Certified (File #057)



To learn more about Leviton's outstanding offering of devices visit our Website at: www.leviton.com



Porcelain Mogul Base Lampholders

With Leads*

DESCRIPTION	CAT. NO.	RATING	OD	OH
Keyless, Single Circuit. For high pressure sodium lamps up to 1000 watts. 8-32 Mounting Screws on 1 3/8" Centers	8746	1500W 600V 5KV Pulse-rated	2 1/8	3 1/64
Keyless, Single Circuit. Position-oriented. For Super Metalarc HID lamps. 8-32 Mounting Screws on 1 3/8" Centers	8750	1500W 600V	2 5/32	2 39/64
Keyless, Single Circuit. For high-pressure sodium lamps up to 400 watts. 8-32 Mounting Screws on 1 3/8" Centers	8756	1500W 600V 4KV Pulse-rated	2 5/32	2 39/64
Low Pressure Sodium. For use with all single-end bayonet base low pressure sodium lamps★‡	8806	660W 1000V	1 3/8	1 5/8
Designed for Open-Fixture Shielded Metal Halide Lamps. Complies with NFPA 70-2005 for Open-Rated Fixtures. 8-32 Mounting Screws on 1 3/8" Centers	8751	1500W 600V, 4KV Pulse Rated	2 5/32	2 39/64

* Leads types, lengths and ratings vary with the end use applications. Standard leads as well as variations available on inquiry.

Screw Terminals

DESCRIPTION	CAT. NO.	RATING	OD	OH
Keyless; 2-Piece; Single-Pole★	8765	1500W 600V	2 5/16	2 23/64
Keyless; Single Circuit with 8-32 Lock Nuts on 1 3/8" Centers. Die-cast caps available upon request	8694	1500W 600V	2 5/32	2 39/64

CSA Certified except where indicated by★, and NOM Certified except where indicated by‡.



8746



8750



8694

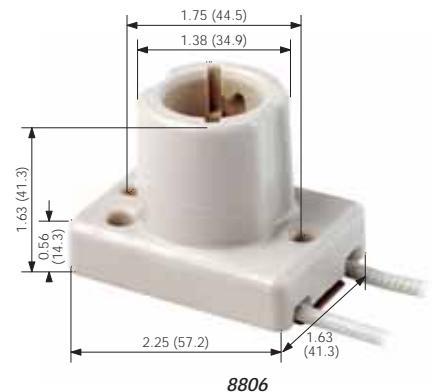

8806

SPECIFICATIONS AND FEATURES

- Cat. No. 8746 – Porcelain body gray glazed with ceramic arc shield; Cat. No. 8750 – Porcelain body yellow glazed; Cat. No. 8751 – Porcelain body pink glazed
- All other moguls listed have white glazed porcelain body
- Copper-alloy nickel-plated screw shell

TESTING AND CODE COMPLIANCE

- UL Listed (File #E-13402)
- CSA Certified (File #LR-1863)
- NOM Certified (File #057)
- Cat. No. 8751 complies with NFPA 70-2005 requirements for open-rated fixtures

Incandescent Lampholders



660W 250V • 1500W 600V

Medium, Mogul and Candelabra Base Incandescent Lampholders



2005



19062



9880

Socket Extensions — Single Circuit

Medium-Medium

DESCRIPTION	CAT. NO.	RATING
2-Piece Porcelain; Mounting Hole 1 ³ / ₈ " Dia. Extension 1 ¹ / ₄ "**	2004	660W 250V
1-Piece Porcelain; Slotted Mounting Hole 1 ³ / ₈ " Dia. Extension 1 ¹ / ₄ "**	2005	660W 250V
1-Piece Phenolic. Extension 1 ³ / ₁₆ "***	2006	660W 250V

*To be used with porcelain sockets only

**To be used with phenolic sockets only

Mogul-Mogul

DESCRIPTION	CAT. NO.	RATING
1-Piece Porcelain. Extension 2 ³ / ₈ "†	8647	1500W 600V

Socket Adapter

Mogul-To-Porcelain Medium

DESCRIPTION	CAT. NO.	RATING
1-piece. Meets Fed. Spec. W-L-142a†	8681	660W 250V
Same as above, except 4 KV Pulse-Rated‡	8681-400	660W 250V 4 KV Pulse-Rated

Appliance Heating Receptacle

Porcelain Two-Piece

DESCRIPTION	CAT. NO.	RATING
2-piece Heating Receptacle. Gasket Furnished‡	8110	660W 250V

Porcelain and Phenolic Lampholders

Pony Cleat Type

DESCRIPTION	CAT. NO.	RATING	OD	OH	C
Candelabra Base; Plastic. Not UL Listed★†	10028	75W 125V	1 ⁷ / ₁₆	7/8	1 ¹ / ₈
Miniature Base, Plastic. Not UL Listed★†	10020	75W 125V	1 ⁵ / ₁₆	7/8	3 ¹ / ₃₂
Medium Base, Phenolic	9063	660W 250V	1 ⁷ / ₈	1 ¹ / ₂	1 ¹⁵ / ₁₆
Medium Base, Porcelain	19062	660W 250V	1 ⁷ / ₈	1 ¹ / ₂	1 ¹⁵ / ₁₆

Surface Type

DESCRIPTION	CAT. NO.	RATING	OD	OH	C
Medium Base; Porcelain; Low 2-Piece	9880	660W 250V	2 ⁵ / ₁₆	1 ¹ / ₂	1 ³ / ₈
Medium Base; Porcelain; High 2-Piece★†	9882	660W 250V	2 ⁵ / ₁₆	1 ⁷ / ₈	1 ³ / ₈

CSA Certified except where indicated by★, and NOM Certified except where indicated by†.

SPECIFICATIONS AND FEATURES

- Medium-to-Medium Extenders available in phenolic and porcelain
- Pony Cleat Receptacles have open wiring terminals
- Two-piece surface-type lampholders have concealed wiring terminals with wireways for top and continuous wiring

TESTING AND CODE COMPLIANCE

- UL Listed (File #E-3810; E-13396)
- CSA Certified (File #LR-1863)
- NOM Certified (File #057)



Porcelain Snap-In Lampholders — Medium Base

Screw Terminals

DESCRIPTION	CAT. NO.	RATING	OD	OH
1-Piece, Front Mounted. 1/4" Shoulder. Panel Thickness: .025 – .062"	8880	660W 250V	1 11/16	1 1/2
1-Piece, Front Mounted. Shallow Back. Panel Thickness: .030 – .062"	8875	660W 250V	1 11/16	1 11/16

Porcelain Keyless Lampholders Commercial Units — Medium Base

Single Circuit Screw Terminals

DESCRIPTION	CAT. NO.	RATING	OD	OH
Straight Body with Cap. Screw Terminals.	10045	660W 250V	1 1/2	2 1/8
Beaded Body for 1 1/2" Clamp Style Shadeholder with Cap. Screw Terminals.	10065	660W 250V	Body 1 1/2	2 1/8 Bead 1 5/8
Adjustable Glass Retaining Ring with Cap and Ring Nut. Screw Terminals.	20070	660W 250V	2 1/4 ringnut	—
Straight Body with Leads. No. 18 AWG 105°C Plastic; 9" Long, Stripped 3/4" with Two 6/32 Mounting Screws	10085	660W 250V	1 1/2	1 11/16

Porcelain Keyless Fixture Single Circuit — Medium Base

Screw Terminals

DESCRIPTION	CAT. NO.	RATING	OD	OH
1-Piece, Front Mounted for Fixture or Sign Use. Tapped 8-32 Bushings, Mounting Centers 1 13/16".	9885	660W 600V	1 5/8	1 7/16
2-Piece, Ring Type	9350	660W 250V	1 3/4	1 3/8
1-Piece with Removable Strap★	8871	660W 250V	1 11/16	1 9/16
Fixture Pan Lampholder with 1/8" IPS Hickey	3152-8	660W 250V	1 3/8	1 7/16

Leads

DESCRIPTION	CAT. NO.	RATING	OD	OH
2-Piece Ring Type with Leads: No. 18 AWG, 105°C Plastic; 9" Long, Stripped 3/4"	8101	660W 250V	1 3/4	1 3/8
Angle Pan with Leads: No. 18 AWG Type AF 150°C Plastic; 9" Long, Stripped 3/4"	18315	660W 250V	—	—
Removable Bracket with Leads	8052-1	660W 250V	1 3/8	1 7/16
Screw-Mount Pulse-Rated Lampholder with Leads for Open-Fixture Lamps; 18 AWG 200°C 600V SEW-2 (SF-2) wire; 9" Long, Stripped 1/2"	70052-100	660W 600V, 4KV Pulse Rated	1 45/64	2 9/32

Two-Piece Pull Chain

DESCRIPTION	CAT. NO.	RATING	OD	OH
Ring Type; Screw Terminals; Gasket Furnished★†	9814	250W 250V	1 13/16	1 13/16

CSA Certified except where indicated by★, and NOM Certified except where indicated by†.

SPECIFICATIONS AND FEATURES

- Suitable for a wide variety of fixtures, signs and displays
- Unglazed base and ring on two-piece lampholders
- Gasket supplied with two-piece ring type rated at 90°C dry maximum

TESTING AND CODE COMPLIANCE

- UL Listed (File #E-3810)
- CSA Certified (File #LR-1863)
- NOM Certified (File #057)



8880

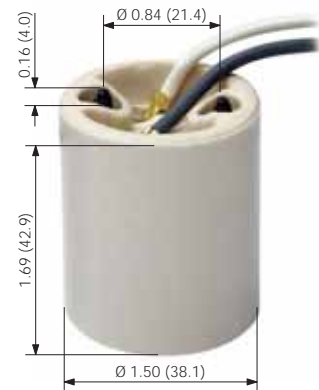

10085



3152



8101



660W 600V • 660W 250V • 250W 250V • 3000W 600V

Medium Base, Metal Halide and Quartz Halogen Incandescent Lampholders

Incandescent Lampholders



3352-1



4005

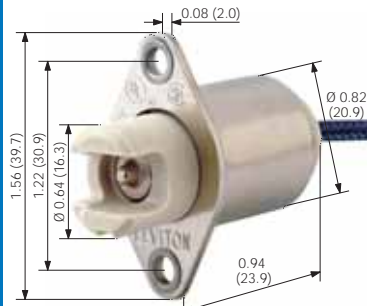

554

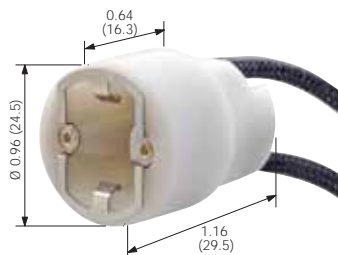

560

Phenolic Keyless Fixture — Medium Base

Screw Terminals

DESCRIPTION	CAT. NO.	RATING
Permanent Bracket. Terminal Screws Backed Out and Staked	3352-1	660W 250V
Same as 3352-1, with Shorter Bracket	3352-F	660W 250V
Removable Hickey. Terminal Screws Backed Out and Staked	3352-8	660W 250V

Hickeys and brackets are available in various types and sizes. Consult a Leviton representative for more information.

Porcelain Keyless, Side-Mounted — Medium Base

Screw Terminals

DESCRIPTION	CAT. NO.	RATING
Single Lampholder w/Side Outlet Bushing—1/8 IPS	10091	660W 250V
Twin Lampholder w/Bushed Flange—1/8 IPS	4010	660W 250V
Twin Lampholder w/Single Outlet Bushing—1/8 IPS	4005	660W 250V
Same as 4005 with 3/8 IPS Bushing	4006	660W 250V

All bushings are tapped and have set screw

Candle Sockets, Bottom Turn Knob — Medium Base

Screw Terminals

DESCRIPTION	CAT. NO.	RATING
Three-light, two-piece phenolic husk. Lighting sequence: LO-MED-HI-OFF★	4063	250W 250V

Lampholders for Recessed Single Contact Lamps

DESCRIPTION	CAT. NO.	RATING
Front Flange Mount. Standard Leads are No. 18 AWG, Type SEW-2, 200°C, 18" Long, Stripped 3/4"†	554	3000W 600V
Rear Flange Mount. Same Leads and Specs as No. 554†	555	3000W 600V

Lampholders for Metal Halide and Quartz Halogen Lamps

DESCRIPTION	CAT. NO.	RATING
Single-Ended Metal Halide for Lamps with a G8.5 Base. Lead-In Edge on Body Ensures Proper Lamping. Standard Leads (2) are Black No. 18 AWG, Type SEW-2, 200°C 600V Wire, 9" Long, Stripped .325"†	560	660W 600V, 5KV Pulse Rated
Single-Ended Metal Halide for Lamps with a GX8.5 Base, such as Philips CDM-R11, rated up to 150W. Standard Leads (2) are Black No. 18 AWG, SEW-2, 200°C 600V Wire, 12" Long, Stripped 1/2"†	565	660W 600V, 5KV Pulse Rated
Twist-In Single-Ended Quartz Halogen for Lamps with a GU10 Base, rated up to 150W. Fully Dimmable; Standard Leads (2) are White, No. 20 AWG Teflon® wire, rated 250°C 600V, 6" Long, Stripped 1/2"†	570	660W 600V

CSA Certified except where indicated by ★, and NOM Certified except where indicated by †.

SPECIFICATIONS AND FEATURES

- Cat. No. 3352 lampholder bodies have wireways
- Side-Mounted lampholders are white glazed porcelain with copper-alloy screwshell
- Recessed Single-Contact lampholders have porcelain body with nickel-plated steel housing
- Cat. No. 560 has a metal lamp-positioning clip (patent pending) that maintains lamp seating position
- Cat. No. 565 is designed for energy-efficient CDM lamps
- Cat. No. 570 twists in and is fully dimmable

TESTING AND CODE COMPLIANCE

- UL Listed (File #E-3810) Cat. Nos. 560, 565 and 570: cULus (File #E-13405)
- CSA Certified (File #LR-1863)
- NOM Certified (File #057)



To learn more about Leviton's outstanding offering of devices visit our Website at: www.leviton.com



Candelabra and Medium Base Incandescent Lampholders

Candle Sockets, Bottom Turn Knob — Medium Base

Screw Terminals  

DESCRIPTION	CAT. NO.	RATING
1-Piece Phenolic Body; 2 Leg Bracket; Single Light; Removable Interior; Knurl Nut and Lock Nut	4155	660W 250V
2-Piece Phenolic Husk & Removable Interior Husk; Single Light; Knurl Nut	4158	660W 250V

Candle Sockets, Keyless* — Medium Base

Fiber-Disc Body, Screw Terminals  

DESCRIPTION	CAT. NO.	RATING
Solid Hickey, 2" Overall Height†	8684	660W 250V
Adjustable Hickey, Overall Height: 4–5¾"	9800	660W 250

*Insulating paper liner pushes down against hickey projections.

NOTE: These items are designed for use with standard socket candle tubes (1⁵/₁₆" dia.) and require a minimum of 1³/₁₆" dia. flat bottom of candle cup for clearance.

Candle Sockets, Phenolic — Medium Base

With Removable Turn Knob, Screw Terminals  

DESCRIPTION	CAT. NO.	RATING
Removable Knob (Short Type), Adjustable Hickey. Overall Height: 4–5½"	9805*	250W 250V
Removable Knob, Removable 1-Leg Hickey. Overall Height: 2 ⁷ / ₁₆ "	9805-A*	250W 250V

NOTE: These items are designed for use with standard socket candle tubes (1⁵/₁₆" dia.) and require a minimum of 1³/₁₆" dia. flat at bottom of candle for clearance.

Candelabra Base, Keyless*   †

DESCRIPTION	CAT. NO.	RATING
Screw Terminals; Solid Hickey. Overall Height: 2"	10025	75W 125V
Screw Terminals; Solid Hickey. Overall Height: 1½"	10027	75W 125V
Screw Terminals; Adjustable Hickey: 3¼–4¾"	10026	75W 125V
Double Snap-In Spring Clips. Height of socket from panel is 1". Leads are No. 18 AWG 105°C plastic, 24" long, stripped ½"	10014-800	75W 125V

*7/8" candle tube. All hicckeys tapped 1/8 IPS.

NOM Certified except where indicated by †

SPECIFICATIONS AND FEATURES

- Candle sockets for single-light applications
- Fiber Disc Body for use with standard candle tubes
- Spring-tempered steel clip holds Cat. No. 10014-800 socket rigidly in place

TESTING AND CODE COMPLIANCE

- UL Listed (File #E-3810; E-13400)
- CSA Certified (File #LR-1863)
- NOM Certified (File #057)





75W 125V • 660W 250V

Candelabra and Medium Base Incandescent Lampholders



20025



267



167



55

Candle Sockets — Porcelain

Candelabra Base Screw Terminals

DESCRIPTION	CAT. NO.	RATING
Solid Hickey.* Overall Height: 2 ³ / ₃₂ "★†	20025	75W 125V

*Other hickey sizes available

Keyless Heavy Duty Phenolic Single Circuit Lampholders

Two-Piece Pin Type

DESCRIPTION	CAT. NO.	RATING
Candelabra Base, Detachable Zinc-Plated Wire Hook. Accepts No. 20 – No. 18 Stranded Insulated Wire	267**	75W 125V
Medium Base, Detachable Zinc-Plated Wire Hook. Accepts No. 14 – No. 12 Stranded Insulated Wire	167**	660W 250V

Note: Linings assembled.

**For temporary lighting — not waterproof.

Pigtail Type Medium Base with Leads

DESCRIPTION	CAT. NO.	RATING
Vinyl, Phenolic Interior & Screw Shell, Brass Shell Contact. Leads are No. 14 AWG, 6" Long, Stripped 3/4", Molded into Boots†	55**	660W 250V
Phenolic with Brass Screw Shell. Leads Soldered and Hot Waxed in Deep Well are No. 14 AWG 6" Long	157**	660W 250V
Same as 157 above, with Left-Hand Screw Shell	157-X**	660W 250V
Rubber, Aluminum Screwshell. Leads are No. 16 AWG, 6" Long, Soldered to Terminals and Sealed in Rubber Boot★	124-D	660W 250V

**For temporary lighting—not waterproof.

All devices are UL Listed except Cat.No. 124-D. Also CSA Certified except where indicated by ★, and NOM Certified except where indicated by †

Note: The listed products may be used at construction sites provided that bulb cages are used and suitable splices are made. The listing for the products meets the OSHA requirement and is made for open wiring without a separate outlet box.

SPECIFICATIONS AND FEATURES

- Candle socket has white unglazed porcelain body with aluminum screw shell
- Choice of Pin-Type or Pigtail Type for temporary lighting applications
- Two-Piece Pin Type automatically pierces wire leads

TESTING AND CODE COMPLIANCE

- UL Listed (File #E-13400) 267**
- UL Listed (File #E-3810) 55**, 157**, 157-X** and 167**
- CSA Certified (File #LR-1863)
- NOM Certified (File #057)



Medium, High Output and Slimline—Linear Fluorescent Lampholders

For High Output Lamps — Recessed Double Contact, Pedestal Type

DESCRIPTION	CAT. NO. PLUNGER	CAT. NO. FIXED	RATING
Screw Mount, Push-in wiring.*	13464	13465	660W 600V
Same as 13464/13465 except with Internal Shunt Connection for Electronic Ballasts*	23464	23465	660W 600V
Slide-on, Shallow Base, Quickwire Terminals*	13550	13551	660W 600V
Slide-on, Shallow Base for Power Groove and Jacketed Lamps, Quickwire Terminals*	13556	13557	660W 600V

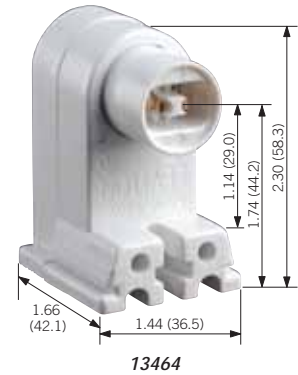

For Slimline, Single Pin Lamps

DESCRIPTION	CAT. NO. PLUNGER	CAT. NO. FIXED	RATING
Butt-On Surface Mounting, 12" Leads†	452	453	660W 1000V 660W 600V
Pedestal Base, Slide-On	466	467	660W 1000V 660W 600V
Shallow Base, Slide-On or Lock-On Mounting, Quickwire Terminals*	2536	2537	660W 1000V 660W 600V



For Medium Bi-Pin Lamps

DESCRIPTION	CAT. NO. WHITE	RATING
Thin Body, Quickwire Terminals Accommodate Rapid-Start Circuits	431-W	660W 600V
Pedestal type, Straight-in Wiring Through Wireways or Screw Terminals‡	390-1W	660W 600V
Same as above, with Starter Base‡	391-1W	660W 600V

Starter Bases

For Medium Bi-Pin Lamps

DESCRIPTION	CAT. NO.	RATING
Starter Base; Screw Terminals, Black‡	380	660W 250V
Starter Base; with Leads, Black‡	396	660W 250V

NOM Certified except where indicated by†

*Suitable for outdoor applications when properly enclosed

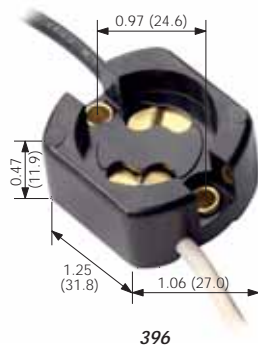

SPECIFICATIONS AND FEATURES

- Silver-plated copper alloy contacts
- Quickwire terminals accept No. 18 AWG twisted and tinned, solder-dipped or solid leads
- Lampholders are white, starter bases are black

TESTING AND CODE COMPLIANCE

- UL Listed (File #E-5833)
- CSA Certified (File #LR-1863; LR-5863; LR-2200)
- NOM Certified (#057)



660W 600V • 660W 1000V • 75W 250V

Medium and Miniature Bi-Pin Lamps—Linear Fluorescent Lampholders

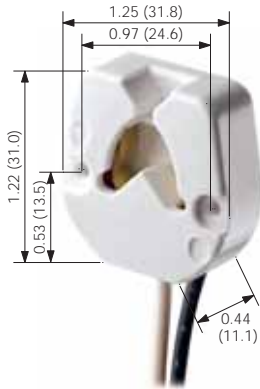

395-W

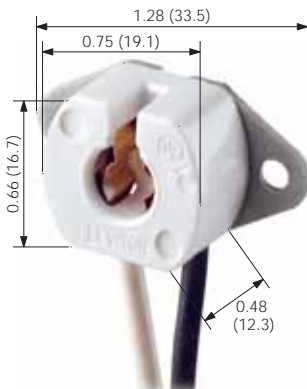

420-W



13518 — see diagram right

For Medium and Miniature Bi-Pin Lamps — Surface Mount with Leads*

DESCRIPTION	CAT. NO. WHITE	RATING
Rapid-Start Medium Bi-Pin, 9" leads	395-W	660W 600V
Rapid-Start Medium Bi-Pin, Disconnect (paired with Cat. No. 395-W), 9" leads	389-W	660W 600V
Miniature Bi-Pin for T5 Lamp, 6" leads	420-W	75W 250V

*Leads are No. 18 AWG, 105°C plastic insulated wire

For Slimline, Medium Bi-Pin, High Output Lamps — Snap-In with Quickwire

DESCRIPTION	CAT. NO. PLUNGER	CAT. NO. FIXED	RATING
Slimline†	516	—	660W 1000V 660W 600V
Medium Bi-Pin, Stainless Steel Coverplate & Clip	13518	13519	660W 600V 660W 600V
Medium Bi-Pin, Same as above, with Internal Shunt for Use with Electronic Ballasts	23518	23519	660W 600V 660W 600V
High Output 800mA and 1500mA ‡	523	524	660W 600V 660W 600V

NOM Certified except where indicated by †

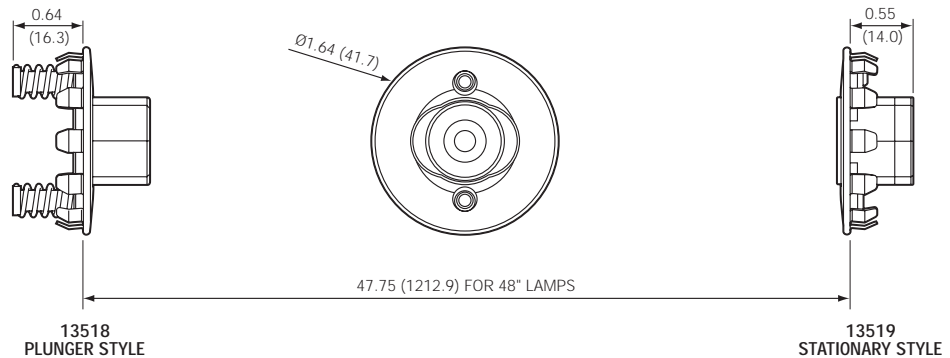

Medium Bi-Pin Spacing

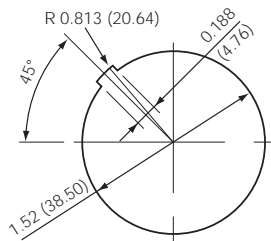

PANEL OPENING FOR 13518/13519
PANEL THICKNESS 0.035-0.050 (0.89-1.27)

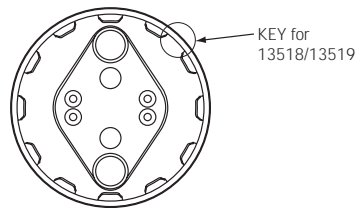

SPECIFICATIONS AND FEATURES

- Versatile snap-in mounting reduces fixture assembly time
- Quickwire terminals accept either No. 18 AWG (stranded, twisted or tinned), No. 18 AWG solid or No. 16 AWG solid.
- Internal Shunt versions stamped "S" on back for easy identification

TESTING AND CODE COMPLIANCE

- UL Listed (File #E-5833)
- CSA Certified (File #LR-5863; LR-1863)
- NOM Certified (#057)



Medium Bi-Pin Lamps—Linear Fluorescent Lampholders

For Medium Bi-Pin Lamps — Turn-Type

DESCRIPTION	CAT. NO.	RATING
Low Profile, Slide-On, with Captive Nut	13353-N	660W 600V
Tall Profile, Slide-On, with Captive Nut	13357-N	660W 600V
Tall Profile without Side Grooves, Slide-On, with Captive Nut	13359-N	660W 600V
Low Profile Disconnect, Slide-On	13351-D	660W 600V
Tall Profile Disconnect, Slide-On	13354-D	660W 600V
Low-Profile; Shunted, Slide-On	23351	660W 600V

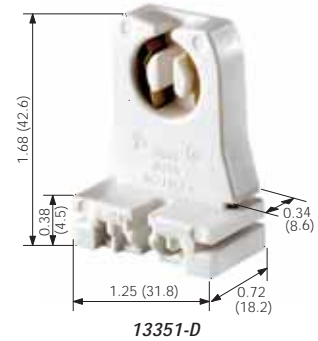

For Medium Bi-Pin Lamps — Straight-In

DESCRIPTION	CAT. NO.	RATING
Low Profile, Slide-On	13150-UR5	660W 600V
Self-Locking; Slide-In, with Captive Nut. For use with T-8 Lamps	13451-N	660W 600V

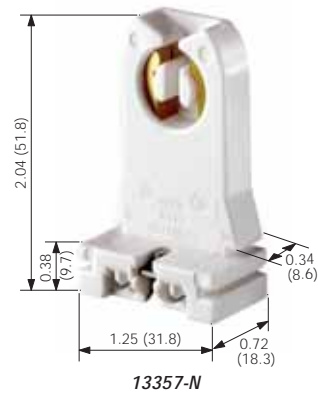

For Medium Bi-Pin Lamps — Snap-In/Slide-On Design and Lamp-Lock

DESCRIPTION	CAT. NO.	RATING
Snap-In or Slide-On Mounting Featuring Lamp-Lock, with Panel Locator Post. For T-8 and T-12 Lamps	13653-WP	660W 600V
Same as Above, Less Locator Post	13653-NP	660W 600V
Same as 13653-WP, Except with Internal Shunt Connection for Electronic Ballasts	23653-WP	660W 600V
Same as Above, Less Locator Post	23653-NP	660W 600V
Snap-In or Slide-On Mounting Featuring Lamp-Lock, Optional Panel Locator Post. Dedicated for Energy-Efficient T-8 Lamps Only	13652-WP	660W 600V
Same as 13652, Except with Internal Shunt Connection for Electronic Ballasts	23652-WP	660W 600V
Snap-In or Slide-On Mounting Featuring Lamp-Lock, for Energy-Efficient T-8 Lamps Only. Wide-Wing Design	13652-WWP	600W 600V
Same as Above, Less Locator Post	13652-WNP	600W 600V
Same as 13652-WWP, Except with Internal Shunt Connection for Electronic Ballasts	23652-WWP	600W 600V
Same as Above, Less Locator Post	23652-WNP	600W 600V
Snap-In or Slide-On Mounting Featuring Lamp-Lock, for T-8 and T-12 Lamps. Wide-Wing Design	13653-WWP	600W 600V
Same as Above, Less Locator Post	13653-WNP	600W 600V
Same as 13653-WWP, Except with Internal Shunt Connection for Electronic Ballasts	23653-WWP	600W 600V
Same as Above, Less Locator Post	23653-WNP	600W 600V



NOTE: Also available with bottom push-in wiring. Contact your Leviton representative for further details.

SPECIFICATIONS AND FEATURES

Lamp-Lock

- Four-position lamp-lock socket rotates 90°, forward and back, for quick relamping
- Lamp-Lock models have slim, low profile silhouette that fits 22 to 25 gauge panels
- Chemical-resistant white thermo-plastic body

TESTING AND CODE COMPLIANCE

- UL Listed (File #E-5833)
- CSA Certified (File #LR-1863; LR-5863; LR-2200)
- NOM Certified (#057)
- Medium Bi-Pin lamps with Snap-In/Slide-On Design and Lamp-Lock are VDE Certified to IEC

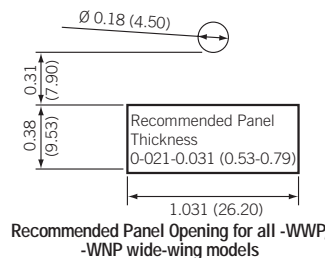
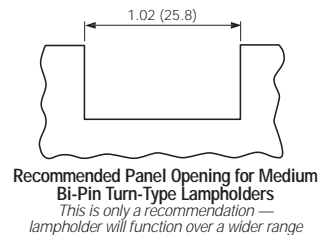
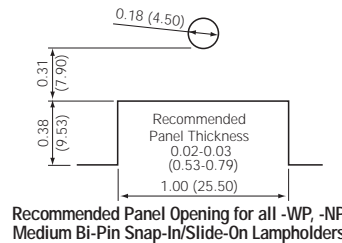



120W 600V • 660W 600V

Medium and Miniature Bi-Pin Lamps—Linear Fluorescent Lampholders

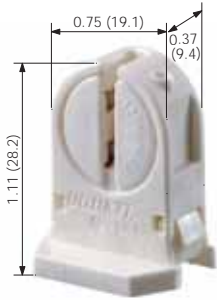

13654-SNP

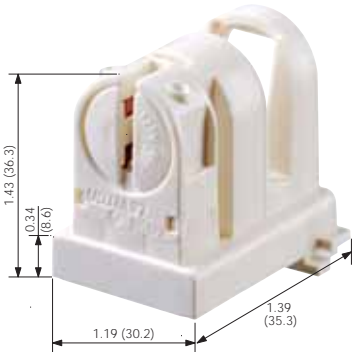

13654-EXL

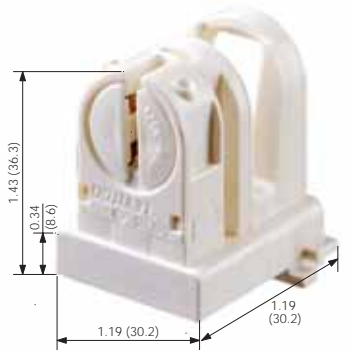

13654-EXS

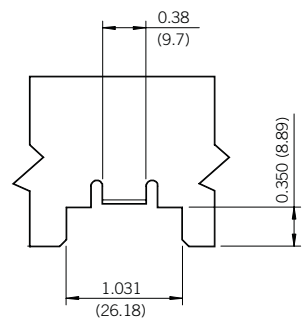

Recommended Panel Opening for Medium Bi-Pin Slide-On Lampholders

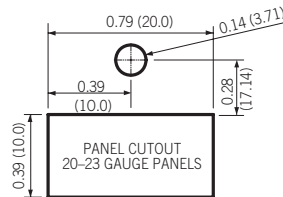

Recommended Panel Opening for Miniature Bi-Pin Snap-In/Slide-On Lampholders

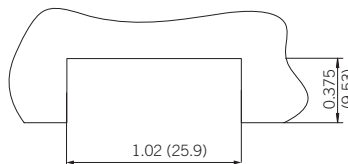

Recommended Panel Opening for T-8 to T-5 Adapter

For Medium Bi-Pin Lamps — Slide-On Design and Lamp-Lock[®]

DESCRIPTION	CAT. NO.	RATING
Medium Profile 0.91 (23.0) Lamp Center. Slide-On Mounting Featuring Lamp Lock. For T-8 and T-12 Lamps	13661	660W-600V
Same as 13661, Except with Internal Shunt Connection for Electronic Ballasts	23661	660W-600V
Tall Profile 1.18 (30.0) Lamp Center. Slide-On Mounting Featuring Lamp Lock. For T-8 and T-12 Lamps	13660	660W-600V
Same as 13660, Except with Internal Shunt Connection for Electronic Ballasts	23660	660W-600V

For Miniature Bi-Pin Lamps — Snap-In/Slide-On Design and Lamp-Lock[®]

DESCRIPTION	CAT. NO.	RATING
Low Profile 0.62 (15.7) Lamp Center, Snap-In or Slide-On Mounting Featuring Lamp-Lock, with Panel Locator Post. For T-5 Lamps	13654-SWP	120W 600V
Same as Above, Less Locator Post	13654-SNP	120W 600V
Tall Profile 0.98 (24.9) Lamp Center, Snap-In or Slide-On Mounting Featuring Lamp-Lock, with Panel Locator Post. For T-5 Lamps	13654-TWP	120W 600V
Same as Above, Less Locator Post	13654-TNP	120W 600V
Low Profile 0.62 (15.7) Lamp Center, Snap-In or Slide-On Mounting Featuring Lamp-Lock, with Panel Locator Post. For T-5 Lamps. Internal Shunt Connection for Electronic Ballasts	23654-SWP	120W 600V
Same as Above, Less Locator Post	23654-SNP	120W 600V
Tall Profile 0.98 (24.9) Lamp Center, Snap-In or Slide-On Mounting Featuring Lamp-Lock, with Panel Locator Post. For T-5 Lamps. Internal Shunt Connection for Electronic Ballasts.	23654-TWP	120W 600V
Same as above, Less Locator Post	23654-TNP	120W 600V

T-8 to T-5 Adapter

Long T-8 to T-5 Adapter, converts existing T-8 fixtures to accept energy-efficient T-5 lamps; with Lamp Lock. <i>Specify lamp length for proper ordering</i>	13654-EXL	120W 600V
Short T-8 to T-5 Adapter, converts existing T-8 fixtures to accept energy-efficient T-5 lamps; with Lamp Lock. <i>Specify lamp length for proper ordering</i>	13654-EXS	120W-600V

SPECIFICATIONS AND FEATURES

Lamp-Lock

- Four-position lamp-lock socket rotates 90°, forward and back, for quick relamping
- Lamp-Lock models have slim, low profile silhouette that fits 22 to 25 gauge panels
- Chemical-resistant white thermoplastic body

T-8 to T-5 Adapter

- Cost-effective solution to incorporate miniature bi-pin T-5 lamps into existing T-8 configurations

TESTING AND CODE COMPLIANCE

- UL Listed (File #E-5833)
- CSA Certified (File #LR-1863; LR-5863; LR-2200)
- NOM Certified (#057)
- Medium Bi-Pin Lamps with Slide-On Design and Lamp-Lock are VDE Certified to IEC



Long Twin Tube with 2G11 Base—Compact Fluorescent Lampholders

4-Pin Long Twin-Tube with 2G11 Base — Slide-In Mounting

DESCRIPTION	CAT. NO.	RATING
Slide-In for 18-20 Ga. Panels, Quickwire Terminals	13452	660W 600V

4-Pin Long Twin-Tube with 2G11 Base — Bottom or Back Mounting

DESCRIPTION	CAT. NO.	RATING
Vertical Snap-In Mounting, Side Push-In Wiring	13453	660W 600V
Same as above, with Internal Shunt Connection for Electronic Ballasts	23453	660W 600V
Horizontal Snap-In Mounting, Bottom Push-In Wiring	13454	660W 600V
Same as above, with Internal Shunt Connection for Electronic Ballasts	23454	660W 600V
Horizontal Screw-Mount, Bottom Push-In Wiring	13455	660W 600V
Same as above, with Internal Shunt Connection for Electronic Ballasts	23455	660W 600V

Note: See page S18 for Lamp Support Clips



13453



13454

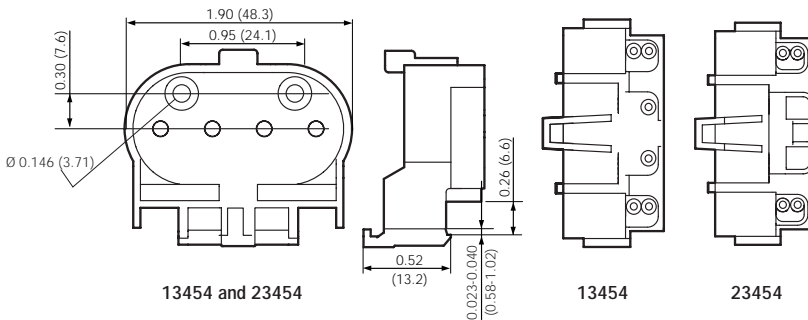
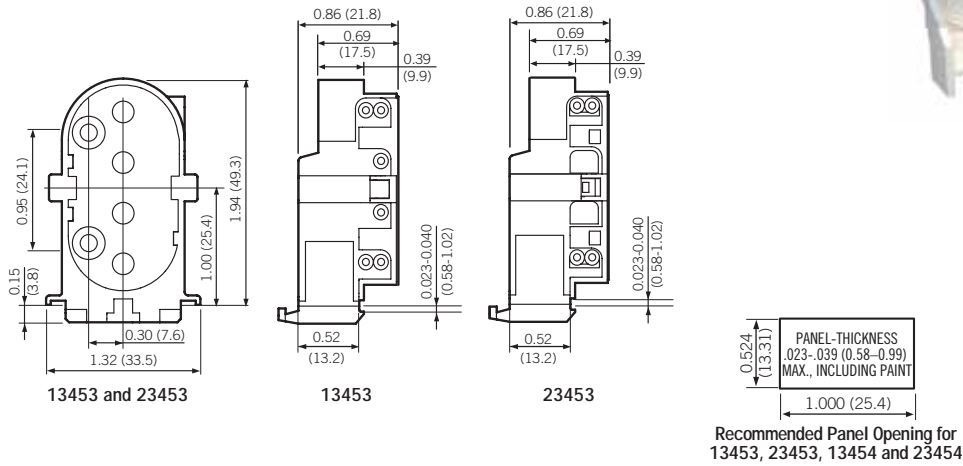

SPECIFICATIONS AND FEATURES

- Vertical Snap-In model allows wires to be routed on either top or bottom of panel
- Two wiring ports per contact speed harness wiring
- Internal Shunt models eliminate need for extra jumper wire in fixtures designed for electronic ballasts
- Low-profile design for smaller, more compact fixtures
- Superior metal-spring lamp retainer clips

TESTING AND CODE COMPLIANCE

- UL Listed (File #E-5833)
- CSA Certified (File #LR-1863)
- NOM Certified (File #057)

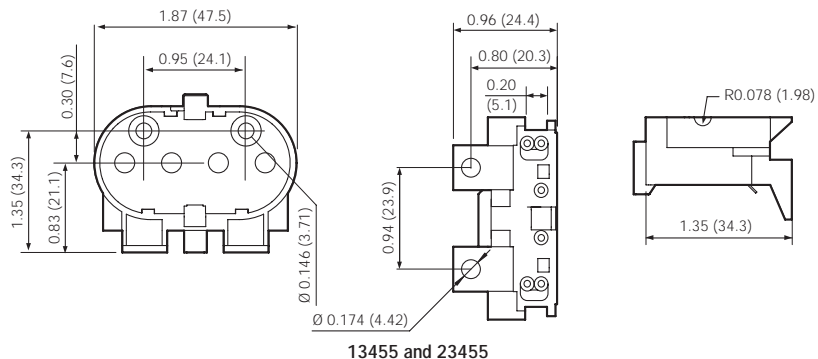



LAMP SUPPORT CLIPS

Lamp Support Clips for Long Twin Tube 2G11 Base Fluorescent Lampholders



23452-H



23452-V



23452-MTS



23452-MTL

Plastic and Stainless Steel Lamp Support Clips

DESCRIPTION	CAT. NO.
Plastic Lamp Support Clip, Slide-On	23452-A*
Plastic Lamp Support Clip, Screw Mount	23452-B*
Horizontal Snap-In Lamp Support Clip for 13454, 23454, 13455 and 23455. UV-Stable, Clear Polycarbonate	23452-H*
Vertical Snap-In Lamp Support Clip for 13453 and 23453. UV-Stable, Clear Polycarbonate	23452-V*
Stainless Steel Horizontal Lamp Support Clip, Short Version	23452-MTS
Stainless Steel Horizontal Lamp Support Clip, Tall Version	23452-MTL

*Note: Leviton strongly recommends replacing support clips 23452-A, 23452-B, 23452-V and 23452-H during lamp replacement.

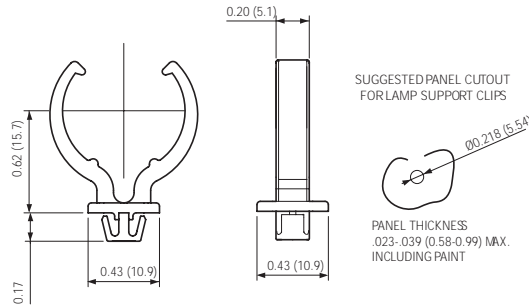

Vertical Lamp Support Clip—23452-V

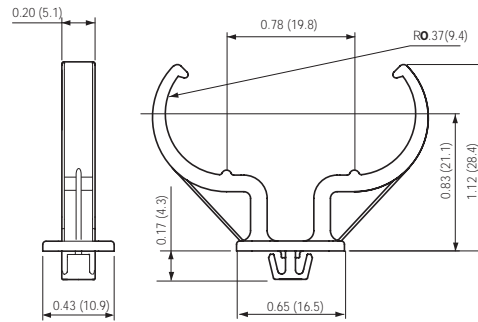

Horizontal Lamp Support Clip—23452-H

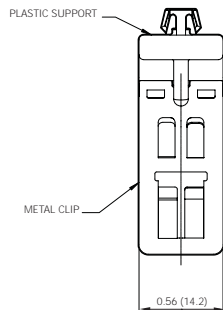

Horizontal Lamp Support Clips
23452-MTS, 23452-MTL

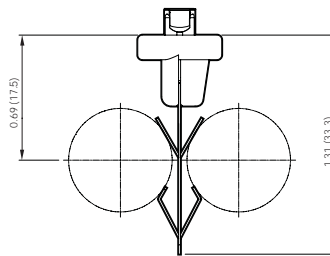

Horizontal Lamp Support Clip, Short
23452-MTS

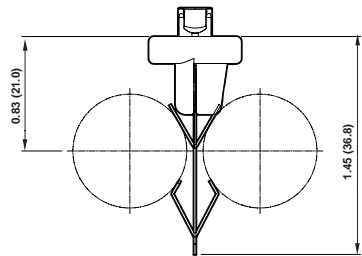

Horizontal Lamp Support Clip, Tall
23452-MTL

SPECIFICATIONS AND FEATURES

- Choice of quality lamp support clips in a variety of configurations for long twin tube lamps with 2G11 base
- UV stable clear polycarbonate clips for vertical or horizontal mounting
- Stainless steel clips with UV stable clear polycarbonate base for horizontal mounting only; short or tall versions
- Plastic clips for slide-on or screw-mount



Compact Fluorescent Lampholders (CFLs)

10mm Compact Fluorescent Lampholders

For G23 and G23-2 Lamp Bases — Rating: 75 WATT 600V

MOUNTING	CAT. NO.	COLOR	LAMP BASE	PHILIPS	OSRAM SYLVANIA	GE LIGHTING
Horizontal Snap-In	26719-100	White	G23, G23-2			
Horizontal Screw-Down	26719-200	White	G23, G23-2	PL-S 5W, 7W 9W	DULUX S 5W, 7W, 9W DULUX D 9W	BIAX 5W, 7W 9W DOUBLE BIAX 9W
Vertical Top Snap-In	26719-300*	White	G23			
4-Hole Vertical Screw-Down	26719-400	White	G23, G23-2			
Vertical Bottom Snap-In	26719-500	White	G23, G23-2			

*Not compatible with 9-watt DTT lamps

For GX23 and GX23-2 Lamp Bases — Rating: 75 WATT 600V

MOUNTING	CAT. NO.	COLOR	LAMP BASE	PHILIPS	OSRAM SYLVANIA	GE LIGHTING
Horizontal Snap-In	26720-100	White w/Black	GX23, GX23-2			
Horizontal Screw-Down	26720-200	White w/Black	GX23, GX23-2	PL-S 13W PL-C 13W	DULUX S 13W DULUX D 13W	BIAX 13W DOUBLE BIAX 13W
Vertical Top Snap-In	26720-300*	White w/Black	GX23			
4-Hole Vertical Screw-Down	26720-400	White w/Black	GX23, GX23-2			
Vertical Bottom Snap-In	26720-500	White w/Black	GX23, GX23-2			

*Not compatible with 13-watt DTT lamps



26719-100



26719-200



26720-300



26720-400

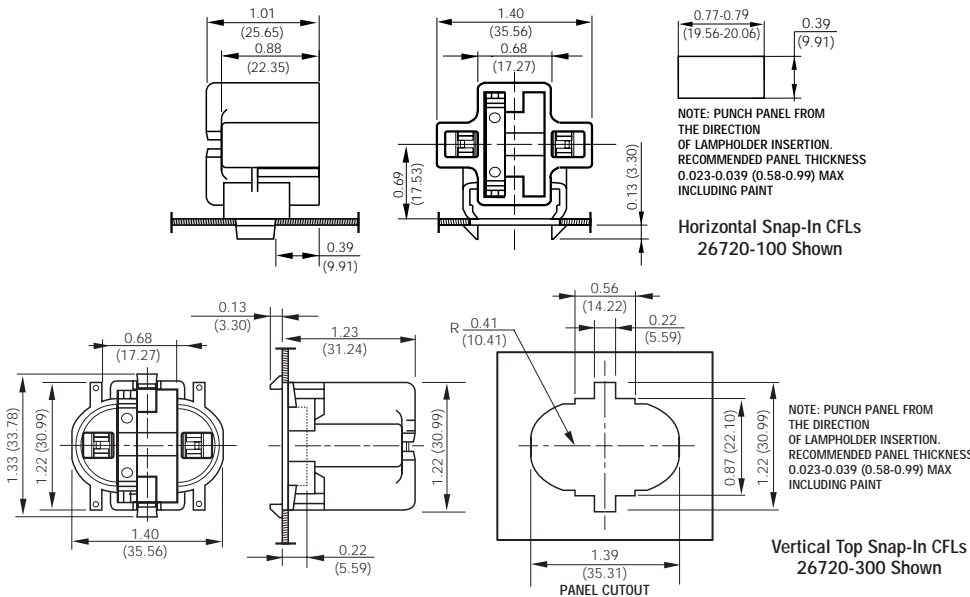

SPECIFICATIONS AND FEATURES

- “Smart” CFL Lampholders are color-coded for easy wattage identification
- Bottom Snap-In versions for easier panel assembly
- Snap-In versions designed for 16 Ga. panels
- Metal-spring lamp-retainer clip provides positive lamp retention and is more durable than plastic clips
- Two wiring ports per contact speed harness wiring

- Four screw holes for greater mounting flexibility
- Wire-routing options for top or bottom side of mounting panel for easier assembly
- White thermoplastic body

TESTING AND CODE COMPLIANCE

- UL Listed (File #E-5833)
- UL Listed for indoor and outdoor applications when properly enclosed
- CSA Certified (File #LR-1863)
- NOM Certified (File #057)

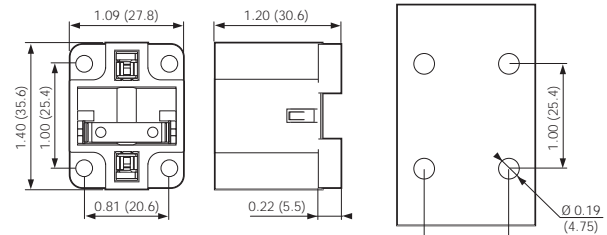



75W 600V

Compact Fluorescent Lampholders (CFLs)



26725-213



26725-419

10mm Compact Fluorescent Lampholders

For G24d Lamp Bases 2-Pin — Rating: 75 WATT 600V

MOUNTING	CAT. NO.	COLOR	LAMP BASE	PHILIPS	OSRAM SYLVANIA	GE LIGHTING
Bottom Snap-In						
For 16 Ga. Panels For 18-20 Ga. Panels	26725-201 26725-221	White w/Black	G24d-1	PL-C 10W, 13W	DULUX D 10W, 13W	DOUBLE BIAX 10W, 13W
For 16 Ga. Panels For 18-20 Ga. Panels	26725-202 26725-222	Green	G24d-2	PL-C 18-W	DULUX D 18W	DOUBLE BIAX 18W
For 16 Ga. Panels For 18-20 Ga. Panels	26725-203 26725-223	Orange	G24d-3	PL-C 26W	DULUX D 26W	DOUBLE BIAX 26W
Bottom Screw-Down						
4-Hole	26725-211	White w/Black	G24d-1	PL-C 10W, 13W	DULUX D 10W, 13W	DOUBLE BIAX
4-Hole	26725-212	Green	G24d-2	PL-C 18W	DULUX D 18W	DOUBLE BIAX 18W
4-Hole	26725-213	Orange	G24d-3	PL-C 26W	DULUX D 26W DULUX T 26W	DOUBLE BIAX 26W

For G24q and GX24q Lamp Bases 4-Pin — Rating: 75 WATT 600V
Suitable for Dimming or Electronic Ballasts

MOUNTING	CAT. NO.	COLOR	LAMP BASE	PHILIPS	OSRAM SYLVANIA	GE LIGHTING
Bottom Snap-In						
For 16 Ga. Panels For 18-20 Ga. Panels	26725-401 26725-421	White w/Black	G24q-1	PL-C 10W, 13W	DULUX D/E 10W, 13W	DOUBLE BIAX 10W, 13W
For 16 Ga. Panels For 18-20 Ga. Panels	26725-402 26725-422	Green	G24q-2	PL-C 18W	DULUX D/E 18W	DOUBLE BIAX 18W
For 16 Ga. Panels For 18-20 Ga. Panels	26725-403 26725-423	Orange	G24q-3, GX24q-3	PL-C 26W PL-T 26W, 32W	DULUX D/E DULUX T/E 26W	DOUBLE BIAX
For 16 Ga. Panels For 18-20 Ga. Panels	26725-404 26725-424	Yellow	GX24q-4	PL-T 42W	DULUX T/E 42W	PERFORMANCE BIAX 42W
For Universal ballast only, 18-20 Ga. Panels	26725-429	White	G24q-3 GX24q-4	PL-T 26W, 32W, 42W	DULUX T/E 26W, 32W, 42W	TRIPLE BIAX 26W, 32W, 42W
Bottom Screw-Down						
4-Hole	26725-411	White w/Black	G24q-1	PL-C 10W, 13W	DULUX D/E 10W, 13W	DOUBLE BIAX 10W, 13W
4-Hole	26725-412	Green	G24q-2	PL-C 18W	DULUX D/E 18W	DOUBLE BIAX 18W
4-Hole	26725-413	Orange	G24q-3, GX24q-3	PL-C 26W PL-T 26W, 32W	DULUX D/E DULUX T/E 26W, 32W	DOUBLE BIAX 26W
4-Hole	26725-414	Yellow	GX24q-4	PL-T 42W	DULUX T/E 42W	PERFORMANCE BIAX 42W
4-Hole for Universal ballast only	26725-419	White	G24q-3 GX24q-4	PL-T 26W, 32W, 42W	DULUX T/E 26W, 32W, 42W	TRIPLE BIAX 26W, 32W, 42W

SPECIFICATIONS AND FEATURES

- “Smart” CFL Lampholders are color-coded for easy wattage identification
- Bottom snap-in versions for easier panel assembly available for 16 Ga. and 18–20 Ga. panels
- All 4-pin lampholders have internal rejection feature that prevents insertion of 2-pin lamps
- Metal-spring lamp-retainer clip provides positive lamp retention and is more durable than plastic clips
- Two wiring ports per contact speed harness wiring
- Four screw holes for greater mounting flexibility
- Wire-routing options for top or bottom side of mounting panel for easier assembly
- White thermoplastic body

TESTING AND CODE COMPLIANCE

- UL Listed (File #E-5833)
- UL Listed for indoor and outdoor applications when properly enclosed
- CSA Certified (File #LR-1863)
- NOM Certified (File #057)

Note: Lamp names are trademarked by manufacturers

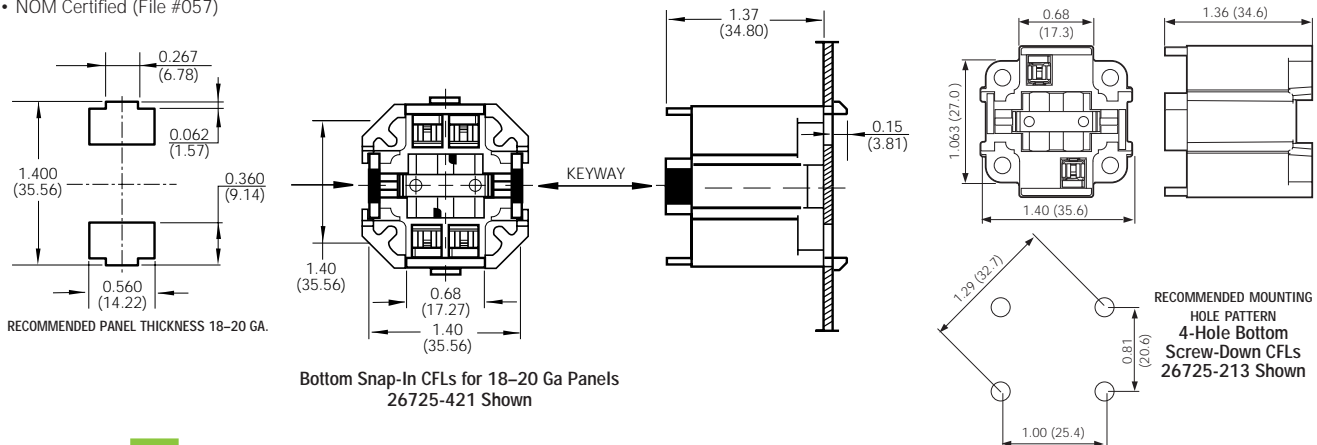

Bottom Snap-In CFLs for 18–20 Ga Panels
26725-421 Shown

RECOMMENDED MOUNTING HOLE PATTERN
4-Hole Bottom Screw-Down CFLs
26725-213 Shown



To learn more about Leviton's outstanding offering of devices visit our Website at: www.leviton.com



Compact Fluorescent Lampholders (CFLs)

10mm Compact Fluorescent Lampholders for High-Wattage Lamps

For GX24q Lamp Bases, 4-Pin — Rating: 75 WATT 600V
Suitable for Dimming or Electronic Ballasts

MOUNTING	CAT. NO.	COLOR	LAMP BASE	OSRAM SYLVANIA	GE LIGHTING
Bottom Snap-In for 16 Ga. Panels	26725-405	Blue	GX24q-5	DULUX T/E 57W	BIAX Q/E 57W
4-Hole Bottom Screw-Down	26725-415	Blue	GX24q-5	DULUX T/E 57W	BIAX Q/E 57W
2-Hole Bottom Screw-Down, Round Body	26725-4A5	Blue	GX24q-5	DULUX T/E 57W	BIAX Q/E 57W
Bottom Snap-In for 18–20 Ga. Panels	26725-425	Blue	GX24q-5	DULUX T/E 57W	BIAX Q/E 57W
Bottom Snap-In for 16 Ga. Panels	26725-406	Red	GX24q-6	—	BIAX Q/E 70W
4-Hole Bottom Screw-Down	26725-416	Red	GX24q-6	—	BIAX Q/E 70W
2-Hole Bottom Screw-Down, Round Body	26725-4A6	Red	GX24q-6	—	BIAX Q/E 70W
Bottom Snap-In for 18–20 Ga. Panels	26725-426	Red	GX24q-6	—	BIAX Q/E 70W



26725-406



26725-425



26725-416

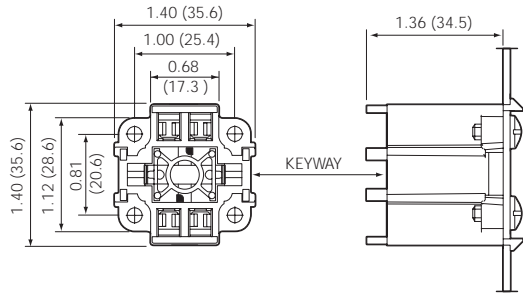

RECOMMENDED MOUNTING SCREW #8 SELF-CUTTING

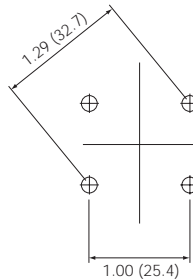

RECOMMENDED HOLE PATTERN

4-Hole Bottom Screw-Down CFLs
26725-415 Shown

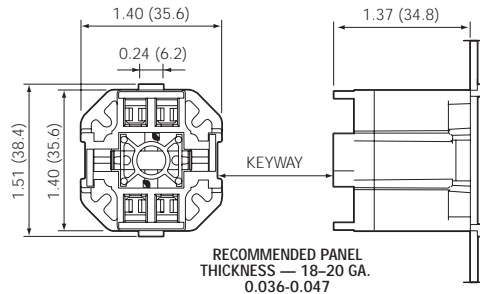

RECOMMENDED PANEL THICKNESS — 18–20 GA.
0.036–0.047

Bottom Snap-In CFLs for 18–20 Ga Panels
26725-426 Shown

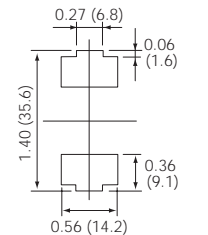

RECOMMENDED PANEL OPENING

SPECIFICATIONS AND FEATURES

- “Smart” CFL Lampholders are color-coded for easy wattage identification
- Bottom Snap-In versions for easier panel assembly available for 16 Ga. and 18–20 Ga. panels
- All 4-pin lampholders have internal rejection feature that prevents insertion of 2-pin lamps
- Metal-spring lamp-retainer clip provides positive lamp retention
- Two wiring ports per contact speed harness wiring
- Wire-routing options for top or bottom side of mounting panel for easier assembly
- Bodies are white thermoplastic (with color-coding as indicated)
- Quick-connect push-in wiring terminals accept No. 18 AWG solid or twisted-and-overtinned leads, stripped 3/8 inch

TESTING AND CODE COMPLIANCE

- UL Listed (File #E-5833)
- UL Listed for indoor and outdoor applications when properly enclosed
- CSA Certified (File #LR-1863)
- NOM Certified (#057)

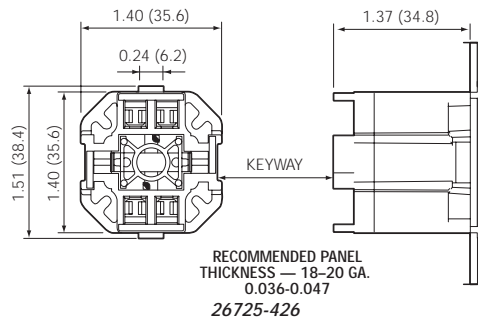

RECOMMENDED PANEL THICKNESS — 18–20 GA.
0.036–0.047
26725-426



75W 600V

Compact Fluorescent Lampholders (CFLs)



26725-4A2

10mm Compact Fluorescent Lampholders with Round Bodies

For G24d Lamp Bases, 2-Pin — Rating: 75 WATT 600V
Bottom Screw-Down Mounting

CAT. NO.	COLOR	LAMP BASE	PHILIPS	OSRAM SYLVANIA	GE LIGHTING
26725-2A1	Black	G24d-1	PL-C 10W, 13W	DULUX D 10W, 13W	DOUBLE BIAX 10W, 13W
26725-2A2	Green	G24d-2	PL-C, 18W	DULUX D, 18W DULUX T, 18W	DOUBLE BIAX 18W
26725-2A3	Orange	G24d-3	PL-C, 26W	DULUX D, 26W DULUX T, 26W	DOUBLE BIAX 26W



26725-4A3

For G24q and GX24q Lamp Bases, 4-Pin — Rating: 75 WATT 600V
Bottom Screw-Down Mounting — Suitable for Dimming or Electronic Ballasts

CAT. NO.	COLOR	LAMP BASE	PHILIPS	OSRAM SYLVANIA	GE LIGHTING
26725-4A1	Black	G24q-1	PL-C 10W, 13W	DULUX-D 10W, 13W	DOUBLE BIAX 10W, 13W TRIPLE BIAX 13W
26725-4A2	Green Green	G24q-2 GX24q-2	PL-C, 18W PL-C, 18W	DULUX D, 18W DULUX T/E, 18W	DOUBLE BIAX, 18W TRIPLE BIAX, 18W
26725-4A3	Orange Orange	G24q-3 GX24q-3	PL-C, 26W PL-T 26W, 32W	DULUX D, 26W DULUX T/E 26W, 32W	DOUBLE BIAX, 26W TRIPLE BIAX 26W, 32W
26725-4A4	Yellow	GX24q-4	PL-T, 42W	DULUX T/E, 42W	PERFORMANCE BIAX 42W
26725-4A5	Blue	GX24q-5	—	DULUX T/E, 57W	BIAX Q/E, 57W
26725-4A6	Red	GX24q-6	—	—	BIAX Q/E, 70W
26725-4A9 Universal*	No color code White body only	G24q-3 GX24q-4	PL-T 26W, 32W 42W	DULUX T/E 26W, 32W, 42W	TRIPLE BIAX 26W, 32W, 42W

*For use with universal ballast only
Note: Lamp names are trademarked by manufacturers

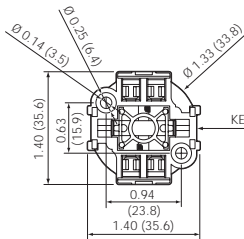

26725-4A5

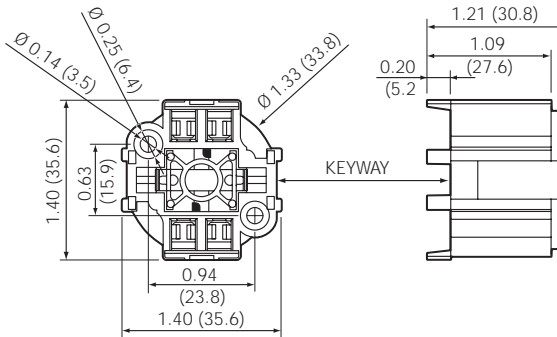

All Round-Body CFLs
26725-4A5 Shown

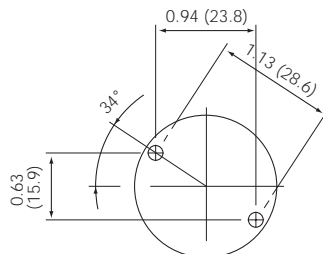

RECOMMENDED PANEL OPENING FOR ALL
ROUND-BODY CFLs

SPECIFICATIONS AND FEATURES

- "Smart" CFL Lampholders are color-coded for easy wattage identification
- All 4-pin lampholders have internal rejection feature that prevents insertion of 2-pin lamps
- Metal-spring lamp-retainer clip provides positive lamp retention and is more durable than plastic clips
- Two wiring ports per contact speed harness wiring
- Wire-routing options for top or bottom side of mounting panel for easier assembly
- Bodies are white thermoplastic (with color-coding as indicated)
- Quick-connect push-in wiring terminals accept No. 18 AWG solid or twisted-and-overtinned leads, stripped 3/8 inch

TESTING AND CODE COMPLIANCE

- UL Listed (File #E-5833)
- UL Listed for indoor and outdoor applications when properly enclosed
- CSA Certified (File #LR-1863)
- NOM Certified (#057)

Appliance Switches

INDEX

Appliance Switches

- Single Pole Pull ChainT2
- Single Pole RotaryT2
- Two Circuit RotaryT3
- Single Pole PushbuttonT3
- Door Jamb SwitchT3
- Fluorescent Starter PushbuttonT4
- Single Pole ToggleT4
- Feed-Through Cord SwitchT5
- Miniature Feed-Through Cord SwitchT5





3 AMP 125V • 6 AMP 125V

Commercial Grade Appliance Switches

THE LEVITON WIRING DEVICES INCLUDED IN THIS SECTION CONSTITUTE ONLY A PARTIAL LISTING OF LEVITON'S COMPLETE APPLIANCE DEVICE LINE.

To learn more about the availability of appliance devices to meet your specialized needs, please contact your Leviton representative.

Appliance Switches



1689-75



10041-500



10097-8



90572

Single Pole Pull Chain Switches

3 AMP 125V AC-L 6 AMP 125V AC 3 AMP 250V AC 1/4 HP 125/250V

DESCRIPTION	CAT. NO.	SEQUENCE
Heavy Duty, Single Circuit, Black and Red Leads	1689-75	ON-OFF (L1, OFF)
Heavy Duty, Two Circuit, Four Positions, Black, Blue, Red Leads	1689-50	LOW-MED-HIGH-OFF (L1, L2, L1 & 2, OFF)
Heavy Duty, Two Speed, Four Positions, Black, Blue, Red Leads	1691-50	ONE-OFF-TWO-OFF (L1, L2, L3, OFF)

3 AMP 125V 1 AMP 125VT 1 AMP 250V

DESCRIPTION	CAT. NO.	SEQUENCE
Compact, Single Circuit, Black Leads	10097-8	ON-OFF

3 AMP 125V AC-L 6 AMP 125V AC 3 AMP 250V AC

DESCRIPTION	CAT. NO.	SEQUENCE
Compact, Single Circuit, Black Leads	10041-500	ON-OFF

Single Pole Rotary Switches

6 AMP 125V AC 3 AMP 250V AC

DESCRIPTION	CAT. NO.	SEQUENCE
Non-Removable Black Plastic Knob, Black Leads	90572	ON-OFF
Non-Removable Metal Knob, Brass or Nickel Finish, Black Leads	90577-010	ON-OFF

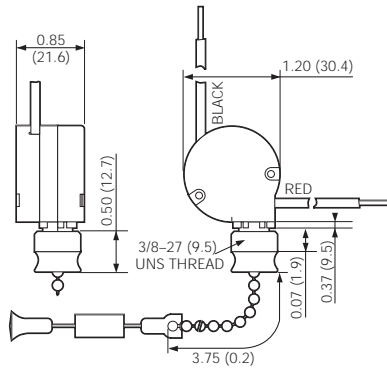

1689-75—HEAVY DUTY PULL CHAIN SWITCH

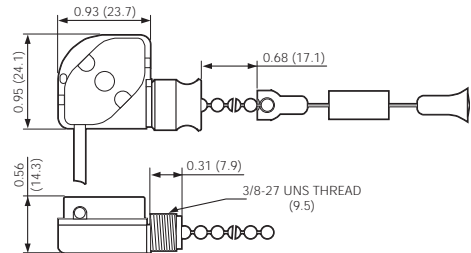

10097-8—COMPACT PULL CHAIN SWITCH

SPECIFICATIONS AND FEATURES

Single Pole Pull Chain Switches

- Standard finish of metal chain is nickel
- Standard leads are No. 18 AWG 105°C plastic 6" long, stripped 1/2"
- 3/4" chain connector, 3' braided cord, end bell
- Bushing 3/8-27 x 3/8" long
- Piercing 13/32" dia.

Single Pole Rotary Switches

- Standard leads are No. 18 AWG 105°C plastic 6" long, stripped 1/2"
- Cat. No. 90572
- Bushing 3/8-27 x 1 1/32" long; panel opening 13/32" dia.

TESTING AND CODE COMPLIANCE

- UL Recognized Component (File #E-7458)—Cat. Nos. 1689-75, 1689-50, 1691-50, 10041-500, 90572, 90577-010
- UL Listed (File #E-7443)—Cat. No. 10097-8
- CSA Certified (File #LR-3413)
- NOM Certified (#057)

MATERIAL CHARACTERISTICS

Environmental: Flammability UL-94, V2 Rating
Operating Temperature: -40°C to 120°C



To learn more about Leviton's outstanding offering of devices visit our Website at: www.leviton.com



Two Circuit Rotary Switches

6 AMP 125VT 3 AMP 250V

DESCRIPTION	CAT. NO.	SEQUENCE
Two Circuit, Four Position, Heavy Duty, Black, Blue, Red Leads	663	LOW-MED-HIGH-OFF (L1, L2, L1 & 2, OFF)

3 AMP 125VT 1 AMP 250V

DESCRIPTION	CAT. NO.	SEQUENCE
Two Circuit, Four Position, Black, Blue, Red Leads	573	LOW-MED-HIGH-OFF (L1, L2, L1 & 2, OFF)

Single Pole Pushbutton Switches

3 AMP 125V AC-L 1.5 AMP 250V AC

DESCRIPTION	CAT. NO.	SEQUENCE
Single Circuit, Black Leads, Molded Brown Pushbutton	9575-250	ON-OFF

3 AMP 125V AC

DESCRIPTION	CAT. NO.	SEQUENCE
Single Circuit, Momentary, for double-insulated applications. Black leads	2591	NORMALLY OFF
Single Circuit, Momentary, for double-insulated applications. Also rated 1.5 AMP 277V AC. Black leads	2592	NORMALLY ON

3 AMP 125V — Door Jamb Switch

DESCRIPTION	CAT. NO.	SEQUENCE
Single Circuit, Momentary, Metal Pushbutton, No. 18AWG Leads, with Jamb Box, Mounting Screws and Cover Plate	1865	NORMALLY ON

3 AMP 125V AC-L 1.5 AMP 250V AC

DESCRIPTION	CAT. NO.	SEQUENCE
Single Circuit, Compact Body, Black Leads, Metal Pushbutton	90679-001	ON-OFF

3 AMP 125VT 1 AMP 250V

DESCRIPTION	CAT. NO.	SEQUENCE
Two Speed, Three-Position, Black, Blue, Red Leads	585	L1, L2, OFF



9575-250



2591



1865



90679-001

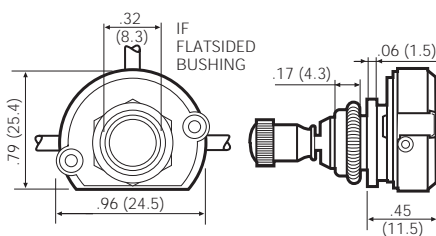

573—TWO CIRCUIT ROTARY SWITCH

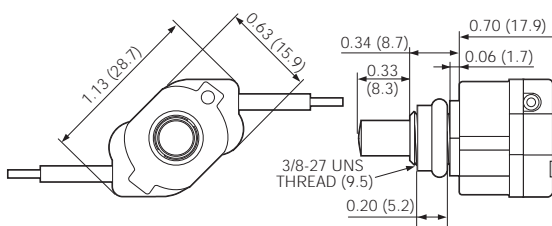

9575-250—SINGLE CIRCUIT PUSHBUTTON SWITCH

SPECIFICATIONS AND FEATURES

Rotary Switches

- Standard leads are No. 18 AWG 105°C plastic 6" long, stripped 1/2"

Cat. Nos. 663, 573

- Bushing 3/8-27 x 3/8" long; panel opening 1 1/32" dia.; knob spindle 4-36 x 5/32"

Single Pole Pushbutton Switches

- Standard leads are No. 18 AWG 105°C plastic 6" long, stripped 1/2"
- Plastic actuators are brown molded plastic unless otherwise indicated

Cat. No. 9575-250

- Plastic button; bushing 3/8-27 x 1 1/32" long; panel opening 1 1/32" dia. Leads stripped 3/4"

Cat. Nos. 2591, 2592

- Plastic button; bushing 3/8-27 x 27/64" long
- 2591: One 12" lead and one 6" lead

Cat. No. 1865 – Door Jamb Switch

- Bushing 1 5/32-32 x 9/16" long

Cat. No. 90679-001

- Metal button; bushing 3/8-27 x 27/64" long. Leads stripped 3/4"

Cat. No. 585

- Metal button; bushing 3/8-27 x 27/64" long. Leads stripped 3/4"

TESTING AND CODE COMPLIANCE

- UL Recognized Component (File #E-7458)—Cat. Nos. 9575-250, 2591, 2592, 90679-001, 585
- UL Listed (File #E-7443)—Cat. Nos. 663, 573, 1865
- CSA Certified (File #LR-3413)—All, except Cat. Nos. 2591 and 2592
- NOM Certified (#057)

MATERIAL CHARACTERISTICS

Environmental: Flammability UL-94, V2 Rating
Operating Temperature: -40°C to 120°C

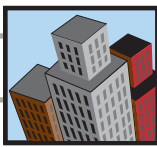

40 WATT 125V • 6 AMP 125V • 8 AMP 125V • 15 AMP 125V

Commercial Grade Appliance Switches

Pushbutton Switches Fluorescent Starter

40 WATT 125V AC

DESCRIPTION	CAT. NO.	SEQUENCE
Metal Button, 2 Black, 2 Blue Leads	388	ON-OFF
Plastic Button, 2 Black, 2 Blue Leads	9382	ON-OFF

Single Pole Toggle Switches

6 AMP 125V 3 AMP 250V

DESCRIPTION	CAT. NO.	SEQUENCE
Single-Throw Ball Toggle. Nickel Finish ON-OFF Indicator Plate keyed to bushing. #6-32 Brass Terminal Screws	735	ON-OFF

6 AMP 125V 3 AMP 125VT 3 AMP 250V

DESCRIPTION	CAT. NO.	SEQUENCE
Single-Throw Metal Bat Toggle. ON-OFF Indicator Plate keyed to bushing. No. 18 AWG leads.	720-L5	ON-OFF
Same as above, with Molded Nylon Bat Toggle. Meets UL requirements for double insulated applications	1720-T	ON-OFF

8 AMP 125V

DESCRIPTION	CAT. NO.	SEQUENCE
Single-Throw Metal Bat Toggle. Nickel Finish ON-OFF Indicator Plate keyed to bushing with No. 16 AWG leads.	738	ON-OFF
Similar to Cat. No 738, with Black Molded Nylon Bat Toggle. No. 16 AWG leads. For double insulated applications	1738	ON-OFF

15 AMP 125V AC 10 AMP 250V AC 3/4 HP 125/250V AC

DESCRIPTION	CAT. NO.	SEQUENCE
Single-Throw Heavy-Duty Aluminum Bat Toggle. Stamped with ON-OFF marking. Screw terminals	5731	ON-OFF
Single-Throw Heavy-Duty Aluminum Bat Toggle. Stamped with ON-OFF marking. Quick connect tabs	5721	ON-OFF

Appliance Switches



388



735



1720-T



5731

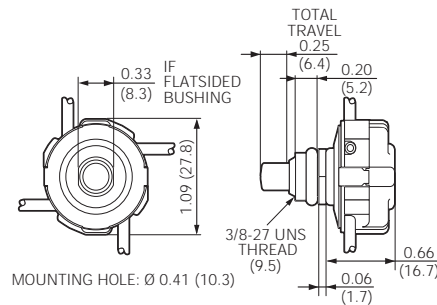

388—FLUORESCENT STARTER SWITCH

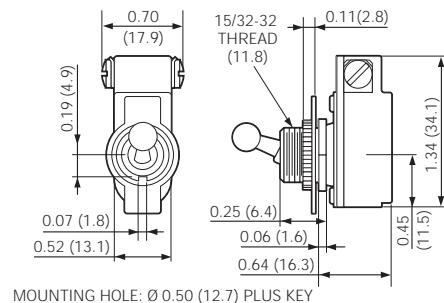

735—SINGLE POLE TOGGLE SWITCH

SPECIFICATIONS AND FEATURES

Cat. Nos. 388, 9382

- Bushing 3/8-27 x 1 1/32" long; panel opening 1 3/32" dia.

Cat. No. 735

- Bushing 15/32-32 x 1/4" long

Cat. No. 720-L5

- Bushing 15/32-32 x 1/4" long

Cat. No. 1720-T

- Bushing 15/32-32 x 1 1/32" long

Cat. Nos. 1738, 738

- Bushing 15/32-32 x 1 1/32" long; panel opening 1/2" dia.

Cat. Nos. 5731, 5721

- Bushing 15/32-32 x 3 1/64" long. Bat-type toggle extends 1 1/16" from top of bushing

TESTING AND CODE COMPLIANCE

- UL Listed (File #E-18134)—Cat. Nos. 388, 9382
- UL Listed (File #E-7458)—Cat. Nos. 735, 720-L5, 1720-T, 738, 1738, 5731, 5721
- CSA Certified (File #LR-8255)—Cat. No. 388
- CSA Certified (File #LR-3413)—Cat. Nos. 9382, 735, 720-L5, 1720-T, 738, 1738, 5731, 5721
- NOM Certified (#057)

MATERIAL CHARACTERISTICS

Environmental: Flammability UL-94, V2 Rating
Operating Temperature: -40°C to 120°C



To learn more about Leviton's outstanding offering of devices visit our Website at: www.leviton.com

Courtesy of Steven Engineering, Inc. • 230 Ryan Way, South San Francisco, CA 94080-6370 • General Inquiries: (800) 670-4183 • www.stevenengineering.com

T
4



Feed-Through Cord Switches

3 AMP 125V 1/2 H.P. 125V

DESCRIPTION	CAT. NO.	SEQUENCE	COLOR*
Heavy Duty, Single Pole, 18/2 – 16/2 Type SPT-1, SPT-2 or Round Cord 18/2, Type SVT and other cords up to 9/32" outer jacket.	5410	ON-OFF	I, W <small>Basic Cat. No. denotes Brown</small>

Miniature Feed-Through Cord Switch

6 AMP 125V 3 AMP 125VT 3 AMP 250V

DESCRIPTION	CAT. NO.	COLOR*
Miniature Single Pole, ON-OFF Sequence, Captive Screw. For use with #18 ga. SPT-1 conductors	423-3	I, W <small>Basic Cat. No. denotes Brown</small>



5410-W



423-3I

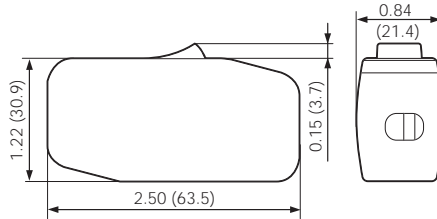

5410—FEED-THROUGH SWITCH

TESTING AND CODE COMPLIANCE

- UL Listed (File #E-7458)
- CSA Certified (File #LR-3413)
- NOM Certified (#057)

***COLOR**

Basic Cat. No. denotes Brown. Add the suffix to catalog number as follows for additional color selections: Ivory (-I), White (-W).

MATERIAL CHARACTERISTICS

Environmental: Flammability UL-94, V2 Rating
Operating Temperature: -40°C to 120°C

HOW TO USE THIS CATALOG

The L-101 Leviton Wiring Device Catalog is designed to help you find the device you're seeking in the quickest and easiest way possible. Most product sections are divided into three distinct categories in the following sequence—Industrial Grade, Commercial Grade and Residential Grade—and grouped according to amperage and voltage, lowest to highest. For example, if you need to order 15 Amp, 125 Volt Industrial Grade straight-blade duplex receptacles, begin your search with the main Table of Contents at the front of the book. Here you'll see that all straight blade receptacles are listed in Section G. Turn to Section G for a more detailed Table of Contents on the first page. Each section page contains product descriptions, ratings and catalog numbers. There are also helpful highlights including Specifications and Features, Testing and Code Compliance, Color listing, Material Characteristics and dimensioned color product photos. Any product page in the L-101 Catalog can be clearly copied or faxed to customers and prospects for use as a specifier sheet or as part of a presentation.

The Quick Reference Guide follows the main Table of Contents to help you pinpoint and locate specific products. Technical Section V provides general product and test data, industry standards, NEMA configuration charts, a glossary of wiring device terms, ANSI architectural symbols and other related information. Specific catalog numbers are listed in the exhaustive index at the back of the catalog.

15 AMP 125 and 250V • 20 AMP 125 and 250V

Industrial Grade Straight Blade Receptacles

Back and Side Wired (Basic Cat. No. Denotes Brown Device*)

DESCRIPTION	CAT. NO./COLOR 15A/125V	CAT. NO./COLOR 15A/250V	CAT. NO./COLOR 20A/125V	CAT. NO./COLOR 20A/250V
LEVSPEC® Duplex Receptacle, Brass Strap	5262 I, W, GY, R, E	5662 I	5362 I, W, GY, R, E	5462 I, GY
Single Receptacle	5261 I, W, GY	5661 I	5361 I, W, A, T, GY	5461 I, A, T, GY
Narrow Body Duplex Receptacle	5252 I, W, A, T, GY, R, BU		5352 I, W, A, T, GY, R,	

5362-IG

For complete wallplate selection, see Section E.

80703-IG

80703-I

80704-GY

80716-R

84003-40

84004-40

84016-40

5242-W

SPECIFICATIONS AND FEATURES

Back & Side Wired Duplex

- Impact-resistant thermoplastic nylon cover and body
- Smooth face does not collect dirt
- Four corner latches securely fasten face
- Single-piece brass mounting strap on LEVSPEC devices, multi-piece steel strap on other devices
- Large, triple-wipe, brass "T" contacts for superior contact and conductivity
- Back and side-wiring options
- Brass terminal screws to reduce conductor oxidation
- Break-off tabs for easy two-circuit conversion
- Apron barrier to prevent accidental contact between terminal screw heads and metal box
- Exclusive V-shaped, serrated back-wiring clamp for superior contact and conductivity

TESTING AND CODE COMPLIANCE

- UL Listed 498 (UL File #13399); UL Federal Specification WC-596

- Meets NEMA WD-1 & 6, and ANSI standards
- Backed by a Limited 10-Year Warranty
- SPECCLASS devices backed by a Limited 2-Year Warranty

***COLOR**

Basic Cat. Nos. shown above denote Brown device, except for Isolated Ground (-IG) devices Basic Cat. No. denotes Orange. Isolated Ground Receptacle is distinguished by an orange triangle on its face. For other color selections, add suffix to the catalog number as follows: Ivory (-I), White (-W), Brown (For IG devices only, add -B), Almond (-A), Light Almond (-T), Gray (-G or -GY), Black (-E), Red (-R) and Blue (-BU); for IG devices only, add -BIG)

MATERIAL CHARACTERISTICS

Environmental: Flammability, Rated V2
Operating Temperature: From -40° C (without impact) to 60°C maximum continuous

- | | | |
|---------------------------------------|--|--------------------------------------|
| A RATING | E CATALOG NUMBER | I SPECIFICATIONS & FEATURES |
| B Choose GRADE, if appropriate | F DESCRIPTION | J TESTING AND CODE COMPLIANCE |
| C DIMENSIONED PHOTOGRAPH | G Check for NEMA CONFIGURATION | K COLOR LISTING |
| D WIRING/CERTIFICATIONS | H WALLPLATE REFERENCE, if appropriate | L MATERIAL CHARACTERISTICS |

Electrical Accessories and Decorative Devices

INDEX

Residential Grade Electrical Accessories and Decorative Devices

Taps and Adapters	U2
Night Lights	U3
Guide Lights	U4
Fluorescent Utility Lights	U4
Child Protection Devices	U4
Accessories	U4
Wallplates	U5





ADAPTERS

Residential Grade Devices

LEVITON OFFERS A VARIETY OF ELECTRICAL ACCESSORIES FOR RESIDENTIAL USE, INCLUDING TAPS, SURFACE OUTLETS, ADAPTERS, NIGHT LIGHTS AND SAFETY ITEMS USED FOR CHILD PROTECTION.

Switch Tap

13 AMP 125V 2-Pole 2-Wire Non-Grounding

DESCRIPTION	CAT. NO.	COLOR	NEMA CONFIG.
Plug-In Switch Tap	1469	I, W	1-15R



1469-W



69-W



607-W



698-W



1403-W

Plug-In Outlet Adapters

15 AMP 125V 2-Pole 2-Wire Non-Grounding

DESCRIPTION	CAT. NO.	COLOR	NEMA CONFIG.
Single-to-Triple 3 round or flat plugs accepted	63	I, W	1-15R
Single-to-Triple Right Angle, 3 round or flat plugs accepted★	65	I, W	
Single-to-Triple, Swivel, 3 flat plugs accepted	69	I, W	
Cube Tap, Vinyl, 3 round or flat plugs accepted	531	I, W	

15 AMP 125V 2-Pole 3-Wire Grounding

DESCRIPTION	CAT. NO.	COLOR	NEMA CONFIG.
3-Wire, Grounding Duplex-to-Six, 6 small or 4 large plugs accepted	49686	I, W	5-15R
3-Wire, Grounding Single-to-Triple, 3 straight or angle plugs acceptedH	697	I, W	
3-Wire, Grounding Single-to-Triple, Vinyl, 3 straight or angle plugs accepted	699	Orange only	
3-Wire, Grounding Single-to-Triple, 3 straight plugs accepted	694	Orange, Green	
Triple Cube Adapter	692	I, W	

15 AMP 125V 2-Pole 2-Wire to 2-Pole 3-Wire Grounding

DESCRIPTION	CAT. NO.	COLOR	NEMA CONFIG.
Adapter, 2-Wire to Grounding, 1 straight or 1 angle plug accepted★	274	Gray	5-15R
2-Wire to Grounding, 3 straight plugs accepted★	698	I, W	

Note: All Leviton #274 and #698 adapters use the outlet wallplate screws for grounding.

Medium Base Lampholder Outlet Adapters

660 WATT 125V 2-Pole 2-Wire

DESCRIPTION	CAT. NO.	COLOR	NEMA CONFIG.
Outlet-to-Lampholder★	61	I, W	1-15R
Lampholder-to-Outlet	125	I, W	
Keyless Lampholder and 2 Outlets	1403	I, W, E	
Single Lampholder-to-Twin Lampholder (660W-250V)	128	I	

660 WATT 125V Max. Total 2-Pole 2-Wire

DESCRIPTION	CAT. NO.	COLOR	NEMA CONFIG.
Pull Chain Lampholder and 2 Outlets. Pull chain controls lamp socket ONLY. Outlet continuously live.	1406	I, W, E	1-15R

CSA Certified except where indicated by★

SPECIFICATIONS AND FEATURES

Plug-In Switch

- Provides ON/OFF switching at outlet location

Plug-In Outlet Adapters

- Convenient expansion of outlet capacity

TESTING AND CODE COMPLIANCE

- UL Listed (File #E13393 – Cat. No. 125; File #E13394 – Cat. Nos. 1469, 49686, 692, 694, 697, 698, 274, 128, 1403 and 1406; File #E-13399 – Cat. Nos. 63, 65, 69, 531)
- CSA Certified (File #LR-406 – Cat. No. 125; File #LR-1523 – Cat. No. 63; File #LR-2780 – Cat. No. 128; File #LR-61476 – Cat. Nos. 65, 69, 531 and 1469; File #LR-91345 – Cat. No. 49686)
- NOM Certified (#057)
- Backed by a Limited Two-Year Warranty

*COLOR

Basic Cat. No. denotes Brown device. For other color selections, add suffix to catalog number as follows: Ivory (-I), White (-W), Almond (-A) and Black (-E).



Night Lights

ON/OFF Night Light 4 WATT 125V

DESCRIPTION	CAT.NO	COLOR*
ON/OFF switching with sleek, contemporary styling	48566	I, W

Automatic Light Directing LED Night Light .25W 120V

DESCRIPTION	CAT.NO	COLOR
Removable shade slides up and down to direct light	48585	W

Automatic Rotating Spotlight 120V

DESCRIPTION	CAT.NO	COLOR
Automatic ON/OFF with 360° rotating head directs light and varies intensity (2.4W)	49566	W
LED Automatic ON/OFF with 360° rotating head directs light and varies intensity (.5W)	49566-LED	W

Automatic Night Light 4 WATT 125V

DESCRIPTION	CAT.NO	COLOR* (Night Light Base)
Automatic ON/OFF sensor with sleek, contemporary styling	48568	I, W

Automatic LED Night Light .25W 120V

DESCRIPTION	CAT.NO	COLOR
Automatic ON/OFF with light-reflecting, crystal-faceted shade	48580	BLU (Blue) GRN (Green) WHT (White)

Automatic Sound-Activated Night Light 125V

DESCRIPTION	CAT.NO	COLOR
Sound-Activated with adjustable sensitivity (4W)	51012	W
LED Sound-Activated with adjustable sensitivity (.5W)	51012-LED	W

Decorative Shade LED Night Lights .5W 120V

DESCRIPTION	CAT.NO	COLOR
49563 Series —Consult your Leviton representative for available shade designs	49563	W



Leviton's Energy Smart Living Program

Leviton offers a broad range of energy-efficient lighting devices for homes and businesses. From dimmers, timers and motion sensors to night-lights and more, Leviton has the electrical products you need to save energy and conserve resources. Look for the Energy Smart Living logo, your assurance of an environmentally friendly lighting product. For more information, visit our website at www.leviton.com.



48568-W



48580-WHT



51012



49563-SWL



49563-PLM

SPECIFICATIONS AND FEATURES

Automatic Night Lights

- Turn ON automatically at dusk and OFF automatically at dawn, by sound or by movement depending on model
- Long-life 4 watt bulb or LED included

TESTING AND CODE COMPLIANCE

- UL Listed (File #E-39445 – Cat. Nos. 16509, 48566, 48581, 49563, 49566 and 51012; File #E-121173 – Cat. No. 48568)
- CSA Certified (File #LR-1863 – Cat. Nos. 48566, 48568 and 49566)
- NOM Certified (#057)
- Backed by a Limited Two-Year Warranty

*COLOR

Add suffix to catalog number as follows for color selections: Ivory (-I), White (-W).



Residential Grade Devices

Electrical Accessories and Decorative Devices



49568



6511-6



6516



12540

Guide Lights

DESCRIPTION	CAT.NO	COLOR
Button-Style Neon Guide Light .25 Watt 120V AC	49567	W
LED Guide Light with clear shade .5 Watt 120V AC	49568	W (Amber LED) BLU (Blue LED)

Cool Glow Night Light

DESCRIPTION	CAT.NO	COLOR
Electro-Luminescent Guide Light 1 pack .03W 115V	16509-1PK	W
Electro-Luminescent Guide Light 2 pack .03W 115V	16509-2PK	W

Utility Lights

DESCRIPTION	CAT.NO	COLOR
6" Battery-Operated Fluorescent Light —With 4W replaceable bulb. Requires 4 AA batteries (not included). 6V DC Jack for use with AC/DC adapter (Sold separately)	6511-6	(White base only)
6" Battery-Operated Closet Utility Light with ON/OFF switch (2 pack) —Requires 3 AA batteries (not included)	6516-2PK	(White base only)

Child Protection Devices

Outlet Cover Night Light .25 WATT

DESCRIPTION	CAT.NO	COLOR
Cool neon light on top outlet, cover on bottom outlet	48500	(White base only)

Outlet Caps

DESCRIPTION	CAT.NO	COLOR
Outlet Caps—12 Pack	12777	White only

Tamper Resistant Receptacles 15 AMP 125V 2-Pole 3-Wire Grounding

DESCRIPTION	CAT. NO.	COLOR	NEMA CONFIG.
Tamper Resistant Receptacle	5321	I, W	5-15R

Electrical Accessories

DESCRIPTION	CAT.NO	COLOR
Insulated Staples — ⁵ / ₈ " long, for use with 18/2 or smaller cord (40 Pieces)	12533	White
Plastic Staples —for 1/2" 14/2 & 12/2 NM Cable (50 Pieces)	12536	White
Wiring Fasteners —Includes 1/2" Plastic Staples, Coax Cable Fasteners and 1/2" X 1" Metal Staples (47 Mixed Pieces)	12537	White/Black/ Metal Mix
NM Cable Fittings — ³ / ₈ " dia. for 14/2, 14/3 & 12/3 NM Cable (4 Pack)	12538	—
8" Cable Ties —Holds wires, cables, bundles and hoses; comes in assorted lengths and colors	12540	White, BL (Black) NE (Neon)

SPECIFICATIONS AND FEATURES

- Guide Lights**
 - Energy-efficient with soft, comforting light
 - Compact Neon model keeps second outlet free
 - No bulb to replace in LED models
- Utility Lights**
 - Battery operation adds light without wiring anywhere extra light is needed
 - Includes adhesives for easy, anywhere mounting
- Outlet Caps**
 - Insert into unused outlets to serve as a barrier
 - Can be easily removed by adults when needed for lights and appliances
- Tamper Resistant Receptacle**
 - Exclusive design helps prevent insertion of anything but a properly rated plug
 - Floating shutters behind outlet faces block clear access to energized contacts

TESTING AND CODE COMPLIANCE

- UL Listed (File #E-84313 – Cat. Nos. 48500; File #E-7416 – Cat. No. 12777; File #E-13399 – Cat. No. 5321)
- CSA Certified (File #LR-64317 – Cat. No. 48500; File #LR-406 – Cat. No. 5321)
- NOM Certified (#057)
- Backed by a Limited Two-Year Warranty

***COLOR**

Add suffix to catalog number as follows for color selections: Ivory (-I), White (-W), Black (-E).



The Finishing Touch® Wallplates

Available in warm wood tones and decorative metals, The Finishing Touch® wallplates are perfect for decorating, redecorating or adding an accent to any room. These wallplates feature elegant and stylish finishes with an oversize silhouette for complete coverage.

Decorative Wood — Straight Edge

DESCRIPTION	CAT. NO.	COLOR
1-GANG, 1-Toggle	89201-OAK	Oak
	89201-CHR	Cherry
	89201-UNF	Unfinished
	89201-WWP	Whitewash
2-GANG, 2-Toggles	89209-OAK	Oak
	89209-CHR	Cherry
	89209-UNF	Unfinished
	89209-WWP	Whitewash
1-GANG, 1-Duplex	89203-OAK	Oak
	89203-CHR	Cherry
	89203-UNF	Unfinished
	89203-WWP	Whitewash

Wood — Scalloped Edge

DESCRIPTION	CAT. NO.	COLOR
1-GANG, 1-Toggle	89201-CVP	Pine
2-GANG, 2 Toggle	89203-CVP	Pine
1-GANG, 1 Duplex	89209-CVP	Pine

Wood — Beveled Edge

DESCRIPTION	CAT. NO.	COLOR
1-GANG, 1-Toggle	89201-POK	Oak
1-GANG, 1-Duplex	89203-POK	Oak

Decorative Metal

DESCRIPTION	CAT. NO.	COLOR
1-GANG, 1-Toggle	89301-ATB	Antique Brass
	89301-SSS	Satin Chrome
	89601-STB	Stepped Brass
2-GANG, 2-Toggles	89309-ATB	Antique Brass
	89309-SSS	Satin Chrome
	89609-STB	Stepped Brass
1-GANG, 1-Duplex	89303-ATB	Antique Brass
	89303-SSS	Satin Chrome
	89603-STB	Stepped Brass

For the full offering of Decorative Wallplates contact your Leviton representative.

SPECIFICATIONS AND FEATURES

Decorative Wood and Metal Wallplates

- Genuine wood available in Oak, Cherry, Whitewash and Unfinished
- Metal available in Antique Brass, Satin Chrome White Vinyl and Stepped Brass
- Sturdy impact-resistant construction for long-lasting performance
- Modern design with oversized silhouette for complete coverage
- Clean attractive appearance
- Smooth surface is easy to keep clean
- Mounting screws included—Metal plates feature matching-color screws



89201-OAK



89209-CHR



89203-CVP



89309-SSS



89601-STB

TABLE OF CONTENTS with Quick Reference Index

The L-101 Leviton Wiring Device Catalog is designed to help you find the device you're seeking in the quickest and easiest way possible. Most product sections are divided into three distinct categories in the following sequence—Industrial Grade, Commercial Grade and Residential Grade—and grouped according to amperage and voltage, lowest to highest. For example, if you need to order 15 Amp, 125 Volt Industrial Grade straight-blade duplex receptacles, begin your search with the main Table of Contents at the front of the book. Here you'll see that all straight blade receptacles are listed in Section G. Turn to Section G for a more detailed Table of Contents on the first page. Each section page contains product descriptions, ratings and catalog numbers. There are also helpful highlights including Specifications and Features, Testing and Code Compliance, Color listing, Material Characteristics and dimensioned color product photos. Any product page in the L-101 Catalog can be clearly copied or faxed to customers and prospects for use as a specifier sheet or as part of a presentation.

The Quick Reference Guide follows the main Table of Contents to help you pinpoint and locate specific products. Technical Section V provides general product and test data, industry standards, NEMA configuration charts, a glossary of wiring device terms, ANSI architectural symbols and other related information. Specific catalog numbers are listed in the exhaustive index at the back of the catalog.

15 AMP 125 and 250V • 20 AMP 125 and 250V

Industrial Grade Straight Blade Receptacles

4.06 (103.2)
3.28 (83.3)
1.53 (38.9)
2.77 (70.4)
0.87 (22.2)

Back and Side Wired (Basic Cat. No. Denotes Brown Device*)

DESCRIPTION	CAT. NO./COLOR 15A/125V	CAT. NO./COLOR 15A/250V	CAT. NO./COLOR 20A/125V	CAT. NO./COLOR 20A/250V
LEVSPEC® Duplex Receptacle, Brass Strap	5262 I, W, GY, R, E	5662 I	5362 I, W, GY, R, E	5462 I, GY
Single Receptacle	5261 I, W, GY	5661 I	5361 I, W, A, T, GY	5461 I, A, T, GY
Narrow Body Duplex Receptacle	5252 I, W, A, T, GY, R, E, BU		5352 I, W, A, T, GY, R,	

0.85 (21.6)

5362-IG

80703-IG 80703-I 80704-GY 80716-R

For complete wallplate selection, see Section E.

84003-40 84004-40 84016-40

SPECIFICATIONS AND FEATURES

Back & Side Wired Duplex

- Impact-resistant thermoplastic nylon cover and body
- Smooth face does not collect dirt
- Four corner latches securely fasten face
- Single-piece brass mounting strap on LEVSPEC devices, multi-piece steel strap on other devices
- Large, triple-wipe, brass "T" contacts for superior contact and conductivity
- Back and side-wiring options
- Brass terminal screws to reduce conductor oxidation
- Break-off tabs for easy two-circuit conversion
- Apron barrier to prevent accidental contact between terminal screw heads and metal box
- Exclusive V-shaped, serrated back-wiring clips for superior contact and conductivity

TESTING AND CODE COMPLIANCE

- UL Listed 498 (UL File #13399); UL Federal Specification WC-596

***COLOR**

Basic Cat. Nos. shown above denote Brown device, except for Isolated Ground (-IG) devices. Basic Cat. No. denotes Orange. Isolated Ground Receptacle is distinguished by an orange triangle on its face. For other color selections, add suffix to the catalog number as follows: Ivory (-I), White (-W), Brown (For IG devices only, add -B), Almond (-A), Light Almond (-T), Gray (-G or -GY), Black (-E), Red (-R) and Blue (-BU; for IG devices only, add -BIG)

MATERIAL CHARACTERISTICS

Environmental: Flammability, Rated V2
Operating Temperature: From -40° C (without impact) to 60° C maximum continuous

- | | | |
|--|---|--|
| <p>A RATING</p> <p>B Choose GRADE, if appropriate</p> <p>C DIMENSIONED PHOTOGRAPH</p> <p>D WIRING/CERTIFICATIONS</p> | <p>E CATALOG NUMBER</p> <p>F DESCRIPTION</p> <p>G Check for NEMA CONFIGURATION</p> <p>H WALLPLATE REFERENCE, if appropriate</p> | <p>I SPECIFICATIONS & FEATURES</p> <p>J TESTING AND CODE COMPLIANCE</p> <p>K COLOR LISTING</p> <p>L MATERIAL CHARACTERISTICS</p> |
|--|---|--|

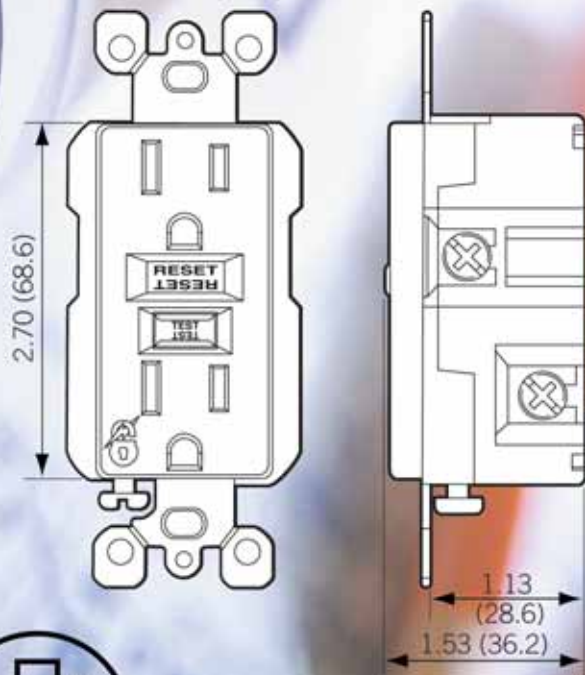
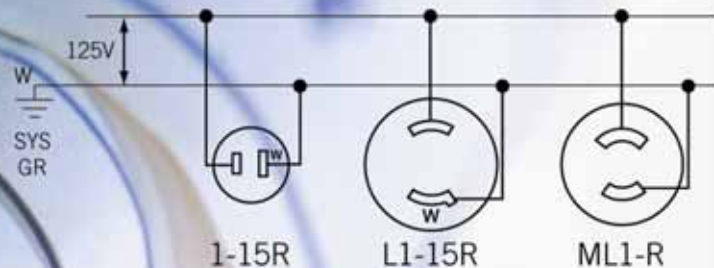

● Hospital Grade

● Hospital Grade

Technical Information

INDEX

- List of AbbreviationsV2
- National Electrical Code (NEC) Requirements . . .V3
- Associations, Organizations and Standards . .V4, V5
- Certification Agencies and MarkingsV5
- UL, CSA and NEMA Standards Pertaining to LevitonV6
- High-Abuse, UL Listed Hospital Grade Wiring DevicesV7
- Glossary of Electrical Wiring Device Terms . .V8-V10
- SwitchesV11
- DimmersV11
- ReceptaclesV11, V12
- Ground Fault Circuit Interrupters (GFCI's) . . .V12
- Enclosure ClassificationsV13-V15
- Materials Used in Wiring DevicesV15, V16
- ANSI Architectural SymbolsV17
- NEMA Straight Blade ConfigurationsV18
- NEMA Locking ConfigurationsV19
- Horsepower Ratings for NEMA Configurations . .V20
- Circuit Wiring DiagramsV21-V23
- Switch Wiring DiagramsV24
- Diameter Ranges of Jacketed CordV25
- Wallplate DimensionsV26
- Telephone Wiring Devices — Codes and StandardsV27
- Wire Color Codes and Jack Pin Designations . .V28





INDUSTRY STANDARDS, RELEVANT DEFINITIONS, PERTINENT PRODUCT DATA, REPRESENTATIVE DIMENSIONAL DRAWINGS AND GENERAL PRODUCT REFERENCES ARE INCLUDED IN THIS SECTION.

List of Abbreviations Used In Leviton Catalogs

ANSI

American National Standards Institute, Inc.
11 West 42nd St., New York, NY 10036

An independent organization that identifies industrial and public requirements for national consensus standards and coordinates and manages their development, resolves national standards problems, and ensures effective participation in international standardization.

Various U.S. Government Agencies often adopt ANSI Standards. For example, the Department of Defense has made mandatory the use of ANSI Standard Y32.9-1972, "Graphic Symbols for Electrical Wiring and Layout Diagrams used in Architecture and Building Construction." Such Standards are often developed by specialized technical societies for ANSI. The Standard referred to above was prepared by the Institute of Electrical and Electronics Engineers (IEEE) and the American Society of Mechanical Engineers (ASME).

GSA

General Services Administration Federal Supply Service
Crystal Mall Bldg. 4, Washington, D.C. 20406

The U.S. Government administration responsible for the approval of Federal Specifications used in the purchase of products by all Federal Agencies.

The two most relevant Federal Specifications for Electrical Wiring Devices are:

W-C-596, for Electrical Power Connector, Plug, Receptacle and Cable Outlet

W-S-896, for Toggle and Lock, Flush Mounted Switches

Leviton devices that comply with these specifications, as verified by Underwriters Laboratories Inc., are also listed in this catalog.

NEC

National Electrical Code
Published by the NFPA (see listing)

The purpose of the Code is the practical safeguarding of persons and property from hazards arising from the use of electricity. This Code is sponsored by NFPA under the auspices of ANSI. It is revised every three years. OSHA (see listing) has adopted the NEC as the code to follow in order to comply with OSHA requirements.

NEMA

National Electrical Manufacturers Association
2101 L St. NW, Washington, D.C. 20003

An organization of electrical manufacturers that establishes standards for manufacture and tests for performance and reliability of electrical products. NEMA tests are often the basis or prerequisite for approval by the Federal Government and/or by Underwriter's Laboratories, Inc.

NFPA

National Fire Protection Association
Battery March Park, Quincy, MA 02269

An organization devoted to promoting the science and improving the methods of Fire Protection. Membership is open to anyone interested. Every three years, the NFPA produces a new edition of the NEC (see listing). The NFPA also provides many other useful publications dealing with fire prevention.

OSHA

Occupational Safety and Health Administration
(U.S. Department of Labor), 200 Constitution Ave. NW, Washington D.C. 20210 (plus regional offices)

That part of the U.S. Department of Labor responsible for assuring that employers provide safe and healthful working conditions and equipment for employees, and that employees properly avail themselves of these conditions.

In addition to specific regulations published in the Federal Register, OSHA has also adopted the National Electrical Code in part for existing installations and equipment and completely for new construction.

Note: OSHA does not approve products. Compliance with OSHA regulations is contingent on two factors: The approval or listing of the product by an authorized testing laboratory, such as UL (see listing), and the proper installation and/or use of the product in accordance with OSHA guidelines.

UL

Underwriters Laboratories Inc.
Northbrook, IL; Melville, NY; Santa Clara, CA

"An independent, not-for-profit organization testing for public safety." Tests by UL are the basis for acceptance by various government agencies. Listing by UL denotes initial testing and periodic retesting to assure continuing conformance to standards.

NOM

Norma Oficial Mexicana
(Mexican Official Standard) SECOFI
Avenida Puente de Tecamachalco #6
Col. Lomas de Tecamachalco 53950
Naucalpan, Edomex Mexico



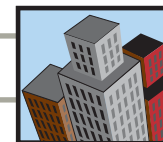

Industry Standards for Electrical Wiring Devices

National Electrical Code Requirements for Wiring Devices

National Electrical Code NFPA No. 70-1996 (Selected Articles)

ARTICLE 90 — Introduction

ARTICLE 100 — Definitions

ARTICLE 110 — Requirements for Electrical Installations

- 110-18 Arcing Parts
- 110-21 Marking

ARTICLE 200 — Use and Identification of Grounded Conductors

- 200-9 Means of Identification of Terminals
- 200-10 Identification of Terminals

ARTICLE 210 — Branch Circuits

- 210-4 Multiwire Branch Circuits
- 210-6 Branch Circuit Voltage Limitations
- 210-7 Receptacles and Cord Connectors
- 210-8 Ground Fault Protection for Personnel
- 210-21 Outlet Devices
- 210-24 Branch Circuit Requirements
- 210-50 Required Outlets, General
- 210-52 Dwelling Unit Receptacle Outlets
- 210-60 Guest Rooms
- 210-63 Rooftop Heating, Air Conditioning and Refrigeration Equipment Outlet
- 210-70 Lighting Outlets Required

ARTICLE 220 — Branch Circuit, Feeder and Service Calculations

- 220-4 Branch Circuits Required

ARTICLE 250 — Grounding

- 250-45 Equipment Connected by Cord and Plug
- 250-50 Equipment Grounding Conductor Connections
- 250-51 Effective Grounding Path
- 250-59 Cord and Plug Connected Equipment
- 250-74 Connecting Receptacle Grounding Terminal to Box

ARTICLE 310 — Conductors for General Wiring

- 310-15 Ampacities

ARTICLE 380 — Switches

- 380-1 Scope
- 380-2 Switch Connections
- 380-8 Accessibility and Grouping
- 380-9 Faceplates for Flush-Mounted Snap Switches
- 380-14 Rating and Use of Snap Switches
- 380-15 Marking

ARTICLE 410 — Lighting Fixtures, Lampholders, Lamps, Receptacles

- 410-29 Cord-Connected Showcases
- 410-56 Receptacles, Cord Connectors and Attachment Plugs
- 410-57 Receptacles in Damp or Wet Locations
- 410-58 Grounding-Type Receptacles, Adapters, Cord Connectors and Attachment Plugs

ARTICLE 422 — Appliances

- 422-22 Disconnection of Cord- and Plug-Connected Appliances

ARTICLE 511 — Commercial Garages, Repair and Storage

- 511-10 Ground Fault Circuit Interrupter Protection for Personnel

ARTICLE 517 — Health Care Facilities

- 517-3 Definitions
- 517-12 Wiring Methods
- 517-13 Grounding of Receptacles and Fixed Electric Equipment
- 517-16 Receptacles with Insulated Grounding Terminals
- 517-18 General Care Areas
- 517-19 Critical Care Areas
- 517-19(e) Additional Protective Techniques
- 517-20 Wet Locations
- 517-21 Ground Fault Circuit Interrupter Protection for Personnel
- 517-31 Emergency System
- 517-44 Sources of Power
- 517-61 Wiring and Equipment
 - (a) Within Hazardous (Classified) Anesthetizing Locations
 - (b) Above Hazardous (Classified) Anesthetizing Locations
 - (c) Other-Than-Hazardous (Classified) Anesthetizing Locations
- 517-62 Grounding
- 517-64 Low-Voltage Equipment and Instruments

ARTICLE 518 — Places of Assembly

- 518-3(b) Temporary Wiring Receptacles

ARTICLE 550 — Mobile Homes and Mobile Home Parks

- 550-5(c) Attachment Plug Cap
- 550-8 Receptacle Outlets

ARTICLE 555 — Marinas and Boatyards

- 555-3 Receptacles
- 555-7 Grounding

ARTICLE 625 — Electrical Vehicle Charging System Equipment

- 625-22 (New Article) GFCI Protection for Cord- and Plug-Connected Electric Vehicle Supply Equipment

ARTICLE 680 — Swimming Pools, Fountains and Similar Installations

- 680-4 Definitions
- 680-5 Transformers and Ground Fault Circuit Interrupters
- 680-6(a) Receptacles
- 680-6(b) Lighting Fixtures, Lighting Outlets, Switching Devices and Ceiling Fans
- 680-7 Cord- and Plug-Connected Equipment
- 680-40 Outdoor Installations
- 680-41 Indoor Installations
- 680-51 Lighting Fixtures, Submersible Pumps and Other Submersible Equipment
- 680-62 Cord- and Plug-Connected Equipment
- 680-62 Therapeutic Tubs (Hydrotherapeutic Tanks)
- 680-62(a) Ground Fault Circuit Interrupter
- 680-62(c) Methods of Bonding



Associations, Organizations and Standards

The following listings define the common acronyms used for a variety of organizations.

Standards Development Organizations

Primarily involved in the development and/or promulgation of standards

NFPA	National Fire Protection Agency
IEC	International Electrotechnical Commission
IEEE	Institute of Electrical and Electronics Engineers
ANSI	American National Standards Institute
CANENA	Consejo de Armonizacion de Normas Electrotecnicas de Norte America (Council for Harmonization of Electrotechnical Standardization of North America)
SAE	Society of Automotive Engineers
ISA	Instrument Society of America
SME	Society of Manufacturing Engineers
ISO	International Standards Organization
ASME	American Society of Mechanical Engineers

Codes and Standards

Installation codes and product safety, performance and interchangeability standards.

NEC	National Electrical Code
NOM	Normas Oficiales de Mexicanas (Official Mexican Standard)
NMX	Normas Mexicanas
CEC	Canadian Electrical Code
CEE	European Electrotechnical Committee

Industry Associations

For the purpose of standardization, trade, and professional development, etc.

NMDA	National Marine Distributor Association
NEMA	National Electrical Manufacturers Association
ABYC	American Boat and Yacht Council
EIA/TIA	Electronics Industry Association/Telecommunications Industry Association
NAED	National Association of Electrical Distributors
NAW	National Association of Wholesalers
BICISI	Building Industry Consulting Services International
IBI	Intelligent Building Institute

EPRI	Electric Power Research Institute
NEMRA	National Electrical Manufacturers Representative Association
IAEI	International Association of Electrical Inspectors
IFMA	International Facilities Management Association
BOMA	Building Owners Management Association
SEMI	Semi-Conductor Equipment and Material International
CEMRA	Canadian Electrical Manufacturers Representatives Association
NMRA	National Marine Representative Association
EFI	Electro-Federation Incorporated
NECA	National Electrical Contractors Association
IECA	Independent Electrical Contractors Association
ECOC	Electrical Contractors of Canada
CANAME	Camara Nacional de Manufacturas Electricas (Mexico)

Certification Agencies

Primarily involved in certification of products or manufacturers to standards developed by the certification agency or by others.

UL	Underwriters Laboratories Inc.
CSA	Canadian Standards Association
ANCE	National Association of Normalization and Certification of the Electrical Sector (Mexico)
TUV	TUV Rheinland of N.A., Inc.
VDE	Verband Deutscher Elektrotechniker (Germany)
BSI	British Standards Institute
FM	Factory Mutual
NRTL	National Recognized Testing Laboratories
OSHA	Occupational Safety and Health Administration
FCC	Federal Communications Commission
DESC	Defense Electronic Supply Center
IAPA	Independent Accident and Protection Association (Canada)
CE	European Compliance (This is not a certification agency, but CE is the European Compliance Mark)
ETL	ETL Testing Laboratories



European Agencies: IEC and CEE

The IEC

The IEC is the International Electrotechnical Commission. Formed in 1906, it is a worldwide organization primarily involved in the international standardization of electrical standards and equipment. As of 1994, 48 countries are represented in the IEC. IEC member countries produce and consume the majority of the world's electrical energy. They also manufacture and use the majority of the world's electrical products.

The IEC works towards standardization of the following areas:

- Universal technical language; including definitions, and electrical symbols
- Systems for ratings, testing requirements and methods of testing
- Electrical system characteristics; including voltages, frequencies and tolerances
- Dimensional requirements and tolerances
- Universal electrical safety requirements







The CEE

The CEE is the European Electrotechnical Committee. The CEE works on safety standards, definitions for conformity and certifications for electrical equipment. Cooperation between the CEE and the IEC has led to worldwide publications for standards pertaining to electrical equipment.

Certification and Markings

Certification marks indicate a product has been tested to the requirements of a specific certification agency. Manufacturers may choose a particular product identity (e.g. Specification Grade) even though no outside certification agency is involved. The following table illustrates the variety of certification markings typically used for 15A and 20A Straight Blade Receptacles.

Typical Product Certification Marks — 15 & 20 Amp Straight Blade Receptacles. Products with these markings must meet the specific testing standards indicated.

Certification Mark	UL498	CSA, C22.2, No. 42M	UL 498 Hospital Grade	CSA, C22.2, No. 42M, Hosp. Grade	DESC W-C-596F	Certification Agency
Spec Grade*	No Product Testing Required — Manufacturer's Term Only					Manufacturer Only
	X					Underwriters Laboratories Inc. Recognized Component for OEM use.
	X					Underwriters Laboratories Inc.
		X				Canadian Standards Association
	X		X			Underwriters Laboratories Inc.
		X		X		Canadian Standards Association
	X				X	Underwriters Laboratories Inc. and Defense Electronic Supply Center
	X		X		X	Underwriters Laboratories Inc. and Defense Electronic Supply Center

*Includes variations such as Industrial Spec. Grade, Premium Spec. Grade, etc.

NOTE: The C-UL listing mark is applied to products for the Canadian market evaluated by UL to Canadian safety standards. The C-UL US listing mark indicates compliance with both U. S. and Canadian safety standards.

Cross References

The cross-reference guides supplied by manufacturers are convenient for determining compatible devices but they are not official confirmation of compliance to any standard or testing criteria. Similarly, common catalog numbers used by different manufacturers in no way imply compliance to any standard or testing criteria.



UL, CSA and NEMA Standards Pertaining to Leviton Devices

UL Standards Pertaining to Leviton Devices

UL20	General-use switches
UL50	Enclosures for electrical equipment
UL94	Flammability testing for materials
UL486E	Equipment and wiring terminals
UL498	Plugs, connectors, receptacles, inlets, outlets, taps and adapters
UL508	Industrial equipment (including motor control switches)
UL514A	Metallic boxes/covers/wallplates
UL514C	Non-metallic boxes/covers/wallplates
UL817	Cordsets
UL943	GFCI's
UL1363	Temporary power taps
UL1436	Outlet circuit testers
UL1449	Surge suppression devices
UL1567	Switches and receptacles used with AL wire
UL1682 & 1686	Pin & Sleeve devices
UL1776	High-pressure cleaning equipment
FS	Federal Spec receptacles
WC596F	
FS	Federal Spec switches
WS896	

Note: Straight blade and locking NEMA configurations are defined by UL 1681 and NEMA WD 6.

Each UL standard consists of requirements that cover three characteristics of the product being reviewed:

- | | |
|------------------------|---|
| 1. Construction | Material properties and general design |
| 2. Performance | Mechanical and electrical testing |
| 3. Markings | Identification of manufacturer, applicable ratings, etc. |

CSA Standards Pertaining to Leviton Devices

C22.2, No. 0.17	Polymeric materials
C22.2, No. 42	General-use receptacles, attachment plugs
C22.2, No. 55	Special-use switches
C22.2, No. 111	General-use switches
C22.2, No. 182.1	Industrial-type, special-use attachment plugs, receptacles and connectors. Pin and sleeve devices
C22.2, No. 182.2	Industrial locking type

NEMA Standards Pertaining To Leviton Devices — In Accordance With NEMA Standard WD-1

WD 1-1.01	CORD CONNECTOR A cord connector is a portable receptacle which is provided with means for attachment to a flexible cord and which is not intended for permanent mounting. <i>NEMA Standard 7-13-1967</i>
WD 1-1.02	GROUNDING CONDUCTOR (SYSTEM GROUND) A grounded conductor is a circuit conductor (normally current carrying) which is intentionally connected to earth ground. (It is identified as the white conductor.) <i>NEMA Standard 7-13-1967</i>
WD 1-1.03	GROUNDING CONDUCTOR (EQUIPMENT GROUND) A grounding conductor is a conductor which connects noncurrent-carrying metal parts of equipment to earth ground to provide an intentional path for fault current to ground (It is bare, or, when covered, is identified as the green or green with yellow stripes conductor.) <i>NEMA Standard 7-13-1967</i>

WD 1-1.04 **LAMPHOLDER**
A lampholder is a device which is intended to support an electric lamp mechanically and to connect it electrically to a circuit.
NEMA Standard 7-13-1967

WD 1-1.05 **MALE BASE (INLET)**
A male base is a plug which is intended for flush or surface mounting on an appliance or equipment and which serves to connect utilization equipment to a connector.
NEMA Standard 7-13-1967

WD 1-1.06 **OUTLET**
An outlet is a point on the wiring system at which current is taken to supply utilization equipment.
NEMA Standard 7-13-1967

WD 1-1.07 **PLUG**
A plug is a device with male blades which, when inserted into a receptacle, establishes connection between the conductors of the attached flexible cord and the conductors connected to the receptacle.
NEMA Standard 7-1-1967

WD 1-1.08 **POLARIZATION (PLUGS AND RECEPTACLES)**
Polarization is a means of assuring the mating of plugs and receptacles of the same rating in only the correct position.
NEMA Standard 7-1-1967

WD 1-1.09 **POLE**
The term "pole" as used in designating plugs and receptacles refers to a terminal to which a circuit conductor (normally current carrying) is connected.
In switches, the number of poles indicates the number of conductors being controlled.
NEMA Standard 7-1-1967

WD 1-1.10 **RECEPTACLE**
A receptacle is a device with female contacts which is primarily installed at an outlet or on equipment and which is intended to establish electrical connection with an inserted plug.
NEMA Standard 7-1-1967

WD 1-1.11 **SLANT SYMBOL (/)**
The "slant" line (/) as used in wiring device ratings indicates that two or more voltage potentials are present simultaneously between different terminals of a wiring device.
NEMA Standard 7-1-1967

- WD 1-1.12** **SWITCH**
A switch is a device for making, breaking, or changing the connections in an electric circuit.
- A. Single-pole Switch (Single-pole, Single-throw)**
A switch which makes or breaks the connection of one conductor.
 - B. Double-pole Switch (Double-pole, Single-throw)**
A switch which makes or breaks the connection of two conductors of a single branch circuit.
 - C. Three-way Switch (Single-pole, Double-throw)**
A switch which changes the connection of one conductor and which is normally used in pairs to control one utilization equipment from two locations.
 - D. Four-way Switch (Double-pole, Double-throw Reversing)**
A form of double-pole switch which is used in conjunction with two three-way switches to control one utilization equipment from three or more locations.
NEMA Standard 7-13-1967

WD 1-1.13 **TERMINAL (ON A WIRING DEVICE)**
A terminal is a fixed location on a wiring device where a conductor is intended to be connected.
NEMA Standard 7-13-1967

WD 1-1.14 **WIRE (PLUGS AND RECEPTACLES)**
The term "wire" as used in designating plugs and receptacles indicates the number of either normally current-carrying or equipment grounding connected conductors.
NEMA Standard 7-13-1967



High-Abuse Wiring Devices — UL Listed Hospital Grade

Why was it developed?

Hospital Grade Listed devices were developed to provide maximum safety in high-abuse applications where constant strenuous use of the device is common. These highest reliability devices are built to protect against possible human negligence and keep the devices safe and functional.

What are the applications for Hospital Grade, High Abuse Devices?

Rough use occurs not just in hospitals, but every place where people can't or won't be cautious with devices...the cleaning person who yanks the floor waxer plug down the hall, the mechanic who pulls the drill plug from the wall, or the child who removes the electric lawn-mower plug from 40 feet away!

In addition, Leviton realized that devices in rough use situations are often exposed to many corrosive liquids, such as cleaning fluids, rug shampoos, chlorinated water, sprays, salt air and chemical fumes. Our corrosion resistant devices permit use in environments where these conditions are common.

Demanding Tests for UL Hospital Grade Listing

Leviton has designed a line of wiring devices that withstand impact, wear, crushing, and corrosive environments that would destroy ordinary heavy-duty devices. Leviton's comprehensive line of Hospital Grade and Industrial Grade plugs, connectors and receptacles include devices that have passed a series of demanding UL Hospital Grade tests. This assures the end-user of top performance in the harshest industrial environments. Here are examples of how Leviton devices meet or exceed the requirements of the most rigorous testing!

Receptacles

Abrupt Removal of Plug Test

A steel-bodied test plug with brass blades is inserted into the receptacle. A 10-pound weight dropped from at least 24 inches yanks the plug out of the receptacle. This test is done eight times with the receptacle rotated into different positions to create the greatest stress on its face and contact. After this, the grounding contact must retain a four ounce, 0.184" diameter grounding pin, with the receptacle face down, for one minute. "There shall be no breakage of the receptacle that interferes with the receptacle function or the integrity of the enclosure. The receptacle shall maintain the grounding path integrity through the receptacle."

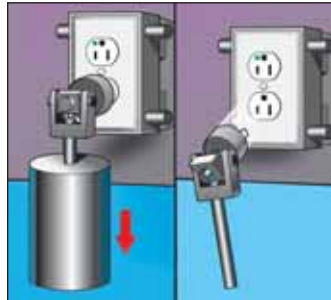

Ground Pin Test

The grounding contact of the receptacle is conditioned by 20 insertions with a 0.204" diameter oversized pin. "After conditioning, a 0.184" diameter pin shall be inserted in the grounding contact and shall be capable of supporting at least four ounces for one minute."

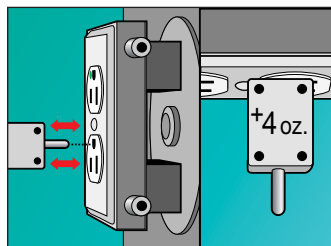

Power Blade Retention Test

A test plug with oversized blades of .075" is inserted into the current-carrying opening of the connector for 20 conditioning cycles. After the conditioning cycles, "the contact shall be capable of supporting for one minute 1 1/2 lbs, secured to a single .055" thick solid steel blade without holes."

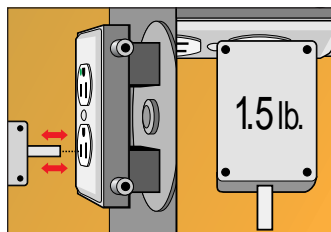

Plugs and Connectors

500 lb. Crush Test

A wired plug or connector is placed between two steel plates and subjected to a force which is steadily increased to 500 pounds. "There shall be no breakage, deformation or other effect that may interfere with the function of the device." Leviton knows that in real industrial environments, plugs and connectors are crushed by forces exceeding 500 lbs. Leviton performs the crush test with force of 2500 lbs to ensure that our devices withstand the really heavy hits on the job.

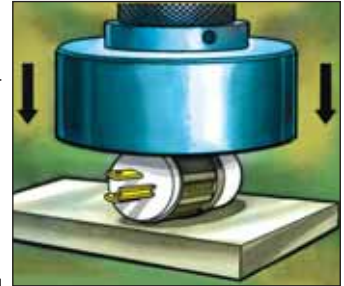

Impact Test

A wired plug or connector is subjected to impact from a 10 lb. weight dropped from a height of 18 inches. "There shall be no breakage, deformation or other effect that may interfere with the function of the device." Plugs and connectors are subjected to severe impacts in industrial settings. Therefore, Leviton exceed the UL requirement by dropping the weight from a height of 36 inches.



Cord Pull Test

The cord must remain securely fastened after straight pulls of 30 pounds, and rotating pulls (in a 3-inch circle) of 10 pounds for two hours. "Displacement of conductors, insulation, and outer jacket of the flexible cord AWG 18 SVT shall not exceed 1/32 inch. There shall be no cuts, rips, or tears in cord insulation."



Heavy-duty cord stress is typical abuse for industrial plugs and connectors. Leviton increases the weight in the straight cord pull test to 175 lbs. with AWG 14 ST and in the rotating pull test to 20 lbs, ensuring positive strain relief under industrial conditions.

Mechanical Drop Test

A sample wired plug or connector is suspended horizontally by its attached cord and released so that it impacts a hard wood surface 45 inches below the point of suspension — repeated for 1300 cycles. "There shall be no breakage, deformation or other damage which would interfere with the functioning of the device."



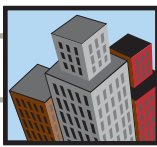

Glossary of Electrical Wiring Device Terms

General Terms

Adapter — An accessory used for interconnecting non-mating devices or converting an existing device for modified use.

Ballast — A transformer that steps down AC line voltage to voltage that can be used by fluorescent or other types of lighting. Ballasts may be electromagnetic or electronic.

Cord Connector — A portable receptacle designed for attachment to or provided with flexible cord, not intended for fixed mounting.

Flanged Inlet — A plug intended for flush mounting on appliances or equipment to provide a means for power connection via a cord connector.

Flanged Outlet — A receptacle intended for flush mounting on appliances or equipment to provide a means for power connection via an inserted plug.

Fluorescent Starter — A device with a voltage-sensitive switch and a capacitor that provides a high-voltage pulse to start a fluorescent lamp. Rated in watts.

Lampholder — A device with contacts that establishes mechanical and electrical connection to an inserted lamp.

Plug — A device with male contacts intended for insertion into a receptacle to establish electrical connection between the attached flexible cord and the conductors connected to the receptacle.

Receptacle — A device with female contacts designed for fixed installation in a structure or piece of equipment and which is intended to establish electrical connection with an inserted plug.

Switch — A device for making, breaking, or changing the connections in an electric circuit.

Wallplate — A plate designed to enclose an electrical box, with or without a device installed within the box.

Adapter Variations

Cube Tap — An adapter that converts one receptacle opening into multiple openings.

Current Tap — An adapter designed for medium base lampholders which has one or two receptacle openings. Available with or without integral switch.

Duplex — An adapter that provides two female receptacle openings when plugged into a single receptacle opening.

Grounding — An adapter that converts a two-wire receptacle opening into a two-pole, three-wire grounding receptacle opening.

Lampholder — A threaded adapter that converts the thread size of the lampholder in which it is inserted so that the lampholder can accept an incandescent lamp bulb of a different size thread.

Molded-On — An adapter that is factory molded to a length of flexible cord.

Series — An adapter wired in series to a flexible cord containing an in-line switch used to control electrical equipment plugged into the adapter.

“W” Type — Same as “Y” type, except having three cord connectors arranged in the form of the letter “W”.

“Y” Type — An adapter in the form of a letter “Y”, having two cord connectors on one end and a male plug on the other end.

Cord Connectors

Angle — A connector that allows the attached flexible cord to exit at right angles.

Corrosion Resistant — A connector constructed of special materials and/or suitably plated metal parts that is designed to withstand corrosive environments. Corrosion resistant devices must pass the ASTM B117-13 five-hundred hour Salt Spray (Fog) Test with no visible corrosion.

Dust Proof — A connector designed so that dust will not interfere with its operation. The IP Suitability Rating designates the degree of protection a device offers against the ingress of foreign objects (e.g. IP 20).

Explosion Proof — A connector constructed to meet the requirements of hazardous locations as defined by the National Electrical Code, NFPA-70.

Hospital Grade — A connector designed to meet the performance requirements of high-abuse areas typically found in health care facilities. These connectors are tested to the Hospital Grade requirements of Underwriters Laboratories Inc. Standard 498.

Locking — A connector designed to lock an inserted plug with a matching blade configuration when the plug is rotated in a clockwise direction. The plug can only be removed by first turning it in a counter-clockwise direction.

Midget — A connector designed with a smaller body diameter than standard connectors with a similar rating.

Molded On — A connector that is factory molded to a length of flexible cord.

Pin and Sleeve — A connector with hollow, cylindrical sleeve-type contacts.

Straight Blade — A non-locking connector into which mating plugs are inserted at a right angle to the plane of the connector face.

Weatherproof — A connector specially constructed so that exposure to weather will not interfere with its operation.

Flanged Inlets

Corrosion Resistant — An inlet constructed of special materials and/or suitably plated metal parts that is designed to withstand corrosive environments. Corrosion resistant devices must pass the ASTM B117-13 five-hundred hour Salt Spray (Fog) Test with no visible corrosion.

Flush-Mounted — An inlet intended to be installed flush with the surface of a panel or a piece of equipment.

Locking — An inlet designed to lock an inserted matching connector when the connector is rotated in a clockwise direction. The connector can only be removed by first turning it in a counter-clockwise direction.

Midget — An inlet designed with a smaller body diameter than standard connectors with a similar rating.

Pin and Sleeve — An inlet with round pin-type contacts intended to mate with a connector having hollow cylindrical female contacts.

Straight Blade — A non-locking inlet into which mating connectors are inserted at a right angle to the plane of the connector face.

Surface-Mounted — An inlet designed to be surface mounted on a panel or piece of equipment.

Watertight — An inlet specially constructed so that water will not enter under specified test conditions. The IP Suitability Rating designates the degree of protection a device offers against the ingress of moisture and water (e.g. IP 55, IP 44).

Weatherproof — An inlet specially constructed to protect it from the effects of weather in outdoor locations.

Flanged Outlets

Corrosion Resistant — An outlet constructed of special materials and/or suitably plated metal parts that is designed to withstand corrosive environments. Corrosion resistant devices must pass the ASTM B117-13 five-hundred hour Salt Spray (Fog) Test with no visible corrosion.

Flush-Mounted — An outlet intended to be installed flush with the surface of a panel or a piece of equipment.

Locking — An outlet designed to lock an inserted plug with a matching blade configuration when the plug is rotated in a clockwise direction. The plug can only be removed by first turning it in a counter-clockwise direction.

Midget — An outlet designed with a smaller body diameter than standard devices with a similar rating.

Pin and Sleeve — An outlet with hollow cylindrical female contacts intended to mate with a plug having round pin contacts.

Straight Blade — A non-locking outlet into which mating straight-blade plugs are inserted at a right angle to the plane of the outlet face.

Surface-Mounted — An outlet designed to be surface mounted on a panel or piece of equipment.

Watertight — An outlet specially constructed so that water will not enter under specified test conditions. The IP Suitability Rating designates the degree of protection a device offers against the ingress of moisture and water (e.g. IP 55, IP 44).

Weatherproof — An outlet specially constructed so that exposure to weather will not interfere with its operation.

Fluorescent Starters

Automatic Reset — A starter that automatically restarts a new replacement fluorescent lamp after the circuit is energized.

Direct Current — A thermal-type starter designed for use on direct current (DC) circuits.

Glow Discharge — A starter that provides a rapid lamp start-up and will continue to try to start a failed fluorescent lamp, causing the lamp to flicker until it is replaced.

Manual Reset — A starter that automatically deactivates a failed fluorescent lamp to eliminate flickering. A reset button provides a means of activating the circuit after lamp replacement.

Lampholders

Bayonet — Designed for incandescent lamps having an unthreaded metal shell with two diametrically opposite keyways that mate with the keyways on the lampholder. Pushing down on the bulb and turning it clockwise in the lampholder locks the bulb in place.

Candelabra — A small screw-base threaded lampholder designed for candelabra-base incandescent lamps commonly used in chandeliers, night lights, and ornamental lighting.

Circline — A four-contact, double-ended lampholder designed for use with tubular, circular fluorescent lamps.

Compact Fluorescent — A lampholder designed for the Compact Fluorescent Lamps (CFLs) that are increasingly being used to replace incandescent lamps for energy efficiency.

Dimmer — An electronic device with either a round knob, slide lever or finger-tip controlled buttons used to dim/brighten incandescent lighting. Available in a variety of wattages; fluorescent version also available.

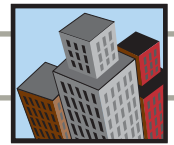

Glossary of Electrical Wiring Device Terms

Double-Contact Recessed — Designed for high-output fluorescent lamps.

Edison Base — An internally-threaded lampholder, with the inner shell approx. 1" in diameter. Designed for widely-used standard medium base lamps.

Electrolier — Similar to the Edison Medium Base lampholder, but with a smaller outer diameter.

Incandescent — Designed for use with all manufactured incandescent lamps, most of which have threaded bases.

Intermediate — A lampholder with a threaded screw shell designed for intermediate base lamps that have a 1³/₃₂" threaded base (smaller than the standard 1" dia. medium base). Mostly used in decorative lighting.

Key — A lampholder with a flat or round "key" knob that operates an internal switching mechanism ("Keyless" lampholders do not provide an internal switching mechanism).

Lumiline — A specially designed lampholder for tubular Lumiline-type incandescent lamps, typically used in bathrooms and retail display cases.

Medium Base — Same as the Edison base lampholder. An internally-threaded lampholder, with the inner shell approx. 1" in diameter. Designed for widely-used standard medium base lamps.

Miniature — Designed for the smallest available incandescent lamps with a screw-in base, approx. 3/8" dia. Widely used in flashlights and toys, etc.

Mogul — The largest screw-in type lampholder, designed for mogul incandescent lamps with a screw base of approx. 1 1/2" dia. Used in street lights and numerous commercial/industrial applications.

Medium Bi-Pin — A fluorescent lampholder with two contacts, used in pairs. For type T-8 tubular fluorescent lamps, approx. 1" in diameter.

Miniature Bi-Pin — Similar to medium bi-pin lampholders, but designed for type T-5 tubular fluorescent lamps, approx. 5/8" in diameter.

Outlet Box — Medium-base incandescent lampholder designed for mounting in 3 1/4" or 4" electrical boxes. Available with or without pull-chain mechanism, and with or without built-in receptacle.

Pull-Chain — An incandescent lampholder with an internal switching mechanism that is activated by pulling down on a beaded chain or cord.

Push-Through — An incandescent lampholder with an insulated lever that is pushed from either side to activate an internal ON/OFF switching mechanism.

Slimline Single-Pin — A fluorescent lampholder with a single contact designed for Slimline fluorescent lamps such as the T-12 (1 1/2" dia.), T-8 (1" dia.), and the smaller version T-6 (3/4" dia.).

Snap-In — An incandescent or compact fluorescent lampholder with factory-assembled spring clips that securely snap into a panel cutout without requiring additional fasteners.

Surface-Mounted — A lampholder of any type that mounts on a flat or plane surface.

Plugs

Angle — A plug that allows the attached flexible cord to exit at right angles.

Corrosion Resistant — A plug constructed of special materials and/or suitably plated metal parts that is designed to withstand corrosive environments. Corrosion resistant devices must pass the ASTM B117-13 five-hundred hour Salt Spray (Fog) Test with no visible corrosion.

Dust Proof — A plug designed so that dust will not interfere with its operation. The IP Suitability Rating designates the degree of protection a device offers against the ingress of foreign objects (e.g. IP 20).

Explosion Proof — A plug constructed to meet the requirements of hazardous locations as defined by the National Electrical Code, NFPA-70.

Hospital Grade — A plug designed to meet the performance requirements of high-abuse areas typically found in health care facilities. These plugs are tested to the Hospital Grade requirements of Underwriter's Laboratories Inc. Standard 498.

Locking — A plug designed to lock into a matching connector or receptacle configuration when the plug is rotated in a clockwise direction. The plug can only be removed by turning it in a counter-clockwise direction.

Midget — A plug designed with a smaller body diameter than standard plugs with a similar rating.

Molded On — A plug that is factory molded to a length of flexible cord.

Pin and Sleeve — A plug with round pin contacts.

Straight Blade — A non-locking plug that is inserted at a right angle to the plane of the matching device face.

Weatherproof — A plug specially constructed so that exposure to weather will not interfere with its operation.

Receptacles

AL/CU — 30A, 50A or 60A receptacles designated for use with aluminum or copper circuit conductors, identified by "AL/CU" stamped on the device. Receptacles without this designation must never be used with aluminum circuit conductors.

Clock Hanger — A single, recessed receptacle with a specialized cover plate that provides a hook or other means of supporting a wall clock.

CO/ALR — 15A or 20A receptacles designated for use with aluminum or copper circuit conductors, identified by "CO/ALR" stamped on the device. Receptacles without this designation must never be used with aluminum circuit conductors.

Corrosion Resistant — A receptacle constructed of special materials and/or suitably plated metal parts that is designed to withstand corrosive environments. Corrosion resistant devices must pass the ASTM B117-13 five-hundred hour Salt Spray (Fog) Test with no visible corrosion.

Display — Receptacle with a special cover plate intended for flush mounting on raised floors or walls.

Duplex — Two receptacles built with a common body and mounting means; accepts two plugs.

Dust Proof — A receptacle designed so that dust will not interfere with its operation. The IP Suitability Rating designates the degree of protection a device offers against the ingress of foreign objects (e.g. IP 20).

Explosion Proof — A receptacle constructed to meet the requirements of hazardous locations as defined by the National Electrical Code, NFPA-70.

Fan Hanger — A single receptacle with a specialized cover plate that provides a hook or other means of supporting a wall fan.

Four-In-One or "Quad" — A receptacle in a common housing that accepts up to four plugs. Four-In-One receptacles can be installed in place of duplex receptacles mounted in a single-gang box, providing a convenient means of adding receptacles without rewiring.

GFCI (Ground Fault Circuit Interrupter) — A receptacle with a built in circuit that will detect leakage current to ground on the load side of the device. When the GFCI detects leakage current to ground, it will interrupt power to the load side of the device, preventing a hazardous ground fault condition. GFCI receptacles must conform to UL Standard 943 Class A requirements, and their use is required by the National Electric Code NFPA-70 in a variety of indoor and outdoor locations.

Hospital Grade — A receptacle designed to meet the performance requirements of high-abuse areas typically found in health care facilities. These receptacles are tested to the Hospital Grade requirements of Underwriters Laboratories Inc. Standard 498.

Interchangeable — A receptacle or combination of receptacles with a common mounting dimension that may be installed on a single or multiple-opening mounting strap.

Isolated Ground — Receptacles intended for use in an Isolated Grounding system where the ground path is isolated from the facility grounding system. The grounding connection on these receptacles is isolated from the mounting strap.

Lighted (Illuminated) — A receptacle with a face that becomes illuminated when the device is connected to an energized electrical circuit.

Locking — A receptacle designed to lock an inserted plug with a matching blade configuration when the plug is rotated in a clockwise direction. The plug can only be removed by first turning it in a counter-clockwise direction.

Pin and Sleeve — A receptacle with cylindrical sleeve-type contacts.

Safety or Tamper-Resistant — A receptacle specially constructed so that access to its energized contacts is limited. Tamper-resistant receptacles are required by the National Electric Code NFPA-70 in specific pediatric care areas in health care facilities.

Single — A receptacle that accepts only one plug.

Snap-In — A receptacle with factory-assembled spring clips that securely snap into a panel cutout without requiring additional fasteners.

Split-Circuit — A duplex receptacle that allows each receptacle to be wired to separate circuits. Most duplex receptacles provide break-off tabs that allow them to be converted into split-circuit receptacles.

Straight Blade — A non-locking receptacle into which mating plugs are inserted at a right angle to the plane of the receptacle face.

Surface-Mounted — Any receptacle that mounts on a flat or plane surface.

Surge-Suppression — A receptacle with built-in circuitry designed to protect its load side from high-voltage transients and surges. The circuitry will limit transient voltage peaks to help protect sensitive electronic equipment such as PC's, modems, audio/video equipment, etc.

Triplex — A receptacle with a common mounting means which accepts three plugs.

Weatherproof — A receptacle specially constructed so that exposure to weather will not interfere with its operation.

Switches

AC/DC — A switch designated for use with either Alternating Current (AC) or Direct Current (DC)

AC Only — A switch designated for use with Alternating Current (AC) only.

Dimmer — A switch with electronic circuitry that provides DIM/BRIGHT control of lighting loads.



Glossary of Electrical Wiring Device Terms

Door — A momentary contact switch, usually installed on a doorjamb, that is activated when the door is opened or closed.

Double-Pole, Single-Throw (DPST) — A switch that makes or breaks the connection of two circuit conductors in a single branch circuit. This switch has four terminal screws and ON/OFF markings.

Double-Pole, Double-Throw (DPDT) — A switch that makes or breaks the connection of two conductors to two separate circuits. This switch has six terminal screws and is available in both momentary and maintained contact versions, and may also have a center OFF position.

Feed-Through — An in-line switch that can be attached at any point on a length of flexible cord to provide switching control of attached equipment.

Flush-Mounted — A switch designed for flush installation with the surface of a panel or equipment.

Four-Way — A switch used in conjunction with two 3-Way switches to control a single load (such as a light fixture) from three or more locations. This switch has four terminal screws and no ON/OFF marking.

Horsepower Rated — A switch with a marked horsepower rating, intended for use in switching motor loads.

Interchangeable — A switch or combination of switches with a common mounting dimension that may be installed on a single or multiple-opening mounting strap.

Lighted Handle — A switch with an integral lamp in its actuator (toggle, rocker or pushbutton) that illuminates when the switch is connected to an energized circuit and the actuator is in the OFF position.

Locking — A switch equipped with a locking mechanism that requires a key to operate the switching functions.

Low-Voltage — A switch rated for use on low-voltage circuits of 50 volts or less.

L-Rated — A switch specially designated with the letter "L" in its rating that is rated for controlling tungsten filament lamps on AC circuits only.

Maintained Contact — A switch where the actuator (toggle, rocker, pushbutton or key mechanism) makes and retains circuit contact when moved to the ON position. The contacts will only be opened when the actuator is manually moved to the OFF position. Ordinary light switches are maintained contact switches.

Manual Motor Controller — A switch designed for controlling small DC or AC motor loads, without overload protection.

Mercury — A type of switch that uses mercury as the contact means for making and breaking an electrical circuit.

Momentary Contact — A switch that makes circuit contact only as long as the actuator (toggle, rocker, pushbutton or key mechanism) is held in the ON position, after which it returns automatically to the OFF position. This is a "Normally Open" switch. A "Normally Closed" switch will break circuit contact as long as it is held in the OFF position, and then automatically return to the ON position. Available in "Center OFF" versions with both Momentary ON and Momentary OFF positions.

Pendant — A type of switch designed for installation at the end of a length of portable cord or cable.

Pilot Light — A switch with an integral lamp in its actuator (toggle, rocker or pushbutton) that illuminates when the switch is connected to an energized circuit and the actuator is in the ON position.

Pull — A switch where the making or breaking of contacts is controlled by pulling downward or outward on the actuator mechanism.

Push Button — A switch with an actuator mechanism that is operated by depressing a button.

Rotary — A switch where rotating the actuator in a clockwise direction makes the circuit connection, and then rotating the actuator in either the same or opposite direction breaks the connection.

Single-Pole, Double-Throw (SPDT) — A switch that makes or breaks the connection of a single conductor with either of two other single conductors. This switch has 3 terminal screws, and is commonly used in pairs and called a "Three-Way" switch.

Single-Pole, Single-Throw (SPST) — A switch that makes or breaks the connection of a single conductor in a single branch circuit. This switch has two screw terminals and ON/OFF designations. It is commonly referred to as a "Single-Pole" Switch.

Slide — A switch with a slide-action actuator for making or breaking circuit contact. Dimmer switches and fan speed controls are also available with slide-action mechanisms for lighting and fan speed control.

Surface-Mounted — Any switch that mounts on a flat or plane surface.

Three-Position, Center OFF — A two circuit switch, either maintained or momentary contact, where the OFF position is designated as the center position of the actuator.

Three-Way — A switch, always used in pairs, that controls a single load such as a light fixture from two locations. This switch has three terminal screws and has no ON/OFF marking.

Time Delay — A switch with an integral mechanism or electronic circuit that will automatically switch a load OFF at a predetermined time interval.

Timer — A switch with an integral mechanism or electronic circuit that can be set to switch an electrical load ON at a predetermined time.

Toggle — A switch with a lever-type actuator that makes or breaks switch contact as its position is changed.

T-Rated — A switch specially designated with the letter "T" in its rating that is rated for controlling tungsten filament lamps on direct current (DC) or alternating current (AC) circuits.

Wallplates

Combination — A multiple-gang wallplate with openings in each gang to accommodate different devices.

Decora® — Wallplates with Decora-size openings for compatibility with Leviton's entire line of Decora devices. Available in a variety of multiple-gang configurations. Screwless-design snap-on versions also available.

Flush — A wallplate designed for flush-mounting with wall surfaces or the plane surfaces of electrical equipment.

Gang — A term that describes the number of devices a wallplate is sized to fit (i.e. "2-gang" designates two devices).

Midway — Wallplates that are approx. 3/8" higher and wider than the standard size that can be mounted onto larger volume outlet boxes and/or used to hide wall surface irregularities. These wallplates are approx. 1/4" deep to ensure a proper fit when used with protruding devices.

Oversized — Wallplates that are approx. 3/4" higher and wider than the standard size and are used to conceal greater wall irregularities than those hidden by Midway wallplates. These wallplates are approx. 1/4" deep to ensure a proper fit when used with protruding devices.

Modular — Individual-section wallplates with different openings that can be configured into a multi-gang plate.

Multi-Gang — A wallplate that has two or more gangs.

Tandem — A wallplate with individual gangs arranged vertically one above the other.

Weatherproof (with Cover Closed) — A UL Listed cover that meets specific test standards for use in wet and damp locations with the cover closed.

Weatherproof (with Cover Open) — A UL Listed cover that meets specific test standards for use in wet and damp locations with the cover open or closed.

Surge Suppression

Clamping Voltage — The peak voltage that can be measured after a Surge Protective Device has limited or "clamped" a transient voltage surge.

Clamping voltage must be determined by using IEEE Standard C62 testing and evaluated by UL Standard 1449.

Joule Rating — The measurement of a Surge Protective Device's ability to absorb heat energy created by transient surges. Note that the Joule rating is not a part of IEEE or UL Standards. It is not as significant a specification as Clamping Voltage, Maximum Surge Current and other parameters recognized by these agencies.

Transient Voltage Surges — High-speed, high-energy electrical disturbances present on AC power lines and data and communication lines, generated by utility switching, motor-load switching and lightning strikes.

Response Time — The interval of time it takes for a surge protective device to react to a transient voltage surge. Note that this parameter is not a part of IEEE or UL Standards and is only based on estimations made by manufacturers.

Surge Protective Device — See "Transient Voltage Surge Suppressor (TVSS)" definition.

Transient Voltage Surge Suppressor (TVSS) — A device designed to protect sensitive electronic equipment such as computers and computer peripherals, logic controls, audio/video equipment and a wide range of microprocessor-based (computer chip) equipment from the harmful effects of transient voltage surges. Also referred to as a Surge Protective Device (SPD).

Maximum (Peak) Surge Current — The peak surge current a Surge Protective Device can withstand, based on IEEE Standard C62.45 test waveforms.

MOV (Metal Oxide Varistor) — The primary component used in most Surge Protective Devices to clamp down transient voltages.

UL 1449 Listing — The industry standard for Surge Protective Devices. A Surge Protective Device must have a UL 1449 Surge Suppression rating on its label in order to verify that the device has been tested with IEEE standardized waveforms. Devices without this identification should not be considered reliable surge protective devices.

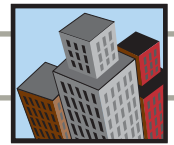

Switches

Types of Switches

Switches used in branch circuit wiring are rated in two general categories: AC ONLY and AC/DC. Originally, the electrical power furnished to residences and businesses by utility companies was Direct Current or DC. Because DC current was always flowing at full value, the making or breaking of a circuit created a rather strong arc during switch operation. For this reason, the contacts had to be widely gapped and the operation had to be "quick make, quick break" to avoid excessive pitting or welding of the contact points.

Alternating current operates between zero and full power 120 times per second. Because of the oscillating characteristic of AC power, the arc from an AC circuit is self-extinguishing on the "break" of the current. This means a slower breaking action is possible on an AC switch, as opposed to the breaking action required of a switch made for use with continuous full-power DC. The pulsating nature of AC can, however, cause a "chattering" or very fast series of "makes" and "breaks" if the circuit is closed too quickly. For this reason an AC ONLY switch works with a somewhat slower "fast make" and "break" than an AC/DC switch.

Because the make and break actions of an AC/DC switch must be fast, it can be rather noisy, and must use contact metals capable of enduring such comparatively violent action while still offering acceptable electrical conductivity. An alloy of copper is most often used.

Silver and its oxides are better conductors than copper and its oxides. Silver is much softer than copper and therefore cannot be used in the AC/DC switch. However, silver can be used in the AC ONLY switch because of its gentler "fast make" characteristic, especially when silver is alloyed with cadmium oxide, a good conductor that's quite hard.

Switch Ratings

AC ONLY switches are often called AC Quiet switches because they can be made to operate very quietly, unlike AC/DC switches. AC ONLY switches are rated at their full current value for lighting, including tungsten filament, quartz metal-halide, and fluorescent; and 80% current value or full horsepower rating value for motor (inductive) loads.

AC/DC switches used for incandescent lighting should have a "T" rating (tungsten-filament rating). The "T" rating assures end-users of the longevity of the switch through the surge currents of a "make" action across a tungsten filament. Such capacity is already inherent in the design of AC Quiet switches.

AC/DC switches are rated at only 50% of their current capacity for motor loads. A 20 amp AC/DC switch could be used to control a 10 amp motor load, while a 20 amp AC Quiet switch can operate a 16 amp motor load.

In the past, MERCURY switches were available that operated by making and breaking contact within a hermetically sealed capsule containing a pool of mercury. MERCURY switches were actually silent in operation. However, due to health concerns about mercury, these switches are no longer manufactured and sold. MERCURY switches may still be in service in some installations

Horsepower Ratings

Switches marked with Horsepower (HP) Ratings are suitable for controlling the motor loads of the HP ratings shown on the switch, as well as loads with a lower HP rating.

To qualify for an HP rating, a switch is tested at six times the full motor load current corresponding the HP rating marked on the switch. For DC motor load controllers, the test is made at 10 times the full motor load current corresponding to the DC HP rating marked on the switch. The test is conducted on six samples and consists of 50 On-Off operations at the load. For a 3/4 HP rating at 120/240 VAC, two sets of six samples each are tested in addition to the regular overload endurance, heating and insulation tests. The test circuit characteristics are:

	For 3/4 HP Rating @ 120 VAC	For 3/4 HP @ 240 VAC
Closed Circuit Volts	120 VAC	240 VAC
Current	82.8 amps	41.4 amps
Power-Factor	0.40 - 0.50	0.40 - 0.50

Note: The current at 240 VAC is 1/2 that at 120 VAC

All switches must be in good operating condition after the tests have been completed. There must be no excessive arcing, welding or burning of the contacts nor arc-over to ground (the switch frames are grounded during the Stalled Rotor Test).

Dimmers

A common misconception about box-mounted dimmers is that they are simply variable resistors (rheostats) that absorb power to dim the lights. In fact, a rheostat would be too bulky, inefficient and heat producing to ever be practical as a wall-mounted dimmer. In the 1950's, the advent of solid state technology and a type of semi-conductor called the TRIAC fostered the development of full-range dimmers and fan speed controls that were versatile, efficient and compact enough to fit in a standard wallbox.

Leviton has always taken an active role in the development lighting control technologies. Leviton introduced the Trimatron™ Rotary Dimmer that was only half as deep as conventional dimmers, allowing easier installation and wiring in a crowded wallbox. Today, Leviton offers innovative all-digital lighting controls that feature scene lighting and multi-location control capabilities for sophisticated residential and commercial installations. Leviton's complete line of controls for incandescent, low-voltage and fluorescent lighting includes Decora-style and architectural specification grade devices, as well as traditional rotary devices. There is also a wide selection of Fan Speed Controls

See Section C for information on Leviton's comprehensive line of Lighting and Fan Speed Controls.

Receptacles

Types of Receptacles

Receptacles generally are made to accommodate either of two types of plugs. *Straight-Blade* plugs are pushed in and pulled straight out. *Locking* plugs are pushed in and rotated slightly in a clockwise direction to a position where they cannot be pulled straight out. They must be rotated counterclockwise back to the insertion position in order to be withdrawn. This locking action is intended to prevent accidental disconnection of the circuit by pulling the plug straight out unintentionally.

Grounding

Originally, residential electrical circuitry was "2-pole, 2-wire" and did not have an equipment grounding means at the receptacle. The only grounding point was at the service entrance, where the neutral (white) conductor was grounded. The receptacle slot for the neutral wire, according to NEMA configuration 1-15R, must be longer than the slot for the phase or hot wire (typically black or red). This enables certain items of equipment, like TV sets and home appliances, to have their external metal parts or casing grounded through the white neutral connection. Such equipment uses a polarized plug where the neutral plug blade is wider than the hot plug blade, ensuring that it mates properly with the NEMA 1-15R configuration receptacle. Receptacles designed for 2-pole, 2-wire circuits do not have mounting straps that are connected to a grounding terminal. Leviton still offers 2-pole, 2-wire receptacles for replacement use only in existing non-grounding systems.

Experience proved that a single grounding point through the neutral conductor was not sufficiently safe. Conditions could occur where fault currents and differences in potential lead to shocks, overheating, equipment burnout and fire. Therefore, the 2-pole, 3-wire circuit was developed. A third conductor, called the grounding conductor, does not carry current during normal circuit operation. It is connected to the neutral bus bar at the service entrance and runs along with the current-carrying neutral and hot conductors. The grounding conductor is connected only to outlet boxes, chassis and other non-current carrying components that may carry current in case of damage or defects in the wiring system. It is sometimes referred to as the "equipment grounding conductor."

The grounding contacts on the 2-pole, 3-wire receptacles are most commonly shaped like a "U", which is how the term "U-ground" evolved. The grounding contacts on these receptacles are securely fastened to the mounting strap. In Leviton receptacles, the grounding contacts are permanently riveted to the mounting strap, and in most Leviton Hospital Grade and Industrial Grade receptacles they are an integral part of the strap. Many Leviton receptacles offer dual ground connection options to help ensure that the receptacle is properly connected to the grounding system: An integral green grounding screw for direct connection to the green or bare grounding wire, and a patented Groundamatic® self-grounding clip riveted to the strap to provide automatic ground connection when the receptacle is mounted in a properly grounded metal wallbox.

Isolated-Ground Receptacles

Although the conventional grounding system provides safety for personnel and equipment, it may be a source of electrical interference that can cause problems in modern electronic equipment. Because the conventional grounding network runs through an entire facility, it can unintentionally function as a pick-up of transient electrical signals or "noise."



TECHNICAL INFORMATION

These transient signals will then be introduced to equipment through the ground connection. Microprocessor-based equipment, including computers, cash registers, medical equipment and audio/video equipment, may malfunction as a result of this noise.

Isolated-Grounding Receptacles can help eliminate problems caused by electrical interference in a conventional ground system. The ground contacts on Isolated-Ground Receptacles are electrically isolated from the mounting strap and therefore they are isolated from the conventional ground system. The green ground screw is connected to a pure ground path that is separate from a facility's grounding network. The isolated ground network is relatively free of electrical noise because it is not a facility-wide grounding path and it's connected to ground at a single point.

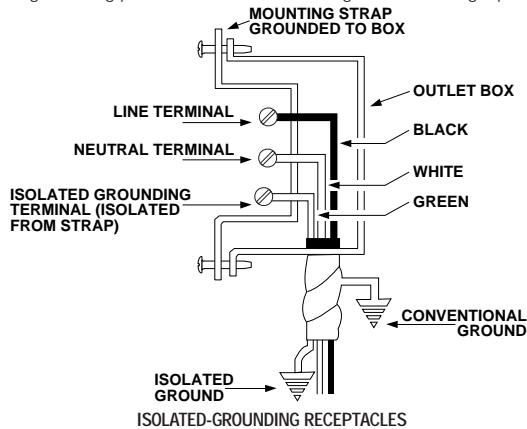

Mounting Straps

There are basically two kinds of mounting straps for receptacles. The "through" type passes between the receptacle body and cover. The "wrap-around" type acts as a cradle for the receptacle, surrounding its side, ends and bottom surfaces.

Power Contact Design

The "contact" does more than make contact with the plug blade — It must grip the plug blade for maximum electrical conductivity and mechanical strength. Leviton receptacles feature double-wipe contacts that grip both sides of each blade, including the U-ground contacts that are often single-wipe in receptacles made by other manufacturers. Leviton Hospital Grade and Industrial Grade receptacles feature triple-wipe contacts for added strength and durability in high-abuse applications. Leviton contacts are made of the copper alloys that offer maximum strength and electrical conductivity.

Wiring of Leviton Receptacles



Side Wiring
Loop wire around terminal screw. Screw head locks wire against terminal. For copper or copper/clad aluminum conductors.



Quickwire™ Connection
Insert wire into wire well. Wire is automatically clamped by spring action, insuring good electrical connection. For copper conductors only.



Quickwire™ and Screw
Option of (1) side wiring or (2) Quickwire connection. NOTE: For continuous wiring, both sets of terminals (screw and Quickwire) can be used together.



Back & Side Wiring
Option of (1) side wiring or (2) back wiring: Insert wire into well. Tighten screw, thus clamping wire against terminal. Back wiring for copper or copper/clad aluminum conductors.



Two-Circuit Conversion
To power each outlet of a duplex receptacle separately, simply break off the tab between the two terminals.

Ground Fault Circuit Interrupters (GFCI's)

The Need for Ground Fault Protection

Circuit breakers and fuses protect equipment and building structures from overheating and fire caused by short circuits and high-current overloads. However, the current level needed to trip a breaker is many times greater than the amount of current needed to deliver a powerful, and possibly lethal electrical shock. For example, the hot conductor in an electrical device can become exposed through a break in its insulation, and it may end up touching the device's metal enclosure. The leakage current that now flows through the metal enclosure will be conducted to ground through any available path — including the body of a human being that happens to touch the faulty device. This condition is called a Ground Fault, and the current flowing through the person to ground can be life threatening, though there is usually nowhere near enough current to trip a circuit breaker.

How a GFCI Works

When there is a ground fault condition, all of the current flowing through the "hot" conductor is not returning through the neutral conductor. A Ground Fault Circuit Interrupter (GFCI) monitors the difference in current flow between hot and neutral conductors. If the GFCI senses even a very tiny difference in current flow between the conductors (a ground fault), it interrupts the flow of electrical current through the device by opening its internal double-pole contacts. According to UL Standard 943 Class A, the GFCI must trip when there is a ground fault of 5 milliamperes ($\pm 1\text{mA}$). The GFCI must also trip within approximately 25 milliseconds.

GFCI receptacles are rated for 15 or 20 amp circuits. They are used in place of standard box-mounted duplex receptacles. GFCI receptacles can also be feed-through wired to provide ground fault protection to feed-through wired receptacles downstream.

See Section H for information on Leviton's comprehensive line of Ground Fault Circuit Interrupter Devices.

UL 2006 Code Requirements (Effective July 28, 2006)

- If a miswiring (line-load reversal) occurs during installation, the GFCI must not be capable of supplying power to either the GFCI's face or to feed-through terminals
- GFCIs must provide a visual and/or audible indication OR be able to render themselves incapable of delivering power when they no longer offer ground fault protection based on a failure to pass their internal test

Note that the National Electrical Code strongly recommends monthly testing of all GFCIs.

Leviton SmartLockPRO® GFCI with Lockout Action

The TEST and RESET functions on Leviton's SmartLock GFCI work together so that a tripped GFCI cannot be reset if the GFCI circuit is no longer providing ground fault protection. The RESET button is blocked if GFCI protection has been compromised, eliminating the possibility of end-users incorrectly assuming that a reset GFCI is providing ground fault protection when it actually is not.

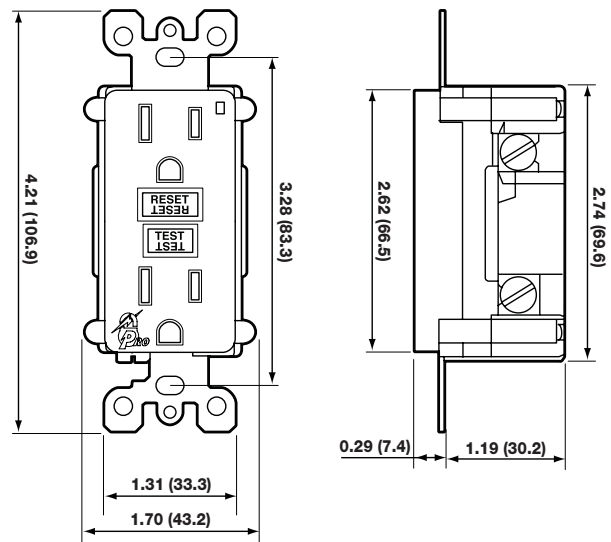

SmartLockPRO® GFCI RECEPTACLE
7599 Series

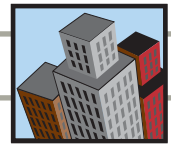

Enclosure Type Designations

Enclosures serve the dual purpose of protecting personnel from incidental contact with the enclosed electrical equipment and protecting the enclosed equipment against specified environmental conditions. Enclosures are rated for use in specific environmental conditions by NEMA, UL, CSA and the IEC. The major rating systems used are the NEMA Type Numbers and the IEC Enclosure Classification Designation.

The IEC Enclosure Classification Designation — IP Suitability Ratings

The IP Suitability Ratings are a system for classifying the degree of protection provided by enclosures of electrical equipment. The higher the number in the rating, the greater the degree of protection provided by the enclosure. Note that the rating will ONLY apply to properly installed equipment. The chart below defines the numerals in the IP Code.

1. The First Numeral indicates the degree of protection for persons against access to hazardous parts inside the enclosure and/or against the ingress of solid foreign objects
2. The Second Numeral indicates the degree of protection of equipment inside enclosures against damage from the ingress of water.

Elements of the IP Code

Meaning for the Protection of Equipment		
Code Letters	First Number	Second Number
Ingress Protection	Against Ingress of Solid Foreign Objects	Against Ingress of Water with Harmful Effects
IP	0 – Non protected	0 – Non protected
	1 – ≥ 50 mm diameter	1 – Vertically dripping
	2 – ≥ 12.5 mm diameter	2 – Dripping (15 °tilted)
	3 – ≥ 2.5 mm diameter	3 – Spraying
	4 – ≥1.0 mm	4 – Splashing
	5 – Dust-protected	5 – Jetting
	6 – Dust-tight	6 – Power jetting
		7 – Temporary immersion
	8 – Continuous immersion	

Note: > denotes greater than or equal to.

Example: IP 54 Suitability Rating = Ingress Protection/Dust-protected/Splashing

Enclosure Types for Non-Hazardous Locations

NATIONAL ELECTRICAL MANUFACTURERS ASSOCIATION

NEMA Standards Publication No. 250-1991
Enclosures for Electrical Equipment (1000 Volts max.)

Type Designation	Intended Use and Description
	An enclosure is a surrounding case constructed to provide a degree of protection to personnel against incidental contact with the enclosed equipment and to provide a degree of protection to enclosed equipment against the specified environmental conditions.
Type 1	Enclosures are intended for indoor use primarily to provide a degree of protection against limited amounts of falling dirt.
Type 2	Enclosures are intended for indoor use primarily to provide a degree of protection against limited amounts of falling water or dirt.
Type 3	Enclosures are intended for outdoor use primarily to provide a degree of protection against rain, sleet, windblown dust, and damage from external ice formation.

UNDERWRITERS LABORATORIES INC.

UL50
Standard for Enclosures for Electrical Equipment (10th Edition)

Type Designation	Intended Use and Description
	Enclosure — A surrounding case constructed to provide a degree of protection against incidental contact with the enclosed equipment and to provide a degree of protection to the enclosed equipment against specified environmental conditions. A complete enclosure shall be provided for all live parts that may be housed in it. The enclosure shall be tight and, unless designed for a specific installation, such as a cast metal junction or pull box intended to be installed in poured concrete, shall be provided with means for mounting.
Type 1	Indoor use primarily to provide a degree of protection against limited amounts of falling dirt.
Type 2	Indoor use primarily to provide a degree of protection against limited amounts of falling water or dirt.
Type 3	Outdoor use primarily to provide a degree of protection against rain, sleet, windblown dust and damage from external ice formation.

CANADIAN STANDARDS ASSOCIATION

CAN/CSA C22.2 No. 94-M91
Special Purposes Enclosures

Type Designation	Intended Use and Description
	Enclosures — provide a degree of protection against accidental contact with the enclosed equipment, and to the enclosed equipment against specified environmental conditions.
	No CSA equivalent.
Type 2	An enclosure for indoor use, constructed so as to provide a degree of protection against dripping and light splashing of non-corrosive liquids, and falling dirt.
Type 3	An enclosure for either indoor or outdoor use, constructed so as to provide a degree of protection against rain and snow, undamaged by the external formation of ice on the enclosures.



TECHNICAL INFORMATION

Enclosure Types for Non-Hazardous Locations

NATIONAL ELECTRICAL MANUFACTURERS ASSOCIATION

NEMA Standards Publication No. 250-1991
Enclosures for Electrical Equipment (1000 Volts max.)

Type Designation	Intended Use and Description
Type 3R	Enclosures are intended for outdoor use primarily to provide a degree of protection against rain, sleet, and damage from external ice formation.
Type 3S	Enclosures are intended for outdoor use primarily to provide a degree of protection against rain, sleet, windblown dust, and to provide for operation of external mechanisms when ice laden.
Type 4	Enclosures are intended for indoor or outdoor use primarily to provide a degree of protection against windblown dust and rain, splashing water, hose-directed water, and damage from external ice formation.
Type 4X	Enclosures are intended for indoor or outdoor use primarily to provide a degree of protection against corrosion, windblown dust and rain, splashing water, hose directed water, and damage from external ice formation.
Type 5	Enclosures are intended for indoor use primarily to provide a degree of protection against settling airborne dust, falling dirt, and dripping noncorrosive liquids.
Type 6	Enclosures are intended for indoor or outdoor use primarily to provide a degree of protection against hose-directed water, the entry of water during occasional temporary submersion at a limited depth, and damage from external ice formation.
Type 6P	Enclosures are intended for indoor or outdoor use primarily to provide a degree of protection against hose-directed water, the entry of water during prolonged submersion at a limited depth, and damage from external ice formation.
Type 12	Enclosures are intended for indoor use primarily to provide a degree of protection against circulating dust, falling dirt, and dripping noncorrosive liquids.
Type 12K	Enclosures with knockouts are intended for indoor use primarily to provide a degree of protection against circulating dust, falling dirt, and dripping noncorrosive liquids.
Type 13	Enclosures are intended for indoor use primarily to provide a degree of protection against dust, spraying of water, oil, and noncorrosive coolants.

UNDERWRITERS LABORATORIES INC.

UL50
Standard for Enclosures for Electrical Equipment
(10th Edition)

Type Designation	Intended Use and Description
Type 3R	Outdoor use primarily to provide a degree of protection against rain, sleet, and damage from external ice formation.
Type 3S	Outdoor use primarily to provide a degree of protection against rain, sleet, windblown dust, and to provide for operation of external mechanisms when ice laden.
Type 4	Indoor or outdoor use primarily to provide a degree of protection against windblown dust and rain, splashing water, hose-directed water, and damage from external ice formation.
Type 4X	Indoor or outdoor use primarily to provide a degree of protection against corrosion, windblown dust and rain, splashing water, hose-directed water and damage from external ice formation.
Type 5	Indoor use primarily to provide a degree of protection against settling airborne dust, falling dirt, and dripping noncorrosive liquids.
Type 6	Indoor or outdoor use primarily to provide a degree of protection against hose-directed water, the entry of water during occasional temporary submersion at a limited depth, and damage from external ice formation.
Type 6P	Indoor or outdoor use primarily to provide a degree of protection against hose-directed water, the entry of water during prolonged submersion at a limited depth, and damage from external ice formation.
Type 12	Indoor use primarily to provide a degree of protection against circulating dust, falling dirt, and dripping noncorrosive liquids.
Type 12K	Indoor use primarily to provide a degree of protection against circulating dust, falling dirt, and dripping noncorrosive liquids.
Type 13	Indoor use primarily to provide a degree of protection against dust, spraying of water, oil, and noncorrosive coolant.

CANADIAN STANDARDS ASSOCIATION

CAN/ CSA C22.2 No. 94-M91
Special Purposes Enclosures

Type Designation	Intended Use and Description
Type 3R	An enclosure for either indoor or outdoor use, constructed so as to provide a degree of protection against rain and snow, undamaged by the external formation of ice on the enclosure.
Type 3S	An enclosure for either indoor or outdoor use, constructed so as to provide a degree of protection against rain, snow and windblown dust, the external mechanism(s) remain operable while ice covered.
Type 4	An enclosure for either indoor or outdoor use, constructed so as to provide a degree of protection against rain, snow, windblown dust, splashing and hose-directed water; undamaged by the external formation of ice on the enclosure.
Type 4X	An enclosure for either indoor or outdoor use, constructed so as to provide a degree of protection against rain, snow, windblown dust, splashing and hose-directed water; undamaged by the external formation of ice on the enclosure.
Type 5	An enclosure for indoor use, constructed so as to provide a degree of protection against dripping and light splashing of noncorrosive liquids and settling dust, lint, fibers, and flyings.
Type 6	An enclosure for either indoor or outdoor use, constructed so as to provide a degree of protection against the entry of water during occasional temporary submersion at a limited depth; undamaged by the external formation of ice on the enclosure.
Type 6P	An enclosure for either indoor or outdoor use, constructed so as to provide a degree of protection against the entry of water during prolonged submersion at a limited depth; undamaged by the external formation of ice on the enclosure; resists extended corrosion.
Type 12	An enclosure for indoor use, constructed so as to provide a degree of protection against circulating dust, lint, fibers, and flyings; dripping and light splashing of noncorrosive liquids; not provided with knockouts.
Type 12K	An enclosure for indoor use, constructed so as to provide a degree of protection against circulating dust, lint, fibers, and flyings; dripping and light splashing of noncorrosive liquids; and provided with knockouts.
Type 13	An enclosure for indoor use, constructed so as to provide a degree of protection against circulating dust, lint, fibers, and flyings; seepage and spraying of noncorrosive liquids including oils and coolants.

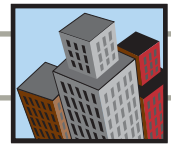

NEMA and IEC Enclosure Classifications

Comparing NEMA Enclosure Type Numbers and IEC Enclosure Classification Designations (IP Suitability Rating)

IEC

IEC Publication 529, "Classification of Degrees of Protection Provided by Enclosures", defines the IP (Ingress Protection) Suitability Rating. The IP Suitability Rating is a system for classifying the degree of protection provided by enclosures of electrical equipment. The higher the number in the rating, the greater the degree of protection provided by the enclosure. The first numeral of the code indicates the degree of protection for persons against access to hazardous parts inside the enclosure and/or against the ingress of solid foreign objects. The second numeral indicates the degree of protection of equipment inside enclosures against damage from the ingress of water. For a more detailed explanation of the IP Suitability Code, refer to page U-12.

The IP Suitability Rating defined by IEC 529 does not specify any degree of protection against mechanical damage of equipment, risk of explosions, or conditions such as moisture (i.e. condensation), corrosive vapors, fungus, or vermin.

NEMA

NEMA Standards Publication 250 defines the NEMA Enclosure Type Numbers. Unlike the IEC Enclosure Classification Designations, NEMA Standards Publication 250 does tests for environmental condition such as corrosion, rust, icing, oil and coolants. For this reason and because the tests and evaluations for other characteristics are not identical, the IEC Enclosure Classification Designations cannot be exactly equated with NEMA Enclosure Type Numbers.

The table below provides an equivalent conversion from NEMA Enclosure Type Numbers to IEC Enclosure Classification Designations. Note that the NEMA Types meet or exceed the test requirements for the associated IEC Classifications. Therefore, this table cannot be used to convert from IEC Classifications to NEMA Types.

Converting NEMA Type Numbers to IEC Classification Designations

(Note: This table cannot be used to convert IEC classification designations to NEMA type numbers)

NEMA Enclosure Type Number	Equivalent IEC Enclosure Classification Designation
1	IP10
2	IP11
3	IP54
3R	IP14
3S	IP54
4 and 4X	IP56
5	IP52
6 and 6P	IP67
12 and 12K	IP52
13	IP54

Materials Used in Wiring Devices

The following is an overview of the materials commonly used in wiring devices. Note that specific brand names of materials used in Leviton devices are subject to change due to a variety of factors. These changes will never compromise the quality, performance and durability features of our wiring devices. Leviton is committed to maintaining the positive qualities of the materials being replaced and choosing new materials with superior qualities as they become available.

Brass

The type of brass commonly used in wiring devices is referred to as standard or "70/30" brass. It is an alloy of 70% copper and 30% zinc that provides the strength and conductivity needed for power and ground contacts, wiring terminals and terminal screws. It is also used for some mounting straps and wallplates.

The Olin Corporation offers a series of alloys sometimes referred to as

High Performance Brass or "Olin Brass." Olin brass is a copper alloy consisting of more than 90% copper. It is more resilient than 70/30 brass and used by Leviton to form the power contacts in some Industrial Grade and Hospital Grade devices.

Phosphor Bronze

Phosphor Bronze, an alloy of copper and tin, is superior in strength to 70/30 brass. The advantage of using phosphor bronze parts is that they can be thinner than comparable parts made of standard brass without any loss in strength. For example, Leviton uses a phosphor bronze alloy of 95% copper and 5% tin to form power contacts in some Industrial Grade receptacles. Phosphor bronze power contacts at .031" outperform brass power contacts of a thicker gauge.

Beryllium Copper

An alloy of copper and .5% beryllium is used to form some of the components in Leviton Industrial Grade devices. Beryllium Copper provides excellent strength, durability, electrical conductivity. It also retains its resiliency at elevated temperatures. These properties make Beryllium Copper ideal for the contact arm in heavy-duty switches.

Silver-Cadmium Oxide

Although pure silver is an excellent conductor (superior to copper), it cannot be used for switch contacts. Over time, arcing caused by actuation would weld the silver contacts together. Silver-cadmium oxide, an alloy of 90% silver and 10% cadmium oxide, is widely used by Leviton to form switch contacts. Microscopic particles of cadmium oxide in the silver will decompose due to the heat buildup, preventing the contacts from welding together.

Zinc-Plated Steel

In addition to being strong and durable, zinc-plated steel provides a higher degree of corrosion resistance than standard cold-rolled steel. Leviton uses zinc-plated steel mounting straps in many of their devices. Leviton also offers zinc-plated steel wallplates for power receptacles, available with either a brass or aluminum finish.

Nickel-Plated Metals

Nickel-plating adds a high degree of corrosion resistance to either brass or steel. All the metal parts in Leviton Corrosion Resistant devices (blades, contacts, terminals, mounting straps and screws) are nickel-plated for maximum corrosion resistance. In some cases, cupronickel screws are used, which provide a high degree of corrosion resistance.

Leviton uses an electroless nickel-plating process. The standard plating process uses an electrical charge to coat the metal with nickel. This can produce uneven results, leaving some areas of the metal more coated than others. The more effective electroless process involves submerging the metal in a chemical bath where salts decompose and deposit nickel on the metal substrate. Every surface of the metal is evenly coated. Leviton uses this electroless process to ensure that their Corrosion Resistant wiring devices provide maximum performance in extremely damp and corrosive environments.

Stainless Steel

Type 430 Standard Stainless Steel

Type 430 stainless steel is resistant to the corrosive effects of moisture. Leviton offers a wide selection of wallplates made from this material. Leviton's Raintight-While-In-Use Covers are supplied with stainless-steel mounting screws to help ensure a long service life in wet applications. Note that Type 430 Stainless Steel does have magnetic properties that may interfere with magnetic-sensitive equipment.

Type 302/304 Non-Magnetic Stainless Steel

Type 302/304 Non-Magnetic Stainless Steel is suitable for applications where sensitive equipment may be affected by magnetic material. For example, navigational equipment in marine applications and MRI equipment in health care environments are susceptible to magnetic interference. In addition to being non-magnetic, Type 302/304 stainless Steel is more corrosion resistant than Type 430 stainless steel. Types 302 and 304 differ in composition, but there is virtually no difference between them in terms of non-magnetic and corrosion-resistant properties.



TECHNICAL INFORMATION

Leviton offers a complete selection of wallplates made of Type 302/304 Non-Magnetic Stainless Steel. These wallplates are ideal for any application where magnetic interference must be avoided. Leviton's Corrosion Resistant wiring devices feature non-magnetic stainless steel assembly screws to ensure their suitability in marine applications. For health care applications where non-magnetic devices are desired, Leviton's Corrosion Resistant devices should also be used.

CO/ALR Devices

Aluminum is used for residential wiring in Europe because it is a good conductor and considerably cheaper than copper. Houses with aluminum wiring were built in the United States, but the practice stopped at least twenty years ago. It was discovered that poor connections between aluminum wire and steel or brass terminal screws led to serious fires. There are still homes with aluminum wiring, and the National Electrical Code stipulates that only CO/ALR devices are to be used in these applications.

Aluminum wire tends to oxidize over time, and the oxide layer does not conduct electricity. This results in a poor connection with the wiring device terminal screws, particularly if they are steel. The connections gradually heat up to the point where fires are started inside the walls. For this reason, all standard wiring devices contain the warning, "For use with copper or copper-clad wire ONLY. Do not use with aluminum wire." The only exception to this are CO/ALR wiring devices.

Leviton offers a selection of CO/ALR devices for use with aluminum wire. In CO/ALR devices, the terminal screws are plating with the element Indium. Indium is an extremely soft metal that forms a gas-sealed connection with the aluminum wire, eliminating problems caused by oxidation.

Thermoset and Thermoplastic Material

There are significant benefits in using thermoplastics in wiring devices instead of thermosets. Each type of thermoplastic also has particular characteristics that may make it ideally suited for a specific application.

Thermosets

Thermoset components are manufactured by compression molding, where powdered material is molded by heat and pressure. Thermoset materials cannot be remolded. The major types of thermoset materials are Phenolic, Urea and Melamine. Phenolic is primarily used for dark colors, while Urea is used for lighter colors.

All thermoset materials provide dimensional stability when used in wiring devices. Phenolic is also a flame-resistant material. Thermosets do not provide a high degree of resistance to impacts, chemicals and solvents, and therefore they are not suitable for heavy-duty applications. Thermosets are not used in Leviton Industrial Grade devices. Urea is still widely used to manufacture wallplates.

Thermoplastics

Thermoplastic components are manufactured by injection molding where pellets of the material are heated to a liquid which can flow into a mold. Unlike thermosets, thermoplastics can be remolded. These materials are the preferred choice for heavy-duty applications because they provide superior resistance to impacts, chemicals and solvents compared to thermosets. The following is a list of the major types of thermoplastic materials, along with some well-known brand names.

- Nylon: Zytel® 101 Type 66 and Zytel Supertough ST 801 Type66
- Polycarbonate: Lexan®, Calibre®, Makrolon®
- Polyester: Valox®, Rynite®
- ABS
- Acrylic
- Polypropylene

Zytel® and Rynite® are registered trademarks of the Dupont Co. Lexan® and Valox® are registered trademarks of the General Electric Co. Calibre® is a registered trademark of the Dow Chemical Co. Makrolon® is a registered trademark of Bayer, Inc.

Chemical Resistance of Materials Commonly Used in Wiring Devices*

CHEMICALS	Nylon	Melamine	Phenolic	Urea	Polyvinyl Chloride	Poly-carbonate	Rubber	Polyester	Poly-propylene
Acids	C	B	B	B	A	B	B	A	A
Alcohol	A	A	A	A	A	A	B	A	A
Caustic Bases	A	B	B	B	A	C	C	B	A
Gasoline	A	B	A	C	A	B	B	A	A
Grease	A	A	A	A	A	B	B	A	A
Kerosene	A	A	A	A	A	B	A	A	A
Oil	A	A	A	A	A	B	A	A	A
Solvents	A	A	A	A	C	C	C	B	B
Water	A	A	A	A	A	A	B	A	A

A – Completely resistant — Good to excellent for general use.
 B – Resistance is fair to good — Recommended for limited service.
 C – Slow attack. No recommended for use.

Thermoplastic Enhancements

UV Stability

Thermoplastics provide varying degrees of UV (Ultraviolet Light) stability. For example, standard grade nylon will lose tensile strength and durability when exposed to sunlight and weathering. Discoloring will also occur. There are additives that will increase the UV stability of thermoplastics. UV Stabilized thermoplastics should be used when a device is intended for extensive outdoor use. For example, Leviton uses UV-stabilized Lexan in their Raintight-While-In-Use Cover, with excellent results.

Glass-Reinforced Thermoplastics

Several types of thermoplastics are available in glass-reinforced versions, including Rynite®, Lexan®, Valox® and nylon. Glass reinforcement increases the rigidity of the material and also raises the operating temperature. For example, Leviton Momentary and Maintained Contact Switches feature glass-reinforced thermoplastic construction, making these switches ideally suited for rugged applications.



ANSI Architectural Symbols

1. LIGHTING OUTLETS

	Ceiling	Wall
1.1 Surface or Pendant Incandescent, Mercury-Vapor, or Similar Lamp Fixture		
1.2 Recessed Incandescent, Mercury-Vapor, or Similar Lamp Fixture		
1.3 Surface or Pendant Individual Fluorescent Fixture		
1.4 Recessed Individual Fluorescent Fixture		
1.5 Surface or Pendant Continuous Row Fluorescent Fixture		
1.6 Recessed Continuous Row Fluorescent Fixture		
1.7 Bare-Lamp Fluorescent Strip		
1.8 Surface or Pendant Exit Light		
1.9 Recessed Exit Light		
1.10 Blanket Outlet		
1.11 Junction Box		
1.12 Outlet Controlled by Low-Voltage Switching when Relay is Installed in Outlet Box		

2. RECEPTACLE OUTLETS

	Grounded	Ungrounded
2.1 Single Receptacle Outlet		
2.2 Duplex Receptacle Outlet		
2.3 Triplex Receptacle Outlet		
2.4 Quadruplex Receptacle Outlet		
2.5 Duplex Receptacle Outlet — Split Wired		
2.6 Triplex Receptacle Outlet — Split Wired		
2.7 Single Special-Purpose Receptacle Outlet		
2.8 Duplex Special-Purpose Receptacle Outlet		
2.9 Range Outlet (typical)		

	Grounded	Ungrounded
2.10 Special Purpose Connection or Provision for Connection		
2.11 Multi-outlet assembly		
2.12 Clock Hanger Receptacle		
2.13 Fan Hanger Receptacle		
2.14 Floor Single Receptacle Outlet		
2.15 Floor Duplex Receptacle Outlet		
2.16 Floor Special-Purpose Outlet		

3. SWITCH OUTLETS

3.1 Single-Pole Switch	S
3.2 Double-Pole Switch	S2
3.3 Three-Way Switch	S3
3.4 Four-Way Switch	S4
3.5 Key-Operated Switch	SK
3.6 Switch and Pilot Lamp	SP
3.7 Switch for Low-Voltage switching System	SL
3.8 Maser Switch for Low-Voltage Switching System	SLM
3.9 Switch and Single Receptacle	
3.10 Switch and Double Receptacle	
3.11 Door Switch	SD
3.12 Time Switch	ST
3.13 Circuit Breaker Switch	SCB
3.14 Momentary Contact Switch or Pushbutton for Other Than Signaling System	SMC
3.15 Ceiling Pull Switch	

4. RESIDENTIAL OCCUPANCIES

4.1 Pushbutton	
4.2 Buzzer	
4.3 Bell	
4.4 Combination Bell-Buzzer	
4.5 Chime	
4.6 Annunciator	



TECHNICAL INFORMATION

NEMA Straight Blade Configurations

NEMA CONFIGURATIONS FOR GENERAL-PURPOSE NONLOCKING PLUGS AND RECEPTACLES

WIRING / VOLTAGE		15 AMPERE		20 AMPERE		30 AMPERE		50 AMPERE		60 AMPERE		
		RECEPTACLE	PLUG	RECEPTACLE	PLUG	RECEPTACLE	PLUG	RECEPTACLE	PLUG	RECEPTACLE	PLUG	
2-POLE 2-WIRE	125V	1	1-15R	1-15P								
	250V	2		2-15P	2-20R	2-20P	2-30R	2-30P				
	277V AC	3										
	600V	4										
2-POLE 3-WIRE GROUNDING	125V	5	5-15R	5-15P	5-20R	5-20P	5-30R	5-30P	5-50R	5-50P		
	250V	6	6-15R	6-15P	6-20R	6-20P	6-30R	6-30P	6-50R	6-50P		
	277V AC	7	7-15R	7-15P	7-20R	7-20P	7-30R	7-30P	7-50R	7-50P		
	347V AC	24	24-15R	24-15P	24-20R	24-20P	24-30R	24-30P	24-50R	24-50P		
	480V AC	8										
	600V	9										
3-POLE 3-WIRE	125/250V	10			10-20R	10-20P	10-30R	10-30P	10-50R	10-50P		
	3Ø 250V	11	11-15R	11-15P	11-20R	11-20P	11-30R	11-30P	11-50R	11-50P		
	3Ø 480V	12										
	3Ø 600V	13										
3-POLE 4-WIRE GROUNDING	125/250V	14	14-15R	14-15P	14-20R	14-20P	14-30R	14-30P	14-50R	14-50P	14-60R	14-60P
	3Ø 250V	15	15-15R	15-15P	15-20R	15-20P	15-30R	15-30P	15-50R	15-50P	15-60R	15-60P
	3Ø 480V	16										
	3Ø 600V	17										
4-POLE 4-WIRE	3ØY 120/208V	18	18-15R	18-15P	18-20R	18-20P	18-30R	18-30P	18-50R	18-50P	18-60R	18-60P
	3ØY 277/480V	19										
	3ØY 347/600V	20										
4-POLE 5-WIRE GROUNDING	3ØY 120/208V	21										
	3ØY 277/480V	22										
	3ØY 347/600V	23										

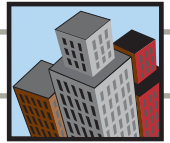

NEMA Locking Configurations

NEMA CONFIGURATIONS FOR LOCKING TYPE PLUGS AND RECEPTACLES

WIRING / VOLTAGE			15 AMPERE		20 AMPERE		30 AMPERE	
			RECEPTACLE	PLUG	RECEPTACLE	PLUG	RECEPTACLE	PLUG
2-POLE 2-WIRE	125V	L1	L1-15R	L1-15P				
	250V	L2			L2-20R	L2-20P		
	277V AC	L3			RESERVED FOR FUTURE CONFIGURATIONS			
	600V	L4			RESERVED FOR FUTURE CONFIGURATIONS			
2-POLE 3-WIRE GROUNDING	125V	L5	L5-15R	L5-15P	L5-20R	L5-20P	L5-30R	L5-30P
	250V	L6	L6-15R	L6-15P	L6-20R	L6-20P	L6-30R	L6-30P
	277V AC	L7	L7-15R	L7-15P	L7-20R	L7-20P	L7-30R	L7-30P
	347V AC	L24			L24-20R	L24-20P		
	480V AC	L8			L8-20R	L8-20P	L8-30R	L8-30P
	600V AC	L9			L9-20R	L9-20P	L9-30R	L9-30P
3-POLE 3-WIRE	125/250V	L10			L10-20R	L10-20P	L10-30R	L10-30P
	3Ø 250V	L11	L11-15R	L11-15P	L11-20R	L11-20P	L11-30R	L11-30P
	3Ø 480V	L12			L12-20R	L12-20P	L12-30R	L12-30P
	3Ø 600V	L13					L13-30R	L13-30P
3-POLE 4-WIRE GROUNDING	125/250V	L14			L14-20R	L14-20P	L14-30R	L14-30P
	3Ø 250V	L15			L15-20R	L15-20P	L15-30R	L15-30P
	3Ø 480V	L16			L16-20R	L16-20P	L16-30R	L16-30P
	3Ø 600V	L17					L17-30R	L17-30P
4-POLE 4-WIRE	3ØY 120/208V	L18			L18-20R	L18-20P	L18-30R	L18-30P
	3ØY 277/480V	L19			L19-20R	L19-20P	L19-30R	L19-30P
	3ØY 347/600V	L20			L20-20R	L20-20P	L20-30R	L20-30P
4-POLE 5-WIRE GROUNDING	3ØY 120/208V	L21			L21-20R	L21-20P	L21-30R	L21-30P
	3ØY 277/480V	L22			L22-20R	L22-20P	L22-30R	L22-30P
	3ØY 347/600V	L23			L23-20R	L23-20P	L23-30R	L23-30P



TECHNICAL INFORMATION

Horsepower Ratings for NEMA Configurations — for Plugs and Receptacles Only

STRAIGHT BLADE CONFIGURATIONS

NEMA	AC HP Rating	Rating
1-15	0.5	15A-125V
2-15	1.5*	15A-250V
2-20	2*	20A-250V
2-30	2*	30A-250V
5-15	0.5	15A-125V
5-20	1	20A-125V
5-30	2	30A-125V
5-50	2	50A-125V
6-15	1.5*	15A-250V
6-20	2*	20A-250V
6-30	2*	30A-250V
6-50	3*	50A-250V
7-15	2	15A-277V AC Only
7-20	2	20A-277V AC Only
7-30	3	30A-277 V AC Only
7-50	5	50A-277V AC Only
10-20	2 L-L*/1 L-N	20A-125/250V
10-30	2 L-L*/2 L-N	30A-125/250V
10-50	3 L-L*/2 L-N	50A-125/250V
11-15	2	15A-250V 3Ø
11-20	3	20A-250V 3Ø
11-30	3	30A-250V 3Ø
11-50	7.5	50A-250V 3Ø
14-15	1.5 L-L*/0.5 L-N	15A-125/250V
14-20	2 L-L*/1 L-N	20A-125/250V
14-30	2 L-L*/2 L-N	30A-125/250V
14-50	3 L-L*/2 L-N	50A-125/250V
14-60	3 L-L*/2 L-N	60A-125/250V
15-15	2	15A-250V 3Ø
15-20	3	20A-250V 3Ø
15-30	3	30A-250V 3Ø
15-50	7.5	50A-250V 3Ø
15-60	10	60A-250V 3Ø
18-15	2	15A-120/208V 3ØY
18-20	2	20A-120/208V 3ØY
18-30	3	30A-120/208V 3ØY
18-50	7.5	50A-120/208V 3ØY
18-60	7.5	60A-120/208V 3ØY

L-L Denotes phase-to-phase HP rating

L-N Denotes phase-to-neutral HP rating

*Suitable for 208V motor applications at HP rating

LOCKING CONFIGURATIONS

NEMA	AC HP Rating	Rating
L1-15	0.5	15A-125V
L2-20	2*	20A-250V
L5-15	0.5	15A-125V
L5-20	1	20A-125V
L5-30	2	30A-125V
L6-15	1.5*	15A-250V
L6-20	2*	20A-250V
L6-30	2*	30A-250V
L7-15	2	15A-277V AC Only
L7-20	2	20A-277V AC Only
L7-30	3	30A-277V AC Only
L8-20	3	20A-480V AC Only
L8-30	5	30A-480V AC Only
L9-20	NA	20A-600V AC Only
L9-30	NA	30A-600V AC Only
L10-20	2 L-L*/1 L-N	20A-125/250V
L10-30	2 L-L*/2 L-N	30A-125/250V
L11-15	2	15A-250V 3Ø
L11-20	3	20A-250V 3Ø
L11-30	3	30A-250V 3Ø
L12-20	5	20A-480V 3Ø
L12-30	10	30A-480V 3Ø
L13-30	NA	30A-600V 3Ø
L14-20	2 L-L*/1 L-N	20A-125/250V
L14-30	2 L-L*/2 L-N	30A-125/250V
L15-20	3	20A-250V 3Ø
L15-30	3	30A-250V 3Ø
L16-20	5	20A-480V 3Ø
L16-30	10	30A-480V 3Ø
L17-30	NA	30A-600V 3Ø
L18-20	2	20A-120/208V 3ØY
L18-30	3	30A-120/208V 3ØY
L19-20	5	20A-277/480V 3ØY
L19-30	10	30A-277/480V 3ØY
L20-20	NA	20A-347/600V 3ØY
L20-30	NA	30A-347/600V 3ØY
L21-20	2	20A-120/208V 3ØY
L21-30	3	30A-120/208V 3ØY
L22-20	5	20A-277/480V 3ØY
L22-30	10	30A-277/480V 3ØY
L23-20	NA	20A-347/600V 3ØY

L-L Denotes phase-to-phase HP rating

L-N Denotes phase-to-neutral HP rating

*Suitable for 208V motor applications at HP rating

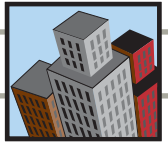

Circuit Wiring Diagrams

WIRING DIAGRAMS FOR NEMA CONFIGURATIONS

125V — 2-POLE, 2-WIRE

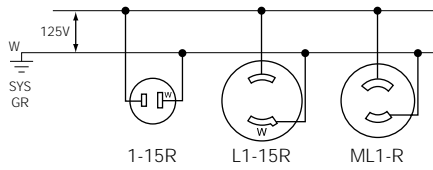

250V — 2-POLE, 2-WIRE

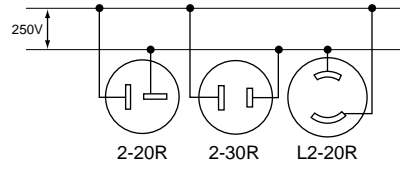

125V — 2-POLE, 3-WIRE GROUNDING

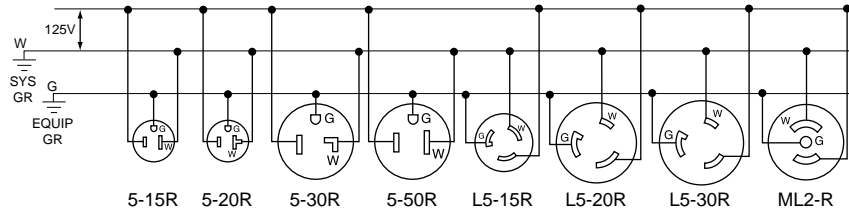

250V — 2-POLE, 3-WIRE GROUNDING

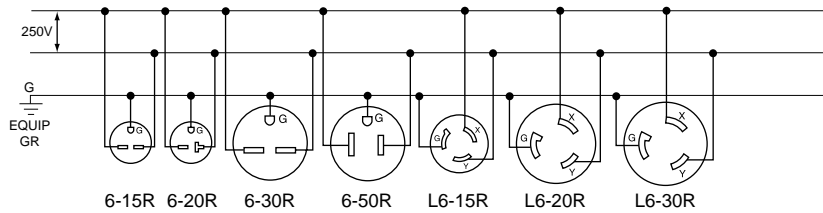

277V AC — 2-POLE, 3-WIRE GROUNDING

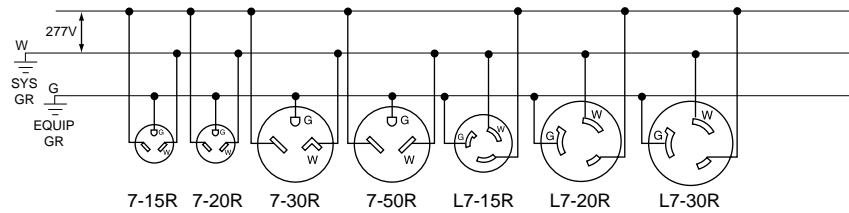

480V AC — 2-POLE, 3-WIRE GROUNDING

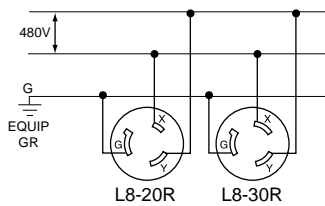

600V AC — 2-POLE, 3-WIRE GROUNDING

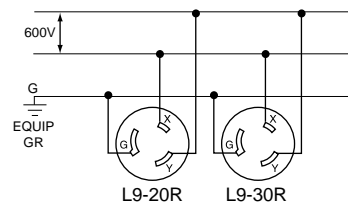

125/250V — 3-POLE, 3-WIRE

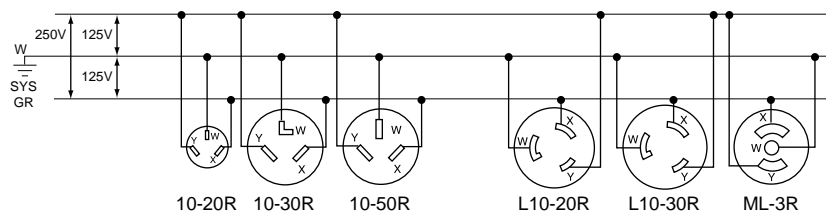

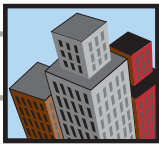

TECHNICAL INFORMATION

Circuit Wiring Diagrams

WIRING DIAGRAMS FOR NEMA CONFIGURATIONS

3Ø 250V — 3-POLE, 3-WIRE

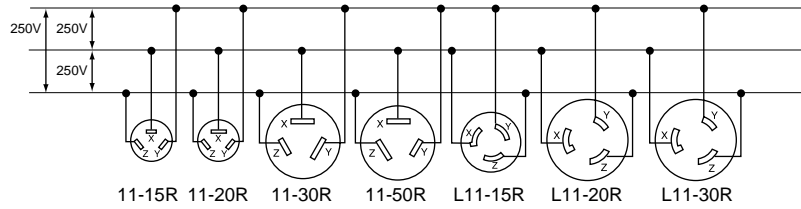

3Ø 480V — 3-POLE, 3-WIRE

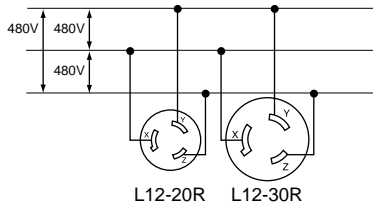

3Ø 600V — 3-POLE, 3-WIRE

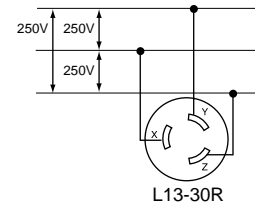

125/250V — 3-POLE, 4-WIRE GROUNDING

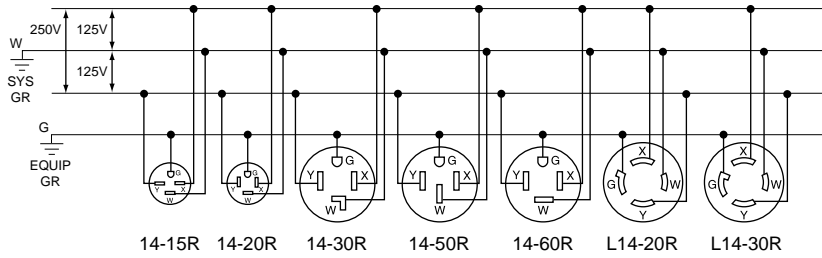

3Ø 250V — 3-POLE, 4-WIRE GROUNDING

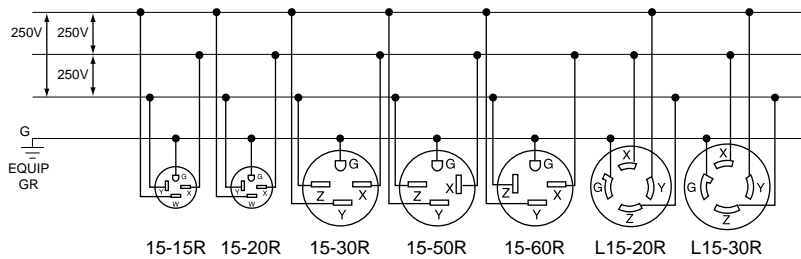

3Ø 480V — 3-POLE, 4-WIRE GROUNDING

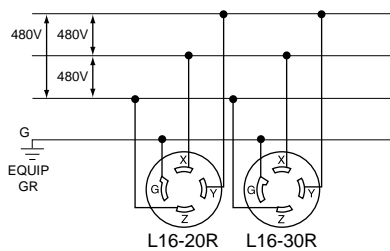

3Ø 600V — 3-POLE, 4-WIRE GROUNDING

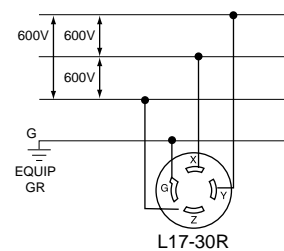



Circuit Wiring Diagrams

WIRING DIAGRAMS FOR NEMA CONFIGURATIONS

3ØY 120/208V — 4-POLE, 4-WIRE

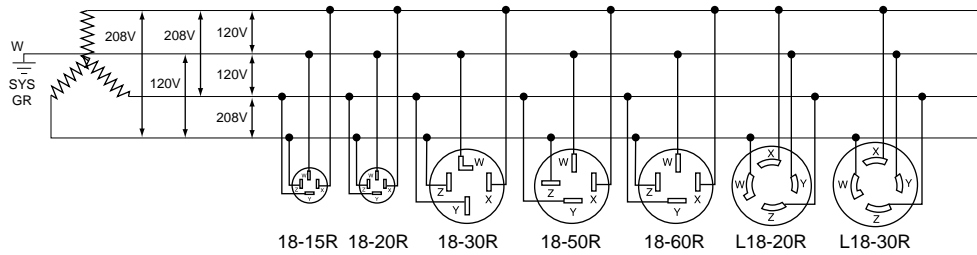

3ØY 277/480V — 4-POLE, 4-WIRE

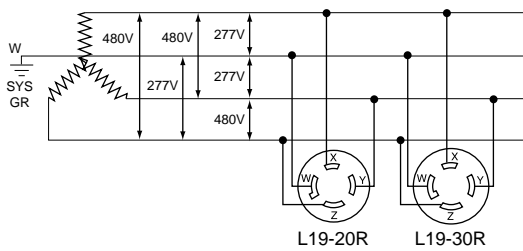

3ØY 347/600V — 4-POLE, 4-WIRE

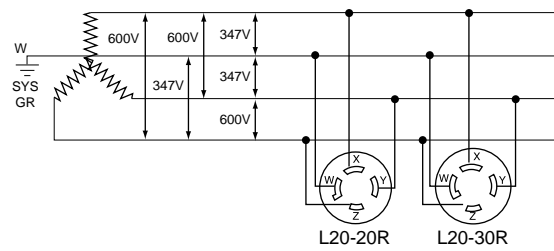

3ØY 120/208V — 4-POLE, 5-WIRE GROUNDING

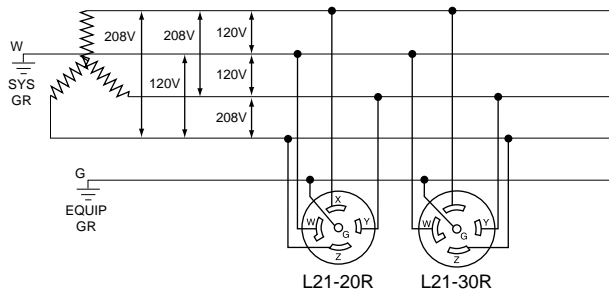

3ØY 277/480V — 4-POLE, 5-WIRE GROUNDING

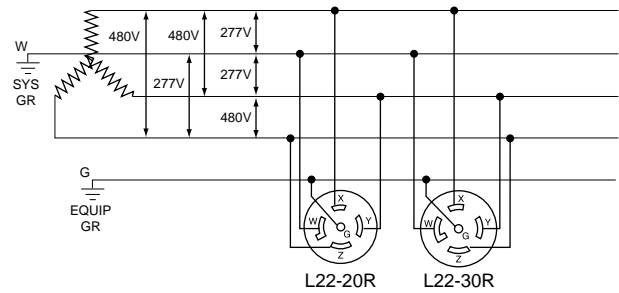

3ØY 347/600V — 4-POLE, 5-WIRE GROUNDING

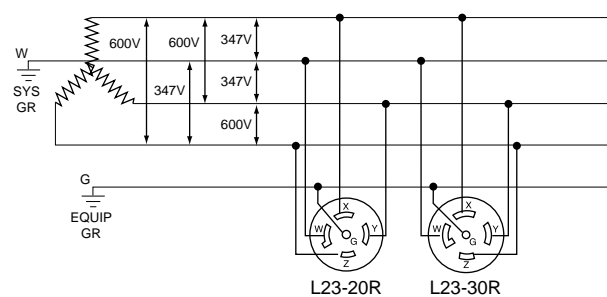



Switch Wiring Diagrams

STANDARD TOGGLE TYPE SWITCHES

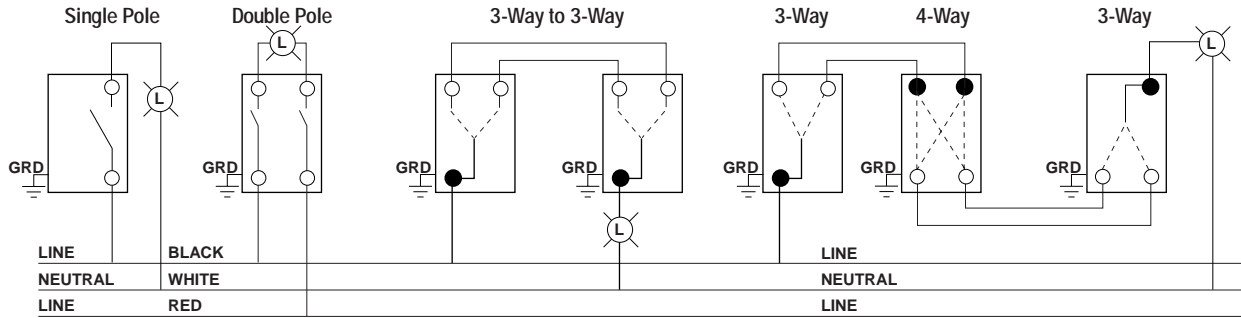

LIGHTED HANDLE SWITCHES

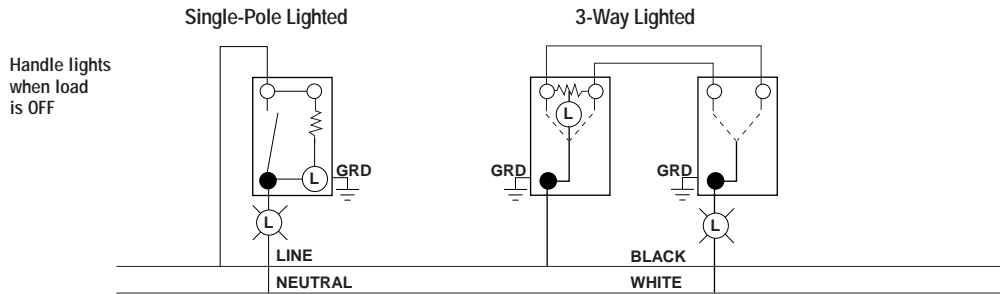

PILOT LIGHT SWITCHES

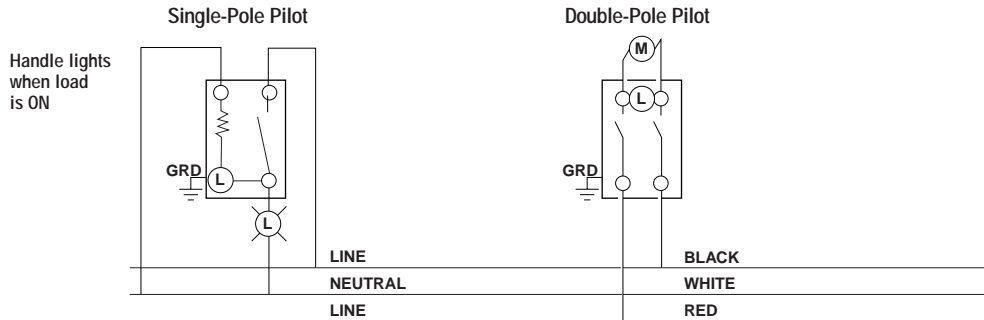

3-WAY PILOT SWITCHES

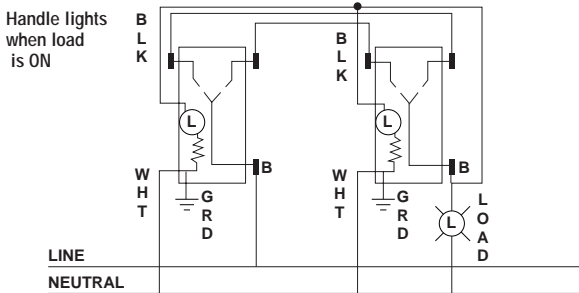

3-POSITION SWITCHES MOMENTARY AND MAINTAINED

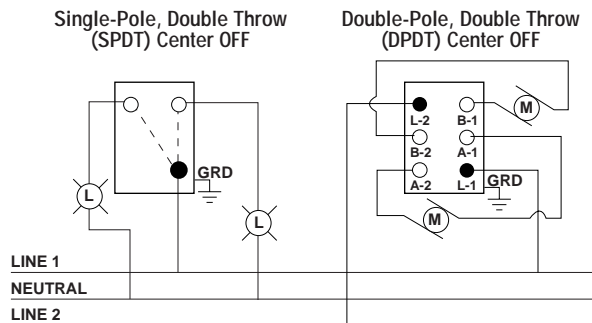



Diameter Ranges of Jacketed Cord in Accordance with Standard UL62

Acceptable range for overall diameter of jacketed cord indicated in inches and millimeters (in parentheses)

TYPE OF CORD	AWG SIZE	2-CONDUCTOR	3-CONDUCTOR	4-CONDUCTOR	5-CONDUCTOR	
SV, SVO, SVT, SVTO	18	.22-.26 (5.6-6.6)	.23-.27 (5.8-6.9)	—	—	
	SJ, SJ0, SJT, SJTO	18	.28-.32 (7.1-8.1)	.30-.34 (7.6-8.6)	.33-.37 (8.4-9.4)	—
SJ, SJ0, SJT, SJTO	16	.31-.34 (7.9-8.6)	.33-.36 (8.4-9.1)	.35-.40 (8.9-10.2)	—	
	14	.34-.38 (8.6-9.7)	.36-.40 (9.1-10.2)	.39-.44 (9.9-11.2)	—	
	12	.41-.46 (10.4-11.7)	.43-.48 (10.9-12.2)	.47-.52 (11.9-13.2)	—	
	10	.54-.61 (13.7-15.5)	.57-.64 (14.5-16.3)	.63-.70 (16.0-17.8)	—	
	S, S0, ST, ST0	18	.34-.39 (8.6-9.9)	.36-.40 (9.1-10.2)	.39-.43 (9.9-10.9)	.46-.51 (11.7-13.0)
		16	.37-.41 (9.4-10.4)	.39-.43 (9.9-10.9)	.41-.46 (10.4-11.7)	.49-.55 (12.4-14.0)
14		.50-.55	.52-.58 (12.7-14.0)	.56-.62 (13.2-14.7)	.63-.71 (14.2-15.7) (16.0-18.0)	
12		.57-.63 (14.5-16.0)	.59-.66 (15.0-16.8)	.64-.71 (16.3-18.0)	.70-.77 (17.8-19.6)	
10		.62-.69 (15.7-17.5)	.65-.72 (16.5-18.3)	.70-.78 (17.8-19.8)	.76-.84 (19.3-21.3)	
8		.78-.88 (19.8-22.4)	.83-.93 (21.1-23.6)	.93-1.05 (23.6-26.7)	1.00-1.15 (25.4-29.2)	
6		.92-1.05 (23.4-26.7)	.97-1.10 (24.6-27.9)	1.05-1.20 (26.7-30.5)	1.18-1.33 (30.0-33.8)	
4		1.06-1.21 (26.9-30.7)	1.13-1.28 (28.7-32.5)	1.25-1.45 (31.8-36.8)	—	
2	1.21-1.40 (30.7-35.6)	1.30-1.50 (33.0-38.1)	1.45-1.65 (36.8-41.9)	—		



TECHNICAL INFORMATION

Wallplates

WALLPLATE DIMENSIONS

Gangs	Standard 4.50 H x D* (114.3 H x D*)	Midway 4.88 H x .260 D (123.8 H x 6.5 D)	Oversizes 5.25 H x .260 D (133.4 H x 6.5 D)
1	2.75 (69.9)W	3.13 (79.4)W	3.50 (88.9)W
2	4.56 (115.9)W	4.94 (125.4)W	5.31 (134.9)W
3	6.38 (161.9)W	6.75 (171.5)W	—
4	8.19 (208.0)W	<i>NOTE: This chart is based on the standard calculation of adding 1.81" (46.0) width for each gang in multi-gang wallplates.</i>	
5	10 (254.0)W		
6	11.81 (300.0)W		

*DEPTHS OF STANDARD WALLPLATES: Plastic — .22 (5.6)
Metal — .19 (4.7)

WALLPLATE SIZE COMPARISON

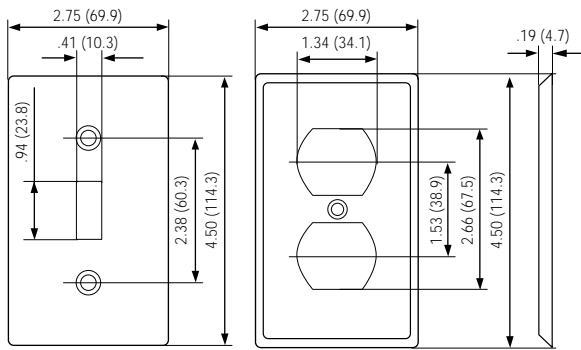
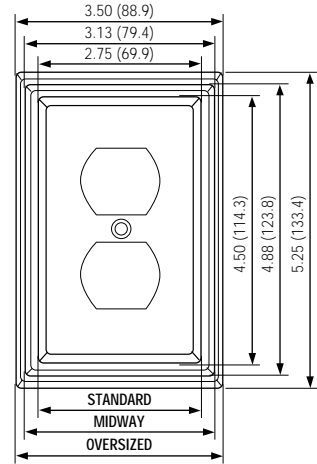

STANDARD SIZE WALLPLATE
81001 Series and 81003 Series

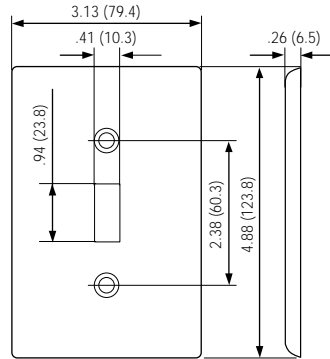

MIDWAY SIZE WALLPLATE
80501 Series

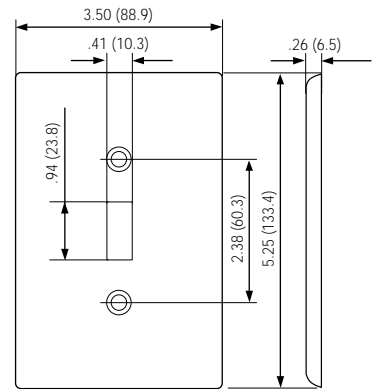

OVERSIZED WALLPLATE
85101 Series

POWER RECEPTACLE WALLPLATES

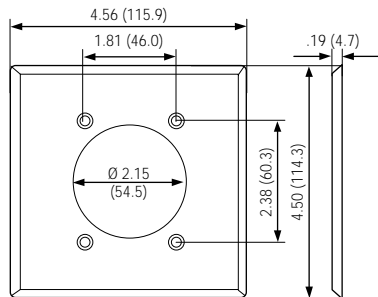

4934 Series

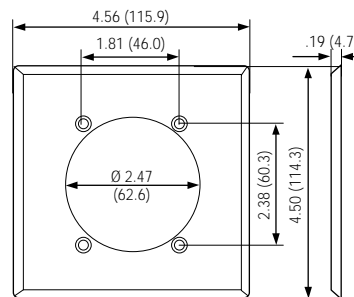

S701

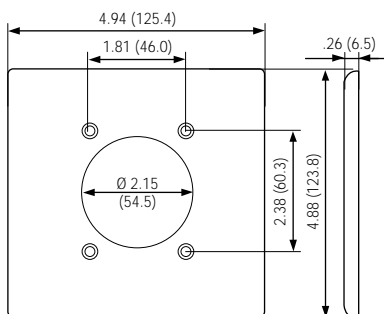

80526 Series

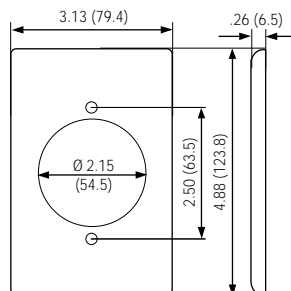

80528 Series

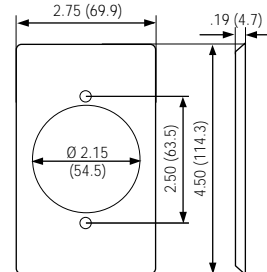

4927 Series

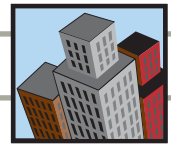

Telephone Wiring Devices Codes and Standards

Industry Standards

At Leviton, our concern since deregulation has been the proliferation of poor quality devices and equipment being attached to the network. These devices meet few of the customary standards for mechanical integrity and combustibility and have caused a number of problems for those who have installed them.

The responsibility for ensuring that no sub-standard devices are connected to the network rests on everyone's shoulders. In fact, the FCC recently issued a Public Notice strongly reminding manufacturers, carriers and customers that the manufacture and installation of sub-standard devices and equipment will not be tolerated — and that a substantial fine is the penalty for noncompliance. Recently, organizations such as the Federal Communications Commission (FCC), Underwriter's Laboratories (UL), the Canadian Standards Association (CSA), and the Telecommunications Industry Association (TIA) have been developing standards for premise wiring systems. Additionally, Article 800 of the National Electrical Code (NEC), published by the National Fire Protection Association (NFPA), mandated "listing" of equipment connected to telecommunications networks. Leviton has always played a role in the standards-making process and will continue to do so. We wholeheartedly support this new standards environment.



Industry Basics: Drawing the Line

The dividing line between public network and customer premises is called the demarcation point. Equipment, including wiring, on the network side of the demarcation point is the property and responsibility of the local telephone company (telco). Equipment and wiring on the customer side is the responsibility of the customer, who may procure equipment, materials, and service from the provider of their choice. A subscriber network interface (SNI) often called a "demarcation jack", is recommended to be installed at the demarcation point. A standard registered jack is often used at this point so that the network and the premise wiring system can be quickly separated from each other. The location of the SNI depends on local rules and on such factors as the number of units in the facility, access, and the type and age of connecting hardware. The SNI may be inside the building or outside.

FCC Part 68 Requirements

The equipment standards outlined in FCC Part 68 were developed long before divestiture to assure consumers, manufacturers and carriers that terminal equipment and wiring could be connected without degrading the network. Part 68 describes minimum requirements for the mechanical or physical properties of wiring devices such as the amount of gold on jack contacts, electrical performance, dimensional integrity, material properties, and spring characteristics of contacts. Only equipment meeting FCC Part 68 standards may be manufactured and connected to the network. The vast changes that have occurred in the industry because of evolving deregulation have made it necessary to modify Part 68. To this end, FCC Wiring Docket 88-57 was issued in 1990. There have been numerous attempts to change this docket; however, as of this writing, the following guidelines are true:

- Since 1984, Part 68 specified that all connections to the network be made through the standard plugs and standard telephone company-provided jacks described in Subpart F or Part 68. Now, Docket 88-57 permits customers to connect to the carrier's jack or wiring.
- The demarcation point has been redefined to be not more than 12 inches from the protector, or when no protector is present, 12 inches from the point of entry to the premises. In the past, the demarcation point could extend into the customer premise hundreds of feet, if necessary, depending on the wiring application. The new 12-inch ruling limits the carrier's access to the customer premise.
- The carriers are not responsible for customer wiring unless they have an agreement for such responsibility. Because the customer can now install a jack at the network interface, the customer is responsible for any wiring errors and malfunctions that occur.

- The "extraordinary procedures," acceptance testing, and carrier notification for wiring clause has been eliminated. The carrier is no longer required to take steps to protect the network from harm when there is a violation of Part 68 a failure during testing of newly installed wiring, or when harm has actually occurred. Once again, because the carriers now have less access to the customer premise, they will also have less responsibility in maintaining the network.
- Customer-provided, as well as carrier-provided plugs and jacks must meet Subpart F of Part 68 when newly installed on or after January 1, 1991. Prior to this ruling, Part 68 could be interpreted to require that only the jack at the network interface conform to Part 68.

Beware of the Number Game

FCC Part 68, Subpart F, specifies that contacts in the telephone jacks must have 50 micro-inches of gold over 100 micro-inches of nickel. Some manufacturers claim .5 microns of gold plating on their jack contacts. At 39.37 micro-inches per micron, that's only 19.7 micro-inches — less than half of what is required to meet FCC Part 68 specifications. If jack contacts have not been plated with the right thickness or quality of gold, corrosion at these critical points can cause signal degradation, equipment failure, and even damage to the public telephone network. Data networks are more at risk because even slight imperfections result in transmission error or data loss.

Reduce Risks — Specify Leviton

There are no two ways about it. The risk to your operation and equipment is so great that it only makes sense to insist on top-quality station products. When you specify Leviton jacks, you're assured maximum contact life with minimum resistance. We start with durable phosphor-bronze contacts and plate them with a full 50 micro-inches of lubricated hard gold over 100 micro-inches of nickel (or the electrical performance equivalent as specified in FCC Part 68 requirements). Jack openings are built within precise tolerances. High-quality thermoplastic rated UL 94V-0 resists distortion from changes in temperature and humidity, physical stress, and aging. Spring contacts are engineered to maintain positive contact pressure over the life of the device.

Telecommunications Industry Association Standards

If FCC regulations protect the telephone network from harm and UL requirements protect the consumer from harm, who is responsible for providing performance standards for the telecommunications industry? Recently, the FCC asked the Telecommunications Industry Association (TIA), a sister organization of the Electronic Industries Association (EIA), to take on this task, and they accepted the challenge. The TIA was asked to define minimum standards for such things as how to wire a building, what kind of wire to use, and so on. The following standards went into effect in 1991.

- **Pathway Standard (EIA/TIA 569-A):** This standard for installing pipe and conduit in commercial buildings is now available through TIA and the American National Standards Institute (ANSI).
- **Residential/Light Commercial Wiring (EIA/TIA 570):** A draft of this standard, which applies to premises with up to four telephone lines, has been reviewed by ANSI and TIA committees and released.
- **Commercial Wiring Standard (EIA/TIA 568-A):** The Commercial Wiring Standard applies to premises with more than four telephone lines. This draft has also been reviewed and released by ANSI and TIA committees. At time of printing, the standards are undergoing major revisions and are currently up for ballot.

We're the "Standards" People

Because Leviton is an active participant in the formation of North American codes and standards, you can be assured that our product development activities fully support this emerging standards environment. In fact, we have prepared several publications which describe standard practices and provide installation guidelines for contractors. Many Leviton distributors also sponsor training programs dealing with telecom wiring. And, of course, Leviton's Applications Engineering Group is always ready to assist you with any questions you may have about standards and codes, standard practices, or any installation problem.



Wire Color Codes and Jack Pin Designations

Electrical Network Connection

From 1 to 25 single or multiple-pair circuits bridged to the network or other connected equipment.

Mechanical Arrangement

Circuits are provided on numbered tip and ring positions on a miniature 50-pin ribbon connector (Amphenol-type). Pins 1 (ring) and 26 (tip) are considered position 1. Pins 2 (ring) and 27 (tip) of the ribbon connector are position 2. This pairing continues through twenty-five pairs.

Typical Usage

Many key and PBX systems specify the RJ21X, or 'Amphenol-type' as the network interface device. Many of these systems also use the RJ21X as a connector for stations or telephone sets, wired from the KSU or PBX Main Distribution Frame.

Note: Sometimes an RJ11 or RJ14C can be installed in place of an RJ21X. While many smaller systems that require only a few lines may show the RJ21X as the 'official' jack required under registration, less complex jacks such as the RJ11 or RJ14C can often be specified (perhaps in multiples). If the system requires only a few lines but the RJ21X is specified on the registration label, under FCC Part 68 you may specify the RJ11C, RJ14C, RJ25C, or RJ61X instead.

Many Leviton jacks can be used for the RJ21X configuration where 'intermixing' is permitted. Substitution of these special jacks is often both economical and practical. Contact Leviton Telcom Applications Engineering for information about versions to meet your requirements.

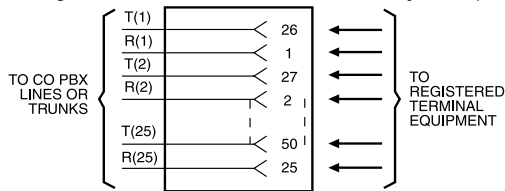

25-PAIR COLOR CODING/ISDN CONTACT ASSIGNMENTS

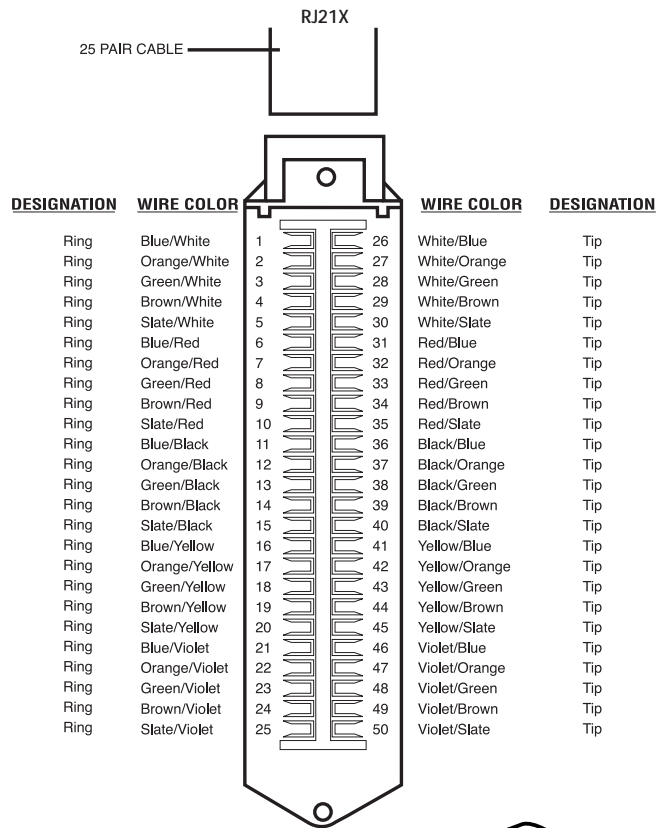

ISDN Assignment of Contact Numbers as specified by ISO Document 8877: 1987 (E)

Contact assignments for plugs and jacks:

CONTACT NUMBER	TE	NT	POLARITY
1	Power source 3	Power sink 3	+
2	Power source 3	Power sink 3	-
3	Transmit	Receive	+
4	Receive	Transmit	+
5	Receive	Transmit	-
6	Transmit	Receive	-
7	Power sink 2	Power source 2	-
8	Power sink 2	Power source 2	+

Note: For use in TE to TE interconnections, power source/sink 3 shall conform to the requirements specified in CCITT Recommendation 1.430, section 9.2 for power source/sink 2.

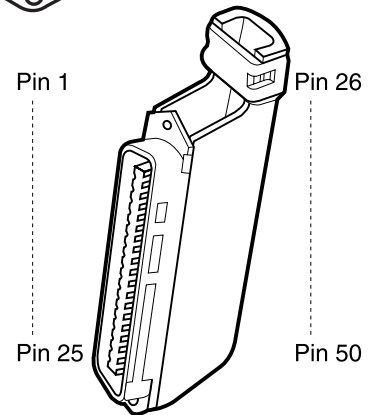
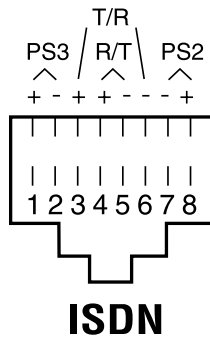

WIRE COLOR CODES

Standard 4-Pair Wiring Color Codes		
PAIR 1	T	White/Blue
	R	Blue/White
PAIR 2	T	White/Orange
	R	Orange/White
PAIR 3	T	White/Green
	R	Green/White
PAIR 4	T	White/Brown
	R	Brown/White

Note: For 6-wire jacks use pair 1, 2 and 3 color codes. For 4-wire jacks use pair 1 and 2 color codes.

A. Band-Striped Twisted-Pair Wire

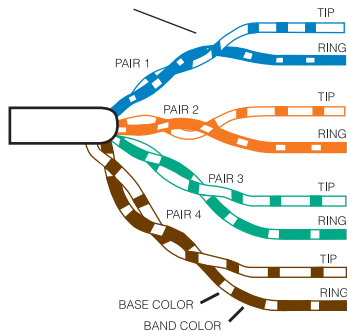

B. Solid-Color Twisted-Pair Wire

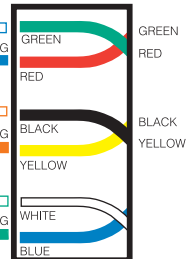

C. Quad Wire* (Solid-Color, Non-Twisted Wire)

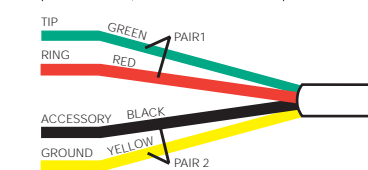

***CAUTION**
Quad wire is no longer acceptable for installation in multi-line environments. If encountered during a retrofit, quad wire should be replaced with 100Ω UTP. Connecting new quad to installed quad will only amplify existing problems and limitations associated with quad wire; leaving existing quad in place and connecting 100Ω UTP to it may also be ineffective, as the quad wire may negate the desired effect of the UTP.

CATALOG NUMBER ALPHANUMERIC INDEX



Important: Dash-numbers, indicating different product colors or other variations, are listed on the same page as the basic catalog numbers shown below, unless otherwise indicated.

THIS PAGE A0001-IPF01

CAT. NO.	PAGE NO.	CAT. NO.	PAGE NO.	CAT. NO.	PAGE NO.
A0001	P18	ACWM4-ST5	.A6	CS63-60C	.N26
A0002	P18	ACWM5-ST5	.A6	CS63-61C	.N26
A0003	P18	ACWM6-ST5	.A6	CS63-64C	.N26
A0004	P18	ACWP1-W	.A6, L17	CS63-65C	.N26
A0005	P18	ACWP2	.A6, L17	CS63-69	.N26
A0006	P18	ACWP3	.A6, L17	CS63-70	.N26
A0007	P18	ACWP4	.A6, L17	CS63-75	.N26
AC00R-10	.A3	ACWP5	.A6, L17	CS63-77	.N26
AC00R-1L	.A3	ACWP6	.A6, L17	CS81-64C	.N26
AC00R-7B	.A3	ACX10-1L	.A3	CS81-65C	.N26
AC084	.A7, L17	ACX12-7B	.A3	CS81-69	.N26
AC0SR-10	.A4	AE6MA	.J27	CS81-75	.N26
AC0SR-1L	.A4	AE6MC	.J27	CS82-64C	.N26
AC108-R*5	.A7, L17	AEC65	.J23	CS82-65C	.N26
AC201-1L	.A4	AEC80	.J23	CS82-69	.N26
AC201-7L	.A4	AECCS	.J24	CS82-75	.N26
AC203-1L	.A4	AEH50	.J25	CS83-64C	.N26
AC204-1L	.A4	AEHTK	.J34	CS83-65C	.N26
AC204-7L	.A4	AEI55	.J24	CS83-69	.N26
AC215	.A5	AEI65	.J23	CS83-75	.N26
AC220	.A5	AEI80	.J23	CS84-64C	.N26
AC315	.A2, A5	AEM65	.J23	CS84-65C	.N26
AC320	.A5	AEMRK	.J34	CS84-69	.N26
AC642	.A7, L17	AEN24	.J24	CS84-75	.N26
AC643	.A7, L17	AEPC8	.J24	CS115-2	.F12
AC644	.A7, L17	AEPHK	.J25	CS120-2	.F12
AC646	.A7, L17	AEPI6	.J24	CS215-2	.F12
AC734	.A7, L17	AEPI8	.J24	CS220-2	.F12
AC735	.A7, L17	AEPIS	.J24	CS315-2	.F12
AC830	.A7, L17	AES36	.J24	CS320-2	.F12
AC831	.A7, L17	AESS5	.J25	CS415-2	.F12
AC832	.A7, L17	AESUB	.J25	CS420-2	.F12
AC833	.A7, L17	BR15	.G13	CSB1-15	.F12
AC837	.A7, L17	BR20	.G13	CSB1-20	.F12
ACE04-1L	.A3	BX60-V	.O5	CSB2-15	.F12
ACE06-1L	.A3	BX100-V	.O5	CSB2-20	.F12
ACE06-1LW	.A3	BX230-V	.O4	CSB3-15	.F12
ACF01-1L	.A3	C0001	.P18	CSB3-20	.F12
ACGF1	.A5	C2623	.N12	CSB4-15	.F12
ACGF2	.A5	C2623-B	.N12	CSB4-20	.F12
ACH06-7B	.A3	C2623-CY	.N12	D32CK	.C3
ACH08-1L	.A3	C2651	.N13	D3204-1LW	.C3
ACI06-1L	.A3	C2653	.N13	D3204-2LW	.C3
ACI06-1LW	.A3	CA060	.O22	D3206-1LW	.C3
ACM06-1L	.A3	CA320	.O22	D3206-2LW	.C3
ACM10-1L	.A3	CA343	.O22	D3208-1LW	.C3
ACP0R-CB	.A4	CA420	.O22	D4000 Series	.C6
ACP15-CB	.A4	CA520	.O22	D4200	.C5
ACS15-1L	.A2, A4	CA530	.O22	D4200-OW	.C6
ACSIS-1L	.A4	CN100-OD0	.D18	D42CS	.C6
ACSR6	.A2, A5	CN200-00C	.D18	D42ET	.C6
ACSSR	.A5	CN220-00C	.D18	D42IR	.C6
ACT60-L	.A4	CN221-00C	.D18	D42LI	.C6
ACW14	.A6	CR015	.G14	D42LO	.C6
ACWM1-ST5	.A6	CR15	.G14	D42M0	.C6
ACWM2-ST5	.A6	CR15S-G	.G14	D42P1	.C6
ACWM3-ST5	.A6	CR020	.G14	D42P4	.C6
		CR20	.G14	D42P8	.C6
				D42P9	.C6
				D42RL	.C6
				D42SQ	.C6
				D670K	.L31
				D675E	.L31
				D6701	.L31
				D6706	.L31
				D6710	.L31
				D6720	.L31
				D6721	.L31
				D8000	.C5
				DCK05-OC	.C4
				DCK3D	.K5
				DCK4A	.K5
				DCK4D	.K5
				DCKS7	.C25
				DRK0D-1LX	.K9
				DRKOR-00	.K12, C23
				DRKDD-1L	.C23-C24
				DRKOS-OLX	.K4, K9
				DRK1D-00X	.K4
				DRKOS-OLX	.K9
				DS30-AX	.F9
				DS60-AX	.F9
				DS100-AX	.F9
				DS30-FAX	.F9
				DS60-FAX	.F9
				HCA02-10E	.K16
				HCCPRF-1TW	.K6
				HCCKR-E	.K6
				HCCUR	.K6
				HCM06-1DW	.K8
				HCM10-1DW	.K8
				HCM06-1SW	.K9
				HCM10-1SW	.K9
				HCP03-10W	.K10
				HCS10-1SW	.K9
				HKABH	.J26
				HKABV	.J26
				HKAVR	.J26
				HKCDC	.J26
				HKDVD	.J26
				HKPOD	.J26
				HKRMS	.J26
				HXC3D-1TW	.K5
				HXC4A-1TW	.K5
				HXC4D-1TW	.K5
				HXC7S-1TW	.K5
				HXC10-1TW	.K4
				HXC1A-1TW	.K4
				HXC1D-1TW	.K4
				HXC2D-1TW	.K4
				HXM06-1TW	.K8
				HXM10-1TW	.K8
				HXS08-1TW	.K8
				HXP15-1TW	.K10
				IPE04	.C30
				IPF01	.C30

CATALOG NUMBER ALPHANUMERIC INDEX

Important: Dash-numbers, indicating different product colors or other variations, are listed on the same page as the basic catalog numbers shown below, unless otherwise indicated.

THIS PAGE IPF05-RA520	
CAT. NO.	PAGE NO.
IPF05	.C30
IPI06	.C30
IPI10-1L	.C30
IPIM10	.C30
IPKIT	.C30
IPM06	.C30
IPP15-IL	.D6
IPPOR-1L	.D6
IPOFK	.C30
IP710	.C30
IPX10	.C30
KRS-A9519	.H7
KUS-A9519	.H7
L21-20P	.R18
L7500 Series	.Q15
L7600 Series	.Q15
L7700 Series	.Q17
L7900 Series	.Q18, Q25
L7902	.Q22
L7903	.Q22
L7904	.Q22
L7905	.Q22
L7918	.Q18
L8000 Series	.Q18
L8500 Series	.Q8-Q11
L8600 Series	.Q11-Q14
L8700 Series	.Q14
L8800 Series	.Q9, Q26
L9500 Series	.Q20-Q21
L9600 Series	.Q23, Q25
L9700 Series	.Q21, Q23
LVS-XXX	.D26
MCM06-1L	.C23, C24
MCM10	.C24
MCX10	.C24
MDE03	.C23
MDF01	.C23
MDI06	.C23
MDI10	.C23
MDM06	.C23
MH101	.R18
MH122	.R18
ML1-AC	.N29
ML1-AP	.N29
ML1-C	.N29
ML1-P	.N29
ML1-PB	.N29
ML1-PER	.N29
ML2-AC	.N29
ML2-AP	.N29
ML2-C	.N29
ML2-P	.N29
ML2-PB	.N29
ML2-PER	.N29
ML3-AC	.N29
ML3-AP	.N29
ML3-C	.N29

CAT. NO.	PAGE NO.
ML3-P	.N29
ML3-PB	.N29
ML3-PER	.N29
MNE04	.C11
MNF07	.C11
MNF10	.C11
MNI06	.C11
MNI10	.C11
MNI15	.C11
MNK0R	.C11
MNKIT	.C11
MNM06	.C11
MNM10	.C11
MNM15	.C11
MNS20-1L	.C12
MNS20-D3	.C12
MNS20-D4	.C12
MNX10	.C11
MNX15	.C11
MNX20	.C11
MNX30	.C11
MN00C-1LW	.C25
MN00R-DOW	.C11
MNOLA	.C11
MNOSA	.C11
MSE0R-10	.C23
MS00R-10	.C23
MS2-P	.N29
MS2-AP	.N29
MS302	.F7
MS302-S	.F7
MS303	.F7
MS303-S	.F7
MS402	.F7
MS403	.F7
MS602-BW	.F7
MS602-FW	.F7
MS603-BW	.F7
MS603-FW	.F7
MV121	.R18
MV122	.R18
MV123	.R18
MV241	.R18
MV242	.R18
NE100-00C	.C4, D18
NE200-00E	.D18
NE210	.C4
NE505	.C4
NE515	.C4
NE600	.C4
N13NC	.F7, E34
N138	.E27
N751	.E29
N1302	.F7
N1303	.F7
N3302	.F7
N3303	.F7
N3602	.F7

CAT. NO.	PAGE NO.
N3603	.F7
ODCCG	.D9
ODCCG-000	.D10, D11, D12
ODCOP	.D18
ODCOS-I1W	.D9
ODCOS-I2W	.D9
ODCOS-I7W	.D9
ODSIOD-ID	.D4
ODSOD-TD	.D4
ODS10-ID	.D3
ODS15-ID	.D3
OPB15-ODW	.D8
OSA20-R00	.D15
OSCO4-IOW	.D12, D17
OSCO5-M0W	.D10, D17
OSCO5-U0W	.D11, D17
OSC10-M0W	.D10, D17
OSC10-U0W	.D11, D17
OSC15-I0W	.D12, D17
OSC20-M0W	.D10, D17
OSC20-U0W	.D11
OSFHU-ITW	.D7
OSFOA-00W	.D7
OSP15-R30	.D15
OSP20-0D0	.D15
OSP20-RD0	.D15
OSPNA-000	.D15
OSSMT-MD	.D4
OSSNL-ID	.D3
OSS10-ID	.D3
OSW12-M0W	.D13, D17
OSWHB-I0W	.D14
OSWWW-I0W	.D14, D17
OSWLR-I0W	.D14, D17
P22	.E15
P32	.E15
P38	.E24
P48	.E24
P326	.E25
P1020-12S	.R17
P1021-12S	.R17
P1022-12L	.R17
P1023-12L	.R17
P1024-12L	.R17
P1025-12L	.R17
P1040-10S	.R17
P1041-10S	.R17
P1042-10L	.R17
P1043-10S	.R17
P1044-10L	.R17
P1045-10L	.R17
P1046-10L	.R17
P1047-10L	.R17
P1426	.E28
P2262	.E25
PB101-SGF	.H7
PB103-SGF	.H7
PCC55	.J33

CAT. NO.	PAGE NO.
PCC55-KIT	.J24
PCI65	.J33
PCI80	.J33
PCORD	.R18, R19
PC60	.Q22
PC100	.Q22
PC320	.Q22
PC420	.Q22
PC520	.Q22
PC530	.Q22
PC3430	.Q22
PEAUX	.C7
PEAU7	.C7
PE100	.C7
PE200	.C7
PE300	.C7
PE400	.C7
PJ1	.E7
PJ2	.E7
PJ3	.E7
PJ4	.E8
PJ7	.E12
PJ8	.E10, E29
PJ11	.E13
PJ13	.E16
PJ18	.E23
PJ23	.E16
PJ26	.B22, E4
PJ82	.E10, E29
PJ126	.E25
PJ226	.E25
PJ262	.B22, E4
PJ263	.B22, E4
PJ264	.E5
PJ826	.E27
PLG1	.Q22
PR150-1L	.D5
PR180-1L	.D5
PSC1	.E29
PSC7	.E29
PSC8	.E29
PSC14	.E29
PSC26	.E29
PSE1	.E29
PSE7	.E29
PSE8	.E29
PSE14	.E29
PSE26	.E29
PS110-10	.D16
PS110-1F	.D16
PS200-10	.D16
PS200-1F	.D16
RA060	.Q22
RA100	.Q22
RA320	.Q22
RA343	.Q22
RA420	.Q22
RA520	.Q22

CATALOG NUMBER ALPHANUMERIC INDEX



Important: Dash-numbers, indicating different product colors or other variations, are listed on the same page as the basic catalog numbers shown below, unless otherwise indicated.

THIS PAGE RA530-5G271

CAT. NO.	PAGE NO.	CAT. NO.	PAGE NO.	CAT. NO.	PAGE NO.
RA530	.O22	SGO99	.J33	U0700	.R23
RB241-XXX	.D23	SGVCK	.J28	U0800	.R23
RB243-XXX	.D23	SGVSM	.J28	U0825	.R24
RB421-XXX	.D23	SGVST	.J28	U1000	.R23, R24
RB423-XXX	.D23	SH081	.R19	U1500	.R23, R24
RE4BD-XXX	.D24	SH082	.R19	U2000	.R23
RE4SD-XXX	.D24	SJ26	.B20, B22, E2, E4	U2200	.R24
RELAY-XXX	.D22	SJ262	.B20, B22, E2, E4	U3000	.R23
RO8BD-XXX	.D22	SJ263	.B20, B22, E2, E4	VSHUB	.J19
RPI06	.C31	SJ264	.B20, B23, E2, E5	VSIND	.J19
RS110-10	.D16	SJ265	.B20, B23, E2, E5	VSOUT	.J19
RS110-1F	.D16	SJ266	.B20, B23, E2, E5	VSQIP	.J19
RTD01-1L	.C31	SO26	.E4	VZ00R-1L	.C20
RTF01-1L	.C31	SO262	.E4	VZ00R-7L	.C20
RZCOP-1LW	.C21	SO263	.E4	VZ00R-10	.C20, C22
RZC1-1L	.C22	SP316B	.O20	VZOSR-10	.C20, D6
RZC24-1L	.C22	SP316B4	.O16	VZOSR-1L	.C20, D6
RZCPG-OSG	.C22	SP316B6	.O16	VZE04-1L	.C19
RZCPG-BSG	.C22	SP316C	.O18	VZE06-1L	.C19
RZCS1-1L	.C22	SP316C4	.O16	VZF01-1L	.C19
RZCS4-1L	.C22	SP316C6	.O16	VZH06-7L	.C19
RZI06-1L	.C21	SP316P	.O18	VZH08-1L	.C19
RZI10-1L	.C21	SP316P4	.O16	VZI06-1L	.C19
RZM10-1L	.C21	SP316P6	.O16	VZKIT-CD	.C19, C20
RZMR1-OSG	.C22	SP316R	.O19	VZKIT-CS	.C19, C20
RZP03-1LW	.C21	SP316R4	.O16	VZKIT-MD	.C19, C20, C21, C22
RZP15-1LW	.C21	SP316R6	.O16	VZKIT-MS	.C19, C20, C22
RZS15-1L	.C21	SP332B	.O20	VZKIT-S4	.C22
S48-N	.E24	SP332B4	.O16	VZKIT-Z4	.C22
S54-N	.E18	SP332B6	.O16	VZM06-1L	.C19
S73-N	.E12	SP332C	.O18	VZM10-1L	.C19
S112-N	.E27	SP332C4	.O16	VZS15-1LZ	.C19
S126	.E25	SP332C6	.O16	VZX10-1L	.C19
S214-N	.E26	SP332P	.O18	VZX12-7L	.C19
S426-N	.E25	SP332P4	.O16	W1000	.L52
S601	.E9	SP332P6	.O16	WP1	.E33
S602	.E9	SP332R	.O19	WP2	.E33
S603	.E9	SP332R4	.O16	WS402	.F7
S604	.E9	SP332R6	.O16	Z1000	.L50, L51
S701	.E20	SP363B	.O20	ZMDSW-XXX	.D26
S701-40	.E20	SP363B6	.O16	2KL	.F10
S746-N	.E21	SP363C	.O18	4S255	.L30
S751	.E29	SP363C6	.O16	4W006	.L56
S1000 Series	.R15	SP363P	.O18	4W254	.L54, L56
S1426-N	.E28	SP363P6	.O16	4W256	.L29
S2000 Series	.R15	SP363R	.O19	5D000	.L41, L42, L43
SAA12	.O22	SP363R6	.O16	5D460	.L32
SAB12	.O22	SP416B	.O20	5S460	.L32
SAB34	.O22	SP416B6	.O16	5F100	.J11, L49
SAC34	.O22	SP416C	.O18	5G108-B*5	.L3
SAC100	.O22	SP416C6	.O16	5G108-R*5	.L3
SAC125	.O22	SP416P	.O18	5G110-B*5	.L3
SAD125	.O22	SP416P6	.O16	5G110-R*5	.L3
SGAMP	.J31	SP416R	.O19	5G210	.L37
SGC65	.J33	SP416R6	.O16	5G220	.L37
SGI65	.J33	SP432B	.O20	5G240	.L37
SGI80	.J33	SP432B6	.O16	5G270	.L26, L29
		SP432C	.O18	5G271	.L27
		SP432C6	.O16		
		SP432P	.O18		
		SP432P6	.O16		
		SP432R	.O19		
		SP432R6	.O16		
		SP463B	.O20		
		SP463B6	.O16		
		SP463C	.O18		
		SP463C6	.O16		
		SP463P	.O18		
		SP463P6	.O16		
		SP463R	.O19		
		SP463R6	.O16		
		SP516B	.O20		
		SP516B6	.O16		
		SP516C	.O18		
		SP516C6	.O16		
		SP516P	.O18		
		SP516P6	.O16		
		SP516R	.O19		
		SP516R6	.O16		
		SP532B	.O20		
		SP532B6	.O16		
		SP532C	.O18		
		SP532C6	.O16		
		SP532P	.O18		
		SP532P6	.O16		
		SP532R	.O19		
		SP532R6	.O16		
		SP563B	.O20		
		SP563B6	.O16		
		SP563C	.O18		
		SP563C6	.O16		
		SP563P	.O18		
		SP563P6	.O16		
		SP563R	.O19		
		SP563R6	.O16		
		SV161	.R19		
		SV162	.R19		
		TBI03	.C35		
		TCORD	.R19		
		TGI06-1L	.C28		
		TGI10-1L	.C28		
		TGM10-1L	.C28		
		TT00R	.C27		
		TTI06	.C27		
		TTI10	.C27		
		TTKIT	.C27		
		TTKTR	.C27		
		TTM10	.C27		
		T5979	.E32		
		T5979-GY	.E32		
		T5979-T	.E32		
		T5979-W	.E32		
		U0425	.R24		
		U0500	.R24		
		U0600	.R24		
		U0625	.R24		

CATALOG NUMBER ALPHANUMERIC INDEX

Important: Dash-numbers, indicating different product colors or other variations, are listed on the same page as the basic catalog numbers shown below, unless otherwise indicated.

THIS PAGE 5G34A-27CM-20

CAT. NO.	PAGE NO.	CAT. NO.	PAGE NO.	CAT. NO.	PAGE NO.
5G34A	.L37	15D22	.P7	17D21	.P14
5G34B	.L37	15D23	.P7	17D22	.P14
5G460	.L32	15D24	.P7	17D23	.P14
5G596	.L26	15D25	.P7	17D24	.P14
5G597	.L27	15P21-E	.P7	17P21	.P14, P17
5L000	.J4, L42, L43, L44	15P22-E	.P7	17P22	.P17
5P030	.L41	15SDF-S	.P7	17R21	.P14, P17
5P130	.L41	15SDM	.P7	17R22	.P14
5P230	.L41	15W33	.M5	17R23	.P14
5P330	.L41	15W47	.M5	17R24	.P14
5R030	.L41	15W48	.M5	17SDM	.P14
5R1UA	.L45	15W49	.M5	17V22	.P14
5R1UE	.L45	16A21	.P10	17V23	.P14
5R100	.L42, L50	16A22	.P10	17V26-E	.P14
5R130	.L41, L42	16A23	.P10	18A22	.P13
5R2UA	.L45	16A24	.P10	18A25	.P13
5R230	.L41, L42	16A25	.P10	18D21	.P11
5R3UA	.L45	16A26	.P10	18D22	.P11
5R330	.L41	16CLF	.P18	18D23	.P12
5R430	.L42	16CLM	.P18	18D24	.P12
5R440	.L42	16D21	.P8	18D25	.P11
5R460	.L42	16D22	.P8	18D25-C	.P11
5R730	.L43	16D23	.P9	18D29	.P11
5R740	.L43	16D24	.P9	18D31	.P11
5R760	.L43	16D24-C	.P9	18D33	.P12
5R930	.L43	16D25	.P8	18D34	.P11
5R940	.L43	16D26	.P8	18D37	.P12
5R960	.L43	16D27	.P8	18F21	.P13
5S100	.L42, L43	16D28	.P9	18P21	.P12
5S180	.L3	16D31	.P8	18P22	.P12
5T000	.L42, L43, L50	16D31-C	.P8	18R21	.P13
6D460	.L32	16D32	.P9	18R22	.P13
6S460	.L32	16D33	.P9	18R23	.P13
6S180	.L3	16D33-C	.P9	18R24	.P13
5W110	.L44	16D34	.P8	19D21	.P15
5W120	.L44	16D35	.P8	19D22	.P15
5W170	.L44	16D36	.P8	19D23	.P15
5W310	.L44	16D37	.P9	19D24	.P15
5W320	.L44	16D37-C	.P9	19P21	.P15
5W370	.L44	16F21	.P10	19R21	.P15
5W710	.L44	16F22	.P10	19R22	.P15
5W720	.L44	16P21	.P9	19R24	.P15
5W770	.L44	16P22	.P9	19V23	.P15
6	.S4	16R21	.P10	20FC-CL	.P3
14W	.N17	16R22	.P10	20FC-E	.P3
14W33	.M5	16R23	.P10	20FP-CL	.P3
14W34	.M5	16R24	.P10	20FP-E	.P3
14W47	.M5	16RSW	.P10	20IS-E	.P3
14W48	.M5	16SDF-14	.P9	20MC-CL	.P3
14W49	.M5	16SDF-22	.P8, P9	20MC-E	.P3
15A21	.P7	16SDM-14	.P9	20MP-CL	.P3
15A22	.P7	16SDM-22	.P8	20MP-E	.P3
15A23	.P7	16V22	.P8	20RS-E	.P3
15CLF	.P18	16V24	.P9	22L21	.P16
15CLM	.P18	16V26	.P8	22L21-C	.P16
15D21	.P7	16V28	.P9	22L22	.P16
15D22-SC	.P7	17CLF	.P18	22L22-C	.P16
		17CLM	.P18	22L22-S	.P16
				22L23	.P16
				22L24	.P16
				22L25	.P16
				22L25-C	.P16
				22L25-S	.P16
				22L26	.P16
				22R21	.P16
				22R22	.P16
				22R23	.P16
				22R24	.P16
				22R26	.P16
				22R28	.P16
				22SVF	.P16
				22SVM	.P16
				23CM-10	.N21
				23CM-11	.N21
				23CM-13	.N21
				23CM-20	.N21
				23CM-30	.N21
				23L22	.P17
				23L23	.P17
				23L25	.P17
				23L26	.P17
				23R21	.P17
				23R22	.P17
				23R23	.P17
				23R24	.P17
				24CM-10	.N21
				24CM-20	.N21
				24CM-30	.N21
				24W34	.N17
				24W47	.N17
				24W49	.N17
				25W34	.N17
				25W47	.N17
				25W49	.N17
				26W	.N17, N18
				26CM-10	.N22
				26CM-11	.N22
				26CM-13	.N22
				26CM-20	.N22
				26CM-21	.N22
				26CM-23	.N22
				26W08	.N18
				26W09	.N18
				26W47	.N17
				26W47-B	.N17
				26W48	.N17
				26W49	.N17
				26W74	.N18
				26W75	.N18
				26W76	.N18
				26W81	.N18
				26W81-B	.N18
				26W82	.N18
				26W83	.N18
				27CM-10	.N22
				27CM-20	.N22

CATALOG NUMBER ALPHANUMERIC INDEX



Important: Dash-numbers, indicating different product colors or other variations, are listed on the same page as the basic catalog numbers shown below, unless otherwise indicated.

THIS PAGE 26W08-430MI12W		CAT. NO.	PAGE NO.	CAT. NO.	PAGE NO.	CAT. NO.	PAGE NO.
CAT. NO.	PAGE NO.	41880	.L38	306	.G17	389W	.S14
27W08	.N18	45CM-60	.N20	321	.M5	390-1W	.S13
27W09	.N18	45CM-70C	.N20	320B	.07	391-1W	.S13
27W47	.N17	45CM-79C	.N20	320C	.06	395-W	.S14
27W47-B	.N17	47CM-10	.N20	320C4W	.04	396	.S13
27W48	.N17	47CM-20C	.N20	320C6W	.04	403	.E36
27W49	.N17	47CM-29C	.N20	320C7W	.04	404	.E36
27W74	.N18	47CM-60	.N20	320MI6W	.012	405	.E36
27W75	.N18	50W50	.N17	320MI7W	.012	406	.E36
27W76	.N18	50W52	.N17-N18	320P	.06	41LBL	.L60
27W81	.N18	50W54	.N19	320P4W	.04	420B	.07
27W81-B	.N18	52CM-62	.N20	320P6W	.04, 012	420B5W	.04
27W82	.N18	52CM-66C	.N20	320P7W	.04, 012	420B7W	.04
27W83	.N18	52CM-69C	.N20	320R	.07	420B9W	.04
28W	.N19	53CM-62	.N21	320R4W	.04	420B12W	.04
28W08	.N19	53CM-66C	.N21	320R6W	.04	420C	.06
28W09	.N19	53CM-69C	.N21	320R7W	.04	420C5W	.04
28W47	.N19	55	.S12	330B	.07	420C7W	.04
28W47-B	.N19	60FP-E	.P3	330B4W	.04	420C9W	.04
28W48	.N19	60IB-E	.P3	330B6W	.04	420C12W	.04
28W49	.N19	60IS-E	.P3	330B7W	.04	420MF5W	.012
28W74	.N19	60MP-E	.P3	330C	.06	420MF7W	.012
28W75	.N19	60RB-E	.P3	330C4W	.04	420MF9W	.012
28W76	.N19	60RS-E	.P3	330C6W	.04	420MF12W	.012
28W77	.N19	61	.U2	330C7W	.04	420MI5W	.012
28W81	.N19	61C05	.L3	330MI6W	.012	420MI7W	.012
28W82	.N19	63	.U2	330MI7W	.012	420MI9W	.012
28W83	.N19	65	.U2	330P	.06	420MI12W	.012
29W08	.N19	69	.U2	330P4W	.04	420P	.06
29W09	.N19	100FP-E	.P3	330P6W	.04, 012	420P5W	.04, 012
29W47	.N19	100IB-E	.P3	330P7W	.04, 012	420P7W	.04, 012
29W47-B	.N19	100MP-E	.P3	330R	.07	420P9W	.04, 012
29W48	.N19	100RB-E	.P3	330R4W	.04	420P12W	.04, 012
29W49	.N19	101	.M15	330R6W	.04	420R	.07
29W74	.N19	102	.M15	330R7W	.04	420R5W	.04
29W75	.N19	113	.M16	341-D4U	.S6	420R7W	.04
29W76	.N19	114	.M16	357-8	.S6	420R9W	.04
29W77	.N19	115PR	.M15	360B	.07	420R12W	.04
29W81	.N19	115PV	.M15	360B4W	.05	420-W	.S14
29W82	.N19	123	.M15	360B6W	.05	423-3	.T5
29W83	.N19	124-D	.S12	360B7W	.05	430B	.07
41AB2	.L35	125	.U2	360C	.06	430B5W	.04
41AB6	.L33	128	.U2	360C4W	.05	430B7W	.04
41AW1	.L35	157	.S12	360C6W	.05	430B9W	.04
41AW2	.L35	157-X	.S12	360C7W	.05	430B12W	.04
41A10	.L35	167	.S12	360MF6W	.013	430C	.06
41CMS	.L38, L57	177BI	.C25	360MI6W	.013	430C5W	.04
41DW1	.L35	177IR	.C25	360MI7W	.013	430C7W	.04
41DW2	.L35	177RC	.C25	360P4W	.05	430C9W	.04
41D10	.L35	223	.G17	360P6W	.05, 013	430C12W	.04
410L2	.L35	267	.S12	360P7W	.05, 013	430MF5W	.012
41DR2	.L36, L38	274	.U2	360R	.07	430MF7W	.012
41D1R	.L34	275-T	.M14	360R4W	.05	430MF9W	.012
41DBR	.L36	278	.G8, M8	360R6W	.05	430MF12W	.012
41DR6	.L35	278-PM	.G8	360R7W	.05	430MI5W	.012
41MB2	.L38	279	.G10, M9	368-1	.S6	430MI7W	.012
41NB2	.L35	279-PM	.G10	380	.S13	430MI9W	.012
41NB6	.L33	287-T	.M14	388	.T4	430MI12W	.012

CATALOG NUMBER ALPHANUMERIC INDEX

Important: Dash-numbers, indicating different product colors or other variations, are listed on the same page as the basic catalog numbers shown below, unless otherwise indicated.

THIS PAGE 430P-1281

CAT. NO.	PAGE NO.	CAT. NO.	PAGE NO.	CAT. NO.	PAGE NO.
430P	.06	520B	.07	560MI5W	.012, 013
430P5W	.04, 012	520B5W	.04	560MI7W	.012, 013
430P7W	.04, 012	520B7W	.04	560MI9W	.013
430P9W	.04, 012	520B9W	.04	560P	.06
430P12W	.04, 012	520C	.06	560P5W	.05, 013
430R	.07	520C5W	.04	560P7W	.05, 013
430R5W	.04	520C7W	.04	560P9W	.05, 013
430R7W	.04	520C9W	.04	560R	.07
430R9W	.04	520CA	.M13	560R5W	.05
430R12W	.04	520CV	.M13	560R7W	.05
431W	.S13	520MI5W	.012	560R9W	.05
432C3WL	.019	520MI7W	.012	565	.S10
432P3WL	.016, 018	520MI9W	.012	570	.S10
452	.S13	520P	.06	573	.T3
453	.S13	520P5W	.04, 012	585	.T3
460B	.07	520P7W	.04, 012	612	.M15
460B5W	.05	520P9W	.04, 012	615CA	.M12
460B7W	.05	520PA	.M13	615PA	.M12
460B9W	.05	520PV	.M13	615PV	.M12
460B12W	.05	520R	.07	617	.M16
460C	.06	520R5W	.04	620CA	.M13
460C5W	.05	520R7W	.04	620CV	.M13
460C7W	.05	520R9W	.04	620PA	.M13
460C9W	.05	523	.S14	620PR	.M13
460C12W	.05	524	.S14	620PV	.M13
460MF5W	.013	530B	.07	638	.M15
460MF7W	.013	530B5W	.04	663	.T3
460MF9W	.013	530B7W	.04	688	.G17, J35
460MF12W	.013	530B9W	.04	689	.B26, J35
460MI5W	.013	530C	.06	690	.B26, J35
460MI7W	.013	530C5W	.04	692	.U2
460MI9W	.013	530C7W	.04	694	.U2
460MI12W	.013	530C9W	.04	697	.U2
460P	.06	530MF5W	.012	698	.U2
460P5W	.05, 013	530MF7W	.012	699	.U2
460P7W	.05, 013	530MI5W	.012	720-L5	.T4
460P9W	.05, 013	530MI7W	.012	735	.T4
460P12W	.05, 013	530MI9W	.012	738	.T4
460R	.07	530P	.06	830-T	.G6, M14
460R5W	.05	530P5W	.04, 012	905	.S6
460R7W	.05	530P7W	.04, 012	911	.B8, C34
460R9W	.05	530P9W	.04, 012	930	.M14
460R12W	.05	530R	.07	931	.M14
466	.S13	530R5W	.04	1101-2	.F6
467	.S13	530R7W	.04	1101-2L	.F6
491RU	.L53	530R9W	.04	1101-C	.F12
492RU	.L53	531	.U2	1102-2	.F6
510-R	.N23	554	.S10	1102-2L	.F6
515AN	.M12	560	.S10	1102-C	.F12
515CA	.M12	560B	.07	1103-2	.F6
515CR	.M12	560B5W	.05	1103-2L	.F6
515CV	.M12	560B7W	.05	1103-C	.F12
515PA	.M12	560B9W	.05	1104-2	.F6
515PR	.M12	560C	.06	1104-2L	.F6
515PV	.M12	560C5W	.05	1104-C	.F12
516	.S14	560C7W	.05	1121-2	.F6
517	.S14	560C9W	.05	1121-2L	.F6
		560MF9W	.013	1122-2	.F6
				1122-2L	.F6
				1123-2	.F6
				1123-2L	.F6
				1124-2	.F6
				1124-2L	.F6
				1201-2	.F3
				1201-2L	.F3
				1201-LH	.F4
				1201-PL	.F4
				1202-2	.F3
				1202-2L	.F3
				1202-PL	.F4
				1203-2	.F3
				1203-2L	.F3
				1203-LH	.F4
				1203-PL	.F4
				1204-2	.F3
				1204-2L	.F3
				1221-2	.F3
				1221-2L	.F3
				1221-2KL	.F10
				1221-7P	.F4
				1221-LH	.F4
				1221-PL	.F4
				1221-S	.F3
				1222-2	.F3
				1222-2L	.F3
				1222 2KL	.F10
				1222-7P	.F4
				1222-S	.F3
				1221-7L	.F4
				1222-PL	.F4
				1223-2	.F3
				1223-2L	.F3
				1223-2KL	.F10
				1223-7L	.F4
				1223-7P	.F4
				1223-LH	.F4
				1223-PL	.F4
				1223-S	.F3
				1224-2	.F3
				1224-2L	.F3
				1224-2KL	.F10
				1224-S	.F3
				1228	.G16
				1241	.F3
				1242	.F3
				1243	.F3
				1244	.F3
				1254	.G5
				1254-H	.G5
				1254-IG	.G5
				1256	.F5
				1257	.F5
				1257-L	.F5
				1260	.F5
				1262	.F5
				1281	.F5

CATALOG NUMBER ALPHANUMERIC INDEX



Important: Dash-numbers, indicating different product colors or other variations, are listed on the same page as the basic catalog numbers shown below, unless otherwise indicated.

THIS PAGE 1281-L-2695

CAT. NO.	PAGE NO.	CAT. NO.	PAGE NO.	CAT. NO.	PAGE NO.
1281-L	F5	2311-PLB	N7	2413	N9
1282	F5	2311-PLC	N7	2415	N9
1285	F5	2313	N7	2416	N9
1285-L	F5	2313-B	N7	2420	N9
1286	F5	2313-CY	N7	2420-IG	N9
1287	F5	2313-PLB	N7	2421	N9
1287-L	F5	2313-PLC	N7	2423	N9
1288	F5	2315	N7	2425	N9
1288-L	F5	2316	N7	2426	N9
1306	G17	2320	N7	2430	N10
1373	G17	2320-IG	N7	2430-IG	N10
1374	G17	2321	N7	2431	N10
1403	U2	2321-PLB	N7	2433	N10
1406	U2	2321-PLC	N7	2435	N10
1420	C35	2321-CY	N7	2436	N10
1432	E34	2323	N7	2440	N10
1433	M5	2323-CY	N7	2441	N10
1447	M5	2323-PLC	N7	2443	N10
1448	M5	2325	N7	2445	N10
1449	M5	2326	N7	2446	N10
1451	F14	2330	N7	2447	N5
1451-2	F14	2330-IG	N7	2450	N10
1451-4	F14	2331	N7	2451	N10
1453	F14	2331-PLC	N7	2453	N10
1453-2	F14	2333	N7	2455	N10
1453-4	F14	2333-PLC	N7	2456	N10
1461-XXX	F14	2335	N7	2460	N10
1463-XXX	F14	2336	N7	2461	N10
1469	U2	2340	N8	2463	N10
1533	M5	2340-IG	N8	2465	N10
1547	M5	2341	N8	2466	N10
1548	M5	2343	N8	2510	N11
1549	M5	2345	N8	2510-IG	N11
1689-50	T2	2346	N8	2511	N11
1689-75	T2	2350	N8	2513	N11
1691-50	T2	2350-IG	N8	2515	N11
1720-T	T4	2351	N8	2516	N11
1738	T4	2353	N8	2520	N11
1754	B17, I4	2355	N8	2520-IG	N11
1754-IL	B17, I4	2356	N8	2521	N11
1754-2	B17, I4	2360	N8	2523	N11
1755	B17, I4	2361	N8	2525	N11
1755-2	B17, I4	2363	N8	2526	N11
1759	B17, I4	2365	N8	2530	N11
1865	T3	2366	N8	2530-IG	N11
1901	E7	2370	N8	2531	N11
1903	E10	2371	N8	2533	N11
1909	E7	2373	N8	2536	S13
2004	S8	2375	N8	2537	S13
2005	S8	2376	N8	2545	N11
2006	S8	2380	N8	2546	N11
2152	E36	2381	N8	2547	N5
2310	N7	2383	N8	2591	T3
2310-IG	N7	2385	N8	2592	T3
2311	N7	2386	N8	2610	N12
2311-B	N7	2410	N9	2610-IG	N12
2311-CY	N7	2410-IG	N9	2611	N12
		2411	N9	2611-B	N12
				2611-CY	N12
				2611-PLB	N12
				2611-PLC	N12
				2613	N12
				2613-B	N12
				2613-CY	N12
				2613-PLB	N12
				2613-PLC	N12
				2615	N12
				2616	N12
				2620	N12
				2620-IG	N12
				2621	N12
				2621-B	N12
				2621-CY	N12
				2621-PLC	N12
				2625F	N12
				2623-PLC	N12
				2626F	N12
				2630	N12
				2630-IG	N12
				2631	N12
				2631-PLC	N12
				2633	N12
				2633-PLC	N12
				2635	N12
				2636	N12
				2640	N13
				2640-IG	N13
				2641	N13
				2643	N13
				2645	N13
				2646	N13
				2650	N13
				2650-IG	N13
				2651-2	F14
				2653-2	F14
				2655	N13
				2656	N13
				2660	N13
				2661	N13
				2663	N13
				2665	N13
				2666	N13
				2670	N13
				2671	N13
				2673	N13
				2675	N13
				2676	N13
				2680	N14
				2681	N14
				2683	N14
				2685	N14
				2686	N14
				2690	N14
				2691	N14
				2693	N14
				2695	N14

CATALOG NUMBER ALPHANUMERIC INDEX

Important: Dash-numbers, indicating different product colors or other variations, are listed on the same page as the basic catalog numbers shown below, unless otherwise indicated.

THIS PAGE 2696-4710

CAT. NO.	PAGE NO.	CAT. NO.	PAGE NO.	CAT. NO.	PAGE NO.
2696	.N14	2833	.N16	3500-PC	.R21
2710	.N14	2835	.N16	3500-PT	.R21
2710-IG	.N14	2836	.N16	3520	.N24
2711	.N14	3031-2	.F3	3521-C	.N24
2711-CY	.N14	3031-2L	.F3	3523-C	.N24
2713	.N14	3031-LH	.F4	3524-C	.N24
2713-CY	.N14	3031-PL	.F4	3525-C	.N24
2715	.N14	3032-2	.F3	3720	.N8
2716	.N14	3032-2L	.F3	3721	.N8
2720	.N14	3033-2	.F3	3723	.N8
2720-IG	.N14	3033-2L	.F3	3755	.N8, N25
2721	.N14	3032-PL	.F4	3756	.N8
2723	.N14	3100B	.07	3762-C	.N25
2725	.N14	3100B4W	.05	3763-C	.N25
2726	.N14	3100B6W	.05	3764-C	.N25
2730	.N15	3100B7W	.05	3765-C	.N25
2730-IG	.N15	3100C	.06	3769	.N25
2731	.N15	3100C4W	.05	3771	.N25
2733	.N15	3100C6W	.05	3775	.N25
2735	.N15	3100C7W	.05	3777	.N25
2736	.N15	3100MI4W	.013	3800-DIN	.R12
2740	.N15	3100MI6W	.013	3800-OEM	.R12
2740-IG	.N15	3100MI7W	.013	3800-OWM	.R12
2741	.N15	3100P	.06	3801-DIN	.R12
2743	.N15	3100P4W	.05, 013	3803-485	.R11
2745	.N15	3100P6W	.05, 013	3803-CAN	.R11
2746	.N15	3100P7W	.05, 013	3803-MOD	.R11
2750	.N15	3100R	.07	3803-SPX	.R11
2751	.N15	3100R4W	.05	3803-DHP	.R11
2753	.N15	3100R6W	.05	3812-DIN	.R12
2755	.N15	3100R7W	.05	3812-OEM	.R12
2756	.N15	3125B6W	.016, 019	3812-OWM	.R12
2760	.N15	3125C6W	.016	3824-DIN	.R12
2761	.N15	3125CW	.019	3824-OEM	.R12
2763	.N15	3125P6W	.016	3824-OWM	.R12
2765	.N15	3125P	.018	3840-DIN	.R12
2766	.N15	3125R	.019	3840-OEM	.R12
2770	.N16	3125R6W	.016	3840-OWM	.R12
2771	.N16	3152-8	.S9	3848-DIN	.R12
2773	.N16	3254	.G5, R14	3848-OEM	.R12
2775	.N16	3325-C	.N24	3848-OWM	.R12
2776	.N16	3326-C	.N24	3860-GEF	.R11
2810	.N16	3330	.N25	3861-ETH	.R11
2810-IG	.N16	3331-C	.N25	3862-CON	.R11
2811	.N16	3333-C	.N25	3863-DEV	.R11
2813	.N16	3334-C	.N25	3880-DIN	.R11, R12
2815	.N16	3335-C	.N25	3950-BKT	.R22
2816	.N16	3352-1	.S10	4005	.S10
2820	.N16	3352-8	.S10	4006	.S10
2820-IG	.N16	3352-F	.S10	4010	.S10
2821	.N16	3420-009	.R11	4015-D4F	.S6
2823	.N16	3420-035	.R11	4017-D2F	.S6
2825	.N16	3430	.N25	4020-A3A	.S6
2826	.N16	3431-C	.N25	4032-E5F	.S6
2830	.N16	3433-C	.N25	4034-F5A	.S6
2830-IG	.N16	3434-C	.N25	4063	.S10
2831	.N16	3435-C	.N25	4090-24W	.J30
		3500-P	.R21	4100B	.07
				4100B5W	.05
				4100B7W	.05
				4100B9W	.05
				4100B12W	.013
				4100C	.06
				4100C5W	.05
				4100C7W	.05
				4100C9W	.05
				4100C12W	.05
				4100MI5W	.013
				4100MI7W	.013
				4100MI9W	.013
				4100MI12W	.013
				4100P	.06
				4100P5W	.05, 013
				4100P7W	.05, 013
				4100P9W	.05, 013
				4100P12W	.05, 013
				4100R	.07
				4100R5W	.05
				4100R7W	.05
				4100R9W	.05
				4100R12W	.05
				4108W	.L11
				4125B6W	.016, 019
				4125CW	.019
				4125C6W	.016
				4125P	.018
				4125P6W	.016
				4125R	.019
				4125R6W	.016
				4155	.S11
				4158	.S11
				4254	.G5, R14
				4505 Series	.R17
				4550	.N6
				4550-IG	.N6
				4560	.N6
				4560-IG	.N6
				4570-C	.N6
				4570-CA	.N6
				4570-CY	.N6
				4570-IG	.N6
				4570-PLC	.N6
				4579-C	.N6
				4579-CY	.N6
				4579-PLC	.N6
				4585-C	.N6
				4585-CWP	.N30
				4586-C	.N6
				4586-CWP	.N30
				4625A	.L22
				4625B	.L18
				4700	.N5
				4700-IG	.N5
				4702-IIR	.N5
				4703-IIR	.N5
				4710	.N5

CATALOG NUMBER ALPHANUMERIC INDEX



Important: Dash-numbers, indicating different product colors or other variations, are listed on the same page as the basic catalog numbers shown below, unless otherwise indicated.

THIS PAGE 4710-IG-5458-SS

CAT. NO.	PAGE NO.	CAT. NO.	PAGE NO.	CAT. NO.	PAGE NO.
4710-IG	.N5	4990	.E34, H7	5226	.I2
4710-SS	.N5	4992	.E34, H7	5239	.M12
4715-C	.N5	4996	.E35, H7	5240	.M12
4715-CWP	.N30	4998	.E35, H7	5241	.I2
4715-FWP	.N30	5000	.G17	5242	.G4
4716-C	.N5	5015	.G14	5243	.I2
4716-CWP	.N30	5028	.G14	5245	.I2
4716-FWP	.N30	5029	.G14	5246	.I2
4720-C	.N5	5031	.G13	5248-4	.G16
4720-CA	.N5	5032	.G15, M8	5248-CP	.G16
4720-CB	.N5	5032-I	.M8	5249-CAP	.G14
4720-CY	.N5	5040	.G14	5249-FBA	.G14
4720-PLC	.N5	5042	.G14	5250	.G14
4729-C	.N5	5050	.G10	5251	.G4
4729-CB	.N5	5054	.G7	5252	.G4
4729-CY	.N5	5059	.G14	5256-VA	.M6
4729-PLC	.N5	5088	.G13	5256-VB	.M6
4750	.N6	5089	.G13	5256-VG	.M6
4760	.N6	5098	.G13	5256-VY	.M6
4760-IG	.N6	50W50	.M5, N17	5258-SS	.G14
4770-C	.N6	5100	.R3	5259-VB	.M6
4770-CA	.N6	5100B	.O7	5259-VG	.M6
4770-CY	.N6	5100B5W	.O5	5259-VY	.M6
4770-PLC	.N6	5100B7W	.O5	5261	.G4
4779-C	.N6	5100B9W	.O5	5261-CH	.G4, J35
4779-CY	.N6	5100C	.O6	5261-CR	.N20
4779-PLC	.N6	5100C5W	.O5	5262	.G4
4785-C	.N6	5100C7W	.O5	5262-IG	.G4
4786-C	.N6	5100C9W	.O5	5262-S	.G4
4792	.N30	5100-IPS	.R4	5266-C	.M3
4794-1R	.N30	5100IS2	.R4	5266-CA	.M3
4795-2R	.N30	5100MI5W	.O13	5266-CB	.M3
4870	.N6	5100MI7W	.O13	5266-CG	.M3
4880-C	.N6	5100MI9W	.O13	5266-CO	.M3
4889-C	.N6	5100P	.R3, O6	5266-CY	.M3
4900-P	.R15	5100-PS	.R4	5266-N	.M3
4900-PC	.R15	5100P5W	.O5, O13	5266-PLB	.M3
4900-PT	.R15	5100P7W	.O5, O13	5266-PLC	.M3
4925-2	.E34	5100P9W	.O5, O13	5269-C	.M3
4925C	.L54	5100R	.O7	5269-CA	.M3
4926	.E34	5100R5W	.O5	5269-CB	.M3
4927	.E19	5100R7W	.O5	5269-CG	.M3
4928	.E19	5100R9W	.O5	5269-CO	.M3
4934	.E19	5100-S15	.R4	5269-CY	.M3
4935L	.L53	5125B6W	.O16, O19	5269-N	.M3
4937	.M16	5125C6W	.O16	5269-PLB	.M3
4950-PS	.R15	5125CW	.O19	5269-PLC	.M3
4950-PSC	.R15	5125P	.O18	5278-C	.M3
4950-PST	.R15	5125P6W	.O16	5278-CWP	.M7
4970	.E34	5125R	.O19	5278-FWP	.M7
4976	.E35	5125R6W	.O16	5279-C	.M3
4976-FS	.E35	5200-PS	.R4	5279-CWP	.M7
4978	.E35	5200-S15	.R4	5279-FWP	.M7
4979	.E35	5206	.G10, M9	5280	.B13, R13
4980	.E35	5207	.G7, M8	5280-IG	.B13, R13
4980L	.L53	5224	.I2	5292	.G4
4986	.E35	5224-2	.I2	5300-HTS	.R4
		5225	.I2	5300-IPS	.R4
				5300-PS	.R4
				5300-PSC	.R4
				5300-PST	.R4
				5300-S15	.R4
				5320-CP	.G16
				5320-S	.G16
				5320-4	.G16
				5321	.U4
				5325	.B12
				5325-I	.B9
				5325-S	.B12
				5328	.B12
				5334	.I2
				5335	.I2
				5336	.I2
				5340	.G14
				5342	.G14
				5349-FBA	.G14
				5351	.G4
				5352	.G4
				5356-VA	.M6
				5356-VB	.M6
				5356-VY	.M6
				5359-VB	.M6
				5359-VY	.M6
				5361	.G4
				5361-CH	.G4, J35
				5361-CR	.N21
				5362	.G4
				5362-S	.G4
				5362-IG	.G4
				5366-C	.M4
				5366-CA	.M4
				5366-CG	.M4
				5366-CY	.M4
				5366-PLB	.M4
				5366-PLC	.M4
				5369-C	.M4
				5369-CA	.M4
				5369-CG	.M4
				5369-CY	.M4
				5369-PLB	.M4
				5369-PLC	.M4
				5371	.G6, M8
				5371-IG	.G7, M8
				5372	.G7, M8
				5372-IG	.G7, M8
				5373	.G9, M9
				5374	.G9, M9
				5374-IG	.G9, M9
				5376	.G7
				5378	.G9
				5380	.B13, R13
				5380-IG	.B13, R13
				5410	.T5
				5456-VA	.M6
				5456-VY	.M6
				5458-SS	.G14

CATALOG NUMBER ALPHANUMERIC INDEX

Important: Dash-numbers, indicating different product colors or other variations, are listed on the same page as the basic catalog numbers shown below, unless otherwise indicated.

THIS PAGE 5459-VY-7899-XXX

CAT. NO.	PAGE NO.	CAT. NO.	PAGE NO.	CAT. NO.	PAGE NO.
5459-VY	.M6	5639-2	.B6	6032	.N27
5461	.G4	5640	.B16, I3	6033	.N27
5461-CR	.N21	5641	.B16, I3	6034	.N27
5462	.G4	5643	.B16, I3	6124H	.D20
5462-IG	.G4	5645	.B16 I3	6151	.M12,C35
5466-C	.M4	5646	.B16, I3	6161	.C35
5466-CY	.M4	5649-2	.B6	6185	.F5
5469-C	.M4	5651	.G4	6196	.H7
5469-CY	.M4	5657-2	.B5	6196-FS	.H7, E34
5478-C	.M4	5658-SS	.G14	6196-V	.H7
5478-CWP	.M7	5659-2	.B6	6196-VFS	.H7, E34
5479-C	.M4	5661	.G4	6197	.B24, H4, E36
5479-CWP	.M7	5661-CR	.N20	6210G	.L32
5480	.G5, R14	5662	.G4	6212H	.D19
5480-IG	.G5, R14	5662-IG	.G4	6215M	.D19
5490	.G5, R14	5666-C	.M3	6227	.K13
5490-IG	.G5, R14	5666-CA	.M3	6230M	.D19
5500-NL	.R16	5666-CY	.M3	6250-3	.C35
5500-2NL	.R16	5669-C	.M3	6260M	.D19
5500-15L	.R16	5669-CY	.M3	6280	.K13
5500-15N	.R16	5685-2	.B5	6284	.K16
5500-20L	.R16	5686-2	.B5	6285	.K16
5500-20N	.R16	5691-2	.B4	6287	.K17
5500-190	.R16	5691-C	.B19	6288	.K17
5500-192	.R16	5693-2	.B4	6289	.K17
5501-8	.F12	5693-C	.B19	6291-WI	.K11
5501-LH	.F13	5694-C	.B19	6293-WI	.K11
5502-8	.F12	5721	.T4	6294	.K12
5503-LH	.F13	5731	.T4	6296	.K13
5505-190	.R16	5801	.G14	6298	.K13
5585	.G15	5821	.G14	6299	.K16
5601 Series	.B7	5822	.G14	6312	.K7
5601-Z2	.B8	5823	.G13	6315	.K7
5601-X2	.B8	5824	.G13	6316	.K7
5602-2 Series	.B7	5842	.G13	6320	.K7
5603 Series	.B7	5844	.G13	6337	.K14
5604-2 Series	.B7	5891	.G13	6360-CR	.N23
5611 Series	.B8	5951	.J14	6361-CR	.N23
5613 Series	.B8	5952	.J14	6364-CR	.N23
5614-2 Series	.B8	5953	.J14	6365-CR	.N23
5618-2	.B8	5954	.J14	6369-CR	.N23
5621-2	.B4	5955	.J14	6370-CR	.N23
5621-C	.B19	5957	.J14	6371-I	.K12
5623-2	.B4	5958	.J14	6375	.K14
5623-C	.B19	5959	.J14	6375-CR	.N23
5624-2	.B4	5976	.E32	6376	.K14
5624-C	.B19	5977	.H7, E32,	6377-CR	.N23
5625	.B16, I3	5978	.E32	6386	.K17
5626	.B16, I3	5996	.E32	6512H	.D19
5627	.B16, I3	5997	.H7, E32	6515M	.D19
5628-2	.B6	5998	.E32	6516-2PK	.U4
5631-2	.B6	6017	.M4	6560M	.D15
5633-2	.B6	6017-L	.N27	6593	.H5
5634	.B16, I3	6017-Y	.M4	6594	.H5
5636	.B16, I3	6018	.M4, K2, K3	6602	.C33
5637	.B16, I3	6018-L	.N27	6602-220	.C33
5638-2	.B6	6018-Y	.M4	6613	.C32
		6031	.N27	6615	.C32
				6627	.C32
				6628	.C32
				6629	.C32
				6630	.C32
				6631	.C32
				6633-P	.C32
				6637-P	.C32
				6639	.C33
				6641	.C34
				6643	.C34
				6651	.D20
				6652	.D20
				6668	.C32
				6681	.C33
				6683	.C33
				6691	.C34
				6693	.C34
				6893	.H5
				6894	.H5
				7070	.S5
				7070-M	.S5
				7080	.S5
				7080-M	.S5
				7090	.S5
				7090-M	.S5
				7092-2M	.S5
				7250-FR	.G6, M8
				7251-C	.G6, M8
				7280	.B13, R13
				7299	.B15, B17, H4
				7310-B	.N24
				7313	.G6
				7314-C	.N24
				7379	.N25
				7380	.B13, R13
				7408-C	.N24
				7409-C	.N24
				7410-B	.N24
				7411-C	.N24
				7413-C	.N24
				7420-CR	.E33
				7556	.N24
				7557	.N24
				7565-C	.N24
				7567-C	.N24
				7582	.N24
				7599	.B15, H4
				7599-DIN	.B15, H4
				7599-HG	.B15, H4
				7599-L	.H4
				7599-W	.B9
				7715-CR	.N23
				7717-CR	.N23
				7764-C	.N25
				7765-C	.N25
				7770	.N23
				7788-CR	.N23
				7899-XXX	.B15, H4

CATALOG NUMBER ALPHANUMERIC INDEX



Important: Dash-numbers, indicating different product colors or other variations, are listed on the same page as the basic catalog numbers shown below, unless otherwise indicated.

THIS PAGE 7958-17100-2WY

CAT. NO.	PAGE NO.	CAT. NO.	PAGE NO.	CAT. NO.	PAGE NO.
7958	.N25	8400	.G3	9716-C	.S4
8004	.S5	8430	.G8, M8	9726-C	.S4
8004-M	.S5	8432-P	.G8, M8	9730-A	.G7, M8
8052-1	.S9	8450	.G10, M9	9730-P	.M8
8101	.S9	8450-IG	.G10, M9	9750-A	.G9, M9
8110	.S8	8452-P	.G10, M9	9750-P	.G9, M9
8200	.G3	8456-V	.M6	9800	.S11
8200-H	.G3	8459-V	.M6	9805	.S11
8200-L	.G3	8460	.G11, M10	9805-A	.S11
8200-IG	.G3	8462-P	.G11, M10	9814	.S9
8200-LIG	.G3	8480	.G5, R14	9820	.S4
8200-SG	.G3	8480-IG	.G5, R14	9839	.S4
8200-HL	.G3	8490	.G5, R14	9860 Series	.S4
8200-PL	.G3	8490-IG	.G5, R14	9865	.S4
8210	.G3	8590	.B15, H4	9874	.S3
8210-IG	.G3	8600	.G3	9875	.S3
8215-C	.M3	8647	.S8	9875-2	.S3
8215-CT	.M3	8656-V	.M6	9880	.S8
8215-CAT	.M3	8659-V	.M6	9882	.S8
8215-PLC	.M3	8681	.S8	9883	.S3
8219-C	.M3	8681-400	.S8	9885	.S9
8219-CT	.M3	8684	.S11	9965-C	.N24
8219-PLC	.M3	8694	.S7	10014-800	.S11
8256-V	.M6	8746	.S7	10020	.S8
8259-V	.M6	8750	.S7	10025	.S11
8280	.B13, R13	8751	.S7	10026	.S11
8280-IGB	.B9, B13, R13	8756	.S7	10027	.S11
8281-IG	.B13, R13	8765	.S7	10028	.S8
8300	.G3	8806	.S7	10041-500	.T2
8300-H	.G3	8827-CW1	.S3	10045	.S9
8300-IG	.G3	8827-CW2	.S3	10065	.S9
8300-L	.G3	8827-CW4	.S3	10083-16	.S5
8300-LIG	.G3	8829-CW1	.S3	10083-M	.S5
8300-SG	.G3	8829-CW2	.S3	10085	.S9
8300-HL	.G3	8829-CW4	.S3	10091	.S10
8300-PL	.G3	8871	.S9	10097-8	.T2
8310	.G3	8875	.S9	12533	.U4
8310-IG	.G3	8880	.S9	12536	.U4
8315-C	.M4	8895	.H5	12537	.U4
8315-CAT	.M4	9063	.S8	12538	.U4
8315-CT	.M4	9151-N	.M8	12540	.U4
8315-PLC	.M4	9332-P	.G7, M8	12650	.G16
8319-C	.M4	9346	.S5	12777	.U4
8319-CT	.M4	9346-M	.S5	13150-UR5	.S15
8319-PLC	.M4	9347	.S5	13351-D	.S15
8330	.G8, M8	9350	.S9	13353-N	.S15
8332-P	.G8, M8	9382	.T4	13354-D	.S15
8350	.G11, M9	9432-P	.G8, M8	13357-N	.S15
8352-P	.G11, M9	9450-P	.G10, M9	13359-N	.S15
8356-V	.M6	9452-P	.G10, M9	13451-N	.S15
8359-V	.M6	9460	.G11, M10	13452	.S17
8360	.G11, M10	9460-IG	.G11, M10	13453	.S17
8362-P	.G11, M10	9462-P	.G11, M10	13454	.S17
8380	.B13, R12	9530-P	.G6, M8	13455	.S17
8380-IG	.B13, R13	9550-P	.G9, M9	13464	.S13
8381	.B13, R13	9575-250	.T3	13465	.S13
8381-IG	.B13, R13	9630-P	.G7, M8	13518	.S14
		9650-P	.G9, M9	13519	.S14
				13550	.S13
				13551	.S13
				13556	.S13
				13557	.S13
				13652	.S15
				13653	.S15
				13654-EXL	.S16
				13654-EXS	.S16
				13654-SNP	.S16
				13654-SWP	.S15
				13654-TNP	.S16
				13654-TWP	.S16
				13660	.S16
				13661	.S16
				15378-C	.M4
				15378-CWP	.M7
				15379-C	.M4
				15379-CWP	.M7
				15656-VA	.M6
				15656-VY	.M6
				15659-VY	.M6
				15678-C	.M7
				15678-CWP	.M3
				15679-C	.M3
				15679-CWP	.M7
				16241	.B11
				16242	.B11
				16251	.B11
				16252	.B11
				16262	.B10
				16262-HG	.B10
				16262-IG	.B10
				16262-PL	.B10
				16262-SGI	.B9, B10
				16292-I	.B9, B11
				16341	.B11
				16342	.B11
				16351	.B11
				16352	.B11
				16362-PLR	.B9
				16362-XX	.B10
				16441	.B11
				16451	.B11
				16462	.B11
				16462-HG	.B10
				16509-1PK	.U4
				16509-2PK	.U4
				16592	.H5
				16593	.H5
				16641	.B11
				16651	.B11
				16662	.B11
				16893	.H5
				1689-50	.T2
				1689-75	.T2
				1691-50	.T2
				17100-1WY	.C25
				17100-2WY	.C25

CATALOG NUMBER ALPHANUMERIC INDEX

Important: Dash-numbers, indicating different product colors or other variations, are listed on the same page as the basic catalog numbers shown below, unless otherwise indicated.

THIS PAGE 18201-48500

CAT. NO.	PAGE NO.	CAT. NO.	PAGE NO.	CAT. NO.	PAGE NO.
18201	.F3	29816-C	.S3	40888	.J30
18201-C	.F13	29816-C2	.S3	40905	.J30
18202	.F3	29816-CM	.S3	40914	.L20
18202-C	.F13	32120-1	.R10	40944	.L19
18203	.F3	32120-DY3	.R10	40949	.L19
18203-C	.F13	32277-DY3	.R10	40951	.J32
18204	.F3	32347-DY3	.R10	40952	.J32
18204-C	.F13	32412-DS3	.R10	40959	.L19
18221	.F3	36592-E	.H6	40985	.L4, L5
18222	.F3	37120-007	.R9	40988	.L65
18223	.F3	37277-4X7	.R9	40989	.L61
18224	.F3	40050	.L40	41010	.L58
18302-1	.S4	40054	.L40, L57	41020	.L58
18315	.S9	40066	.L39	41030	.L23, L58
19062	.S8	40067	.L41	41034	.L22
19980	.S5	40070	.L66	41036	.L22
19980-M	.S5	40072	.L40	41038	.L22
20025	.S12	40089	.L28	41044	.L22
20070	.S9	40201	.L21	41046	.L22
20403	.N28	40214	.L20	41048	.L22
21254	.G5	40215	.S13	41054	.L21
21254-H	.G5	40216	.L20	41058	.L21
21254-IG	.G5	40223	.L20	41080	.L10, L60
21414-B	.N28	40226	.L20	41084	.L4, L7
21415-B	.N28	40238	.L18	41085	.L7
23000-HG	.N28	40244	.L20	41086	.L22
23001-HG	.N28	40249	.L18	41087	.L11
23004-HG	.N28	40253	.L20	41088	.L22
23030	.N28	40257	.L20	41089	.L16
23031-A	.N28	40258	.L18	41091	.L10
23034-A	.N28	40259	.L18	41100	.L60
23452	.S18	40263	.L20	41106-	.R6, L3
23453	.S17	40266	.L20	41108-R3	.L3
23454	.S17	40274	.L22	41108-R5	.L3
23455	.S17	40278	.L22	41108-R8	.L3
23464	.S13	40280	.L18	41150	.L55
23465	.S13	40280	.L18	41188	.L54
23518	.S14	40539	.L19	41225	.L58
23519	.S14	40544	.L19	41290	.L14
23652 Series	.S15	40549	.L18	41291	.L14
23653 Series	.S15	40566	.L19	41292	.L14
23654 Series	.S16	40580	.L18	41293	.L14
23660	.S16	40588	.L19	41294	.L14
23661	.S16	40638	.B18, L19	41295	.L14
25403	.N28	40649	.B18, L19	41296	.L14
25414-B	.N28	40680	.B18, L19	41360	.L21
25415-B	.N28	40681	.B18, B24	41361	.L22
26115	.C33	40682	.B18	41364	.L21
26591-37C	.H6	40734	.L4	41365	.L21
26592-E	.H6	40735	.L4	41366	.L21
26666-31	.C14	40740	.L60	41367	.L21
26666-37	.C14	40782	.L4	41368	.L21
26719 Series	.S19	40830	.L4	41600	.L40
26720 Series	.S19	40831	.L4	41610	.L40
26725 Series	.S20, S21	40832	.L4	41620	.L40
26725-2A Series	.S22	40833	.L5	41642	.B18, L9
26725-4A Series	.S22	40837	.L5	41643	.L9
		40839	.L5	41644	.L9
		40841	.J29		
				41646	.L9
				41647	.L15
				41649	.L14
				41650	.L11
				41650-6	.G15
				41650-F	.G15
				41652-000	.G15, L11
				41652-006	.L11
				41652-06F	.L11
				41652-6	.G15
				41652-6F	.G15
				41658	.B18, L9
				41666	.B18, L9
				41668	.B18, L9
				41688	.B18, L9
				42001-FMC	.R10
				42080	.L10
				42120-1	.R10
				42120-DY3	.R10
				42277-DY3	.R10
				42347-DY3	.R10
				42400	.J11
				42412-DS3	.R10
				42777	.L23
				43080	.L11
				43105	.L58
				43108	.L58
				43112	.L58
				43115	.L58
				45224	.L58
				46666	.L66
				46700	.L58
				47000	.J22
				47120-007	.R9
				47120-4X7	.R9
				47277-007	.R9
				47277-4X7	.R9
				47347-007	.R9
				47602	.J5
				47603	.J9, J10, J11, J35
				47604	.J6
				47605	.J3, J4, J6, J10, J13
				47606	.J9
				47609	.J10, J11
				47611	.J10, J15
				47612	.J11, J12
				47616	.J10, J11
				47617-XXX	.B26, J35
				47621	.J35
				47689	.L28
				47690	.J18, J21
				47691	.J18
				47693	.J16
				48210	.J17, J34
				48211	.J29, J31
				48212	.J14
				48213	.J20, J21
				48500	.U4

CATALOG NUMBER ALPHANUMERIC INDEX

Important: Dash-numbers, indicating different product colors or other variations, are listed on the same page as the basic catalog numbers shown below, unless otherwise indicated.

THIS PAGE 80421-84085-40	
CAT. NO.	PAGE NO.
80421	E25
80423	B23, E5
80431	E25
80436	B23, E5
80455	E27
80479	E27
80501	E7
80503	E10
80504	E12
80505	E23
80506	E26
80508	E27
80509	E7
80511	E7
80512	E8
80513	E13
80514	E16
80516	E10
80521	E24
80525	E16
80526	E19
80528	E19
80530	E20
80532	E19
80533	E16
80601	B22, E4
80605	E25
80608	E28
80609	B22, E4
80611	B22, E4
80612	B23, E5
80700	E36
80701	E7
80701-RE	E30
80703	E10
80703-XXX	E30
80703-IG	E29
80703-RE	E29
80704	E12, L21
80704-IG	E29
80705	E23
80706	E26
80707	E25
80708	E28
80709	E7
80711	E7
80712	E8
80714	E16
80716	E10, E29
80718	E14
80719	E17
80720	E19, E30
80721	E24
80723	E8
80726	E19
80730	E10
80731	E25

CAT. NO.	PAGE NO.
80732	E25
80734	E17
80735	E16
80736	E8
80743	E24
80745	E25
80746	E27
80747	E28
80781	E31, L18
80782	E31, L18
80800	C14
80827	C15
81000	C14
81000-3	C14
81000-L	C14
81000-L3	C14
81001	E7
81001-PB	E7
81003	E10
81003-PB	E10
81004	E12
81005	E23
81009	E7
81009-PB	E7
81011	E7
81011-PB	E7
81012	E8
81012-PB	E8
81013	E13
81014	E16
81017	E13
81021	E24
81023	E8
81023-PB	E8
81025	E16
81036	E8
81040	E21
81045	E28
81079	E22
81080	E22
81127	C15
81401	B22, E4
81401-PB	B22, E4
81409	B22, E4
81409-PB	B22
81411	E4
81411-PB	E4
81412	E5
81423	E5
81500	C14
81500-3	C14
81527	C15
82000	C14
82000-L	C14
82000-3	C14
82000-L3	C14
82001	E7
82003	E10

CAT. NO.	PAGE NO.
82004	E12
82005	E23
82009	E7
82011	E7
82012	E8
82013	E13
82014	E16
82016	E10
82021	E24
82023	E8
82025	E16
82036	E8
82080	E22
82400	B24
82400-PRT	E36
82601	E4
82602	E4
82605	E25
83000-PRT	E36
83001	E7
83003	E10
83004	E12
83005	E23
83009	E7
83011	E7
83012	E8
83013	E13
83014	E16
83014-EXT	E35
83016	E10
83025	E16
83025-EXT	E35
83026	E19
83028	E19
83401	E4
83409	E4
83411	E4
84000-PRT	E36
84001	E7
84001-40	E7
84001-E40	E30
84001-LOK	E34
84003	E10
84003-40	E10
84003-E40	E29
84003-IG	E29
84004	E12
84004-40	E12
84005	E23
84005-40	E23
84006-40	E26
84007	E23
84007-40	E23
84008-40	E27
84009	E7
84009-40	E7
84011	E7
84011-40	E7

CAT. NO.	PAGE NO.
84012	E8
84012-40	E8
84013	E13
84013-40	E13
84014	E16
84014-40	E16
84016	E10
84016-40	E10
84016-E40	E29
84017-40	E13
84018-40	E14
84019	E17
84019-40	E17
84020-40	E19
84021-40	E24
84022	E20
84023-40	E8
84025	E16
84025-40	E16
84026	E19
84028	E19
84030-40	E10
84033-40	E16
84034-40	E17
84035-40	E17
84036-40	E8
84037-40	E14
84039-40	E21
84040-40	E21
84041	E11
84042-40	E23
84043	E24
84045-40	E28
84046-40	E26
84047-40	E28
84048-40	E9
84049-40	E9
84050-40	E9
84052-40	E12
84055-40	E11
84056-40	E11
84057-40	E18
84061-40	E13
84062-40	E13
84064	E16
84064-40	E16
84065-40	E16
84066-40	E17
84067-40	E17
84068-40	E17
84070-40	E9
84071-40	E35
84077-40	E26
84078-40	E27
84079-40	E22
84080-40	E22
84081-40	E22
84085-40	E28

CATALOG NUMBER ALPHANUMERIC INDEX



Important: Dash-numbers, indicating different product colors or other variations, are listed on the same page as the basic catalog numbers shown below, unless otherwise indicated.

THIS PAGE 84087-40-97092

CAT. NO.	PAGE NO.	CAT. NO.	PAGE NO.	CAT. NO.	PAGE NO.		
84087-40	E28	85025	E16	86107	E13	88057	E18
84088-40	E23	85030	E10	86108	E27	88062	E13
84092-40	E21	85033	E16	86109	E7	88064	E16
84101	E7	85036	E8	86111	E7	88078	E27
84101-40	E7	85041	E11	86113	E14	88079	E22
84103	E10	85047	E28	86114	E16	88080	E22
84103-40	E10	85052	E12	86116	E10	88085	E28
84105-40	E23	85064	E16	86400	B24	88087	E28
84109-40	E7	85101	E7	86400-PRT	E36	88101	E7
84111-40	E7	85103	E10	86593	H5	88103	E10
84112-40	E8	85111	E7	86601	E4	88105	E23
84114	E16	85114	E16	86602	E4	88106	E10, E26
84114-40	E16	85116	E10	86605	E25	88111	E7
84116-40	E10	85400	B24	86500-PRT	E36	88113	E14
84119-40	E17	85400-PRT	E36	86593	H5	88114	E16
84121-40	E24	85500-PRT	E36	87000-PRT	E36	88116	E10
84125-40	E16	86000-PRT	E36	87001	E7	88400-PRT	E36
84130-40	E10	86001	E7	87003	E10	88500-PRT	E36
84133-40	E16	86003	E10	87005	E23	88605	E25
84134-40	E17	86004	L22, E12	87009	E7	89201	U5
84137	E14	86005	E23	87011	E7	89203	U5
84137-40	E14	86006	E26	87012	E8	89209	U5
84146-40	E26	86007	E23	87014	E16	89301	U5
84147-40	E28	86008	E27	87016	E10	89303	U5
84400	B24	86009	E7	87025	E16	89309	U5
84400-PRT	E36	86011	E7	87400	B24	89500-PRT	E36
84401-40	B22, E4	86012	E8	87400-PRT	E36	90572	T2
84409-40	B22, E4	86013	E13	88000-PRT	E36	90577-010	T2
84411-40	E4	86014	E16	88101	E7	90679-001	T3
84412-40	B23, E5	86016	E10	88001	E7	95080	S5
84421-40	E25	86017	E13	88003	E10	95110	S5
84423-40	B23, E5	86018	E14	88004	E12	97092	S5
84436-40	B23, E5	86019	E17	88005	E23		
84440	E36	86021	E24	88006	E26		
84441-40	E31	86022	E8	88007	E23		
84442-40	E31	86025	E16	88008	E27		
84444-40	E31	86030	E10	88009	E7		
84455-40	E27	86033	E16	88011	E7		
84500-PRT	E36	86034	E17	88012	E8		
85000-PRT	E36	86035	E17	88013	E13		
85001	E7	86036	E8	88014	E16		
85003	E10	86041	E11	88016	E10		
85004	E12	86046	E26	88017	E13		
85005	E23	86047	E28	88018	E14		
85006	E26	86052	E12	88019	E17		
85007	E23	86057	E18	88021	E24		
85008	E27	86062	E13	88023	E8		
85009	E7	86064	E16	88025	E16		
85011	E7	86077	E27	88030	E10		
85012	E8	86078	E27	88033	E16		
85013	E13	86079	E22	88034	E17		
85014	E16	86080	E22	88035	E17		
85016	E10	86085	E28	88036	E8		
85018	E14	86087	E28	88037	E14		
85019	E17	86101	E7, E8	88041	E11		
85021	E24	86103	E10	88046	E26		
85023	E8	86105	E23	88047	E28		
		86106	E26	88052	E12		

Access Everything Leviton on One, Easy-to-Use Website

Clean, modern and easy to navigate, our redesigned website consolidates all Leviton product group sites into a single domain—leviton.com. Whether you're an electrical professional or consumer, you'll find everything Leviton has to offer at your fingertips, from our database-driven product catalog to company news, services and customer support.

leviton.com at a glance:

- Pull-down menus link to our complete catalog for all Leviton products
- Powerful, user-friendly search capability
- New Distribution, OEM and Retail sections target your market
- Clean, modern and easy to navigate design
- One comprehensive website where you can browse between product families without having to go to multiple websites
- And much more...

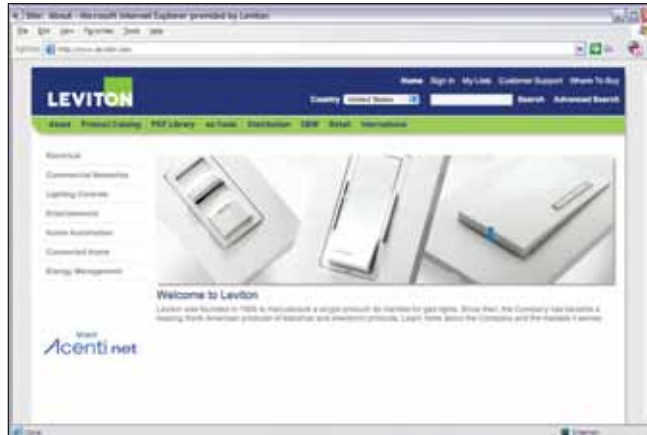

Start at the Leviton Home Page, your portal to the wide world of leviton.com



Select your area of interest

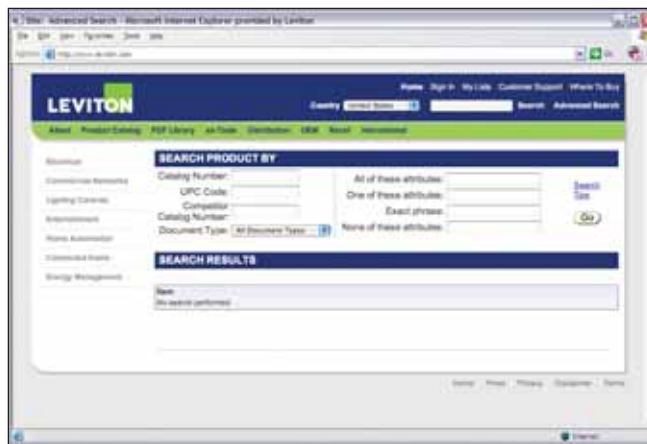

Find what you're looking for with our powerful search engine

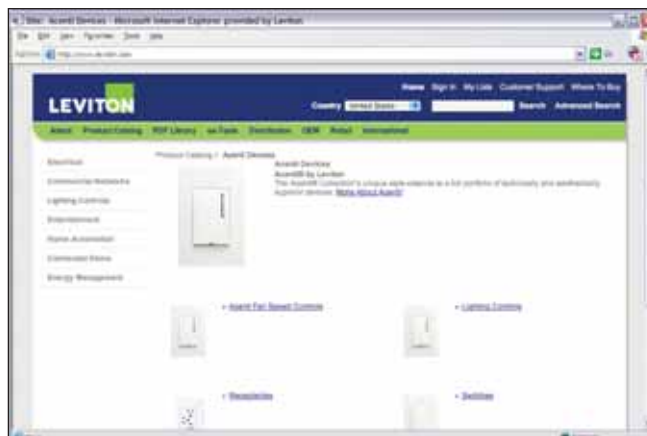

Explore the Product Catalog and create lists for your next project

**100,000,000+ homes,
20,000+ products,
100+ years,
1 brand...**

LEVITON  [®]

Leviton Manufacturing proudly presents our new look. A concise visual expression to help better communicate the qualities that make us the unique, one-of-a-kind industry leader customers and distributors have come to know and trust over the past one hundred years. This trust is at the core of our success, and we pledge our continued devotion to the pursuit of excellence every day, in everything we do.

THE FUTURE IS ON



Leviton Manufacturing Co., Inc.

59-25 Little Neck Parkway, Little Neck, NY 11362-2591

Telephone: 1-800-323-8920 • FAX: 1-800-832-9538

Tech Line (8:30AM–7:30PM E.S.T. Monday–Friday): 1-800-824-3005

Leviton Manufacturing of Canada, Ltd.

165 Hymus Boulevard, Pointe Claire, Quebec H9R 1E9

Telephone: 1-800-469-7890 • FAX: 1-800-563-1853

Leviton S. de R.L. de C.V.

Lago Tana 43, Mexico DF, Mexico CP 11290

Tel. (+52) 55-5082-1040 • www.leviton.com.mx