

# TE Connectivity Enterprise Networks

Product Catalog

2nd Edition



Featuring AMP NETCONNECT  
and TrueNet product brands

# TE Connectivity Enterprise Networks Warranty

---



## 25 Year System Performance Coverage\*

We are confident that your TE Connectivity (TE) Enterprise Network cabling system will keep performing to current TIA/EIA industry standards. If the registered system ever fails to meet those standards within 25 years of the date of installation, we'll provide the reasonable parts and labor to replace or repair the TE product.



## 25 Year Component Coverage\*

TE Connectivity also offers a 25 Year Component Warranty to protect individual TE cabling system components. If a component fails within 25 years of the date of installation, we'll provide the reasonable parts to replace or repair the registered TE product.

### IT'S STANDARD EQUIPMENT

This coverage is automatically part of the package when\*:

- TE Connectivity products are specified end-to-end
- A TE Connectivity authorized Network Design & Installation (ND&I) contractor registers the network project with TE
- That ND&I performs the actual installation in accordance with TE requirements

### WHO'S COVERED

Unlike most systems suppliers, TE provides warranty coverage directly to the end user. Many suppliers provide coverage to the installers, who then provide coverage to the customer. But with TE warranties, there are no middlemen. The warranties are between you and TE Connectivity.

*For more information, please visit: [www.te.com/aboutus/pdf/tc.pdf](http://www.te.com/aboutus/pdf/tc.pdf)*

*Or call: 1-800-553-0938*

*Outside the U.S., please contact your local TE product sales office.*

## People and Products to Answer the Cabling Challenge.

Network communications infrastructure implementations are complicated regardless of the business you're in. You need the right resources, products and services to achieve the high performance, flexible environment your business and end users demand. At TE Connectivity, we offer custom network infrastructure cabling products and solutions that can help you now and for years to come. Our in-depth technical expertise combined with our more than 70 years in the industry has made us the leading provider of premise cabling solutions. TE has one of the most diverse and complete product sets for a wide range of network needs including power, data, voice, video, IP and more.

More than just the technology you need, TE helps ensure the solutions are effectively and efficiently installed by working with our distributors and customers in a hands-on design process. You get the solutions you need when and where you need them and have them installed through our network of certified installation contractors.

Optimize your network performance, increase productivity and benefit from a more immediate return on your infrastructure investment with TE Enterprise Networks solutions that are engineered smarter, faster and better.

\*Some conditions may apply. Contact TE customer service for more information at 800-553-0938.

EVERY CONNECTION COUNTS



# TE Connectivity Enterprise Networks

## Table of Contents

---

<b>Fiber.....</b>	<b>1-1</b>
Fiber Solutions Reference Guide.....	1-3
Fiber Cable Assemblies.....	1-7
Fiber Trunk Solutions.....	1-7
10/40/100 MIGRATION.....	1-7
Fiber Optic Patch Cords.....	1-18
Fiber Optic Cables and Field Terminated Connectors.....	1-22
Fiber Enclosures.....	1-57
Q3000.....	1-58
UCP.....	1-59
TFP.....	1-65
RMG/AMP NETCONNECT.....	1-75
Core Vertical Switch Management (VSM).....	1-82
Optical Distribution Frame Solutions.....	1-89
OMX.....	1-107
Storage Area Management (SAN Fiber Channel Management).....	1-109
Optical LAN Solution Supporting PON Technologies.....	1-112
Fiber Optic Accessories and Tooling.....	1-130
Fiber Optic Test Equipment.....	1-145
<b>SECURE Network Solutions.....</b>	<b>2-1</b>
SECURE Network Solutions - Fiber Products.....	2-3
SECURE Network Solutions - Copper Products.....	2-17
<b>Copper.....</b>	<b>3-1</b>
Copper Solution Reference Guide.....	3-3
Category 6A Products.....	3-8
Category 6A Twisted Pair Cable.....	3-8
Category 6A Patch Panels.....	3-11
Category 6A Modular Jacks.....	3-13
Category 6A Cable Assemblies.....	3-15
Category 6A Termination Blocks.....	3-17
Category 6 Products.....	3-20
Category 6 Twisted Pair Cable.....	3-20
Category 6 Patch Panels.....	3-26
Category 6 Modular Jacks.....	3-28
Category 6 Modular Plugs and Plug Boots.....	3-30
Category 6 Termination Blocks.....	3-31
Category 5e Products.....	3-36
Category 5e Twisted Pair Cable.....	3-36
Category 5e Patch Panels.....	3-41
Category 5e Modular Jacks.....	3-43
Category 5e Modular Plugs and Plug Boots.....	3-45
Category 5e Cable Assemblies.....	3-47
Category 5e Termination Blocks.....	3-48
Copper Trunk Solutions.....	3-54
MRJ21 Cable Assemblies.....	3-54
Sigma-Link.....	3-63
Specialty Products.....	3-66
Universal Connectivity Platform.....	3-66
Core Vertical Switch Management (VSM).....	3-72
High Speed Copper Cable Assemblies.....	3-80
Media Converters and Switches.....	3-83
Patch Panels.....	3-89
Jacks and Couplers.....	3-96
Modular plugs.....	3-98
Feed-Thru Termination Block System and Accessories.....	3-99
Zone Cabling Solutions.....	3-104

# TE Connectivity Enterprise Networks

## Table of Contents

---

Undercarpet Cabling .....	3-110
Copper Accessories .....	3-119
Cable wrap, Clamps, Ties, Accessories .....	3-119
Identification Labels and Accessories .....	3-121
Copper Tooling .....	3-133
<b>Work Area Outlets .....</b>	<b>4-1</b>
Faceplates and Outlets .....	4-3
Inserts .....	4-22
<b>Managed Connectivity .....</b>	<b>5-1</b>
Infrastructure Configuration Manager (ICM) .....	5-3
Infrastructure Configuration Manager (ICM) Mobile App .....	5-7
Quareo .....	5-8
<b>Cable Management .....</b>	<b>6-1</b>
Fiber Cable Raceway FiberGuide .....	6-3
Equipment Racks .....	6-18
Horizontal and Vertical Cable Management .....	6-19
Cable Management Accessories .....	6-21
<b>Supplementary Solutions .....</b>	<b>7-1</b>
Distributed Antenna Systems .....	7-3
Broadcast Products .....	7-3
Pre-Manufactured, Modular Power System .....	7-3
Residential Products .....	7-3
<b>Technical Reference .....</b>	<b>8-28</b>
<b>Index .....</b>	<b>9-1</b>
By Product Name .....	9-3
By Part Number .....	9-14



# TE Connectivity Enterprise Networks

## Introduction

---

Technology is everywhere we turn. Even the simplest action—making a phone call, connecting to the Internet, turning on a light, pushing the brake pedal in a car—sends power and data through hundreds of connections. We rely on these connections to work flawlessly every day. But what if they did something more? What if they could make technology faster, more efficient and smarter? At TE Connectivity (TE), our goal is to find innovative ways to solve our customers' toughest connectivity challenges and help them make even bigger innovations possible. We believe "Every Connection Counts" and live it each day.

From education, healthcare and financial institutions, to hospitality, government and corporate organizations, every transaction, communication and facility operation is being accomplished with an ever-increasing number of devices and applications that connect to a data center, central office or communication closet. These organizations need to maintain and manage more connections than ever before throughout the physical layer infrastructure of the network. In the data center, the growing number of applications, virtual servers, storage devices and high-density switches also is requiring more connections in physical layer cross-connects between servers and switches. All of these connections—from the desktop to the data center—yield a much more complex physical layer. Today's office networks are complex, media-rich environments. The addition of IP-based networks, wireless technology, and preparing for applications that could approach 10 - 40 - 100 GbE has become the new normal.

TE's Enterprise Networks portfolio supports data transmission at speeds of up to 100 Gbps. Many of the world's most complex networks run applications over TE products selected from our AMP NETCONNECT, KRONE and ADC TrueNet brands. TE offers best-in-class copper and fiber technology that helps network managers anticipate change, provide complete protection and support the bandwidth demands of their critical business applications now and in the future.

In a World Where Everything is Connected, Every Connection Counts.







## Fiber Products

Fiber Solutions Reference Guide.....	1-3
Fiber Cable Assemblies.....	1-7
Fiber Trunk Solutions.....	1-7
10/40/100 MIGRATION .....	1-7
Fiber Optic Patch Cords.....	1-18
Fiber Optic Cables and Field Terminated Connectors.....	1-22
Fiber Enclosures .....	1-57
Q3000.....	1-58
UCP.....	1-59
TFP.....	1-65
RMG/AMP NETCONNECT .....	1-75
Core Vertical Switch Management (VSM).....	1-82
Optical Distribution Frame Solutions .....	1-89
OMX.....	1-107
Storage Area Management (SAN Fiber Channel Management).....	1-109
Optical LAN Solution Supporting PON Technologies.....	1-112
Fiber Optic Accessories and Tooling.....	1-130
Fiber Optic Test Equipment.....	1-145

For decades, TE has been a leading global fiber infrastructure provider. TE fiber connectivity solutions assure smooth integration of new equipment for all networks, as well as long-term reliability and flexibility that are so critical for your business.

Optical fiber is the backbone of the world's global information infrastructure — the conduit enabling society's ever-increasing reliance on high-speed, media-rich communications. TE is a pioneer in optical communications technologies, making optical fiber more reliable, better performing, easier and more cost effective to install. With over seven decades of research, development and real-world deployment experience with our legacy brands including AMP, Raychem, ADC and Bell Laboratories, fiber is in our DNA. TE's innovative fiber infrastructure solutions can help provide peak performance with solution-specific density, modularity and functionality. Due to the demands of today's internet and mobile network boom, the amount of data transmitted at the enterprise business level is rapidly climbing as networks need to support more devices and advanced applications than ever before. Fiber counts are on the rise and TE solutions help you build a migration path to get from 10GbE to 40 and 100GbE in a simple and cost-effective manner. TE's fiber product line can help you achieve a higher level of network understanding, manageability and security.

# Fiber

## Fiber Solutions Guide

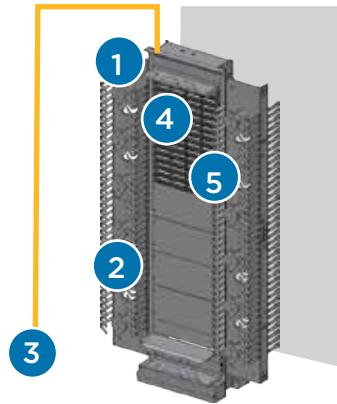

### Fiber Optic OM2 Solution

19-Inch Rack <b>1</b>		Cable Management <b>2</b>				
2 post, 3" deep	1933559-1	Horizontal 2RU panel	Single sided	1933532-1		
4 post adjustable	1933570-1		Double sided	1933533-1		
		Double-sided vertical manager	6"	1933534-1		
			6" Combination	1933540-1		
Indoor Cable <b>3</b>						
		Interconnect		Distribution		
		Riser	Plenum	Riser	Plenum	
Dual	1-1553416-2	1-1553417-2				
Quad	1-1553418-2	1-1553419-2				
6-Fiber				1-1553307-2	1-1553308-2	
12-Fiber				1-1553311-2	1-1553312-2	
24-Fiber				1-1553315-2	1-1553316-2	
					2-1777121-7	
					2-1777117-7	
					1-1553420-2	
Indoor/Outdoor Cable <b>3</b>		Outdoor Cable <b>3</b>				
		Riser	Plenum	All Dielectric	Armored	
6-Fiber	6-1553342-2	6-1553343-2		6-1553387-2	6-1553397-2	
12-Fiber	6-1553346-2	6-1553347-2		6-1553389-2	6-1553399-2	
24-Fiber	6-1553348-2	6-1553349-2		6-1553390-2	6-1553400-2	
Patch Panels <b>4</b>						
TFP	1RU	TFP-1TT00-000B		RMG	1RU	RMG-1000-000B
	2RU	TFP-2TT00-000B			2RU	RMG-2000-000B
	5RU	TFP-5TT00-000B			4RU	RMG-4000-000B
TFP Adapters	6 SC Duplex	TFP-12APLC3 and TFP-12APRC3		RMG Adapters	6 SC Duplex	RMG-12ADPC3
	12 LC Duplex	TFP-24APLQ1 and TFP-24APRQ1			12 LC Duplex	RMG-24ADPQ3
Patch Cords <b>5</b>						
		1 m	2 m	3 m	5 m	
SC/SC Duplex	PAT-SCSC-R20C001M	PAT-SCSC-R20C002M	PAT-SCSC-R20C003M	PAT-SCSC-R20C005M		
SC/LC Duplex	PAT-LCSC-R20C001M	PAT-LCSC-R20C002M	PAT-LCSC-R20C003M	PAT-LCSC-R20C005M		
LC/LC Duplex	PAT-LCLC-R20C001M	PAT-LCLC-R20C002M	PAT-LCLC-R20C003M	PAT-LCLC-R20C005M		

# Fiber

## Fiber Solutions Guide

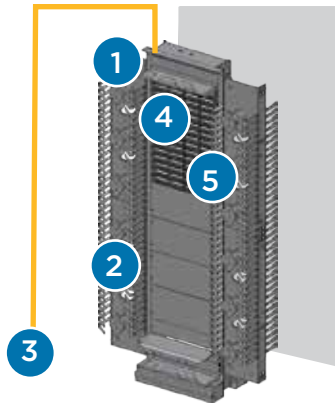

### Fiber Optic OM3 Solution

19-Inch Rack <b>1</b>		Cable Management <b>2</b>			
2 post, 3" deep	1933559-1	Horizontal 2RU panel	Single sided	1933532-1	
4 post adjustable	1933570-1		Double sided	1933533-1	
		Double-sided vertical manager	6"	1933534-1	
			6" Combination	1933540-1	
<b>3</b> Indoor Cable					
	Interconnect		Distribution		Armored
	Riser	Plenum	Riser	Plenum	Plenum
Dual	3-1553416-9	3-1553417-9			
Quad	3-1553418-9	3-1553419-9			
6-Fiber			3-1553307-9	3-1553308-9	3-1777121-7
12-Fiber			3-1553311-9	3-1553312-9	3-1777117-7
24-Fiber			3-1553315-9	3-1553316-9	3-1553420-9
<b>3</b> Indoor/Outdoor Cable		<b>3</b> Outdoor Cable			
	Riser	Plenum	All Dielectric	Armored	
6-Fiber	6-1553342-4	6-1553343-4	6-1553387-4	6-1553397-4	
12-Fiber	6-1553346-4	6-1553347-4	6-1553389-4	6-1553399-4	
24-Fiber	6-1553348-4	6-1553349-4	6-1553390-4	6-1553400-4	
<b>4</b> Patch Panels					
TFP	1RU	TFP-1TT00-000B	RMG	1RU	RMG-1000-000B
	2RU	TFP-2TT00-000B		2RU	RMG-2000-000B
	5RU	TFP-5TT00-000B		4RU	RMG-4000-000B
TFP Adapters	6 SC Duplex	TFP-12APLC4 and TFP-12APRC4	RMG Adapters	6 SC Duplex	RMG-12ADPC4
	12 LC Duplex	TFP-24APLQ2 and TFP-24APRQ2		12 LC Duplex	RMG-24ADPQ4
<b>5</b> Patch Cords					
	1 m	2 m	3 m	5 m	
SC/SC Duplex	PAT-SCSC-R30C001M	PAT-SCSC-R30C002M	PAT-SCSC-R30C003M	PAT-SCSC-R30C005M	
SC/LC Duplex	PAT-LCSC-R30C001M	PAT-LCSC-R30C002M	PAT-LCSC-R30C003M	PAT-LCSC-R30C005M	
LC/LC Duplex	PAT-LCLC-R30C001M	PAT-LCLC-R30C002M	PAT-LCLC-R30C003M	PAT-LCLC-R30C005M	



# Fiber

## Fiber Solutions Guide

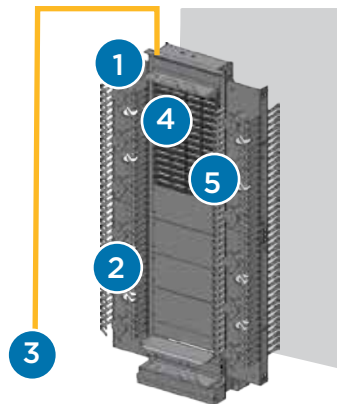

### Fiber Optic OM4 Solution

19-Inch Rack <b>1</b>		Cable Management <b>2</b>			
2 post, 3" deep	1933559-1	Horizontal 2RU panel	Single sided	1933532-1	
4 post adjustable	1933570-1		Double sided	1933533-1	
		Double-sided vertical manager	6"	1933534-1	
			6" Combination	1933540-1	
<b>3</b> Indoor Cable					
		Interconnect		Distribution	
	Riser	Plenum	Riser	Plenum	Armored Plenum
Dual	4-1553416-9	4-1553417-9			
Quad	4-1553418-9	4-1553419-9			
6-Fiber			4-1553307-9	4-1553308-9	7-1777121-7
12-Fiber			4-1553311-9	4-1553312-9	7-1777117-7
24-Fiber			4-1553315-9	4-1553316-9	4-1553420-9
<b>3</b> Indoor/Outdoor Cable		<b>3</b> Outdoor Cable			
	Riser	Plenum	All Dielectric	Armored	
6-Fiber	6-1553342-5	6-1553343-5	6-1553387-5	6-1553397-5	
12-Fiber	6-1553346-5	6-1553347-5	6-1553389-5	6-1553399-5	
24-Fiber	6-1553348-5	6-1553349-5	6-1553390-5	6-1553400-5	
Patch Panels <b>4</b>					
TFP	1RU	TFP-1TT00-000B	RMG	1RU	RMG-1000-000B
	2RU	TFP-2TT00-000B		2RU	RMG-2000-000B
	5RU	TFP-5TT00-000B		4RU	RMG-4000-000B
TFP Adapters	6 SC Duplex	TFP-12APLC4 and TFP-12APRC4	RMG Adapters	6 SC Duplex	RMG-12ADPC4
	12 LC Duplex	TFP-24APLQ2 and TFP-24APRQ2		12 LC Duplex	RMG-24ADPQ4
Patch Cords <b>5</b>					
	1 m	2 m	3 m	5 m	
SC/LC Duplex	PAT-LCSC-R40C001M	PAT-LCSC-R40C002M	PAT-LCSC-R40C003M	PAT-LCSC-R40C005M	
LC/LC Duplex	PAT-LCLC-R40C001M	PAT-LCLC-R40C002M	PAT-LCLC-R40C003M	PAT-LCLC-R40C005M	

# Fiber

## Fiber Solutions Guide

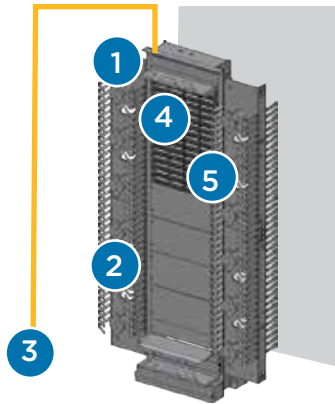

### Fiber Optic Singlemode Solution

19-Inch Rack 1		Cable Management 2			
2 post, 3" deep	1933559-1	Horizontal 2RU panel	Single-sided	1933532-1	
4 post adjustable	1933570-1		Double-sided	1933533-1	
		Double-sided vertical manager	6"	1933534-1	
			6" Combination	1933540-1	
3 Indoor Cable					
		Interconnect		Distribution	
	Riser	Plenum	Riser	Plenum	Armored Plenum
Dual	7-1553416-3	7-1553417-3			
Quad	7-1553418-3	7-1553419-3			
6-Fiber			7-1553307-3	7-1553308-3	4-1777121-7
12-Fiber			7-1553311-3	7-1553312-3	4-1777117-7
24-Fiber			7-1553315-3	7-1553316-3	7-1553420-3
3 Indoor/Outdoor Cable		3 Outdoor Cable			
	Riser	Plenum	All Dielectric	Armored	
6-Fiber	6-1553342-3	6-1553343-3	6-1553387-3	6-1553397-3	
12-Fiber	6-1553346-3	6-1553347-3	6-1553389-3	6-1553399-3	
24-Fiber	6-1553348-3	6-1553349-3	6-1553390-3	6-1553400-3	
Patch Panels 4					
TFP	1RU	TFP-1TT00-000B	RMG	1RU	RMG-1000-000B
	2RU	TFP-2TT00-000B		2RU	RMG-2000-000B
	5RU	TFP-5TT00-000B		4RU	RMG-4000-000B
TFP Adapters	6 SC Duplex	TFP-12APLC8 and TFP-12APRC8	RMG Adapters	6 SC Duplex	RMG-12ADPC8
	12 LC Duplex	TFP-24APLQ5 and TFP-24APRQ5		12 LC Duplex	RMG-24ADPQ8
Patch Cords 5					
	1 m	2 m	3 m	5 m	
SC/LC Duplex	PAT-LCSC-RS0C001M	PAT-LCSC-RS0C002M	PAT-LCSC-RS0C003M	PAT-LCSC-RS0C005M	
LC/LC Duplex	PAT-LCLC-RS0C001M	PAT-LCLC-RS0C002M	PAT-LCLC-RS0C003M	PAT-LCLC-RS0C005M	

# Fiber

## Fiber Cable Assemblies

### Fiber Trunk Solutions

#### 24-FIBER MPOPTIMATE SYSTEM FOR 10/40/100 MIGRATION

Bandwidth and storage demand is expanding at a breathtaking rate. The environment is rapidly evolving. The impact on data center design and management is profound. Networks will migrate from 10 to 40 to 100 Gigabit/second Ethernet speeds dynamically, and data center managers and designers need to be able to manage this migration to maximize network efficiency and responsiveness while minimizing cost.

TE's 24-Fiber MPOptimate system can take you from 10 to 40 and even 100GbE and beyond. Consisting of the 24-fiber trunk cables from the back of the fiber panels to the equipment distribution area, this system can help you migrate your applications, increase bandwidth and flexibility as well as capture much needed space in the rack.

TE's data center fiber trunking and interconnect system provides a simple yet robust migration pathway with the following advantages:

- A single trunking format that can be replicated and upgraded simply and flexibly
- Unified solutions for 10, 40 and 100 GbE applications
- Pre-engineered paths and polarity
- Higher fiber utilization versus 12 fiber systems
- Fewer trunks, connections and components
- Standardized practices for design, installation, documentation and troubleshooting
- Component and trunk re-use
- Minimized waste of space, time and money

For more information, visit [www.te.com/DataCenterMigration](http://www.te.com/DataCenterMigration).



Universal Connectivity Platform



Q3000



RMG

<b>10G</b>			
<b>40G or 100G*</b>			
<b>100G+</b>			

\*100G implemented as 4x25G  
†100G implemented as 10x10G

# Fiber

## Fiber Cable Assemblies

FIBER

### Universal Connectivity Platform (UCP) 24-Fiber 10 Gigabit Interconnect

The 10 Gigabit Interconnect Solution, like all of the planned migration designs, employs a 24-fiber optical trunk with a single MPO-type connector at each end. A trunk interfaces with the rear of a 24-fiber UCP cassette that breaks out the trunk fibers into twelve duplex LC connections at the front, supporting 24 fibers per cassette. This cassette resides in a time-proven UCP panel which provides cable management and protection for both the MPOs at the rear and LC cords at the front. UCP enclosures are stackable and support up to 48 duplex LCs (96 fibers) per rack unit (RU). They can be populated all at once, or added to by upgrading one cassette at a time in the future. The UCP enclosure also supports high density 10 Gigabit modules, as well as 40 and 100 GbE versions, allowing an upgrade path by changing the cassette at the front and using existing and additional 24-fiber trunks at the rear.

#### Example of 10/40/100 GbE 24-Fiber Design

##### 24-Fiber MPO Trunk A-Polarity (Type A)

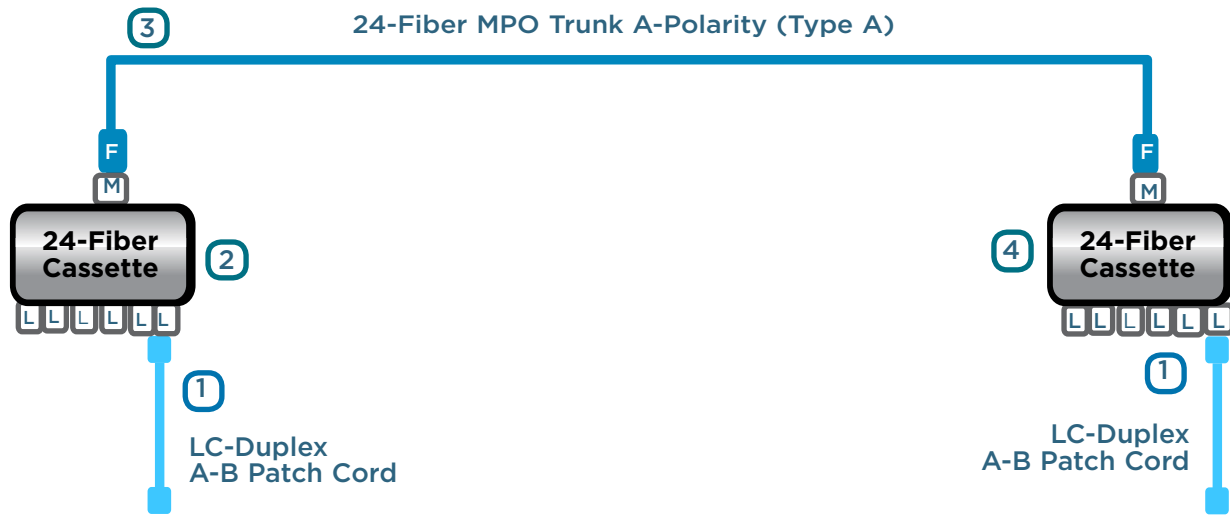

LC-MPO Cassette



24-Fiber Trunk



UCP 1 RU Panel



UCP 1 RU Drawer

#### DESIGN GUIDES FOR 10/40/100 GbE MIGRATION

For in-depth 10/40/100 design guides, see the following literature on [www.te.com/DataCenterMigration](http://www.te.com/DataCenterMigration)

- Universal Connectivity Platform Design Guide (literature #317291AE)
- Q3000 Design Guide (literature #315924AE)
- RMG Design Guide (literature #315990AE)

# Fiber

## Fiber Cable Assemblies

### Fiber Trunk Solutions

TE Connectivity's plug-and-play MPO trunk assemblies are round 12-fiber optical trunk cables pre-terminated with a high-density MPO connector on both ends. They can be used in conjunction with any of the other plug-and-play connectivity products to rapidly deploy fiber into a data center or Local Area Network (LAN). The microcable assemblies can simply be plugged into any plug-and-play cassette or fiber enclosure which eliminates the need for on-site fiber termination.



MPO Cable Assemblies

### FEATURES

- Available in OM1, OM2, OM3, OM4 and singlemode glass types
- Compatible with FiberGuide optical raceway system to add increased protection and manageability
- Pulling socks or stealth pulling eye protect MPO connectors during installation
- Factory terminated and tested
- 12 and 24 fiber trunks available on either interconnect-rated or backbone-rated cable styles

### ORDERING INFORMATION

MPO Trunk Assemblies	Part Number
<b>OM4 MPO Trunk Assemblies</b>	
OM4 MPO-MPO, 12-fiber 3 mm interconnect, plenum (OFNP) rated	MPA-NCNCJ40xxxF-NN
OM4 MPO-MPO, 24-fiber backbone (2x12) with 3 mm interconnect subunits, OFNP/OFNP	MPA-NCNCD40xxxF-yy
<b>OM3 MPO Trunk Assemblies</b>	
OM3 MPO-MPO, 12-fiber 3 mm interconnect, plenum (OFNP) rated	MPA-NCNCJ30xxxF-NN
OM3 MPO-MPO, 24-fiber backbone (2 x 12) with 3 mm interconnect subunits, OFNR/OFNP	MPA-NCNCD30xxxF-yy
<b>OM2 MPO Trunk Assemblies</b>	
OM2 MPO-MPO, 12-fiber 3 mm interconnect, plenum (OFNP) rated	MPA-NCNCJ20xxxF-NN
OM2 MPO-MPO, 24 (2 x 12) with 3 mm interconnect subunits, OFNR/OFNP	MPA-NCNCD20xxxF-yy
<b>OM1 MPO Trunk Assemblies</b>	
OM1 MPO-MPO, 12-fiber 3 mm interconnect, plenum (OFNP) rated	MPA-NCNCJ10xxxF-NN
OM1 MPO-MPO, 24-fiber backbone (2 x 12) 3 mm interconnect subunits, OFNR/OFNP	MPA-NCNCD10xxxF-yy
<b>Singlemode Trunk Assemblies</b>	
OS2 Singlemode, 12-fiber, 12-fiber 3 mm interconnect, plenum (OFNP) rated	MPA-NCNCJ50xxxF-NN
OS2 Singlemode, 24-fiber, 24 (2 x 12) Fiber backbone with 3 mm interconnect subunits, plenum (OFNP) rated	MPA-NCNCD50xxxF-yy

Note: xxx denotes length in feet of overall trunk, 001=1 foot, 010=10 feet, 100=100 feet

Note: yy denotes breakout definition for each end

SS=Standard, AA=TFP to TFP, AB=TFP to ODF, BB=ODF to ODF, FF=RMG to RMG, NN=No breakout for 12-fiber interconnect cable

# Fiber

## Fiber Cable Assemblies

### TE's High Fiber Count Plug-and-Play Trunks

TE's high fiber count plug-and-play trunks provide the backbone cabling for TE's Plug-and-Play system. These high count trunk cables come pre-terminated with a high-density MPO connectors on both ends and provide an easy and efficient way to pull large numbers of fibers at one time to help in the rapid deployment of the Plug-and-Play system either in the data center or Local Area Network (LAN). Each trunk has custom breakouts designed to work with the TE Plug-and-Play connectivity. TE's high fiber count trunks can simply be plugged into any plug-and-play cassette in the optical distribution frame or fiber enclosure which eliminates the need for on-site fiber termination and preparation.



#### FEATURES

- Construction of rugged loose-tube fiber cable
- Ship with a pulling sock on one end to aid with installation
- Cable assemblies contain OFNP flame rated cable
- Breakouts specifically designed to work with TE's Plug-and-Play connectivity

#### ORDERING INFORMATION

OM4 High Fiber Count Trunks	Part Number
24-fiber, MPO-MPO (no pins), OFNP rated	MPA-NCNCD40xxxF-yy
24-fiber, MPO-MPO (no pins) 3 mm dual zip, OFNP rated	MPA-NCNCZ40xxxF-yy
48-fiber, MPO-MPO (no pins) 3mm round, OFNP rated	MPA-NCNC440xxxF-yy
72-fiber, MPO-MPO (no pins) 3 mm round, OFNP rated	MPA-NCNC740xxxF-yy
96-fiber, MPO-MPO (no pins) 3 mm round, OFNP rated	MPA-NCNC940xxxF-yy
OM3 High Fiber Count Trunks	
24-fiber, MPO-MPO (no pins), OFNP rated	MPA-NCNCD30xxxF-yy
24-fiber, MPO-MPO (no pins) 3 mm dual zip, OFNP rated	MPA-NCNCZ30xxxF-yy
48-fiber, MPO-MPO (no pins) 3 mm round, OFNP rated	MPA-NCNC430xxxF-yy
72-fiber, MPO-MPO (no pins) 3 mm round, OFNP rated	MPA-NCNC730xxxF-yy
96-fiber, MPO-MPO (no pins) 3 mm round, OFNP rated	MPA-NCNC930xxxF-yy
Singlemode High Fiber Count Trunks	
24-fiber, MPO-MPO (no pins), OFNP rated	MPA-NCNCD50xxxF-yy
24-fiber, MPO-MPO (no pins) 3 mm dual zip, OFNP rated	MPA-NCNCZ50xxxF-yy
48-fiber, MPO-MPO (no pins) 3 mm round, OFNP rated	MPA-NCNC450xxxF-yy
72-fiber, MPO-MPO (no pins) 3 mm round, OFNP rated	MPA-NCNC750xxxF-yy
96-fiber, MPO-MPO (no pins) 3 mm round, OFNP rated	MPA-NCNC950xxxF-yy

Note: xxx denotes length in feet of overall trunk, 001=1 foot, 010=10 feet, 100=100 feet

Note: yy denotes breakout definition for each end

SS=Standard, AA=TFP to TFP, AB=TFP to ODF, BB=ODF to ODF, FF=RMG to RMG



# Fiber

## Fiber Cable Assemblies

### TE's High Fiber Count Plug-and-Play Array Cables

TE's 12-fiber plug-and-play array cables provide a convenient and efficient method to connect active equipment into the network. These 12-fiber round 3 mm cables contain a pre-terminated high-density MPO pinned connector on one end and either LC or SC connectors on the other. TE's 12-fiber plug-and-play array cable assemblies can simply be mated to any non-pinned MPO assembly in the optical distribution frame or fiber enclosure or plugged into any MPO transceiver which eliminates the need for on-site fiber termination and preparation.



#### FEATURES

- Round design with outer diameter of 3 mm eliminates preferential bend issues which results in increased density and greater manageability
- Each LC or SC leg is clearly labeled and identified
- Custom lengths available upon request
- Standard breakout length is 18 inches, which is optimum to connect to active equipment
- MPO pinned array cable assemblies mate to any non-pinned MPO assembly

#### ORDERING INFORMATION

OM4 High Fiber Count Trunks	Part Number
MPO pinned - LC; 18" breakout; 3 m length	MPA-PCLCJ40003M-NC
MPO pinned - LC; 18" breakout; 4 m length	MPA-PCLCJ40004M-NC
MPO pinned - LC; 18" breakout; 5 m length	MPA-PCLCJ40005M-NC
MPO pinned - SC; 18" breakout; 3 m length	MPA-PCSCJ40003M-NC
MPO pinned - SC; 18" breakout; 4 m length	MPA-PCSCJ40004M-NC
MPO pinned - SC; 18" breakout; 5 m length	MPA-PCSCJ40005M-NC
OM3 High Fiber Count Trunks	
MPO pinned - LC; 18" breakout; 3 m length	MPA-PCLCJ30003M-NC
MPO pinned - LC; 18" breakout; 4 m length	MPA-PCLCJ30004M-NC
MPO pinned - LC; 18" breakout; 5 m length	MPA-PCLCJ30005M-NC
MPO pinned - SC; 18" breakout; 3 m length	MPA-PCSCJ30003M-NC
MPO pinned - SC; 18" breakout; 4 m length	MPA-PCSCJ30004M-NC
MPO pinned - SC; 18" breakout; 5 m length	MPA-PCSCJ30005M-NC
Singlemode High Fiber Count Trunks	
MPO pinned - LC/UPC; 18" breakout; 3 m length	MPA-PCLCJ50003M-NC
MPO pinned - LC/UPC; 18" breakout; 4 m length	MPA-PCLCJ50004M-NC
MPO pinned - LC/UPC; 18" breakout; 5 m length	MPA-PCLCJ50005M-NC
MPO pinned - SC/UPC; 18" breakout; 3 m length	MPA-PCSCJ50003M-NC
MPO pinned - SC/UPC; 18" breakout; 4 m length	MPA-PCSCJ50004M-NC
MPO pinned - SC/UPC; 18" breakout; 5 m length	MPA-PCSCJ50005M-NC

# Fiber

## Fiber Cable Assemblies

### Fiber Trunk Configurator

FIBER

#### Part Number

MP - - - - -

#### Performance/Polarity

C	Standard Performance Polarity C
A	Standard Performance Polarity A
B	Standard Performance Polarity B
T	OPTIMATE Polarity A
E	OPTIMATE Polarity C
F	OPTIMATE Polarity B

#### Connector A Type

N	12-Fiber MPO w/o pins
P	12-Fiber MPO with pins
C	12-Fiber MPO Secure w/o pins
E	12-Fiber MPO Secure with pins
1	24 Fiber MPO with pins
2	24 Fiber MPO w/o pins
A	24 Fiber MPO Secure with pins
H	24 Fiber MPO Secure w/o pins

#### Connector A Color

C	Non-secure	W	Brown
O	Red	S	Slate
B	Blue	V	Violet
G	Green	P	Rose
Y	Yellow	A	Aqua
N	Orange		

#### Connector B Type

N	12-Fiber MPO w/o pins
P	12-Fiber MPO w/pins
C	12-Fiber MPO Secure w/o pins
E	12-Fiber MPO Secure w/pins
1	24 Fiber MPO w/pins
2	24 Fiber MPO w/o pins
A	24 Fiber MPO Secure w/pins
H	24 Fiber MPO Secure w/o pins
L	LC Duplex
S	SC Duplex
T	ST Dual
F	FC Dual
M	MT-RJ plug w/o pins
8	LC Duplex Secure
9	MT-RJ plug Secure w/o pins
7	LC/APC Duplex
6	SC/APC Duplex
W	MT-RJ plug w/pins
O	Stub/pigtail

#### Connector B Color

C	Non-secure	W	Brown
O	Red	S	Slate
B	Blue	V	Violet
G	Green	P	Rose
Y	Yellow	A	Aqua
N	Orange		

#### Breakout Length (L2 & L3)

	L2	L3
A	TFP	30.50"
B	NGF	13.75"
C	Customer length	18"
F	RMG	25"
N	No breakout	NA
S	Standard	36"
U	Customer length	79"
XX	Custom	10"-99"

#### Unit of Measure

F	Feet
M	Meters

#### Assembly Length

001	Shortest possible length
999	Longest possible length

#### Cable Jacket Color

O	Standard
---	----------

#### Cable Type

Use charts below

#### OM1

J1	12-Fiber 3 mm interconnect, OFNP
11	12-Fiber backbone, 1x12F, 3 mm interconnect Subunit, OFN
D1	24-Fiber backbone, 2x12F, 3 mm interconnect subunits, OFNP
Z1	24-Fiber 3.0 mm interconnect-rated zipcable, OFNP

#### OM2

J2	12-Fiber 3 mm interconnect, OFNP
12	12-Fiber backbone, 1x12F, 3 mm interconnect Subunit, OFNP
D2	24-Fiber backbone, 2x12F, 3 mm interconnect subunits, OFNP
Z2	24-Fiber 3.0 mm interconnect-rated zipcable, OFNP

#### OM3

J3	12-Fiber 3 mm interconnect, OFNP
13	12-Fiber backbone, 1x12F, 3 mm interconnect Subunit, OFNP
D3	D3 24-Fiber backbone, 2x12F, 3 mm interconnect subunits, OFNP
M3	24-Fiber backbone, 1x24F, 3.8 mm interconnect subunits, OFNP
Z3	24-Fiber 3.0 mm interconnect-rated zipcable, OFNP

#### OM4

J4	12-Fiber 3mm interconnect, OFNP
14	12-Fiber backbone, 1x12F, 3 mm interconnect Subunit, OFNP
D4	24 Fiber backbone, 2x12F, 3 mm interconnect subunits, OFNP
M4	24 Fiber backbone, 1x24F, 3.8 mm interconnect subunits, OFNP
Z4	24-Fiber 3.0 mm interconnect-rated zipcable, OFNP

#### Singlemode

J5	12-Fiber 3mm interconnect, OFNP
15	12-Fiber backbone, 1x12F, 3 mm interconnect Subunit, OFNP
D5	24-Fiber backbone, 2x12F, 3 mm interconnect subunits, OFNP
M5	24-Fiber backbone, 1x24F, 3.8 mm interconnect subunits, OFNP
Z5	24-Fiber 3.0 mm interconnect-rated zipcable, OFNP

\* Higher fiber counts available upon request

# Fiber

## Fiber Cable Assemblies

### Cable Assembly Configuration



**Figure 1**  
12-fiber MPO to MPO assembly on 3 mm interconnect cable or 24 Fiber MPO to MPO assembly on 3.8 mm interconnect cable



**Figure 2**  
MPO to MPO assembly on 24 fiber 3 mm interconnect zipcord cable.



**Figure 3**  
12-fiber MPO to MPO assembly on 12-fiber backbone cable with 1x12 fiber 3 mm interconnect subunit, or 24 fiber MPO to MPO assembly on 24 fiber backbone cable with 1x24 fiber 3.8 mm interconnect subunit.

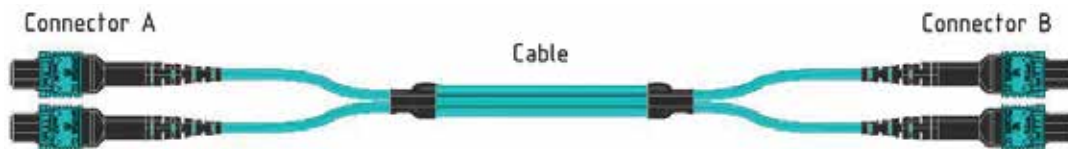

**Figure 4**  
MPO to MPO on backbone cable with 12-fiber 3 mm interconnect subunits. Fiber counts range from 12 to 144.

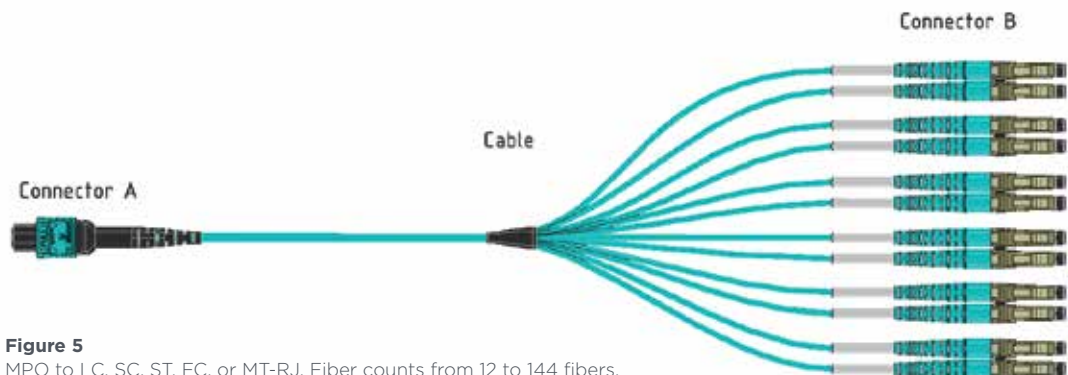

**Figure 5**  
MPO to LC, SC, ST, FC, or MT-RJ. Fiber counts from 12 to 144 fibers.

# Fiber

## Fiber Cable Assemblies

### Assembly Length

Measured from tip of connector A ferrule to tip of connector B ferrule. The unit of measure is dependent on the selection in position 12. Each pair of subunits beyond the first two will be 2" longer on each end of the assembly, as shown (this allows a smaller pulling sock to be used).

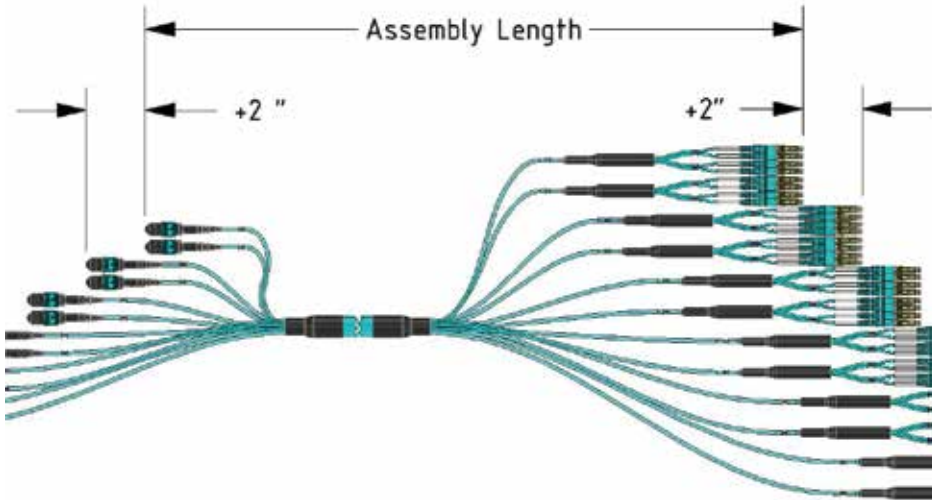

### Breakout Length



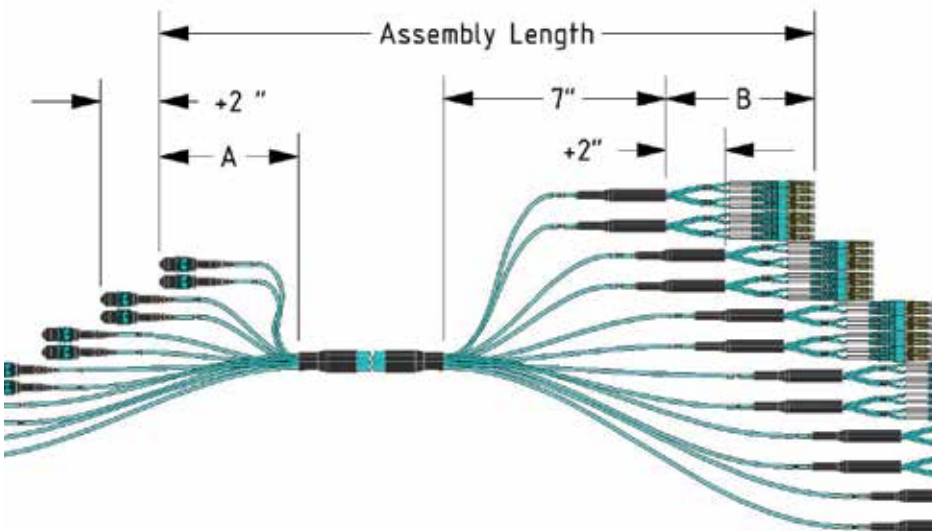







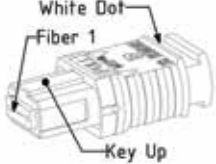

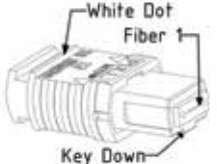











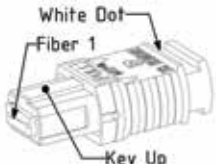

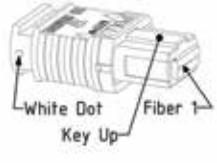











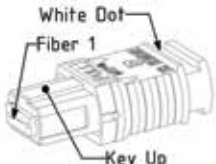

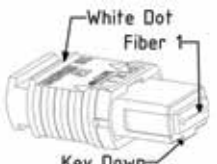

Choose the breakout length for each end. An entry of BF will result in 13.75" on the left and 25" on the right. The breakout length is defined from the end of the heat shrink transition to the tip of the connector ferrule as shown. The 7" section of exposed subunit shown here will exist on assemblies with any connector other than MPOs selected for connector B, and is non-configurable. Each pair of subunits beyond the first two will be 2" longer on each end of the assembly, as shown (this allows a smaller pulling sock to be used).



# Fiber

## Fiber Cable Assemblies

### MPO to MPO Polarity for Cable Assemblies

Description		Connector A Fiber Number	Fiber Color	Connector B Fiber Number		
Polarity A (Straight Through) with Standard Performance		1	Blue		1	
		2	Orange		2	
		3	Green		3	
		4	Brown		4	
		5	Slate		5	
		6	White		6	
		7	Red		7	
		8	Black		8	
		9	Yellow		9	
		10	Violet		10	
		11	Rose		11	
		12	Aqua		12	
Polarity B (Reversed) with Standard Performance		1	Blue		12	
		2	Orange		11	
		3	Green		10	
		4	Brown		9	
		5	Slate		8	
		6	White		7	
		7	Red		6	
		8	Black		5	
		9	Yellow		4	
		10	Violet		3	
		11	Rose		2	
		12	Aqua		1	
Polarity C (Pairs Flipped) with Standard Performance		1	Blue		2	
		2	Orange		1	
		3	Green		4	
		4	Brown		3	
		5	Slate		6	
		6	White		5	
		7	Red		8	
		8	Black		7	
		9	Yellow		10	
		10	Violet		9	
		11	Rose		12	
		12	Aqua		11	

# Fiber

## Fiber Cable Assemblies

### Polarity for MPO to MT-RJ, LC, SC, ST, or FC

Polarity A must be chosen when connector B is a simplex connector (FC, ST, LC/APC, or SC/APC).  
OPTIMATE performance can only be chosen when connector B is MPO, LC, or SC.

FIBER

Description	Connector A Fiber Number	Fiber Color	Connector B			
			Fiber Number	Pair	Duplex Position	
<b>Polarity A (Straight Through) with Standard Performance</b> 	1	Blue	1	1	A	
	2	Orange	2		B	
	3	Green	3	2	A	
	4	Brown	4		B	
	5	Slate	5	3	A	
	6	White	6		B	
	7	Red	7	4	A	
	8	Black	8		B	
	9	Yellow	9	5	A	
	10	Violet	10		B	
	11	Rose	11	6	A	
	12	Aqua	12		B	
<b>Polarity C (Pairs Flipped) with Standard Performance</b> 	1	Blue	2	1	B	
	2	Orange	1		A	
	3	Green	4	2	B	
	4	Brown	3		A	
	5	Slate	6	3	B	
	6	White	5		A	
	7	Red	8	4	B	
	8	Black	7		A	
	9	Yellow	10	5	B	
	10	Violet	9		A	
	11	Rose	12	6	B	
	12	Aqua	11		A	



# Fiber

## Fiber Cable Assemblies

### ASSEMBLY PERFORMANCE

#### Singlemode MPO OS2

	Connector	12F MPO	24F MPO
Insertion Loss (dB Maximum)	1310 nm	0.50	0.75
	1550 nm	0.50	0.75
Return Loss (dB Minimum)	1310 nm	55	55
	1550 nm	55	55

#### Multimode 12 and 24 Fiber MPO

	Assembly Length (meters)	12F MPO	24F MPO
Insertion Loss (dB Maximum)	850 nm	0.50	0.50
	1300 nm	0.50	0.50
Return Loss (dB Minimum)	850 nm	20	20
	1300 nm	20	20

#### Multimode 12-fiber MPO OPTIMATE OM3 and OM4

	Assembly Length (meters)	12F MPO	24F MPO
Insertion Loss (dB Maximum)	850 nm	0.35	0.35
Return Loss (dB Minimum)	850 nm	28	28

#### Multimode LC, SC, ST, and FC OM1, OM2, OM3, and OM4

	Assembly Length (meters)	≤20 m	>20 to ≤40
Insertion Loss (dB Maximum)	850 nm	0.35	0.35
	1300 nm	0.35	0.35
Return Loss (dB Minimum)	850 nm	20	20
	1300 nm	20	20

#### Singlemode

	Connector	LC, SC, ST, FC	MT-RJ	LC APC	SC APC, FC APC
Insertion Loss (dB Maximum)	1310 nm	0.30	0.50	0.20	0.30
	1550 nm	0.30	0.50	0.20	0.30
Return Loss (dB Minimum)	1310 nm	55	26	65	65
	1550 nm	55	26	65	65

#### Multimode LC, SC OPTIMATE OM3, and OM4

	Assembly Length (meters)	12F MPO	24F MPO
Insertion Loss (dB Maximum)	850 nm	0.15	0.15
	1300 nm	0.15	0.15
Return Loss (dB Minimum)	850 nm	35	35
	1300 nm	35	35

#### Multimode MT-RJ OM1, OM2, OM3, and OM4

	Assembly Length (meters)	12F MPO	24F MPO
Insertion Loss (dB Maximum)	850 nm	0.50	0.50
	1300 nm	0.50	0.50
Return Loss (dB Minimum)	850 nm	20	20
	1300 nm	20	20

# Fiber

## Fiber Cable Assemblies

### Fiber Optic Patch Cords

As an integral part of the fiber product portfolio, TE Connectivity's fiber optic patch cords are essential to meet the needs of high-speed data networks. These patch cords can be used throughout the network in cross-connect, test or equipment areas to link optical equipment and are available in build to order lengths and components.

#### FEATURES

- Fiber connector types available in multimode and singlemode include LC, SC, MTRJ, ST, and FC connectors featuring ceramic ferrules
- SECURE connectors available for LC and MTRJ
- Build to order configurations for any length fiber cable assembly
- Cable assemblies available in OFNP or OFNR ratings
- All patch cords are shipped with insertion loss tests for individual cords
- Factory terminated and tested



# Fiber

## Fiber Cable Assemblies

### Fiber Patch Cord Configurator

**Catalog Number**

PAT- \_\_\_\_\_ - \_\_\_\_\_ - \_\_\_\_\_ - \_\_\_\_\_ - \_\_\_\_\_ - \_\_\_\_\_ - \_\_\_\_\_

#### Connector A Type

L	LC
S	SC
T	ST
F	FC
M	MTRJ w/o pins*
W	MTRJ w/pins*
3	LC optimate duplex
4	SC optimate duplex
6	SC APC
7	LC APC
8	LC secure duplex
9	MT-RJ secure plug*

#### Connector A Color/Keying

C	Standard
B	Secure blue
N	Secure orange
G	Secure green
W	Secure brown
S	Secure slate
R	Secure red
Y	Secure yellow
V	Secure violet
P	Secure rose
A	Secure aqua

#### Connector B Type

O	None/pigtails
L	LC
S	SC
T	ST
F	FC
M	MTRJ w/o pins
W	MTRJ w/pins
3	LC optimate duplex
4	SC optimate duplex
5	FC APC
6	SC APC
7	LC APC
8	LC secure duplex
9	MT-RJ secure plug

#### Connector B Color/Keying

C	Standard
O	None/pigtails
B	Secure blue
N	Secure orange
G	Secure green
W	Secure brown
S	Secure slate
R	Secure red
Y	Secure yellow
V	Secure violet
P	Secure rose
A	Secure aqua

#### Polarity

BLANK	Standard A to B duplex
S	Straight A to A

#### Unit of Measure

F	Feet
M	Meters

#### Assembly Length

001	Shortest possible length
999	Longest possible length

#### Cable Type

A	1.6 mm zipcord****
B	1.8 mm zipcord*
C	2.0 mm zipcord
D	3.0 mm zipcord
E	900 μm buffered fiber**
F	2.0 mm simplex****

#### Cable Jacket Color\*\*\*

O	Standard
---	----------

#### Fiber Type

1	OM1
2	OM2
3	OM3
4	OM4
S	OS2

#### Cable Jacket Material

P	Plenum
R	Riser
O	900 μm buffered fiber



# Fiber

## Fiber Cable Assemblies

### ORDERING INFORMATION

Description	Part Number		
<b>OM3 and OM4 (50/125 μm) Multimode</b>	<b>OM3 and OM4 (50/125 μm) multimode LC cable assemblies</b>		
	OM3 2.0 mm zipcord LC-LC connectors	PAT-LCLC-P30CxxxM	
	OM3 2.0 mm zipcord LC-SC connectors	PAT-LCSC-P30CxxxM	
	OM3 2.0 mm zipcord LC-ST connectors	PAT-LCTC-P30CxxxM	
	OM4 2.0 mm zipcord LC-LC connectors	PAT-LCLC-P40CxxxM	
	<b>OM3 and OM4 (50/125 μm) multimode MTRJ cable assemblies</b>		
	OM3 1.8 mm zipcord LC-MTRJ connectors	PAT-LCMC-P30BxxxM	
	OM3 1.8 mm zipcord SC-MTRJ connectors	PAT-SCMC-P30BxxxM	
	<b>OM3 and OM4 (50/125 μm) multimode SC cable assemblies</b>		
	OM3 2.0 mm zipcord SC-SC connectors	PAT-SCSC-P30CxxxM	
	OM4 2.0 mm zipcord SC-SC connectors	PAT-SCSC-P40CxxxM	
	OM3 2.0 mm zipcord SC-ST connectors	PAT-SCTC-P30CxxxM	
	<b>OM3 and OM4 (50/125 μm) multimode ST cable assemblies</b>		
	OM3 2.0 mm zipcord ST-ST connectors	PAT-TCTC-P30CxxxM	
	<b>OM2 (50/125 μm) Multimode</b>	<b>OM2 (50/125 μm) multimode LC cable assemblies</b>	
OM2 2.0 mm LC-LC connectors		PAT-LCLC-P20CxxxM	
OM2 2.0 mm zipcord LC-SC connectors		PAT-LCSC-P20CxxxM	
OM2 2.0 mm zipcord LC-ST connectors		PAT-LCTC-P20CxxxM	
<b>OM2 (50/125 μm) multimode MTRJ cable assemblies</b>			
OM2 1.8 mm zipcord LC-MTRJ connectors		PAT-LCMC-P20BxxxM	
OM2 1.8 mm zipcord SC-MTRJ connectors		PAT-SCMC-P20BxxxM	
<b>OM2(50/125 μm) multimode SC cable assemblies</b>			
OM2 2.0 mm zipcord SC-SC connectors		PAT-SCSC-P20CxxxM	
OM2 2.0 mm zipcord SC-ST connectors		PAT-SCTC-P20CxxxM	
<b>OM2 (50/125 μm) multimode ST cable assemblies</b>			
OM3 2.0 mm zipcord ST-ST connectors		PAT-TCTC-P30CxxxM	
<b>OM1 (62.5/125 μm) Multimode</b>		<b>OM1 (62.5/125 μm) multimode LC cable assemblies</b>	
		OM1 2.0 mm zipcord LC-LC connectors	PAT-LCLC-P10CxxxM
		OM1 2.0 mm zipcord LC-SC connectors	PAT-LCSC-P10CxxxM
	OM1 2.0 mm zipcord LC-ST connectors	PAT-LCTC-P10CxxxM	
	<b>OM1 (62.5/125 μm) multimode MTRJ cable assemblies</b>		
	OM1 1.8 mm zipcord LC-MTRJ connectors	PAT-LCMC-P10BxxxM	
	OM2 1.8 mm zipcord SC-MTRJ connectors	PAT-SCMC-P10BxxxM	
	<b>OM1 (62.5/125 μm) multimode SC cable assemblies</b>		
	OM1 2.0 mm zipcord SC-SC connectors	PAT-SCSC-P10CxxxM	
	OM1 2.0 mm zipcord SC-ST connectors	PAT-SCTC-P10CxxxM	
	<b>OM1 (62.5/125 μm ) multimode ST cable assemblies</b>		
	OM1 2.0 mm zipcord ST-ST connectors	PAT-TCTC-P10CxxxM	
	<b>Singlemode</b>	<b>Singlemode LC cable assemblies</b>	
		OS2 2.0 mm zipcord LC-LC connectors	PAT-LCLC-PS0CxxxM
		OS2 2.0 mm zipcord LC-SC connectors	PAT-LCSC-PS0CxxxM
OS2 2.0 mm zipcord LC-ST connectors		PAT-LCTC-PS0CxxxM	
<b>Singlemode MTRJ cable assemblies</b>			
OS2 1.8 mm zipcord LC-MTRJ connectors		PAT-LCMC-PS0BxxxM	
OS2 1.8 mm zipcord SC-MTRJ connectors		PAT-SCMC-PS0BxxxM	
<b>Singlemode SC cable assemblies</b>			
OS2 2.0 mm zipcord SC-SC connectors		PAT-SCSC-PS0CxxxM	
OS2 2.0 mm zipcord SC-ST connectors		PAT-SCTC-PS0CxxxM	
<b>Singlemode ST cable assemblies</b>			
OS2 2.0 mm zipcord ST-ST connectors		PAT-TCTC-PS0CxxxM	

xxx = length in meters or feet

# Fiber

## Fiber Cable Assemblies

### ASSEMBLY PERFORMANCE

#### Multimode LC, SC, ST, and FC

(OM1, OM2, OM3, and OM4)

	Assembly Length (meters)	LC, SC, ST, and FC
Insertion Loss (dB Maximum)	850 nm	0.35
	1300 nm	
Return Loss (dB Minimum)	850 nm	20
	1300 nm	

#### Multimode LC, SC OPTIMATE

(OM3, and OM4)

	Assembly Length (meters)	LC, SC Optimate
Insertion Loss (dB Maximum)	850 nm	0.15
	1300 nm	
Return Loss (dB Minimum)	850 nm	35
	1300 nm	

#### Multimode MT-RJ

	Assembly Length (meters)	Multimode MT-RJ
Insertion Loss (dB Maximum)	850 nm	0.50
	1300 nm	
Return Loss (dB Minimum)	850 nm	20
	1300 nm	

#### Singlemode

	Connector	LC, SC, ST, FC	MT-RJ	LC APC	SC APC, FC APC
Insertion Loss (dB Maximum)	1310 nm	0.30	0.50	0.20	0.30
	1550 nm	0.30	0.50	0.20	0.30
Return Loss (dB Minimum)	1310 nm	55	26	65	65
	1550 nm	55	26	65	65

# Fiber

## Fiber Optic Cables and Field Terminated Connectors

### Fiber Optic Cables and Field Terminated Connectors

TE Connectivity's fiber optic solutions offer a complete family of high-performance singlemode and multimode cables including indoor/outdoor cables, compact building cables, armored versions and patch cord pigtail cables. All cable is produced by highly automated manufacturing processes and each fiber is tested to specifications after cabling to ensure consistent quality and dependability.

All multimode fibers exceed IEEE 802.3z standards for Gigabit Ethernet performance. Fiber cable solutions also support IEEE 802.3ae standards for 300 meter 10 Gbps applications as well as 550 meter 10 Gbps applications. Advanced construction techniques simplify termination and allow faster installation. Each fiber cable offers low attenuation for optimum signal reliability while offering excellent crush, cut and abrasion resistance.

TE Optical Fiber Cables are tested and designed to be the most recent applicable industry standards for premise cabling, network and telecommunications applications, including:

IEEE 802.3	Ethernet	Fast Ethernet	Gigabit Ethernet
10 Gigabit Ethernet	FDDI	ATM	Fibre Channel
Token Ring	ANSI/TIA-568	ISO 11801	ICEA-596
ICEA-640	ICEA-696	IEC 793-1	IEC 794-1
Telecordia GR-409-CORE	Telecordia GR-20-CORE		

### FEATURES

- Fiber optic cables contain fibers for use in optical fiber applications including: local area networks (LANs), wide area networks (WANs), fiber to the curb (FTTC), fiber to the home (FTTH), fiber to the desk (FTTD) and others.
- TE Connectivity's optical fiber system is a high-performance cabling system designed to meet or exceed the requirements of 10 Gigabit Ethernet application.
- Optical fiber cables are tested and designed to the most recent applicable industry standards for premise cabling, network and telecommunications applications.
- TE Connectivity's LightCrimp PLUS connectors offer easy installation with no epoxy or polishing required. Simply strip, cleave and crimp.





# Fiber

## Fiber Optic Cables and Field Terminated Connectors

### Optical Fiber Interconnect Cable

- Suitable for direct termination with epoxy/polish, LightCrimp, LightCrimp PLUS, and MT-RJ jacks for use in pigtails, and patch cords
- Simplex and zipcord cables are additionally suitable for use in internal equipment connections
- Aramid yarn reinforcement
- UL and cUL listed OFNR (riser) or OFNP (plenum)
- Hybrid cables and custom jacket colors are available
- OS2 singlemode fibers conform to IEC 60793-2-10 B1.3 specifications for low water peak OS2 fibers
- See customer specification 114-92001 at [www.te.com/EnterpriseNetworks](http://www.te.com/EnterpriseNetworks) for additional information

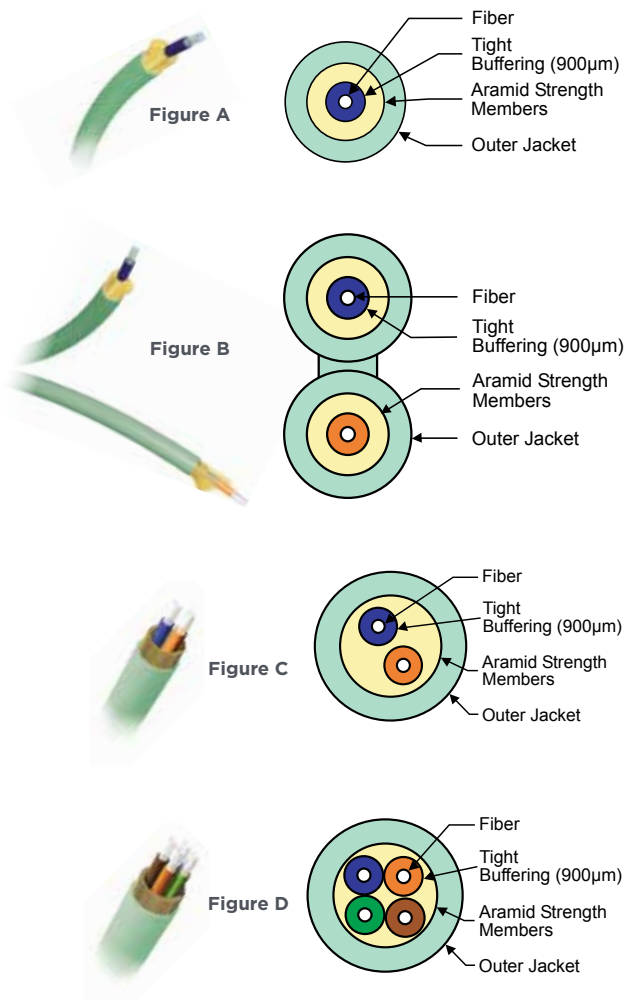

### OM3 and OM4 (50/125 µm) Multimode Optical Fiber Interconnect Cable

- Outer jacket color: aqua
- All fiber is bend-insensitive



### ORDERING INFORMATION

Cable Type	Fiber Count	Unit Count Units (Fibers/Unit)	Figure	Part Number			
				OM3 Riser (OFNR)	OM3 Plenum (OFNP)	OM4 Riser (OFNR)	OM4 Plenum (OFNP)
Simplex (2.0 mm)	1	1 (1)		3-1553406-9	3-1553407-9	4-1553406-9	4-1553407-9
Simplex (2.9 mm)	1	1 (1)	A	3-1553408-9	3-1553409-9	4-1553408-9	4-1553409-9
Zipcord (2.0 mm)	2	2 (1)		3-1553410-9	3-1553411-9	4-1553410-9	4-1553411-9
Zipcord (2.9 mm)	2	2 (1)	B	3-1553412-9	3-1553413-9	4-1553412-9	4-1553413-9
Dual (2.9 mm)	2	1 (2)	C	3-1553414-9	3-1553415-9	4-1553414-9	4-1553415-9
Dual (4.8 mm)	2	1 (2)		3-1553416-9	3-1553417-9	4-1553416-9	4-1553417-9
Quad (4.8 mm)	4	1 (4)	D	3-1553418-9	3-1553419-9	4-1553418-9	4-1553419-9

# Fiber

## Fiber Optic Cables and Field Terminated Connectors

### 50/125 $\mu\text{m}$ OM2 Multimode Optical Fiber Interconnect Cable

- Outer jacket color: orange
- All fiber is bend-insensitive

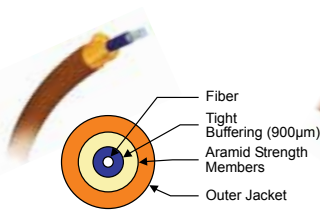

Figure A

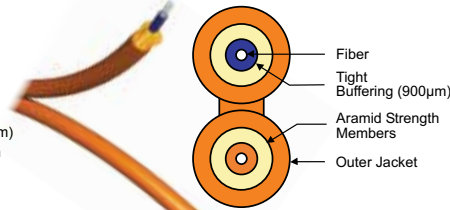

Figure B

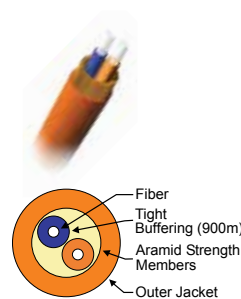

Figure C

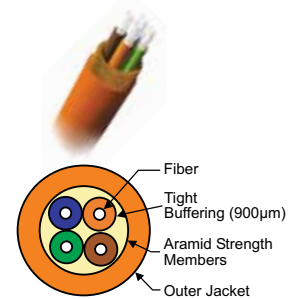

Figure D

#### ORDERING INFORMATION

Cable Type	Fiber Count	Unit Count	Units (Fibers/Unit)	Figure	Part Number	
					Riser (OFNR)	Plenum (OFNP)
Simplex (2.0 mm)	1		1 (1)		1-1553406-2	1-1553407-2
Simplex (2.9 mm)	1		1 (1)	A	1-1553408-2	1-1553409-2
Zipcord (2.0 mm)	2		2 (1)		1-1553410-2	1-1553411-2
Zipcord (2.9 mm)	2		2 (1)	B	1-1553412-2	1-1553413-2
Dual (2.9 mm)	2		1 (2)	C	1-1553414-2	1-1553415-2
Dual (4.8 mm)	2		1 (2)		1-1553416-2	1-1553417-2
Quad (4.8 mm)	4		1 (4)	D	1-1553418-2	1-1553419-2

### 62.5/125 $\mu\text{m}$ OM1 Multimode Optical Fiber Interconnect Cable

- Outer jacket color: orange

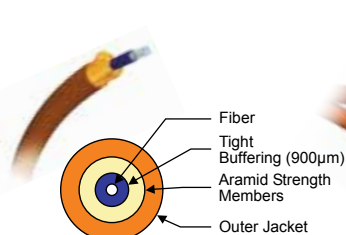

Figure A

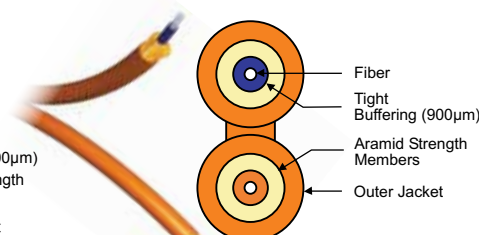

Figure B

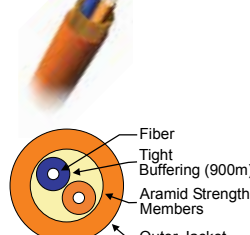

Figure C

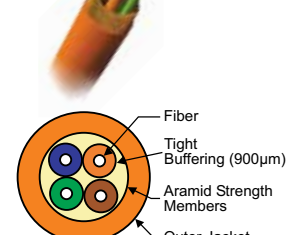

Figure D

#### ORDERING INFORMATION

Cable Type	Fiber Count	Unit Count	Units (Fibers/Unit)	Figure	Part Number	
					Riser (OFNR)	Plenum (OFNP)
Simplex (2.0 mm)	1		1 (1)		1-1553406-1	1-1553407-1
Simplex (2.9 mm)	1		1 (1)	A	1-1553408-1	1-1553409-1
Zipcord (2.0 mm)	2		2 (1)		1-1553410-1	1-1553411-1
Zipcord (2.9 mm)	2		2 (1)	B	1-1553412-1	1-1553413-1
Dual (2.9 mm)	2		1 (2)	C	1-1553414-1	1-1553415-1
Dual (4.8 mm)	2		1 (2)		1-1553416-1	1-1553417-1
Quad (4.8 mm)	4		1 (4)	D	1-1553418-1	1-1553419-1

# Fiber

## Fiber Optic Cables and Field Terminated Connectors

### OS2 Singlemode Optical Fiber Interconnect Cable



- Outer jacket color: yellow
- All fiber is bend-insensitive ITU-T G657.A2

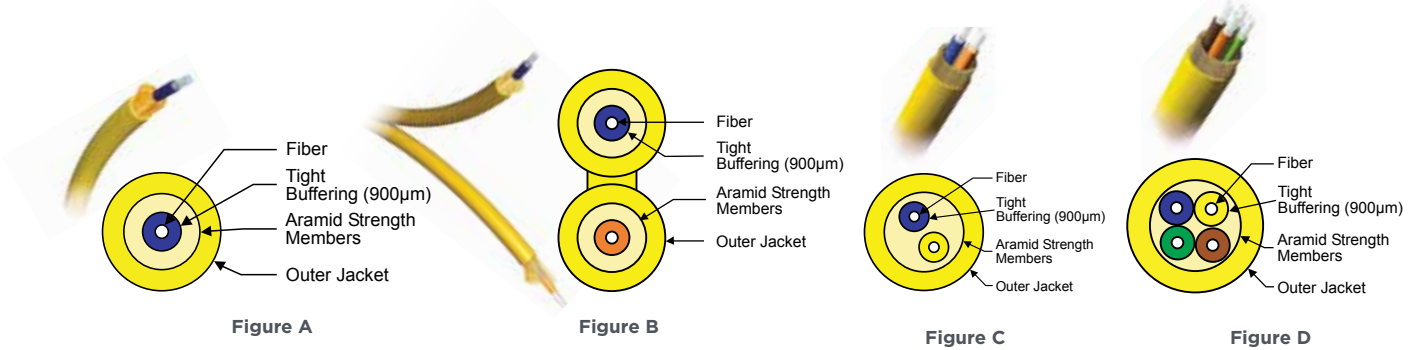

### ORDERING INFORMATION

Cable Type/Jacket Diameter	Fiber Count	Unit Count	Units (Fibers/Unit)	Figure	Riser (OFNR)	Plenum (OFNP)
Simplex (2.0 mm)	1		1 (1)		7-1553406-3	7-1553407-3
Simplex (2.9 mm)	1		1 (1)	A	7-1553408-3	7-1553409-3
Zipcord (2.0 mm)	2		2 (1)		7-1553410-3	7-1553411-3
Zipcord (2.9 mm)	2		2 (1)	B	7-1553412-3	7-1553413-3
Dual (2.9 mm)	2		1 (2)	C	7-1553414-3	7-1553415-3
Dual (4.8 mm)	2		1 (2)		7-1553416-3	7-1553417-3
Quad (4.8 mm)	4		1 (4)	D	7-1553418-3	7-1553419-3

FIBER

# Fiber

## Fiber Optic Cables and Field Terminated Connectors

### Optical Fiber Distribution Cable

- Suitable for horizontal and in-building backbone cabling and for direct termination with epoxy/polish, LightCrimp, LightCrimp PLUS and MT-RJ jacks
- Strippable 900 μm tight buffer coating allows for easy connectorization
- TIA color-coded fibers for easy identification
- UL and cUL listed OFNR (riser) or OFNP (plenum)
- Hybrid cables and other jacket colors are available
- OS2 singlemode fibers conform to IEC 60793-2-10B1.3 specifications for low water peak OS1 fibers
- See customer specification 114-92000 at: [www.te.com/EnterpriseNetworks](http://www.te.com/EnterpriseNetworks) for additional information



Figure A



Figure B



Figure C

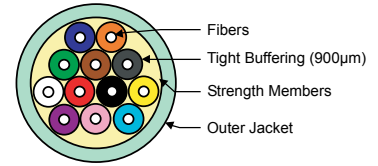

12-Fiber Cable Cross Section

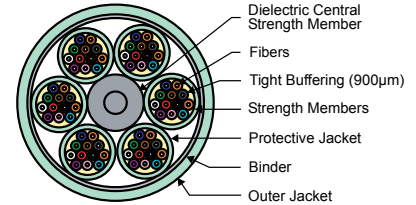

72-Fiber Cable Cross Section

### OM3 and OM4 (50/125 μm) Multimode Optical Fiber Distribution Cable

- Outer jacket color: aqua
- All fiber is bend-insensitive



### ORDERING INFORMATION

Fiber Count	Unit Count Unit (Fibers/Unit)	Figure	Part Number			
			OM3 Riser (OFNR)	OM3 Plenum (OFNP)	OM4 Riser (OFNR)	OM4 Plenum (OFNP)
6	1 (6)	A	3-1553307-9	3-1553308-9	4-1553307-9	4-1553308-9
8	1 (8)		3-1553309-9	3-1553310-9	4-1553309-9	4-1553310-9
12	1 (12)		3-1553311-9	3-1553312-9	4-1553311-9	4-1553312-9
24	1 (24)		3-1553313-9	3-1553314-9	4-1553313-9	4-1553314-9
	2 (12)	B	3-1553315-9	3-1553316-9	4-1553315-9	4-1553316-9
	4 (6)		3-1553317-9	3-1553318-9	4-1553317-9	4-1553318-9
36	6 (6)		3-1553319-9	3-1553320-9	4-1553319-9	4-1553320-9
48	4 (12)	C	3-1553321-9	3-1553322-9	4-1553321-9	4-1553322-9
72	6 (12)		3-1553323-9	3-1553324-9	4-1553323-9	4-1553324-9
96	8 (12)		3-1553325-9	3-1553326-9	4-1553325-9	4-1553326-9
144	12 (12)		3-1553327-9	3-1553328-9	4-1553327-9	4-1553328-9

# Fiber

## Fiber Optic Cables and Field Terminated Connectors

### 50/125 $\mu\text{m}$ OM2 Multimode Optical Fiber Interconnect Cable

- Outer jacket color: orange
- All fiber is bend-insensitive



#### ORDERING INFORMATION

Fiber Count	Unit Count Unit (Fibers/Unit)	Figure	Part Number	
			Riser (OFNR)	Plenum (OFNP)
6	1 (6)	A	1-1553307-2	1-1553308-2
8	1 (8)		1-1553309-2	1-1553310-2
12	1 (12)		1-1553311-2	1-1553312-2
	1 (24)		1-1553313-2	1-1553314-2
	2 (12)	B	1-1553315-2	1-1553316-2
24	4 (6)		1-1553317-2	1-1553318-2
	6 (6)		1-1553319-2	1-1553320-2
48	4 (12)	C	1-1553321-2	1-1553322-2
72	6 (12)		1-1553323-2	1-1553324-2
96	8 (12)		1-1553325-2	1-1553326-2
144	12 (12)		1-1553327-2	1-1553328-2

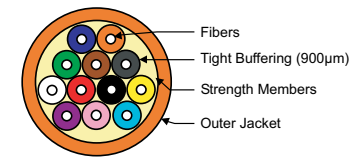

12-Fiber Cable Cross Section

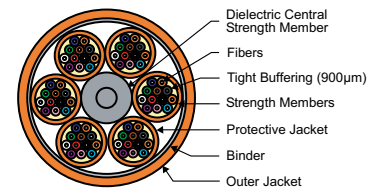

72-Fiber Cable Cross Section

### 62.5/125 $\mu\text{m}$ OM1 Multimode Optical Fiber Interconnect Cable

- Outer jacket color: orange



#### ORDERING INFORMATION

Fiber Count	Unit Count Unit (Fibers/Unit)	Figure	Part Number	
			Riser (OFNR)	Plenum (OFNP)
6	1 (6)	A	1-1553307-1	1-1553308-1
8	1 (8)		1-1553309-1	1-1553310-1
12	1 (12)		1-1553311-1	1-1553312-1
	1 (24)		1-1553313-1	1-1553314-1
	2 (12)	B	1-1553315-1	1-1553316-1
24	4 (6)		1-1553317-1	1-1553318-1
	6 (6)		1-1553319-1	1-1553320-1
48	4 (12)	C	1-1553321-1	1-1553322-1
72	6 (12)		1-1553323-1	1-1553324-1
96	8 (12)		1-1553325-1	1-1553326-1
144	12 (12)		1-1553327-1	1-1553328-1

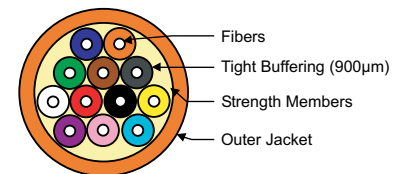

12-Fiber Cable Cross Section

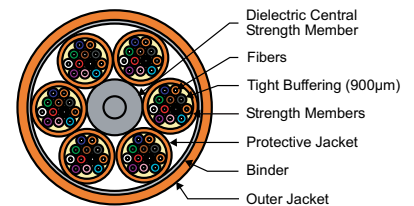

72-Fiber Cable Cross Section

# Fiber

## Fiber Optic Cables and Field Terminated Connectors

### OS2 Singlemode Optical Fiber Interconnect Cable

- Outer jacket color: yellow
- All fiber is bend insensitive ITU-T G.657.A2



FIBER

#### ORDERING INFORMATION

Fiber Count	Unit Count Unit (Fibers/Unit)	Figure	Riser (OFNR)	Plenum (OFNP)
6	1 (6)	A	7-1553307-3	7-1553308-3
8	1 (8)		7-1553309-3	7-1553310-3
12	1 (12)		7-1553311-3	7-1553312-3
24	1 (24)		7-1553313-3	7-1553314-3
	2 (12)	B	7-1553315-3	7-1553316-3
	4 (6)		7-1553317-3	7-1553318-3
36	6 (6)		7-1553319-3	7-1553320-3
48	4 (12)	C	7-1553321-3	7-1553322-3
72	6 (12)		7-1553323-3	7-1553324-3
96	8 (12)		7-1553325-3	7-1553326-3
144	12 (12)		7-1553327-3	7-1553328-3



Figure A



Figure B



Figure C

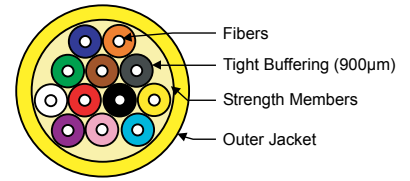

12-Fiber Cable Cross Section

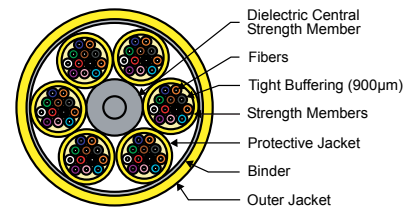

72-Fiber Cable Cross Section

# Fiber

## Fiber Optic Cables and Field Terminated Connectors

### Interlocking Armor Optical Fiber Distribution Cable

- Robust construction provides extra protection for optical fibers
- Interlocking armor enhances flexibility
- Lightweight aluminum armor simplifies handling
- Installer-friendly plenum rated over-jacketing makes cable pulls easier
- Outer/over jacketing color: aqua (OM3 and OM4); orange (OM2 and OM1); yellow (singlemode)
- Hybrid cables and other jacket colors are available
- Pending local codes, may eliminate the need for innerduct
- OFCP (plenum) rated
- TIA color-coded fibers
- Strippable 900  $\mu\text{m}$  tight buffer coating allows for easy connectorization
- Indoor/Outdoor and specialty versions available



FIBER

### ORDERING INFORMATION

Fiber Count	Unit Count Units (Fibers/Unit)	UL/NEC Ratings	OM4 (50/125 $\mu\text{m}$ ) (aqua)	OM3 (50/125 $\mu\text{m}$ ) (aqua)	OM2 (50/125 $\mu\text{m}$ ) (orange)	OM1 (62.5/125 $\mu\text{m}$ ) (orange)	OS1 Singlemode (yellow)
6	1 (6)	Plenum (OFCP)	7-1777121-7	3-1777121-7	2-1777121-7	1-1777121-7	4-1777121-7
12	1 (12)	Plenum (OFCP)	7-1777117-7	3-1777117-7	2-1777117-7	1-1777117-7	4-1777117-7
24	1 (24)	Plenum (OFCP)	4-1553420-9	3-1553420-9	1-1553420-2	1-1553420-1	7-1553420-3
	2(12)	Plenum (OFCP)	7-1777122-7	3-1777122-7	2-1777122-7	1-1777122-7	4-1777122-7
48	4 (12)	Plenum (OFCP)	7-1777123-7	3-1777123-7	2-1777123-7	1-1777123-7	4-1777123-7
72	6 (12)	Plenum (OFCP)	7-1777124-7	3-1777124-7	2-1777124-7	1-1777124-7	4-1777124-7

# Fiber

## Fiber Optic Cables and Field Terminated Connectors

### Optical Fiber Indoor/Outdoor Cable

- Suitable for building and inter-building backbone cabling
- Can eliminate the need for a transition point and splicing when entering buildings – go directly from outdoors into building riser or plenum spaces
- Water-blocked buffer tube for water penetration protection
- Flame-retardant UV-protected jacket for harsh outdoor environments
- All-dielectric construction
- UL and cUL listed OFNR (riser) or OFNP (plenum)
- Outer jacket color is black for all fiber types
- Single loose tube cables:
  - TIA color-coded fibers for easy identification
  - Water-blocked buffer tube for water penetration protection
  - Small diameter single tube construction saves space inside ducts
- Stranded loose tube cables:
  - Hybrid cables and other jacket colors are available
  - Reverse oscillating lay construction for easy midspan access
  - Dry water blocking technology
  - TIA color-coded fibers in TIA color-coded tubes for easy identification
- See customer specification 114-92002 at: [www.te.com/EnterpriseNetworks](http://www.te.com/EnterpriseNetworks) for additional information

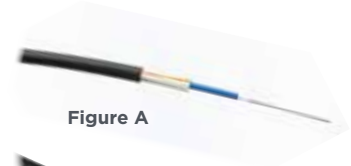

Figure A



Figure B



Figure C

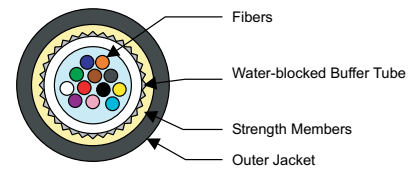

12-Fiber Cable Cross Section

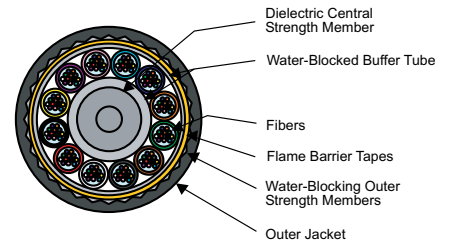

144-Fiber Cable Cross Section

### OM3 and OM4 (50/125 μm) Optical Fiber Indoor/Outdoor Cable

#### ORDERING INFORMATION

Cable Type	Fiber Count	Unit Count Unit (Fibers/Unit)	Figure	Part Number			
				OM3 (50/125μm) Riser (OFNR)	OM3 (50/125μm) Plenum (OFNP)	OM4 (50/125μm) Riser (OFNR)	OM4 (50/125μm) Plenum (OFNP)
Single Loose Tube	6	1 (6)	A	6-1553342-4	6-1553343-4	6-1553342-5	6-1553343-5
	8	1 (8)		6-1553344-4	6-1553345-4	6-1553344-5	6-1553345-5
	12	1 (12)	B	6-1553346-4	6-1553347-4	6-1553346-5	6-1553347-5
Stranded Loose Tube	24	2 (12)		6-1553348-4	6-1553349-4	6-1553348-5	6-1553349-5
	36	3 (12)		6-1553350-4	6-1553351-4	6-1553350-5	6-1553351-5
	48	4 (12)	C	6-1553352-4	6-1553353-4	6-1553352-5	6-1553353-5
	72	6 (12)		6-1553354-4	6-1553355-4	6-1553354-5	6-1553355-5
	96	8 (12)		6-1553356-4	6-1553357-4	6-1553356-5	6-1553357-5
	144	12 (12)		6-1553358-4	6-1553359-4	6-1553358-5	6-1553359-5



# Fiber

## Fiber Optic Cables and Field Terminated Connectors

### OM2, OM1 and Singlemode Optical Fiber Indoor/Outdoor Cable

#### ORDERING INFORMATION

Cable Type	Fiber Count	Unit Count Units (Fibers/Unit)	Figure	OM2 (50/125m) Riser (OFNR)	OM2 (50/125m) Plenum (OFNP)	OM1 (62.5/125m) Riser (OFNR)	OM1 (62.5/125m) Plenum (OFNP)	OS2 Singlemode Riser (OFNR)	OS2 Singlemode Plenum (OFNP)
Single Loose Tube	6	1 (6)	A	6-1553342-2	6-1553343-2	6-1553342-1	6-1553343-1	6-1553342-3	6-1553343-3
	8	1 (8)		6-1553344-2	6-1553345-2	6-1553344-1	6-1553345-1	6-1553344-3	6-1553345-3
Standard Loose Tubet	12	1 (12)	B	6-1553346-2	6-1553347-2	6-1553346-1	6-1553347-1	6-1553346-3	6-1553347-3
	24	2 (12)		6-1553348-2	6-1553349-2	6-1553348-1	6-1553349-1	6-1553348-3	6-1553349-3
	36	3 (12)		6-1553350-2	6-1553351-2	6-1553350-1	6-1553351-1	6-1553350-3	6-1553351-3
	48	4 (12)	C	6-1553352-2	6-1553353-2	6-1553352-1	6-1553353-1	6-1553352-3	6-1553353-3
	72	6 (12)		6-1553354-2	6-1553355-2	6-1553354-1	6-1553355-1	6-1553354-3	6-1553355-3
	96	8 (12)		6-1553356-2	6-1553357-2	6-1553356-1	6-1553357-1	6-1553356-3	6-1553357-3
	144	12 (12)		6-1553358-2	6-1553359-2	6-1553358-1	6-1553359-1	6-1553358-3	6-1553359-3

FIBER

# Fiber

## Fiber Optic Cables and Field Terminated Connectors

### Optical Fiber Outside Plant (OSP) Cable

- Suitable for inter-building backbone cabling (aerial, duct or direct burial)
- Dry water-blocking technology
- UV-protected jacket for harsh outdoor environment
- Low friction jacket for ease of pulling through ducts
- All-dielectric construction
- Outer jacket color is black
- See customer specification 114-92003 at: [www.te.com/EnterpriseNetworks](http://www.te.com/EnterpriseNetworks) for additional information
- Single loose tube cables:
  - TIA color-coded fibers for easy identification
  - Small diameter single tube construction saves space inside ducts
- Stranded loose tube cables:
  - Reverse oscillating lay construction for easy midspan access
  - TIA color-coded fibers and buffer tubes for easy identification



Figure A

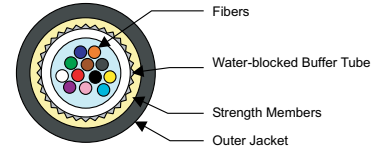

12-Fiber Cable Cross Section

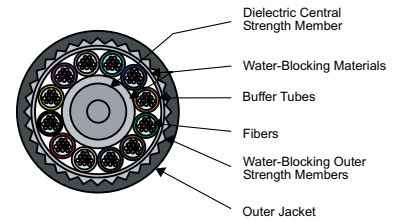

144-Fiber Cable Cross Section

### ORDERING INFORMATION

Fiber Count	Unit Count	Units (Fibers/Unit)	Figure	OM4 (50/125µm)	OM3 (50/125µm)	OM2 (50/125µm)	OM1 (62.5/125µm)	OS2 Singlemode
4	1	(4)		6-1553386-5	6-1553386-4	6-1553386-2	6-1553386-1	6-1553386-3
6	1	(6)		6-1553387-5	6-1553387-4	6-1553387-2	6-1553387-1	6-1553387-3
8	1	(8)		6-1553388-5	6-1553388-4	6-1553388-2	6-1553388-1	6-1553388-3
12	1	(12)		6-1553389-5	6-1553389-4	6-1553389-2	6-1553389-1	6-1553389-3
24	2	(12)		6-1553390-5	6-1553390-4	6-1553390-2	6-1553390-1	6-1553390-3
36	3	(12)		6-1553391-5	6-1553391-4	6-1553391-2	6-1553391-1	6-1553391-3
48	4	(12)		6-1553392-5	6-1553392-4	6-1553392-2	6-1553392-1	6-1553392-3
72	6	(12)		6-1553393-5	6-1553393-4	6-1553393-2	6-1553393-1	6-1553393-3
96	8	(12)		6-1553394-5	6-1553394-4	6-1553394-2	6-1553394-1	6-1553394-3
144	12	(12)	A	6-1553395-5	6-1553395-4	6-1553395-2	6-1553395-1	6-1553395-3

# Fiber

## Fiber Optic Cables and Field Terminated Connectors

### Multimode Optical Fiber Outside Plant Armored (OSPA) Cable

- Suitable for inter-building backbone cabling (aerial, duct or direct buried)
- Dry water-blocking technology
- UV-protected jacket for harsh outdoor environment
- Low friction jacket for ease of pulling through ducts
- Corrugated steel tape armor for rugged environments and rodent protection
- Outer jacket color is black for all fiber types
- See customer specification 114-92003 at: [www.te.com/EnterpriseNetworks](http://www.te.com/EnterpriseNetworks) for additional information
- Single loose tube cables:
  - TIA color-coded fibers for easy identification
  - Small diameter single tube construction saves space inside ducts
- Stranded loose tube cables:
  - TIA color-coded fibers and buffer tubes for easy identification
  - Reverse oscillating lay construction for easy midspan access
  - Hybrid cables (with singlemode and multimode fibers) are available to provide a built-in migration path for future applications that will require singlemode fibers



Figure A



Figure B

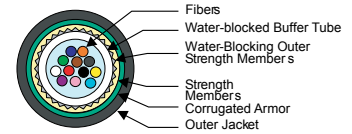

12-Fiber Cable Cross Section

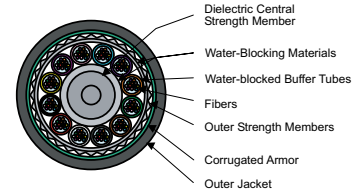

144-Fiber Cable Cross Section

### ORDERING INFORMATION

Cable Type	Fiber Count	Unit Count Units (Fibers/Unit)	Figure	OM4 (50/125µm)	OM3 (50/125µm)	OM2 (50/125µm)	OM1 (62.5/125µm)	OS2 Singlemode
Single Loose Tube	4	1 (4)		6-1553396-5	6-1553396-4	6-1553396-2	6-1553396-1	6-1553396-3
	6	1 (6)	A	6-1553397-5	6-1553397-4	6-1553397-2	6-1553397-1	6-1553397-3
	8	1 (8)		6-1553398-5	6-1553398-4	6-1553398-2	6-1553398-1	6-1553398-3
	12	1 (12)		6-1553399-5	6-1553399-4	6-1553399-2	6-1553399-1	6-1553399-3
Stranded Loose Tube	24	2 (12)		6-1553400-5	6-1553400-4	6-1553400-2	6-1553400-1	6-1553400-3
	36	3 (12)		6-1553401-5	6-1553401-4	6-1553401-2	6-1553401-1	6-1553401-3
	48	4 (12)	B	6-1553402-5	6-1553402-4	6-1553402-2	6-1553402-1	6-1553402-3
	72	6 (12)		6-1553403-5	6-1553403-4	6-1553403-2	6-1553403-1	6-1553403-3
	96	8 (12)		6-1553404-5	6-1553404-4	6-1553404-2	6-1553404-1	6-1553404-3
	144	12 (12)		6-1553405-5	6-1553405-4	6-1553405-2	6-1553405-1	6-1553405-3

# Fiber

## Fiber Optic Cables and Field Terminated Connectors

### Multimode Optical Fiber Performance

Fiber Type	Gigabit Ethernet @ 850 nm	Gigabit Ethernet @ 1300 nm	Gigabit Ethernet @ 1310 nm	10 Gigabit Ethernet @ 850 nm	10 Gigabit Ethernet @ 1300 nm	10 Gigabit Ethernet @1310 nm
<b>OM4 (850 nm LO 50 μm) Multimode</b>	>800 m	550 m	-	550 m	300 m	-
<b>OM3 (850 nm LO 50 μm) Multimode</b>	800 m	550 m	-	300 m	300 m	-
<b>OM2 (50/125 μm) Multimode</b>	550 m	550 m	-	82 m	300 m	-
<b>OM1 (62.5/125 μm) Multimode</b>	300 m	550 m	-	33 m	300 m	-
<b>Singlemode</b>	-	-	5000 m	-	-	10000 m

### Multimode (850/1300 nm) and Singlemode (1310/1550 nm) Optical Fiber Cable Performance Specifications

Cable Type	Fiber Type	Maximum Attenuation dB/km		Maximum Attenuation dB/km		OFL Bandwidth MHz-km		Laser Bandwidth MHz-km	
		850 nm	1300 nm	1310 nm	1550 nm	850 nm	1300 nm	850 nm	1300 nm
<b>OM3 and OM4 indoor, Indoor/Outdoor, and OSP Loose Tube Cables</b>	OM3 Multimode	3.0	1.0	-	-	1500	500	2000	-
	OM4 Multimode	3.0	1.0	-	-	3500	500	4700	-
<b>OM2 (50/125 μm) Indoor, Indoor/Outdoor and OSP Loose Tube Cables</b>	OM2 Multimode	3.5	1.5	-	-	500	500	-	-
<b>OM1 (62.5/125 μm) Indoor, Indoor/Outdoor and OSP Loose Tube Cables</b>	OM1 Multimode	3.5	1.2	-	-	200	500	-	-
<b>Singlemode Indoor and Indoor/Outdoor Cables</b>	SM OS2 BIF	-	-	0.4	0.3	-	-	-	-
<b>Singlemode OSP Loose Tube Cables</b>	SM OS2 BIF	-	-	0.35	0.25	-	-	-	-

# Fiber

## Fiber Optic Cables and Field Terminated Connectors

### Optical Fiber Cable Temperature Ranges

Cable Type	Condition	Riser	Plenum
Interconnect (Tight Buffered) Cables	Storage	-40° C to +65° C (-40° F to +149° F)	-40° C to +65° C (-40° F to +149° F)
	Operating	-20° C to +50° C (-4° F to +122° F)	-20° C to +50° C (-4° F to +122° F)
	Installation	-20° C to +50° C (-4° F to +122° F)	-20° C to +50° C (-4° F to +122° F)
Indoor, Distribution (Tight Buffered) Cables	Storage	-40° C to +70° C (-40° F to +158° F)	-40° C to +70° C (-40° F to +158° F)
	Operating	-20° C to +70° C (-4° F to +158° F)	0° C to +70° C (32° F to +158° F)
	Installation	-10° C to +60° C (14° F to +140° F)	0° C to +60° C (32° F to +140° F)
Indoor/Outdoor Cables	Storage	-40° C to +70° C (-40° F to +160° F)	-40° C to +70° C (-40° F to +160° F)
	Operating	-40° C to +70° C (-40° F to +160° F)	-40° C to +70° C (-40° F to +160° F)
	Installation	-20° C to +60° C (-4° F to +140° F)	0° C to +60° C (32° F to +140° F)
<b>Stranded Cables</b>			
OSP (Loose Tube) Cables	Storage	-40° C to +70° C (-40° F to +158° F)	-
	Operating	-40° C to +70° C (-40° F to +158° F)	-
	Installation	-30° C to +60° C (-22° F to +140° F)	-

### Optical Fiber Cable Technical Information

Cable Type	Fiber Count	Unit Count Units (Fibers/Unit)	Diameter mm (in)	Weight kg/km (lb/kft)	Tensile Load N (lbf)		Bending Radius mm (in)	
					Installation	Long Term	Installation	Long Term
Outside Plant, Single Loose Tube	4	1 (4)	8.3 (0.33)	50 (34)	2670 (600)	890 (200)	176 (6.9)	88 (3.5)
	6	1 (6)	8.3 (0.33)	50 (34)	2670 (600)	890 (200)	176 (6.9)	88 (3.5)
	8	1 (8)	8.3 (0.33)	50 (34)	2670 (600)	890 (200)	176 (6.9)	88 (3.5)
	12	1 (12)	8.3 (0.33)	50 (34)	2670 (600)	890 (200)	176 (6.9)	88 (3.5)
Outside Plant, Stranded Loose Tube	24	2 (12)	11.0 (0.43)	100 (67)	2670 (600)	890 (200)	242 (9.5)	121 (4.8)
	36	3 (12)	11.0 (0.43)	93 (62)	2670 (600)	890 (200)	242 (9.5)	121 (4.8)
	48	4 (12)	11.0 (0.43)	97 (65)	2670 (600)	890 (200)	242 (9.5)	121 (4.8)
	72	6 (12)	11.9 (0.47)	130 (87)	2670 (600)	890 (200)	252 (9.9)	126 (5.0)
	96	8 (12)	13.6 (0.53)	158 (106)	2670 (600)	890 (200)	287 (11.3)	144 (5.6)
Outside Plant, Armored Single Loose Tube	144	12 (12)	17.6 (0.69)	252 (169)	2670 (600)	890 (200)	364 (14.3)	182 (7.2)
	4	1 (4)	10.9 (0.43)	140 (94)	2670 (600)	890 (200)	244 (9.6)	122 (4.8)
	6	1 (6)	10.9 (0.43)	140 (94)	2670 (600)	890 (200)	244 (9.6)	122 (4.8)
	8	1 (8)	10.9 (0.43)	140 (94)	2670 (600)	890 (200)	244 (9.6)	122 (4.8)
Outside Plant, Armored Stranded Loose Tube	12	1 (12)	10.9 (0.43)	140 (94)	2670 (600)	890 (200)	244 (9.6)	122 (4.8)
	24	2 (12)	13.8 (0.55)	214 (144)	2670 (600)	890 (200)	315 (12.4)	158 (6.2)
	36	3 (12)	13.8 (0.55)	218 (146)	2670 (600)	890 (200)	315 (12.4)	158 (6.2)
	48	4 (12)	13.8 (0.55)	223 (150)	2670 (600)	890 (200)	315 (12.4)	158 (6.2)
	72	6 (12)	14.8 (0.58)	265 (178)	2670 (600)	890 (200)	335 (13.2)	167 (6.6)
	96	8 (12)	16.7 (0.69)	307 (206)	2670 (600)	890 (200)	378 (14.9)	189 (7.4)
	144	12 (12)	21.4 (0.84)	498 (335)	2670 (600)	890 (200)	455 (17.9)	228 (9)

# Fiber

## Fiber Optic Cables and Field Terminated Connectors

### Optical Fiber Cable Technical Information (Continued)

Cable Type	Fiber Count	Unit Count Units (Fibers/Unit)	UL/NEC Ratings	Diameter mm (in)	Weight kg/km (lb/kft)	Tensile Load N (lbf)		Bending Radius mm (in)	
						Installation	Long Term	Installation	Long Term
Interconnect, Simplex	1	1 (1)	OFNR	2.0 (0.08)	5 (3)	40 (9)	12 (3)	50 (1.97)	25 (0.98)
			OFNP	2.0 (0.08)	6 (4)	40 (9)	12 (3)	50 (1.97)	25 (0.98)
			OFNR	2.9 (0.11)	8 (5)	100 (22)	30 (7)	58 (2.3)	29 (1.1)
			OFNP	2.9 (0.11)	9 (6)	100 (22)	30 (7)	58 (2.3)	29 (1.1)
Interconnect, Zipcord	2	2 (1)	OFNR	2.0 (0.08) x 4.1 (0.16)	8 (5)	40 (9)	12 (3)	50 (1.97)	25 (0.98)
			OFNP	2.0 (0.08) x 4.1 (0.16)	10 (7)	40 (9)	12 (3)	50 (1.97)	25 (0.98)
			OFNR	2.9 (0.11) x 5.9 (0.23)	15 (10)	100 (22)	30 (7)	58 (2.3)	29 (1.1)
			OFNP	2.9 (0.11) x 5.9 (0.23)	15 (10)	100 (22)	30 (7)	58 (2.3)	29 (1.1)
Interconnect, Dual	2	1 (2)	OFNR	2.9 (0.11)	7 (5)	100 (22)	30 (7)	57 (2.2)	29 (1.1)
			OFNP	2.9 (0.11)	9 (6)	100 (22)	30 (7)	57 (2.2)	29 (1.1)
			OFNR	4.8 (0.3)	20 (13)	100 (22)	30 (7)	96 (3.8)	48 (1.9)
			OFNP	4.8 (0.3)	30 (20)	100 (22)	30 (7)	96 (3.8)	48 (1.9)
Interconnect, Quad	4	1 (4)	OFNR	4.8 (0.3)	25 (17)	100 (22)	30 (7)	96 (3.8)	48 (1.9)
			OFNP	4.8 (0.3)	30 (20)	100 (22)	30 (7)	96 (3.8)	48 (1.9)
Distribution	6	1 (6)	OFNR	5.2 (0.20)	29 (19)	660 (150)	198 (45)	114 (4.5)	57 (2.2)
			OFNP	4.8 (0.19)	24 (16)	440 (100)	132 (30)	110 (4.3)	55 (2.2)
	8	1 (8)	OFNR	5.7 (0.22)	24 (16)	660 (150)	198 (45)	136 (5.4)	68 (2.7)
			OFNP	5.0 (0.20)	26 (17)	440 (100)	132 (30)	110 (4.3)	55 (2.2)
	12	1 (12)	OFNR	6.0 (0.24)	37 (25)	660 (150)	198 (45)	128 (5)	64 (2.5)
			OFNP	5.7 (0.23)	46 (31)	440 (100)	132 (30)	128 (5)	64 (2.5)
	24	1 (24)	OFNR	8.0 (0.31)	61 (41)	1320 (300)	396 (90)	178 (7)	89 (3.5)
			OFNP	7.7 (0.30)	69 (46)	660 (150)	198 (45)	168 (6.6)	84 (3.3)
	24	2 (12)	OFNR	7.4 x 13.0 (0.29 x 0.51)	87 (58)	1320 (300)	396 (90)	284 (11.2)	142 (5.6)
			OFNP	7.0 x 12.4 (0.28 x 0.49)	92 (62)	660 (150)	198 (45)	264 (10.4)	132 (5.2)
	24	4 (6)	OFNR	13.4 (0.53)	180 (121)	1320 (300)	396 (90)	275 (10.8)	137 (5.4)
			OFNP	13.3 (0.52)	200 (134)	660 (150)	198 (45)	266 (10.5)	133 (5.2)
	36	6 (6)	OFNR	16.4 (0.65)	220 (148)	1320 (300)	396 (90)	342 (13.5)	171 (6.7)
			OFNP	16.0 (0.63)	255 (171)	660 (150)	198 (45)	327 (12.9)	164 (6.4)
	48	4 (12)	OFNR	16.0 (0.63)	250 (168)	1320 (300)	396 (90)	350 (13.8)	175 (6.9)
			OFNP	15.2 (0.60)	202 (136)	660 (150)	198 (45)	312 (12.3)	156 (6.1)
	72	6 (12)	OFNR	18.9 (0.75)	301 (202)	1320 (300)	396 (90)	386 (15.2)	193 (7.6)
			OFNP	18.5 (0.73)	316 (212)	660 (150)	198 (45)	386 (15.2)	193 (7.6)
	96	8 (12)	OFNR	22.8 (0.90)	433 (291)	1320 (300)	396 (90)	462 (18.2)	231 (9.1)
			OFNP	22.0 (0.86)	466 (313)	660 (150)	198 (45)	448 (17.6)	224 (8.8)
144	12 (12)	OFNR	24.8 (0.98)	461 (310)	1320 (300)	396 (90)	514 (20.2)	257 (10.1)	
		OFNP	24.2 (0.95)	474 (319)	660 (150)	198 (45)	514 (20.2)	257 (10.1)	

# Fiber

## Fiber Optic Cables and Field Terminated Connectors

### Optical Fiber Cable Technical Information (Continued)

Cable Type	Fiber Count	Unit Count Units (Fibers/Unit)	UL/NEC Ratings	Diameter mm (in)	Weight kg/km (lb/kft)	Tensile Load N (lbf)		Bending Radius mm (in)	
						Installation	Long Term	Installation	Long Term
Distribution, Interlocking Armor	6	1 (6)	OFCP	13.1 (0.52)	117 (79)	1335 (300)	400 (90)	197 (7.8)	131 (5.2)
	12	1 (12)	OFCP	13.3 (0.52)	129 (87)	1335 (300)	400 (90)	199 (7.8)	133 (5.2)
	24	1 (24)	OFCP	14.8 (0.58)	176 (119)	1780 (400)	534 (120)	223 (8.8)	148 (5.8)
	24	2(12)	OFCP	18.9 (0.74)	240 (161)	1780 (400)	534 (120)	192 (7.6)	128 (5.0)
	48	4 (12)	OFCP	23.4 (0.92)	408 (274)	2640 (600)	800 (180)	351 (13.8)	234 (9.2)
	72	6 (12)	OFCP	24.7 (0.97)	537 (361)	2640 (600)	800 (180)	371 (14.6)	247 (9.7)
Indoor/ Outdoor, Single Loose Tube	6	1 (6)	OFNR	6.5 (0.26)	45 (30)	1335 (300)	400 (90)	97 (3.8)	65 (2.6)
			OFNP	6.6 (0.26)	45 (30)	1335 (300)	400 (90)	99 (3.9)	66 (2.6)
	8	1 (8)	OFNR	6.5 (0.26)	45 (30)	1335 (300)	400 (90)	97 (3.8)	65 (2.6)
			OFNP	6.6 (0.26)	46 (31)	1335 (300)	400 (90)	99 (3.9)	66 (2.6)
	12	1 (12)	OFNR	6.5 (0.26)	45 (30)	1335 (300)	400 (90)	97 (3.8)	65 (2.6)
			OFNP	6.6 (0.26)	46 (31)	1335 (300)	400 (90)	99 (3.9)	66 (2.6)
Indoor/ Outdoor, Stranded Loose Tube	24	2 (12)	OFNR	10.1 (0.40)	84 (56)	2670 (600)	890 (200)	151 (5.9)	101 (4.0)
			OFNP	9.7 (0.38)	86 (58)	2670 (600)	890 (200)	145 (5.7)	97 (3.8)
	36	3 (12)	OFNR	10.1 (0.40)	84 (56)	2670 (600)	890 (200)	151 (5.9)	101 (4.0)
			OFNP	9.7 (0.38)	86 (58)	2670 (600)	890 (200)	145 (5.7)	97 (3.8)
	48	4 (12)	OFNR	10.1 (0.40)	84 (56)	2670 (600)	890 (200)	151 (5.9)	101 (4.0)
			OFNP	9.7 (0.38)	86 (58)	2670 (600)	890 (200)	145 (5.7)	97 (3.8)
	72	6 (12)	OFNR	11.9 (0.47)	111 (75)	2670 (600)	890 (200)	178 (7.0)	119 (4.7)
			OFNP	11.7 (0.46)	101 (68)	2670 (600)	890 (200)	175 (6.9)	117 (4.6)
	96	8 (12)	OFNR	13.7 (0.54)	147 (99)	2670 (600)	890 (200)	206 (8.1)	137 (5.4)
			OFNP	13.5 (0.53)	175 (118)	2670 (600)	890 (200)	203 (8.0)	135 (5.3)
	144	12 (12)	OFNR	17.8 (0.70)	252 (169)	4448 (1000)	1335 (300)	267 (10.5)	178 (7.0)
			OFNP	17.7 (0.70)	300 (202)	4448 (1000)	1335 (300)	255 (10.1)	170 (6.7)

# Fiber

## Fiber Optic Cables and Field Terminated Connectors

### Multimode LightCrimp PLUS Connectors (No epoxy/No polish)

- Easy installation:
  - No epoxy, no polishing
  - No bench tool required
  - Strip, cleave, and crimp
- Match fiber type of cable to boot color of LightCrimp PLUS
- Mates with standard couplers, adapters, and adapter plates
- LC small form factor design is half the size of SC
- Select appropriate part number for termination to:
  - 900  $\mu\text{m}$  tight-buffered fiber or 250  $\mu\text{m}$  coated fiber
  - 2.0 mm jacketed fiber
  - 3 mm jacketed fiber
- LC connector clip turns simplex connectors into duplex connectors and allows for polarity correction after termination
- LC-SECURE LightCrimp PLUS Simplex Connectors can be found in the SECURE Network Solutions Fiber Products in section 2 of the catalog



Figure A

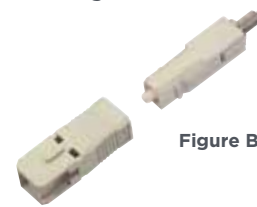

Figure B



Figure C



Figure E

Figure D

### OM3 and OM4 (50/125 $\mu\text{m}$ ) Multimode LightCrimp PLUS Connectors (No epoxy/No polish)

#### ORDERING INFORMATION

Connector Type	Housing Color	Boot Color	Used With	Figure	Part Number
LC Simplex	Beige	Aqua	900 $\mu\text{m}$ buffered and 250 $\mu\text{m}$ coated fibers	A	6754483-4
			2.0 mm jacketed cable		1918627-3
SC Simplex	Beige	Aqua	900 $\mu\text{m}$ buffered fibers, 250 $\mu\text{m}$ coated fibers, and 3 mm jacketed cable	B	6588291-2
ST	Metallic	Aqua	900 $\mu\text{m}$ buffered fibers, 250 $\mu\text{m}$ coated fibers, and 3 mm jacketed cable	C	6278082-2
Duplex LC Clip, package of 6	Black	-	Simplex LC connectors	D	1754371-2
SC Duplex Clip two are required to make a complete clip	Black	-	Simplex SC connectors	E	6348522-1

Note: Termination instructions may be found at [www.te.com/foguide](http://www.te.com/foguide)



# Fiber

## Fiber Optic Cables and Field Terminated Connectors

### 50/125 $\mu\text{m}$ OM2 Multimode LightCrimp PLUS Connectors (No epoxy/No polish)



Figure A

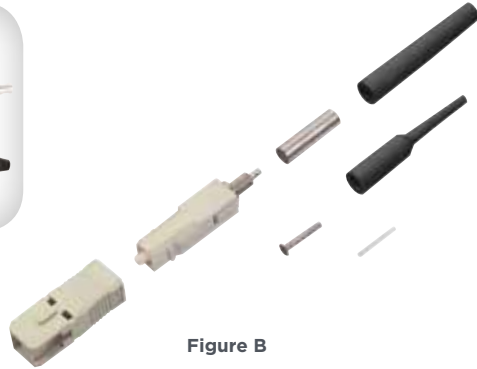

Figure B



Figure C



Figure D



Figure E

### ORDERING INFORMATION

Connector Type	Housing Color	Boot Color	Used With	Figure	Part Number
LC Simplex	Beige	Black	900 $\mu\text{m}$ buffered and 250 $\mu\text{m}$ coated fibers	A	6754483-2
			2.0 mm jacketed cable		1918627-2
SC Simplex	Beige	Black	900 $\mu\text{m}$ buffered fibers, 250 $\mu\text{m}$ coated fibers, and 3 mm jacketed cable	B	6278079-2
ST	Metallic	Black	900 $\mu\text{m}$ buffered fibers, 250 $\mu\text{m}$ coated fibers, and 3 mm jacketed cable	C	6278082-1
Duplex LC Clip, package of 6	Black	-	Simplex LC connectors	D	1754371-2
SC Duplex Clip two are required to make a complete clip	Black	-	Simplex SC connectors	E	6348522-1

Note: Termination instructions may be found at [www.te.com/foguide](http://www.te.com/foguide)

# Fiber

## Fiber Optic Cables and Field Terminated Connectors

### 62.5/125 μm OM1 Multimode LightCrimp PLUS Connectors (No epoxy/No polish)



Figure A

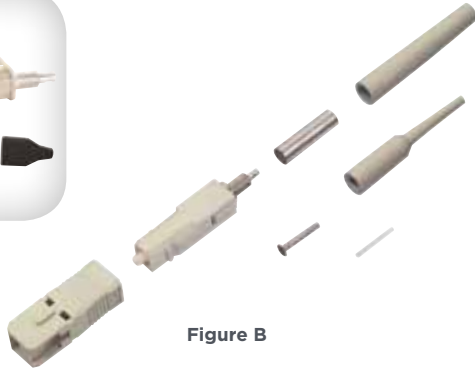

Figure B



Figure C



Figure D

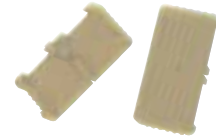

Figure E

### ORDERING INFORMATION

Connector Type	Housing Color	Boot Color	Used With	Figure	Part Number
LC Simplex	Beige	Beige	900 μm buffered and 250 μm coated fibers	A	6754483-1
			2.0 mm jacketed cable		1918627-1
SC Simplex	Beige	Beige	900 μm buffered fibers, 250 μm coated fibers, and 3 mm jacketed cable	B	5492643-1
ST	Metallic	Beige	900 μm buffered fibers, 250 μm coated fibers, and 3 mm jacketed cable	C	5492642-2
Duplex LC Clip, package of 6	Beige	-	Simplex LC connectors	D	1754371-5
SC Duplex Clip two are required to make a complete clip	Beige	-	Simplex SC connectors	E	6348522-4

Note: Termination instructions may be found at [www.te.com/foguide](http://www.te.com/foguide)

# Fiber

## Fiber Optic Cables and Field Terminated Connectors

### Singlemode LightCrimp PLUS Connectors (No epoxy/No polish)



Figure A

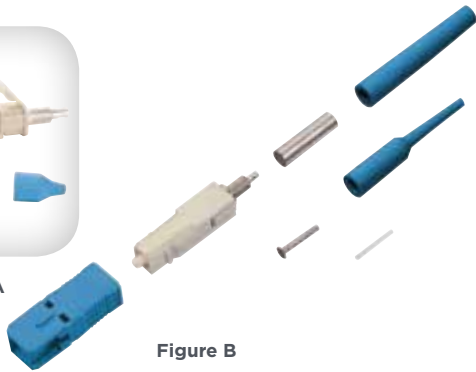

Figure B



Figure C



Figure D

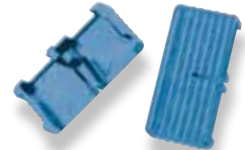

Figure E

### ORDERING INFORMATION

Connector Type	Housing Color	Boot Color	Used With	Figure	Part Number
LC Simplex, APC	Green	Blue	900 $\mu$ m buffered and 250 $\mu$ m coated fibers		2064181-1
LC Simplex	Blue	Blue	900 $\mu$ m buffered and 250 $\mu$ m coated fibers	A	6754482-1
			2.0 mm jacketed cable		1918626-1
SC Simplex, APC	Green	Blue	900 $\mu$ m buffered and 250 $\mu$ m coated fibers		2064184-1
SC Simplex	Blue	Blue	900 $\mu$ m buffered fibers, 250 $\mu$ m coated fibers, and 3 mm jacketed cable	B	6693276-1
ST	Metallic	Black	900 $\mu$ m buffered fibers, 250 $\mu$ m coated fibers, and 3 mm jacketed cable	C	1828953-3
Duplex LC Clip, package of 6	Blue	-	Simplex LC connectors	D	1754371-4
SC Duplex Clip two are required to make a complete clip	Blue	-	Simplex SC connectors	E	6348522-3

Note: APC (Angle Polish Connector) connectors are for use with other APC products. Termination instructions may be found at [www.te.com/foguide](http://www.te.com/foguide)

# Fiber

## Fiber Optic Cables and Field Terminated Connectors

### LightCrimp Splice

- Terminates 250  $\mu\text{m}$  coated, 900  $\mu\text{m}$  tight-buffered, and 2.0 mm jacketed fibers
- Use with multimode and singlemode 125  $\mu\text{m}$  diameter fibers
- No epoxy, set-up, or workstation required
- Use Termination Tool Kit part number 1553212-1
- Splice Performance Characteristics:
  - Attenuation: Typical 0.1 dB
  - Return Loss: (at ambient: 18 to 28° C)
    - >40 dB Multimode
    - >60 dB Single-mode
  - Operating Temperature:
    - 25 to 70° C
- Tensile Retention:
  - 250  $\mu\text{m}$  coated: 2.0 N
  - 900  $\mu\text{m}$  buffered: 3.0 N
  - Jacketed: 50 N



Figure A

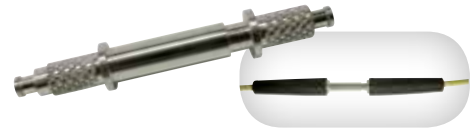

Figure B



Insert First Fiber and Complete Buffer Crimp



Insert Second Fiber and Actuate Crimp



Complete Second Buffer Crimp and Remove Splice from Tool

### ORDERING INFORMATION

Description	Figure	Part Number
LightCrimp Splice for 250 $\mu\text{m}$ Coated and 900 $\mu\text{m}$ tight-buffered Fibers	A	1985374-1
LightCrimp Splice for 2.0 mm Jacketed Fiber	B	1985805-1

# Fiber

## Fiber Optic Cables and Field Terminated Connectors

### Multimode Epoxy/Polish Connectors

- Each connector kit comes with accessories needed to terminate to 250 μm fiber, 900 μm tight-buffered fiber, 900 μm easy-strip, buffer tube splitter kits, 2 mm or 3 mm cable (select appropriate part number)
- Suitable for use with heat-cured or anaerobic (quick cure) adhesive
- See instruction sheet for recommended anaerobic adhesive
- Mates with standard couplers, adapters, and adapter plates
- LC small form factor design is half the size of SC
- Pre-radiused ceramic ferrules for easy polishing
- Duplex SC can be assembled using two simplex SC connectors and one duplex clip
- Boot type and coupling nut options (select appropriate part number)

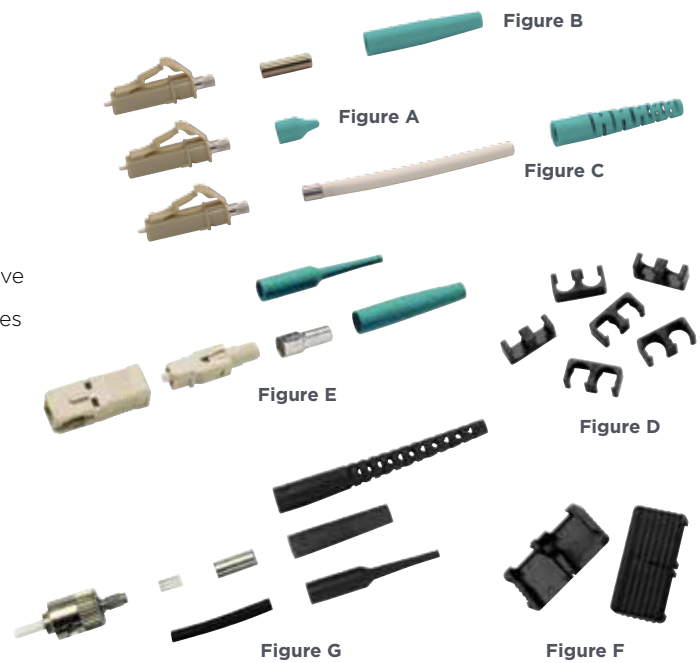

### OM3 and OM4 Multimode Epoxy/Polish Connectors

#### ORDERING INFORMATION

Description	Housing Color	Boot Color	Used With	Figure	Part Number
LC Simplex	Beige	Aqua	900 μm buffered and 250 μm coated fibers	A	1918385-3
			2 mm jacketed cable	B	1918267-3
			3.0 mm jacketed cable	C	1918375-3
Duplex LC Clip, package of 6	Black	-	Simplex LC connectors	D	1754371-2
SC Simplex	Beige	Aqua	900 μm buffered fibers, 250 μm coated fibers, and 3 mm jacketed cable	E	1-5503948-1
			3 mm jacketed cable		1-5503948-0
			900 μm buffered and 250 μm coated fibers	E	5504932-5
			2 mm jacketed cable		5504931-5
SC Duplex Clip two are required to make a complete clip	Black	-	Simplex SC connectors	F	6348522-1
ST	Black	Black	900 μm buffered fibers, 250 μm coated fibers, and 3 mm jacketed cable		5503571-3
			900 μm buffered fibers, 250 μm coated fibers, and 3 mm jacketed cable	G	5492458-1
	Metallic	Black	3 mm jacketed cable		1-5501380-6
			900 μm buffered fibers, 250 μm coated fibers, and 3 mm jacketed cable	G	5501380-1
			900 μm buffered fibers, 250 μm coated fibers, and 3 mm jacketed cable	G	5501380-1

# Fiber

## Fiber Optic Cables and Field Terminated Connectors

### 50/125 μm OM2 Multimode Epoxy/Polish Connectors

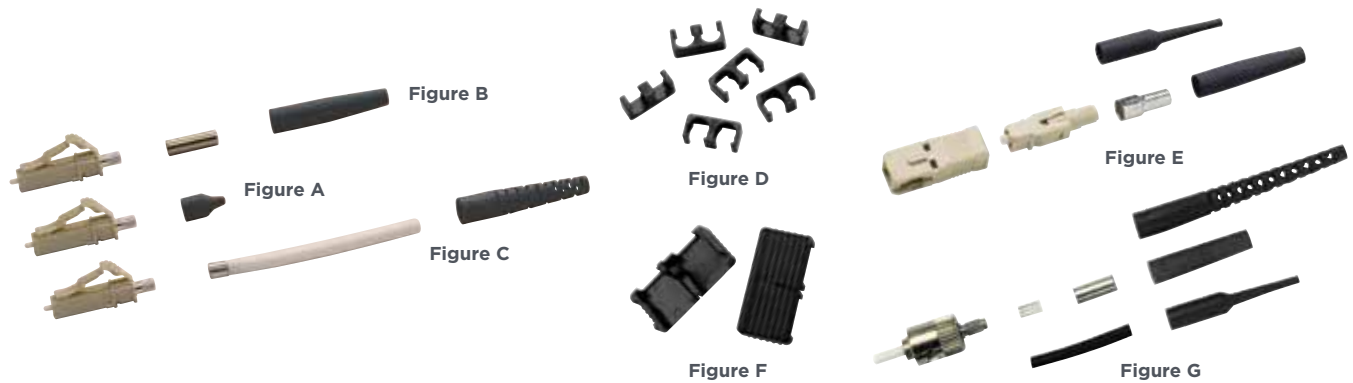

### ORDERING INFORMATION

Description	Housing Color	Boot Color	Used With	Figure	Part Number
LC Simplex	Beige	Black	900 μm buffered and 250 μm coated fibers	A	1918385-4
			2 mm Jacketed Cable	B	1918267-4
			3.0 mm Jacketed Cable	C	1918375-4
Duplex LC Clip, package of 6	Black	-	Simplex LC Connectors	D	1754371-2
SC Simplex	Beige	Black	900 μm buffered fibers, 250 μm coated fibers, and 3 mm Jacketed Cable	E	1-5503948-3
			3 mm Jacketed Cable		1-5503948-2
			900 μm buffered and 250 μm coated fibers	E	5504932-1
			2 mm Jacketed Cable		5504931-6
SC Duplex Clip two are required to make a complete clip	Black	-	Simplex SC Connectors	F	6348522-1
ST	Black	Black	900 μm buffered fibers, 250 μm coated fibers, and 3 mm Jacketed Cable		5503571-3
	Metallic	Black	900 μm buffered fibers, 250 μm coated fibers, and 3 mm Jacketed Cable	G	5492458-1
			3 mm Jacketed Cable		1-5501380-6
			900 μm buffered fibers, 250 μm coated fibers, and 3 mm Jacketed Cable	G	5501380-1

# Fiber

## Fiber Optic Cables and Field Terminated Connectors

### 62.5/125 μm OM1 Multimode Epoxy/Polish Connectors

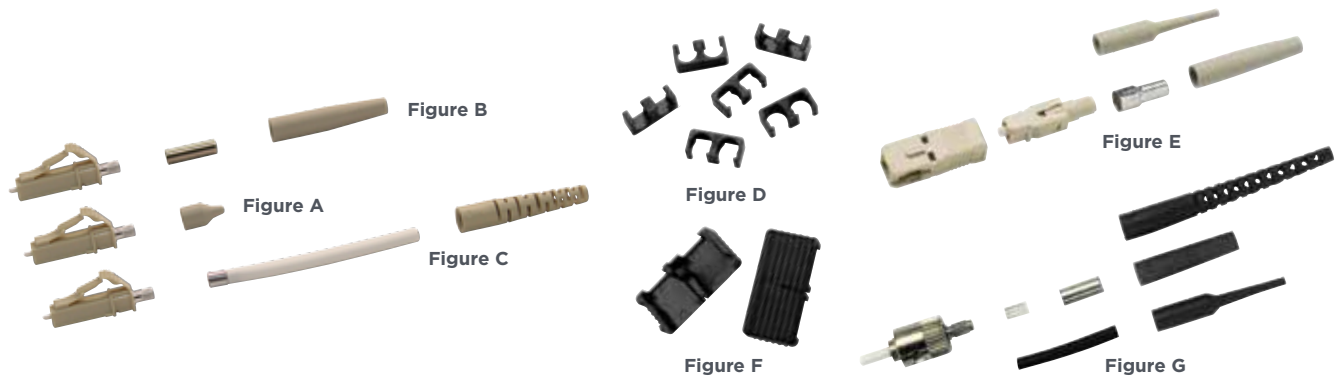

#### ORDERING INFORMATION

Description	Housing Color	Boot Color	Used With	Figure	Part Number
LC Simplex	Beige	Beige	900 μm buffered and 250 μm coated fibers	A	1918385-1
			2 mm jacketed cable	B	1918267-1
			3.0 mm jacketed cable	C	1918375-1
Duplex LC Clip, package of 6	Beige	-	Simplex LC connectors	D	1754371-5
SC Simplex	Beige	Beige	900 μm buffered fibers, and 3 mm jacketed cable	E	5503948-5
			3 mm jacketed cable		5503948-1
			900 μm buffered and 250 μm coated fibers	E	5504932-6
			2 mm jacketed cable		5504931-1
SC Duplex Clip two are required to make a complete clip	Beige	-	Simplex SC connectors	F	6348522-4
ST	Black	Black	900 μm buffered fibers, 250 μm coated fibers, and 3 mm jacketed cable		5503571-3
	Metallic	Black	900 μm buffered fibers, 250 μm coated fibers, and 3 mm jacketed cable	G	5492458-1
			3 mm jacketed cable		1-5501380-6
			900 μm buffered fibers, 250 μm coated fibers, and 3 mm jacketed cable	G	5501380-1

# Fiber

## Fiber Optic Cables and Field Terminated Connectors

### Singlemode Epoxy/Polish Connectors

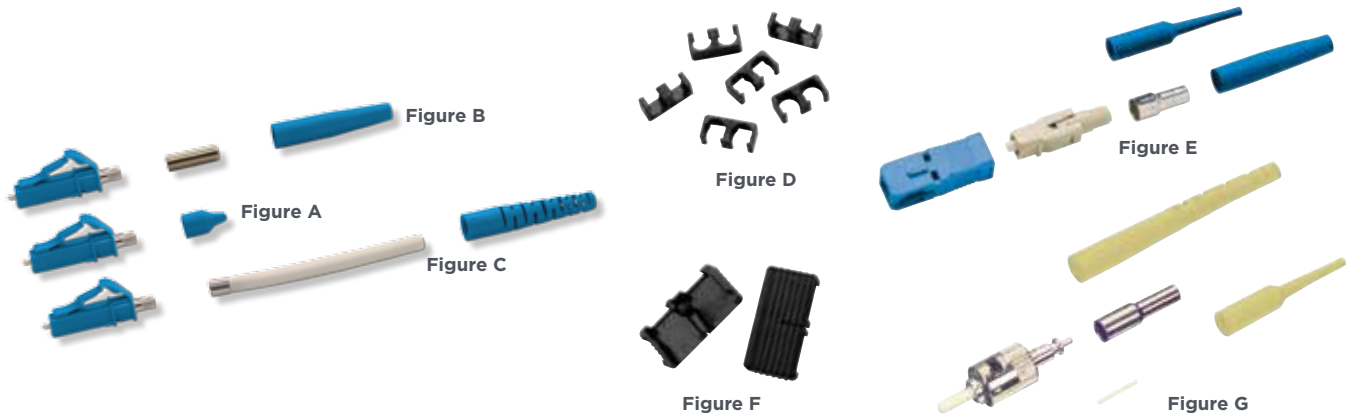

### ORDERING INFORMATION

Description	Housing Color	Boot Color	Used With	Figure	Part Number
LC Simplex	Blue	Blue	900 $\mu$ m buffered and 250 $\mu$ m coated fibers	A	1918384-1
			1.6 to 2 mm jacketed cable	B	1918266-1
			3.0 mm jacketed cable	C	1918374-1
Duplex LC Clip, package of 6	Blue	-	Simplex LC connectors	D	1754371-4
SC Simplex	Blue	Blue	900 $\mu$ m buffered fibers, 250 $\mu$ m coated fibers, and 3 mm jacketed cable	E	5504646-7
			3 mm jacketed cable		5504646-1
			900 $\mu$ m buffered and 250 $\mu$ m coated fibers	E	5492123-1
			2 mm jacketed cable		5504934-2
SC Duplex	Blue	Blue	2 mm jacketed cable		5504655-1
SC Duplex Clip two are required to make a complete clip	Blue	-	Simplex SC connectors	F	6348522-3
ST	Metallic	Yellow	900 $\mu$ m buffered fibers and 3 mm jacketed cable		5503613-2
			900 $\mu$ m buffered fibers, 250 $\mu$ m coated fibers, and 3 mm jacketed cable	G	5502579-2
			900 $\mu$ m buffered fibers, 250 $\mu$ m coated fibers, and 3 mm jacketed cable, short boot	G	5502580-2



# Fiber

## Fiber Optic Cables and Field Terminated Connectors

### Multimode MT-RJ Jacks (No epoxy/No polish)

- Patch panel jacks terminate either two 900  $\mu\text{m}$  tight-buffered fibers or two 250  $\mu\text{m}$  coated fibers (select appropriate part number)
- Outlet jacks terminate two 900  $\mu\text{m}$  tight-buffered fibers
- Match fiber type of cable to fiber type of MT-RJ Jack
- No epoxy, no polishing, no crimping
- Two fibers in one ferrule
- Jacks can be reterminated improving yield
- Tunable
- No bench tool required
- Small form factor design is half the size of SC duplex
- Jack design eliminates need for MT-RJ coupler
- Each outlet jack part number includes:
  - One MT-RJ jack
  - One actuation tool
  - One bend-limiting boot
  - One SL series housing – allows use in any faceplate or outlet that accepts SL series jacks
- Each patch panel jack part number includes:
  - Six patch panel jacks
  - Two actuation tools
  - One fiber guide
  - One icon wheel
- SL series housing and bend limiting boot are also available separately

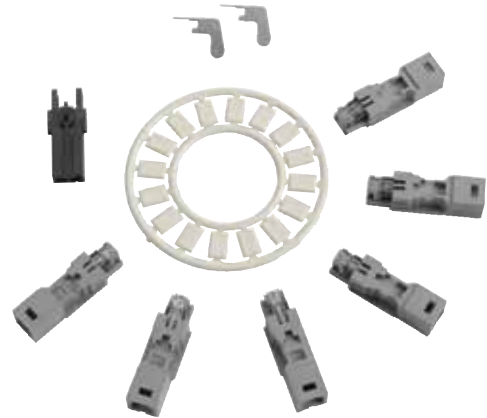

MT-RJ Patch Panel Jacks



Strip

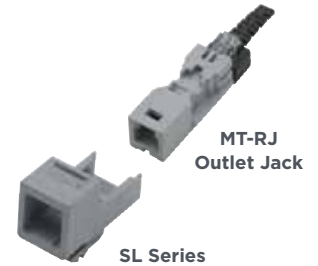

SL Series Housing (Gray)



Cleave



Lock

### OM3 and OM4 Multimode MT-RJ Jacks (No epoxy/No polish)

#### ORDERING INFORMATION

Description	Jack Color	SL Series Housing Color	For Use With	
			900 $\mu\text{m}$ Tight-Buffered Fibers	250 $\mu\text{m}$ Coated Fibers
MT-RJ Patch Panel Jack	Gray	-	6588880-3	6278303-4
MT-RJ Outlet Jack	Gray	Gray	1-6278414-2	-

# Fiber

## Fiber Optic Cables and Field Terminated Connectors

### 50/125 $\mu\text{m}$ OM2 Multimode MT-RJ Jacks (No epoxy/No polish)

FIBER

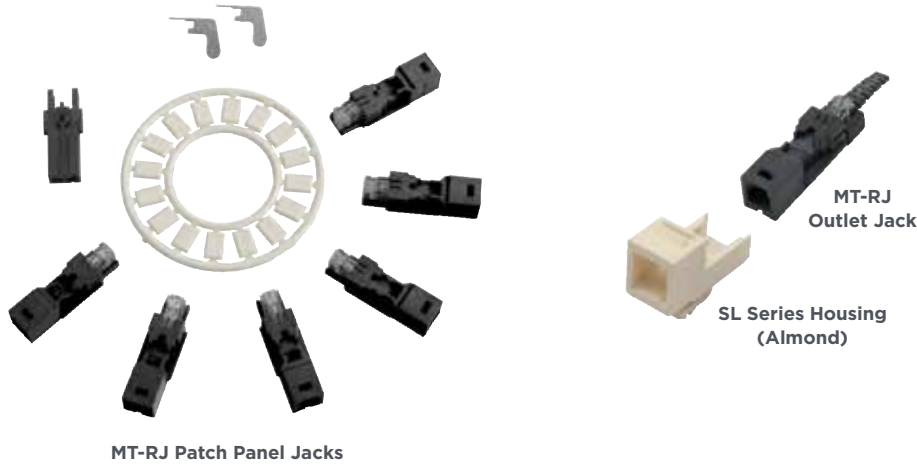

#### ORDERING INFORMATION

Description	Jack Color	SL Series Housing Color	For Use With	
			900 $\mu\text{m}$ Tight-buffered Fibers	250 $\mu\text{m}$ Coated Fibers
MT-RJ Patch Panel Jack	Black	-	6588880-1	6278303-1
		Almond	6278414-1	-
MT-RJ Outlet Jack	Black	Black	6278414-2	-
		White	6278414-3	-
		Gray	6278414-4	-
		Orange	6278414-5	-
		Blue	6278414-6	-
		Red	6278414-7	-
		Yellow	6278414-8	-
		Green	6278414-9	-
		Violet	1-6278414-0	-
		Electrical Ivory	1-6278414-1	-

# Fiber

## Fiber Optic Cables and Field Terminated Connectors

### 62.5/125 m OM1 Multimode MT-RJ Jacks (No epoxy/No polish)

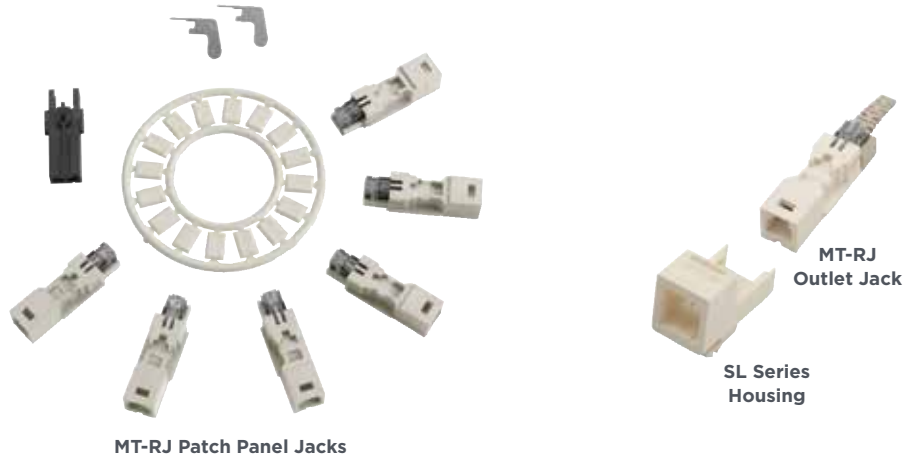

### ORDERING INFORMATION

Description	Jack Color	SL Series Housing Color	For Use With	
			900 m Tight-buffered Fibers	250 m Coated Fibers
MT-RJ Patch Panel Jack	Beige	-	6588880-2	6278303-2
MT-RJ Outlet Jack	Beige	Almond	6278415-1	-
		Black	6278415-2	-
		White	6278415-3	-
		Gray	6278415-4	-
		Orange	6278415-5	-
		Blue	6278415-6	-
		Red	6278415-7	-
		Yellow	6278415-8	-
		Green	6278415-9	-
		Violet	1-6278415-0	-
		Electrical Ivory	1-6278415-1	-

# Fiber

## Fiber Optic Cables and Field Terminated Connectors

### Multimode MT-RJ Jack Accessories (OM4, OM3, OM2, and OM1)

- Parallel dress clips:
  - 1-Port clip holds one MT-RJ jack (sold separately)
  - 2-Port clip holds two MT-RJ jacks (sold separately)
  - Allow use of MT-RJ jacks in faceplates and outlets that hold flanged optical fiber adapters
  - Can be used with HIDEAWAY and HIDEOUT outlets
- Bend limiting boots:
  - Compatible with all MT-RJ jacks
  - Comes in a package of six
  - Protects fiber transition at back of MT-RJ jack
- SL Series housing easily snap into SL series modules, mounting straps, patch panels, and faceplates
- SL series housing accepts one MT-RJ jack sold separately
- MT-RJ outlet jacks not included with any accessory listed here



Figure A



Figure B



Figure C



Figure D



Figure E

### ORDERING INFORMATION

Description		Package Quantity	Figure	SL Series Housing Color	Part Number
<b>Parallel Dress Clip</b>	1-Port (Accepts 1 MT-RJ Jack)	6	A	-	1374206-1
	2-Port (Accepts 2 MT-RJ Jacks)	3	B	-	1374205-1
<b>Bend Limiting Boot</b>	Black	6	C	-	6374208-4
	Beige	6		-	6374208-5
<b>SL Series Housing</b>	1-Port (Accepts 1 MT-RJ Jack)	1	D	Almond	1374416-1
				Black	1374416-2
				White	1374416-3
				Gray	1374416-4
				Orange	1374416-5
				Blue	1374416-6
				Red	1374416-7
				Yellow	1374416-8
				Green	1374416-9
				Violet	1-1374416-0
				Electrical Ivory	1-1374416-1
				Rose	2-1374416-3
				Aqua	2-1374416-4
				Brown	2-1374416-5
	Slate	2-1374416-6			

# Fiber

## Fiber Optic Cables and Field Terminated Connectors

### Multimode Snap-in Adapter Plates

- All snap-in adapter plates fit RMG unloaded optical fiber enclosures
- MT-RJ jack adapter plates:
  - Hold up to six (6) MT-RJ (standard or secure) jacks or pigtail jack cable assemblies
  - Accepts labeling icons
- MT-RJ plug adapter plates hold up to twelve (12) MT-RJ plugs (standard only)
- Package quantity = 1 per pack
- SL Series multimedia adapter plates accept SL series jacks and inserts

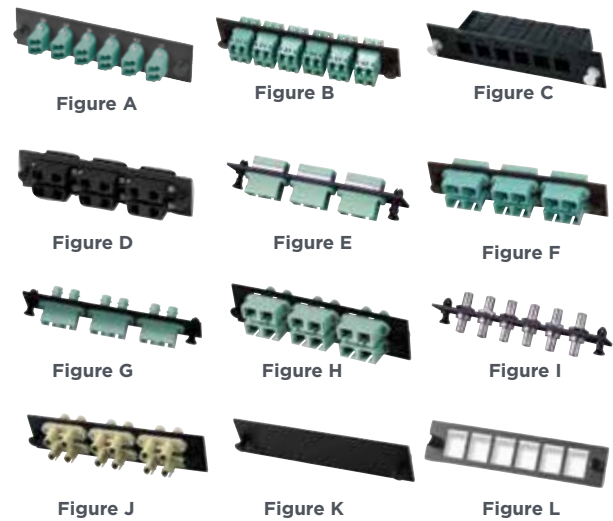

### OM3 and OM4 (50/125 μm) Multimode Snap-in Adapter Plates

#### ORDERING INFORMATION

Coupling Adapter	Fibers	Duplex Ports	Coupler Count	Adapter Color	Figure	Part Number
LC Duplex	12	6	6	Aqua	A	1374463-5
	24	12	12	Aqua	B	1435516-5
MT-RJ, Holds 6 Jacks	12	6	-	-	C	1278328-3
MT-RJ, 12 Plugs	24	12	-	Black	D	1435440-2
SC Simplex	6	3	3	Aqua		559517-8
SC Duplex	6	3	3	Aqua	E	559558-6
	12	6	6	Aqua	F	559596-6
SC Duplex to Dual ST	6	3	3	Aqua	G	559601-5
	12	6	6	Aqua	H	1278368-3
ST	6	3	6	Metallic	I	559557-1
	12	6	6	Beige	J	1278567-1
MPO	-	-	6	Black		1374598-1
Blank	-	-	-	-	K	559523-1
SL Series Multimedia Adapter Plate	-	-	-	-	L	1479506-1

# Fiber

## Fiber Optic Cables and Field Terminated Connectors

### 50/125 $\mu\text{m}$ OM2 Multimode Snap-in Adapter Plates



Figure A



Figure B



Figure C



Figure D



Figure E



Figure F



Figure G



Figure H



Figure I



Figure J



Figure K



Figure L

### ORDERING INFORMATION

Coupling Adapter	Fibers	Duplex Ports	Coupler Count	Adapter Color	Figure	Part Number
LC Duplex	12	6	6	Black	A	1374463-4
	24	12	12	Black	B	1435516-4
MT-RJ, Holds 6 Jacks	12	6	-	-	C	1278328-3
MT-RJ, 12 Plugs	24	12	-	Black	D	1435440-2
SC Simplex	6	3	3	Black		559517-3
SC Duplex	6	3	3	Black	E	559558-5
	12	6	6	Black	F	559596-5
SC Duplex to Dual ST	6	3	3	Black	G	559601-4
	12	6	6	Black	H	1278368-2
ST	6	3	6	Metallic	I	559557-1
	12	6	6	Beige	J	1278567-1
MPO	-	-	6	Black		1374598-1
Blank	-	-	-	-	K	559523-1
SL Series Multimedia Adapter Plate	-	-	-	-	L	1479506-1

# Fiber

## Fiber Optic Cables and Field Terminated Connectors

### 62.5/125 $\mu\text{m}$ OM1 Multimode Snap-in Adapter Plates



Figure A



Figure B



Figure C



Figure D



Figure E



Figure F



Figure G



Figure H



Figure I



Figure J



Figure K



Figure L

### ORDERING INFORMATION

Coupling Adapter	Fibers	Duplex Ports	Coupler Count	Adapter Color	Figure	Part Number
LC Duplex	12	6	6	Beige	A	1374463-2
	24	12	12	Beige	B	1435516-2
MT-RJ, Holds 6 Jacks	12	6	-	-	C	1278328-3
MT-RJ, 12 Plugs	24	12	-	Beige	D	1435440-1
SC Simplex	6	3	3	Beige		559517-7
SC Duplex	6	3	3	Beige	E	559558-1
	12	6	6	Beige	F	559596-1
SC Duplex to Dual ST	6	3	3	Beige	G	559601-1
	12	6	6	Beige	H	1278368-1
ST	6	3	6	Metallic	I	559557-1
	12	6	6	Beige	J	1278567-1
MPO	-	-	6	Black		1374598-1
Blank	-	-	-	-	K	559523-1
SL Series Multimedia Adapter Plate	-	-	-	-	L	1479506-1

# Fiber

## Fiber Optic Cables and Field Terminated Connectors

### Singlemode Snap-in Adapter Plates



Figure A



Figure B



Figure C



Figure D



Figure E



Figure F



Figure G



Figure H



Figure I



Figure J



Figure K



Figure L

### ORDERING INFORMATION

Coupling Adapter	Fibers	Duplex Ports	Coupler Count	Adapter Color	Figure	Part Number
LC Duplex	12	6	6	Blue	A	1374463-1
	24	12	12	Blue	B	1435516-1
LC Duplex, APC	12	6	6	Green		1374463-6
	24	12	12	Green		1435516-6
MT-RJ, Holds 6 Jacks	12	6	-	-	C	1278328-3
MT-RJ, 12 Plugs	24	12	-	Blue	D	1435440-3
SC Simplex	6	3	3	Blue		559517-1
SC Simplex, APC	6	3	3	Green		559517-2
SC Duplex	6	3	3	Blue	E	559558-2
	12	6	6	Blue	F	559596-2
SC Duplex, APC	6	3	3	Green		559558-7
	12	6	6	Green		559596-3
SC Duplex to Dual ST	6	3	3	Blue	G	559601-6
	12	6	6	Blue	H	1278368-5
ST	6	3	6	Metallic	I	559515-2
	12	6	6	Blue	J	1278567-2
MPO	-	-	6	Black		1374598-1
Blank	-	-	-	-	K	559523-1
SL Series Multimedia Adapter Plate	-	-	-	-	L	1479506-1

Note: APC (Angle Polish Connector) connectors are for use with other APC products.



# Fiber

## Fiber Optic Cables and Field Terminated Connectors

### Multimode Couplers and Adapters

- MT-RJ couplers mate multimode or singlemode MT-RJ plugs
- Duplex coupler mates four MT-RJ plugs (4-fibers total, 2-fibers/mated pair)
- Simplex coupler mates two MT-RJ plugs (2-fibers total, 2-fibers/mated pair)
- Mounting screws are available for couplers with mounting tabs (flanged)
- FOCIS - compliant designs

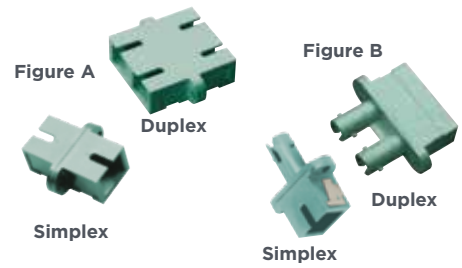

### OM3 and OM4 Multimode Couplers and Adapters

#### ORDERING INFORMATION

Description	Color	Figure	Part Number	
			Simplex	Duplex
MT-RJ Coupler	Almond		1278017-1	6374906-1
SC Coupler	Aqua	A	2-5502632-4	2-5502776-6
SC to ST Coupling Adapter	Aqua	B	2-5502780-1	1-5503137-9
ST Coupler	Metallic/Beige	C	501381-1	504662-2
LC Coupler	Aqua	D	-	1-6457567-6

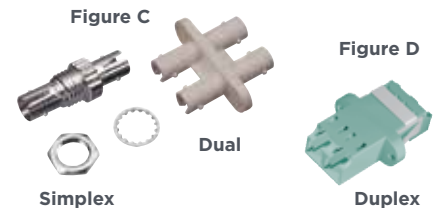

# Fiber

## Fiber Optic Cables and Field Terminated Connectors

### 62.5/125 μm OM1 Multimode Couplers and Adapters

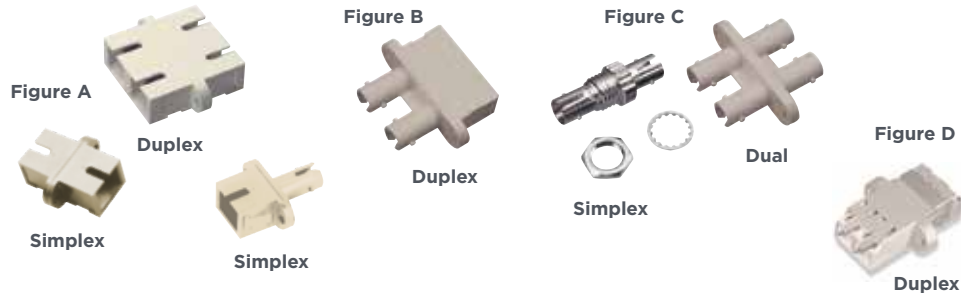

#### ORDERING INFORMATION

Description	Color	Figure	Simplex	Duplex
MT-RJ Coupler	Almond		1278017-1	6374906-1
SC Coupler	Beige	A	5504614-1	5504640-1
SC to ST Coupling Adapter	Beige	B	5502780-3	5504663-4
ST Coupler	Metallic/Beige	C	501381-1	504662-2
LC Coupler	Beige	D	-	6457567-5

### Singlemode Couplers and Adapters

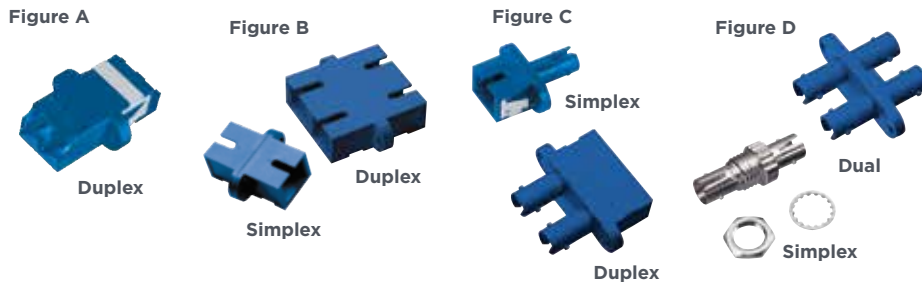

#### ORDERING INFORMATION

Description	Color	Figure	Part Number		
			Simplex	Duplex	Quadplex (Dual Duplex)
MT-RJ Coupler	Almond		1278017-1	6374906-1	-
LC Coupler	Blue	A	1457062-1	6457567-4	1695790-4
SC Coupler	Blue	B	5502632-8	1-5502776-1	-
SC to ST Coupling Adapter	Blue	C	5502780-2	5503137-5	-
ST Coupler	Metallic/Blue	D	504021-1	503273-5	-

# Fiber

## Fiber Enclosures

---

### Fiber Enclosure Comparison

#### Q3000

- Highest Feature - Highest manageable density
- Uses blades as user interface
- Addresses termination/MPO applications in same chassis



#### UCP

- High Feature
- Modular cassette solution
- Highest density (96fibers in 1U)



#### TFP

- Medium Feature - Lower density for better connector access
- Modular solution (Unique TE footprint)
- Single chassis for all applications



#### RMG/AMP NETCONNECT

- Modular solution (Industry LGX footprint)
- Single chassis for all applications



# Fiber

## Fiber Enclosures - Q3000

### Fiber Enclosures - Q3000

Q3000 Series Fiber Panels are the latest innovation in the Quareo suite of products. The Q3000 Series fiber enclosure supports applications with high density fiber terminations through simplified access to individual connectors, combined with enhanced cable management features. The Q3000 series accommodates singlemode and multimode LC and MPO connectivity. Q3000 panels are compatible with the Quareo Cross-Connect Frame to provide enhanced density in an accessible yet highly-managed system.

#### FEATURES

- Support IEEE 802.3ae, IEEE 802.3ba, IEEE 802.3z
- Exceed ANSI/TIA-568-C.3 and ISO 11801 Edition 2 cabling system requirements
- OM3/OM4 and OS2
- 19-Inch rack mountable
- Available in 1, 2, and 4RU chassis
- 48-fiber (24 Duplex LC) LC-to-LC or LC-to-MPO blade
- 192-fiber (16 MPO Ports) MPO-to-MPO blade

#### ORDERING INFORMATION

Product Description		Part Number	
Fiber Enclosures - Q3000	Q3000 series chassis	Q3200; 1RU (1.75" x 19" x 15"), accommodates 2 blades	QUCH-1RU
		Q3400; 2RU (3.5" x 19" x 15"), accommodates 4 blades	QUCH-2RU
		Q3800; 4RU (7" x 19" x 15"), accommodates 8 blades	QUCH-4RU
	Front door kits	Q3200; 1RU	QDR-1RU
		Q3400; 2RU	QDR-2RU
		Q3800; 4RU	QDR-4RU
Blank blade cover	For covering unused slots in Q3000 or Q4000 chassis	QBCB-HR	
Q3000 Blades	LC to LC; 24 Port Duplex LC (48-fiber), LC-to-LC	OM3/OM4 Multimode LC-LC blade	QUFB-48FDLCLMMHR
		Singlemode LC-LC blade	QUFB-48FDLCLSMHR
	LC to MPO; 24 Duplex LC ports (48-fibers) distributed from 2 each 12 fiber MPO connectors	OM3/OM4 Multimode LC-MPO elite blade Multimode (OM3/OM4) Loss (<0.5 dB) @ 850 nm/1300 nm	QUFB-48FDLCMM3HR
		Singlemode ultra polish LC-MPO elite blade Singlemode Loss (<0.75 dB) @ 1310 nm/1550 nm	QUFB-48FDLCMSMHR
	MPO to MPO; 16 MPO ports with 12-fibers each	OM3/OM4 Multimode MPO-MPO elite blade	QUFB-192FMPOMMHR
		Singlemode MPO-MPO blade	QUFB-192FMPOS MHR



Q3200; 1RU



Q3400; 2RU



Q3800; 4RU



LC-LC Blade



LC-MPO Blade



MPO-MPO Blade

# Fiber

## Fiber Enclosures – Universal Connectivity Platform

### Universal Connectivity Platform – A Modular Approach to Infrastructure Design

TE Connectivity's Universal Connectivity Platform (UCP) provides a fully modular approach to designing data centers and telecommunications rooms. This patch panel is ideal for rapidly evolving environments because it supports both TE's plug-and-play copper and fiber solutions.

TE's UCP enables business transformation by virtue of its modularity. It is designed to accommodate all of TE's cabling media, whether copper or fiber, to support the 10, 40 and 100 Gigabit network connections in a single patch panel. By simply selecting the media, network equipment can be changed in a controlled fashion as the network demands.

Rack space is always a premium in the data center or telecommunications room, especially in existing infrastructure. The UCP is designed with this in mind, incorporating maximum flexibility for different needs and architecture. The panels can be installed in a 19 inch cabinet/rack, or installed overhead or under raised floors. By moving the panels overhead or under the floor, they can be easily shared between cabinets/racks.

Data Centers and co-location sites have undergone radical changes over the past few years and will again in the future. TE's Universal Connectivity Platform helps network managers address this change by delivering added flexibility and scalability.



#### FEATURES

- Multimedia Quick-Fit configurations accommodate both copper and fiber
- Compatible with MPOptimate multimode (OM3/OM4) and singlemode (OS1/OS2) fiber media
- Compatible with U/UTP, F/UTP and S/FTP copper media
- Can be installed inside a cabinet/rack, to a wire basket or under a raised floor
- Scalable to meet all applications from 100 Mbps to 100 Gbps including high-density 10 Gbps deployments

# Fiber

## Fiber Enclosures – Universal Connectivity Platform

### UCP Patch Panel

#### FEATURES

- 19" 1RU unloaded modular patch panel with 4 Quick-Fit cutouts
- Modular rear cable bracket to manage and bundle different media cabling



Description	Part Number
UCP Patch Panel 1RU Flush; includes grounding bolt	1-1671594-1

### UCP Drawer Style Enclosure

#### FEATURES

- 19" 1RU enclosure with 4 Quick-Fit cutouts
- Mounting bracket for flush or recessed mounting



Description	Part Number
1RU Drawer style Enclosure	1933443-1

### Zero RU Quick-Fit Bracket

#### FEATURES

- Bracket designed for copper and fiber Quick-Fit cassettes and modules
- 5" horizontal clearance required



Description	Part Number
Zero RU Quick-Fit Bracket; includes grounding bolt	1-1671548-1

# Fiber

## Fiber Enclosures – Universal Connectivity Platform

### MRJ21 Quick-Fit Cassettes

Compatible with MRJ21 cable assemblies for superior performance.

#### FEATURES

- Factory terminated and tested
- Available in 1GbE and 10GbE
- High-density
  - 48 ports 1RU 1000 BASE-T
  - 32 Ports 1RU 10 GBASE-T
- Integrated bonding

Description	Part Number
MRJ21 XG Quick-Fit cassette for 10GBase-T	2153115-1
MRJ21 Quick-Fit cassette for 1000BaseT	1711970-1



10 GbE



1 GbE

### STP and UTP Quick-Fit Modules

#### FEATURES

- Accommodates CAT 5e, 6, 6A SL jacks
- STP version has integrated bonding
- Labels included

Description	Part Number
STP Quick-Fit module	2111093-1
UTP Quick-Fit module	2111117-1
Blank Module; used to close unused cut-outs in panels	1479698-1



Quick-Fit Module



Blank Module

# Fiber

## Fiber Enclosures – Universal Connectivity Platform

FIBER

### MPOptimate to LC 10 Gigabit Quick-Fit Cassettes

#### 12-Fiber Trunking Solutions

##### FEATURES

- Factory terminated and tested
- Front: 6 x LC Duplex or 6 x LC Quad  
Back: one or two 12 fiber MPO or MPOptimate connector(s)
- Available in OS2, OM3 or OM4 MPOptimate
- Port number labeling and additional label strip included
- Part numbers noted are Straight Polarity. Other polarities are available upon request



LC Duplex

Description	Fiber Type	Fiber Count	Part Number
LC duplex	50 μm, MM, OM3	12	1671205-3
	9 μm, SM, OS2	12	1671205-4
	50 μm, MM, OM4 MPOptimate	12	1671226-5
LC quad	50 μm, MM, OM3	24	1671206-3
	9 μm, SM, OS2	24	1671206-4
	50 μm, MM, OM4 MPOptimate	24	1671227-5

### MPOptimate to LC 10 Gigabit Quick-Fit Cassettes

#### 24-Fiber Trunking Solutions

##### FEATURES

- Factory terminated and tested
- Front: 12 x LC Duplex  
Back: 1 x 24 fiber MPO connector
- Available in OM4 MPOptimate
- Port number labeling and additional label strip included



LC Quad

Description	Part Number
Cassette OM3 Straight A-A/B-B	2160266-3
Cassette OM3 Polarity Flipped A-B/B-A	1-2160266-3
Cassette OM4 Straight A-A/B-B	2160266-5
Cassette OM4 Polarity Flipped A-B/B-A	1-2160266-5



# Fiber

## Fiber Enclosures – Universal Connectivity Platform

### MPOptimate 40 Gigabit Quick-Fit Cassettes

#### FEATURES

- Factory terminated and tested
- Front: 6 x 8-fiber MPO connectors  
Back: 2 x 24 fiber MPO connector
- MPOptimate
- Port number labeling and additional label strip included
- Fiber path for part numbers noted is Polarity “A” or Polarity “B”



6x 40G Cassette

Description	Part Number
Cassette OM4 Straight A-A/B-B	2160530-5
Cassette OM4 Polarity Flipped A-B/B-A	1-2160530-5

### MPO/MPOptimate Quick-Fit Module

#### FEATURES

- Quick-Fit modules with 6 or 12 MPO couplers
- Compatible with 10/40/100 Gbps MPO trunks and arrays
- Port number labeling and additional label strip included
- MPO coupler joins MPO pinned to non-pinned connectors



6x MPO Coupler Module

Description	Part Number
6x MPO coupler module; black	1671200-1
12x MPO coupler module	1711987-1

### Quick-Fit Fiber Modules

#### FEATURES

- Available in LC and SC configurations
- Available in singlemode and multimode

Description	Fiber Type	Ferrule	Color	Part Number
12 Fiber LC	OM3/OM4	Ceramic	aqua	0-1671196-3
12 Fiber LC	SM	Ceramic	blue	0-1671196-1
24 Fiber LC	OM3/OM4	Ceramic	aqua	0-1671202-3
24 Fiber LC	SM	Ceramic	blue	0-1671202-1
12 Fiber SC	OM3/OM4	Ceramic	aqua	1671201-3
12 Fiber SC	SM	Ceramic	blue	1671201-1



12 Fiber LC



24 Fiber LC

# Fiber

## Fiber Enclosures – Universal Connectivity Platform

FIBER

### Vertical Panel Mounting Brackets

#### FEATURES

- Fully flexible system for installing 19" panels vertically outside of the 19" area
- Available in 1RU

Description	Part Number
1RU Vertical Panel Mounting Brackets	1-1671549-1



### Subfloor Panel Holder Kit

#### FEATURES

- Fully flexible system for installing 19" panels underneath cabinets/racks in raised floor environments
- Pedestal distance maximum 24"
- The clamping range varies from 0.6" up to 1.2"
- Pedestal can be round or square
- Available in 2RU

Description	Part Number
Subfloor Panel Holder Kit 2RU	1671189-2



### Aerial Panel Holder Kit for Wire Mesh Cable Trays

#### FEATURES

- Fully flexible system for installing 19" panels above cabinets/racks attached to wire mesh cable trays
- Available in 2RU

Description	Part Number
Aerial Panel Holder Kit (2RU)	1-1671603-1



Note:

For information on Copper and Fiber cable assemblies visit [www.te.com/EnterpriseNetworks](http://www.te.com/EnterpriseNetworks) to view the below documents. Fiber trunk assemblies and patch cords, see document numbers 402-1007 and 402-1008.

# Fiber

## Fiber Enclosures - TFP

### Fiber Enclosures - TFP Series Rack Mount Fiber Panels

The rack mount TrueNet Fiber Panel (TFP) is an integral part of TE's fiber product portfolio. The TFP fiber panels can be ordered in one, two, four and five rack unit sizes and are completely modular to configure to a variety of applications. The unique modular adapter packs incorporate an angled adapter design to allow easy access to each port and superior cable management and bend radius protection.

#### FEATURES

- TFP panels combine the unique features of vertical cable guides and angle-left/angle-right adapters, offering bend radius protection, intuitive routing and easy connector access
- Rear access makes field termination or splicing fast and efficient. 1RU and 2RU versions feature convenient sliding access to terminations and splicing
- Sold separately for maximum flexibility with minimum lead time, TFP adapter packs can also be pre-configured at the factory for more efficient service turn-up
- 288-position high-density termination/splice in the space of just five rack units (8.75-inch)
- Panels are equipped with adjustable mounting brackets to provide either 19- or 23-inch rack or cabinet mounting (EIA or WECCO) as well as 4- or 5-inch recess mounting
- Field-installable vertical cable guides on either side of the panel provide bend radius protection and management of fibers exiting the panel

#### APPLICATIONS AND BENEFITS

- Best suited for rack or cabinet mounting in horizontal and equipment distribution areas
- Modularity, functionality and density make the TFP ideal for mounting in close proximity to servers, switches, routers and SANs



# Fiber

## Fiber Enclosures - TFP

### TFP Empty Chassis

#### ORDERING INFORMATION

Termination only rack or cabinet mount, Black	Dimensions	Part Number
1RU empty panel, black; accommodates 1 angle LEFT and 1 angle RIGHT adapter packs; T-handle latch close	1.75"	TFP-1TT00-000B
2RU empty panel, black; accommodates 2 angle LEFT and 2 angle RIGHT adapter packs; T-handle latch close	3.50"	TFP-2TT00-000B
4RU empty panel, black; accommodates 4 angle LEFT and 4 angle RIGHT adapter packs; T-handle latch close	7.00"	TFP-4TT00-000B
5RU empty panel, black; accommodates 6 angle LEFT and 6 angle RIGHT adapter packs; T-handle latch close	8.75"	TFP-5TT00-000B



#### Accessories

Heat Shrink Fusion Splice Tray (Splice Tray Capacity: 48 fibers)	FST-HS-48
Velcro Kit for Splice Tray	TFP-VELSTP
Blank plates	TFP-00AP00

### TFP Series Rack Mount Fiber Panels

#### GENERAL SPECIFICATIONS

Maximum Density	1RU	2RU	4RU	5R
LC Connector:	48	96	192	288
SC Style Connector:	24	48	96	144
Adapter Pack Configuration:	2 modular adapter packs: 1 Angle right/ 1 Angle left	4 modular adapter packs: 2 Angle right/ 2 Angle left	8 modular adapter packs: 4 Angle right/ 4 Angle left	12 modular adapter packs: 6 Angle right/ 6 Angle left

# Fiber

## Fiber Enclosures - TFP

### TFP Product Overview

<b>Recommended Applications</b>	Multi-purpose high-density modular solution ideal for cabinet or rack mount applications near servers, switches, routers and SANS
<b>Description</b>	Termination, termination/splice
<b>Chassis sizes</b> in rack units	1, 2, 4, and 5
<b>Termination only capacity using:</b>	
Simplex adapters	24, 48, 96, 144
Duplex adapters	24, 48, 96, 144
Small form factor (LC)	48, 96, 192, 288
<b>Flexibility/ability to grow</b>	Ideal for growth
<b>Interconnect</b>	Yes
<b>Cross-connect</b>	Yes
<b>Accommodates on-frame splicing</b>	Yes. Built-in
<b>Rear access</b>	Yes
<b>All-front-access</b>	No
<b>Customer premises application</b>	Ideal
<b>19" mounting</b>	Yes
<b>23" mounting</b>	Yes
<b>Cabinet mount</b>	Yes
<b>Wall mount</b>	No
<b>Mix equipment with fiber product?</b>	Ideal
<b>Vertical cable guide</b>	Ships with every panel
<b>Features at a Glance</b>	Angled left/right adapter packs, highest density with maximum cable management features

### SPECIFICATIONS

<b>Storage/operating temperature:</b>	40 to 85° C (-40° to 185° F)
<b>Approximate weight (empty panel)</b>	
<b>1RU model:</b>	8.25 lbs
<b>2RU model:</b>	10.25 lbs
<b>4RU model:</b>	15.91 lbs
<b>5RU model:</b>	15.86 lbs

# Fiber

## Fiber Enclosures - TFP

### TFP Series Standard Adapter Packs

The TFP series offers a variety of standard modular adapter packs to accommodate most applications. The modular design is user-friendly and offers maximum flexibility to the end-user (for other adapter offerings or adapter packs loaded with pigtails, see the custom configuration section).



TFP Fiber Panel



TFP Adapter Pack

The TFP modular adapter packs can only be used with the TFP series panels. They are not interchangeable with RMG, WMG, FL1000 or FL2000 panels.

### ORDERING INFORMATION

Description	Color	Pack Orientation	Part Number
<b>OM1/OM2 Multimode Adapter Only Packs</b>			
SC duplex adapters, 6 adapters or 12 fiber ports per adapter pack	Beige	Left	TFP-12APLC3
		Right	TFP-12APRC3
LC adapters, 12 adapters or 24 fiber ports per adapter pack		Left	TFP-24APLQ1
		Right	TFP-24APRQ1
<b>OM3/OM4 Multimode Adapter Only Packs</b>			
SC duplex adapters, 6 adapters or 12 fiber ports per adapter pack <sup>1</sup>	Aqua	Left	TFP-12APLC4
		Right	TFP-12APRC4
LC adapters, 12 adapters or 24 fiber ports per adapter pack <sup>1</sup>		Left	TFP-24APLQ2
		Right	TFP-24APRQ2
<b>Singlemode Adapter Only Packs</b>			
SC duplex adapters, 6 adapters or 12 fiber ports per adapter pack	Blue	Left	TFP-12APLC8
		Right	TFP-12APRC8
LC adapters, 12 adapters or 24 fiber ports per adapter pack		Left	TFP-24APLQ5
		Right	TFP-24APRQ5
<b>OM3 Multimode Adapter Packs with Stranded Pigtails</b>			
SC duplex adapters, 6 adapters or 12 fiber ports per adapter pack	Aqua	Left	TFP-12APLC4DE3
		Right	TFP-12APRC4DE3
LC adapters, 12 adapters or 24 fiber ports per adapter pack		Left	TFP-24APLQ2DE3
		Right	TFP-24APRQ2DE3
<b>OM4 Multimode Adapter Packs with Stranded Pigtails</b>			
SC duplex adapters, 6 adapters or 12 fiber ports per adapter pack	Aqua	Left	TFP-12APLC4FE3
		Right	TFP-12APRC4FE3
LC adapters, 12 adapters or 24 fiber ports per adapter pack		Left	TFP-24APLQ2FE3
		Right	TFP-24APRQ2FE3
<b>Singlemode Adapter Packs with Stranded Pigtails</b>			
SC UPC duplex adapters, 6 adapters or 12 fiber ports per adapter pack	Blue	Left	TFP-12APLC8SB3
		Right	TFP-12APRC8SB3
LC UPC adapters, 12 adapters or 24 fiber ports per adapter pack		Left	TFP-24APLQ5SB3
		Right	TFP-24APRQ5SB3

<sup>1</sup> TE Connectivity recommends the use of aqua colored adapters with laser-optimized multimode fiber for 10 Gigabit applications for circuit identification.

# Fiber

## Fiber Enclosures - TFP

### TFP Custom Adapter and Preterminated Adapter Packs

TE Connectivity's TFP modular adapter packs are available to be shipped from the factory with preterminated 3 meter pigtailed or in non-standard ST or SC adapter only configurations. These custom configurations can simplify the ordering process and reduce installation time and cost for the end-user. Please note, these products are non-standard or custom configurations based on the end-user's needs.

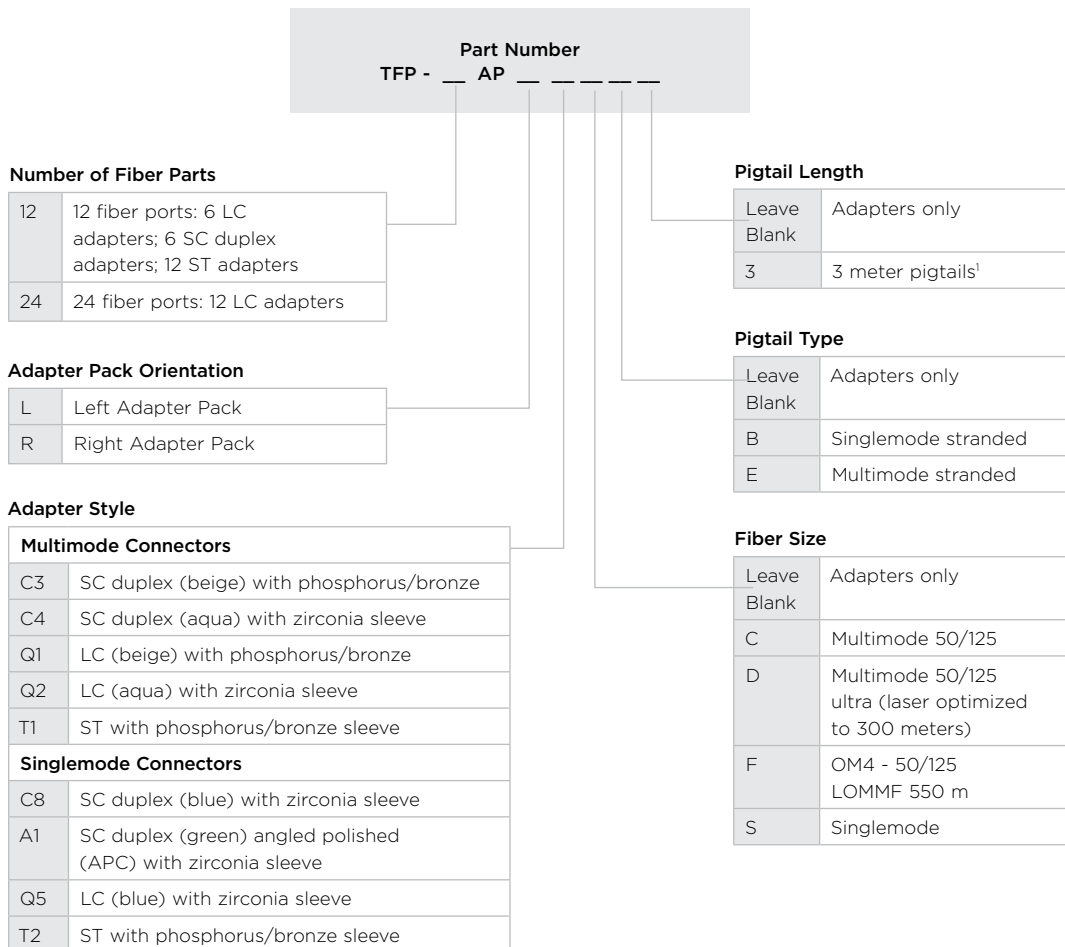

<sup>1</sup>Note: Adapter packs with pigtailed come automatically as a left/right pair. This is to ensure the color order scheme is correct on both the angled left and angled right sides. Please use the configurator to select the correct adapter pack style and count; a left and right version will be shipped.

# Fiber

## Fiber Enclosures - TFP

### TFP Pre-configured Termination/Splice Fiber Panels

TE Connectivity's TFP series fiber panels are available to be shipped with factory installed adapter packs and/or preterminated pigtail assemblies which simplifies the ordering process and reduces installation and costs. These products are non-standard or custom configurations based on the end-user's needs.

FIBER

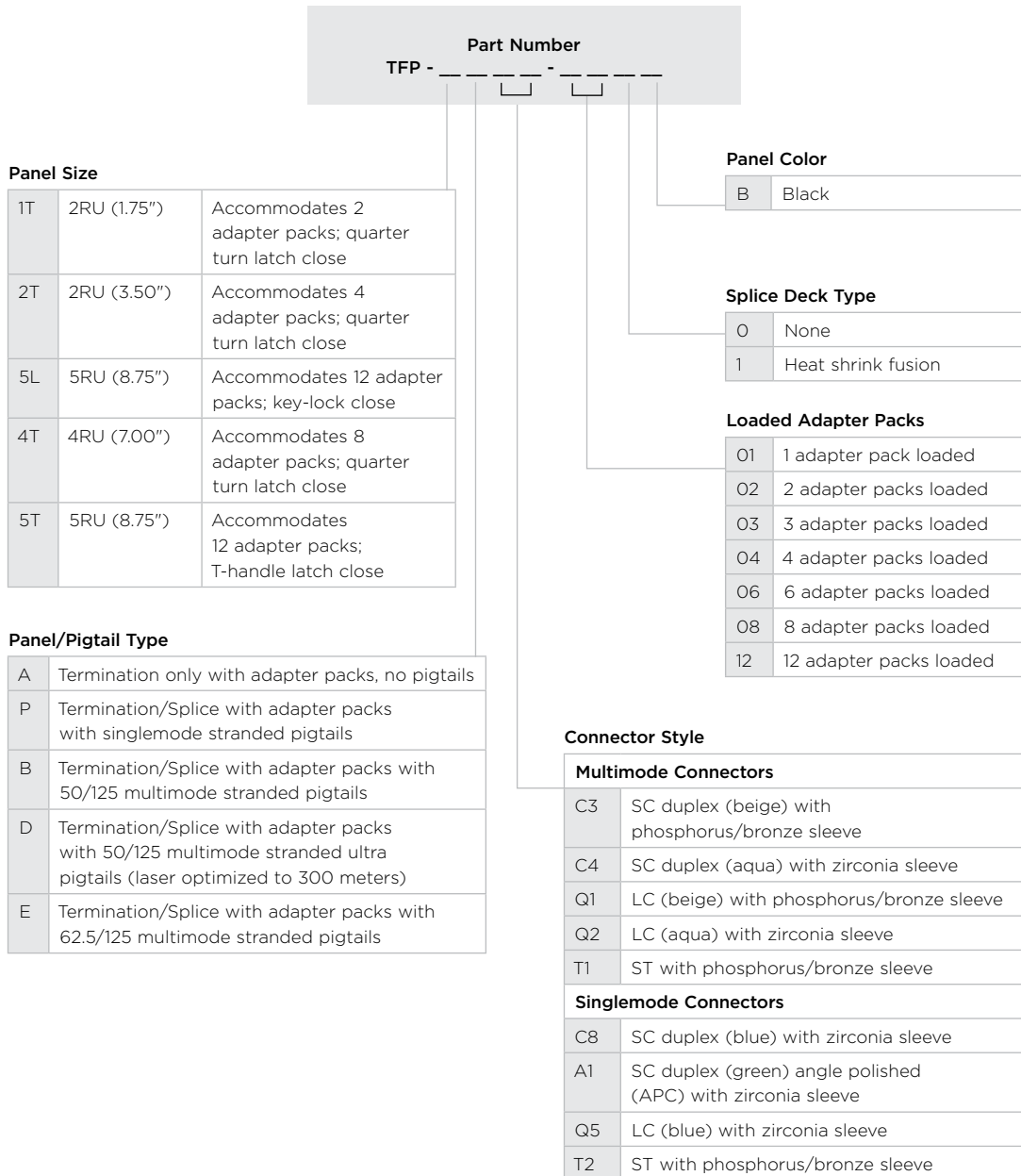



# Fiber

## Fiber Enclosures - TFP

### TFP Plug-and-Play Cassettes

TE's TrueNet Fiber Panels (TFP) combine the unique features of vertical cable guides and our patented angle-left/angle-right adapters, which offer bend radius protection, intuitive routing and easy connector access. Our TFP series can be ordered in one, two, four or five rack-unit sizes to fit your unique needs. Designed for rack or cabinet mounting in the horizontal or equipment distribution area, the TFP's modularity, functionality and density make them ideal for mounting in close proximity to servers, switches, routers and SANs.

The TFP's functionality can be extended with its plug-and-play angled cassettes, which add up to 24-fiber terminations each for jumper management in SANs-rich environments. These cassettes snap into place effortlessly; and even come from the factory pre-labeled with simple installation instructions.



#### FEATURES

- Eliminates the need for on-site fiber terminations, which means rapid deployments
- Incorporates angle-left/angle-right adapters to ensure proper bend radius
- Uses the same 1, 2, 4, and 5 rack unit standard TFP chassis, which simplifies ordering

#### ORDERING INFORMATION

Description	Part Number	
<b>Termination only rack or cabinet mount panel, black</b>		
1RU empty panel, black; accommodates 2 plug-and-play cassettes; T-handle latch close	TFP-1TT00-000B	
2RU empty panel, black; accommodates 4 plug-and-play cassettes; T-handle latch close	TFP-2TT00-000B	
4RU Termination only empty chassis, accommodates 8 TFP modular adapter packs; black	TFP-4TT00-000B	
5RU empty panel, black; accommodates 12 plug-and-play cassettes; T-handle latch close	TFP-5TT00-000B	
<b>Plug-and-Play Cassettes</b>		
<b>OM3 - 50/125 LOMMF 300 m</b>		
12-fiber cassettes; 6 LC (aqua) to 1 MPO adapter	Angle <b>LEFT</b> cassette	TFP-12MPLDQ2
	Angle <b>RIGHT</b> cassette	TFP-12MPRDQ2
24-fiber cassettes; 12 LC (aqua) to 2 MPO adapters	Angle <b>LEFT</b> cassette	TFP-24MPLDQ2
	Angle <b>RIGHT</b> cassette	TFP-24MPRDQ2
<b>OM4- 50/125 LOMMF 550 m</b>		
12-fiber cassettes; 6 LC (aqua) to 1 MPO adapter	Angle <b>LEFT</b> cassette	TFP-12MPLFQ2
	Angle <b>RIGHT</b> cassette	TFP-12MPRFQ2
24-fiber cassettes; 12 LC (aqua) to 2 MPO adapters	Angle <b>LEFT</b> cassette	TFP-24MPLFQ2
	Angle <b>RIGHT</b> cassette	TFP-24MPRFQ2
<b>Singlemode</b>		
12-fiber cassettes; 6 LCUPC to 1 MPO adapter	Angle <b>LEFT</b> cassette	TFP-12MPLSQ5
	Angle <b>RIGHT</b> cassette	TFP-12MPRSQ5
24-fiber cassettes; 12 LCUPC to 2 MPO adapters	Angle <b>LEFT</b> cassette	TFP-24MPLSQ5
	Angle <b>RIGHT</b> cassette	TFP-24MPRSQ5

# Fiber

## Fiber Enclosures - TFP

FIBER

### TFP Plug-and-Play Cassettes

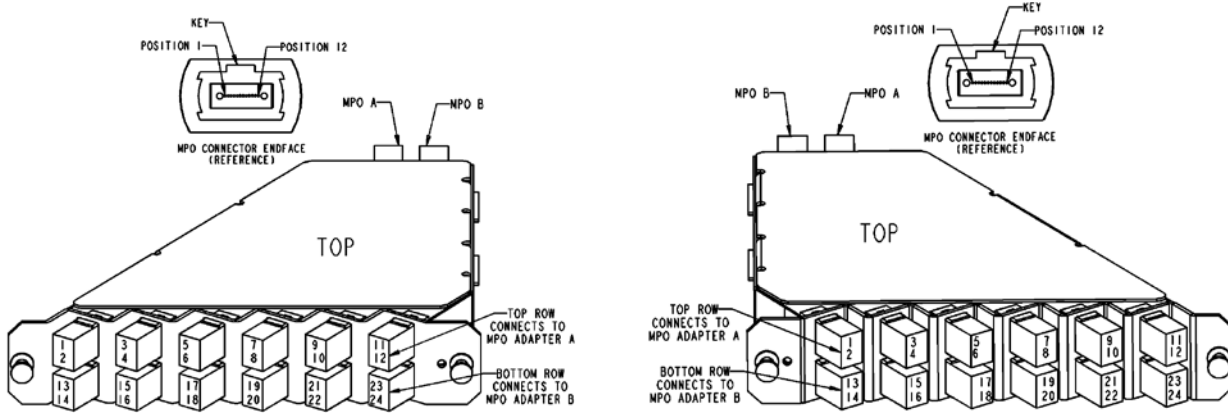

#### Angle Left Polarity/Wiring Scheme

MPO - Fiber Position	LC Connector	Fiber Color
MPO-1	LC-1 and LC-13	Blue
MPO-2	LC-2 and LC-14	Orange
MPO-3	LC-3 and LC-15	Green
MPO-4	LC-4 and LC-16	Brown
MPO-5	LC-5 and LC-17	Slate
MPO-6	LC-6 and LC-18	White
MPO-7	LC-7 and LC-19	Red
MPO-8	LC-8 and LC-20	Black
MPO-9	LC-9 and LC-21	Yellow
MPO-10	LC-10 and LC-22	Violet
MPO-11	LC-11 and LC-23	Rose
MPO-12	LC-12 and LC-24	Aqua

#### Angle Right Polarity/Wiring Scheme

MPO - Fiber Position	LC Connector	Fiber Color
MPO-1	LC-2 and LC-14	Blue
MPO-2	LC-1 and LC-13	Orange
MPO-3	LC-4 and LC-16	Green
MPO-4	LC-3 and LC-15	Brown
MPO-5	LC-6 and LC-18	Slate
MPO-6	LC-5 and LC-17	White
MPO-7	LC-8 and LC-20	Red
MPO-8	LC-7 and LC-19	Black
MPO-9	LC-10 and LC-22	Yellow
MPO-10	LC-9 and LC-21	Violet
MPO-11	LC-12 and LC-24	Rose
MPO-12	LC-11 and LC-23	Aqua

# Fiber

## Fiber Enclosures - TFP

### Panel Configurations

#### SPECIFICATION

TFP series chassis utilize modular adapter packs which are unique to either the right or left position of the chassis. The left/right position must be specified to ensure proper adapter orientation and color order in the backplane. Information below illustrates the various configurations for the three TFP chassis.

##### 1RU Chassis

MPL	MPR
-----	-----

##### 2RU Chassis

MPL	MPR
MPL	MPR

##### 4RU Chassis

MPL	MPR
MPL	MPR
MPL	MPR
MPL	MPR

##### 5 RU Chassis

MPL	MPR
MPL	MPR
MPL	MPR
MPL	MPR
MPL	MPR
MPL	MPR

MPL = angle left plug-and-play cassette  
 MPR = angle right plug-and-play cassette

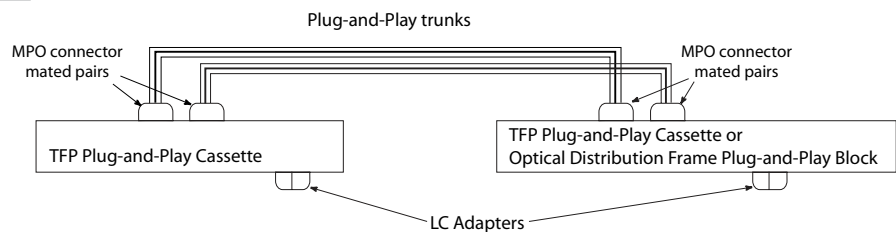

#### OPTICAL SPECIFICATIONS

MODULE LOSS (MEASURED THROUGH MPO MATED PAIR TO LC ADAPTER):	850 NM	1310 NM
<b>INSERTION LOSS:</b>		
<b>Maximum:</b>	0.5 dB	0.55 dB
<b>Typical:</b>	0.25 dB	0.25 dB
<b>RETURN LOSS:</b>		
<b>Maximum:</b>	—	-55 dB
<b>TRUNK LOSS (PER METER):</b>		
<b>Maximum:</b>	.0035 dB	.001 dB
<b>CHANNEL/LINK LOSS with 31 m trunk (100') as in figure above:</b>		
<b>Maximum:</b>	1.1085 dB	1.131 dB
<b>Typical:</b>	0.6085 dB	0.531 dB

#### ENVIRONMENTAL CHARACTERISTICS

<b>Storage Temperature:</b>	-40° to 70° C	(-40° to 158° F)
<b>Operating Temperature:</b>	0° to 70° C	(32° to 158° F)
<b>Installation Temperature:</b>	0° to 70° C	(32° to 158° F)

# Fiber

## Fiber Enclosures - TFP

### TFP MPO Pack

TE introduces an MPO adapter pack for the TFP series fiber panel enclosures. This unique adapter pack contains 6 MPO adapters to terminate 6 (12 fiber) MPO trunks in each one. Due to their high density, the MPO adapter packs are only available for the 1 and 2RU TFP chassis. With the use of these adapter packs, the 1RU will hold 144 fiber terminations, and the 2RU will hold 288 terminations.



The TFP MPO adapter pack is ideally suited for applications with high-density switches, where the additional loss of the MPO cassette is not desired. Either the microcable trunks or high count plug-and-play trunks can be terminated in the back of the adapter pack and a plug-and-play array cable can be terminated in the front of the adapter pack.

### FEATURES

- Provides higher density in 1, 2RU TFP chassis by terminating 12 fibers in each adapter
- Limits insertion loss for loss sensitive optical budgets
- Unique angle right/angle left design allows for optimal management of the array cables off the front of the panel

### ORDERING INFORMATION

Description	Part Number
<b>Termination Only Rack Mount Panel</b>	
1RU empty panel, black; accommodates 2 modular adapter packs; T-handle latch close	TFP-1TT00-000B
2RU empty panel, black; accommodates 24 modular adapter packs; T-handle latch close	TFP-2TT00-000B
<b>MPO adapter pack</b>	
Contains 6 MPO adapters; can be installed in either left or right position	TFP-72APOMP
<b>Cable Clamp</b>	
For use with 1/2RU chassis with high fiber count trunk applications	TFP-ACC002

# Fiber

## Fiber Enclosures - RMG/AMP NETCONNECT

### Fiber Enclosures – RMG/AMP NETCONNECT Series Fiber Enclosures

TE introduces the RMG/AMP NETCONNECT series of rack mount fiber enclosures as an integral part of the TE's product portfolio. The RMG/AMP NETCONNECT series fiber enclosure provides rugged and durable protection for patching or splicing of fiber cables. Especially designed to be user friendly, the slide-out design and removable front and rear panels provide convenient access points.

TE's RMG/AMP NETCONNECT series offers a cost effective and high-density rack mount fiber enclosure in one, two and four rack unit sizes. Its modular design and flexible configurations make it very user friendly and easy to install.



FIBER

#### FEATURES

- 1RU and 2RU units contain sliding and removable front and rear access panels, providing convenient access points
- Designed for 48.26 cm (19 inch) EIA rack or cabinet environment; optional brackets to accommodate 58.42 cm (23 inch) rack or cabinet mounting
- Density: up to 72 terminations in 1RU
- Low profile design with higher density for space limited applications
- User friendly design utilizing industry standard LSX/LGX modular adapter packs
- Side and rear cable entry points on back of panel supports a wide range of deployment applications

### RMG/AMP NETCONNECT Empty Panels

#### ORDERING INFORMATION

Description	Panel Height	Part Number
<b>Rack or Cabinet Mount Panel, black</b>		
1RU empty panel; accommodates 3 modular adapter packs; black	4.45 cm (1.75")	RMG-1000-000B
2RU empty panel; accommodates 6 modular adapter packs; black	8.89 cm (3.50")	RMG-2000-000B
4RU empty panel; accommodates 12 adapter packs; also includes cable management bracket and cable clamp; black	17.78 cm (7.00")	RMG-4000-000B
<b>Accessories</b>		
Cable Clamp Kit (for 1RU and 2RU)		RMG-ACC001
Blank Plates		RMG-00ADPO0
<b>Splice Tray</b>		
Heat shrink fusion (Splice Tray Capacity: 24 fibers)		FST-DV-HS
Mechanical (Splice Tray Capacity: 24 fibers)		FST-DV-MT
<b>Extender Brackets; 48.26 cm (19" - 23")</b>		
1RU		EB-17B
2RU		EB-35B
Q-Frame 4RU Mounting Bracket		RMG-ACCQBRKT4RU

# Fiber

## Fiber Enclosures - RMG/AMP NETCONNECT

FIBER

### RMG/AMP NETCONNECT Product Overview

<b>Recommended Applications</b>	Multi-purpose high-density modular solution ideal for telecommunications closets or to terminate incoming fiber trunks
<b>Description</b>	Termination, termination/splice
<b>Chassis sizes (in rack units)</b>	1, 2, and 4
<b>Termination only capacity using:</b>	
Simplex adapters	18, 36, 72
Duplex adapters	36, 72, 144 (includes standard LC)
Small form factor (LC)	72, 144, 288 (using quad LC)
<b>Flexibility/ability to grow</b>	Ideal for growth
<b>Interconnect</b>	Yes
<b>Cross-connect</b>	No
<b>Accommodates on-frame splicing</b>	Yes. Built-in
<b>Rear access</b>	Yes
<b>All-front-access</b>	Yes
<b>Customer premises application</b>	Ideal
<b>19" mounting</b>	Yes
<b>23" mounting</b>	Yes, with separate extender bracket
<b>Cabinet mount</b>	Yes
<b>Wall mount</b>	No
<b>Mix equipment with fiber product?</b>	Ideal
<b>Vertical cable guide</b>	No
<b>Features at a Glance</b>	Limited cable management, high density with features and price comparable to traditional LGX style panels.

### RMG/AMP NETCONNECT SPECIFICATIONS

**Storage/operating temperature:** -40° C to 85° C (-40° F to 185° F)

**Approximate weight (empty panel)**

**1RU model:** 5.44 Kg (12 lbs)

**2RU model:** 5.90 Kg (13 lbs)

**4RU model:** 6.80 Kg (15 lbs)

**Configuration options and capacity**

**Termination only**

**1RU maximum density<sup>1</sup>:** 72 terminations

**2RU maximum density<sup>1</sup>:** 144 terminations

**4RU maximum density<sup>1</sup>:** 288 terminations

**Termination/splice**

**1RU maximum density:** 36 terminations

**2RU maximum density:** 72 terminations

**4RU maximum density:** 144 terminations

<sup>1</sup>Maximum density achieved using quad LC connectors.

# Fiber

## Fiber Enclosures - RMG/AMP NETCONNECT

### RMG/AMP NETCONNECT Maximum Capacity by Adapter Style and Chassis Height

#### TERMINATION ONLY APPLICATION

Chassis Height (in Rack Units)/ Application	Maximum Number of Fiber Terminations in Chassis	Maximum Number of Adapter Packs per Chassis	Number of Fiber Terminations per Adapter Pack	Adapter Style
1	18	3	6	Simplex SC, ST
1	36	3	12	Duplex SC, standard LC,
1	72	3	24	Quad LC
2	36	6	6	Simplex SC, ST
2	72	6	12	Duplex SC, standard LC,
2	144	6	24	Quad LC
4	72	12	6	Simplex SC, ST
4	144	12	12	Duplex SC, standard LC,
4	288	12	24	Quad LC

#### TERMINATION/SPLICE APPLICATION

Chassis Height (in Rack Units)/ Application	Maximum Number of Fiber Terminations in Chassis	Maximum Number of Adapter Packs per Chassis	Number of Fiber Terminations per Adapter Pack	Adapter Style
1	18	3	6	Simplex SC, ST
1	36	3	12	Duplex SC, standard LC,
1	48	2	24	Quad LC
2	36	6	6	Simplex SC, ST
2	72	6	12	Duplex SC, standard LC,
2	96	4	24	Quad LC
4	72	12	6	Simplex SC, ST
4	144	12	12	Duplex SC, standard LC,
4	144	12	24	Quad LC

# Fiber

## Fiber Enclosures - RMG/AMP NETCONNECT

### Unloaded Rack Mount Patch Enclosures

Snap-in adapter plates or MPO cassettes sold separately

#### 1U enclosure 1657014 features:

- Heavy duty, smooth operating, slide mounting brackets
- Clear, removable top cover
- Flush mounting
- Holds 2 splice trays (sold separately) P/N: 1639192-1 (package of two)
- Fits standard TIA 19-inch racks

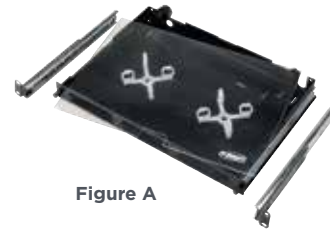

Figure A

#### 2U, 3U and 4U Enclosures feature:

- Removable front and rear covers for easy access and installation
- Front and rear fiber/cable management rings
- Edge guard on front cable entries for cable assembly protection
- Forward, flush or recessed mounting
- Fits standard TIA 19" and 23" racks
- Standard Cable Enclosure includes cable strain relief
- Enclosures shown loaded for reference only



Figure B



Figure C



Figure D

### ORDERING INFORMATION

Height	Compatible Racks	Capacity		Recommended Cable Types	Figure	Part Number
		Adapter Plates	Cassettes			
1U (1.75")	19"	3	3	Standard	A	1-1657014-7
2U (3.50")	19" or 23"	4	4	Standard	B	559542-2
3U (5.25")	19" or 23"	8	8	Standard	C	559614-2
4U (7.00")	19" or 23"	12	12	Standard	D	559552-2

### Unloaded Rack Mount Patch Enclosure Fiber Densities

Enclosure	Fully Loaded Density	6-Fiber Adapter Plates	12-Fiber Adapter Plates or MPO Cassettes	24-Fiber Adapter Plates or MPO Cassettes
1U Enclosures	Fiber Density	18	36	72
	Duplex Port Density	9	18	36
2U Enclosures	Fiber Density	24	48	96
	Duplex Port Density	12	24	48
3U Enclosures	Fiber Density	48	96	192
	Duplex Port Density	24	48	96
4U Enclosures	Fiber Density	72	144	288
	Duplex Port Density	36	72	144



# Fiber

## Fiber Enclosures - RMG/AMP NETCONNECT

### RMG/AMP NETCONNECT Adapter Packs

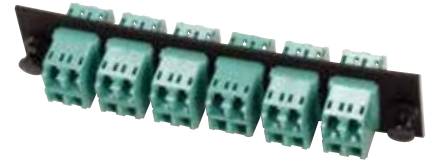

#### ORDERING INFORMATION

Description	Equivalent To Part Number	Part Number
<b>OM1/OM2 Multimode adapter only packs</b>		
LC adapters, beige color 12 duplex adapters or 24 fiber per adapter pack	RMG-24ADPQ3	1435516-2
LC adapters, beige color 6 adapters or 12 fiber per adapter pack	RMG-12ADPQ1	1374463-2
SC duplex adapters, beige color 6 adapters or 12 fiber per adapter pack	RMG-12ADPC3	559596-1
SC adapters, beige color 6 adapters or 6 fiber ports per adapter pack	RMG-06ADPC1	559558-1
ST adapters 6 adapters or 6 fiber ports per adapter pack	RMG-06ADPT1	559557-1
<b>OM3/OM4 multimode adapter only packs<sup>1</sup></b>		
LC adapters, aqua color 12 duplex adapters or 24 fiber per adapter pack	RMG-24ADPQ4	1435516-5
LC adapters, aqua color 6 adapters or 12 fiber per adapter pack	RMG-12ADPQ2	1374463-5
SC duplex adapters, aqua color 6 adapters or 12 fiber per adapter pack	RMG-12ADPC4	559596-6
SC adapters, aqua color 6 adapters or 6 fiber ports per adapter pack	RMG-06ADPC2	559558-6
<b>Singlemode (UPC) adapter only packs</b>		
LC UPC adapters, blue color 12 duplex adapters or 24 fiber per adapter pack	RMG-24ADPQ8	1435516-1
LC UPC adapters, blue color 6 adapters or 12 fiber per adapter pack	RMG-12ADPQ5	1374463-1
SC UPC duplex adapters, blue color 6 adapters or 12 fiber per adapter pack	RMG-12ADPC8	559596-2
SC UPC adapters, blue color 6 adapters or 6 fiber ports per adapter pack	RMG-06ADPC7	559558-2
ST UPC adapters 6 adapters or 6 fiber ports per adapter pack	RMG-06ADPT2	559515-2

<sup>1</sup> TE recommends the use of aqua colored adapters with laser-optimized multimode fiber for 10 Gigabit applications for circuit identification.

# Fiber

## Fiber Enclosures - RMG/AMP NETCONNECT

FIBER

### Custom Modular Adapter Packs

TE's RMG/AMP NETCONNECT modular adapter pack assemblies can be used in any of the RMG/AMP NETCONNECT series fiber enclosures in a variety of connector styles and with or without preterminated 3 m (9.84') pigtailed. Its modular design is user friendly and easy to install. Use the following matrix to configure the correct catalog number for the application. If the resulting catalog number is not on the standard list, the product is considered custom and may have longer lead times.

#### FEATURES

- Can be ordered with all standard types of duplex multimode and singlemode adapters
- Available with preterminated 3 m (9.84') pigtailed to reduce installation time and cost
- One end of pigtail terminated to chosen connector style and installed into adapter pack plug-in adapters

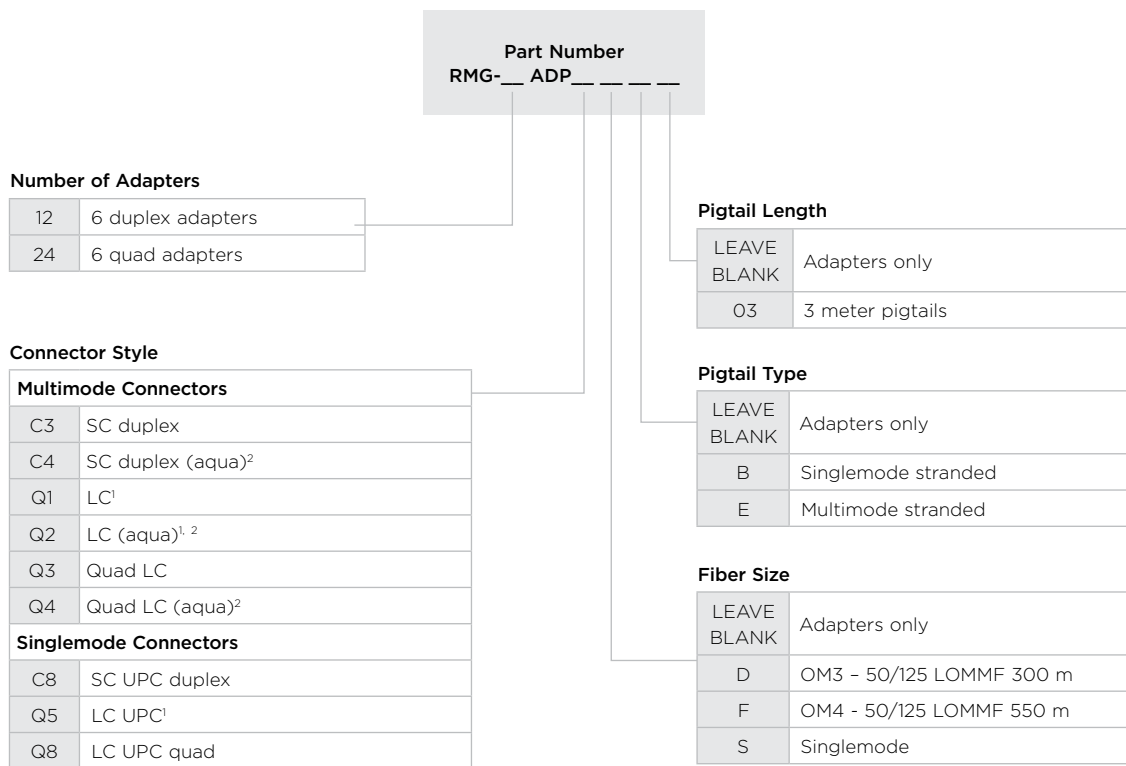

<sup>1</sup> LC adapters terminate two fibers at each adapter and should be considered duplex adapters in this ordering scheme

<sup>2</sup> TE recommends the use of aqua colored adapters with laser optimized multimode fiber applications for 10 Gigabit circuit identification.

# Fiber

## Fiber Enclosures - RMG/AMP NETCONNECT

### RMG/AMP NETCONNECT Plug-and-Play Cassettes\*

#### ORDERING INFORMATION

Description	Fiber Type	Fiber Count	Polarity	Equivalent To	Part Number
LC	OM1	12	Straight		1938059-1
			Flipped		1918781-1
	OM1	24	Straight		1938970-1
			Flipped		1918782-1
	OM2	12	Straight		1938057-1
			Flipped		1918779-1
	OM2	24	Straight		1938968-1
			Flipped		1918780-1
	OM3	12	Straight	RMG-12MPODQ4	1938058-1
			Flipped		1918783-1
	OM3	24	Straight	RMG-24MPODQ4	1938969-1
			Flipped		1918784-1
	OM4	12	Straight	RMG-12MPOFQ4	2193006-1
			Flipped		1553448-1
	OM4	24	Straight	RMG-24MPOFQ4	2193236-1
			Flipped		1553449-1
	SM	12	Straight	RMG-12MPOSQ8	1938060-1
			Flipped		1938056-1
SM	24	Straight	RMG-24MPOSQ8	1938971-1	
		Flipped		1918786-1	
SC	OM1	12	Straight		6435180-1
			Flipped		6435180-2
	OM2		Straight		6435181-1
			Flipped		6435181-2
	OM3		Straight		6754333-1
			Flipped		6754333-2
	SM		Straight		6435069-1
			Flipped		6435069-2
ST	OM1	12	Straight		6278418-1
			Flipped		6278418-2
	OM2		Straight		6435067-1
			Flipped		6435067-2
<b>MPOptimate Performance;</b> (Max Insertion Loss of each cassette is .35dB when tested at 850nm)					
LC	OM3	12	Straight		1920753-1
			Flipped		1-1920753-1
	OM3	24	Straight		1920698-1
			Flipped		1-1920698-1

\*Note:  
 Cassettes come in various options of: Fiber count - 12 or 24 fibers  
 Fiber Types - OM1, OM2, OM3, OM4, SM  
 Polarity - straight or flipped  
 Front-facing connector - LC, SC or ST

See drawings for specifics of any particular part number at: [www.te.com/Enterprise](http://www.te.com/Enterprise)



LC Duplex, 24-fiber  
MPO Cassette

FIBER

# Fiber

## Fiber Enclosures – Core Vertical Switch Management (VSM)

### Core Vertical Switch Management (VSM)

The Core Vertical Switch Management (VSM) platform is an application-driven solution for the unique cabling challenges presented by vertical blade-based core switch systems.

This modular system is designed to efficiently and effectively support deployment of cabling on the front of a Cisco 7010 series chassis.

#### FEATURES

**Cabling routes directly from switch ports to patch panels above the switch** – Frees up space at the sides of the mounting rails for other cabling, more effective air flow and hand access.

**Logical representation of the switch ports and ease of access** – The vertical patch management allows the cabling to be deployed neatly and in the same plane as the blade and port presentation. Patch fields in line with the switch ports simplify installation, MACs, documentation and troubleshooting.

**Single patch cord lengths** – Simplifies Day 2 activities and reduces inventory.

**Simplified blade changeover** – Blades and cabling can be preconfigured away from the switch, dramatically lowering changeover times and the corresponding outages, while greatly reducing patching errors.

**Robust design** – Provides the durability you expect with expanded hand access.

**Designed to support UCP** – Quick-Fit cassettes and modules allow a mix of copper and fiber in the same panel.

**Supports mixed media applications** and migration from fiber to copper in the same chassis.



# Fiber

## Fiber Enclosures – Core Vertical Switch Management (VSM)

### Rack Mount Quick-Fit Panel

#### FEATURES

- Accepts up to 9 Quick-Fit modules
- Including cable support bars with tie down options
- Designed to support UCP Quick-Fit cassettes and modules allow a mix of copper and fiber in the same panel

**Color:** Black and galvanized finish



Rack Mount Quick-Fit Panel



Panel with UCP QuickFit modules

#### ORDERING INFORMATION

Description	Part Number
Rack Mount Quick-Fit Panel	O-1671907-1

### Cable Management Tray

#### FEATURES

- Optimized to replace Cisco Nexus 7010 switch cable manager
- Provides vertical patch cord guiding
- Allows re-use of management front cover

**Color:** Black



#### ORDERING INFORMATION

Description	Part Number
Cable Management Tray for Cisco Nexus 7010	1671633-1

# Fiber

## Fiber Enclosures – Core Vertical Switch Management (VSM)

FIBER

### MRJ21 XG Quick-Fit Cassette 8 Port (10 Gb/s)

#### FEATURES

- Optimized for use in combination with UCP patch panels: plug-and-play deployment
- Compatible with MRJ21 XG cable assemblies for 10 GbE performance
- Front side: 8 x RJ45 jack (2 rows of 4 jacks)
- Rear side: 2 x MRJ21 receptacle
- Factory terminated and tested solution
- NOTE: The MRJ21 XG System for 10 Gb/s is not backwards compatible to the MRJ21 1 Gb/s solution!



#### ORDERING INFORMATION

Description	Part Number
MRJ21 XG Quick-Fit cassette for 10GBase-T	2153115-1

### MRJ21 Quick-Fit Cassette 12 port (1 Gb/s)

#### FEATURES

- Pre-terminated Quick-Fit cassette
- High Performance TP Cabling for guaranteed application performance
- High-density, small form factor connectivity
- Modular solution



#### ORDERING INFORMATION

Description	Part Number
MRJ21 Quick-Fit cassette for 1000Base-T	1711970-1

# Fiber

## Fiber Enclosures – Core Vertical Switch Management (VSM)

### CAT6A F/UTP Cable Assembly

#### FEATURES

- Meets or exceeds the channel specifications of ANSI/TIA-568-C.2 Category
- 6A shielded and Amendment 1 to ISO/IEC 11801:2002 Class EA up to 500 MHz when used as a component in a properly installed TE F/UTP channel
- Meets or exceeds all requirements for IEEE 802.3an 10 GbE
- Clear, flexible, strain relief boot maintains proper bend radius to ensure peak performance
- Non-plenum (CM rated)
- 4-Pair stranded shielded conductors
- Universal wiring (T568A/T568B)
- RoHS compliant

#### ORDERING INFORMATION

Description	Part Number
CAT6A Shielded Cable Assemblies	TCPC-6ARFVB-WTYF*

### CAT5E U/UTP Cable Assembly

#### FEATURES

- Meets and exceeds ANSI/TIA performance requirements for CAT5E
- 4 pair stranded UTP cable
- Slim profile clear plug and boot
- Universal wiring

#### ORDERING INFORMATION

Description	Part Number
Patch cord RJ45 CAT5E UTP, White	TCPC-5ERUVA-WTYF*

\*YY- Denotes footage. More color options are available. Contact TE Customer Service.

# Fiber

## Fiber Enclosures – Core Vertical Switch Management (VSM)

FIBER

### MRJ21 XG to MRJ21 XG cable assemblies (10 Gb/s shielded)

#### FEATURES

- Friendly field installable 10 GbE solution
- Factory terminated and 100% tested solution
- Dense double blade connector with offset jackscrews for latching
- 16 pair shielded cable with AWG 26 solid conductors

**Color:** White



#### ORDERING INFORMATION

Description	Part Number (Y-0000000-X)
MRJ21 XG to MRJ21 XG, 10 Gb/s, 180°-180° back shell; CMR	2111521-X
MRJ21 XG to MRJ21 XG, 10 Gb/s, 180°-45° back shell; CMR	2111522-X

Y- -X	Length
0- -3	3 m
0- -5	5 m
1- -0	10 m
1- -5	15 m
2- -0	20 m
2- -5	25 m
3- -0	30 m
3- -5	35 m
4- -0	40 m

### MRJ21 to MRJ21 cable assemblies (1 Gb/s)

#### FEATURES

- Field installable 1 GbE solution
- Enhanced screening and improved EMC
- Factory terminated and 100% tested solution
- Dense double blade connector with offset jackscrews for latching
- 1.5 to 4 times the port density of 2 x 6 Stacked Mod Jack (RJ-45)
- 24 pair unshielded cable with AWG 24 solid conductors

**Color:** Gray



**MRJ21 180°  
Back Shell**



**MRJ21 45°  
Back Shell**

#### ORDERING INFORMATION

Description	Part Number (Y-0000000-X)
MRJ21 to MRJ21, 1 Gb/s, 180°-180° back shell; straight to straight	2111366-X
MRJ21 to MRJ21, 1 Gb/s, 180°-45° back shell; straight to angled	2111371-X

Y- -X	Length
0- -5	5 m
1- -0	10 m
1- -5	15 m
2- -0	20 m
2- -5	25 m
3- -0	30 m
3- -5	35 m
4- -0	40 m
5- -0	50 m



# Fiber

## Fiber Enclosures – Core Vertical Switch Management (VSM)

### MPOptimate to LC Quick-Fit cassettes

#### FEATURES

- Pre-terminated low loss cassettes
- Front: 6 duplex LC (12 fiber) or 6 Quad receptacles (24 fiber) LC
- Back: 1 or 2 low loss MPOptimate connector(s)
- Available in straight or flipped pair version
- Optical performance for OM3/OM4:  
IL  $\leq$  0.35 dB/cassette (max.)  
RL  $\geq$  27 dB
- Port number labeling and additional label strip included



#### ORDERING INFORMATION

Description	Pairs straight Part Number	Pairs flipped Part Number
1 x MPOptimate to 6 x LC Duplex (12 fiber); OM4 XGA 10 Gb/s	1671226-5	1-1671226-5
1 x MPOptimate to 6 x LC Duplex (12 fiber); OM3 XG 10 Gb/s	1671226-3	1-1671226-3
2 x MPOptimate to 6 x LC Quad (24 fiber); OM4 XGA 10 Gb/s	1671227-5	1-1671227-5
2 x MPOptimate to 6 x LC Quad (24 fiber); OM3 XG 10 Gb/s	1671227-3	1-1671227-3

### MPOptimate coupler Quick-Fit module

#### FEATURES

- Quick-Fit module with 6 or 12 MPO couplers (supporting 72 to 288 fibers)
- Port number labeling and additional label strip included
- Cable assemblies at rear of panel should be non-pinned

**Color:** Black



#### ORDERING INFORMATION

Description	Part Number
6 x MPO coupler module	1671200-1
12 x MPO coupler module	1711987-1

# Fiber

## Fiber Enclosures – Core Vertical Switch Management (VSM)

### MPOptimate LC patch cords

#### FEATURES

- Patch cords with optimized LC connectors
- Cable performance: OM4 or OM3 XG 10 Gb/s



#### ORDERING INFORMATION

Description		Part Number
<b>OM3 and OM4 (50/125 μm) multimode LC cable assemblies</b>	OM3 2.0 mm zipcord LC-LC connectors	PAT-3C3C-P30CxxxM
	OM4 2.0 mm zipcord LC-LC connectors	PAT-3C3C-P40CxxxM
<b>Singlemode LC cable assemblies</b>	OS2 2.0 mm zipcord LC-LC connectors	PAT-LCLC-PS0CxxxM

Note: XXX=length in meters, three digits required (example: 40 meters is 040).

### MPOptimate pre-terminated trunks

#### FEATURES

- Pulling socks and stealth pulling eye protect MPO connectors during installation

**Color:** Aqua



#### ORDERING INFORMATION

MPO Trunk Assemblies	Part Number
<b>OM4 MPO Trunk Assemblies</b>	
OM4 MPO-MPO, 12-fiber 3 mm interconnect, plenum (OFNP) rated	MPT-NCNCJ40xxxF-FF
OM4 MPO-MPO, 24-fiber backbone (2x12) with 3 mm interconnect subunits, OFNP/OFNP	MPT-NCNCD40xxxF-FF
<b>OM3 MPO Trunk Assemblies</b>	
OM3 MPO-MPO, 12-fiber 3 mm interconnect, plenum (OFNP) rated	MPT-NCNCJ30xxxF-FF
OM3 MPO-MPO, 24-fiber backbone (2 x 12) with 3 mm interconnect subunits, OFNR/OFNP	MPT-NCNCD30xxxF-FF
<b>Singlemode Trunk Assemblies</b>	
OS2 Singlemode, 12-fiber, 12-fiber 3 mm interconnect, plenum (OFNP) rated	MPA-NCNCJ50xxxF-FF
OS2 Singlemode, 24-fiber, 24 (2 x 12) Fiber backbone with 3 mm interconnect subunits, plenum (OFNP) rated	MPA-NCNCD50xxxF-FF

Note: XXX=length in feet, three digits required (example: 40 feet is 040).

### MPOptimate patch cords

#### FEATURES

- Connector performance: IL ≤ 0.35 dB (max.); RL ≥ 28 dB
- Available in female/female and male/female version in straight and total flipped wiring
- Additional configurations are available, please see specification 402-1008 on [www.te.com/Enterprise](http://www.te.com/Enterprise)

**Color:** Aqua



#### ORDERING INFORMATION

Description	Part Number
12-Fiber MPO Patch Cord, Polarity A (Type A)	MPT-NCNCJ40xxxM-NN

Note: XXX=length in meters, three digits required (example: 40 meters is 040).

# Fiber

## Fiber Enclosures - Optical Distribution Frame Solutions

---

### Fiber Enclosures – Optical Distribution Frame Solutions

TIA-942 presents the cross-connect architecture as the best practice for Main Distribution Area (MDA). Utilizing a centralized cross-connect frame allows maintenance to be performed without disrupting the cables attached to active equipment. All moves, adds and changes can be performed on the passive cross-connect frame. The benefits of deploying a cross-connect architecture in the MDA include: lower operating costs, enhanced reliability, and a reduced risk of downtime due to poor fiber jumper management.

### Frames

TE developed its innovative Optical Distribution Frame (ODF) for high-fiber count applications. At 2304 terminations in a single frame, its unique, user-friendly design and superior cable management provide enterprise customers an optimum solution to handle applications with high fiber counts such as data centers.

TE's ODF product line is designed to fit a variety of termination, splice, and storage applications. This frame is designed with an emphasis on superior cable management and ease of use, including features such as ample trough space for cable and jumpers, easy access to connectors, and storage for jumpers. The frame sections are shipped from the factory fully equipped with all cable management hardware including a built-in jumper storage panel.

### Fiber Termination Blocks (FTBs)

Fiber Termination Blocks (FTBs) are available with SC adapters in block configurations of 144-positions, and with LC adapters in 144- and 192-positions. FTBs utilize sliding adapter packs to gain easy access to both the front and rear connectors. FTBs can be ordered with adapters only, with factory terminated IFC stubs, or as plug-and-play cassettes.

### Sliding Adapter Packs

Sliding adapter packs house groups of fiber optic adapters and are mounted in fiber termination blocks to provide easy access to connectors. Sliding adapter packs are available with SC and LC adapters. The adapters come in packs of four and six depending on the adapter type and the desired termination density.



FIBER

# Fiber

## Fiber Enclosures - Optical Distribution Frame Solutions

---

### FEATURES

#### Ample Trough Space

- Reduces jumper pile-up and congestion
  - Reduces maintenance time due to easy removal and tracing of jumpers
  - Minimizes risk of microbends or damage to fiber

#### Built-in Jumper Storage Panel

- Minimizes number of required jumper lengths
- Maintains fiber bend radius
- Simplifies frame installation
  - Saves money by reducing the number of different jumper lengths that have to be kept in inventory
  - Minimizes risk of microbends or damage to fiber
- Enclosed system ensures easy cable access without fiber cross-over points

#### Sliding Adapter Packs

- Promotes high density
- Provides easy access to connectors
  - Saves valuable floor space
  - Reduces time required for operations and maintenance

#### Intelligent Cable Routing System

- No fiber cross-over points
- Multiple vertical troughways
  - Reduces maintenance time due to easier removal and tracing of jumpers and minimizes fiber “weaving”

#### Bend Radius Protection at Every Turn

- ODF provides complete bend radius at every turn to ensure network performance and reliability

# Fiber

## Fiber Enclosures - Optical Distribution Frame Solutions

### Fiber Main Distribution Frame (FMDF)

The FMDF is the cornerstone of the ODF product line. This innovative frame has six 5" horizontal troughs for a total of 30" of horizontal trough space. This abundant trough space minimizes fiber pile up and congestion leading to easier moves, adds and changes. The frame has twelve Fiber Termination Block (FTB) mounting positions equally divided between vertical columns on the left and right sides of the frame as shown in the figure here. The frame is available in 30" wide version and provides additional vertical trough space for the highest termination density applications. The built-in jumper storage panel will store up to 3.5 m (12') of jumper slack.

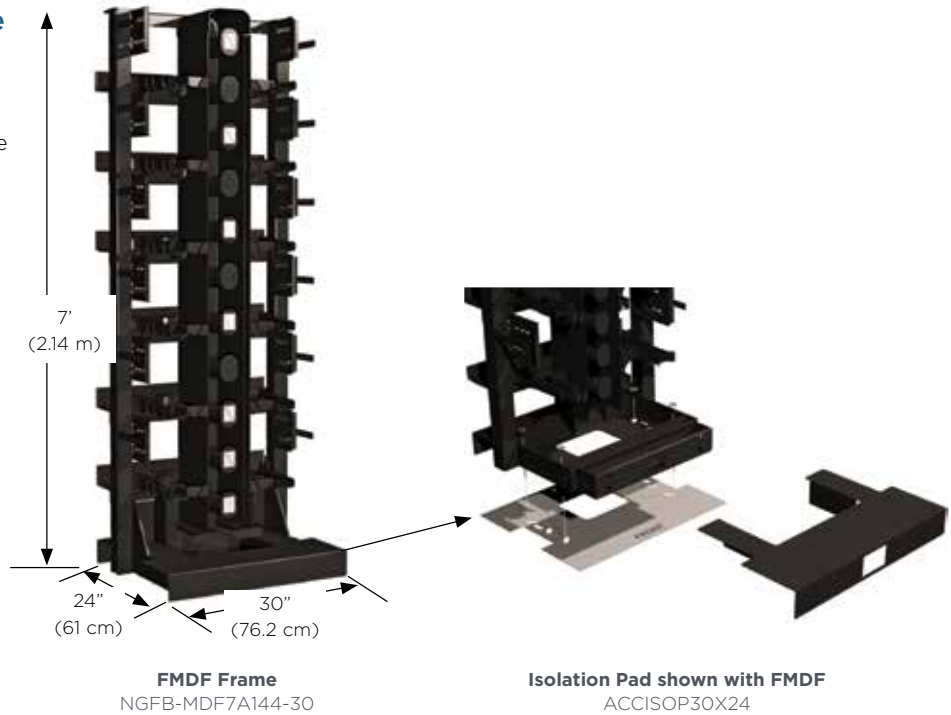

**FMDF Frame**  
NGFB-MDF7A144-30

**Isolation Pad shown with FMDF**  
ACCISOP30X24

### ORDERING INFORMATION

Description	Dimensions (HxWxD)	Part Number
<b>Fiber Main Distribution Frame (FMDF)</b> Accommodates 12 Fiber Termination Blocks (FTBs) or 12 Plug-and-Play Cassette Blocks		
<b>Short Bracket 30" Frame</b> For use with SC 144-position FTBs, or LC 192-position FTBs, LC 144- and 192-position Plug-and-Play Cassette Blocks <sup>1</sup>	7' x 30" x 24" (2.14 m x 76.2 cm x 61 cm)	NGFB-MDF7A144-30
<b>Long Bracket 30" Frame</b> For use with LC 144-position FTBs		NGFB-MDF7A100-30

Each frame section includes heavy duty floor anchor bolts for concrete floor applications. Note: TE recommends the use of 1.7 mm/1.6 mm jumpers when deploying 192-position FTBs.

# Fiber

## Fiber Enclosures - Optical Distribution Frame Solutions

FIBER

### Fiber Optic Terminal Patch Cord Storage Panel

The fiber optic terminal patch cord storage panel is an optional filler panel that provides up to 5 m (16.4') of slack storage for patch cords that run between terminal equipment and the rear ports of an ODF terminal block in cross-connect applications. This slack storage capability allows for greater flexibility in determining patch cord lengths and allows for use of more standard length patch cords. This panel is installed within the ODF frame lineup between ODF frames. The fiber optic terminal storage panels are available in two different configurations depending on the way the ODF frame system is zoned. ODF frames can be zoned by vertical or by frame. A 12" wide panel is available that serves two verticals (one on each side) for use when frames are zoned by vertical. Also, 8" wide versions are available that serve a single vertical (left or right) for use when frames are zoned by frame.

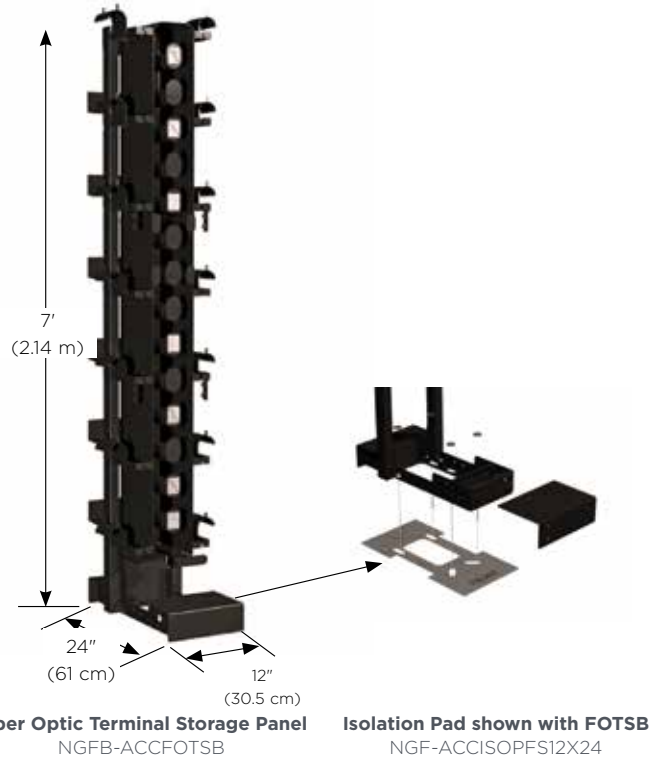

### ORDERING INFORMATION

Description	Dimensions (HxWxD)	Part Number
<b>Fiber Optic Terminal Patch Cord Storage Panel</b> Use with FMDF frame Color: black	7' x 12" x 24" (2.14 m x 30.5 cm x 61 cm)	NGFB-ACCFOTSB
<b>Isolation Pad - Storage Panel</b> A template for frame installation providing isolation between the frame and the ground		NGF-ACCISOPFS12X24

Note: When using the Fiber Optic Terminal Storage Panels, a cable exit UP block must be used.

# Fiber

## Fiber Enclosures - Optical Distribution Frame Solutions

### End Guard

End guards provide protection for the fibers entering and exiting frames at the end of a lineup. They are designed for universal fit to be used on either end of the lineup.

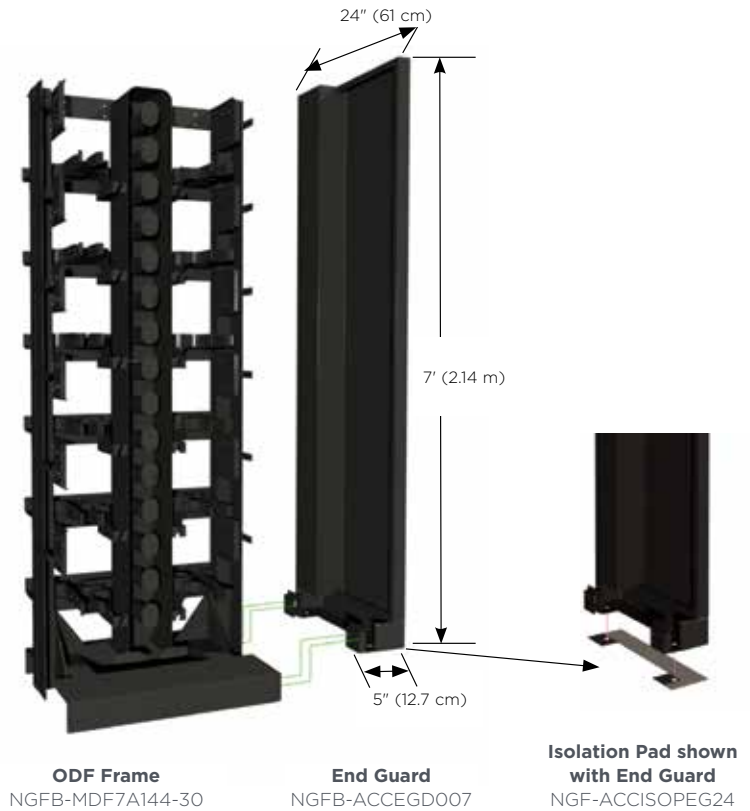

### ORDERING INFORMATION

Description	Dimensions (HxWxD)	Part Number
<b>End Guard</b> Use with FMDF frames Color: black	7' x 5" x 24" (2.14 m x 12.7 cm x 61 cm)	NGFB-ACCEGD007
<b>Isolation Pad - End Guard</b> A template for frame installation providing isolation between the frame and the ground		NGF-ACCISOPEG24

# Fiber

## Fiber Enclosures - Optical Distribution Frame Solutions

FIBER



**Preterminated Fiber Termination Blocks**

Arrive from the Factory with Either IFC or OSP Cables



**Fiber Cable Easily Uncoils**  
During Installation



**Fiber Termination Block**  
Ships Inside the Drum

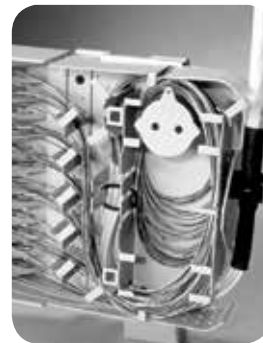

**IFC Cables**  
Loaded into FTB

### Configuration Information

Fiber Termination Blocks (FTB) are available with factory terminated indoor rated cable (IFC) in ribbon or stranded configurations. All blocks are 100% factory tested to guarantee continuity and reliable connections. Factory terminated FTBs make installation quick and easy, reducing labor costs. Before ordering, determine the block orientation and cable exit direction. Factory terminated FTBs may be ordered with a “left” orientation (mounts on the left side of the frame) or a “right” orientation (mounts on the right side of the frame). The cable exit direction will be either “upward” (cables terminated to the rear side of the block exit up toward the top of the frame) or “downward” (cables terminated to the rear side of the block exit down toward the bottom of the frame).

#### Definition of Variables

1	<b>Block Style</b> General adapter type required in the FTB
2	<b>Block Configuration</b> Maximum number of terminations that the FTB will accommodate when fully loaded
3	<b>Block Orientation</b> Vertical column of the frame the FTB is to be mounted on
4	<b>Cable Exit Direction</b> Direction the equipment patch cords or IFC cable will exit from the FTB
5	<b>Adapter/Connector #1</b> Specific adapter/connector type required in the FTB. Refers to the adapter/connector type at the FTB
6	<b>Connector #2</b> Specific connector type required at the cable end opposite the FTB
7	<b>Cable Type</b> Type of cable to be terminated to the FTB
8	<b>Cable Length</b> Required length of the cable terminated to the FTB



# Fiber

## Fiber Enclosures - Optical Distribution Frame Solutions

### SC style FTB's with Factory Terminated Stubs 144-position Block

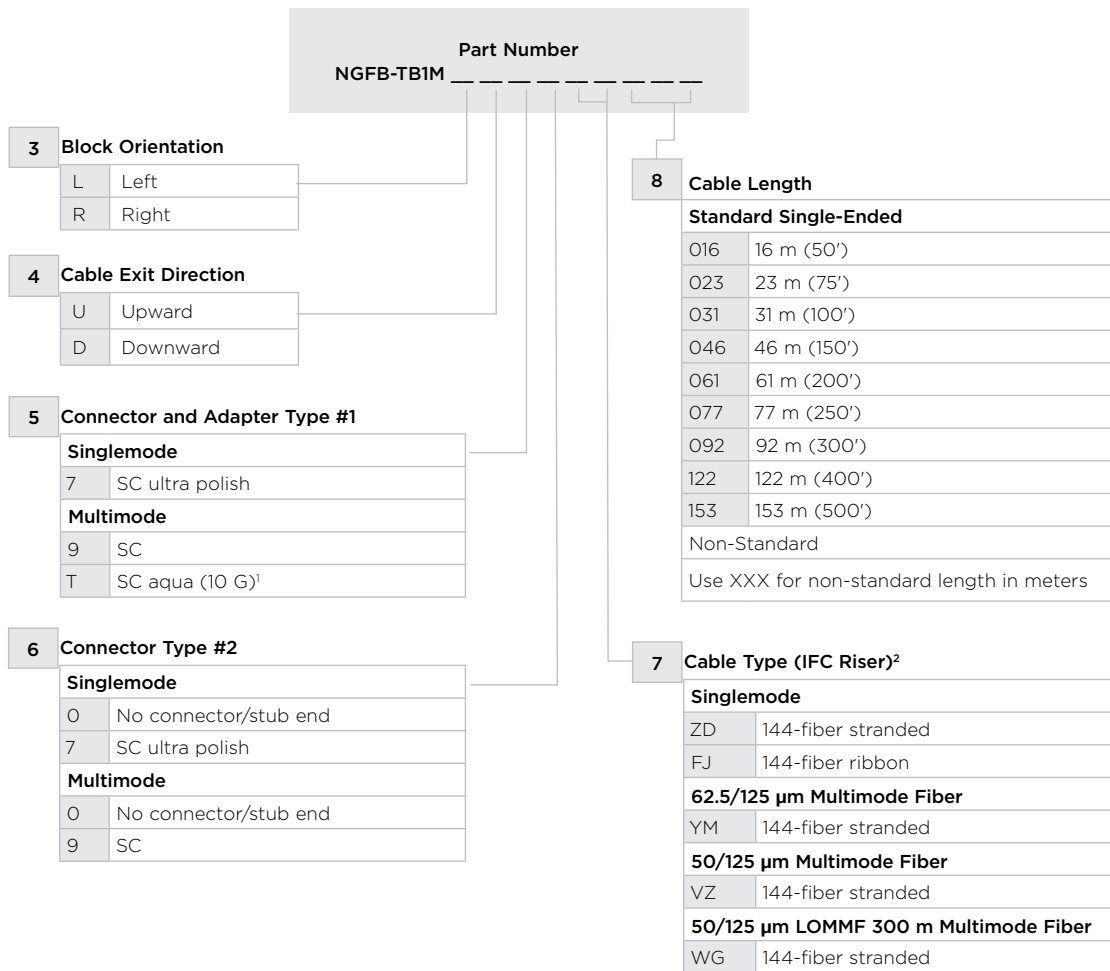

<sup>1</sup> TE recommends the use of aqua colored adapters with laser optimized multimode fiber for identification of 10 Gigabit circuits.

<sup>2</sup> Panels using TE's standard cable offering have a shorter lead time than panels using a specific cable manufacturer. TE provides GR-409 compliant cable that meets or exceeds our high quality standards. Standard cable offering above will use Corning SMF28-e, Sumitomo, Alcatel or similar singlemode fiber based on current market availability. See previous page for definition of variables. Other configurations are available upon request. Please contact TE Technical Assistance Center.

# Fiber

## Fiber Enclosures - Optical Distribution Frame Solutions

### LC Style FTBs with Factory Terminated Stubs

FIBER

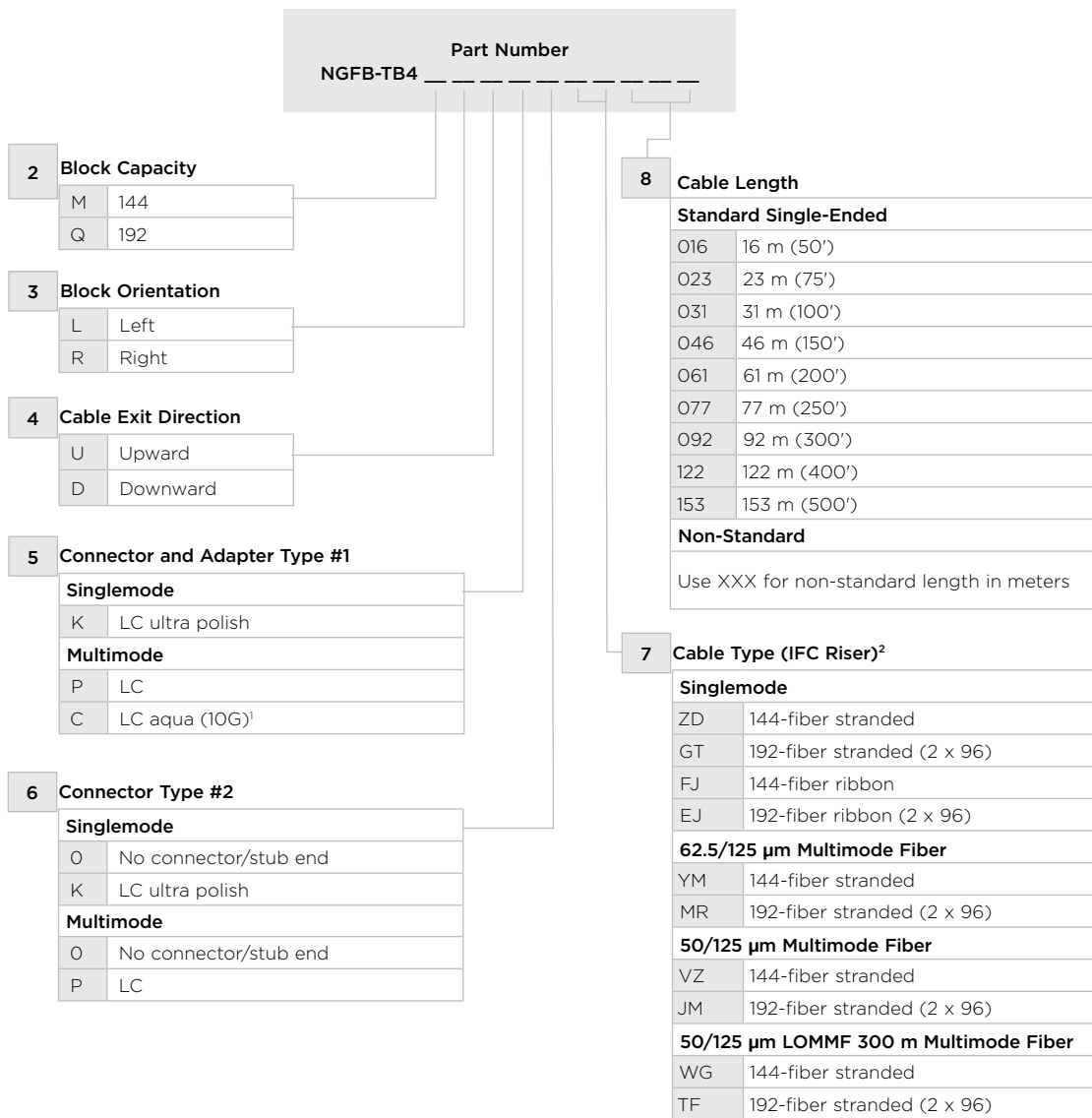

<sup>1</sup> TE recommends the use of aqua colored adapters with laser optimized multimode fiber for identification of 10 Gigabit circuits.

<sup>2</sup> Panels using TE's standard cable offering have a shorter lead time than panels using a specific cable manufacturer. TE provides GR-409 compliant cable that meets or exceeds our high quality standards. Standard cable offering above will use Corning SMF28-e, Sumitomo, Alcatel or similar singlemode fiber based on current market availability. See previous page for definition of variables. Other configurations are available upon request. Please contact TE Technical Assistance Center.

# Fiber

## Fiber Enclosures - Optical Distribution Frame Solutions

### Fiber Termination Blocks (FTBs) - Unterminated (Adapter Only)

FTBs without fiber can be ordered fully loaded with adapters. Before ordering, determine the block orientation and cable exit direction. Unterminated FTBs may be ordered with a “left” orientation (mounts on the left side of the frame) or a “right” orientation (mounts on the right side of the frame). The cable exit direction will be either “upward”\* (cables terminated to the rear side of the block exit up toward the top of the frame) or “downward” (cables terminated to the rear side of the block exit down toward the bottom of the frame). All blocks with adapters only are configured to terminate single or dual jumpers on the rear of the block. If a multifiber breakout style cable (i.e., OSP/IFC) is to be terminated to the rear of the block, a separate clamping kit and replacement rear storage area kit is required (see next page). FTBs cannot be ordered with a combination of singlemode and multimode adapters. If this combination is desired, TE recommends purchasing a fully loaded adapter only termination block, and separate sliding adapter packs to customize the block on-site.

\*Note: When using the Fiber Optic Terminal Storage Panels, a cable exit UP block must be used.

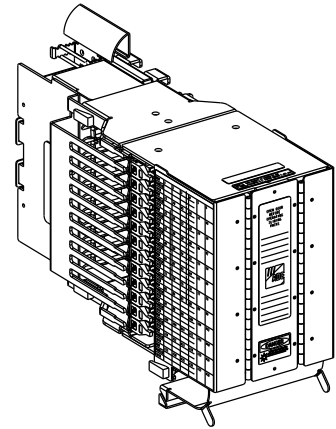

**144-Position Right Upward**  
FTB Shown

# Fiber

## Fiber Enclosures - Optical Distribution Frame Solutions

### Fiber Termination Blocks (FTBs) - Unterminated (Adapter Only)

#### ORDERING INFORMATION

Description	Part Number
<b>144-position Blocks</b>	
<b>Multimode LC</b>	
LC (beige) adapters; cable exit up; RIGHT block orientation	NGFB-TB4MRUP
LC (beige) adapters; cable exit up; LEFT block orientation	NGFB-TB4MLUP
LC (beige) adapters; cable exit down; RIGHT block orientation	NGFB-TB4MRDP
LC (beige) adapters; cable exit down; LEFT block orientation	NGFB-TB4MLDP
<b>Multimode SC</b>	
SC (beige) adapters; cable exit up; RIGHT block orientation	NGFB-TB1MRU9
SC (beige) adapter; cable exit up; LEFT block orientation	NGFB-TB1MLU9
SC (beige) adapters; cable exit down; RIGHT block orientation	NGFB-TB1MRD9
SC (beige) adapters; cable exit down; LEFT block orientation	NGFB-TB1MLD9
<b>10G Multimode LC<sup>1</sup></b>	
LC (aqua) adapters with zirconia sleeves; cable exit up; RIGHT block orientation	NGFB-TB4MRUC
LC (aqua) adapters with zirconia sleeves; cable exit up; LEFT block orientation	NGFB-TB4MLUC
LC (aqua) adapters with zirconia sleeves; cable exit down; RIGHT block orientation	NGFB-TB4MRDC
LC (aqua) adapters with zirconia sleeves; cable exit down; LEFT block orientation	NGFB-TB4MLDC
<b>10G Multimode SC</b>	
SC (aqua) adapters with zirconia sleeves; cable exit up; RIGHT block orientation	NGFB-TB1MRUT
SC (aqua) adapters with zirconia sleeves; cable exit up; LEFT block orientation	NGFB-TB1MLUT
SC (aqua) adapters with zirconia sleeves; cable exit down; RIGHT block orientation	NGFB-TB1MRDT
SC (aqua) adapters with zirconia sleeves; cable exit down; LEFT block orientation	NGFB-TB1MLDT
<b>Singlemode LC</b>	
LC (blue) adapters with zirconia sleeves; cable exit up; RIGHT block orientation	NGFB-TB4QRUK
LC (blue) adapters with zirconia sleeves; cable exit up; LEFT block orientation	NGFB-TB4QLUK
LC (blue) adapters with zirconia sleeves; cable exit down; RIGHT block orientation	NGFB-TB4QRDK
LC (blue) adapters with zirconia sleeves; cable exit down; LEFT block orientation	NGFB-TB4QLDK
<b>Singlemode SC</b>	
SC (blue) adapters with zirconia sleeves; cable exit up; RIGHT block orientation	NGFB-TB1MRU7
SC (blue) adapters with zirconia sleeves; cable exit up; LEFT block orientation	NGFB-TB1MLU7
SC (blue) adapters with zirconia sleeves; cable exit down; RIGHT block orientation	NGFB-TB1MRD7
SC (blue) adapters with zirconia sleeves; cable exit down; LEFT block orientation	NGFB-TB1MLD7

<sup>1</sup> TE recommends the use of aqua colored adapters with laser optimized multimode fiber for identification of 10 Gigabit circuits.

# Fiber

## Fiber Enclosures - Optical Distribution Frame Solutions

### ORDERING INFORMATION, continued

Description	Part Number
<b>192-position Blocks</b>	
<b>Multimode LC</b>	
LC (beige) adapters; cable exit up; RIGHT block orientation	NGFB-TB4QRUP
LC (beige) adapters; cable exit up; LEFT block orientation	NGFB-TB4QLUP
LC (beige) adapters; cable exit down; RIGHT block orientation	NGFB-TB4QRDP
LC (beige) adapters; cable exit down; LEFT block orientation	NGFB-TB4QLDP
<b>10G Multimode LC<sup>1</sup></b>	
LC (aqua) adapters with zirconia sleeves; cable exit up; RIGHT block orientation	NGFB-TB4QRUC
LC (aqua) adapters with zirconia sleeves; cable exit up; LEFT block orientation	NGFB-TB4QLUC
LC (aqua) adapters with zirconia sleeves; cable exit down; RIGHT block orientation	NGFB-TB4QRDC
LC (aqua) adapters with zirconia sleeves; cable exit down; LEFT block orientation	NGFB-TB4QLDC
<b>Singlemode LC</b>	
LC (blue) adapters with zirconia sleeves; cable exit up; RIGHT block orientation	NGFB-TB4QRUK
LC (blue) adapters with zirconia sleeves; cable exit up; LEFT block orientation	NGFB-TB4QLUK
LC (blue) adapters with zirconia sleeves; cable exit down; RIGHT block orientation	NGFB-TB4QRDK
LC (blue) adapters with zirconia sleeves; cable exit down; LEFT block orientation	NGFB-TB4QLDK

<sup>1</sup> TE recommends the use of aqua colored adapters with laser optimized multimode fiber for identification of 10 Gigabit circuits.

# Fiber

## Fiber Enclosures - Optical Distribution Frame Solutions

FIBER

### Fiber Termination Blocks (FTBs)

#### CONFIGURATION INFORMATION

##### Definition of Variables

1	<b>Block Style</b> General adapter type required in the FTB
2	<b>Block Configuration</b> Maximum number of terminations that the FTB will accommodate when fully loaded
3	<b>Block Orientation</b> Vertical column of the frame the FTB is to be mounted on
4	<b>Cable Exit</b> Direction Direction the equipment jumpers or OSP cable will exit from the FTB
5	<b>Adapter Type</b> Specific adapter type required in the FTB

### Cable Clamping/Block Conversion Kits

Adapter-only blocks are configured to accommodate single fiber jumpers or multifiber breakout cables. If loading a preterminated intrafacility (IFC) cable or a preterminated OSP cable is desired, additional hardware will be required. Block conversion kits are available to convert adapter only blocks to blocks that will accept preterminated IFC or OSP style cables. The conversion kits contain the cable management hardware, brackets and cable clamps required to convert the block. The kit required will depend on the block style originally purchased.

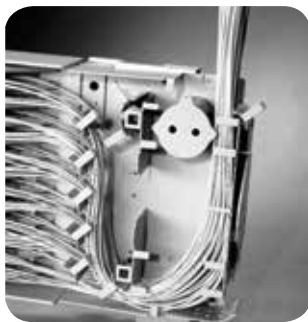

**72-Position Block**  
Loaded with Jumpers

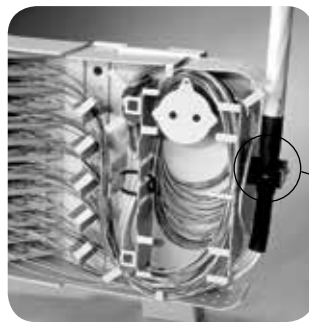

**72-Position Block**  
Loaded with Multifiber Breakout Cable

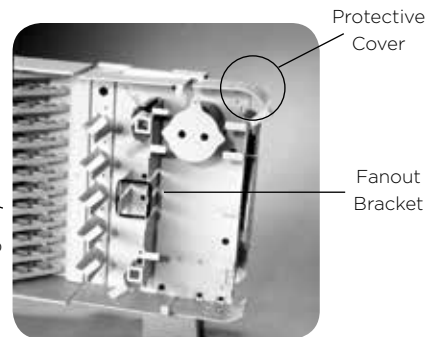

**72-Position Block**  
with Clamping Kit

#### ORDERING INFORMATION

Description	Part Number
<b>Block style originally purchased</b>	
144- or 192-position <b>left up</b> blocks	NGFB-ACCRCMSLU
144- or 192-position <b>right up</b> blocks	NGFB-ACCRCMSRU
144- or 192-position <b>left down</b> blocks	NGFB-ACCRCMSLD
144- or 192-position <b>right down</b> blocks	NGFB-ACCRCMSRD

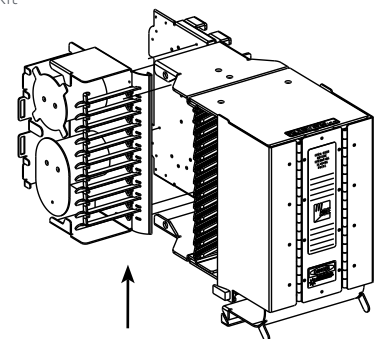

**Rear Cable Management Tray**  
for 144 Block Conversion Kit

# Fiber

## Fiber Enclosures - Optical Distribution Frame Solutions

### Sliding Adapter Packs

Sliding adapter packs house groups of fiber optic adapters and are mounted in Fiber Termination Blocks to provide easy access to connectors. Sliding Adapter Packs are available with SC and LC adapters. The adapters come in packs of six and eight depending on the adapter type and the desired termination density. See table below for configuration guidelines.



**SC pack**  
Style K



**LC pack 144-position**  
Style K

### ORDERING INFORMATION

Description	Part Number <sup>1</sup>
<b>144-position Blocks</b>	
Multimode LC	NGF-SAPP0K00
Multimode SC	NGF-SAP90K00
10G Multimode LC <sup>1</sup>	NGF-SAPC0K00
10G Multimode SC <sup>1</sup>	NGF-SAPT0K00
Singlemode LC	NGF-SAPK0K00
Singlemode SC	NGF-SAP70K00
<b>192-position Blocks</b>	
Multimode LC	NGF-SAPP0J00
10G Multimode LC <sup>1</sup>	NGF-SAPC0J00
Singlemode LC	NGF-SAPK0J0

<sup>1</sup> TE recommends the use of aqua colored adapters with laser optimized multimode fiber for 10 Gigabit circuit identification.

Note: TE recommends the use of 1.7 mm/1.6 mm jumpers when deploying 192-position FTBs.

### SLIDING ADAPTER PACK CONFIGURATION GUIDELINES SPECIFICATIONS

Block Configuration	Adapter Type	Adapter Pack Configuration	Adapter Pack Option
144-Position (block code 'M')	SC, LC	6 Pack/6 Pack	K
192-Position (block code 'Q')	LC	8 Pack/8 Pack	J

# Fiber

## Fiber Enclosures - Optical Distribution Frame Solutions

### Data Center Optical Distribution Frame with Plug-and-Play Cassettes

TE’s data center optical distribution frame (ODF) with plug-and-play (MPO) cassettes is the highest density optical distribution frame solution available today. It efficiently manages up to 1,728 fiber terminations using the 144-position block in a single frame in either a cross-connect or inter-connect design.

Its patented design incorporates the fundamentals of cable management while using the industry’s highest fiber count MPO plug-and-play cassettes.

#### FEATURES

- Rapid installation of new deployments
- MPO trunks can enter rack from either under-floor or overhead
- Slack storage included in each rack allows for the use of a single jumper length
- On frame jumper routing provides bend radius and physical protection with slack easily and intuitively managed

#### APPLICATIONS

- Provides managed high-density solution for optical distribution frames in the main distribution area of the data center
- Can be successfully deployed in the cross-connect architecture recommended in TIA-942, and still provide clear, managed pathways for fiber

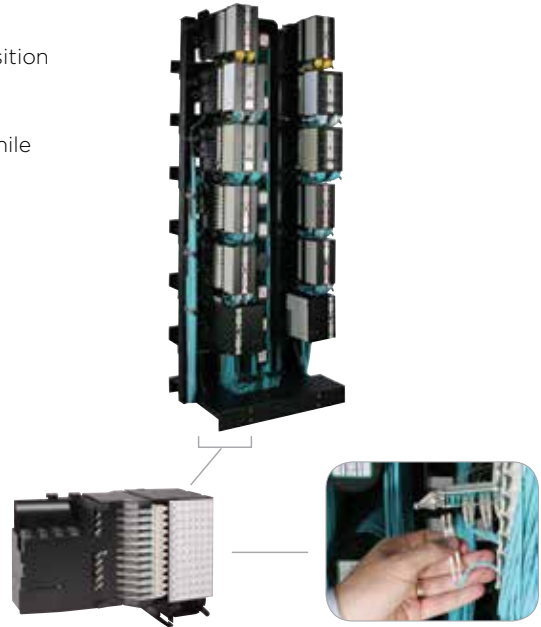

#### SPECIFICATIONS

**MODULE LOSS (measured through MPO mated pair to LC adapter)    850 nm          1310 nm**

**INSERTION LOSS:**

<b>Maximum:</b>	0.7 dB	0.55 dB
<b>Typical:</b>	0.25 dB	0.25 dB

**RETURN LOSS:**

<b>Maximum:</b>	—	-55 dB
-----------------	---	--------

**TRUNK LOSS (PER METER):**

<b>Maximum:</b>	.0035 dB	.001 dB
-----------------	----------	---------

**CHANNEL/LINK LOSS: with 31 m trunk (100')**

<b>Maximum:</b>	1.3085 dB	1.131 dB
<b>Typical:</b>	0.6085 dB	0.531 dB

#### ENVIRONMENTAL CHARACTERISTICS

<b>Storage Temperature:</b>	-40° to 70° C (-40° to 158° F)
<b>Operating Temperature:</b>	0° to 70° C (32° to 158° F)
<b>Installation Temperature:</b>	0° to 70° C (32° to 158° F)



# Fiber

## Fiber Enclosures - Optical Distribution Frame Solutions

### Data Center Optical Distribution Frame with Plug-and-Play Cassettes Specifications

#### SPECIFICATIONS

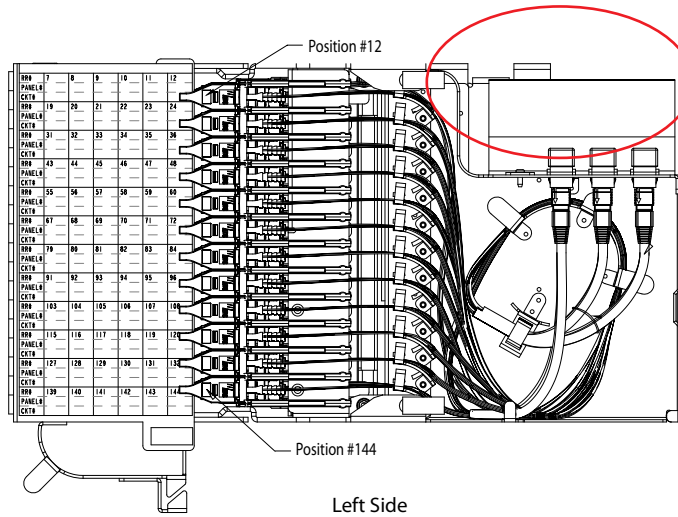

CONNECTION TABLE 144 POS												FIBER COLOR
MPO CONECTOR TRAY												
1-48			49-96			97-144			FIBER BUNDLE NUMBER			
1	2	3	4	5	6	7	8	9	10	11	12	
T/B POSITION												
1	13	25	37	49	61	73	85	97	109	121	133	BLUE
2	14	26	38	50	62	74	86	98	110	122	134	ORANGE
3	15	27	39	51	63	75	87	99	111	123	135	GREEN
4	16	28	40	52	64	76	88	100	112	124	136	BROWN
5	17	29	41	53	65	77	89	101	113	125	137	SLATE
6	18	30	42	54	66	78	90	102	114	126	138	WHITE
7	19	31	43	55	67	79	91	103	115	127	139	RED
8	20	32	44	56	68	80	92	104	116	128	140	BLACK
9	21	33	45	57	69	81	93	105	117	129	141	YELLOW
10	22	34	46	58	70	82	94	106	118	130	142	VIOLET
11	23	35	47	59	71	83	95	107	119	131	143	ROSE
12	24	36	48	60	72	84	96	108	120	132	144	AQUA

Top View

Fiber Bundle/MPO Connector Locations

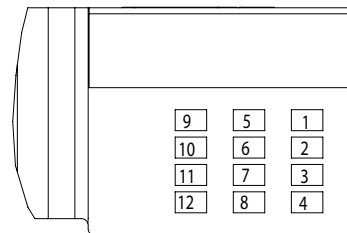

#### OPTICAL SPECIFICATIONS

##### Plug-and-Play

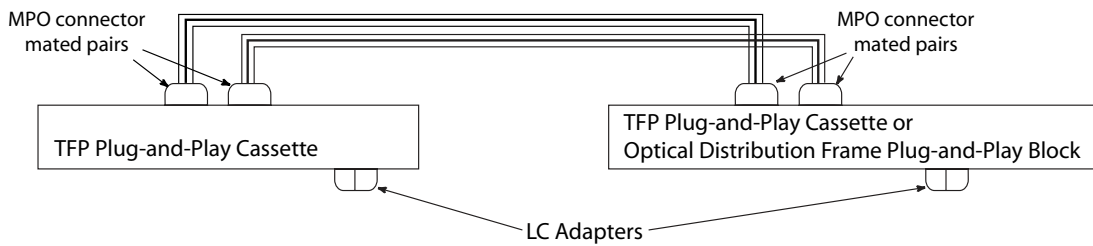

# Fiber

## Fiber Enclosures - Optical Distribution Frame Solutions

### Data Center Optical Distribution Frame with Plug-and-Play Cassettes

#### ORDERING INFORMATION

Description	Catalog Number
<b>144-position MPO - LC Blocks; Black</b>	
OM3 - 50/125 LOMMF 300m; 12 MPO to 144 LC (aqua) adapters	
LEFT block orientation	NGFB-MPML0C112
RIGHT block orientation	NGFB-MPMR0C112
OM4 - 50/125 LOMMF 550m; 12 MPO to 144 LC (aqua) adapters	
LEFT block orientation	NGFB-MPML0C412
RIGHT block orientation	NGFB-MPMR0C412
Singlemode - 12 MPO to 144 LC adapters	
LEFT block orientation	NGFB-MPML0K512
RIGHT block orientation	NGFB-MPMR0K512
<b>192-position MPO - LC Blocks; Black</b>	
OM3 - 50/125 LOMMF 300m; 16 MPO to 192 LC (aqua) adapters	
LEFT block orientation	NGFB-MPQL0C116
RIGHT block orientation	NGFB-MPQR0C116
OM4 - 50/125 LOMMF 550m; 16 MPO to 192 LC (aqua) adapters	
LEFT block orientation	NGFB-MPQL0C416
RIGHT block orientation	NGFB-MPQR0C416
Singlemode; 16 MPO to 192 LCUPC (blue) adapters	
LEFT block orientation	NGFB-MPQL0K516
RIGHT block orientation	NGFB-MPQR0K516
<b>Rack</b>	
30" x 24" x 7 ft frame with shorter MPO block mounting brackets; black	NGFB-MDF7A144-30
<b>Rack Accessories</b>	
ISO Pad	NGF-ACCISOP30X24
End Guard	NGFB-ACCEGD007
End Guard ISO Pad	NGF-ACCISOPEG24
Rack Installation Kit Raised Floor	FDF-ACCI46

# Fiber

## Fiber Enclosures - Optical Distribution Frame Solutions

### Cable Clamp Kit

Cable clamp kits are available for securing IFC/OSP cable or equipment jumpers on the rear of the FTB. Each FTB has three cable clamp mounting positions.

#### Cable clamp kit for active equipment patch cord includes:

- Cable clamp bracket 1 each
- O-ring 1 each
- Screws 2 each

#### Cable clamp kit for trunk cables includes:

- Clamp cover 1 each
- Clamps 2 each
- 0.5" Grommet (inner diameter) 1 each
- 0.6" Grommet (inner diameter) 1 each
- 0.7" Grommet (inner diameter) 1 each
- #14 - #6 AWG split bolt 1 each
- Shield bonding connector 1 each
- 1-foot lead wire 1 each
- #6 AWG ring terminal lug 1 each
- Clamp cover plate 1 each

### ORDERING INFORMATION

Description	Part Number
<b>Cable clamp kit</b> for equipment patch cords (included with fiber termination blocks loaded with adapters only)	NGF-ACCCLMP04
<b>Cable clamp kit*</b> for trunk cables, dielectric cable without grounding hardware (included with fiber termination blocks with IFC)	NGF-ACCCLMP08

\* One NGF-ACCCLMP08 is also included with each cable clamp kit and block conversion kit

# Fiber

## Fiber Enclosures - Optical Distribution Frame Solutions

### Frame Installation Kit

Frame installation kits may be used on network frames and are seismic zone 4 rated.

#### Computer floor kit includes:

- Threaded rods 4 each,  $\frac{5}{8}$ " - 11" x 30"
- Heavy nuts, locks and flat washers 12 each
- Nuts with springs 4 each,  $\frac{1}{2}$ " x 30" and shoulder washers
- Unistrut and anchor kit 1 each, 10'

#### Overhead support kit includes:

- Designation card holder 1 each
- Two-bar channel 4 each
- Framing clip with 0.56 4 each
- Framing clip with 0.69 4 each
- Clip J-bolt 4 each,  $\frac{1}{2}$ " - 13" x 18" long
- Threaded rod 2 each,  $\frac{5}{8}$ " x 18" long
- Hex nut 4 each,  $\frac{1}{2}$ " x 13"
- Hex nut 4 each,  $\frac{5}{8}$ " x 11"

### Standard Cross-Connect Patch Cord Lengths

#### SPECIFICATIONS

Total Number of Sections Traversed <sup>1</sup>	Approximate Patch Cord Length Meters (Feet)
Same frame	6 m (18')
Adjacent frames	7 m (23')
3 to 4	8 m (26')
5 to 6	10 m (33')
7 to 8	11 m (36')
9 to 10	12 m (39')

#### ORDERING INFORMATION

Description	Part Number
Frame installation kit for computer floor	FDf-ACC146
Overhead support	RINST-TOP7

<sup>1</sup> Depending on office requirements, 11 or more frame sections may require the use of interbay tie panels.

For additional information, please call TE Technical Assistance Center, 1-800-366-3891.

For recommended cross-connect method and installation instructions, refer to User Manual ADCP-90-285.

# Fiber

## Fiber Enclosures - OMX

### Fiber Enclosures - OMX Splice Cabinet

The data center splice cabinet is a high-density splice solution, housing up to 1,440 splices within a 23.6" by 11.8" footprint. Shipped complete with the necessary cable management, it features slots which secure and protect the round splice trays and can hold up to sixty 12-fiber splice trays on which the cables enter from above or below.

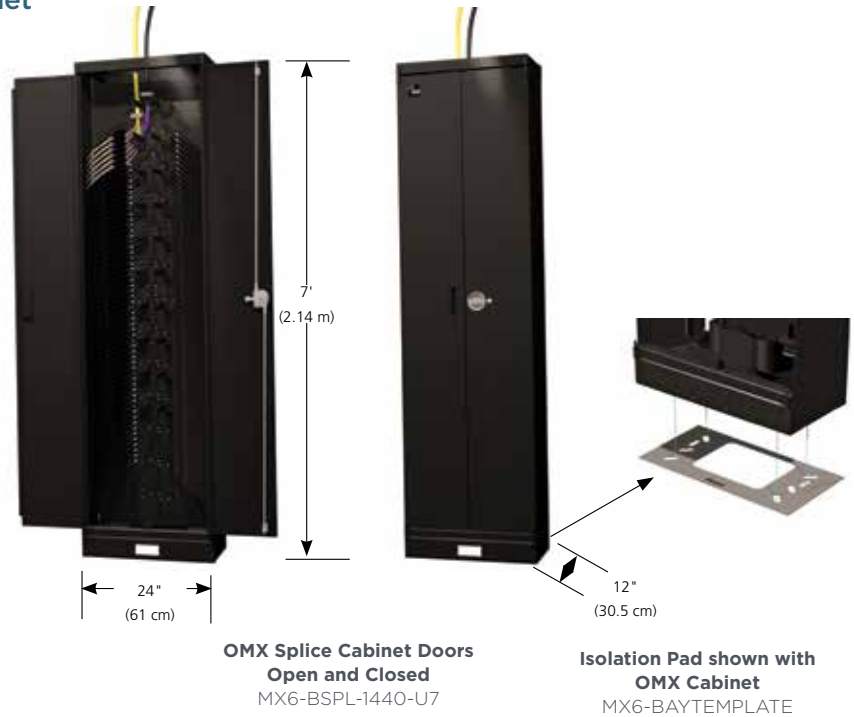

### ORDERING INFORMATION

Description	Dimensions (HxWxD)	Part Number
<b>Fully Configured Splice Cabinet</b> Accommodates up to 1440 fiber splices Cable enters from top Color: black	7' x 24" x 12" (2.14 m x 61 cm x 30.5 cm)	
<b>Cabinet - Cable Exit Up</b> Cable enters from above Color: black		MX6-BSPL-1440-U7
<b>Cabinet - Cable Exit Down</b> Cable enters from below Color: black		MX6-BSPL-1440-D7
<b>Isolation Pad - Splice Cabinet</b> A template for cabinet installation providing isolation between the cabinet and the ground		MX6-BAYTEMPLATE

# Fiber

## Fiber Enclosures - OMX

### Splice Wheel

#### ORDERING INFORMATION

Description	Part Number
<b>Splice Wheel</b> Accommodates up to 24 fiber splices, heat shrink fusion chip Accommodates 2x12 mass ribbon fusion splices	FST-DRS24-NT FST-DRS12-MT



### Cable Clamps

#### ORDERING INFORMATION

Description	Part Number
<b>OMX Splice Frame Cable Clamps</b> For OSP Cable For IFC Cable	FEC-ACCCLMP01 MX6-SPLIFCCLMP

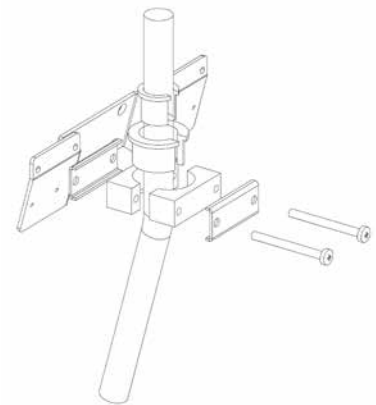

MX6-SPLIFCCLMP

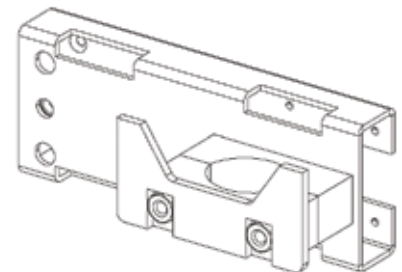

FEC-ACCCLMP01

# Fiber

## Storage Area Management (SAN Fiber Channel Management)

### Storage Area Management (SAN Fiber Channel Management)

TE Connectivity's Storage Area Management (SAM) solution for network infrastructures is designed to reduce the bulkiness of cabling in the data center by up to 80% and enable high-density deployment with fewer costly cabinet or infrastructure upgrades. SAM can help you save time, reduce costs, maximize efficiency and open up much needed space in your data center. It takes the complexity out of cable management, and optimizes the performance of your data center floor space, racks and electronics.

#### FEATURES

- Reduce SAN switch cabling volume by up to 80%
- Implement high-density deployment with fewer cabinet or infrastructure upgrades
- Minimize footprint - no additional front vertical, side, or horizontal cable management devices
- Minimize cable mass and slack management using linecard-optimized hydra assemblies
- Speed up deployments and reduce connection errors with color-coded and keyed connections

More information on TE's SAM solution can be found at [www.te.com/SAM](http://www.te.com/SAM)

#### ORDERING INFORMATION

Product Description	Part Number	
<b>Rack Mount Patch Enclosure, 2RU MPO Secure</b>	1553761-1	
<b>SAM Far End Enclosure, 1RU MPO to Quad LC</b>	<b>32-Port</b>	<b>48-Port</b>
XG OM3/OM4 (850 nm LO 50 µm) Multimode	1553533-2	1553533-1
Singlemode	1553657-2	1553657-1

### Five Simple Components

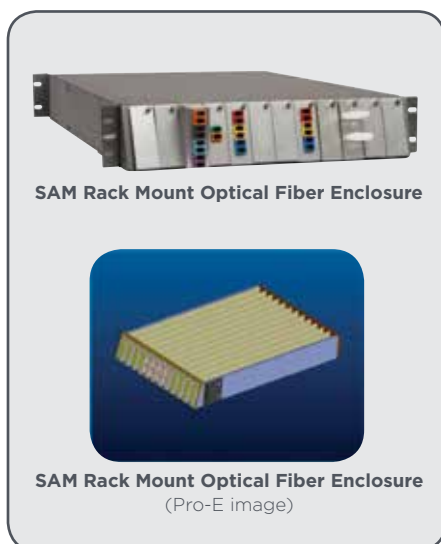

# Fiber

## Storage Area Management (SAN Fiber Channel Management)

### Q3000 SAM Blades

#### FEATURES

- Replaces SAM Far End Enclosures
- Compatible with standard Q3000 frame
- Maintains port similarity with switches and SAM MPO linecard kits
- Each blade supports two SAM trunks
- 16 LC duplex ports (32 fibers) per 1/2 RU blade
- OM3/OM4 and OS2 versions
- Fully pre-assembled and pre-tested



Q3000 SAM Blade

#### ORDERING INFORMATION

Product Description	Fiber/ Port Count	Front/ Rear Connector	Part Number
<b>Q3000 SAM Blades</b>			
Q3200 SAM Blade OM3/OM4	32/16	Duplex LC/MPO	QUFB-32FDLCMM4HR
Q3000 SAM Blade Singlemode	32/16	Duplex LC/MPO	QUFB-32FDLCMSMHR

Product Description	Part Number
<b>Q3000 Chassis Fiber Enclosure</b>	
Q3200; 1RU (1.75" x 19" x 15"), accommodates 2 blades	QUCH-1RU
Q3400; 2RU (3.5" x 19" x 15"), accommodates 4 blades	QUCH-2RU

Product Description	Coupling Adapter/Interface	Part Number
<b>SAM MPO Adapter Plates</b>		
Adapter Plate	Blank with Cable Management	2111481-1
<b>SAM System Miscellaneous Components</b>		
Cable Management Bracket Kit		1553658-1



Adapter Plates



# Fiber

## Storage Area Management (SAN Fiber Channel Management)

### ORDERING INFORMATION CONTINUED

Product Description	Part Number			
	Plates	Hydras	Kits	
<b>SAM MPO Linecard Kits (Kit includes Plates and Hydras)</b>				
<b>16-Port Kit</b>	OM3 (850 nm LO 50µm) Multimode 8GFC	2193050-1	1553608-1, 1553609-1	2193057-1
	Singlemode	2193050-1	1553635-1, 1553636-1	2193058-1
<b>32-Port Kit</b>	16 Gigabit SAM Kit	2111648-1	2111649-1, 2111649-2, 2111650-1, 2111650-2	2111651-1
	OM3 (850 nm LO 50µm) Multimode 8GFC	2193051-1	1553608-1, 1553608-2, 1553609-1, 1553609-2	2193057-2
	Singlemode	2193051-1	1553635-1, 1553635-2, 1553636-1, 1553636-2	2193058-2
<b>48-Port Kit</b>	OM3 (850 nm LO 50µm) Multimode 8GFC /16GFC	2193052-1	1553527-1, 1553527-2, 1553528-1, 1553528-2, 1553529-1, 1553529-2	2193057-3
	Singlemode	2193052-1	1553676-1, 1553676-2, 1553677-1, 1553677-2, 1553678-1, 1553678-2	2193057-3
<b>64-Port Kit</b>	OM3 (850 nm LO 50µm) Multimode 8GFC	2193016-1	2193045-1, 2193046-1, 2193046-2, 2193047-1, 2193047-2, 2193048-1, 2193048-2	2193057-4
	Singlemode	2193016-1	2193053-1, 2193053-2, 2193054-1, 2193054-2, 2193055-1, 2193055-2, 2193056-1, 2193056-2	2193058-4



SAM MPO Cable Assemblies



SAM Hydra

SAM MPO Cable Assemblies	End A	End B	Length	Part Number
OM3 (850 nm LO 50 µm) Multimode	MPO	MPO	3 m (10')	1553534-1
			6 m (20')	1553534-2
			9 m (30')	1553534-3
			12 m (40')	1553534-4
			15 m (50')	1553534-5
			18 m (60')	1553534-6
			21 m (70')	1553534-7
			24 m (80')	1553534-8
			27 m ( 90')	1553534-9
			30 m ( 100')	1-1553534-0
Singlemode	MPO	MPO	3 m (10')	1553640-1
			6 m (20')	1553640-2
			9 m (30')	1553640-3
			12 m (40')	1553640-4
			15 m (50')	1553640-5
			18 m (60')	1553640-6
			21 m (70')	1553640-7
			24 m (80')	1553640-8
			27 m ( 90')	1553640-9
			30 m ( 100')	1-1553640-0

# Fiber

## Optical LAN Solution Supporting PON Technologies

As optical fiber moves closer to end users, rapid changes are underway in both the data center and the equipment closet. As a result, new installation and maintenance techniques are being employed within enterprise applications. Passive Optical Network (PON) applications are now being deployed. Fiber is no longer limited to just access equipment. Fiber connectivity to a single user is a reality.

TE Connectivity offers complete, end-to-end PON infrastructure solutions called Optical LAN Solution (OLS). From the data center to the desktop, our customers have tapped the experience and innovation of TE to build their PON networks. TE's suite of end-to-end connectivity solutions is truly comprehensive. This ordering guide highlights the most commonly used components that feature field-proven attributes that can save time, money and help improve customer satisfaction.

The diagram below highlights a PON deployment using one of the TE OLS solutions. Each number corresponds to a specific innovative TE product which is described in more detail on the following pages.

For more information on TE's Optical LAN Solution, visit [www.PONsource.com](http://www.PONsource.com).

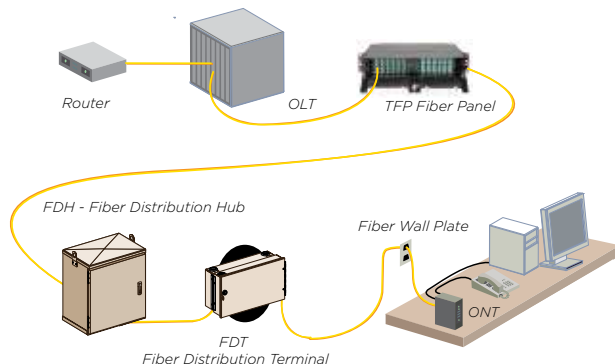

**End-to-End Network Infrastructure**

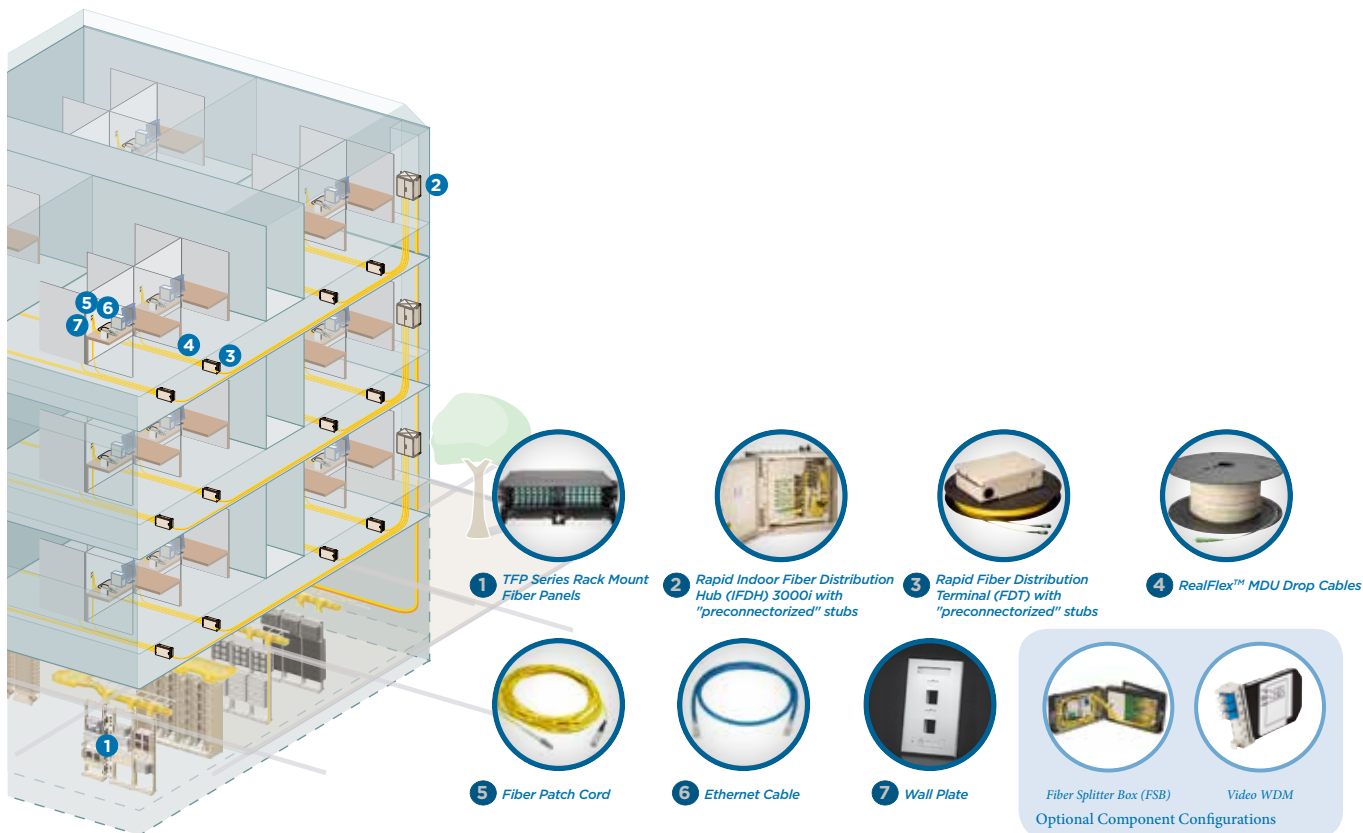

# Fiber

## Optical LAN Solution Supporting PON Technologies

### TFP Fiber Panels

TE's TrueNet Fiber Panels (TFP) combine the unique features of vertical cable guides, patented angle-left/angle-right adapters, and plug-and-play angled cassettes, which offer bend radius protection, intuitive routing, and easy connector access. The TFP series can be ordered in one, two, four, or five rack-unit sizes to fit your unique needs. Designed for rack mounting in the equipment distribution area, the TFP's modularity, functionality and density make it ideal for mounting in close proximity to the enterprise aggregation switch (OLT). The cassettes snap into place effortlessly and come from the factory pre-labeled with simple installation instructions.

The TFP panels are ideal for the interconnection points between the active OLT and the iFDH if it is co-located in the same building as the OLS deployment. The TFP cassettes are equipped with MPO adapters on the back allowing a simple plug-in from the feeder cable.



1RU TFP Panel



TFP Angled-Left Cassette

FIBER

### FEATURES

- Eliminates the need for on-site fiber terminations, which means more rapid deployments
- Incorporates angle left/angle right adapters to ensure proper bend radius
- Use the same 1, 2, 4 and 5 rack unit standard TFP chassis which simplifies ordering
- TFP cassettes equipped with MPO adapters on back allow simple plug-in from feeder cables

### ORDERING INFORMATION

Description		Height	Part Number
<b>Termination Only Rack- or Cabinet-Mount Panel;</b> Black; T-handle latch close	1RU empty panel, Accommodates 2 plug-and-play cassettes	1.75"	TFP-1TT00-000B
	2RU empty panel, Accommodates 4 plug-and-play cassettes	3.50"	TFP-2TT00-000B
	4RU empty panel, Accommodates 8 plug-and-play cassettes	7.00"	TFP-4TT00-000B
	5RU empty panel, Accommodates 12 plug-and-play cassettes	8.75"	TFP-5TT00-000B
<b>Plug-and-Play Cassettes</b> **To maintain consistency with fiber distribution hubs and terminals order SC/APC cassettes for TFP panel.	12 fiber cassettes**; 12 SC/APC Singlemode Adapters	Angle LEFT cassette	TFP-12MPLSA1
		Angle RIGHT cassette	TFP-12MPRSA1
<b>Recommended Accessories</b>	3RU Horizontal Glide Cable Manager; with integrated slack storage spools		ADCCMHIBS-3U
<b>Adapter plates</b>	TFP Blank Plate		TFP-00AP00
	TFP SC/APC Adapter Plate Left		TFP-12APLA1
	TFP SC/APC Adapter Plate Right		TFP-12APRA1

# Fiber

## Optical LAN Solution Supporting PON Technologies

### Rapid Fiber Distribution Hub (iFDH)

TE's Rapid Fiber Distribution Hub organizes and administers optical fiber cables and passive optical splitters for enterprise PON applications. The enclosures support plug-and-play termination with a cross-connect/interconnect interface that makes installation, maintenance, and changes faster and easier. The RapidReel feeder cable speeds up installation time and conveniently stores slack inside the iFDH.

#### FEATURES

- Supports plug-and-play termination
- Can be either wall or rack mounted with the hardware provided
- Traditional swing-frame design allows superior rear access
- Includes RapidReel feeder cable
- Designed to meet NEMA-12 requirements
- UL 1863 Listed



**Rapid Indoor FDH front panel**

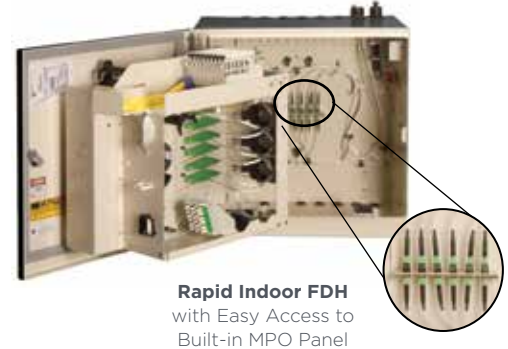

**Rapid Indoor FDH with Easy Access to Built-in MPO Panel**

#### ORDERING INFORMATION

Description	Feeder Cable Type	Distribution Type	Feeder Stub Length	Part Number
<b>72-Port</b> with 9 splitter ports	12-fiber plenum	6 MPO adapters	100'	OLH-MK072J00M0MKCA
			250'	OLH-MK072J00M0MKEA
			500'	OLH-MK072J00M0MKBA
<b>72-Port Empty Hub</b>	No feeder cable**			OLH-MK072J00M0M000
<b>288-Port</b> with 18 splitter ports	24-fiber plenum	24 MPO adapters	100'	OLH-MM288J00M0MKCB
			250'	OLH-MM288J00M0MKEB
			500'	OLH-MM288J00M0MKBB
<b>288-Port Empty Hub</b>	No feeder cable**			OLH-MM288J00M0M000
<b>432-Port</b> with 22 splitter ports	24-fiber plenum	36 MPO adapters	100'	OLH-MN432J00M0MKCB
			250'	OLH-MN432J00M0MKEB
			500'	OLH-MN432J00M0MKBB
<b>432-Port Empty Hub</b>	No feeder cable**			OLH-MN432J00M0M000

\*Note: Splitters are purchased separately; ordering information on the following page.

\*\* See page 1-114 for MPO-MPO cable assemblies.

# Fiber

## Optical LAN Solution Supporting PON Technologies

### Mini Plug-and-Play Splitter Modules

TE's Mini Plug-and-Play Splitter Modules support centralized splitting architectures. The modules are available in a wide range of split ratios. The rugged packaging is built for high performance, while the true plug-and-play design reduces installation time.

#### FEATURES

- Bend-optimized fiber and ruggedized extreme temperature cabling
- Operating temperature range -55° to +85° C
- Wavelength range of 1260-1635 nm
- Easy to insert and remove without affecting adjacent splitters
- UL 1863 Listed



Plug and Play splitter



FMT Rack Mounted Splitter Panel

#### SPECIFICATIONS:

Splitter Type	Max Loss	Typical Loss	Uniformity	Return Loss	Directivity	PDL	Wavelength Range
1x16	13.5 dB	12.8 dB	1.0 dB	55 dB	60 dB	0.3 dB	1260-1635 nm
1x32	16.7 dB	16.0 dB	1.3 dB	55 dB	60 dB	0.3 dB	1260-1635 nm

#### ORDERING INFORMATION

Description	Part Number	
<b>Optical Splitter Module</b> Angled SC Pigtailed, Used with iFDH, FSB, Splitter drawer, and Splitter Panels	1 x 32 splitter	OLS-MPP13266
	1 x 16 splitter	OLS-MPP11666
	1 x 8 splitter	OLS-MPP10866
	2 x 16 splitter	OLS-MPP1P66
	2 x 32 WDM Splitter	OLS-MPP1E66
<b>1RU FMT Rack Mount Splitter with Splitter</b>	1 x 32 splitter	OPS-FMTSP-AJJ01
	2 x 32 splitter	OPS-FMTSP-GJJ01
<b>1 RU Rack Mount Splitter Drawer</b> Accommodates up to 4 mini Plug-and-Play Splitters (purchased separately)	OPS-MPPACCRMPNL	
<b>Splitter Adapter Plate</b>	1 x 32 Splitter	2111684-1
	1 x 16 Splitter	2111684-2

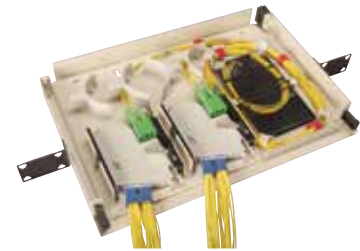

1RU Rack Mount Splitter Drawer



Splitter Adapter Plate  
(LGX/LSX footprint)

See 316500AE for more details.

# Fiber

## Optical LAN Solution Supporting PON Technologies

FIBER

### Rapid Fiber Distribution Terminal

TE's Rapid Fiber Distribution Terminal (FDT) provides a compact, NEMA-12 rated solution for connecting optical fiber cables within enterprise environments and serves as a distribution/consolidation point. It eliminates the need for splice cases and separate cable assemblies by integrating the RapidReel cable payout system. Use of factory terminated and tested MPO connectors instead of splicing provide a plug-and-play environment that reduces labor costs and speeds project completion. The Rapid FDT provides a lockable consolidation point and localized patch field, allowing for precise cable length customization in the field, while reducing overall cable volume and simplifying routing from the FDH to the user area. The iFDT's compact footprint enables it to be placed under raised floors, above ceilings, or wall mounted.

#### FEATURES

- Built-in RapidReel technology allows for easy payoff of MPO stub
- Patented break-away spool flanges reduce slack storage size to within the enclosures footprint
- Utilizes reduced bend radius fiber
- UL 1863 listed

#### ORDERING INFORMATION

Description	Stub	Feeder Stub Length	Part Number
<b>12-fiber</b> Loose tube plenum cable	MPO	100'	OLR-SJ12J00D1002A
		200'	OLR-SJ12J00D2002A
		300'	OLR-SJ12J00D3002A
<b>24-fiber</b> Loose tube plenum cable		100'	OLR-SJ24J00D1002A
		200'	OLR-SJ24J00D2002A
		300'	OLR-SJ24J00D3002A
<b>Mini-RDT 12-fiber</b> : Lengths over 100 ft use external reel	MPO	500'	OLR-SJ24J00D5002A
		100'	ODT-SM12J00D03090
		200'	ODT-SM12J00D0619A
		300'	ODT-SM12J00D0929A
		400'	ODT-SM12J00D1229A
		500'	ODT-SM12J00D1529A

\*Note: Other cable lengths available. Contact your local TE sales engineer.

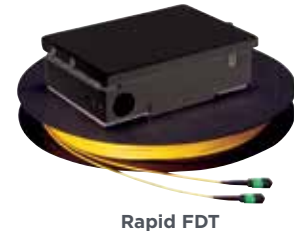

Rapid FDT



Rapid FDT using slider adapter packs



Mini RDT 12 Fiber



Mini RDT and Spool



Mini RDT Open and Pulling Rapid

# Fiber

## Optical LAN Solution Supporting PON Technologies

### Fiber Splitter Boxes

TE's Fiber Splitter Boxes (FSB) are mini Fiber Distribution Hubs that can be used for plug-and-play (PNP) or fusion splice applications.

When used as a plug-and-play box, they are ideal for uses such as lower count floors or buildings, extra capacity requirements beyond the standard Fiber Distribution Hub (FDH), and when localized splitting or physical path redundancy (using a 2x32 split) is desired.

The same box can also be used to extend services beyond the primary building to other smaller buildings with limited users on the campus. In this type of application, the FSB is typically spliced to the OSP fiber cable connecting the buildings and would offer the optical splitting required to provide PON services to the second building.

These wall boxes provide a small footprint for splitting, terminating, and splicing. FSBs accept standard plug-and-play splitters and can be easily added after the wall box has been installed. FSBs accommodate 1x8, 1x16, 1x32, 2x16 and 2x32 splitters. Wall mounting provides significant space savings and the unique swing frame design allows for easy access to the back section of the wall box.



FSB-32 Indoor Enclosure

### FEATURES AND BENEFITS

- Dual hinge design creates separation between rear splitter section and front patching access
- Splitters can be easily installed after wall box installation allowing for separate purchase
- Provides up to 32 customer access ports per splitter
  - Dual hinge provides small footprint on the wall while maintaining excellent hand access to connectors
- Accepts standard mini-PNP splitter modules (same as iFDH)
- UL 1863 Listed

### ORDERING INFORMATION

Description		Part Number
<b>FSB-32 Indoor Enclosure;</b> with SC/APC adapters, 32-fiber distribution	No splitters, no splice trays	OSB-SBJ032000000
	No splitters, with heat shrink splice trays	OSB-SBJ232000000
	(1) 1x32 splitter installed, no splice trays	OSB-SBJ032A10000
	(1) 1x32 splitter installed, with heat shrink splice trays	OSB-SBJ232A10000
	2 x 32 splitter installed, no splice trays	OSB-SBJ032G10000
	2 x 32 splitter installed, with heat shrink splice trays	OSB-SBJ232G10000
<b>Optical Splitter Module - Angled SC Pigtails</b>	1x32 splitter	OLS-MPPI3266
	1x16 splitter	OLS-MPPI1666
	1x8 splitter	OLS-MPPI0866
	2x16 splitter	OLS-MPPI1666
	2x32 splitter	OLS-MPPI2A66



# Fiber

## Optical LAN Solution Supporting PON Technologies

FIBER

### Optical Fiber Cables

The TE reduced bend radius singlemode cable assemblies are used to connect the user area to the Rapid FDT or when connecting the ONT to the wall plate at the user end of the PON. With nearly 40 years of fiber cable manufacturing experience, TE offers a complete family of high performance cable and related products.

TE's singlemode reduced bend radius cable assemblies have a bend radius of 7.5 mm and are backwards compatible with standard singlemode fiber. TE offers ultra physical contact (UPC) or angled physical contact (APC) SC connector styles. TE maintains tight tolerances regarding the geometry and concentricity of the ferrule to maintain low insertion loss values. All cable assemblies undergo stringent testing for both insertion loss and return loss at the factory before shipment which ensures a high quality product is delivered.



### Simplex Drop Cables

#### ORDERING INFORMATION

Description	Length in Meters	Part Number
SCAPC-SCAPC Plenum Ivory	3 (10')	PAT-6C6C-PSIG003M
	8 (25')	PAT-6C6C-PSIG008M
	16 (50')	PAT-6C6C-PSIG016M
	23 (75')	PAT-6C6C-PSIG023M
	31 (100')	PAT-6C6C-PSIG031M
	38 (125')	PAT-6C6C-PSIG038M
	46 (150')	PAT-6C6C-PSIG046M
SCUPC-SCAPC Plenum Ivory	3 (10')	PAT-SC6C-PSIG003M
	8 (25')	PAT-SC6C-PSIG008M
	16 (50')	PAT-SC6C-PSIG016M
	23 (75')	PAT-SC6C-PSIG023M
	31 (100')	PAT-SC6C-PSIG031M
	38 (125')	PAT-SC6C-PSIG038M
	46 (150')	PAT-SC6C-PSIG046M



Stapled 3 mm Drop Cable

Additional configurations and lengths are available; contact TE for assistance.  
 Note: Reduced bend radius cable is used on all Drop Cables.



# Fiber

## Optical LAN Solution Supporting PON Technologies

### Jumper Assemblies

#### ORDERING INFORMATION

Description	Length in Meters	Part Number
SCAPC-SCAPC Plenum Yellow	3 (10')	PAT-6C6C-PSOG003M
	8 (25')	PAT-6C6C-PSOG008M
	16 (50')	PAT-6C6C-PSOG016M
	23 (75')	PAT-6C6C-PSOG023M
	31 (100')	PAT-6C6C-PSOG031M
	38 (125')	PAT-6C6C-PSOG038M
	46 (150')	PAT-6C6C-PSOG046M
SCUPC-SCAPC Plenum Yellow	3 (10')	PAT-SC6C-PSOG003M
	8 (25')	PAT-SC6C-PSOG008M
	16 (50')	PAT-SC6C-PSOG016M
	23 (75')	PAT-SC6C-PSOG023M
	31 (100')	PAT-SC6C-PSOG031M
	38 (125')	PAT-SC6C-PSOG038M
	46 (150')	PAT-SC6C-PSOG046M

Additional configurations and lengths are available; contact TE for assistance.

# Fiber

## Optical LAN Solution Supporting PON Technologies

### Singlemode Reduced Bend Radius Multifiber Cable Assemblies

#### ORDERING INFORMATION

##### Description

12-Fiber 3 mm Singlemode Reduced Bend Radius Plenum Cable	Length in Feet	Part Number
MPO to SC/APC	50'	MPA-NC6CJ50050F-NF
	100'	MPA-NC6CJ50100F-NF
	200'	MPA-NC6CJ50200F-NF
	300'	MPA-NC6CJ50300F-NF
MPO to SC/UPC	50'	MPA-NCSCJ50050F-NF
	100'	MPA-NCSCJ50100F-NF
	200'	MPA-NCSCJ50200F-NF
	300'	MPA-NCSCJ50300F-NF
MPO to ST/UPC	50'	MPA-NCTCJ50050F-NF
	100'	MPA-NCTCJ50100F-NF
	200'	MPA-NCTCJ50200F-NF
	300'	MPA-NCTCJ50300F-NF

Additional configurations and lengths are available; contact TE for assistance.

### MPO-MPO Cable Assemblies

#### ORDERING INFORMATION

##### Description

12-Fiber 3 mm Singlemode Reduced Bend Radius Plenum Cable	Length in Feet	Part Number
12-Fiber MPO-MPO	100'	MPA-NCNCJ50100F-NN
	200'	MPA-NCNCJ50200F-NN
	300'	MPA-NCNCJ50300F-NN
	400'	MPA-NCNCJ50400F-NN
	500'	MPA-NCNCJ50500F-NN
	600'	MPA-NCNCJ50600F-NN
	750'	MPA-NCNCJ50750F-NN
	1000'	MPA-NCNCJ50305M-NN
24-Fiber Zip MPO-MPO	100'	MPA-NCNCZ50100F-NN
	200'	MPA-NCNCZ50200F-NN
	300'	MPA-NCNCZ50300F-NN
	400'	MPA-NCNCZ50400F-NN
	500'	MPA-NCNCZ50500F-NN
	600'	MPA-NCNCZ50600F-NN
	750'	MPA-NCNCZ50750F-NN
	1000'	MPA-NCNCZ50305M-NN

Additional configurations and lengths are available; contact TE for assistance.

# Fiber

## Optical LAN Solution Supporting PON Technologies

### Armored Cable

Our Secured Armored Optical LAN Solution allows high-security customers to have confidence that their optical network will be secure when deployed. The secured OLS platform uses TE's interlocking armored cable that provides a tamper-proof protection cable connecting to a secured junction box that can be mounted on the ceiling or in a sub floor. The junction box allows up to four input cables with a maximum of 72 fibers. The drop side of the junction box will allow up to 72 armored fibers to be run to secured user facilities connecting to a user box that can be mounted either under or on top of the desktop. The ONT box offers access separation for authorized network personnel only and simple access from a locked door allowing approved user access with issued key.

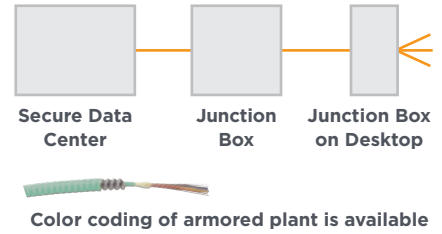

### ORDERING INFORMATION

Description		Part Number
<b>Armored cable</b>	6-fiber, SM Interlocking Aluminum Armor	4-1777121-7
	12-fiber, SM Interlocking Aluminum Armor	4-1777117-7
	24-fiber, SM Interlocking Aluminum Armor	7-1553420-3
	72-fiber, SM Interlocking Aluminum Armor	4-1777124-7
<b>SC APC LightCrimp PLUS Connector*</b>	900 µm buffered and 250 µm coated fibers	2064184-1
	900 µm buffered and 250 µm coated fibers, 3.0mm jacketed cable	2064184-2



Colored, keyed, SECURE cable assemblies and other armored configurations are available. Contact your local TE Connectivity Sales Engineer.

\* Tooling Kit, SC APC (1278118-4), reference page 1-131

Handheld Optical Fiber Cleaver, SC APC (1871696-1), reference page 1-133

FIBER

# Fiber

## Optical LAN Solution Supporting PON Technologies

### Patch Cords



TE's patch cord cables are available in Category 5E, 6, or augmented CAT 6 and in a variety of lengths and colors for interconnecting output of ONT to user's computer.

### Category 5E Patch Cords



Category 5E Patch Cords

#### ORDERING INFORMATION



Description	Cable Color	Part Number
<b>RJ45 plug to RJ45 plug, T568B</b> Quantity: 1 Wired straight through 	White	TCPC-5ERUVB-WTxxF
	Red	TCPC-5ERUVB-RDxxF
	Blue	TCPC-5ERUVB-BLxxF
	Green	TCPC-5ERUVB-GNxxF
	Yellow	TCPC-5ERUVB-YLxxF
	Gray	TCPC-5ERUVB-GYxxF
<b>RJ45 plug to RJ45 plug, T568A</b> Quantity: 1 Wired straight through 	White	TCPC-5ERUVA-WTxxF
	Red	TCPC-5ERUVA-RDxxF
	Blue	TCPC-5ERUVA-BLxxF
	Green	TCPC-5ERUVAGNxxF
	Yellow	TCPC-5ERUVA-YLxxF
	Gray	TCPC-5ERUVA-GYxxF

\*Replace xx with: 04 = 4'    10 = 10'    25 = 25'  
 07 = 7'    15 = 15'    50 = 50'

Contact TE for additional cable colors and lengths.

### Category 6 Patch Cords

#### ORDERING INFORMATION

Description	Cable Color	Part Number
<b>RJ45 plug to RJ45 plug, T568B</b> Quantity: 1 Wired straight through 	Black	TCPC-6RUVB-BKxxF
	Blue	TCPC-6RUVB-BLxxF
	Green	TCPC-6RUVB-GNxxF
	Gray	TCPC-6RUVB-GYxxF
	Red	TCPC-6RUVB-RDxxF
	White	TCPC-6RUVB-WTxxF
<b>RJ45 plug to RJ45 plug, T568A</b> Quantity: 1 Wired straight through 	Yellow	TCPC-6RUVB-YLxxF
	Blue	TCPC-6RUVA-BLxxF
	Green	TCPC-6RUVA-GNxxF
	Gray	TCPC-6RUVA-GYxxF
	Red	TCPC-6RUVA-RDxxF
	White	TCPC-6RUVA-WTxxF
Yellow	TCPC-6RUVA-YLxxF	

\*Replace xx with: 04 = 4'    10 = 10'    25 = 25'  
 07 = 7'    15 = 15'    50 = 50'

Contact TE for additional cable colors and lengths.



Category 6 Patch Cord



# Fiber

Optical LAN Solution Supporting PON Technologies

## Category 6A Patch Cords

### ORDERING INFORMATION

#### RJ45 to RJ45 Patch Cord

	Color	Part Number
<b>568B wiring</b> 	White	TCPC-6ARFVB-WTxxF
	Red	TCPC-6ARFVB-RDxxF
	Blue	TCPC-6ARFVB-BLxxF
	Yellow	TCPC-6ARFVB-YLxxF
	Green	TCPC-6ARFVB-GNxxF
	Gray	TCPC-6ARFVB-GYxxF
<b>568A wiring</b> 	White	TCPC-6ARFVA-WTxxF
	Red	TCPC-6ARFVA-RDxxF
	Blue	TCPC-6ARFVA-BLxxF
	Yellow	TCPC-6ARFVA-YLxxF
	Green	TCPC-6ARFVA-GNxxF
	Gray	TCPC-6ARFVA-GYxxF



Category 6A Patch Cord

\*Replace xx with: 04 = 4'      10 = 10'      25 = 25'  
 07 = 7'      15 = 15'      50 = 50'

Contact TE for additional cable colors and lengths.

## Security Key Plug

### FEATURES

- Works with standard RJ45 jacks
- Prevents unauthorized port connections
- Prevents disconnection from active devices
- Lock to RJ45 modular jacks
- Can be used in public areas or conference rooms
- 1871456-1 key/lock pairs are randomly selected from 100 different key numbers (numbered 800-899)
- 1871456-2, -3, and -4 use specific reserved key/lock pair number 456A
- RoHS compliant



Security Key Plug

# Fiber

## Optical LAN Solution Supporting PON Technologies

FIBER

### Security Key Patch Cord

#### FEATURES

- Works with standard RJ45 ports
- Prevents disconnection from active devices
- Prevents unauthorized disconnection
- Can be used for secure connections (e.g. server lines)
- Uses specific reserved key/lock pair number 456A (two keys included)
- RoHS compliant
- Category 6 patch cables are backward compatible with Category 5E components
- Security patch cord color:
  - CAT 6: black
  - CAT 6A F/UTP: blue



CAT 6 Patch Cord



CAT 6A Patch Cord

#### ORDERING INFORMATION

Category	Length	Locks on Both Ends	Locks on one End
CAT 6 Unshielded	1' (0.30 m)	2111179-1	2111225-1
	2' (0.61 m)	2111179-2	2111225-2
	3' (0.91 m)	2111179-3	2111225-3
	4' (1.22 m)	2111179-4	2111225-4
	5' (1.52 m)	2111179-5	2111225-5
	6' (1.83 m)	2111179-6	2111225-6
	7' (2.13 m)	2111179-7	2111225-7
	8' (2.44 m)	2111179-8	2111225-8
	9' (2.74 m)	2111179-9	2111225-9
	10' (3.05 m)	1-2111179-0	1-2111225-0
	12' (3.66 m)	1-2111179-2	1-2111225-2
	14' (4.27 m)	1-2111179-4	1-2111225-4
	16' (4.88 m)	1-2111179-6	1-2111225-6
	18' (5.49 m)	1-2111179-8	1-2111225-8
20' (6.10 m)	2-2111179-0	2-2111225-0	
CAT 6A Shielded	1' (0.30 m)	2111190-1	2111236-1
	2' (0.61 m)	2111190-2	2111236-2
	3' (0.91 m)	2111190-3	2111236-3
	4' (1.22 m)	2111190-4	2111236-4
	5' (1.52 m)	2111190-5	2111236-5
	6' (1.83 m)	2111190-6	2111236-6
	7' (2.13 m)	2111190-7	2111236-7
	8' (2.44 m)	2111190-8	2111236-8
	9' (2.74 m)	2111190-9	2111236-9
	10' (3.05 m)	1-2111190-0	1-2111236-0
	12' (3.66 m)	1-2111190-2	1-2111236-2
	14' (4.27 m)	1-2111190-4	1-2111236-4
	16' (4.88 m)	1-2111190-6	1-2111236-6
	18' (5.49 m)	1-2111190-8	1-2111236-8
20' (6.10 m)	2-2111190-0	2-2111236-0	

# Fiber

## Optical LAN Solution Supporting PON Technologies

### Angled Faceplates

#### FEATURES

- Accepts all AMP-TWIST jacks, SL series jacks, and SL series inserts
- Angled connector exits
- Protects connections
- Allows closer furniture placement



#### ORDERING INFORMATION

Description	Figure	Color	Part Number	
<b>Angled Faceplates</b>				
2-port	A	Almond	1375155-1	
4-port	B	Almond	406185-1	
<b>Inserts</b>				
LC Duplex couplers	Singlemode APC	C	Green	1933286-3
	Singlemode	D	Blue	1933286-4
SC Simplex coupler; singlemode	E	Green	1499836-9	
F-Connector coupler, 2 GHz	F	Almond	1499855-1	
Blank	G	Almond	1116412-1	

Other colors are available, contact TE for additional options.



Figure A



Figure B



Figure C



Figure D



Figure E



Figure F



Figure G

# Fiber

## Optical LAN Solution Supporting PON Technologies

### SL Series Faceplates

#### FEATURES

- Single gang and double gang, single-sided faceplates accept three 1 unit or two 1.5 unit SL series modules
- Double gang, double-sided faceplates accept three 1 unit or two 1.5 unit SL series modules on each side
- Front-loading modules eliminate need to remove faceplates from wall for changes or repairs
- Double gang, double-sided SL series faceplates:
  - Dimensions (DxWxH): 0.675" x 4.490" x 4.540"
  - For use with openings a minimum of 2.81" x 3.59" (not suitable for mud rings/device covers)



Figure A



Figure B



#### ORDERING INFORMATION

Description	Width		Figure	Part Number
SL Series Faceplates Almond	Single Gang	Single-sided	A	1339118-1
	Double Gang	Double-sided	B	1479486-1

Other colors are available, contact TE for additional options.

### HIDEAWAY Multimedia Outlets

#### FEATURES

- Accepts the following (see table for detailed load information):
  - Shielded and unshielded SL series jacks
  - AMP-TWIST jacks
  - SL series inserts
- Fits single and double gang electrical J-boxes
- Features “invisible” icon holes which remain hidden until used
- Features integral tabs for easy fiber loop management
- Breakaway tabs in duplex fiber coupler cut outs allow HIDEAWAY outlets to accept “flangless” SECURE LC duplex, standard LC duplex, or hybrid LC duplex couplers with retention clips (break out the tabs when using standard duplex couplers)



Figure A

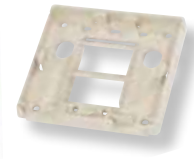
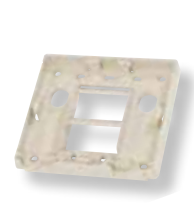

Figure B



#### ORDERING INFORMATION

Description	Figure	Part Number
4-Port	A	1479946-1
6-Port	B	1479815-1



# Fiber

## Optical LAN Solution Supporting PON Technologies

### HIDEOUT Outlets

#### FEATURES

- Double gang box with single gang cover recommended
- May not fit all single gang boxes
- Hides and protects cable connections
- Feeds from bottom to allow flush furniture placement
- Fits standard electrical boxes
- Each kit includes sub-plate, faceplate, adhesive labels, cable ties, and mounting screws. Media modules and icons must be ordered separately. Faceplates are plastic except for the stainless steel version
- Accepts the following (see table for detailed load information):
  - Shielded or unshielded SL series jacks
  - Unshielded 110Connect jacks
  - SL series inserts
- Shielded SL series jacks work in bottom row of faceplate only



Snap-on Cover



Screw-on Cover

#### ORDERING INFORMATION

Description	Included Faceplate	Part Number
HIDEOUT Outlet Kit Almond	Screw-on	503997-1
	Snap-on	503999-1

Note: Hideaway and Hide out Outlets can use SCAPC adapter pn 2-5502776-3

# Fiber

## Optical LAN Solution Supporting PON Technologies

### Desktop Monuments

#### FEATURES

- Power Monuments:
  - Provide access to duplex power outlet at the desktop
  - Eliminates the need to feed power cables behind or through desks
  - Supplied with an 8' (2.4 m), 3-prong power cord for connection to existing electrical outlets
- Voice/Data Monuments:
  - Accepts standard FLEX-MODE faceplates
  - Horizontal cabling can be connected directly to SL series modular jacks (recommended for Category 5E applications)
- Attach to any desktop from 0.90" - 1.78" (22.9 mm - 45.2 mm)
- No special tools required to attach, simply place the monument onto the edge of the desktop and tighten the integrated thumb screw
- UL listed and CSA certified



Figure A



Figure B



Figure C

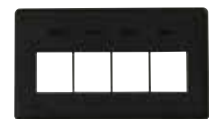

Figure D

#### ORDERING INFORMATION

Description	Figure	Color	Part Number
<b>Power Monument; 15 Amp</b>	A	Black	556222-3
<b>Voice/Data Monument Empty Housing; requires FLEX-MODE faceplate</b>	B	Black	1116360-3
<b>Flex-Mode flush faceplate; 2-port</b>	C	Black	558106-1
<b>SL series; 4-port</b>	D	Black	1933134-1

### Consolidation Point Transition Cable Assemblies

#### FEATURES

- Ideal for shared ONT applications
- Form connections between remote/shared ONTs and the work area
- Compatible with all SL series faceplates
- Factory-assembled and tested
- Save time and money on moves, adds and changes
- Lead-free (no heavy metals)
- Gray cable jacket



Transition Cable Assembly

#### ORDERING INFORMATION

End A	End B	Length	Plenum (CMP) T568A	Plenum (CMP) T568B
<b>Category 5E Modular Plug</b>	SL Series Category 5E Modular Jack	20'	219174-1	219175-1
		30'	219174-2	219175-2
		40'	219174-3	219175-3
		50'	219174-4	219175-4
<b>Category 6 Modular Plug</b>	Un-terminated	50'	1499057-4	1499057-8
<b>Category 6A Modular Plug</b>			5-1499783-0	5-1933335-0

# Fiber

## Optical LAN Solution Supporting PON Technologies

### Media Convergence Center

#### FEATURES

- 20 AWG steel with white powder coat
- Multiple knockouts on all surfaces
- Versatile mounting grid for multiple connectivity panels and modules
- Two (2) knockouts for duplex electrical boxes
- 20 AWG steel with white powder coat
- Beveled edge for safety & aesthetics
- Screw on cover
- Lock for added security

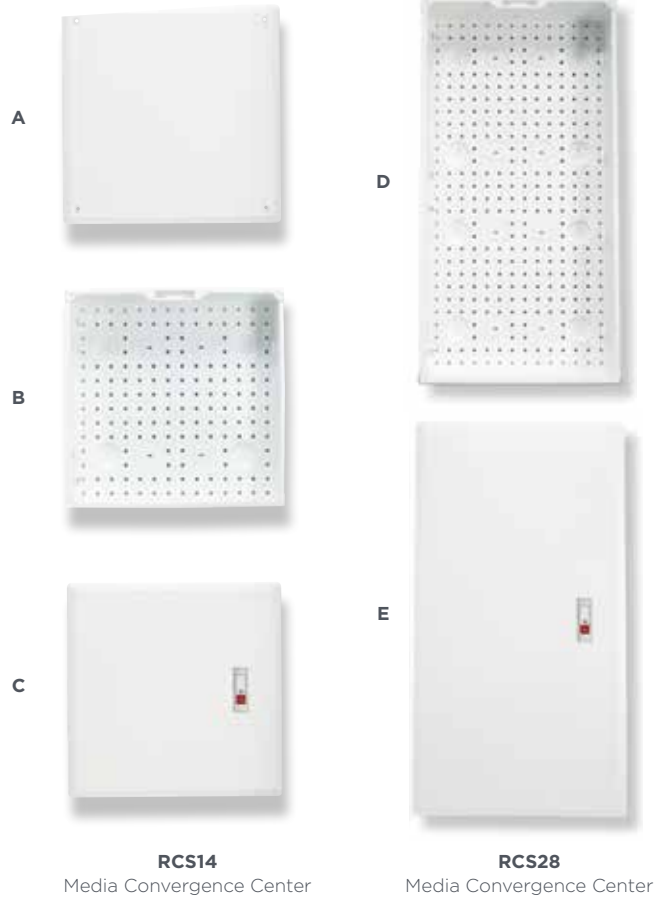

#### ORDERING INFORMATION

Description	Dimension	Figure	Part Number
RCS14 Enclosure with screw-on Cover		A	1933691-1
RCS14 Enclosure without Cover	14.3 in H x 14.3 in W x 3.6 in D	B	1933837-1
RCS 14 Hinged Lockable Cover		C	1933694-1
RCS28 Enclosure with screw on Cover			1933692-1
RCS28 Enclosure without Cover	28.0 in H x 14.3 in W x 3.6 in D	D	1933838-1
RCS28 Hinged, Lockable Cover		E	1933695-1

# Fiber

## Fiber Optic Accessories and Tooling

### Fiber Optic Accessories and Tooling

TE Connectivity's tool kits include all tools and consumables necessary for fiber termination

- Universal toolkits for installing all LightCrimp PLUS connectors
- Includes tools for installing MT-RJ and MT-RJ SECURE jacks
- Includes all tools necessary to install epoxy/polish connectors



### LightCrimp PLUS LC/SC and LightCrimp Splice Termination Tool Kit

- Includes all tools need for installing LightCrimp PLUS LC, LC SECURE, SC, and LightCrimp Splice
- Convenient carrying case
- Tool kit includes:
  - Splice/Cable buffer holder
  - PRO-CRIMPER III hand tool
  - LC/SC/Splice die set
  - Fiber cleaver
  - 2.0 mm cable splitter
  - Buffer stripper
  - Cable jacket stripper
  - Strength member shears



### Tool Kit Compatibility Chart

#### ORDERING INFORMATION

Tool Kit Name	MT-RJ Jacks	MT-RJ SECURE Jacks	LightCrimp PLUS			LightCrimp Splice	Epoxy/Polish			Tool Kit Part Number
			**LC	SC	ST		LC	SC	ST	
LightCrimp PLUS Termination Tool Kit	-	-	X	X	-	X	-	-	-	1553212-1
LightCrimp PLUS No-epoxy/No-polish Universal Tool Kit	X	X	X	X	X	-	-	-	-	1278118-4
LightCrimp PLUS No-epoxy/No-polish Universal Tool Kit	X	X	X	X	X	-	-	-	-	1278118-5
LightCrimp PLUS No-epoxy/No-polish LC and SC Tool Kit	-	-	X	X	-	-	-	-	-	1754845-1
LightCrimp PLUS No-epoxy/No-polish LC and SC Tool Kit	-	-	X	X	-	-	-	-	-	1754845-2
LightCrimp PLUS No-epoxy/No-polish ST Tool Kit	-	-	-	-	X	-	-	-	-	492697-1
LightCrimp PLUS No-epoxy/No-polish ST Tool Kit	-	-	-	-	X	-	-	-	-	492697-2
MT-RJ Jack Tool Kit	X	X	-	-	-	-	-	-	-	1278346-1
	X	X	-	-	-	-	-	-	-	1278346-2
Epoxy/Polish Tool Kits	-	-	-	-	-	-	X*	X	-	503746-7
	-	-	-	-	-	-	X*	-	X	503746-1

\*Note: Termination of LC Epoxy/Polish Connectors requires additional tools listed in this chapter.

\*\*Note: Termination includes LC SECURE Connectors

Termination instructions may be found at [www.te.com/foguide](http://www.te.com/foguide)

# Fiber

## Fiber Optic Accessories and Tooling

### Epoxy/Polish Connector Consumables/Compatibility Chart

#### ORDERING INFORMATION

Epoxy/Polish Connector	Epoxies			Polishing Films					Consumables Package*
	EPO-TEK 504035-1	TRA-CON 1918652-1	HYSOL 502418-1	9 $\mu$ m 1374484-1	5 $\mu$ m 228433-8	Diamond Film 503887-1	0.3 $\mu$ m 228433-5	Final Polishing Film 502748-2	
LC Singlemode	X	X	X	X	X	X	X	-	502306-4
LC Multimode	X	X	X	X	X	X	X	-	502306-4
SC Singlemode	X	X	X	-	X	-	X	X	502306-2
SC Multimode	X	X	X	-	X	-	X	X	502306-2
ST Singlemode	-	X	X	-	X	-	X	X	502306-2
ST Multimode	-	X	X	-	X	-	X	-	502306-1

\*Note: Epoxy and film for  $\approx$  100 connectors.

### LightCrimp PLUS Termination Tool Kits

#### FEATURES

- Universal kits Include all tools needed for installing all LightCrimp PLUS no-epoxy/no-polish connectors, MT-RJ, and MT-RJ SECURE jacks
- Convenient carrying case



#### ORDERING INFORMATION

Description	For Use With	Optional Components		Part Number
		Cleave Tool 1871696-1	Inspection Microscope 1754767-1	
Universal LightCrimp PLUS No-epoxy/No-polish Tool Kit	LC, MT-RJ, SC, ST	X	-	1278118-4
		X	X	1278118-5
LightCrimp PLUS Connector Termination Tool Kit	LC, SC	X	-	1754845-1
		X	X	1754845-2
	ST	X	-	492697-1
		X	X	492697-2

Termination instructions may be found at [www.te.com/foguide](http://www.te.com/foguide)

# Fiber

## Fiber Optic Accessories and Tooling

FIBER

### MT-RJ Jack Termination Tool Kit

Includes all tools needed for installing MT-RJ and MT-RJ SECURE jacks.



#### ORDERING INFORMATION

Description	Optional Components		Part Number
	Cleave Tool 1871696-1	Inspection Microscope 1754767-1	
MT-RJ Termination Tool Kit with cleave tool	X	-	1278346-1
	X	X	1278346-2

### LightCrimp PLUS Cable Holders

Used in LightCrimp PLUS connector terminations (included in LightCrimp PLUS Tool Kits).

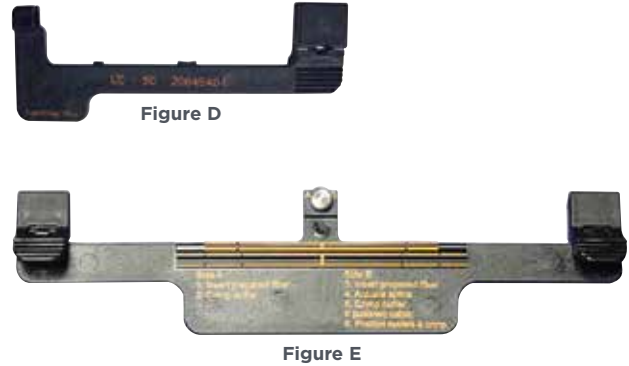

#### ORDERING INFORMATION

Connector Type	Figure	Part Number
ST	A	492703-1
SC	B	1278023-1
LC	C	1754138-1
LC and SC	D	*2064540-1
LightCrimp Splice Holder	E	*1985771-1

\* Used with die set 1985766-1  
Termination instructions may be found at [www.te.com/foguide](http://www.te.com/foguide)

# Fiber

## Fiber Optic Accessories and Tooling

### Hand Held Optical Fiber Cleaver

#### FEATURES

- Cleave fibers for LightCrimp PLUS connectors, MT-RJ, and MT-RJ SECURE jacks
- Operator independent
- Blade life-span more than 10,000 cleaves
- Cleave surface angle <math><1.5^\circ</math>
- No fracture, roll-off, or lip cleaves



#### ORDERING INFORMATION

Description	Part Number
Hand Held Optical Fiber Cleaver	1871696-1

### Epoxy/Polish Connector Termination Tool Kits

#### FEATURES

- Includes all tools necessary to install the listed epoxy/polish connectors
- For LC terminations, also order LC termination accessories kit
- Tool kits include:
  - Pro-Crimper III Hand
  - Tool and crimping dies
  - Polishing bushings
  - Polishing film
  - Fiber strippers
  - Scribe tool
  - Includes polishing films to install 60 epoxy/polish connectors
  - Epoxy is sold separately
  - Does not include curing oven or microscope
  - Convenient carrying case



#### ORDERING INFORMATION

Description	For Use With	Part Number
LC Termination Accessories Kit (use with 503746)	LC	1754462-1
Epoxy/Polish Connector Termination Tool Kits	SC	503746-7
	ST	503746-1

Termination instructions may be found at [www.te.com/foguide](http://www.te.com/foguide)

# Fiber

## Fiber Optic Accessories and Tooling

### EPO-TEK 353ND Epoxy

#### FEATURES

- For use with SC and LC Connectors
- Pre-measured two-part packets for consistent results
- Long pot life once mixed
- Heat-cured epoxy
- Supplied in 4-gram packets
- Cures in 15 minutes at 115° C
- Epoxy curing time starts after the oven has restabilized to the desired temperature after inserting the connectors into the curing block



#### ORDERING INFORMATION

Description	Part Number
EPO-TEK 353ND Epoxy	504035-1

### TRA-CON Epoxy

#### FEATURES

- For use with SC, LC and ST Connectors
- Pre-measured two-part packets for consistent results
- Can be heat-cured or cured at ambient temperature
- Supplied in 2-gram packets
- Each packet terminates  $\approx$  250 connectors
- 25 packets per pack
- Pot life  $\approx$  30 minutes
- Cures in:
  - 24 hours @ 25° C
  - 2 hours @ 65° C
  - 10 minutes @ 110° C
- Epoxy curing time starts after the oven has restabilized to the desired temperature after inserting the connectors into the curing block



#### ORDERING INFORMATION

Description	Part Number
TRA-CON Epoxy	1918652-1



# Fiber

## Fiber Optic Accessories and Tooling

### HYSOL Epoxy-Tubes

#### FEATURES

- For use with SC, LC and ST Connectors
- Two-part epoxy in two tubes
- Heat-cured epoxy
- Terminates  $\approx$  400 connectors
- One set of two (2) tubes per part number
- Pot life  $\approx$  30 minutes
- Cures in 30 minutes at 100° C
- Epoxy curing time starts after the oven has restabilized to the desired temperature after inserting the connectors into the curing block



#### ORDERING INFORMATION

Description	Part Number
HYSOL Epoxy-Tubes	502418-1

### Epoxy Applicator Syringe

#### ORDERING INFORMATION

Description	Part Number
Epoxy Applicator Syringe	501473-3



# Fiber

## Fiber Optic Accessories and Tooling

FIBER

### Polishing Films and Consumables Kits

- Polishing films used to install LightCrimp and epoxy/polish connectors
- See listing of correct films by connector type
- Consumable kits include all consumables needed to install ≈ 100 of the listed epoxy/polish connectors

#### ORDERING INFORMATION

Description	For Use With	Package Quantity	Grit Grade	Part Number
Hand Polishing Film	Epoxy/Polish Connectors	100	15 µm	228433-9
		15	9 µm	1374484-1
		100	5 µm	228433-8
		100	1 µm	228433-7
		5	Diamond	503887-1
		100	0.3 µm	228433-5
Final Polishing Film	Epoxy/Polish Connectors	5	Final	502748-2
Consumables Kit	Multimode ST	-	-	502306-1
	SC, singlemode ST	-	-	502306-2
	LC	-	-	502306-4

### Epoxy Curing Oven

#### FEATURES

- Reduces time required to cure epoxy
- Provides a uniform, controlled curing environment
- Used for all of TE's AMP NETCONNECT optical fiber epoxy/polish connectors
- Variable temperature control (60° C to 125° C)
- Includes thermometer - Epoxy curing time starts after the oven has restabilized to the desired temperature after inserting the connectors into the curing block
- Includes cable support bracket
- Two voltage options
- Comes equipped to cure up to four duplex connectors and twelve simplex connectors at once
  - Optional blocks reconfigure to eight duplex or twenty-four simplex connectors



#### ORDERING INFORMATION

Description	Part Number	
Curing Oven	110 VAC	502134-1
	220 VAC	502134-2
Adapter Block for 8 Duplex Connectors		502222-1
Adapter Block for 24 Single Connectors		502129-1
LC Oven Block Assembly		1457628-1

# Fiber

## Fiber Optic Accessories and Tooling

### Inspection Microscope

- Optimal visual examination of terminated ends
- 500 µm field of view
- Dual illumination
- Coaxial for inspecting polish quality
- Oblique for general conditions
- Pre-centered, threaded adapter mount provides easy focusing and changing of connectors
- Field and laboratory examination for multimode and singlemode fibers
- Portable
- Integral infrared filter for safety
  - Do NOT use any microscope to view active fiber signals
- Disposable, Type LR44 batteries
- Long-life LED (approximately 100,000 hours of operation)
- Each Kit includes:
  - 10-power objective microscope with an impact resistant ergonomic rubber shell and high quality glass optics
  - 20-power eyepiece
  - Padded carrying case with an integrated belt loop and internal adapter storage pocket
  - Neck lanyard with safety breakaway feature
  - Universal 2.5 mm ferrule adapter (for SC, ST and FC)



### ORDERING INFORMATION

Description	Part Number	
<b>Inspection Microscope</b>	1754767-1	
1.25 mm Universal (LC and MU)	1754765-1	
2.5 mm Universal (SC, ST and FC)	1754766-1	
LC Duplex	2123273-1	
LC APC adapter	1553785-1	
MT-RJ	1754768-1	
SC APC	1828833-1	
<b>Connector Adapters</b>		
MPX	1828834-1	
MPX APC	1828835-1	
MPO	1828836-1	
MPO APC	1828837-1	
FSMA	Connector Adapter	1985040-1
	Coupling adapter <b>(Required for FSMA adapter)</b>	1985041-1

**DANGER: Active fibers should never be viewed through a microscope.**

# Fiber

## Fiber Optic Accessories and Tooling

### Polishing Bushings, Curing Sleeves, and Strip Card Kit

#### FEATURES

- Polishing bushings included in many tool kits
- Curing sleeves hold connectors in oven

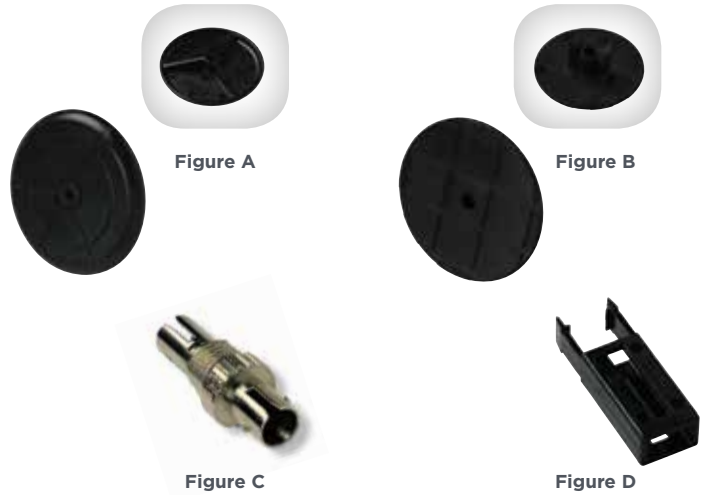

#### ORDERING INFORMATION

Description	Cable Jacket Diameter (mm)	Used With	Notes	Figure	Part Number
LC Fiber Protectors, for Buffered Fiber	-	Epoxy/polish LC connectors			1457630-1
LC Fiber Protectors, for Jacketed Cable	-	Epoxy/polish LC connectors			1457630-2
Polish Bushing	3.0	Ceramic and stainless steel ST connectors	Metal		503337-1
		Ceramic, stainless steel and polymer composite ST connectors	Black Polymer	A	503304-1
		SC connectors	Black Polymer	B	502631-1
	-	LC connectors	Metal		1754074-1
Curing Sleeve	3.0	Ceramic, stainless steel and polymer composite ST connectors	12 pieces	C	502259-1
		SC connectors	1 piece	D	502656-1
Strip Template Kit	-	SC and ST connectors			501818-1

# Fiber

## Fiber Optic Accessories and Tooling

### PRO-CRIMPER III Fiber Optic Hand Tool and Die Sets

#### FEATURES

- Crimp tool and die sets for LightCrimp, LightCrimp PLUS, and Epoxy/Polish style connectors
- Ergonomic tool design for comfort and easy actuation
- Die sets are interchangeable in the crimp tool
- Die set 1985766-1 can be used with the fiber protective end cap in place for LightCrimp PLUS LC and SC connectors



Figure A



Figure B

#### ORDERING INFORMATION

Description		Figure	Part Number	
<b>PRO-CRIMPER III Hand Tool (Die Sets Purchased Separately)</b>		A	2064431-1	
<b>For Use With</b>	<b>Cable Jacket Diameter (mm)</b>		<b>Die Set Only</b>	<b>Hand Tool w/Die Set</b>
<b>SC (Polymer Crimp Body)</b>	3.0		503910-1	503911-1
	2.4 and 3.0		492025-1	492026-1
<b>SC (Metal Crimp Body)</b>	1.6 - 2.0, 2.4		1588175-1	1588176-1
	3.0		492131-1	-
<b>LC</b>	1.6 - 2.0, 2.4, 3.0		1588175-1	1588176-1
<b>ST, Ceramic</b>	3.0		58424-1	58433-4
<b>ST, Stainless Steel</b>	3.0		58424-1	58433-4
<b>ST, Stainless Steel (504000-X Series Only)</b>	3.0		58552-1	58551-1
<b>ST Ceramic Used with Loose Tube</b>	3.8		503890-1	-
<b>LightCrimp PLUS LC</b>	1.6 - 2.0		1754136-1	1754137-1
<b>LightCrimp PLUS and LightCrimp SC</b>	3.0		492783-1	492782-1
<b>LightCrimp PLUS and LightCrimp ST</b>	3.0		492622-1	492623-1
<b>LightCrimp PLUS LC and SC, LightCrimp Splice</b>	2.0	B	1985766-1	2064603-1

Termination instructions may be found at [www.te.com/foguide](http://www.te.com/foguide)

# Fiber

## Fiber Optic Accessories and Tooling

### MTP/MPO IBC (In Bulkhead Cleaner)

#### FEATURES

- Dry cloth cleaner utilizes densely woven micro-fiber cloth
- Cleans male (with pins) or female MTP/MPO connectors in adapters, bulkheads, and faceplates
- Pre-washed cleaning cloth is lint and debris free
- Each cleaner is capable of more than 400 cleanings
- Protective dust cover doubles as an adapter cap for cleaning unmated connectors
- FOCIS 5-Type MTP/MPO interface compliant
- Removes dust and oil contamination



#### ORDERING INFORMATION

Description	Part Number
MTP/MPO IBC (In Bulkhead Cleaner)	1918809-1

### OPTIPOP R Reel Optical Connector Cleaner

- Densely woven micro-fiber cloth cleans fiber optic connector tips while reducing static charge
- Variety of reel cleaner configurations allow for use on the major connector types including FC, SC, ST, LC, MT-RJ, and MPO

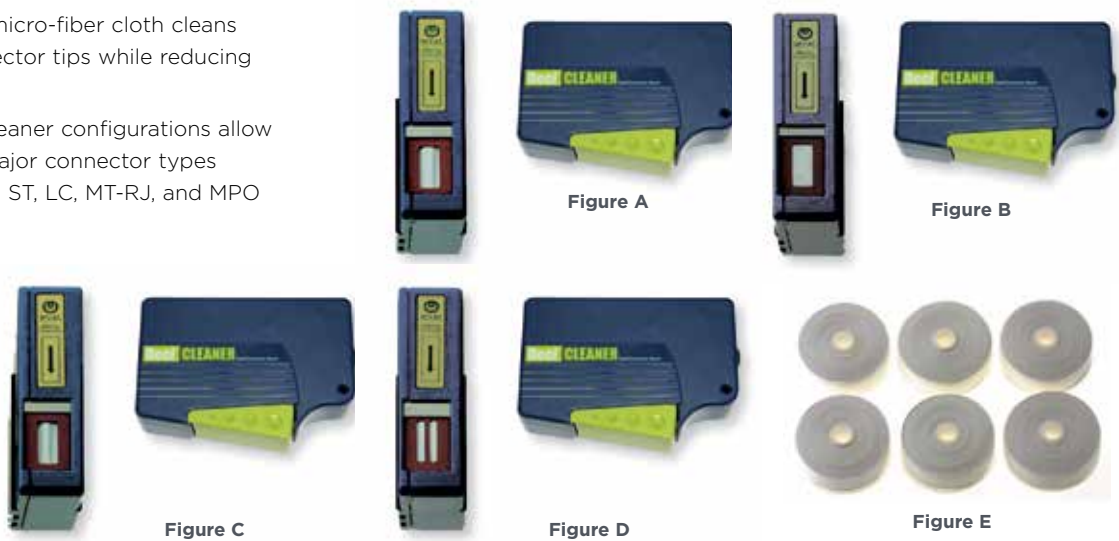

#### ORDERING INFORMATION

Description	Figure	Part Number
MPO w/pins Reel Cleaner	A	1918802-1
One slot Reel Cleaner; 1.25mm, 2.5mm, MT no pins	B	1918803-1
MT-RJ plug w/pins Reel Cleaner	C	1918804-1
Two slot Reel Cleaner; 1.25mm and 2.5mm	D	1918805-1
Reel Cleaner refill (6 per pack)	E	1918806-1

# Fiber

## Fiber Optic Accessories and Tooling

### OPTIPOP C Card Optical Connector Cleaner

#### FEATURES

- Densely woven micro-fiber cloth cleans fiber optic connector tips while reducing static charge
- For use on the major connector types including FC, SC, ST, LC, MT-RJ, and MPO
- Captures debris and other contamination
- Cloth dimensions:  
120 mm x 57 mm (4.72" x 2.24")



#### ORDERING INFORMATION

Description	Part Number
Fiber Connector Card Cleaner	1918810-1
Card Cleaner Refill (10 per pack)	1918811-1

### NEOCLEAN Stick Cleaner

#### FEATURES

- Dry cloth stick cleaners utilize a densely woven micro-fiber cloth to clean fiber optic connector tips while reducing static charge
- Perforated handle for customizing length and angle
- Overall stick length: 151 mm (5.94")
- 250 Sticks per package

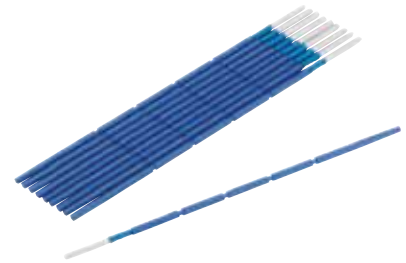

#### ORDERING INFORMATION

Description	Part Number
Stick Cleaner - 2.5 mm Tip Diameter	1918807-1
Stick Cleaner - 1.25 mm Tip Diameter	1918808-1

# Fiber

## Fiber Optic Accessories and Tooling

FIBER

### LC and SC Connector Cleaner (In Bulkhead Cleaner)

#### FEATURES

- Dry cloth cleaners specially designed to clean single fiber connectors in adapters, bulkheads, and faceplates
- Dust cap of the cleaner acts as an adapter for cleaning unmated connectors
- Extended tip reaches recessed connectors
- Removes dust and oil contamination
- Disposable cleaner with 525+ cleanings per unit

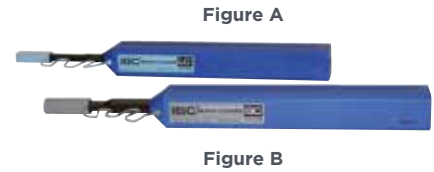

#### ORDERING INFORMATION

Description	Figure	Part Number
LC Connector Cleaner (In Bulkhead Cleaner)	A	2064500-1
SC Connector Cleaner (In Bulkhead Cleaner)	B	2064499-1

### Professional Fiber Connector Inspection/Cleaning Kits

#### FEATURES

- Perform inspection, cleaning, maintenance, and troubleshooting on optical connectors
- Kits include: carrying case, 200x inspection microscope, visual fault locator, various styles of connector cleaners, and detailed inspection and cleaning instructions



#### ORDERING INFORMATION

For Use With	Figure	Part Number
LC, SC, ST, FC, MT-RJ, and MPO Style Connectors	A	2064651-1
LC, SC, ST, FC, and MT-RJ Style Connectors		2064651-2
LC, SC, ST, and FC Style Connectors		2064651-3



# Fiber

## Fiber Optic Accessories and Tooling

### Velcro Cable Ties

For 8" and 12" ties, an order quantity of one equals one roll of ten ties.



### ORDERING INFORMATION

Description	Figure	Part Number	
		Black	Blue
1" x 8"	A	1375253-2	-
1" x 12"	B	1375254-2	-
5/8" x 5 yards	C	1375255-2	1375255-6
1" x 12" Flame Retardant*		1375256-2	-

\* NOTE: Complies with NEC 300-22(c) and (d) for use in environmental air handling spaces. Available in black only.

### AMP-TY Nylon Cable Ties

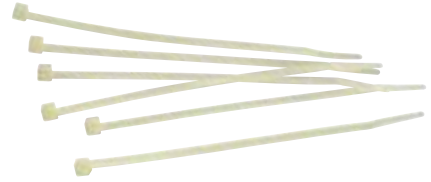

### ORDERING INFORMATION

Length	Dimensions (Approximate)		Minimum Tensile Strength	Maximum Bundle Diameter	Package Quantity	Color	
	Width	Thickness				Natural	Black
4" [103.0 mm]	0.096" [2.44 mm]	0.037" [0.94 mm]	18 lbs [80.1 N]	0.75" [19.10 mm]	1000	2-604771-9	2-604771-0
					100	1-604771-9	1-604771-0
6" [155.0 mm]	0.140" [3.56 mm]	0.045" [1.14 mm]	30 lbs [133.5 N]	1.25" [31.75 mm]	1000	2-603227-9	2-603227-0
					100	1-603227-9	1-603227-0
8" [204.0 mm]	0.184" [4.67 mm]	0.047" [1.19 mm]	50 lbs [222.5 N]	1.75" [44.45 mm]	1000	2-604772-9	2-604772-0
					100	1-604772-9	1-604772-0
12" [300.0 mm]	0.183" [4.65 mm]	0.051" [1.30 mm]	50 lbs [222.5 N]	3.00" [76.20 mm]	1000	2-604751-9	2-604751-0
					100	1-604751-9	1-604751-0

# Fiber

## Fiber Optic Accessories and Tooling

### TE's TrueNet Copper and Fiber Labeling Software and Labeling Sheets

TE offers a complete labeling solution by SharpMark for the most popular copper and fiber solutions. TE labels are design to be used with a PC and standard laser printer. All label sheets are available through an TE authorized distribution partner. Contact TE Customer Service at 1-800-553-0938 for more details.

### Free Labeling Software

The free labeling software can be downloaded from TE's website at [www.te.com/TruenetLabeling](http://www.te.com/TruenetLabeling) in less than 5 minutes.

### FEATURES

- Easy to download software can be used with Windows or Vista
- Label sheets are designed specifically for TE's most popular products

### ORDERING INFORMATION

Description	UOM	Part Number
Adhesive label for TE's TrueNet patch cords or horizontal cable 1/2" x 1 1/2' Each label sheet contains 105 individual labels	SH	ADCLS-CL4A
Adhesive label for TE's TrueNet patch cords or horizontal cable 1" x 1 1/2' Each label sheet contains 49 individual labels	SH	ADCLS-CL10A
Adhesive label for TE's TrueNet patch cords or horizontal cable 1" x 2 1/4" Each label sheet contains 35 individual labels	SH	ADCLS-CL12A
Adhesive label for TE's TrueNet patch cords or horizontal cable 1" x 5 1/2" Each label sheet contains 14 individual labels	SH	ADCLS-CL24A
Adhesive label for TE's TrueNet 192 Fiber NGF Blocks Each label sheet contains 1 label sheet for left side of block	SH	ADCLS-NGF192LCAL
Adhesive label for TE's TrueNet 192 Fiber NGF Blocks Each label sheet contains 1 label sheet for right side of block	SH	ADCLS-NGF192LCAR
Adhesive label for TE's TrueNet 144 Fiber NGF Blocks Each label sheet contains 1 label sheet for left side of block	SH	ADCLS-NGF144SCAL
Adhesive label for TE's TrueNet 144 Fiber NGF Blocks Each label sheet contains 1 label sheet for right side of block	SH	ADCLS-NGF144LCAR
Adhesive label for TE's TrueNet 1RU TFP Fiber Panel Each label sheet contains 16 labels for the front and back of the hinged label	SH	ADCLS-TFP1RUA
Adhesive label for TE's TrueNet 2RU TFP Fiber Panel Each label sheet contains 6 labels for the front and back of the hinged label	SH	ADCLS-TFP2RUA
Adhesive label for TE's TrueNet 5RU TFP Fiber Panel Each label sheet contains 2 labels for the front and back of the hinged label	SH	ADCLS-TFP5RUA



**Label Sheets**  
designed for NGF Blocks

# Fiber

## Fiber Optic Test Equipment

### OM3 and OM4 (50 µm) and OM2 (50/125 µm) Multimode LC Test Kits

#### FEATURES

- Test Kits include:
  - Cable assemblies
  - LC duplex clips
  - Mandrels
  - Carrying case
- Test kits for LC SECURE connector systems also available
- See “FIELD TESTING LC OPTICAL FIBER SYSTEMS” white paper (available on-line at [www.te.com/EnterpriseNetworks](http://www.te.com/EnterpriseNetworks)) for test details



#### ORDERING INFORMATION

Description		Part Number
	SC Transmit and LC Receive Ports	1828867-1
For use with Dual Fiber Testers with	ST Transmit and LC Receive Ports	1828867-2
	LC Transmit and LC Receive Ports	1828867-3

### OM3 and OM4 (50 µm) and OM2 (50/125 µm) Multimode Replacement Components for LC Test Kits

#### FEATURES

- Assemblies are 3 meters in length
- Assemblies are simplex style
- Cable assemblies are riser (OFNR) rated

#### ORDERING INFORMATION

Description	Part Number
Mandrels (Transmit side only)	1435119-1
LC Duplex Clips (pack of 6)	1754371-2
SC to LC Simplex Assembly, 3 m	1907490-3
ST to LC Simplex Assembly, 3 m	1907493-3
LC to LC Simplex Assembly, 3 m	1907496-3

# Fiber

## Fiber Optic Test Equipment

### 62.5/125 $\mu\text{m}$ OM1 Multimode LC Test Kits

#### FEATURES

- Test kits include:
  - Cable assemblies
  - LC duplex clips
  - Mandrels
  - Carrying case
- Test kits for LC SECURE connector systems also available
- See “FIELD TESTING LC OPTICAL FIBER SYSTEMS” white paper (available on-line at [www.te.com/EnterpriseNetworks](http://www.te.com/EnterpriseNetworks)) for test details

#### ORDERING INFORMATION

Description		Part Number
	SC Transmit and LC Receive Ports	1828868-1
For use with Dual Fiber Testers with	ST Transmit and LC Receive Ports	1828868-2
	LC Transmit and LC Receive Ports	1828868-3

### 62.5/125 $\mu\text{m}$ OM1 Multimode Replacement Components for LC Test Kits

#### FEATURES

- Assemblies are 3 meters in length
- Assemblies are simplex style
- Cable assemblies are riser (OFNR) rated

#### ORDERING INFORMATION

Description	Part Number
Mandrels (Transmit side only)	1435118-1
LC Duplex Clips (pack of 6)	1754371-2
SC to LC Simplex Assembly, 3 m	1907491-3
ST to LC Simplex Assembly, 3 m	1907494-3
LC to LC Simplex Assembly, 3 m	1907497-3

# Fiber

## Fiber Optic Test Equipment

### Singlemode LC Test Kits

#### FEATURES

- Test kits include:
  - Cable assemblies
  - LC duplex clips
  - Mandrels
  - Carrying case
- Test kits for LC SECURE connector systems also available
- See “FIELD TESTING LC OPTICAL FIBER SYSTEMS” white paper (available on-line at [www.te.com/EnterpriseNetworks](http://www.te.com/EnterpriseNetworks)) for test details

#### ORDERING INFORMATION

Description		Part Number
For use with Dual Fiber Testers with	SC Transmit and LC Receive Ports	1828869-1
	ST Transmit and LC Receive Ports	1828869-2
	LC Transmit and LC Receive Ports	1828869-3

### Replacement Components for Singlemode LC Test Kits

#### FEATURES

- Assemblies are 3 meters in length
- Assemblies are simplex style
- Cable assemblies are riser (OFNR) rated

#### ORDERING INFORMATION

Description	Part Number
LC Duplex Clips (pack of 6)	1754371-4
LC to SC Simplex Assembly, 3 m	1907489-3
LC to ST Simplex Assembly, 3 m	1907492-3
LC to LC Simplex Assembly, 3 m	1907495-3





## SECURE Products

SECURE Network Solutions – Fiber Products .....2-3  
 SECURE Network Solutions – Copper Products ..... 2-17

TE is a proven provider of reliable network infrastructure for the most mission-critical networks. We understand the serious nature of a network installation and its security issues. TE offers a variety of options with our SECURE products including color-coded, keyed technologies and more. Available for both our copper and fiber cabling solutions, we can meet your requirements for secure applications and compliance to global regulations.







# SECURE Network Solutions

## Fiber Products

### SECURE Fiber Connectivity

The solution to managing multiple networks with reduced risks of improper cross-connection, inadvertent physical access, and of malicious access.

#### FEATURES

- Keyed connectors, adapters and cable assemblies prevent improper connection of separate networks with common access points
- Color codes make proper connection easier
- Standard connector versions will not mate with SECURE systems
- SECURE Cassettes are installed into RMG chassis



### LC SECURE LightCrimp PLUS Simplex Connectors (No epoxy/No polish)

#### FEATURES

- Ten color-coded keyed designs limit improper connections in segregated networks
- LC SECURE connectors only mate with LC SECURE adapters of the same color
- LC SECURE LightCrimp PLUS connectors feature ceramic ferrules
- Select appropriate part number for termination to:
  - 900  $\mu\text{m}$  tight-buffered or 250  $\mu\text{m}$  coated fibers
  - 1.6 – 2.0 mm jacketed fiber
- Easy installation:
  - No epoxy, no polishing
  - No bench tool required
  - Strip, cleave, and crimp
- LC SECURE LightCrimp PLUS connector uses the same installation tooling as the standard LC LightCrimp PLUS connector
- LC Duplex clip (black, sold separately) links two simplex LC connectors to make one duplex LC connector and allows for polarity correction after termination



#### ORDERING INFORMATION

Fiber Type	Boot Color	900 $\mu\text{m}$ Tight-buffered	250 $\mu\text{m}$ Coated	1.6 – 2.0 mm Jacketed	Part Number									
					Red	Yellow	Green	Blue	Rose	Aqua	Brown	Violet	Orange	Slate
50 $\mu\text{m}$ OM2	Black	x	x	x	1985959-1	1985959-2	1985959-3	1985959-4	1985959-5	1985959-6	1985959-7	1985959-8	1985959-9	1-1985959-0
XG OM3/OM4 50 $\mu\text{m}$	Aqua	x	x	x	1985960-1	1985960-2	1985960-3	1985960-4	1985960-5	1985960-6	1985960-7	1985960-8	1985960-9	1-1985960-0
62.5 $\mu\text{m}$ OM1	Beige	x	x	x	1985961-1	1985961-2	1985961-3	1985961-4	1985961-5	1985961-6	1985961-7	1985961-8	1985961-9	1-1985961-0
Singlemode	Blue	x	x		1828856-1	1828856-2	1828856-3	1828856-4	1828856-5	1828856-6	1828856-7	1828856-8	1828856-9	1-1828856-0
				x	1828860-1	1828860-2	1828860-3	1828860-4	1828860-5	1828860-6	1828860-7	1828860-8	1828860-9	1-1828860-0

Note: Table colors are for reference only.

# SECURE Network Solutions

## Fiber Products

### LC Duplex Clips

#### FEATURES

- Used to link two simplex LC connectors to make one duplex LC connector
- Compatible with singlemode or multimode simplex connectors
- Available colors: black
- Available in packages of six (6)



#### ORDERING INFORMATION

Description	Package Quantity	Part Number
LC Duplex Clips	6	1754371-2

### LC SECURE Epoxy/Polish Simplex Connectors

#### FEATURES

- Ten color-coded keyed designs limit improper connections in segregated networks
- LC SECURE connectors only mate with LC SECURE adapters of the same color
- Duplex clip (black, sold separately) attaches two simplex connectors into duplex form and allows for polarity correction after termination
- Two LC SECURE connector kits for each fiber type (multimode and singlemode)
- One terminates either one 250 μm coated fiber or one 900 μm tight-buffered fiber
- One terminates one 1.6 mm to 2.0 mm jacketed fiber
- Multimode connectors are suitable for use with 50/125 μm, XG OM3/OM4 50/125 μm, and 62.5/125 μm fibers and come with beige boots
- Singlemode connectors are suitable for use with all singlemode fiber types and come with blue boots
- LC SECURE connectors uses the same LC installation tooling as standard LC
- Suitable for use with heat-cured or anaerobic (quick cure) adhesives



#### ORDERING INFORMATION

Fiber Type	For Use with	Part Number									
		Red	Yellow	Green	Blue	Rose	Aqua	Brown	Violet	Orange	Slate
Multimode	1.6 - 2.0 mm Jacketed Fiber	1828078-1	1828078-2	1828078-3	1828078-4	1828078-5	1828078-6	1828078-7	1828078-8	1828078-9	1-1828078-0
	900 μm Tight-buffered or 250 μm Coated Fibers	1828861-1	1828861-2	1828861-3	1828861-4	1828861-5	1828861-6	1828861-7	1828861-8	1828861-9	1-1828861-0
Singlemode	1.6 - 2.0 mm Jacketed Fiber	1828079-1	1828079-2	1828079-3	1828079-4	1828079-5	1828079-6	1828079-7	1828079-8	1828079-9	1-1828079-0
	900 μm Tight-buffered or 250 μm Coated Fibers	1828862-1	1828862-2	1828862-3	1828862-4	1828862-5	1828862-6	1828862-7	1828862-8	1828862-9	1-1828862-0

Note: Table colors are for reference only.

# SECURE Network Solutions

## Fiber Products











### LC SECURE SL Series Duplex Couplers

#### FEATURES

- Ten color-coded keyed designs limit improper connections in segregated networks
- LC SECURE connectors only mate with LC SECURE couplers of the same color
- Hybrid Coupler - mates LC SECURE connectors to standard connectors
- LC SECURE coupler on the work area side
- Couplers suitable for use with multimode and singlemode LC SECURE connectors
- Easily snaps into SL series modules, duplex mounting straps, patch panels, and enclosures
- May be used in straight or angled faceplate modules
- Configure faceplates with one or more LC SECURE connectors to provide a common access point to multiple segregated or secured networks



#### ORDERING INFORMATION

Description	Fiber Type	Part Number									
		Red 	Yellow 	Green 	Blue 	Rose 	Aqua 	Brown 	Violet 	Orange 	Slate 
LC SECURE Coupler	Multimode and Singlemode	1933422-1	1933422-2	1933422-3	1933422-4	1933422-5	1933422-6	1933422-7	1933422-8	1933422-9	1-1933422-0
LC SECURE Hybrid Coupler	Multimode and Singlemode	1933285-1	1933285-2	1933285-3	1933285-4	1933285-5	1933285-6	1933285-7	1933285-8	1933285-9	1-1933285-0

Note: Table colors are for reference only.

# SECURE Network Solutions

## Fiber Products

### LC SECURE Snap-In Adapter Plates

#### FEATURES

- Ten color-coded keyed designs limit improper connections in segregated networks
- LC SECURE connectors only mate with LC SECURE adapters of the same color
- Package quantity: 1 plate per pack
- Adapters suitable for use with multimode or singlemode LC SECURE connectors
- Snap-in adapter plates fit in unloaded optical fiber enclosures
- Snap-in adapter plates are pre-loaded with either six (6) or twelve (12) duplex LC SECURE adapters
- Adapter plates with shutters contain a spring loaded cover to protect connectors from fine particulates
- SECURE snap-in adapter plates fit RMG unloaded optical fiber enclosures



**SECURE Adapter Plate**  
with Blue Shutters



**SECURE Adapter Plate**  
without Shutters

#### ORDERING INFORMATION

Fiber Type	Fiber Count	Duplex Port Count	Shutters	Part Number									
				Red <span style="color:red">■</span>	Yellow <span style="color:yellow">■</span>	Green <span style="color:green">■</span>	Blue <span style="color:blue">■</span>	Rose <span style="color:purple">■</span>	Aqua <span style="color:cyan">■</span>	Brown <span style="color:olive">■</span>	Violet <span style="color:blue">■</span>	Orange <span style="color:orange">■</span>	Slate <span style="color:gray">■</span>
Multi mode or Single mode	12	6	Without	1777127-1	1777127-2	1777127-3	1777127-4	1777127-9	1-1777127-0	1777127-6	1777127-8	1777127-5	1777127-7
			With Blue	1777265-1	1777265-2	1777265-3	1777265-4	1777265-9	1-1777265-0	1777265-6	1777265-8	1777265-5	1777265-7
			With Aqua	1777266-1	1777266-2	1777266-3	1777266-4	1777266-9	1-1777266-0	1777266-6	1777266-8	1777266-5	1777266-7
	24	12	Without	1499702-2	1499703-2	1499704-2	1499705-2	1499706-2	1499707-2	1499708-2	1499709-2	1499710-2	1499711-2

Note: Table colors are for reference only.

# SECURE Network Solutions

## Fiber Products

### MPO SECURE to Non-SECURE LC Optical Fiber Cassettes

#### FEATURES

- Ten color-coded keyed designs limit improper connections in segregated networks
- Cassettes have one MPO connection (12-fiber) or two MPO connections (24-fiber) on the back
- Cassettes house one or two 12-fiber break-out assemblies
- Cassette fiber polarity is pair-flipped (AB/BA)
- Cassettes with pair-straight polarity (AB/AB) are available - call for details
- Cassettes have same footprint as the snap-in adapter plates and fit in unloaded RMG optical fiber enclosures
- Factory tested and ready for installation
- For use with standard (non-secure) MPO trunk assemblies



#### ORDERING INFORMATION

Fiber Type	Fiber Count	Duplex Port Count	Part Number									
			Red <span style="color:red">■</span>	Yellow <span style="color:yellow">■</span>	Green <span style="color:green">■</span>	Blue <span style="color:blue">■</span>	Rose <span style="color:purple">■</span>	Aqua <span style="color:cyan">■</span>	Brown <span style="color:orange">■</span>	Violet <span style="color:blue">■</span>	Orange <span style="color:red">■</span>	Slate <span style="color:grey">■</span>
62.5 $\mu$ m OM1	12	6	1985799-2	1985799-5	1985799-3	1985799-4	1985799-9	1-1985799-1	1985799-7	1985799-8	1985799-6	1-1985799-0
	24	12	1938967-2	1938967-5	1938967-3	1938967-4	1938967-9	1-1938967-1	1938967-7	1938967-8	1938967-6	1-1938967-0
50 $\mu$ m OM2	12	6	1985798-2	1985798-5	1985798-3	1985798-4	1985798-9	1-1985798-1	1985798-7	1985798-8	1985798-6	1-1985798-0
	24	12	1938966-2	1938966-5	1938966-3	1938966-4	1938966-9	1-1938966-1	1938966-7	1938966-8	1938966-6	1-1938966-0
XG OM3 50 $\mu$ m	12	6	1985713-2	1985713-5	1985713-3	1985713-4	1985713-9	1-1985713-1	1985713-7	1985713-8	1985713-6	1-1985713-0
	24	12	1918785-2	1918785-5	1918785-3	1918785-4	1918785-9	1-1918785-1	1918785-7	1918785-8	1918785-6	1-1918785-0
Single mode	12	6	1985797-2	1985797-5	1985797-3	1985797-4	1985797-9	1-1985797-1	1985797-7	1985797-8	1985797-6	1-1985797-0
	24	12	1918786-2	1918786-5	1918786-3	1918786-4	1918786-9	1-1918786-1	1918786-7	1918786-8	1918786-6	1-1918786-0

Note: Table colors are for reference only.

# SECURE Network Solutions

## Fiber Products

### LC SECURE Duplex Hybrid Cable Assemblies

#### FEATURES

- Assemblies have SECURE connector on one end and a standard connector on the other end for connecting to equipment
- Other constructions and combinations are available - call for details
- Ten color-coded keyed designs limit improper connections in segregated networks
- LC SECURE plugs only mate with LC SECURE adapters of the same color
- LC SECURE connectors feature ceramic ferrules
- Standard jacket color is yellow for singlemode, orange for 50/125  $\mu\text{m}$  and 62.5/125  $\mu\text{m}$ , and aqua for OM3 and OM4
- Cable assemblies are riser-rated (Other ratings are available - call for details)

#### ORDERING INFORMATION

Description	Part Number
OM1 Duplex LC SECURE to Duplex LC	PAT-LC8z-R10CxxxM
OM1 Duplex LC SECURE to MT-RJ	PAT-MC8z-R10BxxxM
OM2 Duplex LC SECURE to Duplex LC	PAT-LC8z-R20CxxxM
OM2 Duplex LC SECURE to MT-RJ	PAT-MC8z-R20BxxxM
OM3 Duplex LC SECURE to Duplex LC	PAT-LC8z-R30CxxxM
OM3 Duplex LC SECURE to MT-RJ	PAT-MC8z-R30BxxxM
OM4 Duplex LC SECURE to Duplex LC	PAT-LC8z-R40CxxxM
OM4 Duplex LC SECURE to MT-RJ	PAT-MC8z-R40BxxxM

Note: z = color: B = Blue, N = Orange, G = Green, W = Brown,  
S = Slate, R = Red, Y = Yellow, V = Violet, P = Rose, A = Aqua,  
xxx = length in feet or meters: M = Meters

Refer to Cable Assembly spec 402-1007 for complete ordering information

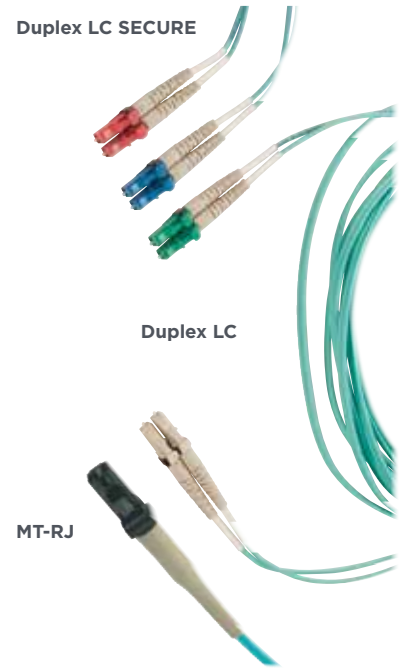

# SECURE Network Solutions

## Fiber Products

### Fiber Patch Cord Configurator

**Catalog Number**  
**PAT- - - - -**

**Connector A Type**

L	LC
S	SC
T	ST
F	FC
M	MTRJ w/o pins
W	MTRJ w/pins
3	LC Optimate Duplex
4	SC Optimate Duplex
5	FC APC
6	SC APC
7	LC APC
8	LC Secure Duplex
9	MT-RJ Secure Plug

**Connector A Color/Keying**

C	Standard
B	Secure Blue
N	Secure Orange
G	Secure Green
W	Secure Brown
S	Secure Slate
R	Secure Red
Y	Secure Yellow
V	Secure Violet
P	Secure Rose
A	Secure Aqua

**Connector B Type**

O	None/Pigtails
L	LC
S	SC
T	ST
F	FC
M	MTRJ w/o pins
W	MTRJ w/pins
3	LC Optimate Duplex
4	SC Optimate Duplex
5	FC APC
6	SC APC
7	LC APC
8	LC Secure Duplex
9	MT-RJ Secure Plug

**Connector B Color/Keying**

C	Standard
O	None/Pigtails
B	Secure Blue
N	Secure Orange
G	Secure Green
W	Secure Brown
S	Secure Slate
R	Secure Red
Y	Secure Yellow
V	Secure Violet
P	Secure Rose
A	Secure Aqua
U	Universal

**Polarity**

BLANK	Standard A to B Duplex
S	Straight A to A

**Unit of Measure**

F	Feet
M	Meters

**Assembly Length**

001	Shortest possible length
999	Longest possible length

**Cable Type**

A	1.6 mm Zipcord
B	1.8 mm Zipcord*
C	2.0 mm Zipcord
D	3.0 mm Zipcord
E	900 µm Buffered Fiber**
F	2.0 mm Simplex

**Cable Jacket Color\*\*\***

O	Standard
B	Blue
N	Orange
G	Green
W	Brown
S	Slate
R	Red
Y	Yellow
V	Violet
P	Rose
A	Aqua

**Fiber Type**

1	OM1
2	OM2
3	OM3
4	OM4
S	OS2

**Cable Jacket Material**

P	Plenum
R	Riser
O	900 µm Buffered Fiber

SECURE NETWORK SOLUTIONS

\* MT-RJ cords must use 1.8 mm zip cable

\*\* Standard Colors: 900um buffer: white; OM1, OM2 : orange; OM3, OM4: Aqua; OS2: Yellow

\*\*\* Custom jacket colors only available in plenum jacket material

# SECURE Network Solutions

## Fiber Products

### LC SECURE Duplex Hybrid Cable Assemblies

#### ORDERING INFORMATION

Description	Part Number
OM1 Duplex LC SECURE to Duplex SC	PAT-SC8z-R10CxxxM
OM1 Duplex LC SECURE to Dual ST	PAT-TC8z-R10BxxxM
OM2 Duplex LC SECURE to Duplex SC	PAT-SC8z-R20CxxxM
OM2 Duplex LC SECURE to Dual ST	PAT-TC8z-R20BxxxM
OM3 Duplex LC SECURE to Duplex SC	PAT-SC8z-R30CxxxM
OM3 Duplex LC SECURE to Dual ST	PAT-TC8z-R30BxxxM
OM4 Duplex LC SECURE to Duplex SC	PAT-SC8z-R40CxxxM
OM4 Duplex LC SECURE to Dual ST	PAT-TC8z-R40BxxxM

Note: z = color: B = Blue, N = Orange, G = Green, W = Brown,  
S = Slate, R = Red, Y = Yellow, V = Violet, P = Rose, A = Aqua,  
xxx = length in feet or meters: M = Meters  
Refer to Cable Assembly spec 402-1007 for complete ordering information

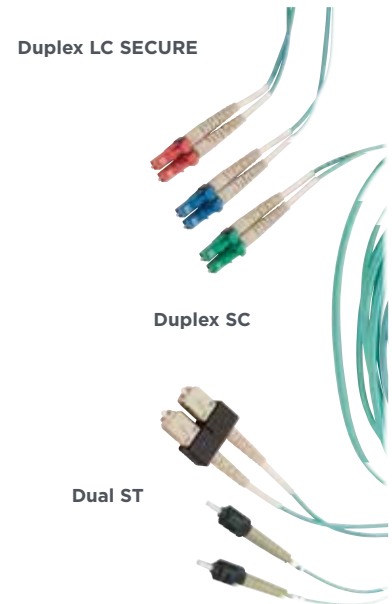



# SECURE Network Solutions

## Fiber Products

### MT-RJ SECURE Hybrid Cable Assemblies

#### FEATURES

- Assemblies have SECURE connector on one end and a standard connector on the other end for connecting to equipment
- Other constructions and combinations are available - call for details
- Ten color-coded keyed designs limit improper connections in segregated networks
- MT-RJ plugs only mate with similar type SECURE jacks of the same color
- Each MT-RJ and MT-RJ SECURE connector houses two fibers
- Standard jacket color is yellow for singlemode, orange for 50/125  $\mu\text{m}$  and 62.5/125  $\mu\text{m}$ , and aqua for XG OM3 50/125  $\mu\text{m}$
- Cable assemblies are riser-rated (Other ratings are available - call for details)



#### ORDERING INFORMATION

Description	Part Number
OM1 Duplex MTRJ SECURE to MTRJ	PAT-MC9z-R10BxxxM
OM1 Duplex MTRJ SECURE to LC Duplex	PAT-LC9z-R10BxxxM
OM1 Duplex MTRJ SECURE to SC Duplex	PAT-SC9z-R10BxxxM
OM1 Duplex MTRJ SECURE to Dual ST	PAT-TC9z-R10BxxxM
OM2 Duplex MTRJ SECURE to MTRJ	PAT-MC9z-R20BxxxM
OM2 Duplex MTRJ SECURE to LC Duplex	PAT-LC9z-R20BxxxM
OM2 Duplex MTRJ SECURE to SC Duplex	PAT-SC9z-R20BxxxM
OM2 Duplex MTRJ SECURE to Dual ST	PAT-TC9z-R20BxxxM
OM3 Duplex MTRJ SECURE to MTRJ	PAT-MC9z-R30BxxxM
OM3 Duplex MTRJ SECURE to LC Duplex	PAT-LC9z-R30BxxxM
OM3 Duplex MTRJ SECURE to SC Duplex	PAT-SC9z-R30BxxxM
OM3 Duplex MTRJ SECURE to Dual ST	PAT-TC8z-R30BxxxM
OM4 Duplex MTRJ SECURE to Duplex SC	PAT-LC9z-R40BxxxM
OM4 Duplex MTRJ SECURE to Dual ST	PAT-MC9z-R40BxxxM

Note: z = color: B = Blue, N = Orange, G = Green, W = Brown, S = Slate, R = Red, Y = Yellow, V = Violet, P = Rose, A = Aqua, xxx = length in feet or meters: M = Meters  
Refer to Cable Assembly spec 402-1007 for complete ordering information

# SECURE Network Solutions

## Fiber Products

### MT-RJ SECURE Outlet Jacks

#### FEATURES

- Ten color-coded keyed designs limit improper connections in segregated networks
- MT-RJ SECURE plugs only mate with MT-RJ SECURE jacks of the same color
- Match cable fiber type to jack fiber type for correct part number
- MT-RJ optical fiber jacks terminate two fibers per jack
- Jack design eliminates need for MT-RJ SECURE adapter
- Small form factor design is half the size of SC duplex
- No epoxy, no polishing, no crimping
- Can be re-terminated - improves yield
- Each fiber is tunable and locked separately
- No bench tool required
- Shares the same installation tools and procedures as standard MT-RJ jacks
- MT-RJ SECURE outlet jacks are for use with 900  $\mu\text{m}$  tight-buffered fibers
- Each MT-RJ SECURE outlet jack part number includes:
  - One (1) MT-RJ SECURE outlet jack
  - Actuation tool
  - SL series housing in matching color
  - Bend-limiting boot (black)
- MT-RJ SECURE patch panel jacks are for use with 900  $\mu\text{m}$  tight-buffered fibers or 250  $\mu\text{m}$  coated fibers (select appropriate part number)
- MT-RJ SECURE patch panel jack part number includes:
  - Six (6) MT-RJ SECURE patch panel jacks
  - Two (2) actuation tools
  - Fiber guide
  - Icon wheel
- Six patch panel jacks fit in one MT-RJ Snap-in Adapter Plate (sold separately)
- SL series housings and bend-limiting boots sold separately
- MT-RJ SECURE cable assemblies listed in this chapter
- Singlemode MT-RJ SECURE jacks are available as pigtail assemblies. Call for details

#### Easy 3 Step Termination



Strip



Cleave



Lock

# SECURE Network Solutions

## Fiber Products

### MT-RJ SECURE Outlet Jacks

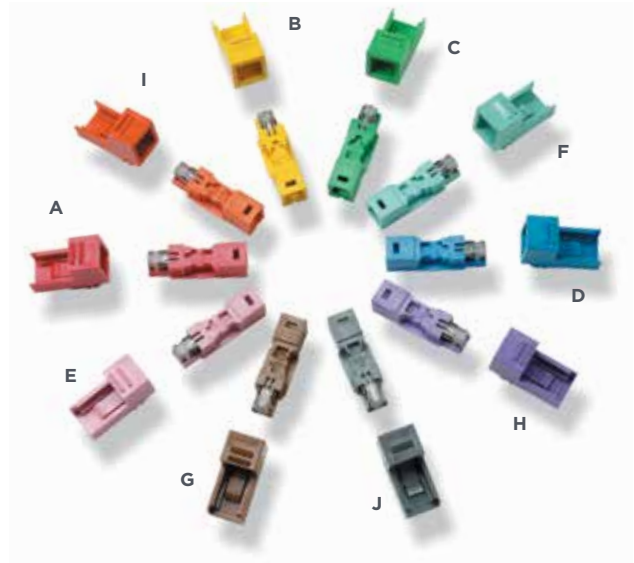
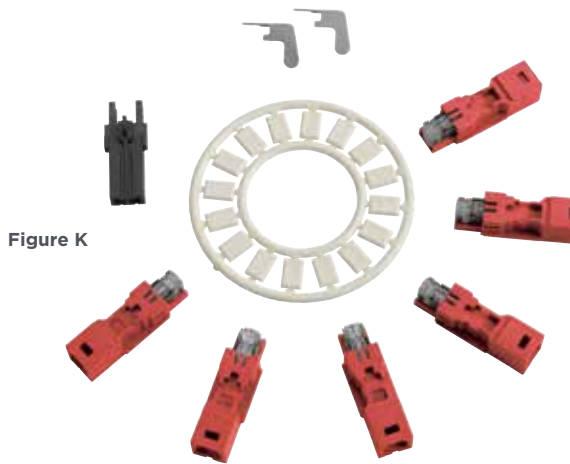

### ORDERING INFORMATION

Jack Type	SECURE Jack Color	Figure	Part Number					
			62.5 $\mu\text{m}$ OM1		50 $\mu\text{m}$ OM2		XG OM3 50 $\mu\text{m}$	
			900 $\mu\text{m}$ Tight-buffered Fibers	250 $\mu\text{m}$ Coated Fiber	900 $\mu\text{m}$ Tight-buffered Fibers	250 $\mu\text{m}$ Coated Fiber	900 $\mu\text{m}$ Tight-buffered Fibers	250 $\mu\text{m}$ Coated Fiber
Outlet	Red	A	6278810-1	-	6278811-1	-	6754252-1	-
	Yellow	B	6278810-2	-	6278811-2	-	6754252-2	-
	Green	C	6278810-3	-	6278811-3	-	6754252-3	-
	Blue	D	6278810-4	-	6278811-4	-	6754252-4	-
	Rose	E	6278810-5	-	6278811-5	-	6754252-5	-
	Aqua	F	6278810-6	-	6278811-6	-	6754252-6	-
	Brown	G	6278810-7	-	6278811-7	-	6754252-7	-
	Violet	H	6278810-8	-	6278811-8	-	6754252-8	-
	Orange	I	6278810-9	-	6278811-9	-	6754252-9	-
	Slate	J	1-6278810-0	-	1-6278811-0	-	1-6754252-0	-
Patch Panel	Red	K	6588878-1	6278808-1	6588879-1	6278807-1	6693949-1	6693951-1
	Yellow		6588878-2	6278808-2	6588879-2	6278807-2	6693949-2	6693951-2
	Green		6588878-3	6278808-3	6588879-3	6278807-3	6693949-3	6693951-3
	Blue		6588878-4	6278808-4	6588879-4	6278807-4	6693949-4	6693951-4
	Rose		6588878-5	6278808-5	6588879-5	6278807-5	6693949-5	6693951-5
	Aqua		6588878-6	6278808-6	6588879-6	6278807-6	6693949-6	6693951-6
	Brown		6588878-7	6278808-7	6588879-7	6278807-7	6693949-7	6693951-7
	Violet		6588878-8	6278808-8	6588879-8	6278807-8	6693949-8	6693951-8
	Orange		6588878-9	6278808-9	6588879-9	6278807-9	6693949-9	6693951-9
	Slate		1-6588878-0	1-6278808-0	1-6588879-0	1-6278807-0	1-6693949-0	1-6693951-0

Note: Table colors are for reference only.

# SECURE Network Solutions

## Fiber Products

### MPO SECURE Optical Fiber Cassettes

#### FEATURES

- Ten color-coded keyed designs limit improper connections in segregated networks
- MPO SECURE plugs only mate with MPO SECURE adapters of the same color
- Cassettes have one MPO SECURE connection (12-Fiber) or two MPO SECURE connections (24-Fiber) on the back
- Cassettes house one or two 12-fiber break-out assemblies
- MPO SECURE cassette color matches the LC SECURE or MT-RJ SECURE adapter color of the cassette
- Cassette fiber polarity is pair-flipped (AB/BA)
- Cassettes with pair-straight polarity (AB/AB) are available - call for details
- Cassettes have same footprint as the snap-in adapter plates and fit in unloaded RMG optical fiber enclosures
- Factory tested and ready for installation



#### ORDERING INFORMATION

SECURE Color	Fiber Count	Duplex Port Count	Part Number							
			MT-RJ SECURE				LC SECURE			
			62.5 $\mu$ m OM1	50 $\mu$ m OM2	XG OM3 50 $\mu$ m	Singlemode	62.5 $\mu$ m OM1	50 $\mu$ m OM2	XG OM3 50 $\mu$ m	Singlemode
Red	12	6	6754285-2	6754286-2	1918777-2	1938996-2	1918781-2	1918779-2	1918783-2	1938056-2
	24	12	6754287-2	6754288-2	1918778-2	6828819-2	1918782-2	1918780-2	1918784-2	1938965-2
Green	12	6	6754285-3	6754286-3	1918777-3	1938996-3	1918781-3	1918779-3	1918783-3	1938056-3
	24	12	6754287-3	6754288-3	1918778-3	6828819-3	1918782-3	1918780-3	1918784-3	1938965-3
Blue	12	6	6754285-4	6754286-4	1918777-4	1938996-4	1918781-4	1918779-4	1918783-4	1938056-4
	24	12	6754287-4	6754288-4	1918778-4	6828819-4	1918782-4	1918780-4	1918784-4	1938965-4
Yellow	12	6	6754285-5	6754286-5	1918777-5	1938996-5	1918781-5	1918779-5	1918783-5	1938056-5
	24	12	6754287-5	6754288-5	1918778-5	6828819-5	1918782-5	1918780-5	1918784-5	1938965-5
Orange	12	6	6754285-6	6754286-6	1918777-6	1938996-6	1918781-6	1918779-6	1918783-6	1938056-6
	24	12	6754287-6	6754288-6	1918778-6	6828819-6	1918782-6	1918780-6	1918784-6	1938965-6
Brown	12	6	6754285-7	6754286-7	1918777-7	1938996-7	1918781-7	1918779-7	1918783-7	1938056-7
	24	12	6754287-7	6754288-7	1918778-7	6828819-7	1918782-7	1918780-7	1918784-7	1938965-7
Violet	12	6	6754285-8	6754286-8	1918777-8	1938996-8	1918781-8	1918779-8	1918783-8	1938056-8
	24	12	6754287-8	6754288-8	1918778-8	6828819-8	1918782-8	1918780-8	1918784-8	1938965-8
Rose	12	6	6754285-9	6754286-9	1918777-9	1938996-9	1918781-9	1918779-9	1918783-9	1938056-9
	24	12	6754287-9	6754288-9	1918778-9	6828819-9	1918782-9	1918780-9	1918784-9	1938965-9
Slate	12	6	1-6754285-0	1-6754286-0	1-1918777-0	1-1938996-0	1-1918781-0	1-1918779-0	1-1918783-0	1-1938056-0
	24	12	1-6754287-0	1-6754288-0	1-1918778-0	1-6828819-0	1-1918782-0	1-1918780-0	1-1918784-0	1-1938965-0
Aqua	12	6	1-6754285-1	1-6754286-1	1-1918777-1	1-1938996-1	1-1918781-1	1-1918779-1	1-1918783-1	1-1938056-1
	24	12	1-6754287-1	1-6754288-1	1-1918778-1	1-6828819-1	1-1918782-1	1-1918780-1	1-1918784-1	1-1938965-1

Note: Table colors are for reference only.

# SECURE Network Solutions

## Fiber Products

### MPO SECURE Trunk Cable Assemblies, Plenum (OFNP)

#### FEATURES

- Ten color-coded keyed designs limit improper connections in segregated networks
- MPO SECURE plugs only mate with MPO SECURE adapters of the same color
- Twelve (12) fibers per MPO SECURE connector
- Easy installation—MPO SECURE plugs are push/pull connectors
- Plenum cables can be used in riser spaces
- Trunk cables come pre-tested and ready for immediate use with MPO SECURE plugs on both ends
- Pulling socks protect MPO SECURE terminations during installation
- Quick Ship available for MPO SECURE cable assemblies
- Standard lengths are in 10' increments from 10' to 300'
- Plug into cassettes found on pages 3-13
- See Spec 402-1008 for detailed information



#### ORDERING INFORMATION

Description	Part Number	
12-Fiber	OM1 MPO SECURE to MPO SECURE	MPC-CzCzJ10xxxF-NN
	OM2 MPO SECURE to MPO SECURE	MPC-CzCzJ20xxxF-NN
	OM3 MPO SECURE to MPO SECURE	MPC-CzCzJ30xxxF-NN
	OM4 MPO SECURE to MPO SECURE	MPC-CzCzJ40xxxF-NN
24-Fiber	OM1 MPO SECURE to MPO SECURE	MPC-CzCzD10xxxF-SS
	OM2 MPO SECURE to MPO SECURE	MPC-CzCzD20xxxF-SS
	OM3 MPO SECURE to MPO SECURE	MPC-CzCzD30xxxF-SS
	OM4 MPO SECURE to MPO SECURE	MPC-CzCzD40xxxF-SS

Note: z = color: B = Blue, N = Orange, G = Green, W = Brown, S = Slate, R = Red, Y = Yellow, V = Violet, P = Rose, A = Aqua, xxx = length in feet or meters: F=Feet  
MPC- part numbers have pairs flipped. See spec 402-1008 for information on other fiber paths

# SECURE Network Solutions

## Fiber Products

### ORDERING INFORMATION

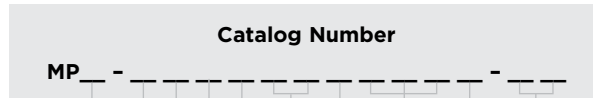

**Performance/Polarity**

C	Standard Performance Polarity C
A	Standard Performance Polarity A
B	Standard Performance Polarity B
T	Optimate Polarity A
E	Optimate Polarity C
F	Optimate Polarity B

**Breakout Length (L2 & L3)**

A	TFP
B	NGF
F	RMG
S	Standard
U	Customer length
XX	Custom

**Connector A Type**

N	12 Fiber MPO w/o pins
P	12 Fiber MPO w/pins
C	12 Fiber MPO secure w/o pins
E	12 Fiber MPO secure w/pins

**Unit of Measure**

F	Feet
M	Meters

**Connector A Color**

C	Non-secure
O	Red
B	Blue
G	Green
Y	Yellow
N	Orange
W	Brown
S	Slate
V	Violet
P	Rose
A	Aqua

**Assembly Length**

001	Shortest possible length
999	Longest possible length

**Cable Jacket Color**

O	Standard
C	Blue
N	Orange
G	Green
W	Brown
S	Slate
R	Red
Y	Yellow
V	Violet
P	Rose
A	Aqua

**Connector B Type**

N	12 Fiber MPO w/o pins
P	12 Fiber MPO w/pins
C	12 Fiber MPO Secure w/o pins
E	12 Fiber MPO Secure w/pins
O	Stub/pigtail

**Cable Type**

Use charts below

**Connector B Color**

C	Non-secure
O	Red
B	Blue
G	Green
Y	Yellow
N	Orange
W	Brown
S	Slate
V	Violet
P	Rose
A	Aqua

<p><b>OM1</b></p> <table border="1"> <tr><td>J1</td><td>12 Fiber 3 mm Interconnect, OFNP</td></tr> <tr><td>11</td><td>12 Fiber backbone, 1x12F, 3 mm Interconnect Subunit, OFN</td></tr> <tr><td>D1</td><td>24 Fiber backbone, 2x12F, 3 mm Interconnect Subunits, OFNP</td></tr> </table> <p><b>OM2</b></p> <table border="1"> <tr><td>J2</td><td>12 Fiber 3mm Interconnect, OFNP</td></tr> <tr><td>12</td><td>12 Fiber backbone, 1x12F, 3 mm Interconnect Subunit, OFNP</td></tr> <tr><td>D2</td><td>24 Fiber backbone, 2x12F, 3 mm Interconnect Subunits, OFNP</td></tr> </table> <p><b>OM3</b></p> <table border="1"> <tr><td>J3</td><td>12 Fiber 3 mm Interconnect, OFNP</td></tr> <tr><td>13</td><td>12 Fiber backbone, 1x12F, 3 mm Interconnect Subunit, OFNP</td></tr> <tr><td>D3</td><td>D3 24 Fiber backbone, 2x12F, 3mm Interconnect Subunits, OFNP</td></tr> <tr><td>M3</td><td>24 Fiber backbone, 1x12F, 3.8 mm Interconnect Subunits, OFNP</td></tr> </table>	J1	12 Fiber 3 mm Interconnect, OFNP	11	12 Fiber backbone, 1x12F, 3 mm Interconnect Subunit, OFN	D1	24 Fiber backbone, 2x12F, 3 mm Interconnect Subunits, OFNP	J2	12 Fiber 3mm Interconnect, OFNP	12	12 Fiber backbone, 1x12F, 3 mm Interconnect Subunit, OFNP	D2	24 Fiber backbone, 2x12F, 3 mm Interconnect Subunits, OFNP	J3	12 Fiber 3 mm Interconnect, OFNP	13	12 Fiber backbone, 1x12F, 3 mm Interconnect Subunit, OFNP	D3	D3 24 Fiber backbone, 2x12F, 3mm Interconnect Subunits, OFNP	M3	24 Fiber backbone, 1x12F, 3.8 mm Interconnect Subunits, OFNP	<p><b>OM4</b></p> <table border="1"> <tr><td>J4</td><td>12 Fiber 3 mm Interconnect, OFNP</td></tr> <tr><td>14</td><td>12 Fiber backbone, 1x12F, 3 mm Interconnect Subunit, OFNP</td></tr> <tr><td>D4</td><td>24 Fiber backbone, 2x12F, 3 mm Interconnect Subunits, OFNP</td></tr> <tr><td>M4</td><td>24 Fiber backbone, 1x12F, 3.8 mm Interconnect Subunits, OFNP</td></tr> </table> <p><b>Singlemode</b></p> <table border="1"> <tr><td>J5</td><td>12 Fiber 3 mm Interconnect, OFNP</td></tr> <tr><td>15</td><td>12 Fiber backbone, 1x12F, 3 mm Interconnect Subunit, OFNP</td></tr> <tr><td>D5</td><td>24 Fiber backbone, 2x12F, 3 mm Interconnect Subunits, OFNP</td></tr> <tr><td>M5</td><td>24 Fiber backbone, 1x12F, 3.8 mm Interconnect Subunits, OFNP</td></tr> </table> <p>* Higher fiber counts available upon request</p>	J4	12 Fiber 3 mm Interconnect, OFNP	14	12 Fiber backbone, 1x12F, 3 mm Interconnect Subunit, OFNP	D4	24 Fiber backbone, 2x12F, 3 mm Interconnect Subunits, OFNP	M4	24 Fiber backbone, 1x12F, 3.8 mm Interconnect Subunits, OFNP	J5	12 Fiber 3 mm Interconnect, OFNP	15	12 Fiber backbone, 1x12F, 3 mm Interconnect Subunit, OFNP	D5	24 Fiber backbone, 2x12F, 3 mm Interconnect Subunits, OFNP	M5	24 Fiber backbone, 1x12F, 3.8 mm Interconnect Subunits, OFNP
J1	12 Fiber 3 mm Interconnect, OFNP																																				
11	12 Fiber backbone, 1x12F, 3 mm Interconnect Subunit, OFN																																				
D1	24 Fiber backbone, 2x12F, 3 mm Interconnect Subunits, OFNP																																				
J2	12 Fiber 3mm Interconnect, OFNP																																				
12	12 Fiber backbone, 1x12F, 3 mm Interconnect Subunit, OFNP																																				
D2	24 Fiber backbone, 2x12F, 3 mm Interconnect Subunits, OFNP																																				
J3	12 Fiber 3 mm Interconnect, OFNP																																				
13	12 Fiber backbone, 1x12F, 3 mm Interconnect Subunit, OFNP																																				
D3	D3 24 Fiber backbone, 2x12F, 3mm Interconnect Subunits, OFNP																																				
M3	24 Fiber backbone, 1x12F, 3.8 mm Interconnect Subunits, OFNP																																				
J4	12 Fiber 3 mm Interconnect, OFNP																																				
14	12 Fiber backbone, 1x12F, 3 mm Interconnect Subunit, OFNP																																				
D4	24 Fiber backbone, 2x12F, 3 mm Interconnect Subunits, OFNP																																				
M4	24 Fiber backbone, 1x12F, 3.8 mm Interconnect Subunits, OFNP																																				
J5	12 Fiber 3 mm Interconnect, OFNP																																				
15	12 Fiber backbone, 1x12F, 3 mm Interconnect Subunit, OFNP																																				
D5	24 Fiber backbone, 2x12F, 3 mm Interconnect Subunits, OFNP																																				
M5	24 Fiber backbone, 1x12F, 3.8 mm Interconnect Subunits, OFNP																																				

# SECURE Network Solutions

## Copper Products

### SECURE Copper Connectivity

TE Connectivity's copper connectivity offers premiere solutions with unique keying technology to secure your network against unauthorized access. The RJ45 SECURE solution is offered in six different colors allowing RJ45 SECURE plugs to mate with RJ45 SECURE jacks of the same color. The jacks are compatible with any SL series faceplate latch design. The RJ45 Security Key Solution has a mechanical key which is required to remove secured plugs and jacks and helps to protect against inadvertent disconnects of critical systems. The RJ45 security key solution is compatible with any standard RJ45 interface used in panel, outlet areas, wireless LANs, security cameras and servers.



Terminated  
Shielded Jack

### RJ45 SECURE SL Series Category 6 Modular Jacks

#### FEATURES

- Six color-coded keyed designs limit improper connections in segregated networks
- RJ45 SECURE plugs only mate with RJ45 SECURE jacks of the same color
- Configure faceplates with one or more RJ45 SECURE connectors to provide a common access point to multiple segregated or secure networks
- Same thin profile as standard RJ45 SL series jacks - easily snaps into SL series modules, duplex mounting straps, patch panels, and enclosures
- May be used in straight or angled faceplate modules
- 180° cable dress for easy termination
- Unshielded jacks also allow 90° cable dress
- Universal wiring label permits wiring to T568A or T568B
- Bend-limiting strain relief included with unshielded jacks
- UL Listed: E81956
- 8-Position RJ45 SECURE modular jacks for 1-, 2-, 3-, and 4-pair applications
- Shielded and unshielded jacks
- Can be terminated with SL series modular jack termination tool 1725150-1



Figure A



Figure B

#### ORDERING INFORMATION

Shielding	Rear Cable Entry	Figure	Part Number					
			Red <span style="color:red">■</span>	Yellow <span style="color:yellow">■</span>	Green <span style="color:green">■</span>	Blue <span style="color:blue">■</span>	Violet <span style="color:purple">■</span>	Orange <span style="color:orange">■</span>
Unshielded	90° or 180°	A	1479794-1	1479794-2	1479794-3	1479794-4	1479794-8	1479794-9
Shielded	180°	B	1479795-1	1479795-2	1479795-3	1479795-4	1479795-8	1479795-9

Note: Table colors are for reference only.

# SECURE Network Solutions







## Copper Products

### RJ45 SECURE Category 6 Modular Plugs

#### FEATURES

- Six color-coded keyed designs limit improper connections in segregated networks
- Gray (universal key) available for use in testing
- RJ45 SECURE plugs only mate with RJ45 SECURE jacks of the same color
- See page 3-25 for color-matched snagless boots
- 5 - 6 mm plug terminated with Pro-Crimper III hand-tool 354940-1 and die set 1976200-2 or combination tool/die set 1976200-1
- 6 - 7 mm plug terminated with Pro-Crimper III hand-tool 354940-1 and die set 1976200-4 or combination tool/die set 1976200-3

#### ORDERING INFORMATION

Conductor Type	Cable O.D.	Quantity Per Box	Part Number						
			Red 	Yellow 	Green 	Blue 	Violet 	Orange 	Gray (Universally Keyed) 
Standard	5-6 mm	100	5-1479802-3	5-1479804-3	5-1479806-3	5-1479808-3	5-1499675-3	5-1499677-3	5-1499679-3
	6-7 mm	100	5-1499549-3	5-1499551-3	5-1499553-3	5-1499555-3	5-1499557-3	5-1499559-3	5-1499561-3
Solid	5-6 mm	100	5-1479803-3	5-1479805-3	5-1479807-3	5-1479809-3	5-1499676-3	5-1499678-3	5-1499680-3
	6-7 mm	100	5-1499550-3	5-1499552-3	5-1499554-3	5-1499556-3	5-1499558-3	5-1499560-3	5-1499562-3

Note: Table colors are for reference only.



# SECURE Network Solutions

## Copper Products

### RJ45 SECURE Category 6 Patch Cable Assemblies

#### FEATURES

- Six color-coded keyed designs limit improper connections in segregated networks
- RJ45 SECURE plugs only mate with RJ45 SECURE jacks of the same color
- RJ45 SECURE assemblies have a standard plug on one end and a RJ45 SECURE plug on the other end
- Color-matched snagless boots
- Universal wiring (T568A/T568B)
- 26 AWG stranded conductors
- Shielded and unshielded cable assemblies
- Cable assemblies are riser-rated



#### ORDERING INFORMATION

Length	Part Number					
	Red ■		Yellow ■		Green ■	
	Unshielded	Shielded	Unshielded	Shielded	Unshielded	Shielded
2' (0.61 m)	1499841-2	1499848-2	1499842-2	1499849-2	1499843-2	1499850-2
3' (0.91 m)	1499841-3	1499848-3	1499842-3	1499849-3	1499843-3	1499850-3
4' (1.22 m)	1499841-4	1499848-4	1499842-4	1499849-4	1499843-4	1499850-4
5' (1.52 m)	1499841-5	1499848-5	1499842-5	1499849-5	1499843-5	1499850-5
6' (1.83 m)	1499841-6	1499848-6	1499842-6	1499849-6	1499843-6	1499850-6
7' (2.13 m)	1499841-7	1499848-7	1499842-7	1499849-7	1499843-7	1499850-7
8' (2.44 m)	1499841-8	1499848-8	1499842-8	1499849-8	1499843-8	1499850-8
9' (2.74 m)	1499841-9	1499848-9	1499842-9	1499849-9	1499843-9	1499850-9
10' (3.05 m)	1-1499841-0	1-1499848-0	1-1499842-0	1-1499849-0	1-1499843-0	1-1499850-0
12' (3.66 m)	1-1499841-2	1-1499848-2	1-1499842-2	1-1499849-2	1-1499843-2	1-1499850-2
14' (4.27 m)	1-1499841-4	1-1499848-4	1-1499842-4	1-1499849-4	1-1499843-4	1-1499850-4
16' (4.88 m)	1-1499841-6	1-1499848-6	1-1499842-6	1-1499849-6	1-1499843-6	1-1499850-6
20' (6.10 m)	2-1499841-0	2-1499848-0	2-1499842-0	2-1499849-0	2-1499843-0	2-1499850-0
25' (7.62 m)	2-1499841-5	2-1499848-5	2-1499842-5	2-1499849-5	2-1499843-5	2-1499850-5
30' (9.14 m)	3-1499841-0	3-1499848-0	3-1499842-0	3-1499849-0	3-1499843-0	3-1499850-0
40' (12.19 m)	4-1499841-0	4-1499848-0	4-1499842-0	4-1499849-0	4-1499843-0	4-1499850-0
50' (15.24 m)	5-1499841-0	5-1499848-0	5-1499842-0	5-1499849-0	5-1499843-0	5-1499850-0

Note: Table colors are for reference only.

Length	Part Number					
	Blue ■		Violet ■		Orange ■	
	Unshielded	Shielded	Unshielded	Shielded	Unshielded	Shielded
2' (0.61 m)	1499844-2	1499851-2	1499845-2	1499852-2	1499846-2	1499853-2
3' (0.91 m)	1499844-3	1499851-3	1499845-3	1499852-3	1499846-3	1499853-3
4' (1.22 m)	1499844-4	1499851-4	1499845-4	1499852-4	1499846-4	1499853-4
5' (1.52 m)	1499844-5	1499851-5	1499845-5	1499852-5	1499846-5	1499853-5
6' (1.83 m)	1499844-6	1499851-6	1499845-6	1499852-6	1499846-6	1499853-6
7' (2.13 m)	1499844-7	1499851-7	1499845-7	1499852-7	1499846-7	1499853-7
8' (2.44 m)	1499844-8	1499851-8	1499845-8	1499852-8	1499846-8	1499853-8
9' (2.74 m)	1499844-9	1499851-9	1499845-9	1499852-9	1499846-9	1499853-9
10' (3.05 m)	1-1499844-0	1-1499851-0	1-1499845-0	1-1499852-0	1-1499846-0	1-1499853-0
12' (3.66 m)	1-1499844-2	1-1499851-2	1-1499845-2	1-1499852-2	1-1499846-2	1-1499853-2
14' (4.27 m)	1-1499844-4	1-1499851-4	1-1499845-4	1-1499852-4	1-1499846-4	1-1499853-4
16' (4.88 m)	1-1499844-6	1-1499851-6	1-1499845-6	1-1499852-6	1-1499846-6	1-1499853-6
20' (6.10 m)	2-1499844-0	2-1499851-0	2-1499845-0	2-1499852-0	2-1499846-0	2-1499853-0
25' (7.62 m)	2-1499844-5	2-1499851-5	2-1499845-5	2-1499852-5	2-1499846-5	2-1499853-5
30' (9.14 m)	3-1499844-0	3-1499851-0	3-1499845-0	3-1499852-0	3-1499846-0	3-1499853-0
40' (12.19 m)	4-1499844-0	4-1499851-0	4-1499845-0	4-1499852-0	4-1499846-0	4-1499853-0
50' (15.24 m)	5-1499844-0	5-1499851-0	5-1499845-0	5-1499852-0	5-1499846-0	5-1499853-0

Note: Table colors are for reference only.

# SECURE Network Solutions

## Copper Products

### Security Key Plug

#### FEATURES

- Works with standard RJ45 jacks
- Prevents unauthorized port connections
- Prevents disconnection from active devices
- Lock to RJ45 modular jacks
- Can be used in public areas or conference rooms
- 1871456-1 key/lock pairs are randomly selected from 100 different key numbers (numbered 800-899)
- 1871456-2, -3, and -4 use specific reserved key/lock pair number 456A
- RoHS compliant

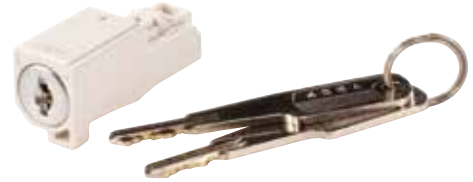

#### ORDERING INFORMATION

Description	Included Keys	Part Number
Security Key Plug with	2 Keys, random number	1871456-1
	2 Keys, reserved number	1871456-2
Security Key Plug reserved number	None, for use with 1871456-4	1871456-3
Key for Reserved Number Security Key Plug	-	1871456-4

### Security Key Jack

#### FEATURES

- Works with standard RJ45 plugs
- Prevents unauthorized port connections
- Prevents disconnection from active devices
- Lock to RJ45 modular plugs
- Can be used to secure un-used patch cords
- Uses specific reserved key/lock pair number 456A
- RoHS compliant



#### ORDERING INFORMATION

Description	Included Keys	Part Number
Security Key Jack	2 Keys, reserved number	1-1871456-2

# SECURE Network Solutions

## Copper Products

### Security Key Patch Cord

#### FEATURES

- Works with standard RJ45 ports
- Prevents disconnection from active devices
- Prevent unauthorized disconnection
- Can be used for secure connections (e.g. server lines)
- Uses specific reserved key/lock pair number 456A (two keys included)
- RoHS compliant
- Category 6 patch cables are backwardly compatible with Category 5e components
- Security patch cord color:
  - CAT 6: black
  - CAT 6A F/UTP: blue



CAT 6 Patch Cord



CAT 6A Patch Cord

#### ORDERING INFORMATION

Category	Length	Part Number	
		Locks on Both Ends	Locks on one End
CAT 6 Unshielded	1' (0.30 m)	2111179-1	2111225-1
	2' (0.61 m)	2111179-2	2111225-2
	3' (0.91 m)	2111179-3	2111225-3
	4' (1.22 m)	2111179-4	2111225-4
	5' (1.52 m)	2111179-5	2111225-5
	6' (1.83 m)	2111179-6	2111225-6
	7' (2.13 m)	2111179-7	2111225-7
	8' (2.44 m)	2111179-8	2111225-8
	9' (2.74 m)	2111179-9	2111225-9
	10' (3.05 m)	1-2111179-0	1-2111225-0
	12' (3.66 m)	1-2111179-2	1-2111225-2
	14' (4.27 m)	1-2111179-4	1-2111225-4
	16' (4.88 m)	1-2111179-6	1-2111225-6
	18' (5.49 m)	1-2111179-8	1-2111225-8
20' (6.10 m)	2-2111179-0	2-2111225-0	
CAT 6A Shielded	1' (0.30 m)	2111190-1	2111236-1
	2' (0.61 m)	2111190-2	2111236-2
	3' (0.91 m)	2111190-3	2111236-3
	4' (1.22 m)	2111190-4	2111236-4
	5' (1.52 m)	2111190-5	2111236-5
	6' (1.83 m)	2111190-6	2111236-6
	7' (2.13 m)	2111190-7	2111236-7
	8' (2.44 m)	2111190-8	2111236-8
	9' (2.74 m)	2111190-9	2111236-9
	10' (3.05 m)	1-2111190-0	1-2111236-0
	12' (3.66 m)	1-2111190-2	1-2111236-2
	14' (4.27 m)	1-2111190-4	1-2111236-4
	16' (4.88 m)	1-2111190-6	1-2111236-6
	18' (5.49 m)	1-2111190-8	1-2111236-8
20' (6.10 m)	2-2111190-0	2-2111236-0	





## Copper Products

Copper Solution Reference Guide .....	3-3
Category 6A Products .....	3-8
Category 6A Twisted Pair Cable .....	3-8
Category 6A Patch Panels .....	3-11
Category 6A Modular Jacks .....	3-13
Category 6A Cable Assemblies .....	3-15
Category 6A Termination Blocks .....	3-17
Category 6 Products .....	3-20
Category 6 Twisted Pair Cable .....	3-20
Category 6 Patch Panels .....	3-26
Category 6 Modular Jacks .....	3-28
Category 6 Modular Plugs and Plug Boots .....	3-30
Category 6 Termination Blocks .....	3-31
Category 5e Products .....	3-36
Category 5e Twisted Pair Cable .....	3-36
Category 5e Patch Panels .....	3-41
Category 5e Modular Jacks .....	3-43
Category 5e Modular Plugs and Plug Boots .....	3-45
Category 5e Cable Assemblies .....	3-47
Category 5e Termination Blocks .....	3-48
Copper Trunk Solutions .....	3-54
MRJ21 Cable Assemblies .....	3-54
Sigma-Link .....	3-63
Specialty Products .....	3-66
Universal Connectivity Platform .....	3-66
Core Vertical Switch Management (VSM) .....	3-72
High Speed Copper Cable Assemblies .....	3-80
Media Converters and Switches .....	3-83
Patch Panels .....	3-89
Jacks and Couplers .....	3-96
Modular plugs .....	3-98
Feed-Thru Termination Block System and Accessories .....	3-99
Zone Cabling Solutions .....	3-104
Undercarpet Cabling .....	3-110
Copper Accessories .....	3-119
Cable wrap, Clamps, Ties, Accessories .....	3-119
Identification Labels and Accessories .....	3-121
Copper Tooling .....	3-133





## Copper Products (Continued)

The industry embraces copper cabling solutions for better performance and noise immunity—critical elements in any network infrastructure. TE offers a broad portfolio of innovative, high-performance copper solutions comprised of industry-leading technology and backed by a 25-year performance and component warranty.

Combining products from our AMP NETCONNECT, KRONE and TrueNet portfolios, TE's copper solutions cover all applications from 1 GbE to 10 GbE. Shielded, unshielded and pre-terminated options provide our customers with the industry's strongest range of fully warranted solutions from the desktop to the data center.



# Copper

## Solution Reference Guide

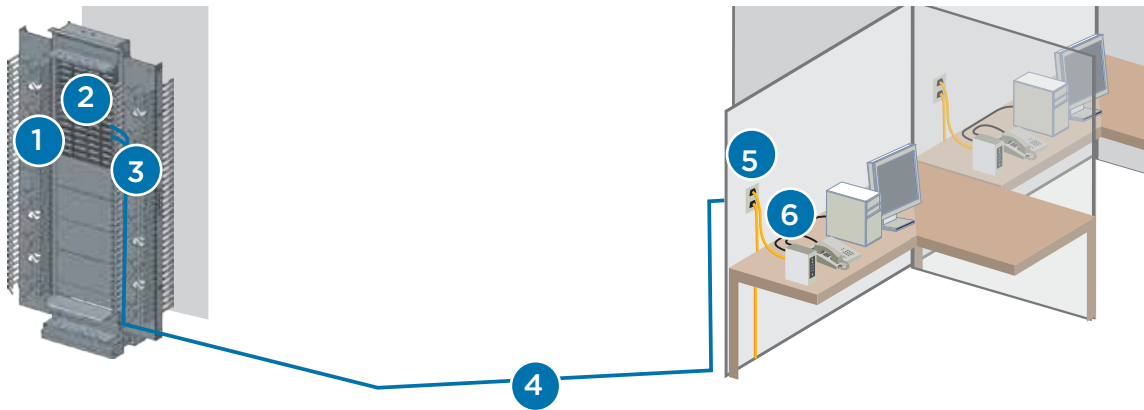

### Category 6A Shielded Solution

19-Inch Rack	1		2 post, 3" deep	1933559-1
			4 post adjustable	1933570-1
Cable Management	1	Horizontal 2RU panel	Single-sided	1933532-1
			Double-sided	1933533-1
		Double-sided vertical manager	6"	1933534-1
			6" Combination	1933540-1
CAT 6A F/UTP Cable	4		Plenum	TE640PF-XX02**
			Riser	TE640RF-XX02**
CAT 6A Shielded Patch Panel	2	Straight	24 port	1933319-2
			48 port	1933320-2
		Angled	24 port	1933321-2
			48 port	1933322-2
CAT 6A F/UTP Cable Assemblies	3 6		White	TCPC-6AFVB-WTYF**
			Blue	TCPC-6AFVB-BLYF**
CAT 6A Shielded Outlet	5	Faceplate single gang w/ label and icons	1 port	2111008-x*
			2 port	2111009-x*
			4 port	2111011-x*
		Surface Mount Module	2 port	1933668-x*
			4 port	1933671-x*
			RJ45 without dust cover	1711342-2
RJ45 with dust cover	1711160-2			

\*denotes color

\*\*denotes color (XX) and length (YY)

# Copper

## Solution Reference Guide

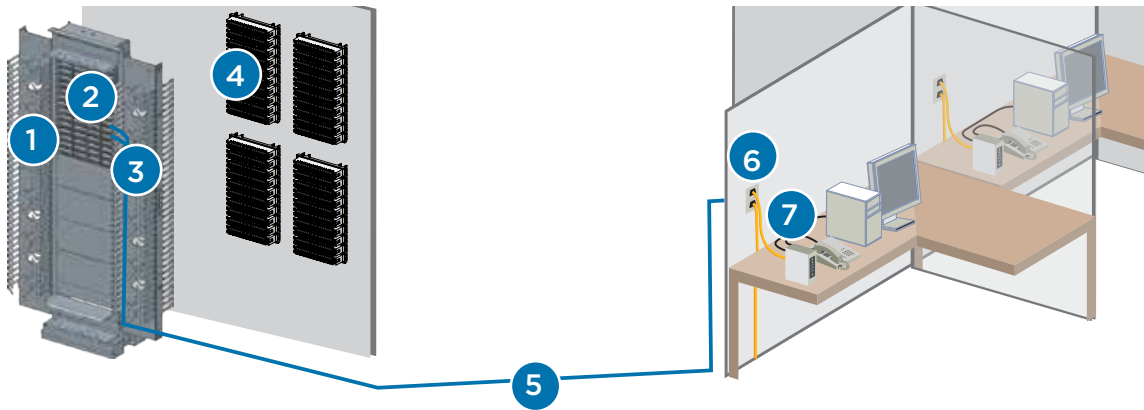

### Category 6A UTP Solution

19-Inch Rack	1		2 post, 3" deep	1933559-1
			4 post adjustable	1933570-1
Cable Management	1	Horizontal 2RU panel	Single -sided	1933532-1
		Double-sided vertical manager	Double -sided	1933533-1
			6"	1933534-1
		6" Combination	1933540-1	
CAT 6A UTP Cable	5		Plenum	TE640P-XX02**
			Riser	TE640R-XX02**
CAT 6A UTP Patch Panel	2	Dynamic	24 port	PP24AC6AT
			48 port	PP48AC6AT
		Straight	24 port	2111570-1
			48 port	2111571-1
		Angled	24 port	2111572-1
			48 port	2111573-1
CAT 6A U/UTP Cable Assemblies	3 7	568B	White	TCPC-6ARUVB-WTYF**
			Blue	TCPC-6ARUVB-BLYF**
CAT 6A UTP Termination Blocks	4	HighBand	144-pair kit - 12-way kit	6450 1 107-01
			HighBand 25 cable trough	6450 2 157-00
			Vertical Management Rings	6450 2 156-20
			Vertical Management Cover	6450 2 158-20
CAT 6A UTP Outlet	6	Faceplate single gang w/ label and icons	1 port	2111008-x*
			2 port	2111009-x*
			4 port	2111011-x*
		Surface Mount Module	2 port	1933668-x*
			4 port	1933671-x*
			RJ45 without dust cover	1933476-x*
		RJ45 with dust cover	2111676-x*	

\*denotes color

\*\*denotes color (XX) and length (YY)



# Copper

## Solution Reference Guide

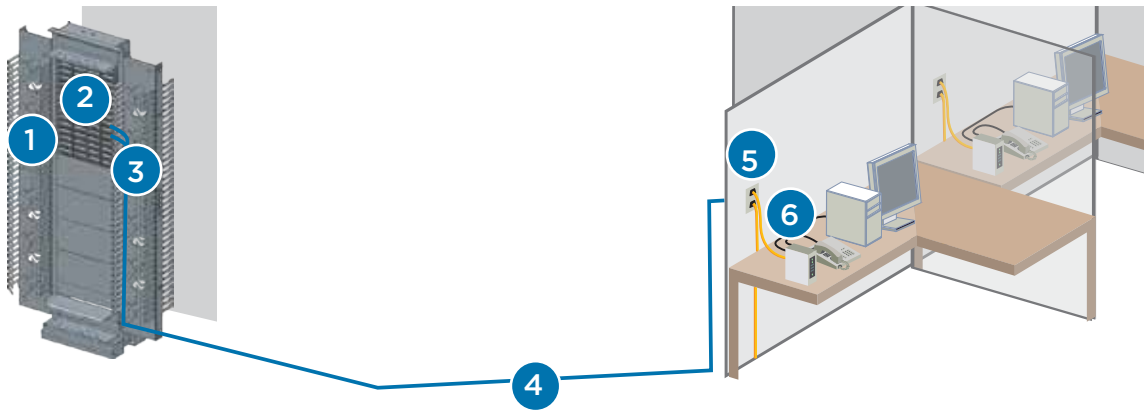

### Category 6 Shielded Solution

<b>19-Inch Rack</b>	<b>1</b>		2 post, 3" deep	1933559-1
			4 post adjustable	1933570-1
<b>Cable Management</b>	<b>1</b>	Horizontal 2RU panel	Single -sided	1933532-1
			Double -sided	1933533-1
		Double-sided vertical manager	6"	1933534-1
			6" Combination	1933540-1
<b>CAT 6 F/UTP Cable</b>	<b>4</b>		Plenum	TE620PF-XXYY**
			Riser	TE620RF-XXYY**
<b>CAT 6 Shielded Patch Panel (Discrete without jacks)</b>	<b>2</b>	Straight	24 port	1933307-1
			48 port	1933308-1
		Angled	24 port	1933309-1
			48 port	1933310-1
<b>CAT 6 F/UTP Cable Assemblies</b>	<b>3</b> <b>6</b>		White	TCPC-6ARFVB-WTYF**
			Blue	TCPC-6ARFVB-BLYF**
<b>CAT 6 Shielded Outlet</b>	<b>5</b>	Faceplate single gang w/label and icons	1 port	2111008-x*
			2 port	2111009-x*
			4 port	2111011-x*
		Surface Mount Module	2 port	1933668-x*
			4 port	1933671-x*
				RJ45 without dust cover

\*denotes color

\*\*denotes color (XX) and length (YY)

# Copper

## Solution Reference Guide

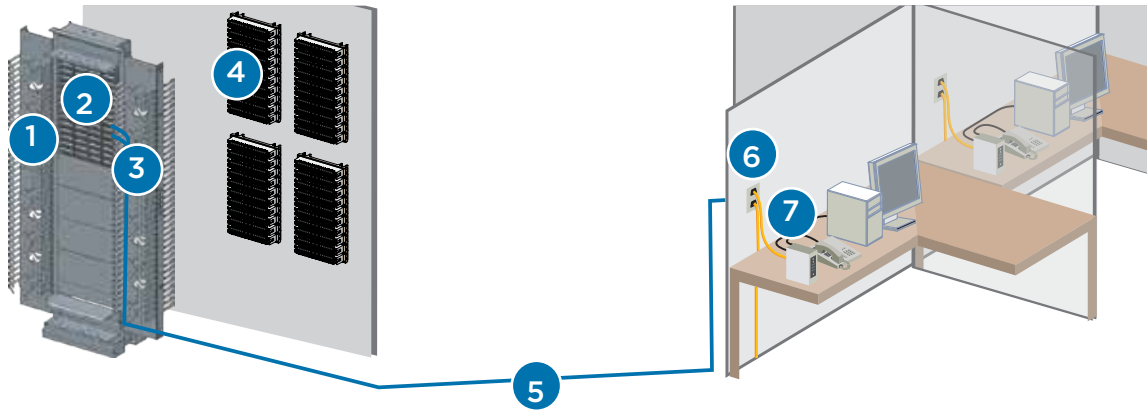

### Category 6 UTP Solution

19-Inch Rack	1		2 post, 3" deep	1933559-1
			4 post adjustable	1933570-1
Cable Management	1	Horizontal 2RU panel	Single -sided	1933532-1
			Double -sided	1933533-1
		Double-sided vertical manager	6"	1933534-1
			6" Combination	1933540-1
CAT 6 UTP Cable - 620 series	5		Plenum	TE620P-XXRB**
			Riser	TE620R-XXRB**
CAT 6 UTP Patch Panel	2	Straight	24 port	1375014-2
			48 port	1375015-2
		Angled	24 port	1499600-2
			48 port	1499601-2
		Dynamic Angled	24 port	PP24AC6T
		Dynamic Angled	48 port	PP48AC6T
CAT 6 UTP Cable Assemblies	3 7		White	TCPC-6RUVB-BLYYF88**
			Blue	TCPC-6RUVB-BLYYF**
CAT 6 UTP Termination Blocks	4	HighBand	300-pair kit - 12-way kit	6450 1 101-10
			HighBand 25 cable trough	6450 2 157-00
			Vertical Management Rings	6450 2 156-20
			Vertical Management Cover	6450 2 158-20
CAT 6 UTP Outlet	6	Faceplate single gang w/label and icons	1 port	2111008-x*
			2 port	2111009-x*
			4 port	2111011-x*
		Surface Mount Module	2 port	1933668-x*
			4 port	1933671-x*
			RJ45 without dust cover	1375055-x*
RJ45 with dust cover	1375187-x*			

\*denotes color

\*\*denotes color (XX) and length (YY)

# Copper

## Solution Reference Guide

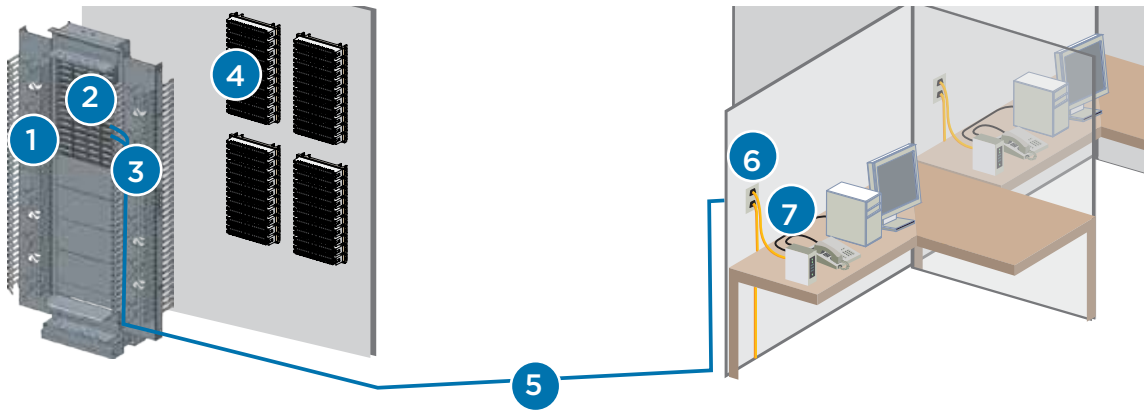

### Category 5e UTP Solution

<b>19-Inch Rack</b>	<b>1</b>		2 post, 3" deep	1933559-1
			4 post adjustable	1933570-1
<b>Cable Management</b>	<b>1</b>	Horizontal 2RU panel	Single sided	1933532-1
			Double sided	1933533-1
	Double-sided vertical manager	6"	1933534-1	
		6" Combination	1933540-1	
<b>CAT 5e UTP Cable - 520 series</b>	<b>5</b>		Plenum	TE520P-XXRB**
			Riser	TE520R-XXRB**
<b>CAT 5e UTP Patch Panel</b>	<b>2</b>	Straight SL	24 port	1479154-2
			48 port	1479155-2
		Angled SL	24 port	1499602-2
			48 port	1499603-2
		Dynamic	24 port	PP24AC5ET
		Dynamic	48 port	PP48AC5ET
<b>CAT 5e UTP Cable Assemblies</b>	<b>3</b> <b>7</b>		White	TCPC-5ERUVB-WTYF**
			Blue	TCPC-5ERUVB-BLYF**
<b>CAT 5e UTP Termination Blocks</b>	<b>4</b>	110Connect XC	100-pair kit	569439-1
			300-pair kit	569445-1
			Cable trough with legs	569389-1
<b>CAT 5e UTP Outlet</b>	<b>6</b>	Faceplate single gang w/ label and icons	1 port	2111008-x*
			2 port	2111009-x*
			4 port	2111011-x*
		Surface Mount Module	2 port	1933668-x*
			4 port	1933671-x*
		RJ45 without dust cover		1375191-x*
		RJ45 with dust cover		1375190-x*

\*x denotes color

\*\*denotes color (XX) and length (YY)

# Copper

## Category 6A Products

### 640 Series Category 6A F/UTP Twisted Pair Cable

640 Series CAT 6A F/UTP cables offer superior noise immunity at higher frequencies where applications like 10 Gigabit Ethernet reside, without hampering performance. Combined with outstanding margins on critical parameters such as crosstalk and return loss, TE640 F/UTP cables are an excellent choice for your 10 gig network. Along with unsurpassed electrical performance, 640 F/UTP cables feature an industry-low outside diameter for increased fill rates, driving down installation costs.

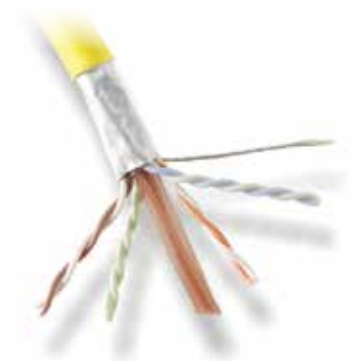

#### FEATURES

- Meets or exceeds the channel specifications of ANSI/TIA-568-C.2 Category 6A and Amendment 1 to ISO/IEC 11801:2002 Class EA up to 500 MHz when used as a component in a properly installed TE Connectivity F/UTP channel
- Foil shield for increased signal isolation
- Resistant to alien crosstalk
- AirES patented design on CMP for higher throughput and reduced size
- Independently tested by Intertek ETL SEMKO third party testing services
- Meets or exceeds all requirements for IEEE 802.3an 10 Gigabit Ethernet
- RoHS compliant

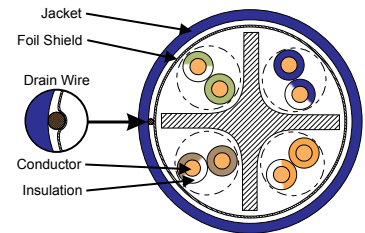

#### ORDERING INFORMATION

UL/NEC Rating	Pair Count	Package	OD (in)	AWG	Weight lbs/Kft	Part number
CMP	4	1000' reel	0.265"	23	42	TE640PF-XX02
CMR	4	1000' reel	0.275"	24	42	TE640RF-XX02

The following jacket colors are available. Replace "XX" with  
BL-Blue      WT-White      GY-Gray      YL-Yellow      GN-Green  
BK-Black      RD-Red      OR-Orange      VT-Violet      BN-Brown  
Additional reel sizes available, please contact TE Customer Service.

# Copper

## Category 6A Products

### 640 Series Category 6A U/UTP Twisted Pair Cable

TE Connectivity's 640 Series UTP cable enables 10 Gigabit Ethernet performance with an industry-low outside diameter. The 640 Series Category 6A plenum cables feature the best in class AirES technology. This patented design saves as much as 32% of the available space in cable runs and is a key component of the TE structured cabling system. The smaller diameter also saves space in the communications closet, reduces the amount of cable management accessories required and lowers the risk associated with fire and smoke in the plenum space. TE's 640 cable also features a patented oblique elliptical offset filler to minimize alien crosstalk.



#### FEATURES

- Unique oblique elliptical offset filler for improved alien crosstalk
- AirES patented design on CMP for higher throughput and reduced size
- Manufactured with lead-free materials
- Meets or exceeds all requirements for IEEE 802.3an 10 Gigabit Ethernet
- RoHS compliant



#### ORDERING INFORMATION

UL/NEC Rating	Pair Count	Package	OD (in)	AWG	Weight lbs/Kft	Part Number
CMP	4	1000' reel	0.285"	23	41	TE640P-XX02
CMR	4	1000' reel	0.295"	23	41	TE640R-XX02

The following jacket colors are available. Replace "XX" with

BL-Blue      WT-White      GY-Gray      YL-Yellow      GN-Green  
BK-Black      RD-Red      OR-Orange      VT-Violet      BN-Brown

Additional reel sizes available, please contact TE Customer Service.

# Copper

## Category 6A Products

### Specifications

#### TWISTED PAIR CABLE TEMPERATURES

Category	Condition	Riser/Plenum
CAT 6A	Storage	-4 - 176° F (-20 - 80° C)
	Operating	-4 - 167° F (-20 - 75C)
	Installation	41 - 122° F (5 - 50° C)



**Wooden Reels**

Note: Unless otherwise specified, all lengths are 1000 feet (305 meters). Other lengths and colors available. Contact TE customer service.

#### 4-Pair Conductor Color Code

Pair		Jacket Color
1	Tip	White
	Ring	Blue 
2	Tip	White
	Ring	Orange 
3	Tip	White
	Ring	Green 
4	Tip	White
	Ring	Brown 

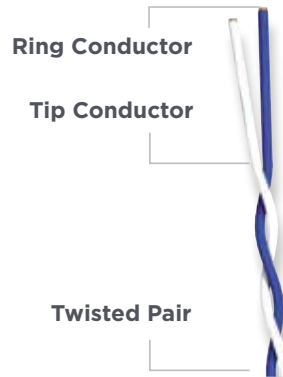

# Copper

## Category 6A Products

### Category 6A Patch Panels

TE Connectivity's Category 6A AMP-TWIST patch panels deliver the next generation of 10 GbE performance and continue the evolution of high-density solutions for the data center and LAN environments while meeting all the requirements for Category 6A ANSI/TIA and ISO standards. These are available in several different styles and port configurations. This includes: shielded, unshielded, standard flat, fixed angled, 24-port and 48-port configurations along with TE's patented dynamic angled panels.

#### FEATURES FOR STANDARD AND ANGLED

- Meets or exceeds the channel specifications of ANSI/TIA-568-C.2 Category 6A and Amendment 1 to ISO/IEC 11801:2002 Class EA up to 500 MHz when used as a component in a properly installed TE Connectivity XG F/UTP or U/UTP channel
- Meets or exceeds all requirements for IEEE 802.3an 10 GbE
- Ports may be individually replaced
- Standard and angled panels are packaged unloaded with jacks bagged separately for termination with SL series jack termination tool
- Front load removable 6 pack modules
- Labels and label covers included
- Accommodates icons (sold separately)
- Standard and angled panels feature integrated bonding bar makes bonding simple and requires no extra steps in shielded applications
- UL1863 listed and Category 6A performance verified
- RoHS compliant

#### FEATURES FOR DYNAMIC ANGLED

- Patented angle right/left eases stress on patch cords allowing for improved cable management
- Low profile dynamic angling allows for greater flexibility and use in cabinet environments
- Universal wiring label for easy termination of either T568A/B
- Conductors can be terminated with either a KRONE or 110 tool
- 45 degree silver-plated IDCs provide secure, reliable gas-tight connection
- Includes adhesive paper labels for station identification
- Universal wiring label for easy termination of either T568A/B
- Patch panels are designed to support Gigabit Ethernet transmission speeds
- Rear wire manager included
- UL 1863 listed and Category 6A performance verified
- RoHS compliant



# Copper

## Category 6A Products

### Standard and Angled Panels

#### ORDERING INFORMATION

Footprint	Shielding	Port Count	Height	Width	Figure	Part Number
Standard	Shielded	24	1RU (1.75")	19.0"		1933319-2
		48	2RU (3.50")	19.0"	A	1933320-2
	Unshielded	24	1RU (1.75")	19.0"		2111570-1
		48	2RU (3.50")	19.0"	A	2111571-1
Angled	Shielded	24	1RU (1.75")	19.0"	B	1933321-2
		48	2RU (3.50")	19.0"		1933322-2
	Unshielded	24	1RU (1.75")	19.0"	B	2111572-1
		48	2RU (3.50")	19.0"		2111573-1
Dynamic Angled	Unshielded	24	1RU (1.75")	19.0"	C	PP24AC6AT
		48	2RU (3.50")	19.0"		PP48AC6AT



Figure A



Figure B



Figure C



# Copper

## Category 6A Products

---

### Category 6A Modular Jacks

TE Connectivity's AMP NETCONNECT Category 6A AMP-TWIST modular jacks deliver the next generation of 10G performance and continue the evolution of high-density solutions for the data center and LAN environments while meeting all the requirements for Category 6A ANSI/TIA and ISO standards. The F/UTP jack offers superior noise immunity to eliminate alien crosstalk and RFI/EMI while offering integrated mechanical bonding and grounding through normal installation practices. The U/UTP jack utilizes superior technology to reduce alien crosstalk noise to enhance overall performance. The AMP-TWIST termination technology provides for the fastest most reliable termination on the market. The modular jacks contain integrated cutting blades to allow all four pairs of a four pair cable to be terminated at one time. Universal wiring labels permit termination to either T568A or T568B wiring patterns.



### FEATURES

- Meets or exceeds the channel specifications of ANSI/TIA-568-C.2 Category 6A and Amendment 1 to ISO/IEC 11801:2002 Class EA up to 500 MHz when used as a component in a properly installed AMP NETCONNECT XG channel
- Termination time: about 90 seconds (using AMP NETCONNECT SL series termination tool, without lacing fixture - 1725150-3)
- Meets or exceeds all requirements for IEEE 802.3an 10 GbE
- Easy installation
- Integrated strain relief and shield clamp
- Integrated dust cover option
- Re-usable
- Universal wiring label permits wiring to T568A or T568B
- 8-Position RJ45 modular jacks for 1, 2, 3, and 4-Pair applications
- RoHS compliant
- UL1863 listed and Category 6A performance verified

# Copper

## Category 6A Products

### ORDERING INFORMATION

Description	Shielding	Entry	Dust Cover Option	Figure	Part Number
CAT 6A F/UTP	Shielded	Rear	without Dust Cover	A	1711342-2
			with clear Dust Cover		1711160-2
		Side	without Dust Cover	B	1711343-2
			with clear Dust Cover		1711295-2
CAT 6A U/UTP	Unshielded	Rear	without Dust Cover	C	1933476-X
			with clear Dust Cover		2111676-X
CAT 6A U/UTP Color cap	Unshielded		without Dust Cover	D	2111243-X
			with clear Dust Cover		2111244-X

Note: Replace -X in Cat6 U/UTP part numbers with corresponding color number as follows:  
(EX: 1933476-x for Blue and 1-1933476-3 for Alpine White)

-1 = Almond	-5 = Orange	-8 = Yellow	1--1 = Electrical Ivory
-2 = Black	-6 = Blue	-9 = Green	1--3 = Alpine White
-4 = Gray	-7 = Red	1--0 = Violet	



Figure A



Figure B



Figure D



Figure C

### Colored Dust Covers for CAT 6A F/UTP AMP-TWIST Modular Jacks with Integrated Dust Covers

#### FEATURES

- For use with AMP-TWIST modular jacks 1711160-2 and 1711295-2 only
- Replaces existing clear dust cover on 1711160-2 and 1711295-2 (jack is not included with colored dust cover)
- Packaged 50/bag
- Application Spec: 114-93016
- RoHS compliant

### ORDERING INFORMATION

Description	Colors	Part Number
Colored Dust Covers; for CAT 6A F/UTP AMP-TWIST Modular Jacks	Light Almond	1-1711691-1
	Black	1-1711691-2
	White	1-1711691-3
	Violet	1-1711691-4
	Orange	1-1711691-5
	Blue	1-1711691-6
	Red	1-1711691-7
	Yellow	1-1711691-8
	Green	1-1711691-9



# Copper

## Category 6A Products

### Category 6A F/UTP Shielded Cable Assemblies

TE Connectivity's Category 6A F/UTP shielded patch cable assemblies are manufactured using patented techniques that create consistent performance superior to standard cable assemblies. TE Connectivity's Category 6A F/UTP shielded cable assemblies are CM (riser) rated and constructed using colored, stranded cable and clear polycarbonate snagless boots.



#### FEATURES

- Exceeds the channel specifications of ANSI/TIA-568-C.2 Category 6A F/UTP shielded to ISO/IEC 11801:2002 Edition 2 Class EA when used as a component in a properly installed TE F/UTP channel
- Exceeds all requirements for IEEE 802.3an 10 GbE
- Clear, flexible strain relief boot maintains proper bend radius to ensure peak performance
- Non-plenum (CM rated)
- 4-Pair stranded shielded conductors
- UL 1863 listed
- RoHS compliant

#### ORDERING INFORMATION

Description	Part Number	
RJ45 to RJ45 patch cord	T568B	TCPC-6ARFVB-XXYYF
	T568A	TCPC-6ARFVA-XXYYF

Replace XX for color:

WT = White      YL = Yellow  
RD = Red        GN = Green  
BL = Blue        GY = Gray

Replace YY for length:

04 = 4'            15 = 15'  
07 = 7'            25 = 25'  
10 = 10'          50 = 50''

Contact TE for information on additional colors and custom lengths.

# Copper

## Category 6A Products

### Category 6A U/UTP Cable Assemblies

#### FEATURES

- Reduced cable assembly OD 0.23 inches or 24% smaller
- Exceeds channel specifications for ANSI/TIA-568-C.2 Category 6A unshielded to ISO/IEC 11801:2002 Edition 2 Class EA when used as a component in a properly installed TE UTP channel
- Flexible clear strain relief boot maintains proper bend radius to ensure peak performance
- Non-plenum (CM rated)
- RoHS compliant
- UL 1863 Listed



Description	Part Number	
RJ45 to RJ45 patch cord	568B wiring	TCPC-6ARUVB-XXYF
	568A wiring	TCPC-6ARUVA-XXYF

Replace XX for color:

WT = White      YL = Yellow  
RD = Red        GN = Green  
BL = Blue        GY = Gray

Replace YF for length:

04 = 4'            15 = 15'  
07 = 7'            25 = 25'  
10 = 10'          50 = 50'

Contact TE for information on additional colors and custom lengths.

# Copper

## Category 6A Products

### Category 6A 8-pair and 20-pair Termination Blocks

TE Connectivity's HighBand cross connect solution allows for maximum network throughput to support 10 GbE and most advanced networks. The solution is comprised of high-performance disconnection modules, user friendly cable management and innovative anti-snag patch cords. It is the ideal cabling solution for companies who require efficiency, guaranteed performance and appealing aesthetics. The solution is based on Patch-by-Exception, which is a unique termination technology that is ideally suited for VoIP networks and offers material, installation and operational cost savings, making it a compelling alternative to traditional RJ45 products. TE's products maintain superior connectivity during hundreds of re-terminations and deliver the best electrical performance in the industry.

#### FEATURES

- Meets performance requirements of ANSI/TIA-568-C.2 standards
- 45-degree silver-plated IDCs provide secure, reliable gas-tight connections
- Color-coded for ease of termination
- Modules are terminated with the standard KRONE termination tools, and may also be terminated with a 110 tool
- Four-pair to four-pair patch cords are available for Patch-by-Exception installations
- Four-pair to RJ45 cords are available to interface with network and other equipment
- Center test port allows for circuit monitoring without service disruption
- Unique Patch-by-Exception functionality saves time and money while improving performance and aesthetics
- Eight-pair disconnect module design for use with TE universal mounting system (UMS) and type 105 rod-mount bracket



#### ORDERING INFORMATION

Category 6A 8 pair block	Part Number
Black universal mounting bracket	6657 2 165-40
Gray universal mounting bracket	6657 2 165-00
Type 105 label holder with label and protective cover	6630 2 004-05
Disconnection Module, 8-pair	6468 5 070-00

# Copper

## Category 6A Products

### Category 6A Termination Blocks (Continued)

#### ORDERING INFORMATION

Description	Part Number
<b>12-position termination block and mounting kit</b> Includes: stainless steel 12-position mounting frame; 12 Category 6A modules with rear cable management, each module accommodating (5) 4-pair Category 6A cables; 12 label holders	6450 1 107-01



### HighBand Cable Management

The cable management rings control vertical cable management between frames, ensuring that cables do not interfere when adds, moves and changes occur. The cable manager is ideal for high-density or heavily patched installations and provides a neat, clean finish to the HighBand system.

Cable troughs mounted on the top and bottom of each frame ensure superior cable management and correct bend radius between frames.



Cable Management Rings

#### ORDERING INFORMATION

Description	Part Number
<b>12-way Cable Management Kit</b> Includes (2) cable management rings and (1) cover	6450 1 103-10
<b>Cable Management Rings (2)</b>	6450 2 156-20
<b>Cover (1)</b>	6450 2 158-20
<b>Cable Troughs</b>	
Cable Trough Top (1)	6450 2 157-10
Cable Trough Bottom (1)	6450 2 157-20



Vertical Management Cover



Top Cable Trough



Bottom Cable Trough

# Copper

## Category 6A Products

### Category 6A U/UTP 8-pair and 20-pair Termination Block Patch Cords

Impedance matched for use in TE structured cabling systems; these Category 6A termination block patch cords exceed all performance requirements for Augmented Category 6. These cords allow direct patching capability between Category 6A U/UTP 8-pair and 20-pair blocks or patching from a Category 6A termination block to an active device or an RJ45 patch panel. The plug is designed with integrated strain relievers that prevent the cable from moving at the termination point when the cable is flexed, safeguarding circuit integrity and guaranteeing maximum performance.

#### FEATURES

- Meets or exceeds TIA/EIA and ISO Category 6A requirements
- Protective shroud to assist in protecting the user from electrical transfer on the contacts
- Impedance matched patch cord for maximum throughput
- Flexible strain relief boot maintains proper bend radius to ensure peak performance
- UL 1863 listed
- Durable design to be in operation beyond 25-year product warranty

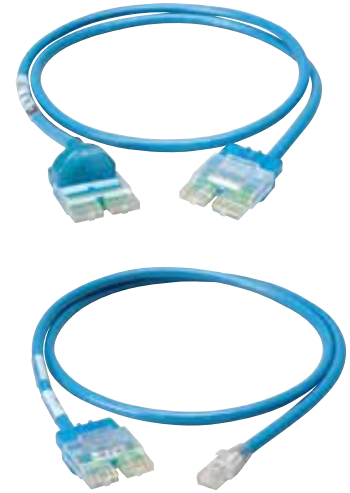

#### ORDERING INFORMATION

Description	Part Number
<b>Category 6A 4-pair to Category 6A 4-Pair</b>	
Category 6A 4-Pair to Category 6A 4-Pair wired 568B	TP6ATH-XXYY
Category 6A 4-Pair to Category 6A-Pair wired 568A	TP6ATHOXXYY
<b>Category 6A 4-pair to RJ45</b>	
Category 6A 4-Pair to RJ45 Plug wired 568B	TP6ATB-XXYY
Category 6A 4-Pair to RJ45 Plug wired 568A	TP6ATBOXXYY

Replace XX for color: BL=Blue, BK=Black, GY=Gray, RD=Red, GN=Green, YL=Yellow, WT=White

Contact TE for additional colors

Replace YY for length: 04= 4 feet, 07= 7 feet, 10=10 feet, 15=15 feet, 25=25 feet, 50=50 feet

Contact TE for additional lengths

# Copper

## Category 6 Products

### Category 6 Twisted Pair Cable

TE Connectivity offers a variety of Category 6 cables designed to meet your performance needs while providing options for differing budgetary requirements. 620 and 630 series CMP cables utilize TE's patented AirES cable technology that improves data throughput, saves space and eases installation. Through a unique design and advanced manufacturing techniques we are able to build AirES cable using air as a conductor insulator. This groundbreaking process results in a cable that incorporates superior performance while reducing overall size.

### 630 Series, Category 6E U/UTP Cable

- TE's highest performing Category 6 cable
- Performance characterized to 600 MHz
- AirES patented design on CMP for higher throughput and reduced size
- 12 dB NEXT performance above Category 6
- Star filler for electrical performance
- Meets or exceeds ANSI/TIA-568-C.2 Category 6 and ISO 11801: 2002 Class E specifications
- Independently verified by Intertek ETL SEMKO testing services
- Exceeds all requirements for Gigabit Ethernet
- RoHS compliant

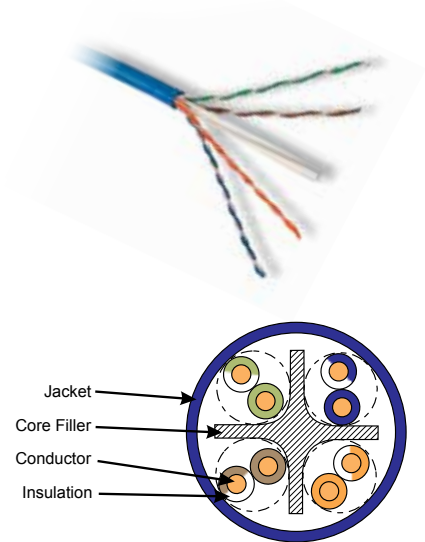

### ORDERING INFORMATION

UL/NEC Rating	Pair Count	Package	OD (in)	AWG	Weight lbs/Kft	Part Number
CMP	4	1000' Reel in box	0.212"	23	32	TE630P-XXRB
		1000' Reel			30	TE630P-XX02
CMR	4	1000' Reel in box	0.235"	24	33	TE630R-XXRB
		1000' Reel			31	TE630R-XX02

The following jacket colors are available. Replace XX with:

BL=Blue    WT=White    GY=Gray    YL=Yellow    GN=Green  
BK=Black    RD=Red    OR=Orange    VT=Violet    BN=Brown

Additional reel sizes available, please contact TE Customer Service.



# Copper

## Category 6 Products

### 620 Series Category 6 F/UTP Twisted Pair Cable

#### FEATURES

- Meets or exceeds the channel specifications of ANSI/TIA-568-C.2 Category 6 and ISO Class E 11801:2002 specifications
- Performance characterized to 600 MHz
- Foil shield for increased signal isolation
- AirES patented design on CMP for higher throughput and reduced size
- Independently tested by Intertek ETL SEMKO third party testing services
- Exceeds all requirements for Gigabit Ethernet
- RoHS compliant

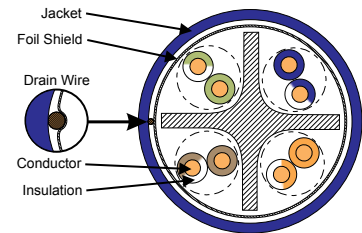
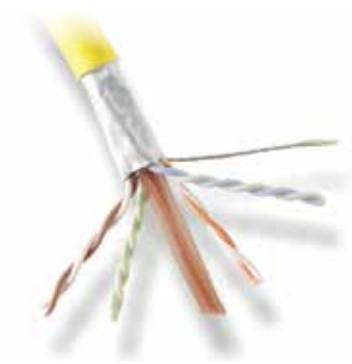

#### ORDERING INFORMATION

UL/NEC Rating	Pair Count	Package	OD (in)	AWG	Weight lbs/Kft	Part number
CMP	4	1000' reel	0.253"	23	42	TE620PF-XX02
CMR	4	1000' reel	0.265"	24	42	TE620RF-XX02

The following jacket colors are available. Replace "XX" with  
BL-Blue      WT-White      GY-Gray      YL-Yellow      GN-Green  
BK-Black      RD-Red      OR-Orange      VT-Violet      BN-Brown  
Additional reel sizes available, please contact TE Customer Service.

# Copper

## Category 6 Products

### 620 Series, Category 6 U/UTP Cable

#### FEATURES

- AirES cable patented design on CMP for higher throughput
- Performance characterized to 600 MHz
- 7 dB NEXT performance above Category 6
- Meets or exceeds ANSI/TIA-568-C.2 Category 6 and ISO Class E 11801: 2002 specifications
- Available in side-by-side configuration
- Independently verified by Intertek ETL SEMKO testing services
- Exceeds all requirements for Gigabit Ethernet
- RoHS compliant

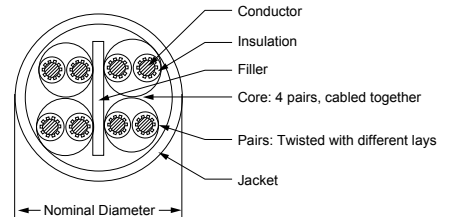
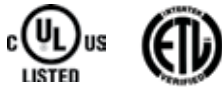

#### ORDERING INFORMATION

UL/NEC Rating	Pair Count	Package	OD (in)	AWG	Weight lbs/Kft	Part Number
CMP	4 Pair	1000' Reel in box	0.215"	23	31	TE620P-XXRB
		1000' Pull box			28	TE620P-XXII
		1000' Reel			28	TE620P-XX02
	4 Pair Side-by-Side	1000' Reel	0.215" x 0.430"		59	TE620PX2-XX02
CMR	4 Pair	1000' Reel in box	0.210"	24	31	TE620R-XXRB
		1000' Pull box			28	TE620R-XXII
		1000' Reel			28	TE620R-XX02
	4 Pair Side-by-Side	1000' Reel	0.210" x 0.435"		59	TE620RX2-XX02

The following jacket colors are available. Replace "XX" with  
 BL-Blue      WT-White      GY-Gray      YL-Yellow      GN-Green  
 BK-Black      RD-Red      OR-Orange      VT-Violet      BN-Brown  
 Additional reel sizes available, please contact TE Customer Service.

# Copper

## Category 6 Products

### Outback 620 Series, Outdoor Category 6 U/UTP Cable

- 4-pair, 23 AWG Category 6 cable designed for outdoor use
- Aerial cable, not intended for wet locations
- Excellent transmission and weather resistant properties
- Polyethylene jacket for weather resistance
- Performance characterized to 600 MHz
- Meets or exceeds all requirements for Gigabit Ethernet
- RoHS compliant



### ORDERING INFORMATION

Pair Count	Package	OD (in)	AWG	Weight lbs/Kft	Color	Part Number
4	1000' Reel	0.250"	23	29	Black	TE6200SP-BK02

Additional reel sizes available, please contact TE Customer Service.

# Copper

## Category 6 Products

### 610 Series, Category 6 U/UTP Cable

- Performance characterized to 400 MHz
- Meets ANSI/TIA-568-C.2 Category 6 and ISO Class E 11801: 2002 specifications
- Exceeds all requirements for Gigabit Ethernet
- RoHS compliant
- Independently verified by Intertek ETL SEMKO testing services

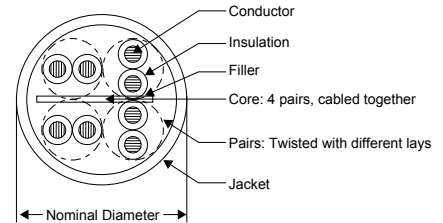

### ORDERING INFORMATION

UL/NEC Rating	Pair Count	Package	OD (in)	AWG	Weight lbs/Kft	Part Number
CMP	4	1000' Pull box	0.210"	24	24	TE610P-XXII
		1000' Reel				TE610P-XX02
		3000' Reel			82	TE610P-XX06
CMR	4	1000' Pull box	0.210"	24	24	TE610R-XXII
		1000' Reel				TE610R-XX02
		3000' Reel			82	TE610R-XX06

The following jacket colors are available. Replace "XX" with  
 BL-Blue    WT-White    GY-Gray    YL-Yellow    GN-Green  
 BK-Black    RD-Red    OR-Orange    VT-Violet    BN-Brown  
 Additional reel sizes available, please contact TE Customer Service.

# Copper

## Category 6 Products

### Twisted Pair Cable Packaging Reference



RB = Reel-in-a-Box



O2 = Plastic Reels



II = Pull Box

Note: Unless otherwise specified, all lengths are 1000 feet (305 meters). Other lengths and colors available. Call for details. Package types are listed in each chart.

### 4-PAIR CONDUCTOR COLOR CODE

Pair		Jacket Color
1	Tip	White
	Ring	Blue 
2	Tip	White
	Ring	Orange 
3	Tip	White
	Ring	Green 
4	Tip	White
	Ring	Brown 

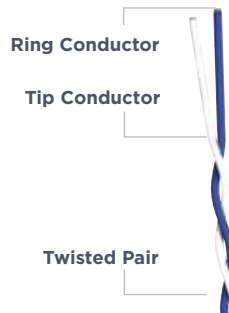

### TWISTED PAIR CABLE TEMPERATURES

Category	Condition	Riser/Plenum
CAT 6	Storage	-4 - 176° F (-20 - 80° C)
	Operating	-4 - 167° F (-20 - 75° C)*
	Installation	41 - 122° F (5 - 50° C)

\*TE610P Operating Condition is -4 - 140° F (-20 - 60° C)



COPPER

# Copper

## Category 6 Products

### Category 6 Patch Panels

TE Connectivity patch panels are offered in several different styles and port configurations. This includes standard flat panels, fixed angled panels and TE's patented dynamic angled panels. All panels exceed ANSI/TIA 568-C.2 and ISO/IEC 11801 component requirements and Category 6/Class E system performance. The Category 6 system from TE complies with all of the performance requirements for current and proposed applications such as Gigabit Ethernet (1000BASE-TX), 10 and 100BASE-TX, token ring, 155 Mbps ATM, 100 Mbps TP-PMD, ISDN, analog and digital video and analog and digital voice (VoIP). All panels offer universal wiring labels which permit field installation to either T568A or T568B wiring, while simplifying ordering and inventorying.

#### FEATURES FOR SL PANELS

- All panels are packaged unloaded with jacks bagged separately for termination with SL series jack termination tool, universal wiring — may be terminated to T568A or T568B
- 12-Port mini patch panels mount vertically on 89D bracket (included)
- 48-port, 1RU patch panels:
  - Accommodate adhesive labels or icons for port identification
  - Are supplied with 48 specially designed SL series jacks (these jacks can not be purchased separately – they are supplied with panel assembly only)
- Angled panels allow elimination of horizontal cable management for higher rack densities and ease of cable dress
- Ports may be individually replaced
- RoHS Compliant

#### FEATURES FOR DYNAMIC ANGLE PANELS

- Patented angle right/left eases stress on patch cords allowing for improved cable management
- Low profile dynamic angling allows for greater flexibility and use in cabinet environments
- Conductors can be terminated with either a KRONE or 110 tool
- 45 degree silver-plated IDCs provide secure, reliable gas-tight connection
- Includes adhesive paper labels for station identification
- Universal wiring label for easy termination of either T568A/B
- Patch panels are designed to support Gigabit Ethernet transmission speeds
- Rear wire manager included
- Angled panels allow elimination of horizontal cable management for higher rack densities and ease of cable dress
- RoHS Compliant



# Copper

## Category 6 Products

### Category 6 Patch Panels

#### ORDERING INFORMATION

Port Count	Footprint	Port Configuration	Height (Rack Mount Units)	Width	Figure	Part Number
12	89D Bracket	6 pack modules	10.00"	2.30"	A	1375013-2
24	Standard	Discrete SL Jack	1.75" (1RU)	19.00"	-	1375014-2
		6 pack modules			-	6653 1 679-24
	Dynamic Angle	G			PP24AC6T	
48	Angled	Discrete SL Jack	1.75" (1RU)	19.00"	B	1499600-2
	Standard	Discrete HD Jack*			C	1933458-1*
	Angled	Discrete HD Jack*	D	1933658-1*		
	Standard	Discrete SL Jack	3.50" (2RU)	19.00"	E	1375015-2
		6 pack modules			-	6653 1 679-48
		Dynamic Angle			-	PP48AC6T
Angled	Discrete SL Jack	F	1499601-2			
96	Standard	Discrete SL Jack	7.00" (4RU)	19.00"	-	1375016-2

\* Note: 1RU 48-port panel does not accept standard SL series jacks



COPPER

# Copper

## Category 6 Products

### Category 6 Modular Jacks and Couplers

TE Connectivity's Category 6 SL series modular jacks exceed ANSI/TIA-568-C.2 and ISO/IEC 11801 component requirements and Category 6/Class E system performance. TE's AMP NETCONNECT Category 6 system complies with all of the performance requirements for current and proposed applications such as Gigabit Ethernet (1000BASE-TX), 10 and 100BASE-TX, token ring, 155 Mbps ATM, 100 Mbps TP-PMD, ISDN, analog and digital video, and analog and digital voice (VoIP). The modular jacks have a slim profile and are compatible with SL series and 110Connect faceplates. The universal wiring labels permit termination to either T568A or T568B wiring patterns.



#### FEATURES

- Thin profile improves outlet density
- Modular jacks available with integral dust covers
- 180° or 90° cable dress for easy termination
- Universal wiring label permits wiring to T568A or T568B
- Meets or exceeds all TIA and ISO component performance requirements
- Bend-limiting strain relief included with unshielded jacks
- UL Listed: E81956
- 8-Position RJ45 modular jacks for 1, 2, 3 and 4-pair applications
- Can be terminated with either SL series modular jack termination tool (1725150-1) or standard 110 punch-down tools
- RoHS compliant
- Bulk packaging is 25 jacks per bag, 4 bags per carton
- HD Series
  - Specially designed to use with 1RU 48 port SL Patch Panels
  - Bulk packaged 24 per bag

#### ORDERING INFORMATION

Shielding	Cable Entry	Jack Color	SL Series Without Dust Cover	SL Series With Dust Cover	SL Series Without Dust Cover Bulk Packaged	HD Series**
Unshielded	90° (Side) or 180° (Rear)	Almond	1375055-1	1375187-1	2-1375055-1	1499925-1
		Black	1375055-2	1375187-2	2-1375055-2	1499925-2
		Gray	1375055-4	1375187-4	2-1375055-4	1499925-4
		Orange	1375055-5	1375187-5	2-1375055-5	1499925-5
		Blue	1375055-6	1375187-6	2-1375055-6	1499925-6
		Red	1375055-7	1375187-7	2-1375055-7	1499925-7
		Yellow	1375055-8	1375187-8	2-1375055-8	1499925-8
		Green	1375055-9	1375187-9	2-1375055-9	1499925-9
		Violet	1-1375055-0	1-1375187-0	3-1375055-0	1-1499925-0
		Electrical Ivory	1-1375055-1	1-1375187-1	3-1375055-1	1-1499925-1
	Alpine White	1-1375055-3	1-1375187-3	3-1375055-3	1-1499925-3	
Shielded	180° (Rear)	Black	1375188-1*	-	-	-
		Gray Die Cast Housing	2153249-1	-	-	-

Colors are approximate and for reference only.

\* Shielded jacks are not available in colors, or with dust covers and do not accept strain reliefs.

\*\* Special HD series jacks used only with 1RU 48-port patch panels. Will not interface with any other panels or faceplates.



# Copper

## Category 6 Products

### SL Series Modular Category 6 Jack Accessories

- Compact couplers for two modular plugs
- Snaps into 0.585" x 0.790" cut-outs
- Wired one-to-one



#### ORDERING INFORMATION

Description	Part Number	
Category 6 SL Coupler	Unshielded	2111123-1
	Shielded	2111124-1

### Category 6, 8-Position Modular Plug

- Each kit includes:
  - (1) Modular plug assembly
  - (1) Wire holder
  - (1) Strain relief
- RoHS compliant
- Molded with UL94V-0 plastic
- UL Listed: E81956
- Category 6 modular plug tooling on page 3-118
- Modular plug to die set cross reference on page 3-119

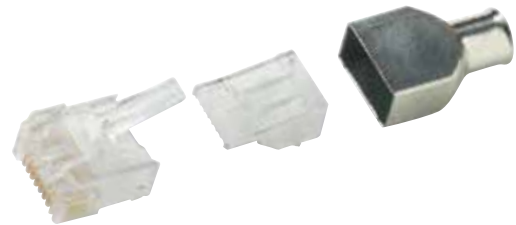

#### ORDERING INFORMATION

Description	Conductor	Insulation O.D.	Cable Jacket O.D. in (mm)	500 per Box	100 per Box
Unshielded or Shielded	Solid 24 - 23 AWG	0.035" to 0.043" (0.89 mm to 1.09 mm)	0.20" to 0.24" (5.0 mm to 6.0 mm)	5-1375204-2	5-1375204-3
		0.035" to 0.043" (0.89 mm to 1.09 mm)	0.24" to 0.28" (6.0 mm to 7.0 mm)	5-1479185-2	5-1479185-3
	Stranded 26 - 24 AWG	0.035" to 0.043" (0.89 mm to 1.09 mm)	0.20" to 0.24" (5.0 mm to 6.0 mm)	5-1375202-2	5-1375202-3
		0.035" to 0.043" (0.89 mm to 1.09 mm)	0.24" to 0.28" (6.0 mm to 7.0 mm)	5-1479184-2	5-1479184-3

# Copper

## Category 6 Products

### Modular Plug Boots for Category 6 Modular Plugs

- For use with Category 6, 8-position modular plugs
- Accept cables with diameters as listed
- Colors in table are approximate
- 100 per box



### ORDERING INFORMATION

Color		Maximum Cable O.D. 0.24" (6 mm)	Maximum Cable O.D. 0.26" (6.5 mm)
White		9-737893-1	9-336513-1
Gray		9-737893-2	9-336513-2
Red		9-737893-3	9-336513-3
Blue		9-737893-4	9-336513-4
Green		9-737893-5	9-336513-5
Yellow		9-737893-6	9-336513-6
Black		9-737893-7	9-336513-7
Orange		9-737893-8	9-336513-8
Violet		9-737893-9	9-336513-9

### Category 6 U/UTP Cable Assemblies

An integral part of TE Connectivity's structured cabling system, these patch cords are designed to maximize transmission speeds, while reducing crosstalk.

### FEATURES

- Copper conductors in the cable pairs are stranded for superior flexibility and compacted to a near-round shape for optimum signal strength
- Exceeds ANSI/TIA 568-C.2 Category 6 performance requirements
- Up to 32% smaller outer diameter than other patch cords
- Enhanced flexibility, which notably improves handling and circuit tracing
- Clear flexible strain relief boot maintains proper bend radius to ensure peak performance
- Part of the TE Connectivity 25-year system warranty



### ORDERING INFORMATION

Description	Part Number	
Category 6 Copper PVC Patch Cords	T568A wiring	TCPC-6RUVA-XXYYF
	T568B wiring	TCPC-6RUVB-XXYYF
	Crossover wiring	TCPC-6RUVX-XXYYF

Contact TE for additional cable colors and lengths.

Replace YY with: 04=4', 07=7', 10=10', 15=15', 25=25', 50=50'

Replace XX with: BL=Blue, DB=Dark Blue, WT=White, GY=Gray, RD=Red YL=Yellow, GN=Green

# Copper

## Category 6 Products

---

### Category 6 Termination Blocks

TE Connectivity's HighBand and Ultim8 cross connect solutions allow for maximum network throughput to support Gigabit Ethernet and support most advanced networks. The solution is comprised of high-performance disconnection modules, user friendly cable management and innovative anti-snag patch cords. It is the ideal cabling solution for companies who require efficiency, guaranteed performance and appealing aesthetics. These solutions are based on Patch-by-Exception, which is a unique termination technology that offers material, installation and operational cost savings, making it a compelling alternative to traditional RJ45 products. TE products maintain superior connectivity during hundreds of re-terminations and deliver the best electrical performance in the industry.

#### FEATURES

- Features disconnect contacts providing unique patch-by-exception functionality and improved administration
- Performance exceeds ANSI/TIA 568-C.2 Category 6
- A test port provides “look-both-ways” testing capability without the removal of any wires; also allows simple circuit monitoring through the use of a test cord
- UL certified



COPPER

# Copper

## Category 6 Products

### Category 6 Termination Blocks

#### ULTIM8 BLOCK

**QUANTITY PER PACK: 10**

Description	Dimensions (HxWxD)	Part Number
8-pair; color-coding for station pairs printed on face of block. Includes wire guides and jumper rings. Three mounting options: snap onto universal mounting bracket in Type 105 position; a Type 105 mounting bracket; Type 105 rod mount bracket	0.88" x 4.88" x 1.63" (22.5mm x 124mm x 41.4mm)	6468 5 060-06

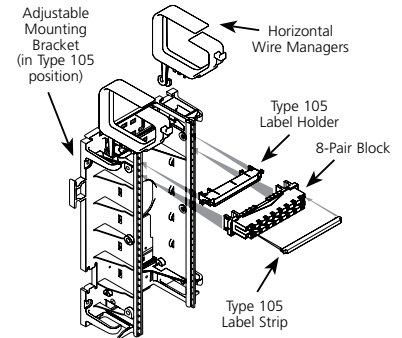

#### ULTIM8 FIELD ASSEMBLY KIT

**QUANTITY: 1**

Description	Dimensions (HxWxD)	Part Number
96-pair (24-port) Supports field termination of (24) 4-pair cables. Includes (12) Ultim8 blocks, (2) horizontal wire managers, (1) black or gray universal mounting bracket and (1) Type 105 label holder with label and protective cover	14.75" x 8.25" x 5.25" (374.7mm x 209.6mm x 33.4mm)	
96-pair (24-port) kit; including black universal mounting kit		6636 1 596-46
96-pair (24-port) kit; including gray universal mounting kit		6636 1 596-06



**HighBand 25**  
back mount frame

#### HIGHBAND 25 25-PAIR BLOCK SYSTEMS

Description	Dimensions (HxWxD)	Part Number
300-pair basic system Consists of (1) back mount frame, (12) 25-pair HighBand 25 blocks and (12) label holders. Patch cords, optional cable troughs, cable management rings, covers ordered separately	20.75" x 7.88" x 8.5" (528mm x 200mm x 215.9mm)	6450 1 101-10
HighBand 25 block with rear cable manager Color-coded; terminates (6) 4-pair Category 6 cables. Rear cable manager simplifies installation; incoming cables routed through slots and held securely by built-in clips <i>Quantity: 12</i>	1.7" x 8.5" x 4.5" (43.2mm x 215.9mm x 114.3mm)	6468 5 600-10
HighBand 25 25-pair voice module with rear cable manager <i>Quantity: 12</i>	1.7" x 8.5" x 4.5" (43.2mm x 215.9mm x 114.3mm)	6468 5 300-10

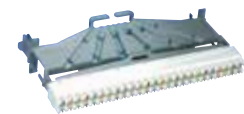

**HighBand 25 block**  
with rear cable manager



**HighBand 25 label holder**  
shown mounted on block

# Copper

## Category 6 Products

### Patch Cords for Ultim8 Blocks

These patch cords allow direct patching capability between Ultim8 blocks or patching from an Ultim8 block to an active device or an RJ45 patch panel.



Ultim8 to RJ45 patch cord



Ultim8 to Ultim8 patch cord

### ORDERING INFORMATION

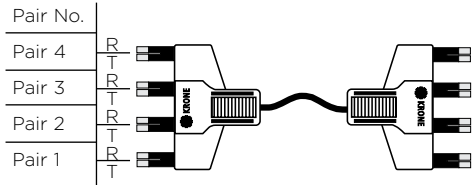
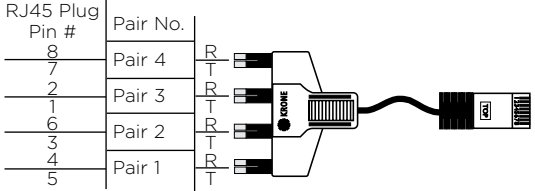
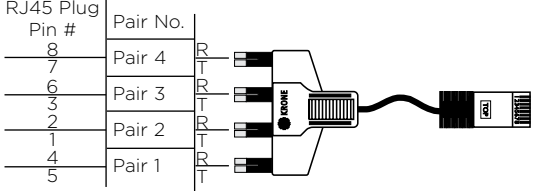
Description	Cable Color	Part Number*
<b>Ultim8 plug to Ultim8 plug,</b> wired straight through; wired top (cable) side only Quantity: 1  	White	TP6TH-WTXX
	Blue	TP6TH-BLXX
	Red	TP6TH-RDXX
	Green	TP6TH-GNXX
	Yellow	TP6TH-YLXX
	Gray	TP6TH-GYXX
<b>Ultim8 plug to RJ45 plug, T568A</b> Quantity: 1  	White	TP6TBOWTXX
	Blue	TP6TB0BLXX
	Red	TP6TB0RDXX
	Green	TP6TB0GNXX
	Yellow	TP6TB0YLXX
	Gray	TP6TB0GYXX
<b>Ultim8 plug to RJ45 plug, T568B</b> Quantity: 1  	White	TP6TB-WTXX
	Blue	TP6TB-BLXX
	Red	TP6TB-RDXX
	Green	TP6TB-GNXX
	Yellow	TP6TB-YLXX
	Gray	TP6TB-GYXX

\*Replace XX with:

- 04 = 4'
- 07 = 7'
- 10 = 10'
- 15 = 15'
- 25 = 25'
- 50 = 50'

Contact TE for additional cable colors and lengths.



# Copper

## Category 6 Products

### Ultim8 1- and 2-Pair Patch Cords

These patch cords provide direct patching capability using standard straight-through wiring. Ultim8 block plugs are keyed for proper insertion and have a latching mechanism to keep them secure. These patch cords are recommended for 10Base-T/Token Ring or voice installations using Ultim8 blocks..

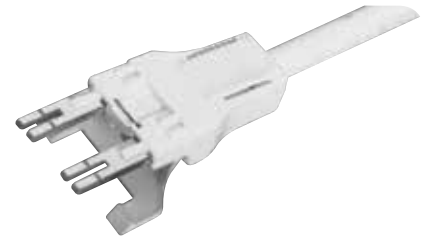

Ultim8 2-pair patch cord

#### ORDERING INFORMATION

Description	Part Number*
<p><b>Ultim8 plug to Ultim8 plug,</b> 1-pair, wired top (cable) side only, white cable Quantity: 1</p>	6648 2 000-XX
<p><b>Ultim8 plug to Ultim8 plug,</b> 2-pair, wired top (cable) side only, white cable Quantity: 1</p>	6648 2 005-XX

\*Replace XX with:

- 04 = 4'
- 07 = 7'
- 10 = 10'
- 15 = 15'
- 25 = 25'
- 50 = 50'

### HighBand Patch Cords

The HighBand patch cords are Category 6 and 6A compliant and come in a number of styles to suit the various applications. The 4-pair rear facing patch cord is ideally suited to the 12-way and 36-way configurations.

The 1-pair patch cord is available for patching voice 1-pair to 1-pair or can also be utilized for single pair testing.

The front facing patch cords are ideal in rack mount installations or when patching is commonplace.



1-pair Rear Facing



4-pair Front Facing



4-pair Rear Facing

# Copper

## Category 6 Products

### ORDERING INFORMATION

Description	Quantity	Length	Color	Product Number
<b>HighBand Category 6A Patch Cords</b>				
4-pair Rear Facing Patch Cord	Bag of 1	1.2m	Blue	6451 2 401C-10
4-pair Rear Facing Patch Cord	Bag of 1	2.1m	Blue	6451 2 401C-20
4-pair Rear Facing Patch Cord	Bag of 1	3.0m	Blue	6451 2 401C-30
4-pair Rear Facing Patch Cord	Bag of 1	4.5m	Blue	6451 2 401C-40
4-pair Front Facing Patch Cord	Bag of 1	1.2m	Blue	6451 2 403C-10
4-pair Front Facing Patch Cord	Bag of 1	2.1m	Blue	6451 2 403C-20
4-pair Front Facing Patch Cord	Bag of 1	3.0m	Blue	6451 2 403C-30
4-pair Front Facing Patch Cord	Bag of 1	4.5m	Blue	6451 2 403C-40
4-pair Rear Facing to RJ45 Patch Cord	Bag of 1	1.2m	Blue	6451 2 400C-10
4-pair Rear Facing To RJ45 Patch Cord	Bag of 1	2.1m	Blue	6451 2 400C-20
4-pair Rear Facing To RJ45 Patch Cord	Bag of 1	3.0m	Blue	6451 2 400C-30
4-pair Rear Facing To RJ45 Patch Cord	Bag of 1	4.5m	Blue	6451 2 400C-40
4-pair Front Facing to RJ45 Patch Cord	Bag of 1	1.2m	Blue	6451 2 404C-10
4-pair Front Facing To RJ45 Patch Cord	Bag of 1	2.1m	Blue	6451 2 404C-20
4-pair Front Facing To RJ45 Patch Cord	Bag of 1	3.0m	Blue	6451 2 404C-30
4-pair Front Facing To RJ45 Patch Cord	Bag of 1	4.5m	Blue	6451 2 404C-40
<b>HighBand Category 6 Patch Cords</b>				
4-pair to 4-pair Rear	Bag of 1	1.2m	Blue	6451 2 701C-10
4-pair to 4-pair Rear	Bag of 1	2.1m	Blue	6451 2 701C-20
4-pair to 4-pair Rear	Bag of 1	3.0m	Blue	6451 2 701C-30
4-pair to 4-pair Rear	Bag of 1	4.5m	Blue	6451 2 701C-40
4-pair to RJ45 Rear	Bag of 1	1.2m	Blue	6451 2 700C-10
4-pair to RJ45 Rear	Bag of 1	2.1m	Blue	6451 2 700C-20
4-pair to RJ45 Rear	Bag of 1	3.0m	Blue	6451 2 700C-30
4-pair to RJ45 Rear	Bag of 1	4.5m	Blue	6451 2 700C-40
1-pair to 1-pair Rear	Bag of 1	1.2m	White	6451 2 702-10
1-pair to 1-pair Rear	Bag of 1	2.1m	White	6451 2 702-20
1-pair to 1-pair Rear	Bag of 1	3.0m	White	6451 2 702-30
1-pair to 1-pair Rear	Bag of 1	4.5m	White	6451 2 702-40
4-pair to 4-pair Front	Bag of 1	1.2m	Blue	6451 2 703C-10
4-pair to 4-pair Front	Bag of 1	2.1m	Blue	6451 2 703C-20
4-pair to 4-pair Front	Bag of 1	3.0m	Blue	6451 2 703C-30
4-pair to 4-pair Front	Bag of 1	4.5m	Blue	6451 2 703C-40
4-pair to RJ45 Front	Bag of 1	1.2m	Blue	6451 2 704C-10
4-pair to RJ45 Front	Bag of 1	2.1m	Blue	6451 2 704C-20
4-pair to RJ45 Front	Bag of 1	3.0m	Blue	6451 2 704C-30
4-pair to RJ45 Front	Bag of 1	4.5m	Blue	6451 2 704C-40

# Copper

## Category 5e Products

### Category 5e Twisted Pair Cable

TE Connectivity offers a wide variety of Category 5e cable. All TE cables are produced by highly automated manufacturing processes that ensure consistent quality and dependability with superior electrical performance. All TE cables are independently verified to ANSI/TIA 568-C.2.

### 520 Series, Category 5e UTP Cable

#### FEATURES

- AirES patented design on CMP for higher throughput and reduced size.
- Performance characterized to 350 MHz
- 7 dB NEXT performance above Category 5e
- Meets or exceeds ANSI/TIA-568-C.2 Enhanced Category 5 and ISO Class D 11801:2002 specifications
- Independently verified by Intertek ETL SEMKO testing services
- RoHS compliant
- 24 AWG, solid conductors
- Available in side-by-side configuration

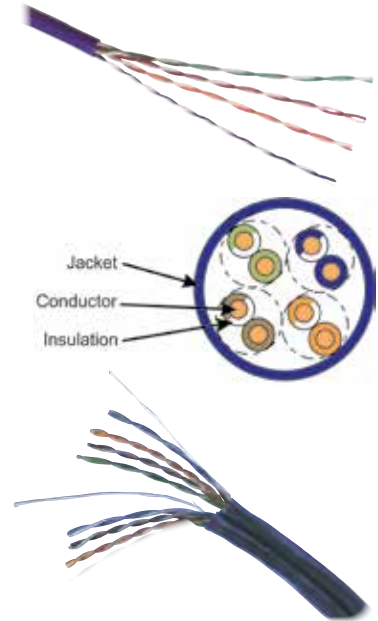

#### ORDERING INFORMATION

UL/NEC Ratings	Pair Count	Package	OD (in)	AWG	Weight lbs/Kft	Part Number
CMP	4 Pair	1000' Reel in box	0.174"	24	23	TE520P-XXRB
		1000' Pull box			20	TE520P-XXII
		1000' Reel			20	TE520P-XX02
	4 Pair Side-by-Side	1000' Reel	.174"x.360"	24	48	TE520PX2-XX02
CMR	4 Pair	1000' Reel in box	0.185"	24	25	TE520R-XXRB
		1000' Pull box			21	TE520R-XXII
		1000' Reel			21	TE520R-XX02
	4 Pair Side-by-Side	1000' Reel	.185"x.380"	24	50	TE520RX2-XX02

The following jacket colors are available. Replace "XX" with

BL-Blue	WT-White	GY-Gray	YL-Yellow	GN-Green
BK-Black	RD-Red	OR-Orange	VT-Violet	BN-Brown

Additional reel sizes available, please contact TE Customer Service.



# Copper

## Category 5e Products

### 520 Series, Category 5e F/UTP Cable

#### FEATURES

- F/UTP design with foil shield for outstanding signal isolation
- Meets or exceeds ANSI/TIA-568-C.2 Enhanced Category 5 and ISO 11801: 2002 Class D specifications
- Exceeds all requirements for Gigabit Ethernet
- 24 AWG, solid conductors
- RoHS compliant

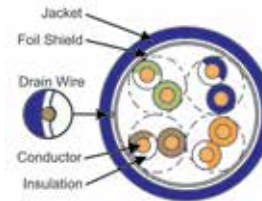

#### ORDERING INFORMATION

UL/NEC Ratings	Pair Count	Package	OD (in)	AWG	Weight lbs/Kft	Part Number
CMP	4	1000' Reel	0.252"	24	36	TE520PF-XX02
CMR	4	1000' Reel	0.250"	24	34	TE520RF-XX02

The following jacket colors are available. Replace "XX" with

BL-Blue	WT-White	GY-Gray	YL-Yellow	GN-Green
BK-Black	RD-Red	OR-Orange	VT-Violet	BN-Brown

Additional reel sizes available, please contact TE Customer Service.

# Copper

## Category 5e Products

### 510 Series, Category 5e U/UTP Cable

#### FEATURES

- Independently verified by Intertek ETL SEMKO testing services
- Meets or exceeds ANSI/TIA-568-C.2 Enhanced Category 5 and ISO 11801: 2002 Class D specifications
- 24 AWG, solid conductors
- RoHS compliant
- Performance characterized to 100 MHz
- Meets or exceeds all requirements for Gigabit Ethernet

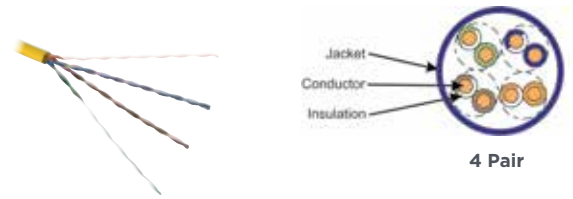

4 Pair

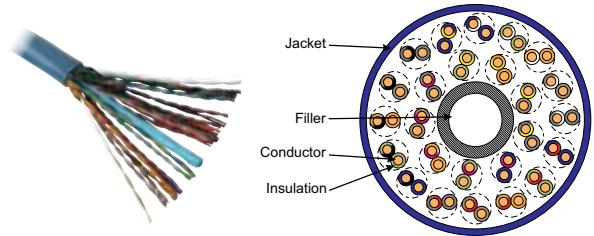

Cat5e  
25 Pair

#### ORDERING INFORMATION

UL/NEC Ratings	Pair Count	Package	OD (in)	AWG	Weight lbs/Kft	Part Number
CMP	4	1000' Pull box	0.182"	24	20	TE510P-XXII
		1000' Reel				TE510P-XX02
CMR	4	1000' Pull box	0.185"	24	20	TE510R-XXII
		1000' Reel				TE510R-XX02

The following jacket colors are available. Replace "XX" with

BL-Blue      WT-White      GY-Gray      YL-Yellow      GN-Green  
 BK-Black      RD-Red      OR-Orange      VT-Violet      BN-Brown

Additional reel sizes available, please contact TE Customer Service.

UL/NEC Ratings	Pair Count	Package	OD (in)	AWG	Weight lbs/Kft	Part Number
CMP	25	1000' Reel	0.460"	24	142	TE510P25-XX02
CMR	25	1000' Reel	0.510"	24	130	TE510R25-XX02

The following jacket colors are available, replace XX with:

BL-Blue      WT-White  
 GY-Gray

# Copper

## Category 5e Products

### Twisted Pair Cable Packaging Reference



RB = Reel-in-a-Box



O2 = Reel



II = Pull Box

Note: Unless otherwise specified, all lengths are 1000 feet (305 meters). Other lengths and colors available.

### 4-PAIR CONDUCTOR COLOR CODE

Pair		Jacket Color
1	Tip	White
	Ring	Blue <span style="color: blue;">■</span>
2	Tip	White
	Ring	Orange <span style="color: orange;">■</span>
3	Tip	White
	Ring	Green <span style="color: green;">■</span>
4	Tip	White
	Ring	Brown <span style="color: brown;">■</span>

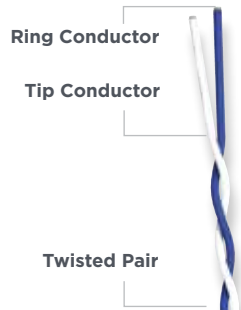

### TWISTED PAIR CABLE TEMPERATURES

Category	Condition	Riser/Plenum
CAT 5e	Storage	-4 - 176° F (-20 - 80° C)
	Operating	-4 - 167° F (-20 - 75° C)*
	Installation	41 - 122° F (5 - 50° C)

\* TE510P Operating Condition is -4 - 140° F (-20 - 60° C)

# Copper

## Category 5e Products

### 25-Pair Conductor Color Code

Color Group	Pair	Conductor Jacket Color	
White (1)	1	Tip	White
		Ring	Blue
	2	Tip	White
		Ring	Orange
	3	Tip	White
		Ring	Green
	4	Tip	White
		Ring	Brown
	5	Tip	White
		Ring	Slate
Red (2)	6	Tip	Red
		Ring	Blue
	7	Tip	Red
		Ring	Orange
	8	Tip	Red
		Ring	Green
	9	Tip	Red
		Ring	Brown
	10	Tip	Red
		Ring	Slate
Black (3)	11	Tip	Black
		Ring	Blue
	12	Tip	Black
		Ring	Orange
	13	Tip	Black
		Ring	Green
	14	Tip	Black
		Ring	Brown
	15	Tip	Black
		Ring	Slate
Yellow (4)	16	Tip	Yellow
		Ring	Blue
	17	Tip	Yellow
		Ring	Orange
	18	Tip	Yellow
		Ring	Green
	19	Tip	Yellow
		Ring	Brown
	20	Tip	Yellow
		Ring	Slate
Violet (5)	21	Tip	Violet
		Ring	Blue
	22	Tip	Violet
		Ring	Orange
	23	Tip	Violet
		Ring	Green
	24	Tip	Violet
		Ring	Brown
	25	Tip	Violet
		Ring	Slate

COPPER

# Copper

## Category 5e Products

### Category 5e Patch Panels

TE Connectivity's patch panels are offered in several different styles and port configurations. This includes standard flat panels, fixed angled panels and TE's patented dynamic angled panels. All panels exceed Enhanced Category 5 ANSI/TIA-568-C.2 and Category 5 ISO/IEC 11801 component requirements and Enhanced Category 5/Class D system performance. The Enhanced Category 5 System from TE complies with all of the performance requirements for current and proposed applications such as Gigabit Ethernet (1000BASE-TX), 10 and 100BASE-Tx, token ring, 155 Mbps ATM, 100 Mbps TP-PMD, ISDN, analog and digital video, and analog and digital voice (VoIP). Panels can be rack mounted in standard EIA 19-inch racks or wall mounted using optional 19-inch hinged wall mount brackets.

#### FEATURES FOR SL SERIES AND 110CONNECT PANELS

- Meet or exceed TIA and ISO Category 5e/Class D component performance requirements
- Universal wiring - ports may be terminated to T568A or T568B
- 110Connect termination patch panels may be terminated using single-wire 110 impact tool, KRONE tool, or 5-pair tool
- Angled and integrated cable management panels allow the elimination of horizontal cable management for higher rack densities and ease of cable dress
- 12-port mini patch panels mount vertically on included 89D bracket
- SL series termination patch panels:
  - Feature individually replaceable ports
  - Are packaged unloaded with jacks bagged separately for termination with SL series jack termination tool
- 48-port 1RU patch panels:
  - Accommodate adhesive labels or icons for port identification
  - Are supplied with 48 specially developed jacks, bagged separately for termination with SL series jack termination tool (Jacks supplied with panel assembly only; they can not be purchased separately.)
- UL1863 Listed
- RoHS compliant

#### FEATURES FOR DYNAMIC ANGLED PANELS

- Patented angle right/left eases stress on patch cords allowing for improved cable management
- Low profile dynamic angling allows for greater flexibility and use in cabinet environments
- Conductors can be terminated with either a KRONE or 110 tool
- 45 degree silver-plated IDCs provide secure, reliable gas-tight connection
- Includes adhesive paper labels for station identification
- Universal wiring label for easy termination of either T568A/B
- Patch panels are designed to support Gigabit Ethernet transmission speeds
- Rear Wire Manager included
- ID Tab adapter bezel included for use with TE ID tabs
- UL1863 Listed
- RoHS compliant

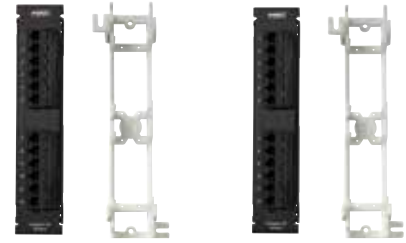

**SL Series Panels**  
Back Detail      Front Detail



**110Connect Panels**  
Back Detail      Front Detail



**Dynamic Angled Panels**

# Copper

## Category 5e Products

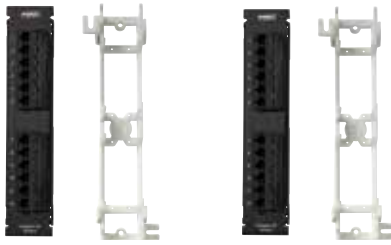

Figure A

Figure B



Figure C - Angled



Figure D - Integrated Cable Management



Figure E - Standard



Figure F - Standard



Figure G - Standard



Figure H - Angled



Figure I - Angled



Figure J - Dynamic Angled

### ORDERING INFORMATION

Port Count	Footprint	Port Configuration	Height (Rack Mount Units)	Width	Figure	Part Number
12	89D Bracket	Discrete SL Jack	10.00"	2.30"	A	1479153-2
	Standard	6 pack modules	1.75" (1RU)		B	406390-1
24	Standard	Discrete SL Jack	1.75" (1RU)	19.00"	-	1479154-2
		6 pack modules			J	PP24AC5ET
	Dynamic Angle	D			1479206-1	
	Integrated Cable Management	C			1499602-2	
	Angled	Discrete SL Jack			E	1933457-1*
48	Standard	Discrete HD Jack*	1.75" (1RU)	19.00"	H	1933657-1*
	Angled				F	1479155-2
	Standard	Discrete SL Jack	3.50" (2RU)		G	406331-1
		6 pack modules			-	PP48AC5ET
	Dynamic Angle	Discrete SL Jack			I	1499603-2
	96	Standard	Discrete SL Jack		7.00" (4RU)	19.00"
6 pack modules			-	406332-1		

\* Note: 1RU 48-port panel does not accept standard SL series jacks

# Copper

## Category 5e Products

### Category 5e Modular Jacks and Couplers

TE Connectivity's Category 5E SL series modular jacks exceed Enhanced Category 5 ANSI/TIA-568-C.2 and Category 5 ISO/IEC 11801 component requirements and Enhanced Category 5/Class D system performance. The AMP NETCONNECT Enhanced Category 5 System from TE complies with all of the performance requirements for current and proposed applications such as Gigabit Ethernet (1000BASE-TX), 10 and 100BASE-Tx, token ring, 155 Mbps ATM, 100 Mbps TP-PMD, ISDN, analog and digital video, and analog and digital voice (VoIP).



### SL Series Category 5e Modular Jacks













#### FEATURES

- Thin profile improves outlet density
- Modular jacks available with integral dust covers
- 180° or 90° cable dress for easy termination
- Universal wiring label permits wiring to T568A or T568B
- Meets or exceeds all TIA and ISO component performance requirements
- Bend-limiting strain relief included with unshielded jacks
- UL Listed: E81956
- 8-Position RJ45 modular jacks for 1, 2, 3 and 4-pair applications
- Can be terminated with either SL series modular jack termination tool (1725150-1) or standard 110 punch-down tools
- RoHS compliant
- The bulk option is 25 jacks per bag, 4 bags per carton
- HD Series
  - Specially designed to use with 1RU 48 port SL patch panels
  - Bulk packaged 24 per bag

# Copper

## Category 5e Products

### ORDERING INFORMATION

Shielding	Cable Entry	SL Series Jack Color	SL Series Without Dust Cover	With Dust Cover	SL Series Without Dust Cover Bulk Packaged	HD Series**
Unshielded	90° (Side) or 180° (Rear)	Almond 	1375191-1	1375190-1	2-1375191-1	1933455-1
		Black 	1375191-2	1375190-2	2-1375191-2	1933455-2
		Gray 	1375191-4	1375190-4	2-1375191-4	1933455-4
		Orange 	1375191-5	1375190-5	2-1375191-5	1933455-5
		Blue 	1375191-6	1375190-6	2-1375191-6	1933455-6
		Red 	1375191-7	1375190-7	2-1375191-7	1933455-7
		Yellow 	1375191-8	1375190-8	2-1375191-8	1933455-8
		Green 	1375191-9	1375190-9	2-1375191-9	1933455-9
		Violet 	1-1375191-0	1-1375190-0	3-1375191-0	1-1933455-0
		Electrical Ivory 	1-1375191-1	1-1375190-1	3-1375191-1	1-1933455-1
		Alpine White 	1-1375191-3	1-1375190-3	3-1375191-3	1-1933455-3
Shielded	180° (Rear)	Black 	1375189-1*	-	-	-

Colors are approximate and for reference only.

\* Shielded jacks are not available in colors, or with dust covers and do not accept strain reliefs.

\*\* Special HD series jacks used only with 1RU 48-port patch panels. Will not interface with any other panels or faceplates.

### SL Series Modular Coupler

#### FEATURES

- Compact couplers for two modular plugs
- Snaps into 0.585" x 0.790" cut-outs
- Wired one-to-one



**Category 5e SL**  
Unshielded Coupler

### ORDERING INFORMATION

Description	Shielding	Part Number
Category 5e SL Coupler	Unshielded	2111121-1
	Shielded	2111122-1



# Copper

## Category 5e Products

### Category 5e Modular Plugs

#### FEATURES

- Meets TIA and ISO requirements for component performance
- Modular plug tooling will be referenced in tooling section
- Each kit includes:
  - Plug housing
  - Load bar
- Load bar helps maintain pair twist
- RoHS compliant
- Molded with UL94V-0 Plastic
- UL Listed: E81956
- Modular plug to die set cross reference will be referenced in tooling section 3-120



#### ORDERING INFORMATION

Description	AWG	Insulation O.D.	Cable Jacket O.D.	Conductor	Part Number	
					500 per box	100 per box
Unshielded	26 - 24	0.035" to 0.039" (0.89 mm to 0.99 mm)	0.190" to 0.220" (4.83 mm to 5.59 mm)	Stranded	5-558530-2	5-558530-3
	26 - 24	0.035" to 0.039" (0.89 mm to 0.99 mm)	0.190" to 0.200" (4.83 mm to 5.08 mm)	Solid	5-569278-2	5-569278-3
Shielded	26 - 24	0.035" to 0.039" (0.89 mm to 0.99 mm)	0.190" to 0.200" (4.83 mm to 5.08 mm)	Stranded	5-569552-2	5-569552-3
				Solid	5-569550-2	5-569550-3

# Copper

## Category 5e Products

### Modular Plug Boots











#### FEATURES

- For use with Category 3, 5 and 5e 8-position modular plugs
- Accept cables with a maximum diameter of 0.210" (5.33 mm)
- 1000 boots per box



Clear Slimline  
Modular Plug Boot

#### ORDERING INFORMATION

Description	Maximum Cable Diameter	Color	Part Number
Modular Plug Boots	0.210" (5.33 mm)	Black 	569875-1
		Almond 	569875-2
		Red 	569875-3
		Green 	569875-4
		Blue 	569875-5
		Yellow 	569875-6
		Orange 	569875-7
		White 	569875-8
		Violet 	569875-9
		Gray 	1-569875-0
Slimline Modular Plug Boots	0.220" (5.59 mm)	Clear 	2111399-1



NOTE: Colors are approximate and for reference only.

### External Strain Reliefs For Modular Plugs

#### FEATURES

- Metal strain relief that positively engages plug housing
- PRO-CRIMPER Tool and Die Set reference will be noted in tooling section
- For use with 8-position Category 3, 5 and 5e Modular Plugs only
- RoHS compliant



#### ORDERING INFORMATION

Description	Part Number
Not for use with Modular Plug Boots	558527-1
For use with Modular Plug Boots	558527-3

# Copper

## Category 5e Products

### Category 5e Cable Assemblies

An integral part of TE Connectivity's structured cabling system, these patch cords are designed to maximize transmission speeds, while reducing crosstalk.

#### FEATURES

- Copper conductors in the cable pairs are stranded for superior flexibility and compacted to a near-round shape for optimum signal strength
- Exceeds ANSI/TIA Category 5e performance requirements
- Up to 28% smaller outer diameter than other patch cords
- Enhanced flexibility, which notably improves handling and circuit tracing
- Slimline design displays clear flexible strain relief boot maintains proper bend radius to ensure peak performance
- Part of the TE Connectivity 25-year system warranty

#### ORDERING INFORMATION

Description	Part Number	
Category 5e Copper PVC Patch Cords	T568A wiring Slimline	TCPC-5ERUVA-XXYYF
	T568B wiring Slimline	TCPC-5ERUVB-XXYYF
	Crossover wiring Slimline	TCPC-5ERUVX-XXYYF
	T568A wiring Bootless	TCPC-5ENUVA-XXYYF

Contact TE for additional cable colors and lengths.

Replace XX with:

BL=Blue      DB=Dark Blue      WT=White  
RD=Red      YL=Yellow      GN=Green  
GY=Gray

Replace YY with:

04=4'      07=7'      10=10'  
15=15'      25=25'      50=50'

#### SPECIFICATIONS

<b>Operating Temperature Range:</b>	-40° to 70° C (-40° to 158° F)
<b>RJ45 Plug Interface According to:</b>	IEC 60603-7
<b>Transmission Performance and Reliability:</b>	≥ ANSI/TIA-568-C.2 Category 5e ≥ ISO 11801 Class D Standard
<b>Number of Plug Insertion Cycles:</b>	≥ 750 (IEC/EN 60603-7)
<b>Conductor:</b>	24 AWG 7X32 stranded tinned copper
<b>Jacket:</b>	Lead free PVC
<b>Nominal Outer Diameter:</b>	5.3 mm ± .13 mm (0.210" ± .005")
<b>Safety Listing:</b>	UL 1863
<b>Flammability Rating:</b>	UL 94V-0



Slimline Cable Assemblies



Bootless, Unshielded

# Copper

## Category 5e Products

### Category 5e Termination Blocks

TE Connectivity's AMP NETCONNECT 110CONNECT XC Cross Connect products exceed Enhanced Category 5 TIA/EIA-568-C.2 performance. The system complies with all of the performance requirements for current and proposed applications such as 100BASE-Tx, 155 Mbps ATM and Gigabit Ethernet. The 110Connect punchdown wiringblocks are terminated from the horizontal station field utilizing 110 single or 5-pair wire tools. Connecting blocks utilizing double-ended IDC contacts are then seated in place connecting to the equipment field.



### 110Connect XC Category 5e Cable Assemblies

#### FEATURES

- Meets or exceeds Category 5e performance requirements
- 4-Pair stranded unshielded 24 AWG conductors
- Modular RJ45 plugs feature color-matched snagless boots
- 110Connect XC to RJ45 patch cable assemblies must be selected to match wiring pattern of work area outlet wiring
- Non-plenum (CM rated)
- Universal wiring (T568A/T568B)
- RoHS compliant



RJ45 Plug



110Connect XC Plug

#### ORDERING INFORMATION

Connector		Part Number						
End A	End B	Pair Count	Wiring	2' (0.61 m)	4' (1.22 m)	6' (1.83 m)	8' (2.44 m)	10' (3.05 m)
110Connect XC	110Connect XC	1	-	569523-2	569523-4	569523-6	569523-8	1-569523-0
		2	-	569524-2	569524-4	569524-6	569524-8	1-569524-0
		4	-	569526-2	569526-4	569526-6	569526-8	1-569526-0
	RJ45	4	T568A	569527-2	569527-4	569527-6	569527-8	1-569527-0
		4	T568B	569528-2	569528-4	569528-6	569528-8	1-569528-0
		2	T568A, 10/100BASE-T	569685-2	569685-4	569685-6	569685-8	1-569685-0
		2	T568B, 10/100BASE-T	569669-2	569669-4	569669-6	569669-8	1-569669-0

# Copper

## Category 5e Products

### 110Connect XC Category 5e Connecting Blocks

#### FEATURES

- Utilize double-ended insulation displacement contacts (IDC) that terminate 24-22 AWG solid or stranded conductors with a maximum O.D. of .063 inch
- Available in 4- and 5-pair sizes with the appropriate color coding
- Supports applications from voice to high-speed data
- Meets or exceeds the TIA specifications for Category 5e
- All components compatible with TE's industry standard AMP NETCONNECT impact tools, the KRONE tool and the 788J1 5-pair tool
- UL listed
- CSA and Austel approved

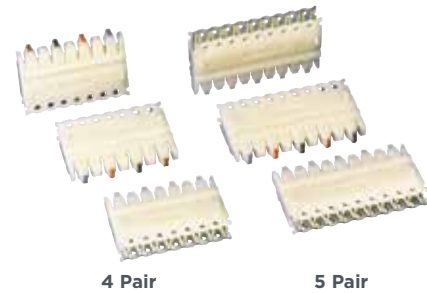

#### ORDERING INFORMATION

Description	Pair Count	Part Number
Connecting Blocks	4	558401-1
	5	558402-1

### 110Connect XC Category 5e Wiring Blocks

#### FEATURES

- Accepts 24-22 AWG conductor
- Blocks are available in 50, 100 and 300-pair sizes with legs for backboard mounting
- Supports applications from voice to high-speed data
- Offers a reliable and economical high-density system
- Meets or exceeds the TIA specifications for Category 5e
- All components compatible with TE's industry standard AMP NETCONNECT impact tools, the KRONE tool and the 788J1 5-pair tool
- UL listed
- CSA and Austel approved

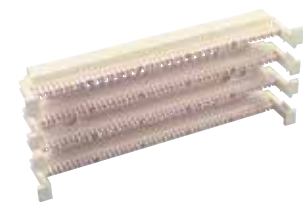

#### ORDERING INFORMATION

Description	Legs	Pair Count	Part Number
Wiring Blocks	With	50	558841-1
		100	558842-1
		300	558843-1
	Without	50	558839-1
		100	558840-1

# Copper

## Category 5e Products

### 110Connect XC Category 5e Kits

#### FEATURES

- Kits include wiring blocks with legs, connecting blocks, designation strips and white labels for the pair counts identified
- Supports applications from voice to high-speed data
- Offers a reliable and economical high-density system
- Meets or exceeds the TIA specifications for Category 5e
- All components compatible with TE's industry standard AMP NETCONNECT impact tools, the KRONE tool and the 788J1 5-pair tool
- UL listed
- CSA and Austel approved

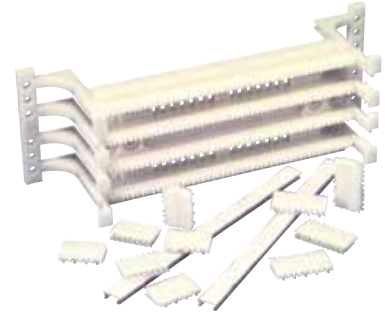

#### ORDERING INFORMATION

Pair Count	Included 4-Pair Connecting Blocks	Included 5-Pair Connecting Blocks	Part Number
50	10	2	569433-1
	0	10	569434-1
100	20	4	569439-1
	0	20	569440-1
300	60	12	569445-1
	0	60	569446-1

### Adapter for 89B Bracket

#### FEATURES

- Used to mount a 50-pair 110Connect XC wiring block on a 89B bracket
- Two adapters are required for each assembly
- Wiring blocks and 89B brackets purchased separately



#### ORDERING INFORMATION

Description	Part Number
Adapter for 89B Bracket	558838-1

# Copper

## Category 5e Products

### 110Connect XC Category 5e Cross-Connect Distribution Frame Kits

#### FEATURES

- Reduce time needed for planning and installing a cross-connect on a backboard
- Includes metal back frame, wiring blocks, connecting blocks, cable management troughs, designation strips and appropriate hardware
- Quick and easy installation
- Available in 300 and 900-pair sizes with 4 and 5-pair connecting blocks
- Supports applications from voice to high-speed data
- Offers a reliable and economical high-density system
- Meets or exceeds the TIA specifications for Category 5e
- All components compatible with TE's industry standard AMP NETCONNECT impact tools, the KRONE tool and the 788J1 5-pair tool
- UL listed
- CSA and Austel approved



#### ORDERING INFORMATION

Pair Count	Included 4-Pair Connecting Blocks	Included 5-Pair Connecting Blocks	Part Number
300	60	12	569854-1
	0	60	569855-1
900	120	24	569857-1
	0	120	569858-1

# Copper

## Category 5e Products

### 110Connect XC Cable Management

#### FEATURES

- Cable management frames and cable management rings provide high capacity storage of patch cables and jumper wire
- Cable Management Trough provides horizontal management and organization of patch cables and jumper wire
- Troughs are available with or without legs
- Suitable for mounting directly to a plywood backboard
- Quick and easy installation

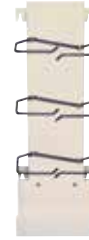

Vertical Cable Management Frame



Cable Management Ring



Cable Management Trough with legs

#### ORDERING INFORMATION

Description	Color	Option	Part Number
Cable Management Trough	White	With Legs	569389-1
		Without Legs	569597-1
Vertical Cable Management Frame	White	300-Pair	569851-1
		900-Pair	569852-1
Cable Management Rings	Black	5.7" W	569431-1
		8.5" W	569599-1



# Copper

## Category 5e Products

### 110Connect XC Category 5e Cross-Connect Rack Mount Panel

#### FEATURES

- For mounting cross-connect hardware on a 19-inch rack
- Wiring block and cable management panels available
- Labels available
- Connecting blocks and plastic label covers purchased separately
- Rack mount cable management panels provide horizontal management and organization of patch cables and jumper wire
- Supports applications from voice to high-speed data
- Offers a reliable and economical high-density system
- Meets or exceeds the TIA specifications for Category 5e
- All components compatible with TE's industry standard AMP NETCONNECT impact tools, the KRONE tool and the 788J1 5-pair tool
- UL listed
- CSA and Austel approved



200 Pair 110Connect XC  
Cross-Connect



Cable Management Trough

#### ORDERING INFORMATION

Description	Pair Count	Height	Width	Part Number
Rack Mount Panel Kits	100	1RU (1.75")	19"	558635-1
	200	2RU (3.50")	19"	558637-1
	400	5RU (8.75")	19"	558639-1
	Cable Management Trough	-	2RU (3.50")	19"

# Copper

## Copper Trunk Solutions – MRJ21

### MRJ21 Copper Cabling Solutions

MRJ21 is a high-density, small form factor modular system that provides space and time saving benefits in today's data center environment. The pluggable design satisfies the current 10/100/1000 BASE-T requirements as well as future 10 GbE system applications. The cable assemblies are factory terminated, 100% tested and serialized.

More information on the MRJ21 solution can be found at [www.te.com/MRJ21](http://www.te.com/MRJ21).

#### FEATURES

- Dense RJ21 style double blade design with offset jackscrews
- Contact layout and footprint for differential pairs creates reduced crosstalk and built-in compensation
- 1.5 to 4 times the port density of 2x6 stacked modular jack (RJ45)
- 3 times the port density of an RJ21 connector
- Jackscrews for positive latching and secure cable retention
- Robust die cast cable covers provide 45° left or right cable exit for ease of routing
- 1 mm pair spacing, 1.5 mm pair-to-pair spacing
- Reduced cable bulk allows better air circulation and equipment cooling in data centers
- Approximately 30% less area and 20% less weight than 4-pair cabling
- Enables 25% less power per port than 4-pair connector on active electronics
- Pre-terminated cable assemblies



# Copper

## Copper Trunk Solutions – MRJ21 XG (10 GbE)

### MRJ21 XG (10 GbE) System

#### INTRODUCING A PRE-TERMINATED, PLUG-AND-PLAY 10 GBE COPPER SYSTEM

The MRJ21 XG solution from TE Connectivity (TE) is a pre-terminated copper cabling system designed to deliver 10 GbE throughput in all architectures where copper cabling is required up to a 40 meter distance. Based on the foundation of TE's industry-leading MRJ21 high-density interface, the MRJ21 XG system helps facilitate management of data center rack and floor space, density and throughput while also capitalizing on its ease of deployment and fast installation rates.

Due to the increasing penetration of 10GBASE-T switches and blades in the data center, the need to quickly deploy a 10 GbE copper system with minimal white space consumption has become critical. The MRJ21 XG answers this challenge in 3 ways:

**Space Saving** – The unique MRJ21 XG trunk cable typically consumes 5% less volume than our standard 1G trunk and up to 37% less than traditional twisted pair systems, thereby reducing containment costs and improving airflow in and around the servers and switches. This can positively impact both initial capital expenditures as well as ongoing operating costs.

**Density** – The MRJ21 XG offers 48 RJ45 ports in a fixed, single rack unit configuration, allowing server or switch-specific designs with maximum rack efficiency and minimal wasted space.

**Throughput** – The MRJ21 XG can be deployed in traditional cross-connect architectures, office LAN environments and the latest server-to-core switch configurations and supports all data rates up to and including 10 Gb/s (Gigabits per second).

#### FEATURES

- Multi-Component System
  - The MRJ21 XG system is comprised of pre-terminated cable assemblies, patch panels, cassettes and CAT 6A shielded patch cords
- Multiple Deployment Options
  - Supports multiple Data Center architectures, including top-of-rack (ToR), end-of-row (EoR) and middle-of-row (MoR)
- Shielded Cable
  - Gives the highest level of signal immunity to cross-talk in the lowest cross-sectional area
- Unique 45 Degree MRJ21 Plug Design
  - The MRJ21 XG trunk cable can also be ordered with a plug supporting 45 degree rear cable entry allowing bend radius maintenance in space constrained installations



48 Port Patch Panel

# Copper

## Copper Trunk Solutions – MRJ21 XG (10 GbE)

### MRJ21 XG to MRJ21 XG Cable Assemblies

#### FEATURES

- Friendly field installable 10 GbE solution
- Dense double blade connector with offset jackscrews for latching
- 16 pair shielded cable with 26 AWG solid conductors
- Available with CMR sheath
- Factory terminated and 100% tested solution



#### ORDERING INFORMATION

Description	Part Number
MRJ21 XG to MRJ21 XG, 10 Gb/s, 180°–180° back shell; CMR sheath; White	TMRJ-XSSRW-SSXXXM
MRJ21 XG to MRJ21 XG, 10 Gb/s, 180°–45° back shell; CMR sheath; White	TMRJ-XSSRW-SAXXXXM

XXX - denotes meters  
Contact customer service for additional lengths.

XXX	Length
003	3 m
005	5 m
010	10 m
015	15 m
020	20 m
025	25 m
030	30 m
035	35 m
040	40 m

### Category 6A Shielded Patch Cable Assemblies

TE's XG Category 6A shielded patch cable assemblies are manufactured using patented techniques that create consistent performance superior to standard cable assemblies. The cable assemblies are CM (PVC) rated and constructed using colored, stranded cable and clear polycarbonate snagless boots.

#### ORDERING INFORMATION

Product Description	*Part Number
RJ45 to RJ45 T568B patch cord	TCPC-6ARFVB-XXYYF
RJ45 to RJ45 T568A patch cord	TCPC-6ARFVA-XXYYF

\*Replace XX for color:      \*Replace YY for length:  
WT = White    YL = Yellow      04 = 4'      15 = 15'  
RD = Red      GN = Green      07 = 7'      25 = 25'  
BL = Blue      GY = Gray      10 = 10'      50 = 50'

Contact TE for information on additional colors and custom lengths.

# Copper

## Copper Trunk Solutions – MRJ21 XG (10 GbE)

### MRJ21 XG 19-Inch Patch Panel, 1RU, Straight

#### FEATURES

- Compatible with MRJ21 XG cable assemblies for 10 GbE performance
- Optimal for use in environments where high density is required
- Straight panel with either 24 or 48 ports on 1RU
- Factory terminated and tested solution



48 Port Patch Panel

#### ORDERING INFORMATION

Description	Part Number
Straight panel 1RU for 10 GbE; MRJ21 Plugs: 6; RJ-45 Ports: 24; Black (RAL 9005)	2153041-1
Straight panel 1RU for 10 GbE; MRJ21 Plugs: 12; RJ-45 Ports: 48; Black (RAL 9005)	2153046-1

### MRJ21 XG Cassette Patch Panel

#### FEATURES

- 19-inch 1RU unloaded patch panel with 4 cut outs
- Accepts MRJ21XG cassettes
- Modular rear cable bracket to manage and bundle cabling
- Includes grounding bolt



#### ORDERING INFORMATION

Description	Part Number
MRJ21 XG Cassette Patch Panel 1RU Flat; Black (RAL 9005)	1-1671594-1

### MRJ21 XG Quick-Fit Cassette 8 Port (10 Gb/s)

#### FEATURES

- Compatible with MRJ21 XG cable assemblies for 10 GbE performance
- Front side: 8 x RJ45 jack (2 rows of 4 jacks)
- Rear side: 2 x MRJ21 receptacle
- Factory terminated and tested solution



#### ORDERING INFORMATION

Description	Part Number
MRJ21 XG Quick-Fit cassette for 10GBase-T; Black (RAL 9005)	0-2153115-1

# Copper

## Copper Trunk Solutions – MRJ21 1GbE

### MRJ21 Ultra Slim Cable Assemblies

#### FEATURES

- Common and additional cable assembly lengths are available - contact your local sales engineer for more information
- Enables 25% less power per port than 4 pair connector on active electronics
- Improves uptime and space efficiency on site
- 50-60% less cable mass in pathways and spaces than comparable 4-pair cabling
- Improves airflow in cabinets and around active electronics
- 40% less weight than comparable 4-pair cabling
- Gigabit Ethernet channel performance
- 30 meters application length restrictions apply
- RoHS compliant

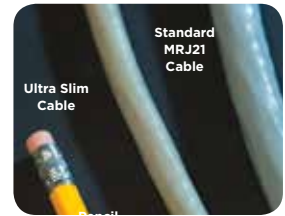

**0.365 inch (9.2 mm),**  
24-pair MRJ21 Ultra Slim  
Cable Size Comparison

#### ORDERING INFORMATION

Description	Rating	Jacket Color	Length	Part Number
<b>MRJ21 Ultra Slim, 180° Back Shell</b>	CMR (Riser)	Gray	2 m (6.56')	TMRJ-1UURG-SS002M
			3 m (9.84')	TMRJ-1UURG-SS003M
			4 m (13.12')	TMRJ-1UURG-SS004M
			5 m (16.40')	TMRJ-1UURG-SS005M
			6 m (19.68')	TMRJ-1UURG-SS006M
			7 m (22.97')	TMRJ-1UURG-SS007M
			8 m (26.25')	TMRJ-1UURG-SS008M
			9 m (29.53')	TMRJ-1UURG-SS009M
			10 m (32.81')	TMRJ-1UURG-SS010M
			12 m (39.37')	TMRJ-1UURG-SS012M
			15 m (49.21')	TMRJ-1UURG-SS015M
			17 m (55.77')	TMRJ-1UURG-SS017M
			20 m (65.62')	TMRJ-1UURG-SS020M
			25 m (82.02')	TMRJ-1UURG-SS025M
30 m (98.42')	TMRJ-1UURG-SS030M			

# Copper

## Copper Trunk Solutions – MRJ21 1GbE

### MRJ21 Cassette Panel (1GbE)

MRJ21 1 GbE cassette panels accept up to three MRJ21 cassettes.



#### ORDERING INFORMATION

Description	Accepts	Part Number
MRJ21 Cassette Panel	3 MRJ21 Cassettes	1479451-1

### MRJ21 1 GbE Cassettes

#### FEATURES

- High-performance copper cabling solution
- High-density, small form factor connectivity
- Factory terminated and tested
- Modular, pluggable design
- 6-Port cassettes support applications which use four or fewer pairs including 10BASE-T, 100BASE-T and 1000BASE-T
- 12-Port cassettes support applications which use two or fewer pairs including 10BASE-T, and 100BASE-T
- Blank adapter plate for MRJ21 (1479451-1) panel only – Do not use 1777046-1 with optical fiber enclosures



#### ORDERING INFORMATION

Description	Port Count	Applications	Active Pairs Per Port	Figure	MRJ21 Connections (Back)	Part Number
Cassette	6	10/100/1000BASE-T	4	A	1	1479459-1
	12	10/100BASE-T	2	B	1	1479452-1
Blank	-	-	-	C	-	1777046-1

# Copper

## Copper Trunk Solutions – MRJ21 1GbE

### Next Generation MRJ21 1GbE Assemblies

#### FEATURES

- Improved overall system performance
- New ergonomic features for easier handling
- New strain relief system provides:
  - Shorter overall connector length
  - Improved strain relief
  - Better bend radius control
- Backward compatible to existing panels
- MRJ21 cable assemblies’ small foot print reduces cable bulk in pathways and conduits
- 25-pair, unshielded, 24 AWG conductors
- Improves uptime and space efficiency on site
- RoHS compliant
- MRJ21 to RJ45 hydra cable assemblies are wired so that all 4-pairs of the RJ45 are active for Gigabit Ethernet
- Most assemblies are available with riser rated (CMR) or plenum rated (CMP) jacketing
- Factory terminated, tested and serialized



Figure A MRJ21 180°  
Back Shell



Figure B MRJ21 45°  
Back Shell

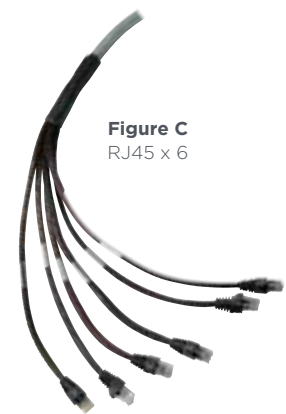

Figure C  
RJ45 x 6

#### ORDERING INFORMATION

Description	Figure	Connector Type	Rating	Part Number
Standard	A	Straight to Straight, 180-180°	CMR	TMRJ-ISURG-SS0xxM
			CMP	TMRJ-ISUPB-SS0xxM
	B	Straight to Angle, 180-45°	CMR	TMRJ-ISURG-SA0xxM
			CMP	TMRJ-ISUPB-SA0xxM
	C	Straight to Hydra 6-leg, 180-RJ45	CMR	TMRJ-ISURG-SH0xxM
			CMP	TMRJ-ISUPB-SH0xxM
		Angle to Hydra 6-leg, 45-RJ45	CMR	TMRJ-ISURG-AH0xxM
Ultra Slim		Straight to Straight, 180-180°	CMR	TMRJ-IUURG-SS0xxM

Note: xxM denotes length in meters  
Contact Customer Service for available lengths.



# Copper

## Copper Trunk Solutions – MRJ21 1GbE

### MRJ21 1 GbE Patch Panels

#### FEATURES

- High-performance copper cabling solution
- High-density, small form factor connectivity
- Factory terminated and tested
- Modular, pluggable design
- 4-Pair MRJ21 patch panels support applications which use four or fewer pairs including 10BASE-T, 100BASE-T and 1000BASE-T
- 2-Pair MRJ21 patch panels support applications which use two or fewer pairs including 10BASE-T, and 100BASE-T



Figure A



Figure B



Figure C  
Front



Figure C  
Back

#### ORDERING INFORMATION

Description	Port Count	Applications	MRJ21 Connections		Footprint	Figure	Part Number
			Back				
MRJ21 Patch Panels, 1RU	24	10/100/1000BASE-T	4		Standard	A	1777029-1
	48	10/100/1000BASE-T	8		Standard	B	1435971-1
		10/100BASE-T	4		Angled	C	1777052-1
		10/100BASE-T	4		Standard		1435965-1

### Cable Support Bars

#### FEATURES

- Mounts to the back of 19-inch racks
- Designed to provide additional cable support and routing control behind 19-inch racks and panels
- MRJ21 slotted manager bar for easy tie down
- Horizontal and vertical mounting option for MRJ21 tie down bar

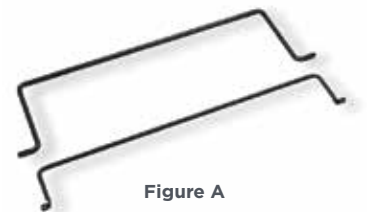

Figure A



Figure B

#### ORDERING INFORMATION

Description	Depth	Figure	Part Number
Standard Support Bar	5"	A	557548-1
	6"	B	1933352-1
MRJ21 Cable Manager Bar	9"		1933352-2
	12"		1933352-3
	16"		1933352-4

# Copper

## Copper Trunk Solutions – MRJ21

### MRJ21 Label Holder Panels and Labels

#### ORDERING INFORMATION

Description	Footprint	Figure	Part Number
<b>Label Holder Panel</b> (Labels sold separately)	Standard	A	1777040-1
	Angled		1777054-1



Figure A

	Color	Part Number	
		5 Sheets/Pack Labels for 22 Panels	100 Sheets/Pack Labels for 450 Panels
<b>Label Sheet</b>	White	1375354-1	5-1375354-1
	Blue	1375354-2	5-1375354-2
	Green	1375354-3	5-1375354-3

# Copper

## Copper Trunk Solutions – Sigma-Link

---

### Sigma-Link

The Sigma-Link solutions from TE Connectivity are pre-terminated cabling systems for high-speed networking applications. Sigma-Link cable assemblies are factory terminated and tested. Designed for quick, easy, reliable operation in data centers. Plus, all components are fully compliant with TIA-942 and EN 50173-5 data center standards.

TE's Sigma-Link systems are the perfect solution for equipment cabling that links data center servers to cabling distributors or cross connects. For smaller data centers, pre-terminated Sigma-Link products can also provide a server to switch-cabling solution with an upgrade path to 40 Gbps. Sigma-Link products also support open office applications that require multiple distribution points in a raised floor or ceiling.



### FEATURES

- Pre-terminated
- Faster installation time
- 100% factory tested
- Performance levels:
  - UTP: TIA-568-C.2 Category 6
  - F/UTP: TIA-568-C.2 Category 6A
- Termination configurations:
  - Cassette-to-cassette
  - Cassette-to-plug
  - Cassette-to-open-end
- Length options from 7' – 295'
- Easy, "single-handed" release feature on cassettes

# Copper

## Copper Trunk Solutions – Sigma-Link

### Sigma-Link Cat6 UTP Cable Assemblies

#### FEATURES

- Meets or exceeds component performance requirements of TIA/EIA-568-C.2
- Six bundled 4-pair, solid conductor, riser (CMR) rated, Category 6 UTP cables
- Available in three configurations:
  - Cassette-to-cassette
  - Cassette-to-plug
  - Cassette-to-unterminated/open
- Each cassette houses six Category 6 SL series modular jacks, wired with all 4-pairs active
- Other lengths available, see customer drawing for details



#### ORDERING INFORMATION

Assembly		Available Lengths									
		7-25' (1' Increments)		26-64' (2' Increments)		75-95' (10' Increments)		105-195' (10' Increments)		200 - 295' (10' Increments)	
End A	End B	7'	25'	26'	64'	75'	95'	105'	195'	205'	295'
Cassette	Cassette	2111290-7	2-2111290-5	2-2111290-6	6-2111290-4	7-2111290-5	9-2111290-5	2111291-5	9-2111291-5	2111292-5	9-2111292-5
	Plug	2111300-7	2-2111300-5	2-2111300-6	6-2111300-4	7-2111300-5	9-2111300-5	2111301-5	9-2111301-5	2111302-5	9-2111302-5
	Open	2111310-7	2-2111310-5	2-2111310-6	6-2111310-4	7-2111310-5	9-2111310-5	2111311-5	9-2111311-5	2111312-5	9-2111312-5

# Copper

## Copper Trunk Solutions – Sigma-Link

### Sigma-Link Cat6A F/UTP Cable Assemblies

#### FEATURES

- Meets or exceeds component performance requirements of TIA/EIA-568-C.2
- Six bundled 4-pair, solid conductor, riser (CMR) rated, Category 6A F/UTP cables
- Available in three configurations:
  - Cassette-to-cassette
  - Cassette-to-plug
  - Cassette-to-unterminated/open
- Each cassette houses six Category 6A AMP-TWIST modular jacks, wired with all 4-pairs active
- Other lengths available, see customer drawing for details



#### ORDERING INFORMATION

Assembly		Available Lengths									
		7-25' (1' Increments)		26 - 64' (2' Increments)		75 - 95' ( 10' Increments)		105 - 195' (10' Increments)		200 - 295' (10' Increments)	
End A	End B	7'	25'	26'	64'	75'	95'	105'	195'	205'	295'
Cassette	Cassette	2111250-7	2-2111250-5	2-2111250-6	6-2111250-4	7-2111250-5	9-2111250-5	2111251-5	9-2111251-5	2111252-5	9-2111252-5
	Plug	2111270-7	2-2111270-5	2-2111270-6	6-2111270-4	7-2111270-5	9-2111270-5	2111271-5	9-2111271-5	2111272-5	9-2111272-5
	Open	2111280-7	2-2111280-5	2-2111280-6	6-2111280-4	7-2111280-5	9-2111280-5	2111281-5	9-2111281-5	2111282-5	9-2111282-5

### Sigma-Link Patch Panel

#### FEATURES

- 19-inch unloaded panel accommodates four Sigma-Link cassettes
- Features integrated cable management bar



#### ORDERING INFORMATION

Description	Part Number
Sigma-Link Patch Panel, 1RU H, 19" W, Standard (Flush) Footprint	1-1671215-1

# Copper

## Specialty Products – Universal Connectivity Platform

### Universal Connectivity Platform – A Modular Approach to Infrastructure Design

TE Connectivity's Universal Connectivity Platform (UCP) provides a fully modular approach to designing data centers and telecommunications rooms. This patch panel is ideal for rapidly evolving environments because it supports both TE's plug-and-play copper and fiber solutions.

TE's UCP enables business transformation by virtue of its modularity. It is designed to accommodate all of TE's cabling media, whether copper or fiber, to support the 10, 40 and 100 Gigabit network connections in a single patch panel. By simply selecting the media, network equipment can be changed in a controlled fashion as the network demands.

Rack space is always a premium in the data center or telecommunications room, especially in existing infrastructure. The UCP is designed with this in mind, incorporating maximum flexibility for different needs and architecture. The panels can be installed in a 19 inch cabinet/rack, or installed overhead or under raised floors. By moving the panels overhead or under the floor, they can be easily shared between cabinets/racks.

Data Centers and co-location sites have undergone radical changes over the past few years and will again in the future. TE's Universal Connectivity Platform helps network managers address this change by delivering added flexibility and scalability.



### FEATURES

- Multi-media Quick-Fit configurations accommodate both copper and fiber
- Compatible with MPOptimate multimode (OM3/OM4) and singlemode (OS1/OS2) fiber media
- Compatible with U/UTP, F/UTP and S/FTP copper media
- Can be installed inside a cabinet/rack, to a wire basket or under a raised floor
- Scalable to meet all applications from 100 Mbps to 100 Gbps including high-density 10 Gbps deployments

# Copper

## Specialty Products – Universal Connectivity Platform

### UCP Patch Panel

#### FEATURES

- 19" 1RU unloaded modular patch panel with 4 Quick-Fit cutouts
- Modular rear cable bracket to manage and bundle different media cabling



Description	Part Number
UCP Patch Panel 1RU Flush; includes grounding bolt	1-1671594-1

### UCP Drawer Style Enclosure

#### FEATURES

- 19" 1RU enclosure with 4 Quick-Fit cutouts
- Mounting bracket for flush or recessed mounting



Description	Part Number
1RU Drawer style Enclosure	1933443-1

### Zero RU Quick-Fit Bracket

#### FEATURES

- Bracket designed for copper and fiber Quick-Fit cassettes and modules
- 5" horizontal clearance required



Description	Part Number
Zero RU Quick-Fit Bracket; includes grounding bolt	1-1671548-1

# Copper

## Specialty Products – Universal Connectivity Platform

### MRJ21 Quick-Fit Cassettes

Compatible with MRJ21 cable assemblies for superior performance.

#### FEATURES

- Factory terminated and tested
- Available in 1GbE and 10GbE
- High-density
  - 48 ports 1RU 1000 BASE-T
  - 32 Ports 1RU 10 GBASE-T
- Integrated bonding



10 GbE



1 GbE

Description	Part Number
MRJ21 XG Quick-Fit cassette for 10GBase-T	2153115-1
MRJ21 Quick-Fit cassette for 1000BaseT	1711970-1

### STP and UTP Quick-Fit Modules

#### FEATURES

- Accommodates CAT 5e, 6, 6A SL jacks
- STP version has integrated bonding
- Labels included

Description	Part Number
STP Quick-Fit module	2111093-1
UTP Quick-Fit module	2111117-1
Blank Module; used to close unused cut-outs in panels	1479698-1



Quick-Fit Module



Blank Module



# Copper

## Specialty Products – Universal Connectivity Platform

### MPOptimate to LC 10 Gigabit Quick-Fit Cassettes

#### 12-Fiber Trunking Solutions

##### FEATURES

- Factory terminated and tested
- Front: 6 x LC Duplex or 6 x LC Quad  
Back: one or two 12 fiber MPO or MPOptimate connector(s)
- Available in OS2, OM3 or OM4 MPOptimate
- Port number labeling and additional label strip included
- Part numbers noted are Straight Polarity. Other polarities are available upon request



LC Duplex

Description	Fiber Type	Fiber Count	Part Number
LC duplex	50 $\mu$ m, MM, OM3	12	1671205-3
	9 $\mu$ m, SM, OS2	12	1671205-4
	50 $\mu$ m, MM, OM4 MPOptimate	12	1671226-5
LC quad	50 $\mu$ m, MM, OM3	24	1671206-3
	9 $\mu$ m, SM, OS2	24	1671206-4
	50 $\mu$ m, MM, OM4 MPOptimate	24	1671227-5

### MPOptimate to LC 10 Gigabit Quick-Fit Cassettes

#### 24-Fiber Trunking Solutions

##### FEATURES

- Factory terminated and tested
- Front: 12 x LC Duplex  
Back: 1 x 24 fiber MPO connector
- Available in OM4 MPOptimate
- Port number labeling and additional label strip included



LC Quad

Description	Part Number
Cassette OM3 Straight A-A/B-B	2160266-3
Cassette OM3 Polarity Flipped A-B/B-A	1-2160266-3
Cassette OM4 Straight A-A/B-B	2160266-5
Cassette OM4 Polarity Flipped A-B/B-A	1-2160266-5

# Copper

## Specialty Products – Universal Connectivity Platform

### MPOptimate 40 Gigabit Quick-Fit Cassettes

#### FEATURES

- Factory terminated and tested
- Front: 6 x 8-fiber MPO connectors  
Back: 2 x 24 fiber MPO connector
- MPOptimate
- Port number labeling and additional label strip included
- Fiber path for part numbers noted is Polarity “A” or Polarity “B”



6x 40G Cassette

Description	Part Number
Cassette OM4 Straight A-A/B-B	2160530-5
Cassette OM4 Polarity Flipped A-B/B-A	1-2160530-5

### MPO/MPOptimate Quick-Fit Module

#### FEATURES

- Quick-Fit modules with 6 or 12 MPO couplers
- Compatible with 10/40/100 Gbps MPO trunks and arrays
- Port number labeling and additional label strip included
- MPO coupler joins MPO pinned to non-pinned connectors



6x MPO Coupler Module

Description	Part Number
6x MPO coupler module; black	1671200-1
12x MPO coupler module	1711987-1

### Quick-Fit Fiber Modules

#### FEATURES

- Available in LC and SC configurations
- Available in singlemode and multimode

Description	Fiber Type	Ferrule	Color	Part Number
12 Fiber LC	OM3/OM4	Ceramic	aqua	0-1671196-3
12 Fiber LC	SM	Ceramic	blue	0-1671196-1
24 Fiber LC	OM3/OM4	Ceramic	aqua	0-1671202-3
24 Fiber LC	SM	Ceramic	blue	0-1671202-1
12 Fiber SC	OM3/OM4	Ceramic	aqua	1671201-3
12 Fiber SC	SM	Ceramic	blue	1671201-1



12 Fiber LC



24 Fiber LC

# Copper

## Specialty Products – Universal Connectivity Platform

### Vertical Panel Mounting Brackets

#### FEATURES

- Fully flexible system for installing 19" panels vertically outside of the 19" area
- Available in 1RU

Description	Part Number
1RU Vertical Panel Mounting Brackets	1-1671549-1



### Subfloor Panel Holder Kit

#### FEATURES

- Fully flexible system for installing 19" panels underneath cabinets/racks in raised floor environments
- Pedestal distance maximum 24"
- The clamping range varies from 0.6" up to 1.2"
- Pedestal can be round or square
- Available in 2RU

Description	Part Number
Subfloor Panel Holder Kit 2RU	1671189-2



### Aerial Panel Holder Kit for Wire Mesh Cable Trays

#### FEATURES

- Fully flexible system for installing 19" panels above cabinets/racks attached to wire mesh cable trays
- Available in 2RU

Description	Part Number
Aerial Panel Holder Kit (2RU)	1-1671603-1



Note:

For information on Copper and Fiber cable assemblies visit [www.te.com/EnterpriseNetworks](http://www.te.com/EnterpriseNetworks) to view the below documents.

Copper trunk assemblies and patch cords, see document number 313948AE.

Fiber trunk assemblies and patch cords, see document numbers 402-1007 and 402-1008.

# Copper

## Specialty Products - Core Vertical Switch Management (VSM)

### Overcoming the Challenges of Core Switch Cable Management

The Core Vertical Switch Management (VSM) platform is an application-driven solution for the unique cabling challenges presented by vertical blade-based core switch systems.

This modular system is designed to efficiently and effectively support deployment of cabling on the front of a Cisco 7010 series chassis.

#### FEATURES

**Cabling routes directly from switch ports to patch panels above the switch** - Frees up space at the sides of the mounting rails for other cabling, more effective air flow and hand access.

**Logical representation of the switch ports and ease of access** - The vertical patch management allows the cabling to be deployed neatly and in the same plane as the blade and port presentation. Patch fields in line with the switch ports simplify installation, MACs, documentation and troubleshooting.

**Single patch cord lengths** - Simplifies Day 2 activities and reduces inventory.

**Simplified blade changeover** - Blades and cabling can be preconfigured away from the switch, dramatically lowering changeover times and the corresponding outages, while greatly reducing patching errors.

**Robust design** - Provides the durability you expect with expanded hand access.

**Designed to support UCP** - Quick-Fit cassettes and modules allow a mix of copper and fiber in the same panel.

**Supports mixed media applications** and migration from fiber to copper in the same chassis.



# Copper

## Specialty Products - Core Vertical Switch Management (VSM)

### Rack Mount Quick-Fit Panel

#### FEATURES

- Accepts up to 9 Quick-Fit modules
- Including cable support bars with tie down options
- Designed to support UCP Quick-Fit cassettes and modules allow a mix of copper and fiber in the same panel

**Color:** Black and galvanized finish



Rack Mount Quick-Fit Panel



Panel with UCP QuickFit modules

#### ORDERING INFORMATION

Description	Part Number
Rack Mount Quick-Fit Panel	O-1671907-1

### Cable Management Tray

#### FEATURES

- Optimized to replace Cisco Nexus 7010 switch cable manager
- Provides vertical patch cord guiding
- Allows re-use of management front cover

**Color:** Black



#### ORDERING INFORMATION

Description	Part Number
Cable Management Tray for Cisco Nexus 7010	1671633-1

# Copper

## Specialty Products - Core Vertical Switch Management (VSM)

### MRJ21 XG Quick-Fit Cassette 8 Port (10 Gb/s)

#### FEATURES

- Optimized for use in combination with UCP patch panels: plug & play deployment
- Compatible with MRJ21 XG cable assemblies for 10 GbE performance
- Front side: 8 x RJ45 jack (2 rows of 4 jacks)
- Rear side: 2 x MRJ21 receptacle
- Factory terminated and tested solution
- NOTE: The MRJ21 XG System for 10 Gb/s is not backwards compatible to the MRJ21 1 Gb/s solution!



#### ORDERING INFORMATION

Description	Part Number
MRJ21 XG Quick-Fit cassette for 10GBase-T	2153115-1

### MRJ21 Quick-Fit Cassette 12 port (1 Gb/s)

#### FEATURES

- Pre-terminated Quick-Fit cassette
- High Performance TP Cabling for guaranteed application performance
- High-density, small form factor connectivity
- Modular solution



#### ORDERING INFORMATION

Description	Part Number
MRJ21 Quick-Fit cassette for 1000Base-T	1711970-1

# Copper

## Specialty Products - Core Vertical Switch Management (VSM)

### CAT6A F/UTP Cable Assembly

#### FEATURES

- Meets or exceeds the channel specifications of ANSI/TIA-568-C.2 Category
- 6A shielded and Amendment 1 to ISO/IEC 11801:2002 Class EA up to 500 MHz when used as a component in a properly installed TE F/UTP channel
- Meets or exceeds all requirements for IEEE 802.3an 10 GbE
- Clear, flexible, strain relief boot maintains proper bend radius to ensure peak performance
- Non-plenum (CM rated)
- 4-Pair stranded shielded conductors
- Universal wiring (T568A/T568B)
- RoHS compliant

#### ORDERING INFORMATION

Description	Part Number
CAT6A Shielded Cable Assemblies	TCPC-6ARFVB-WTYYP*

\* YY- Denotes footage. More color options are available. Contact TE Customer Service.

### CAT5E U/UTP Cable Assemblies

#### FEATURES

- Meets and exceeds ANSI/TIA performance requirements for CAT5E
- 4 pair stranded UTP cable
- Slim profile clear plug and boot
- Universal wiring

#### ORDERING INFORMATION

Description	Part Number
Patch cord RJ45 CAT5E UTP, White	TCPC-5ERUVA-WTYYP*

\* YY- Denotes footage. More color options are available. Contact TE Customer Service.

# Copper

## Specialty Products - Core Vertical Switch Management (VSM)

### MRJ21 XG to MRJ21 XG cable assemblies (10 Gb/s shielded)

#### FEATURES

- Friendly field installable 10 GbE solution
- Factory terminated and 100% tested solution
- Dense double blade connector with offset jackscrews for latching
- 16 pair shielded cable with AWG 26 solid conductors

**Color:** White



Y- -X	Length
0- -3	3 m
0- -5	5 m
1- -0	10 m
1- -5	15 m
2- -0	20 m
2- -5	25 m
3- -0	30 m
3- -5	35 m
4- -0	40 m

#### ORDERING INFORMATION

Description	Part Number Y-0000000-X
MRJ21 XG to MRJ21 XG, 10 Gb/s, 180°-180° back shell; CMR	2111521-X
MRJ21 XG to MRJ21 XG, 10 Gb/s, 180°-45° back shell; CMR	2111522-X

### MRJ21 to MRJ21 cable assemblies (1 Gb/s)

#### FEATURES

- Field installable 1 GbE solution
- Enhanced screening and improved EMC
- Factory terminated and 100 % tested solution
- Dense double blade connector with offset jackscrews for latching
- 1.5 to 4 times the port density of 2 x 6 Stacked Mod Jack (RJ-45)
- 24 pair unshielded cable with AWG 24 solid conductors

**Color:** Gray



**MRJ21 180°**  
Back Shell



**MRJ21 45°**  
Back Shell

Y- -X	Length
0- -5	5 m
1- -0	10 m
1- -5	15 m
2- -0	20 m
2- -5	25 m
3- -0	30 m
3- -5	35 m
4- -0	40 m
5- -0	50 m

#### ORDERING INFORMATION

Description	Part Number Y-0000000-X
MRJ21 to MRJ21, 1 Gb/s, 180°-180° back shell	2111366-X
MRJ21 to MRJ21, 1 Gb/s, 180°-45° back shell	2111371-X



# Copper

## Specialty Products - Core Vertical Switch Management (VSM)

### MPOptimate to LC Quick-Fit cassettes

#### FEATURES

- Pre-terminated low loss cassettes
- Front: 6 duplex LC (12 fiber) or 6 Quad receptacles (24 fiber) LC
- Back: 1 or 2 low loss MPOptimate connector(s)
- Available in straight or flipped pair version
- Optical performance for OM3/OM4:  
IL  $\leq$  0.35 dB/cassette (max.)  
RL  $\geq$  27 dB
- Port number labeling and additional label strip included



#### ORDERING INFORMATION

Description	Pairs straight Part Number	Pairs flipped Part Number
1 x MPOptimate to 6 x LC Duplex (12 fiber); OM4 XGA 10 Gb/s	1671226-5	1-1671226-5
1 x MPOptimate to 6 x LC Duplex (12 fiber); OM3 XG 10 Gb/s	1671226-3	1-1671226-3
2 x MPOptimate to 6 x LC Quad (24 fiber); OM4 XGA 10 Gb/s	1671227-5	1-1671227-5
2 x MPOptimate to 6 x LC Quad (24 fiber); OM3 XG 10 Gb/s	1671227-3	1-1671227-3

### MPOptimate coupler Quick-Fit module

#### FEATURES

- Quick-Fit module with 6 or 12 MPO couplers (supporting 72 to 288 fibers)
- Port number labeling and additional label strip included
- Cable assemblies at rear of panel should be non-pinned

**Color:** Black



#### ORDERING INFORMATION

Description	Part Number
6 x MPO coupler module	1671200-1
12 x MPO coupler module	1711987-1

# Copper

## Specialty Products - Core Vertical Switch Management (VSM)

### MPOptimate LC patch cords

#### FEATURES

- Patch cords with optimized LC connectors
- Cable performance: OM4 or OM3 XG 10 Gb/s



#### ORDERING INFORMATION

Description		Part Number
<b>OM3 and OM4 (50/125 <math>\mu\text{m}</math>) multimode LC cable assemblies</b>	OM3 2.0 mm zipcord LC-LC connectors	PAT-3C3C-P30CxxxM
	OM4 2.0 mm zipcord LC-LC connectors	PAT-3C3C-P40CxxxM
<b>Singlemode LC cable assemblies</b>	OS2 2.0 mm zipcord LC-LC connectors	PAT-LCLC-PS0CxxxM

Note: XXX=length in meters, three digits required (example: 40 meters is 040).

# Copper

## Specialty Products - Core Vertical Switch Management (VSM)

### MPOptimate pre-terminated trunks

#### FEATURES

- Pulling socks and stealth pulling eye protect MPO connectors during installation

**Color:** Aqua



#### ORDERING INFORMATION

MPO Trunk Assemblies	Part Number
<b>OM4 MPO Trunk Assemblies</b>	
OM4 MPO-MPO, 12-fiber 3 mm backbone, plenum (OFNP) rated	MPT-NCNC140xxxF-FF
OM4 MPO-MPO, 24-fiber backbone (2x12) with 3 mm backbone subunits, OFNP/OFNP	MPT-NCNCD40xxxF-FF
<b>OM3 MPO Trunk Assemblies</b>	
OM3 MPO-MPO, 12-fiber 3 mm backbone, plenum (OFNP) rated	MPT-NCNC130xxxF-FF
OM3 MPO-MPO, 24-fiber backbone (2 x 12) with 3 mm backbone subunits, OFNR/OFNP	MPT-NCNCD30xxxF-FF
<b>Singlemode Trunk Assemblies</b>	
OS2 Singlemode, 12-fiber, 12-fiber 3 mm backbone, plenum (OFNP) rated	MPA-NCNC150xxxF-FF
OS2 Singlemode, 24-fiber, 24 (2 x 12) fiber backbone with 3 mm interconnect subunits, plenum (OFNP) rated	MPA-NCNCD50xxxF-FF

Note: XXX=length in feet, three digits required (example: 40 feet is 040).

### MPOptimate patch cords

#### FEATURES

- Connector performance: IL  $\leq$  0.35 dB (max.); RL  $\geq$  28 dB
- Available in female/female and male/female version in straight and total flipped wiring

**Color:** Aqua



#### ORDERING INFORMATION

Description	Part Number
12-Fiber MPO Patch Cord, OM4, Polarity A (Type A)	MPT-NCNCJ40xxxM-NN

Note: XXX=length in meters, three digits required (example: 40 meters is 040).

For complete family of MPO assemblies, see TE Specification 402-1008

# Copper

## Specialty Products – High Speed Copper Cable Assemblies

### TE Connectivity's (TE) SFP+ and QSFP/QSFP+

TE Connectivity's (TE) SFP+ and QSFP/QSFP+ direct attach copper cable assemblies are a high speed, cost effective alternative to fiber optics in 10 Gb Ethernet, 8 Gb Fiber Channel and InfiniBand technology applications. These high speed copper cable assemblies enable hardware OEM's and data center operators to achieve higher port density and configurability at a low cost and reduced power requirement. The QSFP copper cable form factor utilizes eight differential pairs which provide four data transmission channels. TE's SFP+ and QSFP copper assemblies meet or exceed the industry MSA for signal integrity performance.

#### FEATURES

- MSA SFF-8431 compliant
- Supports serial data rates up to 10 Gbps
- Low cost alternative to fiber optic assemblies
- Low power consumption
- Enhanced EMI suppression
- Pull-to-release retractable pin latch
- 24 AWG through 30 AWG cable available
- Passive and active assemblies
- Uses MADISON CABLE brand TurboTwin parallel pair cable

#### PRODUCT APPLICATIONS

- Switches
- Networking – servers, routers and hubs
- Enterprise storage
- Telecommunication equipment
- Network Interface Cards (NIC's)

#### APPLICATIONS BY PROTOCOL

- 10 Gigabit Ethernet and Gigabit Ethernet (IEEE802.3ae)
- Fibre channel: 1-, 2-, 4-, 8-, and 16-GFC
- InfiniBand standard SDR (2.5 Gbps), DDR (5 Gbps) and QDR (10 Gbps)
- Fibre Channel over Ethernet (FCoE)
- Serial data transmission



SFP



QSFP/QSFP+

# Copper

## Specialty Products – High Speed Copper Cable Assemblies

---

### SFP+ High Speed Copper Cable Assemblies

#### ORDERING INFORMATION

AWG	Cable Length	Active/Passive	Data Rate	Part Number
24	0.5 m	Passive	10 Gbps	9-2111653-1
24	1.0 m	Passive	10 Gbps	2111653-1
24	2.0 m	Passive	10 Gbps	2111653-2
24	3.0 m	Passive	10 Gbps	2111653-3
24	5.0 m	Passive	10 Gbps	2111653-5
24	7.0 m	Passive	10 Gbps	2111653-7

### QSFP/QSFP+ High Speed Copper Cable Assemblies

#### ORDERING INFORMATION

AWG	Cable Length	Active/Passive	Data Rate	Part Number
30	0.5 m	Passive	5/10 Gbps	9-2111673-1
30	1.0 m	Passive	5/10 Gbps	2111673-1
30	2.0 m	Passive	5/10 Gbps	2111673-2
30	3.0 m	Passive	5/10 Gbps	2111673-3
26	5.0 m	Passive	5/10 Gbps	2111673-5

Other lengths and cable gauges available. Contact your local TE Sales Engineer.

# Copper

## Specialty Products – High Speed Copper Cable Assemblies

### SPECIFICATIONS

#### CONNECTOR

Interface	PCB paddle card
Contact Material	30μ Gold plated contact pads
Backshell Material	Tin plated Zinc diecast
EMI Spring	Tin plated copper alloy
Latch	Retractable pin
Latch Release	Molded thermoplastic pull tab
Retention Force	90N Max
Durability	100 cycles Min

#### TWIN AXIAL CABLE

Operating Temp	0 to +70° C
Storage Temp	-40° to +80° C
Inner Shield	Aluminum/Poly Tape
Outer Shield	Tin Plated Copper Braid
Safety Certifications	UL Recognized
	CSA Certified
	RoHS Compliant
	REACH 2010 Compliant
Impedance	100 ± 10 Ohms
Jacket Material	Flexible PVC
Bend Radius	3x OD Static
	5x OD Dynamic

CABLE OD	24 AWG	26 AWG	28 AWG	30 AWG
SFP	0.255"	0.205"	0.185"	0.170"
QSFP/QSFP+	-	0.350"	0.310"	0.255"

COPPER

# Copper

## Specialty Products - Media Converters and Switches

### Media Converters, Switches and Mid-Span POE

TE Connectivity offers a wide range of high-performance, cost-effective AMP NETCONNECT Ethernet switches. The AMP NETCONNECT switches include unmanaged compact Ethernet switches, smart Ethernet switches with built-in or optional fiber uplink ports and SNMP managed Ethernet switches with optional fiber or twisted pair Gigabit uplink ports.

TE's AMP NETCONNECT basic, unmanaged compact Ethernet switches are ideal for Small Office/Home Office (SOHO), small workgroup or home networking applications. Smart Ethernet switches have fiber uplink ports either built-in/fixed (8-port switch only) or optional (16- and 24-port switches) to enable high-speed connections to backbones, servers, and network devices over singlemode or multimode (50 or 62.5/125  $\mu\text{m}$ ) fiber using industry standard MT-RJ, SC, and ST-Style connectors. SNMP managed Ethernet switches deliver management capabilities required by most network managers using interfaces such as direct connection to a console port, Telnet, or web browser sessions. Optional fiber or twisted pair uplinks can be added for high-speed network interface. Fiber uplinks include singlemode and multimode (50 or 62.5/125  $\mu\text{m}$ ) Gigabit (1000BASE-SX or LX) and 100BASE-FX. Optional twisted pair uplink is via an RJ-45, 100/1000BASE-T interface. These uplinks can be used in any combination on the switch to deliver a highly flexible backbone solution. With an emphasis on high quality, competitive cost, and ease of use, AMP NETCONNECT Ethernet switches from TE are a great choice for anyone from a home office user to an enterprise IT manager.



COPPER

# Copper

## Specialty Products - Media Converters and Switches

### AMP NETCONNECT Smart Ethernet Switches

AMP NETCONNECT smart Ethernet switches from TE can be mounted in either 10-inch or 19-inch frames.



### AMP NETCONNECT SNMP Managed Ethernet Switches

TE's AMP NETCONNECT SNMP managed Ethernet switches allow network managers excellent control and visibility of distributed switches using advanced functions accessible through a direct connection to the console port, Telnet or web browser sessions, or SNMP programs. This capability is ideal for network managers who want to have versatile control of their network.



### AMP NETCONNECT Ethernet Media Converters

TE's AMP NETCONNECT Ethernet media converters are high quality media conversion products that support 10BASE-T, 100BASE-TX and Gigabit (1000BASE-T) Ethernet standards and can be used in a wide range of applications including office buildings, professional workgroups, campuses, Fiber-to-the-Desk (FtTD), and industrial systems.

Media converters are used to extend Ethernet segments or LANs to servers and other network elements using singlemode or multimode (50 or 62.5  $\mu\text{m}$ ) optical fibers connectorized with the MT-RJ, SC, or ST connectors.



With a strong focus on simple, cost effective, quality installations, AMP NETCONNECT media converters enable a wide range of reliable network solutions.

### AMP NETCONNECT Power over Ethernet Products

TE's AMP NETCONNECT 8-port & 24-port Power over Ethernet (PoE) Midspan device for 802.3af applications offers a per-port, cost-effective solution when powering remote devices like VoIP phones, WLAN access points, security devices, etc. The AMP NETCONNECT 8-port and 24-port PoE midspan devices from TE makes injecting DC power onto existing copper cabling as simple as routing patch cords and it eliminates the PoE costs for powered switch ports when power is not needed.





# Copper

## Specialty Products - Media Converters and Switches

### 5, 8 and 16-Port Compact Ethernet Switch

#### FEATURES

- Compact and easy to install Ethernet switches
- Ideal for Small Office/Home Office (SOHO), small business and home networking applications
- Supports 10BASE-T, 100BASE-TX, 1000BASE-T Ethernet applications
- For use with RJ-45, shielded or unshielded, Category 6, 5e and 5 twisted pair structured cabling systems
- Data rate auto-negotiation and full or half duplex mode auto-selection
- Auto MDI/MDI-X detection eliminates the need for crossover cable assemblies
- Strong metal case helps to protect the switch against damage
- Powered via a compact external AC power adapter



Figure A



Figure B



Figure C

#### ORDERING INFORMATION

Description	Port Count	Ethernet Speed (MBps)	Figure	Part Number
Compact Ethernet Switch	5	10/100/1000	A	1591081-1
	8	10/100/1000	B	1591083-1
	16		C	1591070-1

### 24-Port Smart Ethernet Switch II with Optional Dual Uplink Port

#### FEATURES

- Supports 10BASE-T, 100BASE-TX, and Fast Ethernet standards
- Optional dual or single fiber uplink module only needs to be fitted if fiber link is required
- Fully managed smart switch II through the RS232 console port
- Supports up to 26 port-based VLANs
- Supports QoS (802.1p, DiffServ and port based)
- Programmable port speeds and duplex modes



Figure D

#### ORDERING INFORMATION

Description	Figure	Part Number
24-Port Smart Ethernet Switch II	D	1591093-1

# Copper

## Specialty Products - Media Converters and Switches

### 24-Port Stackable Managed Switch with Optional Expansion Port

#### FEATURES

- Supports 10BASE-T, 100BASE-TX, and Ethernet applications
- Available uplink modules provide optional fiber 100BASE-FX or optical fiber or copper gigabit capabilities
- Supports full or half-duplex auto-negotiation together with N-Way capability on the RJ-45 port
- Auto-MDI/MDI-X eliminates the need for RJ-45 crossover cables
- Managed and controlled from a console port, Telnet, SNMP or web browser
- IP stackable management supporting 8 separate switches
- VLANs, IGMP and QoS support
- Static MAC address port security
- Programmable bandwidth rules
- Comprehensive LED indicators
- Programmable port mirroring
- Up to 7-port trunks supported
- Supports 802-1x user authentication



Figure A

Figure B  
Sold Separately

#### ORDERING INFORMATION

Description	Figure	Part Number
24-Port Stackable Managed Switch	A	1591099-1

Description	Application	Interface Type	Figure	Part Number
Optional Uplink Port Modules	100BASE-Fx	SC Multimode Fiber		1591094-0
		ST Multimode Fiber		1591095-0
		SC Singlemode Fiber		1591096-0
	Dual Gigabit	4-Fiber Multimode 1000BASE-Sx		1591097-0
		4-Fiber Singlemode 1000BASE-Lx		1591098-0
		2-Port Twisted Pair 1000BASE-T	B	2-1591019-0

# Copper

## Specialty Products - Media Converters and Switches

### Fast Ethernet Media Converters

#### FEATURES

- Ideal for both new and legacy LAN applications
- RJ-45 Port:
  - For use with shielded or unshielded, Category 6, 5e, and 5 twisted pair structured cabling systems
  - Supports 10BASE-T and 100BASE-TX Ethernet applications
  - Data rate auto-negotiation and full or half duplex mode auto-selection
  - Auto MDI/MDI-X detection eliminates the need for crossover cable assemblies
- Optical Fiber Port:
  - For use with MT-RJ, SC, or ST, multimode or SC singlemode optical fiber connectors
  - Multimode fiber ports are compatible with 50/125  $\mu\text{m}$  and 62.5/125  $\mu\text{m}$  fiber types
  - Supports 100BASE-FX Ethernet applications
- Increased network resilience through link loss forwarding function that allows suitable Ethernet switches to implement alternate paths when required
- Stand-alone or chassis mountable
- Strong metal case helps to protect the media converter against damage
- Powered via an external, AC power adapter
- Dimensions 4.7" x 3.4" x 1.0"



Figure A

#### ORDERING INFORMATION

Description	Optical Fiber Interface	Figure	Part Number
Fast Ethernet Media Converter	SC Duplex Multimode		1591024-1
	SC Duplex Singlemode	A	1591030-1
	ST Multimode		1591026-1

# Copper

## Specialty Products - Media Converters and Switches

### Gigabit Ethernet Media Converters

#### FEATURES

- Ideal for both new and legacy LAN applications
- RJ-45 Port:
  - For use with shielded or unshielded, Category 6, 5e and 5 twisted pair structured cabling systems
  - Supports 1000BASE-T Ethernet applications data rate auto-negotiation and full or half duplex mode auto-selection
  - Auto MDI/MDI-X detection eliminates the need for crossover cable assemblies
- Optical Fiber Port:
  - For use with SC multimode or singlemode fiber optic connectors
  - Multimode fiber ports are compatible with 50/125  $\mu\text{m}$  and 62.5/125  $\mu\text{m}$  fiber types
  - Supports 1000BASE-SX and 1000BASE-LX Ethernet applications
- Stand-alone or chassis mountable
- Strong metal case helps to protect the media converter against damage
- Powered via an external, AC power adapter
- Dimensions 4.7" x 3.4" x 1.0"



Figure A

#### ORDERING INFORMATION

Description	Figure	Part Number
1000BASE-SX SC Duplex Multimode	A	1591020-1
1000BASE-LX SC Duplex Singlemode		1591022-1

### Rack Mount Media Converter Chassis System

- Mounts in standard 19" racks
- 3U (5.25")
- Accepts up to ten (10) Fast Ethernet or Gigabit Ethernet Media Converters (sold separately)
- Can be loaded with mixed types of media converters for flexibility
- Media converters can be hot-swapped within the chassis
- Media converters are purchased separately
- Media Converter Chassis is shipped unloaded and includes one installed power supply
- A second power supply can be installed for a dual redundancy power system
- Power supplies can be hot swapped for critical availability networks



Media Converters Sold Separately

#### ORDERING INFORMATION

Description	Part Number
Empty Rack Mount Media Converter Chassis System	1591032-1
Spare/Redundant AC Power Unit	1591034-0

# Copper

## Specialty Products – Patch Panels

### 8-Port PoE Midspan Device

#### FEATURES

- IEEE 802.3af compliant
- Supports 10/100/1000 Mb/s Ethernet
- 19-inch metal frame mountable
- Universal 110/220 V (50/60 Hz) power supply
- Full power on every port (15.4 W)



Figure A



Figure B  
Shown Loaded with one 159118  
(Sold Separately)

#### ORDERING INFORMATION

Description	Figure	Part Number
8-Port PoE Midspan	A	1591188-1
1RU, 19" Mounting Frame (holds three 8-Port PoE Midspan Devices)	B	1591185-0

### RJ45 Coupler Panel

TE's RJ45 coupler panel provides feed-through data and voice connectivity on the front and rear for Category 5e, 6 and 6A applications. Connectivity on the front of the panel accommodates standard RJ45 patch cords. Connectivity for hubs, routers and other active equipment on the back of the panel is also designed for RJ45 patch cords—creating a convenient connection field for data applications. Includes port labeling for front and rear. Width is 48.26 cm (19").



RJ45 coupler panel  
front view

#### ORDERING INFORMATION

Description	Port Count	Category	Rack Units	Part Number
RJ45 coupler panel	48	Shielded 6A	1	2111340-1
	24	6	1	ADCPP24606
	48	6	2	ADCPP48606
	24	Shielded 6	1	ADCPP24RJ6-S
	24	Shielded 5e	1	ADCPP24RJ5E-S
	24	5e	1	ADCPP24505
	48	5e	2	ADCPP48505
	16	5e	1	ADCPP16KSRJRJ
	32	5e	1	ADCPP32KSRJRJ

# Copper

## Specialty Products – Patch Panels

### Category 5, 10/100BASE-T, RJ21 (25-Pair) Patch Panel and Cable Assemblies

#### FEATURES

- Meets or exceeds TIA and ISO Category 5 component performance requirements
- Provides RJ45 breakouts from 10/100BASE-T switches and hubs that use the 25-pair telecommunications interface
- Compatible with CISCO hubs and switches
- Use with 25-pair plug to plug cable assemblies listed
- Cable assemblies are for use with this patch panel only
- Saves time in moves, adds, and changes
- Features secure and convenient 25-pair connections on the rear
- Modular 8-pin, 4-pair jacks on the front



**Left-hand Exit**  
Cable Assembly



**Category 5, 10/100BASE-T**  
25-Pair Patch Panel, FRONT

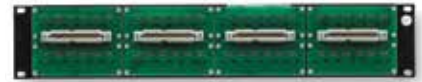

**Category 5, 10/100BASE-T**  
25-Pair Patch Panel, BACK

#### ORDERING INFORMATION

Description	Height	Length	Part Number
<b>Category 5, 10/100BASE-T, 25-Pair Patch Panel</b>	2RU (3.50")	-	1116732-1
		5' (1.52 m)	1116733-5
		7' (2.13 m)	1116733-7
		10' (3.05 m)	1-1116733-0
<b>Left-hand Exit Cable Assembly</b>		15' (4.57 m)	1-1116733-5
		5' (1.52 m)	1116734-5
		7' (2.13 m)	1116734-7
		10' (3.05 m)	1-1116734-0
<b>Right-hand Exit Cable Assembly</b>		15' (4.57 m)	1-1116734-5

### Category 3 Patch Panels

#### FEATURES

- Meets or exceeds TIA and ISO Category 3 component performance requirements
- Available in 2 and 3-pair for voice and low speed data applications



**24-Port**

#### ORDERING INFORMATION

Description	Height	Wiring Pattern	Part Number
24-Port	1RU (1.75")	RJ14C (2-Pair)	557403-1

# Copper

## Specialty Products – Patch Panels

### Category 3 25-Pair Patch Panels

#### FEATURES

- Meets or exceeds TIA and ISO Category 3 component performance requirements
- Available in 1 through 4-pair for voice and low speed data applications
- 25-Pair connectors on the back of the patch panels are male (plugs)



Front Detail



Back Detail

#### ORDERING INFORMATION

Port Count	Height	Width	Modular Jack Type	Active Pins	Wiring Diagram	Number of 25-Pair Plugs (Male)	Part Number
24	1RU (1.75")	19"	1-Pair (6-Pos.)	3&4	A	1	556189-1
			2-Pair (6-Pos.)	2-5	C	2	556183-1
			4-Pair (8-Pos.)	1-8	E	4	556180-1
D	4	556186-1					
48	3RU (5.25")	19"	1-Pair (8-Pos.)	4&5	B	2	555482-1

#### SPECIFICATIONS

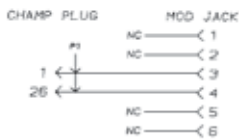

**A. 1-Pair**  
6-Position



**B. 1-Pair**  
8-Position

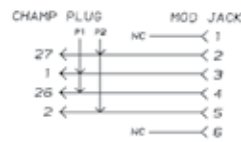

**C. 2-Pair**  
6-Position

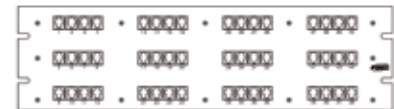

**Category 3, 25-Pair Patch Panel**  
FRONT, 24 Port Count

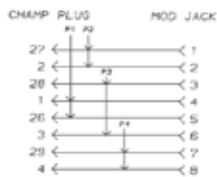

**D. 4-Pair**  
T568B

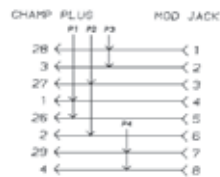

**E. 4-Pair**  
T568A

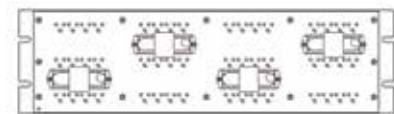

**Category 3, 25-Pair Patch Panel**  
BACK, 24 Port Count

# Copper

## Specialty Products – Patch Panels

### Multimedia SL Series Patch Panels

#### FEATURES

- Shielded panels accept AMP-TWIST, shielded, and unshielded SL series jacks and inserts
- Unshielded panels accept unshielded SL series jacks and inserts (unshielded panels will not accept unshielded AMP-TWIST jacks)
- May be used to create custom configurations — including mixing fiber, twisted-pair, coax and A/V applications
- Ports may be individually replaced
- Angled versions allow elimination of horizontal cable management for higher rack densities and ease of cable dress



Standard



Angled

#### ORDERING INFORMATION

Description	Shielding	Height	Width	Part Number	
				Standard	Angled
12-Port	Shielded	1RU (1.75")	19.0"	1933412-1	-
	Unshielded*	10.00"	2.3"	1375289-1*	-
24-Port	Shielded	1RU (1.75")	19.0"	1933307-1	1933309-1
	Unshielded*	1RU (1.75")	19.0"	1375291-1*	1499622-1*
48-Port	Unshielded	1RU (1.75")	19.0"	2111348-1**	2111349-1**
	Shielded	2RU (3.50")	19.0"	1933308-1	1933310-1
	Unshielded*	2RU (3.50")	19.0"	1375292-1*	1499623-1*
96-Port	Unshielded*	4RU (7.0")	19.0"	2111159-1	
48-Port	Unshielded	1RU	19.0"	2111348-1	2111349-1

\* Unshielded panels will not accept unshielded AMP-TWIST jacks

\*\* 1RU 48 port panels accept HD series jacks only. Will not accept SL series jacks.

### Blank Panels

#### FEATURES

- 19" wide panels are designed for use in filling equipment rack voids



Figure A 1U



Figure B 1U



Figure B 2U

#### ORDERING INFORMATION

Description	Figure	1U [1.75"]	2U [3.50"]
Standard	A	556965-1	556965-2
Angled	B	1479992-1	1479992-2



# Copper

## Specialty Products – Patch Panels

### Cover for Angled Patch Panels

#### FEATURES

- For use with angled patch panels
- Protects cabling from dust and damage



#### ORDERING INFORMATION

Description	Part Number
Cover for Angled Patch Panels	1499614-1

### Multimedia Integrated Cable Management SL Series Patch Panels

#### FEATURES

- Accept unshielded SL series jacks and inserts
- May be used to create custom configurations – including mixing fiber, twisted-pair, coax and A/V applications
- Allow elimination of horizontal cable management for higher rack densities and ease of cable dress
- Ports may be individually replaced
- Replacement labels and clear label covers are available



Figure A

#### ORDERING INFORMATION

Port Count	Height	Width	Figure	Part Number
24	1RU (1.75")	19.0"	A	1479449-1
48	2RU (3.50")	19.0"		1479450-1

### Discrete High-Density Angled SL Series Patch Panel

#### FEATURES

- Accepts AMP-TWIST, shielded, and unshielded SL series jacks and inserts (purchased separately)
- Highest density solution for 2RU (3.50")
- Ports may be individually replaced
- Angled version allow elimination of horizontal cable management for higher rack densities and ease of cable dress



#### ORDERING INFORMATION

Description	Height	Width	Part Number
72-Port Discrete Angled Panel	2RU (3.50")	19.0"	1499613-1

# Copper

## Specialty Products – Patch Panels

### 110Connect Modular Jack Patch Panels

#### FEATURES

- Shielded patch panels accept shielded 110Connect and Inserts for 110Connect modular jack patch panels
- Unshielded patch panels accept unshielded 110Connect and Inserts for 110Connect modular jack patch panels
- May be used to create custom configurations
- Ports may be individually replaced



Figure A  
Unshielded

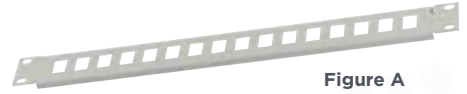

Figure A  
Shielded

#### ORDERING INFORMATION

Port Count	Height	Width	Figure	Part Number	
				Unshielded	Shielded
16	1RU (1.75")	19.0"	A	557429-1	557429-2

NOTE: Shielded patch panels use grounding lug kit 556438-1 for isolated grounding

# Copper

## Specialty Products – Patch Panels

### Inserts for 110Connect Modular Jack Patch Panels

#### FEATURES

- Used with 110Connect modular jack patch panels
- Inserts also work with standard, 0.582" x 0.762" openings



Figure A



Figure B

#### ORDERING INFORMATION

Description	Figure	Part Number	
		Almond	Black
Blank	A	558856-2	558856-1
F-Connector Coupler	B	558862-2	558862-1

NOTE: Not compatible with standard or angled faceplates or office boxes.

### 1RU Rack Mount Fiber Optic Patch Panel

#### FEATURES

- Accepts three (3) snap-in adapter plates or MPO cassettes (sold separately)
- Fits standard TIA 19 inch rack
- 1RU (1.75")



#### ORDERING INFORMATION

Description	Part Number
1RU Rack Mount Fiber Optic Patch Panel	1777125-1

# Copper

## Specialty Products – Jacks and Couplers





### SL Series Category 3 Modular Jacks

#### FEATURES

- Thin profile improves outlet density
- 180° or 90° cable dress for easy termination
- UL Listed: E81956
- Unshielded, 6-Position RJ11c/RJ14c/RJ25c modular jacks for 1, 2 and 3-Pair applications
- Can be terminated with either SL series modular jack termination tool (1725150-1) or standard 110 punch-down tools
- RoHS compliant



#### ORDERING INFORMATION

		Part Number
Color		Without Dust Cover
Almond		1375192-1
Black		1375192-2
Gray		1375192-4
Blue		1375192-6
Alpine White		1-1375192-3

Note: Colors are approximate and for reference only.

### Keystone Category 3 Modular Couplers

#### FEATURES

- Compact couplers for two modular plugs
- Couplers snap into 0.585" x 0.765" rectangular faceplate cutouts
- Wired one-to-one



**Figure A**  
Right-Angle Coupler



**Figure B**  
In-Line Coupler

#### ORDERING INFORMATION

Description	Number of Positions	Figure	Part Number
Right-Angle Coupler	6	A	555049-1
	8		555051-1
	8 (Keyed)		555377-1
In-Line Coupler	6	B	555050-1
	8		555052-1
	8 (Keyed)		555376-1
	6 (MMJ/MMJ)		556625-1
	6 (MMJ/STD)		556627-1

# Copper

## Specialty Products – Jacks and Couplers

### SL Series Modular Jack Strain Relief

- Provide strain relief for terminated cables in the work area
- Strain reliefs are for use with unshielded SL series modular jacks only

#### ORDERING INFORMATION

Description	Color	Figure	Part Number
Bend-Limiting Strain Relief	Smoked Gray	A	1375200-1
Strain Relief	Clear	B	1375157-1



Figure A



Figure B

### RJ45 Dust Covers

#### Removable Plug Dust Cover

##### FEATURES

- RJ45 Dust Covers:
  - Protect contacts from dust, build-up and contaminants which can affect performance
  - Work with any RJ45 jack
  - Made of flexible plastic for snug fit and contact protection
  - Tab makes installation and removal a snap
  - EU RoHS/ELV compliant



Figure A

#### ORDERING INFORMATION

Description	Color	Figure	Part Number
RJ45 Dust Cover	Black	A	2111285-2

### Field Installed Dust Cover

##### FEATURES

- RJ45 Dust Covers:
  - Makes dust cover an integral part of jack
  - Field installed
  - Protect contacts from dust, build-up and contaminants which can affect performance
  - Work with any RJ45 jack



Figure B

#### ORDERING INFORMATION

Description	Color	Figure	Part Number
RJ45 Dust Cover	Clear	B	2111488-1

# Copper

## Specialty Products – Modular plugs

### Category 3 Modular Plugs

#### FEATURES

- Accommodate conductors as listed
- RoHS compliant
- Molded with UL94V-0 rated plastic
- UL Listed: E81956
- For termination tooling, see page 3-120
- Modular plug to die set cross reference on page 3-120
- Refer to Category 5e products on page 3-43 for Modular Plug Boots and External Strain Reliefs



**6-Position,**  
Round, Standard



**6-Position,**  
Round, Long



**6-Position,**  
Flat, Standard



**8-Position,**  
Round, Standard



**8-Position,**  
Flat, Standard



**Shielded 8-Position**  
Round, Standard

#### ORDERING INFORMATION

Positions	Shielding	Keying	Cable Type	Cable Jacket O.D.	Conductor Type	AWG	Insulation O.D.	Body Type	Quantity Per Box	Part Number
6	Unshielded	Unkeyed	Round	0.180" (4.58 mm) max.	Stranded	28-26	0.035" (0.89 mm) max.	Standard	100*	5-554710-3
				0.195" (4.96 mm) max.	Solid	26-24	0.039" (0.99 mm) max.	Long	100*	5-555177-3
			Flat Oval	0.090" x 0.260" (2.29 mm x 6.61 mm) max.	Stranded	28-26	0.029" to 0.039" (0.74 mm to 0.99 mm)	Standard	100*	5-641337-3
					Solid	26-24	0.035" to 0.039" (0.89 mm to 0.99 mm)	Standard	100*	5-555042-3
	Shielded	Unkeyed	Flat Oval	0.110" x 0.270" (2.79 mm x 6.85 mm) max.	Stranded	28-26	0.029" to 0.039" (0.74 mm to 0.99 mm)	Long	500	5-555174-2
			Round	0.180" (4.58 mm) max.	Stranded	28-26	0.029" to 0.039" (0.74 mm to 0.99 mm)	Long	100*	5-555175-3
8	Unshielded	Keyed	Round	0.210" (5.33 mm) max.	Stranded	28-26	0.029" to 0.039" (0.74 mm to 0.99 mm)	Standard	100*	5-554170-3
			Round	0.210" (5.33 mm) max.	Stranded	28-26	0.029" to 0.039" (0.74 mm to 0.99 mm)	Standard	100*	5-554169-3
		Unkeyed	Round	0.200" (5.08 mm)	Solid	26-24	0.029" to 0.039" (0.74 mm to 0.99 mm)	Long	100*	5-557315-3
			Flat Oval	0.100" x 0.350" (2.54 mm x 8.89 mm) max.	Stranded	28-26	0.035" to 0.039" (0.89 mm to 0.99 mm)	Long	100*	5-554739-3
	Shielded	Unkeyed	Round	0.200" (5.08 mm)	Stranded	28-24	0.029" to 0.039" (0.74 mm to 0.99 mm)	Standard	100	5-569532-3
					Solid	26-24	0.029" to 0.039" (0.74 mm to 0.99 mm)	Standard	100	5-569530-3
		Flat Oval	0.110" x 0.355" (2.79 mm x 9.02 mm) max.	Stranded	28-24	0.029" to 0.039" (0.74 mm to 0.99 mm)	Standard	100	5-569542-3	

\* Note: 10 boxes per carton

# Copper

## Specialty Products – Feed-Thru Termination Block System and Accessories

### Feed-Thru Termination Block System and Accessories

The FT field assembly kits feature the universal mounting system, which provides modularity and three mounting options:

- Wall mount
- Wall mount with optional UMS backboard for greater cabling depth
- Rack mount with UMS backboard

FT field assembly kits include a universal mounting bracket, two horizontal wire managers and a choice of 4-pair or 5-pair color-coded FT blocks. Route cable from the top, bottom or rear. Four-pair color-coded blocks are marked with TIA color codes in 4-pair groups. Five-pair coded blocks are marked with a white stripe on every fifth pair. Labeling accessories, such as label holders and paper labels, are sold separately.

#### FEATURES

- Appropriate for both data and voice application
- High-density and quick installation are the hallmarks of the 25-pair Feed-Thru (FT) block system
- The 25-pair FT block is the perfect replacement for 110 installations
- Complete patching and cross-connect options provide the versatility required for any configuration
- Color-coded blocks are offered, with each pair color marked according to industry standards
- Handy label holders provide clear identification of groups or individual pairs

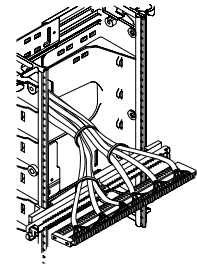

1. Terminate cables

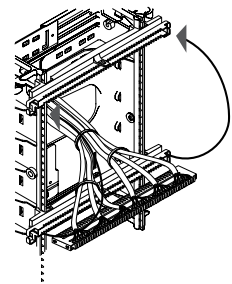

2. Move base unit from bottom to top

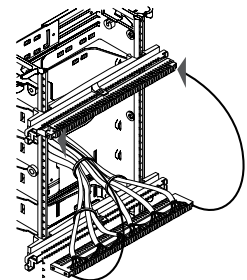

3. Flip and snap into place

# Copper

## Specialty Products – Feed-Thru Termination Block System and Accessories

### Feed-Thru (FT) Termination Block Systems

#### ORDERING INFORMATION

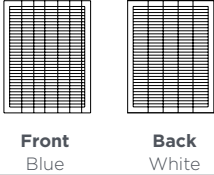
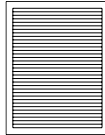
Description	Dimensions (HxWxD)	Part Number
<b>25-pair FT block</b> Quantity: 1		
<b>4-pair color-coded</b> Allows high-density termination in small area; two-piece assembly, consisting of base and connector. 4-pair color-code marked on face of block. Used for terminating 4-pair station cables; each block terminates (6) 4-pair cables	1" x 8.75" x 1.88" (25.4 mm x 225.3 mm x 47.6 mm)	6631 2 135-05
<b>5-pair color-coded</b> Allows high-density termination in small area; two-piece assembly, consisting of base and connector. 5-pair color-code (blue, orange, green, brown, slate) marked on face of block. Used for terminating 25-pair cable	1" x 8.75" x 1.88" (25.4 mm x 225.3 mm x 47.6 mm)	6631 2 135-06
<b>5-pair code</b> Allows high-density termination in small area; two-piece assembly, consisting of base and connector. Marked in white every fifth pair. Used for terminating riser cables or with PBX systems. Each block terminates 25-pair	1" x 8.75" x 1.88" (25.4 mm x 225.3 mm x 47.6 mm)	6631 2 135-00
<b>Type 160 hinged label holder</b> Used on 25-pair FT block to identify cable groups or individual pairs; folds out of the way when punching down wires; can be used for 1- to 25-pair configurations Quantity: 1		6631 2 003-00
<b>Label sheets for Type 160 hinged label holder</b> Each 8.5" x 11" sheet contains 34 perforated labels    Quantity: 1 sheet per package		
<b>Blue and white</b> One side is blue and marked in 4-pair increments; other side is white and marked in 5-pair increments		6631 3 100-26
<b>Gray/brown</b>	 <b>Type 160 Hinged</b>	6631 3 100-22
<b>Yellow/red</b>		6631 3 100-23
<b>Orange</b>		6631 3 100-27
<b>Purple</b>		6631 3 100-28
<b>Blue</b>		6631 3 100-29
<b>Green</b>		6631 3 100-30

COPPER



# Copper

## Specialty Products – Feed-Thru Termination Block System and Accessories

### Feed-Thru (FT) Field Assembly Kits

#### ORDERING INFORMATION

Description	Dimensions (HxWxD)	Part Number
<b>100-pair, 4-pair color-coded kit</b> Includes (4) 25-pair FT blocks with 4-pair color-coding, 2 horizontal wire managers, 1 universal mounting bracket. Terminates (24) 4-pair station cables. Hinged label holders for identification of stations or pairs ordered separately	14.75" x 10.75" x 5.25" (374.7 mm x 273.1 mm x 133.4 mm)	6642 1 115-04
<b>100-pair, 5-pair color-coded kit</b> Includes (4) 25-pair FT blocks with 5-pair code marked on face of block, 2 horizontal wire managers, 1 universal mounting bracket. Hinged label holder for identification of stations or pairs ordered separately	14.75" x 10.75" x 5.25" (374.7 mm x 273.1 mm x 133.4 mm)	6642 1 115-05
<b>300-pair, 4-pair color-coded kit</b> Includes (12) 25-pair FT blocks with 4-pair color-coding, 2 horizontal wire managers, 1 universal mounting bracket. Terminates (72) 4-pair station cables. Hinged label holder for identification of stations or pairs ordered separately	14.75" x 10.75" x 5.25" (374.7 mm x 273.1 mm x 133.4 mm)	6642 1 315-04
<b>300-pair, 5-pair color-coded kit</b> Includes (12) 25-pair FT blocks with 5-pair code marked on face of block, 2 horizontal wire managers, 1 universal mounting bracket. Hinged label holder for identification of stations or pairs ordered separately	14.75" x 10.75" x 5.25" (374.7 mm x 273.1 mm x 133.4 mm)	6642 1 315-05

# Copper

## Specialty Products – Feed-Thru Termination Block System and Accessories

### Patch Cords for Feed-Thru (FT)

These FT patch cords use TE Category 5e cable and exceed the requirements for Category 5e.



#### ORDERING INFORMATION

Description			Cable Color	Part Number*
<b>4-pair FT plug to FT plug, wired straight through</b> Quantity: 1			White	TP5ETF-WTXX
<b>Pair No.</b>			Red	TP5ETF-RDXX
<b>Pair 4</b>	R		Blue	TP5ETF-BLXX
	T		Green	TP5ETF-GNXX
<b>Pair 3</b>	R		Yellow	TP5ETF-YLXX
	T		Gray	TP5ETF-GYXX
<b>Pair 2</b>	R			
	T			
<b>Pair 1</b>	R			
	T			
<b>4-pair FT plug to RJ45 (8P8C) plug, wired T568A</b> Quantity: 1			White	TP5ETBOWTXX
<b>Wired to Pin #</b>			Red	TP5ETBORDXX
8	<b>Pair 4</b>	R	Blue	TP5ETB0BLXX
		T	Green	TP5ETBOGNXX
7		R	Yellow	TP5ETBOYLXX
		T	Gray	TP5ETBOGYXX
2	<b>Pair 3</b>	R		
		T		
1		R		
		T		
6	<b>Pair 2</b>	R		
		T		
3		R		
		T		
4	<b>Pair 1</b>	R		
		T		
5		R		
		T		

\*Replace XX with: 04 = 4'  
 07 = 7'  
 10 = 10'  
 15 = 15'  
 25 = 25'  
 50 = 50'

# Copper

## Specialty Products – Feed-Thru Termination Block System and Accessories

### Patch Cords for Feed-Thru (FT) Blocks

#### ORDERING INFORMATION

Description			Cable Color	Part Number*															
<b>4-pair FT plug to RJ45 (8P8C) plug, wired T568B</b> Quantity: 1 <b>Wired to Pin #</b> <table border="1" style="display: inline-table; vertical-align: top;"> <thead> <tr> <th>Pair No.</th> <th>R</th> <th>T</th> </tr> </thead> <tbody> <tr> <td>Pair 4</td> <td>8</td> <td>7</td> </tr> <tr> <td>Pair 3</td> <td>6</td> <td>3</td> </tr> <tr> <td>Pair 2</td> <td>2</td> <td>1</td> </tr> <tr> <td>Pair 1</td> <td>4</td> <td>5</td> </tr> </tbody> </table>			Pair No.	R	T	Pair 4	8	7	Pair 3	6	3	Pair 2	2	1	Pair 1	4	5	White	TP5ETB-WTXX
Pair No.	R	T																	
Pair 4	8	7																	
Pair 3	6	3																	
Pair 2	2	1																	
Pair 1	4	5																	
			Red	TP5ETB-RDXX															
			Blue	TP5ETB-BLXX															
			Green	TP5ETB-GNXX															
			Yellow	TP5ETB-YLXX															
<b>1-pair FT plug to FT plug, wired straight through</b> Quantity: 1 <b>Pair No.</b> <table border="1" style="display: inline-table; vertical-align: top;"> <thead> <tr> <th>Pair No.</th> <th>R</th> <th>T</th> </tr> </thead> <tbody> <tr> <td>Pair 1</td> <td>R</td> <td>T</td> </tr> </tbody> </table>			Pair No.	R	T	Pair 1	R	T	White	6645 2 251-XX									
Pair No.	R	T																	
Pair 1	R	T																	
			Red	6645 2 264-XX															
			Blue	6645 2 265-XX															
<b>2-pair FT plug to FT plug, wired straight through</b> Quantity: 1 <b>Pair No.</b> <table border="1" style="display: inline-table; vertical-align: top;"> <thead> <tr> <th>Pair No.</th> <th>R</th> <th>T</th> </tr> </thead> <tbody> <tr> <td>Pair 2</td> <td>R</td> <td>T</td> </tr> <tr> <td>Pair 1</td> <td>R</td> <td>T</td> </tr> </tbody> </table>			Pair No.	R	T	Pair 2	R	T	Pair 1	R	T	White	6645 2 266-XX						
Pair No.	R	T																	
Pair 2	R	T																	
Pair 1	R	T																	
			Red	6645 2 267-XX															
			Blue	6645 2 268-XX															

\*Replace XX with: 04 = 4'      15 = 15'  
 07 = 7'      25 = 25'  
 10 = 10'      50 = 50'

### Feed Thru (FT) Block Test Cord

#### ORDERING INFORMATION

Description	Part Number
<b>FT block test cord</b> 1-pair FT connector to 2 banana plugs (connect to test equipment), 1' length. Used to bridge or monitor circuit. Quantity: 1	6645 2 254-01



FT test cord

# Copper

## Specialty Products – Zone Cabling Solutions

### Consolidation Points for Raised Floor Systems

#### FEATURES

- Designed for use in 2' x 2' raised floor systems
- Accommodate standard 19-inch patch panels and/or cable management panels as listed
- Consolidation points for 2.5" high raised floor systems are designed to fit low profile raised floors
- Consolidation points for 10" high raised floor systems are intended for high density applications in data centers, server rooms, etc.
- Consolidation points for 6"– 10" high raised floor systems feature hinged patch panel mounts which allow easy access to patch panels for moves, adds and changes
- Complies with NEC 300-22(c) requirements for use in environmental air spaces
- Allows moves, adds and changes without re-terminating and re-testing cable
- Forms an interconnect between work area cabling and horizontal feeder cables
- Complies with TIA/EIA-568-C and ISO 11801:2002 requirements
- Fiber Support Bar accepts Fiber Snap-in Adapter Plates or MPO Cassettes
- Security consolidation point includes lockable cover and fits under floor tiles allowing access from a single tile

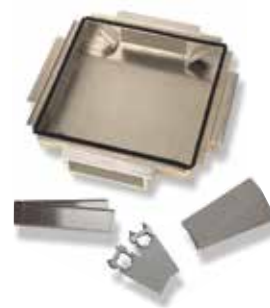

Figure A

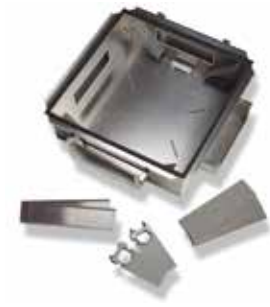

Figure B



Figure C



Figure D



Figure E



Forward Position



Installed

#### ORDERING INFORMATION

Description	For Use With	Total Capacity	Figure	Part Number
<b>Consolidation Points for Raised Floors</b>	2.5" Raised Floors	2RU (1RU + 1RU)		1479158-1
	4" Raised Floors	2RU or Angled MRJ21 Patch Panels		1479956-1
	6" Raised Floors	4RU (2RU + 2RU)	A	1479042-1
	7" Raised Floors	8RU (4RU + 4RU)	B	1479359-1
	10" Raised Floors	12RU (6RU + 6RU)	C	1479360-1
<b>Security Consolidation Point for Raised Floors (drop in box with lock)</b>	8" Raised Floors	8RU (4RU + 4RU)	D	1479297-1
<b>Fiber Support Bar Kit</b>	1479359,1479360, 1479040, and 1479297	12 Adapter Plates or MPO Cassettes	E	1479326-1

# Copper

## Specialty Products – Zone Cabling Solutions

### Consolidation Points for Drop Ceiling Systems

#### FEATURES

- Designed for use in 2' x 2' ceiling tile grid systems
- Passive consolidation points accommodate standard 19-inch patch panels, cable management panels or 300-Pair cross-connects as listed
- Active consolidation points accommodate 2RU of active LAN equipment in addition to same passive components as the passive consolidation point 1479040
- Complies with NEC 300-22(c) requirements for use in environmental air spaces
- Allows moves, adds and changes without re-terminating and re-testing cable
- Forms an interconnect between work area cabling and horizontal feeder cables
- Complies with TIA/EIA-568-C and ISO 11801:2002 requirements



Figure A



Figure B



Figure C

#### ORDERING INFORMATION

Description	Total Capacity	Figure	Part Number
Passive Consolidation Points	5RU (2RU+1RU+2RU) for passive equipment	A	1479040-1
	Two 300-pair cross-connect blocks without legs	B	1479041-1
Active Consolidation Point	5RU (2RU+1RU+2RU) for passive equipment, 2RU (2RU) for active equipment	C	1479039-1

# Copper

## Specialty Products – Zone Cabling Solutions

### Modular and Cross-Connect Consolidation Points

#### FEATURES

- Designed for use in both raised floor and drop ceiling systems
- Allows moves, adds and changes without re-terminating and retesting cable
- Forms an interconnect between work area cabling and horizontal feeder cables
- Complies with TIA/EIA-568-C and ISO 11801 requirements
- Cross-connect consolidation points accommodate two 100-Pair 110Connect XC wiring blocks without legs
- 24-Port modular consolidation points accommodate four connector modules
- 48-port modular consolidation points accommodate eight connector modules
- Complies with NEC 300-22 (c) requirements for use in environmental air spaces
- Compliant with UL 2043 for use in environmental air spaces
- UL listed: file number E81956

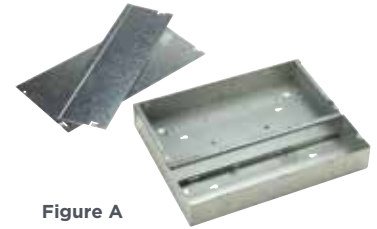

Figure A

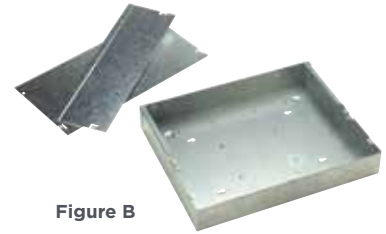

Figure B

#### ORDERING INFORMATION

Description	Maximum Capacity	Accommodates	Figure	Part Number
<b>Modular Consolidation Points</b>	24-Port	Four Consolidation Point Modules	A	406771-1
	48-Port	Six Consolidation Point Modules		1479322-1
<b>Cross-connect Consolidation Point</b>	200-Pair	Two 100-Pair 110Connect XC Wiring Blocks	B	406771-2

### Modular Consolidation Point Modules

#### FEATURES

- Comply with TIA/EIA-568-C and ISO 11801 requirements
- Multimedia module accepts up to six SL series jacks, MT-RJ outlet jacks or SL series inserts enabling custom configurations
- SL series Modules feature individually replaceable ports
- MT-RJ module holds up to six MT-RJ patch panel jacks (sold separately)
- SC Modules suitable for multimode connectors



Figure A



Figure B



Figure C

#### ORDERING INFORMATION

Description	Port Count	Figure	Part Number
<b>Modular Consolidation Point Modules</b>	Category 6 (Jacks Included)	6-Port	A 1375367-1
	Category 5e (Jacks Included)	6-Port	406772-1
	Multimedia, Unshielded (Connectivity Not Included)	6-Port	1479696-1
	Multimedia, Shielded (Connectivity Not Included)	6-Port	1933895-1
	MT-RJ (MT-RJ Patch Panel Jacks Not Included)	6-Ports/12-Fibers	B 1375093-1
	SC Duplex (Includes Couplers)	6-Ports/12-Fibers	C 406788-1
	MPO Cassette and Fiber Insert		1479142-1

# Copper

## Specialty Products – Zone Cabling Solutions

### Consolidation Point Transition Cable Assemblies

#### FEATURES

- Form connections between work area and consolidation point
- Factory-assembled and tested
- Save time and money on moves, adds and changes
- Lead-Free (no heavy metals)
- Gray Cable Jacket
- Category 6 and 6A cable assemblies require jacks to be ordered and terminated separately



Figure A

#### ORDERING INFORMATION

End A	End B	Figure	Length	Part Number			
				Riser (CMR) T568A	Riser (CMR) T568B	Plenum (CMP) T568A	Plenum (CMP) T568B
Category 6A Shielded Modular Plug	Un-terminated		40'	4-1933920-0	4-1933921-0	4-1499783-0	4-1933335-0
			50'	5-1933920-0	5-1933921-0	5-1499783-0	5-1933335-0
			60'	6-1933920-0	6-1933921-0	6-1499783-0	6-1933335-0
			70'	7-1933920-0	7-1933921-0	7-1499783-0	7-1933335-0
			80'	8-1933920-0	8-1933921-0	8-1499783-0	8-1933335-0
			90'	9-1933920-0	9-1933921-0	9-1499783-0	9-1933335-0
Category 6 Modular Plug	Un-terminated		20'	1499056-1	1499056-5	1499057-1	1499057-5
			30'	1499056-2	1499056-6	1499057-2	1499057-6
			40'	1499056-3	1499056-7	1499057-3	1499057-7
			50'	1499056-4	1499056-8	1499057-4	1499057-8
Category 5e Modular Plug	SL series category 5e modular jack	A	20'	219172-1	219173-1	219174-1	219175-1
			30'	219172-2	219173-2	219174-2	219175-2
			40'	219172-3	219173-3	219174-3	219175-3
			50'	219172-4	219173-4	219174-4	219175-4

# Copper

## Specialty Products – Zone Cabling Solutions

### Fiber Cable Assembly for Zone Cabling 50/125 μm OM1 Multimode MT-RJ Transition Point Cable Assemblies

#### FEATURES

- Form connections between work area and consolidation point
- Factory-assembled and tested
- Save time and money on moves, adds and changes
- Riser (OFNR) rated
- Orange jacketing



#### ORDERING INFORMATION

Connector		Part Number				
		Length				
End 1	End 2	10'	20'	30'	40'	50'
MT-RJ Plug	MT-RJ Jack (with Right Angle Boot)	6457240-1	6457240-2	6457240-3	6457240-4	6457240-5

COPPER

### Easy Access Zone (EAZ) Enclosure

#### FEATURES

- Very low profile
- Supports a single adapter plate, MRJ21 cassette, or MPO cassette
- Gasketed entry to reduce dust intrusion
- Separate mounting/strain relief plate
- Not plenum rated
- Captive fasteners
- Economical
- Can be magnet mounted
- Robust construction
- Tamper resistant version available
- Internal bonding lug
- Nominal dimensions: 1.75" (4.5 cm) H x 11" (28 cm) D x 5.4" (14 cm) W



Figure A

Figure B

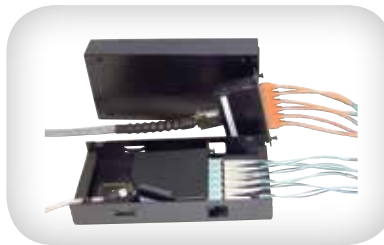

#### ORDERING INFORMATION

Description	Figure	Part Number
Easy Access Zone Enclosure	with Phillips Head 1/4 Turn Fasteners	A 1777215-1
	with Tamper-proof Cover Fasteners	1777215-2
Strain Relief Bracket for Easy Access Zone Enclosure	B	1777224-1



# Copper

## Specialty Products – Zone Cabling Solutions

### Wall/Furniture Mounting Bracket

#### FEATURES

- Options to accept up to two snap-in adapter plates, MPO, MRJ21 cassettes (sold separately)
- Mounting holes for fastening to TIA rack, wall, or furniture
- Bracket color: black
- Compatible with magnetic mounts
- Optional cable management ring is not compatible with cassettes



Shown with optional cable ring

#### ORDERING INFORMATION

Description	Part Number
Wall/Furniture Mounting Bracket for snap-in adapter plates and MPO Cassettes	1777126-1
Optional Cable Management Ring	1206146-1
Wall/Furniture Mount Bracket for MRJ21 Cassettes	1933981-1

# Copper

## Undercarpet Cabling – Undercarpet Power, Voice and Data Distribution

TE's AMP NETCONNECT undercarpet cabling system is a low profile, flexible system that makes even the most complex cabling job in office, retail, or gaming environments simple, economical and beautifully invisible. The cabling to provide power, voice and data services to your equipment can be handled with ease - from desk lights to network connections. And it's interchangeable! If changes are required after the initial installation, don't worry about the cabling. You can change it to fit your new requirements just about as easily as you move the furniture or retail display fixtures.

Take up a few sections of carpet squares, change the routing of the undercarpet cables and relocate the floor fittings. Presto! You're back in business. With this system, all your power, voice and data networks can be routed virtually anywhere under the carpet without the restrictions encountered with under-floor ducts, walls, partitions and power/data poles.



### FACTS

- Ideal for retail, gaming or office applications
- Economical alternative to power poles or trenching
- Eliminates the need to disturb or access adjacent stores in shopping locations to gain access to pull cables
- Provides better control of quality and work schedule
- UL Listed and CSA Certified
- Approved for use per NEC Article 324 and CEC Article 12-800
- Power available in 3 and 5 circuit design
- Isolated ground circuit cable and components available
- Category 5e and 6 cable to support voice/data applications
- Designed for use with carpet squares for accessibility to make system changes easy as requirements change
- Pre-packaged kits available for "store-in-a-box" concept
- Components design provides simple termination from undercarpet cable to round wire
- Suitable for use in slab-ongrade, first floor areas
- Use in open lobby, customer reception, or other areas wheretraditional cabling methods

### Undercarpet Cabling System, Layout and Planning Manual

- Everything you need to know to make your installation a success
- Example layouts, usage diagrams, interconnection instructions and more
- Get a free, downloadable copy today by visiting: <http://www.te.com/power>

Description	Part Number
<b>Undercarpet Cabling System, Layout and Planning Manual</b>	409-5566
<b>Undercarpet Cabling Installation Video</b>	1773443-5



# Copper

## Undercarpet Cabling – Undercarpet Power, Voice and Data Distribution

### Transition Boxes and Covers

- Holds transition block used to transition from round cable to undercarpet power cable
- Power transition block must be ordered separately
- Transition boxes may be used with communications transition blocks
- Transition boxes and covers can be ordered separately or as a kit

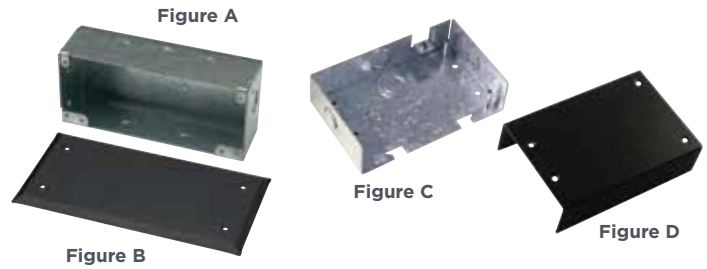

Mounting	Component	Figure	Color	Part Numbers
Flush, Wall Mounting	Kit (Includes Box and Cover)	A & B	Black	1375045-1
			Gray	1375045-3
	Box	A	-	554805-1
	Cover	B	Black	1-553292-1
Surface, Wall Mounting	Kit (Includes Box and Cover)	C&D	Black	1375032-1
			Gray	1375032-3
	Box	C	-	1375033-1
	Cover	D	Black	1375034-1
			Gray	1375034-3

### Power Transition Block

The power transition block is used to transition from round cable to 3 or 5-conductor undercarpet power cable.



Description	Part Number
Power Transition Block	554862-1

### Power Whip Kits

- Used to transition from 3 or 5-conductor undercarpet to standard, round power cable at locations away from walls
- Includes power transition block
- Accepts AMPINNERGY power entry or line entry cable assemblies for easy interface between systems
- Accepts 0.5 in [12.7mm] fitting for conduit



Description	Color	Part Number
Power Whip Kit	Black	554181-1
	Gray	554181-3

# Copper

## Undercarpet Cabling – Undercarpet Power, Voice and Data Distribution

### Floor Preparation

- Yellow vinyl floor preparation
- Used with both 3 and 5-conductor undercarpet power cable
- Required for slab-on-grade installations
- Recommended for all installations
- Provides smooth, even surface for installation

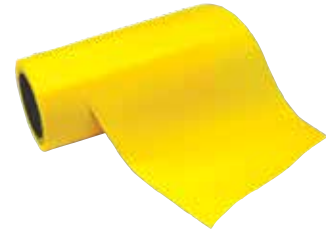

Description	Width	Length on Roll	Part Number
Floor Preparation	8 in [203.2 mm]	50 ft [15.25 m]	554123-3
		100 ft [30.48 m]	554123-4
		250 ft [76.20 m]	554123-1

### Top Shield

- Made of stainless steel
- Used with both 3 and 5-conductor undercarpet power cable
- Fully grounded component covering the entire system
- Protects the cable against penetration hazards
- Bonding clips are required to join two pieces of top shield together; bonding clips are sold separately (see page 4)



Description	Width	Length on Roll	Part Number
Top Shield	6.62 in [168.15 mm]	50 ft [15.25 m]	553536-3
		100 ft [30.48 m]	553536-4
		250 ft [76.20 m]	553536-1

### Undercarpet Power Cable

- Available in 3 and 5-conductor versions
- Undercarpet cable with isolated ground is for use with sensitive computer equipment
- UL Listed, File Number: E73212
- CSA Certified, File Number: LR7189
- Flat conductor cable (Type FCC) permitted per Article 324 of the 2008 National Electrical Code (NEC) and Rule 12-800 of the Canadian Electrical Code (CEC)

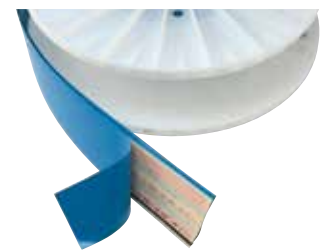

Ground	Conductor Size	Number of Conductors	Conductor Colors	Width inches [millimeters]	Part Number		
					50 ft [15.25 m]	100 ft [30.48 m]	250 ft [76.20 m]
Standard	12 AWG [3.32 mm <sup>2</sup> ]	3	White, Green, Black	2.77 [70.36]	3-553079-3	3-553079-4	3-553079-1
		5	White, Green, Black, Blue, Red	4.62 [117.35]	3-553239-3	3-553239-4	3-553239-1
Isolated	12 AWG [3.32 mm <sup>2</sup> ]	5	White, Green, Black, Red, Green/Yellow	4.62 [117.35]	3-553820-3	3-553820-4	3-553820-1

# Copper

## Undercarpet Cabling – Undercarpet Power, Voice and Data Distribution

### Direct Connecting Receptacle (DCR) Kits

- Available in 3 and 5-conductor versions
- Rated at 125 VAC, 20 A
- 5-Conductor DCR Kits require a circuit adapter to select which circuit the DCR will be used on

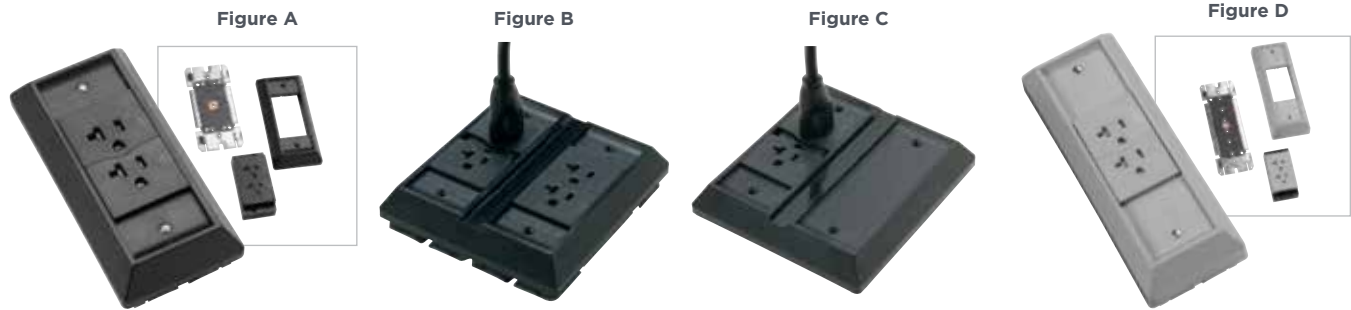

Description	Height	Duplex Receptacles	Figure	Color	Part Numbers
DCR Kit For Use With 3-Conductor Undercarpet Power Cable	1 in [25.4 mm]	Single	A	Black	553947-1
				Gray	553947-3
		Double	B	Black	554192-1
				Gray	554192-3
DCR Kit For Use With 5-Conductor Undercarpet Power Cable	1.39 in [35.3 mm]	Single, with Dual Voice/Data Knockouts	C	Black	554142-1
				Gray	554142-3
DCR Kit For Use With 5-Conductor, Isolated Ground Undercarpet Power Cable	1.39 in [35.3 mm]	Single, Isolated Ground	D	Black	554186-1*
				Gray	554186-3*
				Black	558650-1*
				Gray	558650-3*

\*NOTE: 5-conductor DCR kits require circuit adapters (ordered separately).

### Circuit Adapters for 5-Conductor DCR Kits

- Used with 5-conductor DCR kits to select which circuit is utilized
- Required for 5-conductor undercarpet power cable installations

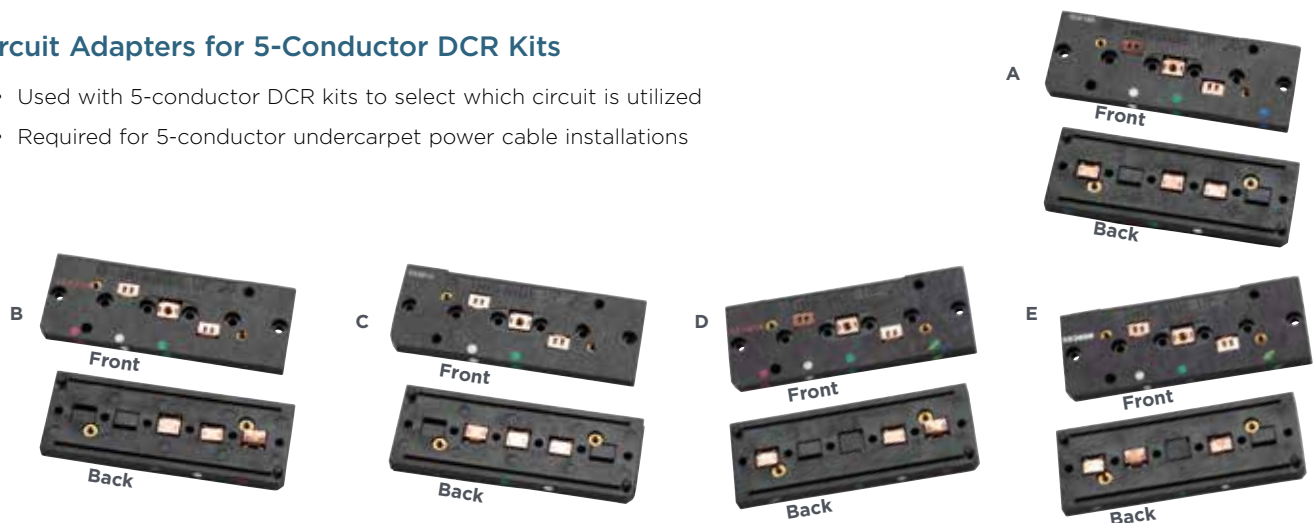

Description	Ground System	Circuit Selected	Figure	Part Numbers
5-Conductor Circuit Adapter	Standard	Blue	A	554188-1
		Red	B	554189-1
		Black	C	553910-1
	Isolated Ground	Red	D	553908-1
		Black	E	553909-1

# Copper

## Undercarpet Cabling – Undercarpet Power, Voice and Data Distribution

### Power Cable Installation Tools and Accessories

- Taps allow additional undercarpet power runs to be added to undercarpet power circuits (connects two sections of undercarpet power cable)
- Splices allow two sections of undercarpet power cable to be joined to extend lengths of undercarpet power cable
- Taps and splices require the following components:
  - Tap or splice (one per undercarpet power cable conductor)
  - Hand tool
  - Insulator kit
  - Top shield
  - Top shield bonding clip (minimum of two per tap or splice)
  - Hold down tape
- Tap/splice hand tool crimps taps and splices securely to undercarpet power cable
- DCR removal requires floor fitting patch kit
- Floor fitting patch kit includes:
  - Insulator kit
  - Top shield
  - Top shield bonding clip
  - Hold down tape
- Spray adhesive is used to help seal the installation against residual moisture
- Hold down tape is used to install cable and top shield
- For more information on the use of these products see instruction sheets 409-5566 or 408-3150



Description	Package Quantity	Figure	Part Numbers
Individual Tap	15	A	553455-2
Individual Splice	15	B	553454-1
Tap/Splice Hand Tool	1	C	91392-1
Top Shield Bonding Clip*	50	D	553534-1*
	12		6-553534-1
Stainless Steel Bonding Clip†	50		554178-1†
Insulator Kit	5	E	556411-1
	12		553453-2
Spray Adhesive	1	F	6-553453-2
Hold Down Tape, 180 ft [45.72 m]	1	G	553481-1
Floor Fitting Patch Kit	1	H	1479151-1

\*NOTE: Top shield bonding clips (553534) are required for turns, taps and splices.

†NOTE: Stainless steel bonding clips (554178) can be used to replace lost DCR clips or for bonding top shield to transition boxes

# Copper

## Undercarpet Cabling – Undercarpet Power, Voice and Data Distribution

### Communications Transition Boxes and Covers

- Holds transition block used to transition from round cable to undercarpet communications cable
- Communications transition block must be ordered separately
- Transition boxes and covers must be ordered separately
- Power transition boxes may be used in place of communications transition boxes if desired; see part numbers 1375045 and 1375034 (Note: covers are not interchangeable)

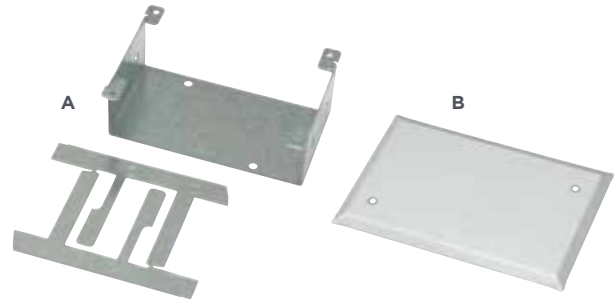

Description	Figure	Part Numbers
Flush Wall Frame	A	553739-2
Flush Wall Frame Cover	B	553095-1

### Communications Transition Blocks

- Transition blocks meet or exceed all TIA/ISO requirements for Enhanced Category 5 (Cat5e)/Class D or Category 6/Class E channel performance
- Transitions up to six (6) 4-pair cables
- 110Connect blocks may be terminated using standard 110-style punch-down tools (AMP NETCONNECT part number 1375308-1)

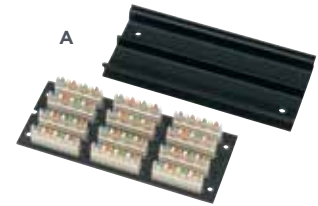

Description	TIA/EIA Category	Figure	Part Numbers
Universal Communications Transition Wiring Block	5e and 6	A	2111682-1

### Punch-down tools

- Impact tool includes blade and can be used with all 110-style terminations including 110Connect, 610XC, and SL series modular jacks



Description	Figure	Part Numbers
Pro Impact Tool with Extended-life Blade	A	1375308-1

### Undercarpet Communications Cable

- Available on reels of 250 ft [76.2 m] and 100 ft [30.48 m]
- Exceeds TIA/EIA and ISO specifications for Categories specified
- Exceeds all requirements for Gigabit Ethernet
- Independently verified by Intertek ETL SEMKO testing services
- UL Listed; UL Type CMUC
- CSA Certified; CSA Type CMH
- Lead-free jacketing

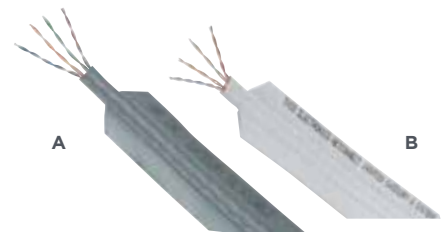

Description	TIA/EIA Category	Figure	Part Numbers	
			100 ft [30.48 m]	250 ft [76.2 m]
Undercarpet Communications Cable, UTP, 4-Pair	5e	A	1499119-5	1499119-1
	6	B	1499539-5	1499539-1



# Copper

## Undercarpet Cabling – Undercarpet Power, Voice and Data Distribution

### Communications Cable Notching Tool

- For notching undercarpet communications cable to allow smooth turns in cable runs



Description	Part Numbers
Notching Tool for Undercarpet Communications Cable	1725698-1

### Low Profile Communications Floor Fittings

- Modular jack kits are available separately, see below
- Matches the design of the DCR kits
- Accepts SL series modular jacks or SL Series Multimedia Jacks & Inserts
- 2-port accepts up to two modular jacks
- 4-port accepts up to four modular jacks



Description		Figure	Part Numbers	
Low Profile Communications Floor Fittings	2-Port	Black	A	554206-1
		Gray		554206-3
	4-Port	Black	B	555287-1
		Gray		555287-3

### Low Profile Multimedia Floor Fitting

- Replicates the design of the DCR kits
- Mounts to floor with double sided tape (supplied), screws or studs (customer supplied)
- Cable entry from sides or bottom
- Can also accommodate up to four ACO (AMP Communications Outlet) single port installation kits (purchased separately)
- Accepts up to four SL series modular jacks, or SL series multimedia jacks or inserts
- Accepts up to two SVGA (or similar sized connector) connectors (ordered separately)



Description	Part Numbers
Low Profile Multimedia Floor Fitting Kit	1479542-1

### Modular Jack Kits and Accessories

- Modular jack kits include black colored jack
- Bracket mounts to floor fitting with double sided tape (supplied)
- Bracket accepts SL series modular and multimedia jacks and inserts
- Modular jacks meet or exceed TIA and ISO component performance requirements
- Modular jacks feature universal wiring labels to permit wiring to either T568A or T568B patterns

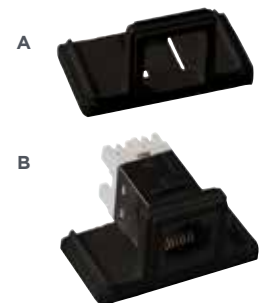

Description	Jack Color	Figure	EIA/TIA Category	Part Numbers
Modular Jack Bracket	-	A	-	1499543-1
SL Series Modular Jack Bracket Kits	Black	B	CAT 5e	558054-1
			CAT 6	1933377-1



# Copper

## Undercarpet Cabling – Undercarpet Power, Voice and Data Distribution

### Surface Mount Floor Cover Kit

- Used as a surface-mount transition point between UnderCarpet and round cable
- Ideal for use over existing poke-thru fittings. Accommodates ½ or ¾ inch conduit fittings
- Can be used for UnderCarpet Power or Communications separately but not combined
- 2 inches high, 14 inches long, 11.25 inches wide
- Must order surface mount box (1375033-1) separately
- Transition blocks for power and communications not included



Description	Color	Part Numbers
Surface Mount Floor Cover Kit	Black	2111420-1

### Flush Floor Outlet Box Kits

- Flush mount outlet alternative to DCRs
- Intended for use in concrete floors
- Used for UnderCarpet power or communications separately but not combined in the same box
- Maybe used as a transition point (1375130-1)
- Available with or without outlet covers. Designed to accept Thomas and Betts metallic or non-metallic floor box covers (640 and 840 Series)
- 2.5 inches deep, 12 inches long, 8 inches wide
- Duplex power or communications jacks not included

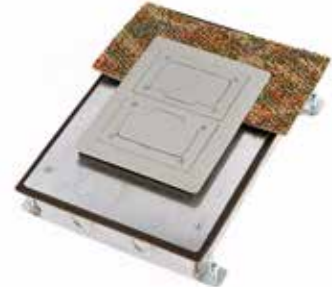

Description	Part Numbers
1-Gang, Flush Floor Outlet Box (outlet covers not included)	1375130-1
2-Gang, Flush Floor Outlet Box (outlet covers not included)	1375130-2
1-Gang, Flush Floor Outlet Box (outlet covers included)	2111353-1
2-Gang, Flush Floor Outlet Box (outlet covers included)	2111353-2

# Copper

## Undercarpet Cabling – Undercarpet Power, Voice and Data Distribution

### Conference Room Kits

- Provides services for power and communications (4 ports of communications and 2 duplex power receptacles)
- Kits do not include carpet tiles
- Reduces cost of installation, no core drilling required
- Yields a more aesthetically pleasing and cleaner installation than power poles
- More flexible than any other method of service distribution
- No tripping over extension cords, unsightly “speed bumps” or duct taped cables
- Provides one circuit of power to two duplex receptacles in a compact, durable floor mounted outlet
- Provides four ports of any combination of voice or data on Category 5e or Category 6 cable to RJ45 modular jacks in a compact, durable floor mounted outlet
- Transition boxes can be easily retrofitted in place of existing power and communications wall outlets



Description	TIA/EIA Category	Figure	Part Number
<b>Undercarpet Conference Room Kit</b>	Category 5e	A	1479050-1
	Category 6	B	1933466-1
<b>Kit Contents</b>	<b>Component*</b>	<b>1479050-1</b>	<b>1933466-1</b>
<b>Category 5e Undercarpet Communications Cable</b>	1499119-1	100 ft	-
<b>Category 6 Undercarpet Communications Cable</b>	1499539-1	-	100 ft
<b>3-Conductor, 12 AWG, Standard Ground, Undercarpet Power Cable</b>	3-553079-3	50 ft	50 ft
<b>Flush Wall Frame Communications Transition Box</b>	553739-2	1	1
<b>Flush Wall Frame Communications Transition Box Cover</b>	553095-1	1	1
<b>Universal Communications Transition Block, CAT 5e and 6</b>	2111682-1	1	1
<b>4-Port Low Profile Communications Floor Fitting</b>	555287-1	1	1
<b>Modular Jack Kit, Category 5e</b>	558054-1	4	-
<b>Modular Jack Kit, Category 6</b>	1933377-1	-	4
<b>Flush Wall Power Transition Box</b>	554805-1	1	1
<b>Flush Wall Power Transition Box Cover</b>	1-553292-3	1	1
<b>Transition Block for Power</b>	554862-1	1	1
<b>Top Shield</b>	553536-3	50 ft	50 ft
<b>Floor Preparation</b>	554123-3	50 ft	50 ft
<b>Spray Adhesive</b>	6-553453-1	1 can	1 can
<b>Hold Down Tape</b>	553481-1	1 Roll	1 Roll
<b>Dual Duplex Receptacle DCR Kit</b>	554192-1	1	1

\* Equivalent components may be used as a substitute.

NOTE: Custom pre-packaged kits available for a “store-in-a-box” concept for retail applications.

# Copper

## Copper Accessories

### Velcro Cable Ties

#### FEATURES

For 8-inch and 12-inch ties, an order quantity of one equals one roll of ten ties.

#### ORDERING INFORMATION

Description	Figure	Part Number	
		Black	Blue
1" x 8"	A	1375253-2	-
1" x 12"	B	1375254-2	-
5/8" x 5 yards	C	1375255-2	1375255-6
1" x 12" Flame Retardant*		1375256-2	-

\* NOTE: Complies with NEC 300-22(c) and (d) for use in environmental air handling spaces. Available in black only.

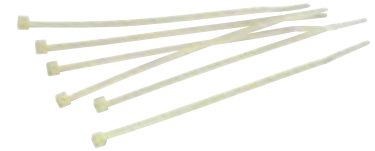

Figure B



### AMP-TY Nylon Cable Ties

#### ORDERING INFORMATION



Dimensions (Approximate)			Minimum Tensile Strength	Maximum Bundle Diameter	Package Quantity	Part Number	
Length	Width	Thickness				Natural	Black
4" (103.0 mm)	0.096" (2.44 mm)	0.037" (0.94 mm)	18 lbs (80.1 N)	0.75" (19.10 mm)	1000	2-604771-9	2-604771-0
					100	1-604771-9	1-604771-0
6" (155.0 mm)	0.140" (3.56 mm)	0.045" (1.14 mm)	30 lbs (133.5 N)	1.25" (31.75 mm)	1000	2-603227-9	2-603227-0
					100	1-603227-9	1-603227-0
8" (204.0 mm)	0.184" (4.67 mm)	0.047" (1.19 mm)	50 lbs (222.5 N)	1.75" (44.45 mm)	1000	2-604772-9	2-604772-0
					100	1-604772-9	1-604772-0
12" (300.0 mm)	0.183" (4.65 mm)	0.051" (1.30 mm)	50 lbs (222.5 N)	3.00" (76.20 mm)	1000	2-604751-9	2-604751-0
					100	1-604751-9	1-604751-0

# Copper

## Copper Accessories

### Icon Wheels

#### FEATURES

Used with the following products:

- SL series modules
- SL series furniture outlets
- SL series mounting straps
- Modular jack boxes
- Faceplates
- Surface mount modules
- HideAway outlet
- HideOut outlet
- Iconable ACO faceplates
- FLEX-MODE faceplates
- MT-RJ rack mount enclosure
- MT-RJ snap-in adapter plate
- SL series Category 5E and 6 patch panels
- 110Connect Category 5 and 5e patch panels
- SL series multimedia jack patch panels
- Iconable ACO patch panels



Each Wheel Contains:

Part Number

	Data	Blank	Phone	Fax	Modem	Print	CAT 5	CAT 5e	CAT 6	CAT 6A	V1	V2	D1	D2	Almond	Red	Green	Blue	Yellow	Black	Orange	White	Violet	Gray	Electrical Ivory
1	4	1	-	-	-	-	2	2	2	1	1	1	1	1	1375092-1	1375092-2	1375092-3	1375092-4	1375092-5	1375092-6	1375092-7	1375092-8	1375092-9	1-1375092-0	1-1375092-1
16	-	-	16	-	-	-	-	-	-	-	-	-	-	-	558198-1	558198-2	558198-3	558198-4	558198-5	558198-6	558198-7	558198-8	558198-9	1-558198-0	1-558198-1
-	-	-	-	-	-	-	-	-	-	-	-	-	-	-	558199-1	558199-2	558199-3	558199-4	558199-5	558199-6	558199-7	558199-8	558199-9	1-558199-0	1-558199-1
-	16	-	-	-	-	-	-	-	-	-	-	-	-	-	558821-1	-	-	-	-	558821-6	-	558821-8	-	1-558821-0	1-558821-1

# Copper

## Copper Accessories

### Identification Labels and Accessories

TE Connectivity is partnered with Silver Fox utilizing labeling software, label sheets and templates to meet today's labeling needs. Select from perforated card stock or pre-cut self-adhesive polyester label sheets which can be used with various style printers. The standard free version is ideal for small simple jobs or upgrade to the advanced version which offers enhanced features for complex builds. A variety of accessories and labels are also offered to support Type 105 mounting applications.

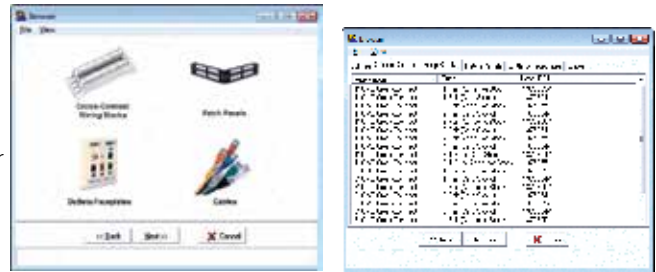

Visit [www.te.com/labeling](http://www.te.com/labeling) to download a free trial copy or to order software from Silver Fox, Ltd.

### Advanced Purchased License

#### FEATURES

- Create simple builds
- Copy and paste information directly from spreadsheets or other applications
- Change font style
- Integrated tutorials
- Integrated context sensitive help
- No limit to printing pages per job
- Create complex builds
- Change font size
- Multiple builds
- Split labels
- Repeat previous build
- Import multiple column csv spreadsheet files
- Select start line for printing
- Save and open jobs
- Job notes facility
- Add symbols
- Change text alignment
- Change viewing scale
- Copy job from label type to another
- Print job notes
- Print page number and date
- Automatic web update facility\*
- Purchase from our website eShop
- A trial of the advanced version is included with the standard version

\*internet connection required

### Standard Free Trial

#### FEATURES

- Create simple builds
- Copy and paste information directly from spreadsheets or other applications
- Change font style
- Integrated tutorials
- Integrated context sensitive help
- Limited to 5 pages printing per job
- Download free of charge from our website

All versions are delivered via web download. Disks are available upon request from our sales team. Please note that there will be an extra charge for this service. Multiple-user licenses are available direct from our sales team - contact us for details.

# Copper

## Copper Accessories

### AMP NETCONNECT Labeling Software

#### FEATURES

- Compatible with 32 or 64-bit versions of Microsoft Windows 2000, NT, XP, Vista or 7 operating systems
- Flexible build option to produce more complex alphanumeric identifiers
- Create identifiers consisting of up to 12 independent segments
- Can cope easily with the TIA/EIA-606-A standard identification sequences
- Insert symbols (all standard Windows symbols can be used)
- Save and edit builds
- Fine tune adjustment
- Split your label format as required
- Job notepad facility for builds saved to file
- Justify text
- Adjust font style and size
- Context-sensitive help

Visit [www.te.com/labeling](http://www.te.com/labeling) to download a free trial copy or to order software from Silver Fox, Ltd.

### Standard Labels for Outlets

#### FEATURES

- Labels are designed to fit TE Connectivity faceplates and outlets (Reference compatibility list for correct label/out compatibility)
- Card stock labels are perforated and compatible with inkjet and laser printers
- Self-adhesive polyester labels are pre-cut and compatible with laser printers
- Labels are supplied on 8.5" x 11" sheets
- For use with:
  - SL series faceplates
  - HideAway multimedia outlet
  - Wiremold raceway faceplates
  - Universal office box, 6-port
  - Multimedia security outlet
  - ACO faceplates



Figure A



Figure B

#### ORDERING INFORMATION

Description	Label Size (W x H)	Labels per Sheet	Figure	Part Number	
				5 Sheets	100 Sheets
Card Stock	1.98" x 0.373"	72	A	1375356-1	5-1375356-1
Self-adhesive Polyester	1.98" x 0.373"	72	A	1375357-1	5-1375357-1
Card Stock	1.88" x .600"	45	B	2111415-1	5-2111415-1
Self-adhesive Polyester	1.88" x .600"	45	B	2111416-1	5-2111416-1

WIREMOLD is a trademark.

# Copper

## Copper Accessories

### Label Covers for Faceplates

#### FEATURES

- Kit includes fifty die-cut labels and clear plastic covers
- For use in SL series, angled, iconable ACO, and Wiremold compatible faceplates



#### ORDERING INFORMATION

Description	Color	Part Number
Label Cover	Transparent	1375345-1

### Universal Labels

TE's AMP NETCONNECT labeling software allows customization of the universal labels listed for use with multiple products.



#### ORDERING INFORMATION

Description	Application	Labels per Sheet	Labels per Package		Part Number	
			5 Sheets	100 Sheets	5 Sheets	100 Sheets
Self-adhesive Polyester	Modular jack box, 1-port	216	1,080	21,600	1375358-1	5-1375358-1
	Modular jack box, 2-port	120	600	12,000	1375358-1	5-1375358-1
	SL series furniture outlet	72	360	7,200	1375358-1	5-1375358-1
	SL series faceplate, double gang	72	360	7,200	1375358-1	5-1375358-1
	110Connect office box, 2-port and 4-port	144	720	14,400	1375353-1	5-1375353-1

WIREMOLD is a trademark.

# Copper

## Copper Accessories

### Labels for Patch Panels

#### FEATURES

- All labels are designed to fit panels listed in referenced compatibility
- Labels are supplied on 8.5 x 11" sheets
- Card stock labels are perforated and compatible with inkjet and laser printers
- Self-adhesive polyester labels are pre-cut and compatible with laser printers
- Special 0.25" high label is provided for use when icons are also desired
- For use with:
  - 110Connect CAT 6 patch panels and mini patch panels
  - 110Connect CAT 5e patch panels and mini patch panels
  - 110Connect CAT 5 patch panels and mini patch panels
  - SL series multimedia patch panels and mini patch panels
- 48-port 1RU SL CAT 5e and CAT 6 patch panels



#### ORDERING INFORMATION

Description	Label Size (W x H)	Labels per Sheet	Labels per Package		Part Number	
			5 Sheets	100 Sheets	5 Sheets	100 Sheets
Card Stock	3.10" x 0.50"	36	180	3600	1375351-1	5-1375351-1
Self-adhesive Polyester	3.10" x 0.50"	36	180	3600	1375352-1	5-1375352-1
	3.30" x 0.25"	72	360	7200	1375353-1	5-1375353-1
Card Stock	3.54" x .500"	36	180	3600	2111413-1	5-2111413-1
Self-adhesive Polyester	3.54" x .500"	36	180	3600	2111414-1	5-2111414-1
Self-adhesive Polyester	3.75" x .250"	72	360	7200	2111425-1	5-2111425-1

### Label Covers for Patch Panels

#### FEATURES

- Includes twenty-five sheets, four clear plastic label covers per sheet
- Clear polyester plastic covers for use with Category 6, 5e, 5 and SL series multimedia patch panels with rear load interface housings
- Plastic covers for use with Category 6A and SL series shielded multimedia patch panels with front load interface housings
- Included with compatible patch panels



#### ORDERING INFORMATION

Description	Part Number	
Label Covers for Patch Panels	Clear polyester plastic for use with rear load interface housing	1116044-2
	Plastic for use with front load interface housing	1-1933814-9



# Copper

## Copper Accessories

### Labels for 110Connect XC Cross-Connect Wiring Blocks

#### FEATURES

- Labels are designed to fit TE's AMP NETCONNECT 610XC and 110Connect XC Cross-connect systems and other similar products
- Card stock labels: designed to fit into standard clear designation strips, available in TIA/EIA-606-A compliant colors, perforated, and compatible with inkjet and laser printers
- White self-adhesive polyester labels: designed for easy application to the front of the clear designation strips, pre-cut and compatible with laser printers
- Labels are supplied on 8.5 x 11" sheets



#### ORDERING INFORMATION

Description	Label Size (W x H)	Labels per Sheet	Color	90 Labels (5 Sheets)	1800 Labels (100 Sheets)
Card Stock	7.90" x 0.48"	18	White	1375354-1	5-1375354-1
			Blue	1375354-2	5-1375354-2
			Green	1375354-3	5-1375354-3
Self-adhesive Polyester	7.90" x 0.48"	18	White	1375355-1*	5-1375355-1*

\*Note: Available in white only.

### Clear Label Holder for 110Connect XC Wiring Blocks

Clear Label holders are used with 110Connect XC cross-connect systems.



#### ORDERING INFORMATION

Description	Part Number
Clear Label 110Connect XC Wiring Blocks	558417-1

### Labels for Cable and Cable Assemblies

#### FEATURES

- Labels are designed for use on cable and cable assemblies
- Labels are pre-cut and compatible with laser printers



#### ORDERING INFORMATION

Description	Application	Label Size (W x H)	Labels per Sheet	Labels per Package		Part Number	
				5 Sheets	100 Sheets	5 Sheets	100 Sheets
Self-adhesive Polyester	4-Pair Cable	0.984" x 1.496"	48	240	4800	1479002-1	5-1479002-1
	25-Pair Cable	0.984" x 2.480"	24	120	2400	1479003-1	5-1479003-1

# Copper

## Copper Accessories

### Faceplate/Outlet and Label Compatibility List

#### ORDERING INFORMATION

Description	New Card FP 2111415	New Adhesive FP 5111416	Card Stock 1375356	Self-Adhesive 1375357	Self-Adhesive 1375358	Self-Adhesive 1375353	Part Number
Labeled Faceplate Kit	X	X					2111008
	X	X					2111009
	X	X					2111010
	X	X					2111011
	X	X					2111012
	X	X					2111013
	X	X					2111014
	X	X					2111015
Non-Labled Faceplate Kits		X					2111021
		X					2111022
		X					2111023
		X					2111024
		X					2111025
SL Series Faceplates			X	X			1339118
			X	X			1479486
Angled Faceplates			X	X			1375155
			X	X			406185
Hideaway Outlet						X	503999
						X	503997
						X	503998
Hideaway Multimedia Outlet			X	X			1479815
			X	X			1479946
Multimedia Security Outlet							1116535
Surface Mount Outlet							557366
12-Port Universal Office Box			X	X			1479358
Modular Jack Boxes					X		1116697
					X		1116698
Wiremold Raceway Faceplates			X	X			1375050
			X	X			1375049
SL Series Furniture Outlets					X		1375005
					X		1375006

4-Pair cable assemblies available in all part numbers with self-adhesive 1479002

25-Pair cable assemblies available in all part numbers with self-adhesive 1479003

WIREMOLD is a trademark.

## Faceplate/Outlet and Label Compatibility List

### ORDERING INFORMATION

Description		Part Number	Description		Part Number
<b>Patch Panel Assembly</b> Front Load Housing	New-Card PP 2111413 New-Adhesive PP 2111414	1933307	<b>Patch Panel Assembly</b> Rear Load Housing	Card-Stock FP 1375351 Self-Adhesive FP 1375352 Self-Adhesive FP 1375353	406390
		1933308			406981
		1933309			406330
		1933310			406331
		1933198			406332
		1933319			1499604
		1933320			1499605
		1933321			1479206
		1933322			1479208
		1933412			1375013
	1933776	1375014			
	1933199	1375015			
	New-Adhesive PP 2111425	1933457			1375016
		1933458			1499600
		1933657			1499601
		1933199			1479153
		2111348			1479154
		2111349			1479155
					1479156
		1499602			
	1499603				

4-Pair cable assemblies available in all part numbers with self-adhesive 1479002  
 25-Pair cable assemblies available in all part numbers with self-adhesive 1479003



# Copper

## Copper Accessories

### Faceplate/Outlet and Label Compatibility List

#### ORDERING INFORMATION

Description		Part Number
<b>110xc Cross Connect</b>	Card-Stock 1375354 Self-Adhesive 1375355	558841
		558842
		558843
		558839
		558840
		569432
		569433
		569434
		569438
		469439
		569440
		569444
		569445
		569446
		569853
		569854
		569855
		569856
		569857
		569858

4-Pair cable assemblies available in all part numbers with self-adhesive 1479002  
25-Pair cable assemblies available in all part numbers with self-adhesive 1479003

COPPER

# Copper

## Copper Accessories

### Copper Connectivity Solutions – Accessories and Labels



**HighBand**  
to Series 2 adapter



**HighBand**  
dummy plug

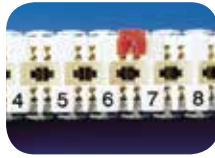

**HighBand**  
marking cap



**HighBand**  
bridging test cord



**HighBand**  
“look-both-ways”  
test cord



**HighBand**  
winged test adapter



**HighBand**  
disconnect plug

### ORDERING INFORMATION

Description	Quantity	Part Number
<b>HighBand 10 to Series 2 adapter</b> 1-pair adapter accepts any single pair Series 2 test cord for HighBand 10 testing	1	6451 2 178-04
<b>Red dummy plug</b> Plastic plug inserts into test/patch port of Ultim8 or HighBand 10 blocks for quick identification of special circuits. Flat surface can be written on or accepts a small adhesive sticker. Plugs block access to the pair and prevent accidental removal of jumper wires	100	6451 5 035-00
<b>Red marking cap</b> Plastic cap snaps over an Ultim8 or HighBand 10 block pair for quick identification of special circuits. Caps block access to prevent accidental removal of jumper wires, but do not interfere with patching	20	6462 2 101-01
<b>Disconnect plug</b> Plastic plugs insert into the patch/test port of Ultim8 or HighBand 10 blocks to open (disconnect) a circuit	20	
White		6462 2 097-00
Green		6462 2 097-20
<b>Bridging test cord</b> 1-pair connector to two banana plugs (connect to test equipment); used to test parallel to the circuit		6648 2 900-XX*
<b>“Look-both-ways” test cord</b> 1-pair connector to four banana plugs; provides ability to isolate cable side from jumper side	1	6648 2 901-XX*
<b>Winged test adapter</b> Provides ability to monitor a circuit without disruption	1	6646 3 001-01
<b>Ultim8/Highband 10 1-pair site mounted test cord</b> Monitor or “look-both-ways” test circuit with the flip of a switch. Mounts on 1 position of back mount frame or directly on a wall. Includes RJ11 jack to quickly isolate feeder or distribution network problems	1	6645 2 127-XX*

\*Note: Replace XX with:   01 = 1'   07 = 7'  
                                  04 = 4'   10 = 10'

# Copper

## Copper Accessories

### Type 105 Label Strip

Recommended for patched environments, this transparent label strip snaps onto the face of an Ultim8 or HighBand 10 block. The label strip covers only the top row of the block and is fully visible with patch cords in place. Includes slide-in paper labels (Part number: 6631 3 102-XX) or can be written on directly.

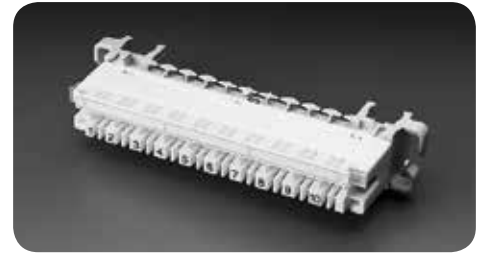

Type 105 label strip  
shown on HighBand 10 block

#### ORDERING INFORMATION

Description	Dimensions (HxWxD)	Part Number
Type 105 label strip Quantity per Pack: 10	0.81" x 4.25" x 0.88" (20.6 mm x 107.9 mm x 22.2 mm)	6462 2 096-00

### Type 105 Label Holder

The label holder mounts on a universal mounting system mounting bracket in the Type 105 position, a Type 105 mounting bracket or a Type 105 rod mount bracket to provide extensive labeling. Jumper rings on both sides provide additional wire management. Each label holder requires one block position. A paper label and plastic cover are included. Accepts label part number: 6631 3 106-XX.

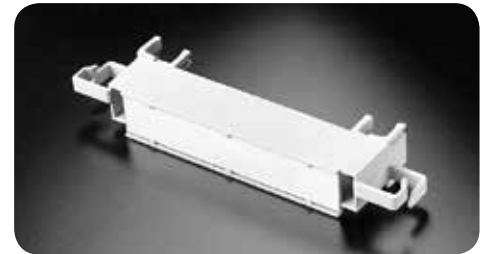

Type 105 label holder

#### ORDERING INFORMATION

Description	Dimensions (HxWxD)	Part Number
Type 105 label holder Quantity: 1	0.81" x 5.63" x 1.31" (20.57 mm x 143 mm x 33.27 mm)	6630 2 004-05

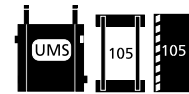

### Type 105 Hinged Label Holder

Recommended for jumpered environments, the holder snaps onto a block face to provide a hinged cover over the block termination contacts and patch/test ports. A clear plastic protective cover and a paper label (Catalog Number: 6631 3 100-03) are included for each side of the hinged cover. The hinged label holder extends 0.38 inches (9.5 mm) from the face of the block.



Hinged label holder  
closed

#### ORDERING INFORMATION

Description	Dimensions (HxWxD)	Part Number
Type 105 hinged label holder Quantity: 1	0.63" x 4.31" x 0.63" (16 mm x 109.5 mm x 16 mm)	6089 2 015-01



Hinged label holder  
open

# Copper

## Copper Accessories

### Side-Mount Label Holder

The holder mounts onto the side of any Ultim8 or HighBand 10 block. Two side-mount label holders attach to each block, one on each side. A small rectangular paper label is included with each holder.

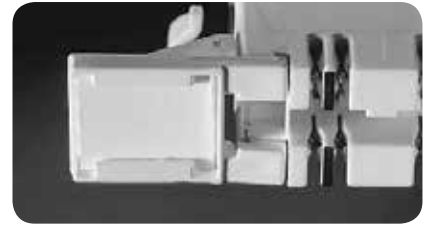

Side-mount label holder

### ORDERING INFORMATION

Description	Dimensions (HxWxD)	Part Number
Side-mount label holder Quantity: 1	0.63" x 1" x 0.31" (16 mm x 25.4 mm x 7.87 mm)	6462 2 016-00

### Paper Labels

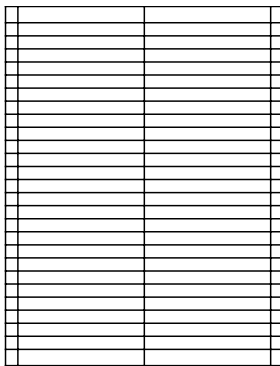

Label Sheet for Type 105  
Hinged

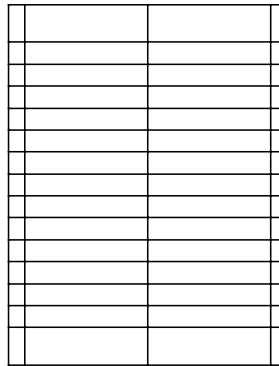

Label Sheet for Type 105  
Label Holder

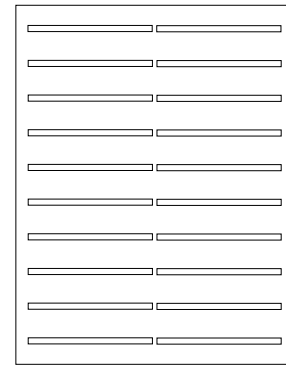

Label Sheet for Type 105  
Label Strip

### EXAMPLES OF TIA/EIA-606 COLOR CODING

Color	Standard Usage
Orange	Demarcation point (e.g., central office terminations)
Green	Network connections (e.g., network and auxiliary equipment)
Purple	Common equipment, PBX, LANs, multiplexers (e.g., switching and data equipment)
White	First level backbone (e.g., main cross-connect [MC (campus distributor [CD])] to a horizontal cross-connect [HC (floor distributor [FD])] or to an intermediate cross-connect [IC (building distributor [BD])])
Gray	Second level backbone (e.g., IC [BD] to a HC [FD])
Blue	Horizontal cable (e.g., horizontal connections to telecommunications outlets; formerly referred to as "station cable")
Brown	Interbuilding backbone (campus cable terminations) NOTE: Brown takes precedence over white or gray for interbuilding runs
Yellow	Miscellaneous (e.g., auxiliary, alarms, security)
Red	Reserved for future use (also, key telephone systems)

Based on ANSI/TIA/EIA-606-A, May 1, 2002

**Tech Tip** - Use of the TIA/EIA-606 color standards greatly increases identification of network system components. TE strongly recommends following standards whenever possible.

# Copper

## Copper Accessories

### Paper Labels

#### ORDERING INFORMATION

Description	Part Number
<b>Paper label sheet for Type 105 hinged label holder</b> Quantity: 1 sheet per package Labels come pre-cut on a white, 8.5" x 11" sheet, with 50 labels per sheet; accommodate hand or laser printing	6631 3 100-03
<b>Paper label sheets in TIA/EIA-606 colors for Type 105 hinged label holder</b> Quantity: 1 sheet per package Labels come pre-cut on an 8.5" x 11" sheet with 50 labels per sheet; accommodate hand or laser printing	6631 3 105-XX* Not available in -05 (brown), -06 (yellow), -07 (red) or -08 (white)
<b>Paper label sheet for Type 105 label holder</b> Quantity: 1 sheet per package Labels come pre-cut on an 8.5" x 11" sheet, with 26 labels per sheet	6631 3 106-XX*
<b>Paper label sheet for Type 105 label strip</b> Quantity: 1 sheet per package Labels come perforated on an 8.5" x 11" sheet, 20 labels per sheet; accommodate hand or laser printing. Available in all TIA/EIA-606 specified colors, two colors per sheet (one color on each side)	
Orange, red	6631 3 102-01/09
Green, purple	6631 3 102-02/03
White, blue	6631 3 102-04/06
Gray, brown	6631 3 102-05/07
Yellow, white	6631 3 102-08

\*Replace XX with:

00 = orange	05 = brown
01 = green	06 = yellow
02 = purple	07 = red
03 = gray	08 = white
04 = blue	



# Copper

## Tooling

### SL Series Modular Jack Termination Tool and Accessories

#### FEATURES

- Termination tool for SL series jacks
- Simplifies the termination
- More consistent terminations
- Terminates and cuts all 8 conductors at once
- Simplifies lacing process and speeds up terminations
- Tool without lacing fixture is for use with SL series AMP-TWIST 6A modular jacks
- Termination video can be viewed at [www.te.com/EnterpriseNetworks](http://www.te.com/EnterpriseNetworks)



#### ORDERING INFORMATION

Description		Part Number
SL Series Modular Jack Termination Tool	With Lacing Fixture	1725150-1
	Without Lacing Fixture	1725150-3
Replacement Lacing Fixture		1673956-1

#### SL Series Modular Jack Termination Tool UTP Termination Method



COPPER

# Copper

## Tooling

### Pro-Installer Twisted Pair Tool Kit

For use with 110Connect and SL series modular jacks and other 110-style terminations

#### FEATURES

- Installer's knife
- Pro impact tool with extended-life blade
- Shears
- TE's AMP NETCONNECT tool pouch



#### ORDERING INFORMATION

Description	Part Number
Pro-Installer Twisted Pair Tool Kit	1375307-1

### 110 Punch Down Tools with Blades

#### FEATURES

- The industry standard termination tool for all 110Connect terminations
- Each tool comes with a blade
- For use with 110Connect and SL series modular jacks and other 110-style terminations

#### ORDERING INFORMATION

Description	Figure	Part Number
Pro Impact Tool with Extended-Life Blade	A	1375308-1
Standard Impact Tool with Standard Blade	B	1583608-1
Non-Impact Tool with Standard Blade	C	1583236-1

Figure A



Figure B



Figure C



### 110 Punch Down Tool Replacement Blades

Extended-life blades have a lifetime three times longer than standard blades.

#### ORDERING INFORMATION

Description	Figure	Part Number
Extended-Life 110 Blade	A	1375309-1
Extended-Life 66/110 Blade	B	1375310-1

Figure A



Figure B



# Copper

## Tooling

### KRONE Insertion Tool

#### FEATURES

- Insertion sensor ensures the conductor is fully inserted into the block contacts before allowing any excess wire to be cut off
- An inhibitor lock prevents the scissors from operating—particularly useful in applications in which conductors are daisy-chained through several contacts
- Universal scissors cut a variety of cable types, including 20 AWG through 26 AWG and Type 1 foam-insulated conductors
- Specially designed wire hook removes terminated conductors
- Blade helps to remove blocks easily from back mount frames



#### ORDERING INFORMATION

##### Description

Insertion tool Quantity: 1

Disposable tool Quantity: 1

Terminates wire into contact, will not cut excess wire; snips required to cut off excess wire

##### Inhibitor Lock

Prevents the automatic trimming of excess wire to enable daisy-chaining

##### Part Number

6417 2 055-01

6417 3 006-01

##### Blade

Used to remove termination blocks from back mount frames

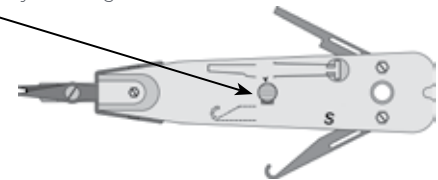

##### Hook

Used to grab and remove wires for changes

### Palm Grip Tool

#### FEATURES

- Fits comfortably into one hand
- Holds one 110Connect jack, one SL series 110Connect jack, or ACO 110 card edge connector for termination



#### ORDERING INFORMATION

##### Description

Palm Grip Tool

##### Part Number

569949-1

# Copper

## Tooling

### Cable Strippers and Cutters

#### FEATURES

- Cyclops stripper suitable for use with UTP Cable
- Coaxial stripper can be adjusted for use with RG-6, RG-58 and RG-59 cable

#### ORDERING INFORMATION

Description	Figure	Part Number
Cyclops Cable Stripper	A	1375317-1
Coaxial Cable Stripper	B	1490490-1
Diagonal Cutters	C	1116571-1



COPPER

### PRO-CRIMPER III Hand Tool and Die Sets for Twisted Pair Applications

#### FEATURES

- Ratchet control provides complete termination cycle
- Interchangeable die sets accommodate all plug sizes
- Sold with or without die. Dies can be purchased separately

#### ORDERING INFORMATION

Description	Part Number	
PRO-CRIMPER III Hand Tool	354940-1	
Tooling for External 8 Position Category 3, 5 and 5e Modular Plugs	Hand Tool and Die Set	224928-1
	Die Set Only	224928-2



# Copper

## Tooling

### Tooling Category 6 Modular Plugs

#### FEATURES

- Used with Category 6 modular plugs
- Ratchet control provides complete termination cycle
- Die set and tool crimps both the strain relief and the modular contacts at the same time
- Interchangeable die sets accommodate all plug sizes
- Sold with or without die. Dies can be purchased separately



#### ORDERING INFORMATION

Description	Part Number		
	Hand Tool Only	354940-1	
Die Set Only	1-790163-0	790163-6	790163-2
Tool with Die	790163-9	790163-5	790163-1
Cable OD		6-7 mm	5-6 mm
Plug Style	Full Body	Short	Long
1479682			x
1479683			x
1479185		x	
1479184		x	
1375202			x
1357204			x
2111283			x
2111434			x
1499598	x		
1933433	x		

# Copper

## Tooling

### Pro-Installer's Modular Plug Hand Tool

#### FEATURES

- Ratchet control provides complete termination cycle
- Sold with and without die sets
- Interchangeable die sets accommodate all plug sizes
- Die set to modular plug cross-reference shown



#### ORDERING INFORMATION

##### Hand Tool without Die: 2-231652-0

DOT COLOR	Gray	White	Blue	Violet	Black
<b>Die Only P/N</b>	1-853400-4	1-853400-0	853400-8	853400-7	853400-1
<b>Hand Tool with Die</b>	3-231652-6	3-231652-0	2-231652-8	2-231652-7	2-231652-1

##### CAT 3 and CAT 5

1479583		x			
1479584		x			
1479585		x			
1479586		x			
554169					x
554170					x
554710			x		
554720					x
554739					x
555042			x		
555174				x	
555175				x	
555177				x	
555426				x	
557315					x
558530		x			
569278		x			
569550		x			
569552		x			
569530					x
569532					x
569542			x		
641337			x		
641335			x		

##### CAT 6

1933373			x		
1933374			x		
2111262	x				

# Copper

## Tooling

### Pro-Installer's Modular Plug Hand Tool Kits and Accessories

#### FEATURES

- Each kit contains carrying case, blade replacement kit, screw driver, and items as listed
- Modular plug to die set cross reference listed as shown



#### ORDERING INFORMATION

Description	Included Components						Part Number
	Hand Tool 2-231652-0	High Performance, 8-Position Die Set 1-853400-0	8-Position Line Die Set 853400-1	6-Position, Long Body Die Set 853400-7	4- & 6-Position Line Die Set 853400-8	4-Position Handset Die Set 853400-3	
Pro-Installer's Mod Plug Hand Tool Kits	X	X	X	X	X	—	1-231666-4
	X	—	X	X	X	X	1-231666-3
	X	—	X	X	X	—	1-231666-2
	X	—	X	—	X	X	1-231666-1
	X	—	X	—	X	—	1-231666-0
Carrying Case, Blade Replacement Kit and Screw Driver ONLY							231666-9
Replacement Blade Kit (5 Cutters and 5 sets of Strip Blades)							231662-5
Cutter Blade							856727-1

# Copper

## Tooling

### Pistol Grip Tool for AMP-BARREL Edge Connectors

#### FEATURES

- The pistol grip tool terminates AMP-BARREL edge connectors one pair at a time
- Shortens assembly time by trimming conductors to the proper length and helps maintain proper pair twist for high performance cables
- This tool requires the installation kit to be fitted with a special edge connector, part number 406351-1

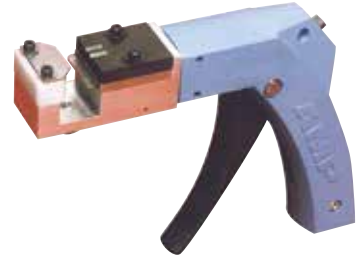

#### ORDERING INFORMATION

Description	Part Number
Pistol Grip Tool with Head	58568-1
Head only	122533-1

### AMP-BARREL Wire Insertion Tools

- Used to insert and terminate wires into the special edge connector for use with the pistol grip tool
- Wire insertion tools for undercarpet transition blocks may be used to insert and terminate wires into AMP-BARREL connectors used in undercarpet cabling system transition blocks
- Wire insertion tools for undercarpet transition blocks cuts off conductor when it is inserted

Figure A



Figure B



#### ORDERING INFORMATION

For Use With:	Figure	Part Number
ACO Edge Connectors	A	556706-1
Wire Insertion Tool for UC Transition Blocks	B	231890-1



# Copper

## Tooling

### Portable “Butterfly” Hand Tool (MI-1) for CHAMP 25-Pair Connectors

#### FEATURES

- Mass terminates and shears all wires in a single operation
- Wires can be laced in tool or in separate lacing fixture
- Base plate can be bench-mounted



#### ORDERING INFORMATION

Description	Part Number
Standard 14-50 Positions, 90° Wire Dress	229378-1
Optional Lacing Fixture	230328-3

### Palm Grip Hand Tool Kits

#### FEATURES

- 14 to 64-position kit includes wire inserter, all 5 sizes of index slides, cable clamp, insertion/extraction tool (230238-1), and carrying case
- 50-position kit includes wire inserter, 50-position index slide and cable clamp



#### ORDERING INFORMATION

Description	Part Number
14 to 64-Position	229764-2
50-Position only	229451-2

### Insertion/Extraction Tools

#### FEATURES

- Used with CHAMP Connectors
- Wire insertion tool is used to insert individual wires when making repairs
- Contact insertion/extraction tool is used to replace damaged contacts

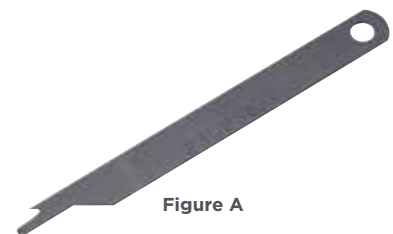

Figure A

#### ORDERING INFORMATION

Description	Figure	Part Number
Contact Insertion/Extraction Tool	A	230238-1
T-Handle Wire Insertion Tool	B	229384-1



Figure B

### Twisted Pair Testing Tools

#### FEATURES

- 4-Pair UTP Tester:
  - Tests for opens, shorts and wire map (mis-wires, reversals, and split pairs)
  - Auto-on/off feature
  - Battery low indicator
- Butt Set:
  - LCD display shows: on-hook voltage, number dialed, off-hook current, caller ID, stored numbers, etc.
  - Tone and pulse dialing
  - 6-Position modular cord set attachment included
  - Auto-off feature
- Tone Generator:
  - Three built-in tones
  - Auto-off feature
  - Separate talk battery for increased voltage and power for test sets
  - 6-Position modular jack allows multiple cord/test lead sets to be used for different applications
  - Comes with test lead set
- Tone Tracer:
  - Permits wire and cable identification without direct metallic contact
  - Ergonomic design
  - Can be used with any tone generator
  - Quick change tips available



Figure A



Figure B



Figure C



Figure D

#### ORDERING INFORMATION

Description	Figure	Part Number
4-Pair UTP Tester	A	1490530-1
Butt Set	B	1490532-1
Tone Generator	C	1490531-1
Tone Tracer	D	1490533-1



## Work Area Outlets

Faceplates and Outlets.....	4-3
Inserts.....	4-22

For a finished look, TE offers a variety of work area outlet products to enhance accessibility and improve aesthetics. From faceplates and mounting straps, to desktop monuments and surface boxes, TE has a wide selection of outlet options for both business and residential applications. Available in a choice of colors and styles, our work area outlet products are installed in thousands of buildings and homes worldwide. From education institutions and hospitals, to retailers and large, hi-rise apartments and condominiums, TE's work area outlet solutions are offered in a variety of modern styles and designs.





# Work Area Outlets

## Faceplates and Outlets

---

### Faceplates and Outlets

TE Connectivity's new modern design improve the appearance of outlet areas that house data, telephony and A/V connectors in everything from classrooms and hospitals to offices and homes. Our new faceplates offer molded icon slots and convex labels for maximum visibility in low density areas. Engineered for residential and commercial applications offer a wide range of port configurations, including single gang in 1-, 2-, 3-, 4- and 6-port configurations and double gang in 6-, 8- and 12-port configurations. They accommodate unshielded and shielded AMP-TWIST and SL series jacks along with a variety of SL series multimedia inserts and SL series fiber inserts (MT-RJ, LC).



# Work Area Outlets

## Faceplates and Outlets

### Faceplates and Accessories

#### FEATURES

- Accepts all AMP-TWIST jacks, SL series jacks, 110Connect jacks, MT-RJ outlet jacks and SL series inserts
  - Single gang dimensions:
    - 2.75" (69.85 mm) x
    - 4.5" (114.30 mm) x
    - 0.22" (5.59 mm)
  - Double gang dimensions:
    - 4.56" (115.82 mm) x
    - 4.5" (114.30 mm) x
    - 0.22" (5.59 mm)
- Models available with and without labeling options
- Label areas with integrated, hinged covers
- Mold-over icon and leveling (for icons see copper accessories section)
- Improved label viewing area is larger with integrated, convex label covers that flip down and snap in place
- Larger radius on the faceplate edge and the convex shape of the label covers allow labels to be more easily viewed from above when faceplates are behind furniture
- Extender kits are used to add 0.5" (12.7 mm) of space between the mounting surface and the faceplate
  - Extender kit dimensions:
    - 5.21" (132.33 mm) x
    - 2.89" (73.50 mm) x
    - 0.50" (12.70 mm)
- Oversize adapter plate will accept any style single or double gang faceplate. Dimensions: 5.75" (46.05 mm) x 6.00" (152.4mm) x .15" (3.81 mm)
- Drywall faceplate adapter used for adding outlet to wall with no backbox; compatible with all TE single gang faceplates; adjustable to fit 0.25" thick to 1" thick wallboard, paneling or drywall. Can be mounted horizontally or vertically and can be used as template for cutout hole; thin front lip design allows adapter to seat better on drywall



Figure A Figure B Figure C Figure D Figure E

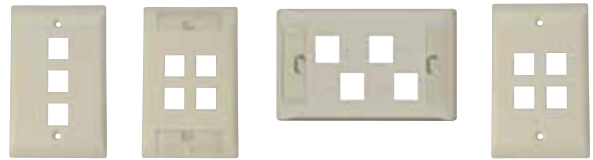

Figure F Figure G Figure H Figure I

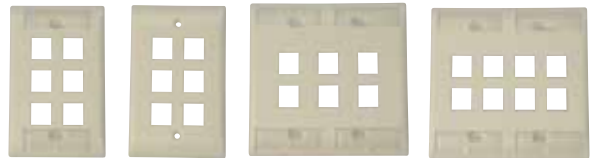

Figure J Figure K Figure L Figure M

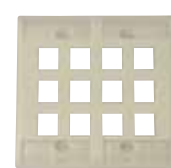

Figure N



Figure O



Figure P



Figure Q

# Work Area Outlets

## Faceplates and Outlets

### ORDERING INFORMATION

Port Count	Footprint	Integrated Labeling Options	Orientation	Figure	Part Number				
					Almond	Black	Gray	Electrical Ivory	Alpine White
1	Single Gang	Label covers and icons	Vertical	A	2111008-1	2111008-2	2111008-4	1-2111008-1	1-2111008-3
		None	Vertical	B	2111021-1	2111021-2	2111021-4	1-2111021-1	1-2111021-3
2	Single Gang	Label covers and icons	Vertical	C	2111009-1	2111009-2	2111009-4	1-2111009-1	1-2111009-3
		None	Vertical	D	2111022-1	2111022-2	2111022-4	1-2111022-1	1-2111022-3
3	Single Gang	Label covers and icons	Vertical	E	2111010-1	2111010-2	2111010-4	1-2111010-1	1-2111010-3
		None	Vertical	F	2111023-1	2111023-2	2111023-4	1-2111023-1	1-2111023-3
4	Single Gang	Label covers and icons	Vertical	G	2111011-1	2111011-2	2111011-4	1-2111011-1	1-2111011-3
			Horizontal	H	2111203-1	2111203-2	2111203-4	1-2111203-1	1-2111203-3
		None	Vertical	I	2111024-1	2111024-2	2111024-4	1-2111024-1	1-2111024-3
6	Single Gang	Label covers and icons	Vertical	J	2111012-1	2111012-2	2111012-4	1-2111012-1	1-2111012-3
		None	Vertical	K	2111025-1	2111025-2	2111025-4	1-2111025-1	1-2111025-3
8	Double Gang	Label covers and icons	Vertical	L	2111013-1	2111013-2	2111013-4	1-2111013-1	1-2111013-3
12	Double Gang	Label covers and icons	Vertical	M	2111014-1	2111014-2	2111014-4	1-2111014-1	1-2111014-3
<b>Extender Kit</b>				O	2111201-1	2111201-2	2111201-4	1-2111201-1	1-2111201-3
<b>Oversize Adapter Plate</b>				P	2111332-1				1-2111332-3
<b>Drywall Faceplate Adapter</b>				Q	6644 2 019-00				

# Work Area Outlets

## Faceplates and Outlets

### SL Series Faceplates

#### FEATURES

- Single gang and double gang footprint
- Single gang faceplates accept three 1 unit or two 1.5 unit SL series modules
- Double gang, double-sided faceplates accept three 1 unit or two 1.5 unit SL series modules on each side
- Front-loading modules eliminate need to remove faceplates from wall for changes or repairs
- Double gang, double-sided SL series faceplates:
  - Dimensions: 0.675" D x 4.490" W x 4.540" H
  - For use with openings a minimum of 2.81" x 3.59" (not suitable for mud rings/device covers)

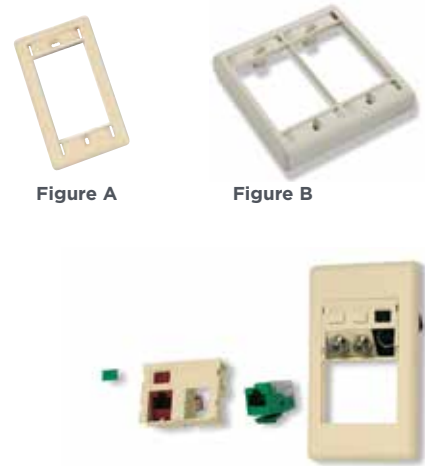

#### ORDERING INFORMATION

Description	Width	Figure	Part Number					
			Almond	Black	Gray	Electrical Ivory	Alpine White	
SL Series Faceplates	Single Gang	Single-sided	A	1339118-1	1339118-2	1339118-4	1-1339118-1	1-1339118-3
	Double Gang	Double-sided	B	1479486-1	1479486-2	1479486-4	1-1479486-1	1-1479486-3

### SL Series Modules

#### FEATURES

- Modules fit SL series faceplates
- Front loading
- 2-Port modules are suitable for use with all SL series jacks, MT-RJ outlet jacks and SL series inserts
- 3-Port module is suitable for use with unshielded SL series jacks, MT-RJ outlet jacks and SL series multimedia inserts
- SVGA multimedia modules are unloaded for use with 15 position subminiature D connectors (sold separately)

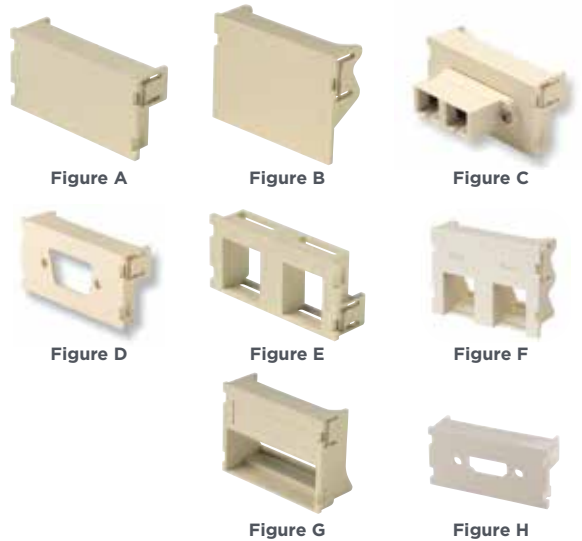

#### ORDERING INFORMATION

Description	Units	Figure	Part Number					
			Almond	Black	Gray	Electrical Ivory	Alpine White	
Blank	1	A	1116410-1	1116410-2	1116410-4	1-1116410-1	1-1116410-3	
	1.5	B	1116407-1	1116407-2	1116407-4	1-1116407-1	1-1116407-3	
SC Duplex	singlemode, Blue Coupler	1	C	1375306-1	1375306-2	1375306-4	1-1375306-1	1-1375306-3
SVGA	Unloaded	1	D	1479079-1	1479079-2	1479079-4	1-1479079-1	1-1479079-3
2-Port	Straight	1	E	1116409-1	1116409-2	1116409-4	1-1116409-1	1-1116409-3
	Angled	1.5	F	1116406-1	1116406-2	1116406-4	1-1116406-1	1-1116406-3
3-Port	Angled	1.5	G	1116408-1	1116408-2	1116408-4	1-1116408-1	1-1116408-3
HDMI	Unloaded	1	H	1933686-1	1933686-2	1933686-4	1-1933686-1	1-1933686-3



# Work Area Outlets

## Faceplates and Outlets

### Wall Phone Faceplate

#### FEATURES

- For use with 110Connect or SL series modular jacks
- Features studs used to mount standard wall mount telephones



#### ORDERING INFORMATION

Description	Part Number		
	Almond	Electrical Ivory	Alpine White
Wall Phone Faceplate	1479152-1	1-1479152-1	1-1479152-3

### Angled Faceplates

#### FEATURES

- Accept all AMP-TWIST jacks, SL series jacks, MT-RJ outlet jacks and SL series inserts
- Angled port allows connector to exit downward protecting connector and allowing closer furniture placement



Figure A



Figure B



Figure B shown with jacks

#### ORDERING INFORMATION

Description	Port Count	Figure	Part Number				
			Almond	Black	Gray	Electrical Ivory	Alpine White
Angled Faceplates	2	A	1375155-1	1375155-2	1375155-4	1-1375155-1	1-1375155-3
	4	B	406185-1	406185-2	406185-4	1-406185-1	1-406185-3

# Work Area Outlets

## Faceplates and Outlets

### Stainless Steel Faceplates from Semtron

#### FEATURES

- Faceplates with labels have slotted mounting holes that allow for faceplate alignment at installation
- Flush mount installation
- 1FM-ØE-AMP-PHONE is for use with 110Connect or SL series modular jacks and features studs used to mount standard wall mount telephones
- 2-, 4- and 6-Port Faceplates accept SL series jacks, AMP-TWIST jacks, MT-RJ outlet jacks, and SL series inserts
- Double gang stainless steel faceplates with power additionally accept one duplex power receptacle (sold separately)
- These faceplates are available directly from:

**Semtron, Inc.**  
 6465 Corunna Rd.  
 Flint, MI 48532  
 Phone: 1-800-732-9080  
 Fax: 810-732-9665  
 Email: semtron@semtron.com  
 Web: www.semtron.com



Figure A      Figure B      Figure C



Figure D      Figure E      Figure F

#### ORDERING INFORMATION

Description	Port Count	Foot Print	Duplex Power	Labeling	Figure	Semtron Part Number
<b>SEMTRON Stainless Steel Wall Phone Faceplate</b>	1	Single Gang	-	-	A	1FM-ØE-AMP-PHONE
<b>SEMTRON Stainless Steel Faceplates</b>	1	Single Gang	-	-	B	1FM-ØE-AMP-LAB
	2	Single Gang	-	-	C	1FM-ØØE-AMP
			-	with Labels and Label Covers		1FM-ØØE-AMP-LAB
	2	Double Gang	with Duplex Opening	-		2FM-DØØE-AMP
			-	with Labels and Label Covers		1FM-(3)ØE-AMP-LAB
	3	Single Gang	-	-		1FM-(4)ØE-AMP
			-	with Labels and Label Covers		1FM-(4)ØE-AMP-LAB
	4	Single Gang	-	-	D	1FM-(4)ØE-AMP-LAB
			with Duplex Opening	-		2FM-D(4)ØE-AMP
	6	Single Gang	-	-		1FM-(6)ØE-AMP
-			with Labels and Label Covers	1FM-(6)ØE-AMP-LAB		
Double Gang		with Duplex Opening	-	E	2FM-D(6)ØE-AMP	
		-	with Labels and Label Covers	F	2FM-(6)ØE-AMP-LAB	
12	Double Gang	-	with Labels and Label Covers		2FM-(12)ØE-AMP-LAB	

# Work Area Outlets

## Faceplates and Outlets

### Mounting Straps

#### FEATURES

- Accept SL series jacks, MT-RJ outlet jacks, and SL series inserts
- Duplex mounting straps fit standard duplex faceplates
- Decorator mounting straps fit standard decorator faceplates
- Allow easy mounting of communications outlets in power poles and floor pedestals
- Accommodates icons for port identification

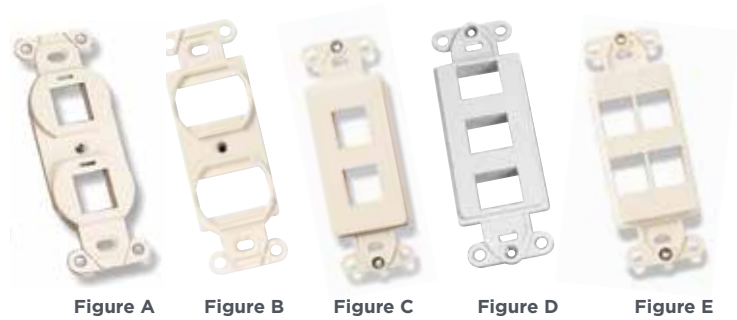

#### ORDERING INFORMATION

Description	Port Count	Figure	Part Number				
			Almond	Black	Gray	Electrical Ivory	Alpine White
106 Duplex Mounting Strap	2	A	1116618-1	1116618-2	1116618-4	1-1116618-1	1-1116618-3
	4	B	1339120-1	1339120-2	1339120-4	1-1339120-1	1-1339120-3
Decorator Mounting Strap	2	C	1479784-1	1479784-2	1479784-4	1-1479784-1	1-1479784-3
	3	D	1116616-1	1116616-2	1116616-4	1-1116616-1	1-1116616-3
	4	E	1479504-1	1479504-2	1479504-4	1-1479504-1	1-1479504-3

### Faceplates for Mounting Straps

#### FEATURES

- Duplex faceplates accept 2- and 4-port duplex mounting straps
- Decorator faceplates accept 2-, 3- and 4-port decorator mounting straps



#### ORDERING INFORMATION

Description	Footprint	Figure	Part Number				
			Almond	Black	Gray	Electrical Ivory	Alpine White
Decorator Faceplate	Single Gang	A	1479159-1	1479159-2	1479159-4	1-1479159-1	1-1479159-3
	Double Gang	B	1479625-1	1479625-2	1479625-4	1-1479625-1	1-1479625-3
Duplex Faceplate	Single Gang	C	1479160-1	1479160-2	1479160-4	1-1479160-1	1-1479160-3

# Work Area Outlets

## Faceplates and Outlets

### HIDEOUT Outlets

#### FEATURES

- Double gang box with single gang cover recommended
- May not fit all single gang boxes
- Hides and protects cable connections
- Feeds from bottom to allow flush furniture placement
- Fits standard electrical boxes
- Icons in copper accessories section
- Each kit includes sub-plate, faceplate, adhesive labels, cable ties, and mounting screws. Media modules and icons must be ordered separately
- Accepts the following (see table for detailed load information):
  - Shielded or unshielded SL series jacks
  - Unshielded 110Connect jacks
  - MT-RJ outlet jacks
  - Duplex fiber optic adapters
  - MT-RJ parallel dress clips
  - SL series inserts
- Shielded SL series jacks work in bottom row of faceplate only



#### ORDERING INFORMATION

Description	Included Faceplate	Part Number		
		Almond	Alpine White	Stainless Steel
HIDEOUT Outlet Kit	Screw-on	503997-1	1-503997-3	503998-1
	Snap-on	503999-1	-	-

#### SPECIFICATIONS

Accepted Connectivity	Maximum Load Capacity			
	Option 1	Option 2	Option 3	Option 4
Unshielded SL Series, 110Connect Jacks, MT-RJ Outlet Jacks, or SL Series Inserts	4	2	0	0
Shielded SL Series Jacks	0	2	2	0
Duplex Fiber Optic Adapters, or MT-RJ Parallel Dress Clips	1	1	1	2

# Work Area Outlets

## Faceplates and Outlets

### HIDEAWAY Multimedia Outlets

#### FEATURES

- Accepts the following (see table for detailed load information):
  - Shielded and unshielded SL series jacks
  - AMP-TWIST jacks
  - MT-RJ outlet jacks
  - Duplex couplers
  - MT-RJ parallel dress clips
  - SL series inserts
- Fit single and double gang electrical J-boxes
- Feature “invisible” icon holes which remain hidden until used
- Feature integral tabs for easy fiber loop management
- Breakaway tabs in duplex fiber coupler cut outs allow HIDEAWAY outlets to accept “flangless” SECURE LC duplex, standard LC duplex, or hybrid LC duplex couplers with retention clips (break out the tabs when using standard duplex couplers)

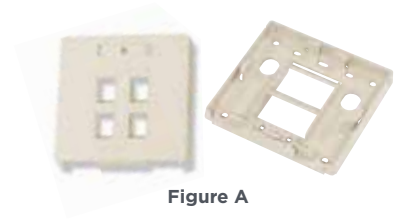

Figure A

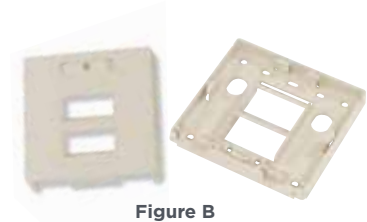

Figure B

#### ORDERING INFORMATION

Port Count	Figure	Part Number
		Almond
4	A	1479946-1
6	B	1479815-1

#### SPECIFICATIONS

Accepted Connectivity	Maximum Load Capacity	
	4-Port	6-Port
Unshielded SL Series, MT-RJ Outlet Jacks, or SL Series Inserts	4	6
Shielded SL Series Jacks, AMP-TWIST Jacks	4	4
Duplex Fiber Optic Adapters, or MT-RJ Parallel Dress Clips	2	2

# Work Area Outlets

## Faceplates and Outlets

### Surface Mount Outlet and Accessories

#### FEATURES

- Provides a convenient and aesthetically pleasing workstation outlet for virtually all network needs
- Capability to install mixed media: coax, fiber and twisted pair
- Simply select the adapter kits for the media being used and install them in the surface mount outlet
- The kit is shipped with matching icons
- Surface mount outlet is available in almond only



#### ORDERING INFORMATION

Description	Part Number
Surface Mount Outlet Assembly - Top, bottom, label, cover, hardware, 8 blank inserts	557366-1
Blank Insert	557361-1
Surface Raceway Adapter	557685-1
Duplex ST or Duplex SC Insert (Fiber receptacles not included)	1116111-1
Dual ST Bulkhead Adapter Insert (Receptacle included)	557350-1
Single 110Connect Jack, SL Series or MT-RJ Insert (Jack not included)	1116098-1
Dual 110Connect Jack, SL Series or MT-RJ Insert (Jacks not included)	557775-1

#### SUGGESTED LOADING PATTERN FOR THE SURFACE MOUNT OUTLET

The application chart is a suggested loading pattern for the surface mount outlet. The surface mount outlet inserts can be configured according to network requirements. The size of the connectors, however, limits some applications. In particular, the corner slots present some loading problems when using larger connectors. Therefore, this application chart was developed to assist in adjacent corner connector configuration. The "X" denotes the suggested loading patterns for the corner slots of the surface mount outlet.

	Dual ST or SC	110Connect, SL Series, or MT-RJ Jacks	Dual 110Connect, SL Series, or MT-RJ Jacks
Dual ST or SC		X	
110Connect, SL Series, or MT-RJ Jacks	X	X	X
Dual 110Connect, SL Series, or MT-RJ Jacks		X	

# Work Area Outlets

## Faceplates and Outlets

### Surface Mount Modules

#### FEATURES

- Provide flexible surface mounting of 2-, 4- or 6-ports
- Accept AMP-TWIST, SL series jacks, MT-RJ outlet jacks, and SL series inserts
- Compatible with most surface raceway systems and modular furniture raceways
- Modules include label, clear label cover, double-sided foam tape, self-tapping screws, and cable ties
- Modules can be mounted with magnets (purchased separately)
- Dimensions:
  - 2-port: 1.5" H x 3.0" W x 4.0" D
  - 4-port: 1.5" H x 5.6" W x 4.6" D
  - 6-port: 1.5" H x 5.6" W x 4.6" D



Figure A



Figure B



Figure C

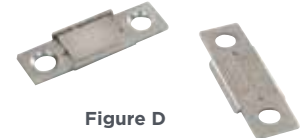

Figure D

#### ORDERING INFORMATION

Description	Port Count	Figure	Part Number				
			Almond	Black	Gray	Electrical Ivory	Alpine White
Surface Mount Modules	2	A	1933668-1	1933668-2	1933668-4	1-1933668-1	1-1933668-3
	4	B	1933671-1	1933671-2	1933671-4	1-1933671-1	1-1933671-3
	6	C	1933674-1	1933674-2	1933674-4	1-1933674-1	1-1933674-3
Surface Mount Module Magnets	Pack of 4	D	1933677-1				

# Work Area Outlets

## Faceplates and Outlets

### 12-Port Universal Surface Mount Outlet

#### FEATURES

- Accepts all SL series jacks, 110Connect jacks, MT-RJ outlet jacks, and SL series inserts
- Molded numbering for each port
- Low profile design
- Features fiber loop storage
- Compatible with most surface raceways
- Mounts to standard NEMA single and double gang surface boxes
- Integrated modular jack holder for terminations
- “Invisible” icon holes stay hidden until used
- Accommodates up to twelve 4-pair cables



#### ORDERING INFORMATION

Description	Part Number				
	Almond	Black	Gray	Electrical Ivory	Alpine White
12-Port Universal Surface Mount Outlet	1479358-1	1479358-2	1479358-4	1-1479358-1	1-1479358-3
Surface Mount Module Magnets, Pack of 4	1479398-1				

### Surface Boxes

#### FEATURES

- One-piece construction simplifies installation
- Single gang surface box is 1 3/4" deep
- Double gang surface box is 2" deep



Figure A



Figure B

#### ORDERING INFORMATION

Footprint	Figure	Part Number				
		Almond	Black	Gray	Electrical Ivory	Alpine White
Single Gang	A	558251-1	558251-2	558251-4	1-558251-1	1-558251-3
Double Gang	B	569499-1	569499-2	569499-4	1-569499-1	1-569499-3



# Work Area Outlets

## Faceplates and Outlets

### Modular Jack Boxes

#### FEATURES

- Accepts unshielded SL series jacks, 110Connect jacks and MT-RJ outlet jacks
- “Invisible” icon holes remain hidden when not used

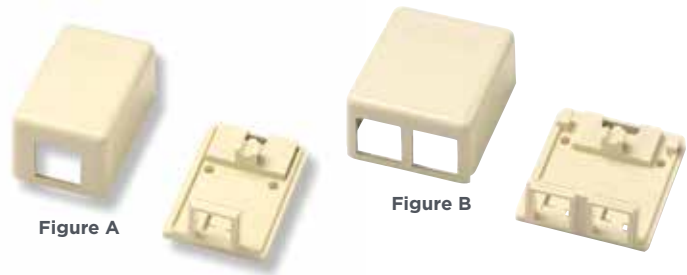

#### ORDERING INFORMATION

Description	Port Count	Figure	Part Number				
			Almond	Black	Gray	Electrical Ivory	Alpine White
Modular Jack Boxes	1-Port	A	1116697-1	1116697-2	1116697-4	1-1116697-1	1-1116697-3
	2-Port	B	1116698-1	1116698-2	1116698-4	1-1116698-1	1-1116698-3
Blank Insert for Modular Jack Boxes			1933172-1	-	-	-	1-1933172-3

NOTE: Modular jack boxes do not accept Multimedia inserts. Blank Insert only works with these boxes.

### Faceplates for WIREMOLD Raceways

#### FEATURES

- Designed to be identical to Wiremold 5507 series faceplates and will mount in 4049, 5400, and 5500 series device plates and brackets
- Accept all SL series jacks and multimedia inserts
- “Invisible” icon holes remain hidden when not used



#### ORDERING INFORMATION

Description	Port Count	Figure	Part Number	
			Almond	Gray
Faceplates for WIREMOLD Raceways	3	A	1375050-1	1375050-4
	4	B	1375049-1	1375049-4

WIREMOLD is a trademark.

# Work Area Outlets

## Faceplates and Outlets

### WIREMOLD 2A Inserts

#### FEATURES

- Allows the use of SL series jacks and inserts in Wiremold raceways, poke-thru service fittings, and power poles
- Accepts up to two SL series jacks or inserts
- Installation and configuration ease
- Modules feature a front load snap-in design for ease of installation and allowing outlet configuration changes to be made quickly
- To order contact:  
The Wiremold Company  
60 Woodlawn Street  
West Hartford, CT 06110  
1-800-621-0049  
Fax: 860-232-2062  
Web: [www.wiremold.com](http://www.wiremold.com)



#### ORDERING INFORMATION

Description	Color	Part Number
Wiremold 2A, 2-Port Inserts	Ivory	CM2-U2AMP
	White	CM2-U2AMP-WH
	Black	CM2-U2AMP-BK
	Gray - Steel Raceway	CM2-U2AMP-G
	Light Gray - Aluminum Raceway	CM2-U2AMP-GY

WIREMOLD is a trademark.

# Work Area Outlets

## Faceplates and Outlets

### Desktop Monuments

#### FEATURES

- Power monuments:
  - Provide access to duplex power outlet at the desktop
  - Eliminates the need to feed power cables behind or through desks
  - Supplied with an 8' (2.4 m), 3-prong power cord for connection to existing electrical outlets
- Voice/Data monuments:
  - Accepts standard FLEX-MODE faceplates
  - Horizontal cabling can be connected directly to SL series modular jacks (recommended for Category 5e applications)
- Attach to any desktop from 0.90" - 1.78" (22.9 mm - 45.2 mm)
- No special tools required to attach, simply place the monument onto the edge of the desktop and tighten the integrated thumb screw
- UL listed and CSA certified



Figure A



Figure B

#### ORDERING INFORMATION

Description	Color	Figure	Part Number
Power Monument, 15 Amp	Black	A	556222-3
Voice/Data Monument Empty Housing (requires FLEX-MODE Faceplate)	Black	B	1116360-3

# Work Area Outlets

## Faceplates and Outlets

### Standard FLEX-MODE Modular Furniture Faceplate Kits

#### FEATURES

- FLEX-MODE faceplates:
  - Accept all SL series jacks, MT-RJ outlet jacks or SL series inserts
  - Compatible with Telecommunications furniture outlet openings as specified in ANSI/TIA-569-B standard
- 110Connect 4-port modules:
  - Printed circuit board assemblies include 4 jacks
  - Ideal for thin panels



Figure A

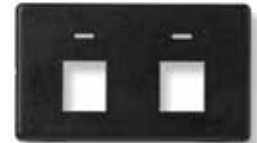

Figure B

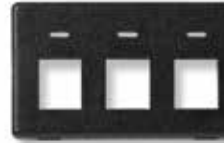

Figure C



Figure D

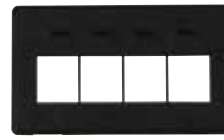
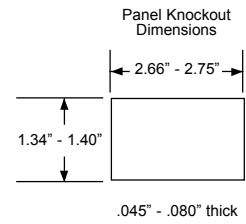

Figure E



#### ORDERING INFORMATION

Description	Port Count	Wiring	Figure	Part Number		
				Almond	Black	Gray
Blank Plate	-	-	A	558471-2	558471-1	558471-4
FLEX-MODE Flush Faceplate	2	-	B	558106-2	558106-1	558106-4
	3	-	C	558107-2	558107-1	558107-4
Category 5e, 110 Connect 4-Port Module	4	T568A/T568B	D	1116580-2	1116580-1	1116580-4
SL Series	4	-	E	1933134-2	1933134-1	1933134-4

# Work Area Outlets

## Faceplates and Outlets

### SL Series Furniture Outlets

#### FEATURES

- Accept up to 4 unshielded SL series jacks, MT-RJ outlet jacks and SL series multimedia inserts
- Two bases adapt to a wide range of hole sizes
- Tabs on base fold over and crimp to furniture raceway cover
- “Invisible” icon holes stay hidden until used

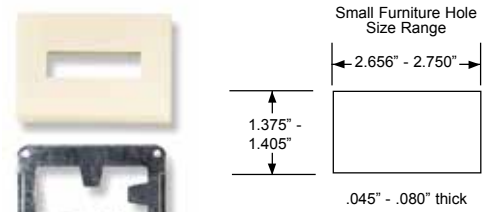

Figure A

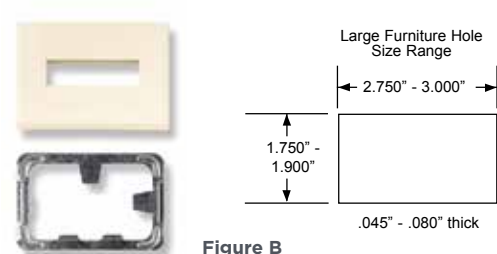

Figure B

#### ORDERING INFORMATION

Description		Figure	Part Number			
			Almond	Black	Gray	Alpine White
SL Series Furniture Outlet	Small opening	A	1375005-1	1375005-2	1375005-4	1-1375005-3
	Large opening	B	1375006-1	1375006-2	1375006-4	1-1375006-3

# Work Area Outlets

## Faceplates and Outlets

### Faceplates for Herman Miller Furniture

#### FEATURES

- Flush faceplates:
  - Accepts unshielded 110Connect jacks, all SL series jacks and MT-RJ outlet jacks
  - Jacks fit flush with front of faceplate
  - No backup plate required
- Standard faceplates:
  - Accepts unshielded 110Connect jacks, all SL series jacks, MT-RJ outlet jacks, and 110Connect and SL series Multimedia Inserts
  - May require backup plates depending on furniture style



Figure A

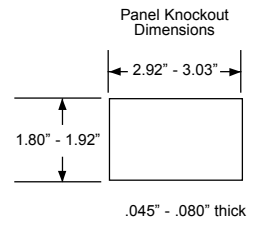

Figure B

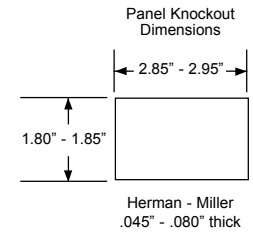
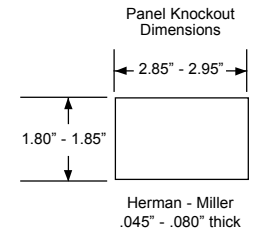

Figure C



#### ORDERING INFORMATION

Description	Port Count	Figure	Part Number			
			Almond	Black	Gray	
Faceplate for Herman Miller Furniture	Flush	4	A	558357-2	558357-1	558357-4
	Standard	2	B	569127-2	569127-1	569127-4
		4	C	558191-2	558191-1	558191-4

Herman Miller is a trademark.

# Work Area Outlets

## Faceplates and Outlets

### Extenders and Adapters for Furniture Faceplates

#### FEATURES

- Extenders:
  - Use when depth of furniture panel is limited
  - Reduces panel opening to accept standard FLEX-MODE faceplates
  - Raise outlet face approximately  $\frac{3}{4}$ " above surface of raceway
- Adapters are used to adapt standard FLEX-MODE Faceplates to other hole sizes

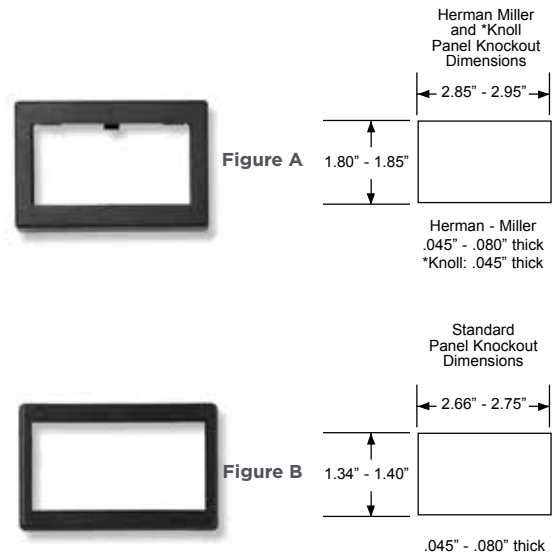

#### ORDERING INFORMATION

Description	Figure	Part Number			
		Almond	Black	Gray	
<b>STANDARD</b>	Extender	A	1933468-2	1933468-1	1933468-4
<b>Herman Miller</b>	Extender	A	558488-2	558488-1	558488-4
	Adapter	B	558493-2	558493-1	558493-4
<b>KNOLL</b> Prior to 1992	Extender	A	558489-2*	558489-1*	558489-4*
	Adapter	B	558492-2*	558492-1*	558492-4*

\* Note: Used to adapt standard FLEX-MODE Electrical faceplates to Knoll furniture manufactured prior to 1992.

### FLEX-MODE Modular Furniture Faceplate Accessories

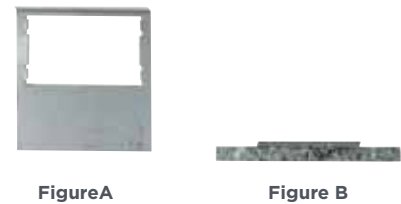

#### ORDERING INFORMATION

Description	For use with	Figure	Part Number
Backup Plate	Herman Miller Action Office 2 and Ethospace Furniture (1991 or later)	A	608440-1
Accessory Clip	Herman Miller Furniture (before 1991)	B	608441-1

Herman Miller, Action Office and Ethospace are trademarks.

# Work Area Outlets

## Inserts

### SL Series Multimedia Inserts

TE Connectivity's AMP NETCONNECT SL series Inserts offer flexibility and density at the work area outlet. The Inserts are available in a variety of copper, fiber and A/V inserts to meet most multimedia applications. SL series Inserts can be installed in any AMP NETCONNECT faceplate or outlet designed to the SL series jack footprint.

#### FEATURES

- May be used in straight or angled faceplates, SL series faceplate modules, surface mount modules, mounting straps and SL series patch panels
- Inserts easily snap into place
- RCA 110 termination multimedia jack:
  - Use where distances are less than 130'
  - For audio and video signals
  - Uses one pair of twisted-pair cable
  - White, red or yellow dielectrics to match home theater equipment
  - Not recommended for component DVD connections
- S-Video 110 termination multimedia jack:
  - Use where distances are less than 130'
  - For S-Video Y/C (luminance/chrominance black and white/color) signals
  - Uses two pairs of a standard twisted-pair cable
- Front Load SVGA
  - Suitable for standard keystone wall plates
  - Accepts wire gauge sizes from 20 to 28
  - Supports cable types
    - 5 conductor mini-coax
    - 4 pair performance cable



Figure A



Figure B



Figure C



Figure D



Figure E



Figure F



Figure G



Figure H



Figure I



Figure J



Figure K



Figure L



Figure M



Figure N



Figure O



Figure P



Figure Q



Figure R



# Work Area Outlets

## Inserts

### ORDERING INFORMATION

Insert Type	Figure	Part Number					
		Almond	Black	Gray	Electrical Ivory	Alpine White	
<b>3.5 mm Stereo, Mini-Headphone</b>	Screw Terminal	A	1933582-1				1-1933582-3
<b>Blank</b>		B	1116412-1	1116412-2	1116412-4	1-1116412-1	1-1116412-3
<b>BNC Coupler</b>		C	2111615-1	2111615-2			1-2111615-3
<b>F-Connector Coupler</b>	2 GHz	D	1499855-1	1499855-2	1499855-4	1-1499855-1	1-1499855-3
<b>RCA to 110 Punch Down</b>	Red Dielectric	E	1479230-1				1-1479230-3
	White Dielectric		1479231-1				1-1479231-3
	Yellow Dielectric		1479232-1				1-1479232-3
<b>RCA Coupler</b>	Red Dielectric	F	1375361-1				1-1375361-3
	White Dielectric	G	1375362-1				1-1375362-3
	Yellow Dielectric		1375363-1				1-1375363-3
	Green Dielectric		1933192-1				1-1933192-3
	Blue Dielectric		1933193-1				1-1933193-3
	Orange Dielectric		1933194-1				1-1933194-3
<b>RCA to F-Connector</b>		H	1933096-1				1-1933096-3
<b>ST Coupler</b>	Multimode	I	1339123-1	1339123-2			1-1339123-3
	Singlemode	I	1479181-1	1479181-2			1-1479181-3
<b>Speaker Post</b>	Black Stripe	J	1479190-1				1-1479190-3
	Red Stripe	K	1479191-1				1-1479191-3
<b>SC Simplex Coupler</b>	Singlemode/Multimode	L	1499836-1	1499836-2	1499836-4	1-1499836-1	1-1499836-3
<b>S-Video</b>		M		1375149-2	-		
<b>USB A to A Coupler</b>		N	1933659-1	1933659-2	-	-	1-1933659-3
<b>USB B to A Coupler</b>		O	1933661-1		-	-	1-1933661-3
<b>HDMI Coupler</b>		P		2111500-2			
<b>Front Load SVGA</b>		Q			1-2111550-3		
<b>LC Duplex Coupler</b>	Beige, OM1 (62.5 μm) Multimode					1-1933286-2	
	Black, OM2 (50 μm) Multimode					1-1933286-1	
	Aqua, OM3 and OM4 (XG 50 μm) Multimode					1933286-6	
	Green, Singlemode APC					1933286-3	
	Blue, Singlemode	R				1933286-4	

Note: APC (Angle Polish Connector) couplers are for use with angle polished connectors.

# Work Area Outlets

## Inserts

### MT-RJ, LC Adapters and SL

#### FEATURES

- Easily snap into place
- MT-RJ SL series housing accepts one MT-RJ jack sold separately
- LC adapters and SL series housings are purchased separately to mix and match custom color port identification

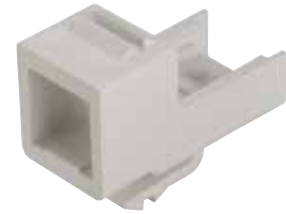

Figure A

#### ORDERING INFORMATION

Description	Figure	Color	Part Number
MT-RJ SL Series Housing	A	Almond	1374416-1
		Black	1374416-2
		White	1374416-3
		Gray	1374416-4
		Orange	1374416-5
		Blue	1374416-6
		Red	1374416-7
		Yellow	1374416-8
		Green	1374416-9
		Violet	1-1374416-0
		Electrical Ivory	1-1374416-1
		Rose	2-1374416-3
		Aqua	2-1374416-4
		Brown	2-1374416-5
Slate	2-1374416-6		
SL Series LC Housing	B	Light Almond	2111408-1
		Black	2111408-2
		Orange	2111408-5
		Blue	2111408-6
		Red	2111408-7
		Yellow	2111408-8
		Green	2111408-9
		Beige	1-2111408-2
		Alpine White	1-2111408-3
Aqua	2-2111408-4		
Duplex LC Adapter	C	Blue	2111407-2
		Green	2111407-5
		Beige	2111407-6
		Black	2111407-7
		Aqua	2111407-8



Figure B



Figure C

# Work Area Outlets

## Inserts

### Multimedia Modules for Work Area Outlets

#### FEATURES

- SVGA 110 termination modules:
  - Supported resolutions:
    - VGA (640 x 480)
    - SVGA (800 x 600)
    - XGA (1024 x 760)
  - Features 110-Style termination for easy installation
  - Is suitable for use with standard Category 5e or 6 UTP or F/UTP (recommended) cables
  - Can be used where distances between monitor and computer do not exceed:
    - 20' with CAT 5e or 6 UTP cable
    - 35' with CAT 5e or 6 FTP cable
  - Utilizing drain wire for 9th conductor is recommended for use with FTP cables
  - Dimensions: 1.180" D x 1.480" W x 0.875" H
  - Stuffer caps and hex head stand-off screws included
  - Fits SVGA blank SL series module, P/N: 1479079
- SVGA screw terminal termination module:
  - Works with VGA and SVGA signals
  - Allows field termination of SVGA cable
  - For distances of up to 150' at a resolution of 800 x 600 using standard 5 conductor 26 AWG coaxial video cable
  - Fits SVGA blank SL series module, P/N:1479079
- SVGA - Screw terminal
  - Allows field termination of SVGA cable
  - For distances up to 150'
  - Supported Resolutions: 800 x 600
  - Recommended for use with 5 conductor, 26 AWG stranded coaxial video cable
- HDMI modules fit into HDMI blank SL series module, P/N: 1933686



Figure B



WIRING DIAGRAM

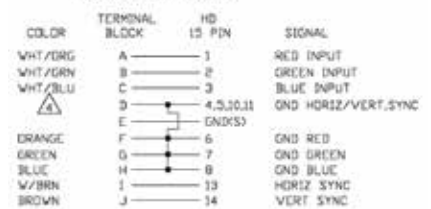

Figure C



WIRING DIAGRAM

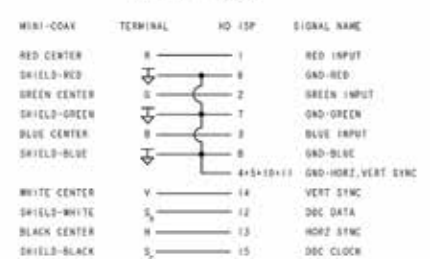

Figure D

#### ORDERING INFORMATION

Description	Figure	Part Number
HDMI Adapter Cable Assembly, Type A	B	1933636-2
SVGA Assembly, 110 Termination	C	1479287-2
SVGA Assembly, Screw Terminal Termination	D	1933424-2





## Managed Connectivity

Infrastructure Configuration Manager (ICM) .....5-3  
 Infrastructure Configuration Manager (ICM) Mobile App.....5-7  
 Quareo .....5-8

Businesses and organizations worldwide are more dependent on their physical layer than ever before. From computers, phones and wireless devices, to alarm systems, security cameras and video conferencing, today’s network physical layer touches virtually every device inside an organization. Security of the physical layer also has become a top concern among network and data center managers, especially in healthcare, financial and mission-critical organizations where data is required to be secure.

TE’s Managed Connectivity solution, with its Infrastructure Configuration Manager (ICM) software and Quareo Connection Point Identification hardware technology, delivers full knowledge and visibility of the physical layer. ICM can be seamlessly integrated into your existing network management software to give full control and visibility of the complete network helping to establish the highest security standards possible. These solutions enable higher network availability, while lowering network costs, by integrating full visibility of the physical layer into existing network management applications—all the way from the data center to the desktop. TE’s Managed Connectivity solutions are helping network and data center managers bridge the gap between network management and physical layer management, transforming the physical layer into a strategic asset and revolutionizing the way networks are managed and controlled. By providing a real-time comprehensive picture of every connection point in the physical layer, managed connectivity significantly improves productivity and efficiency of physical layer management and maintenance processes while reducing costly downtime and operating costs.



For more information on TE’s Managed Connectivity solution, visit [www.knowyournetwork.com](http://www.knowyournetwork.com).



# Managed Connectivity

## Infrastructure Configuration Manager (ICM)

Infrastructure Configuration Manager (ICM) is a software application specifically designed for customers of TE's managed connectivity solutions. ICM powers TE's advanced Quareo connection point identification technology, providing customers with a single platform for both solutions.

ICM creates an automated, accurate, real-time physical layer management system that is designed to explore, discover and map all the connections of the network, allowing data center and network managers to simplify the process of all moves, adds and changes, improve security and reduce operating expense.

TE's managed connectivity solutions, enabled by ICM, help customers eliminate time-consuming manual work order processes, easily identify and locate specific ports, auto-discover IP assets, and trace data center circuits from the switch through the cross-connect to the server. The systems also help maximize network investment by identifying under-utilized assets and improving security through real-time monitoring and programmable alerts.

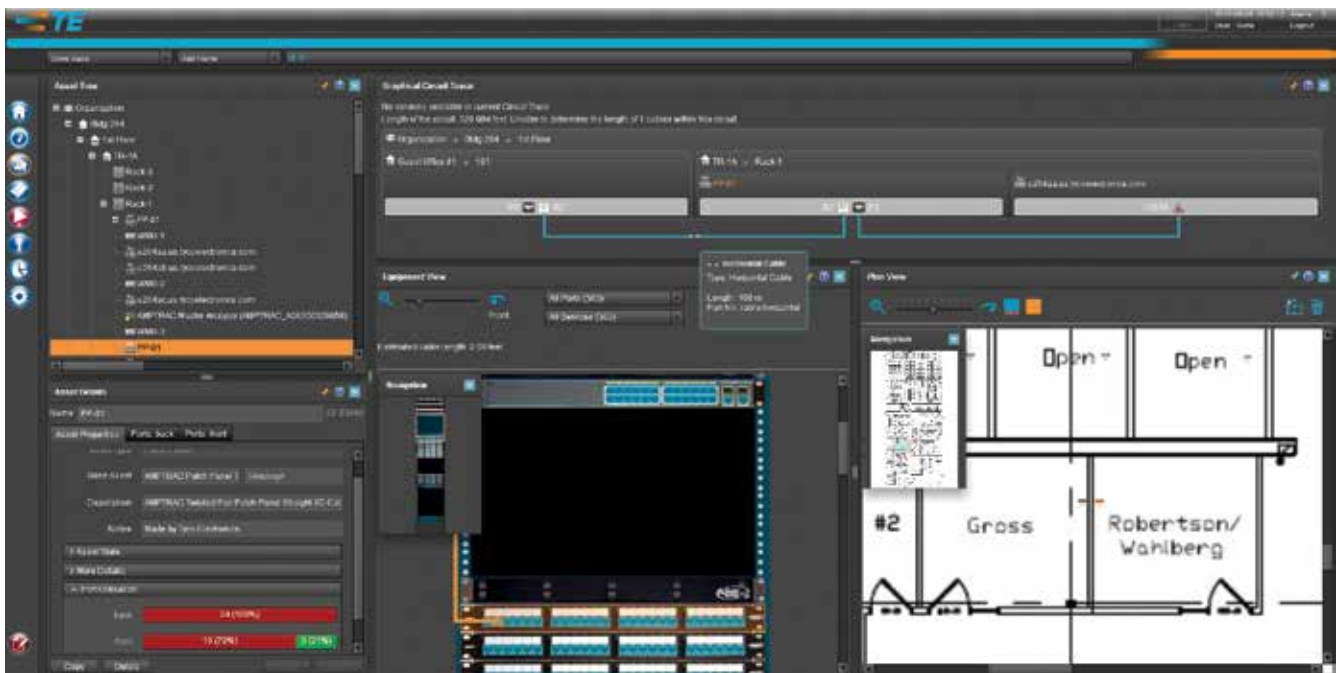

### FEATURES

When used with Quareo, ICM allows immediate response to changes in connectivity and automatically records the connections of the physical layer cabling system and its devices with accurate documentation. Other advantages of deploying ICM include:

- Accountability of assets by location and date
- Availability of assets and utilization is improved
- Reduced operational costs
- Best practice and regulatory requirements are more easily attained
- Network problems are more easily diagnosed and corrected
- Security is greatly enhanced
- Remote visibility of the physical layer
- DoD/DISA/JITC Tested

# Managed Connectivity

## Infrastructure Configuration Manager (ICM)

The advanced system architecture allows full customization of the graphical user interface. Multiple users and multiple screens can be supported enhancing the usefulness of the system. Different color schemes are available that can be applied on a per user basis enhancing the user interface experience.

The graphical user interface supports multiple screens that visualize the network physical infrastructure in a detail not previously available. User access and profiles can be secured and controlled to a granular level based on responsibilities, roles and use cases.

The network infrastructure can be viewed in a classical tree hierarchy with branches nested below. Additionally, multiple drawings of a building can be added to the database and these can be allocated to different parts of the building, floor or room that is documented. These drawings can have network assets 'placed' and these assets remain dynamic within the drawing, allowing for information to be coordinated and viewed with a single click.

The network rack, cabinet or closet can be documented and visualized in full detail that shows the front and rear of any installed assets. Patch cables and their planned routing can be viewed including estimated minimum lengths.

Circuit traces can be viewed showing every element of the circuit path from switch port to end device and all intermediate steps.

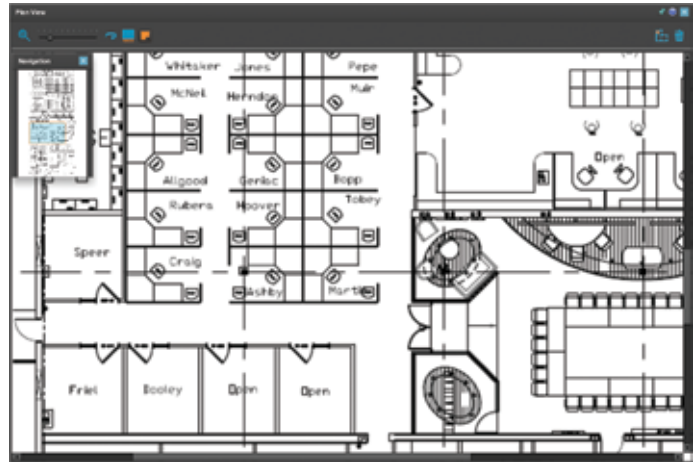

MANAGED CONNECTIVITY

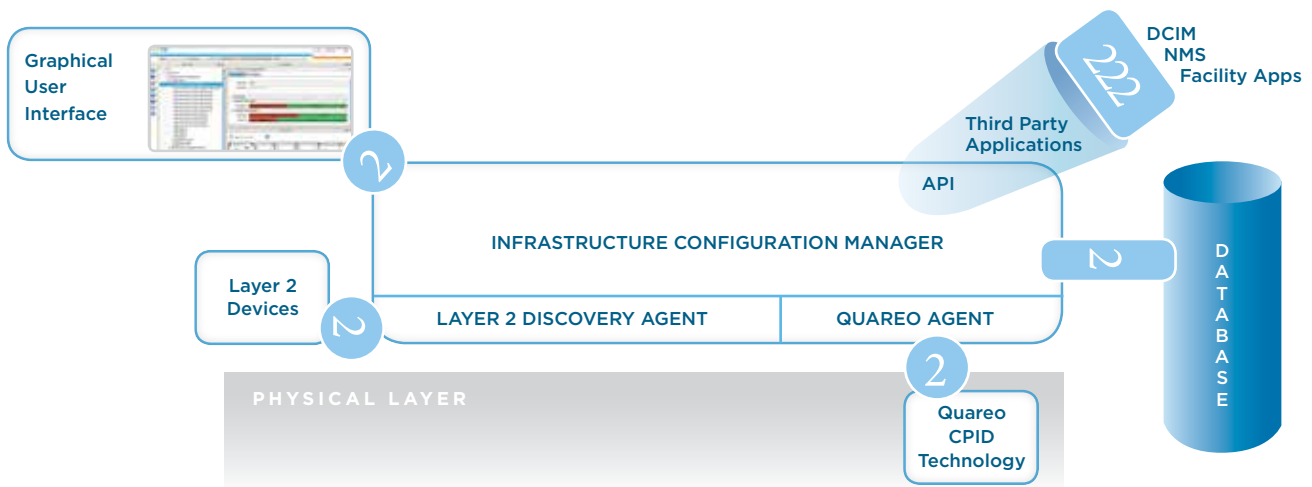



# Managed Connectivity

## Infrastructure Configuration Manager (ICM)

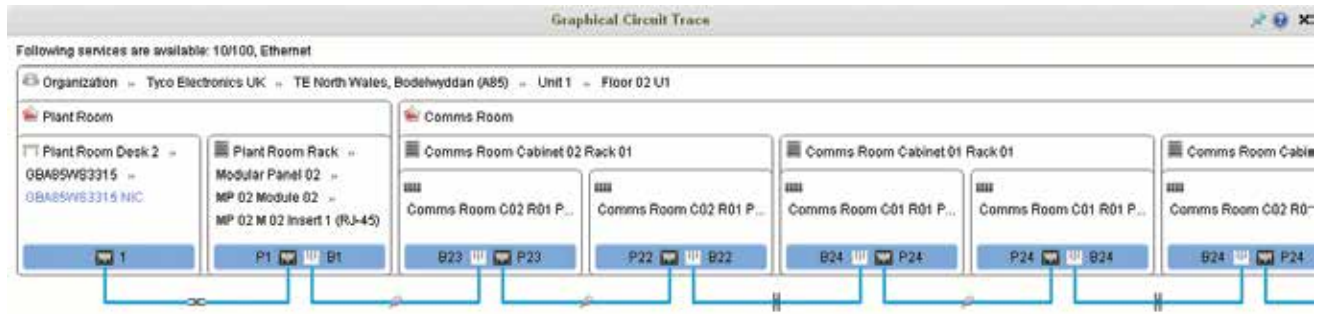

Asset details are recorded and displayed in multiple screens and views. These details combine discovered and manually provided information. Asset utilization can be continually monitored with charts/meters providing instantaneous and real time updates at a glance. All documented information can be searched in real time and items immediately displayed.

With a fully documented network, reports can be used to provide active and passive utilization, availability and asset details. ICM contains numerous reports but also provides flexibility for users to write and tailor reports to suit organizational and compliance needs.

ICM boasts over 30 different views or 'frames' of information, many of them graphical in nature, which can be used individually for specific details, or in combination to perform common tasks or determine more complex findings.

With pre-defined screen layouts of typically required frames of information, the ICM software is organized into seven common tasks:

- System status
- User administration
- Network explorer
- Reports
- Work orders
- System configuration
- Alarms

Custom views and combinations of various frames can be established and saved for specific tasks or processes that require unique determinations or information. Basic views that are most commonly used as building blocks to make basic determinations and support common tasks are:

- Equipment View:** Accurate real time view of equipment in closet or rack
- Asset Tree:** View of all network assets showing parents and children
- Asset Details:** View specific network components with details from location to utilization
- Circuit Traces:** View end-to-end circuits with all connection points
- Plan View:** Floor plan can be added with interactive 'links' to assets and locations
- Event View:** Real-time view of all events and status with filters
- Alarms:** Configurable alarms with status, persistence and acknowledgement capabilities



### OTHER KEY FEATURES INCLUDE:

- Automatic discovery: Switches and end devices can be discovered and placed in the DB
- Multiple reports: Powerful report tool with support for BIRT reporting
- Accurate and simple search: Full contextual search with filtering by class available
- User/Role configuration: Flexible user configuration supports LDAP and local passwords
- Work Order system: Flexible work order system for full work flow management
- API and SDK: Ease of integration with third-party software
- Fully compatible with Quareo AIM systems

# Managed Connectivity

## Infrastructure Configuration Manager (ICM)

### ORDERING INFORMATION

	Description	Part Number
<b>ICM Software</b> is available either bundled with specific AIM hardware/ analyzers or stand-alone in the following license-blocks by managed monitored port counts	480 Port License	5-1899725-2
	2400 Port License	5-1899725-3
	4800 Port License	5-1899725-4
	9600 Port License	5-1899725-5
	24,000 Port License	5-1899725-6
	48,000 Port License	5-1899725-7
	96,000 Port License	5-1899725-8
	ICM API/SDK	5-1899725-9

	Description	Access	Help-Desk Support	Part Number
<b>Annual Maintenance The ICM</b> Maintenance SLA covers updates and help-desk support on an annual basis based on port thresholds as shown in the table below. Technical Assistance Center (TAC) access includes patches and bug fixes as well as minor and major releases.	<b>480 Ports</b>	One Year TAC	M - F 8:00 am to 5:00 pm CST/CDT	6-1899725-0
		Three Year TAC		6-1899725-2
	<b>2400 Ports</b>	One Year TAC		6-1899725-4
		Three Year TAC		6-1899725-6
	<b>4800 Ports</b>	One Year TAC		6-1899725-8
		Three Year TAC		7-1899725-0
	<b>9600 Ports</b>	One Year TAC		7-1899725-2
		Three Year TAC		7-1899725-4
	<b>24000 Ports</b>	One Year TAC		7-1899725-6
		Three Year TAC		7-1899725-8
	<b>48000 Ports</b>	One Year TAC		8-1899725-0
		Three Year TAC		8-1899725-2
	<b>96000 Ports</b>	One Year TAC		8-1899725-4
		Three Year TAC		8-1899725-6

### MINIMUM SERVER HARDWARE REQUIREMENTS

- **Processor:** Dual core 2 GHz or higher (x64) processor required
- **Memory:** 8 GB
- **Available Disk Space:** 20 GB
- **Network connection:** 1 GB Network card

### SERVER OPERATING SYSTEM REQUIREMENTS:

- **Microsoft® Windows Server® 2008 R2 (64-bit)**
- **Red Hat® Enterprise Linux® 5.4 and above (64-bit)**

**DATABASE REQUIREMENTS** As part of the installation process, the following database platform will be installed on your server:

- **PostgreSQL 9.1**
- **Apache™ Tomcat™ web server**

### OTHER REQUIREMENTS

- **Java Runtime Engine 1.6 or higher** (can be installed as part of ICM installation)
- **Adobe Flash Player 11.1.102.62 or higher** (client desktop only)
- **Administrator log in privileges on the server for installation**

### SUPPORTED WEB BROWSERS

- **IE 8 or higher**
- **Firefox 10.0.2 or higher**

(Although ICM may work in other browsers, they have not been tested, and are not supported at this time)

*Microsoft Windows Server, Red Hat Enterprise Linux, Apache Tomcat, Adobe, and Firefox are trademarks.*

# Managed Connectivity

## Infrastructure Configuration Manager (ICM)

### ICM Mobile

ICM is now an app. ICM Mobile is the on-the-go physical network management tool for use with an active ICM software system. ICM Mobile links with your ICM server to coordinate planned work orders and provide direct technician messaging and responses while enabling unprecedented management, details and control of the Information Transport System (ITS). ICM Mobile is available for download from iTunes\*.

#### FEATURES

- Work order selection listing
- Work order synchronization
- Work order/LED activation controls
- Work order step selector/manager
- Auto-detect completion indicators
- Manual completion indicators
- Response attachment handling
- Incident response logging
- Events and alarms
- Guided setup and configuration validation
- On-screen guidance tips

\*iTunes is a trademark.

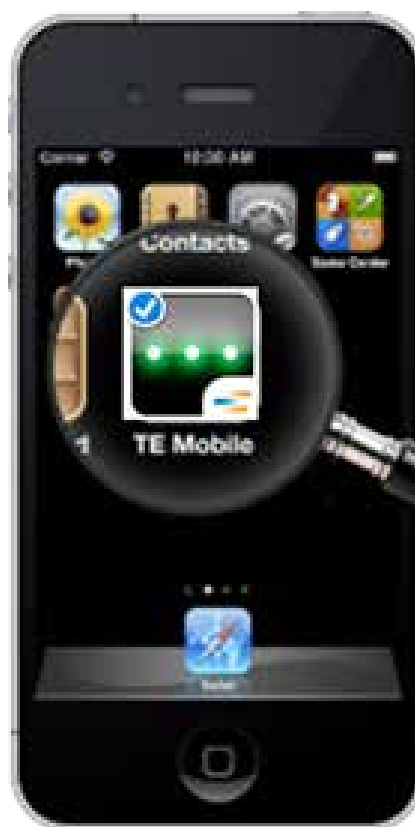

#### FEATURE SET FOR ICM MOBILE

ICM Mobile allows a technician to access the following ICM software desktop functionality from an iPhone:

##### Work Orders

- Carry out steps in work orders assigned to technician and mark them done
- Perform general, connect and disconnect work order steps
- Both managed and unmanaged connect and disconnect steps can be performed
- Add and display photos from the iPhone camera to document a work order step
- Add notes to a work order and an individual work order step

##### Events

View events and alarms as they appear in the ICM desktop event viewer

##### Settings

- View logged in user and ICM server information
- Log out of ICM and reset all connection details
- View App and API versions
- View End User License Agreement (EULA)
- Supported Devices and iOS Versions
- iPhone 4 and above
- iOS 5 and above

# Managed Connectivity

## Quareo

### Quareo Series Network Chassis

Q4000 Series Network Chassis featuring Quareo Technology allows network personnel to view, manage and audit the physical layer. This means, for the first time, the physical layer is now subject to the same compliance policy as higher layers of the network. With 70% of network outages attributed to errors made in the physical layer, TE introduces a new category of products. Simply put, Quareo enables Managed Connectivity using connection point identification (CPID) technology.

### Q4000 Series

#### FEATURES

- Support IEEE 802.3ae and IEEE 802.3ba
- Exceed ANSI/TIA-568-C.3 and ISO 11801 Edition 2 cabling system requirements
- OM3/OM4 and OS1
- 19-Inch rack mountable
- Available in 2, 4, and 8 slot chassis
- 48 Fiber (24 Duplex LC) LC-to-LC or LC to MPO blade
- 192 Fiber (16 MPO Ports) MPO-to-MPO blade



#### ORDERING INFORMATION

Product Description	Part Number
1RU Network Chassis, Accommodates 2 each Q3 or Q4 series blades	QCH-1RU
2RU Network Chassis, Accommodates 4 each Q3 or Q4 series blades	QCH-2RU
4RU Network Chassis, Accommodates 8 each Q3 or Q4 series blades	QCH-4RU

### Door Kits

#### ORDERING INFORMATION

Product Description	Part Number
<b>QDR-1RU:</b> Quareo 1RU Front Door Kit	QDR-1RU
<b>QDR-2RU:</b> Quareo 2RU Front Door Kit	QDR-2RU
<b>QDR-4RU:</b> Quareo 4RU Front Door Kit	QDR-4RU

### Blank Chassis Covers

#### ORDERING INFORMATION

Product Description	Part Number
<b>QBCB-HR:</b> Front Blank Cover (used to cover up unpopulated chassis positions)	QBCB-HR

# Managed Connectivity

Quareo

## SPECIFICATIONS

### 4200 PHYSICAL:

<b>Rack Mounting:</b>	EIA/ETSI/WECO/IEC 60297 19-inch equipment racks
<b>Height in Rack:</b>	1RU 44.5 mm, (1.75")
<b>Dimensions (HxWxD):</b>	44.5 mm x 483 mm x 338 mm (1.75" x 19" x 13.3")
<b>Grounding:</b>	2-screw grounding location for standard grounding lug

### Q4400 PHYSICAL:

<b>Rack Mounting:</b>	EIA/ETSI/WECO/IEC 60297 19-inch equipment racks
<b>Height in Rack:</b>	2RU 88.9 mm, (3.5")
<b>Dimensions (HxWxD):</b>	87.63 mm x 482.85 mm x 338 mm (3.45" x 19" x 13.3")
<b>Grounding:</b>	2-screw grounding location for standard grounding lug

### Q4800 PHYSICAL:

<b>Rack Mounting:</b>	EIA/ETSI/WECO/IEC 60297 19-inch equipment racks
<b>Height in Rack:</b>	4RU 177.8 mm, (7")
<b>Dimensions (HxWxD):</b>	177.8 mm x 483 mm x 338 mm (7" x 19" x 13.3")
<b>Grounding:</b>	2-screw grounding location for standard grounding lug

### ENVIRONMENTAL:

<b>Operating Temperature:</b>	-10 °C to +60° C (+14 °F to +140° F)
<b>Storage Temperature:</b>	-40 °C to +85° C (-40°F to +185° F)
<b>Humidity:</b>	5% to 95% non-condensing RoHS Compliant

### SAFETY:

<b>Flammability:</b>	(UL), c(UL), CE, A-TICK (UL) 94 V-0 UL 1863
----------------------	---

### EMC:

EMC Directive, 2004/108/EEC

MANAGED CONNECTIVITY

# Managed Connectivity

Quareo

## Blades: LC-to-LC, LC-to-MPO, MPO-to-MPO



### ORDERING INFORMATION

Product Description	Part Number	
LC-to-LC Q4000 Chassis Blade; fiber, 24 port duplex LC, 1/2 RU blade	Multimode (OM3/OM4)	QFB-48FDLCLMMHR
	Singlemode	QFB-48FDLCLSMHR
LC-to-MPO Q4000 Chassis Blade; fiber, 24 port duplex LC, 1/2 RU blade	Multimode (OM3/OM4); Loss (<0.5 dB) @ 850 nm/1300 nm	QFB-48FDLCMMHR
	Singlemode; Loss (<0.75 dB) @ 1310 nm/1550 nm)	QFB-48FDLCMSHR
MPO-to-MPO Q4000 Chassis Blade; fiber, 16 MPO Ports, 1/2 RU blade	Multimode (OM3/OM4)	QFB-192FMPOMHR
	Singlemode	QFB-192FMPSMHR

### SPECIFICATIONS

#### PHYSICAL

**Dimensions (HxWxD):** 19.3 mm x 438.4 mm x 373.1 mm (0.76" x 17.26" x 14.69")

#### ENVIRONMENTAL

**Operating Temperature:** -10° C to +60° C (+14° F to +140° F)

**Storage Temperature:** -40° C to +85° C (-40° F to +185° F)

**Humidity:** 5% to 95% non-condensing

#### ELECTRICAL

**Input Power:** 1.0 W Max.

#### Optical Interface

**MPO-to-MPO:** 12 Fiber MPO

**LC-to-MPO:** Duplex LC (front), 12 Fiber MPO (rear)

**LC-to-LC:** Duplex LC

#### COMPLIANCE

RoHS Compliant

**Safety:** (UL), c(UL), CE, A-TICK

**Flammability:** (UL) 94 V-0

UL 1863

**EMC:** EMC Directive, 2004/108/EEC

# Managed Connectivity

Quareo

## QCC-4 Chassis Controller

COMPATIBLE WITH Q4000 NETWORK CHASSIS



### FEATURES

- Chassis controller (one per chassis) operates with the Q4000 series
- Designed to fit with the rear of the chassis, does not require additional rack space
- Power can be supplied through IEEE 802.3af compliant switch port (class 0) or auxiliary power supply (can be simultaneous)

### ORDERING INFORMATION

Product Description	Part Number
<b>QCC-4;</b> Chassis Controller for Q4000 Network Chassis	QCPU-MCBM-1
<b>QPWRS-USA:</b> ASSY, Power Supply W/US Cord	QPWRS-USA

## Quareo Managed Fiber Cables

MULTIMODE AND SINGLEMODE - MANAGED FIBER CABLES WITH CPID

### FEATURES

- Standard lengths: 4, 7, 10, 15, 25 and 50 feet
- Standard colors: Aqua for multimode, yellow for singlemode
- Standard materials:
  - Plenum PVC (LSZH available upon request)
- Performance specifications: ANSI/TIA-568-C.3 and ISO 11801, Edition 2 for OM3/OM4 multimode, OS1 for singlemode



### ORDERING INFORMATION

Description	Fiber Type		Polarity	Part Number
LC-to-LC Plenum	Multimode	OM3	A-to-A	QFPC-MPPM3PA-xxxF
			A-to-B	QFPC-MPPM3PB-xxxF
		OM4	A-to-A	QFPC-MPPM4PA-xxxF
			A-to-B	QFPC-MPPM4PB-xxxF
	Singlemode		A-to-A	QFPC-MKKSMMPA-xxxF
			A-to-B	QFPC-MKKSMMPB-xxxF

Replace xxx with desired length in feet. Other materials available upon request.

MANAGED CONNECTIVITY

# Managed Connectivity

Quareo

## Quareo Managed Trunk and Array Cables



### ORDERING INFORMATION

Description	Fiber Type		Managed Cable Type	Connectors	Part Number
<b>12 Fiber</b> Plenum	Multimode	OM3	Array	MPO (pinned/male)-LC	QFA-1MPM3PNxxxFAA
			Trunk	LC-to-LC	QFA-1PPM3PNxxxFAA
				MPO (no pins/female) to MPO (no pins/female)	QFA-1FFM3PNxxxFAA
		OM4	Array	MPO (pinned/male)-LC	QFA-1MPM4PNxxxFAA
			Trunk	LC-to-LC	QFA-1PPM4PNxxxFAA
				MPO (no pins/female) to MPO (no pins/female)	QFA-1FFM4PNxxxFAA
	Singlemode		Array	MPO (pinned/male)-LC	QFA-1RKSM3PNxxxFAA
			Trunk	LC-to-LC	QFA-1KKSM3PNxxxFAA
				MPO (no pins/female) to MPO (no pins/female)	QFA-1WWSM3PNxxxFAA
<b>24 Fiber</b> Plenum	Multimode	OM3	Trunk	LC-to-LC	QFA-2PPM3PNxxxFAA;
				MPO (no pins/female) to MPO (no pins/female)	QFA-2FFM3PNxxxFAA
		OM4	Trunk	LC-to-LC	QFA-2PPM4PNxxxFAA
				MPO (no pins/female) to MPO (no pins/female)	QFA-2FFM4PNxxxFAA
	Singlemode		Trunk	LC-to-LC	QFA-2KKSMPNxxxFAA
				MPO (no pins/female) to MPO (no pins/female)	QFA-2WWSMPNxxxFAA
<b>48 Fiber</b> Plenum	Multimode	OM3	Trunk	LC-to-LC	QFA-4PPM3PNxxxFAA
				MPO (no pins/female) to MPO (no pins/female)	QFA-4FFM3PNxxxFAA
		OM4	Trunk	LC-to-LC	QFA-4PPM4PNxxxFAA
				MPO (no pins/female) to MPO (no pins/female)	QFA-4FFM4PNxxxFAA
	Singlemode		Trunk	LC-to-LC	QFA-4KKSMPNxxxFAA
				MPO (no pins/female) to MPO (no pins/female)	QFA-4WWSMPNxxxFAA
<b>96 Fiber</b> Plenum	Multimode	OM3	Trunk	LC-to-LC	QFA-8PPM3PNxxxFAA
				MPO (no pins/female) to MPO (no pins/female)	QFA-8FFM3PNxxxFAA
		OM4	Trunk	LC-to-LC	QFA-8PPM4PNxxxFAA
				MPO (no pins/female) to MPO (no pins/female)	QFA-8FFM4PNxxxFAA
	Singlemode		Trunk	LC-to-LC	QFA-8KKSMPNxxxFAA
				MPO (no pins/female) to MPO (no pins/female)	QFA-8WWSMPNxxxFAA

Replace xxx with desired length in feet. Other materials available upon request.



# Managed Connectivity

Quareo

## SPECIFICATIONS FOR ARRAY CABLE: MEASURED THROUGH MPO MATED PAIR TO LC ADAPTER

### Multimode (OM3, OM4)

Insertion Loss (dB)	<b>850 nm</b>	<b>1300 nm</b>
Maximum:	0.70 dB	0.70 dB
Typical:	0.25 dB	0.4 dB
Return Loss (dB)		
Maximum:	-20 dB	-20 dB

### Singlemode

Insertion Loss (dB)	<b>1310 nm</b>	<b>1550 nm</b>
Maximum:	1.0 dB	1.0 dB
Typical:	0.25 dB	0.35 dB
Return Loss (dB)		
Minimum:	-55 dB	-55 dB

## SPECIFICATIONS FOR TRUNK CABLE : MPO-TO-MPO AND LC-TO-LC

### Multimode (OM3, OM4)

Insertion Loss (dB)	<b>850 nm</b>	<b>1310 nm</b>
Maximum:	0.70 dB	0.70 dB
Typical:	0.25 dB	0.4 dB
Return Loss (dB)		
Maximum:	-20 dB	-20 dB

### Singlemode

Insertion Loss (dB)	<b>1310 nm</b>	<b>1550 nm</b>
Maximum:	1.0 dB	1.0 dB
Typical:	0.25 dB	0.35 dB
Return Loss (dB)		
Minimum:	-55 dB	-55 dB

# Managed Connectivity

Quareo

## Quareo Cross Connect Frame

The Quareo Cross-Connect Frame (Q-Frame) system provides the cable management necessary for the fiber intensive areas of today's data centers. This innovative frame has eight 9" horizontal troughs for a total of 72" of horizontal trough space. This abundant trough space minimizes fiber pile up and congestion simplifying moves, adds and changes.

The frame system mounts to a standard 19-inch rack allowing the rear troughing system to line up between racks maximizing the routing between racks. The built-in patch cord storage panel will store up to 3.5 m (12') of patch cord slack and allows for the use of single patch cord length to connect any port within a single rack.

The Q-Frame is compatible with the Q4000 managed chassis, Q3000 unmanaged chassis, RMG series 4RU chassis, and TFP series 4RU chassis and can accommodate 8 of either of these fiber panel products in a single frame.

The unique design of the Quareo Cross-Connect frame allows for any port within a single frame to be connected using a 6 m patch cord. As the line-up increases by a frame, the length to connect any port in the line-up increases by one meter. See table below for recommended fiber patch cord lengths for cross-connects in a continuous line-up.

For more information on the Q-Frame, visit [www.te.com/Qframe](http://www.te.com/Qframe).

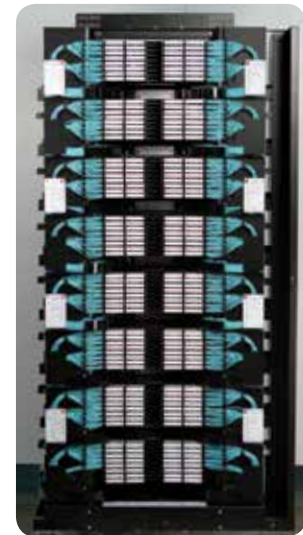

**Q-Frame**  
loaded with (8) 4RU Quareo chassis and  
(64) Quareo LC-to-MPO blades (3,072 LC  
fiber terminations)

## FEATURES

### Ample Trough Space

- Reduces patch cord pile-up and congestion
  - Reduces maintenance time due to easy removal and tracing of patch cords
  - Minimizes risk of microbends or damage to fiber
- Manages 3072 strands of LC and 24,576 of MPO for 100GbE

### Built-in Patch Cord Storage Panel

- Simplifies frame installation
  - Saves money by reducing the number of different patch cord lengths that have to be kept in inventory
  - Minimizes risk of microbends or damage to fiber
- Maintains fiber bend radius
- Enclosed system ensures easy cable access without fiber cross-over points

### Intuitive Cable Routing System

- No fiber cross-over points
- Multiple horizontal troughways
  - Reduces maintenance time due to easier removal and tracing of patch cords
- Minimizes fiber "weaving"

### Bend Radius Protection at Every Turn

- Provides complete bend radius at every turn to ensure network performance and reliability

# Managed Connectivity

Quareo

Number of 19-inch racks <sup>1</sup>	Patch cord length <sup>2</sup>
1	6 meters
2	7 meters
3	8 meters
4	9 meters
5	10 meters
6	11 meters

<sup>1</sup> Up to a maximum of ten racks

<sup>2</sup> Add one meter for each additional rack



## ORDERING INFORMATION

Product Description	Part Number
Q-Frame 19-inch rack kit	Q-OFX-V
19-inch channel rack	ADCRACKBLK73
Left end guard kit	Q-OFX-GL
Right end guard kit	Q-OFX-GR
Cross-connect frame isolation pad kit	Q-IPCCM-KT
End guard isolation pad kit	Q-IPEG-KT

## SPECIFICATIONS

### MECHANICAL

**Tower Dimensions (H x W x D):** 84" x 40.7" x 23.9"

**Weight (each tower):** 90 lbs

**End Guard Dimensions (H x W x D):** 84" x 3.5" x 23.9"

### ENVIRONMENTAL

**Operating Temperature:** 14° F to 140° F

**Relative Operating Humidity:** 5 to 95 %  
(No condensation)

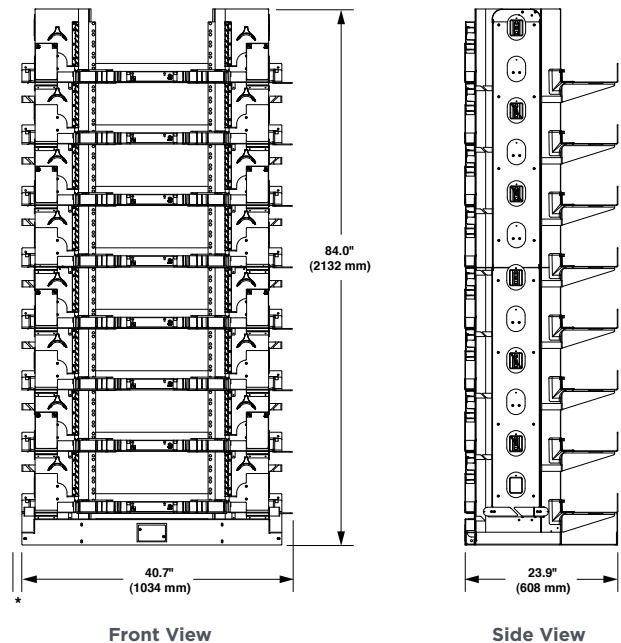

\* Add 3.25" (82.6 mm) when installing end guard.

MANAGED CONNECTIVITY

# Managed Connectivity

Quareo

## Q2000 Series Network Panels

Q2000 Series Network Panels featuring Quareo Technology allow network personnel to view, manage and audit the physical layer. This means, for the first time, the physical layer is now subject to the same compliance policy as higher layers of the network. With 70% of network outages attributed to errors made in the physical layer, TE introduces a new category of products. Simply put, Quareo enables managed connectivity using connection point identification (CPID) technology.

### FEATURES

- Quareo enabled functionality with dual color port illumination (LED)
- Integral cable management bar
- 45° IDC contacts providing secure, gas-tight connections
- Accepts 110 style termination tools
- Universal 568A/B wiring
- Discrete labeling system
- Maintenance services available on this product

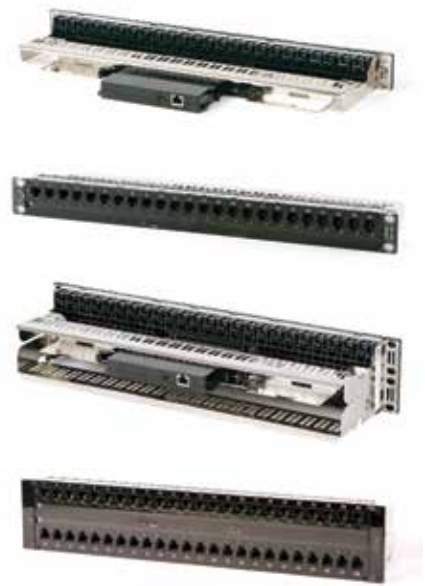

## QPC-2 Panel Controller Compatible with Q2000 Network Panels

### FEATURES

- Panel controller operates with the Q2000 family of Network Panels
- Designed to fit inside the rear cable manager without interfering with panel connectivity, does not require additional rack space
- Power can be supplied through IEEE 802.3af compliant switch port or additional auxiliary power supply (can be simultaneous)
- Link and activity status LEDs at the rear of unit
- Seamless power transition from PoE to aux supply
- Maintenance services available on this product



### ORDERING INFORMATION

Product Description	Part Number
<b>Q2324 Network Panel;</b> 24 port (1RU) network panel with jacks	
CAT 6A U/UTP	QCPP-24MC6AU
CAT 6A STP	QCPP-24MC6AS
CAT 6 U/UTP	QCPP-24MC6U
<b>Q2348 Network Panel;</b> 48 port (2RU) network panel with jacks	
CAT 6A U/UTP	QCPP-48MC6AU
CAT 6A STP	QCPP-48MC6AS
CAT 6 U/UTP	QCPP-48MC6U
<b>QPC-2;</b> Panel controller for Q2000 Network Panels	QCPU-MPPM-1
<b>QPWRS-USA;</b> ASSY, Power Supply W/US Cord	QPWRS-USA

# Managed Connectivity

Quareo

## SPECIFICATIONS

<b>Product Dimensions (HxWxD):</b>	21 mm x 143 mm x 105 mm (0.82" x 5.62" x 4.142")
<b>Environmental:</b>	
<b>Operating Temperature:</b>	-10° C to +60° C (+14° F to +140° F)
<b>Compliance</b>	
<b>Flammability:</b>	(UL) 94 V-0 RoHS Compliant UL/CSA Approved, CE, C-TICK Conformance with 8 way modular (RJ45) jack requirements according to IEC-60603-7 series and TIA/EIA-968-A (FCC 68.500) Alternate power source to comply with AC/DC desktop power supply brick
<b>Alternate Input Power:</b>	
<b>Minimum requirements:</b>	
<b>Input Voltage:</b>	100-240VAC, 50-60Hz, 0.5A
<b>Output Voltage:</b>	48VDC, 0.4A

ELECTRICAL	FUNCTION	UNIT	NOTES
<b>Input Voltage:</b>	36 - 56	Volts	PoE 37.5 - 56V
<b>Input Current:</b>	.200	Amps	Max current at 36V input
<b>Output Voltage:</b>	3.3VDC +/- 5%	Volts	
<b>Output Current:</b>	3.5	Amps	Max Continuous
<b>Efficiency:</b>	85	%	Peak Efficiency @48V input
<b>Transition time PoE to AUX:</b>	Seamless	Sec	
<b>Transition time AUX to PoE:</b>	<30	Sec	Depends on PoE Power Supply
<b>PoE Classification:</b>	Class 0		

<b>Q2324 PHYSICAL:</b>	
<b>Rack Mounting:</b>	44.5 mm x 1.75 mm (19" x 1RU)

<b>Q2348 PHYSICAL:</b>	
<b>Rack Mounting:</b>	88.9 mm, x 3.50 mm (19" x 2RU)

<b>ENVIRONMENTAL:</b>	
<b>Operating temperature:</b>	-40° to 70° C (104 to 158° F)
<b>Number of plug insertions:</b>	≥750 (IEC/EN 60603-7)

<b>DIAMETER RANGE:</b>	
<b>Solid and stranded copper conductors:</b>	26 AWG to 22 AWG (0.4 mm dia to 0.6 mm dia) solid core cable and 24 AWG stranded cable.
<b>Wire insulation diameter range:</b>	1.04 mm to 1.60 mm (0.041" x 0.063")
<b>Insulation resistance:</b>	at 40° C and 93% RH ≥500 MΩ
<b>Contact resistance:</b>	≤1 mΩ typical
<b>Contact re-terminations:</b>	≥200

<b>COMPLIANCE :</b>	
	UL/CSA Approved, CE, A-TICK UL 94 V-0 UL186 RoHS compliant Performance to ANSI/TIA-568-C.2 and ISO 11801, Edition 2 for Category 6/Class E and Category 6a/Class EA. Independently certified. RJ socket, 8 positions FCC Part (IEC 60603-7)

# Managed Connectivity

Quareo

## Managed Copper Cables

Impedance-matched for use in Quareo structured cabling systems, these managed cables exceed all performance requirements for Category 6 (CAT 6) and Augmented Category 6A (CAT 6A). The plug is designed with integrated strain relievers that prevent the cable from moving at the termination point when the cable is flexed, safeguarding circuit integrity and guaranteeing maximum performance. The strain relievers also ensure that proper bend radii are maintained throughout the network.



### FEATURES

- Quareo technology with connection point identification
- Connector interface: plug type RJ45 shielded/unshielded that conforms to 8 way modular RJ45 jack in accordance with IEC 60603-7 series and TIA/EIA-968-A
- Latch type: snagless
- Boot: flexible with built in strain relief to maintain proper bend radius
- Wiring configuration: T568A, T568B and T568A – T568B (cross-over)

### ELECTRICAL

ANSI/TIA-568-C.2 and ISO 11801, Edition 2 for Category 6/Class E and Category 6A/Class EA  
Category 5e, 5 and 3 backward compatible

### ENVIRONMENTAL

Controlled Environment

GR-63, Section 4.1.2

Operating Temperature:

-10° C to +60° C

Storage Temperature:

-0° C to +50° C

Relative Humidity:

5% to 90% non-condensing

Relative Humidity:

5% to 95% non-condensing

### COMPLIANCE

UL 94 V-0

TICK N355

C(UL)us 49S3

CE

RoHS and IEEE 2002/95/EC Directive on the restriction of the use of certain hazardous substances in electrical and electronic equipment

MANAGED CONNECTIVITY

Product Description	Available Colors Replace XX	Available Lengths Replace YY			Part Number	
Category 6 U/UTP managed copper cable	BK = Black	04'	15'	PVC	T568A	QCPC-6RUVA-XXYYF
	BL = Blue	07'	25'		T568B	QCPC-6RUVB-XXYYF
	GN = Green	10'	50		Crossover	QCPC-6RUVX-XXYYF
	OR = Orange	01 m	02 m	LSZH	T568A	QCPC-6RUZA-XXYYM
	RD = Red	03 m	05 m		T568B	QCPC-6RUZB-XXYYM
	GY = Gray	7.5 m			Crossover	QCPC-6RUZX-XXYYM
	VT = Violet					
Category 6A U/UTP managed copper cable	WT = White			PVC	T568A	QCPC-6ARUVA-XXYYF
	YL = Yellow				T568B	QCPC-6ARUVB-XXYYF
					Crossover	QCPC-6ARUVX-XXYYF
				LSZH	T568A	QCPC-6ARUZA-XXYYM
					T568B	QCPC-6ARUZB-XXYYM
					Crossover	QCPC-6ARUZX-XXYYM
Category 6A F/UTP managed copper cable	BL = Blue	04'	15'	PVC	T568A	QCPC-6ARFVA-XXYYF
	GY = Gray	07'	25'		T568A	QCPC-6ARFVB-XXYYF
	WT = White	10'	50'		Crossover	QCPC-6ARFVX-XXYYF



## Cable Management

Fiber Cable Raceway FiberGuide .....	6-3
Equipment Racks.....	6-18
Horizontal and Vertical Cable Management .....	6-19
Cable Management Accessories .....	6-21

A cluttered cabling infrastructure is not an efficient one. Planning, mapping-out and meticulously managing your network is your best option to increase up-time and make moves, adds and changes easier. Our copper and fiber optic cabling, cable management systems, patch panels and enclosures help create reliable, high-speed data center connectivity even given limited space requirements. TE offers unique solutions for your tight spaces. From our fiber cable raceway systems and horizontal and vertical cable management options to equipment racks and accessories, TE has a cable management option for you.







# Cable Management

## Fiber Cable Raceway FiberGuide

### Fiber Cable Raceway FiberGuide Systems

TE's Fiber management systems offer the greatest breadth of optical raceway products in the industry. In response to customer requirements, TE continues to innovate and improve FiberGuide systems, adding greater flexibility and driving down installation time to ensure a smooth deployment.

FiberGuide is a raceway system designed to protect and route fiber optic patch cords, multi-fiber cable assemblies and intrafacility fiber cable (IFC) to and from fiber splice enclosures, fiber distribution frames and fiber optic terminal devices. FiberGuide ensures a two-inch minimum bend radius is maintained throughout the system. Tool-less, Snap-Fit junctions, cover options and Plenum Express Exit drops significantly reduce the amount of time required for installation.

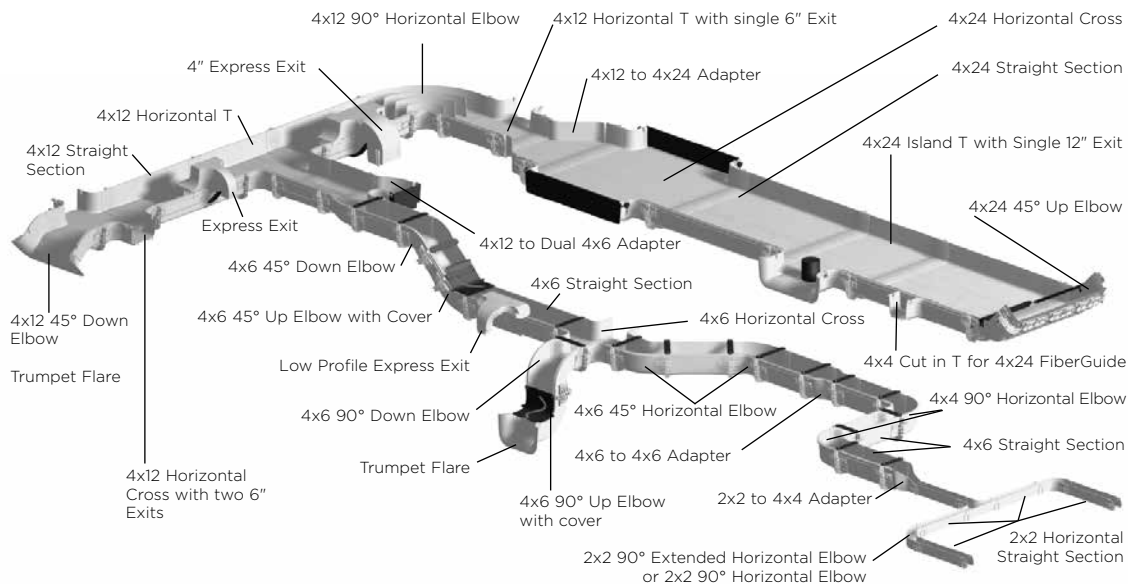

#### FEATURES

- Speed of Installation
  - FiberGuide systems feature a variety of products that allow for quick and easy installation. Express Exit drops as well as tool-less products including Snap-Fit junctions, snap-on covers and new hinged cover options save valuable time for installers
- Speed of Deployment
  - The Express Exit system enables new drops to be added or removed quickly and easily. A drop can be added into a fully loaded raceway in seconds – without cutting
- Raceway Flexibility
  - FiberGuide features 38 support structures, over 75 fittings, multiple drop options and several other components to suit any application you create
- Fiber Protection
  - TE's fiber expertise translates into maximum protection for your network. Two inch minimum bend radius is maintained throughout the system regardless of the raceway size
- Strength and Durability
  - 100% raceway reliability – stands up to any challenge

# Cable Management

## Fiber Cable Raceway FiberGuide

### Express Exits Units

(For use with 4x4, 4x6, 4x12 and 4x24 systems)

#### ORDERING INFORMATION

Description for Black Fiber Guide	Part Number
2" Express Exit Unit	FGSB-MEXP-A/B/F
4" Express Exit base with base cover	FGSB-MEXP-E-A/B/F
4" Express Exit rear cover kit	FGSB-MEXC-E-A/B/F
Rear cover, 4" Express Exit—4x4 system	FGSB-MEXC-E-A
Rear cover, 4" Express Exit—4x6 system	FGSB-MEXC-E-B
Rear cover, 4" Express Exit—4x12 system	FGSB-MEXC-E-F
Low profile Express Exit	FGSB-MEXP-LP-A/B/F



Express Exit

### 2x2 Fittings and Junctions

#### ORDERING INFORMATION

Description	Part Number
2x2 horizontal cross with cover	FGSB-MHXP-C
2x2 horizontal tee with cover	FGSB-MHTA-C
2x2 45° horizontal elbow with cover	FGSB-MH4A-C
2x2 90° horizontal elbow with cover	FGSB-MH9A-C
2x2 to 4" straight adapter with cover	FGSB-MDSA-AC
2x2 end cap kit (includes junction)	FGS-HMEC-C
2x2 45° up elbow with cover	FGSB-MU4A-C
2x2 45° down elbow with cover	FGSB-MD4A-C
2x2 90° up elbow with cover	FGSB-MU9A-C
2x2 90° down elbow with cover	FGSB-MD9A-C
2x2 junction	FGSB-MJWR-C



Horizontal Tee With Cover  
FGSB-MHTA-C

### 2x2 Straight Section

#### ORDERING INFORMATION

Description	Part Number
2x2 horizontal straight section with cover (6')	FGSB-MSHA-C



Horizontal Straight Section With Cover  
FGSB-MSHA-C

# Cable Management

## Fiber Cable Raceway FiberGuide

### 2x2 Downspout Options

#### ORDERING INFORMATION

Description	Part Number
2x2 standard downspout with cover	FGSB-MSDS-C
2x2 extended downspout with cover	FGSB-MDSP-C
2x2 flex tube attachment with 5' length 2" flex tube and 2x2 junction	FGSB-MEX1-C-5F
2x2 extended downspout kit with 2' length 2" flex tube and cover	FGSB-KDH2-C
Dual 7/8" flex tube attachment with (2) 5' lengths flex tube and 2x2 junction	FGSB-KT03-C
Kit of ten 7/8" flex tube clamps	FGS-HSHS-C



**Standard Downspout With Cover**  
FGSB-MSDS-C

### 2x2 Direct Support Kits

#### ORDERING INFORMATION

Description	Part Number
2x2 ladder rack support kit	FGS-HLR2-C
2x2 bay top short L bracket kit	FGS-BTBS-C
2x2 bay top long L bracket kit	FGS-BTBL-C
2x2 digital cableway support kit	FGS-HDCB-C
2x2 underfloor support kit	FGS-HUFB-C

### 2x2 Track Support Kits

#### ORDERING INFORMATION

Description	Part Number
2x2 aluminum track support kit (6')	FGS-HASK-C
New threaded rod kit (5/8")	FGS-HTR2-5/8
New threaded rod kit (1/2")	FGS-HTR2-1/2
2x2 track connecting bar kit	FGS-HAEJ-C
Ladder rack bracket kit (5/8")	FGS-HLDR-5/8
Threaded rod 12" long	FGS-HTHR-5/8-12
Dual threaded rod bracket kit	FGS-HTUB-2-AB

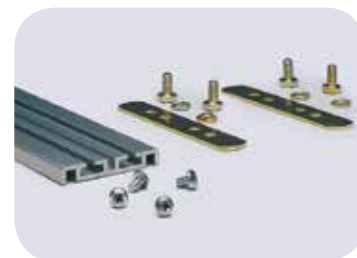

**2x2 Aluminum Track Support Kit**  
FGS-HASK-C

# Cable Management

## Fiber Cable Raceway FiberGuide

### 2x6 Fittings

#### ORDERING INFORMATION

Description	Part Number
2x6 to 2x2 downspout	FGSB-MDSP-G
2x6 horizontal T	FGSB-MHRT-G
2x6 horizontal cross	FGSB-MHXP-G
2x6 90° horizontal elbow	FGSB-MH9E-G
2x6 90° down elbow	FGSB-MD9E-G
2x6 45° horizontal elbow	FGSB-MH4E-G
2x6 45° up elbow with cover	FGSB-MU4E-G
2x6 45° down elbow	FGSB-MD4E-G
2x6 to 4x4 adapter	FGSB-MDSA-GA
2x6 to 4x6 adapter	FGSB-MDSA-GB
2x6 trumpet flare	FGSB-MTRM-G
2x6 end cap	FGS-HMEC-G1
2x6 Express Exit	FGSB-MEXP-LP-G



**Horizontal Elbow**  
FGSB-MH9E-G

### 2x6 Straight Section

#### ORDERING INFORMATION

Description	Part Number	
2x6 horizontal straight section	6'	FGSB-MSHS-G
	Hinged cover	FGSB-MSNC-B/G
2x6 junction	FGSB-JUNC-G	



# Cable Management

## Fiber Cable Raceway FiberGuide

### 4x4 Fittings and Junctions

#### ORDERING INFORMATION

Description	Part Number
4x4 downspout	FGSB-MDSP-A
4x4 and 4x6 downspout cover	FGSB-MCDS-AB
4x4 extended downspout	FGSB-MDSP-EX-A
4x4 and 4x6 extended downspout cover	FGSB-MCDS-EX-AB
4x4 horizontal T	FGSB-MHRT-A
4x4 horizontal T cover	FGSB-SHRT-A
4x4 horizontal cross	FGSB-MHXP-A
4x4 horizontal cross cover	FGSB-SHXP-A
4x4 90° horizontal elbow	FGSB-MH9E-A
4x4 90° horizontal elbow cover	FGSB-SH9E-A
4x4 45° horizontal elbow	FGSB-MH4E-A
4x4 45° horizontal elbow cover	FGSB-SH4E-A
4x4 90° up elbow with cover	FGSB-MU9E-A
4x4 90° down elbow	FGSB-MD9E-A
4x4 90° down elbow cover	FGSB-SD9E-A
4x4 45° up elbow with cover	FGSB-MU4E-A
4x4 45° down elbow	FGSB-MD4E-A
4x4 45° down elbow cover	FGSB-SD4E-A
4x4 to 4x6 straight adapter	FGSB-MDSA-AB
4x4 to 4x6 straight adapter cover	FGSB-SDSA-AB
4x4 end cap	FGS-HMEC-A
4x4 Snap-Fit junction	FGSB-MFAW-A
4x4 cut-in T	FGSB-MHIS-A
Cut-in T fixture	FGS-MHIS-JIG-A/B/F
4x4 IFC tie bracket	FGS-HIFC-A



**4x4 Snap-Fit Junction**  
FGSB-MFAW-A



**Horizontal Cross**  
FGSB-MHXP-A



**90° Down Elbow**  
FGSB-MD9E-A



**45° Horizontal Elbow**  
FGSB-MH4E-A

### 4x4 Straight Section

#### ORDERING INFORMATION

Description	Part Number
4x4 horizontal straight section (6')	FGSB-MSHS-A
4x4 horizontal straight section hinged cover (6')	FGSB-MSHC-A
4x4 expandable straight section	FGSB-MVAR-A



**Horizontal Elbow**  
FGSB-MSHS-A

# Cable Management

## Fiber Cable Raceway FiberGuide

### 4x4 and 4x6 Downspout Options

#### ORDERING INFORMATION

Description	Part Number
4x4 downspout junction kit	FGSB-MJWR-A
2x2 flex tube attachment with 5' length 2" flex tube and 2x2 junction	FGSB-MEX1-C-5F
4x4/4x6 downspout insert (adapts to 2x2 system)	FGS-HDSI-AB
4x4 trumpet flare kit	FGSB-MTRM-A
4" square to 2" round adapter with 5' flex tubing	FGSB-ASRI-5F
4" square to 2" round adapter with 10' flex tubing	FGSB-ASRI-10F
4" square to 2" round adapter with 15' flex tubing	FGSB-ASRI-15F
4x4 single flex tube attachment with (1) 5' length 2" flex tubing	FGSB-KT03-A1
4x4 dual flex tube attachment with (2) 5' lengths 2" flex tubing	FGSB-KT03-A



**Trumpet Flare Kit**  
FGSB-MTRM-A

### 2x6, 4x4 and 4x6 Support Kits

#### ORDERING INFORMATION

Description	Part Number
New threaded rod bracket (5/8")	FGS-HNTR-5/8
New threaded rod bracket (1/2")	FGS-HNTR-1/2
Modified new threaded rod bracket (5/8")	FGS-HNTR-5/8-A
Existing threaded rod bracket (5/8")	FGS-HETR-5/8
Existing threaded rod bracket (1/2")	FGS-HETR-1/2
Modified existing threaded rod bracket (5/8")	FGS-HETR-5/8-A
Center support bracket (5/8")	FGS-HTUB-5/8
Center support bracket (1/2")	FGS-HTUB-1/2
L bay support bracket	FGS-HLBK
Digital cableway bracket kit (12")	FGS-HCBL-12
Digital cableway bracket kit (15")	FGS-HCBL-15
Top support C-bracket	FGS-HNTS-5/8
Top support low profile C-bracket	FGS-HNTS-5/8-LP
Ladder rack center support bracket kit	FGS-HNLR-AB
Threaded rod, 5/8-11x12"	FGS-HTHR-5/8-12
Threaded rod, 5/8-11x30"	FGS-HTHR-5/8-30
Threaded rod, 5/8-11x72"	FGS-HTHR-5/8-30
Auxiliary framing clip kit 5/8-11 thread	FGS-HTHR-5/8-72
Auxiliary framing clip kit 1/2-11 thread	FGS-HFCK-5/8
Adjacent angle support bracket 5/8-11/36"	FGS-HFCK-1/2
Adjacent angle support bracket 5/8-11/48"	FGS-HASB-5/8-36
Adjacent angle support bracket 1/2-13/36"	FGS-HASB-5/8-48
Adjacent angle support bracket 1/2-13/36"	FGS-HASB-1/2-36
Adjacent angle support bracket 1/2-13/48"	FGS-HASB-1/2-48
Ladder rack bracket kit (5/8")	FGS-HLDR-5/8
Unistrut nut kit (5/8")	FGS-HDGR



**FGSB-MTRM-A with  
FGSB-MSHS-A**

# Cable Management

## Fiber Cable Raceway FiberGuide

### 4x6 Fittings and Junctions

#### ORDERING INFORMATION

Description	Part Number
4x6 downspout	FGSB-MDSP-B
4x4/4x6 downspout cover	FGSB-MCDS-AB
4x6 extended downspout	FGSB-MDSP-EX-B
4x4/4x6 extended downspout cover	FGSB-MCDS-EX-AB <sup>1</sup>
4x6 horizontal T	FGSB-MHRT-B
4x6 horizontal T cover	FGSB-SHRT-B
4x6 horizontal cross	FGSB-MHXP-B
4x6 horizontal cross cover	FGSB-SHXP-B
4x6 90° horizontal elbow	FGSB-MH9E-B
4x6 90° horizontal elbow cover	FGSB-SH9E-B
4x6 45° horizontal elbow	FGSB-MH4E-B
4x6 45° horizontal elbow cover	FGSB-SH4E-B
4x6 45° up elbow with cover	FGSB-MU4E-B
4x6 45° down elbow	FGSB-MU4E-B
4x6 45° down elbow cover	FGSB-MD4E-B
4x6 90° down elbow	FGSB-SD4E-B
4x6 90° down elbow cover	FGSB-MD9E-B
4x6 90° up elbow with cover	FGSB-SD9E-B
4x6 cut-in T	FGSB-MHIS-B
Cut-in T fixture	FGS-MHIS-JIG-A/B/F
4x6 trumpet flare kit	FGSB-MTRM-B
4x6 end cap	FGS-HMEC-B
4x6 Snap-Fit junction	FGSB-MFAW-B
4x6 IFC tie bracket	FGS-HIFC-B

<sup>1</sup>Dual downspout requires 2 covers.



**4x6 Trumpet Flare Kit**  
FGSB-MTRM-B



**4x6 90° Horizontal Elbow**  
FGSB-MH9E-B



**4x6 Snap-Fit Junction**  
FGSB-MFAW-B

### 4x6 Straight Section

#### ORDERING INFORMATION

Description	Part Number
6' horizontal straight section	FGSB-MSHS-B
6' horizontal straight section hinged cover	FGSB-MSHC-B
4x6 expandable straight section	FGSB-MVAR-B



**6' Horizontal Straight Section**  
FGS-MSHS-B

# Cable Management

## Fiber Cable Raceway FiberGuide

### 4x12 Fittings

#### ORDERING INFORMATION

Description	Part Number
4x12 horizontal T	FGSB-MHRT-F
4x12 to 4x6 horizontal T	FGSB-MHRT-F/B
4x12 horizontal cross	FGSB-MHXP-F
4x12 to 4x6 horizontal cross	FGSB-MHXP-B/F
4x12 to 4x6 adapter	FGSB-MDSA-FB
4x12 90° horizontal elbow	FGSB-MH9E-F
4x12 45° horizontal elbow	FGSB-MH4E-F
4x12 end cap	FGS-HMEC-F
4x12 cut-in T	FGSB-MHIS-F
Cut-in T fixture	FGS-MHIS-JIG-A/B/F1
4x12 45° up elbow with cover	FGSB-MU4E-F
4x12 45° down elbow	FGSB-MD4E-F
4x12 90° down elbow	FGSB-MD9E-F
4x12 trumpet flare kit	FGSB-MTRM-F
4x12 downspout with 4x6 exit	FGSB-MDSP-F
4x12 downspout with rear T	FGSB-MDRT-F
4x12 to dual 4x6 adapter	FGSB-MDSA-F2B
4x12 IFC tie bracket	FGS-HIFC-F

Note: Covers are available for 4x12 fittings. Please contact TE or visit [www.TE.com/EnterpriseNetworks](http://www.TE.com/EnterpriseNetworks)



**4x12 to 4x6 Adapter**  
FGSB-MDSA-FB



**4x12 Trumpet Flare Kit**  
FGSB-MTRM-F



**Downspout With 4X6 Exit**

### 4x12 Straight Section

#### ORDERING INFORMATION

Description	Part Number
6' horizontal straight section	FGSB-MSHS-F
4x12 expandable straight section	FGSB-MVAR-F
6' hinged cover	FGSB-MSNC-F



**FGSB-MH9E-F**



**6' Horizontal Straight Section**  
FGSB-MSHS-F

### 4x12 Junction

#### ORDERING INFORMATION

Description	Part Number
4x12 snap fit junction	FGSB-MFAW-F



**4x12 Snap Fit Junction**  
FGSB-MFAW-F



# Cable Management

## Fiber Cable Raceway FiberGuide

### 4x12 System Support Kits

#### ORDERING INFORMATION

Description	Part Number
New threaded rod bracket ( $\frac{5}{8}$ "	FGS-HNTR-F-5/8
Existing threaded rod bracket ( $\frac{5}{8}$ "	FGS-HETR-F-5/8
Top support threaded rod bracket kit	FGS-HNTS-F-5/8
Top support low profile threaded rod bracket kit	FGS-HNTS-F-5/8-LP
Trapeze bracket kit	FGS-HNTP-F-5/8
Ladder rack center support bracket kit	FGS-HNLR-F



### Vertical Duct Systems

#### ORDERING INFORMATION

Description	Part Number
2x2 vertical slotted duct kit, 6'	FGSB-KTW1-C
2x2 vertical 1.5-inch slotted duct kit, 6'	FGSB-KTW1-CA
2x2 vertical solid duct	FGSB-KTW4-C
1x2 vertical duct kit	FGSB-KTW1-E
1x2 solid vertical duct kit	FGSB-KTW4-E
2x2 vertical to 1x2 vertical adapter bracket	FGSB-ACC063
2x2 vertical slotted duct, 6'	FGSB-MSHS-C
2x2 vertical 1.5" slotted duct, 6'	FGSB-MSHS-CA
Cover for 2x2 vertical duct, 6'	FGSB-MSHC-C
2x2 vertical duct mounting bracket	FGS-HWMB-C
4x4 vertical duct kit	FGSB-KTW2-D
4x4 vertical adapter junction kit	FGSB-MJWR-D
4x4 vertical slotted duct, 6'	FGSB-MSHS-D
Cover for 4x4 vertical duct, 6'	FGSB-MSHC-D
4x4 vertical duct mounting bracket	FGS-HWMB-D



**2X2 Vertical Slotted Duct, 6'**  
FGSB-MSHS-C

# Cable Management

## Fiber Cable Raceway FiberGuide

### Fiber Cable Raceway Accessories

#### ORDERING INFORMATION

Description	Part Number
<b>Flex Tubing</b>	
2" outer diameter slotted flex tube, 5'	FGSB-MIDY-5F
2" outer diameter slotted flex tube, 10'	FGSB-MIDY-10F
2" outer diameter slotted flex tube, 15'	FGSB-MIDY-15F
1" outer diameter slotted flex tube, 100'	FGSB-MLDY-100F
1" outer diameter slotted flex tube, 150'	FGSB-MLDY-150F
1" outer diameter slotted flex tube, 200'	FGSB-MLDY-200F
1" outer diameter slotted flex tube, 250'	FGSB-MLDY-250F
7/8" outer diameter slotted flex tube, 5'	FGSB-MFTY-5F
7/8" outer diameter slotted flex tube, 10'	FGSB-MFTY-10F
7/8" outer diameter slotted flex tube, 15'	FGSB-MFTY-15F
7/8" outer diameter slotted flex tube, 200'	FGSB-MFTY-200F
<b>Accessories</b>	
Hinge kit for 4x4 and 4x6 covers (kit of 1)	FGS-HHGK
Self-closing hinge (kit of 3)	FGS-HVHG
Retainer rings (kit of 10)	FGS-HFRR-10
Trough cover clip kit	FGS-KT09
Mitre box and saw	FGS-MKIT-ABF
Quick knobs (10)	FGS-KQKB
Quick knobs (100)	FGS-HQKK
Flex tube clamps (kit of 10)	FGS-HHEC-10



**2" Outer Diameter Slotted Flex Tube**  
(FGS-MIDY)



**7/8" Outer Diameter Slotted Flex Tube**  
(FGS-MFTY)



**Retainer Rings**  
(FGS-HFRR-101)



**Flex Tube Clamp**  
(FGS-HHEC-101)



**Quick-Knobs - Kit of 10**  
(FGS-KQKB)

# Cable Management

## Fiber Cable Raceway FiberGuide

### 4x24 System – Straight Section

The unique double wall channel design of the 4x24 straight section provides exceptional strength and durability for high fiber count applications and allows the standard system to be attached to the support structure without the need to cut or drill any holes within the trough. The six channel design ensures that the patch cords will not come in contact with any screw heads or bolts, an important consideration in 4x24 systems where higher cable counts apply increased pressure on patch cords at the bottom of the trough.



**4x24 straight section**  
(FGSB-MSHS-H)

#### ORDERING INFORMATION

Description	Part Number
4x24 straight section; horizontal straight section, 6' long	FGSB-MSHS-H

### 4x24 Snap-Fit Junction

The Snap-Fit junction assembly is available for the 24" FiberGuide system. The Snap-Fit junction is a completely tool-less junction. No additional tools are required for installation or removal. The junction exhibits superior holding force and accommodates support brackets. A warning label is included with each junction kit.



**4x24 Snap-Fit junction**  
(FGSB-MFAW-H)

#### ORDERING INFORMATION

Description	Part Number
4x24 Snap-Fit junction	FGSB-MFAW-H



# Cable Management

## Fiber Cable Raceway FiberGuide

### 4x24 System Fittings – 4" H x 24" W

#### ORDERING INFORMATION

Description	Part Number
<b>4x24 fittings</b>	
45° horizontal elbow	FGSB-MH4E-H
Horizontal T with single 12" exit	FGSB-MHRT-H/F
Horizontal T with three 24" exits	FGSB-MHRT-H
Horizontal cross	FGSB-MHXP-H
Horizontal cross with dual 12" exits	FGSB-MHXP-F/H
45° up elbow	FGSB-MU4E-H
45° down elbow	FGSB-MD4E-H
<b>4x24 conversions</b>	
12" cut-in T for 4x24 <sup>1</sup>	FGSB-MHIS-F/H
6" cut-in T for 4x24 <sup>1</sup>	FGSB-MHIS-B/H
4" cut-in T for 4x24 <sup>1</sup>	FGSB-MHIS-A/H
4x24 to 4x12 adapter	FGSB-MDSA-HF
<b>4x24 end cap</b>	FGS-HMEC-H

<sup>1</sup> Designed exclusively for the 4x24" system



**End Cap**  
(FGS-HMEC-H)

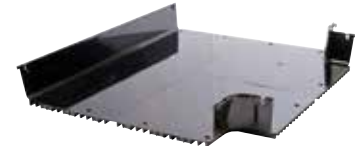

**Horizontal T with Three 24" Exits**  
(FGSB-MHRT-H)



**4x24 to 4x12 Adapter**  
(FGSB-MDSA-HF)

### 4x24 System Downspouts – 4" H x 24" W

4x24 downspouts and attachments feed fiber from overhead straight sections into fiber optic equipment below.

#### ORDERING INFORMATION

Description	Part Number
Island T with single 12" exit	FGSB-ISLAND-H/F
Trumpet flare	FGS-MTRM-H



**Trumpet Flare**  
(FGS-MTRM-H)

# Cable Management

## Fiber Cable Raceway FiberGuide

### 4x24 System Support Kits

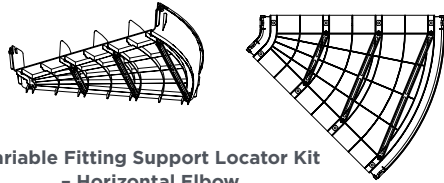

**Variable Fitting Support Locator Kit - Horizontal Elbow**  
(FGS-MH4E-H-VS)

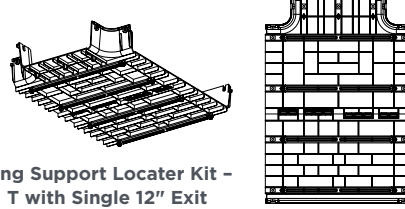

**Variable Fitting Support Locator Kit - Horizontal T with Single 12" Exit**  
(FGS-MHRT-H/F-VS)

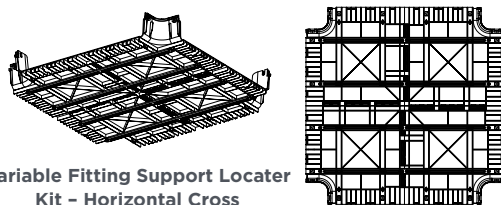

**Variable Fitting Support Locator Kit - Horizontal Cross**  
(FGS-MHXP-H-VS)

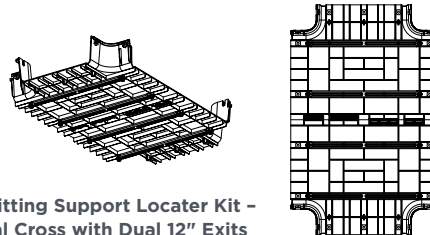

**Variable Fitting Support Locator Kit - Horizontal Cross with Dual 12" Exits**  
(FGS-MHXP-F/H-VS)

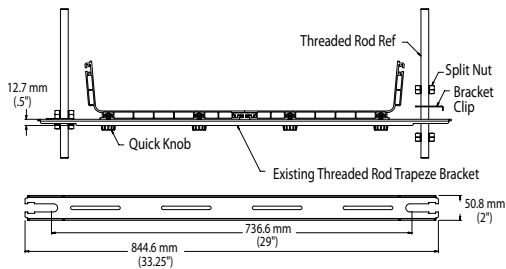

**Existing 5/8" Threaded Rod Trapeze Bracket Kit**  
(FGS- HETP-H-5/8)

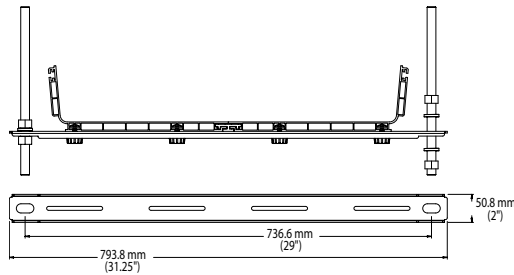

**New 5/8" Threaded Rod Trapeze Bracket Kit**  
(FGS-HNTP-H-5/8)

### ORDERING INFORMATION

Description	Part Number
<b>4x24 System Support Kits</b>	
<b>Variable fitting support locator kit for</b>	
Horizontal elbow	FGS-MH4E-H-VS
Horizontal T with single 12" exit	FGS-MHRT-H/F-VS
Horizontal cross	FGS-MHXP-H-VS
Horizontal cross with dual 12" exits	FGS-MHXP-F/H-VS
<b>Threaded rod trapeze bracket kit for</b>	
Existing; 5/8"	FGS-HETP-H-5/8
New; 5/8"	FGS-HNTP-H-5/8

# Cable Management

## Fiber Cable Raceway FiberGuide

### RECOMMENDED • MAXIMUM DENSITY

Recommended capacity takes into consideration random patch cord placement into the FiberGuide system. Maximum density refers to the maximum number of fiber patch cords in a given cross-section of a FiberGuide installation. The TracerLight connector identification system is TE's newest patch cord solution. It features slightly different dimensions than standard patch cords.

### SPECIFICATIONS

1.7 mm Patch Cords (per in <sup>2</sup> )	2.0 mm Patch Cords (per in <sup>2</sup> )	3.0 mm Patch Cords (per in <sup>2</sup> )
120/142	90/102	40/44

### TROUGH PILEUP • RECOMMENDED/MAXIMUM DENSITY

	2-inch	3-inch	4-inch
<b>4x24 System</b>			
1.7 mm	5760/6816	8640/10224	11520/13632
2.0 mm	4320/4869	6480/7344	8640/9792
3.0 mm	1920/2112	2880/3168	3840/4224
<b>4x12 System</b>			
1.7 mm	2880/3408	4320/5112	5760/6816
2.0 mm	2160/2448	3240/3672	4320/4896
3.0 mm	960/960	1440/1584	1920/2112
<b>4x6 System</b>			
1.7 mm	1440/1704	2160/2556	2880/3408
2.0 mm	1080/1224	1620/1836	2160/2448
3.0 mm	480/528	720/792	960/1056
<b>4x4 System</b>			
1.7 mm	960/1136	1440/1704	1920/2272
2.0 mm	720/816	1080/1224	1440/1632
3.0 mm	320/352	480/528	640/704
<b>2x6 System</b>			
1.7 mm	1440/1740	-	-
2.0 mm	1080/1224	-	-
3.0 mm	480/528	-	-
<b>2x2 System</b>			
1.7 mm	480/568	-	-
2.0 mm	360/408	-	-
3.0 mm	160/176	-	-

# Cable Management

## Fiber Cable Raceway FiberGuide

### TRACERLIGHT PATCH CORDS—65 PATCH CORDS PER INCH

	2-inch	3-inch	4-inch
4x24 System	3120	4680	6420
4x12 System	1560	2340	3120
4x6 System	780	1170	1560
4x4 System	520	780	1040
2x6 System	780	-	-
2x2 System	260	-	-

### FiberGuide Materials Product Statement

The FiberGuide fiber management system is a UL-listed (E151158) general purpose fiber optic raceway system. All FiberGuide products are manufactured from flame-retardant materials. No FiberGuide system parts contain PVC. The table summarizes the fire-resistant properties of FiberGuide straight sections, molded parts and flex tube.

	Raw Material Meets UL Requirement	Finished Product Meets UL Requirement
FiberGuide Straight Sections (All FiberGuide Systems)	Flame rated: UL94V-0	UL94V-0 and UL2024
FiberGuide Molded Fittings (All FiberGuide Systems)	Flame rated: UL94V-0	UL94V-0 and UL2024
FiberGuide Flex Tube (2")	Flame rated: UL94V-0	UL2024
FiberGuide Flex Tube (1")	Flame rated: UL94V-0	UL2024
FiberGuide Flex Tube (7/8")	Flame rated: UL94V-2	UL2024

Note: FiberGuide flex tube complies with the National Electrical Code (NEC) Article 770-51 and Underwriters Laboratory UL2024 requirements for general purpose fiber optic raceways.

# Cable Management

## Equipment Racks

### Equipment Racks

TE Connectivity offers a variety of rack options with two and four post racks to support enterprise network solutions in today's modern IT infrastructure. All racks are designed of high quality materials and construction to meet TIA, EIA and IEEE requirements. Each rack features mounting hole patterns per EIA-310-E standards.

#### FEATURES

- Available in two and four post designs
- Made of 6061-T6 aluminum alloy
- Flat black powder coat finish
- Features pre-tapped #12-24 mounting holes
- Shipped unassembled with all components and instructions required to assemble a fully functional rack
- Feature double sided, EIA universal rails with 0.625" (16 mm), 0.625" (16 mm), 0.5" (13 mm) mounting spaces
- Three inch deep, two post rack features include:
  - Universal junction hole pattern
  - Conformance to EIA-310-E
- Two post, high capacity network equipment racks offer increased cable capacity over standard racks. Features include:
  - Large vertical cable duct for increased cable capacity and D-rings for out-of-the-box cable management
  - Large side cable pass-thru holes for rack-to-rack cabling
  - Adjustable waterfalls on top cable management trays
  - Top angles with pre-drilled mounting holes for runway attachment
  - Can be assembled for either 19" or 23" equipment
- Four post network equipment racks offer stability, accessibility and open cooling with industry standard features. Features include:
  - Nearly 360° of access - completely open to allow excess heat from equipment to quickly dissipate
  - Stamped, RMU (rack mount unit) markings conform to EIA-310-E

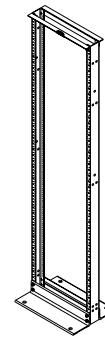

Figure A

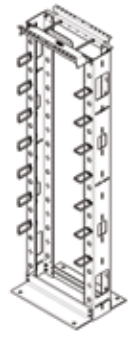

Figure B



Figure C

#### ORDERING INFORMATION

Description	Channel Depth	Width (inches)	Height RMU (inches)	Figure	Part Number
2 Post Rack	3"	19	45 (84)	A	1933559-1
2 Post Rack with Vertical Cable Management	6"	19 or 23	45 (84)	B	1933560-1
4 Post Rack	3"	19	45 (84)	C	1933570-1



# Cable Management

## Horizontal and Vertical Cable Management

### Stationary, Ventilated Shelf

#### FEATURES

- Ventilation slots easily allow air flow
- Requires 2RU (3.50")
- Fits standard 19-inch racks
- Includes fastening hardware

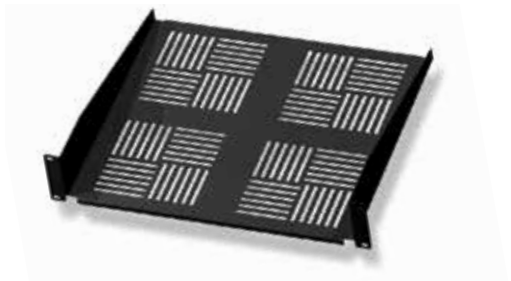

#### ORDERING INFORMATION

Description	Part Number
Stationary, Ventilated Shelf for Standard 19-inch Racks	1435049-1

### Horizontal High-Density Cable Management

#### FEATURES

- Snap-on removable hinged door remains open past 180°
- #12-24 mounting hardware is included
- Flat black powder coat aluminum with UL 94V-0 black plastic components
- Standard fingers are 5.5" deep



Single Sided



Double Sided

#### ORDERING INFORMATION

Rack Mount Units (Height)	Width	Finger Type	Part Number	
			Single Sided	Double Sided
1RU	19"	Standard Fingers	1933530-1	1933531-1
2RU	19"	Standard Fingers	1933532-1	1933533-1
		Extended Fingers	1933566-1	1933567-1
3RU	19"	Standard Fingers	1933561-1	1933562-1

# Cable Management

## Horizontal and Vertical Cable Management

### Double-Sided High-Density Vertical Cable Managers

#### FEATURES

- Standard fingers are spaced 1RU vertically and are 8.5" deep
- Gates have 9RU vertical spacing and are 8.5" deep
- Two-piece doors with snap on hinges allow for quick opening from either side or complete removal
- Six snap-on gates retain cables when doors are opened or removed
- Easy installation, can be done in minutes using standard hand tools
- Works with EIA-310-E compliant two and four post equipment racks using industry standard mounting holes
- 1/4" accessory mounting holes run the full height on both sides of cable manager to accommodate the attachment of cable management accessories
- Separator panel with pass through openings, vertical slots for attaching straps and keyhole slots for attaching spools, included with each manager
- Front and rear vertical sections can be spaced apart when mounting on racks deeper than 3" (76 mm)
- Flat black powder coat aluminum with UL 94V-0 black plastic components
- Vertical cable managers include:
  - Front and Rear vertical cabling section, (4) doors, (6) gates, (50) push-in fasteners, (12) cable strap mounts, Separator panel and mounting hardware
  - On 10" and 12" wide cable managers only: (2) spool kits are included



Figure A



Figure B

#### ORDERING INFORMATION

Description	Figure	Front/Rear Duct Type	Part Number		
			6"Width	10" Width	12" Width
High-Density Vertical Cable Manager, 84", Double-sided	A	Standard Fingers/ Standard Fingers	1933534-1	1933535-1	1933536-1
High-Density Combination Vertical Cable manager, 84", Double-sided	B	Standard Fingers/Gates	1933540-1	1933541-1	1933542-1

# Cable Management

## Cable Management Accessories

### High-Density Cable Management Accessories

#### FEATURES

- Replacement door kits:
  - Include an upper and lower door section
  - Are for use with high-density double-sided and double-sided combination vertical cable managers
- Finger brackets (Figure A):
  - High-density finger bracket mounts directly to a relay rack and provides cable support at each rack mounting unit
  - Fingers align with rack mounting units
  - Includes (1) finger bracket and mounting hardware
  - Flat black powder coat aluminum bracket with UL 94V-0 black plastic finger section
- Cable spools (Figure B):
  - Provide 1.1" (28 mm) bend radius
  - Cable spools attach quickly to keyhole slots provided in mounting channels and optional back covers
  - Facilitates storage and routing of cable
  - Unique spool kit design provides for vertical and horizontal adjustability to suit any need
  - Spool kits include (2) spools, mounting channels and hardware
  - Flat black powder coat steel with UL 94V-0 black plastic
- Fasteners (Figure C):
  - Used to quickly attach accessories to 1/4" (6 mm) mounting holes in cable manager
  - Can be easily removed for relocation
  - Standard pack: 100 pieces
  - Black plastic UL 94V-2
- Cable strap mounts (Figure D):
  - Provides attachment for cable straps up to 3/4" (19 mm) wide
  - Attach with push-in fastener 1933554-1 to 1/4" (6 mm) accessory mounting holes in cable manager
  - Standard pack: 100 pieces
  - Black plastic UL 94V-0

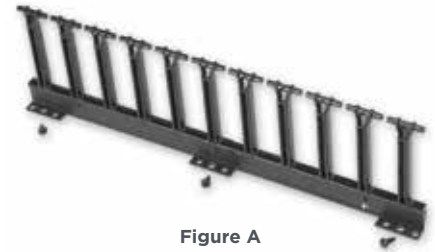

Figure A



Figure B



Figure C



Figure D

#### ORDERING INFORMATION

Description	Figure	Part Number		
		6" Width	10" Width	12" Width
Replacement Door Kits		1933556-1	1933557-1	1933558-1
		<b>Part Number</b>		
Finger Bracket	A	1933552-1		
Cable Spools	B	1933553-1		
Fasteners	C	1933554-1		
Cable Strap Mounts	D	1933555-1		

# Cable Management

## Cable Management Accessories

### Horizontal Finger Duct Panels and Accessories

#### FEATURES

- Cable management accessories for EIA standard 19-inch equipment racks
- Suitable for high-performance twisted pair and optical fiber distribution cables and patch cords
- Horizontal finger duct panels available in single and double-sided versions
- Extended covers bridge the gap between finger duct and vertical cable management



Figure A - Standard Cover



Figure B - Standard Cover

#### ORDERING INFORMATION

Description	Panel Height	Front (HxD)	Rear (HxD)	Figure	Part Number		
					Standard Covers	Extended Covers	
Cable Management Panel	Single Sided	1RU (1.75")	1.5" x 2"	-		1375161-1	1375161-2
			1.5" x 3"	-		1375162-1	1375162-2
		2RU (3.50")	3.0" x 3"	-	A	1375163-1	1375163-2
	Double Sided	1RU (1.75")	1.5" x 2"	1" x 4"		1375160-1	1375160-2
			1.5" x 3"	1" x 4"		1375159-1	1375159-2
		2RU (3.50")	3.0" x 3"	2" x 4"	B	1375158-1	1375158-2
Front Replacement Covers	1RU (1.75")	-	-		1479225-1	1479225-2	
	2RU (3.50")	-	-		1479222-1	1479222-2	
Rear Replacement Covers	1RU (1.75")	-	-		1479224-1	-	
	2RU (3.50")	-	-		1479223-1	-	

CABLE MANAGEMENT

### Vertical Finger Duct Panels

#### FEATURES

- Cable management accessories for EIA standard 19-inch equipment racks
- Suitable for high-performance twisted pair and optical fiber distribution cables and patch cords
- Vertical finger duct panels available in single and double-sided versions
- Center mount vertical finger duct panels mount between racks for added stability



Figure A



Figure B

#### ORDERING INFORMATION

Description	Mounting Position	Panel Height	Front (W x D)	Rear (W x D)	Figure	Part Number
Single-Sided	Side Mount	35"	4" x 5"		A	1375165-1
		78"	4" x 5"			1375258-1
	Center Mount	35"	4" x 5"		B	1375167-1
		78"	4" x 5"			1375260-1
Double-Sided	Side Mount	35"	4" x 5"	4" x 5"	A	1375164-1
		78"	4" x 5"	4" x 5"		1375257-1
	Center Mount	35"	4" x 5"	4" x 5"	B	1375166-1
		78"	4" x 5"	4" x 5"		1375259-1

# Cable Management

## Cable Management Accessories

### Hinged Wall Brackets for 19-Inch Panels

#### FEATURES

- Can be installed with hinges on either side for easier access
- Provided with cable tie laces to aid in dressing cables, have multiple threaded holes allowing more than one panel to be mounted on a bracket, and rear entry cable holes



Figure A

#### ORDERING INFORMATION

Panel Height	Depth	Figure	Part Number
1RU (1.75")	6"		558266-1
2RU (3.5")	6"	A	558267-1
3RU (5.25")	6"		558268-1
4RU (7.00")	6"		558269-1
6RU (10.50")	6"		2111279-1

### Hinged Patch Panel Accessories

#### FEATURES

- For use with standard patch panels for hinged application where access behind patch panel is limited
- Hinged feature allows patch panel to be folded down for easy access to the back of the panel, while snapping securely into place for normal use
- Cable management panels have special ring spacing for hinged applications
- Hinged panels may not be stacked adjacent to one another in a rack without a cable management panel with a 1/2" of empty space between them



Figure A



Figure B

#### ORDERING INFORMATION

Description	Rack Mount Units	Figure	Part Number
Patch Panel Hinge Kit	1RU (1.75")		1479582-1
	2RU (3.50")	A	1479402-1
Cable Management Panel for Hinged Patch Panels	1RU (1.75")		1479732-1
	2RU (3.50")	B	1479733-1



Open

Closed  
(Installed)

# Cable Management

## Cable Management Accessories

### Horizontal Ringed Cable Management Panels

#### FEATURES

- Panels mount to the front of 19-inch racks and provide for the orderly dressing and routing of cable assemblies
- Threaded studs on the back of the panels allow the installation of an optional Cable Support Bar (see this chapter)
- 2U (3.50") 569049-1 comes with cable clips

#### ORDERING INFORMATION

Description	Height	Figure	Part Number
1RU Panel	1.75"	A	558329-1
2RU Panel	3.50"	B	558331-1



Figure A



Figure B

### Rack Mount Cable Trough

#### FEATURES

- Light weight durable 11 AWG aluminum
- Fit standard 19-inch racks
- Top trough features:
  - Down-radiused cable exit to vertical cable management
  - Dimensions (overall): 4.20" H x 19.00" W x 3.75" D
  - Mounts in 1RU (1.75") of rack space
- Bottom/middle trough features:
  - Dimensions (overall): 5.22" H x 19.00" W x 3.75" D
  - Mounts in 3RU (5.25") of rack space
- Mounts to standard EIA hole pattern
- Provide cable management within the rack bay or multiple rack line-ups

#### ORDERING INFORMATION

Description	Figure	Part Numbers
Top Trough	A	559370-1
Bottom/Middle Trough	B	559369-1



Figure A



Figure B

# Cable Management

## Cable Management Accessories

### Grounding Lug Kit

#### FEATURES

- Use for grounding panels to locations other than rack
- Accommodates a maximum wire size of 6 AWG



#### ORDERING INFORMATION

Description	Part Number
Grounding Lug Kit	556438-1

### C-LOK, Solid and Stranded Copper Bonding Connectors

#### FEATURES

- Connects solid or stranded copper conductors in grounding applications
- Installs quickly and safely without special tools
- Meets requirements of: Telcordia TR-NWT-001075; UL Listed; Canadian Standards Association
- Search C-LOK connectors at [www.te.com/EnterpriseNetworks](http://www.te.com/EnterpriseNetworks) for additional information and part numbers



### Cable Support Bars

#### FEATURES

- Designed to provide additional cable support and routing control in the rear of 19-inch racks and panels
- Cable support bars that mount directly to rack provide the best support. Other bars are available for specialty application

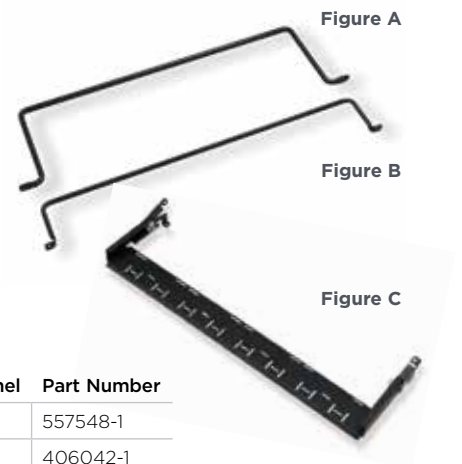

#### ORDERING INFORMATION

Mounting	Figure	Compatible with Panel	Part Number
Mounts to Back of Rack, 5" deep	A		557548-1
Mounts to Back of Rack, 2" deep	B		406042-1
Mounts to Back of Cable Management Panels		558329, 558331	558301-1
Mounts to Back of 110Connect and SL Series Patch Panels			1479860-1
Mounts to Back of 1RU XG and SL Series Multimedia Patch Panels	C		1933425-1

# Cable Management

## Cable Management Accessories

### MRJ21 Cable Support Bars

#### FEATURES

- Mounts to the back of 19-inch racks
- Designed to provide additional cable support and routing control behind 19-inch racks and panels
- MRJ21 slotted manager bar for easy tie down
- Horizontal and vertical mounting option for MRJ21 tie down bar

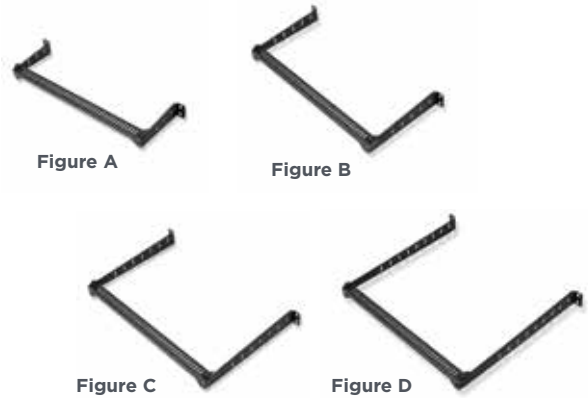

#### ORDERING INFORMATION

Description	Depth	Figure	Part Number
MRJ21 Cable Manager Bar	6"	A	1933352-1
	9"	B	1933352-2
	12"	C	1933352-3
	16"	D	1933352-4

### Termination Block Mounting Hardware

Mounting hardware is available for either wall or rack mount applications. Included is a full range of mounting system hardware and backboards, cable management hardware, mounting frames and support bars, as well as comprehensive fiber optic cable raceway systems for overhead and Plenum applications.

To better understand how the hardware can be utilized, the reference guide on this page gives appropriate use information. The icons shown within the reference chart represent the following equipment:



= Universal Mounting System (UMS)



= Type 105 Rod Mount Bracket



= Type 105 Back Mount Frame

#### FEATURES

- Various options provide flexibility
- Fit standard 19", 23" and 35.5" equipment racks
- Mounting hardware and backboards available for either wall or rack mounting
- Wire management built-in, or available as accessory

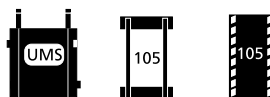

#### Block/Patch Panel

Ultim8 Block	•	•	•
Feed-Thru (FT) Block	•		



# Cable Management

## Cable Management Accessories

### Universal Mounting System (UMS)

The Universal Mounting System (UMS) accepts Ultim8, HighBand 10, 10-pair Series 2, and 25-pair FT (Feed-Thru) blocks and UMS/Mini patch panels. It is a rugged, low cost, versatile alternative to traditional mounting systems. Besides providing a sturdy, easy-to-install interlinking foundation, the UMS features built-in wire and cable management, and convenient add-ons.

The mounting brackets interlink left-to-right and top-to-bottom to provide a foundation that is easy to install and easy to expand. The brackets are suitable for both rack and wall mount installations.

For fast installation, use the push rivets provided with the UMS backboard to attach the UMS brackets to the backboards.



UMS In Type 105 position



UMS In Type 160 position

### ORDERING INFORMATION

Description	Dimensions (HxWxD)	Part Number
<b>UMS Basic Kit</b> Includes one pair of adjustable universal mounting brackets (holds up to 13 Ultim8 blocks and/or label holders), two horizontal wire managers, and appropriate screws and rivets. Typical installation holds 96 pairs using (12) 8-pair Ultim8 blocks (24-ports) and (1) Type 105 label holder. Kit mounts directly to a wall, or to an optional rack or wall mount backboard. Quantity: 1	14.75" x 8.25" x 5.25" (374.7 mm x 209.6 mm x 133.4 mm)	
UMS Basic Kit; Black		6657 2 165-40
UMS Basic Kit; Gray		6657 2 165-00

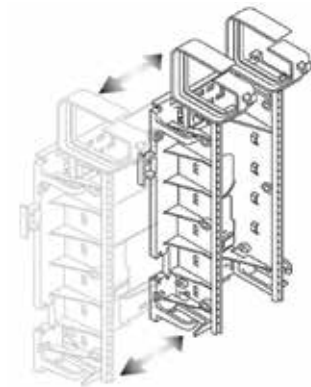

The UMS easily expands from the Type 105 position to the Type 160 position

# Cable Management

## Cable Management Accessories

### Universal Mounting System (UMS) Cable and Wire Managers

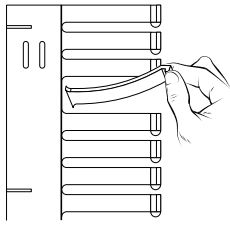

Individual ribs on the vertical cable manager remove to provide additional room for routing patch cords or cables.



Vertical cable manager

Connect here for  
Ultim8 blocks

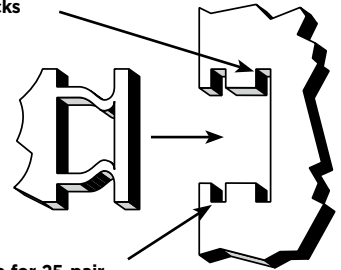

Connect here for 25-pair  
FT blocks

#### TECH TIP

When connecting two UMS brackets, use the inner slot for HighBand blocks or 10-pair Series 2 blocks (Type 105) and the outer slot for 25-pair FT blocks (Type 160).

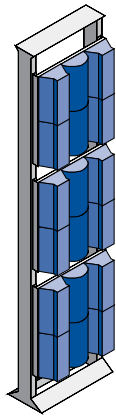

19" equipment rack with three dual height backboards, each holding four Type 105 Universal Mounting Brackets and two vertical cable managers (1,152 pairs or 288 ports).

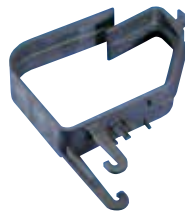

Horizontal wire manager

CABLE MANAGEMENT

### ORDERING INFORMATION

Description	Dimensions (HxWxD)	Part Number
<b>UMS Vertical Cable Manager</b> Same footprint as the universal mounting bracket in the Type 105 position; provides additional cable management for larger installations or for patch cords. Unique restraining-finger design ensures cables remain in the channel, even with the cover removed. Interlinking tabs, left-to-right and top-to-bottom, match interlinking tabs on the universal mounting bracket. Quantity: 1	11.88" x 8.25" x 5.25" (301.6 mm x 209.6 mm x 133.4 mm)	
UMS Vertical Cable Manager; Black		6657 2 005-44
UMS Vertical Cable Manager; Gray		6657 2 005-04
<b>Horizontal Wire Manager</b> Includes individual horizontal wire manager and two nylon rivets to lock manager in position on UMS bracket. Attaches to top or bottom of UMS bracket. Two managers are included with each UMS basic kit; additional managers are spares or provide wire management along the bottom of an installation. Quantity: 1	5.38" x 1" x 5" (136.5 mm x 25.4 mm x 127.0 mm)	
Horizontal Wire Manager; Black		6657 2 005-43
Horizontal Wire Manager; Gray		6657 2 005-03

# Cable Management

## Cable Management Accessories

### Universal Mounting System (UMS) Backboards

UMS backboards provide a base for UMS brackets, and are available in standard equipment rack widths. Each width is available in single or dual height, holding one or two rows of mounting brackets, respectively. Backboards are black and match UMS brackets and cable managers.

Backboards will hold combinations of mounting brackets in both Type 105 (Ultim8 and HighBand) and Type 160 (Feed-Thru) positions. Rotate backboards with mixed types 180° to reverse the order of mounting. Silk-screening identifies which holes to use in different mounting configurations.

Wall mount backboards provide the same mounting base as the rack mount backboards but provide a deeper channel. They stand four inches (rather than 1.5") off the wall to allow for proper cable routing. Silk screening indicates correct installation of the UMS adjustable mounting brackets.

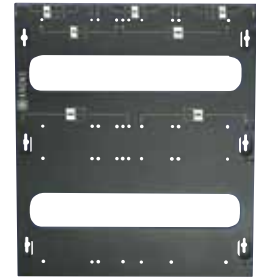

19" backboard, dual height

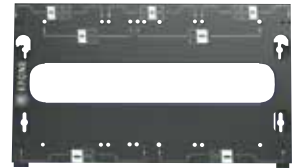

19" backboard, single height

### ORDERING INFORMATION

Description	Dimensions (HxWxD)	Rack	Wall	Part Number	
				Black	Grey
<b>UMS backboard</b> Backboards ship one to a package	11.5" x 19" x 1.5"	•		6652 2 080-19	6652 2 069-19
	23" x 19" x 1.5"	•		6652 2 081-19	6652 2 070-19
	11.5" x 19" x 4"	•	•	6652 2 082-19	6652 2 067-19
	23" x 19" x 4"	•	•	6652 2 083-19	6652 2 068-19
	11.5" x 23" x 1.5"	•		6652 2 080-23	6652 2 069-23
	23" x 23" x 1.5"	•		6652 2 081-23	6652 2 070-23

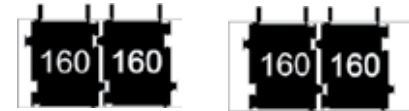
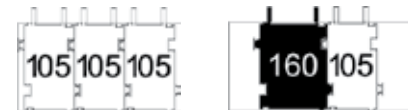

19" configurations

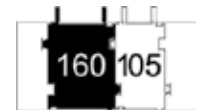

23" configurations

# Cable Management

## Cable Management Accessories

### Universal Mounting System (UMS) High Volume Cable Managers

For larger installations, the high volume cable manager provides greater capacity and strength than horizontal wire managers that attach directly to UMS brackets.

Available in widths to match standard equipment racks, the high volume cable manager can be either rack or wall mounted. The manager includes a back mounting plate and a set of 6" by 6" rings. The number and position of rings vary to allow use of the manager with a variety of UMS configurations. Mounting holes across the face of the mounting plate allow the position of rings to change to match the varying widths of UMS brackets in either Type 105 or Type 160 positions.

Designed as a companion to the universal mounting system, the high volume cable manager works in any application.

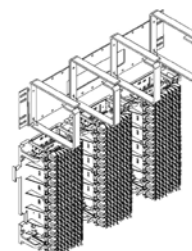

**19" high volume cable manager with 4 rings,**  
shown mounted above 3 Type 105 mounting brackets

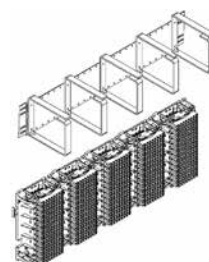

**35.5" high volume cable manager with 5 rings,**  
shown mounted above 5 Type 105 mounting brackets



**35.5" cable manager with 6 rings**



**19" cable manager with 3 rings**

### ORDERING INFORMATION

Description	Dimensions (HxWxD)	Part Number
<b>19" cable manager, black only</b> Quantity: 1	6" x 19" x 6.5" (152.4 mm x 482.6 mm x 165.1 mm)	
3 rings		6657 2 005-19/03
4 rings		6657 2 005-19/04
<b>23" cable manager, black only</b> Quantity: 1	6" x 23" x 6.5" (152.4 mm x 584.2 mm x 165.1 mm)	
3 rings		6657 2 005-23/03
4 rings		6657 2 005-23/04
<b>35.5" cable manager, black only</b> Quantity: 1	6" x 35.5" x 6.5" (152.4 mm x 901.7 mm x 165.1 mm)	
4 rings		6657 2 005-35/04
5 rings		6657 2 005-35/05
6 rings		6657 2 005-35/06
<b>6.5" cable manager, gray only; 2 rings</b> Quantity: 1	6.5" x 6.5" x 4.75" (165.1 mm x 165.1 mm x 120.65 mm)	6657 2 006-06/02
<b>9" cable manager, gray only; 3 rings</b> Quantity: 1 Designed to fit directly above UMS in Type 160 position	6.5" x 9.1" x 4.75" (165.1 mm x 231.4 mm x 120.65 mm)	6657 2 006-09/03

# Cable Management

## Cable Management Accessories

### Type 85 Back Mount Frames

Type 85 back mount frames accept 8-pair Series 2 blocks. The frames come with cable entry holes on the back and protective rubber grommets. Grommet holes are 1.5" (38.1 mm) in diameter. Back mount frames are made of stainless steel.

#### ORDERING INFORMATION

Description	Dimensions (HxWxD)	Part Number
<b>Type 85 back mount frames Quantity: 1</b>		
6 block positions, 1 hole	5.25" x 3.31" x 2.75" (133.3 mm x 84.1 mm x 69.9 mm)	6654 2 350-06/1
11 block positions, 1 hole	9.63" x 3.31" x 2.75" (244.5 mm x 84.1 mm x 69.9 mm)	6654 2 350-11/1
21 block positions, 2 holes	18.38" x 3.31" x 2.75" (466.7 mm x 84.1 mm x 69.9 mm)	6654 2 350-21/2



**Type 85 back mount frame**

Note: The depth dimensions listed are the actual depths of mounting brackets with no blocks installed.

### Type 105 Back Mount Frames

Type 105 back mount frames accept Ultim8, HighBand 10 and 10-pair Series 2 blocks and Type 105 UMS/Mini patch panels. The frames come with cable entry holes on the back and protective rubber grommets. Grommet holes are 1.5" (38.1 mm) in diameter. Back mount frames are made of stainless steel.

#### ORDERING INFORMATION

Description	Dimensions (HxWxD)	Part Number
<b>Type 105 back mount frames Quantity: 1</b>		
6 block positions, 1 hole	5.25" x 4.06" x 2.75" (133.3 mm x 103.2 mm x 69.9 mm)	6655 2 450-06/1
11 block positions, 1 hole	9.63" x 4.06" x 2.75" (244.5 mm x 103.2 mm x 69.9 mm)	6655 2 450-11/1
21 block positions, 2 holes	18.38" x 4.06" x 2.75" (466.7 mm x 103.2 mm x 69.9 mm)	6655 2 450-21/2
31 block positions, 3 holes	27.13" x 4.06" x 2.75" (689.0 mm x 103.2 mm x 69.9 mm)	6655 2 450-31/3



**Type 105 back mount frame**

Note: The depth dimensions listed are the actual depths of mounting brackets with no blocks installed.

# Cable Management

## Cable Management Accessories

### Type 105 Back Mount Frames with Ground Lug

These back mount frames have a standard 2.0" (50 mm) channel depth and come with an attached ground lug.

#### ORDERING INFORMATION

Description	Dimensions (HxWxD)	Part Number
<b>Type 105 back mount frames Quantity: 1</b>		
6 block positions, 1 hole	5.25" x 4.06" x 2.75" (133.3 mm x 103.2 mm x 69.9 mm)	6655 2 400-03
21 block positions, 1 hole	18.38" x 4.06" x 2.75" (466.7 mm x 103.2 mm x 69.9 mm)	6655 2 400-00



Back mount frame with ground lug (21-position shown)

### Type 85 Rod Mount Brackets

Type 85 rod mount brackets accept 8-pair Series 2 rod mount blocks. Install rod mount brackets using support bars, or directly to a plywood backboard.

#### ORDERING INFORMATION

Description	Dimensions (HxWxD)	Part Number
<b>Type 85 rod mount brackets Quantity: 1</b>		
6 block positions	5.5" x 4.19" x 2" (139.7 mm x 106.4 mm x 50.8 mm)	6652 2 039-06
11 block positions	9.88" x 4.19" x 2" (250.8 mm x 106.4 mm x 50.8 mm)	6652 2 039-11
21 block positions	18.63" x 4.19" x 2" (473.1 mm x 106.4 mm x 50.8 mm)	6652 2 039-21



Type 85 rod mount bracket

# Cable Management

## Cable Management Accessories

### Type 105 Rod Mount Brackets

Type 105 rod mount brackets accept Ultim8, HighBand 10 and 10-pair Series 2 rod mount blocks and 105 mm UMS/Mini Patch Panels. Install rod mount brackets using support bars, or directly to a plywood backboard.

#### ORDERING INFORMATION

Description	Dimensions (HxWxD)	Part Number
<b>Type 105 rod mount brackets</b> Quantity: 1		
6 block positions	5.5" x 4.19" x 2" (139.7 mm x 106.4 mm x 50.8 mm)	6652 2 040-06
11 block positions	9.88" x 4.19" x 2" (250.8 mm x 106.4 mm x 50.8 mm)	6652 2 040-11
21 block positions	18.63" x 4.19" x 2" (473.1 mm x 106.4 mm x 50.8 mm)	6652 2 040-21



Type 105 rod mount bracket

### Rod Mount Bracket Spacer

Rod mount bracket spacers are optional pieces that snap over the 0.47" (12 mm) rods to maintain uniform distances between rod mount blocks.

#### ORDERING INFORMATION

Description	Part Number
<b>Rod mount bracket spacer</b> Quantity: 1	
0.1" (2.5 mm)	6619 2 046-00
0.2" (5.0 mm)	6619 2 046-01

# Cable Management

## Cable Management Accessories

### Wall or Rack Mount Mounting Frames

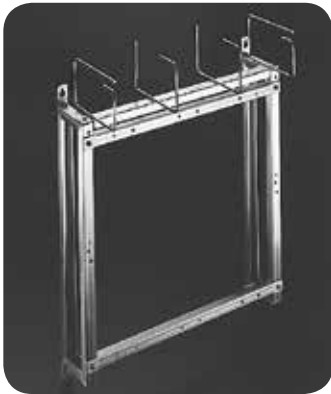

19" wide mounting frame

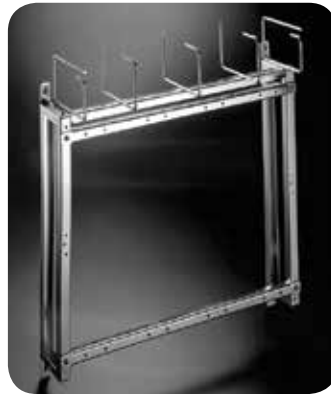

23" wide mounting frame



35.5" wide mounting frame

### ORDERING INFORMATION

Description	Dimensions (HxWxD)	Part Number
<b>19" mounting frame, 3-position Quantity: 1</b> Supports up to (3) 21-position Type 85 or Type 105 mounting brackets; can be wall or rack mounted (EIA standard 19" equipment rack; 3 mounting frames fit vertically in 7' rack) with 4 mounting screws (included). Fixed jumper routing rings included	25" x 19.38" x 4.25" (635 mm x 492.1 mm x 108 mm)	6652 2 100-00
<b>23" mounting frame, 3-position Quantity: 1</b> Supports up to (3) 21-position Type 85 or Type 105 mounting brackets; can be wall or rack mounted (23" equipment rack) with 4 mounting screws (included). Fixed jumper routing rings included	25" x 24" x 4.25" (635 mm x 609.6 mm x 108 mm)	6652 2 114-00
<b>23" mounting frame, 4-position Quantity: 1</b> Supports up to (4) 21-position Type 85 or Type 105 mounting brackets; can be wall or rack mounted (23" equipment rack) with 4 mounting screws (included). Fixed jumper routing rings included	25" x 24" x 4.25" (635 mm x 609.6 mm x 108 mm)	6652 2 113-00
<b>35.5" mounting frame, 5-position Quantity: 1</b> Supports up to (5) 21-position Type 85 or Type 105 mounting brackets; can be wall or rack mounted (23" equipment rack) with 4 mounting screws (included). Fixed jumper routing rings included	26.5" x 35.5" x 4.25" (673.1 mm x 901.7 mm x 108 mm)	6652 2 101-00





## Supplementary Solutions

Distributed Antenna Systems .....	7-3
Broadcast Products .....	7-3
Pre-Manufactured, Modular Power System .....	7-3
Residential Products .....	7-3

Sometimes you need more than cabling. TE offers a number of complementary products to our core foundation of copper and fiber cabling infrastructure management solutions. From AMPINNERGY’s modular power distribution system, to Wireless, Broadcast or home network systems, TE Connectivity can provide you with a custom solution and the accessories you need for your specific application.





## Supplementary Products

### TE Connectivity's Supplementary Product Families

#### Distributed Antenna Systems

As a leader in distributed antenna systems (DAS) for in-building and microcellular networks, TE's wireless solutions transform the way mobile service delivery networks are created, deployed and used for new mobile applications.

**For more information, visit [www.te.com/ENWireless](http://www.te.com/ENWireless)**



#### Broadcast Products

Bandwidth is in high demand and only TE products can meet the challenges of today's always on, instant communications environment. From fiber connectivity to audio and video products to modular systems and connectors, TE's Broadcast product line can help ensure reliability, scalability and flexibility of your network.

**For more information, visit [www.te.com/broadcast](http://www.te.com/broadcast)**



#### Pre-Manufactured, Modular Power System

This UL/CSA-listed, AMPINNERGY brand modular power distribution system can be used to deliver power to workstations in raised floor installations, in modular offices furniture panels, retail display fixtures, gaming fixtures and more. All AMPINNERGY system components are factory tested and plug-and-play compatible allowing for easy reconfiguration and load balancing. AMPINNERGY is available in 5-wire shared neutral, and 8-wire shared or dedicated neutral systems.

**To learn more, visit [www.te.com/power](http://www.te.com/power)**



#### Residential Products

Imagine whole-house data, voice, video and audio streamlined into one solution. TE's AMP NETCONNECT Home Net-Works Residential Cabling System can perfect your multi-media signals with greater bandwidth and security. Bring office-like quality to your high-tech home with our next generation residential offerings.

**For more information, visit [www.te.com/residential](http://www.te.com/residential)**







## Technical Reference

TE products and solutions adhere to the latest industry standards including TIA, UL and more. This section is for your reference and to help you with specific installation issues like: designing an optimized data center, supporting industry standards, selecting the right cabling infrastructure and more.

**AirES cable improves attenuation due to lower dielectric loss — resulting in smaller gauge copper than other cable.**

**The choice of conductor insulation is critical to cable performance.**

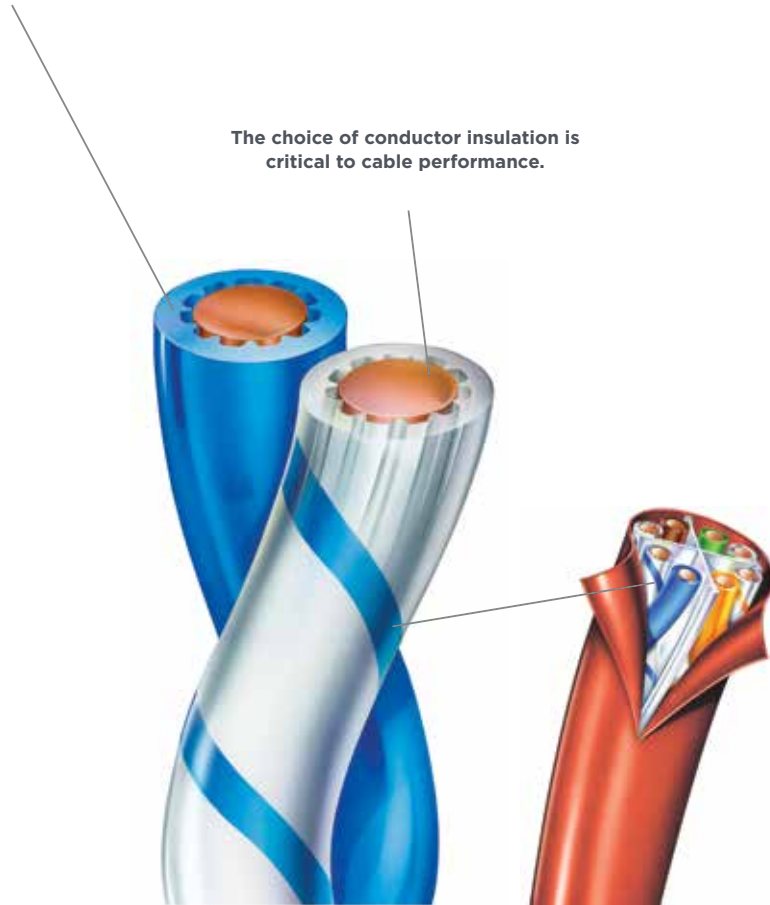

# Technical Reference

## Industry Standards

---

### Product Solution Pages

TE offers many product specific solution pages. Visit any of these pages for more information on the following solutions.

- 24-fiber MPOptimate for 10/40//100 Migration: [www.TE.com/DataCenterMigration](http://www.TE.com/DataCenterMigration)
- Broadcast/Entertainment: [www.TE.com/broadcast](http://www.TE.com/broadcast)
- Core Vertical Switch Management (VSM): [www.TE.com/coreVSM](http://www.TE.com/coreVSM)
- FiberGuide: [www.TE.com/FiberGuide](http://www.TE.com/FiberGuide)
- In-Building Wireless: [www.TE.com/ENwireless](http://www.TE.com/ENwireless)
- Infrastructure Configuration Manager (ICM) software: [www.TE.com/ICM](http://www.TE.com/ICM)
- Managed Connectivity: [www.knowyournetwork.com](http://www.knowyournetwork.com)
- MRJ21: [www.TE.com/MRJ21](http://www.TE.com/MRJ21)
- Optical LAN Solution/PON: [www.PONsource.com](http://www.PONsource.com)
- Power Products: [www.TE.com/power](http://www.TE.com/power)
- Q-Frame: [www.TE.com/Qframe](http://www.TE.com/Qframe)
- Residential Products: [www.TE.com/residential](http://www.TE.com/residential)
- SAM: <http://www.TE.com/SAM>
- Universal Connectivity Platform: [www.TE.com/UCP](http://www.TE.com/UCP)
- Virtual Tour: [www.TE.com/VirtualTour](http://www.TE.com/VirtualTour)

# Technical Reference

## Industry Standards

### Copper Design Technology

#### UPTIME PERFORMANCE STARTS AT CABLE CONNECTIONS

With Angled Insulation Displacement Contact (IDC) Technology, connections will never be the source of system weakness. Cable connections and terminations within data centers are subject to vibrations and mechanical stresses not seen elsewhere within the enterprise. Seventy percent of network downtime is attributed to the physical layer, or cables and connectivity equipment. Angled IDC Technology produces the highest performing, most reliable IDC in the industry. Angled IDC technology is used throughout TE's jacks, panels and termination blocks.

#### Angled IDC contacts are the most secure available, anywhere.

1. Insulation clamping ribs hold the wire securely—isolating the contact area from vibration and mechanical stress.
2. Angled IDC's make contact at 45° angles across the wire's axis, to make a solid, gas-tight connection.

#### Billions of Connections

Angled IDC technology has been used in billions of connections worldwide, and continues to set the pace for others to follow.

#### FEATURES

- Accepts 26-22 AWG insulated conductors
- Accepts solid or stranded insulated conductors
- If needed, they can be re-terminated 200 or more times

### Paired Terminal Technology

#### DESIGNED FOR PERFORMANCE

Angled IDC Technology produces Paired Terminal Technology. Angled contacts allow for closer placement for contacts within a pair, and separation between pairs of contacts—providing better coupling performance and increase NEXT performance.

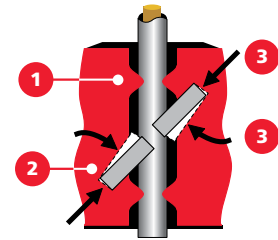

#### The LSA-PLUS Contact Differences:

1. Insulation clamping ribs hold the wire securely - isolating the contact area from vibration and mechanical stress.
2. Silver-plated contact tags at 45° angles across the wire's axis make a solid, gas-tight connection.
3. Axial and torsional restoring forces make a solid, gas-tight connection.



#### Angled IDC Technology

leaves more wire between contact points; provides a more reliable stress resistant connection.



Typical primary wire after being punched into a 110 IDC positioning contacts at a 90° angle results in a weak connection, which is prone to breakage.



# Technical Reference

## Industry Standards

### Cycle Life

#### UPTIME PERFORMANCE CONTINUES WITH LONG CYCLE LIFE

##### TE Connectivity Jacks are designed to go the distance

- SL series jacks are tested to IEC 60512-9 durability with a 6 position plug in an 8 position jack
  - Contact constructed of high-strength Beryllium Copper for maximum elasticity
  - Terminal will not take a set after using a 6 position plug
- IDC design
  - Maximizes stored elastic energy and reduces permanent set
  - Exceeds ANSI/TIA 568 durability requirements of 200 terminations

### SL Series Tool

#### Better Terminations – Less Time – More Reliable

- Easier terminations
  - Simple lacing process
  - Less hand fatigue vs. punch down tool
- Faster terminations
  - Simplified process allows terminations in half the time compared to a 110 punchdown
- More consistent terminations
  - Pair twist controlled for every termination
  - More consistent, repeatable termination quality and results across various technicians
- Optimal reliability solution
- Capable of over 5000 terminations



SL Series Modular Jack Termination Tool UTP Termination Method



Step 1



Step 2



Step 3



Step 4



Step 5



Step 6



# Technical Reference

## Industry Standards

### How AirES Cable Technology Lowers Temperatures While Increasing Uptime

#### Deployed in the Data Center:

- 32% smaller than conventional Category 6 cable for space savings
- Increased uptime
  - Improved electrical and physical properties
  - Increased reliability of electronics lowers Zero Bit-Errors
  - Increased reliability by improving airflow and thermal fluctuations
  - Increased reliability by providing better circuit access
- Improved scalability
  - Better utilization of floor space
  - Decreased cable size
  - Fewer and smaller pathways
- The choice of conductor insulation is critical to cable performance
  - In AirES technology, air channels are used in the traditional FEP
  - Insulation, which results in a 17% better dielectric constant over conventional FEP cables
  - The result: Improved data communications in a smaller diameter cable.
  - 32% smaller than typical CAT 6A cable
- Hard to crush an AirES cable
  - Air channels within the FEP insulation are distributed evenly along the entire conductor, forming a unified system of arched channels to strengthen the construction

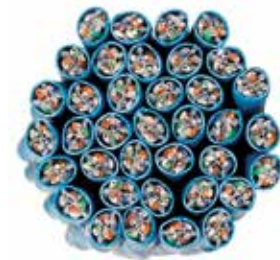

TE's Plenum  
Category 6A with AirES



Competitor's  
CAT 6A

AirES cable improves attenuation due to lower dielectric loss — resulting in smaller gauge copper than other cable.

The choice of conductor insulation is critical to cable performance.



# Technical Reference

## Industry Standards

### THE BENEFITS OF STANDARDS

Imagine trying to link railroads together that are based on different gauges, to build anything with a combination of metric and American parts, to type a letter on something other than a QWERTY keyboard, or to wire a building for voice, data and video if all the components had different requirements. The key to simplifying all of these tasks is standardization. Bringing standards to the wiring and cabling segments of the building industry has enabled the industry to define a common infrastructure that allows many companies to provide common components. Strict adherence to these standards benefits everyone.

The ANSI/TIA-568 Series standard defines a typical, generic telecommunications cabling system.

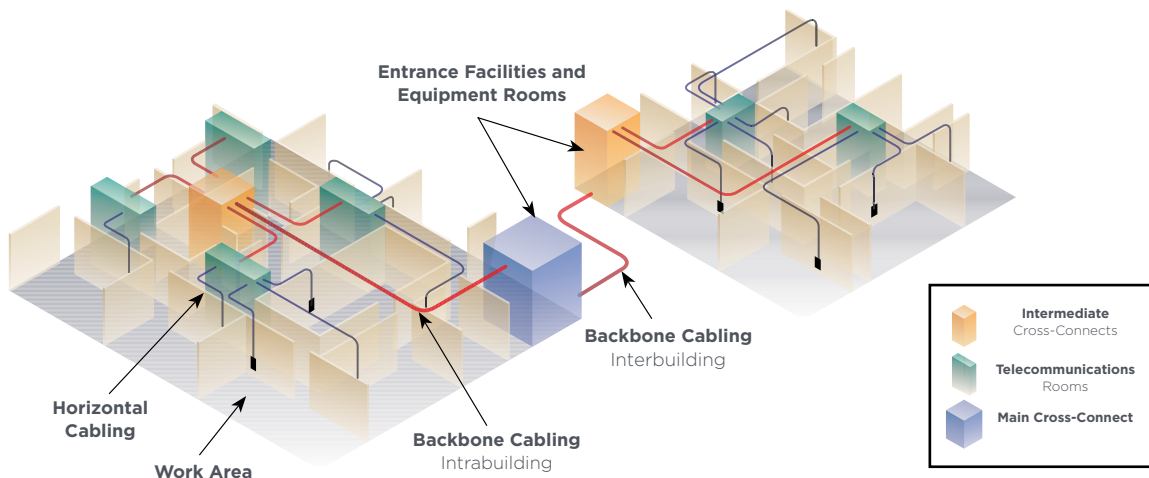

### TE'S POSITION ON STANDARDS

TE is a strong proponent of standards-based design for structured cabling systems. A strictly defined set of standards helps ensure uniform application of physical layer networking products and creates a usable infrastructure for communications networks.

However, TE also believes that by nature, the standards evolve into a lowest-common denominator indicator of performance. In order to accommodate various competing interests, a significant amount of “flexibility” gets built into the allowable tolerances. The cumulative effect of these tolerances can result in structured cabling channels in which different components can have radically different electrical performance characteristics.

Consequently, when various standards-compliant components from randomly selected vendors are used, the net result could be conformance to the standards, but not optimum performance.

The research undertaken by TE for the TE Connectivity structured cabling system revealed that only an impedance-matched structured cabling channel that conforms to a tightly defined subset of the performance standards is capable of flawless data transmission.

As a full system supplier, TE is able to deliver a complete system of impedance-matched components so there is no guesswork. Choosing standards-compliant components randomly from unrelated vendors will yield a standards-compliant channel, but may not result in optimum network performance.

Therefore, use the standards as a design guide, then make sure that you purchase matched components that meet or exceed the standards requirements.

# Technical Reference

## Industry Standards

---

### ENTRANCE FACILITIES

The entrance facility provides a connection point between the outside plant facilities—whether it is public network services, private network customer premises or a combination of both—and the interior premises cabling. Products used in this area include cables, connecting hardware, special protection devices and other connecting hardware.

The demarcation point separating the service provider's cabling and the customer's cabling may be part of the entrance facilities. Because the location of the demarcation point is determined by state and federal regulations, the local regulated carrier (telephone service provider) or competitive access provider should be contacted for detailed information.

The primary standards for this area are outlined in ANSI/TIA-569, Commercial Building Standard for Telecommunications Pathways and Spaces, and J-STD-607, Commercial Building Grounding/Bonding Requirements.

TE manufactures special overvoltage blocks, protection devices and building entrance terminals for both fiber and copper cabling for use in this area.

### EQUIPMENT ROOMS

The ANSI/TIA-568 Series standard makes a distinction between equipment rooms and telecommunications rooms because of the nature of complexity of the equipment they contain. However, an equipment room may alternately provide any or all of the functions of a telecommunications room.

Equipment rooms provide a controlled environment to house telecommunications equipment. This equipment may include connecting hardware, splice closures, grounding and bonding facilities and protection devices, where applicable. Switches, routers and other active equipment may reside in the same rack or cabinet space as the passive cabling infrastructure.

In the premises cabling backbone hierarchy, an equipment room may contain either the main crossconnect or the intermediate cross-connect. The equipment room may also contain network trunk terminations and auxiliary terminations that are under the control of the premises cabling administrator.

The primary standards for this area are outlined in ANSI/TIA-569, Commercial Building Standard for Telecommunications Pathways and Spaces.

TE manufactures a wide variety of fiber and copper patch panels, termination blocks and cable management solutions that are well suited for this area.

# Technical Reference

## Industry Standards

---

### TELECOMMUNICATIONS ROOMS

Telecommunications rooms may provide various functions for the cabling system and because of this they are treated as a distinct subset in the cabling system hierarchy.

The primary function of a telecommunications room is to provide a termination point for horizontal cable distribution, that supports all voice, data, video and other applications such as building automation systems requiring structured cabling. The telecommunications room also serves as a termination point for backbone cable. The cross-connection of these two parts of the premises cabling is an important function of the telecommunications room. Cross-connections may be accomplished using jumper wires or patch cords, and TE products handle both methods equally well.

Telecommunications rooms may also house cross-connects for different portions of the backbone cabling system. These cross-connects are sometimes used to tie different rooms together in a ring, bus or tree configuration.

Telecommunications rooms also provide a controlled environment for specific areas of a building. These rooms may house telecommunications equipment, connecting hardware and splice closures as well as devices such as routers and hubs. In some instances, the demarcation point and protection devices may be located in a telecommunications room.

The ANSI/TIA-568 series standard details cable routing and installation practices for telecommunications rooms to prevent cable stress and to properly organize and manage cables.

Additional standards for this area are outlined in ANSI/TIA-569, Commercial Building Standard for Telecommunications Pathways and Spaces.

TE manufactures a wide variety of blocks and patch panels capable of providing termination and cable management for a wide range of wire sizes and cable types found in telecommunications rooms.

### FOR MORE INFORMATION

Although this catalog presents a brief overview of information contained in the standard, persons involved with the installation and maintenance of structured cabling systems should obtain a copy of the complete standard and/or related standards.

Technical standards that address various aspects of commercial cabling include:

- ANSI/TIA-568, Series, Commercial Building Telecommunications Cabling Standard
- ANSI/TIA-569, Commercial Building Standard for Telecommunications Pathways and Spaces
- ANSI/TIA-570, Residential Telecommunications Cabling Standard
- ANSI/TIA-606, Administration Standard for the Telecommunications Infrastructure of Commercial Buildings
- J-STD-607, Commercial Building Grounding/Bonding Requirements

For information on obtaining copies of any of these standards, please contact:

# Technical Reference

## Industry Standards

### ANSI/TIA-568 Series Horizontal Channel/Link Model

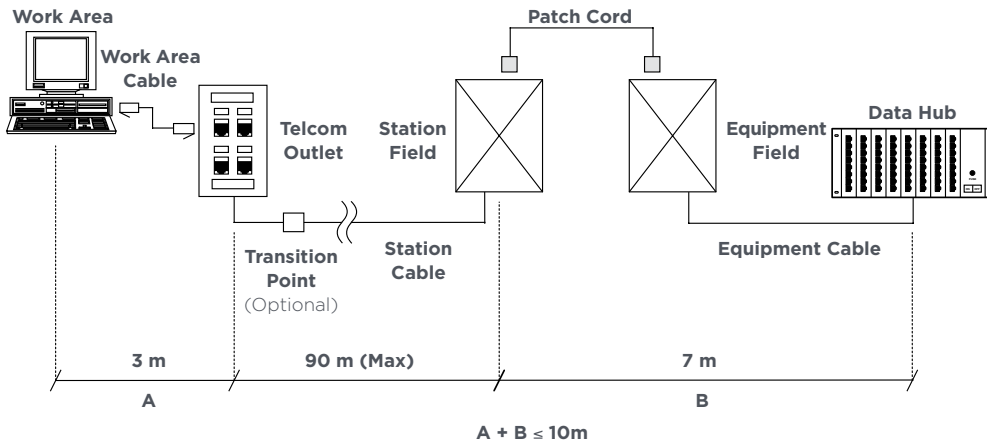

### ISO/IEC 11801 Horizontal Channel/Link Model

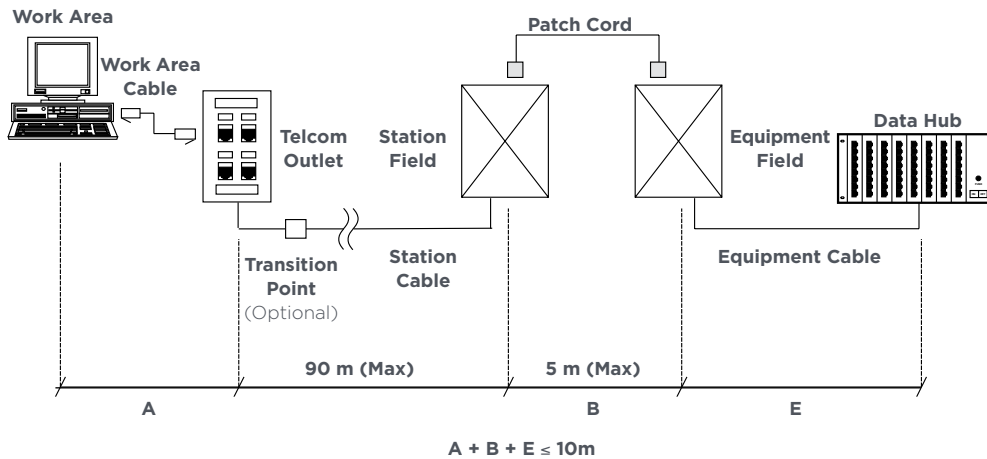

Global Engineering Documents  
800.854.7179 or 303.397.7956  
[www.global.ihs.com](http://www.global.ihs.com)

ISO 11801 (International Standard) [www.iso.ch](http://www.iso.ch)

NEC (National Electrical Code), written and distributed by the National Fire Protection Association (NFPA)  
[www.NFPA.org](http://www.NFPA.org)

# Technical Reference

## Industry Standards

### INTERCONNECTION VS. CROSS-CONNECTION

The ANSI/TIA-568 series standard addresses two basic wiring schemes for the telecommunications room: interconnection and cross-connection.

Both the backbone and the horizontal cabling are terminated on connecting hardware that meets the requirements of the ANSI/TIA-568 series standard. However, the standard prohibits the use of these terminations for moves, adds and changes. Any connection between the backbone and horizontal cabling must be accomplished through the use of a “horizontal cross-connect” between the common equipment and the connecting hardware to which the horizontal cabling is terminated. This connection may be made using an interconnection or a cross-connection cabling scheme.

An interconnection is a cabling scheme that provides for a direct connection between connecting hardware, such as a patch panel, and active equipment.

A cross-connection is a cabling scheme between cabling runs, subsystems and equipment using patch cords or jumper wires that attach to connecting hardware on each end.

Common equipment that utilizes cables that extend an individual port may be permanently terminated or interconnected to the connecting hardware for the horizontal cabling. Direct interconnections such as this reduce the number of connections in a channel, but may also reduce the flexibility, especially as the volume of moves, adds and changes increases.

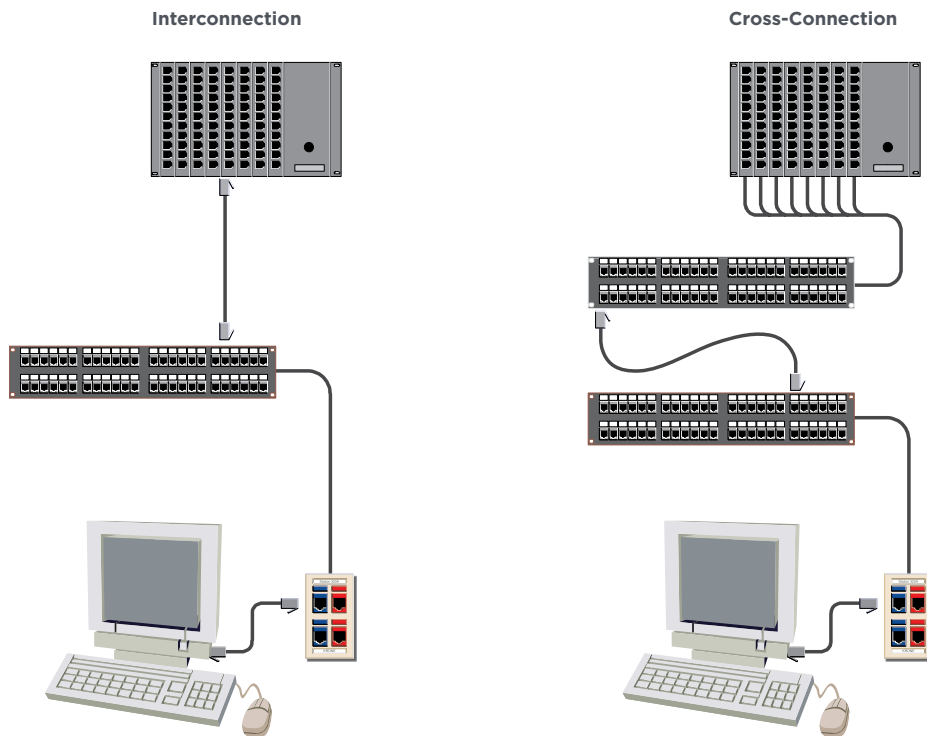

# Technical Reference

## Industry Standards

### Backbone Cabling

Backbone cabling provides interconnections between the telecommunications rooms, equipment rooms and entrance facilities. Backbone cabling consists of cables, main and intermediate crossconnects, mechanical terminations and patch cords or jumper wires. Backbone cabling can be within buildings (intrabuilding) or between buildings (interbuilding).

The ANSI/TIA-568 series standard recommends that backbone cabling use a hierarchical star topology. Each horizontal cross-connect in a telecommunications room is cabled to an intermediate cross-connect and then to a main cross-connect (or directly to a main crossconnect), with no more than two hierarchical levels of cross-connect in the backbone cabling. These cross-connects may be located in telecommunications rooms, equipment rooms or entrance facilities.

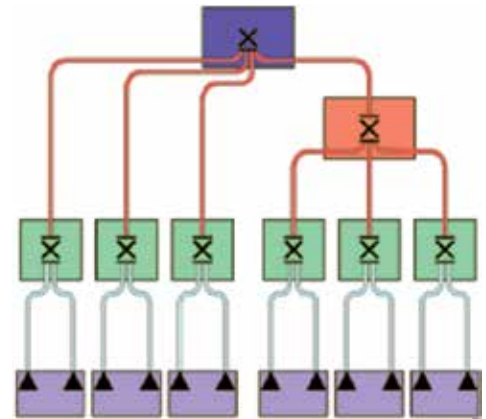
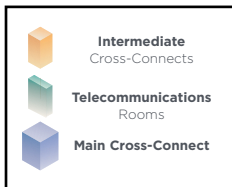
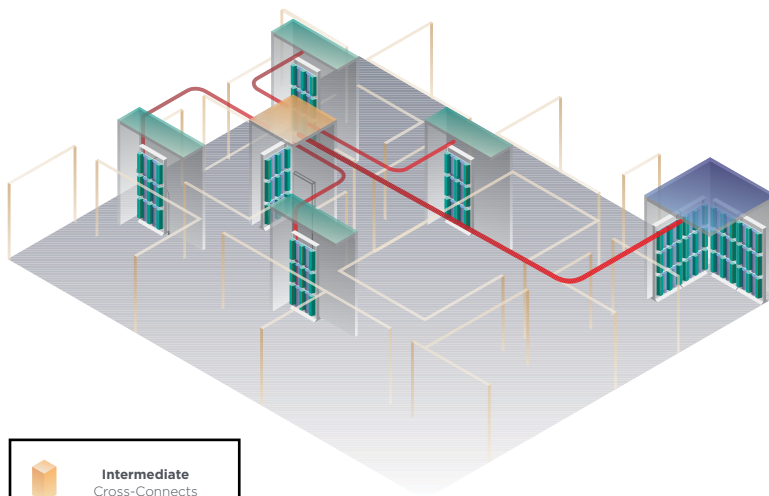

Backbone cabling uses a hierarchical star topology.

Recognized cables for use in backbone cabling include the following:



100 Ohm UTP shielded or unshielded twisted pair cable four or more pairs



OM1 62.5/125  $\mu\text{m}$ , multimode optical fiber cable



OM2 50  $\mu\text{m}$ , multimode optical fiber cable



50  $\mu\text{m}$ , laser optimized multimode fiber optic cable OM3 and OM4



OS1 or OS2 Singlemode optical fiber cable

# Technical Reference

## Industry Standards

### Horizontal Cabling

Horizontal cabling extends from the work area telecommunications outlet to the horizontal cross-connect in the telecommunications room. Horizontal cabling includes the cables, the telecommunications outlet in the work area, the mechanical termination and patch cords or jumper wires and cable management solutions located in the telecommunications room.

- Voice service
- Internet service
- Video and conferencing services
- Premises switches, routers and hubs
- Data communications to support fax, storage servers, network printers
- Local area networks (LANs)
- Life safety systems such as security, fire alarm and door entrance
- Automation systems such as lighting and HVAC control
- Other building signaling systems, such as CCTV, nurse call, paging, audio and others

Recognized cables for use in horizontal cabling include the following:



**100 Ohm UTP** unshielded or shielded CAT 5e, CAT 6 or CAT 6A twisted pair **cable** four pairs



**OM1 62.5/125 μm, multimode optical fiber cable**



**OM2 50 μm, multimode optical fiber cable**



**50 μm, laser optimized multimode fiber optic cable**  
OM3 and OM4

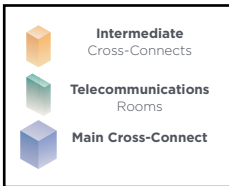
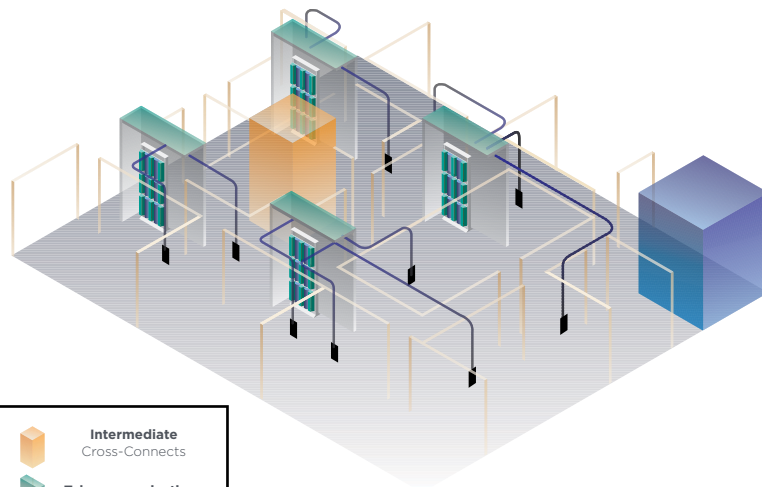



# Technical Reference

## Industry Standards

Moving offices, changing floor plan layouts and relocating equipment and people is a common practice in an organization. Horizontal cabling is often one of the more dynamic areas of the premises system. However, after installation, horizontal cabling is often much less accessible than backbone cabling, and the time, effort and skills required to change or modify it can be extremely high. Horizontal cabling should be designed with the intention of minimizing ongoing maintenance and relocation so that moves, adds and changes can be accomplished from the telecommunications and equipment rooms. Additional consideration should be given to accommodating a wide range of applications in order to reduce the necessity of changes to the cabling as users' needs evolve.

Care should be given to separate telecommunications cabling from electrical facilities that generate high levels of electromagnetic interference (EMI). Fluorescent lights, copy machines, heating/cooling devices, motors and transformers that support the building's mechanical requirements all contribute to EMI. ANSI/TIA-569 specifies separation of horizontal cabling pathways from common sources of EMI.

Horizontal cabling is recommended to use a star topology. Each work area telecommunications outlet is to be connected to a horizontal cross-connect or interconnect in the telecommunications room.

### MAXIMUM DISTANCES

The maximum distance of a copper horizontal cabling run is 90 meters (approximately 295 feet) from the mechanical termination at the horizontal cross-connect in the telecommunications room to the telecommunications outlet in the work area.

Patch cords used in the horizontal cabling run shall not exceed 5 meters (approx 16ft).

**Color Codes for Horizontal 100 Ohm UTP Cable or for Patch Cords**



**Pair 1 = White-Blue/Blue**



**Pair 2 = White-Orange/Orange**



**Pair 3 = White-Green/Green**



**Pair 4 = White-Brown/Brown**

# Technical Reference

## Industry Standards

### WORK AREA

The work area components of a premises cabling system are the most visible to office workers. Work area components extend from the telecommunications outlet to the station equipment, such as traditional telephones, VoIP devices, networked computers, fax machines and shared devices such as network printers. The length of cords used in the work area are assumed to be no longer than 5 meters (approximately 16 feet) in establishing the maximum length for the horizontal cabling of 100 meters total, and the cords should meet or exceed the requirements for patch cords outlined in the standard.

Common patch cords used in the work area have identical connectors on both ends, but cords may vary widely. If adapters are used, they should be external to the outlet and not a part of the Permanent Link.

Types of adapters include:

- Special adapters to mate an equipment connector to the telecommunications outlet when they are different styles (e.g. baluns)
- A “Y” adapter to branch two services off of a single cable
- Adapter which transpose pairs for compatibility
- Adapters for equipment that requires termination resistors

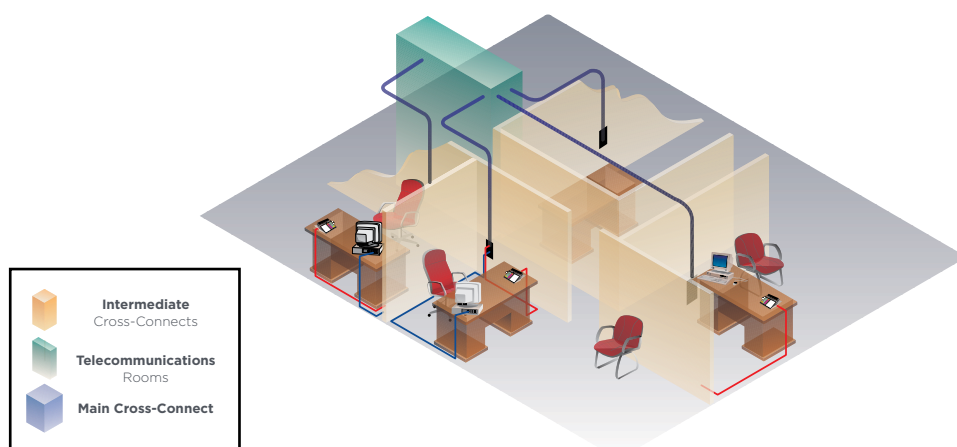

These and other types of adapters can have a detrimental effect on the transmission performance of the telecommunications cabling system. It is important to consider the compatibility of these adapters to premises cabling equipment before connecting them to the network.

A successful, high-performance premises wiring system requires more than simply purchasing the proper standards-compliant cables and hardware. Care must be taken to ensure that the components are installed properly according to industry-recognized practices.







Performance specifications called out in the ANSI/TIA-568 series standard are based on the assumption that proper installation techniques and management practices have been followed. If recommended cabling precautions and installation methods are not observed, specified transmission capabilities of cabling components may not be achieved.

Installation should be performed by trained, certified installers such as TE Connectivity Network Design and Installation (ND&I) contractors who are authorized to provide a TE product and performance warranty.

# Technical Reference

## Industry Standards

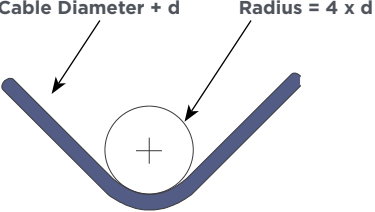
### Cable Installation

DO	DON'T
 <p data-bbox="293 464 667 506"><b>Do pull cables to minimize the distance of the run and eliminate large loops.</b></p>	 <p data-bbox="743 464 1117 506"><b>Don't exceed 110 Newton's (25 lb/f) of pulling forces when running cables.</b></p>
 <p data-bbox="293 699 667 741"><b>Do bundle cables in a neat, orderly fashion, and use hook-and-loop ties.</b></p>	 <p data-bbox="743 699 1117 741"><b>Don't cinch cable bundles too tightly, or use plastic cable ties.</b></p>
 <p data-bbox="277 1073 678 1213"><b>Do follow recommendations for cable bend radius.</b> In spaces with UTP terminations, cable bend radius should not be less than four-times the cable diameter for horizontal cable, and should not be less than ten times the cable diameter for multipair cable.</p>	 <p data-bbox="732 1073 1117 1094"><b>Don't ever bend or kink cable too sharply.</b></p>
<p data-bbox="293 1255 667 1325"><b>Do make sure that pair twists are maintained within 1/2" (12 mm) or less of the termination point.</b></p>	<p data-bbox="743 1255 1105 1276"><b>Don't untwist pairs when terminating.</b></p>

### Suggested Modular Jack Cutouts

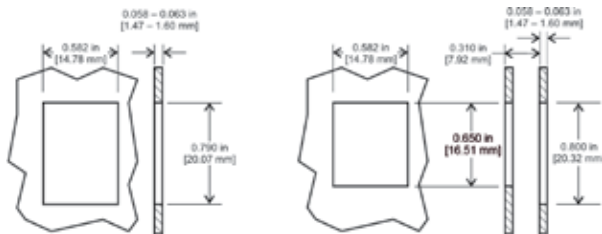

**Suggested Single Panel Cutout**

**Suggested Flush Mount Panel Application Cutout**

# Technical Reference

## Industry Standards

### Jack Pin-Outs

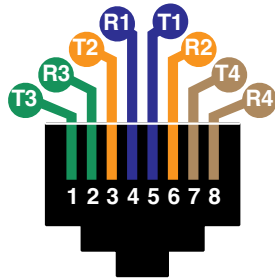

T568A RJ45

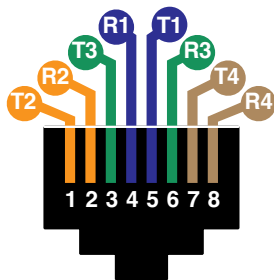

T568B RJ45

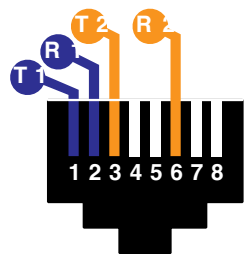

10Base-T

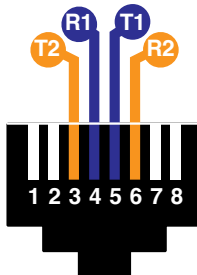

Token Ring

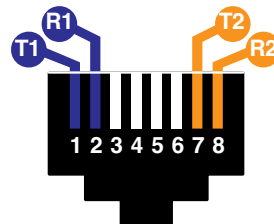

TP-PMD

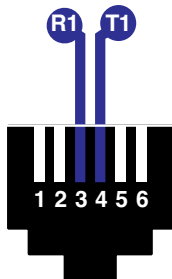

USOC RJ11



USOC RJ14

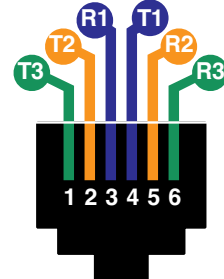

USOC RJ25

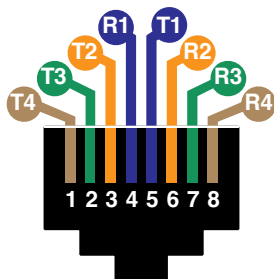

USOC RJ61

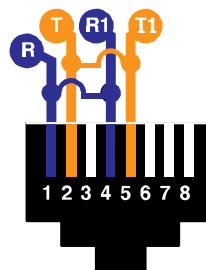

USOC RJ48X







Position 1  
Shorts to  
Position 4

Position 2  
Shorts to  
Position 5

# Technical Reference

## Industry Standards

### 25-Pair Cable Color-Coding

Pair Number	Cable Color	Color Coding	Tip & Ring	50-Pin Positions	66 or 110 Positions
1		White/Blue Blue/White	Tip 1 Ring 1	26 1	1 2
2		White/Orange Orange/White	Tip 2 Ring 2	27 3	3 4
3		White/Green Green/White	Tip 3 Ring 3	28 3	5 6
4		White/Brown Brown/White	Tip 4 Ring 4	29 4	7 8
5		White/Slate Slate/White	Tip 5 Ring 5	30 5	9 10
6		Red/Blue Blue/Red	Tip 6 Ring 6	31 6	11 12
7		Red/Orange Orange/Red	Tip 7 Ring 7	32 7	13 14
8		Red/Green Green/Red	Tip 8 Ring 8	33 8	15 16
9		Red/Brown Brown/Red	Tip 9 Ring 9	34 9	17 18
10		Red/Slate Slate/Red	Tip 10 Ring 10	35 10	19 20
11		Black/Blue Blue/Black	Tip 11 Ring 11	36 11	21 22
12		Black/Orange Orange/Black	Tip 12 Ring 12	37 12	23 24
13		Black/Green Green/Black	Tip 13 Ring 13	38 13	25 26
14		Black/Brown Brown/Black	Tip 14 Ring 14	39 14	27 28
15		Black/Slate Slate/Black	Tip 15 Ring 15	40 15	29 30
16		Yellow/Blue Blue/Yellow	Tip 16 Ring 16	41 16	31 32
17		Yellow/Orange Orange/Yellow	Tip 17 Ring 17	42 17	33 34
18		Yellow/Green Green/Yellow	Tip 18 Ring 18	43 18	35 36
19		Yellow/Brown Brown/Yellow	Tip 19 Ring 19	44 19	37 38
20		Yellow/Slate Slate/Yellow	Tip 20 Ring 20	45 20	39 40
21		Violet/Blue Blue/Violet	Tip 21 Ring 21	46 21	41 42
22		Violet/Orange Orange/Violet	Tip 22 Ring 22	47 22	43 44
23		Violet/Green Green/Violet	Tip 23 Ring 23	48 23	45 46
24		Violet/Brown Brown/Violet	Tip 24 Ring 24	49 24	47 48
25		Violet/Slate Slate/Violet	Tip 25 Ring 25	50 25	49 50

# Technical Reference

## Industry Standards

### WIRING TO STANDARDS

The ANSI/TIA-569 Series Commercial Building Telecommunications Wiring Standard defines pin/pair assignments for eight-position modular jacks in the work area. ANSI/TIA 568 Series allows for two wiring configurations – T568A and T568B.

For modular RJ45 patch cords, 568A or 568B wiring are both usable, regardless of which wiring scheme is used in the horizontal cabling.

A crossover cord is wired T568A on one end and T568B on the other, and is typically used for peer to peer networking or to connect stacked hubs or switches. Many active devices now have a switch that crosses one port, negating the need for a crossover cable.

Wiring schemes also raise a variety of questions:

- Q: What's the difference between T568A and T568B?  
A: The only difference is the positioning of the green and orange pairs of wires.
- Q: Is there a performance difference between T568A and T568B?  
A: No. Both wiring schemes have to meet the same performance criteria.
- Q: Why two schemes?  
A: The reason is outside of the scope of this discussion but it is related to old telephone legacy issues. All you really need to know is that there are two schemes, and how to deal with them.

The solution really is fairly simple: Just pick one wiring scheme and use it consistently throughout your network. The only problem you would ever encounter would be if the two wiring schemes were accidentally mixed in an installation. T568B is the predominate scheme in the United States; T568A is popular in Canada and in many other countries. The safest way to determine which to use is to check with the network equipment provider to determine the predominant wiring scheme used in the equipment. The reason for this check is quite simple: you can change the wiring scheme used in the network but you cannot change the wiring scheme used in the network equipment.

### TIA/EIA T568A Standard

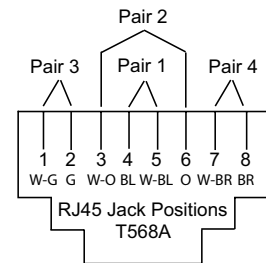

### TIA/EIA T568B Standard

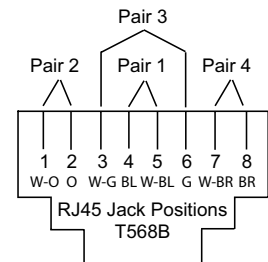

### HOW TO CHOOSE THE RIGHT CABLING INFRASTRUCTURE

#### A Brief History of Cabling

Over the past 40 plus years there have been unprecedented advances in networking technology. Since the early 1970s with the development of Ethernet, rates for point-to-point data transfer have increased by a factor of ten thousand. From one Mb/s StarLan to 10 Gb/s Ethernet, the steady increase in bandwidth has been fueled by an ever increasing demand for more; more speed, more applications, more memory and more devices.

Demand for faster speed comes from continual increases in processor capability and advanced operating systems that enable development of new applications. These applications and their associated devices create more network usage and congestion, driving demand for more bandwidth. The need for this additional bandwidth is seen first at network bottlenecks. When a section of the network becomes a bottleneck, network equipment, such as Ethernet switches and servers, are replaced with the next generation of equipment with faster processors, more memory, improved operating systems and the inherent ability to run more complex applications.

Over time, network equipment speeds outpace the infrastructure that connects the devices; In the transition of 10Base-T to 100Base-TX, for example. Networks with Category 3 cabling systems could support the first few generations of switches and computers that supported 10 Mb/s Ethernet up to 100 meters. With the introduction of the 100Base-TX protocol, bandwidth limitations between devices were removed. However, Category 3 cabling was insufficient to support the 10x increase in data rate, which led to the development of Category 5 cabling to support 100 Mb/s up to 100 meters.

Ignoring Category 4, which came and went quickly, network planners faced a decision on which cabling system to install. At that time, the majority of networks operated with 10Base-T network devices. Yet Category 3 cabling would not support the emerging 100Base-TX protocol. The good news, however, was that Category 5 would run 100Base-TX and was backward compatible with Category 3. In other words, any application designed for Category 3 (10Base-T) would run just as well, if not better, on Category 5 cabling systems. The logical choice was to install Category 5 in anticipation of applications requiring 100Base-TX.

# Technical Reference

## Industry Standards

### Selecting the Infrastructure: Follow the Lead of IEEE

The same scenario faces network planners today as cabling systems are designed to withstand multiple replacements of active equipment. Most active network equipment—including computers, servers, Ethernet switches, routers and hubs—have a maximum useful life of three to five years before they become obsolete. In contrast, structured cabling historically has a useful life of 10 to 15 years. Therefore, the structured cabling you install today must outlive at least three generations of networking equipment upgrades.

The challenge is how to determine what types of active equipment will exist in three product generations; the answer can be found with IEEE. This organization consists of networking, equipment manufacturers such as Cisco, Nortel, Juniper and others that look at the future of networking, and develop solutions for future product generations. Using IEEE standards as a guide, it is possible to see the direction for both active equipment and cabling requirements for the next few generations.

IEEE has already released standards for 10 GbE over optical fiber, over short range copper (CX4), and twisted pair copper.

With the advent of these new standards it is clear that the IEEE has set a direction that 10 GbE over UTP is going to be a reality in upcoming generations of network equipment and this is fully supported by the standards making bodies, TIA and ISO.

### IEEE STANDARDS ACTIVITY

IEEE 802.3z	Gigabit Ethernet over Fiber	Released 1998
IEEE 802.3ab	1000Base-T (Gigabit Ethernet over UTP)	Released 1999
IEEE 802.3ae	10 GbE over Fiber	Released 2002
IEEE 802.3ak	10 GbE over short range Copper (CX4)	Released 2003
IEEE 802.3an	10Gbase-T (10GbE over Copper)	Released 2006
IEEE 802.3ba	40Gb/s and 100 Gb/s Ethernet	Released 2010

### Focus on the Critical Decision Criteria

The questions remain: with all the fiber and copper cabling choices at your disposal, which do you install today? There is no simple answer, because each network is unique. Beware of one-size-fits-all solutions as they cannot possibly account for the infinite numbers of variables you must consider when selecting your cabling infrastructure.

As you make your cabling infrastructure decisions, keep in mind your bandwidth requirements and the timing of your implementation. The following are just three possible scenarios based upon very different network requirements:

**Scenario 1:** You need 10 GbE right now. If this is the case, choose Augmented Category 6 cable or 10 GbE over fiber. Fiber can be more expensive than copper, due to media conversion and more expensive ports on equipment, but 10 GbE fiber ports are readily available today from most major switch manufacturers. 10GBASE-T products for Augmented Category 6 products are in their infancy, as of this publication, but will become more main stream in the coming years.

**Scenario 2:** You are occupying the space for the short-term only. Your plan is to move in the next two to three years. In this case, the logical choice is a Category 6 cabling solution. You will not be in the building long and Category 6 will support 10 GbE at the shorter distance of 37 meters, just in case you do require 10 GbE in the near term. Why is Category 5e not a good choice in this scenario? Back in 2005, the dominant UTP cabling standard for new installations shifted from Category 5e to Category 6. In addition, Category 5e is not recognized by IEEE or TIA to support 10GBASE-T because Category 5e cannot support 10 GbE for any practical distance.



# Technical Reference

## Industry Standards

**Scenario 3:** Building space is on a long-term lease or the building is owned; bandwidth requirements are substantial. Choose Augmented Category 6. History says your upfront investment will pay off in the long-term. Augmented Category 6 will be more expensive than Category 6, however, the installation time and cost will be virtually the same. In this scenario, Augmented Category 6 offers a cabling system that will be in service for at least three generations of active network gear. In the scope of any networking project, the infrastructure is a relatively small expense. Adding the small capital expense for Augmented Category 6 cabling will defer or eliminate future costs of cabling system upgrades as new applications require replacement of active networking gear.

### Building For Bandwidth in the Future

Technology advancements in networking will continue. New processor technology, coupled with new operating systems, will allow the creation of advanced applications and services. These new applications will demand more and more bandwidth, driving the need for higher speed protocols and cabling to support these protocols. Your situation may dictate a fiber or a Category 6 solution. Yet if you own your space, or have a long term lease, a good rule of thumb is to design your passive cabling infrastructure to endure at least three generations of active networking gear with an Augmented Category 6 solution. To design for three generations, look to the IEEE and educate yourself on the applications being developed for the future. This offers an invaluable guide toward building for bandwidth in the future.

### TE Infrastructure Solutions

TE manufactures and distributes a complete portfolio of standards-based, technologically superior solutions that support voice, data, security, audio, video, controls and other building and campus systems. The TE Connectivity Structured Cabling Solution provides a complete fiber and copper cable, connectivity and cable management solution from the entrance facility to the desktop and across the campus. Supported by an exceptional warranty, TE is the choice of network managers worldwide who operate high-value and mission-critical networks.

The chart below shows just a few of the TE cable solutions used to support common enterprise applications. Integral to each solution are the TE patch panels, fiber frames, connectors, cable management, termination/splice/storage panels and other products for every unique requirement in the passive portion of your network.

IEEE Standard	Designation	Data Rate	Distance Limitation	Common Applications	TE Connectivity Solutions
802.3ab	1000Base-T	1000 Mb/s	100 Meters	Desktop Computing	Category 5e, 6 and 6A
802.3z	1000Base-SX	1000 Mb/s	550 Meters	Enterprise backbone	Laser Optimized Multimode Fiber
	1000Base-LX	1000 Mb/s	5 Kilometers	WAN, MAN	Singlemode Fiber
802.3an	10GBase-T	10 Gb/s	100 Meters (CAT)	Data Center, R&D Computing, High Resolution Video, Advanced Desktop Computing	Category 6A
			55 Meters (CAT 6)		Category 6
802.3ae	10GBase-SR/SW	10 Gb/s	300 Meters	Data Center and Enterprise Backbone Cabling	Laser Optimized Multimode Fiber
	10GBase-LR/LW	10 Gb/s	10 Kilometers	WAN, MAN	Singlemode Fiber
	10GBase-ER/EW	10 Gb/s	40 Kilometers	WAN	Singlemode Fiber
	10GBase-LX-4	10 Gb/s	300 Meters	Data Center and Enterprise Backbone Cabling	Standard Grade Multimode Fiber
	10GBase-LX-4	10 Gb/s	10 Kilometers	WAN, MAN	Singlemode Fiber
802.3af	Power over Ethernet	10/100/1000 Mb/s	100 Meters	VoIP, WiFi, RFID, IP Security	Midspan PoE
802.3ba	40GBASE-KR4 40GBASE-CR4 100GBASE-CR10 40GBASE-SR4 100GBASE-SR10 40GBASE-LR4 100GBASE-LR4 100GBASE-ER4	40/100 GbE	100 or 150 Meters	Data Center	Laser Optimized Multimode and Singlemode Fiber

# Technical Reference

## Industry Standards

---

### CHOOSING THE RIGHT ETHERNET PATCH PANELS

Category 5e, 6, or 6A?

IDC punchdown or modular? T568A or T568B? Shielded or unshielded?

Will I choose the right Ethernet patch panel for my application?

Will this choice work with future applications? Am I getting the best overall value?

How do I ensure the integrity of my network?

Can the infrastructure grow and change without service disruptions?

With all the choices you face as you design your network and select equipment, including available Ethernet patch panels, it is easy to become confused and frustrated. Ultimately your choice of Ethernet panels should fit the applications you plan to run. TE has written this short tutorial to guide you through these decisions, to make them as painless as possible and offer you the best solution for your network.

First, let's ask a few key questions. Your answers will help guide you in the decision process. Next, we will briefly discuss each of the most popular options available so you can draw conclusions based on your network needs.

### DISCOVERY QUESTIONS

- What applications are you, or do you, plan to run in this facility? Take into account not only what you are doing today, but what you probably will be doing tomorrow i.e. 10/100Base-T? 1000Base-T? 10GBase-T?
- What type of LAN network are you designing? Data center? Data backbone? Workstation?
- Is the project a new network installation or an addition to an existing network?
- Is the installation being built to expand existing capacity with current data capabilities or is it for new, faster data applications?

Answers to these questions will guide you to a particular cable type, a particular data patch panel, and the means to terminate the cable into the patch panel—whether the terminations into the patch panel involve “punchdown” cable terminations, pre-made telco-type multi-pair cable ends, or standard RJ45 cable ends.

The general guidelines for network transmission capabilities segment the data network; data center and data network backbone system applications require the highest level of transmission capabilities, while feeds to work areas generally require a bit less. However, all network connectivity should be designed with only the highest network engineering standards available.

# Technical Reference

## Industry Standards

---

### Category 5e, 6 and 6A Cabling

The Telecommunications Industry Association (TIA) standards group consists of a variety of industry experts including connectivity and cable manufacturers, distributors, installers, and end customers. The TIA determines certain transmission characteristics that must be met to qualify a cable for certain network applications.

**Category 5e** is currently the minimum TIA recommended Category of wiring for new installations. Electrical characteristics for NEXT, FEXT, ELFEXT, PSNEXT, PSELFEXT, delay skew, propagation delay, attenuation, and return loss are specified to 100 MHz. Category 5e was developed with the specific intent of supporting Gigabit Ethernet. Because all TIA standards require backwards compatibility, Category 5e will also support all lower-rated categories and protocols such as 10/100 Base-T.

**Category 6** is gaining popularity for new installations. Electrical characteristics for NEXT, FEXT, ELFEXT, PSNEXT, PSELFEXT, delay skew, propagation delay, attenuation, and return loss are specified to 250 MHz. Improvements in all electrical parameters are part of the higher TIA Category 6 standard. Category 6, while providing a “bigger pipe” for improved throughput, also has a maximum 100 meters of support for Gigabit Ethernet transmission.

**Category 6A** is similar to CAT 6, but is characterized to 500 MHz and is also capable of running 10GBASE-T. Testing parameters are similar to that of Category 5e and Category 6, with the added benefit of compliance to Alien (Bundled) Crosstalk requirements: ANEXT, AACRF, PSANEXT and PSAACRF.

So, which should you use? There is quite a bit of misleading information in the industry on this subject, the biggest myth being that Category 6 is required to run Gigabit Ethernet over copper (1000Base-T). However, as of this writing, the TIA recommends Category 6 or Category 5e as the minimum cabling for new network infrastructure installations.

When do I use Category 6 or 6A? Does the application standard (i.e., Gigabit Ethernet, 10G, etc.) specify Category 6 as a minimal requirement? As of this writing, the TIA and IEEE 802.3an committee have ratified standards for 10 Gigabit Ethernet over UTP. This standard requires an Category 6A system to run the standard 100 meters length. The good news is that Category 6A, as is the case with all TIA standards, is backward compatible and will have no trouble running existing applications such as 10/100Base-T and 1000Base-T.

The Category 6A System is TE's version of Augmented Category 6. It provides not only support for the transmission protocols of today, such as 10/100/1000 Mbps, but also that of 10GBASE-T. It is worth noting that the complexity of Category 6A is transparent to the end user and installer. The products have simply been modified to overcome the shortcomings of standard Category 6 to achieve the desired signal to noise ratios, taking into account bundled crosstalk, to achieve all of the current IEEE 802.3an (10GBASE-T) requirements.

# Technical Reference

## Industry Standards

### CABLE TYPE SUMMARY

The chart below summarizes the industry standard UTP cable types used in current networking installations.

Category	Test Frequency	10/100BaseT	1000BaseT	10 GBASE-T	Relative Cost
Category 5e	100 MHz	Yes	Yes	No	\$
Category 6	250 MHz	Yes	Yes	No	\$\$
Category 6A	500 MHz	Yes	Yes	Yes	\$\$\$

In addition to the UTP cabling described above, you should understand the issues of cable shielding, and stranded versus solid cable.

### SHIELDED VS. UNSHIELDED TWISTED PAIR

TE Connectivity offers both shielded and unshielded cables. Unshielded twisted pair (UTP) cabling provides immunity to electromagnetic interference (EMI) with the properties of the two conductors that make up a transmission pair being twisted together. When UTP cabling encounters electrical interference, the noise crossing the twisted pairs is cancelled by the twists in the cable (called “Common Mode Rejection,” a subject outside the scope of this discussion).

Standard Category 5e, 6 and 6A cables are available in both shielded and unshielded versions and contain four unshielded twisted pairs that may or may not be shielded. For 10BASE-T and 100BASE-TX applications, only two pairs are used, one for the transmit circuit and one for receive circuit. For 1000BASE-T and 10GBASE-T all four pairs are required.

There are actually two methods of shielding a twisted pair cable. Foiled twisted pair cable (F/UTP) provides an overall screen or metal foil around the four pairs of conductors, but each individual twisted pair is unshielded. Shielded twisted pair cable (S/FTP) has each individual pair shielded, plus an overall screen around the four individually shielded pairs. The legacy token ring IBM Type 1 cable and ISO Class F cable are examples of STP cable. STP cable requires metal encapsulated connectors that bond the cable shield to the telecommunications ground, in order to carry the interfering signals safely away from the signal conducting pairs. Throughout the industry, there is a misconception that grounding and bonding of shielded twisted-pair (STP) copper cabling systems is more difficult, more time consuming, and more technique sensitive. This is simply not true. Properly grounding and bonding of a shielded copper cabling system is straightforward and essentially no different than grounding and bonding a UTP system.

### STRANDED VS. SOLID CONDUCTOR CABLE

Stranded cable is flexible and often used for patch panel jumpers and work area connections. Stranded cabling is used for shorter patching applications for its flexible cable construction, but also exhibits higher attenuation due to the smaller diameter conductors, and as such should not be used for long, permanent installations. Solid conductor cable is used for the “horizontal” cable runs. The typical gauge for Category 5e cable is 24 AWG. Category 6/6A is 23 AWG—the larger conductor diameter improves attenuation characteristics and signal-to-noise ratio versus the smaller conductor diameter of Category 5e.

# Technical Reference

## Industry Standards

---

### Patch Panel Rear Termination Options

Popular choices for patch panel rear terminations include insulation displacement contact (IDC) punchdown termination, and connectorized cable end terminations (MR21, RJ45 and RJ-21X).

Many popular data patch panels are designed using IDCs, requiring the manual punchdown termination of each individual wire. A typical 24-port panel requires 192 individual punchdown terminations. With this many manual terminations, installation mistakes are common, including incorrect wire mapping (cross-wiring), opens, shorts, and excessive untwisting of the wire pairs. Terminating the “horizontal” cabling room typically uses IDC punchdown panels.

#### CHOOSING THE RIGHT ETHERNET PATCH PANELS

There are two predominant types of IDCs on the market today, the 110 and the Angled IDC Technology. Many manufacturers have now started to migrate to a 45° IDC due to its superior technical advantages, such as lower resistance, torsional forces, better stability when vibrated and the ability to accept multiple and stranded conductors.

For patch-panel-to-patch-panel connections in a data center or telecommunications room, preterminated cable assemblies and connectorized patch panels can improve installation time and connectivity success. A preconnectorized solution dramatically decreases the assembly time and increases the quality of the termination, as the contact’s points are typically gold-on-gold with high contact forces. Preconnectorized solutions do require up-front planning—the distances between panels must be determined so the correct cable assembly length can be ordered.

RJ45-to-RJ45 and RJ45-to-RJ-21X panels are the two most popular preconnectorized systems. The RJ-21X, also known as 50-pin telco or 25-pair connectors, is popular because six 4-pair Ethernet (1000BaseT) or twelve 2-pair Ethernet (10/100BaseT) circuits can be terminated at one time on a panel using the correct multi-pair cable assembly. The main requirement for 25-pair cable and connectors is the PowerSum NEXT or PSNEXT requirement. The MRJ21 connector system saves installation time and eliminates errors when used with the RJ45/MRJ21 panel option, essentially replacing the need for the traditional punchdown termination.

#### CABLE MANAGEMENT

Careful attention should be paid to the cable management scheme that surrounds patch panels and Ethernet equipment. Ideally, all Ethernet equipment is permanently terminated in a cross-connect field so that moves, adds, and changes (MACs) are done using patch cords. This enables circuit rerouting, upgrades for Ethernet equipment, and routine maintenance with less downtime—and less chance for damaging active equipment ports and cables. At a minimum, the Ethernet network should include the following characteristics:

- **Access to cables.** Especially as rack density increases, it is important that cables can be easily identified and traced for MACs. Otherwise, simple rearrangements turn into hours of downtime and technician time.
- **Cable routing.** Establishing defined cable routing paths within racks, between racks, and between equipment rooms ensures that patch cords and cables remain organized and neat. This increases both the service life of cables and the availability of Ethernet services for users.
- **Physical protection and storage.** Cables dangling from overhead or laying the floor invite problems. The proper method is to provide storage within each rack so that inadvertent damage and downtime is avoided.

# Technical Reference

## Industry Standards

---

### KEY FIBER OPTIC CABLE MANAGEMENT CONCEPTS

Proper cable management practices make fiber networks less susceptible to accidental damage, quicker to install, less expensive to own and operate over the long haul and easier to expand as needs grow.

#### Key cable management concepts include:

- **Bend radius:** At turns in fiber runs, maintain a bend radius of 10X the cable outside diameter. Tighter bends may cause macro-bending of individual fibers that allow light to escape the signal path, resulting in signal attenuation. More severe bends can break fiber strands completely, resulting in signal loss.
- **Cable troughing:** Used to route fiber optic cable, troughing systems provide a protected pathway for fiber to traverse spans between rooms and equipment racks. Good troughing systems will keep fiber separate from copper cable, protect it from out-of-tolerance bends and promote neat, easily accessible runs.
- **Vertical cable protection:** Allowing fiber to hang unprotected from the back of equipment can be a recipe for disaster. Exposed cables are easy to snag accidentally with a hand or foot, which can result in damage to the connector or fiber itself. Additionally, over time the weight of hanging fiber can cause bends outside the acceptable limit and consequently, damage to the fiber. Proper vertical cable management in panels or equipment bays provides adequate support, cable protection and a transition from the vertical run to the back of the equipment that does not damage the fiber.
- **Cable pile-up:** In horizontal fiber runs, it is unacceptable to allow a pile of fiber cable to exceed two inches. Beyond that point, the weight of the bundle will surpass the crush tolerance limit of the fiber at the bottom of the stack, resulting in microscopic damage and signal attenuation.
- **Cable segregation:** Keep fiber runs separate from legacy copper cable. Copper cable is relatively heavy and can crush fiber cables. Additionally, segregating coax from fiber ensures that technicians repairing coax do not accidentally damage the fiber cable while working on the copper.
- **Labeling:** As you would in a legacy copper environment, develop good labeling practices. Know where fibers originate and terminate. Doing so will reduce maintenance time and the likelihood that a maintenance technician will make hasty decisions on fiber routing that can lead to a rat's nest of cable and patch cords.
- **Density:** When selecting products for a fiber network, remember future maintenance. The more densely connectors are packed onto a panel, the more difficult it will be for even the most dexterous technicians to maintain. Remember, inevitably cables will be moved, so the ability to trace and re-route them is critical to working efficiently.
- **Future proofing:** When planning rack configurations with a given number of terminations to accommodate a relatively low number of fibers for today's requirements, don't forget the future. A fiber path that easily supports 12 fibers today may be inadequate to support the 200 fibers needed in a few years. Planning up front for the future can save the expense of ripping out outgrown capacity down the road.

Proper cable management is extremely important to the success of an evolving high-performance communications network. The fact that a single fiber may transmit mission-critical signals underlies the importance of taking the steps necessary to manage fiber's installation and use.

#### SINGLEMODE VERSUS MULTIMODE FIBER

Fiber optic cable comes in two varieties: singlemode and multimode. Both have applications in structured cabling applications. Singlemode fiber optic cables transmit a single ray of light used to carry modulated signals. It is normally used in applications requiring the transmission of signals over a long distance, for example, between separate facilities on a campus.

Multimode fiber optic cable carries multiple light rays with different reflection angles within the fiber core. With a fiber core that's larger in diameter than singlemode fiber, multimode cable is better suited for short runs, such as those between equipment and panels. Multimode should be used to connect devices such as optical routers and servers.

Fiber optic cable offers a level of security that exceeds copper or microwave transmission because it is difficult to tap without breaking.

#### ULTRA PHYSICAL CONTACT (UPC) CONNECTORS AND ANGLED PHYSICAL CONTACT (APC) CONNECTORS

Attaching a connector to a (UPC) fiber optic cable will cause some of the light traversing that (APC) fiber to be lost. Regardless of whether the connector was installed in the factory or the field, its presence will be responsible for some light being reflected back towards its source, the laser. Commonly known as return loss (RL), these reflections can damage the laser and degrade the signal's performance. The degree of signal degradation caused by RL depends on the laser's specifications; some lasers are more sensitive to RL than others.

The amount of optical return loss generated is related to the type of polish that is used on the connector.

The **angled physical contact** (APC) connector is best for video, high bandwidth applications and long haul links since it offers the lowest return loss characteristics of connectors currently available. In an APC connector, the endface of a termination is polished precisely at an eight degrees angle to the fiber cladding so that most RL is reflected into the cladding where it cannot interfere with the transmitted signal or damage the laser source. As a result, APC connectors offer a superior RL performance of -65 dB.

However, it is extremely difficult to field terminate an angled physical contact connector at eight degrees with any consistent level of success. Therefore, if an APC patch cord is damaged in the field it should be replaced with a factory-terminated APC patch cord. If it is not a patch cord, fusion splicing with a factory-terminated APC pig-tail is recommended.

The **ultra physical contact** (UPC) connector—while not offering the superior optical return loss performance of an APC connector—has RL characteristics that are acceptable for data transmissions. When using UPC connectors, make sure your laser's specifications can handle the return loss your UPC connectors will generate.

Offering -57 dB RL, ultra physical contact connectors rely on machine polishing to deliver their low optical return loss characteristics. Ultra physical contact polishing refers to the radius of the endface polishing administered to the ferrule, the precision tube used to hold a fiber in place for alignment. The rounded finish created during the polishing process allows fibers to touch on a high point near the fiber core where light travels. Unlike APC connectors, UPC connectors can, with the proper tools and training, be repaired in the field.

# Technical Reference

## Industry Standards

---

### CONNECTOR STYLES

- **SC:** The SC style offers excellent loss characteristics and comes in a standard footprint. It is easy to snap in and remove. The SC is pull-proof and is available in UPC and APC.
- **LC:** The most popular of all connectors, the LC is a small-form-factor connector. The LC features are similar to SC, but its size allows double the density. Available in UPC and APC.
- **ST:** Very similar in appearance to a BNC connector, the ST is a bayonet type connector. It does not offer the pull-proof resiliency of SC and LC connectors. ST connectors, which are made of metal components, are only available with UPC polishing. In recent years, the popularity of ST connectors has waned as the use of SC and LC connectors has grown.
- **Duplex SC:** Offers the same features as the SC style but supports two-way communication.
- **MT-RJ:** Each MT-RJ fiber connector houses two fibers and is less than half the size of SC duplex connector and transceiver, doubling the port density of fiber-optic LAN equipment.

When designing a fiber network for routing signals through a facility, standardizing on a single connector type will make network repairs and technician training faster and less expensive. However, despite efforts to standardize on a single connector style, it may be necessary to use a hybrid cable in some applications.





## Index

By Product Name .....	9-3
By Part Number .....	9-14



# Index

## By Product Name

### A

Accessories.....	4-4-4-26
Adapter for 89B Bracket.....	3-50
Adapters for Furniture Faceplates.....	4-21-4-26
Advanced Purchased License.....	3-121
Aerial Panel Holder Kit for Wire Mesh Cable Trays.....	1-64
AMP-BARREL Wire Insertion Tools.....	3-140
AMP NETCONNECT Labeling Software.....	3-122
AMP-TY Nylon Cable Ties.....	1-143, 3-119
Angled Faceplates.....	4-7-4-26
Angled Panels.....	3-12
Assembly Length.....	1-14

### B

Backbone Cabling.....	8-11
Blades: LC-to-LC, LC-to-MPO, MPO-to-MPO.....	5-10
Blank Chassis Covers.....	5-8
Blank Panels.....	3-92
Breakout Length.....	1-14
Broadcast Products.....	7-3

### C

Cable Assemblies.....	3-125
Cable Assembly Configuration.....	1-13
Cable Clamping/Block Conversion Kits.....	1-100
Cable Clamp Kit.....	1-105
Cable Cutters.....	3-136
Cable Installation.....	8-15
Cable Management.....	6-1-6-34
2x2 Direct Support Kits.....	6-5
2x2 Downspout Options.....	6-5
2x2 Fittings and Junctions.....	6-4
2x2 Straight Section.....	6-4
2x2 Track Support Kits.....	6-5
2x6 Fittings.....	6-6
2x6 Straight Section.....	6-6
2x6 Support Kits.....	6-8
4x4 Downspout Options.....	6-8
4x4 Fittings and Junctions.....	6-7
4x4 Straight Section.....	6-7
4x4 Support Kits.....	6-8
4x6 Downspout Options.....	6-8
4x6 Fittings.....	6-9
4x6 Junctions.....	6-9
4x6 Straight Section.....	6-9
4x12 Fittings.....	6-10
4x12 Junction.....	6-10
4x12 Straight Section.....	6-10
4x12 System Support Kits.....	6-11
4x24 Snap-Fit Junction.....	6-13
4x24 System Downspouts - 4" H x 24" W.....	6-14
4x24 System Fittings - 4" H x 24" W.....	6-14

4x24 System - Straight Section.....	6-13
4x24 System Support Kits.....	6-15
Cable Support Bars.....	6-25
C-LOK, Solid and Stranded Copper Bonding Connectors.....	6-25
Double-Sided High-Density Vertical Cable Managers.....	6-20
Equipment Racks.....	6-18
Express Exits Units.....	6-4
Fiber Cable Raceway Accessories.....	6-12
Fiber Cable Raceway FiberGuide Systems.....	6-3
FiberGuide Materials Product Statement.....	6-17
Grounding Lug Kit.....	6-25
High-Density Cable Management Accessories.....	6-21
Hinged Patch Panel Accessories.....	6-23
Hinged Wall Brackets for 19-Inch Panels.....	6-23
Horizontal Finger Duct Accessories.....	6-22
Horizontal Finger Duct Panels.....	6-22
Horizontal Ringed Cable Management Panels.....	6-24
MRJ21 Cable Support Bars.....	6-26
Rack Mount Cable Trough.....	6-24
Rack Mount Mounting Frames.....	6-34
Rod Mount Bracket Spacer.....	6-33
Solid Copper Bonding Connectors.....	6-25
Stationary, Ventilated Shelf.....	6-19
Stranded Copper Bonding Connectors.....	6-25
Termination Block Mounting Hardware.....	6-26
Type 85 Back Mount Frames.....	6-31
Type 85 Rod Mount Brackets.....	6-32
Type 105 Back Mount Frames.....	6-31
Type 105 Back Mount Frames with Ground Lug.....	6-32
Type 105 Rod Mount Brackets.....	6-33
Universal Mounting System (UMS).....	6-27
Universal Mounting System (UMS) Backboards.....	6-29
Universal Mounting System (UMS) Cable.....	6-28
Universal Mounting System (UMS) High Volume Cable Managers.....	6-30
Universal Mounting System (UMS) Wire Managers.....	6-28
Vertical Duct Systems.....	6-11
Vertical Finger Duct Panels.....	6-22
Wall Mount Mounting Frames.....	6-34
Cable Strippers.....	3-136
Cable Support Bars.....	3-61, 6-25
CAT5E U/UTP Cable Assemblies.....	3-75
CAT6A F/UTP Cable Assembly.....	3-75
Category 3 25-Pair Patch Panels.....	3-91
Category 3 Modular Plugs.....	3-98
Category 3 Patch Panels.....	3-90
Category 5, 10/100BASE-T, RJ21 (25-Pair) Patch Panel and Cable Assemblies.....	3-90
Category 5e, 6 and 6A Cabling.....	8-23
Category 5e Cable Assemblies.....	3-47
Category 5e Couplers.....	3-43
Category 5e Modular Jacks.....	3-43

# Index

## By Product Name

Category 5e Modular Plugs.....	3-45
Category 5e Patch Panels.....	3-41
Category 5e Termination Blocks.....	3-48
Category 5e Twisted Pair Cable.....	3-36
Category 5e UTP Solution.....	3-7
Category 6, 8-Position Modular Plug.....	3-29
Category 6A 8-pair Termination Blocks.....	3-17
Category 6A 20-pair Termination Blocks.....	3-17
Category 6A F/UTP Shielded Cable Assemblies.....	3-15
Category 6A Modular Jacks.....	3-13
Category 6A Patch Cords.....	1-123
Category 6A Patch Panels.....	3-11
Category 6A Shielded Patch Cable Assemblies.....	3-56
Category 6A Shielded Solution.....	3-3
Category 6A Termination Blocks.....	3-18
Category 6A UTP Solution.....	3-4
Category 6A U/UTP Cable Assemblies.....	3-16
Category 6 Couplers.....	3-28
Category 6 Modular Jacks.....	3-28
Category 6 Patch Panels.....	3-26-3-27
Category 6 Termination Blocks.....	3-31-3-32
Category 6 Twisted Pair Cable.....	3-20
Category 6 UTP Solution.....	3-5, 3-6
Category 6 U/UTP Cable Assemblies.....	3-30
Category U/UTP 8-pair and 20-pair Termination Block Patch Cords.....	3-19
Clear Label Holder for 110Connect XC Wiring Blocks.....	3-125
C-LOK Copper Bonding Connectors.....	6-25
Configuration Information.....	1-94
Consolidation Points for Drop Ceiling Systems.....	3-105
Consolidation Points for Raised Floor Systems.....	3-104
Consolidation Point Transition Cable Assemblies.....	3-107
Consumables Kits.....	1-136
Copper 3-54-3-142, 3-57, 3-66-3-142 1RU Rack Mount Fiber Optic Patch Panel.....	3-95
4-Pair Conductor Color Code.....	3-10
5-Port Compact Ethernet Switch.....	3-85
8-Port Compact Ethernet Switch.....	3-85
8-Port PoE Midspan Device.....	3-89
16-Port Compact Ethernet Switch.....	3-85
24-Port Smart Ethernet Switch II with Optional Dual Uplink Port.....	3-85
24-Port Stackable Managed Switch with Optional Expansion Port.....	3-86
25-Pair Conductor Color Code.....	3-40
110Connect Modular Jack Patch Panels.....	3-94
110Connect XC Cable Management.....	3-52
110Connect XC Category 5e Cable Assemblies.....	3-48
110Connect XC Category 5e Connecting Blocks.....	3-49
110Connect XC Category 5e Cross-Connect Distribution Frame Kits.....	3-51
110Connect XC Category 5e Cross-Connect Rack Mount Panel.....	3-53
110Connect XC Category 5e Kits.....	3-50
110Connect XC Category 5e Wiring Blocks.....	3-49
110 Punch Down Tool Replacement Blades.....	3-134
110 Punch Down Tools with Blades.....	3-134
520 Series, Category 5e F/UTP Cable.....	3-37
520 Series, Category 5e UTP Cable.....	3-36
640 Series Category 6A F/UTP Twisted Pair Cable.....	3-8
640 Series Category 6A U/UTP Twisted Pair Cable.....	3-9
Adapter for 89B Bracket.....	3-50
Advanced Purchased License.....	3-121
AMP-BARREL Wire Insertion Tools.....	3-140
AMP NETCONNECT Labeling Software.....	3-122
AMP-TY Nylon Cable Ties.....	3-119
Angled Panels.....	3-12
Blank Panels.....	3-92
Cable Assemblies.....	3-125
Cable Cutters.....	3-136
Cable Strippers.....	3-136
Cable Support Bars.....	3-61
Category 3 25-Pair Patch Panels.....	3-91
Category 3 Modular Plugs.....	3-98
Category 3 Patch Panels.....	3-90
Category 5, 10/100BASE-T, RJ21 (25-Pair) Patch Panel and Cable Assemblies.....	3-90
Category 5e Cable Assemblies.....	3-47
Category 5e Couplers.....	3-43
Category 5e Modular Jacks.....	3-43
Category 5e Modular Plugs.....	3-45
Category 5e Patch Panels.....	3-41
Category 5e Termination Blocks.....	3-48
Category 5e Twisted Pair Cable.....	3-36
Category 5e UTP Solution.....	3-7
Category 6, 8-Position Modular Plug.....	3-29
Category 6A 8-pair Termination Blocks.....	3-17
Category 6A 20-pair Termination Blocks.....	3-17
Category 6A Modular Jacks.....	3-13
Category 6A Patch Panels.....	3-11
Category 6A Shielded Patch Cable Assemblies.....	3-56
Category 6A Shielded Solution.....	3-3
Category 6A Termination Blocks.....	3-18
Category 6A UTP Solution.....	3-4
Category 6A U/UTP Cable Assemblies.....	3-16
Category 6 Couplers.....	3-28
Category 6 Modular Jacks.....	3-28
Category 6 Patch Panels.....	3-26-3-27
Category 6 Termination Blocks.....	3-31-3-32
Category 6 Twisted Pair Cable.....	3-20
Category 6 UTP Solution.....	3-5, 3-6
Clear Label Holder for 110Connect XC Wiring Blocks....	3-125
Consolidation Points for Drop Ceiling Systems.....	3-105
Consolidation Points for Raised Floor Systems.....	3-104
Consolidation Point Transition Cable Assemblies.....	3-107

# Index

## By Product Name

### Copper Connectivity Solutions -

Accessories and Labels .....	3-129
Cover for Angled Patch Panels.....	3-93
Die Sets for Twisted Pair Applications .....	3-136
Discrete High-Density Angled SL Series Patch Panel.....	3-93
Easy Access Zone (EAZ) Enclosure .....	3-108
Ethernet Media Converters.....	3-84
External Strain Reliefs For Modular Plugs .....	3-46
Faceplate/Outlet Compatibility List.....	3-126-3-128
Fast Ethernet Media Converters.....	3-87
Feed Thru (FT) Block Test Cord.....	3-103
Feed-Thru (FT) Field Assembly Kits.....	3-101
Feed-Thru (FT) Termination Block Systems.....	3-100
Feed-Thru Termination Accessories.....	3-99
Feed-Thru Termination Block System.....	3-99
Gigabit Ethernet Media Converters .....	3-88
HighBand Patch Cords.....	3-34-3-35
Icon Wheels.....	3-120
Identification Accessories.....	3-121
Identification Labels .....	3-121
Insertion/Extraction Tools.....	3-141
Inserts for 110Connect Modular Jack Patch Panels.....	3-95
Keystone Category 3 Modular Couplers.....	3-96
KRONE Insertion Tool.....	3-135
Label Compatibility List.....	3-126-3-128
Label Covers for Faceplates.....	3-123
Label Covers for Patch Panels .....	3-124
Labels for 110Connect XC Cross-Connect	
Wiring Blocks.....	3-125
Labels for Cable.....	3-125
Labels for Patch Panels .....	3-124
Media Converters .....	3-83
Mid-Span POE .....	3-83
Modular and Cross-Connect Consolidation Points.....	3-106
Modular Consolidation Point Modules.....	3-106
Modular Plug Boots .....	3-46
MRJ21 1 GbE Cassettes .....	3-59
MRJ21 1 GbE Patch Panels .....	3-61
MRJ21 Cassette Panel (1GbE).....	3-59
MRJ21 Copper Cabling Solutions .....	3-54
MRJ21 Label Holder Panels.....	3-62
MRJ21 Labels.....	3-62
MRJ21 Ultra Slim Cable Assemblies .....	3-58
MRJ21 XG (10 GbE) System.....	3-55
MRJ21 XG 19-Inch Patch Panel, 1RU, Straight.....	3-57
MRJ21 XG Cassette Patch Panel .....	3-57
MRJ21 XG to MRJ21 XG Cable Assemblies.....	3-56
Multimedia Integrated Cable Management	
SL Series Patch Panels.....	3-93
Multimedia SL Series Patch Panels.....	3-92
Next Generation MRJ21 1GbE Assemblies.....	3-60
Palm Grip Hand Tool Kits.....	3-141

Palm Grip Tool.....	3-135
Paper Labels.....	3-131-3-132
Patch Cords for Feed-Thru (FT) .....	3-102
Patch Cords for Feed-Thru (FT) Blocks.....	3-103
Patch Cords for Ultim8 Blocks.....	3-33-3-34
Pistol Grip Tool for AMP-BARREL Edge Connectors.....	3-140
Portable “Butterfly” Hand Tool (MI-1) for	
CHAMP 25-Pair Connectors.....	3-141
Power over Ethernet Products .....	3-84
PRO-CRIMPER III Hand Tool .....	3-136
Pro-Installer’s Modular Plug Hand Tool .....	3-138
Pro-Installer’s Modular Plug Hand Tool Kits	
and Accessories.....	3-139
Pro-Installer Twisted Pair Tool Kit .....	3-134
QSFP/QSFP+ .....	3-80
QSFP/QSFP+ High Speed Copper Cable Assemblies.....	3-81
Rack Mount Media Converter Chassis System.....	3-88
RJ45 Coupler Panel.....	3-89
RJ45 Dust Cover.....	3-97
SFP+ .....	3-80
SFP+ High Speed Copper Cable Assemblies .....	3-81
Side-Mount Label Holder.....	3-131
Sigma-Link.....	3-63
Sigma-Link Cat6A F/UTP Cable Assemblies .....	3-65
Sigma-Link Cat6 UTP Cable Assemblies.....	3-64
Sigma-Link Patch Panel.....	3-65
SL Series Category 3 Modular Jacks.....	3-96
SL Series Category 5e Modular Jacks .....	3-43
SL Series Modular Category 6 Jack Accessories.....	3-29
SL Series Modular Coupler.....	3-44
SL Series Modular Jack Strain Relief.....	3-97
SL Series Modular Jack Termination Accessories .....	3-133
SL Series Modular Jack Termination Tool.....	3-133
Smart Ethernet Switches.....	3-84
SNMP Managed Ethernet Switches .....	3-84
Standard Labels for Outlets.....	3-122
Standard Panels.....	3-12
Switches.....	3-83
Tooling Category 6 Modular Plugs .....	3-137
Twisted Pair Cable Packaging Reference.....	3-25, 3-39
Twisted Pair Testing Tools .....	3-142
Type 105 Hinged Label Holder .....	3-130
Type 105 Label Holder .....	3-130
Type 105 Label Strip .....	3-130
Ultim8 1-Pair Patch Cords.....	3-34-3-35
Ultim8 2-Pair Patch Cords.....	3-34-3-35
Universal Connectivity Platform (UCP) .....	1-59
Universal Labels.....	3-123
Velcro Cable Ties.....	3-119
Wall/Furniture Mounting Bracket .....	3-109
Copper and Fiber Labeling Software and Labeling Sheets.....	1-144
Copper Connectivity Solutions - Accessories and Labels..	3-129

# Index

## By Product Name

Copper Design Technology .....	8-3
Cover for Angled Patch Panels.....	3-93
Curing Sleeves .....	1-138
Custom Modular Adapter Packs.....	1-80
Cycle Life .....	8-4

### D

Data Center Optical Distribution Frame with Plug-and-Play Cassettes .....	1-102
Data Center Optical Distribution Frame with Plug-and-Play Cassettes Specifications.....	1-103-1-104
Desktop Monuments.....	4-17-4-26
Die Sets for Twisted Pair Applications.....	3-136
Discrete High-Density Angled SL Series Patch Panel.....	3-93
Distributed Antenna Systems.....	7-3
Door Kits.....	5-8
Double-Sided High-Density Vertical Cable Managers .....	6-20

### E

Easy Access Zone (EAZ) Enclosure .....	3-108
End Guard.....	1-93
EPO-TEK 353ND Epoxy.....	1-134
Epoxy Applicator Syringe.....	1-135
Epoxy Curing Oven.....	1-136
Epoxy/Polish Compatibility Chart.....	1-131
Epoxy/Polish Connector Consumables.....	1-131
Epoxy/Polish Connector Termination Tool Kits.....	1-133
Epoxy/Polish Tool Kits.....	1-130
Equipment Racks.....	6-18
Ethernet Media Converters.....	3-84
Express Exits Units.....	6-4
Extenders for Furniture Faceplates.....	4-21-4-26
External Strain Reliefs For Modular Plugs.....	3-46

### F

Faceplate/Outlet Compatibility List.....	3-126-3-128
Faceplates.....	4-3-4-26, 4-4-4-26
Faceplates for Herman Miller Furniture.....	4-20-4-26
Faceplates for Mounting Straps.....	4-9-4-26
Faceplates for WIREMOLD Raceways.....	4-15-4-26
Fast Ethernet Media Converters.....	3-87
Feed Thru (FT) Block Test Cord.....	3-103
Feed-Thru (FT) Field Assembly Kits.....	3-101
Feed-Thru (FT) Termination Block Systems.....	3-100
Feed-Thru Termination Accessories.....	3-99
Feed-Thru Termination Block System.....	3-99
Fiber	
50/125 $\mu\text{m}$ OM2 Multimode Epoxy/Polish Connectors ....	1-44
50/125 $\mu\text{m}$ OM2 Multimode LightCrimp PLUS Connectors (No epoxy/No polish) .....	1-39
50/125 $\mu\text{m}$ OM2 Multimode MT-RJ Jacks (No epoxy/No polish).....	1-48

50/125 $\mu\text{m}$ OM2 Multimode Optical Fiber Interconnect Cable.....	1-24, 1-27
50/125 $\mu\text{m}$ OM2 Multimode Snap-in Adapter Plates.....	1-52
62.5/125 m OM1 Multimode MT-RJ Jacks (No epoxy/No polish).....	1-49
62.5/125 $\mu\text{m}$ OM1 Multimode Adapters .....	1-56
62.5/125 $\mu\text{m}$ OM1 Multimode Couplers.....	1-56
62.5/125 $\mu\text{m}$ OM1 Multimode Epoxy/Polish Connectors	1-45
62.5/125 $\mu\text{m}$ OM1 Multimode LC Test Kits.....	1-146
62.5/125 $\mu\text{m}$ OM1 Multimode LightCrimp PLUS Connectors (No epoxy/No polish).....	1-40
62.5/125 $\mu\text{m}$ OM1 Multimode Optical Fiber Interconnect Cable.....	1-24, 1-27
62.5/125 $\mu\text{m}$ OM1 Multimode Replacement Components for LC Test Kits.....	1-146
62.5/125 $\mu\text{m}$ OM1 Multimode Snap-in Adapter Plates.....	1-53
AMP-TY Nylon Cable Ties.....	1-143
Assembly Length.....	1-14
Cable Assembly Configuration.....	1-13
Cable Clamping/Block Conversion Kits.....	1-100
Cable Clamp Kit.....	1-105
Configuration Information.....	1-94
Consumables Kits .....	1-136
Copper and Fiber Labeling Software and Labeling Sheets.....	1-144
Curing Sleeves .....	1-138
Custom Modular Adapter Packs.....	1-80
Data Center Optical Distribution Frame with Plug-and-Play Cassettes .....	1-102
Data Center Optical Distribution Frame with Plug-and-Play Cassettes Specifications .....	1-103-1-104
End Guard.....	1-93
EPO-TEK 353ND Epoxy.....	1-134
Epoxy Applicator Syringe .....	1-135
Epoxy Curing Oven.....	1-136
Epoxy/Polish Compatibility Chart.....	1-131
Epoxy/Polish Connector Consumables.....	1-131
Epoxy/Polish Connector Termination Tool Kits .....	1-133
Fiber Enclosure Comparison .....	1-57
Fiber Main Distribution Frame (FMDF).....	1-91
Fiber Optic Accessories and Tooling.....	1-130
Fiber Optic OM2 Solution.....	1-3
Fiber Optic OM4 Solution.....	1-5
Fiber Optic Patch Cords.....	1-18
Fiber Optic Singlemode Solution.....	1-6
Fiber Optic Terminal Patch Cord Storage Panel.....	1-92
Fiber Patch Cord Configurator .....	1-19, 2-9
Fiber Termination Blocks.....	1-89
Fiber Termination Blocks (FTBs).....	1-100
Fiber Termination Blocks (FTBs) Underterminated (Adapter Only).....	1-97-1-99
Fiber Trunk Configurator .....	1-12

# Index

## By Product Name

Fiber Trunk Solutions.....	1-9	Optical Fiber Cable Temperature Ranges.....	1-35
Five Simple Components.....	1-109	OPTIPOP C Card Optical Connector Cleaner.....	1-141
Frame Installation Kit.....	1-106	OPTIPOP R Reel Optical Connector Cleaner.....	1-140
Free Labeling Software.....	1-144	OS2 Singlemode Optical Fiber Interconnect Cable 1-25, 1-28	
Hand Held Optical Fiber Cleaver.....	1-133	Polarity for MPO to MT-RJ, LC, SC, ST, or FC.....	1-16
HYSOL Epoxy-Tubes.....	1-135	Polishing Bushings.....	1-138
Inspection Microscope.....	1-137	Polishing Films.....	1-136
LC Connector Cleaner (In Bulkhead Cleaner).....	1-142	PRO-CRIMPER III Fiber Die Sets.....	1-139
LC Style FTBs with Factory Terminated Stubs.....	1-96	PRO-CRIMPER III Fiber Optic Hand Tool.....	1-139
LightCrimp PLUS Cable Holders.....	1-132	Professional Fiber Connector Inspection/Cleaning Kits.1-142	
LightCrimp PLUS LC/SC and LightCrimp		Q3000.....	1-58
Splice Termination Tool Kit.....	1-130	Q3000 Blades.....	1-58
LightCrimp PLUS Termination Tool Kits.....	1-131	Q3000 SAM Blades.....	1-110
LightCrimp Splice.....	1-42	Replacement Components for Singlemode	
MPO to MPO Polarity for Cable Assemblies.....	1-15	LC Test Kits.....	1-147
MTP/MPO IBC (In Bulkhead Cleaner).....	1-140	RMG.....	1-75
MT-RJ Jack Termination Tool Kit.....	1-132	RMG Maximum Capacity by Adapter	
Multimode (850/1300 nm) Optical Fiber		Style and Chassis Height.....	1-77
Cable Performance Specifications.....	1-34	RMG Plug-and-Play Cassettes.....	1-81
Multimode Adapters.....	1-55	RMG Standard Adaptor Packs.....	1-79
Multimode Couplers.....	1-55	SC Connector Cleaner (In Bulkhead Cleaner).....	1-142
Multimode Epoxy/Polish Connectors.....	1-43	SC style FTB's with Factory Terminated	
Multimode LightCrimp PLUS Connectors		Stubs 144-position Block.....	1-95
(No epoxy/No polish).....	1-38	Singlemode (1310/1550 nm) Optical Fiber	
Multimode MT-RJ Jack Accessories		Cable Performance Specifications.....	1-34
(OM4, OM3, OM2, and OM1).....	1-50	Singlemode Adapters.....	1-56
Multimode MT-RJ Jacks (No epoxy/No polish).....	1-47	Singlemode Couplers.....	1-56
Multimode Optical Fiber Outside Plant Armored		Singlemode Epoxy/Polish Connectors.....	1-46
(OSPA) Cable.....	1-33	Singlemode LC Test Kits.....	1-147
Multimode Optical Fiber Performance.....	1-34	Singlemode LightCrimp PLUS Connectors	
Multimode Snap-in Adapter Plates.....	1-51	(No epoxy/No polish).....	1-41
NEOCLEAN Stick Cleaner.....	1-141	Singlemode Snap-in Adapter Plates.....	1-54
OM2, OM1 and Singlemode Optical Fiber		Sliding Adapter Packs.....	1-89, 1-101
Indoor/Outdoor Cable.....	1-31	Standard Cross-Connect Patch Cord Lengths.....	1-106
OM3 and OM4 (50/125 $\mu$ m) Multimode LightCrimp PLUS		Strip Card Kit.....	1-138
Connectors (No epoxy/No polish).....	1-38	TFP.....	1-65
OM3 and OM4 (50/125 $\mu$ m) Multimode Optical		TFP Empty Chassis.....	1-66
Fiber Distribution Cable.....	1-26	TFP MPO Pack.....	1-74
OM3 and OM4 (50/125 $\mu$ m) Multimode Optical		TFP Plug-and-Play Cassettes.....	1-71-1-72
Fiber Interconnect Cable.....	1-23	TFP Pre-configured Termination/Splice Fiber Panels.....	1-70
OM3 and OM4 (50 $\mu$ m) and OM2 (50/125 $\mu$ m)		TFP Product Overview.....	1-67
Multimode LC Test Kits.....	1-145	TFP Series Rack Mount Fiber Panels.....	1-66
OM3 and OM4 (50 $\mu$ m) and OM2 (50/125 $\mu$ m) Multimode		TFP Series Standard Adapter Packs.....	1-68
Replacement Components for LC Test Kits.....	1-145	Tool Kit Compatibility Chart.....	1-130
OM3 and OM4 Multimode Epoxy/Polish Connectors.....	1-43	TRA-CON Epoxy.....	1-134
OM3 and RMG OM4 (50/125 $\mu$ m) Multimode		Velcro Cable Ties.....	1-143
Snap-in Adapter Plates.....	1-51	Fiber Cable Assembly for Zone Cabling 50/125 $\mu$ m OM1	
OMX Cable Clamps.....	1-108	Multimode MT-RJ Transition Point Cable Assemblies.....	3-108
OMX Splice Cabinet.....	1-107	Fiber Cable Raceway.....	6-3
OMX Splice Wheel.....	1-108	Fiber Cable Raceway Accessories.....	6-12
Optical Distribution Frame.....	1-89	Fiber Cable Raceway FiberGuide Systems.....	6-3
Optical Fiber Cable Technical Information.....	1-35-1-37	Fiber Enclosure Comparison.....	1-57

# Index

## By Product Name

Fiberguide.....	6-3	Interlocking Armor Optical Fiber Distribution Cable.....	1-29
FiberGuide Materials Product Statement .....	6-17	Introduction.....	III
Fiber Main Distribution Frame (FMDF).....	1-91	<b>J</b>	
Fiber Optic Accessories and Tooling.....	1-130	Jack Pin-Outs.....	8-16
Fiber Optic OM2 Solution.....	1-3	Jacks, Colored Dust Covers	
Fiber Optic OM4 Solution.....	1-5	for Cat 6A F/UTP AMP-TWIST Modular .....	3-14
Fiber Optic Singlemode Solution.....	1-6	<b>K</b>	
Fiber Optic Terminal Patch Cord Storage Panel .....	1-92	Keystone Category 3 Modular Couplers.....	3-96
Fiber Support Bar Kit.....	3-104	KRONE Insertion Tool.....	3-135
Fiber Termination Blocks .....	1-89	<b>L</b>	
Fiber Termination Blocks (FTBs).....	1-100	Label Compatibility List.....	3-126-3-128
Fiber Termination Blocks (FTBs) Unterminated (Adapter Only). 1-97-1-99		Label Covers for Faceplates.....	3-123
Fiber Trunk Configurator.....	1-12	Label Covers for Patch Panels .....	3-124
Fiber Trunk Solutions.....	1-9	Labels for 110Connect XC Cross-Connect Wiring Blocks..	3-125
FLEX-MODE Modular Furniture		Labels for Cable.....	3-125
Faceplate Accessories.....	4-21-4-26	Labels for Patch Panels.....	3-124
Frame Installation Kit.....	1-106	LC Connector Cleaner (In Bulkhead Cleaner) .....	1-142
Frames .....	1-89	LC Duplex Clips.....	2-4
Free Labeling Software.....	1-144	LC SECURE Duplex Hybrid Cable Assemblies.....	2-8, 2-10
<b>G</b>		LC SECURE Epoxy/Polish Simplex Connectors.....	2-4
Gigabit Ethernet Media Converters.....	3-88	LC SECURE LightCrimp PLUS Simplex Connectors (No epoxy/No polish).....	2-3
Grounding Lug Kit.....	6-25	LC SECURE SL Series Duplex Couplers.....	2-5
<b>H</b>		LC SECURE Snap-In Adapter Plates.....	2-6
Hand Held Optical Fiber Cleaver.....	1-133	LC Style FTBs with Factory Terminated Stubs .....	1-96
HIDEAWAY Multimedia Outlets.....	4-11-4-26	LightCrimp PLUS Cable Holders.....	1-132
HIDEOUT Outlets.....	4-10-4-26	LightCrimp PLUS LC/SC and LightCrimp Splice Termination Tool Kit .....	1-130
HighBand Patch Cords.....	3-34-3-35	LightCrimp PLUS No-epoxy/No-polish LC and SC Tool Kit.....	1-130
High-Density Cable Management Accessories.....	6-21	LightCrimp PLUS No-epoxy/No-polish ST Tool Kit.....	1-130
High Fiber Count Plug-and-Play Array Cables .....	1-11	LightCrimp PLUS No-epoxy/No-polish Universal Tool Kit.....	1-130
High Fiber Count Plug-and-Play Trunks .....	1-10	LightCrimp PLUS Termination Tool Kit.....	1-130
Hinged Patch Panel Accessories .....	6-23	LightCrimp PLUS Termination Tool Kits .....	1-131
Hinged Wall Brackets for 19-Inch Panels.....	6-23	LightCrimp Splice .....	1-42
Horizontal Cabling.....	8-12	<b>M</b>	
Horizontal Finger Duct Accessories .....	6-22	Managed Connectivity.....	5-8-5-18
Horizontal Finger Duct Panels .....	6-22	Blades: LC-to-LC, LC-to-MPO, MPO-to-MPO.....	5-10
Horizontal Ringed Cable Management Panels.....	6-24	Blank Chassis Covers .....	5-8
How AirES Cable Technology Lowers Temperatures While Increasing Uptime.....	8-5	Door Kits.....	5-8
HYSOL Epoxy-Tubes .....	1-135	Q2000 Series Network Panels.....	5-16
<b>I</b>		Q4000 Series .....	5-8
ICM Mobile .....	5-7	QCC-4 Chassis Controller .....	5-11
ICM Software.....	5-6	Q-Frame.....	5-14
Icon Wheels.....	3-120	QPC-2 Panel Controller Compatible with Q2000 Network Panels .....	5-16
Identification Accessories.....	3-121	Quareo Cross Connect Frame .....	5-14
Identification Labels .....	3-121	Quareo Managed Array Cables .....	5-12
Infrastructure Configuration Manager (ICM).....	5-4	Quareo Managed Fiber Cables.....	5-11
Insertion/Extraction Tools.....	3-141		
Inserts for 110Connect Modular Jack Patch Panels.....	3-95		
Inspection Microscope.....	1-137		



# Index

## By Product Name

Quareo Managed Trunk and Array Cables .....	5-12
Quareo Series Network Chassis.....	5-8
Media Converters .....	3-83
Mid-Span POE.....	3-83
Modular and Cross-Connect Consolidation Points.....	3-106
Modular Consolidation Point Modules.....	3-106
Modular Jack Boxes.....	4-15-4-26
Modular Plug Boots .....	3-46
Modular Plug Boots for Category 6 Modular Plugs.....	3-30
Mounting Straps .....	4-9-4-26
MPO Microcable Trunk Assemblies .....	1-9, 3-79
MPO/MPOOptimate Quick-Fit Module.....	1-63
MPOOptimate 40 Gigabit Quick-Fit Cassettes.....	1-63
MPOOptimate coupler Quick-Fit module.....	3-77
MPOOptimate LC patch cords .....	3-78
MPOOptimate pre-terminated trunks .....	3-79
MPOOptimate to LC 10 Gigabit Quick-Fit Cassettes.....	1-62
MPOOptimate to LC Quick-Fit cassettes.....	3-77
MPO SECURE Optical Fiber Cassettes .....	2-14
MPO SECURE to Non-SECURE LC Optical Fiber Cassettes..	2-7
MPO SECURE Trunk Cable Assemblies, Plenum (OFNP).....	2-15
MPO to MPO Polarity for Cable Assemblies .....	1-15
MPO Trunk Assemblies .....	1-88
MRJ21 1 GbE Cassettes .....	3-59
MRJ21 1 GbE Patch Panels.....	3-61
MRJ21 Cable Support Bars .....	6-26
MRJ21 Cassette Panel (1GbE).....	3-59
MRJ21 Copper Cabling Solutions .....	3-54
MRJ21 Label Holder Panels.....	3-62
MRJ21 Labels .....	3-62
MRJ21 Quick-Fit Cassette 12 port (1 Gb/s) .....	3-74
MRJ21 Quick-Fit Cassettes.....	1-61
MRJ21 to MRJ21 cable assemblies (1 Gb/s) .....	3-76
MRJ21 Ultra Slim Cable Assemblies .....	3-58
MRJ21 XG (10 GbE) System.....	3-55
MRJ21 XG 19-Inch Patch Panel, 1RU, Straight.....	3-57
MRJ21 XG Cassette Patch Panel .....	3-57
MRJ21 XG Quick-Fit Cassette 8 Port (10 Gb/s).....	3-57, 3-74
MRJ21 XG to MRJ21 XG Cable Assemblies.....	3-56
MRJ21 XG to MRJ21 XG cable assemblies (10 Gb/s shielded) .....	3-76
MTP/MPO IBC (In Bulkhead Cleaner) .....	1-140
MT-RJ Jack Termination Tool Kit .....	1-132
MT-RJ Jack Tool Kit.....	1-130
MT-RJ, LC Adapters and SL.....	4-24-4-26
MT-RJ SECURE Hybrid Cable Assemblies.....	2-11
MT-RJ SECURE Outlet Jacks.....	2-12, 2-13
Multimedia Integrated Cable Management SL Series Patch Panels.....	3-93
Multimedia Modules for Work Area Outlets .....	4-25-4-26
Multimedia SL Series Patch Panels.....	3-92
Multimode (850/1300 nm) Optical Fiber Cable Performance Specifications .....	1-34
Multimode Adapters.....	1-55
Multimode Couplers .....	1-55
Multimode Epoxy/Polish Connectors.....	1-43
Multimode LightCrimp PLUS Connectors (No epoxy/No polish) .....	1-38
Multimode MT-RJ Jack Accessories (OM4, OM3, OM2, and OM1).....	1-50
Multimode MT-RJ Jacks (No epoxy/No polish).....	1-47
Multimode Optical Fiber Outside Plant Armored (OSPA) Cable.....	1-33
Multimode Optical Fiber Performance.....	1-34
Multimode Snap-in Adapter Plates .....	1-51
<b>N</b>	
NEOCLEAN Stick Cleaner.....	1-141
Next Generation MRJ21 1GbE Assemblies.....	3-60
<b>O</b>	
OM1 (62.5/125 $\mu$ m) multimode LC cable assemblies .....	1-20
OM1 (62.5/125 $\mu$ m) multimode MTRJ cable assemblies.....	1-20
OM1 (62.5/125 $\mu$ m) multimode SC cable assemblies.....	1-20
OM1 (62.5/125 $\mu$ m ) multimode ST cable assemblies .....	1-20
OM1 MPO Trunk Assemblies.....	1-9
OM2 (50/125 $\mu$ m) multimode LC cable assemblies .....	1-20
OM2 (50/125 $\mu$ m) multimode MTRJ cable assemblies.....	1-20
OM2(50/125 $\mu$ m) multimode SC cable assemblies .....	1-20
OM2 (50/125 $\mu$ m) multimode ST cable assemblies .....	1-20
OM2 MPO Trunk Assemblies.....	1-9
OM2, OM1 and Singlemode Optical Fiber Indoor/Outdoor Cable.....	1-31
OM3 and OM4 (50/125 $\mu$ m) multimode LC cable assemblies .....	1-20, 1-88
OM3 and OM4 (50/125 $\mu$ m) Multimode LightCrimp PLUS Connectors (No epoxy/No polish) .....	1-38
OM3 and OM4 (50/125 $\mu$ m) multimode MTRJ cable assemblies .....	1-20
OM3 and OM4 (50/125 $\mu$ m) Multimode Optical Fiber Distribution Cable.....	1-26
OM3 and OM4 (50/125 $\mu$ m) Multimode Optical Fiber I nterconnect Cable .....	1-23
OM3 and OM4 (50/125 $\mu$ m) multimode SC cable assemblies .....	1-20
OM3 and OM4 (50/125 $\mu$ m) multimode ST cable assemblies .....	1-20
OM3 and OM4 (50/125 $\mu$ m) Optical Fiber Indoor/Outdoor Cable.....	1-30
OM3 and OM4 (50 $\mu$ m) and OM2 (50/125 $\mu$ m) Multimode LC Test Kits.....	1-145
OM3 and OM4 (50 $\mu$ m) and OM2 (50/125 $\mu$ m) Multimode Replacement Components for LC Test Kits .....	1-145
OM3 and OM4 Multimode Epoxy/Polish Connectors.....	1-43
OM3 and RMG OM4 (50/125 $\mu$ m) Multimode Snap-in Adapter Plates.....	1-51

# Index

## By Product Name

OM3 High Fiber Count Trunks.....	1-10, 1-11
OM3 MPO Microcable Trunk Assemblies .....	3-79
OM3 MPO Trunk Assemblies.....	1-9, 1-88
OM4 High Fiber Count Trunks.....	1-10, 1-11
OM4 MPO Microcable Trunk Assemblies .....	3-79
OM4 MPO Trunk Assemblies.....	1-9, 1-88
OMX Cable Clamps.....	1-108
OMX Splice Cabinet.....	1-107
OMX Splice Wheel.....	1-108
Optical Distribution Frame .....	1-89
Optical Fiber Cable Technical Information.....	1-35-1-37
Optical Fiber Cable Temperature Ranges.....	1-35
Optical Fiber Distribution Cable .....	1-26
Optical Fiber Indoor/Outdoor Cable .....	1-30
Optical Fiber Interconnect Cable .....	1-23
Optical Fiber Outside Plant (OSP) Cable.....	1-32
OPTIPOP C Card Optical Connector Cleaner.....	1-141
OPTIPOP R Reel Optical Connector Cleaner.....	1-140
OS2 Singlemode Optical Fiber Interconnect Cable ....	1-25, 1-28
Outback 620 Series, Outdoor Category 6 U/UTP Cable .....	3-23
Outlets .....	4-3-4-26

## P

Paired Terminal Technology .....	8-3
Palm Grip Hand Tool Kits.....	3-141
Palm Grip Tool.....	3-135
Panel Configurations.....	1-73
Paper Labels .....	3-131-3-132
Patch Cords for Feed-Thru (FT) .....	3-102
Patch Cords for Feed-Thru (FT) Blocks.....	3-103
Patch Cords for Ultim8 Blocks.....	3-33-3-34
Patch Panel Rear Termination Options .....	8-25
Pistol Grip Tool for AMP-BARREL Edge Connectors.....	3-140
Polarity for MPO to MT-RJ, LC, SC, ST, or FC .....	1-16
Polishing Bushings.....	1-138
Polishing Films.....	1-136
Portable “Butterfly” Hand Tool (MI-1) for CHAMP 25-Pair Connectors .....	3-141
Power over Ethernet Products .....	3-84
Pre-Manufactured, Modular Power System.....	7-3
PRO-CRIMPER III Fiber Die Sets.....	1-139
PRO-CRIMPER III Fiber Optic Hand Tool.....	1-139
PRO-CRIMPER III Hand Tool .....	3-136
Product Solution Pages .....	8-2
Professional Fiber Connector Inspection/Cleaning Kits.....	1-142
Pro-Installer’s Modular Plug Hand Tool .....	3-138
Pro-Installer’s Modular Plug Hand Tool Kits .....	
and Accessories.....	3-139
Pro-Installer Twisted Pair Tool Kit.....	3-134

## Q

Q2000 Series Network Panels.....	5-16
Q3000 .....	1-58
Q3000 Blades.....	1-58
Q3000 SAM Blades .....	1-110
Q4000 Series.....	5-8
QCC-4 Chassis Controller .....	5-11
QCH-1RU.....	5-8
QCH-2RU.....	5-8
QCH-4RU.....	5-8
Q-Frame .....	5-14
Q-Frame 19-inch rack kit.....	5-15
QPC-2 Panel Controller Compatible .....	
with Q2000 Network Panels .....	5-16
QSFP/QSFP+ .....	3-80
QSFP/QSFP+ High Speed Copper Cable Assemblies.....	3-81
Quareo .....	5-8
Quareo Cross Connect Frame.....	5-14
Quareo Managed Array Cables .....	5-12
Quareo Managed Fiber Cables.....	5-11
Quareo Managed Trunk.....	5-12
Quareo Series Network Chassis .....	5-8
QUCH-1RU .....	1-58
QUCH-2RU .....	1-58
QUCH-4RU .....	1-58
Quick-Fit Fiber Modules.....	1-63

## R

Rack Mount Cable Trough.....	6-24
Rack Mount Media Converter Chassis System.....	3-88
Rack Mount Mounting Frames.....	6-34
Replacement Components for Singlemode LC Test Kits ....	1-147
Residential Products.....	7-3
RJ45 Coupler Panel.....	3-89
RJ45 Dust Cover.....	3-97
RJ45 SECURE Category 6 Modular Plugs .....	2-18
RJ45 SECURE Category 6 Patch Cable Assemblies.....	2-19
RJ45 SECURE SL Series Category 6 Modular Jacks .....	2-17
RMG .....	1-75
RMG/AMP NETCONNECT Empty Panels .....	1-75
RMG Maximum Capacity by Adapter Style .....	
and Chassis Height.....	1-77
RMG Plug-and-Play Cassettes .....	1-81
RMG Standard Adaptor Packs.....	1-79
Rod Mount Bracket Spacer.....	6-33

## S

SAM Far End Enclosure .....	1-109
SAM MPO Adapter Plates.....	1-110
SAM MPO Cable Assemblies .....	1-111
SAM MPO Linecard Kits .....	1-111
SAM System Miscellaneous Components.....	1-110

# Index

## By Product Name

SC Connector Cleaner (In Bulkhead Cleaner).....	1-142
SC style FTB's with Factory Terminated Stubs	
144-position Block .....	1-95
SECURE Copper Connectivity.....	2-17
SECURE Fiber Connectivity.....	2-3
SECURE Network Solutions.....	2-3-2-22
LC Duplex Clips.....	2-4
LC SECURE Duplex Hybrid Cable Assemblies.....	2-8, 2-10
LC SECURE Epoxy/Polish Simplex Connectors .....	2-4
LC SECURE LightCrimp PLUS Simplex Connectors (No epoxy/No polish).....	2-3
LC SECURE SL Series Duplex Couplers.....	2-5
LC SECURE Snap-In Adapter Plates .....	2-6
MPO SECURE Optical Fiber Cassettes .....	2-14
MPO SECURE to Non-SECURE LC Optical Fiber Cassettes .....	2-7
MPO SECURE Trunk Cable Assemblies, Plenum (OFNP).....	2-15
MT-RJ SECURE Hybrid Cable Assemblies .....	2-11
MT-RJ SECURE Outlet Jacks.....	2-12, 2-13
RJ45 SECURE Category 6 Modular Plugs.....	2-18
RJ45 SECURE Category 6 Patch Cable Assemblies.....	2-19
RJ45 SECURE SL Series Category 6 Modular Jacks .....	2-17
SECURE Copper Connectivity.....	2-17
SECURE Fiber Connectivity.....	2-3
Security Key Jack.....	2-20
Security Key Patch Cord.....	2-21
Security Key Plug.....	2-20
Security Consolidation Point for Raised Floors.....	3-104
Security Key Jack.....	2-20
Security Key Patch Cord.....	1-124, 2-21
Security Key Plug.....	1-123, 2-20
SFP+ .....	3-80
SFP+ High Speed Copper Cable Assemblies.....	3-81
Side-Mount Label Holder .....	3-131
Sigma-Link.....	3-63
Sigma-Link Cat6A F/UTP Cable Assemblies.....	3-65
Sigma-Link Cat6 UTP Cable Assemblies.....	3-64
Sigma-Link Patch Panel.....	3-65
Singlemode (1310/1550 nm)	
Optical Fiber Cable Performance Specifications.....	1-34
Singlemode Adapters.....	1-56
Singlemode Couplers.....	1-56
Singlemode Epoxy/Polish Connectors.....	1-46
Singlemode High Fiber Count Trunks.....	1-10, 1-11
Singlemode LC cable assemblies .....	1-20, 1-88
Singlemode LC Test Kits.....	1-147
Singlemode LightCrimp PLUS Connectors (No epoxy/No polish).....	1-41
Singlemode Microcable Trunk Assemblies.....	3-79
Singlemode MTRJ cable assemblies.....	1-20
Singlemode SC cable assemblies.....	1-20
Singlemode Snap-in Adapter Plates.....	1-54
Singlemode ST cable assemblies .....	1-20
Singlemode Trunk Assemblies.....	1-9, 1-88
Sliding Adapter Packs .....	1-89, 1-101
SL Series Category 3 Modular Jacks.....	3-96
SL Series Category 5e Modular Jacks .....	3-43
SL Series Faceplates.....	4-6-4-26
SL Series Furniture Outlets.....	4-19-4-26
SL Series Modular Category 6 Jack Accessories.....	3-29
SL Series Modular Coupler.....	3-44
SL Series Modular Jack Strain Relief .....	3-97
SL Series Modular Jack Termination Accessories.....	3-133
SL Series Modular Jack Termination Tool .....	3-133
SL Series Modules.....	4-6-4-26
SL Series Multimedia Inserts .....	4-22-4-26
SL Series Tool.....	8-4
Smart Ethernet Switches.....	3-84
SNMP Managed Ethernet Switches .....	3-84
Solid Copper Bonding Connectors .....	6-25
Stainless Steel Faceplates .....	4-8
Stainless Steel Faceplates from Semtron.....	4-8-4-26
Standard Cross-Connect Patch Cord Lengths.....	1-106
Standard FLEX-MODE Modular Furniture Faceplate Kits.....	4-18-4-26
Standard Labels for Outlets.....	3-122
Standard Panels.....	3-12
Stationary, Ventilated Shelf .....	6-19
STP and UTP Quick-Fit Modules .....	1-61
Stranded Copper Bonding Connectors .....	6-25
Strip Card Kit.....	1-138
Subfloor Panel Holder Kit .....	1-64
Supplementary Solutions .....	7-1-7-4
Broadcast Products.....	7-3
Distributed Antenna Systems.....	7-3
Pre-Manufactured, Modular Power System .....	7-3
Residential Products.....	7-3
Undercarpet Cabling.....	7-3
Surface Boxes.....	4-14-4-26
Surface Mount Accessories .....	4-12-4-26
Surface Mount Module.....	4-13-4-26
Surface Mount Outlet.....	4-12-4-26
Switches .....	3-83
<b>T</b>	
Technical Reference.....	8-3-8-28
25-Pair Cable Color-Coding .....	8-17
Backbone Cabling .....	8-11
Cable Installation.....	8-15
Category 5e, 6 and 6A Cabling.....	8-23
Copper Design Technology .....	8-3
Cycle Life.....	8-4
Horizontal Cabling.....	8-12
How AirES Cable Technology Lowers Temperatures While	

# Index

## By Product Name

Increasing Uptime.....	8-5	Wall Mount Mounting Frames .....	6-34
Jack Pin-Outs.....	8-16	Wall Phone Faceplate .....	4-7-4-26
Paired Terminal Technology .....	8-3	WIREMOLD 2A Inserts.....	4-16-4-26
Patch Panel Rear Termination Options .....	8-25	Work Area Outlets.....	4-1-4-26, 4-8-4-26, 4-14-4-26
SL Series Tool.....	8-4	12-Port Universal Surface Mount Outlet .....	4-14-4-26
Termination Block Mounting Hardware.....	6-26	Accessories.....	4-4-4-26
TFP .....	1-65	Adapters for Furniture Faceplates.....	4-21-4-26
TFP Custom Adapter and Preterminated Adapter Packs .....	1-69	Angled Faceplates.....	4-7-4-26
TFP Empty Chassis .....	1-66	Desktop Monuments.....	4-17-4-26
TFP MPO Pack.....	1-74	Extenders for Furniture Faceplates.....	4-21-4-26
TFP Plug-and-Play Cassettes.....	1-71-1-72	Faceplates.....	4-3-4-26, 4-4-4-26
TFP Pre-configured Termination/Splice Fiber Panels.....	1-70	Faceplates for Herman Miller Furniture.....	4-20-4-26
TFP Product Overview.....	1-67	Faceplates for Mounting Straps.....	4-9-4-26
TFP Series Rack Mount Fiber Panels.....	1-66	Faceplates for WIREMOLD Raceways.....	4-15-4-26
TFP Series Standard Adapter Packs .....	1-68	FLEX-MODE Modular	
Tooling Category 6 Modular Plugs .....	3-137	Furniture Faceplate Accessories .....	4-21-4-26
Tool Kit Compatibility Chart.....	1-130	HIDEAWAY Multimedia Outlets.....	4-11-4-26
TrueNet Labeling Software and Labeling Sheets .....	1-144	HIDEOUT Outlets.....	4-10-4-26
Twisted Pair Cable Packaging Reference.....	3-25, 3-39	Modular Jack Boxes.....	4-15-4-26
Twisted Pair Testing Tools .....	3-142	Mounting Straps .....	4-9-4-26
Type 85 Back Mount Frames .....	6-31	MT-RJ, LC Adapters and SL.....	4-24-4-26
Type 85 Rod Mount Brackets .....	6-32	Multimedia Modules for Work Area Outlets.....	4-25-4-26
Type 105 Back Mount Frames .....	6-31	Outlets .....	4-3-4-26
Type 105 Back Mount Frames with Ground Lug .....	6-32	SL Series Faceplates.....	4-6-4-26
Type 105 Hinged Label Holder .....	3-130	SL Series Furniture Outlets.....	4-19-4-26
Type 105 Label Holder .....	3-130	SL Series Module.....	4-6-4-26
Type 105 Label Strip.....	3-130	SL Series Multimedia Inserts.....	4-22-4-26
Type 105 Rod Mount Brackets.....	6-33	Standard FLEX-MODE Modular Furniture	
		Faceplate Kits .....	4-18-4-26
<b>U</b>		Surface Mount Accessories .....	4-12-4-26
UCP Drawer Style Enclosure.....	1-60	Surface Mount Module.....	4-13-4-26
UCP Patch Panel.....	1-60	Surface Mount Outlet.....	4-12-4-26
Ultim8 1-Pair Patch Cords.....	3-34-3-35	Wall Phone Faceplate .....	4-7-4-26
Ultim8 2-Pair Patch Cords.....	3-34-3-35	WIREMOLD 2A Inserts.....	4-16-4-26
Undercarpet Cabling.....	7-3		
Universal Connectivity Platform (UCP).....	1-59	<b>Z</b>	
Universal Labels.....	3-123	Zero RU Quick-Fit Bracket.....	1-60
Universal Mounting System (UMS).....	6-27		
Universal Mounting System (UMS) Backboards .....	6-29		
Universal Mounting System (UMS) Cable.....	6-28		
Universal Mounting System (UMS)			
High Volume Cable Managers.....	6-30		
Universal Mounting System (UMS) Wire Managers.....	6-28		
<b>V</b>			
Velcro Cable Ties.....	1-143, 3-119		
Vertical Duct Systems.....	6-11		
Vertical Finger Duct Panels.....	6-22		
Vertical Panel Mounting Brackets .....	1-64		
<b>W</b>			
Wall/Furniture Mounting Bracket .....	3-109		

# Index

## By Product Name

<b>1</b>		<b>5</b>	
12-Port Universal Surface Mount Outlet .....	4-14-4-26	5-Port Compact Ethernet Switch.....	3-85
16-Port Compact Ethernet Switch.....	3-85	50/125 $\mu\text{m}$ OM2 Multimode Epoxy/Polish Connectors .....	1-44
110Connect Modular Jack Patch Panels.....	3-94	50/125 $\mu\text{m}$ OM2 Multimode LightCrimp PLUS Connectors (No epoxy/No polish).....	1-39
110Connect XC Cable Management .....	3-52	50/125 $\mu\text{m}$ OM2 Multimode MT-RJ Jacks (No epoxy/No polish).....	1-48
110Connect XC Category 5e Cable Assemblies.....	3-48	50/125 $\mu\text{m}$ OM2 Multimode Optical Fiber Interconnect Cable.....	1-24, 1-27
110Connect XC Category 5e Connecting Blocks.....	3-49	50/125 $\mu\text{m}$ OM2 Multimode Snap-in Adapter Plates.....	1-52
110Connect XC Category 5e Cross-Connect Distribution Frame Kits.....	3-51	510 Series, Category 5e U/UTP Cable.....	3-38
110Connect XC Category 5e Cross-Connect Rack Mount Panel.....	3-53	520 Series, Category 5e F/UTP Cable .....	3-37
110Connect XC Category 5e Kits .....	3-50	520 Series, Category 5e UTP Cable.....	3-36
110Connect XC Category 5e Wiring Blocks .....	3-49	<b>6</b>	
110 Punch Down Tool Replacement Blades.....	3-134	62.5/125 m OM1 Multimode MT-RJ Jacks (No epoxy/No polish).....	1-49
110 Punch Down Tools with Blades.....	3-134	62.5/125 $\mu\text{m}$ OM1 Multimode Adapters.....	1-56
<b>2</b>		62.5/125 $\mu\text{m}$ OM1 Multimode Couplers.....	1-56
2x2 Direct Support Kits .....	6-5	62.5/125 $\mu\text{m}$ OM1 Multimode Epoxy/Polish Connectors ....	1-45
2x2 Downspout Options.....	6-5	62.5/125 $\mu\text{m}$ OM1 Multimode LC Test Kits.....	1-146
2x2 Fittings and Junctions.....	6-4	62.5/125 $\mu\text{m}$ OM1 Multimode LightCrimp PLUS Connectors (No epoxy/No polish).....	1-40
2x2 Straight Section.....	6-4	62.5/125 $\mu\text{m}$ OM1 Multimode Optical Fiber Interconnect Cable .....	1-24, 1-27
2x2 Track Support Kits.....	6-5	62.5/125 $\mu\text{m}$ OM1 Multimode Replacement Components for LC Test Kits.....	1-146
2x6 Fittings.....	6-6	62.5/125 $\mu\text{m}$ OM1 Multimode Snap-in Adapter Plates.....	1-53
2x6 Straight Section.....	6-6	610 Series, Category 6 U/UTP Cable .....	3-24
2x6 Support Kits.....	6-8	620 Series Category 6 F/UTP Twisted Pair Cable .....	3-21
24-Port Smart Ethernet Switch II with Optional Dual Uplink Port.....	3-85	620 Series, Category 6 U/UTP Cable .....	3-22
24-Port Stackable Managed Switch with Optional Expansion Port.....	3-86	630 Series, Category 6E U/UTP Cable .....	3-20
25-Pair Cable Color-Coding.....	8-17	640 Series Category 6A F/UTP Twisted Pair Cable.....	3-8
25-Pair Conductor Color Code.....	3-40	640 Series Category 6A U/UTP Twisted Pair Cable .....	3-9
<b>4</b>		<b>8</b>	
4-Pair Conductor Color Code.....	3-10	8-Port Compact Ethernet Switch.....	3-85
4x4 Downspout Options.....	6-8	8-Port PoE Midspan Device.....	3-89
4x4 Fittings and Junctions.....	6-7		
4x4 Straight Section.....	6-7		
4x4 Support Kits.....	6-8		
4x6 Downspout Options.....	6-8		
4x6 Fittings.....	6-9		
4x6 Junctions.....	6-9		
4x6 Straight Section.....	6-9		
4x6 Support Kits.....	6-8		
4x12 Fittings.....	6-10		
4x12 Junction.....	6-10		
4x12 Straight Section .....	6-10		
4x12 System Support Kits.....	6-11		
4x24 Snap-Fit Junction.....	6-13		
4x24 System Downspouts - 4" H x 24" W .....	6-14		
4x24 System Fittings - 4" H x 24" W.....	6-14		
4x24 System - Straight Section.....	6-13		
4x24 System Support Kits.....	6-15		

# Index

## By Part Number

### A

ADCCMHIBS-3U .....	1-113
ADCLS-CL4A .....	1-144
ADCLS-CL10A .....	1-144
ADCLS-CL12A .....	1-144
ADCLS-CL24A .....	1-144
ADCLS-NGF144LCAR .....	1-144
ADCLS-NGF144SCAL .....	1-144
ADCLS-NGF192LCAL .....	1-144
ADCLS-NGF192LCAR .....	1-144
ADCLS-TFP1RUA .....	1-144
ADCLS-TFP2RUA .....	1-144
ADCLS-TFP5RUA .....	1-144
ADCPP16KSRJRJ .....	3-89
ADCPP24RJ5E-S .....	3-89
ADCPP24RJ6-S .....	3-89
ADCPP32KSRJRJ .....	3-89
ADCPP24505 .....	3-89
ADCPP24606 .....	3-89
ADCPP48505 .....	3-89
ADCPP48606 .....	3-89
ADCRAKBLK73 .....	5-15

### C

CM2-U2AMP .....	4-16
CM2-U2AMP-BK .....	4-16
CM2-U2AMP-G .....	4-16
CM2-U2AMP-GY .....	4-16
CM2-U2AMP-WH .....	4-16

### E

EB-17B .....	1-75
EB-35B .....	1-75

### F

FDf-ACC146 .....	1-104, 1-106
FEC-ACCCLMP01 .....	1-108
FGSB-ACC063 .....	6-11
FGSB-ASRI-5F .....	6-8
FGSB-ASRI-10F .....	6-8
FGSB-ASRI-15F .....	6-8
FGSB-ISLAND-H/F .....	6-14
FGSB-JUNC-G .....	6-6
FGSB-KDH2-C .....	6-5
FGSB-KT03-A .....	6-8
FGSB-KT03-A1 .....	6-8
FGSB-KT03-C .....	6-5
FGSB-KTW1-C .....	6-11
FGSB-KTW1-CA .....	6-11
FGSB-KTW1-E .....	6-11
FGSB-KTW2-D .....	6-11
FGSB-KTW4-C .....	6-11

FGSB-KTW4-E .....	6-11
FGSB-MCDS-AB .....	6-7, 6-9
FGSB-MCDS-EX-AB .....	6-7, 6-9
FGSB-MD4A-C .....	6-4
FGSB-MD4E-A .....	6-7
FGSB-MD4E-B .....	6-9
FGSB-MD4E-F .....	6-10
FGSB-MD4E-G .....	6-6
FGSB-MD4E-H .....	6-14
FGSB-MD9A-C .....	6-4
FGSB-MD9E-A .....	6-7
FGSB-MD9E-B .....	6-9
FGSB-MD9E-F .....	6-10
FGSB-MD9E-G .....	6-6
FGSB-MDRT-F .....	6-10
FGSB-MDSA-AB .....	6-7
FGSB-MDSA-AC .....	6-4
FGSB-MDSA-F2B .....	6-10
FGSB-MDSA-FB .....	6-10
FGSB-MDSA-GA .....	6-6
FGSB-MDSA-GB .....	6-6
FGSB-MDSP-A .....	6-7
FGSB-MDSP-B .....	6-9
FGSB-MDSP-C .....	6-5
FGSB-MDSP-EX-A .....	6-7
FGSB-MDSP-EX-B .....	6-9
FGSB-MDSP-F .....	6-10
FGSB-MDSP-G .....	6-6
FGSB-MEX1-C-5F .....	6-5, 6-8
FGSB-MEXC-E-A .....	6-4
FGSB-MEXC-E-A/B/F .....	6-4
FGSB-MEXC-E-B .....	6-4
FGSB-MEXC-E-F .....	6-4
FGSB-MEXP-A/B/F .....	6-4
FGSB-MEXP-E-A/B/F .....	6-4
FGSB-MEXP-LP-A/B/F .....	6-4
FGSB-MEXP-LP-G .....	6-6
FGSB-MFAW-A .....	6-7
FGSB-MFAW-B .....	6-9
FGSB-MFAW-H .....	6-13
FGSB-MFTY-5F .....	6-12
FGSB-MFTY-10F .....	6-12
FGSB-MFTY-15F .....	6-12
FGSB-MFTY-200F .....	6-12
FGSB-MH4A-C .....	6-4
FGSB-MH4E-A .....	6-7
FGSB-MH4E-B .....	6-9
FGSB-MH4E-F .....	6-10
FGSB-MH4E-G .....	6-6
FGSB-MH4E-H .....	6-14
FGSB-MH9A-C .....	6-4
FGSB-MH9E-A .....	6-7
FGSB-MH9E-B .....	6-9

FGSB-MH9E-F .....	6-10
FGSB-MH9E-G .....	6-6
FGSB-MHIS-A .....	6-7
FGSB-MHIS-B .....	6-9
FGSB-MHIS-F .....	6-10
FGSB-MHIS-F/H .....	6-14
FGSB-MHRT-A .....	6-7
FGSB-MHRT-B .....	6-9
FGSB-MHRT-F .....	6-10
FGSB-MHRT-F/B .....	6-10
FGSB-MHRT-G .....	6-6
FGSB-MHTA-C .....	6-4
FGSB-MHXP-A .....	6-7
FGSB-MHXP-B .....	6-9
FGSB-MHXP-B/F .....	6-10
FGSB-MHXP-C .....	6-4
FGSB-MHXP-F .....	6-10
FGSB-MHXP-G .....	6-6
FGSB-MHXP-H .....	6-14
FGSB-MIDY-5F .....	6-12
FGSB-MIDY-10F .....	6-12
FGSB-MIDY-15F .....	6-12
FGSB-MJWR-A .....	6-8
FGSB-MJWR-C .....	6-4
FGSB-MJWR-D .....	6-11
FGSB-MLDY-100F .....	6-12
FGSB-MLDY-150F .....	6-12
FGSB-MLDY-200F .....	6-12
FGSB-MLDY-250F .....	6-12
FGSB-MSDS-C .....	6-5
FGSB-MSHA-C .....	6-4
FGSB-MSHC-A .....	6-7
FGSB-MSHC-B .....	6-9
FGSB-MSHC-C .....	6-11
FGSB-MSHC-D .....	6-11
FGSB-MSHS-A .....	6-7
FGSB-MSHS-B .....	6-9
FGSB-MSHS-C .....	6-11
FGSB-MSHS-CA .....	6-11
FGSB-MSHS-D .....	6-11
FGSB-MSHS-F .....	6-10
FGSB-MSHS-G .....	6-6
FGSB-MSHS-H .....	6-13
FGSB-MSNC-B/G .....	6-6
FGSB-MSNC-F .....	6-10
FGSB-MTRM-A .....	6-8
FGSB-MTRM-B .....	6-9
FGSB-MTRM-F .....	6-10
FGSB-MTRM-G .....	6-6
FGSB-MU4A-C .....	6-4
FGSB-MU4E-A .....	6-7
FGSB-MU4E-B .....	6-9
FGSB-MU4E-F .....	6-10

# Index

## By Part Number

FGSB-MU4E-G.....	6-6	FGS-HMEC-H.....	6-14	<b>M</b>	
FGSB-MU9A-C.....	6-4	FGS-HNLR-AB.....	6-8	MPA-NC6CJ50050F-NF.....	1-120
FGSB-MU9E-A.....	6-7	FGS-HNLR-F.....	6-11	MPA-NC6CJ50100F-NF.....	1-120
FGSB-MVAR-A.....	6-7	FGS-HNTP-F-5/8.....	6-11	MPA-NC6CJ50200F-NF.....	1-120
FGSB-MVAR-B.....	6-9	FGS-HNTP-H-5/8.....	6-15	MPA-NC6CJ50300F-NF.....	1-120
FGSB-MVAR-F.....	6-10	FGS-HNTR-1/2.....	6-8	MPA-NCNC150xxxF-FF.....	3-79
FGSB-SD4E-A.....	6-7	FGS-HNTR-5/8.....	6-8	MPA-NCNC430.....	1-10
FGSB-SD4E-B.....	6-9	FGS-HNTR-5/8-A.....	6-8	MPA-NCNC440.....	1-10
FGSB-SD9E-A.....	6-7	FGS-HNTR-F-5/8.....	6-11	MPA-NCNC450.....	1-10
FGSB-SD9E-B.....	6-9	FGS-HNTS-5/8.....	6-8	MPA-NCNC730.....	1-10
FGSB-SDSA-AB.....	6-7	FGS-HNTS-5/8-LP.....	6-8	MPA-NCNC740.....	1-10
FGSB-SH4E-A.....	6-7	FGS-HNTS-F-5/8.....	6-11	MPA-NCNC750.....	1-10
FGSB-SH4E-B.....	6-9	FGS-HNTS-F-5/8-LP.....	6-11	MPA-NCNC930.....	1-10
FGSB-SH9E-A.....	6-7	FGS-HQKK.....	6-12	MPA-NCNC940.....	1-10
FGSB-SH9E-B.....	6-9	FGS-HSHS-C.....	6-5	MPA-NCNC950.....	1-10
FGSB-SHRT-A.....	6-7	FGS-HTHR-5/8-12.....	6-5, 6-8	MPA-NCNCD10.....	1-9
FGSB-SHRT-B.....	6-9	FGS-HTHR-5/8-30.....	6-8	MPA-NCNCD20.....	1-9
FGSB-SHXP-A.....	6-7	FGS-HTHR-5/8-72.....	6-8	MPA-NCNCD30.....	1-9, 1-10
FGSB-SHXP-B.....	6-9	FGS-HTR2-1/2.....	6-5	MPA-NCNCD40.....	1-9, 1-10
FGS-BTBL-C.....	6-5	FGS-HTR2-5/8.....	6-5	MPA-NCNCD50.....	1-9, 1-10, 1-88
FGS-BTBS-C.....	6-5	FGS-HTUB-1/2.....	6-8	MPA-NCNCJ10xxxF-NN.....	1-9
FGS-HAEJ-C.....	6-5	FGS-HTUB-2-AB.....	6-5	MPA-NCNCJ20xxxF-NN.....	1-9
FGS-HASB-1/2-36.....	6-8	FGS-HTUB-5/8.....	6-8	MPA-NCNCJ30xxxF-NN.....	1-9
FGS-HASB-1/2-48.....	6-8	FGS-HUFB-C.....	6-5	MPA-NCNCJ40xxxF-NN.....	1-9
FGS-HASB-5/8-36.....	6-8	FGS-HVHG.....	6-12	MPA-NCNCJ50.....	1-88
FGS-HASB-5/8-48.....	6-8	FGS-HWMB-C.....	6-11	MPA-NCNCJ50xxxF-NN.....	1-9
FGS-HASK-C.....	6-5	FGS-HWMB-D.....	6-11	MPA-NCNCJ50100F-NN.....	1-120
FGS-HCBL-12.....	6-8	FGS-KQKB.....	6-12	MPA-NCNCJ50200F-NN.....	1-120
FGS-HCBL-15.....	6-8	FGS-KT09.....	6-12	MPA-NCNCJ50200F-NN.....	1-120
FGS-HDCB-C.....	6-5	FGS-MH4E-H-VS.....	6-15	MPA-NCNCJ50300F-NN.....	1-120
FGS-HDGR.....	6-8	FGS-MHIS-JIG-A/B/F.....	6-7, 6-9	MPA-NCNCJ50305M-NN.....	1-120
FGS-HDSI-AB.....	6-8	FGS-MHIS-JIG-A/B/F1.....	6-10	MPA-NCNCJ50400F-NN.....	1-120
FGS-HETP-H-5/8.....	6-15	FGS-MHRT-H.....	6-14	MPA-NCNCJ50500F-NN.....	1-120
FGS-HETR-1/2.....	6-8	FGS-MHRT-H/F.....	6-14	MPA-NCNCJ50600F-NN.....	1-120
FGS-HETR-5/8.....	6-8	FGS-MHRT-H/F-VS.....	6-15	MPA-NCNCJ50750F-NN.....	1-120
FGS-HETR-5/8-A.....	6-8	FGS-MHXP-F/H-VS.....	6-15	MPA-NCNCZ30.....	1-10
FGS-HETR-F-5/8.....	6-11	FGS-MHXP-H-VS.....	6-15	MPA-NCNCZ40.....	1-10
FGS-HFCK-1/2.....	6-8	FGS-MKIT-ABF.....	6-12	MPA-NCNCZ50.....	1-10
FGS-HFCK-5/8.....	6-8	FGS-MTRM-H.....	6-14	MPA-NCNCZ50100F-NN.....	1-120
FGS-HFRR-10.....	6-12	FGSO-MDSA-HF.....	6-14	MPA-NCNCZ50200F-NN.....	1-120
FGS-HHEC-10.....	6-12	FGSO-MHIS-A/H.....	6-14	MPA-NCNCZ50300F-NN.....	1-120
FGS-HHGK.....	6-12	FGSO-MHIS-B/H.....	6-14	MPA-NCNCZ50305M-NN.....	1-120
FGS-HIFC-A.....	6-7	FGSO-MHXP-F/H.....	6-14	MPA-NCNCZ50400F-NN.....	1-120
FGS-HIFC-B.....	6-9	FGSO-MU4E-H.....	6-14	MPA-NCNCZ50500F-NN.....	1-120
FGS-HIFC-F.....	6-10	FP 1375351.....	3-127	MPA-NCNCZ50600F-NN.....	1-120
FGS-HLBK.....	6-8	FP 1375352.....	3-127	MPA-NCNCZ50750F-NN.....	1-120
FGS-HLDR-5/8.....	6-5, 6-8	FP 1375353.....	3-127	MPA-NCSCJ50050F-NF.....	1-120
FGS-HLR2-C.....	6-5	FST-DRS12-MT.....	1-108	MPA-NCSCJ50100F-NF.....	1-120
FGS-HMEC-A.....	6-7	FST-DRS24-NT.....	1-108	MPA-NCSCJ50200F-NF.....	1-120
FGS-HMEC-B.....	6-9	FST-DV-HS.....	1-75	MPA-NCSCJ50300F-NF.....	1-120
FGS-HMEC-C.....	6-4	FST-DV-MT.....	1-75	MPA-NCTCJ50050F-NF.....	1-120
FGS-HMEC-F.....	6-10	FST-HS-48.....	1-66	MPA-NCTCJ50100F-NF.....	1-120
FGS-HMEC-G.....	6-6			MPA-NCTCJ50200F-NF.....	1-120



# Index

## By Part Number

MPA-NCTCJ50300F-NF .....	1-120	NGFB-MPML0C112.....	1-104	OLH-MM288J00M0MKBB .....	1-114
MPA-PCLCJ30003M-NC.....	1-11	NGFB-MPML0C612.....	1-104	OLH-MM288J00M0MKCB .....	1-114
MPA-PCLCJ30004M-NC .....	1-11	NGFB-MPML0K512.....	1-104	OLH-MM288J00M0MKEB .....	1-114
MPA-PCLCJ30005M-NC.....	1-11	NGFB-MPMR0C112 .....	1-104	OLH-MN432J00M0MKBB .....	1-114
MPA-PCLCJ40003M-NC .....	1-11	NGFB-MPMR0C612 .....	1-104	OLH-MN432J00M0MKCB.....	1-114
MPA-PCLCJ40004M-NC .....	1-11	NGFB-MPMR0K512 .....	1-104	OLH-MN432J00M0MKEB.....	1-114
MPA-PCLCJ40005M-NC .....	1-11	NGFB-TB1MLD7.....	1-98	OLR-SJ12J00D1002A .....	1-116
MPA-PCLCJ50003M-NC.....	1-11	NGFB-TB1MLD9 .....	1-98	OLR-SJ12J00D2002A .....	1-116
MPA-PCLCJ50004M-NC .....	1-11	NGFB-TB1MLDT .....	1-98	OLR-SJ12J00D3002A .....	1-116
MPA-PCLCJ50005M-NC.....	1-11	NGFB-TB1MLU7.....	1-98	OLR-SJ24J00D1002A.....	1-116
MPA-PCSCJ30003M-NC .....	1-11	NGFB-TB1MLU9 .....	1-98	OLR-SJ24J00D2002A.....	1-116
MPA-PCSCJ30004M-NC.....	1-11	NGFB-TB1MLUT .....	1-98	OLR-SJ24J00D3002A.....	1-116
MPA-PCSCJ30005M-NC .....	1-11	NGFB-TB1MRD7 .....	1-98	OLS-MPP1G66.....	1-115
MPA-PCSCJ40003M-NC .....	1-11	NGFB-TB1MRD9.....	1-98	OLS-MPP12A66 .....	1-117
MPA-PCSCJ40004M-NC.....	1-11	NGFB-TB1MRDT .....	1-98	OLS-MPP10866 .....	1-115, 1-117
MPA-PCSCJ40005M-NC.....	1-11	NGFB-TB1MRU7 .....	1-98	OLS-MPP11666.....	1-115, 1-117
MPA-PCSCJ50003M-NC .....	1-11	NGFB-TB1MRU9.....	1-98	OLS-MPP13266.....	1-115, 1-117
MPA-PCSCJ50004M-NC.....	1-11	NGFB-TB1MRUT .....	1-98	OSB-SBJ032A10000 .....	1-117
MPA-PCSCJ50005M-NC .....	1-11	NGFB-TB4MLDC .....	1-98	OSB -SBJ032G10000 .....	1-117
MPC-CzCzD10xxxF-SS.....	2-15	NGFB-TB4MLDK .....	1-98, 1-99	OSB-SBJ232A10000.....	1-117
MPC-CzCzD20xxxF-SS.....	2-15	NGFB-TB4MLDP.....	1-98	OSB -SBJ232G10000 .....	1-117
MPC-CzCzD30xxxF-SS.....	2-15	NGFB-TB4MLUC.....	1-98	OSB-SBJ032000000 .....	1-117
MPC-CzCzD40xxxF-SS .....	2-15	NGFB-TB4MLUK.....	1-98, 1-99	OSB-SBJ232000000 .....	1-117
MPC-CzCzJ10xxxF-NN .....	2-15	NGFB-TB4MLUP.....	1-98		
MPC-CzCzJ20xxxF-NN .....	2-15	NGFB-TB4MRDC.....	1-98	<b>P</b>	
MPC-CzCzJ30xxxF-NN .....	2-15	NGFB-TB4MRDK.....	1-98, 1-99	PAT-3C3C-P30CxxxM.....	1-88, 3-78
MPC-CzCzJ40xxxF-NN .....	2-15	NGFB-TB4MRDP.....	1-98	PAT-3C3C-P40CxxxM.....	1-88, 3-78
MPT-NCNC130xxxF-FF .....	3-79	NGFB-TB4MRUC.....	1-98	PAT-6C6C-PSOG003M.....	1-119
MPT-NCNC140xxxF-FF .....	3-79	NGFB-TB4MRUK.....	1-98, 1-99	PAT-6C6C-PSOG008M.....	1-119
MPT-NCNCD30xxxF-FF .....	1-88, 3-79	NGFB-TB4MRUP .....	1-98	PAT-6C6C-PSOG016M .....	1-119
MPT-NCNCD40xxxF-FF.....	1-88, 3-79	NGFB-TB4QLDC .....	1-99	PAT-6C6C-PSOG023M .....	1-119
MPT-NCNCJ30xxxF-FF .....	1-88	NGFB-TB4QLDP.....	1-99	PAT-6C6C-PSOG031M.....	1-119
MPT-NCNCJ40xxxF-FF.....	1-88	NGFB-TB4QLUC.....	1-99	PAT-6C6C-PSOG038M.....	1-119
MPT-NCNCJ40xxxM-NN.....	3-79	NGFB-TB4QLUP.....	1-99	PAT-6C6C-PSOG046M.....	1-119
MX6-BAYTEMPLATE.....	1-107	NGFB-TB4QRDC.....	1-99	PAT-6C6C-PSIG003M.....	1-118
MX6-BSPL-1440-U7.....	1-107	NGFB-TB4QRDP .....	1-99	PAT-6C6C-PSIG008M.....	1-118
MX6-SPLIFCCLMP.....	1-108	NGFB-TB4QRUC .....	1-99	PAT-6C6C-PSIG016M.....	1-118
		NGFB-TB4QRUP .....	1-99	PAT-6C6C-PSIG023M .....	1-118
<b>N</b>		NGF-SAP70K00 .....	1-101	PAT-6C6C-PSIG031M.....	1-118
NGF-ACCCLMP04.....	1-105	NGF-SAP90K00.....	1-101	PAT-6C6C-PSIG038M.....	1-118
NGF-ACCCLMP08.....	1-105	NGF-SAPCOJ00 .....	1-101	PAT-6C6C-PSIG046M.....	1-118
NGF-ACCIO3P30X24.....	1-104	NGF-SAPCOK00 .....	1-101	PAT-LC8z-R10CxxxM.....	2-8
NGF-ACCISOPEG24 .....	1-93, 1-104	NGF-SAPK0J00 .....	1-101	PAT-LC8z-R20CxxxM.....	2-8
NGF-ACCISOPFS12X24.....	1-92	NGF-SAPKOK00 .....	1-101	PAT-LC8z-R30CxxxM.....	2-8
NGFB-ACCCEGD007.....	1-93, 1-104	NGF-SAPPOJ00 .....	1-101	PAT-LC8z-R40CxxxM.....	2-8
NGFB-ACCFO7SB .....	1-92	NGF-SAPP0K00.....	1-101	PAT-LC9z-R10BxxxM.....	2-11
NGFB-ACCRCMSLD .....	1-100	NGF-SAPP0K00.....	1-101	PAT-LC9z-R20BxxxM.....	2-11
NGFB-ACCRCMSLU .....	1-100	NGF-SAPTOK00.....	1-101	PAT-LC9z-R30BxxxM.....	2-11
NGFB-ACCRCMSRD .....	1-100			PAT-LC9z-R40BxxxM.....	2-11
NGFB-ACCRCMSRU.....	1-100	<b>O</b>		PAT-LCLC-P10C.....	1-20
NGFB-MDF7A100-30 .....	1-91	OLH-MK072J00M0MKBA.....	1-114	PAT-LCLC-P20C.....	1-20
NGFB-MDF7A144-30.....	1-91, 1-104	OLH-MK072J00M0MKCA.....	1-114	PAT-LCLC-P30C.....	1-20
		OLH-MK072J00M0MKEA.....	1-114		



# Index

## By Part Number

PAT-LCLC-P40C .....	1-20	PAT-SC8z-R20CxxxM .....	2-10	QCPC-6ARUVB-XXYYF .....	5-18
PAT-LCLC-PSOC.....	1-20, 1-88	PAT-SC8z-R30CxxxM.....	2-10	QCPC-6ARUVX-XXYYF.....	5-18
PAT-LCLC-R20C001M.....	1-3	PAT-SC8z-R40CxxxM.....	2-10	QCPC-6ARUZA-XXYYM.....	5-18
PAT-LCLC-R20C002M.....	1-3	PAT-SC9z-R10BxxxM .....	2-11	QCPC-6ARUZB-XXYYM.....	5-18
PAT-LCLC-R20C003M.....	1-3	PAT-SC9z-R20BxxxM.....	2-11	QCPC-6ARUZX-XXYYM.....	5-18
PAT-LCLC-R20C005M.....	1-3	PAT-SC9z-R30BxxxM.....	2-11	QCPC-6RUVA-XXYYF .....	5-18
PAT-LCLC-R30C001M.....	1-4	PAT-SCMC-P10B .....	1-20	QCPC-6RUVB-XXYYF.....	5-18
PAT-LCLC-R30C002M.....	1-4	PAT-SCMC-P20B .....	1-20	QCPC-6RUVX-XXYYF .....	5-18
PAT-LCLC-R30C003M .....	1-4	PAT-SCMC-P30B .....	1-20	QCPC-6RUZA-XXYYM.....	5-18
PAT-LCLC-R30C005M .....	1-4	PAT-SCMC-PS0B.....	1-20	QCPC-6RUZB-XXYYM.....	5-18
PAT-LCMC-P10B.....	1-20	PAT-SCSC-P10C .....	1-20	QCPC-6RUZX-XXYYM .....	5-18
PAT-LCMC-P20B.....	1-20	PAT-SCSC-P20C .....	1-20	QCPP-24MC6AS.....	5-16
PAT-LCMC-P30B .....	1-20	PAT-SCSC-P30C .....	1-20	QCPP-24MC6AU .....	5-16
PAT-LCMC-PS0B .....	1-20	PAT-SCSC-P40C.....	1-20	QCPP-24MC6U.....	5-16
PAT-LCSC-P10C.....	1-20	PAT-SCSC-PSOC.....	1-20	QCPP-48MC6AS .....	5-16
PAT-LCSC-P20C .....	1-20	PAT-SCSC-R20C001M.....	1-3	QCPP-48MC6AU.....	5-16
PAT-LCSC-P30C .....	1-20	PAT-SCSC-R20C002M.....	1-3	QCPP-48MC6U .....	5-16
PAT-LCSC-PSOC.....	1-20	PAT-SCSC-R20C003M.....	1-3	QCPU-MCBM-1.....	5-11
PAT-LCSC-R20C001M.....	1-3	PAT-SCSC-R20C005M.....	1-3	QCPU-MPPM-1.....	5-16
PAT-LCSC-R20C002M .....	1-3	PAT-SCSC-R30C001M.....	1-4	QDR-1RU .....	1-58, 5-8
PAT-LCSC-R20C003M .....	1-3	PAT-SCSC-R30C002M.....	1-4	QDR-2RU.....	1-58, 5-8
PAT-LCSC-R20C005M .....	1-3	PAT-SCSC-R30C003M.....	1-4	QDR-4RU.....	1-58, 5-8
PAT-LCSC-R30C001M .....	1-4	PAT-SCSC-R30C005M.....	1-4	QFA-1FFM3PN.....	5-12
PAT-LCSC-R30C002M .....	1-4	PAT-SCTC-P10C.....	1-20	QFA-1FFM4PN .....	5-12
PAT-LCSC-R30C003M.....	1-4	PAT-SCTC-P20C .....	1-20	QFA-1KKSM PN.....	5-12
PAT-LCSC-R30C005M.....	1-4	PAT-SCTC-P30C .....	1-20	QFA-1MPP3PN.....	5-12
PAT-LCTC-P10C.....	1-20	PAT-SCTC-PSOC .....	1-20	QFA-1MPP4PN .....	5-12
PAT-LCTC-P20C.....	1-20	PAT-TC8z-R10BxxxM.....	2-10	QFA-1PPM3PN.....	5-12
PAT-LCTC-P30C.....	1-20	PAT-TC8z-R20BxxxM.....	2-10	QFA-1PPM4PN .....	5-12
PAT-LCTC-PSOC .....	1-20	PAT-TC8z-R30BxxxM.....	2-10, 2-11	QFA-1RKSM PN.....	5-12
PAT-MC8z-R10BxxxM .....	2-8	PAT-TC8z-R40BxxxM.....	2-10	QFA-1WWSM PN.....	5-12
PAT-MC8z-R20BxxxM .....	2-8	PAT-TC9z-R10BxxxM.....	2-11	QFA-2FFM3PN .....	5-12
PAT-MC8z-R30BxxxM .....	2-8	PAT-TC9z-R20BxxxM.....	2-11	QFA-2FFM4PN .....	5-12
PAT-MC8z-R40BxxxM.....	2-8	PAT-TCTC-P10C .....	1-20	QFA-2KKSM PN.....	5-12
PAT-MC9z-R10BxxxM .....	2-11	PAT-TCTC-P30C.....	1-20	QFA-2PPM3PN .....	5-12
PAT-MC9z-R20BxxxM .....	2-11	PAT-TCTC-PSOC.....	1-20	QFA-2PPM4PN .....	5-12
PAT-MC9z-R30BxxxM .....	2-11	PP24AC5ET .....	3-7, 3-42	QFA-2WWSM PN .....	5-12
PAT-MC9z-R40BxxxM.....	2-11	PP24AC6AT.....	3-4, 3-12	QFA-4FFM3PN .....	5-12
PAT-SC6C-PSOG003M.....	1-119	PP48AC6T.....	3-6, 3-27	QFA-4FFM4PN.....	5-12
PAT-SC6C-PSOG008M.....	1-119	PP48AC5ET.....	3-7, 3-42	QFA-4KKSM PN .....	5-12
PAT-SC6C-PSOG016M .....	1-119	PP48AC6AT .....	3-4, 3-12	QFA-4PPM3PN.....	5-12
PAT-SC6C-PSOG023M .....	1-119	PP48AC6T .....	3-6, 3-27	QFA-4PPM4PN.....	5-12
PAT-SC6C-PSOG031M.....	1-119	PWBP-2023 .....	3-10, 3-25, 3-39	QFA-4WWSM PN.....	5-12
PAT-SC6C-PSOG038M.....	1-119	PWBP-4023.....	3-10, 3-25, 3-39	QFA-8FFM3PN .....	5-12
PAT-SC6C-PSOG046M.....	1-119	PWBP-6023 .....	3-10	QFA-8FFM4PN.....	5-12
PAT-SC6C-PSIG003M.....	1-118	<b>Q</b>		QFA-8KKSM PN.....	5-12
PAT-SC6C-PSIG008M.....	1-118	QBCB-HR .....	1-58, 5-8	QFA-8PPM3PN.....	5-12
PAT-SC6C-PSIG016M .....	1-118	QCPC-6ARFVA-XXYYF .....	5-18	QFA-8PPM4PN.....	5-12
PAT-SC6C-PSIG023M .....	1-118	QCPC-6ARFVB-XXYYF .....	5-18	QFA-8WWSM PN .....	5-12
PAT-SC6C-PSIG031M.....	1-118	QCPC-6ARFVX-XXYYF .....	5-18	QFB-48FDLCLMMHR .....	5-10
PAT-SC6C-PSIG038M .....	1-118	QCPC-6ARUVA-XXYYF.....	5-18	QFB-48FDLCLSMHR .....	5-10
PAT-SC6C-PSIG046M.....	1-118			QFB-48FDLCMMMHR .....	5-10
PAT-SC8z-R10CxxxM .....	2-10			QFB-48FDLCMSMHR .....	5-10

# Index

## By Part Number

QFB-192FMPOMMHR.....	5-10	TCPC-5ERUVA-WTxxF.....	1-122	TE510R25-XX02.....	3-38
QFB-192FMPOSMHR.....	5-10	TCPC-5ERUVA-WTYFF.....	1-85, 3-75	TE510R-XX02.....	3-38
QFPC-MKKSMPA-xxxF.....	5-11	TCPC-5ERUVA-XXYFF.....	3-47	TE510R-XXII.....	3-38
QFPC-MKKSMPB-xxxF.....	5-11	TCPC-5ERUVA-YLxxF.....	1-122	TE520PF-XX02.....	3-37
QFPC-MPPM3PA-xxxF.....	5-11	TCPC-5ERUVB-BL.....	3-7	TE520PX2-XX02.....	3-36
QFPC-MPPM3PB-xxxF.....	5-11	TCPC-5ERUVB-BLxxF.....	1-122	TE520P-XX02.....	3-36
QFPC-MPPM4PA-xxxF.....	5-11	TCPC-5ERUVB-GNxxF.....	1-122	TE520P-XXII.....	3-36
QFPC-MPPM4PB-xxxF.....	5-11	TCPC-5ERUVB-GYxxF.....	1-122	TE520P-XXRB.....	3-36
Q-IPCCM-KT.....	5-15	TCPC-5ERUVB-RDxxF.....	1-122	TE520RF-XX02.....	3-37
Q-IPEG-KT.....	5-15	TCPC-5ERUVB-WTxxF.....	1-122	TE520RX2-XX02.....	3-36
Q-OFX-GL.....	5-15	TCPC-5ERUVB-WTYFF.....	3-7	TE520R-XX02.....	3-36
Q-OFX-GR.....	5-15	TCPC-5ERUVB-XXYFF.....	3-47	TE520R-XXII.....	3-36
Q-OFX-V.....	5-15	TCPC-5ERUVB-YLxxF.....	1-122	TE520R-XXRB.....	3-36
QPWRS-USA.....	5-11, 5-16	TCPC-5ERUVX-XXYFF.....	3-47	TE610P-XX02.....	3-24
QUFB-32FDLCMM4HR.....	1-110	TCPC-6ARFVA-BLxxF.....	1-123	TE610P-XX06.....	3-24
QUFB-32FDLCSMHR.....	1-110	TCPC-6ARFVA-GNxxF.....	1-123	TE610P-XXII.....	3-24
QUFB-48FDLCLMMHR.....	1-58	TCPC-6ARFVA-GYxxF.....	1-123	TE610R-XX02.....	3-24
QUFB-48FDLCLSMHR.....	1-58	TCPC-6ARFVA-RDxxF.....	1-123	TE610R-XX06.....	3-24
QUFB-48FDLCMM3HR.....	1-58	TCPC-6ARFVA-WTxxF.....	1-123	TE610R-XXII.....	3-24
QUFB-48FDLCSMHR.....	1-58	TCPC-6ARFVA-XXYFF.....	3-15, 3-56	TE620PF-XX02.....	3-21
QUFB-192FMPOMMHR.....	1-58	TCPC-6ARFVA-YLxxF.....	1-123	TE620PF-XXYY.....	3-5
QUFB-192FMPOSMHR.....	1-58	TCPC-6ARFVB-BLxxF.....	1-123	TE620PX2-XX02.....	3-22
		TCPC-6ARFVB-BLYFF.....	3-5	TE620P-XX02.....	3-22
		TCPC-6ARFVB-GNxxF.....	1-123	TE620P-XXII.....	3-22
		TCPC-6ARFVB-GYxxF.....	1-123	TE620P-XXRB.....	3-6, 3-22
		TCPC-6ARFVB-RDxxF.....	1-123	TE620RF-XX02.....	3-21
		TCPC-6ARFVB-WTxxF.....	1-123	TE620RF-XXYY.....	3-5
		TCPC-6ARFVB-WTYFF.....	1-85, 3-5, 3-75	TE620RX2-XX02.....	3-22
		TCPC-6ARFVB-XXYFF.....	3-15, 3-56	TE620R-XX02.....	3-22
		TCPC-6ARFVB-YLxxF.....	1-123	TE620R-XXII.....	3-22
		TCPC-6ARUVA-XXYFF.....	3-16	TE620R-XXRB.....	3-6, 3-22
		TCPC-6ARUVB-XXYFF.....	3-16	TE630P-XX02.....	3-20
		TCPC-6ARUVA-BLxxF.....	1-122	TE630P-XXRB.....	3-20
		TCPC-6ARUVA-GNxxF.....	1-122	TE630R-XX02.....	3-20
		TCPC-6ARUVA-GYxxF.....	1-122	TE630R-XXRB.....	3-20
		TCPC-6ARUVA-RDxxF.....	1-122	TE640PF-XX02.....	3-8
		TCPC-6ARUVA-WTxxF.....	1-122	TE640P-XX02.....	3-9
		TCPC-6ARUVA-XXYFF.....	3-30	TE640RF-XX02.....	3-8
		TCPC-6ARUVA-YLxxF.....	1-122	TE640R-XX02.....	3-9
		TCPC-6RUVB-BKxxF.....	1-122	TE620OSP-BK02.....	3-23
		TCPC-6RUVB-BLxxF.....	1-122	TFP-00AP00.....	1-66
		TCPC-6RUVB-GNxxF.....	1-122	TFP-1TT00-000B.....	1-3, 1-4, 1-5, 1-6, 1-66, 1-67, 1-71, 1-74, 1-113
		TCPC-6RUVB-GYxxF.....	1-122	TFP-2TT00-000B.....	1-3, 1-4, 1-5, 1-6, 1-66, 1-67, 1-71, 1-74, 1-113
		TCPC-6RUVB-RDxxF.....	1-122	TFP-4TT00-000B.....	1-66, 1-67, 1-71
		TCPC-6RUVB-WT.....	3-6	TFP-5TT00-000B.....	1-3, 1-4, 1-5, 1-6, 1-66, 1-67, 1-71, 1-113
		TCPC-6RUVB-WTxxF.....	1-122	TFP-12APLC3.....	1-3, 1-68
		TCPC-6RUVB-XXYFF.....	3-30	TFP-12APLC4.....	1-4, 1-5, 1-68
		TCPC-6RUVB-YLxxF.....	1-122	TFP-12APLC4DE3.....	1-68
		TCPC-6RUVX-XXYFF.....	3-30	TFP-12APLC4FE3.....	1-68
		TCPV-6RUVB-BL.....	3-6	TFP-12APLC8.....	1-6, 1-68
TCPC-5ENUVA-XXYFF.....	3-47	TE510P25-XX02.....	3-38		
TCPC-5ERUVA-BLxxF.....	1-122	TE510P-XX02.....	3-38		
TCPC-5ERUVAGNxxF.....	1-122	TE510P-XXII.....	3-38		
TCPC-5ERUVA-GYxxF.....	1-122				
TCPC-5ERUVA-RDxxF.....	1-122				

# Index

## By Part Number

TFP-12APLC8SB3.....	1-68	TMRJ-1UURG-SS017M.....	3-58
TFP-12APRC3.....	1-3, 1-68	TMRJ-1UURG-SS020M.....	3-58
TFP-12APRC4.....	1-4, 1-5, 1-68	TMRJ-1UURG-SS025M.....	3-58
TFP-12APRC4DE3.....	1-68	TMRJ-1UURG-SS030M.....	3-58
TFP-12APRC4FE3.....	1-68	TMRJ-XSSRW-SAXXXM.....	3-56
TFP-12APRC8.....	1-6, 1-68	TMRJ-XSSRW-SSXXXM.....	3-56
TFP-12APRC8SB3.....	1-68	TP5ETB0BLXX.....	3-102
TFP-12MPLDQ2.....	1-71	TP5ETBOGNXX.....	3-102
TFP-12MPLFQ2.....	1-71	TP5ETBOGYXX.....	3-102
TFP-12MPLSQ5.....	1-71, 1-113	TP5ETB0RDXX.....	3-102
TFP-12MPRDQ2.....	1-71	TP5ETBOWTXX.....	3-102
TFP-12MPRFQ2.....	1-71	TP5ETBOYLXX.....	3-102
TFP-12MPRSQ5.....	1-71, 1-113	TP5ETB-BLXX.....	3-103
TFP-24APLQ1.....	1-3, 1-68	TP5ETB-GNXX.....	3-103
TFP-24APLQ2.....	1-4, 1-5, 1-68	TP5ETB-RDXX.....	3-103
TFP-24APLQ2DE3.....	1-68	TP5ETB-WTXX.....	3-103
TFP-24APLQ2FE3.....	1-68	TP5ETB-YLXX.....	3-103
TFP-24APLQ5.....	1-6, 1-68	TP5ETF-BLXX.....	3-102
TFP-24APLQ5SB3.....	1-68	TP5ETF-GNXX.....	3-102
TFP-24APRQ1.....	1-3, 1-68	TP5ETF-GYXX.....	3-102
TFP-24APRQ2.....	1-4, 1-5, 1-68	TP5ETF-RDXX.....	3-102
TFP-24APRQ2DE3.....	1-68	TP5ETF-WTXX.....	3-102
TFP-24APRQ2FE3.....	1-68	TP5ETF-YLXX.....	3-102
TFP-24APRQ5.....	1-6, 1-68	TP6ATB0XXYY.....	3-19
TFP-24APRQ5SB3.....	1-68	TP6ATB-XXYY.....	3-19
TFP-24MPLDQ2.....	1-71	TP6ATH0XXYY.....	3-19
TFP-24MPLFQ2.....	1-71	TP6ATH-XXYY.....	3-19
TFP-24MPLSQ5.....	1-71	TP6TB0BLXX.....	3-33
TFP-24MPRDQ2.....	1-71	TP6TB0GNXX.....	3-33
TFP-24MPRFQ2.....	1-71	TP6TB0GYXX.....	3-33
TFP-24MPRSQ5.....	1-71	TP6TB0RDXX.....	3-33
TFP-72APOMP.....	1-74	TP6TB0WTXX.....	3-33
TFP-ACC002.....	1-74	TP6TB0YLXX.....	3-33
TFP-VELSTP.....	1-66	TP6TB-BLXX.....	3-33
TMRJ-1SUPB-SAOxxM.....	3-60	TP6TB-GNXX.....	3-33
TMRJ-1SUPB-SHOxxM.....	3-60	TP6TB-GYXX.....	3-33
TMRJ-1SUPB-SSOxxM.....	3-60	TP6TB-RDXX.....	3-33
TMRJ-1SURG-AHOxxM.....	3-60	TP6TB-WTXX.....	3-33
TMRJ-1SURG-SAOxxM.....	3-60	TP6TB-YLXX.....	3-33
TMRJ-1SURG-SHOxxM.....	3-60	TP6TH-BLXX.....	3-33
TMRJ-1SURG-SSOxxM.....	3-60	TP6TH-GNXX.....	3-33
TMRJ-1UURG-SSOxxM.....	3-60	TP6TH-GYXX.....	3-33
TMRJ-1UURG-SS002M.....	3-58	TP6TH-RDXX.....	3-33
TMRJ-1UURG-SS003M.....	3-58	TP6TH-WTXX.....	3-33
TMRJ-1UURG-SS004M.....	3-58	TP6TH-YLXX.....	3-33
TMRJ-1UURG-SS005M.....	3-58	TRA-CON Epoxy.....	1-134
TMRJ-1UURG-SS006M.....	3-58		
TMRJ-1UURG-SS007M.....	3-58	<b>Y</b>	
TMRJ-1UURG-SS008M.....	3-58	Y-0000000-X.....	1-86
TMRJ-1UURG-SS009M.....	3-58		
TMRJ-1UURG-SS010M.....	3-58		
TMRJ-1UURG-SS012M.....	3-58		
TMRJ-1UURG-SS015M.....	3-58		
		<b>O</b>	
		O-1671196-1.....	1-63
		O-1671196-3.....	1-63
		O-1671202-1.....	1-63
		O-1671202-3.....	1-63
		O-1671907-1.....	1-83
		O-1711970-1.....	1-84
		O-2153115-1.....	1-84, 3-57
		<b>1</b>	
		1-231666-0.....	3-139
		1-231666-1.....	3-139
		1-231666-2.....	3-139
		1-231666-3.....	3-139
		1-231666-4.....	3-139
		1-406185-1.....	4-7
		1-406185-3.....	4-7
		1-503997-3.....	4-10
		1-553292-1.....	3-111
		1-553292-3.....	3-111
		1-558198-0.....	3-120
		1-558198-1.....	3-120
		1-558199-0.....	3-120
		1-558199-1.....	3-120
		1-558251-1.....	4-14
		1-558251-3.....	4-14
		1-558821-0.....	3-120
		1-558821-1.....	3-120
		1-569499-1.....	4-14
		1-569499-3.....	4-14
		1-569523-0.....	3-48
		1-569524-0.....	3-48
		1-569526-0.....	3-48
		1-569527-0.....	3-48
		1-569528-0.....	3-48
		1-569669-0.....	3-48
		1-569685-0.....	3-48
		1-569875-0.....	3-46
		1-603227-0.....	1-143, 3-119
		1-603227-9.....	1-143, 3-119
		1-604751-0.....	1-143, 3-119
		1-604751-9.....	1-143, 3-119
		1-604771-0.....	1-143, 3-119
		1-604771-9.....	1-143, 3-119
		1-604772-0.....	1-143, 3-119
		1-604772-9.....	1-143, 3-119
		1-790163-0.....	3-137
		1-853400-0.....	3-138
		1-853400-4.....	3-138
		1-1116406-1.....	4-6
		1-1116406-3.....	4-6
		1-1116407-1.....	4-6

# Index

## By Part Number

1-1116407-3.....	4-6	1-1479079-3.....	4-6	1-1499849-0.....	2-19
1-1116408-1.....	4-6	1-1479152-1.....	4-7	1-1499849-2.....	2-19
1-1116408-3.....	4-6	1-1479152-3.....	4-7	1-1499849-4.....	2-19
1-1116409-1.....	4-6	1-1479159-1.....	4-9	1-1499849-6.....	2-19
1-1116409-3.....	4-6	1-1479159-3.....	4-9	1-1499850-0.....	2-19
1-1116410-1.....	4-6	1-1479160-1.....	4-9	1-1499850-2.....	2-19
1-1116410-3.....	4-6	1-1479160-3.....	4-9	1-1499850-4.....	2-19
1-1116412-1.....	4-23	1-1479181-3.....	4-23	1-1499850-6.....	2-19
1-1116412-3.....	4-23	1-1479190-3.....	4-23	1-1499851-0.....	2-19
1-1116616-1.....	4-9	1-1479191-3.....	4-23	1-1499851-2.....	2-19
1-1116616-3.....	4-9	1-1479230-3.....	4-23	1-1499851-4.....	2-19
1-1116618-1.....	4-9	1-1479231-3.....	4-23	1-1499851-6.....	2-19
1-1116618-3.....	4-9	1-1479232-3.....	4-23	1-1499852-0.....	2-19
1-1116697-1.....	4-15	1-1479358-1.....	4-14	1-1499852-2.....	2-19
1-1116697-3.....	4-15	1-1479358-3.....	4-14	1-1499852-4.....	2-19
1-1116698-1.....	4-15	1-1479486-1.....	4-6	1-1499852-6.....	2-19
1-1116698-3.....	4-15	1-1479486-3.....	4-6	1-1499853-0.....	2-19
1-1116733-0.....	3-90	1-1479504-1.....	4-9	1-1499853-2.....	2-19
1-1116733-5.....	3-90	1-1479504-3.....	4-9	1-1499853-4.....	2-19
1-1116734-0.....	3-90	1-1479625-1.....	4-9	1-1499853-6.....	2-19
1-1116734-5.....	3-90	1-1479625-3.....	4-9	1-1499855-1.....	4-23
1-1339118-1.....	4-6	1-1479784-1.....	4-9	1-1499855-3.....	4-23
1-1339118-3.....	4-6	1-1479784-3.....	4-9	1-1499925-0.....	3-28
1-1339120-1.....	4-9	1-1499836-1.....	4-23	1-1499925-1.....	3-28
1-1339120-3.....	4-9	1-1499836-3.....	4-23	1-1499925-3.....	3-28
1-1339123-3.....	4-23	1-1499841-0.....	2-19	1-1553307-2.....	1-3
1-1374416-0.....	4-24	1-1499841-2.....	2-19	1-1553308-2.....	1-3
1-1374416-1.....	4-24	1-1499841-4.....	2-19	1-1553311-2.....	1-3
1-1375005-3.....	4-19	1-1499841-6.....	2-19	1-1553312-2.....	1-3
1-1375006-3.....	4-19	1-1499842-0.....	2-19	1-1553315-2.....	1-3
1-1375055-0.....	3-28	1-1499842-2.....	2-19	1-1553316-2.....	1-3
1-1375055-1.....	3-28	1-1499842-4.....	2-19	1-1553406-1.....	1-24
1-1375055-3.....	3-28	1-1499842-6.....	2-19	1-1553406-2.....	1-24
1-1375092-0.....	3-120	1-1499843-0.....	2-19	1-1553407-1.....	1-24
1-1375092-1.....	3-120	1-1499843-2.....	2-19	1-1553407-2.....	1-24
1-1375155-1.....	4-7	1-1499843-4.....	2-19	1-1553408-1.....	1-24
1-1375155-3.....	4-7	1-1499843-6.....	2-19	1-1553408-2.....	1-24
1-1375187-0.....	3-28	1-1499844-0.....	2-19	1-1553409-1.....	1-24
1-1375187-1.....	3-28	1-1499844-2.....	2-19	1-1553409-2.....	1-24
1-1375187-3.....	3-28	1-1499844-4.....	2-19	1-1553410-1.....	1-24
1-1375190-0.....	3-44	1-1499844-6.....	2-19	1-1553410-2.....	1-24
1-1375190-1.....	3-44	1-1499845-0.....	2-19	1-1553411-1.....	1-24
1-1375190-3.....	3-44	1-1499845-2.....	2-19	1-1553411-2.....	1-24
1-1375191-0.....	3-44	1-1499845-4.....	2-19	1-1553412-1.....	1-24
1-1375191-1.....	3-44	1-1499845-6.....	2-19	1-1553412-2.....	1-24
1-1375191-3.....	3-44	1-1499846-0.....	2-19	1-1553413-1.....	1-24
1-1375192-3.....	3-96	1-1499846-2.....	2-19	1-1553413-2.....	1-24
1-1375306-1.....	4-6	1-1499846-4.....	2-19	1-1553414-1.....	1-24
1-1375306-3.....	4-6	1-1499846-6.....	2-19	1-1553414-2.....	1-24
1-1375361-3.....	4-23	1-1499848-0.....	2-19	1-1553415-1.....	1-24
1-1375362-3.....	4-23	1-1499848-2.....	2-19	1-1553415-2.....	1-24
1-1375363-3.....	4-23	1-1499848-4.....	2-19	1-1553416-1.....	1-24
1-1479079-1.....	4-6	1-1499848-6.....	2-19	1-1553416-2.....	1-3, 1-24

# Index

## By Part Number

1-1553417-1.....	1-24	1-1918785-0.....	2-7	1-2111179-8.....	1-124
1-1553417-2.....	1-3, 1-24	1-1918785-1.....	2-7	1-2111190-0.....	1-124
1-1553418-1.....	1-24	1-1918786-0.....	2-7	1-2111190-2.....	1-124
1-1553418-2.....	1-3, 1-24	1-1918786-1.....	2-7	1-2111190-4.....	1-124
1-1553419-1.....	1-24	1-1933096-3.....	4-23	1-2111190-6.....	1-124
1-1553419-2.....	1-3, 1-24	1-1933172-3.....	4-15	1-2111190-8.....	1-124
1-1553420-2.....	1-3	1-1933192-3.....	4-23	1-2111225-0.....	1-124
1-1553534-0.....	1-111	1-1933193-3.....	4-23	1-2111225-2.....	1-124
1-1553640-0.....	1-111	1-1933194-3.....	4-23	1-2111225-4.....	1-124
1-1671215-1.....	3-65	1-1933285-0.....	2-5	1-2111225-6.....	1-124
1-1671226-3.....	1-87, 3-77	1-1933286-1.....	4-23	1-2111225-8.....	1-124
1-1671226-5.....	1-87, 3-77	1-1933286-2.....	4-23	1-2111236-0.....	1-124
1-1671227-3.....	1-87, 3-77	1-1933422-0.....	2-5	1-2111236-2.....	1-124
1-1671227-5.....	1-87, 3-77	1-1933455-0.....	3-44	1-2111236-4.....	1-124
1-1671548-1.....	1-60	1-1933455-1.....	3-44	1-2111236-6.....	1-124
1-1671549-1.....	1-64	1-1933455-3.....	3-44	1-2111236-8.....	1-124
1-1671594-1.....	1-60, 3-57	1-1933582-3.....	4-23	1-2111408-2.....	4-24
1-1671603-1.....	1-64	1-1933659-3.....	4-23	1-2111408-3.....	4-24
1-1711691-1.....	3-14	1-1933661-3.....	4-23	1-2111550-3.....	4-23
1-1711691-2.....	3-14	1-1933668-1.....	4-13	1-2111615-3.....	4-23
1-1711691-3.....	3-14	1-1933668-3.....	4-13	1-2160266-3.....	1-62
1-1711691-4.....	3-14	1-1933671-1.....	4-13	1-2160266-5.....	1-62
1-1711691-5.....	3-14	1-1933671-3.....	4-13	1-2160530-5.....	1-63
1-1711691-6.....	3-14	1-1933674-1.....	4-13	1-5502776-1.....	1-56
1-1711691-7.....	3-14	1-1933674-3.....	4-13	1-6278807-0.....	2-13
1-1711691-8.....	3-14	1-1933686-1.....	4-6	1-6278808-0.....	2-13
1-1711691-9.....	3-14	1-1933686-3.....	4-6	1-6278810-0.....	2-13
1-1777127-0.....	2-6	1-1933814-9.....	3-124	1-6278811-0.....	2-13
1-1777265-0.....	2-6	1-1938056-0.....	2-14	1-6588878-0.....	2-13
1-1777266-0.....	2-6	1-1938056-1.....	2-14	1-6588879-0.....	2-13
1-1828078-0.....	2-4	1-1938965-0.....	2-14	1-6693949-0.....	2-13
1-1828079-0.....	2-4	1-1938965-1.....	2-14	1-6693951-0.....	2-13
1-1828856-0.....	2-3	1-1938966-0.....	2-7	1-6754252-0.....	2-13
1-1828860-0.....	2-3	1-1938966-1.....	2-7	1-6754285-0.....	2-14
1-1828861-0.....	2-4	1-1938967-0.....	2-7	1-6754285-1.....	2-14
1-1828862-0.....	2-4	1-1938967-1.....	2-7	1-6754286-0.....	2-14
1-1871456-2.....	2-20	1-1938996-0.....	2-14	1-6754286-1.....	2-14
1-1918777-0.....	2-14	1-1938996-1.....	2-14	1-6754287-0.....	2-14
1-1918777-1.....	2-14	1-1985713-0.....	2-7	1-6754287-1.....	2-14
1-1918778-0.....	2-14	1-1985713-1.....	2-7	1-6754288-0.....	2-14
1-1918778-1.....	2-14	1-1985797-0.....	2-7	1-6754288-1.....	2-14
1-1918779-0.....	2-14	1-1985797-1.....	2-7	1-6828819-0.....	2-14
1-1918779-1.....	2-14	1-1985798-0.....	2-7	1-6828819-1.....	2-14
1-1918780-0.....	2-14	1-1985798-1.....	2-7	1FM-(3)ØE-AMP-LAB.....	4-8
1-1918780-1.....	2-14	1-1985799-0.....	2-7	1FM-(4)ØE-AMP.....	4-8
1-1918781-0.....	2-14	1-1985799-1.....	2-7	1FM-(4)ØE-AMP-LAB.....	4-8
1-1918781-1.....	2-14	1-1985959-0.....	2-3	1FM-(6)ØE-AMP.....	4-8
1-1918782-0.....	2-14	1-1985960-0.....	2-3	1FM-(6)ØE-AMP-LAB.....	4-8
1-1918782-1.....	2-14	1-1985961-0.....	2-3	1FM-ØE-AMP-LAB.....	4-8
1-1918783-0.....	2-14	1-2111179-0.....	1-124	1FM-ØE-AMP-PHONE.....	4-8
1-1918783-1.....	2-14	1-2111179-2.....	1-124	1FM-ØØE-AMP.....	4-8
1-1918784-0.....	2-14	1-2111179-4.....	1-124	1FM-ØØE-AMP-LAB.....	4-8
1-1918784-1.....	2-14	1-2111179-6.....	1-124	122533-1.....	3-140

# Index

## By Part Number

1116044-2.....	3-124	1339118.....	3-126	1375055-6.....	3-28
1116098-1.....	4-12	1339118-1.....	4-6, 1-126	1375055-7.....	3-28
1116111-1.....	4-12	1339118-2.....	4-6	1375055-8.....	3-28
1116360-3.....	4-17, 1-128	1339118-4.....	4-6	1375055-9.....	3-28
1116406-1.....	4-6	1339120-1.....	4-9	1375092-1.....	3-120
1116406-2.....	4-6	1339120-2.....	4-9	1375092-2.....	3-120
1116406-4.....	4-6	1339120-4.....	4-9	1375092-3.....	3-120
1116407-1.....	4-6	1339123-1.....	4-23	1375092-4.....	3-120
1116407-2.....	4-6	1339123-2.....	4-23	1375092-5.....	3-120
1116407-4.....	4-6	1374416-1.....	4-24	1375092-6.....	3-120
1116408-1.....	4-6	1374416-2.....	4-24	1375092-7.....	3-120
1116408-2.....	4-6	1374416-3.....	4-24	1375092-8.....	3-120
1116408-4.....	4-6	1374416-4.....	4-24	1375092-9.....	3-120
1116409-1.....	4-6	1374416-5.....	4-24	1375093-1.....	3-106
1116409-2.....	4-6	1374416-6.....	4-24	1375130-1.....	3-117
1116409-4.....	4-6	1374416-7.....	4-24	1375130-2.....	3-117
1116410-1.....	4-6	1374416-8.....	4-24	1375149-2.....	4-23
1116410-2.....	4-6	1374416-9.....	4-24	1375155.....	3-126
1116410-4.....	4-6	1374484-1.....	1-136	1375155-1.....	4-7, 1-125
1116412-1.....	4-23, 1-125	1375005.....	3-126	1375155-2.....	4-7
1116412-2.....	4-23	1375005-1.....	4-19	1375155-4.....	4-7
1116412-4.....	4-23	1375005-2.....	4-19	1375157-1.....	3-97
1116535.....	3-126	1375005-4.....	4-19	1375158-1.....	6-22
1116571-1.....	3-136	1375006.....	3-126	1375158-2.....	6-22
1116580-1.....	4-18	1375006-1.....	4-19	1375159-1.....	6-22
1116580-2.....	4-18	1375006-2.....	4-19	1375159-2.....	6-22
1116580-4.....	4-18	1375006-4.....	4-19	1375160-1.....	6-22
1116616-1.....	4-9	1375013.....	3-127	1375160-2.....	6-22
1116616-2.....	4-9	1375013-2.....	3-27	1375161-1.....	6-22
1116616-4.....	4-9	1375014.....	3-127	1375161-2.....	6-22
1116618-1.....	4-9	1375014-2.....	3-6, 3-27	1375162.....	6-22
1116618-2.....	4-9	1375015.....	3-127	1375162-2.....	6-22
1116618-4.....	4-9	1375015-2.....	3-6, 3-27	1375163-1.....	6-22
1116697.....	3-126	1375016.....	3-127	1375163-2.....	6-22
1116697-1.....	4-15	1375016-2.....	3-27	1375164-1.....	6-22
1116697-2.....	4-15	1375032-1.....	3-111	1375165-1.....	6-22
1116697-4.....	4-15	1375032-3.....	3-111	1375166-1.....	6-22
1116698.....	3-126	1375033-1.....	3-111	1375167-1.....	6-22
1116698-1.....	4-15	1375034-1.....	3-111	1375187.....	3-6
1116698-2.....	4-15	1375034-3.....	3-111	1375187-1.....	3-28
1116698-4.....	4-15	1375045-1.....	3-111	1375187-2.....	3-28
1116732-1.....	3-90	1375045-3.....	3-111	1375187-4.....	3-28
1116733-5.....	3-90	1375049.....	3-126	1375187-5.....	3-28
1116733-7.....	3-90	1375049-1.....	4-15	1375187-6.....	3-28
1116734-5.....	3-90	1375049-4.....	4-15	1375187-7.....	3-28
1116734-7.....	3-90	1375050.....	3-126	1375187-8.....	3-28
1206146-1.....	3-109	1375050-1.....	4-15	1375187-9.....	3-28
1278017-1.....	1-56	1375050-4.....	4-15	1375188-1.....	3-28
1278023-1.....	1-132	1375055.....	3-6	1375189-1.....	3-44
1278118-4.....	1-130, 1-131	1375055-1.....	3-28	1375190.....	3-7
1278118-5.....	1-130, 1-131	1375055-2.....	3-28	1375190-1.....	3-44
1278346-1.....	1-130, 1-132	1375055-4.....	3-28	1375190-2.....	3-44
1278346-2.....	1-130, 1-132	1375055-5.....	3-28	1375190-4.....	3-44

# Index

## By Part Number

1375190-5	3-44	1375362-1	4-23	1479225-1	6-22
1375190-6	3-44	1375363-1	4-23	1479225-2	6-22
1375190-7	3-44	1375367-1	3-106	1479230-1	4-23
1375190-8	3-44	1435049-1	6-19	1479231-1	4-23
1375190-9	3-44	1435118-1	1-146	1479232-1	4-23
1375191	3-7	1435119-1	1-145	1479287-2	4-25
1375191-1	3-44	1435965-1	3-61	1479297-1	3-104
1375191-2	3-44	1435971-1	3-61	1479322-1	3-106
1375191-4	3-44	1457062-1	1-56	1479326-1	3-104
1375191-5	3-44	1457628-1	1-136	1479358	3-126
1375191-6	3-44	1457630-1	1-138	1479358-1	4-14
1375191-7	3-44	1457630-2	1-138	1479358-2	4-14
1375191-8	3-44	1479002	3-126, 3-127, 3-128	1479358-4	4-14
1375191-9	3-44	1479002-1	3-125	1479359-1	3-104
1375192-1	3-96	1479003	3-126, 3-127, 3-128	1479360-1	3-104
1375192-2	3-96	1479003-1	3-125	1479398-1	4-14
1375192-4	3-96	1479039-1	3-105	1479402-1	6-23
1375192-6	3-96	1479040-1	3-105	1479449-1	3-93
1375200-1	3-97	1479041-1	3-105	1479450-1	3-93
1375253-2	1-143, 3-119	1479042-1	3-104	1479451-1	3-59
1375254-2	1-143, 3-119	1479050-1	3-118	1479452-1	3-59
1375255-2	1-143, 3-119	1479079-1	4-6	1479459-1	3-59
1375255-6	1-143, 3-119	1479079-2	4-6	1479486	3-126
1375256-2	1-143, 3-119	1479079-4	4-6	1479486-1	4-6, 1-126
1375257-1	6-22	1479142-1	3-106	1479486-2	4-6
1375258-1	6-22	1479151-1	3-114	1479486-4	4-6
1375259-1	6-22	1479152-1	4-7	1479504-1	4-9
1375260-1	6-22	1479153	3-127	1479504-2	4-9
1375289-1	3-92	1479153-2	3-42	1479504-4	4-9
1375291-1	3-92	1479154	3-127	1479542-1	3-116
1375292-1	3-92	1479154-2	3-7, 3-42	1479582-1	6-23
1375306-1	4-6	1479155	3-127	1479625-1	4-9
1375306-2	4-6	1479155-2	3-7, 3-42	1479625-2	4-9
1375306-4	4-6	1479156	3-127	1479625-4	4-9
1375307-1	3-134	1479156-2	3-42	1479696-1	3-106
1375308-1	3-115, 3-134	1479158-1	3-104	1479698-1	1-61
1375309-1	3-134	1479159-1	4-9	1479732-1	6-23
1375310-1	3-134	1479159-2	4-9	1479733-1	6-23
1375317-1	3-136	1479159-4	4-9	1479784-1	4-9
1375345-1	3-123	1479160-1	4-9	1479784-2	4-9
1375351-1	3-124	1479160-2	4-9	1479784-4	4-9
1375352-1	3-124	1479160-4	4-9	1479794-1	2-17
1375353-1	3-123, 3-124	1479181-1	4-23	1479794-2	2-17
1375354	3-128	1479181-2	4-23	1479794-3	2-17
1375354-1	3-62, 3-125	1479190-1	4-23	1479794-4	2-17
1375354-2	3-62, 3-125	1479191-1	4-23	1479794-8	2-17
1375354-3	3-62, 3-125	1479206	3-127	1479794-9	2-17
1375355	3-128	1479206-1	3-42	1479795-1	2-17
1375355-1	3-125	1479208	3-127	1479795-2	2-17
1375356-1	3-122	1479222-1	6-22	1479795-3	2-17
1375357-1	3-122	1479222-2	6-22	1479795-4	2-17
1375358-1	3-123	1479223-1	6-22	1479795-8	2-17
1375361-1	4-23	1479224-1	6-22	1479795-9	2-17

# Index

## By Part Number

1479815.....	3-126	1499709-2 .....	2-6	1499846-8 .....	2-19
1479815-1.....	4-11, 1-126	1499710-2.....	2-6	1499846-9.....	2-19
1479860-1.....	6-25	1499711-2 .....	2-6	1499848-2 .....	2-19
1479946.....	3-126	1499836-1.....	4-23	1499848-3 .....	2-19
1479946-1.....	4-11, 1-126	1499836-2.....	4-23	1499848-4 .....	2-19
1479956-1.....	3-104	1499836-4 .....	4-23	1499848-5 .....	2-19
1479992-1.....	3-92	1499836-9 .....	1-125	1499848-6 .....	2-19
1479992-2.....	3-92	1499841-2.....	2-19	1499848-7.....	2-19
1490490-1.....	3-136	1499841-3.....	2-19	1499848-8 .....	2-19
1490530-1.....	3-142	1499841-4 .....	2-19	1499848-9.....	2-19
1490531-1.....	3-142	1499841-5.....	2-19	1499849-2 .....	2-19
1490532-1.....	3-142	1499841-6.....	2-19	1499849-3 .....	2-19
1490533-1.....	3-142	1499841-7.....	2-19	1499849-4 .....	2-19
1499056-1.....	3-107	1499841-8.....	2-19	1499849-5 .....	2-19
1499056-2.....	3-107	1499841-9.....	2-19	1499849-6 .....	2-19
1499056-3.....	3-107	1499842-2.....	2-19	1499849-7.....	2-19
1499056-4.....	3-107	1499842-3 .....	2-19	1499849-8 .....	2-19
1499056-5.....	3-107	1499842-4 .....	2-19	1499849-9.....	2-19
1499056-6.....	3-107	1499842-5 .....	2-19	1499850-2 .....	2-19
1499056-7 .....	3-107	1499842-6 .....	2-19	1499850-3 .....	2-19
1499056-8.....	3-107	1499842-7.....	2-19	1499850-4 .....	2-19
1499057-1.....	3-107	1499842-8 .....	2-19	1499850-5 .....	2-19
1499057-2.....	3-107	1499842-9 .....	2-19	1499850-6 .....	2-19
1499057-3.....	3-107	1499843-2 .....	2-19	1499850-7 .....	2-19
1499057-4 .....	1-128, 3-107	1499843-3 .....	2-19	1499850-8 .....	2-19
1499057-5.....	3-107	1499843-4 .....	2-19	1499850-9.....	2-19
1499057-6 .....	3-107	1499843-5 .....	2-19	1499851-2.....	2-19
1499057-7.....	3-107	1499843-6 .....	2-19	1499851-3.....	2-19
1499057-8.....	1-128, 3-107	1499843-7.....	2-19	1499851-4.....	2-19
1499119-1 .....	3-115	1499843-8 .....	2-19	1499851-5.....	2-19
1499539-1.....	3-115	1499843-9 .....	2-19	1499851-6.....	2-19
1499543-1.....	3-116	1499844-2.....	2-19	1499851-7.....	2-19
1499600.....	3-127	1499844-3.....	2-19	1499851-8.....	2-19
1499600-2.....	3-6, 3-27	1499844-4.....	2-19	1499851-9.....	2-19
1499601.....	3-127	1499844-5.....	2-19	1499852-2.....	2-19
1499601-2 .....	3-6, 3-27	1499844-6.....	2-19	1499852-3.....	2-19
1499602.....	3-127	1499844-7 .....	2-19	1499852-4.....	2-19
1499602-2.....	3-7, 3-42	1499844-8.....	2-19	1499852-5.....	2-19
1499603.....	3-127	1499844-9.....	2-19	1499852-6.....	2-19
1499603-2.....	3-7, 3-42	1499845-2 .....	2-19	1499852-7 .....	2-19
1499604 .....	3-127	1499845-3 .....	2-19	1499852-8.....	2-19
1499605.....	3-127	1499845-4 .....	2-19	1499852-9.....	2-19
1499613-1.....	3-93	1499845-5 .....	2-19	1499853-2.....	2-19
1499614-1.....	3-93	1499845-6.....	2-19	1499853-3.....	2-19
1499622-1.....	3-92	1499845-7.....	2-19	1499853-4 .....	2-19
1499623-1.....	3-92	1499845-8.....	2-19	1499853-5.....	2-19
1499702-2.....	2-6	1499845-9.....	2-19	1499853-6 .....	2-19
1499703-2.....	2-6	1499846-2 .....	2-19	1499853-7.....	2-19
1499704-2 .....	2-6	1499846-3 .....	2-19	1499853-8.....	2-19
1499705-2.....	2-6	1499846-4.....	2-19	1499853-9 .....	2-19
1499706-2 .....	2-6	1499846-5.....	2-19	1499855-1.....	4-23, 1-125
1499707-2.....	2-6	1499846-6.....	2-19	1499855-2.....	4-23
1499708-2.....	2-6	1499846-7 .....	2-19	1499855-4 .....	4-23



# Index

## By Part Number

1499925-1.....	3-28	1553785.....	1-137	1754462-1.....	1-133
1499925-2.....	3-28	1583236-1.....	3-134	1754765-1.....	1-137
1499925-4.....	3-28	1583608-1.....	3-134	1754766-1.....	1-137
1499925-5.....	3-28	1588175-1.....	1-139	1754767-1.....	1-137
1499925-6.....	3-28	1588176-1.....	1-139	1754768-1.....	1-137
1499925-7.....	3-28	1591020-1.....	3-88	1754845-1.....	1-130, 1-131
1499925-8.....	3-28	1591022-1.....	3-88	1754845-2.....	1-130, 1-131
1499925-9.....	3-28	1591024-1.....	3-87	1777029-1.....	3-61
1553212-1.....	1-130	1591026-1.....	3-87	1777040-1.....	3-62
1553527-1.....	1-111	1591030-1.....	3-87	1777046-1.....	3-59
1553527-2.....	1-111	1591032-1.....	3-88	1777052-1.....	3-61
1553528-1.....	1-111	1591034-0.....	3-88	1777054-1.....	3-62
1553528-2.....	1-111	1591070-1.....	3-85	1777125-1.....	3-95
1553529-1.....	1-111	1591081-1.....	3-85	1777126-1.....	3-109
1553529-2.....	1-111	1591083-1.....	3-85	1777127-1.....	2-6
1553533-1.....	1-109	1591093-1.....	3-85	1777127-2.....	2-6
1553533-2.....	1-109	1591094-0.....	3-86	1777127-3.....	2-6
1553534-1.....	1-111	1591095-0.....	3-86	1777127-4.....	2-6
1553534-2.....	1-111	1591096-0.....	3-86	1777127-5.....	2-6
1553534-3.....	1-111	1591097-0.....	3-86	1777127-6.....	2-6
1553534-4.....	1-111	1591098-0.....	3-86	1777127-7.....	2-6
1553534-5.....	1-111	1591099-1.....	3-86	1777127-8.....	2-6
1553534-6.....	1-111	1591185-0.....	3-89	1777127-9.....	2-6
1553534-7.....	1-111	1591188-1.....	3-89	1777215-1.....	3-108
1553534-8.....	1-111	1671189-2.....	1-64	1777215-2.....	3-108
1553534-9.....	1-111	1671200-1.....	1-87, 1-63, 3-70	1777224-1.....	3-108
1553608-1.....	1-111	1671201-1.....	1-63	1777265-1.....	2-6
1553608-2.....	1-111	1671201-3.....	1-63	1777265-2.....	2-6
1553609-1.....	1-111	1671205-3.....	1-62	1777265-3.....	2-6
1553609-2.....	1-111	1671205-4.....	1-62	1777265-4.....	2-6
1553635-1.....	1-111	1671206-3.....	1-62	1777265-5.....	2-6
1553635-2.....	1-111	1671206-4.....	1-62	1777265-6.....	2-6
1553636-1.....	1-111	1671226-3.....	1-87, 3-77	1777265-7.....	2-6
1553636-2.....	1-111	1671226-5.....	1-87, 1-62, 3-69	1777265-8.....	2-6
1553640-1.....	1-111	1671227-3.....	1-87, 3-77	1777265-9.....	2-6
1553640-2.....	1-111	1671227-5.....	1-87, 1-62, 3-69	1777266-1.....	2-6
1553640-3.....	1-111	1671633-1.....	1-83	1777266-2.....	2-6
1553640-4.....	1-111	1673956-1.....	3-133	1777266-3.....	2-6
1553640-5.....	1-111	1695790-4.....	1-56	1777266-4.....	2-6
1553640-6.....	1-111	1711160-2.....	3-3, 3-14	1777266-5.....	2-6
1553640-7.....	1-111	1711295-2.....	3-14	1777266-6.....	2-6
1553640-8.....	1-111	1711342-2.....	3-3, 3-14	1777266-7.....	2-6
1553640-9.....	1-111	1711343-2.....	3-14	1777266-8.....	2-6
1553657-1.....	1-109	1711970-1.....	1-61, 3-68	1777266-9.....	2-6
1553657-2.....	1-109	1711987-1.....	1-87, 1-63, 3-70	1828078-1.....	2-4
1553658-1.....	1-110	1725150-1.....	3-133	1828078-2.....	2-4
1553676-1.....	1-111	1725150-3.....	3-133	1828078-3.....	2-4
1553676-2.....	1-111	1754074-1.....	1-138	1828078-4.....	2-4
1553677-1.....	1-111	1754136-1.....	1-139	1828078-5.....	2-4
1553677-2.....	1-111	1754137-1.....	1-139	1828078-6.....	2-4
1553678-1.....	1-111	1754138-1.....	1-132	1828078-7.....	2-4
1553678-2.....	1-111	1754371-2.....	1-145, 1-146	1828078-8.....	2-4
1553761-1.....	1-109	1754371-4.....	1-147	1828078-9.....	2-4

# Index

## By Part Number

1828079-1.....	2-4	1828868-1.....	1-146	1918781-2.....	2-14
1828079-2.....	2-4	1828868-2.....	1-146	1918781-3.....	2-14
1828079-3.....	2-4	1828868-3.....	1-146	1918781-4.....	2-14
1828079-4.....	2-4	1828869-1.....	1-147	1918781-5.....	2-14
1828079-5.....	2-4	1828869-2.....	1-147	1918781-6.....	2-14
1828079-6.....	2-4	1828869-3.....	1-147	1918781-7.....	2-14
1828079-7.....	2-4	1871456-1.....	2-20	1918781-8.....	2-14
1828079-8.....	2-4	1871456-2.....	2-20	1918781-9.....	2-14
1828079-9.....	2-4	1871456-3.....	2-20	1918782-2.....	2-14
1828833-1.....	1-137	1871456-4.....	2-20	1918782-3.....	2-14
1828834-1.....	1-137	1871696-1.....	1-133	1918782-4.....	2-14
1828835-1.....	1-137	1907489-3.....	1-147	1918782-5.....	2-14
1828836-1.....	1-137	1907490-3.....	1-145	1918782-6.....	2-14
1828837-1.....	1-137	1907491-3.....	1-146	1918782-7.....	2-14
1828856-1.....	2-3	1907492-3.....	1-147	1918782-8.....	2-14
1828856-2.....	2-3	1907493-3.....	1-145	1918782-9.....	2-14
1828856-3.....	2-3	1907494-3.....	1-146	1918783-2.....	2-14
1828856-4.....	2-3	1907495-3.....	1-147	1918783-3.....	2-14
1828856-5.....	2-3	1907496-3.....	1-145	1918783-4.....	2-14
1828856-6.....	2-3	1907497-3.....	1-146	1918783-5.....	2-14
1828856-7.....	2-3	1918652-1.....	1-134	1918783-6.....	2-14
1828856-8.....	2-3	1918777-2.....	2-14	1918783-7.....	2-14
1828856-9.....	2-3	1918777-3.....	2-14	1918783-8.....	2-14
1828860-1.....	2-3	1918777-4.....	2-14	1918783-9.....	2-14
1828860-2.....	2-3	1918777-5.....	2-14	1918784-2.....	2-14
1828860-3.....	2-3	1918777-6.....	2-14	1918784-3.....	2-14
1828860-4.....	2-3	1918777-7.....	2-14	1918784-4.....	2-14
1828860-5.....	2-3	1918777-8.....	2-14	1918784-5.....	2-14
1828860-6.....	2-3	1918777-9.....	2-14	1918784-6.....	2-14
1828860-7.....	2-3	1918778-2.....	2-14	1918784-7.....	2-14
1828860-8.....	2-3	1918778-3.....	2-14	1918784-8.....	2-14
1828860-9.....	2-3	1918778-4.....	2-14	1918784-9.....	2-14
1828861-1.....	2-4	1918778-5.....	2-14	1918785-2.....	2-7
1828861-2.....	2-4	1918778-6.....	2-14	1918785-3.....	2-7
1828861-3.....	2-4	1918778-7.....	2-14	1918785-4.....	2-7
1828861-4.....	2-4	1918778-8.....	2-14	1918785-5.....	2-7
1828861-5.....	2-4	1918778-9.....	2-14	1918785-6.....	2-7
1828861-6.....	2-4	1918779-2.....	2-14	1918785-7.....	2-7
1828861-7.....	2-4	1918779-3.....	2-14	1918785-8.....	2-7
1828861-8.....	2-4	1918779-4.....	2-14	1918785-9.....	2-7
1828861-9.....	2-4	1918779-5.....	2-14	1918786-2.....	2-7
1828862-1.....	2-4	1918779-6.....	2-14	1918786-3.....	2-7
1828862-2.....	2-4	1918779-7.....	2-14	1918786-4.....	2-7
1828862-3.....	2-4	1918779-8.....	2-14	1918786-5.....	2-7
1828862-4.....	2-4	1918779-9.....	2-14	1918786-6.....	2-7
1828862-5.....	2-4	1918780-2.....	2-14	1918786-7.....	2-7
1828862-6.....	2-4	1918780-3.....	2-14	1918786-8.....	2-7
1828862-7.....	2-4	1918780-4.....	2-14	1918786-9.....	2-7
1828862-8.....	2-4	1918780-5.....	2-14	1918802-1.....	1-140
1828862-9.....	2-4	1918780-6.....	2-14	1918803-1.....	1-140
1828867-1.....	1-145	1918780-7.....	2-14	1918804-1.....	1-140
1828867-2.....	1-145	1918780-8.....	2-14	1918805-1.....	1-140
1828867-3.....	1-145	1918780-9.....	2-14	1918806-1.....	1-140

# Index

## By Part Number

1918807-1.....	1-141	1933422-3.....	2-5	1933561-1.....	6-19
1918808-1.....	1-141	1933422-4.....	2-5	1933562-1.....	6-19
1918809-1.....	1-140	1933422-5.....	2-5	1933566-1.....	6-19
1918810-1.....	1-141	1933422-6.....	2-5	1933567-1.....	6-19
1918811-1.....	1-141	1933422-7.....	2-5	1933570-1.....	1-3, 1-4, 1-5, 1-6, 3-3, 3-4, 3-5, 3-6, 3-7, 6-18
1933096-1.....	4-23	1933422-8.....	2-5	1933582-1.....	4-23
1933134-1.....	4-18, 1-128	1933422-9.....	2-5	1933636-2.....	4-25
1933134-2.....	4-18	1933424-2.....	4-25	1933657.....	3-127
1933134-4.....	4-18	1933425-1.....	6-25	1933657-1.....	3-42
1933172-1.....	4-15	1933443-1.....	1-60	1933658-1.....	3-27
1933192-1.....	4-23	1933455-1.....	3-44	1933659-1.....	4-23
1933193-1.....	4-23	1933455-2.....	3-44	1933659-2.....	4-23
1933194-1.....	4-23	1933455-4.....	3-44	1933661-1.....	4-23
1933198.....	3-127	1933455-5.....	3-44	1933668-.....	3-3, 3-5, 3-6, 3-7
1933199.....	3-127	1933455-6.....	3-44	1933668-1.....	4-13
1933285-1.....	2-5	1933455-7.....	3-44	1933668-2.....	4-13
1933285-2.....	2-5	1933455-8.....	3-44	1933668-4.....	4-13
1933285-3.....	2-5	1933455-9.....	3-44	1933671-.....	3-3, 3-5, 3-6, 3-7
1933285-4.....	2-5	1933457.....	3-127	1933671-1.....	4-13
1933285-5.....	2-5	1933457-1.....	3-42	1933671-2.....	4-13
1933285-6.....	2-5	1933458.....	3-127	1933671-4.....	4-13
1933285-7.....	2-5	1933458-1.....	3-27	1933674-1.....	4-13
1933285-8.....	2-5	1933466-1.....	3-118	1933674-2.....	4-13
1933285-9.....	2-5	1933468-1.....	4-21	1933674-4.....	4-13
1933286-3.....	4-23, 1-125	1933468-2.....	4-21	1933677-1.....	4-13
1933286-4.....	4-23, 1-125	1933468-4.....	4-21	1933686-1.....	4-6
1933286-6.....	4-23	1933476-X.....	3-14	1933686-2.....	4-6
1933307.....	3-127	1933530-1.....	6-19	1933686-4.....	4-6
1933307-1.....	3-5, 3-92	1933531-1.....	6-19	1933691-1.....	1-129
1933308.....	3-127	1933532-1.....	1-3, 1-4, 1-5, 1-6, 3-3, 3-4, 3-5, 3-6, 3-7, 6-19	1933692-1.....	1-129
1933308-1.....	3-5, 3-92	1933533-1.....	1-3, 1-4, 1-5, 1-6, 3-3, 3-4, 3-5, 3-6, 3-7, 6-19	1933694-1.....	1-129
1933309.....	3-127	1933534.....	1-3	1933695-1.....	1-129
1933309-1.....	3-5, 3-92	1933534-1.....	1-4, 1-5, 1-6, 3-3, 3-4, 3-5, 3-6, 3-7, 6-20	1933776.....	3-127
1933310.....	3-127	1933535-1.....	6-20	1933837-1.....	1-129
1933310-1.....	3-5, 3-92	1933536-1.....	6-20	1933838-1.....	1-129
1933319.....	3-127	1933540.....	6-20	1933895-1.....	3-106
1933319-2.....	3-3, 3-12	1933540-1.....	1-3, 1-4, 1-5, 1-6, 3-3, 3-4, 3-5, 3-6, 3-7	1933981-1.....	3-109
1933320.....	3-127	1933541-1.....	6-20	1938056-2.....	2-14
1933320-2.....	3-3, 3-12	1933542-1.....	6-20	1938056-3.....	2-14
1933321.....	3-127	1933552-1.....	6-21	1938056-4.....	2-14
1933321-2.....	3-3, 3-12	1933553-1.....	6-21	1938056-5.....	2-14
1933322.....	3-127	1933554-1.....	6-21	1938056-6.....	2-14
1933322-2.....	3-3, 3-12	1933555-1.....	6-21	1938056-7.....	2-14
1933352.....	6-26	1933556-1.....	6-21	1938056-8.....	2-14
1933352-1.....	3-61	1933557-1.....	6-21	1938056-9.....	2-14
1933352-2.....	3-61, 6-26	1933558-1.....	6-21	1938965-2.....	2-14
1933352-3.....	3-61, 6-26	1933559-1.....	1-3, 1-4, 1-5, 1-6, 3-3, 3-4, 3-5, 3-6, 3-7, 6-18	1938965-3.....	2-14
1933352-4.....	3-61, 6-26	1933560-1.....	6-18	1938965-4.....	2-14
1933377-1.....	3-116			1938965-5.....	2-14
1933412.....	3-127			1938965-6.....	2-14
1933412-1.....	3-92			1938965-7.....	2-14
1933422-1.....	2-5			1938965-8.....	2-14
1933422-2.....	2-5				

# Index

## By Part Number

1938965-9.....	2-14	1985799-2.....	2-7	2-1374416-6.....	4-24
1938966-2.....	2-7	1985799-3.....	2-7	2-1375055-1.....	3-28
1938966-3.....	2-7	1985799-4.....	2-7	2-1375055-2.....	3-28
1938966-4.....	2-7	1985799-5.....	2-7	2-1375055-4.....	3-28
1938966-5.....	2-7	1985799-6.....	2-7	2-1375055-5.....	3-28
1938966-6.....	2-7	1985799-7.....	2-7	2-1375055-6.....	3-28
1938966-7.....	2-7	1985799-8.....	2-7	2-1375055-7.....	3-28
1938966-8.....	2-7	1985799-9.....	2-7	2-1375055-8.....	3-28
1938966-9.....	2-7	1985959-1.....	2-3	2-1375055-9.....	3-28
1938967-2.....	2-7	1985959-2.....	2-3	2-1375191-1.....	3-44
1938967-3.....	2-7	1985959-3.....	2-3	2-1375191-2.....	3-44
1938967-4.....	2-7	1985959-4.....	2-3	2-1375191-4.....	3-44
1938967-5.....	2-7	1985959-5.....	2-3	2-1375191-5.....	3-44
1938967-6.....	2-7	1985959-6.....	2-3	2-1375191-6.....	3-44
1938967-7.....	2-7	1985959-7.....	2-3	2-1375191-7.....	3-44
1938967-8.....	2-7	1985959-8.....	2-3	2-1375191-8.....	3-44
1938967-9.....	2-7	1985959-9.....	2-3	2-1375191-9.....	3-44
1938996-2.....	2-14	1985960-1.....	2-3	2-1499841-0.....	2-19
1938996-3.....	2-14	1985960-2.....	2-3	2-1499841-5.....	2-19
1938996-4.....	2-14	1985960-3.....	2-3	2-1499842-0.....	2-19
1938996-5.....	2-14	1985960-4.....	2-3	2-1499842-5.....	2-19
1938996-6.....	2-14	1985960-5.....	2-3	2-1499843-0.....	2-19
1938996-7.....	2-14	1985960-6.....	2-3	2-1499843-5.....	2-19
1938996-8.....	2-14	1985960-7.....	2-3	2-1499844-0.....	2-19
1938996-9.....	2-14	1985960-8.....	2-3	2-1499844-5.....	2-19
1985040-1.....	1-137	1985960-9.....	2-3	2-1499845-0.....	2-19
1985041-1.....	1-137	1985961-1.....	2-3	2-1499845-5.....	2-19
1985713-2.....	2-7	1985961-2.....	2-3	2-1499846-0.....	2-19
1985713-3.....	2-7	1985961-3.....	2-3	2-1499846-5.....	2-19
1985713-4.....	2-7	1985961-4.....	2-3	2-1499848-0.....	2-19
1985713-5.....	2-7	1985961-5.....	2-3	2-1499848-5.....	2-19
1985713-6.....	2-7	1985961-6.....	2-3	2-1499849-0.....	2-19
1985713-7.....	2-7	1985961-7.....	2-3	2-1499849-5.....	2-19
1985713-8.....	2-7	1985961-8.....	2-3	2-1499850-0.....	2-19
1985713-9.....	2-7	1985961-9.....	2-3	2-1499850-5.....	2-19
1985766-1.....	1-139			2-1499851-0.....	2-19
1985771-1.....	1-132			2-1499851-5.....	2-19
1985797-2.....	2-7	<b>2</b>		2-1499852-0.....	2-19
1985797-3.....	2-7	2-231652-1.....	3-138	2-1499852-5.....	2-19
1985797-4.....	2-7	2-231652-7.....	3-138	2-1499853-0.....	2-19
1985797-5.....	2-7	2-231652-8.....	3-138	2-1499853-5.....	2-19
1985797-6.....	2-7	2-603227-0.....	1-143, 3-119	2-1591019-0.....	3-86
1985797-7.....	2-7	2-603227-9.....	1-143, 3-119	2-1777117-7.....	1-3
1985797-8.....	2-7	2-604751-0.....	1-143, 3-119	2-1777121-7.....	1-3
1985797-9.....	2-7	2-604751-9.....	1-143, 3-119	2-2111179-0.....	1-124
1985798-2.....	2-7	2-604771-0.....	1-143, 3-119	2-2111190-0.....	1-124
1985798-3.....	2-7	2-604771-9.....	1-143, 3-119	2-2111225-0.....	1-124
1985798-4.....	2-7	2-604772-0.....	1-143, 3-119	2-2111236-0.....	1-124
1985798-5.....	2-7	2-604772-9.....	1-143, 3-119	2-2111250-5.....	3-65
1985798-6.....	2-7	2-1374416-3.....	4-24	2-2111250-6.....	3-65
1985798-7.....	2-7	2-1374416-4.....	4-24	2-2111270-5.....	3-65
1985798-8.....	2-7	2-1374416-5.....	4-24	2-2111270-6.....	3-65
1985798-9.....	2-7			2-2111280-5.....	3-65

# Index

## By Part Number

2-2111280-6.....	3-65	2111008.....	3-126	2111236-4.....	1-124
2-2111290-5.....	3-64	2111008-.....	3-3, 3-5, 3-6, 3-7	2111236-5.....	1-124
2-2111290-6.....	3-64	2111009.....	3-126	2111236-6.....	1-124
2-2111300-5.....	3-64	2111009-.....	3-3, 3-5, 3-6, 3-7	2111236-7.....	1-124
2-2111300-6.....	3-64	2111010.....	3-126	2111236-8.....	1-124
2-2111310-5.....	3-64	2111011.....	3-126	2111236-9.....	1-124
2-2111310-6.....	3-64	2111011-.....	3-3, 3-5, 3-6, 3-7	2111243.....	3-14
2-2111408-4.....	4-24	2111012.....	3-126	2111244-X.....	3-14
2FM-(6)ØE-AMP-LAB.....	4-8	2111013.....	3-126	2111250-7.....	3-65
2FM-(12)ØE-AMP-LAB.....	4-8	2111014.....	3-126	2111251-5.....	3-65
2FM-D(4)ØE-AMP.....	4-8	2111015.....	3-126	2111252-5.....	3-65
2FM-D(6)ØE-AMP.....	4-8	2111021.....	3-126	2111270-7.....	3-65
2FM-DØØE-AMP.....	4-8	2111022.....	3-126	2111271-5.....	3-65
219172-1.....	3-107	2111023.....	3-126	2111272-5.....	3-65
219172-2.....	3-107	2111024.....	3-126	2111279-1.....	6-23
219172-3.....	3-107	2111025.....	3-126	2111280-7.....	3-65
219172-4.....	3-107	2111093-1.....	1-61	2111281-5.....	3-65
219173-1.....	3-107	2111117-1.....	1-61	2111282-5.....	3-65
219173-2.....	3-107	2111121-1.....	3-44	2111285-2.....	3-97
219173-3.....	3-107	2111122-1.....	3-44	2111290-7.....	3-64
219173-4.....	3-107	2111123-1.....	3-29	2111291-5.....	3-64
219174-1.....	1-128	2111124-1.....	3-29	2111292-5.....	3-64
219174-2.....	1-128	2111159-1.....	3-92	2111300-7.....	3-64
219174-3.....	1-128	2111179-1.....	1-124	2111301-5.....	3-64
219174-4.....	1-128	2111179-2.....	1-124	2111302-5.....	3-64
219175-1.....	1-128	2111179-3.....	1-124	2111310-7.....	3-64
219175-2.....	1-128	2111179-4.....	1-124	2111311-5.....	3-64
219175-3.....	1-128	2111179-5.....	1-124	2111312-5.....	3-64
219175-4.....	1-128	2111179-6.....	1-124	2111340-1.....	3-89
224928-1.....	3-136	2111179-7.....	1-124	2111348.....	3-127
224928-2.....	3-136	2111179-8.....	1-124	2111348-1.....	3-92
228433-5.....	1-136	2111179-9.....	1-124	2111349.....	3-127
228433-7.....	1-136	2111190-1.....	1-124	2111349-1.....	3-92
228433-8.....	1-136	2111190-2.....	1-124	2111353-1.....	3-117
228433-9.....	1-136	2111190-3.....	1-124	2111353-2.....	3-117
229378-1.....	3-141	2111190-4.....	1-124	2111366-X.....	1-86, 3-76
229384-1.....	3-141	2111190-5.....	1-124	2111371-X.....	1-86, 3-76
229451-2.....	3-141	2111190-6.....	1-124	2111399-1.....	3-46
229764-2.....	3-141	2111190-7.....	1-124	2111407-2.....	4-24
230238-1.....	3-141	2111190-8.....	1-124	2111407-5.....	4-24
230328-3.....	3-141	2111190-9.....	1-124	2111407-6.....	4-24
231662-5.....	3-139	2111225-1.....	1-124	2111407-7.....	4-24
231666-9.....	3-139	2111225-2.....	1-124	2111407-8.....	4-24
231890-1.....	3-140	2111225-3.....	1-124	2111408-1.....	4-24
2064184-1.....	1-121	2111225-4.....	1-124	2111408-2.....	4-24
2064184-2.....	1-121	2111225-5.....	1-124	2111408-5.....	4-24
2064499-1.....	1-142	2111225-6.....	1-124	2111408-6.....	4-24
2064500-1.....	1-142	2111225-7.....	1-124	2111408-7.....	4-24
2064540-1.....	1-132	2111225-8.....	1-124	2111408-8.....	4-24
2064603-1.....	1-139	2111225-9.....	1-124	2111408-9.....	4-24
2064651-1.....	1-142	2111236-1.....	1-124	2111413-1.....	3-124
2064651-2.....	1-142	2111236-2.....	1-124	2111414-1.....	3-124
2064651-3.....	1-142	2111236-3.....	1-124	2111415-1.....	3-122

# Index

## By Part Number

2111416-1.....	3-122	2193054-2.....	1-111	3-1553419-9.....	1-4
2111420-1.....	3-117	2193055-1.....	1-111	3-1553420-9.....	1-4
2111425-1.....	3-124	2193055-2.....	1-111	3-1777117-7.....	1-4
2111481-1.....	1-110	2193056-1.....	1-111	3-1777121-7.....	1-4
2111488-1.....	3-97	2193056-2.....	1-111	354940-1.....	3-136, 3-137
2111500-2.....	4-23	2193057-1.....	1-111		
2111521-X.....	1-86, 3-76	2193057-2.....	1-111	<b>4</b>	
2111522-X.....	1-86, 3-76	2193057-3.....	1-111	4-1499783-0.....	3-107
2111570-1.....	3-12	2193057-4.....	1-111	4-1499841-0.....	2-19
2111571-1.....	3-12	2193058-1.....	1-111	4-1499842-0.....	2-19
2111572-1.....	3-12	2193058-2.....	1-111	4-1499843-0.....	2-19
2111573-1.....	3-12	2193058-4.....	1-111	4-1499844-0.....	2-19
2111615-1.....	4-23			4-1499845-0.....	2-19
2111615-2.....	4-23	<b>3</b>		4-1499846-0.....	2-19
2111648-1.....	1-111	3-231652-0.....	3-138	4-1499848-0.....	2-19
2111649-1.....	1-111	3-231652-6.....	3-138	4-1499849-0.....	2-19
2111649-2.....	1-111	3-553079-1.....	3-112	4-1499850-0.....	2-19
2111650-1.....	1-111	3-553079-3.....	3-112	4-1499851-0.....	2-19
2111650-2.....	1-111	3-553079-4.....	3-112	4-1499852-0.....	2-19
2111651-1.....	1-111	3-553239-1.....	3-112	4-1499853-0.....	2-19
2111653-1.....	3-81	3-553239-3.....	3-112	4-1553307-9.....	1-5
2111653-2.....	3-81	3-553239-4.....	3-112	4-1553308-9.....	1-5
2111653-3.....	3-81	3-553820-1.....	3-112	4-1553311-9.....	1-5
2111653-5.....	3-81	3-553820-3.....	3-112	4-1553312-9.....	1-5
2111653-7.....	3-81	3-553820-4.....	3-112	4-1553315-9.....	1-5
2111673-1.....	3-81	3-1375055-0.....	3-28	4-1553316-9.....	1-5
2111673-2.....	3-81	3-1375055-1.....	3-28	4-1553416-9.....	1-5
2111673-3.....	3-81	3-1375055-3.....	3-28	4-1553417-9.....	1-5
2111673-5.....	3-81	3-1375191-0.....	3-44	4-1553419-9.....	1-5
2111676-X.....	3-14	3-1375191-1.....	3-44	4-1553420-9.....	1-5
2111682-1.....	3-115	3-1375191-3.....	3-44	4-1777117-7.....	1-6, 1-121
2123273-1.....	1-137	3-1499841-0.....	2-19	4-1777121-7.....	1-6, 1-121
2153041-1.....	3-57	3-1499842-0.....	2-19	4-1777124-7.....	1-121
2153046-1.....	3-57	3-1499843-0.....	2-19	4-1933335-0.....	3-107
2153115-1.....	1-61, 3-68	3-1499844-0.....	2-19	4-1933920-0.....	3-107
2153249-1.....	3-5, 3-28	3-1499845-0.....	2-19	4-1933921-0.....	3-107
2160266-3.....	1-62	3-1499846-0.....	2-19	406042-1.....	6-25
2160266-5.....	1-62	3-1499848-0.....	2-19	406185.....	3-126
2160530-5.....	1-63	3-1499849-0.....	2-19	406185-1.....	4-7, 1-125
2193016-1.....	1-111	3-1499850-0.....	2-19	406185-2.....	4-7
2193045-1.....	1-111	3-1499851-0.....	2-19	406185-4.....	4-7
2193046-1.....	1-111	3-1499852-0.....	2-19	406330.....	3-127
2193046-2.....	1-111	3-1499853-0.....	2-19	406330-1.....	3-42
2193047-1.....	1-111	3-1553307-9.....	1-4	406331.....	3-127
2193047-2.....	1-111	3-1553308-9.....	1-4	406331-1.....	3-42
2193048-1.....	1-111	3-1553311-9.....	1-4	406332.....	3-127
2193048-2.....	1-111	3-1553312-9.....	1-4	406332-1.....	3-42
2193050-1.....	1-111	3-1553315-9.....	1-4	4063390.....	3-127
2193051-1.....	1-111	3-1553316-9.....	1-4	406390-1.....	3-42
2193052-1.....	1-111	3-1553416-9.....	1-4	406641-1.....	3-53
2193053-1.....	1-111	3-1553417-9.....	1-4	406771-1.....	3-106
2193053-2.....	1-111	3-1553418-9.....	1-4	406771-2.....	3-106
2193054-1.....	1-111				

# Index

## By Part Number

406772-1.....	3-106	5-1375357-1.....	3-122	5-1899725-6.....	5-6
406788-1.....	3-106	5-1375358-1.....	3-123	5-1899725-7.....	5-6
406981.....	3-127	5-1479002-1.....	3-125	5-1899725-8.....	5-6
406981-1.....	3-42	5-1479003-1.....	3-125	5-1899725-9.....	5-6
469439.....	3-128	5-1479184-2.....	3-29	5-1933335-0.....	1-128, 3-107
492025-1.....	1-139	5-1479184-3.....	3-29	5-1933920-0.....	3-107
492026-1.....	1-139	5-1479185-2.....	3-29	5-1933921-0.....	3-107
492131-1.....	1-139	5-1479185-3.....	3-29	5-2111413-1.....	3-124
492622-1.....	1-139	5-1479802-3.....	2-18	5-2111414-1.....	3-124
492623-1.....	1-139	5-1479803-3.....	2-18	5-2111415-1.....	3-122
492697-1.....	1-130, 1-131	5-1479804-3.....	2-18	5-2111416-1.....	3-122
492697-2.....	1-130, 1-131	5-1479805-3.....	2-18	5-2111425-1.....	3-124
492703-1.....	1-132	5-1479806-3.....	2-18	58424-1.....	1-139
492782-1.....	1-139	5-1479807-3.....	2-18	58433-4.....	1-139
492783-1.....	1-139	5-1479808-3.....	2-18	58551-1.....	1-139
		5-1479809-3.....	2-18	58552-1.....	1-139
<b>5</b>		5-1499549-3.....	2-18	58568-1.....	3-140
5-554169-3.....	3-98	5-1499550-3.....	2-18	501381-1.....	1-56
5-554170-3.....	3-98	5-1499551-3.....	2-18	501473-3.....	1-135
5-554710-3.....	3-98	5-1499552-3.....	2-18	501818-1.....	1-138
5-554720-3.....	3-98	5-1499553-3.....	2-18	502129-1.....	1-136
5-554739-3.....	3-98	5-1499554-3.....	2-18	502134-1.....	1-136
5-555042-3.....	3-98	5-1499555-3.....	2-18	502134-2.....	1-136
5-555174-2.....	3-98	5-1499556-3.....	2-18	502222-1.....	1-136
5-555175-3.....	3-98	5-1499557-3.....	2-18	502259-1.....	1-138
5-555177-3.....	3-98	5-1499558-3.....	2-18	502306-1.....	1-131, 1-136
5-555426-3.....	3-98	5-1499559-3.....	2-18	502306-2.....	1-131, 1-136
5-557315-3.....	3-98	5-1499560-3.....	2-18	502306-4.....	1-131, 1-136
5-558530-2.....	3-45	5-1499561-3.....	2-18	502418-1.....	1-135
5-558530-3.....	3-45	5-1499562-3.....	2-18	502631-1.....	1-138
5-569278-2.....	3-45	5-1499675-3.....	2-18	502656-1.....	1-138
5-569278-3.....	3-45	5-1499676-3.....	2-18	502748-2.....	1-136
5-569530-3.....	3-98	5-1499677-3.....	2-18	503273-5.....	1-56
5-569532-3.....	3-98	5-1499678-3.....	2-18	503304-1.....	1-138
5-569542-3.....	3-98	5-1499679-3.....	2-18	503337-1.....	1-138
5-569550-2.....	3-45	5-1499680-3.....	2-18	503746-1.....	1-130, 1-133
5-569550-3.....	3-45	5-1499783-0.....	1-128, 3-107	503746-7.....	1-130, 1-133
5-569552-2.....	3-45	5-1499841-0.....	2-19	503887-1.....	1-136
5-569552-3.....	3-45	5-1499842-0.....	2-19	503890-1.....	1-139
5-641337-3.....	3-98	5-1499843-0.....	2-19	503910-1.....	1-139
5-1375202-2.....	3-29	5-1499844-0.....	2-19	503911-1.....	1-139
5-1375202-3.....	3-29	5-1499845-0.....	2-19	503997.....	3-126
5-1375204-2.....	3-29	5-1499846-0.....	2-19	503997-1.....	4-10, 1-127
5-1375204-3.....	3-29	5-1499848-0.....	2-19	503998.....	3-126
5-1375351-1.....	3-124	5-1499849-0.....	2-19	503998-1.....	4-10
5-1375352-1.....	3-124	5-1499850-0.....	2-19	503999.....	3-126
5-1375353-1.....	3-123, 3-124	5-1499851-0.....	2-19	503999-1.....	4-10, 1-127
5-1375354-1.....	3-62, 3-125	5-1499852-0.....	2-19	504021-1.....	1-56
5-1375354-2.....	3-62, 3-125	5-1499853-0.....	2-19	504035-1.....	1-134
5-1375354-3.....	3-62, 3-125	5-1899725-2.....	5-6	504662-2.....	1-56
5-1375355-1.....	3-125	5-1899725-3.....	5-6	553095-1.....	3-115
5-1375356-1.....	3-122	5-1899725-4.....	5-6	553453-2.....	3-114
		5-1899725-5.....	5-6	553454-1.....	3-114

# Index

## By Part Number

553455-2.....	3-114	557366-1.....	4-12	558488-1.....	4-21
553481-1.....	3-114	557403-1.....	3-90	558488-2.....	4-21
553534-1.....	3-114	557429-1.....	3-94	558488-4.....	4-21
553536-1.....	3-112	557429-2.....	3-94	558489-1.....	4-21
553536-3.....	3-112	557548-1.....	3-61, 6-25	558489-2.....	4-21
553536-4.....	3-112	557685-1.....	4-12	558489-4.....	4-21
553739-2.....	3-115	557775-1.....	4-12	558492-1.....	4-21
553908-1.....	3-113	558054-1.....	3-116	558492-2.....	4-21
553909-1.....	3-113	558106-1.....	4-18, 1-128	558492-4.....	4-21
553910-1.....	3-113	558106-2.....	4-18	558493-1.....	4-21
553947-1.....	3-113	558106-4.....	4-18	558493-2.....	4-21
553947-3.....	3-113	558107-1.....	4-18	558493-4.....	4-21
554123-1.....	3-112	558107-2.....	4-18	558527-1.....	3-46
554123-3.....	3-112	558107-4.....	4-18	558527-3.....	3-46
554123-4.....	3-112	558191-1.....	4-20	558635.....	3-128
554142-1.....	3-113	558191-2.....	4-20	558635-1.....	3-53
554142-3.....	3-113	558191-4.....	4-20	558637.....	3-128
554178-1.....	3-114	558198-1.....	3-120	558637-1.....	3-53
554181-1.....	3-111	558198-2.....	3-120	558639.....	3-128
554181-3.....	3-111	558198-3.....	3-120	558639-1.....	3-53
554186.....	3-113	558198-4.....	3-120	558650-1.....	3-113
554186-3.....	3-113	558198-5.....	3-120	558650-3.....	3-113
554188-1.....	3-113	558198-6.....	3-120	558821-1.....	3-120
554189-1.....	3-113	558198-7.....	3-120	558821-6.....	3-120
554192-1.....	3-113	558198-8.....	3-120	558821-8.....	3-120
554192-3.....	3-113	558198-9.....	3-120	558838-1.....	3-50
554206-1.....	3-116	558199-1.....	3-120	558839.....	3-128
554206-3.....	3-116	558199-2.....	3-120	558839-1.....	3-49
554805-1.....	3-111	558199-3.....	3-120	558840.....	3-128
554862-1.....	3-111	558199-4.....	3-120	558840-1.....	3-49
555049-1.....	3-96	558199-5.....	3-120	558841.....	3-128
555050-1.....	3-96	558199-6.....	3-120	558841-1.....	3-49
555051-1.....	3-96	558199-7.....	3-120	558842.....	3-128
555052-1.....	3-96	558199-8.....	3-120	558842-1.....	3-49
555287-1.....	3-116	558199-9.....	3-120	558843.....	3-128
555287-3.....	3-116	558251-1.....	4-14	558843-1.....	3-49
555376-1.....	3-96	558251-2.....	4-14	558856-1.....	3-95
555377-1.....	3-96	558251-4.....	4-14	558856-2.....	3-95
555482-1.....	3-91	558266-1.....	6-23	558862-1.....	3-95
556180-1.....	3-91	558267-1.....	6-23	558862-2.....	3-95
556183-1.....	3-91	558268-1.....	6-23	559369-1.....	6-24
556186-1.....	3-91	558269-1.....	6-23	559370-1.....	6-24
556189-1.....	3-91	558301-1.....	6-25	569127-1.....	4-20
556222-3.....	4-17, 1-128	558329-1.....	6-24	569127-2.....	4-20
556411-1.....	3-114	558331-1.....	6-24	569127-4.....	4-20
556438-1.....	6-25	558357-1.....	4-20	569389-1.....	3-7, 3-52
556625-1.....	3-96	558357-2.....	4-20	569431-1.....	3-52
556627-1.....	3-96	558357-4.....	4-20	569432.....	3-128
556706-1.....	3-140	558401-1.....	3-49	569433.....	3-128
556965-1.....	3-92	558402-1.....	3-49	569433-1.....	3-50
556965-2.....	3-92	558417-1.....	3-125	569434.....	3-128
557350-1.....	4-12	558471-1.....	4-18	569434-1.....	3-50
557361-1.....	4-12	558471-2.....	4-18	569438.....	3-128
557366.....	3-126	558471-4.....	4-18	569439-1.....	3-7, 3-50



# Index

## By Part Number

569440.....	3-128	569875-2.....	3-46	6-1553389-5.....	1-5
569440-1.....	3-50	569875-3.....	3-46	6-1553390-2.....	1-3
569444.....	3-128	569875-4.....	3-46	6-1553390-3.....	1-6
569445.....	3-128	569875-5.....	3-46	6-1553390-4.....	1-4
569445-1.....	3-7, 3-50	569875-6.....	3-46	6-1553390-5.....	1-5
569446.....	3-128	569875-7.....	3-46	6-1553397-2.....	1-3
569446-1.....	3-50	569875-8.....	3-46	6-1553397-3.....	1-6
569499-1.....	4-14	569875-9.....	3-46	6-1553397-4.....	1-4
569499-2.....	4-14	569949-1.....	3-135	6-1553397-5.....	1-5
569499-4.....	4-14	5502632-8.....	1-56	6-1553399-2.....	1-3
569523-2.....	3-48	5502780-2.....	1-56	6-1553399-3.....	1-6
569523-4.....	3-48	5502780-3.....	1-56	6-1553399-4.....	1-4
569523-6.....	3-48	5503137-5.....	1-56	6-1553399-5.....	1-5
569523-8.....	3-48	5504614-1.....	1-56	6-1553400-2.....	1-3
569524-2.....	3-48	5504640-1.....	1-56	6-1553400-3.....	1-6
569524-4.....	3-48	5504663-4.....	1-56	6-1553400-4.....	1-4
569524-6.....	3-48			6-1553400-5.....	1-5
569524-8.....	3-48			6-1899725-0.....	5-6
569526-2.....	3-48	<b>6</b>		6-1899725-2.....	5-6
569526-4.....	3-48	6-553453-2.....	3-114	6-1899725-4.....	5-6
569526-6.....	3-48	6-553534-1.....	3-114	6-1899725-6.....	5-6
569526-8.....	3-48	6-1499783-0.....	3-107	6-1899725-8.....	5-6
569527-2.....	3-48	6-1553342-2.....	1-3	6-1933335-0.....	3-107
569527-4.....	3-48	6-1553342-3.....	1-6	6-1933920-0.....	3-107
569527-6.....	3-48	6-1553342-4.....	1-4	6-1933921-0.....	3-107
569527-8.....	3-48	6-1553342-5.....	1-5	6-2111250-4.....	3-65
569528-2.....	3-48	6-1553343-2.....	1-3	6-2111270-4.....	3-65
569528-4.....	3-48	6-1553343-3.....	1-6	6-2111280-4.....	3-65
569528-6.....	3-48	6-1553343-4.....	1-4	6-2111290-4.....	3-64
569528-8.....	3-48	6-1553343-5.....	1-5	6-2111300-4.....	3-64
569597-1.....	3-52	6-1553346-2.....	1-3	6-2111310-4.....	3-64
569599-1.....	3-52	6-1553346-3.....	1-6	6089 2 015-01.....	3-130
569669-2.....	3-48	6-1553346-4.....	1-4	6417 2 055-01.....	3-135
569669-4.....	3-48	6-1553346-5.....	1-5	6417 3 006-01.....	3-135
569669-6.....	3-48	6-1553347-2.....	1-3	6450 1 101-00.....	3-32
569669-8.....	3-48	6-1553347-3.....	1-6	6450 1 101-10.....	3-6
569685-2.....	3-48	6-1553347-4.....	1-4	6450 1 103-10.....	3-18
569685-4.....	3-48	6-1553347-5.....	1-5	6450 1 107-01.....	3-4, 3-18
569685-6.....	3-48	6-1553348-2.....	1-3	6450 2 156-20.....	3-4, 3-6, 3-18
569685-8.....	3-48	6-1553348-3.....	1-6	6450 2 157-00.....	3-4, 3-6
569851-1.....	3-52	6-1553348-4.....	1-4	6450 2 157-10.....	3-18
569852-1.....	3-52	6-1553348-5.....	1-5	6450 2 157-20.....	3-18
569853.....	3-128	6-1553349-2.....	1-3	6450 2 158-20.....	3-4, 3-6, 3-18
569854.....	3-128	6-1553349-3.....	1-6	6451 2 178-04.....	3-129
569854-1.....	3-51	6-1553349-4.....	1-4	6451 2 400C-10.....	3-35
569855.....	3-128	6-1553349-5.....	1-5	6451 2 400C-20.....	3-35
569855-1.....	3-51	6-1553387-2.....	1-3	6451 2 400C-30.....	3-35
569856.....	3-128	6-1553387-3.....	1-6	6451 2 400C-40.....	3-35
569857.....	3-128	6-1553387-4.....	1-4	6451 2 401C-10.....	3-35
569857-1.....	3-51	6-1553387-5.....	1-5	6451 2 401C-20.....	3-35
569858.....	3-128	6-1553389-2.....	1-3	6451 2 401C-30.....	3-35
569858-1.....	3-51	6-1553389-3.....	1-6	6451 2 401C-40.....	3-35
569875-1.....	3-46	6-1553389-4.....	1-4	6451 2 403C-10.....	3-35

# Index

## By Part Number

6451 2 403C-20.....	3-35	6631 3 102-02/03.....	3-132	6654 2 350-06/1.....	6-31
6451 2 403C-30.....	3-35	6631 3 102-04/06.....	3-132	6654 2 350-11/1.....	6-31
6451 2 403C-40.....	3-35	6631 3 102-05/07.....	3-132	6654 2 350-21/2.....	6-31
6451 2 404C-10.....	3-35	6631 3 102-08.....	3-132	6655 2 400-03.....	6-32
6451 2 404C-20.....	3-35	6631 3 105-05.....	3-132	6655 2 450-06/1.....	6-31
6451 2 404C-30.....	3-35	6631 3 105-06.....	3-132	6655 2 450-11/1.....	6-31
6451 2 404C-40.....	3-35	6631 3 105-07.....	3-132	6655 2 450-21/2.....	6-31
6451 2 700C-10.....	3-35	6631 3 105-08.....	3-132	6655 2 450-31/3.....	6-31
6451 2 700C-20.....	3-35	6631 3 106-XX.....	3-132	6657 2 005-03.....	6-28
6451 2 700C-30.....	3-35	6636 1 596-06.....	3-32	6657 2 005-04.....	6-28
6451 2 700C-40.....	3-35	6636 1 596-46.....	3-32	6657 2 005-19/03.....	6-30
6451 2 701C-10.....	3-35	6642 1 115-04.....	3-101	6657 2 005-19/04.....	6-30
6451 2 701C-20.....	3-35	6642 1 115-05.....	3-101	6657 2 005-23/03.....	6-30
6451 2 701C-30.....	3-35	6642 1 315-04.....	3-101	6657 2 005-23/04.....	6-30
6451 2 701C-40.....	3-35	6642 1 315-05.....	3-101	6657 2 005-35/04.....	6-30
6451 2 702-10.....	3-35	6645 2 127.....	3-129	6657 2 005-35/05.....	6-30
6451 2 702-20.....	3-35	6645 2 251-XX.....	3-103	6657 2 005-35/06.....	6-30
6451 2 702-30.....	3-35	6645 2 254-01.....	3-103	6657 2 005-43.....	6-28
6451 2 702-40.....	3-35	6645 2 264-XX.....	3-103	6657 2 005-44.....	6-28
6451 2 703C-10.....	3-35	6645 2 265-XX.....	3-103	6657 2 006-06/02.....	6-30
6451 2 703C-20.....	3-35	6645 2 266-XX.....	3-103	6657 2 006-09/03.....	6-30
6451 2 703C-30.....	3-35	6645 2 267-XX.....	3-103	6657 2 165-00.....	3-17, 6-27
6451 2 703C-40.....	3-35	6645 2 268-XX.....	3-103	6657 2 165-40.....	3-17, 6-27
6451 2 704C-10.....	3-35	6645-2-805.....	3-4	608440-1.....	4-21
6451 2 704C-20.....	3-35	6646 3 001-01.....	3-129	608441-1.....	4-21
6451 2 704C-30.....	3-35	6648 2 000-XX.....	3-34	6278807-1.....	2-13
6451 2 704C-40.....	3-35	6648 2 005-XX.....	3-34	6278807-2.....	2-13
6451 5 035-00.....	3-129	6648 2 900.....	3-129	6278807-3.....	2-13
6462 2 016-00.....	3-131	6648 2 901.....	3-129	6278807-4.....	2-13
6462 2 096-00.....	3-130	6652 2 039-06.....	6-32	6278807-5.....	2-13
6462 2 097-00.....	3-129	6652 2 039-11.....	6-32	6278807-6.....	2-13
6462 2 097-20.....	3-129	6652 2 039-21.....	6-32	6278807-7.....	2-13
6462 2 101-01.....	3-129	6652 2 040-06.....	6-33	6278807-8.....	2-13
6468 5 060-06.....	3-32	6652 2 040-11.....	6-33	6278807-9.....	2-13
6468 5 070-00.....	3-17	6652 2 040-21.....	6-33	6278808-1.....	2-13
6468 5 300-00.....	3-32	6652 2 067-19.....	6-29	6278808-2.....	2-13
6468 5 600-00.....	3-32	6652 2 068-19.....	6-29	6278808-3.....	2-13
6619 2 046-00.....	6-33	6652 2 069-19.....	6-29	6278808-4.....	2-13
6619 2 046-01.....	6-33	6652 2 069-23.....	6-29	6278808-5.....	2-13
6630 2 004-05.....	3-17, 3-130	6652 2 070-19.....	6-29	6278808-6.....	2-13
6631 2 003-00.....	3-100	6652 2 070-23.....	6-29	6278808-7.....	2-13
6631 2 135-00.....	3-100	6652 2 080-19.....	6-29	6278808-8.....	2-13
6631 2 135-05.....	3-100	6652 2 080-23.....	6-29	6278808-9.....	2-13
6631 2 135-06.....	3-100	6652 2 081-19.....	6-29	6278810-1.....	2-13
6631 3 100-03.....	3-132	6652 2 081-23.....	6-29	6278810-2.....	2-13
6631 3 100-22.....	3-100	6652 2 082-19.....	6-29	6278810-3.....	2-13
6631 3 100-23.....	3-100	6652 2 083-19.....	6-29	6278810-4.....	2-13
6631 3 100-26.....	3-100	6652 2 100-00.....	6-34	6278810-5.....	2-13
6631 3 100-27.....	3-100	6652 2 101-00.....	6-34	6278810-6.....	2-13
6631 3 100-28.....	3-100	6652 2 113-00.....	6-34	6278810-7.....	2-13
6631 3 100-29.....	3-100	6652 2 114-00.....	6-34	6278810-8.....	2-13
6631 3 100-30.....	3-100	6653 1 679-24.....	3-27	6278810-9.....	2-13
6631 3 102-01/09.....	3-132	6653 1 679-48.....	3-27	6278811-1.....	2-13

# Index

## By Part Number

6278811-2.....	2-13	6754252-3.....	2-13	7-1553315-3.....	1-6
6278811-3.....	2-13	6754252-4.....	2-13	7-1553316-3.....	1-6
6278811-4.....	2-13	6754252-5.....	2-13	7-1553406-3.....	1-25
6278811-5.....	2-13	6754252-6.....	2-13	7-1553407-3.....	1-25
6278811-6.....	2-13	6754252-7.....	2-13	7-1553408-3.....	1-25
6278811-7.....	2-13	6754252-8.....	2-13	7-1553409-3.....	1-25
6278811-8.....	2-13	6754252-9.....	2-13	7-1553410-3.....	1-25
6278811-9.....	2-13	6754285-2.....	2-14	7-1553411-3.....	1-25
6374906-1.....	1-56	6754285-3.....	2-14	7-1553412-3.....	1-25
6457240-1.....	3-108	6754285-4.....	2-14	7-1553413-3.....	1-25
6457240-2.....	3-108	6754285-5.....	2-14	7-1553414-3.....	1-25
6457240-3.....	3-108	6754285-6.....	2-14	7-1553415-3.....	1-25
6457240-4.....	3-108	6754285-7.....	2-14	7-1553416-3.....	1-6, 1-25
6457240-5.....	3-108	6754285-8.....	2-14	7-1553417-3.....	1-6, 1-25
6457567-4.....	1-56	6754285-9.....	2-14	7-1553418-3.....	1-6, 1-25
6457567-5.....	1-56	6754286-2.....	2-14	7-1553419-3.....	1-6, 1-25
6588878-1.....	2-13	6754286-3.....	2-14	7-1553420-3.....	1-121
6588878-2.....	2-13	6754286-4.....	2-14	7-1777117-7.....	1-5
6588878-3.....	2-13	6754286-5.....	2-14	7-1777121-7.....	1-5
6588878-4.....	2-13	6754286-6.....	2-14	7-1899725-0.....	5-6
6588878-5.....	2-13	6754286-7.....	2-14	7-1899725-2.....	5-6
6588878-6.....	2-13	6754286-8.....	2-14	7-1899725-4.....	5-6
6588878-7.....	2-13	6754286-9.....	2-14	7-1899725-6.....	5-6
6588878-8.....	2-13	6754287-2.....	2-14	7-1899725-8.....	5-6
6588878-9.....	2-13	6754287-3.....	2-14	7-1933335-0.....	3-107
6588879-1.....	2-13	6754287-4.....	2-14	7-1933920-0.....	3-107
6588879-2.....	2-13	6754287-5.....	2-14	7-1933921-0.....	3-107
6588879-3.....	2-13	6754287-6.....	2-14	7-2111250-5.....	3-65
6588879-4.....	2-13	6754287-7.....	2-14	7-2111270-5.....	3-65
6588879-5.....	2-13	6754287-8.....	2-14	7-2111280-5.....	3-65
6588879-6.....	2-13	6754287-9.....	2-14	7-2111290-5.....	3-64
6588879-7.....	2-13	6754288-2.....	2-14	7-2111300-5.....	3-64
6588879-8.....	2-13	6754288-3.....	2-14	7-2111310-5.....	3-64
6588879-9.....	2-13	6754288-4.....	2-14	790163-1.....	3-137
6693949-1.....	2-13	6754288-5.....	2-14	790163-2.....	3-137
6693949-2.....	2-13	6754288-6.....	2-14	790163-5.....	3-137
6693949-3.....	2-13	6754288-7.....	2-14	790163-6.....	3-137
6693949-4.....	2-13	6754288-8.....	2-14	790163-9.....	3-137
6693949-5.....	2-13	6754288-9.....	2-14		
6693949-6.....	2-13	6828819-2.....	2-14	<b>8</b>	
6693949-7.....	2-13	6828819-3.....	2-14	8-1499783-0.....	3-107
6693949-8.....	2-13	6828819-4.....	2-14	8-1899725-0.....	5-6
6693949-9.....	2-13	6828819-5.....	2-14	8-1899725-2.....	5-6
6693951-1.....	2-13	6828819-6.....	2-14	8-1899725-4.....	5-6
6693951-2.....	2-13	6828819-7.....	2-14	8-1899725-6.....	5-6
6693951-3.....	2-13	6828819-8.....	2-14	8-1933335-0.....	3-107
6693951-4.....	2-13	6828819-9.....	2-14	8-1933920-0.....	3-107
6693951-5.....	2-13			8-1933921-0.....	3-107
6693951-6.....	2-13	<b>7</b>		853400-1.....	3-138
6693951-7.....	2-13	7-1499783-0.....	3-107	853400-7.....	3-138
6693951-8.....	2-13	7-1553307-3.....	1-6	853400-8.....	3-138
6693951-9.....	2-13	7-1553308-3.....	1-6	856727-1.....	3-139
6754252-1.....	2-13	7-1553311-3.....	1-6		
6754252-2.....	2-13	7-1553312-3.....	1-6		

# Index

## By Part Number

---

### 9

9-336513-1.....	3-30
9-336513-2.....	3-30
9-336513-3.....	3-30
9-336513-4.....	3-30
9-336513-5.....	3-30
9-336513-6.....	3-30
9-336513-7.....	3-30
9-336513-8.....	3-30
9-336513-9.....	3-30
9-737893-1.....	3-30
9-737893-2.....	3-30
9-737893-3.....	3-30
9-737893-4.....	3-30
9-737893-5.....	3-30
9-737893-6.....	3-30
9-737893-7.....	3-30
9-737893-8.....	3-30
9-737893-9.....	3-30
9-1499783-0.....	3-107
9-1933335-0.....	3-107
9-1933920-0.....	3-107
9-1933921-0.....	3-107
9-2111250-5.....	3-65
9-2111251-5.....	3-65
9-2111252-5.....	3-65
9-2111270-5.....	3-65
9-2111271-5.....	3-65
9-2111272-5.....	3-65
9-2111280-5.....	3-65
9-2111281-5.....	3-65
9-2111282-5.....	3-65
9-2111290-5.....	3-64
9-2111291-5.....	3-64
9-2111292-5.....	3-64
9-2111300-5.....	3-64
9-2111301-5.....	3-64
9-2111302-5.....	3-64
9-2111310-5.....	3-64
9-2111311-5.....	3-64
9-2111312-5.....	3-64
9-2111653-1.....	3-81
9-2111673-1.....	3-81
91392-1.....	3-114

## CATALOG

**Contact us:**

Greensboro, NC  
USA 27409-8420  
Tel: 1-800-553-0938  
Fax: 1-717-986-7406

[www.te.com/EnterpriseNetworks](http://www.te.com/EnterpriseNetworks)



ADC, AirES, AMP, AMP NETCONNECT, AMPINERGY, AMPMODU, AMP-TWIST, Compact Building, CopperTen, Express Exit, FiberGuide, FL2000, HighBand, KRONE, LightCrimp PLUS, LSA-PLUS, MPO Optimate, MRJ21, MT-RJ SECURE, NETCONNECT, NETpodium, OMX, OPTIMATE, Pro-Crimper, Quareo, Quick-Fit, RapidReel, RealFlex, RJ45, Sigma-Link, SlimLine, Snap-Fit, TracerLight, TrueNet, Tyco, Ultim8, TE Connectivity, TE connectivity (logo), Tyco Electronics, and TE (logo) are trademarks. All other logos, products and/or company names referred to herein might be trademarks of their respective owners.

While TE Connectivity has made every reasonable effort to ensure the accuracy of the information in this document, TE Connectivity does not guarantee that it is error-free, nor does TE Connectivity make any other representation, warranty or guarantee that the information is accurate, correct, reliable or current. TE Connectivity reserves the right to make any adjustments to the information contained herein at any time without notice. TE Connectivity expressly disclaims all implied warranties regarding the information contained herein, including, but not limited to, any implied warranties of merchantability or fitness for a particular purpose. The dimensions in this document are for reference purposes only and are subject to change without notice. Specifications are subject to change without notice. Consult TE Connectivity for the latest dimensions and design specifications.

Tyco Electronics Corporation, a TE Connectivity Ltd. Company. All Rights Reserved.

313948AE 11/13 Revision © 2013