

Task / Linear Lighting

Energy-Efficient Under-Cabinet,
Workspace and Concealed Lighting
April 2016



The CSL Task/Linear Lighting lines continue to grow and provide solutions for undercabinet, workspace and concealed illumination needs.

With a variety of sizes, options, and light sources, our innovative undercabinet solutions can be installed wherever counter or workspace task lighting is needed. CSL's Task/Linear Lighting products reach beyond providing illumination by offering complete wiring, inter-connection and switching options.

CounterAttack LED	10
CounterAttack Xenon	10
Eco-Counter EdgeLit	2
Eco-Cove LED	22
Eco-Invizilite LED	18
Eco-Lightbar LED	6
ProPuck LED	14
ProPuck Xenon	14
SpeedLink System	24
Index	25

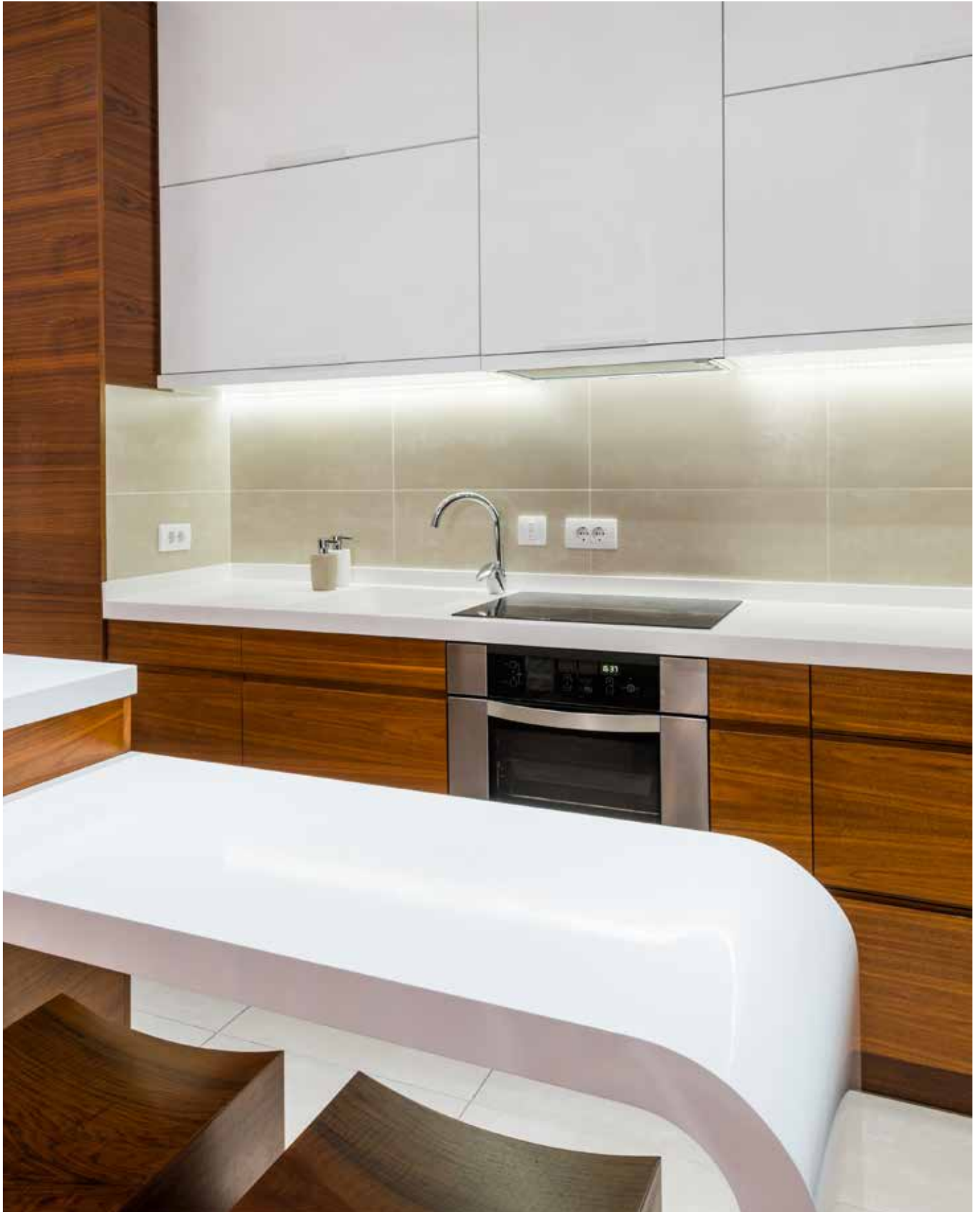



CSL introduces edge-lit technology into its collection of Task Lighting solutions. This new lighting technology offers smoother LED illumination that reflects uniformly across the diffuser, providing a cost-saving LED light with no visible hot spots. Eco-Counter EdgeLit fixtures can easily be linked to illuminate a wide space using CSL's trademarked SpeedLink™ system.



Eco-Counter EdgeLit LED

120V LED EdgeLit Undercabinet Lighting
Integrated | Linkable | Hardwire

Eco-Counter EdgeLit LED Series

Eco-Counter EdgeLit 120V LED

ECL-8
120V 8"
6W



ECL-16
120V 16"
12W

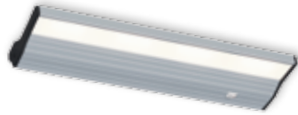

ECL-24
120V 24"
18W



ECL-32
120V 32"
24W

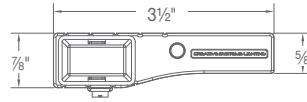

Fixture

- Integrated 120V system – no remote transformers or drivers
- Two color temperature options:
 - 2,700°K ± 50°K, 90CRI
 - 3,000°K ± 50°K, 90CRI
- 50,000 hour lamp life @ 70% lumen maintenance
- Incandescent and ELV dimmable
- Available in four lengths: 8", 16", 24", 32"
- Low profile – only 7/8" high
- No UV or infrared energy – objects will not discolor or fade over time
- SpeedLink™ system links a maximum of 600W
- On / Off switch
- Title 24 and EnergyStar certification pending
- UL/C-UL Listed for damp location



Housing/Heat Sink

- Extruded aluminum housing
- Cool operating temperature
- EdgeLit acrylic lens eliminates lamp image on surfaces
- See www.csllighting.com for current photometric data

Mounting

- Captive screws and SpeedLink™ technology (Hardwire, Portable, Linkable) make for quick installation. See pg 24 for SpeedLink™ options and descriptions

Finishes

- WT White
- SA Satin Aluminum
- BZ Bronze

Wiring Modules

- ECL-MS controls multiple units from one switch. The Wiring Module / Switch may be connected to the end of the Eco-Counter Edge Lit fixture or mounted in a more convenient location and connected to the fixture with a SpeedLink interlink cable.

120V LED Driver

50,000-hour LED, 90 CRI, Incandescent / ELV dimming

ITEM NUMBER *	L x W x H	WATTS	LUMENS
ECL-8-XX-27-3	8" x 3 1/2" x 7/8"	6W	350
ECL-16-XX-27-3	16" x 3 1/2" x 7/8"	12W	700
ECL-24-XX-27-3	24" x 3 1/2" x 7/8"	18W	1050
ECL-32-XX-27-3	32" x 3 1/2" x 7/8"	24W	1400
ECL-8-XX-30-3	8" x 3 1/2" x 7/8"	6W	350
ECL-16-XX-30-3	16" x 3 1/2" x 7/8"	12W	700
ECL-24-XX-30-3	24" x 3 1/2" x 7/8"	18W	1050
ECL-32-XX-30-3	24" x 3 1/2" x 7/8"	24W	1400

* XX indicates two-letter finish code (WT, SA or BZ)

Eco-Counter EdgeLit Accessories

Master Switch



ITEM NUMBER	L x W x H
ECL-MS-XX-3	4" x 3 1/2" x 7/8"

* XX indicates two-letter finish code (WT, SA or BZ)





Eco-Lightbar LED

24VDC LED Task Lighting
Integrated | Linkable | Hardwire



Long, slim, and energy-efficient describe CSL's new Eco-Lightbar LED series. Not even one-half inch in depth, this Task Light provides a barely-there light source for all undercabinet needs. The slim silhouette houses an LED light source, and can be linked in a run or installed as a single unit.

Eco-Lightbar LED Series

Eco-Lightbar 24VDC LED

ELB-12
24VDC 12"
6W



ELB-24
24VDC 24"
12W



ELB-36
24VDC 36"
18W

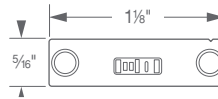

24VDC 120W LED Driver

50,000-hour LED, 90 CRI, ELV dimming

ITEM NUMBER *	L x W x H	WATTS	LUMENS
ELB-12-XX-27	12" x 1 1/8" x 5/16"	6W	500
ELB-12-XX-30	12" x 1 1/8" x 5/16"	6W	500
ELB-24-XX-27	24" x 1 1/8" x 5/16"	12W	1000
ELB-24-XX-30	24" x 1 1/8" x 5/16"	12W	1000
ELB-36-XX-27	36" x 1 1/8" x 5/16"	18W	1500
ELB-36-XX-30	36" x 1 1/8" x 5/16"	18W	1500

* XX indicates two-letter finish code (SA or BZ)

Fixture

- 24VDC, 120W/5 amp max
- Two color temperature options:
 - 2,700°K ±50°K, CRI 90
 - 3,000°K ±50°K, CRI 90
- 50,000 hours, 70% lumen maintenance
- ELV dimmable
- Available in three lengths: 12", 24", 36"
- Very low profile – only 5/16" high
- No UV or infrared energy – objects will not discolor or fade over time
- Linkable up to 120W
- Remote power supply
- UL/C-UL Listed for damp location



Housing/Heat Sink

- Extruded aluminum housing
- Cool operating temperature

Mounting

- Standard mounting clips included. Other mounting options available

Finishes

- SA Satin Aluminum
- BZ Bronze

Eco-Lightbar Accessories

Accessories

DESCRIPTION	ITEM NUMBER
72" Power Feed	ELB-PWR-72
144" Power Feed	ELB-PWR-144
Mounting Clips – 45° Angle	ELB-ANG-MTG
Mounting Clips – Adjustable	ELB-ADJ-MTG
Mounting Clips – Standard (included)	ELB-STN-MTG
3" Connector	ELB-CON-3
6" Connector	ELB-CON-6
12" Connector	ELB-CON-12
24" Connector	ELB-CON-24
36" Connector	ELB-CON-36

Electronic Drivers

DESCRIPTION	ITEM NUMBER
24VDC 20W Electronic Driver	D-133E
24VDC 40W Electronic Driver	D-134E
24VDC 60W Electronic Driver	D-135E
24VDC 100W Electronic Driver	D-136E
24VDC 150W Electronic Driver	D-137E
24VDC 300W Electronic Driver	D-157E

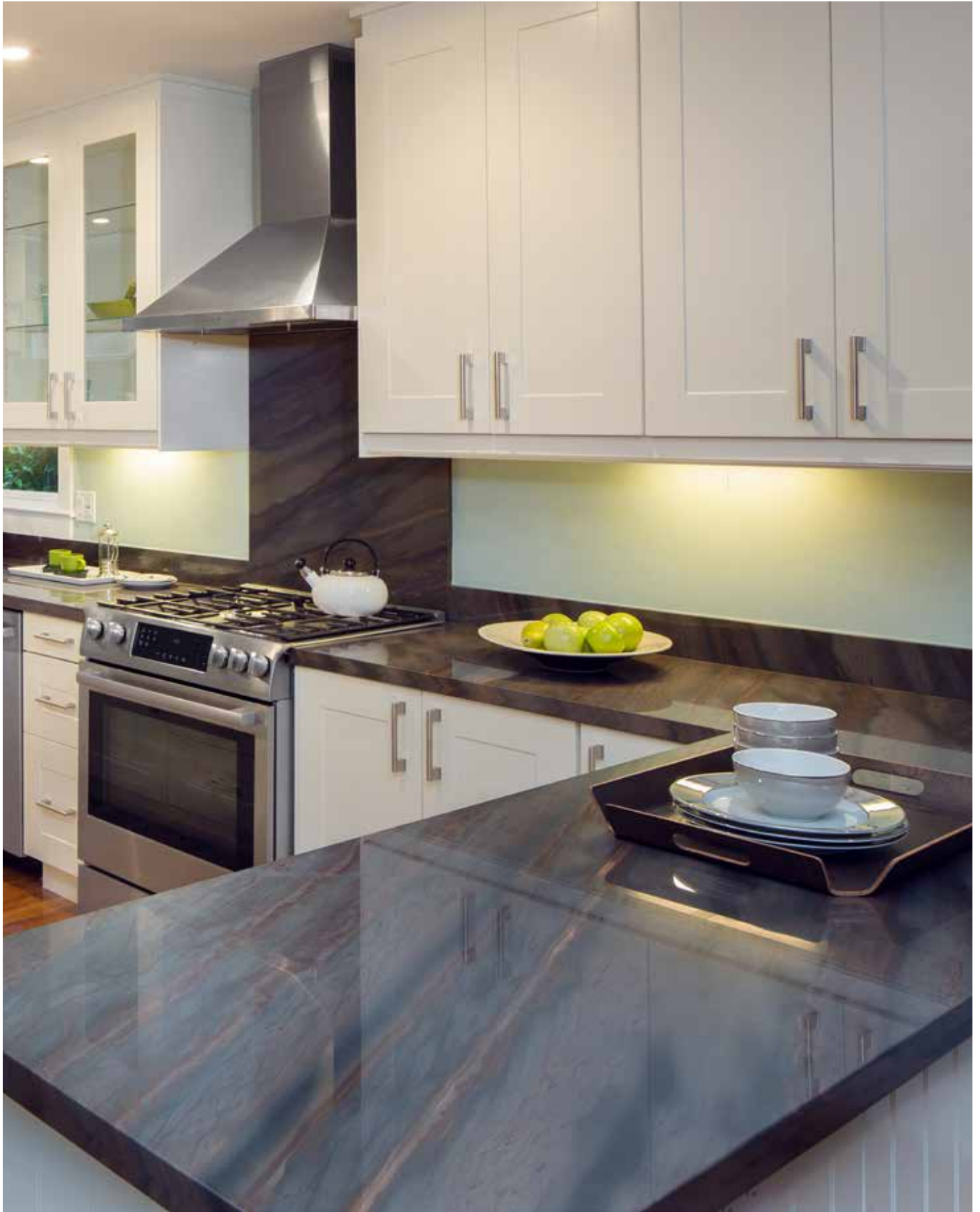



CounterAttack

120V LED & Xenon Task Lighting



CounterAttack LED



CounterAttack Xenon

CounterAttack is CSL's premier undercabinet solution, featuring dimmable functionality and a warm LED or Xenon light. These low profile fixtures can easily be linked together using CSL's trademarked SpeedLink™ system.

CounterAttack LED Series

CounterAttack 120V LED

NCA-LED-8

120V 8"
1 - 4.5W Light Engine

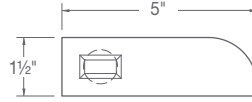

NCA-LED-16

120V 16"
2 - 4.5W Light Engines

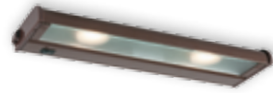

NCA-LED-24

120V 24"
3 - 4.5W Light Engines

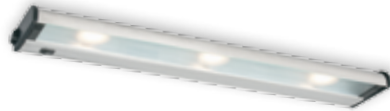

NCA-LED-32

120V 32"
4 - 4.5W Light Engines



120V 4.5W LED Driver

35,000-hour LED, 2,700°K ±100°K, Standard Incandescent dimming

ITEM NUMBER *	L x W x H	LENGTH	LAMPS	LUMENS
NCA-LED-8-XX	8" x 5" x 1½"	8"	1	250
NCA-LED-16-XX	16" x 5" x 1½"	16"	2	500
NCA-LED-24-XX	24" x 5" x 1½"	24"	3	750
NCA-LED-32-XX	32" x 5" x 1½"	32"	4	1000

* XX indicates two-letter finish code (WT, SS or BZ)

CounterAttack Accessories



CS-1XX

Master Switch
3w" x 5" x 1½"
(WT, SS, BZ)



PL96XX

96" Portable Cord
(WT,BK)

Fixture

- 120V portable/hardwire
- Warm LED color temperature:
 - 2,700°K ±100°K, 90 CRI
- 35,000-hour LED
- Dimmable with standard Incandescent dimmer (must meet minimum load of dimmer)
- Available in four lengths: 8", 16", 24", 32"
- 4.5W light engine per lamp
- SpeedLink system links a maximum of 600W
- UL/C-UL Listed for damp location 

Housing/Heat Sink

- Metal construction
- Hinged, removable, UV coated, glass prismatic diffuser for maximum light distribution
- Trade-sized knockouts on back and top for through-wiring, wiremold, flex, Romex® or rigid conduit
- Internal connectors allow instant hardwiring without wire nuts
- On/Off switch

Mounting

- Captive screws and SpeedLink™ technology (Hardwire, Portable, Linkable) make for quick installation. See pg 24 for SpeedLink™ options and descriptions

Finishes

- WT White
- SS Stainless Steel
- BZ Bronze

Connectors/Accessories

- SpeedLink™ system allows fast and easy linking of multiple units
- Custom connectors allow end-to-end mounting with instant electrical connections – no wiring between units
- If not mounted end-to-end, SpeedLink inter-connect cables allow easy and fast linking
- Master Switch module (CS-1) controls a run of CounterAttack SpeedLink with a single switch.



Standard Linking – End-to-End Connections

CounterAttack Xenon Series

CounterAttack 120V Xenon

NCAX-120-8

120V 8" 1-35W Lamps



NCAX-120-16

120V 16" 2-35W Lamps



NCAX-120-24

120V 24" 3-35W Lamps



NCAX-120-32

120V 32" 4-35W Lamps



NCAX-120-40

120V 40" 5-35W Lamps

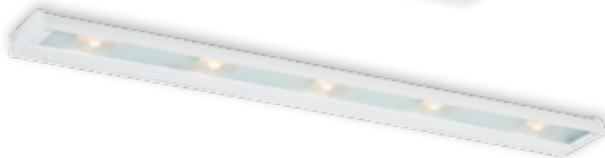

120V 35W Xenon Lamps

2,900°K, 270 lm, Standard Incandescent dimming

ITEM NUMBER *	L X W X H	LENGTH	LAMPS	VERSION
NCAX-120-8XX	8" x 5" x 1½"	8"	1	Non-linking
NCAX120L-8XX	8" x 5" x 1½"	8"	1	SPEED&LINK
NCAX-120-16XX	16" x 5" x 1½"	16"	2	Non-linking
NCAX120L-16XX	16" x 5" x 1½"	16"	2	SPEED&LINK
NCAX-120-24XX	24" x 5" x 1½"	24"	3	Non-linking
NCAX120L-24XX	24" x 5" x 1½"	24"	3	SPEED&LINK
NCAX-120-32XX	32" x 5" x 1½"	32"	4	Non-linking
NCAX120L-32XX	32" x 5" x 1½"	32"	4	SPEED&LINK
NCAX-120-40XX	40" x 5" x 1½"	40"	5	Non-linking

* XX indicates two-letter finish code (WT, SS or BZ)

Replacement Lamp

120V 35W Xenon
Type JCD, G-8 Base, Clear, 2900°K, 270 lm

L-35

Fixture

- 120V hardwire and portable SpeedLink options
- Warm 120V, 35W Xenon, 2,900°K color temperature
- 9,000-hour lamp life
- Dimmable with standard Incandescent dimmer (must meet minimum load of dimmer)
- Available in five lengths: 8", 16", 24", 32", 40"
- SpeedLink system links a maximum of 600W
- Low profile – only 1½" high
- Linking and non-linking versions available
- On/Off switch
- UL/C-UL listed for damp location

Housing/Heat Sink

- Rolled steel, painted post manufacturing with molded plastic end caps
- Non-yellowing U.V.-coated glass prismatic diffuser for maximum light distribution and U.V. protection
- Removable hinged diffuser for easy and safe lamp replacement
- Patented cooling system provides longer lamp life than other models
- Repositioned cooling slots
- Trade-sized knockouts on back and top for through-wiring, Wiremold, flex, Romex, or rigid conduit

Mounting

- Installs easily with two easy-to-access captive screws
- Knockouts on ends (non-linking only), back and top for through-wiring, Wiremold, flex, Romex or rigid conduit

Finishes

- WT White
- SS Stainless Steel
- BZ Bronze



ProPuck

120V Surface or Recessed Task Lighting
Integrated | Linkable
LED | Xenon



ProPuck LED



ProPuck Xenon

The CSL ProPuck fixtures provide the best in puck lighting technology. These small, dimmable lights can provide a light source anywhere it is needed, and they fit well into any residential or commercial application. ProPuck is available in both LED and Xenon options.

ProPuck LED

ProPuck 120V LED System

No transformer or drivers required



Surface Mount



Recess Mount Flange

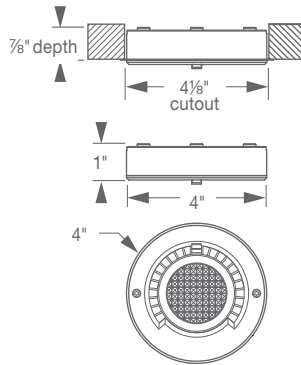

120V 4.5W LED

35,000-hour LED, 2,700°K ±100°K, Standard Incandescent dimming

WT - WHITE	SA - SATIN ALUMINUM	BZ - BRONZE	BK - BLACK
PPL-WT	PPL-SA	PPL-BZ	PPL-BK

ProPuck Accessories

Accessory Lenses



0-19
Prismatic Spread Lens



0-16
Mini Prismatic Lens



0-18
Linear Spread Lens

Accessories



PP-CON

Flex conduit connector. Fits up to 1/2" flex conduit. Side knockout only.



INVWC3

Low-profile wiring compartment 4"l x 2 1/8"w x 1"h



PP-PLG-BK
Black cord w/ plug, 6'

PP-PLG-WT
White cord w/ plug, 6'



PP-CRD-BK
Black linking cord, 10'

PP-CRD-100-BK
Black linking cord, 100'

PP-CRD-WT
White linking cord, 10'

PP-CRD-100-WT
White linking cord, 100'

Fixture

- Surface or recessed mount (not for recessed installation in ceilings or walls)
- High-power 4.5W LED
 - 2700°K ±100°K, 90 CRI, 250 lm, 4.5W total consumption
- 35,000-hour lamp life @ 70% lumen maintenance
- No transformer or drivers required
- Dimmable with standard Incandescent dimmer (must meet minimum load of dimmer)
- Link a maximum of 450W
- Solite lens included; additional accessory lenses available
- UL and C-UL approved

Housing

- Diecast aluminum construction for durability and excellent heat dissipation
- Hardwire knockouts on sides and back. Additional MC connectors available.
- Internal terminal block included, no wire nuts or connectors needed
- Integral mounting standoffs create an airgap between fixture and mounting surface, minimizing heat transfer in surface mount applications
- See www.csllighting.com for current photometric data

Finishes

- WT White
- SA Satin Aluminum
- BZ Bronze
- BK Black

ProPuck Xenon

ProPuck 120V Xenon System

No transformer required



Surface Mount



Easy access for relamping

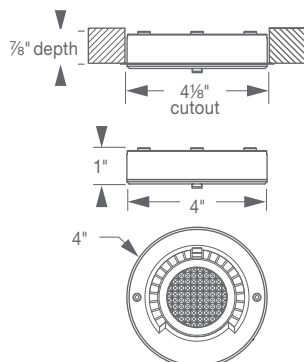

120V 20W Xenon

7,000-hour Xenon G8, Standard Incandescent dimming

WT - WHITE	SA - SATIN ALUMINUM	BZ - BRONZE	BK - BLACK
PP-WT-1	PP-SA-1	PP-BZ-1	PP-BK-1

ProPuck Accessories

Accessory Lenses



0-19
Prismatic
Spread Lens



0-16
Mini Prismatic
Lens



0-18
Linear Spread
Lens

Accessories



PP-CON

Flex conduit connector. Fits up to 1/2" flex conduit. Side knockout only.



INVWC3

Low-profile wiring compartment
4"l x 2 1/8"w x 1"h



PP-PLG-BK

Black cord w/ plug, 6'



PP-PLG-WT

White cord w/ plug, 6'



PP-CRD-BK

Black linking cord, 10'

PP-CRD-100-BK

Black linking cord, 100'

PP-CRD-WT

White linking cord, 10'

PP-CRD-100-WT

White linking cord, 100'

Fixture

- Surface or recessed mount (not for recessed installation in ceilings or walls)
- No transformer required
- 120V 20W Xenon lamp
- 2900K
- 7,000-hour rated lamp life
- Link a maximum of 450W
- Dimmable with standard Incandescent dimmer (must meet minimum load of dimmer)
- Complete with lamp, flange and clips for recessing, screws for surface mount, and mini strain reliefs
- Metal honeycomb lens included, additional accessory lenses available
- UL listed for portable & hardwire applications and as a wiring compartment; C-UL when used with C-UL strain relief



Housing

- Diecast aluminum construction for durability and excellent heat dissipation
- Integral mounting standoffs create an airgap between fixture and mounting surface minimizing heat transfer in surface-mount applications.
- Internal terminal block included, no wire nuts or connectors needed
- Hardwire knockouts on sides and back, additional MC connectors available
- See www.csllighting.com for current photometric data

Finishes

- **WT** White
- **SA** Satin Aluminum
- **BZ** Bronze
- **BK** Black



Eco-Invizilite LED

24VDC LED Linear Lighting

Flexible | Concealed | Dimmable

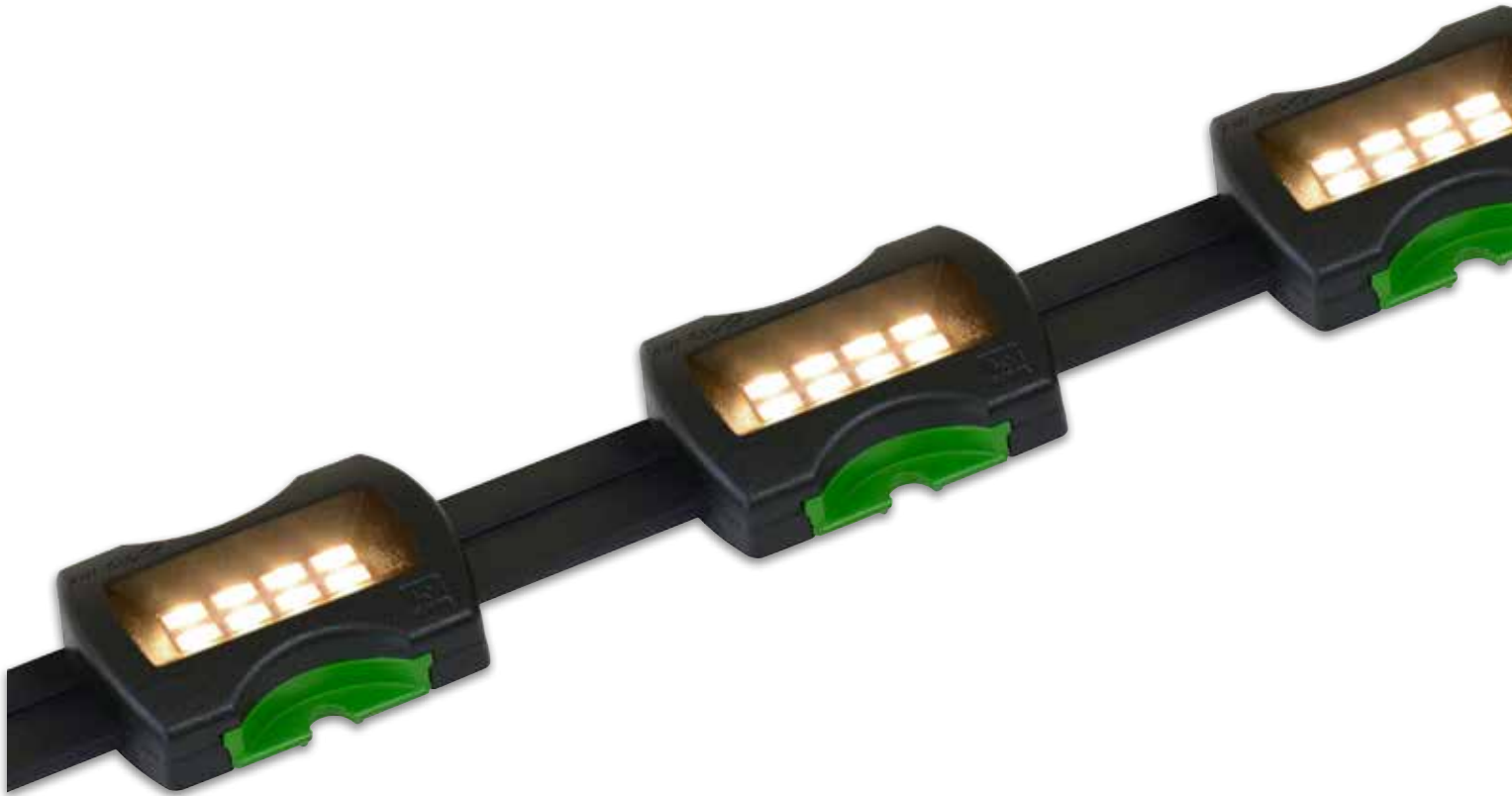

CSL's Eco-Invizilite LED offers linear lighting at its best. Designed to illuminate invisibly, its small sockets are placed at 3" or 4" intervals and can be cut to any customized length. Eco-Invizilite is dimmable and mounts easily to any surface.

Eco-Invizilite LED

Eco-Invizilite 24VDC LED Series

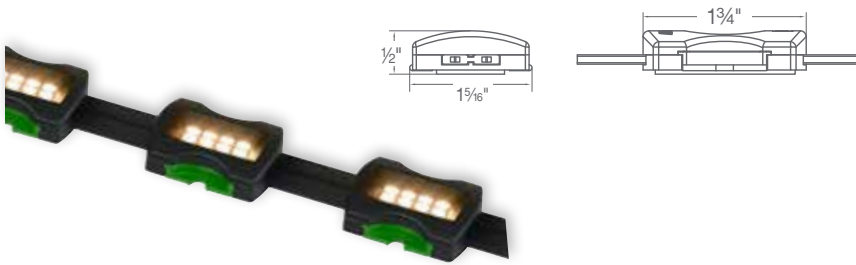

Factory-Cut Per-Foot Lengths

24VDC, 2.5W per socket

INVLED-3-27-2	2700°K ±50°K, 170 LM per socket, 90 CRI	3" O.C.
INVLED-3-40-2	4000°K ±50°K, 170 LM per socket, 80 CRI	3" O.C.
INVLED-4-27-2	2700°K ±50°K, 170 LM per socket, 90 CRI	4" O.C.
INVLED-4-40-2	4000°K ±50°K, 170 LM per socket, 80 CRI	4" O.C.

Kits – 100-foot-lengths

24VDC, 2.5W per socket

4 power feeds, 4 dead ends, mounting screws included

INVLED-3-27-100-2	2700°K ±50°K, 170 LM per socket, 90 CRI	3" O.C.
INVLED-3-40-100-2	4000°K ±50°K, 170 LM per socket, 80 CRI	3" O.C.
INVLED-4-27-100-2	2700°K ±50°K, 170 LM per socket, 90 CRI	4" O.C.
INVLED-4-40-100-2	4000°K ±50°K, 170 LM per socket, 80 CRI	4" O.C.



Mounting Track

INVLED-EXT 48" Extruded Mounting Track, Clear Polycarbonate,

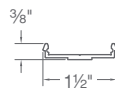

45° Mounting Track

INVLED-EXT45 48" – 45° Mounting Track, Clear Polycarbonate

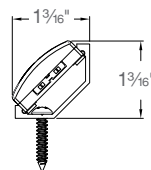

Reflector

INVLED-KICK-BK	48" Kick Reflector	Black
INVLED-KICK-BZ	Powder-coated, Formed-	Bronze
INVLED-KICK-WT	Aluminum	White

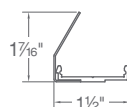

Fixture

- High-power 2.5W LED per socket
 - 2,700°K ±50°K, CRI 90, 170 lm per socket
 - 4,000°K ±50°K, CRI 80, 170 lm per socket
- 24VDC, remote transformer
- 600W / 25amp max.
- 2.5W per socket
- 4 power feeds, 4 dead ends and mounting screws included
- ELV dimmable
- Available with sockets installed at 3" or 4" O.C.
- LED sockets easily removed or relocated
- UL/C-UL listed for damp location

Cable

- Two-conductor black cable (proprietary patent pending)
- LED sockets pre-installed at 3" or 4" O.C.
- Flexible cable conforms easily to fit tight radii and sharp turns; lights confined coves and restrictive spaces
- Includes double sided tape and mounting ear
- Must install with: INVPW1 (or covered wire nuts) and INVDE1

Electronic Drivers

DESCRIPTION	ITEM NUMBER
24VDC 20W Electronic Driver	D-133E
24VDC 40W Electronic Driver	D-134E
24VDC 60W Electronic Driver	D-135E
24VDC 100W Electronic Driver	D-136E
24VDC 150W Electronic Driver	D-137E
24VDC 300W Electronic Driver	D-157E



Lens

INVLED-LENS 48" Extruded Lens, Frosted Acrylic

Eco-Invizilite LED Accessories

Terminal Block with Cover

14" L x 7/8" W x 13/16" H

- 30A terminal block with hinged lid
- 10 AWG max.
- Clear, high-grade polycarbonate
- Snaps into INV4STE, INV4WWE, INV4CE

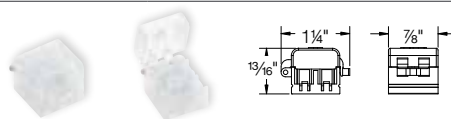

INVPW1	Terminal Block with Cover
INVPW1-10	Terminal Block with Cover, 10-pack

End-Feed Wiring Compartment

4" l x 28" w x 1 3/4" h

- Joins connection from transformer to Eco-Invizilite cable within box at start of run
- 16-gauge galvanized steel
- Meets UL2108 UL Codes

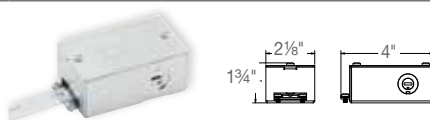

INVWC1	End-Feed Wiring Compartment
---------------	-----------------------------

Metal Three-Way Wiring Compartment

5 7/8" l x 2 1/2" w x 1 3/4" h

- Multi-use wiring compartment for start of run, or for "L" or "T" connection within run
- 16-gauge galvanized steel
- Meets UL2108 UL Codes

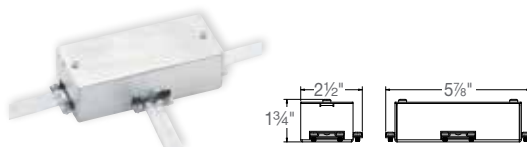

INVWC2	Metal Three-Way Wiring Compartment
---------------	------------------------------------

Low-Profile Wiring Compartment

4" l x 2 1/8" w x 1" h

- Joins connection from transformer to Eco-Invizilite cable within box at start of run
- 16-gauge galvanized steel
- Low-profile, 1" high
- Meets UL2108 UL Codes

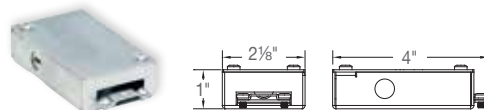

INVWC3	Low-Profile Wiring Compartment
---------------	--------------------------------

Dead End Cap

1 7/16" l x 7/8" w x 1/4" h

- Dead end termination
- Snaps over end of cable without tools
- Double-sided tape and mounting ear with screw included for installation
- Clear, high-grade polycarbonate
- Snaps into INV4STE, INV4WWE, INV4CE



INVDE1	Dead End Cap
INVDE1-10	Dead End Cap, 10-pack

Cable Clip

1 3/16" l x 1 1/8" w x 1/4" h

- Secures cable to surface between sockets set far apart
- Installs with pre-attached, double-sided tape, or screws down through pre-drilled screw hole
- Clear, high-grade polycarbonate



INVCL-10	Cable Clip, 10-pack
INVCL-100	Cable Clip, 100-pack



Eco-Cove LED

120V LED Cove Lighting
Integrated | Linkable | Wet Location



Eco-Cove LED Series

Eco-Cove 120V LED

ECV-10

120V 6W
10½" L x 1½" W x 1¾" H

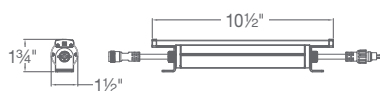

ECV-20

120V 12W
21" L x 1½" W x 1¾" H



Adjustable
120° Total
Rotation

Power

- Integrated 120V linkable system – no external remote transformers or drivers
- Two sizes: 10.5" length, 21" length
- Linkable up to 100'
- UL/C-UL Listed for wet location (IP67)



LEDs

- 2,700°K ±50, CRI 90
4,000°K ±50, CRI 80
- Long life, low maintenance:
50,000-hour lamp life @ 70% Lumen maintenance (L70)
- Two sizes:
 - 10.5" length – 6W, 400 lm
 - 21" length– 12W, 800 lm
- Standard dimming; compatible with INC (incandescent/triac) and ELV dimmers

Housing/Heat Sink

- Adjustable – 120° total rotation
- Brushed aluminum extruded heat sink
- Polycarbonate lens
- PVC driver housing
- Stainless steel mounting brackets

120V Linkable System

50,000-hour LED, ELV dimmable

ITEM NUMBER	LEDs	WATTAGE
ECV-10-27-2	2700°K ±50°K, 400 lm, 90 CRI	6W
ECV-10-40-2	4000°K ±50°K, 400 lm, 80 CRI	6W
ECV-20-27-2	2700°K ±50°K, 800 lm, 90 CRI	12W
ECV-20-40-2	4000°K ±50°K, 800 lm, 80 CRI	12W

Eco-Cove Accessories

Connectors and Power Feed

DESCRIPTION	ITEM NUMBER
1-Foot Connector	ECV-CON-1
5-Foot Connector	ECV-CON-5
10-Foot Connector	ECV-CON-10
20-Foot Power Feed	ECV-PWR-20

SpeedLink™

Linking Interconnect System

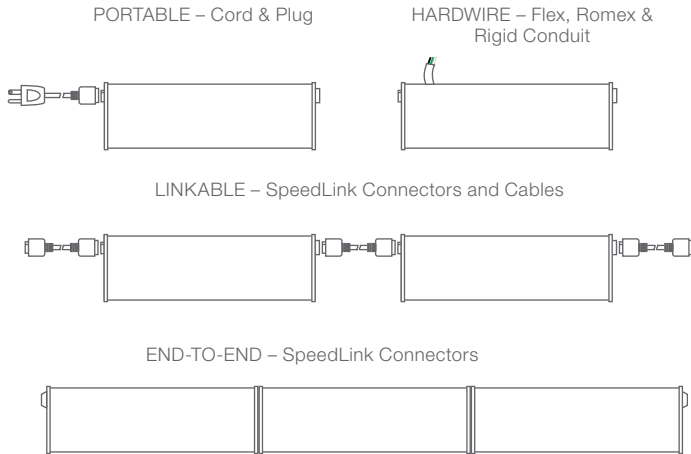

The SpeedLink System

- SpeedLink – fast and easy linking of multiple units
- Custom connectors that for end-to-end mounting with instant electrical connections – no wiring is required between units
- SpeedLink inter-connect cables allow easy and fast linking for non- end-to-end installation
- Two power feed options: hardwiring at any point along the run or cord and plug
- One power feed is required per run, up to the maximum number of lamps (20 lamps for 120 V).



End-to-end connection requires no wiring.



Cord connection for linking and portable cord

Accessories



QL-10WT	QL-10BK	PL96WT	PL96BK
Interlink Cable, 10", White	Interlink Cable, 10", Black	Portable cord and plug, 96", White	Portable cord and plug, 96", Black
QL-18WT	QL-18BK		
Interlink Cable, 18", White	Interlink Cable, 18", Black		



Index

0-16	16, 17	ELB-12	8	IINVLED-KICK	20	NCA-120-40	13
0-18	16, 17	ELB-24	8	INVLED-LENS	20	PL96	12, 24
0-19	16, 17	ELB-36	8	INVPW1	21	PP	17
CS-1	12	ELB-ADJ-MTG	8	INVPW1-10	21	PP-CON	16, 17
D-133E	8, 20	ELB-ANG-MTG	8	INVWC1	21	PP-CRD	16, 17
D-134E	8, 20	ELB-CON-3	8	INVWC2	21	PP-CRD-100	16, 17
D-135E	8, 20	ELB-CON-6	8	INVWC3	16, 17, 21	PP-PLG	16, 17
D-136E	8, 20	ELB-CON-12	8	L-35	13	PPL	16
D-137E	8, 20	ELB-CON-24	8	NCA-LED-8	12	QL-10	24
D-157E	8, 20	ELB-CON-36	8	NCA-LED-16	12	QL-18	24
ECL-8	4	ELB-PWR-72	8	NCA-LED-24	12		
ECL-16	4	ELB-PWR-144	8	NCA-LED-32	12		
ECL-24	4	ELB-STN-MTG	8	NCA-120-8	13		
ECL-32	4	INVCL	21	NCA-120-16	13		
ECL-MS	4	INVDE1	21	NCA-120-24	13		
ECV	23	INVLED	20	NCA-120-32	13		
ECV-CON	23	NVLED-EXT	20	NCA-120-40	13		
ECV-PWR	23	INVLED-EXT45	20	PL96	12, 24		

CSL Task / Linear Lighting Fixtures

UL and C-UL approved for damp locations; see individual fixture details





A Division of Troy-CSL Lighting, Inc.

14508 Nelson Avenue
City of Industry CA 91744
Tel: 626.336.4511
Fax: 626.330.4266

www.csllighting.com

