

Meter Mounting Equipment

Western Region Area



MILBANK[®]





Charles A. Milbank
1879-1966

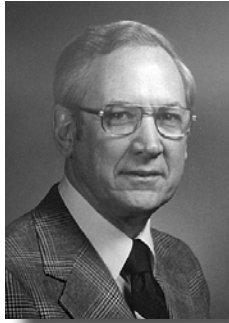

Bill Martin
1916-1998



Robert F. Waldrop
1922-2002



Robert F. Waldrop, II
Chairman



Katrina Waldrop Henke
Vice Chairman

Milbank–Quality Metering Products for 80 Years

Milbank Manufacturing Company was established in 1927 by Charles A. Milbank. Originally, the company manufactured high voltage switches; however, by 1941 Milbank devoted itself primarily to the manufacture of sheet metal enclosures and related equipment for the electrical generation and distribution industry. Today we are an industry leader in the manufacture of electrical meter sockets. Through a national network of manufacturer's representatives we provide wholesale electrical distributors with quality electrical products for the utility, contractor, industrial and OEM markets.

As the meter standards have changed, Milbank has been successful in adapting its product line to these changes. Our full scale engineering department designs products to meet customer specifications and satisfy all utility requirements. Milbank's employee base of over 1,000 workers, along with our

five manufacturing facilities comprising almost 550,000 square feet give us the flexibility to schedule, produce, and ship orders quickly. Currently, Milbank manufactures over 10,000 different catalog items, and this list continues to grow. Our unique product offering includes: Residential & Commercial Meter Sockets; Residential & Commercial Meter Pedestals; RV/MH Power Outlets, Service Pedestals, and Transformers; Commercial & Industrial Electrical Enclosures; Circuit Breakers; Disconnects & Safety Switches; Safety Sockets; Utility & Residential Secondary Pedestals; Hubs, and related accessories. If you don't find a unit in this catalog to service your needs, send us your specifications and we will be happy to work with you.

Our success has come from a loyal customer base that can rely on us to build quality products at a fair price in a timely manner. Our willingness and ability to design and produce new products

to meet our customer demands is an important factor to remain competitive in today's electrical market.

Milbank has been serving the electric utility & wholesale distribution industries for 80 years with innovative, quality engineered products. So remember us for all of your meter mounting and related requirements, and we will be happy to serve you as we have in the past – with dependable service and quality products!

We take great pride in being one of the few family-owned businesses left in our industry. We are a third generation run business and truly believe that...

**FAMILY MAKES A
DIFFERENCE!**



AC DISCONNECTS **SECTION A**

30 & 60 Amp – Fusible/Non-Fusible Air Conditioner Disconnect1
 Combination AC Disconnect / 20 Amp GFCI Receptacle.....2
 Hot Tub Disconnect or Sub Panel Breaker Enclosure – Type 3R2

METER SOCKETS **SECTION B**

SINGLE POSITION (NO BYPASS)

30-100 Amp – Economy Cast Socket – Ring Type, 4T1
 125-200 Amp, Ringless, 4T, 5T & 7T2-3
 125-200 Amp, Ring Type, 4T & 7T2,4
 125-200 Amp, Ring Type with Manual Circuit Closing Blocks, 4T & 7T9
 200 Amp, Ring Type, Flush Mount, 4T5
 320 Amp, Ringless (Non-Lever Bypass), 4T10

SINGLE POSITION (WITH BYPASS)

125-200 Amp, Ringless (Non-Jaw Clamping Lever Bypass), 4T, 5T & 7T6-7
 200 Amp, Ringless (Jaw Clamping Lever Bypass), 4T, 5T & 7T8
 320 Amp, Ringless (Lever Bypass), 4T10
 320 Amp, Ring Type (Link Bypass), 4T11
 320 Amp, Ringless (Lever Bypass), Side Wireway, 7T11

MULTIPLE POSITION

100-125 Amp, Ringless/Ring Type Horizontal Gang Sockets, 4T12
 200 Amp, Ringless/Ring Type Horizontal Gang Sockets, 4T13
 125-200 Amp, Condominium Metering Banks, Ringless15-16

METER MAINS AND SERVICE ENTRANCE EQUIPMENT **SECTION C**

100/150/200 Amp, Ringless/Ring Type Meter Main, 4T & 5T – 22K AIC2
 200 Amp, Ring Type, 4T & 7T1
 200 Amp, Unmetered, Service Entrance Main Breaker, 4T3
 400 Amp, 320 Amp Continuous, Ringless Meter Main with Split Load, 4T4
 400 Amp, 320 Amp Continuous, Ring Type Meter Main with Split Load, 4T5
 400 Amp, 320 Amp Continuous, Ring Type Plug-In Socket – Meter Main with Split Load, 4T6
 400 Amp, 320 Amp Continuous, Ring Type Meter Main Combination, 4T7-8

COMMERCIAL METERING – SAFETY SOCKETS, METER MAINS, TERMINATION BOXES, BUSSED GUTTERS **SECTION D**

SAFETY SOCKETS

100/200 Amp – TB Series – 600 Volt Self-Contained / Socket Only, 4T, 5T & 7T1
 100 Amp, MTB Series – 10K AIC – 240 Volt Self-Contained Meter Main / CB, 4T, 5T & 7T2
 100 Amp, MTB Series – 22K AIC – 240 Volt Self-Contained Meter Main / CB, 4T & 7T3
 100 Amp, MTB Series – 14K AIC – 480 Volt Self-Contained Meter Main / CB, 4T, 5T & 7T4
 100 Amp, MTB-P & MTB-P48 Series – 200K AIC – 240 & 480 Volt Self-Contained Meter Main /
 T-Fuse Pullout, 4T, 5T & 7T5
 200 Amp, MTB Series – 10K AIC – 240 Volt Self-Contained Meter Main / CB, 4T, 5T & 7T6
 200 Amp, MTB Series – 22K AIC – 240 Volt Self-Contained Meter Main / CB, 4T & 7T7
 200 Amp, MTB Series – 35K AIC – 480 Volt Self-Contained Meter Main / CB, 4T & 7T8
 200 Amp, Test Block Bypass – MTB-P & MTB-P48 Series – 200K AIC – 240/480 Volt Self-Contained Meter Main /
 T-Fuse Pullout, 4T, 5T & 7T9
 100 & 200 Amp, MTBL All-In-One Series, 10K & 200K AIC – 240 Volt Meter Main – Circuit Breaker /
 T-Fuse Pullout10
 Safety Socket Replacement Circuit Breakers & Pullouts14-15
 Safety Socket & T-Fuse Replacement Parts16

UNDERGROUND TERMINATION BOXES & BUSSED GUTTERS

Underground Termination Boxes – 600 VAC11
 Bussed Gutters – Type 3R - 3Ø4W – 600 VAC12
 Bussed Gutters – Type 3R - 3Ø4W – 600 VAC13

COMMERCIAL METER PEDESTALS **SECTION E**

Commercial Meter Pedestals Overview1
 Applications & Accessories2
 Catalog Number Logic3
 ML Series – Main Load Center4
 SL Series – Switched Load Center5
 400 Amp Series6
 IR Series – Irrigation Control7
 BBS/UPS Series8

Power Transfer Series – Metered & Unmetered	9
General Specifications	10
Commercial Meter Pedestal Drawings – 16” Metered & Unmetered	11
Commercial Meter Pedestal Drawings – 24” Metered & Unmetered	12
Commercial Meter Pedestal Drawings – 32” Metered	13
Commercial Meter Pedestal Drawings – Metered	14

CT CABINETS, TEST SWITCHES, POLYPHASE ENCLOSURES SECTION F

Current Transformer Cabinets – Type 3R – Door Mount CT Rated Socket	1
Current Transformer Cabinets	2
Current Transformer Cabinets – Mounting Racks	3
Metered Transformer Cabinets – Overhead & Underground	4
20 Amp – 4, 5, 6, 7, 8 & 13 Terminal Current Transformer Rated – Ringless/Ring Type	5
20 Amp – 600 VAC – 5, 6, 8, 13 & 15 Terminal Current Transformer – Test Switch Provision	6
Milbank Test Switches – 4, 7 & 10 Pole	7
Test Switches – 4, 7 & 10 Pole – 600 VAC – Per ANSI C12.9 Standard	8
Milbank Test Switch Worksheet	9

SERVICE PEDESTALS SECTION G

125 Amp – Mobile Home Metered Pedestal – Hardwired – 120/240VAC	1
200 Amp – Mobile Home Metered Pedestal – Hardwired – 120/240VAC	2
100/200 Amp – Load Center Power Pedestals – All Purpose & RV Applications	3
200 Amp Series U5240 & U5241 Ring Type Metered Pedestals	4-5
200 Amp Series U5136 & 5137 Ringless Metered Pedestals	6-7
U5706 & U5707 Temp to Final Service Pedestal – Ringless/Ring Type	8-9
Mobile Home Rebuild Kits	10-11

RV SECTION H

Series U5000 – Unmetered – Surface Mount Power Outlet	1-2
Series U5100 – Metered – Surface Mount Power Outlet	3-4
Series U5200 – Unmetered – Pedestal Power Outlet	5-6
Series U5300 – Metered – Pedestal Power Outlet	7-8
Millennium Features	9-10
600/1200 Amp – Pad Mounted Panel Board	11
100, 200 & 400 Amp – Terminal Box	12
Lighting Accessories	13
Telecommunications and Pedestal Accessories	14
Pedestal Mounting Accessories	15
Metering & Single Receptacle Accessories	16
RV Replacement Parts & Accessories	17-18
RV Product Information – Wiring Diagram Label – Warranty	19

TEMPORARY POWER SECTION I

U4908/U4909 Underground Service Power Outlet – Ringless/Ring Type	1-2
Series U5000 – Unmetered – Surface Mount Power Outlet	3-4
Series U5001 – Unmetered – Surface Mount Power Outlet	5
Series U5100 & U5101 Overhead – Ringless/Ring Type – Metered – Surface Mount Power Outlet	6-7
Replacement Parts for MPAP/MPRV/HP Pedestals	8

TRANSFORMERS SECTION J

Galvanized Steel Distribution Transformer – 1Ø	1
--	---

MISCELLANEOUS SECTION K

Accessories	1,2
UQFP Plug-In Series Circuit Breakers	3
UQFB Bolt-On Series Circuit Breakers	4
Conduit, Ampacity, SCCR Information	5
Energization of Electrical Equipment	6
Materials and Finishes	7
Meter Forms	8
Watt-hour Meter Forms – Standard Forms, Transformer Rated or Self-Contained	9
Standard NEMA Configurations	10
Additional Milbank Products	11

ALPHA-NUMERIC INDEX SECTION L

Alpha-Numeric Index	1-2
---------------------------	-----

Catalog Number Logic

U = UL Listed
S = Non-UL Listed
UAP = UL / Alum / Painted

TG = Triplex Ground
QG = Quadplex Ground

KK = Horn By-Pass Provision

Specific Utility Designation

Milbank Drawing Number

Barrel Lock

U7040-RL-TG-KK-5T9-BL-AUT

HUB OPENINGS / CLOSING PLATES

O	Plain Top	WL	1"	For -RL Opening
RL	Small Hub Opening	YL	1¼"	For -RL Opening
R	Large Hub Opening	ZL	1½"	For -RL Opening
XL	Small Closing Plate	DL	2"	For -RL Opening
X	Large Closing Plate	EL	2½"	For -RL Opening
RXL	Large Hub Opening adapted to small Closing Plate.	F	3"	For -R Opening
		G	3½"	For -R Opening
RRL	Large Hub Opening adapted to small Hub Opening	H	4"	For -R Opening

Fifth Terminal Designation

- 5T6 installed at 6:00
- 5T9 installed at 9:00

Barrel Lock / Guard Provision

U2448-X-QG-5T9-K3-BLG-ARE

Milbank Drawing Number

TG = Triplex Ground
QG = Quadplex Ground

Specific Utility Designation

Lugs [1Ø or 3Ø – 350 or 600 kcmil]

- Single [K1, K3, K5, K7]
- Twin [K2, K4, K6, K8]

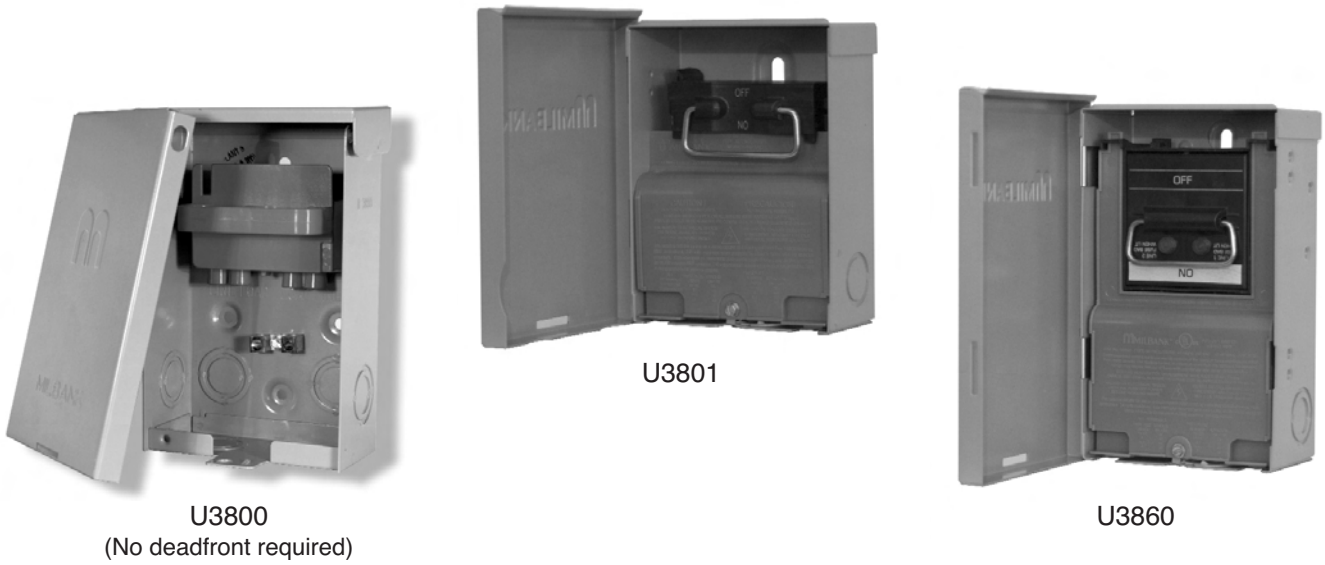
PROFILE

Milbank's air conditioner disconnect has a removable hinged cover which makes wiring a breeze. Our compact design meets all wire bending space requirements in the NEC and, also, complies with article 440-14 in the NEC. To insure the safest conditions, we designed our disconnect pullers to be removable or they may be reinstalled in the off position. Another safety feature is the padlock provision on the front cover. As with all Milbank products, our enclosure is constructed of G90U galvanized steel and finished with an attractive, light gray, baked powder coating. Our state of the art finish combines epoxy and polyester hybrid resins into a hybrid powder coating which is then electrostatically applied. This offers a durable, nonfading finish.

TECHNICAL INFORMATION

AMP	TYPE	CATALOG NUMBER	MAX H.P.	WT. @ #	LINE & LOAD WIRE RANGE		GROUND WIRE RANGE	DIMENSIONS			WIRE RATING	
					CU	AL	CU/AL	D"	W"	H"	CU °C	AL °C
30	FUSIBLE	U3830	3	2.7	#14-#3 AWG	#14-#3 AWG	#14-3 AWG	2-5/8	5	7	60°/75°	60°/75°
60	FUSIBLE	U3860	10	3.3	#14-#3 AWG	#14-#3 AWG	#14-3 AWG	3	5	9¼	60°/75°	60°/75°
60	NONFUSIBLE	U3800	10	3.25	#14-#2 AWG	#12-#2 AWG	#14-3 AWG	3	5	8	60°/75°	60°/75°
60	NONFUSIBLE	U3801	10	2.5	#14-#3 AWG	#14-#3 AWG	#14-3 AWG	2-3/8	5	6-3/4	60°/75°	60°/75°

- ✓ U/L listed as Enclosed Pullout Switch
- ✓ 1Ø, 240 VAC
- ✓ Type 3R Rainproof
- ✓ Six one-inch concentric knockouts

Utility requirements for this equipment may vary. Always consult the serving utility for their requirements before ordering or installing equipment in this catalog.

Combination AC Disconnect / 20 Amp GFCI Receptacle—Together in 1 Box

SECTION A

AC DISCONNECTS

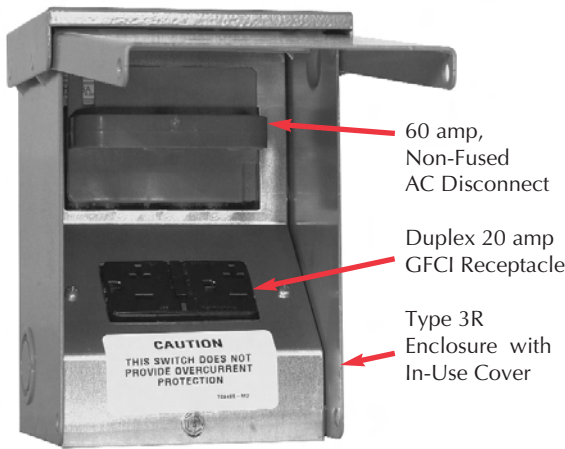

U3822-20GR

- Meets NEC # 210.63 Requirements *
- UL Listed as Power Outlet
- Type 3R Enclosure
- In-Use Cover**
- Duplex Ground Connector
- 1" Concentric Knockouts

AC DISCONNECT

- 1Ø, 240 Volt
- 60 amp, Non-Fused

GFCI RECEPTACLE

- 20 amp
- Reset/Test Button
- Padlock provision

* NEC® #210.63 Heating, Air-Conditioning and Refrigeration Equipment Outlet.

...The receptacle shall be located on the same level and within 7.5 m (25 ft.) of the heating, air-conditioning and refrigeration equipment.

* NEC® #210.08 Ground-Fault Circuit- Interruptor protection for personnel.

AMP	TYPE	CATALOG NUMBER	MAX H.P.	WT. #	LINE & LOAD CONNECTOR WIRE RANGE		GROUND CONNECTOR WIRE RANGE	DIMENSIONS			WIRE RATING	
					CU	AL	CU/AL	D"	W"	H"	CU °C	AL °C
60	NONFUSIBLE	U3822-20GR	10	6	#14-#2	#12-#2	#14-4	4.8	5.25	7.4	60°/75°	60°/75°

To ensure the safest conditions, Milbank disconnect pullers are designed to be reversible so they may be reinstalled in the OFF position. All units are designed with a padlock provision on the cover for security.

****Note:** U3822-20GR cover rated as *IN-USE COVER* (Cover may be closed with cords plugged into receptacle).

*Reprinted with permission from NFPA 70-2002, *National Electrical Code*®, Copyright 2001, National Fire Protection Association, Quincy, MA 02269. This reprinted material is not the complete and official position of the NFPA on the referenced subject, which is represented only by the standard in its entirety. National Electrical Code® and NEC® are registered trademarks of the National Fire Protection Association, Quincy, MA.

Hot Tub Disconnect or Sub Panel Breaker Enclosure—Type 3R

Spa Box with GFCI Protection



U4881-O-50GB

- 240 volt ground fault protection
- UL listed, Type 3R rainproof
- Milbank reliability
- Easy installation
- 2 pole, 50 amp GFCI breaker protection
- Compact size:
8-1/2" H x 7-1/2" W x 3-3/4" D
- 3 or 4 wire installation
- 1Ø, 120 / 240 VAC
- Standard package of 12
- 2 extra one-pole breaker spaces
- 100 amp overall rating

Sub Panel Breaker Enclosure

- Use as a 100 amp, 4 circuit sub panel enclosure



AMP	TYPE	CATALOG NUMBER	WT. #	LINE & LOAD CONNECTOR WIRE RANGE		GROUND CONNECTOR WIRE RANGE	DIMENSIONS		
				CU	AL	CU/AL	D"	W"	H"
50	BREAKER	U4881-O-50GB	8	#14-1/0	#14-1/0	#14-1/0	3 3/4	7 1/2	8 1/2
60	BREAKER	U4881-O-60GB	8	#14-1/0	#14-1/0	#14-1/0	3 3/4	7 1/2	8 1/2



ECONOMY SOCKET

100 amp max rated is ideal for use on:

- Temporary Service
- Outdoor Advertising
- Small Customer Service
- Other Low Amperage Requirements

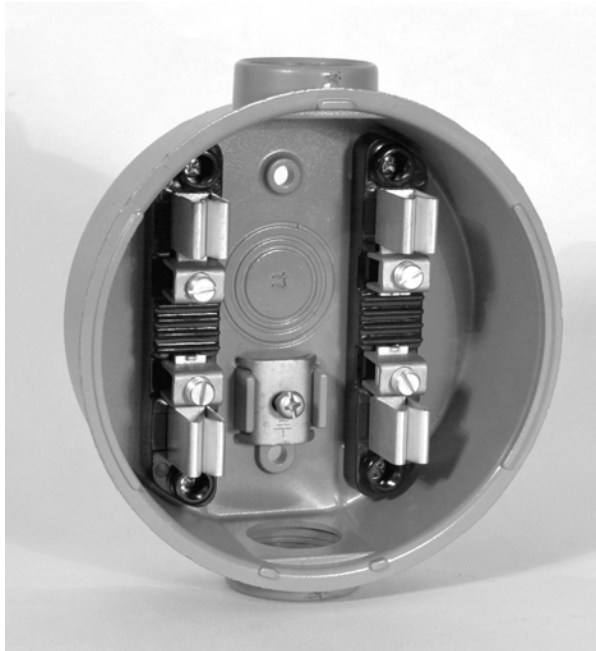

**FOR USE WITH SINGLE PHASE
SELF-CONTAINED 4 TERMINAL METERS**

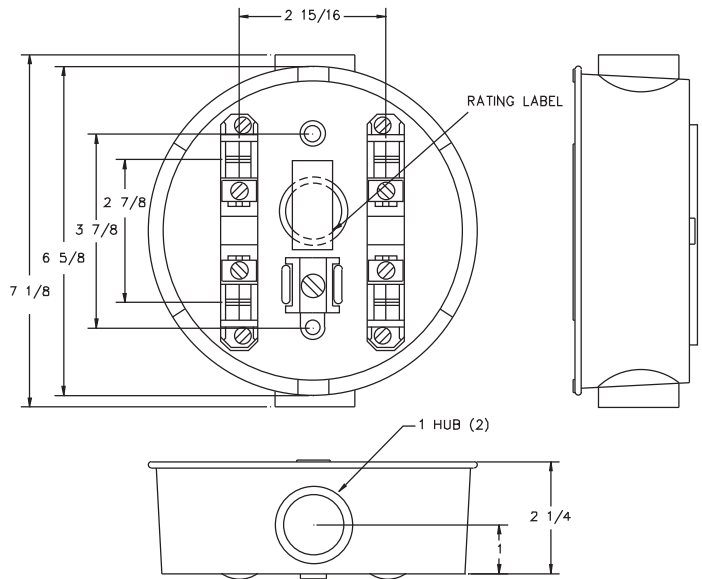

SECTION B

METER SOCKETS

Our enclosure is made of die cast aluminum. The electrostatically applied epoxy and polyester resins, which are baked on, form a durable, light gray exterior. The current carrying parts are of copper alloy. The ground connector is designed to insure a positive electrical connection by effectively clamping the conductor against a serrated surface.

30-100 AMP—4 TERMINAL—ECONOMY CAST SOCKET—RING TYPE

SERVICE	CATALOG NUMBER	HUB SIZE	CONNECTOR CU/AL	QUANTITY PER PACKAGE	CONCENTRIC KNOCKOUTS
OH/UG	AP2300-03	1"	#12-#1	12	3/4", 1"
OH/UG	AP2300-04	1 1/4"	#12-#1	12	3/4", 1"

FIFTH & SIXTH TERMINAL: Contact factory.

SEALING RING: Supplied with a snap action sealing ring.

HUB: Units supplied with cast in hub on top and bottom. Consult factory for availability of other hub sizes.

BYPASS: Also available with auto bypass. Contact factory.

Utility requirements for this equipment may vary. Always consult the serving utility for their requirements before ordering or installing equipment in this catalog.



U7487-RL

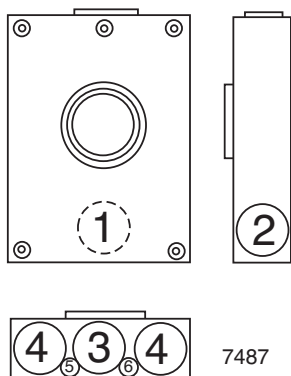

7487

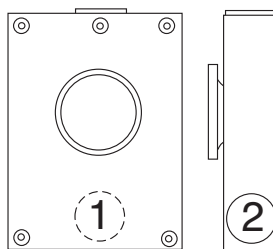

7490

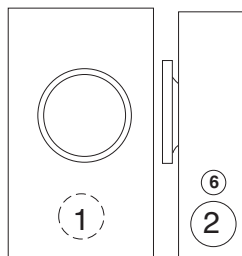
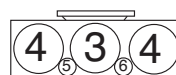

U7490-O

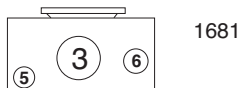

1681

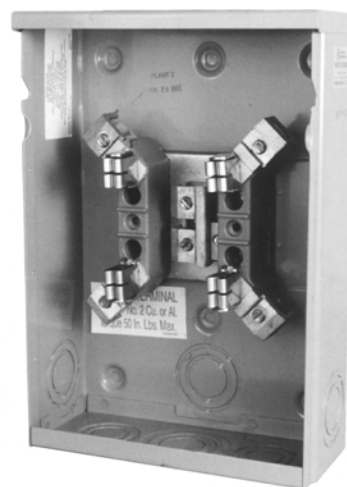

125 AMP—SINGLE POSITION—4 TERMINAL—RINGLESS

AMP	SERVICE	CATALOG NUMBER	HUB	CONNECTORS CU/AL	DIMENSIONS			CONCENTRIC K.O.'S					
					D"	W"	H"	1	2	3	4	5	6
125	UG	U7487-O	BLANK	#6-2/0	3 ⁵ / ₁₆	8	11 ¹ / ₂	1 ¹ / ₂	1 ¹ / ₂	2	1 ¹ / ₄	—	1 ¹ / ₄
125	OH/UG	U7487-RL	H.O.	#6-2/0	3 ⁵ / ₁₆	8	11 ¹ / ₂	1 ¹ / ₂	1 ¹ / ₂	2	1 ¹ / ₄	—	1 ¹ / ₄

125 AMP—SINGLE POSITION—4 TERMINAL—RING TYPE

AMP	SERVICE	CATALOG NUMBER	HUB	CONNECTORS CU/AL	DIMENSIONS			CONCENTRIC K.O.'S					
					D"	W"	H"	1	2	3	4	5	6
125	OH/UG	U7490-RL	H.O.	#6-2/0	3 ⁵ / ₁₆	8	11 ¹ / ₂	1 ¹ / ₂	1 ¹ / ₂	2	1 ¹ / ₄	—	1 ¹ / ₄
125	UG	U7490-O	BLANK	#6-2/0	3 ⁵ / ₁₆	8	11 ¹ / ₂	1 ¹ / ₂	1 ¹ / ₂	2	1 ¹ / ₄	—	1 ¹ / ₄

125 AMP—7 TERMINAL—RING TYPE

AMP	SERVICE	CATALOG NUMBER	HUB	CONNECTORS CU/AL	DIMENSIONS			CONCENTRIC K.O.'S					
					D"	W"	H"	1	2	3	4	5	6
125	OH	U1681-RL	H.O.	#6-2/0	4 ⁷ / ₈	10	18 ¹ / ₂	2	2	2	—	1 ¹ / ₄ , 1 ¹ / ₂	3 ³ / ₄

FIFTH TERMINAL: For field mounted fifth terminal on the U7487 & U7490 order catalog number 5T8K2 to fit into round opening at the 9 o'clock position.

HUBS: For proper hub selection see the hub suffix chart on the accessory page.

CONNECTORS: Extruded aluminum connectors are tin plated.

SEALING RINGS: Ring type units supplied with an MR-2 snap action sealing ring as standard.

Utility requirements for this equipment may vary. Always consult the serving utility for their requirements before ordering or installing equipment in this catalog.



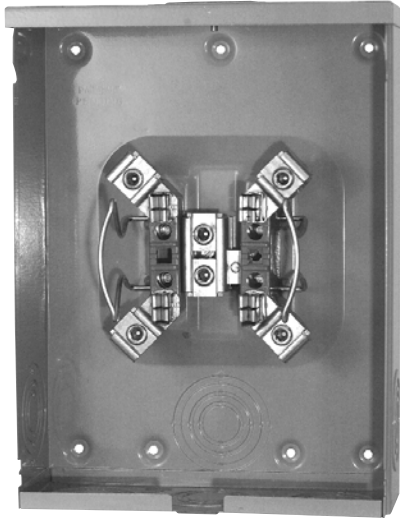

U7040-XL-TG



U1060-RL

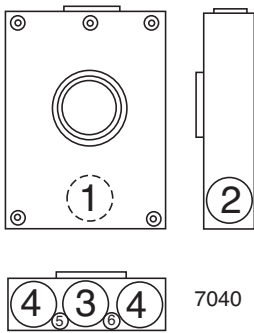

7040

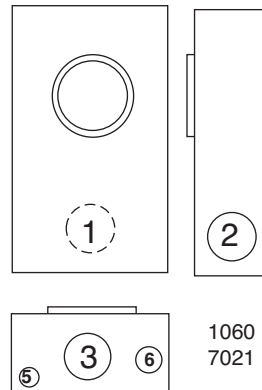

1060
7021

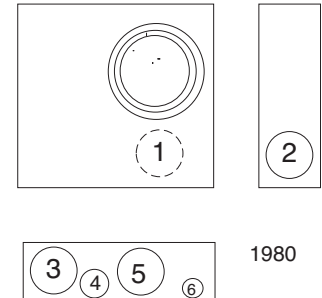

1980

200 AMP—SINGLE POSITION—4 TERMINAL—RINGLESS

AMP	SERVICE	CATALOG NUMBER	HUB	CONNECTORS CU/AL	DIMENSIONS			CONCENTRIC K.O.'S					
					D"	W"	H"	1	2	3	4	5	6
200	OH	U1060-RL	H.O.	#2-350	4 ¹ / ₈	8	15 ¹ / ₂	2	2	2	—	—	1/4
200	UG	U1527-O	BLANK	#2-350	4 ¹ / ₈	11	15 ¹ / ₂	2	2	2	2 ¹ / ₂	1/4, 1/2	1/4
200	UG	U1980-O	BLANK	#6-350	4 ¹ / ₂	13	15 ¹ / ₄	2 ¹ / ₂	2 ¹ / ₂	3	1 ¹ / ₂	2 ¹ / ₂	1/4, 1/2
200	OH	U7021-RL-TG	H.O.	#6-350	4 ¹ / ₈	8	15 ¹ / ₂	2 ¹ / ₂	2 ¹ / ₂	2 ¹ / ₂	—	1/4	1/4, 1/2
200	OH/UG	U7040-XL-TG	C.P.	#6-350	4 ¹ / ₈	11	15 ¹ / ₂	2 ¹ / ₂	2 ¹ / ₂	2 ¹ / ₂	2 ¹ / ₂	1/4, 1/2	1/4
200	OH/UG	U7043-XL-TG	C.P.	#6-350	4 ⁷ / ₈	13	15 ¹ / ₂	2 ¹ / ₂	2 ¹ / ₂	3	3	1/4	1/4, 1/2

FIFTH TERMINAL: For field mounted fifth terminal order catalog number **K5T** to fit into square opening at the 9 o'clock position.

HUBS: For proper hub selection see the hub suffix chart on accessory page.

CONNECTORS: Extruded aluminum connectors are tin plated.

Utility requirements for this equipment may vary. Always consult the serving utility for their requirements before ordering or installing equipment in this catalog.

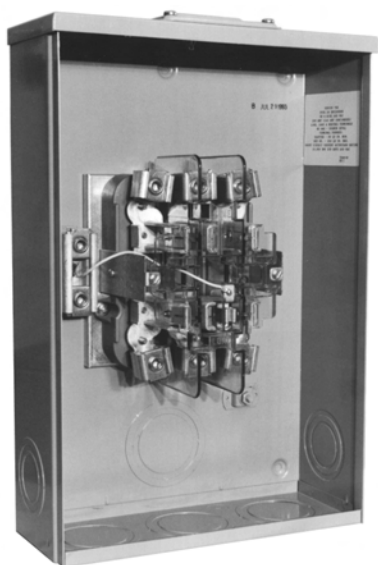

U3328-RXL

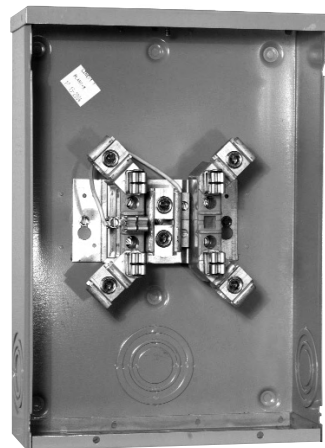

U4518-O-W

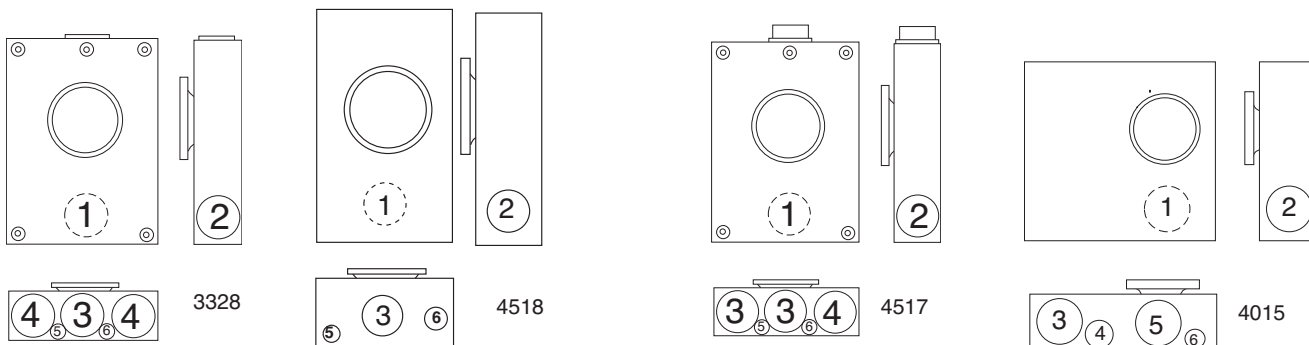

200 AMP—SINGLE POSITION—4 TERMINAL—RING TYPE

AMP	SERVICE	CATALOG NUMBER	HUB	CONNECTORS CU/AL	DIMENSIONS			CONCENTRIC K.O.'S					
					D"	W"	H"	1	2	3	4	5	6
200	OH	U4517-DL-M4	2"	#6-350	4 ¹ / ₈	8	15 ¹ / ₂	2 ¹ / ₂	2 ¹ / ₂	2 ¹ / ₂	—	1 ¹ / ₄	1 ¹ / ₄ , 1 ¹ / ₂
200	OH/UG	U4518-XL-W	C.P.	#6-350	4 ¹ / ₈	11	15 ¹ / ₂	2	2	2	2 ¹ / ₂	1 ¹ / ₄ , 1 ¹ / ₂	1 ¹ / ₄
200	UG	U4518-O-W	BLANK	#6-350	4 ¹ / ₈	11	15 ¹ / ₂	2	2	2	2 ¹ / ₂	1 ¹ / ₄ , 1 ¹ / ₂	1 ¹ / ₄
200	UG	U4015-O	BLANK	#6-350	6	14	16 ¹ / ₄	2 ¹ / ₂	2 ¹ / ₂	3	1 ¹ / ₂	2 ¹ / ₂	1 ¹ / ₄ , 1 ¹ / ₂

200 AMP—7 TERMINAL—RING TYPE

AMP	SERVICE	CATALOG NUMBER	HUB	CONNECTORS CU/AL	DIMENSIONS			CONCENTRIC K.O.'S					
					D"	W"	H"	1	2	3	4	5	6
200	OH/UG	U3328-RXL	C.P.	#6-350	4 ⁷ / ₈	13	19	3	2 ¹ / ₂	3	3	1 ¹ / ₄	1 ¹ / ₄ , 1 ¹ / ₂

FIFTH TERMINAL: For field mounted fifth terminal order catalog number **K5T** to fit into square opening at the 9 o'clock position.

HUBS: For proper hub selection see the hub suffix chart on the accessory page.

CONNECTORS: Extruded aluminum connectors are tin plated.

SEALING RINGS: The above ring type units are supplied with an **MR-4** screw type sealing ring as standard.

Utility requirements for this equipment may vary. Always consult the serving utility for their requirements before ordering or installing equipment in this catalog.



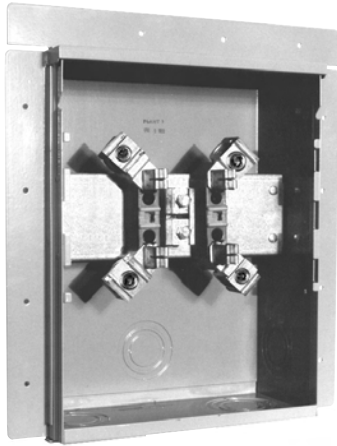

UF4518-KO

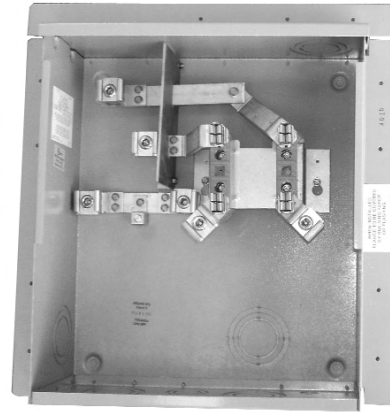

UF4015-KO

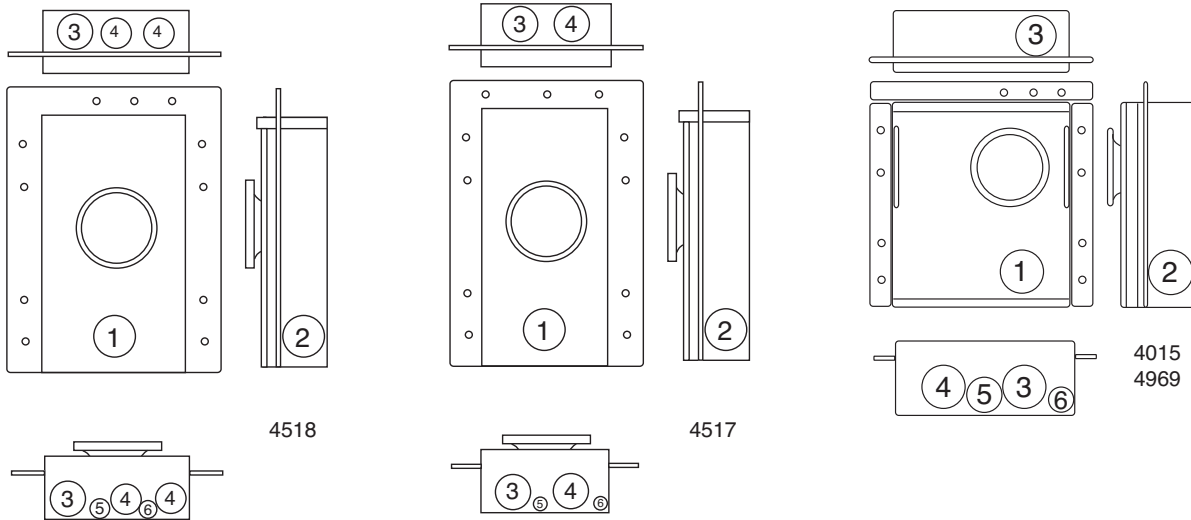

200 AMP—4 (1Ø3W) TERMINAL—FACTORY WELDED FLUSH MOUNT—RING TYPE

TERM.	AMP	SERVICE	CATALOG NUMBER	HUB	CONNECTORS CU/AL	DIMENSIONS			CONCENTRIC K.O.'S					
						D"	W"	H"	1	2	3	4	5	6
4	200	OH	UF4517-KO	K.O.	#6-350	5 ¹ / ₈	8	15 ¹ / ₂	2	2	2	2	1/4	1/4, 1/2
4	200	OH/UG	UF4518-KO	K.O.	#6-350	5 ¹ / ₈	11	15 ¹ / ₂	2	2	2 ¹ / ₂	2	1/4, 1/2	1/4
4	200	UG	UF4015-KO	K.O.	#6-350	5	14	16 ¹ / ₄	2 ¹ / ₂	2 ¹ / ₂	2 ¹ / ₂	2 ¹ / ₂	1 ¹ / ₂	1/4, 1/2
4	200	UG	UF4969-KO*	K.O.	#6-350	7 ¹ / ₂	14	16 ¹ / ₄	2 ¹ / ₂	2 ¹ / ₂	2 ¹ / ₂	3	1 ¹ / ₂	1/4, 1/2

FIFTH TERMINAL: For field mounted fifth terminal order catalog number **K5T** to fit into square opening at the 9 o'clock position.

CONNECTORS: Extruded aluminum connectors are tin plated.

SEALING RINGS: Ring type units supplied with an **MR-4** screw type sealing ring as standard.

* **UF4969** can only be used in a 2 x 6 wall.

Utility requirements for this equipment may vary. Always consult the serving utility for their requirements before ordering or installing equipment in this catalog.



U9319-XL

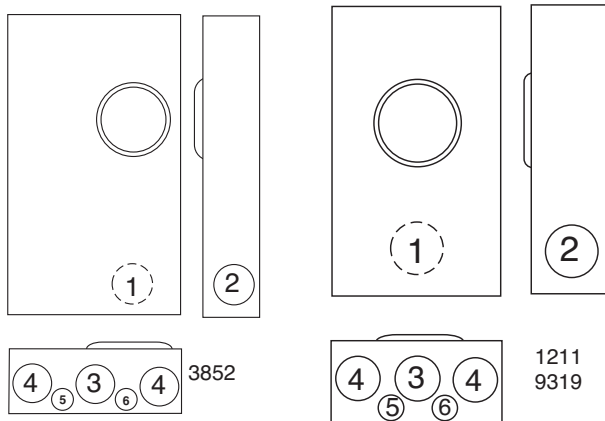

200 AMP—4 TERMINAL—RINGLESS—1Ø3W

TERM	SERVICE	CATALOG NUMBER	HUB	CONNECTORS	BY-PASS	DIMENSIONS			CONCENTRIC K.O.'S						
				CU/AL		D"	W"	H"	1	2	3	4	5	6	
4	OH/UG	U3852-XL	C.P.	#2-350	LEVER	4 ⁷ / ₈	13	19	3	2 ¹ / ₂	2 ¹ / ₂	2 ¹ / ₂	2 ¹ / ₂	1/4	1/4, 1/2

FIFTH TERMINAL: Fifth terminal is not available for this unit.

TRIPLEX GROUND: Factory installed as standard.

200 AMP—4 & 5 TERMINAL—RINGLESS—1Ø3W OR 3Ø3W

TERM	SERVICE	CATALOG NUMBER	HUB	CONNECTORS	BY-PASS	DIMENSIONS			CONCENTRIC K.O.'S						
				CU/AL		D"	W"	H"	1	2	3	4	5	6	
4	OH/UG	U1211-RXL	C.P.	#6-350	LEVER	4 ⁷ / ₈	13	19	3	2 ¹ / ₂	3	3	3	1/4	1/4, 1/2
5	OH/UG	U9319-XL	C.P.	#6-350	LEVER	4 ⁷ / ₈	13	19	3	2 ¹ / ₂	3	3	3	1/4	1/4, 1/2

FIFTH TERMINAL: For field mounted fifth terminal, order as extra **K3866** for the **U1211**.

HUBS: For proper hub selection see the hub suffix chart on the accessory page.

BYPASS: 200 amp continuous duty bypass. Lever operates bypass only. Not jaw clamping.

CONNECTORS: Units are supplied with extruded aluminum connectors and bonded, triplex neutral.

Utility requirements for this equipment may vary. Always consult the serving utility for their requirements before ordering or installing equipment in this catalog.





U7573-RL

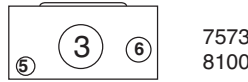
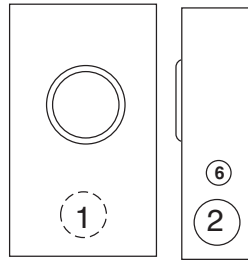

7573
8100

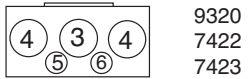
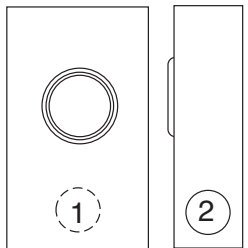

9320
7422
7423



U7423-RXL

125 AMP-7 TERMINAL-RINGLESS-3Ø4W

AMP	SERVICE	CATALOG NUMBER	HUB	CONNECTORS CU/AL	BY-PASS	DIMENSIONS			CONCENTRIC K.O.'S					
						D"	W"	H"	1	2	3	4	5	6
125	OH	U7573-RL	H.O.	#6-2/0	LEVER	4 ⁷ / ₈	10	18 ¹ / ₂	2	2	2	—	1/4, 1/2	3/4
125	OH	U8100-RL	H.O.	#6-2/0	NONE	4 ⁷ / ₈	10	18 ¹ / ₂	2	2	2	—	1/4, 1/2	3/4
125	OH/UG	U9320-RXL	C.P.	#6-2/0	LEVER	4 ⁷ / ₈	13	19	3	2 ¹ / ₂	3	3	1/4	1/4, 1/2

200 AMP-7 TERMINAL-RINGLESS-3Ø4W

AMP	SERVICE	CATALOG NUMBER	HUB	CONNECTORS CU/AL	BY-PASS	DIMENSIONS			CONCENTRIC K.O.'S					
						D"	W"	H"	1	2	3	4	5	6
200	OH/UG	U7422-RXL	C.P.	#6-350	NONE	4 ⁷ / ₈	13	19	3	2 ¹ / ₂	3	3	1/4	1/4, 1/2
200	OH/UG	U7423-RXL	C.P.	#6-350	LEVER	4 ⁷ / ₈	13	19	3	2 ¹ / ₂	3	3	1/4	1/4, 1/2

HUBS: For proper hub selection, see hub suffix chart in accessories page.

BYPASS: 200 amp continuous duty bypass. Lever operates bypass only. Not jaw clamping.

CONNECTORS: Extruded aluminum connectors are tin plated. Units supplied with bonded, duplex neutral.

Utility requirements for this equipment may vary. Always consult the serving utility for their requirements before ordering or installing equipment in this catalog.



U9701-RXL

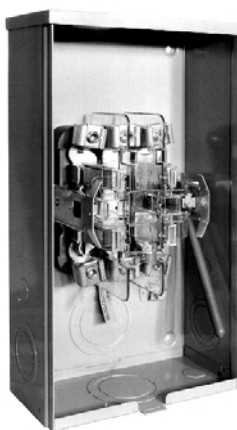

U9800-RRL



U9551-RXL

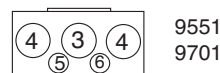
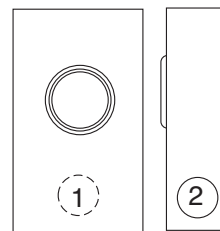
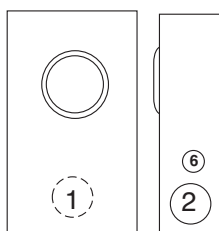
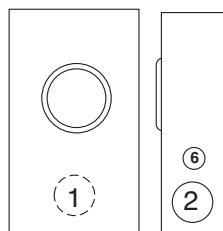

200 AMP—4 TERMINAL—RINGLESS—1Ø3W OR 3Ø3W

AMP	SERVICE	CATALOG NUMBER	HUB	CONNECTORS CU/AL	BY-PASS	DIMENSIONS			CONCENTRIC K.O.'S					
						D"	W"	H"	1	2	3	4	5	6
200	OH	U9800-RRL ①	H.O.	#6-350	LEVER	4 ⁷ / ₈	10	18 ¹ / ₂	3	2 ¹ / ₂	3	—	1/4, 1/2	3/4
200	OH/UG	U9801-RXL ①	C.P.	#6-350	LEVER	4 ⁷ / ₈	13	19	3	2 ¹ / ₂	3	3	1/4	1/4, 1/2

200 AMP—5 TERMINAL—RINGLESS—1Ø3W OR 3Ø3W

AMP	SERVICE	CATALOG NUMBER	HUB	CONNECTORS CU/AL	BY-PASS	DIMENSIONS			CONCENTRIC K.O.'S					
						D"	W"	H"	1	2	3	4	5	6
200	OH	U9550-RRL	H.O.	#6-350	LEVER	4 ⁷ / ₈	10	18 ¹ / ₂	3	2 ¹ / ₂	3	—	1/4, 1/2	3/4
200	OH/UG	U9551-RXL	C.P.	#6-350	LEVER	4 ⁷ / ₈	13	19	3	2 ¹ / ₂	3	3	1/4	1/4, 1/2

200 AMP—7 TERMINAL—RINGLESS—3Ø4W

AMP	SERVICE	CATALOG NUMBER	HUB	CONNECTORS CU/AL	BY-PASS	DIMENSIONS			CONCENTRIC K.O.'S					
						D"	W"	H"	1	2	3	4	5	6
200	OH	U9700-RRL	H.O.	#6-350	LEVER	4 ⁷ / ₈	10	18 ¹ / ₂	3	2 ¹ / ₂	3	—	1/4, 1/2	3/4
200	OH/UG	U9701-RXL	C.P.	#6-350	LEVER	4 ⁷ / ₈	13	19	3	2 ¹ / ₂	3	3	1/4	1/4, 1/2

HUBS: For proper hub selection, see hub suffix chart in accessories page.

BY-PASS: Lever supplies clamping action and also operates bypass device.

CONNECTORS: Extruded aluminum connectors are tin plated. **U9550** and **U9551** units are supplied with duplex neutral, with removable bonding strap for insulated neutral. **U9700** series units are supplied with duplex neutral.

① Internal Hex Connectors. For main and/or service disconnect, use with U5484-O enclosed circuit breaker.

Utility requirements for this equipment may vary. Always consult the serving utility for their requirements before ordering or installing equipment in this catalog.



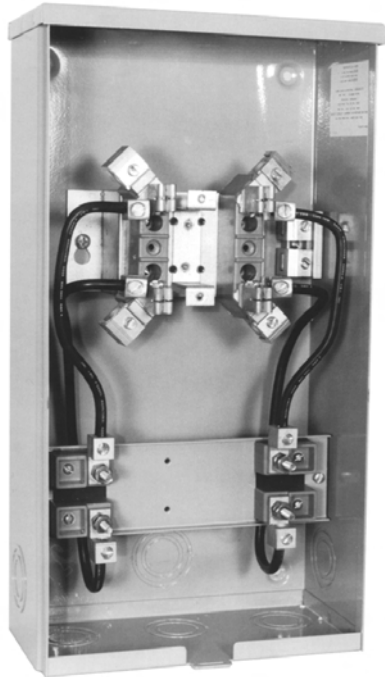

U3504-XL

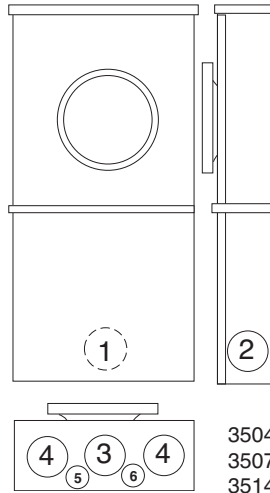

- 3504
- 3507
- 3514
- 3517

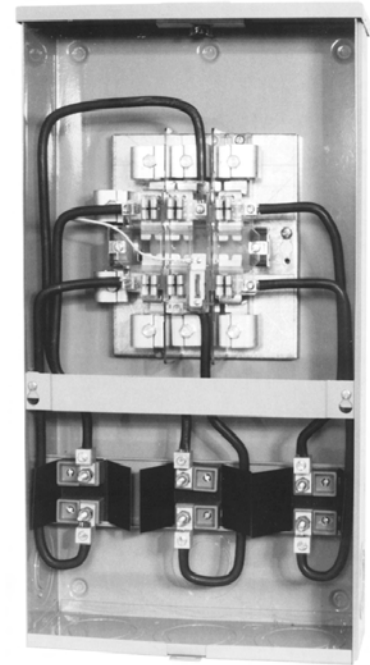

U3517-XL

SECTION B

METER SOCKETS

125 AMP—RING TYPE

TERM.	SERVICE	CATALOG NUMBER	HUB	CONNECTORS CU/AL	BY-PASS	DIMENSIONS			CONCENTRIC K.O.'S					
						D"	W"	H"	1	2	3	4	5	6
4	OH/UG	U3504-XL	C.P.	#6-2/0	LINK	4 ⁷ / ₈	10	18 ¹ / ₂	2	2	2	2	—	1/4
7	OH/UG	U3507-XL	C.P.	#6-2/0	LINK	4 ⁷ / ₈	10	21	2	2	2	2	1/4	—

200 AMP—RING TYPE

TERM.	SERVICE	CATALOG NUMBER	HUB	CONNECTORS CU/AL	BY-PASS	DIMENSIONS			CONCENTRIC K.O.'S					
						D"	W"	H"	1	2	3	4	5	6
4	OH/UG	U3514-XL	C.P.	#6-350	LINK	4 ⁷ / ₈	13	21	2 ¹ / ₂	2 ¹ / ₂	3	3	1/4	1/2
7	OH/UG	U3517-XL	C.P.	#6-350	LINK	4 ⁷ / ₈	13	24 ¹ / ₂	2 ¹ / ₂	2 ¹ / ₂	2 ¹ / ₂	2 ¹ / ₂	1/4	1/2

FIFTH TERMINAL: For field mounted fifth terminal order catalog number **5T8K2** for the **U3504**; order **K5T** for the **U3514**.

CONNECTORS: Extruded aluminum connectors are tin plated.

SEALING RINGS: Ring type units supplied with an **MR-4** screw type sealing ring as standard.

LINK BYPASS: Links provided by utility.

Utility requirements for this equipment may vary. Always consult the serving utility for their requirements before ordering or installing equipment in this catalog.

**400 AMP MAX
320 AMP CONTINUOUS**

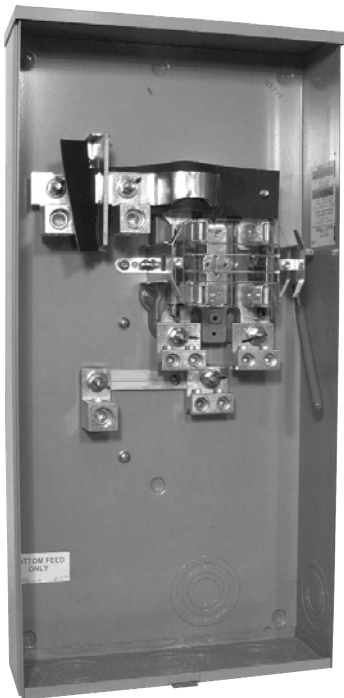

U1797-O-K3L-K2L

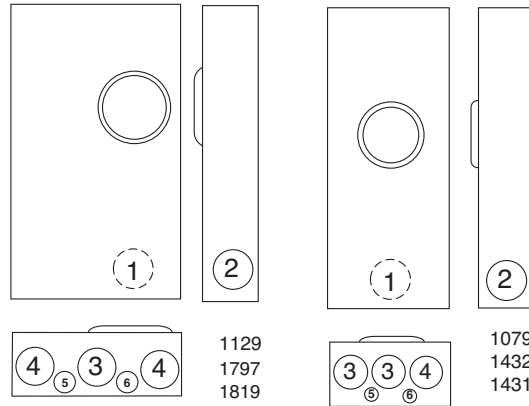

U1129-O-K3L-K2L

320 AMP—4 TERMINAL—RINGLESS—600 VAC

AMP	SVC.	CATALOG NUMBER	FIFTH TERM.	HUB	CONNECTORS CU/AL		BY-PASS	DIMENSIONS			CONCENTRIC K.O.'S					
					LINE	LOAD		D"	W"	H"	1	2	3	4	5	6
320	OH	U1079-R	K3866	H.O.	3/8"-16 STUDS		LEVER	4 7/8	13	38 3/4	3	2 1/2	3	3	1/4	1/4, 1/2
320	UG	U1129-O-K3L-K2L	K3865	BLANK	#4-600 or (2) 1/0-250	TWIN #6-350	LEVER	4 7/8	15	30	3	2 1/2	3	3	1/4	1/4, 1/2
320	OH/UG	U1431-R*	K3866	H.O.	3/8"-16 STUDS		NONE	4 7/8	13	38 3/4	3	2 1/2	3	3	1/4	1/4, 1/2
320	UG	U1432-O*	K3865	BLANK	3/8"-16 STUDS		NONE	4 7/8	13	29 3/4	3	2 1/2	3	3	1/4	1/4, 1/2
320	UG	U1819-X*	K3865	C.P.	3/8"-16 STUDS		NONE	4 7/8	15	30	3	3	3	3	1/4	1/4, 1/2
320	UG	U1797-O-K3L-K2L	K3865	BLANK	#4-600 or (2) 1/0-250	TWIN #6-350	LEVER	4 7/8	15	30	3	3	3	3	1/4	1/4, 1/2

HUBS: For proper hub selection, see hub suffix chart in accessories page.

BY-PASS: *Lever supplies clamping action on meter spades only on the **U1431, U1432** and **U1819**. Lever supplies clamping action and also operates bypass device on the **U1079, U1129** & **U1797**.

CONNECTOR KITS: Stud type units are supplied with 3/8"-16 hex head nuts with Belleville washers. Order two connector kits to cover both line and load. Order **K1539** (single #350), **K1540** (single #600) or **K1350** (twin #350). See accessories page.

NOTE: The **U1129** unit has a single connector on the line side only.

FIFTH TERMINAL: For field mounted fifth terminal, order as extra **K3866** for the **U1079** & **U1431**. Order as extra **K3865** for units **U1129, U1432, U1819,** and **U1797**.

LUG SIZE RANGE: See accessories page for lug size range for the **U1129** & **U1797** units.

Utility requirements for this equipment may vary. Always consult the serving utility for their requirements before ordering or installing equipment in this catalog.



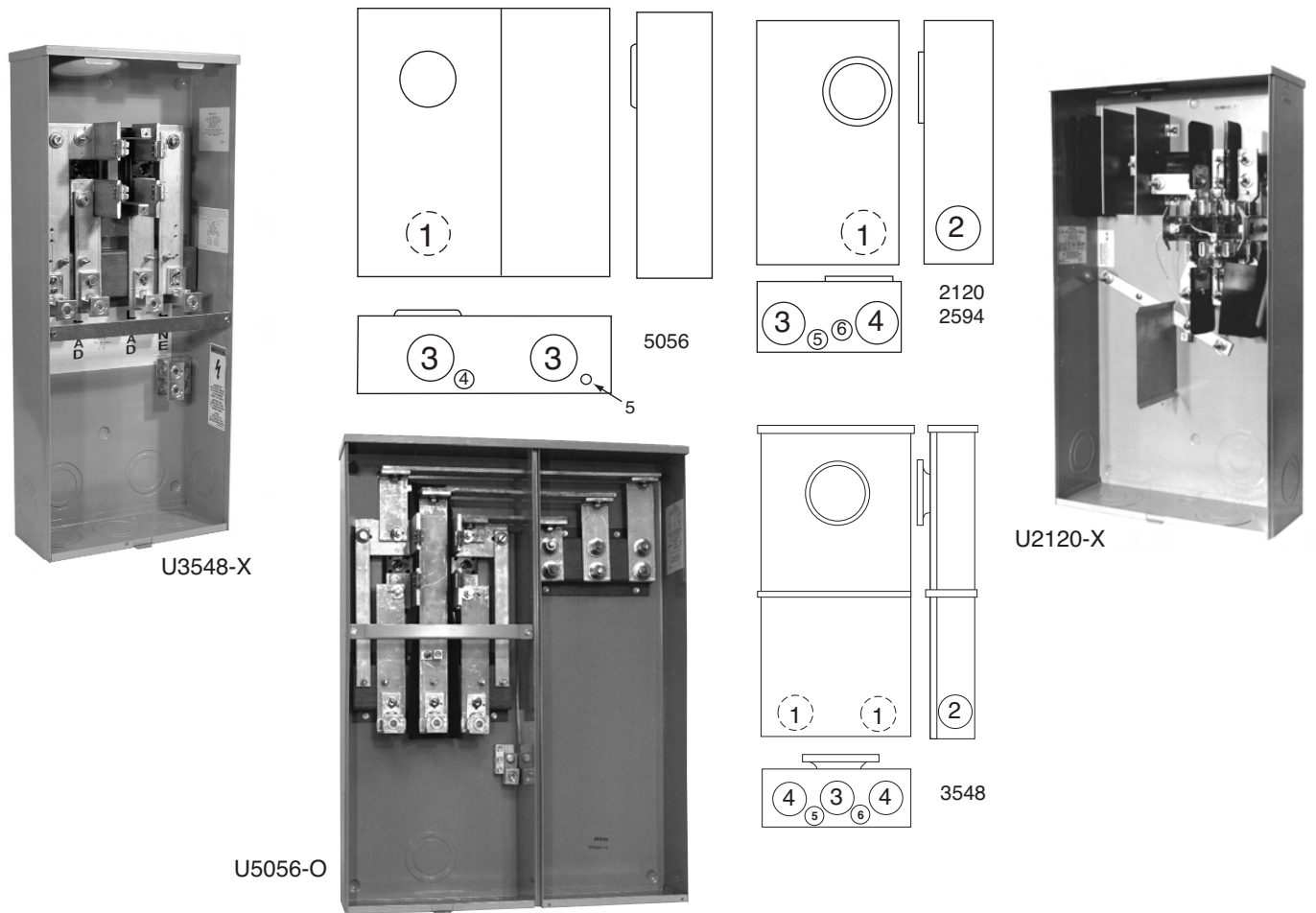

SECTION B
METER SOCKETS

320 AMP—4 TERMINAL—LINK BYPASS—RING TYPE—1Ø3W

SERVICE	CATALOG NUMBER	HUB	CONNECTORS CU/AL		BY-PASS	DIMENSIONS			CONCENTRIC K.O.'S					
			LINE	LOAD		D"	W"	H"	1	2	3	4	5	6
OH/ UG	U3548-X*	C.P.	SINGLE = 4-600 PARALLEL = 1/0-250		LINK	6	14	33	3	3	3	3	1/4	1/4, 1/2
UG	U5056-O**	BLANK	1/2"-13 STUDS	#4-600 or twin 1/0-250	LINK	6	24	32	3	—	4	1/4, 1/2	1/4	—

SEALING RING: Ring type units are supplied with an MR-4, screw type, sealing ring as standard.

TRIPLE TAP LUG: For triple tap lug kit order **K5049**.

LINK BYPASS: Links provided by utility.

***FLUSH MOUNT KIT:** For field mounted flush mount kit order **K4086**.

****This is a PP&L approved unit.**

320 AMP—7 TERMINAL—SIDE WIREWAY—RINGLESS

AMP	SERVICE	CATALOG NUMBER	HUB	CONNECTORS CU/AL	BY-PASS	DIMENSIONS			CONCENTRIC K.O.'S					
						D"	W"	H"	1	2	3	4	5	6
320	UG	U2120-X	C.P.	3/8"-16 STUDS	LEVER	6 1/2	17 3/4	31 3/4	4	3	4	4	1/4	1
320	OH/UG	U2594-X	C.P.	3/8"-16 STUDS	LEVER	6 1/2	19	34 1/8	—	3	4	4	1/4	1/2, 3/4, 1

BYPASS: Lever supplies clamping action on meter spades and operates bypass device.

CONNECTOR KITS: Stud type units are supplied with 3/8"-16 hex head nuts with Belleville washers. Order two connector kits to cover both line and load. For single lug connector kits for the **U2120** and **U2594** units, order as extra **K3082** (350 kcmil) or **K3441** (600 kcmil). For twin lug connectors order as extra: **K3442** (350 kcmil). Separate kits are required for both line and load.

Utility requirements for this equipment may vary. Always consult the serving utility for their requirements before ordering or installing equipment in this catalog.



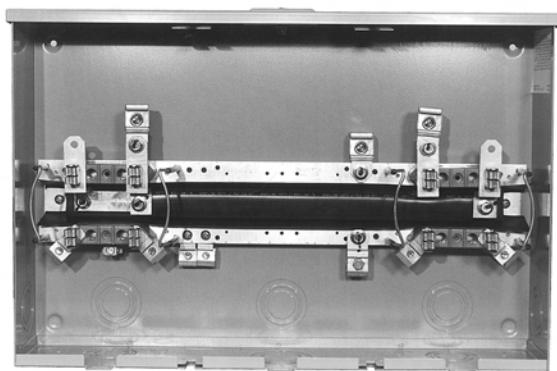

U8032-XL

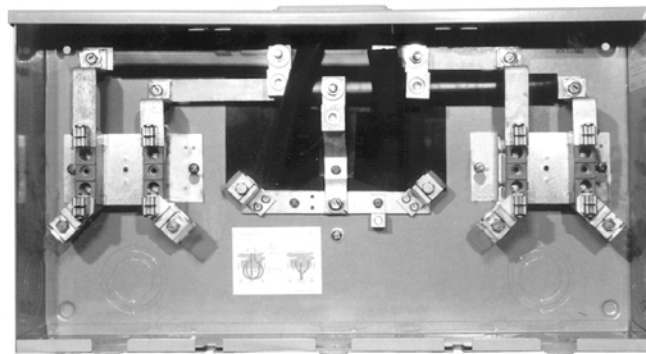
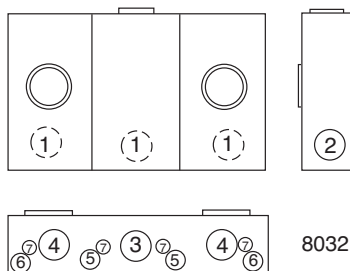

U3522-XL

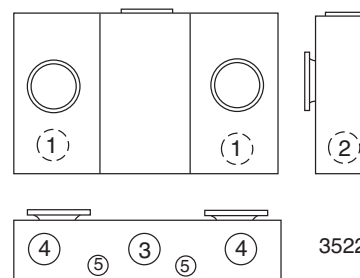

100 AMP / POSITION—CONTINUOUS—4 TERMINAL—RINGLESS

NO. OF POS.	SERVICE	CATALOG NUMBER	HUB	CONNECTORS CU/AL		DIMENSIONS			CONCENTRIC K.O.'S						
				LINE	LOAD	D"	W"	H"	1	2	3	4	5	6	7
2	OH/UG	U8032-XL	C.P.	#2-350	#6-2/0	4 ¹ / ₂	24 ¹ / ₂	16	2	2	2 ¹ / ₂	2	1/2	1/4, 1/2	5/16
3	OH/UG	U8033-XL	C.P.	#2-350	#6-2/0	4 ¹ / ₂	32 ³ / ₄	16	2	2	2 ¹ / ₂	(3) 2	1/2	1/4, 1/2	5/16
4	OH/UG	U8034-XL	C.P.	#2-350	#6-2/0	4 ¹ / ₂	40 ⁷ / ₈	16	2	2	2 ¹ / ₂	(4) 2	1/2	1/4, 1/2	5/16
5	OH/UG	U8035-XL	C.P.	#2-350	#6-2/0	4 ¹ / ₂	49 ¹ / ₁₆	16	2	2	2 ¹ / ₂	(5) 2	1/2	1/4, 1/2	5/16
6	OH/UG	U8036-XL	C.P.	#2-350	#6-2/0	4 ¹ / ₂	57 ¹ / ₄	16	2	2	2 ¹ / ₂	(6) 2	1/2	1/4, 1/2	5/16

125 AMP / POSITION—CONTINUOUS—4 TERMINAL—RING TYPE

NO. OF POS.	SERVICE	CATALOG NUMBER	HUB	CONNECTORS CU/AL		DIMENSIONS			CONCENTRIC K.O.'S					
				LINE	LOAD	D"	W"	H"	1	2	3	4	5	6
2	OH/UG	U3522-XL-K1	C.P.	#2-350	#6-2/0	4 ¹ / ₂	24 ¹ / ₂	14	1 ¹ / ₂	1 ¹ / ₂	2 ¹ / ₂	2 ¹ / ₂	1/4, 1/2	—
3	OH/UG	U3523-XL-K1	C.P.	#2-350	#6-2/0	4 ¹ / ₂	32 ³ / ₄	14	1 ¹ / ₂	1 ¹ / ₂	2 ¹ / ₂	(3) 2 ¹ / ₂	1/4, 1/2	—
4	OH/UG	U3524-XL-K2	C.P.	#2-350	#6-2/0	4 ¹ / ₂	40 ⁷ / ₈	14	1 ¹ / ₂	1 ¹ / ₂	2 ¹ / ₂	(4) 2 ¹ / ₂	1/4, 1/2	—
5	UG	U3525-XL-K2*	C.P.	#2-350	#6-2/0	4 ¹ / ₂	49 ¹ / ₁₆	16	1 ¹ / ₂	1 ¹ / ₂	2 ¹ / ₂	(5) 2 ¹ / ₂	1/4, 1/2	—

***FOR OVERHEAD SERVICE:** The U3525 is factory configured for underground service. If overhead service is desired, an extension kit is required. Order separately, catalog number K3937.

FIFTH TERMINAL: For field mounted fifth terminal, order catalog number 5T8K2 (6 o'clock only on 100 amp units, 9 o'clock only on 125 amp units.)

HUBS: For proper hub selection, see the hub suffix chart in accessories page.

SEALING RINGS: Ring type units are supplied with one MR-4 screw type sealing ring per position.

MAIN BUS RATING: See general engineering page.

Utility requirements for this equipment may vary. Always consult the serving utility for their requirements before ordering or installing equipment in this catalog.



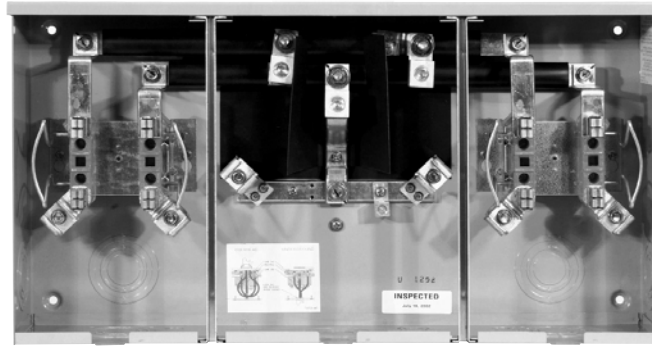

U1252-X-K1

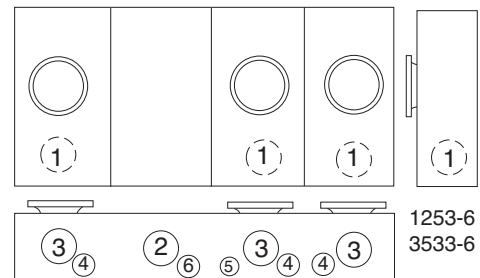
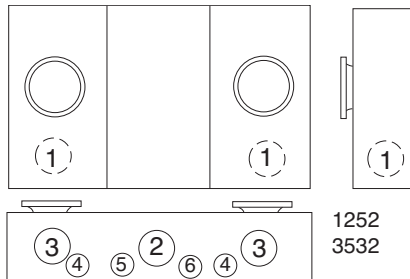
200 AMP / POSITION—4 TERMINAL—RINGLESS

NO. OF POS.	SERVICE	CATALOG NUMBER	HUB	CONNECTORS CU/AL		DIMENSIONS			CONCENTRIC K.O.'S					
				LINE	LOAD	D"	W"	H"	1	2	3	4	5	6
2	OH/UG	U1252-X-K1	C.P.	#6-350	#2-350	5 ¹ / ₈	26 ¹ / ₂	14	2 ¹ / ₂	3	2 ¹ / ₂	1/2	1/4	1
3	OH/UG	U1253-X-K3	C.P.	#4-600	#2-350	5 ¹ / ₈	34 ³ / ₄	14	2 ¹ / ₂	3	(3)2 ¹ / ₂	1/2	1/4	1
4	UG	U1254-X-K3*	C.P.	#4-600	#2-350	5 ¹ / ₈	42 ⁷ / ₈	16	2 ¹ / ₂	3	(4)2 ¹ / ₂	1/2	1/4	1
5	UG	U1255-X-K4*	C.P.	(2)#2-600	#2-350	5 ¹ / ₈	54 ⁷ / ₈	16	2 ¹ / ₂	3	(5)2 ¹ / ₂	1/2	1/4	1
6	UG	U1256-X-K4*	C.P.	(2)#2-600	#2-350	5 ¹ / ₈	63 ¹ / ₁₆	18	2 ¹ / ₂	3	(6)2 ¹ / ₂	1/2	1/4	1

200 AMP / POSITION—4 TERMINAL—RING TYPE

NO. OF POS.	SERVICE	CATALOG NUMBER	HUB	CONNECTORS CU/AL		DIMENSIONS			CONCENTRIC K.O.'S					
				LINE	LOAD	D"	W"	H"	1	2	3	4	5	6
2	OH/UG	U3532-X-K1	C.P.	#6-350	#2-350	5 ¹ / ₈	26 ¹ / ₂	14	2 ¹ / ₂	3	2 ¹ / ₂	—	1/4	1
3	OH/UG	U3533-X-K3	C.P.	#4-600	#2-350	5 ¹ / ₈	34 ³ / ₄	14	2 ¹ / ₂	3	(3)2 ¹ / ₂	—	1/4	1

***FOR OVERHEAD SERVICE:** These units are factory configured for underground service. If overhead service is desired, an extension kit is required. Order as extra, **K3923** (4 & 5 position), **K3955** (6 position).

FIFTH TERMINAL: For field mounted fifth terminal order catalog number **K5T** to fit into square opening at the 9 o'clock position.

HUBS: For proper hub selection, see the hub suffix chart in accessories page.

SEALING RINGS: Ring type units are supplied with one **MR-4** screw type sealing ring per position.

MAIN BUS RATING: See general engineering page. **U1252 & U3532** only rated 400 amp overall.

Utility requirements for this equipment may vary. Always consult the serving utility for their requirements before ordering or installing equipment in this catalog.

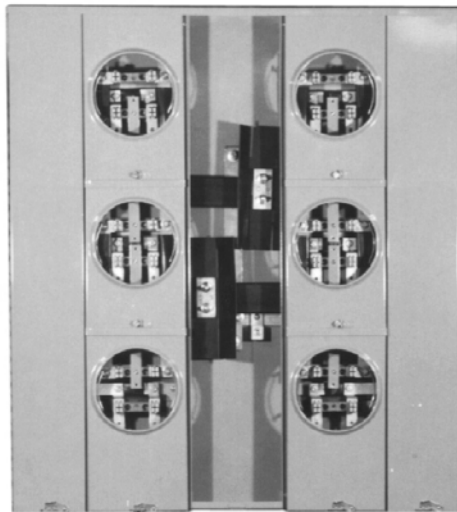

U2866-X



U2854-X-4/125
(Order circuit breakers as extra)

125 AMP/POSITION

VERTICAL

200 AMP/POSITION

NO. OF POS.	CATALOG NUMBER	MAIN BUS RATING	LINE CONNECTOR SIZE
2	U2852-X	200 AMP	*3/8"-16 STUD
3	U2853-X	200 AMP	*3/8"-16 STUD

NO. OF POS.	CATALOG NUMBER	MAIN BUS RATING	LINE CONNECTOR SIZE
2	U2862-X	250 AMP	*3/8"-16 STUD
3	U2863-X	300 AMP	*3/8"-16 STUD

125 AMP/POSITION

RECTANGULAR

200 AMP/POSITION

NO. OF POS.	CATALOG NUMBER	MAIN BUS RATING	LINE CONNECTOR SIZE
4	U2854-X	400 AMP	*3/8"-16 STUD
5	U2855-X	400 AMP	*3/8"-16 STUD
6	U2856-X	400 AMP	*3/8"-16 STUD

NO. OF POS.	CATALOG NUMBER	MAIN BUS RATING	LINE CONNECTOR SIZE
4	U2864-X	400 AMP	*3/8"-16 STUD
5	U2865-X	600 AMP	*3/8"-16 STUD
6	U2866-X	600 AMP	*3/8"-16 STUD

CONNECTOR KITS *

SIZE	SUFFIX	KIT NUMBER	COMPATIBLE WITH	WIRE RANGE
SINGLE	-K1	K1539	U2852-56 U2862-66	#6-350
	-K3	K1540	U2854-56 U2864-66	#4-600
TWIN	-K2	K1350	U2854-56 U2863-66	#6-350
	-K4	K1541	U2864-66	#2-600

*CONNECTORS: For line wire connector kits, order separately.

FIFTH TERMINALS: For field mounted fifth terminal order catalog number K2381. Order one per meter position (9 o'clock position only).

BREAKERS: Units have provision for one double pole main per meter position. Breakers not included. Order as extra Milbank.

PLUG-IN BREAKER COMPATIBILITY CHART

AMPS	CUTLER-HAMMER (WESTINGHOUSE)	SIEMENS (ITE)	SIEMENS MURRAY / CROUSE-HINDS	G.E.	SQ-D
125-200	HQP / BR / WBJ	—	MD	THQ	—
≤ 100	QP / BR / HQP	QP	MP	THQ	HOMELINE

Utility requirements for this equipment may vary. Always consult the serving utility for their requirements before ordering or installing equipment in this catalog.



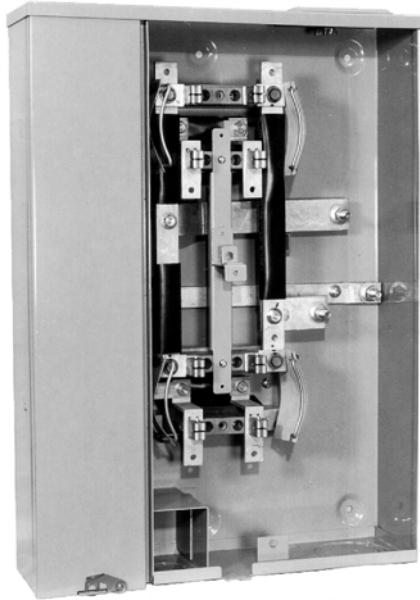

U2852-X

VERTICAL

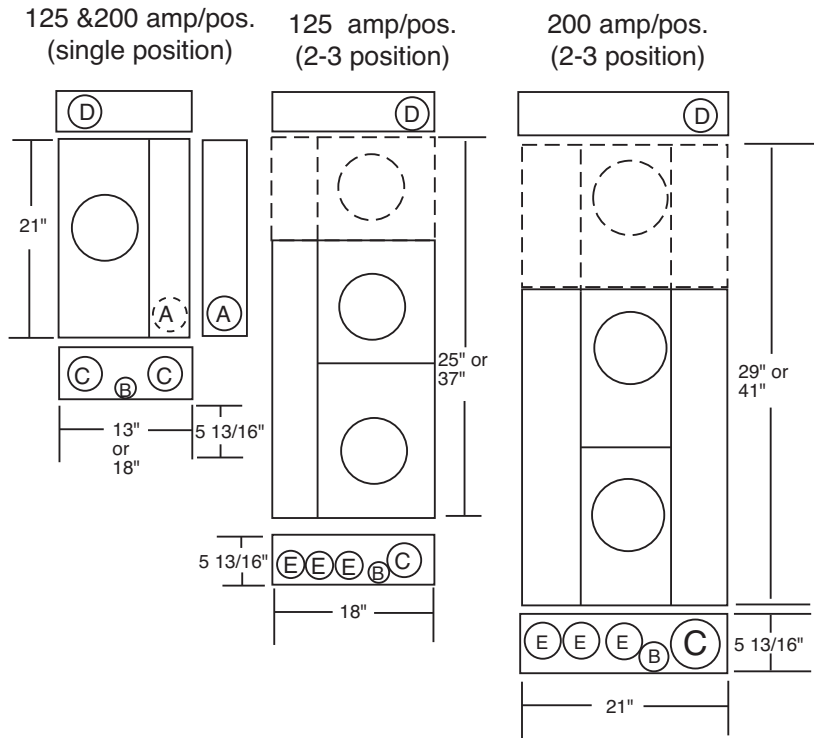

CONDOMINIUM METERING BANKS

RECTANGULAR

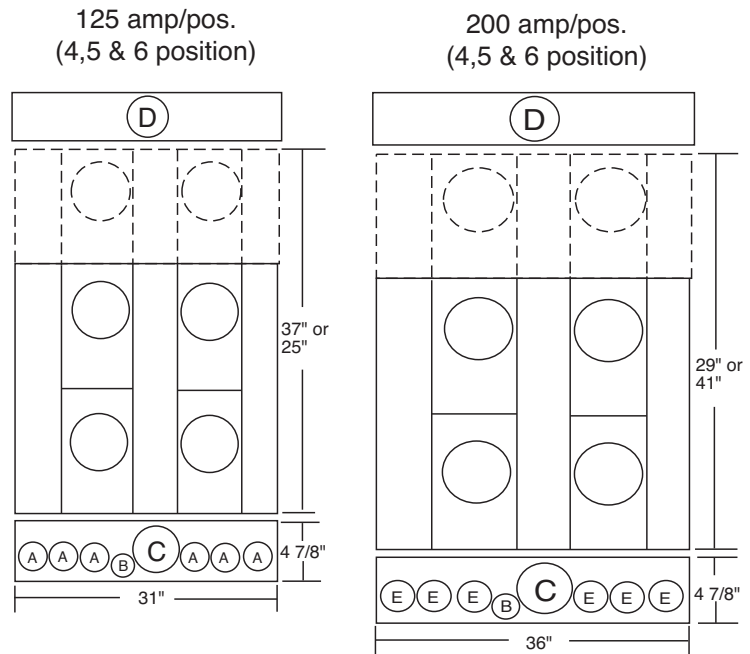
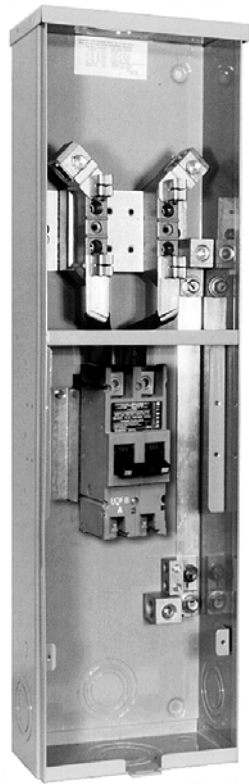
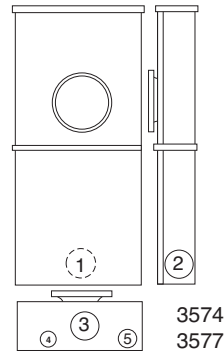
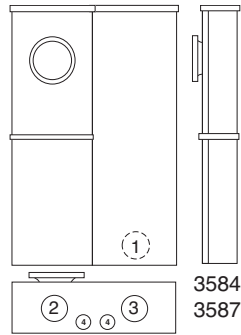

FIG.	DIMENSIONS
A	1 1/4" CONCENTRIC K.O.
B	1/4, 1/2" CONCENTRIC K.O.
C	3" CONCENTRIC K.O.
D	4" HUB OPENING
E	2" CONCENTRIC K.O.

Utility requirements for this equipment may vary. Always consult the serving utility for their requirements before ordering or installing equipment in this catalog.



U3574-RL-200



200 AMP—4 & 7 TERMINAL—RING TYPE

NO. OF TERMS	SERVICE	CATALOG NUMBER	BREAKER	CONNECTORS CU/AL		DIMENSIONS			CONCENTRIC K.O.'S					
				LINE	LOAD	D"	W"	H"	1	2	3	4	5	6
4	OH	U3574-RL-200	200A-2P	#2-350	#3-300	4 ¹ / ₈	8	30	2	2	2 ¹ / ₂	1/4	1/4, 1/2	—
7	OH	U3577-RL-200	200A-3P	#2-350	#3-300	4 ⁷ / ₈	10	34	2	2	2 ¹ / ₂	1/4	1/4, 1/2	—
4	UG	U3584-O-200	200A-2P	#6-350	#3-300	5 ¹ / ₂	14 ¹ / ₈	26	3	3	3	1/4, 1/2	—	—
7	UG	U3587-O-200	200A-3P	#6-350	#3-300	5 ¹ / ₂	14 ¹ / ₈	26	3	3	3	1/4, 1/2	—	—

BREAKERS: Units are supplied with bolt-on 200 amp circuit breakers where specified above.

SEALING RINGS: Units are supplied with an MR-4 screw type sealing ring.

SECTION C
METER MAINS AND SERVICE ENTRANCE EQUIPMENT

Utility requirements for this equipment may vary. Always consult the serving utility for their requirements before ordering or installing equipment in this catalog.





U5168-XTL-200

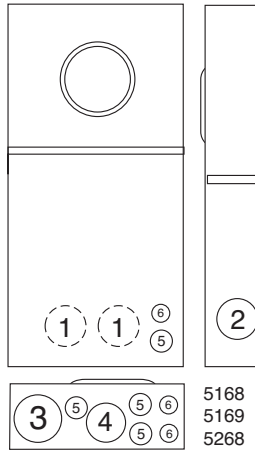

- 5168
- 5169
- 5268
- 5269

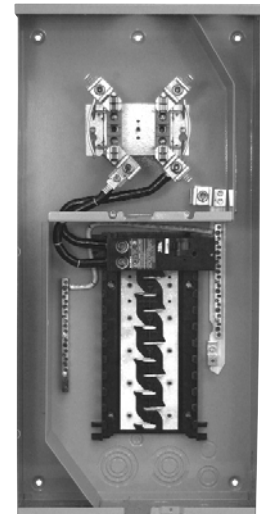

U5268-XTL-200-KK

100/150/200 AMP-4 & 5 TERMINAL-METER MAIN-22K AIC-120/240 VOLT-1Ø3W-RINGLESS / RING TYPE OVERHEAD / UNDERGROUND-8 & 20 CIRCUIT INTERIOR

NO. OF TERMS	AMP	CIRCUITS	CATALOG NUMBER	HUB	CONNECTORS		DIMENSIONS			CONCENTRIC K.O.'S					
					LINE	BY-PASS	D"	W"	H"	1	2	3	4	5	6
4	100	10	U5168-XTL-100 **	C.P.	#6-350	NONE	4 1/2	14 1/8	32	2	2	3	2 1/2	1 1/2, 3/4, 1	1/2, 3/4
4	150	8	U5168-XTL-150 **	C.P.	#6-350	NONE	4 1/2	14 1/8	32	2	2	3	2 1/2	1 1/2, 3/4, 1	1/2, 3/4
4	200	8	U5168-XTL-200 **	C.P.	#6-350	NONE	4 1/2	14 1/8	32	2	2	3	2 1/2	1 1/2, 3/4, 1	1/2, 3/4
4	100	10	U5168-XTL-100-KK **	C.P.	#6-350	HORN	4 1/2	14 1/8	32	2	2	3	2 1/2	1 1/2, 3/4, 1	1/2, 3/4
4	150	8	U5168-XTL-150-KK **	C.P.	#6-350	HORN	4 1/2	14 1/8	32	2	2	3	2 1/2	1 1/2, 3/4, 1	1/2, 3/4
4	200	8	U5168-XTL-200-KK **	C.P.	#6-350	HORN	4 1/2	14 1/8	32	2	2	3	2 1/2	1 1/2, 3/4, 1	1/2, 3/4
5	100	10	U5168-XTL-100-KK-5T **	C.P.	#6-350	HORN	4 1/2	14 1/8	32	2	2	3	2 1/2	1 1/2, 3/4, 1	1/2, 3/4
5	150	8	U5168-XTL-150-KK-5T **	C.P.	#6-350	HORN	4 1/2	14 1/8	32	2	2	3	2 1/2	1 1/2, 3/4, 1	1/2, 3/4
4	100	10	U5169-XTL-100	C.P.	#6-350	NONE	4 1/2	14 1/8	32	2	2	3	2 1/2	1 1/2, 3/4, 1	1/2, 3/4
4	150	8	U5169-XTL-150	C.P.	#6-350	NONE	4 1/2	14 1/8	32	2	2	3	2 1/2	1 1/2, 3/4, 1	1/2, 3/4
4	200	8	U5169-XTL-200	C.P.	#6-350	NONE	4 1/2	14 1/8	32	2	2	3	2 1/2	1 1/2, 3/4, 1	1/2, 3/4
4	150	20	U5268-XTL-150 **	C.P.	#6-350	NONE	4 1/2	14 1/8	32	2	2	3	2 1/2	1 1/2, 3/4, 1	1/2, 3/4
4	200	20	U5268-XTL-200 **	C.P.	#6-350	NONE	4 1/2	14 1/8	32	2	2	3	2 1/2	1 1/2, 3/4, 1	1/2, 3/4
4	150	20	U5268-XTL-150-KK **	C.P.	#6-350	HORN	4 1/2	14 1/8	32	2	2	3	2 1/2	1 1/2, 3/4, 1	1/2, 3/4
4	200	20	U5268-XTL-200-KK **	C.P.	#6-350	HORN	4 1/2	14 1/8	32	2	2	3	2 1/2	1 1/2, 3/4, 1	1/2, 3/4
4	200	20	U5269-XTL-200	C.P.	#6-350	NONE	4 1/2	14 1/8	32	2	2	3	2 1/2	1 1/2, 3/4, 1	1/2, 3/4

HUB: Supplied with (2) closing plates packed inside. Order hubs as a separate item. See accessory page for hub options.

INTERIOR: U5168 units have 8-circuit interior; U5268 units have 20-circuit interior.

FIFTH TERMINAL: Order K5T and field install for 208Y/120 network systems. Installs in the 9 o'clock position only.

BREAKERS: Rated 22K AIC with Milbank QNR2200H main installed.

INTERLOCK KIT: For generator auxiliary circuit breaker interlock, order K5815 for large QN with small frame Q; order K5820 for large frame QN with large frame QN.

SUB-FEED LUGS: #6-350 kcmil sub-feed lugs provided on 8 and 10 circuit interior. Not available on 20 circuit interior.

*Amperage rating limited to main breaker rating. Interior has 10 branch circuit breaker provisions.

****RINGLESS**

Utility requirements for this equipment may vary. Always consult the serving utility for their requirements before ordering or installing equipment in this catalog.



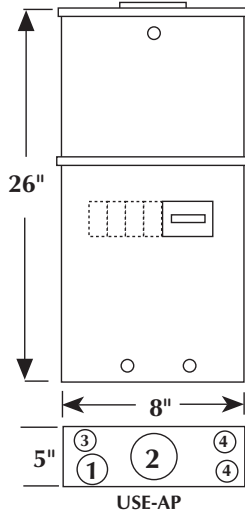

USE-AP-200-ML

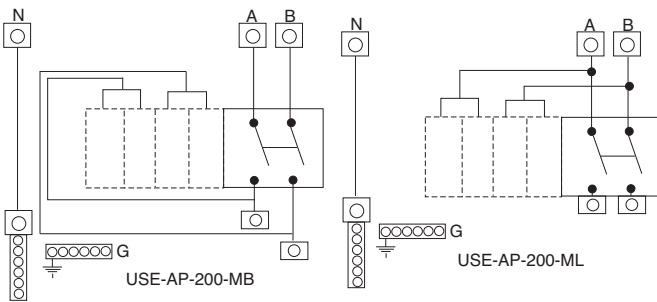

200 AMP—4 TERMINAL—BREAKER ENCLOSURE—1Ø3W, 120/240V—10K AIC RATING

NO. OF TERM.	SERVICE	CATALOG NUMBER	HUB	CONNECTORS	DIMENSIONS			CONCENTRIC K.O.'S			
				LINE	D"	W"	H"	1	2	3	4
4	OH	USE-AP-200-MB	2"	#4-250	5	8	26	1	2	1/2, 3/4	1/2, 3/4
4	OH	USE-AP-200-ML	2"	#4-250	5	8	26	1	2	1/2, 3/4	1/2, 3/4

NOTE: The neutral bus / ground bar is factory installed.

USE-AP-200-MB: 200 Amp main wired in series with plug-in style bus. UQFP-M-200 factory installed. Additional 4 branch circuits available for (1) two-pole and (2) one-pole, or (4) one pole breakers. **One 2" hub included.**

USE-AP-200-ML: 200 Amp breaker wired in parallel with plug-in style bus. UQFP-200 factory installed. Additional 4 branch circuits available for (1) two-pole and (2) one-pole, or (4) one pole breakers. **One 2" hub included.**

Utility requirements for this equipment may vary. Always consult the serving utility for their requirements before ordering or installing equipment in this catalog.



U5059-X-2/200

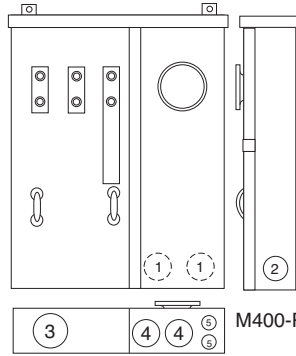
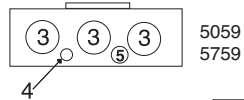
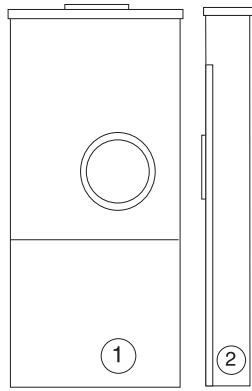

M400-PAR-UG

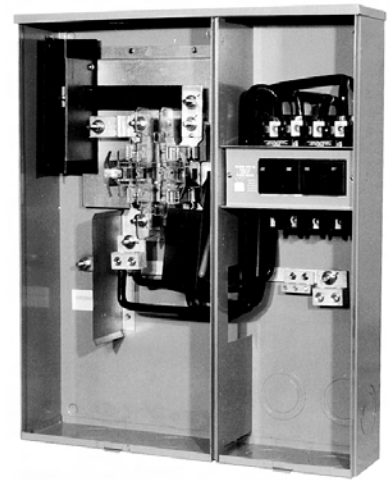

U4031-O-2/200

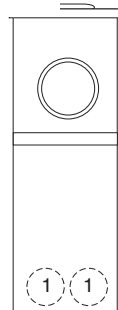

M400-PAR

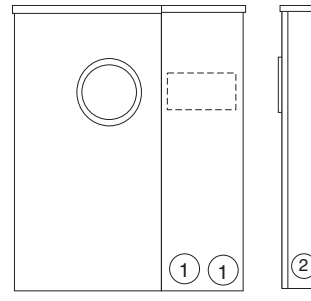

4031

4 TERMINAL—1Ø3W—RINGLESS / 22K AIC

SERV.	CATALOG NUMBER	PRIMARY DISCONNECT	SECONDARY DISCONNECT	BY-PASS	DIMENSIONS			CONCENTRIC K.O.'S				
					D"	W"	H"	1	2	3	4	5
OH	M400-PAR ①②③	200 Amp / 2 Pole Circuit Breaker	See note ①	LEVER	6 ¹ / ₈	9 ¹ / ₂	47 ¹ / ₈	2	2	2	1 ¹ / ₂	1 ¹ / ₂ , 3 ³ / ₄
UG	M400-PAR-UG**①	200 Amp / 2 Pole Circuit Breaker	See note ①	LEVER	6 ¹ / ₈	22 ¹ / ₈	36	2 ¹ / ₂	2 ¹ / ₂	4	2 ¹ / ₂	1 ¹ / ₂ , 3 ³ / ₄
UG	U4031-O-2/200 ④	200 Amp / 2 Pole Circuit Breaker	200 Amp / 2 Pole Circuit Breaker	LEVER	5 ³ / ₄	25	30	3	3	4	3	1 ¹ / ₄ , 1 ¹ / ₂
OH/UG	U5059-X-2/200 ④	200 Amp / 2 Pole Circuit Breaker	200 Amp / 2 Pole Circuit Breaker	LEVER	4 ⁷ / ₈	15	42	3	3	3	1 ¹ / ₄	1 ¹ / ₄ , 1 ¹ / ₂
OH/UG	U5759-X-2/200*④	200 Amp / 2 Pole Circuit Breaker	200 Amp / 2 Pole Circuit Breaker	NONE	4 ⁷ / ₈	15	42	3	3	3	1 ¹ / ₄	1 ¹ / ₄ , 1 ¹ / ₂

NEUTRAL: Bonded neutral and ground factory Installed.

FLUSH MOUNT: Flush mounting available on underground units. Order catalog number **FK-M400-UG** separately.

SHORT CIRCUIT CURRENT WITHSTAND RATING: 22K AIC Standard.

BYPASS: Lever supplies clamping action and operates bypass device.

FIFTH TERMINAL: For field installed fifth terminal for the **U5059** & **U5759**, order separately catalog number **K3866**.

CONVERSION KIT: To field convert **M400** UG units to OH, order **K4787-R**. Includes connectors (#2-600).

① 200 amp primary disconnect factory installed. Order secondary disconnect separately. Specify **UQFPH-100, 125, 150, 175** or **200**.

② **OVERHEAD:** Includes one 3" hub.

③ Provided with connectors for #4-600 or twin 1/0-250.

④ **LINE SIDE CONNECTOR KITS:** Two 1/2" studs per phase on 1 3/4" centers. Factory installed for the **U5759**, for the **U5059** order anti-rotation connector kit **K1540L** to accommodate #4-600 kcmil single or **K1350L** for twin 350 kcmil connectors.

*Lever supplies clamping action only—does NOT operate bypass on the **U5759**.

****LUG KIT:** Mechanical lug kit available for M400-APS-UG, order **K4920** (#2-500).

Utility requirements for this equipment may vary. Always consult the serving utility for their requirements before ordering or installing equipment in this catalog.



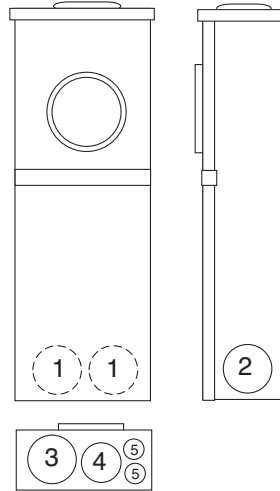

M400-APS-BS

4 TERMINAL—1Ø3W—TYPE 3R—RING TYPE — 120/240 VAC

SERV	CATALOG NUMBER	PRIMARY DISCONNECT	SECONDARY DISCONNECT	BY-PASS	DIMENSIONS			CONCENTRIC K.O.'S					
					D"	W"	H"	1	2	3	4	5	6
OH	M400-APS	200 Amp / 2 Pole Circuit Breaker	See note ①	NONE	6 ¹ / ₈	9 ¹ / ₂	47 ¹ / ₈	2	2	2	1 ¹ / ₂	1 ¹ / ₂ , 3 ³ / ₄	—
OH	M400-APS-BS	200 Amp / 2 Pole Circuit Breaker	See note ①	LINK	6	11 ¹ / ₂	47	1-2 ¹ / ₂	2-2 ¹ / ₂	3-3	4-3	5 ¹ / ₂	3 ³ / ₄

EUSERC: Meets EUSERC requirements. Consult local utility for acceptability before ordering or installing.

NEUTRAL: Bonded neutral and ground factory Installed.

LINE SIDE CONNECTORS: Connectors provided for 4-600 or twin 1/0-250.

OVERHEAD: Overhead units include one 3" hub.

① 200 amp primary disconnect factory installed. Order secondary disconnect separately. Specify **UQFPH-100, 125, 150, 175 or 200.**

Utility requirements for this equipment may vary. Always consult the serving utility for their requirements before ordering or installing equipment in this catalog.

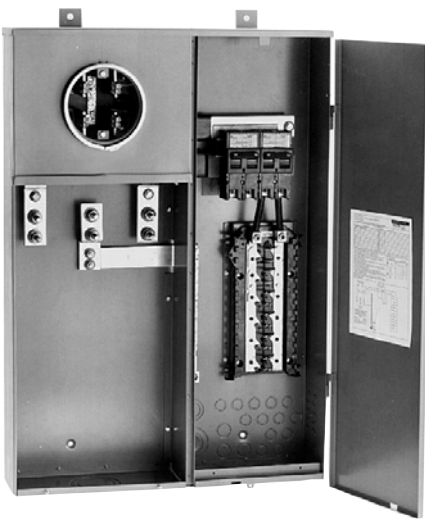

M400-UG-APS-LC
(see next page for dwg. & chart)

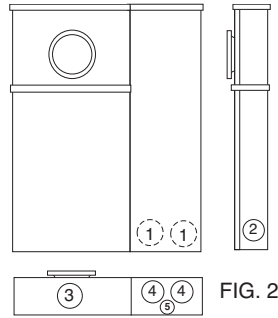
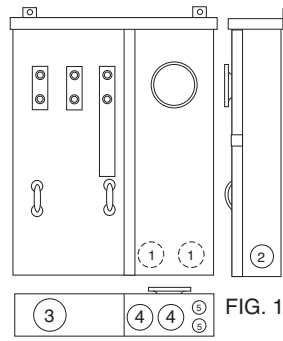

U3251-O-200-CB

4 TERMINAL—1Ø3W—TYPE 3R—RING TYPE PLUG-IN SOCKETS—120/240 VAC

SERV	CATALOG NUMBER	PRIMARY DISCONNECT	SECONDARY DISCONNECT	BY-PASS	DIMENSIONS			CONCENTRIC K.O.'S					FIG.
					D"	W"	H"	1	2	3	4	5	
UG	M400-UG-APS-F ①	200 Amp / 2 Pole Circuit Breaker	See note ①	NONE	6 ¹ / ₈	22 ¹ / ₈	36	2 ¹ / ₂	2 ¹ / ₂	4	2 ¹ / ₂	1 ¹ / ₂ , 3 ³ / ₄	1
UG	M400-UG-APS-F-BS ①	200 Amp / 2 Pole Circuit Breaker	See note ①	LINK	6	29	41 ⁷ / ₁₆	1 ¹ / ₂	2 ¹ / ₂	4	3 ³ / ₄	1	—
UG	M400-UG-APS-P ②	200 Amp 2 Pole—T-Fuse	200 Amp 2 Pole—T-Fuse	NONE	6 ¹ / ₈	22 ¹ / ₈	36	2 ¹ / ₂	2 ¹ / ₂	4	2 ¹ / ₂	1 ¹ / ₂ , 3 ³ / ₄	1
UG	M400-UG-APS-LC ④	200 Amp / 2 Pole Circuit Breaker	200 Amp / 2 Pole Circuit Breaker	NONE	6	29	41 ⁷ / ₁₆	1 ¹ / ₂	2 ¹ / ₂	4	3 ³ / ₄	1	—
UG	M400-UG-APS-LC-BS ④	200 Amp / 2 Pole Circuit Breaker	200 Amp / 2 Pole Circuit Breaker	LINK	6	29	41 ⁷ / ₁₆	1 ¹ / ₂	2 ¹ / ₂	4	3 ³ / ₄	1	—
UG	U3251-O-200-CB ③	200 Amp / 2 Pole Circuit Breaker	200 Amp / 2 Pole Circuit Breaker	LINK	6 ³ / ₄	24	40 ¹ / ₄	3	3	4	3	1 ¹ / ₂ , 3 ³ / ₄	2

EUSERC: Meets EUSERC requirements. Consult local utility for acceptability before ordering or installing.

NEUTRAL: Bonded neutral and ground factory Installed.

LINE SIDE CONNECTORS: Two 1/2" studs per phase on 1 3/4" centers.

LOAD SIDE CONNECTORS: 1/0-300

FLUSH MOUNT: Flush mount kit included with M400-UG-APS-F, M400-UG-APS-BS, M400-UG-APS-LC and M400-UG-APS-LC-BS. Available for other underground units. Order catalog number FK-M400-UG separately.

SHORT CIRCUIT CURRENT WITHSTAND RATING: 22K AIC standard, 200K AIC standard on T-fuse models.

LUG KIT: Mechanical lug kit available, order K4920 (#2-500).

CONVERSION KIT: To field convert M400 UG units to OH, order K4787-R. Includes connectors (#2-600).

① 200 amp primary disconnect factory installed. Order secondary disconnect separately. Specify UQFPH-100, 125, 150, 175 or 200.

② Two 200 amp T-fuse pull-outs factory installed as primary and secondary disconnects.

③ Two 200 amp 2-pole bolt-on UQFBH main breakers factory installed.

④ **BREAKERS:** Two 200 Amp 2-pole main breakers factory installed, and semi-flush flange kit packed inside meter section. Universal Copper 24/40 Circuit interior accepts Challenger, GE, Murraray, Siemens / ITE, and Cutler-Hammer / Westinghouse universal type plug-in branch circuit breakers.

Utility requirements for this equipment may vary. Always consult the serving utility for their requirements before ordering or installing equipment in this catalog.



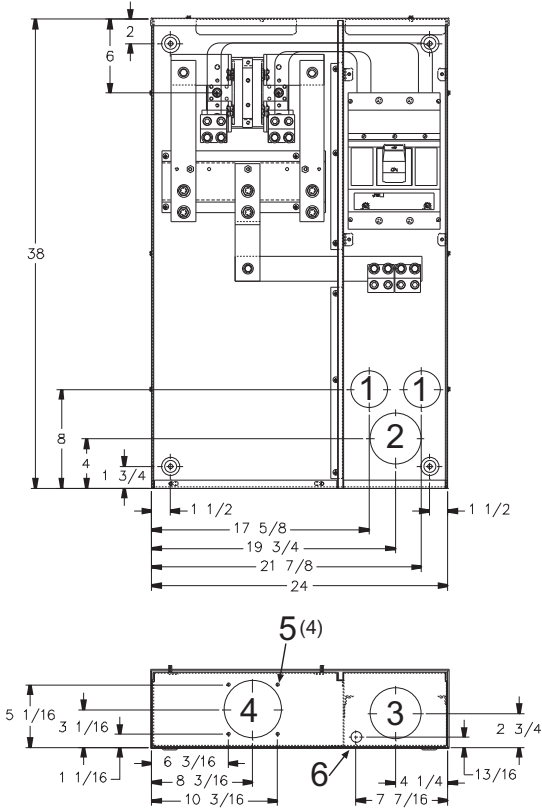

M401-UG

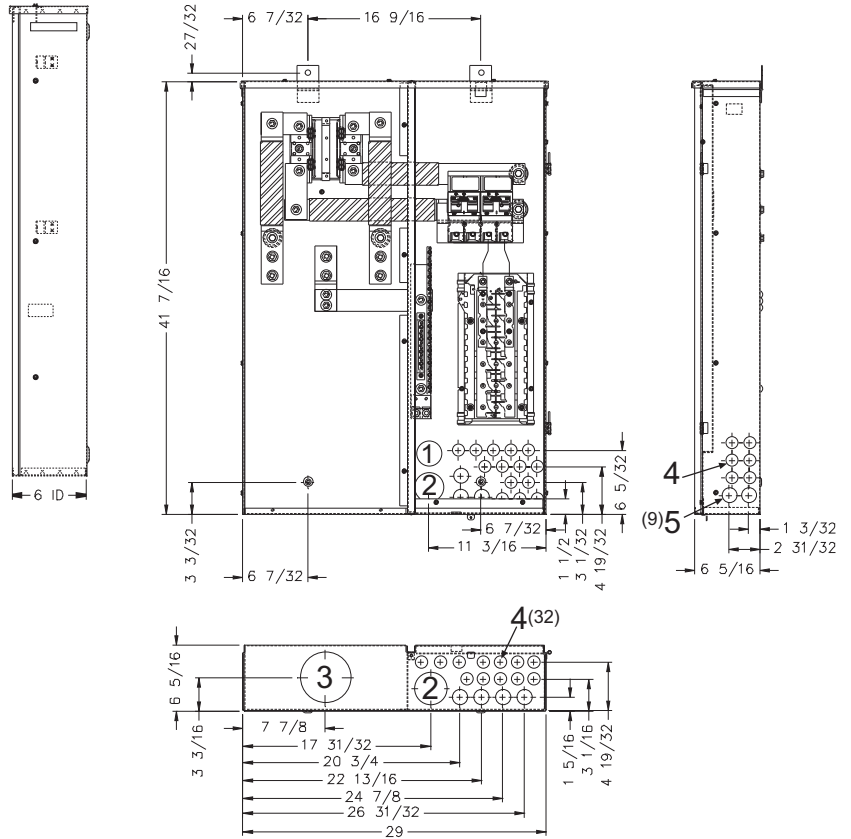

M400-UG-APS-LC
(see previous page for details)

400 AMP MAIN BREAKER—4 TERMINAL—1Ø3W—TYPE 3R—RING TYPE—120/240 VAC

SERV.	CATALOG NUMBER	MAIN DISCONNECT	CONNECTORS CU/AL		BY-PASS	DIMENSIONS			CONCENTRIC K.O.'S					
			LINE	LOAD		D"	W"	H"	1	2	3	4	5	6
UG	M401-UG	(1) 400 AMP 2 POLE BREAKER	STUDS	C.B.ⓐ	NONE	6	24	38	2 1/2	3 1/2	3 1/2	4	1/4	1/2
UG	M401-UG-BS	(1) 400 AMP 2 POLE BREAKER	STUDS	C.B.ⓐ	LINK	6	24	38	2 1/2	3 1/2	3 1/2	4	1/4	1/2

EUSERC: Meets EUSERC requirements. Consult local utility for acceptability before ordering or installing.

NEUTRAL: Bonded neutral and ground factory installed.

LINE SIDE CONNECTORS: Two 1/2" studs per phase on 1-3/4" centers.

LUG KIT: Mechanical lug kit available, order **K4920** (#2-500).

FLUSH MOUNT: Flush mount kits are NOT available for these units.

SHORT CIRCUIT CURRENT WITHSTAND RATING: 22K AIC standard.

ⓐ CB load side (1) or (2) copper conductors 3/0-500, (2) aluminum conductors 4/0-500 or (1) aluminum conductor 250-500.

SECTION C
METER MAINS AND SERVICE ENTRANCE EQUIPMENT

Utility requirements for this equipment may vary. Always consult the serving utility for their requirements before ordering or installing equipment in this catalog.



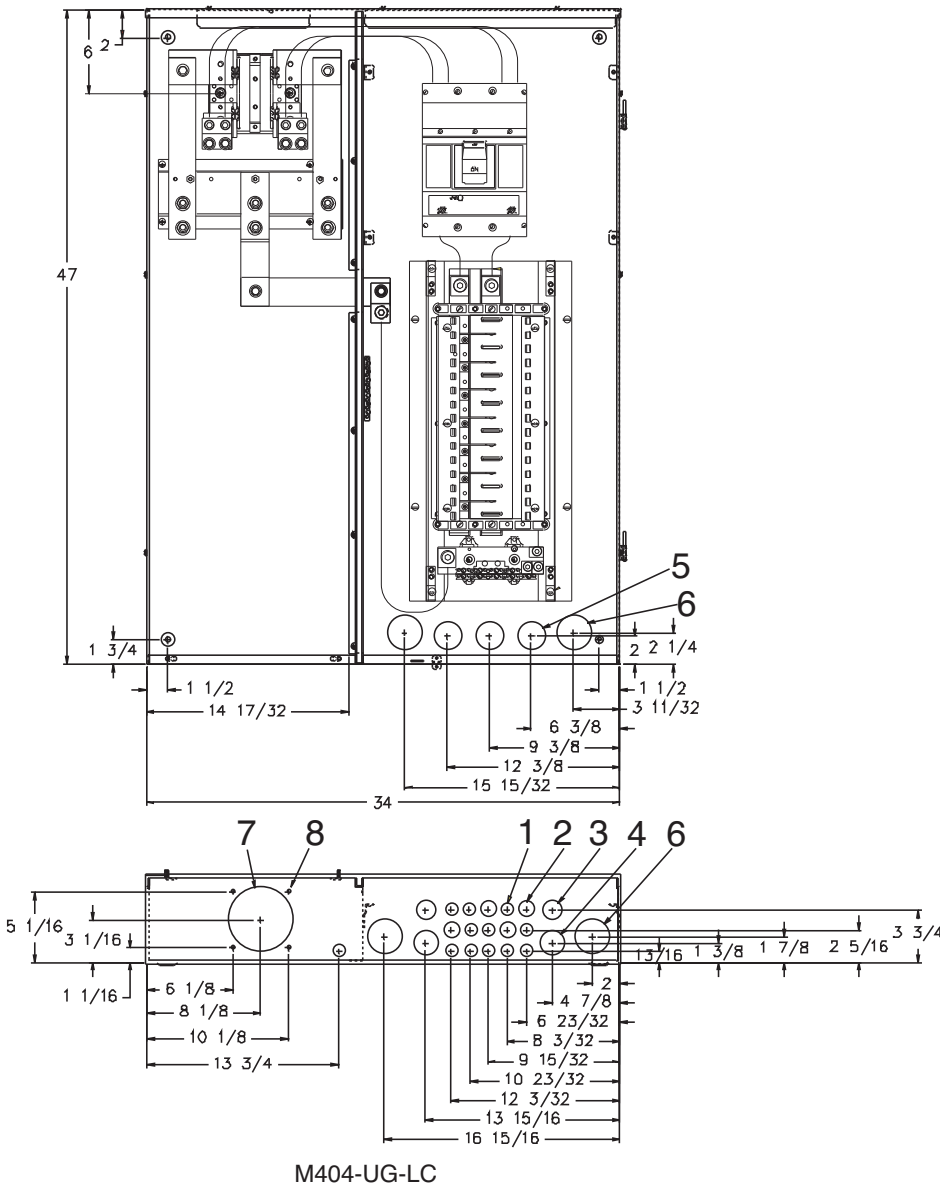

CONCENTRIC K.O.'S	
1=	(12) 1/2" K.O.
2=	(4) 1/2, 3/4
3=	(4) 3/4, 1"
4=	(2) 1/2, 3/4, 1, 1 1/4"
5=	(3) 3/4, 1, 1 1/4, 1 1/2"
6=	(4) 1, 1 1/4, 1 1/2, 2"
7=	(1) 3, 3 1/2, 4"
8=	(4) 1/4 diameter hole

M404-UG-LC
400 AMP MAIN WITH CIRCUIT LOAD CENTER—4 TERMINAL—1Ø3W
RING TYPE—120/240 VAC

SERV.	CATALOG NUMBER	PRIMARY DISCONNECT	SECONDARY DISCONNECT	BY-PASS	DIMENSIONS			CONCENTRIC K.O.'S							
					D"	W"	H"	1	2	3	4	5	6	7	8
UG	M404-UG-LC*	400 AMP 2 POLE BREAKER	N/A	NONE	6	34	47	1/2	1/2, 3/4	1	1 1/4	1 1/2	2	4	1/4
UG	M404-UG-LC-BS*	400 AMP 2 POLE BREAKER	N/A	LINK	6	34	47	1/2	1/2, 3/4	1	1 1/4	1 1/2	2	4	1/4

- EUSERC:** Meets EUSERC requirements. Consult local utility for acceptability before ordering or installing.
- NEUTRAL:** Bonded neutral and ground factory installed.
- LINE SIDE CONNECTORS:** (2) 1/2" studs per phase on 1-3/4" centers.
- LUG KIT:** Mechanical lug kit available, order **K4920** (#2-500).
- FLUSH MOUNT:** Flush mounting available on underground units. Order catalog number **FK-M404-UGLC** separately.
- SHORT CIRCUIT CURRENT WITHSTAND RATING:** 22K AIC standard.
- BRANCH BREAKERS:** Use Siemens, Cutler-Hammer, GE or Siemens/Murray breakers to maintain 22K rating.
- * Includes a 30-circuit load center.

Utility requirements for this equipment may vary. Always consult the serving utility for their requirements before ordering or installing equipment in this catalog.



These UL Listed products are for use in areas requiring Electrical Utility Service Equipment Requirements Committee (EUSERC) compliance.

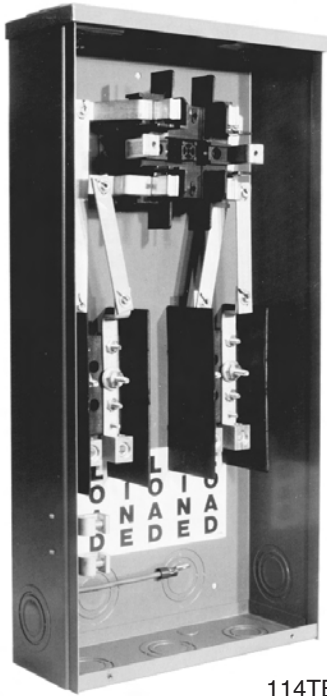

114TB

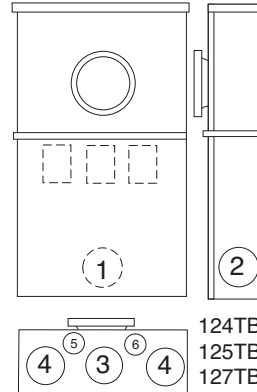
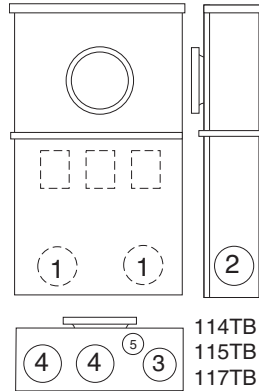

127TB

100 AMP—4, 5 & 7 TERMINAL— FOR USE WITH REMOTE MAIN—RING TYPE

NO. OF TERM.	TYPE OF SERVICE	CATALOG NUMBER	CONNECTORS CU/AL	TYPE OF SERVICE	DIMENSIONS			CONCENTRIC K.O.'S					
			LINE & LOAD		D"	W"	H"	1	2	3	4	5	6
4	OH/UG	114TB*	#6-1/0	1Ø3W *	4 ⁵ / ₈	12	25	2	2	1½	2	½	—
5	OH/UG	115TB	#6-1/0	3Ø3W	4 ⁵ / ₈	12	25	2	2	1½	2	½	—
7	OH/UG	117TB	#6-1/0	3Ø4W	4 ⁵ / ₈	12	25	2	2	1½	2	½	—

200 AMP—4, 5 & 7 TERMINAL—FOR USE WITH REMOTE MAIN—RING TYPE

NO. OF TERM.	TYPE OF SERVICE	CATALOG NUMBER	CONNECTORS CU/AL	TYPE OF SERVICE	DIMENSIONS			CONCENTRIC K.O.'S					
			LINE & LOAD		D"	W"	H"	1	2	3	4	5	6
4	OH/UG	124TB*	#1/0-250	1Ø3W *	6	14	30	2½	2½	3	3	9/32	½
5	OH/UG	125TB	#1/0-250	3Ø3W	6	14	30	2½	2½	3	3	9/32	½
7	OH/UG	127TB	#1/0-250	3Ø4W	6	14	30	2½	2½	3	3	9/32	½

HUBS: OH units use hub up to 2½" (see accessory page). Units provided with closing plates.

SEALING RINGS: Units furnished with MR-2 snap style sealing rings.

NEUTRAL: "Lay-in" connectors will accommodate #6-2/0 (for 100 amp units) and #2-250 (for 200 amp units) copper or aluminum wire.

RING PROTECTOR: Add suffix -RP to catalog number for factory installed ring protector (ex. 117TB becomes 117TB-RP).

* For 3W (208Y/120) network service, install field mounted fifth terminal catalog number 105J. See accessories page.

SHORT CIRCUIT CURRENT WITHSTAND RATING UP TO 200K AIC DEPENDING ON OVERCURRENT PROTECTION DEVICE USED

Utility requirements for this equipment may vary. Always consult the serving utility for their requirements before ordering or installing equipment in this catalog.

These UL Listed products are for use in areas requiring Electrical Utility Service Equipment Requirements Committee (EUSERC) compliance.

SECTION D
COMMERCIAL METERING—SAFETY SOCKETS, METER MAINS, TERMINATION BOXES, BUSSED GUTTERS

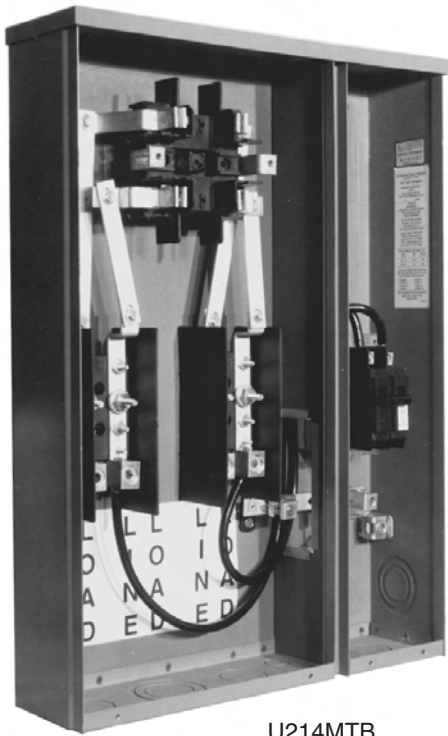

U214MTB

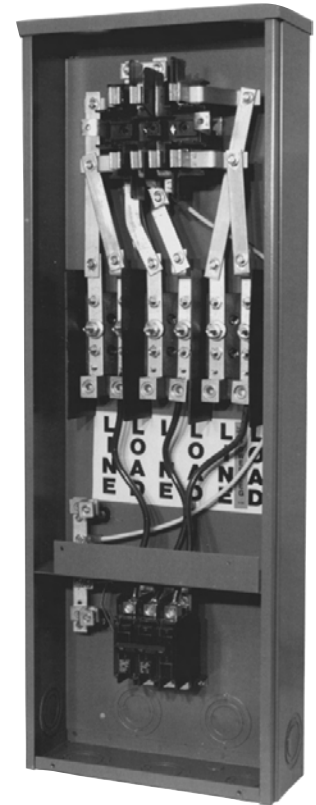
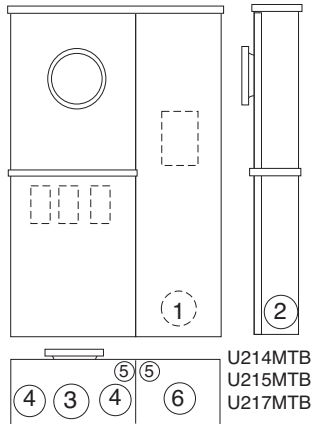

217MTB

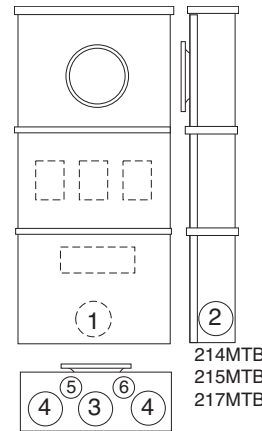

100 AMP—4, 5, & 7 TERMINAL—240 VOLT—BREAKER INSTALLED—RING TYPE

NO. OF TERM.	TYPE OF SERVICE	CATALOG NUMBER	CONNECTORS		TYPE OF SERVICE	DIMENSIONS			CONCENTRIC K.O.'S					
			LINE	LOAD NEUTRAL		D"	W"	H"	1	2	3	4	5	6
4	OH	214MTB*	#6-2/0	#14-1/0	1Ø3W *	4 ⁵ / ₈	12	34	2	2	2	1 ¹ / ₂	9 ³ / ₃₂	1 ¹ / ₂
5	OH	215MTB	#6-2/0	#14-1/0	3Ø3W	4 ⁵ / ₈	12	34	2	2	2	1 ¹ / ₂	9 ³ / ₃₂	1 ¹ / ₂
7	OH	217MTB	#6-2/0	#14-1/0	3Ø4W	4 ⁵ / ₈	12	34	2	2	2	1 ¹ / ₂	9 ³ / ₃₂	1 ¹ / ₂
4	OH/UG	U214MTB*	#6-2/0	#14-1/0	1Ø3W *	4 ⁵ / ₈	18	25	2	2	2 ¹ / ₂	2	3 ³ / ₄	2
5	OH/UG	U215MTB	#6-2/0	#14-1/0	3Ø3W	4 ⁵ / ₈	18	25	2	2	2 ¹ / ₂	2	3 ³ / ₄	2
7	OH/UG	U217MTB	#6-2/0	#14-1/0	3Ø4W	4 ⁵ / ₈	18	25	2	2	2 ¹ / ₂	2	3 ³ / ₄	2

REPLACEMENT MAIN DISCONNECTS: For replacement main disconnect see pages D14 & D15.

HUBS: OH units use hub up to 2¹/₂" (see accessory page). Units provided with closing plate.

SEALING RINGS: Units furnished with MR-2 snap style sealing rings.

NEUTRAL: "Lay-in" connectors will accommodate #6-2/0 (for 100 amp units) and #2-250 (for 200 amp units) copper or aluminum wire.

* For 3W (208Y/120) network service, install field mounted fifth terminal catalog number 105J. See accessories page.



These UL Listed products are for use in areas requiring Electrical Utility Service Equipment Requirements Committee (EUSERC) compliance.

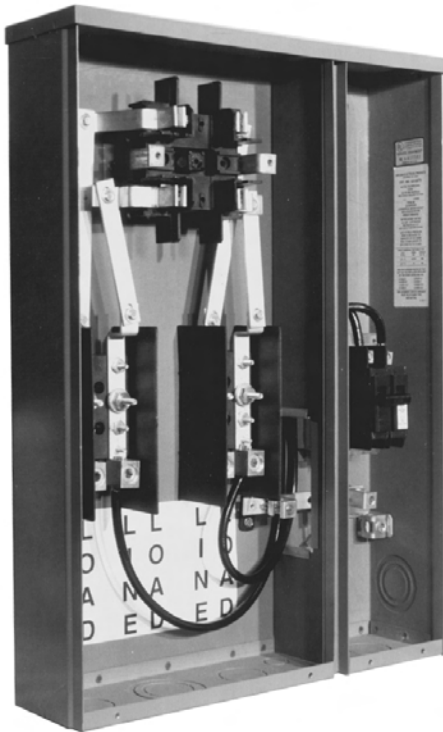

U214MTB/22

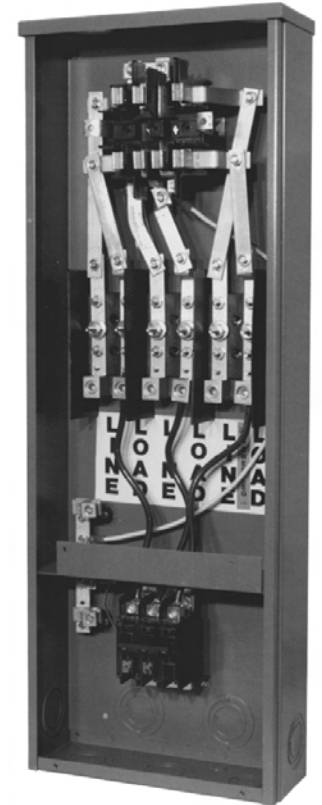

217MTB/22

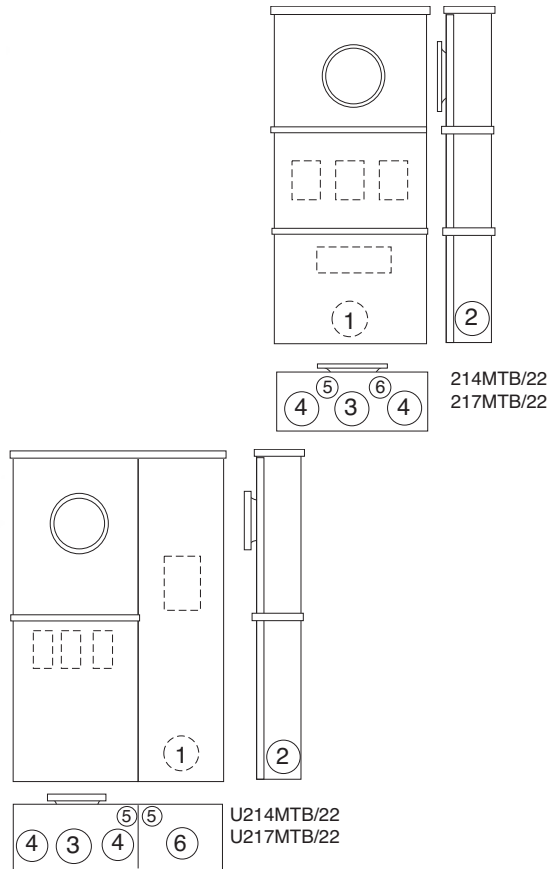

100 AMP—4 & 7 TERMINAL—240 VOLT—BREAKER INSTALLED—RING TYPE

NO. OF TERM.	TYPE OF SERVICE	CATALOG NUMBER	CONNECTORS		TYPE OF SERVICE	DIMENSIONS			CONCENTRIC K.O.'S					
			LINE	LOAD NEUTRAL		D"	W"	H"	1	2	3	4	5	6
4	OH	214MTB/22*	#6-2/0	#14-1/0	1Ø3W *	4 ⁵ / ₈	12	34	2	2	2	1 ¹ / ₂	9 ³ / ₃₂	1 ¹ / ₂
7	OH	217MTB/22	#6-2/0	#14-1/0	3Ø4W	4 ⁵ / ₈	12	34	2	2	2	1 ¹ / ₂	9 ³ / ₃₂	1 ¹ / ₂
4	OH/UG	U214MTB/22*	#6-2/0	#14-1/0	1Ø3W *	4 ⁵ / ₈	18	25	2	2	2 ¹ / ₂	2	3 ³ / ₄	2
7	OH/UG	U217MTB/22	#6-2/0	#14-1/0	3Ø4W	4 ⁵ / ₈	18	25	2	2	2 ¹ / ₂	2	3 ³ / ₄	2

REPLACEMENT MAIN DISCONNECTS: For replacement main disconnect see pages D14 & D15.

* For 3W (208Y/120) network service, install field mounted fifth terminal catalog number 105J. See accessories page.

HUBS: OH units use hub up to 2¹/₂" (see accessory page). Units provided with closing plate.

SEALING RINGS: Units furnished with MR-2 snap style sealing rings.

NEUTRAL: "Lay-in" connectors will accommodate #6-2/0 (for 100 amp units) and #2-250 (for 200 amp units) copper or aluminum wire.

SECTION D
COMMERCIAL METERING—SAFETY SOCKETS, METER MAINS, TERMINATION BOXES, BUSSED CUTTERS

Utility requirements for this equipment may vary. Always consult the serving utility for their requirements before ordering or installing equipment in this catalog.

These UL Listed products are for use in areas requiring Electrical Utility Service Equipment Requirements Committee (EUSERC) compliance.

SECTION D
COMMERCIAL METERING—SAFETY SOCKETS, METER MAINS, TERMINATION BOXES, BUSSED GUTTERS

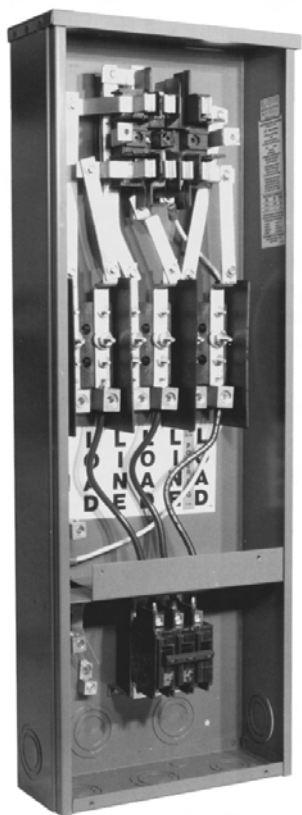

217MTB-48

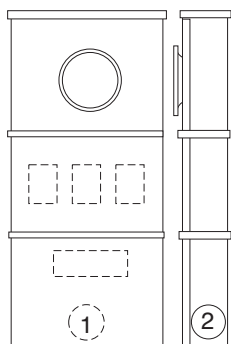

214MTB-48
215MTB-48
217MTB-48

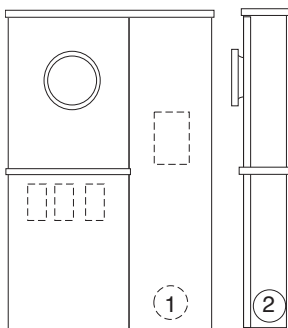

U214MTB-48
U215MTB-48
U217MTB-48

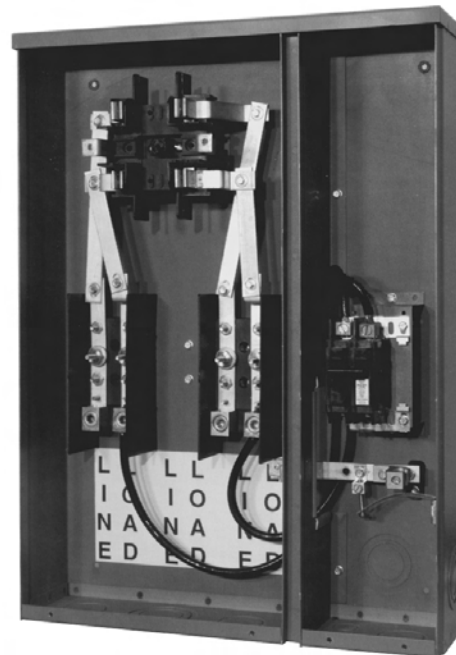

U214MTB-48

100 AMP—4, 5 & 7 TERMINAL—480 VOLT—BREAKER INSTALLED—RING TYPE

NO. OF TERM.	TYPE OF SERVICE	CATALOG NUMBER	CONNECTORS		TYPE OF SERVICE	DIMENSIONS			CONCENTRIC K.O.'S					
			LINE	LOAD NEUTRAL		D"	W"	H"	1	2	3	4	5	6
4	OH	214MTB-48*	#6-250	#14-1/0	1Ø3W	6	14	48	2½	2½	3	3	9/32	1/2
5	OH	215MTB-48	#6-250	#14-1/0	3Ø3W	6	14	48	2½	2½	3	3	9/32	1/2
7	OH	217MTB-48	#6-250	#14-1/0	3Ø4W	6	14	48	2½	2½	3	3	9/32	1/2
4	OH/UG	U214MTB-48*	#6-250	#14-1/0	1Ø3W	4 ⁵ / ₈	18	25	2	2	2½	2	3/4	2
5	OH/UG	U215MTB-48	#6-250	#14-1/0	3Ø3W	4 ⁵ / ₈	18	25	2	2	2½	2	3/4	2
7	OH/UG	U217MTB-48	#6-250	#14-1/0	3Ø4W	4 ⁵ / ₈	18	25	2	2	2½	2	3/4	2

REPLACEMENT MAIN DISCONNECTS: For replacement main disconnect see pages D14 & D15.

HUBS: OH units use hub up to 2½" (see accessory page.) Units provided with closing plate.

SEALING RINGS: Units furnished with MR-2 snap style sealing rings.

NEUTRAL: "Lay-in" connectors will accommodate #6-2/0 aluminum wire.

* For 3W (208Y/120) network service, install field mounted fifth terminal catalog number 105J. See accessory page.



These UL Listed products are for use in areas requiring Electrical Utility Service Equipment Requirements Committee (EUSERC) compliance.

200K Short Circuit Current Withstand Rating



214MTB-P

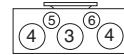
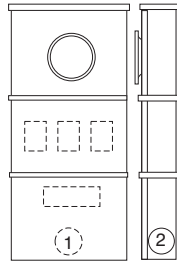

- 214MTB-P
- 215MTB-P
- 217MTB-P
- 214MTB-P48
- 215MTB-P48
- 217MTB-P48

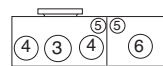
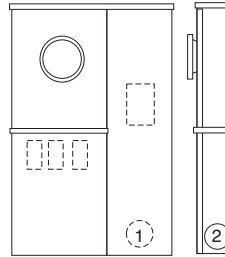

- U214MTB-P
- U215MTB-P
- U217MTB-P
- U214MTB-P48
- U215MTB-P48
- U217MTB-P48

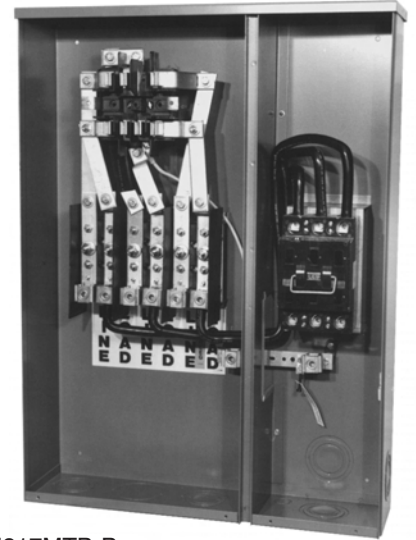

U217MTB-P

100 AMP—4, 5, & 7 TERMINAL—240 VOLT—PULL-OUT INSTALLED—RING TYPE

NO. OF TERM.	TYPE OF SERVICE	CATALOG NUMBER	CONNECTORS		TYPE OF SERVICE	DIMENSIONS			CONCENTRIC K.O.'S					
			LINE	LOAD NEUTRAL		D"	W"	H"	1	2	3	4	5	6
4	OH	214MTB-P*	#1/0-250	#14-1/0	1Ø3W *	6	14	48	2½	2½	3	3	9/32	1/2
5	OH	215MTB-P	#1/0-250	#14-1/0	3Ø3W	6	14	48	2½	2½	3	3	9/32	1/2
7	OH	217MTB-P	#1/0-250	#14-1/0	3Ø4W	6	14	48	2½	2½	3	3	9/32	1/2
4	OH/UG	U214MTB-P*	#6-2/0	#14-1/0	1Ø3W *	4 ⁵ / ₈	18	25	2	2	2½	2	3/4	2
5	OH/UG	U215MTB-P	#6-2/0	#14-1/0	3Ø3W	4 ⁵ / ₈	18	25	2	2	2½	2	3/4	2
7	OH/UG	U217MTB-P	#6-2/0	#14-1/0	3Ø4W	4 ⁵ / ₈	18	25	2	2	2½	2	3/4	2

100 AMP—4, 5, & 7 TERMINAL—480 VOLT—PULL-OUT INSTALLED—RING TYPE

NO. OF TERM.	TYPE OF SERVICE	CATALOG NUMBER	CONNECTORS		TYPE OF SERVICE	DIMENSIONS			CONCENTRIC K.O.'S					
			LINE	LOAD NEUTRAL		D"	W"	H"	1	2	3	4	5	6
4	OH	214MTB-P48*	#6-250	#14-1/0	1Ø3W *	6	14	48	2½	2½	3	3	9/32	1/2
5	OH	215MTB-P48	#6-250	#14-1/0	3Ø3W	6	14	48	2½	2½	3	3	9/32	1/2
7	OH	217MTB-P48	#6-250	#14-1/0	3Ø4W	6	14	48	2½	2½	3	3	9/32	1/2
4	OH/UG	U214MTB-P48*	#6-250	#14-1/0	1Ø3W *	4 ⁵ / ₈	18	25	2	2	2½	2	3/4	2
5	OH/UG	U215MTB-P48	#6-250	#14-1/0	3Ø3W	4 ⁵ / ₈	18	25	2	2	2½	2	3/4	2
7	OH/UG	U217MTB-P48	#6-250	#14-1/0	3Ø4W	4 ⁵ / ₈	18	25	2	2	2½	2	3/4	2

REPLACEMENT MAIN DISCONNECTS: For replacement main disconnect see pages D14 & D15.

* For 3W (208Y/120) network service, install field mounted fifth terminal catalog number 105J. See accessory page.

HUBS: OH units use hub up to 2½" (see accessory page). Units provided with closing plate.

SEALING RINGS: Units furnished with MR-2 snap style sealing rings.

NEUTRAL: "Lay-in" connectors will accommodate #6-2/0 aluminum wire.

PULL-OUTS: For use with T-fuses only. Fuses are included with fused safety sockets.

Utility requirements for this equipment may vary. Always consult the serving utility for their requirements before ordering or installing equipment in this catalog.

These UL Listed products are for use in areas requiring Electrical Utility Service Equipment Requirements Committee (EUSERC) compliance.

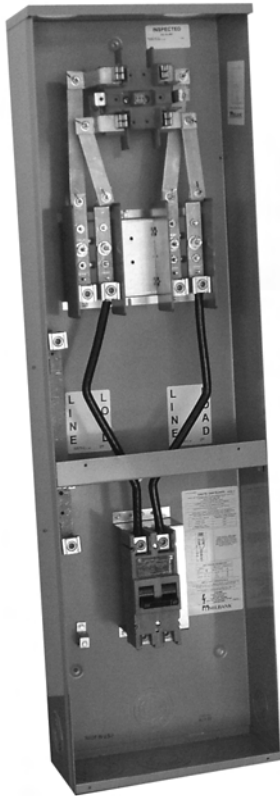

224MTB

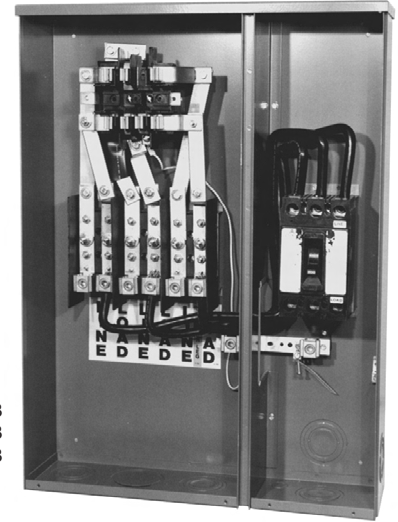
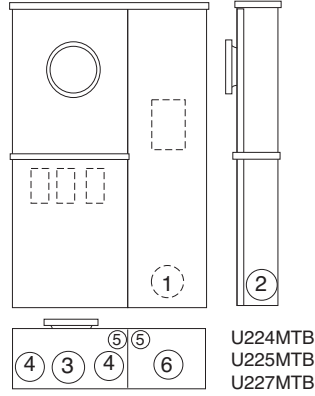
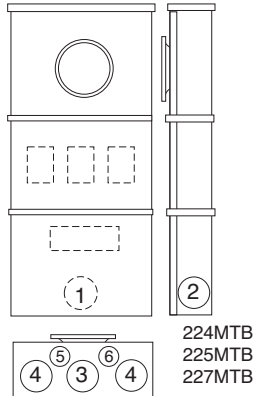

U227MTB

200 AMP—4, 5 & 7 TERMINAL—240 VOLT—BREAKER INSTALLED—RING TYPE

NO. OF TERM.	TYPE OF SERVICE	CATALOG NUMBER	CONNECTORS		TYPE OF SERVICE	DIMENSIONS			CONCENTRIC K.O.'S					
			LINE	LOAD NEUTRAL		D"	W"	H"	1	2	3	4	5	6
4	OH	224MTB*	#6-250	#2/0-250	1Ø3W *	6	14	48	2½	2½	3	3	9/32	1/2
5	OH	225MTB	#6-250	#2/0-250	3Ø3W	6	14	48	2½	2½	3	3	9/32	1/2
7	OH	227MTB	#6-250	#2/0-250	3Ø4W	6	14	48	2½	2½	3	3	9/32	1/2
4	OH/UG	U224MTB*	#6-250	#2/0-250	1Ø3W *	6	22¾	30	2½	2½	3	2½	¾	2½
5	OH/UG	U225MTB	#6-250	#2/0-250	3Ø3W	6	22¾	30	2½	2½	3	2½	¾	2½
7	OH/UG	U227MTB	#6-250	#2/0-250	3Ø4W	6	22¾	30	2½	2½	3	2½	¾	2½

REPLACEMENT MAIN DISCONNECTS: For replacement main disconnect see pages D14 & D15.

HUBS: OH units use hub up to 2½" (see accessory page). Units provided with closing plate.

SEALING RINGS: Units furnished with MR-2 snap stye sealing rings.

NEUTRAL: "Lay-in" connectors will accommodate #2-250 copper or aluminum wire.

*For 3W (208Y/120) network service, install field mounted fifth terminal catalog number 105J. See accessory page.

SECTION D
COMMERCIAL METERING—SAFETY SOCKETS, METER MAINS,
TERMINATION BOXES, BUSSED GUTTERS



These UL Listed products are for use in areas requiring Electrical Utility Service Equipment Requirements Committee (EUSERC) compliance.

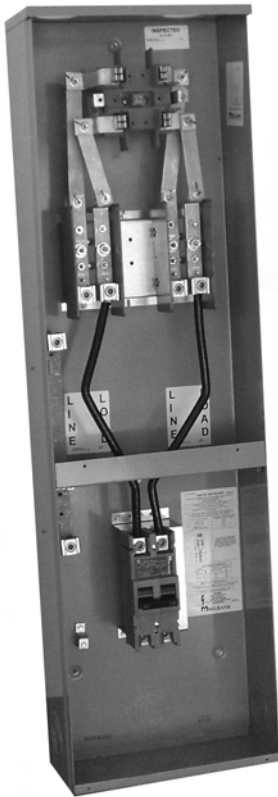

224MTB/22

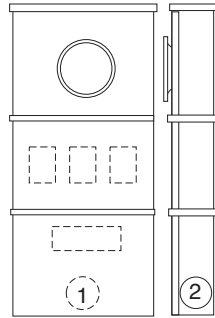

224MTB/22
227MTB/22

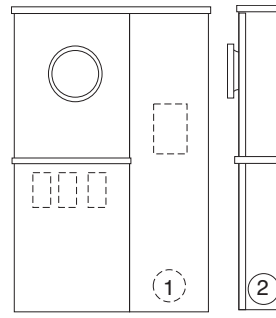

U224MTB/22
U227MTB/22

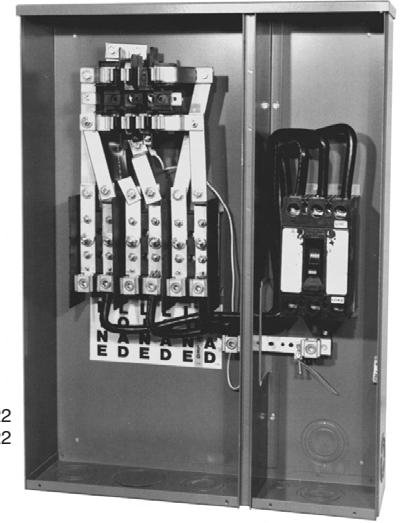

U227MTB/22

200 AMP—4 & 7 TERMINAL—240 VOLT—BREAKER INSTALLED—RING TYPE

NO. OF TERM.	TYPE OF SERVICE	CATALOG NUMBER	CONNECTORS		TYPE OF SERVICE	DIMENSIONS			CONCENTRIC K.O.'S					
			LINE	LOAD NEUTRAL		D"	W"	H"	1	2	3	4	5	6
4	OH	224MTB/22*	#6-250	#2/0-250	1Ø3W *	6	14	48	2½	2½	3	3	9/32	1/2
7	OH	227MTB/22	#6-250	#2/0-250	3Ø4W	6	14	48	2½	2½	3	3	9/32	1/2
4	OH/UG	U224MTB/22*	#6-250	#2/0-250	1Ø3W *	6	22¾	30	2½	2½	3	2½	¾	2½
7	OH/UG	U227MTB/22	#6-250	#2/0-250	3Ø4W	6	22¾	30	2½	2½	3	2½	¾	2½

REPLACEMENT MAIN DISCONNECTS: For replacement main disconnect see pages D14 & D15.

HUBS: OH units use hub up to 2½" (see accessory page). Units provided with closing plate.

SEALING RINGS: Units furnished with MR-2 snap style sealing rings.

NEUTRAL: "Lay-in" connectors will accommodate #2-250 copper or aluminum wire.

*For 3W (208Y/120) network service, install field mounted fifth terminal catalog number 105J. See accessory page.

SECTION D
COMMERCIAL METERING—SAFETY SOCKETS, METER MAINS,
TERMINATION BOXES, BUSSED CUTTERS

Utility requirements for this equipment may vary. Always consult the serving utility for their requirements before ordering or installing equipment in this catalog.

These UL Listed products are for use in areas requiring Electrical Utility Service Equipment Requirements Committee (EUSERC) compliance.

35K Short Circuit Current Withstand Rating

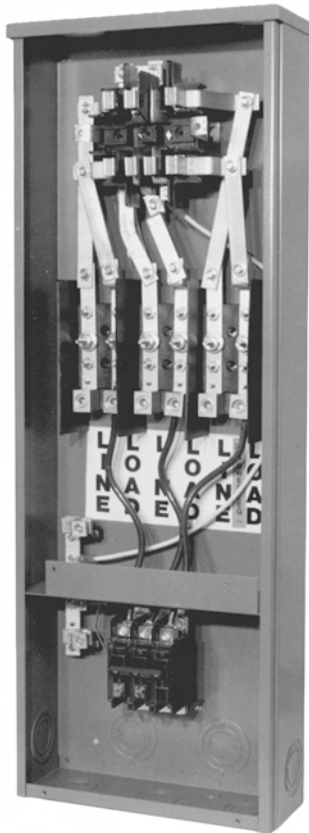

227MTB-48

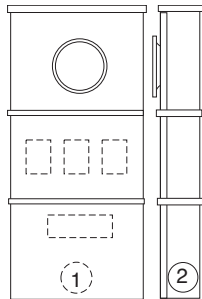

224MTB-48
227MTB-48

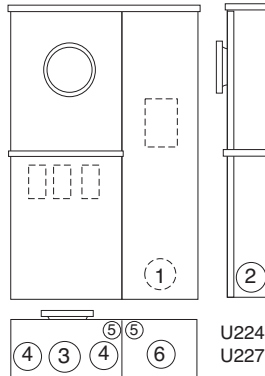

U224MTB-48
U227MTB-48

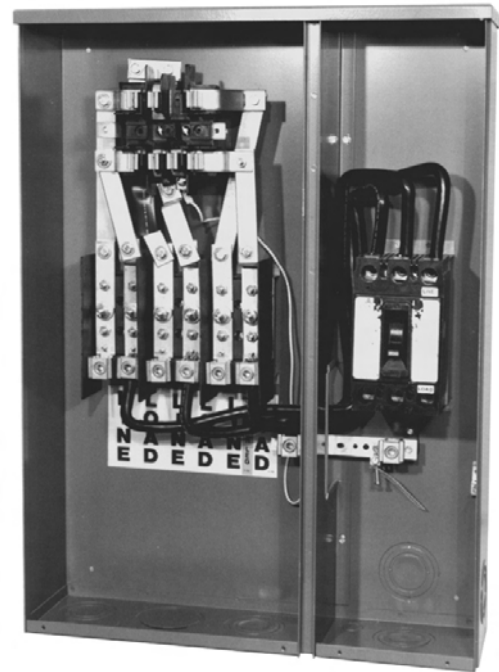

U227MTB-48

200 AMP—4 & 7 TERMINAL—480 VOLT—BREAKER INSTALLED—RING TYPE

NO. OF TERM.	TYPE OF SERVICE	CATALOG NUMBER	CONNECTORS		TYPE OF SERVICE	DIMENSIONS			CONCENTRIC K.O.'S					
			LINE	LOAD NEUTRAL		D"	W"	H"	1	2	3	4	5	6
7	OH	227MTB-48	#6-250	#2/0-250	3Ø4W	6	14	48	2½	2½	3	3	9/32	1/2
4	OH/UG	U224MTB-48*	#6-250	#2/0-250	1Ø3W *	6	22¾	30	2½	2½	3	2½	¾	2½
7	OH/UG	U227MTB-48	#6-250	#2/0-250	3Ø4W	6	22¾	30	2½	2½	3	2½	¾	2½

REPLACEMENT MAIN DISCONNECTS: For replacement main disconnect see pages D14 & D15.

HUBS: OH units use hub up to 2½" (see accessory page). Units provided with closing plate.

SEALING RINGS: Units furnished with MR-2 snap style sealing rings.

NEUTRAL: "Lay-in" connectors will accommodate #2-250 copper or aluminum wire.

* For 3W (208Y/120) network service, install field mounted fifth terminal catalog number 105J. See accessory page.

SECTION D
COMMERCIAL METERING—SAFETY SOCKETS, METER MAINS, TERMINATION BOXES, BUSSED GUTTERS



These UL Listed products are for use in areas requiring Electrical Utility Service Equipment Requirements Committee (EUSERC) compliance.

200K Short Circuit Current Withstand Rating



224MTB-P

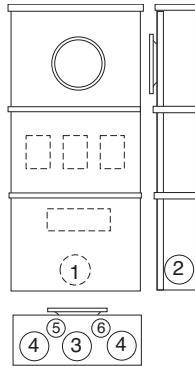

- 224MTB-P
- 225MTB-P
- 227MTB-P
- 224MTB-P48
- 225MTB-P48
- 227MTB-P48

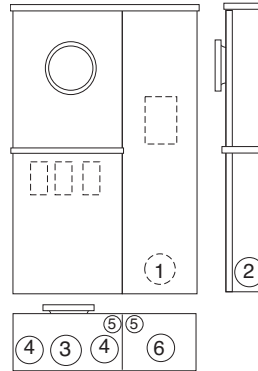

- U224MTB-P
- U227MTB-P
- U224MTB-P48
- U227MTB-P48



U227MTB-P

200 AMP—4, 5 & 7 TERMINAL—240 VOLT PULLOUT INSTALLED—RING TYPE

NO. OF TERM.	TYPE OF SERVICE	CATALOG NUMBER	CONNECTORS		TYPE OF SERVICE	DIMENSIONS			CONCENTRIC K.O.'S					
			LINE	LOAD NEUTRAL		D"	W"	H"	1	2	3	4	5	6
4	OH	224MTB-P*	#6-250	#1/0-250	1Ø3W *	6	14	48	2½	2½	3	3	9/32	1/2
5	OH	225MTB-P	#6-250	#1/0-250	3Ø3W	6	14	48	2½	2½	3	3	9/32	1/2
7	OH	227MTB-P	#6-250	#1/0-250	3Ø4W	6	14	48	2½	2½	3	3	9/32	1/2
4	OH/UG	U224MTB-P*	#6-250	#1/0-250	1Ø3W *	6	22¾	30	2	2	2½	2	¾	2
7	OH/UG	U227MTB-P	#6-250	#1/0-250	3Ø4W	6	22¾	30	2	2	2½	2	¾	2

200 AMP—4, 5 & 7 TERMINAL—200 AMP-480 VOLT PULLOUT INSTALLED —RING TYPE

NO. OF TERM.	TYPE OF SERVICE	CATALOG NUMBER	CONNECTORS		TYPE OF SERVICE	DIMENSIONS			CONCENTRIC K.O.'S					
			LINE	LOAD NEUTRAL		D"	W"	H"	1	2	3	4	5	6
4	OH	224MTB-P48*	#6-250	#1/0-250	1Ø3W *	6	14	48	2½	2½	3	3	9/32	1/2
5	OH	225MTB-P48	#6-250	#1/0-250	3Ø3W	6	14	48	2½	2½	3	3	9/32	1/2
7	OH	227MTB-P48	#6-250	#1/0-250	3Ø4W	6	14	48	2½	2½	3	3	9/32	1/2
4	OH/UG	U224MTB-P48*	#6-250	#1/0-250	1Ø3W *	6	22¾	30	2	2	2½	2	¾	2
7	OH/UG	U227MTB-P48	#6-250	#1/0-250	3Ø4W	6	22¾	30	2	2	2½	2	¾	2

REPLACEMENT MAIN DISCONNECTS: For replacement main disconnect see pages D14 & D15.

HUBS: OH units use hub up to 2½" (see accessory page). Units provided with closing plate.

SEALING RINGS: Units furnished with MR-2 snap style sealing rings.

NEUTRAL: "Lay-in" connectors will accommodate #2-250 copper or aluminum wire.

PULL-OUTS: For use with T-fuses only. Fuses are included with fused safety sockets.

* For 3W (208Y/120) network service, install field mounted fifth terminal catalog number 105J. See accessory page.

SECTION D
COMMERCIAL METERING—SAFETY SOCKETS, METER MAINS,
TERMINATION BOXES, BUSSED CUTTERS

Utility requirements for this equipment may vary. Always consult the serving utility for their requirements before ordering or installing equipment in this catalog.



These UL Listed products are for use in areas requiring Electrical Utility Service Equipment Requirements Committee (EUSERC) compliance.

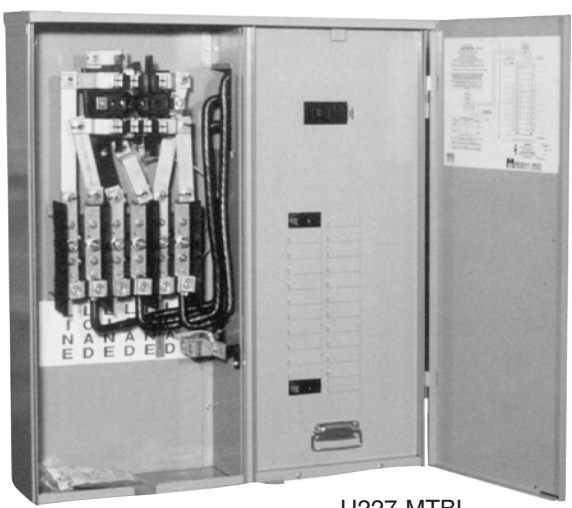

U227-MTBL

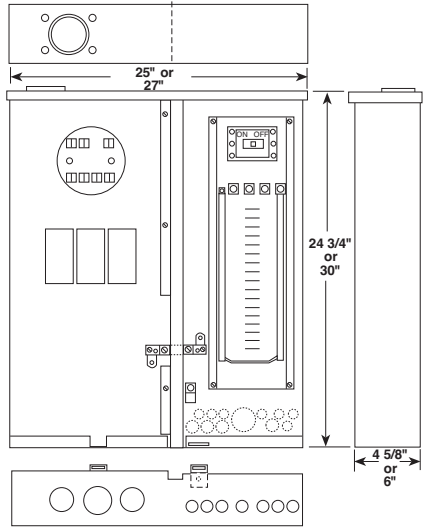

SECTION D

COMMERCIAL METERING—SAFETY SOCKETS, METER MAINS, TERMINATION BOXES, BUSSED GUTTERS

CATALOG NUMBER	RATING	NO. INTERNAL CIRCUITS	MAIN CIRCUIT BREAKER OR FUSE PULLOUT	DIMENSIONS			BOTTOM CONDUIT K.O.'S	BACK CONDUIT K.O.'S
				D"	W"	H"		
U214MTBL ^①	100A, 120/240 VAC 1Ø3W	12/24	100A, 2P, 10K <i>Milbank Q2100</i>	4 ⁵ / ₈	25	24 ³ / ₄	UTILITY SECTION (1) 1/2" (3) 1 1/4", 1 1/2", 2", 2 1/2"	CUSTOMER SECTION (7) 1/2" (4) 1/2", 3/4" (1) 3/4", 1", 1 1/4", 1 1/2"
U214MTBPL ^①	100A, 120/240 VAC 1Ø3W	12/24	100A, 2P, 100K <i>Boltswitch PT223</i>	4 ⁵ / ₈	25	24 ³ / ₄	CUSTOMER SECTION (3) 1/2", 3/4" (1) 1/2", 3/4", 1", 1 1/4" (2) 3/4", 1", 1 1/4", 1 1/2"	
U217MTBL	100A, 240Δ/120; 208Y/120 VAC 3Ø4W	18/36	100A, 3P, 10K <i>Siemens BQ3100</i>	4 ⁵ / ₈	25	24 ³ / ₄	(3) 1/2", 3/4" (1) 1/2", 3/4", 1", 1 1/4" (2) 3/4", 1", 1 1/4", 1 1/2"	
U217MTBPL	100A, 240Δ/120; 208Y/120 VAC 3Ø4W	18/36	100A, 3P, 100K <i>Boltswitch PT323</i>	4 ⁵ / ₈	25	24 ³ / ₄		
U224MTBL ^①	200A, 120/240 VAC 1Ø3W	20/40	200A, 2P, 10K <i>Milbank UQFP-200</i>	6	27	30	UTILITY SECTION (1) 1/2", 3/4" (2) 1 1/4", 1 1/2", 2", 2 1/2" (1) 2 1/2", 3"	CUSTOMER SECTION (6) 1/2" (4) 1/2", 3/4" (1) 3/4", 1", 1 1/4", 1 1/2"
U224MTBPL ^①	200A, 120/240 VAC 1Ø3W	20/40	200A, 2P, 100K <i>Boltswitch PT224</i>	6	27	30	CUSTOMER SECTION (11) 1/2" (2) 1/2", 3/4" (1) 1/2", 3/4", 1", 1 1/4" (2) 3/4", 1", 1 1/4", 1 1/2"	
U227MTBL	200A, 240Δ/120; 208Y/120 VAC 3Ø4W	24/42	200A, 3P, 10K <i>Siemens QJ23B200</i>	6	27	30		
U227MTBPL	200A, 240Δ/120; 208Y/120 VAC 3Ø4W	24/42	200A, 3P, 100K <i>Boltswitch PT324</i>	6	27	30		

LINE: Underground or overhead service. Line Lug: 100A, 14-2/0 and 200A 1/0-250
LOAD: Underground only.
BRANCH BREAKERS: Single phase units—approved for Siemens/ITE Type Q, Challenger, Cutler-Hammer/Westinghouse, General Electric, Murray. Three phase units—approved for Siemens/ITE Type Q.
HUBS: OH units use hub up to 2 1/2" (see accessory page). Units provided with closing plate.
PULL-OUTS: For use with T-fuses only. Fuses are included with fused safety sockets.
^① For 208Y/120 applications, order separately and field install kit **105J**.

Utility requirements for this equipment may vary. Always consult the serving utility for their requirements before ordering or installing equipment in this catalog.



These UL Listed products are for use in areas requiring Electrical Utility Service Equipment Requirements Committee (EUSERC) compliance.

PB-012

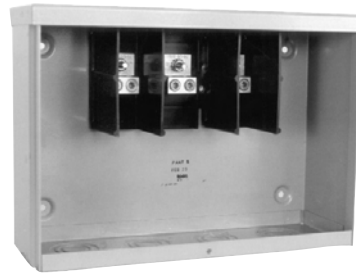
PB-038

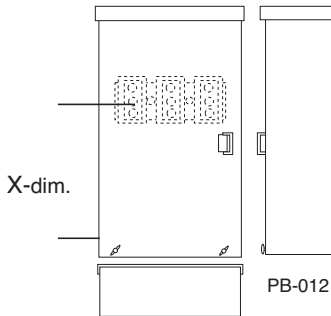
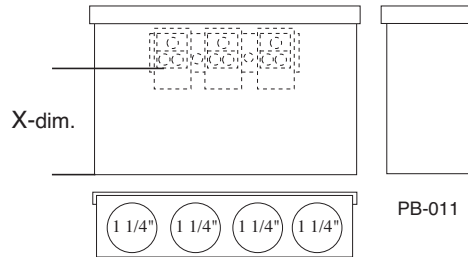
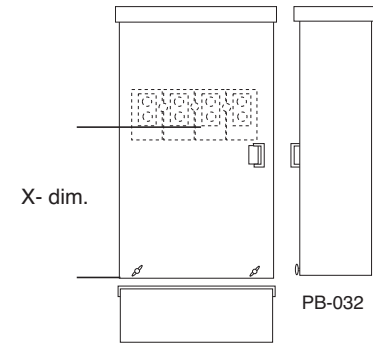
PB-011

PB-032

PB-012

PB-011

PB-032
UNDERGROUND TERMINATION BOXES

AMPS	TYPE OF SERVICE	CATALOG NUMBER	CONNECTORS		DIMENSIONS				SHORT CIRCUIT CURRENT WITHSTAND RATING
			LINE	LOAD	D"	W"	H"	X"	
100	1Ø-3W	PB-011 ^①	#14-1/0	#14-1/0	4	12	8½	3¾	10K AMPS
200	1Ø-3W	PB-012	#6-250	#6-250	6	12	26	14¼	10K AMPS
400	1Ø-3W	PB-014 ^② PB-014-NK	1/2"-13 studs	#4-600	6	16	36	22	50K AMPS
				twin ½-250					
800	1Ø-3W	PB-018 ^② PB-018-NK	1/2"-13 studs ^②	#4-600	11	24	48	26	50K AMPS
				twin ½-250					
200	3Ø-4W	PB-032	#6-250	#6-250	6	16	26	14 ¹¹ / ₁₆	10K AMPS
400	3Ø-4W	PB-034 ^② PB-034-NK	1/2"-13 studs ^②	#4-600	6	16	36	22	50K AMPS
				twin ½-250					
800	3Ø-4W	PB-038 ^②	1/2"-13 studs ^②	#4-600	11	24	48	26	50K AMPS *
				twin ½-250					

CONNECTORS AND BUSSING: Extruded aluminum connectors and bus bars are tin plated.

For no knockouts, add suffix -NK to the above catalog numbers.

① No lift handles provided on the **PB-011**.

② 2 studs per lug position provided for 400 amp units. 4 studs per lug position provided for 800 amp units.

Utility requirements for this equipment may vary. Always consult the serving utility for their requirements before ordering or installing equipment in this catalog.

These UL Listed products are for use in areas requiring Electrical Utility Service Equipment Requirements Committee (EUSERC) compliance.

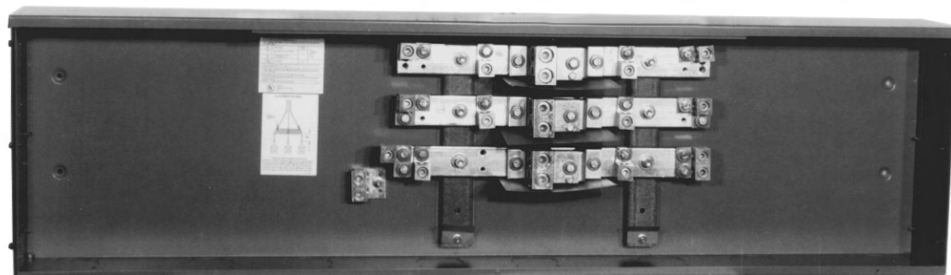

BC418

FOR COMMERCIAL SAFETY SOCKET APPLICATIONS

1Ø3W—BUSSED GUTTERS—TYPE 3R—600 VAC

METER POSITION	CATALOG NUMBER	AMPERE RATING	DIMENSIONS			LENGTH OF BUS	LINE LUGS PER EACH BUS	LOAD LUGS PER EACH BUS
			D"	W"	H"			
2	BC214	400	6	28 ⁵ / ₈	15 ¹ / ₂	20" Bar	(1) 600	(2) 6-250
3	BC318	800	6	43	15 ¹ / ₂	(2) 20" Bars	(2) 600	(3) 6-250
4	BC418	800	6	57 ¹ / ₄	15 ¹ / ₂	(2) 20" Bars	(2) 600	(4) 6-250
5	BC518	800	6	71 ⁵ / ₈	15 ¹ / ₂	(2) 20" Bars	(2) 600	(5) 6-250
6	BC618	800	6	85 ⁷ / ₈	15 ¹ / ₂	(2) 20" Bars	(2) 600	(6) 6-250

3Ø4W—BUSSED GUTTERS—TYPE 3R—600 VAC

METER POSITION	CATALOG NUMBER	AMPERE RATING	DIMENSIONS			LENGTH OF BUS	LINE LUGS PER EACH BUS	LOAD LUGS PER EACH BUS
			D"	W"	H"			
2	BC234	400	6	28 ⁵ / ₈	15 ¹ / ₂	20" Bar	(1) 600	(2) 6-250
3	BC338	800	6	43	15 ¹ / ₂	(2) 20" Bars	(2) 600	(3) 6-250
4	BC438	800	6	57 ¹ / ₄	15 ¹ / ₂	(2) 20" Bars	(2) 600	(4) 6-250
5	BC538	800	6	71 ⁵ / ₈	15 ¹ / ₂	(2) 20" Bars	(2) 600	(5) 6-250
6	BC638	800	6	85 ⁷ / ₈	15 ¹ / ₂	(2) 20" Bars	(2) 600	(6) 6-250

- SHORT CIRCUIT CURRENT WITHSTAND RATING:** Standard bracing is 42K AIC.
- CONNECTORS AND BUSSING:** Extruded aluminum connectors and bus bars are tin plated.
- COVER:** Lift handles provided along with a cover sealing provision. A removable, sealable cover is provided at both ends for pull box assembly.
- HARDWARE:** Meter socket mounting hardware included.
- SUITABLE FOR USE ON LINE SIDE OF SERVICE EQUIPMENT.**

Utility requirements for this equipment may vary. Always consult the serving utility for their requirements before ordering or installing equipment in this catalog.



These UL Listed products are for use in areas requiring Electrical Utility Service Equipment Requirements Committee (EUSERC) compliance.

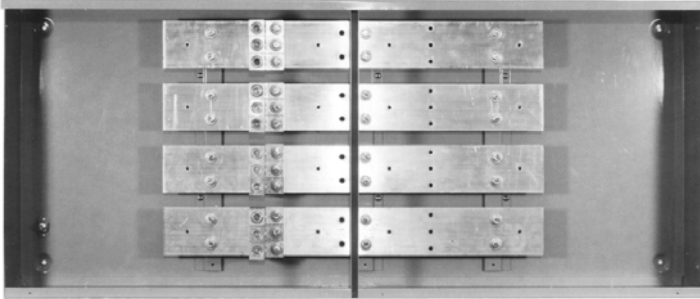

- Enclosure without knockouts
- Tin plated aluminum bus bars
- Furnished with line lugs only
- Bus is drilled and tapped for easy installation of load lugs

3Ø4W—BUSSED GUTTERS—TYPE 3R—600 VAC

METER POSITION	CATALOG NUMBER	AMPERE RATING	DIMENSIONS			LENGTH OF BUS	LINE LUGS PER EACH BUS
			D"	W"	H"		
2	U3462-O	400	6	24	24	17" Bar	(1) 600
3	U3463-O	600	6	36	24	24" Bars	(2) 600
4	U3464-O	800	6	48	24	32" Bars	(3) 600
5	U3465-O	800	6	60	24	40" Bars	(3) 600
6	U3466-O	800	6	72	24	56" Bars	(3) 600

SHORT CIRCUIT CURRENT WITHSTAND RATING: The 400 and 600 amp units have a withstand rating of 50K amps, and the 800 amp units have a rating of 65K amps.

SUITABLE FOR USE ON LINE SIDE OF SERVICE EQUIPMENT.

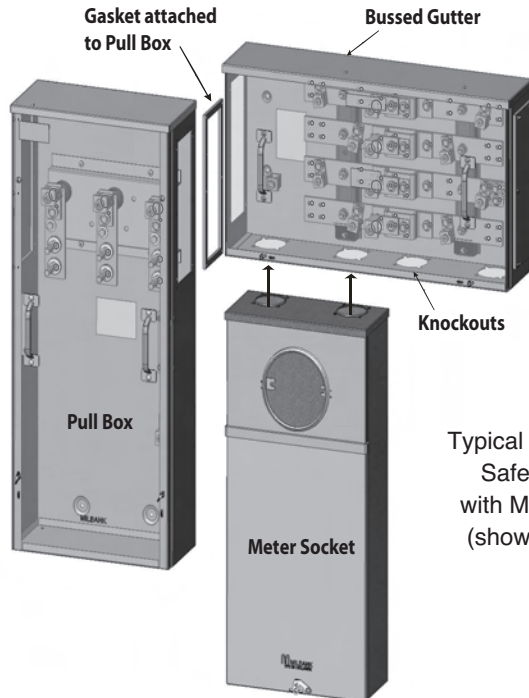

Typical Application of Safety Sockets with Multi-Metering (shown with KOs)

Utility requirements for this equipment may vary. Always consult the serving utility for their requirements before ordering or installing equipment in this catalog.

REPLACEMENT CIRCUIT BREAKERS

REPLACEMENT CIRCUIT BREAKERS, cont.

CATALOG NUMBER	CIRCUIT BREAKER	MFG.	PART NUMBER
214MTB	BQ2B100L	Milbank	917930-MO
214MTB-48	ED42B100	Siemens	705831-MO
214MTB/22	BQ2B100HL	Milbank	917960-MO
U214MTB	BQ2B100L	Milbank	917930-MO
U214MTB-48	ED42B100	Siemens	705831-MO
U214MTB/22	BQ2B100HL	Milbank	917960-MO
U214MTBL	BQ2B100L	Milbank	917915-MO

CATALOG NUMBER	CIRCUIT BREAKER	MFG.	PART NUMBER
227MTB	UQFB-3200	Milbank	916777-MO
227MTB-125	UQFB-3125	Milbank	916759-MO
227MTB-150	UQFB-3150	Milbank	916765-MO
227MTB-175	UQFB-3175	Milbank	926772-MO
227MTB-48	FXD63B200	Siemens	706036-MO
227MTB/22	QJH23B200L	Siemens	707503-MO
227MTB	UQFB-3200	Milbank	916777-MO
U227MTB-125	UQFB-3125	Milbank	916759-MO
U227MTB-150	UQFB-3150	Milbank	916765-MO
U227MTB-175	UQFB-3175	Milbank	926772-MO
U227MTB-48	FXD63B200	Siemens	706036-MO
U227MTB/22	QJH23B200L	Siemens	707503-MO
U227MTBL	QJ23B200	Siemens	707403-MO

215MTB	BQ3B100L	Milbank	917990-MO
215MTB-48	ED43B100	Siemens	708571-MO
U215MTB	BQ3B100L	Milbank	917990-MO
U215MTB-48	ED43B100	Siemens	708571-MO

217MTB	BQ3B100L	Milbank	917990-MO
217MTB-48	ED43B100	Siemens	708571-MO
217MTB/22	BQ3B100HL	Milbank	918020-MO
U217MTB	BQ3B100L	Milbank	917990-MO
U217MTB-48	ED43B100	Siemens	708571-MO
U217MTB/22	BQ3B100HL	Milbank	918020-MO
U217MTBL	BQ3B100L	Milbank	917990-MO

224MTB	UQFB-200	Milbank	915548-MO
224MTB/22	UQFBH-200	Milbank	915748-MO
U224MTB	UQFB-200	Milbank	915548-MO
U224MTB-48	FXD62B200	Siemens	705747-MO
U224MTB/22	UQFBH-200	Milbank	915748-MO
U224MTBL	UQFB-200	Milbank	915548-MO

U225MTB	UQFB-3200	Milbank	916777-MO
U225MTBL	QJ23B200	Siemens	707403-MO

LUG KITS FOR CIRCUIT BREAKERS

SIEMENS CIRCUIT BREAKER	NUMBER OF LUG COLLARS REQUIRED	PART NUMBER
ED42B100	(2) LN13100	705831-MO
ED43B100	(3) LN1E100	708572-AC
FXD62B200	(4) TA1FD350	708573-AC
FXD63B200	(6) TA1FD350	706036-MO
QJ22B200H	(2) TA1Q300	707523-MO
QJ23B200	(1) TA1Q300	707403-MO
QJH23B200L	(1) TA1Q300	707503-MO

When replacing Siemens Circuit Breaker (FXD,ED,QJ) in safety sockets, lug collars must be ordered separately.

SECTION D
COMMERCIAL METERING-SAFETY SOCKETS, METER MAINS,
TERMINATION BOXES, BUSSED GUTTERS

REPLACEMENT T-FUSE PULLOUTS

CATALOG NUMBER	T-FUSE PULLOUT	MFG.	PART NUMBER
214MTB-P	PT223	Boltswitch	707674-MO
214MTB-P48	PT263	Boltswitch	708564-MO
U214MTB-P	PT223	Boltswitch	707674-MO
U214MTB-P48	PT263	Boltswitch	708564-MO
U214MTBPL	PT223	Boltswitch	707674-MO
215MTB-P	PT323	Boltswitch	708565-MO
215MTB-P48	PT363	Boltswitch	708566-MO
U215MTB-P	PT323	Boltswitch	708565-MO
U215MTB-P48	PT363	Boltswitch	708566-MO
217MTB-P	PT323	Boltswitch	708565-MO
217MTB-P48	PT363	Boltswitch	708566-MO
U217MTB-P	PT323	Boltswitch	708565-MO
U217MTB-P48	PT363	Boltswitch	708566-MO
U217MTBPL	PT323	Boltswitch	708565-MO
224MTB-P	PT224	Boltswitch	707684-MO
224MTB-P48	PT264	Boltswitch	708567-MO
U224MTB-P	PT224	Boltswitch	707684-MO
U224MTB-P48	PT264	Boltswitch	708567-MO
U224MTBPL	PT224	Boltswitch	707684-MO
225MTB-P48	PT364	Boltswitch	708569-MO
U225MTBPL	PT324	Boltswitch	708568-MO
227MTB-P	PT324	Boltswitch	708568-MO
227MTB-P48	PT364	Boltswitch	708569-MO
U227MTB-P	PT324	Boltswitch	708568-MO
U227MTB-P48	PT364	Boltswitch	708569-MO
U227MTBPL	PT324	Boltswitch	708568-MO

LUG KITS FOR T-FUSE PULLOUTS

T-FUSE PULLOUTS	NUMBER OF LUG COLLARS REQUIRED	PART NUMBER
PT223	(2) TK100P	707682-AC
PT224	(2) TK200P	708570-AC
PT263	(2) TK100P	707682-AC
PT264	(2) TK200P	708570-AC
PT323	(3) TK100P	707682-AC
PT324	(3) TK200P	708570-AC
PT363	(3) TK100P	707682-AC
PT364	(3) TK200P	708570-AC

NOTE: T-Fuse pullouts provided with load side lugs. Order line side lugs separately from above chart.

These UL Listed products are for use in areas requiring Electrical Utility Service Equipment Requirements Committee (EUSERC) compliance.

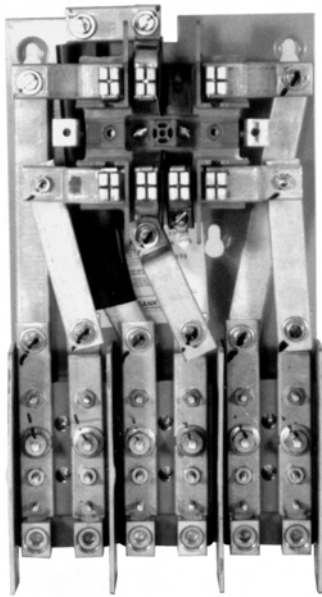

MS-27-TB

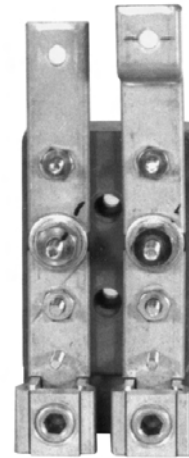

TB200-47

TENANT METER SOCKETS

AMPS	CATALOG NUMBER	VOLTAGE / SYSTEM
200	MS-24-TB	600V / 1Ø3W
200	MS-27-TB	600V / 3Ø4W

REPLACEMENT TEST BLOCKS

AMPS	CATALOG NUMBER	PHASE
100	TB100-47	PHASE A, B & C
100	TB100-5 CENTER BLOCK ONLY	PHASE B—3Ø3W
200	TB200-47	PHASE A, B & C
200	TB200-5 CENTER BLOCK ONLY	PHASE B—3Ø3W
200	TB200-LL	LUG—LUG
—	TB-BARR #Z707371-MO	TEST BLOCK BARRIER

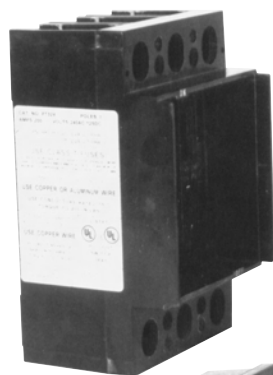

PT324

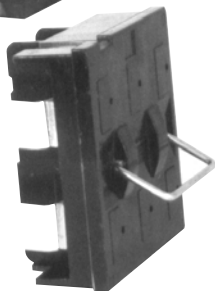

240 VOLT MAIN DISCONNECTS PULLOUT SWITCH (USES TYPE "T" FUSE)

AMPS	CATALOG NUMBER	RATING
100	PT223	2 POLE—240 VOLT
200	PT224	2 POLE—240 VOLT
100	PT323	3 POLE—240 VOLT
200	PT324	3 POLE—240 VOLT

480 VOLT MAIN DISCONNECTS PULLOUT SWITCH (USES TYPE "T" FUSE)

AMPS	CATALOG NUMBER	RATING
100	PT263	2 POLE, 480 VOLT
200	PT264	2 POLE, 480 VOLT
100	PT363	3 POLE, 480 VOLT
200	PT364	3 POLE, 480 VOLT

Utility requirements for this equipment may vary. Always consult the serving utility for their requirements before ordering or installing equipment in this catalog.



SECTION D COMMERCIAL METERING—SAFETY SOCKETS, METER MAINS, TERMINATION BOXES, BUSSED GUTTERS

Commercial Pedestals

- *Attractive*
- *Easy to install*
- *Secure*
- *Cost effective*

**Un-Strut
Your
Stuff...**



Milbank Commercial Pedestals are pad-mounted, weatherproof electrical enclosures consisting of a utility pull section with optional meter socket, and a customer section containing distribution and control equipment. Milbank

Commercial Pedestals are an attractive, secure, easy to install and cost-effective solution when underground remote site power distribution and control equipment is required, replacing unsightly and inefficient strut and backboard structures.

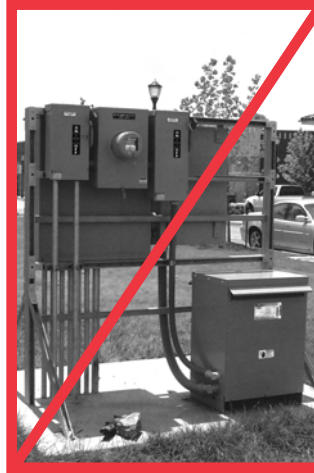

Strut and backboard design



Commercial Pedestal

UL Listed as Industrial Control Equipment (File E113855).



Ringless Socket



Ring-type Socket

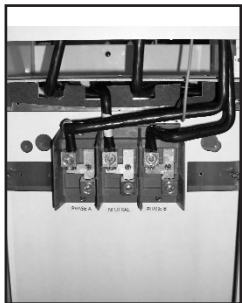

Utility Lug Landing

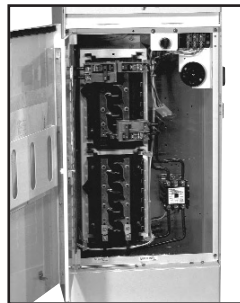

Customer Interior

STANDARD FEATURES –COMMERCIAL PEDESTALS

- Type 3R rainproof, vandal-resistant cabinet of polyurethane powder-coated steel (aluminum or stainless steel also available)
- UL listed as enclosed industrial control equipment (UL508)
- Isolated, lockable & sealable utility metering & lug landing sections
- Lockable customer section for distribution & control equipment with internal deadfront
- Print pocket inside customer section door contains wiring schematics and installation instructions
- Most load centers are UL listed for use with various manufacturers' circuit breakers
- All stainless steel external hardware (screws, bolts, hinges, handles, hasps and sealing screws)
- Meets EUSERC 308 and other utility standards.



SECTION E

COMMERCIAL METER PEDESTALS

Utility requirements for this equipment may vary. Always consult the serving utility for their requirements before ordering or installing equipment in this catalog.

APPLICATIONS

These units are ideal for controlling and metering:

- Traffic signals
- Street lighting
- Irrigation / sprinkler systems
- Cell towers / telephone vaults
- Pump stations
- Temporary power for fairgrounds, swap meets, outdoor markets, portable offices, holiday lights, etc.
- Outdoor lighting for athletic fields, tennis and basketball courts, parking lots, landscaping and subdivision entrances, etc.



AVAILABLE FACTORY-INSTALLED OPTIONS

- Meter sockets – ring type or **ringless**, to 400 amp (unmetered pedestals also available)
- Main and branch breakers or T fuses
- Distribution – copper load centers & panel boards
- Clocks / timers / relays
- Photoelectric cells and controls
- Power receptacles – pin & sleeve, twist lock or straight blade
- Contactors – definite purpose, electrical or mechanically held, IEC and mercury types
- Surge protection & lightning arrestors
- Reserve inlet generator receptacle with interlocked circuit breakers
- Motor starters, relays
- Push button controls
- Thermostat controls, fans and heating strips
- Power blocks and terminal blocks
- Steel, aluminum and plywood back boards
- Transformers
- Interlock devices for circuit breakers
- Available in steel, aluminum (raw painted or anodized) or stainless steel construction with powder-coated finish available in 8 standard colors or special ordered RAL colors.
- Available for applications up to 400 amp, 120V, 208V, 240V, 277V, 480V – 1Ø or 3Ø.

ACCESSORIES



K3865
Fifth terminal kit for use with ringless meter sockets

105J
Fifth terminal kit for use with ring-type meter sockets



- CP-TC7D** 7-day time clock kit
- CP-TC24H** 24-hour time clock kit
- CP-TCWIRE** Male four-pin connector and wiring harness for use with time clocks other than shown

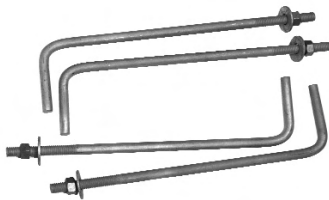
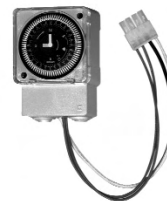

CP-ABK5/8
Anchor bolt kit (includes four 5/8 - 13 x 18" anchor bolts)



CP-16PDMNT-CALT
Pedestal mounting base for 16" pedestal
CP-24PDMNT-CALT
Pedestal mounting base for 24" pedestal (includes mounting hardware)



CP-PE-HOA-3POS
HOA switch – for field installation

Utility requirements for this equipment may vary. Always consult the serving utility for their requirements before ordering or installing equipment in this catalog.

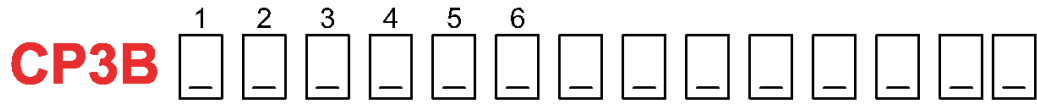

1. METER SOCKET

- 0 – No Socket
- 1 – 1 Ring Type Socket (w/Test Bypass)
- 2 – 2 Ring Type Sockets (w/Test Bypass)
- 3 – 2 Ring Type Sockets
(1 w/Test Bypass, 1 w/out Test Bypass)
- 4 – 1 Ring Type Socket (No Test Bypass)
- 5 – 1 Ringless Socket (w/Lever Bypass)
- 6 – 2 Ringless Sockets (w/Lever Bypass)
- 7 – 1 Ringless Socket (No Test Bypass)
- 8 – 1 Bolt On Meter (w/Manual Bypass)
- 9 – 1 Ringless Socket (KK Horn Bypass)
- A – 2 Ringless Sockets (KK Horn Bypass)
- B – 1 Ring Type Socket (w/Test Switches)¹
- C – 1 Ringless Socket (w/Test Switches)¹

2. AMP RATING

- 0 – No Rating
- 1 – 100 Amp
- 2 – 200 Amp
- 3 – 125 Amp
- 4 – 400 Amp
- 5 – (Reserved)
- 6 – 600 Amp

3. SYSTEM VOLTAGE

- 0 – 120V, 1Ø, 2W (4 Jaw)
- 1 – 120/240V, 1Ø, 3W (4 Jaw)
- 2 – 208Y/120V, 1Ø, 3W (4 Jaw + 105J)
- 3 – 240/480V, 1Ø, 3W (4 Jaw)
- 4 – 480Y/277V, 1Ø, 3W (4 Jaw + 105J)
- 5 – 208Y/120V, 3Ø, 4W (7 Jaw)
- 6 – 240Δ/120V, 3Ø, 4W (7 Jaw)
- 7 – 240ΔV, 3Ø, 3W (5 Jaw)
- 8 – 480Y/277V, 3Ø, 4W (7 Jaw)
- 9 – 480ΔV, 3Ø, 3W (5 Jaw)
- A – No Rating
- B – 480Δ/240V, 3Ø, 4W (7 Jaw)
- C – 120/240V, 1Ø, 3W (5 Jaw)
- D – 240/480V, 1Ø, 3W (5 Jaw)
- E – 480V, 1Ø, 2W (4 Jaw)

4. MAIN DISCONNECT

- 0 – No Main (Up to 6 Disconnects Max)
- 1 – (1) Circuit Breaker Main
- 2 – (2) Circuit Breaker Mains
- 3 – (1) T-Fuse Pullout Main
- 4 – (3) Circuit Breaker Mains
- 5 – (Obsolete)
- 6 – (1) 4-Pole Main (100 Amp Max)
- 7 – (Obsolete)
- 8 – (1) 4-Pole 100A & (1) 2-Pole 100A
- 9 – (Reserved)
- A – (Obsolete)
- B – (2) Circuit Breaker Mains w/Interlock
- C – (2) T-Fuse Pullout Mains

6. ENCLOSURE SIZE

- A – 16"W x 17"D x 48"H
- B – 24"W x 17"D x 48"H
- C – 24"W x 30"D x 48"H
- C – 16"W x 5"D x 46"H (CP2B)
- D – 44"W x 24"D x 60"H
- D – 12"W x 9"D x 64"H (CP3A)
- E – 16"W x 17"D x 41"H
- F – 12"W x 9"D x 64"H
- G – 16"W x 17"D x 48"H*
- H – 24"W x 17"D x 48"H*
- J – 16"W x 17"D x 32"H
- K – 32"W x 20"D x 60"H
- L – 16"W x 17"D x 48"H
- M – 24"W x 17"D x 41"H
- N – 16"W x 6"D x 46"H
- X – 24"W x 24"D x 48"H
- Y – 32"W x 24"D x 48"H

5. DISTRIBUTION INTERIOR

- 0 – (2) 16-Circuit Loadcenters
- 1 – (1) Metered 8-Circuit Loadcenter & (1) Unmetered 8-Circuit Loadcenter
- 2 – (2) 8-Circuit Loadcenters
- 3 – (1) 12-Circuit Loadcenter
- 4 – (1) 12-Circuit Loadcenter & (1) 8-Circuit Loadcenter
- 5 – (1) 16-circuit Loadcenter
- 6 – Lug-Lug Main & Branch Breakers Only
- 7 – (1) 8-Circuit Loadcenter & (1) 16-Circuit Loadcenter
- 8 – Fused Pullout Switch
- 9 – (1) 24 Circuit Loadcenter
- A – (2) Metered 8-Circuit Loadcenters & (1) Unmetered 8-Circuit Loadcenter
- B – (2) 24-Circuit Loadcenters
- C – (1) 24-Circuit Panelboard
- D – (1) 42-Circuit Panelboard
- E – (1) 30-Circuit Panelboard
- F – (1) 18-Circuit Panelboard
- G – (1) 30-Circuit Loadcenter
- H – (2) 12-Circuit Loadcenters
- J – No Distribution (Main Only)
- K – (1) Metered 4-Circuit Loadcenter & (1) Unmetered 4-Circuit Loadcenter
- L – No Branch Breakers (Distribution Blocks Only)
- M – (Obsolete)
- N – Metered & Unmetered Lug-Lug Breakers
- P – Metered Lug-Lug Breakers
- R – (1) Metered 8-Circuit Loadcenter, (1) Unmetered 8-Circuit Loadcenter, & (1) Metered 12-Circuit Loadcenter
- T – (1) 8-Circuit Loadcenter
- U – Unmetered Lug-Lug Breakers
- V – (1) 6-Circuit Loadcenter
- W – (2) 6-Circuit Loadcenters
- X – Non Standard
- Y – (1) 42 Circuit Loadcenter

SECTION E COMMERCIAL METER PEDESTALS

Note: due to size and regulatory constraints not all combinations will result in a valid catalog number

Logic description subject to change and factory interpretation.

CP3B “ML” Series

Main Load Center Series

1Ø 3 wire 120/240 or 208Y/120 volt

Typical applications: Remote site service for multiple loads

The **Milbank Main Load Center Commercial Pedestals** are designed to handle the vast majority of all requirements in a standard, stocked configuration.

- No waiting or extra charge
- Units all feature a load center with a plug-on, back-fed main breaker.
- Load center has 16 positions for the 100 amp pedestals and 24 circuits for the 200 amp pedestals.
- Both sizes include sub-feed lugs to allow feeding an external panel

If your application requires turning loads on based on “dusk-to-dawn” requirements, be sure to see the **Milbank Switched Load Center Commercial Pedestal** products on the following page.



Features:

These units include everything required for remote site service:

- ➔ NEMA 3R construction
- ➔ Expandable – Load centers allow for future expansion without costly modifications
- ➔ All units feature 200 amp meter socket with optional field-installable fifth terminal kit available
- ➔ 22K ampere interrupting capacity (AIC) standard
- ➔ Optional mounting base can be embedded in concrete for fast, easy installation
- ➔ Separate sealable and lockable utility termination section
- ➔ Separate sealable and lockable metering section with the option of:

EITHER

- Milbank ring-type socket with test / bypass blocks (conforms to EUSERC 308)

OR

- Milbank heavy duty ringless socket with lever bypass
- ➔ A separate sealable and lockable customer section with a load center for “always on” loads that includes:
 - Main circuit breaker
 - Twenty (200 or 125 amp model) or fourteen (100 amp model) blank breaker spaces
 - A circuit directory to document configuration

SECTION E
COMMERCIAL METER PEDESTALS

STOCKED PEDESTALS*	OPTIONAL FIFTH TERMINAL KIT	MAIN CB AMPS	LOAD CENTER SPACES	LOAD CENTER CIRCUITS	AIC	METER SOCKET TYPE
CP3B11115A22	105J	100	1,2	16	22K	Ring-type with test / bypass blocks
CP3B11115A42	105J	100	1,2	16	42K	Ring-type with test / bypass blocks
CP3B12119A22	105J	200	1,2,3,4	24	22K	Ring-type with test / bypass blocks
CP3B51115A22	K3865	100	1,2	16	22K	Ringless socket with lever bypass
CP3B52119A22	K3865	200	1,2,3,4	24	22K	Ringless socket with lever bypass

*NOTE: Chart shows standard, stocked items. Other options and features are available. Contact factory for options details and availability.

Utility requirements for this equipment may vary. Always consult the serving utility for their requirements before ordering or installing equipment in this catalog.



CP3B “SL” Series

Switched Load Center Series

1Ø 3 wire 120/240 or 208Y/120 volt

Typical applications: Traffic signal, parking lot, highway, & athletic field lighting

The Milbank Switched Load Center Commercial Pedestals are designed to not only provide power for various loads, but also to switch specific loads on and off under certain conditions. A photoelectric cell is used for these controlled loads, and an optional time clock is also available.



Features:

These units include everything required for remote service:

- NEMA 3R construction
- Expandable – Load centers allow for future expansion without costly modifications
- All units feature 200 amp meter socket with optional field-installable fifth terminal kit available
- 22K ampere interrupting capacity (AIC) standard
- Optional mounting base can be embedded in concrete for fast, easy installation
- Separate sealable and lockable utility termination section
- Separate sealable and lockable metering section with the option of:

EITHER

- Milbank ring-type socket with test / bypass blocks (conforms to EUSERC 308)

OR

- Milbank heavy duty ringless socket with lever bypass
- A separate sealable and lockable customer section with:
 - Control circuit including:
 - PE receptacle, Lexan® window and glare shield
 - Hand-Off-Auto (HOA) switch
 - Contactor controlling a 16-circuit load center for controlled loads
 - Pre-mounted DIN rail and pre-wired connector to add an optional “plug and play” time clock kit for PE on and TC off operation
 - A circuit directory to document configuration
 - A load center for “always on” loads that includes:
 - Main circuit breaker
 - Control power circuit breaker
 - Switched load center main breaker
 - Nine (200 amp model) or eleven (100 amp model) blank breaker spaces
 - A circuit directory to document configuration

SECTION E
COMMERCIAL METER PEDESTALS

STOCKED PEDESTALS*	OPTIONAL FIFTH TERMINAL KIT	MAIN CB AMPS	CB SPACES	CONTACTOR AMPERAGE	METER SOCKET TYPE
CP3B11110A22SL1	105J	100	(1,3)	60	Ring-type with test / bypass blocks
CP3B12110A22SL1	105J	200	(1,2,3,4)	100	Ring-type with test / bypass blocks
CP3B51110A22SL1	K3865	100	(1,3)	60	Ringless socket with lever bypass
CP3B52110A22SL1	K3865	200	(1,2,3,4)	100	Ringless socket with lever bypass

*NOTE: Chart shows standard, stocked items. Other options and features are available. Contact factory for options details and availability.

Utility requirements for this equipment may vary. Always consult the serving utility for their requirements before ordering or installing equipment in this catalog.



CP3B “400” Series

400 amp Series

1Ø 3 wire 120/240 or 208Y/120 volt

Typical applications: Remote site service for residential and commercial jobsites

The Milbank 400 amp Commercial Pedestal is designed to provide a weather and vandal resistant metered enclosure for various loads and distribution. Each pedestal has been designed to handle a wide range of applications using standard, stocked configurations.

- Choice of a single main breaker or twin service disconnect breakers gives flexibility to the pedestal design.
- Optional distribution with feed-thru lugs below the service disconnect breakers allows the pedestal to handle numerous applications.
- Typical applications include remote homes where the metering is best located at the curb side or other remote area. The pedestal can also provide power to secondary residence, on-site business, workshop, irrigation, lighting, security or other secondary load.
- Available in custom colors to match home or landscaping.



Features:

These units include everything required for remote site service:

- NEMA 3R construction
- Main circuit breaker or dual service disconnects
- Expandable – Load center units allow for future expansion without costly modifications
- 22K ampere interrupting capacity (AIC) standard
- Optional mounting base can be embedded in concrete for fast, easy installation
- Separate sealable and lockable utility termination section with lug termination
- Separate sealable and lockable metering section
- A separate sealable and lockable customer section with a circuit directory and a print pocket to hold all documentation

Meter Socket Options:

- Ring type with bypass studs
- Ringless with heavy duty lever bypass
- K type bolt-on

STOCKED PEDESTALS*	OPTIONAL FIFTH TERMINAL KIT	MAIN CB	LOAD CENTER CIRCUITS	AIC	METER SOCKET TYPE
CP3B1411JB22	N/A	320 amp (400 max)	0	22K	Ring type with test / bypass studs
CP3B14120B22	N/A	2-200 amp	(2) 12 ckt ^①	22K	Ring type with test / bypass studs
CP3B5411JB22	K3865	320 amp (400 max)	0	22K	Ringless with lever bypass
CP3B54120B22	K3865	2-200 amp	(2) 12 ckt ^①	22K	Ringless with lever bypass
CP3B8411JB22	②	400 amp	0	22K	K4 Bolt-on
CP3B84120B22	②	2-200 amp	(2) 12 ckt ^①	22K	K4 Bolt-on

*NOTE: Chart shows standard, stocked items. Other options and features are available. Contact factory for options details and availability.

Stud utility landing is standard. Lug kits are available from factory.

① Units with load centers have (2) #6-250 sub-feed lugs on each load center. (Each load center is 200 amp rated and UL Listed with: Siemens, General Electric and Cutler-Hammer plug-in style circuit breakers.)

② When ordering, specify lugs or studs for utility landings.

Three phase units available — contact factory.

Utility requirements for this equipment may vary. Always consult the serving utility for their requirements before ordering or installing equipment in this catalog.



CP3B “IR” Series

Irrigation Control Pedestals

1Ø 3 wire 120/240 or 208Y/120 volt

Typical application: Metered Power Pedestal for Irrigation Systems

The Milbank “IR” series Commercial Pedestals are designed to provide a weather and vandal resistant metered enclosure for irrigation controllers. Breakers and a GFI duplex receptacle are provided to power the irrigation controllers supplied by others. A plywood backboard is mounted behind the deadfront door for mounting the irrigation controller. A large plan pocket is mounted inside the customer section door to hold plans and specifications. Light green powder coated steel or stainless steel pedestals are normally in stock.



Features:

These units include everything required for remote site service:

- NEMA 3R construction
- 2 each 20 amp single pole circuit breakers: one breaker for standard 20 amp GFCI receptacle and one breaker for irrigation control circuit
- Large plywood back panel for mounting irrigation controller
- All units feature 200 amp meter socket with optional field-installable fifth terminal kit available
- 10K ampere interrupting capacity (AIC) standard
- Optional mounting base can be embedded in concrete for fast, easy installation
- Separate sealable and lockable utility termination section
- Separate sealable and lockable metering section with the option of

EITHER:

- Milbank ring-type socket with test / bypass blocks (conforms to EUSERC 308)

OR

- Milbank heavy duty ringless socket with lever bypass

SECTION E
COMMERCIAL METER PEDESTALS

STOCKED PEDESTALS*	OPTIONAL FIFTH** TERMINAL KIT	EXTERIOR CABINET	METER SOCKET TYPE
CP3B111IRASP	105J	Steel, Light Green	Ring type meter socket with test / bypass blocks
CP3B111IRASS	105J	Stainless Steel	Ring type meter socket with test / bypass blocks
CP3B511IRASP	K3865	Steel, Light Green	Ringless heavy duty meter socket with lever bypass

*NOTE: Chart shows standard, stocked items. Other options and features are available. Contact factory for options details and availability.

*See page E2 for options (accessories) details.

Utility requirements for this equipment may vary. Always consult the serving utility for their requirements before ordering or installing equipment in this catalog.



CP3B BBS & UPS Series

1Ø 3 wire 120/240 or 120/208 volt

Typical applications: Metered emergency uninterrupted power for traffic intersections, wireless - phone, communication equipment, parking lots, camera and security locations.

The Milbank BBS / UPS Series Commercial Pedestals are designed to provide continuous power for various loads, and also to switch specific loads on and off under certain conditions. A photoelectric cell or time clock may be used to control lighting circuits as an example. Metered and non-metered power distribution options are available. The back-up power pedestal is designed to handle the vast majority of today's back-up power requirements. By using 19" rack design, shelves can be adjusted to accommodate the required batteries and manufactures DC to AC inverters, transfer switches and other related equipment. This design gives the user a wide range of design and configuration options. Complete turnkey, ready to power-up pedestals are offered along with basic and custom configurations.



Features:

- NEMA 3R construction, UL listed as "Enclosed Industrial Control Equipment"
- 100 through 320 amp meter socket with the option of either:
 - Milbank ring type socket (conforms to EUSERC 309) with or without test / bypass blocks
 - Milbank heavy duty ringless socket with lever bypass
- Separate sealable utility termination compartment
- An isolated separate customer section with:
 - Service disconnects
 - Power distribution options
 - Power control
- 19" wide rack in customer compartment for easy layout of equipment
- Battery trays
- Thermostat with cooling fan
- Filtered louvers for heat rise flow through ventilation (UL Listed 508A)
- Three point door latch (key or pad lockable)

Options:

- Manual Bypass switch (used for maintenance of BBS/UPS)
- Transfer switch for generator power back-up
- Generator inlet receptacles 30 amps through 200 amps
- Pad lockable provision for receptacles
- Police access door
- Metered load center distribution
- Non metered load center distribution
- Photo electric controls (for street lighting)
- Time clocks
- HOA switches
- Contactors
- GFI duplex receptacles
- Thermostat for heating control
- Heating pads or elements
- Roll out shelves for batteries
- Surge arrestors and lighting arrestors

Utility requirements for this equipment may vary. Always consult the serving utility for their requirements before ordering or installing equipment in this catalog.



CP3B “Power Transfer” Series

1Ø3W 120/240 volt thru 3Ø4W 277/480 volt

Typical applications: Traffic intersections, Cell sites, Phone company broadband service, Cable TV, Pump and Lift stations requiring utility power with back up generator power

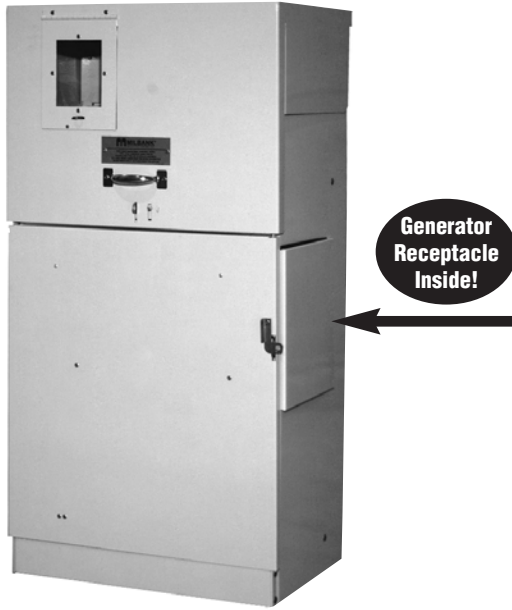

CP3B “Power Transfer” Series – Metered

The Milbank Commercial Pedestal “Power Transfer Series” provides metered AC power, distribution, surge suppression, mechanical interlock and stand by generator receptacle. All electrical equipment including the generator receptacle is built inside the pedestal, giving it a clean appearance and making it extremely vandal resistant. ▲

Features & Options:

- 120/240v 1Ø3W thru 277/480v 3Ø4W ratings
- Choice of EUSERC ring type or ringless meter sockets
- 60 amps thru 400 amp ratings
- 10K AIC up to 50K AIC ratings
- UL Listed 508A, NEMA 3R rated
- Pad lockable, isolated utility compartments
- 20 amp GFI convenience receptacle
- Lockable recessed generator receptacle door
- Utility and generator indicator light options
- All stainless steel hardware
- Galvanized steel, aluminum or stainless steel cabinet options
- Custom designs available

CP3B “Power Transfer” Series – Unmetered

The Milbank Commercial Pedestal “Power Transfer Series” provides non metered AC power, distribution, surge suppression, mechanical interlock and stand-by generator receptacle – all in a neat, compact pedestal. ▲

Features & Options:

- 120/240v 1Ø3W thru 277/480v 3Ø4W ratings
- 60 amps thru 400 amp ratings
- 10K AIC up to 50K AIC ratings
- UL listed 508A, NEMA 3R rated
- Pad lockable, isolated utility compartments
- 20 amp GFI convenience receptacle
- Utility and generator indicator light options
- All stainless steel hardware
- Galvanized steel, aluminum or stainless steel cabinet options
- Custom designs available



Utility requirements for this equipment may vary. Always consult the serving utility for their requirements before ordering or installing equipment in this catalog.

Example of specifications for a Metered Commercial Pedestal

Commercial pedestal shall be type _____ .
Catalog # _____

Voltage rating : _____ (120/240v 1P 3W)____
AIC rating: _____ 10____
Amperage rating : _____ (100 amps)____

The pedestal shall be of NEMA Type 3R rainproof construction and shall be UL Listed as “Enclosed Industrial Control Equipment” (UL 508A). External construction shall comply with UL50 requirements and shall be of G90 galvanized steel with light green #14672 Federal Specification 595 polyurethane industrial grade powder paint of 1.7 mil minimum thickness (unless otherwise specified). Aluminum and stainless steel are other factory options available. Internal construction shall be G90 galvanized steel and 1.7 mil minimum thickness polyurethane industrial grade powder coat painted or bare aluminum. No fasteners except sealing screws shall be removable by external access. Hinges shall be stainless steel and of the continuous piano hinge type.

The pedestal mounting bolts shall not be externally accessible. The pedestal shall be offered with an optional base designed to be embedded in concrete in place of anchor bolts. Either pedestal mounting base or anchor bolt kit is required for installation.

The service pedestal must have three separate isolated sections for metering equipment, utility termination and customer equipment.

The metering section must be pad-lockable and sealable and have a hinged swing back hood with an integral hinged polycarbonate sealable window for access to demand meters. An external nameplate shall be permanently attached to the hood. A stainless steel handle shall be provided on the front exterior of the hood. Meter socket type shall meet the requirements of the serving utility.

The utility termination section must be pad-lockable and sealable and shall have a stainless steel handle provided on a lift-off cover. Sufficient clearance shall be provided for a 4-inch diameter conduit for utility cables entrance. Utility landing lugs shall be UL listed and shall accommodate #6 – 350 kcmil conductors.

The customer compartment door to be hinged on the left hand side. A stainless pad-lockable hasp provided to secure customer compartment. A door keeper provided to keep the door in an open position. A print pocket on the inside of the door shall hold all wiring schematics, circuit directories and instructions in a clear, weatherproof sleeve. Required UL labeling shall be located on the inside of the customer door. Distribution and control equipment shall be behind an internal dead-front door with a quarter-turn securing latch and be hinged to open more than 90 degrees. The dead-front door shall be hinged on the same side as the customer section door. All distribution and control equipment shall be factory wired using 600 volt wire sized to NEC and UL requirements.

The service pedestal shall be rated for operation at 10K minimum (AIC) amps interrupting capacity. The provided documentation shall list circuit breaker combinations and those to be used for de-rated operation for series ratings. Circuit breakers shall be permanently labeled with engraved name plates.

Utility requirements for this equipment vary. Always consult the serving utility for their requirements before ordering or installing this equipment.

"A" Style 16" Metered Commercial Pedestal

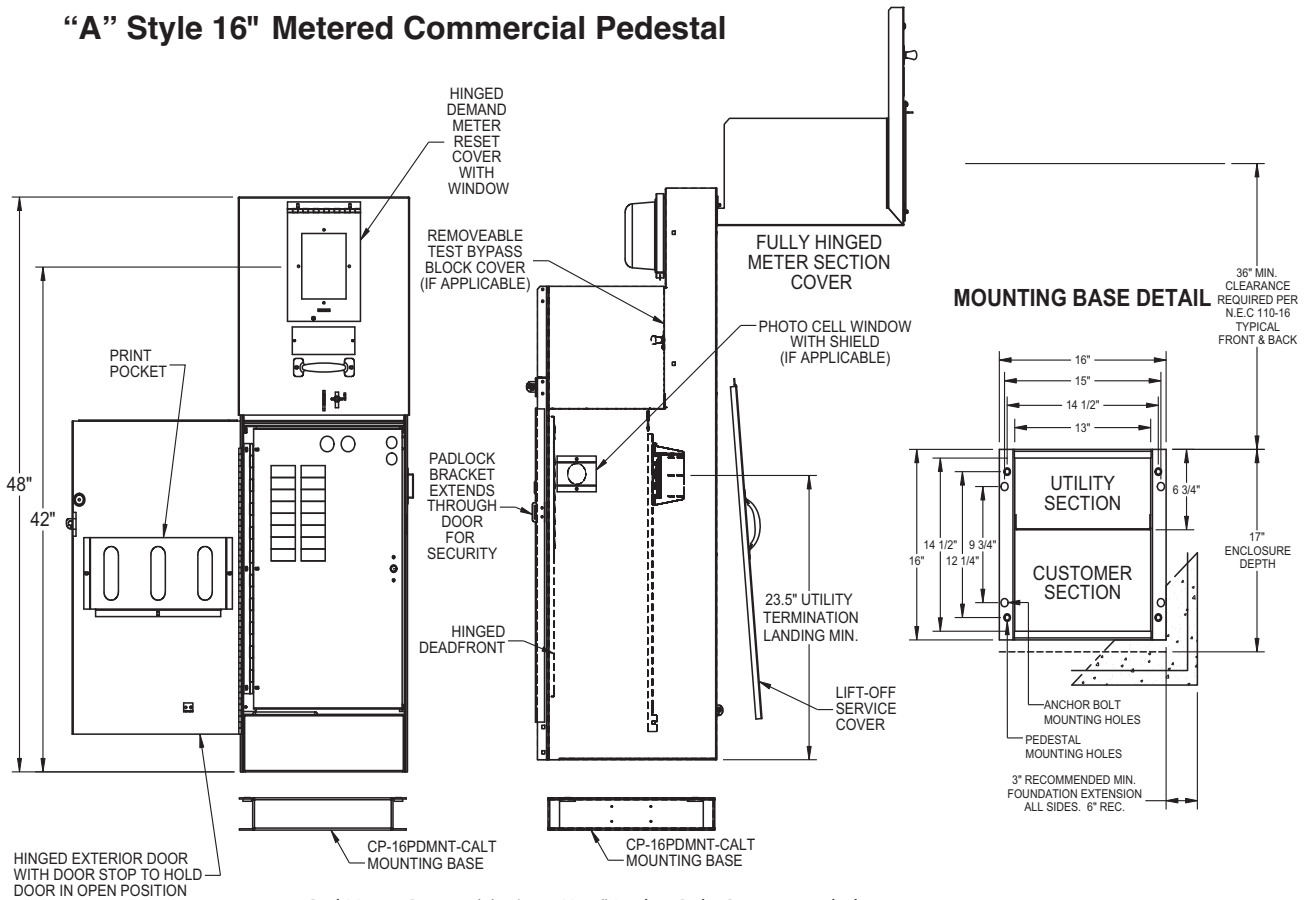

Pad Mount Base or (4) 5/8-11 X 18" Anchor Bolts Recommended

"E" Style 16" Unmetered Commercial Pedestal—Low Profile

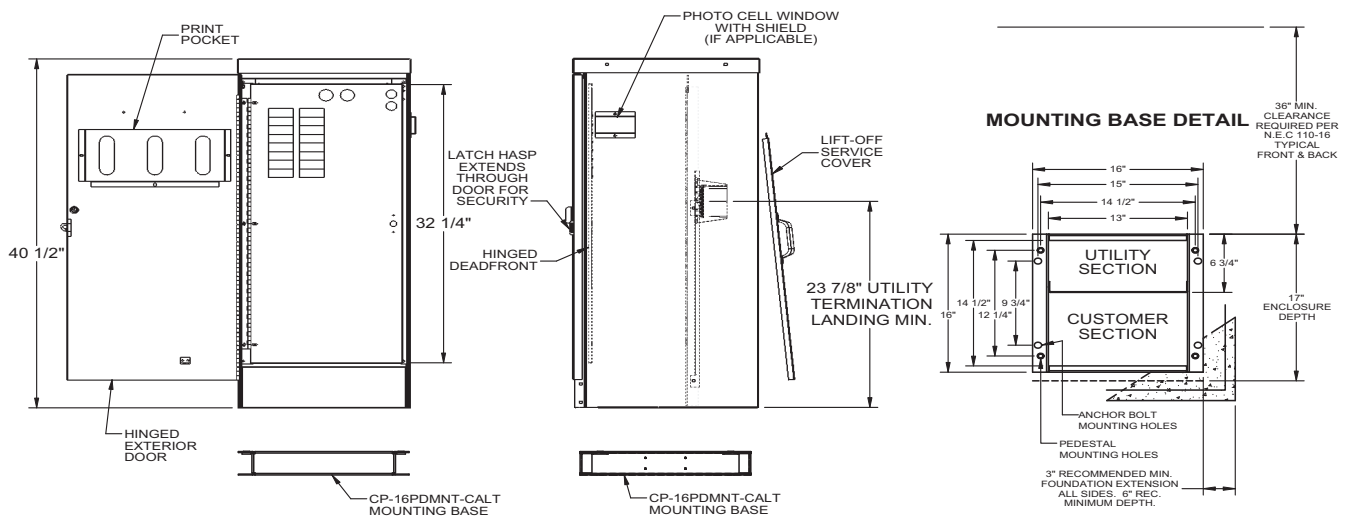

Pad Mount Base or (4) 5/8-11 X 18" Anchor Bolts Recommended

SECTION E
COMMERCIAL METER PEDESTALS

Utility requirements for this equipment may vary. Always consult the serving utility for their requirements before ordering or installing equipment in this catalog.



“B” Style 24" Metered Commercial Pedestal (With one or two meters)

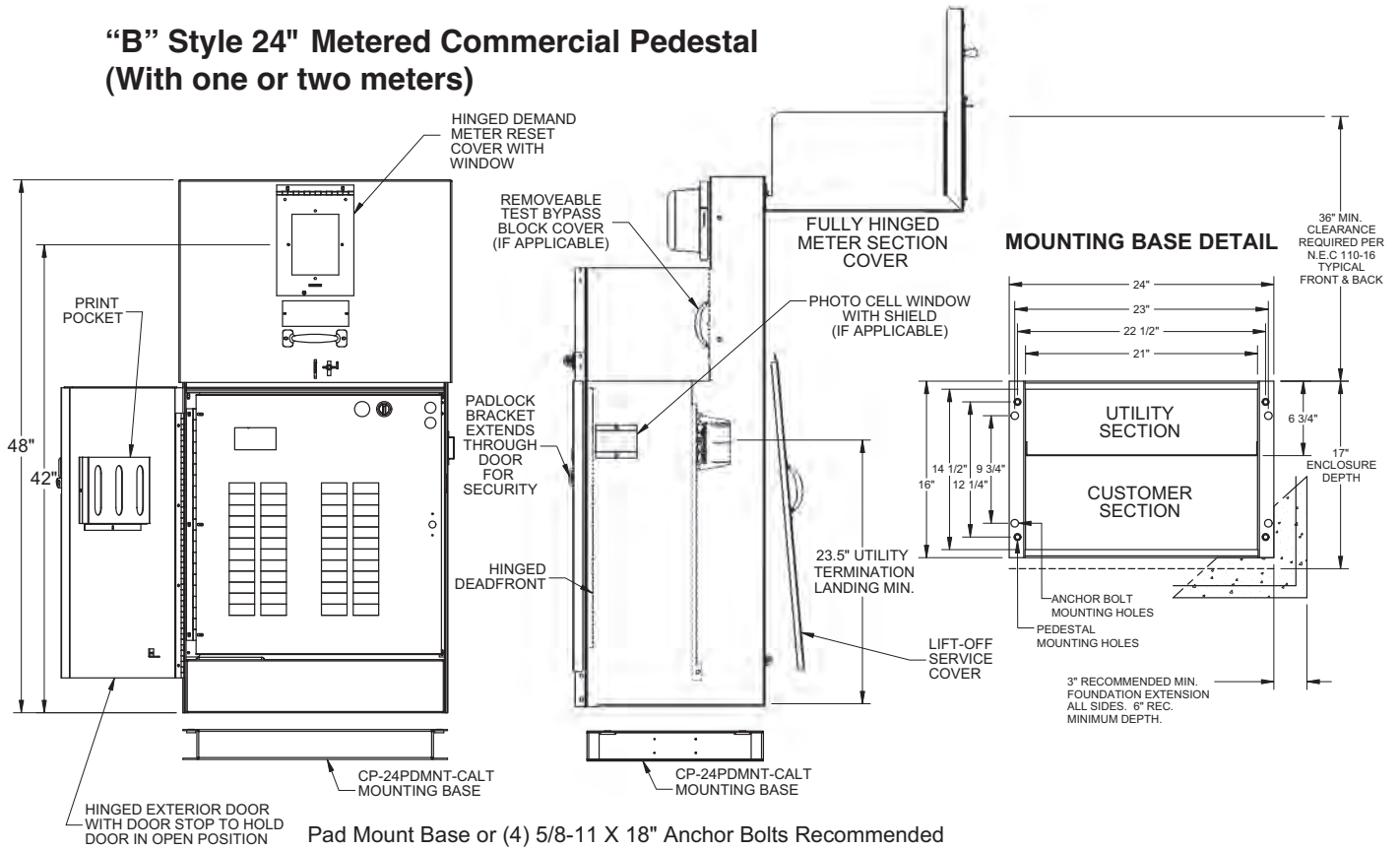

“M” Style 24" Unmetered Commercial Pedestal

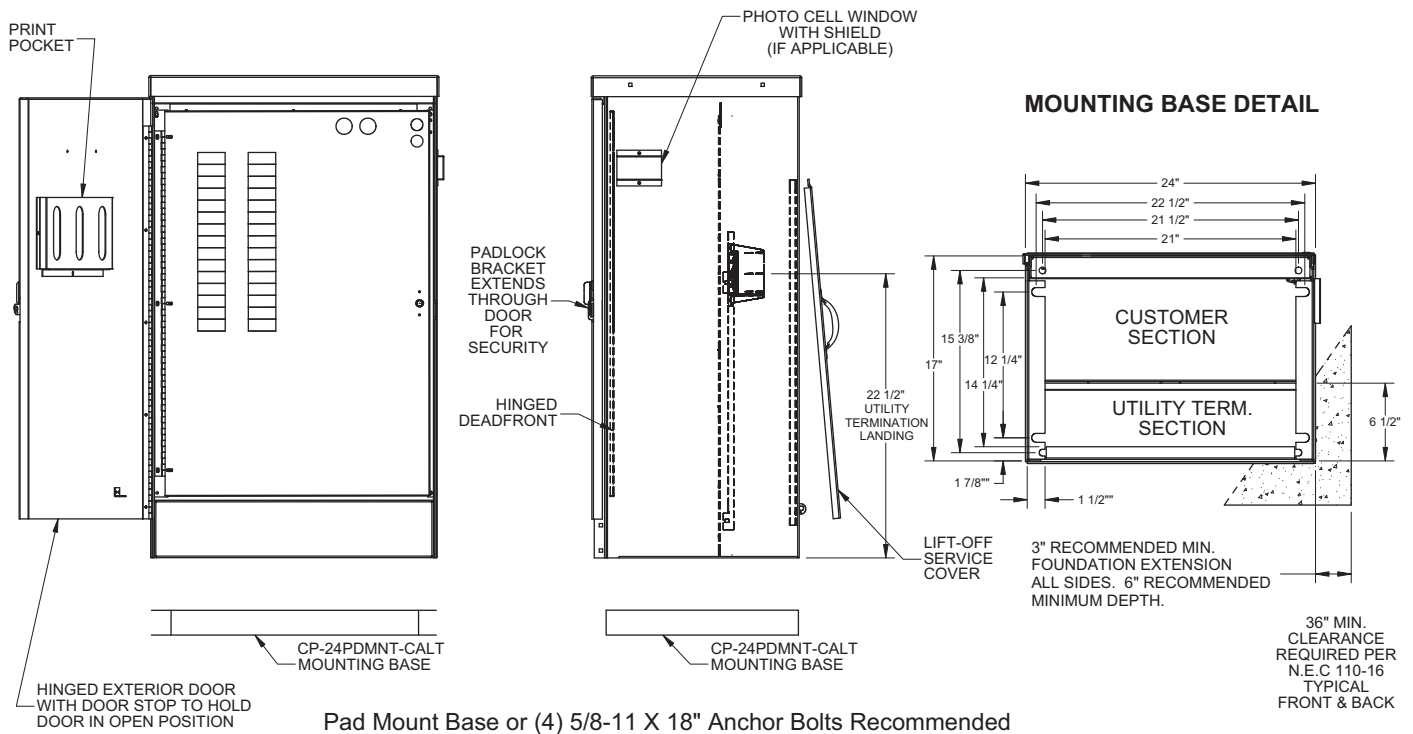

SECTION E

COMMERCIAL METER PEDESTALS

Utility requirements for this equipment may vary. Always consult the serving utility for their requirements before ordering or installing equipment in this catalog.



**"K" Style 32" Metered Commercial Pedestal
(With one or two meters)**

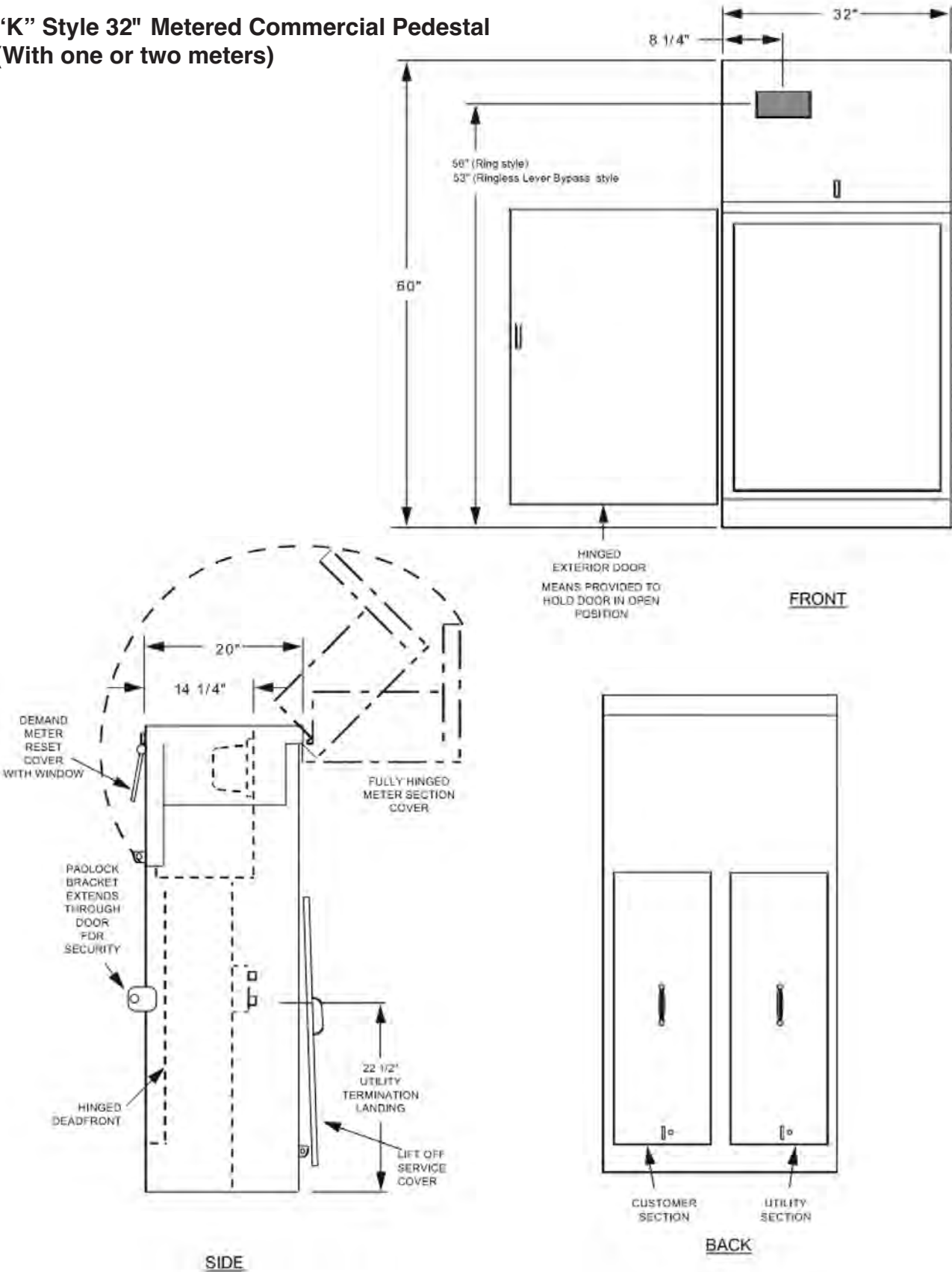

SECTION E
COMMERCIAL METER PEDESTALS

(4) 5/8-11 X 18" Anchor Bolts Recommended
Catalog Number CP-ABK5/8

Utility requirements for this equipment may vary. Always consult the serving utility for their requirements before ordering or installing equipment in this catalog.



“D” Style Metered Commercial Pedestal

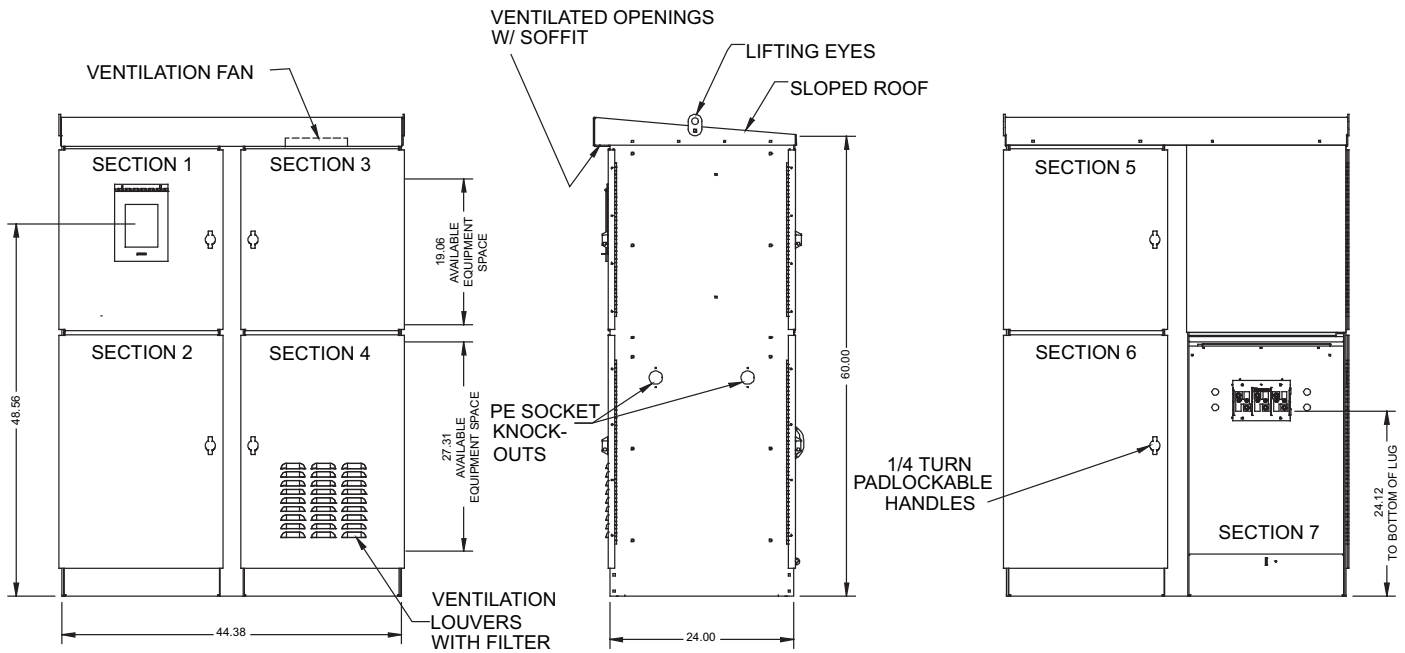

“C” Style 54" Metered Commercial Pedestal

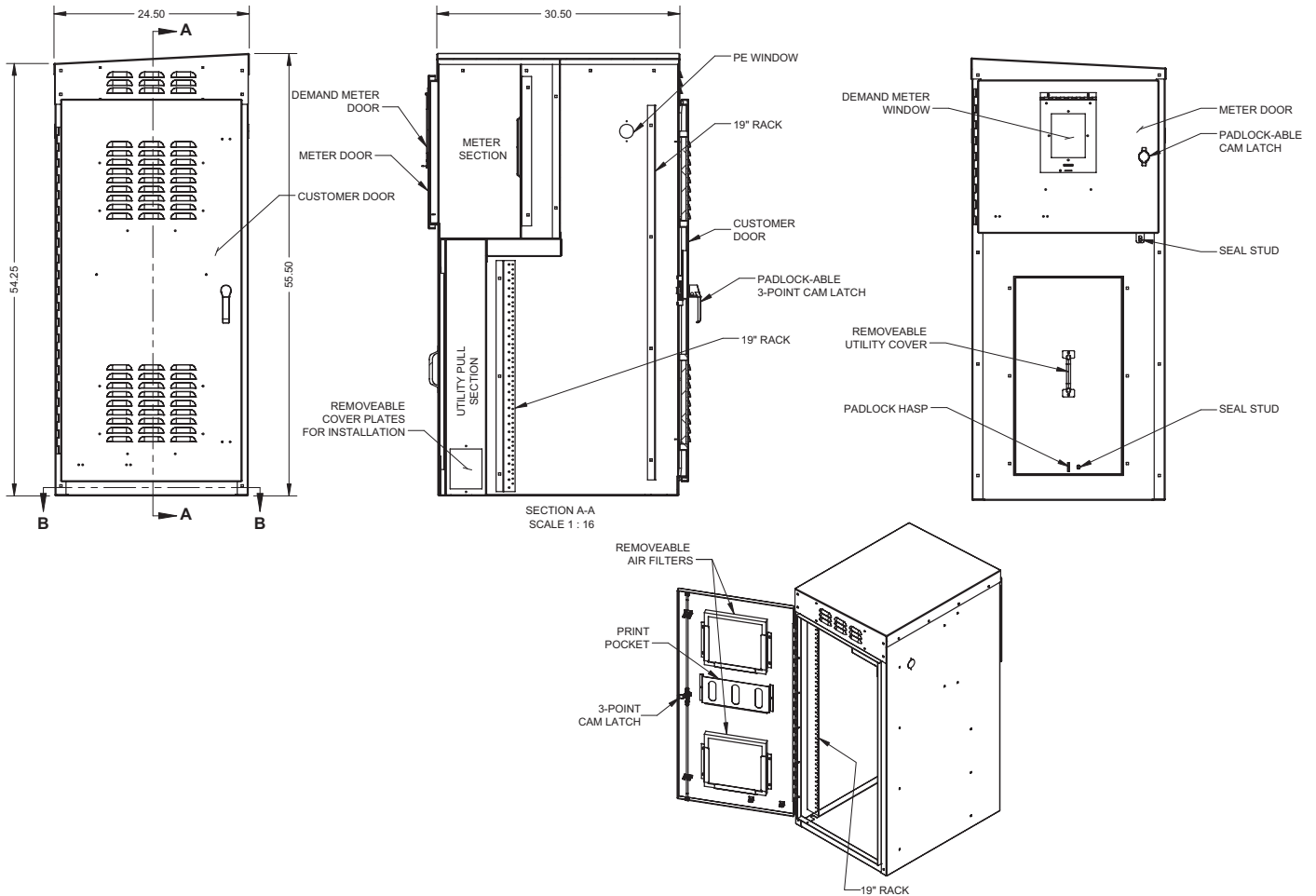

SECTION E

COMMERCIAL METER PEDESTALS

Utility requirements for this equipment may vary. Always consult the serving utility for their requirements before ordering or installing equipment in this catalog.





Commercial Pedestal Worksheet

Phone (816)483-5314 • Fax (816)483-6357

Please answer all of the questions as best as you can. Additional comments as to application and future requirements will help Milbank will determine the best product for your job.

Distributor: _____ Phone: _____ Fax: _____

Contact Name: _____ Application: _____

Milbank Representative: _____ Salesmen: _____

Job Name & Location: _____

Agency Specifications: (DOT-City-Other) _____

Unit Amperage: _____ Voltage: _____ Phase: _____ Wire: _____

Meter socket (200 Amp) RING-TYPE RINGLESS Fifth Terminal? NO YES (at _____ o'clock)

Meter socket (200 Amp) RING-TYPE RINGLESS Fifth Terminal? NO YES (at _____ o'clock)

Main breaker requirements: Amp: _____ Poles: _____ KAIC: _____

Main breaker requirements: Amp: _____ Poles: _____ KAIC: _____

Interior #1 0-42 circuits _____ Load center _____ Panel board _____ Metered? YES NO

Interior #2 0-42 circuits _____ Load center _____ Panel board _____ Metered? YES NO

Branch breakers: Amps: _____ Poles: _____ KAIC: _____ Label & Special requirements: _____

Qty _____ Breakers _____

Qty _____ Breakers _____

Qty _____ Breakers _____

Qty _____ Breakers _____

Qty _____ Breakers _____

Qty _____ Breakers _____

Controls:

Qty _____ Time Clock: 24 Hr _____ 7 Day _____ 365 Day Astro _____ Description: _____

Qty _____ Photo Electric Control Receptacle

Qty _____ Test switch: 2 Pos. _____ 3 Pos. _____ HOA Type _____ Other _____

Qty _____ Control Transformer _____ Voltage _____ VA Size (required for all 277/480v)

Contactors:

Type: Lighting - LT / Definite Purpose - DP / Mechanical Held - MH / Mercury - MV / IEC - IC

Qty _____ Type _____ Amps _____ Poles _____ Coil voltage _____ Other _____

Qty _____ Type _____ Amps _____ Poles _____ Coil voltage _____ Other _____

Qty _____ Type _____ Amps _____ Poles _____ Coil voltage _____ Other _____

Cabinet / Finish requirements: Alum - Untreated = AO / Alum Anodized = AL / Stainless Steel = SS

Aluminum - Painted = A / GALVANIZED STEEL PAINTED (STANDARD) _____ (specify paint below)

MINT GREEN (STANDARD) = G / Pine Green = PG / Dark Green = DG / Black = BK / Desert Tan = DT

White = W / Gray = P / Summerland Gray = SG / Other (RAL finish number) _____

Other Requirements: _____

Please send any drawings, plans, specifications, and load/panel board schedules with worksheet

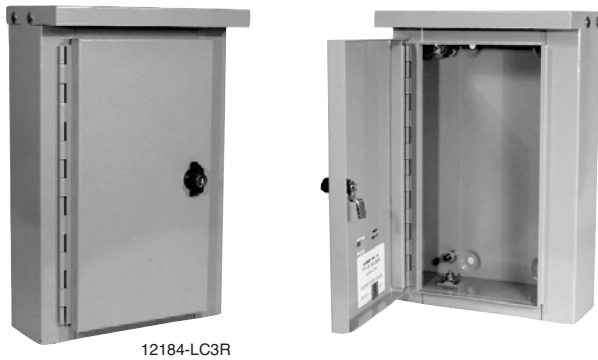
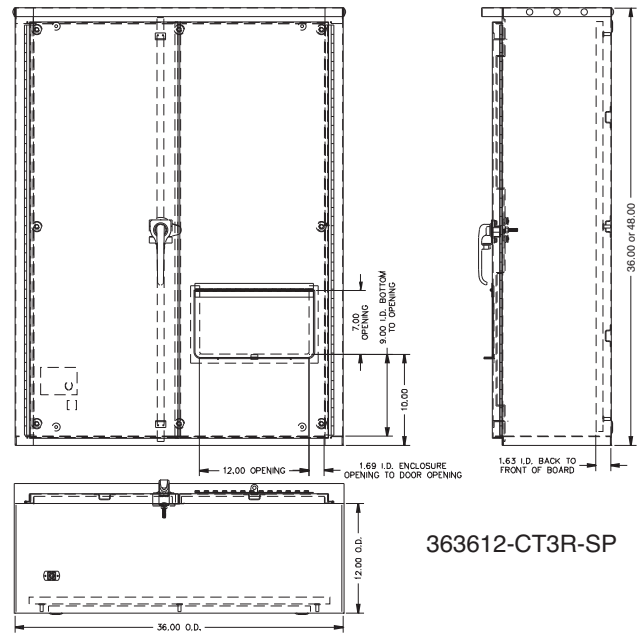
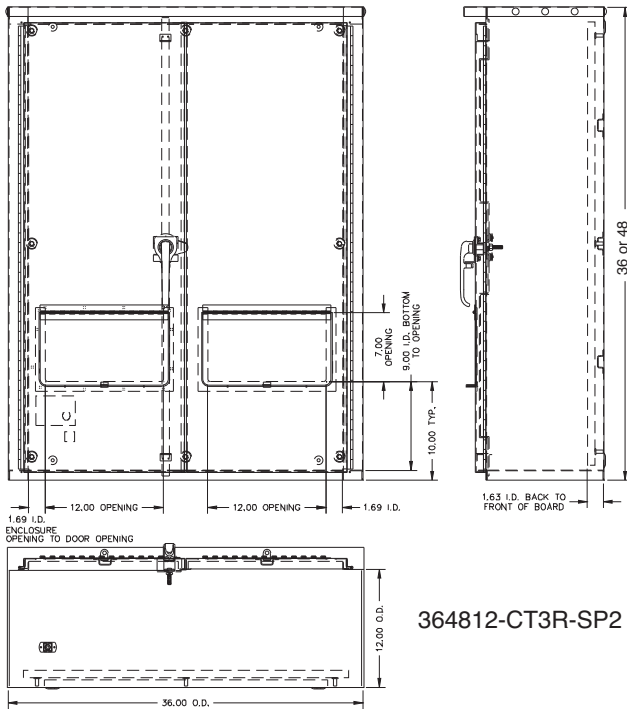

DOOR MOUNT C.T. RATED SOCKET

NO. OF TERMS.	CATALOG NUMBER	BYPASS	CONNECTORS	AMPS	DIMENSIONS		
					D"	W"	H"
13	K4806-BP	Plunger	#14-4 Max	20 A	2½	7⅞	7½

BP: The -BP suffix indicates plunger bypass.

CURRENT TRANSFORMER RATED CABINETS—TYPE 3R

CATALOG NUMBER	DIMENSIONS			GAUGE OF STEEL	PANEL SIZE		PANEL & BACKBOARD CATALOG NUMBERS	
	D"	W"	H"		W" x H"		PAINTED STEEL PANEL	WOOD BACKBOARD
243210-LC3R-SP	10	24	32	14	21	29	A-24P32	A-24P32W
323610-LC3R-SP	10	32	36	14	29	33	A-32P36	A-32P36W
363016-CT3R	16	36	30	14	33	27	A-36P30	A-36P30W
363612-CT3R-SP	12	36	36	14	33	33	A-36P36	A-36P36W INCLUDED
364812-CT3R-SP2	12	36	48	14	33	45	A-48P36	A-48P36W INCLUDED

Utility requirements for this equipment may vary. Always consult the serving utility for their requirements before ordering or installing equipment in this catalog.



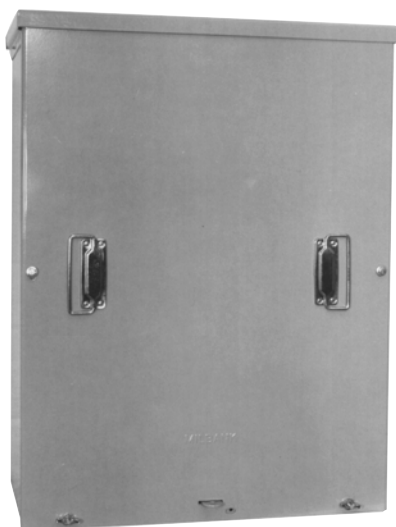

CT18249-SC



CT203611-HC

SCREW COVER

CATALOG NUMBER	C.T. RACKS	SIZE W" X H" X D"	FRONT COVER
CT24329-SC	C, M	24 X 32 X 9	1 PIECE
CT242411-SC	A4, C, M	24 X 24 X 11	1 PIECE
CT243011-SC	A4, C, M	24 X 30 X 11	1 PIECE
CT243611-SC	A4, C, J, M	24 X 36 X 11	1 PIECE
CT244811-SC	A, C, D, G, J, M	24 X 48 X 11	1 PIECE
CT303011-SC	A4, B4, C, E, L, M	30 X 30 X 11	1 PIECE
CT303611-SC	A4, B4, C, E, J, K, L, M	30 X 36 X 11	1 PIECE
CT303614-SC	A4, B4, C, E, J, K, L, M	30 X 36 X 14	1 PIECE
CT363611-SC	A4, B4, C, E, J, K, L, M	36 X 36 X 11	1 PIECE
CT364211-SC	A4, B4, C, E, J, K, L, M	36 X 42 X 11	2 PIECES
CT364811-SC	A, B, C, D, E, F, G, H, J, K, L, M	36 X 48 X 11	2 PIECES
CT364814-SC	A, B, C, D, E, F, G, H, J, K, L, M	36 X 48 X 14	2 PIECES
CT424211-SC	A4, B4, C, E, J, K, L, M	42 X 42 X 11	2 PIECES
CT484811-SC	A, B, C, D, E, F, G, H, J, K, L, M	48 X 48 X 11	2 PIECES

HINGE COVER

CATALOG NUMBER	C.T. RACKS	SIZE W" X H" X D"	FRONT COVER
CT203611-HC	C	20 X 36 X 11	1 PIECE
CT243011-HC	A4, C, M	24 X 30 X 11	1 PIECE
CT243611-HC	C, M	24 X 36 X 11	1 PIECE
CT244811-HC	A, C, D, G, J, M	24 X 48 X 11	1 PIECE
CT303611-HC	A4, B4, C, E, J, K, L, M	30 X 36 X 11	1 PIECE
CT304811-HC	A, B, C, D, E, F, G, H, J, K, L, M	30 X 48 X 11	1 PIECE
CT363611-HC	A4, B4, C, E, J, K, L, M	36 X 36 X 11	1 PIECE
CT364811-HC	A, B, C, D, E, F, G, H, J, K, L, M	36 X 48 X 11	1 PIECE
CT484811-HC	A, B, C, D, E, F, G, H, J, K, L, M	48 X 48 X 11	2 PIECE
CT364814-HC	A, B, C, D, E, F, G, H, J, K, L, M	36 X 48 X 14	2 PIECE
CT484814-HC	A, B, C, D, E, F, G, H, J, K, L, M	48 X 48 X 14	2 PIECE

ENCLOSURE: These units are rated Type 3R, powder coated, and constructed of galvanized steel.

MOUNTING RACK: Select CT mounting rack from next page.

MOUNTING: 1/4-20 welded studs.

Utility requirements for this equipment may vary. Always consult the serving utility for their requirements before ordering or installing equipment in this catalog.



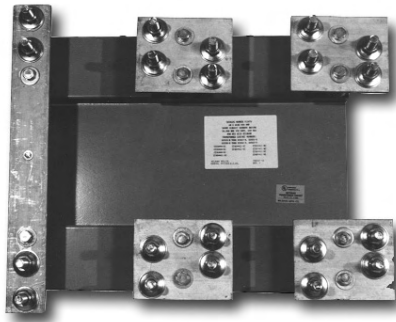
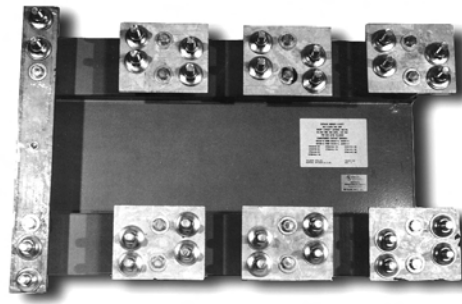
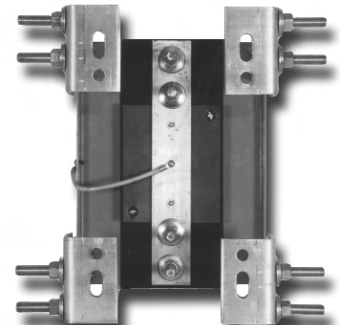
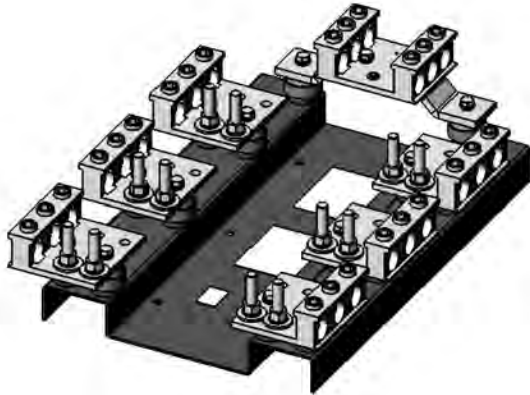
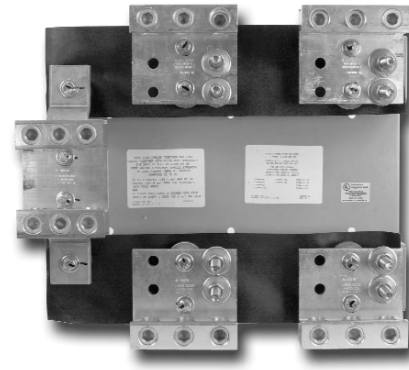

K4797

K4798

K4793 / K4795

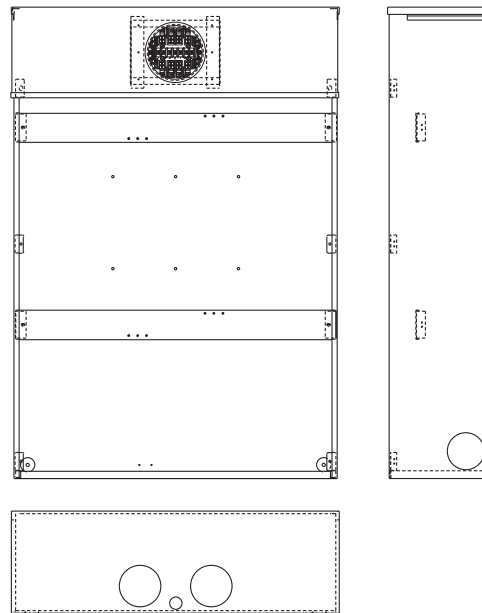
K4722

K4729
CURRENT TRANSFORMER ENCLOSURE MOUNTING RACKS

CODE	CATALOG NUMBER	AIC RATING	AMPS	VOLTS	TYPE OF SERVICE	TERMINATION TYPE
A4	K4797	50K	400	600	1Ø3W	1/2-13 studs on 1-3/4" centers
A	K4797	50K	800	600	1Ø3W	1/2-13 studs on 1-3/4" centers
B4	K4798	50K	400	600	3Ø4W	1/2-13 studs on 1-3/4" centers
B	K4798	50K	800	600	3Ø4W	1/2-13 studs on 1-3/4" centers
C	K4793	10K	201-400	600	1Ø3W	1/2-13 studs on 1-3/4" centers
D	K4795	10K	401-800	600	1Ø3W	1/2-13 studs on 1-3/4" centers
E	K4794	10K	201-400	600	3Ø4W	1/2-13 studs on 1-3/4" centers
F	K4796	10K	401-800	600	3Ø4W	1/2-13 studs on 1-3/4" centers
G	K4729	50K	800	600	1Ø3W	(3) #4 - 600 or (6) #1 - 250
H	K4722	50K	800	600	3Ø4W	(3) #4 - 600 or (6) #1 - 250
J	K4903	50K	400	600	1Ø3W	(1) #4 - 600 or (2) #1 - 250
K	K4904	50K	400	600	3Ø4W	(1) #4 - 600 or (2) #1 - 250
L	K5747	50K	800	600	3Ø4W	Line: 1/2-13 studs on 1-3/4" centers Load: (3) #4 - 600 or (6) #1 - 250
M	K5752	50K	800	600	1Ø3W	Line: 1/2-13 studs on 1-3/4" centers Load: (3) #4 - 600 or (6) #1 - 250

Select CT enclosures from previous page.

Utility requirements for this equipment may vary. Always consult the serving utility for their requirements before ordering or installing equipment in this catalog.



U3565-O

SECTION F

CT CABINETS, TEST SWITCHES, POLYPHASE ENCLOSURES

METERED TRANSFORMER CABINETS—RING TYPE

SERVICE	HUB	CATALOG NUMBER	C.T. RACKS	NO. OF TERMS	DIMENSIONS			TYPE OF SERVICE
					D"	W"	H"	
OH	H.O.	U3320-R	A, C, D, J, L, M	6	11	24	42	1Ø3W
OH	H.O.	U3322-R	B, E, F, G, H, L, M	13	11	36	42	3Ø4W Yor Δ
OH	H.O.	U3555-R	B, E, F, G, H, L, M	15	11	36	42	3Ø4W Yor Δ
UG	NONE	U3340-O	A, C, D, J, L, M	6	11	24	52	1Ø3W
UG	NONE	U3342-O	B, E, F, G, H, L, M	13	11	36	52	3Ø4W Yor Δ
UG	NONE	U3565-O	B, E, F, G, H, L, M	15	11	36	52	3Ø4W Yor Δ

METER SOCKET: 20 amp current transformer meter socket built in.

ENCLOSURE: NEMA Type 3R with screw cover.

CURRENT TRANSFORMER MOUNTING: 1/4-20 welded studs.

HUBS: For proper hub selection, see hub suffix chart in the accessory section.

SEALING RINGS: Supplied with MR-4 screw type sealing ring.

MOUNTING RACKS: For mounting rack information refer to previous page.

Utility requirements for this equipment may vary. Always consult the serving utility for their requirements before ordering or installing equipment in this catalog.





UC7582-XL

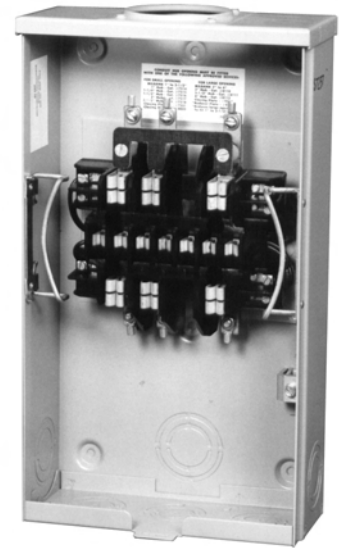
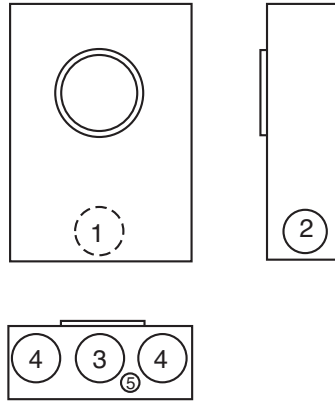

UC7237-RL

RINGLESS—PLUNGER TYPE BYPASS—OVERHEAD / UNDERGROUND

NO. OF TERMS	METER FORM	CATALOG NUMBER	HUB	CONNECTORS CU	BY-PASS	DIMENSIONS			CONCENTRIC K.O.'S					
						D"	W"	H"	1	2	3	4	5	6
5	3S	UC1290-XL	C.P.	#14 - #10	PLUNGER*	3 ⁵ / ₁₆	8	14	1 1/2	1 1/4	1 1/4	2	1 1/4	1/4
6	4S	UC1299-XL	C.P.	#14 - #10	PLUNGER*	3 ⁵ / ₁₆	8	14	1 1/2	1 1/4	1 1/4	2	1 1/4	1/4
7	7,14,15 & 24S	UC7233-XL	C.P.	#14 - #10	PLUNGER*	3 ⁵ / ₁₆	8	14	1 1/2	1 1/4	1 1/4	2	1 1/4	1/4
8	5S	UC7235-XL	C.P.	#14 - #10	PLUNGER*	3 ⁵ / ₁₆	8	14	1 1/2	1 1/4	1 1/4	2	1 1/4	1/4
13	6,8,9S & (ALT) 10S	UC7237-XL	C.P.	#14 - #10	PLUNGER*	3 ⁵ / ₁₆	8	14	1 1/2	1 1/4	1 1/4	2	1 1/4	1/4

RING TYPE—PLUNGER TYPE BYPASS—OVERHEAD / UNDERGROUND

NO. OF TERMS	METER FORM	CATALOG NUMBER	HUB	CONNECTORS CU	BY-PASS	DIMENSIONS			CONCENTRIC K.O.'S					
						D"	W"	H"	1	2	3	4	5	6
5	3S	UC1291-RL	H.O.	#14 - #4 MAX	PLUNGER*	3 ⁵ / ₁₆	8	14	1 1/2	1 1/4	1 1/4	2	1 1/4	1/4
6	4S	UC1300-RL	H.O.	#14 - #4 MAX	PLUNGER*	3 ⁵ / ₁₆	8	14	1 1/2	1 1/4	1 1/4	2	1 1/4	1/4
8	5S	UC7544-RL	H.O.	#14 - #4 MAX	PLUNGER*	3 ⁵ / ₁₆	8	14	1 1/2	1 1/4	1 1/4	2	1 1/4	1/4
13	6,8,9S & (ALT) 10S	UC7545-RL	H.O.	#14 - #4 MAX	PLUNGER*	3 ⁵ / ₁₆	8	14	1 1/2	1 1/4	1 1/4	2	1 1/4	1/4
13	6,8,9S & (ALT) 10S	UC7582-XL	C.P.	#14 - #10	NONE	3 ⁵ / ₁₆	8	14	1 1/2	1 1/4	1 1/4	2	1 1/4	1/4

HUBS: For proper hub selection see the hub suffix chart on the accessory page.

***BYPASS:** Plunger type bypass automatically closes when meter is removed.

CONNECTORS: Units are supplied with sleeve type connectors (#14-#2)

Utility requirements for this equipment may vary. Always consult the serving utility for their requirements before ordering or installing equipment in this catalog.

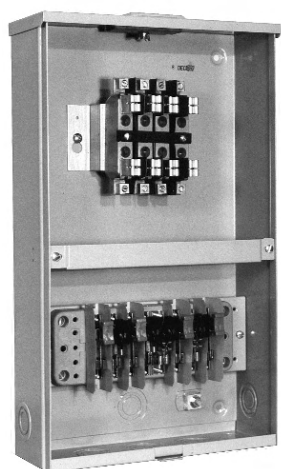

UC3438-XL-TS080025
(with test switch factory installed)



UC3423-XL

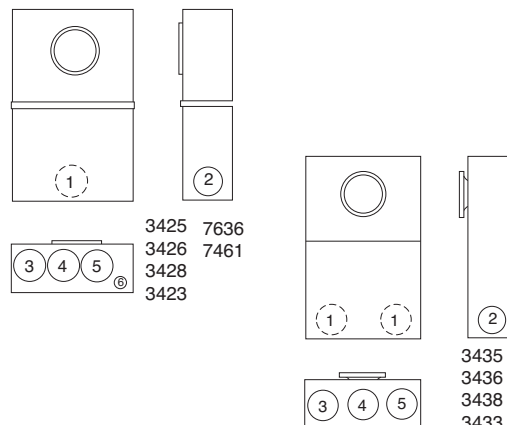

RINGLESS—WITH PROVISION FOR TEST SWITCH—TWO PIECE FRONT

NO. OF TERMS	SERVICE	CATALOG NUMBER	HUB	CONNECTORS	BY-PASS	DIMENSIONS			CONCENTRIC K.O.'S						
						D"	W"	H"	1	2	3	4	5	6	
5	OH / UG	UC3425-XL	C.P.	#14 - #2	NONE	5 ¹ / ₈	12	20	1 ¹ / ₄	1 ¹ / ₄	1 ¹ / ₄	1 ¹ / ₄	1 ¹ / ₄	1 ¹ / ₄	1/4, 1/2
6	OH / UG	UC3426-XL	C.P.	#14 - #2	NONE	5 ¹ / ₈	12	20	1 ¹ / ₄	1 ¹ / ₄	1 ¹ / ₄	1 ¹ / ₄	1 ¹ / ₄	1 ¹ / ₄	1/4, 1/2
8	OH / UG	UC3428-XL	C.P.	#14 - #2	NONE	5 ¹ / ₈	12	20	1 ¹ / ₄	1 ¹ / ₄	1 ¹ / ₄	1 ¹ / ₄	1 ¹ / ₄	1 ¹ / ₄	1/4, 1/2
13	OH / UG	UC3423-XL	C.P.	#14 - #2	NONE	5 ¹ / ₈	12	20	1 ¹ / ₄	1 ¹ / ₄	1 ¹ / ₄	1 ¹ / ₄	1 ¹ / ₄	1 ¹ / ₄	1/4, 1/2

***RING TYPE—TEST SWITCH FACTORY PREWIRED—TWO PIECE FRONT
APPROVED FOR TUCSON ELECTRIC POWER**

NO. OF TERMS	SERVICE	CATALOG NUMBER	HUB	CONNECTORS	BY-PASS	DIMENSIONS			CONCENTRIC K.O.'S						
						D"	W"	H"	1	2	3	4	5	6	
6	OH	UC7636-YL-TGE-DES	1 ¹ / ₄ "	#14 - #2	TEST SWITCH	4 ¹ / ₈	12	20	1 ¹ / ₄	1 ¹ / ₄	1 ¹ / ₄	1 ¹ / ₄	1 ¹ / ₄	1 ¹ / ₄	1/4, 1/2
13	OH	UC7461-YL-TGE-DES	1 ¹ / ₄ "	#14 - #2	TEST SWITCH	4 ¹ / ₈	12	20	1 ¹ / ₄	1 ¹ / ₄	1 ¹ / ₄	1 ¹ / ₄	1 ¹ / ₄	1 ¹ / ₄	1/4, 1/2

***RING TYPE—WITH PROVISIONS FOR TEST SWITCH—EUSERC COMPLIANT—TWO PIECE FRONT**

NO. OF TERMS	SERVICE	CATALOG NUMBER	HUB	CONNECTORS	BY-PASS	DIMENSIONS			CONCENTRIC K.O.'S						
						D"	W"	H"	1	2	3	4	5	6	
5	OH / UG	UC3435-XL	C.P.	#14 - #2	NONE	5 ¹ / ₈	12	20	2	2	2	2	2	2	—
6	OH / UG	UC3436-XL	C.P.	#14 - #2	NONE	5 ¹ / ₈	12	20	2	2	2	2	2	2	—
8	OH / UG	UC3438-XL	C.P.	#14 - #2	NONE	5 ¹ / ₈	12	20	2	2	2	2	2	2	—
13	OH / UG	UC3433-XL	C.P.	#14 - #2	NONE	5 ¹ / ₈	12	20	2	2	2	2	2	2	—
15	OH / UG	UC3434-XL	C.P.	#14 - #2	NONE	5 ¹ / ₈	12	20	2	2	2	2	2	2	—

***SEALING RINGS:** Ring type units are supplied with one MR-4, screw type, sealing ring.

PREWIRING: If factory prewiring is required consult factory before ordering. Please include meter socket catalog number, test switch number, meter form number, and a copy of your wiring diagram.

TEST SWITCH COVERS: Units on this page can be used with clear lexan cover (except units 7636 and 7461).

CONNECTORS: Units are supplied with sleeve type connectors (#14-#2)

HUBS: For proper hub selection see the hub suffix chart in accessory section.

Utility requirements for this equipment may vary. Always consult the serving utility for their requirements before ordering or installing equipment in this catalog.

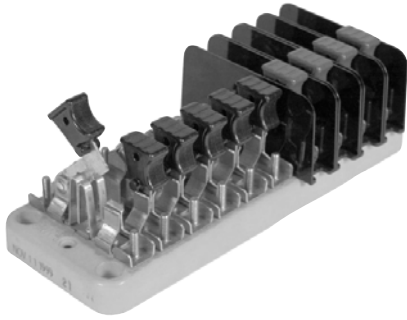

SECTION F
CT CABINETS, TEST SWITCHES, POLYPHASE ENCLOSURES

SWITCH BLADES

Two dimples coined into one side of the switch blade ensure positive contact in corrosive, sooty environments—even after years of inactivity.

TEST SWITCH BASE

The base is molded from a high strength, fiberglass reinforced, thermoset polyester. This material is track resistant, flame retardant and has low water absorption qualities. Bases are available in 7 pole and 10 pole sizes.

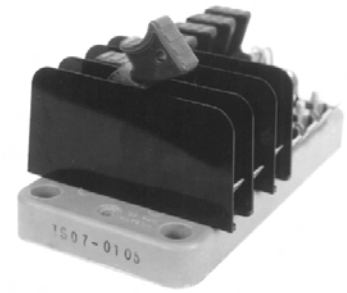
POLARITY BARRIER

For maximum protection potential circuits are supplied with permanently mounted, rigid barriers made from high tensile strength, polycarbonate.

TEST SWITCH COVERS

Standard test switch covers are made from break resistant, clear, thermal plastic which has excellent tracking and moisture resistant properties. If covers are required, add suffix “-WC” (with cover) to the catalog number or order separately catalog number **K3388**. Black flush mount covers are also available. Order catalog number **K3388-BLK-FL**. 10 pole base only.

STANDARD COVER

K3388
SWITCH JAWS

The switch blade jaw clips are constructed from spring grade copper alloy. The material and design ensure excellent contact which prevents overheating.

CURRENT CARRYING PARTS

Highly conductive copper and copper alloy materials are used on all current carrying parts. This ensures conductivity and deters corrosion. Spring grades are used where appropriate. Plating is available if required. Contact general offices to special order.

FLUSH MOUNT COVER BLACK

K3388-BLK-FL

Units must be 5 1/8" deep for Cover

FACTORY INSTALLED: For cover installed add the suffix **-WC** or **-WCFL** to the catalog number of desired test switch

FIELD INSTALLED: For field installed cover order kit number **K3388** or **K3388-BLK-FL**.

The MILBANK test switch is designed to meet the critical requirements of the electric utility industry. Not only do they meet EEI, ANSI C12.9, and UL standards but they combine several special features giving the MILBANK test switch increased safety, durability and reliability. One such feature is our unique switch blade contact points which cut through residue that builds up after years of service. Another distinction is our polarity barrier which is designed to be flexible as well as offer exceptional insulating qualities. Our test switches are constructed from the latest materials available using modern fabricating and assembly methods.

Utility requirements for this equipment may vary. Always consult the serving utility for their requirements before ordering or installing equipment in this catalog.

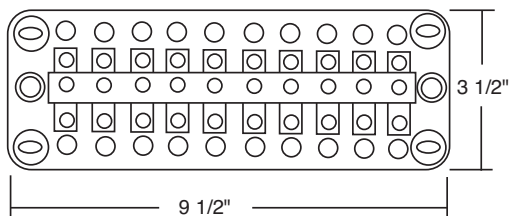
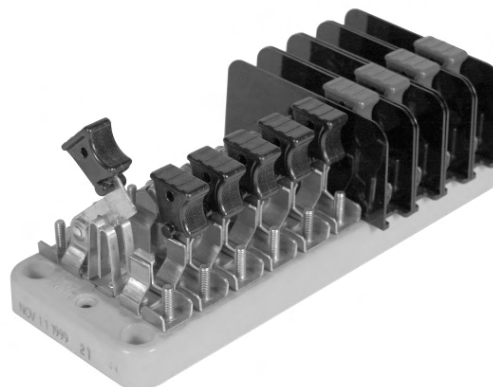
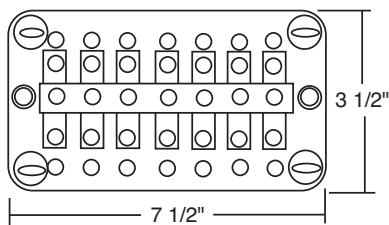

CATALOG NUMBER	4-POLE						
TS04-0101	X	P	<input type="checkbox"/> Pn	X	C+	C	X
TS04-0104	X	C+	C	X	<input type="checkbox"/> P	Pn	X

CATALOG NUMBER	7-POLE						
TS07-0105	<input type="checkbox"/> P	P	<input type="checkbox"/> Pn	C+	C	C+	C

CATALOG NUMBER	7-POLE ON A 10 POLE BASE									
TS07-0049	<input type="checkbox"/> P	X	<input type="checkbox"/> P	X	<input type="checkbox"/> Pn	X	C+	C	C	C+
TS07-0106	X	<input type="checkbox"/> P	C+	C	<input type="checkbox"/> P	C+	C	<input type="checkbox"/> Pn	X	X

CATALOG NUMBER	10-POLE									
TS10-0109	P	<input type="checkbox"/> P	P	<input type="checkbox"/> Pn	C+	C	C+	C	C+	C
TS10-0110	<input type="checkbox"/> P	C+	C	<input type="checkbox"/> P	C+	C	<input type="checkbox"/> P	C+	C	<input type="checkbox"/> Pn
TS10-0111	P	<input type="checkbox"/> P	P	<input type="checkbox"/> Pn	C	C+	C	C+	C	C+
TS10-0112	C+	C	C+	C	C+	C	<input type="checkbox"/> P	P	<input type="checkbox"/> P	Pn
TS10-0016	<input type="checkbox"/> P	<input type="checkbox"/> P	<input type="checkbox"/> P	PN	C	C+	C	C+	C	C+

CUSTOM POLE ARRANGEMENTS:
 The key may be used to diagram your own pole arrangement. Be sure to specify base size and whether all C+ line side, current switch / shunt circuit assemblies are to be bussed together. The catalog numbers shown above are connected in line-load pairs; therefore, if bussed is required, different catalog numbers will apply.

KEY	
P	Potential Switch
C+	Line side current switch with short circuit assembly
C	Load side current switch with test jack assembly
N	Neutral bar (no switch)
Pn	Neutral potential switch
X	Unused position on base
<input type="checkbox"/>	Insulating barrier, isolates both sides of switch

SECTION F
 CT CABINETS, TEST SWITCHES, POLYPHASE ENCLOSURES

Utility requirements for this equipment may vary. Always consult the serving utility for their requirements before ordering or installing equipment in this catalog.



TEST SWITCH BASE

The base is molded from a high strength, fiberglass reinforced, thermoset polyester. This material is track-resistant, flame-retardant and has low water absorption qualities. Bases are available in two standard sizes following NEMA mounting classifications.

CUSTOMER NAME: _____

 ADDRESS: _____

PHONE / FAX: _____ / _____

HANDLE COLOR KEY

BK	Black	P	Purple	Y	Yellow	GN	Green
R	Red	BL	Blue	W	White	BKS	BK/Stripe
BR	Brown	GR	Grey	O	Orange	WS	W/Stripe

POLE POSITION CHART

1	2	3	4	5	6	7	8	9	10

SPECIAL FEATURES

FEATURE	1	2	3	4	5	6	7	8	9	10
45° ANGLE STOPS										
GANGED HANDLES (C)										
BUSSING										
COLORED HANDLES										

 ENGINEERING INFORMATION: _____

KEY

P	Potential Switch
C+	Line side current switch with short circuit assembly
C	Load side current switch with test jack assembly
N	Neutral bar (no switch)
Pn	Neutral potential switch
X	Unused position on base
	Insulating barrier, isolates both sides of switch

CUSTOM POLE ARRANGEMENTS: The key may be used to diagram your own pole arrangement. Be sure to specify base size and whether all C+ line side, current switch / shunt circuit assemblies are to be bussed together. The catalog numbers shown above are connected in line-load pairs; therefore, if bussed is required, different catalog numbers will apply.

NUMBER OF POLES

- 4
 7
 10
 OTHER _____

TEST SWITCH COVER*

- YES ___ CLEAR ___ BLACK
 NO

BASE SIZE

- 7 POLE
 10 POLE

*Test switch covers are only available for 10 pole bases.

Utility requirements for this equipment may vary. Always consult the serving utility for their requirements before ordering or installing equipment in this catalog.

SECTION F
NOTES

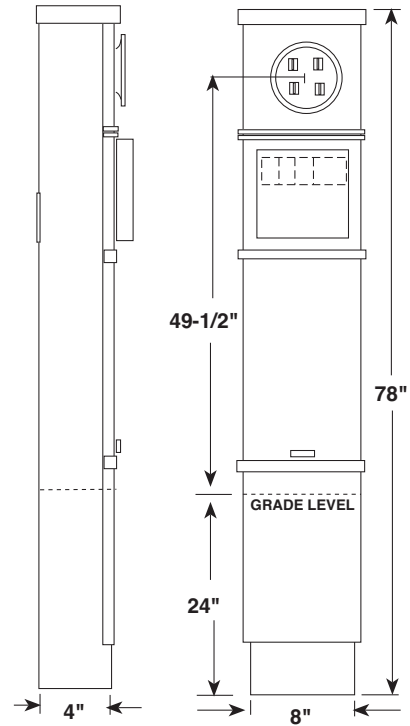
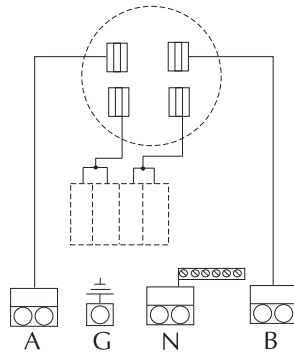
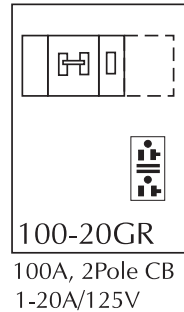
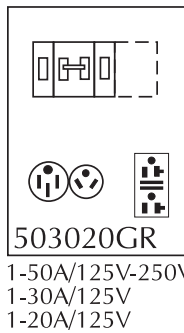
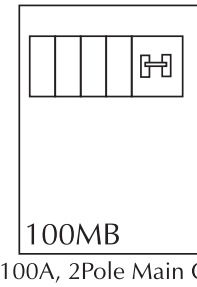
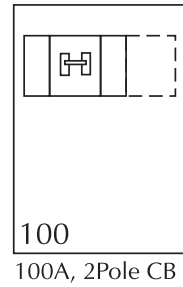
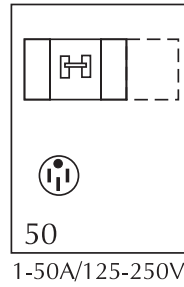
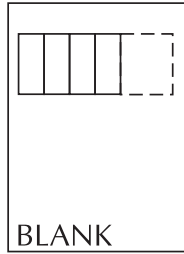

MPRV-100-MB-78

STANDARD CONFIGURATIONS

SINGLE

SPECIFICATIONS

- UL Listed 100 amp continuous duty meter socket.
- 120/240 volt single phase service.
- Twin line termination lugs #6-350 kcmil CU/AL per phase for looping.
- Space for four (4) single, or one double (240V C/B center-positions only) and two (2) single pole universal style, plug-in circuit breakers.
- **Ringless** version equipped with horn bypass as standard.
- For fifth terminal field installed order kit **105J** in the 3 o'clock or 9 o'clock position.
- Direct rear feed kit **PF-KR** included.
- Specify **MPRV-100-78** for 100 amp service pedestal with direct feed kit and 100 amp CB wired in parallel. Space for two additional single pole CBs provided. Series wiring available; specify **MPRV-100-MB-78**.
- **MR-2** sealing ring standard with ring type cover.
- No knockouts.

CATALOG NUMBER	DESCRIPTION
MPRV-BLANK-78	Ring type, parallel wired
MPRV-BLANK-78-R-5T	Ringless , horn bypass
MPRV-100-78	Ring type, parallel wired
MPRV-100-MB-78	Ring type, series wired
MPRV-100-20GR-78	Ring type, parallel wired
MPRV-50-78	Ring type
MPRV-503020GR-78	Ring type

Utility requirements for this equipment may vary. Always consult the serving utility for their requirements before ordering or installing equipment in this catalog.

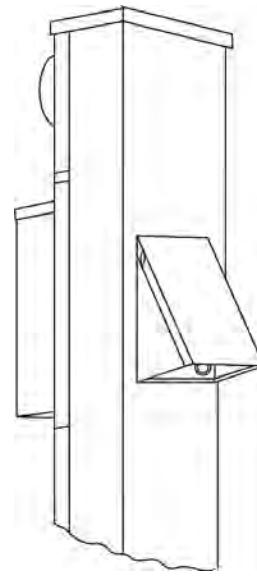
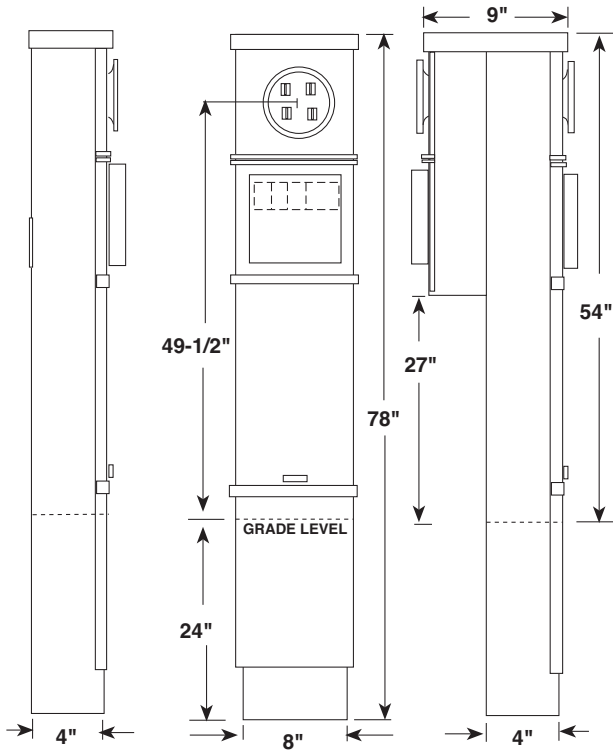

MPAP-200-78



STANDARD CONFIGURATIONS

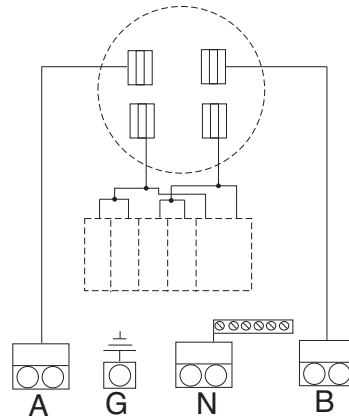
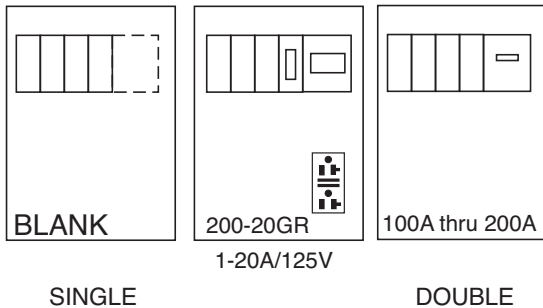

SPECIFICATIONS

- 120/240 volt single phase service.
- Twin line termination lugs #6-350 CU/AL per phase for looping.
- **UQFP** breaker provisions factory wired in parallel with branch breaker bus. Series wiring available. Specify **MB** after breaker rating, ex. **MPAP-200-MB**.
- Furnished with space for four single or one double (240V C/B center-positions only) and two single pole universal style, plug-in circuit breakers in addition to main.
- **Ringless** version equipped with horn bypass as standard.
- For fifth terminal field installed order kit **105J** in the 3 o'clock or 9 o'clock position.
- Direct rear feed kit **PF-KR** included.
- **MR-2** sealing ring standard with ring type cover.

CATALOG NUMBER	DESCRIPTION
MPAP-BLANK-78	Ring type, parallel wired
MPAP-BLANK-78-R	Ringless , horn bypass, parallel wired
MPAP-100-78	Ring type, parallel wired
MPAP-100-MB-78	Ring type, series wired
MPAP-200-78	Ring type, parallel wired
MPAP-200-MB-78	Ring type, series wired
MPAP-200-20GR-78	Ring type, parallel wired
MPAPD-BLANK-78	Ring type, parallel wired
MPAPD-BLANK-78R	Ringless , horn bypass, parallel wired

Utility requirements for this equipment may vary. Always consult the serving utility for their requirements before ordering or installing equipment in this catalog.



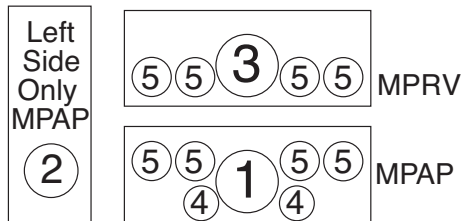
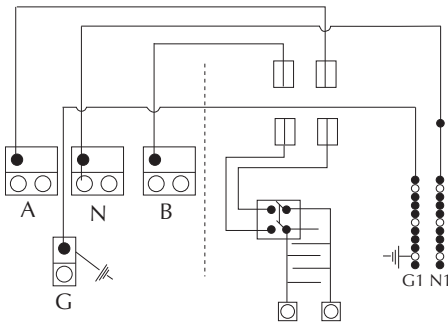
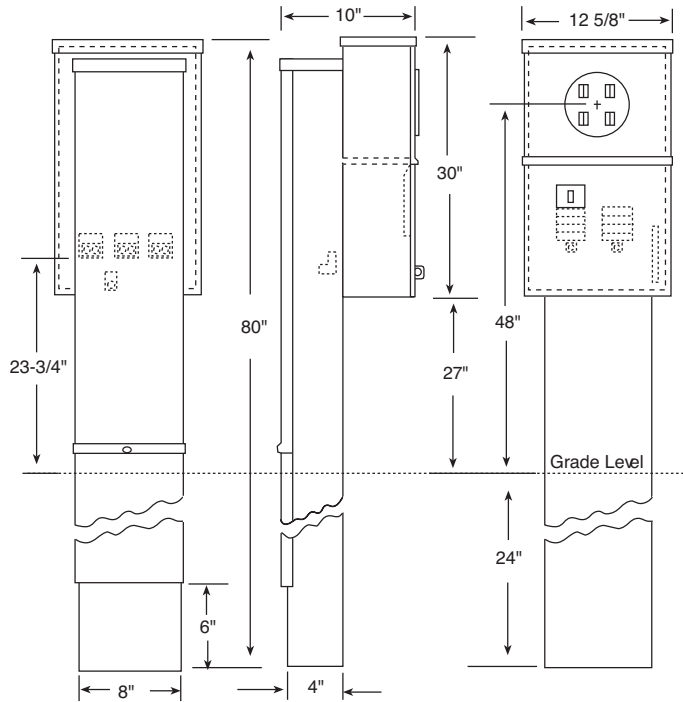

MPAP-200-MBLC-80

SERVICE PEDESTALS

SECTION C

100 & 200 AMP—LOAD CENTER POWER OUTLETS

CATALOG NUMBER	DESCRIPTION	CONCENTRIC K.O.'S (INCHES)				
		1	2	3	4	5
MPRV-100-MBLC-80	100 Amp Metered Pedestal with (8) Circuit Load Center	2½	2	1½	1¼	½,¾
MPAP-200-MBLC-80	200 Amp Metered Pedestal with (8) Circuit Load Center	2½	2	1½	1¼	½,¾

SPECIFICATIONS

- UL Listed 100 / 200 amp continuous duty meter socket.
- Approved for 120/240 volt single phase service.
- Twin line termination lugs #6-350 CU/AL per phase for looping. Rear termination
- Space for (8) single, or (4) double and two single pole universal style plug-in circuit breakers
- Series main breaker factory installed.
- Direct feed lugs standard.

Utility requirements for this equipment may vary. Always consult the serving utility for their requirements before ordering or installing equipment in this catalog.



U5240-O-200S with series wired main & K5400-520GR kit

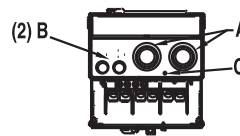
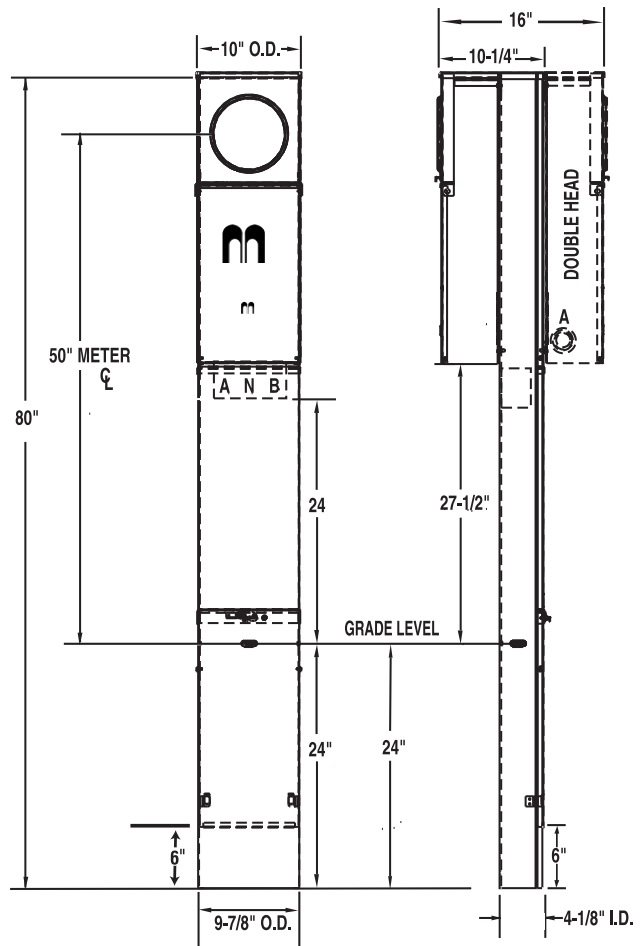

KO's	
A	= 1, 1-1/4, 1-1/2, 2
B	= 1/2, 3/4
C	= 1/4 SOLID

SPECIFICATIONS

- UL Listed – conforms to EUSERC drawing number 307
- 200 amp maximum, 120/240 volt, single phase, three wire meter socket
- Ring type meter socket with stainless steel screw-type sealing ring
- Short circuit withstand rating 22K AIC.
- Type 3R construction for durable outdoor use, one piece post – lockable and sealable
- Milbank grey polyester powder coat finish
- Wire terminations accept copper or aluminum conductors
- Line & Neutral: (2) #6-350 kcmil per phase
- Line Ground: (4) #14-1/0
- Load (CB): 2/0 to 300 kcmil per pole
- Load Neutral: (1) #6-350 kcmil
- Load Ground: (2) #14-1/0, (4) #14/6
- Milbank plug-in main circuit breaker. Available in 100, 125, 150 & 200 amp. Type **UQFPH-M**.
- Four-circuit plated copper interior accepts (2) 2-pole or (4) 1-pole standard plug-in type circuit breakers up to a total of 125 amps maximum. Acceptable manufacturers: Cutler-Hammer, GE or Siemens
- Factory or field installable receptacle bridge and receptacle / circuit breaker kits available. See accessories.

Utility requirements for this equipment may vary. Always consult the serving utility for their requirements before ordering or installing equipment in this catalog.



SINGLE PEDESTAL (Direct Burial)

<u>CATALOG NUMBER</u>	<u>MAIN BREAKER</u>	<u>MAIN CB</u>	<u>BRANCH</u>	<u>WEIGHT (lbs)</u>
◆ U5240-O-100S	◆ UQFPH-M-100	100	4 Circuit	82
◆ U5240-O-200S	◆ UQFPH-M-200	200	4 Circuit	82
◆ U5240-O (parallel wired)	provision for UQFPH-M Series	—	4 Circuit	80

SINGLE PEDESTAL (Pad Mount)

◆ U5242-O-200S	UQFPH-M-200	200	4 Circuit	82
◆ U5242-O (parallel wired)	provision for UQFPH-M Series	—	4 Circuit	80



DOUBLE PEDESTAL (Direct Burial)

<u>CATALOG NUMBER</u>	<u>MAIN BREAKER</u>	<u>MAIN CB</u>	<u>BRANCH</u>	<u>WEIGHT (lbs)</u>
◆ U5241-O-100S	(2) UQFPH-M-100	100	4 Circuit	115
◆ U5241-O-200S	(2) UQFPH-M-200	200	4 Circuit	115
◆ U5241-O (parallel wired)	provision for (2) UQFPH-M Series	—	4 Circuit	111

DOUBLE PEDESTAL (Pad Mount)

U5243-O (parallel wired)	provision for (2) UQFPH-M Series	—	4 Circuit	111
--------------------------	----------------------------------	---	-----------	-----

RECEPTACLE / CIRCUIT BREAKER KITS AND ACCESSORIES (ORDER SEPARATELY)

<u>CATALOG #</u>	<u>RECEPTACLE</u>	<u>CIRCUIT BREAKER</u>	<u>CONDUCTOR</u>	<u>CONFIGURATION</u>
◆ K5400-520GR	5-20R Duplex GFI	20 Amp, 1 Pole	12 Awg	 GFI Rec.
◆ K5400-TT30	TT30R	30 Amp, 1 Pole	10 Awg	
◆ K5400-1450	14-50R	50 Amp, 2 Pole	8 Awg	
◆ K5400-BRIDGE-1POS	Self-grounded one position receptacle bridge with hardware			
◆ K5400-BRIDGE-2POS	Self-grounded two position receptacle bridge with hardware			
◆ K5415	Stabilizer Foot with hardware			
◆ K5035	Pad Mount Kit with hardware for U5242/43 pad mount pedestals required			
◆ K5T	5th Terminal for 208y / 120 volt 3-wire service			
◆ K5193	Bus kit to convert series-wired main breaker to parallel			
◆ K5194	Wire kit to convert parallel-wired main breaker to series			
◆ K3450	Telephone / CATV mounting bracket (mounts left or right)			
◆ K5039	Penta bolt utility cover			

- Up to two receptacle / circuit breaker kits can be field-installed in each powerhead. Order mounting bridge and receptacle kits separately from above. For three receptacles or factory-installed kits, contact factory.
 - Receptacle / circuit breaker kits include receptacle, circuit breaker, connected wire, cover plate and mounting screws. Other receptacle / circuit breaker kits available.
 - **K5415** Stabilizer Foot sold separately. Recommended for double pedestals.
 - Pad mount pedestals require **K5035** pad mount kit. Order separately.
 - ◆ Stock item – availability subject to prior sale.
- Non-stock items – minimum order quantity required.

Utility requirements for this equipment may vary. Always consult the serving utility for their requirements before ordering or installing equipment in this catalog.

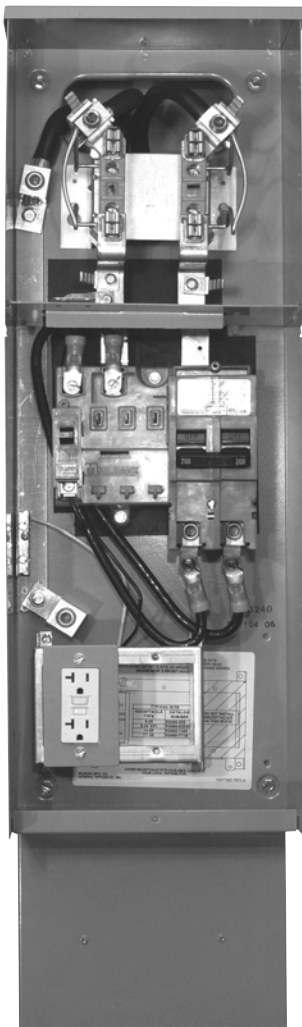

U5136-O-200S with series wired main & K5400-520GR kit

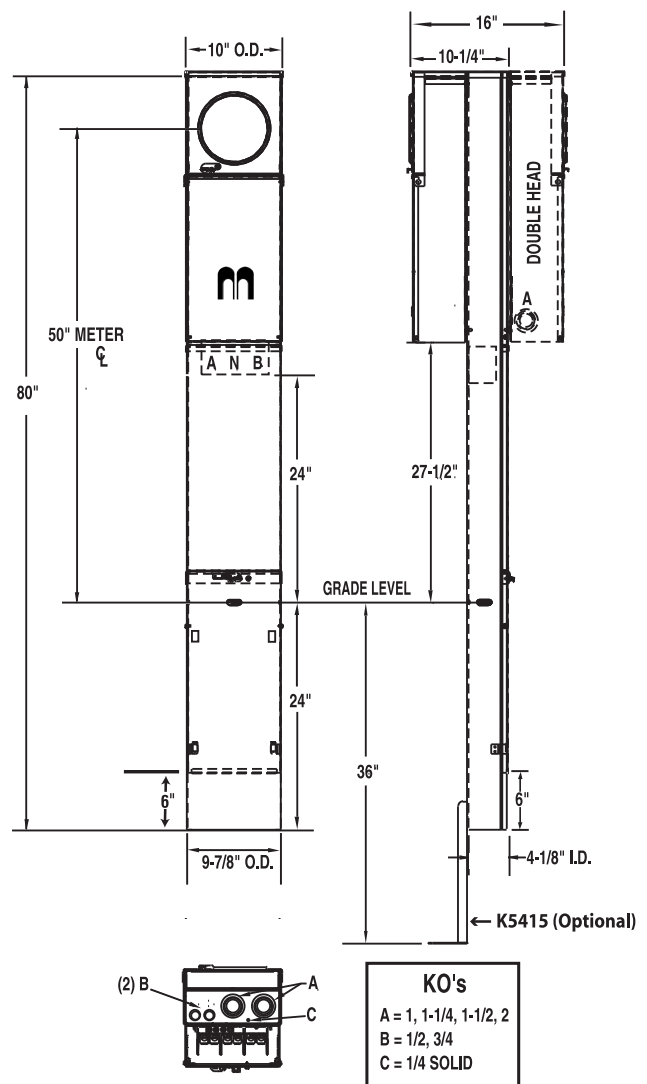

SPECIFICATIONS

- UL Listed – conforms to EUSERC drawing number 307
- 200 amp maximum, 120/240 volt, single phase, three wire meter socket
- Ringless meter socket with horn bypass and stainless steel latch
- Short circuit withstand rating 22K AIC.
- Type 3R construction for durable outdoor use, one piece post – lockable and sealable
- Milbank grey polyester powder coat finish
- Wire terminations accept copper or aluminum conductors
- Line & Neutral: (2) #6-350 kcmil per phase
- Line Ground: (4) #14-1/0
- Load (CB): 2/0 to 300 kcmil per pole
- Load Neutral: (1) #6-350 kcmil
- Load Ground: (2) #14-1/0, (4) #14/6
- Milbank plug-in main circuit breaker. Available in 100, 125, 150 & 200 amp. Type **UQFPH-M**.
- Four-circuit plated copper interior accepts (2) 2-pole or (4) 1-pole standard plug-in type circuit breakers up to a total of 125 amps maximum. Acceptable manufacturers: Cutler-Hammer, GE or Siemens
- Factory or field installable receptacle bridge and receptacle / circuit breaker kits available. See accessories.

Utility requirements for this equipment may vary. Always consult the serving utility for their requirements before ordering or installing equipment in this catalog.

SINGLE PEDESTAL (Direct Burial)

<u>CATALOG NUMBER</u>	<u>MAIN BREAKER</u>	<u>MAIN CB</u>	<u>BRANCH</u>	<u>WEIGHT (lbs)</u>
◆ U5136-O-100S	◆ UQFPH-M-100	100	4 Circuit	82
◆ U5136-O-200S	◆ UQFPH-M-200	200	4 Circuit	82
◆ U5136-O (parallel wired)	provision for UQFPH-M Series	—	4 Circuit	80



SINGLE PEDESTAL (Pad Mount)

U5138-O-200S	UQFPH-M-200	200	4 Circuit	82
U5138-O (parallel wired)	provision for UQFPH-M Series	—	4 Circuit	80

DOUBLE PEDESTAL (Direct Burial)

<u>CATALOG NUMBER</u>	<u>MAIN BREAKER</u>	<u>MAIN CB</u>	<u>BRANCH</u>	<u>WEIGHT (lbs)</u>
◆ U5137-O-100S	(2) UQFPH-M-100	100	4 Circuit	115
◆ U5137-O-200S	(2) UQFPH-M-200	200	4 Circuit	115
◆ U5137-O (parallel wired)	provision for (2) UQFPH-M Series	—	4 Circuit	111

RECEPTACLE / CIRCUIT BREAKER KITS AND ACCESSORIES (ORDER SEPARATELY)

<u>CATALOG #</u>	<u>RECEPTACLE</u>	<u>CIRCUIT BREAKER</u>	<u>CONDUCTOR</u>	<u>CONFIGURATION</u>
◆ K5400-520GR	5-20R Duplex GFI	20 Amp, 1 Pole	12 Awg	 GFI Rec.
◆ K5400-TT30	TT30R	30 Amp, 1 Pole	10 Awg	
◆ K5400-1450	14-50R	50 Amp, 2 Pole	8 Awg	
◆ K5400-BRIDGE-1POS	Self-grounded one position receptacle bridge with hardware			
◆ K5400-BRIDGE-2POS	Self-grounded two position receptacle bridge with hardware			
◆ K5415	Stabilizer Foot with hardware			
◆ K5035	Pad Mount Kit with hardware for U5138/39 pad mount pedestals required			
◆ K5T	5th Terminal for 208y / 120 volt 3-wire service			
◆ K5193	Bus kit to convert series-wired main breaker to parallel			
◆ K5194	Wire kit to convert parallel-wired main breaker to series			
◆ K3450	Telephone / CATV mounting bracket (mounts left or right)			
◆ K5039	Penta bolt utility cover			

- Up to two receptacle / circuit breaker kits can be field-installed in each powerhead. Order mounting bridge and receptacle kits separately from above. For three receptacles or factory-installed kits, contact factory.
 - Receptacle / circuit breaker kits include receptacle, circuit breaker, connected wire, cover plate and mounting screws. Other receptacle / circuit breaker kits available.
 - **K5415** Stabilizer Foot sold separately. Recommended for double pedestals.
 - Pad mount pedestals require **K5035** pad mount kit. Order separately.
 - ◆ Stock item – availability subject to prior sale.
- Non-stock items – minimum order quantity required.

Utility requirements for this equipment may vary. Always consult the serving utility for their requirements before ordering or installing equipment in this catalog.

**Concentric Knockouts**

A (4) = 1, 1-1/2, 2, 2-1/2"

B (1) = 1-1/4, 1-1/2, 2"

C (1) = 3/4, 1"

D (1) = 1/4, 1/2"

E (1) = 1" Solid

U5706-O-200P

**(Shown with (2) K5400-520GR receptacles, K5400-BRIDGE-2POS & line side conductor installed.)*

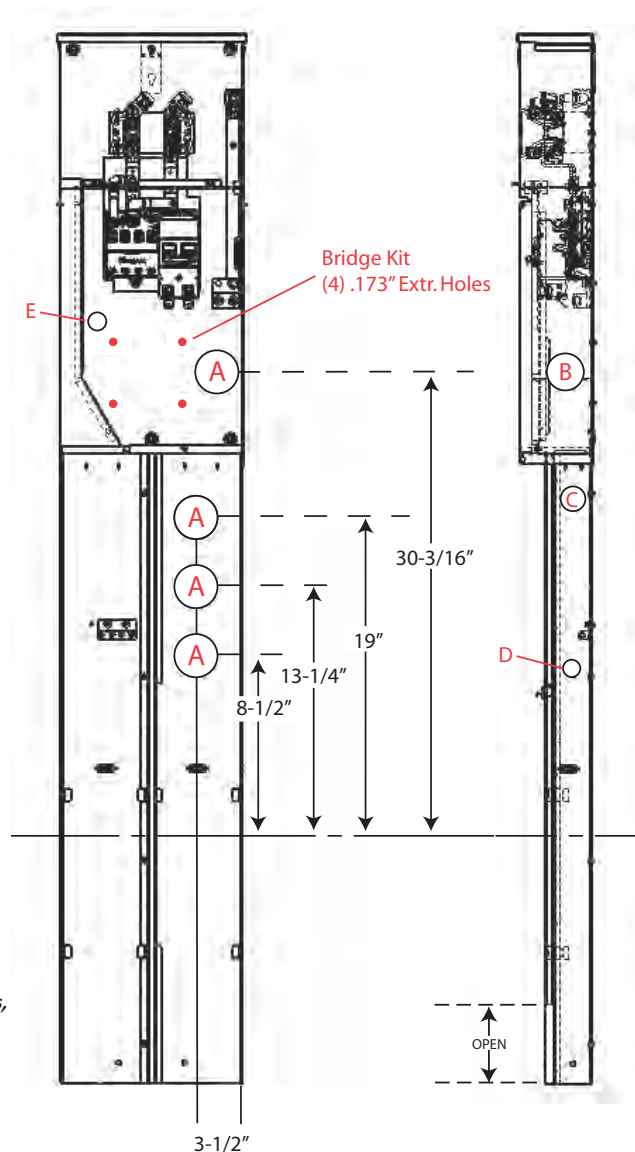
**SPECIFICATIONS**

- 200 amp, 1Ø, 120/240 volt, 22K AIC, underground service only.
- U5706 has Ringless meter socket available with or without horn bypass (-KK).
- U5707 has Ring type meter socket with MR-4 screw type meter ring.
- Suitable for use as service equipment, mobile home service equipment and temporary power service equipment.
- * Provisions for up to two Type 3R in-use receptacle kits.
- * Order receptacle and bridge kits separately. See ordering information.
- Direct burial pedestal suitable for free standing or structure mounted installation.
- Separate line and load wireways are removable, lockable and sealable for security.
- Left side is for utility connection. Right side is for customer underground load exit.
- Convenient knockouts in post for thru-wall load exit requirements.
- Type 3R enclosure constructed with type G90 galvanized steel.
- Repaintable light gray polyester powder coat finish.
- Wire terminations accept copper or aluminum conductors: Line & Neutral: #6-350 Ground: (4) #14-1/0.
- Main circuit breaker can be series or parallel connected.
- Universal 4 circuit branch 125 amp interior (up to (2) 2-pole) accepts most manufacturers plug-in type circuit breakers. See wiring diagram.

Utility requirements for this equipment may vary. Always consult the serving utility for their requirements before ordering or installing equipment in this catalog.

U5706 Ringless Pedestal

<u>Catalog Number</u>	<u>Amps</u>	<u>Service</u>	<u>By-Pass</u>	<u>Main Circuit Breaker</u>	<u>Main Wired</u>	<u>Replacement Main Type*</u>	<u>Branch Circuits</u>	<u>Weight LBS.</u>
◆ U5706-O-200S	200	120/240	None	200a 2p	Series	UQFPH-M	4	79
◆ U5706-O-200S-KK	200	120/240	Horn	200a 2p	Series	UQFPH-M	4	79

U5707 Ring Type Pedestal

<u>Catalog Number</u>	<u>Amps</u>	<u>Service</u>	<u>By-Pass</u>	<u>Main Circuit Breaker</u>	<u>Main Wired</u>	<u>Replacement Main Type*</u>	<u>Branch Circuits</u>	<u>Weight LBS.</u>
◆ U5707-O-200S	200	120/240	None	200a 2p	Series	UQFPH-M	4	79

Up to two receptacle/circuit breaker kits can be field or factory installed. See below for ordering information. Contact factory for factory installed kits.

To increase pedestal height, order field-installed post extension kit **K5708**.

For field installed fifth terminal in the 9 o'clock position, order kit **K5T**.

For field converting from parallel to series wired, order kit **K5194**. For field converting from series to parallel wired, order kit **K5193**.

Receptacle / Circuit Breaker Kits & Receptacle Bridge Kits

<u>Catalog Number</u>	<u>Amps/ Volts</u>	<u>NEMA Config</u>	<u>Circuit Breaker</u>	<u>Conductor</u>	<u>Configuration</u>
◆ K5400-520GR	20a 120v	5-20R Duplex GFI	20a 1p	12 awg	Fig. 1
◆ K5400-620	20a 240v	6-20R Simplex	20a 2p	12 awg	Fig. 2
◆ K5400-620GB	20a 240v	6-20R Simplex	20a 240v GFI	12 awg	Fig. 3
◆ K5400-1450	50a 120/240v	14-50R	50a 120/240v	8 awg	Fig. 4
◆ K5400-1450GB	50a 120/240v	14-50R	50a 120/240v GFI	8 awg	Fig. 4
◆ K5400-BRIDGE-1POS	Self-grounded ONE position bridge with hardware and instructions.				Fig. 5
◆ K5400-BRIDGE-2POS	Self-grounded TWO position bridge with hardware and instructions.				Fig. 6

Receptacle kits include: receptacle, circuit breaker, connected wire, cover plate, mounting screws and instructions. Contact factory for other kits.

NOTE: Receptacle grounding is provided by metal contact with bridge and pedestal. Be sure to torque all fasteners per torque requirements.

◆ Stock item – availability subject to prior sale.

Non-stock items – minimum order quantity required.

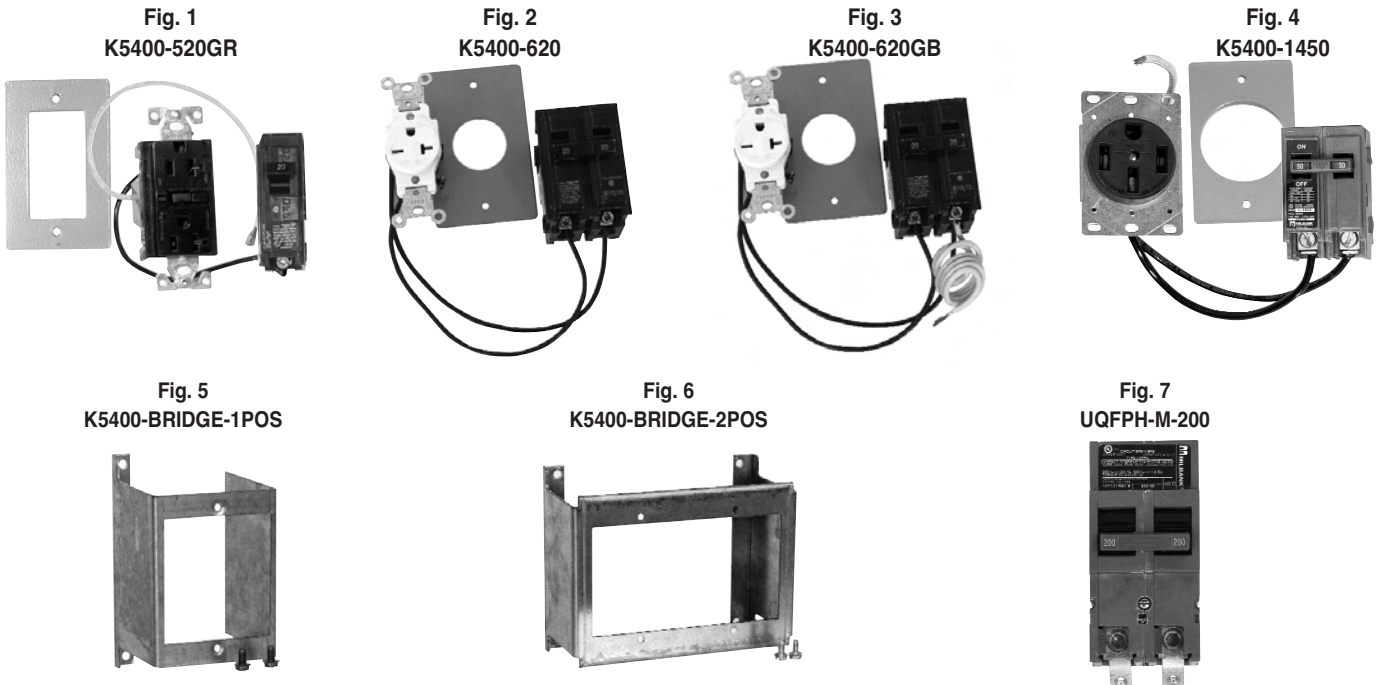

Utility requirements for this equipment may vary. Always consult the serving utility for their requirements before ordering or installing equipment in this catalog.

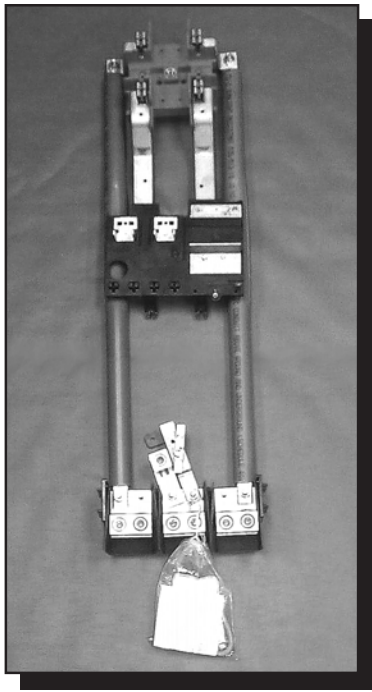

Catalog # 020-148-00-00-0
MPAP 200A interior rebuild kit

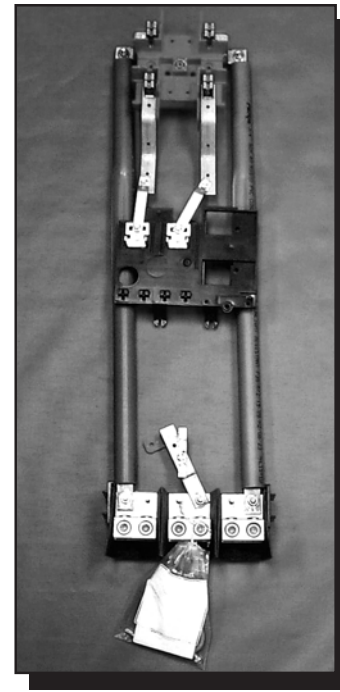

Catalog # 020-147-00-00-0
MPRV 100A interior rebuild kit

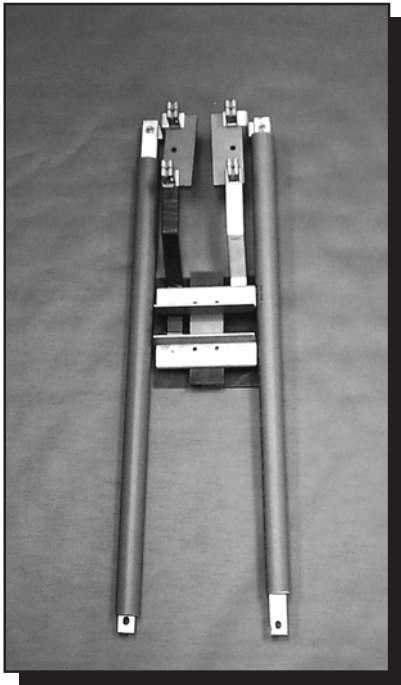

Catalog # RBK-1
Unicorn MPP (pre-1969)
interior rebuild kit

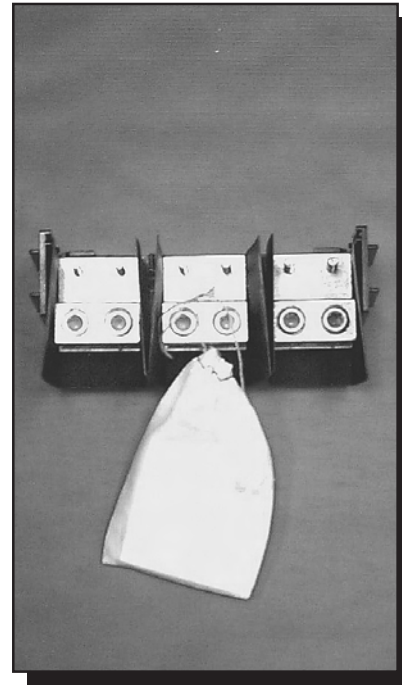

Catalog # Z1048284
MPAP, MPRV & Unicorn MPP
lug landing assembly with grounding kit

Above items sold as complete assemblies only. Individual components not available.

Utility requirements for this equipment may vary. Always consult the serving utility for their requirements before ordering or installing equipment in this catalog.



Catalog # PF-BL
MPAP / MPRV blank deadfront
with hinged cover



Catalog # PF-KR
MPAP / MPRV rear connector kit

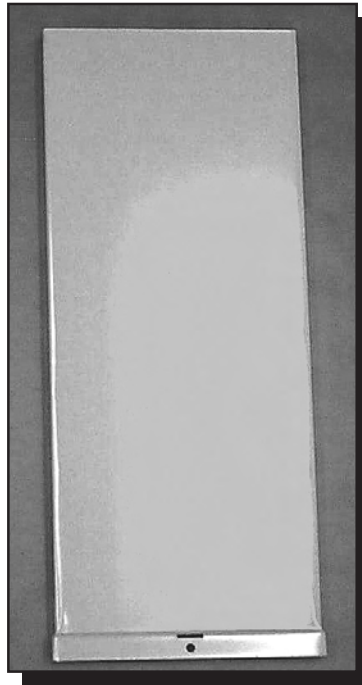

Lug cover for MPAP / MPRV
Order Catalog # **403456-SC**
(8½" W x 20½" H) for 72" pedestals
and Cat. # **403457-SC** (8½" W x 26½" H)
for 78" pedestals.

Utility requirements for this equipment may vary. Always consult the serving utility for their requirements before ordering or installing equipment in this catalog.



U5000-XL-75

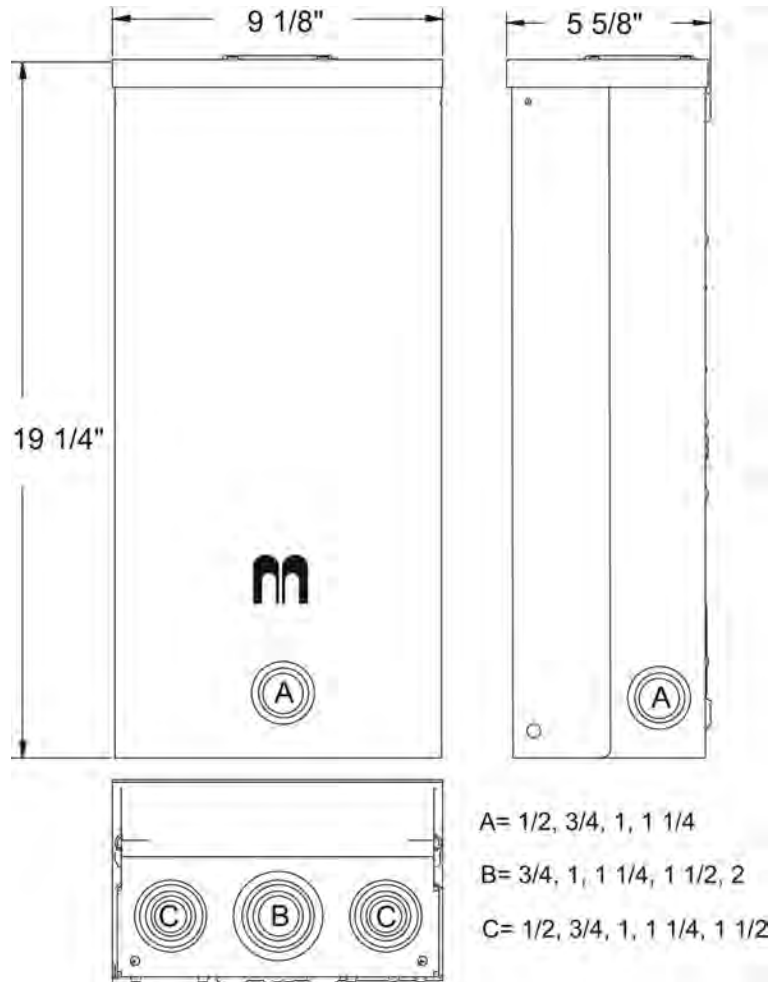

SPECIFICATIONS:

- UL Listed 125 Amp, 120/240 Volt, 1Ø Power Outlet.
- Short circuit current withstand rating 10K RMS symmetrical amperes.
- Type 3R welded enclosure for durable outdoor use.
- Enclosure constructed with galvanized 16 gauge steel.
- ASA 61 grey polyester powder coat finish.
- Convenient concentric knock-out configurations and mounting embosses.
- Hub opening with closure plate allows for meter retrofit.
- Wire terminations accept copper or aluminum conductors for loop feed wiring.
 Line: (2) 1/0-#12 Ground: (2) 1/0-#14 & (4) #6-#14 Neutral: (2) 1/0-#14 & (4) #6-#14
- Six circuit plated copper interior accepts standard plug-in type circuit breakers. Rated up to 125 amps.
- Three position **self-grounded** receptacle bridge accepts most standard NEMA receptacles with mounting plates.
- Components factory wired with stranded copper wire.
- Lockable hinge cover and dead front are removable for installation and maintenance. Stay-open hinge cover has safety interlock on dead front. Dead front cover must be removed before hinge cover can be removed.
- Low wattage, 120 Volt fluorescent site light available. Factory or field installable.
- Unit weight: 21 lbs.

Utility requirements for this equipment may vary. Always consult the serving utility for their requirements before ordering or installing equipment in this catalog.



U5000 STANDARD MODELS

CATALOG #	RECEPTACLES		CIRCUIT BREAKERS	
◆ U5000-XL-41	(1) TT30R (1) 5-20R GFI		(1) 30A, 1P, 120V (1) 20A, 1P, 120V	
◆ U5000-XL-332	(2) TT30R (1) 5-20R GFI		(2) 30A, 1P, 120V (1) 20A, 1P, 120V	
◆ U5000-XL-55	(1) 14-50R (1) 5-20R GFI		(1) 50A, 2P, 120/240V (1) 20A, 1P, 120V	
◆ U5000-XL-75	(1) 14-50R (1) TT30R (1) 5-20R GFI		(1) 50A, 2P, 120/240V (1) 30A, 1P, 120V (1) 20A, 1P, 120V	
U5000-XL-75GB	(1) 14-50R (1) TT30R (1) 5-20R		(1) 50A, 2P, 120/240V (1) 30A, 1P, 120V (1) 20A, 1P, 120V, GFI	

U5000 STANDARD BASE MODEL

Order up to (3) receptacle / breaker kits. Sold separately for field installation.

CATALOG #	DESCRIPTION
◆ U5000-XL	Base model without receptacles or circuit breakers.

RECEPTACLE & CIRCUIT BREAKER KITS

CATALOG #	RECEPTACLES	CIRCUIT BREAKERS	CONDUCTORS	CONFIGURATION
◆ K5400-520GR	5-20R Duplex GFI	20 Amp, 1 Pole	12 Awg	GFI Rec.
K5400-520GB	5-20R Duplex	20 Amp, 1 Pole GFI	12 Awg	GFI CB
◆ K5400-TT30	TT30R	30 Amp, 1 Pole	10 Awg	
K5400-TT30GB	TT30R	30 Amp, 1 Pole GFI	10 Awg	GFI CB
◆ K5400-1450	14-50R	50 Amp, 2 Pole	8 Awg	

◆ **Stock model. Availability subject to prior sale.**

Note: 20 Amp GFI required at each RV site by UL and NEC 551-71

INTERNAL LIGHT KITS Factory or field installed. See accessory page.

Utility requirements for this equipment may vary. Always consult the serving utility for their requirements before ordering or installing equipment in this catalog.

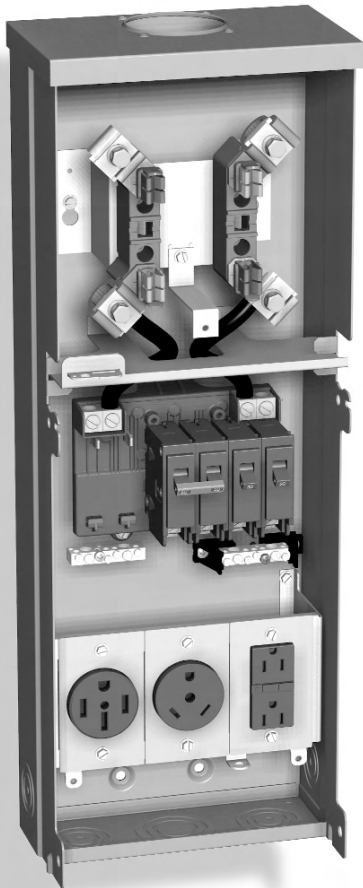

U5100-XL-75

Loop feed not available.

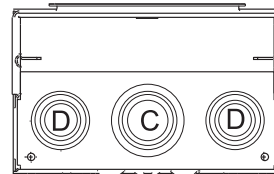
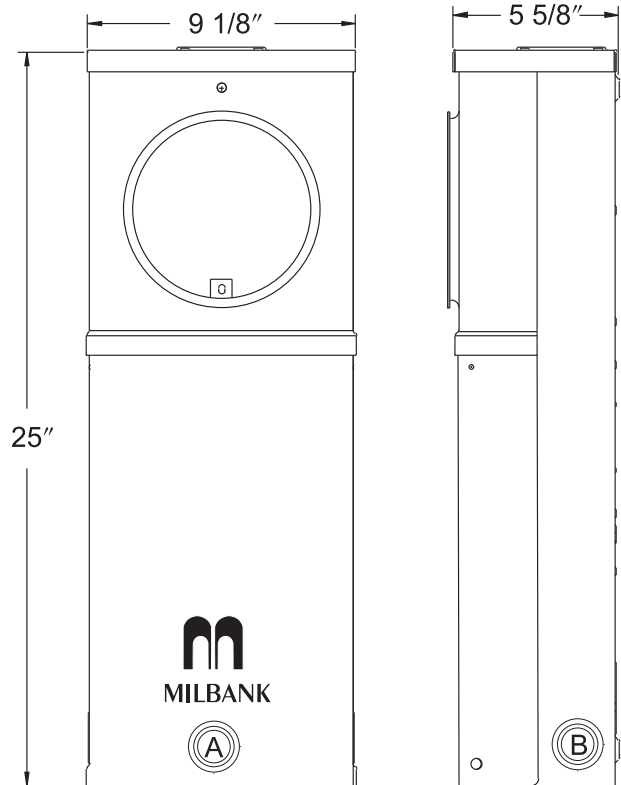

- A= 1-1/4 Solid
- B= 1/2, 3/4, 1, 1-1/4
- C= 3/4, 1, 1-1/4, 1-1/2, 2
- D= 1/2, 3/4, 1, 1-1/4, 1-1/2

SPECIFICATIONS

- UL Listed 125 Amp, 120/240 Volt—1Ø Power Outlet.
- This is an **overhead only** unit.
- Short circuit current withstand rating 10K RMS symmetrical amperes.
- Type 3R welded enclosure for durable outdoor use.
- Enclosure constructed with galvanized 16 gauge steel.
- ASA 61 grey polyester powder coat finish.
- Convenient concentric knock-out configurations and mounting embosses.
- Hub opening with closure plate.
- Wire terminations accept copper or aluminum conductors. Loop feed not available.
- Line: (1) #6-250 kcmil Ground: (2) 1/0-#14 & (4) #6-#14 Neutral: (2) 1/0-#14 & (4) #6-#14
- Six circuit plated copper interior accepts standard plug-in type circuit breakers. Rated up to 125 amps.
- Three position **self-grounded** receptacle bridge accepts most standard NEMA receptacles with mounting plates.
- Four terminal, drawn ring type meter socket with aluminum sealing ring. **Ringless** meter socket available. Use **U5101** prefix.
- Components factory wired with stranded copper wire.
- Lockable hinge cover and dead front are removable for installation and maintenance. Stay-open hinge cover has safety interlock on dead front. Dead front must be removed before hinge cover can be removed.
- Low wattage, 120 Volt fluorescent site light available. Factory or field installable.
- Unit weight: 26 lbs.

Utility requirements for this equipment may vary. Always consult the serving utility for their requirements before ordering or installing equipment in this catalog.



U5100 STANDARD MODELS

CATALOG #	RECEPTACLES	CIRCUIT BREAKERS	
◆ U5100-XL-41	(1) TT30R (1) 5-20R GFI		(1) 30A, 1P, 120V (1) 20A, 1P, 120V
◆ U5100-XL-55	(1) 14-50R (1) 5-20R GFI		(1) 50A, 2P, 120/240V (1) 20A, 1P, 120V
◆ U5100-XL-75	(1) 14-50R (1) TT30R (1) 5-20R GFI		(1) 50A, 2P, 120/240V (1) 30A, 1P, 120V (1) 20A, 1P, 120V
U5100-XL-75GB	(1) 14-50R (1) TT30R (1) 5-20R		(1) 50A, 2P, 120/240V (1) 30A, 1P, 120V (1) 20A, 1P, 120V, GFI
U5100-XL-552GR	(2) 14-50R (1) 5-20R GFI		(2) 50A, 2P, 120/240V (1) 20A, 1P, 120V, GFI

U5100 STANDARD BASE MODELS

Order up to (3) receptacle / breaker kits. Sold separately for field installation.

CATALOG #	DESCRIPTION
◆ U5100-XL	Ring-type base model without receptacles or circuit breakers.
◆ U5101-XL	Ringless-type base model without receptacles or circuit breakers.

RECEPTACLE & CIRCUIT BREAKER KITS

CATALOG #	RECEPTACLES	CIRCUIT BREAKERS	CONDUCTORS	CONFIGURATION
◆ K5400-520GR	5-20R Duplex GFI	20 Amp, 1 Pole	12 Awg	GFI Rec.
K5400-520GB	5-20R Duplex	20 Amp, 1 Pole GFI	12 Awg	GFI CB
◆ K5400-TT30	TT30R	30 Amp, 1 Pole	10 Awg	
K5400-TT30GB	TT30R	30 Amp, 1 Pole GFI	10 Awg	GFI CB
◆ K5400-1450	14-50R	50 Amp, 2 Pole	8 Awg	

◆ **Stock model. Availability subject to prior sale.**

Note: 20 Amp GFI required at each RV site by UL and NEC 551-71

INTERNAL LIGHT KITS *Factory or field installed. See accessory page.*

Utility requirements for this equipment may vary. Always consult the serving utility for their requirements before ordering or installing equipment in this catalog.



**U5200-XL-75
DIRECT BURIAL**

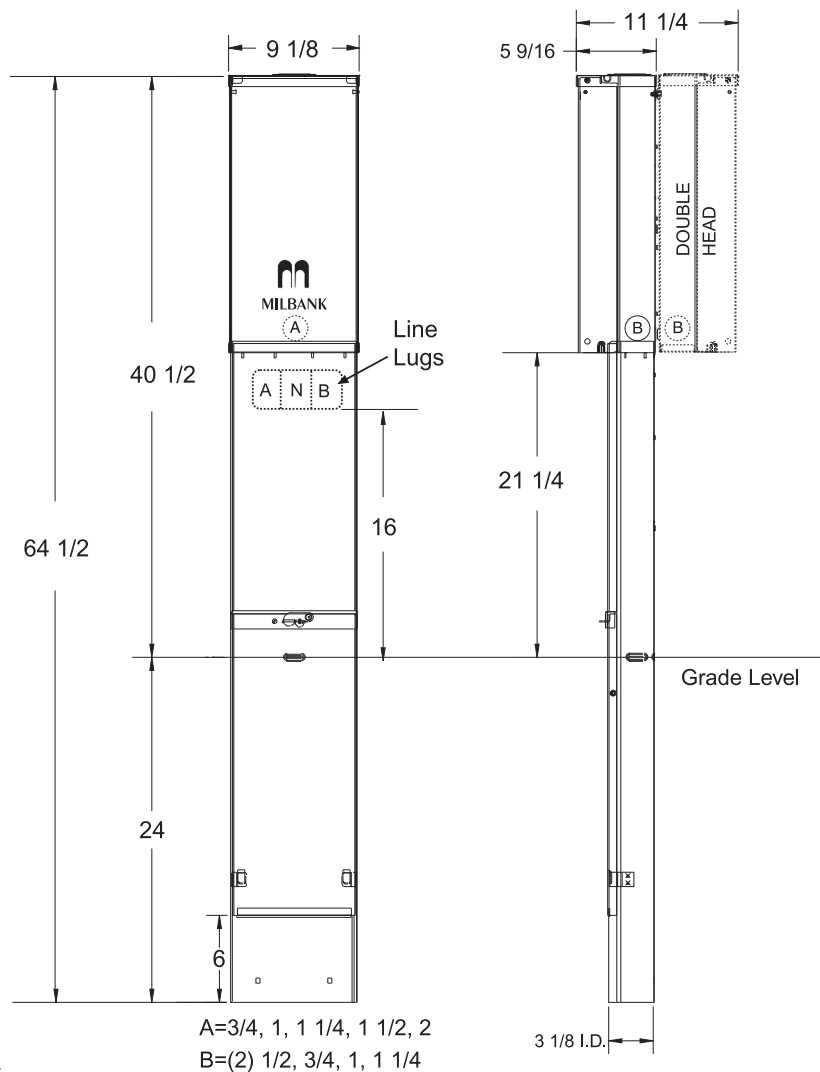





SPECIFICATIONS

- UL Listed 125 Amp, 120/240 Volt—1Ø Power Outlet.
- Short circuit current withstand rating 10K RMS symmetrical amperes.
- Type 3R welded enclosure for durable outdoor use.
- Enclosure constructed with galvanized 16 gauge steel.
- Direct burial or pad mounted post constructed with 14 gauge galvanized steel. Two removable front covers for ease of installation. Accepts up to (3) 2 1/2" conduits.
- ASA 61 grey polyester powder coat finish.
- Convenient concentric knock-out configurations. See note A & B above.
- Hub opening with closure plate allows for meter retrofit.
- Wire terminations accept copper or aluminum conductors for loop feed wiring.
Line: (2) #6-350 kcmil Ground: (2) #14-2/0 Neutral: (2) #6-350 kcmil
- Six circuit plated copper interior accepts standard plug-in type circuit breakers. Rated up to 125 amps.
- Three position **self-grounded** receptacle bridge accepts most standard NEMA receptacles with mounting plates.
- Components factory wired with stranded copper wire.
- Lockable hinge cover and dead front are removable for installation and maintenance. Stay-open hinge cover has safety interlock on dead front. Dead front must be removed before hinge cover can be removed.
- Low wattage, 120 Volt fluorescent site light available. Factory or field installable.
- Unit weight: Single—48 lbs. Double—70 lbs.

Utility requirements for this equipment may vary. Always consult the serving utility for their requirements before ordering or installing equipment in this catalog.

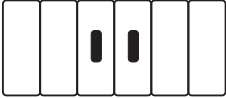

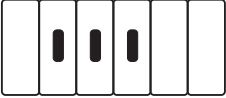
U5200 STANDARD MODELS

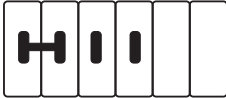



SINGLE HEAD	DBL. HEAD				
CATALOG #	CATALOG#	RECEPTACLES		CIRCUIT BREAKERS	
◆ U5200-XL-41	◆ U5220-XL-41	(1) TT30R (1) 5-20R GFI		(1) 30A, 1P, 120V (1) 20A, 1P, 120V	
U5200-XL-41GB		(1) TT30R (1) 5-20R		(1) 30A, 1P, 120V (1) 20A, 1P, 120V, GFI	
◆ U5200-XL-332		(2) TT30R (1) 5-20R GFI		(2) 30A, 1P, 120V (1) 20A, 1P, 120V	
◆ U5200-XL-75	◆ U5220-XL-75	(1) 14-50R (1) TT30R (1) 5-20R GFI		(1) 50A, 2P, 120/240V (1) 30A, 1P, 120V (1) 20A, 1P, 120V	
U5200-XL-75GB		(1) 14-50R (1) TT30R (1) 5-20R		(1) 50A, 2P, 120/240V (1) 30A, 1P, 120V (1) 20A, 1P, 120V, GFI	

U5200 STANDARD BASE MODELS

Order up to (3) receptacle / breaker kits. Sold separately for field installation.

CATALOG #	DESCRIPTION
◆ U5200-XL	Single head base model on direct burial post.
◆ U5210-XL	Single head base model on pad mount post. Order K5410 pad mount base separately.
◆ U5220-XL	Double head base model on direct burial post.
◆ U5230-XL	Double head base model on pad mount post. Order K5410 pad mount base separately.

RECEPTACLE & CIRCUIT BREAKER KITS

CATALOG #	RECEPTACLES	CIRCUIT BREAKERS	CONDUCTORS	CONFIGURATION
◆ K5400-520GR	5-20R Duplex GFI	20 Amp, 1 Pole	12 Awg	 GFI Rec.
K5400-520GB	5-20R Duplex	20 Amp, 1 Pole GFI	12 Awg	 GFI CB
◆ K5400-TT30	TT30R	30 Amp, 1 Pole	10 Awg	
K5400-TT30GB	TT30R	30 Amp, 1 Pole GFI	10 Awg	 GFI CB
◆ K5400-1450	14-50R	50 Amp, 2 Pole	8 Awg	

◆ **Stock model. Availability subject to prior sale.**

Note: 20 Amp GFI required at each RV site by UL and NEC 551-71

INTERNAL LIGHT KITS *Factory or field installed. See accessory page.*

Utility requirements for this equipment may vary. Always consult the serving utility for their requirements before ordering or installing equipment in this catalog.



**U5310-O-75
PAD MOUNT**

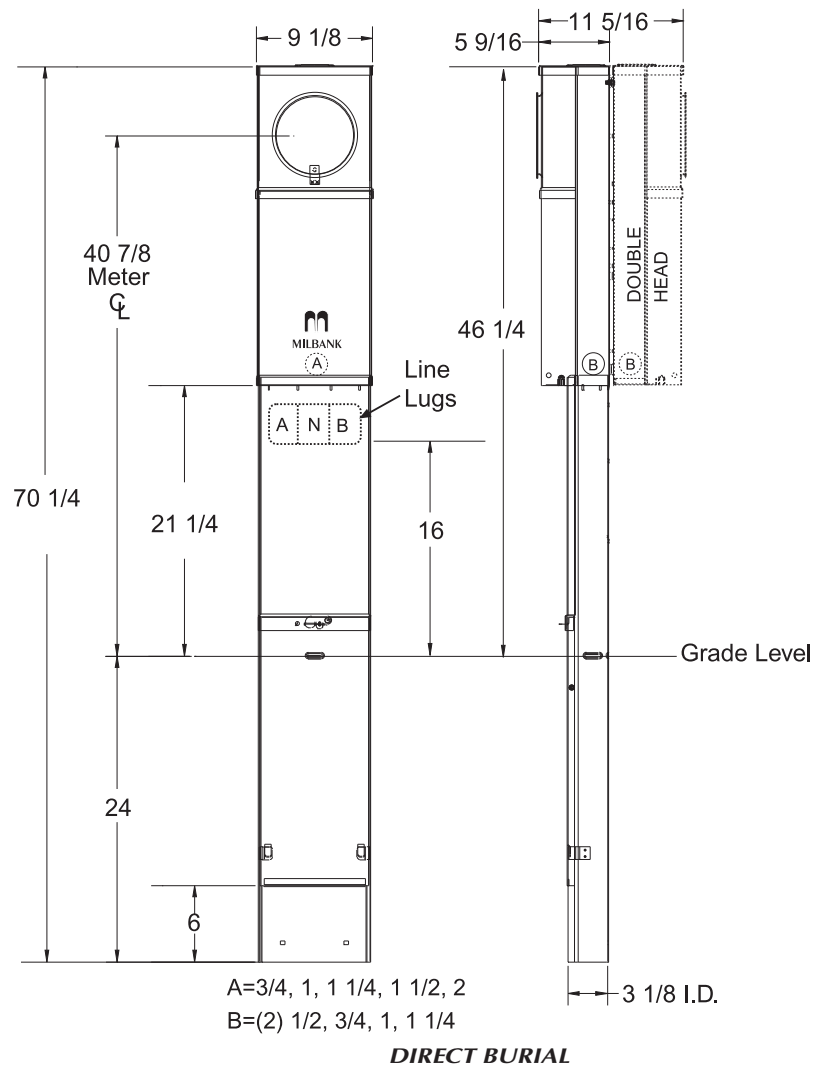

DIRECT BURIAL







SPECIFICATIONS

- UL Listed 125 Amp, 120/240 Volt—1Ø Power Outlet.
- Short circuit current withstand rating 10K RMS symmetrical amperes.
- Type 3R welded enclosure for durable outdoor use.
- Enclosure constructed with galvanized 16 gauge steel.
- Direct burial or pad mounted post constructed with 14 gauge galvanized steel. Two removable front covers for ease of installation. Accepts up to (3) 2 1/2" conduits.
- ASA 61 grey polyester powder coat finish.
- Wire terminations accept copper or aluminum conductors for loop feed wiring.
Line: (2) #6-350 kcmil Ground: (2) #14-2/0 Neutral: (2) #6-350 kcmil
- Six circuit plated copper interior accepts standard plug-in type circuit breakers. Rated up to 125 amps.
- Three position **self-grounded** receptacle bridge accepts most standard NEMA receptacles with mounting plates.
- Four terminal, drawn ring type meter socket with aluminum sealing ring.
- Components factory wired with stranded copper wire.
- Lockable hinge cover and dead front are removable for installation and maintenance. Stay-open hinge cover has safety interlock on dead front. Dead front must be removed before hinge cover can be removed.
- Low wattage, 120 Volt fluorescent site light available. Factory or field installable.
- Unit weight: Single—53 lbs. Double—80 lbs.

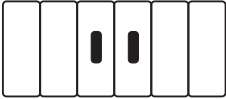
Utility requirements for this equipment may vary. Always consult the serving utility for their requirements before ordering or installing equipment in this catalog.



U5300 STANDARD MODELS





<i>SINGLE HEAD</i>	<i>DBL. HEAD</i>				
<i>CATALOG #</i>	<i>CATALOG#</i>	<i>RECEPTACLES</i>			<i>CIRCUIT BREAKERS</i>
◆ U5300-O-41		(1) TT30R (1) 5-20R GFI		(1) 30A, 1P, 120V (1) 20A, 1P, 120V	
◆ U5300-O-55		(1) 14-50R (1) 5-20R GFI		(1) 50A, 2P, 120/240V (1) 20A, 1P, 120V	
◆ U5300-O-75	◆ U5320-O-75	(1) 14-50R (1) TT30R (1) 5-20R GFI		(1) 50A, 2P, 120/240V (1) 30A, 1P, 120V (1) 20A, 1P, 120V	
U5300-O-552GR		(2) 14-50R (1) 5-20R GFI		(2) 50A, 2P, 120/240V (1) 20A, 1P, 120V	

U5300 STANDARD BASE MODELS

Order up to (3) receptacle / breaker kits. Sold separately for field installation.

<i>CATALOG #</i>	<i>DESCRIPTION</i>
◆ U5300-O	Single head base model on direct burial post.
◆ U5310-O	Single head base model on pad mount post. Order K5410 pad mount base separately.
◆ U5320-O	Double head base model on direct burial post.
◆ U5330-O	Double head base model on pad mount post. Order K5410 pad mount base separately.

RECEPTACLE & CIRCUIT BREAKER KITS

<i>CATALOG #</i>	<i>RECEPTACLES</i>	<i>CIRCUIT BREAKERS</i>	<i>CONDUCTORS</i>	<i>CONFIGURATION</i>
◆ K5400-520GR	5-20R Duplex GFI	20 Amp, 1 Pole	12 Awg	 GFI Rec.
K5400-520GB	5-20R Duplex	20 Amp, 1 Pole GFI	12 Awg	 GFI CB
◆ K5400-TT30	TT30R	30 Amp, 1 Pole	10 Awg	 GFI Rec.
K5400-TT30GB	TT30R	30 Amp, 1 Pole GFI	10 Awg	 GFI CB
◆ K5400-1450	14-50R	50 Amp, 2 Pole	8 Awg	

◆ Stock model. Availability subject to prior sale.

Note: 20 Amp GFI required at each RV site by UL and NEC 551-71

INTERNAL LIGHT KITS Factory or field installed. See accessory page.

Utility requirements for this equipment may vary. Always consult the serving utility for their requirements before ordering or installing equipment in this catalog.

MILLENNIUM SERIES BY MILBANK

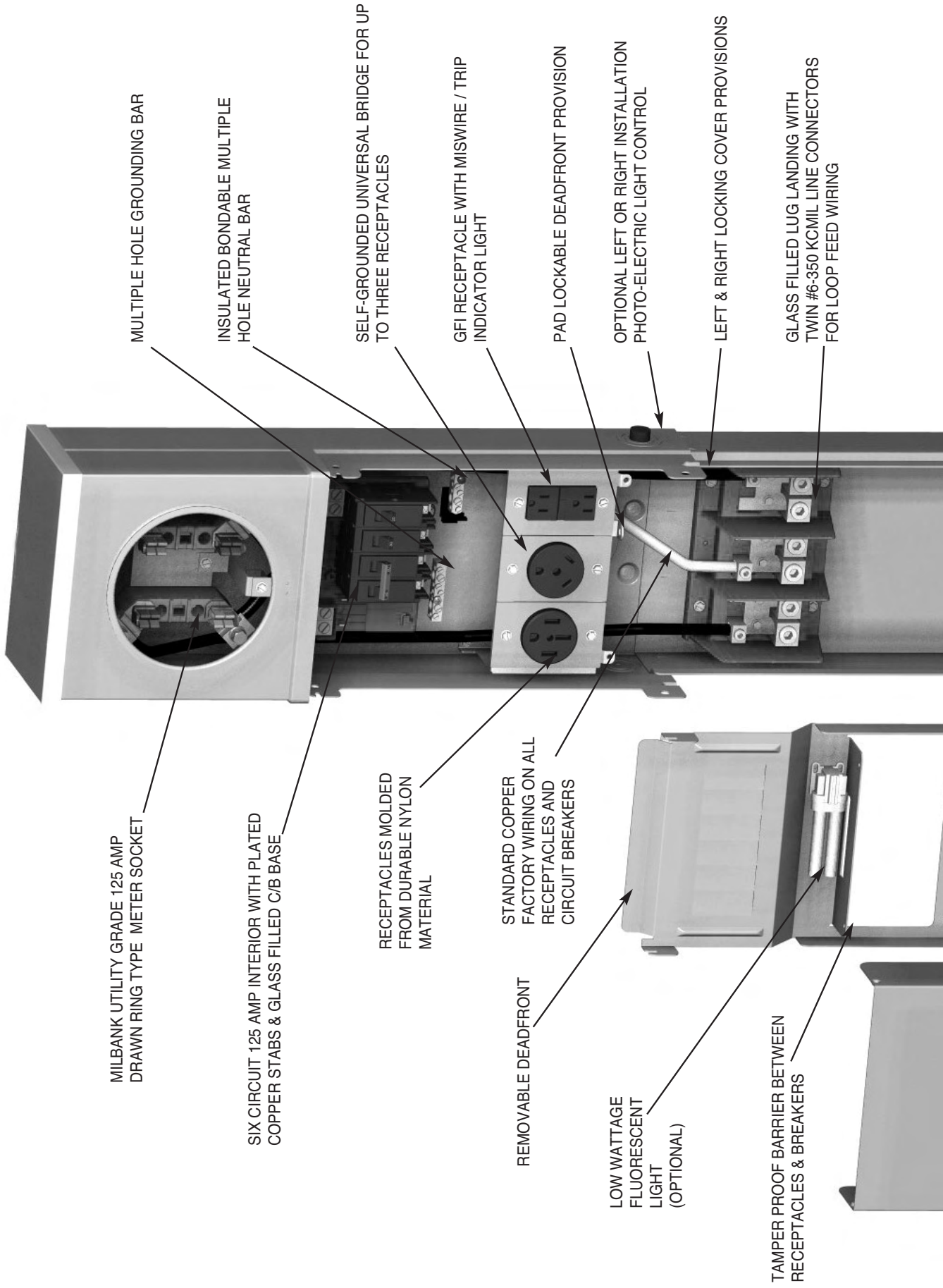

MILBANK UTILITY GRADE 125 AMP DRAWN RING TYPE METER SOCKET

SIX CIRCUIT 125 AMP INTERIOR WITH PLATED COPPER STABS & GLASS FILLED C/B BASE

RECEPTACLES MOLDED FROM DURABLE NYLON MATERIAL

STANDARD COPPER FACTORY WIRING ON ALL RECEPTACLES AND CIRCUIT BREAKERS

REMOVABLE DEADFRONT

LOW WATTAGE FLUORESCENT LIGHT (OPTIONAL)

TAMPER PROOF BARRIER BETWEEN RECEPTACLES & BREAKERS

MULTIPLE HOLE GROUNDING BAR

INSULATED BONDABLE MULTIPLE HOLE NEUTRAL BAR

SELF-GROUNDED UNIVERSAL BRIDGE FOR UP TO THREE RECEPTACLES

GFI RECEPTACLE WITH MISWIRE / TRIP INDICATOR LIGHT

PAD LOCKABLE DEADFRONT PROVISION

OPTIONAL LEFT OR RIGHT INSTALLATION PHOTO-ELECTRIC LIGHT CONTROL

LEFT & RIGHT LOCKING COVER PROVISIONS

GLASS FILLED LUG LANDING WITH TWIN #6-350 KCMIL LINE CONNECTORS FOR LOOP FEED WIRING



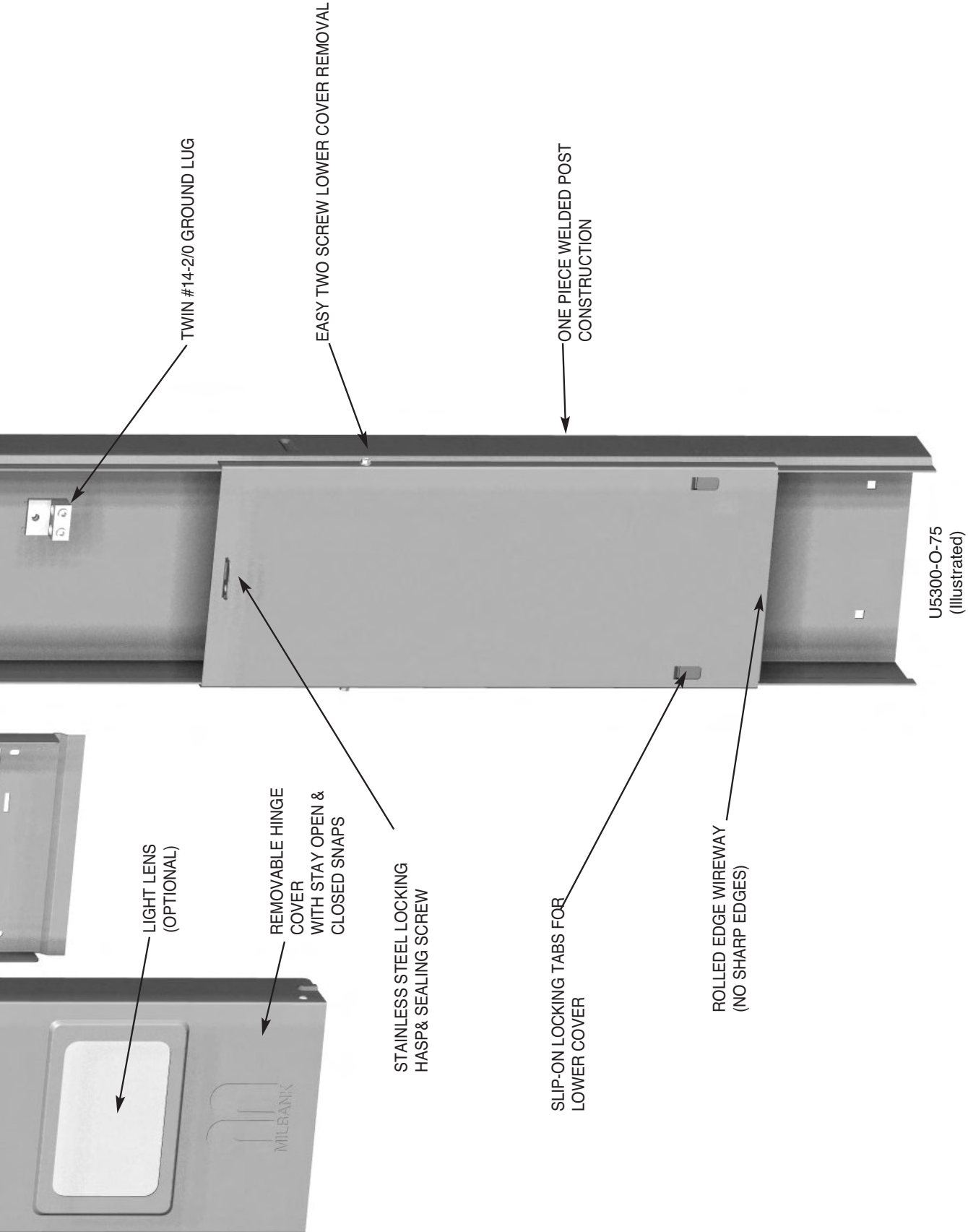



SPECIFICATIONS

- 600 to 1200 amp, 120/240 Volt, 1Ø distribution bus accepts up to (6) 2 pole, 200 amp circuit breakers. Order from chart below.
- Costly main breaker not required per NEC 230-71.
- Economical alternative to costly wall hung or strut-mounted panel boards and load centers.
- Low profile, aesthetic design can be located near utility transformers or fed from a main service to a convenient location.
- Pad mounted Type 3R powder coated aluminum enclosure – Standard color is gray.
- Hinge door and lift off rear service door are lockable and sealable for security.
- **NOTE:** Consult local code enforcement for pad size requirements. Order Catalog # CP-24-PDMNT-CALT pad mount base or Catalog # CP-ABK5/8 anchor bolt kit separately.

CIRCUIT BREAKERS

CATALOG #	AMPS	PHASE	VOLTS	LINE CONNECTORS	D	W	H
CP3B-AUX-1200	1200	1Ø	120/240	(3) 1-600 kcmil / Ø or (3) 2-250 kcmil / Ø	17"	24"	41"

**200 AMP FRAME—PLUG-IN—10K AIC & 22K AIC
TWO-POLE—COMMON TRIP**

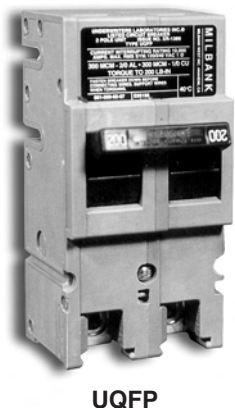

2-POLE RATING	10K AIC PLUG-IN	22K AIC PLUG-IN	PKG QTY	WIRE RANGE	
				CU	AL
100	UQFP-100	UQFPH-100	1	#3-#1	#1-1/0
125	UQFP-125	UQFPH-125	1	#3-#1	#1-1/0
150	UQFP-150	UQFPH-150	1	1/0-300	2/0-300
175	UQFP-175	UQFPH-175	1	1/0-300	2/0-300
200	UQFP-200	UQFPH-200	1	1/0-300	2/0-300
225	UQFP-225	UQFPH-225	1	1/0-300	2/0-300

Utility requirements for this equipment may vary. Always consult the serving utility for their requirements before ordering or installing equipment in this catalog.



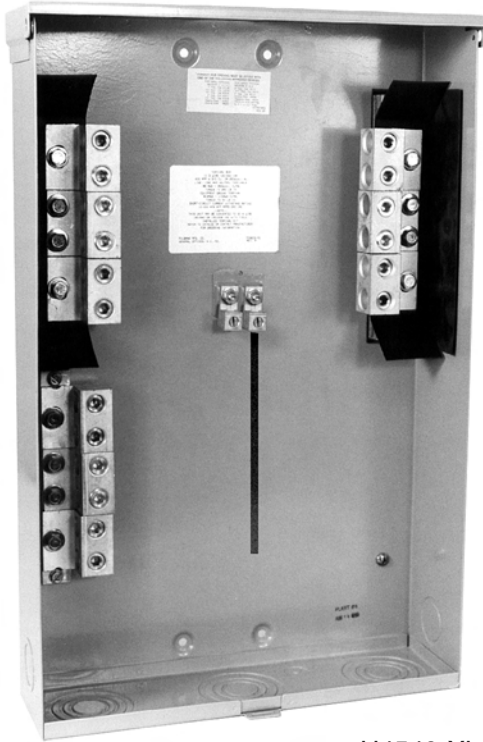

U4540-XL

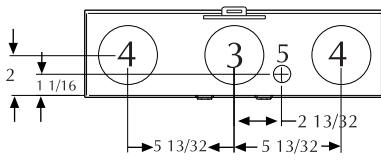
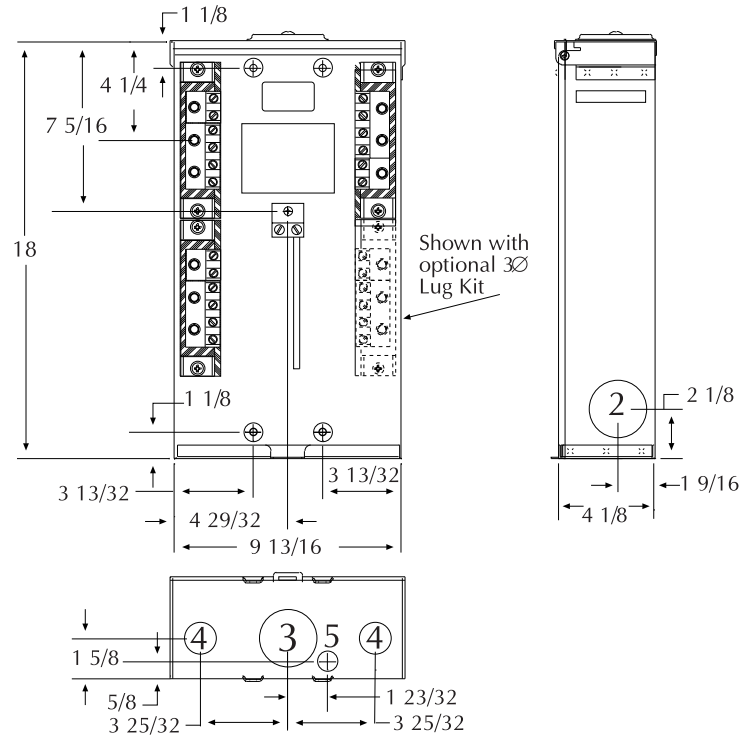

U4540
U4542

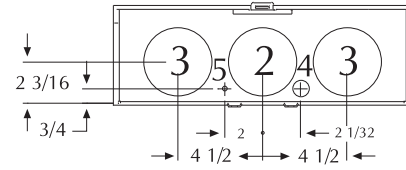

U4548
U4549

100, 200, & 400 AMP—TERMINAL BOXES—1Ø & 3Ø—120/240 VOLT

PHASE	AMPS	VOLTS	CATALOG NUMBER	HUB	CONNECTORS CU7AL	1Ø TO 3Ø KIT	DIMENSIONS			CONCENTRIC K.O.'S				
							D"	W"	H"	1	2	3	4	5
1	100	120/240	U4544-XL	C.P.	(6) #12-1/0	K4543	4 1/8	9 13/16	18	—	2	2	1	1/4, 1/2
3	100	600	U4546-XL	C.P.	(6) #12-1/0	N/A	4 1/8	9 13/16	18	—	2	2	1	1/4, 1/2
1	200	120/240	U4540-XL	C.P.	(6) #6-350	K4539	4 1/8	14 13/16	23	—	1 1/4	2 1/2	2 1/2	1/4, 1/2
3	200	600	U4542-XL	C.P.	(6) #6-350	N/A	4 1/8	14 13/16	23	—	1 1/4	2 1/2	2 1/2	1/4, 1/2
1	400	120/240	U4548-RXL	C.P.	(3) #6-350 or (2) #4-600	K4547	5	15 1/2	27	3	3	3	1/4, 1/2	1/4
3	400	600	U4549-RXL	C.P.	(3) #6-350 or (2) #4-600	N/A	5	15 1/2	27	3	3	3	1/4, 1/2	1/4

HUB: Standard hub opening on top with closing plate attached.

FEATURES: UL Listed pad lockable Type 3R enclosure.

3Ø 120/240V APPLICATION: Field installable 3Ø lug kit converts 1Ø unit to 3Ø unit.

Utility requirements for this equipment may vary. Always consult the serving utility for their requirements before ordering or installing equipment in this catalog.

INTERNAL LIGHT KITS FOR POWER OUTLETS

Application:

- Internal light kit for **U5000 & U5200 UNMETERED** power outlets.

Features:

- Includes 5 watt fluorescent lamp socket, ballast, lamp shield and opaque hinge cover lens. Factory wired to 20 amp GFI circuit. May be wired to separate 20 amp circuit breaker. Order **Q120** separately.
- Cover on unmetered power outlet is 19 1/8" in height.

Ordering:

- Order with **-L** suffix (after catalog number) for factory installed.
- Order catalog number **K5411** for field installed.



Application:

- Internal light kit for **U5100 & U5300 METERED** power outlets.

Features:

- Includes 5 watt fluorescent lamp socket, ballast, lamp shield and opaque hinge cover lens. Factory wired to 20 amp GFI circuit. May be wired to separate 20 amp circuit breaker. Order **Q120** separately.
- Cover on metered power outlet is 15 1/4" in height.

Ordering:

- Order with **-L** suffix (after catalog number) for factory installed.
- Order catalog number **K5412** for field installed.

PHOTOELECTRIC LIGHT CONTROL KIT



Application:

- Photoelectric light control kit for **K5411 & K5412** light kits.

Features:

- 2.5 amp, 120 Volt photo electrical control wired in series with **K5411 & K5412** light kits.

Ordering:

- Order with **-LPC** suffix for factory installed light and PE control.
- Order catalog number **K5413** for field installed.

WARNING: Always disconnect power prior to installing these devices.

Utility requirements for this equipment may vary. Always consult the serving utility for their requirements before ordering or installing equipment in this catalog.

TELEPHONE AND CABLE TV KIT

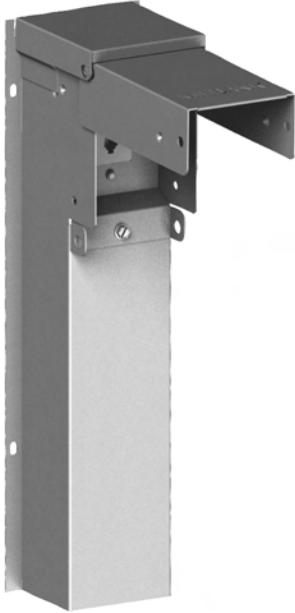

K4709-02-3R



K4709-02

Application:

- Mounts to rear of pedestal series **U5200 & U5300**. May also be adaptable to a wooden or similar structure.

Features:

- Single: 16" galvanized raceway, (1) **RJ11** telephone jack & (1) Type F coaxial CATV jack.
- Dual: 16" galvanized raceway, (2) **RJ11** telephone jack & (1) Type F coaxial CATV jack.
- Includes mounting hardware & instructions.

Ordering:

- Single Line Telephone & Cable TV kit order catalog number **K4709-02**.
- Weatherproof Type 3R "in-use" cover available. Add **-3R** to catalog numbers above.

NOTE:

- **Confirm acceptability with Cable TV & Telephone provider before ordering or installing these devices.**

WATER SHROUD WITH HARDWARE

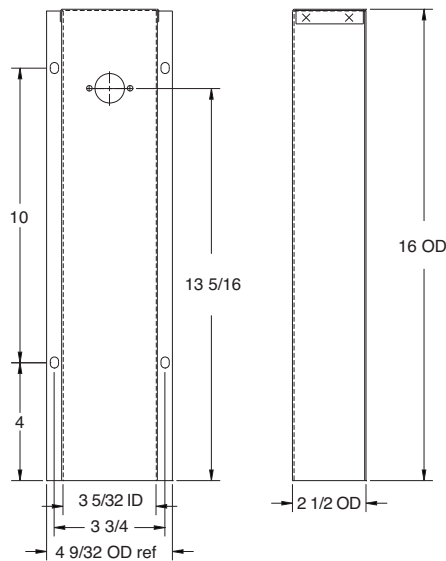

Application:

- Used to cover water pipe and provide means to mount hose bib to rear of pedestal.

Features:

- Includes mounting hardware and instructions.
- Matches **K4709** kits when mounted side by side.

Ordering:

- Order catalog number **K4709-WS**.

Utility requirements for this equipment may vary. Always consult the serving utility for their requirements before ordering or installing equipment in this catalog.

FIELD INSTALLED PAD MOUNT KIT

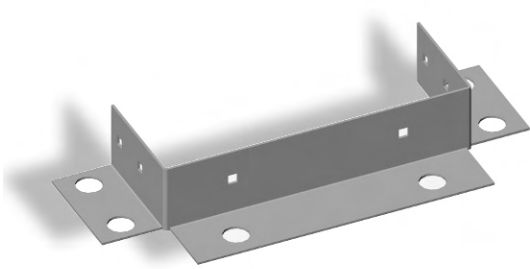

Application:

- Field installed pad mount kit with (6) 3/4" mounting holes.

Features:

- Includes 1/4-20 stainless steel hardware to attach pad mount base to post.
- Anchor bolt kit sold separately (order catalog number **K5421**).

Ordering:

- Order catalog number **K5410**.

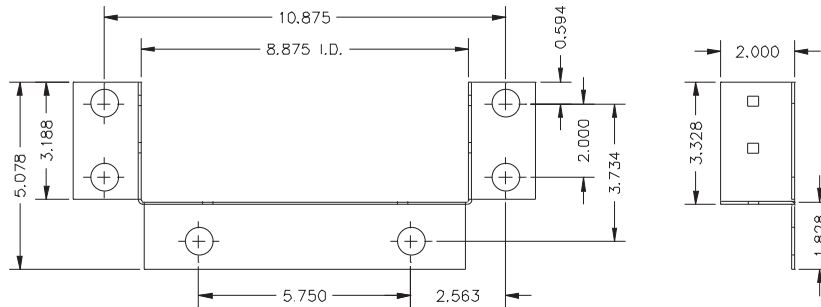

STABILIZER FOOT WITH HARDWARE

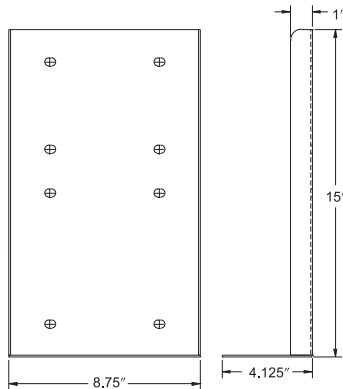
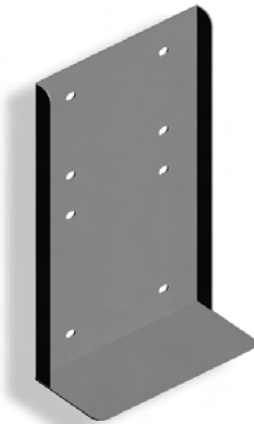

Application:

- Stabilizes direct burial type posts in unstable soil conditions.

Features:

- Includes 1/4-20 hardware to attach to **U5200 & U5300** pedestals.

Ordering:

- Order catalog number **K5415**.

ANCHOR BOLT KIT

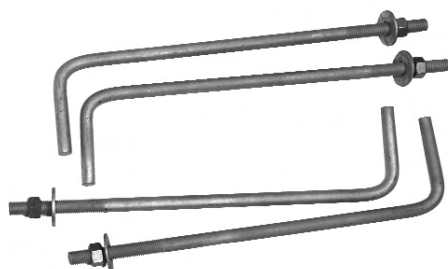

Application:

- Concrete anchor bolt kit designed to attach pad mount base to concrete.

Features:

- (4) sets of zinc-plated 5/8-11 x 10" bolt with 2" toe.
- Includes nut and flat washer.

Ordering:

- Order catalog number **K5421**.

Utility requirements for this equipment may vary. Always consult the serving utility for their requirements before ordering or installing equipment in this catalog.

FIELD INSTALLED METER KITS



Application:

- Field installed meter kit for **U5000 & U5200** power outlets.

Features:

- 100 amp cast meter socket, CL200 E-Z Read Meter, sealing ring, security seal, 1" Milbank hub, nipple and mounting screws.
- Optional 1" liquid-tight hub available for existing units without extruded hub opening. See ordering information.
- See CL200 for Watt-hour meter specifications.

Ordering:

- Order catalog number **K4800-01**.

E-Z READ WATT-HOUR METER



Application:

- 200 Amp E-Z read watt-hour meter designed to be field installed on the **U5100 & U5300** metered power outlets.

Features:

- 200 Amp Form 2S 120/240 Volt.
- Numeric read-out in full kilowatt increments. No "tenths" dial.
- Remanufactured to 1% accuracy.

Ordering:

- Order catalog number **CL200**. Sold in multiples of (4) per carton.

***SINGLE RECEPTACLE ONLY POWER OUTLET**



WARNING: Always disconnect power prior to installing these devices.

Application:

- Overhead/underground power outlet receptacle, suitable for RV, temporary service, campground, marina & boatyard equipment.

Features:

- Type 3R, 120/240 Volt single phase.
- Lockable cover.

Ordering:

- Order catalog number from chart below.

P-10GR
20A 120V GFI

P-13
30A 120V

P-54
50A 120/250V

Utility requirements for this equipment may vary. Always consult the serving utility for their requirements before ordering or installing equipment in this catalog.



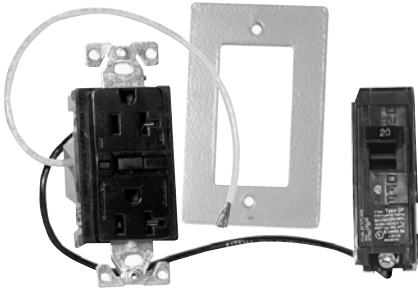

K5400-520GR
20 amp 120V GFI receptacle and circuit breaker kit

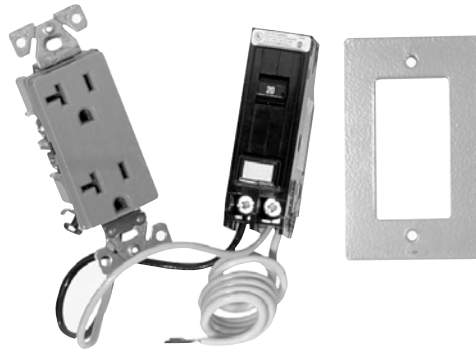

K5400-520GB
20 amp 120V receptacle and GFI circuit breaker kit



708080-MO
20 amp GFI receptacle NEMA 520



K5400-TT30
30 amp 120V receptacle and circuit breaker kit

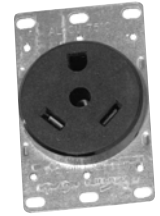

701776-MO
30 amp receptacle NEMA TT30



K5400-1450
50 amp 120 / 240V receptacle and circuit breaker kit

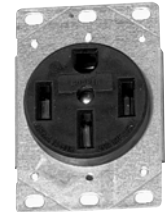

708767-MO
50 amp receptacle NEMA 1450

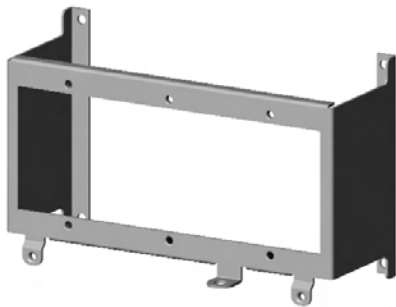

K5400-BRIDGE
Receptacle bridge (3) position

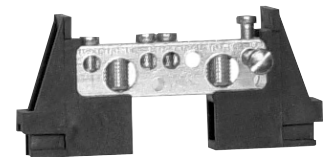

K5400-NEUTRAL
Neutral assembly



K5400-BLANK



RV
SECTION H

Utility requirements for this equipment may vary. Always consult the serving utility for their requirements before ordering or installing equipment in this catalog.

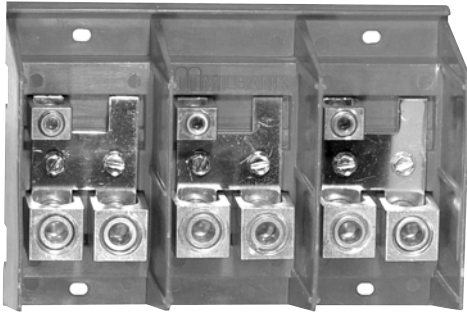

Z918466-AC
Lug landing base

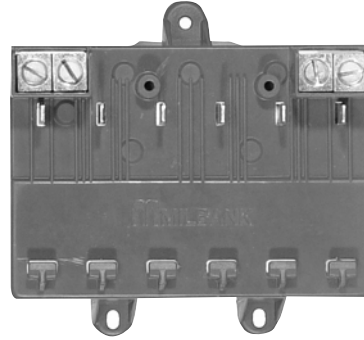

Z917602-AC
Circuit breaker base
(6 circuit)



Q120
20 amp 1 pole
circuit breaker

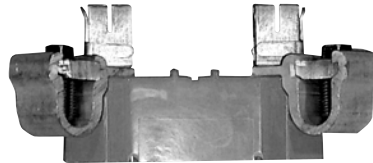

Z915141-AC
Left or right
meter block assembly



708784-MO
20 amp 1 pole GFI
circuit breaker

SEALING RING



**SNAP ACTION
MR-2**



Q130
30 amp 1 pole
circuit breaker

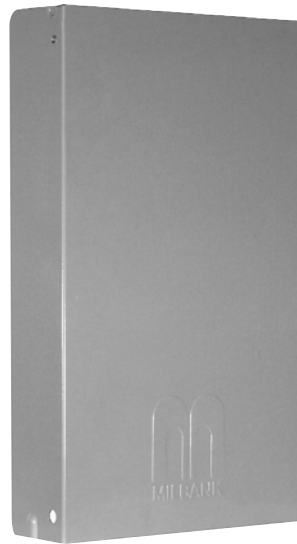

HINGE COVER
Z918449-SC 19" Unmetered
Z918447-SC 15" Metered



DEADFRONT
Z818052-SC 19" Unmetered
Z818480-SC 15" Metered



Q250
50 amp 2 pole
circuit breaker

RV
SECTION H

Utility requirements for this equipment may vary. Always consult the serving utility for their requirements before ordering or installing equipment in this catalog.

U5300-O SERIES

RATING: 125 amps maximum—120/240 VAC—1Ø3W
METER SOCKET: 100 amp continuous—600 VAC—Rainproof NEMA Type 3R
SHORT CIRCUIT CURRENT RATING: 10,000 RMS symmetrical amperes at 240 VAC maximum, but is limited to the lowest short circuit current rating of any installed circuit breaker. Wathour meter not included in short circuit current rating.
REPLACEMENT CIRCUIT BREAKER: Must be the same type and rating. Use Milbank: UCP; Siemens/ITE: QP, QT; Cutler-Hammer /Westinghouse: QP, BD, BR; General Electric: TQ, THQ, THQL; Challenger: C, Q, QC, QP, A.
SUITABLE FOR USE AS: Service equipment, mobile home service equipment, temporary power service equipment and recreational vehicle site supply power. See rating label below.

Size of field installed conductors shall be 60°, 75°, or 90°C sized to 60°C rating for 110 Amps or less, and 75° C or 90°C sized to 75° C for 125 Amps and above.

FOR UNDERGROUND FEED ONLY

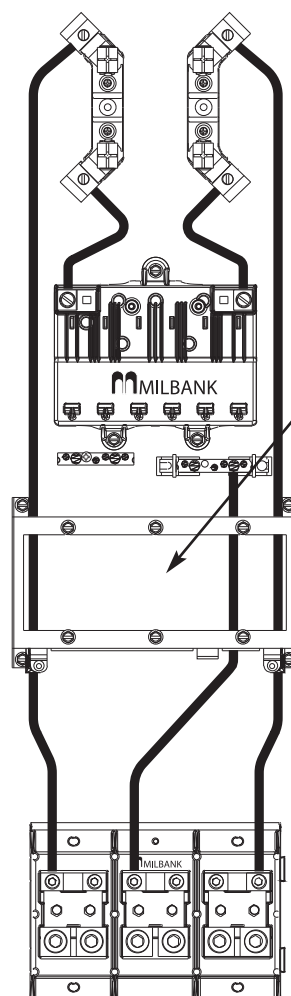

RECEPTACLE KIT	RV
K5400-520GR	R ①
K5400-520GB	R ①
K5400-TT30	A
K5400-TT30GB	A
K5400-1450	A
K5400-BLANK	A

A = Acceptable
 R = Required
 ① K5400-520GR or K5400-520GB required

WIRE TERMINAL INFORMATION—USE AL-CU CONDUCTORS

TERMINAL	WIRE RANGE	TORQUE LB. / IN.
Line & Neutral	Twin 350 kcmil - #6	250
Load, Neutral and Ground	14 - 10 8 6 - 4 3 - 1/0	35 40 45 50
Load, Neutral and Ground	14 - 10 8 6	20 25 35
<p>DANGER Hazard of Electrical Shock or Burn TURN OFF POWER Supplying this equipment before working inside</p>	On Trip Off To reset breaker move to "off" then to "on"	<p>Shipping tends to loosen bolted connections. Check and tighten all hardware before energizing unit.</p>

RV

SECTION H

WARRANTY

- If any equipment manufactured by seller fails due to defects in material or workmanship within one year from the date seller shipped the equipment, such equipment will be replaced or repaired at seller's option. This warranty is limited to the repair or replacement of the equipment or component part or parts of the equipment and becomes void if any equipment failure is due to improper installation, purchaser's negligence, unreasonable use, damage (not resulting from defects in material or workmanship) or misapplication. This warranty does not include reimbursement for the expense of installation, removal of the equipment from the line, transportation, or any other expenses which may be incurred.
- In no event shall seller be liable for consequential or incidental damages and seller's liability for any and all losses and damages sustained by the purchaser or any other person arising out of or by reason of the use of the equipment, a defect in the equipment (whether discoverable or latent), a claim of negligence or for any other reason, shall not exceed the purchase price paid by the purchaser.
- **THIS WARRANTY IS MADE EXPRESSLY IN LIEU OF ANY OTHER WARRANTY AND SELLER MAKES NO OTHER REPRESENTATION OR WARRANTY OF ANY OTHER KIND, EXPRESS OR IMPLIED, WITH RESPECT TO THE EQUIPMENT, WHETHER AS TO MERCHANTABILITY, FITNESS FOR A PARTICULAR PURPOSE OR ANY OTHER MATTER.**
- **AUTHORIZATION MUST BE OBTAINED FROM MILBANK'S GENERAL OFFICE BEFORE EQUIPMENT IS RETURNED.**

Utility requirements for this equipment may vary. Always consult the serving utility for their requirements before ordering or installing equipment in this catalog.

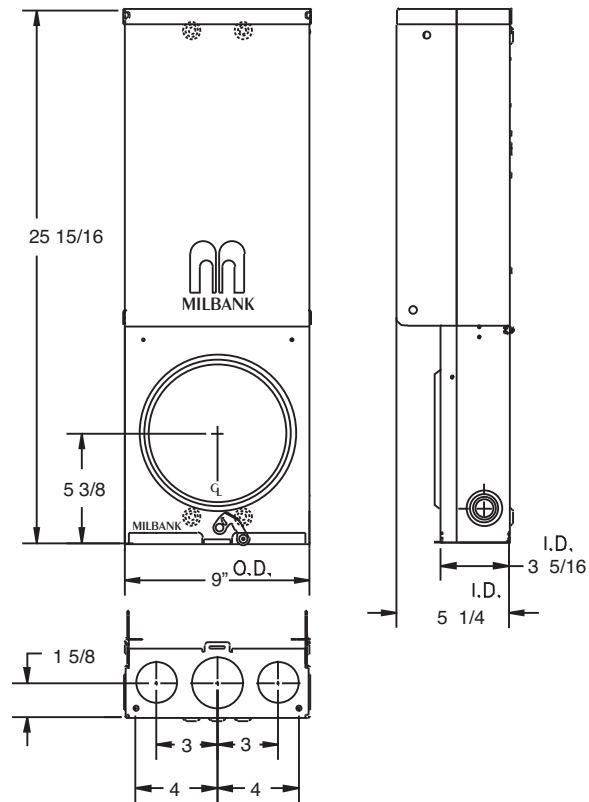

U4909-O-11GR

SPECIFICATIONS

- Available in **ringless** style (**U4908** series) or ring type (**U4909** series)
- UL Listed 100 Amp, 120/240 Volt – 1Ø Underground Service Power Outlet
- Short circuit current withstand rating 10K RMS symmetrical amperes
- Type 3R welded enclosure for durable outdoor use
- Enclosure constructed with galvanized 16 gauge steel
- ASA 61 grey polyester powder coat finish
- Convenient concentric knock-out configurations and mounting embosses
- Wire terminations accept copper or aluminum conductors
Service-Line & Neutral: (1) #6-2/0 Load Ground: (2) 1/0-#14 & (4) #6-#14
Load Neutral: (2) 1/0-#14 & (4) #6-#14 Service Ground: #2-#8
- Six circuit plated copper interior accepts standard plug-in type circuit breakers
- Three position **self-grounded** receptacle bridge accepts most standard NEMA receptacles with mounting plates
- Four terminal, ringless meter socket with stainless steel locking hasp. Ring type socket has aluminum **MR-2** snap action sealing ring
- Lockable hinge cover and deadfront are removable for installation and maintenance. Stay-open hinge cover has safety interlock on deadfront. Deadfront must be removed before hinge cover can be removed.
- Tamper proof fastening available

Utility requirements for this equipment may vary. Always consult the serving utility for their requirements before ordering or installing equipment in this catalog.

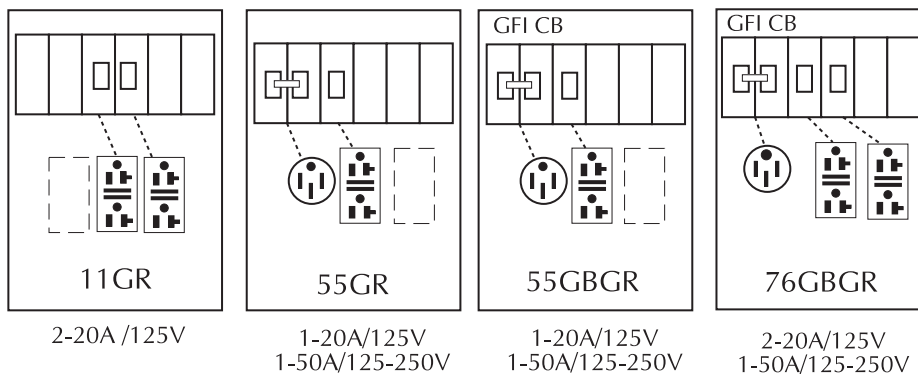
U4908 / U4909 STANDARD CONFIGURATIONS



ORDERING INFORMATION

CATALOG #	SOCKET TYPE	DESCRIPTION
◆ U4908-O	Ringless	Order base model and up to three factory installed receptacle/breaker kit separately from list below. Other kits available. Consult factory.
◆ U4908-O-11GR	Ringless	
◆ U4908-O-55GBGR	Ringless	
◆ U4909-O	Ring type	Order base model and up to three factory installed receptacle/breaker kit separately from list below. Other kits available. Consult factory.
◆ U4909-O-11GR	Ring type	
◆ U4909-O-55GBGR	Ring type	

RECEPTACLE & CIRCUIT BREAKER KITS

CATALOG NUMBER	AMP	BLADE	VOLTAGE	NEMA CONFIG.	TYPE	CIRCUIT BREAKER TYPE
◆ K5400-520	20	Straight	120	5-20	Std. Duplex	20 Amp 1 Pole
◆ K5400-520GR	20	Straight	120	5-20	GFI Duplex	20 Amp 1 Pole
◆ K5400-620	20	Straight	240	6-20	Single	20 Amp 2 Pole
◆ K5400-620GB	20	Straight	240	6-20	Single	20 Amp 2 Pole GFI
◆ K5400-1450	50	Straight	120/240	14-50	Single	30 Amp 2 Pole
◆ K5400-1450GB	50	Straight	120/240	14-50	Single	30 Amp 2 Pole GFI

Flat cover may not close completely with twist locking devices in use.

Order slope-front 3R cover # 1107681 separately to use with twist lock type receptacles.

◆ Stock item – availability subject to prior sale.

Non-stock items – minimum order quantity required

Utility requirements for this equipment may vary. Always consult the serving utility for their requirements before ordering or installing equipment in this catalog.

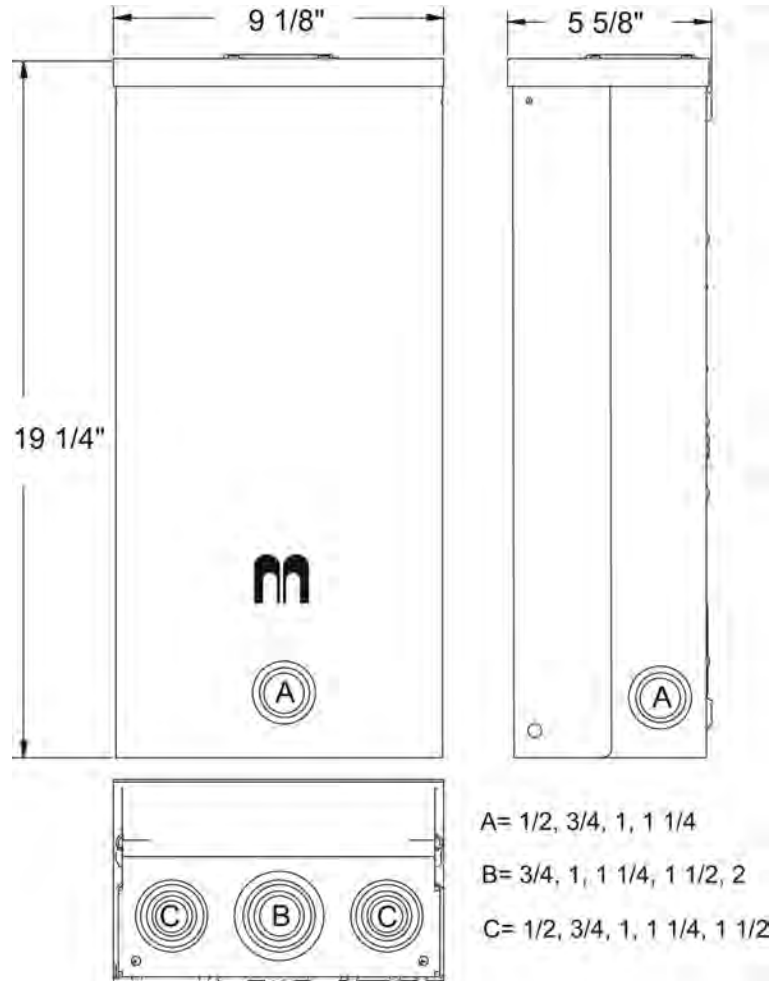
U5000-XL-38GR

TEMPORARY POWER

SECTION I

SPECIFICATIONS:

- UL Listed 125 Amp, 120/240 Volt, 1Ø Power Outlet.
- Short circuit current withstand rating 10K RMS symmetrical amperes.
- Type 3R welded enclosure for durable outdoor use.
- Enclosure constructed with galvanized 16 gauge steel.
- ASA 61 grey polyester powder coat finish.
- Convenient concentric knock-out configurations and mounting embosses.
- Hub opening with closure plate installed.
- Wire terminations accept copper or aluminum conductors for loop feed wiring.
 Line: (2) 1/0-#12 Ground: (2) 1/0-#14 & (4) #6-#14 Neutral: (2) 1/0-#14 & (4) #6-#14
- Six circuit plated copper interior accepts standard plug-in type circuit breakers.
- Three position **self-grounded** receptacle bridge accepts most standard NEMA receptacles with mounting plates.
- Components factory wired with stranded copper wire.
- Lockable hinge cover and dead front are removable for installation and maintenance. Stay-open hinge cover has safety interlock on dead front. Dead front cover must be removed before hinge cover can be removed.
- **NOTE:** Cover may not close completely with twist-locking devices in use.
- Tamper proof fastening available.

Utility requirements for this equipment may vary. Always consult the serving utility for their requirements before ordering or installing equipment in this catalog.

U5000 STANDARD CONFIGURATIONS

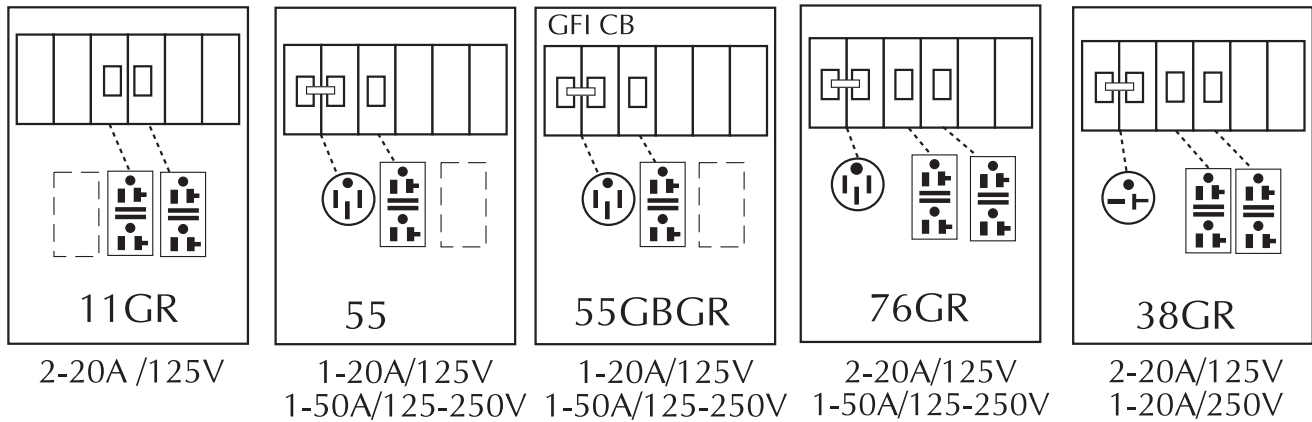

ORDERING INFORMATION

CATALOG #	DESCRIPTION
U5000-XL-(*)	(*) Add suffix from above chart to complete catalog number (ie: U5000-XL-11GR)
U5000-XL	Order base model and up to three factory installed receptacle/breaker kit separately from list below. Other kits available. Consult factory.

RECEPTACLE & CIRCUIT BREAKER KITS

CATALOG NUMBER	AMP	BLADE	VOLTAGE	NEMA CONFIG.	TYPE	CIRCUIT BREAKER TYPE
K5400-520	20	Straight	120	5-20	Std. Duplex	20 Amp 1 Pole
K5400-520GR	20	Straight	120	5-20	GFI Duplex	20 Amp 1 Pole
K5400-620	20	Straight	240	6-20	Single	20 Amp 2 Pole
K5400-620GB	20	Straight	240	6-20	Single	20 Amp 2 Pole GFI
K5400-1450	50	Straight	120/240	14-50	Single	30 Amp 2 Pole
K5400-1450GB	50	Straight	120/240	14-50	Single	30 Amp 2 Pole GFI

* Cover may not close completely while in use with Twist-Locking devices.

Utility requirements for this equipment may vary. Always consult the serving utility for their requirements before ordering or installing equipment in this catalog.

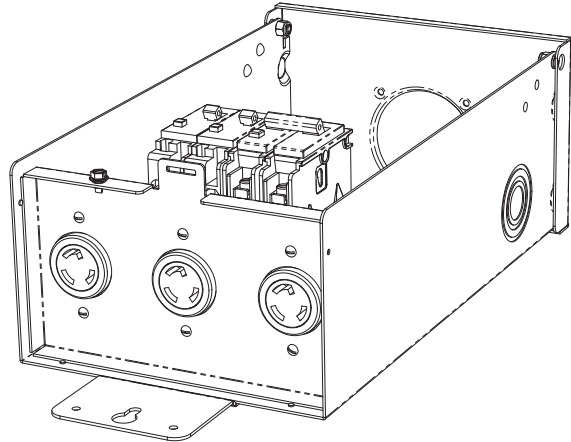
U5001-RL-01

SPECIFICATIONS:

- UL Listed 125 Amp, 120/240 Volt, 1Ø Power Outlet.
- Short circuit current withstand rating 10K RMS symmetrical amperes.
- Type 3R welded enclosure for durable outdoor use.
- ASA 61 grey polyester powder coat finish.
- Wire terminations accept copper or aluminum conductors.
Line: 1/0-#4 Ground/Neutral: (4) 1/0-#14 & (11) #14-#6
- Six circuit plated copper interior accepts standard plug-in type circuit breakers.
- Components factory wired with stranded copper wire.
- Lockable hinge cover and dead front are removable for installation and maintenance.
- U5001-RL-01 includes:
 - (1) L6-30 (1) 30A, 2P, 240V GFI Breaker
 - (2) L5-20 (2) 20A, IP, 120V GFI Breaker

Utility requirements for this equipment may vary. Always consult the serving utility for their requirements before ordering or installing equipment in this catalog.



U5100-XL-11GR

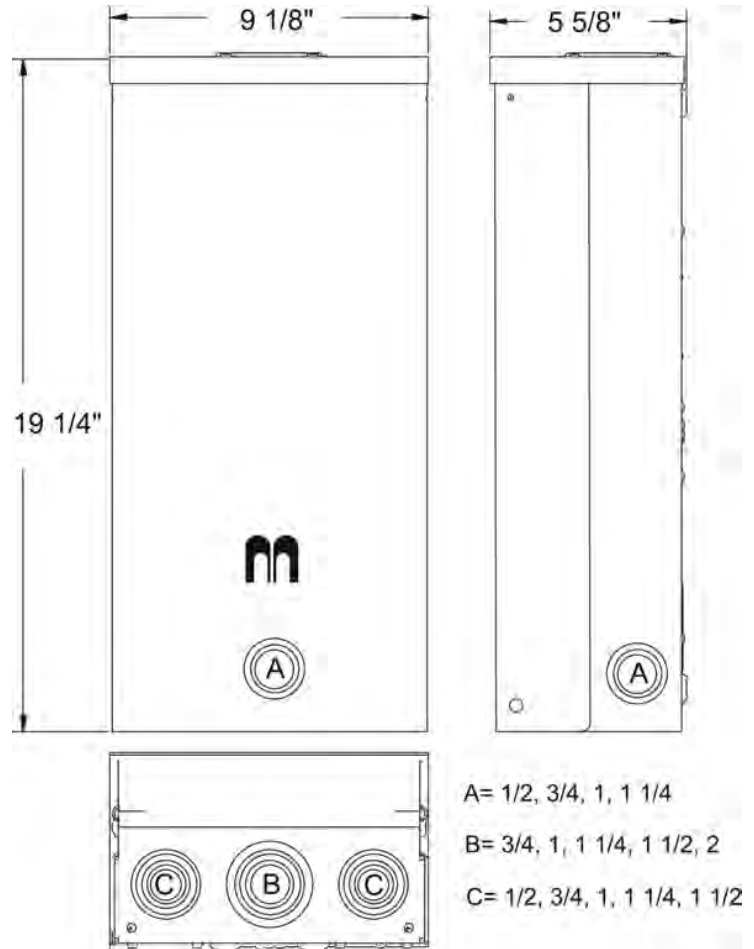

SPECIFICATIONS

- Available in **ringless** style (U5101 series) or ring type (U5100 series).
- UL Listed 125 Amp, 120/240 Volt—1Ø Power Outlet.
- Short circuit current withstand rating 10K RMS symmetrical amperes.
- Type 3R welded enclosure for durable outdoor use.
- Enclosure constructed with galvanized 16 gauge steel.
- ASA 61 grey polyester powder coat finish.
- Convenient concentric knock-out configurations and mounting embosses.
- Hub opening with closure plate installed.
- Wire terminations accept copper or aluminum conductors.
Line: (1) #6-250 kcmil Ground: (2) 1/0-#14 & (4) #6-#14 Neutral: (2) 1/0-#14 & (4) #6-#14
- Six circuit plated copper interior accepts standard plug-in type circuit breakers.
- Three position **self-grounded** receptacle bridge accepts most standard NEMA receptacles with mounting plates.
- Four terminal, ringless meter socket with stainless steel locking hasp.
- Components factory wired with stranded copper wire.
- Lockable hinge cover and dead front are removable for installation and maintenance. Stay-open hinge cover has safety interlock on dead front. Dead front must be removed before hinge cover can be removed.
NOTE: Cover may not close completely with twist-locking devices in use.
- Tamper proof fastening available.

Utility requirements for this equipment may vary. Always consult the serving utility for their requirements before ordering or installing equipment in this catalog.

U5100 & U5101 STANDARD CONFIGURATIONS

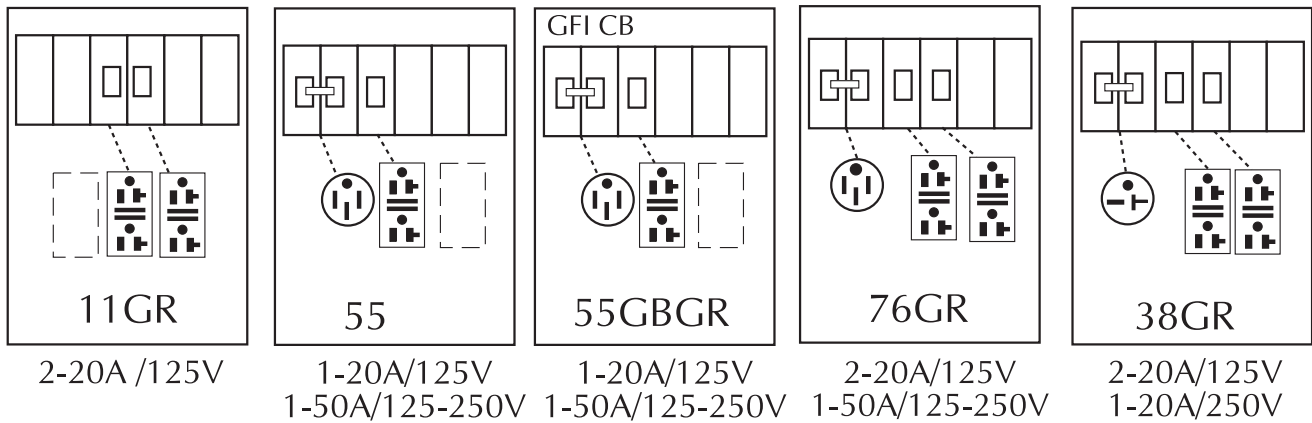

ORDERING INFORMATION

CATALOG #	SOCKET TYPE	DESCRIPTION
U5100-XL-(*)	Ring type	(*) Add suffix from above chart to complete catalog number (ie: U5100-XL-11GR)
U5100-XL	Ring type	Order base model and up to three factory installed receptacle/breaker kit separately from list below. Other kits available. Consult factory.
U5101-XL-(*)	Ringless	(*) Add suffix from above chart to complete catalog number (ie: U5101-XL-11GR)
U5101-XL	Ringless	Order base model and up to three factory installed receptacle/breaker kit separately from list below. Other kits available. Consult factory.

RECEPTACLE & CIRCUIT BREAKER KITS

CATALOG NUMBER	AMP	BLADE	VOLTAGE	NEMA CONFIG.	TYPE	CIRCUIT BREAKER TYPE
K5400-520	20	Straight	120	5-20	Std. Duplex	20 Amp 1 Pole
K5400-520GR	20	Straight	120	5-20	GFI Duplex	20 Amp 1 Pole
K5400-620	20	Straight	240	6-20	Single	20 Amp 2 Pole
K5400-620GB	20	Straight	240	6-20	Single	20 Amp 2 Pole GFI
K5400-1450	50	Straight	120/240	14-50	Single	30 Amp 2 Pole
K5400-1450GB	50	Straight	120/240	14-50	Single	30 Amp 2 Pole GFI

* Cover may not close completely while in use with Twist-Locking devices.

Utility requirements for this equipment may vary. Always consult the serving utility for their requirements before ordering or installing equipment in this catalog.

CATALOG #	CIRCUIT BREAKER DESCRIPTION
Q115	15 Amp—1 Pole—120/240—Plug-In Circuit Breaker
Q120	20 Amp—1 Pole—120/240—Plug-In Circuit Breaker
Q130	30 Amp—1 Pole—120/240—Plug-In Circuit Breaker
Q220	20 Amp—2 Pole—120/240—Plug-In Circuit Breaker
Q250	50 Amp—2 Pole—120/240—Plug-In Circuit Breaker
Q2100	100 Amp—2 Pole—120/240—Plug-In Circuit Breaker
708784-MO	20 Amp—GFCI—1 Pole—120/240—Plug-In Circuit Breaker
708785-MO	30 Amp—GFCI—1 Pole—120/240—Plug-In Circuit Breaker
707915-MO	50 Amp—GFCI—2 Pole—120/240—Plug-In Circuit Breaker
703997-MO	50 Amp—Quad—2 Pole—120/240—Circuit Breaker

CATALOG #	RECEPTACLE DESCRIPTION
708777-MO	20 Amp—120V—NEMA 5-20R—Duplex Receptacle
708080-MO	20 Amp—120V—NEMA 5-20—GFCI Duplex Receptacle
704995-MO	20A—250V—NEMA 6-20R—Single Receptacle
701776-MO	30 Amp—120V—NEMA TT-30R—Travel Trailer Receptacle
706761-MO	50A—120V—3 Pole—3 Wire—NEMA 10-50R—Receptacle
Z700911-MO	50A—120/250V—3 Pole—4 Wire—NEMA 14-50R—Receptacle

CATALOG #	LUG LANDINGS & BREAKER BASE DESCRIPTION
Z020-509-01-00-0	MPRV / MPAP—Lug Landing (Twin #6-350 KCMIL)
Z020-148-00-00-0	MPAP—Complete Interior Assembly

***NOTE:** The following brand names may be supplied when replacement circuit breakers are ordered: Cutler-Hammer/ Westinghouse—QP, BQC, BD, BR. Siemens/ITE—Q, QT. General Electric—TQ, THQ, THQL. Challenger—C, Q, QC, QP. Contact sales office for brand specific requirements.

Utility requirements for this equipment may vary. Always consult the serving utility for their requirements before ordering or installing equipment in this catalog.

DRY TYPE TRANSFORMERS WITH DISTRIBUTION FOR RV & MOBILE HOME PARK APPLICATIONS

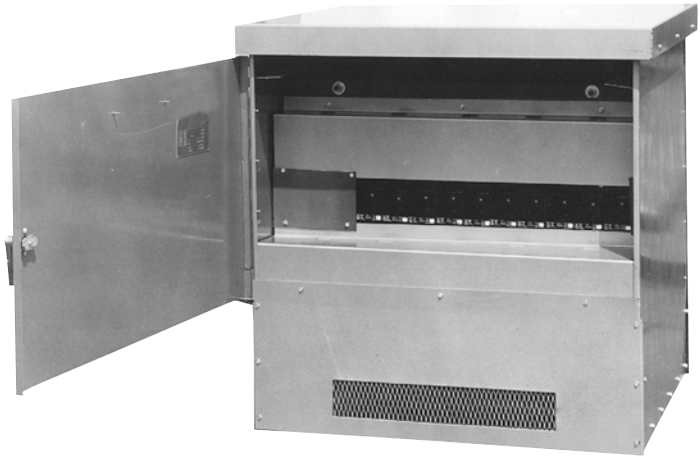

480 VOLTS TO 120/240 SINGLE PHASE		
KVA	CAT. NO.	WT.
75	7URMD	850#
100	10URMD	1050#
167 ½	16URMD	1400#
200	20URMD	1650#
250	25URMD	1950#

VOLTAGE	DIMENSIONS		
	A	B	C
480V, A	48"	38"	40"
2400V, A	48"	41"	53"

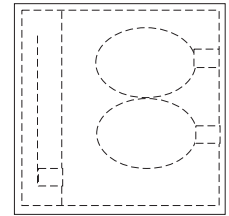

2400 VOLTS TO 120/240 SINGLE PHASE		
KVA	CAT. NO.*	WT.
75	7URMD24	1050#
100	10URMD24	1200#
167 ½	16URMD24	1650#
200	20URMD24	1900#
250	25URMD24	2200#

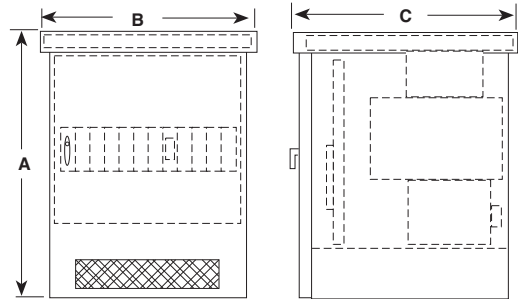
Specifications

- Built in accordance with NEMA, ASA and AIEEE standards. Designed and tested to withstand 150% of rated load for two hours continuously. 480 Volt units are UL listed. Consult local utility for acceptance of this product.
- Integrated design of the enclosure, core and coil, and secondary distribution panel permits convenient vertical line and load terminations.
- Primary and / or secondary main circuit breaker protection available. Consult local utility for 480 volt overcurrent protection requirements. Single fuse primary overcurrent protection provided on 2400 volt and above units.
- Other primary voltages available: 4160, 4800, 7200, 7960, & 12,470. Consult factory. Not UL listed.

CORE AND COIL:

- Aluminum wound (Copper available)
- Standard voltage taps @ 2FCAN and 4FCBN
- Rated at 150° C temperature rise

DISTRIBUTION BUS:

- 1600 Amp tin plated aluminum
- Space available for up to (12) circuit breakers – 1600 amp maximum
- Uses Milbank type UQFP-100 through 200 amp circuit breakers (See page 18)

ENCLOSURE:

- Type 3R enclosure
- Powder coated galvanized steel (aluminum available)
- Lockable primary and secondary doors
- Lifting hooks and fork lift slots provided

* These models are not UL listed.



NOTES

SECTION J

INTERCHANGEABLE UNIT HUBS



HUB ADAPTER PLATE
(Converts 4" opening to 2½")
S8324



SMALL "RL" OPENING (STANDARD)

SUFFIX	SIZE	MILBANK NO.
WL	1"	A7514
YL	1¼"	A7515
ZL	1½"	A7516
DL	2"	A7517
EL	2½"	A7518

LARGE "R" OPENING (HEAVY DUTY)

SUFFIX	SIZE	MILBANK NO.
F	3"	A8110
G	3½"	A8111
H	4"	A8112



REMOVABLE HUB CLOSING PLATE

DESCRIPTION	SUFFIX	CAT. #
STANDARD (for -RL opening)	-XL	A7551
LARGE (for -R opening)	-X	A9064

CLOSING COVERS

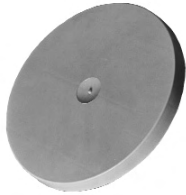

METER CLOSING PLATE
(Ring type / Ringless)
6003 (Gray Plastic)
6116 (Clear Plastic)

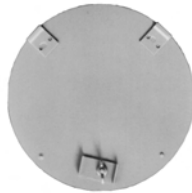

METAL CLOSING PLATE
(For Ringless sockets)
CP-21

(For Ring type sockets)
MCP

HUB SUFFIX CHART

O	Plain Top	WL	1"	For -RL Opening
RL	Small Hub Opening	YL	1¼"	For -RL Opening
R	Large Hub Opening	ZL	1½"	For -RL Opening
XL	Small Closing Plate	DL	2"	For -RL Opening
X	Large Closing Plate	EL	2½"	For -RL Opening
RXL	Large Hub Opening adapted to small Closing Plate	F	3"	For -R Opening
		G	3½"	For -R Opening
RRL	Large Hub Opening adapted to small Hub Opening	H	4"	For -R Opening

CONNECTOR KITS



SINGLE



TWIN

For use with 3/8"-16 stud type units only

SUFFIX CATALOG # (3 per set) - 1 Ø

K1	K1539	6-350
K3	K1540	4-600 or (2) 1/0-250
K3L	K1540L	4-600 or (2) 1/0-250 Non-rotating

SUFFIX CATALOG # (4 per set) - 3 Ø

K5	K3082	6-350
K7	K3441	4-600 or (2) 1/0-250

SUFFIX CATALOG # (3 per set) - 1 Ø

K2	K1350	6-350
K2L	K1350L	6-350 Non-rotating
K4	K1541	4-600

SUFFIX CATALOG # (4 per set) - 3 Ø

K6	K3442	6-350
K8	K3083	4-600

Utility requirements for this equipment may vary. Always consult the serving utility for their requirements before ordering or installing equipment in this catalog.

FIFTH TERMINALS

Consult factory for 5th terminal selection

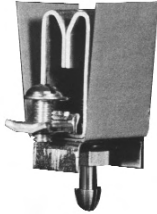

100-200 amp
"PLUG-IN" FIFTH TERMINAL
5T8K2



HEAVY DUTY JAW
CLAMPING
K3865
(K3866 w/out neutral wire)

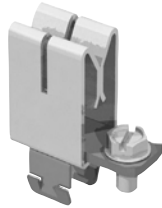

200 amp
FIFTH TERMINAL
K5T
(New style block with square hole)

SEALING RINGS



SNAP ACTION
MR-2



SCREW TYPE
(Stainless Steel)
MR-4

STAINLESS STEEL
MR2-SS

LOAD TAP CONNECTORS

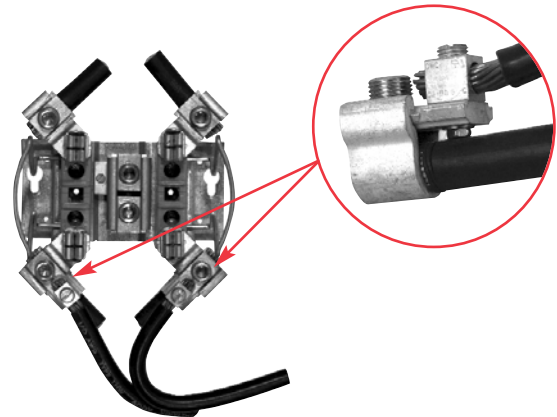

BYPASS LINK



K8180
(Bypass links sold in pairs)

DISCONNECT SLEEVE *

M5-144
(*NOT TO BE USED WITH LEVER
BYPASS SOCKETS)

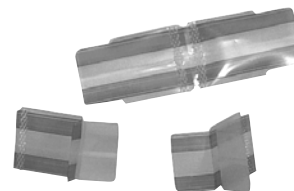

Utility requirements for this equipment may vary. Always consult the serving utility for their requirements before ordering or installing equipment in this catalog.



UQFP



UQFP-M

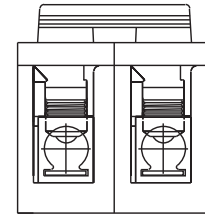
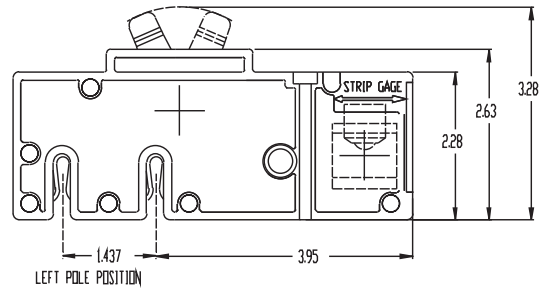
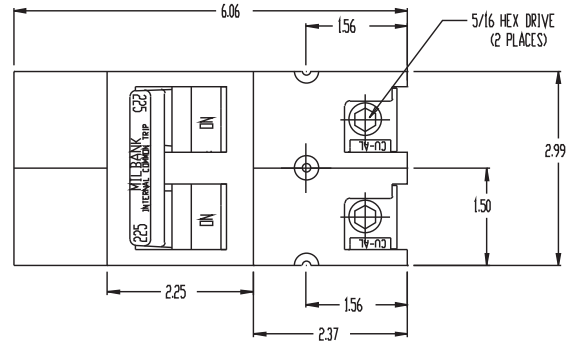

**200 AMP FRAME—PLUG-IN—10,000 AIC & 22,000 AIC
TWO-POLE—COMMON TRIP**

AMPS	10K AIC PLUG-IN	22K AIC PLUG-IN	10K AIC PLUG-IN	22K AIC PLUG-IN	WIRE RANGE	
					CU	AL
100	UQFP-100	UQFPH-100	UQFP-M-100	UQFPH-M-100	#3-#1	#1-1/0
125	UQFP-125	UQFPH-125	UQFP-M-125	UQFPH-M-125	#3-#1	#1-1/0
150	UQFP-150	UQFPH-150	UQFP-M-150	UQFPH-M-150	1/0-300	2/0-300
175	UQFP-175	UQFPH-175	UQFP-M-175	UQFPH-M-175	1/0-300	2/0-300
200	UQFP-200	UQFPH-200	UQFP-M-200	UQFPH-M-200	1/0-300	2/0-300

UL LISTED: For use with 60°C or 75°C wire.

UQFP: For parallel main circuit breaker applications

UQFP-M: For series main circuit breaker applications. Split load tab features allow for feed through capability.

STANDARD PACKAGING: 5 units per 16 lb. carton.

Utility requirements for this equipment may vary. Always consult the serving utility for their requirements before ordering or installing equipment in this catalog.





UQFB-X1



UQFB-X



UQFB



UQFB-X-MOD

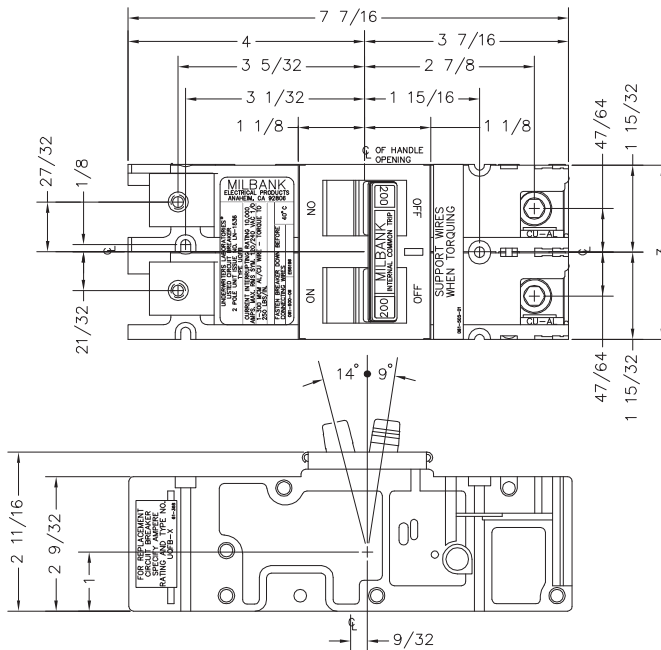

200 AMP FRAME—BOLT-ON—10K AIC & 22K AIC
TWO-POLE—COMMON TRIP

AMPS	10K AIC BOLT-ON	22K AIC BOLT-ON	10K AIC BOLT-ON	WIRE RANGE	
				CU	AL
100	UQFB-100	UQFBH-100	UQFB-100-X1	#3-#1	#1-1/0
125	UQFB-125	UQFBH-125	UQFB-125-X1	#3-#1	#1-1/0
150	UQFB-150	UQFBH-150	UQFB-150-X1	1/0-300	2/0-300
175	UQFB-175	UQFBH-175	UQFB-175-X1	1/0-300	2/0-300
200	UQFB-200	UQFBH-200	UQFB-200-X1	1/0-300	2/0-300

UL LISTED: For use with 60°C or 75°C wire.

UQFB: (2) 1/0-300 kcmil lugs provided on load and line side (cable-in, cable-out.)

UQFB3: Three pole available. Consult factory.

UQFB-X: (2) 1/0-300 kcmil lugs provided on load side and (2) line bar bus connections on line side.

UQFB-M: For series main circuit breaker applications. Split load tab features allow for feed through capability.

UQFB-X-MOD: Replacement circuit breaker with line barriers removed.

STANDARD PACKAGING: 5 units per 16 lb. carton.

Utility requirements for this equipment may vary. Always consult the serving utility for their requirements before ordering or installing equipment in this catalog.



MAXIMUM NUMBER OF CONDUCTORS IN CONDUIT*

TYPE	CONDUCTOR SIZE AWG,MCM	CONDUIT TRADE SIZES (INCHES)									
		1/2	3/4	1	1 1/4	1 1/2	2	2 1/2	3	3 1/2	4
RHW & RHH (without outer covering) THW	14	6	10	16	29	40	65	93	143	192	
	12	4	8	13	24	32	53	76	117	157	
	10	4	6	11	19	26	43	61	95	127	163
	8	1	3	5	10	13	22	32	49	66	85
	6	1	2	3	7	10	16	23	36	48	62
TW THW FEPB (6 thru 2), RHW and RHH (without outer covering) RH, THHW	1/0		1	1	2	3	5	8	12	16	21
	2/0		1	1	1	3	5	7	10	14	18
	3/0		1	1	1	2	4	6	9	12	15
	4/0		1	1	1	3	5	7	10	13	
	250			1	1	1	2	4	6	8	10
	300			1	1	1	2	3	5	7	9
	350			1	1	1	3	4	6	8	
	400			1	1	1	2	4	5	7	
	500			1	1	1	1	3	4	6	
	600					1	1	1	3	4	5
700					1	1	1	2	3	4	
750					1	1	1	2	3	4	

*This table is for concentric stranded conductors only. For cables with compact conductors refer to N.E.C.

SHORT CIRCUIT CURRENT RATING PER UL 414 TABLE 14.1

SHORT CIRCUIT CURRENT RATING: WHEN USED IN CONJUNCTION WITH THE FOLLOWING OVERCURRENT PROTECTIVE DEVICE, METER SOCKET IS RATED FOR USE ON A CIRCUIT CAPABLE OF DELIVERING NOT MORE THAN THE FOLLOWING RMS SYMMETRICAL AMPERES:					
RMS SYM. AMPS,MAX.	MAX. OVERCURRENT PROTECTION,AMPS	VOLTS MAX.	RMS SYM. AMPS,MAX.	MAX. OVERCURRENT PROTECTION,AMPS	VOLTS MAX.
200,000	200 CLASS J OR T FUSE	600	42,000	200 CLASS RK1 FUSE	480
100,000	400 CLASS J OR T FUSE	600	25,000	100 CIRCUIT BREAKER	240
100,000	100 CLASS RK5 FUSE	600	22,000	1Ø 125 CIRCUIT BREAKER	240
50,000	600 CLASS T(300V) FUSE	300	18,000	200 CIRCUIT BREAKER	240
			14,000	ANY CIRCUIT BREAKER	600

WATTHOUR METER NOT INCLUDED IN SHORT-CIRCUIT CURRENT RATING.

Note: Prior to purchase, verify amps, voltage and type of device used to protect circuit per this chart.

**SEE CATALOG PAGES FOR APPLICABLE DEVICES.
THIS CHART DOES NOT APPLY TO ALL PRODUCTS.**

Overall ampere ratings of UL Listed Milbank multiple position meter sockets are based on **1993 N.E.C. Manual article 220-32** and **ANSI / UL-414** (except where restricted by line connector size.) These requirements provide for a diversity factor / demand factor being utilized in determining the overall (main bus / lug) rating of a gang socket. All Milbank UL Listed gang sockets meet or exceed these diversity factor/demand factor requirements. Standard overall ampacity ratings for UL Listed and non UL Listed gang sockets are as shown in the chart below. Ampere ratings of meter sockets are based on the meter socket being wired with 75° C insulated wire conductor, sized in accordance with **Table 310-16** of the **National Electric Code**.

GANG SOCKET OVERALL AMPACITIES

NO. OF METER POSITIONS	100A / POS. AMPACITY	125A / POS. AMPACITY	150A / POS. AMPACITY	200A / POS. AMPACITY
2	200A	200A	200A	200A
3	200A	225A	225A	270A
4	200A	250A	270A	360A
5	225A	285A	338A	450A
6	270A	330A	396A	528A

All meter sockets are 600 volt rated unless otherwise noted.

All meter socket ampacity ratings are continuous duty unless otherwise noted.

*CU		AL or Cu-Clad AL	
A	B	A	C
18	—	—	—
16	—	—	—
14	20+	—	—
12	25+	12	20+
10	35+	10	30+
8	50	8	40
6	65	6	50
4	85	4	65
3	100	3	75
2	115	2	90
1	130	1	100
1/0	150	1/0	120
2/0	175	2/0	135
3/0	200	3/0	155
4/0	230	4/0	180
250	255	250	205
300	285	300	230
350	310	350	250
400	335	400	270
500	380	500	310
600	420	600	340
700	460	700	375
750	475	750	385

* Allowable ampacities of insulated Copper & Aluminum conductors (3W in conduit) 75°C (167°F)

† Unless otherwise permitted elsewhere in the Code, the overcurrent protection for conductor types marked with an obelisk (†) shall not exceed 15 amps for 14 AWG, 20 amps for 12 AWG, and 30 amps for 10 AWG copper: or 15 amps for 12 AWG and 25 amps for 10 AWG aluminum and copper-clad aluminum after any correction factors for ambient temperature and number of conductors have been applied.

A = Size: AWG/MCM

B = Ampere Rating for Insulation Types: FEPW, RH, RHW, THW, THWN, XHHW, USE, 2W.

C = Ampere Rating for Insulation Types: RH, RHW, THW, THWN, XHHW, USE

(Per NEC table 310-16)

AMPACITY CORRECTION FACTORS

AMBIENT TEMP. C°	CORRECTION FACTOR	AMBIENT TEMP. F°
21 - 25	1.05	70 - 77
26 - 30	1.00	79 - 86
31 - 35	.94	88 - 95
36 - 40	.88	97 - 104
41 - 45	.82	106 - 113
46 - 50	.75	115 - 122
51 - 55	.67	124 - 131
56 - 60	.58	133 - 140
61 - 65	.33	142 - 158
66 - 70	—	160 - 176

IMPORTANT NOTE

In addition to national and local electrical codes, many utilities have specific requirements for metering equipment. Always consult the serving utility for their specifications and requirements prior to ordering or installing Milbank meter mounting equipment.

BEFORE ENERGIZING

- A. Give equipment a thorough visual examination to determine that:
 - 1) No shipping or installation damage exists.
 - 2) Proper clearances have been maintained.
 - 3) All connections have been made.
 - 4) Equipment is clean and dry.
- B. Make a thorough examination to:
 - 1) Verify tightness of all bolted connections (see table below).
 - 2) Manually operate all circuit breakers, switches, relays, etc.
 - 3) Check rigidity of all mountings, bus bars and components.
 - 4) Use test equipment to check continuity of circuitry and integrity of insulation.
- C. All switches and circuit breakers should be in the “off” position.
- D. Verify that manual meter bypass (if applicable) is in non-bypass position.
- E. Install cover and/or close doors.
- F. If installation is not being energized at this time, follow “after-energizing” steps listed below. These steps will secure the installation in case of accidental energization.

WHEN ENERGIZING

- A. Use caution and follow established safety procedures:
 - 1) Wear safety apparel.
 - 2) Use safety equipment.
 - 3) Take action to prevent injury to yourself and others in the event of failure of the installation.
 - 4) Take action to prevent/decrease damage to property in the event of failure of the installation.
 - 5) If you are unsure how to safely energize the installation, get someone who is knowledgeable to do it.

AFTER ENERGIZING

- A. Secure the installation:
 - 1) To prevent accidental contact with energized parts, cover all openings with approved filler devices.
 - 2) To prevent unauthorized access, secure all covers and/or doors with approved security devices.
 - 3) Attach/post information to advise others of potential hazards associated with the installation.

RECOMMENDED TORQUE FOR GENERAL APPLICATIONS*

NOMINAL SIZE	JOINT DESCRIPTION		HEAD TYPE	TORQUE (INCH LBS.)
	SCREW	NUT		
10	BRASS	Brass Nut or Extruded Hole	ALL	20-25 in. lbs.
10	STEEL	CU or AL Busbar $\leq 1/8"$	ALL	25-30 in. lbs.
10	STEEL	Steel Nut or EH; CU or AL Busbar $> 1/8"$	ALL	30-35 in. lbs.
12	STEEL	Aluminum Extruded Hole	ALL	30-35 in. lbs.
12	STEEL	Steel Nut or Extruded Hole	ALL	40-50 in. lbs.
1/4	STEEL	Aluminum Extruded Hole	ALL	40-50 in. lbs.
1/4	STEEL	Steel Nut or EH; CU or AL Busbar	ALL	50-60 in. lbs.
5/16	STEEL	Aluminum Extruded Hole	HEX	60-70 in. lbs.
5/16	STEEL	Steel Nut or EH; CU or AL Busbar	HEX	100-150 in. lbs.
3/8	STEEL	Steel Nut	HEX	150-200 in. lbs.
1/2	STEEL	Steel Nut	HEX	200-250 in. lbs.

*Interior labels typically indicate the required torque for wire connectors and studs, and should be referenced first.

EH: Extruded Hole
CU: Copper
AL: Aluminum

MATERIALS

STEEL QUALITY

The meter equipment listed in this catalog is made of galvanized steel (AISI* G90) to afford the best possible weather proofing. *American Iron and Steel Institute.

STEEL SHEET

16 gauge, galvanized, sheet: 1 1/4 oz./ sq.ft. class zinc-coated.
(AISI G90)
14 gauge, galvanized, sheet: 1 1/4 oz./ sq.ft. class zinc-coated.

ALUMINUM EXTRUSION

Wire-Terminals: Alloy; 6061-T6, Tin-plated for CU/AL wire.
Bus Bar: Alloy; 6101-o & 6063-O

ALUMINUM SHEET

3000 series aluminum sheet, H14, or 5052 series aluminum sheet, H32. Where applicable thicknesses range from .064 — .125

COPPER SHEET & BUS

Electrolytic copper with tin plating in most applications.

INSULATING MATERIALS

- In most units, support bases for current-carrying components are molded from fiberglass reinforced high-strength, track resistant, thermoset polyester molding compounds.
- Clear or black safety shields and polarity barriers are molded from high-strength, track resistant, polycarbonate molding compounds.
- Various sheet insulating materials, as appropriate for the application are utilized in the fabrication of flat, formed and punched component parts and barriers.

FINISH

PROCESS

Light gray “state of the art” electrostatically applied powder paint offers a durable, non-fading finish. For further information concerning the chemical analysis of the weather resistant finish, please contact the factory.

METAL FASTENERS

Zinc-coated with a chromate dip.

RATING

NEMA RATING

Milbank meter sockets, CT cans and meter socket / breaker units have a type 3R rating.

DIAGRAM A
1∅2W with 1 P.T. & 1 C.T.
Single Stator Meter(2W1∅) - Form 3S
5T Socket, Test Switch #TS04-0101

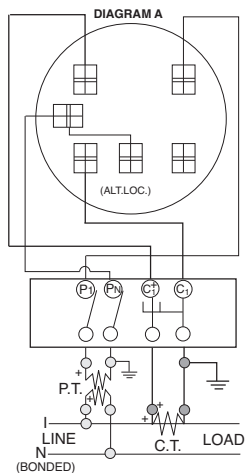

DIAGRAM B
1∅3W with 1 C.T.
Single Stator Meter(2W1∅) - Form 3S
5T Socket, Test Switch #TS04-0101

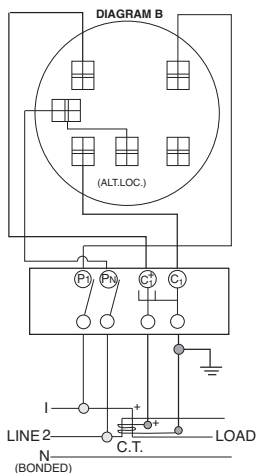

DIAGRAM C
1∅3W with 2 C.T.'s
Single Stator Meter(3W1∅) - Form 4S
6T Socket, Test Switch #TS07-0105

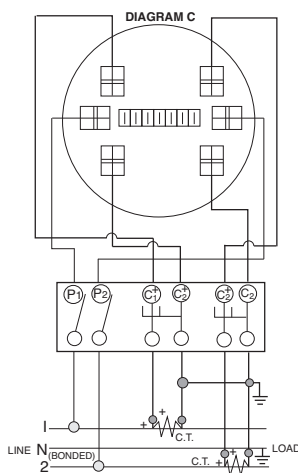

DIAGRAM D
1∅3W or 3W Network with 2 C.T.'s
2 Stator Meter - Form 5S
8T Socket, Test Switch #TS07-0105

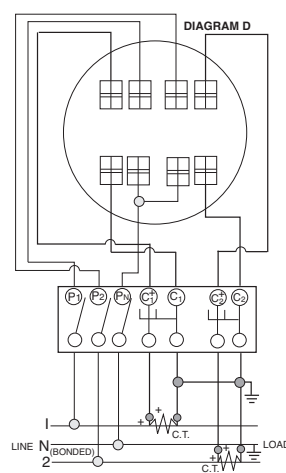

DIAGRAM E
3∅3W "Δ" with 2 P.T.'s & 2 C.T.'s
2 Stator Meter - Form 5S
8T Socket, Test Switch #TS07-0105

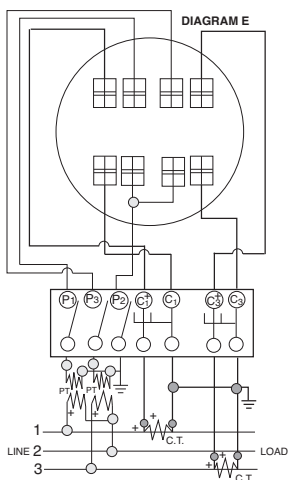

DIAGRAM F
3∅3W "Δ" with 2 C.T.'s
2 Stator Meter - Form 5S
8T Socket, Test Switch #TS07-0105

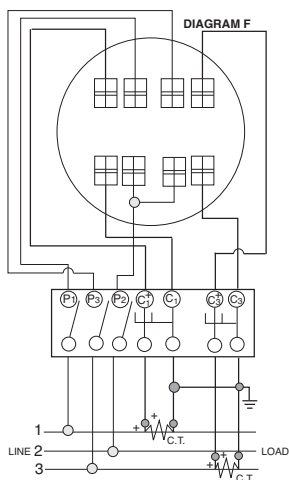

DIAGRAM G
3∅4W "Y" with 3 C.T.'s
2 1/2 Stator Meter - Form 6S
13T Socket, Test Switch #TS10-0109

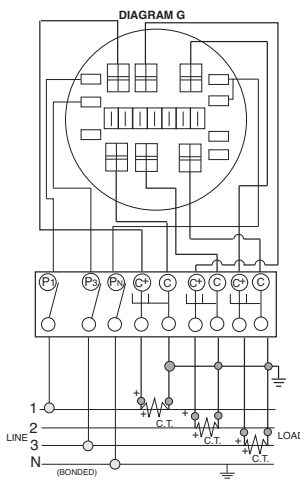

DIAGRAM H
3∅4W "Y" with 2 P.T.'s & 3 C.T.'s
2 1/2 Stator Meter - Form 6S
13T Socket, Test Switch #TS10-0109

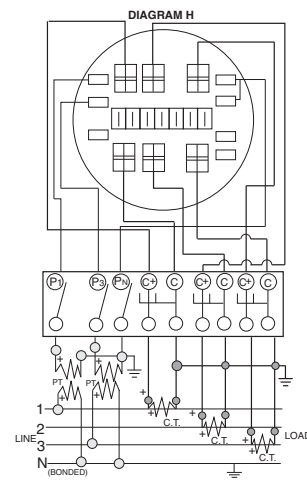

DIAGRAM I
3∅4W "Y" or "Δ" with 3 C.T.'s
"Y" 3 Stator Meter - Form 9S
"Δ" 2 Stator Meter - Form 8S
13T Socket, Test Switch #TS10-0109

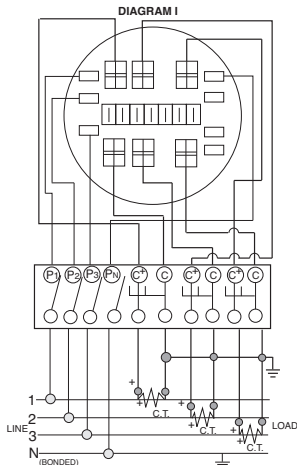
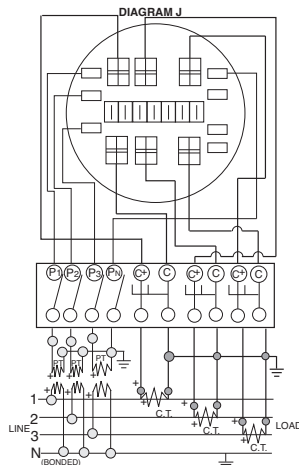
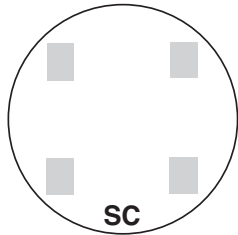

DIAGRAM J
3∅4W "Y" with 3 P.T.'s & 3 C.T.'s
3 Stator Meter - Form 9S
13T Socket, Test Switch #TS10-0109



PREWIRING: If standard factory prewiring is required, refer to wiring diagrams on this page. Determine appropriate diagram and send a copy with order. If custom factory prewiring is required, specify on order. Be sure to include meter socket catalog number, test switch make and catalog number, meter form number and provide a copy of your wiring diagram.



SC
2 and 3-WIRE FORMS
1S & 2S

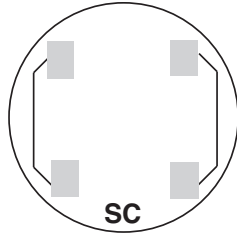

SC
2 and 3-WIRE FORMS
1S & 2S with BYPASS

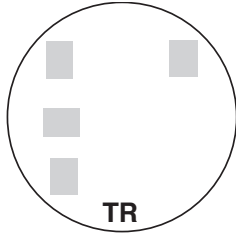

TR
2-WIRE FORM 3S
5th Term. 9 o'clock

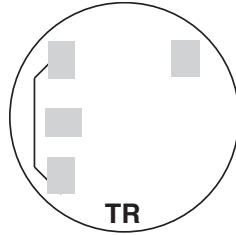

TR
2-WIRE FORM 3S
with BYPASS

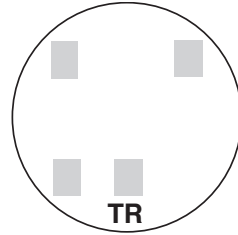

TR
2-WIRE FORM 3S
5th Term. 6 o'clock

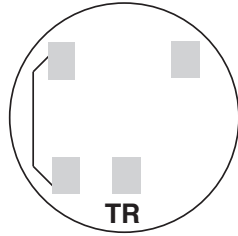

TR
2-WIRE FORM 3S
with BYPASS

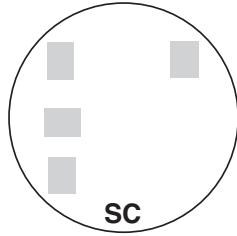

SC
2 ELEMENT
3-WIRE NETWORK
FORM 12S 5th
TERM. 9 o'clock

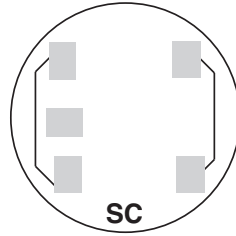

SC
2 ELEMENT 3-WIRE
NETWORK FORM 12S
with BYPASS
5th Term. 9 o'clock

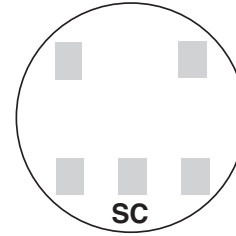

SC
2 ELEMENT
3-WIRE NETWORK
FORM 12S 5th
TERM. 6 o'clock

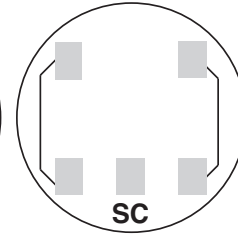

SC
2 ELEMENT 3-WIRE
NETWORK FORM 12S
with BYPASS
5th Term. 6 o'clock

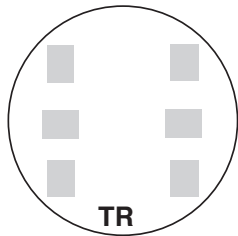

TR
3-WIRE FORM 4S

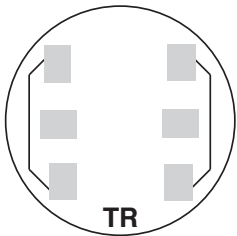

TR
3-WIRE FORM 4S
WITH BYPASS

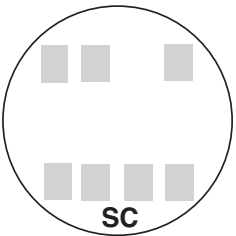

SC
2 or 3 ELEMENT
3Ø4W Y or Δ
Y FORM 14S
Δ FORM 15S

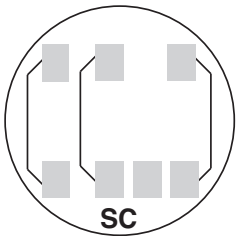

SC
2 or 3 ELEMENT
3Ø4W Y or Δ
FORMS 14S & 15S
with BYPASS

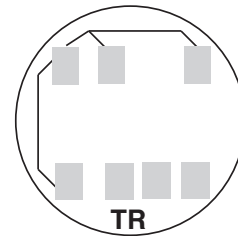

TR
2 ELEMENT
3Ø4W Y or Δ
Y FORM 7S
Δ FORM 24S
with BYPASS

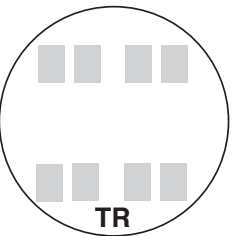

TR
2 ELEMENT
2Ø3W, 2Ø4W, 3Ø3W
FORM 5S

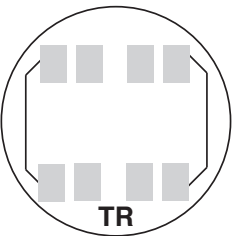

TR
2 ELEMENT 2Ø3W,
2Ø4W, 3Ø3W
FORM 5S with
BYPASS

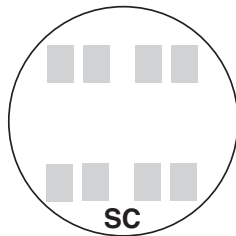

SC
2 ELEMENT
2Ø3W, 2Ø4W, 3Ø3W
FORM 13S

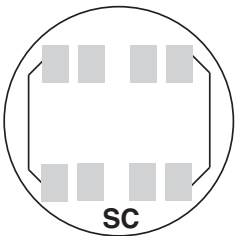

SC
2 or 3 ELEMENT
2Ø3W, 2Ø4W, 3Ø3W
FORM 13S with
BYPASS

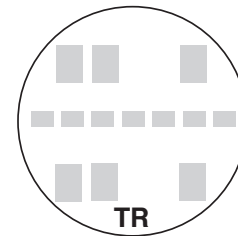

TR
2 or 3 ELEMENT
3Ø4W Y or Δ
Y FORM 9S
Δ FORM 8S

TR = TRANSFORMER RATED
SC = SELF CONTAINED

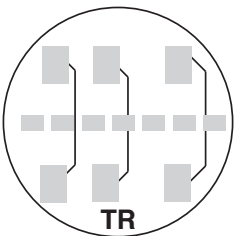

TR
2 or 3 ELEMENT
3Ø4W Y or Δ
FORMS 8S & 9S
with BYPASS

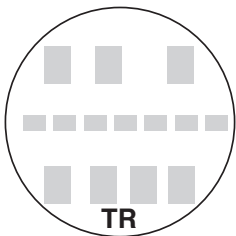

TR
2 ELEMENT
3Ø4W Y
FORM 6S

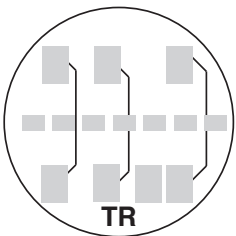

TR
2 ELEMENT
3Ø4W Y
FORM 6S
with BYPASS

Utility requirements for this equipment may vary. Always consult the serving utility for their requirements before ordering or installing equipment in this catalog.

2 POLE—3 WIRE—GROUNDING RECEPTACLES

STRAIGHT BLADE WIRING DEVICES						TWIST-LOCK WIRING DEVICES		
VOLTS	CODE	15 AMPS	20 AMPS	30 AMPS	50 AMPS	15 AMPS	20 AMPS	30 AMPS
125V	5							
		5-15R	5-20R	5-30R	5-50R	L5-15R	L5-20R	L5-30R
250V	6							
		6-15R	6-20R	6-30R	6-50R	L6-15R	L6-20R	L6-30R
277 VAC	7							
		7-15R	7-20R	7-30R	7-50R	L7-15R	L7-20R	L7-30R

3 POLE—3 WIRE—SPECIAL APPLICATIONS

STRAIGHT BLADE WIRING DEVICES					TWIST-LOCK	
VOLTS	CODE	20 AMPS	30 AMPS	50 AMPS	20 AMPS	30 AMPS
125V 250V	10					
		10-20R	10-30R	10-50R	L10-20R	L10-30R

3 POLE—4 WIRE—GROUNDING

STRAIGHT BLADE WIRING DEVICES						TWIST-LOCK	
VOLTS	CODE	15 AMPS	20 AMPS	30 AMPS	50 AMPS	20 AMPS	30 AMPS
125V 250V	14						
		14-15R	14-20R	14-30R	14-50R	L14-20R	L14-30R

2 POLE—3 WIRE—GROUNDING—NEMA TRAILER

STRAIGHT BLADE		
VOLTS	CODE	30 AMPS
125V	TT	
		TT-30R

Utility requirements for this equipment may vary. Always consult the serving utility for their requirements before ordering or installing equipment in this catalog.

Other quality products available from Milbank

Commercial Pedestals

- Attractive • Easy to install
- Secure • Cost effective



Un-Strut Your Stuff...

816-483-5314 phone
816-483-6357 fax
www.milbankmfg.com
ComPed 04/05 (2-5K)



COMMERCIAL ENCLOSURES

2007 PRICE LIST

Effective June 26, 2006
Supersedes and cancels all previous Milbank lists.
All prices listed within are subject to change without notice.

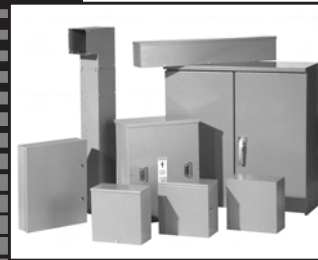

MILBANK MFG. CO. - ENCLOSURE GROUP
1601 South St. Louis Street
Concordia, MO 64020
Tel: 660-463-0805 Fax: 660-463-7950
Toll Free: 1-877-483-5314
www.milbankmfg.com



**Recreational Vehicle Park
Electrical Products & Accessories**

Millennium Series

INCLUDES REPLACEMENT PARTS

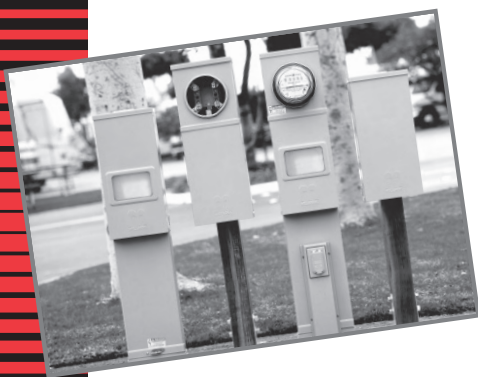

In addition to your local utility's meter mounting equipment, Milbank also manufactures supporting products, such as...

- Air Conditioner Disconnects**
- Hot Tub Disconnects**
- RV/Mobile Home Power Outlets**
- Terminal Boxes**
- Temporary Power Outlets**
- Commercial Pedestals**
- Commercial Enclosures**
- CT Enclosures**
- Circuit Breakers**
- Enclosed Circuit Breakers**
- Safety Switches**
- Test Switches**

**Contact your local distributor or go to
www.milbankmfg.com
to find additional product literature.**

6003K1	708785-MOI8	CT303611-HCF2	K5400-520GRI2	MPRV-100-78G1
6116K1	A3800A1	CT303614-SCF2	K5400-620G9	MPRV-100-MB-78G1
020-147-00-00-0G10	A7514K1	CT304811-HCF2	K5400-620I2	MPRV-100-MBLC-80G3
020-148-00-00-0G10	A7515K1	CT363611-SCF2	K5400-620GBI2	MPRV-200-MBLC-80G3
020-509-01-00-0G10	A7516K1	CT364211-SCF2	K5400-620GRG9	MPRV-503020GR-78G1
105JE2	A7517K1	CT364811-HCF2	K5400-BLANKH17	MPRV-50-78G1
114TBD1	A7518K1	CT364811-SCF2	K5400-BRIDGEH17	MPRV-BLANK-78G1
115TBD1	A7551K1	CT364814-HCF2	K5400-BRIDGE-1POS..G5-9	MPRV-BLANK-78-R-5T ...G1
116TBD1	A8110K1	CT364814-SCF2	K5400-BRIDGE-2POS..G5-9	MR-2H18
124TBD1	A8111K1	CT424211-SCF2	K5400-GBH17	MR-2K2
125TBD1	A8112K1	CT484811-HCF2	K5400-NEUTRALH17	MR-2SSK2
127TBD1	A9064K1	CT484811-SCF2	K5400-TT30G5-9, H2-10	MR-4K2
214MTBD2	AP-2300-03B1	CT484814-HCF2	K5400-TT30H17	MS24-TBD16
214MTB/22D3	AP-2300-04B1	ED42B100D14	K5400-TT30GBH2-10	MS27-TBD16
214MTB-48D4	BC214D12	ED43B100D14	K5410H15	P-10GRH16
214MTB-PD5	BC234D12	FXD62B200D14	K5411H13	P-13H16
214MTB-P48D5	BC318D12	FXD63B200D14	K5412H13	P-54H16
215MTBD2	BC338D12	K1350B15	K5413H13	PB-011D11
215MTB-48D4	BC418D12	K1350K1	K5415G5-7	PB-012D11
215MTB-PD5	BC438D12	K1350LK1	K5415H15	PB-014D11
215MTB-P48D5	BC518D12	K1539B15	K5421H15	PB-014-NKD11
217MTBD2	BC538D12	K1539K1	K5421H15	PB-018D11
217MTB/22D3	BC618D12	K1540B15	K5747F3	PB-018-NKD11
217MTB-48D4	BC638D12	K1540K1	K5757F3	PB-032D11
217MTB-PD5	CL200H16	K1540LK1	K5TG5-7	PB-034D11
217MTB-P48D5	CP-16PDMNT-CALTE2	K1541B15	K5TK2	PB-034-NKD11
224MTBD6	CP-21K1	K1541K1	K8180K2	PB-038D11
224MTB/22D7	CP-24PDMNT-CALTE2	K3082K1	KK3388F7	PF-BLG11
224MTB-PD9	CP3B11110A22SL1E5	K3083K1	KK3388-BLK-FLF7	PF-KRG11
224MTB-P48D9	CP3B11115A22E4	K3441K1	M400-APSC5	PT223D16
225MTBD6	CP3B11115A42E4	K3442K1	M400-APS-BSC5	PT224D16
225MTB-PD9	CP3B1111IRASPE7	K3450G5-7	M400-PARC4	PT263D16
225MTB-P48D9	CP3B1111IRASSE7	K3865E2	M400-PAR-UGC4	PT264D16
227MTBD6	CP3B12110A22SL1E5	K3865K2	M400-UG-APS-FC6	PT323D16
227MTB/22D7	CP3B12119A22E4	K3866K2	M400-UG-APS-F-BSC6	PT324D16
227MTB-125D14	CP3B1411JB22E6	K4709-02H14	M400-UG-APS-LCC6	PT363D16
227MTB-150D14	CP3B14120B22E6	K4709-WSH14	M400-UG-APS-LC-BSC6	PT364D16
227MTB-175D14	CP3B51110A22SL1E5	K4722F3	M400-UG-APS-PC6	Q115I8
227MTB-48D8	CP3B51115A22E4	K4729F3	M401-UGC7	Q120H18
227MTB-PD9	CP3B5111IRASPE7	K4793F3	M401-UG-BSC7	Q120I8
227MTB-P48D9	CP3B52110A22SLE5	K4794F3	M404-UG-LCC8	Q130H18
243210-LC3R-SPF1	CP3B52119A22E4	K4795F3	M404-UG-LC-BSC8	Q130I8
323610-LC3R-SPF1	CP3B5411JB22E6	K4796F3	M5-144K2	Q220I8
363016-CT3RF1	CP3B8411JB22E6	K4797F3	MCPK1	Q250H18
363612-CT3R-SPF1	CP3B84120B22E6	K4798F3	MN1020-TVJ1	Q250I8
364812-CT3R-SP2F1	CP3B-AUX-1200H11	K4800-01H16	MN1100J1	QJ22B200HD14
403456-SCG11	CP-ABK5/8E2	K4903F3	MN1100-NGJ1	QJ23B200D14
403457-SCG11	CP-PE-HOA-3POSE2	K4904F3	MN-1100-TVJ1	QJH23B200LD14
5T8K2K2	CP-TC24HE2	K5035G5-7	MN2200J1	RBK-1G10
701776-MOH17	CP-TC7DE2	K5039G5-7	MN900J1	S8324K1
701776-MOI8	CP-TCWIREE2	K5193G5-7	MN900-BJ1	TB100-47D16
703997-MOI8	CT203611-HCF2	K5194G5-7	MPAP-100-78G2	TB100-5D16
704995-MOI8	CT242411-SCF2	K5400-1450G5-9, H2-10	MPAP-100-MB-78G2	TB200-47D16
706761-MOI8	CT243011-HCF2	K5400-1450H17	MPAP-200-20GR-78G2	TB200-LLD16
707915-MOI8	CT243011-SCF2	K5400-1450I2	MPAP-200-78G2	TB-BARRD16
708080-MOH17	CT24329-SCF2	K5400-1450GBG9	MPAP-200-MB-78G2	TS04-0049F8
708080-MOI8	CT243611-HCF2	K5400-1450GBI2	MPAP-BLANK-78G2	TS04-0101F8
708676-MOH17	CT243611-SCF2	K5400-520I2-7	MPAP-BLANK-78-RG2	TS04-0104F8
708777-MOI8	CT244811-HCF2	K5400-520GBH2-10	MPAPD-BLANK-78G2	TS04-0105F8
708784-MOH18	CT244811-SCF2	K5400-520GRG5-9, H2-10	MPAPD-BLANK-78RG2	TS04-0106F8
708784-MOI8	CT303011-SCF2	K5400-520GRH17	MPRV-100-20GR-78G1	TS10-0016F8

TS10-0109.....F8	U2854-X.....B15	U4909-O.....I2	U5268-XTL-150.....C2	UQFB-100-X1.....K4
TS10-0110.....F8	U2855-X.....B15	U4909-O-11GR.....I2	U5268-XTL-150-KK.....C2	UQFB-125.....K4
TS10-0111.....F8	U2856-X.....B15	U4909-O-55GBGR.....I2	U5268-XTL-200.....C2	UQFB-125-X1.....K4
TS10-0112.....F8	U2862-X.....B15	U4969-KO.....B5	U5268-XTL-200-KK.....C2	UQFB-150.....K4
U1060-RL.....B3	U2863-X.....B15	U5000-XL.....H2	U5269-XTL-200.....C2	UQFB-150-X1.....K4
U1079-R.....B10	U2864-X.....B15	U5000-XL.....I4	U5300-O.....H10	UQFB-175.....K4
U1129-O-K3L-K2L.....B10	U2865-X.....B15	U5000-XL-332.....H2	U5300-O-41.....H10	UQFB-175-X1.....K4
U1211-RXL.....B7	U2866-X.....B15	U5000-XL-41.....H2	U5300-O-55.....H10	UQFB-200.....K4
U1252-X-K1.....B13	U3251-O-200-CB.....C6	U5000-XL-55.....H2	U5300-O-552GR.....H10	UQFB-200-X1.....K4
U1253-X-K3.....B13	U3320-R.....F4	U5000-XL-75.....H2	U5300-O-75.....H10	UQFBH-100.....K4
U1254-X-K3.....B13	U3322-R.....F4	U5000-XL-75GB.....H2	U5310-O.....H10	UQFBH-125.....K4
U1255-X-K4.....B13	U3328-RXL.....B4	U5001-RL-01.....I5	U5320-O.....H10	UQFBH-150.....K4
U1256-X-K4.....B13	U3340-O.....F4	U5056-O.....B10	U5330-O.....H10	UQFBH-175.....K4
U1431-R.....B10	U3342-O.....F4	U5059-X-2/200.....C4	U5706-O-200S.....G9	UQFBH-200.....K4
U1432-O.....B10	U3462-O.....D13	U5100-XL.....H4	U5706-O-200S-KK.....G9	UQFP-100.....H11
U1527-O.....B3	U3463-O.....D13	U5100-XL.....I7	U5707-O-200S.....G9	UQFP-100.....K3
U1681-RL.....B2	U3464-O.....D13	U5100-XL-41.....H4	U5759-X-2/200.....C4	UQFP-125.....H11
U1797-O-K3L-K2L.....B10	U3465-O.....D13	U5100-XL-55.....H4	U7021-RL-TG.....B3	UQFP-125.....K3
U1819-X.....B10	U3466-O.....D13	U5100-XL-552GR.....H4	U7040-XL-TG.....B3	UQFP-150.....H11
U1980-O.....B3	U3504-XL.....B9	U5100-XL-75.....H4	U7043-XL-TG.....B3	UQFP-150.....K3
U2120-X.....B11	U3507-XL.....B9	U5100-XL-75GB.....H4	U7422-RXL.....B6	UQFP-175.....H11
U214MTB.....D2	U3514-XL.....B9	U5101-XL.....H4	U7423-RXL.....B6	UQFP-175.....K3
U214MTB/22.....D3	U3517-XL.....B9	U5101-XL.....I7	U7487-O.....B2	UQFP-200.....H11
U214MTB-48.....D4	U3522-XL-K1.....B12	U5136-O.....G7	U7487-RL.....B2	UQFP-200.....K3
U214MTBL.....D10	U3523-XL-K1.....B12	U5136-O-100S.....G7	U7490-O.....B2	UQFP-225.....H11
U214MTB-P.....D5	U3524-XL-K2.....B12	U5136-O-200S.....G7	U7490-RL.....B2	UQFPG-100.....K3
U214MTB-P48.....D5	U3525-XL-K2.....B12	U5137-O.....G7	U7573-RL.....B6	UQFPG-125.....K3
U214MTBPL.....D10	U3532-X-K1.....B13	U5137-O-100S.....G7	U8032-XL.....B12	UQFPG-150.....K3
U215MTB.....D2	U3533-X-K3.....B13	U5137-O-200S.....G7	U8033-XL.....B12	UQFPG-175.....K3
U215MTB-48.....D4	U3548-X.....B11	U5138-O.....G7	U8034-XL.....B12	UQFPG-200.....K3
U215MTB-P.....D5	U3555-R.....F4	U5138-O-200S.....G7	U8035-XL.....B12	UQFPH-100.....H11
U215MTB-P48.....D5	U3565-O.....F4	U5168-100-KK-5T.....C2	U8036-XL.....B12	UQFPH-125.....H11
U217MTB.....D2	U3574-RL-200.....C1	U5168-150-KK-5T.....C2	U8100-RL.....B6	UQFPH-150.....H11
U217MTB/22.....D3	U3577-RL-200.....C1	U5168-XTL-100.....C2	U9319-XL.....B7	UQFPH-175.....H11
U217MTB-48.....D4	U3587-O-200.....C1	U5168-XTL-100-KK.....C2	U9320-RXL.....B6	UQFPH-200.....H11
U217MTBL.....D10	U3800.....A1	U5168-XTL-150.....C2	U9550-RRL.....B8	UQFPH-225.....H11
U217MTB-P.....D5	U3801.....A1	U5168-XTL-150-KK.....C2	U9551-RXL.....B8	UQFPH-M-100.....K3
U217MTB-P48.....D5	U3830.....A1	U5168-XTL-200.....C2	U9700-RRL.....B8	UQFPH-M-125.....K3
U217MTBPL.....D10	U3860.....A1	U5168-XTL-200-KK.....C2	U9701-RXL.....B8	UQFPH-M-150.....K3
U224MTB.....D6	U3822-20GR.....A2	U5169-XTL-100.....C2	UC1290-XL.....F5	UQFPH-M-175.....K3
U224MTB/22.....D7	U3852-XL.....B7	U5169-XTL-150.....C2	UC1291-RL.....F5	UQFPH-M-200.....K3
U224MTB-48.....D8	U3854-O-200.....C1	U5169-XTL-200.....C2	UC1299-XL.....F5	UQFP-M-100.....K3
U224MTBL.....D10	U4015-KO.....B5	U5200-XL.....H5	UC1300-RL.....F5	UQFP-M-125.....K3
U224MTB-P.....D9	U4015-O.....B4	U5200-XL-332.....H5	UC3423-XL.....F6	UQFP-M-150.....K3
U224MTB-P48.....D9	U4031-O-2/200.....C4	U5200-XL-41.....H5	UC3425-XL.....F6	UQFP-M-175.....K3
U224MTBPL.....D10	U4517-DL-M4.....B4	U5200-XL-75.....H5	UC3426-XL.....F6	UQFP-M-200.....K3
U225MTB.....D6	U4517-KO.....B5	U5200-XL-75GB.....H5	UC3428-XL.....F6	USE-AP-200-MB.....C3
U225MTBL.....D14	U4518-KO.....B5	U5210-XL.....H5	UC3433-XL.....F6	USE-AP-200-ML.....C3
U227MTB.....D6	U4518-O-W.....B4	U5220-XL.....H5	UC3434-XL.....F6	Z020-148-00-00-0.....I8
U227MTB/22.....D7	U4518-XL-W.....B4	U5220-XL-41.....H5	UC3435-XL.....F6	Z020-509-11-00-0.....I8
U227MTB-125.....D14	U4540-XL.....H12	U5220-XL-75.....H5	UC3436-XL.....F6	Z818052-SC.....H18
U227MTB-150.....D14	U4542-XL.....H12	U5230-XL.....H5	UC3438-XL.....H12	Z818480-SC.....H18
U227MTB-175.....D14	U4544-XL.....H12	U5240-O.....G5	UC7233-XL.....F5	Z915141-AC.....H18
U227MTB-48.....D8	U4546-XL.....H12	U5240-O-100S.....G5	UC7235-XL.....F5	Z917602-AC.....H18
U227MTBL.....D10	U4548-RXL.....H12	U5240-O-200S.....G5	UC7237-XL.....F5	Z918447-SC.....H18
U227MTB-P.....D9	U4549-RXL.....H12	U5241-O.....G5	UC7461-YL-TGE-DES.....F6	Z918449-SC.....H18
U227MTB-P48.....D9	U4881-O-50GB.....A2	U5241-O-100S.....G5	UC7544-RL.....F5	Z918466-AC.....H18
U227MTBPL.....D10	U4881-O-60GB.....A2	U5241-O-200S.....G5	UC7545-RL.....F5	
U2594-X.....B11	U4908-O.....I2	U5242-O-200S.....G5	UC7582-RL.....F5	
U2852-X.....B15	U4908-O-11GR.....I2	U5243-O.....G5	UC7636-YL-TGE-DES.....F6	
U2853-X.....B15	U4908-O-55GBGR.....I2	U5252-O.....G5	UQFB-100.....K4	

EUSERC INDEX

Milbank Catalog Number	EUSERC Drawing Number	Catalog Page	Milbank Catalog Number	EUSERC Drawing Number	Catalog Page
U3574-RL-200	301	C1	U227MTB/22	305A, 311	D7
U3577-RL-200	301	C1	227MTB-48	305A, 311	D8
U3584-O-200	301	C1	U224MTB-48	305A, 311	D8
U3587-O-200	301	C1	U227MTB-48	305A, 311	D8
U4015-O	301A	B4	224MTB-P	305A, 311	D9
UF4015-KO	301A	B5	225MTB-P	305A, 311	D9
U3548-X	302B	B11	227MTB-P	305A, 311	D9
M400-UG-APS-F	302A	C6	U224MTB-P	305A, 311	D9
M400-UG-APS-F-BS	302	C6	U227MTB-P	305A, 311	D9
M400-UG-APS-P	302A	C6	224MTB-P48	305A, 311	D9
M400-UG-APS-LC	302A	C6	225MTB-P48	305A, 311	D9
M400-UG-APS-LC-BS	302	C6	227MTB-P48	305A, 311	D9
U3251-O-200-CB	302	C6	U224MTB-P48	305A, 311	D9
M401-UG	302A	C7	U227MTB-P48	305A, 311	D9
M401-UG-BS	302	C7	U214MTBL	305A, 311	D10
M404-UG-LC	302A	C8	U214MTBPL	305A, 311	D10
M404-UG-LC-BS	302	C8	U217MTBL	305A, 311	D10
114TB	304, 311	D1	U217MTBPL	305A, 311	D10
115TB	304, 311	D1	U224MTBL	305A, 311	D10
117TB	304, 311	D1	U224MTBPL	305A, 311	D10
124TB	305, 311	D1	U227MTBL	305A, 311	D10
125TB	305, 311	D1	U227MTBPL	305A, 311	D10
127TB	305, 311	D1	PB-011	343A	D11
214MTB	305A, 311	D2	PB-012	343A	D11
215MTB	305A, 311	D2	PB-014	343	D11
217MTB	305A, 311	D2	PB-014-NK	343	D11
U214MTB	305A, 311	D2	PB-018	343	D11
U215MTB	305A, 311	D2	PB-018-NK	343	D11
U217MTB	305A, 311	D2	PB-032	343A	D11
214MTB/22	305A, 311	D3	PB-034	343	D11
217MTB/22	305A, 311	D3	PB-034-NK	343	D11
U214MTB/22	305A, 311	D3	PB-038	343	D11
U217MTB/22	305A, 311	D3	U3320-R	313	F4
214MTB-48	305A, 311	D4		Single Phase Only	
215MTB-48	305A, 311	D4	U3322-R	313	F4
217MTB-48	305A, 311	D4	U3555-R	313	F4
U214MTB-48	305A, 311	D4	U3340-O	314	F4
U215MTB-48	305A, 311	D4		Single Phase Only	
U217MTB-48	305A, 311	D4	U3342-O	314	F4
214MTB-P	305A, 311	D5	U3565-O	314	F4
215MTB-P	305A, 311	D5	CT244811-SC	316, 317	F2
217MTB-P	305A, 311	D5	CT364811-SC	316, 317, 318	F2
U214MTB-P	305A, 311	D5	CT364814-SC	316, 317, 318	F2
U215MTB-P	305A, 311	D5	CT484811-SC	316, 317	F2
U217MTB-P	305A, 311	D5	CT244811-HC	316, 317	F2
214MTB-P48	305A, 311	D5	CT304811-HC	316, 317	F2
215MTB-P48	305A, 311	D5	CT364811-HC	316, 317, 318	F2
217MTB-P48	305A, 311	D5	CT484811-HC	316, 317, 318	F2
U214MTB-P48	305A, 311	D5	CT484814-HC	316, 317, 318	F2
U215MTB-P48	305A, 311	D5	K4903	328B	F3
U217MTB-P48	305A, 311	D5	K4904	329B	F3
224MTB	305A, 311	D6	K4722	329B	F3
225MTB	305A, 311	D6	K4729	328B	F3
227MTB	305A, 311	D6	K4797	328A	F3
U224MTB	305A, 311	D6	K4798	329A	F3
U225MTB	305A, 311	D6	UC3435-XL	339	F6
U227MTB	305A, 311	D6	UC3436-XL	339	F6
224MTB/22	305A, 311	D7	UC3438-XL	339	F6
227MTB/22	305A, 311	D7	UC3433-XL	339	F6
U224MTB/22	305A, 311	D7	UC3434-XL	339	F6

Meter Mounting Equipment & More!

Commercial Electrical Enclosures

Residential & Commercial Metering

Commercial Meter Pedestals

Disconnect Devices

Current Transformer Enclosures

RV/MH Pedestals

Temporary Power Outlets

Circuit Breakers

Enclosed Circuit Breakers

Safety Switches

Test Switches



REPRESENTED BY:

MILBANK MFG. CO.

PO Box 419028

Kansas City, MO 64141-0028

Tel: 816-483-5314 Fax: 816-483-6357

Toll Free: 877-483-5314

www.milbankmfg.com

MILBANK®



www.milbankmfg.com

WRC 8/09 (5K)