

Spring Steel Fasteners

Wall Studs, Conduit & Cable, Acoustical Tee,
Beams, Hangers, Lathers Channel,
Communication & Low Voltage, Accessories,
Anchors

BLF-12

COOPER B-Line

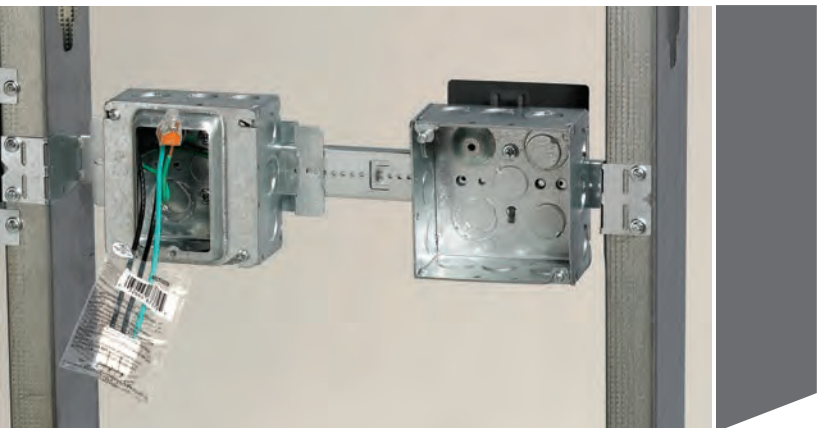

Introduction



Cooper B-Line has long been a leading manufacturer of support systems and electrical enclosures for the mechanical, electrical and telecommunications industries. Our products are used in industrial, commercial utility and OEM installations. Cooper B-Line is proud of the demanding standard of research, design, engineering, and manufacturing that go into each and every product. But exceptional quality and value is nothing new to Cooper B-Line. Our customers have access to the most complete product systems offered including metal framing, cable tray, Cent-R-Rail™, pipe hangers, electrical enclosures and Telecom products.

















Many of Cooper B-Line's products are listed by Underwriters Laboratories, Inc. and approved by Canadian Standards Association. All Cooper B-Line products are manufactured to meet or exceed industry standards for their design and manufacture.

Cooper B-Line products are produced in six modern plants consisting of over 900,000 square feet. These facilities are located in Highland, Illinois; Troy, Illinois; Reno, Nevada; Sherman, Texas; Corona, California; and Pinckneyville, Illinois. Regional sales and distribution centers are located throughout the United States stocking standard Cooper B-Line products for quick service and delivery.

This catalog is designed to be helpful to contractors in the application and selection of spring steel fasteners and support products for construction and maintenance.

If a unique application requires a special design not included in this catalog, Cooper B-Line's engineering personnel are ready to furnish design consultation and realistic cost estimates. In addition, sales representatives with extensive product knowledge are located throughout the United States and abroad for your convenience.

Table Of Contents

Ruff-IN™ Pre-Fab	2-7	
Pictorial Index	8-14	
Numbering Guide	15	
Technical Data	16-17	
Wall Studs	18-41	
Conduit & Cable	42-69	
Acoustical Tee	70-89	
Beams	90-113	
Hangers	114-139	
Lathers Channel	140-143	
Communication & Low Voltage	144-171	
Accessories	172-181	
Anchors	182-215	
NEC Requirements	216-231	
TIA/EIA Requirements	232-233	
Reference Data	234-241	
Alphanumeric Index	242-250	

Website: www.cooperbline.com

Ruff-IN™ Pre-Fab



Cooper B-Line's Ruff-IN product offering continues to expand with product and assembly options.

Due to the fast-paced growth of this category, the detailed product information now resides in its own brochure.

Pages 3 -7 provides a brief overview of the Ruff-IN product line offerings.

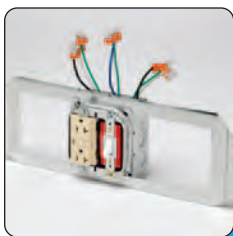

See Ruff-IN Pre-Fab Systems brochure for complete product information and part numbers.

Cooper B-Line Has The Total Pre-Fab Offering...

No matter what your preference for pre-fab may be, we have it!
Choose the pre-fab offering below that best fits your needs:

Basic Ruff-IN

Offering Contents: Bracket, Box, Mud Ring, Ground Wire

- Ideal solution for a contractor sampling pre-fab for the first time that wants to keep the control of his or her project.
- Published lead times of 3-5 days ARO, and NEXT DAY SHIPPING ON (16) QUICK-SHIP ASSEMBLIES.
(See page 5)



Ruff-IN with Wiring Devices and/or MC Cable Whips

Offering Contents: Basic Ruff-IN with Wiring Device, Protective Cover Plates, and MC Cable whip with connector(s)

- Assemblies are pre-wired for quick plug and-play installation using Wago™ or wire nut connectors.
- Cooper Wiring Device's ArrowLink connector offers additional labor savings with its plug in feature.
(See page 4 for more details)
- Pre-wired Ruff-IN assemblies with devices and a pre-cut MC cable whip attached.
- Whip lengths available in 5-foot increments.
- Includes option to order MC cable whips only.

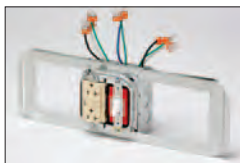

Total Ruff-IN™

Perfect for a contractor that desires take-off services and engineering expertise of Cooper B-Line

- Perfect for a contractor interested in trying pre-fab for the first time that needs the engineering and assembly expertise of Cooper B-Line.
- Industry leading, published lead times for Total Ruff-IN quotation responses and order assembly.



See Ruff-IN Pre-Fab Systems brochure for complete product information and part numbers.

Distributor Quick Ship Program

Next Day Shipping Available on

12 Ruff-In Assemblies & 16 Rapid Ring™ Assemblies

- No need to request a lead time, order today and we'll ship out of stock tomorrow!
- Ask your Cooper B-Line Sales Representative for more information on stock-able Ruff-IN assemblies.

Ruff-IN Quick Ship Pre-Fab Assemblies

CBL Part #	UPC #	Max. Order Qty.
BBF Series Floor-mount		
BBF18-1104DA	78205154072	50
18" BBF floor-mount, 1-gang 5/8" plaster ring, TP403 box, stranded ground wire		
BBF18-1104D	78205154065	50
18" BBF floor-mount, 1-gang 5/8" plaster ring, TP403 box, solid ground wire		
BBF18-1124DA	78205155199	25
18" BBF floor-mount, 1-gang 3/4" plaster ring, TP403 box, stranded ground wire		
BBF18-1124D	78205154176	125
18" BBF floor-mount, 1-gang 3/4" plaster ring, TP403 box, solid ground wire		
Double-Sided Box Support		
BB76-1104DA	78205155200	100
6" Double-sided box support 1-gang 5/8" plaster ring, TP403 box, stranded ground wire		
BB76-1104D	78205138768	25
6" Double-sided box support 1-gang 5/8" plaster ring, TP403 box, solid ground wire		
BB76-1124DA	78205154049	50
6" Double-sided box support 1-gang 3/4" plaster ring, TP403 box, stranded ground wire		
BB76-1124D	78205138771	25
6" Double-sided box support 1-gang 3/4" plaster ring, TP403 box, solid ground wire		
Telescoping Slider Bracket		
BB216TS-1104DA	78205139289	25
16" Telescoping Slider Brkt, 1-gang 5/8" plaster ring, TP403 box, stranded ground wire		
BB216TS-1104D	78205138619	25
16" Telescoping Slider Brkt, 1-gang 5/8" plaster ring, TP403 box, solid ground wire		
BB216TS-1124DA	78205139292	25
16" Telescoping Slider Brkt, 1-gang 3/4" plaster ring, TP403 box, stranded ground wire		
BB216TS-1124D	78205138621	250
16" Telescoping Slider Brkt, 1-gang 3/4" plaster ring, TP403 box, solid ground wire		



BBF18-1104DA



BB216TS-1104D



BB76-1104D

See Ruff-IN Pre-Fab Systems brochure for complete product information and part numbers.

Rapid Ring™ Quick Ship Pre-Fab Assemblies

CBL Part #	UPC #	Max. Order Qty.
BBF18-1RR4DA	78205176289	50
18" BBF floor-mount, 1-gang Rapid Ring, TP403 box, stranded ground wire		
BBF18-1RR4D	78205176290	50
18" BBF floor-mount, 1-gang Rapid Ring, TP403 box, solid ground wire		
BBF18-2RR4DA	78205176084	50
18" BBF floor-mount, 2-gang Rapid Ring, TP403 box, stranded ground wire		
BBF18-2RR4D	78205176293	50
18" BBF floor-mount, 2-gang Rapid Ring, TP403 box, solid ground wire		
BB76-1RR4DA	78205176085	50
6" Double-sided box support 1-gang Rapid Ring, TP403 box, stranded ground wire		
BB76-1RR4D	78205176301	50
6" Double-sided box support 1-gang Rapid Ring, TP403 box, solid ground wire		
BB76-2RR4DA	78205176302	50
6" Double-sided box support 2-gang Rapid Ring, TP403 box, stranded ground wire		
BB76-2RR4D	78205176303	50
6" Double-sided box support 2-gang Rapid Ring, TP403 box, solid ground wire		
BB216TS-1RR4DA	78205176294	50
16" Telescoping Slider Brkt, 1-gang Rapid Ring, TP403 box, stranded ground wire		
BB216TS-1RR4D	78205176295	50
16" Telescoping Slider Brkt, 1-gang Rapid Ring, TP403 box, solid ground wire		
BB216TS-2RR4DA	78205176296	50
16" Telescoping Slider Brkt, 2-gang Rapid Ring, TP403 box, stranded ground wire		
BB216TS-2RR4D	78205176297	50
16" Telescoping Slider Brkt, 2-gang Rapid Ring, TP403 box, solid ground wire		
BB216TCL-1RR4DA	78205176088	50
16" Telescoping Brkt with Croc-Lock, 1-gang Rapid Ring, TP403 box, stranded ground wire		
BB216TCL-1RR4D	78205176298	50
16" Telescoping Brkt with Croc-Lock, 1-gang Rapid Ring, TP403 box, solid ground wire		
BB216TCL-2RR4DA	78205176299	50
16" Telescoping Brkt with Croc-Lock, 2-gang Rapid Ring, TP403 box, stranded ground wire		
BB216TCL-2RR4D	78205176300	50
16" Telescoping Brkt with Croc-Lock, 2-gang Rapid Ring, TP403 box, solid ground wire		



Double Sided Box Support with Rapid Ring

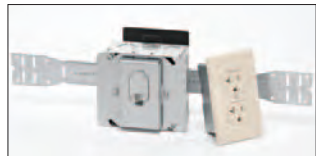

Telescoping Slider Bracket with Rapid Ring

See Ruff-IN Pre-Fab Systems brochure for complete product information and part numbers.

Ruff-IN™ Pre-Fab

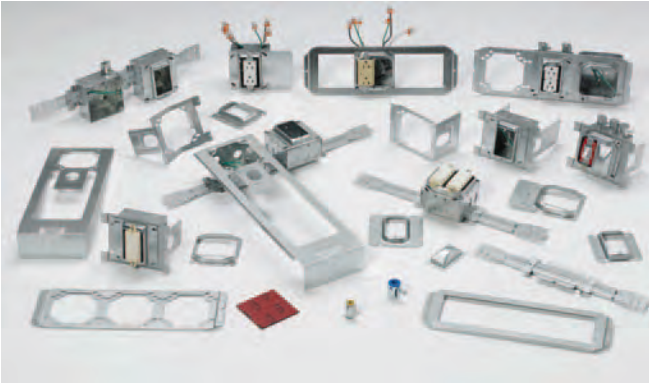

See Ruff-IN Pre-Fab Systems brochure for complete product information and part numbers.

Cooper B-Line's Ruff-IN Configurator program has been developed to simplify the planning process for pre-fab construction. The program will walk you through a component selection process, build customized pre-fab assemblies, and create a project BOM to accelerate the quotation process.

Configurator Features

- Build an assembly to your own specification by choosing from brackets, boxes, plaster rings, wiring devices, and other accessories.
- Check the assembly for accuracy by reviewing a 3D, rotatable image that is created in real time.
- Configure multiple assemblies and save them as a project.
- Divide the project into rooms and specify the types and quantities of assemblies that go in each location.
- Print a customized project submittal package with the push of a button.
- Submit the entire project with your specific job and assembly information to Cooper B-Line for a quote with one click.

All of these features translate into fewer mistakes and less time spent during the take-off process. Let the Cooper B-Line Ruff-IN Configurator go to work for you. Build your next project using Cooper B-Line's Ruff-IN pre-fabricated wiring assemblies today!

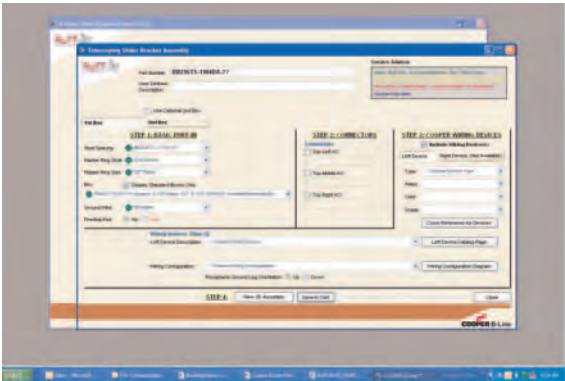

See Ruff-IN Pre-Fab Systems brochure for complete product information and part numbers.

Pictorial Index

Conduit & Cable

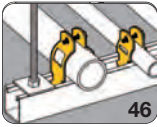

46

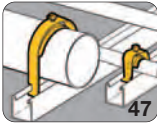

47

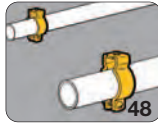

48

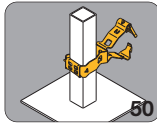

50

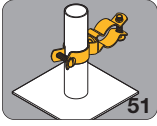

51

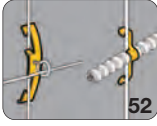

52



53

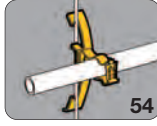

54



55



56



56

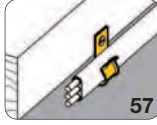

57



58

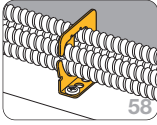

58

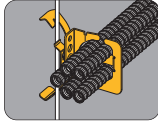

58

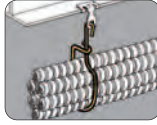

58



59



60

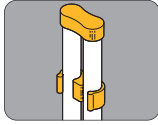

61



62



63



64

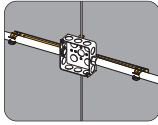

65

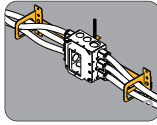

66

Acoustical Tee



77



78

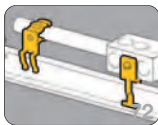

79

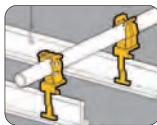

80

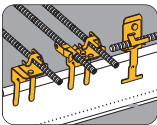

78

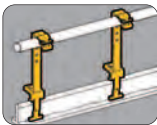

78

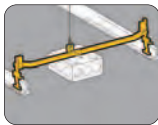

79

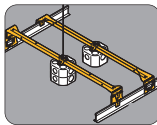

80

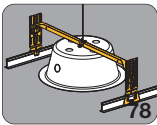

78

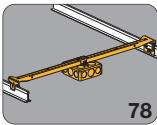

78

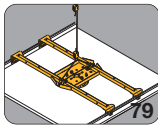

79

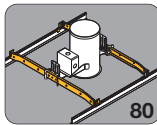

80

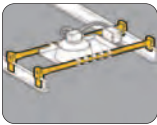

81

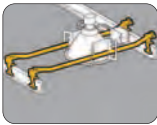

82



83

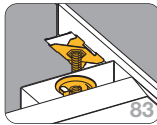

83

Pictorial Index

Acoustical Tee

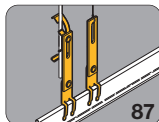
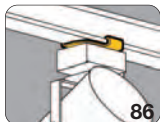
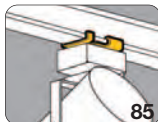
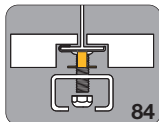
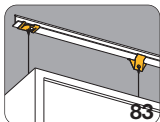

Beams

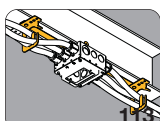
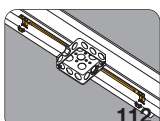
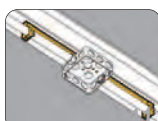
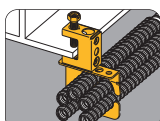
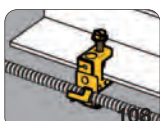
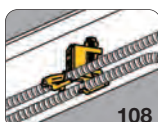
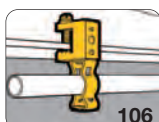
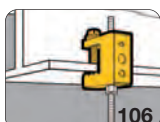
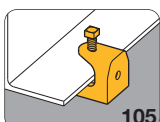
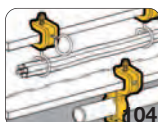
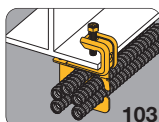
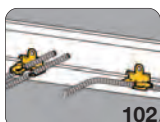
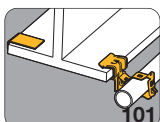
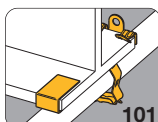
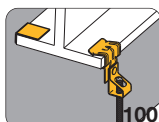
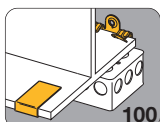
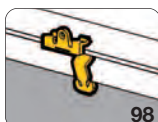
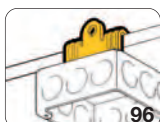
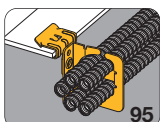
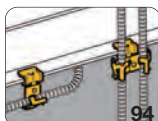
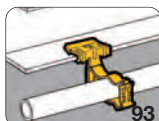
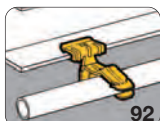
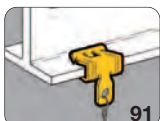

Pictorial Index

Hangers

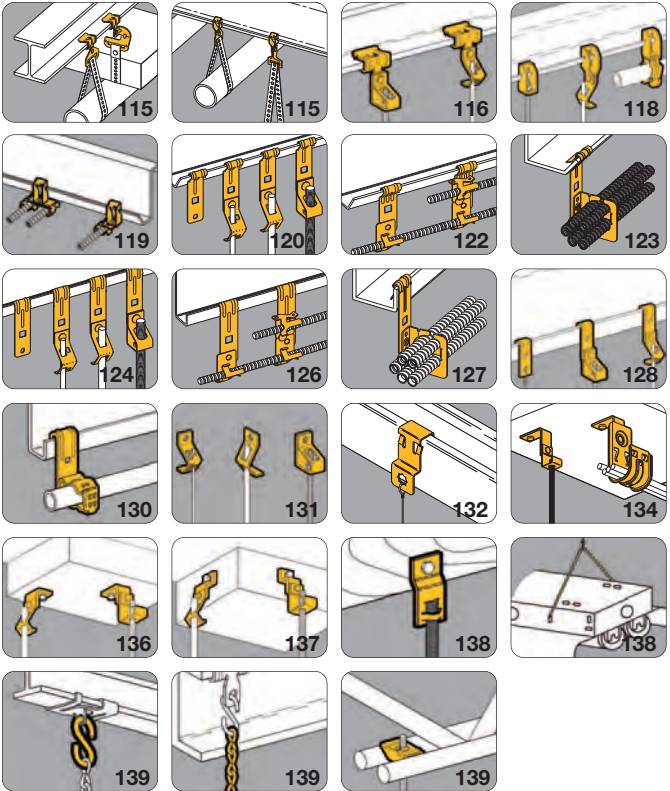

Pictorial Index

Lathers Channel



Pictorial Index

Communication & Low Voltage

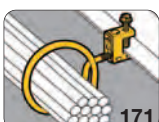
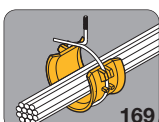
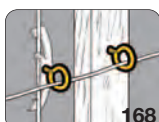
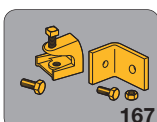
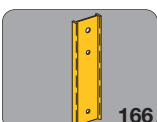
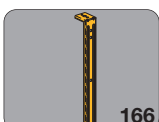
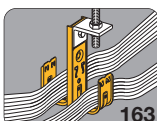
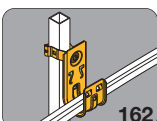
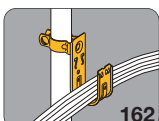
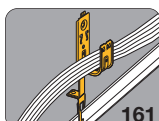
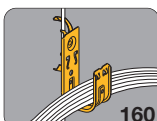
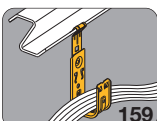
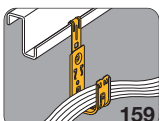
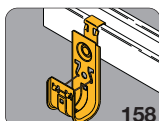
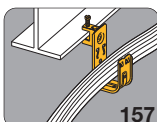
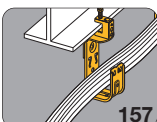
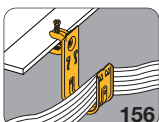
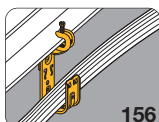
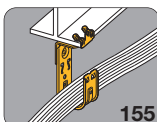
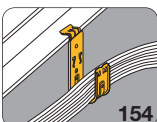
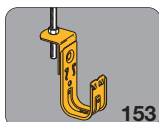
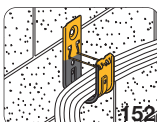
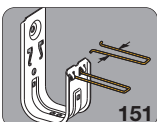
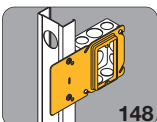
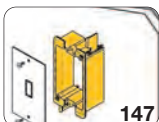
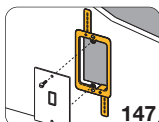
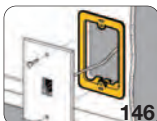
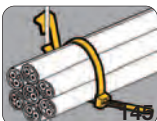
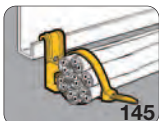

Pictorial Index

Accessories

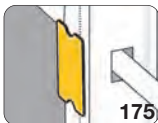
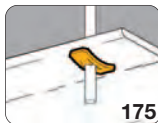
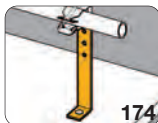
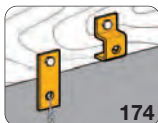
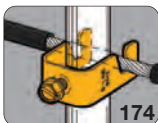

Pictorial Index

Pictorial Index

Anchors

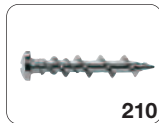

Part Numbering Guide

This part numbering guide can be used to quickly translate our part numbers into meaningful data.

BG - 8-12 - 4T		
Family	Size	Suffix
A Series - Anchors	Based on 16th of an inch	AS - Anchor Strap
*B Series - Pipe Strap		BL - Equipment Blue
BA - Acoustical Tee Component	1 - 1/16"	BN - Brass Nut
BB - Box Attachment	2 - 1/8"	BR - Brown
BC - Beam Clamp	4 - 1/4"	BW - Bright White
*BCH - Cable Hook	5 - 5/16"	CW - Computer White
*BCS/BES - Conduit Spacer	6 - 3/8"	D - Deep Box
BD - Deck Attachment	8 - 1/2"	FB - Flat Black
*BE - Edge Attachment	9 - 9/16"	GR - Green
BF - Flange Attachment	12 - 3/4"	H - Hanger
*BG - Guide-Rite™ Fastener	16 - 1"	LH - Less Hardware
BH - Hanger Attachment	20 - 1 1/4"	LN - Less Nut
BK - KwikWire	24 - 1 1/2"	LS - Less Stud
BL - Conduit Hangers (mini's)	32 - 2"	OR - Orange
BM - Miscellaneous	64 - 4"	R - Right Angle
BN - Push Nuts		RR - Regal Red
*BP - Push Type Fasteners		S - Stud
*BPC - Break Apart Straps		T - Threaded
*BR - Bridle Rings		TG - Telco Gray
BRC - Cable Fastener		W - White
*BRS - Bridle Ring Saddle		WBN - White /Brass Nut
BT - Installation Tools		WN - Wing Nut
*BU - Universal Beam Attachment		YL - Safety Yellow
BW - Bat Wing Fastener		4T - 1/4" Thread Imp.
BX - FMC Support		

* The data in the size column only applies to these product families.

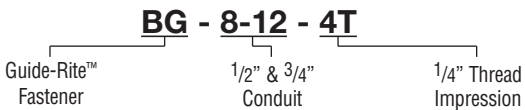

Materials

Steel	Specification
High Carbon Cold Rolled	ASTM A684, AISI 1055
Electrolytic Zinc Coated	ASTM A591
Pre-Galvanized	ASTM A653

Steel

Cooper B-Line's spring steel fasteners are manufactured from spheroidized annealed high carbon cold rolled steel (ASTM A684, AISI 1055). Mild steel fasteners are manufactured from electrolytic zinc coated steel (ASTM A591) or pre-galvanized steel (ASTM A563).

Electrolytic zinc coated and pre-galvanized steel is produced by coating coils of sheet steel with zinc at the mills. These coils are then slit to size and fabricated into Cooper B-Line products.

Heat Treatment

Cooper B-Line spring steel fasteners are heat treated to make the steel hard and give the parts their spring quality and strength. The hardness for a given fastener depends on the required load carrying capacity and the application.

Load Data

The design load ratings for Cooper B-Line fasteners are specified in this catalog as static load capacity or ultimate static load capacity. By definition, the listed static load capacity has a safety factor of three (3.0), the listed ultimate static load capacity has no safety factor. In either case, these stated loads are not to be exceeded, and loads should be applied only as depicted in the catalog and/or instruction sheets. The load capacity of a fastener having more than one component is equal to the load capacity of the lowest rated component.

Fasteners having no load ratings are designed for proper placement of boxes, conduit, etc., and not for supporting loads.

Cooper B-Line fasteners are designed for use with support members (e.g.: angle iron, bar joists, beams, columns, flanges, purlins, wire, rod) that comply with the applicable AISI standards and threaded rod that complies with the applicable AISI standards.

Quality Assurance

Cooper B-Line has an established Q.C. program in which raw material and finished products are sampled, inspected and tested by certified inspectors to assure that all applicable standards are met. Cooper B-Line's fasteners are manufactured in controlled lots and each part is identified by a lot number stamped into the part. This number allows Cooper B-Line to track each step of the manufacturing process including raw material, die set-up, heat treating, and finishing. Samples are tested to verify correct hardness, corrosion resistance and load carrying capacity.

Technical Data - Finishes

Finish	Specification
Zinc-Phosphate	MIL-P-16232 Type Z
Electro-galvanized Zinc	ASTM B633
Pre-Galvanized Zinc	ASTM A653, G90
Gloss White Paint	Acrylic Enamel

Zinc Phosphate

Cooper B-Line's spring steel fasteners receive a coating* of sealant impregnated zinc phosphate. This type of coating was commercially developed by industry to inhibit oxidation of ferrous metals for up to 72 hours in a specified salt fog atmosphere. As applied to its fasteners, Cooper B-Line rates this coating for 30 hours when salt fog tested per ASTM B-117.

Although rust resistant, Cooper B-Line fasteners should be used only indoors and in non-corrosive environments.

Unless otherwise noted, the standard finish for Cooper B-Line's spring steel fasteners is Zinc Phosphate.

*At least 1000 milligrams of zinc phosphate per square foot.

Paint

Some standard fasteners have a gloss white acrylic enamel applied over the zinc phosphate finish for an enhanced appearance that compliments white ceiling grids.

Electro-galvanized Zinc

Electro-galvanized zinc (also known as zinc plated or electroplated) is the process by which a coating of zinc is deposited on the steel by electrolysis from a bath of zinc salts.

The coating is pure zinc and is mechanically bonded to the steel. A maximum of .5 mils of zinc can be applied by this method.

When exposed to air and moisture, zinc forms a tough, adherent, protective film consisting of a mixture of zinc oxides, hydroxides, and carbonates. This film is in itself a barrier coating which slows subsequent corrosive attack of the zinc.

This coating is usually recommended for indoor use in relatively dry areas.

Pre-Galvanized Zinc

Pre-galvanized steel is produced by coating coils of sheet steel with zinc by continuously rolling the material through molten zinc at the mills. This is also known as mill galvanized or hot-dip mill galvanized. These coils are then slit to size and fabricated into Cooper B-Line products.

The G90 specification calls for a coating of .90 ounces of zinc per square foot on each side of the sheet.

During fabrication, cut edges and welded areas are not normally zinc coated; however, the zinc near the uncoated metal becomes a sacrificial anode to protect the bare areas after a short period of time.

Pre-galvanized steel is recommended for indoor use in dry areas.

CAUTION: Do not use Cooper B-Line Fasteners outdoors or in corrosive environments. Proper application of each fastener is shown in this catalog and on the installation sheet inside each carton. Failure due to improper installation may cause harm to personnel and/or property. Allowable loads shown apply to the fastener only and do not account for the structure, which supports the fastener. Flanges, wires and rods used with these fasteners must meet A.I.S.I. standards. To improve personal safety on the jobsite, always observe all federal and local safety regulations: wear gloves, safety glasses and a hard hat.

Wall Studs

Wall Studs



- Attaches with screws to metal studs.
- BB1 supports electrical box.
- BG series features Guide-Rite design.
- BP series features push-type design.

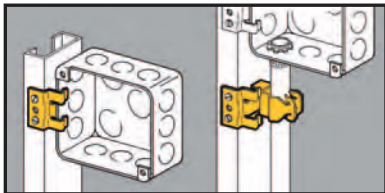

Box To Stud Fastener



UPC/Part Number	Catalog Number	Description	Box Qty.
781011 18145	BB1	Electrical Box Support Clip	100



Guide-Rite™ Conduit To Stud Fastener



UPC/Part Number	Catalog Number	Conduit Size EMT & Rigid	Box Qty.
781011 18420	BG-6-B1 *	3/8"	100
781011 18475	BG-8-12-B1	1/2", 3/4"	100
781011 18555	BG-16-B1	1"	100

Patent #4958792

* BG-6 will accept the following range $\varnothing.420 - \varnothing.675$:
14/2 thru 10/4 MC/AC cable and 5/16 or 3/8 flexible conduit



Push Type Conduit To Stud Fastener

UPC/Part Number	Catalog Number	Conduit Size	Box Qty.
781011 19245	BP-8-B1	1/2" EMT	100
781011 19345	BP-12-B1	3/4" EMT, 1/2" IMC, Rigid	100
781011 19440	BP-16-B1	1" EMT, 3/4" IMC, Rigid	100

Read safety/installation instruction sheets in packages before use. These products are designed for positioning only. No load rating.

Wall Studs

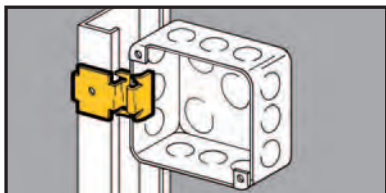

- Attaches electrical boxes (requiring plaster rings) to most metal studs.
- Box mounts flush to back of drywall.
- Simply installed with a hammer.

Box To Stud Fastener



Wall Studs

UPC/Part Number	Catalog Number	Description	Box Qty.
781011 18270	BB9	Electrical Box Support	100

- Provides far-side support for electrical boxes in 2 1/2" thru 6" studs.
- Cut outs facilitate bending to provide precise installation with greater stability.
- Easily snaps onto box side and is secured in place by plaster ring.

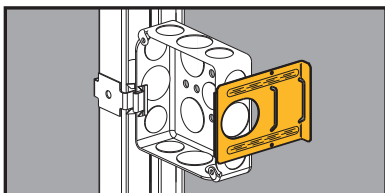

Adjustable Box Stabilizers



BB12



BB12-6



UPC/Part Number	Catalog Number	Metal Stud Size	Box Qty.
781011 92876	BB12	2 1/2" thru 4"	100
781011 92879	BB12-6	6"	100

Read safety/installation instruction sheets in packages before use. These products are designed for positioning only. No load rating.

- Provides far-side support for electrical boxes.
- See BB12 Series for a better solution.

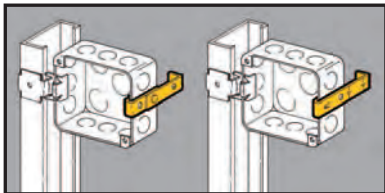

Box Stabilizer



BF1-96



BF1-64



BF1-56



BF1-40



UPC/Part Number	Catalog Number	Metal Stud Size	Box Qty.
781011 18320	BF1-40	2 ¹ / ₂ "	100
781011 18325	BF1-56	3 ¹ / ₂ "	100
781011 18330	BF1-64	4"	100
781011 18335	BF1-96	6"	100

Read safety/installation instruction sheets in packages before use. These products are designed for positioning only. No load rating.

Wall Studs

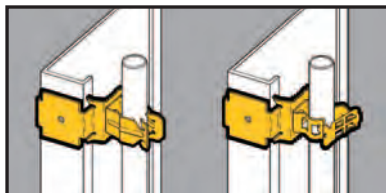

- Attaches conduit to most metal studs.
- BG Series features Guide-Rite design.
- BP Series feature push-type design.

Guide-Rite™ Conduit To Stud Fastener



Wall Studs

UPC/Part Number	Catalog Number	Conduit Size EMT & Rigid	Box Qty.
781011 18425	BG-6-B5 *	3/8" or BX	100
781011 18480	BG-8-12-B5	1/2", 3/4"	100
781011 18560	BG-16-B5	1"	100
781011 18645	BG-20-B5	1 1/4"	50

Patent #4958792

* BG-6 will accept the following range $\varnothing.420 - \varnothing.675$:
14/2 thru 10/4 MC/AC cable and 5/16 or 3/8 flexible conduit

Push Type Conduit To Stud Fastener



UPC/Part Number	Catalog Number	Conduit Size	Box Qty.
781011 19250	BP-8-B5	1/2" EMT	100
781011 19350	BP-12-B5	3/4" EMT, 1/2" IMC, Rigid	100
781011 19445	BP-16-B5	1" EMT 3/4" IMC, Rigid	100

Read safety/installation instruction sheets in packages before use. These products are designed for positioning only. No load rating.

- BB32 adds rigidity to devices in oversize wall openings.
- Holds wiring device firmly in drywall.
- Can be used with switches, receptacles, GFCIs and decorator devices.
- Ideal for positioning devices in pre-fab installations.
- Finish: Pre-Galvanized

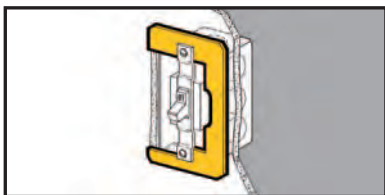

Retainer Level



UPC/Part Number	Catalog Number	Description	Box Qty.
781011 18215	BB32	Adds Rigidity to Oversize Wall Openings	100

- Attaches electrical boxes to finished drywall.
- Box is completely supported by drywall.
- Prevents box from pulling out of wall.
- Finish: Pre-Galvanized

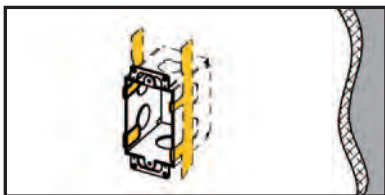

Box Support

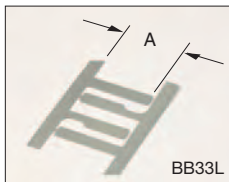
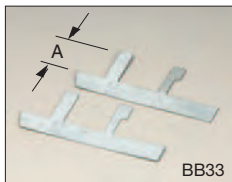

UPC/Part Number	Catalog Number	Description	Length A	Box Qty.
781011 01138	BB33	Box Support	1 1/2"	100 pr.
781011 04936	BB33L	Long Leg Box Support	2 1/4"	100

Read safety/installation instruction sheets in packages before use. These products are designed for positioning only. No load rating.

Wall Studs

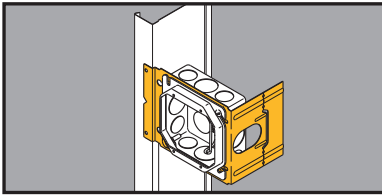

- Improved far-side support stands up during drywall installation and out performs competitor brackets.
- Supports 4" or 4¹¹/₁₆", square boxes.
- Brackets may be piggy-backed in series.
- Finish: Pre-Galvanized.
- See Ruff-IN™ brochure for pre-fab box assemblies.

Box Support Brackets

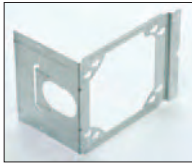

BB4-23



BB4-4



BB4-6



UPC/Part Number	Catalog Number	Metal Stud Size	Box Qty.
781011 18190	BB4-23	3 ¹ / ₂ ", 2 ¹ / ₂ "	100
781011 18200	BB4-4	4", 3 ¹ / ₂ ", 2 ¹ / ₂ "	100
781011 18202	BB4-6	6", 5 ¹ / ₂ ", 3 ¹ / ₂ ", 2 ¹ / ₂ "	100

Read safety/installation instruction sheets in packages before use. These products are designed for positioning only. No load rating.

- Double-side box support, designed for Pre-Fab. Unit can be installed on either side of stud without repositioning box or devices.
- Patented Marty-Mouse™ ears feature an innovative keyhole pattern to secure outlet box to bracket with or without the plaster ring.
- Wider box opening accommodates one or two gang adjustable plaster rings (B1AJ & B2AJ).
- Enhanced far-side support stands up during drywall installation and out performs competitor brackets.
- See Ruff-IN™ brochure for pre-fab box assemblies.
- Finish: Pre-Galvanized

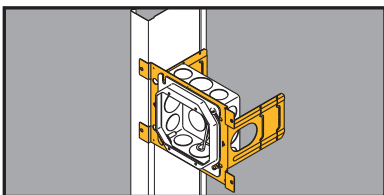

Double-Sided Box Support Bracket w/ Marty-Mouse™ Ears



Wall Studs

1. Bracket is shipped with ear tabs in the open position



3. When plaster ring is installed, the ear tabs are bent down into the closed position



2. Insert box screws into open slots



4. With the tabs closed, the box remains secured to the bracket when the plaster ring is removed



UPC/Part Number	Catalog Number	Stud Size	Box Qty.
782051 38645	BB73	3 1/2", 2 1/2"	50
782051 38717	BB74	4", 3 1/2", 2 1/2"	50
782051 38759	BB76	6", 5 1/2", 3 1/2", 2 1/2"	25

Patent # 5595362

Read safety/installation instruction sheets in packages before use. These products are designed for positioning only. No load rating.

Wall Studs

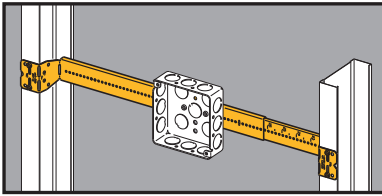

- Completely adjustable - fits a range of stud spacings and 1 1/2" or 2 1/8" deep boxes.
- Pre-punched screw holes provide for easy box installation.
- Bar is marked with scale for stud spacing.
- Finish: Pre-galvanized

Telescoping Box Mounting Bracket



BB2-24T



UPC/Part Number	Catalog Number	Metal Stud Spacing	Box Qty.
781011 04256	BB2-16T	11" to 18"	50
781011 01664	BB2-24T	15" to 26"	50

Licensed under Patent #5386959 • Patent #5209444

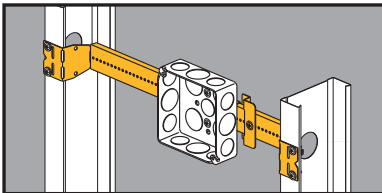

- Designed for pre-fab.
- Box can be attached to slider bracket before or after slider is installed on telescoping bracket.
- Box location can be field adjusted by moving slider along telescoping bracket.
- See Ruff-IN™ brochure for pre-fab box assemblies.
- Finish: Pre-galvanized

Telescoping Slider Bracket

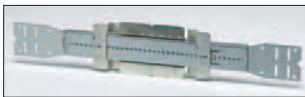

BB216TS



BB2TS



UPC/Part Number	Catalog Number	Stud Spacing	Box Qty.
782051 38614	BB216TS	11" to 18"	20
782051 38628	BB224TS	15" to 26"	20
782051 38613	BB2TS	Slider Bracket Only	50

Patent # 7,472,875

Read safety/installation instruction sheets in packages before use. These products are designed for positioning only. No load rating.

Wall Studs

- Designed for pre-fab..
- Outlet boxes mount to the CROC-LOK with single screw.
- CROC-LOK box assemblies can be attached before or after the telescoping bar is mounted in the stud wall.
- The tool-less design enables CROC-LOK assemblies to be field installed in less than 4 seconds. Simply squeeze, secure and walk away.
- See Ruff-IN™ brochure for pre-fab box assemblies.

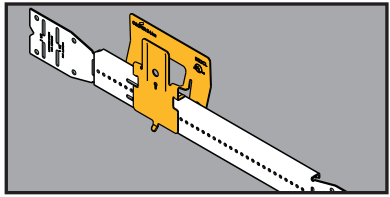

CROC-LOK™ Box Mounting Bracket



UPC/Part Number	Catalog Number	Stud Spacing	Description	Box Qty.
782051 51291	BB2CL	N/A	Croc-Lok only	50
782051 51292	BB216TCL	11"-16"	BB216T with Croc-Lok	20
782051 51293	BB224TCL	15"-24"	BB224T with Croc-Lok	20

U.S. Patent # 8,403,277

Note:

Secures to Cooper B-Line BB2-16T and BB2-24T telescoping brackets only. For a standard 2¹/₈" deep box, the stud depth must be 3¹/₂" or greater. For a shallow 1¹/₂" deep box, the stud depth must be 2¹/₂" or greater.

Mounting Screws



UPC/Part Number	Catalog Number	Description	Box Qty.
781011 01675	BWHS-9	#8 x 9/16" Sheet Metal Screw	1000
781011 04925	BWHS-9D	#8 x 9/16" Self-Drilling Sheet Metal Screw	1000

Note: BWHS-9 & BWHS-9D can be used with all fasteners requiring attachment with sheet metal screws, except on BB2-16, BB2-16D, BB2-24 & BB2-24D which only BWHS-9 can be used.

Read safety/installation instruction sheets in packages before use. These products are designed for positioning only. No load rating.

Wall Studs

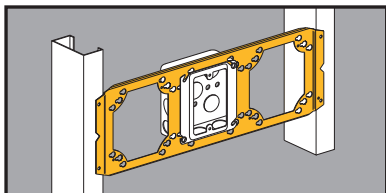

Box Mounting Bracket

- Supports boxes or plaster rings between studs 16" or 24" on center.
- Accepts US & Canadian boxes.
- Accommodates 4" or 4¹¹/₁₆" boxes.
- Allows side-by-side mounting of 1¹/₂" or 2¹/₈" deep boxes.
- See Ruff-IN™ brochure for pre-fab box assemblies.
- Finish: Pre-galvanized

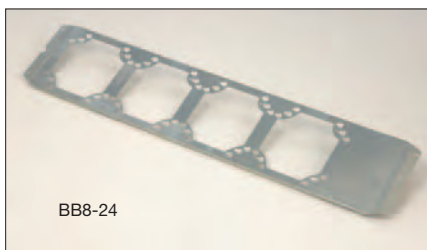
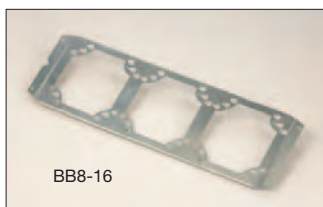

UPC/Part Number	Catalog Number	Description	Box Qty.
781011 02898	BB8-16	16" Stud Spacing	25
781011 02900	BB8-24	24" Stud Spacing	25

Read safety/installation instruction sheets in packages before use. These products are designed for positioning only. No load rating.

- Open box Support secures boxes and plaster rings between studs 16" and 24" on center.
- Accommodates 4", 4^{11/16}" and multi-gang boxes.
- Open design allows infinite adjustability - box can be placed in any horizontal position along the bracket.
- Stamped markings at 1/4", 1/2" and 1" increments allow the installer to easily locate the desired box position.
- See Ruff-IN™ brochure for pre-fab box assemblies.
- Finish: Pre-galvanized

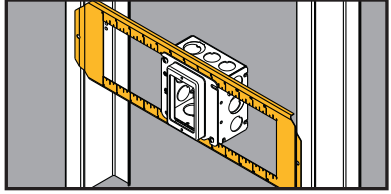

Open Box Mounting Bracket



UPC/Part Number	Catalog Number	Description	Box Qty.
782051 45325	BB7-16	16" Stud Spacing	25
782051 45328	BB7-24	24" Stud Spacing	25

Read safety/installation instruction sheets in packages before use. These products are designed for positioning only. No load rating.

Wall Studs

- New BBF floorstand provides the most rigid support in the industry.
- Far-side support accommodates 6", 5 1/2", 3 5/8", and 2 1/2" stud depths.
- Fold-out tab built-in to attach floor stand to stud if desired.
- Integral "wings" provide rigid support when floorstand is mounted between studs.
- Optional cable containment clip securely attaches to floorstand without hardware.
- Patented Marty Mouse™ ears enable boxes to be secured in place with or without the plaster rings.
- Finish: Pre-galvanized.
- See Ruff-IN™ brochure for pre-fab box assemblies.

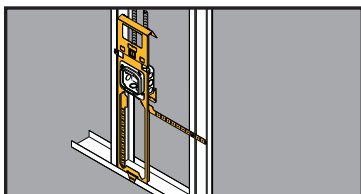

Floor-Mount Box Support

Wall Studs



BBFC

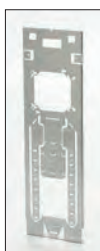

BBF15



BBF18



BBF24



BBFxxC

UPC/Part Number	Catalog Number	Box Center Height	Box Qty.
782051 52944	BBF15	15" Floorstand	25
782051 52945	BBF18	18" Floorstand	25
782051 52946	BBF24	24" Floorstand	25
782051 52947	BBFC	Cable Clip	25
782051 52948	BBF15C	15" Floorstand with Cable Clip	25
782051 52949	BBF18C	18" Floorstand with Cable Clip	25
782051 52950	BBF24C	24" Floorstand with Cable Clip	25

Patent # 5595362
Patent # 7956285 B2

Read safety/installation instruction sheets in packages before use. These products are designed for positioning only. No load rating.

- See BBF Series for a better solution.
- Provides support for electrical box from floor track or concrete forms.
- 18" length with break-away feature for 12" or 16" box mounting.
- Finish: Pre-galvanized

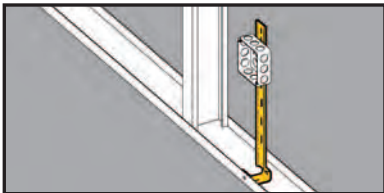

Floor Mounted Box Support



UPC/Part Number	Catalog Number	Description	Box Qty.
781011 03623	BB-18	Floor Mounted Box Support	50

- Attaches 13/16" strut, 1 1/2" lathers channel, 1/2" EMT or 3/4" EMT to metal studs.
- Provides support for vertical runs of conduit.
- Finish: Pre-galvanized

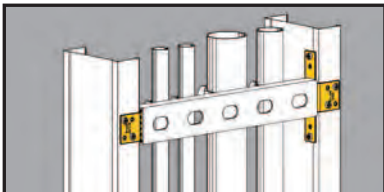

Strut Mounting Brackets

UPC/Part Number	Catalog Number	Description	Box Qty.
781011 01658	BMB1	Strut Mounting Bracket	25 pr.

Read safety/installation instruction sheets in packages before use. These products are designed for positioning only. No load rating.

Wall Studs

Wall Studs

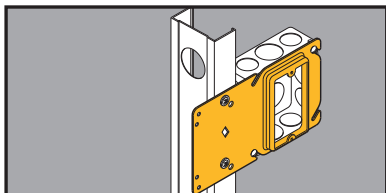

- Uni-Mount provides a secure support for 4" square boxes and features a built-in plaster ring.
- Rigid bracket design eliminates the need for far-side support.
- Enlarged viewing hole makes it easier to find mark lines on the stud.
- Gangable design accepts BB423 bracket to mount boxes on both sides of the stud.
- See Ruff-IN™ brochure for pre-fab box assemblies.
- Finish: Pre-galvanized

Uni-Mount™ Box Support/Cover Plate Mounting Bracket



Double Gang
BB45 Series

Single Gang
BB40 Series



UPC/Part Number	Catalog Number	Description	Box Qty.
782051 22768	BB40-08	1/2" Raise	50
782051 22771	BB40-10	5/8" Raise	50
782051 22772	BB40-12	3/4" Raise	50
782051 22773	BB45-08	1/2" Raise	50
782051 22774	BB45-10	5/8" Raise	50
782051 22775	BB45-12	3/4" Raise	50

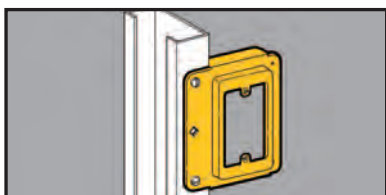

- Provides attachment base for low voltage outlets.
- Replaces electrical box in Class 2 low voltage installations.
- Can be piggy-backed.
- For 1/2" and 5/8" drywall applications.
- Finish: Pre-galvanized

Cover Plate Mounting Bracket



UPC/Part Number	Catalog Number	Description	Box Qty.
781011 19873	BB15	Single Gang Stud Bracket	50

Read safety/installation instruction sheets in packages before use. These products are designed for positioning only. No load rating.

Rapid Ring™ Self Adjusting Pre-Fab Ring

The Rapid Ring self-adjusting pre-fab plaster ring can help you win tight bids and beat the profit squeeze with its innovative 4-step installation. This revolutionary new pre-fab system installs in as little as 15 seconds per unit, compressing your project schedule, cutting operational costs and reducing onsite waste.

Because the Rapid Ring is a self-adjusting pre-fab ring, you'll never need to adjust a mud ring again. With a simple push of the Rapid Ring you're flush every time.



1. Remove protective plate.
2. Connect the wiring device.
3. Position the device assembly.
4. Push in the device assembly—and you're done!

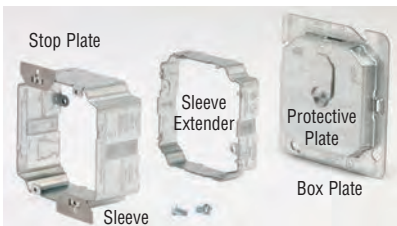

Patent Pending

For Use With		Box Plate ¹ Cat No.	Sleeve ^{2,3} Cat No.	Sleeve Extender ⁴ Cat No.
Wiring Device Qty.	Electrical Box ⁵			
1	4" sq.	B1 RRP4C	B1 RRR	B1 RRE
	4 ¹¹ / ₁₆ " sq.	B1 RRP5C		
2	4" sq.	B2 RRP4C	B2 RRR	B2 RRE
	4 ¹¹ / ₁₆ " sq.	B2 RRP5C		
3	3-gang ⁶	B3 RRPC	B3 RRR	B3 RRE
4	4-gang ⁷	B4 RRPC	B4 RRR	B4 RRE

1. Protective plate included with box plate.

2. Wall thickness range: 1/2" min. to 1 1/4" max.

3. Stop plates included with sleeve.

4. Sleeve extender is an optional accessory to extend max. wall thickness range to 2"
(order separately, mounting hardware included)

5. Minimum electrical box depth is 2 1/8"

6. Keyhole knockouts allow use on 2-gang electrical box.

7. Keyhole knockouts allow use on 3-gang electrical box.

Go to www.blincRapidRing.com for more information.

Read safety/installation instruction sheets in packages before use. These products are designed for positioning only. No load rating.

Wall Studs

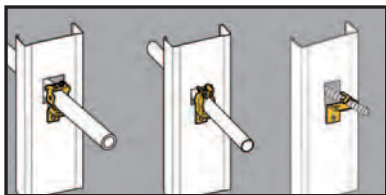

- Supports horizontal runs of conduit, flexible conduit, MC or AC cable through metal studs.
- Attaches easily with a single sheet metal screw.
- Prevents conduit/cable rattling.

Conduit/Cable Supports

Wall Studs



 BG-x-H7



BP-x-H7

 BX4-H7



BX4M-H7

UPC/Part Number	Catalog Number	Conduit/Cable Size	Box Qty.
781011 01228	BG-6-H7 *	3/8", MC, AC, or FMC	100
781011 01238	BG-8-12-H7	1/2" or 3/4"	100
Patent #4958792			
781011 01227	BP-8-H7	1/2" EMT	100
781011 01226	BP-12-H7	3/4" EMT 1/2" IMC, Rigid	100
781011 01200	BX4-H7	MC, AC, or FMC	100
781011 01205	BX4M-H7	MC, AC, or FMC	100

* BG-6 will accept the following range $\varnothing.420 - \varnothing.675$:
14/2 thru 10/4 MC/AC cable and 5/16 or 3/8 flexible conduit

Read safety/installation instruction sheets in packages before use. These products are designed for positioning only. No load rating.

- Attaches MC, AC, sizes 14/2 through 10/3 or 3/8" FMC to studs or flanges up to 3/16" thick.
- Snaps into place on metal stud openings or may be screwed to metal or wood studs.
- BX4M may be snapped in half to make two BX4's.
- Allows cables to be positioned a minimum of 1 1/4" from face of stud as required by NEC Article 300.4(D).

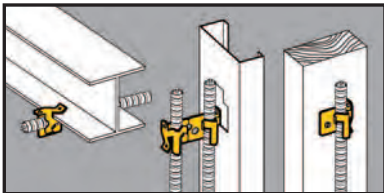

Flexible Conduit/ Cable Fasteners



BX4



BX4M



BX4MD

UPC/Part Number	Catalog Number	Description	Box Qty.
781011 01079	BX4	Single Runs	100
781011 01080	BX4M	Double Runs	100
781011 01224	BX4MD	Up to 4 Runs	100

Read safety/installation instruction sheets in packages before use. These products are designed for positioning only. No load rating.

Wall Studs

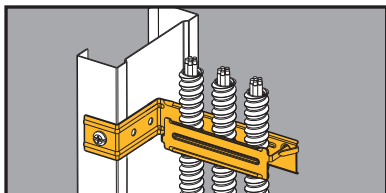

- Metal cable support can be used in plenum-rated areas.
- Longer locking tabs.
- Shipped pre-assembled.
- Hinge can be opened for greater cable capacity.
- Allows cables to be positioned a minimum of 1¹/₄" from face of stud as required by NEC Article 300.4(D).

Cable Support



Wall Studs

**UPC/Part
Number**

**Catalog
Number**

Description

**Box
Qty.**

781011 04980

BRC4M

Up to 3/4" FMC

100

Note: Canadian applications are limited to wood studs only.

Cable Size	Cable Type					
	Non-Metallic (NM)		Metal Clad (MC)		Armored Cable (AC)	
	Qty.	Dia.	Qty.	Dia.	Qty.	Dia.
14-2 w/ Grnd	8	.360	5	.439	5	.464
14-3 w/ Grnd	8	.307	5	.464	5	.483
14-4 w/ Grnd	8	.336	4	.494	4	.517
12-2 w/ Grnd	7	.410	5	.475	4	.498
12-3 w/ Grnd	8	.347	4	.505	4	.521
12-4 w/ Grnd	7	.381	4	.539	4	.557
10-2 w/ Grnd	6	.494	4	.542	4	.560
10-3 w/ Grnd	7	.422	4	.580	4	.588
10-4 w/ Grnd	NA	NA	3	.623	3	.632
8-2 w/ Grnd	4	.612	NA	NA	NA	NA
8-3 w/ Grnd	4	.565	NA	NA	NA	NA
6-2 w/ Grnd	4	.650	NA	NA	NA	NA
5/16 FMC	5 (.470 to .510 Dia.)					
3/8 FMC	4 (.560 to .610 Dia.)					
1/2 FMC	1 (.860 to .920 Dia.)					
3/4 FMC	1 (1.045 to 1.105 Dia.)					

The quantity of cables shown in the chart is the maximum. Fewer cables can be supported. Diameters are based on data from a leading cable manufacturer (may vary slightly).

Diameters of some NM cables refer to the widest dimension of a flat cable. NA = Not applicable

Read safety/installation instruction sheets in packages before use. These products are designed for positioning only. No load rating.

Wall Studs

- Individual plastic staples grip cable and reduce slipping.
- Secures up through #10 type NM cable.
- Supports AC, MC or FMC cable up to 1/2" O.D.
- Break-apart feature allows installation on studs and furring strips.
- Allows cables to be positioned a minimum of 1 1/4" from face of stud as required by NEC Article 300.4(D).

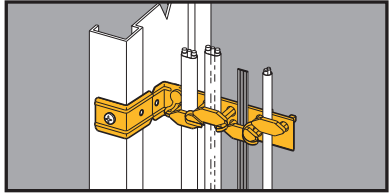

Staple-Lok™ Multi-Purpose Cable Support



Wall Studs

UPC/Part Number	Catalog Number	Cable Size	Box Qty.
781011 03587	BRC4	Up to .500" O.D.	100

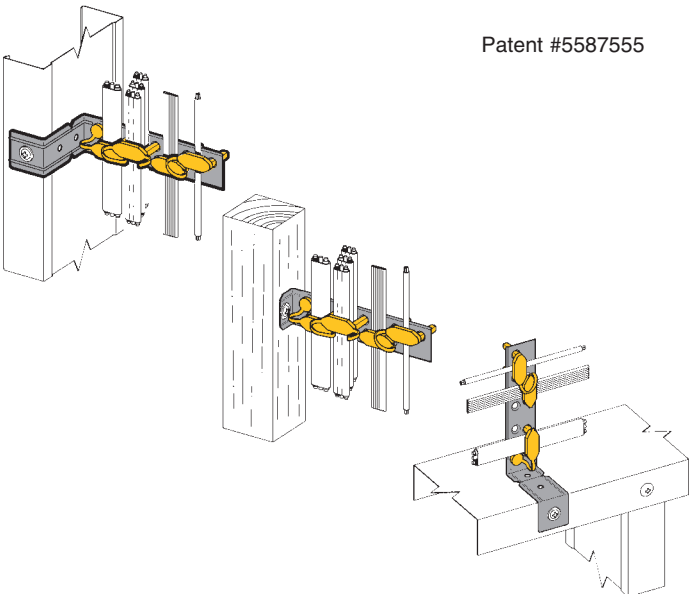

Patent #5587555

Read safety/installation instruction sheets in packages before use. These products are designed for positioning only. No load rating.

Wall Studs

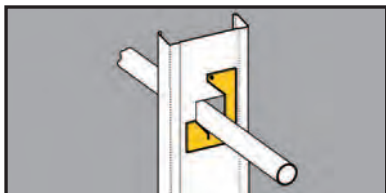

- Allows conduit, MC, AC, or FMC to be pulled through metal studs.
- Provides support for horizontal runs of conduit or cable through metal stud.
- Prevents conduit/cable rattling.
- Finish: Pre-galvanized

Conduit/Cable Supports



Wall Studs

UPC/Part Number	Catalog Number	Conduit/Cable Size	Box Qty.
781011 01657	BX82	Up to 1"	100

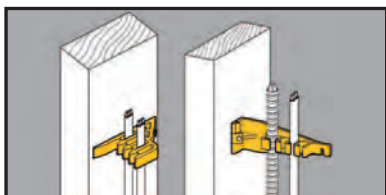

- Attaches Type NM cables to wood studs.
- Can be used to support computer, CATV, telephone, security and instrumentation cables.
- Provided with nail inserted.
- Allows cables to be positioned a minimum of 1 1/4" from face of stud as required by NEC Article 300.4(D).

Cable Fasteners



BRC1



BRC2

UPC/Part Number	Catalog Number	Description	Box Qty.
781011 02941	BRC1	Wood Stud Cable Fastener	50
781011 02942	BRC2	Furring Strip Cable Fastener	50

Read safety/installation instruction sheets in packages before use. These products are designed for positioning only. No load rating.

Wall Studs

- Protects cable, plastic pipe and copper tubing from screw or nail penetration.
- Easily installed with a hammer.
- Complies with NEC Article 300-4.

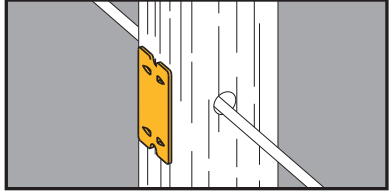

Nail Plates For Wood Studs



UPC/Part Number	Catalog Number	Description	Box Qty.
781011 04927	BM3	Nail Plate	100

Wall Studs

- Protects cable, plastic pipe and copper tubing from screw or nail penetration.
- Comes with industrial grade double stick tape on back for easy installation on stud.
- Complies with NEC Article 300-4.

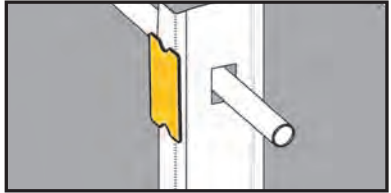

Nail Plates For Metal Studs

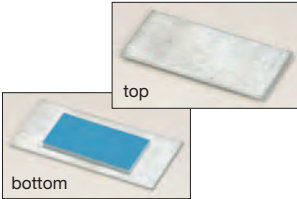

Just Peel Tape and Stick To Stud

UPC/Part Number	Catalog Number	Description	Box Qty.
782051 26251	BM3M	Nail Plate	100

Read safety/installation instruction sheets in packages before use. These products are designed for positioning only. No load rating.

Wall Studs

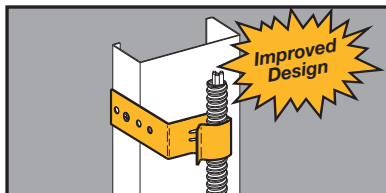

- **Larger capacity:** Redesigned BB38D attaches 1/2" to 1" EMT or flexible conduit to metal or wood studs.
- BB38 attaches MC/AC cable, 1/2" & 3/4" EMT to metal or wood studs.
- Eliminates the need for offset bending of conduit.
- Aligns conduit with standard box knockouts.

Conduit Support



BB38



BB38D

Wall Studs

UPC/Part Number	Catalog Number	Box Depth	Box Qty.
781011 04265	BB38	1 1/2"	100
781011 95244	BB38D	2 1/8"	100

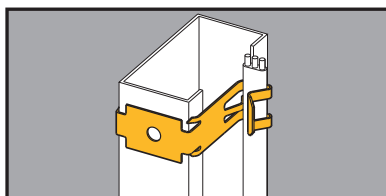

- Secures Romex® sizes 14/2 w/ground thru 12/3 w/ground, MC/AC sizes 14/2 thru 12/3 to metal or wood studs.
- Allows cables to be positioned a minimum of 1 1/4" from face of stud as required by NEC Article 300.4(D).

Flexible Conduit/Cable Fasteners



UPC/Part Number	Catalog Number	Description	Box Qty.
781011 19755	BX5	Secures Flexible Conduit or Cable to Metal or Wood Studs	100

Romex® is a registered trademark used by Southwire® Company, Carrollton, Georgia.

Read safety/installation instruction sheets in packages before use. These products are designed for positioning only. No load rating.

- BM1 snaps into standard 1¹¹/₃₂" diameter holes in metal studs from 25 Ga. to 16 Ga.
- Redesigned BM2 is shipped as one piece and easily separated for installation.
- Universal BM2 provides 360° protection. Fits all factory punched metal stud holes.
- Protects wire insulation in accordance with NEC Article 300.4(B) (1).

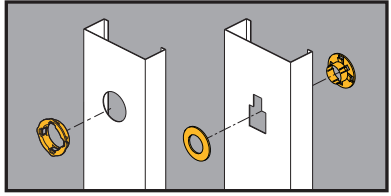

Metal Stud Grommet



BM1



BM2



UPC/Part Number	Catalog Number	Description	Box Qty.
781011 19100	BM1	Plastic Grommet	100
781011 19102	BM1M	Plastic Grommet (Bulk Quantity)	1000
781011 04926	BM2	Universal Grommet	100

Read safety/installation instruction sheets in packages before use. These products are designed for positioning only. No load rating.

Conduit & Cable



Conduit & Cable



Conduit & Cable

- Supports 3/8" to 2" conduit.
- Unique **Guide-Rite** Fastener provides for fast and easy installation with pliers.
- **New** redesigned BG-6 accomodates a wide variety of MC/AC cables.
- Now available in DURA-COPPER™ finish - add DCU to part number.
- Static Load Capacity:
100 Lbs. - Vertical
25 Lbs. - Horizontal

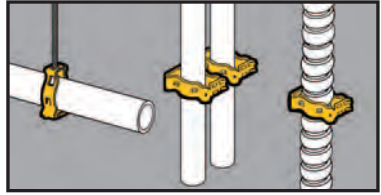

Guide-Rite™ Conduit Fasteners

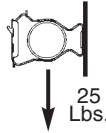

Static Load Capacity

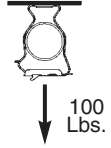

Clearance Hole For 1/4" Bolt



UPC/Part Number	Catalog Number	Conduit Size EMT/Rigid	Box Qty.
781011 18350	BG-6*	3/8"	100
781011 18355	BG-8-12	1/2", 3/4"	100
781011 18360	BG-16	1"	100
781011 18365	BG-20	1 1/4"	100
781011 18370	BG-24	1 1/2"	100
781011 18375	BG-32	2"	100

Patent #4958792



1/4"-20 Thread Impression



UPC/Part Number	Catalog Number	Conduit Size EMT/Rigid	Box Qty.
781011 18380	BG-6-4T*	3/8"	100
781011 18385	BG-8-12-4T	1/2", 3/4"	100
781011 18390	BG-16-4T	1"	100
781011 18395	BG-20-4T	1 1/4"	100
781011 18400	BG-24-4T	1 1/2"	100
781011 18405	BG-32-4T	2"	100

Patent #4958792

- * BG-6 and BG-6-4T will accept the following range $\varnothing.420 - \varnothing.675$:
1 1/2 thru 10/4 MC/AC cable and 5/16 or 3/8 flexible conduit

Read safety/installation instruction sheets in packages before use.

Conduit & Cable

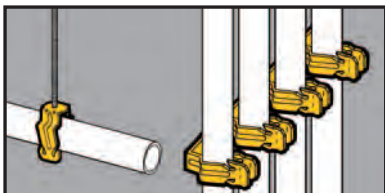

- Conduit easily snaps into push type fastener for secure support.
- Available with clearance hole for 1/4" bolt or 1/4"-20 thread impression.
- **Ultimate Static Load Capacity:**
25 Lbs. Vertical
15 Lbs. Horizontal

Push-Type Conduit Fasteners

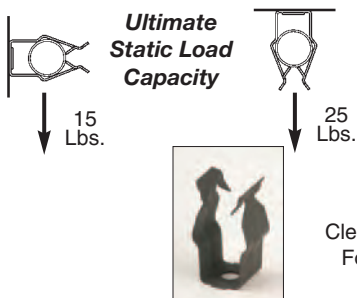

Conduit & Cable

UPC/Part Number	Catalog Number	Conduit Size	Box Qty.
781011 19200	BP-8	1/2" EMT	100
781011 19205	BP-12	3/4" EMT 1/2" IMC, Rigid	100
781011 19210	BP-16	1" EMT 3/4" IMC, Rigid	100



1/4"-20
Thread Impression

UPC/Part Number	Catalog Number	Conduit Size	Box Qty.
781011 19215	BP-8-4T	1/2" EMT	100
781011 19220	BP-12-4T	3/4" EMT 1/2" IMC, Rigid	100
781011 19225	BP-16-4T	1" EMT 3/4" IMC, Rigid	100

Read safety/installation instruction sheets in packages before use.

- For use with 3/8" to 2" conduit.
- **Guide-Rite** Fastener provides for fast and easy installation with pliers.
- **Note:** Total load of trapeze must not exceed 100 Lbs.

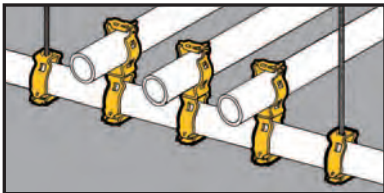

Guide-Rite™ Conduit Trapeze Fasteners



UPC/Part Number	Catalog Number	Conduit To 1" Trapeze	Box Qty.
781011 18615	BG-16-G-6*	3/8"	100
781011 18620	BG-16-G-8-12	1/2" or 3/4"	100
781011 18595	BG-16-G-16	1"	100
781011 18600	BG-16-G-20	1 1/4"	50
781011 18605	BG-16-G-24	1 1/2"	50
781011 18610	BG-16-G-32	2"	50

Patent #4958792

* BG-6 will accept the following range $\varnothing.420 - \varnothing.675$:
14/2 thru 10/4 MC/AC cable and 5/16 or 3/8 flexible conduit

- An ideal spacer between conduits.
- No installation tools required.
- **Ultimate Static Load Capacity:**
25 Lbs.

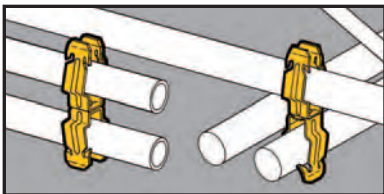

Push-Type Conduit To Conduit Fasteners

UPC/Part Number	Catalog Number	Conduit To 1" Trapeze	Box Qty.
781011 19303	BP-8-P-8	1/2" to 1/2"	100
781011 19295	BP-8-P-12	1/2" to 3/4"	100
781011 19300	BP-8-P-16	1/2" to 1"	100
781011 19395	BP-12-P-12	3/4" to 3/4"	100
781011 19400	BP-12-P-16	3/4" to 1"	100
781011 19495	BP-16-P-16	1" to 1"	100

Note: For rigid conduit with BP series, use next size larger fastener (1/2" Rigid use BP-12).

Read safety/installation instruction sheets in packages before use.

Conduit & Cable

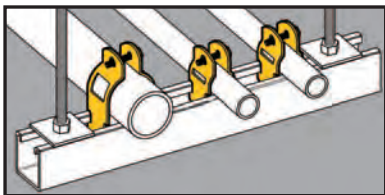

Break-Apart Conduit Clamps



BPC-8 thru BPC-32

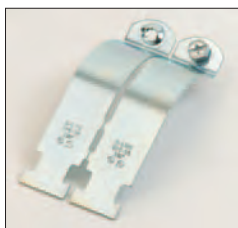

BPC-40 thru BPC-64



- Patented Multi-Grip design fits Rigid, IMC or EMT conduit.
- Convenient break-apart clamp features retained bolt and 5/16" thread impression to eliminate handling of nuts and bolts.
- Finish: Zinc-Plated.
- Static Load Capacity: 200 lbs.

Static Load Capacity

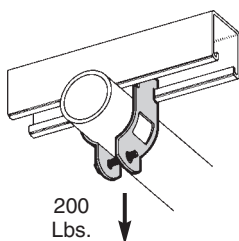

UPC/Part Number	Catalog Number	Rigid or EMT Conduit Size	Box Qty.
781011 01676	BPC-8	1/2"	100
781011 01677	BPC-12	3/4"	100
781011 01680	BPC-16	1"	100
781011 01679	BPC-20	1 1/4"	50
781011 01678	BPC-24	1 1/2"	50
781011 01681	BPC-32	2"	50
781011 03977	BPC-40	2 1/2"	50
781011 03978	BPC-48	3"	50
781011 03979	BPC-56	3 1/2"	25
781011 03981	BPC-64	4"	25

Patent #4044428

Read safety/installation instruction sheets in packages before use.

- Attaches conduit, flexible conduit or cables to standard strut channels.
- B1506S designed to secure and support MC/AC cables.
- Unique one-piece design eliminates handling of hardware and allows easy installation and removal in side-by-side conduit runs.
- Anti-rock feature prevents clamp from disengaging during installation.
- Finish: Zinc-Plated

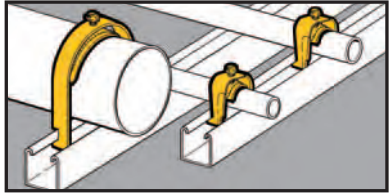

Conduit Strut Clamps



B1508
thru
B1520



B1506S
thru
B1524S



B1532S
thru
B1564S



UPC/Part Number	Catalog Number	Conduit Size		OD Range		Static Load Cap.	Box Qty.
		EMT	Rigid	Min	Max		
781011 63150	B1508	1/2"	--	--	--	200 Lbs.	100
781011 63154	B1512	3/4"	1/2"	--	--	200 Lbs.	100
781011 63157	B1516	1"	3/4"	--	--	300 Lbs.	100
781011 63160	B1520	1 1/4"	1"	--	--	300 Lbs.	100
Note: Clamps without saddle are not recommended for flexible conduit or cable.							
782051 44495	B1506S*	3/8"*	--	.400	.630	200 Lbs.	100
781011 63164	B1508S	1/2"	--	.250	.680	200 Lbs.	100
781011 63168	B1512S	3/4"	1/2"	.500	.840	200 Lbs.	100
781011 63171	B1516S	1"	3/4"	.750	1.050	300 Lbs.	100
781011 63177	B1520S	1 1/4"	1"	1.125	1.315	300 Lbs.	100
781011 63182	B1524S	1 1/2"	1 1/4"	1.375	1.660	400 Lbs.	50
781011 63188	B1532S	2"	1 1/2"	1.875	2.200	400 Lbs.	50
781011 63193	B1534S	--	2"	2.125	2.375	400 Lbs.	25
781011 63199	B1540S	2 1/2"	2 1/2"	2.625	2.875	400 Lbs.	25
781011 63205	B1548S	3"	3"	3.250	3.500	400 Lbs.	25
781011 63211	B1556S	3 1/2"	3 1/2"	3.750	4.000	400 Lbs.	10
781011 63215	B1564S	4"	4"	4.250	4.500	400 Lbs.	10

Patent #5022614

- * B1506S will accept the following
 AC Cable 14/2, 14/3, 14/4, 12/2, 12/3, 12/4, 10/2, 10/3, 10/4
 MC Cable 14/2, 14/3, 14/4, 12/2, 12/3, 12/4, 10/2, 10/3, 10/4

Read safety/installation instruction sheets in packages before use.

Conduit & Cable

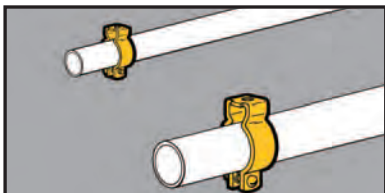

- For use with 1/2" thru 4" Conduit.
- Static Load Capacity: 400 lbs.
- Now available in DURA-COPPER™ finish - add DCU to part number.
- Finish: Zinc-Plated

Conduit Hangers



With Retained Bolt
And
Thread Impression



UPC/Part Number	Catalog Number	Trade Size	Conduit Size		Box Qty.
			EMT	Rigid	
781011 19800	BL1400*	0	1/2"	1/2"	100
781011 19801	BL1410*	1	3/4"	3/4"	100
781011 19802	BL1420*	2	1"	1"	100



With Bolt And Nut



UPC/Part Number	Catalog Number	Trade Size	Conduit Size		Box Qty.
			EMT	Rigid	
781011 19803	BL1425*	2.5	1 1/4"	--	100
781011 19804	BL1430*	3	1 1/2"	1 1/4"	100
781011 19805	BL1440†	4	--	1 1/2"	50
781011 19806	BL1450†	5	2"	2"	50
781011 19807	BL1460†	6	2 1/2"	2 1/2"	25
781011 19808	BL1470†	7	3"	3"	25
781011 19809	BL1480†	8	3 1/2"	3 1/2"	10
781011 19810	BL1490†	9	4"	4"	10

* 9/32" mounting hole. † 11/32" mounting hole.

Read safety/installation instruction sheets in packages before use.

- For use with 1/2" thru 4" Conduit.
- Static Load Capacity: 400 lbs.
- Material: Type 304 Stainless Steel

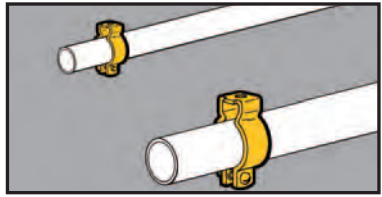

Stainless Steel Conduit Hangers



With Retained Bolt
And
Thread Impression



UPC/Part Number	Catalog Number	Trade Size	Conduit Size		Box Qty.
			EMT	Rigid	
781011 57490	BL1400-SS4*	0	1/2"	1/2"	25
781011 57497	BL1410-SS4*	1	3/4"	3/4"	25
781011 57506	BL1420-SS4*	2	1"	1"	25



With Bolt And Nut



UPC/Part Number	Catalog Number	Trade Size	Conduit Size		Box Qty.
			EMT	Rigid	
781011 87485	BL1425-SS4*	2.5	1 1/4"	--	25
781011 57517	BL1430-SS4*	3	1 1/2"	1 1/4"	25
781011 57525	BL1440-SS4†	4	--	1 1/2"	25
781011 57535	BL1450-SS4†	5	2"	2"	10
781011 57546	BL1460-SS4†	6	2 1/2"	2 1/2"	10
781011 87481	BL1470-SS4†	7	3"	3"	10
781011 87486	BL1480-SS4†	8	3 1/2"	3 1/2"	10
781011 87482	BL1490-SS4†	9	4"	4"	10

* 9/32" mounting hole. † 11/32" mounting hole.

Read safety/installation instruction sheets in packages before use. These products are designed for positioning only. No load rating.

Conduit & Cable

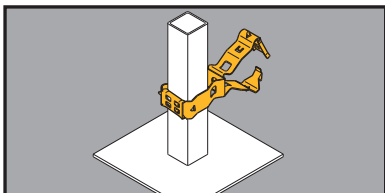

- Supports conduit from square computer floor pedestals.
- Unique **Guide-Rite** Fastener provides for fast and easy installation with pliers.
- Static Load Capacity: 25 lbs.

Guide-Rite™ Conduit To Pedestal Support



Conduit & Cable

UPC/Part Number	Catalog Number	Conduit Size EMT/Rigid	Box Qty.
782051 25589	BG-8-12-G6*	3/8"	100
781011 88538	BG-8-12-G812	1/2" or 3/4"	100
781011 18620	BG-16-G812	1"	100
782051 25594	BG-8-12-G20	1 1/4"	50
782051 25595	BG-8-12-G24	1 1/2"	50
782051 25597	BG-8-12-G32	2"	50

Patent #4958792

- * BG-6 will accept the following range $\varnothing.420$ - $\varnothing.675$:
14/2 thru 10/4 MC/AC cable and $5/16$ or $3/8$ flexible conduit

Read safety/installation instruction sheets in packages before use.

- Supports conduit from 1" O.D. computer floor pedestals.
- Also available in Type 304 Stainless Steel. Contact factory for details.
- Static Load Capacity: 25 lbs.
- Finish: Zinc-Plated

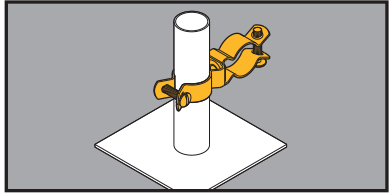

Conduit To Pedestal Support



UPC/Part Number	Catalog Number	Trade Size	Conduit Size		Box Qty.
			Rigid	EMT	
782051 25599	BL1410-L1400	0	1/2"	1/2"	50
782051 25601	BL1410-L1410	1	3/4"	3/4"	50
782051 25602	BL1410-L1420	2	1"	1"	50
782051 25603	BL1410-L1425	2.5	--	1 1/4"	50
782051 25607	BL1410-L1430	3	1 1/4"	1 1/2"	50
782051 25612	BL1410-L1440	4	1 1/2"	--	25
782051 25614	BL1410-L1450	5	2"	2"	25
782051 25617	BL1410-L1460	6	2 1/2"	2 1/2"	10
782051 25618	BL1410-L1470	7	3"	3"	10
782051 25619	BL1410-L1480	8	3 1/2"	3 1/2"	5

Read safety/installation instruction sheets in packages before use.

Conduit & Cable

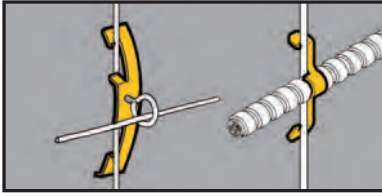

- BW2 and BW6 support #10-24 or 1/4"-20 threaded bridle rings and provide attachment for electrical boxes.
- BW2S & BW6S are provided with one each 1/4"-20 x 3/8" screw and hex nut.
- BW4 supports cables from #12 thru #8 wire.

Rod & Wire Fasteners



UPC/Part Number	Catalog Number	Drop Rod/ Wire Size	Flange Thickness	Box Qty.
781011 19700	BW2	#12 wire thru 1/4" plain or threaded rod	1/8" - 3/8"	100
782051 40156	BW2S	#12 wire thru 1/4" plain or threaded rod	1/8" - 3/8"	100
781011 95516	BW6	3/8" plain or threaded rod	3/8" - 7/16"	100
782051 40157	BW6S	3/8" plain or threaded rod	3/8" - 7/16"	100

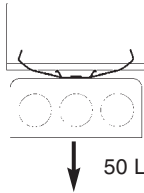

**Static Load
Capacity**



Conduit & Cable

UPC/Part Number	Catalog Number	Description	Box Qty.
781011 19705	BW4	Multi-size Wire Fastener	100



MC/AC Cable Size	#12 Wire	#10 Wire	#8 & #9 Wire
14/2 Cable	BW4	BW4	BW4
14/3 Cable	BW4	BW4	BW4
12/2 Cable	BW4	BW4	BW4
12/3 Cable	BW4	BW-8	BW-8

BW4 is designed for positioning only. No load rating.

Note: An independent means of support is required by NEC Article 300.11. Refer to pages 220-221 for additional support methods.

Read safety/installation instruction sheets in packages before use.

- See BX8 and BX18 for a better solution.
- Attaches conduit to wire rods or flanges.
- Can be used for flexible metallic tubing or armored cable.

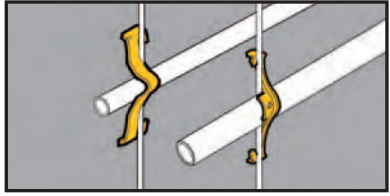

Rod & Wire Fasteners



UPC/Part Number	Catalog Number	Box Qty.
781011 19710	BW-8	100
781011 19715	BW-12	100
781011 19720	BW-16	100
781011 19725	BW-20	100

Conduit Size	#10 & #12 Wire	#8 & #9 Wire	3/16" & 1/4" Rod	1/8" to 1/4" Flange	5/16" to 3/8" Flange	7/16" to 1/2" Flange
1/2" EMT	BW-8	BW-8	BW-8	BW-8	BW-12	BW-12
1/2" Rigid	BW-8	BW-12	BW-12	BW-12	BW-12	BW-16
3/4" EMT	BW-12	BW-12	BW-12	BW-12	BW-16	BW-16
3/4" Rigid	BW-12	BW-12	BW-16	BW-16	BW-20*	BW-20*
1" EMT	---	BW-16	BW-16	BW-16	BW-20*	BW-20*
1" Rigid	---	---	---	BW-20*	BW-20*	BW-20*
1 1/4" EMT	---	BW-20	BW-20	BW-20	---	---

*Note: For horizontal applications only.

Static Load Capacity

Vertical Flange



25 Lbs.

Vertical Wire or Rod

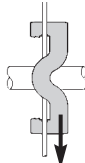

50 Lbs.

Horizontal Flange

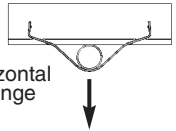

100 Lbs.

Note: An independent means of support is required by NEC Article 300.11. Refer to pages 220-221 for additional support methods.

Read safety/installation instruction sheets in packages before use.

Conduit & Cable

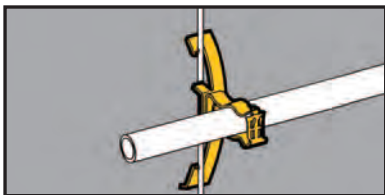

Guide-Rite™ Conduit To Rod Fasteners

- Assemblies support 1/2", 3/4" and 1" conduit.
- W2 series attaches to 1/8" thru 3/8" flanges or #12 wire thru 1/4" plain or threaded rod.
- W6 series attaches to 3/8" thru 7/16" flanges or 3/8" plain or threaded rod.



UPC/Part Number	Catalog Number	Conduit Size EMT/Rigid	Box Qty.
781011 18540	BG-8-12-W2	1/2", 3/4"	100
781011 18640	BG-16-W2	1"	100
781011 95519	BG-8-12-W6	1/2", 3/4"	100
781011 95520	BG-16-W6	1"	100

Patent #4958792

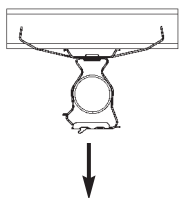

50 Lbs.

**Static Load
Capacity**



25 Lbs.

Note: An independent means of support is required by NEC Article 300.11. Refer to pages 220-221 for additional support methods.

- Assemblies support 1/2", 3/4" and 1" conduit.
- W2 series attaches to 1/8" thru 3/8" flanges or #12 wire thru 1/4" plain or threaded rod.
- W6 series attaches to 3/8" thru 7/16" flanges or 3/8" plain or threaded rod.

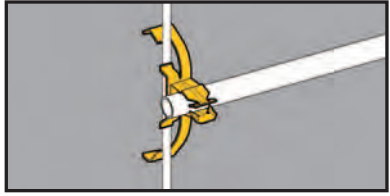

Push-Type Conduit To Rod Fasteners



UPC/Part Number	Catalog Number	Conduit Size	Box Qty.
781011 19325	BP-8-W2	1/2" EMT	100
781011 19420	BP-12-W2	3/4" EMT 1/2" IMC, Rigid	100
781011 19505	BP-16-W2	1" EMT or 3/4" IMC, Rigid	100
<hr/>			
781011 95521	BP-8-W6	1/2" EMT	100
781011 95522	BP-12-W6	3/4" EMT 1/2" IMC, Rigid	100
781011 95523	BP-16-W6	1" EMT or 3/4" IMC, Rigid	100

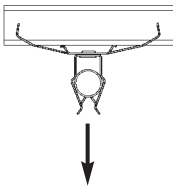

25 Lbs.

Ultimate Static Load Capacity



15 Lbs.

Note: An independent means of support is required by NEC Article 300.11. Refer to pages 220-221 for additional support methods.

Read safety/installation instruction sheets in packages before use.

Conduit & Cable

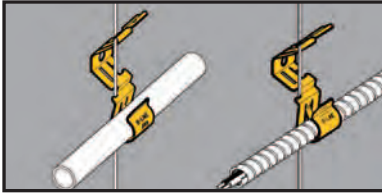

Flex-Rite™ Cable/Conduit To Wire Fasteners



- Can be used in place of batwings.
- Will not bend or deform hanger wire.
- Attaches to #12 - #8 wire and 1/4" plain rod.
- Accommodates MC, AC, 3/8" FMC or 1/2" EMT.
- Cable can be installed before or after attachment to wire.
- Static Load Capacity:
BX-8 - 20 Lbs.
BX-18 - 30 Lbs.

UPC/Part Number	Catalog Number	Cable/Conduit Size	Box Qty.
781011 01402	BX-8	.375" to .706" O.D.	100
781011 02943	BX-18	.706" to 1.380" O.D.	100
781011 01685	BX-8B	Bulk Packed in Fiber Barrels	4000

Conduit & Cable

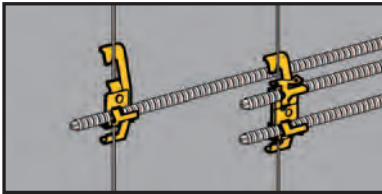

Cable To Rod Fasteners



BX4-W2



BX4M-W2

- Assemblies support MC, AC, sizes 14/2 through 10/3 or 3/8 FMC.
- W2 series attaches to 1/8" thru 3/8" flanges or #12 wire thru 1/4" plain or threaded rod.
- W6 series attaches to 3/8" thru 7/16" flanges or 3/8" plain or threaded rod.

UPC/Part Number	Catalog Number	Description	Box Qty.
781011 01219	BX4-W2	Single Runs	100
781011 01189	BX4M-W2	Double Runs	100
781011 95517	BX4-W6	Single Runs	100
781011 95518	BX4M-W6	Double Runs	100

Note: An independent means of support is required by NEC Article 300.11. Refer to pages 220-221 for additional support methods.

Read safety/installation instruction sheets in packages before use.

- Attaches Type NM cable to most structures.
- Supports cable sizes 14/2 and 12/2 with ground wire.
- May be used with other B-Line fasteners for attachment to acoustical tees, beams, drop wires, etc.

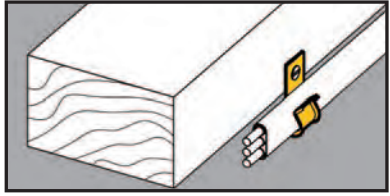

Cable Fasteners



UPC/Part Number	Catalog Number	Description	Box Qty.
781011 03553	BRC3	Type NM Cable Fastener	100

- Supports cable sizes 14/2 and 12/2 with ground wire.
- W2 series supports cable from #12 wire thru 1/4" plain or threaded rod.
- W6 series supports cable from 3/8" plain or threaded rod.

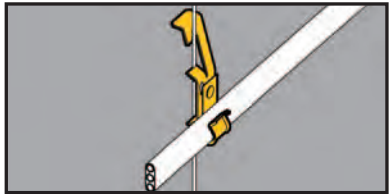

Cable Fasteners



UPC/Part Number	Catalog Number	Description	Box Qty.
781011 03547	BRC3-W2	Type NM Cable To Wire Fastener	100
781011 95524	BRC3-W6	Type NM Cable To Wire Fastener	100

Read safety/installation instruction sheets in packages before use. These products are designed for positioning only. No load rating.

Conduit & Cable

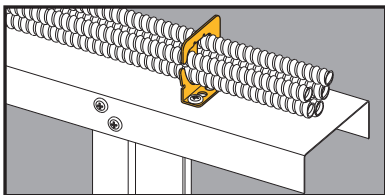

Multi-Run Cable Carrier for MC/AC Cable

- Secures and supports multiple runs of MC/AC cable as required by the NEC.
- Effectively organizes cables and eliminates derating issues.
- Retention tab is open for easy loading and unloading and contains cables when bent in place.
- Compatible with new BCH-HBA for multi-tier assemblies.
- Load Capacity: 50 lbs.
- Finish: Zinc Plated



BRC51



BRC52



BRC53



UPC/Part Number	Catalog Number	Cable Diameter & Number Of Runs	Box Qty.
782051 43593	BRC51	.430" to .560" Up to 4 Runs	50
782051 43594	BRC52	.430" to .560" Up to 9 Runs	50
782051 43595	BRC53	.560" to .690" Up to 7 Runs	50

Read safety/installation instruction sheets in packages before use.

- Secures and supports multiple runs of MC/AC cable as required by the NEC.
- W2 Series attaches to 1/8" thru 3/8" flanges or #12 thru 1/4" plain or threaded rod.
- W6 Series attaches to 3/8" thru 7/16" flanges or 3/8" plain or threaded rod.
- Load Capacity: 50 lbs.
- Finish: Zinc Plated

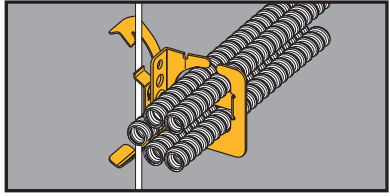

Multi-Run Cable Carrier for MC/AC Cable



UPC/Part Number	Catalog Number	Cable Diameter & Number Of Runs	Box Qty.
782051 44075	BRC51-W2	.430" to .560" Up to 4 Runs	25
782051 44076	BRC52-W2	.430" to .560" Up to 9 Runs	25
782051 44077	BRC53-W2	.560" to .690" Up to 7 Runs	25
782051 44078	BRC51-W6	.430" to .560" Up to 4 Runs	25
782051 44079	BRC52-W6	.430" to .560" Up to 9 Runs	25
782051 44080	BRC53-W6	.560" to .690" Up to 7 Runs	25

Note: An independent means of support is required by NEC Article 300.11. Refer to pages 220-221 for additional support methods.

Read safety/installation instruction sheets in packages before use. These products are designed for positioning only. No load rating.

Conduit & Cable

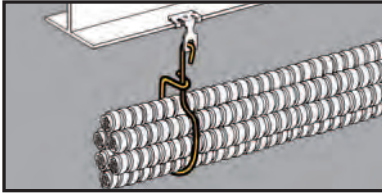

- Designed to support multiple runs of MC, AC, FMC or communication cable.
- Static Load Capacity:
BX2 - 50 lbs.
BX6 & BX24 - 75 Lbs.
- Finish: Zinc Plated

Flexible Cable Support

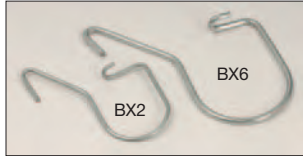

UPC/Part Number	Catalog Number	Description	Box Qty.
782051 04934	BX2	Usable Area = 2 sq. in.	100
781011 19765	BX6	Usable Area = 4 sq. in.	100
781011 19766	BX24	Usable Area = 13 sq. in.	100

Conduit & Cable

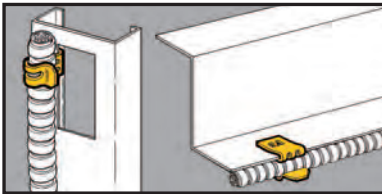

- Fastens flexible conduit and other small cables to beam flanges, bar joists or metal studs.
- Cable O.D. range of 0.42" to 0.70".
- Maximum flange thickness $5/32$ ".

Flexible Conduit/Cable Fasteners



UPC/Part Number	Catalog Number	Description	Box Qty.
781011 19770	BX9	Flexible Conduit Fastener	100

Read safety/installation instruction sheets in packages before use.

- Secures cable along flanges 1/16" to 3/4" thick.
- The BFA flange adapters attach BXS series to thicker flanges.
- BX_-67 accepts 14/2, 12/2 & 10/2 romex with ground.
- BX_-1011 accepts 14/2, 12/2 & 10/2 romex with ground.
- BX_-1214 accepts 10/3, romex with ground.
- Finish: Zinc Plated

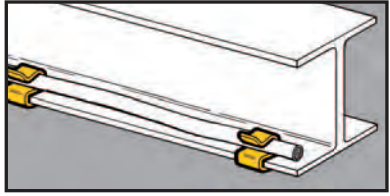

Flexible Conduit/ Cable Fasteners

BFA Series
(For Use with
BXS Series
Only)



BXS
Series



BXL
Series



UPC/Part Number	Catalog Number	Flange Thickness	Cable Diameter	Box Qty.
781011 19973	BXS-67	1/16" - 5/32"	.218 to .281	100
781011 19974	BXS-89	1/16" - 5/32"	.290 to .375	100
781011 19975	BXS-1011	1/16" - 5/32"	.375 to .437	100
781011 19976	BXS-1214	1/16" - 5/32"	.444 to .560	100
781011 19977	BXS-1519	1/16" - 5/32"	.500 to .718	100
781011 19978	BXS-2024	1/16" - 5/32"	.748 to .945	100
781011 19979	BXS-2530	1/16" - 5/32"	.968 to 1.250	100
781011 19980	BXM-67	5/32" - 9/32"	.218 to .281	100
781011 19981	BXM-89	5/32" - 9/32"	.290 to .375	100
781011 19982	BXM-1011	5/32" - 9/32"	.375 to .437	100
781011 19983	BXM-1214	5/32" - 9/32"	.444 to .560	100
781011 19984	BXM-1519	5/32" - 9/32"	.500 to .718	100
781011 19985	BXM-2024	5/32" - 9/32"	.748 to .945	100
781011 19986	BXM-2530	5/32" - 9/32"	.968 to 1.250	100
781011 19987	BXL-67	5/16" - 1/2"	.218 to .281	100
781011 19988	BXL-89	5/16" - 1/2"	.290 to .375	100
781011 19989	BXL-1011	5/16" - 1/2"	.375 to .437	100
781011 19990	BXL-1214	5/16" - 1/2"	.444 to .560	100
781011 19991	BXL-1519	5/16" - 1/2"	.500 to .718	100
781011 19992	BXL-2024	5/16" - 1/2"	.748 to .945	100
781011 19993	BXL-2530	5/16" - 1/2"	.968 to 1.250	100
781011 19955	BFA-1215	1/2" - 5/8"	--	100
781011 19956	BFA-1520	5/8" - 3/4"	--	100

Read safety/installation instruction sheets in packages before use. These products are designed for positioning only. No load rating.

Conduit & Cable

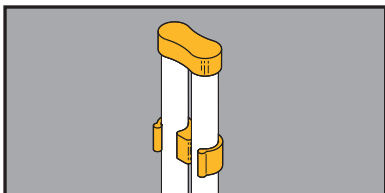

Conduit Quick Caps & Spacers



BCS-C & BES-C
Conduit Caps

BCS & BES
Conduit
Spacers



- Quick caps and spacers eliminate the time consuming method of duct taping conduit stubs.
- Quick spacers are designed to separate and secure conduit during concrete pours.
- Quick caps maintain spacing and keep conduit free from dirt and debris.
- Quick caps and spacers properly space conduit for any 4" square box.
- New EMT sizes now available.

Conduit & Cable

UPC/Part Number	Catalog Number	Conduit Size	Box Qty.
782051 22356	BCS-8	1/2" Rigid Conduit	50
782051 40057	BES-8	1/2" EMT Conduit	50
782051 22357	BCS-12	3/4" Rigid Conduit	50
782051 40058	BES-12	3/4" EMT Conduit	50
782051 22358	BCS-16	1" Rigid Conduit	50
782051 40059	BES-16	1" EMT Conduit	50
782051 22359	BCS-8C	1/2" Rigid Conduit	50
782051 40060	BES-8C	1/2" EMT Conduit	50
782051 22361	BCS-12C	3/4" Rigid Conduit	50
782051 40061	BES-12C	3/4" EMT Conduit	50
782051 22362	BCS-16C	1" Rigid Conduit	50
782051 40062	BES-16C	1" EMT Conduit	50

Patent #5896892

Old Method



New Method with Quick Cap & Spacer



Read safety/installation instruction sheets in packages before use. These products are designed for positioning only. No load rating.

- Eliminates the need for offset bends when used with 1 1/2" deep boxes.
- Attaches conduit to concrete, steel or wood with nails.
- May be attached after conduit positioning.

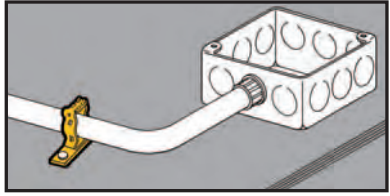

Conduit Spacer Brackets



BP

UPC/Part Number	Catalog Number	Conduit Size	Box Qty.
781011 18495 Patent #4958792	BG-8-12-D3	1/2" or 3/4"	100
781011 19265	BP-8-D3	1/2" EMT	100
781011 19365	BP-12-D3	3/4" EMT or 1/2" IMC, Rigid	100

- Eliminates the need for offset bends when used with 2 1/8" deep boxes.
- Provides secure support between conduit and deck.
- D4 Series is easily installed with screw gun or powder actuated tools.
- Allows for complete conduit layout prior to anchoring.

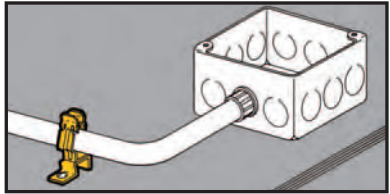

Conduit Spacer Brackets



BP

UPC/Part Number	Catalog Number	Conduit Size	Box Qty.
781011 18500 Patent #4958792	BG-8-12-D4	1/2" or 3/4"	100
781011 19270	BP-8-D4	1/2" EMT	100
781011 19370	BP-12-D4	3/4" EMT or 1/2" IMC, Rigid	100
781011 19460	BP-16-D4	1" EMT or 3/4" IMC, Rigid	100

Read safety/installation instruction sheets in packages before use.

Conduit & Cable

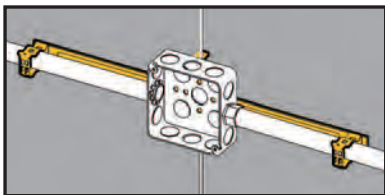

- New BMC3 plate is available to support multiple conduit runs.
- Riveted assembly provides support for electrical boxes and conduit runs on either side of the box.
- Reduces drop wires by 66% when using W2/W6 assemblies.
- Assemblies using BMC3 plate include center conduit clip. Additional conduit clips may be purchased separately.

Guide-Rite™ Conduit & Box Support Fasteners



- See pages Ruff-IN™ brochure for pre-fab box assemblies.



Conduit & Cable

UPC/Part Number	Catalog Number	Conduit Size EMT & Rigid	Box Qty.
781011 03575	BG6-S18 *	3/8"	25
781011 03573	BG812-S18	1/2" or 3/4"	25
781011 03574	BG16-S18	1"	25

With Multiple Conduit Plate

782051 52812	BG6-S18-MC3 *	3/8"	25
782051 52900	BG812-S18-MC3	1/2" or 3/4"	25
782051 52901	BG16-S18-MC3	1"	25

Patent #4958792

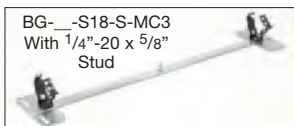
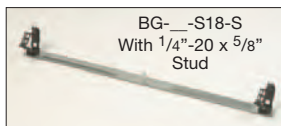

With Stud

782051 52902	BG6-S18S *	3/8"	25
781011 04979	BG812-S18S	1/2" & 3/4"	25
782051 52903	BG16-S18S	1"	25

With Stud & Multiple Conduit Plate

782051 52904	BG6-S18S-MC3 *	3/8"	25
782051 52905	BG812-S18S-MC3	1/2" & 3/4"	25
782051 52906	BG16-S18S-MC3	1"	25

Read safety/installation instruction sheets in packages before use.

Conduit & Cable



UPC/Part Number	Catalog Number	Conduit Size EMT & Rigid	Box Qty.
-----------------	----------------	--------------------------	----------

W2 Series for #12 thru 1/4" Rod **

781011 03578	BG6-S18-W2 *	3/8"	25
781011 03576	BG812-S18-W2	1/2" & 3/4"	25
781011 03577	BG16-S18-W2	1"	25

W2 Series for #12 thru 1/4" Rod & Multiple Conduit Plate **

782051 52855	BG6-S18-W2-MC3 *	3/8"	25
782051 52739	BG812-S18-W2-MC3	1/2" & 3/4"	25
782051 52862	BG16-S18-W2-MC3	1"	25

W6 Series for 3/8" Plain or Threaded Rod **

781011 99581	BG6-S18-W6 *	3/8"	25
781011 99582	BG812-S18-W6	1/2" & 3/4"	25
781011 99580	BG16-S18-W6	1"	25

W6 Series for 3/8" Plain or Threaded Rod & Multiple Conduit Plate **

782051 52856	BG6-S18-W6-MC3 *	3/8"	25
782051 52860	BG812-S18-W6-MC3	1/2" & 3/4"	25
782051 52864	BG16-S18-W6-MC3	1"	25

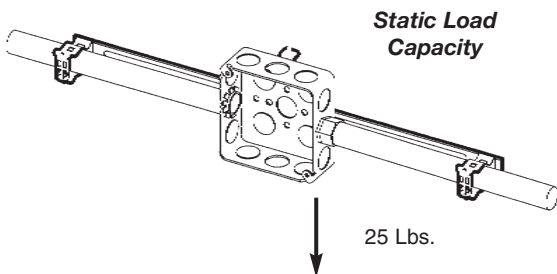

* BG-6 will accept the following range $\varnothing.420 - \varnothing.675$:
14/2 thru 10/4 MC/AC cable and 5/16 or 3/8 flexible conduit

** Note: An independent means of support is required by NEC Article 300.11. Refer to pages 220-221 for additional support methods.

Read safety/installation instruction sheets in packages before use.

Conduit & Cable

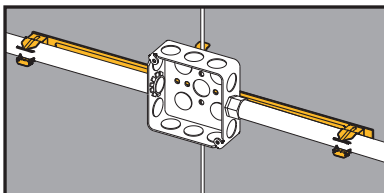

- New BMC3 plate is available to support multiple conduit runs.
- Riveted assembly provides support for electrical boxes and conduit runs on either side of the box.
- Reduces drop wires by 66% when using W2/W6 assemblies.
- Assemblies using BMC3 plate include center conduit clip. Additional conduit clips may be purchased separately.

Push-Type Conduit & Box Support Fasteners

- See pages Ruff-IN™ brochure for pre-fab box assemblies.



Conduit & Cable

UPC/Part Number	Catalog Number	Conduit Size	Box Qty.
782051 23604	BP8-S18	1/2" EMT	25
782051 23605	BP12-S18	3/4" EMT, 1/2" Rigid	25
782051 23606	BP16-S18	1" EMT, 3/4" Rigid	25

With Multiple Conduit Plate

782051 52907	BP8-S18-MC3	1/2" EMT	25
782051 52908	BP12-S18-MC3	3/4" EMT, 1/2" Rigid	25
782051 52909	BP16-S18-MC3	1" EMT, 3/4" Rigid	25

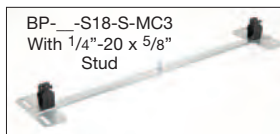
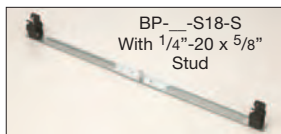

With Stud

782051 23631	BP8-S18S	1/2" EMT	25
782051 23633	BP12-S18S	3/4" EMT, 1/2" Rigid	25
782051 23634	BP16-S18S	1" EMT, 3/4" Rigid	25

With Stud & Multiple Conduit Plate

782051 52913	BP8-S18S-MC3	1/2" EMT	25
782051 52914	BP12-S18S-MC3	3/4" EMT, 1/2" Rigid	25
782051 52915	BP16-S18S-MC3	1" EMT, 3/4" Rigid	25

Read safety/installation instruction sheets in packages before use.

Conduit & Cable



UPC/Part Number	Catalog Number	Conduit Size	Box Qty.
-----------------	----------------	--------------	----------

W2 Series for #12 thru 1/4" Rod **

782051 23615	BP8-S18-W2	1/2" EMT	25
782051 23619	BP12-S18-W2	3/4" EMT, 1/2" Rigid	25
782051 23627	BP16-S18-W2	1" EMT, 3/4" Rigid	25

W2 Series for #12 thru 1/4" Rod & Multiple Conduit Plate **

782051 52847	BP8-S18-W2-MC3	1/2" EMT	25
782051 52848	BP12-S18-W2-MC3	3/4" EMT, 1/2" Rigid	25
782051 52849	BP16-S18-W2-MC3	1" EMT, 3/4" Rigid	25

W6 Series for 3/8" Plain or Threaded Rod **

782051 23628	BP8-S18-W6	1/2" EMT	25
782051 23629	BP12-S18-W6	3/4" EMT, 1/2" Rigid	25
782051 23630	BP16-S18-W6	1" EMT, 3/4" Rigid	25

W6 Series for 3/8" Plain or Threaded Rod & Multiple Conduit Plate **

782051 52850	BP8-S18-W6-MC3	1/2" EMT	25
782051 52851	BP12-S18-W6-MC3	3/4" EMT, 1/2" Rigid	25
782051 52854	BP16-S18-W6-MC3	1" EMT, 3/4" Rigid	25

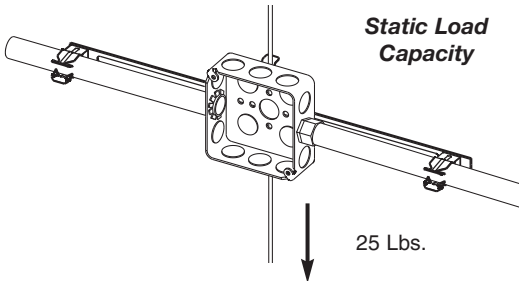

** Note: An independent means of support is required by NEC Article 300.11. Refer to pages 220-221 for additional support methods.

Read safety/installation instruction sheets in packages before use.

Conduit & Cable

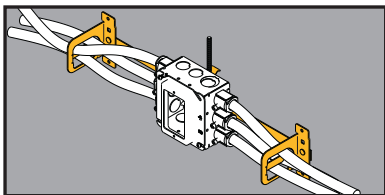

Multi-Run Cable Carrier & Box Support Fasteners



- Riveted assembly provides support for electrical boxes and cable runs on either side of the box.
- Reduces drop wires by 66% when using W2/W6 assemblies.
- Cable retention tab is open for easy loading and contains the cables when bent in place.
- See Ruff-IN™ brochure for pre-fab box assemblies.

Conduit & Cable

UPC/Part Number	Catalog Number	Conduit Size	Box Qty.
782051 52916	BRC51-S18	Up to 4 runs .430" - .560"	25
782051 52918	BRC53-S18	Up to 7 runs .560" - .690"	25

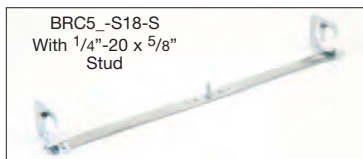

UPC/Part Number	Catalog Number	Conduit Size	Box Qty.
With Stud			
782051 52919	BRC51-S18S	Up to 4 runs .430" - .560"	25
782051 52921	BRC53-S18S	Up to 7 runs .560" - .690"	25

Read safety/installation instruction sheets in packages before use.

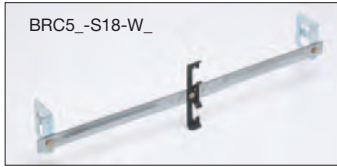

UPC/Part Number	Catalog Number	Conduit Size	Box Qty.
-----------------	----------------	--------------	----------

W2 Series for #12 thru 1/4" Rod **

782051 52865	BRC51-S18-W2	Up to 4 runs .430" - .560"	25
782051 52869	BRC53-S18-W2	Up to 7 runs .560" - .690"	25

W6 Series for 3/8" Plain or Threaded Rod **

782051 52866	BRC51-S18-W6	Up to 4 runs .430" - .560"	25
782051 52870	BRC53-S18-W6	Up to 7 runs .560" - .690"	25

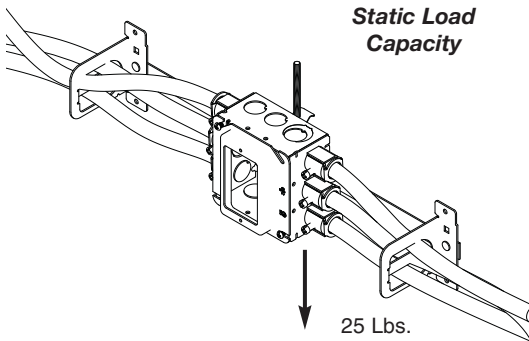

** Note: An independent means of support is required by NEC Article 300.11. Refer to pages 220-221 for additional support methods.

Read safety/installation instruction sheets in packages before use.

Acoustical Tee

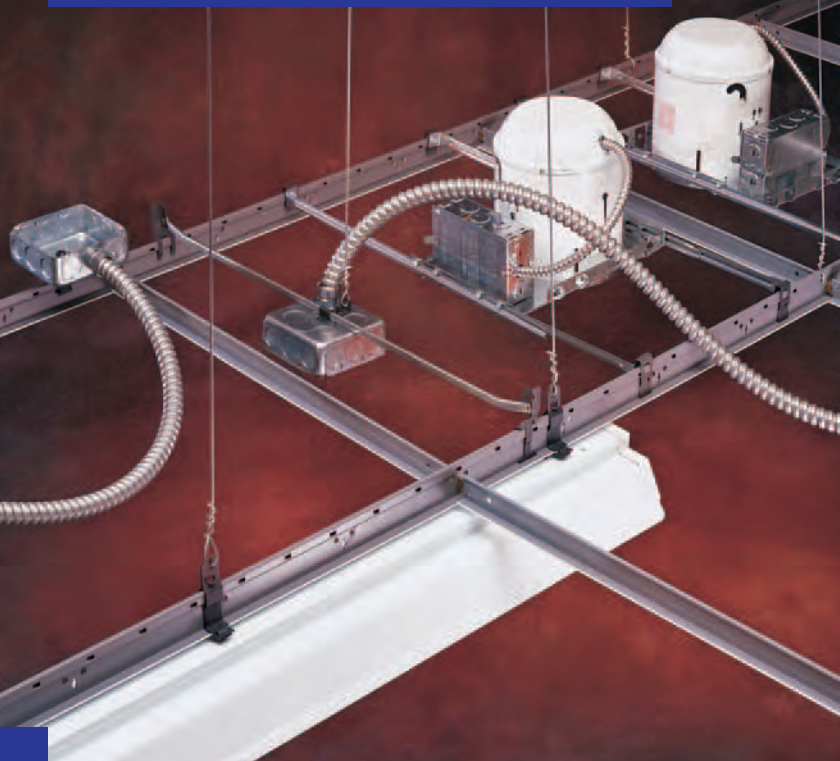

Acoustical Tee

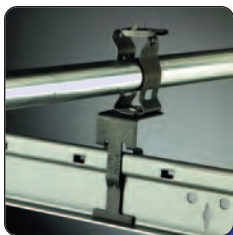

Acoustical Tee

- Attaches to top of acoustical T-Bar with 1/4"-20 screw.
- Has 1/4"-20 thread impression for attachment to box or conduit fastener.
- **Warning:** Do not use for hanging acoustical tee.

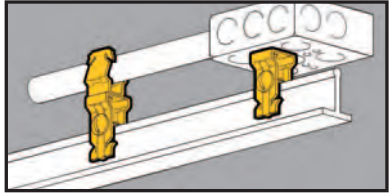

T-Bar Support Fasteners



UPC/Part Number	Catalog Number	Description	Box Qty.
781011 18090	BA14	T-Bar Support Clip	100

- Gives positive support for troffers and lay-in fixtures.
- Complies with NEC Article 410.16(C) for fixtures supported by suspended ceilings.
- Fits rectangular or round head T-Bars.
- Commonly known as "Hurricane Clip".

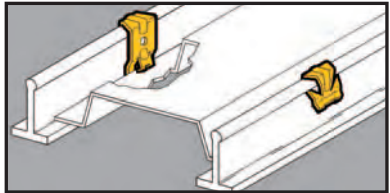

Acoustical Tee

Troffer Fasteners



UPC/Part Number	Catalog Number	Description	Box Qty.
781011 18095	BA15	For Straight Lip or Uprturned Lip Fixtures	100

Read safety/installation instruction sheets in packages before use. These products are designed for positioning only. No load rating.

Acoustical Tee

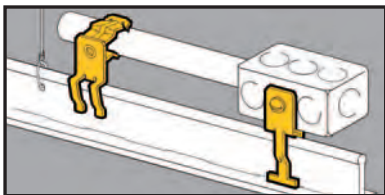

- A positive method for supporting vertical boxes, conduit or cable above T-Bar.
- Allows conduit to clear drop wires.
- **Warning:** Do not use for hanging acoustical tee.

Side Mount T-Bar Fasteners

BA5-4T



UPC/Part Number	Catalog Number	Description	Box Qty.
781011 18120	BA5-4T	With 1/4"-20 Thread Impression	100

Acoustical Tee

BG Series



BP Series



UPC/Part Number	Catalog Number	Conduit Size	Box Qty.
781011 18410	BG-6-A5*	3/8"	100
781011 18465	BG-8-12-A5	1/2", 3/4"	100
781011 18545	BG-16-A5	1"	100
Patent #4958792			
781011 19235	BP-8-A5	1/2" EMT	100
781011 19335	BP-12-A5	3/4" EMT 1/2" IMC, Rigid	100
781011 19430	BP-16-A5	1" EMT 3/4" IMC, Rigid	100

* BG-6 will accept the following range $\varnothing.420 - \varnothing.675$:
14/2 thru 10/4 MC/AC cable and 5/16 or 3/8 flexible conduit

Read safety/installation instruction sheets in packages before use. These products are designed for positioning only. No load rating.

Acoustical Tee

- A positive method for supporting horizontal boxes or conduit above T-Bar.
- Allows conduit to clear drop wires.
- **Warning:** Do not use for hanging acoustical tee.

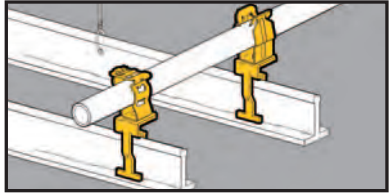

Top Mount T-Bar Fasteners



UPC/Part Number	Catalog Number	Description	Box Qty.
781011 18125	BA6-4T	With 1/4"-20 Thread Impression	100

BG Series



BP Series



Acoustical Tee

UPC/Part Number	Catalog Number	Conduit Size	Box Qty.
781011 88540	BG-6-A6*	3/8"	100
781011 18470	BG-8-12-A6	1/2", 3/4"	100
781011 18550	BG-16-A6	1"	100
Patent #4958792			
781011 19240	BP-8-A6	1/2" EMT	100
781011 19340	BP-12-A6	3/4" EMT 1/2" IMC, Rigid	100
781011 19435	BP-16-A6	1" EMT 3/4" IMC, Rigid	100

* BG-6 will accept the following range $\varnothing.420 - \varnothing.675$:
14/2 thru 10/4 MC/AC cable and 5/16 or 3/8 flexible conduit

Read safety/installation instruction sheets in packages before use. These products are designed for positioning only. No load rating.

Acoustical Tee

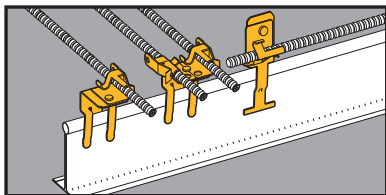

- A positive method for supporting cable or flexible conduit above T-Bar.
- Assemblies support MC, AC, sizes 14/2 through 10/3 or 3/8" FMC.

Top Mount T-Bar Fasteners

BX4-A6



BX4M-A6



UPC/Part Number	Catalog Number	Description	Box Qty.
781011 01220	BX4-A6	Single Runs	100
781011 01216	BX4M-A6	Double Runs	100

Note: Fasteners will rotate 360°.

Acoustical Tee

BX4-A5



BX4M-A5



UPC/Part Number	Catalog Number	Description	Box Qty.
781011 01187	BX4-A5	Single Runs	100
781011 01212	BX4M-A5	Double Runs	100

Note: Fasteners will rotate 360°.

Read safety/installation instruction sheets in packages before use. These products are designed for positioning only. No load rating.

Acoustical Tee

- Supports conduit and electrical boxes above T-Bar.
- Height adjusts from 4¹/₄" to 7¹/₄".
- Conduit fasteners can be attached at 3/4" increments.
- BX4M-A28 supports cable or FMC above T-Bar.

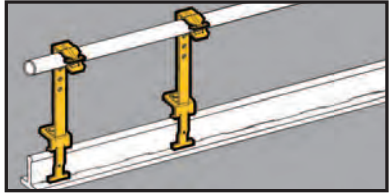

Support Fasteners



BA28

BX4M-A28

UPC/Part Number	Catalog Number	Description	Box Qty.
781011 18115	BA28	1/2" Holes Allow for Adjustment Between 4 ¹ / ₄ " and 7 ¹ / ₄ " or 3/4" increments	50
781011 01211	BX4M-A28	Double Runs MC, AC, or FMC	25



BP-12-A28

UPC/Part Number	Catalog Number	Conduit Size	Box Qty.
781011 19230	BP-8-A28	1/2" EMT	100
781011 19330	BP-12-A28	3/4" EMT 1/2" IMC, Rigid	100
781011 19425	BP-16-A28	1" EMT 3/4" IMC, Rigid	100

Note: Adjustable BP Conduit Fastener is attached with screw in 7¹/₄" top hole position.

Read safety/installation instruction sheets in packages before use. These products are designed for positioning only. No load rating.

Acoustical Tee

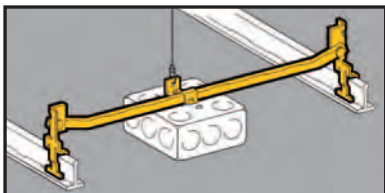

- See BA50 for a stronger, more cost-effective solution.
- Supports octagonal or square boxes.
- Allows for flush mounting or 3/4" offset for plaster ring.
- One BB27 box mounting clip with screw included with each hanger.
- Load Capacity: 20 lbs.
- For additional support, attach dropwire to BB27 box mounting clip.
- **Warning:** Do not use for hanging acoustical tee.

Electrical Box T-Bar Fasteners



UPC/Part Number	Catalog Number	Description	Box Qty.
781011 18080	BA12	Box Hanger 24" Span	50
781011 18082	BA12-12	Box Hanger 12" Span	50
781011 18085	BA12-20	Box Hanger 20" Span	50
781011 18087	BA12-30	Box Hanger 30" Span	50



UPC/Part Number	Catalog Number	Description	Box Qty.
781011 18170	BB27	Box Mounting Clip (with Screw)	50
781011 01673	SRHMS¹/₄x³/₈	1/4"-20 x 3/8" Slotted Round Head Machine Screw	50

Read safety/installation instruction sheets in packages before use.

Acoustical Tee

- Supports octagonal or square boxes on 24" span.
- Bendable ends mount 1 1/2" or 2 1/8" deep boxes without tools.
- Self-centering feature positions box on center.
- Ultimate Static Load Capacity: 50 Lbs. (without dedicated dropwire)
- Static Load Capacity: 70 Lbs. (with dedicated dropwire)
35 Lbs. Canada
- Finish: Pre-galvanized
- See Ruff-IN™ brochure for pre-fab box assemblies.

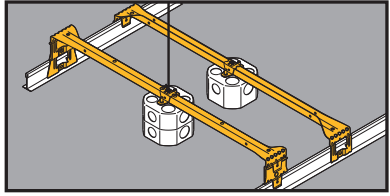

Heavy Duty Electrical Box Hanger



BA50 &
BA50CAN



BA50D &
BA50DCAN



BA50C3T & BA50C4T

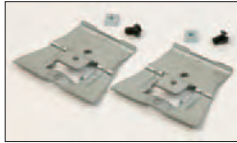

BA50E



UPC/Part Number	Catalog Number	Description	Box Qty.
781011 96490	BA50	Box Hanger	25
782051 35905	BA50CAN*	Box Hanger	25
781011 96491	BA50D	Box Hanger for box with 1 1/2" extension	25
782051 35906	BA50DCAN*	Box Hanger for box with 1 1/2" extension	25
782051 36570	BA50C4T	Box Mounting Clip with Hardware	25
782051 36571	BA50C3T*	Box Mounting Clip with Hardware	25
781011 96489	BA50E	Extender Brackets with Hardware	10 pair

* Canada Only

Read safety/installation instruction sheets in packages before use.

Acoustical Tee

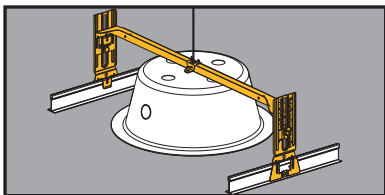

- Adjustable box support for suspended ceilings.
- Accommodates heights from 1¹/₂" to 8³/₄".
- Integral ruler enables height adjustments without measuring.

Adjustable Box Support



- Ideal for installation of speaker cases, emergency light fixtures, etc. in suspended ceilings.
- Static Load Capacity:
25 Lbs. without dedicated dropwire
70 Lbs. with dedicated dropwire
35 Lbs. (Canada) with dedicated dropwire
- See Ruff-IN™ brochure for pre-fab box assemblies.

UPC/Part Number	Catalog Number	Description	Box Qty.
782051 18460	BA50A	Adjustable Box Hanger for T-Bar	10

Acoustical Tee

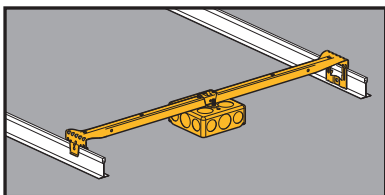

- Pre-assembled T-Bar fasteners speed installation.
- Boxes have 1/2" and 3/4" knockouts.
- Loading not to exceed 50 lbs. in U.S.A. without independent support.
35 Lbs. in Canada
- 24" span

Electrical Box T-Bar Fasteners



UPC/Part Number	Catalog Number	Description	Box Qty.
782051 24855	BA50-OB-24	1 ¹ / ₂ " Deep Box to T-Bar Fastener	10
782051 24856	BA50-OB-34	2 ¹ / ₈ " Deep Box to T-Bar Fastener	10
782051 24857	BA50-SB-24	1 ¹ / ₂ " Deep Box to T-Bar Fastener	10

Read safety/installation instruction sheets in packages before use.

- Pre-assembled fan/ fixture hanger installs on T-Bar in less than 30 seconds.
- Positions and secures fans and fixtures in suspended ceilings.
- Includes Kwik-Wire™ cable and clamps which attach to mounting clips for easy installation.
- Recommended for use in seismic areas.
- UL Listed for fan support up to 70 lbs. or fixture support up to 90 lbs. 35 Lbs. Canada
- Finish: Pre-galvanized

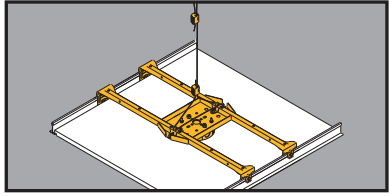

RediMount™ Fan Hanger

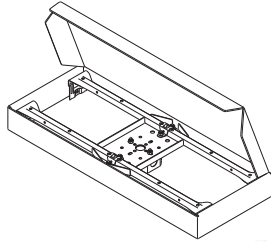

UPC/Part Number	Catalog Number	Description	Box Qty.
781011 96492	BA50F	Fan/Fixture Hanger Includes 4" x 1 1/2" deep Octagon Box	1

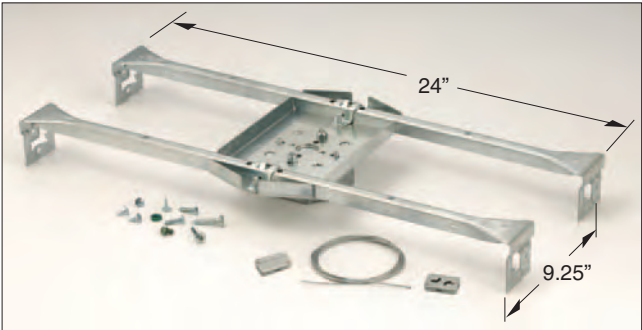

Read safety/installation instruction sheets in packages before use.

Acoustical Tee

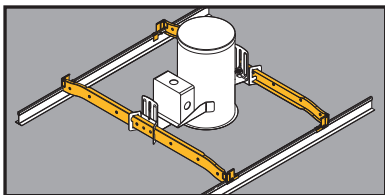

- New QuikFix™ Fastening System mounts spec grade downlights 50% faster than “wire bound” installation methods.
- QuikFix™ System is pre-sized for 24" spacing.
- No tools required.
- Recommended for use in seismic areas.
- UL listed for fixture support up to 50 lbs.

QuikFix™ Fastening System



UPC/Part Number	Catalog Number	Description	Box Qty.
-----------------	----------------	-------------	----------

782051 99873

BA40

Fixture Bar

20 pair

Patent # 6286265

- Innovative design features offset bar hangers with integral locking tabs that secure downlights to T-Bar and prevent lifting or sliding.

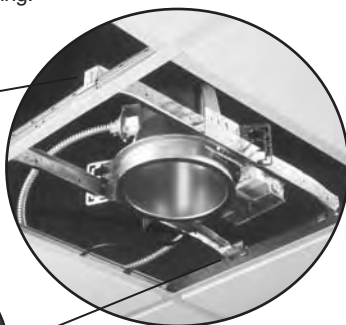
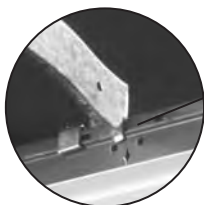

Read safety/installation instruction sheets in packages before use.

- Adjustable span from 20" to 30".
- Fits horizontal and vertical flanges.
- Fixture position is adjustable.
- No center clips or tools required.
- One set completes one fixture installation (four bars per set).

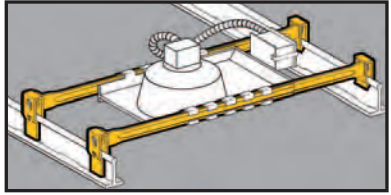

Light Fixture T-Bar Fasteners

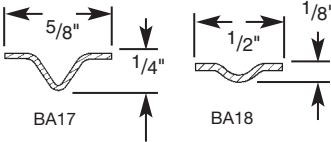

UPC/Part Number	Catalog Number	"High Hat" Fixtures	Box Qty.
781011 18100	BA17 (Wide Bar)	CAPRI ¹ R-9X, R-10C CAPR ¹ R-10X CAPR ¹ PR-751CX HALO ² H7, HALO ² H17 JUNO ³ AP, APT JUNO ³ IC, ICT, J, SC, TC THOMAS ⁴ RI-IC	10 sets
781011 18105	BA18 (Narrow Bar)	CAPRI ¹ HSG LIGHTOLIER ⁵ 711	10 sets

- Fixture position is adjustable within the span of the hanger.
- Fixed span of 24 inches for T-Bar applications.
- Requires only a screwdriver to install.
- One set completes one fixture installation (four bars per set).

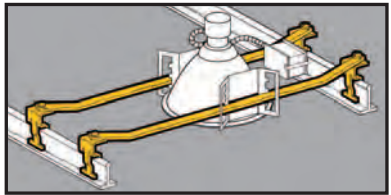

Light Fixture T-Bar Fasteners



UPC/Part Number	Catalog Number	"High Hat" Fixtures	Box Qty.
781011 18110	BA20	Fits LIGHTOLIER ⁵ CALCULITE ⁵ Series Fixtures	10 sets

1. CAPRI is a mark used by Thomas Industries, Inc., Louisville, KY.
2. HALO[®] is the registered trademark of Cooper Industries, Elk Grove, IL.
3. JUNO[®] is the registered trademark of JUNO Lighting, Inc., Morton Grove, IL.
4. THOMAS[®] is the registered trademark of Thomas Industries, Inc., Louisville, KY.
5. LIGHTOLIER[®] and CALCULITE[®] are the registered trademarks of Lightolier, Inc., Secaucus, NJ.

Read safety/installation instruction sheets in packages before use.

Acoustical Tee

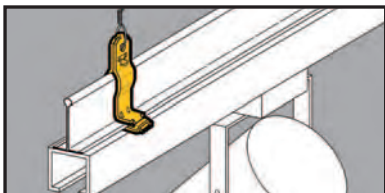

- Allows for independent suspension of fixtures.
- Fits most acoustical T-Bars.
- BA-4-WN wing nut included with all 1/4"-20 suspension hangers.
- Static Load Capacity: 65 Lbs.

Suspension Fasteners

BA1



BA1-T



BA1-T-BN



UPC/Part Number	Catalog Number	T-Bar Size	Stud Size	Box Qty.
781011 18065	BA1	15/16"	1/4"-20 x 5/8"	100
781011 18070	BA1-24	15/16"	1/4"-20 x 1 1/2"	100
781011 18075	BA1-32	15/16"	1/4"-20 x 2"	100
781011 02891	BA1-T	15/16"	#8-32 x 5/8" with Pal Nut	100
781011 02897	BA1-T-BN	15/16"	#8-32 x 5/8" with with Brass Nut	100

BA1-9



BA1-95



UPC/Part Number	Catalog Number	T-Bar Size	Stud Size	Box Qty.
782051 25585	BA1-9	9/16"	1/4"-20 x 5/8"	100
782051 25587	BA1-95	9/16" & 15/16"	1/4"-20 x 5/8"	100

Read safety/installation instruction sheets in packages before use.

Acoustical Tee

- Supports electrical fixtures from standard 15/16" T-Bars.
- BA-4-WN wing nut included.
- 1/4"-20 stud available in varying lengths.
- Static Load Capacity: 50 Lbs.

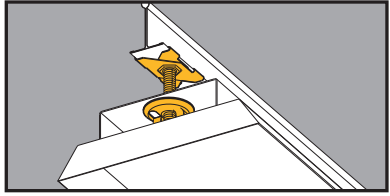

T-Bar Scissor Fasteners



UPC/Part Number	Catalog Number	Stud Length	Box Qty.
781011 04258	BAX-4-16	5/8"	100
781011 04262	BAX-4-16-24	1 1/2"	100
781011 04263	BAX-4-16-32	2"	100
781011 04264	BAX-4-16-48	3"	100

- BA-4-16-H supports signs from 15/16" T-Bar.
- BA-4-16-H1 supports signs from 9/16" or 15/16" T-Bar.
- Static Load Capacity: 40 Lbs.

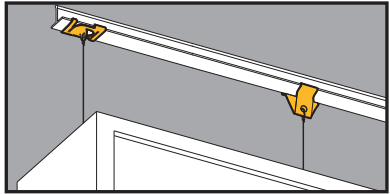

Acoustical Tee

Sign Hangers



BA-4-16-H



BA-4-16-H1



UPC/Part Number	Catalog Number	Stud Length	Box Qty.
781011 18040	BA-4-16-H	Sign Hanger with White Finish	100
781011 04449	BA-4-16-H1	Sign Hanger with Zinc Plated Finish	100

Read safety/installation instruction sheets in packages before use.

Acoustical Tee

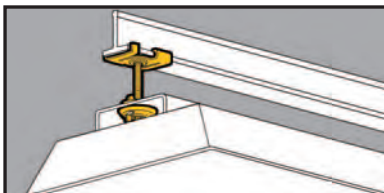

- Supports electrical fixtures from 15/16" T-Bar.
- 1/4"-20 stud available in varying lengths.
- Includes BA-4-WN wing nut with impression.
- Static Load Capacity:
BA4-16 Series = 50 lbs.
BA4-WN Series = 100 lbs.

15/16" Twist Fasteners



BA-4-WN

UPC/Part Number	Catalog Number	Finish	Stud Length	Box Qty.
781011 18020	BA-4-16	Black	5/8"	100
781011 18055	BA-4-16-W	White	5/8"	100
781011 18025	BA-4-16-24	White	1 1/2"	100
781011 18030	BA-4-16-32	White	2"	100
781011 18035	BA-4-16-48	White	3"	100
781011 18060	BA-4-WN	Black		100

Acoustical Tee

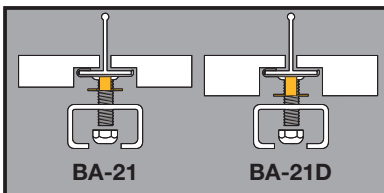

- T-Bar spacer provides flush mounting surface for tegular tile installations.
- Spacer must be used in combination with B-Line's BA-4-16 or BA-2-16 series fasteners.
- Finish: Zinc Plated

T-Bar Spacers



BA-21

BA-21D

UPC/Part Number	Catalog Number	Description	Box Qty.
781011 95575	BA-21	1/4" Spacer	100
781011 99567	BA-21D	3/8" Spacer	100

Read safety/installation instruction sheets in packages before use.

Acoustical Tee

- Supports electrical fixtures from $15/16$ " T-Bar.
- #8-32 stud available in varying lengths.
- Static Load Capacity: 25 Lbs.

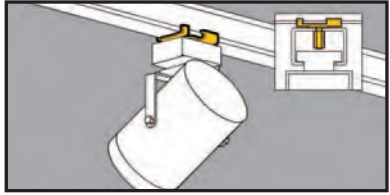

$15/16$ " Twist Fasteners



UPC/Part Number	Catalog Number	Finish	Stud Length	Box Qty.
781011 18000	BA-2-16	Black with Pal Nut	$5/8$ "	100
781011 04259	BA-2-16-7	Black with Pal Nut	$7/16$ "	100
781011 18010	BA-2-16-W	White with Pal Nut	$5/8$ "	100
781011 04261	BA-2-16-7-W	White with Pal Nut	$7/16$ "	100



UPC/Part Number	Catalog Number	Finish	Stud Length	Box Qty.
781011 18000	BA-2-16-BN	Black with Brass Nut	$5/8$ "	100
781011 04260	BA-2-16-7-BN	Black with Brass Nut	$7/16$ "	100
781011 18015	BA-2-16-WBN	White with Brass Nut	$5/8$ "	100
781011 99566	BA-2-16-7-WBN	White with Brass Nut	$7/16$ "	100

Read safety/installation instruction sheets in packages before use.

Acoustical Tee

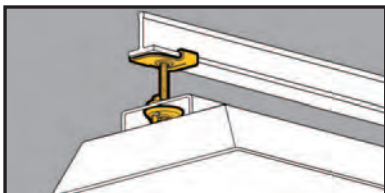

- Supports electrical fixtures from 9/16" T-Bar.
- Stud size: 1/4"-20 x 5/8".
- Static Load Capacity: 40 Lbs.

9/16" Twist Fasteners



UPC/Part Number	Catalog Number	Finish	Stud Length	Box Qty.
781011 03458	BA-4-9	Black	5/8"	100
781011 03461	BA-4-9-W	White	5/8"	100

Acoustical Tee

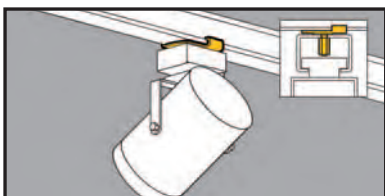

- Supports electrical fixtures and track lighting from 9/16" T-Bar.
- Stud size: #8-32 x length.
- Static Load Capacity: 25 Lbs.

9/16" Twist Fasteners

BA-2-9 Series with Pal Nut



BA-2-9-BN Series with Brass Nut



UPC/Part Number	Catalog Number	Finish	Stud Length	Box Qty.
781011 03467	BA-2-9	Black	5/8"	100
781011 03466	BA-2-9-7	Black	7/16"	100
781011 03459	BA-2-9-W	White	5/8"	100
781011 03465	BA-2-9-BN	Black	5/8"	100
781011 03464	BA-2-9-7-BN	Black	7/16"	100
781011 03460	BA-2-9-WBN	White	5/8"	100

Read safety/installation instruction sheets in packages before use.

Acoustical Tee

- Secures independent support wires to ceiling grid as required by NEC Article 300.11.
- Slotted design permits adjustment when securing rods.
- Bright yellow color, Per NEC 300.11 (A), is easily identified by inspectors.

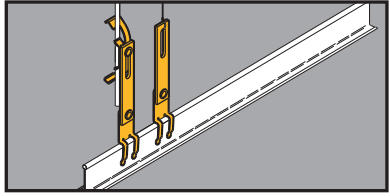

Drop Wire/Rod Securing Clip



BA-311



BA-311-W2 Shown

UPC/Part Number	Catalog Number	Description	Box Qty.
781011 99569	BA311	#12 thru #8 Wire	100
781011 99570	BA311-W2	#12 thru 1/4" Plain or Threaded Rod	100
781011 99571	BA311-W6	3/8" Plain or Threaded Rod	100

Acoustical Tee

Read safety/installation instruction sheets in packages before use.

Acoustical Tee



Seismic Fixture Clamps

- BA-SFC Series provides seismic restraint for light fixtures within a suspended ceiling.
- B-Line's BA-SFC reduces labor by attaching light fixtures to the T-bar frame and eliminating extra drop wires or chains.
- Provides positive attachment of fixtures to ceiling grid members, in compliance with ICBO Acceptance Criteria 184 (AC 184).
- Satisfies NEC 410.16(C) which requires positive attachment for secure fastening of luminaries.
- Load rating: 200 lbs.

UPC/Part Number	Catalog Number	Description	Box Qty.
782051 45911	BA-SFC	Seismic Fixture Clamp attaches one standard 2' x 4' light fixture to T-bar ceiling	25 sets (4 clamps per set)
782051 45912	BA-SFC-E *	For attachment of two standard 2' x 4' light fixtures end-to-end onto T-bar ceiling	25 sets (4 clamps per set)
782051 45913	BA-SFC-S *	For attachment of two standard 2' x 4' light fixtures side-by-side onto T-bar ceiling	25 sets (4 clamps per set)
782051 45914	BA-SFC-CF *	For attachment of standard 2' x 2' light fixtures onto T-bar	50 sets (2 clamps per set)
782051 45915	BA-SFC-CFS	Seismic Fixture Clamp for reinforcement of main runner connection points	100 sets (2 clamps per set)

* BASFC is required to complete installation.

Read safety/installation instruction sheets in packages before use.

Seismic Fixture Clamps cont.



BA-SFC



BA-SFC-E



BA-SFC-S



BA-SFC-CF



BA-SFC-CFS

Single Fixture
Installation

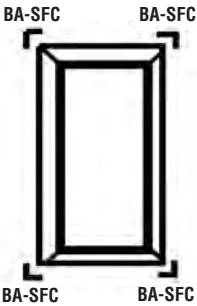

Parts Required:
1 pc. BA-SFC Installation Kit

Two Fixtures (Side by Side)

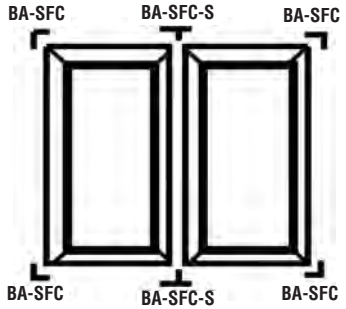

Parts Required:
1 pc. BA-SFC Installation Kit
1 pc. BA-SFC-S Installation Kit

Two Fixtures (End to End)

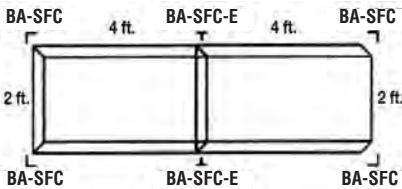

Parts Required:
1 pc. BA-SFC Installation Kit
1 pc. BA-SFC-E Installation Kit



Read safety/installation instruction sheets in packages before use.

Beams



Beams



- Permits fast and easy installation on bulb tees and beams.
- Clearance hole for 1/4" bolt in tab.
- Simply installed with a hammer.

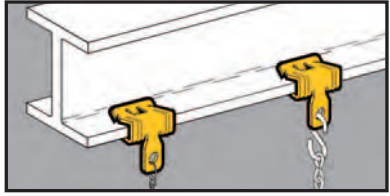

Flange Beam Fasteners



UPC/Part Number	Catalog Number	Flange Thickness	Static Load Cap.	Box Qty.
781011 18290	BE-1-2	3/32" - 9/64"	160 lbs.	100



BE-2-4



UPC/Part Number	Catalog Number	Flange Thickness	Static Load Cap.	Box Qty.
781011 18295	BE-2-4	1/8" - 1/4"	200 lbs.	100
781011 18300	BE-5-8	5/16" - 1/2"	200 lbs.	100
781011 18305	BE-9-12	9/16" - 3/4"	200 lbs.	100

Read safety/installation instruction sheets in packages before use.

Beams

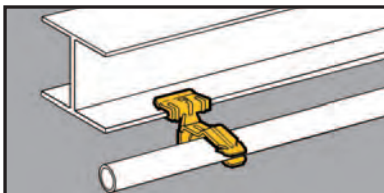

- Quickly attaches conduit to beams.
- Fasteners will rotate 360°.
- Simply installed with a hammer.

Push-Type Conduit To Beam Fasteners



UPC/Part Number	Catalog Number	Conduit Size	Flange Thickness	Box Qty.
781011 19275	BP-8-E-2-4	1/2" EMT	1/8" - 1/4"	100
781011 19280	BP-8-E-5-8	1/2" EMT	5/16" - 1/2"	100
781011 19285	BP-8-E-9-12	1/2" EMT	9/16" - 3/4"	100
781011 19375	BP-12-E-2-4	3/4" EMT 1/2" IMC, Rigid	1/8" - 1/4"	100
781011 19380	BP-12-E-5-8	3/4" EMT 1/2" IMC, Rigid	5/16" - 1/2"	100
781011 19385	BP-12-E-9-12	3/4" EMT 1/2" IMC, Rigid	9/16" - 3/4"	100
781011 19465	BP-16-E-2-4	1" EMT 3/4" IMC, Rigid	1/8" - 1/4"	100
781011 19470	BP-16-E-5-8	1" EMT 3/4" IMC, Rigid	5/16" - 1/2"	100
781011 19475	BP-16-E-9-12	1" EMT 3/4" IMC, Rigid	9/16" - 3/4"	100

**Ultimate
Static Load
Capacity**

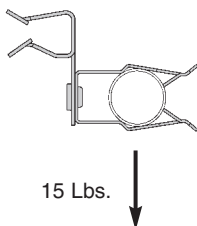

15 Lbs.

Read safety/installation instruction sheets in packages before use.

- Unique **Guide-Rite** Fastener provides for fast and easy installation.
- Fasteners will rotate 360°.
- Simply installed with a hammer and pliers.

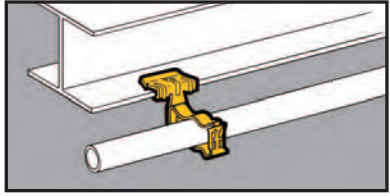

Guide-Rite™ Conduit To Beam Fasteners



UPC/Part Number	Catalog Number	Conduit Size	Flange Thickness	Box Qty.
781011 18430	BG-6-E-2-4*	3/8"	1/8" - 1/4"	100
781011 18435	BG-6-E-5-8*	3/8"	5/16" - 1/2"	100
781011 18440	BG-6-E-9-12*	3/8"	9/16" - 3/4"	100
781011 18505	BG-8-12-E-2-4	1/2", 3/4"	1/8" - 1/4"	100
781011 18510	BG-8-12-E-5-8	1/2", 3/4"	5/16" - 1/2"	100
781011 18515	BG-8-12-E-9-12	1/2", 3/4"	9/16" - 3/4"	100
781011 18575	BG-16-E-2-4	1"	1/8" - 1/4"	100
781011 18580	BG-16-E-5-8	1"	5/16" - 1/2"	100
781011 18585	BG-16-E-9-12	1"	9/16" - 3/4"	100
781011 18660	BG-20-E-2-4	1 1/4"	1/8" - 1/4"	100
781011 18665	BG-20-E-5-8	1 1/4"	5/16" - 1/2"	100
781011 18670	BG-20-E-9-12	1 1/4"	9/16" - 3/4"	100
781011 18705	BG-24-E-2-4	1 1/2"	1/8" - 1/4"	50
781011 18710	BG-24-E-5-8	1 1/2"	5/16" - 1/2"	50
781011 18715	BG-24-E-9-12	1 1/2"	9/16" - 3/4"	50
781011 18745	BG-32-E-2-4	2"	1/8" - 1/4"	50
781011 18750	BG-32-E-5-8	2"	5/16" - 1/2"	50
781011 18755	BG-32-E-9-12	2"	9/16" - 3/4"	50

Patent #4958792

- * BG-6 will accept the following range $\varnothing.420$ - $\varnothing.675$:
14/2 thru 10/4 MC/AC cable
and 5/16 or 3/8 flexible conduit

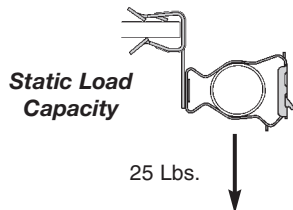

Read safety/installation instruction sheets in packages before use.

Beams

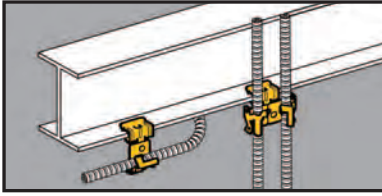

- Attaches MC, AC, sizes 14/2 through 10/3 or 3/8" FMC to beam flanges 1/8" to 3/4" thick.
- Fasteners will rotate 360°.
- Simply installed with a hammer.

Cable To Beam Fasteners



UPC/Part Number	Catalog Number	Type of Runs	Flange Thickness	Box Qty.
781011 01192	BX4-E-2-4	Single	1/8" - 1/4"	100
781011 01193	BX4-E-5-8	Single	5/16" - 1/2"	100
781011 01194	BX4-E-9-12	Single	9/16" - 3/4"	100



UPC/Part Number	Catalog Number	Type of Runs	Flange Thickness	Box Qty.
781011 01213	BX4M-E-2-4	Double	1/8" - 1/4"	100
781011 01214	BX4M-E-5-8	Double	5/16" - 1/2"	100
781011 01215	BX4M-E-9-12	Double	9/16" - 3/4"	100

Read safety/installation instruction sheets in packages before use. These products are designed for positioning only. No load rating.

- Secures and supports MC/AC cables as required by the NEC.
- Effectively organizes cables and eliminates derating issues.
- BRC5-1 secures up to four (4) runs of .430 to .560 diameter cable.
- BRC5-2 secures up to nine (9) runs of .430 to .560 diameter cable.
- BRC5-3 secures up to seven (7) runs of .560 to .690 diameter cable.
- Load Capacity: 50 lbs.

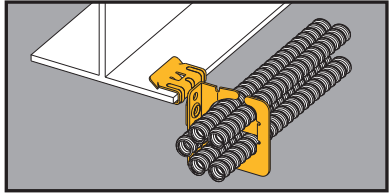

MC/AC Cable Carrier to Beam Fastener



BRC5-2-E24



UPC/Part Number	Catalog Number	Flange Thickness	Box Qty.
782051 44093	BRC51-E12	3/32" - 9/64"	25
782051 44096	BRC51-E24	1/8" - 1/4"	25
782051 44099	BRC51-E58	5/16" - 1/2"	25
782051 44102	BRC51-E912	9/16" - 3/4"	25
782051 44094	BRC52-E12	3/32" - 9/64"	25
782051 44097	BRC52-E24	1/8" - 1/4"	25
782051 44100	BRC52-E58	5/16" - 1/2"	25
782051 44103	BRC52-E912	9/16" - 3/4"	25
782051 44095	BRC53-E12	3/32" - 9/64"	25
782051 44098	BRC53-E24	1/8" - 1/4"	25
782051 44101	BRC53-E58	5/16" - 1/2"	25
782051 44104	BRC53-E912	9/16" - 3/4"	25

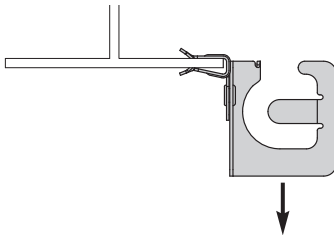

Static Load Capacity

50 Lbs.

Read safety/installation instruction sheets in packages before use.

Beams

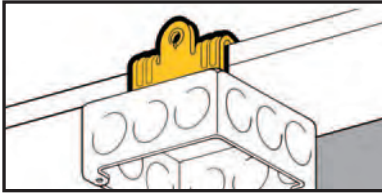

- Suspend boxes or fixtures from beam flanges 1/8" to 3/4" thick.
- Provided with 1/4"-20 thread impression for quick and secure attachment.
- Simply installed with a hammer.

Universal Beam Fasteners



UPC/Part Number	Catalog Number	Flange Thickness	Box Qty.
781011 19600	BU-2-4	1/8" - 1/4"	100
781011 19605	BU-5-8	5/16" - 1/2"	100
781011 19610	BU-9-12	9/16" - 3/4"	100



1/4"-20 x 3/8"
Staked Stud

UPC/Part Number	Catalog Number	Flange Thickness	Box Qty.
781011 19615	BU-2-4-S	1/8" - 1/4"	100
781011 19620	BU-5-8-S	5/16" - 1/2"	100
781011 19625	BU-9-12-S	9/16" - 3/4"	100

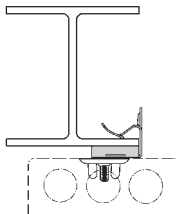
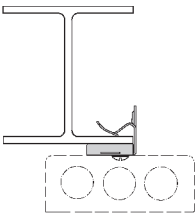

Static Load Capacity

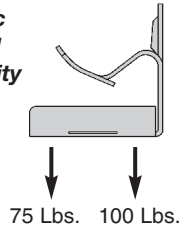

Read safety/installation instruction sheets in packages before use. These products are designed for positioning only. No load rating.

- Secures and supports MC/AC cables as required by the NEC.
- Effectively organizes cables and eliminates derating issues.
- BRC5-1 secures up to four (4) runs of .430 to .560 diameter cable.
- BRC5-2 secures up to nine (9) runs of .430 to .560 diameter cable.
- BRC5-3 secures up to seven (7) runs of .560 to .690 diameter cable.
- Load Capacity: 50 lbs.

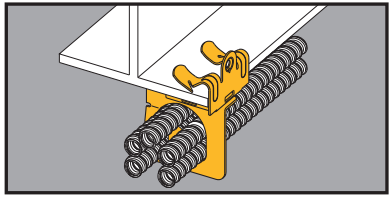

MC/AC Cable Carrier to Beam Fastener



UPC/Part Number	Catalog Number	Flange Thickness	Box Qty.
782051 44066	BRC51-U24	1/8" - 1/4"	25
782051 44069	BRC51-U58	5/16" - 1/2"	25
782051 44072	BRC51-U912	9/16" - 3/4"	25
782051 44067	BRC52-U24	1/8" - 1/4"	25
782051 44070	BRC52-U58	5/16" - 1/2"	25
782051 44073	BRC52-U912	9/16" - 3/4"	25
782051 44068	BRC53-U24	1/8" - 1/4"	25
782051 44071	BRC53-U58	5/16" - 1/2"	25
782051 44074	BRC53-U912	9/16" - 3/4"	25

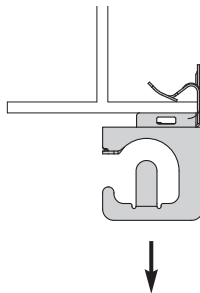

Static Load Capacity

75 Lbs.

Read safety/installation instruction sheets in packages before use.

Beams

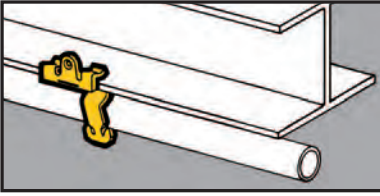

- Quickly attaches conduit to beams.
- Fasteners will rotate 360°.
- Simply installed with a hammer.

Push-Type Conduit To Beam Fasteners



UPC/Part Number	Catalog Number	Conduit Size	Flange Thickness	Box Qty.
781011 19310	BP-8-U-2-4	1/2" EMT	1/8" - 1/4"	100
781011 19315	BP-8-U-5-8	1/2" EMT	5/16" - 1/2"	100
781011 19320	BP-8-U-9-12	1/2" EMT	9/16" - 3/4"	100
781011 19405	BP-12-U-2-4	3/4" EMT 1/2" IMC, Rigid	1/8" - 1/4"	100
781011 19410	BP-12-U-5-8	3/4" EMT 1/2" IMC, Rigid	5/16" - 1/2"	100
781011 19415	BP-12-U-9-12	3/4" EMT 1/2" IMC, Rigid	9/16" - 3/4"	100
781011 19490	BP-16-U-2-4	1" EMT 3/4" IMC, Rigid	1/8" - 1/4"	100
781011 19495	BP-16-U-5-8	1" EMT 3/4" IMC, Rigid	5/16" - 1/2"	100
781011 19500	BP-16-U-9-12	1" EMT 3/4" IMC, Rigid	9/16" - 3/4"	100

**Ultimate
Static Load
Capacity**

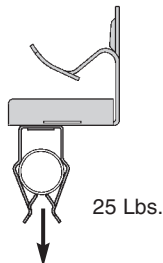

25 Lbs.

Read safety/installation instruction sheets in packages before use. These products are designed for positioning only. No load rating.

- Unique **Guide-Rite** Fastener provides for fast and easy installation.
- Fasteners will rotate 360°.
- Simply installed with a hammer and pliers.

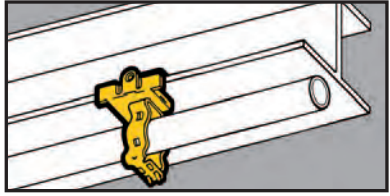

Guide-Rite™ Conduit To Beam Fasteners



UPC/Part Number	Catalog Number	Conduit Size	Flange Thickness	Box Qty.
781011 18450	BG-6-U-2-4*	3/8"	1/8" - 1/4"	100
781011 18455	BG-6-U-5-8*	3/8"	5/16" - 1/2"	100
781011 18460	BG-6-U-9-12*	3/8"	9/16" - 3/4"	100
781011 18525	BG-8-12-U-2-4	1/2", 3/4"	1/8" - 1/4"	100
781011 18530	BG-8-12-U-5-8	1/2", 3/4"	5/16" - 1/2"	100
781011 18535	BG-8-12-U-9-12	1/2", 3/4"	9/16" - 3/4"	100
781011 18625	BG-16-U-2-4	1"	1/8" - 1/4"	100
781011 18630	BG-16-U-5-8	1"	5/16" - 1/2"	100
781011 18635	BG-16-U-9-12	1"	9/16" - 3/4"	100
781011 18680	BG-20-U-2-4	1 1/4"	1/8" - 1/4"	100
781011 18685	BG-20-U-5-8	1 1/4"	5/16" - 1/2"	100
781011 18690	BG-20-U-9-12	1 1/4"	9/16" - 3/4"	100
781011 18720	BG-24-U-2-4	1 1/2"	1/8" - 1/4"	50
781011 18725	BG-24-U-5-8	1 1/2"	5/16" - 1/2"	50
781011 18730	BG-24-U-9-12	1 1/2"	9/16" - 3/4"	50
781011 18760	BG-32-U-2-4	2"	1/8" - 1/4"	50
781011 18765	BG-32-U-5-8	2"	5/16" - 1/2"	50
781011 18770	BG-32-U-9-12	2"	9/16" - 3/4"	50

Patent #4958792

- * BG-6 will accept the following range $\varnothing.420$ - $\varnothing.675$:
1 1/2 thru 10/4 MC/AC cable
and 5/16 or 3/8 flexible conduit

**Static Load
Capacity**

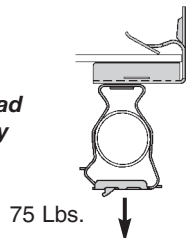

Read safety/installation instruction sheets in packages before use.

Beams

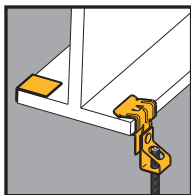
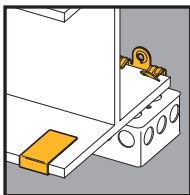

- Anchor strap provides secure attachment to beam flanges.
- Suspends threaded rod from beam flanges.
- 8" anchor straps are provided for 1/8" to 1/4" thick flanges.
- 13" anchor straps are provided for 5/16" to 3/4" thick flanges.

Beam Fasteners With Anchor Straps



Static Load Capacity

75 Lbs.



UPC/Part Number	Catalog Number	Stud Size	Flange Thickness	Box Qty.
781011 04942	BU-2-4-S-AS	1/4"-20 x 3/8"	1/8" - 1/4"	50
781011 04943	BU-5-8-S-AS	1/4"-20 x 3/8"	5/16" - 1/2"	50
781011 04944	BU-9-12-S-AS	1/4"-20 x 3/8"	9/16" - 3/4"	50



Static Load Capacity

160 Lbs.



UPC/Part Number	Catalog Number	Threaded Rod Size	Flange Thickness	Box Qty.
781011 04948	BH4-E-2-4-AS	1/4"-20	1/8" - 1/4"	50
781011 04949	BH4-E-5-8-AS	1/4"-20	5/16" - 1/2"	50
781011 04950	BH4-E-9-12-AS	1/4"-20	9/16" - 3/4"	50
781011 04951	BH6-E-2-4-AS	3/8"-16	1/8" - 1/4"	50
781011 04952	BH6-E-5-8-AS	3/8"-16	5/16" - 1/2"	50
781011 04953	BH6-E-9-12-AS	3/8"-16	9/16" - 3/4"	50

Read safety/installation instruction sheets in packages before use.

- Anchor strap provides secure attachment to beam flanges.
- Unique **Guide-Rite™** Fastener provides for fast and easy installation.
- 8" anchor straps are provided for 1/8" to 1/4" thick flanges.
- 13" anchor straps are provided for 5/16" to 3/4" thick flanges.

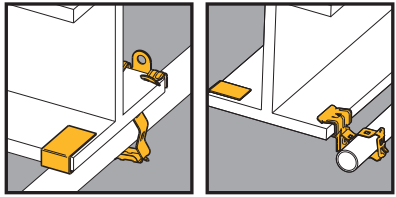

Conduit To Beam Fasteners With Anchor Straps



Static Load Capacity

75 Lbs.



UPC/Part Number	Catalog Number	Conduit Size	Flange Thickness	Box Qty.
781011 04966	BG-8-12-U-2-4-AS	1/2", 3/4"	1/8" - 1/4"	50
781011 04967	BG-8-12-U-5-8-AS	1/2", 3/4"	5/16" - 1/2"	50
781011 04968	BG-8-12-U-9-12-AS	1/2", 3/4"	9/16" - 3/4"	50
781011 04969	BG-16-U-2-4-AS	1"	1/8" - 1/4"	50
781011 04970	BG-16-U-5-8-AS	1"	5/16" - 1/2"	50
781011 04971	BG-16-U-9-12-AS	1"	9/16" - 3/4"	50



Static Load Capacity

25 Lbs.



UPC/Part Number	Catalog Number	Conduit Size	Flange Thickness	Box Qty.
781011 04972	BG-8-12-E-2-4-AS	1/2", 3/4"	1/8" - 1/4"	50
781011 04973	BG-8-12-E-5-8-AS	1/2", 3/4"	5/16" - 1/2"	50
781011 04974	BG-8-12-E-9-12-AS	1/2", 3/4"	9/16" - 3/4"	50
781011 04975	BG-16-E-2-4-AS	1"	1/8" - 1/4"	50
781011 04976	BG-16-E-5-8-AS	1"	5/16" - 1/2"	50
781011 04977	BG-16-E-9-12-AS	1"	9/16" - 3/4"	50

Read safety/installation instruction sheets in packages before use.

Beams

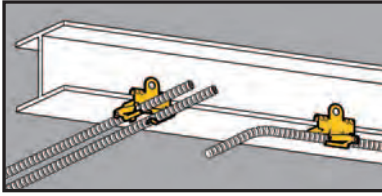

- Attaches MC, AC, sizes 14/2 through 10/3 or 3/8" FMC to flanges 1/8" to 3/4" thick.
- Fasteners will rotate 360°.

Cable To Beam Fasteners



UPC/Part Number	Catalog Number	Description	Flange Thickness	Box Qty.
781011 01197	BX4-U-2-4	Single Runs	1/8" - 1/4"	100
781011 01198	BX4-U-5-8	Single Runs	5/16" - 1/2"	100
781011 01199	BX4-U-9-12	Single Runs	9/16" - 3/4"	100



UPC/Part Number	Catalog Number	Description	Flange Thickness	Box Qty.
781011 01206	BX4M-U-2-4	Double Runs	1/8" - 1/4"	100
781011 01207	BX4M-U-5-8	Double Runs	5/16" - 1/2"	100
781011 01208	BX4M-U-9-12	Double Runs	9/16" - 3/4"	100

- Secures and supports MC/AC cables as required by the NEC.
- Effectively organizes cables and eliminates derating issues.
- Fits beam flanges from 1/8" thru 5/8" thick.
- Load Capacity: 50 lbs.

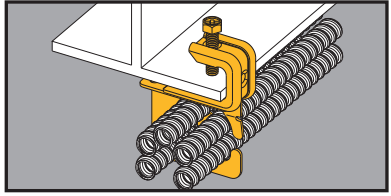

MC/AC Cable Carrier to Beam Fastener



BRC5-1-C442



UPC/Part Number	Catalog Number	Cable Diameter & Number Of Runs	Box Qty.
782051 44087	BRC51-C442	.430" to .560" Up to 4 Runs	25
782051 44088	BRC52-C442	.430" to .560" Up to 9 Runs	25
782051 44089	BRC53-C442	.560" to .690" Up to 7 Runs	25

Read safety/installation instruction sheets in packages before use.

Beams

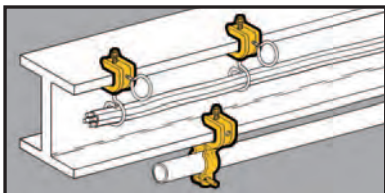

- BC442 fits beam flanges 1/8" to 5/8". BC442-6 fits beam flanges up to 3/4".
- Finish: Zinc Plated
- Static Load Capacity: BC442 = 100 Lbs. BC442-6 = 200 Lbs.

Beam Fasteners



UPC/Part Number	Catalog Number	Description	Box Qty.
781011 18278	BC442	Accepts 1/4"-20 Threaded Rod or 1/4"-20 Threaded Bridle Rings	50
781011 04283	BC442-6	Accepts 3/8"-16 Threaded Rod	25



UPC/Part Number	Catalog Number	Conduit Size Rigid	Conduit Size EMT	Box Qty.
781011 19850	BL1400-C442	1/2"	1/2"	50
781011 19851	BL1410-C442	3/4"	3/4"	50
781011 19852	BL1420-C442	1"	1"	50
781011 19853	BL1425-C442	--	1 1/4"	50
781011 19854	BL1430-C442	1 1/4"	1 1/2"	50
781011 19855	BL1440-C442	1 1/2"	--	25
781011 19856	BL1450-C442	2"	2"	25

Read safety/installation instruction sheets in packages before use. These products are designed for positioning only. No load rating.

- Can be used with 1/4"-20 and 3/8"-16 threaded rod or bridle rings.
- Fits beam flanges through 1/2" thick.
- Safety Factor of 5.
- Finish: Zinc-Plated

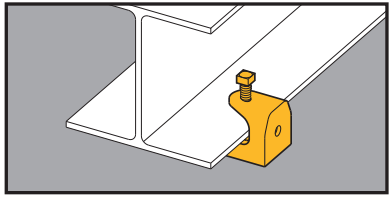

Beam Fasteners



UPC/Part Number	Catalog Number	Rod Size	Static Load Cap.	Box Qty.
781011 55333	B444-1/4	1/4"-20	150 lbs.	50
781011 55338	B444-5/16	5/16"-18	150 lbs.	50
781011 55343	B444-3/8	3/8"-16	350 lbs.	25

Read safety/installation instruction sheets in packages before use.

Beams

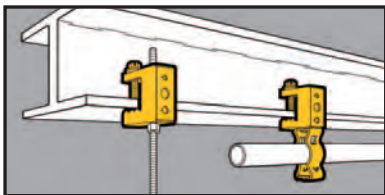

- Fits beam flanges thru 1/2" thick.
- Accepts "S" hooks, 1/4" and 3/8" threaded rod, 1/4"-20 or #10-24 threaded bridle rings.
- Supports conduit and electrical boxes.

Conduit To Beam Fasteners



UPC/Part Number	Catalog Number	Flange Thickness	Static Load Cap.	Box Qty.
781011 18275	BC1	Thru 1/2"	100 Lbs.	100

Guide-Rite™
Fastener



UPC/Part Number	Catalog Number	Conduit Size EMT & Rigid	Static Load Cap.	Box Qty.
781011 18490	BG-8-12-C2	1/2", 3/4"	100 Lbs.	100
781011 18570	BG-16-C2	1"	100 Lbs.	100
781011 18655	BG-20-C2	1 1/4"	100 Lbs.	100
781011 18700	BG-24-C2	1 1/2"	100 Lbs.	100
781011 18740	BG-32-C2	2"	100 Lbs.	100

Read safety/installation instruction sheets in packages before use.



Conduit To Beam Fasteners

Guide-Rite™
Fastener



UPC/Part Number	Catalog Number	Conduit Size EMT & Rigid	Static Load Cap.	Box Qty.
781011 18485	BG-8-12-C1	1/2", 3/4"	25 Lbs.	100
781011 18565	BG-16-C1	1"	25 Lbs.	100
781011 18650	BG-20-C1	1 1/4"	25 Lbs.	100
781011 18695	BG-24-C1	1 1/2"	25 Lbs.	50
781011 18735	BG-32-C1	2"	25 Lbs.	50



Push-Type

UPC/Part Number	Catalog Number	Conduit Size	Ultimate Static Load Cap.	Box Qty.
781011 19260	BP-8-C2	1/2" EMT	25 Lbs.	100
781011 19360	BP-12-C2	3/4" EMT 1/2" IMC, Rigid	25 Lbs.	100
781011 19455	BP-16-C2	1" EMT 3/4" IMC, Rigid	25 Lbs.	100



Push-Type

UPC/Part Number	Catalog Number	Conduit Size	Ultimate Static Load Cap.	Box Qty.
781011 19255	BP-8-C1	1/2" EMT	25 Lbs.	100
781011 19355	BP-12-C1	3/4" EMT 1/2" IMC, Rigid	25 Lbs.	100
781011 19450	BP-16-C1	1" EMT 3/4" IMC, Rigid	25 Lbs.	100

Read safety/installation instruction sheets in packages before use.

Beams

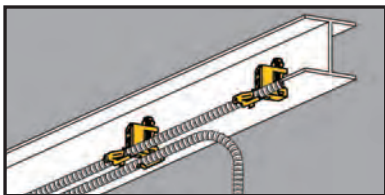

- Attaches MC, AC, sizes 14/2 through 10/3 or 3/8" FMC to beam flanges thru 1/2" thick.
- Fasteners will rotate 360°.
- Requires only a screwdriver to install.

Cable To Beam Fasteners



BX4-C2



BX4M-C2



UPC/Part Number	Catalog Number	Flange Thickness	Box Qty.
781011 01190	BX4-C2	Single Runs	100
781011 01210	BX4M-C2	Double Runs	100

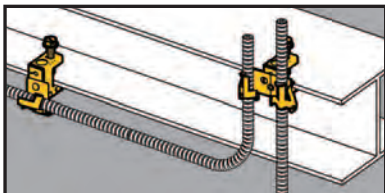

- Attaches MC, AC, sizes 14/2 through 10/3 or 3/8" FMC to beam flanges thru 1/2" thick.
- Fasteners will rotate 360°.
- Requires only a screwdriver to install.

Cable To Beam Fasteners



BX4-C1



BX4M-C1



UPC/Part Number	Catalog Number	Flange Thickness	Box Qty.
781011 01191	BX4-C1	Single Runs	100
781011 01209	BX4M-C1	Double Runs	100

Read safety/installation instruction sheets in packages before use. These products are designed for positioning only. No load rating.

- Secures and supports MC/AC cables as required by the NEC.
- Effectively organizes cables and eliminates derating issues.
- Fits beam flanges thru $\frac{1}{2}$ " thick.
- Load Capacity: 50 lbs.

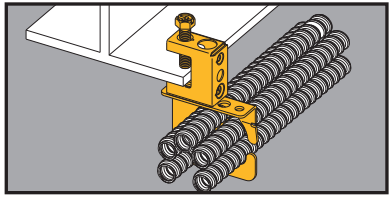

MC/AC Cable Carrier to Beam Fastener



BRC5-x-C2



UPC/Part Number	Catalog Number	Cable Diameter & Number Of Runs	Box Qty.
782051 44090	BRC51-C2	.430" to .560" Up to 4 Runs	25
782051 44091	BRC52-C2	.430" to .560" Up to 9 Runs	25
782051 44092	BRC53-C2	.560" to .690" Up to 7 Runs	25

Read safety/installation instruction sheets in packages before use.

Beams

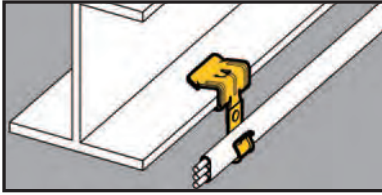

- Attaches Type NM cable to beam flanges 1/8" to 1/2" thick.
- Supports cable sizes 14/2 and 12/2 with ground wire.
- Simply installed with a hammer.

Cable To Beam Fasteners



UPC/Part Number	Catalog Number	Flange Thickness	Box Qty.
781011 03550	BRC3-E-2-4	1/8" to 1/4"	100
781011 03551	BRC3-E-5-8	5/16" to 1/2"	100
781011 03552	BRC3-E-9-12	9/16" to 3/4"	100

- New BMC3 plate is available to support multiple conduit runs.
- Riveted assembly secures electrical boxes and conduit runs to beam flanges 1/8" to 1/2" thick.
- Provides support for conduit on either side of electrical box.
- Assemblies using BMC3 plate include center conduit clamp. Additional conduit clamps may be purchased separately.

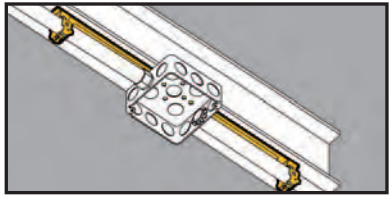

Guide-Rite™ Conduit & Box Support Fasteners



- See Ruff-IN™ brochure for pre-fab box assemblies.



UPC/Part Number	Catalog Number	Conduit Size	Flange Thickness	Box Qty.
781011 03583	BG6-S18-U24 *	3/8"	1/8" to 1/4"	25
781011 03584	BG6-S18-U58 *	3/8"	5/16" to 1/2"	25
781011 03579	BG812-S18-U24	1/2", 3/4"	1/8" to 1/4"	25
781011 03580	BG812-S18-U58	1/2", 3/4"	5/16" to 1/2"	25
781011 03581	BG16-S18-U24	1"	1/8" to 1/4"	25
781011 03582	BG16-S18-U58	1"	5/16" to 1/2"	25

Patent #4958792

With Multiple Conduit Plate

782051 52813	BG6-S18-U24-MC3 *	3/8"	1/8" to 1/4"	25
782051 52814	BG6-S18-U58-MC3 *	3/8"	5/16" to 1/2"	25
782051 52815	BG812-S18-U24-MC3	1/2", 3/4"	1/8" to 1/4"	25
782051 52816	BG812-S18-U58-MC3	1/2", 3/4"	5/16" to 1/2"	25
782051 52817	BG16-S18-U24-MC3	1"	1/8" to 1/4"	25
782051 52823	BG16-S18-U58-MC3	1"	5/16" to 1/2"	25

- * BG-6 will accept the following range $\varnothing.420 - \varnothing.675$:
14/2 thru 10/4 MC/AC cable and 5/16 or 3/8 flexible conduit

Read safety/installation instruction sheets in packages before use.

Beams

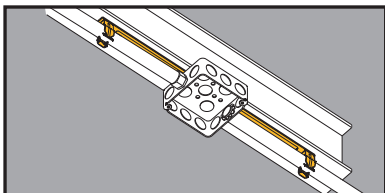

Push-Type Conduit & Box Support Fasteners

- See Ruff-IN™ brochure for pre-fab box assemblies.

- New BMC3 plate is available to support multiple conduit runs.
- Riveted assembly secures electrical boxes and conduit runs to beam flanges 1/8" to 1/2" thick.
- Provides support for conduit on either side of electrical box.
- Assemblies using BMC3 plate include center conduit clamp. Additional conduit clamps may be purchased separately.

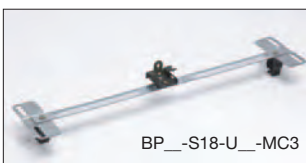

UPC/Part Number	Catalog Number	Conduit Size EMT IMC/Rigid	Flange Thickness	Box Qty.
782051 23635	BP8-S18-U24	3/8"	1/8" to 1/4"	25
782051 23638	BP8-S18-U58	3/8"	5/16" to 1/2"	25
782051 23636	BP12-S18-U24	1/2", 3/4"	1/8" to 1/4"	25
782051 23639	BP12-S18-U58	1/2", 3/4"	5/16" to 1/2"	25
782051 23637	BP16-S18-U24	1"	1/8" to 1/4"	25
782051 23640	BP16-S18-U58	1"	5/16" to 1/2"	25

With Multiple Conduit Plate

782051 52824	BP8-S18-U24-MC3	3/8"	1/8" to 1/4"	25
782051 52826	BP8-S18-U58-MC3	3/8"	5/16" to 1/2"	25
782051 52827	BP12-S18-U24-MC3	1/2", 3/4"	1/8" to 1/4"	25
782051 52828	BP12-S18-U58-MC3	1/2", 3/4"	5/16" to 1/2"	25
782051 52825	BP16-S18-U24-MC3	1"	1/8" to 1/4"	25
782051 52964	BP16-S18-U58-MC3	1"	5/16" to 1/2"	25

- Riveted assembly provides support for electrical box and cable run on either side of box.
- Cable retention tab is open for easy loading and contains cable when bent in place.
- See Ruff-IN™ brochure for pre-fab box assemblies.

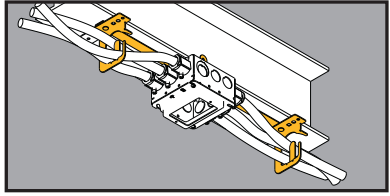

Multi-Run Cable Carrier & Box Support Fastener



UPC/Part Number	Catalog Number	Cable Size # of Runs	Flange Thickness	Box Qty.
782051 52829	BRC51-S18-U24	.43" - .56" up to 4 runs	1/8" to 1/4"	25
782051 52830	BRC51-S18-U58	.56" - .69" up to 7 runs	5/16" to 1/2"	25
782051 52834	BRC53-S18-U24	.43" - .56" up to 4 runs	1/8" to 1/4"	25
782051 52835	BRC53-S18-U58	.56" - .69" up to 7 runs	5/16" to 1/2"	25

Read safety/installation instruction sheets in packages before use.

Hangers

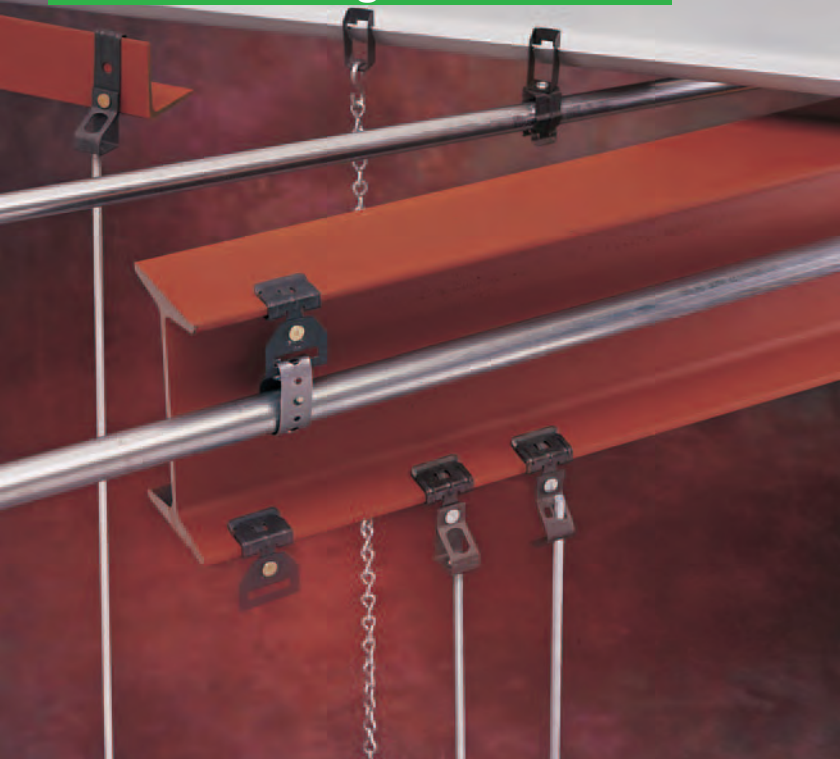

- Suspends straps thru 1 1/2" wide from beam flanges 1/8" to 3/4" thick.
- Suspends straps parallel or at right angles to beams.
- Simply installed with a hammer.
- Static Load Capacity: 200 Lbs.

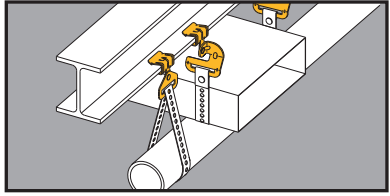

Strap Hangers

Parallel



Right Angle



UPC/Part Number	Catalog Number	Description	Flange Thickness	Box Qty.
781011 04930	BHE-1-2	Parallel	1/16" to 1/8"	100
781011 18870	BH-2-4	Parallel	1/8" to 1/4"	100
781011 18880	BH-5-8	Parallel	5/16" to 1/2"	100
781011 18890	BH-9-12	Parallel	9/16" to 3/4"	100
781011 04115	BH-1-2-R	Right Angle	1/16" to 1/8"	100
781011 18875	BH-2-4-R	Right Angle	1/8" to 1/4"	100
781011 18885	BH-5-8-R	Right Angle	5/16" to 1/2"	100
781011 18895	BH-9-12-R	Right Angle	9/16" to 3/4"	100

"Z" Purlin Hangers



BH-F12



BH-F12-R

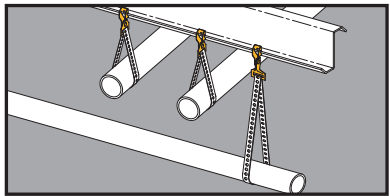

.281"Ø

BH-H7



UPC/Part Number	Catalog Number	Description	Box Qty.
781011 03385	BH-F12	Right Angle	100
781011 03384	BH-F12-R	Parallel	100
781011 19922	BH-H7	Parallel	100

Read safety/installation instruction sheets in packages before use.

Hangers

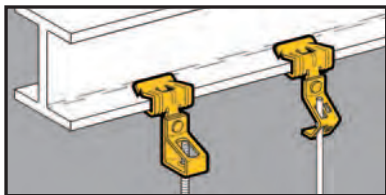

- Suspend wire or plain and threaded rod from beam flanges 1/8" to 3/4" thick.
- Simply installed with a hammer.
- Static Load Capacity: 160 Lbs.

Rod To Beam Hangers



UPC/Part Number	Catalog Number	Flange Thickness	Description	Box Qty.
781011 18900	BH1-E-2-4	1/8" - 1/4"	#8 Wire or 1/4" Plain Rod	100
781011 18905	BH1-E-5-8	5/16" - 1/2"	#8 Wire or 1/4" Plain Rod	100
781011 18910	BH1-E-9-12	9/16" - 3/4"	#8 Wire or 1/4" Plain Rod	100

UPC/Part Number	Catalog Number	Flange Thickness	Plain Rod Size	Box Qty.
781011 18940	BH2-E-2-4	1/8" - 1/4"	3/8"	100
781011 18945	BH2-E-5-8	5/16" - 1/2"	3/8"	100
781011 18950	BH2-E-9-12	9/16" - 3/4"	3/8"	100

Read safety/installation instruction sheets in packages before use.

Rod To Beam Hangers



With Thread Impression



UPC/Part Number	Catalog Number	Flange Thickness	Threaded Rod Size	Box Qty.
781011 18980	BH4-E-2-4	1/8" - 1/4"	1/4"	100
781011 18985	BH4-E-5-8	5/16" - 1/2"	1/4"	100
781011 18990	BH4-E-9-12	9/16" - 3/4"	1/4"	100
781011 19060	BH6-E-2-4	1/8" - 1/4"	3/8"	100
781011 19065	BH6-E-5-8	5/16" - 1/2"	3/8"	100
781011 19070	BH6-E-9-12	9/16" - 3/4"	3/8"	100

Note: BH4 and BH6 have thread impressions.

UPC/Part Number	Catalog Number	Flange Thickness	Threaded Rod Size	Box Qty.
781011 19020	BH5-E-2-4*	1/8" - 1/4"	1/4" or 3/8"	100
781011 19025	BH5-E-5-8*	5/16" - 1/2"	1/4" or 3/8"	100
781011 19030	BH5-E-9-12*	9/16" - 3/4"	1/4" or 3/8"	100

*Nuts Required.

Read safety/installation instruction sheets in packages before use.

Hangers

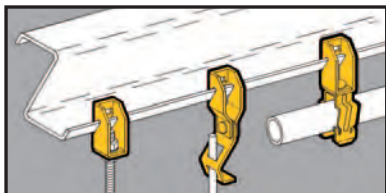

- Compensates for angle of purlin lip.
- Allows for parallel conduit runs or vertical support drops.
- Riveted fasteners will rotate 360°.
- Maximum Purlin thickness of 3/32".

“Z” Purlin Hangers

BF13



BF12



UPC/Part Number	Catalog Number	Description	Static Load Cap. Lbs.	Box Qty.
781011 18345	BF13	With 1/4" Hole	100	100
781011 18340	BF12	For “S” Hooks	100	100



Guide-Rite™
Fastener
BG Series



Push-Type
BP Series

UPC/Part Number	Catalog Number	Conduit Size EMT & Rigid	Static Load Cap. Lbs.	Box Qty.
781011 18445	BG-6-F13*	3/8"	100	100
781011 18520	BG-8-12-F13	1/2", 3/4"	100	100
781011 18590	BG-16-F13	1"	100	100
781011 18675	BG-20-F13	1 1/4"	100	50
781011 19290	BP-8-F13	1/2" EMT	25	100
781011 19390	BP-12-F13	3/4" EMT 1/2" IMC, Rigid	25	100
781011 19480	BP-16-F13	1" EMT 3/4" IMC, Rigid	25	50

* BG-6 will accept the following range $\varnothing.420 - \varnothing.675$:
14/2 thru 10/4 MC/AC cable and 5/16 or 3/8 flexible conduit

Read safety/installation instruction sheets in packages before use.



Universal Beam Fasteners



UPC/Part Number	Catalog Number	Description	Static Load Cap.	Box Qty.
781011 18920	BH1-F12	#8 Wire or 1/4" Plain Rod	100 Lbs.	100
781011 18960	BH2-F12	3/8" Plain Rod	100 Lbs.	100



UPC/Part Number	Catalog Number	Threaded Rod Size	Static Load Cap.	Box Qty.
781011 19000	BH4-F12	1/4"	100 Lbs.	100
781011 19080	BH6-F12	3/8"	100 Lbs.	100
781011 19040	BH5-F12*	1/4" & 3/8"	100 Lbs.	100

*Nuts Required.

Note: BH4 and BH6 have thread impressions.

- Compensates for angle of purlin lip.
- Attaches MC, AC, sizes 14/2 through 10/3 or 3/8" FMC to "Z" Purlins up to 3/32" thick.
- Fastener will rotate 360°.
- Simply installed with a hammer.

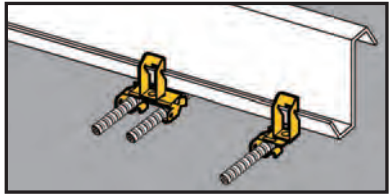

Cable To "Z" Purlin Flange Hangers



BX4-F13



BX4M-F13



UPC/Part Number	Catalog Number	Description	Flange Thickness	Box Qty.
781011 01188	BX4-F13	Single Runs	Thru 3/32"	100
781011 01204	BX4M-F13	Double Runs	Thru 3/32"	100

Read safety/installation instruction sheets in packages before use.

Hangers

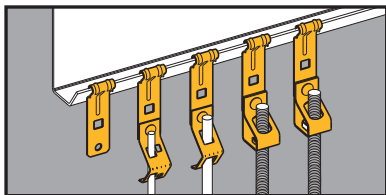

- Suspend wire, or plain and threaded rod from "Z" Purlins.
- Fits "Z" Purlins 1/16" to 1/4" thick.
- Simply installed with a hammer.
- Static Load Capacity: 160 Lbs.

"Z" Purlin Flange Hangers



UPC/Part Number	Catalog Number	Description	Box Qty.
781011 04271	BF4	For "S" Hooks, Bolting Straps and Wrap Wire	100



UPC/Part Number	Catalog Number	Description	Box Qty.
781011 04164	BT3	Installation Tool for BF4 Hangers (Insert 1/2" Rigid conduit for installation)	1

Read safety/installation instruction sheets in packages before use.

“Z” Purlin Flange Hangers



UPC/Part Number	Catalog Number	Description	Box Qty.
781011 04274	BH1-F4	#8 Wire or 1/4" Plain Rod	100
781011 04276	BH2-F4	3/8" Plain Rod	100



UPC/Part Number	Catalog Number	Threaded Rod Size	Box Qty.
781011 04286	BH4-F4	1/4"	100
781011 04280	BH6-F4	3/8"	100
781011 04278	BH5-F4*	1/4" - 3/8"	100

* Nuts required.

Note: BH4 & BH6 have thread impressions.

Read safety/installation instruction sheets in packages before use.

Hangers

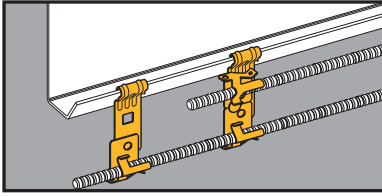

- Attaches MC, AC, sizes 14/2 thru 10/3 or 3/8" FMC to "Z" Purlins.
- Fits "Z" Purlin flanges 1/16" to 1/4" thick.
- Fastener will rotate 360°.

Cable To "Z" Purlin Flange Hangers



UPC/Part Number	Catalog Number	Description	Box Qty.
781011 04931	BX4-F4	Single Runs	100

These products are designed for positioning only. No load rating.



UPC/Part Number	Catalog Number	Description	Box Qty.
781011 04932	BX4M-F4	Double Runs	100

This product is designed for positioning only. No load rating.

Read safety/installation instruction sheets in packages before use.

- Secures and supports multiple runs of MC/AC cable to 'Z' purlins.
- Effectively organizes cables and eliminates derating issues.
- Retention tab is open for easy loading and unloading and contains cables when bent in place.
- Load Capacity: 50 lbs.

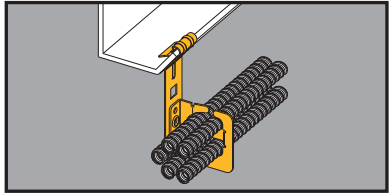

MC/AC Cable Carrier to 'Z' Purlin Flange Hanger



UPC/Part Number	Catalog Number	Cable Diameter & Number Of Runs	Box Qty.
782051 44084	BRC51-F4	.430" to .560" Up to 4 Runs	25
782051 44085	BRC52-F4	.430" to .560" Up to 9 Runs	25
782051 44086	BRC53-F4	.560" to .690" Up to 7 Runs	25

Read safety/installation instruction sheets in packages before use.

Hangers

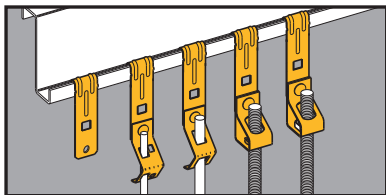

- Suspend wire, or plain and threaded rod from vertical flanges.
- Fits vertical flanges 1/16" to 1/4" thick.
- Static Load Capacity: 160 Lbs.

Vertical Flange Hangers



UPC/Part Number	Catalog Number	Description	Box Qty.
781011 04270	BF3	For "S" Hooks, Bolting Straps and Wrap Wire	100



UPC/Part Number	Catalog Number	Description	Box Qty.
781011 04164	BT3	Installation Tool for BF3 Hangers (Insert 1/2" Rigid conduit for installation)	1

Read safety/installation instruction sheets in packages before use.

Vertical Flange Hangers



UPC/Part Number	Catalog Number	Description	Box Qty.
781011 04273	BH1-F3	#8 Wire or 1/4" Plain Rod	100
781011 04275	BH2-F3	3/8" Plain Rod	100



4 1/4"
Overall Height

UPC/Part Number	Catalog Number	Threaded Rod Size	Box Qty.
781011 04285	BH4-F3	1/4"	100
781011 04279	BH6-F3	3/8"	100
781011 04933	BH5-F3*	1/4", 3/8"	100

* Nuts required.

Read safety/installation instruction sheets in packages before use.

Hangers

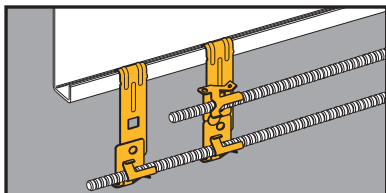

- Attaches MC, AC, sizes 14/2 through 10/3 or 3/8" flexible conduit FMC to vertical flanges 1/16" to 1/4" thick.
- Fastener will rotate 360°.
- Simply installed with a hammer.

Cable To Vertical Flange Hangers



UPC/Part Number	Catalog Number	Description	Box Qty.
781011 04281	BX4-F3	Single Runs	100

This product is designed for positioning only. No load rating.



UPC/Part Number	Catalog Number	Description	Box Qty.
781011 04282	BX4M-F3	Double Runs	100

This product is designed for positioning only. No load rating.

Read safety/installation instruction sheets in packages before use.

- Secures and supports multiple runs of MC/AC cable to vertical flanges.
- Effectively organizes cables and eliminates derating issues.
- Retention tab is open for easy loading and unloading and contains cables when bent in place.
- Load Capacity: 50 lbs.

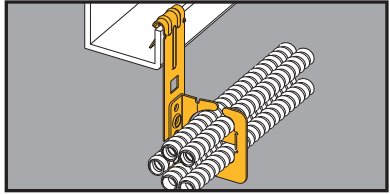

MC/AC Cable Carrier To Vertical Flange Hanger



UPC/Part Number	Catalog Number	Cable Diameter & Number Of Runs	Box Qty.
782051 44081	BRC51-F3	.430" to .560" Up to 4 Runs	25
782051 44082	BRC52-F3	.430" to .560" Up to 9 Runs	25
782051 44083	BRC53-F3	.560" to .690" Up to 7 Runs	25

Read safety/installation instruction sheets in packages before use.

Hangers

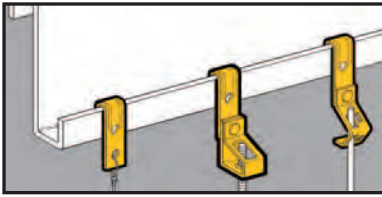

- Suspend wire, or plain or threaded rod from vertical flanges.
- Fits vertical flanges 1/16" to 1/4" thick.
- Static Load Capacity: 160 Lbs.

Vertical Flange Hangers



UPC/Part Number	Catalog Number	Flange Thickness	Description	Box Qty.
781011 18310	BF1	1/16" - 5/32"	For "S" Hooks, Bolting Straps and Wrap Wire	100
781011 18315	BF2	5/32" - 1/4"	For "S" Hooks, Bolting Straps and Wrap Wire	100



UPC/Part Number	Catalog Number	Flange Thickness	Description	Box Qty.
781011 18915	BH1-F1	1/16" - 5/32"	#8 Wire or 1/4" Plain Rod	100
781011 18925	BH1-F2	5/32" - 1/4"	#8 Wire or 1/4" Plain Rod	100



Vertical Flange Hangers



UPC/Part Number	Catalog Number	Flange Thickness	Plain Rod Size	Box Qty.
781011 18955	BH2-F1	1/16" to 5/32"	3/8"	100
781011 18965	BH2-F2	5/32" to 1/4"	3/8"	100



UPC/Part Number	Catalog Number	Flange Thickness	Threaded Rod Size	Box Qty.
781011 18995	BH4-F1	1/16" to 5/32"	1/4"	100
781011 19075	BH6-F1	1/16" to 5/32"	3/8"	100
781011 19005	BH4-F2	5/32" to 1/4"	1/4"	100
781011 19085	BH6-F2	5/32" to 1/4"	3/8"	100

UPC/Part Number	Catalog Number	Flange Thickness	Plain Rod Size	Box Qty.
781011 19035	BH5-F1*	1/16" to 5/32"	1/4", 3/8"	100
781011 19045	BH5-F2*	5/32" to 1/4"	1/4", 3/8"	100

* Nuts required.

Read safety/installation instruction sheets in packages before use.

Hangers

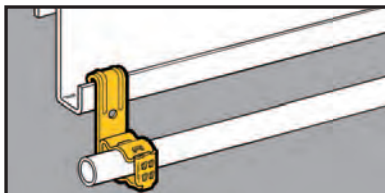

- Supports $\frac{3}{8}$ " to 1" conduit from vertical flanges $\frac{1}{16}$ " to $\frac{1}{4}$ " thick.
- Patented **Guide-Rite™** feature ensures fastener will close and lock every time.
- Simply installed with a hammer and pliers.
- Static Load Capacity: 25 Lbs.

Conduit To Vertical Flange Hangers



Guide-Rite™
Fastener



UPC/Part Number	Catalog Number	Conduit Size	Flange Thickness	Box Qty.
781011 19957	BG-6-F1*	$\frac{3}{8}$ "	$\frac{1}{16}$ " - $\frac{5}{32}$ "	100
781011 19960	BG-6-F2*	$\frac{3}{8}$ "	$\frac{5}{32}$ " - $\frac{1}{4}$ "	100
781011 19958	BG-8-12-F1	$\frac{1}{2}$ " & $\frac{3}{4}$ "	$\frac{1}{16}$ " - $\frac{5}{32}$ "	100
781011 19961	BG-8-12-F2	$\frac{1}{2}$ " & $\frac{3}{4}$ "	$\frac{5}{32}$ " - $\frac{1}{4}$ "	100
781011 19959	BG-16-F1	1"	$\frac{1}{16}$ " - $\frac{5}{32}$ "	100
781011 19962	BG-16-F2	1"	$\frac{5}{32}$ " - $\frac{1}{4}$ "	100

Patent #4958792

* BG-6 will accept the following range $\varnothing.420$ - $\varnothing.675$:
14/2 thru 10/4 MC/AC cable and $\frac{5}{16}$ or $\frac{3}{8}$ flexible conduit



UPC/Part Number	Catalog Number	Wire Size	Flange Thickness	Box Qty.
781011 03556	BRC3-F1	14/2 & 12/2 With Ground	$\frac{1}{16}$ " - $\frac{5}{32}$ "	100
781011 03557	BRC3-F2	14/2 & 12/2 With Ground	$\frac{5}{32}$ " - $\frac{1}{4}$ "	100

Note: These products are designed for positioning only. No load rating.

Read safety/installation instruction sheets in packages before use.

- BH1, BH2: Supports wire or plain rod.
- BH7, BH8: For wire or chain drop from concrete or wood.
- BH4, BH5, BH6 supports 1/4" or 3/8" threaded rod.
- Static Load Capacity: 160 Lbs.



Components

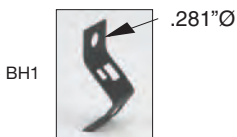

BH1

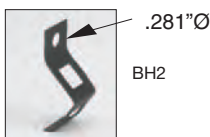

BH2



UPC/Part Number	Catalog Number	Description	Box Qty.
781011 18800	BH1	#8 Wire or 1/4" Plain Rod	100
781011 18805	BH2	For 3/8" Plain Rod	100



BH4
BH6

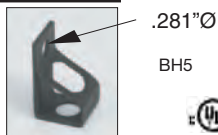

BH5



UPC/Part Number	Catalog Number	Description	Box Qty.
781011 18815	BH4	For 1/4" Threaded Rod	100
781011 18825	BH6	For 3/8" Threaded Rod	100
781011 18820	BH5*	For 1/4" & 3/8" Threaded Rod	100

* Nuts required.

Note: BH4 & BH6 have thread impressions.



BH7



BH8



UPC/Part Number	Catalog Number	Description	Box Qty.
781011 18830	BH7	Angle Bracket With .281"Ø Holes	100
781011 18835	BH7-6	Angle Bracket With .281"Ø & .406"Ø Holes	100
781011 18840	BH8	Offset Bracket With .281"Ø Holes	100
781011 18845	BH8-6	Offset Bracket With .281"Ø & .406"Ø Holes	100

Read safety/installation instruction sheets in packages before use.

Hangers

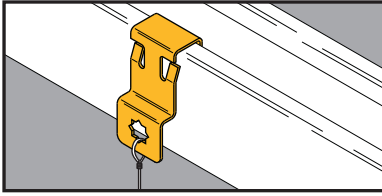

- The BSC4 Series provides a simple, snap-on attachment to strut, eliminating the need for tools and/or drilling during installation.
- Great for retrofit and add-on applications.
- BSC4 provides a 1/4" mounting hole along the side of a standard strut member.
- Riveted assemblies allow for easy attachment of conduit, cable and rod.

Strut Fasteners



UPC/Part Number	Catalog Number	Description	Load Capacity	Box Qty.
782051 46573	BSC4	Strut Clip	60 lbs.	100



UPC/Part Number	Catalog Number	Rod Size	Load Capacity	Box Qty.
782051 46581	BH4-SC4	1/4"-20	60 lbs.	100
782051 46582	BH6-SC4	3/8"-20	60 lbs.	100



BG-SC4



BP-SC4



BL14-SC4

UPC/Part Number	Catalog Number	Conduit Size	Load Capacity	Box Qty.
782051 46577	BG6-SC4	MC/AC & 3/8"	25 lbs.	100
782051 46578	BG812-SC4	1/2" & 3/4"	25 lbs.	100
782051 46579	BP8-SC4	1/2"	15 lbs.	100
782051 46580	BP12-SC4	3/4"	15 lbs.	100
782051 46588	BL1400-SC4	1/2"	60 lbs.	100
782051 46589	BL1410-SC4	3/4"	60 lbs.	100
782051 46590	BL1420-SC4	1"	60 lbs.	100



BX4M-SC4



BRC5-SC4

UPC/Part Number	Catalog Number	Cable Size Runs	Load Capacity	Box Qty.
782051 46584	BX4M-SC4	14/2 - 10/3 up to 2 runs	--	100
782051 46585	BRC51-SC4	.43" - .56" up to 4 runs	50 lbs.	100
782051 46586	BRC52-SC4	.43" - .56" up to 9 runs	50 lbs.	100
782051 46587	BRC53-SC4	.56" - .69" up to 7 runs	50 lbs.	100

Read safety/installation instruction sheets in packages before use.

Hangers

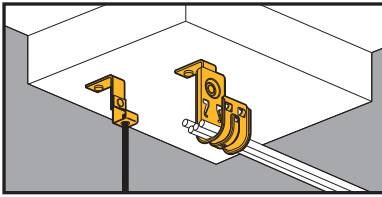

- Special support bracket allows clearance for powder actuated tools.
- Exclusive 1 1/4" drive pin now pre-installed.
- Pins rated for concrete up to 4000 psi.
- Static Load Capacity: 30 Lbs. unless specified. Limited by fastener assembly. Pin rating must be considered before installation.

Drive Pin Fasteners



BPNA



BCH21-PNA
BCH32-PNA



BH-PNA



BH1-PNA
BH2-PNA

UPC/Part Number	Catalog Number	Description	Box Qty.
782051 25583	BPNA	Angle Bracket	100
782051 28090	BCH12-PNA	3/4" Cable Hook	100
782051 25584	BCH21-PNA	1 5/16" Cable Hook	50
782051 25586	BCH32-PNA	2" Cable Hook	50
782051 25588	BCH64-PNAB	4" Cable Hook	25
782051 25611	BH-PNA	Strap Hanger Cable Hook	100
782051 25593	BH1-PNA	#8 Wire or 1/4" Plain Rod	100
782051 25596	BH2-PNA	3/8" Plain Rod	100

Read safety/installation instruction sheets in packages before use.

Drive Pin Fasteners



BH_PNA



BG_PNA



BP_PNA



BL14_PNA



BX4-PNA



BX4M-PNA

UPC/Part Number	Catalog Number	Description	Box Qty.
782051 25604	BH4-PNA*	1/4" Threaded Rod	100
782051 25606	BH6-PNA*	3/8" Threaded Rod	100
782051 25605	BH5-PNA**	1/4" or 3/8" Threaded Rod	100
782051 25613	BG6-PNA***	3/8" Conduit	100
782051 25615	BG8-12-PNA	1/2" & 3/4" Conduit	100
782051 25616	BG16-PNA	1" Conduit	100
782051 25623	BP8-PNA	1/2" EMT	100
782051 25624	BP12-PNA	3/4" EMT	100
782051 25630	BP16-PNA	1" EMT	100
782051 25620	BL1400-PNA	1/2" Conduit	100
782051 25621	BL1410-PNA	3/4" Conduit	100
782051 25622	BL1420-PNA	1" Conduit	100
782051 25590	BX4-PNA	Single Run MC, AC or FMC	100
782051 25591	BX4M-PNA	Double Run MC, AC or FMC	100

* With threaded impressions. ** Nuts required.

*** BG-6 will accept the following range \varnothing .420 - \varnothing .675:
1 1/2 thru 1 3/4 MC/AC cable and 5/16 or 3/8 flexible conduit

Read safety/installation instruction sheets in packages before use.

Hangers

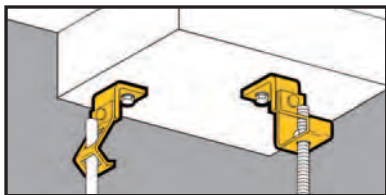

- Suspend plain or threaded rod and drop wire from ceilings, walls, concrete beams, joists and laminated wood beams.
- Clearance hole for 1/4" bolt provided.
- Static Load Capacity: 160 Lbs.

Angle Bracket Fasteners



UPC/Part Number	Catalog Number	Description	Box Qty.
781011 18930	BH1-H7	#8 Wire or 1/4" Plain Rod	100
781011 18970	BH2-H7	3/8" Plain Rod	100



UPC/Part Number	Catalog Number	Threaded Rod Size	Box Qty.
781011 19010	BH4-H7	1/4"-20	100
781011 19090	BH6-H7	3/8"-16	100
781011 19050	BH5-H7*	1/4"-20 or 3/8"-16	100

* Nuts required.

Note: BH4 & BH6 have thread impressions.

- Suspend plain or threaded rod and drop wire from ceilings, walls, beams, and joists.
- Clearance hole for 1/4" bolt provided.
- Static Load Capacity: 160 Lbs.

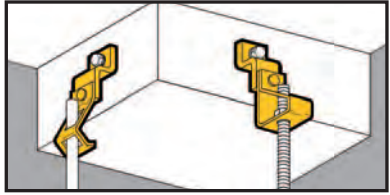

Offset Bracket Fasteners



UPC/Part Number	Catalog Number	Description	Box Qty.
781011 18935	BH1-H8	#8 Wire or 1/4" Plain Rod	100
781011 18975	BH2-H8	3/8" Plain Rod	100



UPC/Part Number	Catalog Number	Threaded Rod Size	Box Qty.
781011 19015	BH4-H8	1/4"-20	100
781011 19095	BH6-H8	3/8"-16	100
781011 19055	BH5-H8*	1/4"-20 or 3/8"-16	100

* Nuts required.

Note: BH4 & BH6 have thread impressions.

Read safety/installation instruction sheets in packages before use.

Hangers

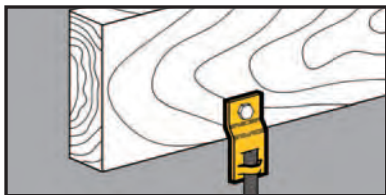

- Suspend $\frac{3}{8}$ " threaded rod from ceilings, walls, beams, and joists.
- Finish: Zinc Plated
- Static Load Capacity: 610 Lbs.

Threaded Rod Hangers

.406"Ø



UPC/Part Number	Catalog Number	Description	Box Qty.
781011 01661	B3223- $\frac{3}{8}$	Offset Eye Socket	100

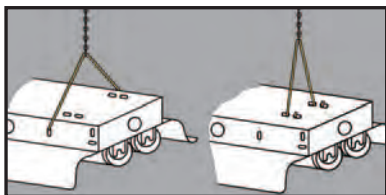

- For hanging industrial class fluorescent lighting fixtures.
- Use with Jack Chain and "S" Hooks.
- Static Load Capacity: 29 Lbs.
- Finish: Zinc Plated

Light Fixture Hangers



BH15



BH16

UPC/Part Number	Catalog Number	Description	Box Qty.
781011 01236	BH15	Side Mount Fluorescent Light Fixture Hanger	100
781011 01237	BH16	Top Mount Fluorescent Light Fixture Hanger	100

Read safety/installation instruction sheets in packages before use.

- For support of light fixtures and signs.
- Static Load Capacity: 29 Lbs.
- Finish: Zinc Plated

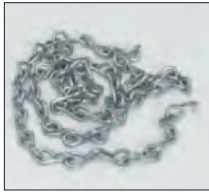
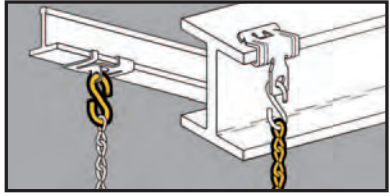

BH9
BH9-10



BH10

Jack Chain & "S" Hooks

UPC/Part Number	Catalog Number	Description	Box Qty.
781011 18850	BH9	#12 Single Jack Chain	100 ft.
781011 02901	BH9-10	#10 Single Jack Chain	100 ft.
781011 18855	BH10	#11 "S" Hook	50

- Allows centering on all open web joists with round bottom chords.
- Static Load Capacity:
BH11 = 200 Lbs.
BH12 = 100 Lbs.

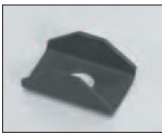
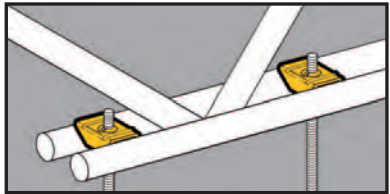

BH11

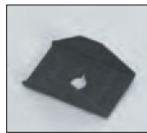

BH12



Wedge Hangers

UPC/Part Number	Catalog Number	Description	Box Qty.
781011 18860	BH11	With 3/8" Clearance Hole	100
781011 18865	BH12	With 1/4"-20 Thread Impression	100

Read safety/installation instruction sheets in packages before use.

Lathers Channel

Lathers Channel

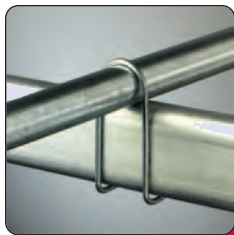

Lathers Channel

- For fastening standard lathers channels to wires and plain rods.
- Fits 1/2" through 5/8" channel flange widths.
- Accepted for use by the City of New York Department of Buildings. MEA 383-91-M.
- Static Load Capacity: 160 Lbs.

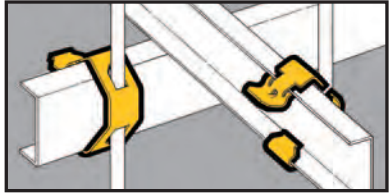

Lathers Channel

Rod & Wire Fasteners



BL-24-2



BL-24-4

Side Mounts



UPC/Part Number	Catalog Number	Channel Size	Rod/Wire Size	Box Qty.
781011 19882	BL-24-2	1 1/2"	#8 Wire	100
781011 19883	BL-24-4	1 1/2"	1/4" Rod	100
781011 19885	BL-32-4	2"	1/4" Rod	100



Center Mount



UPC/Part Number	Catalog Number	Channel Size	Rod/Wire Size	Box Qty.
781011 19884	BL-24-4C	1 1/2"	1/4" Rod	100

Read safety/installation instruction sheets in packages before use.

Lathers Channel

Lathers Channel

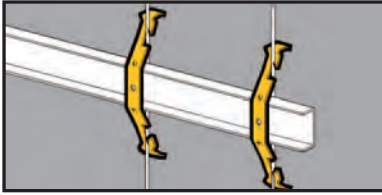

- For fastening standard 1 1/2" lathers channel to wires and plain rods.
- Wire size: #8 and #9.
- Rod size: 3/16" and 1/4".
- Fits 9/16" thru 5/8" channel flange widths.
- Static Load Capacity: 100 Lbs.

Rod & Wire Fasteners



UPC/Part Number	Catalog Number	Description	Box Qty.
781011 19880	BL1	Channel to Rod & Wire	100

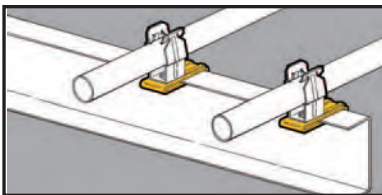

- Serves as a mounting base for conduit fasteners or electrical boxes.
- Attaches to either flange of lathers channel with 1/4"-20 screw (furnished).
- Fits channel flange widths up to 5/8".

Flange Fasteners



UPC/Part Number	Catalog Number	Description	Box Qty.
781011 19881	BL2	Flange Fastener with Screw	100

Note: This product is designed for positioning only. No load rating.

Read safety/installation instruction sheets in packages before use.

Lathers Channel

- Fastens EMT to 1 1/2" lathers channel.
- Static Load Capacity: 50 Lbs.
- Finish: Zinc Plated

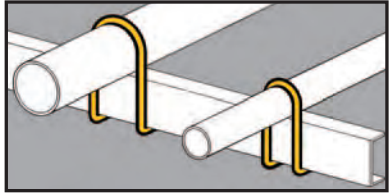

Lathers Channel

Conduit Fasteners

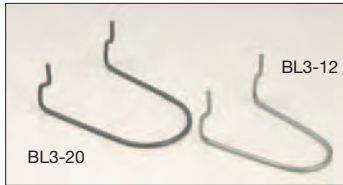

UPC/Part Number	Catalog Number	EMT Conduit Size	Box Qty.
781011 19902	BL3-8	1/2"	100
781011 19903	BL3-12	3/4"	100
781011 19904	BL3-16	1"	100
781011 19905	BL3-20	1 1/4"	100

Read safety/installation instruction sheets in packages before use.

Communication & Low Voltage

Communication & Low Voltage

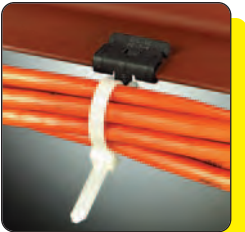
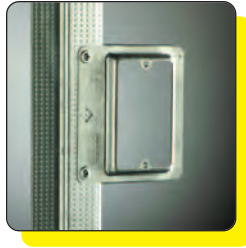
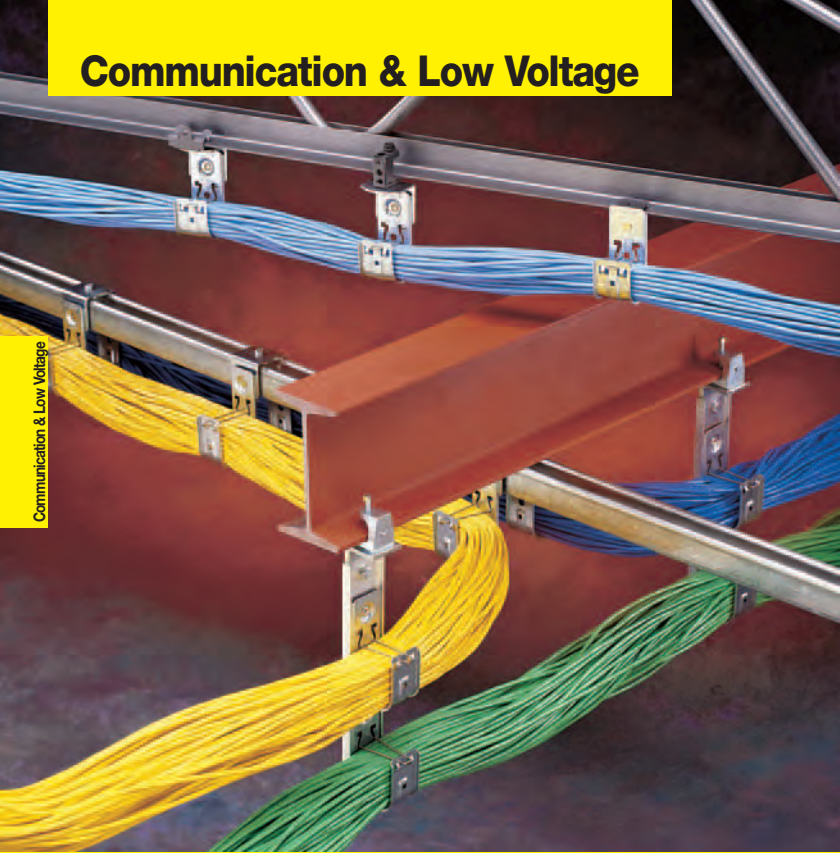

Communication & Low Voltage

- Supports cable ties up to $\frac{9}{32}$ " wide from flanges $\frac{1}{16}$ " to $\frac{3}{4}$ " thick.
- 8" cable tie included.
- Simply installed with a hammer.

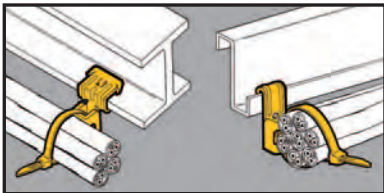

Cable Fasteners



BE Series



BF Series

UPC/Part Number	Catalog Number	Description	Box Qty.
781011 19970	BE-2-4-CT2	$\frac{1}{8}$ " to $\frac{1}{4}$ "	100
781011 19971	BE-5-8-CT2	$\frac{5}{16}$ " to $\frac{1}{2}$ "	100
781011 19972	BE-9-12-CT2	$\frac{9}{16}$ " to $\frac{3}{4}$ "	100
781011 19968	BF1-CT2	$\frac{1}{16}$ " to $\frac{5}{32}$ "	100
781011 19969	BF2-CT2	$\frac{5}{32}$ " to $\frac{1}{4}$ "	100

- Supports cable ties up to $\frac{9}{32}$ " wide from drop wires.
- 8" cable tie included.

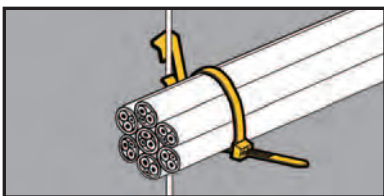

Cable Fasteners



UPC/Part Number	Catalog Number	Description	Box Qty.
781011 02866	BW2-CT2	#12 wire thru $\frac{1}{4}$ " plain or threaded rod	100
781011 95603	BW6-CT2	$\frac{3}{8}$ " plain or threaded rod	100

Read safety/installation instruction sheets in packages before use. These products are designed for positioning only. No load rating.

Communication & Low Voltage

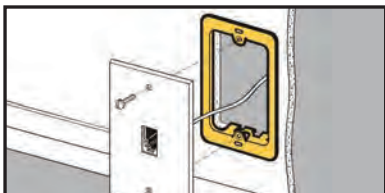

- Replaces electrical box in Class 2 low voltage installations.
- Provides attachment base for low voltage outlets.
- Accepts Decora®* style cover plates.
- Maximum 1 1/4" drywall thickness.
- Finish: Pre-galvanized

Cover Plate Mounting Brackets

Communication & Low Voltage



BB10



BB10-2



BB10-3



BB10-4



UPC/Part Number	Catalog Number	Description	Box Qty.
781011 18150	BB10	Single Gang Bracket	50
781011 18152	BB10-2	Mounts 2 Single Plates	10
781011 19878	BB10-3	Mounts 3 Single Plates	10
781011 19879	BB10-4	Mounts 4 Single Plates	10

Patent # Re.33305



UPC/Part Number	Catalog Number	Description	Box Qty.
781011 18130	BB20	Double Gang Bracket	10

Patent # Re.33305

* Decora® is a registered trademark of Leviton Corporation.

Read safety/installation instruction sheets in packages before use. These products are designed for positioning only. No load rating.

Communication & Low Voltage

- Replaces electrical box in Class 2 low voltage installations.
- Provides attachment base for low voltage outlets.
- Maximum 1 1/4" drywall thickness.
- Finish: Pre-galvanized

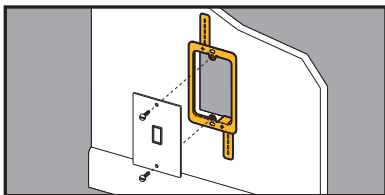

Cover Plate Mounting Bracket



BB10L



BB20L



UPC/Part Number	Catalog Number	Description	Box Qty.
781011 90895	BB10L	Single Gang Bracket	50
781011 90896	BB20L	Double Gang Bracket	50

- Provides attachment base for low voltage outlets.
- Replaces electrical box in Class 2 low voltage installations.
- Design eliminates sharp edges from bracket.
- Maximum wall thickness: 3/4"

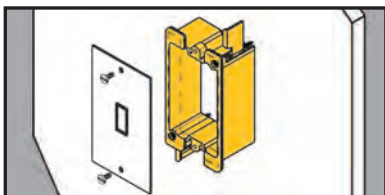

Plastic Cover Plate Mounting Bracket



UPC/Part Number	Catalog Number	Description	Box Qty.
782051 39235	BB10P	Single Gang Bracket	50

Read safety/installation instruction sheets in packages before use. These products are designed for positioning only. No load rating.

Communication & Low Voltage

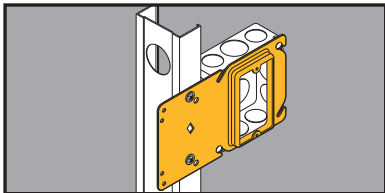

- Uni-Mount™ offers a secure box support for 4" square boxes and features a built-in plaster ring.
- Rigid bracket design eliminates the need for far-side support.
- Replaces electrical boxes in Class 2 low voltage installations.
- Guide tabs ensure consistent alignment on studs.
- Finish: Pre-galvanized

Uni-Mount™ Box Support/Cover Plate Mounting Brackets

Communication & Low Voltage



Single Gang



UPC/Part Number	Catalog Number	Description	Box Qty.
782051 22768	BB40-08	1/2" Raise	50
782051 22771	BB40-10	5/8" Raise	50
782051 22772	BB40-12	3/4" Raise	50



Double Gang



UPC/Part Number	Catalog Number	Description	Box Qty.
782051 22773	BB45-08	1/2" Raise	50
782051 22774	BB45-10	5/8" Raise	50
782051 22775	BB45-12	3/4" Raise	50

Read safety/installation instruction sheets in packages before use. These products are designed for positioning only. No load rating.

Communication & Low Voltage

- Locates communication outlets before drywall is installed.
- Replaces electrical box in Class 2 low voltage installations.
- For 1/2" and 5/8" drywall applications.
- Finish: Pre-galvanized

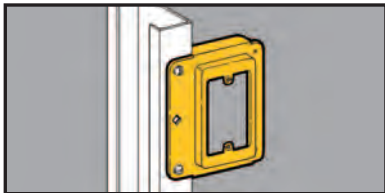

Cover Plate Mounting Bracket

Communication & Low Voltage



UPC/Part Number	Catalog Number	Description	Box Qty.
781011 19873	BB15	Single Gang Stud Bracket	25

Read safety/installation instruction sheets in packages before use. These products are designed for positioning only. No load rating.

Communication & Low Voltage

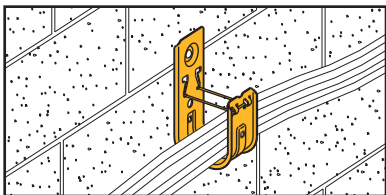

- Supports Cat. 5/5e/6/6A fiber optic, innerduct and low voltage cabling requirements.
- Qwik-Latch™ cable retainers included with hooks.
- Static Load Capacity: 30 Lbs.
- Finish: Pre-Galvanized

Cable Hooks

Communication & Low Voltage

BCH12



Open



Closed



BCH21



BCH32



BCH64



UPC/Part Number	Catalog Number	Hook Size	Capacity Up To	Box Qty.
782051 28060	BCH12	3/4"	16 4-Pair UTP Cat 5e or 2-Strand Fiber Optic Cable or 10 CAT6	50
781011 04713	BCH21	15/16"	50 4-Pair UTP Cat 5e or 2-Strand Fiber Optic Cable or 32 CAT6	50
781011 04717	BCH32	2"	80 4-Pair UTP Cat 5e or 2-Strand Fiber Optic Cable or 50 CAT6	50
781011 04721	BCH64	4"	300 4-Pair UTP Cat 5e or 2-Strand Fiber Optic Cable or 185 CAT6	25

Patent #5961081

For special finish colors see page 151

(See pages 234-235 for technical data.)

Read safety/installation instruction sheets in packages before use.



Painted Cable Hooks

- Powder coated cable hooks are available in a range of colors to help meet your cable identification requirements.
- Standard riveted assemblies are available with painted cable hooks.
- Part numbers can be made by adding the paint color suffix after the cable hook part number.
- Minimum order quantity 500 pieces.
- Standard lead time is 5-10 working days.

Bright White - BW
 Brown - BR
 Computer White - CW
 Equipment Blue - BL
 Flat Black - FB

Green - GR
 Orange - OR
 Regal Red - RR
 Safety Yellow - YL
 Telcom Gray - TG

Part # Example:
 Painted Cable Hook Part Number - BCH32BW
 Painted Cable Hook Assembly - BCH32BW-U24

- Exclusive Qwik-Latch™ retainers are included on all cable hook purchases.
- Provides secure containment of cables and offers quick open/close feature to add or remove cables.
- Finish: Pre-galvanized

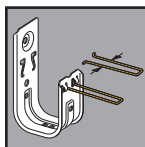

Replacement Cable Retainers

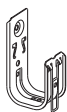

Retainer
 in open
 position

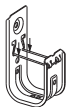

Push
 retainer
 down to
 lock

UPC/Part Number	Catalog Number	Cable Retainer For Hook Size	Box Qty.
781011 04847	BCHR21	15/16"	50
781011 04848	BCHR32	2"	50
781011 04849	BCHR64	4"	50

Patent #5961081

Read safety/installation instruction sheets in packages before use.

Communication & Low Voltage

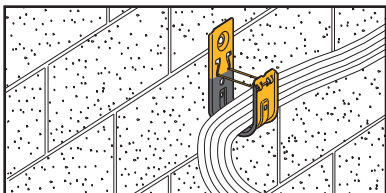

- Xylan® coating provides smooth frictionless surface for cable pulling.
- Great for use in corners, drop-outs or direction change.
- X-Hook has lower coefficient of friction than Teflon®.
- Qwik-Latch cable retainer included with each hook.
- Static Load Capacity: 30 Lbs.

X-Hook Low Friction Cable Hooks

Communication & Low Voltage



BCH64X

New Xylan® coating reduces cable friction. Ideal for pulling cable.



Cable rollers are too expensive and require installation and removal.

UPC/Part Number	Catalog Number	Hook Size	Capacity	Box Qty.
782051 29940	BCH21X	15/16"	50 4-Pair UTP Cat 5e or 2-Strand Fiber Optic Cable or 32 CAT6	50
782051 29941	BCH32X	2"	80 4-Pair UTP Cat 5e or 2-Strand Fiber Optic Cable or 50 CAT6	50
782051 29942	BCH64X	4"	300 4-Pair UTP Cat 5e or 2-Strand Fiber Optic Cable or 185 CAT6	25

Note: For cable hook assemblies with X-Hooks add an X to the part number.

Example: BCH32X-U-2-4

(See pages 234-235 for technical data.)

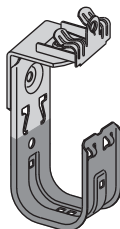

Xylan® is a registered trademark used by Whitford Corporation
Teflon® is a registered trademark used by DuPont®

Read safety/installation instruction sheets in packages before use.

Communication & Low Voltage

- .505" diameter hole designed to support cable from $\frac{3}{8}$ " or $\frac{1}{2}$ " threaded rod.
- Allows back-to-back and multi-tier installations.
- Qwik-Latch™ cable retainer included with each hook.
- Static Load Capacity: 30 Lbs.
- Finish: Pre-galvanized

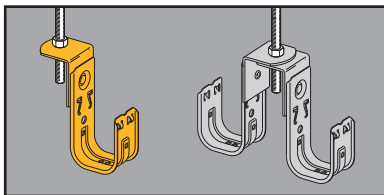

Cable To ATR Fasteners



Communication & Low Voltage

UPC/Part Number	Catalog Number	Hook Size	Hole Size	Box Qty.
781011 04725	BCH21-AB	1 $\frac{5}{16}$ "	.505" Diameter	50
781011 04729	BCH32-AB	2"	.505" Diameter	50
781011 04732	BCH64-AB	4"	.505" Diameter	25

- Designed for direct attachment to structures.
- Supports cable from $\frac{1}{4}$ " threaded rod.
- .265" diameter hole accepts anchors, screws or common nails.
- Qwik-Latch cable retainer included with each hook.
- Static Load Capacity: 30 Lbs.
- Finish: Pre-galvanized

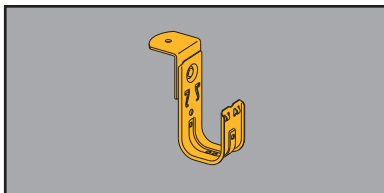

Angle Bracket Cable Fasteners



UPC/Part Number	Catalog Number	Hook Size	Hole Size	Box Qty.
782051 28089	BCH12-RB	$\frac{3}{4}$ "	.265" Diameter	50
781011 04735	BCH21-RB	1 $\frac{5}{16}$ "	.265" Diameter	50
781011 04738	BCH32-RB	2"	.265" Diameter	50
781011 04742	BCH64-RB	4"	.265" Diameter	25

(See pages 234-235 for technical data.)

Read safety/installation instruction sheets in packages before use.

Communication & Low Voltage

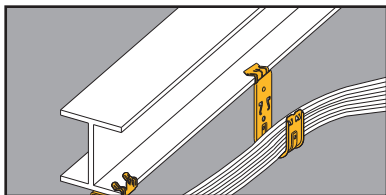

- Permits fast and easy installation on beam flanges.
- Qwik-Latch™ cable retainer included with each hook.
- Static Load Capacity: 30 Lbs.
- Finish: Pre-galvanized

Cable To Beam Fasteners



UPC/Part Number	Catalog Number	Hook Size	Flange Thickness	Box Qty.
782051 28067	BCH12-E-2-4	3/4"	1/8" to 1/4"	50
782051 28072	BCH12-E-5-8	3/4"	5/16" to 1/2"	50
782051 28073	BCH12-E-9-12	3/4"	9/16" to 3/4"	50
781011 04803	BCH21-E-2-4	15/16"	1/8" to 1/4"	50
781011 04805	BCH21-E-5-8	15/16"	5/16" to 1/2"	50
781011 04807	BCH21-E-9-12	15/16"	9/16" to 3/4"	50
781011 04825	BCH32-E-2-4	2"	1/8" to 1/4"	25
781011 04827	BCH32-E-5-8	2"	5/16" to 1/2"	25
781011 04829	BCH32-E-9-12	2"	9/16" to 3/4"	25

(See pages 234-235 for technical data.)

Read safety/installation instruction sheets in packages before use.

Communication & Low Voltage

- Permits fast and easy installation on beam flanges.
- Qwik-Latch™ cable retainer included with each hook.
- Static Load Capacity: 30 Lbs.
- Finish: Pre-galvanized

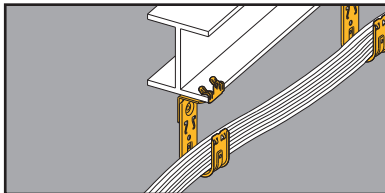

Cable To Beam Fasteners



Allows
360°
Rotation



UPC/Part Number	Catalog Number	Hook Size	Flange Thickness	Box Qty.
782051 28062	BCH12-U-2-4	3/4"	1/8" to 1/4"	50
782051 28064	BCH12-U-5-8	3/4"	5/16" to 1/2"	50
782051 28066	BCH12-U-9-12	3/4"	9/16" to 3/4"	50
781011 04809	BCH21-U-2-4	15/16"	1/8" to 1/4"	50
781011 04811	BCH21-U-5-8	15/16"	5/16" to 1/2"	50
781011 04813	BCH21-U-9-12	15/16"	9/16" to 3/4"	50
781011 04831	BCH32-U-2-4	2"	1/8" to 1/4"	50
781011 04833	BCH32-U-5-8	2"	5/16" to 1/2"	50
781011 04835	BCH32-U-9-12	2"	9/16" to 3/4"	50
781011 04864	BCH64-U-2-4	4"	1/8" to 1/4"	25
781011 04865	BCH64-U-5-8	4"	5/16" to 1/2"	25
781011 04866	BCH64-U-9-12	4"	9/16" to 3/4"	25

(See pages 234-235 for technical data.)

Read safety/installation instruction sheets in packages before use.

Communication & Low Voltage

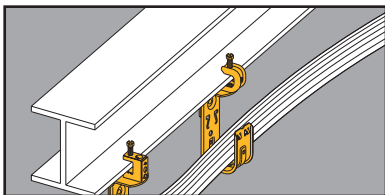

- 360° rotation allows cable to run in any direction.
- Qwik-Latch™ cable retainer included with each hook.
- Static Load Capacity: 30 Lbs.
- Finish: Pre-galvanized

Cable To Beam Fasteners



Communication & Low Voltage

UPC/Part Number	Catalog Number	Hook Size	Flange Thickness	Box Qty.
782051 28077	BCH12-C442	3/4"	1/8" to 5/8"	50
781011 04823	BCH21-C442	15/16"	1/8" to 5/8"	50
781011 04845	BCH32-C442	2"	1/8" to 5/8"	50
781011 04868	BCH64-C442	4"	1/8" to 5/8"	25

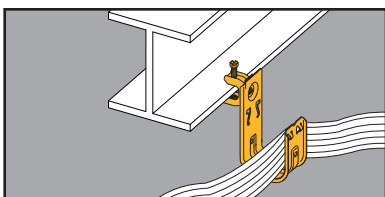

- 360° rotation allows cable to run in any direction.
- Qwik-Latch cable retainer included with each hook.
- Static Load Capacity: 30 Lbs.
- Finish: Pre-galvanized

Cable To Beam Fasteners



UPC/Part Number	Catalog Number	Hook Size	Flange Thickness	Box Qty.
782051 41850	BCH12-C442A	3/4"	1/8" to 5/8"	50
782051 41851	BCH21-C442A	15/16"	1/8" to 5/8"	50
782051 41852	BCH32-C442A	2"	1/8" to 5/8"	50
782051 41853	BCH64-C442A	4"	1/8" to 5/8"	25

(See pages 234-235 for technical data.)

Read safety/installation instruction sheets in packages before use.

Communication & Low Voltage

- 360° rotation allows cable to run in any direction.
- Qwik-Latch™ cable retainer included with each hook.
- Static Load Capacity: 30 Lbs.
- Finish: Pre-galvanized

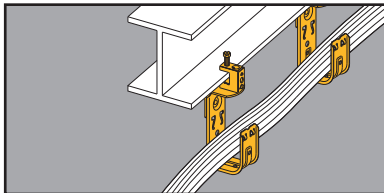

Cable To Beam Fasteners



Communication & Low Voltage

UPC/Part Number	Catalog Number	Hook Size	Flange Thickness	Box Qty.
782051 28074	BCH12-C2	3/4"	thru 1/2"	50
781011 04821	BCH21-C2	15/16"	thru 1/2"	50
781011 04843	BCH32-C2	2"	thru 1/2"	50
781011 04867	BCH64-C2	4"	thru 1/2"	25

- Qwik-Latch cable retainer included with each hook.
- Static Load Capacity: 30 Lbs.
- Finish: Pre-galvanized

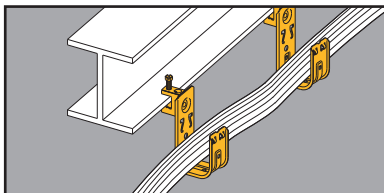

Cable To Beam Fasteners



UPC/Part Number	Catalog Number	Hook Size	Flange Thickness	Box Qty.
782051 41303	BCH12-C1	3/4"	thru 1/2"	50
781011 95578	BCH21-C1	15/16"	thru 1/2"	50
781011 95560	BCH32-C1	2"	thru 1/2"	50
782051 41304	BCH64-C1	4"	thru 1/2"	25

(See pages 234-235 for technical data.)

Read safety/installation instruction sheets in packages before use.

Communication & Low Voltage

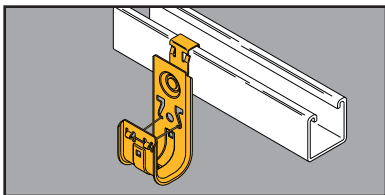

- BSC4 provides a simple snap-on attachment to strut, eliminating the need for tools or drilling.
- Great for retrofit applications.
- Load Capacity: 30 Lbs.
- Finish: Pre-galvanized

Cable Hook To Strut Attachment



Communication & Low Voltage

UPC/Part Number	Catalog Number	Cable Hook Size	Box Qty.
782051 46573	BCH12-SC4	3/4"	50
782051 46574	BCH21-SC4	1 ⁵ / ₁₆ "	50
782051 46575	BCH32-SC4	2"	50
782051 46576	BCH64-SC4	4"	25

(See pages 234-235 for technical data.)

Read safety/installation instruction sheets in packages before use.

Communication & Low Voltage

- Supports cable from vertical flanges.
- Qwik-Latch™ cable retainer included with each hook.
- Static Load Capacity: 30 Lbs.
- Finish: Pre-galvanized

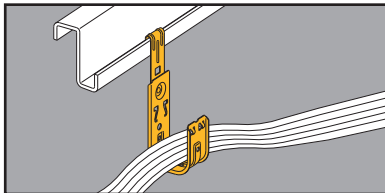

Cable To Flange Fasteners



Communication & Low Voltage

UPC/Part Number	Catalog Number	Hook Size	Flange Thickness	Box Qty.
782051 28078	BCH12-F3	3/4"	1/16" to 1/4"	50
781011 04815	BCH21-F3	1 5/16"	1/16" to 1/4"	50
781011 04837	BCH32-F3	2"	1/16" to 1/4"	50
781011 04869	BCH64-F3	4"	1/16" to 1/4"	25

- Supports cable from angled flanges.
- Qwik-Latch cable retainer included with each hook.
- Static Load Capacity: 30 Lbs.
- Finish: Pre-galvanized

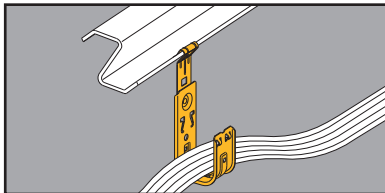

Cable To Flange Fasteners



UPC/Part Number	Catalog Number	Hook Size	Flange Thickness	Box Qty.
782051 28079	BCH12-F4	3/4"	1/16" to 1/4"	50
781011 04817	BCH21-F4	1 5/16"	1/16" to 1/4"	50
781011 04839	BCH32-F4	2"	1/16" to 1/4"	50
781011 04870	BCH64-F4	4"	1/16" to 1/4"	25

(See pages 234-235 for technical data.)

Read safety/installation instruction sheets in packages before use.

Communication & Low Voltage

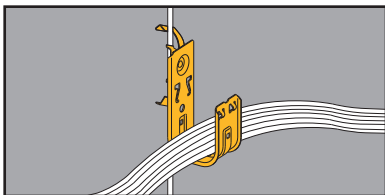

- Supports cable from #12 wire thru 3/8" threaded rod.
- Qwik-Latch™ cable retainer included with each hook.
- W2 series attaches to #12 wire thru 1/4" plain or threaded rod.
- W6 series attaches to 3/8" plain or threaded rod.
- Static Load Capacity: 25 Lbs.
- Finish: Pre-galvanized

Cable To Wire and Rod Fasteners

Communication & Low Voltage



UPC/Part Number	Catalog Number	Description	Box Qty.
782051 28081	BCH12-W2	3/4"	50
781011 04819	BCH21-W2	15/16"	50
781011 04841	BCH32-W2	2"	50
782051 28082	BCH12-W6	3/4"	50
781011 95567	BCH21-W6	15/16"	50
781011 95569	BCH32-W6	2"	50

(See pages 234-235 for technical data.)

Read safety/installation instruction sheets in packages before use.

Communication & Low Voltage

- Supports cable above ceiling grid and allows 360° rotation.
- Provides compliance with the EIA/TIA requirements.
- Permits dropwire attachment if required.
- Qwik-Latch™ cable retainer included with each hook.
- Static Load Capacity: 30 Lbs.
- Finish: Pre-galvanized

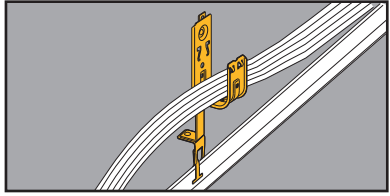

Cable To T-Bar Fasteners

Communication & Low Voltage



UPC/Part Number	Catalog Number	Description	Box Qty.
782051 28083	BCH12-A28	3/4"	50
781011 04857	BCH21-A28	1 ⁵ / ₁₆ "	50
781011 04858	BCH32-A28	2"	50

(See pages 234-235 for technical data.)

Read safety/installation instruction sheets in packages before use.

Communication & Low Voltage

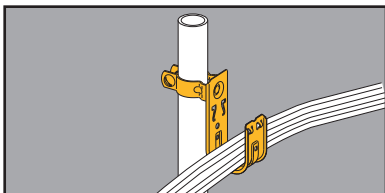

- Supports cable from computer floor post.
- Organizes cable off the floor for a neat installation.
- Qwik-Latch™ cable retainer included with each hook.
- Static Load Capacity: 30 Lbs.
- Finish: Pre-galvanized

Cable To Floor Support Fasteners



Communication & Low Voltage

UPC/Part Number	Catalog Number	Hook Size	Floor Post Size	Box Qty.
782051 28085	BCH12-L1410	3/4"	1" O.D.	50
781011 04851	BCH21-L1410	15/16"	1" O.D.	50
781011 04855	BCH32-L1410	2"	1" O.D.	50
781011 04871	BCH64-L1410	4"	1" O.D.	25

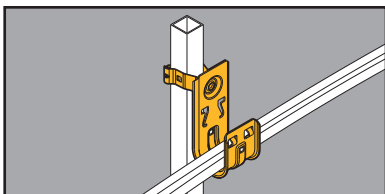

- Supports cable from square computer floor post.
- Organizes cable off the floor for a neat installation.
- Qwik-Latch™ cable retainer included with each hook.
- Static Load Capacity: 30 Lbs.
- Finish: Pre-galvanized

Cable To Floor Support Fasteners



UPC/Part Number	Catalog Number	Hook Size	Floor Post Size	Box Qty.
782051 28086	BCH12-G-8-12	3/4"	1" Square	50
781011 72487	BCH21-G-8-12	15/16"	1" Square	50
781011 72489	BCH32-G-8-12	2"	1" Square	50
781011 72491	BCH64-G-8-12	4"	1" Square	25

(See pages 234-235 for technical data.)

Read safety/installation instruction sheets in packages before use.

Communication & Low Voltage

- Factory assembled multi-tier fasteners speed up installation.
- Unique design prevents hook and assembly rotation when pulling cable.
- All support bars furnished in 6063-T6 aluminum.
- Shown with optional BCHK2 kit.
- Qwik-Latch™ cable retainer included with each hook.
- Static Load Capacity: (per hook) 30 Lbs.
- Finish: Pre-galvanized

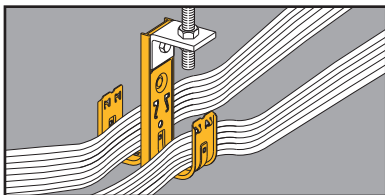

Double-Sided Multi-Tier Cable Fasteners

Communication & Low Voltage

1D



2D



UPC/Part Number	Catalog Number	Hook Size	Description	Box Qty.
781011 04758	BCH21-1D	1 ⁵ / ₁₆ "	1 Tier, 2-Sided, 5 ¹ / ₂ " High	20
781011 04762	BCH32-1D	2"	1 Tier, 2-Sided, 6 ³ / ₁₆ " High	25
781011 04874	BCH64-1D	4"	1 Tier, 2-Sided, 9" High	10
781011 04766	BCH21-2D	1 ⁵ / ₁₆ "	2 Tier, 2-Sided, 9 ¹ / ₄ " High	10
781011 04770	BCH32-2D	2"	2 Tier, 2-Sided, 11" High	10
781011 04875	BCH64-2D	4"	2 Tier, 2-Sided, 18 ¹ / ₄ " High	10

Patent #5961081

(See pages 234-235 for technical data.)

Read safety/installation instruction sheets in packages before use.

Communication & Low Voltage

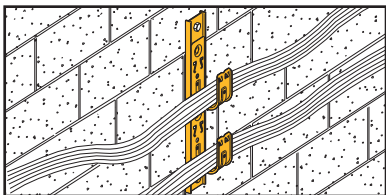

- Factory assembled multi-tier fasteners speed up installation.
- Available in two-six tier assemblies.
- Unique design prevents hook and assembly rotation when pulling cable.
- Qwik-Latch™ cable retainer included with each hook.
- All support bars furnished in 6063-T6 aluminum.
- Static Load Capacity: 30 Lbs. (per hook)

Single-Sided Multi-Tier Cable Fasteners



2S



3S



UPC/Part Number	Catalog Number	Hook Size	Description	Box Qty.
781011 04773	BCH21-2S	1 ⁵ / ₁₆ "	2 Tier, 1-Sided, 11" Overall Height	10
781011 04776	BCH32-2S	2"	2 Tier, 1-Sided, 12 ³ / ₄ " Overall Height	10
781011 95300	BCH64-2S	4"	2 Tier, 1-Sided, 19 ⁵ / ₁₆ " Overall Height	10
781011 04779	BCH21-3S	1 ⁵ / ₁₆ "	3 Tier, 1-Sided, 14 ³ / ₄ " Overall Height	10
781011 04782	BCH32-3S	2"	3 Tier, 1-Sided, 17 ¹ / ₂ " Overall Height	10
781011 95303	BCH64-3S	4"	3 Tier, 1-Sided, 28 ¹ / ₁₆ " Overall Height	10

Patent #5961081

(See pages 234-235 for technical data.)

Read safety/installation instruction sheets in packages before use.

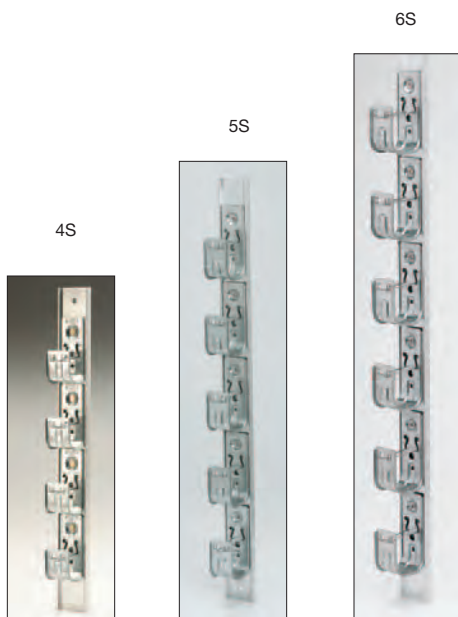

UPC/Part Number	Catalog Number	Hook Size	Description	Box Qty.
781011 04785	BCH21-4S	1 ⁵ / ₁₆ "	4 Tier, 1-Sided, 18 ¹ / ₂ " Overall Height	10
781011 04788	BCH32-4S	2"	4 Tier, 1-Sided, 21 ³ / ₄ " Overall Height	10
781011 97872	BCH64-4S	4"	4 Tier, 1-Sided, 36 ¹³ / ₁₆ " Overall Height	10
781011 04791	BCH21-5S	1 ⁵ / ₁₆ "	5 Tier, 1-Sided, 21 ³ / ₄ " Overall Height	10
781011 04794	BCH32-5S	2"	5 Tier, 1-Sided, 27" Overall Height	10
781011 04797	BCH21-6S	1 ⁵ / ₁₆ "	6 Tier, 1-Sided, 26" Overall Height	10
781011 04800	BCH32-6S	2"	6 Tier, 1-Sided, 31 ³ / ₄ " Overall Height	10

Patent #5961081

(See pages 234-235 for technical data.)

Read safety/installation instruction sheets in packages before use.

Communication & Low Voltage



Shown with
BRC5
Brackets



Shown with
Cable
Hooks

- The BCH-HBA combines a tiered support bar and angle bracket into one piece.
- More flexibility! The BCH-HBA can be supported from $\frac{3}{16}$ ", $\frac{1}{4}$ ", $\frac{5}{16}$ " or $\frac{3}{8}$ " rod.
- Mounts up to three BCH21 or BCH32 cable hooks or two BCH64 cable hooks per side.
- Mounts up to three BRC5 MC/AC cable support brackets per side.
- Load Capacity: 180 lbs.

Multi-Tier Support Bar



UPC/Part Number	Catalog Number	Description	Box Qty.
782051 43819	BCH-HBA	Multi-Tier Support Bar	40

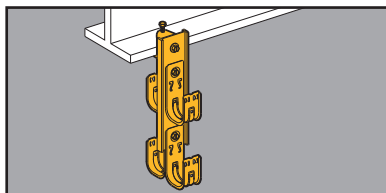

Multi-Tier Cable Hook Kits



- Support bars furnished in 6063-T6 aluminum.



UPC/Part Number	Catalog Number	Description	Box Qty.
781011 99572	BCH-HB21	Support Bar for BCH21 and BCH32 8 $\frac{1}{4}$ " long with .281Ø holes	20
781011 99574	BCH-HB64	Support Bar for BCH64 13 $\frac{5}{16}$ " long with .281Ø holes	20

(See pages 234-235 for technical data.)

Read safety/installation instruction sheets in packages before use.

Multi-Tier Attachment Kits

- BCHK1 includes:
Beam clamp (B444-1/4)
and 1/4"-20 x 1/2"
hex head cap screw



BCHK1

- BCHK2 includes:
Angle bracket (.320"Ø
and .390"Ø holes) and
1/4"-20 x 1/2"
hex head cap screw



BCHK2

- BCHK3 includes:
1 each BCHK1 Kit and
BCHK2 Kit



BCHK3

UPC/Part Number	Catalog Number	Kit Description	Flange Thickness	Box Qty.
781011 04872	BCHK1	Beam Clamp	Thru 1/2"	10
781011 04860	BCHK2	Angle Bracket	--	10
781011 04873	BCHK3	Beam Clamp with Angle Bracket (swivels 360°)	Thru 1/2"	10

Read safety/installation instruction sheets in packages before use.

Communication & Low Voltage

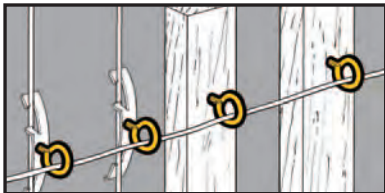

- Supports low voltage communication cables from beams or rods when used with other fasteners.
- *Ultimate Static Load Capacity:* 50 Lbs.
- Finish: Zinc Plated

Threaded Bridle Rings

Communication & Low Voltage



UPC/Part Number	Catalog Number	Ring Size	Thread Size x Thread Length	Box Qty.
781011 19550	BR-8-T	1/2"	#10-24 x 9/16"	100
781011 19555	BR-12-T	3/4"	#10-24 x 9/16"	100
781011 19560	BR-20-T	1 1/4"	#10-24 x 9/16"	100
781011 19570	BR-32-T	2"	#10-24 x 9/16"	100
781011 19565	BR-20-4T	1 1/4"	1/4"-20 x 9/16"	100
781011 19575	BR-32-4T	2"	1/4"-20 x 9/16"	100
781011 19889	BR-64-4T	4"	1/4"-20 x 9/16"	50



Lag Screw
for Wood
Beams

UPC/Part Number	Catalog Number	Ring Size	Thread Size x Thread Length	Box Qty.
781011 19875	BR-16-3W	1"	9/16" x 9/16"	100
781011 19886	BR-24-4W	1 1/2"	1/4" x 27/32"	100
781011 19876	BR-32-4W	2"	1/4" x 7/8"	100

Read safety/installation instruction sheets in packages before use.

Communication & Low Voltage

- The convenience of a bridler ring with the cable-bearing surface of a hook.
- 2" saddle is available separately. Can be easily attached before or after cable installation.

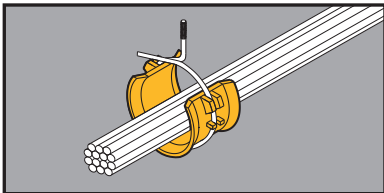

Bridler Ring Saddles



BRS-32A

BRS-64A

BRS-32



UPC/Part Number	Catalog Number	Thread Size x Thread Length/Description	Box Qty.
7820511 22761	BRS-32A	1/4"-20 x 7/8" 2" Ring Assembly.	50
7820511 22762	BRS-64A	1/4"-20 x 1" 4" Ring Assembly.	25
7820511 22759	BRS-32	2" Saddle Only	50

Also available for use with the following B-Line Fasteners.

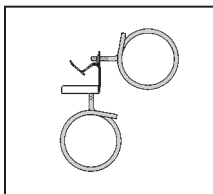

BU-9-12

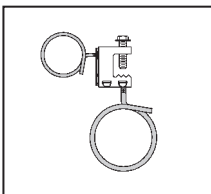

BC1

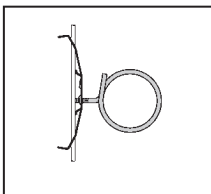

BW2

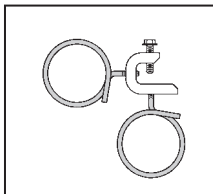

BC442

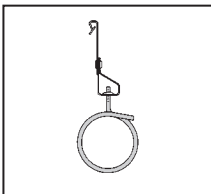

BH4-F3

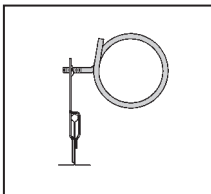

BA5-4T

Read safety/installation instruction sheets in packages before use.

Communication & Low Voltage

Communication & Low Voltage

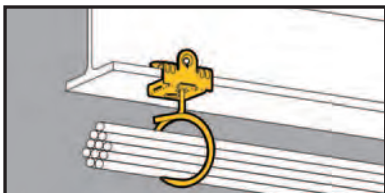

- Supports low voltage communication cables from beam flanges 1/8" to 3/4" thick.
- Pre-assembled with 2" bridle ring.
- Reduces installation time.
- Static Load Capacity : 15 lbs.

Bridle Ring/Beam Fastener Assy.



UPC/Part Number	Catalog Number	Description	Box Qty.
781011 02921	BR-32-4T-U-2-4	1/8" to 1/4"	50
781011 02923	BR-32-4T-U-5-8	5/16" to 1/2"	50
781011 02924	BR-32-4T-U-9-12	9/16" to 3/4"	50

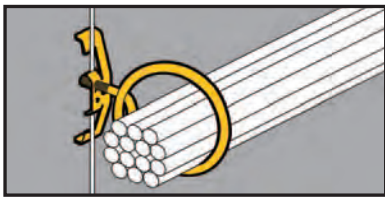

- Supports low voltage communication cables from drop wire.
- Pre-assembled with 2" bridle ring.
- Reduces installation time.
- Static Load Capacity : 15 lbs.

Bridle Ring/Rod & Wire Fastener Assy.



UPC/Part Number	Catalog Number	Description	Box Qty.
781011 02929	BR-32-4T-W2	#12 Wire Thru 1/4" Plain or Threaded Rod	50

Read safety/installation instruction sheets in packages before use.

Communication & Low Voltage

- Supports low voltage communication cables above the T-Bar.
- Pre-assembled with 2" bridler ring.
- Reduces installation time.
- For positioning only - No Load Rating

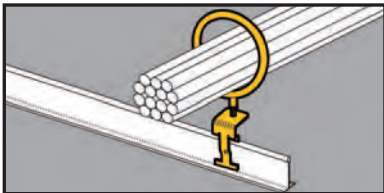

Bridle Ring/T-Bar Fastener Assembly



UPC/Part Number	Catalog Number	Description	Box Qty.
781011 02934	BR-32-4T-A6	2" Ring Size	50

- Supports low voltage communication cables from beam flanges thru 1/2" thick.
- Pre-assembled with 2" bridler ring.
- Reduces installation time.
- Static Load Capacity: 15 lbs.

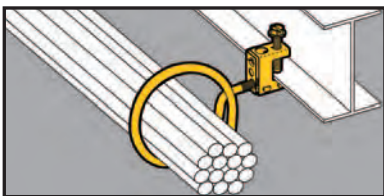

Bridle Ring/Beam Fastener Assembly



UPC/Part Number	Catalog Number	Description	Box Qty.
781011 02937	BR-32-4T-C1	2" Ring Size	50

Read safety/installation instruction sheets in packages before use.

Accessories

Accessories

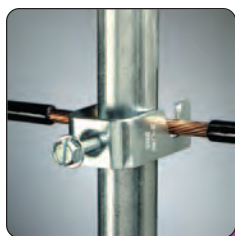

- Allows for rigid attachment of pipe sleeves to wall and floor forms for concrete pouring.
- Accommodates Schedule 40, Schedule 80, or $\frac{5}{16}$ " and smaller wall thickness.

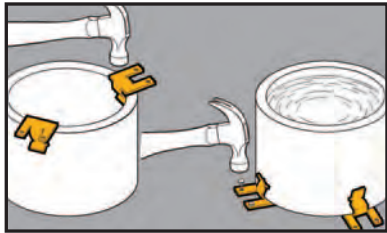

Pipe Sleeve Fasteners



UPC/Part Number	Catalog Number	Sleeve Diameter	Wall Thickness	Box Qty.
781011 18285	BD40	All Dia.	$\frac{5}{16}$ " & Under	100
781011 18285	BD40	2" to 6"	Schedule 40 Pipe	100



UPC/Part Number	Catalog Number	Sleeve Diameter	Wall Thickness	Box Qty.
781011 18300	BE-5-8	6"	Schedule 80 Pipe	100
781011 18300	BE-5-8	8" to 10"	Schedule 40 Pipe	100
781011 18305	BE-9-12	9" to 14"	Schedule 80 Pipe	100

Read safety/installation instruction sheets in packages before use.

Accessories

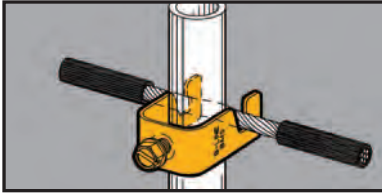

- Attaches signal reference grid wire to computer floor posts.
- Fits #8 thru #4 stranded wire. (.146" O.D. thru .232" O.D.).
- Fits 3/4" to 1" round or square posts.

Reference Wire Fasteners



UPC/Part Number	Catalog Number	Description	Box Qty.
781011 01659	BM5	Single Reference Grid Wire Fastener	100

Accessories

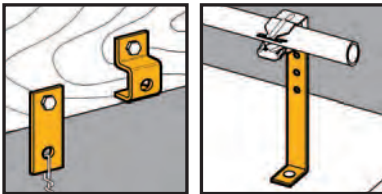

- Brackets are easily attached with screws or drive pins to wood, concrete or steel structures.
- Brackets are adaptable for use with a wide variety of fasteners, wires, "S" hooks and hangers.



BD2



BD4



BA28B

UPC/Part Number	Catalog Number	Description	Box Qty.
781011 01686	BD2	Flat Bracket	100
781011 18280	BD4	Offset Bracket	100
781011 01449	BA28B	Angle Bracket	50

Read safety/installation instruction sheets in packages before use.

Accessories

- Push Nuts designed for use with plain rod.
- "U" Nuts provide 1/4"-20 thread impression for unthreaded hole.
- No installation tools required.

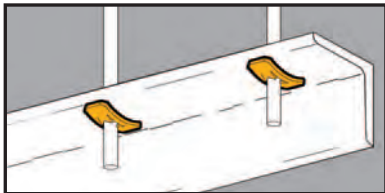

Accessory Nuts



BN-2, BN-4,
BN-6
Push Nuts



BN1
"U" Nuts With
Thread Impression

UPC/Part Number	Catalog Number	Rod/Wire Size	Static Load Capacity	Box Qty.
781011 19115	BN-2	#8 Wire	100 lbs. thru 3/8" hole	100
781011 19120	BN-4	1/4" Plain Rod	100 lbs. thru 3/8" hole	100
781011 19125	BN-6	3/8" Plain Rod	200 lbs. thru 1/2" hole	100
781011 19110	BN1	1/4" Threaded Rod	50 lbs. on 9/32" hole	100

Accessories

- Protects cable, plastic pipe and copper tubing from screw or nail penetration.
- BM3M comes with industrial grade double stick tape on back for easy installation on metal stud.
- BM3 used on wood studs.
- Complies with NEC Article 300-4.

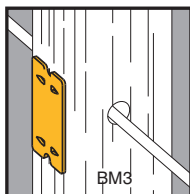
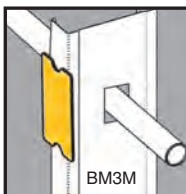

Nail Plates



BM3



BM3M



Just Peel Tape
and
Stick To Stud

UPC/Part Number	Catalog Number	Description	Box Qty.
782051 26251	BM3M	Nail Plate	100
781011 04927	BM3	Nail Plate	100

Read safety/installation instruction sheets in packages before use.

Accessories



- KwikWire™ system replaces jack chain or ATR to support lighting, ductwork, cable tray, etc.
- Can be quickly installed around beams - No drilling required.
- Ideal for sloped ceilings - can hang objects at up to 60° angles.
- Simple height adjustments are made by releasing locking tab, no tools required.
- Spools of wire can be cut to length in field, reducing waste and up front planning.

KwikWire™ Clamps



UPC/Part Number	Catalog Number	For Use With Wire Rope Diameters	Box Qty.
782051 40719	BKC100	1/16" & 3/32"	100
782051 40723	BKC200	1/8" & 3/16"	50

KwikWire™ Clamp Working Loads*

Clamp Part No.	Wire Rope Dia.	Lbs. Safety Factor 5
BKC100	1/16"	0-75
	3/32"	25-150
BKC200	3/32"	25-150
	1/8"	25-250
	3/16"	50-640

* Working loads shown are for hanging vertically. For suspending at 15°, 30°, 45° or 60° angles from vertical use the following percentage of the working loads from the chart:
 15° = 96%, 30° = 86%,
 45° = 70%, 60° = 50%

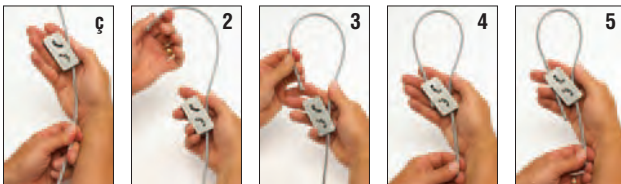

1. Pass the wire through the KwikWire™ Clamp
2. Loop wire through/around support
3. Pass wire back through KwikWire™ Clamp
4. Push wire through clamp leaving 2" to 3" tail, then apply tension on wire
5. To adjust, remove tension and pull wire slightly to disengage teeth, slide adjustment pin in direction shown by arrow to release wire.

Read safety/installation instruction sheets in packages before use.



7 x 7



7 x 19



KwikWire™ Wire Rope

UPC/Part Number	Catalog Number	Rope Dia.	Working Load - Lbs.	Spool Qty.
782051 40725	BKW063 (1)	1/16"	96	500 ft
782051 40727	BKW094 (1)	3/32"	184	500 ft
782051 40733	BKW125 (1)	1/8"	340	500 ft
782051 40734	BKW188 (2)	3/16"	840	250 ft

(1) Wire rope construction Type 7 x 7 (2) Wire rope construction Type 7 x 19
Uncoated Galvanized Wire

- B-Line KwikPak™ includes a supply of kwik-clamps and a spool of wire rope.
- KwikPak are shipped in a specially designed dispenser box to ease field cutting of wire.



KwikPak™

UPC/Part Number	Catalog Number	Kit Includes	Box Qty.
782051 40749	BKP10063	BKC100 (100 pcs.) 1/16"Ø Wire Rope (500 ft.)	1
782051 40751	BKP10094	BKC100 (100 pcs.) 3/32"Ø Wire Rope (500 ft.)	1
782051 40761	BKP20125	BKC200 (50 pcs.) 1/8"Ø Wire Rope (500 ft.)	1
782051 40763	BKP20188	BKC200 (50 pcs.) 3/16"Ø Wire Rope (250 ft.)	1

Read safety/installation instruction sheets in packages before use.

Accessories



- KwikWire™ hanger combines the versatility of a bolt with an adjustable wire rope solution.
- Can be quickly installed in existing anchors or metal brackets with a nut.
- Ideal for supporting light fixtures, wire basket cable tray, HVAC ducts, and sign/banner supports.
- See page 176 for wire rope spools.

KwikWire™ Hanger

Accessories

UPC/Part Number	Thread Size	Wire Rope Dia. in. (mm)	Loading* SF5 lbs. (kg)
BKF100-4	1/4"-20	1/16" (1.5 mm)	45 (20kg)
		3/32" (2.5 mm)	90 (40kg)
BKF100-6	3/8"-16	1/16" (1.5 mm)	45 (20kg)
		3/32" (2.5 mm)	90 (40kg)

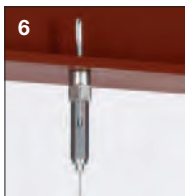
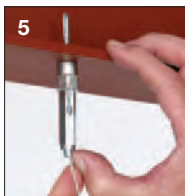
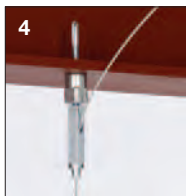

1. Screw KwikWire Hanger into installed hanger support
2. Push wire up through the bottom of KwikWire Hanger
3. Continue pushing through until 1/4" minimum is extending out the side of the KwikWire Hanger
4. To adjust up - pull or push more wire through KwikWire Hanger
5. To adjust down - push up on bottom of KwikWire Hanger and allow wire to feed down
6. When hanging the wire is complete, cut off any excess cable wire if desired

Read safety/installation instruction sheets in packages before use.

KwikWire™ Accessories



BKL Series

Loop Termination

- Available as a wire rope with loop termination only or as a ready-to-use kit with a BKC100 clamp.
- Available in lengths of 40", 80", 120", 180", 240", and 360".



BKH Series

Single & "Y" Style Hook Termination

- Hook designed to accept up to 3/8" diameter wire.
- Available as a wire rope with hook termination only or as a ready-to-use kit with a BKC100 clamp.
- Available in lengths of 40", 80", 120", 180", 240", and 360".
- Available in single, double (Y), and triple (3) leg styles



BKYH Series



BKT Series

Single & "Y" Style Toggle Termination

- Available as a wire rope with toggle termination only or as a ready-to-use kit with a BKC100 clamp.
- Available in lengths of 40", 80", 120", 180", 240", and 360".
- Available in single, double (Y), and triple (3) leg styles
- All triple (3) leg styles are non-stock, consult Cooper B-Line for lead times



BKTY Series



BKB Series

Bolt Loop Termination

- Ideal for use with ARS, ARC, ADI, ACPW, or ACPD anchors.
- Available as a wire rope with bolt termination only or as a ready-to-use kit with a BKC100 clamp.
- Available in lengths of 40", 80", 120", 180", 240", and 360".
- Available in single, double (Y), and triple (3) styles
- All double (Y) and triple (3) styles are non-stock, consult Cooper B-Line for lead times



BKA Series

Angle Bracket Termination

- Available as a wire rope with angle bracket termination only or as a ready-to-use kit with a BKC100 clamp.
- Available in lengths of 40", 80", 120", 180", 240", and 360".

For additional options, refer to **KwikWire Brochure (KWHS)**

Read safety/installation instruction sheets in packages before use.

Accessories



BKCP



B601-62



BKCC

KwikWire™ Accessories

UPC/Part Number	Catalog Number	Description	Qty.
782051 40766	BKCP	Air Duct Corner Protector	100
781011 56059	B601-62	Air Duct Support	50
782051 40297	BKCC	Wire Rope Cutter	1

Danger: Never use cutters on energized circuits, wire, or cable.

Note: Additional accessories include BE Series (pg. 79), BF Series (pgs. 106 & 110), and BPNA Series (pg. 118)

Accessories

KwikWire™ System Recommendations:

- Do not exceed the safe working load of the products shown in their charts
- KwikWire™ Clamp load ratings are guaranteed only when used in combination with B-Line/Cooper supplied wire rope
- Do not use for overhead lifting or hoisting
- Do not use if cable or components are visibly distorted or worn, remove damaged cable end prior to inserting in KwikWire™ Clamp
- Do not paint cable near working area of KwikWire Clamp connector
- Do not apply lubricant
- Keep product clean and free of dirt
- Do not use on coated wire rope
- Do not use in chlorinated or caustic atmospheres
- For use in dry locations
- Cooper's BKCC tool is recommended for cutting wire rope to prevent fraying
- For use on vertical applications only

Application Photos

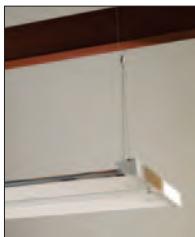

Read safety/installation instruction sheets in packages before use.

Accessories



UPC/Part Number	Catalog Number	Description	Box Qty.
781011 01687	SHHMS 1/4 x 1/2	1/4"-20 x 1/2" Slotted Hex Head Machine Screw	100



UPC/Part Number	Catalog Number	Description	Box Qty.
781011 42103	MSQN1/4	1/4"-20 Machine Square Nut	100



UPC/Part Number	Catalog Number	Description	Box Qty.
781011 10675	BWHS-9	Sheet Metal Screw #8 x 9/16"	1000

Note: BWHS-9 can be used with all fasteners requiring attachments with sheet metal screws.



UPC/Part Number	Catalog Number	Description	Box Qty.
781011 04925	BWHS-9D	#8 x 1/2" Self-Drilling Sheet Metal Screw	1000

Note: BWHS-9 can be used with all fasteners requiring attachments with sheet metal screws except BB2-16, BB2-16D, BB2-24 & BB2-24D.

Read safety/installation instruction sheets in packages before use.

Anchors



Anchors



Glossary

Prefix - Description	Screw Dia.	Length	Suffix
ACB - Concrete Anchor Bolt	4 - #4	75 - 3/4"	AN - Acorn Nut
ACPD - Bang-IT	6 - #6	81 - 13/16"	CH - Combo Head
ACPW - Wood-Knocker	8 - #8	87 - 7/8"	F - Flat
ACS - Concrete Screw	10 - #10	100 - 1"	FL - Flanged
ADA - Drive Anchor	12 - 1/8"	118 - 13/18"	H - Hex
ADE - Double Expansion Anchor	18 - 3/16"	125 - 1 1/4"	HN - Hex Nut
ADH - Hollow-Base Drop-IN	25 - 1/4"	150 - 1 1/2"	HS - Hole Saw
ADI - Drop-In	31 - 5/16"	175 - 1 3/4"	K - Kit
ADM - Mini Drop-In	37 - 3/8"	187 - 1 7/8"	M - Mushroom
ADN - Drive Nail	50 - 1/2"	200 - 2"	OH - Oval Head
AMS - Machine Screw	62 - 5/8"	225 - 2 1/4"	PH - Pan Head
APC - Conical Anchor	75 - 3/4"	250 - 2 1/2"	RH - Rod Hanger
APD - Plastic Driller	87 - 7/8"	275 - 2 3/4"	RS - Slotted Round Head
APDM - Plastic Driller - Mini		300 - 3"	
APH - Plastic Hollow Wall Anchor		325 - 3 1/4"	SS4 - 304 Stainless Steel
APS - Plastic Screw Anchor		350 - 3 1/2"	
ARC - Rapid Rod™ Concrete		375 - 3 3/4"	T - Tool
ARS - Rapid Rod™ Steel		400 - 4"	WH - Wire Hanger
ARW - Rapid Rod™ Wood		425 - 4 1/4"	
ASA - Sleeve Anchor		450 - 4 1/2"	
ASE - Single Expansion Anchor		500 - 5"	
ATB - Toggle Bolt		525 - 5 1/4"	
ATM - Self-Tapping Machine Screw Anchor		550 - 5 1/2"	
		600 - 6"	
AWA - Wedge Anchor		700 - 7"	
AWSD - Seismic Wedge Anchor			
AWS - Wall Screw			
AZD - Zinc Driller			
AZDM - Zinc Driller-Mini			

Read safety/installation instruction sheets in packages before use.

Anchors

Rapid Rod™ Hangers

- One-piece, all steel threaded fastener system for suspending steel threaded rod.
- Suitable for overhead installations such as suspending cable tray, pipe hangers, strut and conduit.
- Side Mount (SW) available for side mounting applications.
- Lower in-place cost, when compared to beam clamps, lag bolts and drop-ins.
- Steel rapid rods can be installed with a screw gun or hammer drill.
- UL & FM approved.
- Made of Zinc Plated carbon steel.

Rapid Rod Hangers Steel

Steel Rapid Rod - Data		
Point Style	#3	#5
Self-Drilling Range (in.)	20 ga. - 3/16	3/16 - 1/2
Screw Size (UNC) *	1/4"-20	1/4"-20
Thread Length (in.) *	1 3/16	3 1/32

* Dimensions for self-drilling (embedded) portion of anchor.

Steel Rapid Rod - Load Data							
Rod/ Anchor Size	Minimum Steel Gauge Thickness						
	20 (.036")	18 (.048")	16 (.060")	14 (.075")	12 (.105")	3/16"	1/4"
1/4	100	155	245	290	390	800	1260
1/4 w/nut	390	390	440	440	510	960	510
3/8	100	155	245	290	390	490	490
3/8 w/nut	365	365	365	365	365	365	365
1/2	120	175	230	390	510	820	1260

Loads shown for ASTM A36 steel beams and ASTM A572 steel purlins include a safety factor of 4.

For UL & FM listings, steel rapid rod must be installed with a retaining nut. UL & FM load rating for 3/8" rapid rod is 365 lbs. and can support up to a maximum 4" pipe.

UL & FM load rating for 1/2" rapid rod is 900 lbs. and can support up to a maximum 6" pipe.

Read safety/installation instruction sheets in packages before use.

Rapid Rod™ Hangers

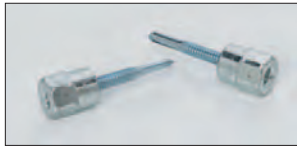

UPC/Part Number	Catalog Number	Rod Size	Shank Size & Length	Box Qty.
Steel Rod Hanger - Point Style #3 For Purlins				
782051 53317	ARS-25-100	1/4"	1/4" X 1"	100
782051 53318	ARS-37-200	3/8"	1/4" X 2"	100
782051 53320	ARS-37-100HN **	3/8"	1/4" X 1" w/nuts	100
782051 53321	ARS-37-150	3/8"	1/4" X 1 1/2"	100
782051 53322	ARS-37-150HN **	3/8"	1/4" X 1 1/2" w/nuts	100

Steel Rod Hanger - Side Mount - Point Style #3 For Purlins

782051 53323	ARS-25-100SW	1/4"	1/4" X 1"	100
782051 53324	ARS-37-100SW	3/8"	1/4" X 1" w/nuts	100

Steel Rod Hanger - Point Style #5 For Beams

782051 53325	ARS-25-150HD	1/4"	#12-24 X 1 1/2"	100
782051 53326	ARS-37-150HDHN **	3/8"	#12-24 X 1 1/2" w/nuts	100
782051 53327	ARS-50-150HDHN **	1/2"	#12-24 X 1 1/2" w/nuts	100

** For UL & FM listings, steel rapid rod should be installed with a retaining nut.

UPC/Part Number	Catalog Number	Tool Description	Box Qty.
Tool			
782051 53287	7187	Universal Steel & Wood Socket	1

Read safety/installation instruction sheets in packages before use.

Anchors

Rapid Rod™ Hangers

- One-piece, all steel threaded fastener system for suspending steel threaded rod.
- Suitable for overhead installations such as suspending cable tray, pipe hangers, strut and conduit.
- Side Mount (SW) available for side mounting applications.
- Lower in-place cost, when compared to beam clamps, lag bolts and drop-ins.
- Wood rapid rods can be installed with a screw gun or hammer drill.
- Concrete rapid rods can be installed with an adjustable torque, battery powered screw gun or hammer drill.
- UL & FM approved.
- Made of Zinc Plated carbon steel.

Rapid Rod Hangers - Concrete

Concrete Rapid Rod - Data	1/4"	3/8"	1/2"
ANSI Drill Bit (in.)	1/4	1/4	3/8
Thread Length (in.)	1 1/8	1 3/8	2 1/2
Min. Embedment Depth (in.)	1 1/4	1 1/2	2 3/4
Load Capacity Tension (lbs.) *	485	650	1510
Load Capacity Shear (lbs.) *	610	660	1580

* Based on concrete compression strength of 4000 psi using applied safety factor of 4.0. For additional loading information contact factory.

FM approved load capacity for 3/8" anchor is 365 lbs., maximum 4" pipe size. FM approved load capacity for 1/2" anchor is 950 lbs., maximum 8" pipe size.

Rapid Rod Hangers - Wood

Wood Rapid Rod - Data	1/4" Thread Forming	3/8" Thread Forming
Pre-Drill Diameter (in.)	1/8	1/8
Point Style	Type 17	Type 17

Wood Rapid Rod - Embedment & Load Data				
Rod/Anchor Size	Embedment Depth	Fir	Pine	Spruce
1/4	1"	170	160	160
3/8	2"	375	375	375
1/2	2 1/2"	665	775	775

Minimum load ratings are based on a safety factor of 4.

UL approved load capacity for 3/8" rod sizes and 1/4" screw size is 260 lbs., maximum 3" pipe. UL approved load capacity for 3/8" rod sizes and 3/8" screw size is 375 lbs., maximum 4" pipe. FM approval only applies to 3/8" x 2 1/2" screw size. Approved for 365 lbs., up to 4" pipe.

Read safety/installation instruction sheets in packages before use.

Rapid Rod™ Hangers



UPC/Part Number	Catalog Number	Rod Size	Shank Size & Length	Box Qty.
-----------------	----------------	----------	---------------------	----------

Concrete Rod Hanger - ANSI Wedge-Bolt OT Thread Shank Style

782051 53328	ARC-25-125	1/4"	1/4" X 1 1/4"	100
782051 53329	ARC-37-150	3/8"	1/4" X 1 1/2"	100
782051 53330	ARC-50-275	1/2"	3/8" X 2 3/4"	50

For side mount concrete applications use ARW-25-100SW or ARW-37-200SW with 1/4" drill bit.

UPC/Part Number	Catalog Number	Rod Size	Shank Size & Length	Box Qty.
-----------------	----------------	----------	---------------------	----------

Wood Rod Hanger - Point Style Type 17

782051 53331	ARW-25-200	1/4"	1/4" X 2"	100
782051 53332	ARW-37-100	3/8"	1/4" X 1"	100
782051 53333	ARW-37-200	3/8"	1/4" X 2"	100
782051 53334	ARW-37-250	3/8"	3/8" X 2 1/2"	100
782051 53335	ARW-50-250	1/2"	3/8" X 2 1/2"	100

Wood Rod Hanger - Side Mount - Point Style Type 17

782051 53336	ARW-25-100SW	1/4"	1/4" X 1"	100
782051 53337	ARW-37-200SW	3/8"	1/4" X 2"	100

UPC/Part Number	Catalog Number	Rod Size	Box Qty.
-----------------	----------------	----------	----------

Tools

782051 53287	7187	Universal Steel & Wood Socket	1
782051 53288	7195	1/4" Concrete Socket	1
782051 53289	7197	3/8" Concrete Socket	1
782051 53290	7198	1/2" Concrete Socket	1
782051 53360	5874	Concrete Tapper Sleeve Assy.	1
782051 53361	5866	1/4" X 6" Hex Shank SDS Drill Bit	1

Read safety/installation instruction sheets in packages before use.

Anchors

Drop-in Anchors

- Designed for use in solid concrete.
- Can be used for overhead applications such as suspending cable tray, strut, pipe supports and lighting.
- Flanged (lipped) version installs flush for easy inspection and standardizes rod heights.
- Smooth wall drop-in can be installed flush mounted or below the base material surface.
- UL & FM approved.
- Available in Zinc Plated finish or Stainless Steel.

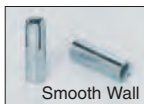

Drop-In Anchors - Data	1/4"	3/8"	1/2"	5/8"	3/4"
ANSI Drill Bit Size (in.)	3/8	1/2	5/8	7/8	1
Max. Tightening Torque (ft-lbs)	5	10	20	40	80
Thread Size (UNC)	1/4"-20	3/8"-16	1/2"-13	5/8"-11	3/4"-10
Min. Embedment Depth (in.)	1	1 9/16	2	2 1/2	3 3/16
Load Capacity Tension (lbs) *	495	1045	1440	1860	3600
Load Capacity Shear (lbs) *	530	1145	1600	3095	3920

* Based on concrete compression strength of 4000 psi using applied safety factor of 4.0. For additional loading information contact factory.

Anchors

UPC/Part Number	Catalog Number	Rod Size	Anchor Length	Thread Depth	Box Qty.
-----------------	----------------	----------	---------------	--------------	----------

Drop-in Anchor - Smooth Wall - Steel

781011 03218	ADI-25	1/4"	1"	7/16"	100
781011 03219	ADI-37	3/8"	1 9/16"	5/8"	50
781011 03220	ADI-50	1/2"	2"	13/16"	50
781011 03221	ADI-62	5/8"	2 1/2"	1 13/16"	25
781011 03222	ADI-75	3/4"	3 3/16"	1 3/8"	10

Drop-in Anchor - Smooth Wall - Stainless Steel

781011 03223	ADI-25SS4	1/4"	1"	7/16"	100
781011 03224	ADI-37SS4	3/8"	1 9/16"	5/8"	50
781011 03226	ADI-50SS4	1/2"	2"	13/16"	50
781011 03227	ADI-62SS4	5/8"	2 1/2"	1 13/16"	25
781011 03228	ADI-75SS4	3/4"	3 3/16"	1 3/8"	10

Drop-in Anchor - Flanged - Steel

782051 53297	ADI-25FL	1/4"	1"	7/16"	100
782051 53298	ADI-37FL	3/8"	1 9/16"	5/8"	50
782051 53299	ADI-50FL	1/2"	2"	13/16"	50

UPC/Part Number	Catalog Number	Rod Size	Pin Length	Box Qty.
-----------------	----------------	----------	------------	----------

Setting Tools

781011 03229	6305	1/4"	39/64"	1
781011 03231	6307	3/8"	61/64"	1
781011 03232	6309	1/2"	13/16"	1
781011 03233	6311	5/8"	15/16"	1
781011 03234	6313	3/4"	16 1/64"	1

Read safety/installation instruction sheets in packages before use.

Mini Drop-in Anchors

- Carbon steel machine bolt anchor for use in shallow embedment applications.
- Can be used in solid concrete and precast hollow core plank, in addition to post-tensioned concrete slabs and concrete pours over metal deck.
- Can be used for overhead applications such as suspending cable tray, strut, pipe supports and lighting.
- Flanged (lipped) version installs flush for easy inspection and standardizes rod heights.
- Setting tool scores flange when set to verify proper expansion
- Available in zinc plated finish.



Anchor

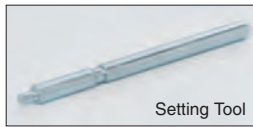

Setting Tool

Mini Drop-In Anchors - Data	1/4"	3/8"	1/2"
ANSI Drill Bit Size (in.)	3/8	1/2	5/8
Max. Tightening Torque (ft-lbs)	3	5	10
Thread Size (UNC)	1/4"-20	3/8"-16	1/2"-13
Min. Embedment Depth (in.)	5/8	3/4	1
Load Capacity Tension (lbs) *	350	530	840
Load Capacity Shear (lbs) *	415	1055	1220

* Based on concrete compression strength of 4000 psi using applied safety factor of 4.0. For additional loading information contact factory.

UPC/Part Number	Catalog Number	Rod Size	Thread Depth	Box Qty.
Mini Drop-in Anchor - Steel				
782051 53300	ADM-25	1/4"	3/8"	100
782051 53302	ADM-37	3/8"	13/32"	50
782051 53304	ADM-50	1/2"	5/8"	50
Setting Tools				
782051 53301	6336	1/4"	--	1
782051 53303	6323	3/8"	--	1
782051 53305	6338	1/2"	--	1

Read safety/installation instruction sheets in packages before use.

Anchors

Hollow Base Drop-in Anchors

- For use in hollow base materials such as hollow concrete block, brick with weep holes, and precast hollow core plank.
- Can also be used in solid base materials.
- Smooth wall drop-in can be installed flush mounted or below the base material surface.
- Available in Zinc Plated finish.

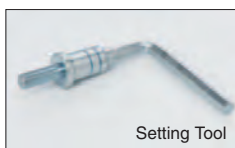

Hollow Base Drop-In - Data	1/4"	3/8"	1/2"
ANSI Drill Bit Size (in.)	3/8	5/8	3/4
Max. Tightening Torque (ft-lbs)	5	10	20
Thread Size (UNC)	1/4"-20	3/8"-16	1/2"-13
Thread Length In Cone (in.)	3/8	5/8	3/4
Min. Embedment Depth (in.)	3/4	1	1 1/2
Load Capacity Tension (lbs) *	285	520	1005
Load Capacity Shear (lbs) *	300	640	1005

* Based on concrete compression strength of 4000 psi using applied safety factor of 4.0. For additional loading information contact factory.

Anchors

UPC/Part Number	Catalog Number	Rod Size	Overall Length	Sleeve Length	Box Qty.
Hollow Base Drop-In					
782051 53291	ADH-25	1/4"	7/8"	5/8"	100
782051 53293	ADH-37	3/8"	1 5/16"	1 5/16"	50
782051 53295	ADH-50	1/2"	1 3/4"	1 1/4"	50
Setting Tools					
782051 53292	9323	1/4"	--	--	1
782051 53294	9343	3/8"	--	--	1
782051 53296	9353	1/2"	--	--	1

Read safety/installation instruction sheets in packages before use.

Concrete Screw Bolts

- For use in racking, shelving, material handling, structural anchorage, masonry and food & beverage facilities.
- One piece heavy-duty anchor with a finished hex-head.
- Fits standard fixture hole dimensions in fabricated steel.
- Fast installation and immediate loading reduces downtime.
- For proper performance, screw anchors must be installed with the corresponding bits. The bits have a matched tolerance range designed to provide optimum performance.



Concrete Screw Bolts - Data	1/4"	3/8"
ACB Drill Bit Size (in.)	1/4	3/8
Concrete Screw Tolerance Range (in.)	0.255 - 0.259	0.385 - 0.389
Min. Embedment Depth (in.)	1	1 1/2
Load Capacity Tension (lbs) *	335	630
Load Capacity Shear (lbs) *	520	1170

* Based on concrete compression strength of 4000 psi in uncracked concrete using applied safety factor of 4.0. For additional loading information contact factory.

For ultimate strength design data in cracked and uncracked concrete, see ICC-ES ESR-2526.

UPC/Part Number	Catalog Number	Anchor Length	Thread Length	Box Qty.
Screw Type Anchor - Steel				
782051 53247	ACB-25-175	1/4" x 1 3/4"	1 5/8"	100
782051 53248	ACB-25-225	1/4" x 2 1/4"	2"	100
782051 53249	ACB-25-300	1/4" x 3"	2 3/4"	100
782051 53250	ACB-37-175	3/8" x 1 3/4"	1 1/2"	50
782051 53251	ACB-37-250	3/8" x 2 1/2"	2 1/4"	50
782051 53252	ACB-37-300	3/8" x 3"	2 3/4"	50
782051 53253	ACB-37-400	3/8" x 4"	3 3/4"	50

UPC/Part Number	Catalog Number	Drill Size	Usable Length	Overall Length	Box Qty.
Drill Bits - Straight Shank Type					
782051 53254	1372	1/4"	4"	6"	1
782051 53256	1380	3/8"	4"	6"	1

Drill Bits - SDS Type

782051 53255	1314	1/4"	4"	6"	1
782051 53257	1316	3/8"	4"	6"	1

Note: Matched tolerance bits must be used for installation.

Read safety/installation instruction sheets in packages before use.

Anchors

Concrete Screws

- Light to medium duty anchor for use in concrete, masonry block and brick base materials.
- Concrete screws are engineered with matched tolerance bits and installation tools to optimize performance.
- High low thread design for greater stability and grip.
- No hole spotting required.
- One drill bit is packaged in each box of concrete screws.
- Blue fluorocarbon coating for corrosion resistance.



Straight Shank Drill Bit



SDS Hex Drill Bit



Hex Head

Hex Head - Data	3/16"	1/4"
ANSI Drill Bit Size (in.)	5/32	3/16
Fixture Clearance Hole (in.)	1/4	5/16
Head Height (in.)	7/64	9/64
Head Width (in.)	1/4	5/16
Washer O.D. (in.)	11/32	13/32
Washer Thickness (in.)	1/32	1/32
Hex Driver (in.)	1/4	5/16



Flat Head

Flat Head - Data	3/16"	1/4"
ANSI Drill Bit Size (in.)	5/32	3/16
Fixture Clearance Hole (in.)	1/4	5/16
Phillips Head O.D. (in.)	3/8	1/2
Phillips Head Height (in.)	9/64	3/16
Phillips Bit Size	2	3

Embedment Depth	Nominal Anchor Dia. / Loading*			
	3/16" Tension	3/16" Shear	1/4" Tension	1/4" Shear
1"	90	175	265	205
1 1/4"	175	230	335	355
1 3/8"	215	230	370	385
1 1/2"	255	230	405	355
1 3/4"	375	235	435	370

* Based on concrete compression strength of 4000 psi using applied safety factor of 4.0. For additional loading information contact factory.

Read safety/installation instruction sheets in packages before use.

Concrete Screws

UPC/Part Number	Catalog Number	Size	Box Qty.	
Hex Head Concrete Screws				
781011 03342	ACS-18-125H	3/16" X 1 1/4"	100	
781011 03343	ACS-18-175H	3/16" X 1 3/4"	100	
781011 03344	ACS-18-225H	3/16" X 2 1/4"	100	
781011 03346	ACS-18-275H	3/16" X 2 3/4"	100	
781011 03347	ACS-18-325H	3/16" X 3 1/4"	100	
781011 03348	ACS-18-375H	3/16" X 3 3/4"	100	
781011 03349	ACS-18-400H	3/16" X 4"	100	
781011 03351	ACS-25-125H	1/4" X 1 1/4"	100	
781011 03352	ACS-25-175H	1/4" X 1 3/4"	100	
781011 03353	ACS-25-225H	1/4" X 2 1/4"	100	
781011 03354	ACS-25-275H	1/4" X 2 3/4"	100	
781011 03356	ACS-25-325H	1/4" X 3 1/4"	100	
781011 03357	ACS-25-375H	1/4" X 3 3/4"	100	
781011 03358	ACS-25-400H	1/4" X 4"	100	
Flat Head Concrete Screws				
782051 53259	ACS-18-125F	3/16" X 1 1/4"	100	
782051 53260	ACS-18-175F	3/16" X 1 3/4"	100	
782051 53261	ACS-18-225F	3/16" X 2 1/4"	100	
782051 53262	ACS-18-275F	3/16" X 2 3/4"	100	
782051 53263	ACS-25-125F	1/4" X 1 1/4"	100	
782051 53264	ACS-25-175F	1/4" X 1 3/4"	100	
782051 53265	ACS-25-225F	1/4" X 2 1/4"	100	
782051 53266	ACS-25-275F	1/4" X 2 3/4"	100	
UPC/Part Number	Catalog Number	Bit Size	Usable Length	Box Qty.
Straight Shank Drill Bits				
782051 53267	2782	5/32" X 4 1/2"	3"	1
782051 53269	2786	3/16" X 4 1/2"	3"	1
SDS Hex Drill Bits				
782051 53268	2793	5/32" X 5"	3"	1
782051 53270	2796	3/16" X 5"	3"	1
UPC/Part Number	Catalog Number	Description	Box Qty.	
Setting Tool				
781011 03453	2791	Concrete Screw Tool Kit	1	

Read safety/installation instruction sheets in packages before use.

Anchors

Wedge Expansion Anchors

- Heavy and medium duty all purpose anchor.
- For use in solid concrete and grout filled block.
- Anchors can be installed through the fixture, no need for hole spotting.
- Interlocking clip wedges prevent anchor spinning during installation.
- Wire hanger hole size $\frac{9}{32}$ " diameter, head height $\frac{3}{4}$ ".
- UL & FM approved.
- Available in Zinc Plated Carbon Steel or Type 304 Stainless Steel.



Wedge Expansion Anchor - Data	1/4"	3/8"	1/2"	5/8"
ANSI Drill Bit Size (in.)	1/4	3/8	1/2	5/8
Fixture Clearance Hole (in.)	5/16	7/16	9/16	11/16
Thread Size (UNC)	1/4"-20	3/8"-16	1/2"-13	5/8"-11
Washer O.D. (in.)	5/8	13/16	1 1/16	1 3/4
Wrench Size	7/16	9/16	3/4	15/16
Max. Tightening Torque (ft-lbs)	8	28	60	90
Min. Embedment Depth (in.)	1 1/8	1 5/8	2 1/4	2 3/4
Load Capacity Tension (lbs) *	360	760	1390	2075
Load Capacity Shear (lbs) *	405	940	1700	2975

* Based on concrete compression strength of 4000 psi using applied safety factor of 4.0. For additional loading contact factory.

Wire Hanger Wedge Anchor - Data	1/4"
ANSI Drill Bit Size (in.)	1/4
Min. Embedment Depth (in.)	1 1/8
Head Height (in.)	3/4
Load Capacity Tension (lbs) *	360
Load Capacity Shear (lbs) *	405

* Based on concrete compression strength of 4000 psi using applied safety factor of 4.0. For additional loading information contact factory.

UPC/Part Number	Catalog Number	Size	Hole Size	Box Qty.
-----------------	----------------	------	-----------	----------

Wire Hanger

781011 03106 **AWA-25-200WH** 1/4" X 2" 9/32" 100

Read safety/installation instruction sheets in packages before use.

Wedge Expansion Anchors

UPC/Part Number	Catalog Number	Size	Thread Length	Box Qty.
Wedge Anchor				
781011 03068	AWA-25-175	1/4" X 1 3/4"	3/4"	100
781011 03069	AWA-25-225	1/4" X 2 1/4"	1 1/4"	100
781011 03070	AWA-25-325	1/4" X 3 1/4"	2 1/4"	100
781011 03071	AWA-37-225	3/8" X 2 1/4"	1 1/4"	50
781011 03072	AWA-37-275	3/8" X 2 3/4"	1 5/8"	50
781011 03073	AWA-37-300	3/8" X 3"	1 7/8"	50
782051 53364	AWA-37-350	3/8" X 3 1/2"	2 3/8"	50
781011 03074	AWA-37-375	3/8" X 3 3/4"	2 5/8"	50
781011 03075	AWA-37-500	3/8" X 5"	3 7/8"	50
782051 53366	AWA-50-275	1/2" X 2 3/4"	1 3/8"	50
781011 03077	AWA-50-375	1/2" X 3 3/4"	2 3/8"	50
782051 45636	AWA-50-450	1/2" X 4 1/2"	3 1/8"	50
781011 03079	AWA-50-550	1/2" X 5 1/2"	4 1/8"	50
781011 03080	AWA-50-700	1/2" X 7"	5 5/8"	25
781011 03081	AWA-62-350	5/8" X 3 1/2"	2"	25
781011 03082	AWA-62-450	5/8" X 4 1/2"	3"	25
781011 03083	AWA-62-500	5/8" X 5"	3 1/2"	25
781011 03084	AWA-62-600	5/8" X 6"	4 1/2"	25
781011 03085	AWA-62-700	5/8" X 7"	5 1/2"	25
Wedge Anchor - Stainless Steel				
781011 03146	AWA-25-175SS4	1/4" X 1 3/4"	3/4"	100
781011 03147	AWA-25-225SS4	1/4" X 2 1/4"	1 1/4"	100
781011 03148	AWA-25-325SS4	1/4" X 3 1/4"	2 1/4"	100
781011 03149	AWA-37-225SS4	3/8" X 2 1/4"	1 1/4"	50
781011 03150	AWA-37-275SS4	3/8" X 2 3/4"	1 5/8"	50
781011 03151	AWA-37-300SS4	3/8" X 3"	1 7/8"	50
782051 53365	AWA-37-350SS4	3/8" X 3 1/2"	2 3/8"	50
781011 03152	AWA-37-375SS4	3/8" X 3 3/4"	2 5/8"	50
781011 03153	AWA-37-500SS4	3/8" X 5"	3 1/8"	50
781011 03154	AWA-50-275SS4	1/2" X 2 3/4"	1 3/8"	50
781011 03155	AWA-50-375SS4	1/2" X 3 3/4"	2 3/8"	50
782051 53367	AWA-50-450SS4	1/2" X 4 1/2"	3 1/8"	50
781011 03157	AWA-50-550SS4	1/2" X 5 1/2"	4 1/8"	50
782051 53368	AWA-50-700SS4	1/2" X 7"	5 5/8"	25
782051 53369	AWA-62-350SS4	5/8" X 3 1/2"	2"	25
782051 53370	AWA-62-450SS4	5/8" X 4 1/2"	3"	25
782051 53779	AWA-62-500SS4	5/8" X 5"	3 1/2"	25
782051 53371	AWA-62-600SS4	5/8" X 6"	4 1/2"	25
782051 43044	AWA-62-700SS4	5/8" X 7"	5 1/2"	25

Read safety/installation instruction sheets in packages before use.

Anchors

Seismic Wedge Anchors

- Fully threaded, torque-controlled, wedge anchor which is designed for consistent performance in cracked and uncracked concrete.
- For use in concrete, structural sand lightweight concrete, and concrete over metal deck.
- Nominal drill bit size is the same as the anchor diameter.
- ICC-ES listed, ESR-2502, Category 1
- Zinc plated carbon steel body with stainless steel expansion clip from premium performance.
- Qualified for seismic and wind loading.



Anchors

Seismic Wedge Anchor - Data	3/8"	1/2"	5/8"	3/4"
ANSI Drill Bit Size (in.)	3/8	1/2	5/8	3/4
Fixture Clearance Hole (in.)	7/16	9/16	11/16	13/16
Minimum Hole Depth (in.)	2 ⁵ / ₈	2 ³ / ₄	4 ¹ / ₄	5
Minimum Concrete Thickness (in.)	4	4 ¹ / ₂	5 ³ / ₄	7
Max. Tightening Torque (ft-lbs)	20	40	60	110
Min. Embedment Depth (in.)	2 ³ / ₈	2 ¹ / ₂	3 ⁷ / ₈	4 ¹ / ₂

For loading information, see ICC-ES ESR-2502.

Read safety/installation instruction sheets in packages before use.

Seismic Wedge Anchors

UPC/Part Number	Catalog Number	Size	Thread Length	Box Qty.
Seismic Wedge Anchor				
782051 53398	AWSD-37-300	3/8" X 3"	1 3/4"	50
782051 53399	AWSD-37-350	3/8" X 3 1/2"	2 1/4"	50
782051 53400	AWSD-37-375	3/8" X 3 3/4"	2 1/2"	50
782051 53401	AWSD-37-500	3/8" X 5"	3 3/4"	50
782051 53402	AWSD-50-375	1/2" X 3 3/4"	2 1/8"	50
782051 53403	AWSD-50-450	1/2" X 4 1/2"	2 7/8"	50
782051 53404	AWSD-50-550	1/2" X 5 1/2"	3 7/8"	50
782051 53405	AWSD-50-700	1/2" X 7"	5 3/8"	50
782051 53406	AWSD-62-475	5/8" X 4 3/4"	2 7/8"	25
782051 53407	AWSD-62-500	5/8" X 5"	3 1/8"	25
782051 53408	AWSD-62-600	5/8" X 6"	4 1/8"	25
782051 53409	AWSD-62-700	5/8" X 7"	5 1/8"	25
782051 53410	AWSD-75-550	3/4" X 5 1/2"	3 1/4"	20
782051 53411	AWSD-75-625	3/4" X 6 1/4"	4"	20
782051 53425	AWSD-75-700	3/4" X 7"	4 3/4"	20

Read safety/installation instruction sheets in packages before use.

Anchors

Drive Anchor

- One-piece, tamper-proof vibration resistant anchor for use in concrete.
- Anchor is formed with an 's' shaped configuration at the working end of the anchor to create an expansion mechanism.
- Anchor is pre-expanded so no secondary tightening operation is required.
- FM approved.
- Made of Zinc Plated carbon steel.



Mushroom Head - Data	3/16"	1/4"
ANSI Drill Bit Size (in.)	3/16	1/4
Fixture Clearance Hole (in.)	1/4	5/16
Head Height (in.)	7/64	7/64
Head Size O.D. (in.)	7/16	1/2
Min. Embedment Depth (in.)	7/8	7/8
Load Capacity Tension (lbs.) *	215	235
Load Capacity Shear (lbs.) *	330	470

Rod Hanger - Data	1/4"	3/8"
ANSI Drill Bit Size (in.)	3/16	1/4
UNC Thread Size	1/4"-20	3/8"-16
Head Height (in.)	1/2	5/8
Head Size O.D. (in.)	13/32	35/64
Min. Embedment Depth (in.)	1 1/4	1 3/4
Load Capacity Tension (lbs.) *	315	500
Load Capacity Shear (lbs.) *	245	525



Wire Hanger - Data	3/16"	1/4"
ANSI Drill Bit Size (in.)	3/16	1/4
Tie-Wire Hole (in.)	3/16	9/32
Head Height (in.)	37/64	41/64
Head Width (in.)	9/64 x 7/16	3/16 x 9/16
Min. Embedment Depth (in.)	1 1/8	1 1/8
Load Capacity Tension (lbs.)*	265	290
Load Capacity Shear (lbs.)*	240	330



* Based on concrete compression strength of 4000 psi using applied safety factor of 4.0. For additional loading information contact factory.

Read safety/installation instruction sheets in packages before use.

Drive Anchors

UPC/Part Number	Catalog Number	Size	Box Qty.
Mushroom Head			
782051 53271	ADA-18-100	3/16" X 1"	100
782051 53272	ADA-18-125	3/16" X 1 1/4"	100
782051 53273	ADA-18-150	3/16" X 1 1/2"	100
782051 53274	ADA-18-200	3/16" X 2"	100
782051 53275	ADA-18-250	3/16" X 2 1/2"	100
782051 53276	ADA-18-300	3/16" X 3"	100
782051 53278	ADA-25-100	1/4" X 1"	100
782051 53279	ADA-25-125	1/4" X 1 1/4"	100
782051 53280	ADA-25-150	1/4" X 1 1/2"	100
782051 53281	ADA-25-200	1/4" X 2"	100
782051 53282	ADA-25-250	1/4" X 2 1/2"	100
782051 53283	ADA-25-300	1/4" X 3"	100

UPC/Part Number	Catalog Number	Head Size	Box Qty.
Rod Hanger			
782051 53284	ADA-25RH	1/4"	100
782051 53286	ADA-37RH	3/8"	100

UPC/Part Number	Catalog Number	Head Size	Box Qty.
Wire Hanger			
782051 53277	ADA-18WH	3/16"	100
782051 53285	ADA-25WH	1/4"	100

Read safety/installation instruction sheets in packages before use.

Anchors

Sleeve Type Expansion Anchors

- For use in concrete and masonry substrates.
- Suitable for solid and hollow core materials.
- Fits standard fixture holes - no need to undersize anchors for proper fit.
- Sleeve has 360° contact area and reduces concrete stress.
- UL & FM approved.
- Available in Zinc Plated Steel or Type 304 Stainless Steel.



Hex Nut (HN)
Style



Acorn Nut (AN)
Style



Slotted Round
Head (RS) Style

Sleeve Type Expansion - Data	1/4"	3/8"	1/2"	5/8"	3/4"
ANSI Drill Bit Size (in.)	1/4	3/8	1/2	5/8	3/4
Fixture Clearance Hole (in.)	5/16	7/16	9/16	11/16	15/16
Plow Bolt Size (UNC)	#10-24	5/16"-18	3/8"-16	1/2"-13	5/8"-11
Min. Embedment Depth (in.)	5/8	15/8	2 1/4	2 1/4	2 1/4
Load Capacity Tension (lbs) *	155	670	1255	1465	2105
Load Capacity Shear (lbs) *	300	610	1055	1800	2900

* Based on concrete compression strength of 4000 psi using applied safety factor of 4.0. For additional loading contact factory.



Rod Hanger
(RH) Style



Wire Hanger
(WH) Style

Sleeve Type Expansion - Data	Hanger Rod			Wire Hanger
	1/4"	3/8"	1/2"	5/16"
ANSI Drill Bit Size (in.)	1/4	3/8	1/2	5/16
Fixture Clearance Hole (in.)	NA	NA	NA	1/4
Plow Bolt Size (UNC)	#10-24	5/16"-18	3/8"-16	1/4"-20
Coupling Height (in.)	7/8	1	1 1/4	NA
Min. Embedment Depth (in.)	5/8	15/8	2 1/4	1 1/2
Load Capacity Tension (lbs) *	155	670	1255	520
Load Capacity Shear (lbs) *	300	610	1055	380

* Based on concrete compression strength of 4000 psi using applied safety factor of 4.0. For additional loading go to www.cooperblin.com.

Read safety/installation instruction sheets in packages before use.

Sleeve Type Expansion Anchors

UPC/Part Number	Catalog Number	Size	Thread Length	Box Qty.
Hex Nut Style				
781011 02995	ASA-37-187HN	3/8" X 17/8"	15/8"	50
781011 02996	ASA-37-300HN	3/8" X 3"	15/8"	50
782051 53346	ASA-37-400HN	3/8" X 4"	15/8"	50
781011 02997	ASA-50-225HN	1/2" X 2 1/4"	2 1/8"	25
781011 02998	ASA-50-300HN	1/2" X 3"	2 1/4"	25
781011 02999	ASA-50-400HN	1/2" X 4"	2 1/4"	25
782051 53351	ASA-50-525HN	1/2" X 5 1/4"	2 1/4"	25
781011 03002	ASA-50-600HN	1/2" X 6"	2 1/4"	10
781011 03003	ASA-62-225HN	5/8" X 2 1/4"	2 1/8"	25
781011 03004	ASA-62-300HN	5/8" X 3"	2 3/4"	25
781011 03005	ASA-62-425HN	5/8" X 4 1/4"	2 3/4"	10
781011 03006	ASA-62-600HN	5/8" X 6"	2 3/4"	10
781011 03007	ASA-75-250HN	3/4" X 2 1/2"	2 1/8"	10
781011 03008	ASA-75-425HN	3/4" X 4 1/4"	3 3/8"	10
781011 03009	ASA-75-625HN	3/4" X 6 1/4"	3 3/8"	10

Hex Nut Style - Stainless Steel

782051 53343	ASA-37-187HNSS4	3/8" X 17/8"	15/8"	50
782051 53345	ASA-37-300HNSS4	3/8" X 3"	15/8"	50
782051 53347	ASA-50-225HNSS4	1/2" X 2 1/4"	2 1/8"	25
782051 53349	ASA-50-300HNSS4	1/2" X 3"	2 1/4"	25
782051 53350	ASA-50-400HNSS4	1/2" X 4"	2 1/4"	25
782051 53352	ASA-62-425HNSS4	5/8" X 4 1/4"	2 3/4"	10
782051 53353	ASA-75-400HNSS4	3/4" X 4"	3 3/8"	10

Acorn Nut Style

782051 53341	ASA-25-62AN	1/4" X 5/8"	1/2"	100
781011 02991	ASA-25-137AN	1/4" X 1 3/8"	1 1/8"	100
781011 02992	ASA-25-225AN	1/4" X 2 1/4"	1 1/8"	100

Slotted Round Head Style

782051 53338	ASA-25-112RS	1/4" X 1 1/8"	1"	100
782051 53340	ASA-25-200RS	1/4" X 2"	1 1/8"	100

UPC/Part Number	Catalog Number	Size	Drill Dia.	Box Qty.
-----------------	----------------	------	------------	----------

Rod Hanger

782051 53339	ASA-25-150RH	1/4" X 1 1/2"	5/16"	50
782051 53344	ASA-37-187RH	3/8" X 1 7/8"	3/8"	50
782051 53348	ASA-50-225RH	1/2" X 2 1/4"	1/2"	25

Wire Hanger

782051 53342	ASA-31-150WH	5/16" X 1 1/2"	5/16"	100
--------------	---------------------	----------------	-------	-----

Read safety/installation instruction sheets in packages before use.

Anchors

Double Expansion Anchors

- For use in concrete, block, brick or stone.
- Double expansion anchor is particularly suited for base materials of questionable strength (job site tests are recommended).
- Internally threaded anchor for easy removability and service work.
- Made of Zamac Alloy material.



Double Expansion - Data	1/4"	3/8"	1/2"	5/8"
ANSI Drill Bit Size (in.)	1/2	3/4	7/8	1
Max. Tightening Torque (ft-lbs)	5	10	20	30
Thread Size (UNC)	1/4"-20	3/8"-16	1/2"-13	5/8"-11
Thread Length In Cone (in.)	1/2	5/8	3/4	7/8
Min. Embedment Depth (in.)	1 1/4	1 3/4	2 1/4	2 1/2
Load Capacity Tension (lbs) *	415	875	1625	1750
Load Capacity Shear (lbs) *	405	1000	1540	2855

* Based on concrete compression strength of 4000 psi using applied safety factor of 4.0. For additional loading information contact factory.

UPC/Part Number	Catalog Number	Rod Diameter	Anchor Length	Box Qty.
781011 03251	ADE-25	1/4"	1 3/8"	50
781011 03253	ADE-37	3/8"	2"	50
781011 03254	ADE-50	1/2"	2 1/2"	25
781011 03256	ADE-62	5/8"	2 3/4"	25

Read safety/installation instruction sheets in packages before use.

Single Expansion Anchors

- For use in concrete, block, brick or stone.
- Recommended for floor and wall attachments.
- Not recommended for overhead applications.
- Internally threaded anchor for easy removability and service work.
- Made of Zamac Alloy material.



Single Expansion - Data	1/4"	3/8"	1/2"	5/8"
ANSI Drill Bit Size (in.)	1/2	3/4	7/8	1
Max. Tightening Torque (ft-lbs)	5	10	20	30
Thread Size (UNC)	1/4"-20	3/8"-16	1/2"-13	5/8"-11
Thread Length In Cone (in.)	5/16	5/16	7/16	5/8
Min. Embedment Depth (in.)	1 3/8	1 5/8	2 1/2	2 3/4
Load Capacity Tension (lbs) *	500	725	1225	2050
Load Capacity Shear (lbs) *	405	950	1540	2855

* Based on concrete compression strength of 4000 psi using applied safety factor of 4.0. For additional loading information contact factory.

UPC/Part Number	Catalog Number	Rod Size	Anchor Length	Box Qty.
Single Expansion				
781011 03245	ASE-25	1/4"	1 5/16"	50
781011 03247	ASE-37	3/8"	1 1/2"	50
781011 03248	ASE-50	1/2"	2 1/16"	25
781011 03249	ASE-62	5/8"	2 5/8"	25

Read safety/installation instruction sheets in packages before use.

Anchors

Wood Knocker Anchors

- Wood-Knocker concrete inserts are installed onto wooden forms used to support newly poured concrete floor slabs, roof slabs or walls.
- When the forms are stripped, the color-coded flange is visibly embedded in the concrete surface.
- The unique, six sided impact plate offers resistance to rotation within the concrete as threaded rod is being installed.
- Suitable for overhead installations such as suspending cable tray, pipe hangers, strut and conduit.
- Color coded by size for all trades.
- UL and FM approved.
- Lowest in-place cost.



Wood Knocker - Data	1/4"	3/8"	1/2"	5/8"	3/4"
Insert Thread Length (in.)	3/8	5/8	11/16	15/16	1 1/8
Plastic Flange Diameter (in.)	1 3/8	1 3/8	1 3/8	1 5/8	1 5/8
Thread Size (UNC)	1/4"-20	3/8"-16	1/2"-13	5/8"-11	3/4"-10
Overall Length (in.)	1 7/8	1 7/8	1 7/8	1 7/8	1 7/8
Min. Insert Spacing (in.)	9	9	9	12	12
Min. End Distance (in.)	6	6	6	9	9
Load Capacity Tension (lbs) *	930	1200	1200	1160	1160
Load Capacity Shear (lbs) *	370	1330	1840	2800	2800

* Based on normal weight concrete with minimum compression strength of 3000 psi. Allowable load capacities are calculated using applied safety factor of 4.0. For additional loading information contact factory. Minimum embedment depth is 2".

UPC/Part Number	Catalog Number	Rod Diameter	Color	Box Qty.
Wood Knocker				
782051 31147	ACPW-25	1/4"	Brown	100
782051 31149	ACPW-37	3/8"	Green	100
782051 31151	ACPW-50	1/2"	Yellow	100
782051 31152	ACPW-62	5/8"	Red	50
782051 31153	ACPW-75	3/4"	Purple	50

Read safety/installation instruction sheets in packages before use.

Bang-It Anchors

- Bang-It concrete inserts are designed for installation in and through metal composite deck used to support newly poured concrete floors or roof slabs.
- After installation, the protective sleeve of the insert protrudes below the surface of the deck, allowing overhead attachment of threaded rod.
- The unique, six sided impact plate offers resistance to rotation within the concrete as threaded rod is being installed.
- Suitable for overhead installations such as suspending cable tray, pipe hangers, strut and conduit.
- Color coded by size for all trades.
- UL and FM approved.
- Lowest in-place cost.



Bang-It - Data	1/4"	3/8"	1/2"	5/8"	3/4"	7/8"
Metal Hole Saw Diameter (in.)	13/16	13/16	13/16	13/16	13/16	13/16
Drilling Speed (rpm)	700-900	700-900	700-900	500-700	500-700	500-700
Insert Thread Length (in.)	3/8	5/8	11/16	15/16	11/8	15/16
Length of Sleeve (in.)	33/8	33/8	33/8	33/8	33/8	33/8
Thread Size (UNC)	1/4"-20	3/8"-16	1/2"-13	5/8"-11	3/4"-10	7/8"-9
Embedment Depth (in.)	2	2	2	2	2	2
Upper Deck Tension Load (lbs) *	835	1435	1775	2200	2200	2200
Lower Deck Tension Load (lbs) *	835	1115	1115	1115	1115	1115
Upper Deck Shear Load (lbs) *	620	620	620	740	740	740
Lower Deck Shear Load (lbs) *	625	840	840	840	840	840

* Based on normal weight concrete with minimum compression strength of 3000 psi. Allowable load capacities are calculated using applied safety factor of 4.0. For additional loading information contact factory.
Minimum insert spacing of 12", minimum end spacing 12".

UPC/Part Number	Catalog Number	Rod Diameter	Color	Box Qty.
Bang-It				
782051 31154	ACPD-25	1/4"	Brown	100
782051 31156	ACPD-37	3/8"	Green	100
782051 31157	ACPD-50	1/2"	Yellow	100
782051 31158	ACPD-62	5/8"	Red	50
782051 31166	ACPD-75	3/4"	Purple	50
782051 53258	ACPD-87	7/8"	Black	50

Tools

782051 31169	ACPD-81HS	13/16" Carbide Hole Saw for 1/4", 3/8", 1/2"	1
782051 311671	ACPD-118HS	13/16" Carbide Hole Saw for 5/8", 3/4", 7/8"	1

Read safety/installation instruction sheets in packages before use.

Anchors

Machine Screw Anchors

- For use in concrete, block, brick or stone.
- Not recommended for use in overhead applications.
- Readily accepts machine bolts.
- Internally threaded anchor for easy removability and service work.
- Anchor installation requires shallow embedment.
- Made of Zamac Alloy material.

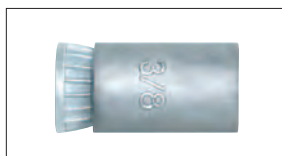

Machine Screw Anchor - Data	1/4"	3/8"	1/2"
ANSI Drill Bit Size (in.)	1/2	3/4	7/8
Max. Tightening Torque (ft-lbs)	5	10	15
Thread Size (UNC)	1/4"-20	3/8"-16	1/2"-13
Min. Embedment Depth (in.)	7/8	1 1/4	1 1/2
Load Capacity Tension (lbs) *	585	775	1095
Load Capacity Shear (lbs) *	355	825	1135

* Based on concrete compression strength of 4000 psi using applied safety factor of 4.0. For additional loading information contact factory.

Anchors

UPC/Part Number	Catalog Number	Rod Diameter	Box Qty.
-----------------	----------------	--------------	----------

Machine Screw Anchor

781011 03239	AMS-25	1/4"	100
781011 03242	AMS-37	3/8"	50
781011 03243	AMS-50	1/2"	50

Setting Tool

782051 09765	9221	1/4"	1
782051 09767	9231	3/8"	1
782051 09768	9241	1/2"	1

Read safety/installation instruction sheets in packages before use.

Self-Tapping Machine Screw Anchors

- For use in normal-weight concrete, structural sand lightweight concrete and concrete over metal deck.
- Anchor design allows for shallow embedment and mechanically interlocks with base material.
- Internally threaded anchor for easy adjustment and removability of threaded rod or bolt.
- Fast anchor installation with a powered impact wrench.
- Suitable for overhead applications such as suspending cable tray, strut, pipe hangers and conduit.
- FM Approved.
- ICC-ES listed, ESR-2272
- Made of Zinc Plated carbon steel.
- Setting tool included.



Self-Tapping Machine Screw - Data	3/8"
ANSI Drill Bit Size (in.)	1/2
Min. Concrete Thickness (in.)	4
Max. Tightening Torque (ft-lbs)	8
Min. Embedment Depth (in.)	1 ⁵ / ₈
Load Capacity Tension (lbs) *	540
Load Capacity Shear (lbs) *	825

* Based on concrete compression strength of 4000 psi in uncracked concrete using applied safety factor of 4.0. For additional loading information contact factory.

For ultimate strength design data in cracked and uncracked concrete, see ICC-ES ESR-2526.

UPC/Part Number	Catalog Number	Size	Thread Depth	Box Qty.
Self-Tapping Machine Screw Anchor				
782051 53362	ATM-37	3/8	1 ¹ / ₁₆ "	50
Tool				
782051 53363	6407 SD	3/8	–	1

Read safety/installation instruction sheets in packages before use.

Anchors

Drive Nail Anchors

- For use in concrete, block or brick.
- Anchor is recommended for light duty, tamper-proof applications.
- Not recommended for overhead applications.
- Made of Zamac Alloy material.



Drive Nail - Data	3/16"	1/4"
ANSI Drill Bit Size (in.)	3/16	1/4
Fixture Clearance Hole (in.)	1/4	5/16
Head Height (in.)	7/64	9/64
Head Size, O.D. (in.)	13/32	35/64
Min. Embedment Depth (in.)	3/4	5/8
Load Capacity Tension (lbs) *	125	150
Load Capacity Shear (lbs) *	175	205

* Based on concrete compression strength of 4000 psi using applied safety factor of 4.0. For additional loading information contact factory.

UPC/Part Number	Catalog Number	Size	Box Qty.
Drive Nail Anchor			
781011 02964	ADN-18-87	3/16" x 7/8"	100
781011 02965	ADN-25-75	1/4" x 3/4"	100
781011 02966	ADN-25-100	1/4" x 1"	100
781011 02967	ADN-25-125	1/4" x 1 1/4"	100
781011 02968	ADN-25-150	1/4" x 1 1/2"	100
781011 02969	ADN-25-200	1/4" x 2"	100
782051 53306	ADN-25-300	1/4" x 3"	100

Read safety/installation instruction sheets in packages before use.

Toggle Bolts

- The toggle bolt is a spring wing type hollow wall anchor designed for use in block, wallboard and other hollow base materials.
- Anchor is a two-part assembly consisting of a machine screw and a spring wing toggle.
- Adjustable to accommodate various wall thicknesses up to 2 1/2".
- Combo round head bolt is provided.
- Made of zinc plated carbon steel.



Toggle Bolt - Data	3/16"		1/4"		3/8"	
	Tension (lbs.)	Shear (lbs.)	Tension (lbs.)	Shear (lbs.)	Tension (lbs.)	Shear (lbs.)
3/8" Wallboard	35	35	55	55	60	65
1/2" Wallboard	45	50	60	60	65	75
5/8" Wallboard	60	60	65	65	75	80
3/4" Wallboard	75	70	80	75	85	90
Hollow Concrete Masonry *	70	70	70	120	195	140

Allowable load capacities are calculated using applied safety factor of 4.0. For additional loading information contact factory.

* Based on hollow wall concrete masonry with minimum compression strength of 1500 psi.

UPC/Part Number	Catalog Number	Drill Diameter	Size	Box Qty.
Toggle Bolt				
782051 53354	ATB-18-300	1/2"	3/16" x 3"	50
782051 53355	ATB-18-400	1/2"	3/16" x 4"	50
782051 53356	ATB-25-300	5/8"	1/4" x 3"	50
782051 53357	ATB-25-400	5/8"	1/4" x 4"	50
782051 53358	ATB-37-300	7/8"	3/8" x 3"	25
782051 53359	ATB-37-400	7/8"	3/8" x 4"	25

Read safety/installation instruction sheets in packages before use.

Anchors

Wall Screws

- One-piece, all steel anchor with high-profile threads for easy fastening into wallboard and other masonry base materials.
- Deep cutting, corkscrew-like threads provide for smooth entry and a strong hold.
- No pre-drilling is required when fastening into wallboard or wood.
- Fastening into concrete, hollow or grout filled block, brick and plaster requires a pre-drilled $\frac{3}{16}$ " ANSI hole.
- Installed with a No. 8 drill bit or No. 2 Phillips driver.
- Made of case hardened carbon steel with chrome finish.

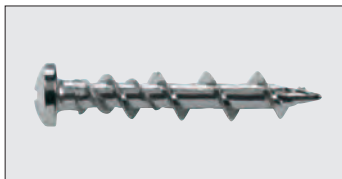

Wall Screw - Data	Minimum Embedment Depth	Load Cap. Tension (lbs.)*	Load Cap. Shear (lbs.)*
Concrete *	$\frac{3}{4}$ "	90	260
$\frac{1}{2}$ " Wallboard	NA	20	60
$\frac{5}{8}$ " Wallboard	NA	35	90
$\frac{3}{4}$ " Plywood	NA	65	150
Grout-Filled Concrete Masonry	1"	55	165
Hollow Concrete Masonry	1"	60	165
Brick Masonry	$\frac{3}{4}$ "	70	120

* Based on concrete compression strength of 4000 psi. Allowable load capacities are calculated using an applied safety factor of 4.0. For additional loading contact factory.

UPC/Part Number	Catalog Number	Size	Head Type	Box Qty.
Wall Screw				
782051 53372	AWS-CH	$\frac{3}{16}$ " x $1\frac{1}{4}$ "	Combo	100
782051 53373	AWS-OH	$\frac{3}{16}$ " x $1\frac{1}{4}$ "	Oval	100
782051 53374	AWS-PH	$\frac{3}{16}$ " x $1\frac{1}{4}$ "	Pan	100

Read safety/installation instruction sheets in packages before use.

Plastic Screw Anchors

- One-piece anchor designed for light duty applications in wallboard, concrete and masonry.
- Works in hollow or solid base materials.
- Suitable for screws with various thread sizes and styles - screws may be installed with a screw gun.



Plastic Screw Anchor - Data	APS-4	APS-6	APS-8
Drill Diameter (in.)	3/16	1/4	5/16
Screw Size Range	#4-#10	#6-#12	#8-#14
Min. Thread Length (in.)	1 ³ / ₁₆	1 ³ / ₈	1 ¹³ / ₁₆
Min. Hole Diameter (in.)	1 ³ / ₈	1 ⁹ / ₁₆	2
Min. Wall Thickness (in.)	1/4	3/8	1/2
Min. Embedded Thread Length (in.)	1 ⁷ / ₈	2	2 ⁹ / ₁₆
Load Capacity Tension (lbs) *	18	20	22
Load Capacity Shear (lbs) *	32	40	45

* Allowable load capacities are calculated using an applied safety factor of 4.0. For additional loading information contact factory.

UPC/Part Number	Catalog Number	Screw Size	Box Qty.
782051 53315	APS-4	#4 - #10	100
782051 53316	APS-6	#6 - #12	100
782051 53319	APS-8	#8 - #14	100

Read safety/installation instruction sheets in packages before use.

Anchors

Plastic Hollow Wall Anchors

- Heavy duty hollow wall anchor designed for use in plaster, wallboard, concrete block, or hollow tile.
- Pre-assembled anchor consisting of a carbon steel wing and a locking cap/ratchet leg assembly molded from engineered plastic.
- When compared to traditional toggles, this anchor can be installed in a smaller hole and does not require a fixture or screw to set it.
- Adjustable to accommodate various wall thickness up to 2 1/2".



Plastic Hollow Wall - Data	3/16"	1/4"	3/8"	1/2"
Thread Size (UNC)	3/16"-24	1/4"-20	3/8"-16	1/2"-13
Max. Tightening Torque (ft-lbs)	5	5	5	5
Minimum Clearance (in.)	1 7/8"	1 7/8"	1 7/8"	1 7/8"

Plastic Hollow Wall - Data	3/16"		1/4"		3/8"		1/2"	
	Tension (lbs.)	Shear (lbs.)	Tension (lbs.)	Shear (lbs.)	Tension (lbs.)	Shear (lbs.)	Tension (lbs.)	Shear (lbs.)
3/8" Wallboard	30	60	35	70	35	70	35	75
1/2" Wallboard	35	70	35	75	40	75	40	90
5/8" Wallboard	50	95	55	105	55	105	55	110
3/4" Wallboard	50	110	55	120	60	120	60	120
Hollow Concrete Masonry *	215	150	270	285	285	465	345	595

Allowable load capacities are calculated using an applied safety factor of 4.0. For additional loading information contact factory.

* Based on hollow wall concrete masonry with minimum compression strength of 1500 psi.

UPC/Part Number	Catalog Number	Anchor Size	Drill Dia.	Wall Thick.	Box Qty.
-----------------	----------------	-------------	------------	-------------	----------

Plastic Hollow Wall Anchor

782051 53311	APH-18	3/16" x 4"	1/2"	3/8" - 2 1/2"	50
782051 53312	APH-25	1/4" x 4"	1/2"	3/8" - 2 1/2"	50
782051 53313	APH-37	3/8" x 4"	3/4"	3/8" - 2 1/2"	25
782051 53314	APH-50	1/2" x 4"	3/4"	3/8" - 2 1/2"	25

Read safety/installation instruction sheets in packages before use.

Self-Drilling Wallboard Anchors

- One-piece self drilling anchor designed for use in hollow wallboard for light to medium duty loads.
- Ideal for mounting electrical fixtures, phone systems, and miscellaneous hardware.
- APD/AZD designed for use in 3/8" to 1" wallboard.
- APDM/AZDM designed for use in 3/8" to 5/8" wallboard.
- Kit includes 50 anchors, 50 screws and #2 Phillips Drive Bit.
- Available in engineered Nylon and Zamac Alloy.



Self-Drilling Wallboard Anchor - Data	APD/AZD	APDM/AZDM
Anchor Length (in.)	1 ¹¹ / ₁₆	1 ⁵ / ₁₆
Min. Screw Engagement (in.)	3/4	3/4

Self-Drilling Wallboard Anchor - Data	APD/AZD		APDM/AZDM	
	Tension (lbs.)	Shear (lbs.)	Tension (lbs.)	Shear (lbs.)
3/8" Wallboard	15	15	10	15
1/2" Wallboard	15	20	15	15
5/8" Wallboard	20	25	20	20
3/4" Wallboard	20	25	20	20

Allowable load capacities are calculated using an applied safety factor of 4.0. For additional loading information contact factory.

UPC/Part Number	Catalog Number	Screw Size	Box Qty.
-----------------	----------------	------------	----------

Self-Drilling Wallboard Anchor

781011 03314	APD-8K	#8 x 1"	50
781011 03318	AZD-8K	#8 x 1"	50
782051 53310	APDM-6K	#6 x 1"	50
782051 53375	AZDM-6K	#6 x 1"	50

Read safety/installation instruction sheets in packages before use.

Anchors

Plastic Conical Anchors

- Designed for use with lightweight fixtures.
- Recommended for use in concrete, block and brick.
- Recommended for light duty static applications where holding power is not critical.
- Not recommended for overhead use.
- Kit includes 100 anchors, 100 screws and one drill bit.
- Made of engineered plastic.



Anchors

Plastic Conical Anchor - Data	#8		#10 - #12	
	Tension (lbs.)	Shear (lbs.)	Tension (lbs.)	Shear (lbs.)
Nominal Weight Concrete *	110	70	140	90
Hollow Concrete Masonry **	60	45	70	55
Clay Brick Masonry ***	30	50	55	65
Minimum Embedment Depth	7/8"	7/8"	1"	1"

* Based on concrete compression strength of 4000 psi.

** Based on hollow concrete masonry with minimum compression strength of 1500 psi.

*** Based on clay brick masonry with minimum compression strength of 1500 psi.

Loads contain an applied safety factor of 4.0. For additional loading information contact factory.

UPC/Part
Number

Catalog
Number

Screw Size

Box
Qty.

Plastic Conical Anchor

782051 53307	APC-8K	#8 x 1"	100
782051 53308	APC-10K	#10 x 1"	100
782051 53309	APC-12K	#12 x 1"	100

Read safety/installation instruction sheets in packages before use.

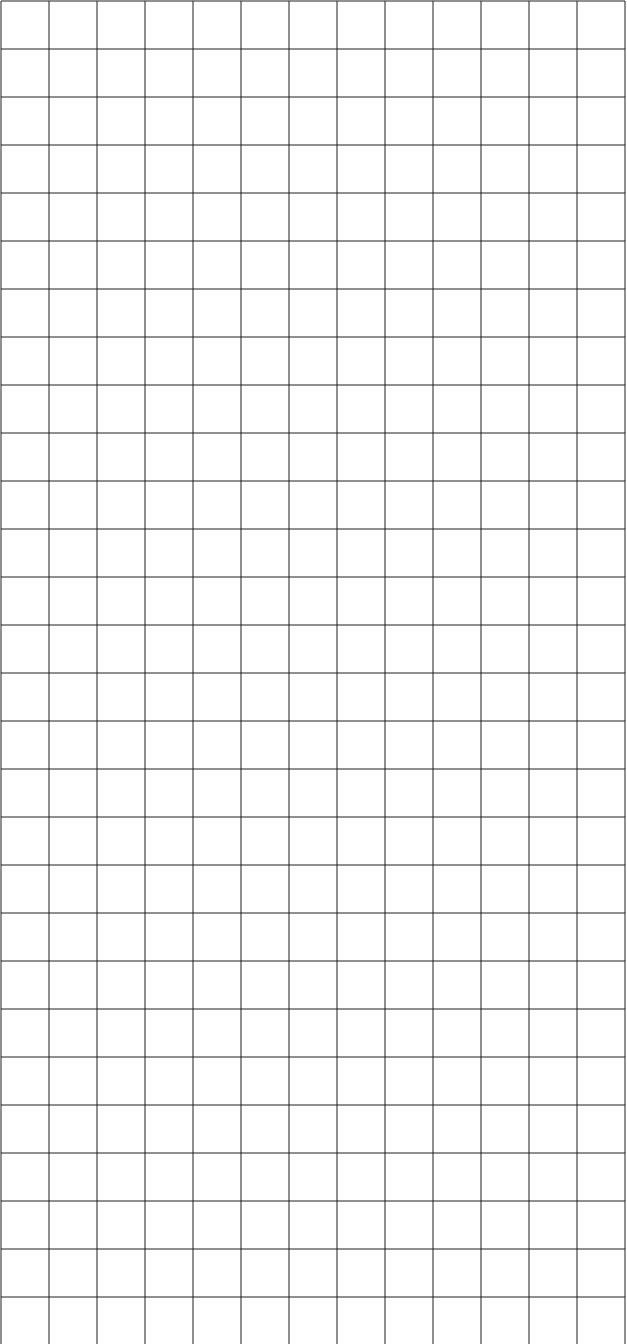

Read safety/installation instruction sheets in packages before use.

Code Compliance for Spring Steel Fasteners Based on the 2005 NEC®

B-Line has recognized the need for a reference source, detailing the National Electrical Code requirements for Spring Steel Fasteners. The following pages are reprinted portions of the 2005 NEC. These sections address nearly every aspect of fastener installations and offer design solutions for the electrical industry. If a topic has not been covered sufficiently to answer a specific question or if additional information is desired, contact B-Line's engineering department.

The following information has been carefully checked for accuracy and is believed to be correct and current. No warranty, either expressed or implied, is made as to either its applicability to, or its compatibility with, specific requirements, of this information, nor for damages consequent to its use. All design characteristics, specifications, tolerances and similar information are subject to change without notice.

To obtain a copy of the NEC® contact:
National Fire Protection Association
1 Batterymarch Park
P.O. Box 9101
Quincy, Massachusetts 02269-9101
1-800-344-3555

National Electrical Code® and *NEC*®
are registered trademarks of the
National Fire Protection Association, Inc.
Quincy, MA 02269.

90.4 Enforcement. This *Code* is intended to be suitable for mandatory application by governmental bodies that exercise legal jurisdiction over electrical installations, including signaling and communications systems, and for use by insurance inspectors. The authority having jurisdiction for enforcement of the *Code* has the responsibility for making interpretations of the rules, for deciding upon the approval of equipment and materials, and for granting the special permission contemplated in a number of the rules.

By special permission, the authority having jurisdiction may waive specific requirements in this *Code* or permit alternate methods where it is assured that equivalent objectives can be achieved by establishing and maintaining effective safety. *

This *Code* may require new products, constructions, or materials that may not yet be available at the time the *Code* is adopted. In such event, the authority having jurisdiction may permit the use of the products, constructions, or materials that comply with the most recent previous edition of this *Code* adopted by the jurisdiction.

Article 100 - Definitions

Listed. Equipment, materials, or services included in a list published by an organization that is acceptable to the authority having jurisdiction and concerned with evaluation of products or services, that maintains periodic inspection of production of listed equipment or materials or periodic evaluation of services, and whose listing states that the equipment, material, or services either meets appropriate designated standards or has been tested and found suitable for a specific purpose.

FPN: The means for identifying listed equipment may vary for each organization concerned with product evaluation, some of which do not recognize equipment as listed unless it is labeled. Use of the system employed by the listing organization allows the authority having jurisdiction to identify a listed product.

***Note:** Local codes may override certain requirements of the National Electrical Code®. Consult your local inspector for further details.

Reprinted with permission from NFPA 70-2005, the *National Electrical Code*®, Copyright® 2005, National Fire Protection Association, Quincy, MA 02269. This reprinted material is not the complete and official position of the National Fire Protection Association, on the referenced subject which is represented only by the standard in its entirety.

NEC Requirements

300.4 Protection Against Physical Damage.

Where subject to physical damage, conductors shall be adequately protected.

(A) Cables and Raceways through Wood Members.

- (1) **Bored Holes.** . . . , holes shall be bored so that the edge of the hole is not less than 32mm (1¹/₄ in.) from the nearest edge of the wood member. Where this distance cannot be maintained, the cable or raceway shall be protected from penetration by screws or nails by a steel plate or bushing, at least 1.6 mm (1/16 in.) thick, and of appropriate length and width installed to cover the area of the wiring. (See Figure 1)

Exception No. 1: Steel plates shall not be required to protect RMC, IMC, RNC, or EMT.

*Exception No. 2: A **listed** and marked steel plate less than 1.6 mm (1/16 in.) thick that provides equal or better protection against nail or screw penetration shall be permitted.*

- (2) **Notches in Wood.** . . . , cables or raceways shall be permitted to be laid in notches in wood studs, joists, rafters, or other wood members where the cable or raceway at those points is protected against nails or screws by a steel plate at least 1.6 mm (1/16 in.) thick, and of appropriate length and width, installed to cover the area of the wiring. The steel plate shall be installed before the building finish is applied. (See Figure 1)

Exception: See Exceptions 1 & 2 from (1) Bored Holes

(B) Nonmetallic-Sheathed Cables and Electrical Nonmetallic Tubing through Metal Framing Members.

- (1) **Nonmetallic-Sheathed Cable.** . . . where nonmetallic-sheathed cables pass through either factory or field punched, cut or drilled slots or holes in metal members, the cable shall be protected by listed bushings or listed grommets covering all metal edges that are securely fastened in the opening prior to installation of the cable. (See Figure 2)

- (2) **Nonmetallic-Sheathed Cable and Electrical Nonmetallic Tubing.** Where nails or screws are likely to penetrate nonmetallic-sheathed cable or electrical nonmetallic tubing, a steel sleeve, steel plate, or steel clip not less than 1.6 mm (1/16 in.) in thickness shall be used to protect the cable or tubing. (See Figure 1)

Exception: See Exception 2 from (A)(1) Bored Holes

(D) Cables and Raceways Parallel to Framing Members and Furring Strips. . . . , the cable or race way shall be installed and supported so that the nearest outside surface of the cable or raceway is not less than 32 mm (1¹/₄ in.) from the nearest edge of the framing member or furring strips where nails or screws are likely to penetrate. Where this distance cannot be maintained, the cable or raceway shall be protected from penetration by nails or screws by a steel plate, sleeve, or equivalent at least 1.6 mm (1¹/₁₆ in.) thick

(See Figures 1, 3, 4)

Exception 1: See Exception 1 from (A)(1) Bored Holes

Exception No. 2: For concealed work in finished buildings, or finished panels for prefabricated buildings where such supporting is impracticable, it shall be permissible to fish the cables between access points.

Exception 3: See Exception 2 from (A)(1) Bored Holes

(E) Cables and Raceways Installed in Shallow Grooves. . . . , shall be protected by 1.6 mm (1¹/₁₆ in.) thick steel plate, sleeve, or equivalent or by not less than 32 mm (1¹/₄ in.) free space for the full length of the groove in which the cable or raceway is installed.

(See Figure 1)

Exception: See Exceptions 1 & 2 from (A)(1) Bored Holes

Figure 1 - BM3 & BM3M

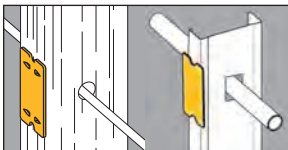

Figure 2 - BM1/BM2

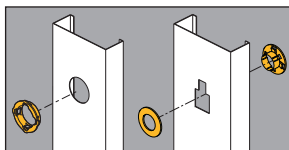

Figure 3 - BRC4 & BRC4M

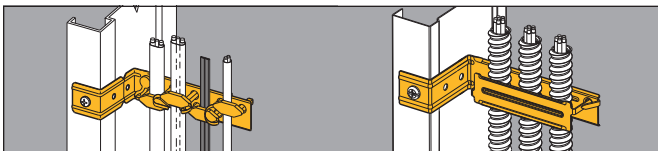
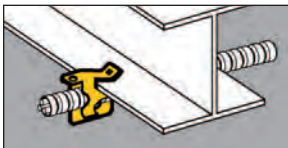

Figure 4 - BX4



Reprinted with permission from NFPA 70-2005, the *National Electrical Code*®, Copyright® 2005, National Fire Protection Association, Quincy, MA 02269. This reprinted material is not the complete and official position of the National Fire Protection Association, on the referenced subject which is represented only by the standard in its entirety.

NEC Requirements

300.11 Securing and Supporting.

(A) Secured in Place. Raceways, cable assemblies, boxes, cabinets, and fittings shall be securely fastened in place. Support wires that do not provide secure support shall not be permitted as the sole support. Support wires and associated fittings that provide secure support and that are installed in addition to the ceiling grid support wires shall be permitted as the sole support. Where independent support wires are used, they shall be secured at both ends. Cables and race ways shall not be supported by ceiling grids.

(1) Fire Rated Assemblies. Wiring located within the cavity of a fire-rated floor-ceiling or roof-ceiling assembly shall not be secured to, or supported by, the ceiling assembly, including the ceiling support wires. An independent means of secure support shall be provided and shall be permitted to be attached to the assembly. Where independent support wires are used, they shall be distinguishable by color, tagging, or other effective means from those that are part of the fire-rated design.

***Exception:** The ceiling support system shall be permitted to support wiring and equipment that have been tested as part of the fire-rated assembly.*

(2) Non-Fire-Rated Assemblies. Wiring located within the cavity of a non-fire-rated floor-ceiling or roof-ceiling assembly shall not be secured to, or supported by, the ceiling assembly, including the ceiling support wires. An independent means of secure support shall be provided.

***Exception:** The ceiling support system shall be permitted to support branch-circuit wiring and associated equipment where installed in accordance with the ceiling system manufacturer's instructions.*

Note: A previously acceptable practice, namely supporting cable and raceways by the ceiling grid, is no longer allowed. The intent of Article 300.11 is simple: an independent means of secure support must be provided for cable assemblies, raceways, boxes, etc. (See Figures 5 - 8)

Typical Drop Wire / Rod Applications

Additional drop wires, which are installed specifically for cable support, must be secured at both ends. When independent wires are used in fire-rated assemblies, they must be distinguishable from those wires that are part of the fire-rated assembly. B-Line's BA-311 series can be used to secure support wire to the ceiling grid. Its bright yellow color allows it to be easily recognized by inspectors. (See Figure 8)

Upper Attachments

Figure 5 - BE Series

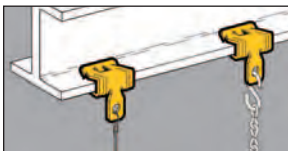

Figure 6 - BF3 Series & BF4 Series

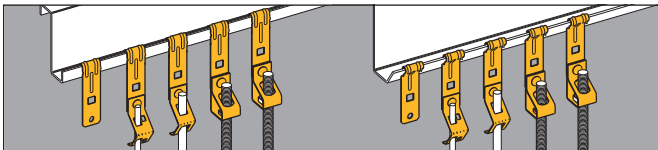

Figure 7 - BG-8-12-S18-W2

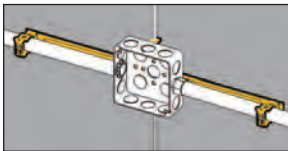
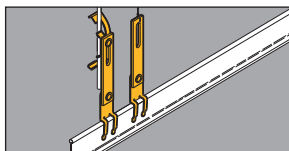

Figure 8 - BA311



NEC Requirements

310.15 Ampacities For Conductors Rated 0-2000 Volts.

(B) Tables

(2) Adjustment Factors.

- (a) More Than Three Current-Carrying Conductors in a Raceway or Cable. Where the number of current-carrying conductors in a raceway or cable exceeds three, or where single conductors or multiconductor cables are stacked or bundled longer than 600 mm (24 in.) without maintaining spacing and are not installed in raceways, the allowable ampacity of each conductor shall be reduced as shown in Table 310.15(B)(2)(a). Each current-carrying conductor of a paralleled set of conductors shall be counted as a current-carrying conductor.

FPN No. 1: See Annex B, Table B.310.11, for adjustment factors for more than three current-carrying conductors in a raceway or cable with load diversity.

FPN No. 2: See 366.23(A), for correction factors for conductors in sheet metal auxiliary gutters and 376.22 for correction factors for conductors in metal raceways.

Exception No. 1: Where conductors of different systems, as provided in 300.3, are installed in a common raceway or cable, the derating factors shown in Table 310.15(B)(2)(a) shall apply only to the number of power and lighting conductors (Articles 210, 215, 220, and 230).

Exception No. 2: For conductors installed in cable trays, the provisions of 392.11 shall apply.

Exception No. 3: Derating factors shall not apply to conductors in nipples having a length not exceeding 600 mm (24 in.).

Exception No. 4: Derating factors shall not apply to underground conductors entering or leaving an outdoor trench if those conductors have physical protection in the form of rigid metal conduit, intermediate metal conduit, or rigid nonmetallic conduit having a length not exceeding 3.05 m (10 ft) and if the number of conductors does not exceed four.

NEC Requirements

Exception No. 5: Adjustment factors shall not apply to Type AC cable or to Type MC cable without an overall outer jacket under the following conditions:

- (1) *Each cable has not more than three current-carrying conductors.*
- (2) *The conductors are 12 AWG copper.*
- (3) *Not more than 20 current-carrying conductors are bundled, stacked, or supported on "bridle rings".*
(See Figure 9)

A 60 percent adjustment factor shall be applied where current-carrying conductors in these cables that are stacked or bundled longer than 600 mm (24 in.) without maintaining spacing exceeds 20.

- (b) *More Than One Conduit, Tube, or Raceway Spacing between conduits, tubing, or raceways shall be maintained.*

Figure 9 - Bridle Rings

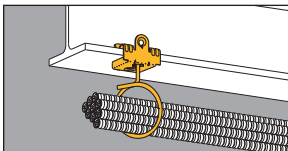
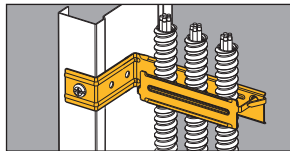

Figure 10 - BRC4M



Reprinted with permission from NFPA 70-2005, the *National Electrical Code*®, Copyright® 2005, National Fire Protection Association, Quincy, MA 02269. This reprinted material is not the complete and official position of the National Fire Protection Association, on the referenced subject which is represented only by the standard in its entirety.

NEC Requirements

314.23 Supports. Enclosures within the scope of this article shall be supported in accordance with one or more of the provisions in 314.23 (A) through (H).

(C) Mounting in Finished Surfaces. An enclosure mounted in a finished surface shall be rigidly secured thereto by clamps, anchors, or fittings identified for the application. *(See Figures 11 & 12)*

(D) Suspended Ceilings. An enclosure mounted to structural or supporting elements of a suspended ceiling shall be not more than 1650 cm³ (100 in.³) in size and shall be securely fastened in place in accordance with either (D)(1) or (D)(2).

(1) Framing Members. An enclosure shall be fastened to the framing members by mechanical means such as bolts, screws, or rivets, or by the use of clips or other securing means identified for use with the type of ceiling framing member(s) and enclosure(s) employed. . . . *(See Figure 13)*

(2) Support Wires. The installation shall comply with the provisions of 300.11(A). The enclosure shall be secured, using methods identified for the purpose to ceiling support wire(s), including any additional support wire(s) installed for that purpose. Support wire(s) used for enclosure support shall be fastened at each end so as to be taut within the ceiling cavity. *(See Figure 14)*

(E) Raceway Supported Enclosures, Without Devices, Luminaries (Fixtures), or Lampholders. . . . It shall be supported by two or more conduits threaded wrenchtight into the enclosure or hubs. Each conduit shall be secured within 900 mm (3 ft) of the enclosure, or within 450 mm (18 in.) of the enclosure if all conduit entries are on the same side. *(See Figure 15)*

(F) Raceway Supported Enclosures, With Devices, Luminaries (Fixtures), or Lampholders. . . . It shall be supported by two or more conduits threaded wrenchtight into the enclosure or hubs. Each conduit shall be secured within 450 mm (18 in.) of the enclosure. *(See Figure 15)*

314.27 Outlet Boxes

(B) Maximum Luminaire (Fixture) Weight. Outlet boxes or fitting installed as required by 314.23 shall be permitted to support luminaires (lighting fixtures) weighing 23 kg (50 lbs.) or less. A luminaire (lighting fixture) that weighs more than 23 kg (50 lbs.) shall be supported independently of the outlet box unless the outlet box is listed for the weight to be supported. *(See Figure 13)*

(D) Boxes at Ceiling-Suspended (Paddle) Fan Outlets.

Outlet boxes or outlet box systems used as the sole support of a ceiling-suspended (paddle) fan shall be listed, shall be marked by their manufacturer as suitable for this purpose, and shall not support ceiling-suspended (paddle) fans that weigh more than 32 kg (70 lb). For outlet boxes or outlet box systems designed to support of a ceiling-suspended (paddle) fans that weigh more than 16 kg (35 lb), the required marking shall include the maximum weight to be supported.

(See Figure 16)

Figure 11 - BB4-23

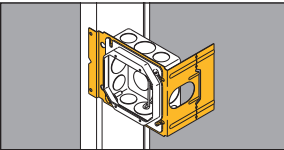

Figure 12 - BB9 & BB12



Figure 13 - BA50

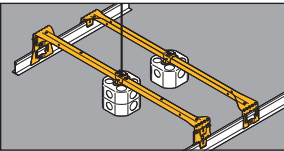

Figure 14 - BG-8-12-S18-W2

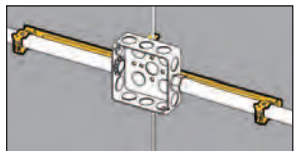

Figure 15 - BG-8-12-S18-U-2-4

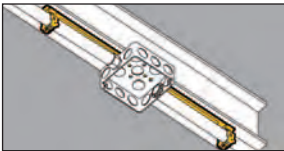
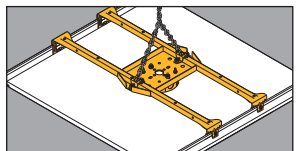

Figure 16 - BA50F



Reprinted with permission from NFPA 70-2005, the *National Electrical Code*®, Copyright® 2005, National Fire Protection Association, Quincy, MA 02269. This reprinted material is not the complete and official position of the National Fire Protection Association, on the referenced subject which is represented only by the standard in its entirety.

NEC Requirements

Article 320 Armored Cable : Type AC

320.17 Through or Parallel to Framing Members.

Type AC cable shall be protected in accordance with 300.4 (A), (C), and (D) where installed through or parallel to framing members. (See Figures 17 & 18)

320.30 Securing and Supporting.

- (A) **General.** Type AC shall be supported and secured by staples, cable ties, straps, hangers, or similar fittings, designed and installed so as not to damage the cable.
- (B) **Securing.** Unless otherwise provided, Type AC cable shall be secured within 300 mm (12 in.) of every out let box, junction box, cabinet, or fitting and at intervals not exceeding 1.4 m (4¹/₂ ft) where installed on or across framing members. (See Figures 19 -22)
- (C) **Supporting.** Unless otherwise provided, Type AC cable shall be supported at intervals not exceeding 1.4 m (4¹/₂ ft). Horizontal runs of Type AC cable installed in wooden or metal framing members or similar supporting means shall be considered supported where such support does not exceed 1.4 m (4¹/₂ ft) intervals.

Article 330 Metal-Clad Cable : Type MC

330.17 Through or Parallel to Framing Members.

Type MC cable shall be protected in accordance with 300.4 (A), (C), and (D) where installed through or parallel to framing members. (See Figures 17 & 18)

330.30 Securing and Supporting.

- (A) **General.** Type MC shall be supported and secured by staples, cable ties, straps, hangers, or similar fittings or other approved means designed and installed so as not to damage the cable.
- (B) **Securing.** Unless otherwise provided, cables shall be secured at intervals not exceeding 1.8 m (6 ft). Cables containing four or fewer conductors sized no larger than 10 AWG shall be secured within 300 mm (12 in.) of every box, cabinet, fitting or other cable termination. (See Figure 19 - 22)
- (C) **Supporting.** Unless otherwise provided, cables shall be supported at intervals not exceeding 1.8 m (6ft). Horizontal runs of Type MC cable installed in wooden or metal framing members or similar supporting means shall be considered supported and secured where such support does not exceed 1.8 m (6 ft) intervals.

Article 334 Nonmetallic Sheathed Cables

334.17 Through or Parallel to Framing Members.

Type NM, NMC, or NMS cable shall be protected in accordance with 300.4 where installed through or

parallel to framing members. Grommets used as required in 300.4(B)(1) shall remain in place and be **listed** for the purpose of cable protection.

(See Figures 17 & 18)

334.30 Securing and Supporting. Nonmetallic-sheathed cable shall be supported and secured by staples, cable ties, straps, hangers, or similar fittings designed and installed so as not to damage the cable, at intervals not exceeding 1.4 m (4¹/₂ ft) and within 300 mm (12 in.) of every outlet box, junction box, cabinet, or fitting. Flat cables shall not be stapled on edge. Sections of cable protected from physical damage by raceway shall not be required to be secured within the raceway.

(See Figures 19 - 22)

(A) Horizontal Runs Through Holes and Notches. In other than vertical runs, cables installed in accordance with 300.4 shall be considered to be supported and secured where such support does not exceed 1.4 m (4¹/₂ ft) intervals and the nonmetallic-sheathed cable is securely fastened in place by an approved means within 300 mm (12 in.) of each box, cabinet, or other nonmetallic-sheathed cable termination.

FPN: See 314.17(C) for support where nonmetallic boxes are used.

Figure 17 - BM1/BM2

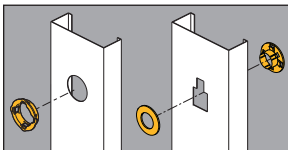

Figure 18 - BM3 & BM3M

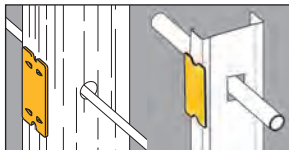

Figure 19 - BG-8-12-H7



Figure 20 - BRC4 & BRC4M

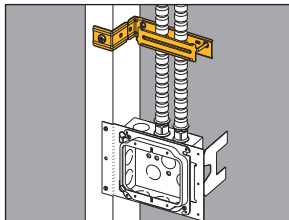

Figure 21 - BX5

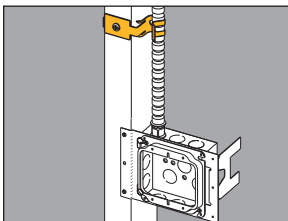
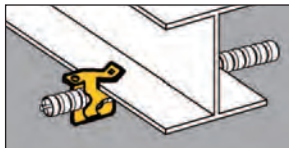

Figure 22 - BX4



Reprinted with permission from NFPA 70-2005, the *National Electrical Code*®, Copyright® 2005, National Fire Protection Association, Quincy, MA 02269. This reprinted material is not the complete and official position of the National Fire Protection Association, on the referenced subject which is represented only by the standard in its entirety.

NEC Requirements

Article 344 Rigid Metal Conduit : Type RMC

344.30 Securing and Supporting.

(A) Securely Fastened. RMC shall be securely fastened within 900 mm (3 ft) of each outlet box, junction box, device box, cabinet, conduit body, or other conduit termination. Fastening shall be permitted to be increased to a distance of 1.5 m (5 ft) where structural members do not readily permit fastening within 900 mm (3 ft). Where approved, conduit shall not be required to be securely fastened within 900 mm (3 ft) of the service head for above-the-roof termination of a mast.

(See Figures 23 - 25)

(B) Supports. RMC shall be supported in accordance with one of the following:

- (1) Conduit shall be supported at intervals not exceeding 3 m (10 ft).
- (2) The distance between supports for straight runs of conduit shall be permitted in accordance with Table 344.30(B)(2),
- (3) Exposed vertical risers from industrial machinery or fixed equipment shall be permitted to be supported at intervals not exceeding 6 m (20 ft)
- (4) Horizontal runs of RMC supported by openings through framing members at intervals not exceeding 3 m (10 ft) and securely fastened within 900 mm (3 ft) of termination points shall be permitted. *(See Figure 26)*

Article 348 Flexible Metal Conduit: Type FMC

348.30 Securing and Supporting.

(A) Securely Fastened. FMC shall be securely fastened in place by an approved means within 300 mm (12 in.) of each box, cabinet, conduit body, or other conduit termination and shall be supported and secured at intervals not to exceed 1.4 m (4½ ft).

(See Figures 23 - 25)

(B) Supports. Horizontal runs of FMC supported by openings through framing members at intervals not greater than 1.4 m (4½ ft) and securely fastened within 300 mm (12 in) of termination points shall be permitted. *(See Figure 26)*

* See NFPA 70-2005 for exceptions.

Article 358 Electrical Metallic Tubing - Type EMT

358.30 Securing and Supporting.

(A) Securely Fastened. EMT shall be securely fastened in place at least every 3 m (10 ft). In addition, each EMT run between termination points shall be securely fastened within 900 mm (3 ft) of each outlet box, junction box,

device box, cabinet, conduit body, or other tubing termination. (See Figures 23 - 25)

Exception No. 1: Fastening of unbroken lengths shall be permitted to be increased to a distance of 1.5 m (5 ft) where structural members do not readily permit fastening within 900 mm (3 ft).

Exception No. 2: For concealed work in finished buildings or prefinished wall panels where such securing is impracticable, unbroken lengths (with out coupling) of EMT shall be permitted to be fished.

(B) Supports. Horizontal runs of EMT supported by openings through framing members at intervals not greater than 3 m (10 ft) and securely fastened within 900 mm (3 ft) of termination points shall be permitted. (See Figure 26)

Article 362

Electrical Nonmetallic Tubing - Type ENT

362.30 Securing and Supporting.

(A) Securely Fastened. ENT shall be securely fastened at intervals not exceeding 900 mm (3 ft). In addition, ENT shall be securely fastened in place within 900 mm (3 ft) of each outlet box, device box, junction box, cabinet, or fitting where it terminates. (See Figures 23 - 25)

Exception No. 1: Lengths not exceeding a distance of 1.8 m (6 ft) from a luminaire (fixture) terminal connection for tap connection to lighting luminaires (fixtures) shall be permitted without being secured.

Exception No. 2: Lengths not exceeding 1.8 m (6 ft) from the last point where the raceway is securely fastened for connection within an accessible ceiling to luminaire(s) [lighting fixture(s)] or other equipment.

(B) Supports. Horizontal runs of ENT supported by openings in framing members at intervals not exceeding 900 mm (3 ft) of termination points shall be permitted. (See Figure 26)

Figure 23 - BG-8-12-S18-U-2-4

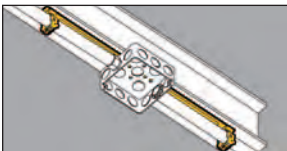

Figure 25 - BG-8-12-B1

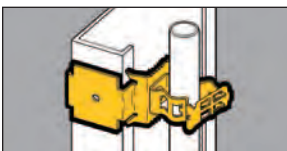

Figure 24 - BB38

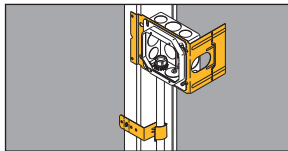
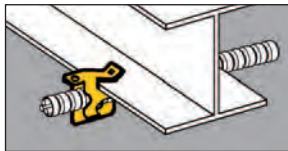

Figure 26 - BX4



Reprinted with permission from NFPA 70-2005, the *National Electrical Code*®, Copyright® 2005, National Fire Protection Association, Quincy, MA 02269. This reprinted material is not the complete and official position of the National Fire Protection Association, on the referenced subject which is represented only by the standard in its entirety.

NEC Requirements

Article 410 Luminaries (Lighting Fixtures), Lampholders, and Lamps

410.16 Means of Support.

(A) Outlet Boxes. Outlet boxes or fittings installed as required by 314.23 and complying with the provisions of 314.27(A) and 314.27(B) shall be permitted to support luminaries (fixtures).

(C) Suspended Ceilings. Framing members of suspended ceiling systems used to support luminaries (fixtures) shall be securely fastened to each other and shall be securely attached to the building structure at appropriate intervals. Luminaries (fixtures) shall be securely fastened to the ceiling framing member by mechanical means such as bolts, screws, or rivets. **Listed** clips identified for use with the type of ceiling framing member(s) and luminaire(s) [fixture(s)] shall also be permitted. (See Figures 27 - 31)

410.104 Fastening. Lighting track shall be securely mounted so that each fastening is suitable for supporting the maximum weight of luminaries (fixtures) that can be installed. Unless identified for supports at greater intervals, a single section 1.2 m (4 ft.) or shorter in length shall have two supports, and, where installed in a continuous row, each individual section of not more than 1.2 m (4 ft.) in length shall have one additional support. (See Figure 30)

422.18 Support of Ceiling-Suspended (Paddle) Fans

Ceiling-suspended (paddle) fans shall be supported independently of an outlet box or by **listed** outlet box or outlet box systems identified for the use and installed in accordance with 314.27(D). (See Figure 32)

Article 800 Communication Circuits

800.24 Mechanical Execution of Work.

Communications circuits and equipment shall be installed in a neat and workmanlike manner. Cables installed exposed on the surface of ceilings and sidewalls shall be supported by the building structure in such a manner that the cable will not be damaged by normal building use. Such cables shall be secured by straps, staples, hangers, or similar fittings designed and installed so as not to damage the cable. The installation shall also conform with 300.4(D) and 300.11.

FPN: Accepted industry practices are described in ANSI/NECA/BICSI 568-2001, Standard for Installing Commercial Building Telecommunications Cabling, and other ANSI-approved installation standards.

Figure 27 - BA15



Figure 28 - BA1



Figure 29 - BA40

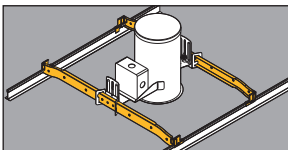

Figure 30 - BA 4-16 Series

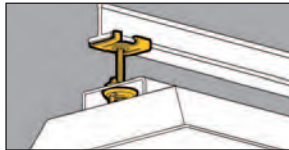

Figure 31 - BAX Series

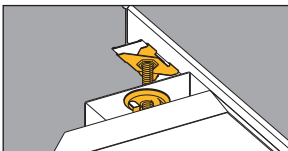
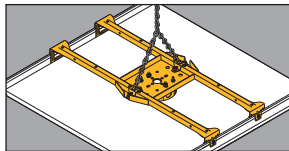

Figure 32 - BA50F



Reprinted with permission from NFPA 70-2005, the *National Electrical Code*®, Copyright® 2005, National Fire Protection Association, Quincy, MA 02269. This reprinted material is not the complete and official position of the National Fire Protection Association, on the referenced subject which is represented only by the standard in its entirety.

ANSI/TIA/EIA-569-A

4. Horizontal pathways and related spaces

4.6 Ceiling pathway

4.6.2 Design guidelines

4.6.2.1 Planning. The design shall provide a suitable means for supporting cable from the telecommunications closet to the work areas to be served. Cable shall not be laid directly on the ceiling tile or rails.

4.6.2.2 Clearance. A minimum of 75 mm (3 in.) clear vertical space shall be available above the ceiling tiles for the horizontal cabling and pathway. (See Figure 33)

4.6.5 Cable support

4.6.5.1 Where zone conduit or cable tray is not available in a suspended ceiling space and where telecommunications cables are allowed to be placed in the ceiling, adequate open-top cable supports, located on 1220-1525 mm (48-60 inch) centers, shall be provided. Where larger quantities of cables (50-75 cables) bunched together in the ceiling at a congested area, such as close to the telecommunications closet, special supports shall be designed and installed to carry the additional weight. (See Figures 33 & 34)

4.6.5.2 A suspended ceiling support rod or wire may be used to mount appropriate cable fasteners loaded with multiple cables up to the total weight for which the fastener is approved. The T-bar rail of a suspended ceiling may be used to mount appropriate cable fasteners loaded with cable up to a total weight of 0.7 kg/m (0.45 lb/ft). The fastener design shall not interfere with the inserting or removing of the ceiling tile. (See Figures 33 & 34)

NOTES

- 1) A weight of 1.0 kg (2.2 lbs.) or 0.7 kg/m with spacing of support wire/rod at 1.5 m (5 ft.) is equivalent to a bundle of sixteen 4-pair 24 AWG UTP cables, including fasteners.
- 2) If any side pull is exerted on the support wire, like a turn in direction of the cables, the level of the ceiling tee rail could be affected.

TIA/EIA Requirements

Figure 33 - BCHxx-A28

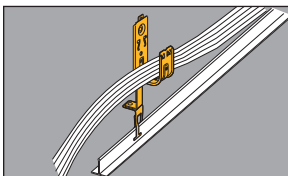
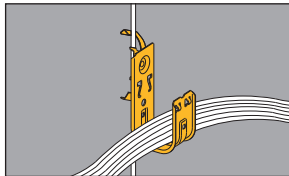

Figure 34 - BCHxx-W2



Reprinted with permission from NFPA 70-2005, the *National Electrical Code*®, Copyright® 2005, National Fire Protection Association, Quincy, MA 02269. This reprinted material is not the complete and official position of the National Fire Protection Association, on the referenced subject which is represented only by the standard in its entirety.

Reference Data

Cable Hook Technical Data

Single-Sided Single-Tier Cable Fasteners

Hook Size In.	'A' In.	'B' In.	'C' In.	'D' In.	'E' In.	'F' In.	'G' In.	'H' In.
3/4	.88	3.18	2.68	1.00	.75	1.69	.94	--
1 ⁵ / ₁₆	1.62	3.62	2.81	1.69	1.31	2.00	1.37	.20
2	1.62	4.31	3.50	2.38	2.00	2.69	2.06	.20
4	2.00	6.81	5.56	4.55	4.00	4.84	4.06	.31

Reference Data

BCH12



Load Capacity

Cable Hook Size In.	Static Load Capacity (S.F. 3)	
	Galvanized & Stainless Steel Lbs.	Spring Steel Lbs.
3/4	30	--
1 ⁵ / ₁₆	30	100
2	30	100
4	30	100

Stated loads are per hook and should not be exceeded. The load capacity of a fastener having more than one component is equal to the load capacity of the lowest rated component.

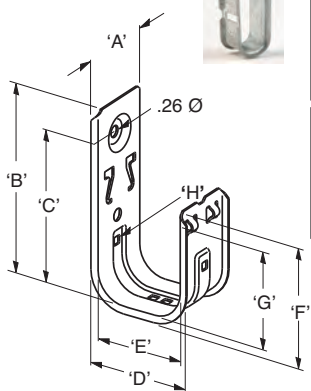

Double-Sided Single-Tier Cable Fasteners

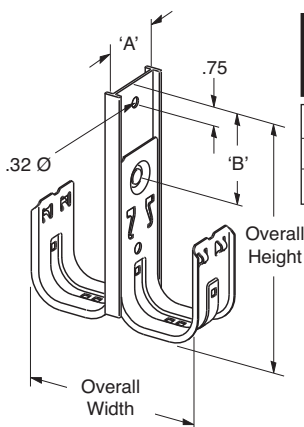

Hook Size In.	'A' In.	'B' In.	Overall Height In.	Overall Width In.
1 ⁵ / ₁₆	1.90	2.50	5.50	3.47
2	1.90	2.50	6.19	4.85
4	2.38	2.94	9.00	9.19

Cable Hook Technical Data

Double-Sided Double-Tier Cable Fasteners

Hook Size In.	'A' In.	'B' In.	Spacing In.	Clearance In.	Overall Height In.	Overall Width In.
1 ⁵ / ₁₆	1.90	2.50	3.75	1.94	9.25	3.47
2	1.90	2.50	4.75	2.25	10.94	4.85
4	2.38	2.94	9.38	4.50	18.20	9.19

Reference Data

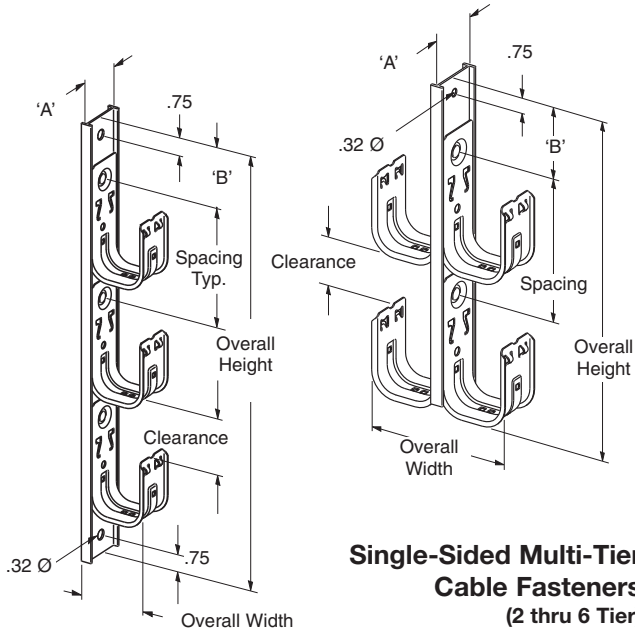

Single-Sided Multi-Tier Cable Fasteners (2 thru 6 Tier)

Hook Size In.	No. Tiers In.	'A' In.	'B' In.	Spacing In.	Clearance In.	Overall Height In.	Overall Width In.
1 ⁵ / ₁₆	2	1.90	2.50	3.75	1.94	11.00	1.96
	3					14.75	
	4					18.50	
	5					22.25	
	6					26.00	
2	2	1.90	2.50	4.75	2.25	12.75	2.66
	3					17.50	
	4					22.25	
	5					27.00	
	6					31.75	
4	2	2.38	2.94	8.75	3.19	19.33	4.82
	3					28.08	

Reference Data

Rigid Steel Conduit (Heavy Wall Conduit)

Nominal Conduit Size In.	Outside Diameter In.	Nominal Inside Diameter In.	Minimum Weight Per 100 Ft. With Couplings Attached Lbs.	Weight of Conduit and Conductors Per 100 Ft.* Lbs.
3/8	0.675	0.493	51.5	65.1
1/2	0.840	0.632	79.0	101.1
3/4	1.050	0.836	105.0	145.8
1	1.315	1.063	153.0	219.3
1 1/4	1.660	1.394	201.0	318.3
1 1/2	1.900	1.624	249.0	408.8
2	2.375	2.083	332.0	593.8
2 1/2	2.875	2.489	527.0	901.0
3	3.500	3.090	682.0	1259.0
3 1/2	4.000	3.570	831.0	1604.0
4	4.500	4.050	972.0	1967.0

Intermediate Metal Conduit (IMC)

Nominal Conduit Size In.	Outside Diameter In.	Nominal Inside Diameter In.	Minimum Weight Per 100 Ft. With Couplings Attached Lbs.	Weight of Conduit and Conductors Per 100 Ft.* Lbs.
1/2	0.815	0.745	60.0	82.1
3/4	1.029	0.954	82.0	122.8
1	1.290	1.205	116.0	182.3
1 1/4	1.638	1.553	150.0	267.3
1 1/2	1.883	1.793	182.0	341.8
2	2.360	2.266	242.0	503.8
2 1/2	2.857	2.727	401.0	775.0
3	3.476	3.346	493.0	1069.0
3 1/2	3.971	3.841	573.0	1346.0
4	4.466	4.336	638.0	1632.0

Dimensions taken from ANSI C80.3 - 1977.

* Conduit plus weight of heaviest conductor combination as specified by the National Electrical Code.

Electrical Metallic Tubing (EMT) - Thinwall Conduit

Nominal Conduit Size In.	Outside Diameter In.	Nominal Inside Diameter In.	Minimum Weight Per 100 Ft. With Couplings Attached Lbs.	Weight of Conduit and Conductors Per 100 Ft.* Lbs.
3/8	0.577	0.493	23.0	36.6
1/2	0.706	0.622	28.5	50.6
3/4	0.922	0.824	43.5	84.3
1	1.163	1.049	64.0	130.3
1 1/4	1.510	1.380	95.0	212.3
1 1/2	1.740	1.610	110.0	269.8
2	2.197	2.067	140.0	401.8
2 1/2	2.875	2.731	205.0	579.0
3	3.500	3.356	250.0	826.3
3 1/2	4.000	3.834	325.0	1098.0
4	4.500	4.334	370.0	1364.0

Rigid Aluminum Conduit

Nominal Conduit Size In.	Outside Diameter In.	Nominal Inside Diameter In.	Minimum Weight Per 100 Ft. With Couplings Attached Lbs.	Weight of Conduit and Conductors Per 100 Ft.* Lbs.
1/2	0.840	0.632	27.4	49.5
3/4	1.050	0.836	36.4	77.2
1	1.315	1.063	53.0	119.3
1 1/4	1.660	1.394	69.6	186.9
1 1/2	1.900	1.624	82.2	242.0
2	2.375	2.083	115.7	377.5
2 1/2	2.875	2.489	182.5	556.5
3	3.500	3.090	238.9	815.2
3 1/2	4.00	3.570	287.7	1061.0
4	4.500	4.050	340.0	1334.0
5	5.563	5.073	465.4	2028.0
6	6.625	6.093	612.5	2870.0

Dimensions taken from ANSI C80.3 - 1977.

* Conduit plus weight of heaviest conductor combination as specified by the National Electrical Code.

Reference Data

Schedule 40 PVC Plastic Pipe

Nominal Pipe Size In.	Outside Diameter In.	Wall Thickness In.	Weight of Pipe Lbs. Per Ft.	Weight of Water Lbs. Per Ft.
1/8	0.405	0.068	0.04	0.02
1/4	0.540	0.088	0.07	0.04
3/8	0.675	0.091	0.10	0.08
1/2	0.840	0.109	0.15	0.10
3/4	1.050	0.113	0.20	0.20
1	1.315	0.133	0.30	0.40
1 1/4	1.660	0.140	0.40	0.60
1 1/2	1.900	0.145	0.50	0.90
2	2.375	0.155	0.60	1.40
2 1/2	2.875	0.203	1.00	2.10
3	3.500	0.216	1.30	3.20
3 1/2	4.000	0.226	1.60	4.30
4	4.500	0.237	1.90	5.50

Electrical Non-Metallic Tubing (ENT)

Nominal Size In.	Outside Diameter In.	Nominal Inside Diameter In.	Minimum Weight of Conduit Lbs. Per 100 Ft.	Weight of Conduit and Conductors Lbs. Per 100 Ft.
1/2	0.840	0.560	11.0	33.1
3/4	1.050	0.760	14.0	54.8
1	1.315	1.000	20.0	86.3
1 1/4	1.660	1.402	19.0	136.3
1 1/2	1.990	1.554	27.0	186.8
2	2.375	2.030	32.0	261.8

All Threaded Rod (ATR)

Thread Size	Root Area	Design Load (SF=5)
1/4"-20	0.027 in. ²	240 lbs.
5/16"-18	0.045 in. ²	400 lbs.
3/8"-16	0.068 in. ²	610 lbs.

Tabulated loads are based on an allowable tensile stress of 12000 psi reduced by 25% resulting in 9000 psi. From ANSI/MSS SP-58, Table 3.

Dimensions taken from ANSI B1.1 1982 Unified Inch Screw Threads. All threads are UNCR series.

MC -- Metal Clad Cable Specifications

Trade Size	Grounding Conductor AWG	Armor O.D. In.	Approximate Wt. Per 100 Ft. Lbs.
14-2 Solid	14	0.470	17.5
14-3 Solid	14	0.480	20.5
14-4 Solid	14	0.510	23.0
12-2 Solid	12	0.495	21.5
12-3 Solid	12	0.530	25.5
12-4 Solid	12	0.565	29.5
10-2 Solid	10	0.560	28.5
10-3 Solid	10	0.600	34.0
10-4 Solid	10	0.645	39.5
8-2 Stranded	10	0.710	45.0
8-3 Stranded	10	0.770	54.5
8-4 Stranded	10	0.835	64.5
6-2 Stranded	8	0.795	59.0
6-3 Stranded	8	0.865	72.0
6-4 Stranded	8	0.945	86.0
4-2 Stranded	8	0.945	78.5
4-3 Stranded	8	1.035	98.5
4-4 Stranded	8	1.135	119.5
3-3 Stranded	6	1.025	107.0
3-4 Stranded	6	1.120	126.0
2-2 Stranded	6	1.075	104.5
2-3 Stranded	6	1.180	134.0
2-4 Stranded	6	1.295	164.0

Category 5 Cable

Pair Count	AWG Size	O.D. In.	Weight Lbs. Per 100 Ft.
2	24	0.16	1.3
3	24	0.18	1.7
4	24	0.20	2.1
6	24	0.27	3.5
8	24	0.30	4.2
25	24	0.50	13.0

Reference Data

Type NM -- Non-Metallic Sheathed Cable

Reference Data

Size AWG	Number of Strands	Ground Wire Size	Approximate O.D. In.	Approximate Weight Lbs. Per 100 Ft.
Without Ground Wire				
14-2	Solid	--	.17 x .37	5.3
12-2	Solid	--	.19 x .40	7.0
10-2	Solid	--	.22 x .45	10.1
14-3	Solid	--	0.295	8.2
12-3	Solid	--	0.332	10.9
10-3	Solid	--	0.396	15.7
8-3	7	--	0.538	27.8
6-3	7	--	0.611	42.2
With Ground Wire				
14-2	Solid	14	.17 x .37	6.4
12-2	Solid	12	.19 x .41	9.0
10-2	Solid	10	.22 x .49	13.3
8-2	7	10	.28 x .61	21.5
6-2	7	10	.32 x .73	31.3
14-3	Solid	14	.322	9.3
12-3	Solid	12	.363	12.9
10-3	Solid	10	.436	18.7
14-4	Solid	14	.450	11.6
12-4	Solid	12	.490	16.1
10-4	Solid	10	.550	23.3
8-3	7	10	.552	30.5
6-3	7	10	.611	45.0
4-3	7	8	.821	66.4
2-3	7	8	.946	93.0

Type THHN -- Insulated Single Conductor Building Wire

Trade Size	Approximate O.D. In.	Approximate Weight Lbs. Per 100 Ft.
14 AWG	0.11	1.7
12 AWG	0.13	2.5
10 AWG	0.16	4.0
8 AWG	0.22	6.5
6 AWG	0.25	9.7
4 AWG	0.32	15.5
3 AWG	0.35	19.1
2 AWG	0.38	23.6
1 AWG	0.45	30.4
1/0 AWG	0.49	37.5

AC -- Armored Cable Specifications

Trade Size	Armor O.D. In.	Approximate Weight Lbs. Per 100 Ft.
14-2 Solid	0.433	18.0
14-3 Solid	0.453	20.0
14-4 Solid	0.486	25.0
12-2 Solid	0.467	21.0
12-3 Solid	0.489	24.5
12-4 Solid	0.520	29.0
10-2 Solid	0.476	25.0
10-3 Solid	0.500	29.5
10-4 Solid	0.541	38.0
8-2 Solid	0.570	34.5
8-3 Solid	0.601	41.5
8-4 Solid	0.654	48.0
8-2 Stranded	0.604	34.5
8-3 Stranded	0.637	42.0
8-4 Stranded	0.695	51.5
6-2 Stranded	0.700	44.5
6-3 Stranded	0.739	56.0
6-4 Stranded	0.807	68.5
4-2 Stranded	0.836	62.0
4-3 Stranded	0.885	80.0
4-4 Stranded	0.971	99.5
3-3 Stranded	0.990	94.0
3-4 Stranded	1.085	118.0
2-2 Stranded	0.956	81.5
2-3 Stranded	1.014	109.5
2-4 Stranded	1.115	138.0

Index

<u>Catalog No.</u>	<u>Page</u>	<u>Catalog No.</u>	<u>Page</u>
A		BA	
ACB Series	191	BA1	82
ACPD Series	205	BA1-9	82
ACPW Series	204	BA1-24	82
ACS Series	192-193	BA1-32	82
ADA Series	198-199	BA1-95	82
ADI Series	188	BA1-T	82
ADE Series	202	BA1-T-BN	82
ADH Series	190	BA-2-9	86
ADM Series	189	BA-2-9-BN	86
ADN Series	206	BA-2-9-W	86
AMS Series	206	BA-2-9-WBN	86
APC Series	214	BA-2-9-7	86
APD Series	213	BA-2-9-7-BN	86
APH Series	212	BA-2-16	85
APS Series	211	BA-2-16-BN	85
ARC Series	186-187	BA-2-16-W	85
ARS Series	184-185	BA-2-16-WBN	85
ARW Series	186-187	BA-2-16-7	85
ASA Series	200-201	BA-2-16-7-BN	85
ASE Series	203	BA-2-16-7-W	85
ATB Series	209	BA-2-16-7-WBN	85
ATM Series	207	BA-4-9	86
AWA Series	194-195	BA-4-9-W	86
AWS Series	210	BA-4-16	84
AWSD Series	196-197	BA-4-16-24	84
AZD Series	213	BA-4-16-32	84
		BA-4-16-48	84
		BA-4-16-H	83
		BA-4-16-H1	83
		BA-4-16-W	84
		BA-4-WN	84
		BA-5-4T	72
		BA-6-4T	73
		BA12	76
		BA12-12	76
		BA12-20	76
		BA12-30	76
		BA14	71
		BA15	71
		BA17	81
		BA18	81
		BA20	81
		BA-21	84
		BA-21D	84
		BA28	75
		BA28B	174
		BA40	80
		BA50	77
		BA50A	78
		BA50CAN	77
		BA50C3T	77
		BA50C4T	77
		BA50D	77
		BA50DCAN	77
		BA50E	77
		BA50F	79
		BA50-OB-24	78
		BA50-OB-34	78
		BA50-SB-24	78
B			
B444- ¹ / ₄	105		
B444- ⁵ / ₁₆	105		
B444- ³ / ₈	105		
B601-62	180		
B1506S	47		
B1508	47		
B1508S	47		
B1512	47		
B1512S	47		
B1516	47		
B1516S	47		
B1520	47		
B1520S	47		
B1524S	47		
B1532S	47		
B1534S	47		
B1540S	47		
B1548S	47		
B1556S	47		
B1564S	47		
B3223- ³ / ₈	138		

<u>Catalog No.</u>	<u>Page</u>	<u>Catalog No.</u>	<u>Page</u>
BA cont.		BBF15	30
BA311	87	BBF15FC	30
BA311-W2	87	BBF18	30
BA311-W6	87	BBF18FC	30
BA-SFC	88	BBF24	30
BA-SFC-CF	88	BBF24FC	30
BA-SFC-CFS	88	BBFC	30
BA-SFC-E	88	BC	
BA-SFC-S	88	BC1	106
BAX-4-16	83	BC442	104
BAX-4-16-24	83	BC442-6	104
BAX-4-16-32	83	BCH12	150
BAX-4-16-48	83	BCH12-A28	161
BB		BCH12-C1	157
BB1	19	BCH12-C2	157
BB2-16T	26	BCH12-C442	156
BB2-24T	26	BCH12-C442A	156
BB2CL	27	BCH12-E-2-4	154
BB2TS	26	BCH12-E-5-8	154
BB4-4	24	BCH12-E-9-12	154
BB4-6	24	BCH12-F3	159
BB4-23	24	BCH12-F4	159
BB7-16	29	BCH12-G-8-12	162
BB7-24	29	BCH12-L1410	162
BB8-16	28	BCH12-PNA	134
BB8-24	28	BCH12-RB	153
BB9	20	BCH12-SC4	158
BB10	146	BCH12-U-2-4	155
BB10-2	146	BCH12-U-5-8	155
BB10-3	146	BCH12-U-9-12	155
BB10-4	146	BCH12-W2	160
BB10L	147	BCH12-W6	160
BB10P	147	BCH21	150
BB12	20	BCH21-1D	163
BB12-6	20	BCH21-2D	163
BB15	32, 149	BCH21-2S	164
BB-18	31	BCH21-3S	164
BB20	146	BCH21-4S	165
BB20L	147	BCH21-5S	165
BB27	76	BCH21-6S	165
BB32	23	BCH21-A28	161
BB33	23	BCH21-AB	153
BB33L	23	BCH21-C1	157
BB38	40	BCH21-C2	157
BB38D	40	BCH21-C442	156
BB40-08	32, 148	BCH21-C442A	156
BB40-10	32, 148	BCH21-E-2-4	154
BB40-12	32, 148	BCH21-E-5-8	154
BB45-08	32, 148	BCH21-E-9-12	154
BB45-10	32, 148	BCH21-F3	159
BB45-12	32, 148	BCH21-F4	159
BB73	25	BCH21-G-8-12	162
BB74	25	BCH21-L1410	162
BB76	25	BCH21-PNA	134
BB216TCL	27	BCH21-RB	153
BB216TS	26	BCH21-SC4	158
BB224TCL	27	BCH21-U-2-4	155
BB224TS	26	BCH21-U-5-8	155

Index

<u>Catalog No.</u>	<u>Page</u>	<u>Catalog No.</u>	<u>Page</u>
BC cont.			
BCH21-U-9-12	155	BCHK1	167
BCH21-W2	160	BCHK2	167
BCH21-W6	160	BCHK3	167
BCH21X	152	BCHR21	151
BCH32	150	BCHR32	151
BCH32-1D	163	BCHR64	151
BCH32-2D	163	BCS-8	62
BCH32-2S	164	BCS-8C	62
BCH32-3S	164	BCS-12	62
BCH32-4S	165	BCS-12C	62
BCH32-5S	165	BCS-16	62
BCH32-6S	165	BCS-16C	62
BCH32-A28	161		
BCH32-AB	153	BD	
BCH32-C1	157	BD2	174
BCH32-C2	157	BD4	174
BCH32-C442	156	BD40	173
BCH32-C442A	156		
BCH32-E-2-4	154	BE	
BCH32-E-5-8	154	BE-1-2	91
BCH32-E-9-12	154	BE-2-4	91
BCH32-F3	159	BE-2-4-CT2	145
BCH32-F4	159	BE-5-8	91, 173
BCH32-G-8-12	162	BE-5-8-CT2	145
BCH32-L1410	162	BE-9-12	91, 173
BCH32-PNA	134	BE-9-12-CT2	145
BCH32-RB	153	BES-8	62
BCH32-SC4	158	BES-8C	62
BCH32-U-2-4	155	BES-12	62
BCH32-U-5-8	155	BES-12C	62
BCH32-U-9-12	155	BES-16	62
BCH32-W2	160	BES-16C	62
BCH32-W6	160		
BCH32X	152	BF	
BCH64	150	BF1	128
BCH64-1D	163	BF1-40	21
BCH64-2D	163	BF1-56	21
BCH64-2S	164	BF1-64	21
BCH64-3S	164	BF1-96	21
BCH64-4S	165	BF1-CT2	145
BCH64-AB	153	BF2	128
BCH64-C1	157	BF2-CT2	145
BCH64-C2	157	BF3	124
BCH64-C442	156	BF4	120
BCH64-C442A	156	BF12	118
BCH64-F3	159	BF13	118
BCH64-F4	159	BFA-1215	61
BCH64-G-8-12	162	BFA-1520	61
BCH64-L1410	162		
BCH64-PNAB	134		
BCH64-RB	153		
BCH64-SC4	158		
BCH64-U-2-4	155		
BCH64-U-5-8	155		
BCH64-U-9-12	155		
BCH64X	152		
BCH-HBA	166		
BCH-HB21	166		
BCH-HB64	166		

<u>Catalog No.</u>	<u>Page</u>	<u>Catalog No.</u>	<u>Page</u>
BG			
BG-6	43	BG812-S18-S-MC3	64
BG-6-4T	43	BG812-S18-U24	111
BG-6-A5	72	BG812-S18-U24-MC3	111
BG-6-A6	73	BG812-S18-U58	111
BG-6-B1	19	BG812-S18-U58-MC3	111
BG-6-B5	22	BG812-S18-W2	65
BG-6-E-2-4	93	BG812-S18-W2-MC3	65
BG-6-E-5-8	93	BG812-S18-W6	65
BG-6-E-9-12	93	BG812-S18-W6-MC3	65
BG-6-F1	130	BG812-SC4	133
BG-6-F2	130	BG-8-12-U-2-4	99
BG-6-F13	118	BG-8-12-U-2-4-AS	101
BG-6-H7	34	BG-8-12-U-5-8	99
BG-6-PNA	135	BG-8-12-U-5-8-AS	101
BG6-S18	64	BG-8-12-U-9-12	99
BG6-S18-MC3	64	BG-8-12-U-9-12-AS	101
BG6-S18-S	64	BG-8-12-W2	54
BG6-S18-S-MC3	64	BG-8-12-W6	54
BG6-S18-U24	111	BG-16	43
BG6-S18-U24-MC3	111	BG-16-4T	43
BG6-S18-U58	111	BG-16-A5	72
BG6-S18-U58-MC3	111	BG-16-A6	73
BG6-S18-W2	65	BG-16-B1	19
BG6-S18-W2-MC3	65	BG-16-B5	22
BG6-S18-W6	65	BG-16-C1	107
BG6-S18-W6-MC3	65	BG-16-C2	106
BG6-SC4	133	BG-16-E-2-4	92
BG-6-U-2-4	99	BG-16-E-2-4-AS	101
BG-6-U-5-8	99	BG-16-E-5-8	93
BG-6-U-9-12	99	BG-16-E-5-8-AS	101
BG-8-12	43	BG-16-E-9-12	93
BG-8-12-4T	43	BG-16-E-9-12-AS	101
BG-8-12-A5	72	BG-16-F1	130
BG-8-12-A6	73	BG-16-F2	130
BG-8-12-B1	19	BG-16-F13	118
BG-8-12-B5	22	BG-16-G-6	45
BG-8-12-C1	107	BG-16-G-8-12	45, 50
BG-8-12-C2	106	BG-16-G-16	45
BG-8-12-D3	63	BG-16-G-20	45
BG-8-12-D4	63	BG-16-G-24	45
BG-8-12-E-2-4	93	BG-16-G-32	45
BG-8-12-E-2-4-AS	101	BG-16-PNA	135
BG-8-12-E-5-8	93	BG-16-S18	64
BG-8-12-E-5-8-AS	101	BG16-S18-MC3	64
BG-8-12-E-9-12	93	BG16-S18-S	64
BG-8-12-E-9-12-AS	101	BG16-S18-S-MC3	64
BG-8-12-F1	130	BG16-S18-U24	111
BG-8-12-F2	130	BG16-S18-U24-MC3	111
BG-8-12-F13	118	BG16-S18-U58	111
BG-8-12-G6	50	BG16-S18-U58-MC3	111
BG-8-12-G20	50	BG16-S18-W2	65
BG-8-12-G24	50	BG16-S18-W2-MC3	65
BG-8-12-G32	50	BG16-S18-W6	65
BG-8-12-G812	50	BG16-S18-W6-MC3	65
BG-8-12-H7	34	BG-16-U-2-4	99
BG-8-12-PNA	135	BG-16-U-2-4-AS	101
BG812-S18	64	BG-16-U-5-8	99
BG812-S18-MC3	64	BG-16-U-5-8-AS	101
BG812-S18S	64	BG-16-U-9-12	99
		BG-16-U-9-12-AS	101

Index

<u>Catalog No.</u>	<u>Page</u>	<u>Catalog No.</u>	<u>Page</u>
BG cont.		BH2-H7	136
BG-16-W2	54	BH2-H8	137
BG-16-W6	54	BH2-PNA	134
BG-20	43	BH-2-4	115
BG-20-4T	43	BH-2-4-R	115
BG-20-B5	22	BH4	131
BG-20-C1	107	BH4-E-2-4	117
BG-20-C2	106	BH4-E-2-4-AS	100
BG-20-E-2-4	93	BH4-E-5-8	117
BG-20-E-5-8	93	BH4-E-5-8-AS	100
BG-20-E-9-12	93	BH4-E-9-12	117
BG-20-F13	118	BH4-E-9-12-AS	100
BG-20-U-2-4	99	BH4-F1	129
BG-20-U-5-8	99	BH4-F2	129
BG-20-U-9-12	99	BH4-F3	125
BG-24	43	BH4-F4	121
BG-24-4T	43	BH4-F12	119
BG-24-C1	107	BH4-H7	136
BG-24-C2	106	BH4-H8	137
BG-24-E-2-4	93	BH4-PNA	135
BG-24-E-5-8	93	BH4-SC4	132
BG-24-E-9-12	93	BH5	131
BG-24-U-2-4	99	BH5-E-2-4	117
BG-24-U-5-8	99	BH5-E-5-8	117
BG-24-U-9-12	99	BH5-E-9-12	117
BG-32	43	BH5-F1	129
BG-32-4T	43	BH5-F2	129
BG-32-C1	107	BH5-F3	125
BG-32-C2	106	BH5-F4	121
BG-32-E-2-4	93	BH5-F12	119
BG-32-E-5-8	93	BH5-H7	136
BG-32-E-9-12	93	BH5-H8	137
BG-32-U-2-4	99	BH5-PNA	135
BG-32-U-5-8	99	BH-5-8	115
BG-32-U-9-12	99	BH-5-8-R	115
BH		BH6	131
BH1	131	BH6-E-2-4	117
BH1-E-2-4	116	BH6-E-2-4-AS	100
BH1-E-5-8	116	BH6-E-5-8	117
BH1-E-9-12	116	BH6-E-5-8-AS	100
BH1-F1	128	BH6-E-9-12	117
BH1-F2	128	BH6-E-9-12-AS	100
BH1-F3	125	BH6-F1	129
BH1-F4	121	BH6-F2	129
BH1-F12	119	BH6-F3	125
BH1-H7	136	BH6-F4	121
BH1-H8	137	BH6-F12	119
BH1-PNA	134	BH6-H7	136
BH-1-2-R	115	BH6-H8	137
BH2	131	BH6-PNA	135
BH2-E-2-4	116	BH6-SC4	132
BH2-E-5-8	116	BH7	131
BH2-E-9-12	116	BH7-6	131
BH2-F1	129	BH8	131
BH2-F2	129	BH8-6	131
BH2-F3	125	BH9	139
BH2-F4	121	BH9-10	139
BH2-F12	119	BH-9-12	115
		BH-9-12-R	115
		BH10	139

<u>Catalog No.</u>	<u>Page</u>
BH cont.	
BH11	139
BH12	139
BH15	138
BH16	138
BHE-1-2	115
BH-F12	115
BH-F12-R	115
BH-H7	115
BH-PNA	134

BK	
BKA Series	179
BKB Series	179
BKC100	176
BKC200	176
BKCC	180
BKCP	180
BKF100-4	178
BKF100-6	178
BKH Series	179
BKL Series	179
BKP10063	177
BKP10094	177
BKP20125	177
BKP20188	177
BKT Series	179
BKW063	177
BKW094	177
BKW125	177
BKW188	177

BL	
BL1	142
BL2	142
BL3-8	143
BL3-12	143
BL3-16	143
BL3-20	143
BL-24-2	141
BL-24-4	141
BL-24-4C	141
BL-32-4	141
BL1400	48, 49
BL1400-C442	104
BL1400-PNA	135
BL1400-SC4	133
BL1410	48, 49
BL1410-C442	104
BL1410-L1400	51
BL1410-L1410	51
BL1410-L1420	51
BL1410-L1425	51
BL1410-L1430	51
BL1410-L1440	51
BL1410-L1450	51
BL1410-L1460	51
BL1410-L1470	51

<u>Catalog No.</u>	<u>Page</u>
BL1410-L1480	51
BL1410-PNA	135
BL1410-SC4	133
BL1420	48, 49
BL1420-C442	104
BL1420-PNA	135
BL1420-SC4	133
BL1425	48, 49
BL1425-C442	104
BL1430	48, 49
BL1430-C442	104
BL1440	48, 49
BL1440-C442	104
BL1450	48, 49
BL1450-C442	104
BL1460	48, 49
BL1470	48, 49
BL1480	48, 49
BL1490	48, 49

BM	
BM1	41
BM1M	41
BM2	41
BM3	39, 175
BM3M	39, 175
BM5	174
BMB1	31
BMR4 Series	187
BMR5 Series	187

BN	
BN1	175
BN-2	175
BN-4	175
BN-6	175

BP	
BP-8	44
BP-8-4T	44
BP-8-A28	75
BP-8-A5	72
BP-8-A6	73
BP-8-B1	19
BP-8-B5	22
BP-8-C1	107
BP-8-C2	106
BP-8-D3	63
BP-8-D4	63
BP-8-E-2-4	92
BP-8-E-5-8	92
BP-8-E-9-12	92
BP-8-F13	118
BP-8-H7	34
BP-8-P-8	45
BP-8-P-12	45
BP-8-P-16	45
BP-8-PNA	135

Index

<u>Catalog No.</u>	<u>Page</u>	<u>Catalog No.</u>	<u>Page</u>
BP cont.			
BP8-S18	66	BP-16-A6	73
BP8-S18-MC3	66	BP-16-B1	19
BP8-S18S	66	BP-16-B5	22
BP8-S18-S-MC3	66	BP-16-C1	107
BP8-S18-U24	112	BP-16-C2	107
BP8-S18-U24-MC3	112	BP-16-D4	63
BP8-S18-U58	112	BP-16-E-2-4	92
BP8-S18-U58-MC3	112	BP-16-E-5-8	92
BP8-S18-W2	67	BP-16-E-9-12	92
BP8-S18-W2-MC3	67	BP-16-F13	118
BP8-S18-W6	67	BP-16-P-16	45
BP8-S18-W6-MC3	67	BP-16-PNA	135
BP8-SC4	133	BP-16-S18	66
BP-8-U-2-4	98	BP16-S18-MC3	66
BP-8-U-5-8	98	BP16-S18S	66
BP-8-U-9-12	98	BP16-S18-S-MC3	66
BP-8-W2	55	BP16-S18-U24	112
BP-8-W6	55	BP16-S18-U24-MC3	112
BP-12	44	BP16-S18-U58	112
BP-12-4T	44	BP16-S18-U58-MC3	112
BP-12-A28	75	BP16-S18-W2	67
BP-12-A5	72	BP16-S18-W2-MC3	67
BP-12-A6	73	BP16-S18-W6	67
BP-12-B1	19	BP16-S18-W6-MC3	67
BP-12-B5	22	BP-16-U-2-4	98
BP-12-C1	107	BP-16-U-5-8	98
BP-12-C2	107	BP-16-U-9-12	98
BP-12-D3	63	BP-16-W2	55
BP-12-D4	63	BP-16-W6	55
BP-12-E-2-4	92	BPC-8	46
BP-12-E-5-8	92	BPC-12	46
BP-12-E-9-12	92	BPC-16	46
BP-12-F13	118	BPC-20	46
BP-12-H7	34	BPC-24	46
BP-12-P-12	45	BPC-32	46
BP-12-P-16	45	BPC-40	46
BP-12-PNA	135	BPC-48	46
BP-12-S18	66	BPC-56	46
BP12-S18-MC3	66	BPC-64	46
BP12-S18S	66	BPNA	134
BP12-S18-S-MC3	66		
BP12-S18-U24	112	BR	
BP12-S18-U24-MC3	112	BR-8-T	168
BP12-S18-U58	112	BR-12-T	168
BP12-S18-U58-MC3	112	BR-16-3W	168
BP12-S18-W2	67	BR-20-4T	168
BP12-S18-W2-MC3	67	BR-20-T	168
BP12-S18-W6	67	BR-24-4W	168
BP12-S18-W6-MC3	67	BR-32-4T	168
BP12-SC4	133	BR-32-4T-A6	171
BP-12-U-2-4	98	BR-32-4T-C1	171
BP-12-U-5-8	98	BR-32-4T-U-2-4	170
BP-12-U-9-12	98	BR-32-4T-U-5-8	170
BP-12-W2	55	BR-32-4T-U-9-12	170
BP-12-W6	55	BR-32-4T-W2	170
BP-16	44	BR-32-4W	168
BP-16-4T	44	BR-32-T	168
BP-16-A28	75	BR-64-4T	168
BP-16-A5	72	BRC1	38

<u>Catalog No.</u>	<u>Page</u>	<u>Catalog No.</u>	<u>Page</u>
BR cont.			
BRC2	38	BRC53-S18-U58	113
BRC3	57	BRC53-S18-W2	69
BRC3-E-2-4	110	BRC53-S18-W6	69
BRC3-E-5-8	110	BRC53-SC4	133
BRC3-E-9-12	110	BRC5-3-U24	97
BRC3-F1	130	BRC5-3-U58	97
BRC3-F2	130	BRC5-3-U912	97
BRC3-W2	57	BRC5-3-W2	59
BRC3-W6	57	BRC5-3-W6	59
BRC4	37	BRS-32	169
BRC4M	36	BRS-32A	169
BRC5-1	58	BRS-64A	169
BRC5-1-C2	109		
BRC5-1-C442	103	BS	
BRC5-1-E12	95	BSC4	132
BRC5-1-E24	95		
BRC5-1-E58	95	BT	
BRC5-1-E912	95	BT3	120, 124
BRC5-1-F3	127		
BRC5-1-F4	123	BU	
BRC51-S18	68	BU-2-4	96
BRC51-S18-S	68	BU-2-4-S	96
BRC51-S18-U24	113	BU-2-4-S-AS	100
BRC51-S18-U58	113	BU-5-8	96
BRC51-S18-W2	69	BU-5-8-S	96
BRC51-S18-W6	69	BU-5-8-S-AS	100
BRC51-SC4	133	BU-9-12	96
BRC5-1-U24	97	BU-9-12-S	96
BRC5-1-U58	97	BU-9-12-S-AS	100
BRC5-1-U912	97		
BRC5-1-W2	59	BW	
BRC5-1-W6	59	BW2	52
BRC5-2	58	BW2-CT2	145
BRC5-2-C2	109	BW2S	52
BRC5-2-C442	103	BW4	52
BRC5-2-E12	95	BW6	52
BRC5-2-E24	95	BW6-CT2	145
BRC5-2-E58	95	BW6S	52
BRC5-2-E912	95	BW-8	53
BRC5-2-F3	127	BW-12	53
BRC5-2-F4	123	BW-16	53
BRC52-SC4	133	BW-20	53
BRC5-2-U24	97	BWHS-9	27, 181
BRC5-2-U58	97	BWHS-9D	27, 181
BRC5-2-U912	97		
BRC5-2-W2	59	BX	
BRC5-2-W6	59	BX2	60
BRC5-3	58	BX4	36
BRC5-3-C2	109	BX4-A5	74
BRC5-3-C442	103	BX4-A6	74
BRC5-3-E12	95	BX4-C1	108
BRC5-3-E24	95	BX4-C2	108
BRC5-3-E58	95	BX4-E-2-4	94
BRC5-3-E912	95	BX4-E-5-8	94
BRC5-3-F3	127	BX4-E-9-12	94
BRC5-3-F4	123	BX4-F3	126
BRC53-S18	68	BX4-F4	122
BRC53-S18-S	68		
BRC53-S18-U24	113		

Index

<u>Catalog No.</u>	<u>Page</u>	<u>Catalog No.</u>	<u>Page</u>
BX cont.		M	
BX4-F13	119	MSQN 1/4	181
BX4-H7	34		
BX4-PNA	135	R	
BX4-U-2-4	102	Rapid Ring™ Series	33
BX4-U-5-8	102		
BX4-U-9-12	102	S	
BX4-W2	56	SHHMS 1/4 x 1/2	181
BX4-W6	56	SRHMS 1/4 x 3/8	76
BX4M	35		
BX4M-A5	74		
BX4M-A6	74		
BX4M-A28	75		
BX4M-C1	108		
BX4M-C2	108		
BX4MD	35		
BX4M-E-2-4	94		
BX4M-E-5-8	94		
BX4M-E-9-12	94		
BX4M-F3	126		
BX4M-F4	122		
BX4M-F13	119		
BX4M-H7	34		
BX4M-PNA	135		
BX4M-SC4	133		
BX4M-U-2-4	102		
BX4M-U-5-8	102		
BX4M-U-9-12	102		
BX4M-W2	56		
BX4M-W6	56		
BX5	40		
BX6	60		
BX-8	56		
BX-8B	56		
BX9	60		
BX-18	56		
BX24	60		
BX82	38		
BXL-67	61		
BXL-89	61		
BXL-1011	61		
BXL-1214	61		
BXL-1519	61		
BXL-2024	61		
BXL-2530	61		
BXM-67	61		
BXM-89	61		
BXM-1011	61		
BXM-1214	61		
BXM-1519	61		
BXM-2024	61		
BXM-2530	61		
BXS-67	61		
BXS-89	61		
BXS-1011	61		
BXS-1214	61		
BXS-1519	61		
BXS-2024	61		
BXS-2530	61		



SYSTEMS THAT MAKE SENSE

NOTICE

Cooper B-Line reserves the right to change the specifications, materials, equipment, prices or the availability of products at any time without prior notice. While every effort has been made to assure the accuracy of information contained in this catalog at the time of publication, Cooper B-Line is not responsible for inaccuracies resulting from undetected errors or omissions.

Service Facility - Canada:

Cooper B-Line - Canada

Div. of Cooper Ind. Canada, Inc.

5925 McLaughlin Road

Mississauga, ON L5R 1B8

Canada

Phone: (800) 569-3660

Fax: (888) 753-3355

Email: blinacanada@cooperindustries.com

Cooper B-Line

509 West Monroe Street

Highland, IL 62249

Phone: 800-851-7415

Fax: 618-654-1917

www.cooperbline.com

Cooper US, Inc.
600 Travis, Ste. 5600
Houston, TX 77002-1001
Phone: 713-209-8400
www.cooperindustries.com