



Arrow Hart Buyer's Guide

High Performance Wiring Devices for Commercial,
Industrial and Institutional Applications

COOPER Wiring Devices



**A history of
exceptional
performance**

From the original invention of the snap switch for electric lamps in 1890, Arrow Hart roots have been steeped in a culture of innovation, high performance and durability. 120 years later, Arrow Hart is still recognized throughout the electrical industry for performance without compromise and innovative solutions for today's toughest electrical problems.



Arrow Electric Tool Room, 1920

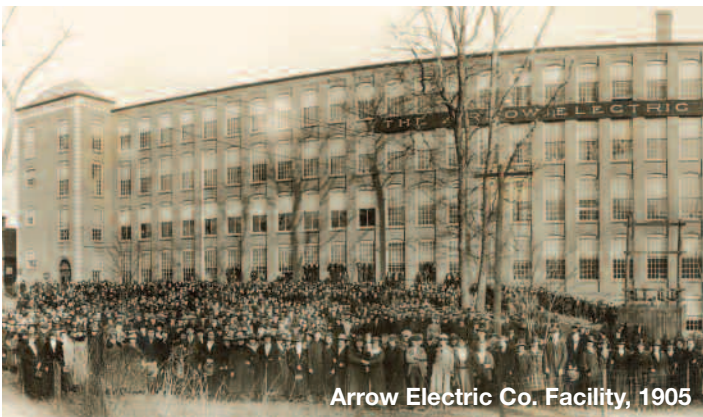

Arrow Electric Co. Facility, 1905



Cooper Wiring Devices & Arrow Hart Headquarters, 2010

- 2 - How To Use the Arrow Hart Buyer's Guide
- 4-5 - Arrow Hart Commercial & Industrial Products
- 6 - NEMA Configuration Chart - Straight Blade Devices & Locking Devices

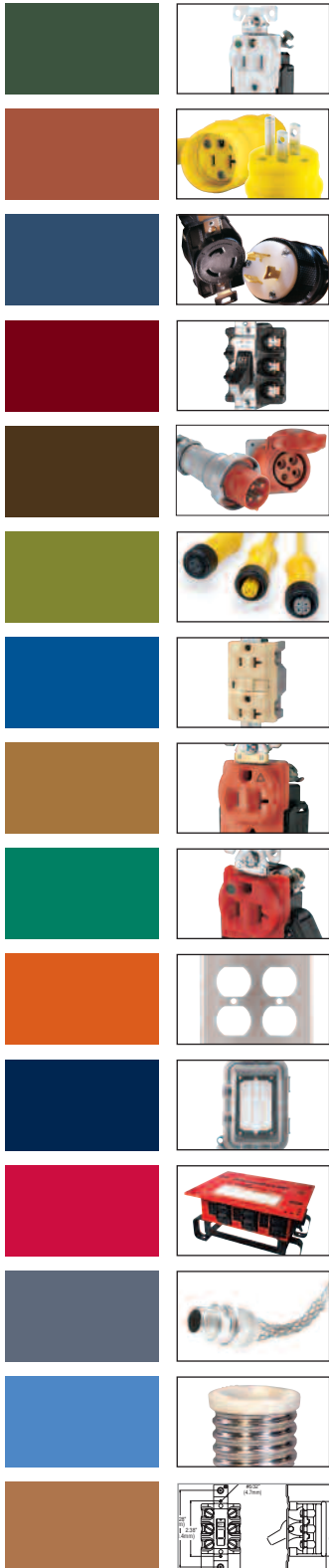

- A - Straight Blade Receptacles**
- B - Straight Blade Plugs & Connectors**
- C - Locking Devices**
- D - Switches & Motor Controls**
- E - Pin and Sleeve Devices**
- F - Industrial Connectivity**
- G - Ground Fault Circuit Interrupters (GFCIs)**
- H - Electronic Protection Devices**
- I - Hospital Grade Devices**
- J - Wallplates**
- K - Weatherproof Covers and Boxes**
- L - Temporary Power**
- M - Wire Mesh Grips**
- N - Electrical Accessories**
- O - Technical Reference**



This 120th anniversary Arrow Hart Buyer's Guide has been developed with you in mind! Whether you're a contractor, specifier, distributor sales person or purchasing agent, we've developed this guide to speed your access to all of the product and technical data you need quickly and efficiently.

The following timesaving features have been included inside this guide:



Table of Contents

A sectional breakdown of the buyer's guide showing order and representative product is highlighted by color so you can quickly flip through the guide to the right section.



Section Index

At the front of each section is an index that helps you quickly find the product locations in the catalog. Sections are divided and bolded into logical electrical groupings with sub categories clearly identified to take you to just the right spot in the catalog.



NEMA Chart Index

Located on page 6-9 and in the technical reference, the NEMA chart allows you to search and identify your product need by applicable NEMA type.

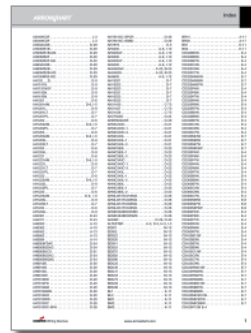

Alphanumeric Index

Located at the back of the buyer's guide, the alphanumeric index allows you to quickly locate the specific catalog item page number.



Feature Products

Feature product pages can be found, throughout the buyer's guide that provide additional information on specific features and benefits of Arrow Hart products.



Specification Information



On the bottom outside corner of each ordering information page you'll see a note directing you to a page with a full specification chart that shows all pertinent product data.



Hospital Grade Receptacles

Hospital Specification Grade Straight Blade Receptacles

2-Pole, 3-Wire Grounding
15A, 125V/AC
20A, 125V/AC
NEMA 5-15R, 5-20R







8200



TR8200



TR8200_M



8310M





Hospital Grade Receptacles					
Back Wire & Side Wire	<table style="width: 100%; border: none;"> <tr> <td style="width: 50%; border: none;"> 15A, 125V NEMA 5-15R </td> <td style="width: 50%; border: none;"> 20A, 125V NEMA 5-20R </td> </tr> </table>	15A, 125V NEMA 5-15R	20A, 125V NEMA 5-20R		
15A, 125V NEMA 5-15R	20A, 125V NEMA 5-20R				
Description	<table style="width: 100%; border: none;"> <tr> <td style="width: 50%; border: none;"> Catalog No. Color Suffix </td> <td style="width: 50%; border: none;"> Catalog No. Color Suffix </td> </tr> <tr> <td style="border: none;"> Duplex Receptacle </td> <td style="border: none;"> Duplex Receptacle </td> </tr> </table>	Catalog No. Color Suffix	Catalog No. Color Suffix	Duplex Receptacle	Duplex Receptacle
Catalog No. Color Suffix	Catalog No. Color Suffix				
Duplex Receptacle	Duplex Receptacle				

Tamper Resistant Hospital Grade Receptacles					
Back Wire & Side Wire	<table style="width: 100%; border: none;"> <tr> <td style="width: 50%; border: none;"> 15A, 125V NEMA 5-15R </td> <td style="width: 50%; border: none;"> 20A, 125V NEMA 5-20R </td> </tr> </table>	15A, 125V NEMA 5-15R	20A, 125V NEMA 5-20R		
15A, 125V NEMA 5-15R	20A, 125V NEMA 5-20R				
Description	<table style="width: 100%; border: none;"> <tr> <td style="width: 50%; border: none;"> Catalog No. Color Suffix </td> <td style="width: 50%; border: none;"> Catalog No. Color Suffix </td> </tr> <tr> <td style="border: none;"> Duplex Receptacle </td> <td style="border: none;"> Duplex Receptacle </td> </tr> </table>	Catalog No. Color Suffix	Catalog No. Color Suffix	Duplex Receptacle	Duplex Receptacle
Catalog No. Color Suffix	Catalog No. Color Suffix				
Duplex Receptacle	Duplex Receptacle				

Panel-Mount Special Use Hospital Grade Single Receptacles					
Back Wire & Side Wire	<table style="width: 100%; border: none;"> <tr> <td style="width: 50%; border: none;"> 15A, 125V NEMA 5-15R </td> <td style="width: 50%; border: none;"> 20A, 125V NEMA 5-20R </td> </tr> </table>	15A, 125V NEMA 5-15R	20A, 125V NEMA 5-20R		
15A, 125V NEMA 5-15R	20A, 125V NEMA 5-20R				
Description	<table style="width: 100%; border: none;"> <tr> <td style="width: 50%; border: none;"> Catalog No. Color Suffix </td> <td style="width: 50%; border: none;"> Catalog No. Color Suffix </td> </tr> <tr> <td style="border: none;"> Strap Center to Center Spacing = 1.9375" (49.2mm) </td> <td style="border: none;"> Duplex Receptacle </td> </tr> </table>	Catalog No. Color Suffix	Catalog No. Color Suffix	Strap Center to Center Spacing = 1.9375" (49.2mm)	Duplex Receptacle
Catalog No. Color Suffix	Catalog No. Color Suffix				
Strap Center to Center Spacing = 1.9375" (49.2mm)	Duplex Receptacle				

Color Ordering Information
For ordering receptacles, include Cat. No. followed by the color code: A (Almond), B (Brown), BK (Black), BL (Blue), GY (Gray), LA (Light Almond), RD (Red), RN (Orange), V (Ivory), W (White)

Icon Key

-  ArrowLink™ option available. Add "M" suffix to Standard catalog number (example 8200V, 8200VM). For ordering information on ArrowLink & ArrowLink SPD connectors, see page A-3.
-  Hospital Grade
-  Build-To-Spec Customizable Devices - see page A-4
-  NAFTA Compliant - see page O-30
-  Tamper Resistant

Accessories for Hospital Grade NEMA 5-15 & 5-20 Receptacles	
Description	Catalog No.
2-Gang, standard size duplex receptacle pre-marked stainless steel wallplate/"Emergency"	<input type="checkbox"/> EM93102
1-Gang, mid-size duplex receptacle wallplate, ivory, REPEL	<input type="checkbox"/> PJ8AMV
1-Gang, mid-size duplex receptacle wallplate, ivory / "GFCI Protected"	<input type="checkbox"/> PJ8GFV
2-Gang, standard size decorator stainless steel wallplate, REPEL	<input type="checkbox"/> 93402AM
2-Gang, mid-size duplex receptacle pre-marked wallplate, red / "Emergency"	<input type="checkbox"/> PJ82EMRD



EM93102



PJ8AMV



PJ8GFV



93402AM



PJ82EMRD

Specification Information:
 HG Receptacles: A-27
 ArrowLink HG Receptacles: A-27
 Tamper Resistant HG Receptacles: A-26
 Panel Mount HG Receptacles: A-26



www.arrowhart.com

A-7

- Sub-category title
- Color coded for easy section location
- NEMA configuration
- Ratings of devices on the page
- Product photos with overlay dimensional data
- Product feature icon
- Product description
- Testing and compliance
- Rating and NEMA information
- Category identifier notes available options and NAFTA compliance
- Color ordering information
- Icon key
- Popular accessories
- Reference to product specification details
- Section page number

*Products that are identified as NAFTA compliant may qualify under the Buy American Act or ARRA program guidelines. Consult specific project guidelines and compliance requirements to assure suitability for your project needs. See page O-30 for more information.

We are committed to an ongoing program of product innovation, development and improvement. Therefore, data in this catalog, including product availability and/or specifications, is subject to change without notice. For specific products inquires contact techsupport@cooperwiringdevices.com.

COOPER Wiring Devices

www.arrowhart.com

3

**Performance
Longevity
Reliability**

Arrow Hart's commercial product offerings have been developed to the highest standards and are engineered with unique features that can help reduce installation time, improve safety and provide years of high performance under constant use.



Specification Grade Receptacles



Electronic Protection Devices



Hospital Grade Devices



LED Accent Lights



GFCI Receptacles

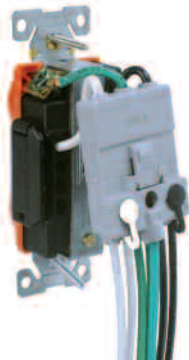

ArrowLink™ Modular Devices



Specification Grade Switches



Wallplates



Tough environments demand products that can stand up and deliver

Arrow Hart's industrial products are designed to provide workhorse performance in the most abusive of manufacturing environments to reduce downtime, improve safety and increase employee productivity.



Watertight Plugs, Connectors & Receptacles



Industrial Straight Blade Plugs, Connectors & Receptacles



Hart-Lock™ and Power-Lock™ Locking Plugs, Connectors and Receptacles

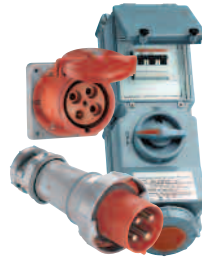

IEC Pin and Sleeve Devices



Manual Motor Controllers



Corrosion Resistant Plugs, Connectors and Receptacles



Temporary Power



LynxPOWER™ Industrial Connectivity



Industrial Switches























































Wire Mesh Grips









































Wallplates & Covers



Poles, Wires	Rating	NEMA Prefix	15A Straight Blade		20A Straight Blade	
			Receptacle, Connector & Flanged Outlet	Plug & Flanged Inlet	Receptacle, Connector & Flanged Outlet	Plug & Flanged Inlet
2-Pole, 2-Wire	125V/AC	1	Page: B-16  1-15R	Page: B-16  1-15P		
2-Pole, 3-Wire Grounding	125V/AC	5	Page: A-6-A-7 A-10-A-12 A-16-A-20 B-6 B-8-B-9 B-17 G-5 H-5-H-6 H-10 K-9  5-15R	Page: B-6 B-8-B-9 B-17  5-15P	Page: A-6-A-7 A-10-A-12 A-16-A-18 B-6 B-10-B-11 B-17 G-5 H-5-H-6 H-10  5-20R	Page: B-6 B-10-B-11 B-17  5-20P
	250V/AC	6	Page: A-8 A-13-A-14 A-21 B-7 B-12-B-13 B-17 H-11  6-15R	Page: B-7 B-12-B-13 B-17  6-15P	Page: A-8 A-13-A-14 A-21 B-7 B-14-B-15 B-17 H-11  6-20R	Page: B-7 B-14-B-15 B-17  6-20P
	277V/AC	7	Page: A-14  7-15R		Page: A-14  7-20R	Page: B-16  7-20P
3-Pole, 3-Wire	125/250V/AC	10			Page: A-22 B-22  10-20R	Page: A-22 B-16 B-22  10-20P
3-Pole, 4-Wire Grounding	125/250V/AC	14			Page: A-23 B-23  14-20R	Page: A-23 B-16 B-23  14-20P
4-Pole, 4-Wire	3ØY 120/208V/AC	18				Page: B-16  18-20P

Poles, Wires	Rating	NEMA Prefix	30A Straight Blade		50A Straight Blade		60A Straight Blade	
			Receptacle, Connector & Flanged Outlet	Plug & Flanged Inlet	Receptacle, Connector & Flanged Outlet	Plug & Flanged Inlet	Receptacle, Connector & Flanged Outlet	Plug & Flanged Inlet
2-Pole, 3-Wire Grounding	125V/AC	5	Page: A-22 B-22  5-30R	Page: A-22 B-22  5-30P	Page: A-22 B-22  5-50R	Page: A-22 B-22  5-50P		
	250V/AC	6	Page: A-22 B-22  6-30R	Page: A-22 B-22  6-30P	Page: A-22 B-22  6-50R	Page: A-22 B-22  6-50P		
	277V/AC	7	Page: A-22 B-22  7-30R	Page: A-22 B-22  7-30P	Page: A-22 B-22  7-50R	Page: A-22 B-22  7-50P		
3-Pole, 3-Wire	125/250V/AC	10	Page: A-22-A-23 B-22-B-23  10-30R	Page: A-22-A-23 B-22-B-23  10-30P	Page: A-22-A-23 B-22-B-23  10-50R	Page: A-22-A-23 B-22-B-23  10-50P		
3-Pole, 4-Wire Grounding	125/250V/AC	14	Page: A-22-A-23 B-22-B-23  14-30R	Page: A-22-A-23 B-22-B-23  14-30P	Page: A-22-A-23 B-22-B-23  14-50R	Page: A-22-A-23 B-22-B-23  14-50P	Page: A-23 B-23  14-60R	Page: A-23 B-23  14-60P
	3Ø 250V/AC	15	Page: A-22-A-23 B-22-B-23  15-30R	Page: A-22-A-23 B-22-B-23  15-30P	Page: A-23 B-23  15-50R	Page: A-23 B-23  15-50P	Page: A-23 B-23  15-60R	Page: A-23 B-23  15-60P
4-Pole, 4-Wire	3ØY 120/208V/AC	18	Page: A-23 B-23  18-30R	Page: A-23 B-23  18-30P	Page: A-23 B-23  18-50R	Page: A-23 B-23  18-50P	Page: A-23 B-23  18-60R	Page: A-23 B-23  18-60P

Poles, Wires	Rating	NEMA Prefix	15A Locking		20A Locking		30A Locking	
			Receptacle, Connector & Flanged Outlet	Plug & Flanged Inlet	Receptacle, Connector & Flanged Outlet	Plug & Flanged Inlet	Receptacle, Connector, & Flanged Outlet	Plug & Flanged Inlet
2-Pole, 2-Wire	125V/AC	ML1	Page: C-53 	Page: C-53 				
	125V/AC	L1	Page: C-6 	Page: C-6 				
	250V/AC	L2			Page: C-7 	Page: C-7 		
2-Pole, 3-Wire Grounding	125V/AC	ML2	Page: C-54 	Page: C-54 				
	125V/AC	L5	Page: C-8 H-13 	Page: C-8 	Page: C-11 H-13 	Page: C-11 	Page: C-16 H-15 	Page: C-16 H-15
	250V/AC	L6	Page: C-9 H-13 	Page: C-9 	Page: C-12 H-14 	Page: C-12 	Page: C-17 H-15 	Page: C-17
	277V/AC	L7	Page: C-10 	Page: C-10 	Page: C-13 H-14 	Page: C-13 	Page: C-18 H-15 	Page: C-18
	480V/AC	L8			Page: C-14 H-14 	Page: C-14 	Page: C-19 H-16 	Page: C-19
	600V/AC	L9			Page: C-15 	Page: C-15 	Page: C-20 	Page: C-20
3-Pole, 3-Wire	125/250V/AC	ML3	Page: C-54 	Page: C-54 				
	125/250V/AC	L10			Page: C-23 	Page: C-23 	Page: C-27 	Page: C-27
	3Ø 250V/AC	L11			Page: C-24 	Page: C-24 	Page: C-28 	Page: C-28
	3Ø 480V/AC	L12			Page: C-25 	Page: C-25 	Page: C-29 	Page: C-29
	3Ø 600V/AC	L13					Page: C-30 	Page: C-30

Poles, Wires	Rating	NEMA Prefix	20A Locking		30A Locking	
			Receptacle, Connector & Flanged Outlet	Plug & Flanged Inlet	Receptacle, Connector, & Flanged Outlet	Plug & Flanged Inlet
3-Pole, 4-Wire Grounding	125/250V/AC	L14	Page: C-31 H-16  L14-20R	Page: C-31  L14-20P	Page: C-34 H-17  L14-30R	Page: C-34  L14-30P
	3Ø 250V/AC	L15	Page: C-32 H-16  L15-20R	Page: C-32  L15-20P	Page: C-35 H-17  L15-30R	Page: C-35  L15-30P
	3Ø 480V/AC	L16	Page: C-33 H-17  L16-20R	Page: C-33  L16-20P	Page: C-36  L16-30R	Page: C-36  L16-30P
	3Ø 600V/AC	L17			Page: C-37  L17-30R	Page: C-37  L17-30P
4-Pole, 4-Wire	3ØY 120/208V/AC	L18	Page: C-39  L18-20R	Page: C-39  L18-20P	Page: C-43  L18-30R	Page: C-43  L18-30P
	3ØY 277/480V/AC	L19	Page: C-40  L19-20R	Page: C-40  L19-20P	Page: C-44  L19-30R	Page: C-44  L19-30P
	3ØY 347/600V/AC	L20	Page: C-41  L20-20R	Page: C-41  L20-20P	Page: C-45  L20-30R	Page: C-45  L20-30P
4-Pole, 5-Wire Grounding	3ØY 120/208V/AC	L21	Page: C-47 H-18  L21-20R	Page: C-47  L21-20P	Page: C-50 H-18  L21-30R	Page: C-50  L21-30P
	3ØY 277/480V/AC	L22	Page: C-48  L22-20R	Page: C-48  L22-20P	Page: C-51 H-18  L22-30R	Page: C-51  L22-30P
	3ØY 347/600V/AC	L23	Page: C-49  L23-20R	Page: C-49  L23-20P	Page: C-52 H-18  L23-30R	Page: C-52  L23-30P

A

Straight Blade Receptacles



	Page		Page
Straight Blade Specifier's Chart	A-1	Construction Grade Receptacles	A-15
ArrowLink™ Modular Connectors	A-2	2-Pole, 3-Wire	
Build-To-Spec	A-4	15A, 125V/AC NEMA 5-15	A-16
Hospital Grade Receptacles	A-5	20A, 125V/AC NEMA 5-20	A-16
2-Pole, 3-Wire		Commercial Grade Receptacles	A-17
15A, 125V/AC NEMA 5-15	A-6-A-7	2-Pole, 3-Wire	
20A, 125V/AC NEMA 5-20	A-6-A-7	15A, 125V/AC NEMA 5-15	A-17-A-21
15A, 250V/AC NEMA 6-15	A-8	20A, 125V/AC NEMA 5-20	A-17-A-18
20A, 250V/AC NEMA 6-20	A-8	15A, 250V/AC NEMA 6-15	A-21
Industrial Grade Receptacles	A-9	20A, 250V/AC NEMA 6-20	A-21
2-Pole, 3-Wire		Straight Blade Power Devices	A-22
15A, 125V/AC NEMA 5-15	A-10-A-12	Specification Information	A-24
20A, 125V/AC NEMA 5-20	A-10-A-12		
15A, 250V/AC NEMA 6-15	A-13-A-14		
20A, 250V/AC NEMA 6-20	A-13-A-14		
15A, 277V/AC NEMA 7-15	A-14		
20A, 277V/AC NEMA 7-20	A-14		

High performance receptacles for the most demanding of environments

Arrow Hart's offering of straight blade receptacles cover the full range of Hospital, Industrial, Construction and Commercial Grades along with special solutions like Corrosion Resistant, Severe Duty Insulated and Watertight Straight Blade Receptacles for complex environments.



Hospital Specification Grade Straight Blade Receptacles

Arrow Hart's feature rich line of Hospital Grade receptacles have been designed to meet and exceed the demanding requirements of UL 498 and Federal Specification WC-596 to provide a consistent means of connectivity where downtime can be critical.



Industrial Specification Grade Straight Blade Receptacles

Designed from the inside out, these receptacles meet and exceed the UL 498 and Federal Specification WC-596 standards to withstand the most abusive environments and excel in applications that demand the highest levels of performance.



Commercial & Construction Specification Grade Straight Blade Receptacles

Engineered for safe, reliable performance, these UL 498 and Federal Specification WC-596 listed devices provide maximum durability in a wide variety of applications while providing installation efficiency to help finish the job on time.

























Industrial Specification Grade Corrosion Resistant Straight Blade Receptacles

Built to defy the potentially damaging effects of moisture, humidity and other corrosive elements, Arrow Hart Corrosion Resistant Devices are listed to UL 498 and Federal Specification WC-596 to provide a dependable connection regardless of the application environment.



Industrial Specification Grade Watertight Straight Blade Receptacles

Listed to UL 498, Arrow Hart Watertight Straight Blade receptacles utilize advanced materials and innovative design features to make them the best choice for superior performance in harsh, wet location environments.

	Feature Group	Premium Hospital Grade	Single Premium Hospital Grade	Isolated Ground Premium Hospital Grade	Single Isolated Ground Premium Hospital Grade	Hospital Grade	Premium Industrial Grade	Single Premium Industrial Grade	Isolated Ground Premium Industrial Grade	Single Isolated Ground Premium Industrial Grade	Industrial Grade	Const. Grade
												
	Product Line	AH8200 AH8300 AH8400 AH8600	8210 8310 8410 8610	IG8200 IG8300 IG8400	IG8210 IG8310	8200 8300 TR8200* TR8300*	AH5262 AH5362 AH5462 AH5662	5261 5361 5461 5661	IG5262 IG5362 IG5462 IG5662	IG5261 IG5361 IG5461 IG5661	5252 5352	5262 5362 5462C 5662C TR5262* TR5362*
5-leaf line contact	Contact design	●		●			●		●		●	
Triple-wipe line contact			●		●	●		●		●		●
Brass mounting strap	Strap Material	●					●					
Steel mounting strap			●	●	●	●		●	●	●	●	●
1-piece integral to mounting strap	Grounding System	●					●					
Brass ground shunt				●	●				●	●	●	
Riveted ground contact			●				●	●				●
Impact & chemical resistant nylon face	Body Materials	●	●	●	●	●	●	●	●	●	●	●
Glass-filled nylon base		●	●	●	●		●	●	●	●	●	
PVC base						●						●
Screw terminal guards	Specialty Features	●		●			●		●		●	
Back wire ground terminal		●		●			●		●			
Tri-combo screws		●	●	●	●	●	●	●	●	●	●	●
Screw-Catch™ feature		●		●			●	●	●		●	●
*Tamper Resistant  available							●					●
Certifications												

* Tamper Resistant Receptacles are cULus, Fed. Spec., and NOM

ArrowLink

Arrow Hart's factory terminated ArrowLink system revolutionizes device installation, unleashing groundbreaking labor savings in installation and maintenance by eliminating traditional pigtail, terminal connections and taping. Use ArrowLink on your next job to reduce labor costs, eliminate installation errors, save money and win!

Color coded terminals for consistent, reliable connections

Durable polycarbonate housing

Terminal accommodation #12-#14 AWG, solid only

Copper alloy contacts for superior wire retention and minimized heat rise

6", #12 AWG ground lead with ring terminal and captive ground screw

Color coded terminal screws guard caps

Color coded terminal screws

Terminal accommodation #12-#14 AWG, solid or stranded

Cut-Away of MCR300FTPI Push-In Terminal

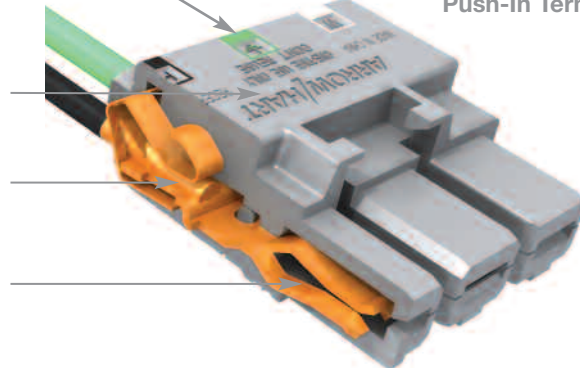

Cut-Away of MCR300FTST Screw Terminal

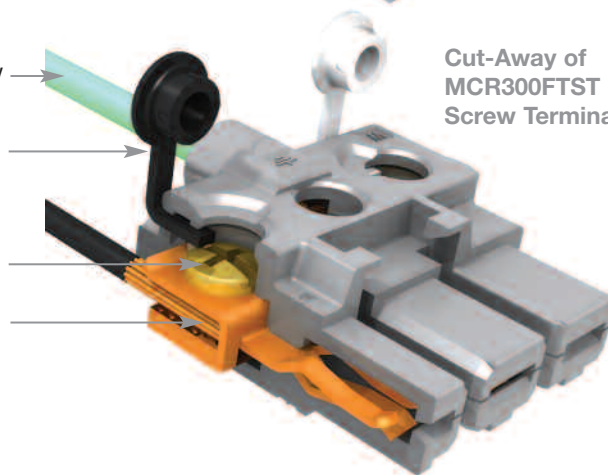
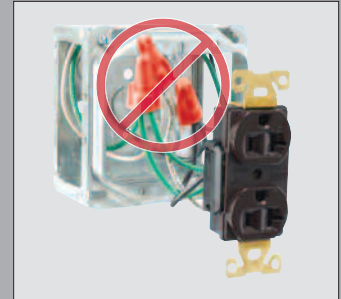
**ArrowLink SPD Benefits**

EASE OF INSTALLATION:
No more twist-on wire connectors



50% TIME SAVINGS:
SPD accelerates both rough-in & trim out installation



EFFICIENT DESIGN:
Low profile connection with feed-through capability



30% REDUCTION in wire volume inside the box

How To Order

1. Select a device to ArrowLink enable. Catalog pages identify available products—simply add an “M” to the catalog number and the devices will be factory enabled with the ArrowLink device-side connection. (For GFCIs add “MOD” suffix)



2. Choose from leaded or unleaded ArrowLink connector versions in screw-down or push-in models.



3. Place your order and get your ArrowLink devices in **bulk packed boxes**, shipped within 5 days of receipt of order!

ArrowLink SPD Comparative Labor Savings Analysis

Traditional Pigtail Installation

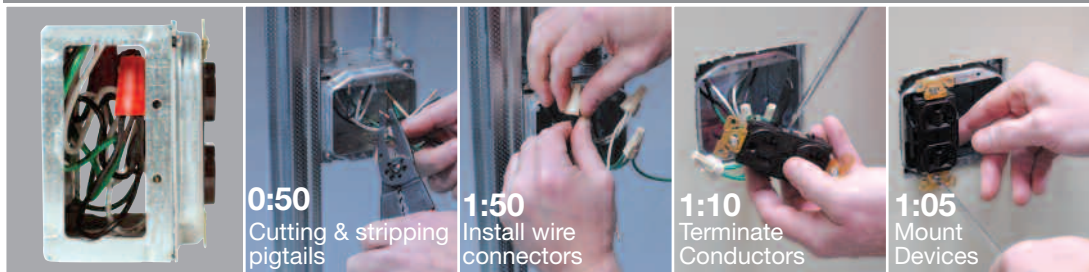

0:50
Cutting & stripping
pigtails

1:50
Install wire
connectors

1:10
Terminate
Conductors

1:05
Mount
Devices

4:55/Receptacle

Total time required to
install 500 pigtail devices:
40.97 Hours

ArrowLink SPD Installation

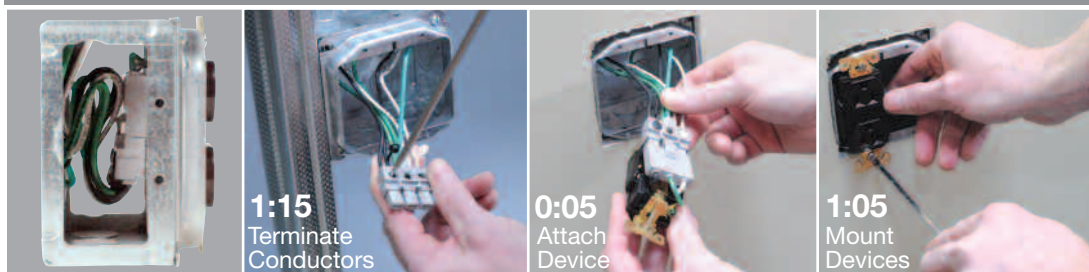

1:15
Terminate
Conductors

0:05
Attach
Device

1:05
Mount
Devices

2:25/Receptacle

Total time required to install
500 ArrowLink SPD devices:
20.13 Hours

Time Saved with SPD
20.84 Hours

ARROWLINK™
Modular Wiring Devices



Leaded ArrowLink Receptacle Connectors

Device Type	Description	Catalog No.
Receptacle	Solid Wire Leads – 125V	<input type="checkbox"/> MCR125SOL
	Stranded Wire Leads – 125V	<input type="checkbox"/> MCR125STR
	Solid Wire Leads – 250V	<input type="checkbox"/> MCR250SOL
	Stranded Wire Leads – 250V	<input type="checkbox"/> MCR250STR

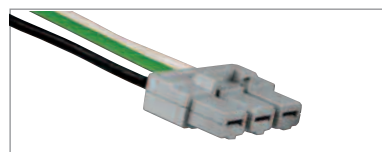

MCR125STR
Leaded
ArrowLink
Connector

ARROWLINK™
SPD



ArrowLink SPD Receptacle Connectors

Device Type	Description	Catalog No.
Receptacle	Screw Terminal	<input type="checkbox"/> MCR300FTST
	Screw Terminal, No Ground Conductor	<input type="checkbox"/> MCR300FTSTNG
	<small>AVAILABLE SUMMER 2010</small> Push-In	<input type="checkbox"/> MCR300FTPI
	<small>AVAILABLE SUMMER 2010</small> Push-In, No Ground Conductor	<input type="checkbox"/> MCR300FTPING

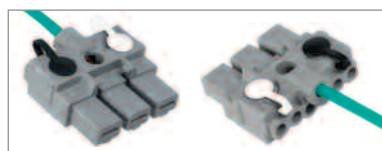

MCR300FTST
Screw Terminal



MCR300FTPI
Push-In
Terminal

ArrowLink Accessories

Device Type	Description	Catalog No.
Circuit Tester	Tests Receptacle & ArrowLink Connectors <small>AVAILABLE SUMMER 2010</small>	<input type="checkbox"/> ALTESTER



ALTESTER
Circuit Tester

Tamper Resistant, Weather Resistant and Tamper & Weather Resistant Receptacles

How the Tamper Resistant system works:

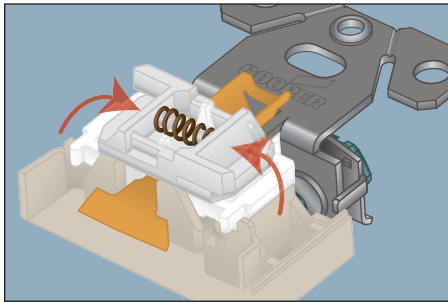

Shutters restrict access in closed position.

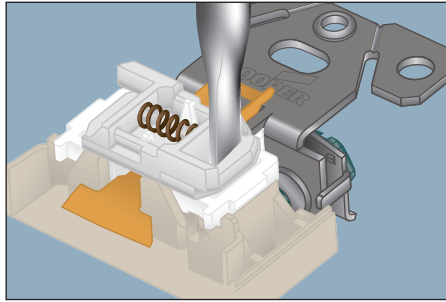

Insertion of object in any one side will not open shutters.

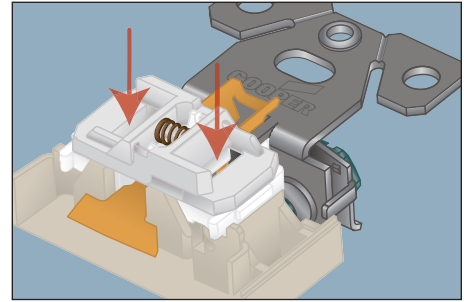

Insertion of two-bladed plug or grounding plug will open shutters.



“TR” mold mark provides quick visual confirmation of tamper resistance when installed.



“WR” identifier quickly indicates during inspections that a weather resistant receptacle has been installed.



Both the “TR” mold mark and “WR” identifier are clearly visible in the finished installation, indicating double-layer protection for maximum safety.

2008 NEC Code Requirements

2008 NEC – 517.18 (C) Pediatric Locations

Receptacles located within the rooms, bathrooms, playrooms, activity rooms and patient care areas of pediatric wards shall be listed under tamper resistant or employ a listed tamper resistant cover.

B) TR for non-hospital sections – 2008 NEC – 406.11 Tamper Resistant Receptacles in Dwelling units

In all areas specified in 210.52 all 125-volt, 15- and 20-amp receptacles shall be listed tamper resistant receptacles.

C) WR for all sections – 2008 NEC – 406.8 Receptacles in Wet or Damp Locations

All 15- and 20-amp, 125- and 250-volt non-locking receptacles installed in wet or damp locations shall be weather resistant receptacles.

Build-To-Spec

For Receptacles, Switches, GFCIs & TVSS devices

Modified at the factory to improve efficiency and speed production at the job site. Arrow Hart’s Build-To-Spec program provides customized device solutions to simplify your project and maximize your bottom line.

Sample Number:

5362W PSOL X Z T G P

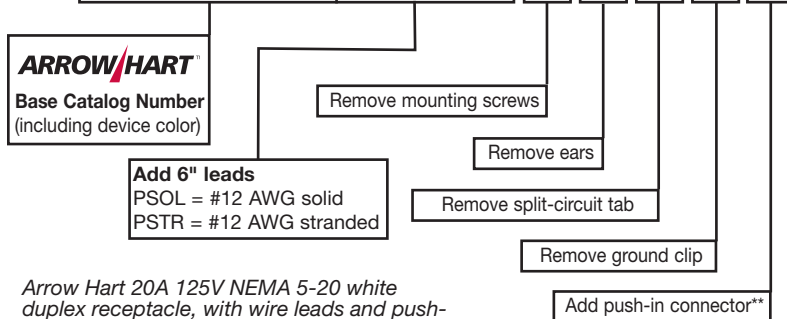

Arrow Hart 20A 125V NEMA 5-20 white duplex receptacle, with wire leads and push-in connectors, without mounting screws, ears, split-circuit tab or grounding clip.

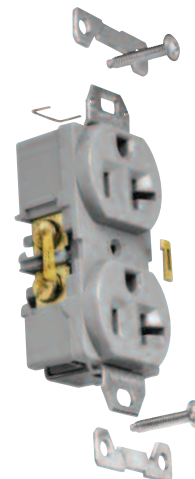

BUILD-TO-SPEC
CUSTOM CONFIGURED DEVICES
ARROW/HART

**For use with leaded receptacles only. Add “PSOL” to back of receptacle catalog number for 6” of #12 AWG solid or “PSTR” for 6” of #12 AWG stranded. (Example: 5362W PSTR + Build to Spec Options).

All receptacles are bulk packed 50 pieces per carton. Minimum order quantity is 100 pieces. Orders under 500 pieces ship within 5 days with larger quantities typically within 10 days.

Performance
Longevity
Reliability

In today's healthcare environment the power to save lives begins with the electrical system. Downtime is not an option and the right receptacle can make the difference in critical situations.



Premium Hospital Grade AH8200, AH8300 Series

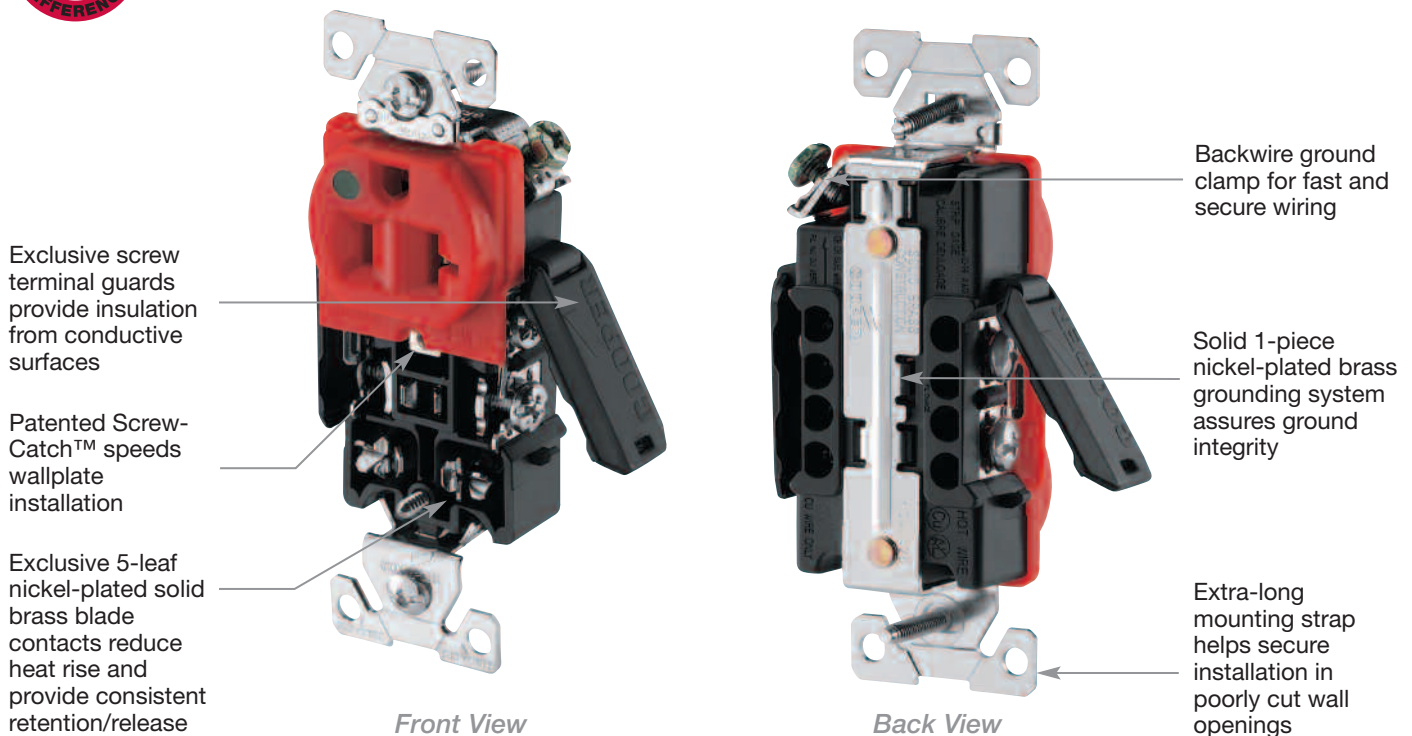

Additional Features and Benefits

- Available in 15A & 20A duplex & single configurations, including lighted, Tamper Resistant and ArrowLink modular styles
- Glass-reinforced nylon base provides superior strength and heat resistance
- High impact- and chemical-resistant nylon face holds structural integrity
- Convenient built-in #10 and #12 AWG wire strippers
- Tri-head combination brass terminal screws are backed out and ready to wire

Hospital Specification Grade Straight Blade Receptacles

2-Pole, 3-Wire Grounding
 15A, 125V/AC
 20A, 125V/AC
 NEMA 5-15R, 5-20R

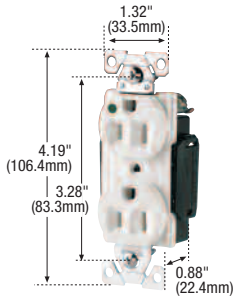
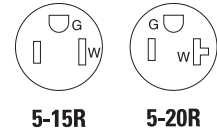

AH8200

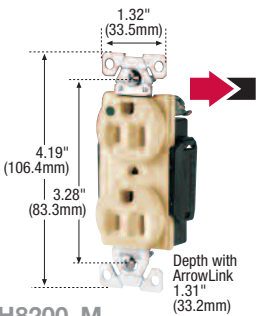

AH8200_M

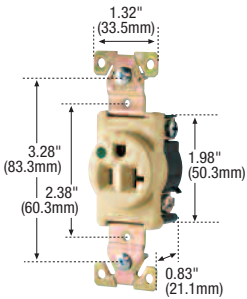

8310

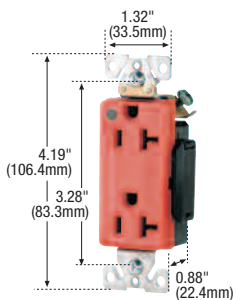

IG8362

Premium Hospital Grade Receptacles

Back Wire & Side Wire	15A, 125V NEMA 5-15R	UL	F	UL	S	SP	NOM 426	20A, 125V NEMA 5-20R	UL	F	UL	S	SP	NOM 426
Description	Catalog No. Color Suffix							Catalog No. Color Suffix						
● Premium Duplex Receptacle	□ AH8200____ B, BK, GY, RD, V, W	●						□ AH8300____ B, BK, GY, LA, RD, V, W	●					
● Premium Illuminated Duplex Receptacle	□ AH8200LT____ RD, V, W	●						□ AH8300LT____ RD, V, W	●					
● Premium Single Receptacle	□ 8210____ B, GY, RD, V, W	●	●	●				□ 8310____ B, GY, RD, V, W	●	●	●			

Premium Decorator Hospital Grade Receptacles

Back Wire & Side Wire	15A, 125V NEMA 5-15R	UL	F	UL	S	SP	NOM 426	20A, 125V NEMA 5-20R	UL	F	UL	S	SP	NOM 426
Description	Catalog No. Color Suffix							Catalog No. Color Suffix						
● Premium Decorator Duplex Receptacle	□ 8262____ B, BK, GY, RD, V, W	●						□ 8362____ B, BK, GY, RD, V, W	●					
● Premium Decorator Illuminated Duplex Receptacle	□ 8262LT____ GY, RD, V, W	●						□ 8362LT____ RD, V, W	●					

Isolated Ground Premium Hospital Grade Receptacles

Back Wire & Side Wire	15A, 125V NEMA 5-15R	UL	F	UL	S	SP	NOM 426	20A, 125V NEMA 5-20R	UL	F	UL	S	SP	NOM 426
Description	Catalog No. Color Suffix							Catalog No. Color Suffix						
● Premium IG Duplex Receptacle	□ IG8200____ GY, RD, RN, V, W	●						□ IG8300____ GY, RD, RN, V, W	●					
● Premium IG Single Receptacle	□ IG8210____* RN	●						□ IG8310____ RN	●					
● Premium IG Decorator Duplex Receptacle	□ IG8262____ GY, RN, V, W	●						□ IG8362____ GY, RN, V, W	●					

* Not Fed. Spec.

Color Ordering Information

For ordering receptacles, include Cat. No. followed by the color code: A (Almond), B (Brown), BK (Black), BL (Blue), GY (Gray), LA (Light Almond), RD (Red), RN (Orange), V (Ivory), W (White)

Icon Key

➡ ArrowLink™ option available. Add "M" suffix to Standard catalog number (example AH8300W, AH8300WM). For ordering information on ArrowLink & ArrowLink SPD connectors, see page A-3.

● Hospital Grade



Build-To-Spec Customizable Devices - see page A-4
 NAFTA Compliant - see page O-30

Specification Information:

Premium HG Receptacles: A-24

ArrowLink Premium HG Receptacles: A-28 & A-29

Isolated Ground Premium HG Receptacles: A-25

Hospital Specification Grade Straight Blade Receptacles

2-Pole, 3-Wire Grounding
 15A, 125V/AC
 20A, 125V/AC
 NEMA 5-15R, 5-20R

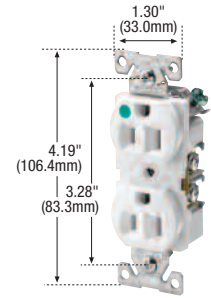
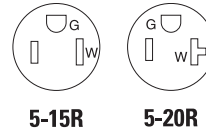

8200

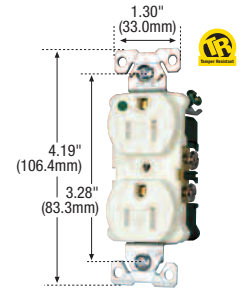

TR8200

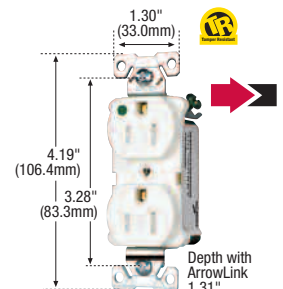

TR8200_M

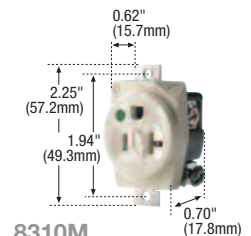

8310M

Hospital Grade Receptacles

Back Wire & Side Wire	15A, 125V NEMA 5-15R	UL FULS SP NOM 426	20A, 125V NEMA 5-20R	UL FULS SP NOM 426
Description	Catalog No. Color Suffix	▶	Catalog No. Color Suffix	▶
● Duplex Receptacle	□ 8200 B, GY, LA, RD, V, W	• • •	□ 8300 B, GY, LA, RD, V, W	• • •

Tamper Resistant Hospital Grade Receptacles

Back Wire & Side Wire	15A, 125V NEMA 5-15R	cUL us FULS SP NOM 426	20A, 125V NEMA 5-20R	cUL us FULS SP NOM 426
Description	Catalog No. Color Suffix	▶	Catalog No. Color Suffix	▶
● Duplex Receptacle	□ TR8200 B, GY, RD, V, W	• •	□ TR8300 B, GY, RD, V, W	• •

Panel-Mount Special Use Hospital Grade Single Receptacles

Back Wire & Side Wire	15A, 125V NEMA 5-15R	UL FULS SP NOM 426	20A, 125V NEMA 5-20R	UL FULS SP NOM 426
Description	Catalog No. Color Suffix	▶	Catalog No. Color Suffix	▶
● Strap Center to Center Spacing = 1.9375" (49.2mm)	□ 8210M B, V	•	□ 8310M B, RD, V	•

Color Ordering Information
 For ordering receptacles, include Cat. No. followed by the color code: A (Almond), B (Brown), BK (Black), BL (Blue), GY (Gray), LA (Light Almond), RD (Red), RN (Orange), V (Ivory), W (White)

Icon Key
 ▶ ArrowLink™ option available. Add "M" suffix to Standard catalog number (example 8200V, 8200VM). For ordering information on ArrowLink & ArrowLink SPD connectors, see page A-3.
 ● Hospital Grade
 Build-To-Spec Customizable Devices - see page A-4
 NAFTA Compliant - see page O-30
 Tamper Resistant

Accessories for Hospital Grade NEMA 5-15 & 5-20 Receptacles

Description	Catalog No.
2-Gang, standard size duplex receptacle pre-marked stainless steel wallplate/"Emergency"	□ EM93102 •
1-Gang, mid-size duplex receptacle wallplate, ivory, REPEL	□ PJ8AMV
1-Gang, mid-size duplex receptacle wallplate, ivory / "GFCI Protected"	□ PJ8GFV
2-Gang, standard size decorator stainless steel wallplate, REPEL	□ 93402AM •
2-Gang, mid-size duplex receptacle pre-marked wallplate, red / "Emergency"	□ PJ82EMRD



Specification Information:
 HG Receptacles: A-27
 ArrowLink HG Receptacles: A-27
 Tamper Resistant HG Receptacles: A-26
 Panel Mount HG Receptacles: A-26

Hospital Specification Grade Straight Blade Receptacles

2-Pole, 3-Wire Grounding
 15A, 250V/AC
 20A, 250V/AC
 NEMA 6-15R, 6-20R

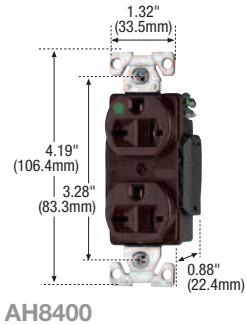
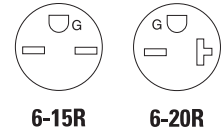

Premium Hospital Grade Receptacles

Back Wire & Side Wire	15A, 250V NEMA 6-15R	UL FULS SP	20A, 250V NEMA 6-20R	UL FULS SP
Description	Catalog No. Color Suffix	▶ US	Catalog No. Color Suffix	▶ US
● Premium Duplex Receptacle	<input type="checkbox"/> AH8600 ____ V, W	●	<input type="checkbox"/> AH8400 ____ B, GY, RD, V, W	●
● Premium Single Receptacle	<input type="checkbox"/> 8610 ____ V, W	●	<input type="checkbox"/> 8410 ____ B, GY, RD, V, W	●

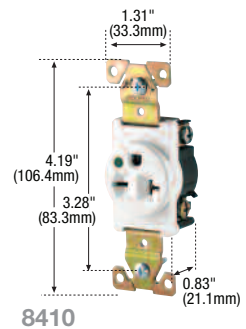

Isolated Ground Premium Hospital Grade Receptacles

Back Wire & Side Wire	20A, 250V NEMA 6-20R	UL FULS SP
Description	Catalog No. Color Suffix	▶ US
● Premium IG Duplex Receptacle	<input type="checkbox"/> IG8400 ____ RN	●

Color Ordering Information

For ordering receptacles, include Cat. No. followed by the color code: A (Almond), B (Brown), BK (Black), BL (Blue), GY (Gray), LA (Light Almond), RD (Red), RN (Orange), V (Ivory), W (White)

Icon Key

▶ ArrowLink™ option available. Add "M" suffix to Standard catalog number (example AH8600W, AH8600WM). For ordering information on ArrowLink & ArrowLink SPD connectors, see page A-3.

▶ Build-To-Spec Customizable Devices - see page A-4
 ▶ NAFTA Compliant - see page O-30

● Hospital Grade

Accessories for Hospital Grade NEMA 6-15 & 6-20 Receptacles

Description	Catalog No.	▶ US
1-Gang standard size duplex receptacle nylon wallplate, ivory	<input type="checkbox"/> 5132V	●
1-Gang standard size single receptacle, stainless steel wallplate, REPEL	<input type="checkbox"/> 93091AM	●
1-Gang mid-size duplex receptacle polycarbonate wallplate, light almond	<input type="checkbox"/> PJ8LA	
1-Gang standard size duplex receptacle stainless steel wallplate, REPEL	<input type="checkbox"/> 93101AM	●

Specification Information:

Premium HG Receptacles: A-24

ArrowLink Premium HG Receptacles: A-28 & A-29

Isolated Ground HG Receptacles: A-25



5132V



93091AM



PJ8



93101AM

Arrow Hart Industrial Receptacles excel in applications where the competition lacks guts!

These durable receptacles are designed from the inside out to provide innovative functionality throughout the product line and withstand the most abusive environments to provide a consistent means of reliable connectivity.



Premium Industrial Grade AH5262, AH5362, AH5462, AH5662

Industrial Grade 5252, 5352

Backwire ground clamp provides fast and secure wiring

High impact and chemical-resistant nylon face holds structural integrity

Exclusive screw terminal guards provide insulation from conductive surfaces

Exclusive 5-leaf solid brass contacts lower heat rise, and provide consistent retention/release

1-piece solid brass mounting strap with integral grounding system assures ground integrity

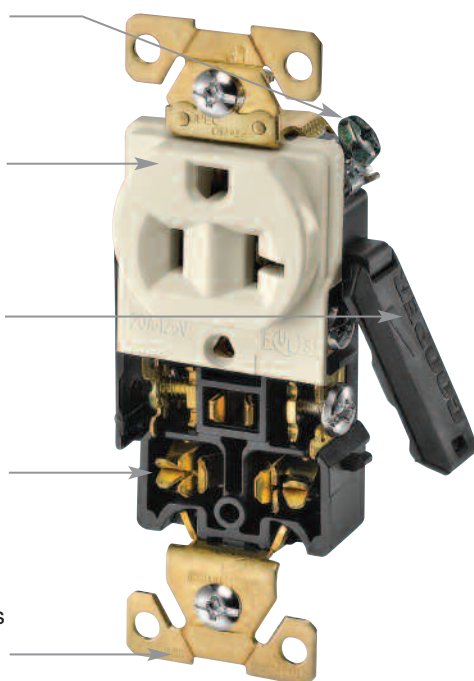

Extra-long mounting straps help secure installation in poorly cut wall openings

1-piece solid brass ground shunt system assures ground integrity

Triple wipe brass line contacts minimize heat rise and maximize plug blade retention

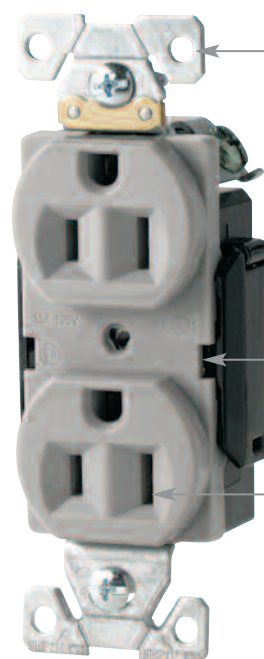

Additional Features and Benefits

- Patented Screw-Catch™ speeds wallplate installation
- Convenient built-in #10 and #12 AWG wire strippers
- Glass-reinforced nylon base provides superior strength and high heat resistance
- Tri-combination head brass terminal screws are backed out and ready to wire
- Available in 15A & 20A duplex & single configurations, including Isolated Ground and ArrowLink modular styles

Industrial Specification Grade Straight Blade Receptacles

2-Pole, 3-Wire Grounding
 15A, 125V/AC
 20A, 125V/AC
 NEMA 5-15R, 5-20R

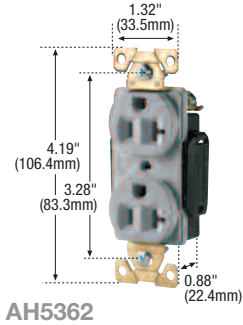
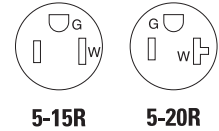

AH5362

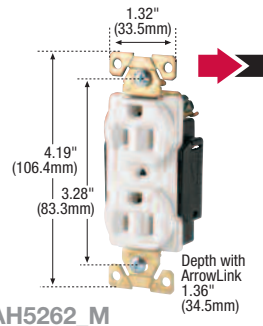

AH5262_M

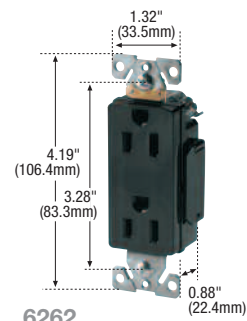

6262

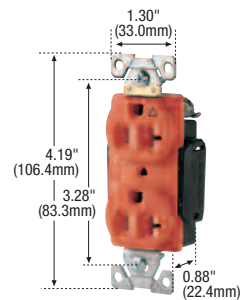

IG5362

Premium Industrial Grade Receptacles

Back Wire & Side Wire	15A, 125V NEMA 5-15R	UL FUL S	SP NOM 426	20A, 125V NEMA 5-20R	UL FUL S	SP NOM 426
Description	Catalog No. Color Suffix	➔	🇺🇸	Catalog No. Color Suffix	➔	🇺🇸
Premium Duplex Receptacle	<input type="checkbox"/> AH5262 B, BK, GY, RD, V, W	•	•	<input type="checkbox"/> AH5362 B, BK, GY, LA, RD, V, W	•	•
Premium Single Receptacle	<input type="checkbox"/> 5261 B, GY, RD, V, W	•	•	<input type="checkbox"/> 5361 B, BK, GY, RD, V, W	•	•

Premium Decorator Industrial Grade Receptacles

Back Wire & Side Wire	15A, 125V NEMA 5-15R	UL FUL S	SP NOM 426	20A, 125V NEMA 5-20R	UL FUL S	SP NOM 426
Description	Catalog No. Color Suffix	➔	🇺🇸	Catalog No. Color Suffix	➔	🇺🇸
Premium Decorator Duplex Receptacle	<input type="checkbox"/> 6262 A, B, BK, GY, LA, RD, V, W	•	•	<input type="checkbox"/> 6362 A, B, BK, GY, LA, RD, V, W	•	•

Isolated Ground Premium Industrial Grade Receptacles

Back Wire & Side Wire	15A, 125V NEMA 5-15R	UL FUL S	SP NOM 426	20A, 125V NEMA 5-20R	UL FUL S	SP NOM 426
Description	Catalog No. Color Suffix	➔	🇺🇸	Catalog No. Color Suffix	➔	🇺🇸
Premium IG Duplex Receptacle	<input type="checkbox"/> IG5262 GY, RD, RN, V, W	•	•	<input type="checkbox"/> IG5362 BK, GY, RD, RN, V, W	•	•
Premium IG Single Receptacle	<input type="checkbox"/> IG5261 RN	•	•	<input type="checkbox"/> IG5361 RN, V	•	•

* Not Fed. Spec.

Color Ordering Information

For ordering receptacles, include Cat. No. followed by the color code: A (Almond), B (Brown), BK (Black), BL (Blue), GY (Gray), LA (Light Almond), RD (Red), RN (Orange), V (Ivory), W (White)

Icon Key

➔ ArrowLink™ option available. Add "M" suffix to Standard catalog number (example AH5262V, AH5262VM). For ordering information on ArrowLink & ArrowLink SPD connectors, see page A-3.

🇺🇸 Build-To-Spec Customizable Devices - see page A-4
 🇺🇸 NAFTA Compliant - see page O-30

Accessories for Industrial Grade NEMA 5-15 & 5-20 Receptacles

Description	Catalog No.	🇺🇸
1-Gang standard size duplex receptacle pre-marked stainless steel wallplate/"Isolated Ground"	<input type="checkbox"/> IG93101	•
2-Gang mid-size decorator wallplate, ivory	<input type="checkbox"/> PJ262V	



IG93101



PJ262V

Specification Information:

Premium Industrial Receptacles: A-31

ArrowLink Premium Industrial Receptacles: A-29 & A-30

Premium Decorator Industrial Receptacles: A-31

Isolated Ground Premium Industrial Receptacles: A-32

ArrowLink Isolated Ground Premium Industrial Receptacles: A-29

Industrial Specification Grade Straight Blade Receptacles

2-Pole, 3-Wire Grounding
 15A, 125V/AC
 20A, 125V/AC
 NEMA 5-15R, 5-20R

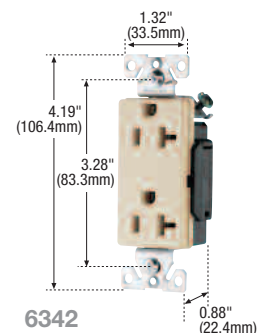
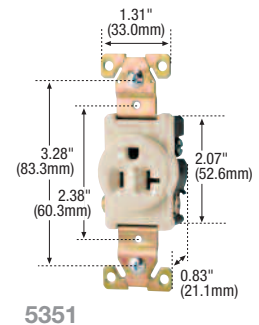
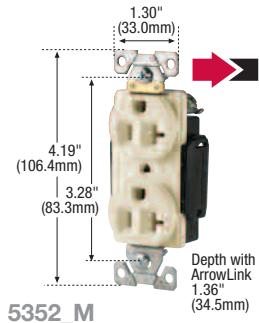
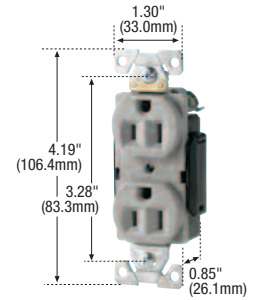
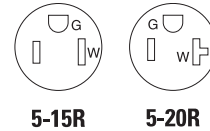

Industrial Grade Receptacles

Back Wire & Side Wire	15A, 125V NEMA 5-15R	UL FULS SR NOM 426	20A, 125V NEMA 5-20R	UL FULS SR NOM 426
Description	Catalog No. Color Suffix	➔	Catalog No. Color Suffix	➔
Back & Side Wire Duplex Receptacle	☐ 5252 A, B, BK, BL, GY, LA, RD, V, W	•	☐ 5352 A, B, BK, BL, GY, LA, RD, V, W	•

Side Wire	15A, 125V NEMA 5-15R	UL FULS SR NOM 426	20A, 125V NEMA 5-20R	UL FULS SR NOM 426
Description	Catalog No. Color Suffix	➔	Catalog No. Color Suffix	➔
Side Wire Duplex Receptacle	☐ 5242 B, BK, GY, V, W		☐ 5342 B, BK, GY, V, W	
Side Wire Single Receptacle	☐ 5251 B, LA, RD, V	•	☐ 5351 B, BK, RD	•

Decorator Industrial Grade Receptacle

Side Wire	20A, 125V; NEMA 5-20R	UL FULS SR NOM 426
Description	Catalog No. Color Suffix	➔
Decorator Duplex Receptacle	☐ 6342 A, LA, V, W	

Color Ordering Information

For ordering receptacles, include Cat. No. followed by the color code: A (Almond), B (Brown), BK (Black), BL (Blue), GY (Gray), LA (Light Almond), RD (Red), RN (Orange), V (Ivory), W (White)

Icon Key

➔ ArrowLink™ option available. Add "M" suffix to Standard catalog number (example 5252RD, 5252RDM). For ordering information on ArrowLink & ArrowLink SPD connectors, see page A-3.

Build-To-Spec Customizable Devices - see page A-4
 NAFTA Compliant - see page O-30

Accessories for Industrial Grade NEMA 5-15 & 5-20 Receptacles

Description	Catalog No.
1-Gang standard size duplex receptacle stainless steel wallplate	☐ 93101
1-Gang, stainless steel single receptacle stainless steel wallplate	☐ 93091



93101



93091

Specification Information:

Duplex Industrial Receptacles: A-32
 Decorator Industrial Receptacles: A-32
 ArrowLink Industrial Receptacles: A-34
 Single Industrial Receptacles: A-33

Industrial Specification Grade Straight Blade Receptacles

2-Pole, 3-Wire Grounding
 15A, 125V/AC
 20A, 125V/AC
 NEMA 5-15R, 5-20R

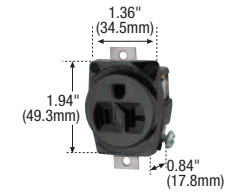
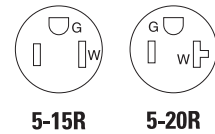

5734

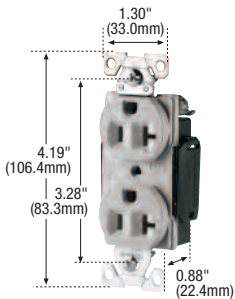

5362CR

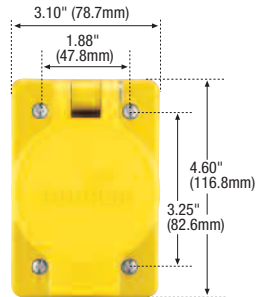

60W47

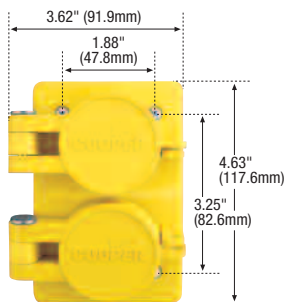

60W47DPLX

Specification Information:

Panel Mount Industrial Receptacles: A-33

Corrosion Resistant Premium Industrial Receptacles: A-37

Watertight Receptacles: A-37

Special Use Panel-Mount Industrial Single Receptacles

Back Wire & Side Wire, Short Strap	15A, 125V NEMA 5-15R	UL SP	20A, 125V NEMA 5-20R	UL FULS
Description	Catalog No. Color Suffix	USA	Catalog No. Color Suffix	USA
Brown, strap center-center spacing 1.9375" (49.2mm)	<input type="checkbox"/> 5284 B		<input type="checkbox"/> 5734 B	

Corrosion Resistant Premium Industrial Grade Receptacles

Back Wire & Side Wire	15A, 125V NEMA 5-15R	UL FULS SP NOM 426	20A, 125V NEMA 5-20R	UL FULS SP NOM 426
Description	Catalog No. Color Suffix	USA	Catalog No. Color Suffix	USA
Premium Corrosion Resistant Duplex Receptacle	<input type="checkbox"/> 5262CR GY, Y		<input type="checkbox"/> 5362CR GY, Y	

Watertight Special Use Industrial Grade Receptacles

Back Wire	15A, 125V NEMA 5-15R	UL cUL	20A, 125V NEMA 5-20R	UL cUL
Description	Catalog No. Color	USA	Catalog No. Color	USA
Single Watertight Receptacle	<input type="checkbox"/> 60W47 Yellow		<input type="checkbox"/> 60W33 Yellow	
Single Watertight Receptacle	<input type="checkbox"/> 60W47BK All-Black		<input type="checkbox"/> 60W33BK All-Black	
Duplex Watertight Receptacle	<input type="checkbox"/> 60W47DPLX Yellow		<input type="checkbox"/> 60W33DPLX Yellow	
Duplex Watertight Receptacle	<input type="checkbox"/> 60W47DPLXBK All-Black		<input type="checkbox"/> 60W33DPLXBK All-Black	

Color Ordering Information

For ordering receptacles, include Cat. No. followed by the color code: A (Almond), B (Brown), BK (Black), BL (Blue), GY (Gray), LA (Light Almond), RD (Red), RN (Orange), V (Ivory), W (White), Y (Yellow)

Icon Key

Build-To-Spec Customizable Devices - see page A-4

NAFTA Compliant - see page O-30

**Industrial Specification
Grade Straight Blade
Receptacles**

2-Pole, 3-Wire Grounding
15A, 250V/AC
20A, 250V/AC
NEMA 6-15R, 6-20R

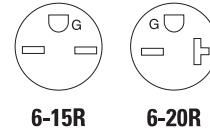

Premium Industrial Grade Receptacles

Back Wire & Side Wire	15A, 250V NEMA 6-15R	20A, 250V NEMA 6-20R
Description	Catalog No. Color Suffix	Catalog No. Color Suffix
Premium Duplex Receptacle	<input type="checkbox"/> AH5662__ B, GY, V, W	<input type="checkbox"/> AH5462__ B, GY, V, W
Premium Single Receptacle	<input type="checkbox"/> 5661__ B, V, W	<input type="checkbox"/> 5461__ B, BK, GY, V, W

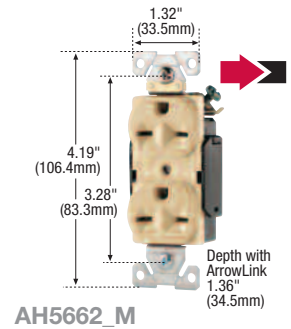

Premium Decorator Industrial Grade Receptacles

Back Wire & Side Wire	15A, 250V NEMA 6-15R	20A, 250V NEMA 6-20R
Description	Catalog No. Color Suffix	Catalog No. Color Suffix
Premium Decorator Duplex Receptacle	<input type="checkbox"/> 6662__ V, W	<input type="checkbox"/> 6462__ V, W

Isolated Ground Premium Industrial Grade Receptacles

Back Wire & Side Wire	15A, 250V NEMA 6-15R	20A, 250V NEMA 6-20R
Description	Catalog No. Color Suffix	Catalog No. Color Suffix
Premium IG Duplex Receptacle	<input type="checkbox"/> IG5662__ RN	<input type="checkbox"/> IG5462__ RN
Premium IG Single Receptacle	<input type="checkbox"/> IG5661__* RN	<input type="checkbox"/> IG5461__* RN

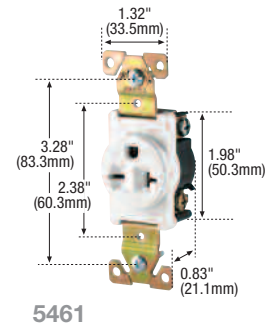

* Not Fed. Spec.

Color Ordering Information

For ordering receptacles, include Cat. No. followed by the color code: A (Almond), B (Brown), BK (Black), BL (Blue), GY (Gray), LA (Light Almond), RD (Red), RN (Orange), V (Ivory), W (White)

Icon Key

➔ ArrowLink™ option available. Add "M" suffix to Standard catalog number (example AH5662W, AH5662WM). For ordering information on ArrowLink & ArrowLink SPD connectors, see page A-3.

🏠 Build-To-Spec Customizable Devices - see page A-4
🇺🇸 NAFTA Compliant - see page O-30

Accessories for Industrial Grade NEMA 6-15 & 6-20 Receptacles

Description	Catalog No.
1-Gang, cast aluminum outlet box, 3 hole 0.75" (19.05mm)	<input type="checkbox"/> 1116
1-Gang, single receptacle pre-marked wallplate, stainless steel/"Isolated Ground"	<input type="checkbox"/> IG97091



1116



IG97091

Specification Information:

Premium Industrial Receptacles: A-31
Premium Decorator Industrial Receptacles: A-31
ArrowLink Premium Industrial Receptacles: A-30
Isolated Ground Premium Industrial Receptacles: A-32

Industrial Specification Grade Straight Blade Receptacles

2-Pole, 3-Wire Grounding
 15A, 250V/AC
 20A, 250V/AC
 NEMA 6-15R, 6-20R



6-15R



6-20R

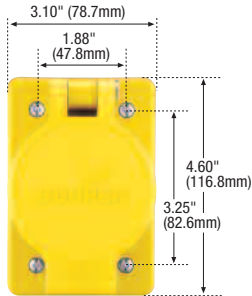

60W48

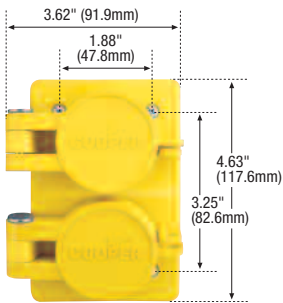

60W49DPLX

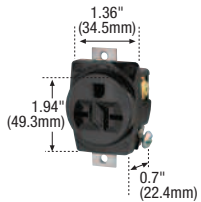

AH5684

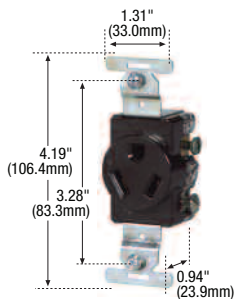

834

Specification Information:

Watertight Industrial Receptacles: A-37

Panel Mount Industrial Receptacles: A-33

Industrial Receptacles: A-32 & A-33

Watertight Special Use Industrial Grade Receptacles

Back Wire	15A, 250V NEMA 6-15R		20A, 250V NEMA 6-20R	
Description	Catalog No. Color		Catalog No. Color	
Single Watertight Receptacle	<input type="checkbox"/> 60W49 Yellow	•	<input type="checkbox"/> 60W48 Yellow	•
Single Watertight Receptacle	<input type="checkbox"/> 60W49BK All-Black	•	<input type="checkbox"/> 60W48BK All-Black	•
Duplex Watertight Receptacle	<input type="checkbox"/> 60W49DPLX Yellow	•	<input type="checkbox"/> 60W48DPLX Yellow	•
Duplex Watertight Receptacle	<input type="checkbox"/> 60W49DPLXBK All-Black	•	<input type="checkbox"/> 60W48DPLXBK All-Black	•

Special Use Panel-Mount Industrial Single Receptacles

Back Wire & Side Wire, Short Strap	15A, 250V NEMA 6-15R		20A, 250V NEMA 6-20R	
Description	Catalog No. Color		Catalog No. Color	
Strap center to center spacing 1.9375" (49.2mm)	<input type="checkbox"/> AH5684 Brown	•	<input type="checkbox"/> 5484B Brown	•

Industrial Specification Grade Straight Blade Receptacles

2-Pole, 3-Wire Grounding
 15A, 277V/AC
 20A, 277V/AC
 NEMA 7-15R, 7-20R



7-15R



7-20R

Industrial Grade Receptacles

Back Wire & Side Wire	15A, 277V NEMA 7-15R		20A, 277V NEMA 7-20R	
Description	Catalog No. Color Suffix		Catalog No. Color Suffix	
Duplex Receptacle	<input type="checkbox"/> 5302 B	•		
Side Wire Only				
Description	Catalog No. Color Suffix		Catalog No. Color Suffix	
Single Receptacle	<input type="checkbox"/> 834 B	•		

Color Ordering Information

For ordering receptacles, include Cat. No. followed by the color code: A (Almond), B (Brown), BK (Black), BL (Blue), GY (Gray), LA (Light Almond), RD (Red), RN (Orange), V (Ivory), W (White)

Icon Key

NAFTA Compliant - see page O-30

**Combines safe, rugged,
reliable performance with
ease of installation**

Arrow Hart Construction Specification Grade receptacles are designed to provide a dependable, long lasting user experience while increasing the speed and efficiency of installation.



Construction Grade 5262 & 5362 Series

Automatic grounding system eliminates need for bonding jumper in grounded metal enclosures

Patented Screw-Catch™ feature speeds mounting of wallplates

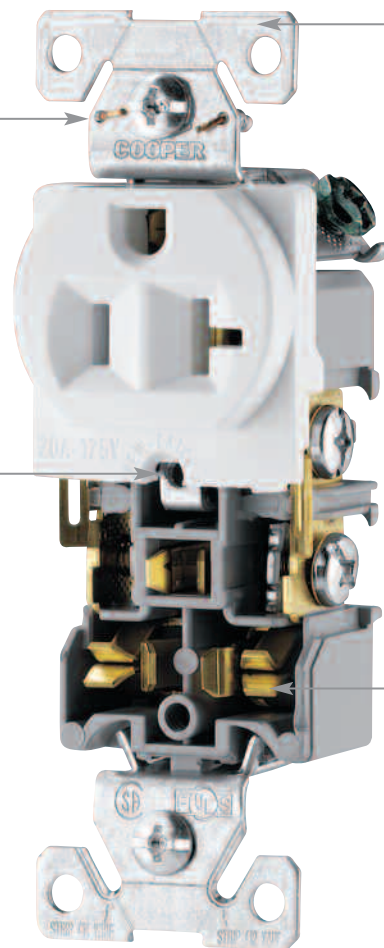

Extra long/wide mounting strap maintains assembly security and helps reach oversize cutouts

0.031" thick triple wipe brass line contacts minimize heat rise and maximize plug retention

Additional Features and Benefits

- Available in 15A & 20A duplex configurations, including Tamper Resistant and ArrowLink modular styles
- High impact- and chemical-resistant nylon face maintains receptacle integrity
- Convenient built-in #10 and #12 AWG wire strippers
- Tri-combo head terminal and mounting screws

Construction Specification Grade Straight Blade Receptacles

2-Pole, 3-Wire Grounding
15A, 125V/AC
20A, 125V/AC
NEMA 5-15R, 5-20R

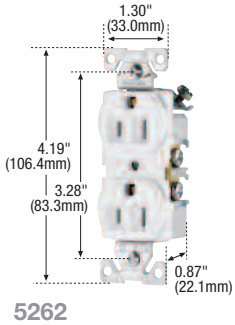
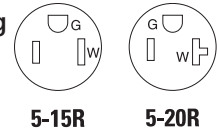

Construction Grade Receptacles

Back Wire & Side Wire	15A, 125V NEMA 5-15R		20A, 125V NEMA 5-20R	
Description	Catalog No. Color Suffix		Catalog No. Color Suffix	
Duplex Receptacle	<input type="checkbox"/> 5262 B, GY, LA, V, W		<input type="checkbox"/> 5362 B, BK, GY, LA, RD, V, W	

Tamper Resistant Construction Grade Receptacles

Back Wire & Side Wire	15A, 125V NEMA 5-15R		20A, 125V NEMA 5-20R	
Description	Catalog No. Color Suffix		Catalog No. Color Suffix	
Duplex Receptacle	<input type="checkbox"/> TR5262 B, GY, LA, V, W		<input type="checkbox"/> TR5362 B, BK, GY, LA, RD, V, W	

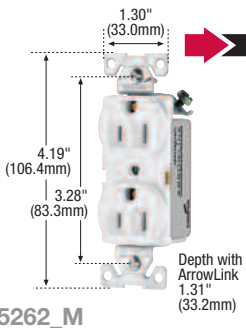

Construction Specification Grade Straight Blade Receptacles

2-Pole, 3-Wire Grounding
15A, 250V/AC
20A, 250V/AC
NEMA 6-15R, 6-20R

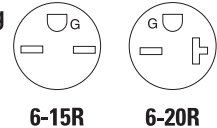

Construction Grade Receptacles

Back Wire & Side Wire	15A, 250V NEMA 6-15R		20A, 250V NEMA 6-20R	
Description	Catalog No. Color Suffix		Catalog No. Color Suffix	
Duplex Receptacle	<input type="checkbox"/> 5662C B, V, W		<input type="checkbox"/> 5462C B, V, W	

Color Ordering Information

For ordering receptacles, include Cat. No. followed by the color code: A (Almond), B (Brown), BK (Black), BL (Blue), GY (Gray), LA (Light Almond), RD (Red), RN (Orange), V (Ivory), W (White)

Icon Key

ArrowLink™ option available. Add "M" suffix to Standard catalog number (example 5262V, 5262VM). For ordering information on ArrowLink & ArrowLink SPD connectors, see page A-3.

- Build-To-Spec Customizable Devices - see page A-4
- NAFTA Compliant - see page O-30
- Tamper Resistant

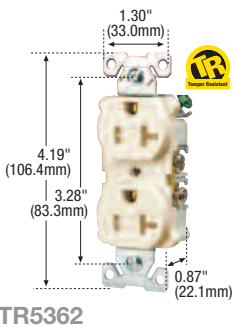

Accessories for Construction Grade 5-15 & 5-20 Receptacles

Description	Catalog No.	
2-Gang, standard size duplex receptacle wallplate, stainless steel	<input type="checkbox"/> 93102	
1-Gang, mid-size screwless duplex receptacle wallplate, ivory	<input type="checkbox"/> PJS8V	
2-Gang, standard size duplex receptacle wallplate, ivory	<input type="checkbox"/> 5150V	

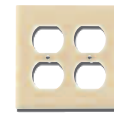
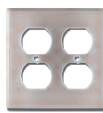

Specification Information:

Construction Grade Receptacles: A-33

ArrowLink Construction Grade Receptacles: A-34

Tamper Resistant Construction Grade Receptacles: A-35

Commercial Specification Grade Straight Blade Receptacles

2-Pole, 3-Wire Grounding
 15A, 125V/AC
 20A, 125V/AC
 NEMA 5-15R, 5-20R

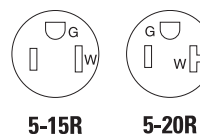

Commercial Grade Receptacles

Back Wire & Side Wire	15A, 125V NEMA 5-15R		20A, 125V NEMA 5-20R	
Description	Catalog No. Color Suffix		Catalog No. Color Suffix	
Duplex Receptacle	<input type="checkbox"/> BR15 A, B, BK, GY, LA, V, W	• •	<input type="checkbox"/> BR20 A, B, BK, GY, LA, RD, V, W	• •

Side Wire	15A, 125V NEMA 5-15R		20A, 125V NEMA 5-20R	
Description	Catalog No. Color Suffix		Catalog No. Color Suffix	
Duplex Receptacle	<input type="checkbox"/> CR15 A, B, BK, GY, LA, V, W	• •	<input type="checkbox"/> CR20 A, B, BK, GY, LA, V, W	• •
Single Receptacle	<input type="checkbox"/> 817 A, B, BK, LA, V, W	• •	<input type="checkbox"/> 1877 A, B, BK, LA, V, W	• •

Decorator Commercial Grade Receptacles

Back Wire & Side Wire	15A, 125V NEMA 5-15R		20A, 125V NEMA 5-20R	
Description	Catalog No. Color Suffix		Catalog No. Color Suffix	
Duplex Receptacle	<input type="checkbox"/> 6252 † A, B, BK, GY, LA, V, W	• •	<input type="checkbox"/> 6352 A, B, BK, GY, LA, RD, V, W	• •
Single Receptacle	<input type="checkbox"/> 6250 V, W	• •	<input type="checkbox"/> 6350 † A, B, V, W	• •

† Not NOM certified

Color Ordering Information

For ordering receptacles, include Cat. No. followed by the color code: A (Almond), B (Brown), BK (Black), BL (Blue), GY (Gray), LA (Light Almond), RD (Red), RN (Orange), V (Ivory), W (White)

Icon Key

- Build-To-Spec Customizable Devices - see page A-4
- NAFTA Compliant - see page O-30

Accessories for Commercial Grade NEMA 5-15 & 5-20 Receptacles

Description	Catalog No.	
2-Gang standard size duplex receptacle wallplate, brown	<input type="checkbox"/> 5150B	•
1-Gang mid-size single receptacle wallplate, 1.4" hole, gray	<input type="checkbox"/> PJ7GY	



5150B



PJ7GY

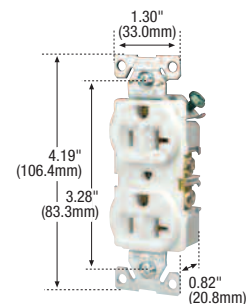

BR20

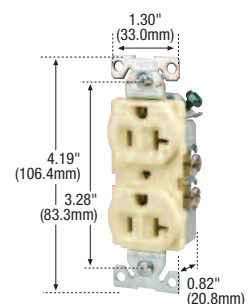

CR20

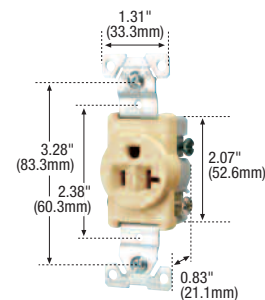

1877

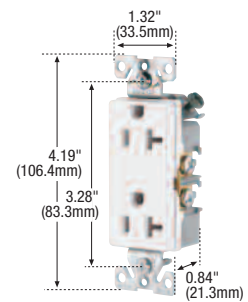

6352

Specification Information:

Commercial Receptacles: A-36

Commercial Specification Grade Straight Blade Receptacles

2-Pole, 3-Wire Grounding
15A, 125V/AC
20A, 125V/AC
NEMA 5-15R, 5-20R



5-15R



5-20R

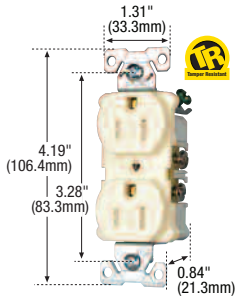

TRBR15

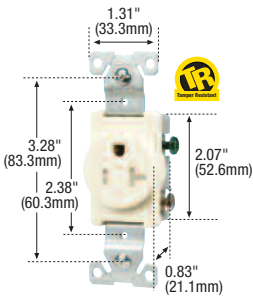

TR1877

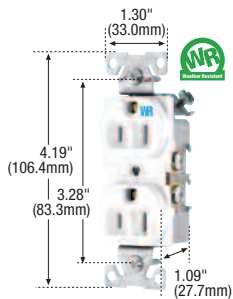

WRBR15

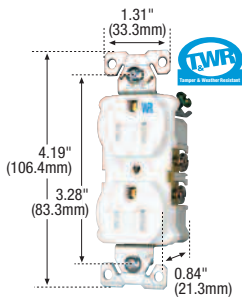

TWRBR15

Tamper Resistant Commercial Grade Receptacles

Back Wire & Side Wire, Side Wire

15A, 125V
NEMA 5-15R



20A, 125V
NEMA 5-20R



Description	Catalog No. Color Suffix			Catalog No. Color Suffix		
Duplex Receptacle, Back & Side Wire	<input type="checkbox"/> TRBR15____ A, B, BK, GY, LA, V, W			<input type="checkbox"/> TRBR20____ A, B, BK, GY, LA, RD, V, W		
Single Receptacle, Side Wire	<input type="checkbox"/> TR817____* A, B, BK, GY, LA, V, W			<input type="checkbox"/> TR1877____* A, B, BK, LA, V, W		
Decorator Duplex Receptacle, Back Wire & Side Wire	<input type="checkbox"/> TR6252____*† A, B, BK, GY, LA, V, W			<input type="checkbox"/> TR6352____ A, B, BK, GY, LA, V, W		
Decorator Single Receptacle, Side Wire	<input type="checkbox"/> TR6250____ A, B, BK, GY, LA, V, W			<input type="checkbox"/> TR6350____* A, B, BK, GY, LA, V, W		

* Not Fed. Spec
† Not NOM certified

Weather Resistant Commercial Grade Receptacles

Back Wire & Side Wire, Side Wire

15A, 125V
NEMA 5-15R



20A, 125V
NEMA 5-20R



Description	Catalog No. Color Suffix			Catalog No. Color Suffix		
Duplex Receptacle	<input type="checkbox"/> WRBR15____ B, GY, V, W			<input type="checkbox"/> WRBR20____ B, GY, V, W		

Tamper & Weather Resistant Commercial Grade Receptacles

Back Wire & Side Wire, Side Wire

15A, 125V
NEMA 5-15R



20A, 125V
NEMA 5-20R



Description	Catalog No. Color Suffix			Catalog No. Color Suffix		
Duplex Receptacle	<input type="checkbox"/> TWRBR15____ B, GY, V, W			<input type="checkbox"/> TWRBR20____ B, GY, V, W		

Color Ordering Information

For ordering receptacles, include Cat. No. followed by the color code: A (Almond), B (Brown), BK (Black), BL (Blue), GY (Gray), LA (Light Almond), RD (Red), RN (Orange), V (Ivory), W (White)

Icon Key

Build-To-Spec Customizable Devices - see page A-4
 NAFTA Compliant - see page O-30

Tamper Resistant
 Weather Resistant

Tamper & Weather Resistant

Accessories for Commercial Grade NEMA 5-15 & 5-20 Receptacles

Description	Catalog No.	
1-Gang WeatherBox™ standard depth, self-closing cover, horizontal/vertical mount	<input type="checkbox"/> WIU-1	
1-Gang with standard size single receptacle wallplate, 1.406" hole, ivory	<input type="checkbox"/> 5131V	
1-Gang, mid-size decorator wallplate, ivory	<input type="checkbox"/> PJ26V	



WIU-1



5131V



PJ26V

Specification Information:

Tamper Resistant Commercial Receptacles: A-35
Weather Resistant Commercial Receptacles: A-35
Tamper & Weather Resistant Commercial Receptacles: A-35

Commercial Specification Grade Straight Blade Receptacles

2-Pole, 3-Wire Grounding
15A, 125V/AC
NEMA 5-15R



5-15R

Clock Hanger Receptacle

FEATURES

- Single receptacle on recessed wallplate with integral hook.
- High impact- and chemical-resistant nylon face.
- 0.035" (8.73mm) galvanized steel wrap-around yoke mounting strap for superior assembly security.
- Tamper Resistant to comply with 2008 NEC®.

Tamper Resistant NEMA 5-15R, Back Wire & Side Wire



Rating A	V/AC	Description	Color	Catalog No.	
15	125	Single Clock Hanger Receptacle with Wallplate	W	□ TR775	



Snap-In Receptacles

Large Face NEMA 5-15R



Rating A	V/AC	Description	Color	Catalog No.	
15	125	Single Receptacle, Plastic Back & Clips, Quick Connect with Screw Terminal Grounding	Black	□ 4067BK	•
		Single Receptacle, Fiber Back & Steel Clips, Quick Connect with Screw Terminal Grounding	Black	□ 4067-01BK	•
		Duplex Receptacle, Plastic Back & Clips, Solder Connect, Slotted Terminals	Black	□ 4070-6BK	•

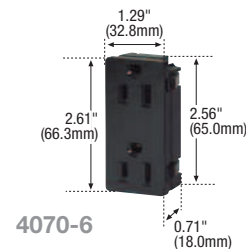

Rectangular NEMA 5-15R



Rating A	V/AC	Description	Color	Catalog No.	
15	125	Single Receptacle, Plastic Back & Clips, Quick Connect with Screw Terminal Grounding	Black	□ 67BK	•
		Single Receptacle, Plastic Back & Clips, Quick Connect with Screw Terminal Grounding	White	□ 67W	•
		Single Receptacle, Plastic Back & Clips, Quick Connect with Wire Lead Grounding	Black	□ 67-2BK	•
		Single Receptacle, Plastic Back & Clips, Quick Connect with Wire Lead Grounding	White	□ 67-2W	•
		Plug, Solder Connect, Slotted Terminals	Black	□ 4049BK*	•

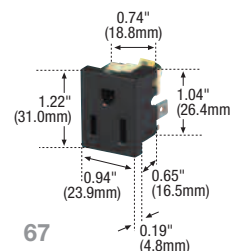

* Not NOM

Color Ordering Information

For ordering receptacles, include Cat. No. followed by the color code: A (Almond), B (Brown), BK (Black), BL (Blue), GY (Gray), LA (Light Almond), RD (Red), RN (Orange), V (Ivory), W (White)

Icon Key

- NAFTA Compliant - see page O-30
- Tamper Resistant

Specification Information:

Snap-In Commercial Receptacles: A-36

Commercial Specification Grade Straight Blade Receptacles

2-Pole, 3-Wire Grounding
15A, 125V/AC
NEMA 5-15

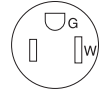

5-15R

Snap-In Receptacles

Rectangular NEMA 5-15R



Rating A V/AC	Description	Color	Catalog No.	
15 125	Single Receptacle, Fiber Back & Steel Clips, Quick Connect with Wire Lead Grounding	Black	□ 67-31BK	•
	Plug, Wire Leads	Black	□ 4049-2BK*	•

* Not NOM

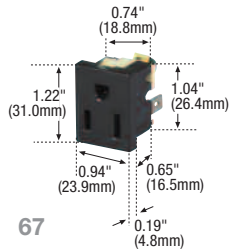

67

Square NEMA 5-15R



Rating A V/AC	Description	Color	Catalog No.	
15 125	Single Receptacle, Fiber Back & Steel Clips, Quick Connect with Screw Terminal Grounding	Black	□ 49-01BK	•
	Single Receptacle, Fiber Back & Steel Clips, Wire Leads	Black	□ 49-21BK	•

For panel cutout dimensional data, see O-Technical Reference

Square NEMA 5-15R



Rating A V/AC	Description	Color	Catalog No.	
15 125	Single Receptacle, Fiber Back & Steel Clips, 90° Quick Connect	Black	□ 49-81BK	•
	Single Receptacle, Plastic Back & Clips, Quick Connect with Screw Terminal Grounding	Black	□ 49BK	•
	Single Receptacle, Plastic Back & Clips, Quick Connect with Screw Terminal Grounding	White	□ 49W	•
	Single Receptacle, Plastic Back & Clips, Parallel Quick Connect	Black	□ 49-7BK	•
	Single Receptacle, Plastic Back & Clips, 90° Quick Connect	Black	□ 49-8BK	•
	Single Receptacle, Plastic Back & Clips, Wire Leads	Black	□ 49-2BK	•
	Single Receptacle, Plastic Back & Clips, Wire Leads	White	□ 49-2W	•

For panel cutout dimensional data, see O-Technical Reference

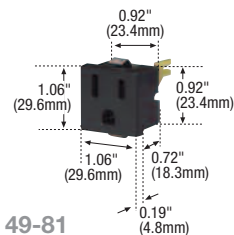

49-81

Specification Information:

Snap-In Commercial
Receptacles: A-36

Icon Key

NAFTA Compliant - see page O-30

Commercial Specification Grade Straight Blade Receptacles

2-Pole, 3-Wire Grounding
Dual Voltage
15A, 125/250V/AC
NEMA 5-15R & 6-15R

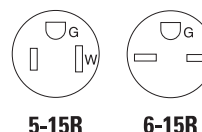

Dual Voltage Commercial Grade Receptacle

Side Wire	15A, 125/250V NEMA 5-15R & 6-15R	UL	SR
Description	Catalog No. Color Suffix	UL	SR
Dual Voltage Duplex Receptacle	<input type="checkbox"/> 829 V		

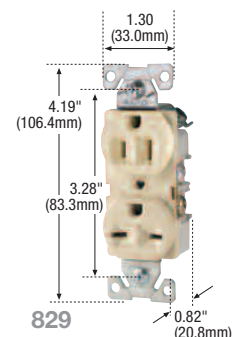

Commercial Specification Grade Straight Blade Receptacles

2-Pole, 3-Wire Grounding
15A, 250V/AC
20A, 250V/AC
NEMA 6-15R, 6-20R

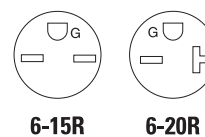

Commercial Grade Receptacles

Side Wire	15A, 250V NEMA 6-15R	UL	SR	NOM 426	20A, 250V NEMA 6-20R	UL	SR	NOM 426
Description	Catalog No. Color Suffix				Catalog No. Color Suffix			
Duplex Receptacle	<input type="checkbox"/> 826 B, V, W				<input type="checkbox"/> 815 B, V, W			
Single Receptacle	<input type="checkbox"/> 816 B, BK, V, W				<input type="checkbox"/> 1876 A, B, BK, LA, V, W			

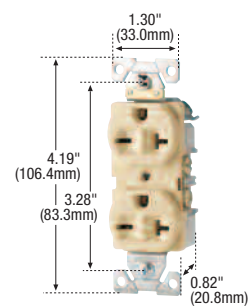
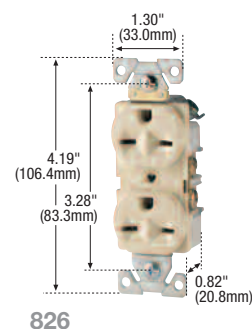

Decorator Commercial Grade Receptacle

Side Wire	20A, 250V NEMA 6-20R	UL	SR
Description	Catalog No. Color Suffix	UL	SR
Single Receptacle	<input type="checkbox"/> 6450 W		

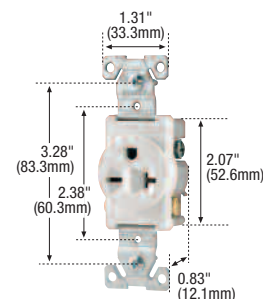

Color Ordering Information

For ordering receptacles, include Cat. No. followed by the color code: A (Almond), B (Brown), BK (Black), BL (Blue), GY (Gray), LA (Light Almond), RD (Red), RN (Orange), V (Ivory), W (White)

Icon Key

- Build-To-Spec Customizable Devices - see page A-4
- NAFTA Compliant - see page O-30

Specification Information:
Commercial Receptacles: A-36

Straight Blade Power Devices - 20, 30, 50 & 60A

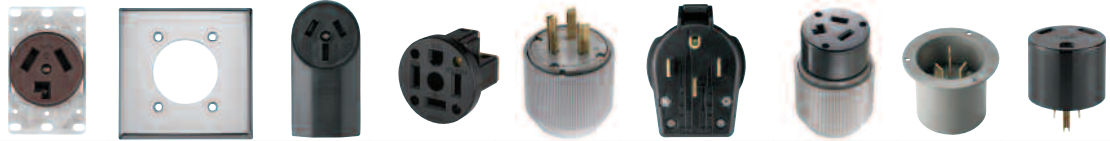

Rating: Amps V/AC	Receptacle/ Plug NEMA Configuration	Flush Receptacle	Wallplate	Surface Receptacle	Panel Mount Receptacle	Plugs	Angle Plugs	Connectors	Flanged Inlets	Adapters
2-Pole, 3-Wire Grounding										
30A 125V	 5-30R	 5-30P	Commercial: 1233 (Brown) Industrial: 5716N (Black)	Standard Size: 39CH, 68, 2068, 2168, 93221, 93227		Industrial: 5717N (Gray)	Commercial: S41 (Black) Industrial: 5717AN (Gray)	Industrial: 6716N (Gray & Black)	Industrial: 5717NFI (Gray)	
30A 125V	 TT-30R	 TT-30P	Commercial: 1263 (Black)		Commercial: U1263 (Black)		Commercial: 83 (Black)			Commercial: 1264 TT-30 (Plug to NEMA 5-15R or 5-20R) (Black)
30A 250V	 6-30R	 6-30P	Commercial: 1234 (Brown) Industrial: 5700N (Black)		Commercial: 1232 (Black)	Industrial: 5701N (Gray)	Commercial: S42 (Black) Industrial: 5701AN (Gray)	Industrial: 6700N (Gray & Black)	Industrial: 5701NFI (Gray)	
30A 277V	 7-30R	 7-30P	Industrial: 5795N (Black)		Mid-Size: 5068, PJ703, PJ724		Industrial: 5703N (Gray)	Industrial: 5703AN (Gray)	Industrial: 6795N (Gray & Black)	Industrial: 5703NFI (Gray)
50A 125V	 5-50R	 5-50P	Commercial: 1253 (Brown)				Industrial: 5712N (Gray)	Commercial: S41 (Black) Industrial: 5712AN (Gray)	Industrial: 6711N (Gray & Black)	Industrial: 5712NFI (Gray)
50A 250V	 6-50R	 6-50P	Commercial: 1254 (Brown) Industrial: 5709N (Black)		Commercial: 1252 (Black)	Industrial: 5710N (Gray)	Commercial: S42 (Black) Industrial: 5710AN (Gray)	Industrial: 6709N (Gray & Black)	Industrial: 5710NFI (Gray)	
50A 277V	 7-50R	 7-50P					Industrial: 5705N (Gray)	Industrial: 5705AN (Gray)	Industrial: 6796N (Gray & Black)	Industrial: 5705NFI (Gray)
3-Pole, 3-Wire Non-Grounding										
20A 125/250V	 10-20R	 10-20P	Commercial: 805 (Ivory)			Industrial: 9151N (Gray) Commercial: 2836 (Armd PVC) (Yellow)				
30A 125/250V Dryer	 10-30R	 10-30P	Commercial: 38B (Brown)	Standard Size: 39CH, 68, 2068, 2168, 93221, 93227	Commercial: 125 (Black)	Industrial: 9337N (Gray)	Commercial: S80 (Black) Industrial: 9352AN (Gray)	Industrial: 9341N (Gray & Black)	Industrial: 9337NFI (Gray)	
50A 125/250V Range	 10-50R	 10-50P	Commercial: 32B (Brown) Industrial: 7985N (Black) Commercial: 122B (Brown)	Mid-Size: 5068, PJ703, PJ724 Standard Size: 192	Commercial: 112 (Black)	Industrial: 4524N (Gray)	Commercial: S80 (Black) Industrial: 7952AN (Gray)	Industrial: 4526N (Gray & Black)	Industrial: 4524NFI (Gray)	

Power Device Dimensional Information: B-24; Specification Information: B-31-B-33

Straight Blade Power Devices - 20, 30, 50 & 60A



Rating: Amps V/AC	Receptacle/ Plug NEMA Configuration	Flush Receptacles	Wallplate	Surface Receptacle	Panel Mount Receptacle	Plugs	Angle Plugs
3-Pole, 4-Wire Grounding							
20A 125/250V	 14-20R	 14-20P	Industrial: 5759 (Black)				
30A 125/250V Dryer	 14-30R	 14-30P	Commercial: 1257 (Black)	Standard Size: 39CH, 68, 2068, 2168, 93221, 93227 Mid-Size: 5068, PJ703, PJ724	Commercial: 1225 (Black)	Industrial: 5746N (Gray)	Commercial: S21 (Black)
			Industrial: 5744N (Black)				Standard Size: 69, 5169, 93223
30A 3Ø 250V	 15-30R	 15-30P	Industrial: 8430N (Black)	Standard Size: 69, 5169, 93223		Industrial: 8432N (Gray)	Industrial: 8432AN (Gray)
50A 125/250V Range	 14-50R	 14-50P	Commercial: 1258 (Black)	Standard Size: 39CH, 68, 2068, 2168, 93221, 93227 Mid-Size: 5068, PJ703, PJ724	Commercial: 1212 (Black)	Commercial: 58 (Black)	Industrial: 5745N (Gray)
			Industrial: 5754N (Black)				Standard Size: 69, 5169, 93223
50A 3Ø 250V	 15-50R	 15-50P	Industrial: 8450N (Black)	Standard Size: 69, 5169, 93223		Industrial: 8452N (Gray)	Industrial: 8452AN (Gray)
60A 125/250V	 14-60R	 14-60P	Industrial: 9460N (Black)	Standard Size: 69, 5169, 93223		Commercial: 60 (Black)	Commercial: S20 (Black)
							Industrial: 9462AN (Gray)
60A 3Ø 250V	 15-60R	 15-60P	Industrial: 8460N (Black)	Standard Size: 69, 5169, 93223		Industrial: AH8462N (Gray)	Industrial: AH8462AN (Gray)
4-Pole, 4-Wire Non-Grounding							
30A 3ØY 120/208V	 18-30R	 18-30P				Industrial: 8332N (Gray)	Industrial: 8332AN (Gray)
50A 3ØY 120V/208V	 18-50R	 18-50P				Industrial: 8352N (Gray)	Industrial: 8352AN (Gray)
60A 3ØY 120/208V	 18-60R	 18-60P	Industrial: 5515N (Black)	Standard Size: 69, 5169, 93223			Commercial: S19 (Black)
							Industrial: 5517N (Gray)

Hospital Specification Grade Premium Receptacles

2-Pole, 3-Wire Grounding
15A, 125V/AC; 15A, 250V/AC; 20A, 125V/AC; 20A 250V/AC
NEMA 5-15, 6-15, 5-20, 6-20

	Device Type	Hospital Grade Premium Duplex Receptacles: AH8200, AH8300, AH8400, AH8600 Series	Hospital Grade Premium Decorator Duplex Receptacles: 8262, 8362 Series	Hospital Grade Premium Single Receptacles: 8210, 8310, 8410, 8610 Series
	Wiring Type	Back & side wire	Back & side wire	Back & side wire
	Testing & Code Compliance	<ul style="list-style-type: none"> Listed to UL 498, file no. E15058 	<ul style="list-style-type: none"> Listed to UL 498, file no. E15058 	<ul style="list-style-type: none"> Listed to UL 498, file no. E15058
		<ul style="list-style-type: none"> UL verified to Federal Spec. WC-596G 	<ul style="list-style-type: none"> UL verified to Federal Spec. WC-596G 	<ul style="list-style-type: none"> UL verified to Federal Spec. WC-596G
		<ul style="list-style-type: none"> CSA certified to C22.2, no. 42, file no. 6914 (6233-01) 	<ul style="list-style-type: none"> CSA certified to C22.2, no. 42, file no. 6914 (6233-01) 	<ul style="list-style-type: none"> CSA certified to C22.2, no. 42, file no. 6914 (6233-01)
		<ul style="list-style-type: none"> NOM certified 	<ul style="list-style-type: none"> NOM certified 	<ul style="list-style-type: none"> NOM certified
Specifications: Environmental	Flammability	Meets UL 94 requirements; V2 rated	Meets UL 94 requirements; V2 rated	Meets UL 94 requirements; V2 rated
	Temperature Rating	-20°C to 90°C (-4°F to 194°F)	-20°C to 70°C (-4°F to 158°F)	-20°C to 90°C (-4°F to 194°F)
Specifications: Electrical	Dielectric Voltage	Withstands 2000V per UL 498	Withstands 2000V per UL 498	Withstands 2000V per UL 498
	Current Interrupting	Yes, at full-rated current	Yes, at full-rated current	Yes, at full-rated current
	Temperature Rise	Max. 30°C (86°F) after 250 cycles of overload @ 200% of rated current (DC)	Max. 30°C (86°F) after 250 cycles of overload @ 200% of rated current (DC)	Max. 30°C (86°F) after 250 cycles of overload @ 200% of rated current (DC)
Specifications: Mechanical	Terminal Accommodation	#14 - 10 AWG	#14 - 10 AWG	#14 - 10 AWG
	Voltage Ratings	Permanently marked on device	Permanently marked on device	Permanently marked on device
Materials:	Face	Nylon	Nylon	Nylon
	Base	Glass-filled nylon	Glass-filled nylon	Nylon
	Strap	0.05" thick brass, nickel plated	0.05" thick brass	0.05" thick galvanized steel
	Auto Ground Clip	Brass	Brass	Phosphor bronze
	Line Contacts	0.031" thick 5-leaf brass, nickel plated	5-leaf brass	0.031" thick triple-wipe brass
	Ground Contact	Integral	Integral	Riveted
	Terminal Screws	#8-32 brass, neutral screw nickel plated	#8-32 steel	#8-32 steel, brass plated, neutral screw nickel plated
	Ground Screw	#8-32 brass (green)	#8-32 steel (green)	#8-32 steel, brass plated (green)
	Screw Terminal Guards	PVC hinged doors	PVC hinged doors	N/A
	Illuminated Models	Long-life neon bulb	Long-life neon bulb	N/A

Hospital Specification Grade Premium Isolated Ground Receptacles

2-Pole, 3-Wire Grounding
15A, 125V/AC; 20A, 125V/AC; 20A 250V/AC
NEMA 5-15, 5-20, 6-20

	Device Type	Hospital Grade Premium Isolated Ground Duplex Receptacles: IG8200, IG8300, IG8400 Series	Hospital Grade Premium Decorator Isolated Ground Duplex Receptacles: IG8260, IG8360 Series	Hospital Grade Premium Isolated Ground Single Receptacles: IG8210, IG8310 Series
	Wiring Type	Back & side wire	Back & side wire	Back & side wire
	Testing & Code Compliance	<ul style="list-style-type: none"> Listed to UL 498, file no. E15058 	<ul style="list-style-type: none"> Listed to UL 498, file no. E15058 	<ul style="list-style-type: none"> Listed to UL 498, file no. E15058
		<ul style="list-style-type: none"> UL verified to Federal Spec. WC-596G 	<ul style="list-style-type: none"> UL verified to Federal Spec. WC-596G 	<ul style="list-style-type: none"> UL verified to Federal Spec. WC-596G
		<ul style="list-style-type: none"> CSA certified to C22.2, no. 42, file no. 6914 (6233-01) 	<ul style="list-style-type: none"> CSA certified to C22.2, no. 42, file no. 6914 (6233-01) 	<ul style="list-style-type: none"> CSA certified to C22.2, no. 42, file no. 6914 (6233-01)
		<ul style="list-style-type: none"> NOM certified 	<ul style="list-style-type: none"> NOM certified 	<ul style="list-style-type: none"> NOM certified
Specifications: Environmental	Flammability	Meets UL 94 requirements; V2 rated	Meets UL 94 requirements; V2 rated	Meets UL 94 requirements; V2 rated
	Temperature Rating	-20°C to 70°C (-4°F to 158°F)	-20°C to 70°C (-4°F to 158°F)	-40°C to 60°C (-40°F to 140°F)
Specifications: Electrical	Dielectric Voltage	Withstands 2000V per UL 498	Withstands 2000V per UL 498	Withstands 2000V per UL 498
	Current Interrupting	Yes, at full-rated current	Yes, at full-rated current	Yes, at full-rated current
	Temperature Rise	Max. 30°C (86°F) after 250 cycles of overload @ 200% of rated current (DC)	Max. 30°C (86°F) after 250 cycles of overload @ 200% of rated current (DC)	Max. 30°C (86°F) after 250 cycles of overload @ 200% of rated current (DC)
Specifications: Mechanical	Terminal Accommodation	#14 - 10 AWG	#14 - #10 AWG	#14 - 10 AWG
	Voltage Ratings	Permanently marked on device	Permanently marked on device	Permanently marked on device
Materials:	Face	Nylon	Nylon	Nylon
	Base	PVC	PVC	Glass-filled nylon
	Strap	0.05" thick solid brass, nickel plated, one piece isolated grounding shunt	0.05" thick solid brass, nickel plated, one piece isolated grounding shunt	0.05" thick galvanized steel one piece isolated grounding shunt
	Auto Ground Clip	Brass	Brass	Bronze wire
	Line Contacts	0.031" thick 5-leaf brass	0.031" thick 5-leaf brass	0.037" thick triple-wipe brass
	Ground Contact	1-piece isolated ground shunt	1-piece isolated ground shunt	1-piece isolated ground shunt
	Terminal Screws	#8-32 brass, neutral screw nickel plated	#8-32 brass, neutral screw nickel plated	#8-32 steel
	Ground Screw	#8-32 brass (green)	#8-32 brass (green)	#8-32 steel (green)
	Screw Terminal Guards	PVC hinged doors	PVC hinged doors	N/A

Hospital Specification Grade Receptacles

2-Pole, 3-Wire Grounding
15A, 125V/AC; 20A, 125V/AC
NEMA 5-15, 5-20

	Device Type	Hospital Grade Panel Mount Receptacles: 8210M, 8310M Series	Hospital Grade Tamper Resistant Duplex Receptacles: TR8200, TR8300 Series 
	Wiring Type	Back & side wire	Back & side wire
	Testing & Code Compliance	• Listed to UL 498, file no. E2369	• cULus Listed to UL 498, file no. E15058
		• UL verified to Federal Spec. WC-596G	• UL verified to Federal Spec. WC-596G
		• CSA certified to C22.2, no. 42, file no. 6914 (6233-01)	
		• NOM certified	• NOM certified
Specifications: Environmental	Flammability	Meets UL 94 requirements; V2 rated	Meets UL 94 requirements; V2 rated
	Temperature Rating	-40°C to 75°C (-40°F to 167°F)	-20°C to 90°C (-4°F to 194°F)
Specifications: Electrical	Dielectric Voltage	Withstands 2000V per UL 498	Withstands 2000V per UL 498
	Current Interrupting	Yes, at full-rated current	Yes, at full-rated current
	Temperature Rise	Max. 30°C (86°F) after 250 cycles of overload @ 200% of rated current (DC)	Max. 30°C (86°F) after 250 cycles of overload @ 200% of rated current (DC)
Specifications: Mechanical	Terminal Accommodation	#14 - 10 AWG	#14 - 10 AWG
	Voltage Ratings	Permanently marked on device	Permanently marked on device
Materials:	Face	Nylon	Nylon
	Base	Nylon	PVC
	Strap	0.05" thick nickel plated steel	0.05" thick steel, zinc plated
	Auto Ground Clip	N/A	Phosphor bronze
	Line Contacts	0.030" 5-leaf nickel plated brass	0.037" thick triple-wipe brass
	Ground Contact	Riveted	Riveted
	Terminal Screws	#8-32 brass, neutral screw nickel plated	#8-32 brass, neutral screw nickel plated
	Ground Screw	#8-32 brass (green)	#8-32 brass (green)
	Screw Terminal Guards	N/A	N/A
Tamper Resistant Shutters	N/A	Reliable Delrin® shutter assembly	

Delrin® is a registered trademark of E.I. du Pont de Nemours

Hospital Specification Grade Receptacles

2-Pole, 3-Wire Grounding
15A, 125V/AC; 20A, 125V/AC
NEMA 5-15, 5-20

		Device Type	Hospital Grade Duplex Receptacles: 8200, 8300 Series	Hospital Grade Duplex Receptacles: 8200_M, 8300_M Series; ArrowLink: MCR125_, MCR250_, MCR300_ Series
Wiring Type	Base Device		Back & side wire	Back & side wire
	ArrowLink		N/A	Integral wire leads, crimped & resistance welded
	ArrowLink SPD		N/A	Backwire feed through
Testing & Code Compliance	Base Device		<ul style="list-style-type: none"> Listed to UL 498, file no. E15058 UL verified to Federal Spec. WC-596G CSA certified to C22.2, no. 42, file no. 6914 (6233-01) NOM certified 	<ul style="list-style-type: none"> Listed to UL 498, file no. E15058 UL verified to Federal Spec. WC-596G CSA certified to C22.2, no. 42, file no. 6914 (6233-01) NOM certified
	ArrowLink		N/A	<ul style="list-style-type: none"> Plug & connector cULus Listed to UL 2459, file no. E325188
	Combined		N/A	<ul style="list-style-type: none"> cULus Listed wiring assembly, UL file no. E326691
Specifications: Environmental	Base Device	Flammability	Meets UL 94 requirements; V2 rated	Meets UL 94 requirements; V2 rated
		Temperature Rating	-20°C to 90°C (-4°F to 194°F)	-20°C to 90°C (-4°F to 194°F)
	ArrowLink	Flammability	N/A	Meets UL 94 requirements; V2 rated
		Temperature Rating	N/A	-20°C to 90°C (-4°F to 194°F)
Specifications: Electrical	Base Device	Dielectric Voltage	Withstands 2000V per UL 498	Withstands 2000V per UL 498
		Current Interrupting	Yes, at full-rated current	Yes, at full-rated current
		Temperature Rise	Max. 30°C (86°F) after 250 cycles of overload @ 200% of rated current (DC)	Max. 30°C (86°F) after 250 cycles of overload @ 200% of rated current (DC)
	ArrowLink	Max. Working Voltage & Continuous Current	N/A	300V/AC; 20A
		Overload	N/A	52.5A/AC for 10 cycles
		Dielectric Voltage	N/A	Withstands 1600V per UL 2549
		Current Interrupting	N/A	Limited cycles at full-rated current
		Temperature Rise	N/A	Max. 50°C (122°F) while conducting 35A after 10 cycles of overload @52.5A/AC
Specifications: Mechanical	Base Device Terminal Accommodation	#14 - 10 AWG	#14 - 10 AWG	
	ArrowLink Wire Leads	N/A	#12 AWG	
	ArrowLink SPD Screw Terminals	N/A	Accepts #12 - #14 AWG stranded and solid wire	
	ArrowLink SPD Ground	N/A	Integral THHN #12 AWG 6" lead with ring terminal and #10 ground screw	
	Voltage Ratings	Permanently marked on device	Permanently marked on device	
Materials:	Base Device	Face	Nylon	Nylon
		Base	PVC	PVC
		Strap	0.045" thick steel, zinc plated	0.045" thick steel, zinc plated
		Auto Ground Clip	Phosphor bronze	Phosphor bronze
		Line Contacts	0.030" thick triple-wipe brass	0.030" thick triple-wipe brass
		Ground Contact	Riveted	Riveted
		Terminal & Ground Screws	#8-32 steel, brass plated, neutral screw nickel plated	#8-32 steel, brass plated, neutral screw nickel plated
		Screw Terminal Guards	N/A	UL recognized insulating material; dielectric strength: 2,000V min.; HWI rating: 4 mind.; relative temperature index, electrical: 80°C (176°F); flammability: V0 (UL94)
	ArrowLink	Housing	N/A	Polycarbonate
		Contacts	N/A	Copper alloy
		Wire Leads	N/A	Solid or stranded THHN #12 AWG
		ArrowLink SPD	Housing	N/A
ArrowLink SPD	Contacts	N/A	Copper alloy	

Hospital Specification Grade ArrowLink™ Modular Receptacles

2-Pole, 3-Wire Grounding
15A, 125V/AC; 15A, 250V/AC; 20A, 125V/AC; 20A 250V/AC
NEMA 5-15, 6-15, 5-20, 6-20

		Device Type	Hospital Grade Premium Modular Duplex Receptacles: AH8200_M, AH8300_M, AH8400_M, AH8600_M Series; ArrowLink: MCR125_, MCR250, MCR300__ Series	Hospital Grade Premium Modular Decorator Duplex Receptacles: 8262_M, 8362_M Series; ArrowLink: MCR125_, MCR300_ Series
Wiring Type	Base Device	Back & side wire	Back & side wire	Back & side wire
	ArrowLink	Integral wire leads, crimped & resistance welded	Integral wire leads, crimped & resistance welded	Integral wire leads, crimped & resistance welded
	ArrowLink SPD	Backwire feed through	Backwire feed through	Backwire feed through
Testing & Code Compliance	Base Device	<ul style="list-style-type: none"> Listed to UL 498, file no. E15058 UL verified to Federal Spec. WC-596G CSA certified to C22.2, no. 42, file no. 6914 (6233-01) NOM certified 	<ul style="list-style-type: none"> Listed to UL 498, file no. E15058 UL verified to Federal Spec. WC-596G CSA certified to C22.2, no. 42, file no. 6914 (6233-01) NOM certified 	<ul style="list-style-type: none"> Listed to UL 498, file no. E15058 UL verified to Federal Spec. WC-596G CSA certified to C22.2, no. 42, file no. 6914 (6233-01) NOM certified
	ArrowLink	• Plug & connector cULus Listed to UL 2459, file no.E325188	• Plug & connector cULus Listed to UL 2459, file no.E325188	• Plug & connector cULus Listed to UL 2459, file no.E325188
	Combined	• cULus Listed wiring assembly, UL file no. E326691	• cULus Listed wiring assembly, UL file no. E326691	• cULus Listed wiring assembly, UL file no. E326691
Specifications: Environmental	Base Device	Flammability	Meets UL 94 requirements; V2 rated	Meets UL 94 requirements; V2 rated
		Temperature Rating	-20°C to 70°C (-4°F to 158°F)	-20°C to 70°C (-4°F to 158°F)
	ArrowLink	Flammability	Meets UL 94 requirements; V2 rated	Meets UL 94 requirements; V2 rated
		Temperature Rating	-20°C to 90°C (-4°F to 194°F)	-20°C to 90°C (-4°F to 194°F)
Specifications: Electrical	Base Device	Dielectric Voltage	Withstands 2000V per UL 498	Withstands 2000V per UL 498
		Current Interrupting	Yes, at full-rated current	Yes, at full-rated current
		Temperature Rise	Max. 30°C (86°F) after 250 cycles of overload @ 200% of rated current (DC)	Max. 30°C (86°F) after 250 cycles of overload
	ArrowLink	Max. Working Voltage & Continuous Current	300V/AC; 20A	300V/AC; 20A
		Overload	52.5A/AC for 10 cycles	52.5A/AC for 10 cycles
		Dielectric Voltage	Withstands 1600V per UL 2549	Withstands 1600V per UL 2549
		Current Interrupting	Limited cycles at full-rated current	Limited cycles at full-rated current
		Temperature Rise	Max. 50°C (122°F) while conducting 35A after 10 cycles of overload @52.5A/AC	Max. 50°C (122°F) while conducting 35A after 10 cycles of overload @52.5A/AC
Specifications: Mechanical	Base Device Terminal Accommodation	#14 - 10 AWG	#14 - 10 AWG	
	ArrowLink Wire Leads	#12 AWG	#12 AWG	
	ArrowLink SPD Screw Terminals	Accepts #12 - #14 AWG stranded and solid wire	Accepts #12 - #14 AWG stranded and solid wire	
	ArrowLink SPD Ground	Integral THHN #12 AWG 6" lead with ring terminal and #10 ground screw	Integral THHN #12 AWG 6" lead with ring terminal and #10 ground screw	
	Voltage Ratings	Permanently marked on device	Permanently marked on device	
Materials:	Base Device	Face	Nylon	Nylon
		Base	Glass-filled nylon	Nylon
		Strap	0.05" thick solid brass, nickel plated	0.05" thick galvanized steel
		Auto Ground Clip	Brass	Bronze wire
		Line Contacts	0.031" thick 5-leaf brass, nickel plated	0.037" thick triple-wipe brass
		Ground Contact	Integral	Integral
		Terminal & Ground Screws	Terminal: #8-32 brass, neutral screw nickel plated Ground: #8-32 brass (green)	Terminal: #8-32 steel Ground: #8-32 steel (green)
		Screw Terminal Guards	PVC hinged doors	PVC hinged doors
		Illuminated Models	Long-life neon bulb	Long-life neon bulb
	ArrowLink	Housing	Polycarbonate	Polycarbonate
		Contacts	Copper alloy	Copper alloy
		Wire Leads	Solid or stranded THHN #12 AWG	Solid or stranded THHN #12 AWG
	ArrowLink SPD	Housing	Polycarbonate	Polycarbonate
		Contacts	Copper alloy	Copper alloy

Hospital & Industrial Specification Grade ArrowLink™ Modular Isolated Ground Receptacles

2-Pole, 3-Wire Grounding
15A, 125V/AC; 15A, 250V/AC;
20A, 125V/AC; 20A 250V/AC
NEMA 5-15, 6-15, 5-20, 6-20

		Device Type	Hospital Grade Premium Modular Isolated Ground Duplex Receptacles: IG8200_M, IG8300_M, IG8400_M Series; ArrowLink: MCR125_, MCR250_, MCR300_ Series	Industrial Grade Premium Modular Isolated Ground Duplex Receptacles: IG5262_M, IG5362_M Series; ArrowLink: MCR125_, MCR250_, MCR300_ Series
Wiring Type	Base Device	Back & side wire	Back & side wire	Back & side wire
	ArrowLink	Integral wire leads, crimped & resistance welded	Integral wire leads, crimped & resistance welded	Integral wire leads, crimped & resistance welded
	ArrowLink SPD	Backwire feed through	Backwire feed through	Backwire feed through
Testing & Code Compliance	Base Device	<ul style="list-style-type: none"> Listed to UL 498, file no. E15058 UL verified to Federal Spec. WC-596G CSA certified to C22.2, no. 42, file no. 6914 (6233-01) NOM certified 	<ul style="list-style-type: none"> Listed to UL 498, file no. E15058 UL verified to Federal Spec. WC-596G CSA certified to C22.2, no. 42, file no. 6914 (6233-01) NOM certified 	<ul style="list-style-type: none"> Listed to UL 498, file no. E15058 UL verified to Federal Spec. WC-596G CSA certified to C22.2, no. 42, file no. 6914 (6233-01) NOM certified
	ArrowLink	• Plug & connector cULus Listed to UL 2459, file no.E325188	• Plug & connector cULus Listed to UL 2459, file no.E325188	• Plug & connector cULus Listed to UL 2459, file no.E325188
	Combined	• cULus Listed wiring assembly, UL file no. E326691	• cULus Listed wiring assembly, UL file no. E326691	• cULus Listed wiring assembly, UL file no. E326691
Specifications: Environmental	Base Device	Flammability	Meets UL 94 requirements; V2 rated	Meets UL 94 requirements; V2 rated
		Temperature Rating	-20°C to 70°C (-4°F to 158°F)	-20°C to 70°C (-4°F to 158°F)
	ArrowLink	Flammability	Meets UL 94 requirements; V2 rated	Meets UL 94 requirements; V2 rated
		Temperature Rating	-20°C to 90°C (-4°F to 194°F)	-20°C to 90°C (-4°F to 194°F)
Specifications: Electrical	Base Device	Dielectric Voltage	Withstands 2000V per UL 498	Withstands 2000V per UL 498
		Current Interrupting	Yes, at full-rated current	Yes, at full-rated current
		Temperature Rise	Max. 30°C (86°F) after 250 cycles of overload @ 200% of rated current (DC)	Max. 30°C (86°F) after 250 cycles of overload @ 200% of rated current (DC)
	ArrowLink	Max. Working Voltage & Continuous Current	300V/AC; 20A	300V/AC; 20A
		Overload	52.5A/AC for 10 cycles	52.5A/AC for 10 cycles
		Dielectric Voltage	Withstands 1600V per UL 2549	Withstands 1600V per UL 2549
		Current Interrupting	Limited cycles at full-rated current	Limited cycles at full-rated current
		Temperature Rise	Max. 50°C (122°F) while conducting 35A after 10 cycles of overload @52.5A/AC	Max. 50°C (122°F) while conducting 35A after 10 cycles of overload @52.5A/AC
Specifications: Mechanical	Base Device Terminal Accommodation	#14 - 10 AWG	#14 - 10 AWG	
	ArrowLink Wire Leads	#12 AWG	#12 AWG	
	ArrowLink SPD Screw Terminals	Accepts #12 - #14 AWG stranded and solid wire	Accepts #12 - #14 AWG stranded and solid wire	
	ArrowLink SPD Ground	Integral THHN #12 AWG 6" lead with ring terminal and #10 ground screw	Integral THHN #12 AWG 6" lead with ring terminal and #10 ground screw	
	Voltage Ratings	Permanently marked on device	Permanently marked on device	
Materials:	Base Device	Face	Nylon	Nylon
		Base	PVC	PVC
		Strap	0.05" thick brass, nickel plated	0.05" thick brass, nickel plated
		Auto Ground Clip	Brass	Brass
		Line Contacts	0.031" thick 5-leaf brass	0.031" thick 5-leaf brass
		Ground Contact	1-piece isolated ground shunt	1-piece isolated ground shunt
		Terminal & Ground Screws	Terminal: #8-32 brass, neutral screw nickel plated Ground: #8-32 brass (green)	Terminal: #8-32 brass, neutral screw nickel plated Ground: #8-32 brass (green)
		Screw Terminal Guards	PVC hinged doors	PVC hinged doors
	ArrowLink	Housing	Polycarbonate	Polycarbonate
		Contacts	Copper alloy	Copper alloy
		Wire Leads	Solid or stranded THHN #12 AWG	Solid or stranded THHN #12 AWG
	ArrowLink SPD	Housing	Polycarbonate	Polycarbonate
		Contacts	Copper alloy	Copper alloy

Industrial Specification Grade ArrowLink™ Modular Receptacles

2-Pole, 3-Wire Grounding
15A, 125V/AC; 15A, 250V/AC; 20A, 125V/AC; 20A 250V/AC
NEMA 5-15, 6-15, 5-20, 6-20

		Device Type	Industrial Grade Premium Modular Duplex & Decorator Duplex Receptacles: AH5262_M, AH5362_M, AH5462_M, AH5662_M, 6262_M, 6362_M Series; ArrowLink: MCR125_, MCR250_, MCR300_ Series	Industrial Grade Premium Modular Single Receptacles: 5261_M, 5361_M Series; ArrowLink: MCR125_, MCR250_, MCR300_ Series
Wiring Type	Base Device	Back & side wire		Back & side wire
	ArrowLink	Integral wire leads, crimped & resistance welded		Integral wire leads, crimped & resistance welded
	ArrowLink SPD	Backwire feed through		Backwire feed through
Testing & Code Compliance	Base Device	<ul style="list-style-type: none"> Listed to UL 498, file no. E15058 UL verified to Federal Spec. WC-596G CSA certified to C22.2, no. 42, file no. 6914 (6233-01) NOM certified 		<ul style="list-style-type: none"> Listed to UL 498, file no. E15058 UL verified to Federal Spec. WC-596G CSA certified to C22.2, no. 42, file no. 6914 (6233-01) NOM certified
	ArrowLink	• Plug & connector cULus Listed to UL 2459, file no.E325188		• Plug & connector cULus Listed to UL 2459, file no.E325188
	Combined	• cULus Listed wiring assembly, UL file no. E326691		• cULus Listed wiring assembly, UL file no. E326691
Specifications: Environmental	Base Device	Flammability	Meets UL 94 requirements; V2 rated	
		Temperature Rating	-20°C to 90°C (-4°F to 194°F), except decorator: -20°C to 70°C (-4°F to 158°F)	
	ArrowLink	Flammability	Meets UL 94 requirements; V2 rated	
		Temperature Rating	-20°C to 90°C (-4°F to 194°F)	
Specifications: Electrical	Base Device	Dielectric Voltage	Withstands 2000V per UL 498	
		Current Interrupting	Yes, at full-rated current	
		Temperature Rise	Max. 30°C (86°F) after 250 cycles of overload @ 200% of rated current (DC)	
	ArrowLink	Max. Working Voltage & Continuous Current	300V/AC; 20A	
		Overload	52.5A/AC for 10 cycles	
		Dielectric Voltage	Withstands 1600V per UL 2549	
		Current Interrupting	Limited cycles at full-rated current	
		Temperature Rise	Max. 50°C (122°F) while conducting 35A after 10 cycles of overload @52.5A/AC	
Specifications: Mechanical	Base Device Terminal Accommodation	#14 - 10 AWG		
	ArrowLink Wire Leads	#12 AWG		
	ArrowLink SPD Screw Terminals	Accepts #12 - #14 stranded and solid wire		
	ArrowLink SPD Ground	Integral THHN #12 AWG 6" lead with ring terminal and #10 ground screw		
	Voltage Ratings	Permanently marked on device		
Materials:	Base Device	Face	Nylon	
		Base	Glass-filled nylon	
		Strap	0.05" thick brass; decorator: galvanized steel	
		Auto Ground Clip	Brass	
		Line Contacts	0.031" thick 5-leaf brass	
		Ground Contact	Integral	
		Terminal & Ground Screws	Terminal: #8-32 brass, neutral screw nickel plated Ground: #8-32 brass (green)	
		Screw Terminal Guards	PVC hinged doors	
	ArrowLink	Housing	Polycarbonate	
		Contacts	Copper alloy	
		Wire Leads	Solid or stranded THHN #12 AWG	
	ArrowLink SPD	Housing	Polycarbonate	
		Contacts	Copper alloy	

**Industrial Specification
Grade Premium
Receptacles**

2-Pole, 3-Wire Grounding
15A, 125V/AC; 15A, 250V/AC; 20A, 125V/AC; 20A 250V/AC
NEMA 5-15, 6-15, 5-20, 6-20

	Device Type	Industrial Grade Premium Duplex Receptacles: AH5262, AH5362, AH5462, AH5662 Series	Industrial Grade Premium Decorator Duplex Receptacles: 6262, 6362, 6462, 6662 Series	Industrial Grade Premium Single Receptacles: 5261, 5361, 5461, 5661 Series
	Wiring Type	Back & side wire	Back & side wire	Back wire
	Testing & Code Compliance	• Listed to UL 498, file no. E15058	• Listed to UL 498, file no. E15058	• Listed to UL 498, file no. E15058
		• UL verified to Federal Spec. WC-596G	• UL verified to Federal Spec. WC-596G	• UL verified to Federal Spec. WC-596G
		• CSA certified to C22.2, no. 42, file no. 6914 (6233-01)	• CSA certified to C22.2, no. 42, file no. 6914 (6233-01)	• CSA certified to C22.2, no. 42, file no. 6914 (6233-01)
		• NOM certified	• NOM certified	• NOM certified
Specifications: Environmental	Flammability	Meets UL 94 requirements; V2 rated	Meets UL 94 requirements; V2 rated	Meets UL 94 requirements; V2 rated
	Temperature Rating	-20°C to 70°C (-4°F to 158°F)	-20°C to 70°C (-4°F to 158°F)	-20°C to 60°C (-4°F to 140°F)
Specifications: Electrical	Dielectric Voltage	Withstands 2000V per UL 498	Withstands 2000V per UL 498	Withstands 2000V per UL 498
	Current Interrupting	Yes, at full-rated current	Yes, at full-rated current	Yes, at full-rated current
	Temperature Rise	Max. 30°C (86°F) after 250 cycles of overload @ 200% of rated current (DC)	Max. 30°C (86°F) after 250 cycles of overload @ 200% of rated current (DC)	Max. 30°C (86°F) after 250 cycles of overload @ 200% of rated current (DC)
Specifications: Mechanical	Terminal Accommodation	#14 - 10 AWG	#14 - 10 AWG	#14 - 10 AWG
	Voltage Ratings	Permanently marked on device	Permanently marked on device	Permanently marked on device
Materials:	Face	Nylon	Nylon	Nylon
	Base	Glass-filled nylon	Glass-filled nylon	Nylon
	Strap	0.05" thick brass	0.05" thick galvanized steel	0.05" thick steel, zinc plated, yellow chromate
	Auto Ground Clip	Brass	Brass	Phosphor bronze
	Line Contacts	0.031" thick 5-leaf brass	0.031" thick 5-leaf brass	0.037" thick 5-leaf brass
	Ground Contact	Integral	1-piece brass ground shunt	Riveted
	Terminal Screws	#8-32 brass, neutral screw nickel plated	#8-32 brass, neutral screw nickel plated	#8-32 brass, neutral screw nickel plated
	Ground Screw	#8-32 brass (green)	#8-32 brass (green)	#8-32 brass (green)
	Screw Terminal Guards	PVC hinged doors	PVC hinged doors	N/A

Industrial Specification Grade Receptacles

2-Pole, 3-Wire Grounding
15A, 125V/AC; 20A, 125V/AC; 15A, 250V/AC; 20A 250V/AC
15A, 277V/AC
NEMA 5-15, 5-20, 6-15, 6-20, 7-15

	Device Type	Industrial Grade Premium Isolated Ground Duplex Receptacles: IG5262, IG5362, IG5462, IG5662 Series	Industrial Grade Premium Isolated Ground Single Receptacles: IG5261, IG5361, IG5461, IG5661 Series	Industrial Grade Duplex Receptacles: 5252, 5352, 5302	Industrial Grade Duplex & Decorator Duplex Receptacles: 5242, 5342, 6342	
	Wiring Type	Back & side wire	Back & side wire	Back & side wire	Side wire only	
	Testing & Code Compliance	<ul style="list-style-type: none"> Listed to UL 498, file no. E15058 UL verified to Federal Spec. WC-596G CSA certified to C22.2, no. 42, file no. 6914 (6233-01) NOM certified 	<ul style="list-style-type: none"> Listed to UL 498, file no. E2369 CSA certified to C22.2, no. 42, file no. 6914 (6233-01) NOM certified 	<ul style="list-style-type: none"> Listed to UL 498, file no. E15058 UL verified to Federal Spec. WC-596G CSA certified to C22.2, no. 42, file no. 6914 (6233-01) NOM certified 	<ul style="list-style-type: none"> Listed to UL 498, file no. E15058 UL verified to Federal Spec. WC-596G CSA certified to C22.2, no. 42, file no. 6914 (6233-01) NOM certified 	
Specifications: Environmental		Flammability	Meets UL 94 requirements; V2 rated	Meets UL 94 requirements; V2 rated	Meets UL 94 requirements; V2 rated	Meets UL 94 requirements; V2 rated
		Temperature Rating	-20°C to 70°C (-4°F to 158°F)	-20°C to 70°C (-4°F to 158°F)	-20°C to 70°C (-4°F to 158°F)	-20°C to 70°C (-4°F to 158°F)
Specifications: Electrical		Dielectric Voltage	Withstands 2000V per UL 498	Withstands 2000V per UL 498	Withstands 2000V per UL 498	Withstands 2000V per UL 498
	Current Interrupting	Yes, at full-rated current	Yes, at full-rated current	Yes, at full-rated current	Yes, at full-rated current	
	Temperature Rise	Max. 30°C (86°F) after 250 cycles of overload @ 200% of rated current (DC)	Max. 30°C (86°F) after 250 cycles of overload @ 200% of rated current (DC)	Max. 30°C (86°F) after 250 cycles of overload @ 200% of rated current (DC)	Max. 30°C (86°F) after 250 cycles of overload @ 200% of rated current (DC)	
Specifications: Mechanical	Terminal Accommodation	#14 - 10 AWG	#14 - 10 AWG	#14 - 10 AWG	#14 - 10 AWG	
	Voltage Ratings	Permanently marked on device	Permanently marked on device	Permanently marked on device	Permanently marked on device	
Materials:	Face	Nylon	Nylon	Nylon	Nylon	
	Base	Nylon	Nylon	Glass-filled nylon	Glass-filled nylon	
	Strap	0.05" thick brass	0.05" thick brass	0.05" thick galvanized steel	0.05" thick galvanized steel	
	Auto Ground Clip	Brass	Phosphor bronze	Brass	Brass	
	Line Contacts	0.031" thick 5-leaf brass	Triple wipe brass	Triple wipe brass	Triple wipe brass	
	Ground Contact	1-piece isolated ground shunt	1-piece isolated ground shunt	1-piece brass ground shunt	Riveted	
	Terminal Screws	#8-32 brass, neutral screw nickel plated	#8-32 brass, neutral screw nickel plated	#8-32 brass, neutral screw nickel plated	#8-32 brass, neutral screw nickel plated	
	Ground Screw	#8-32 brass (green)	#8-32 brass (green)	#8-32 brass (green)	#8-32 brass (green)	
Screw Terminal Guards	PVC hinged doors	N/A	PVC hinged doors	PVC hinged doors		

**Industrial & Construction
Specification Grade
Receptacles**

2-Pole, 3-Wire Grounding
15A, 125V/AC; 20A, 125V/AC; 15A, 250V/AC; 20A 250V/AC
20A 277V/AC
NEMA 5-15, 5-20, 6-15, 6-20, 7-20

	Device Type	Industrial Grade Single Receptacles: 5251, 5351, 834	Industrial Grade Panel Mount Receptacles: 5284, 5484, AH5684, 5734	Construction Grade Duplex Receptacles: 5262, 5362	Construction Grade Duplex Receptacles: 5462C, 5662C
	Wiring Type	Side wire only	Back & side wire	Back & side wire	Back & side wire
	Testing & Code Compliance	• Listed to UL 498, file no. E21369	• Listed to UL 498, file no. E21369	• Listed to UL 498, file no. E15058	• Listed to UL 498, file no. E15058
		• UL verified to Federal Spec. WC-596G	• UL verified to Federal Spec. WC-596G	• UL verified to Federal Spec. WC-596G	• UL verified to Federal Spec. WC-596G
		• CSA certified to C22.2, no. 42, file no. 6914 (6233-01)	• CSA certified to C22.2, no. 42, file no. 7087, except for 5484 and 5284	• CSA certified to C22.2, no. 42, file no. 6914 (6233-01)	• CSA certified to C22.2, no. 42, file no. 6914 (6233-01)
		• NOM certified		• NOM certified	• NOM certified except 5662C
Specifications: Environmental	Flammability	Meets UL 94 requirements; V2 rated	Meets UL 94 requirements; V2 rated	Meets UL 94 requirements; V2 rated	Meets UL 94 requirements; V2 rated
	Temperature Rating	-20°C to 70°C (-4°F to 158°F)	-20°C to 70°C (-4°F to 158°F)	-20°C to 70°C (-4°F to 158°F)	-20°C to 70°C (-4°F to 158°F)
Specifications: Electrical	Dielectric Voltage	Withstands 2000V per UL 498	Withstands 2000V per UL 498	Withstands 2000V per UL 498	Withstands 2000V per UL 498
	Current Interrupting	Yes, at full-rated current	Yes, at full-rated current	Yes, at full-rated current	Yes, at full-rated current
	Temperature Rise	Max. 30°C (86°F) after 250 cycles of overload @ 200% of rated current (DC)	Max. 30°C (86°F) after 250 cycles of overload @ 200% of rated current (DC)	Max. 30°C (86°F) after 250 cycles of overload @ 200% of rated current (DC)	Max. 30°C (86°F) after 250 cycles of overload @ 200% of rated current (DC)
Specifications: Mechanical	Terminal Accommodation	#14 - 10 AWG	#14 - 10 AWG	#14 - 10 AWG	#14 - 10 AWG
	Voltage Ratings	Permanently marked on device	Permanently marked on device	Permanently marked on device	Permanently marked on device
Materials:	Face	Nylon	Nylon	Nylon	Nylon
	Base	Nylon	Nylon	PVC	Glass-filled nylon
	Strap	0.05" thick galvanized steel	0.05" thick galvanized steel	0.05" thick galvanized steel	0.05" thick galvanized steel
	Auto Ground Clip	Phosphor bronze	N/A	Brass	Phosphor bronze
	Line Contacts	Triple wipe brass	0.030" Brass	0.030" thick triple wipe brass	0.037" thick triple wipe brass
	Ground Contact	Riveted	Riveted	Riveted	Riveted
	Terminal Screws	#8-32 steel, brass plated, neutral screw nickel plated	#8-32 steel, brass plated, neutral screw nickel plated	#8-32 steel, brass plated, neutral screw nickel plated	#8-32 steel, brass plated, neutral screw nickel plated
	Ground Screw	#8-32 brass (green)	#8-32 brass (green)	#8-32 brass (green)	#8-32 brass (green)

**Industrial & Construction
Specification Grade ArrowLink™
Modular Receptacles**





2-Pole, 3-Wire Grounding
15A, 125V/AC; 15A, 250V/AC;
20A, 125V/AC; 20A 250V/AC
NEMA 5-15, 6-15, 5-20, 6-20

		Device Type	Industrial Grade Modular Duplex Receptacles: 5252_M, 5352_M Series; ArrowLink: MCR125_, MCR250_, MCR300_ Series	Construction Grade Modular & Tamper Resistant Modular Duplex Receptacles: 5262_M, 5362_M, TR5262_M, TR5362_M Series; ArrowLink: MCR125_, MCR250_, MCR300_ Series
Wiring Type	Base Device	Back & side wire	Back & side wire	Back & side wire
	ArrowLink	Integral wire leads, crimped & resistance welded	Integral wire leads, crimped & resistance welded	Integral wire leads, crimped & resistance welded
	ArrowLink SPD	Backwire feed through	Backwire feed through	Backwire feed through
Testing & Code Compliance	Base Device	<ul style="list-style-type: none"> Listed to UL 498, file no. E15058 UL verified to Federal Spec. WC-596G CSA certified to C22.2, no. 42, file no. 6914 (6233-01) NOM certified 	<ul style="list-style-type: none"> Listed to UL 498, file no. E15058 UL verified to Federal Spec. WC-596G CSA certified to C22.2, no. 42, file no. 6914 (6233-01) NOM certified 	<ul style="list-style-type: none"> Listed to UL 498, file no. E15058 UL verified to Federal Spec. WC-596G CSA certified to C22.2, no. 42, file no. 6914 (6233-01) NOM certified
	ArrowLink	• Plug & connector cULus Listed to UL 2459, file no.E325188	• Plug & connector cULus Listed to UL 2459, file no.E325188	• Plug & connector cULus Listed to UL 2459, file no.E325188
	Combined	• cULus listed wiring assembly, UL file no. E326691	• cULus listed wiring assembly, UL file no. E326691	• cULus listed wiring assembly, UL file no. E326691
Specifications: Environmental	Base Device	Flammability	Meets UL 94 requirements; V2 rated	Meets UL 94 requirements; V2 rated
		Temperature Rating	-20°C to 70°C (-4°F to 158°F)	-20°C to 60°C (-4°F to 140°F)
	ArrowLink	Flammability	Meets UL 94 requirements; V2 rated	Meets UL 94 requirements; V2 rated
		Temperature Rating	-20°C to 90°C (-4°F to 194°F)	-20°C to 90°C (-4°F to 194°F)
Specifications: Electrical	Base Device	Dielectric Voltage	Withstands 2000V per UL 498	Withstands 2000V per UL 498
		Current Interrupting	Yes, at full-rated current	Yes, at full-rated current
		Temperature Rise	Max. 30°C (86°F) after 250 cycles of overload @ 200% of rated current (DC)	Max. 30°C (86°F) after 250 cycles of overload @ 200% of rated current (DC)
	ArrowLink	Max. Working Voltage & Continuous Current	300V/AC; 20A	300V/AC; 20A
		Overload	52.5A/AC for 10 cycles	52.5A/AC for 10 cycles
		Dielectric Voltage	Withstands 1600V per UL 2549	Withstands 1600V per UL 2549
		Current Interrupting	Limited cycles at full-rated current	Limited cycles at full-rated current
		Temperature Rise	Max. 50°C (122°F) while conducting 35A after 10 cycles of overload @52.5A/AC	Max. 50°C (122°F) while conducting 35A after 10 cycles of overload @52.5A/AC
Specifications: Mechanical	Base Device Terminal Accommodation	#14 - 10 AWG	#14 - 10 AWG	
	ArrowLink Wire Leads	#12 AWG	#12 AWG	
	ArrowLink SPD Screw Terminals	Accepts #12 - #14 AWG stranded and solid wire	Accepts #12 - #14 AWG stranded and solid wire	
	ArrowLink SPD Ground	Integral THHN #12 AWG 6" lead with ring terminal and #10 ground screw	Integral THHN #12 AWG 6" lead with ring terminal and #10 ground screw	
	Voltage Ratings	Permanently marked on device	Permanently marked on device	
Materials:	Base Device	Face	Nylon	Nylon
		Base	Glass-filled nylon	PVC
		Strap	0.05" thick galvanized steel	0.05" thick galvanized steel
		Auto Ground Clip	Brass	Phosphor bronze
		Line Contacts	0.031" thick 5-leaf brass	0.037" thick triple wipe brass
		Ground Contacts	Riveted	Riveted
		Terminal & Ground Screws	Terminal: #8-32 brass, neutral screw nickel plated Ground: #8-32 brass (green)	Terminal: #8-32 steel, brass plated, neutral screw nickel plated; Ground: #8-32 steel, brass plated (green)
		Screw Terminal Guards	PVC hinged doors	UL recognized insulating material; dielectric strength: 2,000V mind.; HWI rating: 4 min.; relative temperature index, electrical: 80°C (176°F); flammability: V0 (UL 94)
	Tamper Resistant Shutters	N/A	TR5262 & TR5362 only: Reliable Delrin® shutter assembly	
	ArrowLink	Housing	Polycarbonate	Polycarbonate
		Contacts	Copper alloy	Copper alloy
		Wire Leads	Solid or stranded THHN #12 AWG	Solid or stranded THHN #12 AWG
	ArrowLink SPD	Housing	Polycarbonate	Polycarbonate
Contacts		Copper alloy	Copper alloy	

Delrin® is a registered trademark of E.I. du Pont de Nemours

Construction & Commercial Specification Grade Receptacles

2-Pole, 3-Wire Grounding
15A, 125V/AC; 20A, 125V/AC
NEMA 5-15, 5-20

Device Type	Construction Grade & Commercial Grade Tamper Resistant Duplex & Decorator Duplex: TR5200, TR5300, TR6200, TR6300, TRBR Series 	Commercial Grade Tamper Resistant Single Receptacles: TR1877, TR817 Series 	Commercial Grade Tamper & Weather Resistant Duplex Receptacles: TWRBR Series 	Commercial Grade Weather Resistant Duplex Receptacles: WRBR Series 	
Wiring Type	Back & side wire	Side wire only	Back & side wire	Back & side wire	
Testing & Code Compliance	<ul style="list-style-type: none"> cULus Listed to UL 498, file no. E15058 UL verified to Federal Spec. WC-596/12-1 NOM/ANSI certified 	<ul style="list-style-type: none"> cULus Listed to UL 498, file no. E15058 UL verified to Federal Spec. WC-596/12-1 NOM/ANSI certified 	<ul style="list-style-type: none"> cULus Listed to UL 498, file no. E15058 UL verified to Federal Spec. WC-596 NOM/ANSI certified 	<ul style="list-style-type: none"> cULus Listed to UL 498, file no. E15058 UL verified to Federal Spec. WC-596G NOM/ANSI certified 	
	Flammability	Meets UL 94 requirements; V2 rated	Meets UL 94 requirements; V2 rated	Meets UL 94 requirements; V2 rated	Meets UL 94 requirements; V2 rated
	Temperature Rating	-20°C to 70°C (-4°F to 158°F)	-20°C to 70°C (-4°F to 158°F)	-20°C to 70°C (-4°F to 158°F)	-20°C to 70°C (-4°F to 158°F)
Specifications: Electrical	Dielectric Voltage	Withstands 2000V per UL 498	Withstands 2000V per UL 498	Withstands 2000V per UL 498	Withstands 2000V per UL 498
	Current Interrupting	Yes, at full-rated current	Yes, at full-rated current	Yes, at full-rated current	Yes, at full-rated current
	Temperature Rise	Max. 30°C (86°F) after 250 cycles of overload @ 200% of rated current (DC)	Max. 30°C (86°F) after 100 cycles of overload @ 150% of rated current (DC)	Max. 30°C (86°F) after 250 cycles of overload @ 200% of rated current (DC)	Max. 30°C (86°F) after 250 cycles of overload @ 200% of rated current (DC)
Specifications: Mechanical	Terminal Accommodation	#14 - 10 AWG	#14 - 10 AWG	#14 - 10 AWG	#14 - 10 AWG
	Voltage Ratings	Permanently marked on device	Permanently marked on device	Permanently marked on device	Permanently marked on device
Materials:	Face	Nylon	Nylon	Nylon	Nylon 6/6
	Base	Nylon	Nylon	Nylon	PVC
	Strap	0.050" thick galvanized steel	0.040" thick galvanized steel	0.050" thick steel, nickel plated	0.050" thick steel, nickel plated
	Auto Ground Clip	Phosphor bronze	Brass	Phosphor bronze	Phosphor bronze
	Line Contacts	0.037" thick triple wipe brass	0.030" thick triple wipe brass	0.037" thick triple wipe brass	0.037" thick triple wipe brass
	Ground Contact	Riveted	Riveted	Riveted	Riveted
	Terminal Screws	Terminal: #8-32 brass, neutral screw nickel plated	Terminal: #8-32 brass, neutral screw nickel plated	Terminal: #8-32 brass, neutral screw nickel plated	Terminal: #8-32 brass, neutral screw nickel plated
	Ground Screw	Ground: #8-32 brass (green)	Ground: #8-32 brass (green)	Ground: #8-32 brass (green)	Ground: #8-32 brass (green)
Tamper Resistant Shutters	Reliable Delrin® shutter assembly	Reliable Delrin® shutter assembly	Reliable Delrin® shutter assembly	N/A	

Delrin® is a registered trademark of E.I. du Pont de Nemours

Commercial Specification Grade Receptacles

2-Pole, 3-Wire Grounding
15A, 125V/AC; 20A, 125V/AC
NEMA 5-15, 5-20

	Device Type	Commercial Grade Duplex and Decorator Duplex Receptacles: BR, CR, 6200, 6300, 6400 Series	Commercial Grade Single Receptacles: 800, 1800 Series	Snap-In Receptacles: 49, 67, 4049, 4067, 4070 Series
	Wiring Type	Back & side wire, except CR, 6250, 6350, 6450 series	Side wire	Wire leads & quick connect
	Testing & Code Compliance	<ul style="list-style-type: none"> cULus Listed to UL 498, file no. E15058 	<ul style="list-style-type: none"> Listed to UL 498, file no. E15058 	<ul style="list-style-type: none"> UR (UL Recognized)
		<ul style="list-style-type: none"> BR series only: UL verified to Federal Spec. WC-596G 	<ul style="list-style-type: none"> CSA certified to 22.2, no 42, file no. 6914 (6233-01) 	<ul style="list-style-type: none"> CSA certified to C22.2, no. 42, file no. 6914 (6233-01)
		<ul style="list-style-type: none"> CSA certified to 22.2, no 42, file no. 6914 (6233-01) 	<ul style="list-style-type: none"> NOM/ANSI certified 	<ul style="list-style-type: none"> NOM certified
		<ul style="list-style-type: none"> NOM/ANSI certified 		
Specifications: Environmental	Flammability	Meets UL 94 requirements; V2 rated	Meets UL 94 requirements; V2 rated	Meets UL 94 requirements; V2 rated
	Temperature Rating	-20°C to 70°C (-4°F to 158°F)	-20°C to 70°C (-4°F to 158°F)	-20°C to 70°C (-4°F to 158°F)
Specifications: Electrical	Dielectric Voltage	Withstands 2000V per UL 498	Withstands 2000V per UL 498	Withstands 2000V per UL 498
	Current Interrupting	Yes, at full-rated current	Yes, at full-rated current	Yes, at full-rated current
	Temperature Rise	Max. 30°C (86°F) after 250 cycles of overload @ 200% of rated current (DC)	Max. 30°C (86°F) after 100 cycles of overload @ 150% of rated current (DC)	Max. 30°C (86°F) after 100 cycles of overload @ 150% of rated current (DC)
Specifications: Mechanical	Terminal Accommodation	#14 - 10 AWG	#14 - 10 AWG	#14 - 12 AWG
	Voltage Ratings	Permanently marked on device	Permanently marked on device	Permanently marked on device
Materials:	Face	Nylon	Nylon	Urea
	Base	PVC	Nylon	Polypropylene
	Strap	0.045" thick galvanized steel	0.040" thick galvanized steel	0.030" thick steel
	Auto Ground Clip	Phosphor bronze	0.032" brass	N/A
	Line Contacts	0.030" thick brass	0.030" thick brass	0.032" thick brass
	Ground Contact	Riveted	Riveted	Screw down
	Terminal Screws	Terminal: #8-32 brass, neutral screw nickel plated	Terminal: #8-32 brass, neutral screw nickel plated	N/A
	Ground Screw	Ground: #8-32 brass (green)	Ground: #8-32 brass (green)	Ground: #6-32 brass (green)

**Industrial Specification
Grade Corrosion Resistant
& Watertight Receptacles**

2-Pole, 3-Wire Grounding
15A, 125V/AC; 15A, 250V/AC;
20A, 125V/AC; 20A 250V/AC
NEMA 5-15, 6-15, 5-20, 6-20

	Device Type	Corrosion Resistant Receptacles, Straight Blade: 5262CR, 5362CR	Watertight Receptacles, Straight Blade: 60W47, 60W49, 60W33, 60W48
	Wiring Type	Back & side wire	Back wire
	Testing & Code Compliance	• Listed to UL 498, file no. E15058	• Listed to UL 498, file no. E2369
		• UL verified to Federal Spec WC-596G	
		• CSA certified to C22.2, no. 42, file no. 6914 (6233-01)	• cUL certified to CAN/CSA C22.2 no. 42-99
		• NOM certified	
Specifications: Environmental	Flammability	Meets UL 94 requirements; V2 rated	Meets UL 94 requirements; V2 rated
	Temperature Rating	-20°C to 70°C (-4°F to 158°F)	-40°C to 75°C (-40°F to 167°F)
	Protection	N/A	NEMA 3, 3R, 4, 4X, 12 & IP66
	High Pressure Water Test	N/A	1000 psi spray (mated or closed)
Specifications: Electrical	Dielectric Voltage	Withstands 2000V per UL 498	Withstands 1554V per UL 498
	Current Interrupting	Yes, at full-rated current	Yes, at full-rated current
	Temperature Rise	Max. 30°C (86°F) after 100 cycles of overload	Max. 30°C (86°F) after 250 cycles of overload
Specifications: Mechanical	Terminal Accommodation	#14 - #10 AWG	#18 - #10 AWG
	Voltage Ratings	Permanently marked on device	Permanently marked on device
Materials:	CR Receptacle Face	Nylon	N/A
	CR Receptacle Base	Glass-filled nylon	N/A
	WT Receptacle Flip Lid Cover & Base	N/A	Glass-filled nylon
	WT Receptacle Cover Spring	N/A	Stainless steel, self-closing
	WT Receptacle Lid Liner & Mounting Gasket	N/A	Santoprene thermoplastic elastomeric
	WT Receptacle, Interior Body	N/A	Glass-filled nylon
	WT Receptacle, Terminal Retainer	N/A	Clear lexan
	Strap	0.050" thick brass, nickel plated	N/A
	Auto Ground Clip	Brass, nickel plated	N/A
	Line Contacts	.031" thick high-performance brass, nickel plated; 3-leaf construction	.031" thick bronze, nickel plated; two-leaf construction
	Ground Contact	Integral	Riveted
	Terminal Clamps	Steel, nickel plated	Steel, nickel plated
	Terminal Screws	#10-32 Brass, neutral screw nickel plated	#8-32 brass, neutral screw nickel plated
	Ground Screw	#10-32 brass, zinc plated (green)	#8-32 brass (green)
	Assembly/Mounting Screws	N/A	Stainless steel
	Screw Terminal Guards	PVC hinged doors	N/A
Receptacle Mounting Plate	N/A	Stainless steel	

B

Straight Blade Plugs & Connectors



	Page		Page
Quick Reference Guide	B-1	Industrial & Commercial Straight Blade Power Devices	B-20
Hospital Grade Straight Blade Plugs & Connectors	B-6	2-Pole, 3-Wire Devices	
2-Pole, 3-Wire Devices		30A, 125V/AC Devices NEMA 5-30	B-22
15A, 125V/AC NEMA 5-15	B-6	30A, 250V/AC Devices NEMA 6-30	B-22
20A, 125V/AC NEMA 5-20	B-6	30A, 277V/AC Devices NEMA 7-30	B-22
15A, 250V/AC NEMA 6-15	B-7	50A, 125V/AC Devices NEMA 5-50	B-22
20A, 250V/AC NEMA 6-20	B-7	50A, 250V/AC Devices NEMA 6-50	B-22
		50A, 277V/AC Devices NEMA 7-50	B-22
Industrial Grade Straight Blade Devices	B-8	3-Pole, 3-Wire Devices	
2-Pole, 3-Wire Devices		30A, 125/250V/AC Devices NEMA 10-30	B-22
15A, 125V/AC		50A, 125/250V/AC Devices NEMA 10-50	B-22
Plugs & Connectors NEMA 5-15	B-8	3-Pole, 4-Wire Devices	
Flanged Inlets & Outlets NEMA 5-15	B-9	30A, 125/250V/AC Devices NEMA 14-30	B-23
Watertight Receptacles NEMA 5-15	B-9	30A, 3Ø 250V/AC Devices NEMA 15-30	B-23
20A, 125V/AC		50A, 125/250V/AC Devices NEMA 14-50	B-23
Plugs & Connectors NEMA 5-20	B-10	50A, 3Ø 250V/AC Devices NEMA 15-50	B-23
Flanged Inlets & Outlets NEMA 5-20	B-11	60A, 125/250V/AC Devices NEMA 14-60	B-23
Watertight Receptacles NEMA 5-20	B-11	60A, 3Ø 250V/AC Devices NEMA 15-60	B-23
15A, 250V/AC		4-Pole, 4-Wire Devices	
Plugs & Connectors NEMA 6-15	B-12	30A, 3ØY120/208V/AC Devices . NEMA 18-30	B-23
Flanged Inlets & Outlets NEMA 6-15	B-13	50A, 3ØY120/208V/AC Devices . NEMA 18-50	B-23
Watertight Receptacles NEMA 6-15	B-13	60A, 3ØY120/208V/AC Devices . NEMA 18-60	B-23
20A, 250V/AC		Straight Blade Power Devices, Dimensional Data	B-24
Plugs & Connectors NEMA 6-20	B-14	Specification Information	B-25
Flanged Inlets & Outlets NEMA 6-20	B-15		
Watertight Receptacles NEMA 6-20	B-15		
20A, 277V/AC			
Plugs NEMA 7-20	B-16		
3-Pole, 3-Wire Devices			
20A, 125/250V/AC			
Plugs NEMA 10-20	B-16		
4-Pole, 4-Wire Devices			
20A, 3ØY 120/208V/AC			
Plugs NEMA 18-20	B-16		
Commercial Grade Straight Blade Plugs & Connectors	B-16		
2-Pole, 2-Wire Devices			
15A, 125V/AC NEMA 1-15	B-16		
2-Pole, 3-Wire Devices			
15A, 125V/AC NEMA 5-15	B-17		
20A, 125V/AC NEMA 5-20	B-17		
15A, 250V/AC NEMA 6-15	B-17		
20A, 250V/AC NEMA 6-20	B-17		
Straight Blade Plugs & Connectors, Dimensional Data	B-18-B-19		

Straight blade plugs and connectors for any application

Arrow Hart's extensive offering of straight blade plugs and connectors cover the full range of Hospital, Industrial and Commercial Specification Grades along with special solutions like Watertight, Severe Duty and Corrosion Resistant devices for unique complex environments.

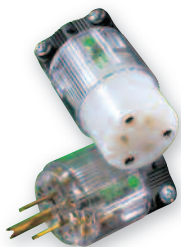

Hospital Specification Grade Plugs & Connectors

Built to meet and exceed UL Federal Specification and Hospital Grade testing, Arrow Hart's Hospital Grade Plugs and Connectors assure reliable performance in the most demanding healthcare applications.



Industrial Specification Grade Plugs, Connectors, Flanged Inlet & Flanged Outlets

With a variety of styles including Safety Grip™, AutoGrip™ and QuickGrip™, these devices are designed to install quickly and easily and provide reliable performance in tough industrial environments.



Industrial Specification Grade Watertight Straight Blade Plugs & Connectors

An extensive offering of watertight devices providing safe and reliable IP66 or greater watertight protection in hose down environments.



Industrial Specification Grade Severe Duty Straight Blade Plugs & Connectors

Designed specifically for use in tough industrial applications, these plugs and connectors take a beating and continue to deliver reliable performance in harsh industrial environments.



Commercial Specification Grade Straight Blade Plugs & Connectors



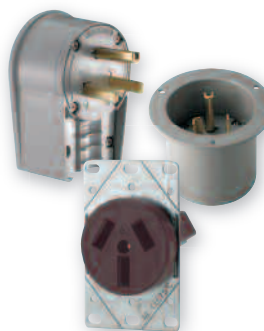





Designed for light commercial applications, where ease-of-use, value and quality are critical.



Specification Grade Straight Blade Power Devices

Heavy duty design and construction make Arrow Hart power devices ideal for any high amperage industrial or commercial power connectivity application.

Straight Blade Plug & Connector Quick Reference Guide

NEMA	Configuration	Product Grade	Product Family	Color	Plug Cat. No.	Connector Cat. No.
5-15 (15A, 125V/AC)	 <p>5-15P</p>  <p>5-15R</p>	Hospital Grade	Safety Grip™	Black & White	6266HG	6269HG
				Clear	6266HGC	6269HGC
			Safety Grip™ Angled	Black & White	6265HG	—
				Clear	6265HGC	—
			AutoGrip™	Black & White	5266NHG	5269NHG
		AutoGrip™ Isolated Ground	Orange	IG5266NHG	—	
		QuickGrip™	Gray	8115GY	—	
		Industrial Grade	Safety Grip™	Black & White	6266	6269
				Black	6266BLK	6269BLK
			Safety Grip™ Angled	Black & White	6265	—
			AutoGrip™	Black & White	5266N	5269N
			AutoGrip™ Corrosion Resistant	Yellow	5266NCR	5269NCR
			QuickGrip™	Black	5965BLK	5969BLK
			Watertight	Yellow	14W47	15W47
		Black		14W47BK	15W47BK	
Commercial Grade	Severe Duty	Yellow & Black	1447	1547		
	Vinyl	Yellow	4867	4887		
		Yellow	4867AN	—		
Vinyl Angled	Yellow	4867ANW	—			
	White	—	—			
5-20 (20A, 125V/AC)	 <p>5-20P</p>  <p>5-20R</p>	Hospital Grade	Safety Grip™	Black & White	6766HG	6769HG
			Safety Grip™ Angled	Black & White	6765HG	—
				Clear	6765HGC	—
		Industrial Grade	AutoGrip™	Black & White	5366NHG	5369NHG
			Safety Grip™	Black & White	6766	6769
			AutoGrip™	Black & White	5366N	5369N
			AutoGrip™ Corrosion Resistant	Yellow	5366NCR	5369NCR
			Watertight	Yellow	14W33	15W33
		Black		14W33BK	15W33BK	
		Commercial Grade	Severe Duty	Yellow & Black	1433	1533
Vinyl	Yellow		4409	4228		
	Yellow		4409AN	—		
Vinyl Angled	Yellow	—	—			
6-15 (15A, 250V/AC)	 <p>6-15P</p>  <p>6-15R</p>	Hospital Grade	Safety Grip™ Angled	Black & White	6665HG	—
				Clear	6665HGC	—
		Industrial Grade	Safety Grip™	Black & White	6666	6669
			AutoGrip™	Black & White	5666N	5669N
			Watertight	Yellow	14W49	15W49
				Black	14W49BK	15W49BK
		Commercial Grade	Severe Duty	Yellow & Black	1449	1549
			Vinyl	Yellow	4866	4227
Vinyl Angled	Yellow	4866AN		—		
6-20 (20A, 250V/AC)	 <p>6-20P</p>  <p>6-20R</p>	Hospital Grade	Safety Grip™ Angled	Black & White	6865HG	—
				Clear	6865HGC	—
		Industrial Grade	Safety Grip™	Black & White	6866	6869
			AutoGrip™	Black & White	5466N	5469N
			Watertight	Yellow	14W48	15W48
				Black	14W48BK	15W48BK
		Commercial Grade	Severe Duty	Yellow & Black	1448	1548
Vinyl	Yellow		4509	4229		
	Vinyl Angled	Yellow	4509AN	—		



Safety Grip Hospital and Industrial Specification Grade Plugs & Connectors

Rugged nylon body resists impact and exposure to chemicals

Neoprene gasket seals around cord for added terminal protection from external elements

Dual range cord grip provides positive cord gripping while limiting strain on conductors

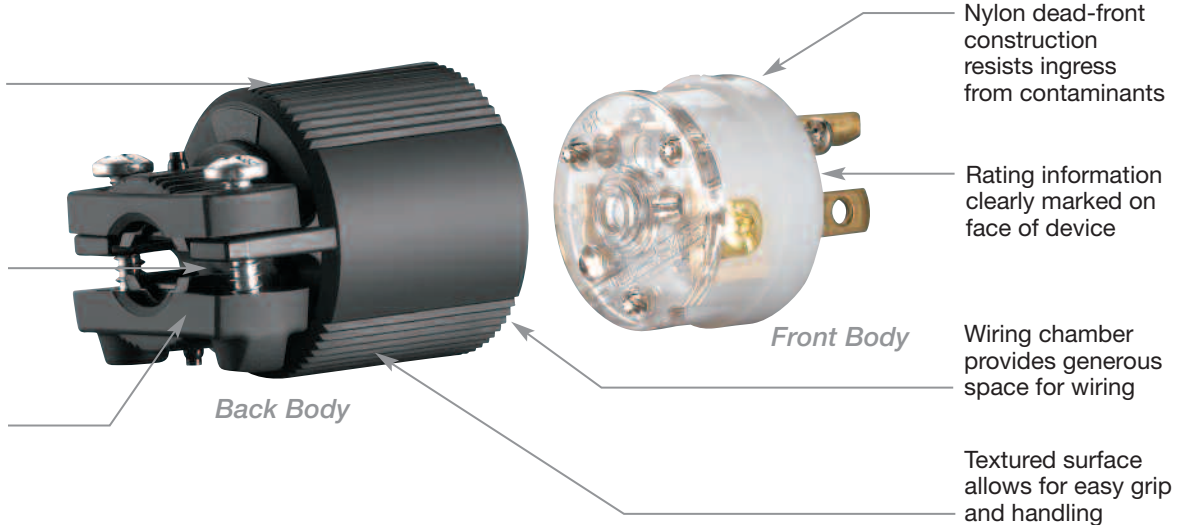

Nylon dead-front construction resists ingress from contaminants

Rating information clearly marked on face of device

Wiring chamber provides generous space for wiring

Textured surface allows for easy grip and handling



Safety Grip™ Hospital Grade devices exceed Federal Spec. and Hospital Grade testing for use in demanding healthcare environments



Clear terminal cover allows for easy inspection of conductors and terminations



Retained quick drive assembly screws speed installation



Angled plug option is ideal for applications requiring power cord to lay close to walls and floors

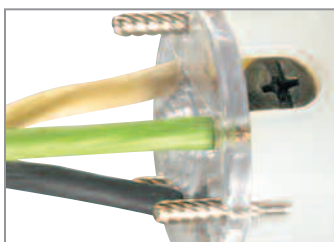

Tapered, individual wire pockets guide stranded wire into contact area for ease of installation



Multiple-head drive screws provide versatility for ease of use



Auto Grip Hospital and Industrial Specification Grade Plugs & Connectors

Smooth, tapered body reduces snagging and provides easy handling

Neoprene gasket seals around cord for added terminal protection from external elements

Rugged nylon body resists impact and exposure to chemicals

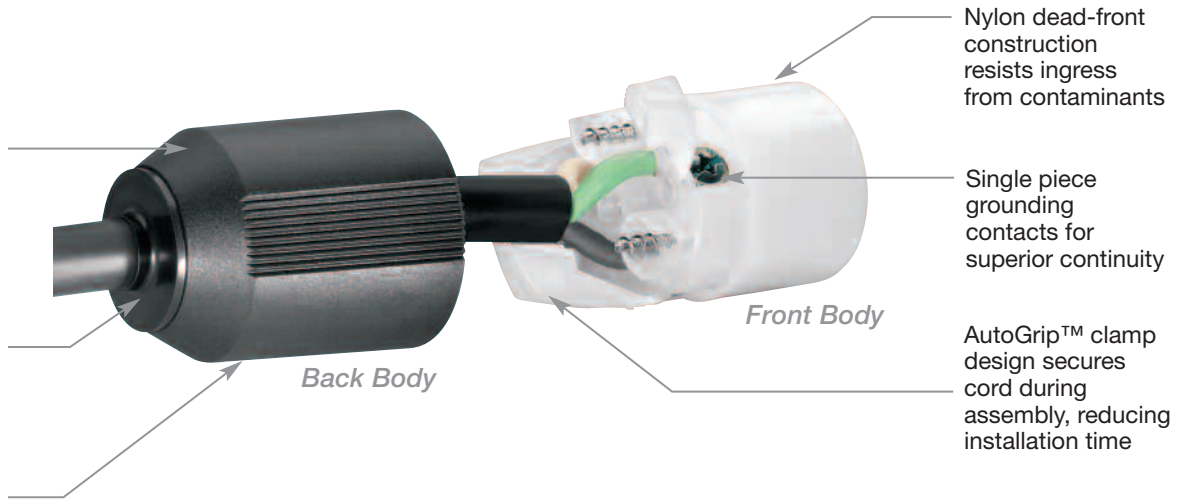

Nylon dead-front construction resists ingress from contaminants

Single piece grounding contacts for superior continuity

AutoGrip™ clamp design secures cord during assembly, reducing installation time



AutoGrip™ Hospital Grade devices exceed Federal Spec. and Hospital Grade testing for use in demanding healthcare environments



Unique clamp design secures cord during assembly, reducing installation time



Retained quick drive assembly screws speed installation



Available in corrosion resistant configurations for reliable performance in corrosive environments



Tapered, individual wire pockets guide stranded wire into contact area for ease of installation



Multiple-head drive screws provide versatility for ease of use



Watertight Plugs & Connectors

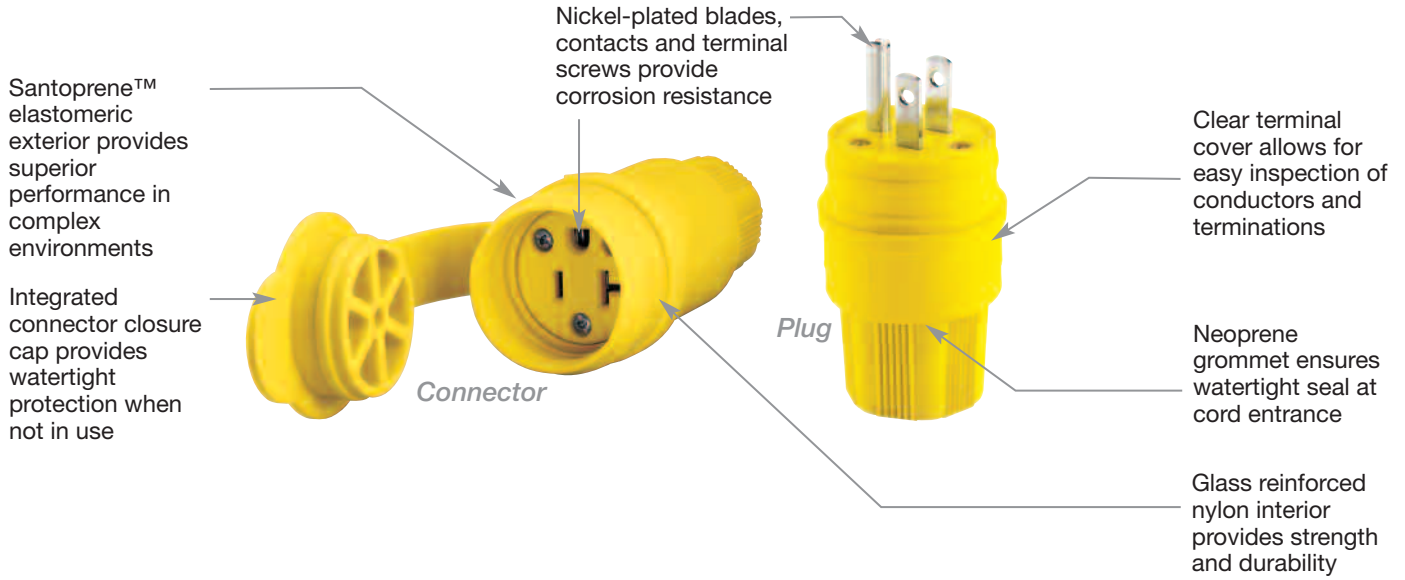

Unique design and sealing system provides multipoint IP67 watertight seal

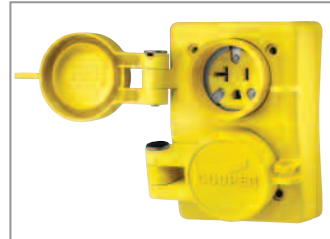

Full range of single and duplex watertight receptacles available

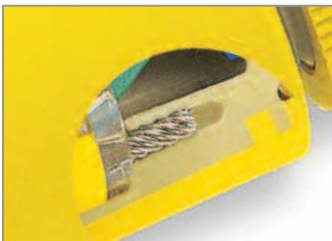

Quick-drive stainless steel assembly screws provide corrosion resistance and speed installation time



Optional plug closure cap provides watertight protection for plug when not in use



Replace threaded cord grip with optional wire mesh fitting for integrated cable strain relief



Tapered, individual wire pockets guide stranded wire into contact area for ease of installation



Severe Duty Plugs & Connectors

Santoprene™ elastomeric exterior provides superior performance in complex environments

Dual range cord grip provides positive cord gripping while limiting strain on conductors



Connector

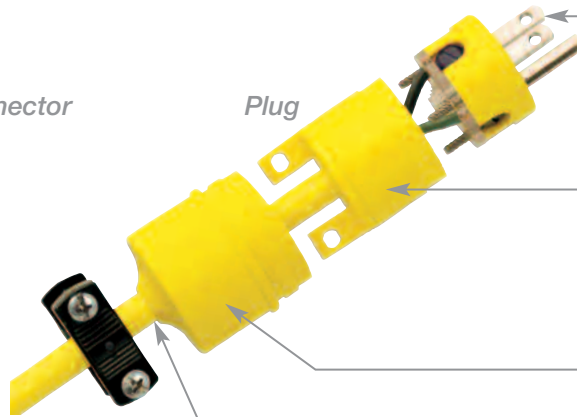

Plug

Nickel-plated blades, contacts and terminal screws provide corrosion resistance

Rugged nylon interior protects and insulates terminals

Wiring chamber provides generous space for wiring

Exterior jacket seals cord entrance



Combination of rugged nylon interior body and elastomeric exterior makes Severe Duty devices ideal for use in harsh environments

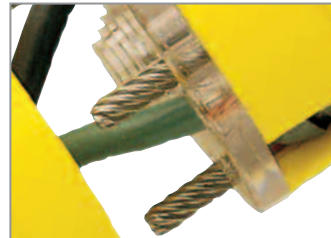

Quick-drive stainless steel assembly screws provide corrosion resistance and speed installation time



Cord grip accommodates wide range of cables and provides strain relief



Protective boots available for added cord entrance protection



Unique exterior jacket seals cord entrance to protect from contaminants



Multiple-head drive screws provide versatility for ease of use

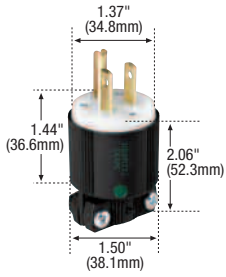

6266HG

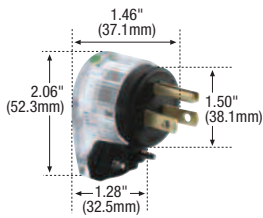

6265HGC



5369NHG

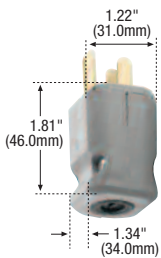

8115GY

Hospital Specification Grade Straight Blade Plugs & Connectors

2-Pole, 3-Wire Grounding
15A, 125V/AC
NEMA 5-15

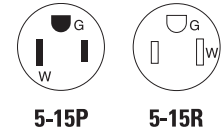

Hospital Grade Plugs & Connectors

Safety Grip™ NEMA 5-15

Rating A V/AC	Product Type & Cord Diameter	Body Color	Plug	Catalog No.	
				Connector	Connector
15 125	● Straight Body 0.33-0.66" (7.6-16.7mm)	Black & White	<input type="checkbox"/> 6266HG	<input checked="" type="checkbox"/> 6269HG	<input checked="" type="checkbox"/> 6269HG
	● Straight Body 0.33-0.66" (7.6-16.7mm)	Clear	<input type="checkbox"/> 6266HGC	<input checked="" type="checkbox"/> 6269HGC	<input checked="" type="checkbox"/> 6269HGC
	● Angled Body 0.33-0.66" (7.6-16.7mm)	Black & White	<input type="checkbox"/> 6265HG	<input checked="" type="checkbox"/>	—
	● Angled Body 0.33-0.66" (7.6-16.7mm)	Clear	<input type="checkbox"/> 6265HGC	<input checked="" type="checkbox"/>	—

AutoGrip™ NEMA 5-15

Rating A V/AC	Product Type & Cord Diameter	Body Color	Plug	Catalog No.	
				Connector	Connector
15 125	● Straight Body 0.33-0.66" (7.6-16.7mm)	Black & White	<input type="checkbox"/> 5266NHG	<input checked="" type="checkbox"/> 5269NHG	<input checked="" type="checkbox"/> 5269NHG
	● Isolated Ground, Straight Body 0.33-0.66" (7.6-16.7mm)	Orange	<input type="checkbox"/> IG5266NHG	<input checked="" type="checkbox"/>	—

QuickGrip™ NEMA 5-15

Rating A V/AC	Product Type & Cord Diameter	Body Color	Plug	Catalog No.	
				Connector	Connector
15 125	● Straight Body 0.22-0.66" (5.6-16.8mm)	Gray	<input type="checkbox"/> 8115GY	<input checked="" type="checkbox"/>	—

Hospital Specification Grade Straight Blade Plugs & Connectors

2-Pole, 3-Wire Grounding
20A, 125V/AC
NEMA 5-20

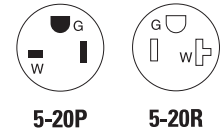

Hospital Grade Plugs & Connectors

Safety Grip™ NEMA 5-20

Rating A V/AC	Product Type & Cord Diameter	Body Color	Plug	Catalog No.	
				Connector	Connector
20 125	● Straight Body 0.33-0.66" (7.6-16.7mm)	Black & White	<input type="checkbox"/> 6766HG	<input checked="" type="checkbox"/> 6769HG	<input checked="" type="checkbox"/> 6769HG
	● Angled Body 0.33-0.66" (7.6-16.7mm)	Black & White	<input type="checkbox"/> 6765HG	<input checked="" type="checkbox"/>	—
	● Angled Body 0.33-0.66" (7.6-16.7mm)	Clear	<input type="checkbox"/> 6765HGC	<input checked="" type="checkbox"/>	—

AutoGrip™ NEMA 5-20

Rating A V/AC	Product Type & Cord Diameter	Body Color	Plug	Catalog No.	
				Connector	Connector
20 125	● Straight Body 0.33-0.66" (7.6-16.7mm)	Black & White	<input type="checkbox"/> 5366NHG	<input checked="" type="checkbox"/> 5369NHG	<input checked="" type="checkbox"/> 5369NHG

Hospital Grade Dimensional Information: B-18

Specification Information:

Safety Grip HG Plugs & Connectors: B-25

AutoGrip HG Plugs & Connectors: B-25

QuickGrip HG Plugs & Connectors: B-25

Icon Key

● Hospital Grade Device

NAFTA Compliant - see page O-30

Hospital Specification Grade Straight Blade Plugs & Connectors

2-Pole, 3-Wire Grounding
15A, 250V/AC
NEMA 6-15

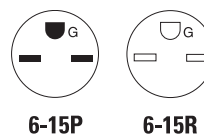

Hospital Grade Plugs & Connectors

Safety Grip™ NEMA 6-15



Rating	Product Type & Cord Diameter	Body Color	Plug	Connector	Catalog No.
A 250	● Angled Body 0.33-0.66" (7.6-16.7mm)	Black & White	□ 6665HG	—	●
	● Angled Body 0.33-0.66" (7.6-16.7mm)	Clear	□ 6665HGC	—	●

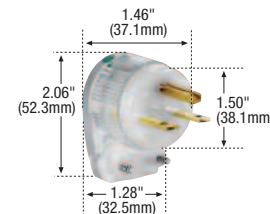

6665HGC

Hospital Specification Grade Straight Blade Plugs & Connectors

2-Pole, 3-Wire Grounding
20A, 250V/AC
NEMA 6-20

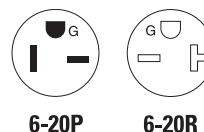

Hospital Grade Plugs & Connectors

Safety Grip™ NEMA 6-20



Rating	Product Type & Cord Diameter	Body Color	Plug	Connector	Catalog No.
A 250	● Angled Body 0.33-0.66" (7.6-16.7mm)	Black & White	□ 6865HG	—	●
	● Angled Body 0.33-0.66" (7.6-16.7mm)	Clear	□ 6865HGC	—	●



6865HG

Icon Key

● Hospital Grade Device

🇺🇸 NAFTA Compliant - see page O-30

Hospital Grade Dimensional Information: B-18

Specification Information:

Safety Grip HG Plugs & Connectors: B-25

Industrial Specification Grade Straight Blade Plugs & Connectors

2-Pole, 3-Wire Grounding
15A, 125V/AC
NEMA 5-15

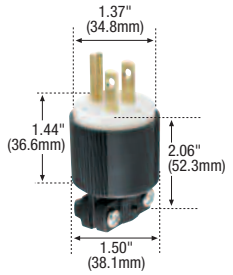
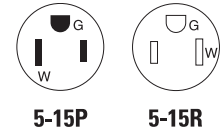

6266

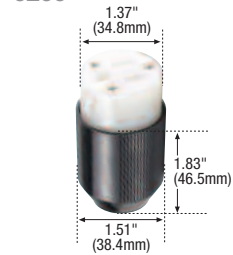

5269N



5969BLK

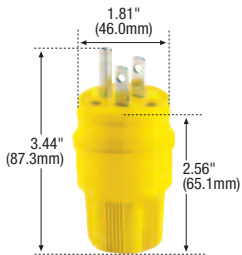

14W47



1547

Industrial Grade Dimensional Information: B-18

Specification Information:

Safety Grip Industrial Plugs & Connectors: B-26

AutoGrip Industrial Plugs & Connectors: B-26

Corrosion Resistant AutoGrip Industrial Plugs & Connectors: B-29

QuickGrip Plugs & Connectors: B-26

Watertight Industrial Plugs & Connectors: B-28

Severe Duty Industrial Plugs & Connectors: B-29

Industrial Grade Plugs & Connectors

Safety Grip™ NEMA 5-15



Rating	A	V/AC	Product Type & Cord Diameter	Color	Plug	Catalog No.	Connector
15	125		Straight Body 0.33-0.66" (6.4-16.7mm)	Black & White	<input type="checkbox"/> 6266	<input checked="" type="checkbox"/> 6269	<input checked="" type="checkbox"/>
			Straight Body 0.33-0.66" (6.4-16.7mm)	Black	<input type="checkbox"/> 6266BLK	<input checked="" type="checkbox"/> 6269BLK	<input checked="" type="checkbox"/>
			Angled Body 0.33-0.66" (7.6-16.7mm)	Black & White	<input type="checkbox"/> 6265	<input checked="" type="checkbox"/>	<input type="checkbox"/>

AutoGrip™ NEMA 5-15



Rating	A	V/AC	Product Type & Cord Diameter	Color	Plug	Catalog No.	Connector
15	125		Straight Body 0.33-0.66" (6.4-16.7mm)	Black & White	<input type="checkbox"/> 5266N	<input checked="" type="checkbox"/> 5269N	<input checked="" type="checkbox"/>
			Corrosion Resistant, Straight Body 0.33-0.66" (6.4-16.7mm)	Yellow	<input type="checkbox"/> 5266NCR	<input checked="" type="checkbox"/> 5269NCR	<input checked="" type="checkbox"/>

QuickGrip™ NEMA 5-15



Rating	A	V/AC	Product Type & Cord Diameter	Color	Plug	Catalog No.	Connector
15	125		Straight Body 0.23-0.72" (5.8-18.3mm)	Black	<input type="checkbox"/> 5965BLK	<input checked="" type="checkbox"/> 5969BLK	<input checked="" type="checkbox"/>

Watertight NEMA 5-15



Rating	A	V/AC	Product Type & Cord Diameter	Color	Plug	Catalog No.	Connector
15	125		Straight Body 0.30-0.65" (7.6-16.5mm)	Yellow	<input type="checkbox"/> 14W47	<input checked="" type="checkbox"/> 15W47	<input checked="" type="checkbox"/>
			Straight Body 0.30-0.65" (7.6-16.5mm)	Black	<input type="checkbox"/> 14W47BK	<input checked="" type="checkbox"/> 15W47BK	<input checked="" type="checkbox"/>

Severe Duty NEMA 5-15



Rating	A	V/AC	Product Type & Cord Diameter	Color	Plug	Catalog No.	Connector
15	125		Straight Body 0.38-1.00" (19.1-25.4mm)	Yellow & Black	<input type="checkbox"/> 1447	<input checked="" type="checkbox"/> 1547	<input checked="" type="checkbox"/>

Icon Key

NAFTA Compliant - see page O-30

Accessories for Industrial Grade NEMA 5-15 Plugs & Connectors

Description	Catalog No.
Watertight plug closure cap for 15A plug	<input type="checkbox"/> 14W <input checked="" type="checkbox"/>
Replacement watertight connector closure cap for 15A connector	<input type="checkbox"/> 15W <input checked="" type="checkbox"/>
Wire mesh grip for 15A watertight plugs & connectors, 0.30-0.50" (7.6-12.7mm) cord dia.	<input type="checkbox"/> WM115 <input checked="" type="checkbox"/>
Wire mesh grip for 15A watertight plugs & connectors, 0.50-0.62" (12.7-15.8mm) cord dia.	<input type="checkbox"/> WM116 <input checked="" type="checkbox"/>



14W



15W



WM115



WM116

Industrial Specification Grade Straight Blade Flanged Inlets & Outlets

2-Pole, 3-Wire Grounding
15A, 125V/AC
NEMA 5-15



5278C

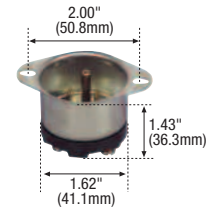

5278

Industrial Grade Flanged Inlets & Outlets

NEMA 5-15



Rating	A	V/AC	Product Type	Color	Flanged Inlet	Catalog No.	Flanged Outlet
15	125		Nylon Construction, Back Wire	Black & White	□ 5278C	•	□ 5279C* •
			Metal Shell, Back Wire	N/A	□ 5278	•	—
			Metal Shell, Side Wire	N/A	—	□ 5246*	•

* UL Certified only

Industrial Specification Grade Straight Blade Watertight Receptacles

2-Pole, 3-Wire Grounding
15A, 125V/AC
NEMA 5-15R

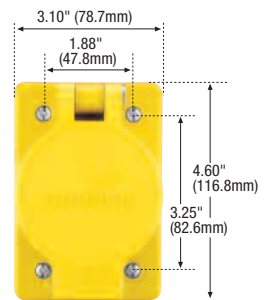

60W47

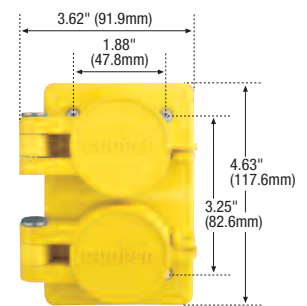

60W47DPLX

Watertight Industrial Grade Receptacles

Back Wire & Side Wire, NEMA 5-15



Rating	A	V/AC	Product Type & Cord Diameter	Color	Catalog No.
15	125		Single Watertight Receptacle 0.30-0.65" (7.6-16.5mm)	Yellow	□ 60W47 •
			Single Watertight Receptacle 0.30-0.65" (7.6-16.5mm)	Black	□ 60W47BK •
			Duplex Watertight Receptacle 0.30-0.65" (7.6-16.5mm)	Yellow	□ 60W47DPLX •
			Duplex Watertight Receptacle 0.30-0.65" (7.6-16.5mm)	Black	□ 60W47DPLXBK •

Icon Key

NAFTA Compliant - see page O-30

Industrial Grade Dimensional Information: B-19

Specification Information:

Industrial Flanged Inlets & Flanged Outlets: B-27

Watertight Industrial Receptacles: B-28

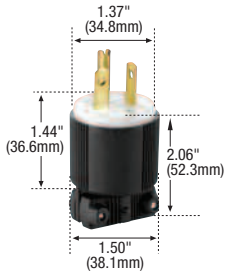

6766

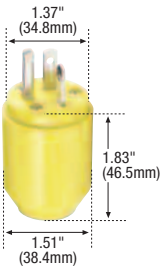

5366NCR

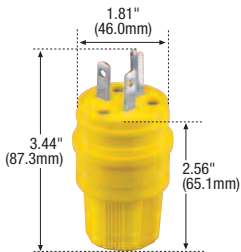

14W33



1533

Industrial Specification Grade Straight Blade Plugs & Connectors

2-Pole, 3-Wire Grounding
20A, 125V/AC
NEMA 5-20



5-20P



5-20R

Industrial Grade Plugs & Connectors

Safety Grip™ NEMA 5-20



Rating	A	V/AC	Product Type & Cord Diameter	Color	Plug	Catalog No.	Connector
20	125		Straight Body 0.33-0.66" (6.4-16.7mm)	Black & White	□ 6766	• □ 6769	•

AutoGrip™ NEMA 5-20



Rating	A	V/AC	Product Type & Cord Diameter	Color	Plug	Catalog No.	Connector
20	125		Straight Body 0.33-0.66" (6.4-16.7mm)	Black & White	□ 5366N	• □ 5369N	•
			Corrosion Resistant, Straight Body 0.33-0.66" (6.4-16.7mm)	Yellow	□ 5366NCR	• □ 5369NCR	•

Watertight NEMA 5-20



Rating	A	V/AC	Product Type & Cord Diameter	Color	Plug	Catalog No.	Connector
20	125		Straight Body 0.30-0.65" (7.6-16.5mm)	Yellow	□ 14W33	• □ 15W33	•
			Straight Body 0.30-0.65" (7.6-16.5mm)	Black	□ 14W33BK	• □ 15W33BK	•

Severe Duty NEMA 5-20



Rating	A	V/AC	Product Type & Cord Diameter	Color	Plug	Catalog No.	Connector
20	125		Straight Body 0.38-1.00" (19.1-25.4mm)	Yellow & Black	□ 1433	• □ 1533	•

Icon Key

NAFTA Compliant - see page O-30

Accessories for Industrial Grade NEMA 5-15 Plugs & Connectors

Description	Catalog No.
Watertight plug closure cap for 20A plug	□ 14W •
Replacement watertight connector closure cap for 20A connector	□ 15W •
Wire mesh grip for 20A watertight plugs & connectors, 0.30-0.50" (7.6-12.7mm) cord dia.	□ WM115 •
Wire mesh grip for 20A watertight plugs & connectors, 0.50-0.62" (12.7-15.8mm) cord dia.	□ WM116 •



14W



15W



WM115



WM116

Industrial Grade Dimensional Information: B-18

Specification Information:

Safety Grip Industrial Plugs & Connectors: B-26

AutoGrip Industrial Plugs & Connectors: B-26

Corrosion Resistant AutoGrip Industrial Plugs & Connectors: B-29

Watertight Industrial Plugs & Connectors: B-28

Severe Duty Industrial Plugs & Connectors: B-29

Industrial Specification Grade Straight Blade Flanged Inlets & Outlets

2-Pole, 3-Wire Grounding
20A, 125V/AC
NEMA 5-20

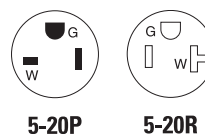

Industrial Grade Flanged Inlets & Outlets

NEMA 5-20



Rating		Product Type	Color	Catalog No.	
A	V/AC			Flanged Inlet	Flanged Outlet
20	125	Nylon Construction, Back Wire	Black & White	□ 5778C	• □ 5779C* •

* UL Certified only



5778C

Industrial Specification Grade Straight Blade Watertight Receptacles

2-Pole, 3-Wire Grounding
20A, 125V/AC
NEMA 5-20R



Watertight Industrial Grade Receptacles

Back Wire & Side Wire, NEMA 5-20



Rating		Product Type & Cord Diameter	Color	Catalog No.	NAFTA
A	V/AC				
20	125	Single Watertight Receptacle 0.30-0.65" (7.6-16.5mm)	Yellow	□ 60W33	•
		Single Watertight Receptacle 0.30-0.65" (7.6-16.5mm)	Black	□ 60W33BK	•
		Duplex Watertight Receptacle 0.30-0.65" (7.6-16.5mm)	Yellow	□ 60W33DPLX	•
		Duplex Watertight Receptacle 0.30-0.65" (7.6-16.5mm)	Black	□ 60W33DPLXBK	•

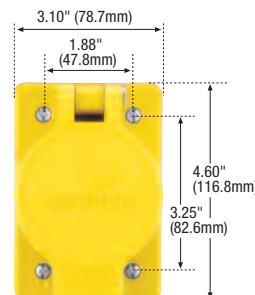

60W33

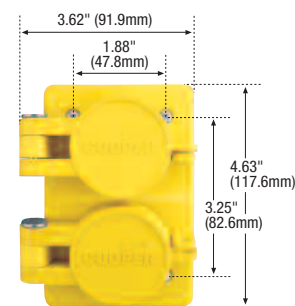

60W33DPLX

Icon Key

NAFTA Compliant - see page O-30

Industrial Grade Dimensional Information: B-19

Specification Information:

Industrial Flanged Inlets & Flanged Outlets: B-27

Watertight Industrial Receptacles: B-28

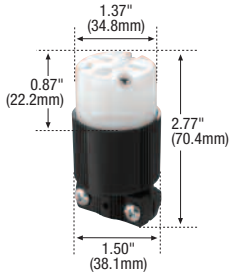

6669



5666N

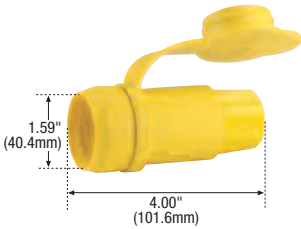

15W49

Industrial Specification Grade Straight Blade Plugs & Connectors

2-Pole, 3-Wire Grounding
15A, 250V/AC
NEMA 6-15

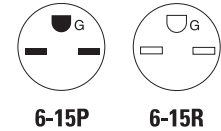

Industrial Grade Plugs & Connectors

Safety Grip™ NEMA 6-15



Rating	A	V/AC	Product Type & Cord Diameter	Color	Plug	Catalog No.	Connector
15	250		Straight Body 0.33-0.66" (6.4-16.7mm)	Black & White	<input type="checkbox"/> 6666	<input checked="" type="checkbox"/> 6669	<input type="checkbox"/> 6669

AutoGrip™ NEMA 6-15



Rating	A	V/AC	Product Type & Cord Diameter	Color	Plug	Catalog No.	Connector
15	250		Straight Body 0.33-0.66" (6.4-16.7mm)	Black & White	<input type="checkbox"/> 5666N	<input checked="" type="checkbox"/> 5669N	<input type="checkbox"/> 5669N

Watertight NEMA 6-15



Rating	A	V/AC	Product Type & Cord Diameter	Color	Plug	Catalog No.	Connector
15	250		Straight Body 0.30-0.65" (7.6-16.5mm)	Yellow	<input type="checkbox"/> 14W49	<input checked="" type="checkbox"/> 15W49	<input type="checkbox"/> 15W49
			Straight Body 0.30-0.65" (7.6-16.5mm)	Black	<input type="checkbox"/> 14W49BK	<input checked="" type="checkbox"/> 15W49BK	<input type="checkbox"/> 15W49BK

Severe Duty NEMA 6-15



Rating	A	V/AC	Product Type & Cord Diameter	Color	Plug	Catalog No.	Connector
15	250		Straight Body 0.38-1.00" (19.1-25.4mm)	Yellow & Black	<input type="checkbox"/> 1449	<input checked="" type="checkbox"/> 1549	<input type="checkbox"/> 1549

Icon Key

NAFTA Compliant - see page O-30

Accessories for Industrial Grade NEMA 5-15 Plugs & Connectors

Description	Catalog No.
Watertight plug closure cap for 15A plug	<input type="checkbox"/> 14W
Replacement watertight connector closure cap for 15A connector	<input type="checkbox"/> 15W
Wire mesh grip for 15A watertight plugs & connectors, 0.30-0.50" (7.6-12.7mm) cord dia.	<input type="checkbox"/> WM115
Wire mesh grip for 15A watertight plugs & connectors, 0.50-0.62" (12.7-15.8mm) cord dia.	<input type="checkbox"/> WM116



14W



15W



WM115



WM116

Industrial Grade Dimensional Information: B-18

Specification Information:

Safety Grip Industrial Plugs & Connectors: B-26

AutoGrip Industrial Plugs & Connectors: B-26

Watertight Industrial Plugs & Connectors: B-28

Severe Duty Industrial Plugs & Connectors: B-29

Industrial Specification Grade Straight Blade Flanged Inlets & Outlets

2-Pole, 3-Wire Grounding
15A, 250V/AC
NEMA 6-15

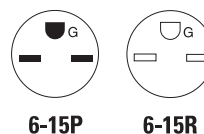

Industrial Grade Flanged Inlets & Outlets

NEMA 6-15

Rating		Product Type	Color	Catalog No.		UL	SR
A	V/AC			Flanged Inlet	Flanged Outlet		
15	250	Nylon Construction, Back Wire	Black & White	□ 5678C	• □ 5679C		



5679C

Industrial Specification Grade Straight Blade Watertight Receptacles

2-Pole, 3-Wire Grounding
15A, 250V/AC
NEMA 6-15R

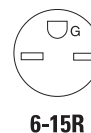

Watertight Industrial Grade Receptacles

Back Wire & Side Wire, NEMA 6-15

Rating		Product Type & Cord Diameter	Color	Catalog No.	UL
A	V/AC				
15	250	Single Watertight Receptacle 0.30-0.65" (7.6-16.5mm)	Yellow	□ 60W49	•
		Single Watertight Receptacle 0.30-0.65" (7.6-16.5mm)	Black	□ 60W49BK	•
		Duplex Watertight Receptacle 0.30-0.65" (7.6-16.5mm)	Yellow	□ 60W49DPLX	•
		Duplex Watertight Receptacle 0.30-0.65" (7.6-16.5mm)	Black	□ 60W49DPLXBK	•

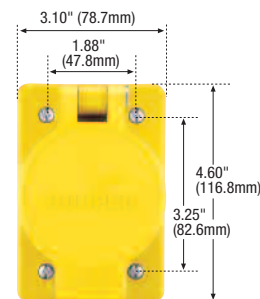

60W49

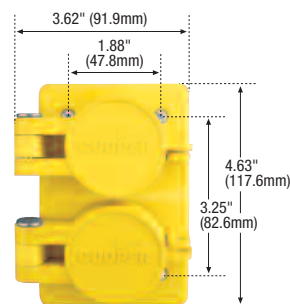

60W49DPLX

Icon Key

NAFTA Compliant - see page O-30

Industrial Grade Dimensional Information: B-19

Specification Information:

Industrial Flanged Inlets & Flanged Outlets: B-27

Watertight Industrial Receptacles: B-28

Industrial Specification Grade Straight Blade Plugs & Connectors

2-Pole, 3-Wire Grounding
20A, 250V/AC
NEMA 6-20

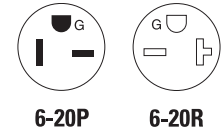

Industrial Grade Plugs & Connectors

Safety Grip™ NEMA 6-20



Rating	A	V/AC	Product Type & Cord Diameter	Color	Plug	Catalog No.	
20	250		Straight Body 0.33-0.66" (6.4-16.7mm)	Black & White	<input type="checkbox"/> 6866	<input checked="" type="checkbox"/> 6869	<input checked="" type="checkbox"/> 6869

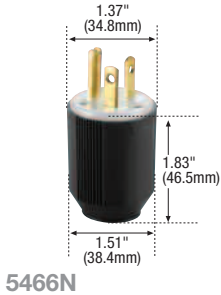

AutoGrip™ NEMA 6-20



Rating	A	V/AC	Product Type & Cord Diameter	Color	Plug	Catalog No.	
20	250		Straight Body 0.33-0.66" (6.4-16.7mm)	Black & White	<input type="checkbox"/> 5466N	<input checked="" type="checkbox"/> 5469N	<input checked="" type="checkbox"/> 5469N

Watertight NEMA 6-20



Rating	A	V/AC	Product Type & Cord Diameter	Color	Plug	Catalog No.	
20	250		Straight Body 0.30-0.65" (7.6-16.5mm)	Yellow	<input type="checkbox"/> 14W48	<input checked="" type="checkbox"/> 15W48	<input checked="" type="checkbox"/> 15W48
			Straight Body 0.30-0.65" (7.6-16.5mm)	Black	<input type="checkbox"/> 14W48BK	<input checked="" type="checkbox"/> 15W48BK	<input checked="" type="checkbox"/> 15W48BK



Severe Duty NEMA 6-20



Rating	A	V/AC	Product Type & Cord Diameter	Color	Plug	Catalog No.	
20	250		Straight Body 0.38-1.00" (19.1-25.4mm)	Yellow & Black	<input type="checkbox"/> 1448	<input checked="" type="checkbox"/> 1548	<input checked="" type="checkbox"/> 1548

Icon Key

NAFTA Compliant - see page O-30

Accessories for Industrial Grade NEMA 5-15 Plugs & Connectors

Description	Catalog No.	
Watertight plug closure cap for 20A plug	<input type="checkbox"/> 14W	<input checked="" type="checkbox"/>
Replacement watertight connector closure cap for 20A connector	<input type="checkbox"/> 15W	<input checked="" type="checkbox"/>
Wire mesh grip for 20A watertight plugs & connectors, 0.30-0.50" (7.6-12.7mm) cord dia.	<input type="checkbox"/> WM115	<input checked="" type="checkbox"/>
Wire mesh grip for 20A watertight plugs & connectors, 0.50-0.62" (12.7-15.8mm) cord dia.	<input type="checkbox"/> WM116	<input checked="" type="checkbox"/>



14W



15W



WM115



WM116

Industrial Grade Dimensional Information: B-18

Specification Information:

Safety Grip Industrial Plugs & Connectors: B-26

AutoGrip Industrial Plugs & Connectors: B-26

Watertight Industrial Plugs & Connectors: B-28

Severe Duty Industrial Plugs & Connectors: B-29

Industrial Specification Grade Straight Blade Flanged Inlets & Outlets

2-Pole, 3-Wire Grounding
20A, 250V/AC
NEMA 6-20

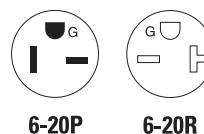

Industrial Grade Flanged Inlets & Outlets

NEMA 6-20



Rating		Product Type	Color	Catalog No.	
A	V/AC			Flanged Inlet	Flanged Outlet
20	250	Nylon Construction, Back Wire	Black & White	□ 5878C	□ 5879C*

* UL Certified only



5879C

Industrial Specification Grade Straight Blade Watertight Receptacles

2-Pole, 3-Wire Grounding
20A, 250V/AC
NEMA 6-20R



Watertight Industrial Grade Receptacles

Back Wire & Side Wire, NEMA 6-20



Rating		Product Type & Cord Diameter	Color	Catalog No.	NAFTA
A	V/AC				
20	250	Single Watertight Receptacle 0.30-0.65" (7.6-16.5mm)	Yellow	□ 60W48	•
		Single Watertight Receptacle 0.30-0.65" (7.6-16.5mm)	Black	□ 60W48BK	•
		Duplex Watertight Receptacle 0.30-0.65" (7.6-16.5mm)	Yellow	□ 60W48DPLX	•
		Duplex Watertight Receptacle 0.30-0.65" (7.6-16.5mm)	Black	□ 60W48DPLXBK	•

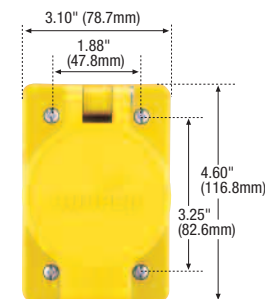

60W48

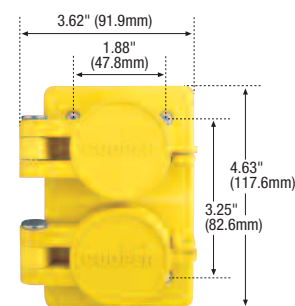

60W48DPLX

Icon Key

NAFTA Compliant - see page O-30

Industrial Grade Dimensional Information: B-19

Specification Information:

Industrial Flanged Inlets & Flanged Outlets: B-27

Watertight Industrial Receptacles: B-28

Industrial Specification Grade Straight Blade Plugs & Connectors

2-Pole, 3-Wire Grounding
20A, 277V/AC
NEMA 7-20

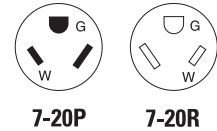

Industrial Grade Plugs & Connectors

Safety Grip™ NEMA 7-20



Rating	A	V/AC	Product Type & Cord Diameter	Color	Catalog No. Plug
20	277		Straight Body 0.38-1.00" (9.5-25.4mm)	Black & White	□ 7624N •



9151N

Industrial Specification Grade Straight Blade Plugs & Connectors

3-Pole, 3-Wire Non-Grounding
20A, 125/250V/AC
NEMA 10-20

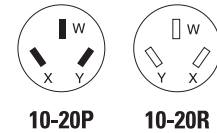

Industrial Grade Plugs & Connectors

Safety Grip™ NEMA 10-20



Rating	A	V/AC	Product Type & Cord Diameter	Color	Catalog No. Plug
20	125/250		Straight Body 0.38-1.00" (9.5-25.4mm)	Black & White	□ 9151N •

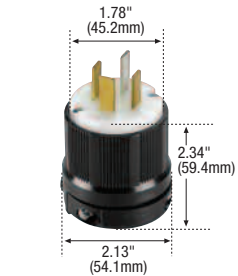

7251N

Industrial Specification Grade Straight Blade Plugs & Connectors

4-Pole, 4-Wire Non-Grounding
20A, 3ØY 120/208V/AC
NEMA 18-20

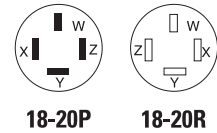

Industrial Grade Plugs & Connectors

Safety Grip™ NEMA 18-20



Rating	A	V/AC	Product Type & Cord Diameter	Color	Catalog No. Plug
20	3ØY	120/208	Straight Body 0.38-1.00" (9.5-25.4mm)	Black & White	□ 7251N •

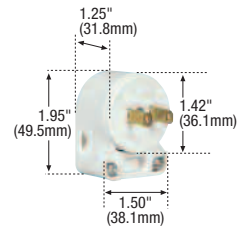

4862ANW

Commercial Specification Grade Straight Blade Plugs & Connectors

2-Pole, 2-Wire Non-Grounding
15A, 125V/AC
NEMA 1-15

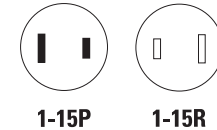

Commercial Grade Plugs & Connectors

Vinyl NEMA 1-15



Rating	A	V/AC	Product Type & Cord Diameter	Color	Plug	Catalog No. Connector
15	125		Straight Body 0.25-0.66" (6.4-16.6mm)	Yellow	□ 4862 •	□ 4882* •
			Angled Body 0.25-0.66" (6.4-16.6mm)	White	□ 4862ANW* •	—

* Not NOM Certified

Icon Key

NAFTA Compliant - see page O-30

Industrial Grade Dimensional Information: B-18

Commercial Grade Dimensional Information: B-19

Specification Information:

Safety Grip Industrial Plugs & Connectors: B-26

Commercial Grade Plugs & Connectors: B-30

Commercial Specification Grade Straight Blade Plugs & Connectors

2-Pole, 3-Wire Grounding
15A, 125V/AC
NEMA 5-15



5-15P

5-15R

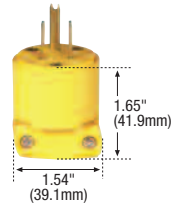

4867

Commercial Grade Plugs & Connectors

Vinyl NEMA 5-15



Rating A	V/AC	Product Type & Cord Diameter	Color	Plug	Catalog No.	
					Plug	Connector
15	125	Straight Body 0.25-0.66" (6.4-16.7mm)	Yellow	□ 4867	•	□ 4887 •
		Angled Body 0.25-0.66" (6.4-16.7mm)	Yellow	□ 4867AN	•	—
		Angled Body 0.25-0.66" (6.4-16.7mm)	White	□ 4867ANW	•	—

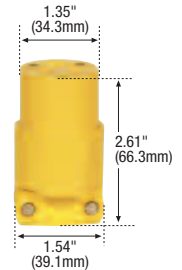

4887

Commercial Specification Grade Straight Blade Plugs & Connectors

2-Pole, 3-Wire Grounding
20A, 125V/AC
NEMA 5-20



5-20P

5-20R

Commercial Grade Plugs & Connectors

Vinyl NEMA 5-20



Rating A	V/AC	Product Type & Cord Diameter	Color	Plug	Catalog No.	
					Plug	Connector
20	125	Straight Body 0.25-0.66" (6.4-16.7mm)	Yellow	□ 4409	•	□ 4228 •
		Angled Body 0.25-0.66" (6.4-16.7mm)	Yellow	□ 4409AN	•	—

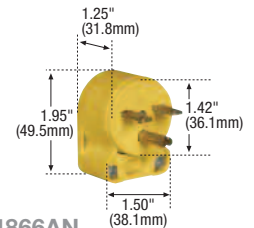

4866AN

Commercial Specification Grade Straight Blade Plugs & Connectors

2-Pole, 3-Wire Grounding
15A, 250V/AC
NEMA 6-15



6-15P

6-15R

Commercial Grade Plugs & Connectors

Vinyl NEMA 6-15



Rating A	V/AC	Product Type & Cord Diameter	Color	Plug	Catalog No.	
					Plug	Connector
15	250	Straight Body 0.25-0.66" (6.4-16.7mm)	Yellow	□ 4866	•	□ 4227 •
		Angled Body 0.25-0.66" (6.4-16.7mm)	Yellow	□ 4866AN	•	—



4229

Commercial Specification Grade Straight Blade Plugs & Connectors

2-Pole, 3-Wire Grounding
20A, 250V/AC
NEMA 6-20



6-20P

6-20R

Commercial Grade Plugs & Connectors

Vinyl NEMA 6-20



Rating A	V/AC	Product Type & Cord Diameter	Color	Plug	Catalog No.	
					Plug	Connector
20	250	Straight Body 0.25-0.66" (6.4-16.7mm)	Yellow	□ 4509	•	□ 4229* •
		Angled Body 0.25-0.66" (6.4-16.7mm)	Yellow	□ 4509AN	•	—

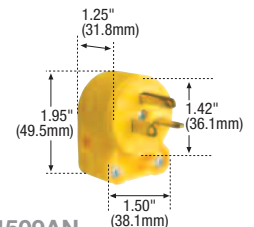

4509AN

* Not NOM Certified

Icon Key

NAFTA Compliant - see page O-30

Commercial Grade Dimensional
Information: B-19

Specification Information:

Commercial Grade Plugs &
Connectors: B-30

Straight Blade Plugs & Connectors

Safety Grip™ Plugs

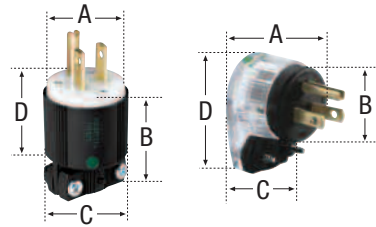

Family	A	B	C	D	Cord Dia.
Hospital Grade	1.37" (34.8mm)	2.06" (52.3mm)	1.50" (38.1mm)	1.44" (36.6mm)	0.33-0.66" (7.6-16.7mm)
Hospital Grade Angled	1.46" (37.1mm)	1.50" (38.1mm)	1.28" (32.5mm)	2.06" (52.3mm)	0.33-0.66" (7.6-16.7mm)
Industrial Grade	1.37" (34.8mm)	2.06" (52.3mm)	1.50" (38.1mm)	1.44" (36.6mm)	0.33-0.66" (6.4-16.7mm)
Industrial Grade Angled	1.28" (32.5mm)	1.46" (37.1mm)	1.50" (38.1mm)	2.06" (52.3mm)	0.33-0.66" (7.6-16.7mm)
Industrial Grade NEMA 7-20, 10-20 & 18-20	1.78" (45.2mm)	2.34" (59.4mm)	2.13" (54.1mm)	-	0.38-1.00" (9.5-25.4mm)

Safety Grip™ Connectors

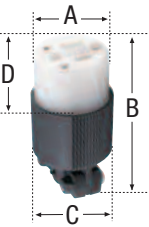

Family	A	B	C	D	Cord Dia.
Hospital Grade	1.37" (34.8mm)	2.77" (70.4mm)	1.50" (38.1mm)	0.87" (22.1mm)	0.33-0.66" (7.6-16.7mm)
Industrial Grade	1.37" (34.8mm)	2.77" (70.4mm)	1.50" (38.1mm)	0.87" (22.1mm)	0.33-0.66" (6.4-16.7mm)

Auto Grip™ Plugs

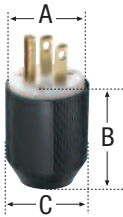

Family	A	B	C	Cord Dia.
Hospital Grade	1.38" (34.9mm)	1.83" (46.5mm)	1.52" (38.6mm)	0.33-0.66" (7.6-16.7mm)
Industrial Grade	1.37" (34.8mm)	1.83" (46.5mm)	1.51" (38.4mm)	0.33-0.66" (6.4-16.7mm)

Auto Grip™ Connectors

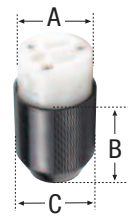

Family	A	B	C	Cord Dia.
Hospital Grade	1.38" (34.9mm)	1.83" (46.5mm)	1.52" (38.6mm)	0.33-0.66" (7.6-16.7mm)
Industrial Grade	1.37" (34.8mm)	1.83" (46.5mm)	1.51" (38.4mm)	0.33-0.66" (6.4-16.7mm)

QuickGrip™ Plugs

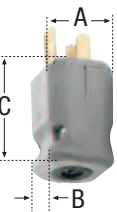

Family	A	B	C	Cord Dia.
Hospital Grade	1.22" (31.0mm)	1.34" (34.0mm)	1.81" (46.0mm)	0.22-0.66" (5.6-16.7mm)
Industrial Grade	1.22" (31.0mm)	1.34" (34.0mm)	1.81" (46.0mm)	0.23-0.72" (5.8-18.3mm)

QuickGrip™ Connectors

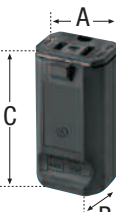

Family	A	B	C	Cord Dia.
Industrial Grade	1.34" (34.0mm)	1.25" (31.8mm)	2.66" (67.6mm)	0.23-0.72" (5.8-18.3mm)

Watertight & Severe Duty Plugs

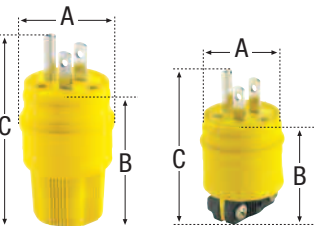

Family	A	B	C	Cord Dia.
Watertight	1.81" (46.0mm)	2.56" (65.1mm)	3.44" (87.3mm)	0.30-0.65" (7.6-16.5mm)
Severe Duty	1.69" (42.9mm)	2.10" (53.3mm)	2.09" (53.1mm)	0.38-1.00" (9.7-25.4mm)

Watertight & Severe Duty Connectors

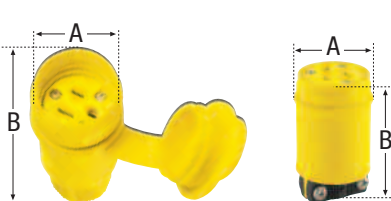

Family	A	B	Cord Dia.
Watertight	1.59" (40.5mm)	4.00" (101.6mm)	0.30-0.65" (7.6-16.5mm)
Severe Duty	1.69" (42.9mm)	2.78" (70.6mm)	0.38-1.00" (9.7-25.4mm)

Straight Blade Plugs & Connectors, & Flanged Inlets & Flanged Outlets

Nylon Shell Flanged Inlets

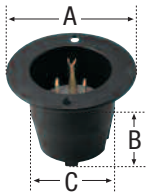

Family	A	B	C
Industrial Grade	2.56" (65.0mm)	1.84" (46.7mm)	1.71" (43.4mm)

Nylon Shell Flanged Outlets



Family	A	B	C
Industrial Grade	2.56" (65.0mm)	1.84" (46.7mm)	1.71" (43.4mm)

Metal Shell Flanged Inlets

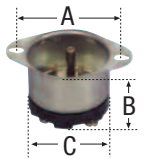

Family	A	B	C
Industrial Grade	2.00" (50.8mm)	1.43" (36.3mm)	1.62" (41.1mm)

Metal Shell Flanged Outlets

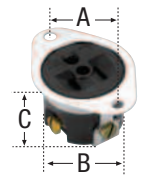

Family	A	B	C
Industrial Grade	2.06" (52.3mm)	1.50" (38.1mm)	1.09" (27.7mm)

Watertight Receptacles

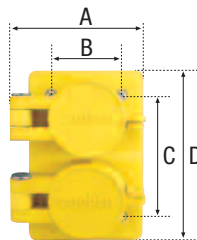
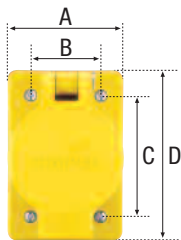

Family	A	B	C	D	Cord Dia.
Single Receptacle	3.10" (78.7mm)	1.88" (47.8mm)	3.25" (82.6mm)	4.60" (116.8mm)	0.30-0.65" (7.6-16.5mm)
Duplex Receptacle	3.62" (91.9mm)	1.88" (47.8mm)	3.25" (82.6mm)	4.63" (117.6mm)	0.30-0.65" (7.6-16.5mm)

Commercial Plugs

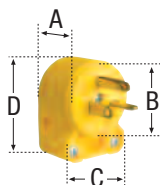
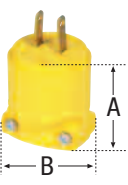

Family	A	B	C	D	Cord Dia.
Commercial Grade	1.65" (41.9mm)	1.54" (39.1mm)	-	-	0.25-0.66" (6.4-16.6mm)
Commercial Grade Angled	1.25" (31.8mm)	1.42" (36.1mm)	1.50" (38.1mm)	1.95" (49.5mm)	0.25-0.66" (6.4-16.6mm)

Commercial Connectors

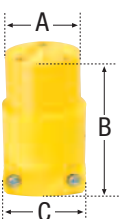

Family	A	B	C	Cord Dia.
Commercial Grade	1.35" (34.3mm)	2.61" (66.3mm)	1.54" (39.1mm)	0.25-0.66" (6.4-16.6mm)



Industrial Straight Blade Power Devices

Rugged high-strength thermoplastic construction

Neoprene gasket seals around cord for added terminal protection from external elements

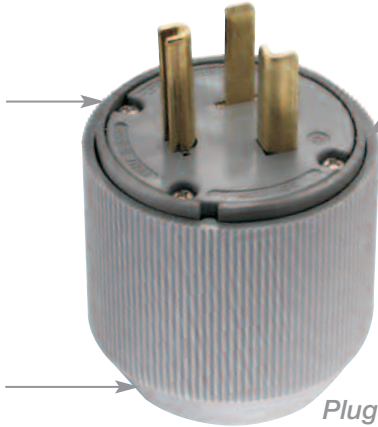

Plug

Unique internal clamp design secures cord during assembly, reducing installation time

Nylon dead-front construction resists ingress from contaminants

Tapered cord grip cover reduces cord snags



Connector

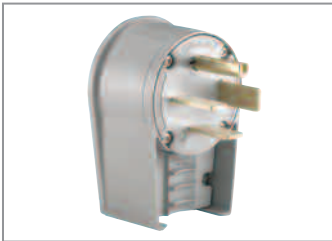

Angled plug versions have 4 possible positions for maximum convenience



Broad selection of flanged inlets accept #12 AWG to #4 AWG conductors

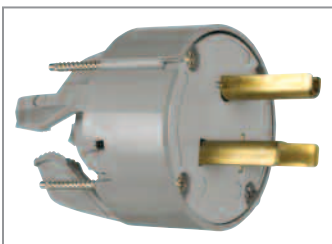

Quick-drive stainless steel assembly screws provide corrosion resistance and speed installation time



Variety of 30A, 50A and 60A configurations available



Commercial Straight Blade Power Devices

Universal plugs include blades for both 30A and 50A configurations of the same voltage

Terminals have pressure plates to protect wires



Plug

Patented lay-in terminals accept up to #4 AWG wire

Back features concentric knockouts and an adjustable cord clamp to allow wiring from back or bottom



Surface Receptacle

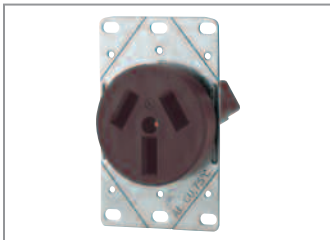

Flush receptacles feature heavy gauge galvanized steel mounting strap and glass-reinforced nylon body



Broad selection of wallplates available for flush receptacle mounting



Surface receptacles can be wired for back or bottom wiring



Variety of 30A, 50A and 60A configurations available

Straight Blade Power Devices - 20, 30, 50 & 60A

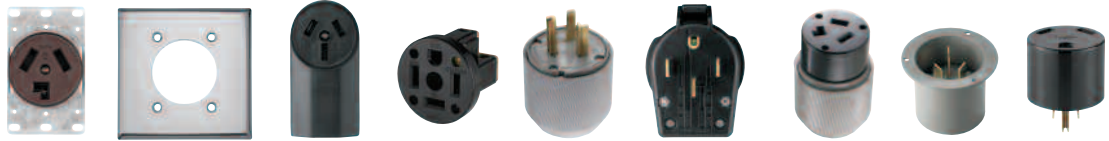

Rating: Amps V/AC	Receptacle/ Plug NEMA Configuration	Flush Receptacle	Wallplate	Surface Receptacle	Panel Mount Receptacle	Plugs	Angle Plugs	Connectors	Flanged Inlets	Adapters	
2-Pole, 3-Wire Grounding											
30A 125V	 5-30R 5-30P	Commercial: 1233 (Brown) Industrial: 5716N (Black)	Standard Size: 39CH, 68, 2068, 2168, 93221, 93227			Industrial: 5717N (Gray)	Commercial: S41 (Black) Industrial: 5717AN (Gray)	Industrial: 6716N (Gray & Black)	Industrial: 5717NFI (Gray)		
30A 125V	 TT-30R TT-30P	Commercial: 1263 (Black)			Commercial: U1263 (Black)		Commercial: 83 (Black)			Commercial: 1264 TT-30 (Plug to NEMA 5-15R or 5-20R) (Black)	
30A 250V	 6-30R 6-30P	Commercial: 1234 (Brown) Industrial: 5700N (Black)			Commercial: 1232 (Black)		Industrial: 5701N (Gray)	Commercial: S42 (Black) Industrial: 5701AN (Gray)	Industrial: 6700N (Gray & Black)	Industrial: 5701NFI (Gray)	
30A 277V	 7-30R 7-30P	Industrial: 5795N (Black)		Mid-Size: 5068, PJ703, PJ724			Industrial: 5703N (Gray)	Industrial: 5703AN (Gray)	Industrial: 6795N (Gray & Black)	Industrial: 5703NFI (Gray)	
50A 125V	 5-50R 5-50P	Commercial: 1253 (Brown)					Industrial: 5712N (Gray)	Commercial: S41 (Black) Industrial: 5712AN (Gray)	Industrial: 6711N (Gray & Black)	Industrial: 5712NFI (Gray)	
50A 250V	 6-50R 6-50P	Commercial: 1254 (Brown) Industrial: 5709N (Black)			Commercial: 1252 (Black)		Industrial: 5710N (Gray)	Commercial: S42 (Black) Industrial: 5710AN (Gray)	Industrial: 6709N (Gray & Black)	Industrial: 5710NFI (Gray)	
50A 277V	 7-50R 7-50P						Industrial: 5705N (Gray)	Industrial: 5705AN (Gray)	Industrial: 6796N (Gray & Black)	Industrial: 5705NFI (Gray)	
3-Pole, 3-Wire Non-Grounding											
20A 125/250V	 10-20R 10-20P	Commercial: 805 (Ivory)				Industrial: 9151N (Gray) Commercial: 2836 (Armd PVC) (Yellow)					
30A 125/250V Dryer	 10-30R 10-30P	Commercial: 38B (Brown)	Standard Size: 39CH, 68, 2068, 2168, 93221, 93227	Commercial: 125 (Black)		Industrial: 9337N (Gray)	Commercial: S80 (Black) Industrial: 9352AN (Gray)	Industrial: 9341N (Gray & Black)	Industrial: 9337NFI (Gray)		
50A 125/250V Range	 10-50R 10-50P	Commercial: 32B (Brown) Industrial: 7985N (Black) Commercial: 122B (Brown)	Mid-Size: 5068, PJ703, PJ724 Standard Size: 192	Commercial: 112 (Black)		Industrial: 4524N (Gray)	Commercial: S80 (Black) Industrial: 7952AN (Gray)	Industrial: 4526N (Gray & Black)	Industrial: 4524NFI (Gray)		

Power Device Dimensional Information: B-24; Specification Information: B-31-B-33

Straight Blade Power Devices - 20, 30, 50 & 60A

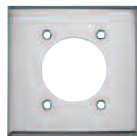

Rating: Amps V/AC	Receptacle/ Plug NEMA Configuration	Flush Receptacles	Wallplate	Surface Receptacle	Panel Mount Receptacle	Plugs	Angle Plugs
3-Pole, 4-Wire Grounding							
20A 125/250V	 14-20R 14-20P	Industrial: 5759 (Black)					
30A 125/250V Dryer	 14-30R 14-30P	Commercial: 1257 (Black)	Standard Size: 39CH, 68, 2068, 2168, 93221, 93227	Commercial: 1225 (Black)		Industrial: 5746N (Gray)	Commercial: S21 (Black)
		Industrial: 5744N (Black)	Standard Size: 69, 5169, 93223				Industrial: 5732AN (Gray)
30A 3Ø 250V	 15-30R 15-30P	Industrial: 8430N (Black)	Standard Size: 69, 5169, 93223			Industrial: 8432N (Gray)	Industrial: 8432AN (Gray)
50A 125/250V Range	 14-50R 14-50P	Commercial: 1258 (Black)	Standard Size: 39CH, 68, 2068, 2168, 93221, 93227	Commercial: 1212 (Black)	Commercial: 58 (Black)	Industrial: 5745N (Gray)	Commercial: S21 (Black)
		Industrial: 5754N (Black)	Standard Size: 69, 5169, 93223				Industrial: 5752AN (Gray)
50A 3Ø 250V	 15-50R 15-50P	Industrial: 8450N (Black)	Standard Size: 69, 5169, 93223			Industrial: 8452N (Gray)	Industrial: 8452AN (Gray)
60A 125/250V	 14-60R 14-60P	Industrial: 9460N (Black)	Standard Size: 69, 5169, 93223		Commercial: 60 (Black)	Industrial: 9462N (Gray)	Commercial: S20 (Black)
							Industrial: 9462AN (Gray)
60A 3Ø 250V	 15-60R 15-60P	Industrial: 8460N (Black)	Standard Size: 69, 5169, 93223			Industrial: AH8462N (Gray)	Industrial: AH8462AN (Gray)
4-Pole, 4-Wire, Non-Grounding							
30A 3ØY 120/208V	 18-30R 18-30P					Industrial: 8332N (Gray)	Industrial: 8332AN (Gray)
50A 3ØY 120/208V	 18-50R 18-50P					Industrial: 8352N (Gray)	Industrial: 8352AN (Gray)
60A 3ØY 120/208V	 18-60R 18-60P	Industrial: 5515N (Black)	Standard Size: 69, 5169, 93223			Industrial: 5517N (Gray)	Commercial: S19 (Black)
							Industrial: 4516AN (Gray)

Straight Blade Power Devices

Flush Receptacles

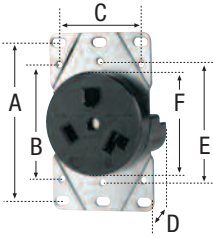

Cat. Nos.	A	B	C	D (depth)	E	F (face dia.)
30 & 1200 Series	3.28" (83.3mm)	2.38" (60.5mm)	1.81" (46.0mm)	1.42" (36.1mm)	2.50" (63.5mm)	2.10" (53.5mm)
5000 & 7000 Series	3.28" (83.3mm)	2.38" (60.5mm)	1.81" (46.0mm)	1.69" (42.9mm)	2.50" (63.5mm)	2.12" (53.8mm)
8000 Series	3.28" (83.3mm)	2.38" (60.5mm)	1.81" (46.0mm)	1.69" (42.9mm)	-	2.38" (60.5mm)

Surface Receptacles

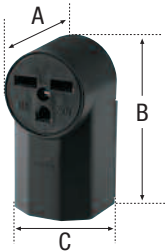

Cat. Nos.	A	B	C
100 & 1200 Series	2.10" (53.3mm)	4.75" (120.7mm)	2.50" (63.5mm)

Panel Mount Receptacles

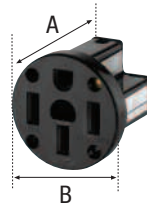

Cat. Nos.	A	B
58, 60	2.80" (71.1mm)	2.80" (71.1mm)
U1263	1.69" (42.9mm)	2.09" (53.1mm)

Angled Plugs

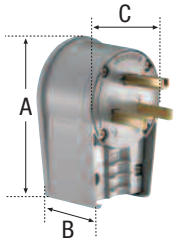

Cat. Nos.	A	B	C	Cord Dia.
80 & 83	2.92" (74.2mm)	1.03" (26.2mm)	2.80" (71.1mm)	83: 0.64" (16.3mm) max. 80: 0.80" (20.3mm) max.
S41 & S42 S20 & S21 S19	3.37" (85.6mm)	1.38" (35.1mm)	2.87" (72.9mm)	S41 & S42: 1.10" (27.9mm) S20 & S21: 1.13" (28.7mm) S19: 1.00" (25.4mm)
4500AN, 5700AN, 7900AN, 8300AN, 8400AN, 9300AN, 9400AN, AH8400AN Series	4.30" (109.2mm)	1.88" (47.8mm)	3.00" (76.2mm)	0.56-1.31" (14.2-33.3mm)

Plugs

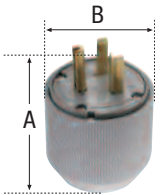

Cat. Nos.	A	B	Cord Dia.
4500N, 5500N, 5700N, 8300N, 8400N, 9300N, 9400N, AH8400N Series	3.34 - 3.81" (84.8 - 96.8mm) varies with dia. of cord	3.12" (79.2mm)	0.43 - 1.31" (10.8 - 33.3mm)

Connectors

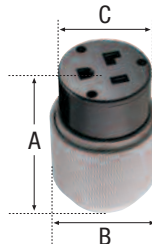

Cat. Nos.	A	B	C	Cord Dia.
6700N, 9300N, 9500N Series	4.71- 5.19" (119.6 - 131.8mm) varies with dia. of cord	3.12" (79.2mm)	2.59" (65.8mm)	0.43- 1.31" (10.8 - 33.3mm)

Flanged Inlets

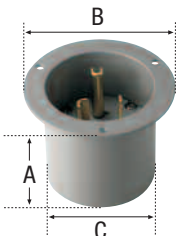

Cat. Nos.	A	B	C
4500NFI, 5700NFI, 9300NFI Series	2.72" (69.1mm)	3.75" (95.3mm)	2.81" (71.4mm)

Miscellaneous Power Devices

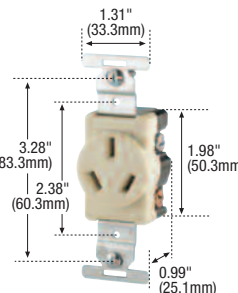

805V

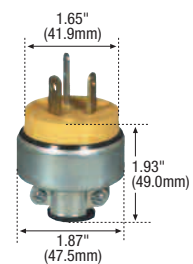

2836

Hospital Specification Grade Plugs & Connectors

2-Pole, 3-Wire Grounding
15A, 125V/AC; 15A, 250V/AC; 20A, 125V/AC; 20A, 250V/AC
NEMA 5-15, 6-15, 5-20, 6-20

	Device Type	Hospital Grade Safety Grip™ Plugs & Connectors, Straight Blade	Hospital Grade AutoGrip™ Plugs & Connectors, Straight Blade	Hospital Grade QuickGrip™ Plugs & Connectors, Straight Blade
	Wiring Type	Back wire	Back wire	Back wire
	Testing & Code Compliance	• Listed to UL498, file no. E3663	• Listed to UL498, file no. E3663	• Listed to UL 498, file no. E146159
		• Complies with Federal Spec. WC-596F	• Complies with Federal Spec. WC-596F	• UL verified to Federal Spec. WC-596F
		• cUL certified to C22.2, no. 42-M1999	• cUL certified to C22.2, no. 42-M1999	• cUL certified to C22.2, no. 42
Specifications: Environmental	Flammability	Meets UL94 requirements; V2 rated	Meets UL94 requirements; V2 rated	Meets UL94 requirements; V2 rated
	Temperature Rating	-40°C to 75°C (-40°F to 167°F)	-40°C to 75°C (-40°F to 167°F)	-40°C to 75°C (-40°F to 167°F)
Specifications: Electrical	Dielectric Voltage	Withstands 1500V per UL498	Withstands 1500V per UL498	Withstands 1500V per UL498
	Current Interrupting	Yes, at full-rated current	Yes, at full-rated current	Yes, at full-rated current
	Temperature Rise	Max. 30°C (86°F) after 250 cycles of overload	Max. 30°C (86°F) after 250 cycles of overload	Max. 30°C (86°F) after 250 cycles of overload
Specifications: Mechanical	Terminal Accommodation	#12 - #18 AWG	#12 - #18 AWG	#12 - #18 AWG
	Voltage Ratings	Permanently marked on device	Permanently marked on device	Permanently marked on device
Materials:	Plug/Connector Outer Shell	Nylon; polycarbonate on C version	Nylon; polycarbonate on C version	Nylon
	Interior Body	Nylon	Nylon	Nylon
	Terminal Retainer	Polycarbonate	Polypropylene	N/A
	Blades	0.065" thick brass	0.065" thick brass	0.060" thick brass
	Line Contacts	0.031" thick brass	0.031" thick brass	0.032" thick brass
	Terminal Clamps	Galvanized steel	Galvanized steel	Brass
	Terminal Screws	#8-32 brass, nickel plated	#8-32 brass, nickel plated	#8-32 steel, hot screw brass plated
	Ground Screw	#8-32 brass, green	#8-32 brass, green	#8-32 steel (green)
	Assembly/ Mounting Screws	Steel	Steel	Steel
	Cord Clamp	Nylon	Polypropylene	Nylon
	Gasket/Dust Shield	EPDM	EPDM	N/A

**Industrial Specification Grade
 Plugs & Connectors**

2-Pole, 3-Wire Grounding
 3-Pole, 3-Wire Non-Grounding
 4-Pole, 4-Wire Non-Grounding

	Device Type	Industrial Grade Safety Grip™ Plugs & Connectors, Straight Blade	Industrial Grade AutoGrip™ Plugs & Connectors, Straight Blade	Industrial Grade QuickGrip™ Plugs & Connectors, Straight Blade	
	Wiring Type	Back wire	Back wire	Back wire	
	Testing & Code Compliance	<ul style="list-style-type: none"> cULus listed to UL 498, file no. E3663 Complies with Federal Spec. WC-596F CSA certified to C22.2, no. 42-99 file no. 7087 (6221-02) 7251N: NOM certified 	<ul style="list-style-type: none"> Listed to UL 498, file no. E3663 UL verified to Fed Spec WC-596F except cat. no. 5266AN CSA certified to C22.2, no. 42-99 file no. 2081 (6221-02) 	<ul style="list-style-type: none"> cULus listed to UL 498, file no. E146159 UL verified to Federal Spec. WC-596F 	
Specifications: Environmental		Flammability	Meets UL94 requirements, V2 rated	Meets UL94 requirements, V2 rated	Meets UL94 requirements, V2 rated
		Temperature Rating	-40°C to 75°C (-40°F to 167°F)	-40°C to 75°C (-40°F to 167°F)	-40°C to 75°C (-40°F to 167°F)
Specifications: Electrical		Dielectric Voltage	Withstands 1500V per UL 498, except 6260 & 6760 Series: 1250V, 7624N: 1554V, 7251N: 4160V	Withstands 1500V per UL 498	Withstands 1500V per UL 498
	Current Interrupting	Yes, at full-rated current	Yes, at full-rated current	Yes, at full-rated current	
	Temperature Rise	Max. 30°C (86°F) after 200 cycles of overload @ 200% of rated current (DC)	Max. 30°C (86°F) after 50 cycles of overload @ 150% of rated current (DC)	Max. 30°C (86°F) after 50 cycles of overload @ 150% of rated current (DC)	
Specifications: Mechanical	Terminal Accommodation	#16 - #12 AWG, except 7624N, 9151N, 7251N: #18 - #10 AWG	#18 - #12 AWG	#18 - #12 AWG	
	Voltage Ratings	Permanently marked on device	Permanently marked on device	Permanently marked on device	
Materials:	Plug/Connector Outer Shell	Nylon	Nylon	Nylon	
	Interior Body	Nylon	Nylon	Nylon	
	Terminal Retainer	Polycarbonate	Polycarbonate	N/A	
	Blades	0.065" thick brass	0.065" thick brass	0.060" thick brass	
	Line Contacts	0.031" thick brass	0.031" thick brass	0.032" thick brass	
	Terminal Clamps	Steel, zinc plated	Steel, zinc plated	Brass	
	Terminal Screws	#8-32 brass, nickel plated	#8-32 brass, nickel plated	Steel, brass plated (hot) and zinc plated (neutral)	
	Ground Contact	0.041" thick brass	0.041" thick bronze	N/A	
	Ground Screw	#8-32 brass, zinc plated, green	#8-32 brass, green	Steel, zinc plated, green	
	Assembly/ Mounting Screws	Steel, zinc plated	Steel, zinc plated	Steel, zinc plated	
	Cord Clamp	Nylon	Polypropylene	Nylon	
	Cord Clamp Screws	Steel, zinc plated	N/A	N/A	
Gasket/Dust Shield	Neoprene	Neoprene	N/A		

Industrial Specification Grade Flanged Inlets & Flanged Outlets

2-Pole, 3-Wire Grounding
15A, 125V/AC; 15A, 250V/AC; 20A, 125V/AC; 20A, 250V/AC
NEMA 5-15, 6-15, 5-20, 6-20

	Device Type	Industrial Grade Flanged Inlets, Straight Blade	Industrial Grade Flanged Outlets, Straight Blade
	Wiring Type	Side wire	Side wire
	Testing & Code Compliance	<ul style="list-style-type: none"> Listed to UL 498, file no. E3663 	<ul style="list-style-type: none"> Listed to UL498, file no. E2369
		<ul style="list-style-type: none"> cUL Listed to CSA C22.2, no. 42-M1999 	<ul style="list-style-type: none"> CSA certified to C22.2, no. 42-99 & 182.3-M1987 file no. 7087 (6233-01)
		<ul style="list-style-type: none"> 5278C, 5678C: also NOM certified 	
Specifications: Environmental	Flammability	Meets UL94 requirements, V2 rated	Meets UL94 requirements, V2 rated
	Temperature Rating	-40°C to 105°C (-40°F to 221°F)	-40°C to 105°C (-40°F to 221°F)
Specifications: Electrical	Dielectric Voltage	Withstands 1500V per UL 497	Withstands 1500V per UL 497
	Current Interrupting	Yes, at full-rated current	Yes, at full-rated current
	Temperature Rise	Max. 30°C (86°F) after 100 cycles of overload @ 150% of rated current (DC)	Max. 30°C (86°F) after 100 cycles of overload @ 150% of rated current (DC)
Specifications: Mechanical	Terminal Accommodation	#14 AWG	#14 AWG
	Voltage Ratings	Permanently marked on device	Permanently marked on device
Materials:	Outer Shell	Nylon, except 5278C: steel	Nylon, except 5246C: steel
	Interior Body	Lexan, except 5278C: urea	Lexan, except 5246C: nylon
	Terminal Retainer	Lexan, except 5278C: urea	Lexan, except 5246C: nylon
	Blades	0.062" thick brass, except 5278C: 0.040"	0.062" thick brass
	Line Contacts	0.062" thick brass	0.062" thick brass, except 5246C: 0.040"
	Terminal Clamps	Brass	Brass
	Terminal Screws	#8-32 steel, brass plated (hot) or nickel plated (neutral), except 5278C: #6-32	#8-32 steel, brass plated (hot) or nickel plated (neutral)
	Ground Screw	#8-32 brass, zinc plated, green, except 5278C: #6-40	#8-32 brass, zinc plated, green
Assembly Screws/Rivets	Steel screws, except 5278C: steel rivets, zinc plated	Steel screws, except 5246C: brass rivets	

**Industrial Specification
Grade Watertight Devices**

2-Pole, 3-Wire Grounding
15A, 125V/AC; 15A, 250V/AC; 20A, 125V/AC; 20A, 250V/AC
NEMA 5-15, 6-15, 5-20, 6-20

	Device Type	Watertight Plugs & Connectors, Straight Blade	Watertight Receptacles, Straight Blade
	Wiring Type	Back wire	Back wire
	Testing & Code Compliance	<ul style="list-style-type: none"> Listed to UL 498, file no. E3663 cUL Certified to CSA C22.2, no. 182.2 	<ul style="list-style-type: none"> Listed to UL 498, file no. E2369 cUL Certified to CAN/CSA C22.2 no. 42-99
Specifications: Environmental	Flammability	Meets UL 94 requirements; V2 rated	Meets UL 94 requirements; V2 rated
	Temperature Rating	-40°C to 75°C (-40°F to 167°F)	-40°C to 75°C (-40°F to 167°F)
	Protection	NEMA 4, 4X, 6, 6P & IP67	NEMA 3, 3R, 4, 4X, 12 & IP66
	High Pressure Water Test	1000 psi spray (mated or with closure cap)	1000 psi spray (mated or closed)
Specifications: Electrical	Dielectric Voltage	Withstands 1500V per UL 498	Withstands 1554V per UL 498
	Current Interrupting	Yes, at full-rated current	Yes, at full-rated current
	Temperature Rise	Max. 30°C (86°F) after 250 cycles of overload	Max. 30°C (86°F) after 250 cycles of overload
Specifications: Mechanical	Terminal Accommodation	#18 - 10 AWG	#18 - #10 AWG
	Voltage Ratings	Permanently marked on device	Permanently marked on device
Materials:	Receptacle Flip Lid Cover & Base	N/A	Thermoplastic, glass-filled nylon
	Receptacle Cover Spring	N/A	Stainless steel, self-closing
	Receptacle Lid Liner & Mounting Gasket	N/A	Santoprene thermoplastic elastomeric
	Plug/Connector Outer Shell	Santoprene thermoplastic elastomeric over polypropylene	N/A
	Interior Body	Nylon	Thermoplastic, glass-filled nylon
	Terminal Retainer	Clear lexan	Clear lexan
	Blades	0.069" thick brass, nickel plated	N/A
	Line Contacts	0.030"-.032" thick brass, nickel plated	0.033" thick bronze, nickel plated; two-leaf construction
	Ground Shunt	N/A	Solid brass
	Terminal Clamps	Steel, nickel plated	Steel, nickel plated
	Terminal Screws	#10-32 brass, neutral screw nickel plated	#8-32 brass, neutral screw nickel plated
	Ground Contact	N/A	0.069" thick brass, nickel plated
	Ground Screw	#10-32 brass, zinc plated (green)	#8-32 brass (green)
	Assembly/ Mounting Screws	Stainless steel	Stainless steel
	Compression Nut	Nylon	N/A
Compression Nut Grommet	Neoprene	N/A	
Receptacle Mounting Plate	N/A	Stainless steel	

**Industrial Specification Grade
Severe Duty & Corrosion
Resistant Devices**

2-Pole, 3-Wire Grounding
15A, 125V/AC; 15A, 250V/AC; 20A, 125V/AC; 20A, 250V/AC
NEMA 5-15, 6-15, 5-20, 6-20

	Device Type	Severe Duty Plugs & Connectors, Straight Blade	Corrosion Resistant Plugs & Connectors, Straight Blade
	Wiring Type	Back wire	Back wire
	Testing & Code Compliance	<ul style="list-style-type: none"> Listed to UL 498, file no. E3663 cUL Certified to C22.2, no. 182.2-M1987 	<ul style="list-style-type: none"> Listed to UL 498, file no. E3663 UL verified to Federal Spec. WC-596F cUL Certified to C22.2, no. 42
Specifications: Environmental	Flammability	Meets UL 94 requirements; V2 rated	Meets UL 94 requirements; V2 rated
	Temperature Rating	-40°C to 75°C (-40°F to 167°F)	-20°C to 75°C (-4°F to 167°F)
Specifications: Electrical	Dielectric Voltage	Withstands 2200V per UL 498	Withstands 1500V per UL 498
	Current Interrupting	Yes, at full-rated current	Yes, at full-rated current
	Temperature Rise	Max. 30°C (86°F) after 250 cycles of overload	Max. 30°C (86°F) after 100 cycles of overload
Specifications: Mechanical	Terminal Accommodation	#14 - 8 AWG	#16 - #12 AWG
	Voltage Ratings	Permanently marked on device	Permanently marked on device
Materials:	Plug/Connector Outer Shell	Santoprene thermoplastic elastomeric over polypropylene	Nylon
	Interior Body	Nylon	Nylon
	Terminal Retainer	Clear lexan	Polypropylene / nylon
	Blades	0.069" thick brass, nickel plated	0.062" brass, nickel plated
	Line Contacts	0.030"-0.032" brass, nickel plated	0.031" Olin brass, nickel plated
	Terminal Clamps	Steel, nickel plated	Brass
	Terminal Screws	#10-32 brass, neutral screw nickel plated	#8-32 Brass, neutral screw nickel plated
	Ground Screw	#10-32 brass, zinc plated (green)	#8-32 brass, zinc plated (green)
	Assembly/ Mounting Screws	Stainless steel	Steel, nickel plated
	Cord Clamp	Nylon	Polypropylene / nylon
	Gasket/Dust Shield	Santoprene thermoplastic elastomeric	EPDM elastomer

Commercial Specification Grade Plugs & Connectors

2-Pole, 3-Wire Grounding & 2-Pole, 2-Wire Non-Grounding
15A, 125V/AC; 15A, 250V/AC; 20A, 125V/AC; 20A, 250V/AC
NEMA 5-15, 6-15, 5-20, 6-20, 1-15

	Device Type	Commercial Grade Vinyl Plugs & Connectors, Straight Blade
	Wiring Type	Back wire
	Testing & Code Compliance	<ul style="list-style-type: none"> Listed to UL498, file no. E15012 CSA certified to C22.2, no. 42-99 file no. 2081 (6221-02) NOM certified, except 4882, 4862ANW
Specifications: Environmental	Flammability	Meets UL94 requirements, V2 rated
	Temperature Rating	-20°C to 60°C (-4°F to 140°F)
Specifications: Electrical	Dielectric Voltage	Withstands 1500V per UL 498
	Current Interrupting	Yes, at full-rated current
	Temperature Rise	Max. 30°C (86°F) after 50 cycles of overload @ 150% of rated current (DC)
Specifications: Mechanical	Terminal Accommodation	#18 - #12 AWG
	Voltage Ratings	Permanently marked on device
Materials:	Plug/Connector Outer Shell	Polypropylene
	Interior Body	Polypropylene, except 4220, 4880 Series: vinyl
	Terminal Retainer	Polypropylene
	Blades	0.058" thick brass
	Line Contacts	0.030" thick brass
	Terminal Clamps	Steel, zinc plated
	Terminal Screws	#6-40 steel, brass plated (hot) and zinc plated (neutral)
	Ground Screw	#6-40 steel, zinc plated, green
	Assembly Screws	Steel, zinc plated
	Cord Clamp Screws	Steel, zinc plated
	Cord Clamp	Polypropylene

**Industrial
Specification Grade
Power Devices**

- 2-Pole, 3-Wire Grounding
- 3-Pole, 3-Wire Non-Grounding
- 3-Pole, 4-Wire Grounding
- 4-Pole, 4-Wire Non-Grounding

	Device Type	Industrial Power Plugs & Connectors, Straight Blade	Industrial Power Receptacles, Straight Blade	Industrial Power Inlets, Straight Blade
	Wiring Type	Back wire	Back wire	Back wire
	Testing & Code Compliance	<ul style="list-style-type: none"> • Listed to UL 498, file no. E3663 • Complies with Federal Spec. WC-596G • cUL certified to CSA C22.2, no. 42-M1999 	<ul style="list-style-type: none"> • Listed to UL 498, file no. E3663 • UL verified to Federal Spec. WC-596 G • CSA certified to C22.2, no. 42-M1999 file no. LR7087 (6233-01) 	<ul style="list-style-type: none"> • cULus listed to UL 498, file no. E3663 • UL verified to Federal Spec. WC-596 G • cUL certified to CSA C22.2, no. 42-M1999
Specifications: Environmental	Flammability	Meets UL 94 requirements, V0 rated	Meets UL 94 requirements, V0 rated	Meets UL 94 requirements; flanged housing: V0 rated, all other components: V2 rated
	Temperature Rating	-20°C to 75°C (-4°F to 167°F)	-20°C to 75°C (-4°F to 167°F)	-40°C to 75°C (-40°F to 167°F)
Specifications: Electrical	Dielectric Voltage	Withstands 2000V per UL 498	Withstands 2000V per UL 498	Withstands 2000V per UL 498
	Current Interrupting	Yes, at full-rated current	Yes, at full-rated current	Yes, at full-rated current
	Temperature Rise	Max. 30°C (00°F) after 50 cycles of overload @ 150% of rated current (DC)	Max. 30°C (00°F) after 50 cycles of overload @ 150% of rated current (DC)	Max. 30°C (00°F) after 50 cycles of overload @ 150% of rated current (DC)
Specifications: Mechanical	Terminal Accommodation	#12 - #4 AWG	#12 - #4 AWG	#12 - #4 AWG
	Voltage Ratings	Permanently marked on device	Permanently marked on device	Permanently marked on device
Materials:	Receptacle Base	N/A	Nylon	N/A
	Receptacle Face	N/A	Nylon	N/A
	Receptacle Strap	N/A	N/A	N/A
	Plug/Connector Outer Shell or Flanged Housing	Nylon	N/A	ABS
	Interior Body	Nylon	N/A	Nylon
	Terminal Retainer	Nylon	N/A	Nylon
	Blades	0.100" thick brass	N/A	0.100" thick brass
	Line Contacts	0.100" thick brass	0.050" thick 90-10 bronze	0.100" thick brass
	Ground Shunt	0.080" thick brass	N/A	N/A
	Terminal Clamps	Brass box lug	0.062" thick steel	Brass
	Terminal Screws	#3/8-27 brass	#10-32 screw	3/8-27 brass
	Ground Contact	0.042" thick bronze	0.042" thick brass	N/A
	Ground Screw	#3/8-27 brass	#10-32 screw	3/8-27 brass, zinc plated, green
	Assembly Screws	#6 steel, zinc plated	N/A	#6 steel, zinc plated
	Mounting Screws	N/A	N/A	#10-32 steel, zinc plated
	Receptacle Mounting Plate	N/A	0.050" thick steel, Cr over zinc plated	N/A
Gasket/Dust Shield	Neoprene	N/A	N/A	

**Commercial
Specification Grade
Power Devices**

- 2-Pole, 3-Wire Grounding
- 3-Pole, 3-Wire Non-Grounding
- 3-Pole, 4-Wire Grounding
- 4-Pole, 4-Wire Non-Grounding

	Device Type	Commercial Power Plugs, Straight Blade	Commercial Power Flush Receptacles, Straight Blade	Commercial Power Surface Receptacles, Straight Blade	Commercial Power Panel Mount Receptacles, Straight Blade
	Wiring Type	Back wire	Back wire	Back wire	Back wire
	Testing & Code Compliance	<ul style="list-style-type: none"> • S41, S42, S80: Listed to UL 498 file no. E15012 	<ul style="list-style-type: none"> • Listed to UL 498, file no. E15058 	<ul style="list-style-type: none"> • Listed to UL 498, file no. E15058 	<ul style="list-style-type: none"> • Listed to UL 498, file no. E15058
		<ul style="list-style-type: none"> • S19, S20, S21: cULus listed to UL 498 file no. E15012 	<ul style="list-style-type: none"> • Complies with Federal Spec. WC-596G 	<ul style="list-style-type: none"> • CSA certified to C22.2, no. 42, file no. 6914 (6233-81) 	<ul style="list-style-type: none"> • CSA certified to C22.2, no. 42, file no. 6914 (6233-81)
		<ul style="list-style-type: none"> • S41, S42: CSA certified to C22.2, no. 42-99 file no. 2081 (6221-02) 	<ul style="list-style-type: none"> • cUL listed to CSA C22.2, no. 42-M1999 	<ul style="list-style-type: none"> • NOM certified 	<ul style="list-style-type: none"> • NOM certified
		<ul style="list-style-type: none"> • NOM certified 			
Specifications: Environmental	Flammability	Meets UL 94 requirements, V0 rated	Meets UL 94 requirements, V0 rated	Meets UL 94 requirements, V0 rated	Meets UL 94 requirements, V0 rated
	Temperature Rating	-20°C to 60°C (-4°F to 140°F)	-20°C to 75°C (-4°F to 167°F)	-20°C to 75°C (-4°F to 167°F)	-20°C to 75°C (-4°F to 167°F)
Specifications: Electrical	Dielectric Voltage	Withstands 1500V per UL 498	Withstands 2000V per UL 498	Withstands 2000V per UL 498	Withstands 2000V per UL 498
	Current Interrupting	Yes, at full-rated current	Yes, at full-rated current	Yes, at full-rated current	Yes, at full-rated current
	Temperature Rise	Max. 30°C (86°F) after 50 cycles of overload @ 150% of rated current (DC)	Max. 30°C (86°F) after 50 cycles of overload @ 150% of rated current (DC)	Max. 30°C (86°F) after 50 cycles of overload @ 150% of rated current (DC)	Max. 30°C (86°F) after 50 cycles of overload @ 150% of rated current (DC)
Specifications: Mechanical	Terminal Accommodation	S19, S20, S21: #10 - #4 AWG S41, S42: #10 - #6 AWG S80: #10 - #8 AWG	#10 - #4 AWG	#10 - #4 AWG	#10 - #4 AWG
	Voltage Ratings	Permanently marked on device	Permanently marked on device	Permanently marked on device	Permanently marked on device
Materials:	Receptacle Base	N/A	Urea	Urea	Urea
	Receptacle Face	N/A	Urea	Polypropylene	Urea
	Plug/Connector Outer Shell	PVC	N/A	N/A	N/A
	Blades	0.096" thick brass	N/A	N/A	N/A
	Line Contacts	N/A	0.040" thick 260 brass	0.040" thick brass, solder plated	0.045" thick brass, tin plated
	Terminal Clamps	Steel, zinc plated	0.072" thick steel with SCR	0.093" thick steel	0.013" thick steel
	Terminal Screws	1/4-28 set screw, steel, zinc plated	5/16-24 steel lug screws, AL lug	1/4-20 set screw, copper plated	1/4-28
	Ground Contact	N/A	0.032" thick brass	0.032" thick brass	0.032" thick brass
	Ground Screw	1/4-28 set screw, steel, zinc plated	5/16-24 steel lug screws	1/4-20 steel, zinc plated, green	1/4-28 steel, zinc plated
	Assembly/ Mounting Screws	#8-32 steel, zinc plated, except S80: #6-32 steel, nickel plated	#6-32 steel, zinc plated	#6-32 steel, zinc plated	#6-32 steel, zinc plated
	Cord Clamp Screws	#8-32 steel, zinc plated, except S80: #6-32 steel, nickel plated	N/A	N/A	N/A
	Cord Clamp	Steel, zinc plated	N/A	N/A	N/A
Receptacle Mounting Plate	N/A	0.045" thick galvanized steel	0.045" thick galvanized steel	0.040" thick steel, galvanized	

**Commercial
Specification Grade
Power Devices**

2-Pole, 3-Wire Grounding: 30A, 125V/AC, NEMA TT-30
3-Pole, 3-Wire Non-Grounding: 20A, 125/250V/AC, NEMA 10-20
3-Pole, 4-Wire Grounding: 20A, 125/250V/AC, NEMA 14-20

	Device Type	Commercial Power Plugs, Straight Blade NEMA 10-20, Cat. No. 2836	Commercial Power Flush Receptacles, Straight Blade NEMA 10-20, Cat. No. 805	Commercial Power NEMA TT-30 Plug & Adapter, Straight Blade Cat. Nos. 83, 1264
	Wiring Type	Back wire	Side wire	Back wire
	Testing & Code Compliance	• Listed to UL 498 file no. E15012	• Listed to UL 498 file no. E15058	• Listed to UL 498 file no. E15012
		• NOM certified	• CSA certified to C22.2 no. 42-M1999, file no. 6914 (6233-01) • NOM certified	• NOM certified
Specifications: Environmental	Flammability	Withstands 1500V per UL 498	Withstands 1500V per UL 498	Withstands 1500V per UL 498
	Temperature Rating	Yes, at full-rated current	Yes, at full-rated current	-20°C to 75°C (-4°F to 167°F)
Specifications: Electrical	Dielectric Voltage	Withstands 1250V per UL 498	Withstands 1500V per UL 498	Withstands 1500V per UL 498
	Current Interrupting	Yes, at full-rated current	Yes, at full-rated current	Yes, at full-rated current
	Temperature Rise	Max. 30°C (86°F) after 100 cycles of overload @ 150% of rated current (DC)	Max. 30°C (86°F) after 100 cycles of overload @ 150% of rated current (DC)	Max. 30°C (86°F) after 100 cycles of overload @ 150% of rated current (DC)
Specifications: Mechanical	Terminal Accommodation	#14 - #10 AWG	#14 - #10 AWG	83: #12 - #10 AWG 1264: N/A
	Voltage Ratings	Permanently marked on device	Permanently marked on device	Permanently marked on device
Materials:	Receptacle Base	N/A	Urea	N/A
	Receptacle Face	N/A	Urea	N/A
	Receptacle Strap	N/A	0.050" thick steel, galvanized	N/A
	Plug/Connector Outer Shell	Steel, zinc-plated	N/A	83: Urea 1264: Phenolic
	Interior Body	PVC	N/A	83: N/A 1264: PVC
	Blades	0.072" thick brass	N/A	83: 0.062" thick brass 1264: 0.058" thick brass
	Line Contacts	N/A	0.040" thick brass	83: N/A 1264: 0.016-0.020" thick brass
	Terminal Clamps	Steel, zinc-plated	0.040" thick brass	N/A
	Terminal Screws	#6-40 brass	#8-32 steel, zinc plated	83: #10-32 brass, zinc plated 1264: N/A
	Ground Contact	N/A	0.032" thick bronze	N/A
	Ground Screw	N/A	N/A	83: #10-32 brass, zinc plated, green 1264: N/A
	Assembly/ Mounting Screws	#5-20 steel, zinc plated	Steel, zinc plated	83: #8-32 steel, zinc plated 1264: N/A
	Cord Clamp Insert	PVC	N/A	N/A
	Cord Clamp Screws	#6-32 steel, zinc plated	N/A	83: #6-32 steel, zinc plated 1264: N/A
Cord Clamp	Steel, zinc plated	N/A	83: steel, zinc plated 1264: N/A	



Locking
Devices



	Page		Page
15A, 20A & 30A Locking Devices	C-1	15A, 20A & 30A Locking Devices (con't)	C-53
2-Pole, 2-Wire Hart-Lock™		Hart-Lock Midget Devices	
15A, 125V/AC NEMA L1-15	C-6	2P, 2W: 15A, 125V/AC NEMA ML1	C-53
20A, 250V/AC NEMA L2-20	C-7	2P, 3W: 15A, 125V/AC NEMA ML2	C-54
2-Pole, 3-Wire Hart-Lock		3P, 3W: 15A, 125/250V/AC NEMA ML3	C-54
15A, 125V/AC NEMA L5-15	C-8	Hart-Lock Switched Enclosure for	
15A, 250V/AC NEMA L6-15	C-9	Hart-Lock Devices	
15A, 277V/AC NEMA L7-15	C-10	Weatherproof Switched Enclosure for	
20A, 125V/AC NEMA L5-20	C-11	20A & 30A Devices	C-55
20A, 250V/AC NEMA L6-20	C-12	50A Locking Devices,	
20A, 277V/AC NEMA L7-20	C-13	Pro-Grip™ & Armored	C-56
20A, 480V/AC NEMA L8-20	C-14	2-Pole, 3-Wire	
20A, 600V/AC NEMA L9-20	C-15	50A, 125V/AC Non-NEMA	C-58–C-59
30A, 125V/AC NEMA L5-30	C-16	50A, 250V/AC Non-NEMA	C-60
30A, 250V/AC NEMA L6-30	C-17	50A, 250V DC / 600V/AC Non-NEMA	C-61
30A, 277V/AC NEMA L7-30	C-18	50A, 480V/AC Non-NEMA	C-62
30A, 480V/AC NEMA L8-30	C-19	3-Pole, 4-Wire	
30A, 600V/AC NEMA L9-30	C-20	50A, 125/250V/AC Non-NEMA	C-63–C-64
3-Pole, 3-Wire Hart-Lock		50A, 3Ø 250V/AC Non-NEMA	C-65
10/15A, 250/125V/AC Non-NEMA	C-21	50A, 250V DC / 600V/AC Non-NEMA	C-66–C-67
20A, 125/250V/AC Non-NEMA	C-22	50A, 3Ø 480V/AC Non-NEMA	C-68
20A, 125/250V/AC NEMA L10-20	C-23	Power-Lock™ Devices	C-69
20A, 3Ø 250V/AC NEMA L11-20	C-24	Hospital Use Devices	
20A, 3Ø 480V/AC NEMA L12-20	C-25	2-P, 3-W: 20A, 125V/AC Non-NEMA	C-70
30A, 125/250V/AC Non-NEMA	C-26	2-P, 3-W: 50A, 250V/AC Non-NEMA	C-70
30A, 125/250V/AC NEMA L10-30	C-27	2-P, 3-W: 60A, 250V/AC Non-NEMA	C-71
30A, 3Ø 250V/AC NEMA L11-30	C-28	2-Pole, 3-Wire	
30A, 3Ø 480V/AC NEMA L12-30	C-29	20A, 125V/AC Non-NEMA	C-72
30A, 3Ø 600V/AC NEMA L13-30	C-30	3-Pole, 3-Wire	
3-Pole, 4-Wire Hart-Lock		20A, 125V/AC Non-NEMA	C-72
20A, 125/250V/AC NEMA L14-20	C-31	3-Pole, 4-Wire	
20A, 3Ø 250V/AC NEMA L15-20	C-32	30/20A, 250V DC / 600V/AC Non-NEMA	C-73
20A, 3Ø 480V/AC NEMA L16-20	C-33	30A, 480V/AC Non-NEMA	C-74
30A, 125/250V/AC NEMA L14-30	C-34	60A, 600V/AC Non-NEMA	C-75
30A, 3Ø 250V/AC NEMA L15-30	C-35	4-Pole, 5-Wire	
30A, 3Ø 480V/AC NEMA L16-30	C-36	30/20A, 250V DC / 600V/AC Non-NEMA	C-76
30A, 3Ø 600V/AC NEMA L17-30	C-37	60A, 600V/AC Non-NEMA	C-77
4-Pole, 4-Wire Hart-Lock		Power-Lock Accessories	
20A, 3ØY 120/208V/AC Non-NEMA	C-38	30A	C-78
20A, 3ØY 120/208V/AC NEMA L18-20	C-39	60A	C-78
20A, 3ØY 277/480V/AC NEMA L19-20	C-40	Locking Device Dimensional Data	C-79
20A, 3ØY 347/600V/AC NEMA L20-20	C-41	Specification Information	C-88
30A, 3ØY 120/208V/AC Non-NEMA	C-42		
30A, 3ØY 120/208V/AC NEMA L18-30	C-43		
30A, 3ØY 277/480V/AC NEMA L19-30	C-44		
30A, 3ØY 347/600V/AC NEMA L20-30	C-45		
4-Pole, 5-Wire Hart-Lock			
20/10A, 250/600V/AC Non-NEMA	C-46		
20A, 3ØY 120/208V/AC NEMA L21-20	C-47		
20A, 3ØY 277/480V/AC NEMA L22-20	C-48		
20A, 3ØY 347/600V/AC NEMA L23-20	C-49		
30A, 3ØY 120/208V/AC NEMA L21-30	C-50		
30A, 3ØY 277/480V/AC NEMA L22-30	C-51		
30A, 3ØY 347/600V/AC NEMA L23-30	C-52		

The industry's most complete line of locking industrial devices

Arrow Hart offers the most rugged, feature-rich, broadest line of quality locking devices to meet the specific needs of demanding industrial applications.

**Hart-Lock™ Locking Devices**

The widest range of NEMA and non-NEMA devices, designed and built with superior materials for long lasting performance.

**Hart-Lock™ 50A Locking Devices**

Rugged Pro-Grip™, armored and marine grade 50A locking devices are ideal for harsh construction and industrial applications.

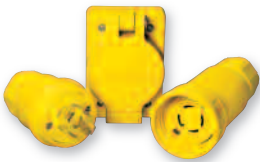
**Hart-Lock™ Watertight Devices**

Hart Lock watertight devices are ideal for unique applications exposed to repeated high pressure hosedown and chemicals.

**Power-Lock™ Devices**

Power-Lock devices offer a positive engagement single-post design in rugged nylon or armored shell housings for reliable service.

**Hart-Lock™ Severe Duty Devices**

Arrow Hart's NEMA and non-NEMA configured plugs & connectors offer excellent resistance to physical abuse, foreign particulates, corrosion, airborne contaminants and UV exposure.

**Hart-Lock™ Flat Cable Devices**

Hart-Lock Flat Cable plugs & connectors are designed specifically for 4-pole, 5-wire flat cable applications in convention and exhibit halls or other high-traffic flat-cable environments.

**Hart-Lock™ Corrosion Resistant Devices**

Hart Lock corrosion resistant devices are specifically designed for environments where moisture, humidity and contaminants challenge electrical connections.

**Hart-Lock™ Switched Locking Devices**

These devices eliminate separate switch and receptacle installations by combining a HP-rated switch with a locking flanged outlet in a NEMA 3R/12 enclosure that accepts any 20A or 30A Hart-Lock flanged outlet.

Rugged, quality locking devices for any application

Superior design and performance make Arrow Hart's Hart-Lock™ devices the ideal choice for industrial applications. Available in a wide range of NEMA and Non-NEMA configurations.



Hart-Lock Safety Grip Plugs & Connectors

Ribbed nylon construction is rugged and durable for dependable use

Multiple-head screws provide versatility for ease of use

Neoprene gasket seals around cord for added terminal protection from external elements

Cord Grip inserts accommodate a wide range of cord diameters



Front Body

Back Body

Retained quick drive screws speed installation

Serrated terminal plates and contoured terminal clamps "bite" on the conductors for positive termination

Tapered, individual wire pockets guide wire into contact area for ease of termination

Clear terminal cover allows for easy inspection of conductors and terminations

Hart-Lock AutoGrip Plugs & Connectors

Smooth, tapered body reduces snagging and provides easy handling

Neoprene gasket seals around cord for added terminal protection from external elements

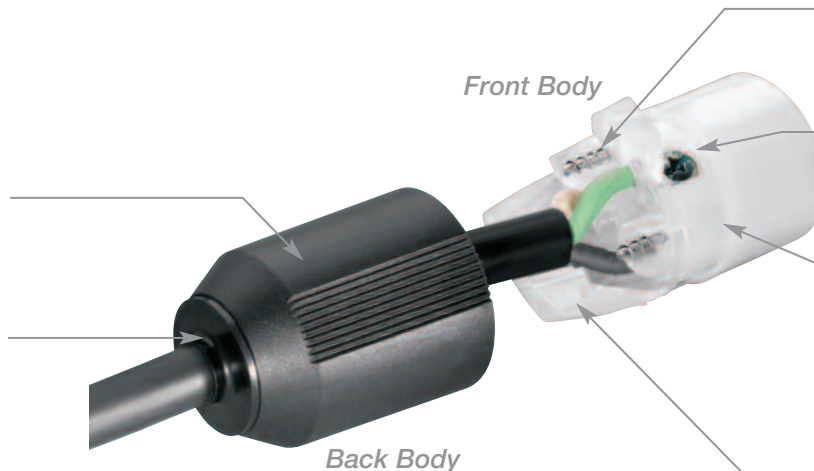

Front Body

Back Body

Retained quick drive screws speed installation

Multiple-head screws provide versatility for ease of use

Single piece grounding contacts for superior continuity

Unique AutoGrip internal cord grip clamps the cord during assembly, reducing installation time

**Hart-Lock Industrial Receptacles**

Heavy duty glass reinforced nylon body and face for rugged durability

Compact body design allows for adequate wire room in wallbox

Heavy interior walls provide additional support to ensure contact retention

Heavy-duty mounting strap is double riveted to body for added strength



One piece brass contacts provide excellent plug retention and electrical continuity with minimum heat rise

Serrated terminal plates bite wire to insure strong, reliable wiring connections

Back and side wired terminal design allows for fast installation

Multiple-head screws provide versatility for ease of use

Hart-Lock Industrial Flanged Inlets & Outlets

Mounting holes interchangeable with other devices

Heavy-duty nylon construction



Individual wiring compartments with tapered channel for easy insertion of wires

Back wire terminal clamps for easy, secure wiring

Innovative solutions for watertight applications

Arrow Hart's watertight locking devices utilize a unique, robust design and superior materials to provide watertight security in harsh environments.



Hart-Lock Watertight Receptacles

Spring-loaded self-closing flip lid cover ensures a watertight seal when the receptacle is not in use – even in water spray at 1,000 psi

Glass-filled nylon cover and exterior shell provide impact resistance in harsh environments

Stainless steel mounting and assembly screws provide corrosion resistance

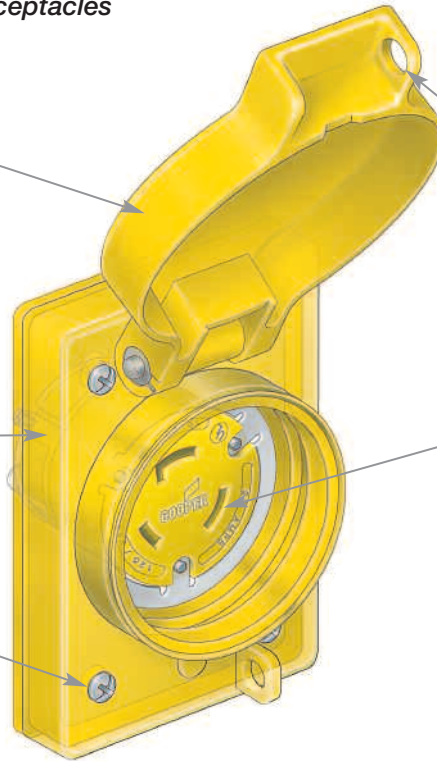

Lockable cover provides means of lockout/tagout

Nickel-plated power contacts and terminal assemblies provide corrosion resistance

Nickel-plated contacts, blades and terminal screws provide corrosion resistance

Quick drive stainless steel assembly screws provide corrosion resistance and fast assembly

Tapered individual wire pockets guide wire into contact area for ease of installation

Hart-Lock Watertight Plugs & Connectors

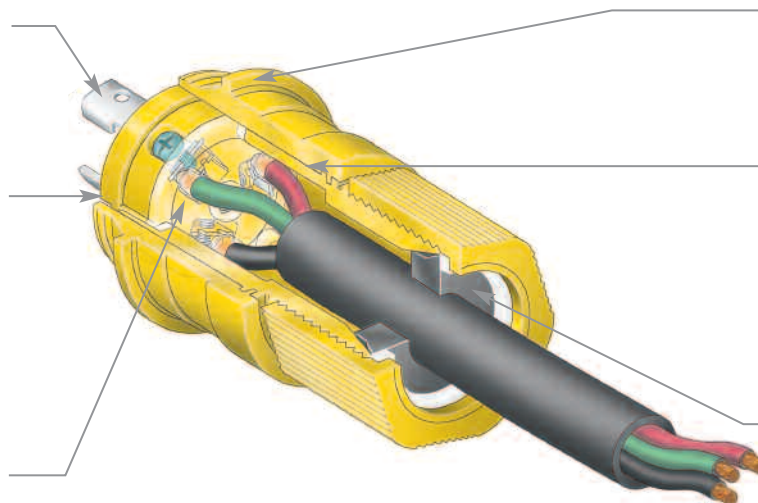

Innovative sealing system provides multipoint watertight seal

Glass reinforced nylon interior and Santoprene™ elastomeric exterior molded together for watertight seal and rugged support

Neoprene grommet ensures a watertight seal

Heavy duty devices for industrial applications

Arrow Hart's unique line of Severe Duty locking devices are designed and built tough for use in demanding environments with exposure to heat, oil, chemicals and impact.

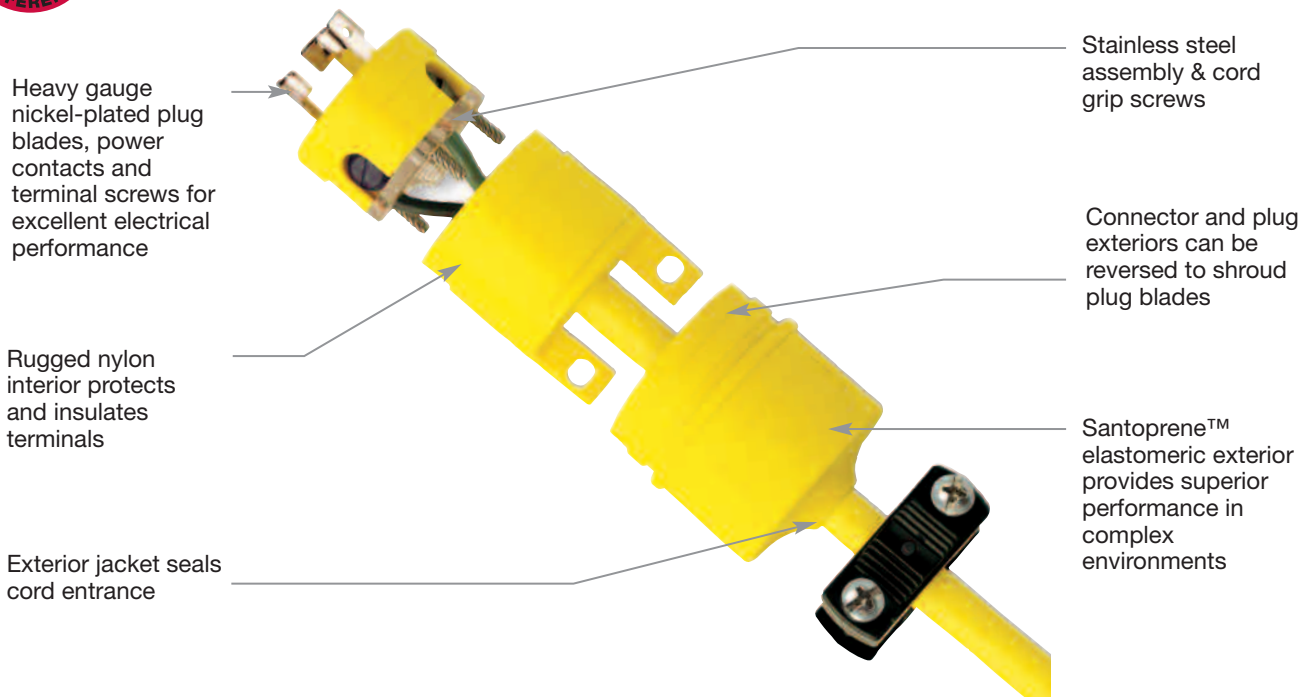
**Hart-Lock Severe Duty Plugs****Hart-Lock Severe Duty Connectors**

Designed specifically for longevity in harsh, corrosive environments

Perfect for industrial or commercial applications, corrosion resistant devices are engineered to deliver long, dependable performance in moisture, humidity, and corrosive environments.



Hart-Lock Corrosion Resistant Receptacles

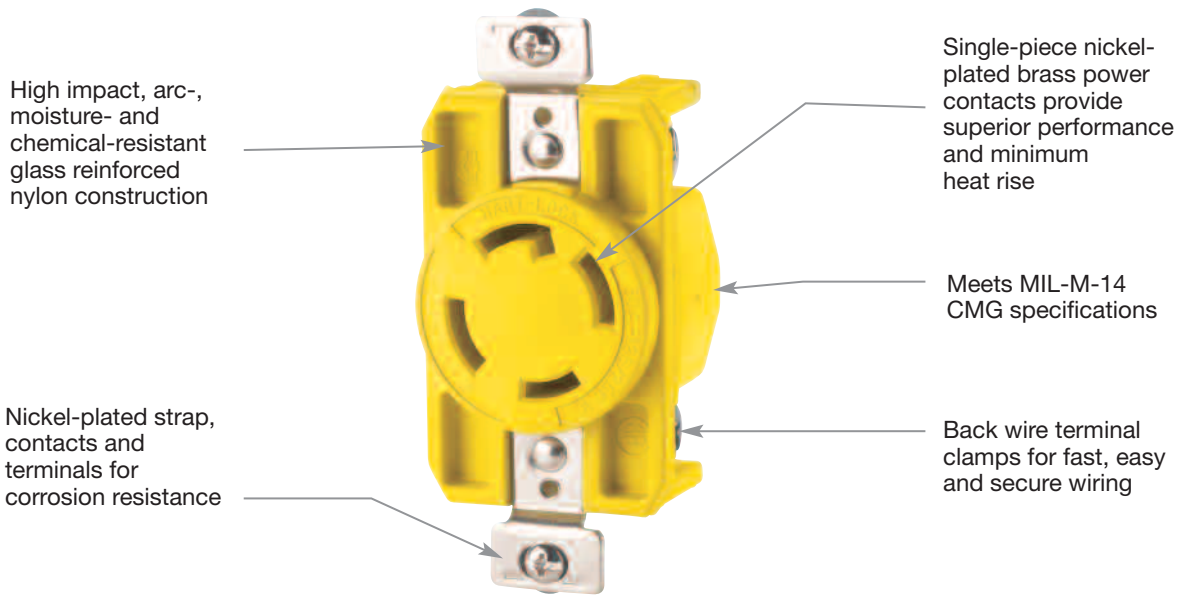

High impact, arc-, moisture- and chemical-resistant glass reinforced nylon construction

Single-piece nickel-plated brass power contacts provide superior performance and minimum heat rise

Meets MIL-M-14 CMG specifications

Nickel-plated strap, contacts and terminals for corrosion resistance

Back wire terminal clamps for fast, easy and secure wiring

Hart-Lock Corrosion Resistant Plugs & Connectors

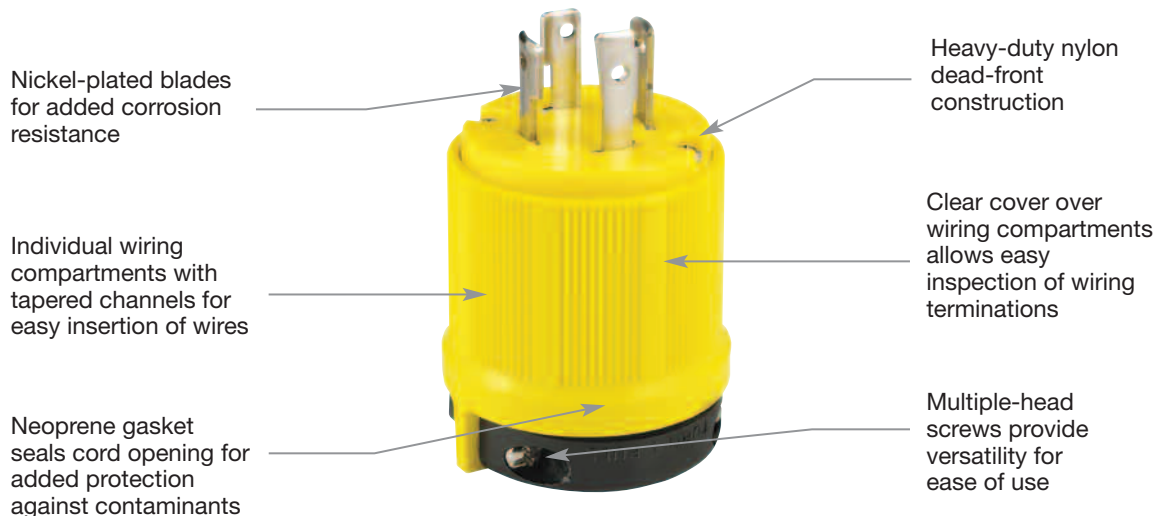

Nickel-plated blades for added corrosion resistance

Heavy-duty nylon dead-front construction

Individual wiring compartments with tapered channels for easy insertion of wires

Clear cover over wiring compartments allows easy inspection of wiring terminations

Neoprene gasket seals cord opening for added protection against contaminants

Multiple-head screws provide versatility for ease of use

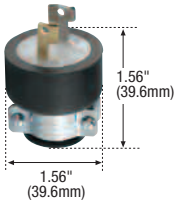

7546

Hart-Lock™ Industrial Specification Grade Locking Devices

2-Pole, 2-Wire Non-Grounding
15A, 125V/AC
NEMA L1-15

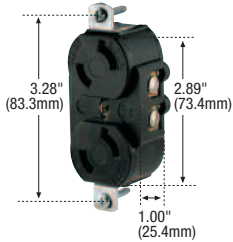
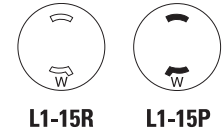

7540

15A, 125V NEMA L1-15

Plugs & Connectors

Rating A V/AC	Style & Description	Cord Dia.	Catalog No.		Certifications		
			Plug	Connector	USA	UL	CSA
15 125	Straight Body, Black	0.31-0.47" (7.9-11.9mm)	□ 7546	—	•	•	•
	Straight Body, Black	0.30-0.56" (7.5-14.3mm)	—	□ 7506	•	•	•

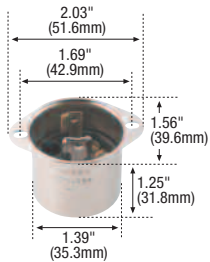

CWL115FI

Receptacles

Rating A V/AC	Style & Description	Catalog No.		Certifications		
		Single Receptacle	Duplex Receptacle	USA	UL	CSA
15 125	Standard Industrial, Black	□ CWL115R	□ 7540	•	•	•

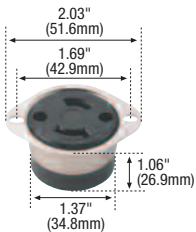

CWL115FO

Flanged Inlets & Outlets

Rating A V/AC	Style & Description	Catalog No.		Certifications		
		Flanged Inlet	Flanged Outlet	USA	UL	CSA
15 125	Standard Industrial, Black & White	□ CWL115FI	□ CWL115FO	•	•	•

Icon Key

NAFTA Compliant - see page O-30

Dimensional Information: C-83 – C-84

Plug & Connector Specification Information:

NEMA L1-15: C-89

Receptacle Specification Information:

NEMA L1-15: C-91

Flanged Inlet & Flanged Outlet Specification Information:

NEMA L1-15: C-92

C-6

Accessories for NEMA L1-15 Locking Devices

Description	Catalog No.	USA
Diecast aluminum single receptacle cover, vertical mount, for FS/FD Boxes	□ 7420	•
Glass filled nylon flanged inlet/outlet cover, vertical mount, for 15A devices	□ WP1	•



7420



WP1

Hart-Lock™ Industrial Specification Grade Locking Devices

2-Pole, 2-Wire Non-Grounding
20A, 250V/AC
NEMA L2-20

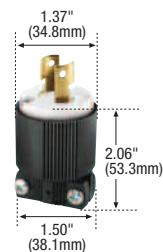
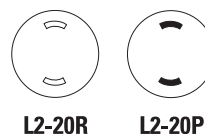

CWL220P

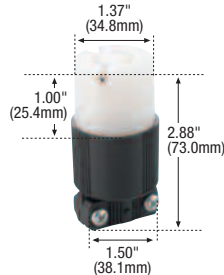

CWL220C

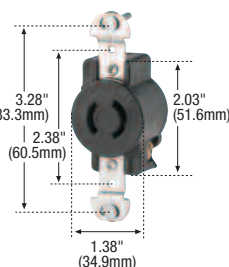

CWL220R



CWL220FO

20A, 250V NEMA L2-20

Safety Grip™ Plugs & Connectors

Rating A	V/AC	Style & Description	Cord Dia.	Catalog No.		Certifications					
				Plug	Connector	USA	CSA	UL	IEC	CCC	
20	250	Straight Body, Black & White	0.33-0.66" (8.4-16.7mm)	<input type="checkbox"/> CWL220P	•	—	•	•	•	•	•
		Straight Body Polarized, Black & White	0.33-0.66" (8.4-16.7mm)	<input type="checkbox"/> CWL220P-6	•	<input type="checkbox"/> CWL220C	•	•	•	•	•

Receptacles

Rating A	V/AC	Style & Description	Catalog No.	Certifications
20	250	Standard Industrial, Black	<input type="checkbox"/> CWL220R	USA, CSA, UL, IEC, CCC

Flanged Inlets & Outlets

Rating A	V/AC	Style & Description	Catalog No.	Certifications
20	250	Standard Industrial, Black	<input type="checkbox"/> CWL220FO	USA, CSA, UL, IEC, CCC

Icon Key

NAFTA Compliant - see page O-30

Accessories for NEMA L2-20 Locking Devices

Description	Catalog No.	USA
Neoprene weather protective boot for 15A plug	<input type="checkbox"/> BS1	•
Neoprene weather protective boot for 15A connector	<input type="checkbox"/> BS2	•



BS1



BS2

Dimensional Information: C-79 & C-83 – C-84

Plug & Connector Specification Information:
NEMA L2-20: C-89

Receptacle Specification Information:
NEMA L2-20: C-91

Flanged Inlet & Flanged Outlet Specification Information:
NEMA L2-20: C-92

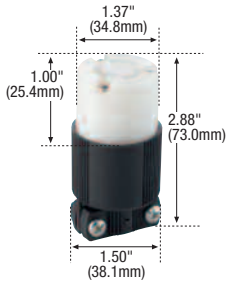

CWL515C



2447

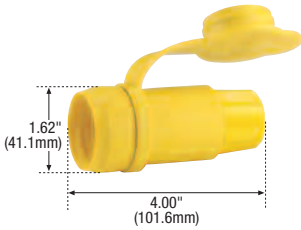

25W47

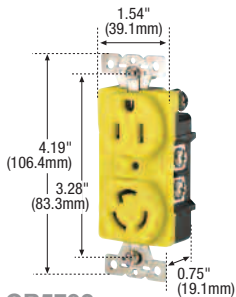

CR5792

Dimensional Information: C-79 – C-82

Plug & Connector Specification Information:

Safety Grip L5-15: C-88

AutoGrip L5-15: C-88

Corrosion Resistant: C-98

Severe Duty: C-97

Watertight: C-95

Receptacle Specification Information:

L5-15: C-90

Isolated Ground L5-15: C-90

Corrosion Resistant: C-98

Watertight: C-96

Flanged Inlet & Flanged Outlet Specification Information:

L5-15: C-92

Hart-Lock™ Industrial Specification Grade Locking Devices

2-Pole, 3-Wire Grounding
15A, 125V/AC
NEMA L5-15



L5-15R



L5-15P

15A, 125V NEMA L5-15

Plugs & Connectors

Style & Description	Cord Dia.	Catalog No.		Certifications				
		Plug	Connector	USA	UL	UL US	FUS	CSA
Safety Grip™ Straight Body, Black & White	0.33-0.66" (8.4-16.7mm)	<input type="checkbox"/> CWL515P	<input type="checkbox"/> CWL515C	•	•	•	•	•
Safety Grip™ Angled Body, Black & White	0.33-0.66" (8.4-16.7mm)	<input type="checkbox"/> CWL515PAN	<input type="checkbox"/> CWL515CAN	•	•	•	•	•
AutoGrip™, Black & White	0.33-0.66" (8.4-16.7mm)	<input type="checkbox"/> 4721N	<input type="checkbox"/> 4731N	•	•	•	•	•
AutoGrip™ Corrosion Resistant, Yellow	0.33-0.66" (8.4-16.7mm)	<input type="checkbox"/> 4721NCR	<input type="checkbox"/> 4731NCR	•	•	•	•	•
Severe Duty, Yellow & Black	0.38-1.00" (9.5-25.4mm)	<input type="checkbox"/> 2447	<input type="checkbox"/> 2547	•	•	•	•	•
Watertight, Yellow	0.30-0.65" (7.6-16.5mm)	<input type="checkbox"/> 24W47	<input type="checkbox"/> 25W47	•	•	•	•	•
Watertight, All-Black	0.30-0.65" (7.6-16.5mm)	<input type="checkbox"/> 24W47BK	<input type="checkbox"/> 25W47BK	•	•	•	•	•

Receptacles

Style & Description	Catalog No.		Certifications				
	Single Receptacle	Duplex Receptacle	USA	UL	UL US	FUS	CSA
Standard Industrial, Black	<input type="checkbox"/> CWL515R	—	•	•	•	•	•
Standard Industrial, Black	—	<input type="checkbox"/> 4700	•	•	•	•	•
Isolated Ground, Orange	<input type="checkbox"/> IGL515R	<input type="checkbox"/> IG4700	•	•	•	•	•
Corrosion Resistant, Yellow	—	<input type="checkbox"/> CR4700	•	•	•	•	•
Combination Locking & Straight Blade NEMA 5-15, Black	—	<input type="checkbox"/> 5792	•	•	•	•	•
Corrosion Resistant Combination Locking & Straight Blade NEMA 5-15, Yellow	—	<input type="checkbox"/> CR5792	•	•	•	•	•
Watertight, Yellow	<input type="checkbox"/> 65W47	<input type="checkbox"/> 65W47DPLX	•	•	•	•	•
Watertight, All-Black	<input type="checkbox"/> 65W47BK	<input type="checkbox"/> 65W47DPLXBK	•	•	•	•	•

Flanged Inlets & Outlets

Style & Description	Catalog No.		Certifications				
	Flanged Inlet	Flanged Outlet	USA	UL	UL US	FUS	CSA
Standard Industrial, Black & White	<input type="checkbox"/> CWL515FI	—	•	•	•	•	•
Standard Industrial, Black & White	—	<input type="checkbox"/> CWL515FO	•	•	•	•	•

Icon Key

NAFTA Compliant - see page O-30

Hart-Lock™ Industrial Specification Grade Locking Devices

2-Pole, 3-Wire Grounding
15A, 250V/AC
NEMA L6-15

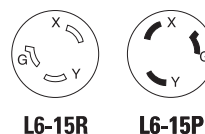

CWL615P



CWL615C

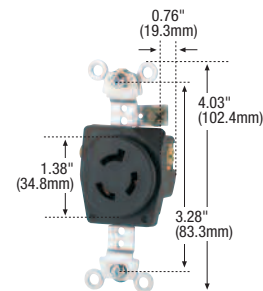

CWL615R



CWL615FI

15A, 250V NEMA L6-15

Plugs & Connectors

Style & Description	Cord Dia.	Catalog No.		Certifications				
		Plug	Connector	USA	UL	UL US	FUS	CSA
Safety Grip™ Straight Body, Black & White	0.33-0.66" (8.4-16.7mm)	□ CWL615P	□ CWL615C	•	•	•	•	•
AutoGrip™, Black & White	0.33-0.66" (8.4-16.7mm)	□ 6565N	□ 6566N	•	•	•	•	•
Severe Duty, Yellow & Black	0.38-1.00" (9.5-25.4mm)	□ 2449	□ 2549	•	•	•	•	•
Watertight, Yellow	0.30-0.65" (7.6-16.5mm)	□ 24W49	□ 25W49	•	•	•	•	•
Watertight, All-Black	0.30-0.65" (7.6-16.5mm)	□ 24W49BK	□ 25W49BK	•	•	•	•	•

Receptacles

Style & Description	Catalog No.		Certifications				
	Single Receptacle	Duplex Receptacle	USA	UL	UL US	FUS	CSA
Standard Industrial, Black	□ CWL615R	—	•	•	•	•	•
Standard Industrial, Black	—	□ 6580	•	•	•	•	•
Isolated Ground, Orange	□ IGL615R	—	•	•	•	•	•
Watertight, Yellow	□ 65W49	□ 65W49DPLX	•	•	•	•	•
Watertight, All-Black	□ 65W49BK	□ 65W49DPLXBK	•	•	•	•	•

Flanged Inlets & Outlets

Style & Description	Catalog No.		Certifications				
	Flanged Inlet	Flanged Outlet	USA	UL	UL US	FUS	CSA
Standard Industrial, Black & White	□ CWL615FI	—	•	•	•	•	•
Standard Industrial, Black & White	—	□ CWL615FO	•	•	•	•	•

Dimensional Information: C-79 – C-82

Plug & Connector Specification Information:

- Safety Grip L6-15: C-88
- AutoGrip L6-15: C-88
- Severe Duty: C-97
- Watertight: C-95

Receptacle Specification Information:

- L6-15: C-90
- Isolated Ground L6-15: C-90
- Watertight: C-96

Flanged Inlet & Flanged Outlet Specification Information:

- L6-15: C-92

Icon Key

NAFTA Compliant - see page O-30

Hart-Lock™ Industrial Specification Grade Locking Devices

2-Pole, 3-Wire Grounding
15A, 277V/AC
NEMA L7-15

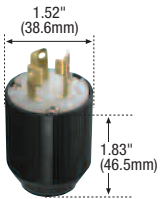
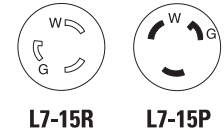

4771N

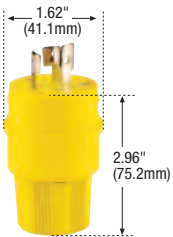

24W34

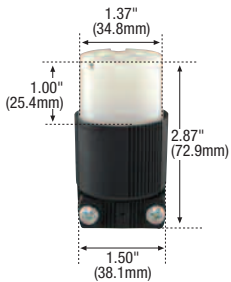

CWL715C

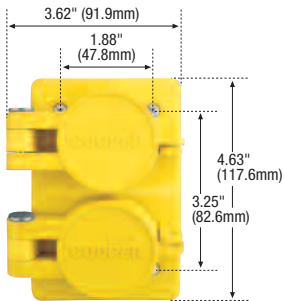

65W34DPLX

Dimensional Information: C-79 – C-82

Plug & Connector Specification Information:

Safety Grip L7-15: C-88

AutoGrip L7-15: C-88

Severe Duty: C-97

Watertight: C-95

Receptacle Specification Information:

L7-15: C-90

Watertight: C-96

Flanged Inlet & Flanged Outlet Specification Information:

L7-15: C-92

C-10

15A, 277V NEMA L7-15

Plugs & Connectors

Style & Description	Cord Dia.	Catalog No.		Certifications				
		Plug	Connector	USA	UL	UL US	FUS	CS
Safety Grip™ Straight Body, Black & White	0.33-0.66" (8.4-16.7mm)	<input type="checkbox"/> CWL715P	<input type="checkbox"/> CWL715C	•	•	•	•	•
AutoGrip™, Black & White	0.33-0.66" (8.4-16.7mm)	<input type="checkbox"/> 4771N	<input type="checkbox"/> 4772N	•	•	•	•	•
Severe Duty, Yellow & Black	0.38-1.00" (9.5-25.4mm)	<input type="checkbox"/> 2434	<input type="checkbox"/> 2534	•	•	•	•	•
Watertight, Yellow	0.30-0.65" (7.6-16.5mm)	<input type="checkbox"/> 24W34	<input type="checkbox"/> 25W34	•	•	•	•	•
Watertight, All-Black	0.30-0.65" (7.6-16.5mm)	<input type="checkbox"/> 24W34BK	<input type="checkbox"/> 25W34BK	•	•	•	•	•

Receptacles

Style & Description	Catalog No.		Certifications				
	Single Receptacle	Duplex Receptacle	USA	UL	UL US	FUS	CS
Standard Industrial, Black	<input type="checkbox"/> CWL715R	<input type="checkbox"/> 4750	•	•	•	•	•
Watertight, Yellow	<input type="checkbox"/> 65W34	<input type="checkbox"/> 65W34DPLX	•	•	•	•	•
Watertight, All-Black	<input type="checkbox"/> 65W34BK	<input type="checkbox"/> 65W34DPLXBK	•	•	•	•	•

Flanged Inlets & Outlets

Style & Description	Catalog No.		Certifications				
	Flanged Inlet	Flanged Outlet	USA	UL	UL US	FUS	CS
Standard Industrial, Black & White	<input type="checkbox"/> CWL715FI	—	•	•	•	•	•
Standard Industrial, Black & White	—	<input type="checkbox"/> CWL715FO	•	•	•	•	•

Icon Key

NAFTA Compliant - see page O-30

Hart-Lock™ Industrial Specification Grade Locking Devices

2-Pole, 3-Wire Grounding
20A, 125V/AC
NEMA L5-20



L5-20R



L5-20P

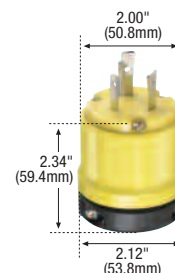

CRL520P



CWL520C

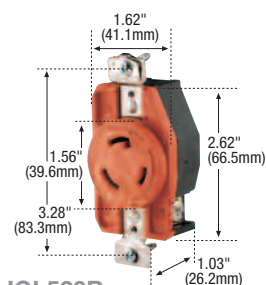

IGL520R



CWL520FO

Dimensional Information: C-79 – C-82

Plug & Connector Specification Information:

Safety Grip L5-20: C-89
Corrosion Resistant: C-98
Severe Duty: C-97
Watertight: C-95

Receptacle Specification Information:

L5-20: C-91
Isolated Ground L5-20: C-91
Corrosion Resistant: C-98
Watertight: C-96

Flanged Inlet & Flanged Outlet Specification Information:

L5-20: C-92

20A, 125V NEMA L5-20

Plugs & Connectors

Style & Description	Cord Dia.	Catalog No.		Certifications						
		Plug	Connector	USA	UL	UL ^{US}	CSA	UL ^S	UL ^S	UL ^S
Safety Grip™ Straight Body, Black & White	0.38-1.00" (9.5-25.4mm)	<input type="checkbox"/> CWL520P	<input type="checkbox"/> CWL520C	•						•
Safety Grip™ Straight Body, Black	0.38-1.00" (9.5-25.4mm)	<input type="checkbox"/> CWL520PBK	<input type="checkbox"/> CWL520CBK	•	•	•				•
Safety Grip™ Corrosion Resistant, Yellow	0.38-1.00" (9.5-25.4mm)	<input type="checkbox"/> CRL520P	<input type="checkbox"/> CRL520C	•						•
Severe Duty, Yellow & Black	0.38-1.00" (9.5-25.4mm)	<input type="checkbox"/> L520PY	<input type="checkbox"/> L520CY	•						•
Watertight, Yellow	0.36-0.84" (9.1-21.3mm)	<input type="checkbox"/> L520PW	<input type="checkbox"/> L520CW	•						•
Watertight, All-Black	0.36-0.84" (9.1-21.3mm)	<input type="checkbox"/> L520PWBK	<input type="checkbox"/> L520CWBK	•						•

Receptacles

Style & Description	Catalog No.	Certifications						
		Single Receptacle	USA	UL	UL ^{US}	UL ^S	UL ^S	UL ^S
Standard Industrial, Black	<input type="checkbox"/> CWL520R		•	•			•	•
Isolated Ground, Orange	<input type="checkbox"/> IGL520R		•	•			•	•
Corrosion Resistant, Yellow	<input type="checkbox"/> CRL520R		•	•			•	•
Watertight, Yellow	<input type="checkbox"/> L520RW		•		•			•
Watertight, All-Black	<input type="checkbox"/> L520RWBK		•		•			•

Flanged Inlets & Outlets

Style & Description	Catalog No.		Certifications					
	Flanged Inlet	Flanged Outlet	USA	UL	UL ^{US}	UL ^S	UL ^S	UL ^S
Standard Industrial, Black & White	<input type="checkbox"/> CWL520FI	<input type="checkbox"/> CWL520FO	•	•				•

Icon Key

NAFTA Compliant - see page O-30

Hart-Lock™ Industrial Specification Grade Locking Devices

2-Pole, 3-Wire Grounding
20A, 250V/AC
NEMA L6-20

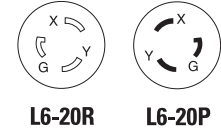

CWL620P

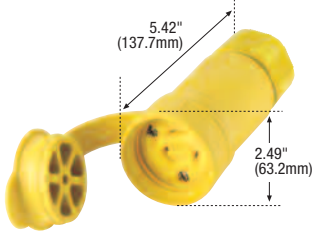

L620CW

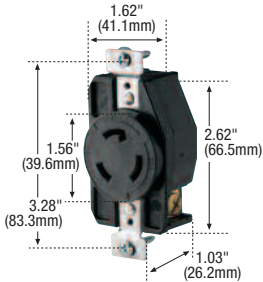

CWL620R



CWL620FI

Dimensional Information: C-79 – C-82

Plug & Connector Specification Information:

- Safety Grip L6-20: C-88
- Corrosion Resistant: C-98
- Severe Duty: C-97
- Watertight: C-95

Receptacle Specification Information:

- L6-20: C-91
- Isolated Ground L6-20: C-91
- Corrosion Resistant: C-98
- Watertight: C-96

Flanged Inlet & Flanged Outlet Specification Information:

- L6-20: C-92

20A, 250V NEMA L6-20

Plugs & Connectors

Style & Description	Cord Dia.	Catalog No.		Certifications					
		Plug	Connector	USA	UL	UL _{CS}	FUS	ETL	ROHS 426
Safety Grip™ Straight Body, Black & White	0.38-1.00" (9.5-25.4mm)	<input type="checkbox"/> CWL620P	<input type="checkbox"/> CWL620C	•	•	•	•	•	•
Safety Grip™ Corrosion Resistant, Yellow	0.38-1.00" (9.5-25.4mm)	<input type="checkbox"/> CRL620P	—	•	•	•	•	•	•
Severe Duty, Yellow & Black	0.38-1.00" (9.5-25.4mm)	<input type="checkbox"/> L620PY	<input type="checkbox"/> L620CY	•	•	•	•	•	•
Watertight, Yellow	0.36-0.84" (9.1-21.3mm)	<input type="checkbox"/> L620PW	<input type="checkbox"/> L620CW	•	•	•	•	•	•
Watertight, All-Black	0.36-0.84" (9.1-21.3mm)	<input type="checkbox"/> L620PWBK	<input type="checkbox"/> L620CWBK	•	•	•	•	•	•

Receptacles

Style & Description	Catalog No.	Certifications					
		Single Receptacle	USA	UL	UL _{CS}	FUS	ETL
Standard Industrial, Black	<input type="checkbox"/> CWL620R	•	•	•	•	•	•
Isolated Ground, Orange	<input type="checkbox"/> IGL620R	•	•	•	•	•	•
Corrosion Resistant, Yellow	<input type="checkbox"/> CRL620R	•	•	•	•	•	•
Watertight, Yellow	<input type="checkbox"/> L620RW	•	•	•	•	•	•
Watertight, All-Black	<input type="checkbox"/> L620RWBK	•	•	•	•	•	•

Flanged Inlets & Outlets

Style & Description	Catalog No.		Certifications					
	Flanged Inlet	Flanged Outlet	USA	UL	UL _{CS}	FUS	ETL	ROHS 426
Standard Industrial, Black & White	<input type="checkbox"/> CWL620FI	—	•	•	•	•	•	•
Standard Industrial, Black & White	—	<input type="checkbox"/> CWL620FO	•	•	•	•	•	•

Icon Key

NAFTA Compliant - see page O-30

Hart-Lock™ Industrial Specification Grade Locking Devices

2-Pole, 3-Wire Grounding
20A, 277V/AC
NEMA L7-20



L7-20R



L7-20P



CWL720P



CWL720C

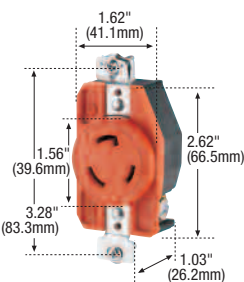

IGL720R



CWL720FO

Dimensional Information: C-79 – C-82

Plug & Connector Specification Information:

Safety Grip L7-20: C-88
Severe Duty: C-97
Watertight: C-95

Receptacle Specification Information:

L7-20: C-91
Isolated Ground L7-20: C-91
Watertight: C-96

Flanged Inlet & Flanged Outlet Specification Information:

L7-20: C-93

20A, 277V NEMA L7-20

Plugs & Connectors

Style & Description	Cord Dia.	Catalog No.		Certifications				
		Plug	Connector	USA	CSA	UL	ULS	ETL
Safety Grip™ Straight Body, Black & White	0.38-1.00" (9.5-25.4mm)	<input type="checkbox"/> CWL720P	<input type="checkbox"/> CWL720C	•				•
Severe Duty, Yellow & Black	0.38-1.00" (9.5-25.4mm)	<input type="checkbox"/> L720PY	<input type="checkbox"/> L720CY	•				•
Watertight, Yellow	0.36-0.84" (9.1-21.3mm)	<input type="checkbox"/> L720PW	<input type="checkbox"/> L720CW	•				•
Watertight, All-Black	0.36-0.84" (9.1-21.3mm)	<input type="checkbox"/> L720PWBK	<input type="checkbox"/> L720CWBK	•				•

Receptacles

Style & Description	Catalog No.		Certifications				
	Single Receptacle		USA	CSA	UL	ULS	ETL
Standard Industrial, Black	<input type="checkbox"/> CWL720R		•	•			•
Isolated Ground, Orange	<input type="checkbox"/> IGL720R		•	•			•
Watertight, Yellow	<input type="checkbox"/> L720RW		•		•		
Watertight, All-Black	<input type="checkbox"/> L720RWBK		•		•		

Flanged Inlets & Outlets

Style & Description	Catalog No.		Certifications				
	Flanged Inlet	Flanged Outlet	USA	CSA	UL	ULS	ETL
Standard Industrial, Black & White	<input type="checkbox"/> CWL720FI	—	•	•	•		
Standard Industrial, Black & White	—	<input type="checkbox"/> CWL720FO	•	•			•

Icon Key

NAFTA Compliant - see page O-30

Accessories for NEMA 20A Locking Devices

Description	Catalog No.	USA
Neoprene weather protective boot for 20A plug	<input type="checkbox"/> BM1	•
Neoprene weather protective boot for 20A connector	<input type="checkbox"/> BM2	•
Closure cap for 20A Severe Duty plug and connector or watertight plug	<input type="checkbox"/> 20PW	•
Replacement closure cap for 20A watertight connector	<input type="checkbox"/> 20CW	•
Diecast aluminum single receptacle cover, vertical mount, for FS/FD boxes	<input type="checkbox"/> 7420	•



BM1



BM2



20PW



20CW



7420

Hart-Lock™ Industrial Specification Grade Locking Devices

2-Pole, 3-Wire Grounding
20A, 480V/AC
NEMA L8-20

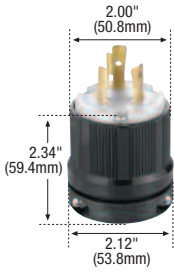
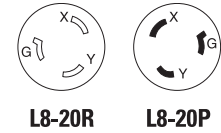

CWL820P



CWL820C

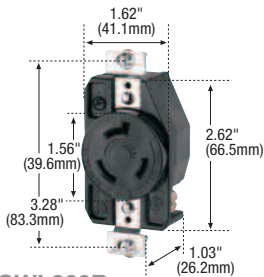

CWL820R

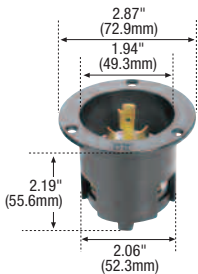

CWL820FI

Dimensional Information: C-79 – C-82

Plug & Connector Specification Information:

Safety Grip L8-20: C-88
Severe Duty: C-97
Watertight: C-95

Receptacle Specification Information:

L8-20: C-91
Isolated Ground L8-20: C-91
Watertight: C-96

Flanged Inlet & Flanged Outlet Specification Information:

L8-20: C-93

C-14

20A, 480V NEMA L8-20

Plugs & Connectors

Style & Description	Cord Dia.	Catalog No.		Certifications				
		Plug	Connector	USA	UL	UL	UL	UL
Safety Grip™ Straight Body, Black & White	0.38-1.00" (9.5-25.4mm)	<input type="checkbox"/> CWL820P	<input type="checkbox"/> CWL820C	•	•	•	•	•
Severe Duty, Yellow & Black	0.38-1.00" (9.5-25.4mm)	<input type="checkbox"/> L820PY	<input type="checkbox"/> L820CY	•				•
Watertight, Yellow	0.36-0.84" (9.1-21.3mm)	<input type="checkbox"/> L820PW	<input type="checkbox"/> L820CW	•				•
Watertight, All-Black	0.36-0.84" (9.1-21.3mm)	<input type="checkbox"/> L820PWBK	<input type="checkbox"/> L820CWBK	•				•

Receptacles

Style & Description	Catalog No.	Certifications				
		Single Receptacle	USA	UL	UL	UL
Standard Industrial, Black	<input type="checkbox"/> CWL820R		•	•		•
Isolated Ground, Orange	<input type="checkbox"/> IGL820R		•	•		•
Watertight, Yellow	<input type="checkbox"/> L820RW		•		•	
Watertight, All-Black	<input type="checkbox"/> L820RWBK		•		•	

Flanged Inlets & Outlets

Style & Description	Catalog No.		Certifications				
	Flanged Inlet	Flanged Outlet	USA	UL	UL	UL	UL
Standard Industrial, Black & White	<input type="checkbox"/> CWL820FI	—	•	•	•		
Standard Industrial, Black & White	—	<input type="checkbox"/> CWL820FO	•	•			•

Icon Key

NAFTA Compliant - see page O-30

Accessories for NEMA L8-20 Locking Devices

Description	Catalog No.	USA
Neoprene weather protective boot for 20A plug	<input type="checkbox"/> BM1	•
Neoprene weather protective boot for 20A connector	<input type="checkbox"/> BM2	•
Closure cap for 20A Severe Duty plug and connector or watertight plug	<input type="checkbox"/> 20PW	•
Replacement closure cap for 20A watertight connector	<input type="checkbox"/> 20CW	•
Diecast aluminum single receptacle cover, vertical mount, for FS/FD boxes	<input type="checkbox"/> 7420	•



BM1



BM2



20PW



20CW



7420

Hart-Lock™ Industrial Specification Grade Locking Devices

2-Pole, 3-Wire Grounding
20A, 600V/AC
NEMA L9-20



L9-20R



L9-20P



CWL920C

20A, 600V NEMA L9-20

Plugs & Connectors

Style & Description	Cord Dia.	Catalog No.		Certifications				
		Plug	Connector	US	CS	UL	ULS	ULS
Straight Body, Black & White	0.30-0.95" (7.6-24.1mm)	<input type="checkbox"/> CWL920P	<input type="checkbox"/> CWL920C	•	•			•

Receptacles

Style & Description	Catalog No.		Certifications				
	Single Receptacle		US	CS	UL	ULS	ULS
Standard Industrial, Black	<input type="checkbox"/> CWL920R	<input type="checkbox"/> CWL920F	•	•			•

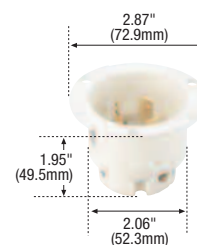

CWL920FI

Flanged Inlets & Outlets

Style & Description	Catalog No.		Certifications				
	Flanged Inlet	Flanged Outlet	US	CS	UL	ULS	ULS
Standard Industrial, Black & White	<input type="checkbox"/> CWL920FI	<input type="checkbox"/> CWL920FO	•	•			•

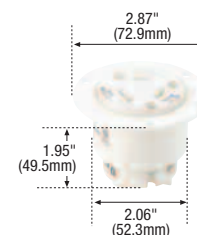

CWL920FO

Icon Key

NAFTA Compliant - see page O-30

Accessories for NEMA L9-20 Locking Devices

Description	Catalog No.	US
Diecast aluminum single receptacle cover, vertical mount, for FS/FD boxes	<input type="checkbox"/> 7420	•
Glass filled nylon flanged inlet/outlet cover, vertical mount, for 20A devices	<input type="checkbox"/> WP2	•



7420



WP2

Dimensional Information: C-80 – C-82

Receptacle Specification Information:
L9-20: C-91



CWL530P



CRL530C

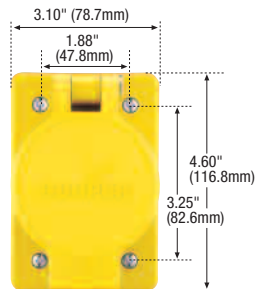

L530RW

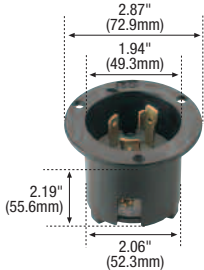

CWL530FI

Hart-Lock™ Industrial Specification Grade Locking Devices

2-Pole, 3-Wire Grounding
30A, 125V/AC
NEMA L5-30



L5-30R



L5-30P

30A, 125V NEMA L5-30

Plugs & Connectors

Style & Description	Cord Dia.	Catalog No.		Certifications				
		Plug	Connector	USA	UL	cUL	cULus	NOM 426
Safety Grip™ Straight Body, Black & White	0.38-1.00" (9.5-25.4mm)	<input type="checkbox"/> CWL530P	<input type="checkbox"/> CWL530C	•	•	•	•	•
Safety Grip™ Isolated Ground, Orange	0.38-1.00" (9.5-25.4mm)	<input type="checkbox"/> IGL530P	—	•	•	•	•	•
Safety Grip™ Corrosion Resistant, Yellow	0.38-1.00" (9.5-25.4mm)	<input type="checkbox"/> CRL530P	<input type="checkbox"/> CRL530C	•	•	•	•	•
Severe Duty, Yellow & Black	0.38-1.00" (9.5-25.4mm)	<input type="checkbox"/> L530PY	<input type="checkbox"/> L530CY	•	•	•	•	•
Watertight, Yellow	0.43-1.15" (10.9-29.2mm)	<input type="checkbox"/> L530PW	<input type="checkbox"/> L530CW	•	•	•	•	•
Watertight, All-Black	0.43-1.15" (10.9-29.2mm)	<input type="checkbox"/> L530PWBK	<input type="checkbox"/> L530CWBK	•	•	•	•	•

Receptacles

Style & Description	Catalog No.	Certifications					
		Single Receptacle	USA	UL	cUL	FUS	CS
Standard Industrial, Black	<input type="checkbox"/> CWL530R	•	•	•	•	•	•
Isolated Ground, Orange	<input type="checkbox"/> IGL530R	•	•	•	•	•	•
Corrosion Resistant, Yellow	<input type="checkbox"/> CRL530R	•	•	•	•	•	•
Watertight, Yellow	<input type="checkbox"/> L530RW	•	•	•	•	•	•
Watertight, All-Black	<input type="checkbox"/> L530RWBK	•	•	•	•	•	•

Flanged Inlets & Outlets

Style & Description	Catalog No.		Certifications				
	Flanged Inlet	Flanged Outlet	USA	UL	cUL	FUS	CS
Standard Industrial, Black & White	<input type="checkbox"/> CWL530FI	—	•	•	•	•	•
Standard Industrial, Black & White	—	<input type="checkbox"/> CWL530FO	•	•	•	•	•

Icon Key

NAFTA Compliant - see page O-30

Accessories for NEMA L5-30 Locking Devices

Description	Catalog No.	USA
Neoprene weather protective boot for 30A plug	<input type="checkbox"/> BM1	•
Neoprene weather protective boot for 30A connector	<input type="checkbox"/> BM2	•
Closure cap for 30A Severe Duty plug and connector or watertight plug	<input type="checkbox"/> 30PW	•
Replacement closure cap for 30A watertight connector	<input type="checkbox"/> 30CW	•



BM1



BM2



30PW



30CW

Dimensional Information: C-79 – C-82

Plug & Connector Specification Information:

- Safety Grip L5-30: C-89
- Corrosion Resistant: C-98
- Severe Duty: C-97
- Watertight: C-95

Receptacle Specification Information:

- L5-30: C-91
- Isolated Ground L5-30: C-91
- Corrosion Resistant: C-98
- Watertight: C-96

Flanged Inlet & Flanged Outlet Specification Information:

- L5-30: C-93

Hart-Lock™ Industrial Specification Grade Locking Devices

2-Pole, 3-Wire Grounding
30A, 250V/AC
NEMA L6-30

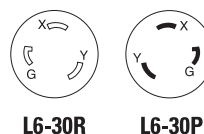

L630PW



CWL630C

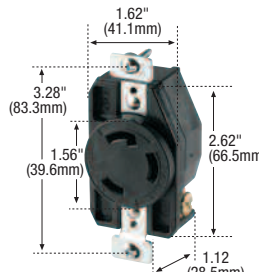

CWL630R



CWL630FO

Dimensional Information: C-79 – C-82

Plug & Connector Specification Information:

- Safety Grip L6-30: C-88
- Corrosion Resistant: C-98
- Severe Duty: C-97
- Watertight: C-95

Receptacle Specification Information:

- L6-30: C-91
- Isolated Ground L6-30: C-91
- Corrosion Resistant: C-98
- Watertight: C-96

Flanged Inlet & Flanged Outlet Specification Information:

- L6-30: C-93

30A, 250V NEMA L6-30

Style & Description	Cord Dia.	Catalog No.		Certifications					
		Plug	Connector	USA	UL	cUL	cULus	FUS	NOM 426
Safety Grip™ Straight Body, Black & White	0.38-1.00" (9.5-25.4mm)	<input type="checkbox"/> CWL630P	<input type="checkbox"/> CWL630C	•				•	
Safety Grip™ Corrosion Resistant, Yellow	0.38-1.00" (9.5-25.4mm)	<input type="checkbox"/> CRL630P	<input type="checkbox"/> CRL630C	•				•	•
Severe Duty, Yellow & Black	0.38-1.00" (9.5-25.4mm)	<input type="checkbox"/> L630PY	<input type="checkbox"/> L630CY	•				•	•
Watertight, Yellow	0.43-1.15" (10.9-29.2mm)	<input type="checkbox"/> L630PW	<input type="checkbox"/> L630CW	•				•	•
Watertight, All-Black	0.43-1.15" (10.9-29.2mm)	<input type="checkbox"/> L630PWBK	<input type="checkbox"/> L630CWBK	•				•	•

Style & Description	Catalog No.	Certifications					
		Single Receptacle	USA	UL	cUL	FUS	CS
Standard Industrial, Black	<input type="checkbox"/> CWL630R	•	•			•	•
Isolated Ground, Orange	<input type="checkbox"/> IGL630R	•	•			•	
Corrosion Resistant, Yellow	<input type="checkbox"/> CRL630R	•		•			•
Watertight, Yellow	<input type="checkbox"/> L630RW	•		•			•
Watertight, All-Black	<input type="checkbox"/> L630RWBK	•		•			•

Style & Description	Catalog No.		Certifications					
	Flanged Inlet	Flanged Outlet	USA	UL	cUL	FUS	CS	
Standard Industrial, Black & White	<input type="checkbox"/> CWL630FI	—		•	•		•	
Standard Industrial, Black & White	—	<input type="checkbox"/> CWL630FO		•			•	

Icon Key
 NAFTA Compliant - see page O-30

Description	Catalog No.	USA
Neoprene weather protective boot for 30A plug	<input type="checkbox"/> BM1	•
Neoprene weather protective boot for 30A connector	<input type="checkbox"/> BM2	•
Closure cap for 30A Severe Duty plug and connector or watertight plug	<input type="checkbox"/> 30PW	•
Replacement closure cap for 30A watertight connector	<input type="checkbox"/> 30CW	•



Hart-Lock™ Industrial Specification Grade Locking Devices

2-Pole, 3-Wire Grounding
30A, 277V/AC
NEMA L7-30



CWL730C

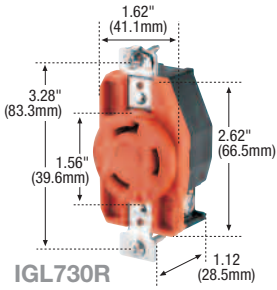

IGL730R

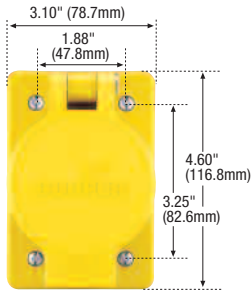

L730RW



CWL730FI

Dimensional Information: C-79 – C-82

Plug & Connector Specification Information:

Safety Grip L7-30: C-88
Severe Duty: C-97
Watertight: C-95

Receptacle Specification Information:

L7-30: C-91
Isolated Ground L7-30: C-91
Watertight: C-96

Flanged Inlet & Flanged Outlet Specification Information:

L7-30: C-93

30A, 277V NEMA L7-30

Plugs & Connectors

Style & Description	Cord Dia.	Catalog No.		Certifications				
		Plug	Connector	USA	UL	UL	UL	UL
Safety Grip™ Straight Body, Black & White	0.38-1.00" (9.5-25.4mm)	<input type="checkbox"/> CWL730P	<input type="checkbox"/> CWL730C	•	•	•	•	•
Severe Duty, Yellow & Black	0.38-1.00" (9.5-25.4mm)	<input type="checkbox"/> L730PY	<input type="checkbox"/> L730CY	•			•	
Watertight, Yellow	0.43-1.15" (10.9-29.2mm)	<input type="checkbox"/> L730PW	<input type="checkbox"/> L730CW	•			•	
Watertight, All-Black	0.43-1.15" (10.9-29.2mm)	<input type="checkbox"/> L730PWBK	<input type="checkbox"/> L730CWBK	•			•	

Receptacles

Style & Description	Catalog No.	Single Receptacle	Certifications				
			USA	UL	UL	UL	UL
Standard Industrial, Black	<input type="checkbox"/> CWL730R		•	•	•	•	•
Isolated Ground, Orange	<input type="checkbox"/> IGL730R		•	•			•
Watertight, Yellow	<input type="checkbox"/> L730RW		•		•		
Watertight, All-Black	<input type="checkbox"/> L730RWBK		•		•		

Flanged Inlets & Outlets

Style & Description	Catalog No.		Certifications				
	Flanged Inlet	Flanged Outlet	USA	UL	UL	UL	UL
Standard Industrial, Black & White	<input type="checkbox"/> CWL730FI	—	•	•	•		
Standard Industrial, Black & White	—	<input type="checkbox"/> CWL730FO	•	•			•

Icon Key

NAFTA Compliant - see page O-30

Accessories for NEMA L7-30 Locking Devices

Description	Catalog No.	USA
Neoprene weather protective boot for 30A plug	<input type="checkbox"/> BM1	•
Neoprene weather protective boot for 30A connector	<input type="checkbox"/> BM2	•
Closure cap for 30A Severe Duty plug and connector or watertight plug	<input type="checkbox"/> 30PW	•
Replacement closure cap for 30A watertight connector	<input type="checkbox"/> 30CW	•



BM1



BM2



30PW



30CW

Hart-Lock™ Industrial Specification Grade Locking Devices

2-Pole, 3-Wire Grounding
30A, 480V/AC
NEMA L8-30



L8-30R



L8-30P



CWL830P



CWL830C

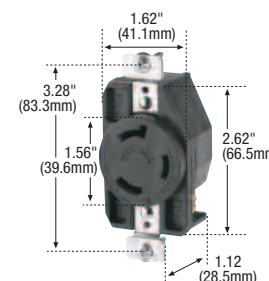

CWL830R

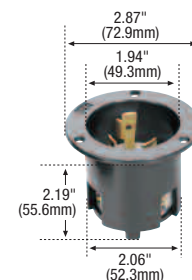

CWL830FI

Dimensional Information: C-79 – C-82

Plug & Connector Specification Information:

Safety Grip L8-30: C-89
Severe Duty: C-97
Watertight: C-95

Receptacle Specification Information:

L8-30: C-91
Isolated Ground L8-30: C-91
Watertight: C-96

Flanged Inlet & Flanged Outlet Specification Information:
L8-30: C-92 & C-93

30A, 480V NEMA L8-30

Plugs & Connectors

Style & Description	Cord Dia.	Catalog No.		Certifications				
		Plug	Connector	USA	CSA	UL	UL US	UL US
Safety Grip™ Straight Body, Black & White	0.38-1.00" (9.5-25.4mm)	<input type="checkbox"/> CWL830P	<input type="checkbox"/> CWL830C	•			•	•
Severe Duty, Yellow & Black	0.38-1.00" (9.5-25.4mm)	<input type="checkbox"/> L830PY	<input type="checkbox"/> L830CY	•			•	
Watertight, Yellow	0.43-1.15" (10.9-29.2mm)	<input type="checkbox"/> L830PW	<input type="checkbox"/> L830CW	•			•	
Watertight, All-Black	0.43-1.15" (10.9-29.2mm)	<input type="checkbox"/> L830PWBK	<input type="checkbox"/> L830CWBK	•			•	

Receptacles

Style & Description	Catalog No.	Certifications				
		Single Receptacle	USA	CSA	UL	UL US
Standard Industrial, Black	<input type="checkbox"/> CWL830R	•	•			•
Isolated Ground, Orange	<input type="checkbox"/> IGL830R	•	•			•
Watertight, Yellow	<input type="checkbox"/> L830RW	•			•	
Watertight, All-Black	<input type="checkbox"/> L830RWBK	•			•	

Flanged Inlets & Outlets

Style & Description	Catalog No.		Certifications				
	Flanged Inlet	Flanged Outlet	USA	CSA	UL	UL US	UL US
Standard Industrial, Black & White	<input type="checkbox"/> CWL830FI	—	•			•	•
Standard Industrial, Black & White	—	<input type="checkbox"/> CWL830FO	•	•			•

Icon Key

NAFTA Compliant - see page O-30

Accessories for NEMA L8-30 Locking Devices

Description	Catalog No.	USA
Neoprene weather protective boot for 30A plug	<input type="checkbox"/> BM1	•
Neoprene weather protective boot for 30A connector	<input type="checkbox"/> BM2	•
Closure cap for 30A Severe Duty plug and connector or watertight plug	<input type="checkbox"/> 30PW	•
Replacement closure cap for 30A watertight connector	<input type="checkbox"/> 30CW	•



BM1



BM2



30PW



30CW

Hart-Lock™ Industrial Specification Grade Locking Devices

2-Pole, 3-Wire Grounding
30A, 600V/AC
NEMA L9-30

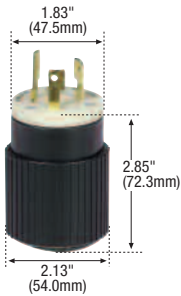
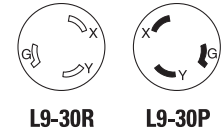

CWL930P



CWL930C

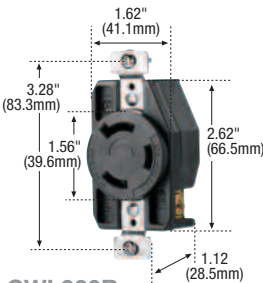

CWL930R

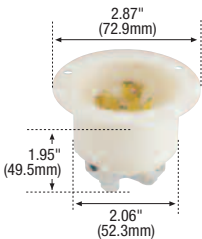

CWL930FI

30A, 600V NEMA L9-30

Plugs & Connectors

Style & Description	Cord Dia.	Plug	Connector	Catalog No.					Certifications										
									USA	UL	UL	UL	UL						
Straight Body, Black & White	0.30-0.95" (7.6-24.1mm)	<input type="checkbox"/> CWL930P	<input type="checkbox"/> CWL930C																

Receptacles

Style & Description	Catalog No.		Certifications										
	Single Receptacle		USA	UL	UL	UL	UL						
Standard Industrial, Black	<input type="checkbox"/> CWL930R												

Flanged Inlets & Outlets

Style & Description	Catalog No.		Certifications									
	Flanged Inlet	Flanged Outlet	USA	UL	UL	UL	UL					
Standard Industrial, Black & White	<input type="checkbox"/> CWL930FI	—										
Standard Industrial, Black & White	—	<input type="checkbox"/> CWL930FO										

Icon Key

NAFTA Compliant - see page O-30

Accessories for NEMA L9-30 Locking Devices

Description	Catalog No.	USA
Die cast aluminum single receptacle cover, vertical mount, for FS/FD boxes	<input type="checkbox"/> 7420	
Glass filled nylon flanged inlet/outlet cover, vertical mount, for 30A devices	<input type="checkbox"/> WP2	



7420



WP2

Dimensional Information: C-80 – C-82

Receptacle Specification Information:
L9-30: C-91

C-20

Hart-Lock™ Industrial Specification Grade Locking Devices

3-Pole, 3-Wire
Non-Grounding
10/15A, 125/250V/AC
Non-NEMA



Receptacle Plug
Non-NEMA
15A 125V; 10A 250V

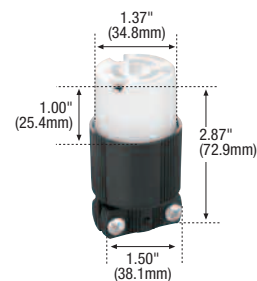

4755



7567N

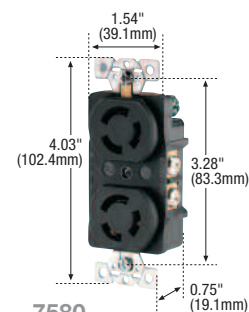

7580

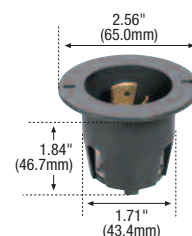

7556C

10/15A, 250/125V Non-NEMA

Plugs & Connectors

Style & Description	Cord Dia.	Catalog No.		Certifications				
		Plug	Connector	USA	CSA	UL	ULus	ULcs
Safety Grip™ Straight Body, Black & White	0.33-0.66" (8.4-16.7mm)	□ 4767	—	•	•	•	•	•
Safety Grip™ Straight Body, Black & White	0.33-0.66" (8.4-16.7mm)	—	□ 4755	•	•	•	•	•
Safety Grip™ Angled Body, Black & White	0.33-0.66" (8.4-16.7mm)	□ 4767AN	—	•	•	•	•	•
AutoGrip™ Straight Body, Black & White	0.33-0.66" (8.4-16.7mm)	□ 7567N	□ 7565N	•	•	•	•	•

Receptacles

Style & Description	Catalog No.		Certifications				
	Single Receptacle	Duplex Receptacle	USA	CSA	UL	ULus	ULcs
Standard Industrial, Black	□ 7582	□ 7580	•	•	•	•	•

Icon Key

NAFTA Compliant - see page O-30

Accessories for Non-NEMA 10/15A Locking Devices

Description	Catalog No.	USA
Neoprene weather protective boot for 10/15A plug	□ BS1	•
Neoprene weather protective boot for 10/15A connector	□ BS2	•
Diecast aluminum single receptacle cover, vertical mount, for FS/FD Boxes	□ 7420	•
Glass filled nylon flanged inlet/outlet cover, vertical mount, for 10/15A devices	□ WP1	•



BS1



BS2



7420



WP1

Dimensional Information: C-79 – C-82

Plug & Connector Specification Information:

Safety Grip Non-NEMA 10/15A: C-88

AutoGrip Non-NEMA 10/15A: C-88

Receptacle Specification Information:

Non-NEMA 10/15A: C-90

Hart-Lock™ Industrial Specification Grade Locking Devices

3-Pole, 3-Wire
Non-Grounding
20A, 125/250V/AC
Non-NEMA

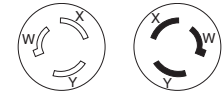

Receptacle Plug
Non-NEMA
20A 125/250V

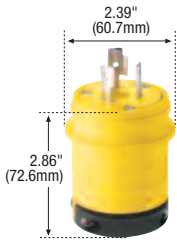

9965PY



7314C

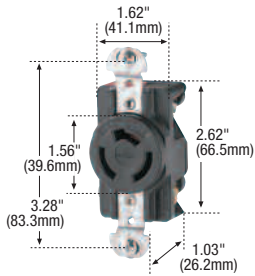

7310B

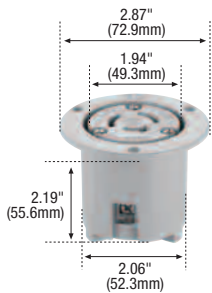

7328N

Dimensional Information: C-79 – C-82

Plug & Connector Specification Information:

Safety Grip Non-NEMA 20A: C-88

Severe Duty: C-97

Watertight: C-95

Receptacle Specification Information:

Non-NEMA 20A: C-91

Watertight: C-96

Flanged Inlet & Flanged Outlet Specification Information:

Non-NEMA 20A: C-93

20A, 125/250V Non-NEMA

Plugs & Connectors

Style & Description	Cord Dia.	Catalog No.		Certifications				
		Plug	Connector	USA	CSA	UL	UL US	UL CS
Safety Grip™ Straight Body, Gray	0.38-1.00" (9.5-25.4mm)	□ 9965C	□ 7314C	•				•
Severe Duty, Yellow & Black	0.38-1.00" (9.5-25.4mm)	□ 9965PY	□ 7314CY	•				•
Watertight, Yellow	0.36-0.84" (9.1-21.3mm)	□ 9965PW	□ 7314CW	•				•
Watertight, All-Black	0.36-0.84" (9.1-21.3mm)	□ 9965PWBK	□ 7314CWBK	•				•

Receptacles

Style & Description	Catalog No.	Certifications				
		Single Receptacle	USA	CSA	UL	UL US
Standard Industrial, Black	□ 7310B		•			
Watertight, Yellow	□ 7314RW	•			•	
Watertight, All-Black	□ 7314RWBK	•			•	

Flanged Inlets & Outlets

Style & Description	Catalog No.		Certifications				
	Flanged Inlet	Flanged Outlet	USA	CSA	UL	UL US	UL CS
Standard Industrial, Black & White	□ 7327N	—	•	•	•		
Standard Industrial, Black & White	—	□ 7328N	•	•			•

Icon Key

NAFTA Compliant - see page O-30

Accessories for Non-NEMA 20A Locking Devices

Description	Catalog No.	
Neoprene weather protective boot for 20A plug	□ BM1	•
Neoprene weather protective boot for 20A connector	□ BM2	•



BM1



BM2

Hart-Lock™ Industrial Specification Grade Locking Devices

3-Pole, 3-Wire Non-Grounding
20A, 125/250V/AC
NEMA L10-20

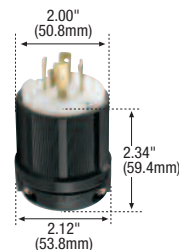
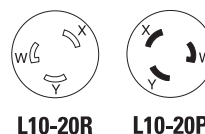

CWL1020P



L1020CY

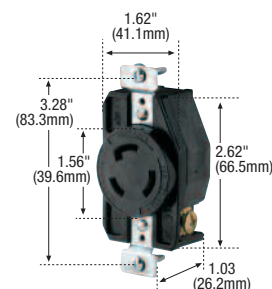

CWL1020R



CWL1020FI

20A, 125/250V NEMA L10-20

Plugs & Connectors

Style & Description	Cord Dia.	Catalog No.		Certifications				
		Plug	Connector	USA	CSA	cUL	cULus	ULS
Safety Grip™ Straight Body, Black & White	0.38-1.00" (9.5-25.4mm)	<input type="checkbox"/> CWL1020P	<input type="checkbox"/> CWL1020C	•				•
Severe Duty, Yellow & Black	0.38-1.00" (9.5-25.4mm)	<input type="checkbox"/> L1020PY	<input type="checkbox"/> L1020CY	•				•
Watertight, Yellow	0.43-1.15" (10.9-29.2mm)	<input type="checkbox"/> L1020PW	<input type="checkbox"/> L1020CW	•				•
Watertight, All-Black	0.43-1.15" (10.9-29.2mm)	<input type="checkbox"/> L1020PWBK	<input type="checkbox"/> L1020CWBK	•				•

Receptacles

Style & Description	Catalog No.	Certifications					
		Single Receptacle	USA	CSA	cUL	cULus	ULS
Standard Industrial, Black	<input type="checkbox"/> CWL1020R		•			•	•
Watertight, Yellow	<input type="checkbox"/> L1020RW		•			•	
Watertight, All-Black	<input type="checkbox"/> L1020RWBK		•			•	

Flanged Inlets & Outlets

Style & Description	Catalog No.		Certifications				
	Flanged Inlet	Flanged Outlet	USA	CSA	cUL	cULus	ULS
Standard Industrial, Black & White	<input type="checkbox"/> CWL1020FI	—	•	•	•		
Standard Industrial, Black & White	—	<input type="checkbox"/> CWL1020FO	•	•			•

Icon Key

NAFTA Compliant - see page O-30

Accessories for NEMA L10-20 Locking Devices

Description	Catalog No.	USA
Neoprene weather protective boot for 20A plug	<input type="checkbox"/> BM1	•
Neoprene weather protective boot for 20A connector	<input type="checkbox"/> BM2	•
Closure cap for 20A Severe Duty plug and connector or watertight plug	<input type="checkbox"/> 20PW	•
Replacement closure cap for 20A watertight connector	<input type="checkbox"/> 20CW	•
Diecast aluminum single receptacle cover, vertical mount, for FS/FD boxes	<input type="checkbox"/> 7420	•



BM1



BM2



20PW



20CW



7420

Dimensional Information: C-79 – C-82

Plug & Connector Specification Information:

Safety Grip L10-20: C-88

Severe Duty: C-97

Watertight: C-95

Receptacle Specification Information:

L10-20: C-91

Watertight: C-96

Flanged Inlet & Flanged Outlet Specification Information:

L10-20: C-93

Hart-Lock™ Industrial Specification Grade Locking Devices

3-Pole, 3-Wire Non-Grounding
20A, 3Ø 250V/AC
NEMA L11-20

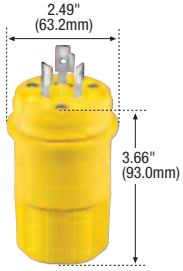
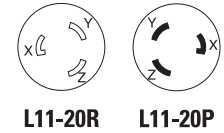

L1120PW



CWL1120C

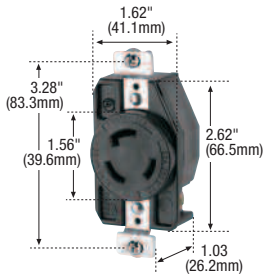

CWL1120R



CWL1120FO

Dimensional Information: C-79 – C-82

Plug & Connector Specification Information:

Safety Grip L11-20: C-89

Severe Duty: C-97

Watertight: C-95

Receptacle Specification Information:

L11-20: C-91

Watertight: C-96

Flanged Inlet & Flanged Outlet Specification Information:

L11-20: C-92 – C-93

20A, 3Ø 250V NEMA L11-20

Plugs & Connectors

Style & Description	Cord Dia.	Catalog No.		Certifications				
		Plug	Connector	USA	UL	cUL	cULus	NOM 426
Safety Grip™ Straight Body, Black & White	0.38-1.00" (9.5-25.4mm)	<input type="checkbox"/> CWL1120P	<input type="checkbox"/> CWL1120C	•			•	•
Severe Duty, Yellow & Black	0.38-1.00" (9.5-25.4mm)	<input type="checkbox"/> L1120PY	<input type="checkbox"/> L1120CY	•			•	•
Watertight, Yellow	0.43-1.15" (10.9-29.2mm)	<input type="checkbox"/> L1120PW	<input type="checkbox"/> L1120CW	•			•	•
Watertight, All-Black	0.43-1.15" (10.9-29.2mm)	<input type="checkbox"/> L1120PWBK	<input type="checkbox"/> L1120CWBK	•			•	•

Receptacles

Style & Description	Catalog No.	Certifications				
		Single Receptacle	USA	UL	cULus	FUS
Standard Industrial, Black	<input type="checkbox"/> CWL1120R		•			•
Watertight, Yellow	<input type="checkbox"/> L1120RW		•			•
Watertight, All-Black	<input type="checkbox"/> L1120RWBK		•			•

Flanged Inlets & Outlets

Style & Description	Catalog No.		Certifications				
	Flanged Inlet	Flanged Outlet	USA	UL	cUL	FUS	CS
Standard Industrial, Black & White	<input type="checkbox"/> CWL1120FI	—	•	•	•		
Standard Industrial, Black & White	—	<input type="checkbox"/> CWL1120FO	•	•	•		•

Icon Key

NAFTA Compliant - see page O-30

Accessories for NEMA L11-20 Locking Devices

Description	Catalog No.	USA
Neoprene weather protective boot for 20A plug	<input type="checkbox"/> BM1	•
Neoprene weather protective boot for 20A connector	<input type="checkbox"/> BM2	•
Closure cap for 20A Severe Duty plug and connector or watertight plug	<input type="checkbox"/> 20PW	•
Replacement closure cap for 20A watertight connector	<input type="checkbox"/> 20CW	•
Diecast aluminum single receptacle cover, vertical mount, for FS/FD boxes	<input type="checkbox"/> 7420	•



BM1



BM2



20PW



20CW



7420

Hart-Lock™ Industrial Specification Grade Locking Devices

3-Pole, 3-Wire Non-Grounding
20A, 3Ø 480V/AC
NEMA L12-20

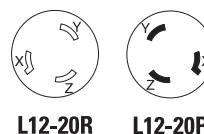

CWL1220P

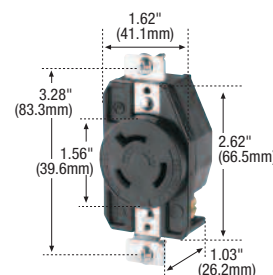

CWL1220R

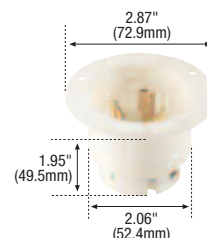

CWL1220FI

20A, 3Ø 480V NEMA L12-20

Plugs & Connectors

Style & Description	Cord Dia.	Catalog No.		Certifications				
		Plug	Connector	US	CS	UL	UL US	UL US CS
Straight Body, Black & White	0.38-1.00" (9.5-25.4mm)	<input type="checkbox"/> CWL1220P	<input type="checkbox"/> CWL1220C	•	•	•	•	•

Receptacles

Style & Description	Catalog No.		Certifications				
	Single Receptacle		US	CS	UL	UL US	UL US CS
Standard Industrial, Black	<input type="checkbox"/> CWL1220R		•	•	•	•	•

Flanged Inlets & Outlets

Style & Description	Catalog No.		Certifications				
	Flanged Inlet	Flanged Outlet	US	CS	UL	UL US	UL US CS
Standard Industrial, Black & White	<input type="checkbox"/> CWL1220FI	—	•	•	•	•	•
Standard Industrial, Black & White	—	<input type="checkbox"/> CWL1220FO	•	•	•	•	•

Icon Key

NAFTA Compliant - see page O-30

Accessories for NEMA L12-20 Locking Devices

Description	Catalog No.	
Diecast aluminum single receptacle cover, vertical mount, for FS/FD boxes	<input type="checkbox"/> 7420	•
Glass filled nylon flanged inlet/outlet cover, vertical mount, for 20A devices	<input type="checkbox"/> WP2	•



7420



WP2

Dimensional Information: C-80 – C-82

Receptacle Specification Information:

L12-20 : C-91



3331N



3333N

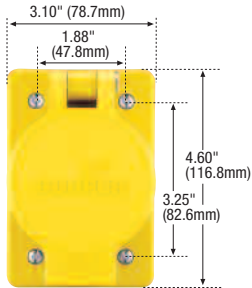

3333RW

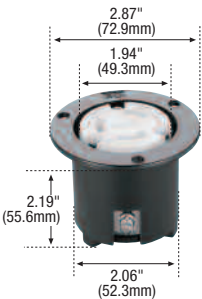

3336N

Hart-Lock™ Industrial Specification Grade Locking Devices

3-Pole, 3-Wire
Non-Grounding
30A, 125/250V/AC
Non-NEMA



Receptacle Plug
Non-NEMA
30A 125/250V

30A, 125/250V Non-NEMA

Plugs & Connectors

Style & Description	Cord Dia.	Catalog No.		Certifications				
		Plug	Connector	USA	UL	UL	UL	UL
Safety Grip™ Straight Body, Black & White	0.38-1.00" (9.5-25.4mm)	□ 3331N	□ 3333N	•	•	•	•	•
Severe Duty, Yellow & Black	0.38-1.00" (9.5-25.4mm)	□ 3331PY	□ 3333CY	•	•	•	•	•
Watertight, Yellow	0.43-1.15" (10.9-29.2mm)	□ 3331PW	□ 3333CW	•	•	•	•	•
Watertight, All-Black	0.43-1.15" (10.9-29.2mm)	□ 3331PWBK	□ 3333CWBK	•	•	•	•	•

Receptacles

Style & Description	Catalog No.	Certifications				
		Single Receptacle	USA	UL	UL	UL
Standard Industrial, Black	□ 3330-2	•	•	•	•	•
Watertight, Yellow	□ 3333RW	•	•	•	•	•
Watertight, All-Black	□ 3333RWBK	•	•	•	•	•

Flanged Inlets & Outlets

Style & Description	Catalog No.		Certifications				
	Flanged Inlet	Flanged Outlet	USA	UL	UL	UL	UL
Standard Industrial, Black & White	□ 3337N	—	•	•	•	•	•
Standard Industrial, Black & White	—	□ 3336N	•	•	•	•	•

Icon Key

NAFTA Compliant - see page O-30

Accessories for Non-NEMA 30A Locking Devices

Description	Catalog No.	USA
Neoprene weather protective boot for 30A plug	□ BM1	•
Neoprene weather protective boot for 30A connector	□ BM2	•
Closure cap for 20A Severe Duty plug and connector or watertight plug	□ 20PW	•
Replacement closure cap for 30A watertight connector	□ 20CW	•
Diecast aluminum single receptacle cover, vertical mount, for FS/FD boxes	□ 7420	•



BM1



BM2



20PW



20CW



7420

Dimensional Information: C-79 – C-82

Plug & Connector Specification Information:

Safety Grip Non-NEMA 30A: C-88

Severe Duty: C-97

Watertight: C-95

Receptacle Specification Information:

Non-NEMA 30A: C-91

Watertight: C-96

Flanged Inlet & Flanged Outlet Specification Information:

Non-NEMA 30A: C-93

Hart-Lock™ Industrial Specification Grade Locking Devices

3-Pole, 3-Wire Non-Grounding
30A, 125/250V/AC
NEMA L10-30

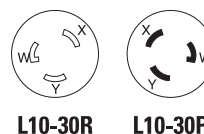

CWL1030P



CWL1030C

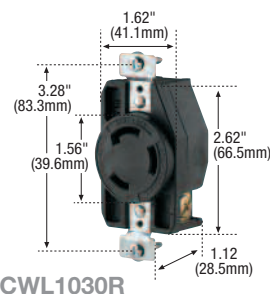

CWL1030R

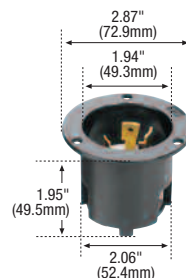

CWL1030FI

Dimensional Information: C-79 – C-82

Plug & Connector Specification Information:

Safety Grip L10-30: C-89

Severe Duty: C-97

Watertight: C-95

Receptacle Specification Information:

L10-30: C-91

Watertight: C-96

Flanged Inlet & Flanged Outlet Specification Information:

L10-30: C-93

30A, 125/250V NEMA L10-30

Plugs & Connectors

Style & Description	Cord Dia.	Catalog No.		Certifications				
		Plug	Connector	USA	CSA	UL	UL US	UL US
Safety Grip™ Straight Body, Black & White	0.38-1.00" (9.5-25.4mm)	<input type="checkbox"/> CWL1030P	<input type="checkbox"/> CWL1030C	•	•			
Severe Duty, Yellow & Black	0.38-1.00" (9.5-25.4mm)	<input type="checkbox"/> L1030PY	<input type="checkbox"/> L1030CY	•				•
Watertight, Yellow	0.43-1.15" (10.9-29.2mm)	<input type="checkbox"/> L1030PW	<input type="checkbox"/> L1030CW	•				•
Watertight, All-Black	0.43-1.15" (10.9-29.2mm)	<input type="checkbox"/> L1030PWBK	<input type="checkbox"/> L1030CWBK	•				•

Receptacles

Style & Description	Catalog No.	Single Receptacle	Certifications				
			USA	CSA	UL	UL US	UL US
Standard Industrial, Black	<input type="checkbox"/> CWL1030R		•				•
Watertight, Yellow	<input type="checkbox"/> L1030RW		•				•
Watertight, All-Black	<input type="checkbox"/> L1030RWBK		•				•

Flanged Inlets & Outlets

Style & Description	Catalog No.		Certifications				
	Flanged Inlet	Flanged Outlet	USA	CSA	UL	UL US	UL US
Standard Industrial, Black & White	<input type="checkbox"/> CWL1030FI	—	•	•	•		
Standard Industrial, Black & White	—	<input type="checkbox"/> CWL1030FO	•	•			•

Icon Key

USA NAFTA Compliant - see page O-30

Accessories for L10-30 Locking Devices

Description	Catalog No.	USA
Neoprene weather protective boot for 30A plug	<input type="checkbox"/> BM1	•
Diecast aluminum single receptacle cover, vertical mount, for FS/FD boxes	<input type="checkbox"/> 7420	•
Glass-filled nylon flanged inlet/outlet cover, vertical mount, for 30A devices	<input type="checkbox"/> WP2	•



BM1



7420



WP2



L1130PY



CWL1130C

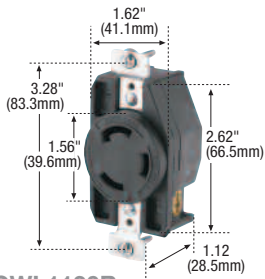

CWL1130R

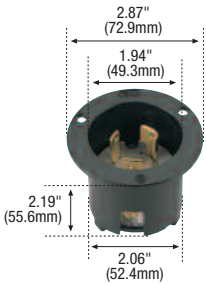

CWL1130FI

Hart-Lock™ Industrial Specification Grade Locking Devices

3-Pole, 3-Wire Non-Grounding
30A, 3Ø 250V/AC
NEMA L11-30

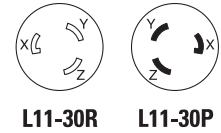

30A, 3Ø 250V NEMA L11-30

Plugs & Connectors

Style & Description	Cord Dia.	Catalog No.		Certifications				
		Plug	Connector	USA	UL	cUL	cULus	NOM 426
Safety Grip™ Straight Body, Black & White	0.38-1.00" (9.5-25.4mm)	<input type="checkbox"/> CWL1130P	<input type="checkbox"/> CWL1130C	•			•	•
Severe Duty, Yellow & Black	0.38-1.00" (9.5-25.4mm)	<input type="checkbox"/> L1130PY	<input type="checkbox"/> L1130CY	•			•	•
Watertight, Yellow	0.43-1.15" (10.9-29.2mm)	<input type="checkbox"/> L1130PW	<input type="checkbox"/> L1130CW	•			•	•
Watertight, All-Black	0.43-1.15" (10.9-29.2mm)	<input type="checkbox"/> L1130PWBK	<input type="checkbox"/> L1130CWBK	•			•	•

Receptacles

Style & Description	Catalog No.	Certifications				
		Single Receptacle	USA	UL	cUL	FUS
Standard Industrial, Black	<input type="checkbox"/> CWL1130R		•			•
Watertight, Yellow	<input type="checkbox"/> L1130RW	•			•	•
Watertight, All-Black	<input type="checkbox"/> L1130RWBK	•			•	•

Flanged Inlets & Outlets

Style & Description	Catalog No.		Certifications				
	Flanged Inlet	Flanged Outlet	USA	UL	cUL	FUS	CS
Standard Industrial, Black & White	<input type="checkbox"/> CWL1130FI	—	•	•	•		
Standard Industrial, Black & White	—	<input type="checkbox"/> CWL1130FO	•	•			•

Dimensional Information: C-79 – C-82

Plug & Connector Specification Information:

Safety Grip L11-30: C-89

Severe Duty: C-97

Watertight: C-95

Receptacle Specification Information:

L11-30: C-91

Watertight: C-96

Flanged Inlet & Flanged Outlet Specification Information:

L11-30: C-93

C-28

Icon Key

NAFTA Compliant - see page O-30

Accessories for NEMA L11-30 Locking Devices

Description	Catalog No.	USA
Neoprene weather protective boot for 30A plug	<input type="checkbox"/> BM1	•
Diecast aluminum single receptacle cover, vertical mount, for FS/FD boxes	<input type="checkbox"/> 7420	•
Glass-filled nylon flanged inlet/outlet cover, vertical mount, for 30A devices	<input type="checkbox"/> WP2	•



BM1



7420



WP2

Hart-Lock™ Industrial Specification Grade Locking Devices

3-Pole, 3-Wire Non-Grounding
30A, 3Ø 480V/AC
NEMA L12-30

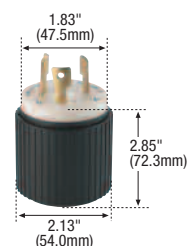
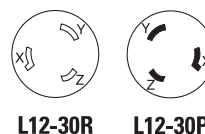

CWL1230P

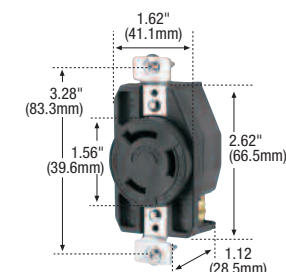

CWL1230R



CWL1230FO



CWL1230FI

30A, 3Ø 480V NEMA L12-30

Plugs & Connectors

Style & Description	Cord Dia.	Catalog No.		Certifications				
		Plug	Connector	USA	CSA	UL	UL US	UL S
Straight Body, Black & White	0.38-1.00" (9.5-25.4mm)	<input type="checkbox"/> CWL1230P	<input type="checkbox"/> CWL1230C	•	•			•

Receptacles

Style & Description	Catalog No.		Certifications				
	Single Receptacle		USA	CSA	UL	UL US	UL S
Standard Industrial, Black	<input type="checkbox"/> CWL1230R		•	•			

Flanged Inlets & Outlets

Style & Description	Catalog No.		Certifications				
	Flanged Inlet	Flanged Outlet	USA	CSA	UL	UL US	UL S
Standard Industrial, Black & White	<input type="checkbox"/> CWL1230FI	—	•	•			•
Standard Industrial, Black & White	—	<input type="checkbox"/> CWL1230FO	•	•			

Icon Key

NAFTA Compliant - see page O-30

Accessories for NEMA L12-30 Locking Devices

Description	Catalog No.	
Diecast aluminum single receptacle cover, vertical mount, for FS/FD boxes	<input type="checkbox"/> 7420	•
Corrosion resistant finish die cast aluminum single receptacle cover, vertical mount, for FS/FD boxes	<input type="checkbox"/> 7420CR	•
Glass-filled nylon flanged inlet/outlet cover, vertical mount, for 30A devices	<input type="checkbox"/> WP2	•



7420



7420CR



WP2

Dimensional Information: C-80 – C-82

Receptacle Specification Information:

L12-30: C-91

Hart-Lock™ Industrial Specification Grade Locking Devices

3-Pole, 3-Wire Non-Grounding
30A, 3Ø 600V/AC
NEMA L13-30

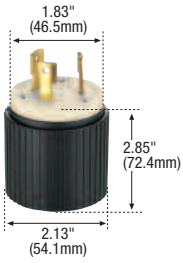
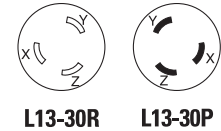

CWL1330P



CWL1330C

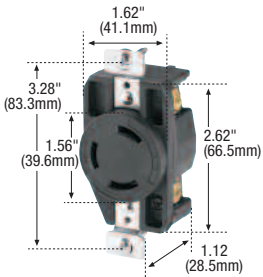

CWL1330R

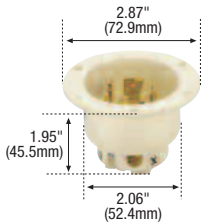

CWL1330FI

30A, 3Ø 600V NEMA L13-30

Plugs & Connectors

Style & Description	Cord Dia.	Catalog No.		Certifications				
		Plug	Connector	USA	UL	UL	UL	UL
Straight Body, Black & White	0.38-1.00" (9.5-25.4mm)	<input type="checkbox"/> CWL1330P	<input type="checkbox"/> CWL1330C	•	•			•

Receptacles

Style & Description	Catalog No.		Certifications				
	Single Receptacle		USA	UL	UL	UL	UL
Standard Industrial, Black	<input type="checkbox"/> CWL1330R		•	•			

Flanged Inlets & Outlets

Style & Description	Catalog No.		Certifications				
	Flanged Inlet	Flanged Outlet	USA	UL	UL	UL	UL
Standard Industrial, Black & White	<input type="checkbox"/> CWL1330FI	—	•	•			•
Standard Industrial, Black & White	—	<input type="checkbox"/> CWL1330FO	•	•			

Icon Key

NAFTA Compliant - see page O-30

Accessories for NEMA L13-30 Locking Devices

Description	Catalog No.	USA
Diecast aluminum single receptacle cover, vertical mount, for FS/FD boxes	<input type="checkbox"/> 7420	•
Corrosion resistant finish diecast aluminum single receptacle cover, vertical mount, for FS/FD boxes	<input type="checkbox"/> 7420CR	•
Glass-filled nylon flanged inlet/outlet cover, vertical mount, for 30A devices	<input type="checkbox"/> WP2	•

Dimensional Information: C-80 – C-82

Receptacle Specification Information:

L13-30: C-91

C-30



7420



7420CR



WP2

Hart-Lock™ Industrial Specification Grade Locking Devices

3-Pole, 4-Wire Grounding
20A, 125/250V/AC
NEMA L14-20

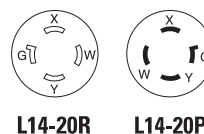

20A, 125/250V NEMA L14-20

Plugs & Connectors

Style & Description	Cord Dia.	Catalog No.		Certifications					
		Plug	Connector	USA	UL	cUL	cULus	ULus	426
Safety Grip™ Straight Body, Black & White	0.38-1.00" (9.5-25.4mm)	<input type="checkbox"/> CWL1420P	<input type="checkbox"/> CWL1420C	•	•	•	•	•	•
Safety Grip™ Straight Body, Black	0.38-1.00" (9.5-25.4mm)	<input type="checkbox"/> CWL1420PBK	<input type="checkbox"/> CWL1420CBK						•
Safety Grip™ Corrosion Resistant, Yellow	0.38-1.00" (9.5-25.4mm)	<input type="checkbox"/> CRL1420P	<input type="checkbox"/> CRL1420C	•					•
Severe Duty, Yellow & Black	0.63-1.16" (15.9-29.4mm)	<input type="checkbox"/> L1420PY	<input type="checkbox"/> L1420CY	•					•
Watertight, Yellow	0.36-0.84" (9.1-21.3mm)	<input type="checkbox"/> L1420PW	<input type="checkbox"/> L1420CW	•					•
Watertight, All-Black	0.36-0.84" (9.1-21.3mm)	<input type="checkbox"/> L1420PWBK	<input type="checkbox"/> L1420CWBK	•					•

CWL1420P

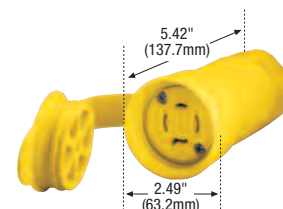

L1420CW

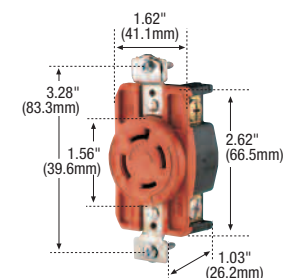

IGL1420R

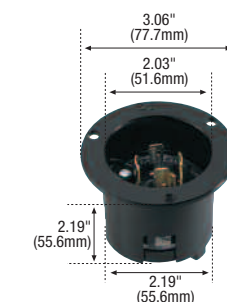

6405BK

Receptacles

Style & Description	Catalog No.	Certifications					
		Single Receptacle	USA	UL	cUL	ULus	426
Standard Industrial, Black	<input type="checkbox"/> CWL1420R		•	•	•	•	•
Isolated Ground, Orange	<input type="checkbox"/> IGL1420R		•	•			•
Corrosion Resistant, Yellow	<input type="checkbox"/> CRL1420R		•				•
Watertight, Yellow	<input type="checkbox"/> L1420RW		•				•
Watertight, All-Black	<input type="checkbox"/> L1420RWBK		•				•

Dimensional Information: C-79 – C-82

Plug & Connector Specification Information:

Safety Grip L14-20: C-88
Corrosion Resistant: C-98
Severe Duty: C-97
Watertight: C-95

Receptacle Specification Information:

L14-20: C-91
Isolated Ground L14-20: C-91
Corrosion Resistant: C-98
Watertight: C-96

Flanged Inlet & Flanged Outlet Specification Information:
L14-20: C-93

Flanged Inlets & Outlets

Style & Description	Catalog No.		Certifications					
	Flanged Inlet	Flanged Outlet	USA	UL	cUL	ULus	426	
Standard Industrial, Black & White	<input type="checkbox"/> CWL1420FI	—	•	•	•	•	•	
Standard Industrial, Black	<input type="checkbox"/> 6405BK	—					•	
Standard Industrial, Black & White	—	<input type="checkbox"/> CWL1420FO	•	•			•	
Standard Industrial, Black	—	<input type="checkbox"/> 6406BK					•	

Icon Key

USA NAFTA Compliant - see page O-30

Accessories for NEMA L14-20 Locking Devices

Description	Catalog No.	USA
Neoprene weather protective boot for 20A 3-P, 4-W plug	<input type="checkbox"/> BL1	•
Neoprene weather protective boot for 20A 3-P, 4-W connector	<input type="checkbox"/> BL2	•



BL1



BL2

Hart-Lock™ Industrial Specification Grade Locking Devices

3-Pole, 4-Wire Grounding
20A, 3Ø 250V/AC
NEMA L15-20

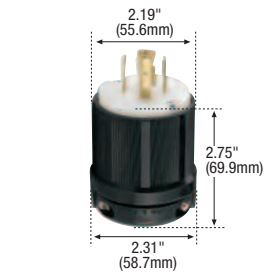
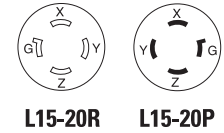

CWL1520P



CWL1520C

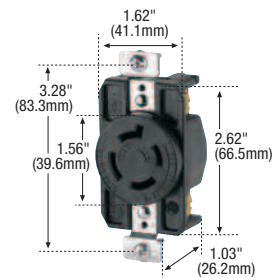

CWL1520R

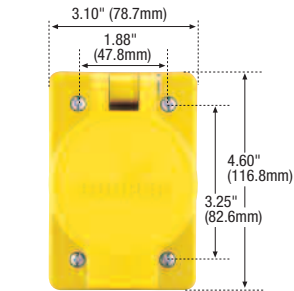

L1520RW

Dimensional Information: C-79 – C-82

Plug & Connector Specification Information:

Safety Grip L15-20: C-88

Corrosion Resistant: C-98

Severe Duty: C-97

Watertight: C-95

Receptacle Specification Information:

L15-20: C-91

Isolated Ground L15-20: C-91

Corrosion Resistant: C-98

Watertight: C-96

Flanged Inlet & Flanged Outlet Specification Information:

L15-20: C-93

20A, 3Ø 250V NEMA L15-20

Plugs & Connectors

Style & Description	Cord Dia.	Catalog No.		Certifications				
		Plug	Connector	USA	UL	cUL	cULus	NOM 426
Safety Grip™ Straight Body, Black & White	0.38-1.00" (9.5-25.4mm)	<input type="checkbox"/> CWL1520P	<input type="checkbox"/> CWL1520C	•				•
Safety Grip™ Corrosion Resistant, Yellow	0.38-1.00" (9.5-25.4mm)	<input type="checkbox"/> CRL1520P	<input type="checkbox"/> CRL1520C	•				•
Severe Duty, Yellow & Black	0.63-1.16" (15.9-29.4mm)	<input type="checkbox"/> L1520PY	<input type="checkbox"/> L1520CY	•				•
Watertight, Yellow	0.36-0.84" (9.1-21.3mm)	<input type="checkbox"/> L1520PW	<input type="checkbox"/> L1520CW	•				•
Watertight, All-Black	0.36-0.84" (9.1-21.3mm)	<input type="checkbox"/> L1520PWBK	<input type="checkbox"/> L1520CWBK	•				•

Receptacles

Style & Description	Catalog No.	Single Receptacle	Certifications				
			USA	UL	cUL	FUS	CS
Standard Industrial, Black	<input type="checkbox"/> CWL1520R		•	•		•	•
Isolated Ground, Orange	<input type="checkbox"/> IGL1520R		•	•		•	•
Corrosion Resistant, Yellow	<input type="checkbox"/> CRL1520R		•	•		•	•
Watertight, Yellow	<input type="checkbox"/> L1520RW		•		•		•
Watertight, All-Black	<input type="checkbox"/> L1520RWBK		•		•		•

Flanged Inlets & Outlets

Style & Description	Catalog No.		Certifications				
	Flanged Inlet	Flanged Outlet	USA	UL	cUL	FUS	CS
Standard Industrial, Black & White	<input type="checkbox"/> CWL1520FI	—	•	•	•		
Standard Industrial, Black & White	—	<input type="checkbox"/> CWL1520FO	•	•			

Icon Key

NAFTA Compliant - see page O-30

Accessories for NEMA L15-20 Locking Devices

Description	Catalog No.	USA
Neoprene weather protective boot for 20A 3-P, 4-W plug	<input type="checkbox"/> BL1	•
Neoprene weather protective boot for 20A connector	<input type="checkbox"/> BL2	•
Diecast aluminum single receptacle cover, vertical mount, for FS/FD boxes	<input type="checkbox"/> 7420	•
Glass-filled nylon flanged inlet/outlet cover, vertical mount, for 20A devices	<input type="checkbox"/> WP2	•



BL1



BL2



7420



WP2

Hart-Lock™ Industrial Specification Grade Locking Devices

3-Pole, 4-Wire Grounding
20A, 3Ø 480V/AC
NEMA L16-20

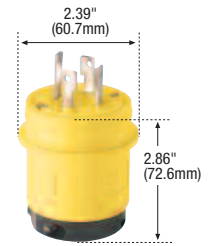
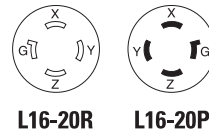

L1620PY



L1620CY

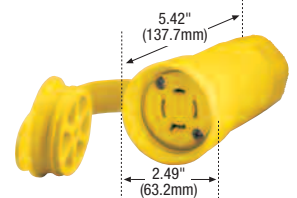

L1620CW



CWL1620FO

Dimensional Information: C-79 – C-82

Plug & Connector Specification Information:

Safety Grip L16-20: C-88
Corrosion Resistant: C-98
Severe Duty: C-97
Watertight: C-95

Receptacle Specification Information:

L16-20: C-91
Isolated Ground L16-20: C-91
Watertight: C-96

Flanged Inlet & Flanged Outlet Specification Information:

L16-20: C-93

20A, 3Ø 480V NEMA L16-20

Plugs & Connectors

Style & Description	Cord Dia.	Catalog No.		Certifications				
		Plug	Connector	USA	CSA	UL	UL US	UL S
Safety Grip™ Straight Body, Black & White	0.38-1.00" (9.5-25.4mm)	<input type="checkbox"/> CWL1620P	<input type="checkbox"/> CWL1620C	•				•
Safety Grip™ Straight Body, Black	0.38-1.00" (9.5-25.4mm)	<input type="checkbox"/> CWL1620PBK	<input type="checkbox"/> CWL1620CBK	•				•
Safety Grip™ Corrosion Resistant, Yellow	0.38-1.00" (9.5-25.4mm)	<input type="checkbox"/> CRL1620P	<input type="checkbox"/> CRL1620C	•	•	•		
Severe Duty, Yellow & Black	0.63-1.16" (15.9-29.4mm)	<input type="checkbox"/> L1620PY	<input type="checkbox"/> L1620CY	•				•
Watertight, Yellow	0.36-0.84" (9.1-21.3mm)	<input type="checkbox"/> L1620PW	<input type="checkbox"/> L1620CW	•				•
Watertight, All-Black	0.36-0.84" (9.1-21.3mm)	<input type="checkbox"/> L1620PWBK	<input type="checkbox"/> L1620CWBK	•				•

Receptacles

Style & Description	Catalog No. Single Receptacle	Certifications				
		USA	CSA	UL	UL US	UL S
Standard Industrial, Black	<input type="checkbox"/> CWL1620R	•	•			•
Isolated Ground, Orange	<input type="checkbox"/> IGL1620R	•	•			•
Watertight, Yellow	<input type="checkbox"/> L1620RW	•		•		
Watertight, All-Black	<input type="checkbox"/> L1620RWBK	•		•		

Flanged Inlets & Outlets

Style & Description	Catalog No.		Certifications				
	Flanged Inlet	Flanged Outlet	USA	CSA	UL	UL US	UL S
Standard Industrial, Black & White	<input type="checkbox"/> CWL1620FI	—	•	•	•		
Standard Industrial, Black & White	—	<input type="checkbox"/> CWL1620FO	•	•			•

Icon Key

USA NAFTA Compliant - see page O-30

Accessories for NEMA L16-20 Locking Devices

Description	Catalog No.	USA
Neoprene weather protective boot for 20A 3-P, 4-W plug	<input type="checkbox"/> BL	•
Neoprene weather protective boot for 20A connector	<input type="checkbox"/> BL2	•
Diecast aluminum single receptacle cover, vertical mount, for FS/FD boxes	<input type="checkbox"/> 7420	•
Glass-filled nylon flanged inlet/outlet cover, vertical mount, for 20A devices	<input type="checkbox"/> WP2	•



BL1



BL2



7420



WP2

Hart-Lock™ Industrial Specification Grade Locking Devices

3-Pole, 4-Wire Grounding
30A, 125/250V/AC
NEMA L14-30

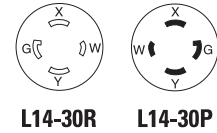

CRL1430P



CRL1430C

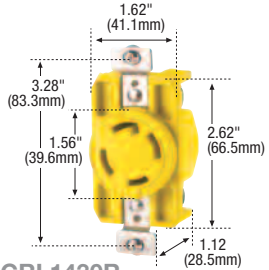

CRL1430R

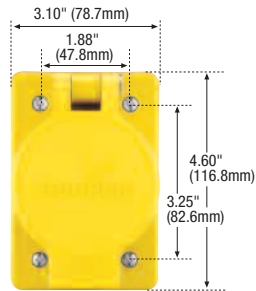

L1430RW

Dimensional Information: C-79 – C-82

Plug & Connector Specification Information:

Safety Grip L14-30: C-88

Corrosion Resistant: C-98

Severe Duty: C-97

Watertight: C-95

Receptacle Specification Information:

L14-30 : C-91

Isolated Ground L14-30: C-91

Corrosion Resistant: C-98

Watertight: C-96

Flanged Inlet & Flanged Outlet Specification Information:

L14-30 : C-92

30A, 125/250V NEMA L14-30

Plugs & Connectors

Style & Description	Cord Dia.	Catalog No.		Certifications					
		Plug	Connector	USA	UL	cUL	cULus	FM	426
Safety Grip™ Straight Body, Black & White	0.63-1.16" (15.9-29.4mm)	<input type="checkbox"/> CWL1430P	<input type="checkbox"/> CWL1430C	•				•	
Safety Grip™ Corrosion Resistant, Yellow	0.63-1.16" (15.9-29.4mm)	<input type="checkbox"/> CRL1430P	<input type="checkbox"/> CRL1430C	•				•	•
Severe Duty, Yellow & Black	0.63-1.16" (15.9-29.4mm)	<input type="checkbox"/> L1430PY	<input type="checkbox"/> L1430CY	•				•	•
Watertight, Yellow	0.43-1.15" (10.9-29.2mm)	<input type="checkbox"/> L1430PW	<input type="checkbox"/> L1430CW	•				•	•
Watertight, All-Black	0.43-1.15" (10.9-29.2mm)	<input type="checkbox"/> L1430PWBK	<input type="checkbox"/> L1430CWBK	•				•	•

Receptacles

Style & Description	Catalog No. Single Receptacle	Certifications					
		USA	UL	cULus	F	FM	426
Standard Industrial, Black	<input type="checkbox"/> CWL1430R	•	•			•	•
Isolated Ground, Orange	<input type="checkbox"/> IGL1430R	•	•			•	•
Corrosion Resistant, Yellow	<input type="checkbox"/> CRL1430R	•					•
Watertight, Yellow	<input type="checkbox"/> L1430RW	•					•
Watertight, All-Black	<input type="checkbox"/> L1430RWBK	•					•

Flanged Inlets & Outlets

Style & Description	Catalog No.		Certifications					
	Flanged Inlet	Flanged Outlet	USA	UL	cUL	FM	426	
Standard Industrial, Black & White	<input type="checkbox"/> CWL1430FI	—	•	•	•		•	
Standard Industrial, Black & White	—	<input type="checkbox"/> CWL1430FO	•	•			•	

Icon Key

NAFTA Compliant - see page O-30

Accessories for NEMA L14-30 Locking Devices

Description	Catalog No.	USA
Neoprene weather protective boot for 30A 3-P, 4-W plug	<input type="checkbox"/> BL1	•
Neoprene weather protective boot for 30A connector	<input type="checkbox"/> BL2	•
Diecast aluminum single receptacle cover, vertical mount, for FS/FD boxes	<input type="checkbox"/> 7420	•
Glass-filled nylon flanged inlet/outlet cover, vertical mount, for 30A devices	<input type="checkbox"/> WP2	•



BL1



BL2



7420



WP2

Hart-Lock™ Industrial Specification Grade Locking Devices

3-Pole, 4-Wire Grounding
30A, 3Ø 250V/AC
NEMA L15-30

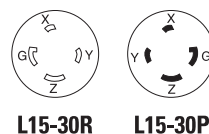

CWL1530P



CWL1530C

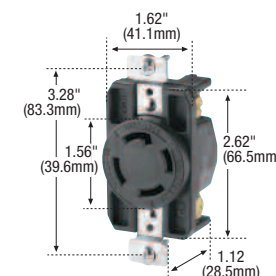

CWL1530R

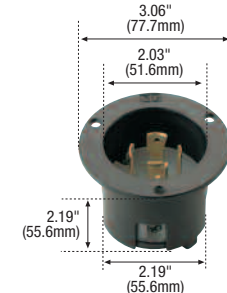

CWL1530FI

Dimensional Information: C-79 – C-82

Plug & Connector Specification Information:

Safety Grip L15-30: C-88
Corrosion Resistant: C-98
Severe Duty: C-97
Watertight: C-95

Receptacle Specification Information:

L15-30 : C-91
Isolated Ground L15-30: C-91
Watertight: C-96

Flanged Inlet & Flanged Outlet Specification Information:
L15-30 : C-93

30A, 3Ø 250V NEMA L15-30

Plugs & Connectors

Style & Description	Cord Dia.	Catalog No.		Certifications					
		Plug	Connector	UL	cUL	cULus	ULus	ULus	ULus
Safety Grip™ Straight Body, Black & White	0.63-1.16" (15.9-29.4mm)	<input type="checkbox"/> CWL1530P	<input type="checkbox"/> CWL1530C	•	•	•	•	•	•
Safety Grip™ Corrosion Resistant, Yellow	0.63-1.16" (15.9-29.4mm)	<input type="checkbox"/> CRL1530P	<input type="checkbox"/> CRL1530C	•				•	•
Severe Duty, Yellow & Black	0.63-1.16" (15.9-29.4mm)	<input type="checkbox"/> L1530PY	<input type="checkbox"/> L1530CY	•				•	•
Watertight, Yellow	0.43-1.15" (10.9-29.2mm)	<input type="checkbox"/> L1530PW	<input type="checkbox"/> L1530CW	•				•	•
Watertight, All-Black	0.43-1.15" (10.9-29.2mm)	<input type="checkbox"/> L1530PWBK	<input type="checkbox"/> L1530CWBK	•				•	•

Receptacles

Style & Description	Catalog No.	Certifications					
		UL	cUL	cULus	ULus	ULus	ULus
Standard Industrial, Black	<input type="checkbox"/> CWL1530R	•	•	•	•	•	•
Isolated Ground, Orange	<input type="checkbox"/> IGL1530R	•	•			•	•
Watertight, Yellow	<input type="checkbox"/> L1530RW	•				•	•
Watertight, All-Black	<input type="checkbox"/> L1530RWBK	•				•	•

Flanged Inlets & Outlets

Style & Description	Catalog No.		Certifications					
	Flanged Inlet	Flanged Outlet	UL	cUL	cULus	ULus	ULus	ULus
Standard Industrial, Black & White	<input type="checkbox"/> CWL1530FI	—	•	•	•			•
Standard Industrial, Black & White	—	<input type="checkbox"/> CWL1530FO	•	•				•

Icon Key

NAFTA Compliant - see page O-30

Accessories for NEMA L15-30 Locking Devices

Description	Catalog No.	UL
Neoprene weather protective boot for 30A 3-P, 4-W plug	<input type="checkbox"/> BL1	•
Neoprene weather protective boot for 30A connector	<input type="checkbox"/> BL2	•
Diecast aluminum single receptacle cover, vertical mount, for FS/FD boxes	<input type="checkbox"/> 7420	•
Glass-filled nylon flanged inlet/outlet cover, vertical mount, for 30A devices	<input type="checkbox"/> WP2	•



Hart-Lock™ Industrial Specification Grade Locking Devices

3-Pole, 4-Wire Grounding
30A, 3Ø 480V/AC
NEMA L16-30

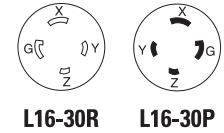

L1630PY



L1630CY

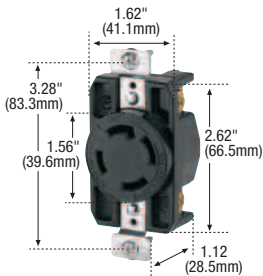

CWL1630R

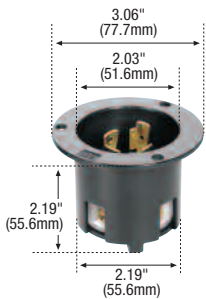

CWL1630FI

Dimensional Information: C-79 – C-82

Plug & Connector Specification Information:

- Safety Grip L16-30: C-88
- Corrosion Resistant: C-98
- Severe Duty: C-97
- Watertight: C-95

Receptacle Specification Information:

- L16-30 : C-91
- Watertight: C-96

Flanged Inlet & Flanged Outlet Specification Information:

- L16-30 : C-93

30A, 3Ø 480V NEMA L16-30

Plugs & Connectors

Style & Description	Cord Dia.	Catalog No.		Certifications				
		Plug	Connector	USA	UL	UL	UL	UL
Safety Grip™ Straight Body, Black & White	0.63-1.16" (15.9-29.4mm)	<input type="checkbox"/> CWL1630P	<input type="checkbox"/> CWL1630C	•	•	•	•	•
Safety Grip™ Corrosion Resistant, Yellow	0.63-1.16" (15.9-29.4mm)	<input type="checkbox"/> CRL1630P	—	•			•	
Severe Duty, Yellow & Black	0.63-1.16" (15.9-29.4mm)	<input type="checkbox"/> L1630PY	<input type="checkbox"/> L1630CY	•			•	
Watertight, Yellow	0.43-1.15" (10.9-29.2mm)	<input type="checkbox"/> L1630PW	<input type="checkbox"/> L1630CW	•			•	
Watertight, All-Black	0.43-1.15" (10.9-29.2mm)	<input type="checkbox"/> L1630PWBK	<input type="checkbox"/> L1630CWBK	•			•	

Receptacles

Style & Description	Catalog No.	Certifications				
		Single Receptacle	USA	UL	UL	UL
Standard Industrial, Black	<input type="checkbox"/> CWL1630R	•	•	•	•	•
Watertight, Yellow	<input type="checkbox"/> L1630RW	•			•	
Watertight, All-Black	<input type="checkbox"/> L1630RWBK	•			•	

Flanged Inlets & Outlets

Style & Description	Catalog No.		Certifications				
	Flanged Inlet	Flanged Outlet	USA	UL	UL	UL	UL
Standard Industrial, Black & White	<input type="checkbox"/> CWL1630FI	—	•	•	•		
Standard Industrial, Black & White	—	<input type="checkbox"/> CWL1630FO	•	•			•

Icon Key

NAFTA Compliant - see page O-30

Accessories for NEMA L16-30 Locking Devices

Description	Catalog No.	USA
Neoprene weather protective boot for 30A 3-P, 4-W plug	<input type="checkbox"/> BL1	•
Neoprene weather protective boot for 30A connector	<input type="checkbox"/> BL2	•
Diecast aluminum single receptacle cover, vertical mount, for FS/FD boxes	<input type="checkbox"/> 7420	•
Glass-filled nylon flanged inlet/outlet cover, vertical mount, for 30A devices	<input type="checkbox"/> WP2	•



BL1



BL2



7420



WP2

Hart-Lock™ Industrial Specification Grade Locking Devices

3-Pole, 4-Wire Grounding
30A, 3Ø 600V/AC
NEMA L17-30

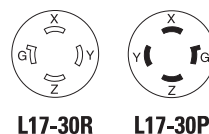

CWL1730P



CWL1730C

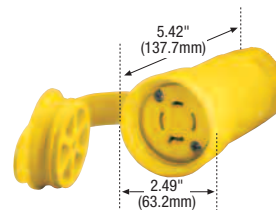

L1730CW

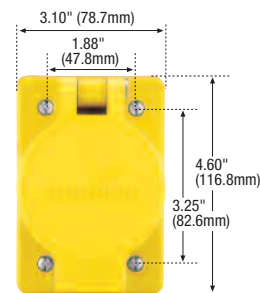

L1730RW

Dimensional Information: C-79 – C-82

Plug & Connector Specification Information:

Safety Grip L17-30: C-88
Severe Duty: C-97
Watertight: C-95

Receptacle Specification Information:

L17-30: C-91
Watertight: C-96

Flanged Inlet & Flanged Outlet Specification Information:

L17-30: C-93

30A, 3Ø 600V NEMA L17-30

Plugs & Connectors

Style & Description	Cord Dia.	Catalog No.		Certifications				
		Plug	Connector	USA	CSA	UL	ULUS	ULS
Safety Grip™ Straight Body, Black & White	0.63-1.16" (15.9-29.4mm)	<input type="checkbox"/> CWL1730P	<input type="checkbox"/> CWL1730C	•				•
Severe Duty, Yellow & Black	0.63-1.16" (15.9-29.4mm)	<input type="checkbox"/> L1730PY	<input type="checkbox"/> L1730CY	•				•
Watertight, Yellow	0.43-1.15" (10.9-29.2mm)	<input type="checkbox"/> L1730PW	<input type="checkbox"/> L1730CW	•				•
Watertight, All-Black	0.43-1.15" (10.9-29.2mm)	<input type="checkbox"/> L1730PWBK	<input type="checkbox"/> L1730CWBK	•				•

Receptacles

Style & Description	Catalog No. Single Receptacle	Certifications				
		USA	CSA	UL	ULUS	ULS
Standard Industrial, Black	<input type="checkbox"/> CWL1730R	•	•			•
Watertight, Yellow	<input type="checkbox"/> L1730RW	•		•		
Watertight, All-Black	<input type="checkbox"/> L1730RWBK	•		•		

Flanged Inlets & Outlets

Style & Description	Catalog No.		Certifications				
	Flanged Inlet	Flanged Outlet	USA	CSA	UL	ULUS	ULS
Standard Industrial, Black & White	<input type="checkbox"/> CWL1730FI	—	•	•	•		
Standard Industrial, Black & White	—	<input type="checkbox"/> CWL1730FO	•	•			•

Icon Key

NAFTA Compliant - see page O-30

Accessories for NEMA L17-30 Locking Devices

Description	Catalog No.	USA
Neoprene weather protective boot for 30A 3-P, 4-W plug	<input type="checkbox"/> BL1	•
Neoprene weather protective boot for 30A connector	<input type="checkbox"/> BL2	•
Diecast aluminum single receptacle cover, vertical mount, for FS/FD boxes	<input type="checkbox"/> 7420	•
Glass-filled nylon flanged inlet/outlet cover, vertical mount, for 30A devices	<input type="checkbox"/> WP2	•



BL1



BL2



7420



WP2

Hart-Lock™ Industrial Specification Grade Locking Devices

4-Pole, 4-Wire
Non-Grounding
20A, 3ØY 120/208V/AC
Non-NEMA

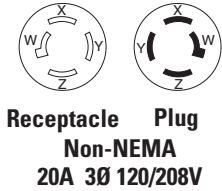

20A, 3Ø 120/208V Non-NEMA

Plugs & Connectors

Style & Description	Cord Dia.	Catalog No.		Certifications				
		Plug	Connector	USA	UL	cUL	cULus	NOM 426
Safety Grip™ Straight Body, Gray	0.63-1.16" (15.9-29.4mm)	<input type="checkbox"/> 7411C	<input type="checkbox"/> 7413C	•			•	•
Severe Duty, Yellow & Black	0.63-1.16" (15.9-29.4mm)	<input type="checkbox"/> 7411PY	<input type="checkbox"/> 7413CY	•			•	•
Watertight, Yellow	0.43-1.15" (10.9-29.2mm)	<input type="checkbox"/> 7411PW	<input type="checkbox"/> 7413CW	•			•	•
Watertight, All-Black	0.43-1.15" (10.9-29.2mm)	<input type="checkbox"/> 7411PWBK	<input type="checkbox"/> 7413CWBK	•			•	•

Receptacles

Style & Description	Catalog No.	Certifications				
		Single Receptacle	USA	UL	cULus	FUS
Standard Industrial, Black	<input type="checkbox"/> 7410B		•			
Watertight, Yellow	<input type="checkbox"/> 7413RW	•		•		
Watertight, All-Black	<input type="checkbox"/> 7413RWBK	•		•		

Flanged Inlets & Outlets

Style & Description	Catalog No.		Certifications				
	Flanged Inlet	Flanged Outlet	USA	UL	cUL	FUS	CS
Standard Industrial, Gray	<input type="checkbox"/> 7408N	—	•	•	•		
Standard Industrial, Gray	—	<input type="checkbox"/> 7409N	•	•			•

Icon Key

NAFTA Compliant - see page O-30

Accessories for Non-NEMA 20A Locking Devices

Description	Catalog No.	USA
Neoprene weather protective boot for 20A 4-P, 4-W plug	<input type="checkbox"/> BL1	•
Neoprene weather protective boot for 20A connector	<input type="checkbox"/> BL2	•
Diecast aluminum single receptacle cover, vertical mount, for FS/FD boxes	<input type="checkbox"/> 7420	•
Glass-filled nylon flanged inlet/outlet cover, vertical mount, for 20A devices	<input type="checkbox"/> WP2	•



BL1



BL2



7420



WP2

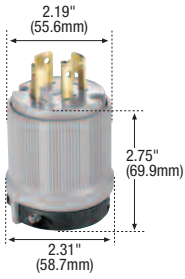

7411C

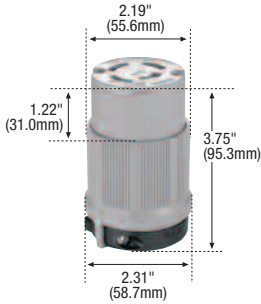

7413C

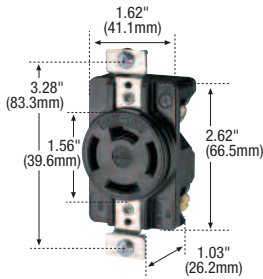

7410B



7408N

Dimensional Information: C-79 – C-82

Plug & Connector Specification Information:

Safety Grip Non-NEMA 20A: C-88

Severe Duty: C-97

Watertight: C-95

Receptacle Specification Information:

Non-NEMA 20A: C-91

Watertight: C-96

Flanged Inlet & Flanged Outlet Specification Information:

Non-NEMA 20A: C-93

Hart-Lock™ Industrial Specification Grade Locking Devices

4-Pole, 4-Wire Non-Grounding
20A, 3ØY 120/208V/AC
NEMA L18-20



L18-20R

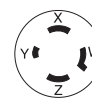

L18-20P



L1820PW

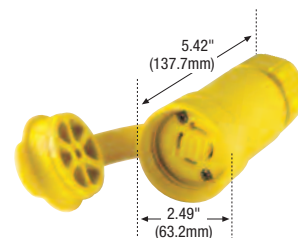

L1820CW



CWL1820R

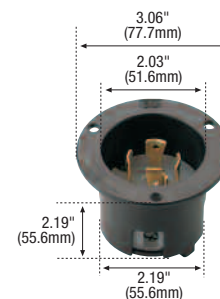

CWL1820FI

Dimensional Information: C-79 – C-82

Plug & Connector Specification Information:

Safety Grip L18-20: C-89

Severe Duty: C-97

Watertight: C-95

Receptacle Specification Information:

L18-20 : C-91

Watertight: C-96

Flanged Inlet & Flanged Outlet Specification Information:

L18-20 : C-93

20A, 3ØY 120/208V NEMA L18-20

Plugs & Connectors

Style & Description	Cord Dia.	Catalog No.		Certifications				
		Plug	Connector	USA	UL	UL US	FS	NOM 426
Safety Grip™ Straight Body, Black & White	0.63-1.16" (15.9-29.4mm)	<input type="checkbox"/> CWL1820P	<input type="checkbox"/> CWL1820C	•	•	•	•	•
Severe Duty, Yellow & Black	0.63-1.16" (15.9-29.4mm)	<input type="checkbox"/> L1820PY	<input type="checkbox"/> L1820CY	•	•	•	•	•
Watertight, Yellow	0.36-0.84" (9.1-21.3mm)	<input type="checkbox"/> L1820PW	<input type="checkbox"/> L1820CW	•	•	•	•	•
Watertight, All-Black	0.36-0.84" (9.1-21.3mm)	<input type="checkbox"/> L1820PWBK	<input type="checkbox"/> L1820CWBK	•	•	•	•	•

Receptacles

Style & Description	Catalog No.	Certifications				
		Single Receptacle	USA	UL	UL US	FS
Standard Industrial, Black	<input type="checkbox"/> CWL1820R	•	•	•	•	•
Watertight, Yellow	<input type="checkbox"/> L1820RW	•	•	•	•	•
Watertight, All-Black	<input type="checkbox"/> L1820RWBK	•	•	•	•	•

Flanged Inlets & Outlets

Style & Description	Catalog No.		Certifications				
	Flanged Inlet	Flanged Outlet	USA	UL	UL US	FS	CS
Standard Industrial, Black & White	<input type="checkbox"/> CWL1820FI	—	•	•	•	•	•
Standard Industrial, Black & White	—	<input type="checkbox"/> CWL1820FO	•	•	•	•	•

Icon Key

USA NAFTA Compliant - see page O-30

Accessories for NEMA L18-20 Locking Devices

Description	Catalog No.	USA
Neoprene weather protective boot for 20A 4-P, 4-W plug	<input type="checkbox"/> BL1	•
Neoprene weather protective boot for 20A connector	<input type="checkbox"/> BL2	•
Diecast aluminum single receptacle cover, vertical mount, for FS/FD boxes	<input type="checkbox"/> 7420	•
Glass-filled nylon flanged inlet/outlet cover, vertical mount, for 20A devices	<input type="checkbox"/> WP2	•



BL1



BL2



7420



WP2

Hart-Lock™ Industrial Specification Grade Locking Devices

4-Pole, 4-Wire Non-Grounding
20A, 3ØY 277/480V/AC
NEMA L19-20

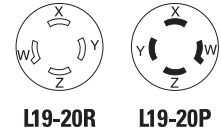

CWL1920P

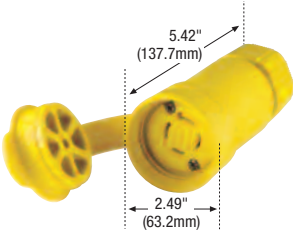

L1920CW

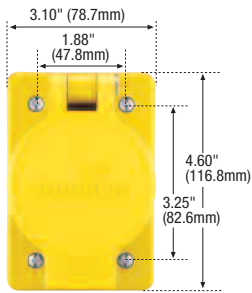

L1920RW



CWL1920FO

Dimensional Information: C-79 – C-82

Plug & Connector Specification Information:

Safety Grip L19-20: C-88

Severe Duty: C-97

Watertight: C-95

Receptacle Specification Information:

L19-20: C-91

Watertight: C-96

Flanged Inlet & Flanged Outlet Specification Information:

L19-20: C-93

C-40

20A, 3ØY 277/480V NEMA L19-20

Plugs & Connectors

Style & Description	Cord Dia.	Catalog No.		Certifications				
		Plug	Connector	USA	UL	UL	UL	UL
Safety Grip™ Straight Body, Black & White	0.63-1.16" (15.9-29.4mm)	<input type="checkbox"/> CWL1920P	<input type="checkbox"/> CWL1920C	•				•
Severe Duty, Yellow & Black	0.63-1.16" (15.9-29.4mm)	<input type="checkbox"/> L1920PY	<input type="checkbox"/> L1920CY	•				•
Watertight, Yellow	0.36-0.84" (9.1-21.3mm)	<input type="checkbox"/> L1920PW	<input type="checkbox"/> L1920CW	•				•
Watertight, All-Black	0.36-0.84" (9.1-21.3mm)	<input type="checkbox"/> L1920PWBK	<input type="checkbox"/> L1920CWBK	•				•

Receptacles

Style & Description	Catalog No.	Certifications				
		Single Receptacle	USA	UL	UL	UL
Standard Industrial, Black	<input type="checkbox"/> CWL1920R		•			
Watertight, Yellow	<input type="checkbox"/> L1920RW		•		•	
Watertight, All-Black	<input type="checkbox"/> L1920RWBK		•		•	

Flanged Inlets & Outlets

Style & Description	Catalog No.		Certifications				
	Flanged Inlet	Flanged Outlet	USA	UL	UL	UL	UL
Standard Industrial, Black & White	<input type="checkbox"/> CWL1920FI	—	•	•	•		
Standard Industrial, Black & White	—	<input type="checkbox"/> CWL1920FO	•	•			•

Icon Key

NAFTA Compliant - see page O-30

Accessories for NEMA L19-20 Locking Devices

Description	Catalog No.	USA
Neoprene weather protective boot for 20A 4-P, 4-W plug	<input type="checkbox"/> BL1	•
Neoprene weather protective boot for 20A connector	<input type="checkbox"/> BL2	•
Diecast aluminum single receptacle cover, vertical mount, for FS/FD boxes	<input type="checkbox"/> 7420	•
Glass-filled nylon flanged inlet/outlet cover, vertical mount, for 20A devices	<input type="checkbox"/> WP2	•



BL1



BL2



7420



WP2

Hart-Lock™ Industrial Specification Grade Locking Devices

4-Pole, 4-Wire Non-Grounding
20A, 3ØY 347/600V/AC
NEMA L20-20



CWL2020P



CWL2020C

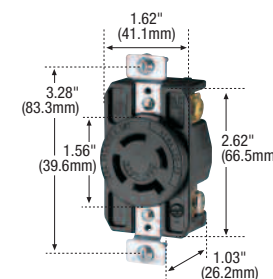

CWL2020R



CWL2020FO

Dimensional Information: C-79 – C-82

Plug & Connector Specification Information:

Safety Grip L20-20: C-88

Severe Duty: C-97

Watertight: C-95

Receptacle Specification Information:

L20-20 : C91

Watertight: C-96

Flanged Inlet & Flanged Outlet Specification Information:

L20-20: C93

20A, 3ØY 347/600V NEMA L20-20

Plugs & Connectors

Style & Description	Cord Dia.	Catalog No.		Certifications				
		Plug	Connector	USA	CSA	UL	UL US	ETL
Safety Grip™ Straight Body, Black & White	0.63-1.16" (15.9-29.4mm)	<input type="checkbox"/> CWL2020P	<input type="checkbox"/> CWL2020C	•				•
Severe Duty, Yellow & Black	0.63-1.16" (15.9-29.4mm)	<input type="checkbox"/> L2020PY	<input type="checkbox"/> L2020CY	•				•
Watertight, Yellow	0.36-0.84" (9.1-21.3mm)	<input type="checkbox"/> L2020PW	<input type="checkbox"/> L2020CW	•				•
Watertight, All-Black	0.36-0.84" (9.1-21.3mm)	<input type="checkbox"/> L2020PWBK	<input type="checkbox"/> L2020CWBK	•				•

Receptacles

Style & Description	Catalog No.	Certifications					
		Single Receptacle	USA	CSA	UL	UL US	ETL
Standard Industrial, Black	<input type="checkbox"/> CWL2020R		•				•
Watertight, Yellow	<input type="checkbox"/> L2020RW		•				•
Watertight, All-Black	<input type="checkbox"/> L2020RWBK		•				•

Flanged Inlets & Outlets

Style & Description	Catalog No.		Certifications				
	Flanged Inlet	Flanged Outlet	USA	CSA	UL	UL US	ETL
Standard Industrial, Black & White	<input type="checkbox"/> CWL2020FI	—	•	•	•		
Standard Industrial, Black & White	—	<input type="checkbox"/> CWL2020FO	•	•			•

Icon Key

USA NAFTA Compliant - see page O-30

Accessories for NEMA L20-20 Locking Devices

Description	Catalog No.	USA
Neoprene weather protective boot for 20A 4-P, 4-W plug	<input type="checkbox"/> BL1	•
Neoprene weather protective boot for 20A connector	<input type="checkbox"/> BL2	•
Diecast aluminum single receptacle cover, vertical mount, for FS/FD boxes	<input type="checkbox"/> 7420	•
Glass-filled nylon flanged inlet/outlet cover, vertical mount, for 20A devices	<input type="checkbox"/> WP2	•



BL1



BL2



7420



WP2

Hart-Lock™ Industrial Specification Grade Locking Devices

4-Pole, 4-Wire
Non-Grounding
30A, 3ØY 120/208V/AC
Non-NEMA

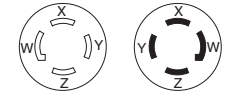

Receptacle Plug
Non-NEMA
30A 3Ø 120/208V

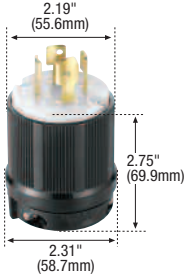

3431N



3433N

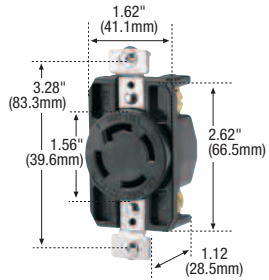

3430

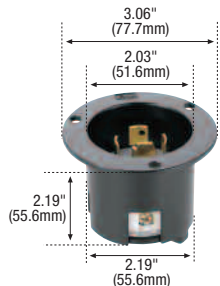

3434N

Dimensional Information: C-79 – C-82

Plug & Connector Specification Information:

Safety Grip Non-NEMA 30A: C-88

Severe Duty: C-97

Watertight: C-95

Receptacle Specification Information:

Non-NEMA 30A: C-91

Watertight: C-95

Flanged Inlet & Flanged Outlet Specification Information:

Non-NEMA 30A: C-93

30A, 3ØY 120/208V Non-NEMA

Plugs & Connectors

Style & Description	Cord Dia.	Catalog No.		Certifications				
		Plug	Connector	USA	UL	UL	UL	UL
Safety Grip™ Straight Body, Black & White	0.63-1.16" (15.9-29.4mm)	□ 3431N	□ 3433N	•	•	•	•	•
Severe Duty, Yellow & Black	0.63-1.16" (15.9-29.4mm)	□ 3431PY	□ 3433CY	•			•	
Watertight, Yellow	0.43-1.15" (10.9-29.2mm)	□ 3431PW	□ 3433CW	•			•	
Watertight, All-Black	0.43-1.15" (10.9-29.2mm)	□ 3431PWBK	□ 3433CWBK	•			•	

Receptacles

Style & Description	Catalog No.	Certifications				
		Single Receptacle	USA	UL	UL	UL
Standard Industrial, Black	□ 3430	•	•	•	•	•
Watertight, Yellow	□ 3433RW	•		•		
Watertight, All-Black	□ 3433RWBK	•		•		

Flanged Inlets & Outlets

Style & Description	Catalog No.		Certifications				
	Flanged Inlet	Flanged Outlet	USA	UL	UL	UL	UL
Standard Industrial, Black & White	□ 3434N	—	•	•	•		
Standard Industrial, Black & White	—	□ 3436N	•	•			•

Icon Key

NAFTA Compliant - see page O-30

Accessories for Non-NEMA 20A Locking Devices

Description	Catalog No.	USA
Neoprene weather protective boot for 30A 4-P, 4-W plug	□ BL1	•
Neoprene weather protective boot for 30A connector	□ BL2	•
Diecast aluminum single receptacle cover, vertical mount, for FS/FD boxes	□ 7420	•
Glass-filled nylon flanged inlet/outlet cover, vertical mount, for 30A devices	□ WP2	•



BL1



BL2



7420



WP2

Hart-Lock™ Industrial Specification Grade Locking Devices

4-Pole, 4-Wire Non-Grounding
30A, 3ØY 120/208V/AC
NEMA L18-30

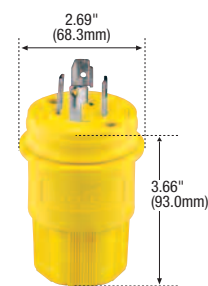
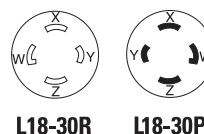

L1830PW

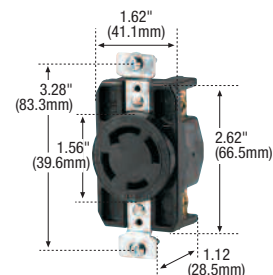

CWL1830R

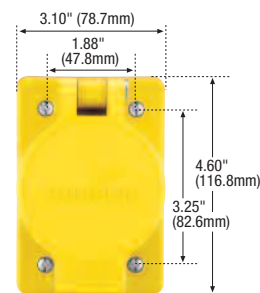

L1830RW

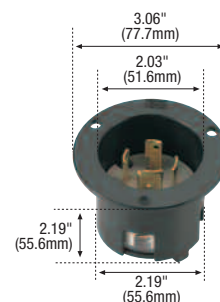

CWL1830FI

Dimensional Information: C-79 – C-82

Plug & Connector Specification Information:

Safety Grip L18-30: C-89

Severe Duty: C-97

Watertight: C-95

Receptacle Specification Information:

L18-30 : C-91

Watertight: C-96

Flanged Inlet & Flanged Outlet Specification Information:

L18-30 : C-93

30A, 3ØY 120/208V NEMA L18-30

Plugs & Connectors

Style & Description	Cord Dia.	Catalog No.		Certifications					
		Plug	Connector	USA	UL	cUL	cULus	ULus	ULus 426
Safety Grip™ Straight Body, Black & White	0.63-1.16" (15.9-29.4mm)	<input type="checkbox"/> CWL1830P	<input type="checkbox"/> CWL1830C	•	•	•	•	•	•
Severe Duty, Yellow & Black	0.63-1.16" (15.9-29.4mm)	<input type="checkbox"/> L1830PY	<input type="checkbox"/> L1830CY	•				•	•
Watertight, Yellow	0.43-1.15" (10.9-29.2mm)	<input type="checkbox"/> L1830PW	<input type="checkbox"/> L1830CW	•				•	•
Watertight, All-Black	0.43-1.15" (10.9-29.2mm)	<input type="checkbox"/> L1830PWBK	<input type="checkbox"/> L1830CWBK	•				•	•

Receptacles

Style & Description	Catalog No.	Certifications					
		Single Receptacle	USA	UL	cUL	FUS	ULus 426
Standard Industrial, Black	<input type="checkbox"/> CWL1830R	•	•	•	•	•	•
Watertight, Yellow	<input type="checkbox"/> L1830RW	•				•	•
Watertight, All-Black	<input type="checkbox"/> L1830RWBK	•				•	•

Flanged Inlets & Outlets

Style & Description	Catalog No.		Certifications					
	Flanged Inlet	Flanged Outlet	USA	UL	cUL	FUS	ULus	
Standard Industrial, Black & White	<input type="checkbox"/> CWL1830FI	—	•	•	•	•	•	
Standard Industrial, Black & White	—	<input type="checkbox"/> CWL1830FO	•	•			•	

Icon Key

NAFTA Compliant - see page O-30

Accessories for NEMA L20-20 Locking Devices

Description	Catalog No.	USA
Neoprene weather protective boot for 30A 4-P, 4-W plug	<input type="checkbox"/> BL1	•
Neoprene weather protective boot for 30A connector	<input type="checkbox"/> BL2	•
Diecast aluminum single receptacle cover, vertical mount, for FS/FD boxes	<input type="checkbox"/> 7420	•
Glass-filled nylon flanged inlet/outlet cover, vertical mount, for 30A devices	<input type="checkbox"/> WP2	•



BL1



BL2



7420



WP2

Hart-Lock™ Industrial Specification Grade Locking Devices

4-Pole, 4-Wire Non-Grounding
30A, 3ØY 277/480V/AC
NEMA L19-30

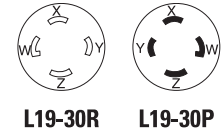

CWL1930P



CWL1930C



CWL1930R

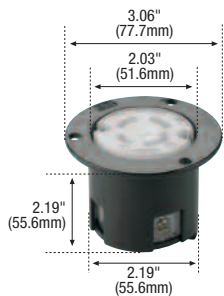

CWL1930FO

Dimensional Information: C-79 – C-82

Plug & Connector Specification Information:

Safety Grip L19-30: C-88

Severe Duty: C-97

Watertight: C-95

Receptacle Specification Information:

L19-30: C-91

Watertight: C-96

Flanged Inlet & Flanged Outlet Specification Information:

L19-30: C-93

30A, 3ØY 277/480V NEMA L19-30

Plugs & Connectors

Style & Description	Cord Dia.	Catalog No.		Certifications				
		Plug	Connector	USA	UL	cUL	cULus	CSA
Safety Grip™ Straight Body, Black & White	0.63-1.16" (15.9-29.4mm)	<input type="checkbox"/> CWL1930P	<input type="checkbox"/> CWL1930C	•				•
Severe Duty, Yellow & Black	0.63-1.16" (15.9-29.4mm)	<input type="checkbox"/> L1930PY	<input type="checkbox"/> L1930CY	•				•
Watertight, Yellow	0.43-1.15" (10.9-29.2mm)	<input type="checkbox"/> L1930PW	<input type="checkbox"/> L1930CW	•				•
Watertight, All-Black	0.43-1.15" (10.9-29.2mm)	<input type="checkbox"/> L1930PWBK	<input type="checkbox"/> L1930CWBK	•				•

Receptacles

Style & Description	Catalog No.	Certifications				
		Single Receptacle	USA	UL	cUL	FUS
Standard Industrial, Black	<input type="checkbox"/> CWL1930R		•			
Watertight, Yellow	<input type="checkbox"/> L1930RW		•		•	
Watertight, All-Black	<input type="checkbox"/> L1930RWBK		•		•	

Flanged Inlets & Outlets

Style & Description	Catalog No.		Certifications				
	Flanged Inlet	Flanged Outlet	USA	UL	cUL	FUS	CSA
Standard Industrial, Black & White	<input type="checkbox"/> CWL1930FI	—	•	•	•		
Standard Industrial, Black & White	—	<input type="checkbox"/> CWL1930FO	•	•			•

Icon Key

NAFTA Compliant - see page O-30

Accessories for NEMA L19-30 Locking Devices

Description	Catalog No.	USA
Neoprene weather protective boot for 30A 4-P, 4-W plug	<input type="checkbox"/> BL1	•
Neoprene weather protective boot for 30A connector	<input type="checkbox"/> BL2	•
Diecast aluminum single receptacle cover, vertical mount, for FS/FD boxes	<input type="checkbox"/> 7420	•
Glass-filled nylon flanged inlet/outlet cover, vertical mount, for 30A devices	<input type="checkbox"/> WP2	•



BL1



BL2



7420



WP2

Hart-Lock™ Industrial Specification Grade Locking Devices

4-Pole, 4-Wire Non-Grounding
30A, 3ØY 347/600V/AC
NEMA L20-30

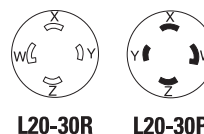

CWL2030P



CWL2030C

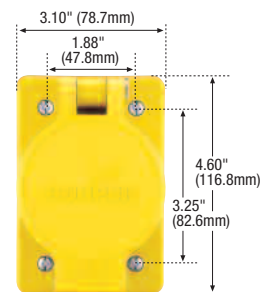

L2030RW



CWL2030FO

Dimensional Information: C-79 – C-82

Plug & Connector Specification Information:

Safety Grip L20-30: C-88

Severe Duty: C-97

Watertight: C-95

Receptacle Specification Information:

L20-30 : C-91

Watertight: C-95

Flanged Inlet & Flanged Outlet Specification Information:

L20-30 : C-93

30A, 3ØY 347/600V NEMA L20-30

Plugs & Connectors

Style & Description	Cord Dia.	Catalog No.		Certifications				
		Plug	Connector	USA	CSA	UL	UL US	UL S
Safety Grip™ Straight Body, Black & White	0.63-1.16" (15.9-29.4mm)	<input type="checkbox"/> CWL2030P	<input type="checkbox"/> CWL2030C	•				•
Severe Duty, Yellow & Black	0.63-1.16" (15.9-29.4mm)	<input type="checkbox"/> L2030PY	<input type="checkbox"/> L2030CY	•				•
Watertight, Yellow	0.43-1.15" (10.9-29.2mm)	<input type="checkbox"/> L2030PW	<input type="checkbox"/> L2030CW	•				•
Watertight, All-Black	0.43-1.15" (10.9-29.2mm)	<input type="checkbox"/> L2030PWBK	<input type="checkbox"/> L2030CWBK	•				•

Receptacles

Style & Description	Catalog No.	Certifications					
		Single Receptacle	USA	CSA	UL	UL US	UL S
Standard Industrial, Black	<input type="checkbox"/> CWL2030R		•				
Watertight, Yellow	<input type="checkbox"/> L2030RW		•		•		
Watertight, All-Black	<input type="checkbox"/> L2030RWBK		•		•		

Flanged Inlets & Outlets

Style & Description	Catalog No.		Certifications				
	Flanged Inlet	Flanged Outlet	USA	CSA	UL	UL US	UL S
Standard Industrial, Black & White	<input type="checkbox"/> CWL2030FI	—	•	•	•		
Standard Industrial, Black & White	—	<input type="checkbox"/> CWL2030FO	•	•			•

Icon Key

NAFTA Compliant - see page O-30

Accessories for NEMA L20-30 Locking Devices

Description	Catalog No.	USA
Neoprene weather protective boot for 30A 4-P, 4-W plug	<input type="checkbox"/> BL1	•
Neoprene weather protective boot for 30A connector	<input type="checkbox"/> BL2	•
Diecast aluminum single receptacle cover, vertical mount, for FS/FD boxes	<input type="checkbox"/> 7420	•
Glass-filled nylon flanged inlet/outlet cover, vertical mount, for 30A devices	<input type="checkbox"/> WP2	•



BL1



BL2



7420



WP2

Hart-Lock™ Industrial Specification Grade Locking Devices

4-Pole, 5-Wire Grounding
20/10A, 250/600V/AC
Non-NEMA

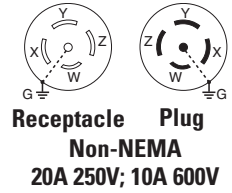

20/10A, 250/600V Non-NEMA

Plugs & Connectors

Style & Description	Cord Dia.	Catalog No.		Certifications				
		Plug	Connector	USA	SP	UL	UL US	CSA
Safety Grip™ Straight Body, Black & White	0.63-1.16" (15.9-29.4mm)	<input type="checkbox"/> 3521BK	<input type="checkbox"/> 3523BK	•			•	



3521BK

Flanged Inlets & Outlets

Style & Description	Catalog No.		Certifications				
	Flanged Inlet	Flanged Outlet	USA	SP	UL	UL US	CSA
Standard Industrial, Black & White	<input type="checkbox"/> 3524BK	<input type="checkbox"/> 3525BK	•	•	•		•

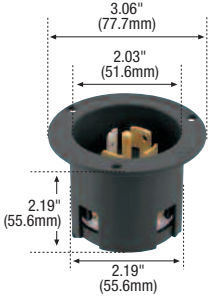

3524BK

Icon Key

NAFTA Compliant - see page O-30

Accessories for Non-NEMA 20/10A Locking Devices

Description	Catalog No.	USA
Neoprene weather protective boot for 20/10A 4-P, 5-W plug	<input type="checkbox"/> BL1	•
Neoprene weather protective boot for 20/10A connector	<input type="checkbox"/> BL2	•
Glass-filled nylon flanged inlet/outlet cover, vertical mount, for 20/100A devices	<input type="checkbox"/> WP2	•

Dimensional Information: C-79 – C-82

Plug & Connector Specification Information:

Safety Grip Non-NEMA 20/10A: C-88

Flanged Inlet & Flanged Outlet Specification Information:

Non-NEMA 20/10A: C-93



BL1



BL2



7420



WP2

Hart-Lock™ Industrial Specification Grade Locking Devices

4-Pole, 5-Wire Grounding
20A, 3ØY 120/208V/AC
NEMA L21-20

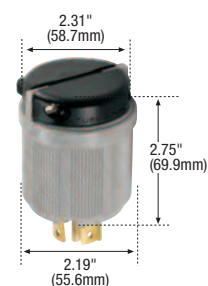

L2120PF



L2120CW

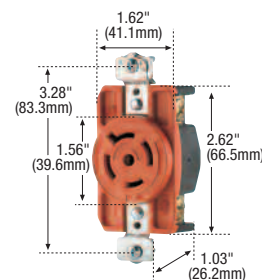

IGL2120R



CWL2120FI

Dimensional Information: C-79 – C-82

Plug & Connector Specification Information:

Safety Grip L21-20: C-89
Severe Duty: C-97
Watertight: C-95

Receptacle Specification Information:

L21-20 : C-91
Isolated Ground L21-20: C-91
Watertight: C-96

Flanged Inlet & Flanged Outlet Specification Information:

L21-20 : C-93

20A, 3ØY 120/208V NEMA L21-20

Plugs & Connectors

Style & Description	Cord Dia.	Catalog No.		Certifications					
		Plug	Connector	USA	UL	UL	UL	UL	UL
Safety Grip™ Straight Body, Black & White	0.63-1.16" (15.9-29.4mm)	<input type="checkbox"/> CWL2120P	<input type="checkbox"/> CWL2120C	•	•	•	•	•	•
Safety Grip™ Straight Body, Black	0.63-1.16" (15.9-29.4mm)	<input type="checkbox"/> CWL2120PBK	<input type="checkbox"/> CWL2120CBK						•
Safety Grip™ Flat Cable Straight Body, Gray	Max. 5-Wire #10 AWG Flat Cable	<input type="checkbox"/> L2120PF	<input type="checkbox"/> L2120CF	•					•
Severe Duty, Yellow & Black	0.63-1.16" (15.9-29.4mm)	<input type="checkbox"/> L2120PY	<input type="checkbox"/> L2120CY	•					•
Watertight, Yellow	0.36-0.84" (9.1-21.3mm)	<input type="checkbox"/> L2120PW	<input type="checkbox"/> L2120CW	•					•
Watertight, All-Black	0.36-0.84" (9.1-21.3mm)	<input type="checkbox"/> L2120PWBK	<input type="checkbox"/> L2120CWBK	•					•

Receptacles

Style & Description	Catalog No.	Certifications					
		USA	UL	UL	UL	UL	UL
Standard Industrial, Black	<input type="checkbox"/> CWL2120R	•	•	•	•	•	•
Isolated Ground, Orange	<input type="checkbox"/> IGL2120R	•	•				•
Watertight, Yellow	<input type="checkbox"/> L2120RW	•		•			•
Watertight, All-Black	<input type="checkbox"/> L2120RWBK	•		•			•

Flanged Inlets & Outlets

Style & Description	Catalog No.		Certifications					
	Flanged Inlet	Flanged Outlet	USA	UL	UL	UL	UL	UL
Standard Industrial, Black & White	<input type="checkbox"/> CWL2120FI	—	•	•	•			
Standard Industrial, Black & White	—	<input type="checkbox"/> CWL2120FO	•	•				•

Icon Key

NAFTA Compliant - see page O-30

Accessories for NEMA L21-20 Locking Devices

Description	Catalog No.	USA
Neoprene weather protective boot for 20A 4-P, 5-W plug	<input type="checkbox"/> BL1	•
Neoprene weather protective boot for 20A connector	<input type="checkbox"/> BL2	•
Diecast aluminum single receptacle cover, vertical mount, for FS/FD boxes	<input type="checkbox"/> 7420	•
Glass-filled nylon flanged inlet/outlet cover, vertical mount, for 20A devices	<input type="checkbox"/> WP2	•



BL1



BL2



7420



WP2

Hart-Lock™ Industrial Specification Grade Locking Devices

4-Pole, 5-Wire Grounding
20A, 3ØY 277/480V/AC
NEMA L22-20

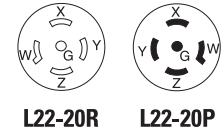

CWL2220P



CWL2220C

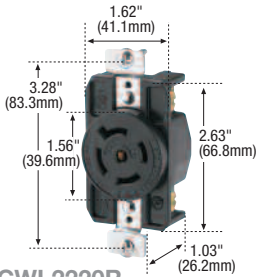

CWL2220R

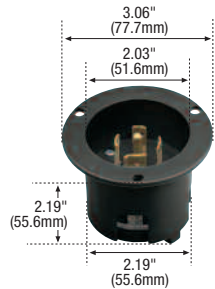

CWL2220FI

Dimensional Information: C-79 – C-82

Plug & Connector Specification Information:

Safety Grip L22-20: C-89

Severe Duty: C-97

Watertight: C-95

Receptacle Specification Information:

L22-20: C-91

Watertight: C-96

Flanged Inlet & Flanged Outlet Specification Information:

L22-20: C-93

20A, 3ØY 277/480V NEMA L22-20

Plugs & Connectors

Style & Description	Cord Dia.	Catalog No.		Certifications				
		Plug	Connector	USA	UL	cUL	cULus	ULus
Safety Grip™ Straight Body, Black & White	0.63-1.16" (15.9-29.4mm)	<input type="checkbox"/> CWL2220P	<input type="checkbox"/> CWL2220C	•	•	•	•	•
Severe Duty, Yellow & Black	0.63-1.16" (15.9-29.4mm)	<input type="checkbox"/> L2220PY	<input type="checkbox"/> L2220CY	•			•	•
Watertight, Yellow	0.36-0.84" (9.1-21.3mm)	<input type="checkbox"/> L2220PW	<input type="checkbox"/> L2220CW	•			•	•
Watertight, All-Black	0.36-0.84" (9.1-21.3mm)	<input type="checkbox"/> L2220PWBK	<input type="checkbox"/> L2220CWBK	•			•	•

Receptacles

Style & Description	Catalog No.	Single Receptacle	Certifications				
			USA	UL	cULus	FUS	ULus
Standard Industrial, Black	<input type="checkbox"/> CWL2220R		•	•	•	•	•
Watertight, Yellow	<input type="checkbox"/> L2220RW		•		•		•
Watertight, All-Black	<input type="checkbox"/> L2220RWBK		•		•		•

Flanged Inlets & Outlets

Style & Description	Catalog No.		Certifications				
	Flanged Inlet	Flanged Outlet	USA	UL	cUL	FUS	ULus
Standard Industrial, Black & White	<input type="checkbox"/> CWL2220FI	—	•	•	•		
Standard Industrial, Black & White	—	<input type="checkbox"/> CWL2220FO	•	•			•

Icon Key

NAFTA Compliant - see page O-30

Accessories for NEMA L22-20 Locking Devices

Description	Catalog No.	USA
Neoprene weather protective boot for 20A 4-P, 5-W plug	<input type="checkbox"/> BL1	•
Neoprene weather protective boot for 20A connector	<input type="checkbox"/> BL2	•
Diecast aluminum single receptacle cover, vertical mount, for FS/FD boxes	<input type="checkbox"/> 7420	•
Glass-filled nylon flanged inlet/outlet cover, vertical mount, for 20A devices	<input type="checkbox"/> WP2	•



BL1



BL2



7420



WP2

Hart-Lock™ Industrial Specification Grade Locking Devices

4-Pole, 5-Wire Grounding
20A, 3ØY 347/600V/AC
NEMA L23-20



L23-20R



L23-20P



CWL2320P



CWL2320C

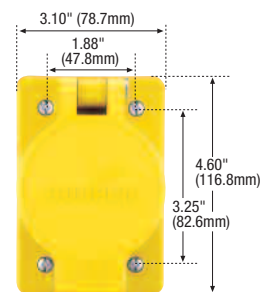

L2320RW



CWL2320FO

Dimensional Information: C-79 – C-82

Plug & Connector Specification Information:

Safety Grip L23-20: C-88

Severe Duty: C-97

Watertight: C-95

Receptacle Specification Information:

L23-20 : C-91

Watertight: C-96

Flanged Inlet & Flanged Outlet Specification Information:

L23-20 : C-93

20A, 3ØY 347/600V NEMA L23-20

Plugs & Connectors

Style & Description	Cord Dia.	Catalog No.		Certifications				
		Plug	Connector	USA	UL	UL	UL	UL
Safety Grip™ Straight Body, Black & White	0.63-1.16" (15.9-29.4mm)	<input type="checkbox"/> CWL2320P	<input type="checkbox"/> CWL2320C	•	•	•	•	•
Severe Duty, Yellow & Black	0.63-1.16" (15.9-29.4mm)	<input type="checkbox"/> L2320PY	<input type="checkbox"/> L2320CY	•				•
Watertight, Yellow	0.36-0.84" (9.1-21.3mm)	<input type="checkbox"/> L2320PW	<input type="checkbox"/> L2320CW	•				•
Watertight, All-Black	0.36-0.84" (9.1-21.3mm)	<input type="checkbox"/> L2320PWBK	<input type="checkbox"/> L2320CWBK	•				•

Receptacles

Style & Description	Catalog No.		Certifications				
	Single Receptacle		USA	UL	UL	UL	UL
Standard Industrial, Black	<input type="checkbox"/> CWL2320R		•	•	•	•	•
Watertight, Yellow	<input type="checkbox"/> L2320RW		•				•
Watertight, All-Black	<input type="checkbox"/> L2320RWBK		•				•

Flanged Inlets & Outlets

Style & Description	Catalog No.		Certifications				
	Flanged Inlet	Flanged Outlet	USA	UL	UL	UL	UL
Standard Industrial, Black & White	<input type="checkbox"/> CWL2320FI	—	•	•	•		
Standard Industrial, Black & White	—	<input type="checkbox"/> CWL2320FO	•	•			•

Icon Key

USA NAFTA Compliant - see page O-30

Accessories for NEMA L23-20 Locking Devices

Description	Catalog No.	USA
Neoprene weather protective boot for 20A 4-P, 5-W plug	<input type="checkbox"/> BL1	•
Neoprene weather protective boot for 20A connector	<input type="checkbox"/> BL2	•
Diecast aluminum single receptacle cover, vertical mount, for FS/FD boxes	<input type="checkbox"/> 7420	•
Glass-filled nylon flanged inlet/outlet cover, vertical mount, for 20A devices	<input type="checkbox"/> WP2	•



BL1



BL2



7420



WP2



L2130PF



CWL2130C

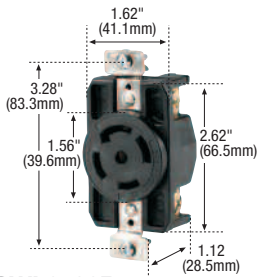

CWL2130R

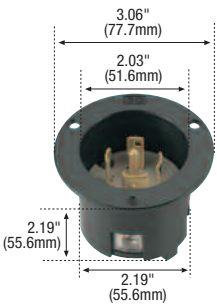

CWL2130FI

Dimensional Information: C-79 – C-82

Plug & Connector Specification Information:

Safety Grip L21-30: C-89

Severe Duty: C-97

Watertight: C-95

Receptacle Specification Information:

L21-30: C-91

Isolated Ground L21-30: C-91

Watertight: C-96

Flanged Inlet & Flanged Outlet Specification Information:

L21-30: C-92

C-50

Hart-Lock™ Industrial Specification Grade Locking Devices

4-Pole, 5-Wire Grounding
30A, 3ØY 120/208V/AC
NEMA L21-30

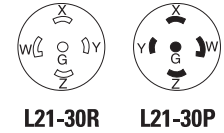

30A, 3ØY 120/208V NEMA L21-30

Plugs & Connectors

Style & Description	Cord Dia.	Catalog No.		Certifications					
		Plug	Connector	USA	UL	cULus	cULus	FS	NOM 426
Safety Grip™ Straight Body, Black & White	0.63-1.16" (15.9-29.4mm)	<input type="checkbox"/> CWL2130P	<input type="checkbox"/> CWL2130C	•	•	•	•	•	•
Safety Grip™ Flat Cable Straight Body, Gray	Max. 5-Wire #10 AWG Flat Cable	<input type="checkbox"/> L2130PF	<input type="checkbox"/> L2130CF	•					•
Severe Duty, Yellow & Black	0.63-1.16" (15.9-29.4mm)	<input type="checkbox"/> L2130PY	<input type="checkbox"/> L2130CY	•					•
Watertight, Yellow	0.43-1.15" (10.9-29.2mm)	<input type="checkbox"/> L2130PW	<input type="checkbox"/> L2130CW	•					•
Watertight, All-Black	0.43-1.15" (10.9-29.2mm)	<input type="checkbox"/> L2130PWBK	<input type="checkbox"/> L2130CWBK	•					•

Receptacles

Style & Description	Catalog No. Single Receptacle	Certifications					
		USA	UL	cULus	FUS	FS	NOM 426
Standard Industrial, Black	<input type="checkbox"/> CWL2130R	•	•			•	•
Isolated Ground, Orange	<input type="checkbox"/> IGL2130R	•	•			•	•
Watertight, Yellow	<input type="checkbox"/> L2130RW	•		•			•
Watertight, All-Black	<input type="checkbox"/> L2130RWBK	•		•			•

Flanged Inlets & Outlets

Style & Description	Catalog No.		Certifications					
	Flanged Inlet	Flanged Outlet	USA	UL	cULus	FS	NOM 426	
Standard Industrial, Black & White	<input type="checkbox"/> CWL2130FI	<input type="checkbox"/> CWL2130FO	•	•			•	

Icon Key

NAFTA Compliant - see page O-30

Accessories for NEMA L21-30 Locking Devices

Description	Catalog No.	USA
Neoprene weather protective boot for 30A 4-P, 5-W plug	<input type="checkbox"/> BL1	•
Neoprene weather protective boot for 30A connector	<input type="checkbox"/> BL2	•
Diecast aluminum single receptacle cover, vertical mount, for FS/FD boxes	<input type="checkbox"/> 7420	•
Glass-filled nylon flanged inlet/outlet cover, vertical mount, for 30A devices	<input type="checkbox"/> WP2	•



BL1



BL2



7420



WP2

Hart-Lock™ Industrial Specification Grade Locking Devices

4-Pole, 5-Wire Grounding
30A, 3ØY 277/480V/AC
NEMA L22-30

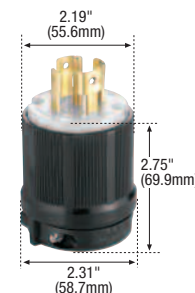
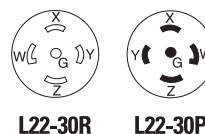

CWL2230P



CWL2230C

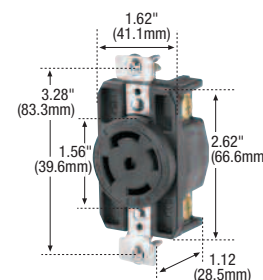

CWL2230R



CWL2230FO

Dimensional Information: C-79 – C-82

Plug & Connector Specification Information:

Safety Grip L22-30: C-89
Severe Duty: C-97
Watertight: C-95

Receptacle Specification Information:

L22-30: C-91
Isolated Ground L22-30: C-91
Watertight: C-96

Flanged Inlet & Flanged Outlet Specification Information:
L22-30: C-93

30A, 3ØY 277/480V NEMA L22-30

Plugs & Connectors

Style & Description	Cord Dia.	Catalog No.		Certifications				
		Plug	Connector	USA	UL	UL US	UL US	UL US
Safety Grip™ Straight Body, Black & White	0.63-1.16" (15.9-29.4mm)	<input type="checkbox"/> CWL2230P	<input type="checkbox"/> CWL2230C	•	•	•	•	•
Safety Grip™ Flat Cable Straight Body, Gray	Max. 5-Wire #10 AWG Flat Cable	<input type="checkbox"/> L2230PF	<input type="checkbox"/> L2230CF	•				•
Severe Duty, Yellow & Black	0.63-1.16" (15.9-29.4mm)	<input type="checkbox"/> L2230PY	<input type="checkbox"/> L2230CY	•				•
Watertight, Yellow	0.43-1.15" (10.9-29.2mm)	<input type="checkbox"/> L2230PW	<input type="checkbox"/> L2230CW	•				•
Watertight, All-Black	0.43-1.15" (10.9-29.2mm)	<input type="checkbox"/> L2230PWBK	<input type="checkbox"/> L2230CWBK	•				•

Receptacles

Style & Description	Catalog No.	Certifications				
		Single Receptacle	USA	UL	UL US	UL US
Standard Industrial, Black	<input type="checkbox"/> CWL2230R	•	•	•	•	•
Isolated Ground, Orange	<input type="checkbox"/> IGL2230R	•	•			•
Watertight, Yellow	<input type="checkbox"/> L2230RW	•				•
Watertight, All-Black	<input type="checkbox"/> L2230RWBK	•				•

Flanged Inlets & Outlets

Style & Description	Catalog No.		Certifications				
	Flanged Inlet	Flanged Outlet	USA	UL	UL US	UL US	UL US
Standard Industrial, Black & White	<input type="checkbox"/> CWL2230FI	—	•	•	•		
Standard Industrial, Black & White	—	<input type="checkbox"/> CWL2230FO	•	•			•

Icon Key

USA NAFTA Compliant - see page O-30

Accessories for NEMA L22-30 Locking Devices

Description	Catalog No.	USA
Neoprene weather protective boot for 30A 4-P, 5-W plug	<input type="checkbox"/> BL1	•
Neoprene weather protective boot for 30A connector	<input type="checkbox"/> BL2	•
Diecast aluminum single receptacle cover, vertical mount, for FS/FD boxes	<input type="checkbox"/> 7420	•
Glass-filled nylon flanged inlet/outlet cover, vertical mount, for 30A devices	<input type="checkbox"/> WP2	•



BL1



BL2



7420



WP2

Hart-Lock™ Industrial Specification Grade Locking Devices

4-Pole, 5-Wire Grounding
30A, 3ØY 347/600V/AC
NEMA L23-30

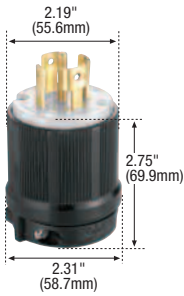
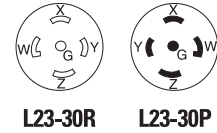

CWL2330P

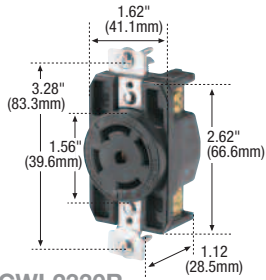

CWL2330R

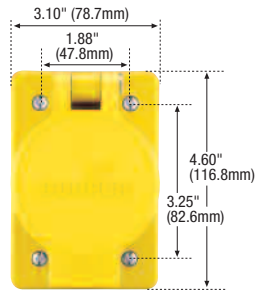

L2330RW



CWL2330FO

Dimensional Information: C-79 – C-82

Plug & Connector Specification Information:

Safety Grip L23-30: C-88
Severe Duty: C-97
Watertight: C-95

Receptacle Specification Information:

L23-30: C-91
Isolated Ground L23-30: C-91
Watertight: C-96

Flanged Inlet & Flanged Outlet Specification Information:

L23-30: C-93

30A, 3ØY 347/600V NEMA L23-30

Plugs & Connectors

Style & Description	Cord Dia.	Catalog No.		Certifications				
		Plug	Connector	USA	UL	UL	UL	UL
Safety Grip™ Straight Body, Black & White	0.63-1.16" (15.9-29.4mm)	<input type="checkbox"/> CWL2330P	<input type="checkbox"/> CWL2330C	•				•
Safety Grip™ Flat Cable Straight Body, Gray	Max. 5-Wire #10 AWG Flat Cable	<input type="checkbox"/> L2330PF	<input type="checkbox"/> L2330CF	•				•
Severe Duty, Yellow & Black	0.63-1.16" (15.9-29.4mm)	<input type="checkbox"/> L2330PY	<input type="checkbox"/> L2330CY	•				•
Watertight, Yellow	0.43-1.15" (10.9-29.2mm)	<input type="checkbox"/> L2330PW	<input type="checkbox"/> L2330CW	•				•
Watertight, All-Black	0.43-1.15" (10.9-29.2mm)	<input type="checkbox"/> L2330PWBK	<input type="checkbox"/> L2330CWBK	•				•

Receptacles

Style & Description	Catalog No.	Certifications				
		Single Receptacle	USA	UL	UL	UL
Standard Industrial, Black	<input type="checkbox"/> CWL2330R		•			•
Isolated Ground, Orange	<input type="checkbox"/> IGL2330R		•			•
Watertight, Yellow	<input type="checkbox"/> L2330RW		•		•	
Watertight, All-Black	<input type="checkbox"/> L2330RWBK		•		•	

Flanged Inlets & Outlets

Style & Description	Catalog No.		Certifications				
	Flanged Inlet	Flanged Outlet	USA	UL	UL	UL	UL
Standard Industrial, Black & White	<input type="checkbox"/> CWL2330FI	—	•	•	•		
Standard Industrial, Black & White	—	<input type="checkbox"/> CWL2330FO	•	•			•

Icon Key

NAFTA Compliant - see page O-30

Accessories for NEMA L23-30 Locking Devices

Description	Catalog No.	USA
Neoprene weather protective boot for 30A 4-P, 5-W plug	<input type="checkbox"/> BL1	•
Neoprene weather protective boot for 30A connector	<input type="checkbox"/> BL2	•
Diecast aluminum single receptacle cover, vertical mount, for FS/FD boxes	<input type="checkbox"/> 7420	•
Glass-filled nylon flanged inlet/outlet cover, vertical mount, for 30A devices	<input type="checkbox"/> WP2	•



BL1



BL2



7420



WP2

Hart-Lock™ Industrial Specification Grade Midget Type Locking Devices

2-Pole, 2-Wire
Non-Grounding
15A, 125V/AC
NEMA ML-1



15A, 125V NEMA ML-1

Plugs & Connectors

Style & Description	Cord Dia.	Catalog No.		Certifications				
		Plug	Connector	USA	CSA	UL	ULus	ULcs
Nylon & Phenolic Straight Body, Black	0.22-0.31" (5.5-7.9mm)	□ 7465N	—	•	•	•	•	•
Nylon & Phenolic Straight Body, Black	0.31-0.50" (7.9-12.7mm)	□ 7428N	—	•			•	
Polarized Nylon & Phenolic Straight Body, Black	0.22-0.31" (5.5-7.9mm)	□ 7479N	□ 7464N	•			•	
Polarized Nylon & Phenolic Straight Body, Black	0.31-0.50" (7.9-12.7mm)	□ 7429N	□ 7427N	•			•	



7466

Flanged Inlets & Outlets

Style & Description	Catalog No.		Certifications				
	Flanged Inlet	Flanged Outlet	USA	CSA	UL	ULus	ULcs
Phenolic Body, Black	□ 7466	—	•	•	•		
Polarized Phenolic Body, Black	□ 7467	—	•	•	•		
Polarized Glass Filled Nylon Body, Black	—	□ 7468	•	•			•

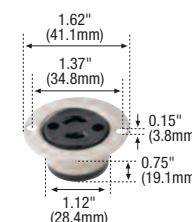

7468

Icon Key

USA NAFTA Compliant - see page O-30

Dimensional Information: C-83 – C-84

Plug & Connector Specification Information:

Midget: C-94

Flanged Inlet & Flanged Outlet Specification Information:

Midget: C-94



7594



7595N

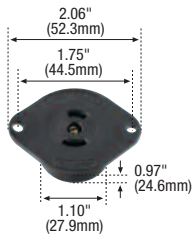

7596N

Hart-Lock™ Industrial Specification Grade Midget Type Locking Devices

2-Pole, 3-Wire
Grounding
15A, 125V/AC
NEMA ML-2

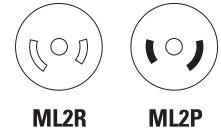

15A, 125V NEMA ML-2

Plugs & Connectors

Style & Description	Cord Dia.	Catalog No.		Certifications				
		Plug	Connector	USA	UL	cUL	cULus	CSA
Nylon & Phenolic Straight Body, Black	0.28-0.42" (7.1-10.7mm)	□ 7594	—	•	•	•	•	•
Glass Filled Nylon Straight Body, Black	0.28-0.42" (7.1-10.7mm)	—	□ 7593	•			•	•

Flanged Inlets & Outlets

Style & Description	Catalog No.		Certifications				
	Flanged Inlet	Flanged Outlet	USA	UL	cUL	FUS	CSA
Nylon & Phenolic Body, Metal Housing, Black	□ 7595	—	•	•	•		
Nylon & Phenolic Body, Metal Housing, Black	—	□ 7596	•	•			•
Glass Filled Nylon Body, Nylon Housing, Black	□ 7595N	—	•	•	•		
Glass Filled Nylon Body, Nylon Housing, Black	—	□ 7596N	•	•			•

Hart-Lock™ Industrial Specification Grade Midget Type Locking Devices

3-Pole, 3-Wire
Non-Grounding
15A, 125/250V/AC
NEMA ML-3

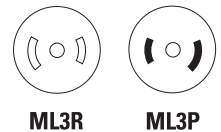

15A, 125/250V NEMA ML-3

Plugs & Connectors

Style & Description	Cord Dia.	Catalog No.		Certifications				
		Plug	Connector	USA	UL	cUL	cULus	CSA
Nylon & Phenolic Straight Body, Black	0.28-0.42" (7.1-10.7mm)	□ 7485	—	•			•	
Nylon & Phenolic Straight Body, Black	0.28-0.42" (7.1-10.7mm)	—	□ 7484	•			•	•

Flanged Inlets & Outlets

Style & Description	Catalog No.		Certifications				
	Flanged Inlet	Flanged Outlet	USA	UL	cUL	FUS	CSA
Glass Filled Nylon Body, Metal Housing, Black	□ 7486	—	•	•	•		
Glass Filled Nylon Body, Metal Housing, Black	—	□ 7487	•	•			•
Nylon & Phenolic Body, Nylon Housing, Black	□ 7486N	—	•	•	•		
Nylon & Phenolic Body, Nylon Housing, Black	—	□ 7487N	•	•			•



7485



7484

Dimensional Information: C-83 – C-84

Plug & Connector Specification Information:

Midget: C-94

Flanged Inlet & Flanged Outlet Specification Information:

Midget: C-94

Icon Key

NAFTA Compliant - see page O-30

Hart-Lock™ Industrial Specification Grade Switched Enclosure

Weatherproof Switched Enclosure
For 20A & 30A 125-600V/AC
Hart-Lock Flanged Outlets

30A, 600V/AC Max.* Manual Disconnect Switch in Enclosure

The Hart-Lock enclosure contains a HP rated manual disconnect switch that you can customize by installing any 20A or 30A Hart-Lock™ flanged outlet. Designed to provide dedicated local power control and eliminate the need for installation of a switch and receptacle in separate enclosures.

FEATURES

- Impact and corrosion-resistant NEMA 3R, 12 thermoplastic enclosure for long-term rainproof or dust-tight application reliability.
- Continuous poured-in place cover gasket cannot be left out or easily damaged during installation and assures enclosure rating.
- Heavy-duty disconnect switch is horsepower rated for motor load applications and is field replaceable.
- Supplied with 0.75" (19.1mm) liquid tight hub and grounding lug for top or bottom entry.
- Captive stainless steel cover mounting screws.
- Hinged enclosure cover for easy wiring.
- Self-closing lift lid cover with neoprene gasket provides weatherproof protection.
- Field installable auxiliary contact for control circuit applications.
- Easy to operate, gasketed nylon rotary handle is clearly marked for ON/OFF indication; can be locked in the "off" position to comply with OSHA lockout/tagout requirements.

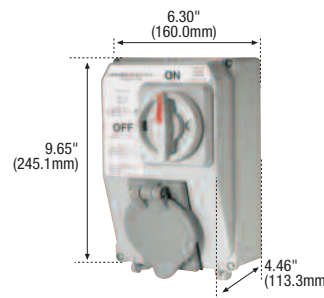

SE6000

Hart-Lock Enclosed Switch without Outlet

Style & Description	Catalog No.	Certifications			
Manual Disconnect Switch for Hart-Lock Flanged Outlets	□ SE6000				

*Ratings are dependent on Hart-Lock flanged outlet installed.

Flanged Outlets for Hart-Lock Enclosed Switch

Flanged Outlet NEMA Configuration & Rating	Poles, Wires	Outlet HP Rating	Catalog No.	Certifications			
L5-20: 20A, 125V/AC	2-P, 3-W	1 HP	□ CWL520FO				
L6-20: 20A, 250V/AC	2-P, 3-W	2 HP	□ CWL620FO				
L5-30: 30A, 125V/AC	2-P, 3-W	1 HP	□ CWL530FO				
L6-30: 20A, 250V/AC	2-P, 3-W	2 HP	□ CWL630FO				
L14-20: 20A, 125/250V/AC	3-P, 4-W	2 HP	□ CWL1420FO				
L15-20: 20A, 3Ø 250V/AC	3-P, 4-W	2 HP	□ CWL1520FO				
L14-30: 30A, 125/250V/AC	3-P, 4-W	2 HP	□ CWL1430FO				
L15-30: 30A, 3Ø 250V/AC	3-P, 4-W	3 HP	□ CWL1530FO				
L16-30: 30A, 3Ø 480V/AC	3-P, 4-W	10 HP	□ CWL1630FO				
L21-20: 20A, 3ØY 120/208V/AC	4-P, 5-W	2 HP	□ CWL1630FO				
L21-30: 30A, 3ØY 120/208V/AC	4-P, 4-W	2.5 HP	□ CWL1630FO				



CWL630FO



CWL1520FO

Icon Key

NAFTA Compliant - see page O-30

Innovative design and rugged durability

Arrow Hart's unique Pro-Grip™ design allows for quick and easy termination and assembly, saving valuable time on the job site. Superior design combined with rugged materials make Arrow Hart 50A devices ideal for temporary power applications.

**Hart-Lock™ Pro-Grip™ 50A Plugs & Connectors**

High-impact-resistant nylon housing can endure the roughest abuse while providing added insulation, resistance to breakage and superior heat performance

Cold rolled plated steel plug shroud adds strength and resists corrosion

Deep tapered wire wells are clearly marked for easy insertion and isolation of up to #4 AWG solid or stranded wires

Pro-Grip™ lock provides visual confirmation that the device is assembled properly; 3-step assembly is fastest and easiest in the industry

Matte finish ribbed housing surface provides improved gripping and handling in any environment

Glass-filled nylon body for resistance to breakage and superior heat performance

Tri-combo assembly screws are stainless steel construction for corrosion resistance



Exceptional receptacles and inlets

Innovative design, rugged materials and superior construction deliver lasting performance and reliable service in harsh industrial environments.



Hart-Lock™ 50A Receptacles

Heavy gauge 0.078" steel shells

Rugged glass filled nylon construction stands up to the toughest environments

Rugged single piece heavy-duty plated mounting strap for corrosion resistance; marine grade models are nickel-plated

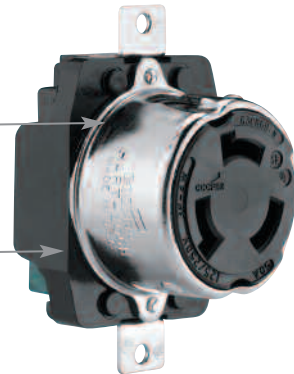

One-piece contacts provide continuity in the grounding and power circuits: brass alloy (shown), or nickel-plated brass (marine grade versions)

Heavy interior walls for additional support

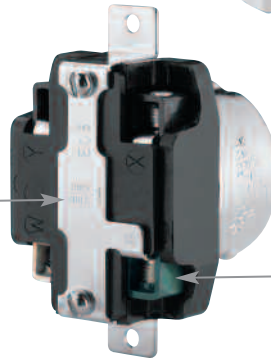

Large terminal box lugs for secure wiring

Hart-Lock 50A Flanged Inlets

Rugged metal shells and housings consist of corrosion resistant plated steel

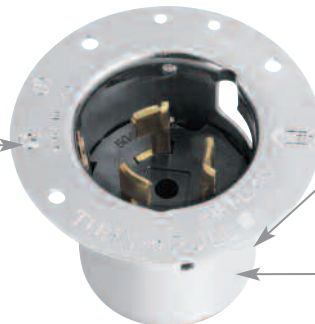

Back wired for quick and dependable conductor termination

Deep, tapered wire wells for positive conductor insulation

Hart-Lock™ Industrial Specification Grade 50A Locking Devices

2-Pole, 3-Wire Grounding
50A, 125V/AC
Non-NEMA, Marine
Corrosion Resistant

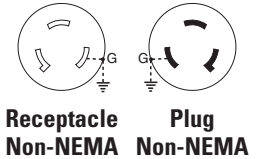

50A, 125V/AC Non-NEMA Marine Grade

Plugs & Connectors

Style & Description	Cord Dia.	Catalog No.		Certifications				
		Plug	Connector	USA	UL	UL	UL	UL
Pro-Grip™ Nylon, Yellow & Black	0.44-1.06" (11.1-26.0mm)	<input type="checkbox"/> 63CR61EX	<input type="checkbox"/> 63CR60EX	•				•
Armored, Stainless Steel	0.68-1.13" (17.3-28.6mm)	<input type="checkbox"/> 63CR61	<input type="checkbox"/> 63CR60	•				•



63CR61



63CR60

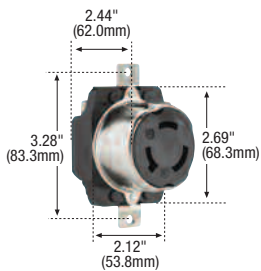

63CR70

Receptacles

Style & Description	Catalog No.	Certifications				
		Single Receptacle	USA	UL	UL	UL
Corrosion Resistant, Black	<input type="checkbox"/> 63CR70		•			•

Icon Key

NAFTA Compliant - see page O-30

Accessories for 50A Marine Grade Locking Devices

Description	Catalog No.	USA
Weather protective yellow (CR), black (BK), gray (GY) glass-filled nylon, w/ lift lid cover	<input type="checkbox"/> 7788CR, BK, GY	•
Weather protective diecast aluminum, w/ lift lid cover	<input type="checkbox"/> 7770	•
Short boot, for 50A armored connector when used w/ 50A armored plug in 7717 boot	<input type="checkbox"/> 7716	•
Long boot, for 50A armored plug when used w/ receptacle or 50A armored connector in 7716 boot	<input type="checkbox"/> 7717	•
For 50A armored connector when used w/ hull inlet	<input type="checkbox"/> 77CR15	•



7788CR



7770



7716



7717



77CR15

Dimensional Information: C-84 – C-85

Plug & Connector Specification Information:

50A Marine Pro-Grip: C-100

50A Marine Armored: C-100

Receptacle Specification Information:

50A Marine: C-100

Hart-Lock™ Industrial Specification Grade 50A Locking Devices

2-Pole, 3-Wire Grounding
50A, 125V/AC
Non-NEMA
California Standard



Receptacle **Plug**
Non-NEMA **Non-NEMA**

50A, 125V/AC Non-NEMA California Standard

Plugs & Connectors

Style & Description	Cord Dia.	Catalog No.		Certifications				
		Plug	Connector	USA	UL	UL	UL	UL
Pro-Grip™ Nylon California Standard, Black & Red	0.44-1.06" (11.1-26.0mm)	<input type="checkbox"/> CS6361EX	<input type="checkbox"/> CS6360EX	•	•	•	•	•
Armored California Standard, Steel	0.68-1.13" (17.3-28.6mm)	<input type="checkbox"/> CS6361	<input type="checkbox"/> CS6360	•			•	



CS6361EX

Receptacles

Style & Description	Catalog No.	Single Receptacle	Certifications				
			USA	UL	UL	UL	UL
California Standard, Black	<input type="checkbox"/> CS6370		•	•			•



CS6360EX

Flanged Inlets

Style & Description	Catalog No.		Certifications				
	Flanged Inlet	Flanged Inlet w/Lid	USA	UL	UL	UL	UL
California Standard, Steel	<input type="checkbox"/> CS6377	<input type="checkbox"/> CS6378	•	•	•		

Icon Key

NAFTA Compliant - see page O-30

Accessories for 50A California Standard Locking Devices

Description	Catalog No.	USA
Weather protective yellow (CR), black (BK), gray (GY) glass-filled nylon, w/ lift lid cover	<input type="checkbox"/> 7788CR, BK, GY	•
Weather protective diecast aluminum, w/ lift lid cover	<input type="checkbox"/> 7770	•
Short boot, for 50A armored connector when used w/ 50A armored plug in 7717 boot	<input type="checkbox"/> 7716	•
Long boot, for 50A armored plug when used w/ receptacle or 50A armored connector in 7716 boot	<input type="checkbox"/> 7717	•



7788CR



7770



7716



7717

Dimensional Information: C-84 – C-85

Plug & Connector Specification Information:

50A Pro-Grip: C-101
50A Armored: C-101

Receptacle Specification Information:

50A: C-101

Flanged Inlet Specification Information:

50A: C-101

Hart-Lock™ Industrial Specification Grade 50A Locking Devices

2-Pole, 3-Wire Grounding
50A, 250V/AC
Non-NEMA
California Standard

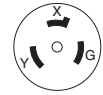

Receptacle Non-NEMA Plug Non-NEMA

50A, 250V/AC Non-NEMA California Standard

Plugs & Connectors

Style & Description	Cord Dia.	Catalog No.		Certifications				
		Plug	Connector	USA	UL	UL	UL	UL
Pro-Grip™ Nylon California Standard, Black & Red	0.44-1.06" (11.1-26.0mm)	<input type="checkbox"/> CS8265EX	<input type="checkbox"/> CS8264EX	•	•	•	•	•
Armored California Standard, Steel	0.68-1.13" (17.3-28.6mm)	<input type="checkbox"/> CS8265	<input type="checkbox"/> CS8264	•			•	



Receptacles

Style & Description	Catalog No.	Certifications				
		Single Receptacle	USA	UL	UL	UL
California Standard, Black	<input type="checkbox"/> CS8269		•	•		•

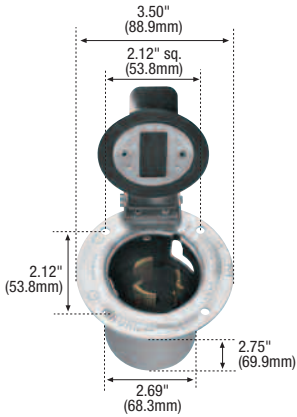

Flanged Inlets

Style & Description	Catalog No.		Certifications				
	Flanged Inlet	Flanged Inlet w/Lid	USA	UL	UL	UL	UL
California Standard, Steel	<input type="checkbox"/> CS8275	<input type="checkbox"/> CS8277	•	•	•		

Icon Key

NAFTA Compliant - see page O-30

Accessories for 50A California Standard Locking Devices

Description	Catalog No.	USA
Weather protective yellow (CR), black (BK), gray (GY) glass-filled nylon, w/ lift lid cover	<input type="checkbox"/> 7788CR, BK, GY	•
Weather protective diecast aluminum, w/ lift lid cover	<input type="checkbox"/> 7770	•
Short boot, for 50A armored connector when used w/ 50A armored plug in 7717 boot	<input type="checkbox"/> 7716	•
Long boot, for 50A armored plug when used w/ receptacle or 50A armored connector in 7716 boot	<input type="checkbox"/> 7717	•



Dimensional Information: C-84 – C-85

Plug & Connector Specification Information:

50A Pro-Grip: C-101
50A Armored: C-101

Receptacle Specification Information:

50A: C-101

Flanged Inlet Specification Information:

50A: C-101

Hart-Lock™ Industrial Specification Grade 50A Locking Devices

2-Pole, 3-Wire Grounding
50A, 250V DC / 600V/AC
Non-NEMA

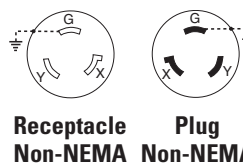

50A, 250V DC / 600V/AC Non-NEMA

Plugs & Connectors

Style & Description	Cord Dia.	Catalog No.		Certifications				
		Plug	Connector	USA	CSA	UL	UL	UL
Pro-Grip™ Nylon, Black & Red	0.44-1.06" (11.1-26.0mm)	□ 3763EX	□ 3762EX	•	•	•	•	•
Armored, Steel	0.68-1.13" (17.3-28.6mm)	□ 3763	□ 3762	•			•	



3763

Receptacles

Style & Description	Catalog No.	Single Receptacle	Certifications				
			USA	CSA	UL	UL	UL
Industrial, Black	□ 3771		•	•			•

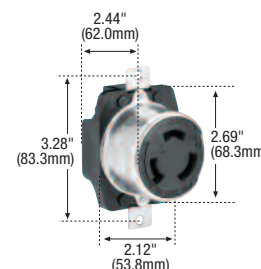

3771

Flanged Inlets

Style & Description	Catalog No.		Certifications				
	Flanged Inlet	Flanged Inlet w/Lid	USA	CSA	UL	UL	UL
Industrial, Steel	□ 3777	□ 3767	•	•	•		

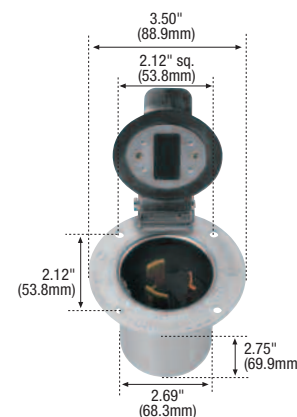

3767

Icon Key

USA NAFTA Compliant - see page O-30

Accessories for 50A Locking Devices

Description	Catalog No.	USA
Weather protective yellow (CR), black (BK), gray (GY) glass-filled nylon, w/ lift lid cover	□ 7788CR, BK, GY	•
Weather protective diecast aluminum, w/ lift lid cover	□ 7770	•
Short boot, for 50A armored connector when used w/ 50A armored plug in 7717 boot	□ 7716	•
Long boot, for 50A armored plug when used w/ receptacle or 50A armored connector in 7716 boot	□ 7717	•



7788CR



7770



7716



7717

Dimensional Information: C-84 – C-85

Plug & Connector Specification Information:

50A Pro-Grip: C-101
50A Armored: C-101

Receptacle Specification Information:

50A: C-101

Flanged Inlet Specification Information:

50A: C-101

Hart-Lock™ Industrial Specification Grade 50A Locking Devices

2-Pole, 3-Wire Grounding
50A, 480V/AC
Non-NEMA
California Standard



Receptacle Non-NEMA Plug Non-NEMA



CS8464

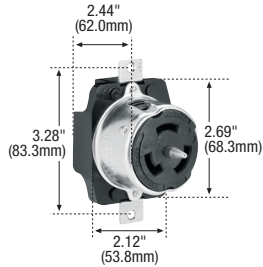

CS8469

50A, 480V/AC Non-NEMA California Standard

Plugs & Connectors

Style & Description	Cord Dia.	Catalog No.		Certifications				
		Plug	Connector	USA	UL	UL	UL	UL
Pro-Grip™ Nylon California Standard, Black & Red	0.44-1.06" (11.1-26.0mm)	<input type="checkbox"/> CS8465EX	<input type="checkbox"/> CS8464EX	•	•	•	•	•
Armored California Standard, Steel	0.68-1.13" (17.3-28.6mm)	<input type="checkbox"/> CS8465	<input type="checkbox"/> CS8464	•			•	

Receptacles

Style & Description	Catalog No.	Single Receptacle	Certifications				
			USA	UL	UL	UL	UL
California Standard, Black	<input type="checkbox"/> CS8469		•	•			•

Flanged Inlets

Style & Description	Catalog No.		Certifications				
	Flanged Inlet	Flanged Inlet w/Lid	USA	UL	UL	UL	UL
California Standard, Steel	<input type="checkbox"/> CS8475	<input type="checkbox"/> CS8477	•	•	•		

Icon Key

NAFTA Compliant - see page O-30

Accessories for 50A California Standard Locking Devices

Description	Catalog No.	USA
Weather protective yellow (CR), black (BK), gray (GY) glass-filled nylon, w/ lift lid cover	<input type="checkbox"/> 7788CR, BK, GY	•
Weather protective diecast aluminum, w/ lift lid cover	<input type="checkbox"/> 7770	•
Short boot, for 50A armored connector when used w/ 50A armored plug in 7717 boot	<input type="checkbox"/> 7716	•
Long boot, for 50A armored plug when used w/ receptacle or 50A armored connector in 7716 boot	<input type="checkbox"/> 7717	•



7788CR



7770



7716



7717

Dimensional Information: C-84 – C-85

Plug & Connector Specification Information:

50A Pro-Grip: C-101

50A Armored: C-101

Receptacle Specification Information:

50A: C-101

Flanged Inlet Specification Information:

50A: C-101

Hart-Lock™ Industrial Specification Grade 50A Locking Devices

3-Pole, 4-Wire Grounding
50A, 125/250V/AC
Non-NEMA, Marine
Corrosion Resistant

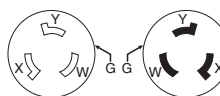

Receptacle Non-NEMA **Plug Non-NEMA**

50A, 125/250V/AC Non-NEMA Marine Grade

Plugs & Connectors

Style & Description	Cord Dia.	Catalog No.		Certifications				
		Plug	Connector	USA	UL	UL	UL	UL
Pro-Grip™ Nylon, Yellow & Black	0.44-1.06" (11.1-26.0mm)	□ 63CR65EX	□ 63CR64EX	•	•	•	•	•
Armored, Stainless Steel	0.68-1.13" (17.3-28.6mm)	□ 63CR65	□ 63CR64	•			•	



63CR64

Receptacles

Style & Description	Catalog No.	Single Receptacle	Certifications				
			USA	UL	UL	UL	UL
Corrosion Resistant, Black	□ 63CR69		•	•	•	•	•

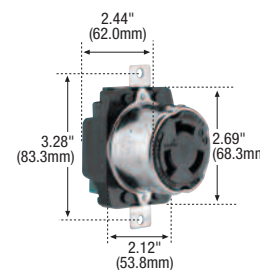

63CR69

Icon Key

NAFTA Compliant - see page O-30

Accessories for 50A Marine Grade Locking Devices

Description	Catalog No.	USA
Weather protective yellow (CR), black (BK), gray (GY) glass-filled nylon, w/ lift lid cover	□ 7788CR, BK, GY •	•
Weather protective diecast aluminum, w/ lift lid cover	□ 7770 •	•
Short boot, for 50A armored connector when used w/ 50A armored plug in 7717 boot	□ 7716 •	•
Long boot, for 50A armored plug when used w/ receptacle or 50A armored connector in 7716 boot	□ 7717 •	•
For 50A armored connector when used w/ hull inlet	□ 77CR15 •	•



7788CR



7770



7716



7717



77CR15

Dimensional Information: C-84 – C-85

Plug & Connector Specification Information:

50A Marine Pro-Grip: C-100
50A Marine Armored: C-100

Receptacle Specification Information:

50A Marine: C-100

Hart-Lock™ Industrial Specification Grade 50A Locking Devices

3-Pole, 4-Wire Grounding
50A, 125/250V/AC
Non-NEMA
California Standard

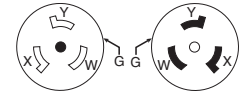

Receptacle Non-NEMA **Plug** Non-NEMA

50A, 125/250V/AC Non-NEMA California Standard

Plugs & Connectors

Style & Description	Cord Dia.	Catalog No.		Certifications				
		Plug	Connector	USA	UL	UL	UL	UL
Pro-Grip™ Nylon California Standard, Black & Red	0.44-1.06" (11.1-26.0mm)	<input type="checkbox"/> CS6365EX	<input type="checkbox"/> CS6364EX	•	•	•	•	•
Armored California Standard, Steel	0.68-1.13" (17.3-28.6mm)	<input type="checkbox"/> CS6365	<input type="checkbox"/> CS6364	•			•	



CS6365EX



CS6364EX

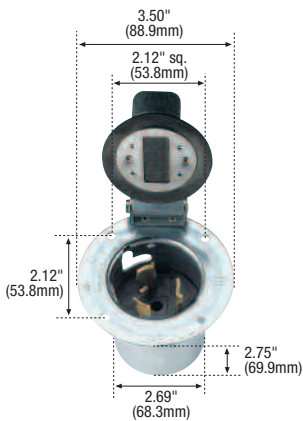

CS6376

Receptacles

Style & Description	Catalog No.	Certifications				
		Single Receptacle	USA	UL	UL	UL
California Standard, Black	<input type="checkbox"/> CS6369		•			•

Flanged Inlets

Style & Description	Catalog No.		Certifications				
	Flanged Inlet	Flanged Inlet w/Lid	USA	UL	UL	UL	UL
California Standard, Steel	<input type="checkbox"/> CS6375	<input type="checkbox"/> CS6376	•	•	•		

Icon Key

NAFTA Compliant - see page O-30

Accessories for 50A California Standard Locking Devices

Description	Catalog No.	USA
Weather protective yellow (CR), black (BK), gray (GY) glass-filled nylon, w/ lift lid cover	<input type="checkbox"/> 7788CR, BK, GY •	
Weather protective diecast aluminum, w/ lift lid cover	<input type="checkbox"/> 7770 •	
Short boot, for 50A armored connector when used w/ 50A armored plug in 7717 boot	<input type="checkbox"/> 7716 •	
Long boot, for 50A armored plug when used w/ receptacle or 50A armored connector in 7716 boot	<input type="checkbox"/> 7717 •	



7788CR



7770



7716



7717

Dimensional Information: C-84 – C-85

Plug & Connector Specification Information:

50A Pro-Grip: C-101

50A Armored: C-101

Receptacle Specification Information:

50A: C-101

Flanged Inlet Specification Information:

50A: C-101

Hart-Lock™ Industrial Specification Grade 50A Locking Devices

3-Pole, 4-Wire Grounding
50A, 3Ø 250V/AC
Non-NEMA
California Standard

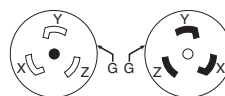

Receptacle Non-NEMA **Plug Non-NEMA**

50A, 3Ø 250V/AC Non-NEMA California Standard

Plugs & Connectors

Style & Description	Cord Dia.	Catalog No.		Certifications				
		Plug	Connector	USA	CS	UL	ULS	ULS
Pro-Grip™ Nylon California Standard, Black & Red	0.44-1.06" (11.1-26.0mm)	<input type="checkbox"/> CS8365EX	<input type="checkbox"/> CS8364EX	•				•
Armored California Standard, Steel	0.68-1.13" (17.3-28.6mm)	<input type="checkbox"/> CS8365	<input type="checkbox"/> CS8364	•				•



CS8364

Receptacles

Style & Description	Catalog No.	Single Receptacle	Certifications				
			USA	CS	UL	ULS	ULS
California Standard, Black	<input type="checkbox"/> CS8369		•	•			•



CS8369

Flanged Inlets

Style & Description	Catalog No.		Certifications				
	Flanged Inlet	Flanged Inlet w/Lid	USA	CS	UL	ULS	ULS
California Standard, Steel	<input type="checkbox"/> CS8375	<input type="checkbox"/> CS8377	•	•	•		

Icon Key

NAFTA Compliant - see page O-30

Accessories for 50A California Standard Locking Devices

Description	Catalog No.	
Weather protective yellow (CR), black (BK), gray (GY) glass-filled nylon, w/ lift lid cover	<input type="checkbox"/> 7788CR, BK, GY	•
Weather protective diecast aluminum, w/ lift lid cover	<input type="checkbox"/> 7770	•
Short boot, for 50A armored connector when used w/ 50A armored plug in 7717 boot	<input type="checkbox"/> 7716	•
Long boot, for 50A armored plug when used w/ receptacle or 50A armored connector in 7716 boot	<input type="checkbox"/> 7717	•



7788CR



7770



7716



7717

Dimensional Information: C-84 – C-85

Plug & Connector Specification Information:

50A Pro-Grip: C-101
50A Armored: C-101

Receptacle Specification Information:

50A: C-101

Flanged Inlet Specification Information:

50A: C-101

Hart-Lock™ Industrial Specification Grade 50A Locking Devices

3-Pole, 4-Wire Grounding
50A, 250V DC / 600V/AC
Non-NEMA

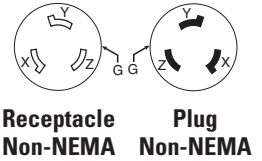

3765



3764

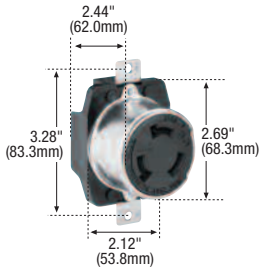

3769

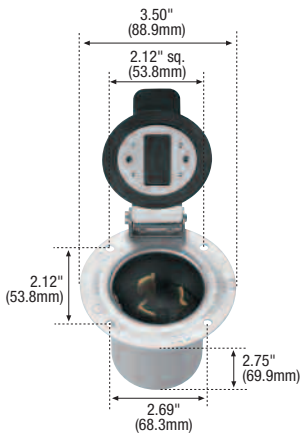

3768

Dimensional Information: C-84 – C-85

Plug & Connector Specification Information:

50A Pro-Grip: C-101
50A Armored: C-101

Receptacle Specification Information:

50A: C-101

Flanged Inlet Specification Information:

50A: C-101

C-66

50A, 250V DC / 600V/AC Non-NEMA California Standard

Plugs & Connectors, New Applications

Style & Description	Cord Dia.	Catalog No.		Certifications				
		Plug	Connector	USA	UL	UL	UL	UL
Pro-Grip™ Nylon California Standard, Black & Red	0.44-1.06" (11.1-26.0mm)	<input type="checkbox"/> 3765EX	<input type="checkbox"/> 3764EX	•				•
Armored California Standard, Steel	0.68-1.13" (17.3-28.6mm)	<input type="checkbox"/> 3765	<input type="checkbox"/> 3764	•				•

Receptacles, New Applications

Style & Description	Catalog No.	Certifications				
		Single Receptacle	USA	UL	UL	UL
California Standard, Black	<input type="checkbox"/> 3769		•			•

Flanged Inlets, New Applications

Style & Description	Catalog No.		Certifications				
	Flanged Inlet	Flanged Inlet w/Lid	USA	UL	UL	UL	UL
California Standard, Steel	<input type="checkbox"/> 3775	<input type="checkbox"/> 3768	•	•	•		

Icon Key

NAFTA Compliant - see page O-30

Accessories for 50A California Standard Locking Devices

Description	Catalog No.	USA
Weather protective yellow (CR), black (BK), gray (GY) glass-filled nylon, w/ lift lid cover	<input type="checkbox"/> 7788CR, BK, GY	•
Weather protective diecast aluminum, w/ lift lid cover	<input type="checkbox"/> 7770	•
Short boot, for 50A armored connector when used w/ 50A armored plug in 7717 boot	<input type="checkbox"/> 7716	•
Long boot, for 50A armored plug when used w/ receptacle or 50A armored connector in 7716 boot	<input type="checkbox"/> 7717	•



7788CR



7770



7716



7717

Hart-Lock™ Industrial Specification Grade 50A Locking Devices

3-Pole, 4-Wire Grounding
50A, 250V DC / 600V/AC
Non-NEMA

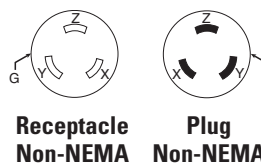

50A, 250V DC / 600V/AC Non-NEMA California Standard

Plugs & Connectors, Replacement Applications

Style & Description	Cord Dia.	Catalog No.		Certifications				
		Plug	Connector	USA	CSA	UL	UL	UL
Pro-Grip™ Nylon California Standard, Black & Red	0.44-1.06" (11.1-26.0mm)	<input type="checkbox"/> 7765EX	<input type="checkbox"/> 7764EX	•				•
Armored California Standard, Steel	0.68-1.13" (17.3-28.6mm)	<input type="checkbox"/> 7765	<input type="checkbox"/> 7764	•				•



7765EX



7764EX

Receptacles, Replacement Applications

Style & Description	Catalog No.	Single Receptacle	Certifications				
			USA	CSA	UL	UL	UL
California Standard, Black	<input type="checkbox"/> 7379		•	•			•

Flanged Inlets, Replacement Applications

Style & Description	Catalog No.		Certifications				
	Flanged Inlet	Flanged Inlet w/Lid	USA	CSA	UL	UL	UL
California Standard, Steel	<input type="checkbox"/> 7958	<input type="checkbox"/> 7968	•	•	•		

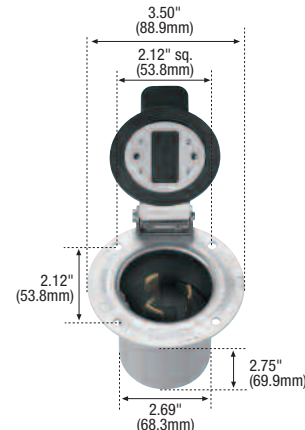

7968

Icon Key

NAFTA Compliant - see page O-30

Accessories for 50A Locking Devices

Description	Catalog No.	
Weather protective yellow (CR), black (BK), gray (GY) glass-filled nylon, w/ lift lid cover	<input type="checkbox"/> 7788CR, BK, GY	•
Weather protective diecast aluminum, w/ lift lid cover	<input type="checkbox"/> 7770	•
Short boot, for 50A armored connector when used w/ 50A armored plug in 7717 boot	<input type="checkbox"/> 7716	•
Long boot, for 50A armored plug when used w/ receptacle or 50A armored connector in 7716 boot	<input type="checkbox"/> 7717	•



7788CR



7770



7716



7717

Dimensional Information: C-84 – C-85

Plug & Connector Specification Information:

50A Pro-Grip: C-101
50A Armored: C-101

Receptacle Specification Information:

50A: C-101

Flanged Inlet Specification Information:

50A: C-101

Hart-Lock™ Industrial Specification Grade 50A Locking Devices

3-Pole, 4-Wire Grounding
50A, 3Ø 480V/AC
Non-NEMA
California Standard

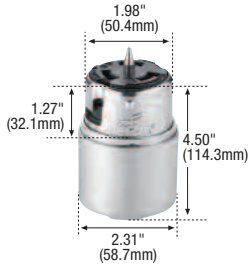
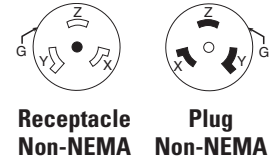

CS8164

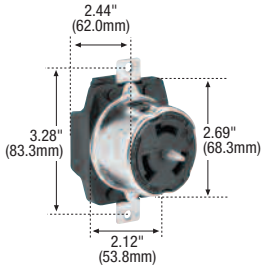

CS8169

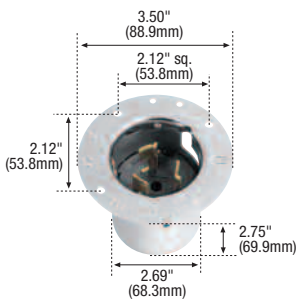

CS8175

50A, 3Ø 480V/AC Non-NEMA California Standard

Plugs & Connectors

Style & Description	Cord Dia.	Catalog No.		Certifications				
		Plug	Connector	USA	UL	UL	UL	UL
Pro-Grip™ Nylon California Standard, Black & Red	0.44-1.06" (11.1-26.0mm)	<input type="checkbox"/> CS8165EX	<input type="checkbox"/> CS8164EX	•				•
Armored California Standard, Steel	0.68-1.13" (17.3-28.6mm)	<input type="checkbox"/> CS8165	<input type="checkbox"/> CS8164	•				•

Receptacles

Style & Description	Catalog No.	Certifications				
		Single Receptacle	USA	UL	UL	UL
California Standard, Black	<input type="checkbox"/> CS8169		•			•

Flanged Inlets

Style & Description	Catalog No.		Certifications				
	Flanged Inlet	Flanged Inlet w/Lid	USA	UL	UL	UL	UL
California Standard, Steel	<input type="checkbox"/> CS8175	<input type="checkbox"/> CS8177	•	•	•		

Icon Key

NAFTA Compliant - see page O-30

Accessories for 50A California Standard Locking Devices

Description	Catalog No.	
Weather protective yellow (CR), black (BK), gray (GY) glass-filled nylon, w/ lift lid cover	<input type="checkbox"/> 7788CR, BK, GY	•
Weather protective diecast aluminum, w/ lift lid cover	<input type="checkbox"/> 7770	•
Short boot, for 50A armored connector when used w/ 50A armored plug in 7717 boot	<input type="checkbox"/> 7716	•
Long boot, for 50A armored plug when used w/ receptacle or 50A armored connector in 7716 boot	<input type="checkbox"/> 7717	•



7788CR



7770



7716



7717

Dimensional Information: C-84 – C-85

Plug & Connector Specification Information:

50A Pro-Grip: C-101

50A Armored: C-101

Receptacle Specification Information:

50A: C-101

Flanged Inlet Specification Information:

50A: C-101

For applications where the need for a secure connection is absolute

Power-Lock™ devices are designed for safety, energizing within a chamber to eliminate the possibility of exterior arcing. They are ideal for high-abuse industrial and specialized hospital applications.



Nylon Power-Lock Plugs & Connectors

High-impact nylon shell ideal for use in high abuse installations

Neoprene gasket seals cord entry hole and prevents dust and moisture from entering terminal area

Tapered cord grip cover prevents cord snagging

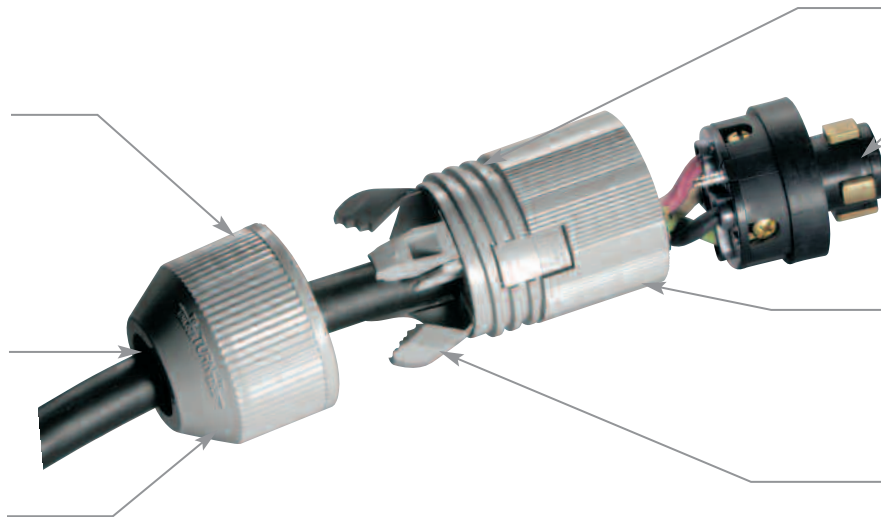

Unique twist type cover eliminates assembly screws

Carefully machined contacts of high alloy brass molded into high impact resistant fiberglass reinforced nylon

Totally insulated design eliminates exposed metal parts

Innovative cord clamping fingers provide exceptional cord retention

Armored Power-Lock Plugs & Connectors

Adjustable external metal cord grip accepts a wide range of cord diameters

Neoprene grommet protects against contamination

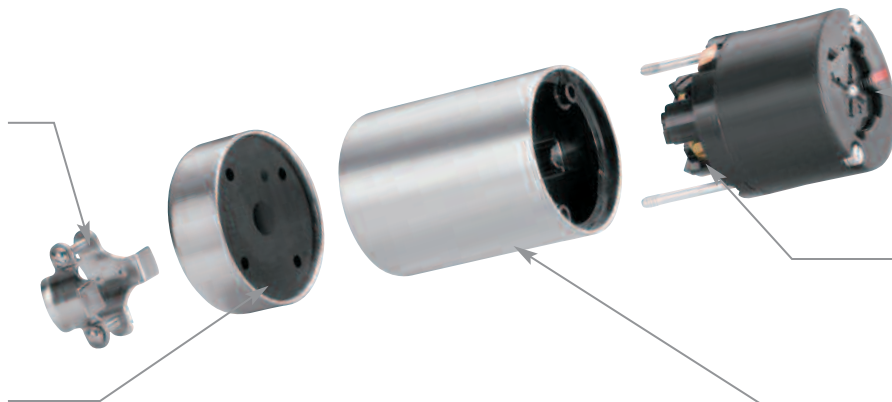

Spring loaded safety shutter ejects the plug if not fully locked in and prevents entrance of foreign matter

Large pressure plate terminals for ease of wiring

Rugged steel shell for maximum protection

Power-Lock™ Hospital Use Locking Devices

2-Pole, 3-Wire Grounding
20A, 125V/AC
Non-NEMA

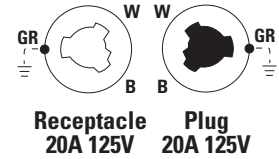

23054

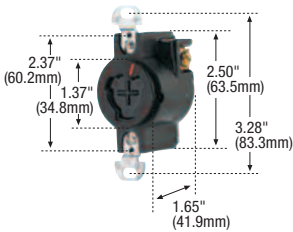

23050

20A, 125V/AC Non-NEMA

Hospital Use Power-Lock Plugs & Connectors

Style & Description	Cord Dia.	Catalog No.		Certifications				
		Plug	Connector	USA	UL	UL	UL	UL
Nylon Back Wired "Dead Front" Design, Gray	0.33-0.66" (8.4-16.7mm)	<input type="checkbox"/> 23056N	<input type="checkbox"/> 23054N	•				•
Armored Back Wired "Dead Front" Design, Gray	0.33-0.66" (8.4-16.7mm)	<input type="checkbox"/> 23056	<input type="checkbox"/> 23054	•				•

Hospital Use Power-Lock Receptacles

Style & Description	Catalog No.	Certifications				
		Single Receptacle	USA	UL	UL	UL
Receptacle, not for use in Hazardous Areas	<input type="checkbox"/> 23050		•			•

Power-Lock™ Hospital Use Mobile X-Ray™ Devices

2-Pole, 3-Wire Grounding
50A, 250V/AC
Non-NEMA

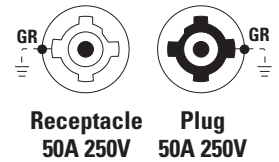

25525

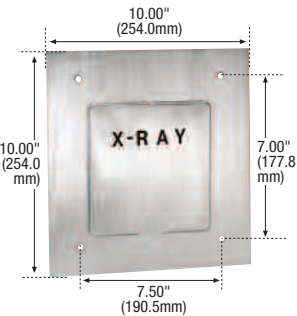

25505

50A, 250V/AC Non-NEMA

Hospital Use Power-Lock Plugs

Style & Description	Cord Dia.	Catalog No.	Plug	Certifications				
				USA	UL	UL	UL	UL
Back Wired "Dead Front" Design, Gray	0.75-1.25" (19.1-31.8mm)	<input type="checkbox"/> 25525		•				•

Hospital Use Power-Lock Receptacles

Style & Description	Catalog No.	Certifications				
		Single Receptacle	USA	UL	UL	UL
Receptacle in Plate Assembly, Stainless Steel	<input type="checkbox"/> 25505		•			•

Icon Key

NAFTA Compliant - see page O-30

Accessories for Power-Lock Hospital Use Locking Devices

Description	Catalog No.	USA
Steel 50A receptacle wallbox, KO sizes 1.25" (31.9mm), 1.50" (38.1mm), 2" (50.8mm)	<input type="checkbox"/> 25509	•

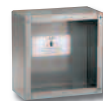

25509

Dimensional Information: C-85
Plug Specification Information:

Hospital Power-Lock: C-102

Receptacle Specification Information:

Hospital Power-Lock: C-102

**Power-Lock™
Hospital Use Mobile
X-Ray™ Devices**

2-Pole, 3-Wire Grounding
60A, 250V/AC
Non-NEMA

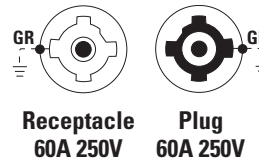

60A, 250V/AC Non-NEMA

Hospital Use Power-Lock Plugs

Style & Description	Cord Dia.	Catalog No. Plug	Certifications				
			USA	CSA	UL	UL US	UL US
Back Wired "Dead Front" Design, Gray	0.75-1.25" (19.1-31.8mm)	□ 25625	•			•	

Hospital Use Power-Lock Receptacles

Style & Description	Catalog No. Single Receptacle	Certifications				
		USA	CSA	UL	UL US	UL US
Receptacle in Plate Assembly, Stainless Steel	□ 25605	•	•			

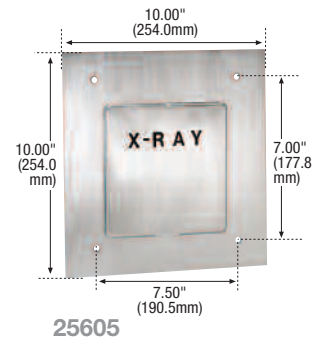

Icon Key

NAFTA Compliant - see page O-30

Accessories for Power-Lock Hospital Use Locking Devices

Description	Catalog No.	
Steel 50A receptacle wallbox, KO sizes 1.25" (31.9mm), 1.50" (38.1mm), 2" (50.8mm)	□ 25509	•



25509

Dimensional Information: C-85
Plug Specification Information:
Hospital Power-Lock: C-102

Receptacle Specification Information:
Hospital Power-Lock: C-102

Power-Lock™ Industrial Specification Grade Locking Devices

2-Pole, 3-Wire Grounding
20A, 125V/AC
Non-NEMA

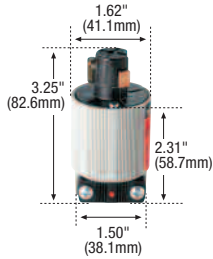
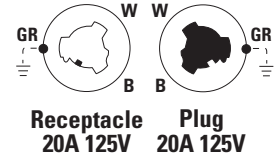

23035N

20A, 125V/AC Non-NEMA

Power-Lock Plugs & Connectors

Style & Description	Cord Dia.	Catalog No.		Certifications				
		Plug	Connector	USA	CSA	UL	UL US	UL US
Nylon Back Wired "Dead Front" Design, Gray	0.33-0.66" (8.4-16.7mm)	<input type="checkbox"/> 23035N	<input type="checkbox"/> 23032N	•		•	•	

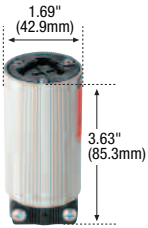

23032N

Power-Lock™ Industrial Specification Grade Locking Devices

3-Pole, 3-Wire Grounding & Non-Grounding
20A, 125V/AC
Non-NEMA

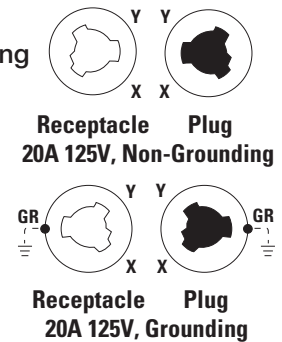

20A, 125V/AC Non-NEMA

Power-Lock Plugs & Connectors

Style & Description	Cord Dia.	Catalog No.		Certifications				
		Plug	Connector	USA	CSA	UL	UL US	UL US
Nylon Back Wired "Dead Front" Design, Gray	0.33-0.66" (8.4-16.7mm)	<input type="checkbox"/> 23005N	<input type="checkbox"/> 23002N	•			•	

Note: Also rated at 10A for 250V DC and 480V/AC

Power-Lock Receptacles

Style & Description	Catalog No.	Certifications				
		Single Receptacle	USA	CSA	UL	UL US
Standard Industrial, Black	<input type="checkbox"/> 23000		•			•
Grounding Industrial, for replacement use only, Black	<input type="checkbox"/> 23000G		•			

Dimensional Information: C-86 – C-87

Plug & Connector Specification Information:

Power-Lock: C-103

Receptacle Specification Information:

Power-Lock: C-104

Icon Key

NAFTA Compliant - see page O-30

Power-Lock™ Industrial Specification Grade Locking Devices

3-Pole, 4-Wire Grounding
30/20A,
250V DC / 600V/AC
Non-NEMA

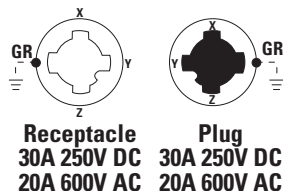

30/20A, 250V DC / 600V AC Non-NEMA

Power-Lock Plugs & Connectors

Style & Description	Cord Dia.	Catalog No.		Certifications				
		Plug	Connector	USA	CSA	UL	UL US	UL US
AutoGrip™ Nylon, Gray	0.40-1.06" (10.2-27.0mm)	□ 20415N	□ 20414N	•				•
Armored w/Sliding Rubber Cord Grip, Steel	0.36-0.48" (9.1-12.3mm)	□ 21415	□ 21414	•				•
Armored w/Sliding Rubber Cord Grip, Steel	0.48-0.75" (12.3-19.1mm)	□ 21426	□ AH21427	•				•
Armored w/Sliding Rubber Cord Grip & Special Mounting Stud (used in automotive welding applications), Steel	0.48-0.75" (12.3-19.1mm)	□ 21426S	—	•				•
Armored w/Sliding Rubber Cord Grip, Steel	0.56-1.00" (14.3-25.4mm)	□ 20415	□ 20414	•				•
Armored w/Sliding Rubber Cord Grip & Special Mounting Stud (used in automotive welding applications), Steel	0.56-1.00" (14.3-25.4mm)	□ 20415S	—	•				•
Armored female, Steel	0.75" (19.1mm)	□ AH21436	—	•	•	•		
Armored female, Steel	0.75" (19.1mm)	—	□ 21434	•	•			



20414N



20415S

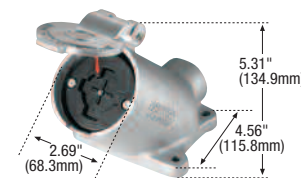

AH21420

Power-Lock Receptacles

Style & Description	Catalog No.	Single Receptacle	Certifications				
			USA	CSA	UL	UL S	UL US
Standard Industrial, Black	□ 20403N		•	•	•	•	•
In Angled Cast Aluminum Cover w/Weather Protective Lift Lid, Black	□ AH21420		•	•			

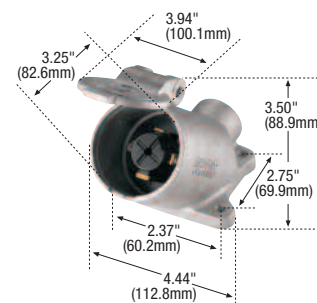

21447

Power-Lock Inlets

Style & Description	Catalog No.	Inlet	Certifications				
			USA	CSA	UL	UL S	UL US
Inlet for FS/FD boxes, black	□ 20418		•	•	•	•	•
Angled Surface Mount Inlet w/Weather Protective Lift Lid Tapped for 0.75" (19.1mm) pipe thread, diecast aluminum	□ 21447		•	•	•		•

Dimensional Information: C-86 – C-87

Plug & Connector Specification Information:

Power-Lock: C-103

Receptacle Specification Information:

Power-Lock: C-104

Inlet Specification Information:

Power-Lock: C-103

Icon Key

USA NAFTA Compliant - see page O-30

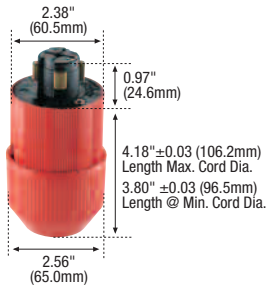

20445N



20444N

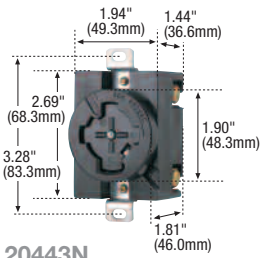

20443N

Power-Lock™ Industrial Specification Grade Locking Devices

3-Pole, 4-Wire Grounding
30A, 480V/AC
Non-NEMA

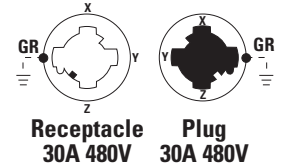

30A, 480V/AC Non-NEMA

Power-Lock Plugs & Connectors

Style & Description	Cord Dia.	Catalog No.		Certifications				
		Plug	Connector	USA	CSA	UL	UL US	UL CS
AutoGrip™ Nylon, Red	0.40-1.06" (10.2-27.0mm)	<input type="checkbox"/> 20445N	<input type="checkbox"/> 20444N	•			•	
Armored, Red	0.49-0.61" (12.3-15.5mm)	<input type="checkbox"/> 20445	<input type="checkbox"/> 20444	•			•	

Power-Lock Receptacles

Style & Description	Catalog No.	Certifications				
		Single Receptacle	USA	CSA	UL	UL US
Standard Industrial, Black	<input type="checkbox"/> 20443N		•			

Dimensional Information: C-86 – C-87

Plug & Connector Specification Information:

Power-Lock: C-103

Receptacle Specification Information:

Power-Lock: C-104

Icon Key

NAFTA Compliant - see page O-30

Power-Lock™ Industrial Specification Grade Locking Devices

3-Pole, 4-Wire Grounding
60A, 600V/AC
Non-NEMA

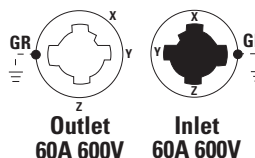

26415



26414



26420



26415A

60A, 600V AC Non-NEMA

Power-Lock Plugs & Connectors

Style & Description	Cord Dia. (19.1-31.8mm)	Catalog No.		Certifications				
		Plug	Connector	USA	CSA	UL	UL	UL
Armored, Yellow	0.75-1.25"	□ 26415	□ 26414	•	•	•	•	•
Armored w/Special Mounting Stud (used in automotive welding applications), Yellow	0.75-1.25"	□ 26415S	—	•	•	•	•	•
Armored w/Rubber Bushing in Cable Clamp, Yellow	0.75-1.25"	□ 26426	□ 26427	•	•	•	•	•
Armored w/Rubber Bushing in Cable Clamp & Special Mounting Stud (used in automotive welding applications), Yellow	0.75-1.25"	□ 26426S	—	•	•	•	•	•

Note: Bushing versions supplied with 3 sizes of rubber bushings

Power-Lock Receptacles

Style & Description	Catalog No. Single Receptacle	Certifications				
		USA	CSA	UL	UL	UL
In Cast Aluminum Cover w/Weather Protective Lift Lid, Black	□ 26420	•	•	•	•	•
In Angled Cast Aluminum Cover w/Weather Protective Lift Lid, Black	□ 26421	•	•	•	•	•

Power-Lock Inlets & Outlets

Style & Description	Cord Dia. (19.1-31.8mm)	Catalog No.		Certifications				
		Flanged Inlet	Flanged Outlet	USA	CSA	UL	UL	UL
Armored Flanged, Steel	0.75-1.25"	□ 26415A	□ 26414A	•	•	•	•	•

Dimensional Information: C-86 – C-87

Plug & Connector Specification Information:

Power-Lock: C-103

Receptacle Specification Information:

Power-Lock: C-104

Inlet Specification Information:

Power-Lock: C-103

Icon Key

USA NAFTA Compliant - see page O-30

Power-Lock™ Industrial Specification Grade Locking Devices

4-Pole, 5-Wire Grounding
30/20A,
250V DC / 600V/AC
Non-NEMA

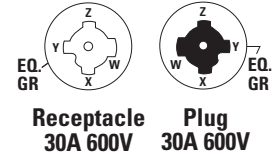

30/20A, 250V DC / 600V AC Non-NEMA

Power-Lock Plugs & Connectors

Style & Description	Cord Dia.	Catalog No.		Certifications				
		Plug	Connector					
AutoGrip™ Nylon, Blue	0.40-1.06" (10.2-27.0mm)	<input type="checkbox"/> 25415N	<input type="checkbox"/> 25414N	•				•
Armored, Blue	0.62-1.00" (15.9-25.4mm)	<input type="checkbox"/> 25415	<input type="checkbox"/> 25414	•				•

Power-Lock Receptacles

Style & Description	Catalog No.	Single Receptacle	Certifications				
In Cast Iron Cover and Steel Shell, Black	<input type="checkbox"/> 25403		•	•			•
In Cast Aluminum Cover w/Weather Protective Lift Lid, Black	<input type="checkbox"/> 25250		•	•			•

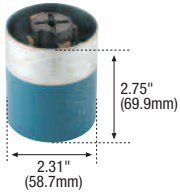

25415

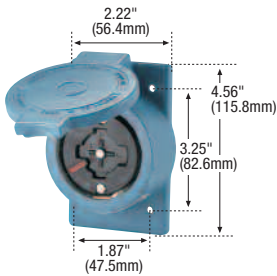

25250

Dimensional Information: C-86 – C-87

Plug & Connector Specification Information:

Power-Lock: C-103

Receptacle Specification Information:

Power-Lock: C-104

Inlet Specification Information:

Power-Lock: C-103

Icon Key

NAFTA Compliant - see page O-30

Power-Lock™ Industrial Specification Grade Locking Devices

4-Pole, 5-Wire Grounding
60A, 600V/AC
Non-NEMA

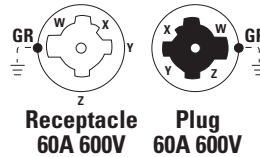

26527



26526

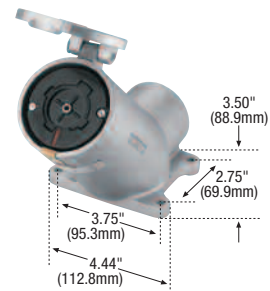

26521



26514A

60A, 600V AC Non-NEMA

Power-Lock Plugs & Connectors

Style & Description	Cord Dia.	Catalog No.		Certifications				
		Plug	Connector	USA	CSA	UL	ULS	ULS
Armored, Yellow	0.75-1.25" (19.1-31.8mm)	□ 26515	□ 26514	•	•	•	•	•
Armored w/Rubber Bushing in Cable Clamp, Yellow	0.75-1.25" (19.1-31.8mm)	□ 26526	□ 26527	•	•	•	•	•
Armored, Accepts Ring Terminals, Yellow	N/A	□ 26515AM	—	•	•	•	•	•

Note: Bushing versions supplied with 3 sizes of rubber bushings

Power-Lock Receptacles

Style & Description	Catalog No.	Certifications				
		Single Receptacle	USA	CSA	UL	ULS
In Cast Aluminum Cover w/Weather Protective Lift Lid, Black	□ 26520	•	•	•	•	•
In Angled Cast Aluminum Cover w/Weather Protective Lift Lid, Black	□ 26521	•	•	•	•	•

Power-Lock Inlets & Outlets

Style & Description	Cord Dia.	Catalog No.		Certifications				
		Flanged Inlet	Flanged Outlet	USA	CSA	UL	ULS	ULS
Armored Flanged, Steel	0.75-1.25" (19.1-31.8mm)	□ 26515A	□ 26514A	•	•	•	•	•

Dimensional Information: C-86 – C-87

Plug & Connector Specification Information:

Power-Lock: C-103

Receptacle Specification Information:

Power-Lock: C-104

Inlet Specification Information:

Power-Lock: C-103

Icon Key

USA NAFTA Compliant - see page O-30



PG300

Power-Lock™ Industrial Specification Grade Locking Devices

Accessories for
30A, 60A Devices

Power Grips for Power-Lock™ Units

Power-Lock Wire Mesh Grips

Rating A	Nominal Grip Diameter	Grip Diameter Range	Catalog No.
30	0.44" (11.2mm)	0.375-0.500" (9.5-12.7mm)	<input type="checkbox"/> PG300
	0.56" (14.2mm)	0.500-0.625" (12.7-15.9mm)	<input type="checkbox"/> PG301
	0.69" (17.5mm)	0.625-0.750" (15.9-19.1mm)	<input type="checkbox"/> PG302
	0.81" (20.6mm)	0.750-0.875" (19.1-22.2mm)	<input type="checkbox"/> PG303
	0.94" (23.9mm)	0.875-1.00" (22.2-25.4mm)	<input type="checkbox"/> PG304
60	1.06" (27.0mm)	1.00-1.125" (25.4-28.6mm)	<input type="checkbox"/> PG600*
	1.06" (27.0mm)	1.00-1.125" (25.4-28.6mm)	<input type="checkbox"/> PG601†

30A for use with Power-Lock catalog nos.: 21415, 21426, 21443, 21414, 21427, 21442, 20445, 20444

* 60A for use with Power-Lock catalog nos.: 26415, 26414, 26515, 26514

† 60A for use with Power-Lock catalog nos.: 26426, 26427, 26526, 26527

NAFTA Compliant

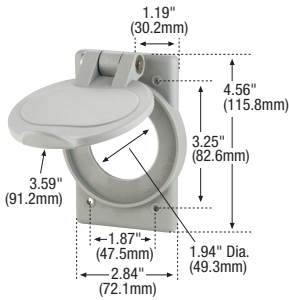

20416N

Accessories for Power-Lock™ Receptacles

Power-Lock Nylon Plates

Rating A	Product Type	Catalog No.
30	Red glass filled nylon with weather protective lift lid cover and gasket Suitable for wet and damp locations with cover closed	<input type="checkbox"/> 20446N
	Gray glass filled nylon with weather protective lift lid cover and gasket Suitable for wet and damp locations with cover closed	<input type="checkbox"/> 20416N

NAFTA Compliant

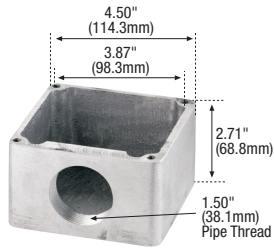

26401

Power-Lock Cast Aluminum Plates

Rating A	Product Type	Catalog No.
30	Diecast aluminum with weather protective lift lid cover and gasket	<input type="checkbox"/> 20416D
	Diecast aluminum cover without lid and gasket	<input type="checkbox"/> 20417N

NAFTA Compliant

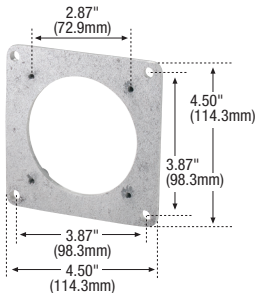

26402

Power-Lock Cast Aluminum Boxes, Covers & Angle Adapters

Rating A	Product Type	Catalog No.
60	Box, only for use with 26040 angle adapter	<input type="checkbox"/> 26401
	Cover, only for 26401 box	<input type="checkbox"/> 26402
	Box and cover complete	<input type="checkbox"/> 26400
	45° angle adapter	<input type="checkbox"/> 26040

60A For use with 26420 & 26520 receptacles

NAFTA Compliant

15A, 20A & 30A Locking Devices, Dimensional Data

Safety Grip™ Plugs

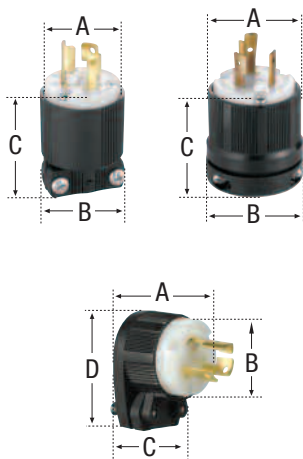

Family	A	B	C	D	Cord Dia.
NEMA L2-20	1.37" (34.8mm)	1.50" (38.1mm)	2.06" (52.3mm)	-	0.33-0.66" (8.4-16.7mm)
15A & 10/15A Locking	1.37" (34.8mm)	1.50" (38.1mm)	2.06" (52.3mm)	-	0.33-0.66" (8.4-16.7mm)
15A Locking Angled	1.28" (32.5mm)	1.47" (37.3mm)	1.50" (38.1mm)	2.06" (52.3mm)	0.33-0.66" (8.4-16.7mm)
20/10A Locking	2.19" (55.6mm)	2.31" (58.7mm)	2.75" (69.9mm)	-	0.63-1.16" (15.9-29.4mm)
20A Locking 2-P, 3-W; 3-P, 3-W	2.00" (50.8mm)	2.12" (53.8mm)	2.34" (59.4mm)	-	0.38-1.00" (9.5-25.4mm)
20A Locking 3-P, 4-W; 4-P, 4-W; 4-P, 5-W	2.19" (55.6mm)	2.31" (58.7mm)	2.75" (69.9mm)	-	0.63-1.16" (15.9-29.4mm)
30A Locking 2-P, 3-W; 3-P, 3-W	2.00" (50.8mm)	2.12" (53.8mm)	2.34" (59.4mm)	-	0.38-1.00" (9.5-25.4mm)
30A Locking 3-P, 4-W; 4-P, 4-W; 4-P, 5-W	2.19" (55.6mm)	2.31" (58.7mm)	2.75" (69.9mm)	-	0.63-1.16" (15.9-29.4mm)

Safety Grip™ Connectors

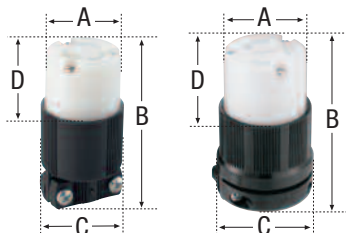

Family	A	B	C	D	Cord Dia.
NEMA L2-20	1.37" (34.8mm)	2.88" (73.0mm)	1.50" (38.1mm)	1.00" (25.4mm)	0.33-0.66" (8.4-16.7mm)
15A & 10/15A Locking	1.37" (34.8mm)	2.88" (73.0mm)	1.50" (38.1mm)	1.00" (25.4mm)	0.33-0.66" (8.4-16.7mm)
20/10A Locking	1.37" (34.8mm)	2.88" (73.0mm)	1.50" (38.1mm)	1.00" (25.4mm)	0.33-0.66" (8.4-16.7mm)
20A Locking 2-P, 3-W; 3-P, 3-W	2.00" (50.8mm)	3.44" (87.3mm)	2.12" (53.8mm)	1.31" (33.3mm)	0.38-1.00" (9.5-25.4mm)
20A Locking 3-P, 4-W	2.00" (50.8mm)	3.44" (87.3mm)	2.12" (53.8mm)	1.31" (33.3mm)	0.38-1.00" (9.5-25.4mm)
20A Locking 4-P, 4-W & 4-P, 5-W	2.19" (55.6mm)	3.75" (95.3mm)	2.31" (58.7mm)	1.22" (31.0mm)	0.63-1.16" (15.9-29.4mm)
30A Locking 2-P, 3-W; 3-P, 3-W	2.00" (50.8mm)	3.44" (87.3mm)	2.12" (53.8mm)	1.31" (33.3mm)	0.38-1.00" (9.5-25.4mm)
30A Locking 3-P, 4-W; 4-P, 4-W; 4-P, 5-W	2.19" (55.6mm)	3.75" (95.3mm)	2.31" (58.7mm)	1.22" (31.0mm)	0.63-1.16" (15.9-29.4mm)

Auto Grip™ Plugs

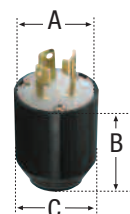

Family	A	B	C	Cord Dia.
15A & 10/15A Locking	1.38" (34.9mm)	1.83" (46.5mm)	1.52" (38.6mm)	0.33-0.66" (8.4-16.7mm)

Auto Grip™ Connectors



Family	A	B	C	Cord Dia.
15A & 10/15A Locking	1.38" (34.9mm)	1.83" (46.5mm)	1.52" (38.6mm)	0.33-0.66" (8.4-16.7mm)

15A, 20A & 30A Locking Devices, Dimensional Data

Locking Plugs

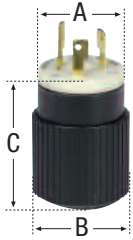

Family	A	B	C	Cord Dia.
NEMA L9-20, L9-30	1.83" (47.5mm)	2.13" (54.1mm)	2.85" (72.3mm)	0.30-0.95" (7.6-16.7mm)
NEMA L12-20, L12-30, L13-30	1.83" (47.5mm)	2.13" (54.1mm)	2.85" (72.3mm)	0.38-1.00" (9.5-25.4mm)

Locking Connectors

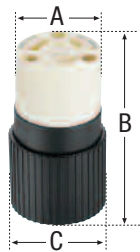

Family	A	B	C	Cord Dia.
NEMA L9-20, L9-30	1.83" (47.5mm)	3.44" (87.3mm)	2.12" (53.8mm)	0.30-0.95" (7.6-16.7mm)
NEMA L12-20, L12-30, L13-30	1.83" (47.5mm)	3.90" (99.1mm)	2.13" (54.1mm)	0.38-1.00" (9.5-25.4mm)

Severe Duty Plugs

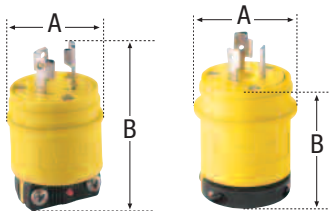

Family	A	B	Cord Dia.
15A Locking	1.69" (42.9mm)	2.09" (53.1mm)	0.38-1.00" (9.5-25.4mm)
20A Locking 2-P, 3-W & 3-P, 3-W	2.39" (60.7mm)	2.86" (72.6mm)	0.38-1.00" (9.5-25.4mm)
20A Locking 3-P, 4-W; 4-P, 4-W; 4-P, 5W	2.39" (60.7mm)	2.86" (72.6mm)	0.63-1.16" (15.9-29.4mm)
30A Locking 2-P, 3-W & 3-P, 3-W	2.64" (67.1mm)	2.86" (72.6mm)	0.38-1.00" (9.5-25.4mm)
30A Locking 3-P, 4-W; 4-P, 4-W; 4-P, 5W	2.64" (67.1mm)	2.86" (72.6mm)	0.38-1.00" (9.5-25.4mm)

Severe Duty Connectors

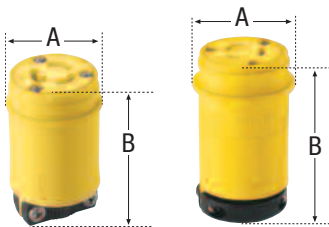

Family	A	B	Cord Dia.
15A Locking	1.69" (42.9mm)	2.78" (70.6mm)	0.38-1.00" (9.5-25.4mm)
20A Locking 2-P, 3-W & 3-P, 3-W	2.39" (60.7mm)	3.86" (98.0mm)	0.38-1.00" (9.5-25.4mm)
20A Locking 3-P, 4-W; 4-P, 4-W; 4-P, 5W	2.39" (60.7mm)	3.86" (98.0mm)	0.63-1.16" (15.9-29.4mm)
30A Locking 2-P, 3-W & 3-P, 3-W	2.64" (67.1mm)	3.94" (100.1mm)	0.38-1.00" (9.5-25.4mm)
30A Locking 3-P, 4-W; 4-P, 4-W; 4-P, 5W	2.64" (67.1mm)	3.94" (100.1mm)	0.38-1.00" (9.5-25.4mm)

15A, 20A & 30A Locking Devices, Dimensional Data

Watertight Plugs

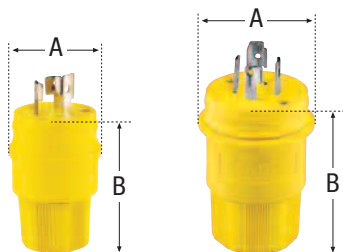

Family	A	B	Cord Dia.
15A Locking	1.62" (41.1mm)	2.96" (75.2mm)	0.30-0.65" (7.6-16.5mm)
20A Locking	2.49" (63.2mm)	3.66" (93.0mm)	0.36-0.84" (9.1-21.3mm)
30A Locking	2.69" (68.3mm)	3.66" (93.0mm)	0.43-1.15" (10.9-29.2mm)

Watertight Connectors

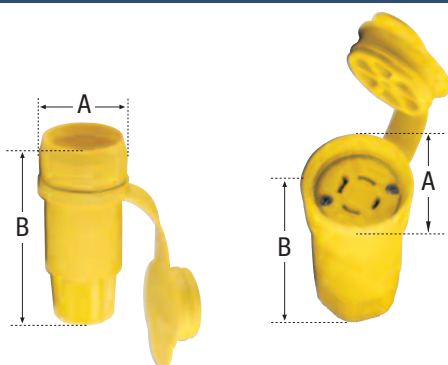

Family	A	B	Cord Dia.
15A Locking	1.62" (41.1mm)	4.00" (101.6mm)	0.30-0.65" (7.6-16.5mm)
20A Locking	2.49" (63.2mm)	5.42" (137.7mm)	0.36-0.84" (9.1-21.3mm)
30A Locking	2.69" (68.3mm)	5.42" (137.7mm)	0.43-1.15" (10.9-29.2mm)

Locking Receptacles

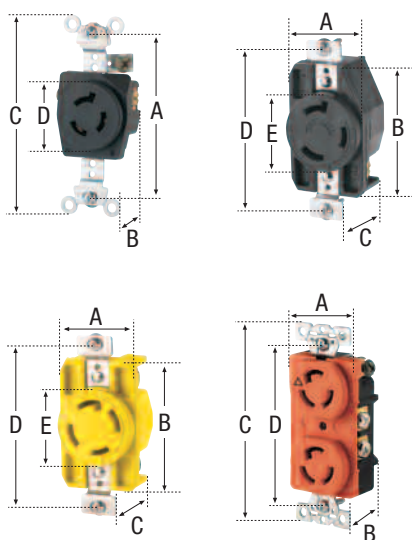

Family	A	B	C	D	E
Single Receptacle, 15A & 10/15A Locking	3.28" (83.3mm)	0.76" (19.3mm)	4.03" (102.4mm)	1.38" (34.8mm)	-
Single Receptacle, 20/10A Locking	1.62" (41.1mm)	2.62" (66.5mm)	1.03" (26.2mm)	3.28" (83.3mm)	1.56" (39.6mm)
Single Receptacle, 20A Locking 2-P, 3-W & 3-P, 3-W	1.62" (41.1mm)	2.62" (66.5mm)	1.03" (26.2mm)	3.28" (83.3mm)	1.56" (39.6mm)
Single Receptacle, 30A Locking 2-P, 3-W & 3-P, 3-W	1.62" (41.1mm)	2.62" (66.5mm)	1.12" (28.5mm)	3.28" (83.3mm)	1.56" (39.6mm)
Single Receptacle, 20A Locking 3-P, 4-W; 4-P, 4-W & 4-P, 5-W	1.62" (41.1mm)	2.62" (66.5mm)	1.03" (26.2mm)	3.28" (83.3mm)	1.56" (39.6mm)
Single Receptacle, 30A Locking 3-P, 4-W; 4-P, 4-W & 4-P, 5-W	1.62" (41.1mm)	2.62" (66.5mm)	1.12" (28.5mm)	3.28" (83.3mm)	1.56" (39.6mm)
Duplex Receptacle, 15A & 10/15A Locking	1.54" (39.1mm)	0.75" (19.1mm)	4.19" (106.4mm)	3.28" (83.3mm)	-

15A, 20A & 30A Locking Devices, Dimensional Data

Watertight Receptacles

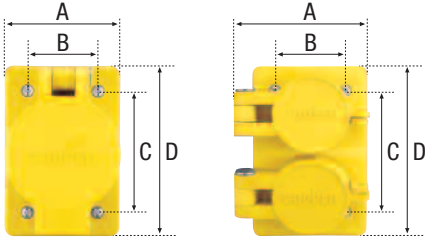

Family	A	B	C	D	Cord Dia.
Single Receptacle	3.10" (78.7mm)	1.88" (47.8mm)	3.25" (82.6mm)	4.60" (116.8mm)	0.30-0.65" (7.6-16.5mm)
Duplex Receptacle	3.62" (91.9mm)	1.88" (47.8mm)	3.25" (82.6mm)	4.63" (117.6mm)	0.30-0.65" (7.6-16.5mm)

Locking Flanged Inlets

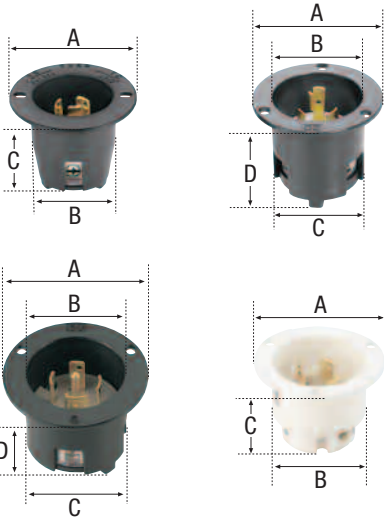

Family	A	B	C	D
15A Locking	2.56" (65.0mm)	1.71" (43.4mm)	1.84" (46.7mm)	-
20A Locking 2-P, 3-W & 3-P, 3-W	2.87" (72.9mm)	1.94" (49.3mm)	2.06" (52.3mm)	2.19" (22.6mm)
20A Locking 3-P, 4-W; 4-P, 4-W; 4-P, 5W	3.06" (77.7mm)	2.03" (51.6mm)	2.19" (55.6mm)	2.19" (55.6mm)
20A Locking NEMA L9-20, L12-20	2.87" (72.9mm)	2.06" (52.3mm)	1.95" (49.5mm)	-
30A Locking 2-P, 3-W & 3-P, 3-W	2.87" (72.9mm)	1.94" (49.3mm)	2.06" (52.3mm)	2.19" (22.6mm)
30A Locking 3-P, 4-W; 4-P, 4-W; 4-P, 5W	3.06" (77.7mm)	2.03" (51.6mm)	2.19" (55.6mm)	2.19" (55.6mm)
30A Locking NEMA L9-30, L12-30, L13-30	2.87" (72.9mm)	2.06" (52.3mm)	1.95" (49.5mm)	-

Locking Flanged Outlets



Family	A	B	C	D
15A Locking	2.56" (65.0mm)	1.71" (43.4mm)	1.84" (46.7mm)	-
20A Locking 2-P, 3-W & 3-P, 3-W	2.87" (72.9mm)	1.94" (49.3mm)	2.06" (52.3mm)	2.19" (22.6mm)
20A Locking 3-P, 4-W; 4-P, 4-W; 4-P, 5W	3.06" (77.7mm)	2.03" (51.6mm)	2.19" (55.6mm)	2.19" (55.6mm)
20A Locking NEMA L9-20, L12-20	2.87" (72.9mm)	2.06" (52.3mm)	1.95" (49.5mm)	-
30A Locking 2-P, 3-W & 3-P, 3-W	2.87" (72.9mm)	1.94" (49.3mm)	2.06" (52.3mm)	2.19" (22.6mm)
30A Locking 3-P, 4-W; 4-P, 4-W; 4-P, 5W	3.06" (77.7mm)	2.03" (51.6mm)	2.19" (55.6mm)	2.19" (55.6mm)
30A Locking NEMA L9-30, L12-30, L13-30	2.87" (72.9mm)	2.06" (52.3mm)	1.95" (49.5mm)	-

15A, 20A & 30A Locking Devices, Dimensional Data

Other Locking Plugs

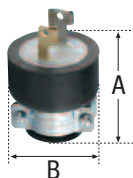

Family	A	B	Cord Dia.
L1-15, #7546	1.56" (39.6mm)	1.56" (39.6mm)	0.31-0.47" (7.9-11.9mm)

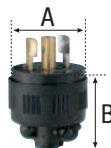

Family	A	B	Cord Dia.
ML-1, #7465N & 7479N	1.00" (25.4mm)	1.19" (30.2mm)	0.22-0.31" (5.5-7.9mm)
ML-1, #7428N & 7429N	1.16" (29.5mm)	0.84" (21.3mm)	0.31-0.50" (7.9-12.7mm)
ML-2 & ML-3	1.16" (29.5mm)	0.84" (21.3mm)	0.28-0.42" (7.1-10.7mm)

Other Locking Connectors



Family	A	B	Cord Dia.
L1-15	2.13" (54.0mm)	1.38" (35.1mm)	0.30-0.56" (7.5-14.3mm)



Family	A	B	C	Cord Dia.
ML-1, #7464N	1.00" (25.4mm)	0.82" (20.8mm)	0.37" (9.4mm)	0.22-0.31" (5.5-7.9mm)
ML-1, #7427N	1.00" (25.4mm)	0.82" (20.8mm)	0.37" (9.4mm)	0.31-0.50" (7.9-12.7mm)
ML-2 & ML-3	1.16" (29.5mm)	1.25" (31.8mm)	0.37" (9.4mm)	0.28-0.42" (7.1-10.7mm)

Other Locking Receptacles

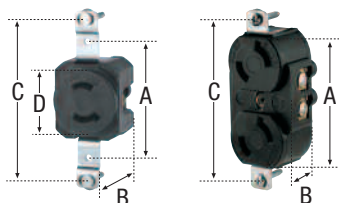

Family	A	B	C	D
Single Receptacle, L1-15R	2.38" (60.5mm)	0.88" (22.4mm)	3.28" (83.3mm)	1.38" (35.1mm)
Duplex Receptacle, L1-15R	2.89" (73.4mm)	1.00" (25.4mm)	3.28" (83.3mm)	-

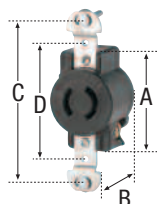

Family	A	B	C	D
Single Receptacle, L2-20R	2.03" (51.6mm)	1.38" (34.9mm)	3.28" (83.3mm)	2.38" (35.1mm)

Other Locking Flanged Inlets

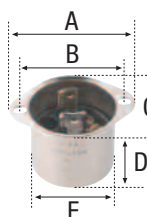

Family	A	B	C	D	E
L1-15	2.03" (51.6mm)	1.69" (42.9mm)	1.56" (39.6mm)	1.25" (31.8mm)	1.39" (35.3mm)

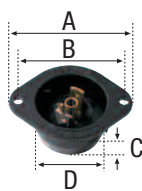
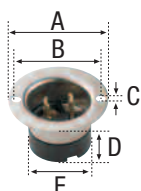

Family	A	B	C	D	E
ML-1	1.62" (41.1mm)	1.37" (34.8mm)	0.15" (3.8mm)	0.94" (23.9mm)	1.12" (28.4mm)
ML-2 & ML-3 Metal	1.63" (41.4mm)	1.75" (44.5mm)	0.16" (4.1mm)	1.00" (25.4mm)	1.22" (31.0mm)
ML-2 & ML-3 Nylon	2.06" (52.3mm)	1.75" (44.5mm)	0.97" (24.6mm)	1.10" (27.9mm)	-

15A, 20A & 30A Locking Devices, Dimensional Data

Other Locking Flanged Outlets

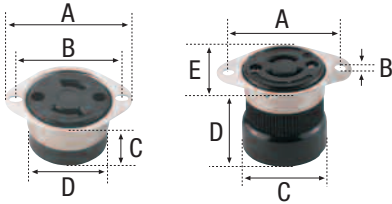

Family	A	B	C	D	E
L1-15	2.03" (51.6mm)	1.69" (42.9mm)	1.06" (26.9mm)	1.37" (34.8mm)	-
L2-20	2.06" (52.4mm)	0.20" (5.1mm)	1.56" (39.6mm)	1.69" (42.9mm)	1.75" (44.5mm)

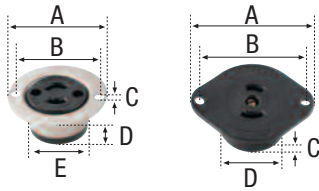

Family	A	B	C	D	E
ML-1	1.62" (41.1mm)	1.37" (34.8mm)	0.15" (3.8mm)	0.75" (19.1mm)	1.12" (28.4mm)
ML-2 & ML-3 Metal	1.63" (41.4mm)	1.75" (44.5mm)	0.16" (4.1mm)	0.97" (24.6mm)	1.17" (29.7mm)
ML-2 & ML-3 Nylon	2.06" (52.3mm)	1.75" (44.5mm)	0.97" (24.6mm)	1.10" (27.9mm)	-

50A Non-NEMA Locking Devices, Dimensional Data

50A Non-NEMA Plugs

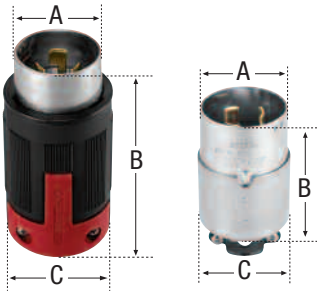

Family	A	B	C	Cord Dia.
Pro-Grip™ Nylon	2.17" (55.1mm)	5.35" (135.8mm)	2.55" (64.7mm)	0.11-1.06" (11.1-26.0mm)
Armored	2.02" (51.2mm)	4.50" (114.3mm)	2.31" (58.7mm)	0.68-1.13" (17.3-28.6mm)

50A Non-NEMA Connectors

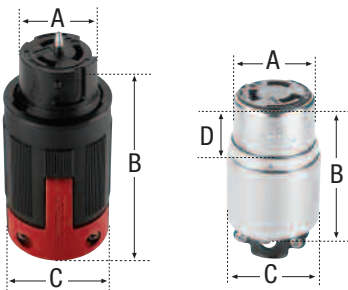

Family	A	B	C		Cord Dia.
Pro-Grip™ Nylon	1.94" (49.3mm)	5.52" (140.2mm)	2.55" (64.7mm)	-	0.11-1.06" (11.1-26.0mm)
Armored	1.98" (50.4mm)	4.50" (114.3mm)	2.31" (58.7mm)	1.27" (32.1mm)	0.68-1.13" (17.3-28.6mm)

50A Non-NEMA Locking Devices, Dimensional Data

50A Non-NEMA Flanged Inlets

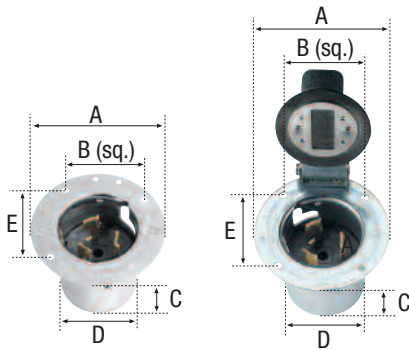

Family	A	B	C	D	E
Flanged Inlet	3.50" (88.9mm)	2.12" (53.8mm)	2.75" (69.9mm)	2.69" (68.3mm)	2.12" (53.8mm)
Flanged Inlet with Lid	3.50" (88.9mm)	2.12" (53.8mm)	2.75" (69.9mm)	2.69" (68.3mm)	2.12" (53.8mm)

Power-Lock™ Devices, Dimensional Data

Hospital Use Power-Lock Plugs

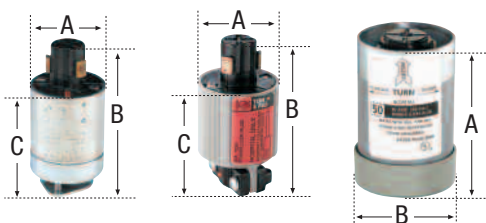

Family	A	B	C	Cord Dia.
Hospital Use 20A Armored	1.63" (41.4mm)	3.25" (82.6mm)	2.59" (65.8mm)	0.33-0.66" (8.4-16.7mm)
Hospital Use 20A Nylon	1.69" (42.9mm)	3.25" (82.6mm)	2.31" (58.7mm)	0.33-0.66" (8.4-16.7mm)
Hospital Use 50A & 60A Armored	4.19" (106.4mm)	2.87" (72.9mm)	-	0.75-1.25" (19.1-31.8mm)

Hospital Use Power-Lock Connectors

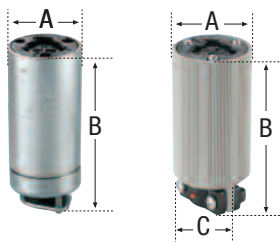

Family	A	B	C	Cord Dia.
Hospital Use 20A Armored	1.62" (41.1mm)	3.87" (96.0mm)	-	0.33-0.66" (8.4-16.7mm)
Hospital Use 20A Nylon	1.69" (42.9mm)	3.63" (92.2mm)	1.50" (38.1mm)	0.33-0.66" (8.4-16.7mm)

Hospital Use Power-Lock Receptacles

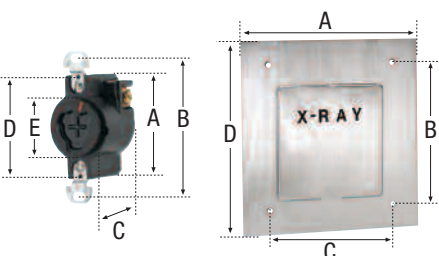

Family	A	B	C	D	E
Single Receptacle	2.50" (63.5mm)	3.28" (83.3mm)	1.65" (41.5mm)	2.37" (60.2mm)	1.37" (34.8mm)
Single Receptacle, In Assembly	10.00" (254.0mm)	7.00" (177.8mm)	7.50" (190.5mm)	10.00" (254.0mm)	-

Power-Lock™ Devices, Dimensional Data

Industrial Use Power-Lock Plugs

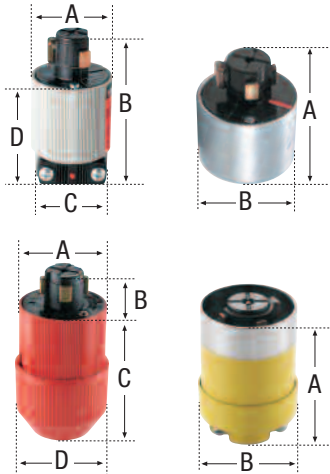

Family	A	B	C	D	Cord Dia.
Industrial 20A Nylon	1.62" (41.1mm)	3.25" (82.6mm)	1.50" (38.1mm)	2.31" (58.7mm)	0.33-0.66" (8.4-16.7mm)
Industrial 30A Armored	2.92" (74.2mm)	2.31" (58.7mm)	-	-	0.49-0.61" (12.3-15.5mm)
Industrial 30/20A 3-P, 4-W Armored	2.44" (62.0mm)	2.31" (58.7mm)	-	-	0.48-0.75" (12.3-19.1mm), except 21415: 0.36-0.48" (9.1-12.3mm), 20415: 0.56-1.00" (14.3-25.4mm), AH21436: 0.75" (19.1mm)
Industrial 30A 3-P, 4-W & 30/20A 4-P, 5W Nylon	2.38" (60.5mm)	0.97" (24.6mm)	Varies with cord dia., min. 3.80" (96.5mm), max. 4.18" (106.2mm)	2.56" (65.0mm)	0.40-1.06" (12.3-15.5mm)
Industrial 30/20A 4-P, 5W Armored	2.75" (69.9mm)	2.31" (58.7mm)	-	-	0.62-1.00" (15.9-25.4mm)
Industrial 60A Armored	3.37" (85.6mm)	2.69" (68.3mm)	-	-	0.75-1.25" (19.1-38.1mm)

Industrial Use Power-Lock Connectors

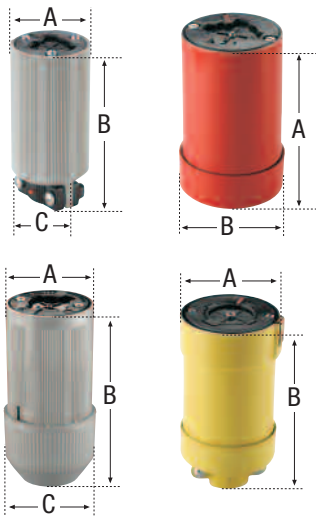

Family	A	B	C	Cord Dia.
Industrial 20A Nylon	1.69" (42.9mm)	3.63" (92.2mm)	1.50" (38.1mm)	0.33-0.66" (8.4-16.7mm)
Industrial 30A Armored	2.32" (58.9mm)	3.21" (81.5mm)	-	0.49-0.61" (12.3-15.5mm)
Industrial 30/20A 3-P, 4-W Armored	2.32" (58.9mm)	3.21" (81.5mm)	-	0.48-0.75" (12.3-19.1mm), except 21414: 0.36-0.48" (9.1-12.3mm), 20414: 0.56-1.00" (14.3-25.4mm), 21434: 0.75" (19.1mm)
Industrial 30A 3-P, 4-W & 30/20A 4-P, 5W Nylon	2.38" (60.5mm)	Varies with cord dia., min. 5.17" (131.3mm), max. 5.55" (141.0mm)	2.56" (65.0mm)	0.40-1.06" (12.3-15.5mm)
Industrial 30/20A 4-P, 5W Armored	2.49" (63.2mm)	3.17" (80.5mm)	-	0.62-1.00" (15.9-25.4mm)
Industrial 60A Armored	2.94" (74.7mm)	4.56" (115.8mm)	-	0.75-1.25" (19.1-38.1mm)

Power-Lock™ Devices, Dimensional Data

Industrial Power-Lock Single Receptacles

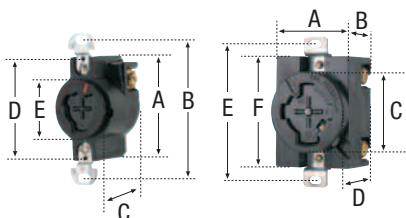

Family	A	B	C	D	E	F
20A Single Receptacle	2.50" (63.5mm)	3.28" (83.3mm)	1.65" (41.5mm)	2.37" (60.2mm)	1.37" (34.8mm)	-
30A & 30/20A Single Receptacle	1.94" (49.3mm)	1.44" (36.6mm)	1.90" (48.3mm)	1.81" (46.0mm)	3.28" (83.3mm)	2.69" (68.3mm)

Industrial Power-Lock Single Receptacles in Covers

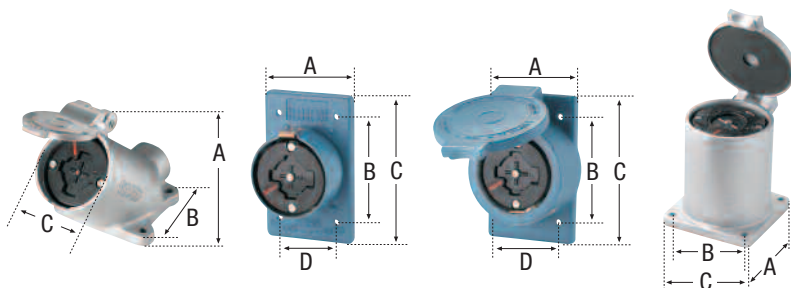

Family	A	B	C	D
30/20A 3-P, 4-W & 60A in Angled Cover	5.31" (134.9mm)	4.56" (115.8mm)	2.69" (68.3mm)	-
30/20A in Cover w/ Shell	2.84" (72.1mm)	3.25" (82.6mm)	4.56" (115.8mm)	1.87" (47.5mm)
30/20A in Cover w/ Lid	2.22" (56.4mm)	3.25" (82.6mm)	4.56" (115.8mm)	1.87" (47.5mm)
60A in Vertical Cover	3.50" (88.9mm)	2.87" sq. (72.9mm)	3.50" (88.9mm)	3.50" (88.9mm)

Industrial Power-Lock Inlets

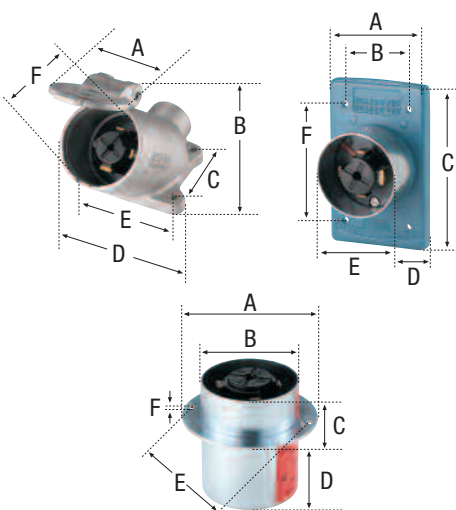

Family	A	B	C	D	E	F
30/20A 3-P, 4-W in Angled Cover	3.94" (100.1mm)	3.50" (88.9mm)	2.75" (69.9mm)	4.44" (112.8mm)	2.37" (60.2mm)	3.25" (82.6mm)
30/20A for FS/FD Boxes	2.84" (72.1mm)	1.87" (47.5mm)	4.56" (115.8mm)	1.65" (42.0mm)	2.31" (58.7mm)	3.25" (82.6mm)
60A 3-P, 4-W Flanged	3.75" (95.3mm)	2.86" (72.6mm)	1.08" (27.4mm)	2.25" (57.2mm)	3.34" (84.8mm)	0.19" (4.8mm)
60A 4-P, 5-W Flanged	3.75" (95.3mm)	2.86" (72.6mm)	1.16" (29.5mm)	2.58" (65.5mm)	3.34" (84.8mm)	0.19" (4.8mm)

Industrial Specification Grade 15A, 20A & 30A Locking Plugs & Connectors

2-Pole, 3-Wire Grounding; 3-Pole, 3-Wire Non-Grounding; 3-Pole, 4-Wire Grounding; 4-Pole, 4-Wire Non-Grounding; 4-Pole, 5-Wire Grounding

	Device Type	15A Safety Grip™ & AutoGrip™ Plugs & Connectors: NEMA L5-15, L6-15, L7-15	15A Safety Grip™ & AutoGrip™ Plugs & Connectors: Non-NEMA 10/15A	20A & 30A Safety Grip™ Plugs & Connectors: L6-20, L7-20, L8-20, L6-30, L7-30, L10-20, L14-20, L15-20, L16-20, L14-30, L15-30, L16-30, L17-30, L19-20, L20-20, L19-30, L20-30, L23-20, L23-30, Non-NEMA 20A, Non-NEMA 30A, Non-NEMA 20/10A
	Wiring Type	Side wire	Back wire	Back wire
	Testing & Code Compliance	<ul style="list-style-type: none"> cULus Listed to UL 498, file no. E3663 UL verified to Federal Spec. WC-596F cUL listed to CSA C22.2, no. 42 file no. E3663 	<ul style="list-style-type: none"> UL recognized component for US & Canada, file no. E3663 	<ul style="list-style-type: none"> cULus Listed to UL 498, file no. E3663
Specifications: Environmental	Flammability	Meets UL 94 requirements, V0 rated	Meets UL 94 requirements, V2 rated	Meets UL 94 requirements, V2 rated
	Temperature Rating	-40°C to 60°C (-40°F to 140°F)	-40°C to 60°C (-40°F to 140°F)	-40°C to 60°C (-40°F to 140°F)
Specifications: Electrical	Dielectric Voltage	Withstands 2,000V per UL 498	Withstands 2,000V per UL 498	Withstands 2,000V per UL 498
	Current Interrupting	Yes, at full-rated current	Yes, at full-rated current	Yes, at full-rated current
	Temperature Rise	Max. 30°C (86°F) after 200 cycles of overload	Max. 30°C (86°F) after 200 cycles of overload	Max. 30°C (86°F) after 200 cycles of overload
Specifications: Mechanical	Terminal Accommodation	#16 - #12 AWG	#16 - #12 AWG	#16 - #12 AWG, except Isolated Ground: #14 - #8 AWG
	Voltage Ratings	Permanently marked on device	Permanently marked on device	Permanently marked on device
Materials:	Outer Shell	Safety Grip: nylon; AutoGrip: phenolic	Nylon	Nylon
	Interior Body	Safety Grip: nylon; AutoGrip: phenolic	Nylon	Nylon
	Terminal Retainer	Polycarbonate	Polycarbonate	Polycarbonate
	Blades	Brass	Brass	Brass
	Line Contacts	Brass	Brass	Brass
	Terminal Clamps	Steel, zinc-plated	Steel, zinc-plated	Steel
	Terminal Screws	Brass	Brass	#10-32 brass, neutral screw nickel plated
	Ground Screw	Brass	Brass	#10-32 brass (green)
	Assembly Screws	Steel, zinc-plated	Steel, zinc-plated	Steel, zinc-plated
	Gasket/Dust Shield	Neoprene	Neoprene	Neoprene
	Cord Clamp Screws	Steel, zinc-plated	Steel, zinc-plated	Steel, zinc-plated
Cord Clamp	Steel, zinc-plated	Steel, zinc-plated	Nylon	

Industrial Specification Grade 15A, 20A & 30A Locking Plugs & Connectors

2-Pole, 3-Wire Grounding; 3-Pole, 3-Wire Non-Grounding; 3-Pole, 4-Wire Grounding; 4-Pole, 4-Wire Non-Grounding; 4-Pole, 5-Wire Grounding

	Device Type	20A & 30A Safety Grip™ Plugs & Connectors: L5-20, L5-30, L8-30, L10-30, L11-20, L11-30, L18-20, L18-30, L21-20, L21-30, L22-20, L22-30	15A & 20A Hart-Lock™ Plugs & Connectors, 2-Pole, 2-Wire: NEMA L1-15, Safety Grip™ NEMA L2-20
	Wiring Type	Back wire	Back wire
	Testing & Code Compliance	<ul style="list-style-type: none"> cULus Listed to UL 498, file no. E3663, except L10-30: UL listed; L2120_F & L2130_F series not listed L8-30 cUL certified to C22.2, no. 42, file no. E3663 NOM certified, except L8-30, L10-30, L22-30, L2120_F series 	<ul style="list-style-type: none"> Listed to UL 498, file no. E3663 cUL Certified to C22.2, no. 42 file no. E3663 L2-20 cUL certified to C22.2, no. 42, file no. E3663 L2-20 NOM certified
Specifications: Environmental	Flammability	Meets UL 94 requirements, V2 rated	Meets UL 94 requirements, V2 rated
	Temperature Rating	-40°C to 60°C (-40°F to 140°F), except Flat Cable: -40°C to 75°C (-40°F to 167°F)	-40°C to 60°C (-40°F to 140°F)
Specifications: Electrical	Dielectric Voltage	Withstands 2000V per UL 498, except Flat Cable: 2200V	Withstands 2000V per UL 498
	Current Interrupting	Yes, at full-rated current	Yes, at full-rated current
	Temperature Rise	Max. 30°C (86°F) after 200 cycles of overload, except Flat Cable: 50 cycles of overload at 150% of rated current (DC)	Max. 30°C (86°F) after 200 cycles of overload
Specifications: Mechanical	Terminal Accommodation	#16 - #12 AWG, except Isolated Ground & Flat Cable: #14 - #8 AWG	#16 - #12 AWG
	Voltage Ratings	Permanently marked on device	Permanently marked on device
Materials:	Outer Shell	Nylon	Nylon, except L1-15: phenolic
	Interior Body	Nylon	Nylon, except L1-15: phenolic
	Terminal Retainer	Polycarbonate	N/A
	Blades	Brass	Brass
	Line Contacts	Brass	Brass
	Terminal Clamps	Steel, zinc plated	Steel, zinc-plated
	Terminal Screws	#10-32 brass, neutral screw nickel plated	Brass
	Ground Screw	#10-32 brass (green)	Brass
	Assembly Screws	Steel, zinc-plated	Steel, zinc-plated
	Gasket/Dust Shield	Neoprene	Neoprene
	Cord Clamp Screws	Steel, zinc-plated	Steel, zinc-plated
Cord Clamp	Nylon, except Flat Cable: glass-filled nylon	Steel, zinc-plated	

Industrial Specification Grade 15A Locking Receptacles

2-Pole, 3-Wire Grounding; 3-Pole, 3-Wire Non-Grounding; 3-Pole, 4-Wire Grounding; 4-Pole, 4-Wire Non-Grounding; 4-Pole, 5-Wire Grounding

	Device Type	15A Hart-Lock™ Single Receptacles: NEMA L5-15, L6-15, L7-15	15A Hart-Lock™ Duplex Receptacles: NEMA L5-15, L6-15, L7-15	15A Hart-Lock™ Single & Duplex Receptacles: Non-NEMA 10/15A	15A Hart-Lock™ Isolated Ground Single & Duplex Receptacles: NEMA L5-15, L6-15
	Wiring Type	Back & side wire	Back & side wire	Back & side wire	Back & side wire
	Testing & Code Compliance	<ul style="list-style-type: none"> Listed to UL 498 , file no. 2369 UL verified to Federal Spec. WC-596G, except CWL515R CSA certified to C22.2, no. 42 	<ul style="list-style-type: none"> Listed to UL 498 , file no. 2369 UL verified to Federal Spec. WC-596G CSA certified to C22.2, no. 42 	<ul style="list-style-type: none"> UL recognized component, file no. E2369 	<ul style="list-style-type: none"> Listed to UL 498 , file no. 2369 CSA certified to C22.2, no. 42, except IGL615R
Specifications: Environmental	Flammability	Meets UL 94 requirements, V0 rated	Meets UL 94 requirements, V0 rated	Meets UL94 requirements, V0 rated	Meets UL 94 requirements, V0 rated
	Temperature Rating	-40°C to 115°C (-40°F to 239°F)	-40°C to 115°C (-40°F to 239°F)	-40°C to 115°C (-40°F to 239°F)	-40°C to 115°C (-40°F to 239°F)
Specifications: Electrical	Dielectric Voltage	Withstands 2500V per UL 498	Withstands 2500V per UL 498	Withstands 2500V per UL 498	Single: withstands 2500V per UL 498 Duplex: withstands 1500V per UL 500
	Current Interrupting	Yes, at full-rated current	Yes, at full-rated current	Yes, at full-rated current	Yes, at full-rated current
	Temperature Rise	Max. 30°C (86°F) after 150 cycles of overload @ 200% of rated current (DC)	Max. 30°C (86°F) after 150 cycles of overload @ 200% of rated current (DC)	Max. 30°C (86°F) after 150 cycles of overload @ 200% of rated current (DC)	Max. 30°C (86°F) after 100 cycles of overload @ 150% of rated current (DC)
Specifications: Mechanical	Terminal Accommodation	#14 - #10 AWG	#14 - #10 AWG	#14 - #10 AWG	#14 - #10 AWG
	Voltage Ratings	Permanently marked on device	Permanently marked on device	Permanently marked on device	Permanently marked on device
Materials:	Face	Glass-filled nylon	Glass-filled nylon	Glass-filled nylon	Glass-filled nylon
	Base	Glass-filled nylon	Glass-filled nylon	Glass-filled nylon	Glass-filled nylon
	Mounting Strap	.050" thick pre-plated steel	.050" thick pre-plated steel	.050" thick pre-plated steel	.050" thick pre-plated steel
	Auto Ground Clip	N/A	Yes	Yes	Yes
	Line Contacts	0.032" thick brass	0.032" thick brass	0.032" thick brass	0.036" thick brass
	Terminal Screws	#8-32 steel screws, nickel plated	#8-32 steel screws, nickel plated	#8-32 steel screws, nickel plated	#8-32 steel screws, nickel plated
	Ground Screw	#8-32 brass screw, green	#8-32 brass screw, green	#8-32 brass screw, green	#8-32 brass screw, green
	Mounting Screws	Steel, zinc-plated	Steel, zinc-plated	Steel, zinc-plated	Steel, zinc-plated

Industrial Specification Grade 15A, 20A & 30A Locking Receptacles

2-Pole, 3-Wire Grounding; 3-Pole, 3-Wire Non-Grounding; 3-Pole, 4-Wire Grounding; 4-Pole, 4-Wire Non-Grounding; 4-Pole, 5-Wire Grounding

	Device Type	20A Hart-Lock™ Single Receptacles: NEMA L5-20, L6-20, L7-20, L8-20, L9-20, L10-20, L11-20, L12-20, L14-20, L15-20, L16-20, L18-20, L19-20, L20-20, L21-20, L22-20, L23-20, Non-NEMA 20A	30A Hart-Lock™ Single Receptacles: NEMA L5-30, L6-30, L7-30, L8-30, L9-30, L10-30, L11-30, L12-30, L13-30, L14-30, L15-30, L16-30, L17-30, L18-30, L19-30, L20-30, L21-30, L22-30, L23-30, Non-NEMA 30A	20A & 30A Hart-Lock™ Isolated Ground Single Receptacles: NEMA L5-20, L6-20, L7-20, L8-20, L5-30, L6-30, L7-30, L8-30, L14-20, L15-20, L16-20, L21-20, L22-20, L23-20, L21-30, L22-30, L23-30	15A & 20A Hart-Lock™ Receptacles, 2-Pole, 2-Wire: NEMA L1-15, L2-20
	Wiring Type	Back & side wire	Back & side wire	Back & side wire	Back & side wire
	Testing & Code Compliance	<ul style="list-style-type: none"> Listed to UL 498, file no. E2369 NEMA L5-20, L6-20, L7-20, L10-20, L14-20, L15-20, L18-20 & L21-20 also UL verified to Federal Spec. WC-596G CSA certified to C22.2, no. 42 except 7310B, NEMA L11-20, L12-20, 7410B, L18-20, L19-20, L20-20 NEMA L11-20, L14-20, L15-20, L18-20, L21-20, L22-20 also NOM certified 	<ul style="list-style-type: none"> Listed to UL 498, file no. E2369 NEMA L5-30, L6-30, L7-30, L14-30, L15-30, L20-30, L21-30, L23-30 also UL verified to Federal Spec. WC-596G CSA certified to C22.2, no. 42 except NEMA L11-20, L12-20, 3330-2, L10-30, L11-30, L12-30, L13-30, 3430, L18-30, L19-30, L20-30 NEMA L5-30, L10-30, L11-30, L14-30, L15-30, L18-30 also NOM certified 	<ul style="list-style-type: none"> Listed to UL 498, file no. E2369 CSA certified to C22.2, no. 42 except NEMA L5-30 NOM certified, except for L7-20, L8-20, L6-30, L7-30, L8-30, L16-20, L21-30, L22-30, L23-30 	<ul style="list-style-type: none"> Listed to UL 498, file no. E2369
		Flammability	Meets UL 94 requirements, V0 rated	Meets UL 94 requirements, V0 rated	Meets UL94 requirements, V0 rated
Temperature Rating		-40°C to 60°C (-40°F to 140°F)	-40°C to 60°C (-40°F to 140°F)	-40°C to 70°C (-40°F to 158°F)	-40°C to 105°C (-40°F to 221°F)
Specifications: Electrical	Dielectric Voltage	Withstands 2,500V per UL 498	Withstands 2,500V per UL 498	Withstands 2,500V per UL 498	Withstands 1500V per UL 498
	Current Interrupting	Yes, at full-rated current	Yes, at full-rated current	Yes, at full-rated current	Yes, at full-rated current
	Temperature Rise	Max. 30°C (86°F) after 200 cycles of overload @ 200% of rated current (DC)	Max. 30°C (86°F) after 200 cycles of overload @ 200% of rated current (DC)	Max. 30°C (86°F) after 200 cycles of overload @ 200% of rated current (DC)	Max. 30°C (86°F) after 100 cycles of overload @ 150% of rated current (DC)
Specifications: Mechanical	Terminal Accommodation	#14 - #8 AWG	#14 - #8 AWG	#14 - #8 AWG	#14 - #10 AWG
	Voltage Ratings	Permanently marked on device	Permanently marked on device	Permanently marked on device	Permanently marked on device
Materials:	Face	Glass-filled nylon	Glass-filled nylon	Glass-filled nylon	Glass-filled nylon
	Base	Glass-filled nylon	Glass-filled nylon	Glass-filled nylon	Glass-filled nylon
	Mounting Strap	.050" thick steel, zinc plated	.050" thick steel, zinc plated	.050" thick steel, zinc plated	.050" thick steel, zinc plated
	Line Contacts	0.042" thick brass	0.042" thick brass	0.042" thick brass	0.032" thick brass, bronze
	Terminal Screws	#10-32 brass, neutral screw nickel plated	#10-32 brass, neutral screw nickel plated	#10-32 brass, neutral screw nickel plated	#8-32 steel, nickel plated
	Ground Screw	#10-32 brass (green)	#10-32 brass (green)	#10-32 brass (green)	#8-32 brass, green
	Contact Springs	.040" thick brass	.040" thick brass	.040" thick brass	0.032" thick brass, bronze
	Terminal Clamps/Plates	.040" thick brass	.040" thick brass	.040" thick brass	0.070" thick steel, zinc plated
	Ground Contacts	.040" thick brass	.040" thick brass	.040" thick brass	N/A
	Back Plate	.040" thick brass, nickel-plated	.040" thick brass, nickel-plated	.040" thick brass, nickel-plated	N/A
	Mounting Screws	Steel, zinc-plated	Steel, zinc-plated	Steel, zinc-plated	Steel, zinc-plated

Industrial Specification Grade 15A, 20A & 30A Locking Flanged Inlets & Outlets

2-Pole, 3-Wire Grounding; 3-Pole, 3-Wire Non-Grounding; 3-Pole, 4-Wire Grounding; 4-Pole, 4-Wire Non-Grounding; 4-Pole, 5-Wire Grounding

	Device Type	15A Hart-Lock™ Flanged Inlets & Flanged Outlets: NEMA L5-15, L6-15, L7-15	15A & 20A Hart-Lock™ Flanged Inlets & Outlets, 2-Pole, 2-Wire: NEMA L1-15, L2-20	20A & 30A Hart-Lock™ Flanged Inlets & Flanged Outlets: CWL520FI, CWL520FO, CWL620FI, CWL830FI, CWL1120FO, CWL1430FI, CWL1430FO, CWL2130FI, CWL2130FO
	Wiring Type	Back wire	Side wire	Back wire
	Testing & Code Compliance	<ul style="list-style-type: none"> Listed to UL 498, file no. E2369 	<ul style="list-style-type: none"> Listed to UL 498, file no. E2369 	<ul style="list-style-type: none"> CWL520FI, CWL520FO, CWL1430FO, CWL2130FI listed to UL 498, file no. E2369; CWL1430FI, CWL2130FO is file no. E3663
<ul style="list-style-type: none"> CWL615FI, CWL715FI also cUL listed to UL 498, file no. E3663 		<ul style="list-style-type: none"> CWL620FI, CWL830FI, CWL1120FO cUL listed to UL 498, file no. E3663 		
<ul style="list-style-type: none"> CWL615FI also UL verified to Federal Spec. WC-596/102-1 		<ul style="list-style-type: none"> CWL520FO, CWL1430FI, CWL2130FI, CWL2130FO also CSA certified to C22.2, no. 42 		
<ul style="list-style-type: none"> CSA certified to C22.2, no.42 except CWL515FO 		<ul style="list-style-type: none"> CWL830FI, CWL1120FO, CWL1430FO CSA certified to C22.2, no. 42 CWL1430FI, CWL1430FO, CWL2130FI, CWL2130FO NOM certified 		
Specifications: Environmental	Flammability	Meets UL 94 requirements, V2 rated	Meets UL 94 requirements, V0 rated	Meets UL 94 requirements, V2 rated
	Temperature Rating	-40°C to 75°C (-40°F to 167°F)	-40°C to 105°C (-40°F to 221°F)	-40°C to 60°C (-40°F to 140°F)
Specifications: Electrical	Dielectric Voltage	Withstands 2,000V per UL 498	Withstands 2,000V per UL 498	Withstands 2,000V per UL 498
	Current Interrupting	Yes, at full-rated current	Yes, at full-rated current	Yes, at full-rated current
	Temperature Rise	Flanged outlets: max. 30°C (86°F) after 50 cycles of overload @ 150% of rated current (DC); flanged inlets; max. 30°C (86°F) @ maximum rated current (DC)	Flanged outlets: max. 30°C (86°F) after 50 cycles of overload @ 150% of rated current (DC); flanged inlets; max. 30°C (86°F) @ maximum rated current (DC)	Flanged outlets: max. 30°C (86°F) after 50 cycles of overload @ 150% of rated current (DC); flanged inlets; max. 30°C (86°F) @ maximum rated current (DC)
Specifications: Mechanical	Terminal Accommodation	#14 - #8 AWG	#14 - #8 AWG	#14 - #8 AWG
	Voltage Ratings	Permanently marked on device	Permanently marked on device	Permanently marked on device
Materials:	Flanged Housing	Nylon	Plated brass	Nylon
	Interior Body	Nylon	Glass-filled nylon, except L2-20: nylon	Nylon
	Terminal Retainer	Polycarbonate	N/A	Polycarbonate
	Blades	.060" thick brass	.060" thick brass	.060" thick brass
	Line Contacts	.060" thick brass	.060" thick brass	.060" thick brass
	Terminal Clamps	Steel	N/A	Steel
	Terminal Screws	#8-32 brass	#6-32 brass	#10-32 brass, neutral screw nickel plated
	Ground Screw	#8-32 brass, green	#6-32 brass, green	#10-32 brass, green
	Assembly Screws	Steel, zinc-plated	Steel, zinc-plated	Steel, zinc-plated
Mounting Screws	Steel, zinc-plated	Steel, zinc-plated	Steel, zinc-plated	

**Industrial Specification Grade
15A, 20A & 30A Locking
Flanged Inlets & Outlets**

2-Pole, 3-Wire Grounding; 3-Pole, 3-Wire Non-Grounding; 3-Pole, 4-Wire Grounding; 4-Pole, 4-Wire Non-Grounding; 4-Pole, 5-Wire Grounding

	Device Type	20A & 30A Hart-Lock™ Flanged Inlets: L7-20, L8-20, L5-30, L6-30, L7-30, L10-20, L11-20, L10-30, L11-30, L14-20, L15-20, L16-20, L15-30, L16-30, L17-30, L18-20, L19-20, L20-20, L18-30, L19-30, L20-30, L21-20, L22-20, L23-20, L22-30, L23-30, Non-NEMA 20A, Non-NEMA 30A, Non-NEMA 20/10A	20A & 30A Hart-Lock™ Flanged Outlets: L8-20, L6-30, L7-30, L8-30, L10-20, L14-20, L15-20, L16-20, L15-30, L16-30, L17-30, L21-20, L22-20, L23-20, L22-30, L23-30	20A & 30A Hart-Lock™ Flanged Outlets: L6-20, L7-20, L5-30, L10-30, L11-30, L18-20, L19-20, L20-20, L18-30, L19-30, L20-30, Non-NEMA 20A, Non-NEMA 30A Non-NEMA 20/10A
	Wiring Type	Back wire	Back wire	Back wire
	Testing & Code Compliance	<ul style="list-style-type: none"> Listed to UL 498 file no. E3663 cUL listed to UL 498, file no. E3663 	<ul style="list-style-type: none"> Listed to UL 498 file no. E2369 CSA certified to C22.2, no. 42 	<ul style="list-style-type: none"> Listed to UL 498 file no. E2369 CSA certified to C22.2, no. 42
Specifications: Environmental	Flammability	Meets UL 94 requirements, V2 rated	Meets UL 94 requirements, V2 rated	Meets UL 94 requirements, V2 rated
	Temperature Rating	-40°C to 60°C (-40°F to 140°F)	-40°C to 60°C (-40°F to 140°F)	-40°C to 60°C (-40°F to 140°F)
Specifications: Electrical	Dielectric Voltage	Withstands 2,000V per UL 498	Withstands 2,000V per UL 498	Withstands 2,000V per UL 498
	Current Interrupting	Yes, at full-rated current	Yes, at full-rated current	Yes, at full-rated current
	Temperature Rise	Max. 30°C (86°F) @ maximum rated current (DC)	Max. 30°C (86°F) after 50 cycles of overload @ 150% of rated current (DC)	Max. 30°C (86°F) after 50 cycles of overload @ 150% of rated current (DC)
Specifications: Mechanical	Terminal Accommodation	#14 - #8 AWG	#14 - #8 AWG	#14 - #8 AWG
	Voltage Ratings	Permanently marked on device	Permanently marked on device	Permanently marked on device
Materials:	Flanged Housing	Nylon	Nylon	Nylon
	Interior Body	Nylon	Nylon	Nylon
	Terminal Retainer	Polycarbonate	Polycarbonate	Polycarbonate
	Blades	.060" thick brass	.060" thick brass	.060" thick brass
	Line Contacts	.060" thick brass	.060" thick brass	.060" thick brass
	Terminal Clamps	Steel	Steel	Steel
	Terminal Screws	#10-32 brass, neutral screw nickel plated	#10-32 brass, neutral screw nickel plated	#10-32 brass, neutral screw nickel plated
	Ground Screw	#10-32 brass, green	#10-32 brass, green	#10-32 brass, green
	Assembly Screws	Steel, zinc-plated	Steel, zinc-plated	Steel, zinc-plated
Mounting Screws	Steel, zinc-plated	Steel, zinc-plated	Steel, zinc-plated	

Industrial Specification Grade Midget Type Locking Devices

2-Pole, 3-Wire Grounding; 3-Pole, 3-Wire Non-Grounding; 3-Pole, 4-Wire Grounding; 4-Pole, 4-Wire Non-Grounding; 4-Pole, 5-Wire Grounding

	Device Type	Hart-Lock™ Midget Locking Plugs & Connectors: NEMA ML1, ML2, ML3	Hart-Lock™ Midget Locking Flanged Inlets & Flanged Outlets: NEMA ML1, ML2, ML3
	Wiring Type	Side wire	Back wire
	Testing & Code Compliance	<ul style="list-style-type: none"> cULus listed to UL 498, file no. E3663 	<ul style="list-style-type: none"> Listed to UL 498 file no. E3663 (inlets) E2369 (outlets)
		<ul style="list-style-type: none"> NEMA ML-2: CSA certified to C22.2, no. 42 	<ul style="list-style-type: none"> Flanged inlets: cULus listed to UL 498, file no. E3663
		<ul style="list-style-type: none"> 7484: cULus certified to C22.2, no. 42 	<ul style="list-style-type: none"> Flanged outlets: CSA certified to C22.2, no. 42
Specifications: Environmental	Flammability	Meets UL94 requirements, V2 rated	Meets UL94 requirements, V0 rated
	Temperature Rating	-40°C to 95°C (-40°F to 203°F) , except nylon: -40°C to 75°C (-40°F to 167°F)	-40°C to 150°C (-40°F to 302°F) , except construction including nylon: -40°C to 75°C (-40°F to 167°F)
Specifications: Electrical	Dielectric Voltage	Withstands 1500V per UL 498, except nylon: 2000V	Withstands 2500V per UL 498
	Current Interrupting	Yes, at full-rated current	Yes, at full-rated current
	Temperature Rise	Max. 30°C (86°F) after 50 cycles of overload @ 150% rated current (DC)	Max. 30°C (86°F) after 50 cycles of overload @ 250V and 15A
Specifications: Mechanical	Terminal Accommodation	#16 - #12 AWG	#16 - #12 AWG
	Voltage Ratings	Permanently marked on device	Permanently marked on device
Materials:	Outer Shell	Phenolic, except 7593, 7484: nylon	Plated brass, except 7595, 7486N: nylon
	Interior Body	Nylon, except 7593, 7484: glass-filled nylon	Phenolic, except 7468, 7596, 7595N, 7596N, 7486, 7487, 7487N: glass-filled nylon
	Blades	0.060" thick brass	0.060" thick brass
	Line Contacts	0.030" thick brass	0.060" thick brass
	Terminal Screws	#5-40 brass	Brass
	Ground Screw	#5-40 brass	Brass
	Assembly Screws	Steel, zinc-plated	Steel, zinc-plated
Cord Clamp Screws	Zinc, except 7593, 7484: steel, zinc-plated	N/A	

Industrial Specification Grade Watertight Locking Devices

2-Pole, 3-Wire Grounding; 3-Pole, 3-Wire Non-Grounding; 3-Pole, 4-Wire Grounding; 4-Pole, 4-Wire Non-Grounding; 4-Pole, 5-Wire Grounding

	Device Type	Hart-Lock™ Watertight Plugs & Connectors, Locking Configurations: L5-15, L6-15, L7-15, L7-20, L8-20, L7-30, L8-30, L10-20, L10-30, L16-20, L16-30, L17-30, L19-20, L20-20, L19-30, L20-30, L23-20, L22-30, L23-30, Non-NEMA 20A 125/250V, Non-NEMA 30A	Hart-Lock™ Watertight Plugs & Connectors, Locking Configurations: L5-20, L6-20, L5-30, L6-30, L11-20, L11-30, L14-20, L15-20, L14-30, L15-30, L18-20, L18-30, L21-20, L22-20, L21-30, Non-NEMA 20A 3Ø 120/208V
	Wiring Type	Back wire	Back wire
	Testing & Code Compliance	<ul style="list-style-type: none"> cULus listed to UL 498, file no. E3663 	<ul style="list-style-type: none"> cULus listed to UL 498, file no. E3663 NOM Certified
Specifications: Environmental	Flammability	Meets UL 94 requirements; V2 rated	Meets UL 94 requirements; V2 rated
	Temperature Rating	-40°C to 75°C (-40°F to 167°F)	-40°C to 75°C (-40°F to 167°F)
	Protection	NEMA 4, 4X, 6, 6P & IP67	NEMA 4, 4X, 6, 6P & IP67
	High Pressure Water Test	1000 psi spray (mated or with closure cap)	1000 psi spray (mated or with closure cap)
Specifications: Electrical	Dielectric Voltage	Withstands 1500V per UL 498	Withstands 1500V per UL 498
	Current Interrupting	Yes, at full-rated current	Yes, at full-rated current
	Temperature Rise	Max. 30°C (86°F) after 250 cycles of overload	Max. 30°C (86°F) after 250 cycles of overload
Specifications: Mechanical	Terminal Accommodation	#18 - 10 AWG	#18 - 10 AWG
	Voltage Ratings	Permanently marked on device	Permanently marked on device
Materials:	Plug/Connector Outer Shell	Santoprene thermoplastic elastomeric over polypropylene	Santoprene thermoplastic elastomeric over polypropylene
	Interior Body	Nylon	Nylon
	Terminal Retainer	Clear lexan	Clear lexan
	Blades	.069" thick brass, nickel plated	.069" thick brass, nickel plated
	Line Contacts	.030"-.032" thick brass, nickel plated	.030"-.032" thick brass, nickel plated
	Terminal Clamps	Steel, nickel plated	Steel, nickel plated
	Terminal Screws	#10-32 brass, neutral screw nickel plated	#10-32 brass, neutral screw nickel plated
	Ground Screw	#10-32 brass, zinc plated (green)	#10-32 brass, zinc plated (green)
	Assembly/ Mounting Screws	Stainless steel	Stainless steel
	Compression Nut	Nylon	Nylon
Compression Nut Grommet	Neoprene	Neoprene	

Industrial Specification Grade Watertight Locking Devices

2-Pole, 3-Wire Grounding; 3-Pole, 3-Wire Non-Grounding; 3-Pole, 4-Wire Grounding; 4-Pole, 4-Wire Non-Grounding; 4-Pole, 5-Wire Grounding

	Device Type	Hart-Lock™ Watertight Receptacles, 15A Locking Configurations: L5-15, L6-15, L7-15	Hart-Lock™ Watertight Receptacles, 20A & 30A Locking Configurations: L7-20, L8-20, L7-30, L8-30, L10-20, L16-20, L16-30, L17-30, L19-20, L20-20, L19-30, L20-30, L23-20, L22-30, L23-30, Non-NEMA 20A, Non-NEMA 30A	Hart-Lock™ Watertight Receptacles, 20A & 30A Locking Configurations: L5-20, L6-20, L5-30, L6-30, L11-20, L10-30, L11-30, L15-20, L14-30, L15-30, L18-20, L18-30, L21-20, L22-20. L21-30
	Wiring Type	Back wire	Back wire	Back wire
	Testing & Code Compliance	• cULus listed to UL 498, file no. E2369	• cULus listed to UL 498, file no. E2369	• cULus listed to UL 498, file no. E2369 • NOM certified
Specifications: Environmental	Flammability	Meets UL 94 requirements; V2 rated	Meets UL 94 requirements; V2 rated	Meets UL 94 requirements; V2 rated
	Temperature Rating	-40°C to 75°C (-40°F to 167°F)	-40°C to 75°C (-40°F to 167°F)	-40°C to 75°C (-40°F to 167°F)
	Protection	NEMA 3, 3R, 4, 4X, 12 & IP66	NEMA 3, 3R, 4, 4X, 12 & IP66	NEMA 3, 3R, 4, 4X, 12 & IP66
	High Pressure Water Test	1000 psi spray (mated or closed)	1000 psi spray (mated or closed)	1000 psi spray (mated or closed)
Specifications: Electrical	Dielectric Voltage	Withstands 1554V per UL 498	Withstands 1696 - 2200V per UL 498	Withstands 1696 - 2200V per UL 498
	Current Interrupting	Yes, at full-rated current	Yes, at full-rated current	Yes, at full-rated current
	Temperature Rise	Max. 30°C (86°F) after 250 cycles of overload	Max. 30°C (86°F) after 250 cycles of overload	Max. 30°C (86°F) after 250 cycles of overload
Specifications: Mechanical	Terminal Accommodation	#18 - #10 AWG	#14 - #8 AWG	#14 - #8 AWG
	Voltage Ratings	Permanently marked on device	Permanently marked on device	Permanently marked on device
Materials:	Receptacle Flip Lid Cover & Base	Thermoplastic, glass-filled nylon	Thermoplastic, glass-filled nylon	Thermoplastic, glass-filled nylon
	Receptacle Cover Spring	Stainless steel, self-closing	Stainless steel, self-closing	Stainless steel, self-closing
	Receptacle Lid Liner & Mounting Gasket	Santoprene thermoplastic elastomeric	Santoprene thermoplastic elastomeric	Santoprene thermoplastic elastomeric
	Interior Body	Thermoplastic, glass-filled nylon	Thermoplastic: glass-filled nylon	Thermoplastic: glass-filled nylon
	Terminal Retainer	Clear lexan	Clear lexan	Clear lexan
	Line Contacts	.033" thick bronze, nickel plated; two-leaf construction	.069" thick brass, nickel plated	.069" thick brass, nickel plated
	Ground Shunt	Solid brass	Solid brass	Solid brass
	Terminal Clamps	Steel, nickel plated	Steel, nickel plated	Steel, nickel plated
	Terminal Screws	#8-32 brass, neutral screw nickel plated	#10-32 brass, neutral screw nickel plated	#10-32 brass, neutral screw nickel plated
	Ground Contact	.069" thick brass, nickel plated	.069" thick brass, nickel plated	.069" thick brass, nickel plated
	Ground Screw	#8-32 brass (green)	#10-32 brass (green)	#10-32 brass (green)
	Assembly/ Mounting Screws	Stainless steel	Stainless steel	Stainless steel
Receptacle Mounting Plate	Stainless steel	Stainless steel	Stainless steel	

**Industrial Specification
Grade Severe Duty
Locking Devices**

2-Pole, 3-Wire Grounding; 3-Pole, 3-Wire Non-Grounding; 3-Pole, 4-Wire Grounding; 4-Pole, 4-Wire Non-Grounding; 4-Pole, 5-Wire Grounding

	Device Type	Hart-Lock™ Severe Duty Plugs & Connectors, Locking Configurations: L5-15, L6-15, L7-15, L7-20, L8-20, L7-30, L8-30, L10-20, L10-30, L16-20, L16-30, L17-30, L19-20, L20-20, L19-30, L20-30, L23-20, L22-30, L23-30, Non-NEMA 20A 125/250V, Non-NEMA 30A	Hart-Lock™ Severe Duty Plugs & Connectors, Locking Configurations: L5-20, L6-20, L5-30, L6-30, L11-20, L11-30, L14-20, L15-20, L14-30, L15-30, L18-20, L18-30, L21-20, L22-20, L21-30, Non-NEMA 20A 3Ø 120/208V
	Wiring Type	Back wire	Back wire
	Testing & Code Compliance	<ul style="list-style-type: none"> cULus listed to UL 498, file no. E3663 	<ul style="list-style-type: none"> cULus listed to UL 498, file no. E3663 NOM certified
Specifications: Environmental	Flammability	Meets UL 94 requirements; V2 rated	Meets UL 94 requirements; V2 rated
	Temperature Rating	-40°C to 75°C (-40°F to 167°F)	-40°C to 75°C (-40°F to 167°F)
Specifications: Electrical	Dielectric Voltage	Withstands 2200V per UL 498	Withstands 2200V per UL 498
	Current Interrupting	Yes, at full-rated current	Yes, at full-rated current
	Temperature Rise	Max. 30°C (86°F) after 250 cycles of overload	Max. 30°C (86°F) after 250 cycles of overload
Specifications: Mechanical	Terminal Accommodation	#18 - #10 AWG	#18 - #10 AWG
	Voltage Ratings	Permanently marked on device	Permanently marked on device
Materials:	Outer Shell	Santoprene thermoplastic elastomeric over polypropylene	Santoprene thermoplastic elastomeric over polypropylene
	Interior Body	Nylon	Nylon
	Terminal Retainers	Clear lexan	Clear lexan
	Blades	.069" thick brass, nickel plated	.069" thick brass, nickel plated
	Line Contacts	.030"-.032" brass, nickel plated	.030"-.032" brass, nickel plated
	Terminal Clamps	Steel, nickel plated	Steel, nickel plated
	Terminal Screws	#10-32 brass, neutral screw nickel plated	#10-32 brass, neutral screw nickel plated
	Ground Screw	#8-32 brass (green)	#8-32 brass (green)
	Cord Clamp	Nylon	Nylon
	Assembly Screws	#6-20 Stainless steel	#6-20 Stainless steel
Gasket/Dust Shield	Santoprene thermoplastic elastomeric	Santoprene thermoplastic elastomeric	

**Industrial Specification
Grade Corrosion Resistant
Locking Devices**

2-Pole, 3-Wire Grounding
3-Pole, 4-Wire Grounding
15A, 20A, 30A

	Device Type	Hart-Lock™ Corrosion Resistant Plugs & Connectors, Locking Configurations	Hart-Lock™ Corrosion Resistant Receptacles, Locking Configurations
	Wiring Type	Back wire	Back & side wire
	Testing & Code Compliance	<ul style="list-style-type: none"> cULus listed to UL 498, file no. E3663 	<ul style="list-style-type: none"> cULus listed to UL 498, file no. E3663, except NEMA L5-15, L5-20, L15-20 UL listed only
		<ul style="list-style-type: none"> NEMA L5-15 also UL verified to Federal Spec. WC-596F 	<ul style="list-style-type: none"> NEMA L5-20, L5-30, L15-20 also UL verified to Federal Spec WC-596G
		<ul style="list-style-type: none"> NEMA L5-20, L6-20, L5-30, L14-20, L15-20, L14-30, L15-30 also NOM certified 	<ul style="list-style-type: none"> NEMA L5-15, L5-20 also CSA certified to C22.2, no. 42 NEMA L5-20, L6-20, L5-30, L6-30, L14-20, L15-20, L14-30 also NOM certified
Specifications: Environmental	Flammability	Meets UL 94 requirements; V2 rated	Meets UL 94 requirements; V2 rated
	Temperature Rating	-40°C to 75°C (-40°F to 167°F)	-20°C to 70°C (-4°F to 158°F)
Specifications: Electrical	Dielectric Voltage	Withstands 1500V per UL 498	Withstands 2000V per UL 498
	Current Interrupting	Yes, at full-rated current	Yes, at full-rated current
	Temperature Rise	Max. 30°C (86°F) after 100 cycles of overload	30°C (86°F) after 100 cycles of overload
Specifications: Mechanical	Terminal Accommodation	#14 - #8 AWG, except L5-15: #16 - #12 AWG	#14 - #10 AWG
	Voltage Ratings	Permanently marked on device	Permanently marked on device
Materials:	Receptacle Face	N/A	Thermoplastic, glass-filled nylon, except duplex: nylon
	Receptacle Base	N/A	Thermoplastic, glass-filled nylon
	Plug/Connector Body	Nylon	N/A
	Terminal Retainer	Clear lexan, except L5-15: polypropylene/nylon	N/A
	Blades	.069" brass, nickel plated, except L5-15: .062"	N/A
	Strap	N/A	0.050" thick brass, except duplex: steel; nickel plated
	Auto Ground Clip	N/A	Brass
	Line Contacts/Terminals	.030- .032" bronze, nickel plated, except L5-15: .031" Olin brass, nickel plated	.040" thick brass, nickel plated, except duplex: 0.036" thick bronze, nickel plated
	Terminal Clamps	Steel, nickel plated	Steel, nickel plated
	Terminal Screws	#10-32 Brass, neutral screw nickel plated, except L5-15: #8-32 and hot is nickel plated	#10-32 Brass, neutral screw nickel plated, except duplex: #8-32
	Ground Screw	#10-32 brass, zinc plated (green), except L5-15: #8-32	#10-32 brass, zinc plated (green) except duplex: #8-32
	Cord Clamp	Nylon, except L5-15: polypropylene	N/A
	Assembly Screws	Stainless steel, except L5-15: nickel-plated steel	N/A
Gasket/Dust Shield	Neoprene elastomer, except L5-15: EPDM elastomer	N/A	

Hart-Lock™ Switched Enclosure for Hart-Lock Flanged Outlets

Weatherproof Switched Enclosure
For 20A & 30A 125-600V/AC
Hart-Lock Flanged Outlets

	Device Type	Hart-Lock™ Switched Enclosure for Hart-Lock Flanged Outlets
	Wiring Type	Side wire
	Testing & Code Compliance	<ul style="list-style-type: none"> Listed to UL 508 & UL 498, file no. E135083 cUL listed to CSA C22.2, no. 14-M91
Specifications: Environmental	Flammability	Meets UL94 requirements, HB rated
	Temperature Rating	-40°C to 75°C (-40°F to 167°F)
	Protection	NEMA 3R / 12
Specifications: Electrical	Current Interrupting	Yes, at full-rated current
	Motor Loads	Horsepower rated per UL 508
	Short-Circuit Protection/Current Rating	Up to 10,000 RMS symmetrical amps, 600V when protected by a Class RK1 fuse
Specifications: Mechanical	Terminal Accommodation	#14 - #8 AWG
	Voltage Ratings	Permanently marked on device
Materials:	Enclosure Back Housing	Polycarbonate
	Enclosure Cover	Polycarbonate
	Enclosure Switch Handle	Nylon
	Enclosure Gasket	Rubber
	Switch Terminal Type	Side wire screw termination
	Flanged Outlet Cover	Glass-filled nylon
	Flanged Outlet Spring	Steel, zinc-plated
	Flanged Outlet Cover Gasket	Foam

Industrial Specification Grade 50A Marine Corrosion Resistant Locking Devices

2-Pole, 3-Wire Grounding
3-Pole, 4-Wire Grounding

	Device Type	50A Marine Grade Corrosion Resistant Locking Pro-Grip™ Plugs & Connectors	50A Marine Grade Corrosion Resistant Locking Armored Plugs & Connectors	50A Marine Grade Corrosion Resistant Locking Receptacles
	Wiring Type	Back wire	Back wire	Back wire
	Testing & Code Compliance	<ul style="list-style-type: none"> cULus listed to UL 498, file no. E3663 	<ul style="list-style-type: none"> cULus listed to UL 498, file no. E3663 cUL listed to CSA C22.2, no. 42 	<ul style="list-style-type: none"> Listed to UL 498, file no. E2369 CSA certified to C22.2, no. 42
Specifications: Environmental	Flammability	Meets UL 94 requirements, V0 rated	Meets UL 94 requirements, V0 rated	Meets UL 94 requirements, V0 rated
	Temperature Rating	-40°C to 105°C (-40°F to 221°F)	-40°C to 95°C (-40°F to 203°F)	-40°C to 105°C (-40°F to 221°F)
Specifications: Electrical	Dielectric Voltage	Withstands 2000V per UL 498	Withstands 2000V per UL 498	Withstands 2000V per UL 498
	Current Interrupting	Yes, at full-rated current	Yes, at full-rated current	Yes, at full-rated current
	Temperature Rise	30°C (86°F) carrying max. rated current	30°C (86°F) carrying max. rated current	Max. 30°C (86°F) after 50 cycles of overload @ 150% of rated current (DC)
Specifications: Mechanical	Terminal Accommodation	#12 - #4 AWG	#12 - #6 AWG	#12 - #6 AWG
	Voltage Ratings	Permanently marked on device	Permanently marked on device	Permanently marked on device
Materials:	Outer Shell	Nylon, impact modified	Stainless steel	Brass, nickel plated
	Interior Body	Glass filled nylon	Glass filled nylon	Glass filled nylon
	Terminal Retainer	Glass filled nylon	Glass filled nylon	Glass filled nylon
	Blades	Brass, nickel plated	Brass alloy, nickel plated	N/A
	Line Contacts	Brass, nickel plated	Brass, nickel plated	Brass, nickel plated
	Ground Shunt	Phosphor bronze	Phosphor bronze	Phosphor bronze
	Terminal Clamps	Brass, nickel plated	Brass, nickel plated	Brass, nickel plated
	Terminal Screws	Brass, nickel plated	Brass, nickel plated	Brass, nickel plated
	Ground Strap	N/A	N/A	Steel, nickel plated
	Ground Screw	Brass, nickel plated	Brass, nickel plated	Brass, nickel plated
	Gasket/Dust Shield	Neoprene rubber	Neoprene rubber	N/A
	Cord Clamp Screws	Stainless steel	Stainless steel	N/A
	Cord Clamp	Nylon, impact modified	Brass, nickel plated	N/A
	Plug Shroud	Cold-rolled steel, nickel plated	Stainless steel	N/A
Receptacle Mounting Strap	N/A	N/A	0.065" thick brass	

**Industrial
Specification Grade
50A Locking Devices**

2-Pole, 3-Wire Grounding
3-Pole, 4-Wire Grounding

	Device Type	50A Locking Pro-Grip™ Plugs & Connectors	50A Locking Armored Plugs & Connectors	50A Locking Receptacles	50A Locking Flanged Inlets
	Wiring Type	Back wire	Back wire	Back wire	Back wire
	Testing & Code Compliance	• cULus listed to UL 498, file no. E3663	• cULus listed to UL 498, file no. E3663	• Listed to UL 498, file no. E3663 • CSA certified to C22.2, no. 42	• Listed to UL 498, file no. E3663 • cUL listed to CSA C22.2, no. 42
Specifications: Environmental	Flammability	Meets UL 94 requirements, V0 rated	Meets UL 94 requirements, V0 rated	Meets UL 94 requirements, V0 rated	Meets UL 94 requirements, V0 rated
	Temperature Rating	-40°C to 105°C (-40°F to 221°F)	-40°C to 95°C (-40°F to 203°F)	-40°C to 105°C (-40°F to 221°F)	-40°C to 105°C (-40°F to 221°F)
Specifications: Electrical	Dielectric Voltage	Withstands 2000V per UL 498	Withstands 2000V per UL 498	Withstands 2000V per UL 498	Withstands 2000V per UL 498
	Current Interrupting	Yes, at full-rated current	Yes, at full-rated current	Yes, at full-rated current	Yes, at full-rated current
	Temperature Rise	For connectors: max. 30°C (86°F) after 50 cycles of overload @ 150% of rated current (DC)	For connectors: max. 30°C (86°F) after 50 cycles of overload @ 150% of rated current (DC)	Max. 30°C (86°F) after 50 cycles of overload @ 150% of rated current (DC)	Max. 30°C (86°F) after 50 cycles of overload @ 150% of rated current (DC)
Specifications: Mechanical	Terminal Accommodation	#10 - #6 AWG	#10 - #6 AWG	#10 - #6 AWG	#10 - #6 AWG
	Voltage Ratings	Permanently marked on device	Permanently marked on device	Permanently marked on device	Permanently marked on device
Materials:	Outer Shell	Nylon, impact modified	Cold-rolled steel, zinc plated	Steel	N/A
	Interior Body	Glass-filled nylon	Glass-filled nylon	Glass-filled nylon	Glass-filled nylon
	Terminal Retainer	Glass-filled nylon	Glass-filled nylon	Glass-filled nylon	Glass-filled nylon
	Blades	Brass alloy	Brass alloy, nickel plated	N/A	Brass alloy, zinc plated
	Line Contacts	Brass alloy, zinc plated	Brass alloy, zinc plated	Brass alloy	N/A
	Ground Shunt	Connectors: 0.027" phosphor bronze	Connectors: 0.027" phosphor bronze	N/A	0.027" phosphor bronze
	Terminal Clamps	Brass alloy, zinc plated	Brass alloy, zinc plated	Brass alloy, zinc plated	Brass alloy, zinc plated
	Terminal Screws	3/8-27 brass	3/8-27 brass	3/8-27 brass	3/8-27 brass
	Ground Screw	3/8-27 brass	3/8-27 brass	3/8-27 brass	3/8-27 brass
	Assembly/ Mounting Screws	N/A	Steel, zinc plated	N/A	Brass
	Gasket/Dust Shield	Neoprene rubber	Neoprene rubber	N/A	Neoprene rubber
	Cord Clamp Screws	Stainless steel	Stainless steel	N/A	N/A
	Cord Clamp	Nylon, impact modified	Steel, zinc plated (black)	N/A	N/A
	Plug Shroud	Cold-rolled steel, zinc plated	Cold-rolled steel, zinc plated	N/A	N/A
	Receptacle Mounting Strap	N/A	N/A	0.060" steel, zinc plated	N/A
Flanged Housing/Base	N/A	N/A	N/A	Steel, zinc plated	

Hospital Use Power-Lock Locking Devices

2-Pole, 3-Wire Grounding
20A, 50A, 60A

	Device Type	Hospital Use Nylon Power-Lock Plugs & Connectors	Hospital Use Armored Power-Lock Plugs & Connectors	Hospital Use Power-Lock Single Receptacles & Receptacle in Plate Assemblies
	Wiring Type	Pressure wire	Pressure wire	Back & side wire
	Testing & Code Compliance	<ul style="list-style-type: none"> cULus listed to UL 498, file no. E3663 	<ul style="list-style-type: none"> cULus listed to UL 498, file no. E3663 	<ul style="list-style-type: none"> Listed to UL 498, file no. E2369 CSA certified to C22.2, no. 42
Specifications: Environmental	Flammability	Meets UL94 requirements, V0 rated	Meets UL94 requirements, V0 rated	Meets UL94 requirements, V0 rated
	Temperature Rating	-40°C to 105°C (-40°F to 221°F)	-40°C to 105°C (-40°F to 221°F)	-40°C to 105°C (-0°F to 221°F)
Specifications: Electrical	Dielectric Voltage	Withstands 2000V per UL 498	Withstands 2000V per UL 498	Withstands 1500V per UL 498
	Current Interrupting	Yes, at full-rated current	Yes, at full-rated current	Yes, at full-rated current
	Temperature Rise	Max. 30°C (86°F) after 50 cycles of overload @ 150% of rated current (DC)	Max. 30°C (86°F) after 50 cycles of overload @ 150% of rated current (DC)	Max. 30°C (86°F) after 100 cycles of overload @ 150% of rated current (DC)
Specifications: Mechanical	Terminal Accommodation	#12 - #4 AWG	#12 - #4 AWG	#12 - #4 AWG
	Voltage Ratings	Permanently marked on device	Permanently marked on device	Permanently marked on device
Materials:	Plug/Connector Outer Shell	Glass-filled nylon	0.062" thick steel	N/A
	Interior Body	Phenolic	Phenolic	Glass fiber reinforced phenolic
	Terminal Retainer	Phenolic	Phenolic	N/A
	Blades	0.070" thick brass	0.070" thick brass	N/A
	Line Contacts	CZP2002-11 Sintered brass	CZP2002-11 Sintered brass	0.030" thick bronze
	Receptacle Contact Support	N/A	N/A	0.020" thick bronze
	Receptacle Terminals	N/A	N/A	0.030" thick brass
	Terminal Clamps	0.080" thick brass	0.080" thick brass	N/A
	Terminal Screws	#8-32 brass	#8-32 brass	N/A
	Ground Screw	#8-32 brass, green	#8-32 brass, green	N/A
	Assembly/Mounting Screws	#6-20 steel, zinc plated	#6-20 steel, zinc plated	N/A
	Cord Clamp Screws	#8-18 steel, CR plated	#8-18 steel, CR plated	N/A
	Cord Clamp	Nylon	Steel	N/A
	Receptacle Housing	N/A	N/A	0.065" thick steel
	Receptacle Top Plate	N/A	N/A	0.060" thick stainless steel
Receptacle Grounding Strap	N/A	N/A	0.020" thick brass	
Receptacle Cover Housing/Base	N/A	N/A	0.035" thick stainless steel	

Industrial Specification Grade Power-Lock Devices

2-Pole, 3-Wire Grounding; 3-Pole, 3-Wire Non-Grounding; 3-Pole, 3-Wire Grounding; 3-Pole, 4-Wire Grounding; 4-Pole, 5-Wire Grounding
20A, 30/20A, 30A, 60A

	Device Type	Nylon & Auto-Grip™ Nylon Power-Lock Plugs & Connectors	Armored Power-Lock Plugs & Connectors	Power-Lock Inlets, Flanged Inlets, Outlets, & Flanged Outlets
	Wiring Type	Pressure wire	Pressure wire	Pressure wire (lug & lug screw)
	Testing & Code Compliance	<ul style="list-style-type: none"> cULus listed to UL 498, file no. E3663 	<ul style="list-style-type: none"> cULus listed to UL 498, file no. E3663, except 21434: UL only 	<ul style="list-style-type: none"> Listed to UL 498, file no. E3663 cUL listed to UL 498, file no. E3663 CSA certified to C22.2, no. 42
Specifications: Environmental	Flammability	Meets UL 94 requirements, V0 rated	Meets UL 94 requirements, V0 rated	Meets UL 94 requirements, V0 rated
	Temperature Rating	-40°C to 105°C (-40°F to 221°F)	-40°C to 105°C (-40°F to 221°F)	-40°C to 105°C (-40°F to 221°F)
Specifications: Electrical	Dielectric Voltage	Withstands 2000V per UL 498	Withstands 2000V per UL 498	Withstands 2000V per UL 498
	Current Interrupting	Yes, at full-rated current	Yes, at full-rated current	Yes, at full-rated current
	Temperature Rise	Max. 30°C (86°F) after 50 cycles of overload @ 150% of rated current (DC)	Max. 30°C (86°F) after 50 cycles of overload @ 150% of rated current (DC)	Max. 30°C (86°F) after 50 cycles of overload @ 150% of rated current (DC)
Specifications: Mechanical	Terminal Accommodation	#12 - #4 AWG	#12 - #4 AWG	#12 - #4 AWG
	Voltage Ratings	Permanently marked on device	Permanently marked on device	Permanently marked on device
Materials:	Inlet Flip Lid Cover & Base	N/A	N/A	If applicable, 0.125" thick cast aluminum
	Flanged Housing	N/A	N/A	If applicable, 0.060" thick steel, zinc plated
	Plug/Connector Outer Shell	Glass-filled nylon	Epoxy coated steel	N/A
	Interior Body	Phenolic	Phenolic	Phenolic
	Terminal Retainer	Phenolic	Phenolic	Phenolic
	Blades	0.070" thick brass	0.070" thick brass	.100" thick 260 brass, tin plated
	Line Contacts	CZP2002-11 Sintered brass	CZP2002-11 Sintered brass	.100" thick 260 brass, tin plated
	Terminal Lug	Brass	Brass	Brass
	Terminal Screws	#8-32 brass	#8-32 brass	3/8-27 brass
	Ground Screw	#8-32 brass, green plated	#8-32 brass, green plated	N/A
	Assembly/ Mounting Screws	#6-20 steel, zinc plated	#6-20 steel, zinc plated	#8-32 steel, chrome over zinc plating
	Cord Clamp Screws	#8-18 steel, CR plated	#8-18 steel, CR plated	N/A
Cord Clamp	Nylon	Steel	N/A	

**Industrial
 Specification Grade
 Power-Lock Devices**

2-Pole, 3-Wire Grounding; 3-Pole, 3-Wire Non-Grounding; 3-Pole, 3-Wire Grounding; 3-Pole, 4-Wire Grounding; 4-Pole, 5-Wire Grounding
 20A, 30/20A, 30A, 60A

	Device Type	Power-Lock Receptacles: 3-Pole, 3-Wire & 3-Pole, 4-Wire 20A, 30A, & 30/20A	Power-Lock Receptacles: 3-Pole, 4-Wire & 4-Pole, 5-Wire 30/20A & 60A
	Wiring Type	Back & side wire	Back & side wire
	Testing & Code Compliance	<ul style="list-style-type: none"> Listed to UL 498, file no. E2369, except 23000G CSA certified to C22.2, no. 42 except 23000G, AH21420, 20443N 	<ul style="list-style-type: none"> Listed to UL 498, file no. E2369 CSA certified to C22.2, no. 42 except 26421, 26521
		Flammability	Meets UL 94 requirements, V0 rated
	Temperature Rating	-40°C to 105°C (-0°F to 221°F)	-40°C to 105°C (-0°F to 221°F)
Specifications: Electrical	Dielectric Voltage	Withstands 1500V per UL 498	Withstands 1500V per UL 498
	Current Interrupting	Yes, at full-rated current	Yes, at full-rated current
	Temperature Rise	Max. 30°C (86°F) after 100 cycles of overload @ 150% of rated current (DC)	Max. 30°C (86°F) after 100 cycles of overload @ 150% of rated current (DC)
Specifications: Mechanical	Terminal Accommodation	#10 - #14 AWG	#10 - #14 AWG
	Voltage Ratings	Permanently marked on device	Permanently marked on device
Materials:	Receptacle Flip Lid Cover & Housing	If applicable, 0.125" thick cast aluminum	If applicable, 0.125" thick cast aluminum, except 25403: cast iron cover and steel shell
	Interior Body/Face & Base	Glass-filled nylon	Glass fiber reinforced phenolic
	Single Receptacle Strap	If applicable, 0.040" thick steel, zinc plated	N/A
	Grounding Strap	N/A	0.030" thick brass
	Contacts	0.024" thick brass	0.030" thick bronze
	Contacts Support	0.020" thick bronze, zinc plated	0.020" thick bronze
	Terminals	0.024" thick brass	0.030" thick brass
	Terminal Screws	#8-32 brass screw	60A: 3/8-27 brass screw
Ground Screw	#8-32 brass screw	60A: 3/8-27 brass screw	

D Switches & Motor Controls



	Page		Page
REPEL Switches	D-1	Manual Motor Controllers	D-17
ArrowLink™ Modular Connectors	D-2	Motor Control Quick Reference Guide	D-19
Build-To-Spec	D-4	Motor Control Switch Enclosure Guide	D-19
15A, 20A & 30A Industrial Switches	D-5	Single-Phase, 2-Pole Motor Controllers	
AC Toggle Switches		30A, 600V/AC	D-20
15A, 120/277V/AC	D-6-D-7	40A, 600V/AC	D-21
20A, 120/277V/AC	D-6-D-7	60A, 600V/AC	D-23
30A, 120/277V/AC	D-6-D-7	Three-Phase, 3-Pole Motor Controllers	
15A, 347V/AC	D-7	30A, 600V/AC	D-20
20A, 347V/AC	D-7	40A, 600V/AC	D-22
AC Three-Position Toggle Switches		60A, 600V/AC	D-23
Maintained Contact: 15A, 120/277V/AC	D-8	Three-Position Maintained Contact Motor Controllers	
Maintained Contact: 20A, 120/277V/AC	D-8	10/20A, 250/125V/AC/DC	D-24
Momentary Contact: 15A, 120/277V/AC	D-8	20/30A, 250/125V/AC/DC	D-24
Momentary Contact: 20A, 120/277V/AC	D-8	20/30A, 600/250V/AC/DC	D-24
AC Locking Switches		Motor Control Switches	D-25
Corbin Type 20A, 120/277V/AC	D-9	X-Switch NSF Certified Motor Control Switch	
15A, 120/277V/AC	D-9	3-Pole: 30A, 600V/AC	D-26
20A, 120/277V/AC	D-9	Disconnect Switches	D-27
30A, 120/277V/AC	D-9	Non-Fused Manual Disconnects	
15A & 20A Commercial Switches	D-10	Single- or 3-Phase: 30A	D-29
AC Decorator Switches		Single- or 3-Phase: 60A	D-29
15A, 120/277V/AC	D-12	3-Phase: 100A	D-29
20A, 122/277V/AC	D-12-D-13	Fused Manual Disconnects	
Back & Side Wire AC Toggle Switches		3-Phase: 30A	D-30
15A, 120/277V/AC	D-14	Specification Information	D-31
20A, 120/277V/AC	D-14		
Side Wire AC Toggle Switches			
15A, 120/277V/AC	D-14		
20A, 120/277V/AC	D-14		
AC Decorator Combination Switches			
Single-Pole with Additional Switch: 15A	D-15		
Single-Pole with Additional Switches: 15A	D-15		
3-Way with Additional Switch: 15A	D-15		
Single-Pole with Receptacle: 15A	D-15		
AC Toggle Combination Switches			
Single-Pole with Additional Switch: 15A	D-16		
Single-Pole with Pilot Light: 15A	D-16		
3-Way with Additional Switch: 15A	D-16		
3-Way with Pilot Light: 15A	D-16		
Single-Pole with Receptacle: 15A	D-16		
3-Way with Receptacle: 15A	D-16		

All our switches are engineered for years of safe, dependable service

Arrow Hart's complete offering of switches are designed with a host of features that save time and labor, and are thoroughly tested to ensure reliable electrical and mechanical performance.

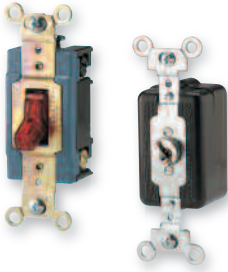

Industrial Specification Grade Switches

Top-of-the-line design, quality and materials provide superior performance in heavy-duty applications. Available in toggle, lighted, pilot light, Corbin and locking versions.



X-Switch™ NSF Certified Motor Control Switches

Specifically designed for use in harsh industrial environments, the X-Switch withstands repeated exposure to hosedown, corrosive elements and a variety of contaminants.

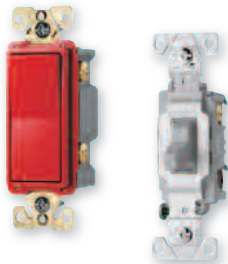

Commercial Specification Grade Switches

A wide range of toggle and decorator switch solutions designed to provide reliability and performance in commercial environments.



Motor Control Switch Enclosures

Available to suit a wide variety of indoor, outdoor and hazardous environments, our enclosures are designed to protect switches from contaminants, provide OSHA compliance, and safely contain wiring.

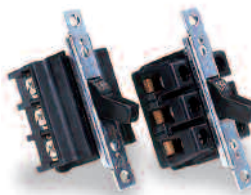

Motor Control Switches

Built tough to provide dependable manual motor control for applications up to 60A, our switches are also available in combination with a variety of enclosures for indoor and outdoor applications.



Disconnect Switches

Available in both fused and non-fused designs, these devices combine HP-rated switches in compact, durable, watertight enclosures that are NEMA 3R, 4X or 12 rated and fulfill NEC Article 430 requirements.

REPEL Switches

Arrow Hart's REPEL Switches are the first of their kind with Agion® Additive



REPEL offers built-in product protection

REPEL Toggle and Decorator Switches
Incorporates Agion® Silver Antimicrobial into the plastic components



REPEL wallplates are also available. See section J for ordering information.



REPEL switches are perfect for:

- Healthcare Facilities
- Schools, Classrooms, and Dormitories
- Assisted Living Facilities
- Food Service Areas
- Industrial Facilities
- Commercial Office Space
- Retail Common Areas

NOTE: REPEL products do not protect the user against disease causing organisms and ongoing regular cleaning practices should be maintained. Agion is a trademark of Agion Technologies Inc. Wakefield, MA.

ArrowLink

Arrow Hart's factory terminated ArrowLink system revolutionizes device installation, unleashing groundbreaking labor savings in installation and maintenance by eliminating leaded terminal connections and taping. Use ArrowLink on your next job to reduce labor costs, eliminate installation errors, save money and win!

6" #12 AWG ground lead with ring terminal and captive ground screw

Durable polycarbonate housing

Terminal accommodation #12-#14 AWG, solid only

Copper alloy contacts for superior wire retention and minimized heat rise

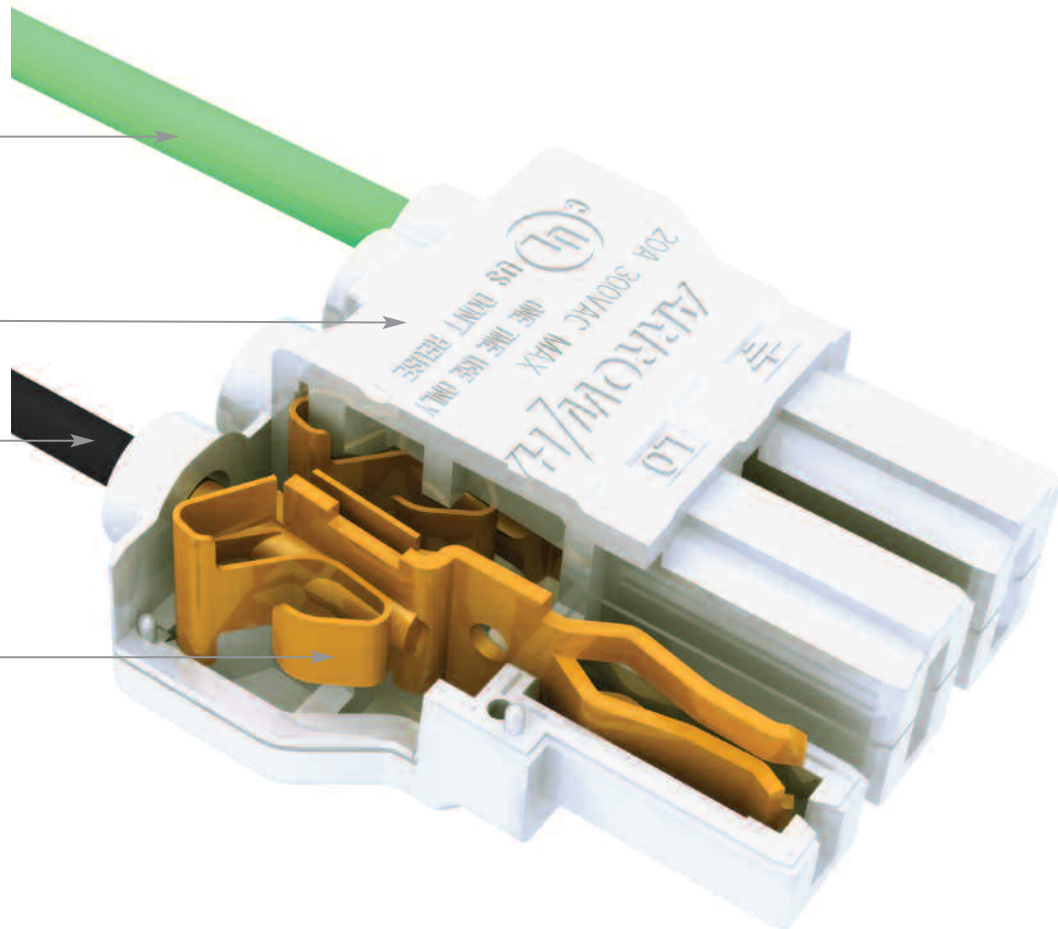

ArrowLink SPD Benefits



TIME SAVINGS:
SPD accelerates both rough-in & trim out installation

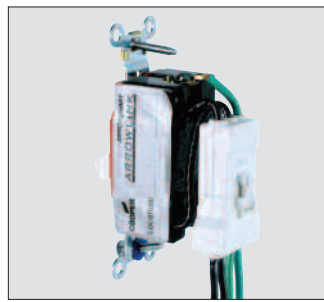

EFFICIENT DESIGN:
Low profile connection with feed-through capability

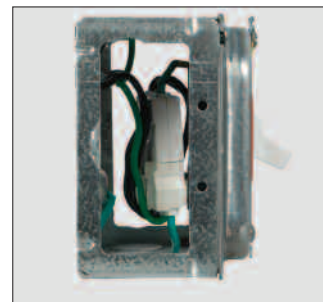

30% REDUCTION in wire volume inside the box versus wire lead terminations

How To Order



1. Select a Device to ArrowLink enable.
Catalog pages identify available products—simply add an “M” to the catalog number and the devices will be factory enabled with the ArrowLink device-side connection.

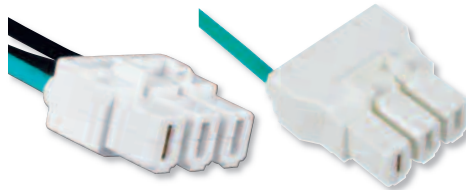

2. Choose from leaded or ArrowLink SPD connector versions.



3. Place your order and get your ArrowLink devices in **bulk packed** boxes, shipped within 5 days of receipt order!

ARROWLINK™
Modular Wiring Devices



Leaded ArrowLink Connectors

Device Type	Description	Catalog No.
Switch	Solid Wire Leads – 120V	<input type="checkbox"/> MCS120SOL
	Stranded Wire Leads – 120V	<input type="checkbox"/> MCS120STR
	Solid Wire Leads– 277V	<input type="checkbox"/> MCS277SOL
	Stranded Wire Leads – 277V	<input type="checkbox"/> MCS277STR

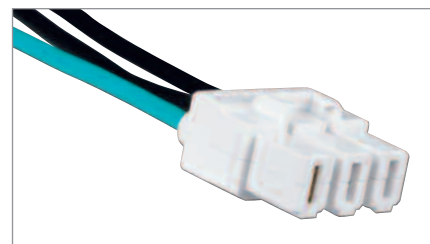

MCS120SOL
Leaded ArrowLink
Connector

ARROWLINK™
SPD



ArrowLink SPD Connectors

Device Type	Description	Catalog No.
Switch	Push-In AVAILABLE SUMMER 2010!	<input type="checkbox"/> MCS300PI

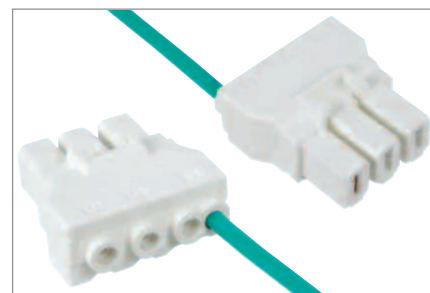

MCS300PI
ArrowLink SPD Push-In Terminal
Connector

ArrowLink Accessories

Device Type	Description	Catalog No.
Terminating Cap	Circuit Completer for Jobsite Testing AVAILABLE SUMMER 2010!	<input type="checkbox"/> MCS300TC
Circuit Tester	Tests Receptacle & ArrowLink Connectors AVAILABLE SUMMER 2010!	<input type="checkbox"/> ALTESTER

ALTESTER
Circuit Tester

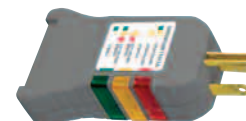



**Work smarter
not harder**

Arrow Hart custom configured wiring devices can match any of your complex industrial or commercial job needs, simplifying your project and maximizing your bottom line.

BUILD-TO-SPEC
CUSTOM CONFIGURED DEVICES

Ordering Matrix

Build-To-Spec Devices

For Switches

Sample Number:

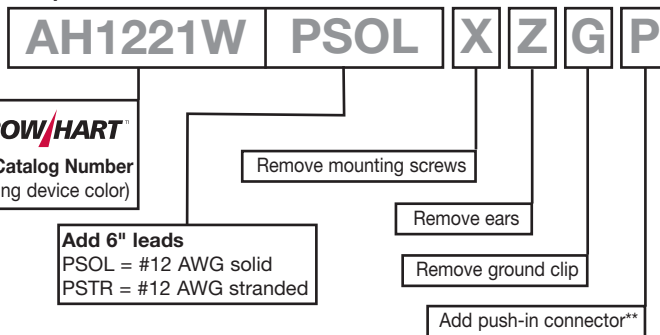

Arrow Hart 20A 120/277V white single-pole switch, with wire leads and push-in connectors, without mounting screws, ears, split-circuit tab or grounding clip.



**For use with leaded devices only. Add "PSOL" to back of device catalog number for 6" of #12 AWG solid or "PSTR" for 6" of #12 AWG stranded. Example: AH1221WPSTR + Build to Spec Options).

All devices are bulk packed 50 pieces per carton. Minimum order quantity is 100 pieces. Orders under 500 pieces ship within 5 days with larger quantities typically within 10 days.

Build-To-Spec Options Available For The Following Switches



Commercial Decorator
7600 Series



Industrial Arrow Hart
AH Series



Commercial Back & Side
Wired CSB Series



Commercial Side Wired
CS Series*

*CS Series switches not available with leads or push-in connectors

Incorporating the most durable design elements in the industry

Arrow Hart's broad line of Industrial Specification Grade switches feature superior engineering, reliable performance and ease of installation.



Industrial AH1200, AH1220, 3030 Series

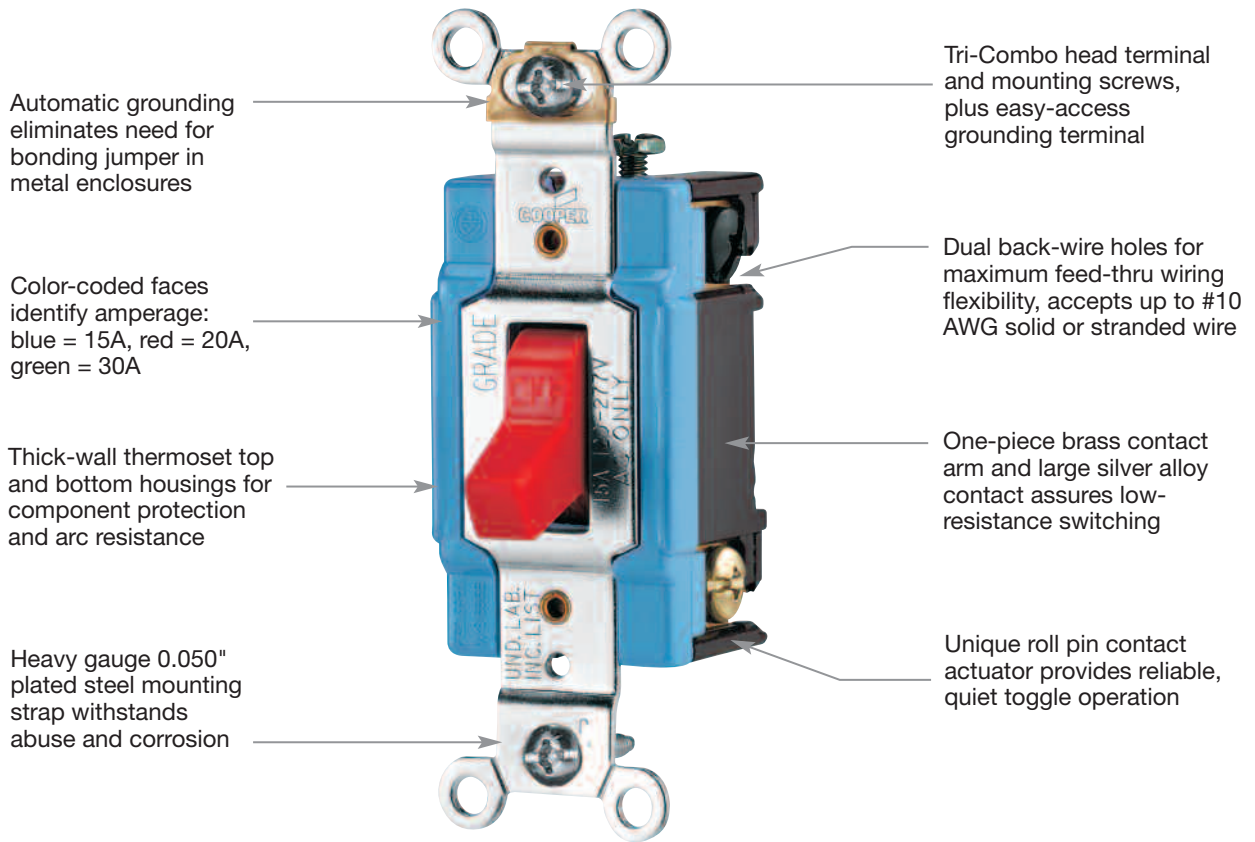

A complete offering of heavy-duty switches available for any industrial application:



REPEL™



ArrowLink™



Lighted & Pilot Lighted



Maintained & Momentary Contact



Corbin Locking & Locking

Industrial Specification Grade AC Toggle Switches

15A, 120/277V/AC; 20A, 120/277V/AC;
30A, 120/277V/AC
Single-Pole, Double-Pole, 3-Way, 4-Way

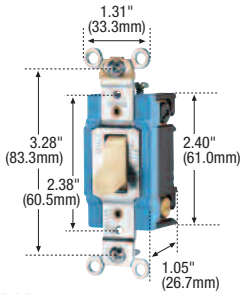

AH1201

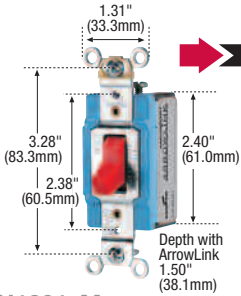

AH1201_M

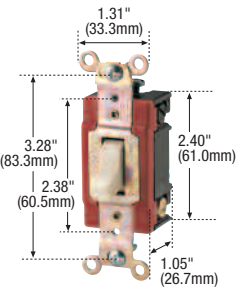

AH1223

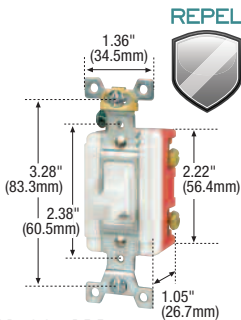

AH1221AM

15A, 20A & 30A AC Toggle Switches

Description	15A, Side Wire			20A, Side Wire			30A, Side Wire				
	Catalog No. Color Suffix	UL US	FUS	NOM 426	Catalog No. Color Suffix	UL US	FUS	NOM 426	Catalog No. Color Suffix	UL US	FUS
Single-Pole, Toggle	<input type="checkbox"/> AH1201 B, GY, RD, V, W	•	•	•	<input type="checkbox"/> AH1221 B, BK, GY, LA, RD, V, W	•	•	•	<input type="checkbox"/> 3031 B, RD, V, W	•	
Double-Pole, Toggle	<input type="checkbox"/> AH1202 B, GY, V, W		•	•	<input type="checkbox"/> AH1222 B, GY, RD, V, W		•	•	<input type="checkbox"/> 3032 B, RD, W		•
3-Way, Toggle	<input type="checkbox"/> AH1203 B, GY, RD, V, W		•	•	<input type="checkbox"/> AH1223 B, BK, GY, LA, RD, V, W		•	•			
4-Way, Toggle	<input type="checkbox"/> AH1204 B, GY, V, W		•	•	<input type="checkbox"/> AH1224 B, BK, GY, LA, RD, V, W		•	•			



REPEL™

Back & Side Wire 15A, 120/277V

Description	15A, Side Wire			20A, Side Wire		
	Catalog No. Color Suffix	UL US	FUS	Catalog No. Color Suffix	UL US	FUS
Single-Pole, Toggle REPEL Switch	<input type="checkbox"/> AH1201AM GY, V, W	•	•	<input type="checkbox"/> AH1221AM GY, LA, RD, V, W	•	•
Double-Pole, Toggle REPEL Switch	<input type="checkbox"/> AH1202AM GY, V, W		•	<input type="checkbox"/> AH1222AM GY, RD, V, W		•
3-Way, Toggle REPEL Switch	<input type="checkbox"/> AH1203AM GY, V, W		•	<input type="checkbox"/> AH1223AM GY, RD, V, W		•

Color Ordering Information

For ordering devices, include Cat. No. followed by the color code: A (Almond), B (Brown), BK (Black), BL (Blue), GY (Gray), LA (Light Almond), RD (Red), RN (Orange), V (Ivory), W (White)

Icon Key

➤ ArrowLink™ option available. Add "M" suffix to standard catalog number (example AH1201B, AH1201BM). For ordering information on ArrowLink & ArrowLink SPD connectors, see page D-3.



Build-To-Spec Customizable Devices - see page D-4



NAFTA Compliant - see page O-30

Accessories for Industrial Specification Grade Switches

Description	Catalog No.
1-Gang, standard size, toggle switch, 302/304 stainless steel wallplate	<input type="checkbox"/> 93071
2-Gang, standard size, toggle switch, 302/304 stainless steel wallplate, REPEL	<input type="checkbox"/> 93072AM

Specification & HP Rating Information:

120/277V Industrial: D-31

120/277V Industrial REPEL: D-34

120/277V Industrial ArrowLink

Modular: D-35



93071



93072AM

Industrial Specification Grade AC Toggle Switches

15A, 120/277V/AC; 20A, 120/277V/AC;
30A, 120/277V/AC
15A, 347V/AC; 20A, 347V/AC
Single-Pole, Double-Pole, 3-Way, 4-Way

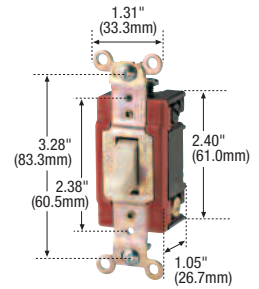

AH1223LT

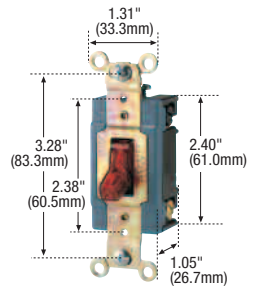

AH1201PL

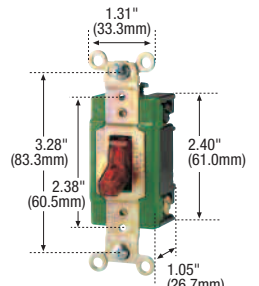

3032PL

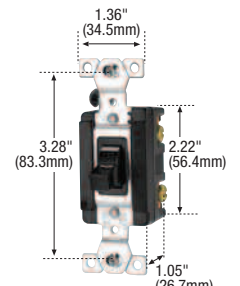

AH18201

15A, 20A & 30A AC Toggle Switches

Lighted, Back Wire & Side Wire

15A, 120/277V 20A, 120/277V

Description	Catalog No. Color Suffix				Catalog No. Color Suffix			
Single-Pole, Lighted Toggle	<input type="checkbox"/> AH1201LT__ V, W	•	•	•	<input type="checkbox"/> AH1221LT__ V, W	•	•	•
3-Way, Lighted Toggle	<input type="checkbox"/> AH1203LT__ V, W	•	•		<input type="checkbox"/> AH1223LT__ V, W	•	•	

Pilot Light, Back Wire & Side Wire

15A, 120/277V 20A, 120/277V 30A, 120/277V

Description	Catalog No. Color Suffix				Catalog No. Color Suffix				Catalog No. Color Suffix			
Single-Pole, Pilot Lighted Red Toggle	<input type="checkbox"/> AH1201PL	•	•		<input type="checkbox"/> AH1221PL	•	•					
Double-Pole, Pilot Lighted Red Toggle	<input type="checkbox"/> AH1202PL	•	•		<input type="checkbox"/> AH1222PL	•	•		<input type="checkbox"/> 3032PL	•	•	

Back Wire & Side Wire

15A, 347V 20A, 347V

Description	Catalog No. Color Suffix			Catalog No. Color Suffix		
Single-Pole, Canadian Voltage Toggle	<input type="checkbox"/> AH18201__ B, GY, I, W	•		<input type="checkbox"/> AH18221__ B, I, W	•	•
Double-Pole, Canadian Voltage Toggle	<input type="checkbox"/> AH18202__ B, I	•		<input type="checkbox"/> AH18222__ B, I	•	•
3-Way, Canadian Voltage Toggle	<input type="checkbox"/> AH18203__ B, GY, I, W	•		<input type="checkbox"/> AH18223__ B, I, W	•	•

Color Ordering Information

For ordering devices, include Cat. No. followed by the color code: A (Almond), B (Brown), BK (Black), BL (Blue), GY (Gray), LA (Light Almond), RD (Red), RN (Orange), V (Ivory), W (White)

Icon Key

ArrowLink™ option available. Add "M" suffix to standard catalog number (example AH1201B, AH1201BM). For ordering information on ArrowLink & ArrowLink SPD connectors, see page D-3.

Build-To-Spec Customizable Devices - see page D-4
 NAFTA Compliant - see page O-30

Accessories for Industrial Specification Grade Switches

Description	Catalog No.	
1-Gang, standard size, toggle switch, nylon wallplate, almond	<input type="checkbox"/> 5134A	•
2-Gang, standard size toggle switch, nylon wallplate, ivory	<input type="checkbox"/> 5139V	•



5134W



5139V

Specification & HP Rating Information:

120/277V Industrial: D-31
347V Industrial: D-31
120/277V Industrial ArrowLink Modular: D-35

Industrial Specification Grade AC Three-Position Switches

15A, 120/277V/AC; 20A, 120/277V/AC;
Maintained & Momentary Contact
Single-Pole, Double-Pole

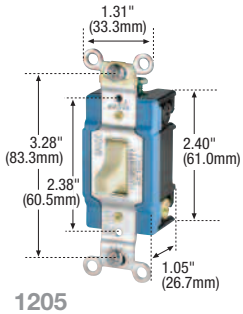

15A & 20A AC Maintained Contact Toggle Switches

Back Wire & Side Wire	15A, 120/277V		20A, 120/277V	
Description	Catalog No. Color Suffix		Catalog No. Color Suffix	
Single-Pole, Maintained Contact Toggle, Center Off	<input type="checkbox"/> 1205 V	•	<input type="checkbox"/> 2225 V	•
Double-Pole, Maintained Contact Toggle, Center Off			<input type="checkbox"/> 2226 B, V	•

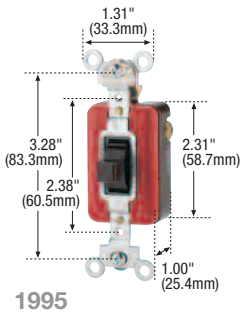

15A & 20A AC Momentary Contact Switches

Back Wire & Side Wire	15A, 120/277V		20A, 120/277V	
Description	Catalog No. Color Suffix		Catalog No. Color Suffix	
Single-Pole, Momentary Contact Toggle, Center Off	<input type="checkbox"/> 1895 B, GY, V	•	<input type="checkbox"/> 1995 B, GY, RD, V	•
Single-Pole, Momentary Contact Locking, Center Off, Nickel Locking Dome	<input type="checkbox"/> 1895L -	•	<input type="checkbox"/> 1995L -	•

Color Ordering Information

For ordering devices, include Cat. No. followed by the color code: A (Almond), B (Brown), BK (Black), BL (Blue), GY (Gray), LA (Light Almond), RD (Red), RN (Orange), V (Ivory), W (White)

Icon Key

NAFTA Compliant - see page O-30

Accessories for Industrial Specification Grade Maintained & Momentary Contact Switches

Description	Catalog No.
Replacement key for momentary contact locking switches, AH1895L & AH1995L	<input type="checkbox"/> AH2000
1-Gang, toggle, 302/304 stainless steel wallplate	<input type="checkbox"/> 93071 •
1-Gang, standard size, toggle unbreakable nylon wallplate, Ivory	<input type="checkbox"/> 5134V •





Specification & HP Rating Information:

120/277V Industrial Maintained & Momentary Contact: D-32

Industrial Specification Grade AC Locking Switches

15A, 120/277V/AC; 20A, 120/277V/AC; 30A, 120/277V/AC
 Locking
 Single-Pole, Double-Pole, 3-Way, 4-Way





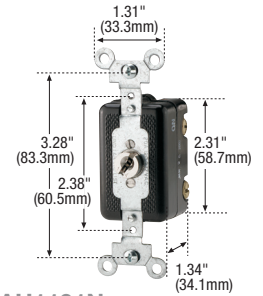









20A AC Corbin Type Locking Switches

Back Wire & Side Wire	20A, 120/277V	
Description	Catalog No.	
Single-Pole, Corbin Locking Switch	<input type="checkbox"/> AH1191N	•
Single-Pole, Corbin Locking Switch, Key Removable in "Off" Position Only	<input type="checkbox"/> AH1191NOF	•
Double-Pole, Corbin Locking Switch	<input type="checkbox"/> AH1192N	•
3-Way, Corbin Locking Switch	<input type="checkbox"/> AH1193N	•



AH1191N

15A, 20A & 30A AC Locking Switches

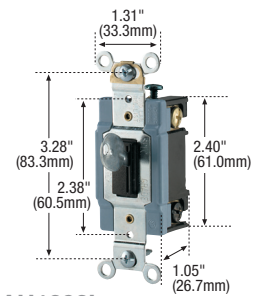

Back Wire & Side Wire	15A, 120/277V	  	20A, 120/277V	  	30A, 120/277V	 
Description	Catalog No. Color Suffix	 	Catalog No. Color Suffix	 	Catalog No. Color Suffix	 
Single-Pole, Locking Switch	<input type="checkbox"/> AH1201L —	• •	<input type="checkbox"/> AH1221L —	• •	<input type="checkbox"/> 3031L —	• •
Double-Pole, Locking Switch	<input type="checkbox"/> AH1202L —	• •	<input type="checkbox"/> AH1222L —	• •	<input type="checkbox"/> 3032L —	• •
3-Way, Locking Switch	<input type="checkbox"/> AH1203L —	• •	<input type="checkbox"/> AH1223L —	• •	<input type="checkbox"/> 3033L —	• •
4-Way, Locking Switch	<input type="checkbox"/> AH1204L —	• •	<input type="checkbox"/> AH1224L —	• •	<input type="checkbox"/> 3034L* —	• •



AH1202L

* UL only

Icon Key

-  Build-To-Spec Customizable Devices - see page D-4
-  NAFTA Compliant - see page O-30

Accessories for Industrial Specification Grade Locking Switches

Description	Catalog No.	
Replacement key for Corbin locking switches	<input type="checkbox"/> AH14	•
Stainless steel wallplate for Corbin locking switches with "On-Off" indicator engraving	<input type="checkbox"/> AH1187	•
Stainless steel wallplate for Corbin locking switches	<input type="checkbox"/> AH1188	•
Replacement key for AH1200, AH2220, AH3030 series locking switches	<input type="checkbox"/> AH2000	•



AH14



AH1187



AH1188



AH2000

Specification & HP Rating Information:

120/277V Industrial Locking: D-33

Commercial durability with contemporary styling

Arrow Hart's Specification Grade Decorator Switches are designed to provide superior quality, reliability and performance in a variety of commercial environments.



Commercial Decorator 7600 Series

Automatic grounding eliminates need for bonding jumper in metal enclosures

Welded construction provides superior assembly security under heavy use

Smooth face for ease of cleaning

Color-coded one-piece mounting strap assures ground integrity and is a quick visual amperage indicator

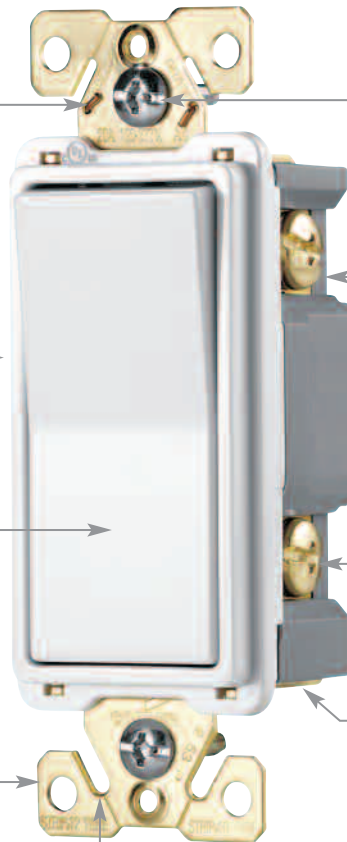

Built-in wire stripper

Tri-Combo head terminal and mounting screws, plus easy-access grounding terminal

Stippled line and ground contacts ensure solid contact; ground screw clamp provides secure wiring

Tapered back-wire openings handle multiple sizes and types, up to #10 AWG solid or stranded wire

Oversized termination screws

Horsepower rated for motor loads

Horsepower Rated for Motor Loads per UL 20			
	120 V/AC	240 V/AC	Max. Amps
15A	1/2 HP	2 HP	12A
20A	1 HP	2 HP	16A

A complete line of switches available for any commercial application:



Lighted & Pilot Lighted



Combination Switches

Designed for reliability and durability in commercial applications

Arrow Hart's Commercial Specification Grade Switches are engineered to deliver safe, reliable performance in all commercial operations.



Back and Side Wired CSB Series

Side Wired CS Series

Automatic grounding eliminates need for bonding jumper in metal enclosures

Industrial design cam action mechanism ensures quiet switch action

Thick-wall thermoset top and bottom housings for component protection and arc resistance

Tri-Combo head terminal and mounting screws

Back and side wire terminals for ease of installation, accepts up to #10 AWG solid or stranded wire

Tapered lead-in slots on back wiring holes assist in gathering stranded wires for faster, more secure connections

Thick steel mounting strap zinc-plated for corrosion resistance

Tri-Combo head terminal and mounting screws

Compact dimensions and shallow depth ideal for tight installations

Built-in line contact wire looper for fast wiring without tools

Stippled line contacts ensure solid engagement of wire

Wider mounting strap for 40% more contact with wallboard has built-in wire stripper

Commercial Specification Grade AC Decorator Switches

15A, 120/277V/AC
 20A, 120/277V/AC
 Single-Pole, Double-Pole, 3-Way, 4-Way

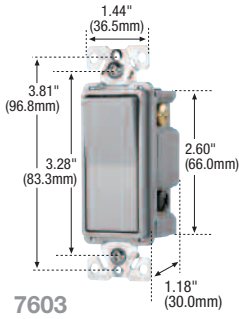

7603

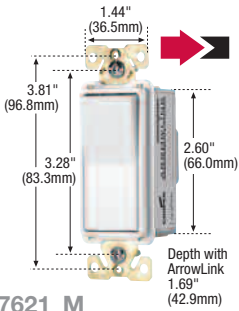

7621_M

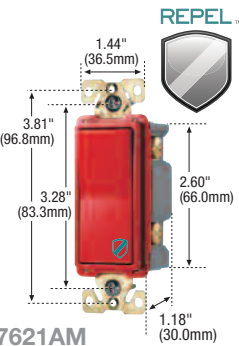

7621AM

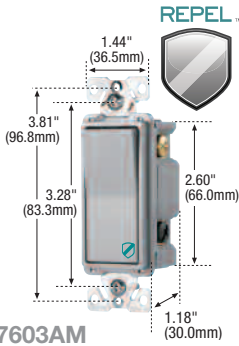

7603AM

Specification & HP Rating Information:

120/277V/AC REPEL Commercial Decorator: D-34

120/277V/AC Commercial ArrowLink Modular Decorator: D-35

120/277V/AC Commercial Decorator: D-36

15A & 20A AC Decorator Switches

Back Wire & Side Wire

15A, 120/277V



20A, 120/277V



Description	Catalog No. Color Suffix	▶	◀	Catalog No. Color Suffix	▶	◀
Single-Pole, Decorator	□ 7601__ A, B, BK, GY, LA, V, W	•	•	□ 7621__ A, B, BK, GY, LA, RD, V, W	•	•
Double-Pole, Decorator				□ 7622__ A, B, BK, GY, LA, V, W		•
3-Way, Decorator	□ 7603__ A, B, BK, GY, LA, V, W		•	□ 7623__ A, B, BK, GY, LA, RD, V, W		•
4-Way, Decorator	□ 7604__ A, B, BK, GY, LA, V, W		•	□ 7624__ A, B, BK, GY, LA, V, W		•

REPEL™ Back & Side Wire

15A, 120/277V



20A, 120/277V



Description	Catalog No. Color Suffix	▶	◀	Catalog No. Color Suffix	▶	◀
Single-Pole, Decorator REPEL Switch	□ 7601AM__ GY, RD, V, W		•	□ 7621AM__ GY, RD, V, W		•
Double Pole, Decorator REPEL Switch				□ 7622AM__ GY, V, W		•
3-Way, Decorator REPEL Switch	□ 7603AM__ GY, RD, V, W		•	□ 7623AM__ GY, RD, V, W		•
4-Way, Decorator REPEL Switch	□ 7604AM__ GY, V, W		•	□ 7624AM__ GY, V, W		•

Color Ordering Information

For ordering devices, include Cat. No. followed by the color code: A (Almond), B (Brown), BK (Black), BL (Blue), GY (Gray), LA (Light Almond), RD (Red), RN (Orange), V (Ivory), W (White)

Icon Key

▶ ArrowLink™ option available. Add "M" suffix to standard catalog number (example 7601B, A7601BM). For ordering information on ArrowLink & ArrowLink SPD connectors, see page D-3.

◀ Build-To-Spec Customizable Devices - see page D-4

**Commercial
Specification Grade
AC Decorator Switches**

15A, 120V/AC
20A, 120/277V/AC
Single-Pole, 3-Way, 4-Way
Lighted, Pilot Light

15A & 20A AC Decorator Switches

**Lighted,
Back Wire & Side Wire**

**20A,
120/277V**



Description	Catalog No. Color Suffix	▶	◀
Single-Pole, Lighted Decorator	□ 7631 ____ A, LA, V, W	•	•
3-Way, Lighted Decorator	□ 7633 ____ A, LA, V, W		•
4-Way, Lighted Decorator	□ 7634 ____ A, LA, V, W		•

**Pilot Light,
Back Wire & Side Wire**

**20A,
120/277V**



Description	Catalog No. Color Suffix	▶	◀
Single-Pole, Pilot Light Decorator	□ 7641 ____ A, V, W		•
3-Way, Pilot Light Decorator	□ 7643 ____ A, LA, V, W		•

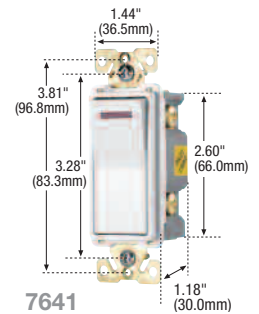

**REPEL™ Lighted Switches
Back & Side Wire**

**20A,
120/277V**



Description	Catalog No. Color Suffix	▶	◀
Single-Pole, Decorator REPEL Switch, Lighted	□ 7631AM ____ V, W	•	•
3-Way, Decorator REPEL Switch, Lighted	□ 7633AM ____ V, W		•
4-Way, Decorator REPEL Switch, Lighted	□ 7634AM ____ V, W		•

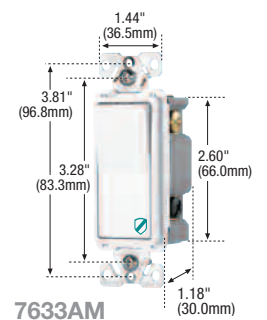

Color Ordering Information

For ordering devices, include Cat. No. followed by the color code: A (Almond), B (Brown), BK (Black), BL (Blue), GY (Gray), LA (Light Almond), RD (Red), RN (Orange), V (Ivory), W (White)

Icon Key

▶ ArrowLink™ option available. Add "M" suffix to standard catalog number (example 7631B, 7631BM). For ordering information on ArrowLink & ArrowLink SPD connectors, see page D-3.



Build-To-Spec Customizable Devices - see page D-4

Accessories for Commercial Specification Grade Switches

Description	Catalog No.
1-Gang, standard size, decorator, 302/304 stainless steel wallplate, REPEL	□ 93401AM



93401AM

Specification & HP Rating Information:

120/277V/AC REPEL Commercial Decorator: D-34

120/277V/AC Commercial ArrowLink Modular Decorator: D-35

120/277V/AC Commercial Decorator: D-36

Commercial Specification Grade AC Toggle Switches

15A, 120/277V/AC
 20A, 120/277V/AC
 Single-Pole, Double-Pole, 3-Way, 4-Way

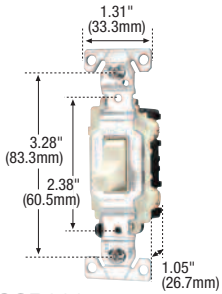

CSB320

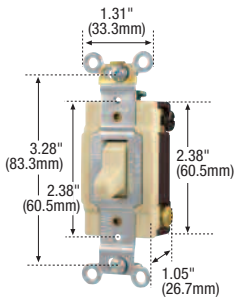

CSB415

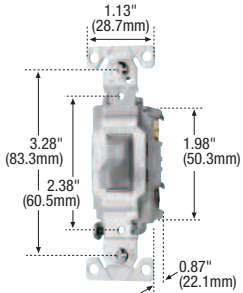

CS320

15A & 20A AC Toggle Switches, Back & Side Wire

Back Wire & Side Wire

15A,
120/277V



20A,
120/277V



Description	Catalog No. Color Suffix			Catalog No. Color Suffix		
Single-Pole, Toggle	<input type="checkbox"/> CSB115 ____ B, GY, LA, V, W	•	•	<input type="checkbox"/> CSB120 ____ B, GY, LA, V, W	•	•
Double-Pole, Toggle	<input type="checkbox"/> CSB215 ____ B, GY, LA, V, W	•	•	<input type="checkbox"/> CSB220 ____ B, GY, LA, V, W	•	•
3-Way, Toggle	<input type="checkbox"/> CSB315 ____ B, GY, LA, V, W	•	•	<input type="checkbox"/> CSB320 ____ B, GY, LA, V, W	•	•
4-Way, Toggle	<input type="checkbox"/> CSB415 ____ B, GY, V, W	•	•	<input type="checkbox"/> CSB420 ____ B, GY, V, W	•	•

15A & 20A AC Toggle Switches, Side Wire

Side Wire

15A,
120/277V

20A,
120/277V

Description	Catalog No. Color Suffix			Catalog No. Color Suffix		
Single Pole Compact Toggle	<input type="checkbox"/> CS115 ____ A, B, BK, GY, LA, V, W	•	•	<input type="checkbox"/> CS120 ____ A, B, BK, GY, LA, V, W	•	•
Double Pole Compact Toggle	<input type="checkbox"/> CS215 ____ A, B, BK, GY, LA*, V, W	•	•	<input type="checkbox"/> CS220 ____ A, B, BK, GY, LA, V, W	•	•
3-Way, Compact Toggle	<input type="checkbox"/> CS315 ____ A, B, BK, GY, LA, V, W	•	•	<input type="checkbox"/> CS320 ____ A, B, BK, GY, LA, V, W	•	•
4-Way, Compact Toggle	<input type="checkbox"/> CS415 ____ A, B, GY, LA, V, W	•	•	<input type="checkbox"/> CS420 ____ A, B, GY, LA, V, W	•	•

* Not NAFTA Compliant

Color Ordering Information

For ordering devices, include Cat. No. followed by the color code: A (Almond), B (Brown), BK (Black), BL (Blue), GY (Gray), LA (Light Almond), RD (Red), RN (Orange), V (Ivory), W (White)

Icon Key

- Build-To-Spec Customizable Devices - see page D-4
- NAFTA Compliant - see page O-30

Accessories for Commercial Specification Grade Toggle Switches

Description	Catalog No.	
1-Gang, standard size toggle, 302/304 stainless steel wallplate, REPEL™	<input type="checkbox"/> 93071AM	•
4-Gang, standard size toggle, unbreakable nylon wallplate, white	<input type="checkbox"/> 5154	•
2-Gang, standard size toggle, stainless steel 302/304 wallplate	<input type="checkbox"/> 93072	•
2-Gang, standard size toggle, unbreakable nylon wallplate, white	<input type="checkbox"/> 5139W	•
1-Gang, standard size toggle, unbreakable nylon wallplate, red	<input type="checkbox"/> 5134RD	•

Specification & HP Rating Information:

120/277V Commercial Toggle: D-37



93071AM



5154



93072



5139W



5134RD

**Commercial Specification
Grade AC Decorator
Combination Switches**

15A, 120/277V/AC
Single-Pole, 3-Way

15A Decorator Combination Switches

**Combination Switches,
Back & Side Wire**

15A,
120/277V



Description	Catalog No. Color Suffix
Two Single-Pole Switches	<input type="checkbox"/> 7728 A, BK, LA, V, W
Three Single-Pole Switches	<input type="checkbox"/> 7729 A, BK, LA, V, W
Two 3-Way Switches	<input type="checkbox"/> 7731 A, BK, LA, V, W
One Single-Pole Switch with One 3-Way Switch	<input type="checkbox"/> 7732 A, BK, LA, V, W

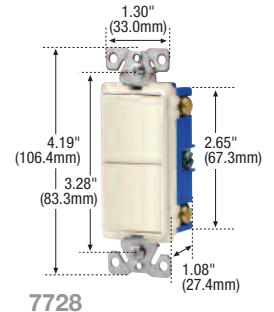

**Switch with Receptacle,
Back & Side Wire**

15A, 120/277V Switch,
15A, 125V Receptacle



Description	Catalog No. Color Suffix
One Single-Pole Switch with NEMA 5-15 2-Pole, 3-Wire Receptacle	<input type="checkbox"/> 7730 A, BK, LA, V, W

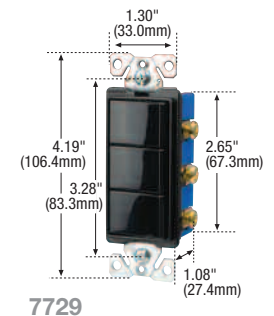

Color Ordering Information

For ordering devices, include Cat. No. followed by the color code: A (Almond), B (Brown), BK (Black), BL (Blue), GY (Gray), LA (Light Almond), RD (Red), RN (Orange), V (Ivory), W (White)

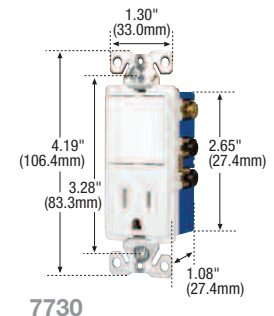

Icon Key

NAFTA Compliant - see page O-30

Accessories for Commercial Specification Grade Decorator Combination Switches

Description	Catalog No.	
1-Gang, standard size, decorator, 302/304 stainless steel wallplate, REPEL™	<input type="checkbox"/> 93401AM	•
1-Gang, standard size, decorator, unbreakable nylon wallplate, white	<input type="checkbox"/> 5151W	•
2-Gang, standard size, decorator, 302/304 stainless steel wallplate	<input type="checkbox"/> 93402	•
1-Gang, weather protective plastic self-closing decorator cover	<input type="checkbox"/> S2966	•
1-Gang, weather protective metal self-closing decorator cover	<input type="checkbox"/> S1966	•

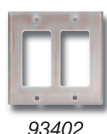

**Specification & HP Rating
Information:**

120/277V Commercial
Decorator Combination: D-36

Commercial Specification Grade AC Toggle Combination Switches

15A, 120/277V/AC; 15A, 120V/AC
20A, 120V/AC
Single-Pole, 3-Way, Pilot Light

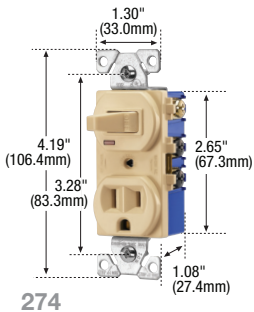
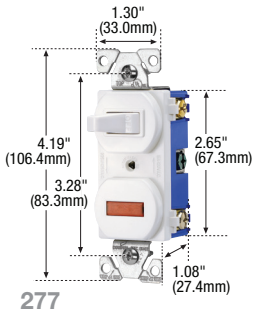
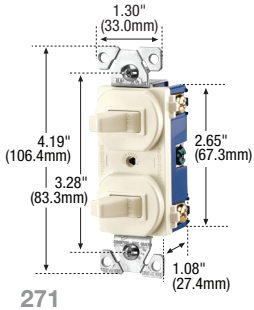

15A Toggle Combination Switches

Combination Switches, 15A, Back & Side Wire



Description	Catalog No. Color Suffix
Two Single-Pole Switches	<input type="checkbox"/> 271__ A, B, LA, V, W
One Single-Pole Switch with One 3-Way Switch	<input type="checkbox"/> 275__ A, B, LA, V, W
Two 3-Way Switches	<input type="checkbox"/> 276__ LA, V, W

Pilot Light Back & Side Wire



Description	Catalog No. Color Suffix
Single-Pole Switch 1/25 W, 125V Pilot Light	<input type="checkbox"/> 277__ A, B, LA, V, W
3-Way Switch with Pilot Light 1/25 W, 125V Pilot Light	<input type="checkbox"/> 294__ A, B, V

Switch with Receptacle, Back & Side Wire



15A, 120V Switch
15A, 125V Receptacle

15A, 120V Switch
20A, 125V Receptacle

Description	Catalog No. Color Suffix	Catalog No. Color Suffix
One Single-Pole Switch with NEMA 5-15 2-Pole, 3-Wire Receptacle	<input type="checkbox"/> 274__ A, B, LA, V, W	
One 3-Way Switch with NEMA 5-15 2-Pole, 3-Wire Receptacle	<input type="checkbox"/> 293__ B, V, W	
One Single-Pole Switch with NEMA 5-20 2-Pole, 3-Wire Receptacle		<input type="checkbox"/> 291__ A, B, V, W

Color Ordering Information

For ordering devices, include Cat. No. followed by the color code: A (Almond), B (Brown), BK (Black), BL (Blue), GY (Gray), LA (Light Almond), RD (Red), RN (Orange), V (Ivory), W (White)

Icon Key

NAFTA Compliant - see page O-30

Accessories for Commercial Specification Grade Toggle Combination Switches

Description	Catalog No.
1-Gang, standard size, duplex 302/304 stainless steel receptacle wallplate	<input type="checkbox"/> 93101 •
1-Gang, standard size, duplex unbreakable nylon receptacle wallplate, white	<input type="checkbox"/> 5132W •

Specification & HP Rating
Information:

120/277V Commercial
Toggle Combination: D-37

D-16



93101



5132W

Switch solutions built tough for dependable motor control

Arrow Hart's comprehensive offering of Industrial Specification Grade manual motor control switches are engineered to provide reliable performance in industrial applications.



Manual Motor Control Switch AH7810UD, AH6810U

Compact, rugged design designed for versatile use in industrial applications

Two sets of contacts per pole distribute load energy, improving heat dissipation and providing reliable service

Heavy-duty zinc-plated strap provides durability and corrosion-resistance



2-pole & 3-pole 30A 600V/AC models available

Front-wire screw termination

Removable terminal screws easily accommodate fork or ring terminals

Heavy-duty brass contact arms with large silver-cadmium buttons

Manual Motor Control Switch AH6808UDAC, AH6808UCO

Compact construction fits all standard boxes, wallplates and covers

2-pole 30A & 40A 600V/AC models available

Heavy-duty zinc-plated strap provides durability and corrosion-resistance

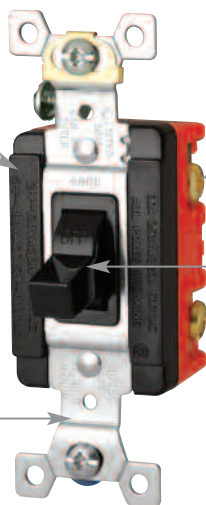

Back and side-wire screw terminations

Rugged impact-resistance thermoplastic toggle

Provided with wrap-around terminal shield to provide insulation for single-gang box installation

**Manual Motor Control Switch AHMC 40 & 60 Series**

Most compact high amperage motor control switch available

Available with screw clamp or box lug terminals

Rugged, impact-resistant glass-filled nylon construction

2-pole & 3-pole 40A & 60A 600V/AC models available

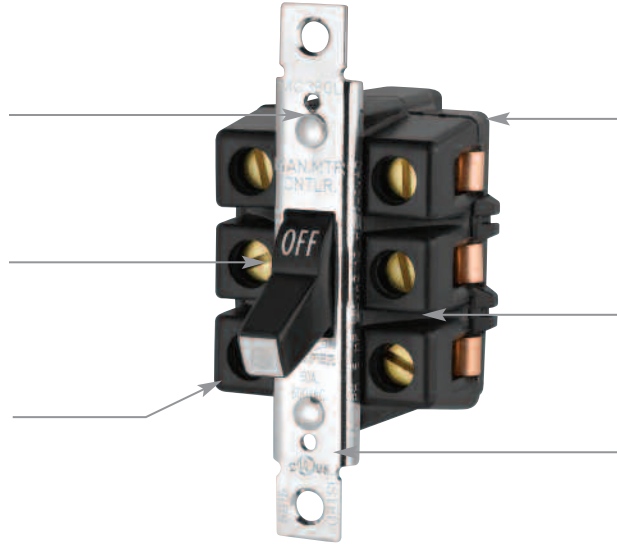

Two sets of contacts per pole distribute load energy, improving heat dissipation and providing reliable service

Heavy duty brass contact arms with large silver-cadmium buttons

Heavy-duty zinc-plated strap provides durability and corrosion-resistance

60A model provided with box lug terminations

Manual Motor Control Switch AH4371, AH4361

Unique three-position, double throw, maintained contact design

Durable thermoset plastic base and cover

2-pole, 5A, 10A, 20A, & 30A 125/250V/AC/DC models available

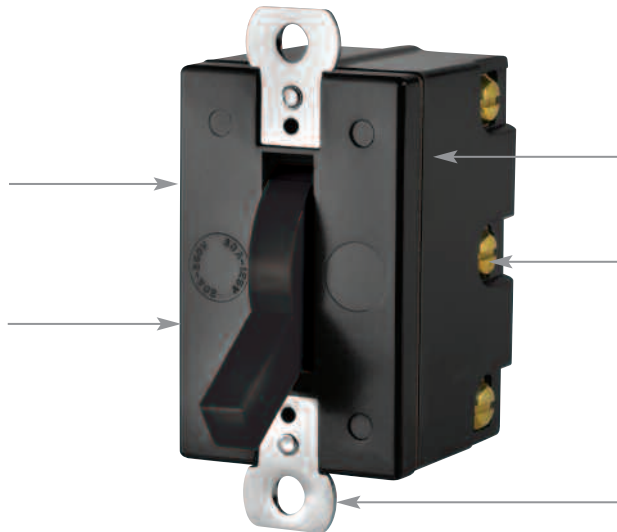

Heavy-duty brass contacts

Rugged brass terminals and terminal screws









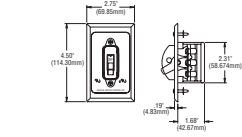

Zinc-plated strap provides durability and corrosion-resistance

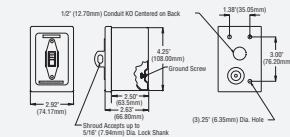
Motor Control Switch Quick Reference Guide

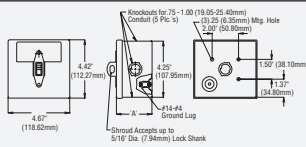
Amps	Volts	Poles	Max. AWG Wire Size	Switch Cat. No.	With Cover Plate	With NEMA 1 Enclosure	With NEMA 3R Enclosure	With NEMA 3, 7 & 9 Enclosure
30	600	2	10	AH6810U	AH6810F	AH6810G	AH6810W	AH6810E
30	600	3	10	AH7810UD*	AH7810FD	AH7810GD	AH7810WD	AH7810ED
40	600	2	8	AH6808UCO	—	—	—	—
40	600	2	8	AHMC240C	—	AHMC240C-1	AHMC240C-3	—
40	600	2	4	AHMC240L	—	AHMC240L-1	AHMC240L-3	—
40	600	3	8	AHMC340C	—	AHMC340C-1	AHMC340C-3	—
40	600	3	4	AHMC340L	—	AHMC340L-1	AHMC340L-3	—
60	600	2	4	AHMC260L	—	AHMC260L-1	AHMC260L-3	—
60	600	3	4	AHMC360L	—	AHMC360L-1	AHMC360L-3	—
10/20	250/125 AC/DC	2	10	AH4361	—	AH27940G	—	—
20/30	250/125 AC/DC	2	10	AH4371	—	—	—	—
20/30	600/250	2	10	AH6808UDAC	AH6808FDAC	AH6808GDAC	AH6808WDAC	—

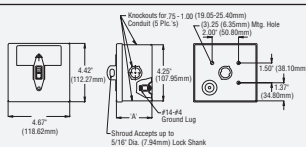
* For NEMA 4X stainless steel enclosure, see X-Switch™ on page D-25

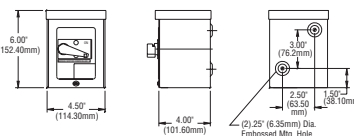
Motor Control Switch Enclosure Quick Reference Guide

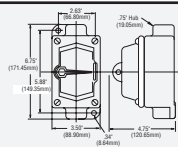
NEMA Type	Description	Catalog No.	Visual Reference	Drawing (Larger versions available in Technical Reference, page O-22)
—	Cover Plate	—		
Type 1	NEMA 1 Enclosure, Single Gang	AHN1GD		
Type 1	NEMA 1 Enclosure, Double Gang	AHN1GD2		
Type 1	NEMA 1 Enclosure, Double Gang Extra Deep	AHN1GD2D		
Type 3R	NEMA 3R Enclosure	AHN3WD		
Type 3, 7 & 9	Type 3, 7 & 9 Enclosure, Class 1, Div 1&2, Groups C, D, Class II, Groups E, F, G	—		

Industrial Specification Grade Manual Motor Controllers

30A, 600V/AC
Double-Pole & 3-Pole

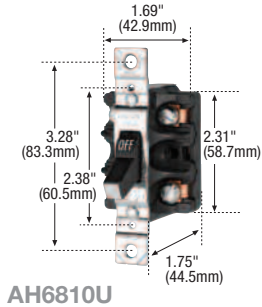

AH6810U

Two-Position, Maintained Contact, Single Throw

Double-Pole, Single-Phase, 30 Amp

Rating A V	Description	Termination Style	Max. AWG Wire Size	Catalog No.	
30 600V/AC	Switch only	Front wired screw	#10 AWG	<input type="checkbox"/> AH6810U	
	Switch in NEMA Type 1 enclosure	Front wired screw	#10 AWG	<input type="checkbox"/> AH6810G	
	Switch in NEMA Type 3R enclosure	Front wired screw	#10 AWG	<input type="checkbox"/> AH6810W*	
	Switch in NEMA Type 3, 7 & 9 enclosure for hazardous enclosures Class I, Div. 1 & 2, Groups C, D Class II, Groups E, F, G	Front wired screw	#10 AWG	<input type="checkbox"/> AH6810E	

*For Canada, order Cat. No. AH6810WR
Type 3, 7, 9 enclosure: iron back box with galvanized and acrylic paint finish copperless aluminum

Horsepower Rated for Motor Loads per UL 508

	120V/AC	240V/AC	480V/AC	600V/AC
HP	2 HP	5 HP	7.5 HP	7.5 HP

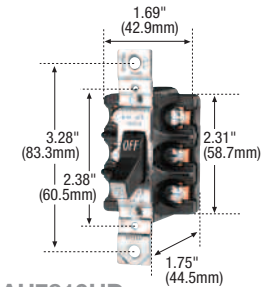

AH7810UD

Two-Position, Maintained Contact, Single Throw

3-Pole, 3-Phase, 30 Amp

Rating A V	Description	Termination Style	Max. AWG Wire Size	Catalog No.	
30 600V/AC	Switch only	Front wired screw & clamp	#10 AWG	<input type="checkbox"/> AH7810UD	
	Switch with cover plate for flush mounting	Front wired screw & clamp	#10 AWG	<input type="checkbox"/> AH7810FD	
	Switch in NEMA Type 1 single-gang enclosure	Front wired screw & clamp	#10 AWG	<input type="checkbox"/> AH7810GD	
	Switch in NEMA Type 1 double-gang enclosure	Front wired screw & clamp	#10 AWG	<input type="checkbox"/> AH7810GDB	
	Switch in NEMA Type 3R enclosure	Front wired screw & clamp	#10 AWG	<input type="checkbox"/> AH7810WD	
	Switch in NEMA Type 3, 7 & 9 enclosure for hazardous enclosures Class I, Div. 1 & 2, Groups C, D Class II, Groups E, F, G	Front wired screw & clamp	#10 AWG	<input type="checkbox"/> AH7810ED	

Type 3, 7, 9 enclosure: iron back box with galvanized steel and acrylic paint finish copperless aluminum
Also available in Type 4X enclosure (see page D-25)

Horsepower Rated for Motor Loads per UL 508

	120V/AC	240V/AC	480V/AC	600V/AC
HP	3 HP	7.5 HP	15 HP	15 HP



AH7810WD

Icon Key

NAFTA Compliant - see page O-30

Accessories for 30A Manual Motor Controllers

Description	Catalog No.	
Wet-location plastic 1-gang weather protective flush mount toggle switch cover	<input type="checkbox"/> S2983	
Cast aluminum single gang 3-hole powder coated back box	<input type="checkbox"/> 1113	



S2983



1113

Specification Information:

AH6800 & AH7800 Series: D-38

**Industrial Specification
Grade Manual Motor
Controllers**

40A, 600V/AC
Double-Pole

Two-Position, Maintained Contact, Single Throw

Double-Pole, Single-Phase, 40 Amp



Rating A V	Description	Termination Style	Max. AWG Wire Size	Catalog No.
40 600V/AC	Switch only	Back & side wired screw	#8 AWG (w/ring term.)	<input type="checkbox"/> AH6808UCO •

Horsepower Rated for Motor Loads per UL 508

	120V/AC	240V/AC	480V/AC	600V/AC
HP	—	5 HP	—	—

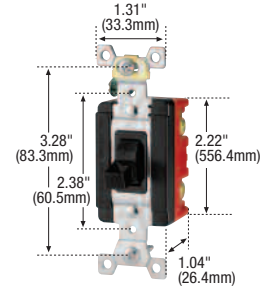

AH6808UCO

Two-Position, Maintained Contact, Single Throw

Double-Pole, Single-Phase, 40 Amp



Rating A V	Description	Termination Style	Max. AWG Wire Size	Catalog No.
40 600V/AC	Switch only	Side wired screw & clamp	#8 AWG	<input type="checkbox"/> AHMC240C •
	Switch in NEMA Type 1 enclosure	Side wired screw & clamp	#8 AWG	<input type="checkbox"/> AHMC240C-1 •
	Switch in NEMA Type 3R enclosure	Side wired screw & clamp	#8 AWG	<input type="checkbox"/> AHMC240C-3 •
40 600V/AC	Switch only	Side wired box lug	#4 AWG	<input type="checkbox"/> AHMC240L •
	Switch in NEMA Type 1 enclosure	Side wired box lug	#4 AWG	<input type="checkbox"/> AHMC240L-1 •
	Switch in NEMA Type 3R enclosure	Side wired box lug	#4 AWG	<input type="checkbox"/> AHMC240L-3 •

Horsepower Rated for Motor Loads per UL 508

	120V/AC	240V/AC	480V/AC	600V/AC
HP	3 HP	5 HP	15 HP	15 HP

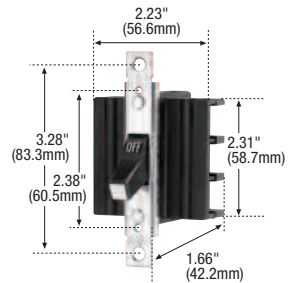

AHMC240C

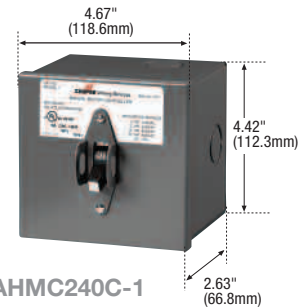

AHMC240C-1

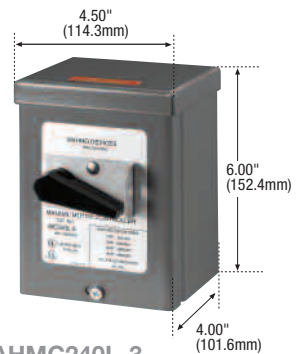

AHMC240L-3

Icon Key

NAFTA Compliant - see page O-30

Accessories for 40A Manual Motor Controllers

Description	Catalog No.
Empty enclosure, NEMA Type 1 single-gang	<input type="checkbox"/> AHN1GD •
Empty enclosure, NEMA Type 3R	<input type="checkbox"/> AHN3WD •
Wet-location plastic 1-gang weather protective flush mount toggle switch cover	<input type="checkbox"/> S2983 •
Cast aluminum single gang 3-hole powder coated back box	<input type="checkbox"/> 1113 •
1-Gang, standards size 302/304 stainless steel wallplate	<input type="checkbox"/> 93071 •



AHN1GD



AHN3WD



S2983

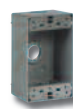

1113



93071

Specification Information:

AH6800 Series: D-38

AHMC200 Series: D-38

Industrial Specification Grade Manual Motor Controllers

40A, 600V/AC
3-Pole

Two-Position, Maintained Contact, Single Throw

3-Pole, 3-Phase, 40 Amp



Rating A V	Description	Termination Style	Max. AWG Wire Size	Catalog No.
40 600V/AC	Switch only	Side wired	#8 AWG	<input type="checkbox"/> AHMC340C •
	Switch in NEMA Type 1 enclosure	Side wired	#8 AWG	<input type="checkbox"/> AHMC340C-1 •
	Switch in NEMA Type 3R enclosure	Side wired	#8 AWG	<input type="checkbox"/> AHMC340C-3 •
40 600V/AC	Switch only	Side wired box lug	#4 AWG	<input type="checkbox"/> AHMC340L •
	Switch in NEMA Type 1 enclosure	Side wired box lug	#4 AWG	<input type="checkbox"/> AHMC340L-1 •
	Switch in NEMA Type 3R enclosure	Side wired box lug	#4 AWG	<input type="checkbox"/> AHMC340L-2 •

Horsepower Rated for Motor Loads per UL 508

	120V/AC	240V/AC	480V/AC	600V/AC
HP	3 HP	7.5 HP	15 HP	20 HP

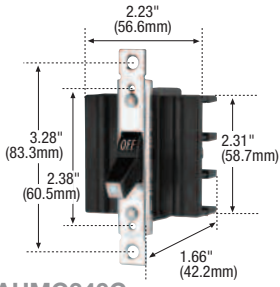

AHMC340C

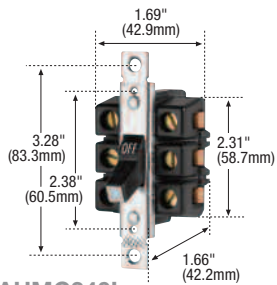

AHMC340L

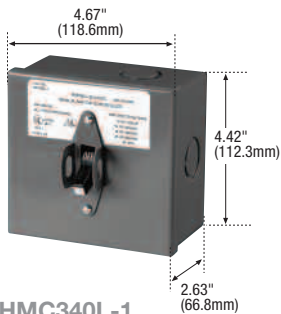

AHMC340L-1

Icon Key

NAFTA Compliant - see page O-30

Accessories for 40A Manual Motor Controllers

Description	Catalog No.
Empty enclosure, NEMA Type 1 single-gang	<input type="checkbox"/> AHN1GD •
Empty enclosure, NEMA Type 1 double-gang	<input type="checkbox"/> AHN1GD2 •
Empty enclosure, NEMA Type 3R	<input type="checkbox"/> AHN3WD •
Wet-location plastic 1-gang weather protective flush mount toggle switch cover	<input type="checkbox"/> S2983 •
1-Gang, standard size, toggle switch, 302/304 stainless steel wallplate	<input type="checkbox"/> 93071 •



AHN1GD



AHN1GD2



AHN3WD



S2983



93071

Specification Information:

AHMC300 Series: D-38

**Industrial Specification
Grade Manual Motor
Controllers**

60A, 600V/AC
Double-Pole & 3-Pole

Two-Position, Maintained Contact, Single Throw

Double-Pole, Single-Phase, 60 Amp



Rating A V	Description	Termination Style	Max. AWG Wire Size	Catalog No.	
60 600V/AC	Switch only	Side wired box lug	#4 AWG	<input type="checkbox"/> AHMC260L	•
	Switch in NEMA Type 1 enclosure	Side wired box lug	#4 AWG	<input type="checkbox"/> AHMC260L-1	•
	Switch in NEMA Type 3R enclosure	Side wired box lug	#4 AWG	<input type="checkbox"/> AHMC260L-3	•

Horsepower Rated for Motor Loads per UL 508

	120V/AC	240V/AC	480V/AC	600V/AC
HP	3 HP	5 HP	15 HP	15 HP

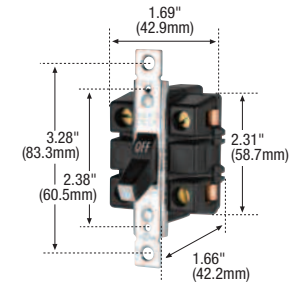

AHMC260L



AHMC260L-1

Two-Position, Maintained Contact, Single Throw

3-Pole, 3-Phase, 60 Amp



Rating A V	Description	Termination Style	Max. AWG Wire Size	Catalog No.	
60 600V/AC	Switch only	Side wired box lug	#4 AWG	<input type="checkbox"/> AHMC360L	•
	Switch in NEMA Type 1 enclosure	Side wired box lug	#4 AWG	<input type="checkbox"/> AHMC360L-1	•
	Switch in NEMA Type 3R enclosure	Side wired box lug	#4 AWG	<input type="checkbox"/> AHMC360L-3	•

Horsepower Rated for Motor Loads per UL 508

	120V/AC	240V/AC	480V/AC	600V/AC
HP	5 HP	10 HP	25 HP	30 HP

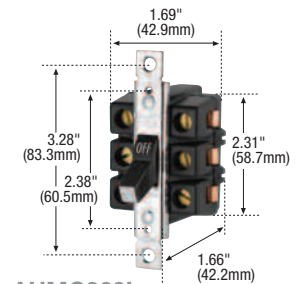

AHMC360L

Icon Key

NAFTA Compliant - see page O-30

Accessories for 60A Manual Motor Controllers

Description	Catalog No.	
Empty enclosure, NEMA Type 1 single-gang	<input type="checkbox"/> AHN1GD	•
Empty enclosure, NEMA Type 3R	<input type="checkbox"/> AHN3WD	•
Wet-location plastic 1-gang weather protective flush mount toggle switch cover	<input type="checkbox"/> S2983	•
Cast aluminum single gang 3-hole powder coated back box	<input type="checkbox"/> 1113	•
1-Gang, standards size 302/304 stainless steel wallplate	<input type="checkbox"/> 93071	•



AHN1GD



AHN3WD



S2983

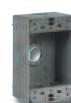

1113



93071

Specification Information:

AHMC200 & AHMC300
Series: D-38

Industrial Specification Grade Manual Motor Controllers

10/20A, 250/125V/AC or DC
20/30A, 250/125V/AC or DC
20/30A, 600/250V/AC
Double-Pole

Three-Position, Two-Circuit, Double Throw Maintained Contact

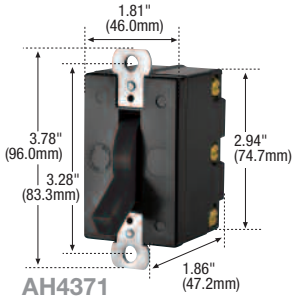

Double-Pole, Single-Phase 10/20 Amp



Rating A V	Description	Termination Style	Max. AWG Wire Size	Catalog No.	Color
10 250V/AC/DC 20 125V/AC/DC	Switch, center "Off"	Side wired screw	#10 AWG	<input type="checkbox"/> AH4361	Black
	Switch, center "Off", in NEMA Type 1 enclosure	Side wired screw	#10 AWG	<input type="checkbox"/> AH27940G	—

Horsepower Rated for Motor Loads per UL 508

	240V/AC	250V/AC/DC	250V/DC
HP	2 HP	—	1.5 HP

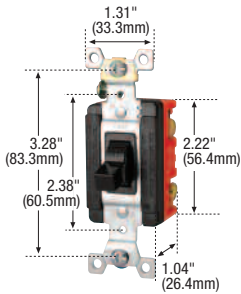

Double Pole, Single-Phase 20/30 Amp



Rating A V	Description	Termination Style	Max. AWG Wire Size	Catalog No.	Color
20 250V/AC/DC 30 125V/AC/DC	Switch, center "Off"	Side wired screw	#10 AWG	<input type="checkbox"/> AH4371	Black

Horsepower Rated for Motor Loads per UL 508

	240V/AC	250V/AC/DC	250V/DC
HP	—	2 HP	—

Two-Position, Maintained Contact, Single Throw

Double Pole, Single-Phase, 20/30 Amp



Rating A V	Description	Termination Style	Max. AWG Wire Size	Catalog No.
20 600V/AC 30 250V/AC	Switch only	Back & side wired screw	#10 AWG	<input type="checkbox"/> AH6808UDAC •
	Switch with cover plate for flush mounting	Back & side wired screw	#10 AWG	<input type="checkbox"/> AH6808FDAC •
	Switch in NEMA Type 1 enclosure	Back & side wired screw	#10 AWG	<input type="checkbox"/> AH6808GDAC •
	Switch in NEMA Type 3R copperless aluminum enclosure	Back & side wired screw	#10 AWG	<input type="checkbox"/> AH6808WDAC •

Horsepower Rated for Motor Loads per UL 508

	120V/AC	240V/AC	480V/AC	600V/AC
HP	2 HP	3 HP	5 HP	7.5 HP



Specification Information:

AH6800 Series: D-38

Icon Key

NAFTA Compliant - see page O-30

The only NSF Splash Zone Certified motor control switch on the market

Designed specifically around the needs of industrial processing areas, Arrow Hart's X-Switch is the ideal motor control solution for food and beverage and complex environments.

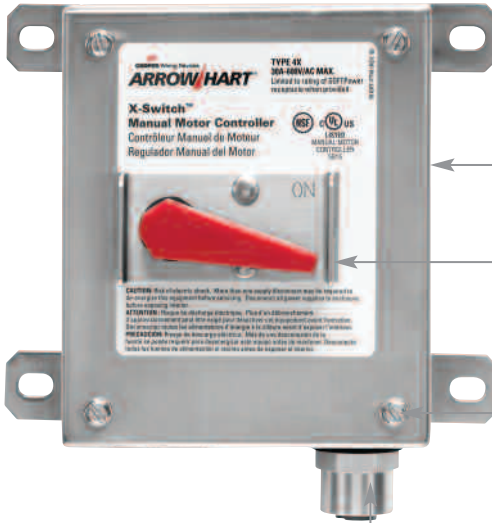

Durable compact stainless steel Type 4X enclosure is ideal for washdown environments

Lockable handle to meet OSHA lockout/tagout requirements

Retained quick-drive slotted hex bolts for quick cover removal

Available with pre-wired SOFTPower™ connectivity for easy motor installation and changeout



ARROW/HART™ X-SWITCH™

NSF Listed for use in food processing splash zone areas per NSF 3-A 14159-1 standard



Continuous silicone gasket provides reliable seal preventing ingress of water and contaminants

Reliable heavy-duty AH7810 30A* switch for durability and longevity

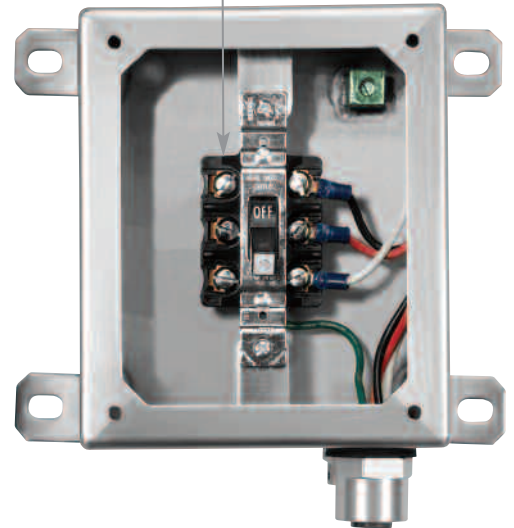

Multiple input & output configurations available

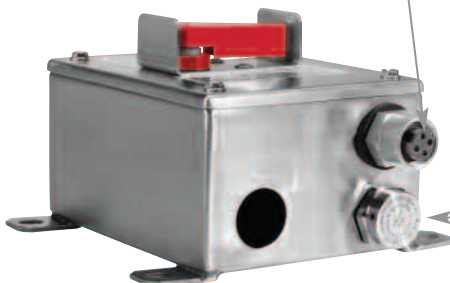

View of Bottom

Optional stainless steel Type 4X breather drain reduces condensation inside enclosure

**When used with SOFTPower ratings will be limited by the SOFTPower items used with the switch.*

Short-Circuit Current Ratings up to 50kA

Industrial Specification Grade NSF Certified Motor Control Switch

Type 4X
30A, 600V/AC Max.
3-Pole, 3-Phase

FEATURES

- NSF listed for use in food processing splash zone areas per NSF 3-A 14159-1 standard.
- Lockable handle to meet OSHA Lockout/Tagout requirements.
- Compact size and minimal footprint ideal for installation versatility in industrial environments.
- Stainless steel enclosure and continuous silicone gasket provide reliable NEMA Type 4X protection even when exposed to the harshest environments.
- Smooth exterior finish and continuous welded seams reduce standing water and collection of contaminants that can promote bacteria growth.
- Heavy-duty 30A switch rated up to 15HP at 600V AC and short-circuit current rated up to 50kA.
- Specially designed mounting feet provide 1/4" spacing from mounting surface to prevent contaminants from collecting behind enclosure.



X-Switch™ Motor Control Switch

3-Pole, 30 Amp, 600V/AC



Ordering Matrix

Sample Number:

AH7810XC14S =
Arrow Hart Type 4X 10A switch,
3/4" pre-drilled thru hole input,
SOFTPower female receptacle
output with breather/drain.

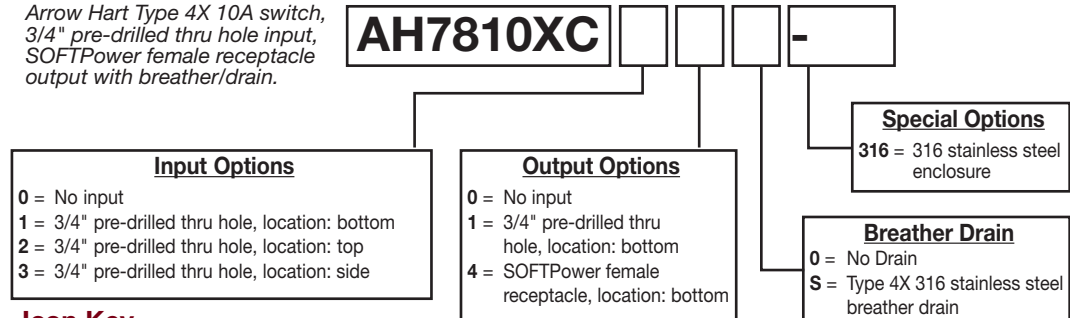

Icon Key

NAFTA Compliant - see page O-30

Accessories for X-Switch

Description	Catalog No.	
Stainless steel breather drain	<input type="checkbox"/> AH7810XC-SSBD	•
X-Switch adapter plate, for mounting to hole locations of Hubbell HBLDS3 switch	<input type="checkbox"/> AH7810XC-APH	•
X-Switch 1" offset spacer kit	<input type="checkbox"/> AH7810XC-SPCR	•
SOFTPower Inlet (male receptacle), 10A 600V/AC, 4-Pole Mini Connector	<input type="checkbox"/> AHMR4E4BC005MX	•
SOFTPower Outlet (female receptacle), 10A 600V/AC, 4-Pole Mini Connector	<input type="checkbox"/> AHMR4D4BC005MX	•
SOFTPower Cordset, 1m long, 10A 600V/AC 4-Pole Mini Connector (male 90° to female straight)	<input type="checkbox"/> AHML4H4TC010MX	•
SOFTPower Cordset, 2m long, 10A 600V/AC 4-Pole Mini Connector (male 90° to female straight)	<input type="checkbox"/> AHML4H4TC020MX	•
SOFTPower Cordset, 3m long, 10A 600V/AC 4-Pole Mini Connector (male 90° to female straight)	<input type="checkbox"/> AHML4H4TC030MX	•
SOFTPower Cordset, 4m long, 10A 600V/AC 4-Pole Mini Connector (male 90° to female straight)	<input type="checkbox"/> AHML4H4TC040MX	•



Specification Information:

X-Switch Motor
Controller Switch: D-39

Safe, dependable disconnect switch solutions

Compact and durable, industrial non-fused switches combine a horsepower-rated switch with a durable watertight enclosure.



Non-Fused Manual Disconnect Switches

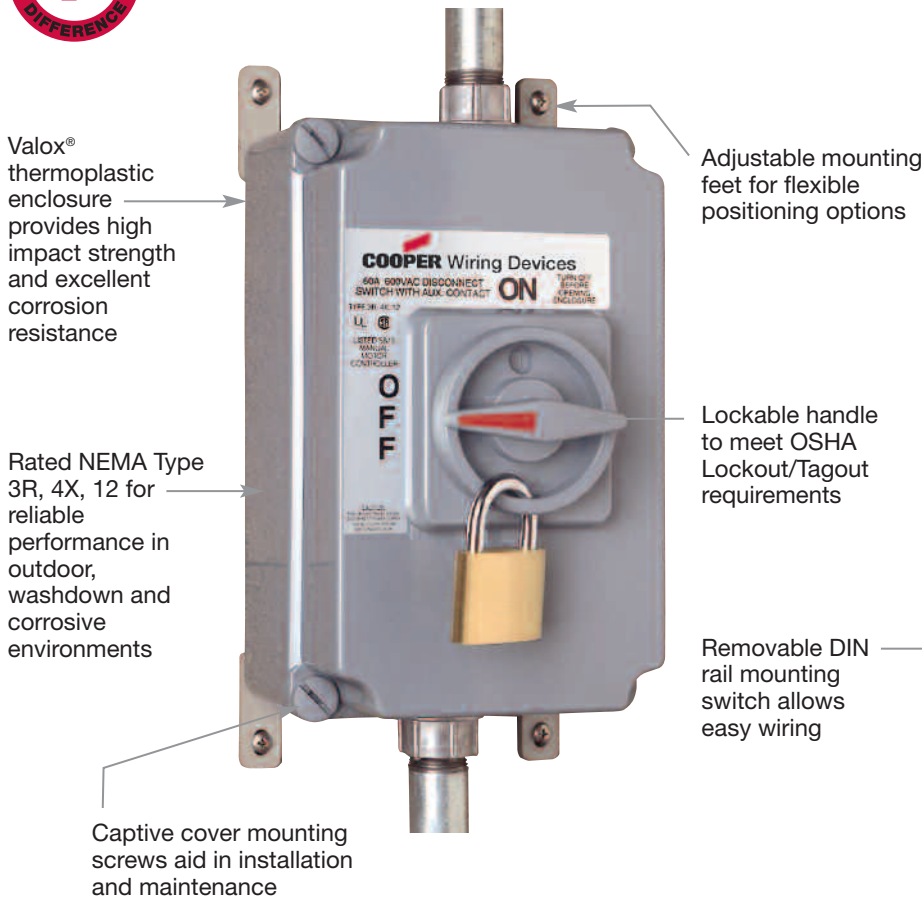

Valox® thermoplastic enclosure provides high impact strength and excellent corrosion resistance

Rated NEMA Type 3R, 4X, 12 for reliable performance in outdoor, washdown and corrosive environments

Captive cover mounting screws aid in installation and maintenance

Meets NEC® Article 430 requirements for separate disconnect means within line sight of motor loads

Adjustable mounting feet for flexible positioning options

Lockable handle to meet OSHA Lockout/Tagout requirements

Removable DIN rail mounting switch allows easy wiring

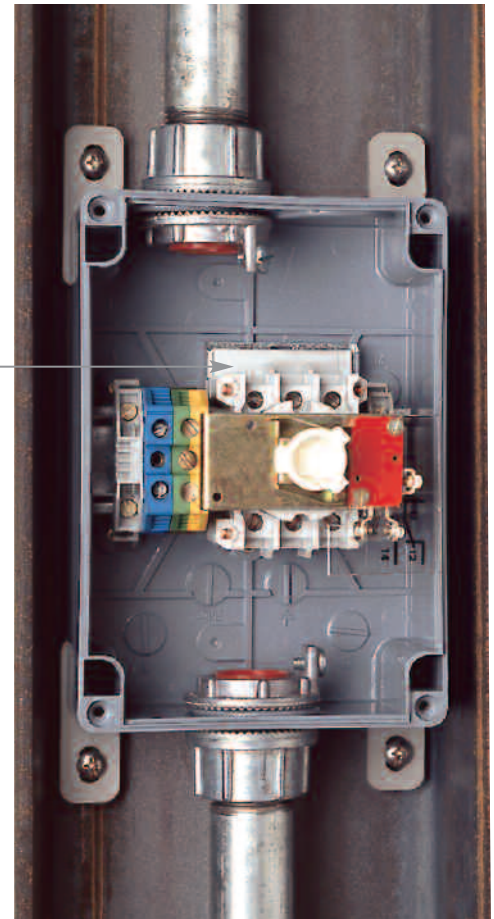

30A non-fused disconnects comply with UL 508

Short-Circuit Current Ratings

- 30A Switch: 10kA, 600V/AC max. when protected by 80A class RK5 fuse
- 60A Switch: 10kA, 600V/AC max. when protected by 110A class RK5 fuses
- 100A Switch: 10kA, 600V/AC max. when protected by 250A RK1 fuses

Valox® is a registered trademark of General Electric, USA.

Superior performance designed for tough industrial use

Heavy-duty horsepower-rated disconnect switches in tough watertight, corrosion- and heat-resistant enclosures specifically designed to provide fused switch control.

Fused Manual Disconnect Switches



Rated NEMA Type 3R, 4X, 12 for reliable performance in outdoor, washdown and corrosive environments

Trunk latch accessory prevents unauthorized removal of cover

Captive stainless steel cover mounting screws are sealed with o-rings and aid in installation and maintenance

Rugged Krydon® fiberglass-reinforced polyester enclosure has high impact strength and corrosion resistance

Removable hinged and gasketed cover

Adjustable mounting feet for flexible positioning options

Lockable handle accepts up to three padlocks to meet OSHA Lockout/Tagout requirements

Meets NEC® Article 430 requirements for separate disconnect means within line sight of motor loads

Class J fuses; “no touch” fuse and switch contacts can only be accessed with switch in “Off” position

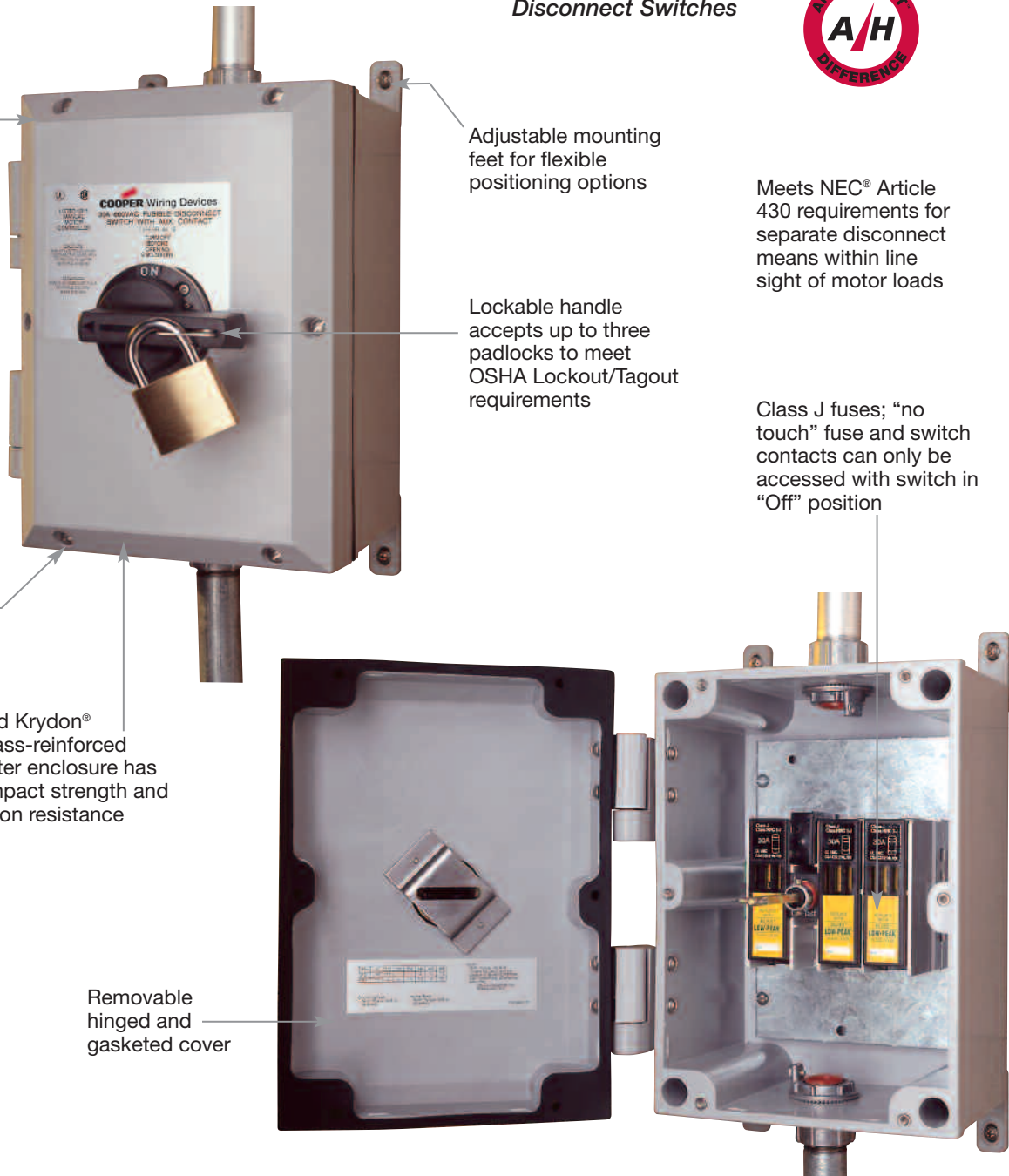

Short-Circuit Current Ratings

Suitable for use on a circuit capable of delivering up to 100kA R.M.S.
Symmetrical, 600V/AC max.

Krydon® is a registered trademark of Cooper Crouse-Hinds.

**Industrial Specification
Grade Enclosed
Manual Disconnects**

30A, 60A & 100A, 600V/AC Max.
Single-Phase & 3-Phase

Non-Fused Disconnect Switches

Single-Phase/3-Phase, 30 Amp



Rating		Description	Catalog No.
A	Max. V		
30	600V/AC	Non-Fused Disconnect Switch without Auxiliary Contacts	<input type="checkbox"/> AH30MS1B
		Non-Fused Disconnect Switch with Auxiliary Contacts	<input type="checkbox"/> AH30MS1B-M2

Horsepower Rated for Motor Loads per UL 508

	120V/AC	200V/AC	208V/AC	240V/AC	480V/AC	600V/AC
Single-Phase	2 HP	5 HP	—	5 HP	—	—
3-Phase	—	10 HP	10 HP	10 HP	20 HP	30 HP

Single-Phase/3-Phase, 60 Amp



Rating		Description	Catalog No.
A	Max. V		
60	600V/AC	Non-Fused Disconnect Switch without Auxiliary Contacts	<input type="checkbox"/> AH60MS2B
		Non-Fused Disconnect Switch with Auxiliary Contacts	<input type="checkbox"/> AH60MS2B-M2

Horsepower Rated for Motor Loads per UL 508

	120V/AC	200V/AC	208V/AC	240V/AC	480V/AC	600V/AC
Single-Phase	3 HP	7.5 HP	—	10 HP	—	—
3-Phase	—	15 HP	15 HP	20 HP	40 HP	50 HP



AH60MS2B

3-Phase, 100 Amp

Rating		Description	Catalog No.
A	Max. V		
100	600V/AC	Non-Fused Disconnect Switch with Auxiliary Contacts	<input type="checkbox"/> AH100MS2-M2

Horsepower Rated for Motor Loads per UL 508

	240V/AC	480V/AC	600V/AC
3-Phase	25 HP	50 HP	50 HP

Accessories for Non-Fused Disconnect Switches

Description	Catalog No.
Auxiliary contacts for 30A: 1 NO, 1 NC, 6A 250V	<input type="checkbox"/> AH30AUXB
Auxiliary contacts for 60A: 1 NO, 1 NC, 6A 250V	<input type="checkbox"/> AH60AUXB
Replacement switch for 30A disconnects	<input type="checkbox"/> AHBR30ANF
Replacement mounting feet kit for 30A & 60A disconnects	<input type="checkbox"/> AHMSF

Industrial Specification Grade Enclosed Manual Disconnects

30A, 600V/AC Max.
Single-Phase & 3-Phase

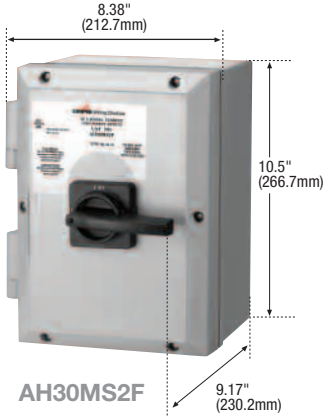

Fused Disconnect Switches

3-Phase, 30 Amp

Rating	A	Max. V	Description	Catalog No.
30	600V/AC		Fused (Class J) Disconnect Switch without Auxiliary Contacts	<input type="checkbox"/> AH30MS2F
			Fused (Class J) Disconnect Switch with Auxiliary Contacts	<input type="checkbox"/> AH30MS2F-M2

Horsepower Rated for Motor Loads per UL 508

	110V/AC	200V/AC	208V/AC	240V/AC	480V/AC	600V/AC
Standard HP	1.5 HP	—	—	3 HP	5 HP	7.5 HP
Maximum HP	3 HP	5 HP	7.5 HP	7.5 HP	15 HP	20 HP

Icon Key

NAFTA Compliant - see page O-30

Accessories for Fused Disconnect Switches

Description	Catalog No.
Replacement mounting feet kit for 30A & 60A disconnects	<input type="checkbox"/> AHMSF

**Industrial
Specification Grade
AC Toggle Switches**

15A & 20A, 120/277V/AC; 15 & 20A, 347V/AC
30A, 120/377V/AC
Single-Pole, Double-Pole, 3-Way, 4-Way

	Switch Type	Industrial 15A & 20A 120/277V Toggle Switches AH1200 & AH1220 Series	Industrial 15A & 20A 347V Toggle Switches AH18200 Series	Industrial 30A 120/277V Toggle Switches 3030 Series
	Wiring Type	Back & side wire	Back & side wire	Back & side wire
	Testing & Code Compliance	• cULus listed to UL 20, file no. E18704	• Listed to UL 20, file no. E135162	• cULus listed to UL 20, file no. E18704
		• UL verified to Federal Spec WS-896-E	• UL verified to Federal Spec WS-896-E	• UL verified to Federal Spec WS-896-E
		• CSA certified to C22.2, no. 111, file no. 10016 (6241-05)	• CSA certified to C22.2, no. 111, file no. 12339 (6241-05)	• CSA certified to C22.2, no. 111, file no. 10016 (6241-05)
Specifications: Environmental	Flammability	Meets UL 94 requirements; V0 rated	Meets UL 94 requirements; V0 rated	Meets UL 94 requirements; V0 rated
	Temperature Rating	-20°C to 60°C (-4°F to 140°F)	-20°C to 60°C (-4°F to 140°F)	-20°C to 60°C (-4°F to 140°F)
Specifications: Electrical	Dielectric Voltage	Withstands 1500V per UL 20	Withstands 1500V per UL 20	Withstands 1500V per UL 20
	Current Interrupting	Yes, at full-rated current	Yes, at full-rated current	Yes, at full-rated current
	Temperature Rise	Max. 30°C (86°F) after 100 cycles of overload and 30,000 cycles of endurance testing	Max. 30°C (86°F) after 100 cycles of overload and 30,000 cycles of endurance testing	Max. 30°C (86°F) after 100 cycles of overload and 30,000 cycles of endurance testing
Specifications: Mechanical	Terminal Accommodation	#14 - 10 AWG	#14 - 10 AWG	#14 - 10 AWG
	Voltage Ratings	Permanently marked on device	Permanently marked on device	Permanently marked on device
	Horsepower Ratings	Rated for motor loads per UL 20: 15A: @ 120V/AC = 1/2 HP, @ 240V/AC = 2 HP; max. amps 12A 20A: @ 120V/AC = 1 HP, @ 240V/AC = 2 HP; max. amps 16A	Rated for motor loads per UL 20: 15A: @ 120V/AC = 1/2 HP, @ 240V/AC = 2 HP; max. amps 12A 20A: @ 120V/AC = 1 HP, @ 240V/AC = 2 HP; max. amps 16A	Rated for motor loads per UL 20: 30A: @ 120V/AC = 1 HP, @ 240V/AC = 2 HP; max. amps 24A
Materials:	Toggle	Urea	Polycarbonate	Urea
	Top Housing	Urea, color-coded by amperage	Phenolic	Urea, color-coded green
	Bottom Housing	Phenolic	Phenolic	Phenolic
	Strap	0.05" thick galvanized steel	0.05" thick galvanized steel	0.050" thick galvanized steel
	Auto Ground Clip	0.030" thick brass	0.016" thick brass	0.030" thick brass
	Terminals	0.031" thick brass	0.032" thick high performance copper alloy	0.032" thick high performance copper alloy
	Terminal Screws	#8-32 brass, black	#10-32 brass, black	#8-32 brass, neutral screw nickel plated
	Ground Screw	#8-32 steel, zinc plated, green	#8-32 steel, zinc plated, green	#8-32 brass, green
	Backwire Clamp	0.030" thick brass	0.040" thick brass	0.030" thick brass
	Contacts	Silver alloy	Silver alloy	Silver alloy
	Moveable Contact Arm	0.031" thick brass	0.031" thick brass	0.031" thick brass
	Pressure Plate	0.068" thick brass	0.068" thick brass	0.068" thick brass
	Illuminated Models	Long-life neon bulb	N/A	Long-life neon bulb
	Pilot Light Models	Red polycarbonate toggle with long-life neon bulb	N/A	Red polycarbonate toggle with long-life neon bulb

**Industrial Specification
Grade Three-Position
AC Toggle Switches**

15A, 20A & 30A, 120/277V/AC
Maintained & Momentary Contact
Single-Pole & Double-Pole

	Switch Type	Industrial 15A & 20A 120/277V Maintained Contact Switches 1205 & 2220 Series	Industrial 15A & 20A 120/277V Momentary Contact Switches AH1890 & AH1990 Series
	Wiring Type	Back & side wire	Back & side wire
	Testing & Code Compliance	<ul style="list-style-type: none"> • 1205: Listed to UL 508, file no. E156836 • 2220 series: cULus Listed to UL 210, file no. E18704 	<ul style="list-style-type: none"> • Listed to UL 508, file no. E135162
		<ul style="list-style-type: none"> • 2220 series: UL verified to Federal Spec. WS-896 	<ul style="list-style-type: none"> • UL verified to Federal Spec. WS-896E
		<ul style="list-style-type: none"> • 1205: CSA certified C22.1, no.111 	<ul style="list-style-type: none"> • CSA certified C22.1, no. 111
		<ul style="list-style-type: none"> • NOM certified 	<ul style="list-style-type: none"> • NOM certified
Specifications: Environmental	Flammability	Meets UL94 requirements; V2 rated	Meets UL94 requirements; V0 rated
	Temperature Rating	-20°C to 65°C (-4°F to 149°F)	-20°C to 60°C (-4°F to 140°F)
Specifications: Electrical	Dielectric Voltage	Withstands 1500V per UL20	Withstands 1500V per UL20
	Current Interrupting	Yes, at full-rated current	Yes, at full-rated current
	Temperature Rise	Max. 30°C (86°F) after 100 cycles of overload and 30,000 cycles of endurance testing	Max. 30°C (86°F) after 100 cycles of overload and 30,000 cycles of endurance testing
Specifications: Mechanical	Terminal Accommodation	#14 - 10 AWG	#14 - 10 AWG
	Voltage Ratings	Permanently marked on device	Permanently marked on device
	Horsepower Ratings	Rated for motor loads per UL 20: 15A: @ 120V/AC = 1/2 HP, @ 240V/AC = 2 HP; Max. amps 12A 20A: @ 120V/AC = 1 HP, @ 240V/AC = 2 HP; Max. amps 16A	Rated for motor loads per UL 20: 15A: @ 120V/AC = 1/2 HP, @ 240V/AC = 2 HP; Max. amps 12A 20A: @ 120V/AC = 1 HP, @ 240V/AC = 2 HP; Max. amps 16A
Materials:	Toggle	Urea	Polycarbonate
	Top Housing	Urea	Urea
	Bottom Housing	Phenolic	Urea
	Strap	0.050" thick steel	0.050" thick galvanized steel
	Auto Ground Clip	0.016" thick brass	0.016" thick brass
	Terminals	0.032" thick brass	0.032" thick high performance copper alloy
	Terminal Screws	#8-32 brass	#10-32 brass
	Ground Screw	#8-32 brass, green	#8-32 steel, zinc plated, green
	Backwire Clamp	0.031" thick brass	0.40" thick brass
	Contacts	Silver alloy	Silver alloy
	Moveable Contact Arm	0.032" thick brass	0.018" thick copper
Pressure Plate	0.069" thick brass	0.063" thick steel	

**Industrial
Specification Grade
AC Locking Switches**

15A & 20A, 120/277V/AC; 15 & 20A, 347V/AC
30A, 120/377V/AC
Single-Pole, Double-Pole, 3-Way, 4-Way

	Switch Type	Industrial 20A 120/277V Corbin Locking Switches AH1190N Series	Industrial 15A & 20A 120/277V Locking Switches AH1200L & AH1220L Series	Industrial 30A 120/277V Locking Switches 3030L Series
	Wiring Type	Back & side wire	Back & side wire	Back & side wire
	Testing & Code Compliance	<ul style="list-style-type: none"> cULus Listed to UL 20, file no. E135162 	<ul style="list-style-type: none"> cULus Listed to UL 20, file no. E18704 	<ul style="list-style-type: none"> cULus Listed to UL 20, file no. E18704
		<ul style="list-style-type: none"> UL verified to Federal Spec. WS-896E 	<ul style="list-style-type: none"> UL verified to Federal Spec. WS-896E 	<ul style="list-style-type: none"> UL verified to Federal Spec. WS-896E NOM certified
Specifications: Environmental	Flammability	Meets UL 94 requirements; V0 rated	Meets UL 94 requirements; V0 rated	Meets UL 94 requirements; V0 rated
	Temperature Rating	-20°C to 65°C (-4°F to 149°F)	-20°C to 65°C (-4°F to 149°F)	-20°C to 65°C (-4°F to 149°F)
Specifications: Electrical	Dielectric Voltage	Withstands 1500V per UL 20	Withstands 1500V per UL 20	Withstands 1500V per UL 20
	Current Interrupting	Yes, at full-rated current	Yes, at full-rated current	Yes, at full-rated current
	Temperature Rise	Max. 30°C (86°F) after 100 cycles of overload and 30,000 cycles of endurance testing	Max. 30°C (86°F) after 100 cycles of overload and 30,000 cycles of endurance testing	Max. 30°C (86°F) after 100 cycles of overload and 30,000 cycles of endurance testing
Specifications: Mechanical	Terminal Accommodation	#14 - 12 AWG	#14 - 10 AWG	#14 - 10 AWG
	Voltage Ratings	Permanently marked on device	Permanently marked on device	Permanently marked on device
	Horsepower Ratings	Rated for motor loads per UL 20: 20A: @ 120V/AC = 1 HP, @ 240V/AC = 2 HP; Max. amps 16A	Rated for motor loads per UL 20: 15A: @ 120V/AC = 1/2 HP, @ 240V/AC = 2 HP; Max. amps 12A 20A: @ 120V/AC = 1 HP, @ 240V/AC = 2 HP; Max. amps 16A	Rated for motor loads per UL 20: 30A: @ 120V/AC = 2 HP, @ 240V/AC = 2 HP; Max. amps 24A
Materials:	Lock Dome/Housing	Steel, nickel plated	Glass-filled nylon	Glass-filled nylon
	Top Housing	Urea	Urea	Urea
	Bottom Housing	Urea	Phenolic	Phenolic
	Strap	0.050" steel	0.050" thick steel	0.050" thick steel
	Auto Ground Clip	N/A	0.016" thick brass	0.016" thick brass
	Stationary Terminals	0.042" thick brass	0.032" thick brass	0.032" thick brass
	Terminal Screws	#6-32 brass	#8-32 brass	#8-32 brass
	Ground Screw	#6-32 brass	#8-32 brass	#8-32 brass
	Backwire Clamp	0.062" thick steel	0.62" thick brass	0.062" thick brass
	Contacts	Silver alloy	Silver alloy	Silver alloy
	Moveable Contact Arm	0.042" thick brass	0.032" thick brass	0.032" thick brass

**Industrial & Commercial
 Specification Grade
 REPEL Switches**

15A, 120/277V/AC
 20A, 120/277V/AC
 Single-Pole, Double-Pole, 3-Way, 4-Way

	Switch Type	Industrial 15A & 20A 120/277V REPEL Toggle Switches AH1200_AM & AH1220_AM Series	Commercial 15A & 20A 120/277V REPEL Decorator Switches 7600_AM Series	
	Wiring Type	Side wire & back wire	Side wire & back wire	
	Testing & Code Compliance	<ul style="list-style-type: none"> cULus Listed to UL 20, file no. E18704 UL verified to Federal Spec. WC-8961G UL Certified to C22.2, no. 111 Agion® Antimicrobial Additive Regulatory Approvals: EPA, FDA, NSF, USDA 	<ul style="list-style-type: none"> cULus Listed to UL 20, file no. E18704 UL verified to Federal Spec. WC-896G Agion® Antimicrobial Additive Regulatory Approvals: EPA, FDA, NSF, USDA 	
Specifications: Environmental		Flammability	Meets UL94 requirements; V0 rated	Meets UL94 requirements; V0 rated
		Temperature Rating	-20°C to 60°C (-4°F to 140°F)	-20°C to 60°C (-4°F to 140°F)
Specifications: Electrical		Dielectric Voltage	Withstands 1500V per UL 20	Withstands 1500V per UL 20
	Current Interrupting	Yes, at full-rated current	Yes, at full-rated current	
	Temperature Rise	Max. 30°C (86°F) after 100 cycles of overload and 30,000 cycles of endurance testing	Max. 30°C (86°F) after 100 cycles of overload and 30,000 cycles of endurance testing	
Specifications: Mechanical	Terminal Accommodation	#14 - 10 AWG	#14 - 10 AWG	
	Voltage Ratings	Permanently marked on device	Permanently marked on device	
Materials:	Toggle/Paddle	Polycarbonate with Agion® Antimicrobial Additive	Polycarbonate with Agion® Antimicrobial Additive	
	Top Housing	Phenolic	Polycarbonate with Agion® Antimicrobial Additive	
	Bottom Housing	Phenolic	Polycarbonate	
	Strap	0.050" thick galvanized steel	0.045" thick steel, zinc plated, (yellow chromate on 20A)	
	Auto Ground Clip	Brass	Phosphor bronze	
	Terminals	0.032" thick high performance copper alloy	0.035" thick brass	
	Terminal Screws	#8-32 brass, line screw black	#8-32 screw with #10 head, steel, brass plated; neutral screw nickel plated, line screw black	
	Ground Screw	#8-32 zinc-plated steel, green	#8-32 steel, brass plated, green	
	Backwire Clamp	0.070" thick brass	Steel, brass plated	
	Contacts	Silver alloy	Silver alloy	
	Moveable Contact Arm	Brass	Brass	
	Pressure Plate	N/A	Brass	

NOTE: REPEL products do not protect the user against disease causing organisms and ongoing regular cleaning practices should be maintained. Agion is a registered trademark of Agion Technologies, Inc., Wakefield, MA

**Industrial & Commercial
Specification Grade
ArrowLink Modular Switches**

15A, 120/277V/AC
20A, 120/277V/AC
Single-Pole

		Switch Type	Industrial Grade Toggle: AH1201_M, AH1221_M Series; ArrowLink: MCS120_, MCS277_, MCS300PI_ Series	Commercial Grade Decorator: 7600_M Series; ArrowLink: MCS120_, MCS277_, MCS300PI_ Series
Wiring Type	Base Device	Back & side wire	Back & side wire	Back & side wire
	ArrowLink	Integral wire leads, crimped & resistance welded	Integral wire leads, crimped & resistance welded	Integral wire leads, crimped & resistance welded
	ArrowLink SPD	Backwire feed through	Backwire feed through	Backwire feed through
Testing & Code Compliance	Base Device	<ul style="list-style-type: none"> cULus Listed to UL 20, file no. E18704 UL verified to Federal Spec. WS-896 NOM certified 	<ul style="list-style-type: none"> cULus Listed to UL 20, file no. E18704 UL verified to Federal Spec. WS-896 	<ul style="list-style-type: none"> cULus Listed to UL 20, file no. E18704 UL verified to Federal Spec. WS-896
	ArrowLink	<ul style="list-style-type: none"> Plug & connector cULus Listed to UL 2459 file no. E325188 	<ul style="list-style-type: none"> Plug & connector cULus Listed to UL 2459 file no. E325188 	<ul style="list-style-type: none"> Plug & connector cULus Listed to UL 2459 file no. E325188
	Combined Devices	<ul style="list-style-type: none"> cULus Listed wiring assembly, UL file no. E326691 	<ul style="list-style-type: none"> cULus Listed wiring assembly, UL file no. E326691 	<ul style="list-style-type: none"> cULus Listed wiring assembly, UL file no. E326691
Specifications: Environmental	Base Device	Flammability	Meets UL 94 requirements; V2 rated	Meets UL 94 requirements; V0 rated
		Temperature Rating	-20°C to 65°C (-4°F to 149°F)	-20°C to 60°C (-4°F to 140°F)
	ArrowLink	Flammability	Meets UL94 requirements; V2 rated	Meets UL94 requirements; V2 rated
		Temperature Rating	-20°C to 90°C (-4°F to 194°F) max.	-20°C to 90°C (-4°F to 194°F) max.
Specifications: Electrical	Base Device	Max. Working Voltage, Continuous Current & Endurance	Maximum working voltage 277V/AC Max. cont. current: 15A, 20A Endurance: 50,000 cycles min.	Maximum working voltage 277V/AC Max. cont. current: 15A, 20A Endurance: 50,000 cycles min.
		Overload	Minimum 4.8 times rated current for 100 cycles	Minimum 4.8 times rated current for 100 cycles
		Temperature Rise	Max. 30°C (86°F) after 250 cycles of overload @ 200% of rated current (DC)	Max. 30°C (86°F) after 100 cycles of overload & 30,000 cycles of endurance
		Horsepower Ratings	Horsepower rated for motor loads per UL 20: 15A @ 120V/AC = 1/2 HP; 15A @ 240V/AC = 2 HP 20A @ 120V/AC = 1 HP; 20A @ 240V/AC = 2 HP	Horsepower rated for motor loads per UL 20: 15A @ 120V/AC = 1/2 HP; 15A @ 240V/AC = 2 HP 20A @ 120V/AC = 1 HP; 20A @ 240V/AC = 2 HP
	ArrowLink	Max. Working Voltage & Continuous Current	Maximum working voltage 300V/AC Maximum continuous current: 20A	Maximum working voltage 300V/AC Maximum continuous current: 20A
		Overload	Overload: 52.5A/AC for 10 cycles	Overload: 52.5A/AC for 10 cycles
		Dielectric Voltage	Withstands 1600V per UL 2459	Withstands 1600V per UL 2459
		Current Interrupting	Limited cycles at full-rated current	Limited cycles at full-rated current
		Temperature Rise	Temperature Rise: Max. 50°C (122°F) while conducting 35A after 10 cycles of overload @ 52.5A / AC	Temperature Rise: Max. 50°C (122°F) while conducting 35A after 10 cycles of overload @ 52.5A / AC
Specifications: Mechanical	Base Device Terminal Accommodation	#14 - #10 AWG	#14 - #10 AWG	
	ArrowLink Wire Leads	#12 AWG	#12 AWG	
	ArrowLink SPD Ground	Integral THHN #12 AWG 6" lead with ring terminal and #10 ground screw	Integral THHN #12 AWG 6" lead with ring terminal and #10 ground screw	
	Voltage Ratings	Permanently marked on device	Permanently marked on device	
Materials:	Base Device	Toggle/Paddle	Urea	Polycarbonate
		Top & Bottom Housing	Phenolic, top is color coded by amperage	Top: polycarbonate; bottom: 0.045" thick PVC
		Strap	0.05" thick galvanized steel	0.05" thick steel, zinc plated, (yellow chromate on 20A)
		Auto Ground Clip	0.030" thick brass	Phosphor bronze wire
		Terminals	0.031" thick brass	0.035" thick brass
		Terminal & Ground Screws	#8-32 brass, black screw; ground: #8-32 steel, zinc plated, green	#8-32 steel, brass plated; neutral screw nickel plated, ground screw green
		Contacts	Silver alloy	Silver alloy
		Moveable Contact Arm	0.031" thick brass	0.035" thick brass
	Pressure Plate	0.068" thick brass	0.035" thick brass	
	Illuminated Models	Long-life neon bulb	Long-life neon bulb	
ArrowLink	ArrowLink Housing	Polycarbonate	Polycarbonate	
	ArrowLink Contacts	Copper alloy	Copper alloy	
	ArrowLink Wire Leads (where applicable)	Solid or stranded THHN #12 AWG	Solid or stranded THHN #12 AWG	

**Commercial
Specification Grade
Decorator Switches**

**15A & 20A 120/277V/AC
15A, 120/277V/AC with 15A, 125V/AC Receptacle
Single-Pole, Double-Pole, 3-Way, 4-Way**

	Switch Type	Commercial 15A & 20A 120/277V Decorator Switches 7600 Series	Commercial 15A 120/277V Decorator Combination Switches 7700 Series	Commercial 15A 120/277V - 15A, 125V Decorator Combination Switch & Receptacle, 7730
	Wiring Type	Back & side wire	Back & side wire	Back & side wire
	Testing & Code Compliance	<ul style="list-style-type: none"> cULus Listed to UL 20, file no. E18704 UL verified to Federal Spec. WC-896E 	<ul style="list-style-type: none"> cULus Listed to UL 20/UL 498, file no. E18704 (combination) 	<ul style="list-style-type: none"> cULus Listed to UL 20/UL 498, file no. E18704 (combination)
Specifications: Environmental	Flammability	Meets UL 94 requirements; V2 rated	Meets UL 94 requirements; V2 rated	Meets UL 94 requirements; V2 rated
	Temperature Rating	-20°C to 60°C (-4°F to 140°F)	-20°C to 60°C (-4°F to 140°F)	-20°C to 60°C (-4°F to 140°F)
Specifications: Electrical	Dielectric Voltage	Withstands 1500V per UL 20	Withstands 1500V per UL 20	Withstands 1500V per UL 20
	Current Interrupting	Yes, at full-rated current	Yes, at full-rated current	Yes, at full-rated current
	Temperature Rise	Max. 30°C (86°F) after 100 cycles of overload and 30,000 cycles of endurance testing	Max. 30°C (86°F) after 100 cycles of overload and 30,000 cycles of endurance testing	Switch: Max. 30°C (86°F) after 100 cycles of overload and 30,000 cycles of endurance testing Receptacle: Max. 30°C (86°F) after 100 cycles of overload at 150% of rated current (DC)
Specifications: Mechanical	Terminal Accommodation	#14 - 10 AWG	#14 - 10 AWG	#14 - 12 AWG
	Voltage Ratings	Permanently marked on device	Permanently marked on device	Permanently marked on device
	Horsepower Ratings	Rated for motor loads per UL 20: 15A: @ 120V/AC = 1/2 HP, @ 240V/AC = 2 HP; Max. amps 12A 20A: @ 120V/AC = 1 HP, @ 240V/AC = 2 HP; Max. amps 16A	Rated for motor loads per UL 20: 15A: @ 120V/AC = 1/2 HP, @ 240V/AC = 2 HP; Max. amps 12A	Switch rated for motor loads per UL 20: 15A: @ 120V/AC = 1/2 HP, @ 240V/AC = 2 HP; Max. amps 12A
Materials:	Paddle	Polycarbonate	PVC	PVC
	Top Housing	Polycarbonate	PVC	PVC
	Bottom Housing	PVC	PVC	PVC
	Strap	0.045" thick steel, zinc plated, (yellow chromate on 20A)	0.045" thick steel, zinc plated	0.045" thick steel, zinc plated
	Auto Ground Clip	Phosphor bronze	Phosphor bronze	Phosphor bronze
	Terminals	0.035" thick brass	0.030" thick brass	0.030" thick brass
	Terminal Screws	#8-32 steel with #10 head, brass plated; neutral screw nickel plated	#8-32 steel, brass plated; neutral screw nickel plated	#8-32 steel, brass plated; neutral screw nickel plated
	Ground Screw	#8-32 steel, brass plated, green	#8-32 steel, brass plated, green	#8-32 steel, brass plated, green
	Backwire Clamp	Steel, brass plated	Brass	Brass
	Contacts	Silver alloy	Silver alloy	Silver alloy
	Moveable Contact Arm	Brass	Brass	Brass
	Pressure Plate	Brass	N/A	N/A
	Illuminated Models	Long-life neon bulb	N/A	N/A
	Pilot Light Models	Red lexan pilot lens with long-life neon bulb	N/A	N/A
Receptacle Line Contacts	N/A	N/A	0.030" thick brass	
Receptacle Ground Shunt	N/A	N/A	0.030" thick brass	

**Commercial
Specification Grade
Switches**

15A & 20A 120/277V/AC
15A, 120/277V/AC with 15A, 125V/AC Receptacle
Single-Pole, Double-Pole, 3-Way, 4-Way

	Switch Type	Commercial 15A & 20A 120/277V Toggle Switches: CSB Series	Commercial 15A & 20A 120/277V Toggle Switches: CS Series	Commercial 15A Toggle Combination Switches: 270 Series, 294	Commercial 15A 120 - 15A, 125V Toggle Combo Switch & Receptacle: 274, 291, 293
	Wiring Type	Back & side wire	Side wire	Back & side wire	Back & side wire
	Testing & Code Compliance	• cULus Listed to UL 20, file no. E18704	• cULus Listed to UL 20, file no. E18704	• cULus Listed to UL 20, file no. E18704 (combination)	• Listed to UL 20/UL 498, file no. E18704 (combination)
		• UL verified to Federal Spec. WC-896G	• UL verified to Federal Spec. WC-896G • CSA certified to C22.2, no. 11 file no. 10016 (6241-05)	• CSA certified to C22.2, no. 11 file no. 10016 (6241-05) • NOM certified	• NOM certified, except 291
Specifications: Environmental	Flammability	Meets UL94 requirements; V0 rated	Meets UL94 requirements; V0 rated	Meets UL94 requirements; V2 rated	Meets UL94 requirements; V2 rated
	Temperature Rating	-20°C to 60°C (-4°F to 140°F)	-20°C to 60°C (-4°F to 140°F)	-20°C to 60°C (-4°F to 140°F)	-20°C to 60°C (-4°F to 140°F)
Specifications: Electrical	Dielectric Voltage	Withstands 1500V per UL 20	Withstands 1500V per UL 20	Withstands 1500V per UL 20	Switch: Withstands 1500V per UL 20 Receptacle: Withstands 2000V per UL 498
	Current Interrupting	Yes, at full-rated current	Yes, at full-rated current	Yes, at full-rated current	Yes, at full-rated current
	Temperature Rise	Max. 30°C (86°F) after 100 cycles of overload and 50,000 cycles of endurance testing	Max. 30°C (86°F) after 100 cycles of overload and 50,000 cycles of endurance testing	Max. 30°C (86°F) after 100 cycles of overload and 30,000 cycles of endurance testing	Switch: Max. 30°C (86°F) after 100 cycles of overload and 30,000 cycles of endurance testing Receptacle: Max. 30°C (86°F) after 100 cycles of overload at 150% of rated current (DC)
Specifications: Mechanical	Terminal Accommodation	#14 - 10 AWG	#14 - 10 AWG	#14 - 1 2 AWG	#14 - 1 2 AWG
	Voltage Ratings	Permanently marked on device	Permanently marked on device	Permanently marked on device	Permanently marked on device
	Horsepower Ratings	Rated for motor loads per UL 20: 15A: @ 120V/AC = 1/2 HP, @ 240V/AC = 2 HP; Max. amps 12A. 20A: @ 120V/AC = 1 HP, @ 240V/AC = 2 HP; Max. amps 16A	Rated for motor loads per UL 20: 15A: @ 120V/AC = 1/2 HP, @ 240V/AC = 2 HP; Max. amps 12A. 20A: @ 120V/AC = 1 HP, @ 240V/AC = 2 HP; Max. amps 16A	Rated for motor loads per UL 20: 15A: @ 120V/AC = 1/2 HP, @ 240V/AC = 2 HP; Max. amps 12A	Switch rated for motor loads per UL 20: 15A: @ 120V/AC = 1/2 HP, @ 240V/AC = 2 HP; Max. amps 12A
Materials:	Toggle	Nylon	Nylon	Nylon	Nylon
	Top Housing	PVC	PVC	PVC	PVC
	Bottom Housing	PVC	PVC	PVC	PVC
	Strap	0.045" thick steel, zinc plated	0.045" thick steel, zinc plated	0.045" thick steel, zinc plated	0.045" thick steel, zinc plated
	Terminals	0.031" thick brass	0.031" thick brass	0.030" thick brass	0.030" thick brass
	Terminal Screws	#8-32 steel, brass plated or zinc plated	#8-32 steel, brass plated or zinc plated	#8-32 steel, brass plated; neutral screw nickel plated	#8-32 steel, brass plated; neutral screw nickel plated
	Ground Screw	#8-32 steel, zinc plated, green	#8-32 steel, zinc plated, green	#8-32 steel, zinc plated, green	#8-32 steel, zinc plated, green
	Backwire Clamp	Brass	N/A	Brass	Brass
	Contacts	Silver alloy	Silver alloy	Silver alloy	Silver alloy
	Moveable Contact Arm	Brass	Brass	Brass	Brass
	Pilot Light Models	N/A	N/A	Red lexan pilot lens with long-life neon bulb	N/A
	Receptacle Line Contacts	N/A	N/A	N/A	0.030" thick brass
Receptacle Ground Shunt	N/A	N/A	N/A	0.030" thick brass	

**Industrial Specification
 Grade Manual Motor
 Controllers**

20/30A, 600/250V/AC; 30A, 250V/AC; 40A, 600V/AC; 30A, 600V/AC
 10/20A, 250/125V/AC/DC; 20/30A, 250/125V/AC/DC
 Single-Phase & 3-Phase

	Switch Type	Industrial Single-Phase & 3-Phase Maintained Contact Motor Controllers AH6800 & AH7800 Series	Industrial Single-Phase & 3-Phase Maintained Contact Motor Controllers AHMC200 & AHMC300 Series	Industrial 3-Position 2-Circuit Maintained & Momentary Contact Motor Controllers AH4300 & AH27900 Series
	Wiring Type	Back & side wire screw, front wired screw or front wired screw & clamp	Side wire, side wired screw & clamp, or side wired box lug	Side wired screw
	Testing & Code Compliance	<ul style="list-style-type: none"> cULus Listed to UL 508, file no. E135083 	<ul style="list-style-type: none"> cULus Listed to UL 508, file no. E135083 	<ul style="list-style-type: none"> Listed to UL 20, file no. E135162, except AH4300 series AH4300 series: UL recognized component
Specifications: Environmental	Flammability	Meets UL 94 requirements; V2 rated	Meets UL 94 requirements; V2 rated	Meets UL 94 requirements; V2 rated
	Temperature Rating	-20°C to 65°C (-4°F to 149°F)	-20°C to 65°C (-4°F to 149°F)	-20°C to 65°C (-4°F to 149°F)
Specifications: Electrical	Dielectric Voltage	Withstands 1500V per UL 20	Withstands 1500V per UL 20	Withstands 1500V per UL 20
	Current Interrupting	Yes, at full-rated current	Yes, at full-rated current	Yes, at full-rated current
	Temperature Rise	Max. 30°C (86°F) after 100 cycles of overload and 30,000 cycles of endurance testing	Max. 30°C (86°F) after 100 cycles of overload and 30,000 cycles of endurance testing	Max. 30°C (86°F) after 100 cycles of overload and 30,000 cycles of endurance testing
Specifications: Mechanical	Terminal Accommodation	#14 AWG - #10 AWG	#14 AWG - #8 AWG #14 AWG - #4 AWG	#14 AWG - #10 AWG
	Voltage Ratings	600V max	600V max	600V max
Materials:	Toggle	Glass-filled nylon	Glass-filled nylon	Thermoplastic, glass-filled nylon
	Top Housing	Glass-filled nylon	Glass-filled nylon	Thermoset
	Bottom Housing	Glass-filled nylon	Glass-filled nylon	Thermoset
	Strap	Plated steel	Plated steel	Plated steel
	Terminals	Copper alloy	Copper alloy	Copper alloy
	Terminal Screws	Plated brass	Brass	Brass
	Contacts	Silver alloy	Silver alloy	Silver plated copper
	Moveable Contact Arm	Copper alloy	Copper alloy	Silver plated copper

**Industrial Specification
Grade X-Switch Motor
Control Switch**

Type 4X
30A, 600V/AC Max.
3-Pole, 3-Phase

	Switch Type	X-Switch Motor Control, 3-Pole, 3 Phase
	Optional Input/Output Connection	10A, 4-Pole SOFTPower Mini Connector (if selected)
	Testing & Code Compliance	<ul style="list-style-type: none"> cULus Listed to UL 508, file no. E135083 NSF evaluated for use in hose-down areas and to NSF/ANSI/3-A Standard 14159-1 Hygiene Requirements for the Design of Meat and Poultry Processing Equipment
Specifications: Environmental	Flammability	Meets UL 94 requirements; rated 94-5V
	Temperature Rating	-40°C to 105°C (-40°F to 221°F)
	Protection	Type 4X
Specifications: Electrical	Maximum Continuous Current	30A
	Endurance, Mechanical	10,000 cycles minimum
	Endurance, Electrical	6,000 cycles minimum
	Motor Loads	Horsepower rated per UL 508, see chart
	Short Circuit Current Rating	5,000 amps RMS when protected with 30A class RK5 fuses; when used with SOFTPower: 5,000 amps RMS when protected with 30A class RK5 fuses, 50,000 amps RMS when tested with 30A class J fuses
Specifications: Mechanical	Terminal Accommodation	#14 - 10 AWG
	Voltage Ratings	Permanently marked on device
Materials:	Enclosure Body	16 gauge Type 304 stainless steel
	Enclosure Handle	Red nylon thermoplastic
	Enclosure Gasket	Silicone
	Manual Contactor Terminal Type	Front-wire screw termination
	Manual Contactor Terminal Screws	Nickel plated 260 brass
	Manual Contactor Contacts	Silver
	Manual Contactor Moveable Arm	Brass
Optional Equipment Materials:	SOFTPower Receptacle Shell	Type 316 stainless steel
	SOFTPower Receptacle Contacts	Machined brass
	SOFTPower Receptacle Potting Compound	Black rigid epoxy
	Breather/Drain Material	Type 316 stainless steel
	Breather/Drain Gasketing	Captive "O" ring

Horsepower Rated for Motor Loads per UL508

V/AC	Horsepower	Current, Amps
120V	3 HP	30A
240V	7.5 HP	30A
480V	15 HP	20A
600V	7.5 HP	10A
600V	15 HP	20A

600V, 3 Phase, 30A General Purpose
All ratings are 3-Phase; all poles breaking load

E

Pin & Sleeve Devices



	Page
Understanding IEC Pin & Sleeve Configurations	E-1
<hr/>	
Pin & Sleeve Devices	E-2
20A Receptacles, Plugs, Connectors & Inlets	E-4
30A Receptacles, Plugs, Connectors & Inlets	E-4
60A Receptacles, Plugs, Connectors & Inlets	E-4
100A Receptacles, Plugs, Connectors & Inlets	E-4
Pin & Sleeve Accessories	E-5
<hr/>	
Pin & Sleeve Mechanical Interlocks	E-6
20A Mechanical Interlocks	E-7
30A Mechanical Interlocks	E-7
60A Mechanical Interlocks	E-8
100A Mechanical Interlocks	E-8
<hr/>	
Pin & Sleeve Dimensional Data	
20A & 30A Dimensional Data	E-9
60A & 100A Dimensional Data	E-10
Accessory Dimensional Data	E-11
Mechanical Interlock Dimensional Data	E-11-E-12
<hr/>	
Specification Information	E-13

A complete line of rugged IEC 309 Watertight Pin & Sleeve products

Arrow Hart's Pin & Sleeve products are recognized for superior performance, durability and ease of installation. Featuring plugs, connectors, receptacles, inlets and a wide range of mechanical interlocks, Arrow Hart offers what OEMs and contractors need and is IEC 309 compliant for intermateability.



Pin & Sleeve Devices

Sturdy nylon construction, rugged design with flat surfaces for secure handling, extra large wiring compartments with deep and tapered wiring pockets, plus a watertight seal that can be wrench-tightened – all features to provide safe, reliable power distribution in the most demanding environments.



Pin & Sleeve Mechanical Interlocks

Factory-wired in a single unit for easy installation, our Watertight Pin & Sleeve Mechanical Interlocks provide an interlocked switch and overload protection within an enclosure that prevents plugs from being engaged or disengaged under load.

IEC 309 Pin & Sleeve Catalog Numbers

Our Series 309 products are as easy to order as they are to use. Simply use the matrix below along with the Pin & Sleeve "clock face" to the right to identify the catalog number you need to order.

Sample Number:

CD420R7W =
Cooper Wiring Devices'
3-Pole, 4-Wire, 20A
watertight pin & sleeve
receptacle, 3 phase
480V/AC



of Wires

- 3 = 3-Wire
- 4 = 4-Wire
- 5 = 5-Wire

Amperage

- 20 = 20 Amps
- 30 = 30 Amps
- 60 = 60 Amps
- 100 = 100 Amps

Pin & Sleeve Product Type

- P** = Plug
- C** = Connector
- R** = Receptacle
- B** = Inlet
- MI** = Mechanical Interlock (Non-Fusible)
- MIF** = Mechanical Interlock (Fusible)
- MIB** = Mechanical Interlock, Fuse Option
- MICB** = Mechanical Interlock, Circuit Breaker Option

Clock Position of Female Grounding Contact

- 3** = 380V/AC, 50Hz - 440V/AC
60Hz
- 4** = 125V/AC
- 5** = 277V/AC or 3Ø 600V/AC
or 3Ø 347/600V/AC
- 6** = 250V/AC or 380-415V/AC
or 220/380-240/415V/AC
- 7** = 480V/AC or 3Ø 480V/AC
or 3ØY 277/480V/AC
- 9** = 380-415V/AC or 3Ø
250V/AC or
3ØY 120/208V/AC
- 11** = 440-460V/AC, 60Hz
- 12** = 125/250V/AC

Exceptions:

- HMI available only on 20A
- MIF available only on 30A & 60A
- MIB & MICB available only on 20A, 30A & 60A
- Not every clock face position available for each pole/amp/device combo. Consult CWD representative for details.

Understanding IEC Pin & Sleeve Configurations

Arrow Hart's full line of Pin & Sleeve products meet or exceed the rigorous IEC 309-1 and 309-2 watertight requirements, and as such are intermateable with all other non-hazardous IEC 309 devices.

A "clock face" is used to represent the grounding contact position for all female connectors and receptacles. With the keyway at the bottom, the female grounding contact will appear at one of the twelve "hour" positions. To identify the system's voltage, identify the housing color and hour location of the connector or receptacle grounding outlet.

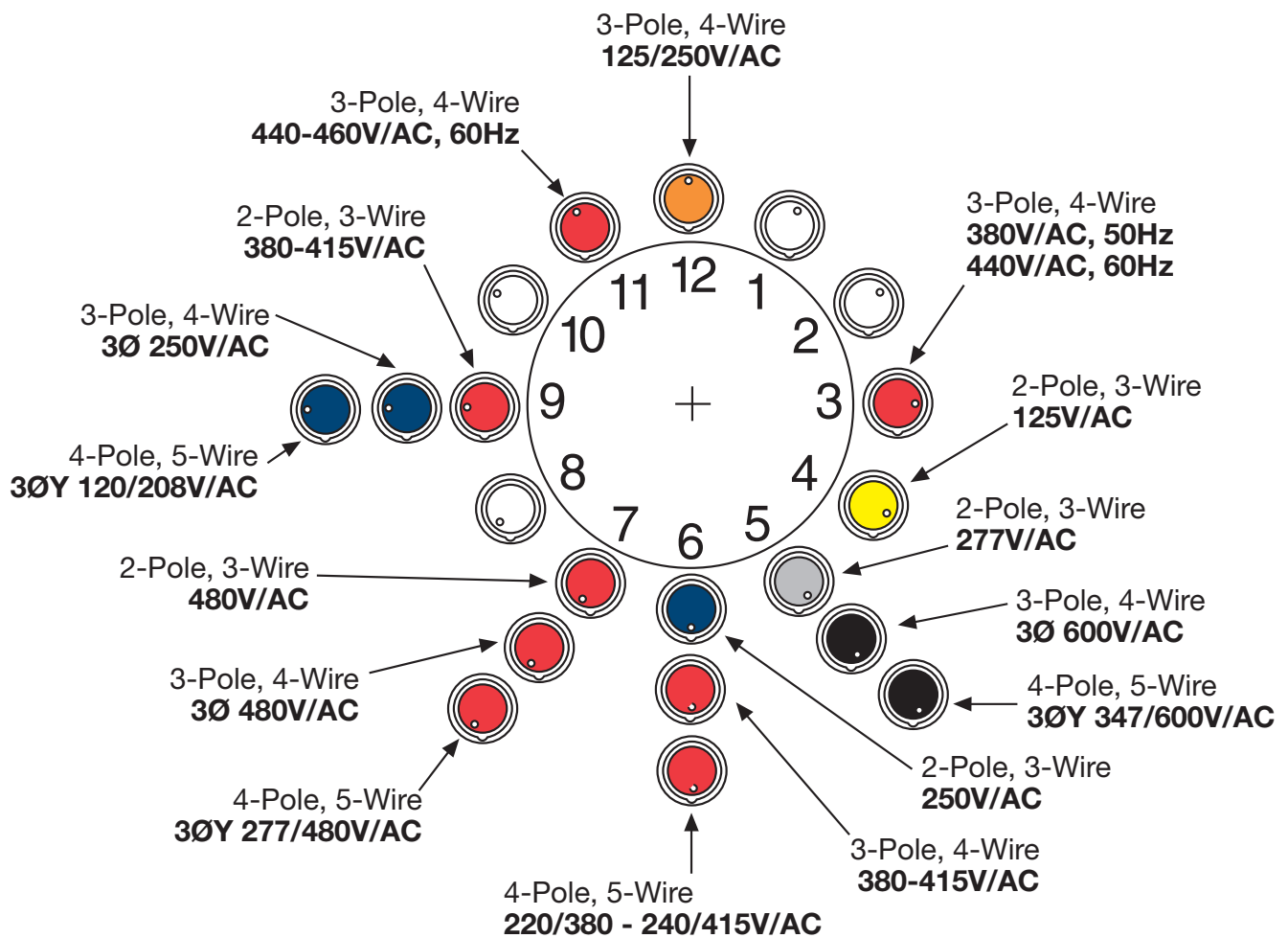

**Pin & Sleeve Plugs**

Mechanical cord clamp with TPE sealing gland and locking screw ensures a positive and watertight strain relief system

Flat wrenching surfaces for tightening down on internal bushing, ensuring complete watertight seal at cord

Durable impact and corrosion resistant thermoplastic body

Color-coded front housing for easy and accurate identification of mating devices of the same voltage

Oversized grounding pin assures mating only with oversized female grounding sleeve; staggered contact to ensure ground makes first and breaks last

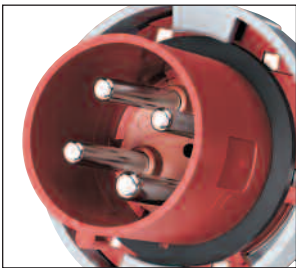
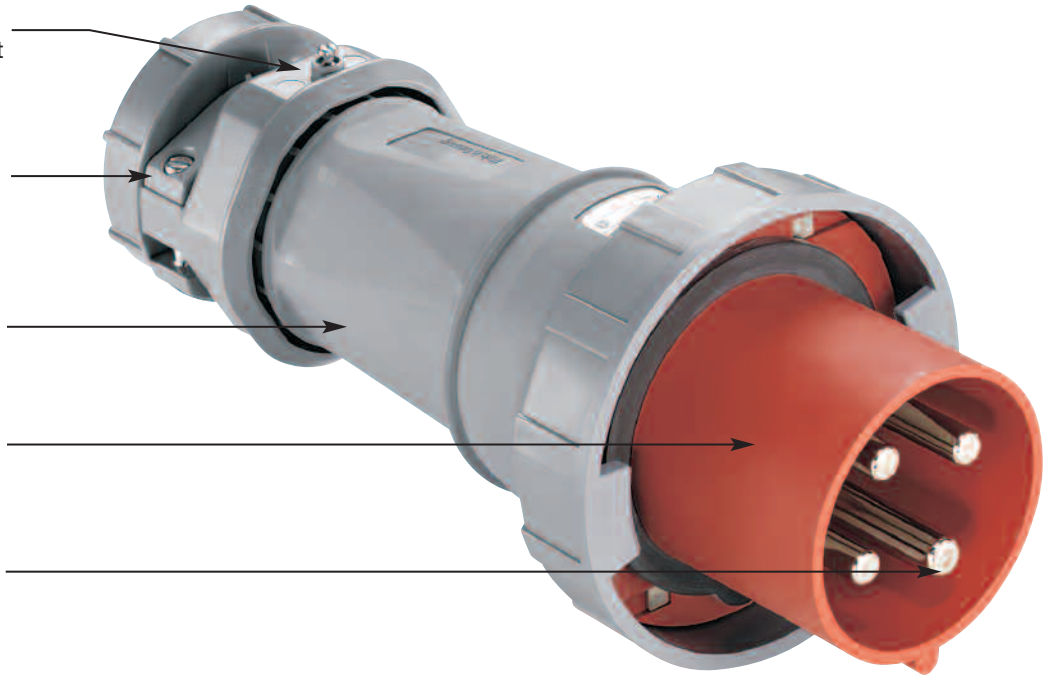

Nickel-plated brass pins offer long-life corrosion protection



Threaded 3/4" NPT cable entry provides means of attaching flexible conduit or wire mesh grips

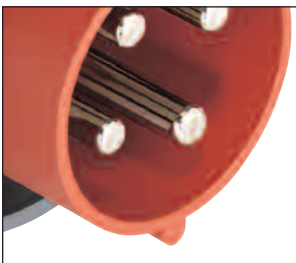

Contacts fully shrouded for mechanical protection

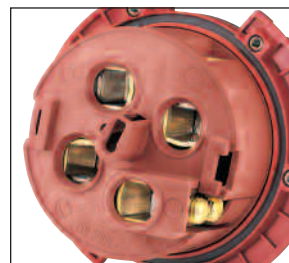

Tapered wiring pockets to ease insertion of stranded wire; deep pockets with clear markings keep bare conductors isolated



Pin & Sleeve Receptacles

Spring-loaded self-closing cap with neoprene gasket protects contacts when not in use

Standard mounting footprints fit all existing back boxes

Rugged materials selected for use in wet locations; provides corrosion resistance

Color-coded cap accurately identifies mating plug of the correct voltage

Deep-slotted terminal screws for easy, secure conductor terminations

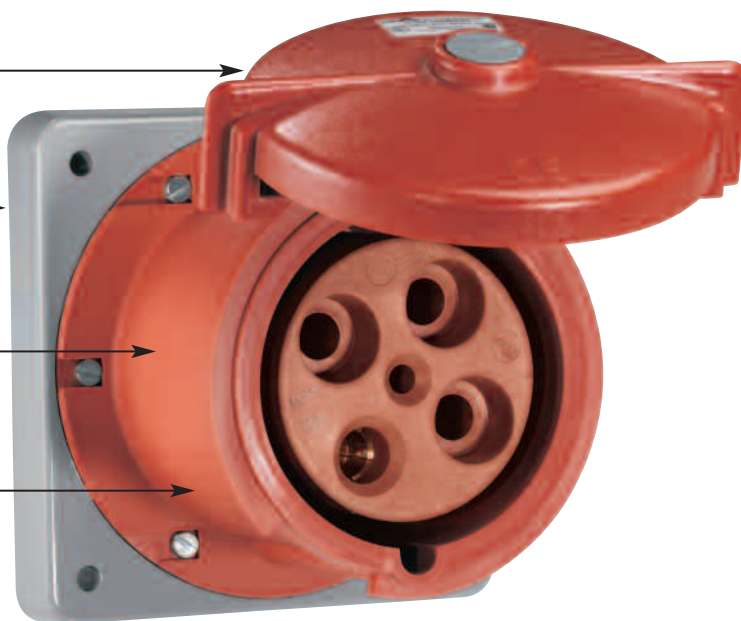

Color-coded cap accurately identifies mating plug of the correct voltage



Watertight cap meets NEMA 4X, 12; IP 66 hosedown standards



Impact-resistant thermoplastic contact carrier provides superior electrical insulation and V0 flammability rating



Brass contacts with self-cleaning field-proven pressure bands for smooth pin insertion, low heat rise and quality electrical performance

IEC 309 Watertight Pin & Sleeve Devices

2-Pole, 3-Wire Grounding
3-Pole, 4-Wire Grounding
4-Pole, 5-Wire Grounding

IEC 309 Pin & Sleeve Devices



Receptacle



Plug



Connector



Inlet

A	Poles/ Wires	V/AC, Color Coding & Configuration	Catalog No.					
			Receptacle	Plug	Connector	Inlet		
20	2-P, 3-W	125		<input type="checkbox"/> CD320R4W	<input type="checkbox"/> CD320P4W	<input type="checkbox"/> CD320C4W	<input type="checkbox"/> CD320B4W	
		250		<input type="checkbox"/> CD320R6W	<input type="checkbox"/> CD320P6W	<input type="checkbox"/> CD320C6W	<input type="checkbox"/> CD320B6W	
		480		<input type="checkbox"/> CD320R7W	<input type="checkbox"/> CD320P7W	<input type="checkbox"/> CD320C7W	<input type="checkbox"/> CD320B7W	
	3-P, 4-W	125/250		<input type="checkbox"/> CD420R12W	<input type="checkbox"/> CD420P12W	<input type="checkbox"/> CD420C12W	<input type="checkbox"/> CD420B12W	
		3Ø 250		<input type="checkbox"/> CD420R9W	<input type="checkbox"/> CD420P9W	<input type="checkbox"/> CD420C9W	<input type="checkbox"/> CD420B9W	
		3Ø 480		<input type="checkbox"/> CD420R7W	<input type="checkbox"/> CD420P7W	<input type="checkbox"/> CD420C7W	<input type="checkbox"/> CD420B7W	
		3Ø 600		<input type="checkbox"/> CD420R5W	<input type="checkbox"/> CD420P5W	<input type="checkbox"/> CD420C5W	<input type="checkbox"/> CD420B5W	
	4-P, 5-W	3ØY 120/208		<input type="checkbox"/> CD520R9W	<input type="checkbox"/> CD520P9W	<input type="checkbox"/> CD520C9W	<input type="checkbox"/> CD520B9W	
		3ØY 277/480		<input type="checkbox"/> CD520R7W	<input type="checkbox"/> CD520P7W	<input type="checkbox"/> CD520C7W	<input type="checkbox"/> CD520B7W	
		3ØY 347/600		<input type="checkbox"/> CD520R5W	<input type="checkbox"/> CD520P5W	<input type="checkbox"/> CD520C5W	<input type="checkbox"/> CD520B5W	
	30	2-P, 3-W	125		<input type="checkbox"/> CD330R4W	<input type="checkbox"/> CD330P4W	<input type="checkbox"/> CD330C4W	<input type="checkbox"/> CD330B4W
			250		<input type="checkbox"/> CD330R6W	<input type="checkbox"/> CD330P6W	<input type="checkbox"/> CD330C6W	<input type="checkbox"/> CD330B6W
480				<input type="checkbox"/> CD330R7W	<input type="checkbox"/> CD330P7W	<input type="checkbox"/> CD330C7W	<input type="checkbox"/> CD330B7W	
3-P, 4-W		125/250		<input type="checkbox"/> CD430R12W	<input type="checkbox"/> CD430P12W	<input type="checkbox"/> CD430C12W	<input type="checkbox"/> CD430B12W	
		3Ø 250		<input type="checkbox"/> CD430R9W	<input type="checkbox"/> CD430P9W	<input type="checkbox"/> CD430C9W	<input type="checkbox"/> CD430B9W	
		3Ø 480		<input type="checkbox"/> CD430R7W	<input type="checkbox"/> CD430P7W	<input type="checkbox"/> CD430C7W	<input type="checkbox"/> CD430B7W	
		3Ø 600		<input type="checkbox"/> CD430R5W	<input type="checkbox"/> CD430P5W	<input type="checkbox"/> CD430C5W	<input type="checkbox"/> CD430B5W	
4-P, 5-W		3ØY 120/208		<input type="checkbox"/> CD530R9W	<input type="checkbox"/> CD530P9W	<input type="checkbox"/> CD530C9W	<input type="checkbox"/> CD530B9W	
		3ØY 277/480		<input type="checkbox"/> CD530R7W	<input type="checkbox"/> CD530P7W	<input type="checkbox"/> CD530C7W	<input type="checkbox"/> CD530B7W	
		3ØY 347/600		<input type="checkbox"/> CD530R5W	<input type="checkbox"/> CD530P5W	<input type="checkbox"/> CD530C5W	<input type="checkbox"/> CD530B5W	
60		2-P, 3-W	125		<input type="checkbox"/> CD360R4W	<input type="checkbox"/> CD360P4W	<input type="checkbox"/> CD360C4W	<input type="checkbox"/> CD360B4W
			250		<input type="checkbox"/> CD360R6W	<input type="checkbox"/> CD360P6W	<input type="checkbox"/> CD360C6W	<input type="checkbox"/> CD360B6W
	480			<input type="checkbox"/> CD360R7W	<input type="checkbox"/> CD360P7W	<input type="checkbox"/> CD360C7W	<input type="checkbox"/> CD360B7W	
	3-P, 4-W	125/250		<input type="checkbox"/> CD460R12W	<input type="checkbox"/> CD460P12W	<input type="checkbox"/> CD460C12W	<input type="checkbox"/> CD460B12W	
		3Ø 250		<input type="checkbox"/> CD460R9W	<input type="checkbox"/> CD460P9W	<input type="checkbox"/> CD460C9W	<input type="checkbox"/> CD460B9W	
		3Ø 480		<input type="checkbox"/> CD460R7W	<input type="checkbox"/> CD460P7W	<input type="checkbox"/> CD460C7W	<input type="checkbox"/> CD460B7W	
		3Ø 600		<input type="checkbox"/> CD460R5W	<input type="checkbox"/> CD460P5W	<input type="checkbox"/> CD460C5W	<input type="checkbox"/> CD460B5W	
	4-P, 5-W	3ØY 120/208		<input type="checkbox"/> CD560R9W	<input type="checkbox"/> CD560P9W	<input type="checkbox"/> CD560C9W	<input type="checkbox"/> CD560B9W	
		3ØY 277/480		<input type="checkbox"/> CD560R7W	<input type="checkbox"/> CD560P7W	<input type="checkbox"/> CD560C7W	<input type="checkbox"/> CD560B7W	
		3ØY 347/600		<input type="checkbox"/> CD560R5W	<input type="checkbox"/> CD560P5W	<input type="checkbox"/> CD560C5W	<input type="checkbox"/> CD560B5W	
	100	2-P, 3-W	125		<input type="checkbox"/> CD3100R4W	<input type="checkbox"/> CD3100P4W	<input type="checkbox"/> CD3100C4W	<input type="checkbox"/> CD3100B4W
			250		<input type="checkbox"/> CD3100R6W	<input type="checkbox"/> CD3100P6W	<input type="checkbox"/> CD3100C6W	<input type="checkbox"/> CD3100B6W
480				<input type="checkbox"/> CD3100R7W	<input type="checkbox"/> CD3100P7W	<input type="checkbox"/> CD3100C7W	<input type="checkbox"/> CD3100B7W	
3-P, 4-W		125/250		<input type="checkbox"/> CD4100R12W	<input type="checkbox"/> CD4100P12W	<input type="checkbox"/> CD4100C12W	<input type="checkbox"/> CD4100B12W	
		3Ø 250		<input type="checkbox"/> CD4100R9W	<input type="checkbox"/> CD4100P9W	<input type="checkbox"/> CD4100C9W	<input type="checkbox"/> CD4100B9W	
		3Ø 480		<input type="checkbox"/> CD4100R7W	<input type="checkbox"/> CD4100P7W	<input type="checkbox"/> CD4100C7W	<input type="checkbox"/> CD4100B7W	
		3Ø 600		<input type="checkbox"/> CD4100R5W	<input type="checkbox"/> CD4100P5W	<input type="checkbox"/> CD4100C5W	<input type="checkbox"/> CD4100B5W	
4-P, 5-W		3ØY 120/208		<input type="checkbox"/> CD5100R9W	<input type="checkbox"/> CD5100P9W	<input type="checkbox"/> CD5100C9W	<input type="checkbox"/> CD5100B9W	
		3ØY 277/480		<input type="checkbox"/> CD5100R7W	<input type="checkbox"/> CD5100P7W	<input type="checkbox"/> CD5100C7W	<input type="checkbox"/> CD5100B7W	
		3ØY 347/600		<input type="checkbox"/> CD5100R5W	<input type="checkbox"/> CD5100P5W	<input type="checkbox"/> CD5100C5W	<input type="checkbox"/> CD5100B5W	

Specification Information:

Pin & Sleeve Devices: E-13-E-15





International rated devices are also available. Consult your Cooper Wiring Devices representative.

Pin & Sleeve Device Accessories

20A, 30A, 60A & 100A
For Receptacles, Plugs,
Connectors & Inlets

Backboxes

Cast Aluminum Backboxes

For Amperage	Description	Catalog No. 
20 & 30	For pin & sleeve receptacles & inlets, 30° angled face, 0.75" (19.1mm) hub Footprint: 2.74" x 2.74" (69.6 x 69.6mm)	<input type="checkbox"/> CDBB1 
60	For pin & sleeve receptacles, 15° angled face, 1.25" (31.8mm) hub Footprint: 3.35" x 3.03" (85.1 x 77.0mm)	<input type="checkbox"/> CDBB3 
	For pin & sleeve inlets, 15° angled face, 1.25" (31.8mm) hub Footprint: 3.54" x 3.54" (89.9 x 89.9mm)	<input type="checkbox"/> CDBB3-MI
100	For pin & sleeve receptacles & inlets, 15° angled face, 2.00" (50.8mm) hub Footprint: 4.09" x 4.09" (103.9 x 103.9mm)	<input type="checkbox"/> CDBB5 

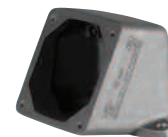

CDBB1



CDBB3

Angle Adapters

Cast Aluminum Angle Adapter

For Amperage	Description	Catalog No. 
20 & 30	For pin & sleeve inlets, 15° angled face Footprint: 2.74" x 2.74" (69.6 x 69.6mm)	<input type="checkbox"/> CDANG1

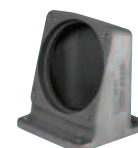

CDANG1

Feed-Throughs

Cast Aluminum Feed-Throughs

For Amperage	Description	Catalog No. 
20 & 30	For pin & sleeve receptacles & inlets, 1.00" (25.4mm) hub Footprint: 2.74" x 2.74" (69.6 x 69.6mm)	<input type="checkbox"/> CDFTBB1



CDFTBB1

Closure Caps

Plug & Inlet Closure Caps

For Amperage	Description	Catalog No. 
20	For 2-pole, 3-wire pin & sleeve devices	<input type="checkbox"/> CDCP320
	For 3-pole, 4-wire pin & sleeve devices	<input type="checkbox"/> CDCP420
	For 4-pole, 5-wire pin & sleeve devices	<input type="checkbox"/> CDCP520
30	For 2-pole, 3-wire and 3-pole, 4-wire pin & sleeve devices	<input type="checkbox"/> CDCP3430
	For 4-pole, 5-wire pin & sleeve devices	<input type="checkbox"/> CDCP530
60	For 2-pole, 3-wire, 3-pole, 4-wire and 4-pole, 5-wire pin & sleeve devices	<input type="checkbox"/> CDCP60
100	For 2-pole, 3-wire, 3-pole, 4-wire and 4-pole, 5-wire pin & sleeve devices	<input type="checkbox"/> CDCP100



CDCP100

Icon Key

 NAFTA Compliant - see page O-30

Combined Pin & Sleeve receptacle and disconnect switch

Pin & Sleeve Mechanical Interlocks provide a separate means of disconnect for motor leads. For extra safety and compliance, these interlocks prevent the plug from being engaged or disengaged under load.



Watertight Pin & Sleeve Mechanical Interlocks

Compact design fits in the web of an I-beam, the smallest footprint in the industry

Switch handles are designed to comply with OSHA lockout/tagout requirements

Unique locking mechanism ensures that switch can only be energized when plug is fully mated



Rugged Valox® housing provides superior corrosion and impact resistance

Hidden hinge system allows full access to internal switch terminations and provides a clean solution in 4x environments

Valox® is a registered trademark of General Electric, USA.



Poured-in seamless gasket and tongue and groove design yields the ultimate seal against moisture and contamination



Dual mounting capability using corner mounting holes or supplied mounting feet



Blank enclosures without pre-drilled entries allow maximum installation flexibility; watertight hub and double grounding blocks provided



Available with option fuses and/or circuit breakers for additional circuit protection

IEC 309 Watertight Pin & Sleeve Mechanical Interlocks

2-Pole, 3-Wire Grounding
3-Pole, 4-Wire Grounding
4-Pole, 5-Wire Grounding

IEC 309 Pin & Sleeve Mechanical Interlocks



A	Poles/Wires	V/AC Color Coding & Configuration	HP Rating Std/Max*	Description	Catalog No.
20	2-P, 3-W	125	1	Horizontal, Non-Fusible	<input type="checkbox"/> CD320HMI4W
		250	2.5	Horizontal, Non-Fusible	<input type="checkbox"/> CD320HMI6W
		480	5	Horizontal, Non-Fusible	<input type="checkbox"/> CD320HMI7W
	3-P, 4-W	125/250	1; 2.5	Horizontal, Non-Fusible	<input type="checkbox"/> CD420HMI12W
			0.5; 1	Fused, w/ Access Panel	<input type="checkbox"/> CD420MIB12W
			0.5; 1	Circuit Breaker, w/ Access Panel	<input type="checkbox"/> CD420MICB12W
		3Ø 250	5	Horizontal, Non-Fusible	<input type="checkbox"/> CD420HMI9W
			5	Fused, w/ Access Panel	<input type="checkbox"/> CD420MIB9W
			5	Circuit Breaker, w/ Access Panel	<input type="checkbox"/> CD420MICB9W
		3Ø 480	10	Horizontal, Non-Fusible	<input type="checkbox"/> CD420HMI7W
			10	Fused, w/ Access Panel	<input type="checkbox"/> CD420MIB7W
			10	Circuit Breaker, w/ Access Panel	<input type="checkbox"/> CD420MICB7W
3Ø 600	10	Horizontal, Non-Fusible	<input type="checkbox"/> CD420HMI5W		
4-P, 5-W	3ØY 120/208	5	Horizontal, Non-Fusible	<input type="checkbox"/> CD520HMI9W	
30	2-P, 3-W	125	2	Non-Fusible	<input type="checkbox"/> CD330MI4W
		250	2	Non-Fusible	<input type="checkbox"/> CD330MI6W
		2.5/5	Fusible	<input type="checkbox"/> CD330MIF6W	
	3-P, 4-W	125/250	10	Non-Fusible	<input type="checkbox"/> CD330MI7W
			2; 5	Non-Fusible	<input type="checkbox"/> CD430MI12W
			0.5; 1.5/2; 5	Fusible	<input type="checkbox"/> CD430MIF12W
		3Ø 250	1; 3	Fused, w/ Access Panel	<input type="checkbox"/> CD430MIB12W
			1; 3	Circuit Breaker, w/ Access Panel	<input type="checkbox"/> CD430MICB12W
			10	Non-Fusible	<input type="checkbox"/> CD430MI9W
		3Ø 480	3/7.5	Fusible	<input type="checkbox"/> CD430MIF9W
			7.5	Fused, w/ Access Panel	<input type="checkbox"/> CD430MIB9W
			7.5	Circuit Breaker, w/ Access Panel	<input type="checkbox"/> CD430MICB9W
	3Ø 600	20	Non-Fusible	<input type="checkbox"/> CD430MI7W	
		5/15	Fusible	<input type="checkbox"/> CD430MIF7W	
		15	Fused, w/ Access Panel	<input type="checkbox"/> CD430MIB7W	
	4-P, 5-W	3Ø 250	15	Circuit Breaker, w/ Access Panel	<input type="checkbox"/> CD430MICB7W
			20	Non-Fusible	<input type="checkbox"/> CD430MI5W
			7.5/20	Fusible	<input type="checkbox"/> CD430MIF5W
3ØY 120/208		7.5	Non-Fusible	<input type="checkbox"/> CD530MI9W	
		7.5	Fused, w/ Access Panel	<input type="checkbox"/> CD530MIB9W	
		7.5	Circuit Breaker, w/ Access Panel	<input type="checkbox"/> CD530MICB9W	
3ØY 277/480		20	Non-Fusible	<input type="checkbox"/> CD530MI7W	
		15	Fused, w/ Access Panel	<input type="checkbox"/> CD530MIB7W	
		15	Circuit Breaker, w/ Access Panel	<input type="checkbox"/> CD530MICB7W	
3ØY 347/600	20	Non-Fusible	<input type="checkbox"/> CD530MI5W		
	15	Fused, w/ Access Panel	<input type="checkbox"/> CD530MIB5W		
	15	Circuit Breaker, w/ Access Panel	<input type="checkbox"/> CD530MICB5W		

*Max. requires time delay fuses.



Horizontal Mechanical Interlock, Non-Fusible



Mechanical Interlock, Fusible or Non-Fusible

Specification Information:
Pin & Sleeve Mechanical Interlocks: E-16-E17

IEC 309 Watertight Pin & Sleeve Mechanical Interlocks

2-Pole, 3-Wire Grounding
3-Pole, 4-Wire Grounding
4-Pole, 5-Wire Grounding

IEC 309 Pin & Sleeve Mechanical Interlocks



Mechanical Interlock,
Fuse or Circuit
Breaker with
Access Panel

A	Poles/ Wires	V/AC Color Coding & Configuration	HP Rating Std/Max*	Description	Catalog No.					
60	2-P, 3-W	250	10	Non-Fusible	<input type="checkbox"/> CD360MI6W					
				Fusible	<input type="checkbox"/> CD360MIF6W					
	3-P, 4-W	480	20	3; 10	Non-Fusible	<input type="checkbox"/> CD360MI7W				
					125/250	3; 10	Non-Fusible	<input type="checkbox"/> CD460MI12W		
							Fusible	<input type="checkbox"/> CD460MIF12W		
							Fused, w/ Access Panel	<input type="checkbox"/> CD460MIB12W		
					Circuit Breaker, w/ Access Panel	<input type="checkbox"/> CD460MICB12W				
					3Ø 250	20	7.5/15	Non-Fusible	<input type="checkbox"/> CD460MI9W	
		Fusible	<input type="checkbox"/> CD460MIF9W							
		Fused, w/ Access Panel	<input type="checkbox"/> CD460MIB9W							
		Circuit Breaker, w/ Access Panel	<input type="checkbox"/> CD460MICB9W							
		3Ø 480	40	15/30				Non-Fusible	<input type="checkbox"/> CD460MI7W	
								Fusible	<input type="checkbox"/> CD460MIF7W	
					Fused, w/ Access Panel	<input type="checkbox"/> CD460MIB7W				
	3Ø 600	50	35	Circuit Breaker, w/ Access Panel	<input type="checkbox"/> CD460MICB7W					
				3ØY 120/208	20	7.5/15	Non-Fusible	<input type="checkbox"/> CD460MI5W		
							Fusible	<input type="checkbox"/> CD460MIF5W		
							Fused, w/ Access Panel	<input type="checkbox"/> CD460MIB5W		
				4-P, 5-W	3ØY 277/480	40	15/30	Circuit Breaker, w/ Access Panel	<input type="checkbox"/> CD460MICB5W	
								3ØY 347/600	50	15/50
	Fusible	<input type="checkbox"/> CD560MIF9W								
	Fused, w/ Access Panel	<input type="checkbox"/> CD560MIB9W								
	100	2-P, 3-W	125					15	Non-Fusible	<input type="checkbox"/> CD560MICB9W
									250	15
Fusible				<input type="checkbox"/> CD560MIF7W						
3-P, 4-W		480	30	5; 15	Non-Fusible	<input type="checkbox"/> CD560MIB7W				
					125/250	5; 15	Non-Fusible	<input type="checkbox"/> CD560MICB7W		
							Fusible	<input type="checkbox"/> CD560MIF7W		
3-P, 4-W	3Ø 250	25	25	Non-Fusible	<input type="checkbox"/> CD3100MI4W					
				3Ø 480	50	Non-Fusible	<input type="checkbox"/> CD3100MI6W			
						Fusible	<input type="checkbox"/> CD3100MIF6W			
	3Ø 600	50	50	Non-Fusible	<input type="checkbox"/> CD3100MI7W					
				3ØY 120/208	25	Non-Fusible	<input type="checkbox"/> CD4100MI12W			
						Non-Fusible	<input type="checkbox"/> CD4100MI9W			
4-P, 5-W	3ØY 277/480	50	50	Non-Fusible	<input type="checkbox"/> CD4100MI7W					
				3ØY 347/600	50	Non-Fusible	<input type="checkbox"/> CD4100MI5W			
						Non-Fusible	<input type="checkbox"/> CD4100MI5W			
	3ØY 120/208	25	25	Non-Fusible	<input type="checkbox"/> CD5100MI9W					
				3ØY 277/480	50	Non-Fusible	<input type="checkbox"/> CD5100MI7W			
						Non-Fusible	<input type="checkbox"/> CD5100MI5W			
3ØY 347/600	50	50	Non-Fusible	<input type="checkbox"/> CD5100MI5W						

NOTE: 100A Mechanical Interlocks with Fuse or Circuit Breaker Access Panel Options are also available. Contact your CWD representative.

Specification Information:

Pin & Sleeve Mechanical
Interlocks: E-18

20A & 30A Receptacles

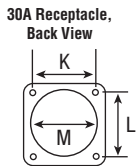
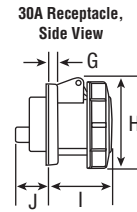
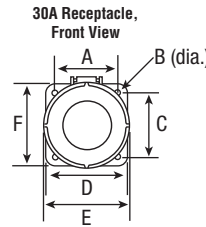
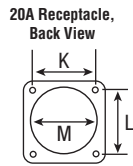
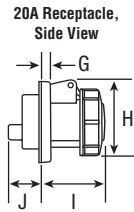
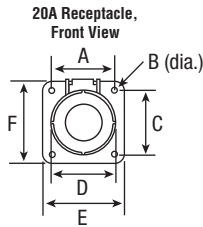

Family	A	B	C	D	E	F	G	H	I	J	K	L	M
20 Amp 2-P, 3-W	2.74" (6.96cm)	0.22" (0.56cm)	2.74" (6.96cm)	2.80" (7.11cm)	3.37" (8.56cm)	3.37" (8.56cm)	0.39" (0.99cm)	3.09" (7.85cm)	2.20" (5.59cm)	1.12" (2.85cm)	2.74" (6.96cm)	2.74" (6.96cm)	2.76" (7.01cm)
20 Amp 3-P, 4-W	2.74" (6.96cm)	0.22" (0.56cm)	2.74" (6.96cm)	3.07" (7.80cm)	3.37" (8.56cm)	3.37" (8.56cm)	0.39" (0.99cm)	3.44" (8.74cm)	2.20" (5.59cm)	1.12" (2.85cm)	2.74" (6.96cm)	2.74" (6.96cm)	2.76" (7.01cm)
20 Amp 4-P, 5-W	2.74" (6.96cm)	0.22" (0.56cm)	2.74" (6.96cm)	3.37" (8.56cm)	3.50" (8.89cm)	3.37" (8.56cm)	0.39" (0.99cm)	3.74" (9.50cm)	2.22" (5.64cm)	1.12" (2.85cm)	2.74" (6.96cm)	2.74" (6.96cm)	2.76" (7.01cm)
30 Amp 2-P, 3-W & 3-P, 4-W	2.74" (6.96cm)	0.22" (0.56cm)	2.74" (6.96cm)	3.37" (8.56cm)	3.76" (7.11cm)	3.37" (8.56cm)	0.39" (0.99cm)	3.90" (9.91cm)	2.70" (6.86cm)	1.38" (3.51cm)	2.74" (6.96cm)	2.74" (6.96cm)	2.76" (7.01cm)
30 Amp 4-P, 5-W	2.74" (6.96cm)	0.22" (0.56cm)	2.74" (6.96cm)	3.37" (8.56cm)	4.02" (10.21cm)	3.37" (8.56cm)	0.39" (0.99cm)	4.12" (10.46cm)	2.70" (6.86cm)	1.38" (3.51cm)	2.74" (6.96cm)	2.74" (6.96cm)	2.76" (7.01cm)

20A & 30A Plugs

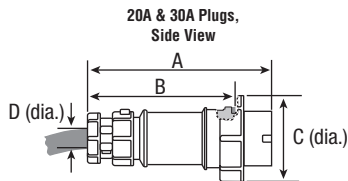

Family	A	B	C	D (cord dia.)	Threaded Entry (NPT)
20 Amp 2-P, 3-W	6.40" (16.26cm)	4.96" (12.60cm)	2.76" (7.01cm)	0.36-0.76" (0.91-1.93cm)	3/4" (1.91cm)
20 Amp 3-P, 4-W	6.69" (16.99cm)	5.26" (13.36cm)	3.07" (7.80cm)	0.36-0.76" (0.91-1.93cm)	3/4" (1.91cm)
20 Amp 4-P, 5-W	7.28" (18.49cm)	5.97" (15.16cm)	3.47" (8.81cm)	0.45-0.94" (1.14-2.39cm)	1" (2.54cm)
30 Amp 2-P, 3-W & 3-P, 4-W	7.80" (19.81cm)	6.14" (15.60cm)	3.70" (9.40cm)	0.43-0.94" (1.09-2.39cm)	1" (2.54cm)
30 Amp 4-P, 5-W	8.43" (21.41cm)	6.77" (17.20cm)	3.98" (10.11cm)	0.43-1.12" (1.09-2.84cm)	1 1/4" (3.18cm)

20A & 30A Connectors

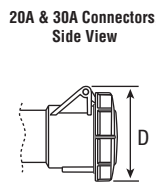
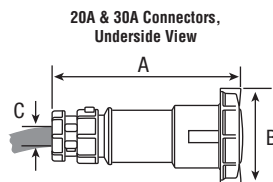

Family	A	B	C (cord dia.)	D	Threaded Entry (NPT)
20 Amp 2-P, 3-W	6.85" (17.40cm)	2.84" (7.21cm)	0.36-0.76" (0.91-1.93cm)	3.11" (7.90cm)	3/4" (1.91cm)
20 Amp 3-P, 4-W	7.28" (18.49cm)	3.11" (7.90cm)	0.36-0.76" (0.91-1.93cm)	3.47" (8.81cm)	3/4" (1.91cm)
20 Amp 4-P, 5-W	7.92" (20.12cm)	3.47" (8.81cm)	0.45-0.94" (1.14-2.39cm)	3.74" (9.50cm)	1" (2.54cm)
30 Amp 2-P, 3-W & 3-P, 4-W	8.78" (22.30cm)	3.78" (9.60cm)	0.43-0.94" (1.09-2.39cm)	3.90" (9.91cm)	1" (2.54cm)
30 Amp 4-P, 5-W	9.18" (23.32cm)	4.02" (10.21cm)	0.43-1.12" (1.09-2.84cm)	4.17" (10.59cm)	1 1/4" (3.18cm)

20A & 30A Inlets

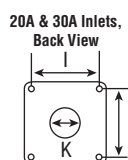
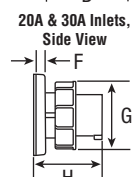
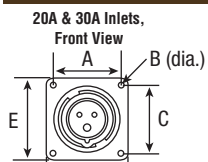

Family	A	B	C	D	E	F	G	H	I	J	K
20 Amp 2-P, 3-W	2.74" (6.96cm)	0.22" (0.56cm)	2.74" (6.96cm)	3.37" (8.56cm)	3.37" (8.56cm)	0.39" (0.99cm)	2.80" (7.11cm)	2.76" (7.01cm)	2.74" (6.96cm)	2.74" (6.96cm)	1.26" (3.18cm)
20 Amp 3-P, 4-W	2.74" (6.96cm)	0.22" (0.56cm)	2.74" (6.96cm)	3.37" (8.56cm)	3.37" (8.56cm)	0.39" (0.99cm)	3.11" (7.11cm)	2.76" (7.01cm)	2.74" (6.96cm)	2.74" (6.96cm)	1.26" (3.18cm)
20 Amp 4-P, 5-W	2.74" (6.96cm)	0.22" (0.56cm)	2.74" (6.96cm)	3.37" (8.56cm)	3.37" (8.56cm)	0.39" (0.99cm)	3.50" (8.89cm)	2.76" (7.01cm)	2.74" (6.96cm)	2.74" (6.96cm)	1.85" (4.70cm)
30 Amp 2-P, 3-W & 3-P, 4-W	2.74" (6.96cm)	0.22" (0.56cm)	2.74" (6.96cm)	3.37" (8.56cm)	3.37" (8.56cm)	0.43" (1.09cm)	3.70" (9.40cm)	2.76" (7.01cm)	2.74" (6.96cm)	2.74" (6.96cm)	1.85" (4.70cm)
30 Amp 4-P, 5-W	2.74" (6.96cm)	0.22" (0.56cm)	2.74" (6.96cm)	3.37" (8.56cm)	3.37" (8.56cm)	0.43" (1.09cm)	4.02" (10.21cm)	2.76" (7.01cm)	2.74" (6.96cm)	2.74" (6.96cm)	1.85" (4.70cm)

60A & 100A Receptacles

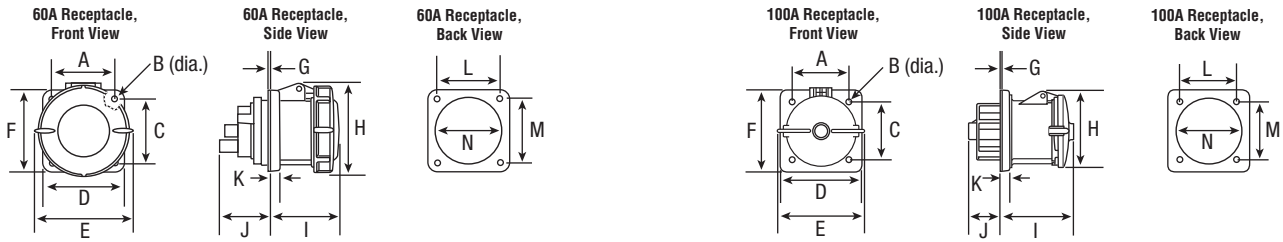

Family	A	B	C	D	E	F	G	H	I	J	K	L	M	N
60 Amp	3.03" (7.70cm)	0.24" (0.61cm)	3.35" (8.51cm)	3.93" (9.98cm)	4.65" (11.81cm)	4.21" (10.69cm)	0.08" (0.20cm)	4.45" (11.30cm)	3.31" (8.41cm)	2.13" (5.41cm)	0.47" (1.19cm)	3.03" (7.70cm)	3.35" (8.51cm)	3.46" (8.79cm)
100 Amp	4.09" (10.39cm)	0.26" (0.66cm)	4.09" (10.39cm)	5.12" (13.00cm)	5.31" (13.49cm)	5.12" (13.00cm)	0.08" (0.20cm)	4.80" (12.19cm)	4.88" (12.40cm)	1.70" (4.32cm)	0.71" (1.80cm)	4.09" (10.39cm)	4.09" (10.39cm)	3.74" (9.50cm)

60A & 100A Plugs

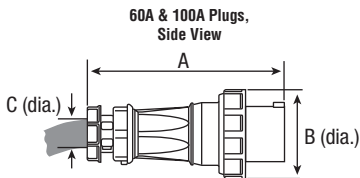

Family	A	B	D (cord dia.)	Threaded Entry (NPT)
60 Amp	9.69" (24.61cm)	4.49" (11.40cm)	0.57-1.42" (1.45-3.61cm)	1 1/2" (3.81cm)
100 Amp	11.54" (29.31cm)	5.16" (13.11cm)	0.98-1.97" (2.49-5.00cm)	2" (5.08cm)

60A & 100A Connectors

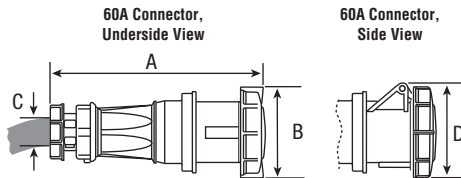

Family	A	B	C (cord dia.)	D	Threaded Entry (NPT)
60 Amp	10.39" (26.39cm)	4.65" (11.81cm)	0.57-1.42" (1.45-3.61cm)	4.45" (11.81cm)	1 1/2" (3.81cm)

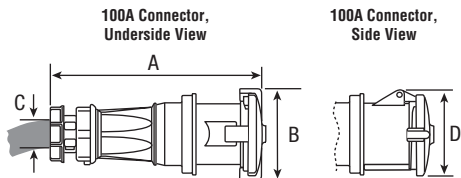

Family	A	B	C (cord dia.)	D	Threaded Entry (NPT)
100 Amp	12.60" (32.00cm)	5.31" (13.49cm)	0.57-1.42" (1.45-3.61cm)	4.88" (12.40cm)	2" (5.08cm)

60A & 100A Inlets

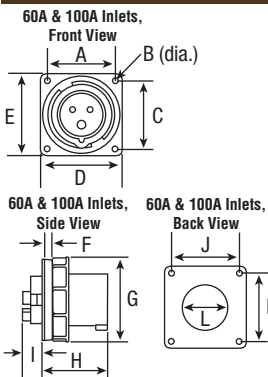

Family	A	B	C	D	E	F	G	H	I	J	K	L
60 Amp	3.54" (8.99 cm)	0.22" (0.56 cm)	3.54" (8.99 cm)	4.17" (10.59 cm)	4.33" (11.00 cm)	0.43" (1.09 cm)	4.45" (11.30 cm)	3.31" (8.41 cm)	1.14" (2.90 cm)	3.54" (8.99 cm)	3.54" (8.99 cm)	2.87" (7.29 cm)
100 Amp	4.10" (10.41 cm)	0.26" (0.66 cm)	4.10" (10.41 cm)	5.12" (13.00 cm)	5.12" (13.00 cm)	0.69" (1.75 cm)	5.20" (13.21 cm)	4.34" (11.02 cm)	1.14" (2.90 cm)	4.10" (10.41 cm)	4.10" (10.41 cm)	3.74" (9.50 cm)

Back Boxes

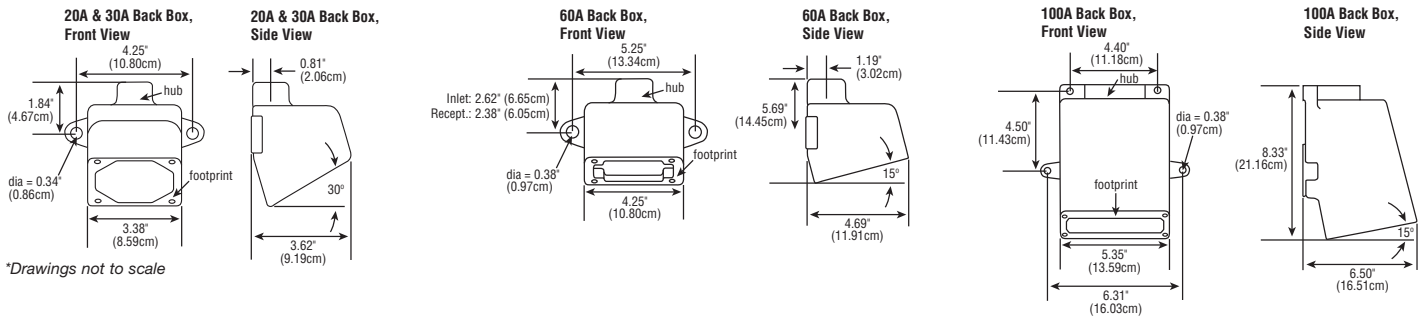

Angle Adapter

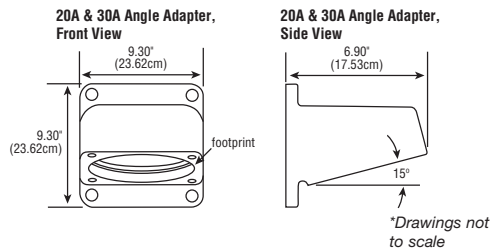

Feed Through

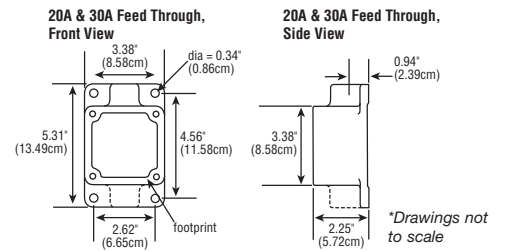

20A Non-Fusible Mechanical Interlocks

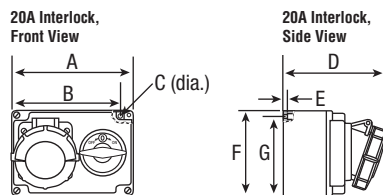

Family	A	B	C	D	E	F	G
20 Amp 2-P, 3-W	6.70" (17.02cm)	5.35" (13.59cm)	0.24" (0.61cm)	5.35" (13.59cm)	0.24" (0.61cm)	4.65" (11.81cm)	4.10" (10.41cm)
20 Amp 3-P, 4-W	6.70" (17.02cm)	5.35" (13.59cm)	0.24" (0.61cm)	5.47" (13.89cm)	0.24" (0.61cm)	4.65" (11.81cm)	4.10" (10.41cm)
20 Amp 4-P, 5-W	6.70" (17.02cm)	5.35" (13.59cm)	0.24" (0.61cm)	5.63" (14.30cm)	0.24" (0.61cm)	4.65" (11.81cm)	4.10" (10.41cm)

20A Fuse or Circuit Breaker Option Mechanical Interlocks

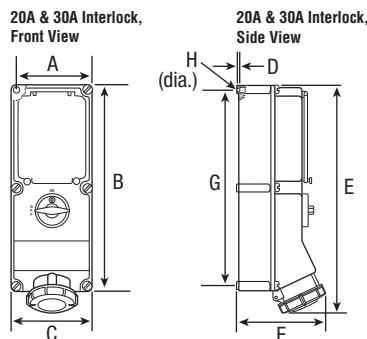

Family	A	B	C	D	E	F	G	H
20 Amp 3-P, 4-W	4.59" (11.66cm)	14.33" (36.40cm)	5.28" (13.41cm)	0.32" (0.81cm)	15.37" (39.04cm)	6.12" (15.54cm)	13.66" (34.70cm)	0.25" (0.64cm)

30A Non-Fusible & Fusible Mechanical Interlocks

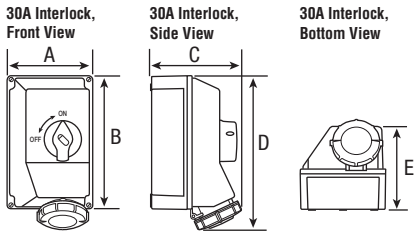

Family	A	B	C	D	E	Hub Size
30 Amp 2-P, 3-W	6.56" (16.66cm)	10.30" (26.16cm)	6.69" (16.99cm)	12.00" (30.48cm)	6.44" (16.36cm)	1" (2.54cm)
30 Amp 3-P, 4-W	6.56" (16.66cm)	10.30" (26.16cm)	6.69" (16.99cm)	12.00" (30.48cm)	6.44" (16.36cm)	1" (2.54cm)
30 Amp 4-P, 5-W	6.56" (16.66cm)	10.30" (26.16cm)	6.69" (16.99cm)	12.00" (30.48cm)	6.44" (16.36cm)	1" (2.54cm)

30A Fuse or Circuit Breaker Option Mechanical Interlocks

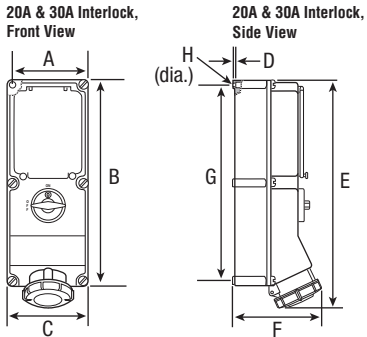

Family	A	B	C	D	E	F	G	H
30 Amp 3-P, 4-W	4.59" (11.66cm)	14.33" (36.40cm)	5.28" (13.41cm)	0.32" (0.81cm)	15.37" (39.04cm)	6.12" (15.54cm)	13.66" (34.70cm)	0.25" (0.64cm)
30 Amp 4-P, 5-W	4.59" (11.66cm)	14.33" (36.40cm)	5.28" (13.41cm)	0.32" (0.81cm)	15.37" (39.04cm)	6.12" (15.54cm)	13.66" (34.70cm)	0.25" (0.64cm)

60A Non-Fusible & Fusible Mechanical Interlocks

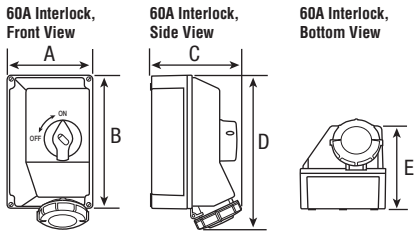

Family	A	B	C	D	E	Hub Size
30 Amp 2-P, 3-W	7.00" (17.78cm)	13.00" (33.02cm)	9.25" (23.50cm)	14.62" (37.13cm)	8.38" (37.13cm)	1 1/4" (3.18cm)
30 Amp 3-P, 4-W	7.00" (17.78cm)	13.00" (33.02cm)	9.25" (23.50cm)	14.62" (37.13cm)	8.38" (37.13cm)	1 1/4" (3.18cm)
30 Amp 4-P, 5-W	7.00" (17.78cm)	13.00" (33.02cm)	9.25" (23.50cm)	14.62" (37.13cm)	8.38" (37.13cm)	1 1/4" (3.18cm)

60A Fuse or Circuit Breaker Option Mechanical Interlocks

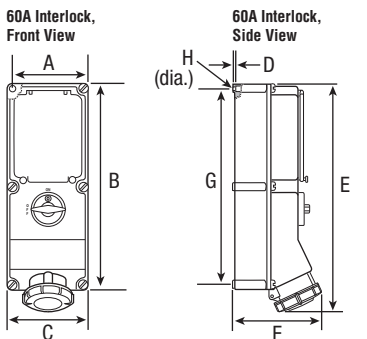

Family	A	B	C	D	E	F	G	H
60 Amp 3-P, 4-W	6.25" (15.88cm)	18.11" (46.00cm)	7.09" (18.01cm)	0.32" (0.81cm)	19.56" (49.68cm)	7.56" (19.20cm)	17.32" (43.99cm)	0.32" (0.81cm)
60 Amp 4-P, 5-W	6.25" (15.88cm)	18.11" (46.00cm)	7.09" (18.01cm)	0.32" (0.81cm)	19.56" (49.68cm)	7.56" (19.20cm)	17.32" (43.99cm)	0.32" (0.81cm)

100A Non-Fusible Mechanical Interlocks

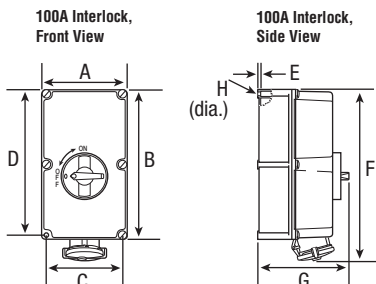

Family	A	B	C	D	E	F	G	H
100 Amp 2-P, 3-W	10.25" (26.04cm)	18.13" (46.05cm)	9.25" (23.50cm)	17.06" (43.33cm)	0.38" (0.97cm)	20.69" (52.55cm)	11.13" (28.27cm)	0.24" (0.11cm)
100 Amp 3-P, 4-W	10.25" (26.04cm)	18.13" (46.05cm)	9.25" (23.50cm)	17.06" (43.33cm)	0.38" (0.97cm)	20.69" (52.55cm)	11.13" (28.27cm)	0.24" (0.11cm)
100 Amp 4-P, 5-W	10.25" (26.04cm)	18.13" (46.05cm)	9.25" (23.50cm)	17.06" (43.33cm)	0.38" (0.97cm)	20.69" (52.55cm)	11.13" (28.27cm)	0.24" (0.11cm)

IEC 309 Watertight
Pin & Sleeve Devices

20A & 30A
2-Pole, 3-Wire Grounding
3-Pole, 4-Wire Grounding; 4-Pole, 5-Wire Grounding

	Device Type	20A & 30A Pin & Sleeve Receptacles	20A & 30A Pin & Sleeve Plugs	20A & 30A Pin & Sleeve Connectors	20A & 30A Pin & Sleeve Inlets
	Testing & Code Compliance	• Conforms to IEC Standards 60309-1 and 60309-2	• Conforms to IEC Standards 60309-1 and 60309-2	• Conforms to IEC Standards 60309-1 and 60309-2	• Conforms to IEC Standards 60309-1 and 60309-2
		• Listed to UL498, UL1682 & UL1686	• Listed to UL498, UL1682 & UL1686	• Listed to UL498, UL1682 & UL1686	• Listed to UL498, UL1682 & UL1686
		• CSA Certified to C22.2, 182.1	• CSA Certified to C22.2, 182.1	• CSA Certified to C22.2, 182.1	• CSA Certified to C22.2, 182.1
Specifications: Environmental	Flammability	Meets UL 94 requirements; V2 rated (housings), V0 rated (contact carriers)	Meets UL 94 requirements; V2 rated (housings), V0 rated (contact carriers)	Meets UL 94 requirements; V2 rated (housings), V0 rated (contact carriers)	Meets UL 94 requirements; V2 rated (housings), V0 rated (contact carriers)
	Protection	Watertight to IP 67 per IEC 529	Watertight to IP 67 per IEC 529	Watertight to IP 67 per IEC 529	Watertight to IP 67 per IEC 529
Specifications: Electrical	Dielectric Voltage	3000V	3000V	3000V	3000V
	Maximum Working Voltage	600V (rms)	600V (rms)	600V (rms)	600V (rms)
	Current Interrupting	Yes, at full-rated current & voltage	Yes, at full-rated current & voltage	Yes, at full-rated current & voltage	Yes, at full-rated current & voltage
	Temperature Rise	Max. 30°C (86°F) after 50 cycles of overload @150% of rated current	Max. 30°C (86°F) after 50 cycles of overload @150% of rated current	Max. 30°C (86°F) after 50 cycles of overload @150% of rated current	Max. 30°C (86°F) after 50 cycles of overload @150% of rated current
	Endurance	5000 cycles	5000 cycles	5000 cycles	5000 cycles
Specifications: Mechanical	Voltage Ratings	Marked on device	Marked on device	Marked on device	Marked on device
	Impact Resistance	CSA 22.2, 182.1, UL1862	CSA 22.2, 182.1, UL1862	CSA 22.2, 182.1, UL1862	CSA 22.2, 182.1, UL1862
	Cable Grip Retention	CSA 22.2, 182.1, UL1862	CSA 22.2, 182.1, UL1862	CSA 22.2, 182.1, UL1862	CSA 22.2, 182.1, UL1862
Materials:	Housing & Flange	PBT polyester & nylon/ABS blend	Type 6 nylon	Type 6 nylon	Type 6 nylon & PC/PET blend
	Back Body	N/A	Type 6 nylon	Type 6 nylon	N/A
	Contact Carrier/Support Isolators	Type 6/6 nylon	Type 6 nylon	Type 6/6 nylon	Type 6 nylon
	Sleeves	Brass	N/A	Brass	N/A
	Contact Spring on Sleeves	Nickel-plated stainless steel	N/A	Nickel-plated stainless steel	N/A
	Pins	N/A	Nickel-plated brass	N/A	Nickel-plated brass
	External Strain Relief Clamp	N/A	PC/PET blend	PC/PET blend	N/A
	Cable Seal	N/A	EPDM rubber	EPDM rubber	N/A
	Support Washer for Cord Grip	N/A	Zinc-plated steel, chromate finish	Zinc-plated steel, chromate finish	N/A
	Rivet	PBT polyester	N/A	PBT polyester	N/A
	Bayonette Ring	N/A	PC/PET blend	N/A	PC/PET blend
	Bayonette Gasket	N/A	NBR rubber	N/A	NBR rubber
	Cover	Type 6 nylon w/ PBT locking ring	N/A	Type 6 nylon w/ PBT locking ring	N/A
	Cover Spring	Stainless steel	N/A	Stainless steel	N/A
	Cover Gasket	NBR rubber	N/A	NBR rubber	N/A
Flange Gasket	EPDM rubber	N/A	EPDM rubber	N/A	
Terminal Screws	Nickel-plated brass	Nickel-plated brass	Nickel-plated brass	Nickel-plated brass	
Assembly Screws	Stainless steel	Stainless steel	Stainless steel	Stainless steel	

**IEC 309 Watertight
Pin & Sleeve Devices**

60A
2-Pole, 3-Wire Grounding
3-Pole, 4-Wire Grounding; 4-Pole, 5-Wire Grounding

	Device Type	60A Pin & Sleeve Receptacles	60A Pin & Sleeve Plugs	60A Pin & Sleeve Connectors	60A Pin & Sleeve Inlets
		<ul style="list-style-type: none"> Conforms to IEC Standards 60309-1 and 60309-2 	<ul style="list-style-type: none"> Conforms to IEC Standards 60309-1 and 60309-2 	<ul style="list-style-type: none"> Conforms to IEC Standards 60309-1 and 60309-2 	<ul style="list-style-type: none"> Conforms to IEC Standards 60309-1 and 60309-2
	Testing & Code Compliance	<ul style="list-style-type: none"> Listed to UL498, UL1682 & UL1686 	<ul style="list-style-type: none"> Listed to UL498, UL1682 & UL1686 	<ul style="list-style-type: none"> Listed to UL498, UL1682 & UL1686 	<ul style="list-style-type: none"> Listed to UL498, UL1682 & UL1686
		<ul style="list-style-type: none"> CSA Certified to C22.2, 182.1 	<ul style="list-style-type: none"> CSA Certified to C22.2, 182.1 	<ul style="list-style-type: none"> CSA Certified to C22.2, 182.1 	<ul style="list-style-type: none"> CSA Certified to C22.2, 182.1
Specifications: Environmental	Flammability	Meets UL 94 requirements; V2 rated (housings), V0 rated (contact carriers)	Meets UL 94 requirements; V2 rated (housings), V0 rated (contact carriers)	Meets UL 94 requirements; V2 rated (housings), V0 rated (contact carriers)	Meets UL 94 requirements; V2 rated (housings), V0 rated (contact carriers)
	Protection	Watertight to IP 67 per IEC 529	Watertight to IP 67 per IEC 529	Watertight to IP 67 per IEC 529	Watertight to IP 67 per IEC 529
Specifications: Electrical	Dielectric Voltage	3000V	3000V	3000V	3000V
	Maximum Working Voltage	600V (rms)	600V (rms)	600V (rms)	600V (rms)
	Current Interrupting	Yes, at full-rated current & voltage	Yes, at full-rated current & voltage	Yes, at full-rated current & voltage	Yes, at full-rated current & voltage
	Temperature Rise	Max. 30°C (86°F) after 50 cycles of overload @150% of rated current	Max. 30°C (86°F) after 50 cycles of overload @150% of rated current	Max. 30°C (86°F) after 50 cycles of overload @150% of rated current	Max. 30°C (86°F) after 50 cycles of overload @150% of rated current
	Endurance	5000 cycles	5000 cycles	5000 cycles	5000 cycles
Specifications: Mechanical	Voltage Ratings	Marked on device	Marked on device	Marked on device	Marked on device
	Impact Resistance	CSA 22.2, 182.1, UL1862	CSA 22.2, 182.1, UL1862	CSA 22.2, 182.1, UL1862	CSA 22.2, 182.1, UL1862
	Cable Grip Retention	CSA 22.2, 182.1, UL1862	CSA 22.2, 182.1, UL1862	CSA 22.2, 182.1, UL1862	CSA 22.2, 182.1, UL1862
Materials:	Housing & Flange	PBT polyester & nylon/ABS blend	Nylon/ABS blend	Nylon/ABS blend	Nylon/ABS blend
	Back Body	N/A	Nylon/ABS blend	Nylon/ABS blend	N/A
	Contact Carrier/Support Isolators	Type 6/6 nylon	Type 6/6 nylon	Type 6/6 nylon	Type 6/6 nylon
	Sleeves	Brass	N/A	Brass	N/A
	Contact Spring on Sleeves	Nickel-plated stainless steel	N/A	Nickel-plated stainless steel	N/A
	Pins	N/A	Nickel-plated brass	N/A	Nickel-plated brass
	External Strain Relief Clamp	N/A	PC/PET blend	PC/PET blend	N/A
	Cable Seal	N/A	EPDM rubber	EPDM rubber	N/A
	Support Washer for Cord Grip	N/A	Zinc-plated steel, chromate finish	Zinc-plated steel, chromate finish	N/A
	Rivet	PBT polyester	N/A	PBT polyester	N/A
	Bayonette Ring	N/A	PBT polyester	N/A	PBT polyester
	Bayonette Gasket	N/A	NBR rubber	N/A	NBR rubber
	Cover	Type 6 nylon w/ PBT locking ring	N/A	Type 6 nylon w/ PBT locking ring	N/A
	Cover Spring	Stainless steel	N/A	Stainless steel	N/A
	Cover Gasket	NBR rubber	N/A	NBR rubber	N/A
	Flange Gasket	EPDM rubber	N/A	EPDM rubber	N/A
Terminal Screws	Nickel-plated brass	Nickel-plated brass	Nickel-plated brass	Nickel-plated brass	
Assembly Screws	Stainless steel	Nickel-plated brass	Nickel-plated brass	Stainless steel	

**IEC 309 Watertight
Pin & Sleeve Devices**

100A
2-Pole, 3-Wire Grounding
3-Pole, 4-Wire Grounding; 4-Pole, 5-Wire Grounding

	Device Type	100A Pin & Sleeve Receptacles	100A Pin & Sleeve Plugs	100A Pin & Sleeve Connectors	100A Pin & Sleeve Inlets
	Testing & Code Compliance	• Conforms to IEC Standards 60309-1 and 60309-2	• Conforms to IEC Standards 60309-1 and 60309-2	• Conforms to IEC Standards 60309-1 and 60309-2	• Conforms to IEC Standards 60309-1 and 60309-2
		• Listed to UL498, UL1682 & UL1686	• Listed to UL498, UL1682 & UL1686	• Listed to UL498, UL1682 & UL1686	• Listed to UL498, UL1682 & UL1686
		• CSA Certified to C22.2, 182.1	• CSA Certified to C22.2, 182.1	• CSA Certified to C22.2, 182.1	• CSA Certified to C22.2, 182.1
Specifications: Environmental	Flammability	Meets UL 94 requirements; V2 rated (housings), V0 rated (contact carriers)	Meets UL 94 requirements; V2 rated (housings), V0 rated (contact carriers)	Meets UL 94 requirements; V2 rated (housings), V0 rated (contact carriers)	Meets UL 94 requirements; V2 rated (housings), V0 rated (contact carriers)
	Protection	Watertight to IP 67 per IEC 529	Watertight to IP 67 per IEC 529	Watertight to IP 67 per IEC 529	Watertight to IP 67 per IEC 529
Specifications: Electrical	Dielectric Voltage	3000V	3000V	3000V	3000V
	Maximum Working Voltage	600V (rms)	600V (rms)	600V (rms)	600V (rms)
	Current Interrupting	Yes, at full-rated current & voltage	Yes, at full-rated current & voltage	Yes, at full-rated current & voltage	Yes, at full-rated current & voltage
	Temperature Rise	Max. 30°C (86°F) after 50 cycles of overload @150% of rated current	Max. 30°C (86°F) after 50 cycles of overload @150% of rated current	Max. 30°C (86°F) after 50 cycles of overload @150% of rated current	Max. 30°C (86°F) after 50 cycles of overload @150% of rated current
	Endurance	5000 cycles	5000 cycles	5000 cycles	5000 cycles
Specifications: Mechanical	Voltage Ratings	Marked on device	Marked on device	Marked on device	Marked on device
	Impact Resistance	CSA 22.2, 182.1, UL1862	CSA 22.2, 182.1, UL1862	CSA 22.2, 182.1, UL1862	CSA 22.2, 182.1, UL1862
	Cable Grip Retention	CSA 22.2, 182.1, UL1862	CSA 22.2, 182.1, UL1862	CSA 22.2, 182.1, UL1862	CSA 22.2, 182.1, UL1862
Materials:	Housing & Flange	PBT polyester & nylon/ABS blend	Nylon/ABS blend	Nylon/ABS blend	Nylon/ABS blend
	Back Body	N/A	Nylon/ABS blend	Nylon/ABS blend	N/A
	Contact Carrier/Support Isolators	Type 6/6 nylon	Type 6/6 nylon	Type 6/6 nylon	Type 6/6 nylon
	Sleeves	Brass	N/A	Brass	N/A
	Contact Spring on Sleeves	Nickel-plated stainless steel	N/A	Nickel-plated stainless steel	N/A
	Pins	N/A	Nickel-plated brass	N/A	Nickel-plated brass
	External Strain Relief Clamp	N/A	PC/PET blend	PC/PET blend	N/A
	Cable Seal	N/A	EPDM rubber	EPDM rubber	N/A
	Support Washer for Cord Grip	N/A	Zinc-plated steel, chromate finish	Zinc-plated steel, chromate finish	N/A
	Rivet	PBT polyester	N/A	PBT polyester	N/A
	Bayonette Ring	N/A	PBT polyester	N/A	PBT polyester
	Bayonette Gasket	N/A	NBR rubber	N/A	NBR rubber
	Cover	Type 6 nylon w/ PBT locking ring	N/A	Type 6 nylon w/ PBT locking ring	N/A
	Cover Spring	Stainless steel	N/A	Stainless steel	N/A
	Cover Gasket	EPDM rubber	N/A	EPDM rubber	N/A
	Flange Gasket	EPDM rubber	N/A	EPDM rubber	N/A
Terminal Screws	Nickel-plated brass	Nickel-plated brass	Nickel-plated brass	Nickel-plated brass	
Assembly Screws	Stainless steel	Nickel-plated brass	Nickel-plated brass	Stainless steel	

**IEC 309 Watertight
Pin & Sleeve
Mechanical Interlocks**

20A
2-Pole, 3-Wire Grounding
3-Pole, 4-Wire Grounding; 4-Pole, 5-Wire Grounding

	Device Type	20A Non-Fusible Mechanical Interlocks	20A Fusible Mechanical Interlocks	20A Fuse Option Mechanical Interlocks	20A Circuit Breaker Option Mechanical Interlocks
	Testing & Code Compliance	• Conforms to IEC Standards 60309-1 and 60309-2	• Conforms to IEC Standards 60309-1 and 60309-2	• Conforms to IEC Standards 60309-1 and 60309-2	• Conforms to IEC Standards 60309-1 and 60309-2
		• Listed to UL508, UL1682 & UL1686	• Listed to UL98, UL1682 & UL1686	• Listed to UL508, UL1682 & UL1686	• Listed to UL508, UL1682 & UL1686
		• CSA Certified to C22.2, no. 4-M91	• CSA Certified to C22.2, nos. 4-M91 & 4-M89	• CSA Certified to C22.2, nos. 4-M91	• CSA Certified to C22.2, nos. 4-M91
Specifications: Environmental	Flammability	Meets UL 94 requirements; 5V rated	Meets UL 94 requirements; 5V rated	Meets UL 94 requirements; 5V rated	Meets UL 94 requirements; 5V rated
	Protection	NEMA 4x; 12 rated enclosure Watertight to IP 66 per IEC 529	NEMA 4x; 12 rated enclosure Watertight to IP 66 per IEC 529	NEMA 4x; 12 rated enclosure Watertight to IP 66 per IEC 529	NEMA 4x; 12 rated enclosure Watertight to IP 66 per IEC 529
Specifications: Electrical	Dielectric Voltage	3000V	3000V	3000V	3000V
	Maximum Working Voltage	600V (rms)	600V (rms)	600V (rms)	600V (rms)
	Current Interrupting	Yes, at full-rated current & voltage	Yes, at full-rated current & voltage	Yes, at full-rated current & voltage	Yes, at full-rated current & voltage
	Temperature Rise	Max. 30°C (86°F) after 50 cycles of overload @150% of rated current	Max. 30°C (86°F) after 50 cycles of overload @150% of rated current	Max. 30°C (86°F) after 50 cycles of overload @150% of rated current	Max. 30°C (86°F) after 50 cycles of overload @150% of rated current
	Endurance	5000 cycles	5000 cycles	5000 cycles	5000 cycles
Specifications: Mechanical	Voltage Ratings	Marked on device	Marked on device	Marked on device	Marked on device
	Impact Resistance	CSA 22.2, 182.1, UL1862	CSA 22.2, 182.1, UL1862	CSA 22.2, 182.1, UL1862	CSA 22.2, 182.1, UL1862
Materials:	Enclosure Back Housing	UV stabilized Valox®	UV stabilized Valox®	UV stabilized Valox®	UV stabilized Valox®
	Enclosure Cover	UV stabilized Valox®	UV stabilized Valox®	UV stabilized Valox®	UV stabilized Valox®
	Enclosure Gasket	Poured-in-place, seamless	Poured-in-place, seamless	Poured-in-place, seamless	Poured-in-place, seamless
	Enclosure Fixing Screws	Stainless steel	Stainless steel	Stainless steel	Stainless steel
	Receptacle Housing & Flange	PBT polyester & nylon/ABS blend	PBT polyester & nylon/ABS blend	PBT polyester & nylon/ABS blend	PBT polyester & nylon/ABS blend
	Receptacle Contact Carrier/Support Isolators	Type 6/6 nylon	Type 6/6 nylon	Type 6/6 nylon	Type 6/6 nylon
	Receptacle Sleeves	Brass	Brass	Brass	Brass
	Contact Spring on Sleeves	Nickel-plated stainless steel	Nickel-plated stainless steel	Nickel-plated stainless steel	Nickel-plated stainless steel
	Receptacle Rivet	PBT polyester	PBT polyester	PBT polyester	PBT polyester
	Receptacle Cover	Type 6 nylon w/ PBT locking ring	Type 6 nylon w/ PBT locking ring	Type 6 nylon w/ PBT locking ring	Type 6 nylon w/ PBT locking ring
	Receptacle Cover Spring	Stainless steel	Stainless steel	Stainless steel	Stainless steel
	Receptacle Cover Gasket	NBR rubber	NBR rubber	NBR rubber	NBR rubber
	Receptacle Flange Gasket	EPDM rubber	EPDM rubber	EPDM rubber	EPDM rubber
	Receptacle Terminal Screws	Nickel-plated brass	Nickel-plated brass	Nickel-plated brass	Nickel-plated brass
Receptacle Assembly Screws	Stainless steel	Stainless steel	Stainless steel	Stainless steel	

**IEC 309 Watertight
Pin & Sleeve
Mechanical Interlocks**

30A
2-Pole, 3-Wire Grounding
3-Pole, 4-Wire Grounding; 4-Pole, 5-Wire Grounding

	Device Type	30A Non-Fusible Mechanical Interlocks	30A Fusible Mechanical Interlocks	30A Fuse Option Mechanical Interlocks	30A Circuit Breaker Option Mechanical Interlocks
	Testing & Code Compliance	• Conforms to IEC Standards 60309-1 and 60309-2	• Conforms to IEC Standards 60309-1 and 60309-2	• Conforms to IEC Standards 60309-1 and 60309-2	• Conforms to IEC Standards 60309-1 and 60309-2
		• Listed to UL508, UL1682 & UL1686	• Listed to UL98, UL1682 & UL1686	• Listed to UL508, UL1682 & UL1686	• Listed to UL508, UL1682 & UL1686
		• CSA Certified to C22.2, no. 4-M91	• CSA Certified to C22.2, nos. 4-M89	• CSA Certified to C22.2, nos. 4-M91	• CSA Certified to C22.2, nos. 4-M91
Specifications: Environmental	Flammability	Meets UL 94 requirements; 5V rated	Meets UL 94 requirements; 5V rated	Meets UL 94 requirements; 5V rated	Meets UL 94 requirements; 5V rated
	Protection	NEMA 4x; 12 rated enclosure Watertight to IP 66 per IEC 529	NEMA 4x; 12 rated enclosure Watertight to IP 66 per IEC 529	NEMA 4x; 12 rated enclosure Watertight to IP 66 per IEC 529	NEMA 4x; 12 rated enclosure Watertight to IP 66 per IEC 529
Specifications: Electrical	Dielectric Voltage	3000V	3000V	3000V	3000V
	Maximum Working Voltage	600V (rms)	600V (rms)	600V (rms)	600V (rms)
	Current Interrupting	Yes, at full-rated current & voltage	Yes, at full-rated current & voltage	Yes, at full-rated current & voltage	Yes, at full-rated current & voltage
	Temperature Rise	Max. 30°C (86°F) after 50 cycles of overload @150% of rated current	Max. 30°C (86°F) after 50 cycles of overload @150% of rated current	Max. 30°C (86°F) after 50 cycles of overload @150% of rated current	Max. 30°C (86°F) after 50 cycles of overload @150% of rated current
	Endurance	5000 cycles	5000 cycles	5000 cycles	5000 cycles
Specifications: Mechanical	Voltage Ratings	Marked on device	Marked on device	Marked on device	Marked on device
	Impact Resistance	CSA 22.2, 182.1, UL1862	CSA 22.2, 182.1, UL1862	CSA 22.2, 182.1, UL1862	CSA 22.2, 182.1, UL1862
Materials:	Enclosure Back Housing	UV stabilized Valox®	UV stabilized Valox®	UV stabilized Valox®	UV stabilized Valox®
	Enclosure Cover	UV stabilized Valox®	UV stabilized Valox®	UV stabilized Valox®	UV stabilized Valox®
	Enclosure Gasket	Poured-in-place, seamless	Poured-in-place, seamless	Poured-in-place, seamless	Poured-in-place, seamless
	Enclosure Fixing Screws	Stainless steel	Stainless steel	Stainless steel	Stainless steel
	Receptacle Housing & Flange	PBT polyester & nylon/ABS blend	PBT polyester & nylon/ABS blend	PBT polyester & nylon/ABS blend	PBT polyester & nylon/ABS blend
	Receptacle Contact Carrier/Support Isolators	Type 6/6 nylon	Type 6/6 nylon	Type 6/6 nylon	Type 6/6 nylon
	Receptacle Sleeves	Brass	Brass	Brass	Brass
	Contact Spring on Sleeves	Nickel-plated stainless steel	Nickel-plated stainless steel	Nickel-plated stainless steel	Nickel-plated stainless steel
	Receptacle Rivet	PBT polyester	PBT polyester	PBT polyester	PBT polyester
	Receptacle Cover	Type 6 nylon w/ PBT locking ring	Type 6 nylon w/ PBT locking ring	Type 6 nylon w/ PBT locking ring	Type 6 nylon w/ PBT locking ring
	Receptacle Cover Spring	Stainless steel	Stainless steel	Stainless steel	Stainless steel
	Receptacle Cover Gasket	NBR rubber	NBR rubber	NBR rubber	NBR rubber
	Receptacle Flange Gasket	EPDM rubber	EPDM rubber	EPDM rubber	EPDM rubber
	Receptacle Terminal Screws	Nickel-plated brass	Nickel-plated brass	Nickel-plated brass	Nickel-plated brass
Receptacle Assembly Screws	Stainless steel	Stainless steel	Stainless steel	Stainless steel	

**IEC 309 Watertight
Pin & Sleeve
Mechanical Interlocks**

60A & 100A
2-Pole, 3-Wire Grounding
3-Pole, 4-Wire Grounding; 4-Pole, 5-Wire Grounding

	Device Type	60A & 100A Non-Fusible Mechanical Interlocks	60A Fusible Mechanical Interlocks	60A Fuse Option Mechanical Interlocks	60A Circuit Breaker Option Mechanical Interlocks
	Testing & Code Compliance	• Conforms to IEC Standards 60309-1 and 60309-2	• Conforms to IEC Standards 60309-1 and 60309-2	• Conforms to IEC Standards 60309-1 and 60309-2	• Conforms to IEC Standards 60309-1 and 60309-2
		• Listed to UL508, UL1682 & UL1686	• Listed to UL98, UL1682 & UL1686	• Listed to UL508, UL1682 & UL1686	• Listed to UL508, UL1682 & UL1686
		• CSA Certified to C22.2, no. 4-M91	• CSA Certified to C22.2, nos. 4-M89	• CSA Certified to C22.2, nos. 4-M91	• CSA Certified to C22.2, nos. 4-M91
Specifications: Environmental	Flammability	Meets UL 94 requirements; 5V rated	Meets UL 94 requirements; 5V rated	Meets UL 94 requirements; 5V rated	Meets UL 94 requirements; 5V rated
	Protection	NEMA 4x; 12 rated enclosure Watertight to IP 66 per IEC 529	NEMA 4x; 12 rated enclosure Watertight to IP 66 per IEC 529	NEMA 4x; 12 rated enclosure Watertight to IP 66 per IEC 529	NEMA 4x; 12 rated enclosure Watertight to IP 66 per IEC 529
Specifications: Electrical	Dielectric Voltage	3000V	3000V	3000V	3000V
	Maximum Working Voltage	600V (rms)	600V (rms)	600V (rms)	600V (rms)
	Current Interrupting	Yes, at full-rated current & voltage	Yes, at full-rated current & voltage	Yes, at full-rated current & voltage	Yes, at full-rated current & voltage
	Temperature Rise	Max. 30°C (86°F) after 50 cycles of overload @150% of rated current	Max. 30°C (86°F) after 50 cycles of overload @150% of rated current	Max. 30°C (86°F) after 50 cycles of overload @150% of rated current	Max. 30°C (86°F) after 50 cycles of overload @150% of rated current
	Endurance	5000 cycles	5000 cycles	5000 cycles	5000 cycles
Specifications: Mechanical	Voltage Ratings	Marked on device	Marked on device	Marked on device	Marked on device
	Impact Resistance	CSA 22.2, 182.1, UL1862	CSA 22.2, 182.1, UL1862	CSA 22.2, 182.1, UL1862	CSA 22.2, 182.1, UL1862
Materials:	Enclosure Back Housing	UV stabilized Valox®	UV stabilized Valox®	UV stabilized Valox®	UV stabilized Valox®
	Enclosure Cover	UV stabilized Valox®	UV stabilized Valox®	UV stabilized Valox®	UV stabilized Valox®
	Enclosure Gasket	Poured-in-place, seamless	Poured-in-place, seamless	Poured-in-place, seamless	Poured-in-place, seamless
	Enclosure Fixing Screws	Stainless steel	Stainless steel	Stainless steel	Stainless steel
	Receptacle Housing & Flange	PBT polyester & nylon/ABS blend	PBT polyester & nylon/ABS blend	PBT polyester & nylon/ABS blend	PBT polyester & nylon/ABS blend
	Receptacle Contact Carrier/Support Isolators	Type 6/6 nylon	Type 6/6 nylon	Type 6/6 nylon	Type 6/6 nylon
	Receptacle Sleeves	Brass	Brass	Brass	Brass
	Contact Spring on Sleeves	Nickel-plated stainless steel	Nickel-plated stainless steel	Nickel-plated stainless steel	Nickel-plated stainless steel
	Receptacle Rivet	PBT polyester	PBT polyester	PBT polyester	PBT polyester
	Receptacle Cover	Type 6 nylon w/ PBT locking ring	Type 6 nylon w/ PBT locking ring	Type 6 nylon w/ PBT locking ring	Type 6 nylon w/ PBT locking ring
	Receptacle Cover Spring	Stainless steel	Stainless steel	Stainless steel	Stainless steel
	Receptacle Cover Gasket	NBR rubber	NBR rubber	NBR rubber	NBR rubber
	Receptacle Flange Gasket	EPDM rubber	EPDM rubber	EPDM rubber	EPDM rubber
	Receptacle Terminal Screws	Nickel-plated brass	Nickel-plated brass	Nickel-plated brass	Nickel-plated brass
Receptacle Assembly Screws	Stainless steel	Stainless steel	Stainless steel	Stainless steel	

F

Industrial Connectivity

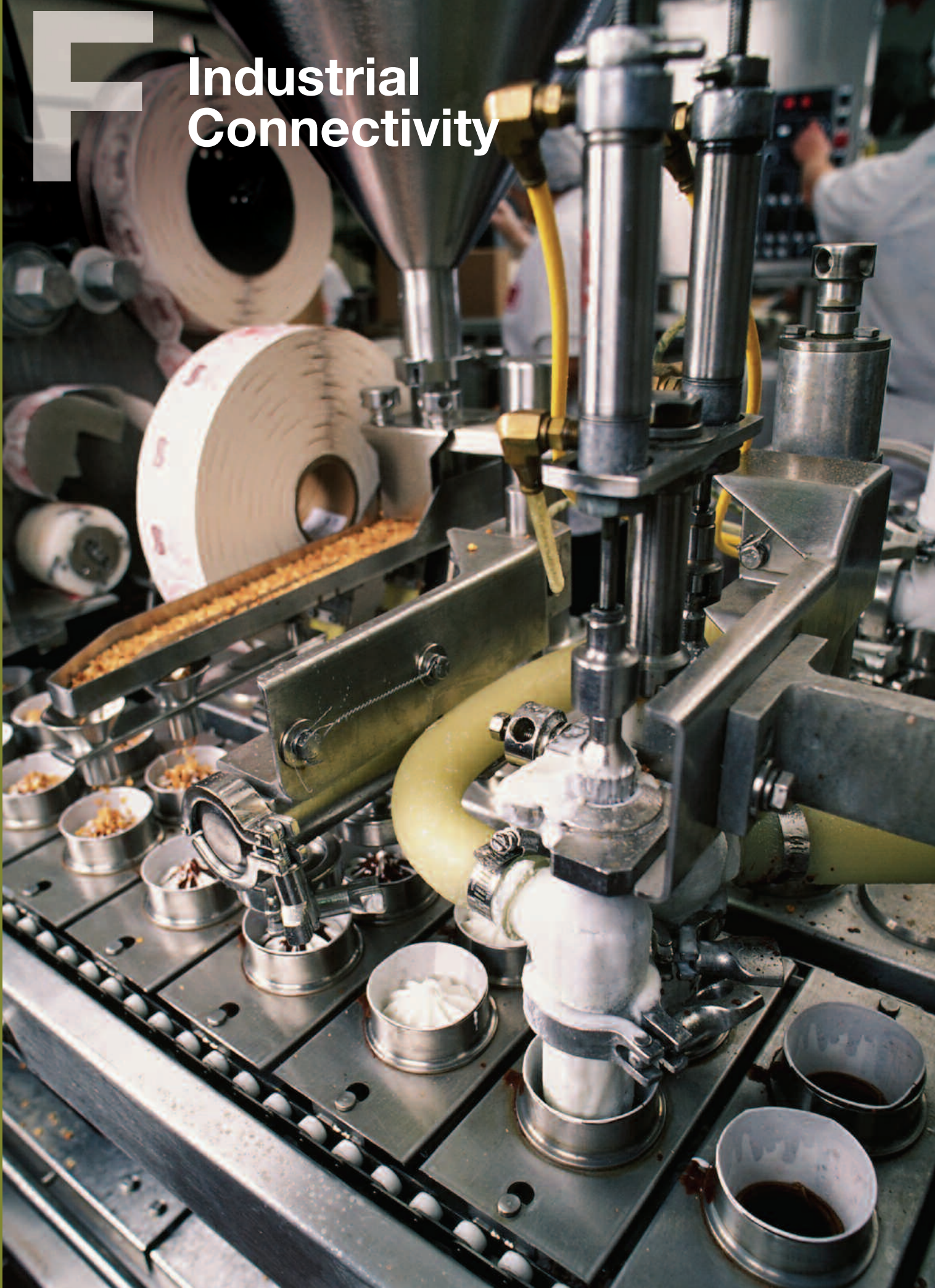

	Page		Page
SOFTPower™	F-1	Industrial Network Products	F-19
Cordsets		Industrial Ethernet/IP	
Change-Out™	F-1–F-3	RJ45 Cordsets	F-19–F-21
Mini-Line™	F-1–F-3	RJ45 to Micro-Mini Cordsets	F-19–F-21
Receptacles		Micro-Mini Cordsets	F-19–F-21
Change-Out	F-1, F-4–F-5	Receptacles	F-19–F-21
Mini-Line™	F-1, F-4–F-5	DeviceNet™	
Mini-Line™	F-6	Mini-Line Cordsets & Receptacles	F-19, F-22–F-23
Cordsets		Micro-Mini Cordsets & Receptacles	F-19, F-22–F-23
Style 1	F-6–F-8	Mini-Line to Micro-Mini Cordsets & Receptacles	F-19, F-22–F-23
Style 2	F-6–F-8	Receptacles	F-19, F-22–F-23
Style 3	F-6–F-8	Profibus	
Receptacles		Micro-Mini Cordsets	F-19, F-24–F-25
Style 1	F-6, F-9–F-10	Micro-Mini Receptacles	F-19, F-24–F-25
Style 2	F-6, F-9–F-10	Industrial Connectivity Accessories	F-26
Style 3	F-6, F-9–F-10	Specification Information	F-27
Micro-Mini™ & Pico Line™	F-11		
Cordsets			
Micro-Mini Dual Key AC	F-11, F-12, F-15		
Micro-Mini DC DIN	F-11, F-13, F-15		
Micro-Mini AC DIN	F-11, F-13, F-15		
Pico-Line Snap-In	F-11, F-14–F-15		
Pico-Line Coupler	F-11, F-14–F-15		
Receptacles			
Micro-Mini Dual Key AC	F-11, F-16, F-18		
Micro-Mini DC DIN	F-11, F-17–F-18		
Micro-Mini AC DIN	F-11, F-17–F-18		
Pico-Line Universal	F-11, F-18		

Realize time and cost savings with LynxPOWER Industrial Connectivity

When operating efficiency and manufacturing uptime are critical, Arrow Hart's extensive offering of industrial connectivity products simplify installations and change-outs for power, signal and data applications.



SOFTPower™

Arrow Hart's full line of SOFTPower cordsets, receptacles and accessories are the preferred choice for modular and portable power applications. SOFTPower connection points mean less downtime, easier maintenance and increased safety by replacing traditional hardwiring with a durable and dependable plug-and-run modular pre-wired system.



Mini-Line™

Mini-Line cordsets, receptacles and accessories are specifically designed for industrial automation applications in which power or signal connections are exposed to long-term physical stresses and subjected to liquids or oils. Mini-Line offers a wide range of standard and custom products in a variety of configurations.



Micro-Mini™ & Pico-Line™

Our broad selection of Micro-Mini and Pico-Line products have been specifically designed for low amperage AC or DC control systems and are ideally suited for use in harsh and abusive manufacturing environments that expose signal connections to constant flexing and vibration plus contaminants, hot chips or welding flash.



Industrial Network Products

Arrow Hart's broad selection of industrial networking products are designed to bridge communication between office and factory floors in your choice of today's communication standards including Ethernet, DeviceNet™, Profibus, SDS™ and Seriplex™. The products are specifically designed for data and signal transfer in industrial environments.

DeviceNet™ is a trademark of Allen-Bradley. Seri-Plex™ is a trademark of Square D Company. SDS™ is a trademark of Honeywell Microswitch.

Heavy duty design and construction ideal for harsh environments

Specifically designed to meet NFPA 79 requirements, SOFTPower products are rated for use in industrial environments without the need for raceway or cable tray.



*Change-Out™
Trunk/Feeder Cordsets*

*Mini-Line™
Drop/Branch Cordsets*

Dual rated TC/STOOW cable provides the crush and impact performance of type MC (metal clad) cable in a flexible PVC jacket

Factory molded-to-cable connector ends provide quick connect and disconnect capabilities

Factory tested connector ends eliminate incorrect wiring in the field

Cable flexibility allows easier installation and more adaptability without sacrificing safety

Environmentally sealed connectors prevent the ingress of dust, water and other contaminants

Shroud and cork design ensures IP 68 and NEMA 6P protection levels



SOFTPower Receptacle

Conductor color coding meets current international standards



LynxPOWER™ SOFTPower Cordsets

IEC IP 68
10A, 13A, 15A, 18A, 25A, 30A
600V



Single-End
Change-Out



Double-End
Change-Out



Single-End
Mini-Line



Double-End
Mini-Line

Change-Out™ Trunk/Feeder Assembly Cordsets



3-Pole: 30A, 4-Pole: 25A

3 conductor 10 AWG international color code
for 30A loads

4 conductor 10 AWG international color code
for 25A loads

- Male or female ends
- Straight and right angle designs
- Single- and double-ended configurations
- Vibration-resistant ratchet coupler design
- Cable: TC/STOOW jacket
- Diecast zinc or stainless steel coupler options

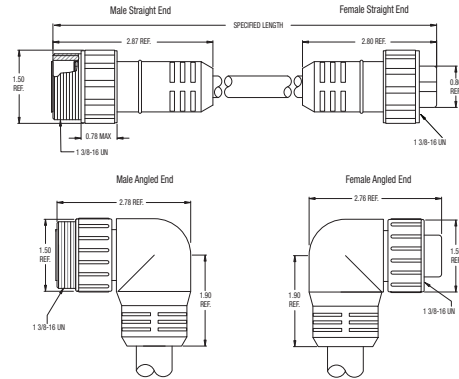

Mini-Line™ Drop/Branch Assembly Cordsets



3-Pole: 13A or 18A, 4-Pole: 10A or 15A

3 conductor 14 AWG international color code
for 18A loads

3 conductor 16 AWG international color code
for 13A loads

4 conductor 14 AWG international color code
for 15A loads

4 conductor 16 AWG international color code
for 10A loads

- Style 1 male or female ends
- Straight and right angle designs
- Single- and double-ended configurations
- Vibration-resistant ratchet coupler design
- Cable: TC/STOOW jacket
- Diecast zinc or stainless steel coupler options

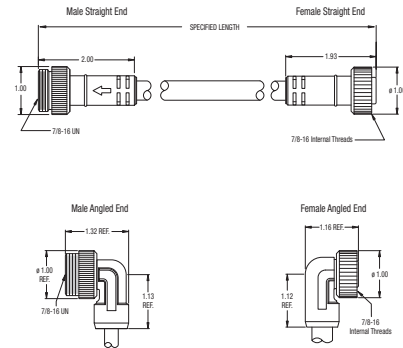

LynxPOWER™
SOFTPower Cordsets

IEC IP 68
10A, 13A, 15A, 18A, 25A, 30A
600V

Change-Out™ Pin Configurations & Color Coding



Conductor Color Coding	International	International
	1. BLK	1. BLK
	2. GRN/YEL	2. GRN/YEL
	3. GRY	3. RED
		4. GRY

Mini-Line™ Pin Configurations & Color Coding

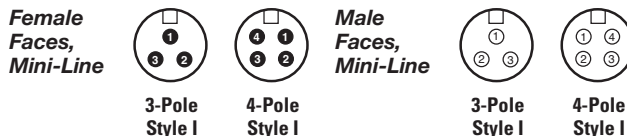

Conductor Color Coding	International	International
	1. GRN/YEL	1. BLK
	2. BLK	2. GRY
	3. GRY	3. RED
		4. GRN/YEL

Catalog Number Matrix

Sample Number:
AHCA4C6TS100MX =
Arrow Hart SOFTPower Change-Out 4-Pole female internal thread plug 10 AWG gray TC/STOOW cable, 10 meter length, stainless steel hardware.

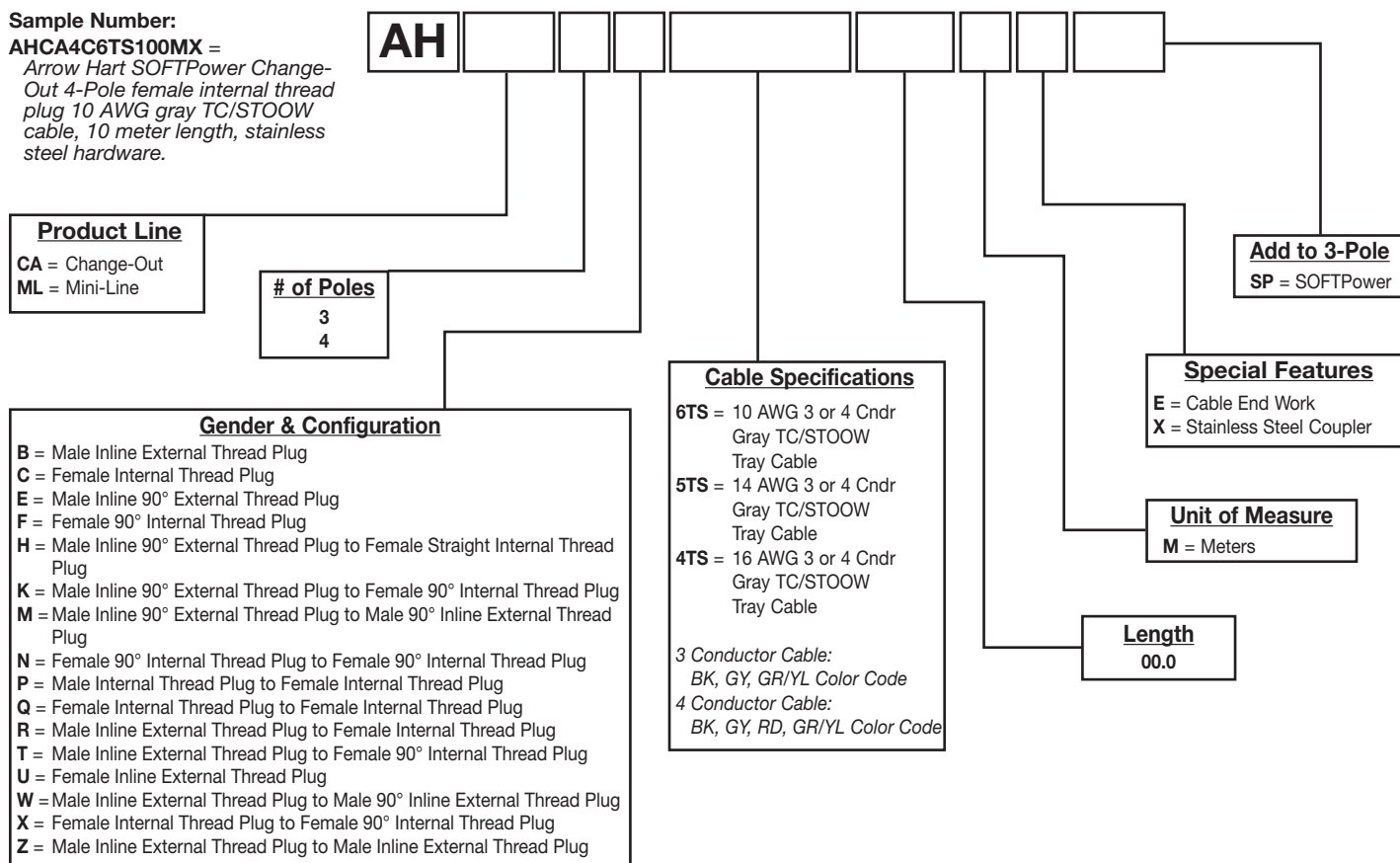

Specification Information:
SOFTPower Cordsets: F-27

LynxPOWER™ SOFTPower Receptacles

IEC IP 68
10A, 13A, 15A, 18A, 25A, 30A
600V

Change-Out™ Trunk/Feeder Assembly Receptacles



3-Pole: 30A, 4-Pole: 25A

3 conductor 10 AWG international color code
for 30A loads

4 conductor 10 AWG international color code
for 25A loads

- Male or female receptacles
- Straight design
- 1/2" - 14 NPT or 3/4" - 14 NPT options
- Male: diecast zinc shell
- Female: aluminum shell

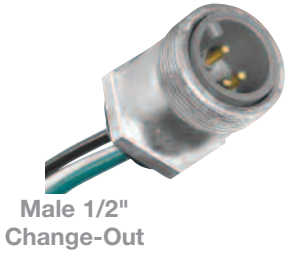
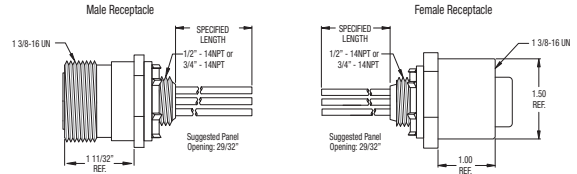

Male 1/2"
Change-Out

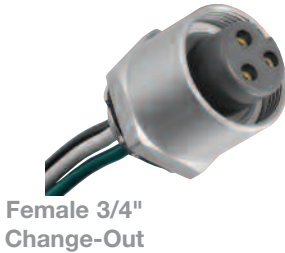

Female 3/4"
Change-Out

Mini-Line™ Drop/Branch Assembly Receptacles



3-Pole: 13A or 18A, 4-Pole: 10A or 15A

3 conductor 14 AWG international color code
for 18A loads

3 conductor 16 AWG international color code
for 13A loads

4 conductor 14 AWG international color code
for 15A loads

4 conductor 16 AWG international color code
for 10A loads

- Male or female receptacles
- Straight design
- 1/2" - 14 NPT
- Male: diecast zinc shell
- Female: aluminum shell

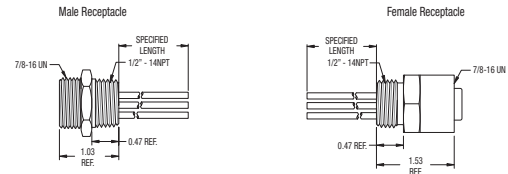

Male 1/2"
Mini-Line

Specification Information:
SOFTPower Receptacles: F-28

LynxPOWER™
SOFTPower Receptacles

IEC IP 68
10A, 13A, 15A, 18A, 25A, 30A
600V

Change-Out™ Pin Configurations & Color Coding

Female Faces, Change-Out



3-Pole



4-Pole

Male Faces, Change-Out



3-Pole



4-Pole

Conductor Color Coding

International	International
1. BLK	1. BLK
2. GRN/YEL	2. GRN/YEL
3. GRY	3. RED
	4. GRY

Mini-Line™ Pin Configurations & Color Coding

Female Faces, Mini-Line



3-Pole Style I



4-Pole Style I

Male Faces, Mini-Line



3-Pole Style I



4-Pole Style I

Conductor Color Coding

International	International
1. GRN/YEL	1. BLK
2. BLK	2. GRY
3. GRY	3. RED
	4. GRN/YEL

Catalog Number Matrix

Sample Number:

AHMR3D6BS010MXSP =
Arrow Hart SOFTPower Mini-Line receptacle, 3-Pole, female internal thread 1/2"-14 NPT, 10 AWG PVC cable 1 meter length, stainless steel shell.

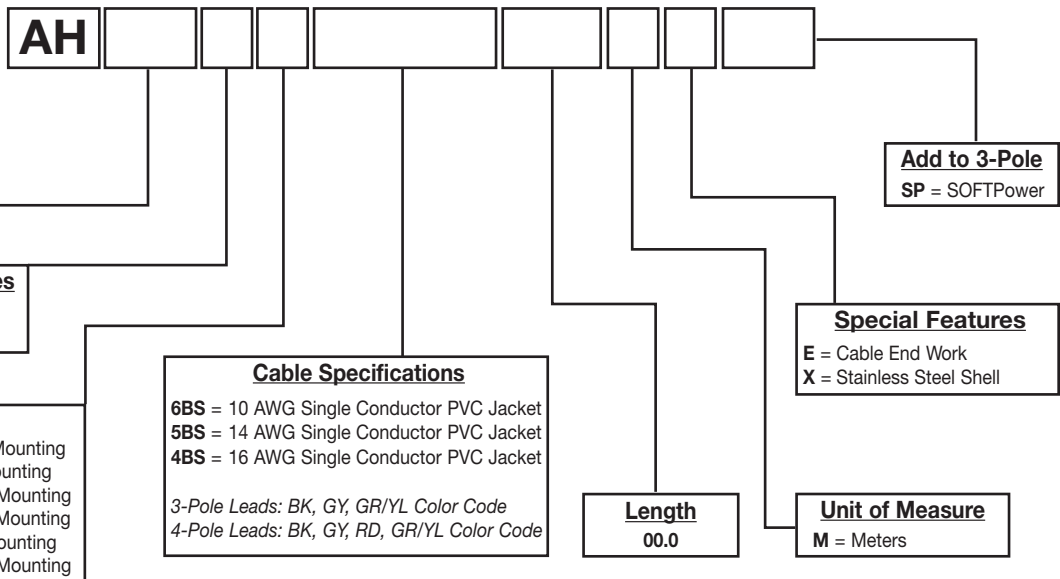

Specification Information:
SOFTPower Receptacles: F-28

**Quality, dependable
connectivity solutions
for today's industrial
applications**

Arrow Hart's Mini-Line cordsets and receptacles are designed for modular use in harsh environments where cable assemblies are exposed to constant flexing and contaminants.



Vibration-resistant ratchet coupler design prevents loosening in severe applications

*Style 1
Cordset*

End-to-cable molded junction securely bonds for excellent reliability

*Style 2
Cordset*

Couplers pass 1,000-hour salt-spray test for exceptional corrosion resistance

*Style 3
Cordset*

Shroud and cork design rated for 1,200 psi hose-down spray, exceeding IEC IP 68 and NEMA 6P ratings

Gold over nickel female contact plating provides superior conductivity and corrosion resistance

*Mini-Line
Receptacle*

Superior bonding receptacle-to-pigtail epoxy potting ensures excellent reliability by preventing pigtail pull-out

LynxPOWER™
Mini-Line Cordsets

IEC IP 68
6A, 7A, 8A, 10A, 13A 600V/AC & 600V/DC
6A 120V/AC

Style 1, Male & Female Ends



2-Pole: 13A, 3-Pole: 13A, 4-Pole: 10A, 5-Pole: 8A, 6-Pole: 6A

2, 3, 4, 5 conductor 16 AWG standard color code cable

3 & 5 conductor 16 AWG automotive color code cable

6 conductor 18 AWG standard color code cable

- Vibration-proof ratchet design
- Cables: ST00W, SO0W, SE0W or AWM jacket
- Meets current SAE #H1738-2 specifications
- Multiple coupler options

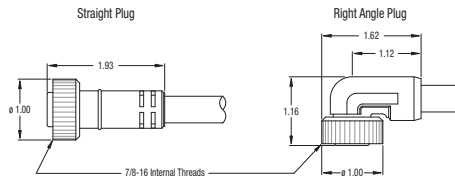

Style 1

Style 2, Male & Female Ends



6-Pole: 8A, 7-Pole: 7A, 8-Pole: 7A

6, 7, 8 conductor 16 AWG standard color code cable

- Vibration-proof ratchet design
- Cables: ST00W or SO0W jacket
- Meets current SAE #H1738-2 specifications
- Multiple coupler options

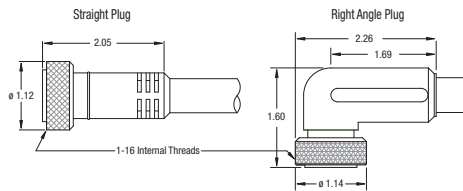

Style 1, Angled Neon



Style 2

Style 3, Male & Female Ends



9-Pole: 7A, 10-Pole: 7A, 12-Pole: 7A

9, 10, 12 conductor 16 AWG standard color code cable

- Vibration-proof ratchet design
- Cables: ST00W or SO0W jacket
- Meets current SAE #H1738-2 specifications
- Machined aluminum coupler

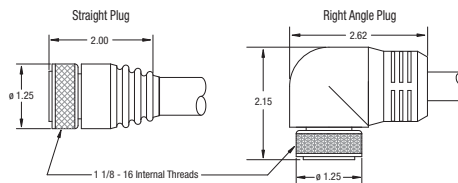

Style 3

Specification Information:
Mini-Line Cordsets: F-29

LynxPOWER™ Mini-Line Cordsets

IEC IP 68
6A, 7A, 8A, 10A, 13A 600V/AC & 600V/DC
6A 120V/AC

Pin Configurations & Color Coding

Female Faces



Male Faces



Conductor Color Coding

Standard	Standard	Standard	Standard	Standard	Standard	Standard	Standard	Standard	Standard	Standard	Standard
1. BLK 2. WHT	1. BLK 2. WHT 3. RED	1. BLK 2. WHT 3. RED 4. GRN	1. BLK 2. WHT 3. RED 4. GRN 5. ORG	1. BLK 2. WHT 3. RED 4. GRN 5. ORG 6. BLU	1. BLK 2. WHT 3. RED 4. GRN 5. ORG 6. BLU	1. BLK 2. WHT 3. RED 4. GRN 5. ORG 6. BLU 7. WHT/BLK	1. BLK 2. WHT 3. RED 4. GRN 5. ORG 6. BLU 7. WHT/BLK 8. RED/BLK	1. BLK 2. WHT 3. RED 4. GRN 5. ORG 6. BLU 7. WHT/BLK 8. RED/BLK 9. GRN/BLK	1. BLK 2. WHT 3. RED 4. GRN 5. ORG 6. BLU 7. WHT/BLK 8. RED/BLK 9. GRN/BLK 10. ORG/BLK	1. BLK 2. WHT 3. RED 4. GRN 5. ORG 6. BLU 7. WHT/BLK 8. RED/BLK 9. GRN/BLK 10. ORG/BLK 11. BLU/BLK 12. BLK/WHT	
Automotive	Automotive	Automotive	Automotive								
1. RED 2. RED/BLK	1. GRN 2. RED/BLK 3. RED/WHT	1. RED/BLK 2. RED/WHT 3. RED 4. GRN	1. RED/WHT 2. RED/BLU 3. GRN 4. RED/ORG 5. RED/BLK								

Catalog Number Matrix

Sample Number:

AHML4A4MC100FX =

Arrow Hart Mini-Line 4-Pole male
internal thread plug 16 AWG yellow
PVC STOOW, U.S. std. color code,
10 foot length, stainless steel coupler.

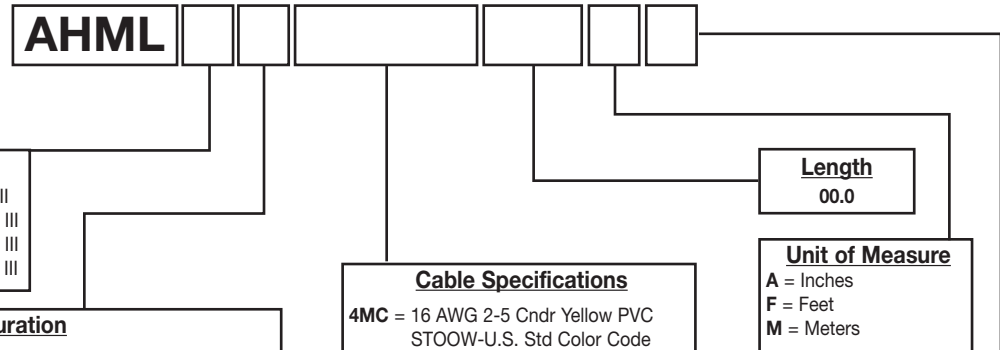

of Poles

2 = 2, Style I	6 = 6, Style I	9 = 9, Style III
3 = 3, Style I	W = 6, Style II	A = 10, Style III
4 = 4, Style I	7 = 7, Style II	B = 11, Style III
5 = 5, Style I	8 = 8, Style II	C = 12, Style III

Gender & Configuration

A = Male Internal Thread Plug
B = Male Inline External Thread Plug
C = Female Internal Thread Plug
D = Male 90° Internal Thread Plug
E = Male Inline 90° External Thread Plug
F = Female 90° Internal Thread Plug
G = Male 90° Internal Thread Plug to Female Straight Internal Thread Plug
H = Male Inline 90° External Thread Plug to Female Straight Internal Thread Plug
J = Male 90° Internal Thread Plug to Female 90° Internal Thread Plug
K = Male Inline 90° External Thread Plug to Female 90° Internal Thread Plug
L = Male 90° Internal Thread Plug to Male 90° Internal Thread Plug
M = Male Inline 90° External Thread Plug to Male 90° Inline External Thread Plug
N = Female 90° Internal Thread Plug to Female 90° Internal Thread Plug
P = Male Internal Thread Plug to Female Internal Thread Plug
Q = Female Internal Thread Plug to Female Internal Thread Plug
R = Male Inline External Thread Plug to Female Internal Thread Plug
S = Male Internal Thread Plug to Female 90° Internal Thread Plug
T = Male Inline External Thread Plug to Female 90° Internal Thread Plug
U = Female Inline External Thread Plug
V = Male Internal Thread Plug to Male 90° Internal Thread Plug
W = Male Inline External Thread Plug to Male 90° Inline External Thread Plug
X = Female Internal Thread Plug to Female 90° Internal Thread Plug
Y = Male Internal Thread Plug to Male Internal Thread Plug
Z = Male Inline External Thread Plug to Male Inline External Thread Plug

Cable Specifications

4MC = 16 AWG 2-5 Cndr Yellow PVC STOOW-U.S. Std Color Code
4WC = 16 AWG 6-12 Cndr Yellow PVC STOOW-U.S. Std Color Code
3MC = 18 AWG Yellow PVC STOOW-U.S. Std Color Code
3MA = 18 AWG Yellow PVC STOOW-U.S. Auto Color Code (for neon plugs)
4SC = 16 AWG 2-12 Cndr Yellow SOOW-U.S. Std Color Code
4SA = 16 AWG 3 or 5 Cndr Yellow SOOW-U.S. Auto Color Code
4YC = 16 AWG 2-5 Cndr Yellow SEOW-U.S. Std Color Code
3YC = 18 AWG 6 Cndr Yellow SEOW-U.S. Std Color Code

Length

00.0

Unit of Measure

A = Inches
F = Feet
M = Meters

Special Features

B = 360° Shielded to Coupler
C = Customer Supplied Cable
E = Cable End Work
G = Nickel Plated Coupler
H = No Ground Pin
K = Wire Mesh Grip, Stainless Steel
L = Lighted (for neon plugs)
S = Special
X = Stainless Steel Coupler
Y = Nylon/Lexan Coupler

Exceptions:

Neon plugs available only in Style 1, 3-Pole 6A 18 AWG AWM cable, in straight or right angle versions.

Specification Information:

Mini-Line Cordsets: F-29

LynxPOWER™ Mini-Line Receptacles

IEC IP 68
6A, 7A, 8A, 10A, 13A 600V/AC & 600V/DC

Style 1 Male & Female Straight & Angled



2-Pole: 13A, 3-Pole: 13A, 4-Pole: 10A, 5-Pole: 8A, 6-Pole: 6A

2, 3, 4, 5, 6 conductor leads available in standard color code

3 & 5 conductor leads available in automotive color code

- 16 AWG pigtail leads
- Meets current SAE #H1738-2 specifications
- Multiple shell material options

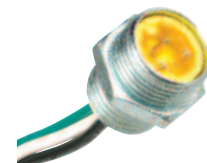
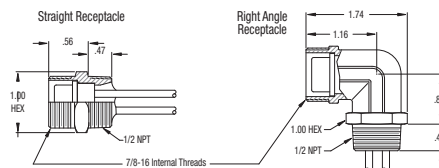

Style 1

Style 1 Male & Female Panel (Flange) Mount



2-Pole: 13A, 3-Pole: 13A, 4-Pole: 10A, 5-Pole: 8A, 6-Pole: 6A

2, 3, 4, 5, 6 conductor leads available in standard color code

- 16 AWG pigtail leads
- Flange mount or 1/2"-14 NPT versions
- Meets current SAE #H1738-2 specifications
- Machined aluminum shell

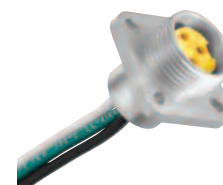
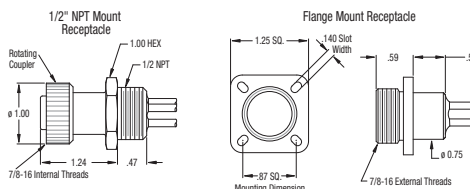

Style 1,
Panel Mount

Style 2 Male & Female Straight & Flange Mount



6-Pole: 8A, 7-Pole: 7A, 8-Pole: 7A

6, 7, 8 conductor leads available in standard color code

- 16 AWG pigtail leads
- Standard or flange mount version
- Meets current SAE #H1738-2 specifications
- Multiple shell material options

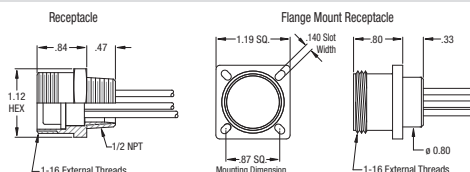

Style 2

Style 3 Male & Female Straight



9-Pole: 7A, 10-Pole: 7A, 12-Pole: 7A

9, 10, 12 conductor leads available in standard color code

- 16 AWG pigtail leads
- Meets current SAE #H1738-2 specifications
- Multiple shell material options

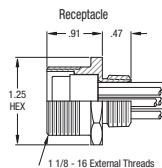

Style 3

Specification Information:
Mini-Line Receptacles: F-30

LynxPOWER™ Mini-Line Receptacles

IEC IP 68
6A, 7A, 8A, 10A, 13A 600V/AC & 600V/DC

Pin Configurations & Color Coding

Female Faces



**2-Pole
Style I**



**3-Pole
Style I**



**4-Pole
Style I**



**5-Pole
Style I**



**6-Pole
Style I**



**6-Pole
Style II**



**7-Pole
Style II**



**8-Pole
Style II**



**9-Pole
Style III**



**10-Pole
Style III**



**12-Pole
Style III**

Male Faces



**2-Pole
Style I**



**3-Pole
Style I**



**4-Pole
Style I**



**5-Pole
Style I**



**6-Pole
Style I**



**6-Pole
Style II**



**7-Pole
Style II**



**8-Pole
Style II**



**9-Pole
Style III**



**10-Pole
Style III**



**12-Pole
Style III**

**Conductor
Color Coding**

Standard
1. BLK
2. WHT

Automotive
1. RED
2. RED/BLK

Standard
1. BLK
2. WHT
3. RED

Automotive
1. GRN
2. RED/BLK
3. RED/WHT

Standard
1. BLK
2. WHT
3. RED
4. GRN

Automotive
1. RED/BLK
2. RED/WHT
3. RED
4. GRN

Standard
1. BLK
2. WHT
3. RED
4. GRN
5. ORG

Automotive
1. RED/WHT
2. RED/BLU
3. GRN
4. RED/ORG
5. RED/BLK

Standard
1. BLK
2. WHT
3. RED
4. GRN
5. ORG
6. BLU

Automotive
1. RED/WHT
2. RED/BLU
3. GRN
4. RED/ORG
5. RED/BLK

Standard
1. BLK
2. WHT
3. RED
4. GRN
5. ORG
6. BLU

Automotive
1. RED/WHT
2. RED/BLU
3. GRN
4. RED/ORG
5. RED/BLK

Standard
1. BLK
2. WHT
3. RED
4. GRN
5. ORG
6. BLU
7. WHT/BLK

Automotive
1. RED/WHT
2. RED/BLU
3. GRN
4. RED/ORG
5. RED/BLK

Standard
1. BLK
2. WHT
3. RED
4. GRN
5. ORG
6. BLU
7. WHT/BLK
8. RED/BLK

Automotive
1. RED/WHT
2. RED/BLU
3. GRN
4. RED/ORG
5. RED/BLK

Standard
1. BLK
2. WHT
3. RED
4. GRN
5. ORG
6. BLU
7. WHT/BLK
8. RED/BLK
9. GRN/BLK

Automotive
1. RED/WHT
2. RED/BLU
3. GRN
4. RED/ORG
5. RED/BLK

Standard
1. BLK
2. WHT
3. RED
4. GRN
5. ORG
6. BLU
7. WHT/BLK
8. RED/BLK
9. GRN/BLK
10. ORG/BLK

Automotive
1. RED/WHT
2. RED/BLU
3. GRN
4. RED/ORG
5. RED/BLK

Standard
1. BLK
2. WHT
3. RED
4. GRN
5. ORG
6. BLU
7. WHT/BLK
8. RED/BLK
9. GRN/BLK
10. ORG/BLK
11. BLU/BLK
12. BLK/WHT

Automotive
1. RED/WHT
2. RED/BLU
3. GRN
4. RED/ORG
5. RED/BLK

Catalog Number Matrix

Sample Number:

AHMR4A4BC010FX =

Arrow Hart Mini-Line, 4-Pole Style I, female internal thread with 1/4"-18 NPT mounting, 16 AWG single conductor PVC U.S. Std. color code, 1 foot long flying leads, with stainless steel receptacle shell.

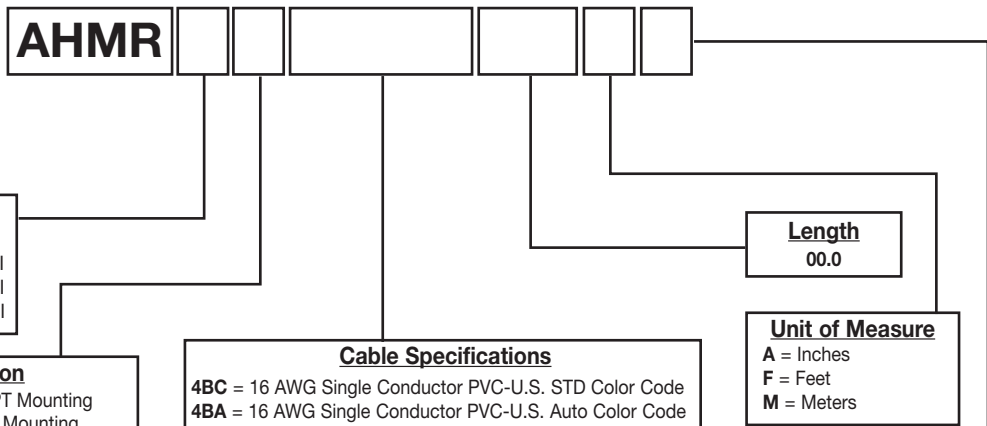

of Poles

2 = 2, Style I 6 = 6, Style I 9 = 9, Style III
3 = 3, Style I W = 6, Style II A = 10, Style III
4 = 4, Style I 7 = 7, Style II B = 11, Style III
5 = 5, Style I 8 = 8, Style II C = 12, Style III

Gender & Configuration

A = Female Internal Thread - 1/4"-18 NPT Mounting
B = Male External Thread - 1/4"-18 NPT Mounting
C = Female External Thread - 1/4"-18 NPT Mounting
D = Female Internal Thread - 1/2"-14 NPT Mounting
E = Male External Thread - 1/2"-14 NPT Mounting
F = Female External Thread - 1/2"-14 NPT Mounting
G = Female 90° External Thread - 1/2"-14 NPT Mounting
H = Male 90° External Thread - 1/2"-14 NPT Mounting
J = Female Internal Thread - 3/4"-14 NPT Mounting
K = Male External Thread - 3/4"-14 NPT Mounting
Q = Male External Thread - Flange Mount
R = Female External Thread - Flange Mount
S = Female External Thread - Back Mount
T = Female Internal Thread - Back Mount
U = Female External Thread - 3/4"-14 NPT Mounting
V = Female Internal Thread Liquidtight
W = Female External Thread - 11.5 NPS Mounting
X = Male External Thread - 11.5 NPS Mounting

Cable Specifications

4BC = 16 AWG Single Conductor PVC-U.S. STD Color Code
4BA = 16 AWG Single Conductor PVC-U.S. Auto Color Code

Exceptions:

Style 1 panel (flange) mount shell available in machined aluminum only.

Length

00.0

Unit of Measure

A = Inches
F = Feet
M = Meters

Special Features

B = 360° Shielded to Coupler
C = Customer Supplied Cable
G = Nickel Plated Shell
H = No Ground Pin
S = Special
X = Stainless Steel Shell
Y = Nylon/Lexan Shell

Specification Information:

Mini-Line Receptacles: F-30

The ideal connectivity solution for sensor and control devices

Arrow Hart's Micro-Mini and Pico-Line cordsets and receptacles are specifically designed for sensor and control equipment used in today's manufacturing environments.



Unique jacketed cable with fillerless design allows quick cable stripping

Vibration-resistant ratchet coupler design prevents loosening in severe applications

Couplers pass 1,000-hour salt-spray test for exceptional corrosion resistance

Heavy duty contact insert provides superior strength for even the most abusive applications

Gold over nickel female contact plating provides superior conductivity and corrosion resistance

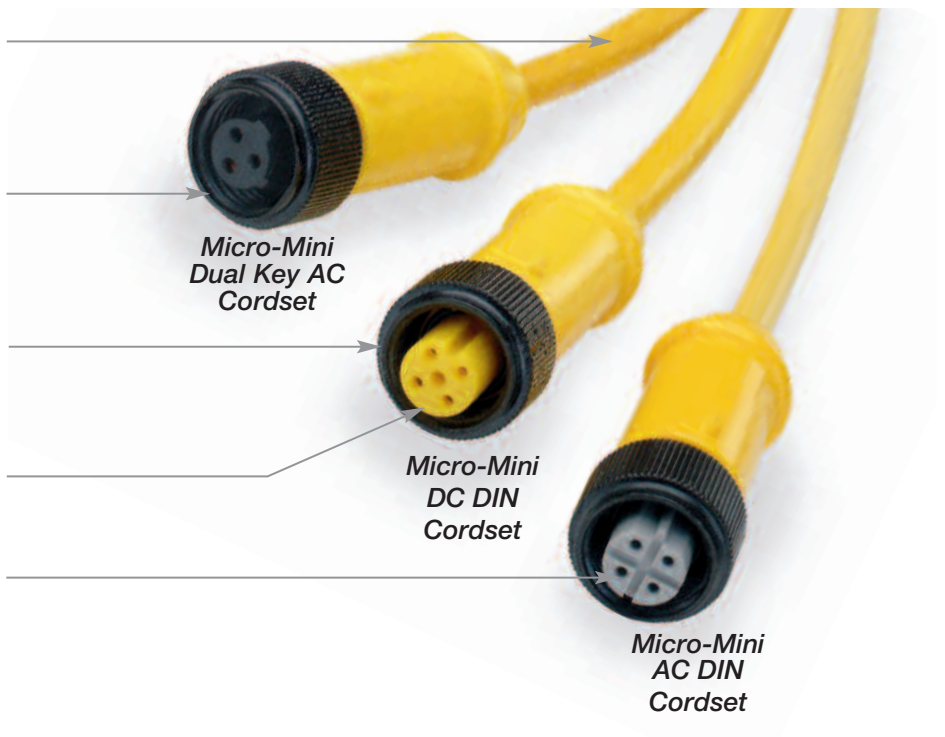

Micro-Mini Dual Key AC Cordset

Micro-Mini DC DIN Cordset

Micro-Mini AC DIN Cordset

Pico-Line Receptacle & Cordset

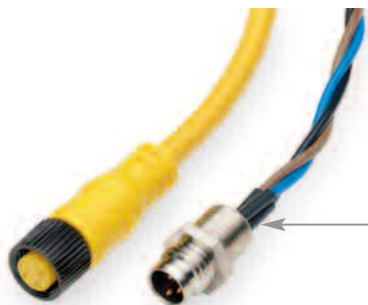

Superior insert-to-overmold bond withstands 20 lbs. sideload force

Snap-in or coupler style cordsets available; coupler style offers same coupler features as Micro-Mini

Micro-Mini Receptacle

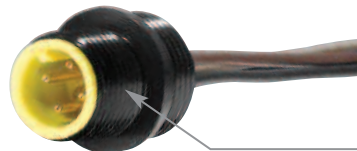

Superior insert-to-overmold bond withstands 20 lbs. sideload force

LynxPOWER™ Micro-Mini Cordsets Dual Key AC

IEC IP 68
3A, 4A, 5A 300V/AC

Dual Key AC, Male & Female Ends



2-Pole: 4A, 3-Pole: 4A, 4-Pole: 4A, 5-Pole: 4A, 6-Pole: 3A/300V/AC

AWM Cable:

- 2, 3, 4, 5 & 6 conductor 3A & 4A cable: 22 AWG standard color code
- 3 & 5 conductor 4A braided cable: 22 AWG standard color code
- 3 & 5 conductor 5A cable: 18 AWG standard color code

SJOOW Cable:

- 3, 4 & 5 conductor 5A cable: 18 AWG standard color code

TPE Cable:

- 3 & 5 conductor 5A cable: 18 AWG standard color code

- Straight and right angle versions
- Meets current SAE #H1738-2 specifications
- Vibration-resistant ratchet design
- Multiple coupler options



Dual Key AC
Male



Dual Key AC
Female

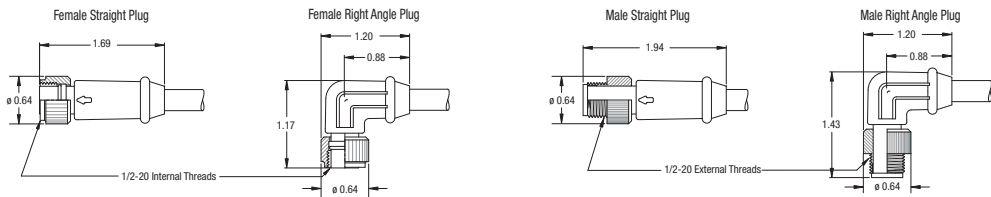

Dual Key AC Pin Configurations & Color Coding

	Female Faces					Male Faces				
	2-Pole Dual Key AC	3-Pole Dual Key AC	4-Pole Dual Key AC	5-Pole Dual Key AC	6-Pole Dual Key AC	2-Pole Dual Key AC	3-Pole Dual Key AC	4-Pole Dual Key AC	5-Pole Dual Key AC	6-Pole Dual Key AC
Conductor Color Coding	Standard 1. BLK 2. WHT	Standard 1. BLK 2. WHT 3. RED	Standard 1. BLK 2. WHT 3. RED 4. GRN	Standard 1. BLK 2. WHT 3. RED 4. GRN 5. ORG	Standard 1. BLK 2. WHT 3. RED 4. GRN 5. ORG 6. BLU	Automotive 1. RED 2. RED/BLK	Automotive 1. GRN 2. RED/BLK 3. RED/WHT	Automotive 1. RED/BLK 2. RED/WHT 3. RED 4. GRN	Automotive 1. RED/WHT 2. RED/BLU 3. GRN 4. RED/ORG 5. RED/BLK	

Specification Information:

Micro-Mini Dual Key AC
Cordsets: F-31

LynxPOWER™ Micro-Mini Cordsets DC & AC DIN

IEC IP 68
3A, 4A, 5A 300V/DC
3A 10-30V/DC; 3A 300V/AC

DC DIN, Male & Female Ends



3-Pole: 4A, 4-Pole: 4A, 5-Pole: 4A / 3-Pole: 5A, 4-Pole: 5A / 300V/DC

AWM Cable:

- 3, 4 & 5 conductor 4A cable: 22 AWG Euro DC color code
- 3 & 4 conductor 4A braided cable: 22 AWG Euro DC color code
- 3, 4 & 5 conductor 4A cable: 18 AWG Euro DC color code

Robotic Cable:

- 3 & 4 conductor 5A cable: 18 AWG Euro DC color code, high-flex stranding cable

SJOOW Cable:

- 3 & 4 conductor 5A cable: 18 AWG Euro DC color code

PUR Cable:

- 3 & 4 conductor 5A cable: 22 AWG Euro DC color code

- Straight and right angle versions
- Meets current SAE #H1738-2 specifications
- Vibration-resistant ratchet design
- Multiple coupler options



DC DIN Robotic

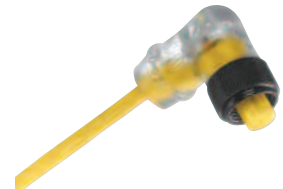

DC DIN LED

DC DIN, LED Female Ends



3-Pole: 3A / 10-30V/DC

AWM Cable: 3 conductor 3A cable: 22 AWG Euro DC color code

- Right angle PNP & NPN versions
- Meets current SAE #H1738-2 specifications
- Vibration-resistant ratchet design
- Multiple coupler options

AC DIN Standard, Female Ends



4-Pole: 3A / 300V/AC

AWM Cable: 4 conductor 3A cable: 22 AWG Euro AC color code

- Straight and right angle versions
- Meets current SAE #H1738-2 specifications
- Vibration-resistant ratchet design
- Multiple coupler options



AC DIN Standard

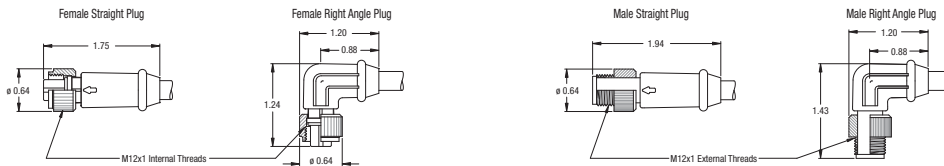

Micro DIN Pin Configurations & Color Coding

	Female Faces				Male Faces			
	3-Pole DC DIN	4-Pole DC DIN	5-Pole DC DIN	4-Pole AC DIN	3-Pole DC DIN	4-Pole DC DIN	5-Pole DC DIN	4-Pole AC DIN
Conductor Color Coding	Euro DC 1. BRN 2. N/C 3. BLU 4. BLK 5. N/C	Euro DC 1. BRN 2. WHT 3. BLU 4. BLK 5. N/C	Euro DC 1. BRN 2. WHT 3. BLU 4. BLK 5. GRN	Euro AC 1. BLK 2. BLU 3. N/C 4. GRN/YEL	Euro DC 1. BRN 2. N/C 3. BLU 4. BLK 5. N/C	Euro DC 1. BRN 2. WHT 3. BLU 4. BLK 5. N/C	Euro DC 1. BRN 2. WHT 3. BLU 4. BLK 5. GRN	Euro AC 1. BLK 2. BLU 3. N/C 4. GRN/YEL

Specification Information:

Micro-Mini DC DIN Cordsets: F-31
Micro-Mini AC DIN Cordsets: F-31

LynxPOWER™ Pico-Line Cordsets

IEC IP 65 & 68
4A 60V/AC RMS; 4A 75V/DC
4A 10-30V/DC

Snap-In 8mm Male & Female Ends

3-Pole: 4A, 4-Pole: 4A / 60V/AC RMS/75V/DC



AWM Cable:

3 & 4 conductor 4A cable: 24 AWG Euro DC color code

- Straight and right angle versions
- Meets current SAE #H1738-2 specifications



Snap-In Pico

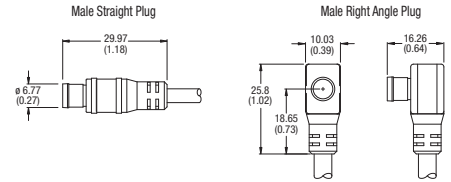

Coupler 8mm Female Ends

3-Pole: 4A, 4-Pole: 4A / 60V/AC RMS/75V/DC



AWM Cable:

3 & 4 conductor 4A cable: 24 AWG Euro DC color code

- Straight and right angle versions
- Meets current SAE #H1738-2 specifications
- Vibration-resistant ratchet design



Coupler Pico

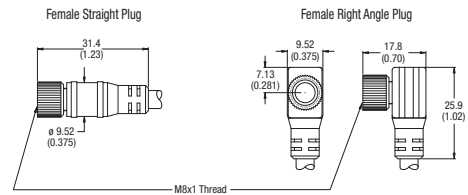

LED 8mm Female Ends

3-Pole: 4A / 10-30V/DC



AWM Cable:

3 conductor 4A cable: 24 AWG Euro DC color code

- Right angle in PNP and NPN versions
- Meets current SAE #H1738-2 specifications
- Coupler version features vibration-resistant ratchet design



Angled Coupler Pico

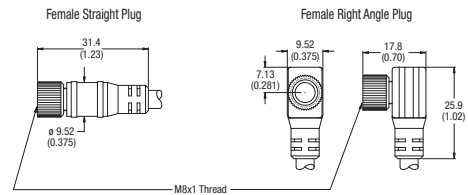

Pico Pin Configurations & Color Coding

Conductor Color Coding	Female Faces		Male Faces	
	3-Pole	4-Pole	3-Pole	4-Pole
	Euro DC	Euro DC	Euro DC	Euro DC
	1. BRN	1. BRN	1. BRN	1. BRN
	2. BLU	2. WHT	2. BLU	2. WHT
	3. BLK	3. BLU	3. BLK	3. BLU
		4. BLK		4. BLK

LynxPOWER™
Micro-Mini &
Pico-Line Cordsets

IEC IP 65 & IP 68
 3A, 4A, 5A 300V/AC; 3A, 4A, 5A 300V/DC
 3A, 4A 10-30V/DC; 4A 10-30V/DC
 4A 60V/AC RMS; 4A 75V/DC

Catalog Number Matrix

Sample Number:

AHDM4C3ME050MX =
Micro-Mini DC DIN Single Key, 4-Pole, female internal thread plug, 18 AWG yellow AWM cable, Euro DC color code, 5 meters long with stainless steel coupler.

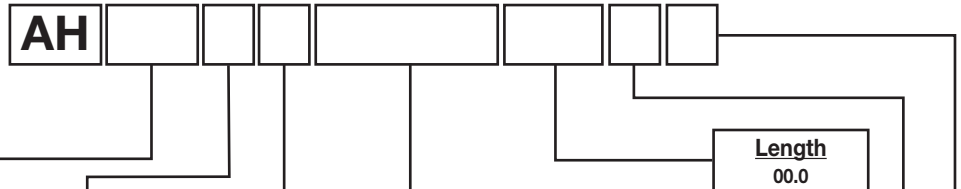

Product Line
AM = Micro-Mini AC Dual Key
DM = Micro-Mini DC Din Single Key
EM = Micro-Mini AC Din Single Key
PL = Pico-Line

of Poles
 2 3 4 5 6

Cable Specifications
2MG = 22 AWG 2-6 Cndr Yellow AWM - U.S. AC Color Code
3MG = 18 AWG 2-5 Cndr Yellow AWM - U.S. AC Color Code
3SG = 18 AWG 3-5 Cndr Yellow SJOOW - U.S. AC Color Code
3AG = 18 AWG 3 or 5 Cndr Yellow TPE - U.S. AC Color Code
1ME = 24 AWG 3 or 4 Cndr Yellow AWM - Euro DC Color Code
2ME = 22 AWG 3-5 Cndr Yellow AWM - Euro DC Color Code
3ME = 18 AWG 3-5 Cndr Yellow AWM - Euro DC Color Code
3RE = 18 AWG 3 or 4 Cndr Yellow Robotic - Euro DC Color Code
3JE = 18 AWG 3 or 4 Cndr Yellow SJOOW - Euro DC Color Code
2PE = 22 AWG 3 or 4 Cndr Yellow PUR - Euro DC Color Code
2MF = 22 AWG 3 Cndr Yellow AWM - Euro AC Color Code

Length
 00.0

Unit of Measure
A = Inches
F = Feet
M = Meters

Gender & Configuration
A = Male Internal Thread Plug
B = Male Inline External Thread Plug
C = Female Internal Thread Plug
D = Male 90° Internal Thread Plug
E = Male Inline 90° External Thread Plug
F = Female 90° Internal Thread Plug
G = Male 90° Internal Thread Plug to Female Straight Internal Thread Plug
H = Male Inline 90° External Thread Plug to Female Straight Internal Thread Plug
J = Male 90° Internal Thread Plug to Female 90° Internal Thread Plug
K = Male Inline 90° External Thread Plug to Female 90° Internal Thread Plug
L = Male 90° Internal Thread Plug to Male 90° Internal Thread Plug
M = Male Inline 90° External Thread Plug to Male 90° Inline External Thread Plug
N = Female 90° Internal Thread Plug to Female 90° Internal Thread Plug
P = Male Internal Thread Plug to Female Internal Thread Plug
Q = Female Internal Thread Plug to Female Internal Thread Plug
R = Male Inline External Thread Plug to Female Internal Thread Plug
S = Male Internal Thread Plug to Female 90° Internal Thread Plug
T = Male Inline External Thread Plug to Female 90° Internal Thread Plug
U = Female Inline External Thread Plug
V = Male Internal Thread Plug to Male 90° Internal Thread Plug
W = Male Inline External Thread Plug to Male 90° Inline External Thread Plug
X = Female Internal Thread Plug to Female 90° Internal Thread Plug
Y = Male Internal Thread Plug to Male Internal Thread Plug
Z = Male Inline External Thread Plug to Male Inline External Thread Plug

Special Features
B = 360° Shielded to Coupler
C = Customer Supplied Cable
E = Cable End Work
G = Nickel Plated Coupler
H = No Ground Pin
J = Pico Snap Coupler
L = Lighted
S = Special
X = Stainless Steel Coupler
Y = Nylon/Lexan Coupler

Exceptions:

Micro-Mini Dual Key AC AWM cable: 22 AWG braided available only in 3- & 4-Pole; 18 AWG available only in 3- & 5-Pole. DC DIN available in Euro DC color code only & not available in 6-Pole: 22 AWG braided available only in 3- & 4-Pole; Robotic & SJOOW cable available only in 3- & 4-Pole 18 AWG; PUR cable available only in 3- & 4-Pole 22 AWG; LED available in 4-Pole only. Micro-Mini AC DIN available in 4-Pole 22 AWG only.
 Pico-Line available in 3- & 4-Pole IEC Color Code 24 AWG only, except LED: available in 3-Pole only.

Specification Information:

Micro-Mini Cordsets: F-31
 Pico-Line Cordsets: F-32

LynxPOWER™ Micro-Mini Receptacles Dual Key AC

IEC IP 68
3A, 4A, 5A 300V/AC

Dual Key AC Male & Female Receptacles



2-Pole: 4A, 3-Pole: 4A, 4-Pole: 4A, 5-Pole: 4A, 6-Pole: 3A / 300V/AC

Male & Female Receptacles:

- 2, 3, 4 & 5 conductor 4A leads: 22 AWG standard color code; male & female receptacles
- 2, 3, 4 & 5 conductor 5A leads: 18 AWG standard color code; male & female receptacles
- 6 conductor 3A leads: 22 AWG standard color code; male receptacles

Female Special Use Receptacles:

- 3, 4 & 5 conductor 5A leads: 18 AWG standard color code
- Available as back mounted internal thread receptacles with black finish, internal thread receptacles with black finish or back mounted thread receptacles with clear finish

- Straight design
- Meets current SAE #H1738-2 specifications
- Multiple shell material options



Dual Key AC Male



Dual Key AC Female



Dual Key AC Female Special Use

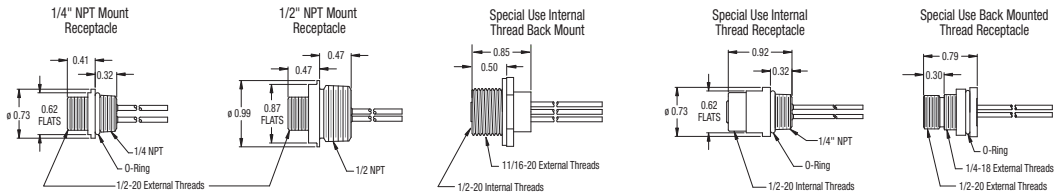

Dual Key AC Pin Configurations & Color Coding

Female Faces



2-Pole Dual Key AC 3-Pole Dual Key AC 4-Pole Dual Key AC 5-Pole Dual Key AC 6-Pole Dual Key AC

Male Faces



2-Pole Dual Key AC 3-Pole Dual Key AC 4-Pole Dual Key AC 5-Pole Dual Key AC 6-Pole Dual Key AC

Conductor Color Coding

	Standard	Standard	Standard	Standard	Standard
1.	BLK	BLK	BLK	BLK	BLK
2.	WHT	WHT	WHT	WHT	WHT
3.	RED	RED	RED	RED	RED
4.		GRN	GRN	GRN	GRN
5.			ORG	ORG	ORG
6.					BLU
Automotive		GRN	RED/BLK	RED/WHT	
1.	RED	RED/BLK	RED/WHT	RED/BLU	
2.	RED/BLK	RED/WHT	RED	GRN	
3.			GRN	RED/ORG	
4.				RED/BLK	

Specification Information:

Micro-Mini Dual Key AC Receptacles: F-33

LynxPOWER™
Micro-Mini Receptacles
DC & AC DIN

IEC IP 68
 4A, 5A 300V/DC
 3A 300V/AC

DC DIN Male & Female Receptacles



3-Pole: 4A, 4-Pole: 4A, 5-Pole: 4A / 300V/DC

Male & Female Receptacles:

3, 4 & 5 conductor 4A leads: 22 AWG Euro DC color code; male external thread or female internal thread receptacles
 3 & 4 conductor 5A cable: 18 AWG Euro DC color code; male external thread receptacles

- Straight design
- Meets current SAE #H1738-2 specifications
- Machined aluminum shell with black anodized finish



DC DIN Male

AC DIN Standard Male Receptacles



4-Pole: 3A / 300V/AC

Male Receptacles:

4 conductor, 3A leads: 22 AWG Euro AC color code

- Straight design
- Meets current SAE #H1738-2 specifications
- Machined aluminum with black anodized finish or nylon 6/6 shell materials



DC DIN Female

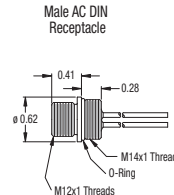
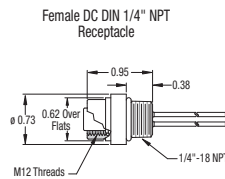
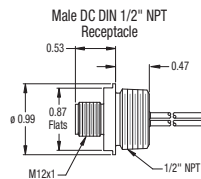
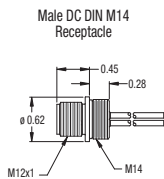

AC DIN Standard Male

See Page F-18 for Micro DIN Configurations & Color Coding

Specification Information:

Micro-Mini DC & AC DIN Receptacles: F-33
 Pico-Line Universal Receptacles: F-33

LynxPOWER™ Pico-Line Universal Receptacles

IEC IP 68
3A, 4A, 5A 300V/AC



Universal 8mm Male Receptacles

3-Pole: 4A, 4-Pole: 4A / 60V/AC RMS/75V/DC

Male Receptacles:

3 & 4 conductor 4A leads: 24 AWG Euro DC color code

- Straight design
- Meets current SAE #H1738-2 specifications
- Machined brass with nickel plated shell

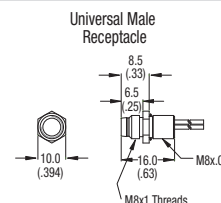

Micro DIN Pin Configurations & Color Coding

	Female Faces	Male Faces
Conductor Color Coding	3-Pole DC DIN Euro DC 1. BRN 2. N/C 3. BLU 4. BLK 5. N/C	4-Pole DC DIN Euro DC 1. BRN 2. WHT 3. BLU 4. BLK 5. N/C
	5-Pole DC DIN Euro DC 1. BRN 2. WHT 3. BLU 4. BLK 5. GRN/YEL	4-Pole AC DIN Euro AC 1. BLK 2. BLU 3. N/C 4. GRN/YEL

Pico Pin Configurations & Color Coding

	Female Faces	Male Faces
Conductor Color Coding	3-Pole Euro DC 1. BRN 2. BLU 3. BLK	4-Pole Euro DC 1. BRN 2. WHT 3. BLU 4. BLK

Catalog Number Matrix

Sample Number:

AHDR4A2CG010FX =
Micro-Mini DC DIN Single Key, 4-Pole, female internal thread with 1/4"-18 NPT mounting, 22 AWG single conductor AWM, 1 foot flying leads with stainless steel receptacle shell.

Product Line
AR = Micro-Mini AC Dual Key
DR = Micro-Mini DC DIN Single Key
ER = Micro-Mini AC DIN Single Key
PR = Pico-Line

Gender & Configuration
A = Female Internal Thread- 1/4"-18 NPT Mounting
B = Male External Thread- 1/4"-18 NPT Mounting
C = Female External Thread- 1/4"-18 NPT Mounting
D = Female Internal Thread- 1/2"-14 NPT Mounting
E = Male External Thread- 1/2"-14 NPT Mounting
F = Female External Thread- 1/2"-14 NPT Mounting
L = Female Internal Thread- M14 Mounting
M = Male External Thread- M14 Mounting
S = Female External Thread- Back Mount
T = Female Internal Thread- Back Mount
Y = Male External Thread- M8x0.5 Mounting
Z = Female Internal Thread- M8x0.5 Mounting

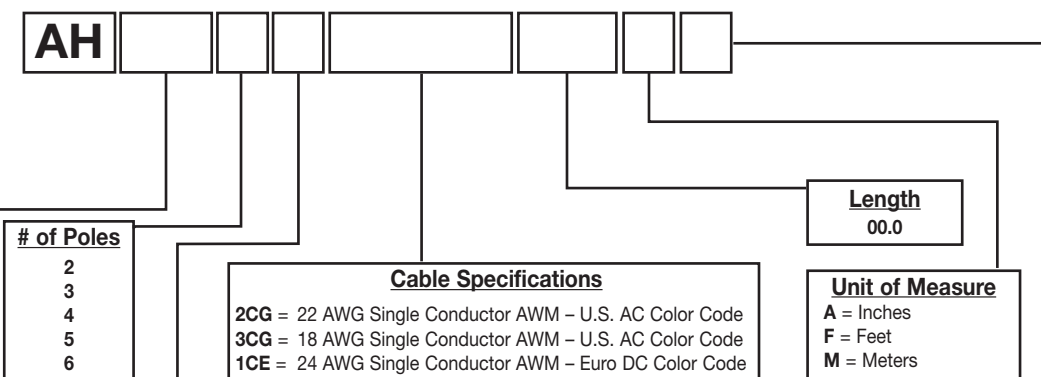

Cable Specifications
2CG = 22 AWG Single Conductor AWM – U.S. AC Color Code
3CG = 18 AWG Single Conductor AWM – U.S. AC Color Code
1CE = 24 AWG Single Conductor AWM – Euro DC Color Code
2CE = 22 AWG Single Conductor AWM – Euro DC Color Code
3CE = 18 AWG Single Conductor AWM – Euro DC Color Code
2CF = 22 AWG Single Conductor AWM – Euro AC Color Code

Length
00.0

Unit of Measure
A = Inches
F = Feet
M = Meters

Special Features
B = 360° Shielded to Coupler
C = Customer Supplied Cable
G = Nickel Plated Shell
H = No Ground Pin
S = Special
X = Stainless Steel Shell
Y = Nylon Shell

Exceptions:
Micro-Mini Dual Key AC Special Use Receptacles available with machined aluminum shell only. Pico-Line Universal Receptacles available in male with machined brass, nickel plated shell only.

Specification Information:

Pico-Line Universal Receptacles: F-33

Facilitating reliable communication with the manufacturing floor

Industrial network connectivity solutions engineered to provide reliable performance in industrial environments that cause regular cables to fail. Superior materials and robust design ensure communication continuity and reduced downtime.



Industrial Ethernet/IP Micro-Mini™ Cordsets and Industrial Ethernet/IP RJ45 Cordsets

Industrial Ethernet cordsets available with RJ45, Micro-Mini 4-pin or Micro-Mini 8-pin ends for Ethernet & IP applications

Industrial grade Cat 5e cable available in your choice of shielded, solid, stranded or high-flex types

RJ45 connectors feature a polyolefin snagless boot



DeviceNet™ Cordsets

Mini-Line End

Micro-Line End



DeviceNet drop cordsets available with Mini-Line or Micro-Mini ends in 5-Pole 22 or 24 AWG cable for 2A applications

Micro-Mini internal gasket assures watertight performance to IP 68 and NEMA 6P ratings

Flexible PVC, CPE or high-flex cable eases installation and delivers signal without interruption

Profibus Cordsets

Vibration-resistant couplers assure devices stay connected under load

Environmentally-sealed ends prevent the ingress of dust, water and other contaminants for superior service

Compact, space-saving thermoplastic bodies



LynxPOWER™ Industrial Ethernet/IP Cordsets & Receptacles

IEC IP 68
2A 60V/AC

RJ45 & RJ45 to Micro-Mini™ (M12) Cordsets

Ethernet Cordsets

Configuration options:

- RJ45 to RJ45
- RJ45 to Female Panel Mount Receptacle (PG9)
- RJ45 to Female 1/2" - 14 NPT Receptacle
- RJ45 to Male Panel Mount Receptacle (PG9)

- Straight design, double-ended configuration, receptacles have 4-pin or 8-pin options
- Cable: 24 AWG, 0.280" dia., meets TIA 568-B.2 specification for ethernet physical layer
- Nickel plated brass or stainless steel receptacle shell options

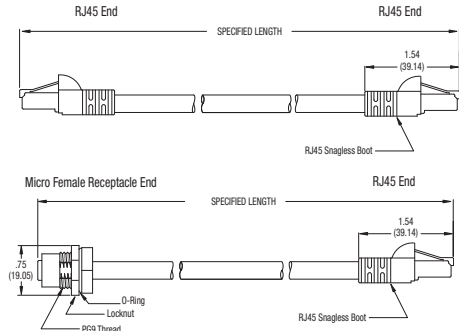

RJ45 to RJ45



RJ45 to Receptacle



4-Pin Micro-Mini Male Cordset End

Micro-Mini (M12) Cordsets & Receptacles

Ethernet Cordsets

Configuration options:

- Male to Male straight or angled
- Female to Female straight or angled
- Male to Female straight or angled

- Double-ended configuration, 4-pin or 8-pin options
- Cable: 24 AWG, 0.280" dia., meets TIA 568-B.2 specification for ethernet physical layer
- Black PUR shell

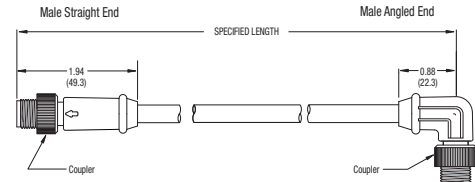

Ethernet Receptacles

Configuration options:

- Female internal thread panel back mount (PG9)
- Male external thread panel back mount (PG9)
- Female internal thread panel front mount (1/2" -14 NPT)

- 4-pin or 8-pin options
- Black PUR, nickel plated brass or stainless steel shell options

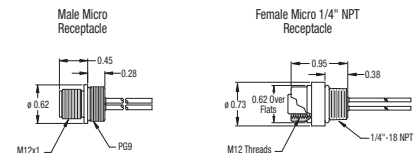

4-Pin Micro-Mini Female Receptacle

Specification Information:

Industrial Ethernet/IP Cordsets & Receptacles: F-34

LynxPOWER™ Industrial Ethernet/IP Cordsets & Receptacles

IEC IP 68
2A 60V/AC

Pin Configurations & Color Coding

RJ45 Face

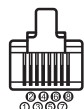

RJ45

Conductor Color Coding

- Cat 5e
1. WHT/ORG (TX+)
2. ORG (TX-)
3. WHT/BLU (RX+)
4. -
5. -
6. BLU (RX-)
7. -
8. -

Female Faces, Micro-Mini™ (M12)



4-Pole



8-Pole

Conductor Color Coding

- | | |
|--------------|--------------|
| Micro Cat 5e | Micro Cat 5e |
| 1. WHT/ORG | 1. LT BLU |
| 2. WHT/BLU | 2. LT BRN |
| 3. ORG | 3. BRN |
| 4. BLU | 4. ORG |
| | 5. LT GRN |
| | 6. WHT |
| | 7. BLU |
| | 8. GRN |

Male Faces, Micro-Mini™ (M12)



4-Pole



8-Pole

Catalog Number Matrix

Sample Number:

AH4EERRB010 =
4-Pin RJ45 to RJ45 Industrial Ethernet
cordset with Cat 5e shielded stranded
teal PVC cable, 1 meter long.



Network Type

* Use this digit space for Micro only

4E = 4-Pin DC Inverted Key Micro Industrial Ethernet

8E = 8-Pin Micro Industrial Ethernet

Product Type

E = Cordset/Extension (connector on both ends)

R = Receptacle

Product Configuration / Cordset End 1

- C** = Micro-Mini Male Inline External Thread
- D** = Micro-Mini Male Inline 90° External Thread
- G** = Micro-Mini Female Internal Thread
- H** = Micro-Mini Female 90° Internal Thread
- K** = Micro-Mini Female Internal Thread 1/2"-14 NPT
- M** = Micro-Mini Male External Thread PG9 Back Mt.
- N** = Micro-Mini Male External Thread 1/2"-14 NPT
- P** = Micro-Mini Female Internal Thread PG9 Back Mt.
- Q** = Micro-Mini Male External Thread M14
- R** = RJ45 Plug
- T** = Micro-Mini Female PG9 with Overmold

Cordset End 2

* Use this digit space for cordsets only

- C** = Micro-Mini Male Inline External Thread
- D** = Micro-Mini Male Inline 90° External Thread
- G** = Micro-Mini Female Internal Thread
- H** = Micro-Mini Female 90° Internal Thread
- K** = Micro-Mini Female Internal Thread 1/2"-14 NPT
- M** = Micro-Mini Male External Thread PG9 Back Mt.
- N** = Micro-Mini Male External Thread 1/2"-14 NPT
- P** = Micro-Mini Female Internal Thread PG9 Back Mt.
- Q** = Micro-Mini Male External Thread M14
- R** = RJ45 Plug
- T** = Micro-Mini Female PG9 with Overmold

Special Features

- B** = Shield (Use for Ethernet)
- C** = Cross Over Wiring
- G** = Gray Compound
- N** = Nylon Coupler
- R** = Robotic Cable
- S** = Special
- X** = Stainless Steel Coupler

Length in Meters

00.0

Cable Type

- B** = Cat 5e Shielded Stranded Teal PVC
- G** = Cat 5e Stranded Black TPE
- J** = Cat 5e Stranded Red TPE
- Q** = Cat 5e Hi-Flex Stranded Teal TPE
- R** = Cat 5e Hi-Flex Stranded Red TPE
- V** = Cat 5e Solid Stranded Teal PVC
- W** = Cat 5e Stranded Teal PVC
- X** = Cat 5e Hi-Flex Stranded Black TPE
- Y** = Cat 5e Solid Stranded Teal TPE
- Z** = Cat 5e Stranded Teal PVC

Specification Information:

Industrial Ethernet/IP Cordsets &
Receptacles: F-34

LynxPOWER™ DeviceNet Cordsets & Receptacles

IEC IP 68
2A, 8A 300V/AC



Mini-Line Trunk
Single Ended



Mini-Line Drop
Double Ended



Micro-Mini Drop
Double Ended



Mini-Line to
Micro-Mini

Mini-Line™ Single- & Double-Ended Cordsets & Receptacles



5-Pole: 2A or 8A

5 conductor 15 & 18 AWG 8A DeviceNet color code cable trunk assemblies

5 conductor 22 & 24 AWG 2A DeviceNet color code cable drop assemblies:

- Male or female ends
- Straight and right angle designs
- Single- and double-ended configurations
- Vibration-resistant ratchet coupler design
- Cable: 0.475" dia. (trunk) or 0.270" dia. (drop), 2 twisted pairs w/foil shield & drain wire
- Diecast zinc or stainless steel coupler options

5 conductor 22 & 24 AWG 2A DeviceNet color code trunk or drop assembly receptacles:

- Female internal thread panel front mount 1/2" -14 NPT

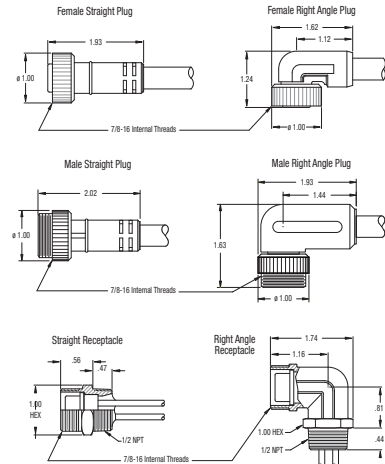

Micro-Mini™ (M12) Single- & Double-Ended Cordsets & Receptacles



5-Pole: 2A

5 conductor 22 & 24 AWG 2A DeviceNet color code cable drop assemblies:

- Male or female ends
- Straight and right angle designs
- Single- and double-ended configurations
- Vibration-resistant ratchet coupler design
- Cable: 0.270" dia., 2 twisted pairs w/foil shield & drain wire
- Diecast zinc or stainless steel coupler options

5 conductor 22 & 24 AWG 2A DeviceNet color code drop assembly receptacles:

- Female internal thread panel front mount, PG9 or 1/2" -14 NPT
- Male external thread panel front mount, PG9

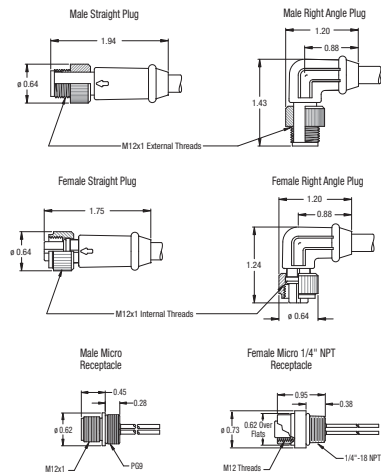

DeviceNet™ is a trademark of Allen-Bradley.

Mini-Line to Micro-Mini (M12) Double-Ended Cordsets



5-Pole: 2A

5 conductor 22 & 24 AWG 2A DeviceNet color code cable drop assemblies:

- Male or female ends
- Straight and right angle designs
- Double-ended configuration
- Vibration-resistant ratchet coupler design
- Cable: 0.270" dia., 2 twisted pairs w/foil shield & drain wire
- Diecast zinc or stainless steel coupler options

See previous page for dimensional drawings of cordset ends

Specification Information:

DeviceNet Cordsets & Receptacles: F-35

LynxPOWER™ DeviceNet Cordsets & Receptacles

IEC IP 68
2A, 8A 300V/AC

Mini Pin Configurations & Color Coding

Female Face, Mini-Line



5-Pole Style I

Male Face, Mini-Line



5-Pole Style I

Conductor Color Coding
DeviceNet
1. DRAIN (bus shield)
2. RED (V+)
3. BLK (V-)
4. WHT (Data +)
5. BLU (Data -)

Micro Pin Configurations & Color Coding

Female Face, Micro-Mini (M12)



5-Pole DC DIN

Male Face, Micro-Mini (M12)



5-Pole DC DIN

Conductor Color Coding
DeviceNet
1. DRAIN (bus shield)
2. RED (V+)
3. BLK (V-)
4. WHT (Data +)
5. BLU (Data -)

Catalog Number Matrix

Sample Number:

AHDNCCC050 =

DeviceNet, single end connector with Micro-Mini male inline external thread plug, with blue #22 & 24 CPE drop, 5 meters long.



Special Features

- G = Gray Compound
- N = Nylon Coupler
- R = Robotic Cable
- S = Special
- X = Stainless Steel Coupler

Length in Meters

00.0

Network Type

DN = DeviceNet (5-Pin Mini or Micro)

Product Type

- A = Attachable (Trunk)
- B = Attachable (Drop)
- C = Cordset/Connector (connector on one end only)
- E = Cordset/Extension (connector on both ends)
- R = Receptacle

Product Configuration / Cordset End 1

- A = Mini-Line Male Inline External Thread
- B = Mini-Line Male Inline 90° External Thread
- C = Micro-Mini Male Inline External Thread
- D = Micro-Mini Male Inline 90° External Thread
- E = Mini-Line Female Internal Thread
- F = Mini-Line Female 90° Internal Thread
- G = Micro-Mini Female Internal Thread
- H = Micro-Mini Female 90° Internal Thread
- K = Micro-Mini Female Internal Thread 1/2"-14 NPT
- L = Mini-Line Female Internal Thread 1/2"-14 NPT
- M = Micro-Mini Male External Thread PG9 Back Mount
- N = Micro-Mini Male External Thread 1/2"-14 NPT
- P = Micro-Mini Female Internal Thread PG9 Back Mount
- Q = Micro-Mini Male External Thread M14
- T = Micro-Mini Female PG9 with Overmold

Cordset End 2

* Use this digit space for cordsets only

- A = Mini-Line Male Inline External Thread
- B = Mini-Line Male Inline 90° External Thread
- C = Micro-Mini Male Inline External Thread
- D = Micro-Mini Male Inline 90° External Thread
- E = Mini-Line Female Internal Thread
- F = Mini-Line Female 90° Internal Thread
- G = Micro-Mini Female Internal Thread
- H = Micro-Mini Female 90° Internal Thread
- K = Micro-Mini Female Internal Thread 1/2"-14 NPT
- L = Mini-Line Female Internal Thread 1/2"-14 NPT
- M = Micro-Mini Male External Thread PG9 Back Mount
- N = Micro-Mini Male External Thread 1/2"-14 NPT
- P = Micro-Mini Female Internal Thread PG9 Back Mount
- Q = Micro-Mini Male External Thread M14
- T = Micro-Mini Female PG9 with Overmold

Cable Type

- C = Blue CPE #22 & 24 Drop
- D = Gray PVC #22 & 24 Drop
- F = Hi-Flex Gray PVC #15 & 18 Trunk
- H = Hi-Flex Gray PVC #22 & 24 Drop
- K = Green PVC #15 & 18 Trunk
- M = Mid-Size Gray PVC #15 & 18 Trunk
- P = Yellow PVC #22 & 24 Drop
- T = Gray PVC #15 & 18 Trunk

Specification Information:

DeviceNet Cordsets & Receptacles: F-35

LynxPOWER™ Profibus Cordsets & Receptacles

IEC IP 68
2A 60V/AC



Micro-Mini
Drop Female



Micro-Mini
Drop Male

Micro-Mini™ (M12) Single- & Double-Ended Cordsets

4-Pole: 2A

4 conductor 18 AWG 2A Profibus color code cable drop assemblies:

- Male or female ends
- Straight and right angle designs
- Single- and double-ended configurations
- Vibration-resistant ratchet coupler design
- Cable: 0.255" dia. with drain wire
- Diecast zinc or stainless steel coupler options

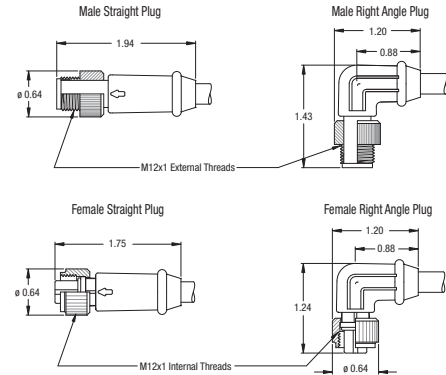

Micro-Mini (M12) Receptacles

4-Pole: 2A

4 conductor 18 AWG 2A Profibus color code drop assembly receptacles:

- Female internal thread panel front mount, PG9 or 1/2" -14 NPT
- Male external thread panel front mount, PG9

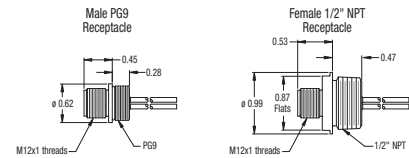

Micro-Mini (M12) Pin Configurations & Color Coding

Female Faces, Micro-Mini (M12)



4-Pole
DC DIN



4-Pole
AC DIN

Male Faces, Micro-Mini (M12)



4-Pole
DC DIN



4-Pole
AC DIN

Conductor Color Coding

- Profibus**
1. ORG or BRN (PA+)
 2. N/C
 3. BLU (PA-)
 4. DRAIN (bus shield)
 5. N/C (DC only)

Specification Information:

Profibus Cordsets &
Receptacles: F-36

LynxPOWER™
Profibus Cordsets & Receptacles

IEC IP 68
 2A 60V/AC

Catalog Number Matrix

Sample Number:

AHPFCGL030 =
Profibus DC Micro, single end cordset with Micro-Mini female inline external thread plug, with blue #18 PVC, 3 meters long.

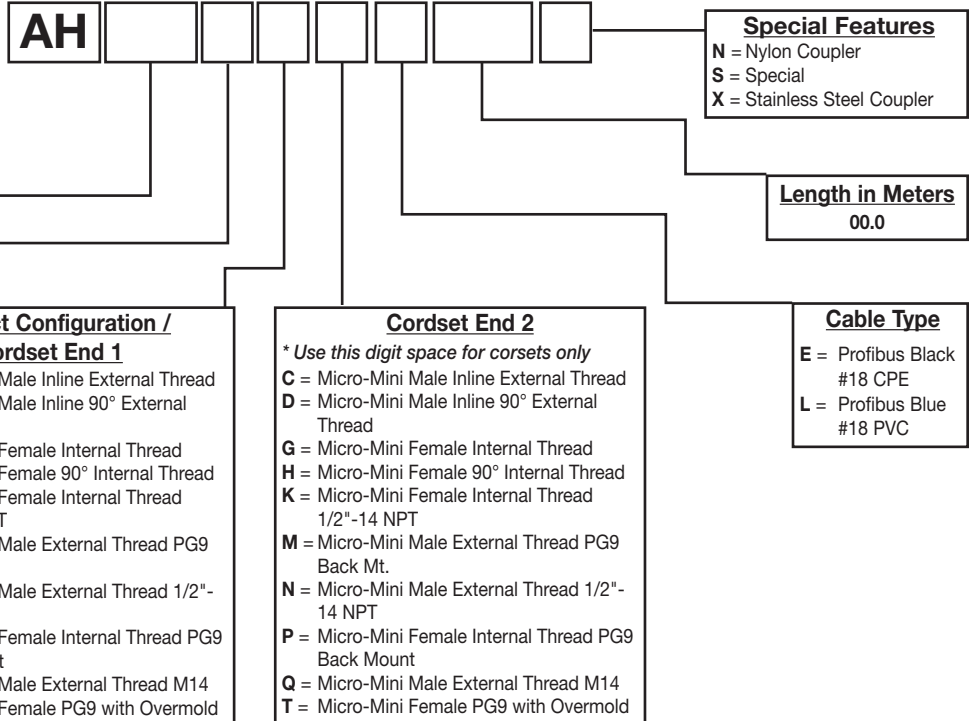

Network Type
PF = Profibus, DC DIN Micro (uses 3 pins, 1 is drain wire)
PFA = Profibus, AC DC DIN Micro (uses 3 pins, 1 is drain wire)

Product Type
B = Attachable (Drop)
C = Cordset/Connector (connector on one end only)
E = Cordset/Extension (connector on both ends)
R = Receptacle

Product Configuration / Cordset End 1
C = Micro-Mini Male Inline External Thread
D = Micro-Mini Male Inline 90° External Thread
G = Micro-Mini Female Internal Thread
H = Micro-Mini Female 90° Internal Thread
K = Micro-Mini Female Internal Thread 1/2"-14 NPT
M = Micro-Mini Male External Thread PG9 Back Mt.
N = Micro-Mini Male External Thread 1/2"-14 NPT
P = Micro-Mini Female Internal Thread PG9 Back Mount
Q = Micro-Mini Male External Thread M14
T = Micro-Mini Female PG9 with Overmold

Cordset End 2
** Use this digit space for cordsets only*
C = Micro-Mini Male Inline External Thread
D = Micro-Mini Male Inline 90° External Thread
G = Micro-Mini Female Internal Thread
H = Micro-Mini Female 90° Internal Thread
K = Micro-Mini Female Internal Thread 1/2"-14 NPT
M = Micro-Mini Male External Thread PG9 Back Mt.
N = Micro-Mini Male External Thread 1/2"-14 NPT
P = Micro-Mini Female Internal Thread PG9 Back Mount
Q = Micro-Mini Male External Thread M14
T = Micro-Mini Female PG9 with Overmold

Special Features
N = Nylon Coupler
S = Special
X = Stainless Steel Coupler

Length in Meters
 00.0

Cable Type
E = Profibus Black #18 CPE
L = Profibus Blue #18 PVC

Specification Information:
 Profibus Cordsets &
 Receptacles: F-36

A complete offering of industrial connectivity accessories

Select from a wide range of accessories to complete any industrial connectivity installation, including plex boxes, tees, splitters and other accessories. Visit www.arrowhart.com for more information.



Mini-Plex™ 6-Port LED PNP Circuit Interconnect Distribution Box



Micro-Plex™ 8-Port Network Interconnect Distribution Box

Plex Boxes

We offer a variety of Interconnect Distribution Boxes fitted with input and output Mini-Line™, Micro-Mini™ AC Dual Key, or Micro-Mini DC DIN fittings. Available in series or parallel wired circuit versions, LED PNP or NPN circuit versions, solenoid configurations, top or side mount outputs for virtually any application requiring mating to Mini-Line or Micro-Mini systems.



SOFTPower Trunk to Drop Reducing Tee



Mini-Line Tapping Tee

Tees

Tees are available for each LynxPOWER™ family: SOFTPower™, Mini-Line, Micro-Mini, Pico-Line™, and Network. They come in a variety of styles, including tapping tees and reducing tees, many in standard and low-profile body styles. Body materials include Santoprene™ and PVC, chosen for their durability and to complement other LynxPOWER product materials.



Micro-Mini Dual Key AC “Y” Splitter, Standard Body Style



Micro-Mini DC DIN “T” Splitter, Standard Body Style

Y & T Splitters

Splitters are available for the Micro-Mini family in either “Y” or “T” configurations. A low-profile body style is available in “Y” versions; all Micro-Mini splitters feature diecast zinc epoxy-coated vibration-resistant ratchet couplers for the same durability as our Micro-Mini cordsets.



SOFTPower Change-Out to Mini-Line Reducing Adapter



Micro-Mini DC DIN Field Attachable

Other Accessories

A variety of other accessories are available for each LynxPOWER family. Choose from in-line field attachables in straight and right angle body styles, right angle adapters, ground adapters, Change-Out™ to Mini adapters, Mini to Micro adapters, network terminator assemblies, plus a variety of cordset and receptacle caps.

LynxPOWER™
SOFTPower Cordsets

IEC IP 68
10A, 13A, 15A, 18A, 25A, 30A
600V

	Cordset Type	Change-Out™ Trunk/Feeder Assembly Cordsets 3-, 4-Pole	Mini-Line™ Drop/Branch Assembly Cordsets 3-, 4-Pole Style 1
	Cable Type(s)	TC/STOOW (PVC jacket)	TC/STOOW (PVC jacket)
	Testing & Code Compliance	• UL Recognized component for US & Canada file no. E322038	• UL Recognized component for US & Canada file no. E322038
Specifications: Environmental	Protection	NEMA 1, 3, 4, 6P & 13; IEC IP 68	NEMA 1, 3, 4, 6P & 13; IEC IP 68
	Temperature Rating	-20°C to 105°C (-4°F to 221°F)	-20°C to 105°C (-4°F to 221°F)
	Corrosion Resistance	500 hr. salt spray	500 hr. salt spray
	High Pressure Water Test	1200 PSI spray	1200 PSI spray
Specifications: Electrical	Contact Resistance	<5mΩ	<5mΩ
	Current Rating	25A or 30A	10A, 13A, 15A or 18A
	Voltage Rating	600V/AC	600V/AC
	Dielectric Voltage	Withstands 2200V/DC	Withstands 2200V/DC
Materials:	Body	Gray, PVC	Gray, PVC
	Cable	Gray, TC/STOOW per UL62	Gray, TC/STOOW per UL62
	Contacts	Machined brass alloy per ASTM B-16	Machined brass per ASTM B-16
	Coupling Nut	Diecast Zamak 5 (zinc) or 316 stainless steel	Black epoxy coated diecast Zamak 5 (zinc) or 316 stainless steel

LynxPOWER™
SOFTPower Receptacles

IEC IP 68
 10A, 13A, 15A, 18A, 25A, 30A
 600V

	Receptacle Type	Change-Out™ Trunk/Feeder Assembly Receptacles 3-, 4-Pole	Mini-Line™ Drop/Branch Assembly Receptacles 3-, 4-Pole Style 1
	Lead Type(s)	10 AWG Pigtails, PVC jacket	14 or 16 AWG Pigtails, PVC jacket
	Testing & Code Compliance	• UL Recognized component for US & Canada file no. E322038	• UL Recognized component for US & Canada file no. E322038
Specifications: Environmental	Protection	Protection: NEMA 1, 3, 4, 6P & 13; IEC IP 68	NEMA 1, 3, 4, 6P & 13; IEC IP 68
	Temperature Rating	-20°C to 105°C (-4°F to 221°F)	-20°C to 105°C (-4°F to 221°F)
	Corrosion Resistance	500 hr. salt spray	500 hr. salt spray
	High Pressure Water Test	1200 PSI spray	1200 PSI spray
Specifications: Electrical	Contact Resistance	<5mΩ	<5mΩ
	Current Rating	25A or 30A	10A, 13A, 15A or 18A
	Voltage Rating	600V/AC	600V/AC
	Dielectric Voltage	Withstands 2200V/DC	Withstands 2200V/DC
Materials:	Insert	Gray, PVC	Gray, PVC
	Pigtail Leads	Color coded type MTW or AWM style 1015/1230	Color coded type MTW or AWM style 1015/1230
	Contacts	Machined brass alloy per ASTM B-16	Machined brass alloy per ASTM B-16
	Receptacle Shell	Diecast Zamak 5 (zinc) or machined aluminum with anodize finish and clear sealant	Diecast Zamak 5 (zinc) or machined aluminum with anodize finish and clear sealant

LynxPOWER™
Mini-Line Cordsets

IEC IP 68
6A, 7A, 8A, 10A, 13A 600V/AC & 600V/DC
6A 120V/AC

Cordset Type	Style 1 2-, 3-, 4-, 5-, 6-Pole	Style 1 Neon 3-Pole	Style 2, 6-, 7-, 8-Pole	Style 3, 9-, 10-, 12-Pole	
Cable Type(s)	STOOW (PVC jacket) SOOW (Thermoset jacket) SEOW (TPE elastomer jacket)	AWM (PVC jacket)	STOOW (PVC jacket) SOOW (Thermoset jacket)	STOOW (PVC jacket) SOOW (Thermoset jacket)	
Testing & Code Compliance	• UL Recognized component for US & Canada file no. E322038	• UL Recognized component for US & Canada file no. E322038	• UL Recognized component for US & Canada file no. E322038	• UL Recognized component for US & Canada file no. E322038	
Specifications: Environmental	Protection	NEMA 1, 3, 4, 6P & 13; IEC IP 68	NEMA 1, 3, 4, 6P & 13; IEC IP 68	NEMA 1, 3, 4, 6P & 13; IEC IP 68	
	Temperature Rating	STOOW: -40°C to 105°C (-40°F to 221°F) SOOW: -50°C to 105°C (-58°F to 221°F) SEOW: -30°C to 105°C (-22°F to 221°F)	-20°C to 105°C (-4°F to 221°F)	STOOW: -40°C to 105°C (-40°F to 221°F) SOOW: -50°C to 105°C (-58°F to 221°F)	STOOW: -40°C to 105°C (-40°F to 221°F) SOOW: -50°C to 105°C (-58°F to 221°F)
	Corrosion Resistance	1000 hr. salt spray per MIL-STD-202F	1000 hr. salt spray per MIL-STD-202F	N/A	N/A
	High Pressure Water Test	1200 PSI spray	1200 PSI spray	N/A	N/A
	Visibility	N/A	360° visibility range	N/A	N/A
Specifications: Electrical	Contact Resistance	<5mΩ	<5mΩ	<5mΩ	<5mΩ
	Current Rating	6A, 8A, 10A or 13A	6A	7A, 8A	7A
	Voltage Rating	600V/AC / 600V/DC	120V/AC	600V/AC / 600V/DC	600V/AC / 600V/DC
	Dielectric Voltage	Withstands 2200V/AC	N/A	Withstands 2200V/AC	Withstands 2200V/AC
Materials:	Body	Yellow, 90A durometer, flame resistant PVC	Clear, UV stabilized PVC	Yellow, 82A durometer, flame resistant PVC	Yellow, 82A durometer, flame resistant PVC
	Cable	Yellow, STOOW, SOOW or SEOW per UL62	Yellow, AWM UL style 2661	Yellow, STOOW or SOOW per UL62	Yellow, STOOW or SOOW per UL62
	Contacts	Machined brass per ASTM B-16	Machined brass per ASTM B-16	Machined brass per ASTM B-16	Machined brass per ASTM B-16
	Female Contact Plating	30 micro-inches of 24 karat gold over 50 micro-inches of nickel	30 micro-inches of 24 karat gold over 50 micro-inches of nickel	30 micro-inches of 24 karat gold over 50 micro-inches of nickel	30 micro-inches of 24 karat gold over 50 micro-inches of nickel
	Coupling Nut	Black epoxy coated diecast Zamak 5 (zinc) or nylon 6/6 weather stabilized or 303 stainless steel	Black epoxy coated diecast Zamak 5 (zinc) or nylon 6/6 weather stabilized or 303 stainless steel	Machined aluminum with anodize finish and clear sealant or nylon 6/6 weather stabilized or 303 stainless steel	Machined aluminum with anodize finish and clear sealant or nylon 6/6 weather stabilized or 303 stainless steel

LED Wiring Diagram

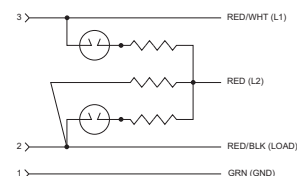

LynxPOWER™
Mini-Line Receptacles

IEC IP 68
6A, 7A, 8A, 10A, 13A 600V/AC & 600V/DC

	Receptacle Type	Style 1 2-, 3-, 4-, 5-, 6-Pole Straight & Angled	Style 1 2-, 3-, 4-, 5-, 6-Pole Panel Mount	Style 2, 6-, 7-, 8-Pole Straight & Flange Mount	Style 3, 9-, 10-, 12-Pole Straight
	Lead Type(s)	16 AWG Pigtails 2, 3, 4, 5, 6 conductor available in standard color code 3, 5 conductor available in automotive color code	16 AWG Pigtails 2, 3, 4, 5, 6 conductor available in standard color code	16 AWG Pigtails 6, 7, 8 conductor available in standard color code	16 AWG Pigtails 9, 10, 12 conductor available in standard color code
	Testing & Code Compliance	• UL Recognized component for US & Canada file no. E322038	• UL Recognized component for US & Canada file no. E322038	• UL Recognized component for US & Canada file no. E322038	• UL Recognized component for US & Canada file no. E322038
Specifications: Environmental	Protection	Protection: NEMA 1, 3, 4, 6P & 13; IEC IP 68	NEMA 1, 3, 4, 6P & 13; IEC IP 68	NEMA 1, 3, 4, 6P & 13; IEC IP 68	NEMA 1, 3, 4, 6P & 13; IEC IP 68
	Temperature Rating	-30°C to 105°C (-22°F to 221°F)	-30°C to 105°C (-22°F to 221°F)	-30°C to 105°C (-22°F to 221°F)	-30°C to 105°C (-22°F to 221°F)
	High Pressure Water Test	1200 PSI spray	1200 PSI spray	N/A	N/A
Specifications: Electrical	Contact Resistance	<5mΩ	<5mΩ	<5mΩ	<5mΩ
	Current Rating	6A, 8A, 10A or 13A	6A, 8A, 10A or 13A	7A, 8A	7A
	Voltage Rating	600V/AC / 600V/DC	600V/AC / 600V/DC	600V/AC / 600V/DC	600V/AC / 600V/DC
	Dielectric Voltage	Withstands 2200V/AC	Withstands 2200V/AC	Withstands 2200V/AC	Withstands 2200V/AC
Materials:	Insert	Yellow, 90A durometer, flame resistant PVC	Yellow, 90A durometer, flame resistant PVC	Yellow, 82A durometer, flame resistant PVC	Yellow, 82A durometer, flame resistant PVC
	Pigtail Leads	Color coded type MTW or AWM style 1015/1230	Color coded type MTW or AWM style 1015/1230	Color coded type MTW or AWM style 1015/1230	Color coded type MTW or AWM style 1015/1230
	Contacts	Machined brass per ASTM B-16	Machined brass per ASTM B-16	Machined brass per ASTM B-16	Machined brass per ASTM B-16
	Female Contact Plating	30 micro-inches of 24 karat gold over 50 micro-inches of nickel	30 micro-inches of 24 karat gold over 50 micro-inches of nickel	30 micro-inches of 24 karat gold over 50 micro-inches of nickel	30 micro-inches of 24 karat gold over 50 micro-inches of nickel
	Receptacle Shell	Diecast Zamak 5 Zinc plated with clear sealer or nylon 6/6 weather stabilized or 303 stainless steel	Machined aluminum with anodize finish and clear sealant	Machined aluminum with anodize finish and clear sealant or 303 stainless steel	Machined aluminum with anodize finish and clear sealant or 303 stainless steel
	Potting Compound	Black rigid epoxy	Black rigid epoxy	Black rigid epoxy	Black rigid epoxy

LynxPOWER™
Micro-Mini Cordsets

IEC IP 68
3A, 4A, 5A 300V/AC

	Cordset Type	Micro-Mini Dual Key AC 2-, 3-, 4-, 5-, 6-Pole	Micro-Mini DC DIN 3-, 4-, & 5-Pole	Micro-Mini AC DIN Standard 4-Pole
	Cable Type(s)	AWM or AWM Braided (PVC jacket) SJOOW (Thermoset jacket) TPE (Elastomer jacket)	AWM or AWM Braided (PVC jacket) Robotic High-Flex (PVC jacket) SJOOW (Thermoset jacket) PUR (Polyurethane jacket)	AWM (PVC jacket)
	Testing & Code Compliance	• UL Recognized component for US & Canada file no. E322038	• UL Recognized component for US & Canada file no. E322038	• UL Recognized component for US & Canada file no. E322038
Specifications: Environmental	Protection	NEMA 1, 3, 4, 6P & 13; IEC IP 68	NEMA 1, 3, 4, 6P & 13; IEC IP 68	NEMA 1, 3, 4, 6P & 13; IEC IP 68
	Temperature Rating	AWM: -20°C to 105°C (-4°F to 221°F) SJOOW: -50°C to 105°C (-58°F to 221°F) TPE: -24°C to 90°C (-11.2°F to 194°F)	AWM: -20°C to 105°C (-4°F to 221°F) Robotic: -30°C to 90°C (-22°F to 194°F) SJOOW: -50°C to 105°C (-58°F to 221°F) PUR: -20°C to 80°C (-4°F to 176°F)	AWM: -20°C to 105°C (-4°F to 221°F)
	Corrosion Resistance	1000 hr. salt spray per MIL-STD-202F	1000 hr. salt spray per MIL-STD-202F	1000 hr. salt spray per MIL-STD-202F
	High Pressure Water Test	N/A	1200 PSI spray	N/A
	Visibility	N/A	LED: 360° visibility range	N/A
Specifications: Electrical	Contact Resistance	<5mΩ	<5mΩ	<5mΩ
	Current Rating	3A, 4A or 5A	3A, 4A or 5A	3A
	Voltage Rating	300V/AC	300V/DC, except LED: 10-30 V/DC	300V/AC/300V/DC
	Dielectric Voltage	Withstands 1600V/AC	1600V/AC (except LED)	Withstands 1600V/AC
Materials:	Body	Yellow, 90A durometer, flame resistant PVC	Yellow, 90A durometer, flame resistant PVC, except PUR cable: 85A durometer oil resistant	Yellow, 90A durometer, flame resistant PVC
	Cable	Yellow, AWM UL style 2661, AWM UL style 2661 with 85% coverage braided shield, SJOOW per UL62 or TPE	Yellow, AWM UL style 2661, AWM UL style 2661 with 85% coverage braided shield, Robotic High Flex, SJOOW or PUR	Yellow, AWM UL style 2661
	Insert	Rigid black polyurethane	Yellow PUR	Gray polyurethane
	Contacts	Machined brass per ASTM B-16	Machined brass per ASTM B-16	Machined brass per ASTM B-16
	Female Contact Plating	30 micro-inches of 24 karat gold over 50 micro-inches of nickel	30 micro-inches of 24 karat gold over 50 micro-inches of nickel	30 micro-inches of 24 karat gold over 50 micro-inches of nickel
	Coupling Nut	Black epoxy coated diecast Zamak 5 (zinc), nylon 6/6 weather stabilized or 303 stainless steel	Black epoxy coated diecast Zamak 5 (zinc), nylon 6/6 weather stabilized or 303 stainless steel	Black epoxy coated diecast Zamak 5 (zinc) or nylon 6/6 weather stabilized

LED Wiring Diagrams

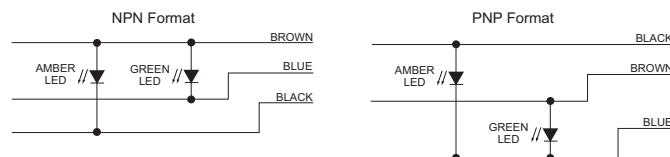

LynxPOWER™
Pico-Line Cordsets

IEC IP 65 & 68
4A 60V/AC RMS; 4A 75V/DC
4A 10-30V/DC

	Cordset Type	Pico-Line 8mm Snap-In 3- & 4-Pole	Pico Line 8mm Coupler 3- & 4-Pole	Pico Line 8mm LED Snap-In & Coupler, 3-Pole
	Cable Type(s)	AWM (PVC jacket)	AWM (PVC jacket)	AWM (PVC jacket)
	Testing & Code Compliance	• UL Recognized component for US & Canada file no. E322038	• UL Recognized component for US & Canada file no. E322038	• UL Recognized component for US & Canada file no. E322038
Specifications: Environmental	Protection	NEMA 4; IEC IP 65	NEMA 1, 3, 4, 6P & 13; IEC IP 68	Snap-In: NEMA 4; IEC IP65 Coupler: NEMA 1, 3, 4, 6P & 13; IEC IP 68
	Temperature Rating	-40°C to 105°C (-40°F to 221°F)	-40°C to 105°C (-40°F to 221°F)	-40°C to 105°C (-40°F to 221°F)
Specifications: Electrical	Contact Resistance	<5mΩ	<5mΩ	<5mΩ
	Current Rating	4A	4A	4A
	Voltage Rating	60V/AC RMS / 75V/DC	60V/AC RMS / 75V/DC	10-30V/DC
	Dielectric Voltage	Withstands 1000V/AC	1000V/AC	Withstands 1000V/AC
Materials:	Body	Yellow, 90A durometer, flame resistant PVC	Yellow, 90A durometer, flame resistant PVC	Clear PVC
	Cable	Yellow, AWM UL style 2661	Yellow, AWM UL style 2661	Yellow, AWM UL style 2661
	Insert	Yellow, PUR	Yellow PUR	Yellow, PUR
	Contacts	Machined brass per ASTM B-16	Machined brass per ASTM B-16	Machined brass per ASTM B-16
	Female Contact Plating	30 micro-inches of 24 karat gold over 50 micro-inches of nickel	30 micro-inches of 24 karat gold over 50 micro-inches of nickel	30 micro-inches of 24 karat gold over 50 micro-inches of nickel
	Coupling Nut	N/A	Black epoxy coated machined brass	Black epoxy coated machined brass (coupler version only)

LED Wiring Diagrams

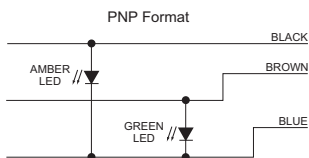
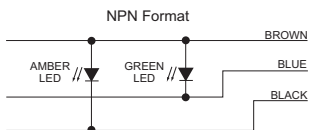

LynxPOWER™
Micro-Mini & Pico-Line Receptacles

IEC IP 68
3A, 4A, 5A 300V/AC
4A, 5A 300V/DC; 3A 300V/AC
4A 60V/AC RMS; 4A 75V/DC

	Receptacle Type	Micro-Mini Dual Key AC 2-, 3-, 4-, 5- & 6-Pole	Micro-Mini DC DIN, 3-, 4- & 5-Pole Micro-Mini AC DIN Standard, 4-Pole	Pico-Line AC DIN Standard 4-Pole, Universal
	Lead Type(s)	AWM (PVC jacket), 22 & 18 AWG SJOOW (Thermoset jacket), 18 AWG TPE (Elastomer jacket), 18 AWG	AWM (PVC jacket), 22 & 18 AWG PUR (Polyurethane jacket), 22 AWG SJOOW (Thermoset jacket), 18 AWG	AWM (PVC jacket), 24 AWG
	Testing & Code Compliance	• UL Recognized component for US & Canada file no. E322038	• UL Recognized component for US & Canada file no. E322038	• UL Recognized component for US & Canada file no. E322038
Specifications: Environmental	Protection	NEMA 1, 3, 4, 6P & 13; IEC IP 68	NEMA 1, 3, 4, 6P & 13; IEC IP 68	NEMA 1, 3, 4, 6P & 13; IEC IP 68
	Temperature Rating	-20°C to 105°C (-4°F to 221°F)	-20°C to 105°C (-4°F to 221°F)	-20°C to 80°C (-4°F to 176°F)
	High Pressure Water Test	N/A	1200 PSI spray	N/A
Specifications: Electrical	Contact Resistance	<5mΩ	<5mΩ	<5mΩ
	Current Rating	3A, 4A or 5A	3A, 4A or 5A	4A
	Voltage Rating	300V/AC	300V/DC or 300V/AC	60V/AC RMS / 75V/DC
	Dielectric Voltage	Withstands 1600V/AC	Withstands 1600V/AC	Withstands 1200V/AC
Materials:	Insert	Black, PUR	Yellow or black, PUR	Black, PUR
	Pigtail Leads	AWM/MTW UL style 1430 or 1569	AWM/MTW UL style 1430 or 1569	AWM/MTW UL style 1061
	Contacts	Machined brass per ASTM B-16	Machined brass per ASTM B-16	Machined brass per ASTM B-16
	Female Contact Plating	30 micro-inches of 24 karat gold over 50 micro-inches of nickel	30 micro-inches of 24 karat gold over 50 micro-inches of nickel	30 micro-inches of 24 karat gold over 50 micro-inches of nickel
	Receptacle Shell, Standard Versions	Machined aluminum with anodized finish & clear sealant or nylon 6/6 weather stabilized (except for 1/2"-NPT), or 303 stainless steel	Machined aluminum with black anodized finish & clear sealant or nylon 6/6 weather stabilized (except DC DIN)	Machined brass with nickel plating
	Receptacle Shell, Special Use Versions	Machined aluminum with anodized finish & clear sealant, except internal thread versions: black anodized finish & clear sealant	N/A	N/A
	Potting Compound	Black rigid epoxy	Black rigid epoxy	Black rigid epoxy

LynxPOWER™
Industrial Ethernet/ IP
Cordsets & Receptacles

IEC IP 68
2A 60V/AC

	Cordset End Type	RJ45	Micro-Mini™ (M12) Connector, 4- or 8-Pin	Micro-Mini (M12) Receptacle, 4- or 8-Pin
	Cable Type(s)	Industrial Cat 5e, PVC or TPE jacket, tinned copper 7 #32	Industrial Cat 5e, PVC or TPE jacket, tinned copper 7 #32	Industrial Cat 5e, PVC or TPE jacket, tinned copper 7 #32
	Testing & Code Compliance	• Meets TIA 568-B.2 specifications for ethernet physical layer	• Meets TIA 568-B.2 specifications for ethernet physical layer	• Meets TIA 568-B.2 specifications for ethernet physical layer
Specifications: Environmental	Protection	NEMA 1, 3, 4, 6P & 13; IEC IP 68	NEMA 1, 3, 4, 6P & 13; IEC IP 68	NEMA 1, 3, 4, 6P & 13; IEC IP 68
	Temperature Rating	PVC: -40°C to 105°C (-40°F to 221°F) TPE: -55°C to 105°C (-67°F to 221°F)	PVC: -40°C to 105°C (-40°F to 221°F) TPE: -55°C to 105°C (-67°F to 221°F)	PVC: -40°C to 105°C (-40°F to 221°F) TPE: -55°C to 105°C (-67°F to 221°F)
	Corrosion Resistance	N/A	500 hr. salt spray	500 hr. salt spray
	High Pressure Water Test	N/A	1200 PSI spray	1200 PSI spray
Specifications: Electrical	Contact Resistance	<5mΩ	<5mΩ	<5mΩ
	Current Rating	2A	2A	2A
	Voltage Rating	60V/AC	60V/AC	60V/AC
	Dielectric Voltage	Withstands 1100V/AC	Withstands 1100V/AC	Withstands 1100V/AC
Materials:	Body	Clear, Polycarbonate	Black, PUR flame resistant rated 94HB	Black, PUR flame resistant rated 94HB
	Insert	N/A	Black, PUR flame resistant rated 94HB	Black, PUR flame resistant rated 94HB
	Boot	Black, polyolefin, snag-less style	N/A	N/A
	Contacts	Phosphor bronze	0.05" machined brass alloy per ASTM B-16	0.05" machined brass alloy per ASTM B-16
	Female Contact Plating	50 micro-inches of 24 karat gold over nickel	30 micro-inches of 24 karat gold over 50 micro-inches of nickel	30 micro-inches of 24 karat gold over 50 micro-inches of nickel
	Coupling Nut	N/A	Black epoxy coated diecast Zamak 5 (zinc)	Black epoxy coated diecast Zamak 5 (zinc)
	Receptacle Shell	N/A	N/A	Black PUR, nickel plated brass or stainless steel
	Potting Compound	N/A	Black rigid epoxy	Black rigid epoxy

LynxPOWER™
DeviceNet Cordsets & Receptacles

IEC IP 68
2A, 8A 300V/AC

	Cordset End/ Device Type	Mini-Line™ Connector, 5-Pole	Mini-Line Receptacle, 5-Pole	Micro-Mini™ (M12) Connector, 5-Pole	Micro-Mini (M12) Receptacle, 5-Pole
	Cable Type(s)	PVC or CPE jacket, tinned copper	PVC or CPE jacket, tinned copper	PVC or CPE jacket, tinned copper	PVC or CPE jacket, tinned copper
	Testing & Code Compliance	• UL Recognized component for US & Canada file no. E322038	• UL Recognized component for US & Canada file no. E322038	• UL Recognized component for US & Canada file no. E322038	• UL Recognized component for US & Canada file no. E322038
Specifications: Environmental	Protection	NEMA 1, 3, 4, 6P & 13; IEC IP 68	NEMA 1, 3, 4, 6P & 13; IEC IP 68	NEMA 1, 3, 4, 6P & 13; IEC IP 68	NEMA 1, 3, 4, 6P & 13; IEC IP 68
	Temperature Rating	PVC: -40°C to 105°C (-40°F to 221°F) CPE: -30°C to 105°C (-22°F to 221°F)	PVC: -40°C to 105°C (-40°F to 221°F) CPE: -30°C to 105°C (-22°F to 221°F)	PVC: -40°C to 105°C (-40°F to 221°F) CPE: -30°C to 105°C (-22°F to 221°F)	PVC: -40°C to 105°C (-40°F to 221°F) CPE: -30°C to 105°C (-22°F to 221°F)
	Corrosion Resistance	500 hr. salt spray	500 hr. salt spray	500 hr. salt spray	500 hr. salt spray
	High Pressure Water Test	1200 PSI spray	1200 PSI spray	1200 PSI spray	1200 PSI spray
Specifications: Electrical	Contact Resistance	<5mΩ	<5mΩ	<5mΩ	<5mΩ
	Current Rating	8A	8A	2A	2A
	Voltage Rating	300V/AC	300V/AC	300V/AC	300V/AC
	Dielectric Voltage	Withstands 1600V/AC	Withstands 1600V/AC	Withstands 1600V/AC	Withstands 1600V/AC
Materials:	Body	Yellow or black, PVC	N/A	Yellow or black, PUR	N/A
	Insert	Yellow or black, PVC	Black, PVC flame resistant rated 94 V0	Yellow or black, PUR	Black, PUR flame resistant rated 94HB
	Contacts	Machined brass alloy per ASTM B-16	Machined brass alloy per ASTM B-16	Machined brass alloy per ASTM B-16	Machined brass alloy per ASTM B-16
	Female Contact Plating	30 micro-inches of 24 karat gold over 50 micro-inches of nickel	30 micro-inches of 24 karat gold over 50 micro-inches of nickel	30 micro-inches of 24 karat gold over 50 micro-inches of nickel	30 micro-inches of 24 karat gold over 50 micro-inches of nickel
	Coupling Nut	Black epoxy coated diecast Zamak 5 (zinc)	N/A	Black epoxy coated diecast Zamak 5 (zinc)	N/A
	Receptacle Shell	N/A	Machined aluminum with black anodized finish & clear sealant or stainless steel	N/A	Machined aluminum with black anodized finish & clear sealant
	Potting Compound	Black rigid epoxy	Black rigid epoxy	Black rigid epoxy	Black rigid epoxy

LynxPOWER™
Profibus Cordsets & Receptacles

IEC IP 68
2A 60V/AC

	Cordset End/Device Type	Micro-Mini™ (M12) Connector, 4-Pole	Micro-Mini (M12) Receptacle, 4-Pole
	Cable Type(s)	PVC or CPE jacket, tinned copper	PVC or CPE jacket, tinned copper
Specifications: Environmental	Protection	NEMA 1, 3, 4, 6P & 13; IEC IP 68	NEMA 1, 3, 4, 6P & 13; IEC IP 68
	Temperature Rating	PVC: -40°C to 105°C (-40°F to 221°F) CPE: -30°C to 105°C (-22°F to 221°F)	PVC: -40°C to 105°C (-40°F to 221°F) CPE: -30°C to 105°C (-22°F to 221°F)
	Corrosion Resistance	500 hr. salt spray	500 hr. salt spray
	High Pressure Water Test	1200 PSI spray	1200 PSI spray
Specifications: Electrical	Contact Resistance	<5mΩ	<5mΩ
	Current Rating	2A	2A
	Voltage Rating	60V/AC	60V/AC
	Dielectric Voltage	Withstands 1100V/AC	Withstands 1100V/AC
Materials:	Body	Black, PUR	N/A
	Insert	Black, PUR	Black, PUR flame resistant rated 94HB
	Contacts	Machined brass alloy per ASTM B-16	Machined brass alloy per ASTM B-16
	Female Contact Plating	30 micro-inches of 24 karat gold over 50 micro-inches of nickel	30 micro-inches of 24 karat gold over 50 micro-inches of nickel
	Coupling Nut	Black epoxy coated diecast Zamak 5 (zinc)	N/A
	Receptacle Shell	N/A	Machined aluminum with black anodized finish & clear sealant
	Potting Compound	Black rigid epoxy	Black rigid epoxy



Ground Fault Circuit Interrupters (GFCIs)



	Page		Page
Build-To-Spec	G-1	Industrial Grade Portable GFCIs	G-7
ArrowLink™ Modular Connectors	G-2	15A Portable GFCIs	
Hospital Specification Grade GFCIs	G-5	Plug Series, Single or Tri-Tap Connector	G-8
2-Pole, 3-Wire Grounding		Plug Series, Field Wireable	G-8
15A, 125V/AC NEMA 5-15	G-5	Inline Series, Single or Tri-Tap Connector	G-8
20A, 125V/AC NEMA 5-20	G-5	Inline Series, Field Wireable	G-8
Specification Grade GFCIs	G-5	20A Portable GFCIs	
2-Pole, 3-Wire Grounding		Inline Series, Field Wireable	G-9
15A, 125V/AC NEMA 5-15	G5-G6	Inline Series, Molded Plug & Connector	G-9
20A, 125V/AC NEMA 5-20	G5-G6	30A Portable GFCIs	
Combination Switch/GFCI, 2-Pole 3-Wire Grounding		Inline Series, Field Wireable, Single Phase	G-10
15A, 125V/AC NEMA 5-15	G-6	Inline Series, Molded Plug & Connector	G-10
Blank Face (Dead-Front), 2-Pole, 3-Wire Grounding		Watertight Portable GFCIs	
20A, 125V/AC	G-6	15A, Straight Blade NEMA 5-15	G-11
		20A, Straight Blade NEMA 5-20	G-11
		20A, Locking NEMA L5-20	G-11
		20A, Locking NEMA L6-20	G-11
		30A, Locking NEMA L5-30	G-11
		30A, Locking NEMA L6-30	G-11
		Specification Information	G-12

Protecting people from electrical shock hazards

ArrowHart's complete offering of Ground Fault Circuit Interrupters (GFCIs) is built to meet every need in commercial, industrial and institutional settings, whether permanent or temporary – and is fully compliant with the latest UL943 standards for GFCIs.



Hospital Specification Grade GFCIs

Designed for safety and reliability, Arrow Hart GFCI receptacles meet the strict standards of UL 943 (GFCI) and UL 498 (Hospital Grade Receptacle Standards). Plus, our broad line provides solutions including Tamper Resistant, ArrowLink Modular and NAFTA compliant versions.



Specification Grade GFCIs

Arrow Hart GFCI receptacles meet the stringent UL 943 (GFCI) standards, plus our broad line provides solutions for commercial, industrial and institutional applications.



Industrial Spec Grade Portable GFCIs

Portable GFCIs are specifically designed to protect personnel and equipment from ground fault hazards in indoor or outdoor jobsite applications.

Tamper Resistant, Weather Resistant and Tamper & Weather Resistant GFCIs

How the Tamper Resistant system works:

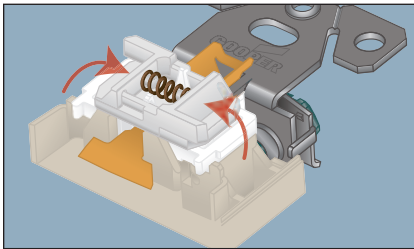

Shutters restrict access in closed position.

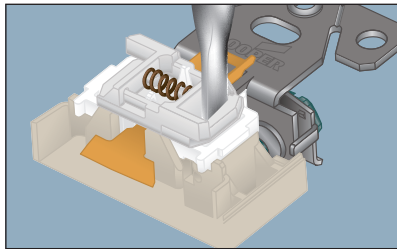

Insertion of object in any one side will not open shutters.

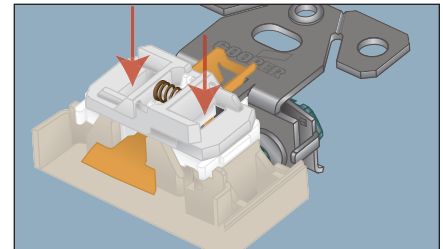

Insertion of two-bladed plug or grounding plug will open shutters.



“TR” mold mark provides quick visual confirmation of tamper resistance when installed.



“WR” identifier quickly indicates during inspections that a weather resistant device has been installed.



Both the “TR” mold mark and “WR” identifier are clearly visible in the finished installation, indicating double-layer protection for maximum safety.

2008 National Electric Code

2008 NEC – 517.18 (C) Pediatric Locations
Receptacles located within the rooms, bathrooms, playrooms, activity rooms and patient care areas of pediatric wards shall be listed under tamper resistant or employ a listed tamper resistant cover.

B) TR for non-hospital sections – 2008 NEC – 406.11 Tamper Resistant Receptacles in Dwelling units
In all areas specified in 210.52 all 125-volt, 15- and 20-amp receptacles shall be listed tamper resistant receptacles.

C) WR for all sections – 2008 NEC – 406.8 Receptacles in Wet or Damp Locations
All 15- and 20-amp, 125- and 250-volt non-locking receptacles installed in wet or damp locations shall be weather resistant receptacles.

Build-To-Spec

For Receptacles, Switches, GFCIs & TVSS devices

Modified at the factory to improve efficiency and speed production at the job site. Arrow Hart’s Build-To-Spec program provides customized device solutions to simplify your project and maximize your bottom line.

Sample Number:



ARROW/HART
Base Catalog Number (including device color)

Remove mounting screws

Add 6" leads

PSOL = #12 AWG solid
PSTR = #12 AWG stranded

Remove ears

Remove ground clip

Add push-in connector**

Arrow Hart 20A 125V NEMA 5-20 white GFCI receptacle, with wire leads and push-in connectors, without mounting screws, ears, or grounding clip.

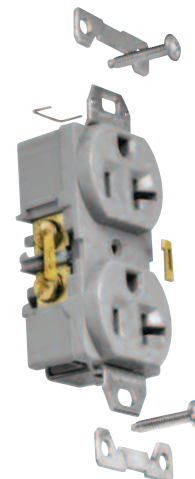

BUILD-TO-SPEC
CUSTOM CONFIGURED DEVICES
ARROW/HART

**For use with leaded receptacles only. Add “PSOL” to back of receptacle catalog number for 6” of #12 AWG solid or “PSTR” for 6” of #12 AWG stranded. (Example: VGF20W PSOL + Build to Spec Options).

All receptacles are bulk packed 50 pieces per carton. Minimum order quantity is 100 pieces. Orders under 500 pieces ship within 5 days with larger quantities typically within 10 days.

ArrowLink

Arrow Hart's factory terminated ArrowLink system revolutionizes device installation, unleashing groundbreaking labor savings in installation and maintenance by eliminating traditional pigtailing, terminal connections and taping. Use ArrowLink on your next job to reduce labor costs, eliminate installation errors, save money and win!

Color coded terminals for consistent, reliable connections

Durable polycarbonate housing

Terminal accommodation #12-#14 AWG, solid only

Copper alloy contacts for superior wire retention and minimized heat rise

6", #12 AWG ground lead with ring terminal and captive ground screw

Color coded terminal screws guard caps

Color coded terminal screws

Terminal accommodation #12-#14 AWG, solid or stranded

Cut-Away of MCR300FTP1 Push-In Terminal

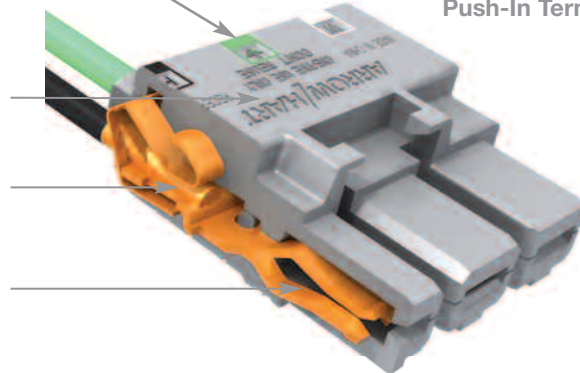

Cut-Away of MCR300FTST Screw Terminal

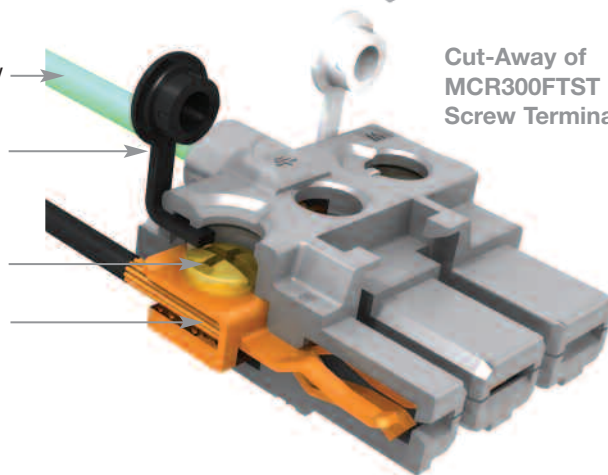

ArrowLink SPD Benefits



EASE OF INSTALLATION:
No more twist-on wire connectors



50% TIME SAVINGS:
SPD accelerates both rough-in & trim out installation

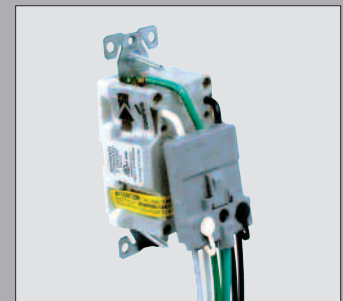

EFFICIENT DESIGN:
Low profile connection with feed-through capability



30% REDUCTION in wire volume inside the box

How To Order



1. Select a Device to ArrowLink enable. Catalog pages identify available products—simply add an "M" to the catalog number and the devices will be factory enabled with the ArrowLink device-side connection. (For GFCIs add "MOD" suffix)

2. Choose from leaded or unleaded ArrowLink connector versions in screw-down or push-in models.

3. Place your order and get your ArrowLink devices in **bulk packed boxes**, shipped within 5 days of receipt of order!

ArrowLink SPD Comparative Labor Savings Analysis

Traditional Pigtail Installation



0:50
Cutting & stripping
pigtails

1:50
Install wire
connectors

1:10
Terminate
Conductors

1:05
Mount
Devices

4:55/Receptacle

Total time required to
install 500 pigtail devices:
40.97 Hours

ArrowLink SPD Installation

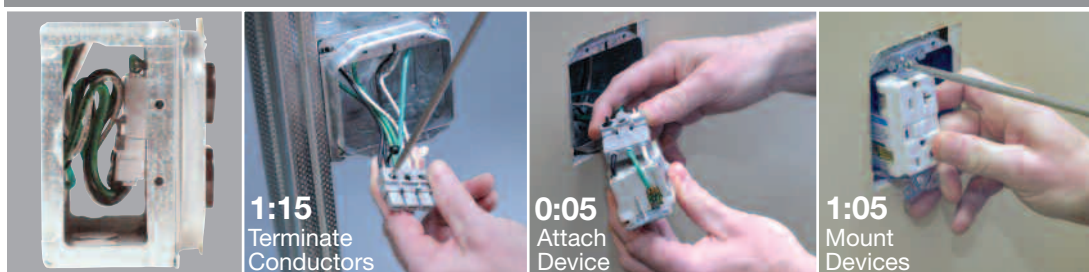

1:15
Terminate
Conductors

0:05
Attach
Device

1:05
Mount
Devices

2:25/Receptacle

Total time required to install
500 ArrowLink SPD devices:
20.13 Hours

Time Saved with SPD
20.84 Hours

ARROWLINK™
Modular Wiring Devices



Leaded ArrowLink Receptacle Connectors

Device Type	Description	Catalog No.
Receptacle	Solid Wire Leads – 125V	<input type="checkbox"/> MCR125SOL
	Stranded Wire Leads – 125V	<input type="checkbox"/> MCR125STR
	Solid Wire Leads – 250V	<input type="checkbox"/> MCR250SOL
	Stranded Wire Leads – 250V	<input type="checkbox"/> MCR250STR

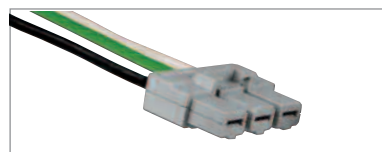

MCR125STR
Leaded
ArrowLink
Connector

ARROWLINK™
SPD



ArrowLink SPD Receptacle Connectors

Device Type	Description	Catalog No.
Receptacle	Screw Terminal	<input type="checkbox"/> MCR300FTST
	Screw Terminal, No Ground Conductor	<input type="checkbox"/> MCR300FTSTNG
	<small>AVAILABLE SUMMER 2010</small> Push-In	<input type="checkbox"/> MCR300FTPI
	<small>AVAILABLE SUMMER 2010</small> Push-In, No Ground Conductor	<input type="checkbox"/> MCR300FTPING

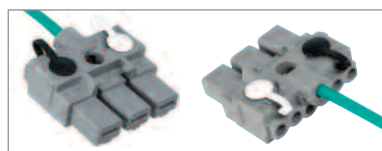

MCR300FTST
Screw Terminal

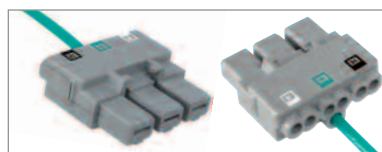

MCR300FTPI
Push-In
Terminal

ArrowLink Accessories

Device Type	Description	Catalog No.
Circuit Tester	Tests Receptacle & ArrowLink Connectors	<input type="checkbox"/> ALTESTER <small>AVAILABLE SUMMER 2010</small>



ALTESTER
Circuit Tester

ShockSentry™ GFCIs provide state-of-the-art, dependable electrical shock protection

In addition to being tested to the highest standards to help ensure safety, Arrow Hart GFCIs will deny power and prevent re-setting if the device is no longer able to provide safe, protected power.

**ShockSentry Ground Fault Circuit Interrupter**

Meets and exceeds 10ka Short Circuit Testing and Underwriters Laboratories (UL) 2006 UL943 Safety standards

Large visual indicator light gives quick notification of a tripped or “end of life” condition

Unbreakable nylon construction provides unsurpassed chemical and impact resistance

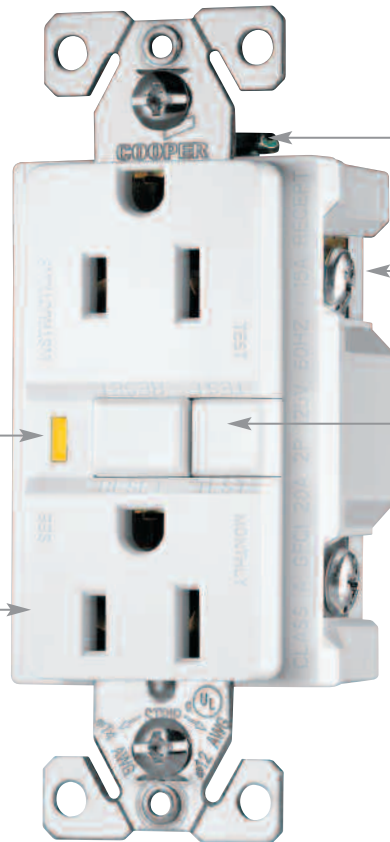

Ground termination with backwire clamp provides secure wiring and reduces installation time

Line side terminals are backed out and staked for fast installation

Horizontal Test/Reset button alignment provides larger unobstructed area

Additional Features and Benefits

- Tapered backwire openings handle multiple wire sizes and types for applications up to #10 AWG solid or stranded wire
- When downstream receptacles are wired from load side, a 20 amp feed-through rating offers full protection
- Test and reset buttons are color matched to provide superior aesthetics
- Longer, wider “bridge” strap provides 40% more contact area with wallboard, virtually eliminating floating installations
- Exclusive built-in wire stripper provides fast stripping of wire without tools
- Line-load miswiring protection: Shock Sentry GFCI's will not provide power downstream when wired incorrectly
- Tri-combo head terminal and mounting screws

Specification Grade Ground Fault Circuit Interrupter Receptacles

2-Pole, 3-Wire Grounding
 15A, 125V/AC
 20A, 125V/AC
 NEMA 5-15, 5-20



5-15R



5-20R

Hospital Grade GFCIs

Back Wire & Side Wire	15A, 125V NEMA 5-15R			20A, 125V NEMA 5-20R		
Description	Catalog No. Color Suffix			Catalog No. Color Suffix		
Hospital GFCI	<input type="checkbox"/> VGFH15____ B, GY, LA, RD, V, W	•	•	<input type="checkbox"/> VGFH20____ B, GY, LA, RD, V, W	•	•
Hospital GFCI NAFTA Compliant	<input type="checkbox"/> VGFH15F____ B, GY, LA, RD, V, W	•	•	<input type="checkbox"/> VGFH20F____ B, GY, LA, RD, V, W	•	•
Tamper Resistant Hospital GFCI	<input type="checkbox"/> TRVGFH15____ B, GY, LA, RD, V, W	•	•	<input type="checkbox"/> TRVGFH20____ B, GY, LA, RD, V, W	•	•
Tamper Resistant Hospital GFCI NAFTA Compliant	<input type="checkbox"/> TRVGFH15F____ B, GY, LA, RD, V, W	•	•	<input type="checkbox"/> TRVGFH20F____ B, GY, LA, RD, V, W	•	•

Includes standard size unbreakable wallplate

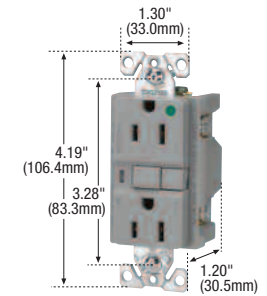

VGFH15

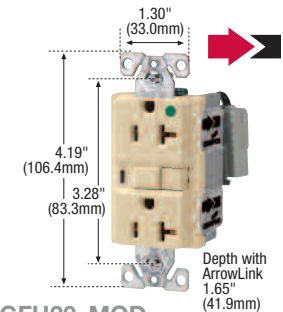

VGFH20_MOD

Specification Grade GFCIs

Back Wire & Side Wire	15A, 125V NEMA 5-15R			20A, 125V NEMA 5-20R		
Description	Catalog No. Color Suffix			Catalog No. Color Suffix		
Duplex GFCI	<input type="checkbox"/> VGF15____ A, B, BK, GY, LA, RD, V, W	•	•	<input type="checkbox"/> VGF20____ A, B, BK, GY, LA, RD, V, W	•	•
Duplex GFCI with Mid-Size Wallplate	<input type="checkbox"/> VGF15____-M A, LA, V, W					
Duplex GFCI NAFTA Compliant	<input type="checkbox"/> VGF15F____ B, BK, GY, LA, RD, V, W	•	•	<input type="checkbox"/> VGF20F____ B, BK, GY, LA, RD, V, W	•	•
Tamper Resistant Duplex GFCI	<input type="checkbox"/> TRVGF15____ A, B, BK, GY, LA, RD, V, W	•	•	<input type="checkbox"/> TRVGF20____ A, B, BK, GY, LA, RD, V, W	•	•
Tamper Resistant Duplex GFCI with Mid-Size Wallplate	<input type="checkbox"/> TRVGF15____-M A, LA, V, W					
Tamper Resistant Duplex GFCI NAFTA Compliant	<input type="checkbox"/> TRVGF15F____ B, BK, GY, LA, RD, V, W	•	•	<input type="checkbox"/> TRVGF20F____ B, BK, GY, LA, RD, V, W	•	•
Weather Resistant Duplex GFCI	<input type="checkbox"/> WRVGF15____ B, GY, V, W	•	•	<input type="checkbox"/> WRVGF20____ B, GY, V, W	•	•
Tamper & Weather Resistant Duplex GFCI	<input type="checkbox"/> TWRVGF15____ B, GY, LA, V, W	•	•	<input type="checkbox"/> TWRVGF20____ B, GY, LA, V, W	•	•

Includes standard size unbreakable wallplate unless otherwise noted
 Consult factory customer service representative for additional packaging options

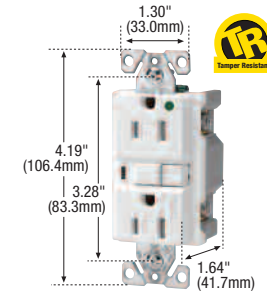

TRVGFH15

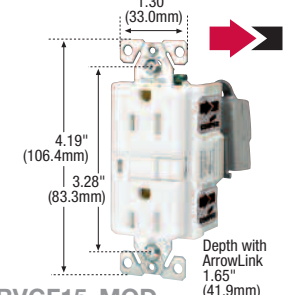

TRVGF15_MOD

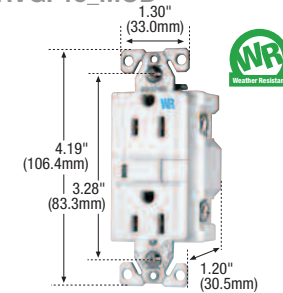

WRVGF15

Color Ordering Information

For ordering devices, include Cat. No. followed by the color code: A (Almond), B (Brown), BK (Black), GY (Gray), LA (Light Almond), RD (Red), RN (Orange), V (Ivory), W (White)

Icon Key

ArrowLink™ option available. Add "MOD" suffix to Standard catalog number (example VGF15W, VGF15WMOD). For ordering information on ArrowLink & ArrowLink SPD connectors, see page G-2.

Hospital Grade

Build-To-Spec Customizable Devices - see page G-1

NAFTA Compliant - see page O-30

Tamper Resistant

Weather Resistant

Tamper & Weather Resistant

Specification Information:

Hospital Grade GFCI: G-12

Spec Grade GFCI: G-13

Specification Grade Ground Fault Circuit Interrupter Receptacles

2-Pole, 3-Wire Grounding
 15A, 125V/AC
 20A, 125V/AC
 NEMA 5-15, 5-20



5-15R



5-20R

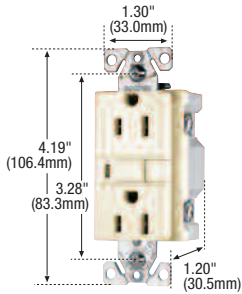

VGFI5-AG

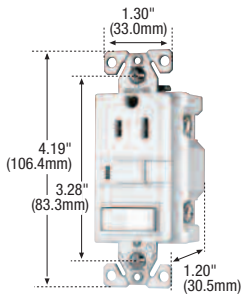

VGFS15-MSP

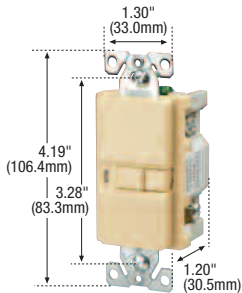

VGFD20

Specification Grade Automatic Ground GFCIs

Back Wire & Side Wire

15A, 125V
 NEMA 5-15R

20A, 125V
 NEMA 5-20R

Description	Catalog No. Color Suffix	Catalog No. Color Suffix
Auto Ground Duplex GFCI	<input type="checkbox"/> VGFI5 __-AG V, W	<input type="checkbox"/> VGFI20 __-AG V, W
Tamper Resistant Duplex GFCI	<input type="checkbox"/> TRVGFI5 __-AG BK, V, W	<input type="checkbox"/> TRVGFI20 __-AG BK, V, W

Includes standard size unbreakable wallplate

Specification Grade Combination GFCI Receptacle & Switch

Back Wire & Side Wire

15A, 125V
 NEMA 5-15R

Description	Catalog No. Color Suffix
NEMA 5-15 GFCI Receptacle with Feed-Through Single-Pole Switch (rated 1800W @ 120V/AC, 60Hz)	<input type="checkbox"/> VGFS15 __-MSP V, W

Includes mid-size unbreakable wallplate

Specification Grade Blank Face GFCI

Back Wire & Side Wire

20A, 125V

Description	Catalog No. Color Suffix
Blank Face (Dead Front) GFCI, Rated as 1.5HP Motor Control Switch	<input type="checkbox"/> VGFD20 __ V, W

Includes standard size unbreakable wallplate

Color Ordering Information

For ordering devices, include Cat. No. followed by the color code: A (Almond), B (Brown), BK (Black), GY (Gray), LA (Light Almond), RD (Red), RN (Orange), V (Ivory), W (White)

Icon Key

NAFTA Compliant - see page O-30

Tamper Resistant

Accessories for GFCIs

Description	Catalog No.
GFCI 7/8" extension ring Add color suffix: B (Brown), BLK (Black), LA (Light Almond), V (Ivory), W (White)	<input type="checkbox"/> GFER __
Metal self-closing horizontal 1-gang weather protective cover, decorator opening	<input type="checkbox"/> S1966 •
While-In-Use metal weather protective standard depth 1-gang cover, vertical mount	<input type="checkbox"/> WIUMV-1 •

Specification Information:

Specification Grade GFCI: G-13

Specification Grade Combo GFCI Receptacle & Switch: G-14

Specification Grade Blank Face GFCI: G-14



GFER



S1966



WIUMV-1

Reliable GFCI protection in remote applications

Arrow Hart's complete offering of portable GFCIs provide electrical protection from ground fault hazards on the jobsite.



PowerTrip™ Portable GFCI

Electro-magnetically latched contacts will not detach in rough use conditions

Dual indication lights display power and fault status

Double insulated user interface provides added safety for user

Industrial design and materials are UV and chemical resistant - ideal for use in rough industrial environments

Heavy-duty cable, plug and connector provide reliable connection



Convenient plug series available with flying leads, single or tri-tap connector



Available in a variety of cord lengths, with terminated devices or flying leads for field terminations



Variety of straight blade and locking plug and connector options, including watertight devices



Available with Manual or Automatic GFCI reset options

Industrial Grade 15A Portable GFCIs

2-Pole, 3-Wire Grounding
15A, 120V/AC



GFP11M1P3



GFP400



GFI11M133



GFI11MN3



GFP100-B



WD3059-DDN

BR20BK

Specification Information:
15A Portable GFCIs: G-15
GFP400 & GFP100-B: G-16

G-8

15A Portable GFCIs, Plug Series

Plug Series - Single & Tri-Tap Connector



Rating A	V/AC	NEMA	NEMA Type	Connector Style	Cord Length	Cord Gauge	Catalog No.*
15	120	5-15	3R	Single-Tap	2' (0.61m)	12/3 AWG	<input type="checkbox"/> GFP11M1P3
			3R	Tri-Tap	2' (0.61m)	12/3 AWG	<input type="checkbox"/> GFP11M1P9
		5-15	3R	Single-Tap	25' (7.62m)	12/3 AWG	<input type="checkbox"/> GFP11M4P3
			3R	Tri-Tap	25' (7.62m)	12/3 AWG	<input type="checkbox"/> GFP11M4P9

*Automatic reset GFCIs are also available. When ordering automatic Portable GFCIs replace "M" in catalog number with "A".
Example: GFP11A1P3 = Automatic; GFP11M1P3 = Manual.

Plug Series - Field Wireable



Rating A	V/AC	NEMA	NEMA Type	Connector Style	Cord Length	Cord Gauge	Catalog No.*
15	120	5-15	3R	Flying Leads	2' (0.61m)	12/3 AWG	<input type="checkbox"/> GFP11MNP

*Automatic reset GFCIs are also available. When ordering automatic Portable GFCIs replace "M" in catalog number with "A".
Example: GFP11ANP = Automatic; GFP11MNP = Manual.

Plug Series - Single Receptacle



Rating A	V/AC	NEMA	Description	Catalog No.
15	120	5-15	Single Outlet Adapter	<input type="checkbox"/> GFP400

15A Portable GFCIs, Inline Series

Inline Series - Single & Tri-Tap Connector



Rating A	V/AC	NEMA	NEMA Type	Connector Style	Cord Length	Cord Gauge	Catalog No.*
15	120	5-15	3R	Single-Tap	2' (0.61m)	12/3 AWG	<input type="checkbox"/> GFI11M133
			3R	Tri-Tap	2' (0.61m)	12/3 AWG	<input type="checkbox"/> GFI11M139
		5-15	3R	Single-Tap	6' (1.83 m)	12/3 AWG	<input type="checkbox"/> GFI11M233
			3R	Tri-Tap	6' (1.83 m)	12/3 AWG	<input type="checkbox"/> GFI11M239
		5-15	3R	Single-Tap	25' (7.62m)	12/3 AWG	<input type="checkbox"/> GFI11M433
			3R	Tri-Tap	25' (7.62m)	12/3 AWG	<input type="checkbox"/> GFI11M439
		5-15	3R	Single-Tap	50' (15.24m)	12/3 AWG	<input type="checkbox"/> GFI11M633
			3R	Tri-Tap	50' (15.24m)	12/3 AWG	<input type="checkbox"/> GFI11M639

*Automatic reset GFCIs also available. When ordering automatic Portable GFCIs replace "M" in catalog number with "A".
Example: GFI11A133 = Automatic; GFI11M133 = Manual.

Inline Series - Field Wireable



Rating A	V/AC	NEMA	NEMA Type	Connector Style	Cord Length	Cord Gauge	Catalog No.
15	120	5-15	3R	-	1' (0.3m)	12/3 AWG	<input type="checkbox"/> GFI11MN3*
15	120	5-15	-	-	-	12-18 AWG	<input type="checkbox"/> GFP100-B**

*Automatic reset GFCIs are also available. When ordering automatic Portable GFCIs replace "M" in catalog number with "A".
Example: GFI11AN3 = Automatic; GFI11MN3 = Manual.

**UL and CSA certified only.

Accessories for 15A Portable GFCIs



Description	Catalog No.
20A 125V/AC NEMA 5-20, Duplex Straight Blade Receptacle - Black	<input type="checkbox"/> BR20BK
Standard Depth, Portable Outlet Box With Cover Plates	<input type="checkbox"/> WD3059-DDN

**Industrial Grade
20A Portable
GFCIs**

2-Pole, 3-Wire Grounding
20A, 120V/AC
20A, 240V/AC

20A Portable GFCIs, Inline Series

Inline Series - Field Wireable

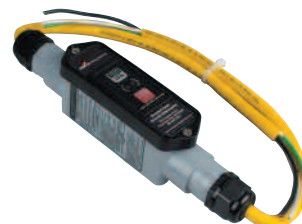

Rating A	V/AC	NEMA	NEMA Type	Connector Style	Cord Length	Cord Gauge	Catalog No.*	
20	120	N/A	4X	Flying leads	2' (0.61m)	12/3 AWG	<input type="checkbox"/> GFI12M1NN	
		N/A	4X	Flying leads	6' (1.83m)	12/3 AWG	<input type="checkbox"/> GFI12M2NN	
		N/A	4X	Flying leads	25' (7.62m)	12/3 AWG	<input type="checkbox"/> GFI12M4NN	
		N/A	4X	Flying leads	50' (15.24m)	12/3 AWG	<input type="checkbox"/> GFI12M6NN	
20	240	N/A	4X	Flying leads	2' (0.61m)	12/3 AWG	<input type="checkbox"/> GFI22M1NN	
		N/A	4X	Flying leads	6' (1.83m)	12/3 AWG	<input type="checkbox"/> GFI22M2NN	
		N/A	4X	Flying leads	25' (7.62m)	12/3 AWG	<input type="checkbox"/> GFI22M4NN	
		N/A	4X	Flying leads	50' (15.24m)	12/3 AWG	<input type="checkbox"/> GFI22M6NN	

*Automatic reset GFCIs are also available and are NAFTA compliant. When ordering automatic Portable GFCIs replace "M" in catalog number with "A". Example: GFI12A1NN = Automatic; GFI12M1NN = Manual.



GFI12M1NN

Inline Series - Molded Plug & Connector

Rating A	V/AC	NEMA	NEMA Type	Plug & Connector Style	Cord Length	Cord Gauge	Catalog No.*	
20	120	5-20	4X	Molded straight blade	2' (0.61m)	12/3 AWG	<input type="checkbox"/> GFI12M133	
		L5-20	4X	Molded locking	2' (0.61m)	12/3 AWG	<input type="checkbox"/> GFI12M144	
20	240	L6-20	4X	Molded locking	2' (0.61m)	12/3 AWG	<input type="checkbox"/> GFI22M144	

*Automatic reset GFCIs are also available and are NAFTA compliant. When ordering automatic Portable GFCIs replace "M" in catalog number with "A". Example: GFI12A133 = Automatic; GFI12M133 = Manual.









GFI12M133

Icon Key

 NAFTA Compliant - see page O-30

Accessories for 20A Portable GFCIs

Description	Catalog No.	
15A 125V/AC NEMA 5-15 Watertight Plug	<input type="checkbox"/> 14W47	
15A 125V/AC NEMA 5-15 Watertight Connector	<input type="checkbox"/> 15W47	
Standard Depth Portable Outlet box with Flip Lids	<input type="checkbox"/> WD3059-DDW	
20A 125V/AC NEMA 5-20 Duplex Straight Blade Receptacle - Black	<input type="checkbox"/> BR20BK	
20A 125V/AC NEMA L5-20 Industrial Receptacle	<input type="checkbox"/> CWL520R	



15W47



WD3059-DDW



BR20BK



CWL520R

Specification Information:
20A Portable GFCIs: G-15

Industrial Grade 30A Portable GFCIs

2-Pole, 3-Wire Grounding
30A, 120V/AC; 30A, 208V/AC
30A, 240V/AC; 30A, 277V/AC

30A Portable GFCIs, Inline Series



GF113M1NN

Inline Series - Field Wireable, Single Phase



Rating A	V/AC	NEMA	NEMA Type	Connector Style	Cord Length	Cord Gauge	Catalog No.*
30	120	N/A	4X	Flying leads	2' (0.61m)	10/3 AWG	<input type="checkbox"/> GF113M1NN
			4X	Flying leads	6' (1.83m)	10/3 AWG	<input type="checkbox"/> GF113M2NN
			4X	Flying leads	25' (7.62m)	10/3 AWG	<input type="checkbox"/> GF113M4NN
			4X	Flying leads	50' (15.24m)	10/3 AWG	<input type="checkbox"/> GF113M6NN
			4X	Flying leads	100' (30.48m)	10/3 AWG	<input type="checkbox"/> GF113M7NN
30	208	N/A	4X	Flying leads	2' (0.61m)	10/3 AWG	<input type="checkbox"/> GF193M1NN
30	240	N/A	4X	Flying leads	2' (0.61m)	10/3 AWG	<input type="checkbox"/> GF123M1NN
			4X	Flying leads	6' (1.83m)	10/3 AWG	<input type="checkbox"/> GF123M2NN
			4X	Flying leads	25' (7.62m)	10/3 AWG	<input type="checkbox"/> GF123M4NN
			4X	Flying leads	50' (15.24m)	10/3 AWG	<input type="checkbox"/> GF123M6NN
			4X	Flying leads	100' (30.48m)	10/3 AWG	<input type="checkbox"/> GF123M7NN
30	277	N/A	4X	Flying leads	2' (0.61m)	10/3 AWG	<input type="checkbox"/> GF1D3M1NN

*Automatic reset GFCIs are also available. When ordering automatic Portable GFCIs replace "M" in catalog number with "A". Example: GF113A1NN = Automatic; GF113M1NN = Manual.



GF113M144

Inline Series - Molded Locking Plug & Connector



Rating A	V/AC	NEMA	NEMA Type	Plug & Connector Style	Cord Length	Cord Gauge	Catalog No.*
30	120	L5-30	4X	Molded locking	2' (0.61m)	10/3 AWG	<input type="checkbox"/> GF113M144
30	240	L6-30	4X	Molded locking	2' (0.61m)	10/3 AWG	<input type="checkbox"/> GF123M144

*Automatic reset GFCIs are also available. When ordering automatic Portable GFCIs replace "M" in catalog number with "A". Example: GF113A144 = Automatic; GF113M144 = Manual.

Icon Key

NAFTA Compliant - see page O-30

Accessories for 30A Portable GFCIs

Description	Catalog No.
30A 125V/AC NEMA L5-30 Locking Plug	<input type="checkbox"/> CWL530P •
30A 125V/AC NEMA L5-30 Locking Connector	<input type="checkbox"/> CWL530C •
30A 125V/AC NEMA L5-30 Industrial Locking Receptacle	<input type="checkbox"/> CWL530R •
30A 125V/AC NEMA L6-30 Industrial Locking Receptacle	<input type="checkbox"/> CWL630R •
Standard Depth Portable Outlet Box	<input type="checkbox"/> WD3059 •



CWL530P



CWL530C



CWL530R



CWL630R



WD3059

Specification Information:

30A Portable GFCIs: G-15

Watertight Portable GFCIs

2-Pole, 3-Wire Grounding
 15A, 120V/AC
 20A, 120V/AC; 20A, 240V/AC
 30A, 120V/AC; 30A, 240V/AC

Watertight Portable GFCIs

Inline Series - Watertight Plug and Connector Ends



Rating A	V/AC	NEMA	NEMA Type	Plug & Connector Style	Cord Length	Cord Gauge	Catalog No.*
15	120	5-15	3R	Straight Blade	2' (0.61m)	12/3 AWG	<input type="checkbox"/> GFI11M155
		5-15	3R	Straight Blade	6' (1.83m)	12/3 AWG	<input type="checkbox"/> GFI11M255
		5-15	3R	Straight Blade	25' (7.62m)	12/3 AWG	<input type="checkbox"/> GFI11M455
		5-15	3R	Straight Blade	50' (15.24m)	12/3 AWG	<input type="checkbox"/> GFI11M655
20	120	5-20	4X	Straight Blade	2' (0.61m)	12/3 AWG	<input type="checkbox"/> GFI12M155 •
		5-20	4X	Straight Blade	6' (1.83m)	12/3 AWG	<input type="checkbox"/> GFI12M255
		5-20	4X	Straight Blade	25' (7.62m)	12/3 AWG	<input type="checkbox"/> GFI12M455
		L5-20	4X	Locking	2' (0.61m)	12/3 AWG	<input type="checkbox"/> GFI12M166
		L5-20	4X	Locking	6' (1.83m)	12/3 AWG	<input type="checkbox"/> GFI12M266
		L5-20	4X	Locking	25' (7.62m)	12/3 AWG	<input type="checkbox"/> GFI12M466
20	240	L6-20	4X	Locking	2' (0.61m)	12/3 AWG	<input type="checkbox"/> GFI22M166
		L6-20	4X	Locking	6' (1.83m)	12/3 AWG	<input type="checkbox"/> GFI22M266
		L6-20	4X	Locking	25' (7.62m)	12/3 AWG	<input type="checkbox"/> GFI22M466
30	120	L5-30	4X	Locking	2' (0.61m)	12/3 AWG	<input type="checkbox"/> GFI13M166
		L5-30	4X	Locking	6' (1.83m)	12/3 AWG	<input type="checkbox"/> GFI13M266
		L5-30	4X	Locking	25' (7.62m)	12/3 AWG	<input type="checkbox"/> GFI13M466
30	240	L6-30	4X	Locking	2' (0.61m)	12/3 AWG	<input type="checkbox"/> GFI23M166
		L6-30	4X	Locking	6' (1.83m)	12/3 AWG	<input type="checkbox"/> GFI23M266
		L6-30	4X	Locking	25' (7.62m)	12/3 AWG	<input type="checkbox"/> GFI23M466



GFI12M155

*Automatic reset GFCIs are also available and are NAFTA compliant. When ordering automatic Portable GFCIs replace "M" in catalog number with "A". Example: GFI12**A**155 = Automatic; GFI12**M**155 = Manual.

Icon Key

NAFTA Compliant - see page O-30

Accessories for Watertight Portable GFCIs

Description	Catalog No.
20A 125V/AC NEMA 5-20 Watertight Single Straight Blade Receptacle	<input type="checkbox"/> 60W33 •
20A 125V/AC NEMA 5-20 Watertight Duplex Straight Blade Receptacle	<input type="checkbox"/> 60W33DPLX •
20A Plug Closure Cap	<input type="checkbox"/> 20PW •
20A 125V/AC NEMA L5-20 Watertight Locking Receptacle	<input type="checkbox"/> L520RW •
30A 125V/AC NEMA L5-30 Watertight Locking Receptacle	<input type="checkbox"/> L530RW •



60W33



60W33DPLX



20PW



L520RW



L530RW

Specification Information:

15A Watertight Portable GFCIs: G-15
 20A Watertight Portable GFCIs: G-15
 30A Watertight Portable GFCIs: G-15

Hospital Specification Grade Ground Fault Circuit Interrupter Receptacles

2-Pole, 3-Wire Grounding
15A, 125V/AC; 20A, 125V/AC
NEMA 5-15, 5-20

		Device Type	Hospital Grade Duplex GFCI 15A & 20A: VGFH Series and VGFH_F ArrowLink: MCR125_, MCR250_, MCR300_ Series	Hospital Grade Tamper Resistant Duplex GFCI 15A & 20A: TRVGFH and TRVGFH_F Series ArrowLink: MCR125_, MCR250_, MCR300_ Series
Wiring Type	Base Device		Back & side wire	Back & side wire
	ArrowLink		Integral wire leads, crimped & resistance welded	Integral wire leads, crimped & resistance welded
	ArrowLink SPD		Backwire feed through	Backwire feed through
Testing & Code Compliance	Base Device		<ul style="list-style-type: none"> cULus Listed to UL 498 and UL 943, file no. E60120 Meets all UL 943 (GFCI), UL 498 (Receptacles), UL 498 Hospital Grade and applicable CSA requirements NOM certified 	<ul style="list-style-type: none"> cULus Listed to UL 498 and UL 943, file no. E60120 Meets all UL 943 (GFCI), UL 498 (Receptacles), UL 498 Hospital Grade and applicable CSA requirements NOM certified
		ArrowLink	<ul style="list-style-type: none"> Plug & connector cULus Listed to to UL 2459, file no. E325188 	<ul style="list-style-type: none"> Plug & connector cULus Listed to to UL 2459, file no. E325188
	Combined		<ul style="list-style-type: none"> cULus Listed wiring assembly, UL file no. E326691 	<ul style="list-style-type: none"> cULus Listed wiring assembly, UL file no. E326691
Specifications: Environmental	Base Device	Flammability	Meets UL 94 requirements; V2 rated	Meets UL 94 requirements; V2 rated
		Temperature Rating	-35°C to 66°C (-31°F to 150.8°F)	-35°C to 66°C (-31°F to 150.8°F)
	ArrowLink	Flammability	Meets UL 94 requirements; V2 rated	Meets UL 94 requirements; V2 rated
		Temperature Rating	-35°C to 66°C (-31°F to 150.8°F)	-35°C to 66°C (-31°F to 150.8°F)
Specifications: Electrical	Base Device	Dielectric Voltage	Withstands 2000V per UL 498	Withstands 2000V per UL 498
		Current Interrupting	Yes, at full-rated current	Yes, at full-rated current
		Temperature Rise	Max. 30°C (86°F) after 100 cycles of overload @ 150% of rated current (DC)	Max. 30°C (86°F) after 100 cycles of overload @ 150% of rated current (DC)
		Trip Time	0.025 seconds (Class A)	0.025 seconds (Class A)
		Frequency	60 Hz; Voltage: 125V; Amperage: 15A/20A 20A Feed Through	60 Hz; Voltage: 125V; Amperage: 15A/20A 20A Feed Through
		Short Circuit Testing	Meets and exceeds 10 kA	Meets and exceeds 10 kA
		Maximum Interrupting Capacity	20 Amps	20 Amps
	ArrowLink	Max. Working Voltage	300V/AC	300V/AC
		Max. Continuous Current	20A	20A
		Overload	52.5A/AC for 10 cycles	52.5A/AC for 10 cycles
		Dielectric Voltage	Withstands 1600V per UL 2459	Withstands 1600V per UL 2459
		Current Interrupting	Limited cycles at full-rated current	Limited cycles at full-rated current
		Temperature Rise	Max. 50°C (122°F) while conducting 35A after 10 cycles of overload @ 52.5A/AC	Max. 50°C (122°F) while conducting 35A after 10 cycles of overload @ 52.5A/AC
Specifications: Mechanical	Base Device Terminal Accommodation	#14 - #10 AWG	#14 - #10 AWG	
	ArrowLink Wire Leads	#12 AWG	#12 AWG	
	ArrowLink SPD Screw Terminals	Accepts #12-#14 stranded and solid wire	Accepts #12-#14 stranded and solid wire	
	ArrowLink SPD Ground	Integral THHN #12 AWG 6" lead with ring terminal and #10 ground screw	Integral THHN #12 AWG 6" lead with ring terminal and #10 ground screw	
	Voltage Rating	Permanently marked on device	Permanently marked on device	
Specifications: Screw Terminal Guards	ArrowLink Models Only	Material: UL recognized insulating material Dielectric Strength: 2,000V min. HWI Rating: 4 min. Relative temperature index, electrical: 80°C (176°F) Flammability: V0 (UL 94)	Material: UL recognized insulating material Dielectric Strength: 2,000V min. HWI Rating: 4 min. Relative temperature index, electrical: 80°C (176°F) Flammability: V0 (UL 94)	
Materials:	Base Device	Top Housing	Thermoplastic, nylon	Thermoplastic, nylon
		Bottom Housing	Polycarbonate	Polycarbonate
		Strap	0.047" thick steel, zinc plated	0.047" thick steel, zinc plated
		Line Contacts	0.030" thick brass	0.030" thick brass
		Terminal & Ground Screws	#8-32 steel, brass plated; neutral screw nickel plated, ground screw green	#8-32 steel, brass plated; neutral screw nickel plated, ground screw green
		Terminal Clamps	0.070" thick steel	0.070" thick steel
	ArrowLink	Housing	Polycarbonate	Polycarbonate
		Contacts	Copper alloy	Copper alloy
		Wire Leads	Solid or stranded THHN #12 AWG	Solid or stranded THHN #12 AWG
	ArrowLink SPD	Housing	Polycarbonate	Polycarbonate
		Contacts	Copper alloy	Copper alloy

**Specification Grade
Ground Fault Circuit
Interrupter Receptacles**

2-Pole, 3-Wire Grounding
15A, 125V/AC; 20A, 125V/AC
NEMA 5-15, 5-20

		Device Type	Specification Grade GFCI 15A & 20A VGF and VGF_F Series, VGF__-AG* ArrowLink: MCR125_, MCR250_, MCR300_ Series	Specification Grade Tamper Resistant & Weather Resistant Duplex GFCI 15A & 20A; TRVGF, TRVGF_F, WRVGF, TWRVGF Series, TRVGF__-AG ArrowLink: MCR125_, MCR250_, MCR300_ Series
Wiring Type	Base Device	Back & side wire		Back & side wire
	ArrowLink	Integral wire leads, crimped & resistance welded		Integral wire leads, crimped & resistance welded
	ArrowLink SPD	Backwire feed through		Backwire feed through
Testing & Code Compliance	Base Device	<ul style="list-style-type: none"> cULus Listed to UL 498 and UL 943, file no. E60120 Meets all UL 943 (GFCI), UL 498 (Receptacles) and applicable CSA requirements NOM certified 		<ul style="list-style-type: none"> cULus Listed to UL 498 and UL 943, file no. E60120 Meets all UL 943 (GFCI), UL 498 (Receptacles) and applicable CSA requirements NOM certified
	ArrowLink	<ul style="list-style-type: none"> Plug & connector cULus Listed to UL 2459, file no. E325188 		<ul style="list-style-type: none"> Plug & connector cULus Listed to UL 2459, file no. E325188
	Combined	<ul style="list-style-type: none"> cULus Listed wiring assembly, UL file no. E326691 		<ul style="list-style-type: none"> cULus Listed wiring assembly, UL file no. E326691
Specifications: Environmental	Base Device	Flammability	Meets UL 94 requirements; V2 rated	
		Temperature Rating	-35°C to 66°C (-31°F to 150.8°F)	
	ArrowLink	Flammability	Meets UL 94 requirements; V2 rated	
		Temperature Rating	-35°C to 66°C (-31°F to 150.8°F)	
Specifications: Electrical	Base Device	Dielectric Voltage	Withstands 2000V per UL 498	
		Current Interrupting	Yes, at full-rated current	
		Temperature Rise	Temperature Rise: max. 30°C (86°F) after 100 cycles of overload @ 150% of rated current (DC)	
		Trip Time	0.025 seconds (Class A)	
		Frequency	60 Hz; Voltage: 125V; Amperage: 15A/20A 20A Feed Through	
		Short Circuit Testing	Meets and exceeds 10 kA	
	ArrowLink	Maximum Interrupting Capacity	20 Amps	
		Max. Working Voltage	300V/AC	
		Max. Continuous Current	20A	
		Overload	52.5A/AC for 10 cycles	
Specifications: Mechanical	Base Device	Dielectric Voltage	Withstands 1600V per UL 2459	
		Current Interrupting	Limited cycles at full-rated current	
		Temperature Rise	Max. 50°C (122°F) while conducting 35A after 10 cycles of overload @ 52.5A/AC	
		Max. Working Voltage	300V/AC	
Max. Continuous Current		20A		
Specifications: Screw Terminal Guards	ArrowLink	Overload	52.5A/AC for 10 cycles	
		Dielectric Voltage	Withstands 1600V per UL 2459	
		Current Interrupting	Limited cycles at full-rated current	
		Temperature Rise	Max. 50°C (122°F) while conducting 35A after 10 cycles of overload @ 52.5A/AC	
		Max. Working Voltage	300V/AC	
Materials:	Base Device	Base Device Terminal Accommodation	#14 - #10 AWG	
		ArrowLink Wire Leads	#12 AWG	
		ArrowLink SPD Screw Terminals	Accepts #12-#14 stranded and solid wire	
		ArrowLink SPD Ground	Integral THHN #12 AWG 6" lead with ring terminal and #10 ground screw	
		Voltage Ratings	Permanently marked on device	
		ArrowLink Models Only	Material: UL recognized insulating material Dielectric Strength: 2,000V min HWI Rating: 4 min. Relative temperature index, electrical: 80°C (176°F) Flammability: V0 (UL 94)	
	Base Device	Top Housing	Thermoplastic, nylon	
		Bottom Housing	PVC	
		Strap	0.047" thick steel, zinc plated	
		Line Contacts	0.030" thick brass	
ArrowLink	Terminal & Ground Screws	#8-32 steel, brass plated; neutral screw nickel plated, ground screw green		
	Terminal Clamps	0.070" thick steel		
ArrowLink SPD	Housing	Polycarbonate		
	Contacts	Copper alloy		
	Wire Leads	Solid or stranded THHN #12 AWG		
ArrowLink SPD	Housing	Polycarbonate		
	Contacts	Copper alloy		

*VGF__-AG not available with ArrowLink

Specification Grade Ground Fault Circuit Interrupters

2-Pole, 3-Wire Grounding
Combo: 15A, 125V/AC Receptacle; 15A, 120V/AC Switch
Dead Front: 20A, 125V/AC

	Device Type	Specification Grade Combination GFCI Receptacle & Switch, 15A: VGFS15, ___-MSP	Specification Grade Blank Face (Dead-Front) GFCI, 20A: VGFD20 Series	
	Wiring Type	Back & side wire	Back & side wire	
	Testing & Code Compliance	<ul style="list-style-type: none"> cULus Listed to UL 498 and UL 943, file no. E60120 Meets all UL 943 (GFCI), UL 498 (Receptacles), UL 20 (Switch) and applicable CSA requirements NOM certified 	<ul style="list-style-type: none"> cULus Listed to UL 498 and UL 943, file no. E60120 Meets all UL 943 (GFCI), UL 498 (Receptacles), UL 508 (Motor Control) and applicable CSA requirements NOM certified 	
Specifications: Environmental		Flammability	Meets UL 94 requirements; V2 rated	Meets UL 94 requirements; V2 rated
		Temperature Rating	-35°C to 66°C (-40°F to 150.8°F)	-35°C to 66°C (-40°F to 150.8°F)
Specifications: Electrical	Dielectric Voltage	Withstands 2000V per UL 498	Withstands 2000V per UL 498	
	Current Interrupting	Yes, at full-rated current	Yes, at full-rated current	
	Temperature Rise	Max. 30°C (86°F) after 100 cycles of overload @ 150% of rated current (DC)	N/A	
	Short Circuit Testing	Meets and exceeds 10 kA	Meets and exceeds 10 kA	
Specifications: Mechanical	Terminal Accommodation	#14 - #10 AWG	#14 - #10 AWG	
	Voltage Ratings	Permanently marked on device	Permanently marked on device	
	Horsepower Ratings	Switch rated for motor loads per UL 20: 15A: @ 120V/AC = 1/2 HP, max. amps: 12 full-load amps	Rated for motor loads per UL 508: 20A: @ 125V/AC = 1.5 HP, max. amps 20 full load amps	
Materials:	Top Housing	Thermoplastic, nylon	Thermoplastic, nylon	
	Bottom Housing	PVC	PVC	
	Strap	0.047" thick steel, zinc plated	0.047" thick steel, zinc plated	
	Line Contacts	0.030" thick brass	N/A	
	Terminal & Ground Screws	#8-32 steel, brass plated; neutral screw nickel plated, ground screw green	#8-32 steel, brass plated; neutral screw nickel plated, ground screw green	
	Terminal Clamps	0.070" thick steel	0.070" thick steel	

**Industrial Grade
Portable GFCIs**

2-Pole, 3-Wire Grounding
15A, 120V/AC
20A, 120V/AC; 20A, 208V/AC; 20A, 240V/AC; 20A, 277V/AC
30A, 120V/AC; 30A, 208V/AC; 30A, 240V/AC; 30A, 277V/AC

	Device Type	15A Portable GFCIs Inline, Plug Series	20A Portable GFCIs Inline Series	30A Portable GFCIs Inline Series
	Connection Type	Molded plug & connector field wireable, or watertight plug & connector	Molded plug & connector, watertight plug & connector, or field wireable flying leads	Molded plug & connector, watertight plug & connector, or field wireable flying leads
	Testing & Code Compliance	<ul style="list-style-type: none"> cULus listed to UL943 	<ul style="list-style-type: none"> Plug & connector ends: cULus listed to UL943 Field wireable: UL recognized component for US & Canada 	<ul style="list-style-type: none"> Plug & connector ends: cULus listed to UL943 Field wireable: UL recognized component for US & Canada
		<ul style="list-style-type: none"> OSHA 29 CFR 1926.404 (b)(1)(ii) & OSHA 29 CFR 1926.405 (a)(2)(ii)(G) 	<ul style="list-style-type: none"> OSHA 29 CFR 1926.404 (b)(1)(ii) & OSHA 29 CFR 1926.405 (a)(2)(ii)(G) 	<ul style="list-style-type: none"> OSHA 29 CFR 1926.404 (b)(1)(ii) & OSHA 29 CFR 1926.405 (a)(2)(ii)(G)
		<ul style="list-style-type: none"> NEC 590.6, NEC 511.12, NEC 600.10, NEC 680.5, NEC 680.40 	<ul style="list-style-type: none"> NEC 590.6, NEC 511.12, NEC 600.10, NEC 680.5, NEC 680.40 	<ul style="list-style-type: none"> NEC 590.6, NEC 511.12, NEC 600.10, NEC 680.5, NEC 680.40
Specifications: Environmental	Enclosure Protection	NEMA 3R rated	NEMA 4X rated	NEMA 4X rated
	Temperature Rating	-35°C to 66°C (-31°F to 150.8°F)	-35°C to 66°C (-31°F to 150.8°F)	-35°C to 66°C (-31°F to 150.8°F)
Specifications: Electrical	Rated Supply Voltage	120V/AC	120V/AC, 208V/AC, 240V/AC, 277V/AC	120VAC, 208V/AC, 240V/AC, 277V/AC
	Rated Current/Current	Up to 15A or rating of wiring device and/or cable	Up to 20A or rating of wiring device and/or cable	Up to 30A or rating of wiring device and/or cable
	Ground Trip Current	4-6 mA	4-6 mA	4-6 mA
	Overload Current	90A @ 125V/AC	120A	180A
	Insulation Voltage	4000V – 1 minute	4000V – 1 minute	4000V – 1 minute
	Response Time	25 mS max.	25 mS max.	25 mS max.
	Let Go Voltage	N/A	60% rated voltage	60% rated voltage
Specifications: Mechanical	Reset Type	Manual or automatic	Manual or automatic	Manual or automatic
	Operating Frequency	60 Hz	60 Hz	60 Hz
	GFCI Type	Class A	Class A	Class A
	Endurance Operations	3,000 operations	3,000 operations	3,000 operations
	Switch Interference	N/A	Double insulated	Double insulated
	Latching Mechanism	N/A	Electro-magnetic	Electro-magnetic
Materials:	Body	Polycarbonate	Polycarbonate & ABS (Gray)	Polycarbonate & ABS (Gray)
	Cord	Heavy duty 12/3 SJTW cable	Heavy duty 12/3 SJEOW cable	Heavy duty 10/3 SJTOW cable

**Industrial Grade
Portable GFCIs
15A Plug Series
& Inline Series**

15A, 120V/AC

	Device Type	Single Outlet GFCI Adapter GFP400	Inline Series-Field Wireable GFP100-B
	Connection Type	Plug in adapter with NEMA 5-15 receptacle	Field Wireable
	Testing & Code Compliance	<ul style="list-style-type: none"> Listed to UL CSA Certified 	<ul style="list-style-type: none"> UL recognized component
Specifications: Environmental	Temperature Rating	-35°C-66°C (-31°F to 150.8°F)	-10°C-60°C (-50°F to 140°F)
Specifications: Electrical	Rated Supply Voltage	15A, 120V/AC	20A, 120V/AC or 10A, 240V/AC
	Trip Level	4-6mA	30mA
	Response Time	< 25mS	< 25mS
	MCOV Protection	205 Joules	3kv ringwave test and 4kV/2kA surge immunity test
	Overload Current	6 times rated current	6 times rated current
	Insulation Voltage	1500V RMS - 1 minute	1500V RMS - 1 minute
	Effect of 10A turn DC shock on ground fault trip	5% max. trip level variation	N/A
Specifications: Mechanical	Operating Frequency	50/60 Hz	50/60 Hz
	Radio Frequency Noise Susceptibility	Operates within normal limits with 0.5V injected on power line 150mHz-230mHz	Operates within normal limits with 0.5V injected on power line 150mHz-230mHz
	Ground Neutral	40 Ohms typical	N/A
	Endurance Operations	3,000 operations min.	5,000 operations min.
	Wire Accommodations	N/A	#12 - #18 AWG, SJT
	Power Indicator	Mechanical, indicates power on	Lighted, indicates power on

Electronic Protection Devices



	Page		Page
Build-To-Spec	H-1	Isolated Ground Locking Devices	H-12
ArrowLink™ Modular Connectors	H-2	2-Pole, 3-Wire	
Straight Blade Surge Protection Receptacles	H-4	15A, 125V NEMA L5-15	H-13
Surge Protection Receptacles w/Audible Alarm & LED Indicators		15A, 250V NEMA L6-15	H-13
15A, 125V/AC NEMA 5-15R	H-5	20A, 125V NEMA L5-20	H-13
20A, 125V/AC NEMA 5-20R	H-5	20A, 250V NEMA L6-20	H-14
Surge Protection Receptacles w/ LED Indicators		20A, 277V NEMA L7-20	H-14
15A, 125V/AC NEMA 5-15R	H-5	20A, 480V NEMA L8-20	H-14
20A, 125V/AC NEMA 5-20R	H-5	30A, 125V NEMA L5-30	H-15
SurgeBloc™ Surge Protection Receptacles with Audible Alarm		30A, 250V NEMA L6-30	H-15
15A, 125V/AC NEMA 5-15R	H-6	30A, 277V NEMA L7-30	H-15
20A, 125V/AC NEMA 5-20R	H-6	30A, 480V NEMA L8-30	H-16
Replacement SurgeBloc Module	H-6	3-Pole, 4-Wire	
Multi-Outlet Surge Protection		20A, 125/250V NEMA L14-20	H-16
Surge Protection Adapters	H-7	20A, 3Ø 250V NEMA L15-20	H-16
Six Outlet Surge Adapters – Plug-In	H-7	20A, 3Ø 480V NEMA L16-20	H-17
Surge Protection Power Strip	H-7	30A, 125/250V NEMA L14-30	H-17
Straight Blade Isolated Ground Receptacles	H-8	30A, 3Ø 250V NEMA L15-30	H-17
Isolated Ground Duplex		4-Pole, 5-Wire	
15A, 125V/AC NEMA 5-15	H-10	20A, 3ØY 120/208V NEMA L21-20	H-18
20A, 125V/AC NEMA 5-20	H-10	30A, 3ØY 120/208V NEMA L21-30	H-18
15A, 250V/AC NEMA 6-15	H-11	30A, 3ØY 277/480V NEMA L22-30	H-18
20A, 250V/AC NEMA 6-20	H-11	30A, 3ØY 347/600V NEMA L23-30	H-18
Isolated Ground Single Receptacle		Specifications	H-19
15A, 125V/AC NEMA 5-15R	H-10		
20A, 125V/AC NEMA 5-20R	H-10		
15A, 250V/AC NEMA 6-15R	H-11		
20A, 250V/AC NEMA 6-20R	H-11		

Protection for sensitive electronic equipment

Our Electronic Protection Devices offer protection against transient voltage and electromagnetic interference which prevent equipment from operating properly.



Hospital Grade Surge Protection Devices

Protection for sensitive electronic equipment that is critical for daily operations.

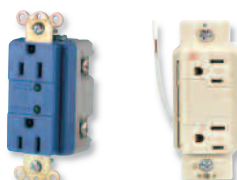

Commercial Grade Surge Protection Devices

Innovative receptacle designs boast features such as built-in alarms or quick-change replacement protection modules.

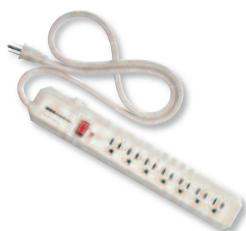

Surge Protection Strips and Adapters

Conveniently provide electronic surge protection where you need it.

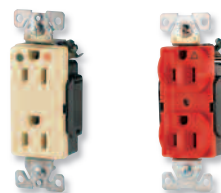

Hospital & Industrial Grade Isolated Ground Devices

Built for heavy-duty use and designed for easy and quick installation.

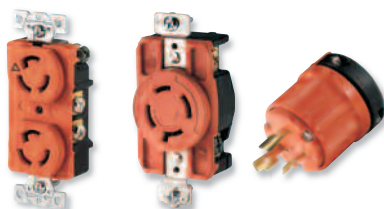

Hart-Lock™ Industrial Isolated Ground Locking Devices

Rugged construction and materials ensure reliable protection of sensitive equipment.

Build-To-Spec

For Receptacles, Switches, GFCIs & TVSS devices

Modified at the factory to improve efficiency and speed production at the job site. Arrow Hart's Build-To-Spec program provides customized device solutions to simplify your project and maximize your bottom line.

Sample Number:

8300BLS PSOL X Z G P

ARROW/HART™
Base Catalog Number
(including device color)

Add 6" leads
PSOL = #12 AWG solid
PSTR = #12 AWG stranded

Remove mounting screws

Remove ears

Remove ground clip

Add push-in connector**

Arrow Hart 20A 125V NEMA 5-20 blue TVSS surge protection receptacle, with wire leads and push-in connectors, without mounting screws, ears, or grounding clip.



BUILD-TO-SPEC
CUSTOM CONFIGURED DEVICES

ARROW/HART™

**For use with leaded devices only. Add "PSOL" to back of device catalog number for 6" of #12 AWG solid or "PSTR" for 6" of #12 AWG stranded. (Example: 8300BLSPSOL + Build to Spec Options).

All devices are bulk packed 50 pieces per carton. Minimum order quantity is 100 pieces. Orders under 500 pieces ship within 5 days with larger quantities typically within 10 days.

ArrowLink

Arrow Hart's factory terminated ArrowLink system revolutionizes device installation, unleashing groundbreaking labor savings in installation and maintenance by eliminating traditional pigtailing, terminal connections and taping. Use ArrowLink on your next job to reduce labor costs, eliminate installation errors, save money and win!

Color coded terminals for consistent, reliable connections

Durable polycarbonate housing

Terminal accommodation #12-#14 AWG, solid only

Copper alloy contacts for superior wire retention and minimized heat rise

6", #12 AWG ground lead with ring terminal and captive ground screw

Color coded terminal screws guard caps

Color coded terminal screws

Terminal accommodation #12-#14 AWG, solid or stranded

Cut-Away of MCR300FTP1 Push-In Terminal

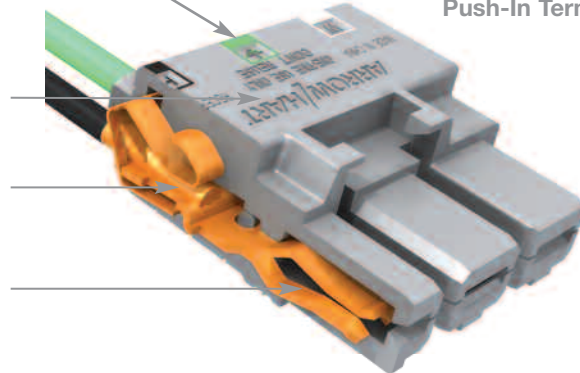

Cut-Away of MCR300FTST Screw Terminal

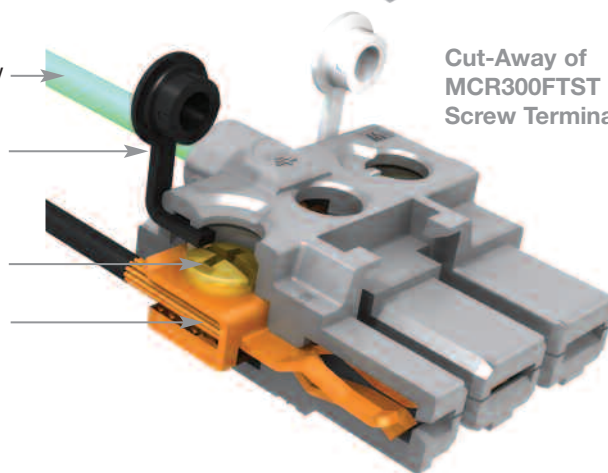
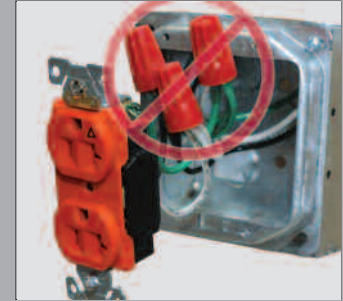
**ArrowLink SPD Benefits**

EASE OF INSTALLATION:
No more twist-on wire connectors



50% TIME SAVINGS:
SPD accelerates both rough-in & trim out installation

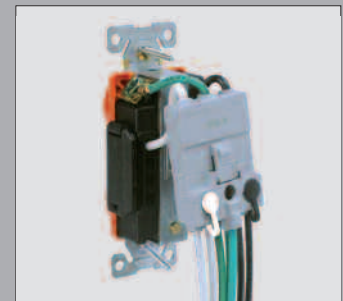

EFFICIENT DESIGN:
Low profile connection with feed-through capability



30% REDUCTION in wire volume inside the box

How To Order

1. Select a Device to ArrowLink enable. Catalog pages identify available products—simply add an "M" to the catalog number and the devices will be factory enabled with the ArrowLink device-side connection. (For GFCIs add "MOD" suffix)

2. Choose from leaded or unleaded ArrowLink connector versions in screw-down or push-in models.

3. Place your order and get your ArrowLink devices in **bulk packed boxes**, shipped within 5 days of receipt of order!

ArrowLink SPD Comparative Labor Savings Analysis

Traditional Pigtail Installation

0:50
Cutting & stripping pigtails

1:50
Install wire connectors

1:10
Terminate Conductors

1:05
Mount Devices

4:55/Receptacle
Total time required to install 500 pigtail devices:
40.97 Hours

ArrowLink SPD Installation

1:15
Terminate Conductors

0:05
Attach Device

1:05
Mount Devices

2:25/Receptacle
Total time required to install 500 ArrowLink SPD devices:
20.13 Hours

Time Saved with SPD
20.84 Hours

ARROWLINK™
Modular Wiring Devices



Leaded ArrowLink Receptacle Connectors

Device Type	Description	Catalog No.
Receptacle	Solid Wire Leads – 125V	<input type="checkbox"/> MCR125SOL
	Stranded Wire Leads – 125V	<input type="checkbox"/> MCR125STR
	Solid Wire Leads – 250V	<input type="checkbox"/> MCR250SOL
	Stranded Wire Leads – 250V	<input type="checkbox"/> MCR250STR

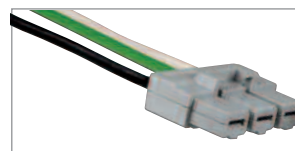

MCR125STR
Leaded
ArrowLink
Connector

ARROWLINK™
SPD



ArrowLink SPD Receptacle Connectors

Device Type	Description	Catalog No.
Receptacle	Screw Terminal	<input type="checkbox"/> MCR300FTST
	Screw Terminal, No Ground Conductor	<input type="checkbox"/> MCR300FTSTNG
	<small>AVAILABLE SUMMER 2010</small> Push-In	<input type="checkbox"/> MCR300FTPI
	<small>AVAILABLE SUMMER 2010</small> Push-In, No Ground Conductor	<input type="checkbox"/> MCR300FTPING

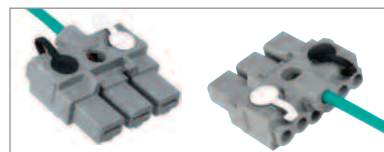

MCR300FTST
Screw Terminal



MCR300FTPI
Push-In
Terminal

ArrowLink Accessories

Device Type	Description	Catalog No.
Circuit Tester	Tests Receptacle & ArrowLink Connectors <small>AVAILABLE SUMMER 2010</small>	<input type="checkbox"/> ALTESTER

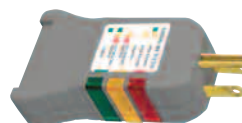

ALTESTER
Circuit Tester

**Protect your valuables
with Arrow Hart Surge
Protection Receptacles**

With over 50% of transient voltage originating from inside a building, Arrow Hart's Surge Protection point of use receptacles provide branch circuit surge protection for sensitive electronic equipment that panel mounted surge protection systems cannot provide.

*Surge Protection Plus*

- Audible alarm signals when transient voltage protection has expired
- Green LED indicators to verify transient voltage protection and wiring diagnostics
- Front access switch for muting audible alarm until device is replaced
- Provides surge protection for hot to neutral, hot to ground and neutral to ground

*SurgeBloc™*

Standard 6" (152.4mm) leads, pre-stripped 0.50" (12.7mm)

SurgeBloc versions feature exclusive patented replacement module to restore expired transient voltage protection

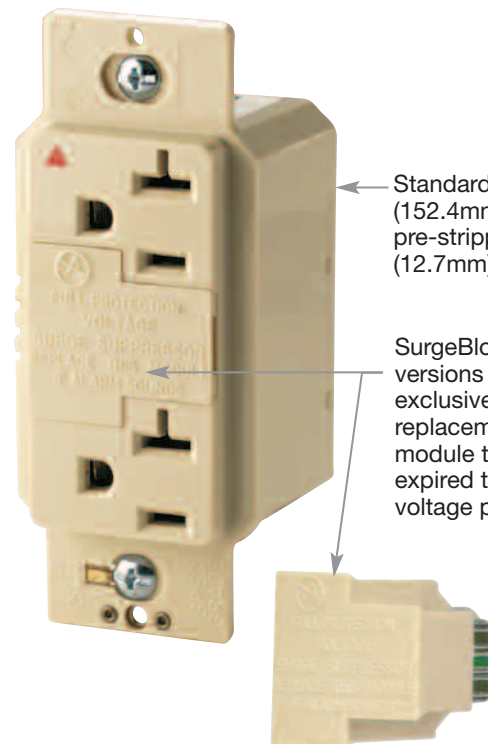
**Additional Features and Benefits****Surge Protection Plus**

- Available in Hospital and Commercial Grades in 15A & 20A 125V configurations with LED, Audible Alarm and Isolated Ground versions
- 8-hole back and side wired
- High impact thermoplastic construction

SurgeBloc™

- Provides surge protection for hot to neutral, hot to ground and neutral to ground
- Available in Isolated Ground versions
- Audible alarm signals when surge protection has expired
- Noise protection against EMI and RFI standard

Surge Protection Receptacles with LED Indicators & Audible Alarm

2-Pole, 3-Wire Grounding
 15A, 125V/AC
 20A, 125V/AC
 NEMA 5-15R & 5-20R

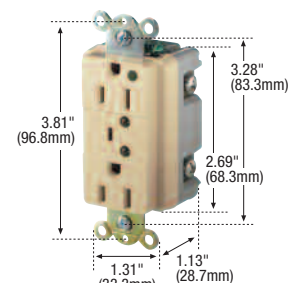
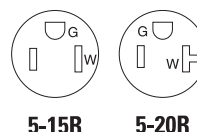

8200_S

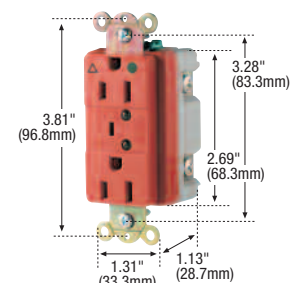

IG8200HG_S

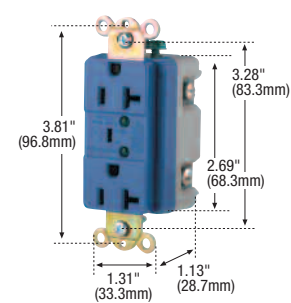

5362_S

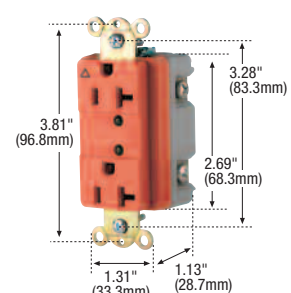

IG5350_S

Surge Protection Receptacles w/Audible Alarm & LED Indicators

560 Joules, max. surge current - 18kA, MCOV - 150V/AC

Description	15A, 125V NEMA 5-15R		20A, 125V NEMA 5-20R	
	Catalog No. Color Suffix	UL US NOM 426	Catalog No. Color Suffix	UL US NOM 426
Hospital Grade Duplex Receptacle	8200_S BL, GY, RD, V, W	• •	8300_S BL, GY, RD, V, W	• •
IG Hospital Grade Duplex Receptacle	IG8200HG_S BL, GY, RN, V, W	• •	IG8300HG_S BL, GY, RN, V, W	• •
Commercial Grade Duplex Receptacle	5262_S BL, GY, V, W	• •	5362_S BL, GY, V, W	• •
IG Commercial Grade Duplex Receptacle	IG5262_S BL, GY, RN, V, W	• •	IG5362_S BL, GY, RN, V, W	• •

Surge Protection Receptacles w/LED Indicators

840 Joules, max. surge current - 18kA, MCOV - 150V/AC

Description	15A, 125V NEMA 5-15R		20A, 125V NEMA 5-20R	
	Catalog No. Color Suffix	UL US	Catalog No. Color Suffix	UL US
Commercial Grade Duplex Receptacle	5250_S BL, GY, V, W	• •	5350_S BL, GY, V, W	• •
IG Commercial Grade Duplex Receptacle	IG5250_S BL, GY, RN, V, W	• •	IG5350_S BL, GY, RN, V, W	• •

Color Ordering Information

For ordering receptacles, include Cat. No. followed by the color code: A (Almond), B (Brown), BK (Black), BL (Blue), GY (Gray), LA (Light Almond), RD (Red), RN (Orange), V (Ivory), W (White)

Icon Key

➡ ArrowLink™ option available. Add "M" suffix to Standard catalog number (example 8300WS, 8300WSM).
 For ordering information on ArrowLink & ArrowLink SPD connectors, see pages H-2 & H-3.

● Hospital Grade Device

⊞ Build-To-Spec Customizable Devices - see H-1

Specification Information:

Surge Protection Receptacles with Audible Alarm & LED: H-19
 Surge Protection Receptacles with LED Indicators: H-20

SurgeBloc™ Surge Protection Receptacles with Audible Alarm

2-Pole, 3-Wire Grounding
 15A, 125V/AC
 20A, 125V/AC
 NEMA 5-15R & 5-20R

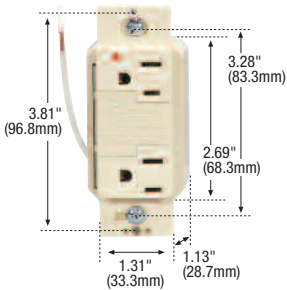
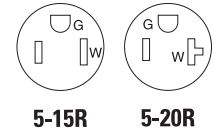

IG1208

SurgeBloc Surge Protection Receptacles w/Audible Alarm

340 Joules, max. surge current - 12kA, MCOV - 127V/AC

Wire Leads	15A, 125V NEMA 5-15R	UL	SR	20A, 125V NEMA 5-20R	UL	SR
Description	Catalog No. Color Suffix	▶	◀	Catalog No. Color Suffix	▶	◀
Commercial Grade Duplex Receptacle	<input type="checkbox"/> 1208 A, V, W	•	•	<input type="checkbox"/> 1210 A, BL, V, W	•	•
IG Commercial Grade Duplex Receptacle	<input type="checkbox"/> IG1208 BL, GY, V, W	•	•	<input type="checkbox"/> IG1210 BL, GY, V, W	•	•



1209

Replacement SurgeBloc Module

Replacement Module



Description	Catalog No. Color Suffix
Replacement Module	<input type="checkbox"/> 1209 A, BL, GY, V, W

Color Ordering Information

For ordering receptacles, include Cat. No. followed by the color code: A (Almond), B (Brown), BK (Black), BL (Blue), GY (Gray), LA (Light Almond), RD (Red), RN (Orange), V (Ivory), W (White)

Icon Key

▶ ArrowLink™ option available. Add "M" suffix to Standard catalog number (example 8300WS, 8300WSM).
 For ordering information on ArrowLink & ArrowLink SPD connectors, see pages H-2 & H-3.

◀ Build-To-Spec Customizable Devices - see H-1

Accessories for Surge Protection Receptacles

Description	Catalog No.
1-Gang mid-size decorator polycarbonate wallplate, pre-marked "COMPUTER", Blue	<input type="checkbox"/> PJ26COBL
1-Gang mid-size decorator polycarbonate wallplate, REPEL, White	<input type="checkbox"/> PJ26AMW
1-Gang mid-size decorator polycarbonate wallplate, pre-marked "ISOLATED GROUND", Orange	<input type="checkbox"/> PJ26IG

Specification Information:
 Commercial Grade SurgeBloc
 Surge Protection
 Receptacles: H-20



PJ26COBL



PJ26AMW



PJ26IG

Surge Protection Adapters

2-Pole, 3-Wire Grounding
15A, 125V/AC
Plug-In, NEMA 5-15R



5-15R



5-15P

Six Outlet Surge Adapters – Plug-In

FEATURES

- Provides full three mode surge protection for hot to neutral, hot to ground and neutral to ground (except 1156CG).
- Center mounting screw provided for permanent attachment to receptacle.
- EMI/RFI filtering minimizes line noise.
- Made of high impact-resistant thermoplastic for long-term durability.
- Coaxial protection provided with “F” type connectors.
- Telephone/fax/modem protection provided with RJ11-type telephone ports (4-wire protection).
- \$5,000 Connected Equipment Warranty on 1161CG, 1162CG and 1177CG.
- \$2,500 Connected Equipment Warranty on 1156CG.

Six Outlet Surge Adapters – Plug-In



Rating A V/AC	Description	Joules Max Surge Current MCOV	Maximum Surge Current	Color	Catalog No.
15 125	Full Protection	170J 150V/AC RMS	12kA/mode	Computer Gray	□ 1177CG
	Full Protection w/ Coaxial Jacks	170J 150V/AC RMS	12kA/mode	Computer Gray	□ 1161CG
	Full Protection w/ Telephone Jacks	170J 150V/AC RMS	12kA/mode	Computer Gray	□ 1162CG
	Basic Protection	170J 150V/AC RMS	12kA/mode	Computer Gray	□ 1156CG



1177CG



1161CG

Surge Protection Power Strip

FEATURES

- Portable strip provides 7 surge-protected outlets anywhere for stereos, TVs, computers or other electronic-based equipment.
- Full mode surge protection for hot to neutral, hot to ground and neutral to ground.
- Made of high impact-resistant thermoplastic for long-term durability.
- Comes complete with 14/3 SJT 4' (1.22m) portable cord.
- Pilot light on/off switch indicates power to unit.
- Resettable 15 amp circuit breaker.

Surge Protection Power Strip



Rating A V/AC	Description	Joules	Color	Catalog No.
15 125	Full Protection 7 Outlet with Circuit Breaker	70	Ivory	□ 1176V



1176

The efficient and economical way to protect sensitive electronics

Operational degradation, disruption and damage from electronic noise in a conventionally grounded circuit can happen to any piece of equipment with a microprocessor; Arrow Hart's Isolated Ground Receptacles eliminate this to improve equipment performance.

Conventional Receptacle

A conventional receptacle is grounded to the building grounding system at the receptacle. When mounted in the box, the receptacle's grounding contacts are connected to the box, fittings, conduit and all other building ground system components which can act as a large antenna for EMI and RFI (electronic) noise.

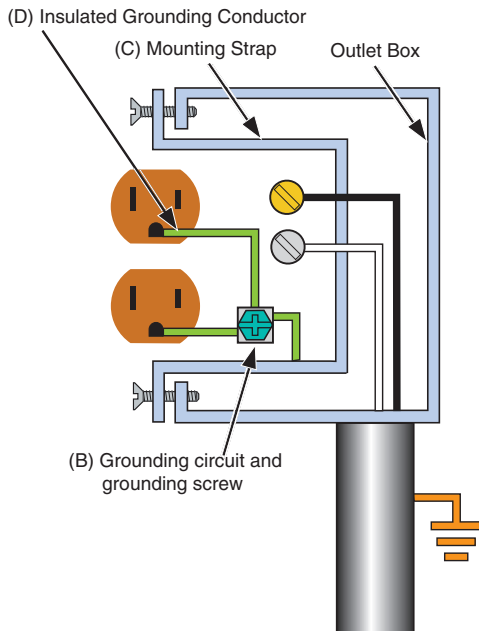

How an Isolated Ground Device is Different

Isolated Ground devices easily protect sensitive electronics or equipment from damage without the expense of using power conditioners. Grounding contacts are bonded directly to the service entrance grounding system. In the illustration the insulating barrier (A) isolates the grounding contacts (B) from the mounting strap (C). The insulated grounding conductor (D) is bonded to the service entrance grounding system, resulting in the protection of equipment that draws power from the isolated ground device.

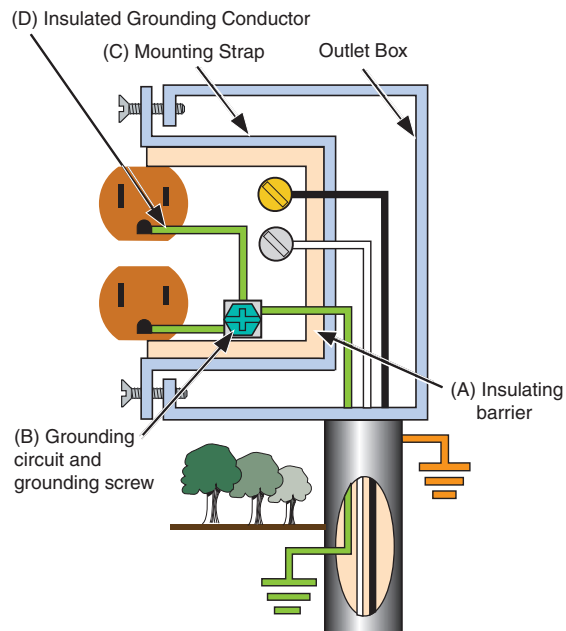

For protection again both transient voltage spikes and electronic noise, choose an isolated ground surge protection TVSS receptacle.

2008 NEC® Section 250.146 Connecting Receptacle Grounding Terminal to Box

(D) Isolated Receptacles. Where installed for the reduction of electrical noise (electromagnetic interference) on the grounding circuit, a receptacle in which the grounding terminal is purposely insulated from the receptacle mounting means may be permitted. The receptacle grounding terminal shall be connected to an insulated equipment grounding conductor run with the circuit conductors. This equipment grounding conductor shall be permitted to pass through one or more panelboards without a connection to the panelboard grounding terminal bar as permitted in 408.40, Exception, so as to terminate within the same building or structure directly at an equipment grounding conductor terminal of the applicable derived system or service. Where installed in accordance with the provisions of this section, this equipment grounding conductor shall also be permitted to pass through boxes, wireways, or other enclosures without being connected to such enclosures.

2008 NEC® Section 406.2 Receptacle Rating and Type

(D) Isolated Ground Receptacles. Receptacles incorporating an isolated grounding conductor connection intended for the reduction of electrical noise (electromagnetic interference) as permitted in 250.146(D) shall be identified by an orange triangle on the face of the receptacle.

Reduce electromagnetic interference (EMI) with Arrow Hart Isolated Ground Receptacles

Use of a properly wired isolated grounding circuit can significantly reduce EMI and provide a relatively “noise free” ground path to enhance the performance of sensitive electronic equipment.



Isolated Ground Straight Blade Receptacles

Exclusive 5-leaf brass line contacts ensure lowest heat rise, smooth plug blade insertion and long-term retention

Screw-Catch™ feature on duplex devices speeds mounting of wallplates

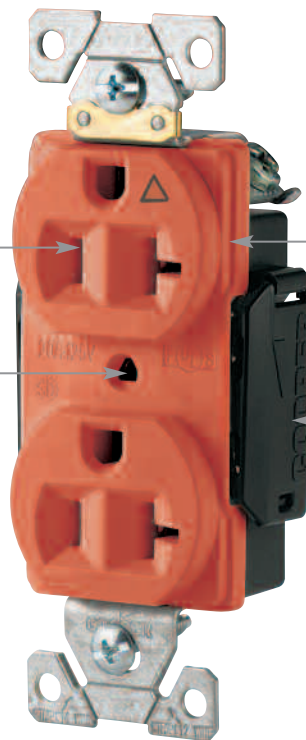

Exclusive 0.030" (0.76mm) solid brass non riveted, one piece isolated grounding shunt

Exclusive screw terminal guards provide fast, easy insulation from conductive surfaces

Additional Features and Benefits

- Available in Hospital and Industrial grade duplex and single receptacles, in 15A & 20A, 125V & 250V configurations
- Rigid, glass reinforced nylon base lends ultimate strength and heat resistance in contact carrier
- High impact and chemical resistant nylon face
- Automatic grounding system assures wallplate is grounded when installed in a grounded metal enclosure

Isolated Ground Straight Blade Receptacles

2-Pole, 3-Wire Grounding
 15A, 125V/AC
 20A, 125V/AC
 NEMA 5-15R & 5-20R

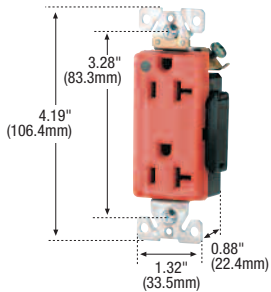
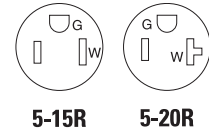

IG8362

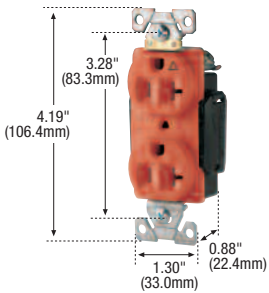

IG5362

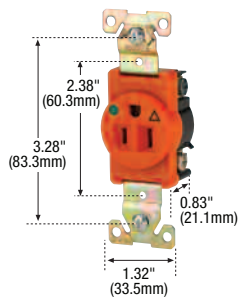

IG8210

Isolated Ground Duplex Straight Blade Receptacles

Back Wire & Side Wire

15A, 125V
 NEMA 5-15R



20A, 125V
 NEMA 5-20R



Description

Hospital Grade
 IG Duplex Receptacle

IG8200____
 GY, RD, RN, V, W



IG8300____
 GY, RD, RN, V, W

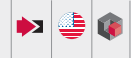

IG Hospital Grade
 Decorator Duplex
 Receptacle

IG8262____
 GY, RN, V, W

IG8362____
 BK, GY, RN, V, W

Industrial Grade
 Duplex Receptacle

IG5262____
 GY, RN, RD, V, W

IG5362____
 GY, RN, V, W

Isolated Ground Single Straight Blade Receptacles

Back Wire & Side Wire

15A, 125V
 NEMA 5-15R



20A, 125V
 NEMA 5-20R



Description

Hospital Grade
 IG Single Receptacle

IG8210____
 RN



IG8310____
 RN



Industrial Grade
 Single Receptacle

IG5261____
 RN

IG5361____
 RN, V

Specification Information:
 IG HG Duplex & Decorator
 Receptacle: H-21

IG Industrial Grade
 Receptacle: H-22

IG HG Single Receptacle: H-21

IG Industrial Grade Single
 Receptacle: H-22

Color Ordering Information

For ordering receptacles, include Cat. No. followed by the color code: A (Almond), B (Brown), BK (Black), BL (Blue), GY (Gray), LA (Light Almond), RD (Red), RN (Orange), V (Ivory), W (White)

Icon Key

ArrowLink™ option available. Add "M" suffix to Standard catalog number (example 8300WS, 8300WSM).
 For ordering information on ArrowLink & ArrowLink SPD connectors, see pages H-2 & H-3.

Hospital Grade Device

Build-To-Spec Customizable Devices - see H-1

NAFTA Compliant - see page O-30

Isolated Ground Straight Blade Receptacles

2-Pole, 3-Wire Grounding
 15A, 250V/AC
 20A, 250V/AC
 NEMA 6-15R, 6-20R

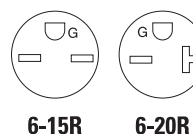

Isolated Ground Duplex Straight Blade Receptacles

Back Wire & Side Wire	15A, 250V/AC NEMA 6-15R	UL SF FULS NOM 426		20A, 250V/AC NEMA 6-20R	UL SF FULS NOM 426		
Description	Catalog No. Color Suffix			Catalog No. Color Suffix			
Hospital Grade IG Duplex Receptacle				<input type="checkbox"/> IG8400 RN			
Industrial Grade Duplex Receptacle	<input type="checkbox"/> IG5662 RN			<input type="checkbox"/> IG5462 RN			

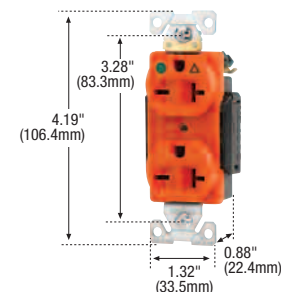

IG8400

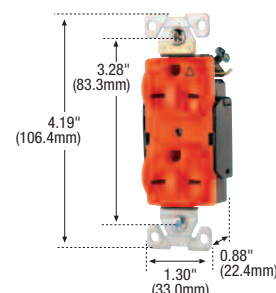

IG5662

Isolated Ground Single Straight Blade Receptacles

Back Wire & Side Wire	15A, 250V/AC NEMA 6-15R	UL SF FULS NOM 426		20A, 250V/AC NEMA 6-20R	UL SF FULS NOM 426		
Description	Catalog No. Color Suffix			Catalog No. Color Suffix			
Industrial Grade Single Receptacle	<input type="checkbox"/> IG5661 RN			<input type="checkbox"/> IG5461 RN			

Color Ordering Information

For ordering receptacles, include Cat. No. followed by the color code: A (Almond), B (Brown), BK (Black), BL (Blue), GY (Gray), LA (Light Almond), RD (Red), RN (Orange), V (Ivory), W (White)

Icon Key

ArrowLink™ option available. Add "M" suffix to Standard catalog number (example 8300WS, 8300WSM).
 For ordering information on ArrowLink & ArrowLink SPD connectors, see pages H-2 & H-3.

- Hospital Grade Device
- Build-To-Spec Customizable Devices - see H-1
- NAFTA Compliant - see page O-30

Accessories for Isolated Ground Straight Blade Receptacles

Description	Catalog No.
1-Gang standard size duplex receptacle pre-marked stainless steel wallplate/"ISOLATED GROUND"	<input type="checkbox"/> IG93101
1-Gang mid-size duplex receptacle polycarbonate wallplate, REPEL, Ivory	<input type="checkbox"/> PJ8AMV
1-Gang standard size duplex receptacle nylon wallplate, pre-marked "ISOLATED GROUND", Orange	<input type="checkbox"/> IG5132RN



IG93101



PJ8AMV



IG5132RN

Specification Information:
 HG IG Duplex Receptacle: H-21
 Industrial Grade Isolated Ground Duplex: H-22
 Industrial Grade Isolated Ground Single: H-22

Rugged design for reliable protection

Superior materials and innovative design provide ease of use and reliable protection of critical equipment.

**Locking Isolated Ground Receptacles**

High strength, glass reinforced nylon body for durability and reliable protection

Grounding contact is isolated from system grounding

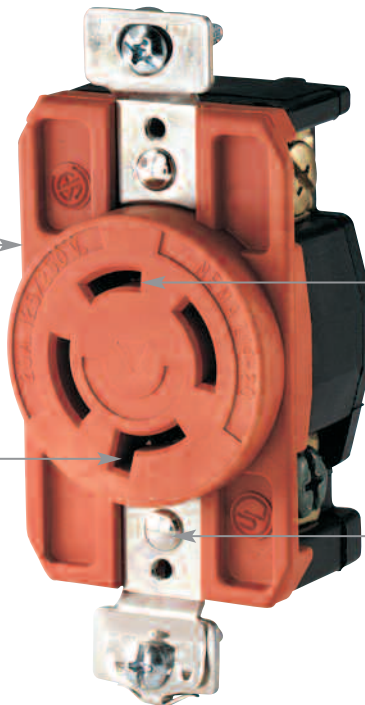

One-piece, double wipe contacts for superior conductivity and long term reliability

Double riveted mounting strap assembly provides reliable performance

Locking Isolated Ground Plugs

Tri-combo slotted/Phillips/Robertson quick drive screws speed installation

Neoprene gasket seals cord opening for added protection against contaminants



One piece grounding contacts for superior continuity

Tapered individual wire pockets guide wire into contact area for ease of installation

Hart-Lock™ Industrial Specification Grade Isolated Ground Locking Devices

2-Pole, 3-Wire Grounding
15A, 125V/AC
NEMA L5-15

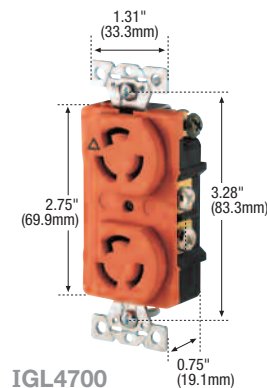

IGL4700

15A, 125V/AC NEMA L5-15

Isolated Ground Receptacles

Style & Description	Catalog No.		Certifications				
	Single Receptacle	Duplex Receptacle	USA	CSA	UL US	UL S	UL E
Isolated Ground, Orange	<input type="checkbox"/> IGL515R	<input type="checkbox"/> IG4700		•			•

Hart-Lock™ Industrial Specification Grade Isolated Ground Locking Devices

2-Pole, 3-Wire Grounding
15A, 250V/AC
NEMA L6-15

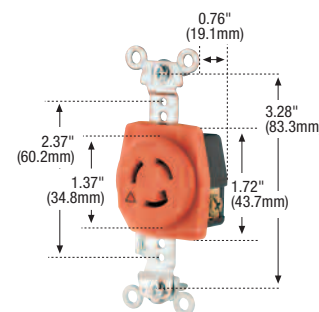

IGL515R

15A, 250V/AC NEMA L6-15

Isolated Ground Receptacles

Style & Description	Catalog No.		Certifications				
	Single Receptacle	Duplex Receptacle	USA	CSA	UL US	UL S	UL E
Isolated Ground, Orange	<input type="checkbox"/> IGL615R		•	•			

Hart-Lock™ Industrial Specification Grade Isolated Ground Locking Devices

2-Pole, 3-Wire Grounding
20A, 125V/AC
NEMA L5-20

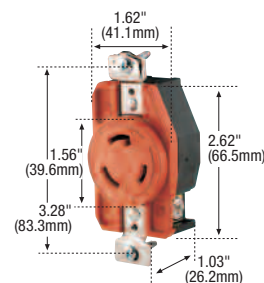

IGL520R

20A, 125V/AC NEMA L5-20

Isolated Ground Receptacles

Style & Description	Catalog No.		Certifications				
	Single Receptacle	Duplex Receptacle	USA	CSA	UL US	UL S	UL E
Isolated Ground, Orange	<input type="checkbox"/> IGL520R		•	•		•	•

Specification Information:
15A Hart-Lock Isolated Ground Single & Duplex Receptacles: C-90
20A Hart-Lock™ Isolated Ground Single Receptacles: C-91

Icon Key

NAFTA Compliant - see page O-30

Hart-Lock™ Industrial Specification Grade Isolated Ground Locking Devices

2-Pole, 3-Wire Grounding
20A, 250V/AC
NEMA L6-20



20A, 250V/AC NEMA L6-20

Isolated Ground Receptacles

Style & Description	Catalog No.	Certifications				
		USA	UL	UL US	CS	UL 426
Isolated Ground, Orange	□ IGL620R	•	•	•	•	•

Hart-Lock™ Industrial Specification Grade Isolated Ground Locking Devices

2-Pole, 3-Wire Grounding
20A, 277V AC
NEMA L7-20



20A, 277V/AC NEMA L7-20

Isolated Ground Receptacles

Style & Description	Catalog No.	Certifications				
		USA	UL	UL US	UL S	UL
Isolated Ground, Orange	□ IGL720R	•	•	•	•	•

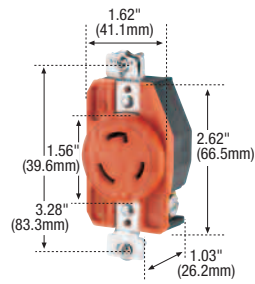

IGL720R

Hart-Lock™ Industrial Specification Grade Isolated Ground Locking Devices

2-Pole, 3-Wire Grounding
20A, 480V/AC
NEMA L8-20



20A, 480V/AC NEMA L8-20

Isolated Ground Receptacles

Style & Description	Catalog No.	Certifications				
		USA	UL	UL US	UL S	UL
Isolated Ground, Orange	□ IGL820R	•	•	•	•	•

Specification Information:
20A Hart-Lock™ Isolated Ground Single Receptacles: C-91

Icon Key

NAFTA Compliant - see page O-30

Hart-Lock™ Industrial Specification Grade Isolated Ground Locking Devices

2-Pole, 3-Wire Grounding
30A, 125V/AC
NEMA L5-30



L5-30R



L5-30P

30A, 125V/AC NEMA L5-30

Isolated Ground Receptacles

Style & Description	Catalog No.	Certifications
Isolated Ground, Orange	□ IGL530R	

Isolated Ground Plug

Style & Description	Catalog No.	Certifications
Safety Grip™ Isolated Ground, Orange	□ IGL530P	

Hart-Lock™ Industrial Specification Grade Isolated Ground Locking Devices

2-Pole, 3-Wire Grounding
30A, 250V/AC
NEMA L6-30



L6-30R

30A, 250V/AC NEMA L6-30

Isolated Ground Receptacles

Style & Description	Catalog No.	Certifications
Isolated Ground, Orange	□ IGL630R	

Hart-Lock™ Industrial Specification Grade Isolated Ground Locking Devices

2-Pole, 3-Wire Grounding
30A, 277V/AC
NEMA L7-30



L7-30R

30A, 277V/AC NEMA L7-30

Isolated Ground Receptacles

Style & Description	Catalog No.	Certifications
Isolated Ground, Orange	□ IGL730R	

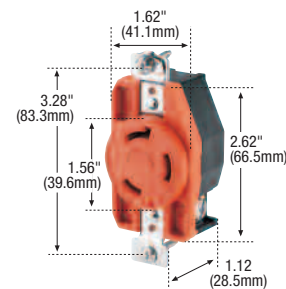

IGL730R

Specification Information:
30A Hart-Lock™ Isolated Ground Single Receptacles: C-91
30A Hart-Lock™ 20A & 30A Safety Grip Plugs: C-89

Icon Key

NAFTA Compliant - see page O-30

Hart-Lock™ Industrial Specification Grade Isolated Ground Locking Devices

2-Pole, 3-Wire Grounding
30A, 480V/AC
NEMA L8-30



L8-30R

30A, 480V/AC NEMA L8-30

Isolated Ground Receptacles

Style & Description	Catalog No.	Certifications				
Isolated Ground, Orange	□ IGL830R	•	•		•	

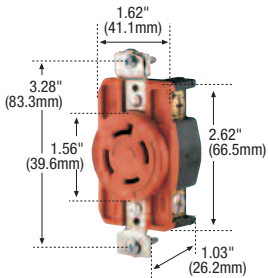

IGL1420R

Hart-Lock™ Industrial Specification Grade Isolated Ground Locking Devices

3-Pole, 4-Wire Grounding
20A, 125/250V/AC
NEMA L14-20



L14-20R

20A, 125/250V/AC NEMA L14-20

Isolated Ground Receptacles

Style & Description	Catalog No.	Certifications				
Isolated Ground, Orange	□ IGL1420R	•	•		•	•

Hart-Lock™ Industrial Specification Grade Isolated Ground Locking Devices

3-Pole, 4-Wire Grounding
20A, 3Ø 250V/AC
NEMA L15-20



L15-20R

20A, 3Ø 250V/AC NEMA L15-20

Isolated Ground Receptacles

Style & Description	Catalog No.	Certifications				
Isolated Ground, Orange	□ IGL1520R	•	•		•	•

Specification Information:

20A & 30A Hart-Lock™ Isolated Ground Single Receptacles: C-91

Icon Key

NAFTA Compliant - see page O-30

Hart-Lock™ Industrial Specification Grade Isolated Ground Locking Devices

3-Pole, 4-Wire Grounding
20A, 3Ø 480V/AC
NEMA L16-20



L16-20R

20A, 3Ø 480V/AC NEMA L16-20

Isolated Ground Receptacles

Style & Description	Catalog No.	Certifications				
		UL	UL	UL	UL	UL
Isolated Ground, Orange	□ IGL1620R	•	•	•	•	•

Hart-Lock™ Industrial Specification Grade Isolated Ground Locking Devices

3-Pole, 4-Wire Grounding
30A, 125/250V/AC
NEMA L14-30



L14-30R

30A, 125/250V/AC NEMA L14-30

Isolated Ground Receptacles

Style & Description	Catalog No.	Certifications				
		UL	UL	UL	UL	UL
Isolated Ground, Orange	□ IGL1430R	•	•	•	•	•

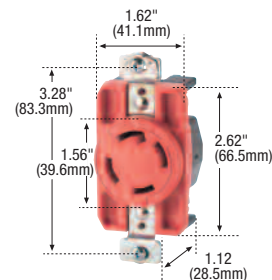

IGL1430R

Hart-Lock™ Industrial Specification Grade Isolated Ground Locking Devices

3-Pole, 4-Wire Grounding
30A, 3Ø 250V/AC
NEMA L15-30



L15-30R

30A, 3Ø 250V/AC NEMA L15-30

Isolated Ground Receptacles

Style & Description	Catalog No.	Certifications				
		UL	UL	UL	UL	UL
Isolated Ground, Orange	□ IGL1530R	•	•	•	•	•

Specification Information:
20A Hart-Lock™ Isolated Ground Single Receptacles: C-91

Icon Key

NAFTA Compliant - see page O-30

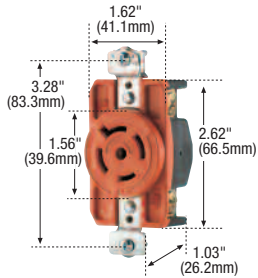

IGL2120R

Hart-Lock™ Industrial Specification Grade Isolated Ground Locking Devices

4-Pole, 5-Wire Grounding
20A, 3ØY 120/208V/AC
NEMA L21-20



L21-20R

20A, 3ØY 120/208V/AC NEMA L21-20

Isolated Ground Receptacles

Style & Description	Catalog No.	Certifications
Isolated Ground, Orange	Single Receptacle <input type="checkbox"/> IGL2120R	

Hart-Lock™ Industrial Specification Grade Isolated Ground Locking Devices

4-Pole, 5-Wire Grounding
30A, 3ØY 120/208V/AC
NEMA L21-30



L21-30R

30A, 3ØY 120/208V/AC NEMA L21-30

Isolated Ground Receptacles

Style & Description	Catalog No.	Certifications
Isolated Ground, Orange	Single Receptacle <input type="checkbox"/> IGL2130R	

Hart-Lock™ Industrial Specification Grade Isolated Ground Locking Devices

4-Pole, 5-Wire Grounding
30A, 3ØY 277/480V/AC
NEMA L22-30



L22-30R

30A, 3ØY 277/480V/AC NEMA L22-30

Isolated Ground Receptacles

Style & Description	Catalog No.	Certifications
Isolated Ground, Orange	Single Receptacle <input type="checkbox"/> IGL2230R	

Hart-Lock™ Industrial Specification Grade Isolated Ground Locking Devices

4-Pole, 5-Wire Grounding
30A, 3ØY 347/600V/AC
NEMA L23-30



L23-30R

30A, 3ØY 347/600V/AC NEMA L23-30

Isolated Ground Receptacles

Style & Description	Catalog No.	Certifications
Isolated Ground, Orange	Single Receptacle <input type="checkbox"/> IGL2330R	

Specification Information:

20A & 30A Hart-Lock™ Isolated Ground Single Receptacles: C-91

Icon Key

NAFTA Compliant - see page O-30

Surge Protection Receptacles

2-Pole, 3-Wire Grounding
15A, 125V/AC; 20A, 125V/AC
NEMA 5-15, 5-20

		Receptacle Type	Hospital Grade 8200_S and 8300_S Duplex Surge Protection; IG8200HG_S and IG8300HG_S Duplex Surge Protection	Commercial Grade 5262_S and 5362_S Duplex Surge Protection; IG5262_S and IG5362_S Duplex Surge Protection
Wiring Type	Base Device		Back & side wire	Back & side wire
	ArrowLink		Integral wire leads, crimped & resistance welded	Integral wire leads, crimped & resistance welded
	ArrowLink SPD		Backwire feed through	Backwire feed through
Testing & Code Compliance	Base Device		• cULus listed to UL 1449 and 498, file no. E2369	• cULus listed to UL 1449 and 498, file no. E2369
	ArrowLink		• Plug & connector cULus listed to UL 2459, file no. E325188	• Plug & connector cULus listed to UL 2459, file no. E325188
	Combined Devices		• cULus listed wiring assembly, UL file no. E326691	• cULus listed wiring assembly, UL file no. E326691
Specifications: Environmental	Base Device	Flammability	Meets UL 94 requirements; V2 rated	Meets UL 94 requirements; V2 rated
		Temperature Rating	-40°C to 60°C (-40°F to 140°F)	-40°C to 60°C (-40°F to 140°F)
	ArrowLink	Flammability	Meets UL 94 requirements; V2 rated	Meets UL 94 requirements; V2 rated
		Temperature Rating	-20°C to 90°C (-4°F to 194°F)	-20°C to 90°C (-4°F to 194°F)
Specifications: Electrical	Base Device	Voltage Protection Rating	L-N & L-G modes: 600V pk; N-G mode: 1200V pk	L-N & L-G modes: 600V pk; N-G mode: 1200V pk
		Surge Performance	560 Joules MCOV - 150V/AC RMS; max. surge current: 18kA per mode	560 Joules MCOV - 150V/AC RMS; max. surge current: 18kA per mode
		Dielectric Voltage	Withstands 2000V per UL 498	Withstands 2000V per UL 498
		Current Interrupting	Yes, at full-rated current	Yes, at full-rated current
		Temperature Rise	Max. 30°C (86°F) after 100 cycles of overload @ 150% of rated current (DC)	Max. 30°C (86°F) after 100 cycles of overload @ 150% of rated current (DC)
	ArrowLink	Max. Working Voltage & Continuous Current	300V/AC; 20A	300V/AC; 20A
		Overload	52.5A/AC for 10 cycles	52.5A/AC for 10 cycles
		Dielectric Voltage	Withstands 1600V per UL 2459	Withstands 1600V per UL 2459
		Current Interrupting	Limited cycles at full-rated current	Limited cycles at full-rated current
		Temperature Rise	Max. 50°C (122°F) while conducting 35A after 10 cycles of overload @ 52.5A/AC	Max. 50°C (122°F) while conducting 35A after 10 cycles of overload @ 52.5A/AC
		Terminal Accommodation	#14 - #10 AWG	#14 - #10 AWG
		Green LED Indicators	Verify surge protection and ground	Verify surge protection and ground
Specifications: Mechanical	Base Device	Alarm	Audible, indicates compromised connection or surge protection has expired	Audible, indicates compromised connection or surge protection has expired
		Front Access Switch	For muting audible arm until device is replaced	For muting audible arm until device is replaced
		Voltage Ratings	Permanently marked on device	Permanently marked on device
		ArrowLink Wire Leads	#12 AWG	#12 AWG
		ArrowLink SPD Screw Terminals	Accepts #12-#14 AWG stranded and solid wire	Accepts #12-#14 AWG stranded and solid wire
Materials:	Base Device	ArrowLink SPD Ground	Integral THHN #12 AWG 6" lead with ring terminal and #10 ground screw	Integral THHN #12 AWG 6" lead with ring terminal and #10 ground screw
		Top Housing	Thermoplastic, nylon	Thermoplastic, nylon
		Bottom Housing	Nylon	Nylon
		Strap	0.050" thick steel, zinc plated with gold chromate	0.05" thick steel, zinc plated with gold chromate
		Line Contacts	0.030" triple wipe brass	0.030" triple wipe brass
	ArrowLink	Terminal & Ground Screws	#8-32 brass, neutral screw nickel plated, ground screw green	#8-32 brass, neutral screw nickel plated, ground screw green
		ArrowLink Housing	Polycarbonate	Polycarbonate
		ArrowLink Contacts	Copper alloy	Copper alloy
		ArrowLink Wire Leads (where applicable)	Solid or stranded THHN #12 AWG	Solid or stranded THHN #12 AWG

Surge Protection Receptacles

2-Pole, 3-Wire Grounding
15A, 125V/AC; 20A, 125V/AC
NEMA 5-15, 5-20

	Receptacle Type	Commercial Grade 5250_S and 5350_S Duplex Surge Protection; IG5250_S and IG5350_S Duplex Surge Protection	Commercial Grade SurgeBloc 1200 Series, IG1200 Series
Wiring Type	Base Device	Back & side wire	6" wire leads
	ArrowLink	Integral wire leads, crimped & resistance welded	N/A
	ArrowLink SPD	Backwire feed-through	N/A
Testing & Code Compliance	Base Device	• cULus listed to UL 1449 and 498, file no. E2369	• Listed to UL 1449 and 498, file no. E15058 • CSA certified to C22.2, no. 42, file no. 6914
	ArrowLink	• Plug & connector cULus listed to UL 2459, file no. E325188	N/A
	Combined Devices	• cULus listed wiring assembly, UL file no. E326691	N/A
Specifications: Environmental	Base Device	Flammability	Meets UL 94 requirements; V2 rated
		Temperature Rating	-40°C to 60°C (-40°F to 140°F)
	ArrowLink	Flammability	Meets UL 94 requirements; V2 rated
		Temperature Rating	-20°C to 90°C (-4°F to 194°F) max.
Specifications: Electrical	Base Device	Voltage Protection Rating	L-N mode: 700V pk; L-G mode: 600V pk; N-G mode: 600V pk
		Surge Performance	840 Joules MCOV - 150V/AC RMS; max. surge current: 18kA per mode
		Dielectric Voltage	Withstands 2000V per UL 498
		Current Interrupting	Yes, at full-rated current
		Temperature Rise	Max. 30°C (86°F) after 100 cycles of overload @ 150% of rated current (DC)
	ArrowLink	Max. Working Voltage & Continuous Current	300V/AC; 20A
		Overload	52.5A/AC for 10 cycles
		Dielectric Voltage	Withstands 1600V per UL 2459
		Current Interrupting	Limited cycles at full-rated current
		Temperature Rise	Max. 50°C (122°F) while conducting 35A after 10 cycles of overload @ 52.5A /AC
		Terminal Accommodation	#14 - #10 AWG
		Green LED Indicators	Verify surge protection and ground
Base Device	Alarm	N/A	
	Voltage Ratings	Permanently marked on device	
	ArrowLink Wire Leads	#12 AWG	
ArrowLink	ArrowLink SPD Screw Terminals	Accepts #12 - #14 AWG stranded and solid wire	
	ArrowLink SPD Ground	Integral THHN #12 AWG 6" lead with ring terminal and #10 ground screw	
Specifications: Mechanical	Base Device	Terminal Accommodation	#14 - #10 AWG
		Green LED Indicators	Verify surge protection and ground
		Alarm	N/A
		Voltage Ratings	Permanently marked on device
	ArrowLink	ArrowLink Wire Leads	#12 AWG
		ArrowLink SPD Screw Terminals	Accepts #12 - #14 AWG stranded and solid wire
		ArrowLink SPD Ground	Integral THHN #12 AWG 6" lead with ring terminal and #10 ground screw
		Terminal Accommodation	#14 - #10 AWG
		Green LED Indicators	Verify surge protection and ground
Materials:	Base Device	Top Housing	Thermoplastic, nylon
		Bottom Housing	Nylon
		Strap	0.05" thick steel, zinc plated with gold chromate
		Line Contacts	0.030" triple wipe brass
		Terminal & Ground Screws	#8-32 brass, neutral screw nickel plated, ground screw green
	ArrowLink	ArrowLink Housing	Polycarbonate
		ArrowLink Contacts	Copper alloy
		ArrowLink Wire Leads (where applicable)	Solid or stranded THHN #12 AWG
		Terminal Accommodation	#14 - #10 AWG

Isolated Ground Receptacles

2-Pole, 3-Wire Grounding
15A, 125V/AC; 15A, 250V/AC; 20A, 125V/AC; 20A 250V/AC
NEMA 5-15, 5-20, 6-15, 6-20

	Receptacle Type	Hospital Grade IG8200, IG8300 and IG8400 Series Duplex Receptacles; IG8262 and IG8362 Series Decorator Duplex Receptacles	Hospital Grade Single Receptacles IG8210, IG8310
Wiring Type	Base Device	Back & side wire	Back & side wire
	ArrowLink	Integral wire leads, crimped & resistance welded	Integral wire leads, crimped & resistance welded
	ArrowLink SPD	Backwire feed-through	Backwire feed-through
Testing & Code Compliance	Base Device	<ul style="list-style-type: none"> Listed to UL 498, file no. E15058 UL verified to Federal Spec. WC-596G CSA certified to C22.2, no. 42, file no. 6914, class 6233-01 NOM certified 	<ul style="list-style-type: none"> Listed to UL 498, file no. E15058 UL verified to Federal Spec. WC-596G CSA certified to C22.2, no. 42, file no. 6914, class 6233-01 NOM certified
	ArrowLink	<ul style="list-style-type: none"> Plug & connector cULus listed to UL 2459, file no. E325188 	<ul style="list-style-type: none"> Plug & connector cULus listed to UL 2459, file no. E325188
	Combined Devices	<ul style="list-style-type: none"> cULus listed wiring assembly, UL file no. E326691 	<ul style="list-style-type: none"> cULus listed wiring assembly, UL file no. E326691
Specifications: Environmental	Base Device	Flammability	Meets UL 94 requirements; V2 rated
		Temperature Rating	-20°C to 70°C (-4°F to 158°F)
	ArrowLink	Flammability	Meets UL 94 requirements; V2 rated
		Temperature Rating	-20°C to 90°C (-4°F to 194°F) max.
Specifications: Electrical	Base Device	Dielectric Voltage	Withstands 2000V per UL 498
		Current Interrupting	Yes, at full-rated current
		Temperature Rise	Max. 30°C (86°F) after 250 cycles of overload @ 200% of rated current (DC)
	ArrowLink	Max. Working Voltage & Continuous Current	300V/AC; 20A
		Overload	52.5A/AC for 10 cycles
		Dielectric Voltage	Withstands 1600V per UL 2459
		Current Interrupting	Limited cycles at full-rated current
Temperature Rise	Max. 50°C (122°F) while conducting 35A after 10 cycles of overload @ 52.5A/AC		
Specifications: Mechanical	Base Device	Terminal Accommodation	#14 - #10 AWG
		Voltage Ratings	Permanently marked on device
	ArrowLink	ArrowLink Wire Leads	#12 AWG
		ArrowLink SPD Screw Terminals	Accepts #12 - #14 AWG stranded and solid wire
		ArrowLink SPD Ground	Integral THHN #12 AWG 6" lead with ring terminal and #10 ground screw
Materials:	Base Device	Top Housing	Thermoplastic, nylon
		Bottom Housing	Glass-filled nylon
		Strap	0.05" thick galvanized steel
		Isolated Ground Contact	0.05" thick brass, one piece
		Auto Ground Clip	Brass
		Line Contacts	Exclusive 0.031" thick 5-leaf brass
		Terminal & Ground Screws	#8-32 brass, neutral screw nickel plated, ground screw green
		Screw Terminal Guards	PVC hinged doors
	ArrowLink	ArrowLink Housing	Polycarbonate
		ArrowLink Contacts	Copper alloy
ArrowLink Wire Leads (where applicable)		Solid or stranded THHN #12 AWG	

Isolated Ground Receptacles

2-Pole, 3-Wire Grounding
15A, 125V/AC; 15A, 250V/AC; 20A, 125V/AC; 20A 250V/AC
NEMA 5-15, 5-20, 6-15, 6-20

	Receptacle Type	Industrial Grade IG5262, IG5362, IG5462, IG5662 Series Duplex Receptacles	Industrial Grade IG5261, IG5361, IG5461 and IG5661 Series Single Receptacles	
Wiring Type	Base Device	Back & side wire	Back & side wire	
	ArrowLink	Integral wire leads, crimped & resistance welded	Integral wire leads, crimped & resistance welded	
	ArrowLink SPD	Backwire feed-through	Backwire feed-through	
Testing & Code Compliance	Base Device	<ul style="list-style-type: none"> Listed to UL 498, file no. E15058 UL verified to Federal Spec. WC-596G CSA certified to C22.2, no. 42, file no. 6914, class 6233-01 NOM certified 	<ul style="list-style-type: none"> Listed to UL 498, file no. E15058 UL verified to Federal Spec. WC-596G CSA certified to C22.2, no. 42, file no. 6914, class 6233-01 NOM certified 	
	ArrowLink	<ul style="list-style-type: none"> Plug & connector cULus listed to UL 2459, file no. E325188 	<ul style="list-style-type: none"> Plug & connector cULus listed to UL 2459, file no. E325188 	
	Combined Devices	<ul style="list-style-type: none"> cULus listed wiring assembly, UL file no. E326691 	<ul style="list-style-type: none"> cULus listed wiring assembly, UL file no. E326691 	
Specifications: Environmental	Base Device	Flammability	Meets UL 94 requirements; V2 rated	Meets UL 94 requirements; V2 rated
		Temperature Rating	-20°C to 70°C (-4°F to 158°F)	-20°C to 70°C (-4°F to 158°F)
	ArrowLink	Flammability	Meets UL 94 requirements; V2 rated	Meets UL 94 requirements; V2 rated
		Temperature Rating	-20°C to 90°C (-4°F to 194°F) max.	-20°C to 90°C (-4°F to 194°F) max.
Specifications: Electrical	Base Device	Dielectric Voltage	Withstands 2000V per UL 498	Withstands 2000V per UL 498
		Current Interrupting	Yes, at full-rated current	Yes, at full-rated current
		Temperature Rise	Max. 30°C (86°F) after 250 cycles of overload @ 200% of rated current (DC)	Max. 30°C (86°F) after 250 cycles of overload @ 200% of rated current (DC)
	ArrowLink	Max. Working Voltage & Continuous Current	300V/AC; 20A	300V/AC; 20A
		Overload	52.5A/AC for 10 cycles	52.5A/AC for 10 cycles
		Dielectric Voltage	Withstands 1600V per UL 2459	Withstands 1600V per UL 2459
		Current Interrupting	Limited cycles at full-rated current	Limited cycles at full-rated current
Temperature Rise	Max. 50°C (122°F) while conducting 35A after 10 cycles of overload @ 52.5A/AC	Max. 50°C (122°F) while conducting 35A after 10 cycles of overload @ 52.5A/AC		
Specifications: Mechanical	Base Device	Terminal Accommodation	#14 - #10 AWG	#14 - #10 AWG
		Voltage Ratings	Permanently marked on device	Permanently marked on device
	ArrowLink	ArrowLink Wire Leads	#12 AWG	#12 AWG
		ArrowLink SPD Screw Terminals	Accepts #12-#14 AWG stranded and solid wire	Accepts #12-#14 AWG stranded and solid wire
		ArrowLink SPD Ground	Integral THHN #12 AWG 6" lead with ring terminal and #10 ground screw	Integral THHN #12 AWG 6" lead with ring terminal and #10 ground screw
Materials:	Base Device	Top Housing	Thermoplastic, nylon	Thermoplastic, nylon
		Bottom Housing	Glass-filled nylon	Thermoplastic, nylon
		Strap	0.05" thick galvanized steel	0.05" zinc plate gold iridite
		Isolated Ground Contact	0.05" thick brass, one piece	0.05" thick solid brass, one piece
		Auto Ground Clip	Brass	Phosphor bronze wire
		Line Contacts	Exclusive 0.031" thick 5-leaf brass	0.037" thick 3-leafbrass
		Terminal & Ground Screws	#8-32 brass, neutral screw nickel plated, ground screw green	#8-32 brass, neutral screw nickel plated, hot screw brass plated, ground screw green
	Screw Terminal Guards	PVC hinged doors	N/A	
	ArrowLink	ArrowLink Housing	Polycarbonate	Polycarbonate
		ArrowLink Contacts	Copper alloy	Copper alloy
ArrowLink Wire Leads (where applicable)		Solid or stranded THHN #12 AWG	Solid or stranded THHN #12 AWG	

I Hospital Grade Devices



	Page		Page
Tamper Resistant	I-1	LED Accent Lights	I-23
Build-To-Spec	I-1	Vertical Louver Faceplate	
ArrowLink™ Modular Connector	I-2-I-3	4W, 120V/AC.....	I-24
REPEL™ Devices	I-4	Low Voltage 12-24V/AC	I-24
15A & 20A Industrial Switches		Vertical Scoop Faceplate with Push Button Switch	
120/277V/AC.....	I-5	3W, 120V/AC.....	I-24
15A & 20A Commercial Switches		Low Voltage 12-24V/AC	I-24
120/277V/AC.....	I-5	Vertical Scoop Faceplate	
REPEL Protected Wallplates		3W, 120V/AC.....	I-24
Stainless Steel	I-6-I-7	Low Voltage 12-24V/AC	I-24
Polycarbonate.....	I-7-I-8	Horizontal Louver Faceplate	
Polycarbonate, screwless.....	I-8	4W, 120V/AC.....	I-24
Straight Blade Receptacles	I-9	Low Voltage 12-24V/AC	I-24
2-Pole, 3-Wire		Special Use Wallplates	I-25
15A, 125V/AC..... NEMA 5-15	I-10-I-11	Pre-marked Standard Size	
20A, 125V/AC..... NEMA 5-20	I-10-I-11	1-Gang	I-25
15A, 250V/AC..... NEMA 6-15.....	I-12	2-Gang	I-25
20A, 250V/AC..... NEMA 6-20.....	I-12	Pre-Marked Mid-Size	
GFCI, Surge Protection and Isolated Ground Receptacles	I-13	1-Gang	I-25
2-Pole, 3-Wire		2-Gang	I-25
15A, 125V/AC..... NEMA 5-15	I-14-I-15		
20A, 125V/AC..... NEMA 5-20	I-14-I-15		
20A, 250V/AC..... NEMA 6-20.....	I-15		
Straight Blade Plugs & Connectors	I-16		
2-Pole, 3-Wire			
15A, 125V/AC..... NEMA 5-15.....	I-18		
20A, 125V/AC..... NEMA 5-20.....	I-18		
15A, 250V/AC..... NEMA 6-15.....	I-19		
20A, 250V/AC..... NEMA 6-20.....	I-19		
Power-Lock Devices	I-20		
Receptacles			
2-P, 3-W, 20A, 125V/AC..... Non-NEMA.....	I-21		
2-P, 3-W, 50A, 250V/AC..... Non-NEMA.....	I-21		
2-P, 3-W, 60A, 250V/AC..... Non-NEMA.....	I-22		
Plugs & Connectors			
2-P, 3-W 20A, 125V/AC..... Non-NEMA.....	I-21		
2-P, 3-W, 50A, 250V/AC..... Non-NEMA.....	I-21		
2-P, 3-W, 60A, 250V/AC..... Non-NEMA.....	I-22		

Reliable healthcare device solutions

Arrow Hart specification grade and hospital grade devices deliver the innovation, performance, construction, and design advantages demanded in medical services environments.



REPEL™ Devices

Arrow Hart REPEL switches and wallplates are an industry first, incorporating Agion® silver antimicrobial into plastic components and powder coating for our stainless steel wallplates.



Hospital Grade Straight Blade Receptacles

Our Hospital Grade receptacles fulfill the demand for long-term reliability, low maintenance and assured performance in any of Arrow Hart's broad line of duplex, decorator, single, panel mount and isolated ground receptacles.



Hospital Grade Straight Blade Plugs & Connectors

Arrow Hart Hospital Grade plugs & connectors are available in both the Safety Grip™ and AutoGrip™ styles, and are built tough to withstand physical and chemical abuse and deliver dependable electrical continuity.

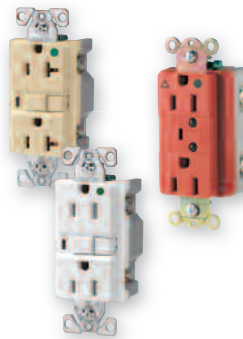

Hospital Grade GFCI & TVSS Devices

Choose Arrow Hart ShockSentry™ GFCIs or Tamper Resistant GFCIs to protect personnel, patients and children from the risks of electric shock. Our Surge Protection and Isolated Ground receptacles offer dependable protection for today's sensitive electronic equipment.



Power-Lock Hospital Use & Mobile X-Ray Devices

Designed to fulfill the requirements of hospital standards for non-interchangeability with regular wiring devices and the added safety of energizing within a sealed chamber, Arrow Hart offers Power-Lock devices that are available in 20A, 50A & 60A configurations for hospital use and mobile X-Ray equipment.



LED Accent Lights

Arrow Hart's innovative LED Accent Lights with advanced LED technology provide functional, yet aesthetically pleasing task lighting or pathway illumination that can stand up to tough abuse in interior and exterior applications throughout healthcare facilities - from patient rooms to outdoor landscapes.

NOTE: REPEL products do not protect the user against disease causing organisms and ongoing regular cleaning practices should be maintained. Agion is a trademark of Agion Technologies Inc. Wakefield, MA.

Tamper & Weather Resistant Receptacles

How the Tamper Resistant system works:

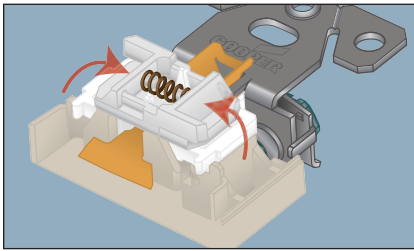

Shutters restrict access in closed position.

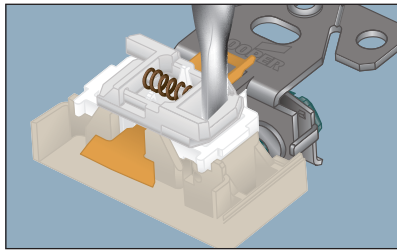

Insertion of object in any one side will not open shutters.

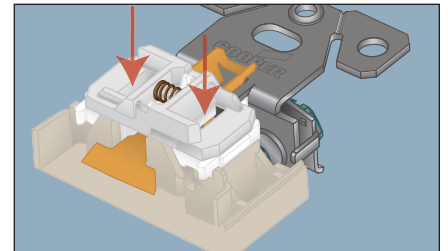

Insertion of two-bladed plug or grounding plug will open shutters.



“TR” mold mark provides quick visual confirmation of tamper resistance when installed.



“WR” identifier quickly indicates during inspections that a weather resistant device has been installed.



Both the “TR” mold mark and “WR” identifier are clearly visible in the finished installation, indicating double-layer protection for maximum safety.

2008 National Electric Code

2008 NEC – 517.18 (C) Pediatric Locations
Receptacles located within the rooms, bathrooms, playrooms, activity rooms and patient care areas of pediatric wards shall be listed under tamper resistant or employ a listed tamper resistant cover.

B) TR for non-hospital sections – 2008 NEC – 406.11 Tamper Resistant Receptacles in Dwelling units
In all areas specified in 210.52 all 125-volt, 15- and 20-amp receptacles shall be listed tamper resistant receptacles.

C) WR for all sections – 2008 NEC – 406.8 Receptacles in Wet or Damp Locations
All 15- and 20-amp, 125- and 250-volt non-locking receptacles installed in wet or damp locations shall be weather resistant receptacles.

Build-To-Spec

For Receptacles, Switches, GFCIs & TVSS devices

Modified at the factory to improve efficiency and speed production at the job site. Arrow Hart’s Build-To-Spec program provides customized device solutions to simplify your project and maximize your bottom line.

Sample Number:

VGFH20W PSOL X Z G P

ARROW/HART
Base Catalog Number (including device color)

Add 6" leads
PSOL = #12 AWG solid
PSTR = #12 AWG stranded

Remove mounting screws

Remove ears

Remove ground clip

Add push-in connector**

Arrow Hart 20A 125V NEMA 5-20 white Hospital Grade GFCI receptacle, with wire leads and push-in connectors, without mounting screws, ears, or grounding clip.

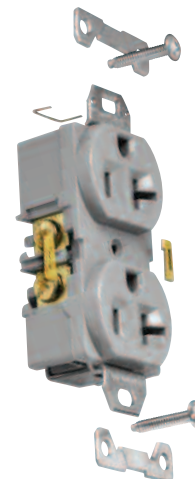

BUILD-TO-SPEC
CUSTOM CONFIGURED DEVICES
ARROW/HART

**For use with leaded receptacles only. Add “PSOL” to back of receptacle catalog number for 6” of #12 AWG solid or “PSTR” for 6” of #12 AWG stranded. (Example: VGFH20W PSOL + Build-To-Spec Options).

All receptacles are bulk packed 50 pieces per carton. Minimum order quantity is 100 pieces. Orders under 500 pieces ship within 5 days with larger quantities typically within 10 days.

ArrowLink

Arrow Hart's factory terminated ArrowLink system revolutionizes device installation, unleashing groundbreaking labor savings in installation and maintenance by eliminating traditional pigtail, terminal connections and taping. Use ArrowLink on your next job to reduce labor costs, eliminate installation errors, save money and win!

Color coded terminals for consistent, reliable connections

Durable polycarbonate housing

Terminal accommodation #12-#14 AWG, solid only

Copper alloy contacts for superior wire retention and minimized heat rise

6", #12 AWG ground lead with ring terminal and captive ground screw

Color coded terminal screws guard caps

Color coded terminal screws

Terminal accommodation #12-#14 AWG, solid or stranded

Cut-Away of MCR300FTPI Push-In Terminal

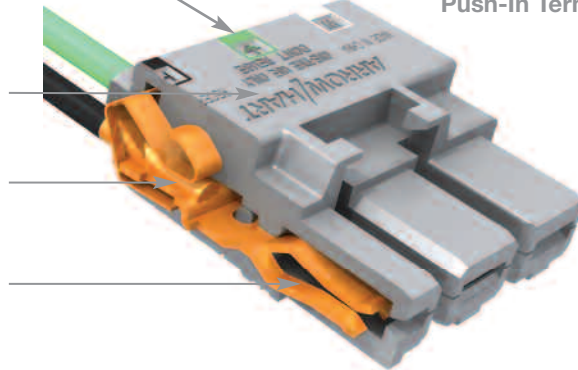

Cut-Away of MCR300FTST Screw Terminal

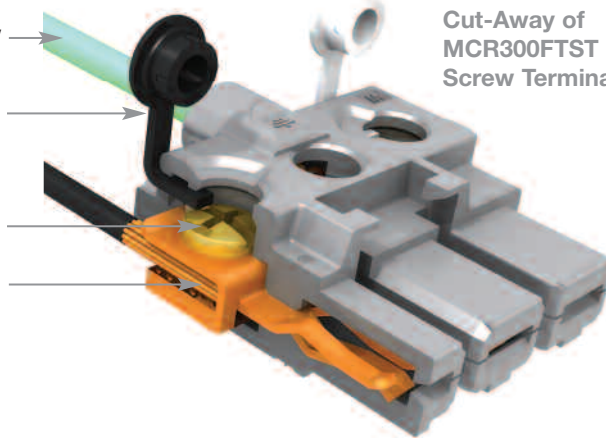

How To Order



1. Select a Hospital Grade Device to ArrowLink enable. Catalog pages identify available products—simply add an "M" to the catalog number and the devices will be factory enabled with the ArrowLink device-side connection. (For GFCIs add "MOD" suffix)

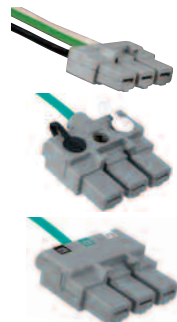

2. Choose from leaded or ArrowLink SPD connector versions in screw-down or push-in models.



3. Place your order and get your ArrowLink devices in **bulk packed** boxes, shipped within 5 days of receipt order!

ArrowLink SPD Benefits

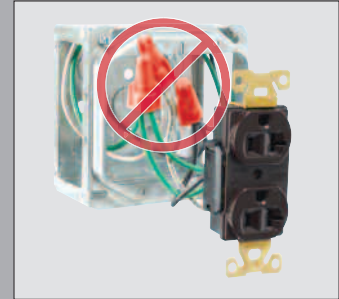

EASE OF INSTALLATION: No more twist-on wire connectors



50% TIME SAVINGS: SPD accelerates both rough-in & trim out installation



EFFICIENT DESIGN: Low profile connection with feed-through capability



30% REDUCTION in wire volume inside the box

ArrowLink SPD Comparative Labor Savings Analysis

Traditional Pigtail Installation

0:50
Cutting & stripping pigtails

1:50
Install wire connectors

1:10
Terminate Conductors

1:05
Mount Devices

4:55/Receptacle

Total time required to install 500 pigtail devices:
40.97 Hours

ArrowLink SPD Installation

1:15
Terminate Conductors

0:05
Attach Device

1:05
Mount Devices

2:25/Receptacle

Total time required to install 500 ArrowLink SPD devices:
20.13 Hours

Time Saved with SPD
20.84 Hours

ARROWLINK™
Modular Wiring Devices



Leaded ArrowLink Receptacle Connectors

Device Type	Description	Catalog No.
Receptacle	Solid Wire Leads – 125V	<input type="checkbox"/> MCR125SOL
	Stranded Wire Leads – 125V	<input type="checkbox"/> MCR125STR
	Solid Wire Leads – 250V	<input type="checkbox"/> MCR250SOL
	Stranded Wire Leads – 250V	<input type="checkbox"/> MCR250STR

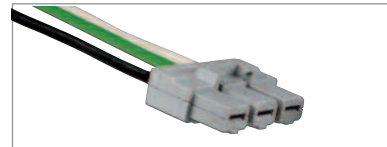

MCR125STR
Leaded
ArrowLink
Connector

ARROWLINK™
SPD



ArrowLink SPD Receptacle Connectors

Receptacle	Screw Terminal	<input type="checkbox"/> MCR300FTST
	Screw Terminal, No Ground Conductor	<input type="checkbox"/> MCR300FTSTNG
	<small>AVAILABLE SUMMER 2010!</small> Push-In	<input type="checkbox"/> MCR300FTPI
	<small>AVAILABLE SUMMER 2010!</small> Push-In, No Ground Conductor	<input type="checkbox"/> MCR300FTPING



MCR300FTST
Screw Terminal



MCR300FTPI
Push-In
Terminal

ArrowLink Accessories

Device Type	Description	Catalog No.
Circuit Tester	Tests Receptacle & ArrowLink Connectors <small>AVAILABLE SUMMER 2010!</small>	<input type="checkbox"/> ALTESTER



ALTESTER
Circuit Tester

REPEL Devices

Arrow Hart's REPEL Switches and Wallplates are the first of their kind with Agion® Additive.



REPEL offers built-in product protection



Toggle and Decorator Switches
REPEL switches incorporate Agion® Silver Antimicrobial Additive into the toggle/paddle and dust skirt.



Stainless Steel
Wallplates feature a powder coating that incorporates Agion® Silver Antimicrobial Additive.



Polycarbonate
Wallplates incorporate Agion® Silver Antimicrobial Additive into the plate material.



REPEL Switches and Wallplates are perfect for:

- Healthcare Facilities
- Schools, Classrooms, and Dormitories
- Assisted Living Facilities
- Food Service Areas
- Industrial Facilities
- Commercial Office Space
- Retail Common Areas







































NOTE: REPEL products do not protect the user against disease causing organisms and ongoing regular cleaning practices should be maintained. Agion is a trademark of Agion Technologies Inc. Wakefield, MA.

REPEL Specification Grade Switches

15A, 120/277V/AC
20A, 120/277V/AC;
Single-Pole, Double-Pole, 3-Way

15A & 20A AC Industrial Toggle Switches

REPEL™ Back & Side Wire

Description	15A, 120/277V			20A, 120/277V		
	Catalog No. Color Suffix	 	 	Catalog No. Color Suffix	 	 
Single-Pole, Toggle REPEL Switches	<input type="checkbox"/> AH1201AM__ GY, V, W	  	 	<input type="checkbox"/> AH1221AM__ GY, RD, V, W	  	 
Double-Pole Toggle REPEL Switches	<input type="checkbox"/> AH1202AM__ GY, V, W	  	 	<input type="checkbox"/> AH1222AM__ GY, RD, V, W	  	 
3-Way, Toggle REPEL Switches	<input type="checkbox"/> AH1203AM__ GY, V, W	  	 	<input type="checkbox"/> AH1223AM__ GY, RD, V, W	  	 

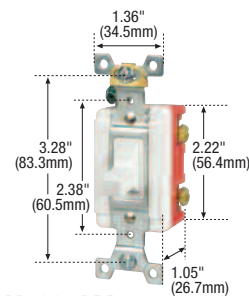



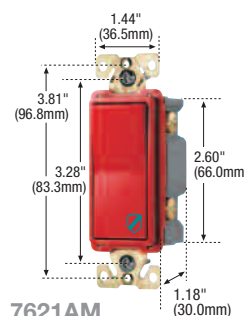













































AH1221AM



7621AM

15A & 20A Commercial AC Decorator Switches





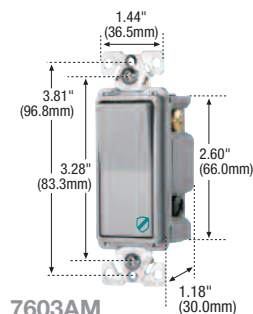











REPEL Back & Side Wire

Description	15A, 120/277V			20A, 120/277V		
	Catalog No. Color Suffix	 	 	Catalog No. Color Suffix	 	 
Single-Pole, Decorator REPEL Switches	<input type="checkbox"/> 7601AM__ GY, RD, V, W	  	 	<input type="checkbox"/> 7621AM__ GY, RD, V, W	  	 
Double-Pole, Decorator REPEL Switches		  	 	<input type="checkbox"/> 7622AM__ GY, V, W	  	 
3-Way, Decorator REPEL Switches	<input type="checkbox"/> 7603AM__ GY, RD, V, W	  	 	<input type="checkbox"/> 7623AM__ GY, RD, V, W	  	 
4-Way, Decorator REPEL Switches	<input type="checkbox"/> 7604AM__ GY, V, W	  	 	<input type="checkbox"/> 7624AM__ GY, V, W	  	 



7603AM

REPEL™ Lighted Switches

Description	20A, 120/277V		
	Catalog No. Color Suffix	 	 
Single-Pole, Decorator REPEL Switch, Lighted	<input type="checkbox"/> 7631AM__ V, W	 	 
3-Way, Decorator REPEL Switch, Lighted	<input type="checkbox"/> 7633AM__ V, W	 	 
4-Way, Decorator REPEL Switch, Lighted	<input type="checkbox"/> 7634AM__ V, W	 	 

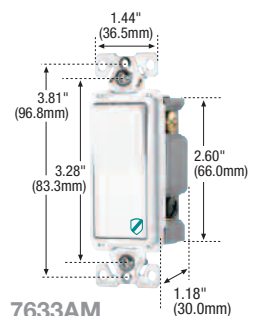

7633AM

Color Ordering Information

For ordering devices, include Cat. No. followed by the color code: A (Almond), B (Brown), BK (Black), BL (Blue), GY (Gray), LA (Light Almond), RD (Red), RN (Orange), V (Ivory), W (White)

Icon Key

 ArrowLink™ option available. Add "M" suffix to standard catalog number (example AH1201AMGY, AH1201AMGYM).

For ordering information on ArrowLink & ArrowLink SPD connectors, see page I-3.



Build-To-Spec Customizable Devices - see page I-4



NAFTA Compliant - see page O-30

Specification Information:

REPEL Decorator Switch: D-32

REPEL Lighted Switch: D-33

REPEL Toggle Switch: D-34

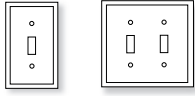

1-Gang 2-Gang

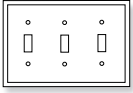

3-Gang

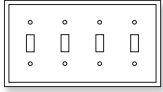

4-Gang

REPEL Standard Size, Stainless Steel, Toggle Switch

Description	Material	Catalog No.	Colors	
1-Gang Toggle	REPEL 302/304 Stainless Steel	☐ 93071AM	—	•
2-Gang Toggle	REPEL 302/304 Stainless Steel	☐ 93072AM	—	•
3-Gang Toggle	REPEL 302/304 Stainless Steel	☐ 93073AM	—	•
4-Gang Toggle	REPEL 302/304 Stainless Steel	☐ 93074AM	—	•

REPEL Standard Size, Stainless Steel, Duplex Receptacle



1-Gang 2-Gang

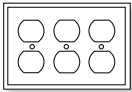

3-Gang

Description	Material	Catalog No.	Colors	
1-Gang Duplex	REPEL 302/304 Stainless Steel	☐ 93101AM	—	•
2-Gang Duplex	REPEL 302/304 Stainless Steel	☐ 93102AM	—	•
3-Gang Duplex	REPEL 302/304 Stainless Steel	☐ 93103AM	—	•

REPEL Standard Size, Stainless Steel, Single Receptacle



1-Gang

Description	Material	Catalog No.	Colors	
1-Gang Toggle with 1.406" (35.712mm) Hole	REPEL 302/304 Stainless Steel	☐ 93091AM	—	•

REPEL Standard Size, Stainless Steel, Decorator

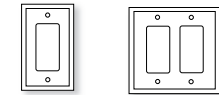

1-Gang 2-Gang

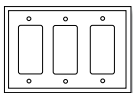

3-Gang

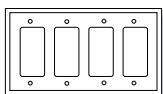

4-Gang

Description	Material	Catalog No.	Colors	
1-Gang Decorator	REPEL 302/304 Stainless Steel	☐ 93401AM	—	•
2-Gang Decorator	REPEL 302/304 Stainless Steel	☐ 93402AM	—	•
3-Gang Decorator	REPEL 302/304 Stainless Steel	☐ 93403AM	—	•
4-Gang Decorator	REPEL 302/304 Stainless Steel	☐ 93404AM	—	•

Color Ordering Information

For ordering wallplates, include Cat. No. followed by the color code: A (Almond), B (Brown), BK (Black), BL (Blue), GY (Gray), LA (Light Almond), RD (Red), RN (Orange), V (Ivory), W (White)

Icon Key

NAFTA Compliant - see page O-30

Certifications

90000 series wallplates are UL and CSA certified

Specification Information:

Wallplates: J-21

REPEL Standard Size, Stainless Steel - Blank Box Mounted

Description	Material	Catalog No.	Colors	
1-Gang	REPEL, 302/304 Stainless Steel	□ 93151AM	—	•
2-Gang	REPEL, 302/304 Stainless Steel	□ 93152AM	—	•
3-Gang	REPEL, 302/304, Stainless Steel	□ 93153AM	—	•
4-Gang	REPEL, 302/304 Stainless Steel	□ 93154AM	—	•



1-Gang



2-Gang



1-Gang

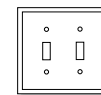

2-Gang

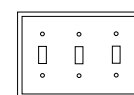

3-Gang

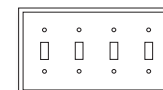

4-Gang

REPEL Mid-Size Toggle Switch

Description	Material	Catalog No.	Colors	
1-Gang Toggle	REPEL Polycarbonate	□ PJ1AM __	GY, RD, V, W	
2-Gang Toggle	REPEL Polycarbonate	□ PJ2AM __	GY, RD, V, W	
3-Gang Toggle	REPEL Polycarbonate	□ PJ3AM __	GY, RD, V, W	
4-Gang Toggle	REPEL Polycarbonate	□ PJ4AM __	GY, V, W	

REPEL Mid-Size Duplex Receptacle

Description	Material	Catalog No.	Colors	
1-Gang	REPEL Polycarbonate	□ PJ8AM __	GY, RD, V, W	
2-Gang	REPEL Polycarbonate	□ PJ82AM __	GY, RD, V, W	



1-Gang



2-Gang

REPEL Mid-Size Decorator

Description	Material	Catalog No.	Colors	
1-Gang	REPEL Polycarbonate	□ PJ26AM __	GY, RD, V, W	
2-Gang	REPEL Polycarbonate	□ PJ262AM __	GY, RD, V, W	
3-Gang	REPEL Polycarbonate	□ PJ263AM __	GY, V, W	
4-Gang	REPEL Polycarbonate	□ PJ264AM __	GY, V, W	



1-Gang

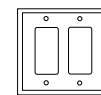

2-Gang

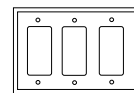

3-Gang

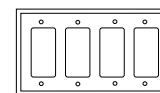

4-Gang

Color Ordering Information

For ordering wallplates, include Cat. No. followed by the color code: A (Almond), B (Brown), BK (Black), BL (Blue), GY (Gray), LA (Light Almond), RD (Red), RN (Orange), V (Ivory), W (White)

Icon Key

 NAFTA Compliant - see page O-30

Certifications

PJ series wallplates are cULus certified
90000 series wallplates are UL and CSA certified

Specification Information:

Wallplates: J-21



1-Gang 2-Gang

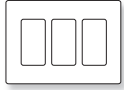

3-Gang

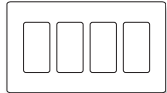

4-Gang



1-Gang



2-Gang



3-Gang



4-Gang



1-Gang



1-Gang

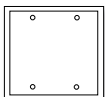

2-Gang

REPEL Mid-Size Screwless Decorator

Description	Material	Catalog No.	Colors
1-Gang	REPEL Polycarbonate	<input type="checkbox"/> PJS26AM __	GY, V, W
2-Gang	REPEL Polycarbonate	<input type="checkbox"/> PJS262AM __	GY, V, W
3-Gang	REPEL Polycarbonate	<input type="checkbox"/> PJS263AM __	V, W
4-Gang	REPEL Polycarbonate	<input type="checkbox"/> PJS264AM __	V, W

REPEL Mid-Size Screwless Toggle

Description	Material	Catalog No.	Colors
1-Gang	REPEL Polycarbonate	<input type="checkbox"/> PJS1AM __	V, W
2-Gang	REPEL Polycarbonate	<input type="checkbox"/> PJS2AM __	V, W
3-Gang	REPEL Polycarbonate	<input type="checkbox"/> PJS3AM __	V, W
4-Gang	REPEL Polycarbonate	<input type="checkbox"/> PJS4AM __	V, W

REPEL Mid-Size Screwless Receptacle

Description	Material	Catalog No.	Colors
1-Gang	REPEL Polycarbonate	<input type="checkbox"/> PJS8AM __	V, W

REPEL Mid-Size Blank - Box & Strap-Mounted

Description	Material	Catalog No.	Colors
1-Gang Box-Mounted	REPEL Polycarbonate	<input type="checkbox"/> PJ13AM __	GY, V, W
1-Gang Strap Mounted	REPEL Polycarbonate	<input type="checkbox"/> PJ14AM __	GY, V, W
2-Gang Box-Mounted	REPEL Polycarbonate	<input type="checkbox"/> PJ23AM __	GY, V, W
2-Gang Strap Mounted	REPEL Polycarbonate	<input type="checkbox"/> PJ24AM __	GY, V, W

Color Ordering Information

For ordering wallplates, include Cat. No. followed by the color code: A (Almond), B (Brown), BK (Black), BL (Blue), GY (Gray), LA (Light Almond), RD (Red), RN (Orange), V (Ivory), W (White)

Certifications

PJ and PJS series wallplates are cULus certified

Specification Information:

Wallplates: J-21

**Performance
Longevity
Reliability**

In today's healthcare environment the power to save lives begins with the electrical system. Downtime is not an option and the right receptacle can make the difference in critical situations.



Premium Hospital Grade AH8200, AH8300 Series

Exclusive screw terminal guards provide insulation from conductive surfaces

Patented Screw-Catch™ speeds wallplate installation

Exclusive 5-leaf nickel-plated solid brass blade contacts reduce heat rise and provide consistent retention/release

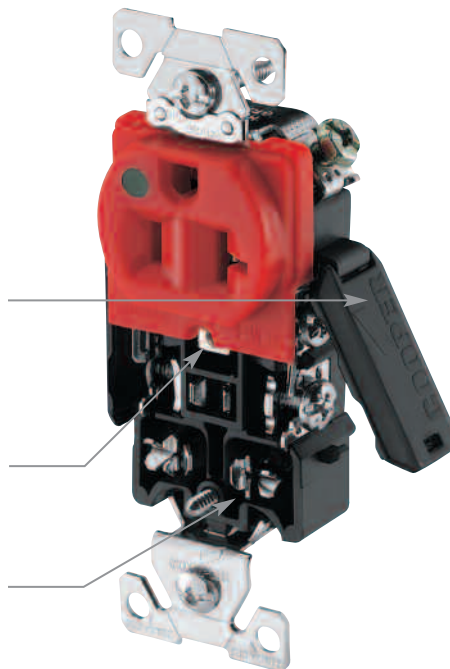

Front View

Backwire ground clamp for fast and secure wiring

Solid 1-piece nickel-plated brass grounding system assures ground integrity

Extra-long mounting strap helps secure installation in poorly cut wall openings

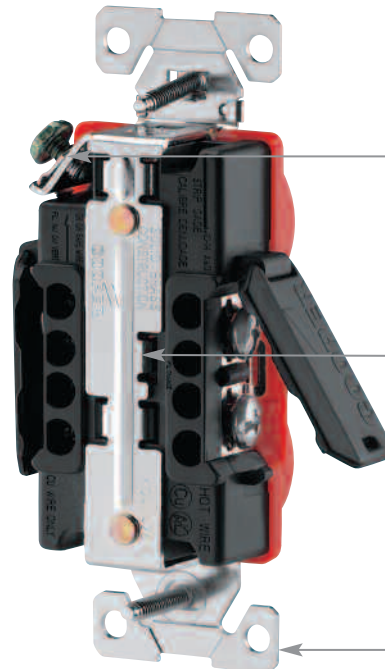

Back View

Additional Features and Benefits

- Available in 15A & 20A duplex & single configurations, including lighted, Tamper Resistant and ArrowLink modular styles
- Glass-reinforced nylon base provides superior strength and heat resistance
- High impact- and chemical-resistant nylon face holds structural integrity
- Convenient built-in #10 and #12 AWG wire strippers
- Tri-head combination brass terminal screws are backed out and ready to wire

Hospital Specification Grade Straight Blade Receptacles

2-Pole, 3-Wire Grounding
15A, 125V/AC
20A, 125V/AC
NEMA 5-15R, 5-20R

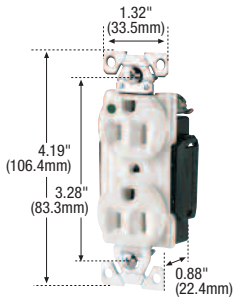
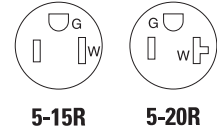

AH8200

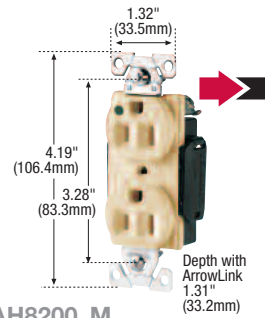

AH8200_M

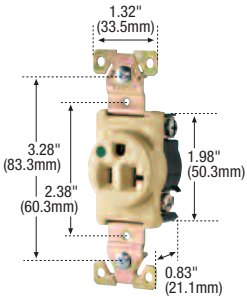

8310

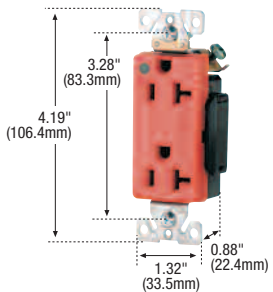

IG8362

Specification Information:

Premium HG Receptacles: A-24
ArrowLink Premium HG Receptacles: A-28 & A-29
Isolated Ground Premium HG Receptacles: A-25

Premium Hospital Grade Receptacles

Back Wire & Side Wire

15A, 125V
NEMA 5-15R

20A, 125V
NEMA 5-20R

Description	Catalog No. Color Suffix				Catalog No. Color Suffix			
Premium Duplex Receptacle	<input type="checkbox"/> AH8200__ B, BK, GY, RD, V, W				<input type="checkbox"/> AH8300__ B, BK, GY, LA, RD, V, W			
Premium Illuminated Duplex Receptacle	<input type="checkbox"/> AH8200LT__ RD, V, W				<input type="checkbox"/> AH8300LT__ RD, V, W			
Premium Single Receptacle	<input type="checkbox"/> 8210__ B, GY, RD, V, W				<input type="checkbox"/> 8310__ B, GY, RD, V, W			

Premium Decorator Hospital Grade Receptacles

Back Wire & Side Wire

15A, 125V
NEMA 5-15R

20A, 125V
NEMA 5-20R

Description	Catalog No. Color Suffix				Catalog No. Color Suffix			
Premium Decorator Duplex Receptacle	<input type="checkbox"/> 8262__ B, BK, GY, RD, V, W				<input type="checkbox"/> 8362__ B, BK, GY, RD, V, W			
Premium Decorator Illuminated Duplex Receptacle	<input type="checkbox"/> 8262LT__ GY, RD, V, W				<input type="checkbox"/> 8362LT__ RD, V, W			

Isolated Ground Premium Hospital Grade Receptacles

Back Wire & Side Wire

15A, 125V
NEMA 5-15R

20A, 125V
NEMA 5-20R

Description	Catalog No. Color Suffix				Catalog No. Color Suffix			
Premium IG Duplex Receptacle	<input type="checkbox"/> IG8200__ GY, RD, RN, V, W				<input type="checkbox"/> IG8300__ GY, RD, RN, V, W			
Premium IG Single Receptacle	<input type="checkbox"/> IG8210__* RN				<input type="checkbox"/> IG8310__ RN			
Premium IG Decorator Duplex Receptacle	<input type="checkbox"/> IG8262__ GY, RN, V, W				<input type="checkbox"/> IG8362__ GY, RN, V, W			

* Not Fed. Spec.

Color Ordering Information

For ordering receptacles, include Cat. No. followed by the color code: A (Almond), B (Brown), BK (Black), BL (Blue), GY (Gray), LA (Light Almond), RD (Red), RN (Orange), V (Ivory), W (White)

Icon Key

ArrowLink™ option available. Add "M" suffix to Standard catalog number (example AH8300W, AH8300WM). For ordering information on ArrowLink & ArrowLink SPD connectors, see page I-3.

Build-To-Spec Customizable Devices - see page I-1
 NAFTA Compliant - see page O-30

Hospital Grade

Hospital Specification Grade Straight Blade Receptacles

2-Pole, 3-Wire Grounding
 15A, 125V/AC
 20A, 125V/AC
 NEMA 5-15R, 5-20R

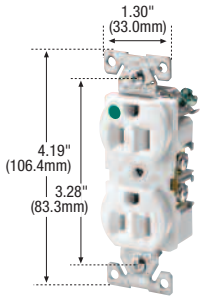
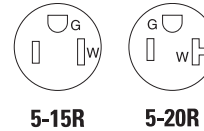

8200

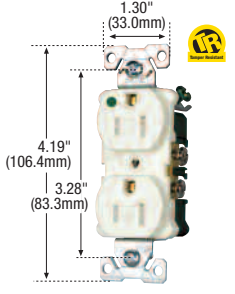

TR8200

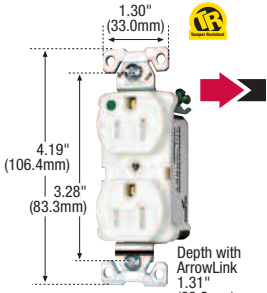

TR8200_M

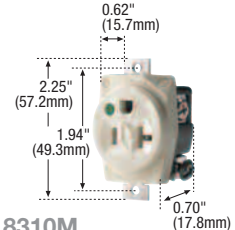

8310M

Hospital Grade Receptacles

Back Wire & Side Wire	15A, 125V NEMA 5-15R	UL FULS SP NOM 426	20A, 125V NEMA 5-20R	UL FULS SP NOM 426
Description	Catalog No. Color Suffix	➔ [US] [Build-To-Spec]	Catalog No. Color Suffix	➔ [US] [Build-To-Spec]
● Duplex Receptacle	□ 8200 B, GY, LA, RD, V, W	• • •	□ 8300 B, GY, LA, RD, V, W	• • •

Tamper Resistant Hospital Grade Receptacles

Back Wire & Side Wire	15A, 125V NEMA 5-15R	cUL us FULS SP NOM 426	20A, 125V NEMA 5-20R	cUL us FULS SP NOM 426
Description	Catalog No. Color Suffix	➔ [US] [Build-To-Spec]	Catalog No. Color Suffix	➔ [US] [Build-To-Spec]
● Duplex Receptacle	□ TR8200 B, GY, RD, V, W	• •	□ TR8300 B, GY, RD, V, W	• •

Panel-Mount Special Use Hospital Grade Single Receptacles

Back Wire & Side Wire	15A, 125V NEMA 5-15R	UL FULS SP NOM 426	20A, 125V NEMA 5-20R	UL FULS SP NOM 426
Description	Catalog No. Color Suffix	➔ [US] [Build-To-Spec]	Catalog No. Color Suffix	➔ [US] [Build-To-Spec]
● Strap Center to Center Spacing = 1.9375" (49.2mm)	□ 8210M B, V	•	□ 8310M B, RD, V	•

Color Ordering Information

For ordering receptacles, include Cat. No. followed by the color code: A (Almond), B (Brown), BK (Black), BL (Blue), GY (Gray), LA (Light Almond), RD (Red), RN (Orange), V (Ivory), W (White)

Icon Key

➔ ArrowLink™ option available. Add "M" suffix to Standard catalog number (example 8200V, 8200VM). For ordering information on ArrowLink & ArrowLink SPD connectors, see page I-3.

● Hospital Grade

[Build-To-Spec Icon] Build-To-Spec Customizable Devices - see page I-1

[US Icon] NAFTA Compliant - see page O-30

[TR Icon] Tamper Resistant

Accessories for Hospital Grade NEMA 5-15 & 5-20 Receptacles

Description	Catalog No.
2-Gang, standard size duplex receptacle pre-marked stainless steel wallplate/"Emergency"	□ EM93102 •
1-Gang, mid-size duplex receptacle wallplate, ivory, REPEL	□ PJ8AMV
1-Gang, mid-size duplex receptacle wallplate, ivory / "GFCI Protected"	□ PJ8GFV
2-Gang, standard size decorator stainless steel wallplate, REPEL	□ 93402AM •
2-Gang, mid-size duplex receptacle pre-marked wallplate, red / "Emergency"	□ PJ82EMRD



EM93102



PJ8AMV



PJ8GFV



93402AM



PJ82EMRD

Specification Information:

HG Receptacles: A-27

ArrowLink HG

Receptacles: A-27

Tamper Resistant HG

Receptacles: A-26

Panel Mount HG

Receptacles: A-26

Hospital Specification Grade Straight Blade Receptacles

2-Pole, 3-Wire Grounding
 15A, 250V/AC
 20A, 250V/AC
 NEMA 6-15R, 6-20R

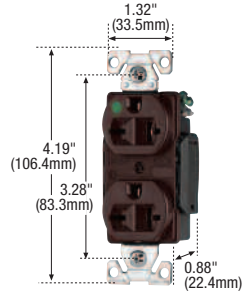
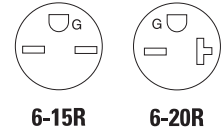

AH8400

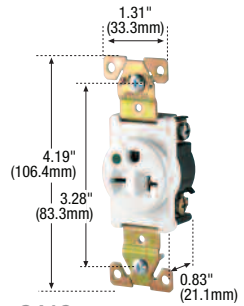

8410

Premium Hospital Grade Receptacles

Back Wire & Side Wire

15A, 250V
 NEMA 6-15R



20A, 250V
 NEMA 6-20R



Description	Catalog No. Color Suffix	➤	USA	3D	Catalog No. Color Suffix	➤	USA	3D
● Premium Duplex Receptacle	<input type="checkbox"/> AH8600____ V, W	●		●	<input type="checkbox"/> AH8400____ B, GY, RD, V, W	●		●
● Premium Single Receptacle	<input type="checkbox"/> 8610____ V, W		●	●	<input type="checkbox"/> 8410____ B, GY, RD, V, W		●	●

Color Ordering Information

For ordering receptacles, include Cat. No. followed by the color code: A (Almond), B (Brown), BK (Black), BL (Blue), GY (Gray), LA (Light Almond), RD (Red), RN (Orange), V (Ivory), W (White)

Icon Key

➤ ArrowLink™ option available. Add "M" suffix to Standard catalog number (example AH8600W, AH8600WM). For ordering information on ArrowLink & ArrowLink SPD connectors, see page I-3.

Build-To-Spec Customizable Devices - see page I-1

NAFTA Compliant - see page O-30

● Hospital Grade

Accessories for Hospital Grade NEMA 6-15 & 6-20 Receptacles

Description	Catalog No.	USA
1-Gang standard size duplex receptacle nylon wallplate, ivory	<input type="checkbox"/> 5132V	●
1-Gang standard size single receptacle, stainless steel wallplate, REPEL	<input type="checkbox"/> 93091AM	●
1-Gang mid-size duplex receptacle polycarbonate wallplate, light almond	<input type="checkbox"/> PJ8LA	
1-Gang standard size duplex receptacle stainless steel wallplate, REPEL	<input type="checkbox"/> 93101AM	●

Specification Information:

Premium HG Receptacles: A-24
 ArrowLink Premium HG Receptacles: A-28 & A-29



5132V



93091AM



PJ8



93101AM

Hospital Grade Protection Devices

Arrow Hart's line of hospital grade GFCI, Surge, and Isolated Ground devices provide protection for both people and sensitive electronic equipment.



Surge Protection Plus

- Audible alarm signals when transient voltage protection has expired
- Green LED indicators to verify transient voltage protection and wiring diagnostics
- Front access switch for muting audible alarm until device is replaced
- Provides surge protection for hot to neutral, hot to ground and neutral to ground



ShockSentry™ Ground Fault Circuit Interrupter

Meets and exceeds 10ka Short Circuit Testing and Underwriters Laboratories (UL) 2006 UL943 Safety standards

- Ground termination with backwire clamp provides secure wiring and reduces installation time
- Line side terminals are backed out and staked for fast installation
- Horizontal Test/Reset button alignment provides larger unobstructed area
- Large visual indicator light gives quick notification of a tripped or "end of life" condition

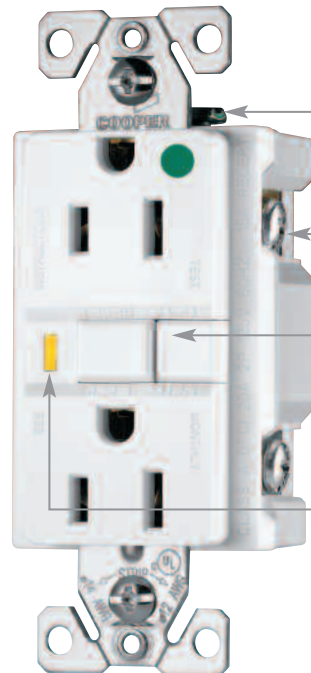

Isolated Ground Straight Blade Receptacles

- Exclusive 5-leaf brass line contacts ensure lowest heat rise, smooth plug blade insertion and long-term retention
- Screw-Catch™ feature on duplex devices speeds mounting of wallplates

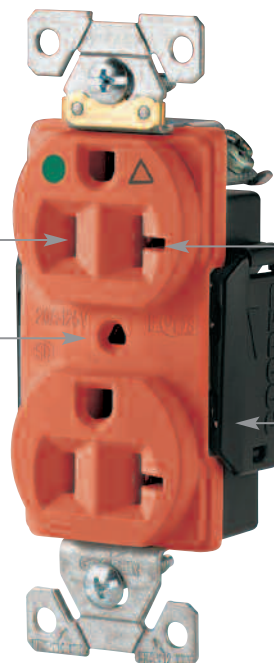

- Exclusive 0.030" (0.76mm) solid brass non riveted, one piece isolated grounding shunt
- Exclusive screw terminal guards provide fast, easy insulation from conductive surfaces

Specification Grade Ground Fault Circuit Interrupter Receptacles

2-Pole, 3-Wire Grounding
15A, 125V/AC
20A, 125V/AC
NEMA 5-15, 5-20

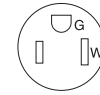

5-15R



5-20R

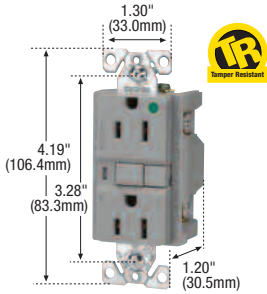

VGFB15

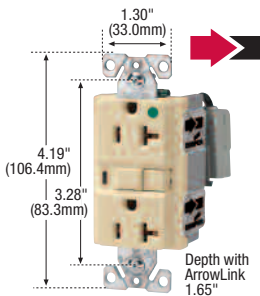

VGFB20_MOD

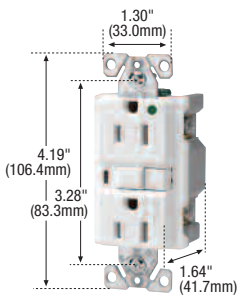

TRVGFB15

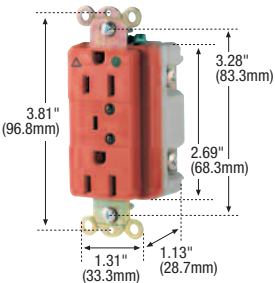

IG8200HG_S

Specification Information:
Hospital Grade GFCI: G-12
Surge Protection Receptacles with Audible Alarm & LED: H-19

Hospital Grade GFCIs

Back Wire & Side Wire	15A, 125V NEMA 5-15R	20A, 125V NEMA 5-20R
Description	Catalog No. Color Suffix	Catalog No. Color Suffix
● Hospital GFCI	□ VGFB15____ B, GY, LA, RD, V, W	□ VGFB20____ B, GY, LA, RD, V, W
● Hospital GFCI NAFTA Compliant	□ VGFB15F____ B, GY, LA, RD, V, W	□ VGFB20F____ B, GY, LA, RD, V, W
● Tamper Resistant Hospital GFCI	□ TRVGFB15____ B, GY, LA, RD, V, W	□ TRVGFB20____ B, GY, LA, RD, V, W
● Tamper Resistant Hospital GFCI NAFTA Compliant	□ TRVGFB15F____ B, GY, LA, RD, V, W	□ TRVGFB20F____ B, GY, LA, RD, V, W

Includes standard size unbreakable wallplate

Surge Protection Receptacles with LED Indicators & Audible Alarm

2-Pole, 3-Wire Grounding
15A, 125V/AC
20A, 125V/AC
NEMA 5-15R & 5-20R

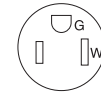

5-15R



5-20R

Surge Protection Receptacles w/Audible Alarm & LED Indicators

560 Joules, max. surge current - 18kA, MCOV - 150V/AC

Back Wire & Side Wire	15A, 125V NEMA 5-15R	20A, 125V NEMA 5-20R
Description	Catalog No. Color Suffix	Catalog No. Color Suffix
● Hospital Grade Duplex Receptacle	□ 8200__S BL, GY, RD, V, W	□ 8300__S BL, GY, RD, V, W
● IG Hospital Grade Duplex Receptacle	□ IG8200HG__S BL, GY, RN, V, W	□ IG8300HG__S BL, GY, RN, V, W

Color Ordering Information

For ordering devices, include Cat. No. followed by the color code: A (Almond), B (Brown), BK (Black), GY (Gray), LA (Light Almond), RD (Red), RN (Orange), V (Ivory), W (White)

Icon Key

➤ ArrowLink™ option available. For GFCIs add "MOD" suffix to Standard catalog number (example VGFB15W, VGFB15WMOD) and M to Surge Protection Devices. For ordering information on ArrowLink & ArrowLink SPD connectors, see page I-3.

- Build-To-Spec Customizable Devices - see page I-1
- NAFTA Compliant - see page O-30
- Tamper Resistant
- Hospital Grade

Isolated Ground Straight Blade Receptacles

2-Pole, 3-Wire Grounding
15A, 125V/AC, 20A, 125V/AC
NEMA 5-15R & 5-20R

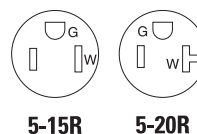

Isolated Ground Duplex and Single Straight Blade Receptacles

Back Wire & Side Wire	15A, 125V NEMA 5-15R	UL SR FULS NOM 426	20A, 125V NEMA 5-20R	UL SR FULS NOM 426
Description	Catalog No. Color Suffix	▶	Catalog No. Color Suffix	▶
● Hospital Grade IG Duplex Receptacle	<input type="checkbox"/> IG8200__ GY, RD, RN, V, W	•	<input type="checkbox"/> IG8300__ GY, RD, RN, V, W	•
● IG Hospital Grade Decorator Duplex Receptacle	<input type="checkbox"/> IG8262__ GY, RN, V, W	•	<input type="checkbox"/> IG8362__ BK, GY, RN, V, W	•
● Hospital Grade IG Single Receptacle	<input type="checkbox"/> IG8210__ RN	•	<input type="checkbox"/> IG8310__ RN	•

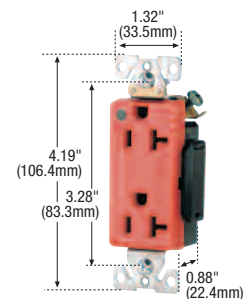

IG8362

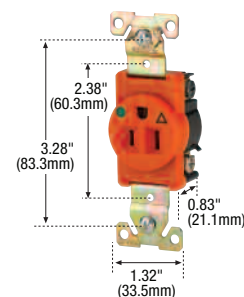

IG8210

Isolated Ground Straight Blade Receptacles

2-Pole, 3-Wire Grounding
15A, 250V/AC
20A, 250V/AC
NEMA 6-15R, 6-20R



Isolated Ground Duplex Straight Blade Receptacles

Back Wire & Side Wire	20A, 250V/AC NEMA 6-20R	UL SR FULS NOM 426
Description	Catalog No. Color Suffix	▶
● Hospital Grade IG Duplex Receptacle	<input type="checkbox"/> IG8400__ RN	•

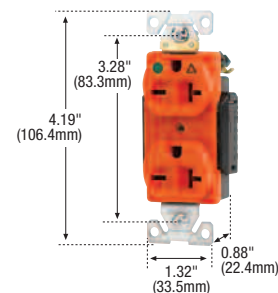

IG8400

Color Ordering Information

For ordering devices, include Cat. No. followed by the color code: A (Almond), B (Brown), BK (Black), GY (Gray), LA (Light Almond), RD (Red), RN (Orange), V (Ivory), W (White)

Icon Key

▶ ArrowLink™ option available. Add "M" suffix to Standard catalog number (example IG8400RN, IG8400RNM). For ordering information on ArrowLink & ArrowLink SPD connectors, see page I-2.

● Hospital Grade

Build-To-Spec Customizable Devices - see page I-1

NAFTA Compliant - see page O-30

Tamper Resistant

Specification Information:

IG HG Duplex & Decorator Receptacle: H-21

IG HG Single Receptacle: H-21



Safety Grip Hospital and Industrial Specification Grade Plugs & Connectors

Rugged nylon body resists impact and exposure to chemicals

Neoprene gasket seals around cord for added terminal protection from external elements

Dual range cord grip provides positive cord gripping while limiting strain on conductors

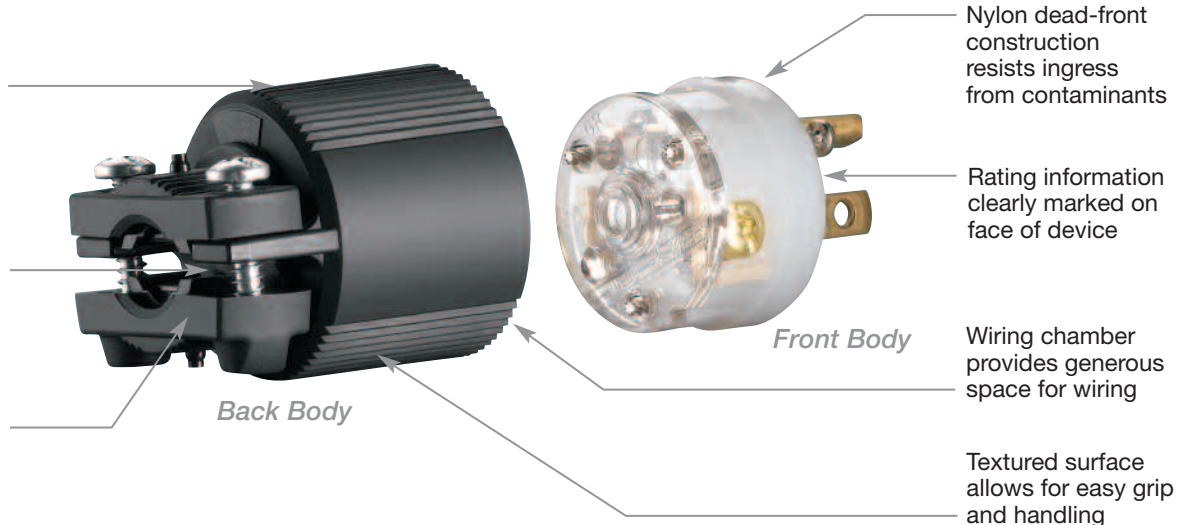

Safety Grip Hospital Grade devices exceed Federal Spec. and Hospital Grade testing for use in demanding healthcare environments



Clear terminal cover allows for easy inspection of conductors and terminations



Retained quick drive assembly screws speed installation



Angled plug option is ideal for applications requiring power cord to lay close to walls and floors

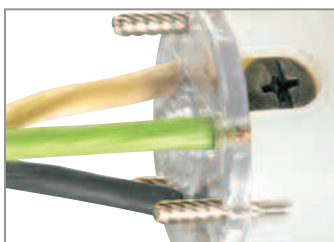

Tapered, individual wire pockets guide stranded wire into contact area for ease of installation



Multiple-head drive screws provide screwdriver versatility for ease of use



**Auto Grip Hospital and Industrial Specification
Grade Plugs & Connectors**

Smooth, tapered body reduces snagging and provides easy handling

Neoprene gasket seals around cord for added terminal protection from external elements

Rugged nylon body resists impact and exposure to chemicals

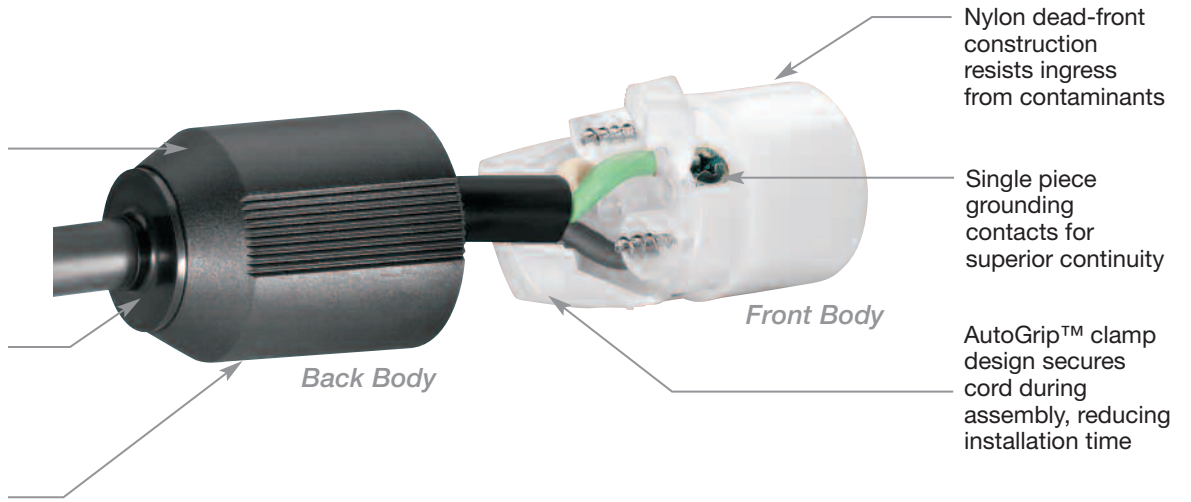

Nylon dead-front construction resists ingress from contaminants

Single piece grounding contacts for superior continuity

AutoGrip™ clamp design secures cord during assembly, reducing installation time



AutoGrip™ Hospital Grade devices exceed Federal Spec. and Hospital Grade testing for use in demanding healthcare environments



Unique clamp design secures cord during assembly, reducing installation time



Retained quick drive assembly screws speed installation



Available in corrosion resistant configurations for reliable performance in corrosive environments



Tapered, individual wire pockets guide stranded wire into contact area for ease of installation



Multiple-head drive screws provide screwdriver versatility for ease of use

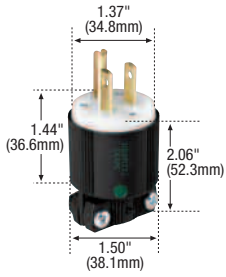

6266HG

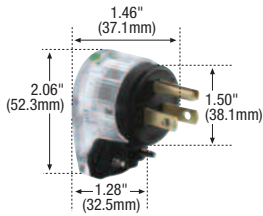

6265HGC



5369NHG

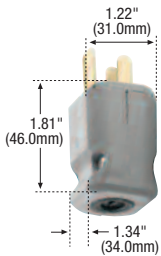

8115GY

Hospital Specification Grade Straight Blade Plugs & Connectors

2-Pole, 3-Wire Grounding
15A, 125V/AC
NEMA 5-15

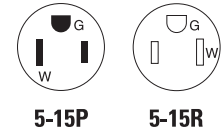

Hospital Grade Plugs & Connectors

Safety Grip™ NEMA 5-15

Rating A V/AC	Product Type & Cord Diameter	Body Color	Plug	Catalog No.	
				Connector	Connector
15 125	● Straight Body 0.33-0.66" (7.6-16.7mm)	Black & White	<input type="checkbox"/> 6266HG	<input checked="" type="checkbox"/> 6269HG	<input checked="" type="checkbox"/> 6269HG
	● Straight Body 0.33-0.66" (7.6-16.7mm)	Clear	<input type="checkbox"/> 6266HGC	<input checked="" type="checkbox"/> 6269HGC	<input checked="" type="checkbox"/> 6269HGC
	● Angled Body 0.33-0.66" (7.6-16.7mm)	Black & White	<input type="checkbox"/> 6265HG	<input checked="" type="checkbox"/>	<input checked="" type="checkbox"/>
	● Angled Body 0.33-0.66" (7.6-16.7mm)	Clear	<input type="checkbox"/> 6265HGC	<input checked="" type="checkbox"/>	<input checked="" type="checkbox"/>

AutoGrip™ NEMA 5-15

Rating A V/AC	Product Type & Cord Diameter	Body Color	Plug	Catalog No.	
				Connector	Connector
15 125	● Straight Body 0.33-0.66" (7.6-16.7mm)	Black & White	<input type="checkbox"/> 5266NHG	<input checked="" type="checkbox"/> 5269NHG	<input checked="" type="checkbox"/> 5269NHG
	● Isolated Ground, Straight Body 0.33-0.66" (7.6-16.7mm)	Orange	<input type="checkbox"/> IG5266NHG	<input checked="" type="checkbox"/>	<input checked="" type="checkbox"/>

QuickGrip™ NEMA 5-15

Rating A V/AC	Product Type & Cord Diameter	Body Color	Plug	Catalog No.	
				Connector	Connector
15 125	● Straight Body 0.22-0.66" (5.6-16.8mm)	Gray	<input type="checkbox"/> 8115GY	<input checked="" type="checkbox"/>	<input checked="" type="checkbox"/>

Hospital Specification Grade Straight Blade Plugs & Connectors

2-Pole, 3-Wire Grounding
20A, 125V/AC
NEMA 5-20

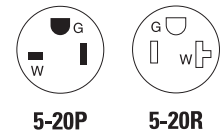

Hospital Grade Plugs & Connectors

Safety Grip™ NEMA 5-20

Rating A V/AC	Product Type & Cord Diameter	Body Color	Plug	Catalog No.	
				Connector	Connector
20 125	● Straight Body 0.33-0.66" (7.6-16.7mm)	Black & White	<input type="checkbox"/> 6766HG	<input checked="" type="checkbox"/> 6769HG	<input checked="" type="checkbox"/> 6769HG
	● Angled Body 0.33-0.66" (7.6-16.7mm)	Black & White	<input type="checkbox"/> 6765HG	<input checked="" type="checkbox"/>	<input checked="" type="checkbox"/>
	● Angled Body 0.33-0.66" (7.6-16.7mm)	Clear	<input type="checkbox"/> 6765HGC	<input checked="" type="checkbox"/>	<input checked="" type="checkbox"/>

AutoGrip™ NEMA 5-20

Rating A V/AC	Product Type & Cord Diameter	Body Color	Plug	Catalog No.	
				Connector	Connector
20 125	● Straight Body 0.33-0.66" (7.6-16.7mm)	Black & White	<input type="checkbox"/> 5366NHG	<input checked="" type="checkbox"/> 5369NHG	<input checked="" type="checkbox"/> 5369NHG

Hospital Grade Dimensional Information: B-18

Specification Information:

Safety Grip HG Plugs & Connectors: B-25

AutoGrip HG Plugs & Connectors: B-25

QuickGrip HG Plugs & Connectors: B-25

Icon Key

● Hospital Grade Device

NAFTA Compliant - see page O-30

Hospital Specification Grade Straight Blade Plugs & Connectors

2-Pole, 3-Wire Grounding
15A, 250V/AC
NEMA 6-15

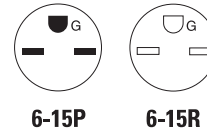

Hospital Grade Plugs & Connectors

Safety Grip™ NEMA 6-15



Rating		Product Type & Cord Diameter	Body Color	Plug	Catalog No.	
A	V/AC				Plug	Connector
15	250	● Angled Body 0.33-0.66" (7.6-16.7mm)	Black & White	□ 6665HG	●	—
		● Angled Body 0.33-0.66" (7.6-16.7mm)	Clear	□ 6665HGC	●	—

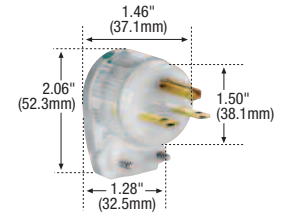

6665HGC

Hospital Specification Grade Straight Blade Plugs & Connectors

2-Pole, 3-Wire Grounding
20A, 250V/AC
NEMA 6-20

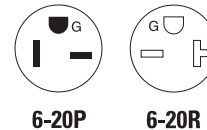

Hospital Grade Plugs & Connectors

Safety Grip™ NEMA 6-20



Rating		Product Type & Cord Diameter	Body Color	Plug	Catalog No.	
A	V/AC				Plug	Connector
20	250	● Angled Body 0.33-0.66" (7.6-16.7mm)	Black & White	□ 6865HG	●	—
		● Angled Body 0.33-0.66" (7.6-16.7mm)	Clear	□ 6865HGC	●	—



6865HG

Icon Key

● Hospital Grade Device

🇺🇸 NAFTA Compliant - see page O-30

Hospital Grade Dimensional Information: B-18

Specification Information:

Safety Grip HG Plugs & Connectors: B-25

For applications where the need for a secure connection is absolute

Power-Lock™ devices are designed for safety, energizing within a chamber to eliminate the possibility of exterior arcing. They are ideal for high-abuse industrial and specialized hospital applications.



Nylon Power-Lock Plugs & Connectors

High-impact nylon shell ideal for use in high abuse installations

Neoprene gasket seals cord entry hole and prevents dust and moisture from entering terminal area

Tapered cord grip cover prevents cord snagging

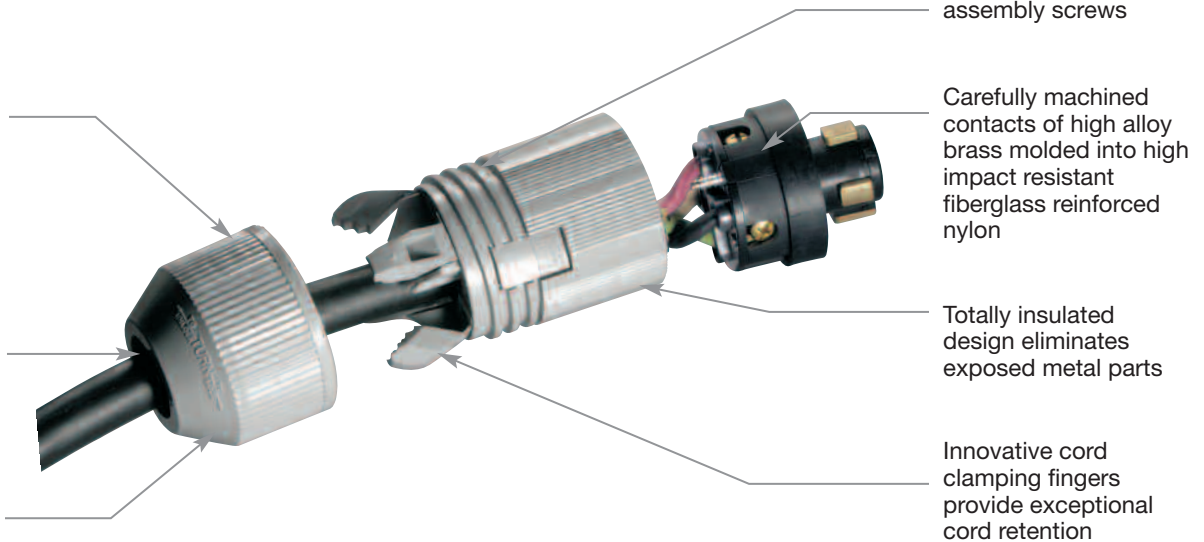

Unique twist type cover eliminates assembly screws

Carefully machined contacts of high alloy brass molded into high impact resistant fiberglass reinforced nylon

Totally insulated design eliminates exposed metal parts

Innovative cord clamping fingers provide exceptional cord retention

Armored Power-Lock Plugs & Connectors

Adjustable external metal cord grip accepts a wide range of cord diameters

Neoprene grommet protects against contamination

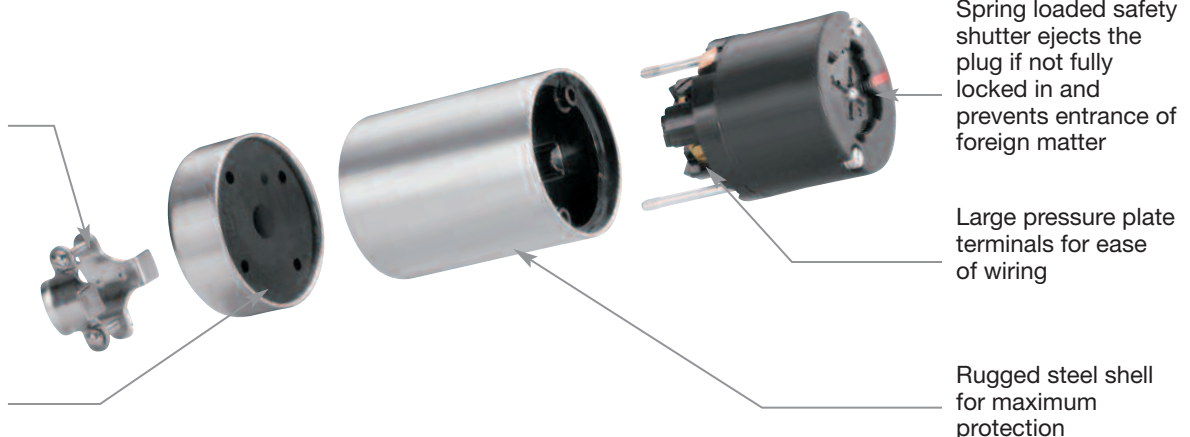

Spring loaded safety shutter ejects the plug if not fully locked in and prevents entrance of foreign matter

Large pressure plate terminals for ease of wiring

Rugged steel shell for maximum protection

Power-Lock™ Hospital Use Locking Devices

2-Pole, 3-Wire Grounding
20A, 125V/AC
Non-NEMA

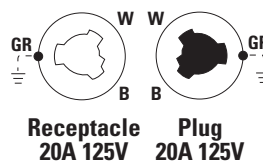

20A, 125V/AC Non-NEMA

Hospital Use Power-Lock Plugs & Connectors

Style & Description	Cord Dia.	Catalog No.		Certifications				
		Plug	Connector	US	CS	UK	US	US
Nylon Back Wired "Dead Front" Design, Gray	0.33-0.66" (8.4-16.7mm)	□ 23056N	□ 23054N	•				•
Armored Back Wired "Dead Front" Design, Gray	0.33-0.66" (8.4-16.7mm)	□ 23056	□ 23054	•				•



23054

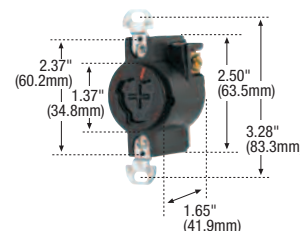

23050

Hospital Use Power-Lock Receptacles

Style & Description	Catalog No.		Certifications				
	Single Receptacle		US	CS	UK	US	US
Receptacle, not for use in Hazardous Areas	□ 23050		•	•			•

Power-Lock™ Hospital Use Mobile X-Ray™ Devices

2-Pole, 3-Wire Grounding
50A, 250V/AC
Non-NEMA

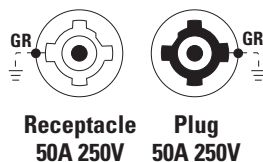

50A, 250V/AC Non-NEMA

Hospital Use Power-Lock Plugs

Style & Description	Cord Dia.	Catalog No.		Certifications				
		Plug		US	CS	UK	US	US
Back Wired "Dead Front" Design, Gray	0.75-1.25" (19.1-31.8mm)	□ 25525		•				•



25525

Hospital Use Power-Lock Receptacles

Style & Description	Catalog No.		Certifications				
	Single Receptacle		US	CS	UK	US	US
Receptacle in Plate Assembly, Stainless Steel	□ 25505		•	•			•

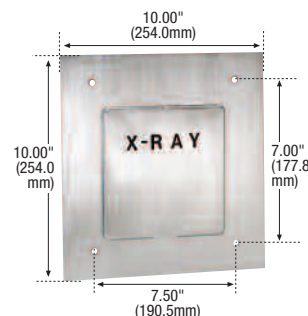

25505

Icon Key

NAFTA Compliant - see page O-30

Accessories for Power-Lock Hospital Use Locking Devices

Description	Catalog No.	
Steel 50A receptacle wallbox, KO sizes 1.25" (31.9mm), 1.50" (38.1mm), 2" (50.8mm)	□ 25509	•

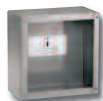

25509

Dimensional Information: C-85
Plug Specification Information:
Hospital Power-Lock: C-102

Receptacle Specification Information:
Hospital Power-Lock: C-102

Power-Lock™ Hospital Use Mobile X-Ray™ Devices

2-Pole, 3-Wire Grounding
60A, 250V/AC
Non-NEMA

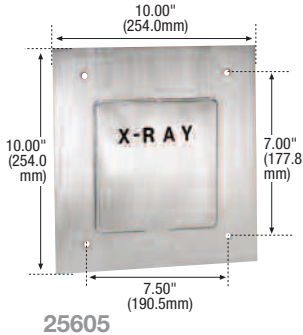
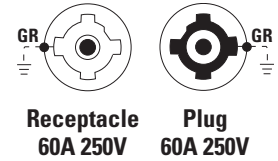

60A, 250V/AC Non-NEMA

Hospital Use Power-Lock Plugs

Style & Description	Cord Dia.	Catalog No.	Certifications					
			Plug	USA	UL	UL	UL	UL
Back Wired "Dead Front" Design, Gray	0.75-1.25" (19.1-31.8mm)	□ 25625	•					

Hospital Use Power-Lock Receptacles

Style & Description	Catalog No.	Certifications				
		Single Receptacle	USA	UL	UL	UL
Receptacle in Plate Assembly, Stainless Steel	□ 25605	•				

Icon Key

NAFTA Compliant - see page O-30

Accessories for Power-Lock Hospital Use Locking Devices

Description	Catalog No.	USA
Steel 50A receptacle wallbox, KO sizes 1.25" (31.9mm), 1.50" (38.1mm), 2" (50.8mm)	□ 25509	•

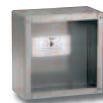

25509

Dimensional Information: C-85
Plug Specification Information:
Hospital Power-Lock: C-102

Receptacle Specification
Information:

Hospital Power-Lock: C-102

Advanced LED technology

Arrow Hart's innovative LED Accent Lights provide functional task lighting or pathway illumination.



LED Accent Lights

Illuminated push button switch can be used in patient rooms without disturbing patients' sleep

LED light provides powerful illumination with 30 lumens for LNL3 and LNL2 models and 15 lumens for LNL1 and LNL4 models

Polycarbonate lens protects electronics from tampering

Fits into standard junction box with one-gang plaster ring for easy installation

Energy-efficient LED 3W or 4W light available in white, amber and red

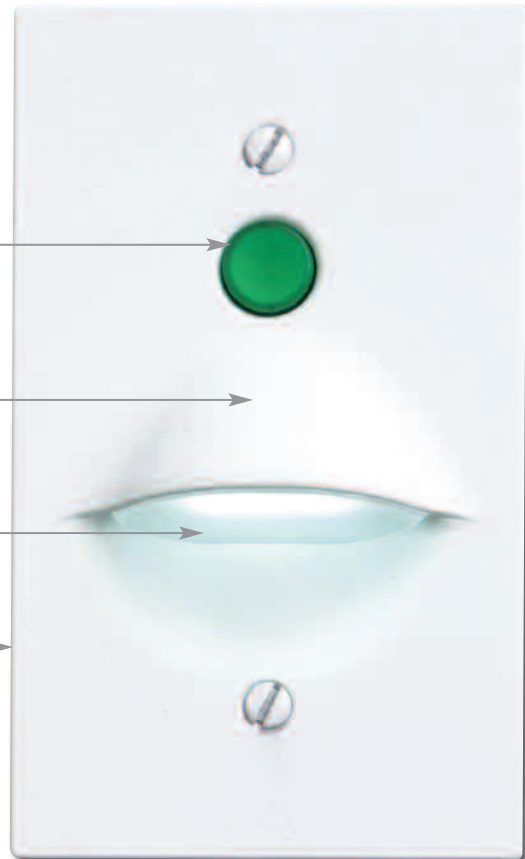

Additional Features and Benefits

- Integrated, illuminated push-button switch standard on LNL2 model
- Wet location configurations available
- Low voltage models available
- Narrow depth is ADA compliant
- White painted faceplate is standard; black and brushed nickel paint options are available
- Operates on standard 120V power supply
- Aluminum louvered or scoop faceplate displays light evenly



LNL1 Series

LED Accent Lights

LED Nightlights with Vertical Louvered Faceplate

W	V/AC	Description	Cat. No.	Faceplate	LED Colors
4	120	Standard	<input type="checkbox"/> LNL1__120	W, B, BN	A, R, W
		Wet Location	<input type="checkbox"/> LNL1__120-WL	W, B, BN	A, R, W
12-24		Low Voltage	<input type="checkbox"/> LNL1__LV	W, B, BN	A, R, W
		Low Voltage, Wet Location	<input type="checkbox"/> LNL1__LV-WL	W, B, BN	A, R, W



LNL2 Series

LED Chart Lights with Push Button Switch & Vertical Scoop Faceplate

W	V/AC	Description	Cat. No.	Faceplate	LED Colors
3	120	Standard	<input type="checkbox"/> LNL2__120	W	W
		Wet Location	<input type="checkbox"/> LNL2__120-WL	W	W
12-24		Low Voltage	<input type="checkbox"/> LNL2__LV	W	W
		Low Voltage, Wet Location	<input type="checkbox"/> LNL2__LV-WL	W	W



LNL3 Series

LED Nightlights with Vertical Scoop Faceplate

W	V/AC	Description	Cat. No.	Faceplate	LED Colors
3	120	Standard	<input type="checkbox"/> LNL3__120	W, B, BN	A, R, W
		Wet Location	<input type="checkbox"/> LNL3__120-WL	W, B, BN	A, R, W
12-24		Low Voltage	<input type="checkbox"/> LNL3__LV	W, B, BN	A, R, W
		Low Voltage, Wet Location	<input type="checkbox"/> LNL3__LV-WL	W, B, BN	A, R, W



LNL4 Series

LED Nightlights with Horizontal Louvered Faceplate

W	V/AC	Description	Cat. No.	Faceplate	LED Colors
4	120	Standard	<input type="checkbox"/> LNL4__120	W, B, BN	A, R, W
		Wet Location	<input type="checkbox"/> LNL4__120-WL	W, B, BN	A, R, W
12-24		Low Voltage	<input type="checkbox"/> LNL4__LV	W, B, BN	A, R, W
		Low Voltage, Wet Location	<input type="checkbox"/> LNL4__LV-WL	W, B, BN	A, R, W

Color Ordering Information

For ordering, include Cat. No. followed by the color code. Faceplates: W (White), B (Black), BN (Brushed Nickel)
LED color: A (Amber), R (Red) W (White). **Example:** LNL4WA120 (white faceplate and amber LED).

Specification Information:
LED Accent Lights: J-22

Certifications

LED accent lights are UL and CSA certified.
ADA Compliant

Pre-Marked Special Use, Standard Size

Description	Material	Catalog No.	Colors	
1-Gang Toggle "Emergency"	Nylon	□ EM5134 __	RD	•
	302/304 Stainless Steel	□ EM93071	—	•
1-Gang Duplex Receptacle "Isolated Ground"	Nylon	□ IG5132 __	GY, V, RN, W	•
	302/304 Stainless Steel	□ IG93101	—	•
1-Gang Duplex Receptacle "Emergency"	Nylon	□ EM5132 __	RD	•
	302/304 Stainless Steel	□ EM93101	—	•
1-Gang Single Receptacle with 1.40" (35.7mm) Hole "Isolated Ground"	Nylon	□ IG5131 __	V, RN	•
2-Gang Single Receptacle with 2.44" (61.9mm) Hole "Isolated Ground"	302/304 Stainless Steel	□ IG4518C	—	•
2-Gang Duplex Receptacle "Emergency"	302/304 Stainless Steel	□ EM93102	—	•

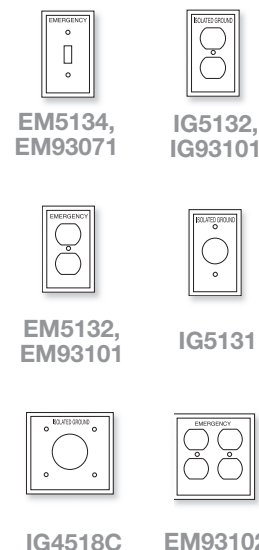

Pre-Marked Special Use, Mid-Sized

Description	Material	Catalog No.	Colors	
1-Gang Toggle "Emergency"	Polycarbonate	□ PJ1EM __	RD	
1-Gang Decorator "Computer"	Polycarbonate	□ PJ26CO __	BL, V, W	
1-Gang Decorator "Emergency"	Polycarbonate	□ PJ26EM __	RD	
1-Gang Decorator "GFCI Protected"	Polycarbonate	□ PJ26GF __	V, W	
1-Gang Orange Decorator "Isolated Ground"	Polycarbonate	□ PJ26IG	—	
1-Gang Orange Single Receptacle, 1.40" (35.7mm) Hole "Isolated Ground"	Polycarbonate	□ PJ7IG	—	
1-Gang Duplex Receptacle "Computer"	Polycarbonate	□ PJ8CO __	V, W	
1-Gang Duplex Receptacle "Emergency"	Polycarbonate	□ PJ8EM __	RD	
1-Gang Duplex Receptacle "GFCI Protected"	Polycarbonate	□ PJ8GF __	V, W	
1-Gang Duplex Receptacle "Isolated Ground"	Polycarbonate	□ PJ8IG __	RN	
2-Gang Toggle "Emergency"	Polycarbonate	□ PJ2EM __	RD	
2-Gang Duplex Receptacle "Emergency"	Polycarbonate	□ PJ82EM __	RD	

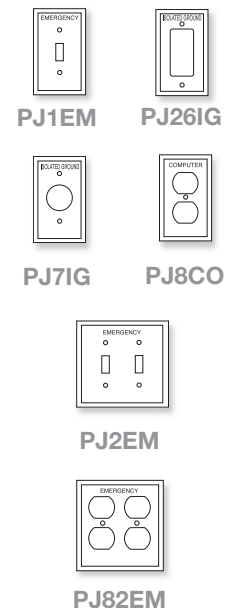

Color Ordering Information

For ordering wallplates, include Cat. No. followed by the color code: A (Almond), B (Brown), BK (Black), BL (Blue), GY (Gray), LA (Light Almond), RD (Red), RN (Orange), V (Ivory), W (White)

Icon Key

 NAFTA Compliant - see page O-30

Certifications

PJ series wallplates are cULus certified
 5000 series wallplates are cULus certified
 90000 series wallplates are UL and CSA certified

Specification Information:

Wallplates: J-21

J

Wallplates



	Page		Page
REPEL Wallplates	J-1	Oversize Wallplates	J-17
Wallplate Dimensional Information	J-2	Toggle Switch	J-17
Mounting Holes	J-2	Decorator	J-17
Plate and Cover Openings	J-2	Duplex Receptacle	J-17
Wallplate Sizes	J-3	Single Receptacle	J-17
Standard Size Wallplates	J-4	Blank - Box Mounted	J-18
Toggle Switch	J-4	Combination 2-Gang	J-18
Duplex Receptacle	J-5	Telephone & Coax	J-18
Single Receptacle	J-5	Accessories	J-18
Decorator	J-6	LED Accent Lights	J-19
Blank - Box Mounted	J-7	Vertical Louvered Faceplate	J-20
Louver	J-7	Vertical Scoop Faceplate With Push Button Switch	J-20
Telephone & Coax	J-8	Vertical Scoop Faceplate	J-20
Combination 2-Gang	J-8	Horizontal Louvered Faceplate	J-20
Combination 3-Gang	J-8	Specification Information	J-21
Combination 4-Gang	J-9		
Power Outlet	J-9		
Standard Size Wallplate Guide for Power Devices	J-9		
Extra Depth	J-10		
Pre-Marked Special Use	J-10		
Mid-Size Wallplates	J-11		
Toggle Switch	J-11		
Duplex Receptacle	J-11		
Single Receptacle	J-12		
Decorator	J-12		
Screwless Decorator	J-13		
Screwless Toggle	J-13		
Screwless Receptacle	J-13		
Blank - Box & Strap Mounted	J-14		
Telephone & Coax	J-14		
Combination 2-Gang	J-15		
Combination 3-Gang	J-15		
Power Outlet	J-15		
Mid-Size Wallplate Guide for Power Devices	J-15		
Sectional Wallplates	J-16		
Pre-Marked Special Use	J-16		

Rugged design and quality materials make Arrow Hart wallplates the best choice

Whether faced with a commercial, institutional or industrial setting, you will find the desired material, configuration, style, size and color you need.



Standard Size wallplates for precision cuts



Mid-Size and Oversize wallplates for applications that require additional wall coverage



Extra Depth wallplates to provide a flush fit to the wall when an old work outlet box is used



Specification Grade Thermoplastic

- Available in both Nylon and Polycarbonate constructions
- Virtually unbreakable plates reduce installation and replacement costs
- Preferred for industrial, institutional, and other high-traffic areas
- Exclusive timesaving Screw-Catch™ feature holds mounting screws captive and simplifies installation
- High gloss finish is soil-resistant
- Available in Standard Size and Mid-Size configurations with screwless and Pre-Marked Special Use versions available



Specification Grade Metal Wallplates

- Constructed of non-corrosive 302/304 Stainless Steel, Brass, or Chrome
- Available in Standard, Mid-Size, and Oversize configurations with Pre-Marked Special Use versions available
- 302/304 Stainless is non-magnetic and non-corrosive for rugged durability
- Solid brass is coated with transparent lacquer to resist premature oxidation
- Shipped with removable protective film
- Recommended for industrial, institutional, and commercial applications

REPEL Wallplates

Arrow Hart's REPEL Wallplates are the first of their kind with Agion® Additive



REPEL offers built-in product protection

**Stainless Steel**

Wallplates feature a powder coating that incorporates Agion® Silver Antimicrobial Additive

**Polycarbonate**

Wallplates incorporate Agion® Silver Antimicrobial additive into the plate material

REPEL switches are also available. See section D for ordering information.

**REPEL wallplates are perfect for:**

- Healthcare Facilities
- Schools, Classrooms, and Dormitories
- Assisted Living Facilities
- Food Service Areas
- Industrial Facilities
- Commercial Office Space
- Retail Common Areas

NOTE: REPEL products do not protect the user against disease causing organisms and ongoing regular cleaning practices should be maintained. Agion is a registered trademark of Agion Technologies, Inc., Wakefield, MA.

Mounting Holes for Wallplates and Covers

These are the most common nominal spacings for mounting holes on wallplates and covers. Holes are normally countersunk for oval head #6-32 screws.

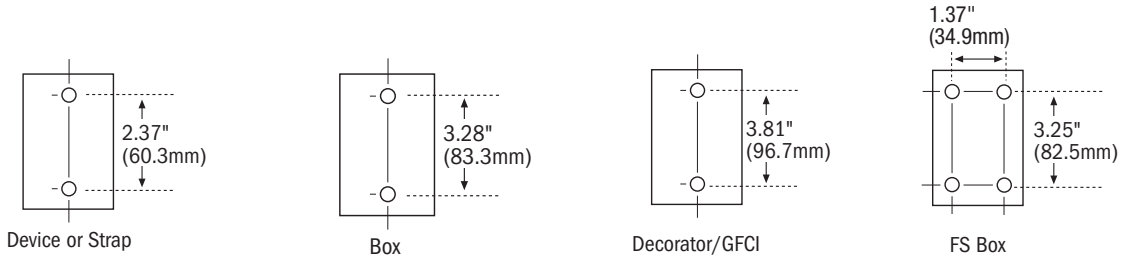
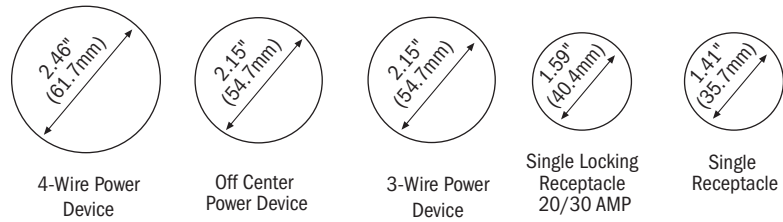

Plate and Cover Opening Dimensions

Cover Openings

Nominal dimensions for plate and cover openings conform to industry standards and practices.



Common Opening Configurations

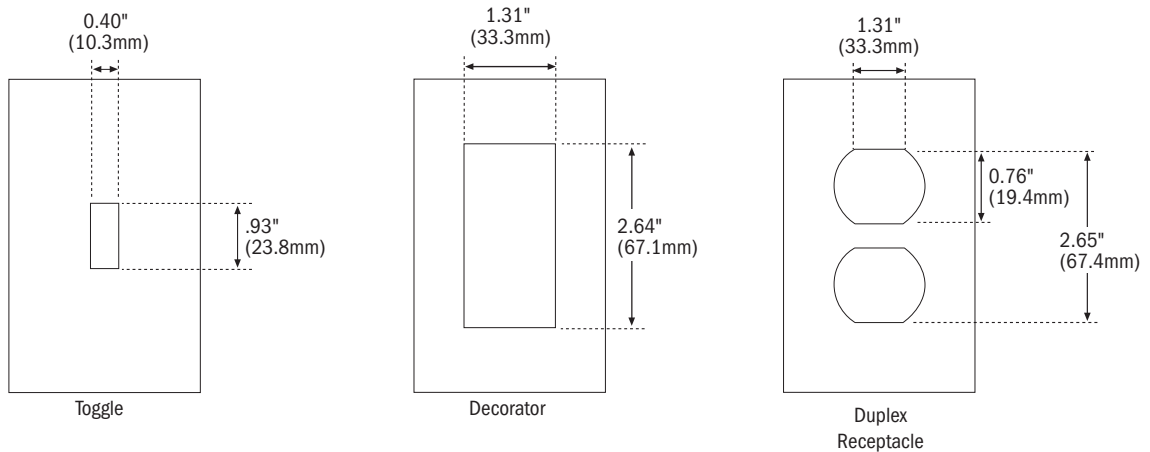

Wallplate Sizes

Description		Height	Width	First Gang to Edge	Gang to Gang
1-Gang	Standard	4.50" (114.3mm)	2.75" (69.8mm)	1.37" (34.9mm)	—
	Mid-Size	4.87" (123.8mm)	3.12" (79.4mm)	1.56" (39.7mm)	—
	Oversize	5.25" (133.3mm)	3.50" (88.9mm)	1.75" (44.4mm)	—
2-Gang	Standard	4.50" (114.3mm)	4.56" (115.9mm)	1.37" (34.9mm)	1.81" (46.0mm)
	Mid-Size	4.87" (123.8mm)	4.94" (125.4mm)	1.56" (39.7mm)	1.81" (46.0mm)
	Oversize	5.25" (133.3mm)	5.31" (134.9mm)	1.75" (44.4mm)	1.81" (46.0mm)
3-Gang	Standard	4.50" (114.3mm)	6.37" (161.9mm)	1.37" (34.9mm)	1.81" (46.0mm)
	Mid-Size	4.87" (123.8mm)	6.75" (171.4mm)	1.56" (39.7mm)	1.81" (46.0mm)
	Oversize	5.25" (133.4mm)	7.17" (182.2mm)	1.75" (44.4mm)	1.81" (46.1mm)
4-Gang	Standard	4.50" (114.3mm)	8.19" (207.9mm)	1.37" (34.9mm)	1.81" (46.0mm)
	Mid-Size	4.87" (123.8mm)	8.56" (217.5mm)	1.56" (39.7mm)	1.81" (46.0mm)
	Oversize	5.25" (133.3mm)	8.94" (227.0mm)	1.75" (44.4mm)	1.81" (46.0mm)
5-Gang	Standard	4.50" (114.3mm)	10.00" (254.0mm)	1.37" (34.9mm)	1.81" (46.0mm)
	Mid-Size	4.87" (123.8mm)	10.37" (263.5mm)	1.56" (39.7mm)	1.81" (46.0mm)
6-Gang	Standard	4.50" (114.3mm)	11.81" (300.0mm)	1.37" (34.9mm)	1.81" (46.0mm)
	Mid-Size	4.87" (123.8mm)	12.18" (309.5mm)	1.56" (39.7mm)	1.81" (46.0mm)

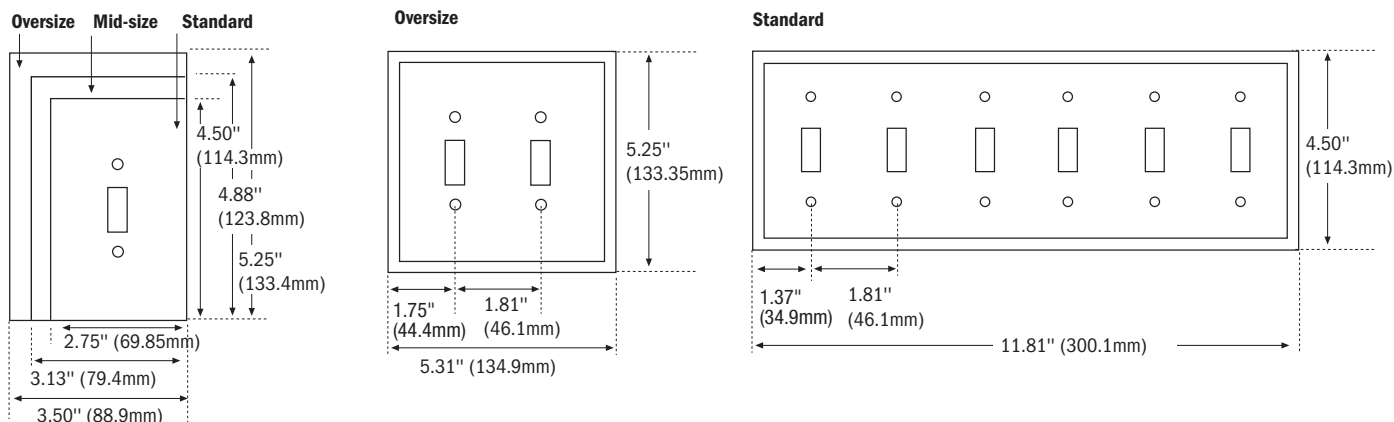



1-Gang



2-Gang

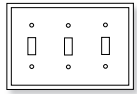

3-Gang

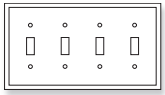

4-Gang

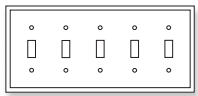

5-Gang

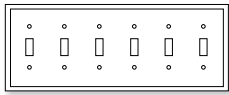

6-Gang

Toggle Switch

Description	Material	Catalog No.	Colors		
1-Gang Toggle	Nylon	□ 5134__	A, B, BK, GY, LA, RD, V, W		•
	Thermoset	□ 2134__	A, B, LA, V, W		•
	302/304 Stainless Steel	□ 93071	—		•
	REPEL, 302/304 Stainless Steel	□ 93071AM	—	•	•
2-Gang Toggle	Nylon	□ 5139__	A, B, BK, GY, LA, RD, V, W		•
	Thermoset	□ 2139__	A, B, LA, V, W		•
	302/304 Stainless Steel	□ 93072	—		•
	REPEL, 302/304 Stainless Steel	□ 93072AM	—	•	•
3-Gang Toggle	Nylon	□ 5141__	A, B, BK, GY, LA, V, W		•
	Thermoset	□ 2141__	A, B, LA, V, W		•
	302/304 Stainless Steel	□ 93073	—		•
	REPEL 302/304, Stainless Steel	□ 93073AM	—	•	•
4-Gang Toggle	Nylon	□ 5154__	A, B, BK, GY, LA, V, W		•
	Thermoset	□ 2154__	A, B, LA, V, W		•
	302/304 Stainless Steel	□ 93074	—		•
	REPEL 302/304 Stainless Steel	□ 93074AM	—	•	•
5-Gang Toggle	Thermoset	□ 2155__	A, B, LA, V, W		•
	302/304 Stainless Steel	□ 93075	—		•
6-Gang Toggle	Thermoset	□ 2156__	A, B, V, W		•
	302/304 Stainless Steel	□ 93076	—		•

Color Ordering Information

For ordering wallplates, include Cat. No. followed by the color code: A (Almond), B (Brown), BK (Black), BL (Blue), GY (Gray), LA (Light Almond), RD (Red), RN (Orange), V (Ivory), W (White)

Icon Key

- NAFTA Compliant - see page O-30
- REPEL Wallplates - see page J-1



Certifications

2000 series wallplates are cULus certified
 5000 series wallplates are cULus certified
 90000 series wallplates are UL and CSA certified

Specification Information:

Wallplates: J-21

Duplex Receptacle

Description	Material	Catalog No.	Colors		
1-Gang Duplex	Nylon	□ 5132__	A, B, BK, GY, LA, RD, V, W		•
	Thermoset	□ 2132__	A, B, LA, V, W		•
	302/304 Stainless Steel	□ 93101	—		•
	REPEL 302/304 Stainless Steel	□ 93101AM	—	•	•
	Brass	□ 94101	—		•
2-Gang Duplex	Nylon	□ 5150__	A, B, BK, GY, LA, RD, V, W		•
	Thermoset	□ 2150__	A, B, LA, V, W		•
	302/304 Stainless Steel	□ 93102	—		•
	REPEL 302/304 Stainless Steel	□ 93102AM	—	•	•
	Brass	□ 94102	—		•
3-Gang Duplex	302/304 Stainless Steel	□ 93103	—		•
	REPEL, 302/304 Stainless Steel	□ 93103AM	—	•	•



1-Gang



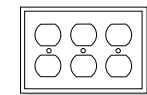

2-Gang



3-Gang

Single Receptacle

Description	Material	Catalog No.	Colors		
1-Gang Single Receptacle with 1.406" (35.712mm) Hole	Nylon	□ 5131__	A, B, BK, GY, LA, V, W		•
	Thermoset	□ 2131__	A, B, LA, V, W		•
	302/304 Stainless Steel	□ 93091	—		•
	REPEL, 302/304 Stainless Steel	□ 93091AM	—	•	•
	Brass	□ 94091	—		•





1-Gang

Color Ordering Information

For ordering wallplates, include Cat. No. followed by the color code: A (Almond), B (Brown), BK (Black), BL (Blue), GY (Gray), LA (Light Almond), RD (Red), RN (Orange), V (Ivory), W (White)

Icon Key

-  NAFTA Compliant - see page O-30
-  REPEL Wallplates - see page J-1

Certifications

2000 series wallplates are cULus certified
 5000 series wallplates are cULus certified
 90000 series wallplates are UL and CSA certified

Specification Information:

Wallplates: J-21

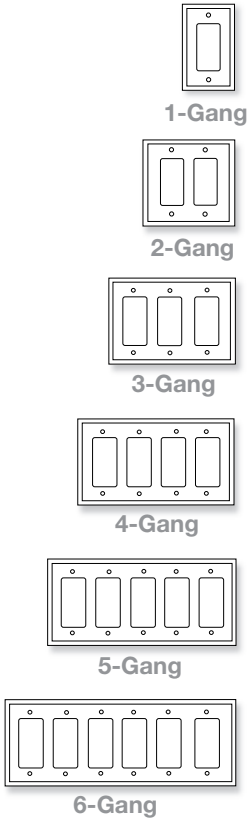

Decorator

Description	Material	Catalog No.	Colors		
1-Gang Decorator	Nylon	□ 5151 __	A, B, BL, BK, GY, LA, RD, V, W		•
	Thermoset	□ 2151 __	A, B, BK, GY, LA, V, W		•
	302/304 Stainless Steel	□ 93401	—		•
	REPEL, 302/304 Stainless Steel	□ 93401AM	—	•	•
2-Gang Decorator	Nylon	□ 5152 __	A, B, BK, GY, LA, V, W		•
	Thermoset	□ 2152 __	A, B, BK, GY, LA, V, W		•
	302/304 Stainless Steel	□ 93402	—		•
	REPEL, 302/304 Stainless Steel	□ 93402AM	—	•	•
3-Gang Decorator	Thermoset	□ 2163 __	A, BK, GY, LA, V, W		•
	302/304 Stainless Steel	□ 93403	—		•
	REPEL, 302/304 Stainless Steel	□ 93403AM	—	•	•
	Thermoset	□ 2164 __	A, B, LA, V, W		•
4-Gang Decorator	302/304 Stainless Steel	□ 93404	—		•
	REPEL, 302/304 Stainless Steel	□ 93404AM	—	•	•
	Thermoset	□ 2165 __	A, B, LA, V, W		•
5-Gang Decorator	302/304 Stainless Steel	□ 93405	—		•
	Thermoset	□ 2166 __	A, B, LA, V, W		•
6-Gang Decorator	302/304 Stainless Steel	□ 93406	—		•

Color Ordering Information

For ordering wallplates, include Cat. No. followed by the color code: A (Almond), B (Brown), BK (Black), BL (Blue), GY (Gray), LA (Light Almond), RD (Red), RN (Orange), V (Ivory), W (White)

Icon Key

- NAFTA Compliant - see page O-30
- REPEL Wallplates - see page J-1



Certifications

2000 series wallplates are cULus certified
 5000 series wallplates are cULus certified
 90000 series wallplates are UL and CSA certified

Specification Information:

Wallplates: J-21

Blank - Box Mounted

Description	Material	Catalog No.	Colors		
1-Gang	Nylon	□ 5129__	A, B, BK, GY, LA, V, W		•
	Thermoset	□ 2129__	A, B, LA, V, W		•
	302/304 Stainless Steel	□ 93151	—		•
	REPEL, 302/304 Stainless Steel	□ 93151AM	—	•	•
	Brass	□ 94151	—		•
2-Gang	Nylon	□ 5137__	A, B, BK, GY, LA, V, W		•
	Thermoset	□ 2137__	A, B, LA, V, W		•
	302/304 Stainless Steel,	□ 93152	—		•
	REPEL, 302/304 Stainless Steel	□ 93152AM	—	•	•
3-Gang	302/304 Stainless Steel	□ 93153	—		•
	REPEL, 302/304, Stainless Steel	□ 93153AM	—	•	•
4-Gang	302/304 Stainless Steel	□ 93154	—		•
	REPEL, 302/304 Stainless Steel	□ 93154AM	—	•	•



1-Gang

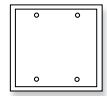

2-Gang

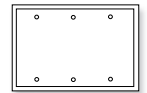

3-Gang

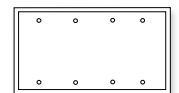

4-Gang

Louver

Description	Material	Catalog No.	
Horizontal	302/304 Stainless Steel	□ 93630	•
Vertical	302/304 Stainless Steel	□ 93631	•

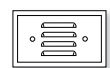

93630

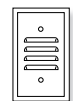



93631

Color Ordering Information

For ordering wallplates, include Cat. No. followed by the color code: A (Almond), B (Brown), BK (Black), BL (Blue), GY (Gray), LA (Light Almond), RD (Red), RN (Orange), V (Ivory), W (White)

Icon Key

-  NAFTA Compliant - see page O-30
-  REPEL Wallplates - see page J-1

Certifications

2000 series wallplates are cULus certified
 5000 series wallplates are cULus certified
 90000 series wallplates are UL and CSA certified

Specification Information:

Wallplates: J-21



1-Gang,
0.375"
Hole



1-Gang,
0.625"
Hole



2-Gang, Toggle
& Single Receptacle



2-Gang, Toggle
& Duplex Receptacle



2-Gang, Toggle &
Decorator



2-Gang, Toggle & Blank



2-Gang, Duplex
Receptacle & Blank



2-Gang, Duplex
Receptacle & Decorator

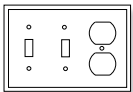

3-Gang, 2 Toggles &
Duplex Receptacle

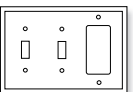

3-Gang, 2 Toggles &
Decorator

Specification Information:

Wallplates: J-21

Telephone & Coax

Description	Material	Catalog No.	Colors	
1-Gang with 0.375" (9.525mm) Hole	Nylon	□ 5128__	B, GY, V, W	•
	Thermoset	□ 2128__	A, B, LA, V, W	•
	302/304 Stainless Steel	□ 93696		•
1-Gang with 0.625" (15.875mm) Hole	Nylon	□ 5159__	B, GY, V, W	•
	Thermoset	□ 2159__	A, B, V, W	•
	302/304 Stainless Steel	□ 93591	-	•

Combination 2-Gang

Description	Material	Catalog No.	Colors	
Toggle & Single Receptacle	302/304 Stainless Steel	□ 93512	—	•
Toggle & Duplex Receptacle	Nylon	□ 5138__	A, B, BK, GY, LA, V, W	•
	Thermoset	□ 2138__	A, B, GY, LA, V, W	•
	302/304 Stainless Steel	□ 93532	—	•
Toggle & Decorator	Brass	□ 94532	—	•
	Nylon	□ 5153__	A, B, BK, GY, LA, V, W	•
	Thermoset	□ 2153__	A, B, LA, V, W	•
Toggle & Blank	302/304 Stainless Steel	□ 93432	—	•
	Brass	□ 94432	—	•
	Nylon	□ 5171__	A, B, BK, LA, V	•
Duplex Receptacle & Blank	Nylon	□ 5170__	A, B, BK, LA, V	•
Duplex Receptacle & Decorator	Thermoset	□ 2157__	A, LA, V, W	•

Combination 3-Gang

Description	Material	Catalog No.	Colors	
2 Toggles & Duplex Receptacle	Nylon	□ 5158__	B, GY, V, W	•
	Thermoset	□ 2158__	A, B, LA, V, W	•
	302/304 Stainless Steel	□ 93543	—	•
2 Toggles & Decorator	Thermoset	□ 2173__	A, LA, V, W	•
	302/304 Stainless Steel	□ 93443	—	•

Color Ordering Information

For ordering wallplates, include Cat. No. followed by the color code: A (Almond), B (Brown), BK (Black), BL (Blue), GY (Gray), LA (Light Almond), RD (Red), RN (Orange), V (Ivory), W (White)

Icon Key

NAFTA Compliant - see page O-30

Certifications

2000 series wallplates are cULus certified
5000 series wallplates are cULus certified
90000 series wallplates are UL and CSA certified

Combination 4-Gang

Description	Material	Catalog No.	Colors	
3 Toggles & Duplex Receptacle	Thermoset	□ 2174__	A, LA, V, W	•
	302/304 Stainless Steel	□ 93554	—	•

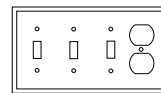

4-Gang, 3 Toggles & Duplex Receptacle

Power Outlet

Description	Material	Catalog No.	Colors	
1-Gang with 1.59" (40.5mm) Hole	302/304 Stainless Steel	□ 93111	—	•
1-Gang with 2.15" (54.8mm) Hole	Thermoset	□ 2068	A, B, V, W	•
	302/304 Stainless Steel	□ 93221	—	•
	Chrome	□ 39CH*	—	•
2-Gang with 2.15" (54.7mm) Hole	Thermoset	□ 2168__	A, B, LA, V, W	•
	302/304 Stainless Steel	□ 93227	—	•
	Chrome	□ 68*	—	•
2-Gang with 2.15" (54.7mm) Off Center Hole	Chrome	□ 192*	—	•
2-Gang with 2.28" (57.9mm) Hole	302/304 Stainless Steel	□ 93228	—	•
2-Gang with 2.47" (62.7mm) Hole	302/304 Stainless Steel	□ 93223	—	•
	Chrome	□ 69*	—	•
2-Gang with 2.47" (62.7mm) Hole	Nylon	□ 5169__	B, V, W	•

* UL certified



93111



93221



192



93223, 69



2168
93227, 68



93228

Standard Size Wallplate Guide for Power Devices

Power Device Catalog No.	Wallplate Catalog No.
32B, 38B, 1233, 1234, 1253, 1254, 1257, 1258, 1263, 5700N, 5709N, 5716N, 5795N, 7985N	39CH, 68, 2068, 2168, 93221, 93227
5515N, 5744N, 5754N, 8430N, 8450N, 8460N, 9460N	69, 5169, 93223
122B	192

Color Ordering Information

For ordering wallplates, include Cat. No. followed by the color code: A (Almond), B (Brown), BK (Black), BL (Blue), GY (Gray), LA (Light Almond), RD (Red), RN (Orange), V (Ivory), W (White)

Icon Key

 NAFTA Compliant - see page O-30

Certifications

2000 series wallplates are cULus certified
 5000 series wallplates are cULus certified
 90000 series wallplates are UL and CSA certified

Specification Information:

Wallplates: J-21



Extra Depth*

Description	Material	Catalog No.	Colors	
1-Gang Toggle	Thermoset	□ 4134 __	V, W	•
1-Gang Duplex Receptacle	Thermoset	□ 4132 __	V, W	•
2-Gang Toggle	Thermoset	□ 4139 __	V, W	•
2-Gang Duplex Receptacle	Thermoset	□ 4150 __	V, W	•
2-Gang Blank	Thermoset	□ 4137 __	V, W	•
2-Gang Toggle & Duplex Receptacle	Thermoset	□ 4138 __	V, W	•
2-Gang Toggle & Blank	Thermoset	□ 4171 __	V, W	•
2-Gang Duplex Receptacle & Blank	Thermoset	□ 4170 __	V, W	•

*Extra Depth Wallplates are approximately 10% deeper than standard size/standard depth counterparts.



Pre-Marked Special Use, Standard Size

Description	Material	Catalog No.	Colors	
1-Gang Toggle "Emergency"	Nylon 302/304 Stainless Steel	□ EM5134 __ □ EM93071	RD —	• •
1-Gang Duplex Receptacle "Isolated Ground"	Nylon 302/304 Stainless Steel	□ IG5132 __ □ IG93101	GY, V, RN, W —	• •
1-Gang Duplex Receptacle "Emergency"	Nylon 302/304 Stainless Steel	□ EM5132 __ □ EM93101	RD —	• •
1-Gang Single Receptacle with 1.40" (35.7mm) Hole "Isolated Ground"	Nylon	□ IG5131 __	V, RN	•
2-Gang Single Receptacle with 2.44" (61.9mm) Hole "Isolated Ground"	302/304 Stainless Steel	□ IG4518C	—	•
2-Gang Duplex Receptacle "Emergency"	302/304 Stainless Steel	□ EM93102	—	•

Color Ordering Information

For ordering wallplates, include Cat. No. followed by the color code: A (Almond), B (Brown), BK (Black), BL (Blue), GY (Gray), LA (Light Almond), RD (Red), RN (Orange), V (Ivory), W (White)

Icon Key

NAFTA Compliant - see page O-30



Certifications

2000 series wallplates are cULus certified
 4000 series wallplates are cULus certified
 5000 series wallplates are cULus certified
 90000 series wallplates are UL and CSA certified

Specification Information:

Wallplates: J-21

Toggle Switch

Description	Material	Catalog No.	Colors		
1-Gang Toggle	Polycarbonate	<input type="checkbox"/> PJ1 __	A, B, BK, GY, LA, RD, V, W		
	REPEL Polycarbonate	<input type="checkbox"/> PJ1AM __	GY, RD, V, W	•	
	Thermoset	<input type="checkbox"/> 2034 __	A, B, LA, V, W		•
	302/304 Stainless Steel	<input type="checkbox"/> 93971	—		•
2-Gang Toggle	Polycarbonate	<input type="checkbox"/> PJ2 __	A, B, BK, GY, LA, RD, V, W		
	REPEL Polycarbonate	<input type="checkbox"/> PJ2AM __	GY, RD, V, W	•	
	Thermoset	<input type="checkbox"/> 2039 __	A, B, LA, V, W		•
	302/304 Stainless Steel	<input type="checkbox"/> 93972	—		•
3-Gang Toggle	Polycarbonate	<input type="checkbox"/> PJ3 __	B, BK, GY, LA, RD, V, W		
	REPEL Polycarbonate	<input type="checkbox"/> PJ3AM __	GY, RD, V, W	•	
	Thermoset	<input type="checkbox"/> 2041 __	A, B, LA, V, W		•
	302/304 Stainless Steel	<input type="checkbox"/> 93973	—		•
4-Gang Toggle	Polycarbonate	<input type="checkbox"/> PJ4 __	A, B, BK, GY, LA, V, W		
	REPEL Polycarbonate	<input type="checkbox"/> PJ4AM __	GY, V, W	•	
	Thermoset	<input type="checkbox"/> 2054 __	A, LA, V, W		•
5-Gang Toggle	Polycarbonate	<input type="checkbox"/> PJ5 __	A, B, BK, GY, LA, V, W		
6-Gang Toggle	Polycarbonate	<input type="checkbox"/> PJ6 __	A, B, BK, GY, LA, V, W		



1-Gang

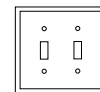

2-Gang

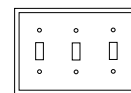

3-Gang

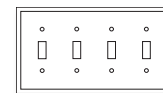

4-Gang

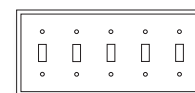

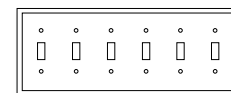

5-Gang



6-Gang

Duplex Receptacle

Description	Material	Catalog No.	Colors		
1-Gang	Polycarbonate	<input type="checkbox"/> PJ8 __	A, B, BK, BL, GY, LA, RD, V, W		
	REPEL Polycarbonate	<input type="checkbox"/> PJ8AM __	GY, RD, V, W	•	
	Thermoset	<input type="checkbox"/> 2032 __	A, B, LA, V, W		•
	302/304 Stainless Steel	<input type="checkbox"/> 93901	—		•
2-Gang	Polycarbonate	<input type="checkbox"/> PJ82 __	A, B, BK, GY, LA, RD, V, W		
	REPEL Polycarbonate	<input type="checkbox"/> PJ82AM __	GY, RD, V, W	•	
	Thermoset	<input type="checkbox"/> 2050 __	A, V, LA, W		•
	302/304 Stainless Steel	<input type="checkbox"/> 93902	—		•



1-Gang

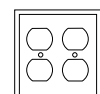



2-Gang

Color Ordering Information

For ordering wallplates, include Cat. No. followed by the color code: A (Almond), B (Brown), BK (Black), BL (Blue), GY (Gray), LA (Light Almond), RD (Red), RN (Orange), V (Ivory), W (White)

Icon Key

-  NAFTA Compliant - see page O-30
-  REPEL Wallplates - see page J-1

Certifications

2000 series wallplates are cULus certified
 5000 series wallplates are cULus certified
 90000 series wallplates are UL and CSA certified

Specification Information:

Wallplates: J-21



1-Gang
with 1.406"
Hole

Single Receptacle

Description	Material	Catalog No.	Colors	
1-Gang with 1.406" (35.712mm) Hole	Thermoset	<input type="checkbox"/> 2031 __	A, B, LA, V, W	•
	302/304 Stainless Steel	<input type="checkbox"/> 93991	—	•



1-Gang

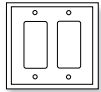

2-Gang

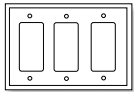

3-Gang

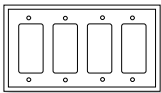

4-Gang

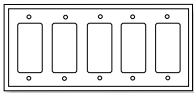

5-Gang

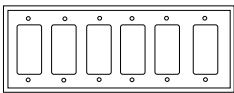

6-Gang

Decorator

Description	Material	Catalog No.	Colors		
1-Gang	Polycarbonate	<input type="checkbox"/> PJ26 __	A, B, BK, BL, GY, LA, RD, V, W		
	REPEL Polycarbonate	<input type="checkbox"/> PJ26AM __	GY, RD, V, W	•	
	Thermoset	<input type="checkbox"/> 2051 __	A, B, LA, V, W		•
	302/304 Stainless Steel	<input type="checkbox"/> 93934	—		•
2-Gang	Polycarbonate	<input type="checkbox"/> PJ262 __	A, B, BK, BL, GY, LA, RD, RN, V, W		
	REPEL Polycarbonate	<input type="checkbox"/> PJ262AM __	GY, RD, V, W	•	
	Thermoset	<input type="checkbox"/> 2052 __	A, LA, V, W		•
	302/304 Stainless Steel	<input type="checkbox"/> 93935	—		•
3-Gang	Polycarbonate	<input type="checkbox"/> PJ263 __	A, B, BK, GY, LA, V, W		
	REPEL Polycarbonate	<input type="checkbox"/> PJ263AM __	GY, V, W	•	
	Thermoset	<input type="checkbox"/> 2063 __	A, LA, V, W		•
	302/304 Stainless Steel	<input type="checkbox"/> 93936	—		•
4-Gang	Polycarbonate	<input type="checkbox"/> PJ264 __	A, B, BK, GY, LA, V, W		
	REPEL Polycarbonate	<input type="checkbox"/> PJ264AM __	GY, V, W	•	
	Thermoset	<input type="checkbox"/> 2064 __	A, LA, V, W		•
5-Gang	Polycarbonate	<input type="checkbox"/> PJ265 __	A, B, BK, GY, LA, V, W		
6-Gang	Polycarbonate	<input type="checkbox"/> PJ266 __	A, B, BK, GY, LA, V, W		

Color Ordering Information

For ordering wallplates, include Cat. No. followed by the color code: A (Almond), B (Brown), BK (Black), BL (Blue), GY (Gray), LA (Light Almond), RD (Red), RN (Orange), V (Ivory), W (White)

Specification Information:

Wallplates: J-21

Icon Key

- NAFTA Compliant - see page O-30
- REPEL Wallplates - see page J-1

Certifications

PJ & PJS series wallplates are cULus certified
 2000 series wallplates are cULus certified
 90000 series wallplates are UL and CSA certified

Screwless Decorator

Description	Material	Catalog No.	Colors	
1-Gang	Polycarbonate	<input type="checkbox"/> PJS26 __	A, B, BK, GY, LA, V, W	
	REPEL Polycarbonate	<input type="checkbox"/> PJS26AM __	GY, V, W	•
2-Gang	Polycarbonate	<input type="checkbox"/> PJS262 __	A, B, BK, GY, LA, V, W	
	REPEL Polycarbonate	<input type="checkbox"/> PJS262AM __	GY, V, W	•
3-Gang	Polycarbonate	<input type="checkbox"/> PJS263 __	A, BK, GY, LA, V, W	
	REPEL Polycarbonate	<input type="checkbox"/> PJS263AM __	GY, V, W	•
4-Gang	Polycarbonate	<input type="checkbox"/> PJS264 __	A, BK, GY, LA, V, W	
	REPEL Polycarbonate	<input type="checkbox"/> PJS264AM __	GY, V, W	•
5-Gang	Polycarbonate	<input type="checkbox"/> PJS265 __	A, BK, GY, LA, V, W	
6-Gang	Polycarbonate	<input type="checkbox"/> PJS266 __	A, BK, GY, LA, V, W	

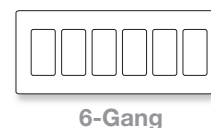
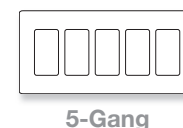
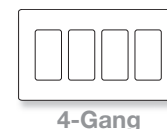
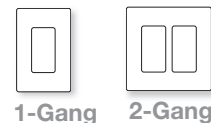

Screwless Toggle

Description	Material	Catalog No.	Colors	
1-Gang	Polycarbonate	<input type="checkbox"/> PJS1 __	A, LA, V, W	
	REPEL Polycarbonate	<input type="checkbox"/> PJS1AM __	V, W	•
2-Gang	Polycarbonate	<input type="checkbox"/> PJS2 __	A, LA, V, W	
	REPEL Polycarbonate	<input type="checkbox"/> PJS2AM __	V, W	•
3-Gang	Polycarbonate	<input type="checkbox"/> PJS3 __	A, LA, V, W	
	REPEL Polycarbonate	<input type="checkbox"/> PJS3AM __	V, W	•
4-Gang	Polycarbonate	<input type="checkbox"/> PJS4 __	A, LA, V, W	
	REPEL Polycarbonate	<input type="checkbox"/> PJS4AM __	V, W	•

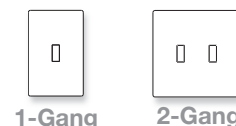

Screwless Receptacle



Description	Material	Catalog No.	Colors	
1-Gang	Polycarbonate	<input type="checkbox"/> PJS8 __	A, LA, V, W	
	REPEL Polycarbonate	<input type="checkbox"/> PJS8AM __	V, W	•



Color Ordering Information

For ordering wallplates, include Cat. No. followed by the color code: A (Almond), B (Brown), BK (Black), BL (Blue), GY (Gray), LA (Light Almond), RD (Red), RN (Orange), V (Ivory), W (White)

Icon Key

-  NAFTA Compliant - see page O-30
-  REPEL Wallplates - see page J-1

Certifications

PJ & PJS series wallplates are cULus certified

Specification Information:

Wallplates: J-21



1-Gang

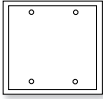

2-Gang

Blank - Box & Strap Mounted

Description	Material	Catalog No.	Colors		
1-Gang Box Mounted	Polycarbonate	<input type="checkbox"/> PJ13 __	A, B, BK, GY, LA, V, W		
	REPEL Polycarbonate	<input type="checkbox"/> PJ13AM __	GY, V, W	•	
	Thermoset	<input type="checkbox"/> 2029 __	A, B, LA, V, W		•
	302/304 Stainless Steel	<input type="checkbox"/> 93951	—		•
1-Gang Strap Mounted	Polycarbonate	<input type="checkbox"/> PJ14 __	A, B, BK, GY, LA, V, W		
	REPEL Polycarbonate	<input type="checkbox"/> PJ14AM __	GY, V, W	•	
2-Gang Box Mounted	Polycarbonate	<input type="checkbox"/> PJ23 __	A, B, BK, GY, LA, V, W		
	REPEL Polycarbonate	<input type="checkbox"/> PJ23AM __	GY, V, W	•	
	Thermoset	<input type="checkbox"/> 2037 __	A, LA, V, W		•
2-Gang Strap Mounted	Polycarbonate	<input type="checkbox"/> PJ24 __	A, B, BK, GY, LA, V, W		
	REPEL Polycarbonate	<input type="checkbox"/> PJ24AM __	GY, V, W	•	



1-Gang with 0.375" Hole



1-Gang with 0.406" Hole, Box Mounted



1-Gang with 0.406" Hole, Strap Mounted

Telephone & Coax

Description	Material	Catalog No.	Colors		
1-Gang with 0.37" (9.5mm) Hole	Thermoset	<input type="checkbox"/> 2028 __	V, W		•
	302/304 Stainless Steel	<input type="checkbox"/> 93996	—		•
1-Gang with 0.40" (10.3mm) Hole, Box Mounted	Polycarbonate	<input type="checkbox"/> PJ11 __	A, B, BK, GY, LA, V, W		
1-Gang with 0.40" (10.3mm) Hole, Strap Mounted	Polycarbonate	<input type="checkbox"/> PJ12 __	A, B, BK, GY, LA, V, W		

Color Ordering Information

For ordering wallplates, include Cat. No. followed by the color code: A (Almond), B (Brown), BK (Black), BL (Blue), GY (Gray), LA (Light Almond), RD (Red), RN (Orange), V (Ivory), W (White)

Icon Key

- NAFTA Compliant - see page O-30
- REPEL Wallplates - see page J-1

Certifications

PJ & PJS series wallplates are cULus certified
 2000 series wallplates are cULus certified
 90000 series wallplates are UL and CSA certified

Specification Information:

Wallplates: J-21

Combination 2-Gang

Description	Material	Catalog No.	Colors	
Toggle & Duplex Receptacle	Polycarbonate	<input type="checkbox"/> PJ18 __	A, B, BK, GY, LA, RD, V, W	
	Thermoset	<input type="checkbox"/> 2038 __	A, B, LA, V, W	•
	302/304 Stainless Steel	<input type="checkbox"/> 93932	—	•
Toggle & Decorator	Polycarbonate	<input type="checkbox"/> PJ126 __	A, BK, GY, LA, V, W	
	Thermoset	<input type="checkbox"/> 2053 __	A, LA, V, W	•
	302/304 Stainless Steel	<input type="checkbox"/> 93937	—	•
Toggle & Blank	Polycarbonate	<input type="checkbox"/> PJ113 __	A, B, BK, GY, LA, V, W	
Duplex Receptacle & Blank	Polycarbonate	<input type="checkbox"/> PJ138 __	A, B, BK, GY, LA, RD, V, W	
Duplex Receptacle & Decorator	Polycarbonate	<input type="checkbox"/> PJ826 __	A, B, BK, GY, LA, RD, V, W	

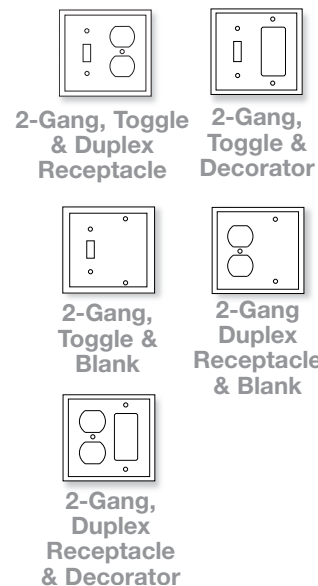

Combination 3-Gang

Description	Material	Catalog No.	Colors	
2 Toggles & Duplex Receptacle	Polycarbonate	<input type="checkbox"/> PJ28 __	A, B, BK, GY, LA, RD, V, W	
2 Toggles & Decorator	Polycarbonate	<input type="checkbox"/> PJ226 __	A, B, BK, GY, LA, RD, V, W	



Power Outlet

Description	Material	Catalog No.	Colors	
1-Gang with 1.40" (35.7mm) Hole	Polycarbonate	<input type="checkbox"/> PJ7 __	A, B, BK, GY, LA, RD, V, W	
1-Gang with 1.59" (40.5mm) Hole	Polycarbonate	<input type="checkbox"/> PJ720 __	B, GY, V, W	
1-Gang with 2.15" (54.7mm) Hole	Polycarbonate	<input type="checkbox"/> PJ724 __	B, BK, V, W	
	Nylon	<input type="checkbox"/> 5068 __	B, V	•
	Thermoset	<input type="checkbox"/> 2068 __	A, B, V, W	•
2-Gang with 2.15" (54.7mm) Hole	Polycarbonate	<input type="checkbox"/> PJ703 __	B, V, W	



Mid-Size Wallplate Guide for Power Devices

Power Device Catalog No.	Wallplate Catalog No.
32B, 38B, 1233, 1234, 1253, 1254, 1257, 1258, 1263, 5700N, 5709N, 5716N, 5795N, 7985N	5068, PJ724, PJ703

Color Ordering Information

For ordering wallplates, include Cat. No. followed by the color code: A (Almond), B (Brown), BK (Black), BL (Blue), GY (Gray), LA (Light Almond), RD (Red), RN (Orange), V (Ivory), W (White)

Icon Key

 NAFTA Compliant - see page O-30

Certifications

PJ & PJS series wallplates are cULus certified
 2000 series wallplates are cULus certified
 5000 series wallplates are cULus certified
 90000 series wallplates are UL and CSA certified

Specification Information:

Wallplates: J-21

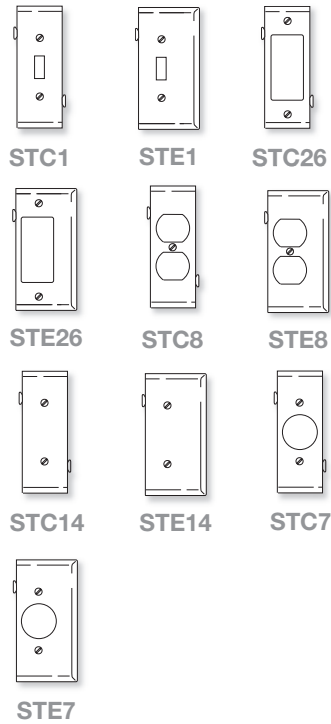

Sectional Wallplates

Description	Material	Location	Catalog No.	Colors
1-Gang Toggle	Polycarbonate	Center	<input type="checkbox"/> STC1 __	V, W
		End	<input type="checkbox"/> STE1 __	V, W
1-Gang Decorator	Polycarbonate	Center	<input type="checkbox"/> STC26 __	V, W
		End	<input type="checkbox"/> STE26 __	V, W
1-Gang Duplex Receptacle	Polycarbonate	Center	<input type="checkbox"/> STC8 __	V, W
		End	<input type="checkbox"/> STE8 __	V, W
1-Gang Blank	Polycarbonate	Center	<input type="checkbox"/> STC14 __	V, W
		End	<input type="checkbox"/> STE14 __	V, W
1-Gang Single Receptacle 1.40" (35.7mm) Hole	Polycarbonate	Center	<input type="checkbox"/> STC7 __	V,
		End	<input type="checkbox"/> STE7 __	V, W

Pre-Marked Special Use

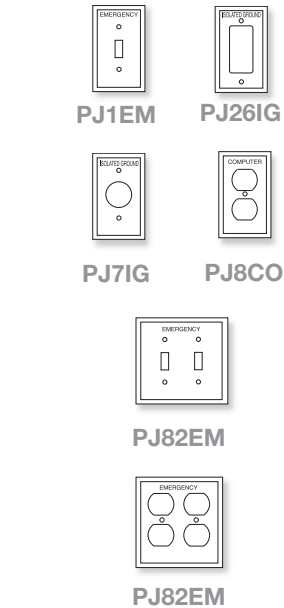

Description	Material	Catalog No.	Colors
1-Gang Toggle "Emergency"	Polycarbonate	<input type="checkbox"/> PJ1EM __	RD
1-Gang Decorator "Computer"	Polycarbonate	<input type="checkbox"/> PJ26CO __	BL, V, W
1-Gang Decorator "Emergency"	Polycarbonate	<input type="checkbox"/> PJ26EM __	RD
1-Gang Decorator "GFCI Protected"	Polycarbonate	<input type="checkbox"/> PJ26GF __	V, W
1-Gang Orange Decorator "Isolated Ground"	Polycarbonate	<input type="checkbox"/> PJ26IG	—
1-Gang Orange Single Receptacle, 1.40" (35.7mm) Hole "Isolated Ground"	Polycarbonate	<input type="checkbox"/> PJ7IG	—
1-Gang Duplex Receptacle "Computer"	Polycarbonate	<input type="checkbox"/> PJ8CO __	V, W
1-Gang Duplex Receptacle "Emergency"	Polycarbonate	<input type="checkbox"/> PJ8EM __	RD
1-Gang Duplex Receptacle "GFCI Protected"	Polycarbonate	<input type="checkbox"/> PJ8GF __	V, W
1-Gang Duplex Receptacle "Isolated Ground"	Polycarbonate	<input type="checkbox"/> PJ8IG __	RN
2-Gang Toggle "Emergency"	Polycarbonate	<input type="checkbox"/> PJ2EM __	RD
2-Gang Duplex Receptacle "Emergency"	Polycarbonate	<input type="checkbox"/> PJ82EM __	RD

Specification Information:
Wallplates: J-21

Color Ordering Information

For ordering wallplates, include Cat. No. followed by the color code: A (Almond), B (Brown), BK (Black), BL (Blue), GY (Gray), LA (Light Almond), RD (Red), RN (Orange), V (Ivory), W (White)

Certifications

PJ & PJS series wallplates are cULus certified
ST series wallplates are cULus certified

Toggle Switch

Description	Material	Catalog No.	Colors	
1-Gang	Thermoset	□ 2144__	A, B, LA, V, W	•
	302/304 Stainless Steel	□ 93871	—	•
2-Gang	Thermoset	□ 2149__	A, B, LA, V, W	•
	302/304 Stainless Steel	□ 93872	—	•
3-Gang	Thermoset	□ 2741__	V, W	•
	302/304 Stainless Steel	□ 93873	—	•
4-Gang	302/304 Stainless Steel	□ 93874	—	•



1-Gang

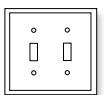

2-Gang

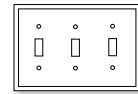

3-Gang

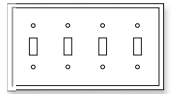

4-Gang

Decorator

Description	Material	Catalog No.	Colors	
1-Gang	Thermoset	□ 2751__	V, W	•
	302/304 Stainless Steel	□ 93834	—	•



1-Gang

Duplex Receptacle

Description	Material	Catalog No.	Colors	
1-Gang	Thermoset	□ 2142__	A, B, LA, V, W	•
	302/304 Stainless Steel	□ 93801	—	•
2-Gang	Thermoset	□ 2750__	V, W	•
	302/304 Stainless Steel	□ 93802	—	•



1-Gang



2-Gang

Single Receptacle

Description	Material	Catalog No.	Colors	
1-Gang with 1.40" (35.7mm) Hole	Thermoset	□ 2731__	V, W	•
	302/304 Stainless Steel	□ 93891	—	•



1-Gang,
1.406" Hole

Color Ordering Information

For ordering wallplates, include Cat. No. followed by the color code: A (Almond), B (Brown), BK (Black), BL (Blue), GY (Gray), LA (Light Almond), RD (Red), RN (Orange), V (Ivory), W (White)

Icon Key

 NAFTA Compliant - see page O-30

Certifications

2000 series wallplates are cULus certified
90000 series wallplates are UL and CSA certified

Specification Information:

Wallplates: J-21



1-Gang



2-Gang



2-Gang,
Toggle &
Duplex
Receptacle

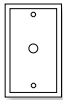

1-Gang,
0.375" Hole



GFER



2160



231



153

Blank - Box Mounted

Description	Material	Catalog No.	Colors	
1-Gang	Thermoset	□ 2729__	V, W	•
	302/304 Stainless Steel	□ 93851	—	•
2-Gang	302/304 Stainless Steel	□ 93852	—	•

Combination 2-Gang

Description	Material	Catalog No.	Colors	
Toggle & Duplex Receptacle	Thermoset	□ 2148__	B, V, W	•

Telephone & Coax

Description	Material	Catalog No.	Colors	
1-Gang with 0.37" (9.5mm) Hole	Thermoset	□ 2728__	V, W	•
	302/304 Stainless Steel	□ 93896	—	•

Wallplate Accessories

Description	Finish/Material	Catalog No.	Colors	
GFCI Extension Ring for use with GFCIs, 7/8" spacer	—	□ GFER-__**	B, BK, LA, V, W	
Adapter - Decorator to Blank	—	□ 2160__	B, V, LA, W	•
Adapter - Decorator to Toggle	—	□ 2161__	V, W	•
Toggle & Receptacle Wallplate Screws #6-32 x 1/2" (12.7mm) for Toggle & Receptacle Wallplates	Baked Enamel Head/Metal	□ 231__	A, B, V, LA, W	
	Nylon	□ 232__	RD, V, W	
Toggle & Receptacle Wallplate Screws #6-32 x 5/16" (7.9mm) for Toggle & Receptacle Wallplates	Baked Enamel Head/Metal	□ 2231__	V, LA, W	
Recessed Pilot Light Lamp Holder with 6 Watt Clear S-6 Bulb	—	□ 153*†	—	•

*For use with louver wallplate

** cULus certified

† UL, CSA certified

Color Ordering Information

For ordering wallplates, include Cat. No. followed by the color code: A (Almond), B (Brown), BK (Black), BL (Blue), GY (Gray), LA (Light Almond), RD (Red), RN (Orange), V (Ivory), W (White)

Icon Key

NAFTA Compliant - see page O-30

Certifications

2000 series wallplates are cULus certified
90000 series wallplates are UL and CSA certified

Specification Information:

Wallplates: J-21

Advanced LED technology

Arrow Hart's innovative LED Accent Lights provide functional task lighting or pathway illumination.



LED Accent Lights

LED light provides powerful illumination with 30 lumens for LNL3 and LNL2 models and 15 lumens for LNL1 and LNL4 models

Fits into standard junction box with one-gang plaster ring for easy installation

Polycarbonate lens protects electronics from tampering

Energy-efficient LED 3W or 4W light available in white, amber and red

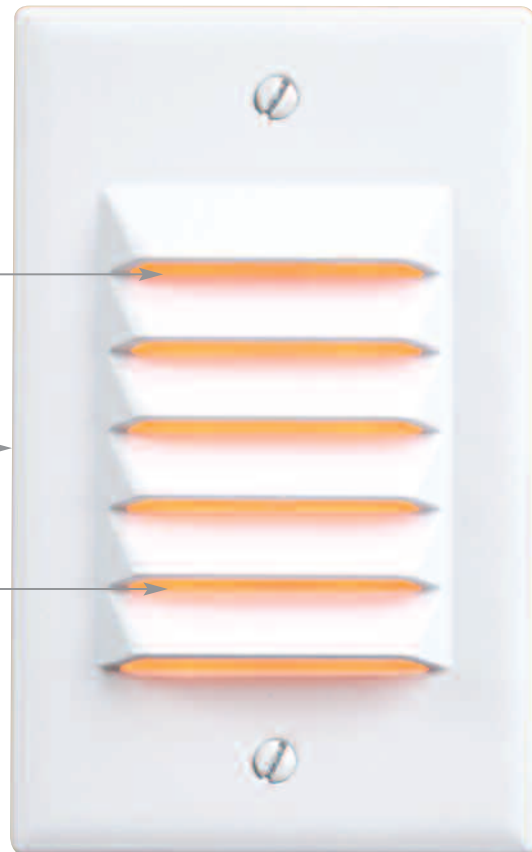

Additional Features and Benefits

- Integrated, illuminated push-button switch standard on LNL2 model
- Wet location configurations available
- Low voltage models available
- Narrow depth is ADA compliant
- White painted faceplate is standard; black and brushed nickel paint options are available
- Operates on standard 120V power supply
- Aluminum louvered or scoop faceplate displays light evenly



LNL1 Series

LED Accent Lights

LED Nightlights with Vertical Louvered Faceplate

W	V/AC	Description	Cat. No.	Faceplate	LED Colors
4	120	Standard	<input type="checkbox"/> LNL1__120	W, B, BN	A, R, W
		Wet Location	<input type="checkbox"/> LNL1__120-WL	W, B, BN	A, R, W
12-24	Low Voltage	Standard	<input type="checkbox"/> LNL1__LV	W, B, BN	A, R, W
		Low Voltage, Wet Location	<input type="checkbox"/> LNL1__LV-WL	W, B, BN	A, R, W



LNL2 Series

LED Chart Lights with Push Button Switch & Vertical Scoop Faceplate

W	V/AC	Description	Cat. No.	Faceplate	LED Colors
3	120	Standard	<input type="checkbox"/> LNL2__120	W	W
		Wet Location	<input type="checkbox"/> LNL2__120-WL	W	W
12-24	Low Voltage	Standard	<input type="checkbox"/> LNL2__LV	W	W
		Low Voltage, Wet Location	<input type="checkbox"/> LNL2__LV-WL	W	W



LNL3 Series

LED Nightlights with Vertical Scoop Faceplate

W	V/AC	Description	Cat. No.	Faceplate	LED Colors
3	120	Standard	<input type="checkbox"/> LNL3__120	W, B, BN	A, R, W
		Wet Location	<input type="checkbox"/> LNL3__120-WL	W, B, BN	A, R, W
12-24	Low Voltage	Standard	<input type="checkbox"/> LNL3__LV	W, B, BN	A, R, W
		Low Voltage, Wet Location	<input type="checkbox"/> LNL3__LV-WL	W, B, BN	A, R, W



LNL4 Series

LED Nightlights with Horizontal Louvered Faceplate

W	V/AC	Description	Cat. No.	Faceplate	LED Colors
4	120	Standard	<input type="checkbox"/> LNL4__120	W, B, BN	A, R, W
		Wet Location	<input type="checkbox"/> LNL4__120-WL	W, B, BN	A, R, W
12-24	Low Voltage	Standard	<input type="checkbox"/> LNL4__LV	W, B, BN	A, R, W
		Low Voltage, Wet Location	<input type="checkbox"/> LNL4__LV-WL	W, B, BN	A, R, W

Color Ordering Information

For ordering, include Cat. No. followed by the color code. Faceplates: W (White), B (Black), BN (Brushed Nickel)
LED color: A (Amber), R (Red) W (White). **Example:** LNL4WA120 (white faceplate and amber LED).

Specification Information:
LED Accent Lights: J-22

Certifications

LED accent lights are UL and CSA certified.
ADA Compliant

Wallplates

Standard Size
Mid-Size
Oversize
REPEL

	Wallplate Type	Standard Size, Mid-Sized & Oversize Wallplates				REPEL	
	Material Type	Thermoset	Nylon	Stainless Steel	Polycarbonate	REPEL Polycarbonate Mid-Sized Wallplates PJ_AM and PJS_AM Series	REPEL Stainless Steel Standard Size Wallplates 93070_AM, 93090_AM, 93100_AM, 93400_AM Series
	Manufacturing Process	Injection Molded	Injection Molded	Stamped	Injection Molded	Injection Molded	Stamped
	Testing & Code Compliance	UL Listed to UL 514D, file no. E33216	UL Listed to UL 514D, file no. E33216	UL Listed to UL 514D, file no. E92003	UL Listed to UL 514D, file no. E33216	UL Listed to UL 514D, file no. E33216	UL Listed to UL 514D, file no. E92003
		cUL certified to C22.2, no. 42.1, UL file E33216	cUL certified to C22.2, no. 42.1, UL file E33216	CSA certified to C22.2, no. 42.1	cUL, UL file E33216 certified to C22.2, no. 42.1	Agion® Antimicrobial Additive: EPA approved for use as product ingredient	Agion® Antimicrobial Additive: EPA approved for use as product ingredient
Specifications: Environmental	Flammability	Meets UL 94 requirements; 5V rated	Meets UL 94 requirements; 5V rated	N/A	Meets UL 94 requirements 5VA rated	Meets UL 94 requirements; 5V rated	N/A
	Temperature Rating	-40°C to 90°C (-40°F to 194°F)	-40°C to 70°C (-40°F to 158°F)	-40°C to 70°C (-40°F to 158°F)	-40° to 70° C (-40°F to 158°F)	-40°C to 70°C (-40°F to 158°F)	-40°C to 70°C (-40°F to 158°F)
Materials:	Body	0.080" thick thermoset urea or phenolic	0.060" thick thermoplastic	0.032" thick stainless steel alloy, 18% chromium and 8% nickel for corrosion resistance	0.08" thick thermoplastic polycarbonate	0.071" thick polycarbonate with Agion® Antimicrobial Additive incorporated	0.032" thick 302/304 stainless steel alloy, 18% chromium and 8% nickel for corrosion resistance, DuPont® Alesta® powder coating with Agion® Antimicrobial incorporated
	Inner Wallplate	N/A	N/A	N/A	0.071" thick polycarbonate	PJS_AM only: 0.071" thick polycarbonate	N/A

NOTE: REPEL products do not protect the user against disease causing organisms and ongoing regular cleaning practices should be maintained. Agion is a registered trademark of Agion Technologies, Inc., Wakefield, MA

Commercial Specification
Grade LED Accent Lights

120 V/AC
60 Hz

	Series Type	Louvered Faceplate LNL1, LNL4 Series	Scoop Faceplate LNL2, LNL3 Series
Illumination		12 LEDs providing 15 Lumens LED life rated 30,000 hours	6 LEDs providing 30 Lumens LED life rated 20,000 hours
Power Consumption		>4 Watts	>3 Watts
Housing		Diecast aluminum	Diecast aluminum
Testing & Code Compliance		<ul style="list-style-type: none"> Listed to UL 1598 CSA certified 	<ul style="list-style-type: none"> Listed to UL 1598 CSA certified
Power Supply		120 V/AC	120 V/AC
Installation		Single-gang junction box	Single-gang junction box
Environmental:	Temperature Rating	25°C (77°F)	25°C (77°F)
	Flammability Rating	UL 945-5V	UL 945-5V
Materials:	Faceplate	Aluminum	Aluminum
	Back body	ABS Plastic	ABS Plastic
	Strap	Aluminum	Aluminum
	Wire	18 AWG, 600V, 105°C	18 AWG, 600V, 105°C

LNL1 Series

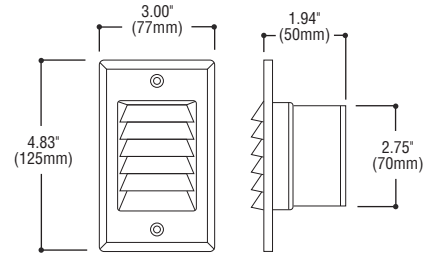

LNL2 Series

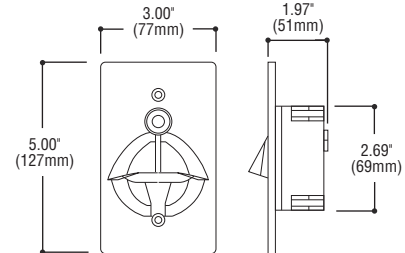

LNL3 Series

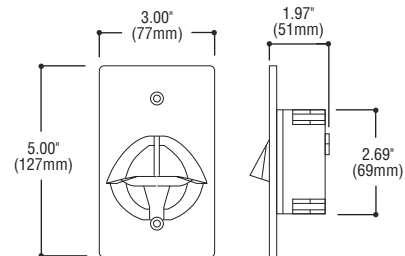

LNL4 Series

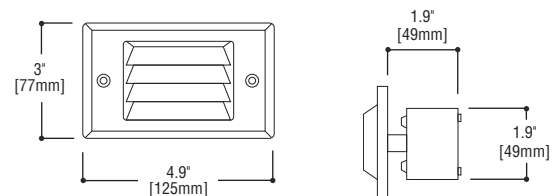

Photometrics

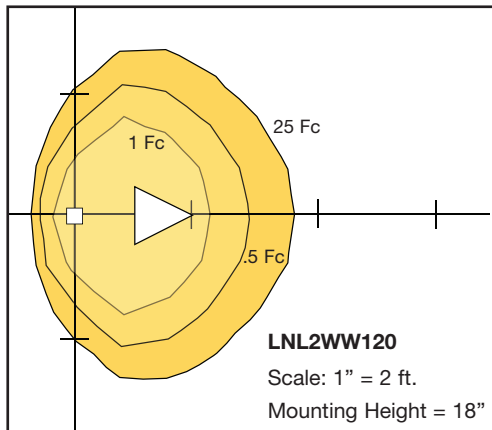



Weatherproof Covers and Boxes



	Page		Page
NEC® Compliance	K-1	Metal Weatherproof Covers	K-8
Weatherproof Receptacle Covers	K-3	Weatherproof Covers with Devices	K-9
Deluxe Weatherproof Covers for FS/FD Boxes	K-3	1-Gang Weatherproof Boxes	K-10
Standard Weatherproof Covers for FS/FD Boxes	K-3	Cast Aluminum FS Boxes	K-10
Weatherproof Covers for 30A, 50A & 60A Straight Blade Receptacles	K-4	Non-Metallic FS Box	K-10
Weatherproof Covers for 50A Locking Devices in FS/FD Boxes	K-4	Weather Protective Boots	K-11
Weatherproof Covers for Power-Lock™ Devices in FS/FD Boxes	K-4	Plug and Connector Weather Protective Boots	K-11
Weatherproof Nylon Covers for 15A, 20A & 30A Devices . .	K-5	50A Armored Plug & Connector Weather Protective Boots	K-11
Weatherproof While-In-Use Covers	K-5		
Metal WeatherBox™	K-5		
Original WeatherBox™ 1-Gang	K-2, K-6		
Original WeatherBox™ 2-Gang	K-2, K-6		
Non-Metallic Weather Protective Covers	K-7		
Weatherproof Receptacle Covers	K-7		
Weatherproof Switch Covers	K-7		
Protective Receptacle Covers	K-7		

**Tough environments
require tough solutions**

Our broad offering of weatherproof products are designed for impact resistance, corrosion resistance, UV resistance and longevity in virtually any outdoor or indoor wet or damp location.

**Deluxe Weatherproof
Covers**

Corrosion resistant diecast aluminum, self-closing design provides superior protection in wet and damp locations. Meets 2008 NEC® 406.8 (A) and 406.8 (B)(2).

**Metal WeatherBox™
While-In-Use Covers**

Diecast aluminum construction with NEMA 3R rating, meets NEC® 406.8(B)(1), and protects electrical connections while-in-use.

**Non-Metallic Weatherproof
Covers**

UL listed for wet locations with cover closed these rugged covers resist high impact and sunlight. Meets 2008 NEC® 406.8 (A) and 406.8 (B)(2).

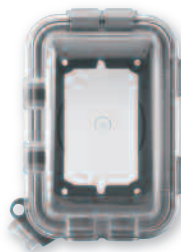
**WeatherBox™
While-In-Use Covers**

Patented moveable hinge design allows for horizontal or vertical mounting and protects your connections while-in-use. Meets NEC® 406.8 (B)(1).

**Weatherproof Switch Cover**

Provides protection for switching in wet or damp locations. Meets NEC® 404.4.

**Weatherproof Nylon Covers**

UL listed for wet and damp locations, these rugged glass reinforced nylon covers provide protection for both straight blade and locking applications. Meets 2008 NEC® 406.8 (A) and 406.8 (B)(2).

**Cast Aluminum FS Boxes**

Powder coated finish for exceptional durability.

**Weather Protective Boots**

Provide protection from the elements for plugs & connector bodies ranging from 15 to 50A.

Wet Locations for 15A and 20A Receptacles



NEC 406.8

The NEC defines Wet Locations as installations underground or in concrete slabs or masonry in direct contact with the earth; in locations subject to saturation with water or other liquids, such as vehicle washing areas; and in unprotected locations exposed to weather.

NEC Article 406.8 (B) (1) requires all 15- and 20-ampere, 125- and 250-volt receptacles installed in a wet location to have an enclosure that is weatherproof whether or not the plug is inserted. These receptacles must use a While-In-Use cover.

Applicable Arrow Hart products:

WIU-1	WIUMV-1
WIU-1D	WIUMH-1
WIU-2	

Wet Locations for Other Receptacles



NEC 406.8 (B) (2)

All other receptacles installed in a wet location shall comply with (B)(2)(a) or (B)(2)(b).

(a) A receptacle installed in a wet location, where the product intended to be plugged into it is not attended while in use, shall have an enclosure that is weatherproof with the attachment plug inserted or removed.

(b) A receptacle installed in a wet location where the product intended to be plugged into it will be attended while in use (e.g. portable tools) shall have an enclosure that is weatherproof when the attachment plug is removed.

Applicable Arrow Hart products:

WLRS1	7420	7420C	20416N	S1951	S3962	S994	S993
WLRS2	7420CR	7770	20416D	S1952	S2966	S989	
WLRA1	7420A	7788	WP1	S1954	S3966	S966	
AH7879	5741NS	20446N	WP2	S2962	S992	S1966	

Damp Locations for Receptacles



NEC 406.8 (A)

A damp location is defined as a location protected from weather and not subject to saturation with water or other liquids but subject to moderate degrees of moisture. Examples of such locations include partially protected locations under canopies, marquees, roofed pen porches, and like locations, and interior locations subject to moderated degrees of moisture, such as basements, barns, and cold storage buildings.

NEC Article 406.8 (A) requires receptacles installed in damp locations to have an enclosure for the receptacle that is weatherproof when the receptacle is covered (attachment plug is not inserted and receptacle cover is closed).

An installation suitable for wet locations shall also be considered suitable for damp locations.

Therefore, all catalog numbers noted for compliance to 406.8 (B)(1) and 406.8 (B)(2) are also suitable for use in damp locations.

Applicable Arrow Hart products:

S1961	S1962
-------	-------

Wet or Damp Locations for Switches



NEC 404.4

A surface-mounted switch or circuit breaker in a damp or wet location shall be enclosed in a weatherproof enclosure, and flush-mounted switches and circuit breakers in damp or wet locations shall be equipped with a weatherproof cover.

Applicable Arrow Hart products:

S983	S2983
S984	S3999

Award-winning design offers superior functionality

The Original WeatherBox™ While-in-Use protective covers combine the best of advanced materials, technology and industrial design for years of solid protection and uninterrupted use in challenging outdoor conditions.

Patented movable polycarbonate hinges allow for easy mounting either horizontally or vertically, will not rust or corrode in wet conditions, and are non-conductive

Durable one-piece corrosion-resistant polycarbonate cover offers additional strength and weather protection

Easy to open/close with a lockable clasp

Three easy-to-install molded inserts for use with decorator devices, duplex or single receptacles, and toggle switches

Pre-applied gasket makes it easy to mount the box

Deep, see-through design of cover offers plenty of space for plugs and cords, along with easy visual confirmation of plug status

Cord opening fits #12 AWG or lighter cord

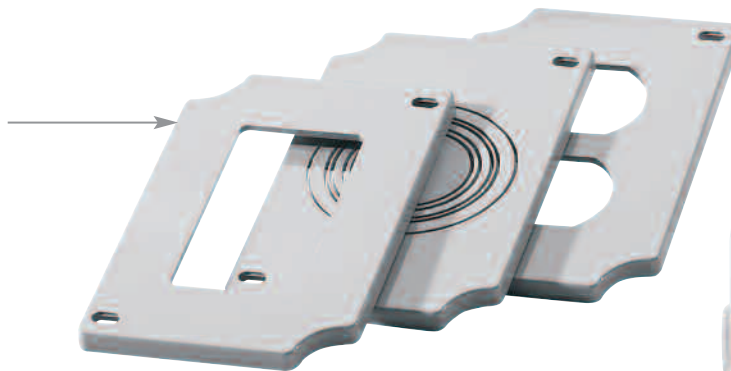
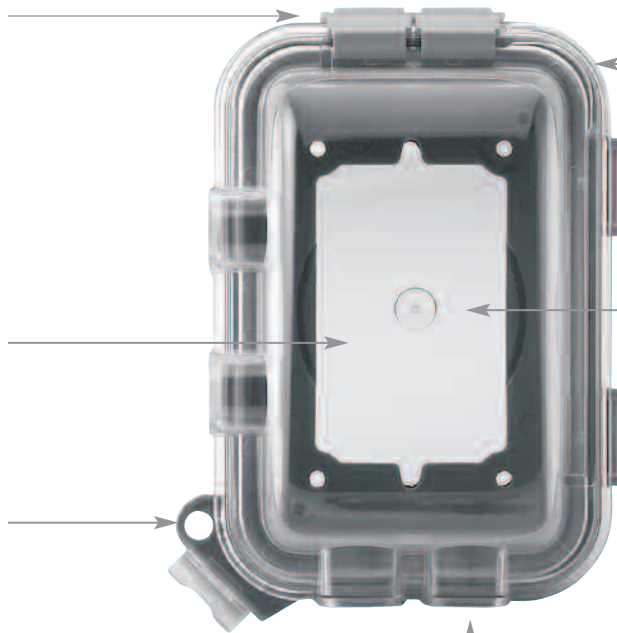

The 2008 NEC® Article 406.8 (B)(1) requires all 15- and 20-ampere, 125- and 250-volt receptacles installed outdoors in wet locations to be installed in enclosures that are weatherproof with or without a plug inserted.



2005 Gold
ADEX Award
by *Design Journal*

Industrial Specification Grade Device Covers

Metal Covers for FS/FD Boxes

Deluxe Weatherproof Covers for FS/FD Boxes

FEATURES

- UL listed for wet locations (cover closed) and damp locations (cover open or closed).
- Meets 2008 NEC 406.8 (A) and 406.8 (B)(2).
- Diecast copper free aluminum with epoxy finish provides maximum corrosion resistance.
- Self-closing spring door assures full protection.
- EPDM gasketing material on WLRD1 and WLR1 provide excellent resistance to ozone, weathering and temperatures from -46° C to 127° C (-50°F to 260°F).

Diecast Aluminum Receptacle Covers



Product Description	Catalog No.	
Duplex receptacle cover, horizontal mounting	<input type="checkbox"/> WLRD1	•
Single receptacle cover, vertical mounting, 1.38" (34.9mm) face diameter, use with 15A, 20A straight blade and 15A Hart-Lock™ receptacles	<input type="checkbox"/> WLR1	•
Single receptacle cover, vertical mounting, 1.56" (39.7mm) face diameter, use with 20A and 30A Hart-Lock™ receptacles	<input type="checkbox"/> WLR2	•
Adapter, flush mounts above covers to standard boxes	<input type="checkbox"/> WLR1*	•

*Not cULus certified

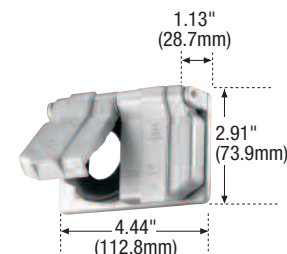

WLRD1

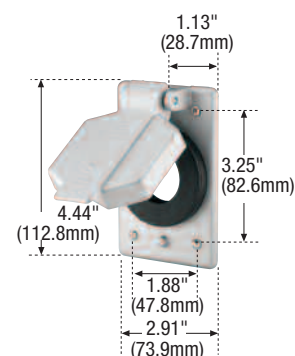

WLR1

Standard Weatherproof Covers for FS/FD Boxes

FEATURES

- UL listed for wet locations (cover closed) and damp locations (cover open or closed).
- Meets 2008 NEC® 406.8 (A) and 406.8 (B)(2).
- Self-closing spring door assures full protection.
- Gasketing material provides excellent resistance to weather.
- Duplex covers can be used with any duplex receptacle.

Diecast Aluminum Receptacle Covers



Product Description	Catalog No.	
Duplex receptacle, vertical mounting	<input type="checkbox"/> AH7879*	•
Single receptacle cover, vertical mounting, 1.38-1.56" (34.9-39.7mm) face diameter, use with 15A and 20A single straight blade receptacles and 15A, 20A and 30A single Hart-Lock™ receptacles	<input type="checkbox"/> 7420	•
Single receptacle cover, vertical mounting, 1.38-1.56" (34.9-39.7mm) face diameter, yellow corrosion resistant finish, used with 15A and 20A single straight blade receptacles and 15A, 20A and 30A single Hart-Lock™ receptacles	<input type="checkbox"/> 7420CR	•
Single receptacle, vertical mounting for 2.12" (53.8mm) face diameter, use with 30A straight blade receptacles	<input type="checkbox"/> 7420A	•

* Not UL listed

Note: Cat. No. 7420, 7420CR have inserts for protecting toggle; can be used with most standard length toggle switches.



7420



7420CR

Icon Key

NAFTA Compliant - see page O-30

Industrial Specification Grade Device Covers

Metal and Nylon Covers

Weatherproof Covers for 30A, 50A & 60A Straight Blade Receptacles

FEATURES

- UL Listed for wet locations (cover closed) and damp locations (cover open or closed).
- Meets 2008 NEC® 406.8 (A) and 406.8 (B)(2).
- Self-closing spring door assures full protection.
- Gasketing material provides excellent resistance to weather.

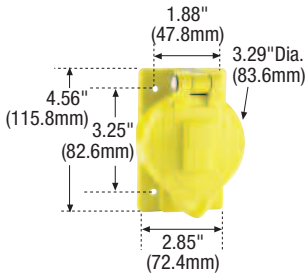

7788CR

Diecast Aluminum Covers

Product Description

Weatherproof lift lid cover for 4.69" (119.1.0mm) flush box, use box 2.125" (53.96mm) deep or larger

Catalog No.

5741NS*

Weatherproof lift lid cover for FS/FD boxes, use box 2.125" (53.96mm) deep or larger

7420C



* Not UL listed.

Weatherproof Covers for 50A Locking Devices in FS/FD Boxes

FEATURES

- UL Listed for wet locations (cover closed) damp locations (cover open or closed).
- Meets 2008 NEC® 406.8 (A) and 406.8 (B)(2).
- Self-closing spring door assures full protection.
- Gasketing material provides excellent resistance to weather.

Diecast Aluminum & Glass-Filled Nylon Covers

Product Description

Diecast aluminum lift lid cover

Catalog No.

7770*

Yellow glass-filled nylon lift lid cover

7788CR

Black glass-filled nylon lift lid cover

7788BK

Gray glass-filled nylon lift lid cover

7788GY



* Not cULus, UL listed only

Weatherproof Covers for Power-Lock™ Devices in FS/FD Boxes

FEATURES

- UL Listed for wet locations (cover closed) damp locations (cover open or closed).
- Meets 2008 NEC® 406.8 (A) and 406.8 (B)(2).
- Self-closing spring door assures full protection.
- Gasketing material provides excellent resistance to weather.

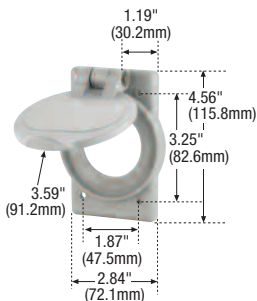

20416N

Diecast Aluminum and Glass Filled Nylon Covers

Product Description

Red glass-filled nylon lift lid cover for 4-wire 30A receptacles

Catalog No.

20446N*

Gray glass-filled nylon lift lid cover for 4-wire 30A receptacles

20416N

Diecast aluminum lift lid cover for 4-wire 30A receptacles

20416D



* Not CSA

Icon Key

NAFTA Compliant - see page O-30

Weatherproof Covers for Locking and Straight Blade Receptacles

Nylon Covers for FS/FD Boxes

Weatherproof Nylon Covers for 15A, 20A & 30A Devices

FEATURES

- UL Listed for wet locations (cover closed) & damp locations (cover open or closed).
- Meets 2008 NEC® 406.8 (A) and 406.8 (B)(2).
- Rugged, glass-filled nylon provides high strength and wide temperature range for long life in abusive environments.
- Easy mounting on FS/FD boxes or equipment panels.
- Self-closing lift lid cover with neoprene gasket and stainless steel spring provides weatherproof protection.
- Universal mounting holes to accept all Cooper 15 & 20A and 30A locking flanged inlets and outlets, receptacles as well as devices with similar dimensions from other manufacturers.

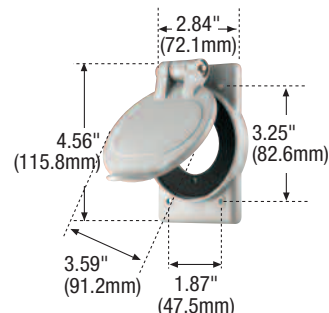

WP1

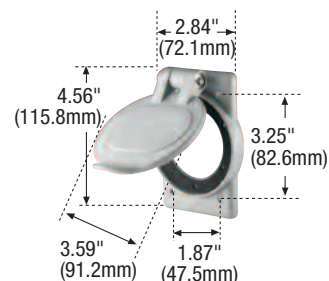

WP2

Glass-Filled Nylon Covers

Product Description	Mtg Hole Pattern	Opening Diameter	Catalog No.	UL	SR
For 15 & 20A straight blade receptacles and 15A Hart-Lock™ flanged inlets & outlets	2 holes 180°, 2.09" (53.1mm) bolt dia. circle	1.75" (44.45mm)	□ WP1*	•	•
For 20 & 30A Hart-Lock™ flanged inlets & outlets and 30 & 50A, 3-W straight blade receptacles	Two sets of 3 equally spaced holes: 3 holes on 2.5" (63.5mm) bolt dia. circle and 3 holes on 2.69" (68.3mm) bolt dia. circle	2.25" (57.15mm)	□ WP2	•	•

* Not CSA

Metal WeatherBox™ While-In-Use Weather Protective Covers

Metal 1-Gang Lockable Cover Boxes

Metal While-In-Use Cover Boxes

FEATURES

- Meets 2008 NEC® 406.8 (B)(1) for receptacles in damp or wet locations.
- Diecast powder coated aluminum.
- NEMA 3R rating.
- Comes with gasket, mounting hardware, duplex receptacle insert and GFCI receptacle insert.
- Lockable to prevent accidental disconnects.

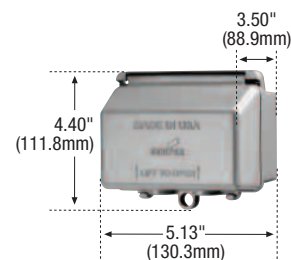

WIUMH-1

Metal Protective Covers

Description	Depth	# of Available Configurations using inserts	Color	Catalog No.	UL
Vertical Mount	3.25" deep (82.6mm)	2	Gray	□ WIUMV-1	•
Horizontal Mount	3.25" deep (82.6mm)	2	Gray	□ WIUMH-1	•



WIUM Inserts

Icon Key

NAFTA Compliant - see page O-30

Original WeatherBox™ While-In-Use Weather Protective Covers

1-Gang Self-Closing
2-Gang Self-Closing

WeatherBox, 1-Gang

FEATURES

- Meets 2008 NEC® 406.8 (B)(1).
- Rugged UV-resistant polycarbonate cover and back protects devices without cracking or breaking and is non-corrosive and non-conductive.
- Moveable hinges reposition easily for vertical or horizontal mounting.
- 1-Gang box includes 3 inserts for 16 different configurations.
- 2-Gang box includes 3 inserts for over 60 different configurations.
- Exceeds UL outdoor low voltage landscape lighting requirements.
- Box cover includes pre-mounted gasket.
- Meets Canadian Electrical Code rule 26-702.



WIU-1



WIU-1 Inserts

Standard Depth, 1-Gang Self-Closing Cover



Description	Depth	# of Available Configurations Using Inserts	Back Housing Color	Catalog No.
Horizontal/ Vertical Mount	Standard - 3.25" deep (82.6mm)	16	Gray	<input type="checkbox"/> WIU-1
Horizontal/ Vertical Mount	Standard - 3.25" deep (82.6mm)	16	White	<input type="checkbox"/> WIU-1W

Extra Depth, 1-Gang Self-Closing Cover



Description	Depth	# of Available Configurations Using Inserts	Back Housing Color	Catalog No.
Horizontal/ Vertical Mount	Deep - 4.75" deep (120.7mm)	16	Gray	<input type="checkbox"/> WIU-1D
Horizontal/ Vertical Mount	Deep - 4.75" deep (120.7mm)	16	White	<input type="checkbox"/> WIU-1DW

WeatherBox, 2-Gang

Standard Depth, 2-Gang Self-Closing Cover



Description	Depth	# of Available Configurations Using Inserts	Back Housing Color	Catalog No.
Vertical Mount	Standard - 3.25" deep (82.6mm)	60+	Gray	<input type="checkbox"/> WIU-2
Vertical Mount	Standard - 3.25" deep (82.6mm)	60+	White	<input type="checkbox"/> WIU-2W

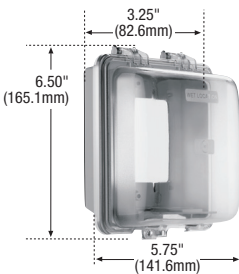

WIU-2

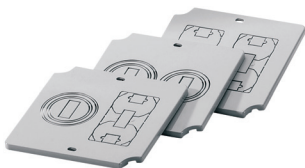

WIU-2 Inserts

Non-Metallic Weather Protective Covers

- 1-Gang Self Closing
- 1-Gang Switch Cover
- 1-Gang Stay Open

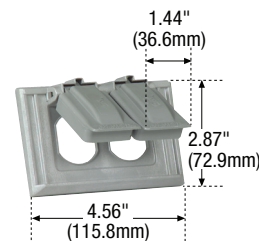

S1952

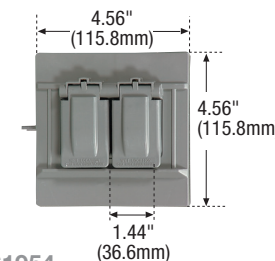

S1954

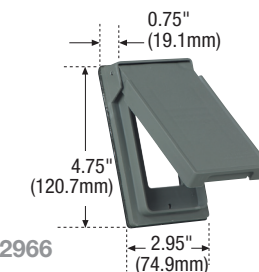

S2966

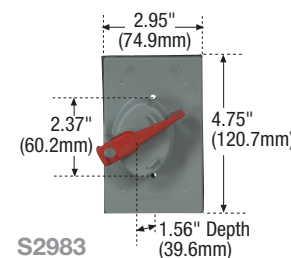

S2983

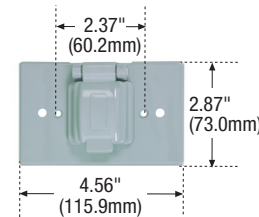

S1961



S1962

Non-Metallic Weatherproof Receptacle Covers

FEATURES

- UL Listed for wet locations with cover closed.
- Meets 2008 NEC® 406.8 (A) and 406.8 (B)(2).
- Tough plastic construction resistant to high impact and sunlight.
- Non-corrosive and non-conductive.
- Gasket provided seals both device openings and edges.

1-Gang Self-Closing Lids

Product Description	Mounting	Gray Catalog No.	Other Colors Catalog No.	Color Suffix	UL	SR	USA
Single Receptacle	Horizontal	<input type="checkbox"/> S1951	<input type="checkbox"/> S1951__	W			•
Duplex Receptacle/Combination Device, 2 Self-Closing Lids	Horizontal	<input type="checkbox"/> S1952	<input type="checkbox"/> S1952__	W			•
Oversize Duplex Receptacle/Combination Device	Horizontal	<input type="checkbox"/> S1954*	—				•
Duplex Receptacle	Vertical	<input type="checkbox"/> S2962	<input type="checkbox"/> S2962__	W			•
	Horizontal	<input type="checkbox"/> S3962	<input type="checkbox"/> S3962__	W			•
GFCI/Decorator	Vertical	<input type="checkbox"/> S2966	<input type="checkbox"/> S2966__	W			•
	Horizontal	<input type="checkbox"/> S3966	<input type="checkbox"/> S3966__	BK, W			•

For ordering devices other than gray, include Cat. No. followed by the color code: BK (Black), W (White)

* Not CSA

Non-Metallic Weatherproof Switch Cover

FEATURES

- Switch lockable in “on” or “off” position.
- Red switch handle for easy visual location.
- Meets 2008 NEC® 404.4.
- Factory-attached gasket to cover minimizes labor for installer.

1-Gang Lids

Product Description	Mounting	Catalog No.	Color	UL	SR	USA
1-Gang Flush Mount Switch Cover	Vertical	<input type="checkbox"/> S2983	Gray			•

Non-Metallic Protective Receptacle Covers

FEATURES

- Not for use in wet locations.
- Tough plastic construction resistant to high impact.
- Non-corrosive and non-conductive.
- Gasket provided seals both device and openings and edges.

1-Gang Stay Open Lids

Product Description	Mounting	Gray Catalog No.	Other Colors Catalog No.	Color Suffix	UL	SR	USA
Single Receptacle	Horizontal	<input type="checkbox"/> S1961*	<input type="checkbox"/> S1961__*	W			•
Duplex Receptacle/Combination Device	Horizontal	<input type="checkbox"/> S1962	<input type="checkbox"/> S1962__	W			•

For ordering devices other than gray, include Cat. No. followed by the color code: W (White)

* Not CSA

Icon Key

NAFTA Compliant - see page O-30

Metal Weatherproof Covers

Metal 1- & 2-Gang Self-Closing Covers
1-Gang Blank Wallplates

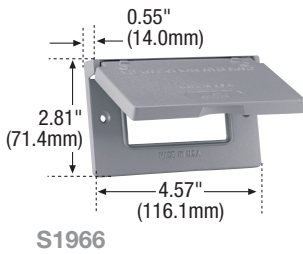
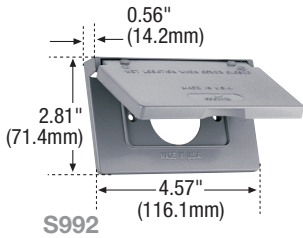

S1987

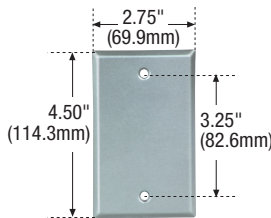

Metal Weatherproof Covers - Wet Locations

FEATURES

- Meets 2008 NEC® 406.8 (A) and 406.8 (B)(2).
- Gasket provided seals both device openings and edges.
- Electrostatically painted with a baked, weather-resistant powder coat finish for exceptional durability.

1-Gang Self-Closing Lids

Product Description	Mounting	Color	Catalog No.	
Single Receptacle	Horizontal	Gray	<input type="checkbox"/> S992	•
Duplex Receptacle	Vertical	Gray	<input type="checkbox"/> S994	•
Duplex Receptacle, 2 Self-Closing Lids	Horizontal	Black	<input type="checkbox"/> S989BLK	•
	Horizontal	Gray	<input type="checkbox"/> S989	•
GFCI/Decorator Receptacle	Vertical	Gray	<input type="checkbox"/> S966	•
	Horizontal	Gray	<input type="checkbox"/> S1966	•
20A and 30A Hart-Lock™ Receptacles 1.625" (41.27mm) diameter opening	Vertical	Gray	<input type="checkbox"/> S993	•

1-Gang Blank Wallplate

Product Description	Mounting	Color	Catalog No.	
Blank Wallplate	Horizontal or Vertical	Gray	<input type="checkbox"/> S1987	•

Icon Key

NAFTA Compliant - see page O-30

Weatherproof Covers with Devices

Metal & Plastic
1-Gang Covers



5-15P

Metal Weatherproof Covers - Wet Locations

FEATURES

- UL Listed for wet locations (with cover closed for S3999).
- Meets 2008 NEC® 404.4.
- Ready for outdoor installation.
- Gasket seals both openings and edges.

1-Gang Metal Cover with Switch



Switch Rating	Description	Mounting	Color	Catalog No.	
10A, 125V "T"; 5A, 250V/AC	Single-Pole Toggle Switch with Metal Switch Cover	Vertical	Gray	□ S983	•
	3-Way Toggle Switch with Metal Switch Cover	Vertical	Gray	□ S984	•

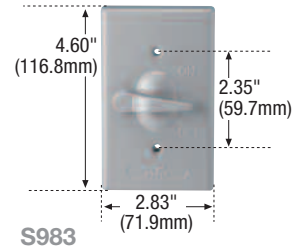

S983

1-Gang Plastic Cover with Motor Base Inlet



Inlet Rating		NEMA	Description	Mounting	Color	Catalog No.	
A	V						
15	125	5-15P	Motor Base Inlet #5278 with Weatherproof Cover # 3963	Horizontal	Gray	□ S3999	•

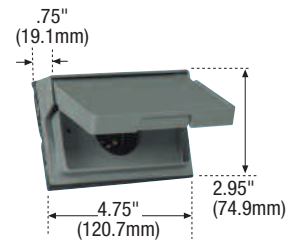

S3999

Icon Key

NAFTA Compliant - see page O-30



Accessories for Specification Grade Receptacle Covers

Description	Catalog No.	
Cast FS Box	□ 1113	•
Non-Metallic FS Box	□ 6080	•



1113



6080

1-Gang Boxes

Cast Aluminum FS Boxes
Non-Metallic FS Boxes

Cast Aluminum Weatherproof FS Boxes

FEATURES

- Electrostatically painted with a baked, weather-resistant powder finish for exceptional durability.
- Accept single gang weatherproof cover and standard FS covers.
- UL Listed for wet and damp locations with appropriate cover installed.
- Mounting lugs provide strength and durability on any mounting surface.
- Raised knockout studs on back of box provide alternative means for wall mounting. Strike desired studs with sharp hammer blow for clean mounting holes.
- Easy access ground screw hole located inside back wall of box.
- Threaded outlets for conduit and connectors.
- Two closure plugs and mounting lugs furnished.

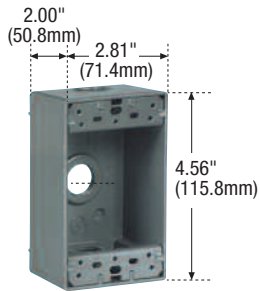

1113

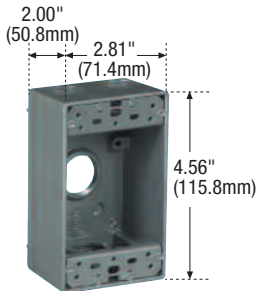

1117

1-Gang FS Boxes



Description	End Openings	Back Openings	Catalog No.	
3 hole 0.50" (12.70mm) dia.	1-1	1	□ 1113	•
4 hole 0.50" (12.70mm) dia.	2-1	1	□ 1114	•
5 hole 0.50" (12.70mm) dia.	2-2	1	□ 1115	•
3 hole 0.75" (19.05mm) dia.	1-1	1	□ 1116	•
4 hole 0.75" (19.05mm) dia.	2-1	1	□ 1117	•
5 hole 0.75" (19.05mm) dia.	2-2	1	□ 1118	•

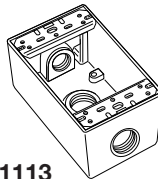

1113

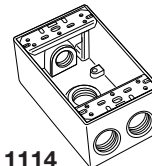

1114

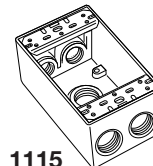

1115

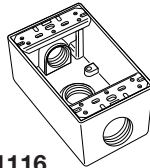

1116

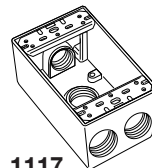

1117

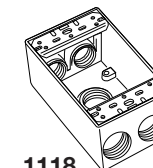

1118

Non-Metallic Weatherproof FS Box

1-Gang FS Box

Product Description	Catalog No.	
Black FS Box with (2) 0.75" (19.05mm) IPS molded-in knockouts	□ 6080	•

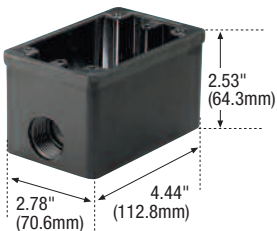

6080

Icon Key

NAFTA Compliant - see page O-30

Weather Protective Boots



For Straight Blade & Locking Devices

Weather Protective Boots

FEATURES

- Neoprene resists oil, grease, and acids plus has long life properties.
- Flexible and easy to apply to plug or connector.
- Cord hole opening can be cut away for large diameter cords.

Plug and Connector Weather Protective Boots

Product May Be Used With:	Catalog No. Plug 	Catalog No. Connector 
15A and 20A, 2-pole, 3-wire straight blade AutoGrip™, Safety Grip™ devices	<input type="checkbox"/> BS1	<input type="checkbox"/> BS2
15A industrial locking devices	<input type="checkbox"/> BS1	<input type="checkbox"/> BS2
20A 2-wire industrial locking devices	<input type="checkbox"/> BS1	<input type="checkbox"/> BS2
20A and 30A 2-pole, 3-wire and 3-pole, 3-wire locking Safety Grip™ devices	<input type="checkbox"/> BM1	<input type="checkbox"/> BM2
20A and 30A 3-wire Industrial locking devices for use with hull inlets	—	<input type="checkbox"/> BM3
20A and 30A 4-wire and 5-wire industrial locking devices	<input type="checkbox"/> BL1	<input type="checkbox"/> BL2
Midget locking ML2 plugs and connectors when used with receptacle or inlet	<input type="checkbox"/> 74CM40 •	<input type="checkbox"/> 74CM40 •



BS1



BM1



BM2

50A Armored Plug and Connector Weather Protective Boots

Product Description	Catalog No. 
Short boot, for 50A armored connector when used with 50A armored plug in 7717 boot	<input type="checkbox"/> 7716
Long boot, for 50A armored plug when used with receptacle or 50A armored connector in 7716 boot	<input type="checkbox"/> 7717



7716



7717

Icon Key

 NAFTA Compliant - see page O-30

Temporary Power Solutions



	Page		Page
Temporary Power Distribution	L-1	Portable Outlet Boxes	L-9
Temporary Power Centers, 50A Input		Portable Outlet Boxes	
RhinoBoxes™, 20A, 30A, 50A Output	L-2	Standard Depth	L-10
Temporary Power Accessories		Extra Depth	L-10
50A Cord Sets	L-3	Extra Depth Feed-Through	L-10
50A Adapters	L-3	Portable Outlet Box Cover Plates	
RhinoBox Replacement Components		Cover Plates	L-10
GFCIs	L-3	Flip Lid Cover Plates	L-10
20A Straight Blade Receptacles	L-3	Portable Outlet Box & Cover Plate Assemblies	
20A Locking Receptacles	L-3	Standard Depth Boxes	L-10
30A Locking Receptacles	L-3	Extra Depth Boxes	L-10
50A Inlets, Outlets & Flip Covers	L-3	Extra Depth Feed-Through Boxes	L-10
Industrial Grade Portable GFCIs	L-4	Specification Information	L-11
15A Portable GFCIs			
Plug Series, Single or Tri-Tap Connector	L-5		
Plug Series, Field Wireable	L-5		
Inline Series, Single or Tri-Tap Connector	L-5		
Inline Series, Field Wireable	L-5		
20A Portable GFCIs			
Inline Series, Field Wireable	L-6		
Inline Series, Molded Plug & Connector	L-6		
30A Portable GFCIs			
Inline Series, Field Wireable, Single Phase	L-7		
Inline Series, Molded Plug & Connector	L-7		
Watertight Portable GFCIs			
15A Straight Blade NEMA 5-15	L-8		
20A Straight Blade NEMA 5-20	L-8		
20A Locking NEMA L5-20	L-8		
20A Locking NEMA L6-20	L-8		
30A Locking NEMA L5-30	L-8		
30A Locking NEMA L6-30	L-8		

Safe and reliable power distribution

Arrow Hart's complete line of heavy duty temporary power devices are built tough to deliver safe, reliable temporary power for the most demanding commercial and industrial applications.



Temporary Power Distribution

Arrow Hart's heavy duty RhinoBox temporary power distribution centers provide "plug & power" capability, multiple configuration options, and automatic or manual GFCI reset versions for reliable temporary power.



Cordsets, Plugs & Connectors

The rugged line of 50A Pro-Grip™ plugs, connectors, cordsets and adapters are engineered to provide safe, secure connections with fast installation, superior performance and outstanding durability.



Portable GFCIs

Portable GFCIs are specifically designed to protect personnel and equipment from ground fault hazards in indoor or outdoor jobsite applications.



Portable Outlet Boxes

Arrow Hart's durable portable outlet boxes provide a safe alternative to common metal junction boxes and are especially useful for pendant station drops and stringer sets.

**Mission critical power when
and where you need it**

RhinoBox™ heavy duty temporary power centers are designed to deliver safe and reliable temporary power on industrial and commercial jobsites.



RhinoBox
Temporary Power Center

Gasketed lift covers provide superior protection from the elements

Weather Resistant “WR” duplex receptacles comply with NEC 406.8 requirements for outdoor temporary power applications

Individual GFCI modules protect against ground faults

Sturdy heavy duty steel legs are reinforced to withstand abuse and provide long lasting performance

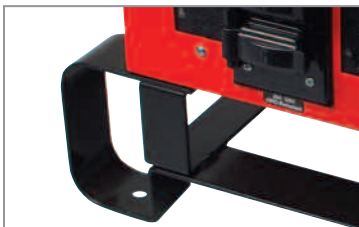

Holes in legs accept 3/8" castor bolts and allows RhinoBox to be attached to fixed surfaces



Unique interlocking legs provide sturdy and secure stacking for storage and transport



Variety of cordsets, adapters and replacement devices available to service any application



Hinged clear polycarbonate door cover provides access and visibility to circuit breakers



Temporary Power Centers with GFCI Protection

50A Input
20A, 30A, 50A Output
120/240V/AC (Max.)

Temporary Power Centers

RhinoBox NEMA 3R



RB300M

Rating A	V/AC	Distribution Devices	Receptacle Rating	Protection Overload	GFCI	Catalog No.*	
50 (Max.)	120/240	(6) WR Duplex Receptacles	20A, 125V	✓	✓	<input type="checkbox"/> RB300M	•
		(1) Locking Receptacle	30A, 250V	✓	-		
		(1) Locking Inlet	50A, 125/250V	-	-		
		(1) Locking Outlet	50A, 125/250V	-	-		
50 (Max.)	120/240	(6) Single Receptacles	20A, 125V	✓	✓	<input type="checkbox"/> RB301M	•
		(1) Locking Receptacle	30A, 250V	✓	-		
		(1) Locking Inlet	50A, 125/250V	-	-		
		(1) Locking Outlet	50A, 125/250V	-	-		
50 (Max.)	120/240	(6) Locking Receptacles	20A, 125V	✓	✓	<input type="checkbox"/> RB302M	•
		(1) Locking Receptacle	30A, 250V	✓	-		
		(1) Locking Inlet	50A, 125/250V	-	-		
		(1) Locking Outlet	50A, 125/250V	-	-		
50 (Max.)	120/240	(3) Single Receptacles	20A, 125V	✓	✓	<input type="checkbox"/> RB303M	•
		(3) Locking Receptacles	20A, 125V	✓	✓		
		(1) Locking Receptacle	30A, 250V	✓	-		
		(1) Locking Inlet	50A, 125/250V	-	-		
		(1) Locking Outlet	50A, 125/250V	-	-		
50 (Max.)	120/240	(7) WR Duplex Receptacles	20A, 125V	✓	✓	<input type="checkbox"/> RB3001M	•
		(1) Locking Inlet	50A, 125/250V	-	-		
		(1) Locking Outlet	50A, 125/250V	-	-		
50 (Max.)	120/240	(7) Locking Receptacles	20A, 125V	✓	✓	<input type="checkbox"/> RB3021M	•
		(1) Locking Inlet	50A, 125/250V	-	-		
		(1) Locking Outlet	50A, 125/250V	-	-		

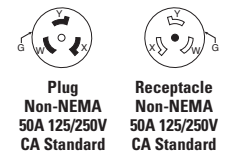

*Automatic GFCI reset configurations are available. When ordering automatic GFCI reset RhinoBox replace "M" in Catalog No. with "A". Example: RB300A = Automatic; RB300M = Manual.

NEMA 1 configurations are available. To order, replace "3" in Catalog No. with "2" for NEMA 1 enclosure. Example: RB300M = NEMA 3R; RB200M = NEMA 1.

Specification Information:

RhinoBox: L-11

Icon Key

NAFTA Compliant - see page O-30



Temporary Power Accessories

50A Input
20A, 30A, 50A Output
120V/240V/AC (Max.)

Temporary Power Accessories

FEATURES

- Connect RhinoBox to power sources and to additional RhinoBoxes in series.
- Pro-Grip™ tough nylon devices resist impact in heavy duty industrial environments.
- Powerful cord-gripping capability helps eliminate conductor cord grip slip and strain on terminals.
- Durable 6/4 SOOW cord.

Cordsets & Adapters

Rating A	V/AC	Cord Length	Description	Plug (Male)	Connector (Female)	Catalog No.	
50A	125/250	50 ft.	Non-NEMA 6/4 (6/3 & 8/1) Flexible Black Extension Cord			<input type="checkbox"/> PC50A	•
		100 ft.	Non-NEMA 6/4 (6/3 & 8/1) Flexible Black Extension Cord			<input type="checkbox"/> PC50B	•
50A	125/250	4 ft.	Non-NEMA 6/4 (6/3 & 8/1) Flexible Black Blank/ Bare Wire Connector	—		<input type="checkbox"/> PA50-6	•
50A	125/250	4 ft.	NEMA 14-30P to 50A Straight Blade to 50A Locking Non-NEMA Adapter			<input type="checkbox"/> A304WCSF	•
		4 ft.	NEMA 14-50P to 50A Straight Blade to 50A Locking Non-NEMA Adapter			<input type="checkbox"/> A504WCSF	•



PC50A

RhinoBox Replacement Components

Description	Catalog No.	
20A GFCI Module (Manual Reset)	<input type="checkbox"/> 20GFMODM	
20A GFCI Module (Automatic Reset)	<input type="checkbox"/> 20GFMODA	
20A 125V/AC NEMA 5-20 Industrial Locking Receptacle	<input type="checkbox"/> L520R	•
20A 125V/AC NEMA 5-20 Single Straight Blade Receptacle	<input type="checkbox"/> 1877BK	
30A 250V/AC NEMA L6-30 Industrial Locking Receptacle	<input type="checkbox"/> L630R	•
30A Locking Receptacle Flip Lid Cover	<input type="checkbox"/> WP2	
50A 125/250V/AC Non-NEMA Locking Inlet (For RB200 Models)	<input type="checkbox"/> CS6375	•
50A 125/250V/AC Non-NEMA Locking Inlet with Flip Lid (for RB300 Models)	<input type="checkbox"/> CS6376	•
50A 125/250V/AC Non-NEMA Locking Outlet	<input type="checkbox"/> CS6369	•
50A Locking Receptacle Flip Lid Cover	<input type="checkbox"/> 7788BK	•

Icon Key

NAFTA Compliant - see page O-30

Reliable GFCI protection in remote applications

Arrow Hart's complete offering of portable GFCIs provide electrical protection from ground fault hazards on the jobsite.

**PowerTrip™ Portable GFCI**

Electro-magnetically latched contacts will not delatch in rough use conditions

Dual indication lights display power and fault status

Double insulated user interface provides added safety for user

Industrial design and materials are UV and chemical resistant - ideal for use in rough industrial environments

Heavy duty cable, plug and connector provide reliable connection



Convenient plug series available with flying leads, single or tri-tap connector



Available in a variety of cord lengths, with terminated devices or flying leads for field terminations



Variety of straight blade and locking plug and connector options, including watertight devices



Available with Manual or Automatic GFCI reset options

Industrial Grade 15A Portable GFCIs

2-Pole, 3-Wire Grounding
15A, 120V/AC

15A Portable GFCIs, Plug Series

Plug Series - Single & Tri-Tap Connector



Rating A	V/AC	NEMA	NEMA Type	Connector Style	Cord Length	Cord Gauge	Catalog No.*
15	120	5-15	3R	Single-Tap	2' (0.61m)	12/3 AWG	<input type="checkbox"/> GFP11M1P3
			3R	Tri-Tap	2' (0.61m)	12/3 AWG	<input type="checkbox"/> GFP11M1P9
		5-15	3R	Single-Tap	25' (7.62m)	12/3 AWG	<input type="checkbox"/> GFP11M4P3
			3R	Tri-Tap	25' (7.62m)	12/3 AWG	<input type="checkbox"/> GFP11M4P9

*Automatic reset GFCIs are also available. When ordering an automatic Portable GFCIs replace "M" in catalog number with "A". Example: GFP11A1P3 = Automatic; GFP11M1P3 = Manual.

Plug Series - Field Wireable



Rating A	V/AC	NEMA	NEMA Type	Connector Style	Cord Length	Cord Gauge	Catalog No.*
15	120	5-15	3R	Flying Leads	2' (0.61m)	12/3 AWG	<input type="checkbox"/> GFP11MNP

*Automatic reset GFCIs are also available. When ordering automatic Portable GFCIs replace "M" in catalog number with "A". Example: GFP11ANP = Automatic; GFP11MNP = Manual.

Plug Series - Single Receptacle



Rating A	V/AC	NEMA	Description	Catalog No.
15	120	5-15	Single Outlet Adapter	<input type="checkbox"/> GFP400

15A Portable GFCIs, Inline Series

Inline Series - Single & Tri-Tap Connector



Rating A	V/AC	NEMA	NEMA Type	Connector Style	Cord Length	Cord Gauge	Catalog No.*
15	120	5-15	3R	Single-Tap	2' (0.61m)	12/3 AWG	<input type="checkbox"/> GFI11M133
			3R	Tri-Tap	2' (0.61m)	12/3 AWG	<input type="checkbox"/> GFI11M139
		5-15	3R	Single-Tap	6' (1.83 m)	12/3 AWG	<input type="checkbox"/> GFI11M233
			3R	Tri-Tap	6' (1.83 m)	12/3 AWG	<input type="checkbox"/> GFI11M239
		5-15	3R	Single-Tap	25' (7.62m)	12/3 AWG	<input type="checkbox"/> GFI11M433
			3R	Tri-Tap	25' (7.62m)	12/3 AWG	<input type="checkbox"/> GFI11M439
		5-15	3R	Single-Tap	50' (15.24m)	12/3 AWG	<input type="checkbox"/> GFI11M633
			3R	Tri-Tap	50' (15.24m)	12/3 AWG	<input type="checkbox"/> GFI11M639

*Automatic reset GFCIs also available. When ordering automatic Portable GFCIs replace "M" in catalog number with "A". Example: GFI11A133 = Automatic; GFI11M133 = Manual.

Inline Series - Field Wireable



Rating A	V/AC	NEMA	NEMA Type	Connector Style	Cord Length	Cord Gauge	Catalog No.
15	120	5-15	3R	-	1' (0.3m)	12/3 AWG	<input type="checkbox"/> GFI11MN3*
15	120	5-15	-	-	-	12-18 AWG	<input type="checkbox"/> GFP100-B**

*Automatic reset GFCIs are also available. When ordering automatic Portable GFCIs replace "M" in catalog number with "A". Example: GFI11AN3 = Automatic; GFI11MN3 = Manual.

**UL and CSA certified only.

Accessories for 15A Portable GFCIs



Description	Catalog No.
20A 125V/AC NEMA 5-20, Duplex Straight Blade Receptacle - Black	<input type="checkbox"/> BR20BK
Standard Depth, Portable Outlet Box With Cover Plates	<input type="checkbox"/> WD3059-DDN



GFP11M1P3



GFP400



GFI11M133



GFI11MN3



GFP100-B



WD3059-DDN



BR20BK

Specification Information:
15A Portable GFCIs: L-12
GFP400 & GFP100-B: G-16

Industrial Grade 20A Portable GFCIs

2-Pole, 3-Wire Grounding
20A, 120V/AC
20A, 240V/AC

20A Portable GFCIs, Inline Series

Inline Series - Field Wireable



Rating A	V/AC	NEMA	NEMA Type	Connector Style	Cord Length	Cord Gauge	Catalog No.*	
20	120	N/A	4X	Flying leads	2' (0.61m)	12/3 AWG	<input type="checkbox"/> GFI12M1NN	
			4X	Flying leads	6' (1.83m)	12/3 AWG	<input type="checkbox"/> GFI12M2NN	
			4X	Flying leads	25' (7.62m)	12/3 AWG	<input type="checkbox"/> GFI12M4NN	
			4X	Flying leads	50' (15.24m)	12/3 AWG	<input type="checkbox"/> GFI12M6NN	
20	240	N/A	4X	Flying leads	2' (0.61m)	12/3 AWG	<input type="checkbox"/> GFI22M1NN	
			4X	Flying leads	6' (1.83m)	12/3 AWG	<input type="checkbox"/> GFI22M2NN	
			4X	Flying leads	25' (7.62m)	12/3 AWG	<input type="checkbox"/> GFI22M4NN	
			4X	Flying leads	50' (15.24m)	12/3 AWG	<input type="checkbox"/> GFI22M6NN	

*Automatic reset GFCIs are also available and are NAFTA compliant. When ordering automatic Portable GFCIs replace "M" in catalog number with "A". Example: GFI12A1NN = Automatic; GFI12M1NN = Manual.



GFI12M1NN



GFI12M133

Inline Series - Molded Plug & Connector



Rating A	V/AC	NEMA	NEMA Type	Plug & Connector Style	Cord Length	Cord Gauge	Catalog No.*	
20	120	5-20	4X	Molded straight blade	2' (0.61m)	12/3 AWG	<input type="checkbox"/> GFI12M133	
			4X	Molded locking	2' (0.61m)	12/3 AWG	<input type="checkbox"/> GFI12M144	
20	240	L6-20	4X	Molded locking	2' (0.61m)	12/3 AWG	<input type="checkbox"/> GFI22M144	

*Automatic reset GFCIs are also available and are NAFTA compliant. When ordering automatic Portable GFCIs replace "M" in catalog number with "A". Example: GFI12A133 = Automatic; GFI12M133 = Manual.

Icon Key

NAFTA Compliant - see page O-30

Accessories for 20A Portable GFCIs

Description	Catalog No.	
15A 125V/AC NEMA 5-15 Watertight Plug	<input type="checkbox"/> 14W47	
15A 125V/AC NEMA 5-15 Watertight Connector	<input type="checkbox"/> 15W47	
Standard Depth Portable Outlet box with Flip Lids	<input type="checkbox"/> WD3059-DDW	
20A 125V/AC NEMA 5-20 Duplex Straight Blade Receptacle - Black	<input type="checkbox"/> BR20BK	
20A 125V/AC NEMA L5-20 Industrial Receptacle	<input type="checkbox"/> CWL520R	



15W47



WD3059-DDW



BR20BK



CWL520R

Specification Information:
20A Portable GFCIs: L-12

**Industrial Grade
30A Portable
GFCIs**

2-Pole, 3-Wire Grounding
30A, 120V/AC; 30A, 208V/AC
30A, 240V/AC; 30A, 277V/AC

30A Portable GFCIs, Inline Series

Inline Series - Field Wireable, Single Phase



Rating A	V/AC	NEMA	NEMA Type	Connector Style	Cord Length	Cord Gauge	Catalog No.*
30	120	N/A	4X	Flying leads	2' (0.61m)	10/3 AWG	<input type="checkbox"/> GFI13M1NN
			4X	Flying leads	6' (1.83m)	10/3 AWG	<input type="checkbox"/> GFI13M2NN
			4X	Flying leads	25' (7.62m)	10/3 AWG	<input type="checkbox"/> GFI13M4NN
			4X	Flying leads	50' (15.24m)	10/3 AWG	<input type="checkbox"/> GFI13M6NN
			4X	Flying leads	100' (30.48m)	10/3 AWG	<input type="checkbox"/> GFI13M7NN
30	208	N/A	4X	Flying leads	2' (0.61m)	10/3 AWG	<input type="checkbox"/> GFI93M1NN
30	240	N/A	4X	Flying leads	2' (0.61m)	10/3 AWG	<input type="checkbox"/> GFI23M1NN
			4X	Flying leads	6' (1.83m)	10/3 AWG	<input type="checkbox"/> GFI23M2NN
			4X	Flying leads	25' (7.62m)	10/3 AWG	<input type="checkbox"/> GFI23M4NN
			4X	Flying leads	50' (15.24m)	10/3 AWG	<input type="checkbox"/> GFI23M6NN
			4X	Flying leads	100' (30.48m)	10/3 AWG	<input type="checkbox"/> GFI23M7NN
30	277	N/A	4X	Flying leads	2' (0.61m)	10/3 AWG	<input type="checkbox"/> GFI3M1NN

*Automatic reset GFCIs are also available. When ordering automatic Portable GFCIs replace "M" in catalog number with "A". Example: GFI13A1NN = Automatic; GFI13M1NN = Manual.



GFI13M1NN

Inline Series - Molded Locking Plug & Connector



Rating A	V/AC	NEMA	NEMA Type	Plug & Connector Style	Cord Length	Cord Gauge	Catalog No.*
30	120	L5-30	4X	Molded locking	2' (0.61m)	10/3 AWG	<input type="checkbox"/> GFI13M144
30	240	L6-30	4X	Molded locking	2' (0.61m)	10/3 AWG	<input type="checkbox"/> GFI23M144

*Automatic reset GFCIs are also available. When ordering automatic Portable GFCIs replace "M" in catalog number with "A". Example: GFI13A144 = Automatic; GFI13M144 = Manual.



GFI13M144

Icon Key

NAFTA Compliant - see page O-30

Accessories for 30A Portable GFCIs

Description	Catalog No.
30A 125V/AC NEMA L5-30 Locking Plug	<input type="checkbox"/> CWL530P •
30A 125V/AC NEMA L5-30 Locking Connector	<input type="checkbox"/> CWL530C •
30A 125V/AC NEMA L5-30 Industrial Locking Receptacle	<input type="checkbox"/> CWL530R •
30A 125V/AC NEMA L6-30 Industrial Locking Receptacle	<input type="checkbox"/> CWL630R •
Standard Depth Portable Outlet Box	<input type="checkbox"/> WD3059 •



Specification Information:
30A Portable GFCIs: L-12

Watertight Portable GFCIs

2-Pole, 3-Wire Grounding
 15A, 120V/AC
 20A, 120V/AC; 20A, 240V/AC
 30A, 120V/AC; 30A, 240V/AC

Watertight Portable GFCIs

Inline Series - Watertight Plug and Connector Ends



GFI12M155

Rating A	V/AC	NEMA	NEMA Type	Plug & Connector Style	Cord Length	Cord Gauge	Catalog No.*			
15	120	5-15	3R	Straight Blade	2' (0.61m)	12/3 AWG	<input type="checkbox"/> GFI11M155			
					6' (1.83m)	12/3 AWG	<input type="checkbox"/> GFI11M255			
					25' (7.62m)	12/3 AWG	<input type="checkbox"/> GFI11M455			
					50' (15.24m)	12/3 AWG	<input type="checkbox"/> GFI11M655			
20	120	5-20	4X	Straight Blade	2' (0.61m)	12/3 AWG	<input type="checkbox"/> GFI12M155 •			
					6' (1.83m)	12/3 AWG	<input type="checkbox"/> GFI12M255			
					25' (7.62m)	12/3 AWG	<input type="checkbox"/> GFI12M455			
					L5-20	4X	Locking	2' (0.61m)	12/3 AWG	<input type="checkbox"/> GFI12M166
								6' (1.83m)	12/3 AWG	<input type="checkbox"/> GFI12M266
								25' (7.62m)	12/3 AWG	<input type="checkbox"/> GFI12M466
20	240	L6-20	4X	Locking	2' (0.61m)	12/3 AWG	<input type="checkbox"/> GFI22M166			
					6' (1.83m)	12/3 AWG	<input type="checkbox"/> GFI22M266			
					25' (7.62m)	12/3 AWG	<input type="checkbox"/> GFI22M466			
30	120	L5-30	4X	Locking	2' (0.61m)	12/3 AWG	<input type="checkbox"/> GFI13M166			
					6' (1.83m)	12/3 AWG	<input type="checkbox"/> GFI13M266			
					25' (7.62m)	12/3 AWG	<input type="checkbox"/> GFI13M466			
30	240	L6-30	4X	Locking	2' (0.61m)	12/3 AWG	<input type="checkbox"/> GFI23M166			
					6' (1.83m)	12/3 AWG	<input type="checkbox"/> GFI23M266			
					25' (7.62m)	12/3 AWG	<input type="checkbox"/> GFI23M466			

*Automatic reset GFCIs are also available and are NAFTA compliant. When ordering automatic Portable GFCIs replace "M" in catalog number with "A". Example: GFI12A155 = Automatic; GFI12M155 = Manual.

Icon Key

NAFTA Compliant - see page O-30

Accessories for Watertight Portable GFCIs

Description	Catalog No.
20A 125V/AC NEMA 5-20 Watertight Single Straight Blade Receptacle	<input type="checkbox"/> 60W33 •
20A 125V/AC NEMA 5-20 Watertight Duplex Straight Blade Receptacle	<input type="checkbox"/> 60W33DPLX •
20A Plug Closure Cap	<input type="checkbox"/> 20PW •
20A 125V/AC NEMA L5-20 Watertight Locking Receptacle	<input type="checkbox"/> L520RW •
30A 125V/AC NEMA L5-30 Watertight Locking Receptacle	<input type="checkbox"/> L530RW •

Specification Information:

15A Watertight Portable GFCIs: L-12

20A Watertight Portable GFCIs: L-12

30A Watertight Portable GFCIs: L-12



60W33



60W33DPLX



20PW



L520RW



L530RW

**Built to withstand,
deliver and perform**

Arrow Hart's portable outlet boxes provide a safe, durable, code compliant non-metallic solution for portable power.



Portable Outlet Boxes

Innovative co-molded one-piece design incorporates integrated strain relief

Bonding strap ensures that device and box are bonded to the grounding conductor(s); required in Canada per CSA C22.2 no. 18-98

Non-conductive Alcryn® material provides protection against electric shock and long-term durability

Integral cover plate mounting holes reduce installation time

Variety of cover plates available with and without flip lids to accommodate any installation

Alcryn® is a registered trademark of Advanced Polymer Alloys, a subsidiary of Ferro Corporation.



Largest internal volume of any non-metallic outlet box for ease of wiring and maintenance



Available in pendant, extra depth and feed-through configurations, in yellow or black



Portable Outlet Box assemblies with boxes and cover plates available for easy ordering



Integrated strain relief system includes grommets to accommodate a wide range of cord sizes

Portable Outlet Boxes, Cover Plates & Assemblies

Standard Depth Box, Extra Depth Box
Feed-Through Box
Portable Outlet Box Covers

Portable Outlet Boxes, Cover Plates & Assemblies

Portable Outlet Boxes

Description	Color	Catalog No.	
Standard Depth	Yellow	<input type="checkbox"/> WD3059*	•
Extra Depth	Yellow	<input type="checkbox"/> WD3099*	•
Extra Depth Feed-Through	Yellow	<input type="checkbox"/> WD3090F*	•

*Also available in All-Black. For ordering, include Cat. No. followed by the color code: BK (Black). All Cooper Wiring Devices' Portable Outlet Boxes have compression fittings.



WD3059



WD3099

Portable Outlet Box Cover Plates

Description	Diameter Opening	Plate Color	Catalog No.	
Duplex Receptacle Cover Plate	—	Black	<input type="checkbox"/> WD3051BK	•
Single Receptacle Cover Plate	1.56" (39.6mm)	Black	<input type="checkbox"/> WD3052BK	•
Single Receptacle Cover Plate	1.39" (35.3mm)	Black	<input type="checkbox"/> WD3054BK	•
Decorator Style Cover Plate	—	Black	<input type="checkbox"/> WD3055BK	•
Decorator Style Cover Plate with Flip Lid	—	Black	<input type="checkbox"/> WD3056BK	•
Duplex Receptacle Cover Plate with Flip Lid	—	Black	<input type="checkbox"/> WD3060BK	•
Blank Cover Plate	—	Black	<input type="checkbox"/> WD3061BK	•

Portable Outlet Box & Cover Plate Assemblies

Outlet Box Type	with Cover Plates-Type	Box Color*	Catalog No.	
Standard Depth POB	(2) WD3051BK - No Flip Lids	Yellow	<input type="checkbox"/> WD3059-DDN*	•
	(2) WD3060BK - With Flip Lids	Yellow	<input type="checkbox"/> WD3059-DDW*	•
	(2) WD3054BK - No Flip Lids	Yellow	<input type="checkbox"/> WD3059-SSN*	•
	(2) WD3052BK - No Flip Lids	Yellow	<input type="checkbox"/> WD3059-LLN*	•
Extra Depth POB	(2) WD3051BK - No Flip Lids	Yellow	<input type="checkbox"/> WD3099-DDN*	•
	(2) WD3060BK - With Flip Lids	Yellow	<input type="checkbox"/> WD3099-DDW*	•
	(2) WD3054BK - No Flip Lids	Yellow	<input type="checkbox"/> WD3099-SSN*	•
	(2) WD3052BK - No Flip Lids	Yellow	<input type="checkbox"/> WD3099-LLN*	•
Extra Depth Feed-Through POB	(2) WD3051BK - No Flip Lids	Yellow	<input type="checkbox"/> WD3090F-DDN*	•
	(2) WD3060BK - With Flip Lids	Yellow	<input type="checkbox"/> WD3090F-DDW*	•
	(2) WD3054BK - No Flip Lids	Yellow	<input type="checkbox"/> WD3090F-SSN*	•
	(2) WD3052BK - No Flip Lids	Yellow	<input type="checkbox"/> WD3090F-LLN*	•

*Also available in All-Black. For ordering, include Cat. No. followed by the color code: BK (Black). Examples : WD3059BK, WD3059BK-DDN. All Cooper Wiring Devices' Portable Outlet Boxes have compression fittings.



Cover Plates



WD3059-DDN

Specification Information:

Portable Outlet Boxes, Covers & Assemblies: L-13

Icon Key

NAFTA Compliant - see page O-30

RhinoBox™ Temporary Power Centers

50A Input
20A, 30A, 50A Output
120/240V/AC (Max.)

	Device Type	NEMA 1 Enclosures RB200 Series, Automatic or Manual Reset	NEMA 3R Enclosures RB300 Series, Automatic or Manual Reset
	Input	50A, 120/240V/AC, 60Hz, 3-Pole, 4-Wire Grounding	50A, 120/240V/AC, 60Hz, 3-Pole, 4-Wire Grounding
	Testing & Code Compliance	<ul style="list-style-type: none"> cETLus Listed for indoor use 	<ul style="list-style-type: none"> cETLus Listed for indoor or outdoor use
		<ul style="list-style-type: none"> Complies with NEC Articles 525 & 590 	<ul style="list-style-type: none"> Complies with NEC Articles 525 & 590
		<ul style="list-style-type: none"> Complies with OSHA Reg. 29CFR, Part 1926, Subpart K, 1926.404, GFCI requirements 	<ul style="list-style-type: none"> Complies with OSHA Reg. 29CFR, Part 1926, Subpart K, 1926.404, GFCI requirements
		<ul style="list-style-type: none"> Conforms to UL 1640 and CSA C22.2, no. 14 	<ul style="list-style-type: none"> Conforms to UL 1640 and CSA C22.2, no. 14
Specifications: Environmental	Enclosure Type	NEMA 1	NEMA 3R
Specifications: Electrical	GFCI Protection for 20A Receptacles	Yes	Yes
	Overload Protection	Yes	Yes
Materials:	Enclosure	Cold-rolled 18 gauge steel	Cold-rolled 18 gauge steel
	Legs	Cold-rolled 10 gauge steel	Cold-rolled 10 gauge steel

**Industrial Grade
Portable GFCIs**

2-Pole, 3-Wire Grounding
15A, 120V/AC
20A, 120V/AC; 20A, 208V/AC; 20A, 240V/AC; 20A, 277V/AC
30A, 120V/AC; 30A, 208V/AC; 30A, 240V/AC; 30A, 277V/AC

	Device Type	15A Portable GFCIs Inline, Plug Series	20A Portable GFCIs Inline Series	30A Portable GFCIs Inline Series
	Connection Type	Molded plug & connector field wireable, or watertight plug & connector	Molded plug & connector, watertight plug & connector, or field wireable flying leads	Molded plug & connector, watertight plug & connector, or field wireable flying leads
	Testing & Code Compliance	<ul style="list-style-type: none"> cULus listed to UL943 	<ul style="list-style-type: none"> Plug & connector ends: cULus listed to UL943 Field wireable: UL recognized component for US & Canada 	<ul style="list-style-type: none"> Plug & connector ends: cULus listed to UL943 Field wireable: UL recognized component for US & Canada
		<ul style="list-style-type: none"> OSHA 29 CFR 1926.404 (b)(1)(ii) & OSHA 29 CFR 1926.405 (a)(2)(ii)(G) 	<ul style="list-style-type: none"> OSHA 29 CFR 1926.404 (b)(1)(ii) & OSHA 29 CFR 1926.405 (a)(2)(ii)(G) 	<ul style="list-style-type: none"> OSHA 29 CFR 1926.404 (b)(1)(ii) & OSHA 29 CFR 1926.405 (a)(2)(ii)(G)
		<ul style="list-style-type: none"> NEC 590.6, NEC 511.12, NEC 600.10, NEC 680.5, NEC 680.40 	<ul style="list-style-type: none"> NEC 590.6, NEC 511.12, NEC 600.10, NEC 680.5, NEC 680.40 	<ul style="list-style-type: none"> NEC 590.6, NEC 511.12, NEC 600.10, NEC 680.5, NEC 680.40
Specifications: Environmental	Enclosure Protection	NEMA 3R rated	NEMA 4X rated	NEMA 4X rated
	Temperature Rating	-35°C to 66°C (-31°F to 151°F)	-35°C to 66°C (-31°F to 151°F)	-35°C to 66°C (-31°F to 151°F)
Specifications: Electrical	Rated Supply Voltage	120V/AC	120V/AC, 208V/AC, 240V/AC, 277V/AC	120VAC, 208V/AC, 240V/AC, 277V/AC
	Rated Current/Current	Up to 15A or rating of wiring device and/or cable	Up to 20A or rating of wiring device and/or cable	Up to 30A or rating of wiring device and/or cable
	Ground Trip Current	4-6 mA	4-6 mA	4-6 mA
	Overload Current	90A @ 125V/AC	120A	180A
	Insulation Voltage	4000V – 1 minute	4000V – 1 minute	4000V – 1 minute
	Response Time	25 mS max.	25 mS max.	25 mS max.
	Let Go Voltage	N/A	60% rated voltage	60% rated voltage
Specifications: Mechanical	Reset Type	Manual or automatic	Manual or automatic	Manual or automatic
	Operating Frequency	60 Hz	60 Hz	60 Hz
	GFCI Type	Class A	Class A	Class A
	Endurance Operations	3,000 operations	3,000 operations	3,000 operations
	Switch Interference	N/A	Double insulated	Double insulated
	Latching Mechanism	N/A	Electro-magnetic	Electro-magnetic
Materials:	Body	Polycarbonate	Polycarbonate & ABS (Gray)	Polycarbonate & ABS (Gray)
	Cord	Heavy duty 12/3 SJTW cable	Heavy duty 12/3 SJEOW cable	Heavy duty 10/3 SJTOW cable

**Portable Outlet Boxes,
Cover Plates &
Assemblies**

Standard Depth Box, Extra Depth Box
Feed-Through Box
Portable Outlet Box Covers

Device Type	Portable Outlet Boxes	Portable Outlet Box Cover Plates	
Color	Yellow or Black	Black	
Testing & Code Compliance	<ul style="list-style-type: none"> Assemblies UL Listed to UL514C, UL467 and UL50 	<ul style="list-style-type: none"> Assemblies UL Listed to UL514C, UL467 and UL50 	
	<ul style="list-style-type: none"> Assemblies are NEMA Type 1 enclosures 	<ul style="list-style-type: none"> Assemblies are NEMA Type 1 enclosures 	
	<ul style="list-style-type: none"> Assemblies CSA certified to C22.2 no. 18 and C22.2 no. 94 	<ul style="list-style-type: none"> Assemblies CSA certified to C22.2 no. 18 and C22.2 no. 94 	
Specifications: Environmental	Enclosure Type/Moisture Resistance	NEMA 1	N/A
	Physical & Contaminant Breakdown Resistance	Resistant to impact & shock, corrosion resistant, weather resistant, heat resistant, oil resistant, chemical resistant, resistant to breakdown from UV exposure	Resistant to impact & shock, corrosion resistant, weather resistant, heat resistant, oil resistant, chemical resistant, resistant to breakdown from UV exposure
	Flammability	Meets UL 94 requirements; V0 rated	Meets UL 94 requirements; V0 rated
	Temperature Rating	-35°C to 80°C (-32°F to 176°F)	-35°C to 80°C (-32°F to 176°F)
Specifications: Mechanical	Strain Relief Fitting	Compression fitting with gaskets to accommodate multiple cord diameters; diameter range #16/3 SO through #12/3 SO or 0.38" through 0.75"	N/A
	Grommet Accommodation	Standard depth box (3 grommets): Small: 14/3 & 16/3 SJO Medium: 16/3 SOW & 12/3 SJO Large: 14/3 SOW & 12/5 SOW Extra depth & feed-through box (2 grommets): Small: 12/3, 12/4, 12/5, 10/3 SOW Large: 10/4 & 10/5 SOW	N/A
Materials:	Body	Valox® Alcryn® for WD3059 Santoprene for WD3099 and WD3090F	Valox®

Alcryn® is a registered trademark of Advanced Polymer Alloys, a subsidiary of Ferro Corporation.
Valox® is a registered trademark of the GE Company.

M

Wire Mesh Grips



	Page		Page
Strain Relief Grips	M-1	Pulling Grips	M-14
Deluxe Cord Grips		Junior Duty	
3/8" NPT Deluxe Cord Grips	M-1	Flexible Eye	M-14
1/2" NPT Deluxe Cord Grips	M-1	Light Duty	
3/4" NPT Deluxe Cord Grips	M-1	Short Length, Flexible Eye	M-14
1" NPT Deluxe Cord Grips	M-2	Standard Length, Flexible Eye	M-14
1-1/4" NPT Deluxe Cord Grips	M-2	Medium Duty	
1-1/2" NPT Deluxe Cord Grips	M-2	Short Length, Flexible Eye, T-Type	M-15
2" NPT Deluxe Cord Grips	M-3	Standard Length, Flexible Eye, T-Type	M-15
2-1/2" NPT Deluxe Cord Grips	M-3	Long Length, Flexible Eye	M-15
3" NPT Deluxe Cord Grips	M-3	Heavy-Duty	
Dust Tight Grips		Short Length, Rotating Eye, K-Type	M-16
Wide Range, Straight Male	M-4	Standard Length, Rotating Eye, K-Type	M-16
Wiring Device I-Grips		Multi-Weave	
Wiring Device I-Grips	M-4	Rotating Eye	M-17
Liquid-Tight Grips		Flexible Eye	M-17
Metallic Flexible Conduit	M-4	Slack – Double Weave – Closed Mesh	
Support Grips	M-5	Standard Length, Offset Eye	M-18
Standard Duty – Closed Mesh		Long Length, Offset Eye	M-18
Single Eye	M-5	Slack – Double Weave – Split Lace	
Double Eye	M-5	Standard Length, Offset Eye	M-19
Offset Eye	M-6	Long Length, Offset Eye	M-19
Locking Bale	M-6	Slack – Single Weave – Split Rod	
Standard Duty – Split Lace		Standard Length, Offset Eye	M-19
Single Eye	M-7	Wire Mesh Grip Reference	M-20
Double Eye	M-7	Selecting Properly Sized Pulling and	
Offset Eye	M-8	Support Grips	M-20–M-21
Locking Bale	M-8	Strength Information	M-22
Standard Duty – Split Rod		Split Lace/Split Rod Attachments	M-22
Single Eye	M-9	AWG or MCM Wire Sizes	M-23
Double Eye	M-9		
Offset Eye	M-10		
Locking Bale	M-10		
Heavy-Duty – Closed Mesh			
Single Eye	M-11		
Double Eye	M-11		
Heavy-Duty – Split Lace			
Single Eye	M-11		
Double Eye	M-11		
Service Drop – Closed Mesh			
Single Eye	M-12		
Locking Bale	M-12		
Bus Drop – Closed Mesh			
Single Eye	M-13		
Locking Bale	M-13		

Complete offering of wire mesh grips built tough for industrial applications

Arrow Hart supplies a broad selection of strain relief, pulling and support grips in a wide range of styles and sizes to serve all of your cable protection needs.

**Strain Relief Grips**

Strain Relief Grips are used to connect cable enclosures and industrial equipment. These grips prevent cable or conduit pull-out at the point of termination due to tension. Strain Relief Grips also distribute strain throughout the length of the mesh during bending, prolonging the life of the cable.

**Support Grips**

Support Grips distribute the weight of vertical drops and sloping runs over the length of the grip to protect the cable from damage. A variety of hanging styles are available to service numerous cable support installations.

**Pulling Grips**

Pulling Grips serve as reusable tools for pulling cables, wires, and/or rope in overhead and underground cable pulls. These grips protect the cable from abrasion and ease the cable through bends and rough surfaces.

Strain Relief Grips - Deluxe Cord Grips

Deluxe cord grips are woven of stainless steel mesh with an aluminum body for corrosion resistance. They are offered in single/double weave construction to help absorb direct pull, to resist flexing and binding, and to eliminate strain. They are recommended for indoor or outdoor use where subjected to moisture in the wiring of pendant stations, processing equipment, hand tools, and extension cord sets. Deluxe grips are suitable for use in hazardous locations per Class I, Div. 2; Class II, Div. 1 & 2; and Class III, Div. 1 & 2.

3/8" NPT Deluxe Cord Grips



Cord Diameter	Straight Male Catalog No.	90° Male Catalog No.
0.19-0.25" (4.8-6.4mm)	<input type="checkbox"/> DC000187	<input checked="" type="checkbox"/> DC000187-90
0.25-0.31" (6.4-7.9mm)	<input type="checkbox"/> DC000250	<input checked="" type="checkbox"/> DC000250-90
0.31-0.38" (7.9-9.7mm)	<input type="checkbox"/> DC000312	<input checked="" type="checkbox"/> DC000312-90
0.38-0.50" (9.7-12.7mm)	<input type="checkbox"/> DC000375	<input checked="" type="checkbox"/> DC000375-90



Deluxe Cord Grips
Straight Male Connector

1/2" NPT Deluxe Cord Grips



Cord Diameter	Straight Male Catalog No.	90° Male Catalog No.	45° Male Catalog No.	Straight Female Catalog No.
0.19-0.25" (4.8-6.4mm)	<input type="checkbox"/> DC100187	<input checked="" type="checkbox"/> DC100187-90	<input checked="" type="checkbox"/> DC100187-45	<input checked="" type="checkbox"/> DC100187-F
0.25-0.38" (6.4-9.6mm)	<input type="checkbox"/> DC100250	<input checked="" type="checkbox"/> DC100250-90	<input checked="" type="checkbox"/> DC100250-45	<input checked="" type="checkbox"/> DC100250-F
0.38-0.50" (9.7-12.7mm)	<input type="checkbox"/> DC100375	<input checked="" type="checkbox"/> DC100375-90	<input checked="" type="checkbox"/> DC100375-45	<input checked="" type="checkbox"/> DC100375-F
0.50-0.63" (12.7-16.0mm)	<input type="checkbox"/> DC100500	<input checked="" type="checkbox"/> DC100500-90	<input checked="" type="checkbox"/> DC100500-45	<input checked="" type="checkbox"/> DC100500-F
0.63-0.75" (16.0-19.1mm)	<input type="checkbox"/> DC100625	—	—	—
0.75-0.88" (19.1-22.4mm)	<input type="checkbox"/> DC100750	—	—	—



Deluxe Cord Grips
90° Male Connector



Deluxe Cord Grips
45° Male Connector

3/4" NPT Deluxe Cord Grips



Cord Diameter	Straight Male Catalog No.	90° Male Catalog No.	45° Male Catalog No.	Straight Female Catalog No.
0.25-0.38" (6.4-9.6mm)	<input type="checkbox"/> DC200250	<input checked="" type="checkbox"/> DC200250-90	<input checked="" type="checkbox"/> DC100250-45	<input checked="" type="checkbox"/> DC200250-F
0.38-0.50" (9.7-12.7mm)	<input type="checkbox"/> DC200375	<input checked="" type="checkbox"/> DC200375-90	<input checked="" type="checkbox"/> DC100375-45	<input checked="" type="checkbox"/> DC200375-F
0.50-0.63" (12.7-16.0mm)	<input type="checkbox"/> DC200500	<input checked="" type="checkbox"/> DC200500-90	<input checked="" type="checkbox"/> DC100500-45	<input checked="" type="checkbox"/> DC200500-F
0.63-0.75" (16.0-19.1mm)	<input type="checkbox"/> DC200625	<input checked="" type="checkbox"/> DC200625-90	<input checked="" type="checkbox"/> DC200625-45	<input checked="" type="checkbox"/> DC200625-F
0.75-0.88" (19.1-22.4mm)	<input type="checkbox"/> DC200750	—	—	—



Deluxe Cord Grips
Straight Female Connector

Icon Key

NAFTA Compliant - see page O-30

Strain Relief Grips - Deluxe Cord Grips

1" NPT Deluxe Cord Grips



Deluxe Cord Grips
Straight Male Connector

Cord Diameter	Straight Male Catalog No.	90° Male Catalog No.	45 Male Catalog No.	Straight Female Catalog No.
0.44-0.56" (11.2-14.0mm)	<input type="checkbox"/> DC300437 •	<input type="checkbox"/> DC300437-90 •	<input type="checkbox"/> DC300437-45 •	<input type="checkbox"/> DC300437-F •
0.56-0.69" (14.2-17.5mm)	<input type="checkbox"/> DC300562 •	<input type="checkbox"/> DC300562-90 •	<input type="checkbox"/> DC300562-45 •	<input type="checkbox"/> DC300562-F •
0.63-0.75" (16.0-19.1mm)	<input type="checkbox"/> DC300625 •	<input type="checkbox"/> DC300625-90 •	<input type="checkbox"/> DC300625-45 •	<input type="checkbox"/> DC300625-F •
0.75-0.88" (19.1-22.4mm)	<input type="checkbox"/> DC300750 •	<input type="checkbox"/> DC300750-90 •	<input type="checkbox"/> DC300750-45 •	<input type="checkbox"/> DC300750-F •
0.88-1.00" (22.4-25.4mm)	<input type="checkbox"/> DC300875 •	<input type="checkbox"/> DC300875-90 •	<input type="checkbox"/> DC300875-45 •	<input type="checkbox"/> DC300875-F •
1.00-1.13" (25.4-28.7mm)	<input type="checkbox"/> DC3001000 •	—	—	—
1.13-1.25" (28.7-31.8mm)	<input type="checkbox"/> DC3001125 •	—	—	—

1-1/4" NPT Deluxe Cord Grips



Deluxe Cord Grips
90° Male Connector

Cord Diameter	Straight Male Catalog No.	90° Male Catalog No.
0.75-0.88" (19.1-22.4mm)	<input type="checkbox"/> DC400750 •	<input type="checkbox"/> DC400750-90 •
0.88-1.00" (22.4-25.4mm)	<input type="checkbox"/> DC400875 •	<input type="checkbox"/> DC400875-90 •
1.00-1.13" (25.4-28.7mm)	<input type="checkbox"/> DC4001000 •	<input type="checkbox"/> DC4001000-90 •
1.13-1.25" (28.7-31.8mm)	<input type="checkbox"/> DC4001125 •	<input type="checkbox"/> DC4001125-90 •
1.25-1.38" (31.8-35.1mm)	<input type="checkbox"/> DC4001250 •	<input type="checkbox"/> DC4001250-90 •



Deluxe Cord Grips
45° Male Connector

1-1/2" NPT Deluxe Cord Grips



Deluxe Cord Grips
Straight Female Connector

Cord Diameter	Straight Male Catalog No.	90° Male Catalog No.
0.75-0.88" (19.1-22.4mm)	<input type="checkbox"/> DC500750 •	<input type="checkbox"/> DC500750-90 •
0.88-1.00" (22.4-25.4mm)	<input type="checkbox"/> DC500875 •	<input type="checkbox"/> DC500875-90 •
1.00-1.13" (25.4-28.7mm)	<input type="checkbox"/> DC5001000 •	<input type="checkbox"/> DC5001000-90 •
1.13-1.25" (28.7-31.8mm)	<input type="checkbox"/> DC5001125 •	<input type="checkbox"/> DC5001125-90 •
1.25-1.38" (31.8-35.1mm)	<input type="checkbox"/> DC5001250 •	<input type="checkbox"/> DC5001250-90 •
1.31-1.44" (33.3-36.6mm)	<input type="checkbox"/> DC5001312 •	—
1.44-1.56" (36.6-39.6mm)	<input type="checkbox"/> DC5001437 •	—
1.56-1.69" (39.6-43.0mm)	<input type="checkbox"/> DC5001562 •	—
1.69-1.81" (43.0-46.0mm)	<input type="checkbox"/> DC5001687 •	—
1.75-1.88" (44.5-47.8mm)	<input type="checkbox"/> DC5001750 •	—

Icon Key

NAFTA Compliant - see page O-30

Strain Relief Grips - Deluxe Cord Grips

2" NPT Deluxe Cord Grips



Cord Diameter	Straight Male Catalog No.		90° Male Catalog No.	
1.25-1.38" (31.8-35.1mm)	<input type="checkbox"/> DC6001250	•	<input type="checkbox"/> DC6001250-90	•
1.31-1.44" (33.3-36.6mm)	<input type="checkbox"/> DC6001312	•	<input type="checkbox"/> DC6001312-90	•
1.44-1.56" (36.6-39.6mm)	<input type="checkbox"/> DC6001437	•	<input type="checkbox"/> DC6001437-90	•
1.56-1.69" (39.6-43.0mm)	<input type="checkbox"/> DC6001562	•	<input type="checkbox"/> DC6001562-90	•
1.69-1.81" (43.0-46.0mm)	<input type="checkbox"/> DC6001687	•	<input type="checkbox"/> DC6001687-90	•
1.75-1.88" (44.5-47.8mm)	<input type="checkbox"/> DC6001750	•	<input type="checkbox"/> DC6001750-90	•
1.81-1.94" (45.9-49.3mm)	<input type="checkbox"/> DC6001812	•	—	—
1.94-2.06" (49.3-52.3mm)	<input type="checkbox"/> DC6001937	•	—	—
2.06-2.19" (52.3-55.5mm)	<input type="checkbox"/> DC6002062	•	—	—
2.19-2.31" (55.5-58.7mm)	<input type="checkbox"/> DC6002187	•	—	—
2.31-2.44" (58.7-61.9mm)	<input type="checkbox"/> DC6002312	•	—	—



Deluxe Cord Grips
Straight Male Connector

2-1/2" NPT Deluxe Cord Grips



Cord Diameter	Straight Male Catalog No.	
1.69-1.81" (43.0-46.0mm)	<input type="checkbox"/> DC7001687	•
1.81-1.94" (46.0-49.3mm)	<input type="checkbox"/> DC7001812	•
1.94-2.06" (49.3-52.3mm)	<input type="checkbox"/> DC7001937	•
2.06-2.19" (52.3-55.6mm)	<input type="checkbox"/> DC7002062	•
2.19-2.31" (55.6-58.7mm)	<input type="checkbox"/> DC7002187	•
2.31-2.44" (58.7-62.0mm)	<input type="checkbox"/> DC7002312	•



Deluxe Cord Grips
90° Male Connector

3" NPT Deluxe Cord Grips



Cord Diameter	Straight Male Catalog No.	
1.69-1.81" (43.0-46.0mm)	<input type="checkbox"/> DC8001687	•
1.81-1.94" (46.0-49.3mm)	<input type="checkbox"/> DC8001812	•
1.94-2.06" (49.3-52.3mm)	<input type="checkbox"/> DC8001937	•
2.06-2.19" (52.3-55.6mm)	<input type="checkbox"/> DC8002062	•
2.19-2.31" (55.6-58.7mm)	<input type="checkbox"/> DC8002187	•
2.31-2.44" (58.7-62.0mm)	<input type="checkbox"/> DC8002312	•
2.44-2.63" (62.0-66.5mm)	<input type="checkbox"/> DC8002437	•
2.63-2.81" (66.5-71.4mm)	<input type="checkbox"/> DC8002625	•
2.81-3.00" (71.4-76.2mm)	<input type="checkbox"/> DC8002812	•
3.00-3.25" (76.2-82.6mm)	<input type="checkbox"/> DC8003000	•



Deluxe Cord Grips
45° Male Connector



Deluxe Cord Grips
Straight Female Connector

Icon Key

NAFTA Compliant - see page O-30

Strain Relief - Wide Range - Straight Male - Dust Tight Grips

Wide range grips are constructed with steel mesh and locknut, aluminum threaded body, neoprene gasket and nylon insulated bushing. Wide range grips are recommended for indoor use in wiring of enclosures, power boxes, machine tools, and power centers.



TCI254

Cord Diameter	NPT	Catalog No. Non-Insulated		Catalog No. Insulated	
0.22-0.32" (5.6-8.1mm)	1/2" (12.7mm)	<input type="checkbox"/> TC124	•	<input type="checkbox"/> TCI124	•
0.30-0.43" (7.6-10.9mm)	1/2" (12.7mm)	<input type="checkbox"/> TC132	•	<input type="checkbox"/> TCI132	•
0.40-0.54" (10.1-13.7mm)	1/2" (12.7mm)	<input type="checkbox"/> TC143	•	<input type="checkbox"/> TCI143	•
0.52-0.73" (13.2-18.5mm)	3/4" (19.0mm)	<input type="checkbox"/> TC254	•	<input type="checkbox"/> TCI254	•
0.70-0.97" (17.8-24.6mm)	1" (25.4mm)	<input type="checkbox"/> TC373	•	<input type="checkbox"/> TCI373	•
0.94-1.25" (23.8-31.8mm)	1-1/4" (31.8mm)	<input type="checkbox"/> TC497	•	<input type="checkbox"/> TCI497	•
1.20-1.50" (30.5-38.1mm)	1-1/2" (38.1mm)	—		<input type="checkbox"/> TCI5125	•
1.40-1.75" (38.1-44.5mm)	2" (50.8mm)	—		<input type="checkbox"/> TCI6150	•
1.62-2.00" (41.1-50.8mm)	2-1/2" (63.5mm)	—		<input type="checkbox"/> TCI7170	•
2.00-2.45" (50.8-62.2mm)	2-1/2" (63.5mm)	—		<input type="checkbox"/> TCI7200	•

Strain Relief - Wiring Device I-Grips

I-Grips provide additional strain relief for wiring device plugs and connectors used on portable equipment in commercial and institutional applications, and industrial plant and construction site areas which are exposed to abnormally high abuse.



I52

Cord Diameter	Mesh Length	Catalog No.	
0.30-0.43" (7.6-10.9mm)	4.75" (120.6mm)	<input type="checkbox"/> I30	•
0.40-0.56" (10.1-14.2mm)	6.00" (152.4mm)	<input type="checkbox"/> I40	•
0.52-0.73" (13.2-18.5mm)	7.00" (177.8mm)	<input type="checkbox"/> I52	•
0.70-0.85" (17.8-21.6mm)	8.50" (215.9mm)	<input type="checkbox"/> I70	•
0.82-1.00" (20.8-25.4mm)	8.50" (215.9mm)	<input type="checkbox"/> I82	•
0.94-1.25" (23.9-31.8mm)	10.50" (266.7mm)	<input type="checkbox"/> I94	•

Strain Relief - Liquid-Tight for Metallic Flexible Conduit

Liquid-Tight grips are woven of stainless steel mesh with zinc plated steel or malleable iron bodies and nuts for corrosion resistance. They are used to connect liquid-tight flexible conduit to electrical enclosures to prevent conduit pullout. Each fitting is supplied with an insulated throat to provide conductor insulation and protect against damage by flexing, heat expansion and contraction. Liquid-Tight grips are recommended in the wiring of motors and any electrical enclosure where liquid-tight conduit is subject to motion or strain.



LTB100



LTB190

NPT Size	Mesh Length	Straight Male Catalog No.		90° Male Catalog No.		45° Male Catalog No.	
3/8" (9.7mm)	2.63" (66.7mm)	<input type="checkbox"/> LTB000		<input type="checkbox"/> LTB090		<input type="checkbox"/> LTB045	
1/2" (12.7mm)	3.88" (98.4mm)	<input type="checkbox"/> LTB100	•	<input type="checkbox"/> LTB190	•	<input type="checkbox"/> LTB145	•
3/4" (19.0mm)	4.38" (111.1mm)	<input type="checkbox"/> LTB200	•	<input type="checkbox"/> LTB290	•	<input type="checkbox"/> LTB245	•
1" (25.4mm)	5.25" (133.3mm)	<input type="checkbox"/> LTB300	•	<input type="checkbox"/> LTB390	•	<input type="checkbox"/> LTB345	•
1-1/4" (31.8mm)	5.63" (142.9mm)	<input type="checkbox"/> LTB400	•	<input type="checkbox"/> LTB490	•	<input type="checkbox"/> LTB445	•
1-1/2" (38.1mm)	5.75" (146.0mm)	<input type="checkbox"/> LTB500	•	<input type="checkbox"/> LTB590	•	<input type="checkbox"/> LTB545	•
2" (50.8mm)	7.50" (190.5mm)	<input type="checkbox"/> LTB600	•	<input type="checkbox"/> LTB690	•	<input type="checkbox"/> LTB645	•
2-1/2" (63.5mm)	9.63" (244.6mm)	<input type="checkbox"/> LTB700	•	<input type="checkbox"/> LTB790	•	<input type="checkbox"/> LTB745	•
3" (76.2mm)	10.63" (270.0mm)	<input type="checkbox"/> LTB800	•	<input type="checkbox"/> LTB890	•	<input type="checkbox"/> LTB845	•
4" (101.6mm)	12.0" (304.8mm)	<input type="checkbox"/> LTB900	•	<input type="checkbox"/> LTB990	•	<input type="checkbox"/> LTB945	•

Icon Key

NAFTA Compliant - see page O-30

Support Grips - Standard Duty - Closed Mesh

Standard closed mesh support grips are designed for loads up to 600 lbs. and vertical runs of no more than 100 ft. They are available in a variety of eye styles and cable ranges for supporting electrical and fiber optic cable, metal rods and tubing. Closed mesh support grips are used when the end of the cable is accessible. Support grips are woven of corrosion resistant tinned-bronze wire.

Single Eye Grips



Cord Diameter	Bale Length	Mesh Length	Approx. Break Strength†	Catalog No.*
0.50-0.62" (12.7-15.7mm)	7" (177.8mm)	11" (279.4mm)	770 lbs.	<input type="checkbox"/> SGS50
0.62-0.74" (15.7-18.8mm)	8" (203.2mm)	11" (279.4mm)	960 lbs.	<input type="checkbox"/> SGS63
0.75-0.99" (19.1-25.1mm)	8" (203.2mm)	14" (355.6mm)	1,300 lbs.	<input type="checkbox"/> SGS75
1.00-1.24" (25.4-31.5mm)	9" (228.6mm)	15" (381.0mm)	1,680 lbs.	<input type="checkbox"/> SGS100
1.25-1.49" (31.8-37.8mm)	10" (254.0mm)	16" (406.4mm)	1,680 lbs.	<input type="checkbox"/> SGS125
1.50-1.74" (38.1-44.2mm)	12" (304.8mm)	18" (457.2mm)	1,680 lbs.	<input type="checkbox"/> SGS150
1.75-1.99" (44.5-50.5mm)	14" (355.6mm)	20" (508.0mm)	2,640 lbs.	<input type="checkbox"/> SGS175
2.00-2.49" (50.8-63.2mm)	16" (406.4mm)	22" (558.8mm)	3,760 lbs.	<input type="checkbox"/> SGS200
2.50-2.99" (63.5-75.9mm)	18" (457.2mm)	24" (609.6mm)	3,760 lbs.	<input type="checkbox"/> SGS250
3.00-3.49" (76.2-88.6mm)	21" (533.4mm)	26" (660.4mm)	5,040 lbs.	<input type="checkbox"/> SGS300
3.50-3.99" (88.9-101.3mm)	24" (609.6mm)	28" (711.2mm)	5,040 lbs.	<input type="checkbox"/> SGS350



SGS100

Double Eye Grips



Cord Diameter	Bale Length	Mesh Length	Approx. Break Strength†	Catalog No.*
0.50-0.61" (12.7-15.5mm)	4" (101.6mm)	11" (279.4mm)	770 lbs.	<input type="checkbox"/> SGD50
0.62-0.74" (15.7-18.8mm)	4" (101.6mm)	11" (279.4mm)	1,150 lbs.	<input type="checkbox"/> SGD63
0.75-0.99" (19.1-25.1mm)	4" (101.6mm)	14" (355.6mm)	1,320 lbs.	<input type="checkbox"/> SGD75
1.00-1.24" (25.4-31.5mm)	5" (127.0mm)	15" (381.0mm)	1,920 lbs.	<input type="checkbox"/> SGD100
1.25-1.49" (31.8-37.8mm)	5" (127.0mm)	16" (406.4mm)	1,920 lbs.	<input type="checkbox"/> SGD125
1.50-1.74" (38.1-44.2mm)	6" (152.4mm)	18" (457.2mm)	1,920 lbs.	<input type="checkbox"/> SGD150
1.75-1.99" (44.5-50.5mm)	6" (152.4mm)	20" (508.0mm)	3,150 lbs.	<input type="checkbox"/> SGD175
2.00-2.49" (50.8-63.2mm)	6" (152.4mm)	22" (558.8mm)	3,360 lbs.	<input type="checkbox"/> SGD200
2.50-2.99" (63.5-75.9mm)	6" (152.4mm)	24" (609.6mm)	3,360 lbs.	<input type="checkbox"/> SGD250
3.00-3.49" (76.2-88.6mm)	8" (203.2mm)	26" (660.4mm)	5,280 lbs.	<input type="checkbox"/> SGD300
3.50-3.99" (88.9-101.3mm)	8" (203.2mm)	28" (711.2mm)	5,280 lbs.	<input type="checkbox"/> SGD350



SGD100

* For stainless steel support grips, add "SS" suffix to the catalog number (example, SGS50SS). Consult Factory for price and availability.

† To determine workload safety factor, divide approximate break strength by 10. See page M-22 for strength information.

Icon Key

NAFTA Compliant - see page O-30

Support Grips - Standard Duty - Closed Mesh

Offset Eye



Cord Diameter	Bale Length	Mesh Length	Approx. Break Strength†	Catalog No.*
0.50-0.61" (12.7-15.5mm)	4" (101.6mm)	11" (279.4mm)	770 lbs.	<input type="checkbox"/> SGO50
0.62-0.74" (15.7-18.8mm)	4" (101.6mm)	11" (279.4mm)	960 lbs.	<input type="checkbox"/> SGO63
0.75-0.99" (19.1-25.1mm)	4" (101.6mm)	14" (355.6mm)	960 lbs.	<input type="checkbox"/> SGO75
1.00-1.24" (25.4-31.5mm)	5" (127.0mm)	15" (381.0mm)	1,680 lbs.	<input type="checkbox"/> SGO100
1.25-1.49" (31.8-37.8mm)	5" (127.0mm)	16" (406.4mm)	1,680 lbs.	<input type="checkbox"/> SGO125
1.50-1.74" (38.1-44.2mm)	5" (127.0mm)	18" (457.2mm)	1,680 lbs.	<input type="checkbox"/> SGO150
1.75-1.99" (44.5-50.5mm)	6" (152.4mm)	20" (508.0mm)	2,640 lbs.	<input type="checkbox"/> SGO175
2.00-2.49" (50.8-63.2mm)	6" (152.4mm)	22" (558.8mm)	3,760 lbs.	<input type="checkbox"/> SGO200
2.50-2.99" (63.5-75.9mm)	8" (203.2mm)	24" (609.6mm)	3,760 lbs.	<input type="checkbox"/> SGO250
3.00-3.49" (76.2-88.6mm)	9" (228.6mm)	26" (660.4mm)	5,040 lbs.	<input type="checkbox"/> SGO300
3.50-3.99" (88.9-101.3mm)	9" (228.6mm)	28" (711.2mm)	5,040 lbs.	<input type="checkbox"/> SGO350



SGO100

Locking Bale Grips



Cord Diameter	Bale Length	Mesh Length	Approx. Break Strength†	Catalog No.*
0.50-0.61" (12.7-15.5mm)	18" (457.2mm)	11" (279.4mm)	770 lbs.	<input type="checkbox"/> SGU50
0.63-0.74" (16.0-18.8mm)	18" (457.2mm)	11" (279.4mm)	1,150 lbs.	<input type="checkbox"/> SGU63
0.75-0.99" (19.1-25.1mm)	18" (457.2mm)	14" (355.6mm)	1,320 lbs.	<input type="checkbox"/> SGU75
1.00-1.24" (25.4-31.5mm)	18" (457.2mm)	15" (381.0mm)	1,920 lbs.	<input type="checkbox"/> SGU100
1.25-1.49" (31.8-37.8mm)	18" (457.2mm)	16" (406.4mm)	1,920 lbs.	<input type="checkbox"/> SGU125
1.50-1.74" (38.1-44.2mm)	18" (457.2mm)	18" (457.2mm)	1,920 lbs.	<input type="checkbox"/> SGU150
1.75-1.99" (44.5-50.5mm)	18" (457.2mm)	20" (508.0mm)	3,150 lbs.	<input type="checkbox"/> SGU175
2.00-2.49" (50.8-63.2mm)	18" (457.2mm)	22" (558.8mm)	3,360 lbs.	<input type="checkbox"/> SGU200
2.50-2.99" (63.5-75.9mm)	18" (457.2mm)	24" (609.6mm)	3,360 lbs.	<input type="checkbox"/> SGU250
3.00-3.49" (76.2-88.6mm)	18" (457.2mm)	26" (660.4mm)	5,280 lbs.	<input type="checkbox"/> SGU300
3.50-3.99" (88.9-101.3mm)	18" (457.2mm)	28" (711.2mm)	5,280 lbs.	<input type="checkbox"/> SGU350



SGU100

* For stainless steel support grips, add "SS" suffix to the catalog number (example, SGS50SS). Consult Factory for price and availability.

† To determine workload safety factor, divide approximate break strength by 10. See page M-22 for strength information.

Icon Key

NAFTA Compliant - see page O-30

Support Grips - Standard Duty - Split Lace

Split lace support grips are designed for loads up to 600 lbs. and vertical runs of no more than 100 ft. They are available in a variety of eye styles and cable ranges for supporting electrical and fiber optic cable, metal rods and tubing. Split lace support grips are used when the end of the cable cannot easily be accessed and the support grip is intended for permanent installation. Support grips are woven of corrosion resistant tinned-bronze wire.

Single Eye



Cord Diameter	Bale Length	Mesh Length	Approx. Break Strength†	Catalog No.*
0.50-0.61" (12.7-15.5mm)	7" (177.8mm)	11" (279.4mm)	770 lbs.	<input type="checkbox"/> SGSL50 •
0.62-0.74" (15.7-18.8mm)	8" (203.2mm)	11" (279.4mm)	960 lbs.	<input type="checkbox"/> SGSL63 •
0.75-0.99" (19.1-25.1mm)	8" (203.2mm)	14" (355.6mm)	1,320 lbs.	<input type="checkbox"/> SGSL75 •
1.00-1.24" (28.4-31.5mm)	9" (228.6mm)	15" (381.0mm)	1,680 lbs.	<input type="checkbox"/> SGSL100 •
1.25-1.49" (31.8-37.9mm)	10" (254.0mm)	16" (406.4mm)	1,680 lbs.	<input type="checkbox"/> SGSL125 •
1.50-1.74" (38.1-44.2mm)	12" (304.8mm)	18" (457.2mm)	1,680 lbs.	<input type="checkbox"/> SGSL150 •
1.75-1.99" (44.5-50.5mm)	14" (355.6mm)	20" (508.0mm)	2,640 lbs.	<input type="checkbox"/> SGSL175 •
2.00-2.49" (50.8-63.2mm)	16" (406.4mm)	22" (558.8mm)	3,760 lbs.	<input type="checkbox"/> SGSL200 •
2.50-2.99" (63.5-75.9mm)	18" (457.2mm)	24" (609.6mm)	3,760 lbs.	<input type="checkbox"/> SGSL250 •
3.00-3.49" (76.2-88.6mm)	21" (533.4mm)	26" (660.4mm)	5,040 lbs.	<input type="checkbox"/> SGSL300 •
3.50-3.99" (88.9-101.3mm)	24" (609.6mm)	28" (711.2mm)	5,040 lbs.	<input type="checkbox"/> SGSL350 •



SGSL75

Double Eye



Cord Diameter	Bale Length	Mesh Length	Approx. Break Strength†	Catalog No.*
0.50-0.61" (12.7-15.5mm)	4" (101.6mm)	11" (279.4mm)	770 lbs.	<input type="checkbox"/> SGDL50 •
0.62-0.74" (15.7-18.8mm)	4" (101.6mm)	11" (279.4mm)	1,150 lbs.	<input type="checkbox"/> SGDL63 •
0.75-0.99" (19.1-25.1mm)	4" (101.6mm)	14" (355.6mm)	1,320 lbs.	<input type="checkbox"/> SGDL75 •
1.00-1.24" (28.4-31.5mm)	5" (127.0mm)	15" (381.0mm)	1,920 lbs.	<input type="checkbox"/> SGDL100 •
1.25-1.49" (31.8-37.9mm)	5" (127.0mm)	16" (406.4mm)	1,920 lbs.	<input type="checkbox"/> SGDL125 •
1.50-1.74" (38.1-44.2mm)	6" (152.4mm)	18" (457.2mm)	1,920 lbs.	<input type="checkbox"/> SGDL150 •
1.75-1.99" (44.5-50.5mm)	6" (152.4mm)	20" (508.0mm)	3,150 lbs.	<input type="checkbox"/> SGDL175 •
2.00-2.49" (50.8-63.2mm)	6" (152.4mm)	22" (558.8mm)	3,360 lbs.	<input type="checkbox"/> SGDL200 •
2.50-2.99" (63.5-75.9mm)	6" (152.4mm)	24" (609.6mm)	3,360 lbs.	<input type="checkbox"/> SGDL250 •
3.00-3.49" (76.2-88.6mm)	8" (203.2mm)	26" (660.4mm)	5,280 lbs..	<input type="checkbox"/> SGDL300 •
3.50-3.99" (88.9-101.3mm)	8" (203.2mm)	28" (711.2mm)	5,280 lbs.	<input type="checkbox"/> SGDL350 •



SGDL75

* For stainless steel support grips, add "SS" suffix to the catalog number (example, SGS50SS). Consult Factory for price and availability.

† To determine workload safety factor, divide approximate break strength by 10. See page M-22 for strength information.

Icon Key

NAFTA Compliant - see page O-30

Support Grips - Standard Duty - Split Lace

Offset Eye

Cord Diameter	Bale Length	Mesh Length	Approx. Break Strength†	Catalog No.*
0.50-0.61" (12.7-15.5mm)	4" (101.6mm)	11" (279.4mm)	770 lbs.	<input type="checkbox"/> SGOL50
0.62-0.74" (15.7-18.8mm)	4" (101.6mm)	11" (279.4mm)	960 lbs.	<input type="checkbox"/> SGOL63
0.75-0.99" (19.1-25.1mm)	4" (101.6mm)	14" (355.6mm)	960 lbs.	<input type="checkbox"/> SGOL75
1.00-1.24" (28.4-31.5mm)	5" (127.0mm)	15" (381.0mm)	1,680 lbs.	<input type="checkbox"/> SGOL100
1.25-1.49" (31.8-37.9mm)	5" (127.0mm)	16" (406.4mm)	1,680 lbs.	<input type="checkbox"/> SGOL125
1.50-1.74" (38.1-44.2mm)	5" (127.0mm)	18" (457.2mm)	1,680 lbs.	<input type="checkbox"/> SGOL150
1.75-1.99" (44.5-50.5mm)	6" (152.4mm)	20" (508.0mm)	2,640 lbs.	<input type="checkbox"/> SGOL175
2.00-2.49" (50.8-63.2mm)	6" (152.4mm)	22" (558.8mm)	3,760 lbs.	<input type="checkbox"/> SGOL200
2.50-2.99" (63.5-75.9mm)	8" (203.2mm)	24" (609.6mm)	3,760 lbs.	<input type="checkbox"/> SGOL250
3.00-3.49" (76.2-88.6mm)	9" (228.6mm)	26" (660.4mm)	5,040 lbs.	<input type="checkbox"/> SGOL300
3.50-3.99" (88.9-101.3mm)	9" (228.6mm)	28" (711.2mm)	5,040 lbs.	<input type="checkbox"/> SGOL350



SGOL100

Locking Bale

Cord Diameter	Bale Length	Mesh Length	Approx. Break Strength†	Catalog No.*
0.50-0.61" (12.7-15.5mm)	18" (457.2mm)	11" (279.4mm)	770 lbs.	<input type="checkbox"/> SGUL50
0.62-0.74" (15.7-18.8mm)	18" (457.2mm)	11" (279.4mm)	1,150 lbs.	<input type="checkbox"/> SGUL63
0.75-0.99" (19.1-25.1mm)	18" (457.2mm)	14" (355.6mm)	1,320 lbs.	<input type="checkbox"/> SGUL75
1.00-1.24" (28.4-31.5mm)	18" (457.2mm)	15" (381.0mm)	1,920 lbs.	<input type="checkbox"/> SGUL100
1.25-1.49" (31.8-37.9mm)	18" (457.2mm)	16" (406.4mm)	1,920 lbs.	<input type="checkbox"/> SGUL125
1.50-1.74" (38.1-44.2mm)	18" (457.2mm)	18" (457.2mm)	1,920 lbs.	<input type="checkbox"/> SGUL150
1.75-1.99" (44.5-50.5mm)	18" (457.2mm)	20" (508.0mm)	3,150 lbs.	<input type="checkbox"/> SGUL175
2.00-2.49" (50.8-63.2mm)	18" (457.2mm)	22" (558.8mm)	3,360 lbs.	<input type="checkbox"/> SGUL200
2.50-2.99" (63.5-75.9mm)	18" (457.2mm)	24" (609.6mm)	3,360 lbs.	<input type="checkbox"/> SGUL250
3.00-3.49" (76.2-88.6mm)	18" (457.2mm)	26" (660.4mm)	5,280 lbs.	<input type="checkbox"/> SGUL300
3.50-3.99" (88.9-101.3mm)	18" (457.2mm)	28" (711.2mm)	5,280 lbs.	<input type="checkbox"/> SGUL350



SGUL100

* For stainless steel support grips, add "SS" suffix to the catalog number (example, SGS50SS). Consult Factory for price and availability.

† To determine workload safety factor, divide approximate break strength by 10. See page M-22 for strength information.

Icon Key

NAFTA Compliant - see page O-30

Support Grips - Standard Duty - Split Rod

Split rod support grips are designed for loads up to 600 lbs. and vertical runs of no more than 100 ft. They are available in a variety of eye styles and cable ranges for supporting electrical and fiber optic cable, metal rods and tubing. Split rod support grips are used when the end of the cable cannot be easily accessed and the installation is temporary. Support grips are woven of corrosion resistant tinned-bronze wire.

Single Eye



Cord Diameter	Bale Length	Mesh Length	Approx. Break Strength†	Catalog No.*
0.50-0.61" (12.7-15.5mm)	7" (177.8mm)	11" (279.4mm)	770 lbs.	<input type="checkbox"/> SGSR50
0.62-0.74" (15.7-18.8mm)	8" (203.2mm)	11" (279.4mm)	960 lbs.	<input type="checkbox"/> SGSR63
0.75-0.99" (19.1-25.1mm)	8" (203.2mm)	14" (355.6mm)	1,320 lbs.	<input type="checkbox"/> SGSR75
1.00-1.24" (28.4-31.5mm)	9" (228.6mm)	15" (381.0mm)	1,680 lbs.	<input type="checkbox"/> SGSR100
1.25-1.49" (31.8-37.9mm)	10" (254.0mm)	16" (406.4mm)	1,680 lbs.	<input type="checkbox"/> SGSR125
1.50-1.74" (38.1-44.2mm)	12" (304.8mm)	18" (457.2mm)	1,680 lbs.	<input type="checkbox"/> SGSR150
1.75-1.99" (44.5-50.5mm)	14" (355.6mm)	20" (508.0mm)	2,640 lbs.	<input type="checkbox"/> SGSR175
2.00-2.49" (50.8-63.2mm)	16" (406.4mm)	22" (558.8mm)	3,760 lbs.	<input type="checkbox"/> SGSR200
2.50-2.99" (63.5-75.9mm)	18" (457.2mm)	24" (609.6mm)	3,760 lbs.	<input type="checkbox"/> SGSR250
3.00-3.49" (76.2-88.6mm)	21" (533.4mm)	26" (660.4mm)	5,040 lbs.	<input type="checkbox"/> SGSR300
3.50-3.99" (88.9-101.3mm)	24" (609.6mm)	28" (711.2mm)	5,040 lbs.	<input type="checkbox"/> SGSR350



SGSR100

Double Eye



Cord Diameter	Bale Length	Mesh Length	Approx. Break Strength†	Catalog No.*
0.50-0.61" (12.7-15.5mm)	4" (101.6mm)	11" (279.4mm)	770 lbs.	<input type="checkbox"/> SGDR50
0.63-0.74" (16.0-18.8mm)	4" (101.6mm)	11" (279.4mm)	1,150 lbs.	<input type="checkbox"/> SGDR63
0.75-0.99" (19.1-25.1mm)	4" (101.6mm)	14" (355.6mm)	1,320 lbs.	<input type="checkbox"/> SGDR75
1.00-1.24" (28.4-31.5mm)	5" (127.0mm)	15" (381.0mm)	1,920 lbs.	<input type="checkbox"/> SGDR100
1.25-1.49" (31.8-37.9mm)	5" (127.0mm)	16" (406.4mm)	1,920 lbs.	<input type="checkbox"/> SGDR125
1.50-1.74" (38.1-44.2mm)	6" (152.4mm)	18" (457.2mm)	1,920 lbs.	<input type="checkbox"/> SGDR150
1.75-1.99" (44.5-50.5mm)	6" (152.4mm)	20" (508.0mm)	3,150 lbs.	<input type="checkbox"/> SGDR175
2.00-2.49" (50.8-63.2mm)	6" (152.4mm)	22" (558.8mm)	3,360 lbs.	<input type="checkbox"/> SGDR200
2.50-2.99" (63.5-75.9mm)	6" (152.4mm)	24" (609.6mm)	3,360 lbs.	<input type="checkbox"/> SGDR250
3.00-3.49" (76.2-88.6mm)	8" (203.2mm)	26" (660.4mm)	5,280 lbs.	<input type="checkbox"/> SGDR300
3.50-3.99" (88.9-101.3mm)	8" (203.2mm)	28" (711.2mm)	5,280 lbs.	<input type="checkbox"/> SGDR350



SGDR75

* For stainless steel support grips, add "SS" suffix to the catalog number (example, SGS50SS). Consult Factory for price and availability.

† To determine workload safety factor, divide approximate break strength by 10. See page M-22 for strength information.

Icon Key

NAFTA Compliant - see page O-30

Support Grips - Standard Duty - Split Rod

Offset Eye



Cord Diameter	Bale Length	Mesh Length	Approx. Break Strength†	Catalog No.*
0.50-0.61" (12.7-15.5mm)	4" (101.6mm)	11" (279.4mm)	770 lbs.	<input type="checkbox"/> SGOR50 •
0.63-0.74" (16.0-18.8mm)	4" (101.6mm)	11" (279.4mm)	960 lbs.	<input type="checkbox"/> SGOR63 •
0.75-0.99" (19.1-25.1mm)	4" (101.6mm)	14" (355.6mm)	960 lbs.	<input type="checkbox"/> SGOR75 •
1.00-1.24" (28.4-31.5mm)	5" (127.0mm)	15" (381.0mm)	1,680 lbs.	<input type="checkbox"/> SGOR100 •
1.25-1.49" (31.8-37.9mm)	5" (127.0mm)	16" (406.4mm)	1,680 lbs.	<input type="checkbox"/> SGOR125 •
1.50-1.74" (38.1-44.2mm)	5" (127.0mm)	18" (457.2mm)	1,680 lbs.	<input type="checkbox"/> SGOR150 •
1.75-1.99" (44.5-50.5mm)	6" (152.4mm)	20" (508.0mm)	2,640 lbs.	<input type="checkbox"/> SGOR175 •
2.00-2.49" (50.8-63.2mm)	6" (152.4mm)	22" (558.8mm)	3,760 lbs.	<input type="checkbox"/> SGOR200 •
2.50-2.99" (63.5-75.9mm)	8" (203.2mm)	24" (609.6mm)	3,760 lbs.	<input type="checkbox"/> SGOR250 •
3.00-3.49" (76.2-88.6mm)	9" (228.6mm)	26" (660.4mm)	5,040 lbs.	<input type="checkbox"/> SGOR300 •
3.50-3.99" (88.9-101.3mm)	9" (228.6mm)	28" (711.2mm)	5,040 lbs.	<input type="checkbox"/> SGOR350 •



SGOR63

Locking Bale



Cord Diameter	Bale Length	Mesh Length	Approx. Break Strength†	Catalog No.*
0.50-0.61" (12.7-15.5mm)	18" (457.2mm)	11" (279.4mm)	770 lbs.	<input type="checkbox"/> SGUR50 •
0.63-0.74" (16.0-18.8mm)	18" (457.2mm)	11" (279.4mm)	1,150 lbs.	<input type="checkbox"/> SGUR63 •
0.75-0.99" (19.1-25.1mm)	18" (457.2mm)	14" (355.6mm)	1,320 lbs.	<input type="checkbox"/> SGUR75 •
1.00-1.24" (28.4-31.5mm)	18" (457.2mm)	15" (381.0mm)	1,920 lbs.	<input type="checkbox"/> SGUR100 •
1.25-1.49" (31.8-37.9mm)	18" (457.2mm)	16" (406.4mm)	1,920 lbs.	<input type="checkbox"/> SGUR125 •
1.50-1.74" (38.1-44.2mm)	18" (457.2mm)	18" (457.2mm)	1,920 lbs.	<input type="checkbox"/> SGUR150 •
1.75-1.99" (44.5-50.5mm)	18" (457.2mm)	20" (508.0mm)	3,150 lbs.	<input type="checkbox"/> SGUR175 •
2.00-2.49" (50.8-63.2mm)	18" (457.2mm)	22" (558.8mm)	3,360 lbs.	<input type="checkbox"/> SGUR200 •
2.50-2.99" (63.5-75.9mm)	18" (457.2mm)	24" (609.6mm)	3,360 lbs.	<input type="checkbox"/> SGUR250 •
3.00-3.49" (76.2-88.6mm)	18" (457.2mm)	26" (660.4mm)	5,280 lbs.	<input type="checkbox"/> SGUR300 •
3.50-3.99" (88.9-101.3mm)	18" (457.2mm)	28" (711.2mm)	5,280 lbs.	<input type="checkbox"/> SGUR350 •



SGUR100

* For stainless steel support grips, add "SS" suffix to the catalog number (example, SGS50SS). Consult Factory for price and availability.

† To determine workload safety factor, divide approximate break strength by 10. See page M-22 for strength information.

Icon Key

NAFTA Compliant - see page O-30

Support Grips - Heavy-Duty - Closed Mesh

Heavy duty support grips feature a double weave mesh and are available in a variety of eye styles and cable ranges for supporting electrical and fiber optic cable, metal rods and tubing. Support grips are woven of corrosion resistant tinned-bronze wire.

Single Eye



Cord Diameter	Bale Length	Mesh Length	Approx. Break Strength†	Catalog No.*
0.75-0.99" (19.1-25.1mm)	10" (254.0mm)	26" (660.4mm)	2,700 lbs.	<input type="checkbox"/> SGTS75
1.00-1.24" (25.4-31.5mm)	10" (254.0mm)	29" (736.6mm)	4,720 lbs.	<input type="checkbox"/> SGTS100
1.25-1.49" (31.8-37.8mm)	10" (254.0mm)	31" (787.4mm)	4,720 lbs.	<input type="checkbox"/> SGTS125
1.50-1.99" (38.1-50.5mm)	10" (254.0mm)	35" (889.0mm)	4,720 lbs.	<input type="checkbox"/> SGTS150



SGTS100

Double Eye



Cord Diameter	Bale Length	Mesh Length	Approx. Break Strength†	Catalog No.*
0.75-0.99" (19.1-25.1mm)	10" (254.0mm)	26" (660.4mm)	2,700 lbs.	<input type="checkbox"/> SGTD75
1.00-1.24" (25.4-31.5mm)	10" (254.0mm)	29" (736.6mm)	4,720 lbs.	<input type="checkbox"/> SGTD100
1.25-1.49" (31.8-37.8mm)	10" (254.0mm)	31" (787.4mm)	4,720 lbs.	<input type="checkbox"/> SGTD125
1.50-1.99" (38.1-50.5mm)	10" (254.0mm)	35" (889.0mm)	4,720 lbs.	<input type="checkbox"/> SGTD150
2.00-2.49" (50.8-63.2mm)	10" (254.0mm)	37" (939.8mm)	10,080 lbs.	<input type="checkbox"/> SGTD200
2.50-2.99" (63.5-75.9mm)	10" (254.0mm)	39" (990.6mm)	10,080 lbs.	<input type="checkbox"/> SGTD250
3.00-3.49" (76.2-88.6mm)	10" (254.0mm)	41" (1041.4mm)	10,080 lbs.	<input type="checkbox"/> SGTD300
3.50-3.99" (88.9-101.3mm)	10" (254.0mm)	45" (1143.0mm)	13,120 lbs.	<input type="checkbox"/> SGTD350
4.00-4.49" (101.6-114.0mm)	10" (254.0mm)	47" (1193.8mm)	13,120 lbs.	<input type="checkbox"/> SGTD400

Support Grips - Heavy-Duty - Split Lace

Single Eye



Cord Diameter	Bale Length	Mesh Length	Approx. Break Strength†	Catalog No.*
0.75-0.99" (19.1-25.1mm)	10" (254.0mm)	26" (660.4mm)	2,700 lbs.	<input type="checkbox"/> SGTSL75
1.00-1.24" (25.4-31.5mm)	10" (254.0mm)	29" (736.6mm)	4,720 lbs.	<input type="checkbox"/> SGTSL100
1.25-1.49" (31.8-37.8mm)	10" (254.0mm)	31" (787.4mm)	4,720 lbs.	<input type="checkbox"/> SGTSL125
1.50-1.99" (38.1-50.5mm)	10" (254.0mm)	35" (889.0mm)	4,720 lbs.	<input type="checkbox"/> SGTSL150



SGTSL100

Double Eye



Cord Diameter	Bale Length	Mesh Length	Approx. Break Strength†	Catalog No.*
0.75-0.99" (19.1-25.1mm)	10" (254.0mm)	26" (660.4mm)	2,700 lbs.	<input type="checkbox"/> SGTDL75
1.00-1.24" (25.4-31.5mm)	10" (254.0mm)	29" (736.6mm)	4,720 lbs.	<input type="checkbox"/> SGTDL100
1.25-1.49" (31.8-37.8mm)	10" (254.0mm)	31" (787.4mm)	4,720 lbs.	<input type="checkbox"/> SGTDL125
1.50-1.99" (38.1-50.5mm)	10" (254.0mm)	35" (889.0mm)	4,720 lbs.	<input type="checkbox"/> SGTDL150
2.00-2.49" (50.8-63.2mm)	10" (254.0mm)	37" (939.8mm)	10,080 lbs.	<input type="checkbox"/> SGTDL200
2.50-2.99" (63.5-75.9mm)	10" (254.0mm)	39" (990.6mm)	10,080 lbs.	<input type="checkbox"/> SGTDL250
3.00-3.49" (76.2-88.6mm)	10" (254.0mm)	41" (1041.4mm)	10,080 lbs.	<input type="checkbox"/> SGTDL300
3.50-3.99" (88.9-101.3mm)	10" (254.0mm)	45" (1143.0mm)	13,120 lbs.	<input type="checkbox"/> SGTDL350
4.00-4.49" (101.6-114.0mm)	10" (254.0mm)	47" (1193.8mm)	13,120 lbs.	<input type="checkbox"/> SGTDL400



SGTDL100

Icon Key

NAFTA Compliant - see page O-30

* For stainless steel support grips, add "SS" suffix to the catalog number (example, SGS50SS). Consult Factory for price and availability.

† To determine workload safety factor, divide approximate break strength by 10. See page M-22 for strength information.

Support Grips - Service Drop - Closed Mesh

Service drop grips provide support for utility distribution lines from service pole to building or from pole to pole. They can also be used for cable TV and fiber optic cable support. They are woven from tinned-bronze wire to provide superior corrosion resistance, and are available in single eye and locking bale configurations.

Single Eye



Cord Diameter	Bale Length	Mesh Length	Approx. Break Strength†	Catalog No.*	
0.22-0.32" (5.6-8.1mm)	4" (101.6mm)	4" (101.6mm)	290 lbs.	<input type="checkbox"/> SDS23	
0.30-0.43" (7.6-10.1mm)	5" (127.0mm)	5" (127.0mm)	500 lbs.	<input type="checkbox"/> SDS32	
0.41-0.56" (10.4-14.2mm)	6" (152.4mm)	5" (127.0mm)	500 lbs.	<input type="checkbox"/> SDS43	
0.53-0.73" (13.4-18.5mm)	8" (203.2mm)	8" (203.2mm)	790 lbs.	<input type="checkbox"/> SDS56	
0.70-0.97" (17.8-24.6mm)	8" (203.2mm)	9" (228.6mm)	1,020 lbs.	<input type="checkbox"/> SDS73	
0.94-1.25" (23.8-31.8mm)	10" (254.0mm)	11" (279.4mm)	1,020 lbs.	<input type="checkbox"/> SDS100	



SDS32

Locking Bale



Cord Diameter	Bale Length	Mesh Length	Approx. Break Strength†	Catalog No.*	
0.22-0.32" (5.6-8.1mm)	10" (254.0mm)	4" (101.6mm)	290 lbs.	<input type="checkbox"/> SDU23	
0.30-0.43" (7.6-10.1mm)	11" (279.4mm)	5" (127.0mm)	500 lbs.	<input type="checkbox"/> SDU32	
0.43-0.56" (10.1-14.2mm)	12" (304.8mm)	5" (127.0mm)	500 lbs.	<input type="checkbox"/> SDU43	
0.56-0.73" (14.2-18.5mm)	14" (355.6mm)	8" (203.2mm)	790 lbs.	<input type="checkbox"/> SDU56	
0.73-0.97" (18.5-24.6mm)	14" (355.6mm)	9" (228.6mm)	1,020 lbs.	<input type="checkbox"/> SDU73	
1.00-1.25" (23.8-31.8mm)	16" (406.4mm)	11" (379.4mm)	1,020 lbs.	<input type="checkbox"/> SDU100	

* For stainless steel support grips, add "SS" suffix to the catalog number (example, SGS50SS). Consult Factory for price and availability.

† To determine workload safety factor, divide approximate break strength by 10. See page M-22 for strength information.

Icon Key

NAFTA Compliant - see page O-30

Support Grips - Bus Drop - Closed Mesh

Bus drop grips are used as cable support. They relieve any direct tension from the critical connection and absorb vibration and flexing. Bus drop grips are woven of galvanized steel wire. They are offered with either the single eye or locking bale attachment.

Single Eye



Cord Diameter	Bale Length	Mesh Length	Approx. Break Strength†	Catalog No.*
0.22-0.32" (5.6-8.1mm)	9" (228.6mm)	3.5" (88.9mm)	1,100 lbs.	<input type="checkbox"/> BDS22
0.30-0.43" (7.6-10.9mm)	9" (228.6mm)	4.5" (114.3mm)	1,100 lbs.	<input type="checkbox"/> BDS30
0.41-0.56" (10.4-14.2mm)	9" (228.6mm)	5.0" (127.0mm)	1,100 lbs.	<input type="checkbox"/> BDS41
0.53-0.73" (13.5-18.5mm)	9" (228.6mm)	6.5" (165.1mm)	1,100 lbs.	<input type="checkbox"/> BDS53
0.70-0.85" (17.8-21.6mm)	9" (228.6mm)	8.5" (215.9mm)	1,900 lbs.	<input type="checkbox"/> BDS70
0.82-1.00" (20.8-25.4mm)	9" (228.6mm)	8.5" (215.9mm)	1,900 lbs.	<input type="checkbox"/> BDS82
0.96-1.25" (24.4-31.8mm)	9" (228.6mm)	11.0" (279.4mm)	1,900 lbs.	<input type="checkbox"/> BDS96



BDS53

Locking Bale



Cord Diameter	Bale Length	Mesh Length	Approx. Break Strength†	Catalog No.*
0.22-0.32" (5.6-8.1mm)	12" (304.8mm)	3.5" (88.9mm)	1,100 lbs.	<input type="checkbox"/> BDU22
0.30-0.43" (7.6-10.9mm)	12" (304.8mm)	4.5" (114.3mm)	1,100 lbs.	<input type="checkbox"/> BDU30
0.41-0.56" (10.4-14.2mm)	12" (304.8mm)	5.0" (127.0mm)	1,100 lbs.	<input type="checkbox"/> BDU41
0.53-0.73" (13.5-18.5mm)	15" (381.0mm)	6.5" (165.1mm)	1,100 lbs.	<input type="checkbox"/> BDU53
0.70-0.85" (17.8-21.6mm)	16" (406.4mm)	8.5" (215.9mm)	1,900 lbs.	<input type="checkbox"/> BDU70
0.82-1.00" (20.8-25.4mm)	16" (406.4mm)	8.5" (215.9mm)	1,900 lbs.	<input type="checkbox"/> BDU82
0.96-1.25" (24.4-31.8mm)	17" (431.8mm)	11.0" (279.4mm)	1,900 lbs.	<input type="checkbox"/> BDU96



BDU53

Accessories for Support Grips: Service Drop & Bus Drop, Closed Mesh Grips

Description	Catalog No.
Safety Spring, 40 lbs. load	<input type="checkbox"/> B2001
Safety Spring, 80 lbs. load	<input type="checkbox"/> B2002



B2001



B2002

* For stainless steel support grips, add "SS" suffix to the catalog number (example, SGS50SS). Consult Factory for price and availability.

† To determine workload safety factor, divide approximate break strength by 10. See page M-22 for strength information.

Icon Key

NAFTA Compliant - see page O-30

Pulling Grips - Junior Duty

Junior duty series grips are indispensable tools for electricians with small job requirements. They are used to connect insulated wire bundles to pulling tape or to pull wire or rope through conduit.

Flexible Eye



Cord Diameter	Mesh Length	Approx. Break Strength†	Catalog No.*	
0.25-0.36" (3.4-9.1mm)	5" (127.0mm)	1,700 lbs.	<input type="checkbox"/> LPJ25	•
0.37-0.49" (9.4-12.4mm)	7" (177.8mm)	1,700 lbs.	<input type="checkbox"/> LPJ37	•
0.50-0.61" (12.7-15.5mm)	8" (203.2mm)	1,700 lbs.	<input type="checkbox"/> LPJ50	•
0.62-0.74" (15.7-19.0mm)	10" (254.0mm)	2,800 lbs.	<input type="checkbox"/> LPJ62	•
0.75-0.99" (19.1-25.1mm)	10" (254.0mm)	4,100 lbs.	<input type="checkbox"/> LPJ75	•
1.00-1.25" (25.4-31.8mm)	12" (304.8mm)	4,100 lbs.	<input type="checkbox"/> LPJ100	•



LPJ62

Pulling Grips - Light Duty

Light duty grips are the most economical pulling grips for many applications, such as industrial plant wiring and rewiring, and underground electrical pulls.

Short Length, Flexible Eye



Cord Diameter	Mesh Length	Approx. Break Strength†	Catalog No.*	
0.50-0.61" (12.7-15.5mm)	11" (279.4mm)	3,400 lbs.	<input type="checkbox"/> LP5011	•
0.62-0.74" (15.7-18.8mm)	11" (279.4mm)	4,100 lbs.	<input type="checkbox"/> LP6211	•
0.75-0.99" (19.1-25.1mm)	13" (330.2mm)	4,100 lbs.	<input type="checkbox"/> LP7512	•
1.00-1.24" (25.4-31.5mm)	14" (355.6mm)	5,800 lbs.	<input type="checkbox"/> LP10013	•
1.25-1.49" (31.8-37.8mm)	15" (381.0mm)	5,800 lbs.	<input type="checkbox"/> LP12514	•
1.50-1.74" (38.1-44.2mm)	16" (406.4mm)	7,500 lbs.	<input type="checkbox"/> LP15015	•
1.75-1.99" (44.5-50.5mm)	18" (457.2mm)	10,000 lbs.	<input type="checkbox"/> LP17517	•
2.00-2.49" (50.8-63.2mm)	19" (482.6mm)	10,000 lbs.	<input type="checkbox"/> LP20018	•
2.50-2.99" (63.5-75.9mm)	19" (482.6mm)	13,000 lbs.	<input type="checkbox"/> LP25018	•



LP7512

Standard Length, Flexible Eye



Cord Diameter	Mesh Length	Approx. Break Strength†	Catalog No.*	
0.50-0.61" (12.7-15.5mm)	16" (406.4mm)	3,400 lbs.	<input type="checkbox"/> LP5016	•
0.62-0.74" (15.7-18.8mm)	16" (406.4mm)	4,100 lbs.	<input type="checkbox"/> LP6216	•
0.75-0.99" (19.1-25.1mm)	20" (508.0mm)	4,100 lbs.	<input type="checkbox"/> LP7520	•
1.00-1.24" (25.4-31.5mm)	20" (508.0mm)	7,500 lbs.	<input type="checkbox"/> LP10020	•
1.25-1.49" (31.8-37.8mm)	22" (558.8mm)	7,500 lbs.	<input type="checkbox"/> LP12521	•
1.50-1.99" (38.1-50.5mm)	25" (635.0mm)	7,500 lbs.	<input type="checkbox"/> LP15023	•
2.00-2.49" (50.8-63.2mm)	26" (660.4mm)	10,000 lbs.	<input type="checkbox"/> LP20025	•
2.50-2.99" (63.5-75.9mm)	28" (711.2mm)	13,000 lbs.	<input type="checkbox"/> LP25027	•
3.00-3.49" (76.2-88.6mm)	30" (762.0mm)	13,200 lbs.	<input type="checkbox"/> LP30030	•
3.50-3.99" (88.9-101.3mm)	32" (872.8mm)	19,400 lbs.	<input type="checkbox"/> LP35032	•



LP7520

* For stainless steel support grips, add "SS" suffix to the catalog number (example, SGS50SS). Consult Factory for price and availability.

† To determine workload safety factor, divide approximate break strength by 10. See page M-22 for strength information.

Icon Key

NAFTA Compliant - see page O-30

Pulling Grips - Medium Duty

Medium duty pulling grips are recommended for heavy or rugged applications, and are ideally suited for overhead and underground installations. These grips are woven in galvanized steel.

Short Length, Flexible Eye, T-Type



Cord Diameter	Eye Diameter	Mesh Length	Approx. Break Strength†	Catalog No.*	
0.50-0.61" (12.7-15.5mm)	7/32" (0.2mm)	21" (533.4mm)	4,500 lbs.	<input type="checkbox"/> MP5021	•
0.62-0.74" (15.7-18.8mm)	1/4" (6.4mm)	24" (609.6mm)	5,600 lbs.	<input type="checkbox"/> MP6224	•
0.75-0.99" (19.1-25.1mm)	1/4" (6.4mm)	24" (609.6mm)	6,800 lbs.	<input type="checkbox"/> MP7524	•
1.00-1.49" (25.4-37.8mm)	5/16" (7.9mm)	24" (609.6mm)	9,600 lbs.	<input type="checkbox"/> MP10024	•
1.50-1.99" (38.1-50.2mm)	7/16" (11.1mm)	24" (609.6mm)	16,400 lbs.	<input type="checkbox"/> MP15024	•
2.00-2.49" (50.8-63.2mm)	7/16" (11.1mm)	24" (609.6mm)	18,500 lbs.	<input type="checkbox"/> MP20024	•
2.50-2.99" (63.5-75.9mm)	1/2" (12.7mm)	24" (609.6mm)	24,500 lbs.	<input type="checkbox"/> MP25024	•
3.00-3.49" (76.2-88.6mm)	1/2" (12.7mm)	24" (609.6mm)	24,500 lbs.	<input type="checkbox"/> MP30024	•
3.50-3.99" (88.9-101.3mm)	5/8" (15.9mm)	26" (660.4mm)	31,000 lbs.	<input type="checkbox"/> MP35026	•



MP25024

Standard Length, Flexible Eye, T-Type



Cord Diameter	Eye Diameter	Mesh Length	Approx. Break Strength†	Catalog No.*	
0.75-0.99" (19.1-25.1mm)	1/4" (6.4mm)	36" (914.4mm)	6,800 lbs.	<input type="checkbox"/> MP7536	•
1.00-1.49" (25.4-37.8mm)	5/16" (7.9mm)	36" (914.4mm)	9,600 lbs.	<input type="checkbox"/> MP10036	•
1.50-1.99" (38.1-50.2mm)	7/16" (11.1mm)	36" (914.4mm)	16,400 lbs.	<input type="checkbox"/> MP15036	•
2.00-2.49" (50.8-63.2mm)	7/16" (11.1mm)	36" (914.4mm)	18,500 lbs.	<input type="checkbox"/> MP20036	•
2.50-2.99" (63.2-70.9mm)	1/2" (12.7mm)	36" (914.4mm)	24,500 lbs.	<input type="checkbox"/> MP25036	•
3.00-3.49" (76.2-88.6mm)	1/2" (12.7mm)	36" (914.4mm)	24,500 lbs.	<input type="checkbox"/> MP30036	•
3.50-3.99" (88.9-101.3mm)	5/8" (15.9mm)	36" (914.4mm)	31,000 lbs.	<input type="checkbox"/> MP35036	•



MP25036

Long Length, Flexible Eye



Cord Diameter	Mesh Length	Approx. Break Strength†	Catalog No.*	
0.75-0.99" (19.1-25.1mm)	48" (1219.2mm)	8,100 lbs.	<input type="checkbox"/> MP7548	•
1.00-1.49" (25.4-37.8mm)	48" (1219.2mm)	11,600 lbs.	<input type="checkbox"/> MP10048	•
1.50-1.99" (38.1-50.2mm)	48" (1219.2mm)	19,400 lbs.	<input type="checkbox"/> MP15048	•
2.00-2.49" (50.8-63.2mm)	48" (1219.2mm)	19,400 lbs.	<input type="checkbox"/> MP20048	•
2.50-2.99" (63.2-70.9mm)	48" (1219.2mm)	25,900 lbs.	<input type="checkbox"/> MP25048	•
3.00-3.49" (76.2-88.6mm)	48" (1219.2mm)	25,900 lbs.	<input type="checkbox"/> MP30048	•
3.50-3.99" (88.9-101.3mm)	48" (1219.2mm)	32,400 lbs.	<input type="checkbox"/> MP35048	•



MP25048

* For stainless steel support grips, add "SS" suffix to the catalog number (example, SGS50SS). Consult Factory for price and availability.

† To determine workload safety factor, divide approximate break strength by 10. See page M-22 for strength information.

Icon Key

NAFTA Compliant - see page O-30

Pulling Grips - Heavy-Duty

K-Type pulling grips feature a double weave of galvanized steel for greater strength and added mesh contact with the cable as well as a forged steel compact rotating eye, which can be attached to a swivel. They are designed to handle longer or heavier pulling jobs such as an installation of underground cables, communication lines and service lines.

Short Length, Rotating Eye, K-Type



Cord Diameter	Eye Diameter	Mesh Length	Approx. Break Strength†	Catalog No.*
0.50-0.61" (12.7-15.5mm)	7/8" (22.2mm)	11" (279.4mm)	5,600 lbs.	<input type="checkbox"/> PH5011
0.62-0.74" (15.7-18.8mm)	7/8" (22.2mm)	11" (279.4mm)	6,800 lbs.	<input type="checkbox"/> PH6211
0.75-0.99" (19.1-25.1mm)	1" (25.4mm)	20" (508.0mm)	9,600 lbs.	<input type="checkbox"/> PH7520
1.00-1.24" (25.4-31.5mm)	1-3/8" (34.9mm)	20" (508.0mm)	16,400 lbs.	<input type="checkbox"/> PH10020
1.25-1.49" (31.8-37.8mm)	1-3/8" (34.9mm)	21" (533.4mm)	16,400 lbs.	<input type="checkbox"/> PH12521
1.50-1.99" (38.1-50.5mm)	1-5/8" (41.3mm)	25" (635.0mm)	27,200 lbs.	<input type="checkbox"/> PH15025
2.00-2.49" (50.8-63.2mm)	1-7/8" (47.6mm)	26" (660.4mm)	33,000 lbs.	<input type="checkbox"/> PH20026
2.50-2.99" (63.5-75.9mm)	1-7/8" (47.6mm)	28" (711.2mm)	41,000 lbs.	<input type="checkbox"/> PH25028
3.00-3.49" (76.2-88.6mm)	1-7/8" (47.6mm)	30" (762.0mm)	48,000 lbs.	<input type="checkbox"/> PH30030
3.50-3.99" (88.9-101.3mm)	1-7/8" (47.6mm)	32" (812.8mm)	48,000 lbs.	<input type="checkbox"/> PH35032
4.00-4.49" (101.6-114.0mm)	1-7/8" (47.6mm)	33" (838.2mm)	48,000 lbs.	<input type="checkbox"/> PH40033



PH7520

Standard Length, Rotating Eye, K-Type



Cord Diameter	Eye Diameter	Mesh Length	Approx. Break Strength†	Catalog No.*
0.50-0.61" (12.7-15.5mm)	7/8" (22.2mm)	16" (406.4mm)	5,600 lbs.	<input type="checkbox"/> PH5016
0.62-0.74" (15.7-18.8mm)	7/8" (22.2mm)	16" (406.4mm)	6,800 lbs.	<input type="checkbox"/> PH6216
0.75-0.99" (19.1-25.1mm)	1" (25.4mm)	32" (812.8mm)	9,600 lbs.	<input type="checkbox"/> PH7532
1.00-1.24" (20.4-31.5mm)	1-3/8" (34.9mm)	33" (838.2mm)	16,400 lbs.	<input type="checkbox"/> PH10033
1.50-1.99" (38.1-50.2mm)	1-3/8" (34.9mm)	34" (863.8mm)	16,400 lbs.	<input type="checkbox"/> PH15034
2.00-2.49" (50.8-63.2mm)	1-5/8" (41.3mm)	36" (914.4mm)	27,200 lbs.	<input type="checkbox"/> PH20036
2.50-2.99" (63.5-75.9mm)	1-7/8" (47.6mm)	38" (968.2mm)	33,000 lbs.	<input type="checkbox"/> PH25038
3.00-3.49" (76.2-88.6mm)	1-7/8" (47.6mm)	39" (990.6mm)	41,000 lbs.	<input type="checkbox"/> PH30039
3.50-3.99" (88.9-101.3mm)	1-7/8" (47.6mm)	41" (1041.4mm)	48,000 lbs.	<input type="checkbox"/> PH35041
4.00-4.49" (101.6-114.0mm)	1-7/8" (47.6mm)	42" (1066.8mm)	48,000 lbs.	<input type="checkbox"/> PH40042
4.50-4.99" (114.3-126.8mm)	1-7/8" (47.6mm)	58" (1473.2mm)	48,000 lbs.	<input type="checkbox"/> PH45058
5.00-5.99" (127.0-152.1mm)	1-7/8" (47.6mm)	60" (1524.0mm)	48,000 lbs.	<input type="checkbox"/> PH50060
6.00-6.99" (152.4-177.6mm)	1-7/8" (47.6mm)	66" (1676.4mm)	48,000 lbs.	<input type="checkbox"/> PH60066



PH7532

* For stainless steel support grips, add "SS" suffix to the catalog number (example, SGS50SS). Consult Factory for price and availability.

† To determine workload safety factor, divide approximate break strength by 10. See page M-22 for strength information.

Icon Key

NAFTA Compliant - see page O-30

Pulling Grips - Multi-Weave

Multi-weave pulling grips are constructed of high strength galvanized steel and are designed for pulling aluminum or copper bare conductor, wire rope and insulated cables. These grips are used in applications such as distribution line stringing and overhead transmission. Multi-weave pulling grips are available with a flexible or rotating eye, which can be attached to a swivel. The forged steel rotating eye will thread through sheaves and blocks without binding, but is not a swivel and will not turn under tension. The rotating eye can turn to relieve pulling torque when tension is relaxed.

Rotating Eye



Cord Diameter	Eye Diameter	Mesh Length	Approx. Break Strength†	Catalog No.*
0.25-0.49" (6.4-12.5mm)	7/8" (22.2mm)	26" (660.4mm)	6,800 lbs.	<input type="checkbox"/> PMR2526
0.50-0.74" (12.7-18.8mm)	1" (25.4mm)	32" (812.8mm)	10,000 lbs.	<input type="checkbox"/> PMR5032
0.75-0.99" (19.1-25.1mm)	1" (25.4mm)	41" (1041.4mm)	14,400 lbs.	<input type="checkbox"/> PMR7541
1.00-1.24" (25.4-31.8mm)	1-3/8" (34.9mm)	52" (1320.8mm)	24,600 lbs.	<input type="checkbox"/> PMR10052
1.25-1.49" (31.8-37.8mm)	1-5/8" (41.3mm)	56" (1422.4mm)	30,600 lbs.	<input type="checkbox"/> PMR12556
1.50-1.74" (38.1-44.2mm)	1-7/8" (47.6mm)	60" (1524.0mm)	30,600 lbs.	<input type="checkbox"/> PMR15060
2.00-2.49" (50.8-63.3mm)	1-7/8" (47.6mm)	50" (1270.0mm)	48,000 lbs.	<input type="checkbox"/> PMR20050
2.50-2.99" (63.5-76.0mm)	1-7/8" (47.6mm)	52" (1320.8mm)	48,000 lbs.	<input type="checkbox"/> PMR25052
3.00-3.49" (76.2-88.6mm)	1-7/8" (47.6mm)	54" (1371.6mm)	48,000 lbs.	<input type="checkbox"/> PMR30054
3.50-3.99" (88.9-101.3mm)	1-7/8" (47.6mm)	56" (1422.4mm)	48,000 lbs.	<input type="checkbox"/> PMR35056

Flexible Eye



Cord Diameter	Eye Diameter	Mesh Length	Approx. Break Strength†	Catalog No.*
0.25-0.49" (6.4-12.5mm)	1/4" (6.4mm)	26" (660.4mm)	6,800 lbs.	<input type="checkbox"/> PMF2526
0.50-0.74" (12.7-18.8mm)	5/16" (7.9mm)	32" (812.8mm)	10,000 lbs.	<input type="checkbox"/> PMF5032
0.75-0.99" (19.1-25.1mm)	3/8" (9.5mm)	41" (1041.4mm)	14,400 lbs.	<input type="checkbox"/> PMF7541
1.00-1.24" (25.4-31.8mm)	1/2" (12.7mm)	52" (1320.8mm)	24,600 lbs.	<input type="checkbox"/> PMF10052
1.25-1.49" (31.8-37.8mm)	1/2" (12.7mm)	56" (1422.4mm)	30,600 lbs.	<input type="checkbox"/> PMF12556
1.50-1.74" (38.1-44.2mm)	1/2" (12.7mm)	60" (1524.0mm)	30,600 lbs.	<input type="checkbox"/> PMF15060
2.00-2.49" (50.8-63.3mm)	5/8" (15.9mm)	50" (1270.0mm)	48,000 lbs.	<input type="checkbox"/> PMF20050
2.50-2.99" (63.5-76.0mm)	5/8" (15.9mm)	52" (1320.8mm)	48,000 lbs.	<input type="checkbox"/> PMF25052
3.00-3.49" (76.2-88.6mm)	5/8" (15.9mm)	54" (1371.6mm)	48,000 lbs.	<input type="checkbox"/> PMF30054
3.50-3.99" (88.9-101.3mm)	5/8" (15.9mm)	56" (1422.4mm)	48,000 lbs.	<input type="checkbox"/> PMF35056



PMF12556

Note: It is recommended that a swivel be used for release of torque during a pull. Use a connecting link when a swivel is not needed. Do not run grips or swivels over bullwheels while under tension. Do not use multi-weave for pulling rope. See installation instructions supplied with grip for recommended swivels, links and clamps or accessories listing.

* For stainless steel support grips, add "SS" suffix to the catalog number (example, SGS50SS). Consult Factory for price and availability.

† To determine workload safety factor, divide approximate break strength by 10. See page M-22 for strength information.

Icon Key

NAFTA Compliant - see page O-30

Pulling Grips - Slack - Double Weave - Closed Mesh

Slack grips are reusable grips used for pulling slack in underground cable preparatory to final placement. They may also be used for cable removal. Slack grips feature an offset eye for easy attachment to the pulling line.

Standard Length, Offset Eye



Cord Diameter	Mesh Length	Approx. Break Strength†	Catalog No.*
0.75-0.99" (19.1-25.1mm)	13" (330.2mm)	3,000 lbs.	<input type="checkbox"/> SKT7512
1.00-1.24" (25.4-31.2mm)	16" (406.4mm)	4,200 lbs.	<input type="checkbox"/> SKT10015
1.25-1.49" (31.8-37.8mm)	17" (431.8mm)	5,500 lbs.	<input type="checkbox"/> SKT12516
1.50-1.74" (38.1-44.2mm)	18" (457.2mm)	7,400 lbs.	<input type="checkbox"/> SKT15017
1.75-1.99" (44.5-50.5mm)	19" (482.6mm)	11,000 lbs.	<input type="checkbox"/> SKT17518
2.00-2.49" (50.8-63.3mm)	20" (508.0mm)	11,000 lbs.	<input type="checkbox"/> SKT20019
2.50-2.99" (63.5-76.0mm)	21" (533.4mm)	11,000 lbs.	<input type="checkbox"/> SKT25020
3.00-3.49" (76.2-88.6mm)	22" (558.8mm)	16,000 lbs.	<input type="checkbox"/> SKT30021
3.50-3.99" (88.9-101.3mm)	23" (584.2mm)	16,000 lbs.	<input type="checkbox"/> SKT35022



SKT15017

Long Length, Offset Eye



Cord Diameter	Mesh Length	Approx. Break Strength†	Catalog No.*
0.75-0.99" (19.1-25.1mm)	21" (533.4mm)	3,000 lbs.	<input type="checkbox"/> SKT7520
1.00-1.24" (25.4-31.2mm)	21" (533.4mm)	5,500 lbs.	<input type="checkbox"/> SKT10020
1.25-1.49" (31.8-37.8mm)	24" (609.6mm)	5,500 lbs.	<input type="checkbox"/> SKT12523
1.50-1.74" (38.1-44.2mm)	26" (660.4mm)	7,400 lbs.	<input type="checkbox"/> SKT15025
2.00-2.49" (50.8-63.3mm)	27" (685.8mm)	11,000 lbs.	<input type="checkbox"/> SKT20026
2.50-2.99" (63.5-76.0mm)	30" (762.0mm)	11,000 lbs.	<input type="checkbox"/> SKT25029
3.00-3.49" (76.2-88.6mm)	33" (838.2mm)	16,000 lbs.	<input type="checkbox"/> SKT30032
3.50-3.99" (88.9-101.3mm)	36" (914.4mm)	16,000 lbs.	<input type="checkbox"/> SKT35035



SKT15025

* For stainless steel support grips, add "SS" suffix to the catalog number (example, SGS50SS). Consult Factory for price and availability.

† To determine workload safety factor, divide approximate break strength by 10. See page M-22 for strength information.

Icon Key

NAFTA Compliant - see page O-30

Pulling Grips - Slack - Double Weave - Split Lace

Standard Length, Offset Eye



Cord Diameter	Mesh Length	Approx. Break Strength†	Catalog No.*
0.75-0.99" (19.1-25.1mm)	13" (330.2mm)	3,000 lbs.	<input type="checkbox"/> SKTL7512 •
1.00-1.24" (25.4-31.2mm)	16" (406.4mm)	4,100 lbs.	<input type="checkbox"/> SKTL10015 •
1.25-1.49" (31.8-37.8mm)	17" (431.8mm)	4,100 lbs.	<input type="checkbox"/> SKTL12516 •
1.50-1.74" (38.1-44.2mm)	18" (457.2mm)	5,500 lbs.	<input type="checkbox"/> SKTL15017 •
1.75-1.99" (44.5-50.5mm)	19" (482.6mm)	7,300 lbs.	<input type="checkbox"/> SKTL17518 •
2.00-2.49" (50.8-63.3mm)	20" (508.0mm)	7,300 lbs.	<input type="checkbox"/> SKTL20019 •
2.50-2.99" (63.5-76.0mm)	21" (533.4mm)	7,300 lbs.	<input type="checkbox"/> SKTL25020 •
3.00-3.49" (76.2-88.6mm)	22" (558.8mm)	9,200 lbs.	<input type="checkbox"/> SKTL30021 •
3.50-3.99" (88.9-101.3mm)	23" (584.2mm)	11,000 lbs.	<input type="checkbox"/> SKTL35022 •



SKTL12516

Long Length, Offset Eye



Cord Diameter	Mesh Length	Approx. Break Strength†	Catalog No.*
0.75-0.99" (19.1-25.1mm)	21" (533.4mm)	3,000 lbs.	<input type="checkbox"/> SKTL7521 •
1.00-1.24" (25.4-31.2mm)	21" (533.4mm)	5,500 lbs.	<input type="checkbox"/> SKTL10021 •
1.25-1.49" (31.8-37.8mm)	24" (609.6mm)	5,500 lbs.	<input type="checkbox"/> SKTL12524 •
1.50-1.74" (38.1-44.2mm)	25" (635.0mm)	7,400 lbs.	<input type="checkbox"/> SKTL15025 •
2.00-2.49" (50.8-63.3mm)	27" (685.8mm)	11,000 lbs.	<input type="checkbox"/> SKTL20027 •
2.50-2.99" (63.5-76.0mm)	30" (762.0mm)	11,000 lbs.	<input type="checkbox"/> SKTL25030 •
3.00-3.49" (76.2-88.6mm)	33" (838.2mm)	16,000 lbs.	<input type="checkbox"/> SKTL30033 •
3.50-3.99" (88.9-101.3mm)	36" (914.4mm)	16,000 lbs.	<input type="checkbox"/> SKTL35036 •



SKTL12524

Pulling Grips - Slack - Single Weave - Split Rod

Standard Length, Offset Eye



Cord Diameter	Mesh Length	Approx. Break Strength†	Catalog No.*
0.50-0.61" (12.7-15.5mm)	7" (177.8mm)	1,800 lbs.	<input type="checkbox"/> SKR506 •
0.62-0.74" (15.7-18.8mm)	9" (228.6mm)	1,900 lbs.	<input type="checkbox"/> SKR628 •
0.75-0.99" (19.1-25.1mm)	11" (279.4mm)	3,000 lbs.	<input type="checkbox"/> SKR7510 •
1.00-1.24" (25.4-31.2mm)	12" (304.8mm)	4,100 lbs.	<input type="checkbox"/> SKR10012 •
1.25-1.49" (31.8-37.8mm)	14" (355.6mm)	5,700 lbs.	<input type="checkbox"/> SKR12514 •
1.50-1.74" (38.1-44.2mm)	16" (406.4mm)	5,800 lbs.	<input type="checkbox"/> SKR15015 •
1.75-1.99" (44.5-50.5mm)	17" (431.8mm)	7,700 lbs.	<input type="checkbox"/> SKR17516 •
2.00-2.49" (50.8-63.3mm)	20" (508.0mm)	9,300 lbs.	<input type="checkbox"/> SKR20019 •
2.50-2.99" (63.5-76.0mm)	21" (533.4mm)	11,300 lbs.	<input type="checkbox"/> SKR25020 •
3.00-3.49" (76.2-88.6mm)	22" (558.8mm)	15,100 lbs.	<input type="checkbox"/> SKR30021 •
3.50-3.99" (88.9-101.3mm)	25" (635.0mm)	15,100 lbs.	<input type="checkbox"/> SKR35024 •



SKR7510

* For stainless steel support grips, add "SS" suffix to the catalog number (example, SGS50SS). Consult Factory for price and availability.

† To determine workload safety factor, divide approximate break strength by 10. See page M-22 for strength information.

Icon Key

NAFTA Compliant - see page O-30

Selecting Properly Sized Pulling And Support Grips

Select grip size based upon the outside diameter or circumference of the cable(s). See the following reference tables for convenience in determining cable diameters.

Use the following grip selection tables to determine the grip diameter range for your application.

Grip selection for one or more cables of equal diameter:

1. Read across top line for number of cables in one grip.
2. Read down for diameter of each cable.
3. Read across to the right to grip diameter range column.

Example: For five cables together with diameter of 0.42" each

1. Locate "5 cables" column.
2. Read down column to range (0.38–0.48").
3. Read across line to grip diameter range (1.00–1.25").

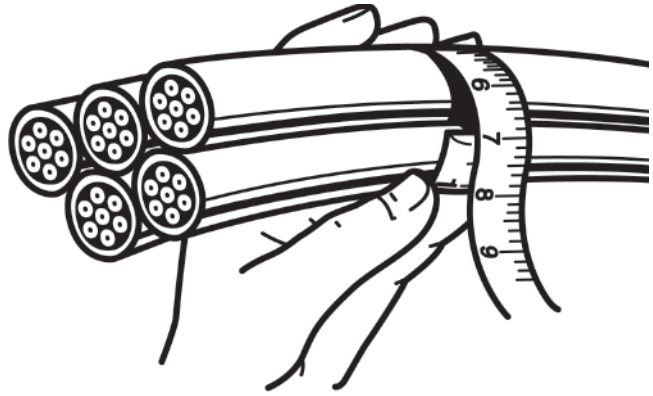

Decimal and Fraction Inch Cable Diameters For One or More Cables of Equal Diameter

1 CABLE	2 CABLES	3 CABLES	4 CABLES	GRIP DIAMETER RANGE
0.25-0.37" = 1/4 - 3/8"	0.16-0.25" = 1/4 - 1/4"	0.15-0.22" = 5/32 - 7/32"	0.12-0.20" = 1/8 - 13/64"	0.25-0.375"
0.37-0.50" = 3/8 - 1/2"	0.25-0.36" = 1/4 - 23/64"	0.22-0.33" = 7/32 - 21/64"	0.20-0.28" = 13/64 - 9/32"	0.375-0.50"
0.50-0.62" = 1/2 - 5/8"	0.27-0.36" = 17/64 - 23/64"	0.26-0.33" = 17/64 - 21/64"	0.24-0.28" = 15/64 - 9/32"	0.50-0.62"
0.62-0.75" = 5/8 - 3/4"	0.36-0.45" = 23/64 - 29/64"	0.33-0.36" = 21/64 - 23/64"	0.28-0.31" = 9/32 - 5/16"	0.62-0.75"
0.75-1.00" = 3/4 - 1"	0.45-0.60" = 29/64 - 39/64"	0.36-0.49" = 23/64 - 31/64"	0.31-0.42" = 5/16 - 27/64"	0.75-1.00"
1.00-1.25" = 1 - 1 1/4"	0.60-0.76" = 39/64 - 49/64"	0.49-0.63" = 39/64 - 5/8"	0.42-0.54" = 27/64 - 35/64"	1.00-1.25"
1.25-1.50" = 1 1/4 - 1 1/2"	0.76-0.91" = 49/64 - 29/32"	0.63-0.75" = 5/8 - 49/64"	0.54-0.65" = 35/64 - 21/32"	1.25-1.50"
1.50-1.75" = 1 1/2 - 1 3/4"	0.91-1.08" = 29/32 - 1 15/64"	0.76-0.89" = 49/64 - 57/64"	0.65-0.77" = 21/32 - 49/64"	1.50-1.75"
1.75-2.00" = 1 3/4 - 2"	1.23-1.54" = 1 15/64 - 1 39/64"	0.89-1.02" = 57/64 - 1 1/64"	0.77-0.88" = 49/64 - 7/8"	1.75-2.00"
2.00-2.50" = 2 - 2 1/2"	1.54-1.84" = 1 15/64 - 1 39/64"	1.02-1.28" = 1 1/64 - 1 13/32"	0.88-1.00" = 7/8 - 1"	2.00-2.50"
2.50-3.00" = 2 1/2 - 3"	1.54-1.84" = 1 35/64 - 1 27/32"	1.28-1.53" = 1 1/32 - 1 17/32"	1.10-1.32" = 1 3/32 - 1 21/64"	2.50-3.00"
3.00-3.50" = 3 - 3 1/2"	1.84-2.15" = 1 27/32 - 25/32"	1.53-1.79" = 1 17/32 - 1 51/64"	1.32-1.54" = 1 21/64 - 1 35/64"	3.00-3.50"
3.50-4.00" = 3 1/2 - 4"	2.15-2.45" = 2 3/32 - 2 29/64"	1.79-2.05" = 1 51/64 - 2 1/64"	1.54-1.76" = 1 35/64 - 1 49/64"	3.50-4.00"

5 CABLES	6 & 7 CABLES	8 CABLES	9 CABLES	GRIP DIAMETER RANGE
0.11-0.14" = 7/64 - 9/64"	0.10-0.11" = 3/32 - 7/64"	0.09-0.10" = 3/32 - 7/64"	0.06-0.09" = 1/16 - 3/32"	0.25-0.375"
0.14-0.21" = 9/64 - 1/4"	0.11-0.25" = 7/64 - 1/4"	0.10-0.20" = 7/64 - 13/64"	0.09-0.19" = 3/32 - 3/16"	0.375-0.50"
0.21-0.25" = 7/32 - 1/4"	0.19-0.22" = 3/16 - 7/32"	0.17-0.20" = 11/64 - 19/64"	0.15-0.19" = 3/32 - 3/16"	0.50-0.62"
0.25-0.29" = 1/4 - 19/64"	0.22-0.26" = 7/32 - 17/64"	0.20-0.23" = 13/64 - 15/64"	0.19-0.22" = 3/16 - 7/32"	0.62-0.75"
0.29-0.38" = 19/64 - 3/8"	0.26-0.34" = 17/64 - 11/32"	0.23-0.31" = 15/64 - 5/16"	0.22-0.31" = 7/32 - 5/16"	0.75-1.00"
0.38-0.48" = 3/8 - 31/64"	0.34-0.43" = 11/32 - 7/16"	0.31-0.39" = 5/16 - 25/64"	0.29-0.36" = 19/64 - 23/64"	1.00-1.25"
0.48-0.58" = 31/64 - 41/64"	0.43-0.52" = 7/16 - 33/64"	0.39-0.46" = 25/64 - 15/32"	0.36-0.43" = 23/64 - 7/16"	1.25-1.50"
0.58-0.67" = 37/64 - 43/64"	0.52-0.60" = 33/64 - 39/64"	0.46-0.54" = 15/32 - 35/64"	0.43-0.49" = 7/16 - 31/64"	1.50-1.75"
0.67-0.77" = 43/64 - 49/64"	0.60-0.69" = 39/64 - 11/16"	0.54-0.62" = 35/64 - 5/8"	0.49-0.57" = 31/64 - 37/64"	1.75-2.00"
0.77-0.96" = 49/64 - 31/32"	0.69-0.86" = 11/16 - 59/64"	0.62-0.77" = 5/8 - 49/64"	0.57-0.72" = 37/64 - 23/32"	2.00-2.50"
0.96-1.16" = 31/32 - 1 1/32"	0.86-1.03" = 59/64 - 1 1/32"	0.77-0.93" = 49/64 - 15/16"	0.72-0.86" = 23/32 - 53/64"	2.50-3.00"
1.16-1.35" = 1 5/32 - 1 23/64"	1.03-1.20" = 1 1/32 - 1 13/64"	0.93-1.08" = 15/16 - 1 5/64"	0.86-1.00" = 53/64 - 1"	3.00-3.50"
1.35-1.54" = 1 23/64 - 1 39/64"	1.20-1.37" = 1 13/64 - 1 3/8"	1.08-1.24" = 1 1/64 - 1 15/64"	1.00-1.14" = 1 - 1 1/64"	3.50-4.00"

Selecting Properly Sized Pulling And Support Grips

Grip circumference range refers to circumference of all cables held together.

1. Determine grip circumference range by measuring circumference of bundle of cables to be held (as shown in illustration).
2. Read down to locate correct range.
3. Read across to grip diameter column.

Example: For three cables together with combined circumference of 6.35"

1. Read down "inches (decimal)" column for 6.35" (6.29-7.86").
2. Read across line to grip diameter range (2.00-2.50").

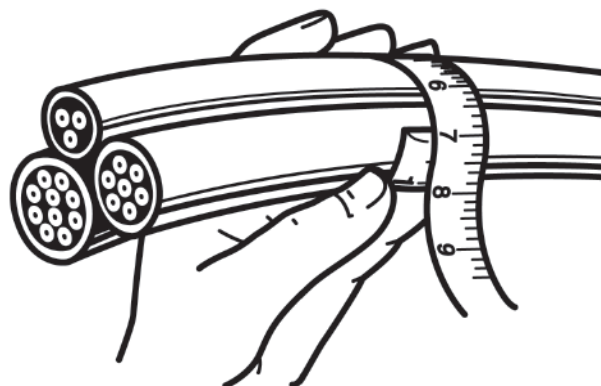

Grip Circumference Range For Cables of Different Diameters

INCHES (FRACTIONAL)	INCHES (DECIMAL)	GRIP DIAMETER RANGE
$\frac{25}{32} - 1\frac{1}{64}$ "	0.78-1.17"	0.25-.375"
$1\frac{11}{64} - 1\frac{37}{64}$ "	1.17-1.57"	0.375-0.50"
$1\frac{37}{64} - 2\frac{3}{8}$ "	1.57-2.37"	0.50-0.75"
$1\frac{15}{16} - 2\frac{3}{8}$ "	1.94-2.37"	0.625-0.75"
$2\frac{3}{8} - 3\frac{5}{32}$ "	2.37-3.15"	0.75-1.00"
$3\frac{3}{32} - 3\frac{5}{16}$ "	3.15-3.94"	1.00-1.25"
$3\frac{15}{16} - 4$ "	3.94-4.72"	1.25-1.50"
$4\frac{23}{32} - 5\frac{33}{64}$ "	4.72-5.51"	1.50-1.75"
$5\frac{33}{64} - 6\frac{19}{64}$ "	5.51-6.29"	1.75-2.00"
$6\frac{19}{64} - 7\frac{55}{64}$ "	6.29-7.86"	2.00-2.50"
$7\frac{55}{64} - 9\frac{7}{16}$ "	7.86-9.43"	2.50-3.00"
$9\frac{7}{16} - 11\frac{1}{64}$ "	9.43-11.01"	3.00-3.50"
$11\frac{1}{64} - 12\frac{37}{64}$ "	11.01-12.58"	3.50-4.00"

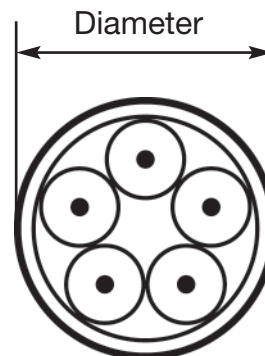

Cord Diameters Reference Table

For your convenience, the following are nominal overall diameters (in inches) for flexible cord.

AWG WIRE SIZE AND TYPE	2 CONDUCTORS	3 CONDUCTORS	4 CONDUCTORS	5 CONDUCTORS
18 SO, STO	0.36"	0.38"	0.41"	0.49"
18 SJO, SJTO	0.30"	0.32"	0.35"	—
16 SO, STO	0.39"	0.41"	0.44"	0.52"
16 SJO, SJTO	0.32"	0.34"	0.37"	—
14 SO, STO	0.52"	0.55"	0.59"	0.67"
12 SO, STO	0.60"	0.62"	0.68"	0.74"
10 SO, STO	0.65"	0.69"	0.74"	0.80"
8 SO, STO	0.83"	0.88"	0.99"	1.08"
6 SO, STO	0.99"	1.04"	1.12"	1.25"

Strength Information

The approximate breaking strength of any Arrow Hart wire mesh cable grip is based on working load information established in laboratory testing. In making these determinations, it is not possible to cover all applications and operating conditions. Variables such as diameters, gripping surfaces, number of items gripped, tension, movement, attachment, abrasion, corrosion, prior use, or abuse must be assessed by the user. Greater safety factors should be utilized when the conditions of application are vague or unknown.

For specific applications where strength and holding power are important, consult the manufacturer. To determine the recommended working load safety factor for listed cable grips, divide the approximate breaking strength by 5 for pulling grips and 10 for support grips. Arrow Hart maintains a 6 sigma safety factor for pulling grips and a 5 sigma safety factor for support grips for these recommended working loads (using average break strengths obtained on new grips under lab test conditions).

Example: For pulling grips – $33,000 \div 5 = 6,600$ lbs. which is the workload factor.

Example: For support grips – $10,080 \div 10 = 1,008$ lbs. which is the workload factor.

All warranties concerning product quality or performance are based on wire mesh grips that are properly stored and handled by the user, and grips that are maintained and inspected at a proper frequency in keeping with their use and condition.

Grip Cable Range Conversion

INCHES (FRACTIONAL)	INCHES (DECIMAL)	METRIC (MM)
$\frac{1}{4}$ - $\frac{23}{64}$ "	0.25-0.36"	6.35-9.13 mm
$\frac{3}{8}$ - $\frac{31}{64}$ "	0.37-0.49"	9.52-12.30 mm
$\frac{1}{2}$ - $\frac{39}{64}$ "	0.50-0.61"	12.70-15.48 mm
$\frac{5}{8}$ - $\frac{47}{64}$ "	0.62-0.74"	15.88-18.65 mm
$\frac{3}{4}$ - $\frac{63}{64}$ "	0.75-0.99"	19.05-25.00 mm
1 - $1\frac{15}{64}$ "	1.00-1.24"	25.40-31.35 mm
$1\frac{1}{4}$ - $1\frac{31}{64}$ "	1.25-1.49"	31.75-37.70 mm
$1\frac{1}{2}$ - $1\frac{63}{64}$ "	1.50-1.99"	38.10-50.40 mm
2 - $2\frac{31}{64}$ "	2.00-2.49"	50.80-63.10 mm
$2\frac{1}{2}$ - $2\frac{63}{64}$ "	2.50-2.99"	63.50-75.80 mm
3 - $3\frac{31}{64}$ "	3.00-3.49"	76.20-88.50 mm
$3\frac{1}{2}$ - $3\frac{63}{64}$ "	3.50-3.99"	88.90-101.20 mm

Split Lace

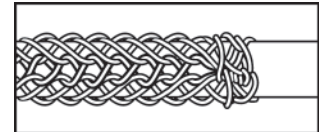
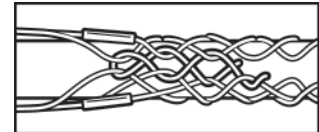

Split-Rod

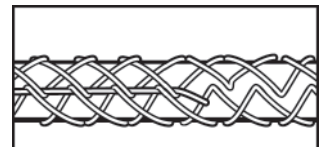
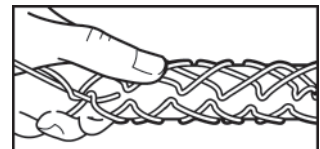

Split Lace/Split Rod Attachments

(For use where end of cable is not accessible)

Beginning at the end of the grip closest to the bale fitting, thread the lacing through the first two loops of the split, pulling lace through until ends are centered evenly. Cross laces and thread through next two loops, and so on down the grip, being careful not to pull lacing too tight. Spacing of laced closure should be approximately the same as mesh weave. When end of grip is reached, twist lacing strands tightly together, wrap ends of lace around grip, and twist again to secure. Excess length may be cut off.

Split grips with rod closing are economical since they are quickly installed, and are reusable. Simply wrap the grip around the cable and thread the rod through the loops, using a corkscrew motion. To remove, pull the rod out, and the grip is ready for re-use.

AWG or MCM Wire Sizes

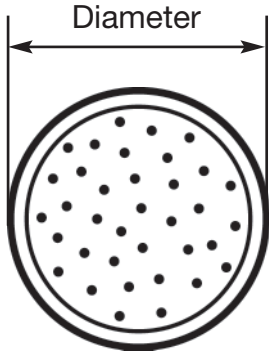

This table to be used as a guide only. Sizes may vary by manufacturer.

AWG OR MCM	APPROXIMATE DIAMETER THHM	APPROXIMATE DIAMETER THW
14	0.105"	0.162"
12	0.122"	0.179"
10	0.153"	0.199"
8	0.201"	0.259"
6	0.257"	0.323"
4	0.328"	0.372"
3	0.356"	0.401"
2	0.388"	0.433"
1	0.450"	0.508"
1/0	0.491"	0.549"
2/0	0.537"	0.595"
3/0	0.588"	0.647"
4/0	0.646"	0.705"
250	0.716"	0.788"
300	0.771"	0.843"
350	0.822"	0.895"
400	0.869"	0.942"
500	0.955"	1.03"
600	1.06"	1.14"
700	1.13"	1.21"
750	1.16"	1.25"
1000	1.32"	1.40"

N

Electrical Accessories



	Page		Page
Ceiling Lampholders	N-1	Sign, Heater & Cleat Sockets	N-5
Plastic		Sign Sockets	
600W, 250V/AC	N-1	660W, 250V/AC	N-5
660W, 250V/AC	N-1	Heater Sockets	
Porcelain		660W, 250V/AC	N-5
660W, 125V/AC	N-1	Cleat Sockets	
Fluorescent Lampholders	N-2	75W, 125V/AC	N-5
Recessed Double Contact		660W, 250V/AC	N-5
660W, 600V/AC	N-2	Miscellaneous Lampholders	N-6
660W, 1000V/AC	N-2	Incandescent Sockets	
Slimline		Fixture Sockets, 660W, 250V/AC	N-6
660W, 600V/AC	N-2	Canopy & Circuit Control Switches	N-7
660W, 1000V/AC	N-2	AC Specialty Switches	
Medium Bi-Pin		Canopy Switches: 1A & 3A, 3A & 6A	N-7
660W, 600V/AC	N-3	Circuit Control Toggle Switches: 3A & 6A	N-7
Pigtail Lampholders	N-3		
Medium Base			
660W, 250V/AC	N-3		
660W, 600V/AC	N-3		
Sign & Scoreboard Lampholders	N-4		
Medium Base			
200W, 250V/AC	N-4		
660W, 250V/AC	N-4		
Intermediate & Base Attachon			
75W, 250V/AC	N-4		
Candelabra Base Attachon			
75W, 125V/AC	N-4		

Electrical accessories for a variety of new and replacement applications

Arrow Hart has one of the most extensive lines of sign and scoreboard lighting devices in the industry and offers a variety of materials for a wide range of incandescent and fluorescent applications including electrical equipment, harnesses and light strings.



Ceiling Lampholders

Our ceiling lampholder family includes lampholders made of high-temperature thermoplastic or high-strength insulator porcelain in either pull chain or keyless configurations with or without extra 2-pole, 2-wire or 2-pole, 3-wire outlets.



Fluorescent Lampholders

The fluorescent family of lampholders includes recessed double contact, slimline and medium bi-pin lampholder styles in either plunger or stationary styles.



Pigtail Lampholders

Primarily for use in electrical equipment, harnesses and light strings, our pigtail lampholders are available in either medium base or miniature base, and include rubber, weatherproof rubber or phenolic designs.



Sign & Scoreboard Lampholders

Arrow Hart's broad selection of sign and scoreboard lampholders includes Attachon designs in medium, intermediate and candelabra bases in a variety of panel mounting options featuring snap-in, screw-in, hook, no hook, and spring-washer models.



Sockets

This family of lampholders includes heater and cleat sockets for use with heater elements, stage lighting and similar applications in Edison, medium, candelabra and miniature bases.



Canopy & Circuit Control Switches

For use in fixtures, appliances, doorways and equipment, this family includes a variety of styles and sizes of push button and pull chain canopy switches and circuit control toggle switches for use in fixtures, appliances, doorways and equipment.

Ceiling Receptacle Lampholders

Medium Base
600W, 250V/AC
660W, 125V/AC
660W, 250V/AC

Medium Base Lampholders

FEATURES

- Mounts on 4" (101.6mm) outlet boxes with breakout for 3.25" (82.5mm) box mounting.
- Leads are 6" (152.4mm) 221°F (105°C) insulated stranded #16, stripped 0.75" (19.0mm).
- Pull chain devices include ball chain, 3' (0.9m) of cord, connector and end bell.
- Top wire versions have terminal screws backed out – ready for wiring – without removing interior.
- Push wire terminals are top wired with two push-in terminals and two screw terminals for continuous wiring.
- Plastic models made with high-temperature thermoset plastic to reduce breakage.
- Porcelain models made with high-strength insulator porcelain; pull chain versions feature removable interiors.

Plastic Ceiling Receptacle Lampholders



Rating W	V/AC	Product Type	Color	Catalog No.		
600	250	Two Piece, Push Wire/Top Wire, Pull Chain Switch	White	<input type="checkbox"/> S759W-CD		
		Two Piece, 6" (152.4mm) Leads, Pull Chain Switch	White	<input type="checkbox"/> S788W		
660	250	Two Piece, w/ 15A 125V/AC 2P2W Outlet, Push Wire/Top Wire, Pull Chain Switch	White	<input type="checkbox"/> S860W		
		Two Piece, w/ 15A 125V/AC, 2P3W Outlet, Push Wire/Top Wire, Pull Chain Switch	White	<input type="checkbox"/> S865W		
		One Piece, 4 Top Wire Screws, Keyless Switch	White	<input type="checkbox"/> S1174W		•
		One Piece, 6" (152.4mm) Leads, Keyless Switch	White	<input type="checkbox"/> S1174-6W*		•
		Two Piece, Push Wire/Top Wire, Keyless Switch	White	<input type="checkbox"/> S768W		
		Two Piece, 6" (152.4mm) Leads, Keyless Switch	White	<input type="checkbox"/> S768-6W*		

* Not cULus & NOM certified

Porcelain Ceiling Receptacle Lampholders



Rating W	V/AC	Product Type	Color	Catalog No.	
660	125	Two Piece, w/ 15A 125V/AC 2P2W Outlet, 2 Screw Terminals, Top Wire, Pull Chain Switch	White	<input type="checkbox"/> 669	
		Two Piece, w/ 15A 125V/AC 2P3W Outlet, 2 Screw Terminals, Top Wire, Pull Chain Switch	White	<input type="checkbox"/> 667	
660	250	One Piece, w/ Feed-Through, 4 Screw Terminals, Top Wire, Keyless Switch	White	<input type="checkbox"/> 604	
		Two Piece, w/ Feed-Through, 4 Screw Terminals, Top Wire, Pull Chain Switch	White	<input type="checkbox"/> 659	

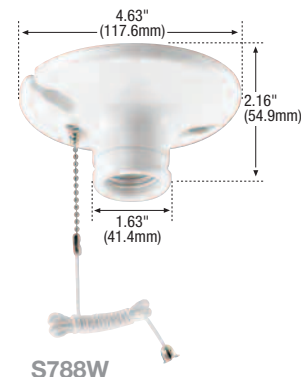

S788W

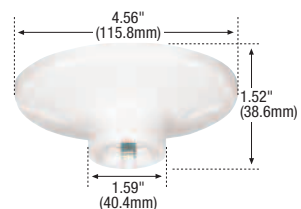

S1174W



669

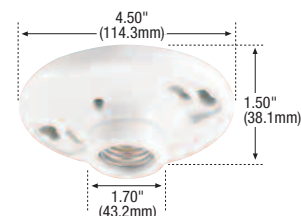

604

Icon Key

NAFTA Compliant - see page O-30

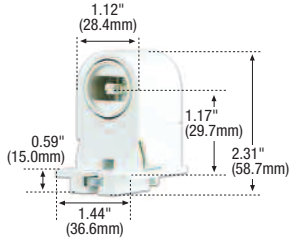

2500W

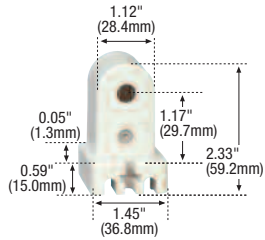

2503W

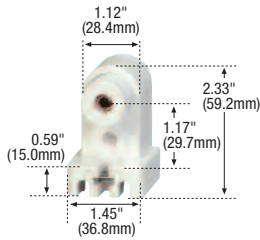

2504W

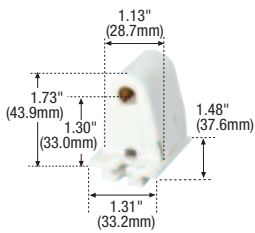

2506W

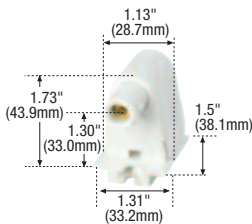

2507W

Fluorescent Lampholders

Recessed Double Contact
Slimline
660W, 600V/AC
660W, 1000V/AC

Recessed Double Contact

FEATURES

- For replacement use in fluorescent lighting fixtures as well as enclosed outdoor signs.
- Recessed double-contact (2500, 2501) lampholders can be used for flush or surface mounting.
- Captive pal nut for easy mounting.
- Push-in wire terminals feature release slots.
- Molded of durable white thermoset plastic.

Recessed Fluorescent Lampholders



Rating	W	V/AC	Product Type	Color	Catalog No.
660	600		Plunger, Push Wire Cap, Screw Switch	White	<input type="checkbox"/> 2501W
			Stationary, Push Wire Cap, Screw Switch	White	<input type="checkbox"/> 2500W

For panel cutout dimensional data, see O-Technical Reference

Slimline

FEATURES

- For replacement use in fluorescent lighting fixtures as well as enclosed outdoor signs.
- Plunger lampholders feature non-sticking, spring-loaded plunger to hold lamp securely.
- Captive pal nut for easy mounting.
- Push-in wire terminals feature release slots.

Slimline Fluorescent Lampholders



Rating	W	V/AC	Product Type	Color	Catalog No.
660	600		Stationary, Push Wire Cap, Slide-On Switch	White	<input type="checkbox"/> 2506W
			Stationary, Push Wire Cap, Screw Switch	White	<input type="checkbox"/> 2503W
660	1000		Plunger, Push Wire Cap, Slide-On Switch	White	<input type="checkbox"/> 2507W*
			Plunger, Push Wire Cap, Screw Switch	White	<input type="checkbox"/> 2504W*

For panel cutout dimensional data, see O-Technical Reference

* Not CSA or NOM certified

Fluorescent Lampholders





Medium Bi-Pin
660W, 600V/AC

Medium Bi-Pin

FEATURES

- For replacement use in fluorescent lighting fixtures.
- Use for flush or surface mounting.
- Captive pal nut for easy mounting.
- Push-in wire terminals feature release slots.

Fluorescent Lampholders

Rating		Product Type	Color	Catalog No.	   
W	V/AC				
660	600	Standard, Push Wire, Slide-On & Screw Switch	White	<input type="checkbox"/> 2509W*	
		Short, Push Wire, Slide-On & Screw Switch	White	<input type="checkbox"/> 2510W	
		Standard, Screw Terminals, Screw Switch	White	<input type="checkbox"/> 924W	

For panel cutout dimensional data, see O-Technical Reference

*Not NOM certified

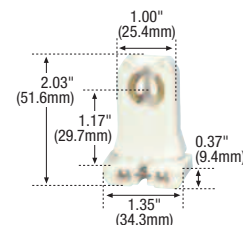

2509W

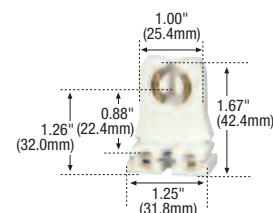

2510W

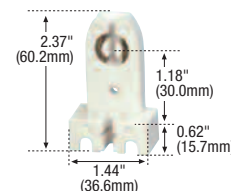

924W

Pigtail Lampholders





Medium Base
660W, 250V/AC
660W, 600V/AC

Medium Base

FEATURES

- For use in electrical equipment, harnesses, light strings and related applications.
- Wire leads are 5" (127.0mm) of color-coded stranded wire, stripped 1" (25.4mm) for easy connection.
- Rubber sockets have an extended lip to seal against bulb.
- Metal shell interiors are aluminum, 145 nickel-plated copper.
- #124 is a weatherproof socket with sealed leads where they enter husk.

Pigtail Lampholders

Rating		Product Type	Catalog No.	    
W	V/AC			
660	250	Phenolic, Wire Size #14 AWG	<input type="checkbox"/> 722*	
660	600	Weatherproof Rubber, Wire Size #16 AWG	<input type="checkbox"/> 124	
		Rubber, Wire Size #14 AWG	<input type="checkbox"/> 145†	

* Not cULus Certified

† Not UL & CSA Certified



722



145

Icon Key

 NAFTA Compliant - see page O-30

Sign and Scoreboard Lighting

Attachon Lampholders,
660W, 250V/AC
200W, 250V/AC
75W, 125V/AC
75W, 250V/AC



732



732-3



4734-2

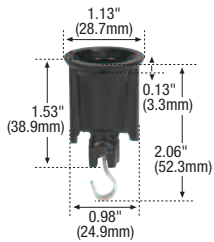

731



731-2



731-3

Medium Base Attachon

FEATURES

- Insulation displacement terminals for stranded wire.
- Lay in wire channels, 1/4 turn twist top speeds installation.
- One piece terminals and contacts, no rivets or eyelets to loosen due to heat.
- Sockets are molded of heat-resistant phenolic.
- #732 is weatherproof, suitable for outdoor use.
- Intermediate and candelabra bases offer snap-in or screw-in panel mounting options.
- Keyed spring washer prevents rotation of socket after installation.

Sign and Scoreboard Lampholders

Rating W V/AC	Product Type	Catalog No.			
660 250	Weatherproof Phenolic, Wire Range #14 to #12 AWG, Hook Mounting	□ 732			
	Weatherproof Phenolic, Wire Range #14 to #12 AWG, No Hook Mounting	□ 732-1			
	Weatherproof Phenolic, Wire Range #14 to #12 AWG, Snap-in Mounting	□ 732-3			
	Phenolic, Wire Range #18 to #12 AWG, Snap-in Mounting	□ 4734-2			
	Phenolic, Wire Range #14 to #12 AWG, Screws Mounting	□ 734			

For panel cutout dimensional data, see section O-Technical Reference

Medium Base Attachon with Guard

Sign and Scoreboard Lampholder

Rating W V/AC	Product Type	Catalog No.		
200 250	Phenolic Socket (732), Yellow Guard, Wire Range #18 to #12 AWG, Hook Mounting	□ 1466Y		

Intermediate Base Attachon

Sign and Scoreboard Lampholders

Rating W V/AC	Product Type	Catalog No.			
75 250	Phenolic, Wire Range #18 to #16 AWG, Hook Mounting	□ 731			
	Phenolic, Wire Range #18 to #16 AWG, No Hook Mounting	□ 731-1*			
	Phenolic, Wire Range #18 to #16 AWG, Spring Washer Mounting	□ 731-2*			
	Phenolic, Wire Range #18 to #16 AWG, Snap-in Mounting	□ 731-3			

For panel cutout dimensional data, see O-Technical Reference

* Not CSA certified

Candelabra Base Attachon

Sign and Scoreboard Lampholders

Rating W V/AC	Product Type	Catalog No.			
75 125	Phenolic, Wire Range #20 to #18 AWG, No Hook Mounting	□ 974			
	Phenolic, Wire Range #20 to #18 AWG, Spring Washer Mounting	□ 974-2*			

*Not CSA certified

For panel cutout dimensional data, see section O-Technical Reference

Icon Key

NAFTA Compliant - see page O-30

Sign, Heater & Cleat Sockets

75W, 125V/AC
660W, 250V/AC

Sign Sockets – Porcelain Base, Thermoset Ring

FEATURES

- High-strength insulator porcelain.

Sign Sockets



Rating W	V/AC	Product Type	Color	Catalog No.
660	250	2-Piece w/ Screw Terminals, Medium Base, Keyless Switch	White	□ 610
		2-Piece w/ 9" (228.6mm) Wire Leads, Medium Base, Keyless Switch	White	□ 609

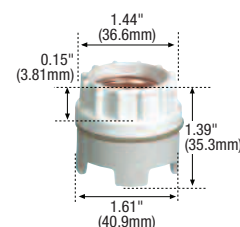

610

Heater Socket – Porcelain

FEATURES

- For use with heater elements.

Heater Socket – Porcelain



Rating W	V/AC	Product Type	Color	Catalog No.
660	250	2-piece w/ Screw Terminals, Edison Base, Keyless Switch	White	□ 602



602

Cleat Socket – Thermoset

FEATURES

- For use with stage lighting and similar applications.

Cleat Socket – Thermoset



Rating W	V/AC	Product Type	Color	Catalog No.
75	125	Front Wire Screw Terminals, Candelabra Base, Keyless Switch	White	□ 304*
		Front Wire Screw Terminals, Miniature Base, Keyless Switch	White	□ 303*
660	250	Front Wire Screw Terminals, Medium Base, Keyless Switch	White	□ S752W

* Not CSA certified

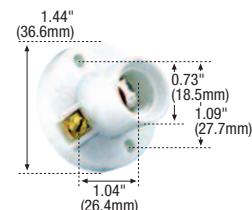

304

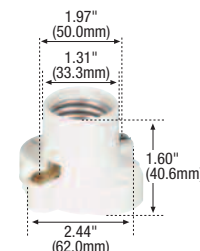

S752W

Incandescent Lampholders

Fixture Sockets
660W, 250V/AC

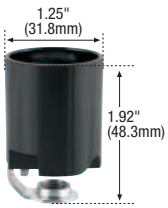

968

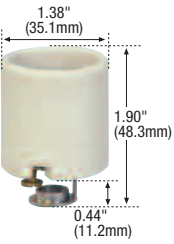

969

Incandescent Medium Base Fixture Sockets

FEATURES

- Interiors have removable turn knobs.
- Hickeys and nipples are threaded for mounting on standard fixture, lamp stems or brackets.

Incandescent Lampholders



Rating		Product Type	Catalog No.
W	V/AC		
660	250	Phenolic, Screw Terminals, Keyless Switch Bracket Height: 0.44" (11.1mm), Overall Height: 1.88" (47.8mm)	<input type="checkbox"/> 968*
		Porcelain, Screw Terminals, Keyless Switch Bracket Height: 0.44" (11.1mm), Overall Height: 1.88" (47.8mm)	<input type="checkbox"/> 969†

* Not cULus certified

† Not UL listed

Commercial Specification Grade AC Specialty Switches

1A, 125V/AC; 1A, 250V/AC
 3A, 125V/AC; 3A, 250V/AC
 6A, 125V/AC
 Single-Pole, Two-Circuit



449NP

Canopy Switches

FEATURES

- Wide variety of sizes for use in fixtures, appliances, doorways and equipment.
- Shank is threaded 15/32"-32 x 15/32" (11.8mm) long.
- Hex nut and finishing nut furnished.
- 6" (152.4mm) wire lead terminals, #18 105°C stripped 0.75" (19.1mm).

Push Button



Rating A V/AC	Circuit	Description	Sequence	Finish	Catalog No.
1A 125V "T" 1A 250V 3A 250V	Single-Pole	Metal Push Button	On-Off	Nickel	☐ 449NP



458BD

Pull Chain



Rating A V/AC	Circuit	Description	Sequence	Finish	Catalog No.
1A 125V "T" 1A 250V 3A 125V	Single-Pole	Pull Chain with End Bell	On-Off	Nickel	☐ 458NP
1A 125V "T" 1A 250V 3A 125V	Single-Pole	Pull Chain with End Bell	On-Off	Brass	☐ 458BD
3A 125V "T" 3A 250V 6A 125V	Single-Pole	Pull Chain with End Bell	On-Off	Nickel	☐ 442



442

Pull Chain



Rating A V/AC	Circuit	Description	Sequence	Finish	Catalog No.
3A 250V 6A 125V	Two-Circuit	Pull Chain with End Bell	Lo-Med-Hi-Off	Brass	☐ 460

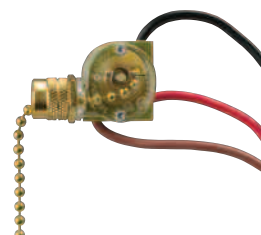

460

Circuit Control Toggle Switch

FEATURES

- Shank is threaded 15/32"-32 x 9/32" (7.1mm) long.
- Keyed shank, indicator plate and finishing nut furnished.
- 6" (152.4mm) wire leads, #18 105°C stripped 0.75" (19.1mm).

Bat Handle



Rating A V/AC	Circuit	Description	Sequence	Catalog No.
3A 250V 6A 125V	SPST	Metal Bat Handle	On-Off	☐ 452



452

Icon Key

NAFTA Compliant - see page O-30



Technical Reference



	Page		Page
NEMA Configurations	O-2	Dimensional Data	O-21
15A & 20A Straight Blade	O-2	Switch Dimensional Data	O-21
30A, 50A, & 60A Straight Blade	O-3	Enclosure Dimensional Data	O-22
15A, 20A & 30A Locking	O-4–O-6	Snap-In Receptacle Panel Cutouts	O-23
10A-30A Non-NEMA Locking	O-7	Attachon Lampholder Panel Cutouts	O-23
50A Non-NEMA Locking	O-7		
Pin & Sleeve Configurations	O-8	Switch Applications	O-24
20A Watertight Pin & Sleeve	O-8	Test Requirements	O-24
30A Watertight Pin & Sleeve	O-8	Maximum Loads	O-25
60A Watertight Pin & Sleeve	O-9		
100A Watertight Pin & Sleeve	O-9	Chemical Resistance of Materials	O-26
		Properties of Common Materials in Wiring Devices	O-26
Horsepower Ratings	O-10	NEMA & IP Enclosures	O-27
For NEMA Configurations (Plugs & Receptacles Only)	O-10	Enclosure Ratings	O-27
		Enclosure Type Cross Reference: NEMA/UL/CSA	O-28–O-29
Common Industry Information	O-11	NAFTA Compliant	O-30
Organization Abbreviations Glossary	O-11	NAFTA Compliant Criteria	O-30
Common Industry Organization Acronyms	O-12		
UL & CSA Standards For Wiring Devices	O-12		
General Purpose Wiring Device Definitions	O-13		
Select NEC® Requirements for Wiring Devices	O-14		
Wire & Cable Information	O-15		
Wire & Cable Abbreviations	O-15		
Diameter Ranges of Jacketed Cord, per UL62	O-15		
Wiring Diagrams	O-16		
By NEMA: 2-Pole, 2-Wire Non-Grounding	O-16		
By NEMA: 2-Pole, 3-Wire Grounding	O-16		
By NEMA: 3-Pole, 3-Wire Non-Grounding	O-16		
By NEMA: 3-Pole, 4-Wire Grounding	O-16–O-17		
By NEMA: 4-Pole, 4-Wire Non-Grounding	O-17		
By NEMA: 4-Pole, 5-Wire Grounding	O-17		
Receptacles & GFCI	O-18		
Combination Devices	O-18		
Switches	O-19		
Manual Contactors & Disconnect Switches	O-20		
Manual Contactors & Disconnect Switches, by Motor Variations	O-20		

Poles, Wires	Rating	NEMA Prefix	15A Straight Blade		20A Straight Blade									
			Receptacle, Connector & Flanged Outlet	Plug & Flanged Inlet	Receptacle, Connector & Flanged Outlet	Plug & Flanged Inlet								
2-Pole, 3-Wire Grounding	2-Pole, 2-Wire	1	4882 ★	4862 ◆										
	125V/AC	5	AH5262 ■M 52629 ★NC 5252 ■ 5279C ● 6262 ■D 5969BLK ★O IG5262 ■IM 6269 ★L 5261 +M VGF15 ■GM 4887 ★ BR15 ■ TRBR15 ■R CR15 ■ TRVGF15 ■RGM 5262 ■M AH8200 ■M 5269NHG ★N 8200 ■HM 6269HG ★L 8210 +M IG8200 ■IM TR8200 ■RM VGFH15 ■GM TRVGFH15 ■RGM	5266N ◆NC 5278C ▲ 6266 ◆ 4867 ◆ 5266NHG ◆N 6266HG ◆L 8115GY ◆O	AH5362 ■M 5369N ★NC 5352 ■M 5779C ● 6362 ■DM 6769 ★L IG5362 ■IM 5361 +M VGF20 ■GM 4228 ★ BR20 ■ TRBR20 ■R CR20 ■ TRVGF20 ■RGM 5362 ■M AH8300 ■M 5369NHG ★N 8300 ■M 6769HG ★L 8310 +M IG8300 ■IM TR8300 ■RM VGFH20 ■GM TRVGFH20 ■RGM	5366N ◆NC 5778C ▲ 6766 ◆L 4409 ◆ 5366NHG ◆N 6766HG ◆L								
			250V/AC	6	AH5662 ■M 5669N ★N 5661 + 5679C ● IG5662 ■I 6669 ★L 6662 ■D 826 ■ 816 + 4227 ★ 5662C ■ AH8600 ■M 8610 +	5666N ◆N 5678C ▲ 6666 ◆ 4866 ◆ 6665HG ◆L	AH5462 ■M 5469N ★N 5461 + 5879C ● IG5462 ■I 6869 ★L 6462 ■D 815 ■ 4229 ★ 5462C ■ AH8400 ■M 8410 + IG8400 ■I	5466N ◆N 5878C ▲ 6866 ◆L 4509 ◆ 6865HG ◆AL						
					277V/AC	7	5302 ■							
					3-Pole, 4-Wire Grounding	125/250V/AC	14			805 +			9151N ◆L 2836 ◆	
3Ø 250V/AC	15													
4-Pole, 4-Wire	3ØY 120/208V/AC	18							7251N ◆L					

Straight Blade Legend

HOW TO USE THIS CHART:

Core catalog number color indicates a device's grade:

Device body:

- Duplex Receptacle
- + Single Receptacle
- ◆ Plug
- ★ Connector
- ▲ Flanged Inlet
- Flanged Outlet

BLACK = Industrial Specification Grade

BLUE = Commercial Specification Grade

ORANGE = Construction Specification Grade

GREEN = Hospital Specification Grade

Device type:



































- A Angled
- D Decorator
- G GFCI
- H Compact
- I Isolated Ground
- L Safety Grip™
- N AutoGrip™
- O QuickGrip™
- R Tamper Resistant
- S Surface

A suffix combining a **RED** shape and alpha letter indicate a device's body, type and available options.

Device options available:

- C Corrosion Resistant
- M ArrowLink™ Modular

Due to spatial constraints not all products are shown on this page. For additional product options in these configurations consult sections A, B, G, H & I.

Poles, Wires	Rating	NEMA Prefix	30A Straight Blade		50A Straight Blade		60A Straight Blade	
			Receptacle, Connector & Flanged Outlet	Plug & Flanged Inlet	Receptacle, Connector & Flanged Outlet	Plug & Flanged Inlet	Receptacle, Connector & Flanged Outlet	Plug & Flanged Inlet
2-Pole, 2-Wire	125V/AC	1						
2-Pole, 3-Wire Grounding	125V/AC	5	6716N ★N 1233 + 5716N + 	5717AN ◆AN 5717N ◆N 5717NFI ▲AN S41 ◆A 	6711N ★N 1253 + 	5712AN ◆AN 5712N ◆N 5712NFI ▲AN S41 ◆A 		
	250V/AC	6	6700N ★N 5700N + 1232 +S 1234 + 	5701AN ◆AN 5701N ◆N 5701NFI ▲AN S42 ◆A 	6709N ★N 5709N + 1252 +S 1254 + 	5710AN ◆AN 5710N ◆N 5710NFI ▲AN S42 ◆A 		
	277V/AC	7	6795N ★N 5795N + 	5703AN ◆AN 5703N ◆N 5703NFI ▲AN 	6796N ★N 	5705AN ◆AN 5705N ◆N 5705NFI ▲AN 		
3-Pole, 3-Wire	125/250V/AC	10	9341N ★N 38B + 125 +S 	9352AN ◆AN 9337N ◆N 9337NFI ▲AN S80 ◆A 	4526N ★N 7985N + 32B + 112 +S 122B + 	4524N ◆N 4524NFI ▲AN 7952AN ◆AN S80 ◆A 		
3-Pole, 4-Wire Grounding	125/250V/AC	14	5744N + 1225 +S 1257 + 	5732AN ◆AN 5746N ◆N S21 ◆A 	5754N + 1212 +S 1258 + 	5752AN ◆AN 5745N ◆N S21 ◆A 	9460N + 	9462AN ◆AN 9462N ◆N S20 ◆AN 
	3Ø 250V/AC	15	8430N + 	8432AN ◆AN 8432N ◆N 	8450N + 	8452AN ◆AN 8452N ◆N 	8460N + 	AH8462AN ◆AN AH8462N ◆N 
4-Pole, 4-Wire	3ØY 120/208V/AC	18		8332AN ◆AN 8332N ◆N 		8352AN ◆AN 8352N ◆N 	5515N + 	4516AN ◆N 5517N ◆N S19 ◆A 

Straight Blade Legend

HOW TO USE THIS CHART:

Core catalog number color indicates a device's grade:

Device body:

- Duplex Receptacle
- + Single Receptacle
- ◆ Plug
- ★ Connector
- ▲ Flanged Inlet
- Flanged Outlet

BLACK = Industrial Specification Grade

BLUE = Commercial Specification Grade

ORANGE = Construction Specification Grade

GREEN = Hospital Specification Grade

Device type:

- A Angled
- D Decorator
- G GFCI
- H Compact
- I Isolated Ground
- L Safety Grip™
- N AutoGrip™
- O QuickGrip™
- R Tamper Resistant
- S Surface

A suffix combining a **RED** shape and alpha letter indicate a device's body, type and available options.

Device options available:

- C Corrosion Resistant
- M ArrowLink™ Modular

Due to spatial constraints not all products are shown on this page. For additional product options in these configurations consult sections A, B, G, H & I.

Poles, Wires	Rating	NEMA Prefix	15A Locking		20A Locking			
			Receptacle, Connector & Flanged Outlet	Plug & Flanged Inlet	Receptacle, Connector & Flanged Outlet	Plug & Flanged Inlet		
2-Pole, 2-Wire	125V/AC	ML1	7464N ★ 7427N ★ 7468 ● 	7465N ◆ 7466 ▲ 7428N ◆ 7467 ▲ 7479N ◆ 7429N ◆ 				
	125V/AC	L1	CWL115FO ● CWL115R + 7506 ★ 7540 ■ 	CWL115FI ▲ 7546 ◆ 7548 ◆ 				
	250V/AC	L2			CWL220C ★L CWL220FO ● CWL220R + 	CWL220P ◆L CWL220P-6 ◆ZL 		
2-Pole, 3-Wire Grounding	125V/AC	ML2	7593 ★ 7596 ● 7596N ● 	7594 ◆ 7595 ▲ 7595N ▲ 				
	125V/AC	L5	CWL515C ★L CWL515FO ● IG4700 ■ 25W47 ★W 65W47 ★W CR4700 ■C 4731N ★N 4731NCR ★CN 	CWL515CAN ★AL CWL515R + IGL515R +I 2547 ★Y 65W47DPLX ■W 4700 ■ 5792 ■ CR5792 ■C 	CWL515FI ▲ CWL515P ◆L CWL515PAN ◆AL 24W47 ◆W 2447 ◆Y 4721N ◆N 4721NCR ◆CN 	CWL520C ★L CWL520FO ● IGL520R +I L520CW ★W L520CY ★Y L520RW ★W CWL520C ★CL CWL520R +C 	CWL520CBK ★L CWL520R + 	CWL520FI ▲ CWL520P ◆L CWL520PBK ◆L L520PW ◆W L520PY ◆Y CWL520P ◆CL
	250V/AC	L6	CWL615C ★L CWL615R + IGL615R +I 2549 ★Y 65W49DPLX ■W 6566N ★N 6580 ■ 	CWL615FO ● 25W49 ★W 65W49 ★W 	CWL615FI ▲ CWL615P ◆L 24W49 ◆W 2449 ◆Y 6565N ◆N 	CWL620C ★L CWL620R + L620CW ★W L620RW ★W CWL620R +C CWL620C ★CL 	CWL620FO ● IGL620R +I L620CY ★Y 	CWL620FI ▲ CWL620P ◆L L620PW ◆W L620PY ◆Y CWL620P ◆C
	277V/AC	L7	CWL715C ★ CWL715R + 25W34 ★W 65W34 ★W 4772N ★N 	CWL715FO ● 65W34DPLX ■W 4750 ■ 2534 ★Y 	CWL715FI ▲ CWL715P ◆L 24W34 ◆W 2449 ◆Y 4771N ◆N 	CWL720C ★L CWL720FO ● CWL720R + IGL720R +I L720CW ★W L720CY ★Y L720RW ★W 	CWL720FI ▲ CWL720P ◆L L720PW ◆W L720PY ◆Y 	
	480V/AC	L8			CWL820C ★L CWL820R + L820CW ★W L820CY ★Y L820RW ★W 	CWL820FO ● IGL820R +I 	CWL820FI ▲ CWL820P ◆L L820PW ◆W L820PY ◆Y 	
	600V/AC	L9			CWL920C ★ CWL920FO ● CWL920R + 	CWL920FI ▲ CWL920P ◆ 		
	3-Pole, 3-Wire	125/250V/AC	ML3	7484 ★ 7487 ● 7487N ● 	7485 ◆ 7486 ▲ 7486N ▲ 			
125/250V/AC		L10			CWL1020C ★L CWL1020R + L1020CY ★Y L1020RW ★W L1020CW ★W 	CWL1020FO ● 	CWL1020FI ▲ CWL1020P ◆L L1020PW ◆W L1020PY ◆Y 	
3Ø 250V/AC		L11			CWL1120C ★L CWL1120R + L1120CY ★Y L1120RW ★W 	CWL1120FO ● L1120CW ★W 	CWL1120FI ▲ CWL1120P ◆L L1120PW ◆W L1120PY ◆Y 	
3Ø 480V/AC		L12			CWL1220C ★ CWL1220FO ● CWL1220R + 	CWL1220FI ▲ CWL1220P ◆ 		
3Ø 600V/AC		L13						

Locking Device Legend

HOW TO USE THESE CHARTS:

Core catalog number color indicates the type of use a device is designed for:

BLACK = Industrial Use



















A suffix combining a **RED** shape and alpha letter indicate a device's body and type.

Device body:

- Duplex Receptacle
- + Single Receptacle
- ◆ Plug
- ★ Connector
- ▲ Flanged Inlet
- Flanged Outlet

Device type:

- A Angled
- C Corrosion Resistant
- I Isolated Ground
- L Safety Grip™
- N AutoGrip™
- P Pro-Grip™ Nylon
- W Watertight
- Y Severe Duty Insulated
- Z With Lid or Cover

Poles, Wires	Rating	NEMA Prefix	30A Locking	
			Receptacle, Connector, & Flanged Outlet	Plug & Flanged Inlet
2-Pole, 2-Wire	125V/AC	ML1		
	125V/AC	L1		
	250V/AC	L2		
2-Pole, 3-Wire Grounding	125V/AC	ML2		
	125V/AC	L5	CWL530FO ● CWL530R + L530CW *W L530RW *W CRL530C *CL CRL530R +C CWL530C *L IGL530R +I L530CY *Y  L5-30R	CWL530FI ▲ CWL530P ◆L IGL530P ◆IL L530PW ◆W L530PY ◆Y CRL530P ◆CL  L5-30P
	250V/AC	L6	CWL630C *L CWL630R +C L630CW *W L630RW *W CRL630C *CL CRL630R +C CWL630FO ● IGL630R +I L630CY *Y  L6-30R	CWL630FI ▲ CWL630P ◆L L630PW ◆W L630PY ◆Y CRL630P ◆CL  L6-30P
	277V/AC	L7	CWL730C *L CWL730R + L730CW *W L730CY *Y L730RW *W CWL730FO ● IGL730R +I  L7-30R	CWL730FI ▲ CWL730P ◆L L730PW ◆W L730PY ◆Y  L7-30P
	480V/AC	L8	CWL830C *L CWL830R + L830CW *W L830CY *Y L830RW *W CWL830FO ● IGL830R +I  L8-30R	CWL830FI ▲ CWL830P ◆L L830PW ◆W L830PY ◆Y  L8-30P
	600V/AC	L9	CWL930C * CWL930FO ● CWL930R +  L9-30R	CWL930FI ▲ CWL930P ◆  L9-30P
	125/250V/AC	ML3		
3-Pole, 3-Wire	125/250V/AC	L10	CWL1030C *L CWL1030R + L1030CW *W L1030CY *Y L1030RW *W CWL1030FO ●  L10-30R	CWL1030FI ▲ CWL1030P ◆L L1030PW ◆W L1030PY ◆Y  L10-30P
	3Ø 250V/AC	L11	CWL1130C * CWL1130R + L1130CW *W L1130CY *Y L1130RW *W CWL1130FO ●  L11-30R	CWL1130FI ▲ CWL1130P ◆L L1130PW ◆W L1130PY ◆Y  L11-30P
	3Ø 480V/AC	L12	CWL1230C * CWL1230FO ● CWL1230R +  L12-30R	CWL1230FI ▲ CWL1230P ◆  L12-30P
	3Ø 600V/AC	L13	CWL1330C * CWL1330FO ● CWL1330R +  L13-30R	CWL1330FI ▲ CWL1330P ◆  L13-30P

For NEMA Configurations L-14 through L-24, see page O-6

Locking Device Legend

HOW TO USE THESE CHARTS:

Core catalog number color indicates the type of use a device is designed for:

BLACK = Industrial Use

A suffix combining a **RED** shape and alpha letter indicate a device's body and type.

Device body:

- Duplex Receptacle
- + Single Receptacle
- ◆ Plug
- * Connector
- ▲ Flanged Inlet
- Flanged Outlet

Device type:

- A Angled
- C Corrosion Resistant
- I Isolated Ground
- L Safety Grip™
- N AutoGrip™
- W Watertight
- Y Severe Duty Insulated

Poles, Wires	Rating	NEMA Prefix	20A Locking		30A Locking			
			Receptacle, Connector & Flanged Outlet	Plug & Flanged Inlet	Receptacle, Connector, & Flanged Outlet	Plug & Flanged Inlet		
3-Pole, 4-Wire Grounding	125/250V/AC	L14	CWL1420C ★L CWL1420FO ● IGL1420R +I L1420CW ★W CRL1420C ★CL CRL1420R +C 6406BK ● 	CWL1420CBK ★L CWL1420R + L1420CY ★Y L1420RW +W 	CWL1420FI ▲ CWL1420P ◆L CWL1420PBK ◆L L1420PW ◆W L1420PY ◆Y CRL1420P ◆CL 6405BK ▲ 	CWL1430C ★L CWL1430R + L1430CW ★W L1430PW ◆W L1430CY ★Y L1430RW +W CRL1430C ★CL CRL1430R +C 	CWL1430FO ● IGL1430R +I 	CWL1430FI ▲ CWL1430P ◆L L1430PW ◆W L1430PY ◆Y CRL1430P ◆CL 6512BK ◆
	3Ø 250V/AC	L15	CWL1520C ★L CWL1520R + L1520CW ★W L1520RW +W CRL1520C ★CL CRL1520R +C 	CWL1520FO ● IGL1520R +I L1520CY ★Y 	CWL1520FI ▲ CWL1520P ◆L L1520PW ◆W L1520PY ◆Y CRL1520P ◆CL 	CWL1530C ★L CWL1530R + L1530CW ★W L1530PW ◆W L1530CY ★Y L1530RW +W CRL1530C ★CL 	CWL1530FO ● IGL1530R +I 	CWL1530FI ▲ CWL1530P ◆L L1530PW ◆W L1530PY ◆Y CRL1530P ◆CL
	3Ø 480V/AC	L16	CWL1620C ★L CWL1620FO ● IGL1620R +I L1620CW ★W L1620CY ★Y L1620RW +W CRL1620C ★CL 	CWL1620CBK ★L CWL1620R + 	CWL1620FI ▲ CWL1620PBK ◆L L1620PW ◆W L1620PY ◆Y CRL1620P ◆CL CWL1620FI ▲ 	CWL1630C ★L CWL1630FO ● CWL1630R + L1630CW ★W L1630PW ◆W L1630CY ★Y L1630RW +W 	CWL1630FI ▲ CWL1630P ◆L L1630PW ◆W L1630PY ◆Y CRL1630P ◆CL 	
	3Ø 600V/AC	L17				CWL1730C ★L CWL1730R + L1730CW ★W L1730CY ★Y L1730RW +W 	CWL1730FO ● 	CWL1730FI ▲ CWL1730P ◆L L1730PW ◆W L1730CY ◆Y
4-Pole, 4-Wire	3ØY 120/208V/AC	L18	CWL1820C ★L CWL1820R + L1820CW ★W L1820CY ★Y L1820RW +W 	CWL1820FO ● 	CWL1820FI ▲ CWL1820P ◆L L1820PW ◆W L1820PY ◆Y 	CWL1830C ★L CWL1830R + L1830CW ★W L1830CY ★Y L1830RW +W 	CWL1830FO ● 	CWL1830FI ▲ CWL1830P ◆L L1830PW ◆W L1830PY ◆Y
	3ØY 277/480V/AC	L19	CWL1920C ★L CWL1920R + L1920CW ★W L1920CY ★Y L1920RW +W 	CWL1920FO ● 	CWL1920FI ▲ CWL1920P ◆L L1920PW ◆W L1920PY ◆Y 	CWL1930C ★L CWL1930R + L1930CW ★W L1930CY ★Y L1930RW +W 	CWL1930FO ● 	CWL1930FI ▲ CWL1930P ◆L L1930PW ◆W L1930PY ◆Y
	3ØY 347/600V/AC	L20	CWL2020C★L CWL2020R+ L2020CW ★W L2020CY ★Y L2020RW +W 	CWL2020FO ● 	CWL2020FI ▲ CWL2020P◆L L2020PW ◆W L2020PY ◆Y 	CWL2030C ★L CWL2030R + L2030CW ★W L2030CY ★Y L2030RW +W 	CWL2030FO ● 	CWL2030FI ▲ CWL2030P ◆L L2030PW ◆W L2030PY ◆Y
4-Pole, 5-Wire Grounding	3ØY 120/208V/AC	L21	CWL2120C ★L CWL2120FO ● IGL2120R +I L2120CW ★W L2120CY ★Y L2120RW +W 	CWL2120CBK ★L CWL2120R + L2120CF ★L 	CWL2120FI ▲ CWL2120P◆L CWL2120PBK ◆L L2120PW ◆W L2120PY ◆Y L2120PF ◆L 	CWL2130C ★L CWL2130R + L2130CW ★W L2130CY ★Y L2130RW +W L2130CF ★L 	CWL2130FO ● IGL2130R +I 	CWL2130FI ▲ CWL2130P ◆L L2130PW ◆W L2130PY ◆Y L2130PF ◆L
	3ØY 277/480V/AC	L22	CWL2220C ★L CWL2220R + IGL2220R +I L2220CW ★W L2220CY ★Y L2220RW +W 	CWL2220FO ● 	CWL2220FI ▲ CWL2220P◆L L2220PW ◆W L2220PY ◆Y 	CWL2230C ★L CWL2230R + IGL2230R +I L2230CW ★W L2230CY ★Y L2230RW +W 	CWL2230FO ● L22230CF ★L 	CWL2230FI ▲ CWL2230P ◆L L2230PW ◆W L2230PY ◆Y L2230PF ◆L
	3ØY 347/600V/AC	L23	CWL2320C ★L CWL2320R + IGL2320R +I L2320CW ★W L2320CY ★Y L2320RW +W 	CWL2320FO ● 	CWL2320FI ▲ CWL2320P◆L L2320PW ◆W L2320PY ◆Y 	CWL2330C ★L CWL2330R + IGL2330R +I L2330CW ★W L2330CY ★Y L2330RW +W 	CWL2330FO ● 	CWL2330FI ▲ CWL2330P ◆L L2330PW ◆W L2330PY ◆Y

Locking Device Legend

HOW TO USE THESE CHARTS:

Core catalog number color indicates the type of use a device is designed for:

BLACK = Industrial Use













A suffix combining a **RED** shape and alpha letter indicate a device's body and type.























Device body:

- Duplex Receptacle
- ◆ Single Receptacle
- ◆ Plug
- ★ Connector
- ▲ Flanged Inlet
- Flanged Outlet

Device type:

- A Angled
- C Corrosion Resistant
- I Isolated Ground
- L Safety Grip™
- N AutoGrip™
- W Watertight
- Y Severe Duty Insulated

Poles, Wires	Rating	10A - 30A Non-NEMA Locking	
		Receptacle, Connector, & Flanged Outlet	Plug & Flanged Inlet
3-Pole, 3-Wire	10/15A 125/250V/AC	4755 ★L 7565N ★N 7580 ■ 7582 + 	4767 ◆L 4767AN ◆AL 7567N ◆N 
	20A 125/250V/AC	7310B + 7314C ★L 7314CW ★W 7314CY ★Y 7314RW +W 7328N ● 	7327N ▲ 9965C ◆L 9965PW ◆W 9965PY ◆Y 
	30A 125/250V/AC	3330-2 + 3333CW ★W 3333CY ★Y 3333RW +W 3333N ★L 3336N ● 	3331N ◆L 3331PW ◆W 3331PY ◆Y 3337N ▲ 
4-Pole, 4-Wire	20A 3Ø 120/208V/AC	7409N ● 7410B + 7413C ★L 7413CW ★W 7413CY ★Y 7413RW +W 	7408N ▲ 7411C ◆L 7411PW ◆W 7411PY ◆Y 
	30A 3Ø 120/208V/AC	3430 + 3433CW ★W 3433CY ★Y 3433N ★L 3433RW +W 3436N ● 	3431N ◆L 3431PW ◆W 3431PY ◆Y 3434N ▲ 
4-P, 5-W Grounding	20/10A 250/600V/AC	3523BK ★L 3525BK ● 	3521BK ◆L 3524BK ▲ 

Poles, Wires	Rating	50A Non-NEMA Locking	
		Receptacle & Connector	Plug, Flanged Inlets & Hull Inlet
2-Pole, 3-Wire Grounding	125V/AC Marine Corrosion Resistant	63CR60EX ★P 63CR60 ★T 63CR70 + 	63CR61EX ◆P 63CR61 ◆T 
	125V/AC California Standard	CS6360EX ★P CS6360 ★T CS6370 + 	CS6361EX ◆P CS6361 ◆T CS6377 ▲ CS6378 ▲Z 
	250V/AC California Standard	CS8264EX ★P CS8264 ★T CS8269 + 	CS8265EX ◆P CS8265 ◆T CS8275 ▲ CS8277 ▲Z 
	250V/DC 600V/AC	3762EX ★P 3762 ★T 3771 + 	3763EX ◆P 3763 ◆T 3777 ▲ 3767 ▲Z 
	480V/AC California Standard	CS8464EX ★P CS8464 ★T CS8469 + 	CS8465EX ◆P CS8465 ◆T CS8475 ▲ CS8477 ▲Z 
3-Pole, 4-Wire Grounding	125/250V/AC Marine Corrosion Resistant	63CR64EX ★P 63CR64 ★T 63CR69 + 	63CR65EX ◆P 63CR65 ◆T 
	125/250V/AC California Standard	CS6364EX ★P CS6364 ★T CS6369 + 	CS6365EX ◆P CS6365 ◆T CS6375 ▲ CS6376 ▲Z 
	3Ø 250V/AC California Standard	CS8364EX ★P CS8364 ★T CS8369 + 	CS8365EX ◆P CS8365 ◆T CS8375 ▲ CS8377 ▲Z 
	250V/DC 600V/AC	3764EX ★P 3764 ★T 3769 + 	3765EX ◆P 3765 ◆T 3775 ▲ 3768 ▲Z 
	250V/DC 600V/AC	7764EX ★P 7764 ★T 7379 + 	7765EX ◆P 7765 ◆T 7958 ▲ 7968 ▲Z 
	3Ø 480V/AC California Standard	CS8164EX ★P CS8164 ★T CS8169 + 	CS8165EX ◆P CS8165 ◆T CS8175 ▲ CS8177 ▲Z 

Locking Device Legend

HOW TO USE THESE CHARTS:

Core catalog number color indicates the type of use a device is designed for:

BLACK = Industrial Use

A suffix combining a **RED** shape and alpha letter indicate a device's body and type.

Device body:

- Duplex Receptacle
- + Single Receptacle
- ◆ Plug
- ★ Connector
- ▲ Flanged Inlet
- Flanged Outlet
- ◆ Hull Inlet

Device type:

- A** Angled
- C** Corrosion Resistant
- L** Safety Grip™
- N** AutoGrip™
- P** Pro-Grip™ Nylon
- T** Armored Body
- W** Watertight
- Y** Severe Duty Insulated
- Z** With Lid or Cover

Poles, Wires	Rating	20A Watertight Pin & Sleeve		30A Watertight Pin & Sleeve	
		Receptacle, Connector & Mechanical Interlocks	Plug & Inlet	Receptacle, Connector & Mechanical Interlocks	Plug & Inlet
2-Pole, 3-Wire Grounding	125V	CD320HMI4W >QX CD320R4W + CD320C4W * 	CD320P4W ◆ CD320B4W ▲ 	CD330MI4W >Q CD330R4W + CD330C4W * 	CD330P4W ◆ CD330B4W ▲
	250V	CD320HMI6W >QX CD320R6W + CD320C6W * 	CD320P6W ◆ CD320B6W ▲ 	CD330MI6W >Q CD330MIF6W >E CD330R6W + CD330C6W * 	CD330P6W ◆ CD330B6W ▲
	480V/AC	CD320HMI7W >QX CD320R7W + CD320C7W * 	CD320P7W ◆ CD320B7W ▲ 	CD330MI7W >Q CD330R7W + CD330C7W * 	CD330P7W ◆ CD330B7W ▲
3-Pole, 4-Wire Grounding	125/250V/AC	CD420HMI12W >QX CD420MIB12W >F CD420MICB12W >B CD420R12W + CD420C12W * 	CD420P12W ◆ CD420B12W ▲ 	CD430MI12W >Q CD430MIB12W >F CD430MICB12W >B CD430MIF12W >E CD430R12W + CD430C12W * 	CD430P12W ◆ CD430B12W ▲
	3Ø 250V/AC	CD420HMI9W >QX CD420MIB9W >F CD420MICB9W >B CD420R9W + CD420C9W * 	CD420P9W ◆ CD420B9W ▲ 	CD430MI9W >Q CD430MIB9W >F CD430MICB9W >B CD430MIF9W >E CD430R9W + CD430C9W * 	CD430P9W ◆ CD430B9W ▲
	3Ø 480V/AC	CD420HMI7W >QX CD420MIB7W >F CD420MICB7W >B CD420R7W + CD420C7W * 	CD420P7W ◆ CD420B7W ▲ 	CD430MI7W >Q CD430MIB7W >F CD430MICB7W >B CD430MIF7W >E CD430R7W + CD430C7W * 	CD430P7W ◆ CD430B7W ▲
	3Ø 600V/AC	CD420HMI5W >QX CD420R5W + CD420C5W * 	CD420P5W ◆ CD420B5W ▲ 	CD430MI5W >Q CD430MIF5W >E CD430R5W + CD430C5W * 	CD430P5W ◆ CD430B5W ▲
4-Pole, 5-Wire Grounding	3ØY 120/208V/AC	CD520HMI9W >QX CD520R9W + CD520C9W * 	CD520P9W ◆ CD520B9W ▲ 	CD530MI9W >Q CD530MIB9W >F CD530MICB9W >B CD530R9W + CD530C9W * 	CD530P9W ◆ CD530B9W ▲
	3ØY 277/480V/AC	CD520R7W + CD520C7W * 	CD520P7W ◆ CD520B7W ▲ 	CD530MI7W >Q CD530MIB7W >F CD530MICB7W >B CD530R7W + CD530C7W * 	CD530P7W ◆ CD530B7W ▲
	3ØY 347/600V/AC	CD520R5W + CD520C5W * 	CD520P5W ◆ CD520B5W ▲ 	CD530MI5W >Q CD530MIB5W >F CD530MICB5W >B CD530R5W + CD530C5W * 	CD530P5W ◆ CD530B5W ▲

Locking Device LEGEND

HOW TO USE THESE CHARTS:

Core catalog number color indicates the type of use a device is designed for:

BLACK = Industrial Use

A suffix combining a RED shape and alpha letter indicate a device's body and type.

Device body:

- ◆ Single Receptacle
- ◆ Plug
- * Connector
- ▲ Flanged Inlet
- > Mechanical Interlock

Device type:

- B Circuit Breaker Option
- E Fusible
- F Fuse Option
- Q Non-Fusible
- X Horizontal

Poles, Wires	Rating	60A Watertight Pin & Sleeve		100A Watertight Pin & Sleeve	
		Receptacle, Connector & Mechanical Interlocks	Plug & Inlet	Receptacle, Connector & Mechanical Interlocks	Plug & Inlet
2-Pole, 3-Wire Grounding	125V	CD360R4W + CD360C4W ★ 	CD360P4W ◆ CD360B4W ▲ 	CD3100M14W >Q CD3100R4W + CD3100C4W ★ 	CD3100P4W ◆ CD3100B4W ▲
	250V	CD360MI6W >Q CD360MIF6W >E CD360R6W + CD360C6W ★ 	CD360P6W ◆ CD360B6W ▲ 	CD3100MI6W >Q CD3100R6W + CD3100C6W ★ 	CD3100P6W ◆ CD3100B6W ▲
	480V/AC	CD360MI7W >Q CD360R7W + CD360C7W ★ 	CD360P7W ◆ CD360B7W ▲ 	CD3100MI7W >Q CD3100R7W + CD3100C7W ★ 	CD3100P7W ◆ CD3100B7W ▲
3-Pole, 4-Wire Grounding	125/250V/AC	CD460MI12W >Q CD460MIB12W >F CD460MICB12W >B CD460MIF12W >E CD460R12W + CD460C12W ★ 	CD460P12W ◆ CD460B12W ▲ 	CD4100MI12W >Q CD4100R12W + CD4100C12W ★ 	CD4100P12W ◆ CD4100B12W ▲
	3Ø 250V/AC	CD460MI9W >Q CD460MIB9W >F CD460MICB9W >B CD460MIF9W >E CD460R9W + CD460C9W ★ 	CD460P9W ◆ CD460B9W ▲ 	CD4100MI9W >Q CD4100R9W + CD4100C9W ★ 	CD4100P9W ◆ CD4100B9W ▲
	3Ø 480V/AC	CD460MI7W >Q CD460MIB7W >F CD460MICB7W >B CD460MIF7W >E CD460R7W + CD460C7W ★ 	CD460P7W ◆ CD460B7W ▲ 	CD4100MI7W >Q CD4100R7W + CD4100C7W ★ 	CD4100P7W ◆ CD4100B7W ▲
	3Ø 600V/AC	CD460MI5W >Q CD460MIB5W >F CD460MICB5W >B CD460MIF5W >E CD460R5W + CD460C5W ★ 	CD460P5W ◆ CD460B5W ▲ 	CD4100MI5W >Q CD4100R5W + CD4100C5W ★ 	CD4100P5W ◆ CD4100B5W ▲
4-Pole, 5-Wire Grounding	3ØY 120/208V/AC	CD560MI9W >Q CD560MIB9W >F CD560MICB9W >B CD560MIF9W >E CD560R9W + CD560C9W ★ 	CD560P9W ◆ CD560B9W ▲ 	CD5100MI9W >Q CD5100R9W + CD5100C9W ★ 	CD5100P9W ◆ CD5100B9W ▲
	3ØY 277/480V/AC	CD560MI7W >Q CD560MIB7W >F CD560MICB7W >B CD560MIF7W >E CD560R7W + CD560C7W ★ 	CD560P7W ◆ CD560B7W ▲ 	CD5100MI7W >Q CD5100R7W + CD5100C7W ★ 	CD5100P7W ◆ CD5100B7W ▲
	3ØY 347/600V/AC	CD560MI5W >Q CD560MIF5W >E CD560R5W + CD560C5W ★ 	CD560P5W ◆ CD560B5W ▲ 	CD5100MI5W >Q CD5100R5W + CD5100C5W ★ 	CD5100P5W ◆ CD5100B5W ▲

Locking Device LEGEND

HOW TO USE THESE CHARTS:

Core catalog number color indicates the type of use a device is designed for:

BLACK = Industrial Use

A suffix combining a RED shape and alpha letter indicate a device's body and type.

Device body:

- + Single Receptacle
- ◆ Plug
- ★ Connector
- ▲ Flanged Inlet
- > Mechanical Interlock

Device type:

- B Circuit Breaker Option
- E Fusible
- F Fuse Option
- Q Non-Fusible
- X Horizontal

Horsepower Ratings for NEMA Configurations (Plugs & Receptacles Only)

Straight Blade Configurations

NEMA	AC HP Rating	Rating
1-15	0.5	15A-125V
2-15	1.5*	15A-250V
2-20	2*	20A-250V
2-30	2*	30A-250V
5-15	0.5	15A-125V
5-20	1	20A-125V
5-30	2	30A-125V
5-50	2	50A-125V
6-15	1.5*	15A-250V
6-20	2*	20A-250V
6-30	2*	30A-250V
6-50	3*	50A-250V
7-15	2	15A-277V/AC Only
7-20	2	20A-277V/AC Only
7-30	3	30A-277V/AC Only
7-50	5	50A-277V/AC Only
10-20	2L-L*/1 L-N	20A-125/250V
10-30	2 L-L*/2 L-N	30A-125/250V
10-50	3 L-L*/2 L-N	50A-125/250V
11-15	2	15A-3Ø 250V
11-20	3	20A-3Ø 250V
11-30	3	30A-3Ø 250V
11-50	7.5	50A-3Ø 250V
14-15	1.5 L-L*/0.5 L-N	15A-125/250V
14-20	2 L-L*/1 L-N	20A-125/250V
14-30	2 L-L*/2 L-N	30A-125/250V
14-50	3 L-L*/2 L-N	50A-125/250V
14-60	3 L-L*/2 L-N	60A-125/250V
15-15	2	15A-3Ø 250V
15-20	3	20A-3Ø 250V
15-30	3	30A-3Ø 250V
15-50	7.5	50A-3Ø 250V
15-60	10	60A-3Ø 250V
18-15	2	15A-3ØY 120/208V
18-20	2	20A-3ØY 120/208V
18-30	3	30A-3ØY 120/208V
18-50	7.5	50A-3ØY 120/208V
18-60	7.5	60A-3ØY 120/208V

L-L denotes phase-to-phase HP rating

L-N denotes phase-to-neutral HP rating

*Suitable for 208V motor applications at HP rating

Locking Configurations

NEMA	AC HP Rating	Rating
L1-15	0.5	15A-125V
L2-20	2*	20A-250V
L5-15	0.5	15A-125V
L5-20	1	20A-125V
L5-30	2	30A-125V
L6-15	1.5*	15A-250V
L6-20	2*	20A-250V
L6-30	2*	30A-250V
L7-15	2	15A-277V/AC Only
L7-20	2	20A-277V/AC Only
L7-30	3	30A-277V/AC Only
L8-20	3	20A-480V/AC Only
L8-30	5	30A-480V/AC Only
L9-20	NA	20A-600V/AC Only
L9-30	NA	30A-600V/AC Only
L10-20	2 L-L*/1 L-N	20A-125/250V
L10-30	2 L-L*/2 L-N	30A-125/250V
L11-15	2	15A-3Ø 250V
L11-20	3	20A-3Ø 250V
L11-30	3	30A-3Ø 250V
L12-20	5	20A-3Ø 480V
L12-30	10	30A-3Ø 480V
L13-30	NA	30A-3Ø 600V
L14-20	2L-L*/1 L-N	20A-125/250V
L14-30	2 L-L*/2 L-N	30A-125/250V
L15-20	3	20A-3Ø 250V
L15-30	3	30A-3Ø 250V
L16-20	5	20A-3Ø 480V
L16-30	10	30A-3Ø 480V
L17-30	NA	30A-3Ø 600V
L18-20	2	20A-3ØY 120/208V
L18-30	3	30A-3ØY 120/208V
L19-20	5	20A-3ØY 277/480V
L19-30	10	30A-3ØY 277/480V
L20-20	NA	20A-3ØY 347/600V
L20-30	NA	30A-3ØY 347/600V
L21-20	2	20A-3ØY 120/208V
L21-30	3	30A-3ØY 120/208V
L22-20	5	20A-3ØY 277/480V
L22-30	10	30A-3ØY 277/480V
L23-20	NA	20A-3ØY 347/600V
L23-30	NA	30A-3ØY 347/600V

L-L denotes phase-to-phase HP rating

L-N denotes phase-to-neutral HP rating

*Suitable for 208V motor applications at HP rating

Organization Abbreviations Glossary

Common abbreviations for organizations often referred to in the electrical industry, and also noted throughout the Arrow Hart catalog:

ANSI

American National Standards Institute, Inc.

ANSI is a private, non-profit organization that administers and coordinates the U.S. voluntary standardization and conformity assessment system. The Institute's mission is to enhance both the global competitiveness of U.S. business and the U.S. quality of life by promoting and facilitating voluntary consensus standards and conformity assessment systems, and safeguarding their integrity. www.ansi.org

CSA

Canadian Standards Association

The Canadian Standards Association is a not-for-profit, membership-based association that conducts product safety testing, and issues certifications. www.csa.org

GSA

General Services Administration Federal Supply Service

GSA's Federal Supply Service provides federal customers with a specific list of manufacturer's products that have been approved to meet stated requirements. The most frequently cited Federal Specifications regarding electrical wiring devices are those for Electrical Power Connector, Plug, Receptacle and Cable Outlet (Fed. Spec. W-C 596) and for Toggle and Lock, Flush Mounted Switches (Fed. Spec. W-S 896). www.gsa.gov

NEC®

National Electrical Code®

Published by the NFPA (see listing) as NFPA 70, the National Electrical Code

This publication, renewed every 3 years under the auspices of ANSI, provides for the adequate protection of life and property from dangers associated with the use of electricity. It is now adopted and enforced in all 50 states in the United States, and is also the basis for electrical codes in several other countries. www.nfpa.org

NEMA

National Electrical Manufacturers Association

Comprised of electrical manufacturers, NEMA provides a forum for the standardization and testing of electrical equipment, enabling consumers to select from a range of safe, effective, and compatible electrical products. NEMA-standards of testing is frequently required by both government and third-party endorsees such as UL and CSA prior to their approval. www.nema.org

NFPA

National Fire Protection Association

The mission of the international non-profit NFPA is to reduce the worldwide burden of fire and other hazards on the quality of life by providing and advocating scientifically based consensus codes and standards, research, training and education. The NFPA authors the NEC® and NPPA 70E electrical safety in the workplace. www.nfpa.org

NOM

Normas Oficiales de Mexico (Official Mexican Standards)

The Official Mexican Standards (referred to as Normas or NOMs) augment the Mexican Hazardous Materials Land Transportation Regulation and provide information relative to importing and exporting hazardous materials from and to Mexico.

OSHA

Occupational Health and Safety Administration, U.S. Department of Labor

OSHA's mission is to assure safe and healthful working conditions for working men and women (having been authorized to enforce standards first created under the Occupational Health and Safety Act of 1970 and since evolved), by assisting and encouraging the States in their efforts to assure safe and healthful working conditions. www.osha.gov

UL

Underwriters Laboratories

Underwriters Laboratories Inc. (UL) is an independent, not-for-profit product safety testing and certification organization. www.ul.com

NSF

NSF International

NSF International helps protect people by certifying products and writing standards for consumer goods. As an independent, not-for-profit organization, NSF works toward allowing everyone to live safer. www.nsf.org

Common Industry Organization Acronyms

Standards Development Organizations		Codes and Standards	
ANSI	American National Standards Institute	CEC	Canadian Electrical Code
ASME	American Society of Mechanical Engineers	CEE	European Electrotechnical Committee
CANENA	Consejo de Armonizacion de Normas Electrotecnicas de Norte America (Council for Harmonization of Electrotechnical Standardization of North America)	NEC	National Electrical Code®
IEC	International Electrotechnical Commission	NMX	Normas Mexicanas
IEEE	Institute of Electrical and Electronics Engineers	NOM	Normas Oficiales de Mexicanas (Official Mexican Standard)
ISA	Instrument Society of America	Industry Associations	
ISO	International Standards Organization	ABYC	American Boat and Yacht Council
NFPA	National Fire Protection Agency	BICSI	Building Industry Consulting Services International
NSF	NSF International	BOMA	Building Owners Management Association
SAE	Society of Automotive Engineers	CANAME	Camara Nacional de Manufacturas Electricas (Mexico)
SME	Society of Manufacturing Engineers	CEMRA	Canadian Electrical Manufacturers Representatives Association
Certification Agencies		ECOC	Electrical Contractors of Canada
ANCE	National Association of Normalization and Certification of the Electrical Sector (Mexico)	EFI	Electro-Federation Incorporated
BSI	British Standards Institute	EIA	Electronics Industry Association
CI	European Compliance (<i>This is not a certification agency, but CE is the European Compliance Mark</i>)	EPRI	Electric Power Research Institute
CSA	Canadian Standards Association	IAEI	International Association of Electrical Inspectors
cUL	Certified to CSA Standards by Underwriters Laboratories	IBI	Intelligent Building Institute
cULus	Meets Canadian & US UL requirements	IECA	Independent Electrical Contractors Association
DESC	Defense Electronic Supply Center	IFMA	International Facilities Management Association
ETL	Electrical Testing Laboratories	NAED	National Association of Electrical Distributors
FCC	Federal Communications Commission	NAW	National Association of Wholesalers
FM	Factory Mutual	NECA	National Electrical Contractors Association
IAPA	Independent Accident and Protection Association (Canada)	NEMA	National Electrical Manufacturers Association
LEED	Leadership in Energy and Environmental Design	NEMRA	National Electrical Manufacturers Representative Association
NRTL	National Recognized Testing Laboratories	NMDA	National Marine Distributor Association
OSHA	Occupational Safety and Health Administration	NMRA	National Marine Representative Association
TUV	TUV Rheinland of N.A., Inc.	SEMI	Semi-Conductor Equipment and Material International
VDE	Verband Deutscher Elektrotechniker (Germany)	TIA	Telecommunications Industry Association
UL	Underwriters Laboratories	USGBC	US Green Building Council

Common UL & CSA Standards For Wiring Devices

UL Standards Pertaining to Arrow Hart Products		UL Standards Pertaining to Arrow Hart Products	
UL 20	General-use switches	UL 1786	Night-lights
UL 50	Enclosures for electrical equipment	UL 1863	Communications circuit accessories
UL 94	Flammability testing for materials, plastic	UL 1917	Solid state fan speed control
UL 486E	Equipment and wiring terminals	FSWC596	Fed. Spec. receptacles
UL 496	Lampholders	FSWS896	Fed. Spec. switches
UL 498	Plugs, connectors, receptacles, inlets, outlets	CSA Standards Pertaining to Arrow Hart Products	
UL 498A	Taps and adapters	C22.2 No. 0.17	Polymeric materials
UL 508	Industrial equipment (including motor control switches)	C22.2 No. 12	Night Lights
UL 514A	Metallic boxes/covers/wallplates	C22.2 No. 42	General-use receptacles, attachment plugs
UL 514D	Nonmetallic boxes/covers/wallplates	C22.2 No. 55	Special-use switches
UL 817	Cord sets	C22.2 No. 111	General-use switches
UL 943	GFCIs	C22.2 No. 144	GFCI
UL 1054	Special use switches	C22.2 No. 182.1	Industrial-type, special-use attachment plugs, receptacles and connectors. Pin and sleeve devices.
UL 1363	Temporary power taps	C22.2 No. 182.2	Industrial locking type
UL 1436	Outlet circuit testers		
UL 1449	Surge suppression devices		
UL 1472	Dimmers		
UL 1567	Switches and receptacles used with AL wire		
UL 1699	Arc fault circuit interrupters		

General Purpose Wiring Device Definitions from NEMA Standard WD-1

NEMA Standards Pertaining to Arrow Hart Products (in accordance with NEMA Standard WD-1)

WD 1-1.01 Cord Connector

A portable receptacle with means for attachment to a flexible cord, the cord connector is not intended for permanent mounting.

NEMA Standard 7-13-1967

WD 1-1.02 Grounded Conductor (System Ground)

This is a usually current-carrying circuit conductor that's purposely connected to earth ground, and is identified as the white conductor.

NEMA Standard 7-13-1967

WD 1-1.03 Grounding Conductor (Equipment Ground)

Unlike the System Ground version, this conductor connects non-current-carrying metallic equipment parts to earth ground, providing a specific path for fault current to ground. It can be bare or covered, in which case it is identified as the green conductor, or green with yellow stripes.

NEMA Standard 7-13-1967

WD 1-1.04 Lampholder

Lampholders mechanically support an electric lamp, and electrically connect it to a circuit.

NEMA Standard 7-13-1967

WD 1-1.05 Male Base (Inlet)

Designed for flush or surface mounting on an appliance or other equipment, male-based plugs serve to connect utilization equipment to a connector.

NEMA Standard 7-13-1967

WD 1-1.06 Outlet

An outlet is a point on the wiring system at which current is taken to supply utilization equipment.

NEMA Standard 7-13-1967

WD 1-1.07 Plug

The male blades of our plugs serve to connect the conductors of the attached, flexible cord with those of the female receptacle.

NEMA Standard 7-1-1967

WD 1-1.08 Polarization (Plugs and Receptacles)

Polarization assures the correct positioning for proper mating of plugs and receptacles of the same rating.

NEMA Standard 7-1-1967

WD 1-1.09 Pole

When used to designate plugs and receptacles, "pole" refers to a terminal that is connected to a regularly current-carrying circuit conductor. In switches, the number of poles indicates how many conductors are being controlled.

NEMA Standard 7-1-1967

WD 1-1.10 Receptacle

This device features female contacts, and is installed primarily at an outlet or on equipment meant to establish electrical connection with an inserted plug.

NEMA Standard 7-1-1967

WD 1-1.11 Slant Symbol (/)

As it applies to wiring device ratings, the "slant" line(/) indicates that there's more than one voltage potential present between different terminals of a wiring device.

NEMA Standard 7-1-1967

WD 1-1.12 Switch

There are several different types of switches available for making, breaking, or changing electrical circuit connections, including:

- A. **Single-Pole Switch** (Single-Pole, Single-Throw), which makes or breaks the connection of a single conductor.
- B. **Double-Pole Switch** (Double-Pole, Single-Throw), which makes or breaks the connection of two conductors on a single branch circuit.
- C. **Three-Way Switch** (Single-Pole, Double-Throw), which changes the connection of a single conductor and is most often utilized in tandem to better control one piece of equipment from two locations.
- D. **Four-Way Switch** (Double-Pole, Double-Throw Reversing) is a double-pole switch used with two three-way switches to control a single piece of equipment from more than two locations.

NEMA Standard 7-13-1967

WD 1-1.13 Terminal (on a Wiring Device)

A terminal is a fixed location on a wiring device where a conductor is designated for connection.

NEMA Standard 7-13-1967

WD 1-1.14 Wire (Plugs and Receptacles)

As it applies in designating plugs and receptacles, the term "wire" stands for the number of either regularly current-carrying or equipment grounding connected conductors.

NEMA Standard 7-13-1967

For answers to technical questions, or for more information on UL, CSA, and NEMA standards pertaining to Cooper Wiring Devices' products, call our toll free number: 1-866-853-4293. Or, visit our website at www.cooperwiringdevices.com.

Selected Articles, National Electric Code (NEC®) Requirements for Wiring Devices From NFPA 70™, NEC® 2008 Edition

Article 210 — Branch Circuits

- 210.8 Ground-Fault Circuit-Interrupter Protection for Personnel
- 210.21 Branch Circuit Ratings, Outlet Devices
- 210.24 Branch Circuit Requirements - Summary
- 210.50 Required Outlets, General
- 210.60 Required Outlets, Guest Rooms, Guest Suites, Dormitories and Similar Occupancies
- 210.62 Required Outlets, Show Windows
- 210.70 Lighting Outlets Required

Article 404 — Switches

- 404.2 Installation, Switch Connections
- 404.3 Installation, Enclosure
- 404.4 Installation, Damp or Wet Locations
- 404.9 Installation, Provisions for General-Use Snap Switches
- 404.14 Rating and Use of Snap Switches
- 404.15 Construction Specifications, Marking

Article 406 — Receptacles, Cord Connectors and Attachment Plugs (Caps)

- 406.2 Receptacle Rating and Type
- 406.3 General Installation Requirements
- 406.4 Receptacle Mounting
- 406.5 Receptacle Faceplates (Cover Plates)
- 406.6 Attachment Plugs, Cord Connectors and Flanged Surface Devices
- 406.7 Noninterchangeability
- 406.8 Receptacles in Damp or Wet Locations
- 406.9 Grounding-Type Receptacles, Adapters, Cord Connectors and Attachment Plugs
- 406.11 Tamper-Resistant Receptacles in Dwelling Units

Article 430 — Motors, Motor Circuits and Controllers

- 430.8 Marking on Controllers
- 430.81 Motor Controllers, General
- 430.82 Motor Controllers, Controller Design
- 430.83 Motor Controllers, Ratings
- 430.90 Combination Fuseholder and Switch as Controller
- 430.102 Disconnecting Means, Location
- 430.109 Disconnecting Means, Type

Article 517 — Health Care Facilities

- 517.2 Definitions
- 517.10 Wiring and Protection, Applicability
- 517.13 Grounding of Receptacles and Fixed Electrical Equipment in Patient Care Areas
- 517.14 Panelboard Bonding
- 517.16 Receptacles with Insulated Grounding Terminals
- 517.17 Ground-Fault Protection
- 517.18 Wiring and Protection, General Care Areas
- 517.19 Wiring and Protection, Critical Care Areas
- 517.20 Wiring and Protection, Wet Procedure Locations
- 517.21 Ground-Fault-Circuit-Interrupter Protection for Personnel
- 517.30 Essential Electrical Systems for Hospitals
- 517.31 Emergency System
- 517.35 Sources of Power
- 517.40 Essential Electrical Systems for Nursing Homes and Limited Care Facilities
- 517.41 Essential Electrical Systems (Nursing Homes, etc.)
- 517.45 Essential Electrical Systems for Other Health Care Facilities
- 517.61 Inhalation Anesthetizing Locations, Wiring and Equipment
- 517.62 Inhalation Anesthetizing Locations, Grounding
- 517.63 Grounded Power Systems in Anesthetizing Locations
- 517.64 Inhalation Anesthetizing Locations, Low-Voltage Equipment and Instruments
- 517.71 X-Ray Installations Connection to Supply Circuit
- 517.72 X-Ray Installations Disconnecting Means
- 517.160 Isolated Power Systems

Article 555 — Marinas and Boatyards

- 555.1 Scope
- 555.13 Wiring Methods and Installations
- 555.19 Receptacles (including GFCI)

Article 590 — Temporary Installations

- 590.4 General (including Receptacles and GFCI)

Article 604 — Manufactured Wiring Systems

- 604.2 Definition
- 604.6 Construction (including Receptacles and Connectors)

Article 630 — Electric Welders

- 630.13 Arc Welders, Disconnecting Means
- 630.33 Resistance Welders, Disconnecting Means

Article 647 — Sensitive Electronic Equipment

- 647.7 Receptacles (including Isolated Ground Receptacles)

Article 660 — X-Ray Equipment

- 660.4 Connection to Supply Circuit
- 660.5 Disconnecting Means

Article 700 — Emergency Systems

- 700.26 Overcurrent Protection, Ground-Fault Protection of Equipment

Wire & Cable Type Abbreviations

KEY:

- S** = Service
- J** = Junior
- T** = Thermoplastic/Vinyl
- W** = Weather Approved
- P** = Parallel

- **SJT:** Hard usage thermoplastic rubber-insulated conductors and overall thermoplastic jacket. 300V, 60°C to 105°C.
- **SJTW:** Hard usage thermoplastic or rubber-insulated conductors and overall thermoplastic jacket. 300V, 60°C to 105°C. Weather resistant for outdoor use.
- **SPT-1:** All thermoplastic construction, parallel jacketed. 300V, 60°C to 105°C, 2 or 3-conductor (18 gauge).
- **SPT-2:** Same as SPT-1, but heavier construction (18-16 gauge).
- **SPT-3:** Same as SPT-2, but heavier construction (18-10 gauge).
- **SRDT:** Portable range or dryer cable, 3-conductor parallel type or 4 insulated conductors, jacketed. All thermoplastic construction. 300V, maximum temperature of 60°C.
- **HPN:** Two-conductor, neoprene-insulated heater cord. Parallel construction. For use in damp locations. 300V, 90°C.

Diameter Ranges of Jacketed Cord in Accordance with Standard UL62

Acceptable Range for Overall Diameter of Jacketed Cord

Type of Cord	Avg. Size	2-Conductor	3-Conductor	4-Conductor	5-Conductor
SV, SVO, SVT, SVTO	18	0.22"-0.26" (5.6mm-6.6mm)	0.23"-0.27" (5.8mm-6.9mm)	—	—
SJ, SJO, SJT, SJTO	18	0.28"-0.32" (7.1mm-8.1mm)	0.30"-0.34" (7.6mm-8.6mm)	0.33"-0.37" (8.4mm-9.4mm)	—
	16	0.31"-0.34" (7.9mm-8.6mm)	0.33"-0.36" (8.4mm-9.1mm)	0.35"-0.40" (8.9mm-10.2mm)	—
	14	0.34"-0.38" (8.6mm-9.7mm)	0.36"-0.40" (9.1mm-10.2mm)	0.39"-0.44" (9.9mm-11.2mm)	—
	12	0.41"-0.46" (10.4mm-11.7mm)	0.43"-0.48" (10.9mm-12.2mm)	0.47"-0.52" (11.9mm-13.2mm)	—
	10	0.54"-0.61" (13.7mm-15.5mm)	0.57"-0.64" (14.5mm-16.3mm)	0.63"-0.70" (16.0mm-17.8mm)	—
S, SO, ST, STO	18	0.34"-0.39" (8.6mm-9.9mm)	0.36"-0.40" (9.1mm-10.2mm)	0.39"-0.43" (9.9mm-10.9mm)	0.46"-0.51" (11.7mm-13.0mm)
	16	0.37"-0.41" (9.4mm-10.4mm)	0.39"-0.43" (9.9mm-10.9mm)	0.41"-0.46" (10.4mm-11.7mm)	0.49"-0.55" (12.4mm-14.0mm)
	14	0.50"-0.55" (12.7mm-14.0mm)	0.52"-0.58" (13.2mm-14.7mm)	0.56"-0.62" (14.2mm-15.7mm)	0.63"-0.71" (16.0mm-18.0mm)
	12	0.57"-0.63" (14.5mm-16.0mm)	0.59"-0.66" (15.0mm-16.8mm)	0.64"-0.71" (16.3mm-18.0mm)	0.70"-0.77" (17.8mm-19.6mm)
	10	0.62"-0.69" (15.7mm-17.5mm)	0.65"-0.72" (16.5mm-18.3mm)	0.70"-0.78" (17.8mm-19.8mm)	0.76"-0.84" (19.3mm-21.3mm)
	8	0.78"-0.88" (19.8mm-22.4mm)	0.83"-0.93" (21.1mm-23.6mm)	0.93"-1.05" (23.6mm-26.7mm)	1.00"-1.15" (25.4mm-29.2mm)
	6	0.92"-1.05" (23.4mm-26.7mm)	0.97"-1.10" (24.6mm-27.9mm)	1.05"-1.20" (26.7mm-30.5mm)	1.18"-1.33" (30.0mm-33.8mm)
	4	1.06"-1.21" (26.9mm-30.7mm)	1.13"-1.28" (28.7mm-32.5mm)	1.25"-1.45" (31.8mm-38mm)	—
2	1.21"-1.40" (30.7mm-35.6mm)	1.30"-1.50" (33.0mm-38.1mm)	1.45"-1.65" (36.8mm-41.9mm)	—	

Wiring Diagrams by NEMA Configurations

2-Pole, 2-Wire Non-Grounding: 125V

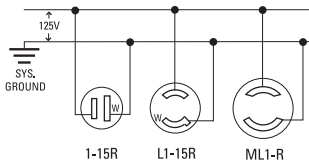

2-Pole, 2-Wire Non-Grounding: 250V

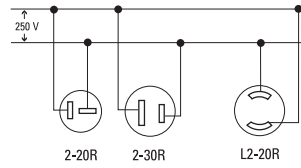

2-Pole, 3-Wire Grounding: 125V

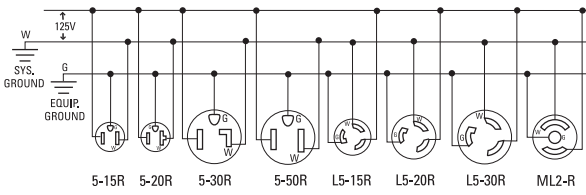

2-Pole, 3-Wire Grounding: 250V

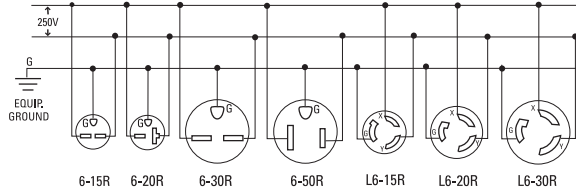

2-Pole, 3-Wire Grounding: 277V AC

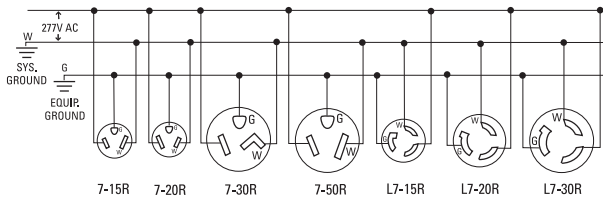

2-Pole, 3-Wire Grounding: 480V AC

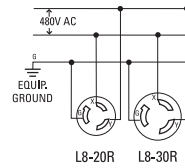

3-Pole, 3-Wire Non-Grounding: 125/250V

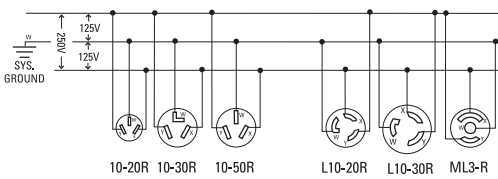

3-Pole, 3-Wire Non-Grounding: 3Ø 250V

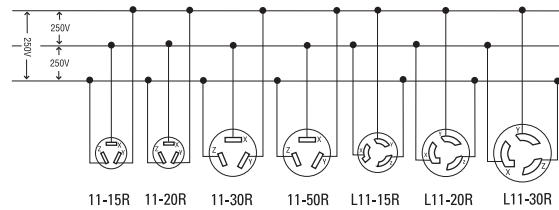

3-Pole, 4-Wire Grounding: 125/250V

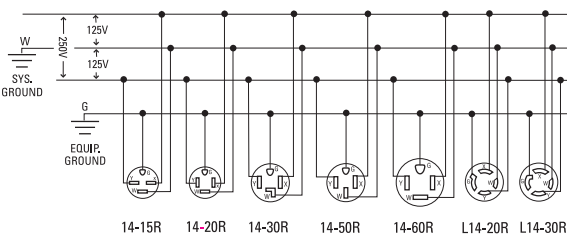

3-Pole, 4-Wire Grounding: 3Ø 250V

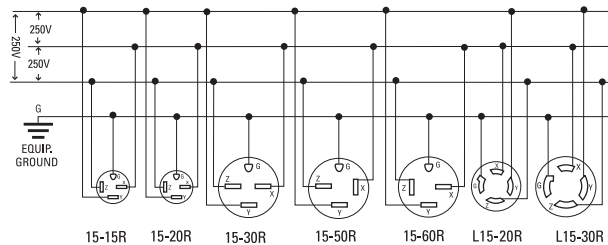

Wiring Diagrams by NEMA Configurations

3-Pole, 4-Wire Grounding: 3Ø 480V

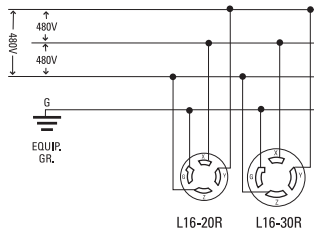

3-Pole, 4-Wire Grounding: 3Ø 600V

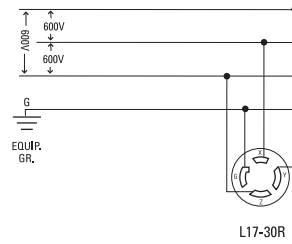

4-Pole, 4-Wire Non-Grounding: 3Ø 120/208V

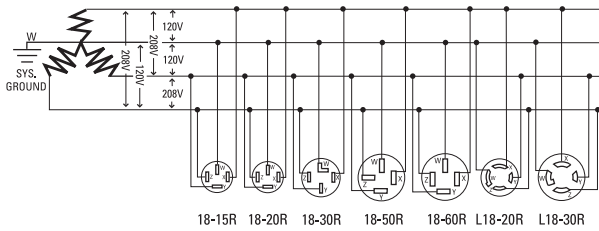

4-Pole, 4-Wire Non-Grounding: 3Ø 277/480V

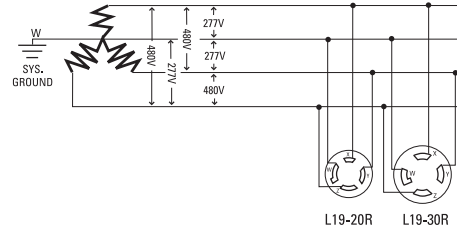

4-Pole, 4-Wire Non-Grounding: 3Ø 347/600V

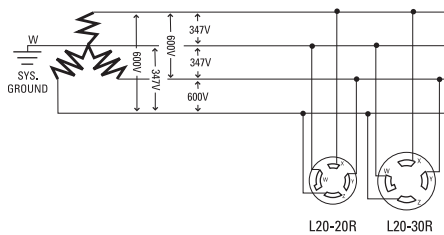

4-Pole, 5-Wire Grounding: 3Ø 120/208V

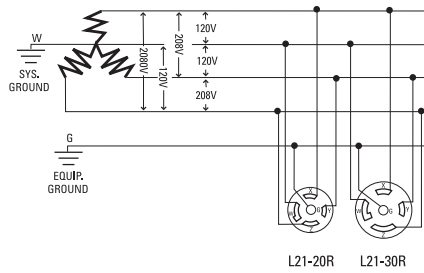

4-Pole, 5-Wire Grounding: 3Ø 277/480V

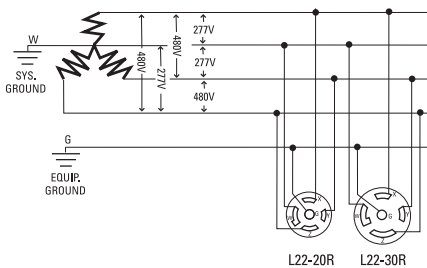

4-Pole, 5-Wire Grounding: 3Ø 347/600V

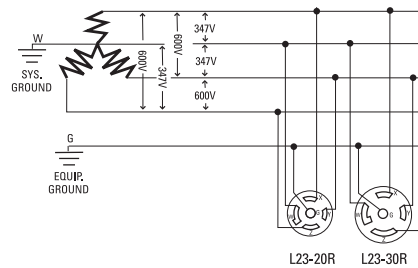

Receptacles

15A-125V

1 Circuit Duplex Receptacle

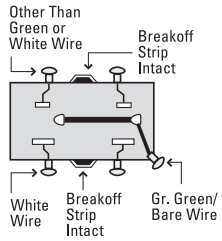

Split Circuit Duplex Receptacle

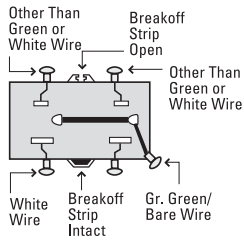

1 Circuit Single Receptacle

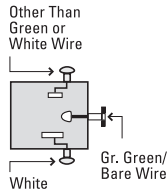

GFCI: Feed-Through Installation with Protection Provided Downstream

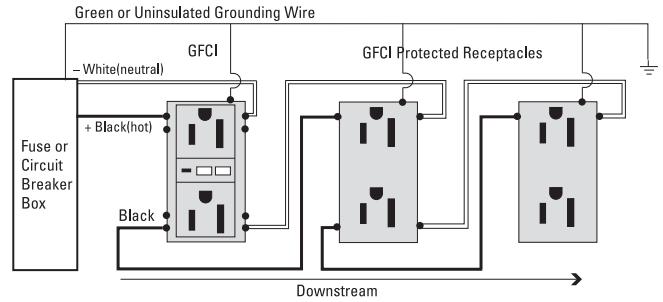

GFCI: Feed-Through Installation with Non-Protected Receptacles Downstream

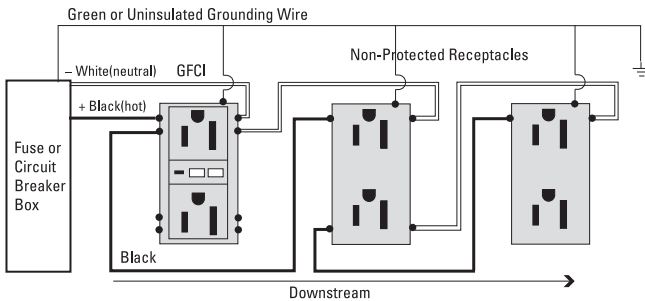

GFCI: Feed-Through Installation with Both Protected and Non-Protected Receptacles Downstream

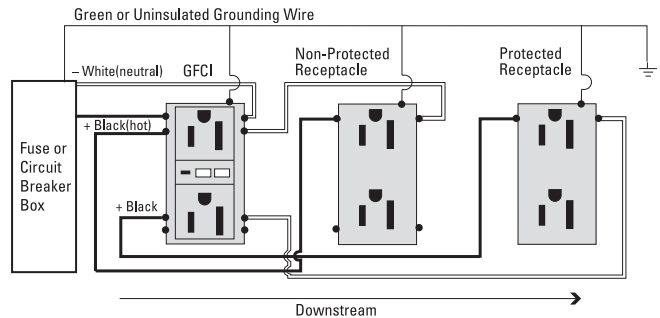

Combination Devices

2 Single-Pole Switches

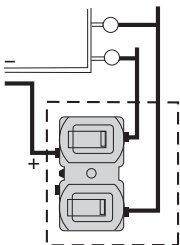

Single-Pole Switch and 2-Pole, 3-Wire 20A U Grounding Receptacle

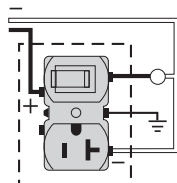

Single-Pole Switch and Neon Pilot Light

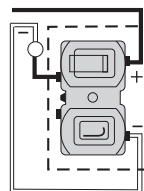

Single-Pole Switch and 2-Pole, 3-Wire U Grounding Receptacle

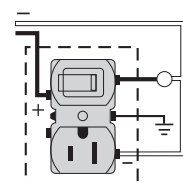

Switches

AC Switches & Standard Switches

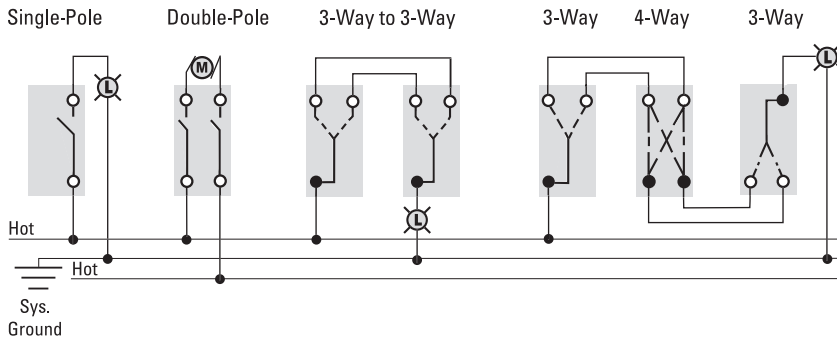

Pilot Light Switch & Lighted Switch, Single and Double Pole

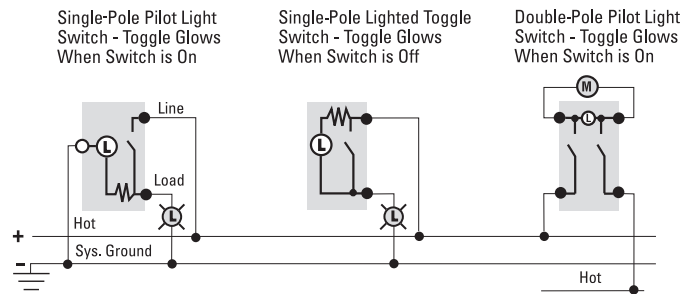

Pilot Light Switch & Lighted Switch, 3-Way

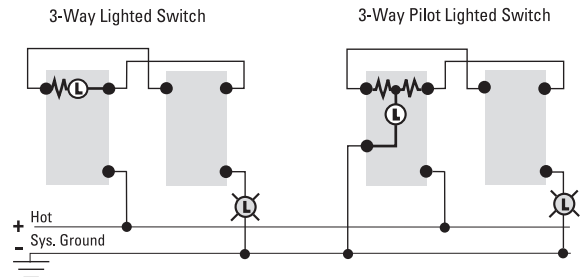

Maintained & Momentary Contact, Single-Pole

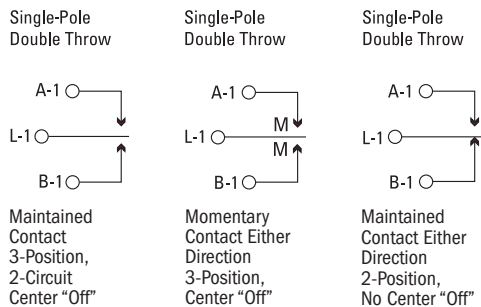

Maintained & Momentary Contact, Double-Pole

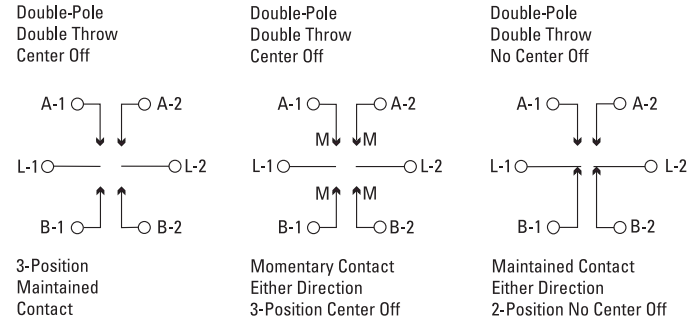

Manual Contactors & Disconnect Switches

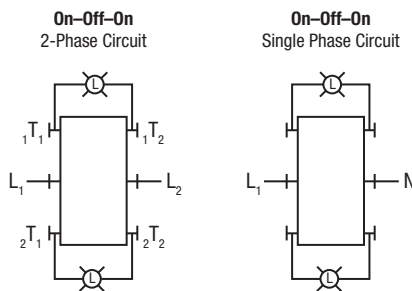

AH4361, AH4371 DPDT Momentary Contact, 2-Circuit With Center "Off" Switch

AH4361, AH4371 DPDT Momentary Contact, 2-Circuit With Center "Off" Switch

Manual Contacts & Disconnect Switches, by Motor Variations

Capacitor Two Windings

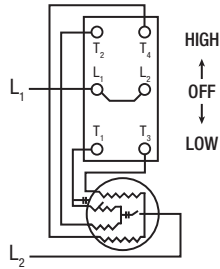

Diagram 1

Repulsion Induction

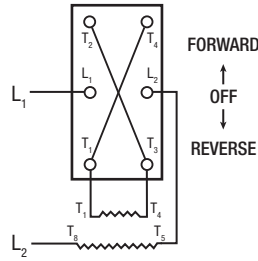

Diagram 2

Series

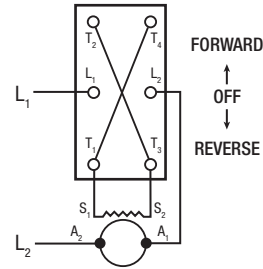

Diagram 3

Capacitor Consequent Pole

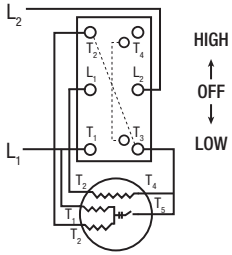

Diagram 4

Diagram 4 Internal Connections

	L ₁	L ₂ & T ₃
LOW	& T ₂	T ₄
HIGH	L ₁ & T ₁	L ₂ to T ₂ & T ₃

Capacitor

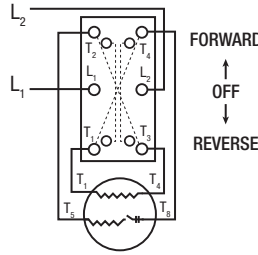

Diagram 5

Diagram 5 & 6 Internal Connections

	L ₁	L ₂
FORWARD	T ₁ & T ₂	T ₃ & T ₄
REVERSE	T ₁ & T ₄	T ₃ & T ₂

Split Phase

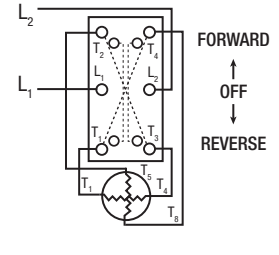

Diagram 6

3-Phase Separate Winding

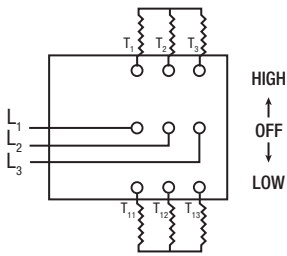

Diagram 7

3-Phase Induction

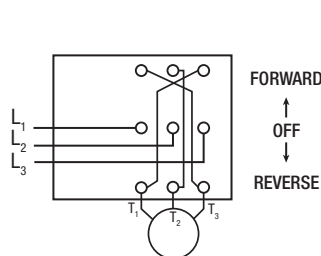

Diagram 8

Series DC

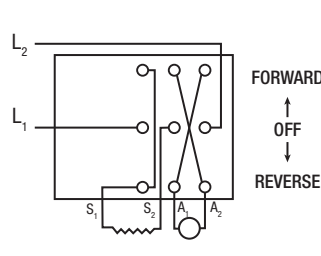

Diagram 9

Shunt DC

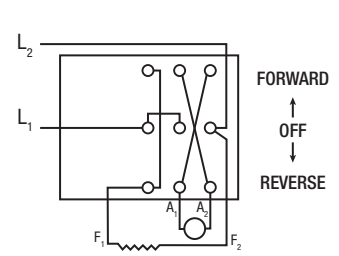

Diagram 10

Compound DC

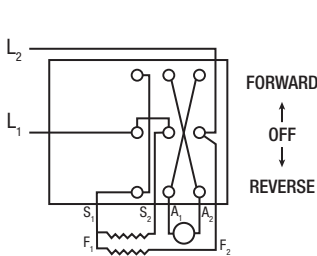

Diagram 11

2-Phase Separate Winding

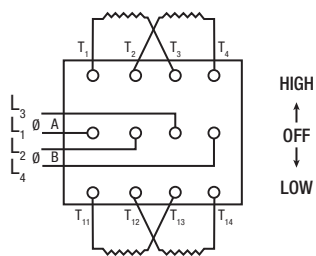

Diagram 12

2-Phase Induction

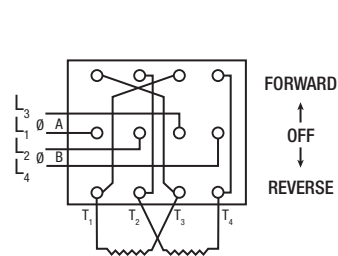
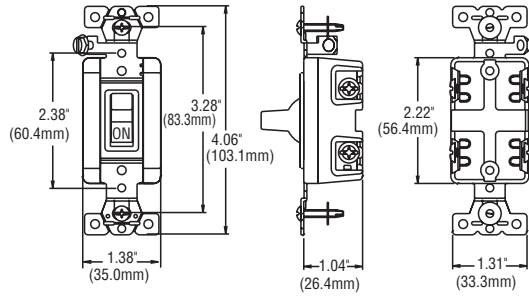

Diagram 13

Switch Dimensional Data

AH6808UDAC, AH6808UCO



AH6810U, AH7810UD

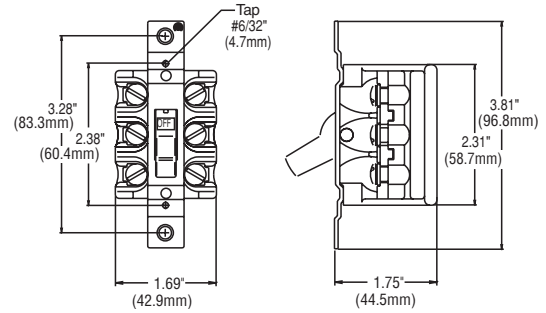

AHMC240L, AHMC340L, AHMC260L, AHMC360L

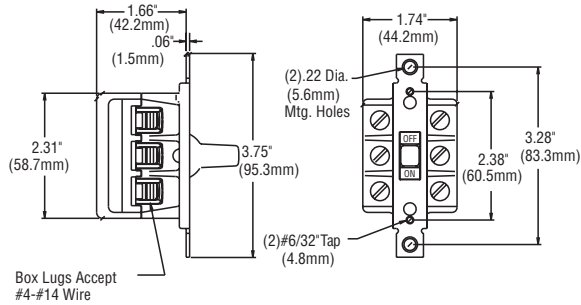

AHMC240C, AHMC340C

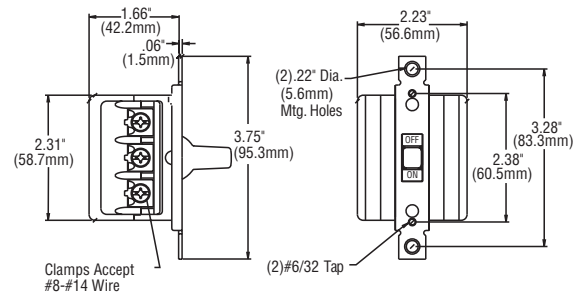

AH4361, AH4371

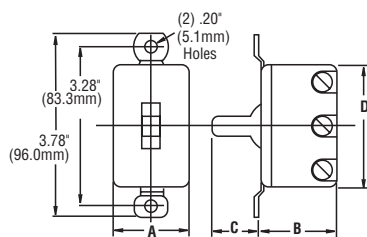

	A	B	C	D
AH4361	1.59" (40.4mm)	1.66" (42.2mm)	0.66" (16.8mm)	2.50" (63.5mm)
AH4371	1.81" (46.0mm)	1.98" (50.3mm)	1.22" (31.0mm)	2.88" (73.2mm)

Enclosure Dimensional Data

AH6810E, AH7810ED

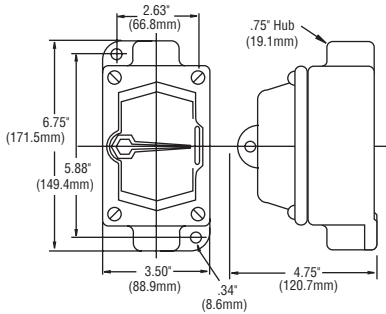

AHMC360L-1, AHMC260L-1, AH7810GD, AHMC340C-1, AHMC340L-1, AH6808GDAC, AH6810G, AHMC240C-1, AHMC240L-1, AH27940G, AHN1GD

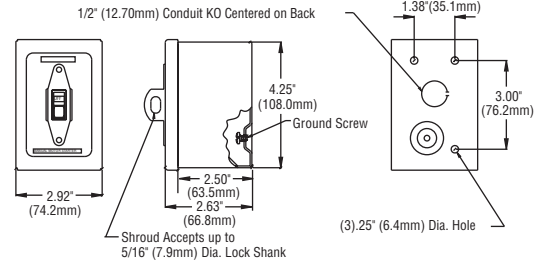

AH6808WDAC

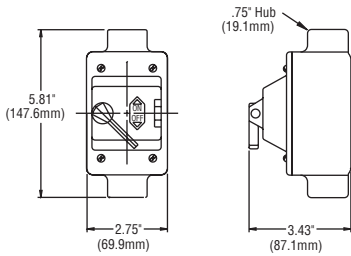

AH7810GDB, AHN1GD2 Dim A=2.63" (66.80mm)

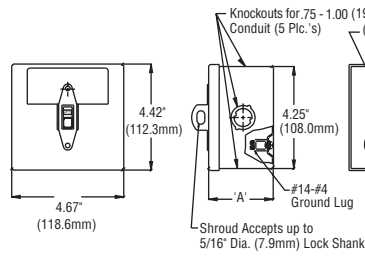

AHN1GD2D Dim A=3.87" (98.30mm)

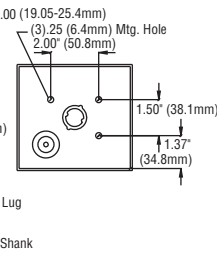

AHN3WD, AH6808WDAC, AH6810W, AHMC240C-3, AHMC240L-2, AHMC260L-3, AHMC340C-3, AHMC340L-2, AHMC360L-2

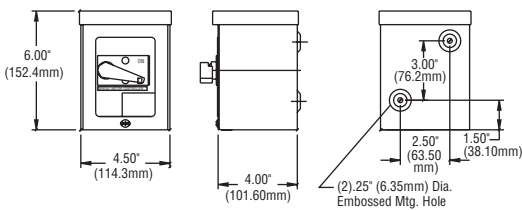

AH6808FDAC (plate only, no toggle guard) AH7810FD

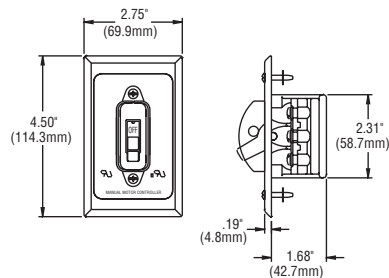

Snap-In Receptacle Panel Cutouts

Panel Cutout
49

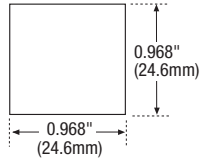

Panel Thickness **0.032" ± 0.070"**
(0.81mm ± 1.78mm)

Panel Cutout
67

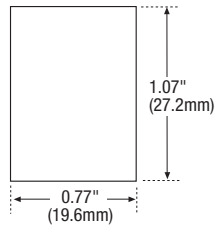

Panel Thickness **0.032" - 0.070"**
(0.81mm - 1.78mm)

Attachon Lampholder Cutouts

Panel Cutout
732-3

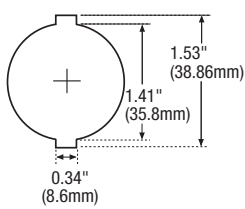

Panel Cutout
734

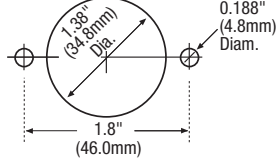

Panel Cutout
4734-2

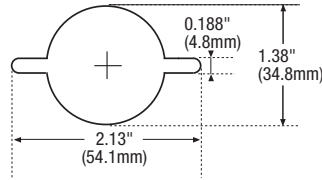

Panel Cutout
731-2, 731-3

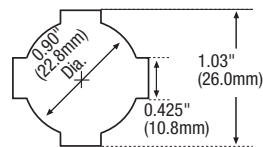

Panel Cutout
974-2

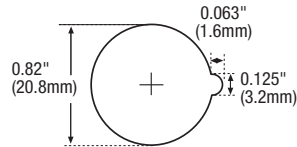

Test Requirements

The maximum permitted load for which a switch is suitable depends on the switch rating and the nature of the load. Proper selection of switches is determined by test standards and requirements of the National Electrical Code®, Articles 380, 430, and 600.

General Use AC switches are suitable for use at full rated current and voltage on loads of fluorescent and incandescent lighting and for other inductive or resistance loads. Our switches are rated for motor loads at 80% of their rated current.

Special Use AC switches may be used at full rating on resistance or inductive loads, including fluorescent. For incandescent (tungsten) lighting loads, they must carry an “L” rating. For motor loads they require an “HP” (horsepower) rating.

To ensure safety and reliability, Arrow Hart switches are tested, rated and marked according to various standards. The following charts indicate both the required performance tests specified by industry standards for switches with standard ratings, and the loads they may control.

Test Requirements - Switches* General Use - AC Only

Rating	Standard*	Overload				Endurance		Resistance Cycles 1.0 pf. †	Inductive Cycles .75 to .8 pf. †	Tungsten Cycles 1,0 pf. †
		Amps	Volts	Power Factor	Cycles	Amps	Volts (Max)			
15A, 120V/AC	UL 20 & NEMA G.D.	72	120 AC	.4 to .5	100	15	120 AC	10,000	10,000	10,000
	WS 896 & NEMA H.D.	72	120 AC	.4 to .5	100	15	120 AC	10,000	50,000	50,000
15A 120/277 277V/AC	UL 20 & NEMA G.D.	72	277 AC	.4 to .5	100	15	277 AC	10,000	10,000	10,000
	WS 896 & NEMA H.D.	72	277 AC	.4 to .5	100	15	277 AC	10,000	50,000	50,000
20A, 120/277 277V/AC	UL 20 & NEMA G.D.	96	277 AC	.4 to .5	100	20	277 AC	10,000	10,000	10,000
	WS 896 & NEMA H.D.	96	277 AC	.4 to .5	100	20	277 AC	10,000	50,000	50,000
20A, 120/277 277V/AC	UL 20 & NEMA G.D.	144	277 AC	.4 to .5	100	30	277 AC	10,000	10,000	10,000
	WS 896 & NEMA H.D.	144	277 AC	.4 to .5	100	30	277 AC	10,000	50,000	50,000

Test Requirements - Switches Special Use - AC Only

Rating	Standard*	Overload				Endurance				Horse Power				“L” Tungsten		
		Amps	Volts	Power Factor	Cycles	Amps	Volts	Power Factor	Cycles	Amps	Volts	Power Factor	Cycles	Amps	Volts	Cycles
8A, 120V/AC	UL 1054	12	120 AC	.4-.5	50	8	120 AC	.75-.8	6000	-	-	-	-	-	-	-
15A, 120V/AC 10A, 240V/AC 3/4 HP, 120-240V/AC	UL 1054	15	240 AC	.4-.5	50	10	240 AC	.75-.8	6000	82.8	120 AC	.4-.5	50	-	-	-
										41.4	240 AC	.4-.5	50	-	-	-
15A, 125-250V/AC 3/4 HP, 120-240V/AC	UL 1054	22.5	250 AC	.4-.5	50	15	250 AC	.75-.8	6000	82.8	120 AC	.4-.5	50	-	-	-
										41.4	240 AC	.4-.5	50	-	-	-
20A, 125V/AC “L” 20A, 250V/AC 1 HP, 120-240V/AC	UL 1054	30	240 AC	.4-.5	50	20	250 AC	.75-.8	6000	96	120 AC	.4-.5	50	20	125 AC	6000
										48	240 AC	.4-.5	50			

*NEMA G.D. is NEMA Standard WD-1 General Duty.
NEMA H.D. is NEMA Standard WD-1 Heavy Duty.
WS896 is current Federal Specification.

All switches are subjected to Resistive Endurance, Inductive Endurance, Tungsten Endurance and then verified that they meet less than a 86°F (30°C) temperature rise at rated current and voltage, followed by a dielectric test at 1500 VAC for 1 minute.

† Power Factor

Maximum Loads

Maximum Loads - Switches - General Use - AC Only

Switch Rating	Incandescent		Inductive (Fluorescent)		Resistance		Motors		
	Volts	Amps	Volts	Amps	Volts	Amps	Volts	HP	Amps
15A, 120V/AC	120 AC	15	120 AC	15	120 AC	15	120 AC	1/2	12
20A, 120V/AC	120 AC	20	120 AC	20	120 AC	20	120 AC	1	16
15A, 120/277V/AC	120 AC	15	277 AC	15	277 AC	15	120 AC	1/2	12
							240 AC	1	12
20A, 120/277V/AC	120 AC	20	277 AC	20	277 AC	20	120 AC	1	16
							240 AC	2	16
30A, 120/277V/AC	120 AC	30	277 AC	30	277 AC	30	120 AC	2	24
							240 AC	2	24

Maximum Loads - Switches - Special Use - AC Only

Switch Rating	Incandescent		Inductive (Fluorescent)		Resistance		Motors		
	Volts	Amps	Volts	Amps	Volts	Amps	V/AC	HP	Amps
8A, 120V/AC 15A, 120V/AC	Not Suitable		120 AC	8	120 AC	8	Not Suitable		
			120 AC	15	120 AC	15			
10A, 240V/AC 3/4HP, 120/240V/AC	Not Suitable		250 AC	10	240 AC	10	240V/AC	3/4	12
15A, 120-240V/AC 3/4HP, 120/240V/AC	Not Suitable		250 AC	15	250 AC	15	240V/AC	3/4	12
20A, 120V/AC "L" 20A, 250V/AC 1HP, 120/240V/AC	125 AC	20	250 AC	20	250 AC	20	240V/AC	1	12

Chemical Resistant Properties of Common Materials in Wiring Devices

Material	Acids	Alcohol	Caustic Bases	Gasoline	Grease	Kerosene	Oil	Solvents	Water
Nylon (Thermoplastic)	3	1	1	1	1	1	1	1	1
Polycarbonate (Thermoplastic)	2	1	3	2	2	2	2	3	1
302/304 Stainless Steel	2	1	3	1	1	1	1	2	1
Polyvinyl Chloride (PVC)	1	1	1	1	1	1	1	3	1
Polypropylene (Thermoplastic)	1	1	1	1	1	1	1	2	1
Polyester	1	1	2	1	1	1	1	2	1
Rubber (Thermoplastic)	2	2	3	2	2	1	1	3	2
Phenolic (Thermoset)	2	1	2	1	1	1	1	1	1
ABS (Thermoplastic)	2	2	1	1	1	2	2	3	1

Chemical resistance factor

- 1 – Completely resistant — Good to excellent for general use when exposed to these factors.
 2 – Resistance is fair to good — Recommended for limited service when exposed to these factors.
 3 – Slow attack. Not recommended for use when exposed to these factors.

*The chemical resistance factor represents general applications. Additional testing is required to determine resistance to chemicals in specific environments.

Terms describing material enhancements

Thermoplastic: Material treated for UV stability to increase tensile strength and decrease discoloration when exposed to UV radiation. Manufactured by injection molding. Superior resistance to impacts, chemical and solvent attack.

Thermoset: Flame resistant material with dimensional stability. Manufactured by compression molding.

Glass Filled: Glass-filled material (most commonly nylon) yields increased material rigidity and permits operation at a higher temperature.

Nickel-Plated: Plating of steel or brass with nickel to increase the corrosion-resistant properties of the metal component.

Zinc-Plated: Plating of cold-rolled steel with zinc to increase the corrosion-resistant properties of the metal component or casing.

NEMA Enclosure Ratings

Protection From	Device Locations		
	Indoors	Indoors or Outdoors	Outdoors with external mechanisms
Limited amounts of falling dirt	NEMA Type 1		
Limited amounts of falling dirt and dripping water	NEMA Type 2		
Rain, sleet, falling dirt, windblown dust, damage from ice formation		NEMA Type 3	
Rain, sleet, falling dirt, damage from ice formation		NEMA Type 3R	
Rain, sleet, windblown dust, ice laden operation possible			NEMA Type 3S
Windblown dust and rain, splashing water, hose-directed water, damage from ice formation		NEMA Type 4	
Corrosion, windblown dust and rain, splashing water, hose-directed water, damage from ice formation		NEMA Type 4X	
Falling dirt and settling airborne dust, lint, fibers and dripping non-corrosive liquids	NEMA Type 5		
Hose-directed water, entry of water during occasional short-term limited depth submersion, damage from ice formation		NEMA Type 6	
Hose-directed water, entry of water during long-term limited depth submersion, damage from ice formation		NEMA Type 6P	
Class I, Division 1, groups A,B,C or D hazardous locations (as defined by NEC®, NFPA 70)	NEMA Type 7 (commonly referred to as explosion-proof)		
Class I, Division 1, groups A,B,C or D hazardous locations (as defined by NEC®, NFPA 70)	NEMA Type 8 (commonly referred to as oil-immersed)		
Class II, Division 1, groups E, F and G hazardous locations (as defined by NEC®, NFPA 70)	NEMA Type 9 (commonly referred to as dust-ignition-proof)		
Meets applicable requirements of the Mine Safety & Health Administration, 30 CFR, Part 18		NEMA Type 10	
Circulating dust, falling dirt, dripping non-corrosive liquids	NEMA Type 12 NEMA Type 12K		
Dust, spraying of water, oil and non-corrosive coolant	NEMA Type 13		

IP Enclosure Ratings

	Second Digit - protection against penetration of liquids	IP_0	IP_1	IP_2	IP_3	IP_4	IP_5	IP_6	IP_7	IP_8
First Digit - protection against persons - touching & ingress of solid objects		Non-protected	Vertical falling of water drops	Falling of water drops at angle up to 15° from vertical	Spraying water (rain) at angle up to 60° from vertical	Splashing water from any direction (360°)	Water jets from any direction (360°)	Power jetting water	Temporary immersion in water	Continuous immersion in water
IP0_	Without protection	IP00								
IP1_	Touching with hand & solid objects > 50mm dia.	IP10	IP11	IP12						
IP2_	Touching with finger & solid objects > 12mm dia.	IP20	IP21	IP22	IP23					
IP3_	Touching with tools, wires, etc. > 2.5mm thick & solid objects > 2.5mm dia.	IP30	IP31	IP32	IP33	IP34				
IP4_	Touching with tools, wires, etc. > 1mm thick & solid objects > 1mm dia.	IP40	IP41	IP42	IP43	IP44				
IP5_	Unlimited protection against contact with live parts & damaging dust deposits	IP50				IP54	IP55			
IP6_	Unlimited protection against contact with live parts & any dust penetration	IP60					IP65	IP66	IP67	IP68

Enclosure Type Cross Reference: NEMA/UL/CSA

NATIONAL ELECTRICAL MANUFACTURERS ASSOCIATION <i>NEMA Standards Publication No. 250-1991, Enclosures for Electrical Equipment (1000V max.)</i>	UNDERWRITERS LABORATORIES UL50 <i>Standard for Enclosures for Electrical Equipment (10th Edition)</i>	CANADIAN STANDARDS ASSOCIATION CAN/CSA C22.2 No. 94-M91 <i>Special Purposes Enclosures</i>
Intended Use and Description	Intended Use and Description	Intended Use and Description
<p>An enclosure is a surrounding case that provides personnel with protection against incidental contact with enclosed equipment, and simultaneously protects enclosed equipment against specific environmental conditions.</p>	<p>An enclosure is a surrounding case that protects equipment enclosed within against incidental contact, as well as specific environmental conditions. A complete enclosure shall be provided for all live parts that may be housed in it. Such an enclosure shall be tight and come with a means for mounting, unless it's designed for a special installation, for example, a cast metal junction or pull-box intended for installation in poured concrete.</p>	<p>Enclosures are constructed to protect against specific environmental conditions, as well as accidental contact with the equipment enclosed within.</p>
<p>Type 1 - Enclosures are intended for indoor use primarily to protect against limited amounts of falling dirt.</p>	<p>Type 1 - Enclosures are intended for indoor use primarily to protect against limited amounts of falling dirt.</p>	<p>Type 1 - (There is no CSA equivalent.)</p>
<p>Type 2 - Enclosures provide a degree of protection, mainly indoors, against limited amounts of dripping water or falling dirt.</p>	<p>Type 2 - Enclosures provide a degree of protection, mainly indoors, against limited amounts of dripping water or falling dirt.</p>	<p>Type 2 - Enclosures are designed to provide protection, primarily indoors, against dripping and small amounts of splashing of non-corrosive liquids, and dirt.</p>
<p>Type 3 - Enclosures, intended primarily for use outdoors, protect against rain, sleet, wind-blown dust, and damage from external ice formation.</p>	<p>Type 3 - Enclosures, intended primarily for use outdoors, protect against rain, sleet, wind-blown dust, and damage from external ice formation.</p>	<p>Type 3 - Enclosures, designed for both indoor and outdoor use, protect against rain and snow, and remain undamaged by the external formation of ice.</p>
<p>Type 3R - Enclosures provide protection primarily against rain, sleet, and damage from external ice formation.</p>	<p>Type 3R - Used primarily outdoors for protection against rain, sleet, and exterior damage caused by the formation of ice.</p>	<p>Type 3R - Enclosures used both indoors and out for protection against rain and snow, remaining undamaged by exterior ice formation.</p>
<p>Type 3S - Enclosures protect primarily against rain, sleet, and wind-blown dust, and enable external mechanisms to operate efficiently even when ice laden.</p>	<p>Type 3S - Used primarily outdoors for protection against rain, sleet, and wind-blown dust, and to enable exterior mechanisms to operate when ice laden.</p>	<p>Type 3S - Enclosures used both indoors and out for protection against rain, snow, and airborne dust, and enable external mechanisms to operate efficiently even when ice laden.</p>
<p>Type 4 - Enclosures provide protection, both indoors and out, against wind-blown dust and rain, splashing or hose-directed water, and ice damage.</p>	<p>Type 4 - For indoor and outdoor use to protect against wind-blown dust and rain, splashing or hose-directed water, and damage caused by exterior ice formation.</p>	<p>Type 4 - Enclosures used both indoors and out for protection against rain, snow, airborne dust, and both splashing and hose-directed water, remaining undamaged by exterior ice.</p>

Enclosure Type Cross Reference: NEMA/UL/CSA

(con't) NATIONAL ELECTRICAL MANUFACTURERS ASSOCIATION <i>NEMA Standards Publication No. 250-1991, Enclosures for Electrical Equipment (1000V max.)</i>
Intended Use and Description
Type 4X - Enclosures used both indoors and out to protect against corrosion, wind-blown dust and rain, splashing or hose-directed water, and damage caused by exterior ice formation.
Type 5 - Enclosures used primarily indoors to provide protection against airborne dust and dirt, and non-corrosive liquids.
Type 6 - Enclosures provide protection both indoors and out against hose-directed water, water entry during occasional short-term submersion at low-pressure depths, and damage caused by exterior ice formation.
Type 6P - Enclosures protect both indoors and out against hose-directed water, water entry during long-term submersion at low-pressure depths, and ice damage.
Type 12 - Enclosures used primarily indoors to protect against airborne dust or dirt, and non-corrosive liquids.
Type 12K - Enclosures with knockouts are used primarily indoors for protection against airborne dust and dirt, and non-corrosive liquids.
Type 13 - Enclosures used primarily indoors to protect against dust, as well as accidental spraying by water, oil, or non-corrosive coolants.

(con't) UNDERWRITERS LABORATORIES UL50 <i>Standard for Enclosures for Electrical Equipment (10th Edition)</i>
Intended Use and Description
Type 4X - For protection indoors and out from corrosion, wind-blown dust and rain, splashing or hose-directed water, and damage caused by exterior ice formation.
Type 5 - Used primarily indoors for protection against airborne dust or dirt, and non-corrosive liquids.
Type 6 - For protection indoors and out against hose-directed water, water entry during occasional short-term submersion at low-pressure depths, and damage caused by exterior ice formation.
Type 6P - For protection indoors and out against hose-directed water, water entry during long-term submersion at low-pressure depths, and damage caused by exterior ice formation.
Type 12 - Used primarily indoors to protect against airborne dust and dirt, and non-corrosive liquids.
Type 12K - Used primarily indoors to protect against dust and dirt, and non-corrosive liquids.
Type 13 - Used primarily indoors to protect against dust, as well as accidental spraying by water, oil, or non-corrosive coolants.

(con't) CANADIAN STANDARDS ASSOCIATION <i>CAN/CSA C22.2 No. 94-M91 Special Purposes Enclosures</i>
Intended Use and Description
Type 4X - Enclosures used both indoors and out for protection against rain, snow, airborne dust, and both splashing and hose-directed water, remaining undamaged by exterior ice formation.
Type 5 - Enclosures exclusively for indoor use, providing protection against dripping and light splashing of non-corrosive liquids, as well as airborne dust, lint, fibers, and filings.
Type 6 - Enclosures used both indoors and out for protection against water entry during occasional short-term submersion at low-pressure depths, remaining undamaged by exterior ice formation.
Type 6P - Enclosures for use both indoors and out for protection against water entry during long-term submersion at low-pressure depths. In addition, it provides corrosion resistance over extended periods of time and remains undamaged by exterior ice formation.
Type 12 - Enclosures exclusively for indoor use, providing protection against airborne dust, lint, fibers, and filings, as well as dripping and light splashing of non-corrosive liquids. These enclosures are not provided with knockouts.
Type 12K - Enclosures provided with knockouts and used exclusively indoors for protection against airborne dust, lint, fibers, and filings, as well as dripping and light splashing of non-corrosive liquids.
Type 13 - Enclosures exclusively for indoor use, providing protection against airborne dust, lint, fibers, and filings, as well as from seepage and spraying of non-corrosive liquids, including oils and coolants.



Products that are identified as NAFTA compliant may qualify under the Buy American Act or ARRA program guidelines. Consult specific project guidelines and compliance requirements to assure suitability for your project needs.

Buy American Act (US Code, Title 41, Section 10 (a-d))

The Buy American Act (often BAA, not to be confused with the Buy America (no "n") Act) applies to all U.S. federal government agency purchases of goods over certain contract thresholds. The BAA restricts purchases of supplies and construction materials to domestic products, unless an exception or waiver applies. Unmanufactured products must be mined or produced in the United States. There is a two-part test for manufactured articles: (1) article must be manufactured in the United States, and (2) cost of U.S. components must exceed 50% of the cost of all components in the item. Note: this calculation does not include labor and overhead for final assembly in the United States. The component cost test is waived for commercial-off-the-shelf (COTS) items. (FAR 25.001(c)(1)). BAA waivers may be available, often at the discretion of the contracting officer.

Buy American Provision, American Recovery and Reinvestment Act (ARRA) (Section 1605)

ARRA Section 1605 establishes requirements for federal government projects funded with stimulus monies: "None of the funds appropriated or otherwise made available by [the ARRA] may be used for a project for the construction, alteration, maintenance, or repair of a public building or public work unless all of the iron, steel, and manufactured goods used in the project are produced in the United States." Iron and steel used as components or subcomponents of other manufactured construction materials do not need to be produced in the United States. There is no requirement that components and subcomponents be U.S.-origin provided the manufactured construction material is "produced in the United States." (FAR 25.001(c)(4)) Section 1605 does not contain a domestic cost requirement. However, the government has not defined "produced" for purposes of the ARRA Buy American provision. Many commentators have adopted the "substantial transformation" test to determine whether a manufactured article is "produced" in the United States for purposes of Section 1605. Section 1605 contains a requirement that the Buy American provision be applied in a manner consistent with U.S. obligations under international agreements. As a result, national treatment is extended to products from countries with which the United States has entered a free trade agreement (e.g., Canada, Mexico, Bahrain, Chile, etc.) and to products from countries that have signed the WTO Government Procurement Agreement. National treatment is also extended to least developed countries (LDCs) (e.g., Bhutan, Mali, Zambia, etc.) but not to Caribbean basin countries (e.g., Belize, Haiti, Bahamas, etc.).



NAFTA compliant products meet specifications at time of print. Product listing subject to change. For specific product details visit www.arrowhart.com or email cwdmarketing@cooperindustries.com.

AH4E Series	F-20, F-21	AH7810UD	D-20	ALTESTER	A-3, D-3, H-3, I-3
AH8E Series	F-20, F-21	AH7810WD	D-20	B2001	M-13
A304WCSF	L-3	AH7810XC	D-26	B2002	M-13
A504WCSF	L-3	AH7810XC-APH	D-26	BDS22	M-13
AH30AUXB	D-29	AH7810XC-SPCR	D-26	BDS30	M-13
AH30MS1B	D-29	AH7810XC-SSBD	D-26	BDS41	M-13
AH30MS1B-M2	D-29	AH7879	K-3	BDS53	M-13
AH30MS2F	D-30	AH8200	A-6, I-10	BDS70	M-13
AH30MS2F-M2	D-30	AH8200LT	A-6, I-10	BDS82	M-13
AH60AUXB	D-29	AH8300	A-6, I-10	BDS96	M-13
AH60MS2B	D-29	AH8300LT	A-6, I-10	BDU22	M-13
AH60MS2B-M2	D-29	AH8400	A-8, I-12	BDU30	M-13
AH100MS2-M2	D-29	AH8462AN	A-23, B-23	BDU41	M-13
AH120_2L	D-9	AH8462N	A-23, B-23	BDU53	M-13
AH1191N	D-9	AH8600	A-8, I-12	BDU70	M-13
AH1191NOF	D-9	AH18201	D-7	BDU82	M-13
AH1192N	D-9	AH18202	D-7	BDU96	M-13
AH1193N	D-9	AH18203	D-7	BL1	K-11
AH1201	D-6	AH18221	D-7	BL2	K-11
AH1201AM	D-6, I-5	AH18222	D-7	BM1	K-11
AH1201L	D-9	AH18223	D-7	BM2	K-11
AH1201LT	D-7	AH21420	C-73	BM3	K-11
AH1201PL	D-7	AH21427	C-73	BR15	A-17
AH1202	D-6	AH21436	C-73	BR20	A-17
AH1202AM	D-6, I-5	AH27940G	D-24	BS1	K-11
AH1202PL	D-7	AHAM Series	F-12, F-15	BS2	K-11
AH1203	D-6	AHAR Series	F-16, F-18	CD320B4W	E-4
AH1203AM	D-6, I-5	AHBRS30ANF	D-29	CD320B6W	E-4
AH1203L	D-9	AHCA Series	F-2, F-3	CD320B7W	E-4
AH1203LT	D-7	AHCR Series	F-4, F-5	CD320C4W	E-4
AH1204	D-6	AHDM Series	F-13, F-15	CD320C6W	E-4
AH1204L	D-9	AHDN Series	F-22, F-23	CD320C7W	E-4
AH1221	D-6	AHDR Series	F-17, F-18	CD320HMI4W	E-7
AH1221AM	D-6, I-5	AHEM Series	F-13, F-15	CD320HMI6W	E-7
AH1221L	D-9	AHER Series	F-17, F-18	CD320HMI7W	E-7
AH1221LT	D-7	AHMC240C	D-21	CD320P4W	E-4
AH1221PL	D-7	AHMC240C-1	D-21	CD320P6W	E-4
AH1222	D-6	AHMC240C-3	D-21	CD320P7W	E-4
AH1222AM	D-6, I-5	AHMC240L	D-21	CD320R4W	E-4
AH1222L	D-9	AHMC240L-1	D-21	CD320R6W	E-4
AH1222PL	D-7	AHMC240L-3	D-21	CD320R7W	E-4
AH1223	D-6	AHMC260L	D-23	CD330B4W	E-4
AH1223AM	D-6, I-5	AHMC260L-1	D-23	CD330B6W	E-4
AH1223L	D-9	AHMC260L-3	D-23	CD330B7W	E-4
AH1223LT	D-7	AHMC340C	D-22	CD330C4W	E-4
AH1224	D-6	AHMC340C-1	D-22	CD330C6W	E-4
AH1224L	D-9	AHMC340C-3	D-22	CD330C7W	E-4
AH1895L	D-8	AHMC340L	D-22	CD330MI4W	E-7
AH1995L	D-8	AHMC340L-1	D-22	CD330MI6W	E-7
AH4361	D-24	AHMC340L-2	D-22	CD330MI7W	E-7
AH4371	D-24	AHMC360L	D-23	CD330MIF6W	E-7
AH5262	A-10	AHMC360L-1	D-23	CD330P4W	E-4
AH5362	A-10	AHMC360L-2	D-23	CD330P6W	E-4
AH5462	A-13	AHML Series	F-2, F-3, F-7, F-8	CD330P7W	E-4
AH5662	A-13	AHML4H4TC010MX	D-26	CD330R4W	E-4
AH5684	A-14	AHML4H4TC020MX	D-26	CD330R6W	E-4
AH6808FDAC	D-24	AHML4H4TC030MX	D-26	CD330R7W	E-4
AH6808GDAC	D-24	AHML4H4TC040MX	D-26	CD360B4W	E-4
AH6808UCO	D-21	AHMR Series	F-4, F-5, F-9, F-10	CD360B6W	E-4
AH6808UDAC	D-24	AHMR4D4BC005MX	D-26	CD360B7W	E-4
AH6808WDAC	D-24	AHMR4E4BC005MX	D-26	CD360C4W	E-4
AH6810E	D-20	AHMSF	D-29, D-30	CD360C6W	E-4
AH6810G	D-20	AHN1GD	D-21, D-22	CD360C7W	E-4
AH6810U	D-20	AHN1GD2	D-22	CD360MI6W	E-8
AH6810W	D-20	AHN3WD	D-21, D-22	CD360MI7W	E-8
AH7810ED	D-20	AHPF Series	F-24, F-25	CD360MIF6W	E-8
AH7810FD	D-20	AHPFA Series	F-24, F-25	CD360P4W	E-4
AH7810GD	D-20	AHPL Series	F-14, F-15	CD360P6W	E-4
AH7810GDB	D-20	AHPR Series	F-18	CD360P7W	E-4

CD360R4W	E-4	CD460MI7W	E-8	CD560MIF5W	E-8
CD360R6W	E-4	CD460MI9W	E-8	CD560MIF7W	E-8
CD360R7W	E-4	CD460MIB12W	E-8	CD560MIF9W	E-8
CD420B12W	E-4	CD460MIB5W	E-8	CD560P5W	E-4
CD420B5W	E-4	CD460MIB7W	E-8	CD560P7W	E-4
CD420B7W	E-4	CD460MIB9W	E-8	CD560P9W	E-4
CD420B9W	E-4	CD460MICB12W	E-8	CD560R5W	E-4
CD420C12W	E-4	CD460MICB5W	E-8	CD560R7W	E-4
CD420C5W	E-4	CD460MICB7W	E-8	CD560R9W	E-4
CD420C7W	E-4	CD460MICB9W	E-8	CD3100B4W	E-4
CD420C9W	E-4	CD460MIF12W	E-8	CD3100B6W	E-4
CD420HMI12W	E-7	CD460MIF5W	E-8	CD3100B7W	E-4
CD420HMI5W	E-7	CD460MIF7W	E-8	CD3100C4W	E-4
CD420HMI7W	E-7	CD460MIF9W	E-8	CD3100C6W	E-4
CD420HMI9W	E-7	CD460P12W	E-4	CD3100C7W	E-4
CD420MIB12W	E-7	CD460P5W	E-4	CD3100MI4W	E-8
CD420MIB7W	E-7	CD460P7W	E-4	CD3100MI6W	E-8
CD420MIB9W	E-7	CD460P9W	E-4	CD3100MI7W	E-8
CD420MICB12W	E-7	CD460R12W	E-4	CD3100P4W	E-4
CD420MICB7W	E-7	CD460R5W	E-4	CD3100P6W	E-4
CD420MICB9W	E-7	CD460R7W	E-4	CD3100P7W	E-4
CD420P12W	E-4	CD460R9W	E-4	CD3100R4W	E-4
CD420P5W	E-4	CD520B5W	E-4	CD3100R6W	E-4
CD420P7W	E-4	CD520B7W	E-4	CD3100R7W	E-4
CD420P9W	E-4	CD520B9W	E-4	CD4100B12W	E-4
CD420R12W	E-4	CD520C5W	E-4	CD4100B5W	E-4
CD420R5W	E-4	CD520C7W	E-4	CD4100B7W	E-4
CD420R7W	E-4	CD520C9W	E-4	CD4100B9W	E-4
CD420R9W	E-4	CD520HMI9W	E-7	CD4100C12W	E-4
CD430B12W	E-4	CD520P5W	E-4	CD4100C5W	E-4
CD430B5W	E-4	CD520P7W	E-4	CD4100C7W	E-4
CD430B7W	E-4	CD520P9W	E-4	CD4100C9W	E-4
CD430B9W	E-4	CD520R5W	E-4	CD4100MI12W	E-8
CD430C12W	E-4	CD520R7W	E-4	CD4100MI5W	E-8
CD430C5W	E-4	CD520R9W	E-4	CD4100MI7W	E-8
CD430C7W	E-4	CD530B5W	E-4	CD4100MI9W	E-8
CD430C9W	E-4	CD530B7W	E-4	CD4100P12W	E-4
CD430MI12W	E-7	CD530B9W	E-4	CD4100P5W	E-4
CD430MI5W	E-7	CD530C5W	E-4	CD4100P7W	E-4
CD430MI7W	E-7	CD530C7W	E-4	CD4100P9W	E-4
CD430MI9W	E-7	CD530C9W	E-4	CD4100R12W	E-4
CD430MIB12W	E-7	CD530MI5W	E-7	CD4100R5W	E-4
CD430MIB7W	E-7	CD530MI7W	E-7	CD4100R7W	E-4
CD430MIB9W	E-7	CD530MI9W	E-7	CD4100R9W	E-4
CD430MICB12W	E-7	CD530MIB5W	E-7	CD5100B5W	E-4
CD430MICB7W	E-7	CD530MIB7W	E-7	CD5100B7W	E-4
CD430MICB9W	E-7	CD530MIB9W	E-7	CD5100B9W	E-4
CD430MIF12W	E-7	CD530MICB5W	E-7	CD5100C5W	E-4
CD430MIF5W	E-7	CD530MICB7W	E-7	CD5100C7W	E-4
CD430MIF7W	E-7	CD530MICB9W	E-7	CD5100C9W	E-4
CD430MIF9W	E-7	CD530P5W	E-4	CD5100MI5W	E-8
CD430P12W	E-4	CD530P7W	E-4	CD5100MI7W	E-8
CD430P5W	E-4	CD530P9W	E-4	CD5100MI9W	E-8
CD430P7W	E-4	CD530R5W	E-4	CD5100P5W	E-4
CD430P9W	E-4	CD530R7W	E-4	CD5100P7W	E-4
CD430R12W	E-4	CD530R9W	E-4	CD5100P9W	E-4
CD430R5W	E-4	CD560B5W	E-4	CD5100R5W	E-4
CD430R7W	E-4	CD560B7W	E-4	CD5100R7W	E-4
CD430R9W	E-4	CD560B9W	E-4	CD5100R9W	E-4
CD460B12W	E-4	CD560C5W	E-4	CDANG1	E-5
CD460B5W	E-4	CD560C7W	E-4	CDBB1	E-5
CD460B7W	E-4	CD560C9W	E-4	CDBB3	E-5
CD460B9W	E-4	CD560MI5W	E-8	CDBB3-MI	E-5
CD460C12W	E-4	CD560MI7W	E-8	CDBB5	E-5
CD460C5W	E-4	CD560MI9W	E-8	CDCP60	E-5
CD460C7W	E-4	CD560MIB7W	E-8	CDCP100	E-5
CD460C9W	E-4	CD560MIB9W	E-8	CDCP320	E-5
CD460MI12W	E-8	CD560MICB7W	E-8	CDCP420	E-5
CD460MI5W	E-8	CD560MICB9W	E-8	CDCP520	E-5

CDCP530	E-5	CS8364EX	C-65	CWL720R	C-13
CDCP3430	E-5	CS8365	C-65	CWL730C	C-18
CDFTBB1	E-5	CS8365EX	C-65	CWL730FI	C-18
CR15	A-17	CS8369	C-65	CWL730FO	C-18
CR20	A-17	CS8375	C-65	CWL730P	C-18
CR4700	C-8	CS8377	C-65	CWL730R	C-18
CR5792	C-8	CS8464	C-62	CWL820C	C-14
CRL520C	C-11	CS8464EX	C-62	CWL820FI	C-14
CRL520P	C-11	CS8465	C-62	CWL820FO	C-14
CRL520R	C-11	CS8469	C-62	CWL820P	C-14
CRL530C	C-16	CS8475	C-62	CWL820R	C-14
CRL530P	C-16	CS8477	C-62	CWL830C	C-19
CRL530R	C-16	CSB115	D-14	CWL830FI	C-19
CRL620P	C-12	CSB120	D-14	CWL830FO	C-19
CRL620R	C-12	CSB215	D-14	CWL830P	C-19
CRL630C	C-17	CSB220	D-14	CWL830R	C-19
CRL630P	C-17	CSB315	D-14	CWL920C	C-15
CRL630R	C-17	CSB320	D-14	CWL920FI	C-15
CRL1420C	C-31	CSB415	D-14	CWL920FO	C-15
CRL1420P	C-31	CSB420	D-14	CWL920P	C-15
CRL1420R	C-31	CWL115FI	C-6	CWL920R	C-15
CRL1430C	C-34	CWL115FO	C-6	CWL930C	C-20
CRL1430P	C-34	CWL115R	C-6	CWL930FI	C-20
CRL1430R	C-34	CWL220C	C-7	CWL930FO	C-20
CRL1520C	C-32	CWL220FO	C-7	CWL930P	C-20
CRL1520P	C-32	CWL220P	C-7	CWL930R	C-20
CRL1520R	C-32	CWL220P-6	C-7	CWL1020C	C-23
CRL1530C	C-35	CWL220R	C-7	CWL1020FI	C-23
CRL1530P	C-35	CWL515C	C-8	CWL1020FO	C-23
CRL1620C	C-33	CWL515CAN	C-8	CWL1020P	C-23
CRL1620P	C-33	CWL515FI	C-8	CWL1020R	C-23
CRL1630P	C-36	CWL515FO	C-8	CWL1030C	C-27
CS115	D-14	CWL515P	C-8	CWL1030FI	C-27
CS120	D-14	CWL515PAN	C-8	CWL1030FO	C-27
CS215	D-14	CWL515R	C-8	CWL1030P	C-27
CS220	D-14	CWL520C	C-11	CWL1030R	C-27
CS315	D-14	CWL520FI	C-11	CWL1120C	C-24
CS320	D-14	CWL520FO	C-11	CWL1120FI	C-24
CS415	D-14	CWL520P	C-11	CWL1120FO	C-24
CS420	D-14	CWL520R	C-11	CWL1120P	C-24
CS6360	C-59	CWL530C	C-16	CWL1120R	C-24
CS6360EX	C-59	CWL530FI	C-16	CWL1130C	C-28
CS6361	C-59	CWL530FO	C-16	CWL1130FI	C-28
CS6361EX	C-59	CWL530P	C-16	CWL1130FO	C-28
CS6364	C-64	CWL530R	C-16	CWL1130P	C-28
CS6364EX	C-64	CWL615C	C-9	CWL1130R	C-28
CS6365	C-64	CWL615FI	C-9	CWL1220C	C-25
CS6365EX	C-64	CWL615FO	C-9	CWL1220FI	C-25
CS6369	C-64, L-3	CWL615P	C-9	CWL1220FO	C-25
CS6370	C-59	CWL615R	C-9	CWL1220P	C-25
CS6375	C-64, L-3	CWL620C	C-12	CWL1220R	C-25
CS6376	C-64, L-3	CWL620FI	C-12	CWL1230C	C-29
CS6377	C-59	CWL620FO	C-12	CWL1230FI	C-29
CS6378	C-59	CWL620P	C-12	CWL1230FO	C-29
CS8164	C-68	CWL620R	C-12	CWL1230P	C-29
CS8164EX	C-68	CWL630C	C-17	CWL1230R	C-29
CS8165	C-68	CWL630FI	C-17	CWL1330C	C-30
CS8165EX	C-68	CWL630FO	C-17	CWL1330FI	C-30
CS8169	C-68	CWL630P	C-17	CWL1330FO	C-30
CS8175	C-68	CWL630R	C-17	CWL1330P	C-30
CS8177	C-68	CWL715C	C-10	CWL1330R	C-30
CS8264	C-60	CWL715FI	C-10	CWL1420C	C-31
CS8264EX	C-60	CWL715FO	C-10	CWL1420FI	C-31
CS8265	C-60	CWL715P	C-10	CWL1420FO	C-31
CS8265EX	C-60, C-62	CWL715R	C-10	CWL1420P	C-31
CS8269	C-60	CWL720C	C-13	CWL1420R	C-31
CS8275	C-60	CWL720FI	C-13	CWL1430C	C-34
CS8277	C-60	CWL720FO	C-13	CWL1430FI	C-34
CS8364	C-65	CWL720P	C-13	CWL1430FO	C-34

CWL1430P	C-34	CWL2220FO	C-48	DC300625-F	M-2
CWL1430R	C-34	CWL2220P	C-48	DC300750	M-2
CWL1520C	C-32	CWL2220R	C-48	DC300750-45	M-2
CWL1520FI	C-32	CWL2230C	C-51	DC300750-90	M-2
CWL1520FO	C-32	CWL2230FI	C-51	DC300750-F	M-2
CWL1520P	C-32	CWL2230FO	C-51	DC300875	M-2
CWL1520R	C-32	CWL2230P	C-51	DC300875-45	M-2
CWL1530C	C-35	CWL2230R	C-51	DC300875-90	M-2
CWL1530FI	C-35	CWL2320C	C-49	DC300875-F	M-2
CWL1530FO	C-35	CWL2320FI	C-49	DC3001000	M-2
CWL1530P	C-35	CWL2320FO	C-49	DC3001125	M-2
CWL1530R	C-35	CWL2320P	C-49	DC400750	M-2
CWL1620C	C-33	CWL2320R	C-49	DC400750-90	M-2
CWL1620FI	C-33	CWL2330C	C-52	DC400875	M-2
CWL1620FO	C-33	CWL2330FI	C-52	DC400875-90	M-2
CWL1620P	C-33	CWL2330FO	C-52	DC4001000	M-2
CWL1620R	C-33	CWL2330P	C-52	DC4001000-90	M-2
CWL1630C	C-36	CWL2330R	C-52	DC4001125	M-2
CWL1630FI	C-36	DC000187	M-1	DC4001125-90	M-2
CWL1630FO	C-36	DC000187-90	M-1	DC4001250	M-2
CWL1630P	C-36	DC000250	M-1	DC4001250-90	M-2
CWL1630R	C-36	DC000250-90	M-1	DC500750	M-2
CWL1730C	C-37	DC000312	M-1	DC500750-90	M-2
CWL1730FI	C-37	DC000312-90	M-1	DC500875	M-2
CWL1730FO	C-37	DC000375	M-1	DC500875-90	M-2
CWL1730P	C-37	DC000375-90	M-1	DC5001000	M-2
CWL1730R	C-37	DC100187	M-1	DC5001000-90	M-2
CWL1820C	C-39	DC100187-45	M-1	DC5001125	M-2
CWL1820FI	C-39	DC100187-90	M-1	DC5001125-90	M-2
CWL1820FO	C-39	DC100187-F	M-1	DC5001250	M-2
CWL1820P	C-39	DC100250	M-1	DC5001250-90	M-2
CWL1820R	C-39	DC100250-45	M-1	DC5001312	M-2
CWL1830C	C-43	DC100250-90	M-1	DC5001437	M-2
CWL1830FI	C-43	DC100250-F	M-1	DC5001562	M-2
CWL1830FO	C-43	DC100375	M-1	DC5001687	M-2
CWL1830P	C-43	DC100375-45	M-1	DC5001750	M-2
CWL1830R	C-43	DC100375-90	M-1	DC6001250	M-3
CWL1920C	C-40	DC100375-F	M-1	DC6001250-90	M-3
CWL1920FI	C-40	DC100500	M-1	DC6001312	M-3
CWL1920FO	C-40	DC100500-45	M-1	DC6001312-90	M-3
CWL1920P	C-40	DC100500-90	M-1	DC6001437	M-3
CWL1920R	C-40	DC100500-F	M-1	DC6001437-90	M-3
CWL1930C	C-44	DC100625	M-1	DC6001562	M-3
CWL1930FI	C-44	DC100750	M-1	DC6001562-90	M-3
CWL1930FO	C-44	DC200250	M-1	DC6001687	M-3
CWL1930P	C-44	DC200250-90	M-1	DC6001687-90	M-3
CWL1930R	C-44	DC200250-F	M-1	DC6001750	M-3
CWL2020C	C-41	DC200375	M-1	DC6001750-90	M-3
CWL2020FI	C-41	DC200375-90	M-1	DC6001812	M-3
CWL2020FO	C-41	DC200375-F	M-1	DC6001937	M-3
CWL2020P	C-41	DC200500	M-1	DC6002062	M-3
CWL2020R	C-41	DC200500-90	M-1	DC6002187	M-3
CWL2030C	C-45	DC200500-F	M-1	DC6002312	M-3
CWL2030FI	C-45	DC200625	M-1	DC7001687	M-3
CWL2030FO	C-45	DC200625-45	M-1	DC7001812	M-3
CWL2030P	C-45	DC200625-90	M-1	DC7001937	M-3
CWL2030R	C-45	DC200625-F	M-1	DC7002062	M-3
CWL2120C	C-47	DC200750	M-1	DC7002187	M-3
CWL2120FI	C-47	DC300437	M-2	DC7002312	M-3
CWL2120FO	C-47	DC300437-45	M-2	DC8001687	M-3
CWL2120P	C-47	DC300437-90	M-2	DC8001812	M-3
CWL2120R	C-47	DC300437-F	M-2	DC8001937	M-3
CWL2130C	C-50	DC300562	M-2	DC8002062	M-3
CWL2130FI	C-50	DC300562-45	M-2	DC8002187	M-3
CWL2130FO	C-50	DC300562-90	M-2	DC8002312	M-3
CWL2130P	C-50	DC300562-F	M-2	DC8002437	M-3
CWL2130R	C-50	DC300625	M-2	DC8002625	M-3
CWL2220C	C-48	DC300625-45	M-2	DC8002812	M-3
CWL2220FI	C-48	DC300625-90	M-2	DC8003000	M-3

EM5132	I-25, J-10	I52	M-4	L630CW	C-17
EM5134	I-25, J-10	I70	M-4	L630CY	C-17
EM93071	I-25, J-10	I82	M-4	L630PW	C-17
EM93101	I-25, J-10	I94	M-4	L630PY	C-17
EM93102	I-25, J-10	IG1208	H-6	L630R	L-3
GF15__M	G-5	IG1210	H-6	L630RW	C-17
GFER-	J-18	IG4518C	I-25, J-10	L720CW	C-13
GF111M133	G-8, L-5	IG4700	C-8, H-13	L720CY	C-13
GF111M139	G-8, L-5	IG5131	I-25, J-10	L720PW	C-13
GF111M155	G-11, L-8	IG5132	I-25, J-10	L720PY	C-13
GF111M233	G-8, L-5	IG5250__S	H-5	L720RW	C-13
GF111M239	G-8, L-5	IG5261	A-10, H-10	L730CW	C-18
GF111M255	G-11, L-8	IG5262	A-10, H-10	L730CY	C-18
GF111M433	G-8, L-5	IG5262__S	H-5	L730PW	C-18
GF111M439	G-8, L-5	IG5266NHG	B-6, I-18	L730PY	C-18
GF111M455	G-11, L-8	IG5350__S	H-5	L730RW	C-18
GF111M633	G-8, L-5	IG5361	A-10, H-10	L820CW	C-14
GF111M639	G-8, L-5	IG5362	A-10, H-10	L820CY	C-14
GF111M655	G-11, L-8	IG5362__S	H-5	L820PW	C-14
GF111MN3	G-8, L-5	IG5461	A-13, H-11	L820PY	C-14
GF112M133	G-9, L-6	IG5462	A-13, H-11	L820RW	C-14
GF112M144	G-9, L-6	IG5661	A-13, H-11	L830CW	C-19
GF112M155	G-11, L-8	IG5662	A-13, H-11	L830CY	C-19
GF112M166	G-11, L-8	IG8200	A-6, H-10, I-10, I-15	L830PW	C-19
GF112M1NN	G-9, L-6	IG8200HG__S	H-5, I-14	L830PY	C-19
GF112M255	G-11, L-8	IG8210	A-6, H-10, I-10, I-15	L830RW	C-19
GF112M266	G-11, L-8	IG8262	A-6, H-10, I-10, I-15	L1020CW	C-23
GF112M2NN	G-9, L-6	IG8300	A-6, H-10, I-10, I-15	L1020CY	C-23
GF112M455	G-11, L-8	IG8300HG__S	H-5, I-14	L1020PW	C-23
GF112M466	G-11, L-8	IG8310	A-6, H-10, I-10, I-15	L1020PY	C-23
GF112M4NN	G-9, L-6	IG8362	A-6, H-10, I-10, I-15	L1020RW	C-23
GF112M6NN	G-9, L-6	IG8400	A-8, H-11, I-15	L1030CW	C-27
GF113M144	G-10, L-7	IG93101	I-25, J-10	L1030CY	C-27
GF113M166	G-11, L-8	IGL515R	C-8, H-13	L1030PW	C-27
GF113M1NN	G-10, L-7	IGL520R	C-11, H-13	L1030PY	C-27
GF113M266	G-11, L-8	IGL530P	C-16, H-15	L1030RW	C-27
GF113M2NN	G-10, L-7	IGL530R	C-16, H-15	L1120CW	C-24
GF113M466	G-11, L-8	IGL615R	C-9, H-13	L1120CY	C-24
GF113M4NN	G-10, L-7	IGL620R	C-12, H-14	L1120PW	C-24
GF113M6NN	G-10, L-7	IGL630R	C-17, H-15	L1120PY	C-24
GF113M7NN	G-10, L-7	IGL720R	C-13, H-14	L1120RW	C-24
GF122M144	G-9, L-6	IGL730R	C-18, H-15	L1130CW	C-28
GF122M166	G-11, L-8	IGL820R	C-14, H-14	L1130CY	C-28
GF122M1NN	G-9, L-6	IGL830R	C-19, H-16	L1130PW	C-28
GF122M266	G-11, L-8	IGL1420R	C-31, H-16	L1130PY	C-28
GF122M2NN	G-9, L-6	IGL1430R	C-34, H-17	L1130RW	C-28
GF122M466	G-11, L-8	IGL1520R	C-32, H-16	L1420CW	C-31
GF122M4NN	G-9, L-6	IGL1530R	C-35, H-17	L1420CY	C-31
GF122M6NN	G-9, L-6	IGL1620R	C-33, H-17	L1420PW	C-31
GF123M144	G-10, L-7	IGL2120R	C-47, H-18	L1420PY	C-31
GF123M166	G-11, L-8	IGL2130R	C-50, H-18	L1420RW	C-31
GF123M1NN	G-10, L-7	IGL2230R	C-51, H-18	L1430CW	C-34
GF123M266	G-11, L-8	IGL2330R	C-52, H-18	L1430CY	C-34
GF123M2NN	G-10, L-7	L520CW	C-11	L1430PW	C-34
GF123M466	G-11, L-8	L520CY	C-11	L1430PY	C-34
GF123M4NN	G-10, L-7	L520PW	C-11	L1430RW	C-34
GF123M6NN	G-10, L-7	L520PY	C-11	L1520CW	C-32
GF123M7NN	G-10, L-7	L520R	L-3	L1520CY	C-32
GF193M1NN	G-10, L-7	L520RW	C-11	L1520PW	C-32
GF1D3M1NN	G-10, L-7	L530CW	C-16	L1520PY	C-32
GFP11M1P3	G-8, L-5	L530CY	C-16	L1520RW	C-32
GFP11M1P9	G-8, L-5	L530PW	C-16	L1530CW	C-35
GFP11M4P3	G-8, L-5	L530PY	C-16	L1530CY	C-35
GFP11M4P9	G-8, L-5	L530RW	C-16	L1530PW	C-35
GFP11MNP	G-8, L-5	L620CW	C-12	L1530PY	C-35
GFP100-B	G-8, L-5	L620CY	C-12	L1530RW	C-35
GFP400	G-8, L-5	L620PW	C-12	L1620CW	C-33
I30	M-4	L620PY	C-12	L1620CY	C-33
I40	M-4	L620RW	C-12	L1620PW	C-33

L1620PY	C-33	L2320CY	C-49	LTB590	M-4
L1620RW	C-33	L2320PW	C-49	LTB600	M-4
L1630CW	C-36	L2320PY	C-49	LTB645	M-4
L1630CY	C-36	L2320RW	C-49	LTB690	M-4
L1630PW	C-36	L2330CF	C-52	LTB700	M-4
L1630PY	C-36	L2330CW	C-52	LTB745	M-4
L1630RW	C-36	L2330CY	C-52	LTB790	M-4
L1730CW	C-37	L2330PF	C-52	LTB800	M-4
L1730CY	C-37	L2330PW	C-52	LTB845	M-4
L1730PW	C-37	L2330PY	C-52	LTB890	M-4
L1730PY	C-37	L2330RW	C-52	LTB900	M-4
L1730RW	C-37	LNL1_120	I-24, J-20	LTB945	M-4
L1820CW	C-39	LNL1_120-WL	I-24, J-20	LTB990	M-4
L1820CY	C-39	LNL1_LV	I-24, J-20	MCR125SOL	A-3, G-3, H-3, I-3
L1820PW	C-39	LNL1_LV-WL	I-24, J-20	MCR125STR	A-3, G-3, H-3, I-3
L1820PY	C-39	LNL2_120	I-24, J-20	MCR250SOL	A-3, G-3, H-3, I-3
L1820RW	C-39	LNL2_120-WL	I-24, J-20	MCR250STR	A-3, G-3, H-3, I-3
L1830CW	C-43	LNL2_LV	I-24, J-20	MCR300FTPI	A-3, G-3, H-3, I-3
L1830CY	C-43	LNL2_LV-WL	I-24, J-20	MCR300FTPING	A-3, G-3, H-3, I-3
L1830PW	C-43	LNL3_120	I-24, J-20	MCR300FTST	A-3, G-3, H-3, I-3
L1830PY	C-43	LNL3_120-WL	I-24, J-20	MCR300FTSTNG	A-3, G-3, H-3, I-3
L1830RW	C-43	LNL3_LV	I-24, J-20	MCS120SOL	D-3
L1920CW	C-40	LNL3_LV-WL	I-24, J-20	MCS120STR	D-3
L1920CY	C-40	LNL4_120	I-24, J-20	MCS277SOL	D-3
L1920PW	C-40	LNL4_120-WL	I-24, J-20	MCS277STR	D-3
L1920PY	C-40	LNL4_LV	I-24, J-20	MCS300PI	D-3
L1920RW	C-40	LNL4_LV-WL	I-24, J-20	MCS300TC	D-3
L1930CW	C-44	LP5011	M-14	MP5021	M-15
L1930CY	C-44	LP5016	M-14	MP6224	M-15
L1930PW	C-44	LP6211	M-14	MP7524	M-15
L1930PY	C-44	LP6216	M-14	MP7536	M-15
L1930RW	C-44	LP7512	M-14	MP7548	M-15
L2020CW	C-41	LP7520	M-14	MP10024	M-15
L2020CY	C-41	LP10013	M-14	MP10036	M-15
L2020PW	C-41	LP10020	M-14	MP10048	M-15
L2020PY	C-41	LP12514	M-14	MP15024	M-15
L2020RW	C-41	LP12521	M-14	MP15036	M-15
L2030CW	C-45	LP15015	M-14	MP15048	M-15
L2030CY	C-45	LP15023	M-14	MP20024	M-15
L2030PW	C-45	LP17517	M-14	MP20036	M-15
L2030PY	C-45	LP20018	M-14	MP20048	M-15
L2030RW	C-45	LP20025	M-14	MP25024	M-15
L2120CF	C-47	LP25018	M-14	MP25036	M-15
L2120CW	C-47	LP25027	M-14	MP25048	M-15
L2120CY	C-47	LP30030	M-14	MP30024	M-15
L2120PF	C-47	LP35032	M-14	MP30036	M-15
L2120PW	C-47	LPJ25	M-14	MP30048	M-15
L2120PY	C-47	LPJ37	M-14	MP35026	M-15
L2120RW	C-47	LPJ50	M-14	MP35036	M-15
L2130CF	C-50	LPJ62	M-14	MP35048	M-15
L2130CW	C-50	LPJ75	M-14	PA50-6	L-3
L2130CY	C-50	LPJ100	M-14	PC50A	L-3
L2130PF	C-50	LTB000	M-4	PC50B	L-3
L2130PW	C-50	LTB045	M-4	PG300	C-78
L2130PY	C-50	LTB090	M-4	PG301	C-78
L2130RW	C-50	LTB100	M-4	PG302	C-78
L2220CW	C-48	LTB145	M-4	PG303	C-78
L2220CY	C-48	LTB190	M-4	PG304	C-78
L2220PW	C-48	LTB200	M-4	PG600	C-78
L2220PY	C-48	LTB245	M-4	PG601	C-78
L2220RW	C-48	LTB290	M-4	PH5011	M-16
L2230CF	C-51	LTB300	M-4	PH5016	M-16
L2230CW	C-51	LTB345	M-4	PH6211	M-16
L2230CY	C-51	LTB390	M-4	PH6216	M-16
L2230PF	C-51	LTB400	M-4	PH7520	M-16
L2230PW	C-51	LTB445	M-4	PH7532	M-16
L2230PY	C-51	LTB490	M-4	PH10020	M-16
L2230RW	C-51	LTB500	M-4	PH10033	M-16
L2320CW	C-49	LTB545	M-4	PH12521	M-16

PH15025.....	M-16	PJ720.....	J-15	S1174-6W.....	N-1
PH15034.....	M-16	PJ724.....	J-15	S1174W.....	N-1
PH20026.....	M-16	PJ826.....	J-15	S1951.....	K-7
PH20036.....	M-16	PJS1.....	J-13	S1952.....	K-7
PH25028.....	M-16	PJS1AM.....	I-8, J-13	S1954.....	K-7
PH25038.....	M-16	PJS2.....	J-13	S1961.....	K-7
PH30030.....	M-16	PJS2AM.....	I-8, J-13	S1962.....	K-7
PH30039.....	M-16	PJS3.....	J-13	S1966.....	K-8
PH35032.....	M-16	PJS3AM.....	I-8, J-13	S1987.....	K-8
PH35041.....	M-16	PJS4.....	J-13	S2962.....	K-7
PH40033.....	M-16	PJS4AM.....	I-8, J-13	S2966.....	K-7
PH40042.....	M-16	PJS8.....	J-13	S2983.....	K-7
PH45058.....	M-16	PJS8AM.....	I-8, J-13	S3962.....	K-7
PH50060.....	M-16	PJS26.....	J-13	S3966.....	K-7
PH60066.....	M-16	PJS26AM.....	I-8, J-13	S3999.....	K-9
PJ1.....	J-11	PJS262.....	J-13	SDS23.....	M-12
PJ1AM.....	I-7, J-11	PJS262AM.....	I-8, J-13	SDS32.....	M-12
PJ1EM.....	I-25, J-16	PJS263.....	J-13	SDS43.....	M-12
PJ2.....	J-11	PJS263AM.....	I-8, J-13	SDS56.....	M-12
PJ2AM.....	I-7, J-11	PJS264.....	J-13	SDS73.....	M-12
PJ2EM.....	I-25, J-16	PJS264AM.....	I-8, J-13	SDS100.....	M-12
PJ3.....	J-11	PJS265.....	J-13	SDU23.....	M-12
PJ3AM.....	I-7, J-11	PJS266.....	J-13	SDU32.....	M-12
PJ4.....	J-11	PMF2526.....	M-17	SDU43.....	M-12
PJ4AM.....	I-7, J-11	PMF5032.....	M-17	SDU56.....	M-12
PJ5.....	J-11	PMF7541.....	M-17	SDU73.....	M-12
PJ6.....	J-11	PMF10052.....	M-17	SDU100.....	M-12
PJ7.....	J-15	PMF12556.....	M-17	SE6000.....	C-55
PJ7IG.....	I-25, J-16	PMF15060.....	M-17	SGD50.....	M-5
PJ8.....	J-11	PMF20050.....	M-17	SGD63.....	M-5
PJ8AM.....	I-7, J-11	PMF25052.....	M-17	SGD75.....	M-5
PJ8CO.....	I-25, J-16	PMF30054.....	M-17	SGD100.....	M-5
PJ8EM.....	I-25, J-16	PMF35056.....	M-17	SGD125.....	M-5
PJ8GF.....	I-25, J-16	PMR2526.....	M-17	SGD150.....	M-5
PJ8IG.....	I-25, J-16	PMR5032.....	M-17	SGD175.....	M-5
PJ11.....	J-14	PMR7541.....	M-17	SGD200.....	M-5
PJ12.....	J-14	PMR10052.....	M-17	SGD250.....	M-5
PJ13.....	J-14	PMR12556.....	M-17	SGD300.....	M-5
PJ13AM.....	I-8, J-14	PMR15060.....	M-17	SGD350.....	M-5
PJ14.....	J-14	PMR20050.....	M-17	SGDL50.....	M-7
PJ14AM.....	I-8, J-14	PMR25052.....	M-17	SGDL63.....	M-7
PJ18.....	J-15	PMR30054.....	M-17	SGDL75.....	M-7
PJ23.....	J-14	PMR35056.....	M-17	SGDL100.....	M-7
PJ23AM.....	I-8, J-14	RB300M.....	L-2	SGDL125.....	M-7
PJ24.....	J-14	RB301M.....	L-2	SGDL150.....	M-7
PJ24AM.....	I-8, J-14	RB3021M.....	L-2	SGDL175.....	M-7
PJ26.....	J-12	RB302M.....	L-2	SGDL200.....	M-7
PJ26AM.....	I-7, J-12	RB303M.....	L-2	SGDL250.....	M-7
PJ26CO.....	I-25, J-16	RB3001M.....	L-2	SGDL300.....	M-7
PJ26EM.....	I-25, J-16	S19.....	A-23, B-23	SGDL350.....	M-7
PJ26GF.....	I-25, J-16	S20.....	A-23, B-23	SGDR50.....	M-9
PJ26IG.....	I-25, J-16	S21.....	A-23, B-23	SGDR63.....	M-9
PJ28.....	J-15	S41.....	A-22, B-22	SGDR75.....	M-9
PJ82.....	J-11	S42.....	A-22, B-22	SGDR100.....	M-9
PJ82AM.....	I-7, J-11	S80.....	A-22, B-22	SGDR125.....	M-9
PJ82EM.....	I-25, J-16	S752W.....	N-5	SGDR150.....	M-9
PJ113.....	J-15	S759W-CD.....	N-1	SGDR175.....	M-9
PJ126.....	J-15	S768-6W.....	N-1	SGDR200.....	M-9
PJ138.....	J-15	S768W.....	N-1	SGDR250.....	M-9
PJ226.....	J-15	S788W.....	N-1	SGDR300.....	M-9
PJ262.....	J-12	S860W.....	N-1	SGDR350.....	M-9
PJ262AM.....	I-7, J-12	S865W.....	N-1	SGO50.....	M-6
PJ263.....	J-12	S966.....	K-8	SGO63.....	M-6
PJ263AM.....	I-7, J-12	S983.....	K-9	SGO75.....	M-6
PJ264.....	J-12	S984.....	K-9	SGO100.....	M-6
PJ264AM.....	I-7, J-12	S989.....	K-8	SGO125.....	M-6
PJ265.....	J-12	S992.....	K-8	SGO150.....	M-6
PJ266.....	J-12	S993.....	K-8	SGO175.....	M-6
PJ703.....	J-15	S994.....	K-8	SGO200.....	M-6

SGO250	M-6	SGTDL125	M-11	SKT20026	M-18
SGO300	M-6	SGTDL150	M-11	SKT25020	M-18
SGO350	M-6	SGTDL200	M-11	SKT25029	M-18
SGOL50	M-8	SGTDL250	M-11	SKT30021	M-18
SGOL63	M-8	SGTDL300	M-11	SKT30032	M-18
SGOL75	M-8	SGTDL350	M-11	SKT35022	M-18
SGOL100	M-8	SGTDL400	M-11	SKT35035	M-18
SGOL125	M-8	SGTS75	M-11	SKTL10015	M-19
SGOL150	M-8	SGTS100	M-11	SKTL10021	M-19
SGOL175	M-8	SGTS125	M-11	SKTL12516	M-19
SGOL200	M-8	SGTS150	M-11	SKTL12524	M-19
SGOL250	M-8	SGTSL75	M-11	SKTL15017	M-19
SGOL300	M-8	SGTSL100	M-11	SKTL15025	M-19
SGOL350	M-8	SGTSL125	M-11	SKTL17518	M-19
SGOR50	M-10	SGTSL150	M-11	SKTL20019	M-19
SGOR63	M-10	SGU50	M-6	SKTL20027	M-19
SGOR75	M-10	SGU63	M-6	SKTL25020	M-19
SGOR100	M-10	SGU75	M-6	SKTL25030	M-19
SGOR125	M-10	SGU100	M-6	SKTL30021	M-19
SGOR150	M-10	SGU125	M-6	SKTL30033	M-19
SGOR175	M-10	SGU150	M-6	SKTL35022	M-19
SGOR200	M-10	SGU175	M-6	SKTL35036	M-19
SGOR250	M-10	SGU200	M-6	SKTL7512	M-19
SGOR300	M-10	SGU250	M-6	SKTL7521	M-19
SGOR350	M-10	SGU300	M-6	STC1	J-16
SGS50	M-5	SGU350	M-6	STC7	J-16
SGS63	M-5	SGUL50	M-8	STC8	J-16
SGS75	M-5	SGUL63	M-8	STC14	J-16
SGS100	M-5	SGUL75	M-8	STC26	J-16
SGS125	M-5	SGUL100	M-8	STE1	J-16
SGS150	M-5	SGUL125	M-8	STE7	J-16
SGS175	M-5	SGUL150	M-8	STE8	J-16
SGS200	M-5	SGUL175	M-8	STE14	J-16
SGS250	M-5	SGUL200	M-8	STE26	J-16
SGS300	M-5	SGUL250	M-8	TC124	M-4
SGS350	M-5	SGUL300	M-8	TC143	M-4
SGSL50	M-7	SGUL350	M-8	TC254	M-4
SGSL63	M-7	SGUR50	M-10	TC497	M-4
SGSL75	M-7	SGUR63	M-10	TCI124	M-4
SGSL100	M-7	SGUR75	M-10	TCI132	M-4
SGSL125	M-7	SGUR100	M-10	TCI143	M-4
SGSL150	M-7	SGUR125	M-10	TCI254	M-4
SGSL175	M-7	SGUR150	M-10	TCI373	M-4
SGSL200	M-7	SGUR175	M-10	TCI497	M-4
SGSL250	M-7	SGUR200	M-10	TCI5125	M-4
SGSL300	M-7	SGUR250	M-10	TCI6150	M-4
SGSL350	M-7	SGUR300	M-10	TCI7170	M-4
SGSR50	M-9	SGUR350	M-10	TCI7200	M-4
SGSR63	M-9	SKR506	M-19	TR775	A-19
SGSR75	M-9	SKR628	M-19	TR817	A-18
SGSR100	M-9	SKR7510	M-19	TR1877	A-18
SGSR125	M-9	SKR10012	M-19	TR5262	A-16
SGSR150	M-9	SKR12514	M-19	TR5362	A-16
SGSR175	M-9	SKR15015	M-19	TR6250	A-18
SGSR200	M-9	SKR17516	M-19	TR6252	A-18
SGSR250	M-9	SKR20019	M-19	TR6350	A-18
SGSR300	M-9	SKR25020	M-19	TR6352	A-18
SGSR350	M-9	SKR30021	M-19	TR8200	A-7, I-11
SGTD75	M-11	SKR35024	M-19	TR8300	A-7, I-11
SGTD100	M-11	SKT7512	M-18	TRBR15	A-18
SGTD125	M-11	SKT7520	M-18	TRBR20	A-18
SGTD150	M-11	SKT10015	M-18	TRVGF15	G-5
SGTD200	M-11	SKT10020	M-18	TRVGF15__AG	G-6
SGTD250	M-11	SKT12516	M-18	TRVGF15__M	G-5
SGTD300	M-11	SKT12523	M-18	TRVGF15F	G-5
SGTD350	M-11	SKT15017	M-18	TRVGF20	G-5
SGTD400	M-11	SKT15025	M-18	TRVGF20__AG	G-6
SGTDL75	M-11	SKT17518	M-18	TRVGF20F	G-5
SGTDL100	M-11	SKT20019	M-18	TRVGFH15	G-5, I-14

TRVGFH15F	G-5, I-14	15W	B-8, B-10, B-12, B-14	231	J-18
TRVGFH20	G-5, I-14	15W33	B-10	232	J-18
TRVGFH20F	G-5, I-14	15W47	B-8	271	D-16
TWRBR15	A-18	15W48	B-14	274	D-16
TWRBR20	A-18	15W49	B-12	275	D-16
TWRVGF15	G-5	20CW	C-13, C-14, C-23, C-24, C-26	276	D-16
TWRVGF20	G-5	20GFMODA	L-3	277	D-16
U1263	A-22, B-22	20GFMODM	L-3	291	D-16
VGf15	G-5	20PW	C-13, C-14, C-23, C-24, C-26	293	D-16
VGf15__AG	G-6	24W34	C-10	294	D-16
VGf15__M	G-5	24W47	C-8	303	N-5
VGf15F	G-5	24W49	C-9	304	N-5
VGf20	G-5	25W34	C-10	442	N-7
VGf20__AG	G-6	25W47	C-8	449NP	N-7
VGf20F	G-5	25W49	C-9	452	N-7
VGFD20	G-6	30CW	C-16, C-17, C-18, C-19	458BD	N-7
VGfH15	G-5, I-14	30PW	C-16, C-17, C-18, C-19	458NP	N-7
VGfH15F	G-5, I-14	32B	A-22, B-22	460	N-7
VGfH20	G-5, I-14	38B	A-22, B-22	602	N-5
VGfH20F	G-5, I-14	39CH	J-9	604	N-1
VGfS15__MSP	G-6	49	A-20	609	N-5
WD3051BK	L-10	49-01	A-20	610	N-5
WD3052BK	L-10	49-2	A-20	659	N-1
WD3054BK	L-10	49-7	A-20	667	N-1
WD3055BK	L-10	49-8	A-20	669	N-1
WD3056BK	L-10	49-21	A-20	722	N-3
WD3059	L-10	49-81	A-20	731	N-4
WD3059-DDN	L-10	58	A-23, B-23	731-1	N-4
WD3059-DDW	L-10	60	A-23, B-23	731-2	N-4
WD3059-LLN	L-10	60W33	A-12, B-11	731-3	N-4
WD3059-SSN	L-10	60W33DPLX	A-12, B-11	732	N-4
WD3060BK	L-10	60W47	A-12, B-9	732-1	N-4
WD3061BK	L-10	60W47DPLX	A-12, B-9	732-3	N-4
WD3090F	L-10	60W48	A-14, B-15	734	N-4
WD3090F-DDN	L-10	60W48DPLX	A-14, B-15	805	A-22, B-22
WD3090F-DDW	L-10	60W49	A-14, B-13	815	A-21
WD3090F-LLN	L-10	60W49DPLX	A-14, B-13	816	A-21
WD3090F-SSN	L-10	63CR60	C-58	817	A-17
WD3099	L-10	63CR60EX	C-58	826	A-21
WD3099-DDN	L-10	63CR61	C-58	829	A-21
WD3099-DDW	L-10	63CR61EX	C-58	834	A-14
WD3099-LLN	L-10	63CR64	C-63	924W	N-3
WD3099-SSN	L-10	63CR64EX	C-63	968	N-6
WIU-1	K-6	63CR65	C-63	969	N-6
WIU-1D	K-6	63CR65EX	C-63	974	N-4
WIU-1DW	K-6	63CR69	C-63	974-2	N-4
WIU-1W	K-6	63CR70	C-58	1113	K-10
WIU-2	K-6	65W34	C-10	1114	K-10
WIU-2W	K-6	65W34DPLX	C-10	1115	K-10
WIUMH-1	K-5	65W47	C-8	1116	K-10
WIUMV-1	K-5	65W47DPLX	C-8	1117	K-10
WLRA1	K-3	65W49	C-9	1118	K-10
WLRD1	K-3	65W49DPLX	C-9	1156CG	H-7
WLRS1	K-3	67	A-19	1161CG	H-7
WLRS2	K-3	67-2	A-19	1162CG	H-7
WM115	B-8, B-10, B-12, B-14	67-31	A-20	1176V	H-7
WM116	B-8, B-10, B-12, B-14	68	J-9	1177CG	H-7
WP1	K-5	69	J-9	1205	D-8
WP2	K-5	74CM40	K-11	1208	H-6
WP2	L-3	77CR15	C-58, C-63	1209	H-6
WRBR15	A-18	83	A-22, B-22	1210	H-6
WRBR20	A-18	112	A-22, B-22	1212	A-23, B-23
WRVGF15	G-5	122B	A-22, B-22	1225	A-23, B-23
WRVGF20	G-5	124	N-3	1232	A-22, B-22
14W	B-8, B-10, B-12, B-14	125	A-22, B-22	1233	A-22, B-22
14W33	B-10	145	N-3	1234	A-22, B-22
14W47	B-8	153	J-18	1252	A-22, B-22
14W48	B-14	166	J-6	1253	A-22, B-22
14W49	B-12	192	J-9	1254	A-22, B-22

1257	A-23, B-23	2226	D-8	4049-2	A-20
1258	A-23, B-23	2231	J-18	4067	A-19
1263	A-22, B-22	2434	C-10	4067-01	A-19
1264	A-22, B-22	2447	C-8	4070-6	A-19
1433	B-10	2449	C-9	4132	J-10
1447	B-8	2500W	N-2	4134	J-10
1448	B-14	2501W	N-2	4137	J-10
1449	B-12	2503W	N-2	4138	J-10
1466Y	N-4	2504W	N-2	4139	J-10
1533	B-10	2506W	N-2	4150	J-10
1547	B-8	2507W	N-2	4170	J-10
1548	B-14	2509W	N-3	4171	J-10
1549	B-12	2510W	N-3	4227	B-17
1876	A-21	2534	C-10	4228	B-17
1877	A-17	2547	C-8	4229	B-17
1877BK	L-3	2549	C-9	4409	B-17
1895	D-8	2728	J-18	4409AN	B-17
1895L	D-8	2729	J-18	4509	B-17
1995	D-8	2731	J-17	4509AN	B-17
1995L	D-8	2741	J-17	4516AN	A-23, B-23
2028	J-14	2750	J-17	4524N	A-22, B-22
2029	J-14	2751	J-17	4524NFI	A-22, B-22
2031	J-12	2836	A-22, B-22	4526N	A-22, B-22
2032	J-11	3031	D-6	4700	C-8
2034	J-11	3031L	D-9	4721N	C-8
2037	J-14	3032	D-6	4721NCR	C-8
2038	J-15	3032L	D-9	4731N	C-8
2039	J-11	3032PL	D-7	4731NCR	C-8
2041	J-11	3033L	D-9	4734-2	N-4
2050	J-11	3034L	D-9	4750	C-10
2051	J-12	3330-2	C-26	4755	C-21
2052	J-12	3331N	C-26	4767	C-21
2053	J-15	3331PW	C-26	4767AN	C-21
2054	J-11	3331PY	C-26	4771N	C-10
2063	J-12	3333CW	C-26	4772N	C-10
2064	J-12	3333CY	C-26	4862	B-16
2068	J-9, J-15	3333N	C-26	4862ANW	B-16
2128	J-8	3333RW	C-26	4866	B-17
2129	J-7	3336N	C-26	4866AN	B-17
2131	J-5	3337N	C-26	4867	B-17
2132	J-5	3430	C-42	4867AN	B-17
2134	J-4	3431N	C-42	4867ANW	B-17
2137	J-7	3431PW	C-42	4882	B-16
2138	J-8	3431PY	C-42	4887	B-17
2139	J-4	3433CW	C-42	5068	J-15
2141	J-4	3433CY	C-42	5128	J-8
2142	J-17	3433N	C-42	5129	J-7
2144	J-17	3433RW	C-42	5131	J-5
2148	J-18	3434N	C-42	5132	J-5
2149	J-17	3436N	C-42	5134	J-4
2150	J-5	3521BK	C-46	5137	J-7
2151	J-6	3523BK	C-46	5138	J-8
2152	J-6	3524BK	C-46	5139	J-4
2153	J-8	3525BK	C-46	5141	J-4
2154	J-4	3762	C-61	5150	J-5
2155	J-4	3762EX	C-61	5151	J-6
2156	J-4	3763	C-61	5152	J-6
2157	J-8	3763EX	C-61	5153	J-8
2158	J-8	3764	C-66	5154	J-4
2159	J-8	3764EX	C-66	5158	J-8
2160	J-18	3765	C-66	5159	J-8
2161	J-18	3765EX	C-66	5169	J-9
2163	J-6	3767	C-61	5170	J-8
2164	J-6	3768	C-66	5171	J-8
2165	J-6	3769	C-66	5242	A-11
2168	J-9	3771	C-61	5246	B-9
2173	J-8	3775	C-66	5250_S	H-5
2174	J-9	3777	C-61	5251	A-11
2225	D-8	4049	A-19	5252	A-11

5261	A-10	5752AN	A-23, B-23	7410B	C-38
5262	A-16	5754N	A-23, B-23	7411C	C-38
5262_S	H-5	5759	A-23, B-23	7411PW	C-38
5262CR	A-12	5778C	B-11	7411PY	C-38
5266N	B-8	5779C	B-11	7413C	C-38
5266NCR	B-8	5792	C-8	7413CW	C-38
5266NHG	B-6, I-18	5795N	A-22, B-22	7413CY	C-38
5269N	B-8	5878C	B-15	7413RW	C-38
5269NCR	B-8	5879C	B-15	7420	K-3
5269NHG	B-6, I-18	5965BLK	B-8	7420A	K-3
5278	B-9	5969BLK	B-8	7420C	K-4
5278C	B-9	6080	K-10	7420CR	K-3
5279C	B-9	6250	A-17	7427N	C-53
5284	A-12	6252	A-17	7428N	C-53
5302	A-14	6262	A-10	7429N	C-53
5342	A-11	6265	B-8	7464N	C-53
5350_S	H-5	6265HG	B-6	7465N	C-53
5351	A-11	6265HGC	B-6, I-18	7466	C-53
5352	A-11	6266	B-8	7467	C-53
5361	A-10	6266BLK	B-8	7468	C-53
5362	A-16	6266HG	B-6, I-18	7479N	C-53
5362_S	H-5	6266HGC	B-6, I-18	7484	C-54
5362CR	A-12	6269	B-8	7485	C-54
5366N	B-10	6269BLK	B-8	7486	C-54
5366NCR	B-10	6269HG	B-6, I-18	7486N	C-54
5366NHG	B-6, I-18	6269HGC	B-6, I-18	7487	C-54
5369N	B-10	6342	A-11	7487N	C-54
5369NCR	B-10	6350	A-17	7506	C-6
5369NHG	B-6, I-18	6352	A-17	7540	C-6
5461	A-13	6362	A-10	7546	C-6
5462C	A-16	6405BK	C-31	7565N	C-21
5466N	B-14	6406BK	C-31	7567N	C-21
5469N	B-14	6450	A-21	7580	C-21
5484B	A-14	6462	A-13	7582	C-21
5515N	A-23, B-23	6565N	C-9	7593	C-54
5517N	A-23, B-23	6566N	C-9	7594	C-54
5661	A-13	6580	C-9	7595	C-54
5662C	A-16	6662	A-13	7595N	C-54
5666N	B-12	6665HG	B-7, I-19	7596	C-54
5669N	B-12	6665HGC	B-7, I-19	7596N	C-54
5678C	B-13	6666	B-12	7601	D-12
5679C	B-13	6669	B-12	7601AM	D-12, I-5
5700N	A-22, B-22	6700N	A-22, B-22	7603	D-12
5701AN	A-22, B-22	6709N	A-22, B-22	7603AM	D-12, I-5
5701N	A-22, B-22	6711N	A-22, B-22	7604	D-12
5701NFI	A-22, B-22	6716N	A-22, B-22	7604AM	D-12, I-5
5703AN	A-22, B-22	6765HG	B-6, I-18	7621	D-12
5703N	A-22, B-22	6765HGC	B-6, I-18	7621AM	D-12, I-5
5703NFI	A-22, B-22	6766	B-10	7622	D-12
5705AN	A-22, B-22	6766HG	B-6, I-18	7622AM	D-12, I-5
5705N	A-22, B-22	6769	B-10	7623	D-12
5705NFI	A-22, B-22	6769HG	B-6, I-18	7623AM	D-12, I-5
5709N	A-22, B-22	6795N	A-22, B-22	7624	D-12
5710AN	A-22, B-22	6796N	A-22, B-22	7624AM	D-12, I-5
5710N	A-22, B-22	6865HG	B-7, I-19	7624N	B-16
5710NFI	A-22, B-22	6865HGC	B-7, I-19	7631	D-13
5712AN	A-22, B-22	6866	B-14	7631AM	D-13, I-5
5712N	A-22, B-22	6869	B-14	7633	D-13
5712NFI	A-22, B-22	7251N	B-16	7633AM	D-13, I-5
5716N	A-22, B-22	7310B	C-22	7634	D-13
5717AN	A-22, B-22	7314C	C-22	7634AM	D-13, I-5
5717N	A-22, B-22	7314CW	C-22	7641	D-13
5717NFI	A-22, B-22	7314CY	C-22	7643	D-13
5732AN	A-23, B-23	7314RW	C-22	7716	K-11
5734	A-12	7327N	C-22	7717	K-11
5741NS	K-4	7328N	C-22	7728	D-15
5744N	A-23, B-23	7379	C-67	7729	D-15
5745N	A-23, B-23	7408N	C-38	7730	D-15
5746N	A-23, B-23	7409N	C-38	7731	D-15

7732	D-15	23000G	C-72	93154	J-7
7764	C-67	23002N	C-72	93154AM	I-7, J-7
7764EX	C-67	23005N	C-72	93223	J-9
7765	C-67	23032N	C-72	93227	J-9
7765EX	C-67	23035N	C-72	93228	J-9
7770	K-4	23050	C-70, I-21	9337N	A-22, B-22
7788BK	K-4, L-3	23054	C-70, I-21	9337NFI	A-22, B-22
7788CR	K-4	23054N	C-70, I-21	93401	J-6
7788GY	K-4	23056	C-70, I-21	93401AM	I-6, J-6
7952AN	A-22, B-22	23056N	C-70, I-21	93402	J-6
7958	C-67	25250	C-76	93402AM	I-6, J-6
7968	C-67	25403	C-76	93403	J-6
7985N	A-22, B-22	25414	C-76	93403AM	I-6, J-6
8115GY	B-6, I-18	25414N	C-76	93404	J-6
8200	A-7, I-11	25415	C-76	93404AM	I-6, J-6
8200_S	H-5, I-14	25415N	C-76	93405	J-6
8210	A-6, I-10	25505	C-70, I-21	93406	J-6
8210M	A-7, I-11	25509	C-70, C-71, I-21, I-22	9341N	A-22, B-22
8262	A-6, I-10	25525	C-70, I-21	93432	J-8
8262LT	A-6, I-10	25605	C-71, I-22	93443	J-8
8300	A-7, I-11	25625	C-71, I-22	93512	J-8
8300_S	H-5, I-14	26040	C-78	9352AN	A-22, B-22
8310	A-6, I-10	26400	C-78	93532	J-8
8310M	A-7, I-11	26401	C-78	93543	J-8
8332AN	A-23, B-23	26402	C-78	93554	J-9
8332N	A-23, B-23	26414	C-75	93591	J-8
8352AN	A-23, B-23	26414A	C-75	93630	J-7
8352N	A-23, B-23	26415	C-75	93631	J-7
8362	A-6, I-10	26415A	C-75	93696	J-8
8362LT	A-6, I-10	26415S	C-75	93801	J-17
8410	A-8, I-12	26420	C-75	93802	J-17
8430N	A-23, B-23	26421	C-75	93834	J-17
8432AN	A-23, B-23	26426	C-75	93851	J-18
8432N	A-23, B-23	26426S	C-75	93852	J-18
8450N	A-23, B-23	26427	C-75	93871	J-17
8452AN	A-23, B-23	26514	C-77	93872	J-17
8452N	A-23, B-23	26514A	C-77	93873	J-17
8460N	A-23, B-23	26515	C-77	93874	J-17
8610	A-8, I-12	26515A	C-77	93891	J-17
9151N	A-22, B-16, B-22	26515AM	C-77	93896	J-18
9460N	A-23, B-23	26520	C-77	93901	J-11
9462AN	A-23, B-23	26521	C-77	93902	J-11
9462N	A-23, B-23	26526	C-77	93932	J-15
9965C	C-22	26527	C-77	93934	J-12
9965PW	C-22	93071	J-4	93935	J-12
9965PY	C-22	93071AM	I-6, J-4	93936	J-12
20403N	C-73	93072	J-4	93937	J-15
20414	C-73	93072AM	I-6, J-4	93951	J-14
20414N	C-73	93073	J-4	93971	J-11
20415	C-73	93073AM	I-6, J-4	93972	J-11
20415N	C-73	93074	J-4	93973	J-11
20415S	C-73	93074AM	I-6, J-4	93991	J-12
20416D	C-78, K-4	93075	J-4	93996	J-14
20416N	C-78, K-4	93076	J-4	94071	J-4
20417N	C-78	93091	J-5	94072	J-4
20418	C-73	93091AM	I-6, J-5	94073	J-4
20443N	C-74	93101	J-5	94091	J-5
20444	C-74	93101AM	I-6, J-5	94101	J-5
20444N	C-74	93102	J-5	94102	J-5
20445	C-74	93102AM	I-6, J-5	94151	J-7
20445N	C-74	93103	J-5	94401	J-6
20446N	C-78, K-4	93103AM	I-6, J-5	94402	J-6
21414	C-73	93111	J-9	94432	J-8
21415	C-73	93151	J-7	94532	J-8
21426	C-73	93151AM	I-7, J-7		
21426S	C-73	93152	J-7		
21434	C-73	93152AM	I-7, J-7		
21447	C-73	93153	J-7		
23000	C-72	93153AM	I-7, J-7		

The entire Cooper Wiring Device product line at your fingertips

www.CooperWiringDevices.com

Commercial
& Industrial

Residential Data
& Electrical

Lighting
Controls

ARROW/HART™

COOPER Wiring Devices

CORE



C3 - Cooper Customer Center
Check inventory, orders and pricing. The C3 Distributor Solutions Center provides up to the minute access to orders and product availability.



Access Literature and Specification Information
You'll find the latest product updates, literature and easy to use specification tools.

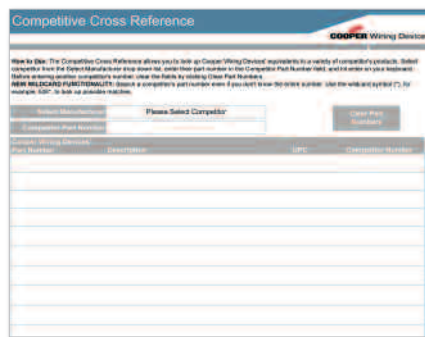

Cross Catalog Numbers
The Cooper Competitor Cross Reference allows you to look up CWD equivalents to a variety of competitors' products.



Find Your Local CWD Supplier
A full database of Cooper Wiring Devices suppliers can be quickly searched for your specific area.



United States

Cooper Wiring Devices
203 Cooper Circle
Peachtree City, GA 30269
P: 866-853-4293
F: 800-329-3055

www.cooperwiringdevices.com

Canada

Cooper Wiring Devices
5925 McLaughlin Road
Mississauga, Ontario, L5R 1B8
P: 800-267-1042
F: 800-761-5748

Mexico

Carr. Tlalnepantla –
Cuautitlan Km 17.8 s/n
Col. Villa Jardin esq.
Cerrada 8 de Mayo
Cuautitlan, Mexico CP 54800
P: +525558999190
F: +525526207116

www.cooperwiringdevices.com.mx

Arrow Hart, ArrowLink, AutoGrip, Change-Out, Cooper Wiring Devices, Hart-Lock, LynxPower, Micro-Mini, Mini-Line, Pico-Line, Power-Lock, PowerTrip, Pro-Grip, Quick Grip, REPEL, RhinoBox, Screw-Catch, Safety Grip, ShockSentry, SOFTPower, SurgeBloc, WeatherBox and X-Switch are trademarks of Cooper Industries, Inc. ©2010 Cooper Industries, Inc.

Your Authorized Cooper Wiring Devices Distributor is:

Cooper Industries, plc.
600 Travis, Ste. 5600
Houston, TX 77002-1001
P: 713-209-8400
www.cooperindustries.com

9-AHBG-10

 **COOPER** Wiring Devices