



FREDRICK RAMOND





# FREDRICK RAMOND

EXPERIENCE THE EXCITING DESIGNS AND UNIQUE DETAILS THAT FREDRICK RAMOND IS KNOWN FOR. CONCEIVED WITH AN ARTISAN SENSE OF CRAFTSMANSHIP, THE MODERN STYLES COMBINE UNEXPECTED MATERIALS AND CUTTING EDGE TECHNOLOGY.

## THE COLLECTIONS

ALEXANDRA	260	LUXE	316
AVA	300	MIDDLEFIELD	296
BARCELONA	270	MIME	262
BENTLEY	284	MONDO	242
BIJOU	258	MONTEREY	280
BROADWAY	252	MUSE	278
CALISTA	250	NEST	289
CAMERON	292	OMNI	240
CARABEL	273	PANDORA	286
CASPIA	268	PROSECCO	256
CELESTE	276	QUATTRO	247
FRANCESCA	266	RENATA	298
GLOBE	312	SPECTRA	310
HAMLET	294	STRATUS	313
ION	248	VIVO	314
JASPER	302	XANADU	254
KARMA	244	ZEN	304
KINGSLEY	282		
LOFT	308	ACCESSORIES	318

# OMNI™

THE MODERN, MINIMAL STYLE OF OMNI FEATURES A UNIQUE FOUR-SIDED STEM HUNG DESIGN WITH WIDE SLOPING ARMS IN A CRISP POLISHED NICKEL FINISH. THE SQUARE ETCHED OPAL GLASS CLIPS INTO A CAST FITTER THAT SITS ON TOP OF THE LARGE, SLANTED RECTANGULAR ARM, CREATING A STRIKING SILHOUETTE.

## FR47200PNI

4.5" W, 7" H, 4" EXT.  
4.5" W, 6.75" H BACK PLATE  
3.75 TTO  
1-60W G9  
ADA Compliant

## FR47201PNI

16" W, 11.75" H  
5" SQUARE CANOPY  
4-60W G9

## FR47204PNI

19" W, 18.75" H  
67.375" MAX. HEIGHT\*  
5" SQUARE CANOPY  
4-60W G9

## FR47206PNI

40" W, 20.75" H  
69.75" MAX. HEIGHT\*  
5" SQUARE CANOPY  
6-60W G9

## FR47208PNI

26" W, 20.125" H  
68.75" MAX. HEIGHT\*  
5" SQUARE CANOPY  
8-60W G9

## FR47209PNI

36" W, 22.375" H  
71" MAX. HEIGHT\*  
5" SQUARE CANOPY  
12-60W G9

*Omni stem hung fixtures are provided with 10' of wire and the following stems : (1) 4", (1) 6", (1) 12" and (1) 24"*

*\*Maximum achievable height with stems included. Additional 12" stems are available : **FR86212PNI***

*Bulbs included. Bulb specifications indicate maximum wattage.*



Omni Bath fixtures are also available.  
See page 335

FR47209PNI [ 36" W, 22.375" H ]



FR47208PNI [ 26" W, 20.125" H ]

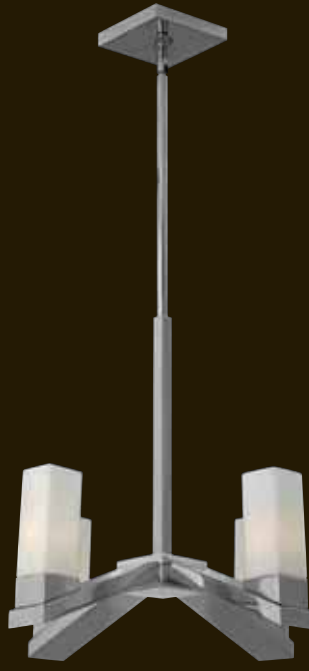

FR47204PNI [ 19" W, 18.75" H ]

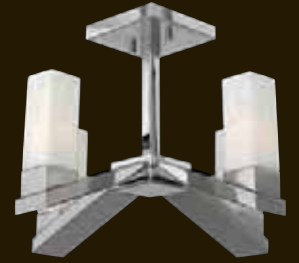

F4720IPNI [ 16" W, 11.75" H ]



FR47200PNI [ 4.5" W, 7" H ]



FR47206PNI [ 40" W, 19.75" H ]

## OMNI™

THE MODERN, MINIMAL STYLE OF OMNI FEATURES A UNIQUE FOUR-SIDED STEM HUNG DESIGN WITH WIDE SLOPING ARMS IN A CRISP POLISHED NICKEL FINISH. THE SQUARE ETCHED OPAL GLASS CLIPS INTO A CAST FITTER THAT SITS ON TOP OF THE LARGE, SLANTED RECTANGULAR ARM, CREATING A STRIKING SILHOUETTE.

# MONDO™

MONDO'S DARING, INTERSECTING SPHERES ENCOMPASS BOLD ARM EXTENSIONS IN A BRILLIANT POLISHED CHROME FINISH. THE FROSTED CUBE-SHAPED GLASS PROVIDES AN ELEMENT OF SOFTNESS TO THIS CONTEMPORARY COLLECTION.

**FR49292PCM**

10.5" W, 20" H, 5.5" EXT.  
4.5" W, 9" H BACK PLATE  
10" TTO  
2-60W G9

*Mondo chandeliers are provided with 12' of wire and 10' of cable.*

*Bulbs included. Bulb specifications indicate maximum wattage.*

**FR49293PCM**

18" DIA., 20.25" H  
7" DIA. CANOPY  
3-60W G9

**FR49296PCM**

22.25" DIA., 23.75" H  
7" DIA. CANOPY  
6-60W G9

**FR49298PCM**

28.25" DIA., 31" H  
7" DIA. CANOPY  
8-60W G9

**FR49299PCM**

36" DIA., 38.75" H  
7" DIA. CANOPY  
12-40W G9



FR49299PCM [ 36" DIA., 38.75" H ]

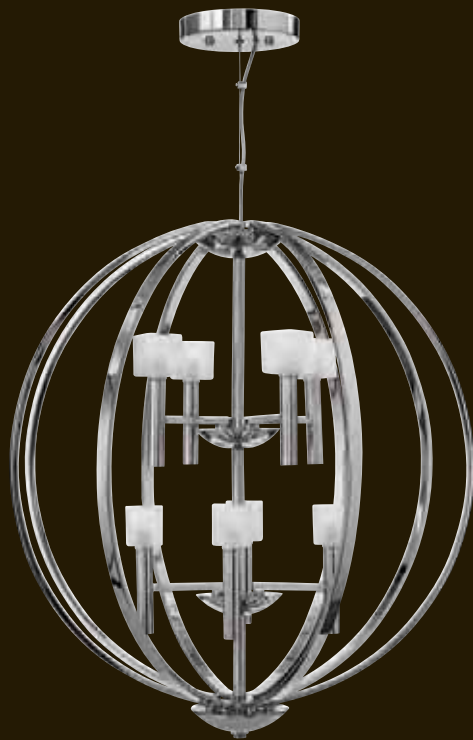

FR49298PCM [ 28.25" DIA., 31" H ]



FR49296PCM [ 22.25" DIA., 23.75" H ]

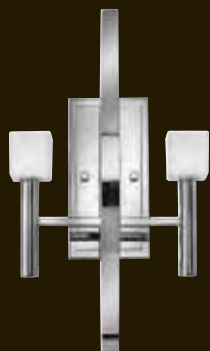

FR49292PCM [ 10.5" W, 20" H ]



FR49293PCM [ 18" DIA., 20.25" H ]

## MONDO™

MONDO'S DARING, INTERSECTING SPHERES ENCOMPASS BOLD ARM EXTENSIONS IN A BRILLIANT POLISHED CHROME FINISH. THE FROSTED CUBE-SHAPED GLASS PROVIDES AN ELEMENT OF SOFTNESS TO THIS CONTEMPORARY COLLECTION.

# KARMA™

KARMA'S MODERN EUROPEAN DESIGN IS CONSTRUCTED FROM LIGHT WEIGHT DIE CAST ALUMINUM. THE UNIQUE ARM DESIGN FEATURES UP AND DOWN LAMPING, COMPLEMENTED BY A CHIC POLISHED ALUMINUM FINISH.

## FR41947PAL

18.25" DIA., 5.75" H  
4.75" DIA. CANOPY  
3-60W CANDELABRA  
Shown with G16½ bulbs.

Invisible mounting hardware

*\*Maximum achievable height with stems included. Additional 12" stems are available : FR86069PAL*

*Bulb specifications indicate maximum wattage.*

## FR41948PAL

30.75" DIA., 11.75" H  
43" MAX. HEIGHT\*  
4.75" DIA. CANOPY  
18-60W CANDELABRA  
Shown with G16½ bulbs.

## FR41949PAL

30.25" DIA., 18.75" H  
50" MAX. HEIGHT\*  
4.75" DIA. CANOPY  
24-60W CANDELABRA  
Shown with G16½ bulbs.

## FR41950PAL

18" DIA., 25.5" H  
56.75" MAX. HEIGHT\*  
4.75" DIA. CANOPY  
24-60W CANDELABRA  
Shown with G16½ bulbs.

*Karma stem hung fixtures are provided with 10' of wire and the following stems : (1) 4", (1) 6", (1) 12", and (1) 18"*

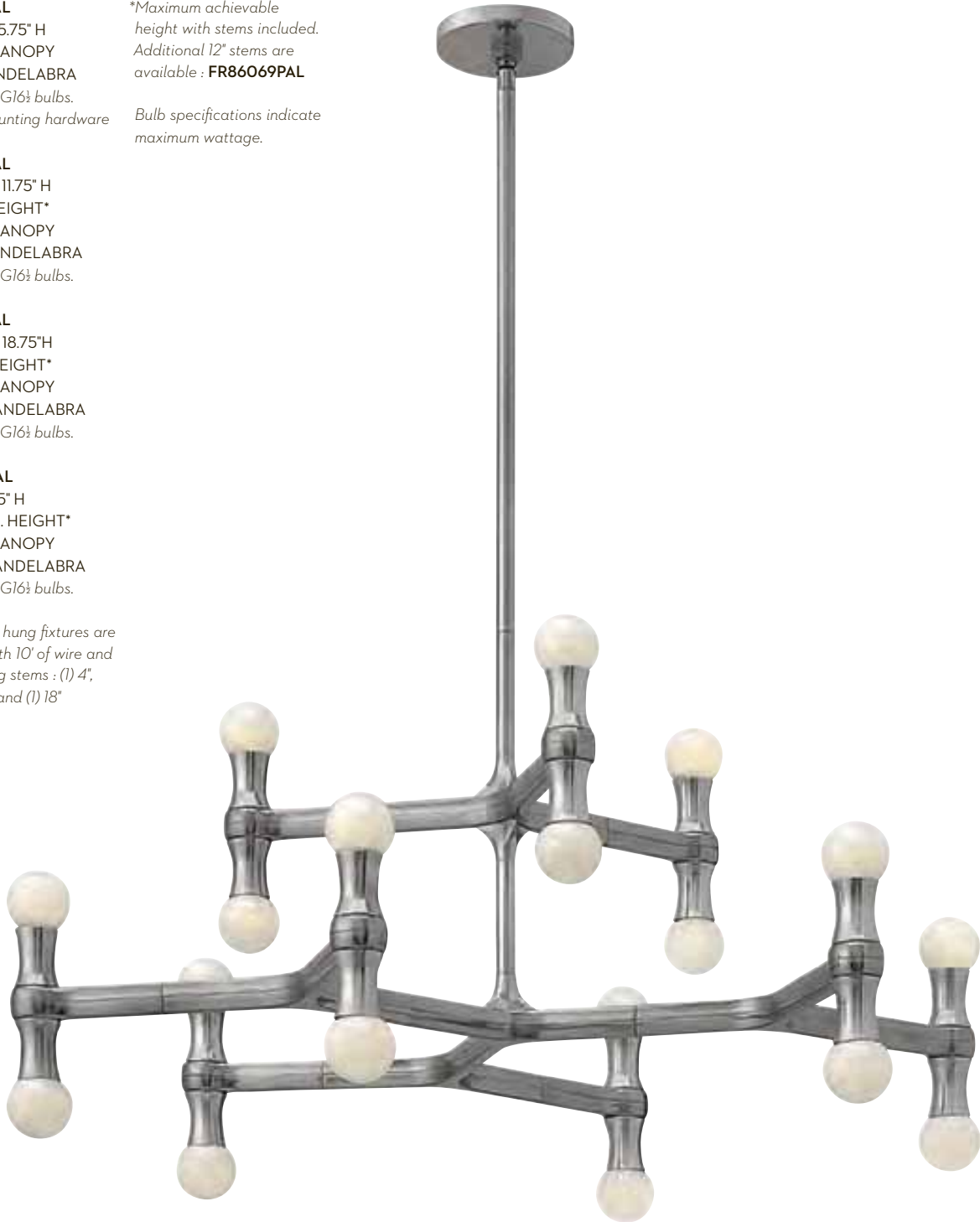

FR41948PAL [ 30.75" DIA., 11.75" H ]



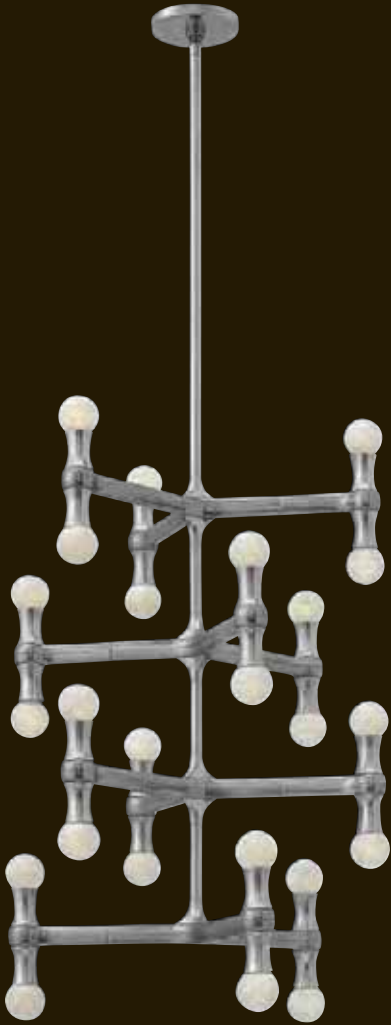

FR41950PAL [ 18" DIA., 25.5" H ]



FR41949PAL [ 30.25" DIA., 18.75" H ]



FR41947PAL [ 18.25" DIA., 5" H ]

## KARMA™

KARMA'S MODERN EUROPEAN DESIGN IS CONSTRUCTED FROM LIGHT WEIGHT DIE CAST ALUMINUM. THE UNIQUE ARM DESIGN FEATURES UP AND DOWN LAMPING, COMPLEMENTED BY A CHIC POLISHED ALUMINUM FINISH.

**FR41941PAL**

5" W, 5" H, 4" EXT.  
5" DIA. BACK PLATE  
2.5" TTO  
2-60W CANDELABRA  
Shown with G16½ bulbs.  
Invisible mounting hardware  
ADA Compliant

**FR41942PAL**

16" W, 5" H, 8.25" EXT.  
4.5" DIA. BACK PLATE  
2.5" TTO  
4-60W CANDELABRA  
Shown with G16½ bulbs.  
Invisible mounting hardware  
ADA Compliant

**FR41943PAL**

18.5" W, 5" H  
36.25" MAX. HEIGHT\*  
4.75" DIA. CANOPY  
6-60W CANDELABRA  
Shown with G16½ bulbs.

**FR41946PAL**

30.25" DIA., 5" H  
36.25" MAX. HEIGHT\*  
4.75" DIA. CANOPY  
12-60W CANDELABRA  
Shown with G16½ bulbs.

*Karma stem hung fixtures are provided with 10' of wire and the following stems : (1) 4", (1) 6", (1) 12", and (1) 18"*

*\*Maximum achievable height with stems included. Additional 12" stems are available : FR86069PAL*

*Bulb specifications indicate maximum wattage.*

**KARMA™**

KARMA'S MODERN EUROPEAN DESIGN IS CONSTRUCTED FROM LIGHT WEIGHT DIE CAST ALUMINUM. THE UNIQUE ARM DESIGN FEATURES UP AND DOWN LAMPING, COMPLEMENTED BY A CHIC POLISHED ALUMINUM FINISH.



FR41946PAL [ 30.25" DIA., 5" H ]



MOUNTED AS A SEMI-FLUSH



SCONCE  
FR41941PAL [ 5" W, 5" H ]

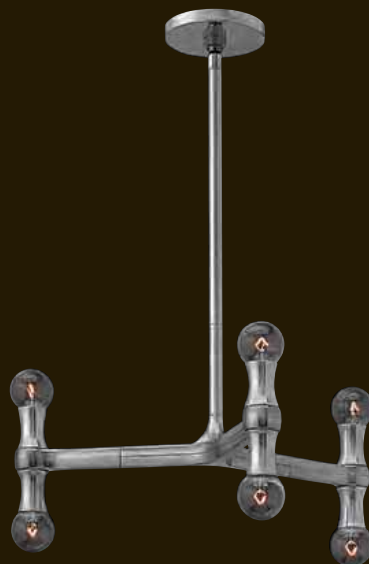

SHOWN WITH CLEAR BULBS  
FR41943PAL [ 18.5" W, 5" H ]



FR41942PAL [ 17" W, 5" H ]

# QUATTRO™

QUATTRO IS MASCULINE YET ELEGANT, WITH GENEROUSLY SCALED METALWORK IN A BRUSHED NICKEL FINISH. THE RECTANGULAR CAPTURED HARDBACK HARVEST SHADES REINFORCE THE STRUCTURED ELEMENTS OF THIS MODERN COLLECTION.



## FR49450BNI

12" W, 15.75" H, 8.25" EXT.  
5.5" W, 11.75" H BACK PLATE  
7" TTO  
1-75W MEDIUM

## FR49454BNI

25.75" DIA., 20" H  
7.25" DIA. CANOPY  
4-75W MEDIUM

## FR49458BNI

41.5" DIA, 28.25" H  
7.25" DIA. CANOPY  
8-75W MEDIUM

*Quattro chandeliers are provided with 12' of wire and 10' of chain.*

*Bulb specifications indicate maximum wattage.*

FR49458BNI [ 41.5" DIA., 28.25" H ]



FR49454BNI [ 25.75" DIA., 20" H ]



FR49450BNI [ 12" W, 15.75" H ]

# ION™

ION'S UNIQUE HAND-CRAFTED, EXPANDABLE DESIGN FEATURES A MODERN, COILED ALUMINUM WIRE. OFFERED IN 3 LUXE FINISHES (ANODIZED SILVER, ANODIZED GOLD AND ANODIZED BLACK), THIS FIXTURE FEATURES CANDELABRA BASE SOCKETS THAT CAN ACCEPT CANDELABRA, G16 OR KRYPTON LAMPS.

## FR36501ANB

21" DIA., 11" H  
5" DIA. CANOPY  
4-60W CANDELABRA  
*Invisible mounting hardware*

## FR36501ANG

21" DIA., 11" H  
5" DIA. CANOPY  
4-60W CANDELABRA  
*Invisible mounting hardware*

## FR36501ANS

21" DIA., 11" H  
5" DIA. CANOPY  
4-60W CANDELABRA  
*Invisible mounting hardware*

## FR36504ANB

22" - 28" DIA.  
(MATERIAL EXPANDS)  
6.25" DIA. CANOPY  
6-60W CANDELABRA

## FR36504ANG

22" - 28" DIA.  
(MATERIAL EXPANDS)  
6.25" DIA. CANOPY  
6-60W CANDELABRA

## FR36504ANS

22" - 28" DIA.  
(MATERIAL EXPANDS)  
6.25" DIA. CANOPY  
6-60W CANDELABRA

*Ion chandeliers are provided with 10' of wire.*

*Bulb specifications indicate maximum wattage.*

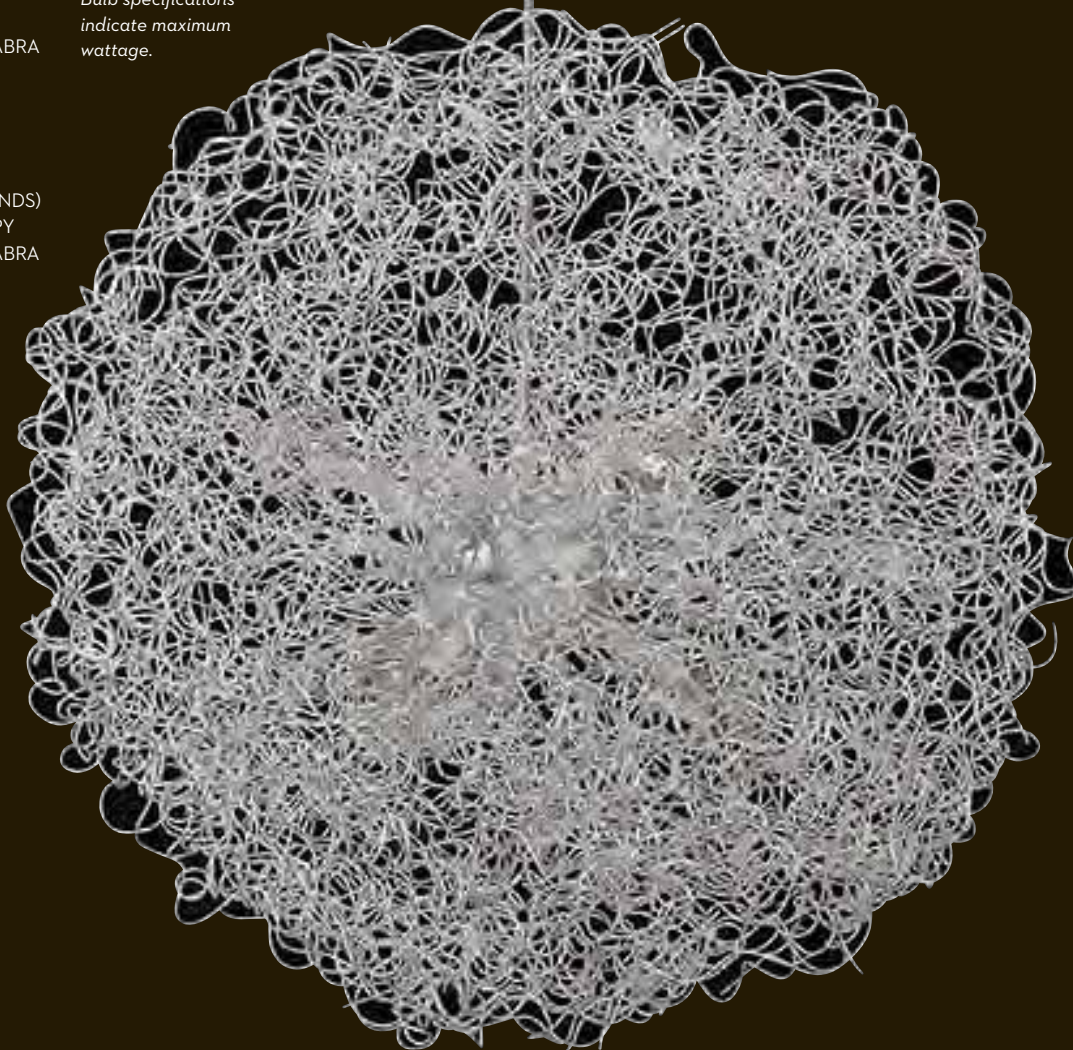

FR36504ANS [ 22" - 28" DIA. ]

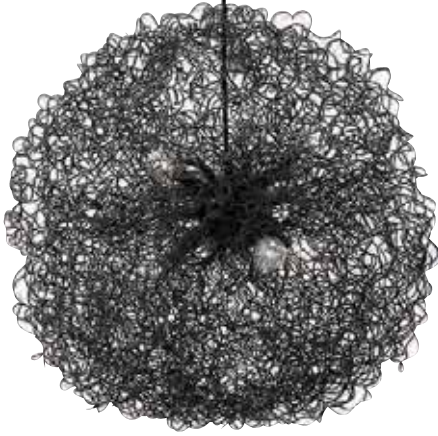

FR36504ANB [ 22" - 28" DIA. ]



FR36504ANG [ 22" - 28" DIA. ]

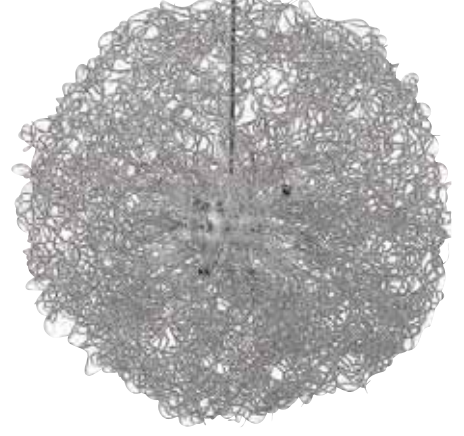

FR36504ANS [ 22" - 28" DIA. ]

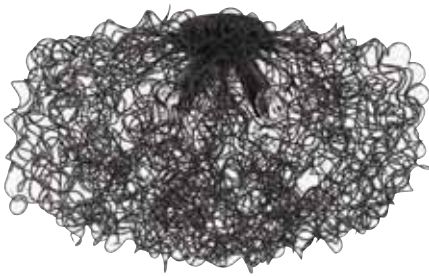

(CEILING MOUNT)  
FR36501ANB [ 21" DIA., 11" H ]

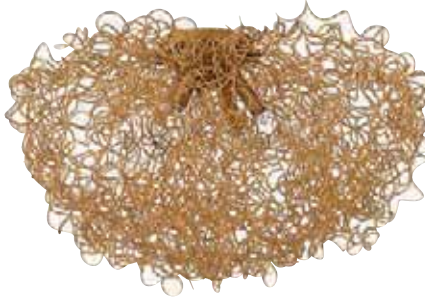

(CEILING MOUNT)  
FR36501ANG [ 21" DIA., 11" H ]

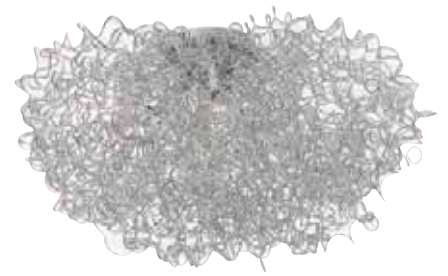

(CEILING MOUNT)  
FR36501ANS [ 21" DIA., 11" H ]



(WALL MOUNT SIDE VIEW)  
FR36501ANB [ 21" W, 21" H, 11" EXT. ]



(WALL MOUNT)  
FR36501ANG [ 21" W, 21" H, 11" EXT. ]

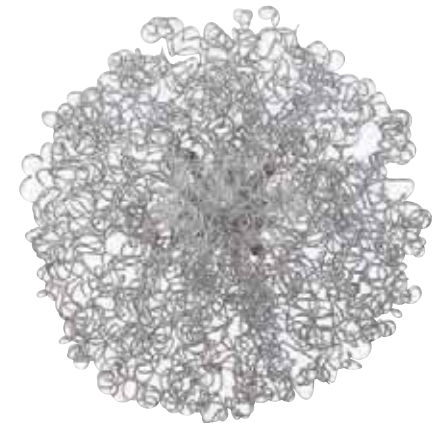

(WALL MOUNT)  
FR36501ANS [ 21" W, 21" H, 11" EXT. ]

# CALISTA™

CALISTA'S MODERN DESIGN REPRESENTS A DELICATELY DECONSTRUCTED FLOWER BOUQUET. THE PETITE 3/8" ARMS WITH ELONGATED BEVELED ENDS RESEMBLE ELEGANT STEMS WITH CAPTURED ETCHED OPAL GLASS AT THE TIPS.

## FR40100BNI

8.75" W, 25" H, 5.25" EXT.  
5.25" DIA. BACK PLATE  
16" TTO  
2-60W G9

## FR40102BNI

8.75" W, 25" H, 5.25" EXT.  
5.25" DIA. BACK PLATE  
16" TTO  
2-60W G9

## FR40103BNI

18.75" DIA., 19.25" H  
60.25" MAX. HEIGHT\*  
(2) 6" AND (3) 12" STEMS  
5.25" DIA. CANOPY  
3-60W G9

## FR40106BNI

29" DIA., 25.75" H  
58.75" MAX. HEIGHT\*  
(1) 6", (2) 12" AND (1) 18" STEMS  
5.25" DIA. CANOPY  
6-60W G9

## FR40108BNI

33" DIA., 34.75" H  
84.25" MAX. HEIGHT\*  
(1) 6", (2) 12", (1) 18" AND  
(2) 24" STEMS  
5.25" DIA. CANOPY  
9-60W G9

*Calista chandeliers are provided with 10' of wire.*

*\*Maximum achievable height with stems included. Additional 12" stems are available : **FR84312BNI***

*Bulbs included. Bulb specifications indicate maximum wattage.*



FR40108BNI [ 33" DIA., 34.75" H ]



FR40106BNI [ 29" DIA., 25.75" H ]

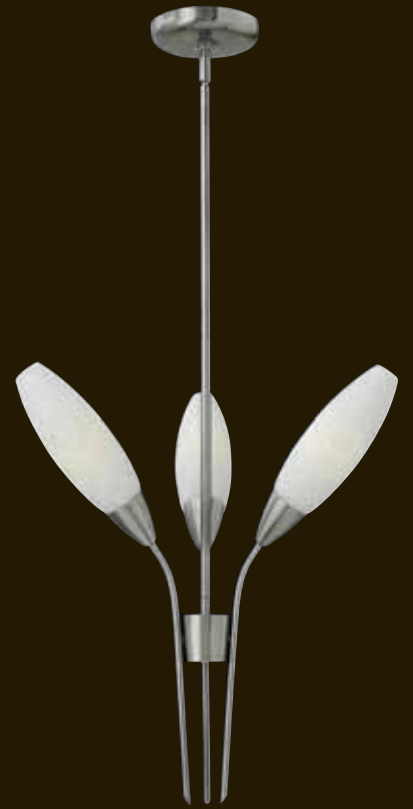

FR40103BNI [ 18.75" DIA., 19.25" H ]



FR40100BNI [ 8.75" W, 25" H ]



FR40102BNI [ 8.75" W, 25" H ]

## CALISTA™

CALISTA'S MODERN DESIGN REPRESENTS A DELICATELY DECONSTRUCTED FLOWER BOUQUET. THE PETITE 3/8" ARMS WITH ELONGATED BEVELED ENDS RESEMBLE ELEGANT STEMS WITH CAPTURED ETCHED OPAL GLASS AT THE TIPS.

# BROADWAY™

THIS SLEEK CONTEMPORARY CABLE HUNG COLLECTION IN POLISHED ALUMINUM FEATURES LOW-PROFILE CIRCULAR LIGHT PODS WITH ETCHED GLASS DIFFUSERS. DETAILED MESH UPLIGHT DIFFUSERS ADD SOPHISTICATION TO THE CHIC DESIGN.

## FR41430PAL

8" W, 5.25" H, 9" EXT.  
4.5" DIA. BACK PLATE  
4" TTO  
1-60W G9

## FR41431PAL

8" W, 8.5" H, 5.25" EXT.  
8" DIA. BACK PLATE  
4" TTO  
1-60W G9

## FR41433PAL

18.75" W, 2.25" H  
5.25" DIA. CANOPY  
3-60W G9

## FR41434PAL

24.25" W, 3.25" H  
7.5" DIA. CANOPY  
7-60W G9

## FR41435PAL

40.5" W, 3.25" H, 8" D  
7.5" DIA. CANOPY  
5-60W G9

## FR41436PAL

8" W, 8.5" H, 2.25" D  
52.75" MAX. HEIGHT\*  
4.5" DIA. CANOPY  
1-60W G9

## FR41439PAL

8" W, 3.25" H  
113" MAX. HEIGHT\*  
5.25" DIA. CANOPY  
1-60W G9

## FR41437PAL

8" W, 3" H  
47.5" MAX. HEIGHT\*  
4.5" DIA. CANOPY  
1-60W G9

*Broadway cable hung fixtures are provided with 12' of wire and 10' of cable.*

*Broadway stem hung fixtures are provided with 10' of wire the following stems : (1) 6" and (3) 12"*

*\*Maximum achievable height with stems included. Additional 12" stems are available.*

## FR84312PAL

*Bulbs included. Bulb specifications indicate maximum wattage.*



FR41434PAL [ 24.25" W, 3.25" H ]



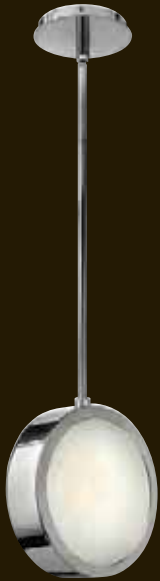

FR41436PAL [ 8" W, 8.5" H ]

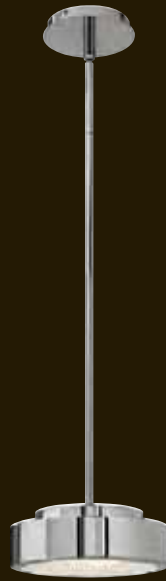

FR41437PAL [ 8" W, 3" H ]

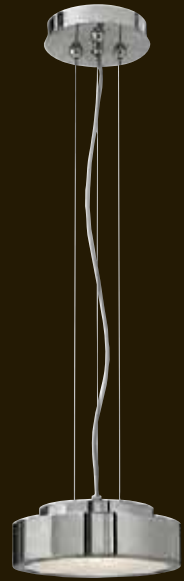

FR41439PAL [ 9" W, 3.25" H ]

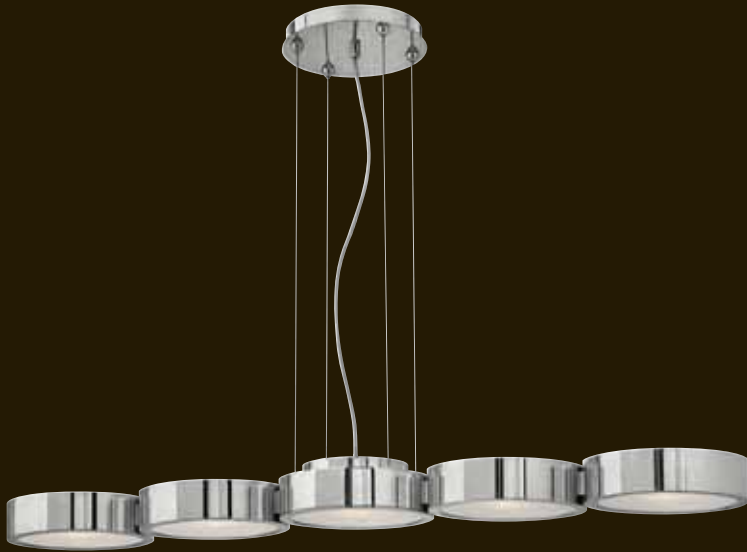

FR41435PAL [ 40.5" W, 3.25" H, 8" D ]

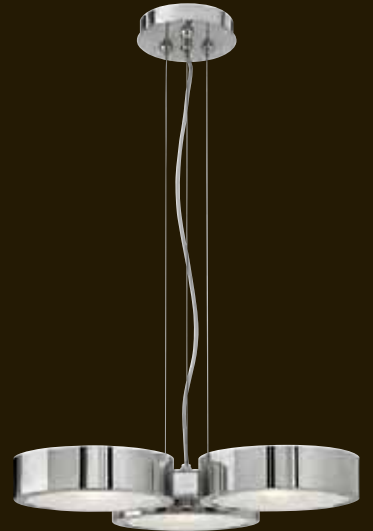

FR41433PAL [ 18.75" W, 2.25" H ]



ROTATING SCONCE  
FR41430PAL [ 8" W, 5.25" H ]



SCONCE MOUNTS WALL OR CEILING  
FR41431PAL [ 8" W, 8.5" H ]

**BROADWAY™**  
THIS SLEEK CONTEMPORARY CABLE HUNG COLLECTION IN POLISHED ALUMINUM FEATURES LOW-PROFILE CIRCULAR LIGHT PODS WITH ETCHED GLASS DIFFUSERS. DETAILED MESH UPLIGHT DIFFUSERS ADD SOPHISTICATION TO THE CHIC DESIGN.

# XANADU™

XANADU TAKES THE TRADITIONAL CHANDELIER DESIGN AND UPDATES IT INTO A UNIQUELY MODERN VERSION. THE BRILLIANT POLISHED STAINLESS STEEL FINISH AND CLEAR CRYSTAL ACCENTS CREATE LAYERS OF DIMENSION FOR A CONTEMPORARY TWIST.

## FR43351PSS

34.75" DIA., 25.25" H  
8.125" DIA. CANOPY  
12-60W CANDELABRA

## FR43352PSS

30.5" DIA., 39.5" H  
8.125" DIA. CANOPY  
12-60W CANDELABRA

## FR43354PSS

27" DIA., 23" H  
6.25" DIA. CANOPY  
6-60W CANDELABRA

## FR43355PSS

18" W, 20.5" H, 7" EXT.  
6.25" DIA. BACK PLATE  
14" TTO  
2-60W CANDELABRA

## FR43358PSS

41" DIA., 42.25" H  
8.125" DIA. CANOPY  
9-60W CANDELABRA  
*Fixture exceeds 50lbs.*

## FR43359PSS

14.75" DIA., 16" H  
6.25" DIA. CANOPY  
5-60W CANDELABRA

*Xanadu chandeliers are provided with 12' of wire and 10' of chain.*

*Bulb specifications indicate maximum wattage.*



FR43358PSS [ 41" DIA., 42.25" H ]



FR43351PSS [ 34.75" DIA., 25.25" H ]



FR43355PSS [ 18" W, 20.5" H ]



FR43359PSS [ 14.75" DIA., 16" H ]



FR43354PSS [ 27" DIA., 23" H ]



FR43352PSS [ 30.5" DIA., 39.5" H ]

## XANADU™

XANADU TAKES THE TRADITIONAL CHANDELIER DESIGN AND UPDATES IT INTO A UNIQUELY MODERN VERSION. THE BRILLIANT POLISHED STAINLESS STEEL FINISH AND CLEAR CRYSTAL ACCENTS CREATE LAYERS OF DIMENSION FOR A CONTEMPORARY TWIST.

# PROSECCO™

PROSECCO FEATURES A WHIMSICAL DESIGN IN A RENAISSANCE COPPER FINISH WITH DELICATE HAND-BLOWN GLASS ORNAMENTS, CRYSTAL BEADS AND IVORY HAND-SEWN PLEATED SHADES.

**FR49430RCO**

12.5" W, 22.25" H, 5.5" EXT.  
7.5" W, 5.25" H BACK PLATE  
13" TTO  
2-60W CANDELABRA

**FR49432RCO**

17" DIA., 19" H  
7" DIA. CANOPY  
3-60W MEDIUM  
*Etched glass diffuser*

**FR49433RCO**

24" DIA., 25" H  
7" DIA. CANOPY  
3-60W CANDELABRA

**FR49434RCO**

23.25" DIA., 31" H  
7" DIA. CANOPY  
3-60W MEDIUM  
*Etched glass diffuser*

**FR49435RCO**

29.5" DIA., 28" H  
7" DIA. CANOPY  
5-60W CANDELABRA

**FR49437RCO**

48.5" W, 27.75" H, 12.5" D  
4.5" W, 12" L CANOPY  
3-75W MEDIUM  
*Etched glass diffuser*

**FR49438RCO**

38.5" DIA., 33" H  
7" DIA. CANOPY  
9-60W CANDELABRA

*Prosecco chandeliers are provided with 12' of wire and 10' of chain.*

*Bulb specifications indicate maximum wattage. G16½ bulbs recommended.*



FR49438RCO [ 38.5" DIA., 33" H ]



FR49433RCO [ 24" DIA., 25" H ]



FR49435RCO [ 29.5" DIA., 28" H ]



FR49434RCO [ 23.25" DIA., 31" H ]



FR49437RCO [ 48.5" W, 27.75" H, 12.5" D ]



FR49432RCO [ 17" DIA., 19" H ]



FR49430RCO [ 12.5" W, 22.25" H ]

## PROSECCO™

PROSECCO FEATURES A WHIMSICAL DESIGN IN A RENAISSANCE COPPER FINISH WITH DELICATE HAND-BLOWN GLASS ORNAMENTS, CRYSTAL BEADS AND IVORY HAND-SEWN PLEATED SHADES.

# BIJOU™

BIJOU CAPTURES THE BEST OF MODERN, EURO-CHIC DESIGN. THE CLEAN LINES OF ITS RICH POLISHED NICKEL LASER CUT FRAME FEATURE ELEGANT STRANDS OF CRYSTAL BEADS THAT SPAN THE ENTIRE CHANDELIER FOR A DRAMATIC EFFECT.

**FR43530PNI**

16" W, 22" H, 4.5" EXT.  
5.5" DIA. BACK PLATE  
14.75" TTO  
1-60W CANDELABRA

*Bijou chandeliers are provided with 12' of wire and 10' of chain.*

*Bulb specifications indicate maximum wattage.*

**FR43531PNI**

15" DIA., 12.5" H  
10.5" DIA. CANOPY  
3-40W CANDELABRA

**FR43535PNI**

28.25" DIA., 30.75" H  
8" DIA. CANOPY  
5-60W CANDELABRA

**FR43536PNI**

32" DIA., 38.75" H  
8" DIA. CANOPY  
6-60W CANDELABRA

**FR43538PNI**

45" DIA., 53.75" H  
8" DIA. CANOPY  
12-60W CANDELABRA  
*Fixture exceeds 50lbs.*

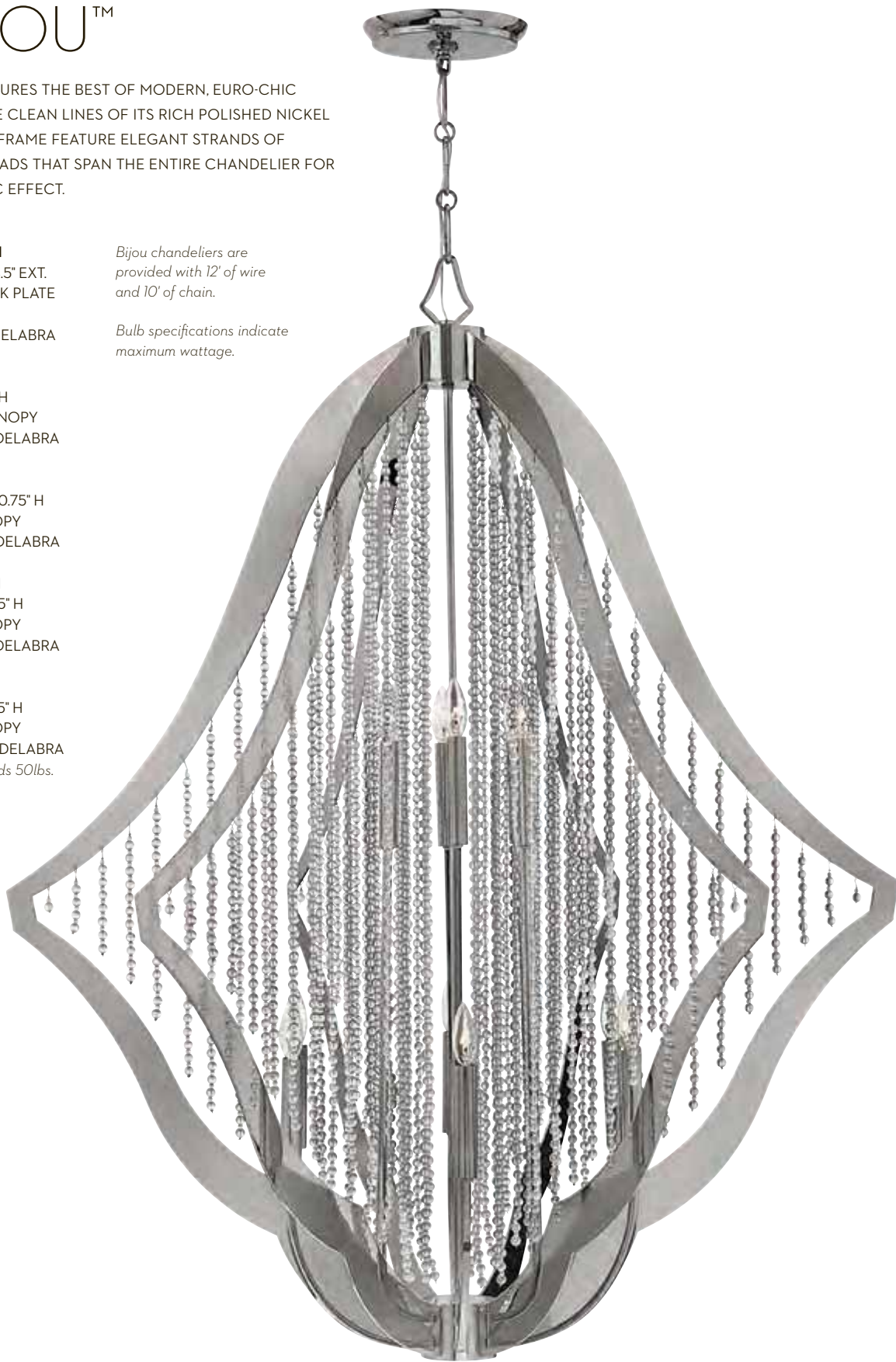

FR43538PNI [ 45" DIA., 53.75" H ]



FR43536PNI [ 32" DIA., 38.75" H ]



FR43535PNI [ 28.25" DIA., 30.75" H ]



FR43531PNI [ 15" DIA., 12.5" H ]



SCONCE  
FR43530PNI [ 16" W, 22" H ]

## BIJOU™

BIJOU CAPTURES THE BEST OF MODERN, EURO-CHIC DESIGN. THE CLEAN LINES OF ITS RICH POLISHED NICKEL LASER CUT FRAME FEATURE ELEGANT STRANDS OF CRYSTAL BEADS THAT SPAN THE ENTIRE CHANDELIER FOR A DRAMATIC EFFECT.

# ALEXANDRA™

THIS ELEGANT COLLECTION FEATURES A POLISHED NICKEL FINISH AND IS ADORNED WITH DELICATE CRYSTAL EMBELLISHMENTS.

**FR43620PNI\***  
15" DIA., 13" H

**FR43621PNI**  
18.5" DIA., 16.25" H  
15" DIA. CANOPY  
4-60W CANDELABRA

**FR43622PNI**  
11.5" W, 12.75" H, 6.5" EXT.  
5" W, 9" H BACK PLATE  
8.25" TTO  
2-60W CANDELABRA

**FR43624PNI**  
18.5" DIA., 24" H  
5.5" DIA. CANOPY  
4-60W CANDELABRA

**FR43625PNI**  
24.5" DIA., 25.25" H  
5.5" DIA. CANOPY  
5-60W CANDELABRA

**FR43626PNI**  
28.5" DIA., 29.5" H  
5.5" DIA. CANOPY  
6-60W CANDELABRA

**FR43628PNI**  
36.5" DIA., 36" H  
5.5" DIA. CANOPY  
12-60W CANDELABRA

*\*Optional decorative canopy for all Alexandra chandeliers.*

*Alexandra chandeliers are provided with 12' of wire and 10' of chain.*

*Bulb specifications indicate maximum wattage.*



*Alexandra features delicately faceted crystal bobesches adding to this collection's chic glamour.*

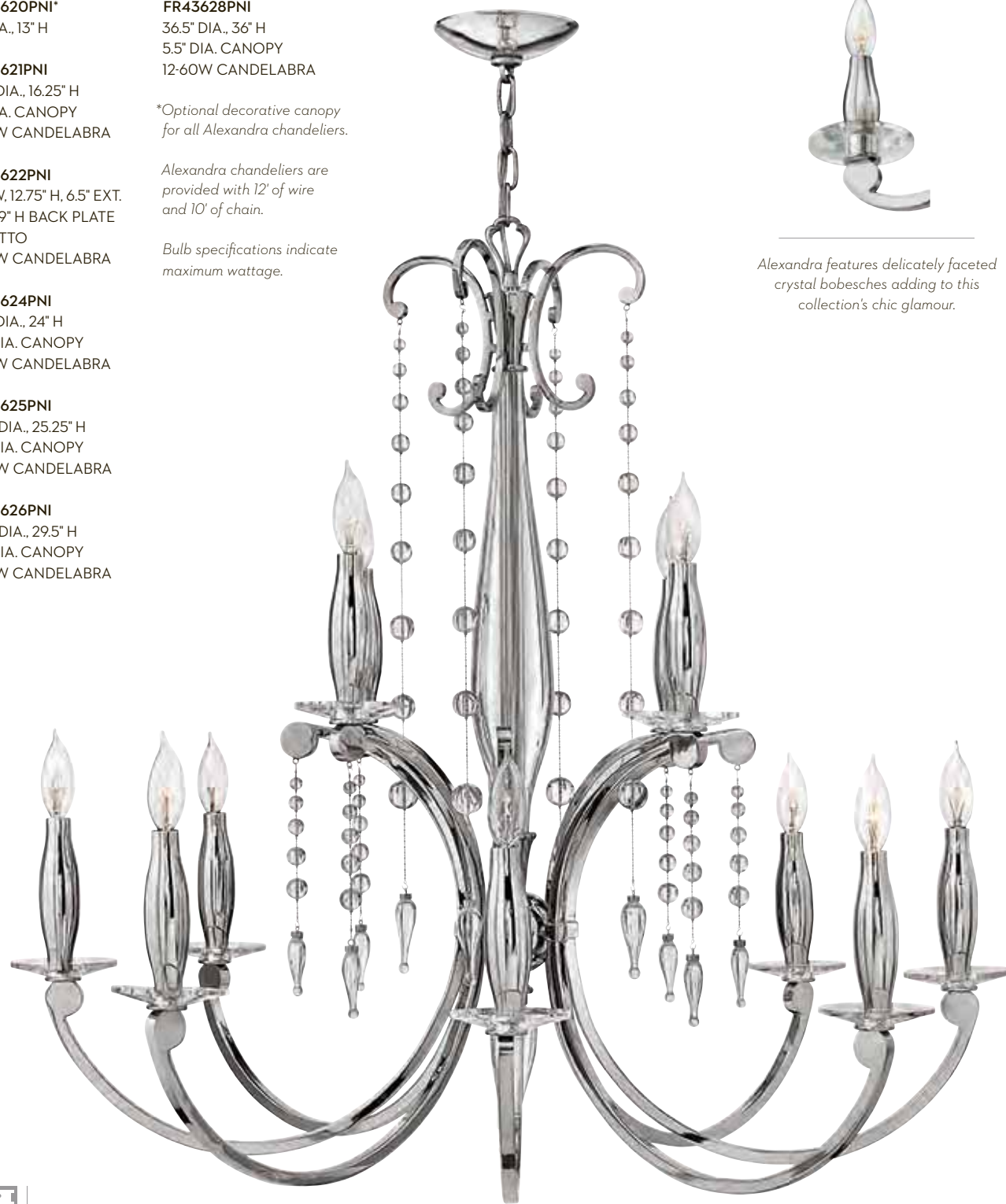

**FR43628PNI [ 36.5" DIA., 36" H ]**

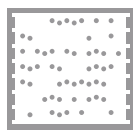

*Scan to view a video of the Alexandra collection.*





FR43626PNI [ 28.5" DIA., 29.5" H ]



FR43622PNI [ 11.5" W, 12.75" H ]



FR43620PNI [ 15" DIA., 13" H ]  
OPTIONAL DECORATIVE CANOPY



FR43621PNI [ 18.5" DIA., 16.25" H ]



FR43624PNI [ 18.5" DIA., 24" H ]



SHOWN WITH OPTIONAL DECORATIVE CANOPY  
FR43625PNI [ 24.5" DIA., 25.25" H ]

## ALEXANDRA™

THIS ELEGANT COLLECTION FEATURES  
A POLISHED NICKEL FINISH AND IS  
ADORNED WITH DELICATE CRYSTAL  
EMBELLISHMENTS.

# MIME™

THIS ELEGANT COLLECTION IN A BRUSHED NICKEL FINISH FEATURES A SHEER TRANSLUCENT DOUBLE HARDBACK SHADE AND TAPERED SQUARE CRYSTAL ACCENTS.

**FR45601BNI**

17.5" DIA., 22" H  
6.5" DIA. CANOPY  
3-60W CANDELABRA

**FR45602BNI**

14" W, 20.5" H, 7" EXT.  
5" DIA. BACK PLATE  
3" TTO  
2-60W CANDELABRA

**FR45604BNI**

24" DIA., 36" H  
5.25" DIA. CANOPY  
4-60W CANDELABRA

**FR45606BNI**

19" DIA., 32" H  
5.25" DIA. CANOPY  
3-60W CANDELABRA

**FR45607BNI**

9" W, 7" H  
39.5" MAX. HEIGHT\*  
5.25" DIA. CANOPY  
1-100W MEDIUM

**FR45608BNI**

30.25" DIA., 41.25" H  
5.25" DIA. CANOPY  
6-60W CANDELABRA

*Mime chandeliers are provided with 12' of wire and 10' of chain.*

*Mime stem hung fixtures are provided with 10' of wire and the following stems : (1) 6" and (2) 12"*

*\*Maximum achievable height with stems included. Additional 12" stems are available : **FR84312BNI***

*Bulb specifications indicate maximum wattage.*



FR45608BNI [ 30.25" DIA., 43.25" H ]



FR45606BNI [19" DIA., 32" H]

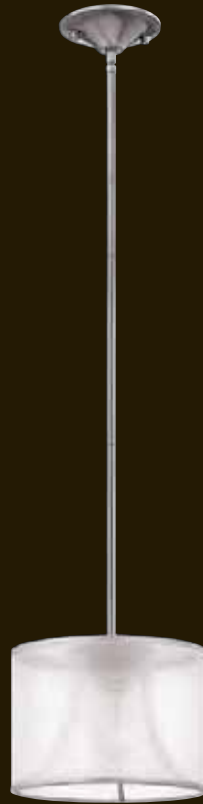

FR45607BNI [9" W, 7" H]



FR45601BNI [17.5" DIA., 22" H]



SCONCE  
FR45602BNI [14" W, 20.5" H]



FR45604BNI [24" DIA., 36" H]

## MIME™

THIS ELEGANT COLLECTION IN A BRUSHED NICKEL FINISH FEATURES A SHEER TRANSLUCENT DOUBLE HARBACK SHADE AND TAPERED SQUARE CRYSTAL ACCENTS.

# MIME™

THIS ELEGANT COLLECTION IN A FRENCH BRONZE FINISH FEATURES A SHEER TRANSLUCENT DOUBLE HARBACK SHADE AND TAPERED SQUARE CRYSTAL ACCENTS.

**FR45601FBZ**  
17.5" DIA., 22" H  
6.5" DIA. CANOPY  
3-60W CANDELABRA

**FR45602FBZ**  
14" W, 20.5" H, 7" EXT.  
5" DIA. BACK PLATE  
3" TTO  
2-60W CANDELABRA

**FR45604FBZ**  
24" DIA., 36" H  
5.25" DIA. CANOPY  
4-60W CANDELABRA

**FR45606FBZ**  
19" DIA., 32" H  
5.25" DIA. CANOPY  
3-60W CANDELABRA

**FR45607FBZ**  
9" W, 7" H  
39.5" MAX. HEIGHT\*  
5.25" DIA. CANOPY  
1-100W MEDIUM

**FR45608FBZ**  
30.25" DIA., 41.25" H  
5.25" DIA. CANOPY  
6-60W CANDELABRA

*Mime chandeliers are provided with 12' of wire and 10' of chain.*

*Mime stem hung fixtures are provided with 10' of wire and the following stems : (1) 6" and (2) 12"*

*\*Maximum achievable height with stems included. Additional 12" stems are available : **FR84312FBZ***

*Bulb specifications indicate maximum wattage.*



FR45608FBZ [ 30.25" DIA., 43.25" H ]



FR45606FBZ [19" DIA., 32" H]



FR45607FBZ [9" W, 7" H]



FR45601FBZ [17.5" DIA., 22" H]



SCONCE  
FR45602FBZ [14" W, 20.5" H]



FR45604FBZ [24" DIA., 36" H]

## MIME™

THIS ELEGANT COLLECTION IN A FRENCH BRONZE FINISH FEATURES A SHEER TRANSLUCENT DOUBLE HARBACK SHADE AND TAPERED SQUARE CRYSTAL ACCENTS.

# FRANCESCA™

FRANCESCA IS A TRADITIONAL, EUROPEAN-INSPIRED CHANDELIER COLLECTION. CRYSTAL FLOWERS BLOOM OUT OF THE CENTER COLUMN AND ETCHED CRYSTAL TEAR DROPS AND BOBESCHES ARE SUSPENDED FROM THE GRACEFULLY SWEEPING ARMS IN A SILVER LEAF FINISH.

**FR40312SLF**

12" W, 22.5" H, 6.75" EXT.  
5" W, 8" H BACK PLATE  
12.75" TTO  
2-60W CANDELABRA

**FR40313SLF**

16" DIA., 22" H  
4.75" DIA. CANOPY  
3-60W CANDELABRA

**FR40315SLF**

24" DIA., 30" H  
4.75" DIA. CANOPY  
5-60W CANDELABRA

**FR40316SLF**

28" DIA., 33" H  
4.75" DIA. CANOPY  
6-60W CANDELABRA

**FR40318SLF**

32" DIA., 39" H  
4.75" DIA. CANOPY  
12-60W CANDELABRA

*Francesca chandeliers are provided with 12' of wire and 10' of chain.*

*Bulb specifications indicate maximum wattage.*



FR40318SLF [ 32" DIA., 39" H ]



FR40316SLF [ 28" DIA., 33" H ]



FR40312SLF [ 12" W, 22.5" H ]



FR40313SLF [ 16" DIA., 22" H ]



FR40315SLF [ 24" DIA., 30" H ]

## FRANCESCA™

FRANCESCA IS A TRADITIONAL, EUROPEAN-INSPIRED CHANDELIER COLLECTION. CRYSTAL FLOWERS BLOOM OUT OF THE CENTER COLUMN AND ETCHED CRYSTAL TEAR DROPS AND BOBESCHES ARE SUSPENDED FROM THE GRACEFULLY SWEEPING ARMS IN A SILVER LEAF FINISH.

# CASPIA™

THIS CHIC CLASSIC CRYSTAL DESIGN IN A LUXURIOUS SILVER LEAF FINISH FEATURES STRANDS OF WHIMSICAL CRYSTALS IN GRADUATING SIZES.

**FR43751SLF**  
16" DIA., 9.5" H  
8" DIA. CANOPY  
2-60W CANDELABRA

*Caspia chandeliers are provided with 12' of wire and 10' of chain.*

**FR43752SLF**  
12" W, 6.5" H, 6" EXT.  
9.5" W, 4.5" H BACK PLATE  
2.5" TTO  
2-60W CANDELABRA

*Bulb specifications indicate maximum wattage.*

**FR43754SLF**  
21" DIA., 28.5" H  
6" DIA. CANOPY  
4-60W CANDELABRA

**FR43758SLF**  
28" DIA., 32" H  
6" DIA. CANOPY  
9-60W CANDELABRA

**FR43759SLF**  
32" W, 35" H  
6" DIA. CANOPY  
12-60W CANDELABRA



FR43759SLF [ 32" W, 35" H ]





FR43758SLF [ 28" DIA., 32" H ]



FR43751SLF [ 16" DIA., 9.5" H ]



SCONCE  
FR43752SLF [ 12" W, 6.5" H ]



FR43754SLF [ 21" DIA., 28.5" H ]

## CASPIA™

THIS CHIC CLASSIC CRYSTAL DESIGN  
IN A LUXURIOUS SILVER LEAF FINISH  
FEATURES STRANDS OF WHIMSICAL  
CRYSTALS IN GRADUATING SIZES.

# BARCELONA™

BARCELONA EMBODIES THE ESSENCE OF CLASSICALLY INFLUENCED DESIGN, FEATURING A FRENCH MARBLE FINISH, TINTED NATURAL ALABASTER AND FACETED CRYSTAL ACCENTS.

**FR44100FRM**  
34.5" DIA., 39.5" H  
6.25" DIA. CANOPY  
3-60W CANDELABRA  
AND 3-75W MEDIUM  
*Fixture exceeds 50lbs.*

*Barcelona chandeliers are provided with 12' of wire and 10' of chain.*

*Bulb specifications indicate maximum wattage.*

**FR44102FRM**  
37.5" DIA., 47" H  
8" DIA. CANOPY  
6-60W CANDELABRA  
AND 4-75W MEDIUM  
*Fixture exceeds 50lbs.*

**FR44104FRM**  
23.5" DIA., 13" H  
6.25" DIA. CANOPY  
3-60W CANDELABRA

**FR44107FRM**  
42.25" DIA., 63.5" H  
8" DIA. CANOPY  
9-60W CANDELABRA  
AND 7-75W MEDIUM  
*Fixture exceeds 50lbs.*

**FR44109FRM**  
30.5" DIA., 26.5" H  
11" DIA. CANOPY  
4-75W MEDIUM



FR44107FRM [ 42.25" DIA., 63.5" H ]



FR44100FRM [ 34.5" DIA., 39.5" H ]



FR44109FRM [ 30.5" DIA., 26.5" H ]



FR44104FRM [ 23.5" DIA., 13" H ]



FR44102FRM [ 37.5" DIA., 47" H ]

## BARCELONA™

BARCELONA EMBODIES THE ESSENCE OF CLASSICALLY INFLUENCED DESIGN, FEATURING A FRENCH MARBLE FINISH, TINTED NATURAL ALABASTER AND FACETED CRYSTAL ACCENTS.

**FR44103FRM**

34" DIA., 47" H  
8" DIA. CANOPY  
4-75W MEDIUM  
*Fixture exceeds 50lbs.*

**FR44105FRM**

21" DIA., 24" H  
6.25" DIA. CANOPY  
3-60W CANDELABRA

**FR44106FRM**

17.5" W, 19.5" H, 5.5" EXT.  
8" W, 4.5" H BACK PLATE  
14" TTO  
1-60W MEDIUM

**FR44110FRM**

12" W, 23" H, 10.25" EXT.  
4.5" DIA. BACK PLATE  
16.5" TTO  
1-60W CANDELABRA

*Barcelona chandeliers are provided with 12' of wire and 10' of chain.*

*Bulb specifications indicate maximum wattage.*



FR44103FRM [ 34" DIA., 47" H ]



SCONCE  
FR44110FRM [ 12" W, 23" H ]



FR44105FRM [ 21" DIA., 24" H ]



SCONCE  
FR44106FRM [ 17.5" W, 19.5" H ]

# BARCELONA™

BARCELONA EMBODIES THE ESSENCE OF CLASSICALLY INFLUENCED DESIGN, FEATURING A FRENCH MARBLE FINISH, TINTED NATURAL ALABASTER AND FACETED CRYSTAL ACCENTS.

# CARABEL™

CARABEL'S FLOURISHING PIERCED METALWORK CREATES A STUNNING ARTISTIC DESIGN IN A LUXURIOUS BRUSHED CHAMPAGNE FINISH. THE ELEGANT SCROLL DETAIL, INSET IVORY LINEN SHADES AND ETCHED DIFFUSERS ADD TO THE BEAUTY OF THIS COLLECTION.

**FR44626BCH**

38.5" W, 32" H, 24" D  
5.5" W, 12" L CANOPY  
6-100W MEDIUM

*Carabel chandeliers are provided with 12' of wire and 10' of chain.*

*Bulb specifications indicate maximum wattage.*



FR44626BCH [ 38.5" W, 32" H, 24" D ]

**FR44620BCH**

12.75" W, 10.75" H, 6.25" EXT.  
6" W, 9.5" H BACK PLATE  
5.5" TTO  
2-60W CANDELABRA

**FR44621BCH**

14.75" DIA., 14" H  
5.75" DIA. CANOPY  
2-100W MEDIUM

**FR44622BCH**

20.5" DIA., 15" H  
5.75" DIA. CANOPY  
3-100W MEDIUM

**FR44623BCH**

21" DIA., 23.5" H  
5.75" DIA. CANOPY  
3-100W MEDIUM

**FR44624BCH**

18" DIA., 36.75" H  
5.75" DIA. CANOPY  
4-60W CANDELABRA

**FR44625BCH**

18" DIA., 35.5" H  
5.75" DIA. CANOPY  
6-60W CANDELABRA

**FR44627BCH**

9" DIA., 12" H  
5.75" DIA. CANOPY  
1-100W MEDIUM

*Carabel chandeliers are provided with 12' of wire and 10' of chain.*

*Bulb specifications indicate maximum wattage.*

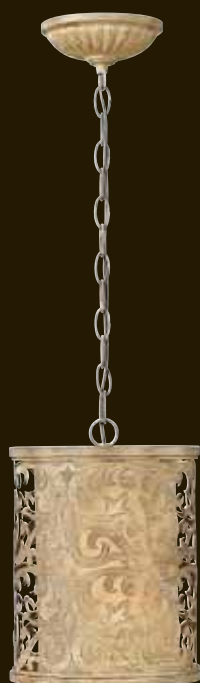

FR44627BCH [ 9" DIA., 12" H ]



FR44623BCH [ 21" DIA., 23.5" H ]



FR44622BCH [ 20.5" DIA., 15" H ]



FR44624BCH [18" DIA., 36.75" H]



FR44625BCH [18" DIA., 35.5" H]



FR44621BCH [14.75" DIA., 14" H]



SCONCE  
FR44620BCH [12.75" W, 10.75" H]

## CARABEL™

CARABEL'S FLOURISHING PIERCED METALWORK CREATES A STUNNING ARTISTIC DESIGN IN A LUXURIOUS BRUSHED CHAMPAGNE FINISH. THE ELEGANT SCROLL DETAIL, INSET IVORY LINEN SHADES AND ETCHED DIFFUSERS ADD TO THE BEAUTY OF THIS COLLECTION.

# CELESTE™

THIS UPDATED CLASSIC TRADITIONAL DESIGN FEATURES DELICATE RECTANGULAR SCROLLWORK IN A BEAUTIFUL SILVER LEAF FINISH. CLEAR OPTIC GLASS SHADES AND CRYSTAL LEAF EMBELLISHMENTS COMPLEMENT THIS STUNNING COLLECTION.

## FR42640SLF

6.5" W, 23.5" H, 8.5" EXT.  
5" W, 8" H BACK PLATE  
13" TTO  
1-60W CANDELABRA

## FR42642SLF

15.5" W, 19" H, 8" EXT.  
6" DIA. BACK PLATE  
12" TTO  
2-60W CANDELABRA

## FR42644SLF

24" DIA., 29.5" H  
5.5" DIA. CANOPY  
4-60W CANDELABRA  
*Shade : Pleated ivory silk  
drum shade with gold  
rope trim.*

## FR42645SLF

30" W, 29.5" H  
5.5" DIA. CANOPY  
5-60W CANDELABRA

*Celeste chandeliers are  
provided with 12' of wire  
and 10' of chain.*

*Bulb specifications  
indicate maximum wattage.*



FR42645SLF [ 30" W, 29.5" H ]





FR42642SLF [ 15.5" W, 19" H ]



FR42640SLF [ 6.5" W, 23.5" H ]



FR42644SLF [ 24" DIA., 29.5" H ]

## CELESTE™

THIS UPDATED CLASSIC TRADITIONAL DESIGN FEATURES DELICATE RECTANGULAR SCROLLWORK IN A BEAUTIFUL SILVER LEAF FINISH. CLEAR OPTIC GLASS SHADES AND CRYSTAL LEAF EMBELLISHMENTS COMPLEMENT THIS STUNNING COLLECTION.

# MUSE™

THIS STRIKING OVERSCALED COLLECTION FEATURES GRACEFUL IRON SCROLLWORK IN A BLACKSMITH FINISH. EACH PIECE OF FAUX MERCURY GLASS IS COMPLEMENTED BY ETCHED OPAL INNER GLASS. CAST CHROME SPHERE ACCENTS ADD ARTISTIC DETAIL.

## FR40600BKS

9.25" W, 20" H, 12.75" EXT.  
4.5" W, 10" H BACK PLATE  
13.5" TTO  
1-60W CANDELABRA

## FR40604BKS

28" DIA., 25.25" H  
7.25" DIA. CANOPY  
4-60W CANDELABRA

## FR40605BKS

31.25" DIA., 25.5" H  
7.25" DIA. CANOPY  
5-60W CANDELABRA

## FR40606BKS

36" W, 28.75" H  
7.25" DIA. CANOPY  
6-60W CANDELABRA

*Muse chandeliers are provided with 12' of wire and 10' of chain.*

*Bulb specifications indicate maximum wattage.*



FR40606BKS [ 36" W, 28.75" H ]



FR40604BKS [ 28" DIA., 25.25" H ]



FR40600BKS [ 9.25" W, 20" H ]



FR40605BKS [ 31.25" DIA., 25.5" H ]

## MUSE™

THIS STRIKING OVERSCALED COLLECTION FEATURES GRACEFUL IRON SCROLLWORK IN A BLACKSMITH FINISH. EACH PIECE OF FAUX MERCURY GLASS IS COMPLEMENTED BY ETCHED OPAL INNER GLASS. CAST CHROME SPHERE ACCENTS ADD ARTISTIC DETAIL.

# MONTEREY™

THIS FLOWING TRADITIONAL EUROPEAN DESIGN FEATURES GRACEFUL SCROLLS IN A BRUSHED MERLOT FINISH. GOLDEN SILK FABRIC SHADES COMPLEMENT THIS OVERSCALED YET DELICATE COLLECTION.

**FR42500BME**

10" W, 20" H, 5.5" EXT.  
7" W, 6.5" H BACK PLATE  
10" TTO  
2-60W CANDELABRA

**FR42504BME**

24" DIA., 28.75" H  
7.25" DIA. CANOPY  
4-100W MEDIUM

**FR42506BME**

30.75" DIA., 26.5" H  
7.25" DIA. CANOPY  
6-60W CANDELABRA

**FR42508BME**

44" W, 38.5" H  
7.25" DIA. CANOPY  
12-60W CANDELABRA

*Monterey chandeliers are provided with 12' of wire and 10' of chain.*

*Bulb specifications indicate maximum wattage.*



FR42508BME [ 44" W, 38.5" H ]



FR42504BME [ 24" DIA., 28.75" H ]



SCONCE  
FR42500BME [ 10" W, 20" H ]



FR42506BME [ 30.75" DIA., 26.5" H ]

## MONTEREY™

THIS FLOWING TRADITIONAL EUROPEAN DESIGN FEATURES GRACEFUL SCROLLS IN A BRUSHED MERLOT FINISH. GOLDEN SILK FABRIC SHADES COMPLEMENT THIS OVERSCALED YET DELICATE COLLECTION.

# KINGSLEY™

KINGSLEY EXUDES AN ELEGANT GLAMOUR. THE HAND-APPLIED SILVER LEAF FINISH HARMONIZES WITH ELEGANT GLASS BOBESCHES, DARK IVORY PLEATED FABRIC SHADES AND DECORATIVE CAST FINIALS FOR REGAL APPEAL.

**FR42720SLF**

9" W, 18.5" H, 12" EXT.  
4.5" W, 13" H BACK PLATE  
9.5" TTO  
1-75W MEDIUM

**FR42721SLF**

16" DIA., 15.5" H  
6" DIA. CANOPY  
3-75W MEDIUM

**FR42724SLF**

20" DIA., 30" H  
7" DIA. CANOPY  
3-75W MEDIUM

**FR42725SLF**

26" DIA., 25.5" H  
7" DIA. CANOPY  
5-60W CANDELABRA

**FR42728SLF**

45" W, 43" H  
7" DIA. CANOPY  
9-60W MEDIUM  
*Fixture exceeds 50lbs.*

*Kingsley chandeliers are provided with 12' of wire and 10' of chain.*

*Bulb specifications indicate maximum wattage.*



*Kingsley features faceted glass bobesches, etched glass diffusers and dark ivory fabric shades.*

FR42728SLF [ 45" W, 43" H ]



FR42725SLF [ 26" DIA., 25.5" H ]



FR42721SLF [ 16" DIA., 15.5" H ]



FR42720SLF [ 9" W, 18.5" H ]



FR42724SLF [ 20" DIA., 30" H ]

## KINGSLEY™

KINGSLEY EXUDES AN ELEGANT GLAMOUR. THE HAND-APPLIED SILVER LEAF FINISH HARMONIZES WITH ELEGANT GLASS BOBESCHES, DARK IVORY PLEATED FABRIC SHADES AND DECORATIVE CAST FINIALS FOR REGAL APPEAL.

# BENTLEY™

THIS SOPHISTICATED COLLECTION FEATURES A BRUSHED BRONZE FINISH WITH OFF-WHITE CINNAMON-TRIMMED SILK SHADES AND DELICATE CRYSTAL ACCENTS.

## FR44500BBZ

5.75" W, 18" H, 6.5" EXT.  
5" DIA. BACK PLATE  
10" TTO  
1-60W CANDELABRA

## FR44501BBZ

16" DIA., 15" H  
5" DIA. CANOPY  
3-60W CANDELABRA

## FR44502BBZ

14" W, 17" H, 4.75" EXT.  
5" DIA. BACK PLATE  
10.5" TTO  
2-60W CANDELABRA

## FR44504BBZ

20.25" DIA., 21.5" H  
6.5" DIA. CANOPY\*  
4-60W CANDELABRA

## FR44505BBZ

24" DIA., 25.75" H  
5" DIA. CANOPY\*  
5-60W CANDELABRA

## FR44506BBZ

27" DIA., 29.25" H  
5" DIA. CANOPY\*  
6-60W CANDELABRA

## FR44508BBZ

35" DIA., 30.5" H  
6.5" DIA. CANOPY\*  
12-60W CANDELABRA

*\*Canopy height measures  
12.75" with crystals.*

*Bentley chandeliers are  
provided with 12' of wire  
and 10' of chain.*

*Bulb specifications  
indicate maximum wattage.*



FR44501BBZ [16" DIA., 15" H]



FR44508BBZ [35" DIA., 30.5" H]





FR44506BBZ [ 27" DIA., 29.25" H ]



FR44500BBZ [ 5.75" W, 18" H ]



FR44502BBZ [ 14" W, 17" H ]



FR44505BBZ [ 24" DIA., 25.75" H ]



FR44504BBZ [ 20.25" DIA., 21.5" H ]

## BENTLEY™

THIS SOPHISTICATED COLLECTION  
FEATURES A BRUSHED BRONZE  
FINISH WITH OFF-WHITE CINNAMON-  
TRIMMED SILK SHADES AND DELICATE  
CRYSTAL ACCENTS.

# PANDORA™

THE STUNNING, CHIC DESIGN OF PANDORA CREATES A DISTINCTIVE STATEMENT WITH INTERSECTING RINGS THAT CAPTURE CYLINDRICAL SHADES FOR A SOFT YET GEOMETRIC STYLE. A RICH BRUSHED CINNAMON FINISH ADDS A LUXURIOUS FEEL TO THIS TIMELESS YET STRIKING COLLECTION.

**FR42404BRC**  
18" DIA., 34" H  
66.5" MAX. HEIGHT\*  
5" DIA. CANOPY  
6-60W CANDELABRA

**FR42405BRC**  
24" DIA., 19" H  
51.25" MAX. HEIGHT  
5" DIA. CANOPY  
5-60W CANDELABRA

**FR42406BRC**  
27.5" DIA., 19" H  
51.25" MAX. HEIGHT\*  
5" DIA. CANOPY  
6-60W CANDELABRA

**FR42408BRC**  
41" DIA., 19" H, 25.5" D  
51.25" MAX. HEIGHT\*  
5" DIA. CANOPY  
8-60W CANDELABRA

*Pandora stem hung fixtures are provided with 10' of wire and the following stems : (1) 6" and (2) 12"*

*\*Maximum achievable height with stems included. Additional 12" stems are available : **FR86212BRC***

*Bulb specifications indicate maximum wattage.*



*Pandora's open cylindrical design offers sophistication from all angles.*



OVAL  
**FR42408BRC** [ 41" DIA., 19" H, 25.5" D ]

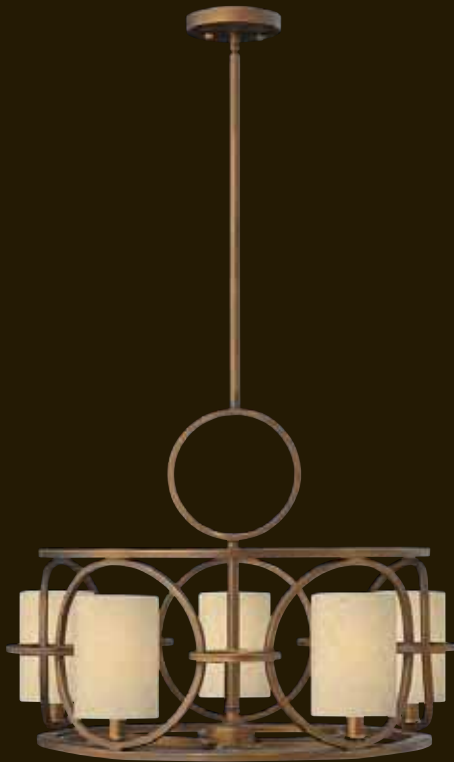

FR42405BRC [ 24" DIA., 19" H ]



FR42404BRC [ 18" DIA., 34" H ]



FR42406BRC [ 27.5" DIA., 19" H ]

## PANDORA™

THE STUNNING, CHIC DESIGN OF PANDORA CREATES A DISTINCTIVE STATEMENT WITH INTERSECTING RINGS THAT CAPTURE CYLINDRICAL SHADES FOR A SOFT YET GEOMETRIC STYLE. A RICH BRUSHED CINNAMON FINISH ADDS A LUXURIOUS FEEL TO THIS TIMELESS YET STRIKING COLLECTION.

**FR42400BRC**

9.5" W, 13" H, 5" EXT.  
4.75" W, 8.75" H BACK  
PLATE  
6.75" TTO  
1-60W CANDELABRA

**FR42401BRC**

14" DIA., 11.5" H  
5" DIA. CANOPY  
3-100W MEDIUM

**FR42402BRC**

44.5" W, 10" H, 4" D  
34" MAX. HEIGHT\*  
5" DIA. CANOPY  
4-60W CANDELABRA

**FR42407BRC**

9.5" DIA., 13" H  
45.25" MAX. HEIGHT\*  
5" DIA. CANOPY  
1-60 CANDELABRA

*Pandora stem hung fixtures  
are provided with 10' of wire  
and the following stems : (1)  
6" and (2) 12"*

*\*Maximum achievable  
height with stems included.  
Additional 12" stems are  
available : FR8621BRC*

*Bulb specifications indicate  
maximum wattage.*



FR42407BRC [ 9.5" DIA., 13" H ]



FR42401BRC [ 14" DIA., 11.5" H ]



FR42400BRC [ 9.5" W, 13" H ]

## PANDORA™

THE STUNNING, CHIC DESIGN OF PANDORA CREATES A DISTINCTIVE STATEMENT WITH INTERSECTING RINGS THAT CAPTURE CYLINDRICAL SHADES FOR A SOFT YET GEOMETRIC STYLE. A RICH BRUSHED CINNAMON FINISH ADDS A LUXURIOUS FEEL TO THIS TIMELESS YET STRIKING COLLECTION.

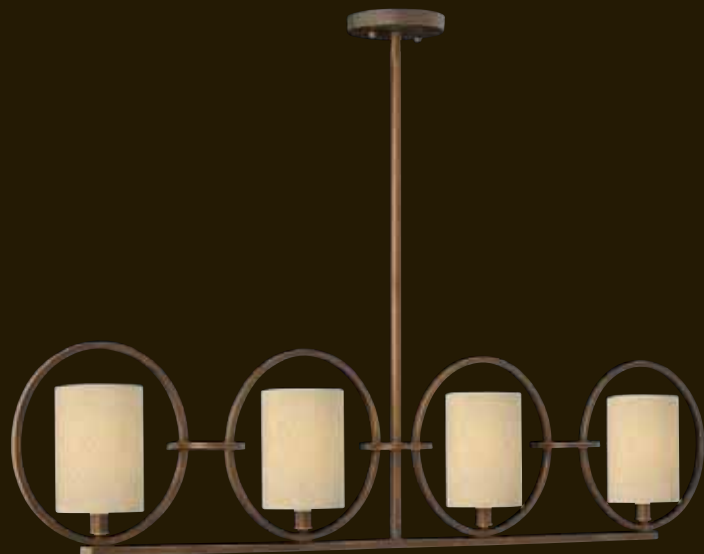

FR42402BRC [ 44.5" W, 10" H ]

# NEST™

NEST FINDS ITS INSPIRATION FROM PATTERNS FOUND IN NATURE. THIS CONTEMPORARY CHANDELIER COLLECTION CONVEYS AN ORGANIC MODERN ELEGANCE IN AN OIL RUBBED BRONZE FINISH COMPLEMENTED BY DISTRESSED AMBER ETCHED GLASS.



*Nest Bath fixtures are also available.  
See page 393*

## **FR41616ORB**

48" W, 27.5" H, 12" D  
4.25" W, 10.25" L CANOPY  
6-75W MEDIUM

*Nest chandeliers are  
provided with 12' of wire  
and 10' of chain.*

*Bulb specifications  
indicate maximum wattage.*



**FR41616ORB** [ 48" W, 27.5" H, 12" D ]

**FR41610ORB**

12" W, 9" H, 5" EXT.  
12" W, 9" H BACK PLATE  
4.5" TTO  
2-60W CANDELABRA

**FR41611ORB**

16.5" DIA., 9.5" H  
2-75W MEDIUM

**FR41612ORB**

9" W, 14" H, 5" EXT.  
9" W, 14" H BACK PLATE  
7.5" TTO  
1-75W MEDIUM

**FR41613ORB**

24" DIA., 23.5" H  
6" DIA. CANOPY  
3-100W MEDIUM

**FR41614ORB**

32" W, 20.5" H, 9" D  
4.25" W, 10.25" L CANOPY  
4-100W MEDIUM

**FR41617ORB**

8" DIA., 15" H  
53.5" MAX. HEIGHT\*  
6" DIA. CANOPY  
1-100W MEDIUM

**FR41621ORB**

8" DIA., 12" H  
1-100W MEDIUM

**FR41622ORB**

20" DIA., 11.5" H  
8" DIA. CANOPY  
3-75W MEDIUM

**FR41624ORB**

21" W, 42" H  
7.5" DIA. CANOPY  
4-100W MEDIUM

**FR41627ORB**

6" DIA., 8.5" H  
41" MAX. HEIGHT  
6" DIA. CANOPY  
1-100W MEDIUM

*Nest chandeliers are provided with 12' of wire and 10' of chain.*

*Nest stem hung fixtures are provided with 10' of wire and the following stems : (1) 6" and (2) 12"*

*\*Maximum achievable height with stems included. Additional 12" stems are available.*

*For FR41617ORB : FR84312ORB  
For FR41627ORB : FR84512ORB*

*Bulb specifications indicate maximum wattage.*



**FR41624ORB** [ 21" W, 42" H ]



**FR41617ORB** [ 8" DIA., 15" H ]



**FR41614ORB** [ 32" W, 20.5" H, 9" D ]



FR41627ORB [ 6" DIA., 8.5" H ]



FR41613ORB [ 24" DIA., 23.5" H ]



SCONCE  
FR41612ORB [ 9" W, 14" H ]



FR41611ORB [ 16.5" DIA., 9.5" H ]



SCONCE  
FR41610ORB [ 12" W, 9" H ]



FR41621ORB [ 8" DIA., 12" H ]



FR41622ORB [ 20" DIA., 11.5" H ]

## NEST™

NEST FINDS ITS INSPIRATION FROM PATTERNS FOUND IN NATURE. THIS CONTEMPORARY CHANDELIER COLLECTION CONVEYS AN ORGANIC MODERN ELEGANCE IN AN OIL RUBBED BRONZE FINISH COMPLEMENTED BY DISTRESSED AMBER ETCHED GLASS.

# CAMERON™

CAMERON'S TRANSITIONAL DESIGN FEATURES STRONG, MODERN ARMS OF A RICH DARK HARD WOOD VENEER. THE STEM HUNG COLLECTION HAS A BOLD TAPERED FOUR-SIDED CENTER COLUMN DETAILED BY CRISP CHROME ACCENTS. ELEGANT TEXTURED METALLIC LINEN SHADES ADD FEMININE SOPHISTICATION.

## FR42340PCM

8" W, 17.5" H, 9" EXT.  
4.75" W, 10" H BACK PLATE  
9" TTO  
1-60W CANDELABRA

## FR42341PCM

18" DIA., 14" H  
5.25" DIA. CANOPY  
3-60W CANDLEABRA

## FR42342PCM

21" DIA., 26.5" H  
59.25" MAX. HEIGHT\*  
5.25" DIA. CANOPY  
3-60W CANDELABRA

## FR42343PCM

23" DIA., 21.5" H  
54.25" MAX. HEIGHT\*  
5.25" DIA. CANOPY  
3-60W CANDELABRA

## FR42344PCM

30" DIA., 27" H  
59.75" MAX. HEIGHT\*  
5.25" DIA. CANOPY  
4-60W CANDELABRA

## FR42347PCM

8" DIA., 13" H  
44.75" MAX. HEIGHT  
5.25" DIA. CANOPY  
1-60W MEDIUM

*Cameron chandeliers and pendants are provided with 10' of wire and the following stems: (1) 6" and (2) 12"*

*\*Maximum achievable height with stems included. Additional 12" stems are available : FR84312PCM*

*Bulb specifications indicate maximum wattage.*



FR42344PCM [ 30" DIA., 27" H ]





FR42341PCM [ 18" DIA., 14" H ]



FR42340PCM [ 8" W, 17.5" H ]



FR42347PCM [ 8" DIA., 13" H ]



FR42343PCM [ 23" DIA., 21.5" H ]



FR42342PCM [ 21" DIA., 26.5" H ]

## CAMERON™

CAMERON'S TRANSITIONAL DESIGN FEATURES STRONG, MODERN ARMS OF A RICH DARK HARD WOOD VENEER. THE STEM HUNG COLLECTION HAS A BOLD TAPERED FOUR-SIDED CENTER COLUMN DETAILED BY CRISP CHROME ACCENTS. ELEGANT TEXTURED METALLIC LINEN SHADES ADD FEMININE SOPHISTICATION.

# HAMLET™

HAMLET IS AN UPDATED BASKET-STYLE CHANDELIER THAT FEATURES STRANDS OF DELICATE CHAIN-WRAPPED NATURAL ROPE ALTERNATING WITH STRANDS OF LIGHT AMBER CRYSTAL. THESE ELEGANT DETAILS CONTRAST WITH THE PROMINENT ARMS IN A LUSH VINTAGE BRONZE FINISH.

**FR42862VBZ**

10.5" W, 16" H, 5.5" EXT.  
5" DIA. BACK PLATE  
11" TTO  
2-60W CANDELABRA

**FR42865VBZ**

24" DIA., 33.5" H  
6" DIA. CANOPY  
5-60W CANDELABRA

**FR42866VBZ**

28" DIA., 29.5" H  
6" DIA. CANOPY  
6-60W CANDELABRA

*Hamlet chandeliers are provided with 12' of wire and 10' of chain.*

*Bulb specifications indicate maximum wattage.*



FR42866VBZ [ 28" DIA., 31" H ]



FR42865VBZ [ 24" W, 33.5" H ]



FR42862VBZ [ 10.5" W, 16" H ]

## HAMLET™

HAMLET IS AN UPDATED BASKET-STYLE CHANDELIER THAT FEATURES STRANDS OF DELICATE CHAIN-WRAPPED NATURAL ROPE ALTERNATING WITH STRANDS OF LIGHT AMBER CRYSTAL. THESE ELEGANT DETAILS CONTRAST WITH THE PROMINENT ARMS IN A LUSH VINTAGE BRONZE FINISH.

# MIDDLEFIELD™

MIDDLEFIELD'S RUSTIC-CHIC DESIGN CAPTURES A HISTORICAL FEEL WITH ITS SOLID DISTRESSED WOOD AND STEEL CONSTRUCTION. A PEAR-SHAPED WOOD FINIAL ADDS AN ADDITIONAL ELEGANT DETAIL AND MAY BE HUNG INSIDE OR OUTSIDE THE FRAME.

## FR40570IRR

5" W, 16.5" H, 7" EXT.  
5" DIA. BACK PLATE  
10.5" TTO  
1-60W CANDELABRA

## FR40572IRR

8" W, 16.5" H, 3.5" EXT.  
5" DIA. BACK PLATE  
10.5" TTO  
2-60W CANDELABRA  
ADA Compliant

## FR40573IRR

16" DIA., 26" H  
6.5" DIA. CANOPY  
3-60W CANDELABRA

## FR40574IRR

22" DIA., 24" H  
6.5" DIA. CANOPY  
4-60W CANDELABRA

## FR40575IRR

20" DIA., 32" H  
6.5" DIA. CANOPY  
5-60W CANDELABRA

## FR40576IRR

30" DIA., 33" H  
6.5" DIA. CANOPY  
6-60W CANDELABRA

*Middlefield chandeliers are provided with 12' of wire and 10' of chain.*

*Bulb specifications indicate maximum wattage.*



FR40576IRR [ 30" DIA., 33" H ]



FR40575IRR [ 20" DIA., 32" H ]



FR40570IRR [ 5" W, 16.5" H ]



FR40572IRR [ 8" W, 16.5" H ]



ADJUSTABLE FINIAL  
FR40574IRR [ 22" DIA., 24" H ]



FR40573IRR [ 16" DIA., 26" H ]

## MIDDLEFIELD™

MIDDLEFIELD'S RUSTIC-CHIC DESIGN CAPTURES A HISTORICAL FEEL WITH ITS SOLID DISTRESSED WOOD AND STEEL CONSTRUCTION. A PEAR-SHAPED WOOD FINIAL ADDS AN ADDITIONAL ELEGANT DETAIL AND MAY BE HUNG INSIDE OR OUTSIDE THE FRAME.

# RENATA™

RENATA'S STRIKING MODERN DESIGN FEATURES AN OUTER SPHERE-SHAPED CAGE CREATED FROM SOLID METAL THAT HAS BEEN FLATTENED AND TAPERED. THE CHANDELIER CAGE ENCOMPASSES ETCHED OPAL LINEN GLASS SHADES WHILE THE CAGED PENDANT STYLES SURROUND A UNIQUE ROUNDED GLOBE OF ETCHED OPAL LINEN GLASS.

**FR32903BKS**

15" DIA., 14.5" H  
5.25" DIA. CANOPY  
1-100W MEDIUM

**FR32904BKS**

10.25" DIA., 10.75" H  
5.25" DIA. CANOPY  
1-100W MEDIUM

**FR32905BKS**

26" DIA., 25" H  
5.25" DIA. CANOPY  
5-60W CANDELABRA

**FR32906BKS**

20" DIA., 19.75" H  
5.25" DIA. CANOPY  
3-60W CANDELABRA

*Renata chandeliers are provided with 12' of wire and 10' of chain.*

*Bulb specifications indicate maximum wattage.*



FR32905BKS [ 26" DIA., 25" H ]



FR32903BKS [15" DIA., 14.5" H]



FR32904BKS [10.25" DIA., 10.75" H]



FR32906BKS [20" DIA., 19.75" H]

## RENATA™

RENATA'S STRIKING MODERN DESIGN FEATURES AN OUTER SPHERE-SHAPED CAGE CREATED FROM SOLID METAL THAT HAS BEEN FLATTENED AND TAPERED. THE CHANDELIER CAGE ENCOMPASSES ETCHED OPAL LINEN GLASS SHADES WHILE THE CAGED PENDANT STYLES SURROUND A UNIQUE ROUNDED GLOBE OF ETCHED OPAL LINEN GLASS.

# AVA™

AVA'S TRANSITIONAL WIRE BIRD CAGE DESIGN CAPTURES AN OVERSCALED STAINED MICA SHADE WITH A CONCEALED LIGHT SOURCE. THE VINTAGE BRONZE FINISH ADDS TO ITS DRAMATIC APPEAL.

## FR42872VBZ

9" W, 12" H, 4.5" EXT.  
4" W, 6" H BACK PLATE  
3" TTO  
1-60W CANDELABRA

## FR42873VBZ

17" DIA., 19" H  
6.25" DIA. CANOPY  
3-100W MEDIUM

## FR42875VBZ

17" DIA., 30" H  
4.75" DIA. CANOPY  
3-100W MEDIUM

## FR42876VBZ

19.5" DIA., 44" H  
4.75" DIA. CANOPY  
4-60W CANDELABRA

*Ava chandeliers are provided with 12' of wire and 10' of chain.*

*Bulb specifications indicate maximum wattage.*



FR42876VBZ [ 19.5" DIA., 44" H ]





FR42873VBZ [17" DIA., 19" H]



SCONCE  
FR42872VBZ [9" W, 12" H]



FR42875VBZ [17" DIA., 30" H]

## AVA™

AVA'S TRANSITIONAL WIRE BIRD CAGE DESIGN CAPTURES AN OVERSCALED STAINED MICA SHADE WITH A CONCEALED LIGHT SOURCE. THE VINTAGE BRONZE FINISH ADDS TO ITS DRAMATIC APPEAL.

# JASPER™

THIS TRANSITIONAL LOFT-INSPIRED COLLECTION IN OUR RUSTIC IRON FINISH FEATURES A COMBINATION OF FORGED IRON AND SMOOTH STAINED WOOD.

## FR40200IRN

5" W, 10" H, 5.5" EXT.  
5" W, 10" H BACK PLATE  
3.5" TTO  
1-60W CANDELABRA

## FR40203IRN

5" W, 30" H, 5.5" EXT.  
5" W, 30" H BACK PLATE  
13.5" TTO  
3-60W CANDELABRA

## FR40204IRN

44" W, 26.5" H, 4.5" D  
4.75" W, 17" L CANOPY  
6-60W CANDELABRA

## FR40205IRN

18" W, 20" H, 16" D  
4.75" W, 7.75" L CANOPY  
4-60W CANDELABRA

## FR40206IRN

32" W, 24.5" H, 16" D  
4.75" W, 13" L CANOPY  
6-60W CANDELABRA

*Jasper chandeliers are provided with 12' of wire and 10' of chain.*

*Bulb specifications indicate maximum wattage.*



FR40206IRN [ 32" W, 24.5" H, 16" D ]



FR402051RN [18" W, 20" H, 16" D]



FR402031RN [5" W, 30" H]



FR402041RN [44" W, 26.5" H, 4.5" D]



FR402001RN [5" W, 10" H]

## JASPER™

THIS TRANSITIONAL LOFT-INSPIRED COLLECTION IN OUR RUSTIC IRON FINISH FEATURES A COMBINATION OF FORGED IRON AND SMOOTH STAINED WOOD.

# ZEN™ LED

THIS MODERN CABLE HUNG DESIGN IS THE ULTIMATE IN ECO-CHIC. CONSTRUCTED WITH SUSTAINABLE, ENVIRONMENTALLY-FRIENDLY SOLID BAMBOO, THIS COLLECTION ALSO UTILIZES AN ENERGY-EFFICIENT LED LIGHT SOURCE. MADE IN THE USA.

**FR46200BAM**

6.25" W, 12" H, 4" EXT.  
4.5" W, 10" H BACK PLATE  
2-5W LEDs

**FR46208BAM**

4" W, 4" H, 4" D  
78.5" MAX. HEIGHT  
5.5" DIA., 2.75" H CANOPY  
1-5W LED

**FR46204BAM**

21" SQUARE, 3.75" H  
78" MAX. HEIGHT\*  
5" W, 12" L, 2.75" H CANOPY  
1-24W LED, DIMMABLE  
*Etched glass bottom lenses*

*Zen fixtures provided with 6' of coaxial cable.*

*\*Maximum achievable height with cable provided.*

**FR46205BAM**

38.5" W, 3.25" H, 4" D  
78" MAX. HEIGHT\*  
5" W, 12" L, 2.75" H CANOPY  
1-12W LED, DIMMABLE  
*Etched glass bottom lens*

*Bulbs included. Bulb specifications indicate maximum wattage.*

**FR46206BAM**

54" W, 3.25" H, 4" D  
78" MAX. HEIGHT  
5" W, 12" L, 2.75" H CANOPY  
6" TTO  
1-18W LED, DIMMABLE  
*Etched glass bottom lens*

**FR46207BAM**

4" W, 8.75" H, 4" D  
82.5" MAX. HEIGHT  
5.5" DIA., 2.75" H CANOPY  
1-5W LED



*Zen's square chandelier features an open center adding minimalist moxie to this contemporary design.*



Made in the USA



**FR46206BAM** [ 54" W, 3.25" H, 4" D ]



FR46204BAM [ 21" SQUARE, 3.75" H ]



FR46208BAM [ 4" W, 4" H, 4" D ]

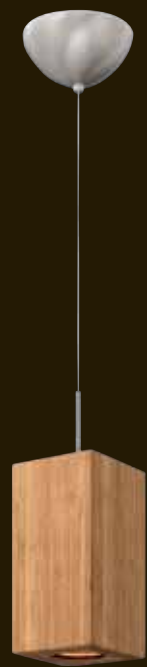

FR46207BAM [ 4" W, 8.75" H, 4" D ]



FR46205BAM [ 38.5" W, 3.25" H, 4" D ]



SCONCE  
FR46200BAM [ 6.25" W, 12" H ]

## ZEN™

THIS MODERN CABLE HUNG DESIGN IS THE ULTIMATE IN ECO-CHIC. CONSTRUCTED WITH SUSTAINABLE, ENVIRONMENTALLY-FRIENDLY SOLID BAMBOO, THIS COLLECTION ALSO UTILIZES AN ENERGY-EFFICIENT LED LIGHT SOURCE. MADE IN THE USA.





# LOFT™ LED

GOING GREEN HAS NEVER BEEN SO STYLISH. EACH OF THE LOFT PENDANTS ARE HAND MADE FROM SELECT GRADE SOLID MAPLE, WALNUT OR CHERRY AND WILL BE INDIVIDUALLY UNIQUE. CHROME, BRUSHED NICKEL AND BRONZE FINISH OPTIONS FOR THE CANOPY ARE AVAILABLE. EACH PIECE IS CABLE HUNG AND INCLUDES AN ENERGY-EFFICIENT LED LIGHT SOURCE.

## LARGE MAPLE PENDANT

FR35002MPL (CHROME)  
FR35003MPL (BRONZE)  
FR35004MPL (BRUSHED NICKEL)  
4" W, 13" H  
88" MAX. HEIGHT\*  
5" DIA., 2.75" H CANOPY  
1-5W LED

## SMALL MAPLE PENDANT

FR35007MPL (BRUSHED NICKEL)  
FR35008MPL (CHROME)  
FR35009MPL (BRONZE)  
4" W, 6.5" H  
81.5" MAX. HEIGHT\*  
5" DIA., 2.75" H CANOPY  
1-5W LED

## LARGE WALNUT PENDANT

FR35012WAL (CHROME)  
FR35013WAL (BRONZE)  
FR35014WAL (BRUSHED NICKEL)  
4" W, 13" H  
88" MAX. HEIGHT\*  
5" DIA., 2.75" H CANOPY  
1-5W LED

## SMALL WALNUT PENDANT

FR35017WAL (BRUSHED NICKEL)  
FR35018WAL (CHROME)  
FR35019WAL (BRONZE)  
4" W, 6.5" H  
81.5" MAX. HEIGHT\*  
5" DIA., 2.75" H CANOPY  
1-5W LED

## LARGE CHERRY PENDANT

FR35022CHY (CHROME)  
FR35023CHY (BRONZE)  
FR35024CHY (BRUSHED NICKEL)  
6" W, 13" H  
88" MAX. HEIGHT\*  
5" DIA., 2.75" H CANOPY  
1-5W LED

## SMALL CHERRY PENDANT

FR35027CHY (BRUSHED NICKEL)  
FR35028CHY (CHROME)  
FR35029CHY (BRONZE)  
6" W, 6" H  
81" MAX. HEIGHT\*  
5" DIA., 2.75" H CANOPY  
1-5W LED

*Loft fixtures provided with 6' of Coaxial cable.*

*\*Maximum achievable height with cable provided.*

*Bulbs included. Bulb specifications indicate maximum wattage.*

Made in the USA



(BRONZE)  
FR35003MPL [ 4" W, 13" H ]

(BRUSHED NICKEL)  
FR35024CHY [ 6" W, 13" H ]

(CHROME)  
FR35012WAL [ 4" W, 13" H ]





(BRUSHED NICKEL)  
FR35004MPL [ 4" W, 13" H ]



(CHROME)  
FR35008MPL [ 4" W, 6.5" H ]



(BRONZE)  
FR35013WAL [ 4" W, 13" H ]



(BRUSHED NICKEL)  
FR35017WAL [ 4" W, 6.5" H ]



(CHROME)  
FR35022CHY [ 6" W, 13" H ]

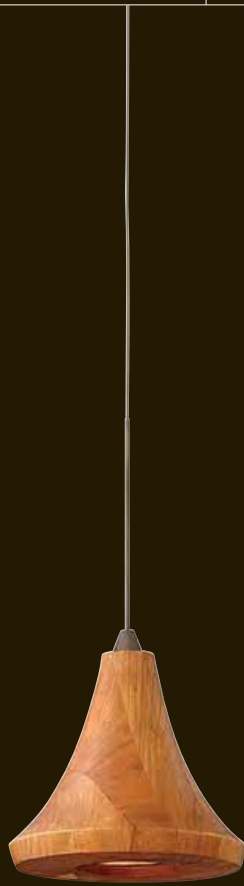

(BRONZE)  
FR35029CHY [ 6" W, 6" H ]

CANOPY FINISH OPTIONS  
BRONZE, CHROME, BRUSHED NICKEL



## LOFT™

GOING GREEN HAS NEVER BEEN SO STYLISH. EACH OF THE LOFT PENDANTS ARE HAND MADE FROM SELECT GRADE SOLID MAPLE, WALNUT OR CHERRY AND WILL BE INDIVIDUALLY UNIQUE. CHROME, BRUSHED NICKEL AND BRONZE FINISH OPTIONS FOR THE CANOPY ARE AVAILABLE. EACH PIECE IS CABLE HUNG AND INCLUDES AN ENERGY-EFFICIENT LED LIGHT SOURCE.

# SPECTRA™

SPECTRA FEATURES A LARGE, FLOATING WHITE ETCHED GLASS SPHERE INSIDE A UNIQUE DIAMOND SHAPED FRAME. AVAILABLE IN BLACK, CLOUD (WHITE), PEWTER OR RETRO BRASS FINISHES, THIS STEM HUNG COLLECTION IS A MODERN STATEMENT WITH VINTAGE FLAIR.

## FR37554BLK

18" DIA., 31" H  
63.5" MAX. HEIGHT\*  
5" DIA. CANOPY  
2-100W MEDIUM

## FR37554RBR

18" DIA., 31" H  
63.5" MAX. HEIGHT\*  
5" DIA. CANOPY  
2-100W MEDIUM

## FR37554PTR

18" DIA., 31" H  
63.5" MAX. HEIGHT\*  
5" DIA. CANOPY  
2-100W MEDIUM

## FR37554CLD

18" DIA., 31" H  
63.5" MAX. HEIGHT\*  
5" DIA. CANOPY  
2-100W MEDIUM

*Spectra stem hung fixtures are provided with 10' of wire and the following stems : (1) 6" and (2) 12"*

*\*Maximum achievable height with stems included. Additional 12" stems are available : FR84312BLK, CLD, PTR, RBR*

*Bulb specifications indicate maximum wattage.*



FR37554BLK [ 18" DIA., 31" H ]



FR37554RBR [ 18" DIA., 31" H ]



FR37554PTR [18" DIA., 31" H]



FR37554CLD [18" DIA., 31" H]

# GLOBE™

THIS UPDATED MID-CENTURY MODERN DESIGN IS AVAILABLE IN A BRUSHED NICKEL, CLOUD (WHITE) OR POLISHED CHROME FINISH. A SMOOTH ROUNDED METALLIC DOME IS COMPLEMENTED BY A RECESSED INNER GLASS.

**FR38510BNI**  
10" DIA., 11" H  
103" MAX. HEIGHT\*  
5" DIA. CANOPY  
2-60W MEDIUM

**FR38510CLD**  
10" DIA., 11" H  
103" MAX. HEIGHT\*  
5" DIA. CANOPY  
2-60W MEDIUM

**FR38510PCM**  
10" DIA., 11" H  
103" MAX. HEIGHT\*  
5" DIA. CANOPY  
2-60W MEDIUM

*Globe pendants provided with 8' of wire.*

*\*Maximum achievable height with wire provided.*

*Bulb specifications indicate maximum wattage.*



(BRUSHED NICKEL)  
FR38510BNI [10" DIA., 11" H]



(CLOUD)  
FR38510CLD [10" DIA., 11" H]

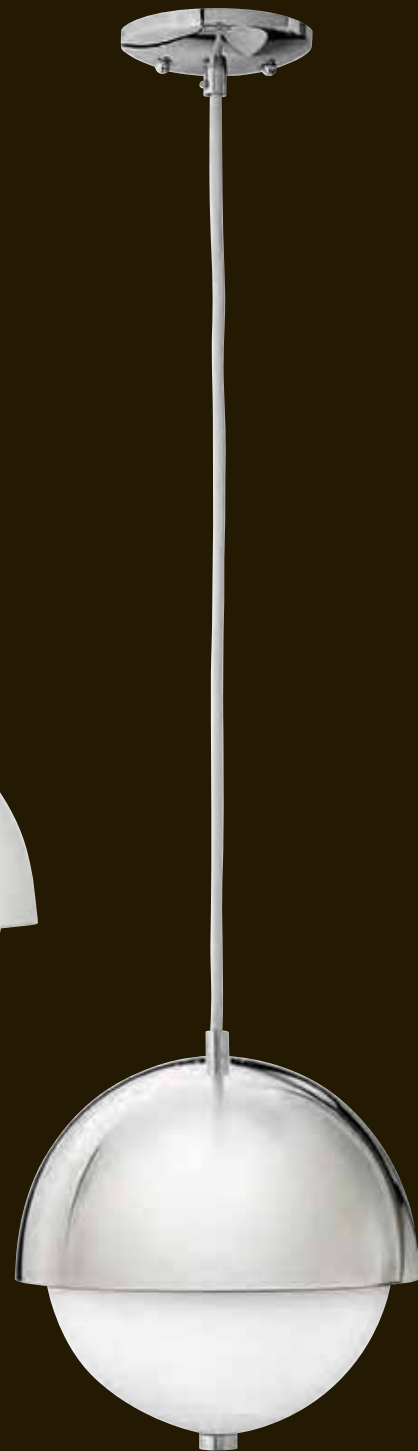

(POLISHED CHROME)  
FR38510PCM [10" DIA., 11" H]

# STRATUS™

THIS CONTEMPORARY CORD HUNG PENDANT COLLECTION FEATURES FLOATING BENT METAL PANELS IN METALLIC FINISHES. STRATUS CASTS LIGHT UP AND DOWN, WHILE ALLOWING A SOFT GLOW TO PERMEATE BETWEEN FLOATING LAYERS.

## FR30407PBA

6.75" W, 10" H  
110" MAX. HEIGHT  
5" DIA. CANOPY  
1100W MEDIUM

## FR30407PNI

6.75" W, 10" H  
110" MAX. HEIGHT  
5" DIA. CANOPY  
1100W MEDIUM

## FR30407BBA

6.75" W, 10" H  
110" MAX. HEIGHT  
5" DIA. CANOPY  
1100W MEDIUM

## FR30407BNI

6.75" W, 10" H  
110" MAX. HEIGHT  
5" DIA. CANOPY  
1100W MEDIUM

*Stratus pendants provided with 10' of wire.*

*\*Maximum achievable height with wire provided.*

*Bulb specifications indicate maximum wattage.*

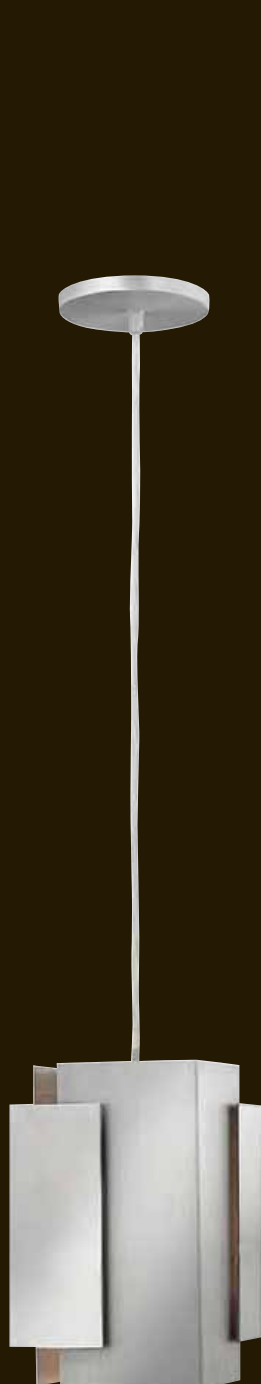

(POLISHED & BRUSHED ALUMINUM)  
FR30407PBA [ 6.75" W, 10" H ]

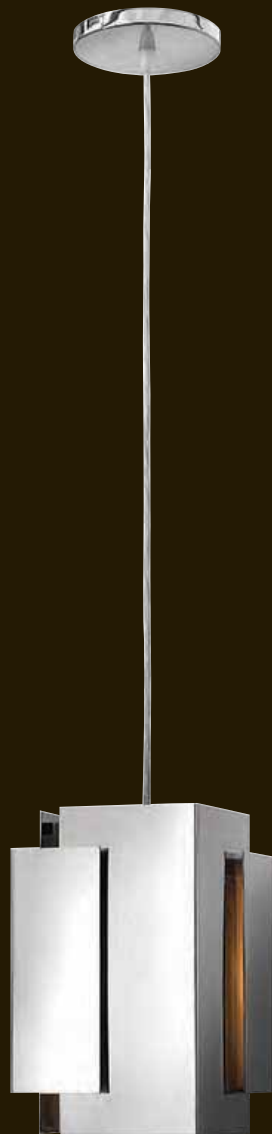

(POLISHED NICKEL)  
FR30407PNI [ 6.75" W, 10" H ]

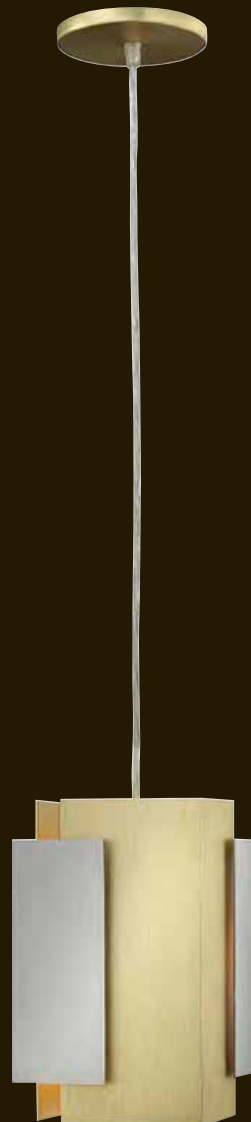

(BRUSHED ALUMINUM & BRUSHED BRONZE)  
FR30407BBA [ 6.75" W, 10" H ]

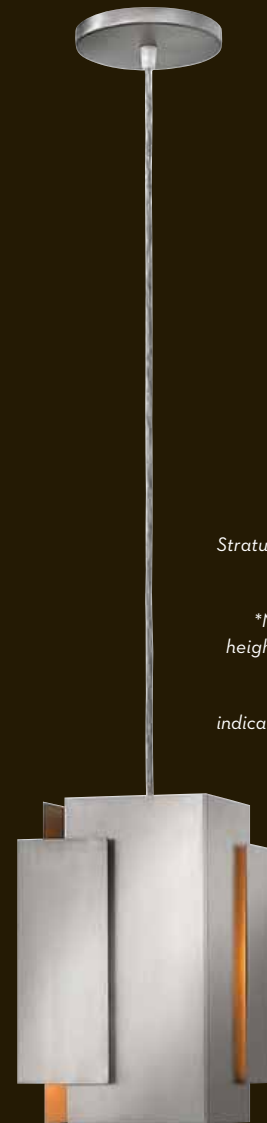

(BRUSHED NICKEL)  
FR30407BNI [ 6.75" W, 10" H ]

# VIVO™

THIS CLEAN AND SIMPLE BUBBLE PENDANT DESIGN IS AVAILABLE IN A CLOUD (WHITE), BRUSHED NICKEL OR POLISHED CHROME FINISH COMPLEMENTED BY FAUX MERCURY OR CLEAR SEEDY GLASS. VIVO CAN BE CUSTOMIZED WITH A VARIETY OF COLORED "INNER" GLASS COMBINATIONS AND ENCOURAGES CREATIVITY WITH BULB SELECTION.

*Fitter and glass are sold separately.*

**WHEN ORDERING, PLEASE INDICATE BOTH FITTER AND GLASS SKU.**

## PENDANT FITTER

**FR33507BNI**

**FR33507CLD**

**FR33507PCM**

3.25" DIA.

9.5" MIN. HEIGHT

33.5" MAX. HEIGHT\*

5.25" DIA. CANOPY

1100W MEDIUM

## FAUX MERCURY GLASS

**FR88105GL**

7.5" W, 6.5" H

4.25" GLASS OPENING

## CLEAR SEEDY GLASS

**FR88101GL**

7.5" W, 6.5" H

4.25" GLASS OPENING

*Vivo stem hung fixtures are provided with 10' of wire and the following stems : (1) 6" and (2) 12"*

*\*Maximum achievable height with stems included. Additional 12" stems are available : **FR84312BNI, CLD, PCM***

*Bulb specifications indicate maximum wattage.*



**FR33507BNI (FITTER) [ 3.25" DIA., 9.5" H ]**  
**FR88101GL (GLASS) [ 7.5" W, 6.5" H ]**



**FR33507CLD (FITTER) [ 3.25" DIA., 9.5" H ]**  
**FR88101GL (GLASS) [ 7.5" W, 6.5" H ]**



**FR33507PCM (FITTER) [ 3.25" DIA., 9.5" H ]**  
**FR88101GL (GLASS) [ 7.5" W, 6.5" H ]**

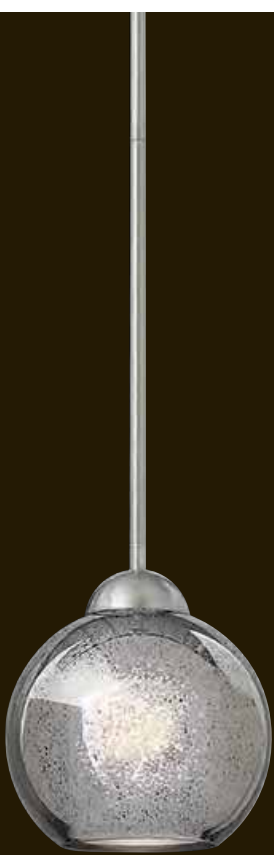

FR33507BNI (FITTER)  
FR88105GL (GLASS)



FR33507CLD (FITTER)  
FR88105GL (GLASS)



FR33507PCM (FITTER)  
FR88105GL (GLASS)



FR33507BNI (FITTER)  
FR88101GL (GLASS)  
SHOWN WITH OPTIONAL  
PLUM GLASS : FR88013GL



FR33507CLD (FITTER)  
FR88105GL (GLASS)  
SHOWN WITH OPTIONAL  
CARAMEL GLASS : FR88033GL



FR33507PCM (FITTER)  
FR88101GL (GLASS)  
SHOWN WITH OPTIONAL  
SPLASH GLASS : FR88021GL

**ACCESSORY GLASS** [ 4" DIA., 5.5" H ]  
For additional accessories see page 318



BIRCH  
FR88005GL



CHERRY  
FR88025GL



MOCHA  
FR88009GL



CARAMEL  
FR88033GL



PLUM  
FR88013GL



SLATE  
FR88037GL



SPLASH  
FR88021GL

VIVO™

THIS CLEAN AND SIMPLE BUBBLE  
PENDANT DESIGN IS AVAILABLE IN  
A CLOUD (WHITE), BRUSHED NICKEL  
OR POLISHED CHROME FINISH  
COMPLEMENTED BY FAUX MERCURY  
OR CLEAR SEEDY GLASS. VIVO CAN  
BE CUSTOMIZED WITH A VARIETY OF  
COLORED "INNER" GLASS COMBINATIONS  
AND ENCOURAGES CREATIVITY WITH  
BULB SELECTION.

# LUXE™

THIS FULLY CUSTOMIZABLE COLLECTION FEATURES PENDANTS IN BRUSHED NICKEL, POLISHED CHROME OR VINTAGE BRONZE FINISHES COMPLEMENTED BY CRYSTAL TIERING. PENDANTS ARE PROVIDED WITH ETCHED OPAL GLASS.

OPTIONAL COLORED GLASS MUST BE ORDERED SEPARATELY.  
FOR COLORED GLASS OPTIONS SEE PAGE 318.

**FR31557BNI**  
6" W, 8" H  
40.5" MAX. HEIGHT\*  
5" DIA. CANOPY  
1100W MEDIUM

**FR31557PCM**  
6" W, 8" H  
40.5" MAX. HEIGHT\*  
5" DIA. CANOPY  
1100W MEDIUM

**FR31557VBZ**  
6" W, 8" H  
40.5" MAX. HEIGHT\*  
5" DIA. CANOPY  
1100W MEDIUM

*Luxe stem pendants are provided with 10' of wire and the following stems : (1) 6" and (2) 12"*

*\*Maximum achievable height with stems included. Additional 12" stems are available :*

**FR84312BNI, PCM, VBZ**

*Bulb specifications indicate maximum wattage.*



**FR31557BNI [ 6" W, 8" H ]**  
*Comes standard with etched opal glass.*



**FR31557PCM [ 6" W, 8" H ]**  
*Comes standard with etched opal glass.*



**FR31557VBZ [ 6" W, 8" H ]**  
*Comes standard with etched opal glass.*



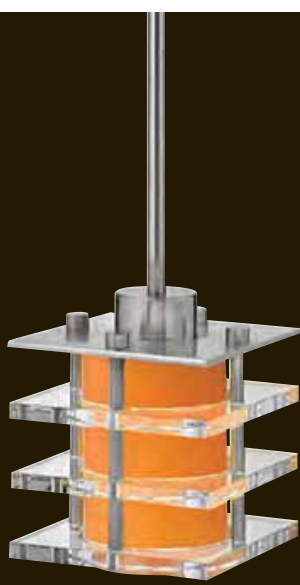

FR31557BNI  
SHOWN WITH OPTIONAL  
CARAMEL GLASS : FR88033GL

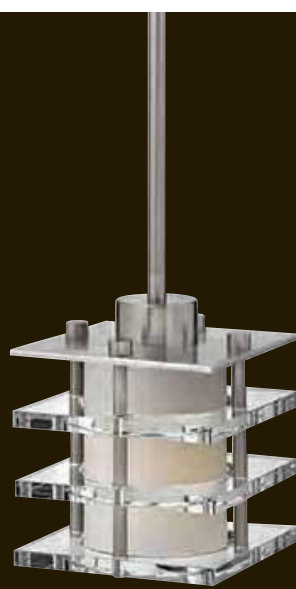

FR31557BNI  
SHOWN WITH OPTIONAL  
SLATE GLASS : FR88037GL

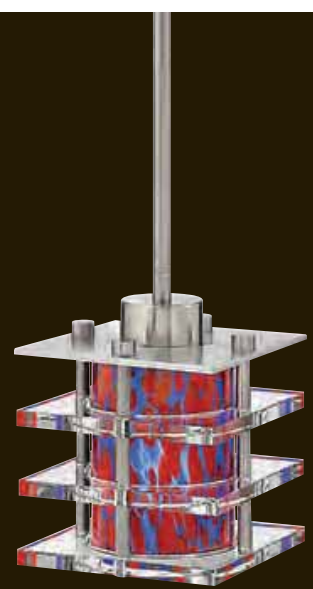

FR31557BNI  
SHOWN WITH OPTIONAL  
SPLASH GLASS : FR88021GL

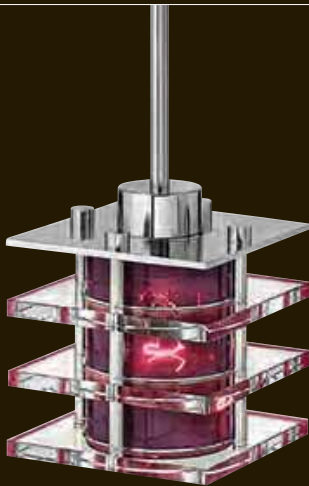

FR31557PCM  
SHOWN WITH OPTIONAL  
PLUM GLASS : FR88013GL



FR31557PCM  
SHOWN WITH OPTIONAL  
CHERRY GLASS : FR88025GL

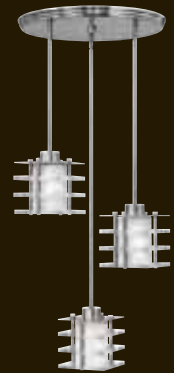

**MOUNTING ACCESSORIES AVAILABLE.**  
*For mounting accessories and colored glass  
options see page 318.*

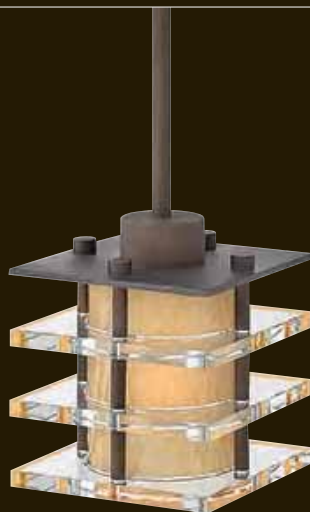

FR31557VBZ  
SHOWN WITH OPTIONAL  
BIRCH GLASS : FR88005GL



FR31557VBZ  
SHOWN WITH OPTIONAL  
MOCHA GLASS : FR88009GL

## LUXE™

THIS FULLY CUSTOMIZABLE  
COLLECTION FEATURES PENDANTS  
IN BRUSHED NICKEL, POLISHED  
CHROME OR VINTAGE BRONZE  
FINISHES, COMPLEMENTED BY  
CRYSTAL TIERING. PENDANTS ARE  
PROVIDED WITH ETCHED OPAL  
GLASS. COLORED GLASS MUST BE  
ORDERED SEPARATELY.

# ACCESSORIES

CEILING ADAPTERS CAN BE UNIVERSALLY USED WITH PENDANTS FROM BOTH HINKLEY AND FREDRICK RAMOND PRODUCT LINES.

## PENDANT FITTER

FR33507BNI  
FR33507CLD  
FR33507PCM  
3.25" DIA.  
9.5" MIN. HEIGHT  
33.5" MAX. HEIGHT\*  
5.25" DIA. CANOPY  
1100W MEDIUM

## ROUND CEILING ADAPTER

FR83661BNI  
FR83661PCM  
FR83661VBZ  
18" DIA.

## LINEAR CEILING ADAPTER

FR83664BNI  
FR83664PCM  
FR83664VBZ  
33.25" L, 5.5" W



## LINEAR CEILING ADAPTER



FR83664BNI



FR83664PCM



FR83664VBZ

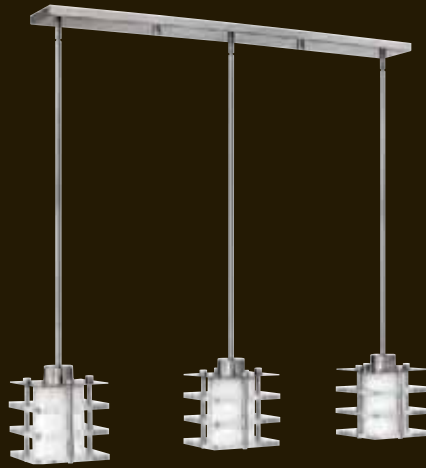

*Luxe pendants shown with linear ceiling adapter.*

## ROUND CEILING ADAPTER



FR83661BNI



FR83661PCM



FR83661VBZ

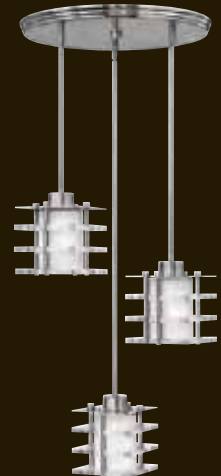

*Luxe pendants shown with round ceiling adapter.*

## ACCESSORY GLASS [ 4" DIA., 5.5" H ]



BIRCH FR88005GL MOCHA FR88009GL PLUM FR88013GL SPLASH FR88021GL CHERRY FR88025GL CARAMEL FR88033GL SLATE FR88037GL

## ACCESSORY GLASS [ 5.5" DIA., 6.5" H ]

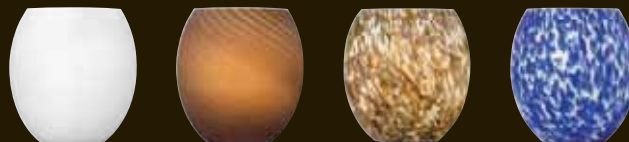

OPAL ELIPSE FR88504GL SANDSTONE FR88508GL DESERT FR88512GL AZURE FR88516GL