

Single Pole Devices

Industrial Grade Plugs, Connectors, Caps, Covers and Accessories



Made in the USA



Leviton Single Pole Cam-Type Devices

Leviton Single Pole Cam-Type Devices are designed to provide superior service and durability, even under the most severe operating conditions. Our 15 Series Taper Nose mini-cam plugs, receptacles and connectors are rated to 140 Amps, making them ideal for entertainment applications such as those found in carnivals and theme parks.

Our 16 Series Taper Nose Cam-Type Devices are rated up to 400 Amps, making them the connectors of choice for power distribution applications such as concerts, sound stages, movie making, television productions, sporting events and conventions.



15D22-Y



16A23-E



16D31-O

The 18 Series Single Pole Ball Nose Cam-Type Devices are also rated to 400 Amps, and are typically favored by the broadcasting and welding industries as well as many end users in Canada.

All of these devices (except vulcanized plugs) feature solid brass contacts and shatter and crack proof Santoprene™ TPV insulators, making them ideal for both outdoor and indoor applications. The positive locking connection maintains its integrity even when subjected to vibration. Plus, they are interoperable and interchangeable with any competitive products.

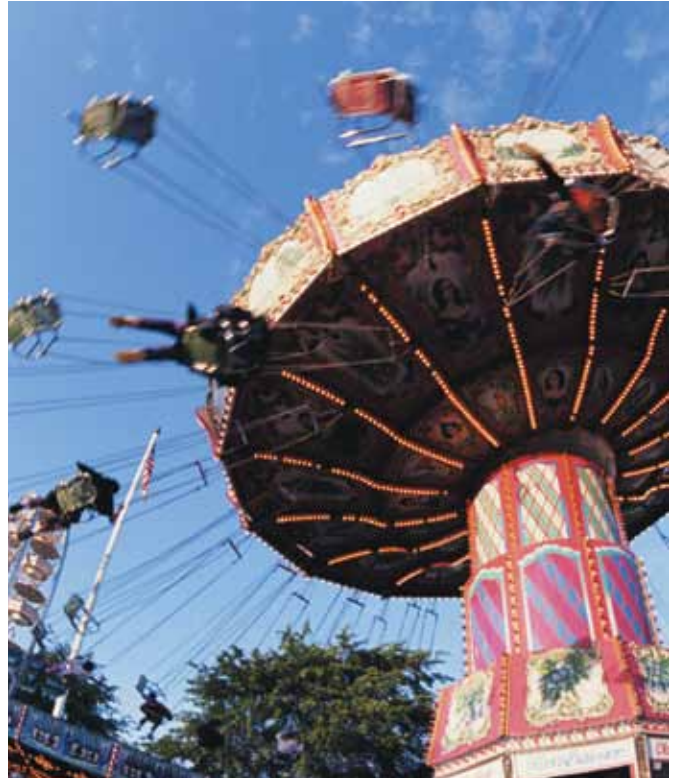

16R28-R



18R22-G

Leviton Single Pole Latching Cam-Type Connectors

Our 17 & 19 Series Taper and Ball Nose devices are rated up to 690 Amps and can withstand grueling, heavy-duty industrial use. Preferred applications for this series include generator test stations, water purification plants, electrochemical machining equipment and other general industrial uses.



17D21-W



17V23-E

Leviton's 22 & 23 Series Single Pole Latching Cam-Type devices are also rated up to 690 Amps providing heavy-duty, completely insulated connections that are vibration-resistant. Contacts can also be retrofitted to existing locations and power distribution systems allowing an effortless installation.

The 22 Series Connectors also offers an innovative solution for all tower-to-cell cable connections in wind turbines. Our In-Line Cam-Type Connectors partnered with pre-assembled harnesses allow quick connect and disconnect on site. In addition when compared to traditional "butt-splice" methods, cam connectors lower total installation costs drastically. These connectors are commonly used to provide power to ships at dock side, and are recognized by ETL Labs to meet U.S. Navy specifications.



22R24-E



22R28-W

rhino-hide® 49 Series Single Pole Connectors and Receptacles

Rhino-Hide 49 Series single pole connectors and receptacles are designed to deliver up to 1,000 Volts AC or DC and up to 1,135 Amps of continuous power under the most extreme conditions with cables ranging in size from 313 MCM to 777 MCM. Leviton's Rhino-Hide products are designed to mate with other manufacturers' high-amperage single pole connectors and receptacles.

Rhino-Hide 49 Series single pole connectors are CE Certified and cURus recognized components engineered to exceptional standards for high-amperage power delivery.



49F53-R, 49M53-R

Rhino-Hide 49 Series products are ideal for any number of demanding applications requiring continuous, reliable high-amperage power in multi phases. Typical locations where these products are used include oil and gas rigs as well as heavy industrial applications. Rhino-Hide 49 Series single pole devices can be installed on both existing silicon-controlled rectifiers (SCR's) and generator stations or on new oil and gas rig construction. These devices are used by SCR drive manufacturers and top drive manufacturers to distribute power from the SCR to mud pumps and top drives.

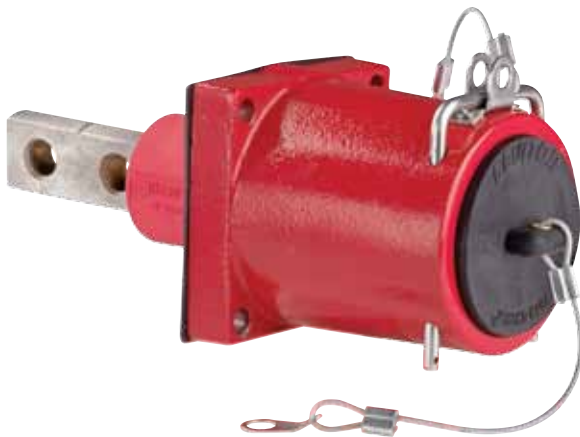

49MR2-CR



49MR1-XR

Made in the USA

Industrial Grade

Cam-Type Connectors

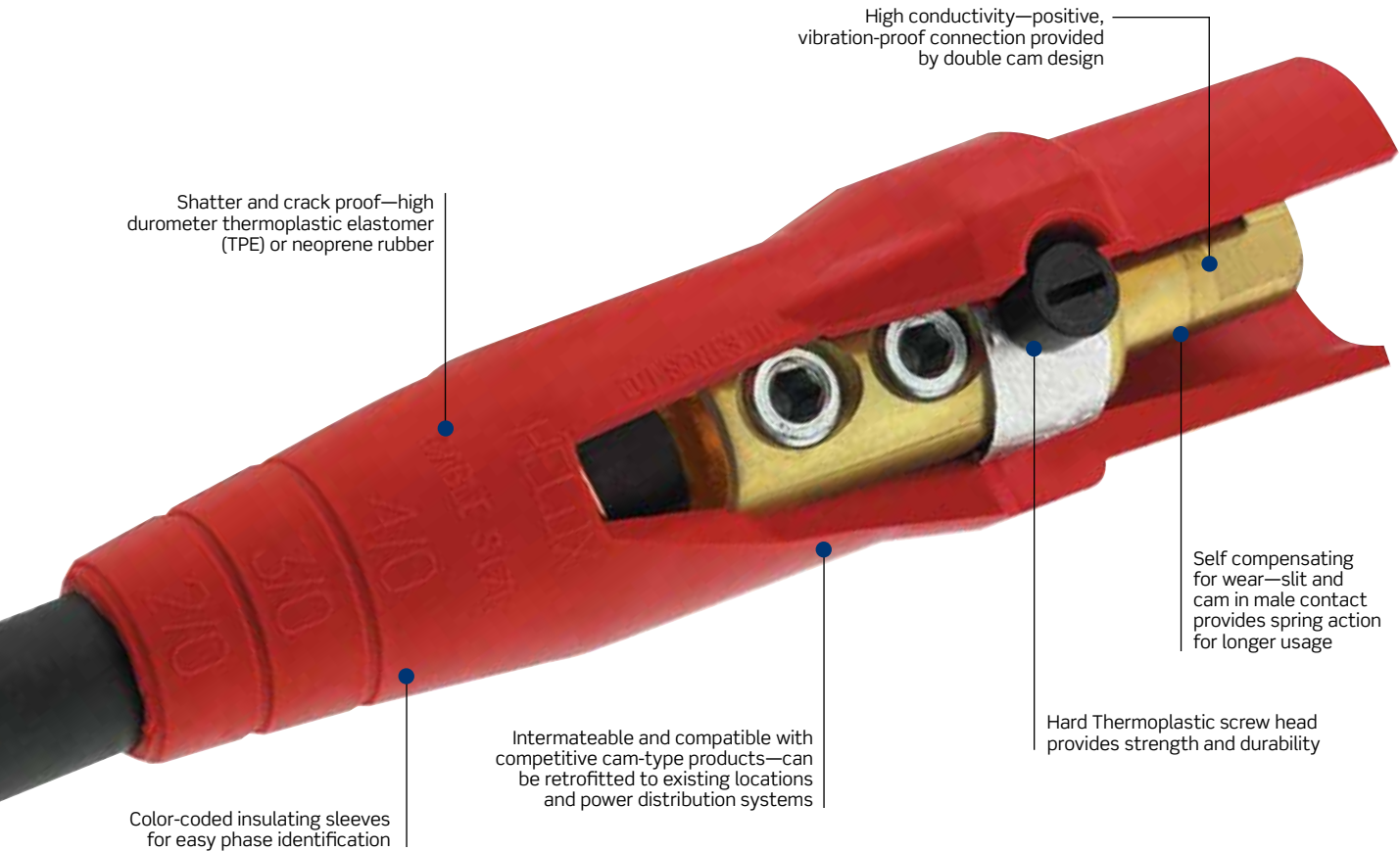

CAM-TYPE CONNECTORS

Connector Type	Component	Description	Standards and Certifications (NEMA, UL, CSA)
15, 16, 18 Series Connectors	Sleeve*	Santoprene™	See individual pages throughout this section for specific Standards and Certifications information
	Contact	Brass	
	Strain Relief	Copper Wire	
17, 19, 22/23 Series Connectors	Sleeve**	Neoprene™	See individual pages throughout this section for specific Standards and Certifications information
	Contact	Brass	
	Strain Relief	Copper Wire	

**V" Series Neoprene™

**22L22/25-S Series Santoprene™

Cam-Type Connectors — 15 Series

Specifications and Features

The 15 Series Taper Nose mini-cam plugs, receptacles and connectors are tough and reliable. Primary applications include carnivals and theme parks, as well as the entertainment industry.

CAM-TYPE CONNECTORS (UP TO 140A, 600V)

15 Series, Taper Nose

Description	Color	Cat. No. Complete	Cat. No. Contact	Cat. No. Insulator
Male Plug Set Screw (Cable Size: #8 - #4)	White	15D21-W	15D21-C	15SDM-48W
	Black	15D21-E	15D21-C	15SDM-48E
	Brown	15D21-H	15D21-C	15SDM-48H*
	Red	15D21-R	15D21-C	15SDM-48R
	Blue	15D21-B	15D21-C	15SDM-48B*
	Orange	15D21-O	15D21-C	15SDM-48O*
	Green	15D21-G	15D21-C	15SDM-48G*
	Yellow	15D21-Y	15D21-C	15SDM-48Y*
Female Plug Set Screw (Cable Size: #8 - #4)	White	15D22-W	15D22-C	15SDF-48W
	Black	15D22-E	15D22-C	15SDF-48E
	Brown	15D22-H	15D22-C	15SDF-48H*
	Red	15D22-R	15D22-C	15SDF-48R
	Blue	15D22-B	15D22-C	15SDF-48B*
	Orange	15D22-O	15D22-C	15SDF-48O*
	Green	15D22-G	15D22-C	15SDF-48G*
	Yellow	15D22-Y	15D22-C	15SDF-48Y*



15SDM-48G



15D22-Y

* Contact factory for availability.

TESTING AND CODE COMPLIANCE

- Meets UL Standards (File #E13399)
- NEMA 3R-Rated (rainproof) for use outdoors
- CSA Certified (File #152105)

DIMENSIONS

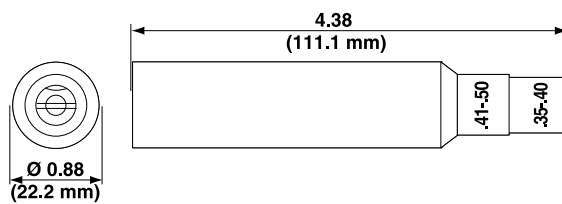

Male Plug – Set Screw

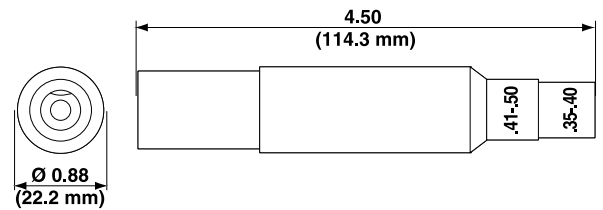

Female Plug – Set Screw

Industrial Grade

CAM-TYPE CONNECTORS (UP TO 140A, 600V)

15 Series, Taper Nose



15D23-B



15D24-E

Description	Color	Cat. No.	Cat. No.	Cat. No.
		Complete	Contact	Insulator
Male Plug - Crimped (Cable Size: #8 - #4)	White	15D23-W	15D23-C	15SDM-48W
	Black	15D23-E	15D23-C	15SDM-48E
	Brown	—	15D23-C	15SDM-48H*
	Red	15D23-R	15D23-C	15SDM-48R
	Blue	15D23-B	15D23-C	15SDM-48B*
	Orange	—	15D23-C	15SDM-48O*
	Green	15D23-G	15D23-C	15SDM-48G*
	Yellow	—	15D23-C	15SDM-48Y*
	Female Plug - Crimped (Cable Size: #8 - #4)	White	15D24-W	15D24-C
Black		15D24-E	15D24-C	15SDF-48E
Brown		—	15D24-C	15SDF-48H*
Red		15D24-R	15D24-C	15SDF-48R
Blue		15D24-B	15D24-C	15SDF-48B*
Orange		—	15D24-C	15SDF-48O*
Green		15D24-G	15D24-C	15SDF-48G*
Yellow		—	15D24-C	15SDF-48Y*

* Contact factory for availability.

TESTING AND CODE COMPLIANCE

- Meets UL Standards (File #E13399)
- NEMA 3R-Rated (rainproof) for use outdoors
- CSA Certified (File #152105)

DIMENSIONS

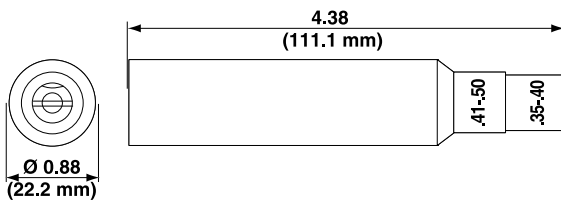

Male Plug - Set Screw

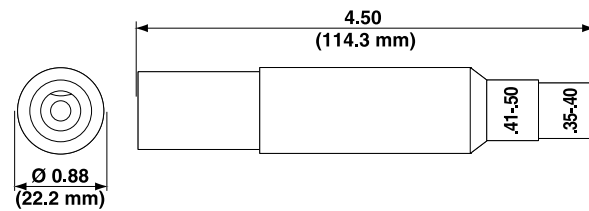

Female Plug - Set Screw

CAM-TYPE CONNECTORS (UP TO 140A, 600V)

15 Series, Taper Nose

Description	Color	Cat. No. Male	Cat. No. Female
Panel Receptacle - Threaded Stud (Cable Size: #8-#4)	White	15R21-W	15R22-W
	Black	15R21-E	15R22-E
	Brown	15R21-H	15R22-H
	Red	15R21-R	15R22-R
	Blue	15R21-B	15R22-B
	Orange	15R21-O	15R22-O
	Green	15R21-G	15R22-G
	Yellow	15R21-Y*	15R22-Y

* Contact factory for availability.



15R21-H

THREE-WAY "T" CONNECTORS

Description	Color	Cat. No. Paralleling T Female-Male-Male	Cat. No. Tapping T Female-Female-Male	Cat. No. Double Female Female-Female
Three-Way "T" Connector	White	15A21-W*	15A22-W	15A23-W*
	Black	15A21-E	15A22-E	15A23-E
	Red	15A21-R*	15A22-R	15A23-R*
	Blue	15A21-B*	15A22-B	15A23-B*
	Green	15A21-G	15A22-G	15A23-G*

* Contact factory for availability.



15A21-G

PROTECTIVE CAPS AND COVERS

Description	Color	Cat. No. Male	Cat. No. Female
Protective Caps	White	—	15P22-W
	Black	15P21-E	15P22-E
NEMA 3R Enclosure - for Male and Female Panel Receptacles	White	15S31-W	—
	Black	15S31-E	—
	Brown	15S31-H	—
	Red	15S31-R	—
	Blue	15S31-B	—
	Orange	15S31-O	—
	Green	15S31-G	—
Yellow	15S31-Y	—	



15P21-E



15S31-R

TESTING AND CODE COMPLIANCE

- Meets UL Standards (File #E13399)
- NEMA 3R-Rated (rainproof) for use outdoors
- CSA Certified (File #152105)

DIMENSIONS

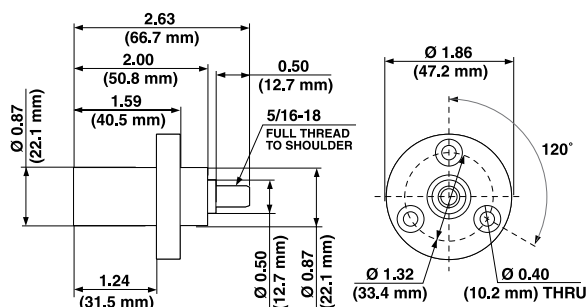

Male Panel Receptacle Threaded Stud

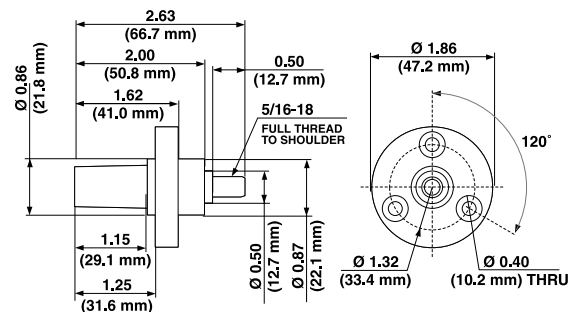

Female Panel Receptacle Threaded Stud

Industrial Grade

Cam-Type Connectors — 16 Series

Specifications and Features

The 16 Series Taper Nose products are the connectors of choice for concerts, sound stages, movie-making, television production, sporting events and conventions.

CAM-TYPE CONNECTORS (UP TO 400A, 600V)

16 Series, Taper Nose



16D21-O



16D29-G

Description	Color	Cat. No. Complete	Cat. No. Contact	Cat. No. Insulator
Male Detachable Plug - Single Set Screw (Cable Size: 2-2/0)	White	16D21-W	16D21-C*	16SDM-22W
	Black	16D21-E	16D21-C*	16SDM-22E
	Brown	16D21-H	16D21-C*	16SDM-22H*
	Red	16D21-R	16D21-C*	16SDM-22R
	Blue	16D21-B	16D21-C*	16SDM-22B
	Orange	16D21-O	16D21-C*	16SDM-22O*
	Green	16D21-G	16D21-C*	16SDM-22G
	Yellow	16D21-Y	16D21-C*	16SDM-22Y*
Female Detachable Plug - Single Set Screw (Cable Size: 2-2/0)	White	16D29-W	16D29-C*	16SDF-22W
	Black	16D29-E	16D29-C*	16SDF-22E
	Brown	16D29-H	16D29-C*	16SDF-22H
	Red	16D29-R	16D29-C*	16SDF-22R
	Blue	16D29-B	16D29-C*	16SDF-22B
	Orange	16D29-O	16D29-C*	16SDF-22O*
	Green	16D29-G	16D29-C*	16SDF-22G
	Yellow	16D29-Y	16D29-C*	16SDF-22Y*

* Contact factory for availability.

TESTING AND CODE COMPLIANCE

- NEMA 3R-Rated (rainproof) for use outdoors
- Only Double Set Screw Version UL/CSA

DIMENSIONS

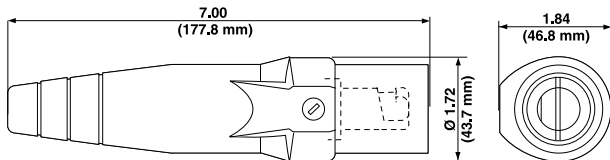

Male Detachable Plug – Single Set Screw

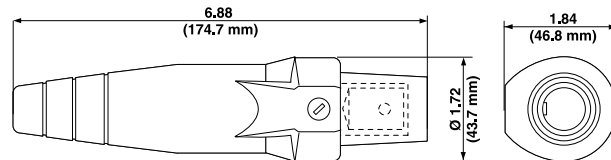

Female Detachable Plug – Single Set Screw

CAM-TYPE CONNECTORS (UP TO 400A, 600V)

16 Series, Taper Nose

Description	Color	Cat. No. Complete	Cat. No. Contact	Cat. No. Insulator
Male Detachable Plug - Single Set Screw (Cable Size: 1/0-4/0)	White	16D23-W	16D23-C*	16SDM-14W
	Black	16D23-E	16D23-C*	16SDM-14E
	Brown	16D23-H	16D23-C*	16SDM-14H*
	Red	16D23-R	16D23-C*	16SDM-14R
	Blue	16D23-B	16D23-C*	16SDM-14B
	Orange	16D23-O	16D23-C*	16SDM-14O
	Green	16D23-G	16D23-C*	16SDM-14G
	Yellow	16D23-Y	16D23-C*	16SDM-14Y
Female Detachable Plug - Single Set Screw (Cable Size: 1/0-4/0)	White	16D32-W	16D32-C*	16SDF-14W
	Black	16D32-E	16D32-C*	16SDF-14E
	Brown	16D32-H	16D32-C*	16SDF-14H*
	Red	16D32-R	16D32-C*	16SDF-14R
	Blue	16D32-B	16D32-C*	16SDF-14B
	Orange	16D32-O	16D32-C*	16SDF-14O*
	Green	16D32-G	16D32-C*	16SDF-14G
	Yellow	16D32-Y	16D32-C*	16SDF-14Y*



16D23-B



16D32-W

* Contact factory for availability.

TESTING AND CODE COMPLIANCE

- NEMA 3R-Rated (rainproof) for use outdoors
- Only Double Set Screw Version UL/CSA

DIMENSIONS

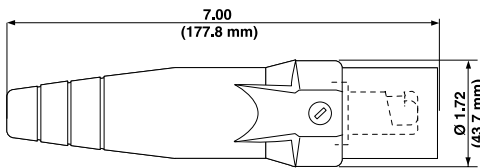

Male Detachable Plug - Single Set Screw

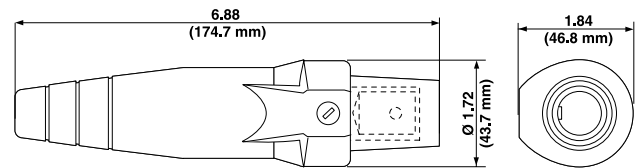

Female Detachable Plug - Single Set Screw

Industrial Grade

CAM-TYPE CONNECTORS (UP TO 400A, 600V)

16 Series, Taper Nose



16D22-E



16D31-O

Description	Color	Cat. No.	Cat. No.	Cat. No.
		Complete	Contact	Insulator
Male Detachable Plug - Double Set Screw (Cable Size: #2-2/0)	White	16D22-W	16D22-C	16SDM-22W
	Black	16D22-E	16D22-C	16SDM-22E
	Brown	16D22-H	16D22-C	16SDM-22H*
	Red	16D22-R	16D22-C	16SDM-22R
	Blue	16D22-B	16D22-C	16SDM-22B
	Orange	16D22-O	16D22-C	16SDM-22O*
	Green	16D22-G	16D22-C	16SDM-22G
	Yellow	16D22-Y	16D22-C	16SDM-22Y*
Female Detachable Plug - Double Set Screw (Cable Size: #2-2/0)	White	16D31-W	16D31-C	16SDF-22W
	Black	16D31-E	16D31-C	16SDF-22E
	Brown	16D31-H	16D31-C	16SDF-22H*
	Red	16D31-R	16D31-C	16SDF-22R
	Blue	16D31-B	16D31-C	16SDF-22B
	Orange	16D31-O	16D31-C	16SDF-22O*
	Green	16D31-G	16D31-C	16SDF-22G
	Yellow	16D31-Y	16D31-C	16SDF-22Y*

* Contact factory for availability.

TESTING AND CODE COMPLIANCE

- Meets UL Standards (File #E13399)
- NEMA 3R-Rated (rainproof) for use outdoors
- CSA Certified (File #152105)

DIMENSIONS

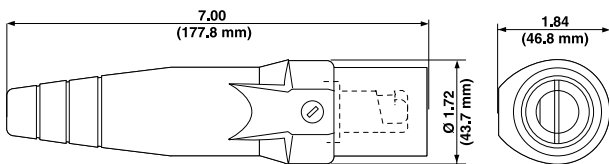

Male Detachable Plug – Double Set Screw

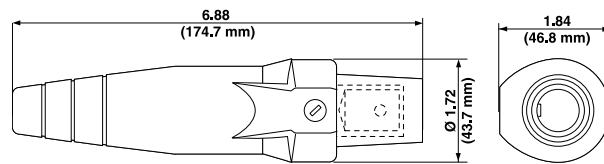

Female Detachable Plug – Double Set Screw

CAM-TYPE CONNECTORS (UP TO 400A, 600V)

16 Series, Taper Nose  

Description	Color	Cat. No. Complete	Cat. No. Contact	Cat. No. Insulator
Male Detachable Plug - Double Set Screw (Cable Size: 1/0-4/0)	White	16D24-W	16D24-C	16SDM-14W*
	Grey	16D24-GY	16D24-C	16SDM-14GY*
	Black	16D24-E	16D24-C	16SDM-14E*
	Brown	16D24-H	16D24-C	16SDM-14H*
	Red	16D24-R	16D24-C	16SDM-14R*
	Blue	16D24-B	16D24-C	16SDM-14B*
	Orange	16D24-O	16D24-C	16SDM-14O*
	Green	16D24-G	16D24-C	16SDM-14G*
	Yellow	16D24-Y	16D24-C	16SDM-14Y*
Female Detachable Plug - Double Set Screw (Cable Size: 1/0-4/0)	White	16D33-W	16D33-C*	16SDF-14W*
	Grey	16D33-GY	16D33-C*	—
	Black	16D33-E	16D33-C*	16SDF-14E
	Brown	16D33-H	16D33-C*	16SDF-14H*
	Red	16D33-R	16D33-C*	16SDF-14R
	Blue	16D33-B	16D33-C*	16SDF-14B*
	Orange	16D33-O	16D33-C*	16SDF-14O*
	Green	16D33-G	16D33-C*	16SDF-14G*
	Yellow	16D33-Y	16D33-C*	16SDF-14Y*



16D33-O



16D24-E

* Contact factory for availability.

TESTING AND CODE COMPLIANCE

- Meets UL Standards (File #E13399)
- NEMA 3R-Rated (rainproof) for use outdoors
- CSA Certified (File #152105)

DIMENSIONS

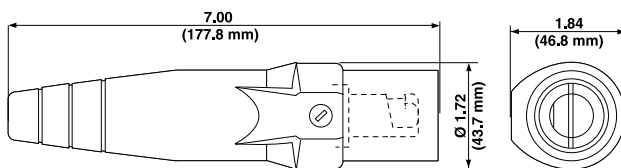

Male Detachable Plug – Double Set Screw

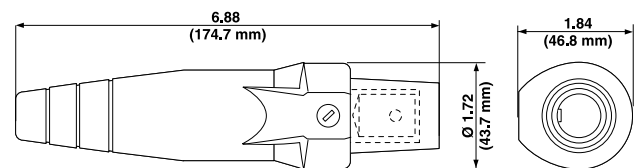

Female Detachable Plug – Double Set Screw

Industrial Grade

CAM-TYPE CONNECTORS (UP TO 400A, 600V)

16 Series, Taper Nose



16D25-R



16D34-B

Description	Color	Cat. No.	Cat. No.	Cat. No.
		Complete	Contact	Insulator
Male Detachable Plug - Crimped (Cable Size: #2-#1)	White	16D25-W	16D25-C*	16SDM-22W
	Black	16D25-E	16D25-C*	16SDM-22E
	Brown	16D25-H*	16D25-C*	16SDM-22H*
	Red	16D25-R	16D25-C*	16SDM-22R
	Blue	16D25-B*	16D25-C*	16SDM-22B
	Orange	16D25-O*	16D25-C*	16SDM-22O*
	Green	16D25-G	16D25-C*	16SDM-22G
	Yellow	16D25-Y*	16D25-C*	16SDM-22Y*
Female Detachable Plug - Crimped (Cable Size: #2-#1)	White	16D34-W	16D34-C*	16SDF-22W
	Black	16D34-E	16D34-C*	16SDF-22E
	Brown	16D34-H*	16D34-C*	16SDF-22H*
	Red	16D34-R	16D34-C*	16SDF-22R
	Blue	16D34-B*	16D34-C*	16SDF-22B
	Orange	16D34-O*	16D34-C*	16SDF-22O*
	Green	16D34-G	16D34-C*	16SDF-22G
	Yellow	16D34-Y*	16D34-C*	16SDF-22Y*

* Contact factory for availability.

TESTING AND CODE COMPLIANCE

- Meets UL Standards (File #E13399)
- NEMA 3R-Rated for use outdoors
- CSA Certified (File #152105)

DIMENSIONS

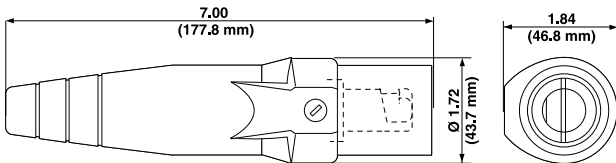

Male Detachable Plug – Crimped

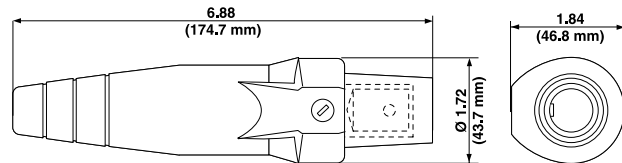

Female Detachable Plug – Crimped

CAM-TYPE CONNECTORS (UP TO 400A, 600V)

16 Series, Taper Nose  

Description	Color	Cat. No.	Cat. No.	Cat. No.
		Complete	Contact	Insulator
Male Detachable Plug - Crimped (Cable Size: 1/0-2/0)	White	16D26-W*	16D26-C*	16SDM-22W
	Black	16D26-E	16D26-C*	16SDM-22E
	Brown	16D26-H*	16D26-C*	16SDM-22H*
	Red	16D26-R*	16D26-C*	16SDM-22R
	Blue	16D26-B*	16D26-C*	16SDM-22B
	Orange	16D26-O*	16D26-C*	16SDM-22O*
	Green	16D26-G	16D26-C*	16SDM-22G
	Yellow	16D26-Y*	16D26-C*	16SDM-22Y*
Female Detachable Plug - Crimped (Cable Size: 1/0-2/0)	White	16D35-W*	16D35-C*	16SDF-22W
	Black	16D35-E	16D35-C*	16SDF-22E
	Brown	16D35-H*	16D35-C*	16SDF-22H*
	Red	16D35-R*	16D35-C*	16SDF-22R
	Blue	16D35-B*	16D35-C*	16SDF-22B
	Orange	16D35-O*	16D35-C*	16SDF-22O*
	Green	16D35-G	16D35-C*	16SDF-22G
	Yellow	16D35-Y*	16D35-C*	16SDF-22Y*



* Contact factory for availability.

TESTING AND CODE COMPLIANCE

- Meets UL Standards (File #E13399)
- NEMA 3R-Rated for use outdoors
- CSA Certified (File #152105)

DIMENSIONS

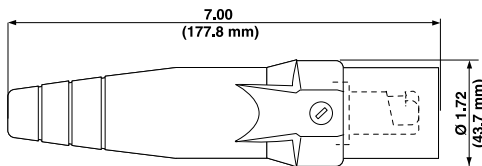

Male Detachable Plug - Crimped

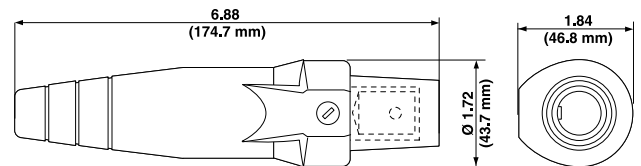

Female Detachable Plug - Crimped

Industrial Grade

CAM-TYPE CONNECTORS (UP TO 400A, 600V)

16 Series, Taper Nose



16D28-W



16D37-H

Description	Color	Cat. No.	Cat. No.	Cat. No.
		Complete	Contact	Insulator
Male Detachable Plug - Crimped (Cable Size: 3/0-4/0)	White	16D28-W	16D28-C	16SDM-14W
	Black	16D28-E	16D28-C	16SDM-14E
	Brown	16D28-H	16D28-C	16SDM-14H*
	Red	16D28-R	16D28-C	16SDM-14R
	Blue	16D28-B	16D28-C	16SDM-14B
	Orange	16D28-O	16D28-C	16SDM-14O
	Green	16D28-G	16D28-C	16SDM-14G
	Yellow	16D28-Y	16D28-C	16SDM-14Y
	Female Detachable Plug - Crimped (Cable Size: 3/0-4/0)	White	16D37-W	16D37-C
Black		16D37-E	16D37-C	16SDF-14E
Brown		16D37-H	16D37-C	16SDF-14H*
Red		16D37-R	16D37-C	16SDF-14R
Blue		16D37-B	16D37-C	16SDF-14B
Orange		16D37-O	16D37-C	16SDF-14O*
Green		16D37-G	16D37-C	16SDF-14G*
Yellow		16D37-Y	16D37-C	16SDF-14Y*

* Contact factory for availability.

TESTING AND CODE COMPLIANCE

- Meets UL Standards (File #E13399)
- NEMA 3R-Rated for use outdoors
- CSA Certified (File #152105)

DIMENSIONS

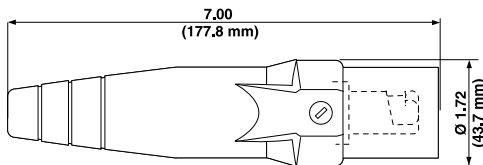

Male Detachable Plug - Crimped

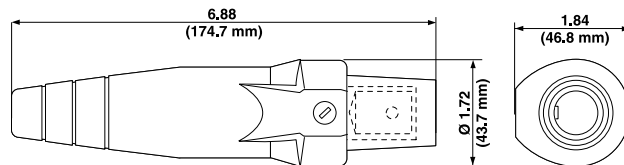

Female Detachable Plug - Crimped

PROTECTIVE CAPS AND COVERS

16 Series

Description	Color	Cat. No.	Cat. No.
		Male	Female
Protective Caps	White	16P21-W	16P22-W
	Black	16P21-E	16P22-E
	Brown	16P21-H	16P22-H
	Red	16P21-R	16P22-R
	Blue	16P21-B	16P22-B
	Orange	16P21-O	16P22-O
	Green	16P21-G	16P22-G
	Yellow	16P21-Y	16P22-Y
Snap Back Covers - for Male and Female Panel Receptacles	White	16S21-W	—
	Black	16S21-E	—
	Brown	16S21-H	—
	Red	16S21-R	—
	Blue	16S21-B	—
	Orange	16S21-O	—
	Green	16S21-G	—
	Yellow	16S21-Y	—
NEMA 3R Enclosure - for Male and Female Panel Receptacles	White	16S31-W	—
	Black	16S31-E	—
	Brown	16S31-H	—
	Red	16S31-R	—
	Blue	16S31-B	—
	Orange	16S31-O	—
	Green	16S31-G	—
	Yellow	16S31-Y	—



16P22-E



16S21-O



16S21 Mounted on 16R24-14R



16S31-R

TESTING AND CODE COMPLIANCE

- NEMA 3R-Rated for use outdoors (Protective Caps Only)

DIMENSIONS

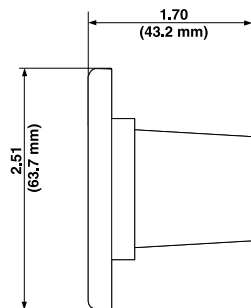

Male Protective Cap

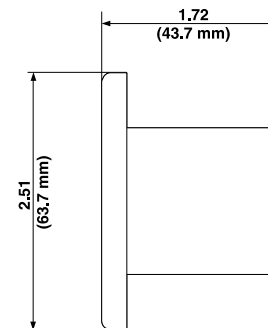

Female Protective Cap

Industrial Grade

CAM-TYPE CONNECTORS (UP TO 400A, 600V)

16 Series, Taper Nose



16V22-B



16V26-R

Description	Color	Cat. No.	Cat. No.	Cat. No.
		Complete	Contact	Insulator
Male Vulcanized Plug - Crimped (Cable Size: 1/0-2/0)	White	16V22-W*	—	—
	Black	16V22-E	—	—
	Brown	16V22-H*	—	—
	Red	16V22-R	—	—
	Blue	16V22-B	—	—
	Orange	16V22-O*	—	—
	Green	16V22-G	—	—
	Yellow	16V22-Y*	—	—
	Female Vulcanized Plug - Crimped (Cable Size: 1/0-2/0)	White	16V26-W	—
Black		16V26-E	—	—
Brown		16V26-H*	—	—
Red		16V26-R	—	—
Blue		16V26-B	—	—
Orange		16V26-O*	—	—
Green		16V26-G*	—	—
Yellow		16V26-Y*	—	—

* Contact factory for availability.

TESTING AND CODE COMPLIANCE

- NEMA 3R-Rated (rainproof) for use outdoors

DIMENSIONS

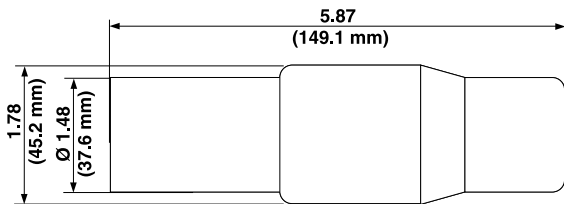

Male Vulcanized Plug - Crimped

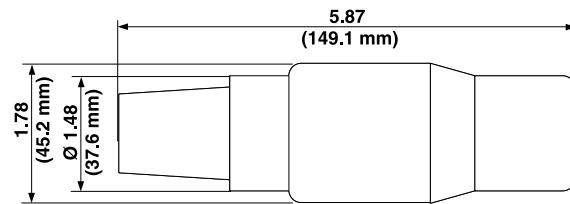

Female Vulcanized Plug - Crimped

CAM-TYPE CONNECTORS (UP TO 400A, 600V)

16 Series, Taper Nose

Description	Color	Cat. No.	Cat. No.	Cat. No.
		Complete	Contact	Insulator
Male Vulcanized Plug - Crimped (Cable Size: 3/0-4/0)	White	16V24-W	16V24-C*	—
	Black	16V24-E	16V24-C*	—
	Brown	16V24-H*	16V24-C*	—
	Red	16V24-R	16V24-C*	—
	Blue	16V24-B	16V24-C*	—
	Orange	16V24-O	16V24-C*	—
	Green	16V24-G	16V24-C*	—
	Yellow	16V24-Y*	16V24-C*	—
Female Vulcanized Plug - Crimped (Cable Size: 3/0-4/0)	White	16V28-W	—	—
	Black	16V28-E	—	—
	Brown	16V28-H*	—	—
	Red	16V28-R	—	—
	Blue	16V28-B	—	—
	Orange	16V28-O*	—	—
	Green	16V28-G	—	—
	Yellow	16V28-Y*	—	—



16V24-Y



16V28-E

* Contact factory for availability.

TESTING AND CODE COMPLIANCE

- NEMA 3R-Rated (rainproof) for use outdoors

DIMENSIONS

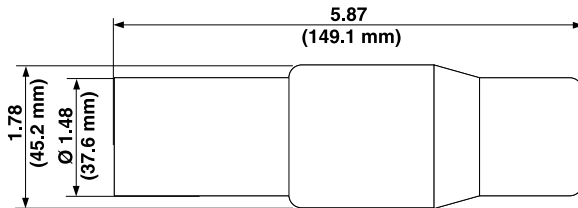

Male Vulcanized Plug – Crimped

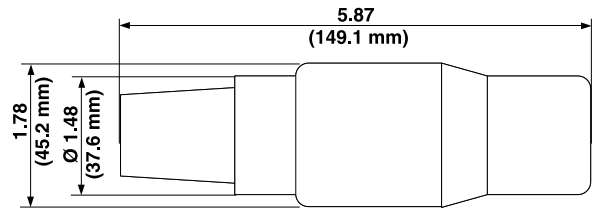

Female Vulcanized Plug – Crimped

Industrial Grade

CAM-TYPE CONNECTORS (UP TO 400A, 600V)

16 Series, Taper Nose



16F21-B

Description	Color	Cat. No.	
		Angle Style	Offset Style
Female Terminal Connector (Cable Size: #2-4/0)	White	16F21-W	16F22-W
	Black	16F21-E	16F22-E
	Brown	16F21-H	16F22-H
	Red	16F21-R	16F22-R
	Blue	16F21-B	16F22-B
	Orange	16F21-O	16F22-O
	Green	16F21-G	16F22-G
	Yellow	16F21-Y	16F22-Y



16R21-R

Description	Color	Cat. No. Double Set Screw Style (Cable Size: 1/0-4/0)		Cat. No. Threaded Stud Style (Cable Size: #2-4/0)		Female w/ Micro Switch
		Male	Female	Male	Female	
Panel Receptacles	White	16R21-W	16R22-W	16R23-W	16R24-W	16RSW-W
	Black	16R21-E	16R22-E	16R23-E	16R24-E	16RSW-E
	Brown	16R21-H	16R22-H	16R23-H	16R24-H	—
	Red	16R21-R	16R22-R	16R23-R	16R24-R	16RSW-R
	Blue	16R21-B	16R22-B	16R23-B	16R24-B	16RSW-B
	Orange	16R21-O	16R22-O	16R23-O	16R24-O	—
	Green	16R21-G	16R22-G	16R23-G	16R24-G	16RSW-G
	Yellow	16R21-Y	16R22-Y	16R23-Y	16R24-Y	—



16RSW-R

Description	Color	Cat. No. (Cable Size: #2-4/0) with Half Round Tapped Terminal		Cat. No. Threaded Stud Style (Cable Size: #2-4/0) with Self-Clinching PEM Nuts-Mounting Plate	
		Male	Female	Male***	Female***
Panel Mount Receptacles	White	16R19-W	16R20-W	16R25-W	16R26-W
	Black	16R19-E	16R20-E	16R25-E	16R26-E
	Brown	—	—	16R25-H	16R26-H
	Red	16R19-R	16R20-R	16R25-R	16R26-R
	Blue	16R19-B	16R20-B	16R25-B	16R26-B
	Orange	—	—	16R25-O	16R26-O
	Green	16R19-G	16R20-G	16R25-G	16R26-G
	Yellow	—	—	16R25-Y	16R26-Y

***1 1/8" Threaded Stud, for other lengths contact factory.

TESTING AND CODE COMPLIANCE

- Meets UL Standards (File #E-13399), Panel Receptacles only
- NEMA 3R-Rated for use outdoors
- CSA Certified (File #152105)

DIMENSIONS

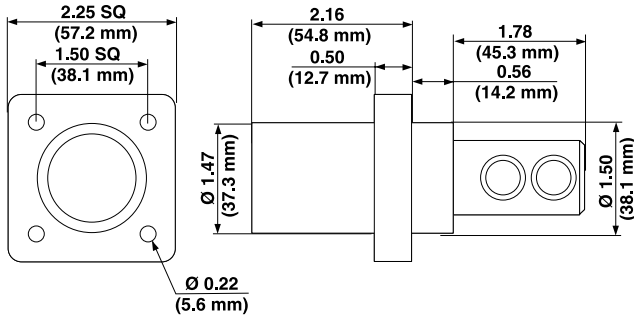

Male Double Set Screw Panel Receptacle

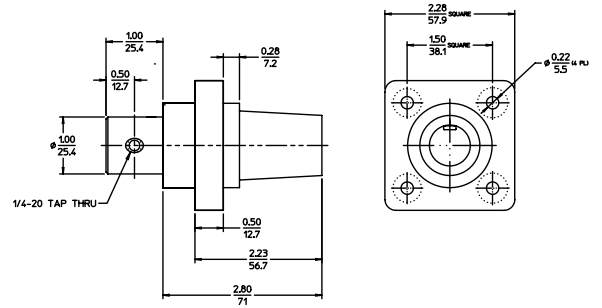
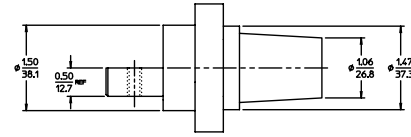

16R20 Female Panel Receptacle Buss Bar Version

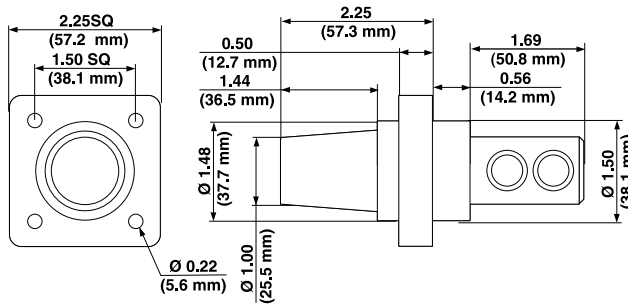

Female Double Set Screw Panel Receptacle

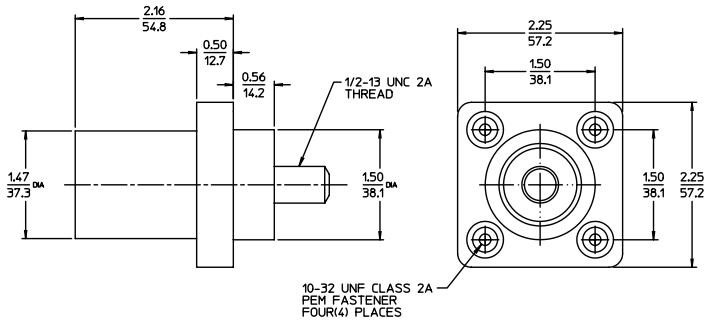

16R25 Male Panel Receptacle with PEM Nuts

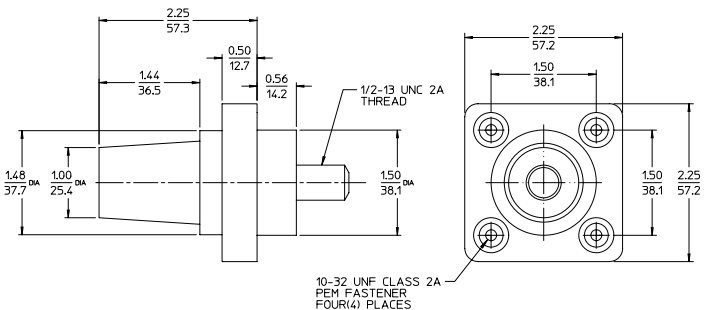

16R26 Female Panel Receptacle with PEM Nuts

Industrial Grade

16 Series 45° Angle Single-Pole Cam-Type Panel Receptacles

Leviton's 45° Angle Single-Pole Panel Receptacles are designed to provide superior service and durability, even under the most severe operating conditions. Featuring solid brass contacts and Santoprene™ TPV insulators, these devices are ideal for use in equipment associated with concerts, sound stages, movie-making, television production and many other power distribution applications. The unique 45° angle is perfect for applications where cables protruding 90° from the panel is impractical. These Leviton 16 Series Single-Pole Panel Receptacles and accessories are UL/CSA Listed and are completely interoperable and interchangeable with any competitive cam-type plugs and receptacles.

Specifications and Features

- Male and Female Receptacles
- Double Set Screw or Threaded Stud Termination
- Self compensating for wear (male receptacle)
- Color-coded insulators for easy phase identification



16R27-G



16R28-R



16R29-E



16R30-E

45° ANGLE CAM-TYPE PANEL RECEPTACLES

16 Series, Taper Nose

Description	Color	Cat. No.		Cat. No.	
		Double Set Screw Style (Cable Size: 1/0-4/0)		Threaded Stud Style (Cable Size: #2-4/0)	
		Male	Female	Male	Female
45° Panel Receptacles	White	16R27-W	16R28-W	16R29-W	16R30-W
	Black	16R27-E	16R28-E	16R29-E	16R30-E
	Red	16R27-R	16R28-R	16R29-R	16R30-R
	Blue	16R27-B	16R28-B	16R29-B	16R30-B
	Green	16R27-G	16R28-G	16R29-G	16R30-G

TESTING AND CODE COMPLIANCE

- Meets UL Standards (File #E13399)
- NEMA 3R-Rated (rainproof) for use outdoors
- CSA Certified (File #152105)

MATERIAL

- Insulator: Santoprene™ TPV
- Contact: Solid Brass

DIMENSIONS

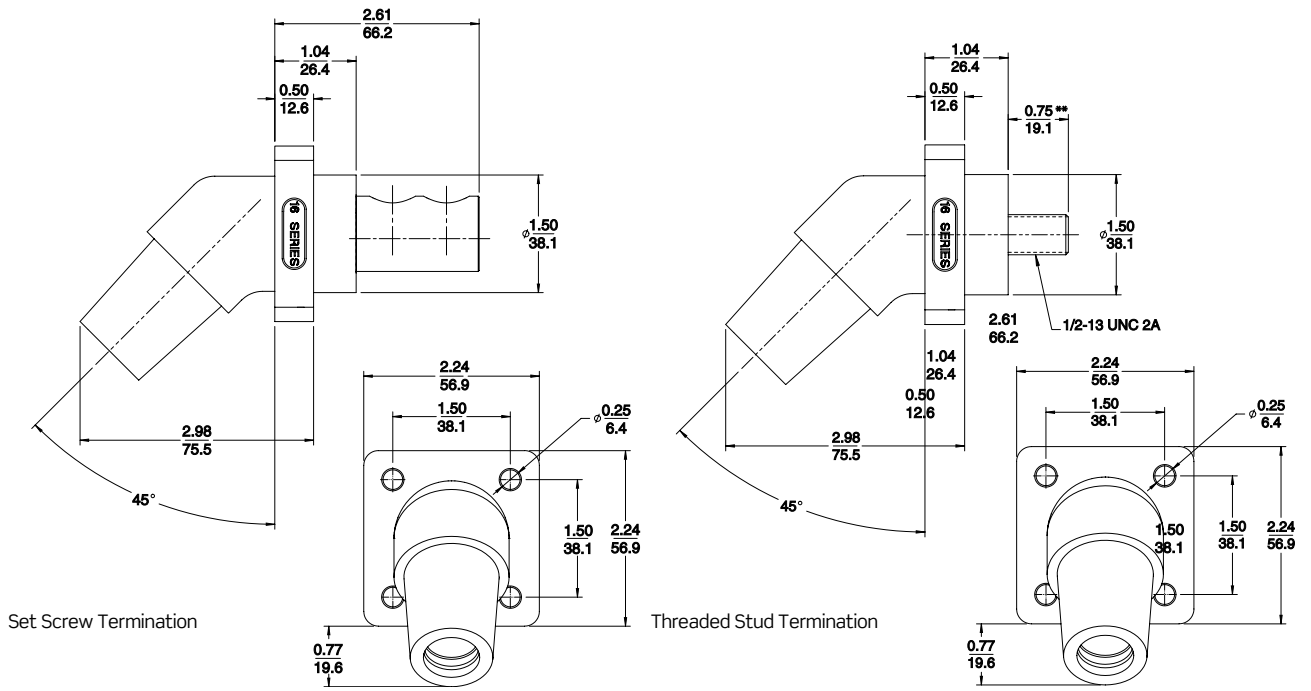

Industrial Grade

CAM-TYPE CONNECTORS (UP TO 400A, 600V)

16 Series, Taper Nose



16A21-G



16A23-E



16A24-W

Description	Color	Cat. No.	
		Paralleling Tee Female-Male-Male	Tapping Tee Female-Female-Male
Multi-Way Connectors	White	16A21-W	16A22-W
	Black	16A21-E	16A22-E
	Brown	16A21-H*	16A22-H*
	Red	16A21-R	16A22-R
	Blue	16A21-B	16A22-B
	Orange	16A21-O	16A22-O
	Green	16A21-G	16A22-G
	Yellow	16A21-Y	16A22-Y*

Description	Color	Cat. No.		Cat. No. Dbl. Female Fem.-Fem.	Cat. No. Dbl. Male Male-Male
		3-Fer Male-Fem.-Fem.-Fem.	Reversed 3-Fer Fem.-Male-Male-Male		
Multi-Way Connectors	White	16A23-W	16A26-W	16A24-W	16A25-W
	Black	16A23-E	16A26-E	16A24-E	16A25-E
	Brown	16A23-H*	—	16A24-H	16A25-H
	Red	16A23-R	—	16A24-R	16A25-R
	Blue	16A23-B	—	16A24-B	16A25-B
	Orange	16A23-O*	—	16A24-O	16A25-O
	Green	16A23-G	16A26-G	16A24-G	16A25-G
	Yellow	16A23-Y	16A26-Y	16A24-Y	16A25-Y*

* Contact factory for availability.

TESTING AND CODE COMPLIANCE

- Meets UL Standards (File #E151429)
- NEMA 3R-Rated (rainproof) for use outdoors
- CSA Certified File #152105

DIMENSIONS

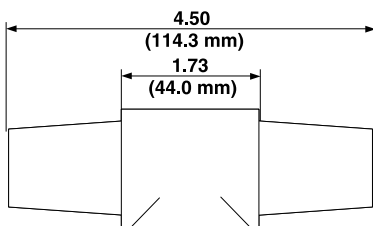

Multi-way Connector - Female to Female

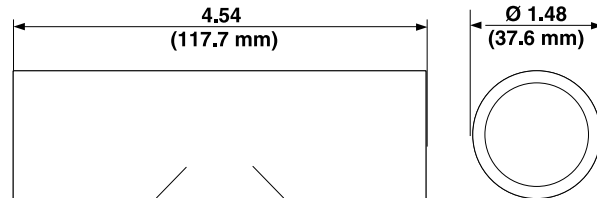

Multi-way Connector - Male to Male

16 Series Single-Pole Cam-Type Adapter Cable Assemblies

Leviton's 16 Series Single-Pole Cam-Type Device line has been expanded to include a variety of assembled adapters. These cable assemblies, or "Soft Adapters", feature the most common adapter configurations. The entire line of Leviton 16 Series Single-Pole Cam-Type Adapter Cable Assemblies are UL/CSA Listed and completely interoperable and interchangeable with any competitive cam-type plugs and receptacles.

Specifications and Features

- 4/0 Cable provides up to 400A/600V capacity
- "Lay flat" design provides for safe cable routing
- Color-coded insulators for easy phase identification

CAM-TYPE ADAPTER CABLE ASSEMBLIES

16 Series, Taper Nose

Description	Color	Cat. No.	Cat. No.	Cat. No.	Cat. No.
		(Cable Size: 4/0) Paralleling Tee	(Cable Size: 4/0) Tapping Tee	(Cable Size: 4/0) 3-Fer	(Cable Size: 4/0) Reverse 3-Fer
"Soft" Cable	White	16A31-W	16A32-W	16A33-W	16A36-W
	Black	16A31-E	16A32-E	16A33-E	16A36-E
	Brown	16A31-H*	—	—	—
	Red	16A31-R	16A32-R	16A33-R	16A36-R
	Blue	16A31-B	16A32-B	16A33-B	16A36-B
	Orange	16A31-O*	—	—	—
	Green	16A31-G	16A32-G	16A33-G	16A36-G
	Yellow	—	—	—	16A36-Y*

* Contact factory for availability.



TESTING AND CODE COMPLIANCE

- Meets UL Standards (File #E13399)
- NEMA 3R-Rated (rainproof) for use outdoors
- CSA Certified (File #152105)

MATERIAL

- Insulator: Santoprene™ TPV
- Contact: Solid Brass
- Cable Insulation: Type SC, -40°C to 105°C

DIMENSIONS

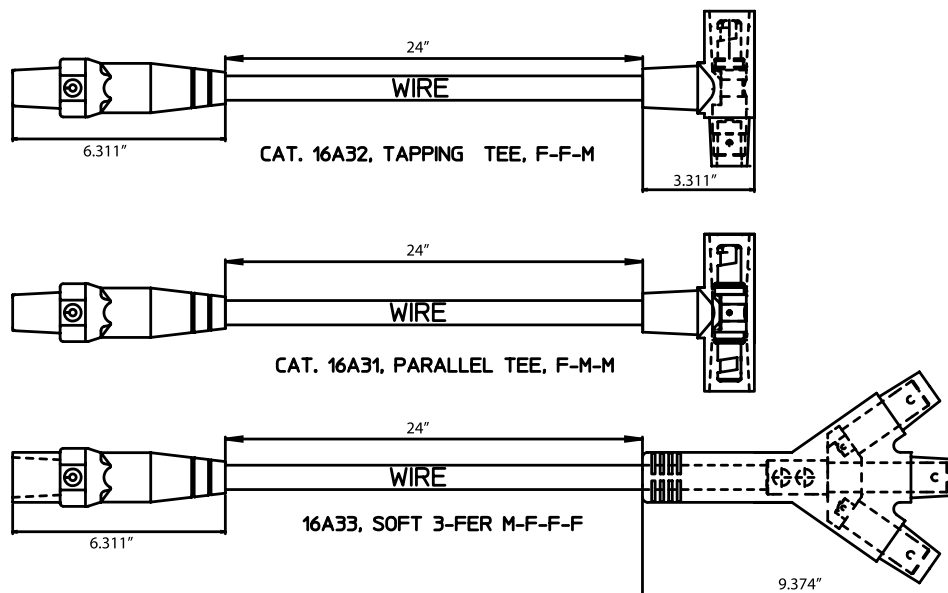

Industrial Grade

Cam-Type Connectors — 18 Series

Specifications and Features

The 18 Series Ball Nose pin and sleeve type plugs, receptacles and connectors are used by the broadcast industry in Canada, as well as the welding industry in the United States.

CAM-TYPE CONNECTORS (UP TO 400A, 600V)

18 Series, Ball Nose



18D21-B



18D29-O

Description	Color	Cat. No. Complete	Cat. No. Contact	Cat. No. Insulator
Male Detachable Plug - Single Set Screw (Cable Size: #2-2/0)	White	18D21-W*	—	18SDM-22W*
	Black	18D21-E	—	18SDM-22E*
	Brown	18D21-H*	—	—
	Red	18D21-R	—	18SDM-22R*
	Blue	18D21-B*	—	18SDM-22B*
	Orange	18D21-O*	—	—
	Green	18D21-G	—	18SDM-22G*
	Yellow	18D21-Y*	—	—
Female Detachable Plug - Single Set Screw (Cable Size: #2-2/0)	White	18D29-W*	—	18SDF-22W*
	Black	18D29-E	—	18SDF-22E*
	Brown	18D29-H*	—	—
	Red	18D29-R	—	18SDF-22R*
	Blue	18D29-B*	—	18SDF-22B*
	Orange	18D29-O*	—	—
	Green	18D29-G	—	18SDF-22G*
	Yellow	18D29-Y*	—	—

* Contact factory for availability.

DIMENSIONS

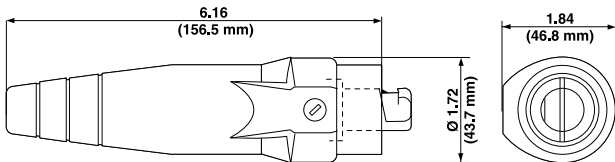

Male Detachable Plug - Single Set Screw

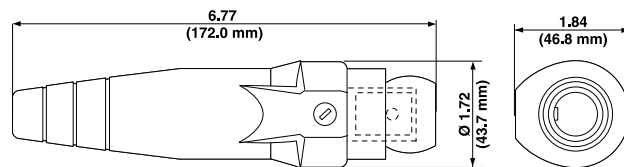

Female Detachable Plug - Single Set Screw

CAM-TYPE CONNECTORS (UP TO 400A, 600V)

18 Series, Ball Nose

Description	Color	Cat. No. Complete	Cat. No. Contact	Cat. No. Insulator
Male Detachable Plug - Single Set Screw (Cable Size: 1/0-4/0)	White	18D23-W*	—	18SDM-14W*
	Black	18D23-E	—	18SDM-14E*
	Brown	18D23-H*	—	—
	Red	18D23-R	—	18SDM-14R*
	Blue	18D23-B*	—	18SDM-14B*
	Orange	18D23-O*	—	—
	Green	18D23-G*	—	18SDM-14G*
Female Detachable Plug - Single Set Screw (Cable Size: 1/0-4/0)	White	18D32-W*	—	18SDF-14W*
	Black	18D32-E	—	18SDF-14E
	Brown	18D32-H*	—	—
	Red	18D32-R*	—	18SDF-14R*
	Blue	18D32-B*	—	18SDF-14B*
	Orange	18D32-O*	—	—
	Green	18D32-G*	—	18SDF-14G*
	Yellow	18D32-Y*	—	—



18D23-Y



18D32-H

* Contact factory for availability.

DIMENSIONS

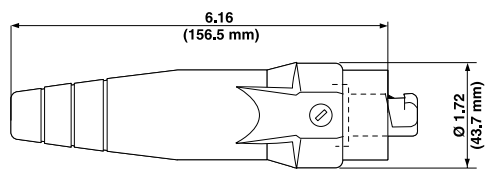

Male Detachable Plug – Single Set Screw

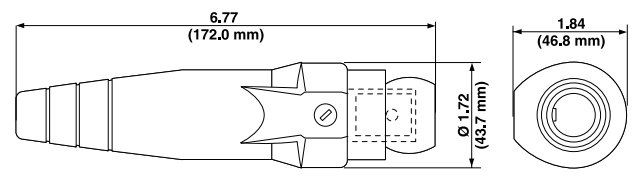

Female Detachable Plug – Single Set Screw

Industrial Grade

CAM-TYPE CONNECTORS (UP TO 400A, 600V)

18 Series, Ball Nose



18D22-G



18D31-W

Description	Color	Cat. No. Complete	Cat. No. Contact	Cat. No. Insulator
Male Detachable Plug - Double Set Screw (Cable Size: #2-2/0)	White	18D22-W	18D22-C*	18SDM-22W*
	Black	18D22-E	18D22-C*	18SDM-22E*
	Brown	18D22-H	18D22-C*	—
	Red	18D22-R	18D22-C*	18SDM-22R*
	Blue	18D22-B	18D22-C*	18SDM-22B*
	Orange	18D22-O*	18D22-C*	—
	Green	18D22-G	18D22-C*	18SDM-22G*
	Yellow	18D22-Y*	18D22-C*	—
Female Detachable Plug - Double Set Screw (Cable Size: #2-2/0)	White	18D31-W	18D31-C*	18SDF-22W*
	Black	18D31-E	18D31-C*	18SDF-22E*
	Brown	18D31-H	18D31-C*	—
	Red	18D31-R	18D31-C*	18SDF-22R*
	Blue	18D31-B	18D31-C*	18SDF-22B*
	Orange	18D31-O*	18D31-C*	—
	Green	18D31-G	18D31-C*	18SDF-22G*
	Yellow	18D31-Y	18D31-C*	—

* Contact factory for availability.

TESTING AND CODE COMPLIANCE

- Meets UL Standards (File #E13399)
- CSA Certified File #152105

DIMENSIONS

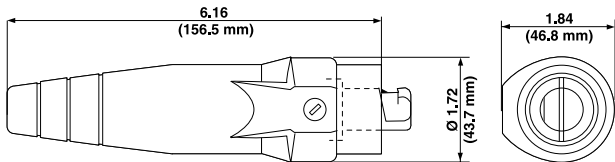

Male Detachable Plug - Double Set Screw

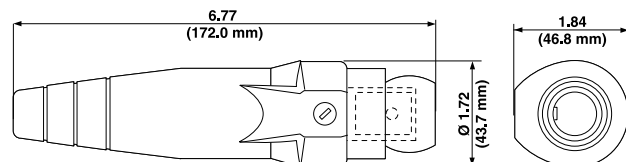

Female Detachable Plug - Double Set Screw

CAM-TYPE CONNECTORS (UP TO 400A, 600V)

18 Series, Ball Nose  

Description	Color	Cat. No. Complete	Cat. No. Contact	Cat. No. Insulator
Male Detachable Plug - Double Set Screw (Cable Size: 1/0-4/0)	White	18D24-W	—	18SDM-14W*
	Black	18D24-E	—	18SDM-14E*
	Brown	18D24-H	—	—
	Red	18D24-R	—	18SDM-14R*
	Blue	18D24-B	—	18SDM-14B*
	Orange	18D24-O	—	—
	Green	18D24-G	—	18SDM-14G*
Female Detachable Plug - Double Set Screw (Cable Size: 1/0-4/0)	White	18D33-W	—	18SDF-14W*
	Black	18D33-E	—	18SDF-14E
	Brown	18D33-H	—	—
	Red	18D33-R	—	18SDF-14R*
	Blue	18D33-B	—	18SDF-14B*
	Orange	18D33-O	—	—
	Green	18D33-G	—	18SDF-14G*
	Yellow	18D33-Y	—	—



18D24-E



18D33-E

* Contact factory for availability.

TESTING AND CODE COMPLIANCE

- Meets UL Standards (File #E13399)
- CSA Certified File #152105

DIMENSIONS

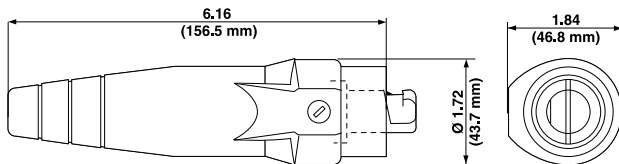

Male Detachable Plug – Double Set Screw

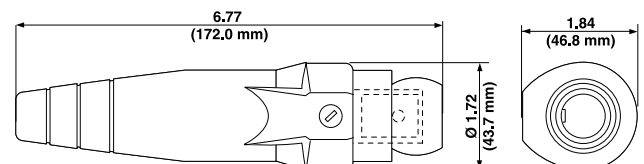

Female Detachable Plug – Double Set Screw

Industrial Grade

CAM-TYPE CONNECTORS (UP TO 400A, 600V)

18 Series, Ball Nose



18F21-E



18P22-E

Description	Color	Cat. No.	Cat. No.
		Angle Style	Offset Style
Female Terminal Connectors (Cable Size: #2-4/0)	White	18F21-W	18F22-W*
	Black	18F21-E*	18F22-E*
	Brown	18F21-H*	18F22-H*
	Red	18F21-R*	18F22-R*
	Blue	18F21-B*	18F22-B*
	Orange	18F21-O*	18F22-O*
	Green	18F21-G*	18F22-G*
	Yellow	18F21-Y*	18F22-Y*
Protective Caps	White	18P21-W*	18P22-W
	Black	18P21-E	18P22-E
	Brown	18P21-H*	18P22-H*
	Red	18P21-R*	18P22-R*
	Blue	18P21-B*	18P22-B*
	Orange	18P21-O*	18P22-O*
	Green	18P21-G	18P22-G
	Yellow	18P21-Y*	18P22-Y*

* Contact factory for availability.

TESTING AND CODE COMPLIANCE

- Meets UL Standards (File #E13399)
- CSA Certified File #152105

DIMENSIONS

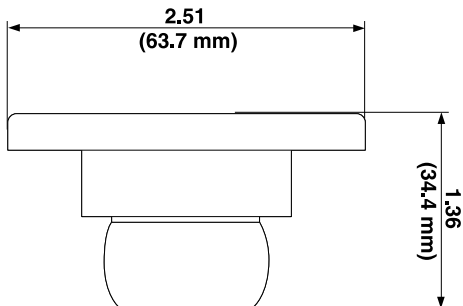

Male Protective Cap

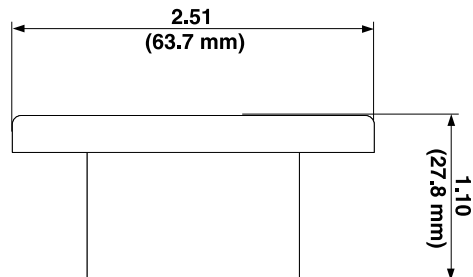

Female Protective Cap

CAM-TYPE CONNECTORS (UP TO 400A, 600V)

18 Series, Ball Nose  

Description	Color	Cat. No.		Cat. No.	
		Paralleling Tee Female-Male-Male		Tapping Tee Female-Female-Male	
Three-Way Lay Down "T" Connectors	White	18A21-W*		18A22-W*	
	Black	18A21-E*		18A22-E	
	Brown	18A21-H*		18A22-H*	
	Red	18A21-R*		18A22-R*	
	Blue	18A21-B*		18A22-B*	
	Orange	18A21-O*		18A22-O*	
	Green	18A21-G*		18A22-G*	
	Yellow	18A21-Y*		18A22-Y*	

Description	Color	Cat. No.		Cat. No.	
		Threaded Stud Style (Cable Size: #2-4/0)		Double Set Screw Style (Cable Size: 1/0-4/0)	
		Male	Female	Male	Female
Panel Receptacles	White	18R21-W	18R22-W	18R23-W	18R24-W
	Black	18R21-E	18R22-E	18R23-E	18R24-E
	Brown	18R21-H*	18R22-H*	18R23-H	18R24-H
	Red	18R21-R	18R22-R	18R23-R	18R24-R
	Blue	18R21-B	18R22-B	18R23-B*	18R24-B
	Orange	18R21-O*	18R22-O*	18R23-O	18R24-O
	Green	18R21-G	18R22-G	18R23-G*	18R24-G
	Yellow	18R21-Y*	18R22-Y*	18R23-Y	18R24-Y



18R22-G



18A22-E

* Contact factory for availability.

TESTING AND CODE COMPLIANCE

- Meets UL Standards (File #E13399)
- CSA Certified (File #152105)

DIMENSIONS

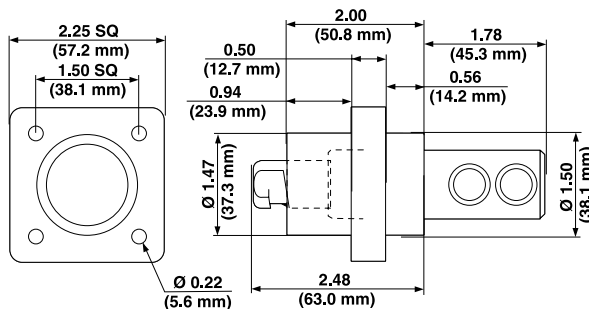

Male Double Set Screw Panel Receptacle

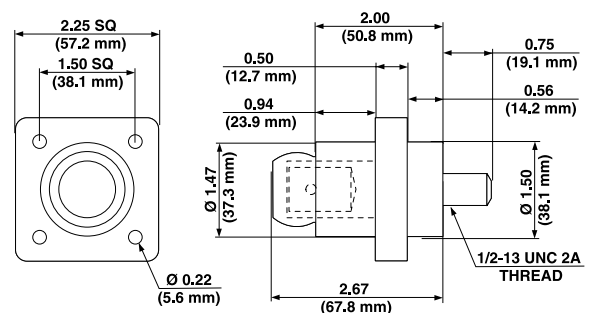

Female Threaded Stud Panel Receptacle

Industrial Grade

CAM-TYPE CONNECTORS (UP TO 400A, 600V)

18 Series, Ball Nose



18A23-E



18A25-E

Description	Color	Cat. No. 3-Fer	
		Male-Female-Female-Female	Female-Female-Female-Male
Multi-Way Connectors	White	18A23-W*	—
	Black	18A23-E*	—
	Brown	18A23-H*	—
	Red	18A23-R*	—
	Blue	18A23-B*	—
	Orange	18A23-O*	—
	Green	18A23-G*	—
	Yellow	18A23-Y*	—

Description	Color	Cat. No. 3-Fer	
		Double Female Female-Female	Double Male Male-Male
Multi-Way Connectors	White	18A24-W*	18A25-W
	Black	18A24-E*	18A25-E*
	Brown	18A24-H*	18A25-H*
	Red	18A24-R*	18A25-R*
	Blue	18A24-B*	18A25-B*
	Orange	18A24-O*	18A25-O*
	Green	18A24-G*	18A25-G
	Yellow	18A24-Y*	18A25-Y*

* Contact factory for availability.

TESTING AND CODE COMPLIANCE

- Meets UL Standards (File #E13399)
- CSA Certified File #152105

DIMENSIONS

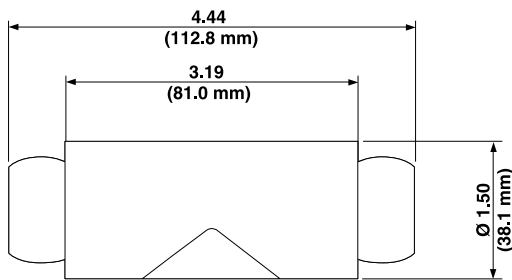

Multi-Way Connector – Female To Female

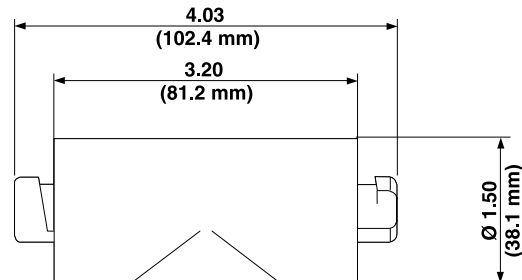

Multi-Way Connector – Male To Male

Cam-Type Connectors — 17 Series

Specifications and Features

The 17 Series Taper Nose connectors withstand grueling, heavy-duty industrial use. Applications include generator test stations, water purification plants, electro-chemical machining equipment and other general industrial uses.

CAM-TYPE CONNECTORS (UP TO 690A, 600V)

17 Series, Taper Nose

Description	Color	Cat. No. Complete	Cat. No. Contact	Cat. No. Insulator
Male Detachable Plug - Double Set Screw (Cable Size: 250-350MCM)	White	17D21-W	—	—
	Black	17D21-E	—	17SDM-E
	Brown	17D21-H	—	—
	Red	17D21-R	—	—
	Blue	17D21-B	—	—
	Orange	17D21-O	—	—
	Green	17D21-G	—	—
	Yellow	17D21-Y	—	—
Female Detachable Plug - Double Set Screw (Cable Size: 250-350MCM)	White	17D23-W	—	—
	Black	17D23-E	—	—
	Brown	17D23-H	—	—
	Red	17D23-R	—	—
	Blue	17D23-B	—	—
	Orange	17D23-O	—	—
	Green	17D23-G	—	—
	Yellow	17D23-Y	—	—



17D21-W



17D23-E

DIMENSIONS

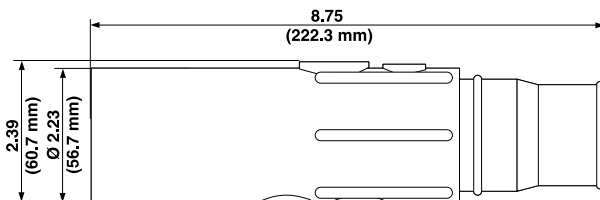

Male Plug - Double Set Screw Detachable

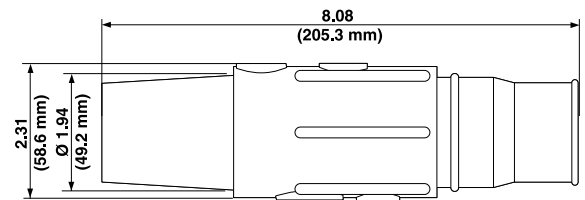

Female Plug - Double Set Screw Detachable

Industrial Grade

CAM-TYPE CONNECTORS (UP TO 690A, 600V)

17 Series, Taper Nose



17D22-E



17D24-E

Description	Color	Cat. No. Complete	Cat. No. Contact	Cat. No. Insulator
Male Detachable Plug - Double Set Screw (Cable Size: 350-500MCM)	White	17D22-W	—	—
	Black	17D22-E	—	17SDM-E
	Brown	17D22-H	—	—
	Red	17D22-R	—	—
	Blue	17D22-B	—	—
	Orange	17D22-O	—	—
	Green	17D22-G	—	—
	Yellow	17D22-Y	—	—
Female Detachable Plug - Double Set Screw (Cable Size: 350-500MCM)	White	17D24-W	—	—
	Black	17D24-E	—	—
	Brown	17D24-H	—	—
	Red	17D24-R	—	—
	Blue	17D24-B	—	—
	Orange	17D24-O	—	—
	Green	17D24-G	—	—
	Yellow	17D24-Y	—	—

DIMENSIONS

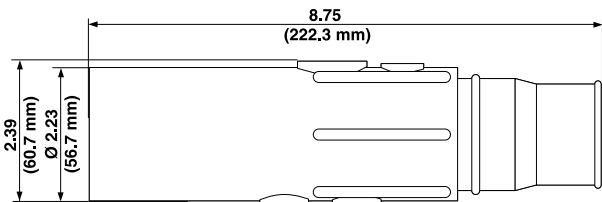

Male Plug – Double Set Screw Detachable

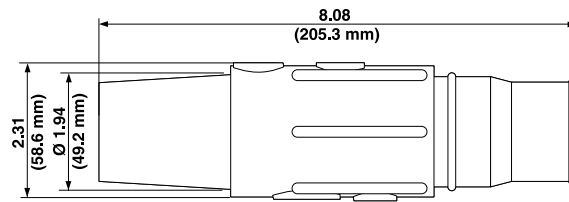

Female Plug – Double Set Screw Detachable

CAM-TYPE CONNECTORS (UP TO 690A, 600V)

17 Series, Taper Nose

Description	Color	Cat. No.	Cat. No.	Cat. No.
		Complete	Contact	Insulator
Male Vulcanized Plug - Crimped (Cable Size: 500-750MCM)	White	17V23-W*	—	—
	Black	17V23-E	—	—
	Brown	17V23-H*	—	—
	Red	17V23-R*	—	—
	Blue	17V23-B*	—	—
	Orange	17V23-O*	—	—
	Green	17V23-G*	—	—
	Yellow	17V23-Y*	—	—
Female Vulcanized Plug - Crimped (Cable Size: 500-750MCM)	White	17V26-W*	—	—
	Black	17V26-E	—	—
	Brown	17V26-H*	—	—
	Red	17V26-R*	—	—
	Blue	17V26-B*	—	—
	Orange	17V26-O*	—	—
	Green	17V26-G*	—	—
	Yellow	17V26-Y*	—	—



17V23-W



17V26-G

* Contact factory for availability.

DIMENSIONS

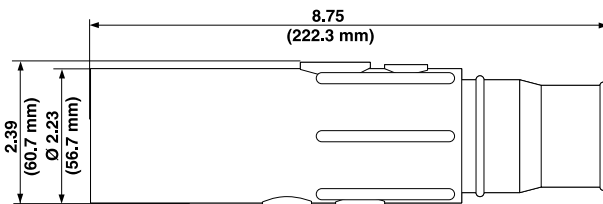

Male Vulcanized Plug - Crimped

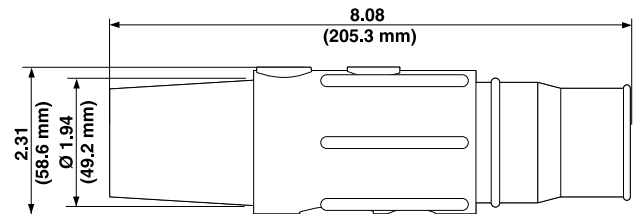

Female Vulcanized Plug - Crimped

Industrial Grade

CAM-TYPE CONNECTORS (UP TO 690A, 600V)

17 Series, Taper Nose



17R21-W

Description	Color	90° Style		30° Style	30° Style
		Male	Female	Male	Female
Panel Receptacle- Threaded Stud (Cable Size: 250-750MCM)	White	17R21-W	17R22-W	17R23-W	17R24-W
	Black	17R21-E	17R22-E	17R23-E	17R24-E
	Brown	17R21-H	17R22-H	17R23-H*	17R24-H*
	Red	17R21-R	17R22-R	17R23-R	17R24-R
	Blue	17R21-B	17R22-B	17R23-B	17R24-B
	Orange	17R21-O	17R22-O	17R23-O*	17R24-O*
	Green	17R21-G	17R22-G	17R23-G	17R24-G
	Yellow	17R21-Y	17R22-Y	17R23-Y*	17R24-Y*
		Color	Angle Style	Offset Style	Protective Caps
				Male	Female
Female Terminal Connectors (Cable Size: 250-750MCM)	White	17F21-W*	—	17P21-W	17P22-W
	Black	17F21-E*	17F22-E*	17P21-E	17P22-E
	Brown	—	—	17P21-H	17P22-H
	Red	—	—	17P21-R	17P22-R
	Blue	—	—	17P21-B	17P22-B
	Orange	—	—	17P21-O	17P22-O
	Green	—	—	17P21-G	17P22-G
	Yellow	—	—	17P21-Y	17P22-Y
		Color	Angle Style	Offset Style	Protective Caps
				Male	Female
Protective Cover for 90° 17/19 Series Receptacles	White	17S31-W	—	—	—
	Black	17S31-E	—	—	—
	Red	17S31-R	—	—	—
	Blue	17S31-B	—	—	—
	Green	17S31-G	—	—	—



17P21-E



17S31-E

* Contact factory for availability.

DIMENSIONS

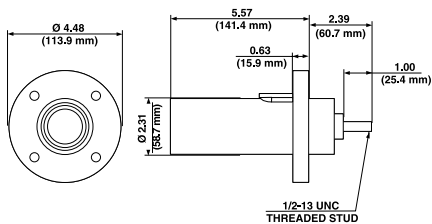

Male Panel Receptacle Threaded Stud – 90°

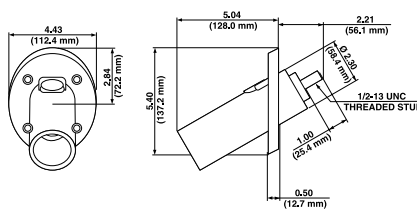
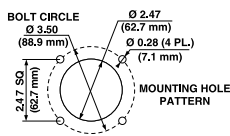

Male Panel Receptacle Threaded Stud – 30°

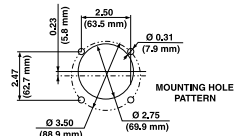

Cam-Type Connectors — 19 Series

Specifications and Features

The 19 Series Ball Nose connectors are designed for general industrial applications.

CAM-TYPE CONNECTORS (UP TO 690A, 600V)

19 Series, Ball Nose

Description	Color	Cat. No. Complete	Cat. No. Contact	Cat. No. Insulator
Male Detachable Plug - Double Set Screw (Cable Size: 250-350MCM)	White	19D21-W*	19D21-C*	19SDM-W*
	Black	19D21-E*	19D21-C*	19SDM-E*
	Brown	19D21-H*	19D21-C*	19SDM-H*
	Red	19D21-R	19D21-C*	19SDM-R*
	Blue	19D21-B*	19D21-C*	19SDM-B*
	Orange	19D21-O*	19D21-C*	19SDM-O*
	Green	19D21-G*	19D21-C*	19SDM-G*
Female Detachable Plug - Double Set Screw (Cable Size: 250-350MCM)	White	19D23-W*	19D23-C*	19SDF-W*
	Black	19D23-E*	19D23-C*	19SDF-E*
	Brown	19D23-H*	19D23-C*	19SDF-H*
	Red	19D23-R	19D23-C*	19SDF-R*
	Blue	19D23-B*	19D23-C*	19SDF-B*
	Orange	19D23-O*	19D23-C*	19SDF-O*
	Green	19D23-G*	19D23-C*	19SDF-G*
	Yellow	19D23-Y*	19D23-C*	19SDF-Y*



19D21-E



19D23-E

* Contact factory for availability.

DIMENSIONS

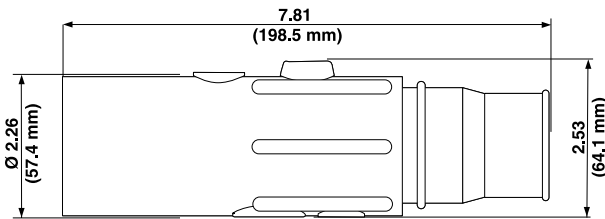

Male Detachable Plug – Double Set Screw

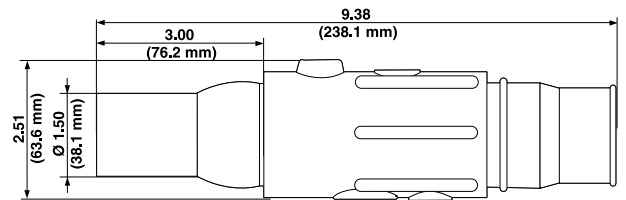

Female Detachable Plug – Double Set Screw

Industrial Grade

CAM-TYPE CONNECTORS (UP TO 690A, 600V)

19 Series, Ball Nose



19D22-E



19D24-E

Description	Color	Cat. No. Complete	Cat. No. Contact	Cat. No. Insulator
Male Detachable Plug - Double Set Screw (Cable Size: 350-500MCM)	White	19D22-W	19D22-C*	19SDM-W*
	Black	19D22-E	19D22-C*	19SDM-E*
	Brown	19D22-H	19D22-C*	19SDM-H*
	Red	19D22-R	19D22-C*	19SDM-R*
	Blue	19D22-B	19D22-C*	19SDM-B*
	Orange	19D22-O	19D22-C*	19SDM-O*
	Green	19D22-G	19D22-C*	19SDM-G*
	Yellow	19D22-Y	19D22-C*	19SDM-Y*
Female Detachable Plug - Double Set Screw (Cable Size: 350-500MCM)	White	19D24-W	19D24-C*	19SDF-W*
	Black	19D24-E	19D24-C*	19SDF-E*
	Brown	19D24-H	19D24-C*	19SDF-H*
	Red	19D24-R	19D24-C*	19SDF-R*
	Blue	19D24-B	19D24-C*	19SDF-B*
	Orange	19D24-O	19D24-C*	19SDF-O*
	Green	19D24-G	19D24-C*	19SDF-G*
	Yellow	19D24-Y*	19D24-C*	19SDF-Y*

* Contact factory for availability.

DIMENSIONS

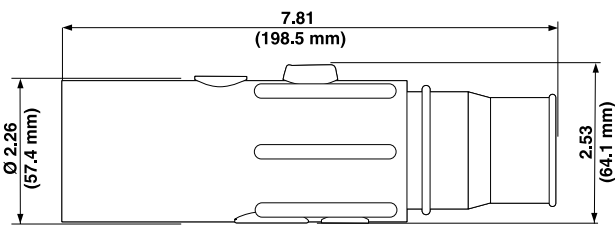

Male Detachable Plug - Double Set Screw

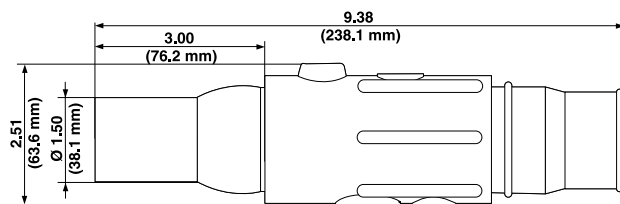

Female Detachable Plug - Double Set Screw

CAM-TYPE CONNECTORS (UP TO 690A, 600V)

19 Series, Ball Nose

Description	Color	90° Style	90° Style	30° Style	30° Style
		Male	Female	Male	Female
Panel Receptacle	White	19R21-W	19R22-W	19R23-W*	19R24-W
Threaded Stud	Black	19R21-E	19R22-E	19R23-E*	19R24-E*
(Cable Size: 250-750MCM)	Brown	19R21-H	19R22-H	19R23-H*	19R24-H*
	Red	19R21-R	19R22-R	19R23-R*	19R24-R*
	Blue	19R21-B	19R22-B	19R23-B*	19R24-B*
	Green	19R21-G	19R22-G	19R23-G*	19R24-G*
	Orange	19R21-O	19R22-O	19R23-O*	19R24-O*
	Yellow	19R21-Y	19R22-Y	19R23-Y*	19R24-Y*
	Color	Angle Style	Offset Style	Protective Caps	
			Male	Female	
Female Terminal Connectors (Cable Size: 250-750MCM)	White	19F21-W*	19F22-W*	19P21-W	19P22-W
	Black	19F21-E*	19F22-E*	19P21-E	19P22-E
	Brown	19F21-H*	19F22-H*	19P21-H	19P22-H
	Red	19F21-R*	19F22-R*	19P21-R	19P22-R
	Blue	19F21-B*	19F22-B*	19P21-B*	19P22-B
	Orange	19F21-O*	19F22-O*	19P21-O	19P22-O
	Green	19F21-G*	19F22-G*	19P21-G	19P22-G
	Yellow	19F21-Y*	19F22-Y*	19P21-Y	19P22-Y



19R21-E



19P21-E

* Contact factory for availability.

DIMENSIONS

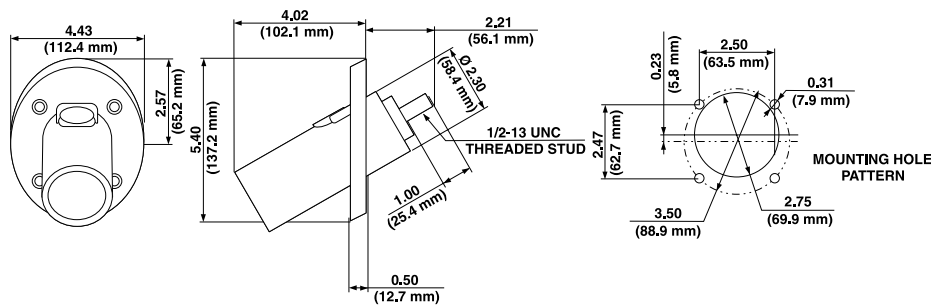

Male Panel Receptacle Threaded Stud – 30°

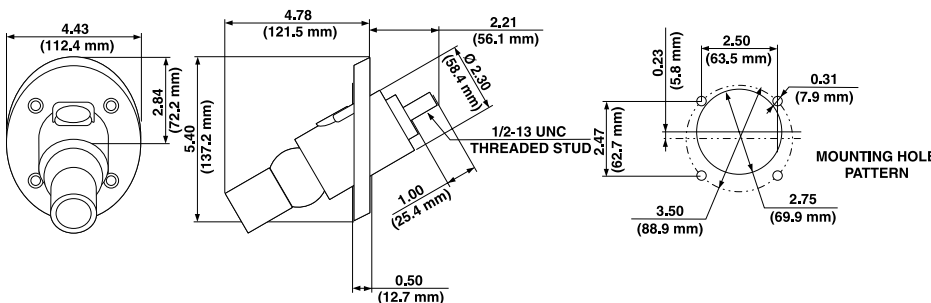

Female Panel Receptacle Threaded Stud – 30°

Industrial Grade

Cam-Type Connectors — 22/23 Series, Latching Ball Nose/ Latching Taper Nose

Specifications and Features

Leviton's Cam-Type positive latching connectors and receptacles are the standard used by Navy bases and shipyards in supplying 3-phase power to ships at dockside. Our latching connector series has been tested to meet Navy specs, including intermateability with competition. They provide heavy duty, completely insulated connectors that are vibration-resistant. These connectors will not vibrate or loosen, ensuring high conductivity and maximum efficiency. Contacts can be retrofitted to existing locations and power distribution systems. Male contacts provide 40% more surface contact with the female vs. competitive products, ensuring greater conductivity while preventing burnout.

CAM-TYPE CONNECTORS (UP TO 690A, 600V)

22/23 Series, Latching Ball Nose



22L21-R



22L22-E



22L25-E

Description	Color	Cat. No. Complete	Cat. No. Contact	Cat. No. Insulator
Ball Nose - In-Line Latching Male Connectors - Crimped (Cable Size: 250-350MCM)	White	22L21-W	—	22SVM-W
	Black	22L21-E	—	22SVM-E
	Red	22L21-R	—	22SVM-R
	Green	22L21-G	—	—
Ball Nose - In-Line Latching Female Connectors Crimped (Cable Size: 250-350MCM)	White	22L24-W	—	—
	Black	22L24-E	—	—
	Red	22L24-R	—	22SVF-R
	Green	22L24-G	—	—
Ball Nose - In-Line Latching Male Connectors - Crimped Style 22L22 Series (Cable Size: 350-500MCM)	White	22L22-W	22L22-C*	22SVM-W
	Black	22L22-E	22L22-C*	22SVM-E
	Red	22L22-R†	22L22-C*	22SVM-R
	White	22L22-SW†	22L22-C*	22SVM-W
Ball Nose - In-Line Latching Male Connectors - Set Screw Style 22L22-S Series (Cable Size: 350-500MCM)	Black	22L22-SE†	22L22-C*	22SVM-E
	Red	22L22-SR†	22L22-C*	22SVM-R
	White	22L25-W	22L25-C	—
	Black	22L25-E	22L25-C	—
Ball Nose - In-Line Latching Female Connectors - Crimped Style 22L25 Series (Cable Size: 350-500MCM)	Red	22L25-R	22L25-C	22SVF-R
	White	22L25-SW†	22L25-C	—
	Black	22L25-SE†	22L25-C	—
	Red	22L25-SR†	22L25-C	22SVF-R

* Contact factory for availability.

† 22L22-S and 22L25-S Series sleeves are Santoprene™ thermoplastic elastomer and detachable.

*Refer to Ampacity Chart for all cable sizes on page 510

TESTING AND CODE COMPLIANCE

- Meets ETL Standards (File #521300)

ENVIRONMENTAL

- Waterproof (when vulcanized) and fire-resistant for outside usage

DIMENSIONS

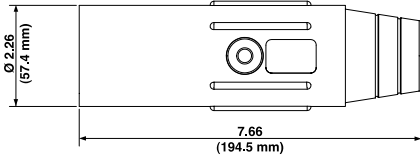

Ball Nose In-line Latching Male Connectors S-Series

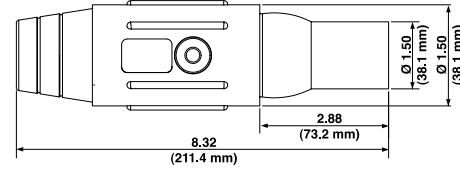

Ball Nose In-line Latching Female Connectors S-Series

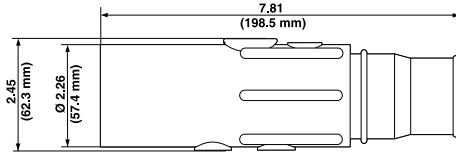

Ball Nose In-line Latching Male Connectors - Crimped

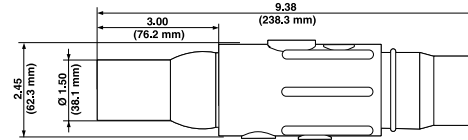

Ball Nose In-line Latching Female Connectors - Crimped

CAM-TYPE CONNECTORS (UP TO 690A, 600V)

22/23 Series, Latching Ball Nose / Latching Taper Nose

Description	Color	Cat. No. Complete	Cat. No. Contact	Cat. No. Insulator
Ball Nose - In-Line Latching Male Connectors Crimped (Cable Size: 500-750MCM)	White	22L23-W	—	22SVM-W
	Black	22L23-E	—	22SVM-E
	Red	22L23-R	—	22SVM-R
Ball Nose - In-Line Latching Female Connectors Crimped (Cable Size: 500-750MCM)	White	22L26-W	—	—
	Black	22L26-E	—	—
	Red	22L26-R	—	22SVF-R*
Taper Nose - In-Line Latching Male Connectors Crimped (Cable Size: 250-350MCM)	White	23L21-W*	—	23SVM-W*
	Black	23L21-E*	—	23SVM-E
	Brown	23L21-H	—	—
	Red	23L21-R*	—	23SVM-R*
	Orange	23L21-O	—	—
	Yellow	23L21-Y	—	—
Taper Nose - In-Line Latching Female Connectors Crimped (Cable Size: 250-350MCM)	White	23L24-W	—	23SVF-W*
	Black	23L24-E	—	23SVF-E*
	Brown	23L24-H	—	—
	Red	23L24-R	—	23SVF-R*
	Orange	23L24-O	—	—
	Yellow	23L24-Y	—	—



22L23-E



23L24-R

* Contact factory for availability.

DIMENSIONS

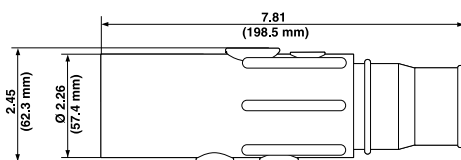

Ball Nose In-line Latching Male Connectors - Crimped

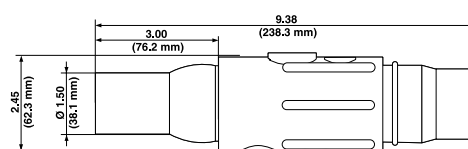

Ball Nose In-line Latching Female Connectors - Crimped

Industrial Grade



23L25-G

CAM-TYPE CONNECTORS (UP TO 690A, 600V)

22/23 Series, Latching Taper Nose

Description	Color	Cat. No. Complete	Cat. No. Contact	Cat. No. Insulator
Taper Nose - In-Line Latching Male Connectors - Crimped (Cable Size: 350-500MCM)	White	23L22-W	—	23SVM-W*
	Black	23L22-E	—	23SVM-E*
	Brown	23L22-H*	—	—
	Red	23L22-R*	—	23SVM-R*
	Blue	23L22-B*	—	—
	Orange	23L22-O*	—	—
	Green	23L22-G*	—	—
	Yellow	23L22-Y*	—	—
Taper Nose - In-Line Latching Female Connectors - Crimped (Cable Size: 350-500MCM)	White	23L25-W*	—	23SVF-W*
	Black	23L25-E	—	23SVF-E*
	Brown	23L25-H	—	—
	Red	23L25-R*	—	23SVF-R*
	Blue	23L25-B	—	—
	Orange	23L25-O	—	—
	Green	23L25-G	—	—
	Yellow	23L25-Y	—	—
Taper Nose - In-Line Latching Male Connectors - Crimped (Cable Size: 500-750MCM)	White	23L23-W	—	23SVM-W*
	Black	23L23-E	—	23SVM-E*
	Brown	—	—	—
	Red	23L23-R	—	23SVM-R*
	Blue	23L23-B	—	—
	Orange	—	—	—
	Green	23L23-G	—	—
	Yellow	—	—	—
Taper Nose - In-Line Latching Female Connectors - Crimped (Cable Size: 500-750MCM)	White	23L26-W	—	23SVF-W*
	Black	23L26-E	—	23SVF-E*
	Brown	—	—	—
	Red	23L26-R	—	23SVF-R*
	Blue	—	—	—
	Orange	—	—	—
	Green	—	—	—
	Yellow	—	—	—

* Contact factory for availability.

TESTING AND CODE COMPLIANCE

- Meets ETL Standards (File #521300)

ENVIRONMENTAL

- Waterproof (when vulcanized) and fire-resistant for outside usage

DIMENSIONS

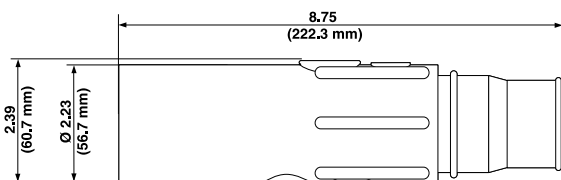

Taper Nose In-line Latching Male Connectors - Crimped

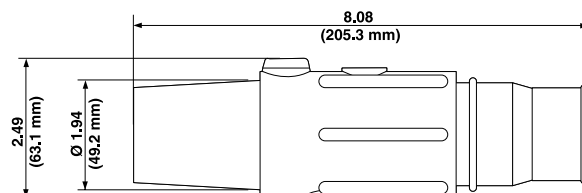

Taper Nose In-line Latching Female Connectors - Crimped

Cam-Type Connectors — 22 Series, Latching Ball Nose/Panel Receptacle 15° Style

Specifications and Features

Leviton's Cam-Type positive latching connectors and receptacles are the standard used by Navy bases and shipyards in supplying 3-phase power to ships at dockside. Our latching connector series has been tested to meet Navy specs, including interchangeability with competition. They provide heavy duty, completely insulated connectors that are vibration-resistant. These connectors will not vibrate or loosen, ensuring high conductivity and maximum efficiency. Contacts can be retrofitted to existing locations and power distribution systems. Male contacts provide 40% more surface contact with the female versus competitive products, ensuring greater conductivity while preventing burnout.

CAM-TYPE CONNECTORS (UP TO 690A, 600V)

22 Series, Latching Ball Nose, Panel Receptacle 15° Style

Description	Color	Cat. No.	Cat. No.
		Threaded Stud 15° Style Female	Threaded Stud 15° Style Female with Micro Switch
Ball Nose Panel receptacle	White	22R26-W	22R28-W
	Black	22R26-E	22R28-E
	Red	22R26-R	22R28-R

NOTE: 22R28 Series complete with protective cap.



22R26-R
with protective cap off



22R28-W
with protective cap off

TESTING CODE AND COMPLIANCE

22R26 & 22R28 Series

Meets All specifications outlined in Unified Facilities Guide Specification

ENVIRONMENTAL

22R26 & 22R28 Series

Rated for 600 volts, 690 amperes, 60 hertz, single pole, continuous duty operation. Provide 15 degree angled, panel mount, female, thermoplastic rubber insulated receptacles with threaded stud termination. Each receptacle shall be provided with protective cap attached via wire on. Receptacles shall be colored black phase A, white phase B, and red phase C. Receptacles indicated to have auxiliary switches which have a thru-center plunger that activates a single-pole double throw, "rocker lever actuated" switch electrically rated for 25,000 cycles at 15A, 125, 250 or 480 VAC, and shall be mechanically rated for 20,000,000 cycles. Panel receptacles and protective caps shall be molded of an Ethylene Propylene Thermoplastic Rubber (EPTR) with the following minimum requirements:

- Constant Service Temperature Range: -60°C to + 135°C (-81°F to +275°F)
- Flammability: UL 94 HB Rated
- Electrical: UL Relative Thermal Index (RTI): 100°C (212°F) minimum
- Durometer Hardness: ASTM D 2240, 55 - 65 A



22R28-W
micro switch (close-up)

DIMENSIONS

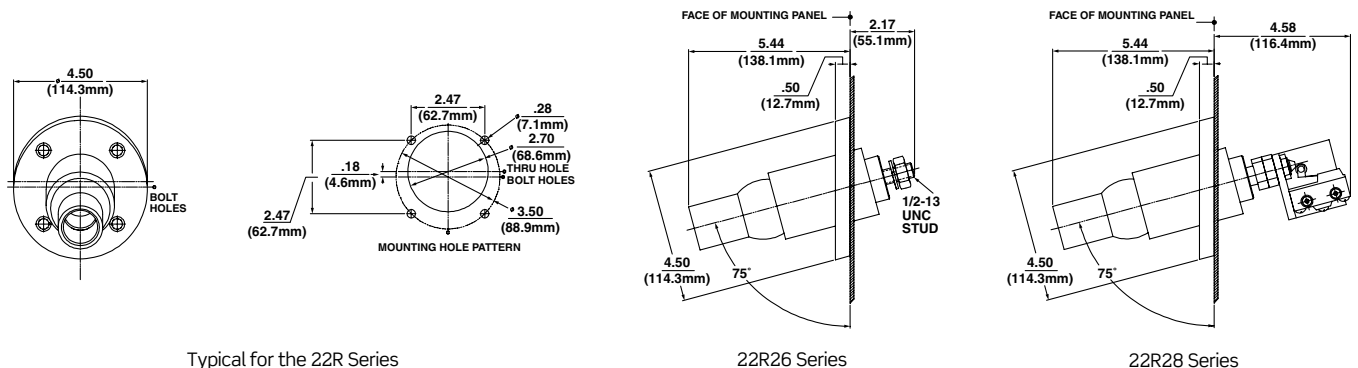

Industrial Grade

Cam-Type Connectors — 22/23 Series, Latching Ball Nose/ Latching Taper Nose

Specifications and Features

Leviton's Cam-Type positive latching connectors and receptacles are the standard used by Navy bases and shipyards in supplying 3-phase power to ships at dockside. Our latching connector series has been tested to meet Navy specs, including intermateability with competition. They provide heavy duty, completely insulated connectors that are vibration-resistant. These connectors will not vibrate or loosen, ensuring high conductivity and maximum efficiency. Contacts can be retrofitted to existing locations and power distribution systems. Male contacts provide 40% more surface contact with the female vs. competitive products, ensuring greater conductivity while preventing burnout.

CAM-TYPE CONNECTORS (UP TO 690A, 600V)

22/23 Series, Latching Ball Nose / Latching Taper Nose

Description	Color	Ball Nose	Ball Nose	Taper Nose	Taper Nose
		Male	Female	Male	Female
Protective Caps	White	22P21-W	22P22-W	23P21-W*	23P22-W*
	Black	22P21-E	22P22-E	23P21-E*	23P22-E*
	Red	22P21-R	22P22-R	23P21-R*	23P22-R*
	Color	Male	Female		
Ball Nose - Thermoplastic Housing	White	22H21-W*	22H22-W*		
Panel Receptacle - Threaded Stud (Cable Size: 250-350MCM)	Black	22H21-E*	22H22-E*		
	Red	22H21-R*	22H22-R*		
Taper Nose - Thermoplastic Housing	White	23H21-W*	23H22-W*		
Panel Receptacle - Threaded Stud (Cable Size: 350-500MCM)	Black	23H21-E*	23H22-E*		
	Red	23H21-R*	23H22-R*		
	Color	90° Style	90° Style	30° Style	30° Style
		Male	Female†	Male	Female†
Ball Nose - Panel Receptacle - Threaded Stud (Cable Size: 250-750MCM)	White	22R21-W	22R22-W	22R23-W	22R24-W
	Black	22R21-E	22R22-E	22R23-E	22R24-E
	Brown	—	—	—	22R24-H
	Red	22R21-R	22R22-R	22R23-R	22R24-R
	Blue	—	—	—	22R24-B
	Orange	—	—	—	22R24-O
	Green	—	—	—	22R24-G
	Yellow	—	—	—	22R24-Y
Tapered Nose - Panel Receptacle - Threaded Stud (Cable Size: 250-750MCM)	White	23R21-W*	23R22-W	23R23-W*	23R24-W
	Black	23R21-E	23R22-E	23R23-E	23R24-E
	Brown	—	23R22-H	23R23-H	23R24-H
	Red	23R21-R*	23R22-R	23R23-R*	23R24-R
	Blue	23R21-B	23R22-B	23R23-B	23R24-B
	Orange	—	23R22-O	23R23-O	23R24-O
	Green	23R21-G	23R22-G	23R23-G	23R24-G
	Yellow	—	23R22-Y	23R23-Y	23R24-Y

* Contact factory for availability.



22P21-E



22P22-E



22R23-E



22R24-E



23R21-E

DIMENSIONS

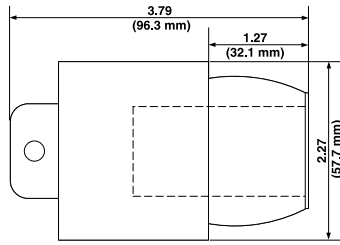

Male Protective Cap: 22P21 Series

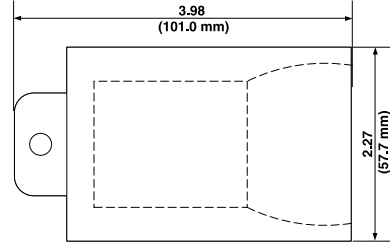

Female Protective Cap: 22P22 Series

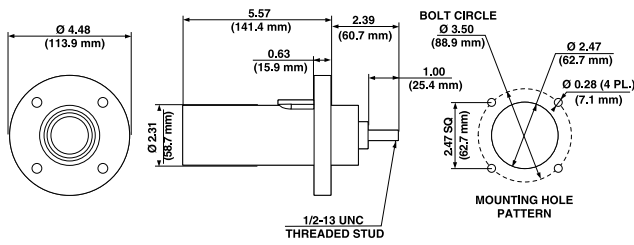

90° Male Panel Receptacle Threaded Stud: 22R21 Series

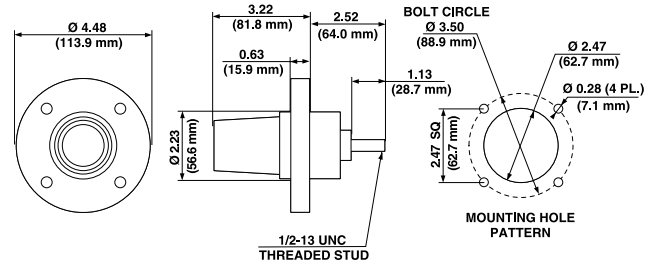

90° Female Panel Receptacle Threaded Stud: 22R22 Series

Industrial Grade

Technical Information

AMPACITY CHART

Cable Size	MAXIMUM ALLOWABLE AMPACITIES		
	60°C (140°F)	75°C (167°F)	90°C (194°F)
#8	60	70	80
#6	80	95	105
#4	105	125	140
#3	120	145	165
#2	140	170	190
#1	165	195	220
1/0	195	230	260
2/0	225	265	300
3/0	260	310	350
4/0	300	360	400
250MCM	340	405	455
300MCM	375	445	505
350MCM	420	505	570
400MCM	455	545	615
500MCM	515	620	690

Cam Connectors for Commercial and Industrial Use

Leviton offers a wide variety of single pin cam-type cable connectors and panel mount receptacles that supply temporary electrical power distribution for multiple indoor and outdoor applications. The heavy-duty connectors are the standard for the following markets:

- Entertainment and Movie Industry
- Concerts and Theme Parks
- Carnival Equipment
- Conventions

Other applications include:

- Motor and Generator Splices
- Mining and Construction Sites
- Commercial and Navy Shipbuilding & Repair
- Other temporary power applications

Leviton manufactures the highest quality single pin connectors available. Our connectors are completely compatible with competitive cam-type products and can be retrofitted to existing locations and power distribution systems. We offer a variety of quick connect/disconnect connectors for various amperage ratings in a multitude of cable sizes. Connectors are available in:

- Set Screw Termination
- Crimp Termination
- Taper nose and Ball nose configurations
- Vulcanized

Leviton Cam-Type Connectors Features and Benefits

- Intermateable and compatible with competitive cam-type products — can be retrofitted to existing locations and power distribution systems
- Locking and reinforcing ring won't melt, break or crack
- Shatter and crack proof - high durometer thermoplastic elastomer (TPE) or neoprene rubber
- Color-coded insulating sleeves - fast and easy phase identification
- Self compensating for wear - slit and cam in male contact provides spring action for longer usage
- Quick connect/disconnect - twist and pull provided by double cam male and cam button in female
- High conductivity - positive, vibration-proof connection provided by double cam design
- Wide range of applications - usable with a wide range of cable and amperage ratings
- Meets NEC Code, UL Listed and CSA Certified. NEMA 3R-Rated for use in outside locations

Experience the Difference

Our cam-type connectors are designed for easy assembly and disassembly without special tools. An insulated screw is used to tightly secure the contact inside the insulating sleeve, making assembly, disassembly and field repairs effortless. The connectors use plastic locking and reinforcement rings molded into insulating sleeves and receptacles. Under severe stress and load conditions, plastic locking and reinforcement rings will not melt, break or crack. Other quality differences include:

- Reusable sleeves and contacts
- Preservation of cable length
- Snug fit due to Helox shape of connection as well as cable cutoffs that accommodate a wide range of cable sizes
- Hard thermoplastic elastomer screw head provides strength and durability
- Collar around port provides protection for insulated screw
- Quick check for cable-to-contact connection

Industrial Grade

“COM-A-LONG” ASSEMBLY TOOL 15 SERIES

Description	Cat. No.
For Female Plug	15CLM



For Male Plug	15CLF
---------------	-------



17 SERIES, 19 SERIES & 22/23 SERIES

Description	Cat. No.
For Female Plug	17CLM



For Male Plug	17CLF
---------------	-------



16 SERIES & 18 SERIES

Description	Cat. No.
For Female Plug	16CLM



For Male Plug	16CLF
---------------	-------



SET SCREWS (10 PER PACKAGE)

Description	Cat. No.
15 Series	A0001



16 Series & 18 Series	A0002
-----------------------	-------



* Contact factory for availability.

COPPER SHIMS (10 PER PACKAGE)

Description	Cat. No.
15 Series	A0006



16 Series & 18 Series	A0004
-----------------------	-------



STRAIN RELIEF WIRE (10 PER PACKAGE)

Description	Cat. No.
15 Series	A0007



16 Series & 18 Series	A0003
-----------------------	-------



INSULATED SCREW (10 PER PACKAGE)

Description	Cat. No.
16 Series & 18 Series	A0005



LUBRICATING SPRAY

Description	Cat. No.
16 Fluid Ounce Can	C0001



* Contact factory for availability.

Industrial Grade

Rhino-Hide® 49 Series Single Pole Connectors and Receptacles

Rhino-Hide® (49 Series Male and Female Connectors, 49 Series Single Pole Connectors) are cURus recognized components engineered to exceptional standards for high-amperage power delivery on land-based and offshore oil and gas rigs. For Use on Land-Based and Off-Shore Oil Drilling Rigs and Other High-Amperage Power Generation Applications. Rhino-Hide® single pole connectors and receptacles are designed to deliver up to 1,000 Volts AC or DC and up to 1,135 Amps of continuous power under the most extreme conditions with cables ranging in size from 313 MCM to 777 MCM. Designed to mate with other manufacturers' high-amperage single pole connectors and receptacles, Rhino-Hide single pole devices can be installed on both existing silicon-controlled rectifiers (SCR's) and generator stations or on new oil and gas rig construction.



Devices are color-coded for visual identification of circuit and phase connections

Specifications and Features

- Ideal for replacement, these connectors mate with other manufacturers' high-amperage single pole connectors and receptacles for fast, easy change-out
- UV stable, polyolefin-based Santoprene™ TPV housings resist fading and cracking for greater service life
- Contacts machined from high conductivity copper alloy and silver-plated for corrosion resistance and superior conductivity
- Color-coded, metal in-line coupler prevents unauthorized separation of connectors
- Male contact silver and gold plated for superior performance
- Attach stripped cable to male or female contact with standard crimp tools
- Color-coded connector housing for quick, visual identification of circuit and phase connections

MALE AND FEMALE CONNECTORS

For Cable Sizes 313 MCM Through 777 MCM



Complete MALE Connector by Cable Size

Color	313 MCM Cable	444 MCM Cable	535 MCM Cable	646 MCM Cable	777 MCM Cable
White	49M31-W	49M44-W	49M53-W	49M64-W	49M77-W
Black	49M31-E	49M44-E	49M53-E	49M64-E	49M77-E
Brown	49M31-H	49M44-H	49M53-H	49M64-H	49M77-H
Red	49M31-R	49M44-R	49M53-R	49M64-R	49M77-R
Blue	49M31-B	49M44-B	49M53-B	49M64-B	49M77-B
Orange	49M31-O	49M44-O	49M53-O	49M64-O	49M77-O
Green	49M31-G	49M44-G	49M53-G	49M64-G	49M77-G
Yellow	49M31-Y	49M44-Y	49M53-Y	49M64-Y	49M77-Y
Purple	—	49M44-P	49M53-P*	—	—

Complete FEMALE Connector by Cable Size

Color	313 MCM Cable	444 MCM Cable	535 MCM Cable	646 MCM Cable	777 MCM Cable
White	49F31-W	49F44-W	49F53-W	49F64-W	49F77-W
Black	49F31-E	49F44-E	49F53-E	49F64-E	49F77-E
Brown	49F31-H	49F44-H	49F53-H	49F64-H	49F77-H
Red	49F31-R	49F44-R	49F53-R	49F64-R	49F77-R
Blue	49F31-B	49F44-B	49F53-B	49F64-B	49F77-B
Orange	49F31-O	49F44-O	49F53-O	49F64-O	49F77-O
Green	49F31-G	49F44-G	49F53-G	49F64-G	49F77-G
Yellow	49F31-Y	49F44-Y	49F53-Y	49F64-Y	49F77-Y
Purple	—	—	49M53-P	—	49M77-P
Gray	—	49F44-GY	49F53-GY	49F64-GY	49F77-GY

Contacts are for copper cable only.



Male Contact



Female Contact

*Contact factory for availability.

Industrial Grade

Rhino-Hide® 49 Series Panel Mounted Receptacles 49MR (Male Receptacles) and 49FR (Female Receptacles)

Rhino-Hide receptacles include a bus bar with male or female contact inserted into a Santoprene™ TPV insulator which is protected by a powder coated metal housing and TPV dust cap. Bus bars are available with single or double holes and each is compatible with the full cable range, 313 MCM to 777 MCM. Choose a male bus bar for the power side of the circuit or a female bus bar for the motor load side of the circuit. “X” Version receptacle housings feature a 45° angle stainless steel clevis pin that permits ganging of multiple receptacles in a very close proximity to each other (as close as 1/4” for installation on smaller panels).



49MR Series



49MR X-Series

RHINO-HIDE 49 SERIES PANEL MOUNTED RECEPTACLES

49MR (Male) and 49FR (Female) for Cable Sizes 313 MCM Through 777 MCM

Description	Color	Complete Male Receptacle		Complete Female Receptacle	
		Single Hole Bus Bar	Double Hole Bus Bar	Single Hole Bus Bar	Double Hole Bus Bar
Cable Size: 313 MCM Through 777 MCM	White	49MR1-CW	49MR2-CW	49FR1-CW	49FR2-CW
	Grey	49MR1-CGY	49MR2-CGY	49FR1-CGY	49FR2-CGY
	Black	49MR1-CE	49MR2-CE	49FR1-CE	49FR2-CE
	Brown	49MR1-CH	49MR2-CH	49FR1-CH	49FR2-CH
Bus Bar	Red	49MR1-CR	49MR2-CR	49FR1-CR	49FR2-CR
Hole Diameter 0.65" / 16.5mm	Blue	49MR1-CB	49MR2-CB	49FR1-CB	49FR2-CB
	Orange	49MR1-CO	49MR2-CO	49FR1-CO	49FR2-CO
	Green	49MR1-CG	49MR2-CG	49FR1-CG	49FR2-CG
	Yellow	49MR1-CY	49MR2-CY	49FR1-CY	49FR2-CY
	Purple	49MR1-CP	49MR2-CP	49FR1-CP	49FR2-CP



Single Hole and Double Hole Bus Bar Terminations

RHINO-HIDE 49 SERIES PANEL MOUNTED RECEPTACLES

X-Series 49MR (Male) and 49FR (Female) for Cable Sizes 313 MCM Through 777 MCM

Description	Color	Complete Male Receptacle		Complete Female Receptacle	
		Single Hole Bus Bar	Double Hole Bus Bar	Single Hole Bus Bar	Double Hole Bus Bar
45° Panel Receptacles	White	49MR1-0XW	49MR2-0XW	49FR1-0XW	49FR2-0XW
	Grey	49MR1-0XGY	49MR2-0XGY	49FR1-0XGY	49FR2-0XGY
	Black	49MR1-0XE	49MR2-0XE	49FR1-0XE	49FR2-0XE
	Brown	49MR1-0XH	49MR2-0XH	49FR1-0XH	49FR2-0XH
	Red	49MR1-0XR	49MR2-0XR	49FR1-0XR	49FR2-0XR
	Blue	49MR1-0XB	49MR2-0XB	49FR1-0XB	49FR2-0XB
	Orange	49MR1-0XO	49MR2-0XO	49FR1-0XO	49FR2-0XO
	Green	49MR1-0XG	49MR2-0XG	49FR1-0XG	49FR2-0XG
	Yellow	49MR1-0XY	49MR2-0XY	49FR1-0XY	49FR2-0XY
	Purple	49MR1-0XP	49MR2-0XP	49FR1-0XP	49FR2-0XP



Dust Cover Cap



Clevis Pin



Coupler

CONNECTOR ACCESSORIES AND REPLACEMENT PARTS

Description	Color	Material	Cat. No.
Clevis pin for in-line connector coupler	Silver	Stainless Steel	49PNR
Dust cap for single pole male connector	Black	Santoprene TPV	49DSM
Dust cap for single pole female connector	Black	Santoprene TPV	49DSF
In-line Coupler for Connectors	See footnote	Powder-coated aluminum	49COP-* **

PANEL MOUNTED RECEPTACLE ACCESSORIES AND REPLACEMENT PARTS

Description	Color	Material	Cat. No.
Clevis pin for panel mount receptacle	Silver	Stainless Steel	49PNR*
Receptacle housing	Silver	Cast Aluminum	49CSR
Dust cover cap for male or female receptacle	Black	Santoprene TPV	49DSR
Receptacle housing gasket	Black	Rubber	49GAS
Locking ground pin	—	Brass	15GND-M†

*Does not fit "X" Version.

**Contact Factory for additional colors available.

To order a color, replace the * with color's suffix: Black (E), White (W), Red (R), Blue (B), Green (G), Yellow (Y), Orange (O), Brown (H). Features and specifications may be subject to change.

For additional information, request a copy of the Rhino-Hide® 49 Series Connectors Product Bulletin.

Or, visit us on-line at www.leviton.com where a pdf file is available for review.

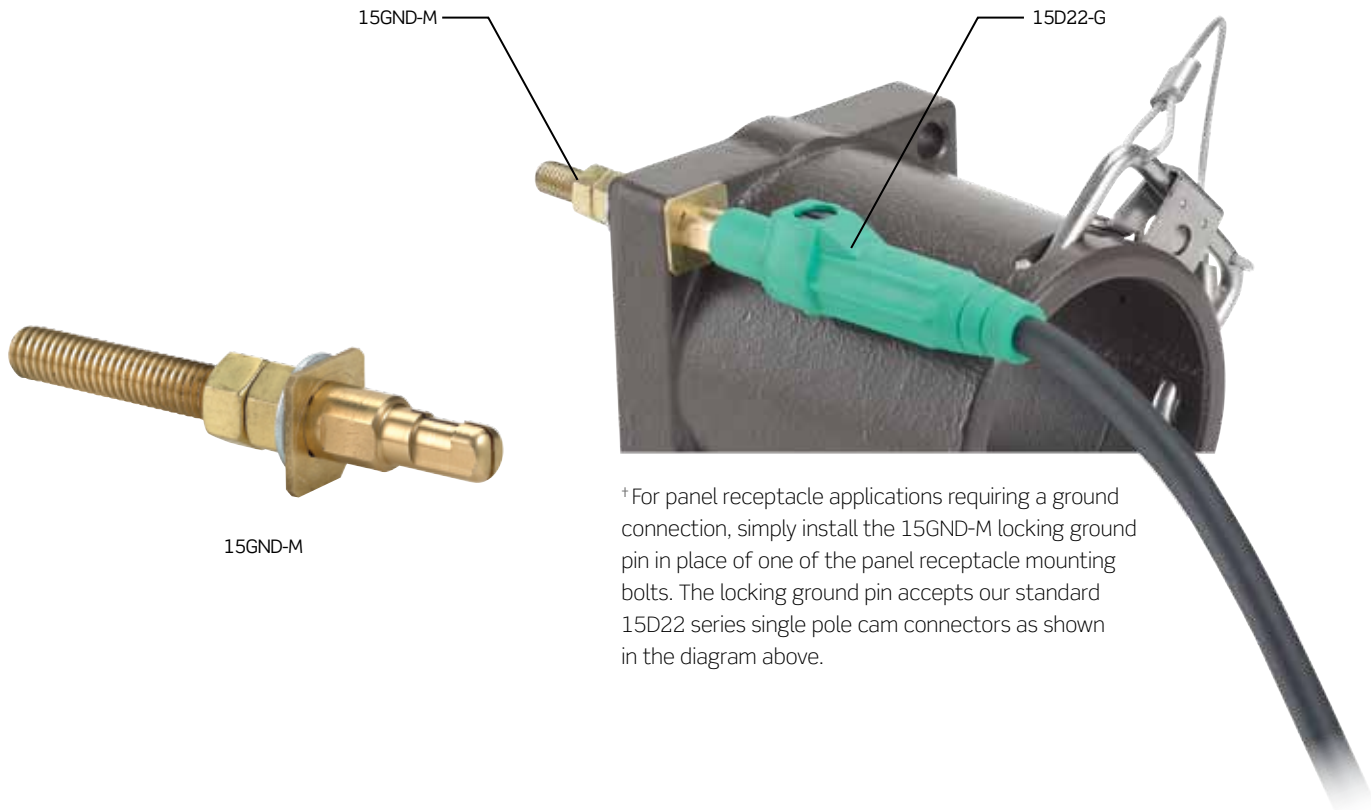

† For panel receptacle applications requiring a ground connection, simply install the 15GND-M locking ground pin in place of one of the panel receptacle mounting bolts. The locking ground pin accepts our standard 15D22 series single pole cam connectors as shown in the diagram above.

Industrial Grade

DIMENSIONS

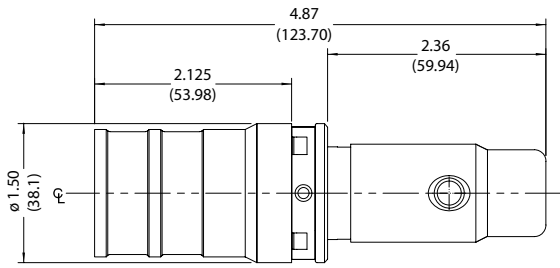

Male Contact

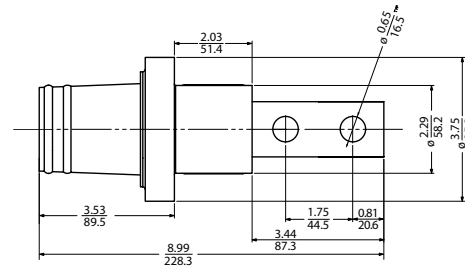

Male 2-Hole Bus Bar

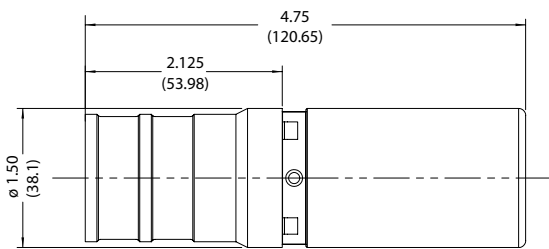

Female Contact

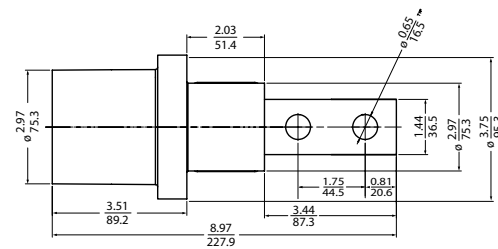

Female 2-Hole Bus Bar

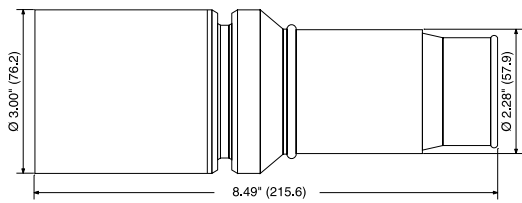

Female Connector Housing

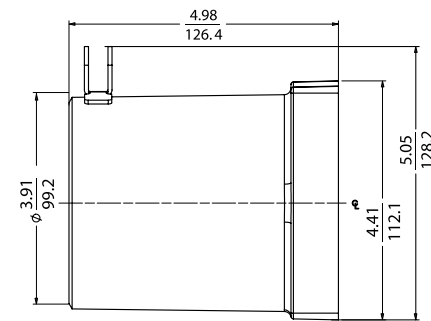

Panel Receptacle Housing

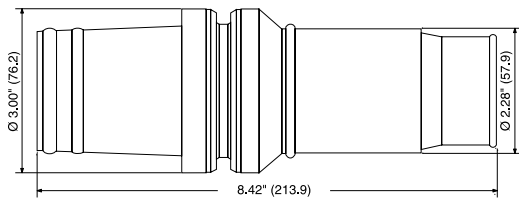

Male Connector Housing

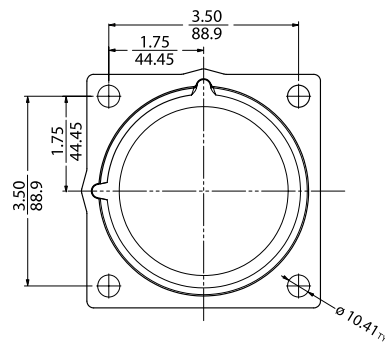

Panel Receptacle Flange

Other Products from Leviton Manufacturing...

Leviton Manufacturing is North America's leading manufacturer of electrical wiring devices, data center connectivity solutions and lighting energy management systems. Founded at the turn of the 20th century, we've grown over the past 100 years to become the preeminent leader in our industry. Today our product portfolio consists of over 25,000 devices and systems used in homes, businesses and industry.

Leviton is developing some of the most innovative products to provide electricity safely and cost-effectively within manufacturing facilities, construction sites, oil rig manufacturing, power distribution and other industrial applications.

Here are some other smart choices you might enjoy from Leviton:



Wetguard Watertight Devices



AC Switches



Corrosion Resistant Devices



Surge Protective Devices



IEC 309 Pin & Sleeve Devices



Temporary power... permanent reliability!



Made in the USA



Leviton offers a wide variety of single pin cam-type cable connectors and panel mount receptacles that supply temporary electrical power distribution for multiple indoor and outdoor applications. Our heavy-duty connectors are the standard for the entertainment and convention industries and can just as readily be found at mining and construction sites.

Assembly, disassembly and field repairs are effortless, requiring no special tools. Tough enough to handle severe stress and load conditions, they'll give you the all-star performance you expect and deserve.

The Power Behind the Performance



Leviton's line of Stage Pin Connectors provide the most rugged, reliable connection for any theatrical lighting application.

Engineered for maximum performance under the most critical conditions. The unique strain relief system assures industry leading security and the ergonomic design provides a comfortable grip.

When Performance Matters, Trust Leviton

For a closer look at all the smart choices we offer, visit us at leviton.com/industrial.



Leviton Manufacturing Co., Inc.

201 N Service Rd, Melville, NY 11747
Telephone: 1-800-323-8920 • Fax: 1-800-832-9538
Tech Line (8:30AM-7:30PM E.S.T. Monday-Friday): 1-800-824-3005

Leviton Manufacturing of Canada, Ltd.

165 Hymus Blvd, Pointe-Claire, QC H9R 1E9
Telephone: 1-800-469-7890 • Fax: 1-800-563-1853

Leviton S. de R.L. de C.V.

Lago Tana 43, Col. Huichapan, Miguel Hidalgo, CP 11290 México DF
Telephone: (+52) 55-5082-1040 • Fax: (+52) 55-5386-1797 • www.leviton.com.mx

Visit our Website at: www.leviton.com/industrial email: industrial@leviton.com

© 2011 Leviton Manufacturing Co., Inc. All rights reserved.

