

Table of Contents

.....

Overview.....B2–B5

Ring TerminalsB6–B15

Flag Terminals.....B16

Fork TerminalsB17–B20

Pin TerminalsB21

Butt SplicesB22–B23

Wire Joints.....B24–B25

Heat-Shrinkable Terminals, Splices and Disconnects.....B26–B27

Disconnects and Male Tabs.....B28–B31

Luminaire DisconnectB32–B33

Insulated FerrulesB34–B35

FerrulesB36–B37

Installing KitsB38–B40

Application Tools.....B41–B51

Die Selection ChartB52–B54

Wire Guide TableB55–B57

Military Standard Cross ReferenceB58

Cross Reference for PackagingB59–B61

Catamount® TerminalsB62–B63

Catamount® Terminal ToolsB64

Polycarbonate Insulated Ring Terminals.....B65

Polycarbonate Insulated Fork Terminals.....B66

Vinyl Insulated Ring Terminals DIN 46237.....B67

Nylon Insulated Ring Terminals DIN 46237B68

Nylon Insulated Fork Terminals DIN 46237B69

Vinyl Insulated Fork Terminals DIN 46237.....B70

Polycarbonate Insulated Pin Terminals.....B71

Insulated Female Disconnects DIN 46245.....B72

Insulated Male Disconnects DIN 46245B73

Fully Insulated Female Disconnects.....B74

Fully Insulated Butt SplicesB75

Insulated Wire JointsB76

Tools.....B77–B78

Overview

Experience the Sta-Kon® advantage!

Thomas & Betts developed the first tool-applied solderless terminals and connectors more than 70 years ago in response to industry awareness of the need for better performance of electrical systems.

Key Features and Benefits

- Metal insulation grip sleeve is included on all nylon terminal for strain relief
- Long barrel selectively annealed
- CSA Certified
- UL Listed unless otherwise specified



Deep Internal Serrations

After the insertion of a wire into the terminal's barrel, a deep, serrated interior ensures a large area of contact that lowers the resistance of a connection. With the mechanical force of the tool, the wire strands cold flow into the serrated interior. This guarantees electrical resistance lower than the wire to which it is applied. This feature also prevents pullout from vibration and mechanical strain. Deep internal serrations can be compared to the effective holding power of a well-treaded tire on a wet highway.

Funneled Terminal Barrel Entry

This feature makes wire insertion faster and easier. A funneled barrel eliminates wire strand "hang up" upon insertion into the terminal's barrel. The loss of even a couple of wire strands can have negative results on electrical efficiency and resistance to mechanical strain.

Sta-Kon® Long Barrel Design

If lowering electrical resistance, preventing wire pullout, eliminating a "missed" crimp and having an insulator that stays on the barrel during installation are your goals, then you must design a terminal with a long barrel. This also provides the insulator with additional surface area, holding tight to the barrel. Most competitive barrel lengths range from 20–50% shorter than Sta-Kon® terminals. The results are usually a stream of electrical failure, rework and added expense. Many competitive insulators come off during crimping due to a limited barrel length.

Note: Listed for solid wire up to #10 AWG, terminals only.

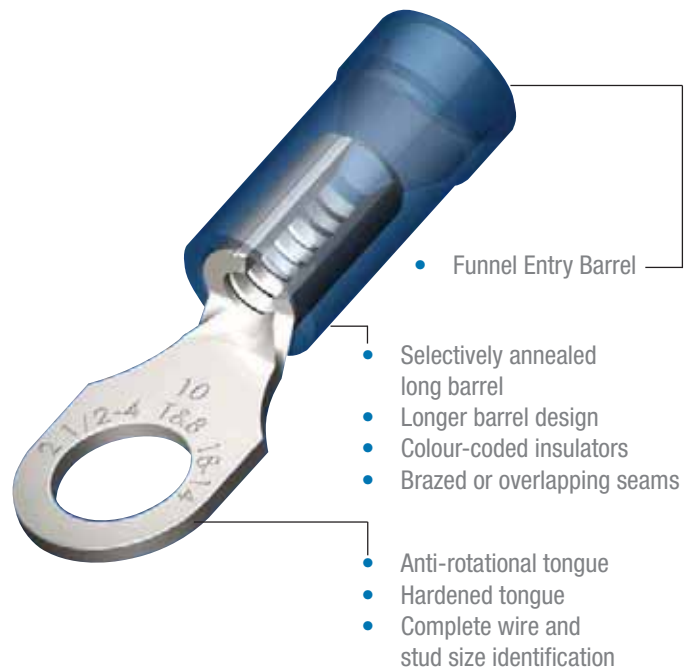

Overview

Why Sta-Kon® Terminals are Better

Selective Annealing

Because of the mechanical strength of copper, an installer can experience fatigue associated with repeated installations. For this reason Thomas & Betts puts our terminals through one more step called selective annealing. This process leaves the barrel soft enough to crimp and form around the wire. However, we “cold form” the tongue during the manufacturing process so it remains strong. This is done so the tongue can withstand repeated bends and bolt tightening strain common in most electrical installations. Many competitors attempt to accomplish similar goals by removing valuable material or using a softer copper which has lower conductivity. This increases electrical resistance as well as the odds for shorting and downtime.



• Deep Internal Serrations.

Anti-Rotational Tongues

This is a unique feature to the Thomas & Betts ring tongue terminal. This design prevents terminal shorting by keeping the terminal secure in the terminal block. The installer can place a greater number of terminals closer together without worry.

- Flat bottom box
- Electro-tin plating
- Center reinforced spring detent for minimum insertion force
- Compound Spring Rails provide positive contact after repeated insertions

Proper Identification

We identify all terminals with Thomas & Betts initials, T&B. We also indicate wire and stud sizes. These markings are clearly visible on the surface of the tongue, taking any guesswork out of replacing or reordering additional parts. Our superior bright plating also assists in visibility.

All Sta-Kon® Terminals are Deburred and Degreased

To ensure a Sta-Kon® terminal is properly plated and insulated, all our parts are put through a process which cleans and smooths the terminal of any manufacturing residues, mainly grease, oils and sharp edges. Many competitive products do not put their product through such rigorous finishing.

Platings/Finish

Electroplated-Tin is standard. All others require **minimum order quantities** and are generally not stocked. Alternative platings as follows: Gold, Silver, Tin-alloys, Nickel, etc.

The following finishes are available on most one-piece Sta-Kon® terminals:

Finish	Suffix	Spec.
Gold Plate	GP	MIL-G-45204 Type II, Grade B, C, D, Class O
Nickel Plate	NP	QQ-N-290 Class 2, Grade G
Plain Finish	PF	None
Silver Plate	SP	MIL-T-16366 Type I or II, 400°F, 204°C
Tin Plate	TP	MIL-T-10727 Type I

To order, add the indicated suffix to the regular catalogue number.

Underwriters Laboratories Listing

Sta-Kon® Rings, Forks, Locking Forks, two-way splices and disconnects are tested and listed to UL standards and all applicable products to CSA standards.

Overview

.....



Sta-Kon® Ring, Fork and Locking Fork

- Complete line of installing tools engineered to match tool with terminal
- First to gain military approval for pressure connections ... many styles available for military applications
- Sta-Kon® products exceed test specification requirements of military, UL and CSA
- Fluoropolymer and Nylon Terminals provided with extra metal sleeve to grip insulation
- Vinyl insulated and bare Sta-Kon® terminals feature brazed seam wire barrels which can be crimped at any place on the barrel circumference
- Ring and Fork terminals can be used with solid wire as follows:
Non-Insulated: 22-8 gauge
Insulated: 22-10 gauge

Sta-Kon® Disconnects

- Internal barrel serrations and long barrel provide for maximum tensile strength
- Complete line of installing tools, engineered to match tool with terminal
- Funnel entry insulators allow for easier inserting of wire into barrel
- Colour-coded for easy installation



ERG4001

The Shure-Stake® Tools are Matched to Terminals

The Shure-Stake® mechanism prevents the dies from releasing the terminal until the proper compression has been completed. With this method, an operator achieves a reliable crimp everytime. Thomas & Betts' tooling techniques correctly match tools, wire size and terminal to produce optimum mechanical and electrical performance.

Overview

Thomas & Betts is pleased to announce that Sta-Kon® RA, RB and RC insulated quick disconnect products are now UL Listed at 600 volts.

Sta-Kon® Technical Data

Terminals & Splices Insulation Rating	UL 94 Flammability	Voltage	Temperature
Nylon	V-2	600V	105°C
Vinyl	V-0		
TEFZEL®	V-0		
Disconnects (non-insulated)		300V	

TEFZEL® is a registered trademark of DuPont.

The Sta-Kon® Terminals Numbering System

Distributor Package 100/50
Bulk "O.E.M." Packaged 1000/500

Common to Both Packages

- Letter **A** denotes 22-18 AWG wire range = Red
- Letter **B** denotes 16-14 AWG wire range = Blue
- Letter **C** denotes 26-22 AWG, 12-10 AWG wire range = Yellow
- Letter **R** preceding the above letters indicates the terminal is insulated
- No letter **R**... no insulation ... no exception!

Distributor Packaged

Part numbers are very descriptive indicating insulation and type, stud size, tongue style and the largest maximum wire that can be put inside.

- If the letter **R** precedes the number, the part is nylon insulated – RA18-6
- If the letter **R** follows the number, the part is vinyl insulated – 14RB-8

EXAMPLE: 10RC-8F

C – Indicates 12-10 AWG
10RC – Vinyl Insulated
8 – Indicates stud size
F – Means a fork tongue terminal
FL – Would indicate locking fork

EXAMPLE: 2RA18X

2 – Indicates a 2 way or butt style connector
X – Means expanded insulation

Ring Terminals

- Complete line of installing tools engineered to match tool with terminal
- First to gain military approval for pressure connections... many styles available for military applications
- Sta-Kon® products exceed test specification requirements of military, UL and CSA
- Include extra metal sleeve to grip insulation
- Vinyl insulated and bare Sta-Kon® terminals feature brazed seam wire barrels that can be crimped at any place on the barrel circumference
- Can be installed with crimping tools having a single indenter or double indenter (recommended for solid wire)
- Serrated barrel increases grip on wire
- Wire range identification on the tongue of each terminal
- Constructed of electrolytic copper for high conductivity



Nylon-Insulated Ring Terminals

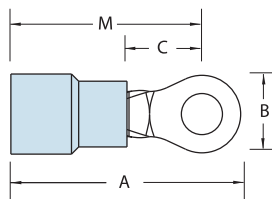

Cat. No.	Pkg. Qty.	Wire Range	Max. Ins. (in.)	Bolt Hole	Rec. Tool	Dimensions (in.)				Stock Thick. (in.)
						A	B	C	M	
RZ22-2**	100	26-22	0.083	#2	ERG4006	0.57	0.14	0.13	0.49	0.02
RZ22-4**	100	26-22	0.083	#4		0.65	0.21	0.20	0.54	
RZ22-6**	100	26-22	0.083	#6		0.65	0.21	0.20	0.54	
RZ22-8**	100	26-22	0.083	#8		0.75	0.25	0.23	0.62	
RZ22-10**	100	26-22	0.083	#10		0.75	0.25	0.23	0.62	
RAX23*	1,000	26-24	0.125	#2	WT145A	0.66	0.14	0.14	0.59	
RAX43*	1,000	26-24	0.125	#4		0.74	0.20	0.19	0.64	
RAX63*	1,000	26-24	0.125	#6		0.84	0.25	0.22	0.72	
RAX83*	1,000	26-24	0.125	#8		0.84	0.25	0.22	0.72	
RAX103*	1,000	26-24	0.125	#10		0.84	0.25	0.24	0.72	
RA18-4	100	22-16	0.136	#4	ERG4001	0.72	0.23	0.14	0.59	0.03
RA323	1,000	22-16	0.136	#4		0.72	0.23	0.14	0.59	
RA333	1,000	22-16	0.136	#6		0.72	0.23	0.14	0.59	
RA18-6	100	22-16	0.136	#6		0.86	0.26	0.25	0.71	
						0.86	0.26	0.25	0.71	

* Not listed by UL or CSA ** CSA Certified only

Most standard bulk catalogue numbers can be put on Mylar Tape for reel feed applications (i.e. 12050 tool and application). Please put the suffix M for Mylar tape i.e. RA2573M.

Cat. No.	Pkg. Qty.	Wire Range	Max. Ins. (in.)	Bolt Hole	Rec. Tool	Dimensions (in.)				Stock Thick. (in.)
						A	B	C	M	
RA853	1,000	22-16	0.136	#6	WT145A	0.86	0.26	0.25	0.71	.03
RA18-8	100			#8		0.89	0.26	0.25	0.71	
RA833	1,000			#8		0.86	0.26	0.25	0.71	
RA863	1,000			#8		0.89	0.26	0.25	0.71	
RA18-10	100			#10		0.89	0.31	0.25	0.71	
RA873	1,000			#10		0.89	0.31	0.25	0.71	
RA18-14	100			1/4 in.		1.10	0.46	0.31	0.84	
RA713	1,000			1/4 in.		1.10	0.46	0.31	0.84	
RA18-516	100			5/16 in.		1.10	0.46	0.31	0.84	
RA723	1,000			5/16 in.		1.10	0.46	0.31	0.84	
RA18-38	100	3/8 in.	1.20	0.53	0.35	0.87	.03			
RA733	1,000	3/8 in.	1.20	0.53	0.35	0.87				
RA18-12	100	1/2 in.	1.30	0.72	0.50	0.92				
RA753	1,000	1/2 in.	1.30	0.72	0.50	0.92				

Ring Terminals

Nylon-Insulated Ring Terminals



Cat. No.	Pkg. Qty.	Wire Range	Max. Ins. (in.)	Bolt Hole	Rec. Tool	Dimensions (in.)				Stock Thick. (in.)
						A	B	C	M	
RB14-4	100	18-14	0.162	#4	ERG4001	0.72	0.26	0.14	0.59	0.03
RB1323	1,000			#4		0.72	0.26	0.14	0.59	
RB14-6	100			#6		0.89	0.31	0.25	0.71	
RB853	1,000			#6		0.89	0.31	0.25	0.71	
RB1333	1,000			#6		0.74	0.26	0.14	0.59	
RB14-8	100			#8		0.89	0.31	0.25	0.71	
RB863	1,000			#8		0.89	0.31	0.25	0.71	
RB14-10	100			#10		0.89	0.31	0.25	0.71	
RB873	1,000			#10		0.89	0.31	0.25	0.71	
RB14-14	100			1/4 in.		1.08	0.47	0.31	0.81	
RB713	1,000			1/4 in.		1.08	0.47	0.31	0.81	
RB14-516	100			5/16 in.		1.08	0.47	0.31	0.84	
RB723	1,000			5/16 in.		1.08	0.47	0.31	0.84	
RB14-38	100			3/8 in.		1.17	0.53	0.35	0.87	
RB733	1,000			3/8 in.		1.17	0.53	0.35	0.87	
RB14-12	100			1/2 in.		1.25	0.72	0.50	0.90	
RB753	1,000	1/2 in.	1.25	0.72	0.50	0.90				

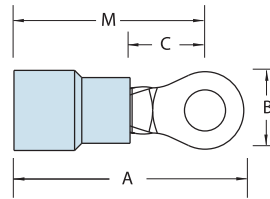
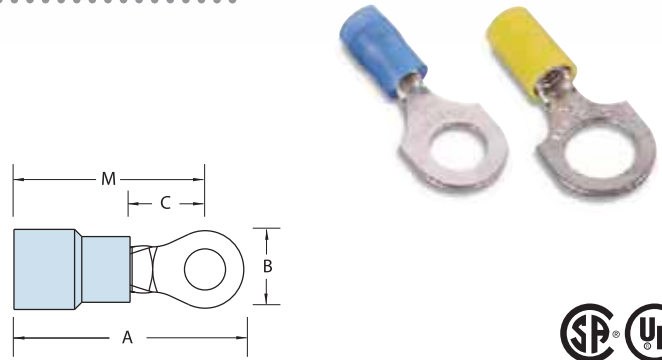

Cat. No.	Pkg. Qty.	Wire Range	Max. Ins. (in.)	Bolt Hole	Rec. Tool	Dimensions (in.)				Stock Thick. (in.)
						A	B	C	M	
RC10-6	50	12-10	0.210	#6	ERG4001	1.00	0.37	0.27	0.81	0.04
RC333	500			#6		1.00	0.37	0.27	0.81	
RC10-8	50			#8		1.00	0.37	0.27	0.81	
RC863	500			#8		1.00	0.37	0.27	0.81	
RC10-10	50			#10		1.00	0.37	0.27	0.81	
RC363	500			#10		1.00	0.37	0.27	0.81	
RC10-14	50			1/4 in.		1.12	0.53	0.32	0.86	
RC713	500			1/4 in.		1.12	0.53	0.32	0.86	
RC10-516	50			5/16 in.		1.21	0.53	0.31	0.94	
RC703	500			5/16 in.		1.21	0.53	0.31	0.94	
RC10-38	50			3/8 in.		1.27	0.59	0.35	0.98	
RC733	500			3/8 in.		1.27	0.59	0.35	0.98	
RC10-12	50			1/2 in.		1.37	0.72	0.52	1.02	
RC753	500			1/2 in.		1.37	0.72	0.52	1.02	

Nylon-Insulated Ring Terminals — Expanded Entry

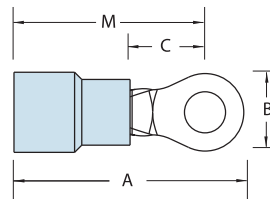

Cat. No.	Pkg. Qty.	Wire Range	Max. Ins. (in.)	Bolt Hole	Rec. Tool	Dimensions (in.)				Stock Thick. (in.)
						A	B	C	M	
RB14-4X	100	18-14	0.190	#4	ERG4001	0.80	0.26	0.14	0.67	0.03
RB14-6X	100			#6		0.95	0.31	0.25	0.79	
RB854	1,000			#6		0.95	0.31	0.25	0.79	
RB14-8X	100			#8		0.95	0.31	0.25	0.79	
RB864	1,000			#8		0.95	0.31	0.25	0.79	
RB14-10X	100			#10		0.95	0.31	0.25	0.79	
RB874	1,000			#10		0.95	0.31	0.25	0.79	
RB14-14X	100			1/4 in.		1.16	0.47	0.31	0.92	
RB714	1,000			1/4 in.		1.16	0.47	0.31	0.92	
RB14-516X	100			5/16 in.		1.16	0.47	0.31	0.92	
RB724	1,000			5/16 in.		1.16	0.47	0.31	0.92	
RB14-38X	100			3/8 in.		1.25	0.53	0.42	0.95	
RB734	1,000			3/8 in.		1.25	0.53	0.42	0.95	

Cat. No.	Pkg. Qty.	Wire Range	Max. Ins. (in.)	Bolt Hole	Rec. Tool	Dimensions (in.)				Stock Thick. (in.)
						A	B	C	M	
RC10-6X	50	12-10	0.250	#6	ERG4001	1.10	0.37	0.27	0.91	0.04
RC334	500			#6		1.10	0.37	0.27	0.91	
RC10-8X	50			#8		1.10	0.37	0.27	0.91	
RC864	500			#8		1.10	0.37	0.27	0.91	
RC10-10X	50			#10		1.10	0.37	0.27	0.91	
RC364	500			#10		1.10	0.37	0.27	0.91	
RC10-14X	50			1/4 in.		1.22	0.53	0.32	0.96	
RC714	500			1/4 in.		1.22	0.53	0.32	0.96	
RC10-516X	50			5/16 in.		1.32	0.53	0.31	1.05	
RC704	500			5/16 in.		1.32	0.53	0.31	1.05	
RC10-38X	50			3/8 in.		1.38	0.59	0.48	1.09	
RC734	500			3/8 in.		1.38	0.59	0.48	1.09	
RC10-12X	50			1/2 in.		1.48	0.72	0.52	1.13	

Ring Terminals

Nylon-Insulated Large Ring Terminals

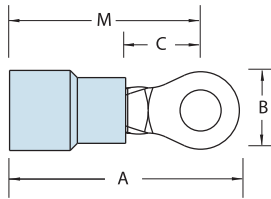

Cat. No.	Pkg. Qty.	Wire Range	Max. Ins. (in.)	Bolt Hole	Rec. Tool	Dimensions (in.)				Stock Thick. (in.)				
						A	B	C	M					
Flex Class 41/24														
RD167	200	8	0.340	#8	ERG4007	1.48	0.42	0.28	1.29	0.04				
RD8-10	25			#10		1.48	0.42	0.28	1.29					
RD367	200			#10		1.48	0.42	0.28	1.29					
RD8-14	25			1/4 in.		1.54	0.46	0.36	1.32					
RD717	200			1/4 in.		1.54	0.46	0.36	1.32					
RD8-516	25			5/16 in.		1.63	0.57	0.36	1.35					
RD727	200			5/16 in.		1.63	0.57	0.36	1.35					
RD8-38	25			3/8 in.		1.63	0.57	0.36	1.35					
RD737	200			3/8 in.	1.63	0.57	0.36	1.35						
RD8-12*	25			1/2 in.	1.79	0.82	0.55	1.39						
RD757*	200			1/2 in.	1.79	0.82	0.55	1.39						
RD10161	200			8AN	0.270	#8	ERG4007	1.40	0.41		0.24	1.20		
RD10361	200					#10		1.40	0.41		0.24	1.20		
RD10711	200					1/4 in.		1.45	0.45		0.27	1.22		
RD10721	200					5/16 in.		1.53	0.56		0.34	1.25		
RD10731	200					3/8 in.		1.53	0.56		0.34	1.25		
Flex Class 63/24														
RE6-10	20	6	0.420	#10	ERG4007	1.65	0.49	0.28	1.40	0.04				
RE267	200			#10		1.65	0.49	0.28	1.40					
RE6-14	20			1/4 in.		1.65	0.49	0.28	1.40					
RE717	200			1/4 in.		1.65	0.49	0.28	1.40					
RE6-516	20			5/16 in.		1.76	0.61	0.34	1.47					
RE727	200			5/16 in.		1.76	0.61	0.34	1.47					
RE6-38	20			3/8 in.		1.76	0.61	0.34	1.47					
RE737	200			3/8 in.		1.76	0.61	0.34	1.47					
RE6-12*	20			0.395	TBM6S	1/2 in.	1.83	0.82	0.55		1.43			
RE757*	200					1/2 in.	1.83	0.82	0.55		1.43			
RE10261	200					6AN	0.315	ERG4007	#10		1.55	0.49	0.24	1.31
RE10711	200								1/4 in.		1.55	0.49	0.27	1.31
RE10721	200			5/16 in.	1.70				0.60		0.34	1.40		
RE10731	200			3/8 in.	1.70				0.60		0.34	1.40		
Flex Class 105/24														
RF4-10	15			4	0.510	#10	TBM6S	1.76	0.56		0.36	1.49	0.04	
RF267	100	#10	1.76			0.56		0.36	1.49					
RF4-14	15	1/4 in.	1.76			0.56		0.36	1.49					
RF717	100	1/4 in.	1.76			0.56		0.36	1.49					
RF4-516	15	5/16 in.	1.84			0.62		0.35	1.53					
RF727	100	5/16 in.	1.84			0.62		0.35	1.53					
RF4-38	15	3/8 in.	1.84			0.62		0.35	1.53					
RF737	100	3/8 in.	1.84			0.62		0.35	1.53					
RF757*	100	0.500	TBM6S			1/2 in.	1.90	0.82	0.55	1.49				
RF10261	100					#10	1.78	0.55	0.30	1.51				
RF10711	100					1/4 in.	1.78	0.55	0.30	1.51				
RF10721	100					5/16 in.	1.80	0.62	0.34	1.49				
RF10731	100	4AN	0.380			TBM6S	3/8 in.	1.80	0.82	0.34	1.49			

Cat. No.	Pkg. Qty.	Wire Range	Max. Ins. (in.)	Bolt Hole	Rec. Tool	Dimensions (in.)				Stock Thick. (in.)		
						A	B	C	M			
RG2-10	10	2	0.588	#10	TBM6S	2.15	0.69	0.40	1.83	0.05		
RG267	50			#10		2.15	0.69	0.40	1.83			
RG2-14	10			1/4 in.		2.15	0.69	0.40	1.83			
RG717	50			1/4 in.		2.15	0.69	0.40	1.83			
RG2-516	10			5/16 in.		2.15	0.69	0.40	1.83			
RG727	50			5/16 in.		2.15	0.69	0.40	1.83			
RG2-38	10			3/8 in.		2.15	0.69	0.40	1.83			
RG737	50			3/8 in.		2.15	0.69	0.40	1.83			
RG2-12	10			1/2 in.		2.35	0.80	0.49	1.93			
RG757	50			1/2 in.		2.35	0.80	0.49	1.93			
RG9711	50			2AN		0.453	1/4 in.	2.07	0.69		0.40	1.74
RG9731	50						3/8 in.	2.07	0.69		0.40	1.74
RG9751	50						1/2 in.	2.26	0.80		0.49	1.84
RH717	50						1/4 in.	2.14	0.77		0.43	1.81
RH727	50			1/0		0.629	5/16 in.	2.14	0.77		0.43	1.81
RH737	50						3/8 in.	2.14	0.77		0.43	1.81
RH757	50	1/2 in.	2.34		0.77		0.54	1.90				
RH9711	50	1/4 in.	2.14		0.77		0.44	1.81				
RH9731	50	1AN	0.500	1/4 in.	2.14	0.77	0.44	1.81				
RH9751	50			3/8 in.	2.14	0.77	0.44	1.81				
RJ717	100	2/0	0.675	1/4 in.	2.34	0.83	0.46	1.96				
RJ727	100			5/16 in.	2.34	0.83	0.46	1.96				
RJ737	100			3/8 in.	2.34	0.83	0.46	1.96				
RJ757	100			1/2 in.	2.48	0.89	0.54	2.03				
RJ9711	50	1/0AN	0.550	1/4 in.	2.35	0.83	0.46	1.97				
RJ9731	50			3/8 in.	2.35	0.83	0.46	1.97				
RJ9751	50			1/2 in.	2.49	0.89	0.55	2.04				
RK717	25			1/4 in.	2.60	0.93	0.54	2.21				
RK727	25	3/0	0.765	5/16 in.	2.60	0.93	0.54	2.21				
RK737	25			3/8 in.	2.60	0.93	0.54	2.21				
RK9731	100	2/0AN	0.610	3/8 in.	2.52	0.93	0.55	2.14				
RK9751	100			1/2 in.	2.60	0.93	0.55	2.15				
RL737	25	4/0	0.785	3/8 in.	2.83	1.04	0.57	2.35				
RL757	25			1/2 in.	2.83	1.04	0.57	2.35				
RL9731	25	3/0AN	0.680	3/8 in.	2.83	1.04	0.57	2.36				
RL9751	25			1/2 in.	2.83	1.04	0.57	2.36				
RM737	20			3/8 in.	3.00	1.13	0.65	2.51				
RM747	20			250kcmil	0.868	7/16 in.	3.00	1.13	0.65	2.51		
RM757	20	1/2 in.	3.00			1.13	0.65	2.51				
RM9731	20	4/0AN	0.750	3/8 in.	3.00	1.13	0.66	2.51				
RM9751	20			1/2 in.	3.00	1.13	0.66	2.51				

*Brazead Seam
AN=Aircraft Wire

Ring Terminals

Vinyl-Insulated Ring Terminals

Extra-length PVC sleeve offers extra protection



Cat. No.	Pkg. Qty.	Wire Range	Max. Ins. (in.)	Bolt Hole	Rec. Tool	Dimensions (in.)				Stock Thick. (in.)				
						A	B	C	M					
18RA-4	100	22-16	0.150	#4	ERG4001	0.97	0.31	0.27	0.81	0.03				
RA77	1,000			#4		0.97	0.31	0.27	0.81					
18RA-6	100			#6		0.94	0.25	0.27	0.81					
RA857	1,000			#6		0.94	0.25	0.27	0.81					
18RA-8	100			#8		0.97	0.31	0.27	0.81					
RA867	1,000			#8		0.97	0.31	0.27	0.81					
18RA-10	100			#10		0.97	0.31	0.27	0.81					
RA717	1,000			#10		0.97	0.31	0.27	0.81					
18RA-14	100			1/4 in.		1.13	0.50	0.37	0.88					
RA717	1,000			1/4 in.		1.13	0.50	0.37	0.88					
18RA-516	100			5/16 in.		1.13	0.50	0.37	0.88					
RA727	1,000			5/16 in.		1.13	0.50	0.37	0.88					
18RA-38	100			3/8 in.		1.24	0.54	0.37	0.91					
RA737	1,000			3/8 in.		1.24	0.54	0.37	0.91					
14RB-4	100			18-14		0.170	#4	ERG4001	0.94		0.25	0.27	0.81	0.03
RB1327	1,000						#4		0.94		0.25	0.27	0.81	
14RB-6	100						#6		0.97		0.31	0.27	0.81	
RB857	1,000						#6		0.97		0.31	0.27	0.81	
14RB-8	100						#8		0.97		0.31	0.27	0.81	
RB867	1,000						#8		0.97		0.31	0.27	0.81	
14RB-10	100	#10	0.97		0.31		0.27		0.81					
RB877	1,000	#10	0.97		0.31		0.27		0.81					
14RB-14	100	1/4 in.	1.14		0.50		0.38		0.89					
RB717	1,000	1/4 in.	1.14		0.50		0.38		0.89					
14RB-516	100	5/16 in.	1.15		0.50		0.38		0.89					
RB727	1,000	5/16 in.	1.15		0.50		0.38		0.89					
14RB-38	100	3/8 in.	1.16		0.54		0.38		0.91					
RB737	1,000	3/8 in.	1.16		0.54		0.38		0.91					
10RC-6	50	12-10	0.210		#6		ERG4001		1.06	0.31	0.27	0.90	0.04	
RC337	500				#6				1.06	0.31	0.27	0.90		
10RC-8	50				#8				1.06	0.31	0.27	0.90		
RC777	500				#8				1.06	0.31	0.27	0.90		
10RC-10	50				#10				1.06	0.31	0.27	0.90		
RC367	500				#10				1.06	0.31	0.27	0.90		
10RC-14	50			1/4 in.	1.16	0.50		0.27	0.90					
RC717	500			1/4 in.	1.16	0.50		0.27	0.90					
10RC-516	50			5/16 in.	1.17	0.50		0.37	0.92					
RC707	500			5/16 in.	1.17	0.50		0.37	0.92					
10RC-38	50			3/8 in.	1.29	0.59		0.44	0.99					
RC737	500			3/8 in.	1.29	0.59		0.44	0.99					

Vinyl-Insulated Ring Terminals — Expanded Insulation

A wider wire entry for heavy-wall insulation



Cat. No.	Pkg. Qty.	Wire Range	Max. Ins. (in.)	Bolt Hole	Rec. Tool	Dimensions (in.)				Stock Thick. (in.)				
						A	B	C	M					
18RA-4X	100	22-16	0.170	#4	ERG4001	0.97	0.31	0.27	0.81	0.03				
18RA-6X	100			#6		0.97	0.31	0.27	0.81					
18RA-8X	100			#8		0.97	0.31	0.27	0.81					
18RA-38X	100			3/8 in.		1.15	0.54	0.35	0.90					
RA857-170	1,000			#6		0.97	0.31	0.27	0.81					
RA867-170	1,000			#8		0.97	0.31	0.27	0.81					
18RA-10X	1,000			#10		0.97	0.31	0.27	0.81					
RA877-170	1,000			#10		0.97	0.31	0.27	0.81					
18RA-14X	100			1/4 in.		1.13	0.50	0.37	0.88					
RA727-170	1,000			5/16 in.		1.13	0.50	0.37	0.88					
14RB-4X	100			18-14		0.200	#4	ERG4001	0.94		0.25	0.27	0.81	0.03
14RB-6X	100						#6		0.97		0.31	0.27	0.81	
RB857-200	1,000						#6		0.97		0.31	0.27	0.81	
14RB-8X	100						#8		0.97		0.31	0.27	0.81	
RB867-200	1,000						#8		0.97		0.31	0.27	0.81	
14RB-10X	100						#10		0.97		0.31	0.27	0.81	
RB877-200	1,000						#10		0.97		0.31	0.27	0.81	
14RB-14X	100						1/4 in.		1.14		0.50	0.38	0.89	
RB717-200	1,000						1/4 in.		1.14		0.50	0.38	0.89	
14RB-516X	100						5/16 in.		1.15		0.50	0.38	0.89	
14RB-38X	100	3/8 in.	1.16		0.54		0.35		0.91					
10RC-6X	50	12-10	0.250		#6		ERG4001		1.06	0.31	0.27	0.90	0.04	
RC337-250	500				#6				1.06	0.31	0.27	0.90		
10RC-8X	50				#8				1.06	0.31	0.27	0.90		
RC777-250	500				#8				1.06	0.31	0.27	0.90		
10RC-14X	50				#10				1.06	0.31	0.27	0.90		
RC717-250	500				#10				1.06	0.31	0.27	0.90		
10RC-516X	50				1/4 in.				1.16	0.50	0.27	0.90		
10RC-38X	50				5/16 in.				1.17	0.50	0.37	0.92		
RC737-250	500				3/8 in.				1.29	0.59	0.44	0.99		
				3/8 in.	1.29	0.59		0.44	0.99					

Ring Terminals

Vinyl-Insulated Large Ring Terminals

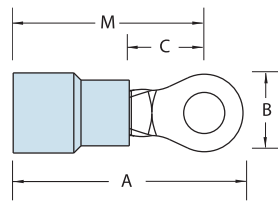

Cat. No.	Wire Range	Max. Ins. (in.)	Bolt Hole	Rec. Tool	Dimensions (in.)				Stock Thick. (in.)
					A	B	C	M	
RDV167	8	0.340	#8	ERG4007	1.48	0.42	0.28	1.17	0.04
RDV367					1.48	0.42	0.28	1.17	
RDV717					1.54	0.46	0.36	1.20	
RDV727					1.63	0.57	0.36	1.23	
RDV737					1.63	0.57	0.36	1.23	
RDV757*	0.310	1/2 in.	TBM6S	1.79	0.82	0.55	1.27		
REV267	6	0.420	#10	ERG4007	1.65	0.45	0.28	1.23	
REV717					1.65	0.49	0.28	1.23	
REV727					1.76	0.61	0.34	1.30	
REV737					1.76	0.61	0.34	1.30	
REV757*					0.395	1/2 in.	TBM6S	1.83	

*Brazen Seam

Ring Terminals

Non-Insulated Ring Terminals

Constructed of electrolytic copper for high conductivity!

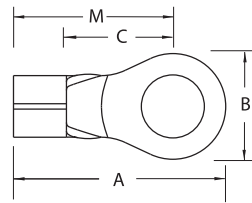

Cat. No.	Pkg. Qty.	Wire Range	Bolt Hole	Rec. Tool	Dimensions (in.)				Stock Thick. (in.)
					A	B	C	M	
A18-4	100	22-16	#4	ERG4002	0.75	0.31	0.27	0.59	0.03
A18-6	100		#6		0.72	0.25	0.27	0.59	
A85	1,000		#6		0.72	0.25	0.27	0.59	
A18-8	100		#8		0.75	0.31	0.27	0.59	
A86	1,000		#8		0.75	0.31	0.27	0.59	
A18-10	100		#10		0.75	0.31	0.27	0.59	
A87	1,000		#10		0.75	0.31	0.27	0.59	
A18-14	100		1/4 in.		0.92	0.50	0.37	0.67	
A71	1,000		1/4 in.		0.92	0.50	0.37	0.67	
A18-516	100		5/16 in.		0.92	0.50	0.37	0.67	
A72	1,000		5/16 in.		0.92	0.50	0.37	0.67	
A18-38	100		3/8 in.		0.99	0.54	0.35	0.67	
A73	1,000		3/8 in.		0.99	0.54	0.35	0.67	
A18-12	100		1/2 in.		1.06	0.72	0.38	0.70	
A75	1,000		1/2 in.		1.06	0.72	0.38	0.70	
B14-4	100		18-14		#4	ERG4002 ERG4005	0.72	0.25	
B132	1,000	#4		0.72	0.25		0.27	0.59	
B14-6	100	#6		0.72	0.25		0.27	0.59	
B133	1,000	#6		0.72	0.25		0.27	0.59	
B14-8	100	#8		0.75	0.31		0.27	0.59	
B86	1,000	#8		0.75	0.31		0.27	0.59	
B14-10	100	#10		0.75	0.31		0.27	0.59	
B87	1,000	#10		0.75	0.31		0.27	0.59	
B14-14	100	1/4 in.		0.93	0.50		0.38	0.68	

Cat. No.	Pkg. Qty.	Wire Range	Bolt Hole	Rec. Tool	Dimensions (in.)				Stock Thick. (in.)
					A	B	C	M	
B71	1,000	18-14	1/4 in.	ERG4002 ERG4005	0.93	0.50	0.38	0.68	0.03
B14-516	100		5/16 in.		0.93	0.50	0.38	0.68	
B72	1,000		5/16 in.		0.93	0.50	0.38	0.68	
B14-38	100		3/8 in.		0.96	0.54	0.35	0.68	
B73	1,000		3/8 in.		0.96	0.54	0.35	0.68	
B14-12	100		1/2 in.		1.06	0.72	0.38	0.70	
B75-TB	1,000		1/2 in.		1.06	0.72	0.38	0.70	
B85	1,000		#6		0.75	0.31	0.27	0.59	
B134	1,000		#8		0.72	0.25	0.27	0.59	
C10-6-SK	50		#6		0.82	0.31	0.27	0.66	
C33	500	#6	0.82	0.31	0.27	0.66			
C10-8-SK	50	#8	0.82	0.31	0.27	0.66			
C77	500	#8	0.82	0.31	0.27	0.66			
C10-10	50	#10	0.85	0.38	0.27	0.66			
C26	500	#10	0.85	0.38	0.27	0.66			
C36	500	#10	0.82	0.31	0.27	0.66			
C10-14	50	1/4 in.	0.91	0.50	0.27	0.66			
C71	500	1/4 in.	0.91	0.50	0.27	0.66			
C10-516	50	5/16 in.	0.98	0.50	0.38	0.73			
C70	500	5/16 in.	0.98	0.50	0.38	0.73			
C72	500	3/8 in.	1.10	0.59	0.45	0.80			
C10-38	50	3/8 in.	1.10	0.59	0.45	0.80			
C73	500	1/2 in.	1.10	0.59	0.45	0.80			
C10-12	50	1/2 in.	1.21	0.72	0.38	0.84			
C75	500	1/2 in.	1.21	0.72	0.38	0.84			

Ring Terminals

Non-Insulated Large Ring Terminals – Brazed Seam



Cat. No.	Pkg. Qty.	Wire Range	Bolt Hole	Rec. Tool	Dimensions (in.)				Stock Thick. (in.)			
					A	B	C	M				
D8-10	25	8	#10	TBM6S	1.09	0.42	0.34	0.90	0.06			
D36	200		#10		1.09	0.42	0.34	0.90				
D26	200		#10		1.13	0.48	0.36	0.90				
D8-14-SK	25		1/4 in.		1.13	0.48	0.36	0.90				
D71	200		1/4 in.		1.13	0.48	0.36	0.90				
D8-516	25		5/16 in.		1.32	0.59	0.49	1.03				
D72	200		5/16 in.		1.32	0.59	0.49	1.03				
D8-38	25		3/8 in.		1.32	0.59	0.49	1.03				
D73	200		3/8 in.		1.32	0.59	0.49	1.03				
D8-12	25		1/2 in.		1.49	0.82	0.55	1.09				
D75	200	1/2 in.	1.49	0.82	0.55	1.09						
E6-10	20	6	#10	TBM6S	1.13	0.48	0.36	0.90	0.07			
E26	200		#10		1.13	0.48	0.36	0.90				
E6-14	20		1/4 in.		1.13	0.48	0.36	0.90				
E71	200		1/4 in.		1.13	0.48	0.36	0.90				
E6-516	20		5/16 in.		1.32	0.60	0.49	1.03				
E72	200		4		5/16 in.	TBM6S	1.32	0.60		0.49	1.03	0.06
E6-38	20				3/8 in.		1.32	0.60		0.49	1.03	
E73	200				3/8 in.		1.32	0.60		0.49	1.03	
E6-12	20				1/2 in.		1.49	0.82		0.55	1.08	
E75	200				1/2 in.		1.49	0.82		0.55	1.08	
F4-10	20	#10		1.16	0.48		0.36	0.93				
F26	200	#10		1.16	0.48		0.36	0.93				
F4-14	20	1/4 in.		1.16	0.48		0.36	0.93				
F71-TB	200	1/4 in.		1.16	0.48		0.36	0.93				
F4-516	20	5/16 in.		1.35	0.60		0.49	1.06				
F72	200	5/16 in.	1.35	0.60	0.49	1.06						
F4-38	20	3/8 in.	1.35	0.60	0.49	1.06						
F73	200	3/8 in.	1.35	0.60	0.49	1.06						
F4-12	20	1/2 in.	1.52	0.82	0.55	1.11						
F75	200	1/2 in.	1.52	0.82	0.55	1.11						



Cat. No.	Pkg. Qty.	Wire Range	Bolt Hole	Rec. Tool	Dimensions (in.)				Stock Thick. (in.)
					A	B	C	M	
H10-14	10	1AN-1/0	1/4 in.	ERG4008 TBM6S	1.65	0.77	0.43	1.32	0.05
H971	100		1/4 in.		1.65	0.77	0.43	1.32	
H972	100		5/16 in.		1.65	0.77	0.43	1.32	
H973	100		3/8 in.		1.65	0.77	0.43	1.32	
H975	100		1/2 in.		1.85	0.77	0.54	1.41	
J971	50		1/4 in.		1.94	0.84	0.48	1.53	
J972	50		5/16 in.		1.94	0.84	0.48	1.53	
J20-38	10		3/8 in.		1.84	0.83	0.46	1.46	
J973	50		1/0AN-2/0		1.99	0.84	0.53	1.58	
J974	50		7/16 in.		1.99	0.89	0.51	1.56	
J975	50	1/2 in.	1.99	0.89	0.51	1.56			
J976	50	5/8 in.	1.99	0.89	0.51	1.56			
K971	50	2/0AN-3/0	1/4 in.	TBM6S	2.08	0.93	0.54	1.69	0.06
K972	50		5/16 in.		2.08	0.93	0.54	1.69	
K30-38	5		3/8 in.		2.08	0.93	0.54	1.69	
K973	50		3/8 in.		2.08	0.93	0.54	1.69	
K974	50		7/16 in.		2.08	0.93	0.54	1.70	
K975	50		1/2 in.		2.08	0.93	0.54	1.70	
L971	50		1/4 in.		2.25	1.04	0.57	1.77	
L972	50		5/16 in.		2.25	1.04	0.57	1.77	
L40-38	5		3/8 in.		2.25	1.04	0.57	1.77	
L973	50		3/8 in.		2.25	1.04	0.57	1.77	
L974	50	7/16 in.	2.25	1.04	0.57	1.77			
L975	50	1/2 in.	2.25	1.04	0.57	1.77			
M972	50	4/0AN-250kcmil	5/16 in.	TBM6S	2.28	1.12	0.62	1.90	0.07
M250-38	5		3/8 in.		2.40	1.12	0.65	1.91	
M973	50		3/8 in.		2.40	1.12	0.65	1.91	
M974	50		7/16 in.		2.40	1.12	0.65	1.91	
M975	50		1/2 in.		2.40	1.12	0.65	1.91	
M975	50		1/2 in.		2.40	1.12	0.65	1.91	

Non-Insulated Large Ring Terminals – Tubular

Select the configuration you need!



Cat. No.	Pkg. Qty.	Wire Range	Bolt Hole	Rec. Tool	Dimensions (in.)				Stock Thick. (in.)			
					A	B	C	M				
D10161	200	8/8AN	#8	ERG4005 ERG4008	1.15	0.41	0.28	0.95	0.04			
D10361	200		#10		1.15	0.41	0.28	0.95				
D10711	200		1/4 in.		1.20	0.45	0.36	0.97				
D10721	200		5/16 in.		1.28	0.56	0.36	1.00				
D10731	200		3/8 in.		1.28	0.56	0.36	1.00				
D975*	200		1/2 in.		1.46	0.83	0.49	1.06				
E10261	200		#10		1.26	0.49	0.24	1.02				
E10711	200		6/6AN		1/4 in.	ERG4005 ERG4008	1.26	0.49		0.27	0.99	0.04
E10721	200				5/16 in.		1.38	0.60		0.34	1.04	
E10731	200				3/8 in.		1.38	0.60		0.34	1.04	
F10261	100	#10		1.37	0.55		0.30	1.07				
F10711	100	4/4AN		1/4 in.	ERG4008		1.37	0.55	0.30	1.07	0.05	
F10721	100			5/16 in.			1.42	0.62	0.34	1.08		
F10731	100			3/8 in.			1.42	0.62	0.34	1.08		
F975*	200			1/2 in.			1.49	0.83	0.45	1.10		
G926	100			#10			1.59	0.69	0.40	1.26		
G2-14	10			1/4 in.			1.59	0.69	0.40	1.26		
G971	100		5/16 in.	1.59		0.69	0.40	1.26				
G2-516	10		5/16 in.	1.59		0.69	0.40	1.26				
G972	100		2/2AN	5/16 in.		ERG4008 TBM6S	1.59	0.69	0.40	1.26		0.05
G2-38	10			3/8 in.			1.59	0.69	0.40	1.26		
G973	100	3/8 in.		1.59	0.69		0.40	1.26				
G2-12	10	1/2 in.		1.79	0.80		0.49	1.36				
G975	100	1/2 in.		1.79	0.80		0.49	1.36				
G975	100	1/2 in.		1.79	0.80		0.49	1.36				

*Brazed Seam AN – Aircraft Wire



Cat. No.	Pkg. Qty.	Wire Range	Bolt Hole	Rec. Tool	Dimensions				Stock Thick. (in.)
					A	B	C	M	
H10-14	10	1AN-1/0	1/4 in.	ERG4008 TBM6S	1.65	0.77	0.43	1.32	0.05
H971	100		1/4 in.		1.65	0.77	0.43	1.32	
H972	100		5/16 in.		1.65	0.77	0.43	1.32	
H973	100		3/8 in.		1.65	0.77	0.43	1.32	
H975	100		1/2 in.		1.85	0.77	0.54	1.41	
J971	50		1/4 in.		1.94	0.84	0.48	1.53	
J972	50		5/16 in.		1.94	0.84	0.48	1.53	
J20-38	10		3/8 in.		1.84	0.83	0.46	1.46	
J973	50		1/0AN-2/0		1.99	0.84	0.53	1.58	
J974	50		7/16 in.		1.99	0.89	0.51	1.56	
J975	50	1/2 in.	1.99	0.89	0.51	1.56			
J976	50	5/8 in.	1.99	0.89	0.51	1.56			
K971	50	2/0AN-3/0	1/4 in.	TBM6S	2.08	0.93	0.54	1.69	0.06
K972	50		5/16 in.		2.08	0.93	0.54	1.69	
K30-38	5		3/8 in.		2.08	0.93	0.54	1.69	
K973	50		3/8 in.		2.08	0.93	0.54	1.69	
K974	50		7/16 in.		2.08	0.93	0.54	1.70	
K975	50		1/2 in.		2.08	0.93	0.54	1.70	
L971	50		1/4 in.		2.25	1.04	0.57	1.77	
L972	50		5/16 in.		2.25	1.04	0.57	1.77	
L40-38	5		3/8 in.		2.25	1.04	0.57	1.77	
L973	50		3/8 in.		2.25	1.04	0.57	1.77	
L974	50	7/16 in.	2.25	1.04	0.57	1.77			
L975	50	1/2 in.	2.25	1.04	0.57	1.77			
M972	50	4/0AN-250kcmil	5/16 in.	TBM6S	2.28	1.12	0.62	1.90	0.07
M250-38	5		3/8 in.		2.40	1.12	0.65	1.91	
M973	50		3/8 in.		2.40	1.12	0.65	1.91	
M974	50		7/16 in.		2.40	1.12	0.65	1.91	
M975	50		1/2 in.		2.40	1.12	0.65	1.91	
M975	50		1/2 in.		2.40	1.12	0.65	1.91	

Ring Terminals

Insulated Heavy-Duty Ring Terminals

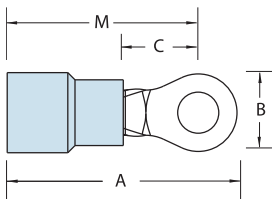

Cat. No.	Pkg. Qty.	Wire Range	Max. Ins. (in.)	Bolt Hole	Rec. Tool	Dimensions (in.)				Stock Thick. (in.)			
						A	B	C	M				
Nylon													
RBC14-6	50	16-14 Heavy-duty	0.210	#6	WT2130A	0.98	0.25	0.29	0.85	0.05			
RBC14-8	50	16-14 Heavy-duty		#8		1.04	0.39	0.29	0.85				
RBC863	500			#8		1.04	0.39	0.29	0.85				
RBC14-10	50	16-14 Heavy-duty		#10		1.04	0.39	0.29	0.85				
RBC14-14	50	16-14 Heavy-duty		1/4 in.		1.10	0.51	0.29	0.85				
RBC713	500			1/4 in.		1.10	0.51	0.29	0.85				
RBC14-516	50	16-14 Heavy-duty		5/16 in.		1.21	0.54	0.38	0.94				
RBC14-38	50	16-14 Heavy-duty		3/8 in.		1.26	0.63	0.38	0.94				
RBC14-12	50	16-14 Heavy-duty		1/2 in.		1.49	0.76	0.54	1.11				
RBC753	500			1/2 in.		1.49	0.76	0.54	1.11				
Vinyl													
14RBC-6	50	16-14 Heavy-duty		0.210		#6	WT2130A	1.06	0.25		0.29	0.93	0.05
RBC857	500		#6		1.06	0.25		0.29	0.93				
14RBC-8	50	16-14 Heavy-duty	#8		1.13	0.39		0.29	0.93				
RBC867	500		#8		1.13	0.39		0.29	0.93				
14RBC-10	50	16-14 Heavy-duty	#10		1.13	0.39		0.29	0.93				
RBC877	500		#10		1.13	0.39		0.29	0.93				
14RBC-14	50	16-14 Heavy-duty	1/4 in.		1.19	0.51		0.29	0.93				
RBC717	500		1/4 in.		1.19	0.51		0.29	0.93				
14RBC-516	50	16-14 Heavy-duty	5/16 in.		1.29	0.54		0.38	1.03				
RBC727	500		5/16 in.		1.29	0.54		0.38	1.03				
14RBC-38	50	16-14 Heavy-duty	3/8 in.		1.34	0.63		0.38	1.03				
RBC797	500		3/8 in.		1.34	0.63		0.38	1.03				
14RBC-12	50	16-14 Heavy-duty	1/2 in.	1.57	0.76	0.54	1.19						

Non-Insulated Heavy-Duty Ring Terminals

The heavy-duty terminal solution!

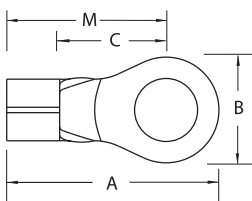

Cat. No.	Pkg. Qty.	Wire Range	Bolt Hole	Rec. Tool	Dimensions (in.)				Stock Thick. (in.)
					A	B	C	M	
BC14-6	50	16-14 Heavy-duty	#6	ERG4002 ERG4005	0.81	0.25	0.29	0.68	0.05
BC85	500		#6		0.81	0.25	0.29	0.68	
BC14-8	50	16-14 Heavy-duty	#8		0.87	0.39	0.29	0.68	
BC86	500		#8		0.87	0.39	0.29	0.68	
BC14-10	50	16-14 Heavy-duty	#10		0.87	0.39	0.29	0.68	
BC87	500		#10		0.87	0.39	0.29	0.68	
BC14-14	50	16-14 Heavy-duty	1/4 in.		0.93	0.51	0.29	0.68	
BC71	500		1/4 in.		0.93	0.51	0.29	0.68	
BC14-516	50	16-14 Heavy-duty	5/16 in.		1.04	0.54	0.38	0.77	
BC72	500		5/16 in.		1.04	0.54	0.38	0.77	
BC14-38	50	16-14 Heavy-duty	3/8 in.		1.09	0.63	0.38	0.77	
BC79	500		3/8 in.		1.09	0.63	0.38	0.77	
BC14-12	50	16-14 Heavy-duty	1/2 in.		1.32	0.76	0.54	0.94	
BC75	500		1/2 in.		1.32	0.76	0.54	0.94	

Ring Terminals

Terminals for nichrome wire NW Series

High-Temperature Non-Insulated Rings — 1200° F Max.

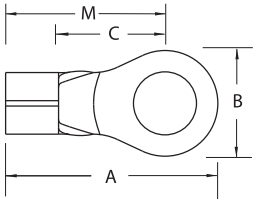

Cat. No.	Pkg. Qty.	Wire Range	Max. Ins. (in.)	Bolt Hole	Rec. Tool	Dimensions (in.)				Stock Thick. (in.)
						A	B	C	M	
NW18-10	100	20-18	2.5	#10	WT1377	0.63	0.31	0.28	0.38	0.032
NW52	1,000			#8						
NW81	1,000	#6								
NW14-8	100	16-14		#8						
NW14-10	100			#10						
NW83	1,000			#10						
NW14-12	100		#12*							
NW84	1,000		#12*							
NW10-8	50		12-10	3	#8	0.66	0.31	0.28	0.51	0.040
NW10-10		#10								
NW10-10		#10								
NW10-12		#12*								

* #12 stud is smaller than 1/4 in. stud

Tefzel® Insulated Rings — Insulation Grip

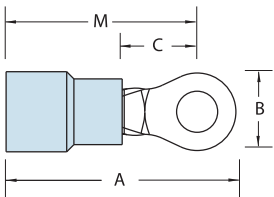

Cat. No.	Pkg. Qty.	Wire Range	Max. Ins. (in.)	Bolt Hole	Rec. Tool	Dimensions (in.)				Stock Thick. (in.)	
						A	B	C	M		
RAT853	1,000	22-18	0.140	#6	WT145C	0.81	0.25	0.25	0.69	0.03	
RAT863				#8							
RAT873				#10							
RAT713		16-14		0.170							1/4 in.
RBT853											#6
RBT863											#8
RBT873	#10										
RBT713	500	12-10	0.210		1/4 in.	1.08	0.46	0.31	0.81	0.04	
RCT333					#6						
RCT863				#8							
RCT363				#10							
RCT713				1/4 in.							
RCT703				5/16 in.							
RCT733	3/8 in.										

Tefzel® is a registered trademark of DuPont

Ring Terminals

Nylon-Insulated Rectangular Rings

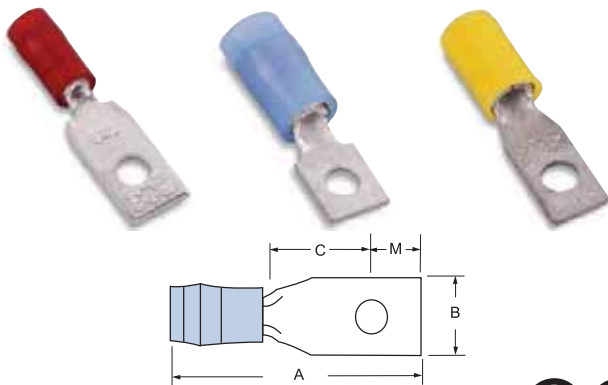

Non-Insulated Rectangular Rings

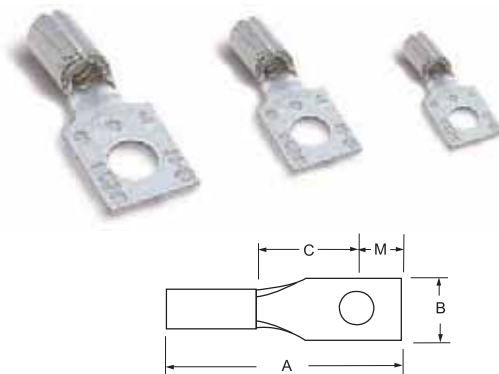

Cat. No.	Pkg. Qty.	Bolt Hole	Wire Range	Rec. Tool	Dimensions (in.)				BU-Ships Tongue Shape	Stock Thick. (in.)			
					A	B	C	M					
RA486	1,000	#4	22-18	ERG4001	0.796	0.237	0.237	0.143	L86P-1	0.03			
RA485		#4			1.015	0.237	0.404	0.195	L85P-1				
RA483		#5			0.859	0.277	0.277	0.143	L83P-1				
RA484		#6			1.015	0.237	0.404	0.195	L84P-1				
RA481		#6			1.109	0.302	0.465	0.227	L81P-1				
RA482		#8			1.109	0.302	0.465	0.227	L82P-1				
RA480*		#8			1.359	0.390	0.621	0.310	L80P-1				
RB486		#4			0.796	0.237	0.237	0.143	L86P-2				
RB485		#4	1.015		0.237	0.404	0.195	L85P-2					
RB483		#5	0.859		0.277	0.277	0.143	L83P-2					
RB484		#6	1.015		0.237	0.404	0.195	L84P-2					
RB481		#6	1.109		0.302	0.465	0.227	L81P-2					
RB482		#8	1.109		0.302	0.465	0.227	L82P-2					
RB480*		#8	1.359		0.390	0.621	0.310	L80P-2					
RC486		500	#4		12-10		0.984	0.237	0.237		0.143	L86P-3	0.04
RC485			#4				1.187	0.237	0.404		0.195	L85P-3	
RC483	#5		1.046	0.277			0.277	0.143	L83P-3				
RC484	#6		1.203	0.237			0.404	0.195	L84P-3				
RC481	#6		1.281	0.302			0.465	0.227	L81P-3				
RC482	#8		1.281	0.302			0.465	0.227	L82P-3				
RC480*	#8		1.531	0.390			0.621	0.310	L80P-3				

* Not available on tape.

Note: RA, RB, RC486 for use with BU-Ships terminal board types 26TB. RA, RB, RC485 for use with 25TB and 27TB. RA, RB, RC483 for use with 8TB. RA, RB, RC484 for use with 10TB and 11TB. RA, RB, RC481 for use with 6TB, 7TB and 9TB. RA, RB, RC482 for use with 15TB. RA, RB, RC480 for use with 3TB, 4TB, 5TB, 16TB, 17TB and 18TB.

Note:

22-18 ga. = 1-2 Navy
 16-14 ga. = 2-1/2-4 Navy
 12-10 ga. = 6-9 Navy

Cat. No.	Pkg. Qty.	Bolt Hole	Wire Range	Rec. Tool	Dimensions (in.)				BU-Ships Tongue Shape	Stock Thick. (in.)			
					A	B	C	M					
A486	1,000	#4	22-18	ERG4002	0.65	0.237	0.237	0.143	L86	0.03			
A485		#4			0.87	0.237	0.404	0.195	L85				
A483		#5			0.70	0.277	0.277	0.143	L83				
A484		#6			0.87	0.237	0.404	0.195	L84				
A481		#6			0.96	0.302	0.465	0.227	L81				
A482		#8			0.96	0.302	0.465	0.227	L82				
A480*		#8			1.21	0.390	0.621	0.310	L80				
B486		#4			0.65	0.237	0.237	0.143	L86				
B485		#4	0.87		0.237	0.404	0.195	L85					
B483		#5	0.70		0.277	0.277	0.143	L83					
B484		#6	0.87		0.237	0.404	0.195	L84					
B481		#6	0.96		0.302	0.465	0.227	L81					
B482		#8	0.96		0.302	0.465	0.227	L82					
B480*		#8	1.21		0.390	0.621	0.310	L80					
C486		500	#4		12-10	ERG4005	0.73	0.237	0.237		0.143	L86	0.04
C485			#4				0.90	0.237	0.404		0.195	L85	
C483	#5		0.76	0.277			0.277	0.143	L83				
C484	#6		0.94	0.237			0.404	0.195	L84				
C481	#6		1.03	0.302			0.465	0.227	L81				
C482	#8		1.03	0.302			0.465	0.227	L82				
C480*	#8		1.27	0.390			0.621	0.310	L80				

* Not available on tape.

Note: A, B, C486 for use with BU-Ships terminal board types 26TB. A, B, C485 for use with 25TB, 27TB. A, B, C483 for use with 8TB. A, B, C484 for use with 10TB and 11TB. A, B, C481 for use with 6TB, 7TB and 9TB. A, B, C482 for use with 15TB. A, B, C480 for use with 3TB, 5TB, 16TB, 17TB and 18TB.

Note:

22-18 ga. = 1-2 Navy
 16-14 ga. = 2-1/2-4 Navy
 12-10 ga. = 6-9 Navy

Flag Terminals

Non-Insulated Flags

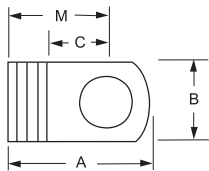

Cat. No.	Pkg. Qty.	Wire Range	Bolt Hole	Rec. Tool	Dimensions (in.)				Stock Thick. (in.)									
					A	B	C	M										
AB14-6A	100	22-14	#6	ERG4004	0.55	0.31	0.22	0.39	0.03									
AB51	1,000		#6															
AB14-8A	100		#8															
AB52	1,000		#8															
AB14-10A	100		#10															
AB53	1,000		#10															
C51	500	12-10	#6	ERG4004	0.66	0.31	0.25	0.48	0.04									
C10-8A	50		#8															
C52-TB	500		#8															
C10-10A	50		#10															
C53	500		#10															
D236	200		8							#10	WT129	0.83	0.50	0.29	0.64	0.06		
D226		#10		0.90														
D271		1/4 in.		0.92														
E226		6	#10	WT129	0.93	0.56	0.29	0.69	0.07									
E271			1/4 in.		0.99													
E272			5/16 in.		1.05													
F226		4	#10		WT129		1.07	0.63		0.33		0.80		0.08				
F271			1/4 in.				1.10											
F272			5/16 in.				1.18											
F273		2	3/8 in.				13642M			1.20		0.75			0.43		0.90	0.10
G671			1/4 in.							1.20								
G672			5/16 in.							1.28								
G673	1/0	3/8 in.	13642M							1.32	0.81		0.46		1.02	0.11		
H672		5/16 in.								1.31								
H673		3/8 in.								1.36								
J672	2/0	5/16 in.		13642M		1.46			0.81	0.41			1.10		0.13			
J673		3/8 in.				1.51												
J675		1/2 in.				1.67												
K672	3/0	5/16 in.			13642M	1.59		1.0		0.41			1.19	0.13				
K673		3/8 in.				1.64												
K675		1/2 in.				1.76												
M673	250kcmil	3/8 in.				13642M	1.89			1.0		0.46	1.43				0.13	
M675		1/2 in.					1.99											

Fork Terminals

- Fork terminals enable easy installation because the mounting screw does not have to be completely removed
- Brazed-seam barrel is serrated for high pull-out value
- Terminal is high-conductivity electrolytic copper, electro-tin plated. Insulation is colour-coded
- Vinyl-insulated fork terminals have extra-long PVC insulation sleeve for protection and stress relief at wire's flex point

Nylon-Insulated Forks

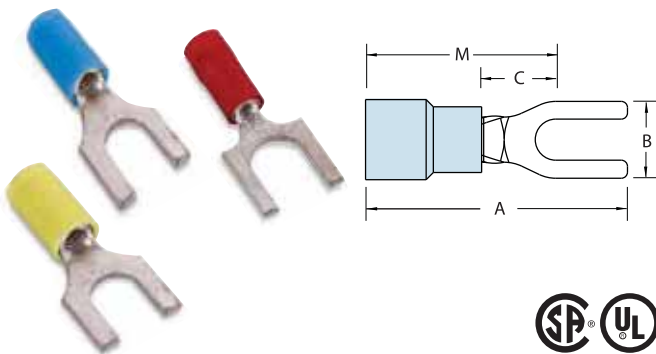

Nylon-Insulated Locking Forks

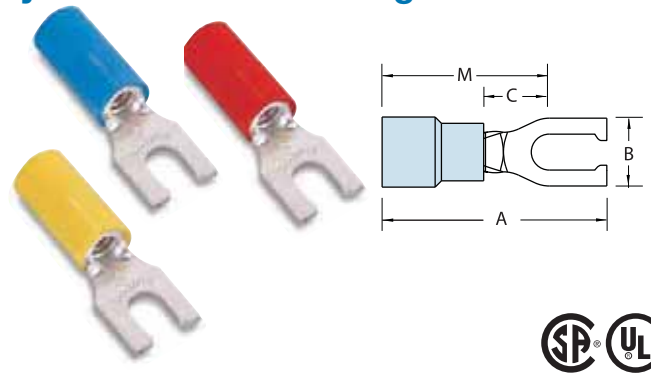

Cat. No.	Pkg. Qty.	Wire Range	Max. Ins. (in.)	Bolt Hole	Rec. Tool	Dimensions (in.)				Stock Thick. (in.)				
						A	B	C	M					
RA18-6F	100	22-16	0.136	#6	ERG4001	0.83	0.25	0.25	0.71	0.02				
RA1103	1,000			#6		0.83	0.25							
RA18-8F	100			#8		0.86	0.31							
RA1123	1,000			#8		0.86	0.31							
RA18-10F	100			#10		0.86	0.31							
RA1153	1,000			#10		0.86	0.31							
RA18-14F	100			1/4 in.		0.95	0.44	0.31	0.70					
RA1163	1,000			1/4 in.		0.95	0.44							
RB14-6F	100			18-14		0.162	#6	ERG4001	0.87		0.31	0.25	0.71	0.03
RB1113	1,000						#6		0.87		0.31			
RB14-8F	100						#8		0.87		0.31			
RB1123	1,000						#8		0.87		0.31			
RB14-10F	100						#10		0.87		0.38			
RB1153	1,000						#10		0.87		0.38			
RB14-14F	100	1/4 in.	0.95		0.44		0.28		0.74					
RB1163	1,000	1/4 in.	0.95		0.44									
RB1103	1,000	#6	0.74		0.28		0.16		0.60					
RB1124	1,000	#8	0.95		0.31									
RB1154	1,000	#10	0.95		0.31		0.25		0.79					
RC10-6F	50	#6	0.97		0.31									
RC1113	500	#6	0.97		0.31		0.04							
RC10-8F	50	#8	1.00		0.37				0.81					
RC1123	500	#8	1.00	0.37										
RC10-10F	50	#10	1.00	0.37	0.27									
RC1153	500	#10	1.00	0.37										
RC10-14F	50	1/4 in.	1.12	0.50	0.86									
RC1163	500	1/4 in.	1.12	0.50										
RC1124	1,000	#8	1.10	0.37	0.91									
RC1154	1,000	#10	1.10	0.37										

Cat. No.	Pkg. Qty.	Wire Range	Max. Ins. (in.)	Bolt Hole	Rec. Tool	Dimensions (in.)				Stock Thick. (in.)				
						A	B	C	M					
RA18-6FL	100	22-16	0.136	#6	ERG4001	0.86	0.25	0.71	0.02					
RA2213	1,000			#6										
RA18-8FL	100			#8										
RA2243	1,000			#8										
RA18-10FL	100			#10			0.29	0.71						
RA2253	1,000			#10										
RB14-6FL	100			18-14			0.162	#6		ERG4001	0.87	0.25	0.71	0.03
RB2213	1,000							#6						
RB2214	1,000							#6			0.95	0.79		
RB14-8FL	100							#8						
RB2233	1,000							#8						
RB14-10FL	100							#10			0.87	0.29	0.71	
RB2253	1,000							#10						
RB2254	1,000							#10			0.95	0.71	0.04	
RC10-6FL	50	#6	0.97		0.31	0.81								
RC2203	500	#6												
RC2204	1,000	#6	1.07		0.91									
RC10-8FL	50	#8												
RC2213	500	#8	1.00		0.27	0.81								
RC10-10FL	50	#10												
RC2223	500	#10	1.00	0.37	0.81									
RC2224	1,000	#10												
RC10-14FL	50	1/4 in.	1.12	0.50	0.86									
RC2233	500	1/4 in.												

Add suffix "X" for wider wire entry to accommodate heavy wall insulation

Fork Terminals

Nylon-Insulated Forks – Flanged Tongue

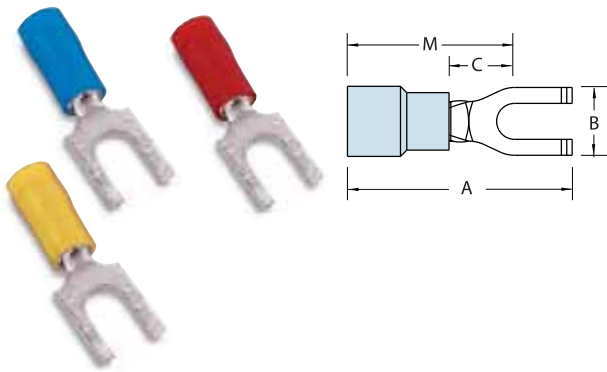

Vinyl-Insulated Forks

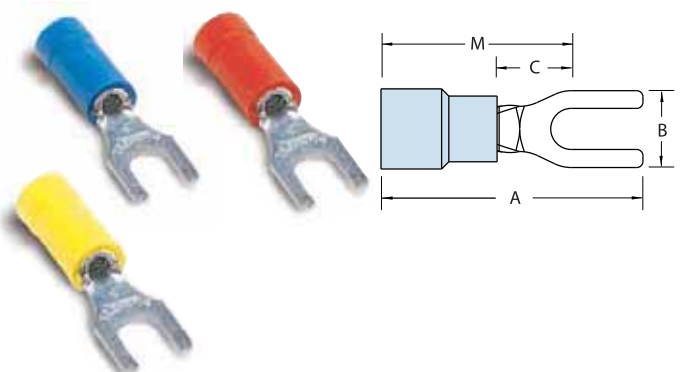

Cat. No.	Pkg. Qty.	Wire Range	Max. Ins. (in.)	Bolt Hole	Rec. Tool	Dimensions (in.)				Stock Thick. (in.)
						A	B	C	M	
RA18-6FS	100	22-16	0.136	#6	ERG4001	0.75	0.28	0.16	0.62	0.02
RA1203	1,000			#6		0.75	0.28	0.16	0.62	
RA18-8FS	100			#8		0.89	0.31	0.23	0.65	
RA1223	1,000			#8		0.89	0.31	0.23	0.65	
RA18-10FS	100			#10		0.93	0.38	0.26	0.68	
RA1253	1,000	#10	0.93	0.38	0.26	0.68				
RB14-6FS	100	18-14	0.162	#6	ERG4001	0.74	0.28	0.16	0.60	0.03
RB1203	1,000			#6		0.74	0.28	0.16	0.60	
RB14-8FS	100			#8		0.89	0.31	0.23	0.66	
RB1223	1,000			#8		0.89	0.31	0.23	0.66	
RB14-10FS	100			#10		0.94	0.38	0.27	0.69	
RB1253	1,000	#10	0.94	0.38	0.27	0.69				
RB1204	1,000	0.190	#6		0.79	0.28	0.16	0.67	0.04	
RB1224	1,000		#8	0.94	0.31	0.23	0.71			
RC10-8FS	50	12-10	0.210	#8		0.97	0.34	0.23	0.73	0.04
RC1223	500			#8	0.97	0.34	0.23	0.73		
RC10-10FS	50			#10	1.00	0.38	0.26	0.74		
RC1253	500			#10	1.00	0.38	0.26	0.74		
RC1224	1,000			#8	1.08	0.34	0.23	0.80		
RC1254	1,000	#10	1.12	0.38	0.26	0.86				

Cat. No.	Pkg. Qty.	Wire Range	Max. Ins. (in.)	Bolt Hole	Rec. Tool	Dimensions (in.)				Stock Thick. (in.)		
						A	B	C	M			
18RA-6F	100	22-16	0.150	#6	ERG4001	0.94	0.25	0.27	0.81	0.02		
RA1167	1,000			#6		0.94	0.25					
18RA-8F	100			#8		0.97	0.31					
RA1147	1,000			#8		0.97	0.31					
18RA-10F	100			#10		0.97	0.31					
RA1157	1,000	#10	0.97	0.31								
14RB-6F	100	18-14	0.170	#6	ERG4001	0.97	0.31	0.27	0.81	0.03		
RB647	1,000			#6		0.97	0.31					
14RB-8FS	100			#8		0.89	0.30				0.25	0.75
14RB-8F	100			#8		0.97	0.31					
RB657	1,000			#8		0.97	0.31					
14RB-10F	100	#10	0.97	0.31								
RB1157	1,000	#10	0.97	0.31								
14RB-14F	100	1/4 in.	1.11	0.44	0.38	0.89						
RB1717	1,000	1/4 in.	1.11	0.44								
10RC-6F	50	12-10	0.210	#6	ERG4001	1.09	0.31	0.27	0.90	0.04		
RC1337	500			#6		1.09	0.31					
10RC-8F	50			#8		1.09	0.38					
RC1147	500			#8		1.09	0.38					
10RC-10F	50			#10		1.09	0.38					
RC1157	500	#10	1.09	0.38								
10RC-14F	50	1/4 in.	1.15	0.50	0.37							
RC1167	500	1/4 in.	1.15	0.50								

Fork Terminals

Vinyl-Insulated Forks — Expanded Insulation

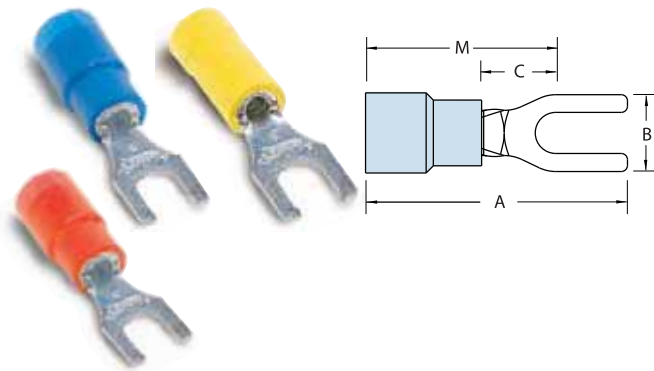

Non-Insulated Locking Fork Terminals

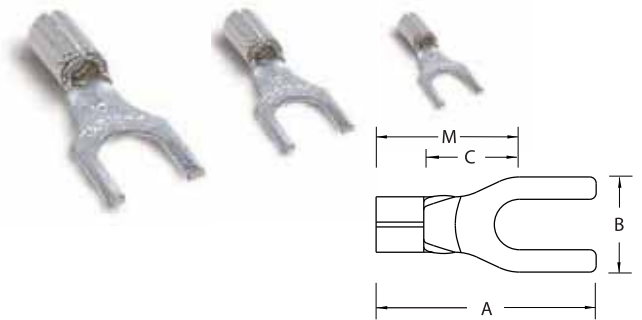

Cat. No.	Pkg. Qty.	Wire Range	Max. Ins. (in.)	Bolt Hole	Rec. Tool	Dimensions (in.)				Stock Thick. (in.)
						A	B	C	M	
18RA-6FX	100	22-16	0.170	#6	ERG4001	0.94	0.25		0.81	0.02
RA1167-170	1,000			#6						
18RA-8FX	100			#8						
RA1147-170	1,000			#8						
18RA-10FX	100			#10						
RA1157-170	1,000	#10								
14RB-6FX	100	18-14	0.200	#6	ERG4001	0.97	0.31	0.27	0.81	0.03
RB647-200	1,000			#6						
14RB-8FX	100			#8						
RB657-200	1,000			#8						
14RB-10FX	100			#10						
RB1157-200	1,000	#10								
10RC-8FX	50	12-10	0.250	#8	ERG4002	1.11	0.38		0.90	0.04
RC1147-250	500			#8						
10RC-10FX	50			#10						
RC1157-250	500			#10						
10RC-14FX	50			1/4 in.						
						1.17	.50	.37		

Cat. No.	Pkg. Qty.	Wire Range	Bolt Hole	Rec. Tool	Dimensions (in.)				Stock Thick. (in.)		
					A	B	C	M			
A18-6F	100	22-16	#6	ERG4002	0.72	0.25	0.27	0.59	0.02		
A116	1,000		#6		0.72	0.25					
A18-8F	100		#8		0.75	0.31					
A114	1,000		#8		0.75	0.31					
A18-10F	100		#10		0.75	0.31					
A115-TB	1,000	#10	0.75	0.31							
B14-6F	100	18-14	#6	ERG4002	0.75	0.31	0.27	0.59	0.03		
B64	1,000		#6		0.75	0.31					
B19	1,000		#6		0.66	0.25				0.13	0.50
B14-8F	100		#8		0.75	0.31					
B65-TB	1,000		#8		0.75	0.31					
B14-10F	100	#10	0.75	0.31							
B115	1,000	#10	0.75	0.31							
B14-14F	100	1/4 in.	0.90	0.44	0.38	0.68					
C10-6F	50	12-10	#6	ERG4005	0.77	0.31	0.27	0.63	0.04		
C133	500		#6		0.77	0.31					
C10-8F	50		#8		0.82	0.38					
C114	500		#8		0.82	0.38					
C10-10F	50		#10		0.82	0.38					
C115	500	#10	0.82	0.38							
C10-14F	50	1/4 in.	0.98	0.50	0.37	0.73					
C116-TB	500	1/4 in.	0.98	0.50							

Fork Terminals

Vinyl-Insulated Locking Forks – Expanded Insulation

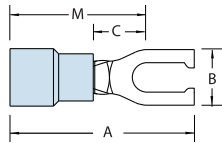

Vinyl-Insulated Locking Forks

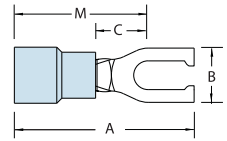

Cat. No.	Pkg. Qty.	Wire Range	Max. Ins. (in.)	Bolt Hole	Rec. Tool	Dimensions (in.)				Stock Thick. (in.)
						A	B	C	M	
18RA-6FLX	100	22-16	0.170	#6	ERG4001	0.97	0.31	0.25	0.81	0.02
RA2217-170	1,000			#6						
18RA-8FLX	100			#8						
18RA-10FLX	100			#10						
RA2257-170	1,000			#10						
14RB-6FLX	100			18-14						
RB2207-200	1,000	#6								
RB2217-200	1,000	#6								
14RB-8FLX	100	#8								
RB2237-200	1,000	#8								
14RB-10FLX	100	#10								
RB2257-200	1,000	#10								
10RC-6FLX	50	12-10	0.250	#6	ERG4001	1.07	0.37	0.91	0.91	0.04
RC2207-250	500			#6						
10RC-8FLX	50			#8						
10RC-10FLX	50			#10						
RC2227-250	500			#10						
10RC-14FLX	50			1/4 in.						
						1.22	0.50	0.32	0.96	

Cat. No.	Pkg. Qty.	Wire Range	Max. Ins. (in.)	Bolt Hole	Rec. Tool	Dimensions (in.)				Stock Thick. (in.)
						A	B	C	M	
18RA-6FL	100	22-16	0.150	#6	ERG4001	0.97	0.25	0.25	0.81	0.02
RA2217	1,000			#6						
RA2227	1,000			#6						
18RA-8FL	100			#8						
RA2247	1,000			#8						
18RA-10FL	100			#10						
RA2257	1,000	#10								
14RB-6FL	100	18-14	0.170	#6	ERG4001	0.97	0.25	0.27	0.81	0.03
RB2207	1,000			#6						
RB2217	1,000			#6						
14RB-8FL	100			#8						
RB2237	1,000			#8						
14RB-10FL	100			#10						
RB2257	1,000	#10								
10RC-6FL	50	12-10	0.220	#6	ERG4001	1.09	0.37	0.90	0.90	0.04
RC2207	500			#6						
10RC-8FL	50			#8						
RC2217	500			#8						
10RC-10FL	50			#10						
RC2227	500			#10						
10RC-14FL	50	1/4 in.								
RC2237	500	1/4 in.								

Non-Insulated Locking Fork Terminals

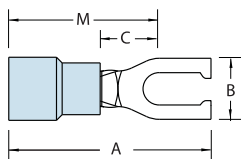

Cat. No.	Pkg. Qty.	Wire Range	Bolt Hole	Rec. Tool	Dimensions (in.)				Stock Thick. (in.)
					A	B	C	M	
A18-6FL	100	22-16	#6	ERG4002	0.75	0.25	0.25	0.59	0.02
A221	1,000		#6						
A18-8FL	100		#8						
A224	1,000		#8						
A18-10FL	100		#10						
A225	1,000		#10						
B14-6FL	100	18-14	#6	ERG4002	0.75	0.25	0.27	0.59	0.03
B220	1,000		#6						
B14-8FL	100		#8						
B223	1,000		#8						
B14-10FL	100		#10						
B225	1,000		#10						
C10-6FL	50	12-10	#6	ERG4005	0.85	0.37	0.37	0.66	0.04
C220-TB	500		#6						
C10-8FL	50		#8						
C221	500		#8						
C10-10FL	50		#10						
C222-TB	500		#10						
C10-14FL	50	1/4 in.							
						0.49			

Pin Terminals

Pin Terminals

- Provide an easy and effective way to terminate stranded wire into European/metric style terminal blocks
- Designed to prevent shorting, wire strand loss and/or wire pullout resulting from improper termination of stranded wire
- Designed to meet emerging global standards which require wire-to-metric style terminal block installations be terminated with a "pin" style terminal
- Available in vinyl insulated, nylon insulated, and non-insulated styles
- All styles offered in 22 AWG to 10 AWG and compatible with existing Sta-Kon® tooling

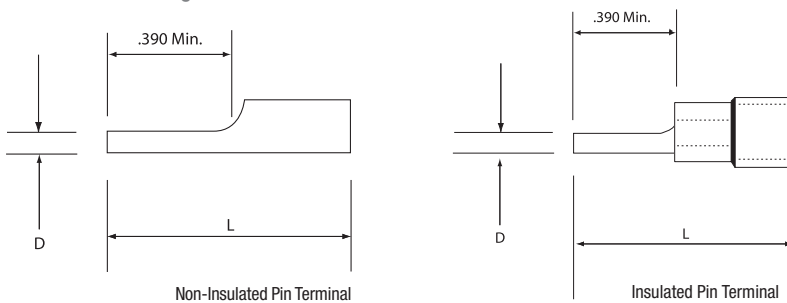

Cat. No.	Pkg. Qty.	Wire Range	D (Dia.) (in.)	L	Rec. Tool	Stock Thick. (in.)
Non-Insulated						
A47PT	1,000	22-18	0.075	0.63	ERG4002	0.02
B47PT	1,000	16-14	0.075	0.63		0.03
C55PT	500	12-10	0.106	0.76		0.04
Vinyl						
18RA-47PT	100	22-18	0.075	0.85	ERG4001	0.02
RA47PT	1,000	22-18	0.075	0.85		0.03
14RB-47PT	100	16-14	0.075	0.87		
RB47PT	1,000	16-14	0.075	0.87		
10RC-55PT	50	12-10	0.106	1.04		
RC55PT	500	12-10	0.106	1.04		
Nylon						
RA18-47PT	100	22-18	0.075	0.85	ERG4001	0.02
RA147PT	1,000	22-18	0.075	0.85		0.03
RB14-47PT	100	16-14	0.075	0.87		
RB147PT	1,000	16-14	0.075	0.87		
RC10-55PT	50	12-10	0.106	1.04		
RC155PT	500	12-10	0.106	1.04		

Butt Splices

Vinyl-Insulated Butt Splices – Expanded Insulation

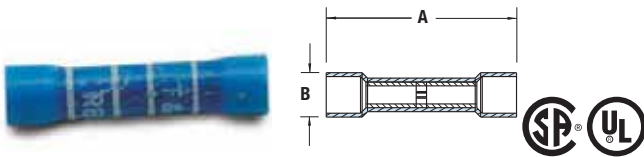

Cat. No.	Pkg. Qty.	Wire Range	Max. Ins. (in.)	Rec. Tool	Dimensions (in.)	
					A	B
2RA18X	100	22-18	0.170	ERG4001	1.13	0.25
RAA217-170	1,000		0.170			0.25
RAA217	1,000		0.150			0.23
2RB14X	100	0.200	0.26			
RBB217-200	1,000	0.200	0.26			
RBB217	1,000	0.170	0.24			
2RC10X	50	12-10	0.250		1.31	0.31
RCC217-250	500		0.250			0.31
RCC217	1,000		0.210			0.28

Note: RCC217 is not expanded

Nylon-Insulated Aircraft Splices



Cat. No.	Pkg. Qty.	Wire Range	Rec. Tool	Dimensions (in.)	
				A	B
2RZZ	50	26-22	ERG4006	1.22	0.15
RZZ23	500			1.22	0.15
2RAA	50	22-18	ERG4001	1.52	0.25
RAA23	500			1.52	0.25
2RBB	50	16-14		1.52	0.28
RBB23	500			1.52	0.28
2RCC	25	12-10		1.54	0.35
				1.54	0.35

Nylon-Insulated Butt Splices

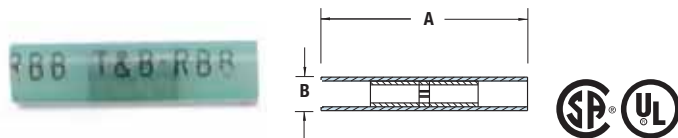

Cat. No.	Pkg. Qty.	Max Ins. (in.)	Wire Range	Rec. Tool	Dimensions (in.)		
					A	B	
2RA18	100	0.115	22-18	ERG4001	1.19	0.18	
RAA21	1,000				0.115	1.19	0.18
2RB14	100				0.148	1.19	0.21
RBB21	1,000	0.148	1.19		0.21		
2RC10	50	0.210	12-10		1.26	0.28	
RCC21	500				0.210	1.26	0.28
2RD8	25	0.340	8		ERG4007	1.69	0.36
RDD27	200					0.340	1.69
2RE6	20	0.420	6		TBM6S	1.85	0.45
REE28	200					0.420	1.85
2RF4	15	0.510	4	TBM6S	1.85	0.52	

Tefzel® Insulated Butt Splices

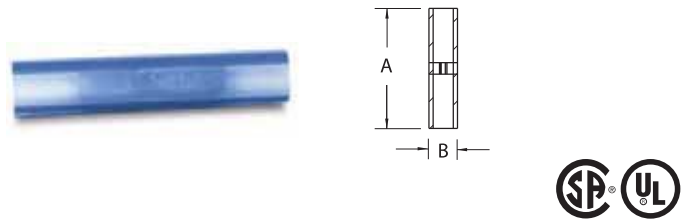

Cat. No.	Pkg. Qty.	Max Ins. (in.)	Wire Range	Rec. Tool	Dimensions (in.)	
					A	B
RAAT21	1,000	1.22	22-18	WT145C	1.22	0.115
RBBT21			16-14			0.148
RCCT21			12-10			0.210

Tefzel® is a registered trademark of DuPont

Butt Splices

Non-Insulated Butt Splices

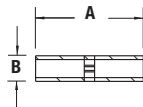

Cat. No.	Pkg. Qty.	Wire Range	Rec. Tool	Dimensions (in.)	
				A	B
2A-18	100	22-18	ERG4002	0.62	0.12
AA2	1,000			0.62	0.12
2B-14	100	16-14	ERG4002	0.62	0.16
BB2	1,000			0.62	0.16
2C-10	50	12-10	ERG4005	0.72	0.22
CC2-TB	500			0.72	0.22
2D-8	25	9-8-7	ERG4005	1.03	0.28
DD102	200			1.03	0.28
2E-6	20	6-5	TBM6S	1.12	0.37
EE2	200			1.12	0.37
2F-4	15	4-3	TBM6S	1.25	0.44
FF2	200			1.25	0.44
2G21	5	2-1	TBM6S	1.72	0.55
GG2	25			1.72	0.55

Nylon-Insulated Butt Splices

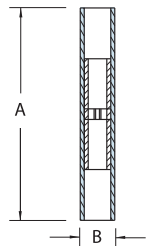

Cat. No.	Pkg. Qty.	Wire Range	Rec. Tool	Dimensions (in.)	
				A	B
2A20	100	22-20	ERG4001	0.84	0.20
RAA24	1,000			0.84	0.20
2B-16	100	18-16	ERG4001	0.84	0.23
RBB25	1,000			0.84	0.23
2C-12	50	14-12	ERG4001	0.90	0.28
RCC26	500			0.90	0.28

Parallel Splices

- Wires are laid side by side in the connector, and the connection is made in one crimp
- Offer advantages in simplicity of installation and small size
- One crimp completes the splice

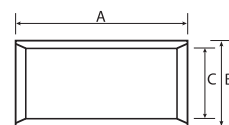

Cat. No.	Wire Range	CIR. Mil Range	Rec. Tool	Length / A (in.)	O.D. / B (in.)	I.D. / C (in.)	Pkg. Qty.
A18-PS-M	22-16 AWG	509-3,260	ERG4002	0.314	0.129	0.086	1,000
B14-PS-M	16-14 AWG	2,050-5,180	ERG4002	0.315	0.155	0.113	1,000
C10-PS-D	12-10 AWG	5,180-13,100	ERG4005	0.380	0.220	0.170	500
D8-PS-D	8 AWG	13,100-20,800	ERG4005	0.375	0.260	0.180	500
E6-PS-D	6 AWG	20,800-33,100	WT115A	0.500	0.365	0.266	500
F4-PS-W	4 AWG	33,100-52,600		0.531	0.410	0.302	250
G2-PS-W	2 AWG	52,600-83,700	TBM8-750M-1	0.640	0.521	0.396	250
H1/0-PS-C	1/0 AWG	83,700-119,500		0.750	0.571	0.446	100
J2/0-PS-C	2/0 AWG	119,500-150,500		0.750	0.632	0.507	100
K3/0-PS-L	3/0 AWG	150,500-190,000		0.750	0.701	0.564	50
L4/0-PS-L	4/0 AWG	190,000-231,100		0.770	0.766	0.629	50
M250-PS-Q	250 kcmil	231,100-300,000		1.063	0.926	0.749	25
N300-PS-X	300 kcmil	300,000-380,000		1.125	1.100	0.882	10
P400-PS-X	400 kcmil	380,000-478,000		1.250	1.200	0.956	10
R500-PS-V	500 kcmil	478,000-600,000		1.438	1.330	1.060	5

The total combined cross sectional area of all wires must be within the circular mil area range. Rated at 150°C.

Wire Joints

Crimp-On Wire Joints, One-Piece Nylon Self-Insulated

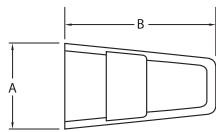

Cat. No.	Pkg. Qty.	Wire Range		Rec. Tool	Dimensions (in.)	
		Min.	Max.		A	B
RB44	100			WT2000	0.31	0.78
RB4-TB	1,000	2#18	2#16		0.31	0.78
RC55	50	4#18	2#12	WT2130A	0.43	0.95
RC6	500				0.43	3
RP12	100	3#14	4#12		0.53	1.00
RP7	1,000			0.53	1.00	

Cat. No.	Allowable Wire Combinations						
	#22	#20	#18	#16	#14	#12	#10
RB4-TB/RB44			2-3				
			1-2	2			
	3						
		3					
	3		1				
	2	3					
	1-2		2				
	2			1			
		3	1				
	1	2					

Cat. No.	Allowable Wire Combinations						
	#22	#20	#18	#16	#14	#12	#10
RC6/RC55			1-4			1	
				1-3		1	
					1-2	1	
						2	
			3-5			1	
				2-4		1	
						3	
			1-4			2	
				1-3		2	
			1-3			3	
				1	3		
				2-5			
			4-6				

Cat. No.	Allowable Wire Combinations						
	#22	#20	#18	#16	#14	#12	#10
RP7/RP12							2
						1	1
					1		1
						2-4	
					2-4	1	
					1-3	2	
					1	3	
					3-6		
					1	2-3	
					2	1-2	

PT Series Crimp-On Wire Joints

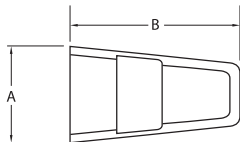
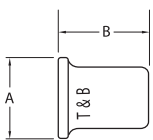
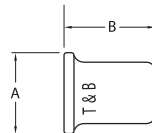

Fig. 2



Installation Procedure for "PT" Connectors

Cat. No.	Fig.	Pkg. Qty.	Wire Range		Rec. Tool	Dimensions (in.)	
			Min.	Max.		A	B
PT66M	1	100	2#18	3#12 combination	WT161M	0.50	0.93
PT6M		—	Insulator only	0.50		0.93	
PT60M		100	2#14	3#12 connector only		0.31	0.37
PT70	2	200	2#14	3#12	WT161M	0.29	0.34
PT70M		200	3#18	4#12		0.31	0.37
PT80		50	2#16	4#10		0.35	0.62



Twist wires, insert through serrated barrel of wire joint. (PT60M, PT70, PT70M, PT80.)



Crimp and trim off excess wire with WT161M hand tool.



Screw PT6M insulator firmly onto PT160M barrel.

90°C rated

Wire Joints

High-Temperature Wire Joints

- Rated for temperatures up to 150°C (302°F), 600V maximum
- Molded, one-piece nylon construction for electrical insulation, UL94-V2
- Brazed copper sleeve prevents separation of connection during crimping
- Internal serrations enable cold flow for increased conductivity and pull-out strength



Cat. No.	Pkg. Qty.	Wire Range		Rec. Tool	Dimensions (in.)	
		Min.	Max.		A	B
RB4-HT	1,000	2#18	2#16	WT2000	0.36	0.82
RB44-HT	100	2#18	2#16	WT2000	0.36	0.82
RC6-HT	500	3#16	3#14	ERG4001, WT2130A	0.48	0.95
RC551-HT	100	3#16	3#14	ERG4001, WT2130A	0.48	0.95
RP7-HT	500	3#14	3#12	ERG4007, WT2130A	0.53	1.00
RP12-HT	100	3#14	3#12	ERG4007, WT2130A	0.53	1.00

Wire Joints UL Listed Combinations

Cat. No.	solid or stranded AWG
RB4-TB, RB44, RB4-10M	(2) or (3) #18
	(2) #16
	(1) #16 and (1) or (2) #18
	(3) #22
	(3) #20
	(3) #22 and (1) #18
	(2) #22 and (3) #20
	(1) or (2) #22 and (2) #18
	(2) #22 and (1) #16
	(3) #20 and (1) #18
	(2) #20 and (1) #22
	(2) #20 and (1) #16
	(1) #20 and (2) #18
	RC6, RC6-5M, RC55
(1) #14 with (3), (4) or (5) #18	
(2) #14 with (1), (2), (3) or (4) #18	
(2) #14 with (1), (2) or (3) #16	
(3) #14	
(4) to (7) #18	
(3) #14 with (1) or (2) #18	
(3) #14 with (1) #16	
(1) #12 with (1), (2), (3) or (4) #18	
(1) #12 with (1), (2) or (3) #16	
(1) #12 with (1) or (2) #14	
(5) #16	

Cat. No.	solid or stranded AWG
RP7, RP-12	(2) to (4) #12 AWG
	(3) to (6) #14 AWG
	(3) #12 and (1) #14
	(2) #12 and (1) #14
	(2) #12 and (2) #14
	(2) #12 and (3) #14
	(1) #12 and (2) #14
	(1) #12 and (3) #14
	(1) #12 and (4) #14
	(2) #10
	(1) #10 and (1) #12
	(1) #10 and (1) #14
	(1) #8 Str. and (1) #16
	(1) #10 and (1) #16
	(1) #12 and (1) #16

Heat-Shrinkable Terminals, Splices and Disconnects

- These ring terminals, butt splices and disconnects are self-insulated with heat-shrinkable polyolefin and internally coated sealant
- Upon completed installation, a fully sealed connection is achieved to protect the joint against the degrading effects of galvanic action, corrosion and environmental exposure



Note: Not approved for outdoor use

Heat-Shrinkable Ring Terminals

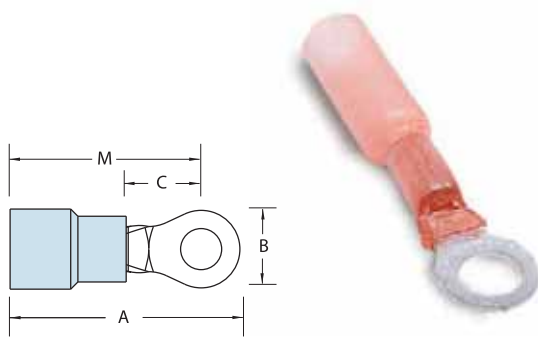

Cat. No.	Pkg. Qty.	Wire Range	Max. Ins. (in.)	Bolt Hole	Rec. Tool	Dimensions (in.)				Stock Thick. (in.)	
						A	B	C	M		
RAS18-6X	100	22-18	0.170	#6	ERG4255	1.23	0.25	0.27	1.10	0.03	
RAS18-8X				#8		1.26	0.31				
RAS18-10X				#10		1.23	0.25				
RBS14-6X		16-14	0.200	#6		1.26	0.31				
RBS14-8X				#8		1.34	0.37				
RBS14-10X				#10							
RCS10-6X	50	12-10	0.250	#6	1/4 in.	1.34	0.37	0.49	0.32	1.15	0.04
RCS10-8X				#8							
RCS10-10X				#10							
RCS10-14X				1/4 in.							

Heat-Shrinkable Locking Fork Terminals

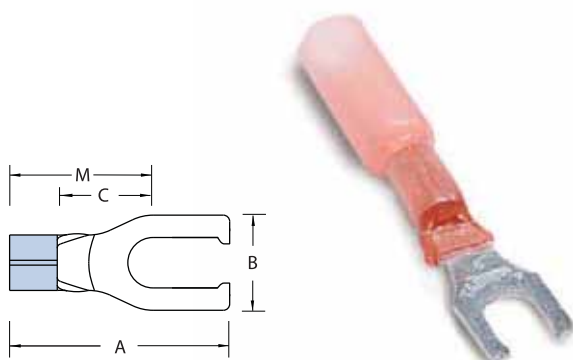

Cat. No.	Pkg. Qty.	Wire Range	Max. Ins. (in.)	Bolt Hole	Rec. Tool	Dimensions (in.)				Stock Thick. (in.)
						A	B	C	M	
RAS18-6FLX	100	22-18	0.170	#6	ERG4255	1.350	0.25	—	—	0.03
RAS18-8FLX				#8			0.29			
RAS18-10FLX				#10			0.29			
RBS14-6FLX		16-14	0.200	#6			0.25			
RBS14-8FLX				#8			0.29			
RBS14-10FLX				#10			0.29			
RCS10-6FLX	50	12-10	0.250	#6	1/4 in.	0.49	0.31	0.37	0.37	0.04
RCS10-8FLX				#8						
RCS10-10FLX				#10						
RCS10-14FLX				1/4 in.						

Heat-Shrinkable Terminals, Splices and Disconnects

Heat-Shrinkable Fully Insulated Female Disconnects



Cat. No.	Pkg. Qty.	Wire Range	Max. Ins. (in.)	Tab Size (in.)	Rec. Tool	A (in.)
RAS18-250AX	25	22-18	0.170	0.250 x 0.032	ERG4255	1.82
RBS14-250AX		16-14	0.200			1.77
RCS10-250AX		12-10	0.250			1.80

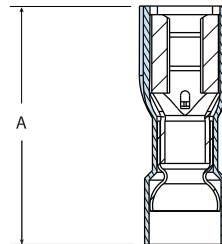

Heat-Shrinkable Fully Insulated Male Tabs



Cat. No.	Pkg. Qty.	Wire Range	Max. Ins. (in.)	Tab Size (in.)	Rec. Tool	A (in.)
18RAS-251TX	25	22-18	0.170	0.250 x 0.032	ERG4255	1.80
14RBS-251TX		16-14	0.200			1.75
10RCS-251TX		12-10	0.250			1.80

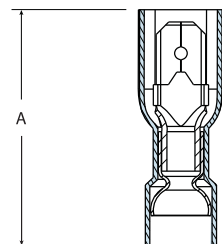

Heat-Shrinkable Butt Splices



Cat. No.	Pkg. Qty.	Wire Range	Max. Ins. (in.)	Rec. Tool	Dimensions (in.)	
					A	B
2RAS18X	50	22-18	0.170	ERG4255	1.50	0.25
RAAS22X	500					0.26
2RBS14X	50	16-14	0.200		1.60	0.31
RBBS22X	500	12-10	0.250			
2RCS10X	25					
RCCS22X	250					



Heat-Shrink Terminal Kit with Tools

Everything you need to make fully sealed connections in one handy kit

- Tools: (1) butane torch; (1) wire stripper; (1) ratchet crimp tool
- Butt Splices: (20) #22-#18 AWG; (20) #16-#14 AWG; (15) #12-#10 AWG
- Ring Terminals: (20) #16-#14 AWG #10 stud;
(2) #16-#14 AWG #8 stud; (15) #12-#10 AWG 1/4 in. stud



Cat. No.	Description	Std. Pkg. Qty.
STAPOUCH-HS	Heat-Shrink Terminal Kit with Tools	1

Disconnects and Male Tabs

- Internal barrel serrations and long barrel provide for maximum tensile strength
- Complete line of installing tools, engineered to match tool with terminal
- Funnel-entry insulators enable easier inserting of wire into barrel
- Colour-coded for easy installation

250 Series — Female Disconnects

- Female disconnect terminals and matching male tabs accommodate a range of #22–#10 AWG, and are available in non-insulated, partially insulated and fully insulated styles, in both nylon and vinyl
- Unique construction of the female disconnect offers long-term dependability
- Brazed-seam serrated barrel provides maximum tensile strength

187 Series — Female Disconnects

- Quick, reliable method of connection to terminal blocks and boards without the use of tools
- Female disconnect terminals and matching male tabs accommodate a range of #22–#10 AWG, and are available in non-insulated, partially insulated and fully insulated styles, in both nylon and vinyl
- Unique construction of the female disconnect offers long-term dependability

250 Series — Female Disconnects

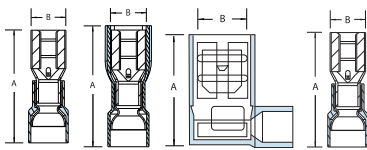

Nylon self-insulated



Vinyl self-insulated



Nylon fully insulated



Nylon open top insulated 90° flag



Non-insulated



Non-insulated/insulation grip



Cat. No.	Pkg. Qty.	Wire Range	Max. Ins. (in.)	Tab Size (in.)	Fig.	Rec. Tool	Dimensions (in.)	
							A	B
Nylon self-insulated								
RA18-250F	100	22–18	0.136	0.250 x 0.032	1	ERG4001	0.91	0.29
RA250-TB	1,000	22–18	0.136					
RB14-250F	100	16–14	0.162					
RB250	1,000	16–14	0.162					
RC10-250F	50	12–10	0.215					
RC250	500	12–10	0.215					
Vinyl self-insulated								
18RA-250F	100	22–18	0.150	0.250 x 0.032	1	ERG4001	0.96	0.29
RA257	1,000	22–18	0.150					
RA257-170	1,000	22–18	0.170					
14RB-250F	100	16–14	0.170					
RB257	1,000	16–14	0.170					
RB257-200	1,000	16–14	0.200					
10RC-250F	50	12–10	0.250					
RC257	500	12–10	0.250					
Nylon fully insulated								
18RA-2577	50	22–18	0.165	0.250 x 0.032	2	ERG4001	1.01	0.38
RA2573	1,000	22–18	0.165					
14RB-2577	50	16–14	0.185					
RB2573	1,000	16–14	0.185					
10RC-2577	50	12–10	0.225					
RC2573	500	12–10	0.225					
Nylon open top insulated 90° flag								
RA18-250A	50	22–18	0.170	0.250 x 0.032	3	ERG4001	0.80	0.71
RA2577F	500	22–18	0.170					0.72
RB14-250A	50	16–14	0.190				0.88	
RB2577F	500	16–14	0.190					
RC10-250A	50	12–10	0.245					
RC2577F	500	12–10	0.245					
Non-insulated								
A18-250	100	22–18	-	0.250 x 0.032	1	ERG4002	0.73	0.31
A250-TB	1,000	22–18						
B14-250	100	16–14						
B250	1,000	16–14						
C10-250F	50	12–10						
C250	500	12–10						
Non-insulated/insulation grip								
B14-250F	100	16–14	-	0.250 x 0.032	4	WT110M	0.87	0.31
B250G	1,000	16–14						

(Continued on facing page)

Disconnects and Male Tabs



250 Series – Female Disconnects (cont'd)

Non-insulated 90° flag



Cat. No.	Pkg. Qty.	Wire Range	Max. Ins. (in.)	Tab Size (in.)	Fig.	Rec. Tool	Dimensions (in.)	
							A	B
A18-250A	50	22-18	—	0.250 x 0.032	3	ERG4002	0.58	0.61
A252G	500	22-18					0.58	0.61
B14-250A	50	16-14					0.58	0.62
B252G	500	16-14					0.58	0.62
C10-250A	50	12-10					0.64	0.63
C252G	500	12-10					0.64	0.63

250 Series – Nylon Piggy Back Disconnects

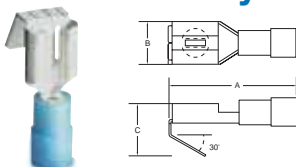

Cat. No.	Pkg. Qty.	Wire Range	Max. Ins. (in.)	Tab Size (in.)	Rec. Tool	Dimensions (in.)		
						A	B	C
RA18-250FP	100	22-18	0.136	0.250 x 0.032	WT112M ERG4001	0.87	0.30	0.43
RA250P	1,000							
RB14-250FP	100	16-14	0.163					
RB250P	1,000							

187 Series – Female Disconnects

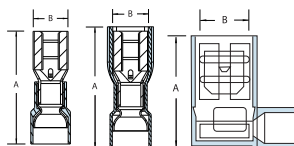

Nylon self-insulated



Vinyl self-insulated



Nylon fully insulated



Non-insulated



Nylon fully insulated 90° flag



Cat. No.	Pkg. Qty.	Wire Range	Max. Ins. (in.)	Tab Size (in.)	Fig.	Rec. Tool	Dimensions (in.)	
							A	B
Nylon self-insulated								
RAD18-183	100	22-18	0.136	0.187 x 0.032	1	ERG4001	0.83	0.23
RAD1833	1,000				1			
RAD18-182	100				1			
RAD1823	1,000			0.187 x 0.020	1			
RBD14-183	100				1			
RBD1833	1,000				1			
RBD14-182	100	16-14	0.163	0.187 x 0.032	1	ERG4001	0.85	0.23
RBD1823	1,000				1			
RBD1827	1,000				1			
Vinyl self-insulated								
18RAD-183	100	22-18	0.150	0.187 x 0.032	1	ERG4001	0.89	0.30
RAD1837	1,000				1			
18RAD-182	100				1			
RAD1827	1,000			0.187 x 0.020	1			
14RBD-183	100				1			
RBD1837	1,000				1			
14RBD-182	100	16-14	0.170	0.187 x 0.032	1	ERG4001	0.89	0.30
RBD1827	1,000				1			
RBD1827	1,000				1			
Nylon fully insulated								
18RAD-18377	100	22-18	0.150	0.187 x 0.032	2	ERG4001	0.89	0.30
RAD18377	1,000				2			
18RAD-18277	100				2			
RAD18277	1,000			0.187 x 0.020	2			
14RBD-18377	100				2			
RBD18377	1,000				2			
14RBD-18277	100	16-14	0.170	0.187 x 0.032	2	ERG4001	0.89	0.30
RBD18277	1,000				2			
RBD18277	1,000				2			
Non-insulated								
AD18-183	100	22-18	—	0.187 x 0.032	1	ERG4002	0.64	0.23
AD183	1,000				1			
AD18-182	100				1			
AD182	1,000			0.187 x 0.020	1			
BD14-183	100				1			
BD183	1,000				1			
BD14-182	100	16-14	0.170	0.187 x 0.032	1	ERG4001	0.74	0.59
RAD18-187A	50				3			
RAD1877F	500				3			
RAD18-188A	50	22-18	0.150	0.187 x 0.032	3	ERG4001	0.74	0.61
RAD1887F	500				3			
RBD14-187A	50				3			
RBD1877F	500			0.187 x 0.020	3			
RBD14-188A	50				3			
RBD1887F	500				3			

Disconnects and Male Tabs

250 Series — Male Tabs



Cat. No.	Pkg. Qty.	Wire Range	Max. Ins. (in.)	Tab Size	Rec. Tool	Dimensions (in.)	
						A	B
18RA-250T	100	22-18	0.150	0.250 x 0.032	ERG4001	0.95	—
RA2517	1,000		0.150				
14RB-250T	100	16-14	0.170				
RB2517	1,000		0.170				
10RC-250T	50	12-10	0.250				
RC2517	500		0.250				
18RA-251T	50	22-18	0.150		WT110M	0.87	—
RA25177	500		0.150				
14RB-251T	50	16-14	0.170				
RB25177	500		0.170				
10RC-251T	25	12-10	0.210		ERG4002	0.68	—
RC25177	500		0.210				
A18-250T	100	22-18	—				
B14-250T	100	20-14					
A18-251T	100	22-18					
A251	1,000						
B14-251T	100	16-14					
B251	1,000						
C10-251T	50	12-10					

187 Series — Male Tabs



Cat. No.	Pkg. Qty.	Max. Ins. (in.)	Wire Range	Tab Size (in.)	Rec. Tool	Dimensions (in.)	
						A	B
18RAD-187	100	0.187 x 0.032	22-18	0.150	ERG4001	0.87	—
18RAD-188		0.187 x 0.020					
14RBD-187		0.187 x 0.032	16-14	0.170			
14RBD-188		0.187 x 0.020					

Disconnects and Male Tabs

250 Series — Adapters and Coupler†

Insulated coupler requires no tool!

6 Non-insulated



7 Insulated coupler

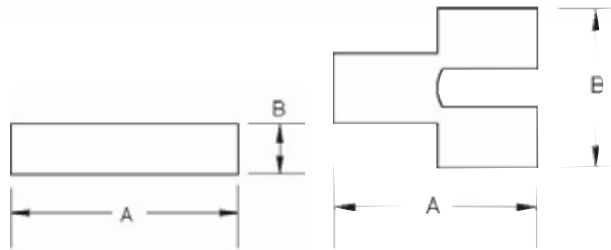

Cat. No.	Pkg. Qty.	Tab Size (in.)	Dimensions (in.)	
			A	B
6 F250TA	50	0.250 x 0.032	0.82	0.56
FTA250	1,000		0.82	0.56
7 RB14-250	50		2.35	0.51
RBB250	500		2.35	0.51

† Not UL Listed

Cat. No. F250TA — Material: brass Finish: tin-plated

Cat. No. RB14-250 — Material: brass Finish: none Insulation: vinyl

110 Series — Disconnects*

Available in variety of wire ranges!

8 Nylon-Insulated



9 Non-Insulated



Cat. No.	Pkg. Qty.	Max. Ins. (in.)	Wire Range	Tab Size (in.)	Rec. Tool	Dimensions (in.)	
						A	B
8 RA18-110F	100	0.110 x 0.032	22-18	0.110	ERG4006	0.75	0.15
RA10-SK	1,000						
RA18-111F	100						
8 RA11	1,000	0.110 x 0.020	16-14	0.135			
RB14-110F	100						
RB10-SK	1,000						
8 RB14-111F	100	0.110 x 0.032	22-18	—	WT111M WT112M WT2000	0.59	
8 RB11-TB	1,000						
A18-110F	100						
9 A10-TB	1,000	0.110 x 0.020	16-14	—			
9 A18-111F	100						
A11	1,000						
9 B14-110F	100	0.110 x 0.032	16-14	—			
B10-TB	1,000						
B14-111F	100						
9 B11-TB	1,000	0.110 x 0.020					

* Not UL Listed or CSA approved

Wristlock Disconnects†

Choose from nylon-insulated or non-insulated!

10 Nylon-insulated



11 Non-insulated



Picture shows wristlock disconnect assembled as two pieces. Parts are sold by the piece not by assemblies.

Cat. No.	Pkg. Qty.	Wire Range	Max. Ins. (in.)	Rec. Tool	Dimensions (in.)	
					A	B
10 RA18D	50	22-18	0.136	WT2000	0.99	1.70
RA23	1,000					
10 RB14D	50					
10 RB23	1,000	16-14	0.162			
B14-D	50					
11 B23	1,000					

† Not UL Listed



Push-In Luminaire Disconnect

Disconnect ballasts under load for safe servicing — in compliance with NEC® requirements

Each year, electricians sustain injuries while attempting to change ballasts without tripping the breaker because they're trying to avoid disconnecting other lighting and equipment from power. That's why recent changes to NEC® and UL standards require a means of disconnecting power to non-residential fluorescent lighting ballasts.

In 2006, Thomas & Betts developed the first UL Listed product to meet this need. Now, in response to customer demand, the new Sta-Kon® Push-In Luminaire Disconnect provides all the same safety benefits as the original, but installs even faster and easier.

- Enables electricians changing ballasts to easily disconnect incoming power for safe servicing without having to trip the main power breaker
- Installs easily — just strip de-energized wires and insert
- Disconnect halves snap together and separate easily — but won't accidentally disconnect
- Foolproof design eliminates the potential for incorrect installation and reverse polarity
- Fits through 1/2 in. knockouts for easy retrofit
- Ballast hot-lead wire entry is colour-coded black for easy visibility
- Finger-safe on both sides
- For use in all non-residential fluorescent lighting applications and in ordinary location HID lighting applications — both up to 600V, 4A maximum
- Complies with NEC®, CEC, UL and CSA requirements
- Sold in mated pairs (male/line and female/load sides)



Specifications

- Housing: Polycarbonate
- Temperature Rating: 105°C (221°F) max.
- Electrical Rating: 600V, 4A max.
- Flammability Rating: UL94V-2
- Contacts: Copper alloy
- Wire Range: #18–#12 AWG solid copper
#14–#12 AWG stranded copper (19 strands or fewer)
- Standards: Complies with 2008 NEC® 410.130(G) and CEC 30-308(4)
- Certifications: UL Listed, CSA Certified



This cutaway shows how the Sta-Kon® Luminaire Disconnect grips and holds the pushed-in wires securely after installation

Sta-Kon® Push-In Luminaire Disconnect



Cat. No.	Description	Std. Pkg. Qty.
LD2P-Q	2-Wire Push-In Luminaire Disconnect, Distributor Pack	25
LD2P-D	2-Wire Push-In Luminaire Disconnect, Bulk Packaging	500

Note: If you prefer lead wires instead of a push-in design and/or need a 3-wire disconnect for switching or dimming applications, order the original Sta-Kon® Luminaire Disconnect, 2-wire Cat. No. LD2 (Cat. No. LD2-D for bulk packaging) or 3-wire Cat. No. LD3 (Cat. No. LD3-D for bulk packaging). See following page.

NEC and National Electrical Code are registered trademarks of the National Fire Protection Association, Inc.

Luminaire Disconnects

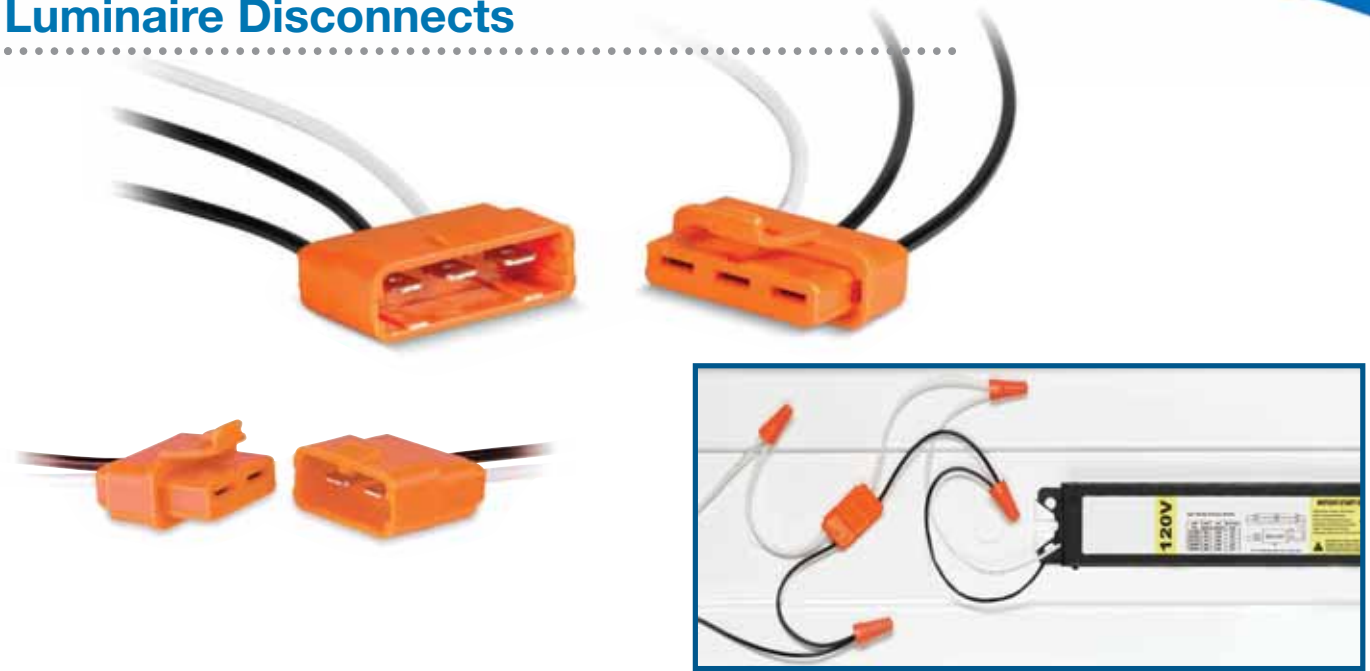

Ordering Information

Cat. No.	Description
LD2C-D	2-pole luminaire disconnect (marrettes not included)
LD3C-D	3-pole luminaire disconnect (marrettes not included)
LD2-C	2-pole luminaire disconnect (2 x 4 marrettes 333 /inner bag)
LD3-C	3-pole luminaire disconnect (6 of each marrettes (331 + 333) /inner bag)

Packaging Options

	Cat. No.	Pkg. Format	Std. Pkg. (Min./Mult.)	
BULK	LD2C-D	Box	Sold without marrettes Sold in multiple of 500	Inner: 50 per inner bag
	LD3C-D	Box		Outer: 250 per outer box
KITS	LD2-C	Bag	Sold with marrettes Sold in multiple of 20	Master: 500 in master box
	LD3-C	Bag		Inner: 2 per inner bag
				Outer: 20 per outer box
				Master: 200 in master box

Disconnect Installation Tool

Faster, easier and safer than manual seating of disconnects!

- Perfect for wire-harness assemblers and panel builders
- Dual-ended with slots to fit red and blue (male and female) or yellow disconnects
- Colour-coded dots for easy matching of disconnect with correct tool end
- Lightweight and only 5-1/8 in. long — fits in a shirt pocket like a pen



This one-of-a-kind tool may be used to seat all sizes of Thomas & Betts disconnects.

Cat. No.	Description	Pkg. Qty.
DT22-10	Sta-Kon® Disconnect Installation Tool	1

Insulated Ferrules

Features

- Ferrules ensure reliable electrical connections when terminating conductors in screw clamp terminal blocks
- Fraying and breaking of wire strands is prevented and the possibility of an unreliable connection is minimized
- Insulated ferrules prevent conductor breakage due to bending, wire stress or vibration, while facilitating wire insertions into the terminal block clamp
- Ferrules are the preferred alternative to twisting wire stands or tinning the wire end before terminating into a terminal block
- Ferrules are thin-walled copper tubes, which are mechanically crimped onto the ends of stranded wires
- They are easy to use — simply strip the wire, slide the ferrule onto the end of the wire and crimp
- Meets emerging global standards, requiring wire-to-metric style terminal block installations to be terminated with a “pin” style terminal
- Vinyl insulated, nylon insulated, and non-insulated styles
- All styles offered in #22 AWG to #10 AWG and compatible with existing Sta-Kon® tooling

How to Apply a Ferrule

- Strip the insulation from the end of the wire and insert into the insulated end of the ferrule
- Using the designated crimping tool, place the metal shaft into the tool's appropriate slot. Compress the tool to make a crescent-shape depression along the length of the ferrule
- Insert the crimped ferrule into the terminal block
- Tighten the ferrule and wire into the terminal block

Materials

- High-conductivity copper
- Tin plating

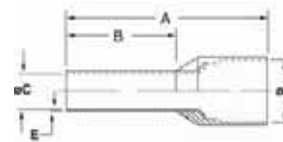

Cat. No.	Conductor Section		Colour	Dimensions in./mm					Installation Tooling	Pkg. Qty.																																																																																																																																																																																																																																																																																																							
	AWG	mm ²		A	B	øC	øD	E																																																																																																																																																																																																																																																																																																									
F4004	26	0.14	Grey	0.413 / 10.5	0.236 / 6.0	0.031 / 0.80	0.079 / 2.0	0.010 / 0.25	T3, ERG4	500																																																																																																																																																																																																																																																																																																							
F4005	26	0.14		0.492 / 12.5	0.315 / 8.0						F4006	24	0.25	Yellow	0.413 / 10.5	0.236 / 6.0	0.031 / 0.80	0.079 / 2.0	0.010 / 0.25	T3, ERG4	F4007	24	0.25	0.492 / 12.5	0.315 / 8.0	F4008	22	0.34	Purple	0.413 / 10.5	0.236 / 6.0	0.031 / 0.80	0.079 / 2.0	0.010 / 0.25	T3, ERG4	F4009	22	0.34	0.492 / 12.5	0.315 / 8.0	F2020	20	0.50	White	0.453 / 11.5	0.236 / 6.0	0.043 / 1.1	0.098 / 2.5	0.010 / 0.25	T3, ERG4	F2021	20	0.50	0.531 / 13.5	0.315 / 8.0	F2022	20	0.50	Grey	0.610 / 15.5	0.394 / 10.0	0.051 / 1.3	0.110 / 2.8	0.010 / 0.25	T3, ERG4	F2023	18	0.75	0.472 / 12.0	0.236 / 6.0	F2024	18	0.75	Grey	0.551 / 14.0	0.315 / 8.0	0.051 / 1.3	0.110 / 2.8	0.010 / 0.25	T3, ERG4	F2025	18	0.75	0.630 / 16.0	0.394 / 10.0	F2026	18	0.75	Red	0.709 / 18.0	0.472 / 12.0	0.059 / 1.5	0.118 / 3.0	0.006 / 0.15	T1, T3 & ERG4	F2027	18	1.00	0.492 / 12.5	0.236 / 6.0	F2028	18	1.00	Red	0.571 / 14.5	0.315 / 8.0	0.059 / 1.5	0.118 / 3.0	0.006 / 0.15	T1, T3 & ERG4	F2029	18	1.00	0.650 / 16.5	0.394 / 10.0	F2030	18	1.00	Black	0.728 / 18.5	0.472 / 12.0	0.071 / 1.8	0.134 / 3.4	0.006 / 0.15	T1, T3 & ERG4	F2031	16	1.50	0.571 / 14.5	0.315 / 8.0	F2032	16	1.50	Black	0.650 / 16.5	0.394 / 10.0	0.071 / 1.8	0.134 / 3.4	0.006 / 0.15	T1, T3 & ERG4	F2033	16	1.50	0.728 / 18.5	0.472 / 12.0	F2034	16	1.50	Blue	0.965 / 24.5	0.708 / 18.0	0.091 / 2.3	0.165 / 4.2	0.006 / 0.15	T1, T3 & ERG4	F2035	14	2.50	0.591 / 15.0	0.315 / 8.0	F2036	14	2.50	Blue	0.748 / 19.0	0.472 / 12.0	0.091 / 2.3	0.165 / 4.2	0.006 / 0.15	T1, T3 & ERG4	F2037	14	2.50	0.984 / 25.0	0.708 / 18.0	F2038	12	4.00	Grey	0.889 / 17.5	0.394 / 10.0	0.114 / 2.9	0.189 / 4.8	0.008 / 0.20	T3 & ERG4	F2039	12	4.00	0.787 / 20.0	0.472 / 12.0	F2040	12	4.00	Yellow	1.024 / 26.0	0.708 / 18.0	0.142 / 3.6	0.244 / 6.2	0.008 / 0.20	T3 & ERG4	F2041	10	6.00	0.787 / 20.0	0.472 / 12.0	F2042	10	6.00	Yellow	0.984 / 25.0	0.708 / 18.0	0.142 / 3.6	0.244 / 6.2	0.008 / 0.20	T3 & ERG4	F2043	8	10.00	0.827 / 21.0	0.472 / 12.0	F2044	8	10.00	Red	1.063 / 27.0	0.708 / 18.0	0.181 / 4.6	0.295 / 7.5	0.008 / 0.20	T3 & ERG4	F2045	6	16.00	0.906 / 23.0	0.472 / 12.0	F2046	6	16.00	Blue	1.142 / 29.0	0.708 / 18.0	0.236 / 6.0	0.346 / 8.8	0.008 / 0.20	T3 & ERG4	F2047	4	25.00	1.142 / 29.0	0.630 / 18.0	F2048	4	25.00	Yellow	1.220 / 31.0	0.708 / 18.0	0.295 / 7.5	0.433 / 11.0	0.008 / 0.20	ERG4	F2049	4	25.00	1.378 / 35.0	0.866 / 22.0	F2050	2	35.00	Red	1.181 / 30.0	0.630 / 16.0	0.335 / 8.5	0.492 / 12.5	0.014 / 0.35	ERG4	F2051	2	35.00	1.260 / 32.0	0.708 / 18.0	F2052	2	35.00	Red	1.535 / 39.0	0.984 / 25.0	0.335 / 8.5	0.492 / 12.5	0.014 / 0.35	ERG4	F2053	1/0	50.00	1.417 / 36.0	0.787 / 20.0	F2054	1/0	50.00	Blue	1.614 / 41.0	0.984 / 25.0	0.413 / 10.5	0.591 / 15.0	0.014 / 0.35	ERG4
F4006	24	0.25	Yellow	0.413 / 10.5	0.236 / 6.0	0.031 / 0.80	0.079 / 2.0	0.010 / 0.25	T3, ERG4																																																																																																																																																																																																																																																																																																								
F4007	24	0.25		0.492 / 12.5	0.315 / 8.0						F4008	22	0.34	Purple	0.413 / 10.5	0.236 / 6.0	0.031 / 0.80	0.079 / 2.0	0.010 / 0.25	T3, ERG4	F4009	22	0.34	0.492 / 12.5	0.315 / 8.0	F2020	20	0.50	White	0.453 / 11.5	0.236 / 6.0	0.043 / 1.1	0.098 / 2.5	0.010 / 0.25	T3, ERG4	F2021	20	0.50	0.531 / 13.5	0.315 / 8.0	F2022	20	0.50	Grey	0.610 / 15.5	0.394 / 10.0	0.051 / 1.3	0.110 / 2.8	0.010 / 0.25	T3, ERG4	F2023	18	0.75	0.472 / 12.0	0.236 / 6.0	F2024	18	0.75	Grey	0.551 / 14.0	0.315 / 8.0	0.051 / 1.3	0.110 / 2.8	0.010 / 0.25	T3, ERG4	F2025	18	0.75	0.630 / 16.0	0.394 / 10.0	F2026	18	0.75	Red	0.709 / 18.0	0.472 / 12.0	0.059 / 1.5	0.118 / 3.0	0.006 / 0.15	T1, T3 & ERG4	F2027	18	1.00	0.492 / 12.5	0.236 / 6.0	F2028	18	1.00	Red	0.571 / 14.5	0.315 / 8.0	0.059 / 1.5	0.118 / 3.0	0.006 / 0.15	T1, T3 & ERG4	F2029	18	1.00	0.650 / 16.5	0.394 / 10.0	F2030	18	1.00	Black	0.728 / 18.5	0.472 / 12.0	0.071 / 1.8	0.134 / 3.4	0.006 / 0.15	T1, T3 & ERG4	F2031	16	1.50	0.571 / 14.5	0.315 / 8.0	F2032	16	1.50	Black	0.650 / 16.5	0.394 / 10.0	0.071 / 1.8	0.134 / 3.4	0.006 / 0.15	T1, T3 & ERG4	F2033	16	1.50	0.728 / 18.5	0.472 / 12.0	F2034	16	1.50	Blue	0.965 / 24.5	0.708 / 18.0	0.091 / 2.3	0.165 / 4.2	0.006 / 0.15	T1, T3 & ERG4	F2035	14	2.50	0.591 / 15.0	0.315 / 8.0	F2036	14	2.50	Blue	0.748 / 19.0	0.472 / 12.0	0.091 / 2.3	0.165 / 4.2	0.006 / 0.15	T1, T3 & ERG4	F2037	14	2.50	0.984 / 25.0	0.708 / 18.0	F2038	12	4.00	Grey	0.889 / 17.5	0.394 / 10.0	0.114 / 2.9	0.189 / 4.8	0.008 / 0.20	T3 & ERG4	F2039	12	4.00	0.787 / 20.0	0.472 / 12.0	F2040	12	4.00	Yellow	1.024 / 26.0	0.708 / 18.0	0.142 / 3.6	0.244 / 6.2	0.008 / 0.20	T3 & ERG4	F2041	10	6.00	0.787 / 20.0	0.472 / 12.0	F2042	10	6.00	Yellow	0.984 / 25.0	0.708 / 18.0	0.142 / 3.6	0.244 / 6.2	0.008 / 0.20	T3 & ERG4	F2043	8	10.00	0.827 / 21.0	0.472 / 12.0	F2044	8	10.00	Red	1.063 / 27.0	0.708 / 18.0	0.181 / 4.6	0.295 / 7.5	0.008 / 0.20	T3 & ERG4	F2045	6	16.00	0.906 / 23.0	0.472 / 12.0	F2046	6	16.00	Blue	1.142 / 29.0	0.708 / 18.0	0.236 / 6.0	0.346 / 8.8	0.008 / 0.20	T3 & ERG4	F2047	4	25.00	1.142 / 29.0	0.630 / 18.0	F2048	4	25.00	Yellow	1.220 / 31.0	0.708 / 18.0	0.295 / 7.5	0.433 / 11.0	0.008 / 0.20	ERG4	F2049	4	25.00	1.378 / 35.0	0.866 / 22.0	F2050	2	35.00	Red	1.181 / 30.0	0.630 / 16.0	0.335 / 8.5	0.492 / 12.5	0.014 / 0.35	ERG4	F2051	2	35.00	1.260 / 32.0	0.708 / 18.0	F2052	2	35.00	Red	1.535 / 39.0	0.984 / 25.0	0.335 / 8.5	0.492 / 12.5	0.014 / 0.35	ERG4	F2053	1/0	50.00	1.417 / 36.0	0.787 / 20.0	F2054	1/0	50.00	Blue	1.614 / 41.0	0.984 / 25.0	0.413 / 10.5	0.591 / 15.0	0.014 / 0.35	ERG4															
F4008	22	0.34	Purple	0.413 / 10.5	0.236 / 6.0	0.031 / 0.80	0.079 / 2.0	0.010 / 0.25	T3, ERG4																																																																																																																																																																																																																																																																																																								
F4009	22	0.34		0.492 / 12.5	0.315 / 8.0						F2020	20	0.50	White	0.453 / 11.5	0.236 / 6.0	0.043 / 1.1	0.098 / 2.5	0.010 / 0.25	T3, ERG4	F2021	20	0.50	0.531 / 13.5	0.315 / 8.0	F2022	20	0.50	Grey	0.610 / 15.5	0.394 / 10.0	0.051 / 1.3	0.110 / 2.8	0.010 / 0.25	T3, ERG4	F2023	18	0.75	0.472 / 12.0	0.236 / 6.0	F2024	18	0.75	Grey	0.551 / 14.0	0.315 / 8.0	0.051 / 1.3	0.110 / 2.8	0.010 / 0.25	T3, ERG4	F2025	18	0.75	0.630 / 16.0	0.394 / 10.0	F2026	18	0.75	Red	0.709 / 18.0	0.472 / 12.0	0.059 / 1.5	0.118 / 3.0	0.006 / 0.15	T1, T3 & ERG4	F2027	18	1.00	0.492 / 12.5	0.236 / 6.0	F2028	18	1.00	Red	0.571 / 14.5	0.315 / 8.0	0.059 / 1.5	0.118 / 3.0	0.006 / 0.15	T1, T3 & ERG4	F2029	18	1.00	0.650 / 16.5	0.394 / 10.0	F2030	18	1.00	Black	0.728 / 18.5	0.472 / 12.0	0.071 / 1.8	0.134 / 3.4	0.006 / 0.15	T1, T3 & ERG4	F2031	16	1.50	0.571 / 14.5	0.315 / 8.0	F2032	16	1.50	Black	0.650 / 16.5	0.394 / 10.0	0.071 / 1.8	0.134 / 3.4	0.006 / 0.15	T1, T3 & ERG4	F2033	16	1.50	0.728 / 18.5	0.472 / 12.0	F2034	16	1.50	Blue	0.965 / 24.5	0.708 / 18.0	0.091 / 2.3	0.165 / 4.2	0.006 / 0.15	T1, T3 & ERG4	F2035	14	2.50	0.591 / 15.0	0.315 / 8.0	F2036	14	2.50	Blue	0.748 / 19.0	0.472 / 12.0	0.091 / 2.3	0.165 / 4.2	0.006 / 0.15	T1, T3 & ERG4	F2037	14	2.50	0.984 / 25.0	0.708 / 18.0	F2038	12	4.00	Grey	0.889 / 17.5	0.394 / 10.0	0.114 / 2.9	0.189 / 4.8	0.008 / 0.20	T3 & ERG4	F2039	12	4.00	0.787 / 20.0	0.472 / 12.0	F2040	12	4.00	Yellow	1.024 / 26.0	0.708 / 18.0	0.142 / 3.6	0.244 / 6.2	0.008 / 0.20	T3 & ERG4	F2041	10	6.00	0.787 / 20.0	0.472 / 12.0	F2042	10	6.00	Yellow	0.984 / 25.0	0.708 / 18.0	0.142 / 3.6	0.244 / 6.2	0.008 / 0.20	T3 & ERG4	F2043	8	10.00	0.827 / 21.0	0.472 / 12.0	F2044	8	10.00	Red	1.063 / 27.0	0.708 / 18.0	0.181 / 4.6	0.295 / 7.5	0.008 / 0.20	T3 & ERG4	F2045	6	16.00	0.906 / 23.0	0.472 / 12.0	F2046	6	16.00	Blue	1.142 / 29.0	0.708 / 18.0	0.236 / 6.0	0.346 / 8.8	0.008 / 0.20	T3 & ERG4	F2047	4	25.00	1.142 / 29.0	0.630 / 18.0	F2048	4	25.00	Yellow	1.220 / 31.0	0.708 / 18.0	0.295 / 7.5	0.433 / 11.0	0.008 / 0.20	ERG4	F2049	4	25.00	1.378 / 35.0	0.866 / 22.0	F2050	2	35.00	Red	1.181 / 30.0	0.630 / 16.0	0.335 / 8.5	0.492 / 12.5	0.014 / 0.35	ERG4	F2051	2	35.00	1.260 / 32.0	0.708 / 18.0	F2052	2	35.00	Red	1.535 / 39.0	0.984 / 25.0	0.335 / 8.5	0.492 / 12.5	0.014 / 0.35	ERG4	F2053	1/0	50.00	1.417 / 36.0	0.787 / 20.0	F2054	1/0	50.00	Blue	1.614 / 41.0	0.984 / 25.0	0.413 / 10.5	0.591 / 15.0	0.014 / 0.35	ERG4																														
F2020	20	0.50	White	0.453 / 11.5	0.236 / 6.0	0.043 / 1.1	0.098 / 2.5	0.010 / 0.25	T3, ERG4																																																																																																																																																																																																																																																																																																								
F2021	20	0.50		0.531 / 13.5	0.315 / 8.0						F2022	20	0.50	Grey	0.610 / 15.5	0.394 / 10.0	0.051 / 1.3	0.110 / 2.8	0.010 / 0.25	T3, ERG4	F2023	18	0.75	0.472 / 12.0	0.236 / 6.0	F2024	18	0.75	Grey	0.551 / 14.0	0.315 / 8.0	0.051 / 1.3	0.110 / 2.8	0.010 / 0.25	T3, ERG4	F2025	18	0.75	0.630 / 16.0	0.394 / 10.0	F2026	18	0.75	Red	0.709 / 18.0	0.472 / 12.0	0.059 / 1.5	0.118 / 3.0	0.006 / 0.15	T1, T3 & ERG4	F2027	18	1.00	0.492 / 12.5	0.236 / 6.0	F2028	18	1.00	Red	0.571 / 14.5	0.315 / 8.0	0.059 / 1.5	0.118 / 3.0	0.006 / 0.15	T1, T3 & ERG4	F2029	18	1.00	0.650 / 16.5	0.394 / 10.0	F2030	18	1.00	Black	0.728 / 18.5	0.472 / 12.0	0.071 / 1.8	0.134 / 3.4	0.006 / 0.15	T1, T3 & ERG4	F2031	16	1.50	0.571 / 14.5	0.315 / 8.0	F2032	16	1.50	Black	0.650 / 16.5	0.394 / 10.0	0.071 / 1.8	0.134 / 3.4	0.006 / 0.15	T1, T3 & ERG4	F2033	16	1.50	0.728 / 18.5	0.472 / 12.0	F2034	16	1.50	Blue	0.965 / 24.5	0.708 / 18.0	0.091 / 2.3	0.165 / 4.2	0.006 / 0.15	T1, T3 & ERG4	F2035	14	2.50	0.591 / 15.0	0.315 / 8.0	F2036	14	2.50	Blue	0.748 / 19.0	0.472 / 12.0	0.091 / 2.3	0.165 / 4.2	0.006 / 0.15	T1, T3 & ERG4	F2037	14	2.50	0.984 / 25.0	0.708 / 18.0	F2038	12	4.00	Grey	0.889 / 17.5	0.394 / 10.0	0.114 / 2.9	0.189 / 4.8	0.008 / 0.20	T3 & ERG4	F2039	12	4.00	0.787 / 20.0	0.472 / 12.0	F2040	12	4.00	Yellow	1.024 / 26.0	0.708 / 18.0	0.142 / 3.6	0.244 / 6.2	0.008 / 0.20	T3 & ERG4	F2041	10	6.00	0.787 / 20.0	0.472 / 12.0	F2042	10	6.00	Yellow	0.984 / 25.0	0.708 / 18.0	0.142 / 3.6	0.244 / 6.2	0.008 / 0.20	T3 & ERG4	F2043	8	10.00	0.827 / 21.0	0.472 / 12.0	F2044	8	10.00	Red	1.063 / 27.0	0.708 / 18.0	0.181 / 4.6	0.295 / 7.5	0.008 / 0.20	T3 & ERG4	F2045	6	16.00	0.906 / 23.0	0.472 / 12.0	F2046	6	16.00	Blue	1.142 / 29.0	0.708 / 18.0	0.236 / 6.0	0.346 / 8.8	0.008 / 0.20	T3 & ERG4	F2047	4	25.00	1.142 / 29.0	0.630 / 18.0	F2048	4	25.00	Yellow	1.220 / 31.0	0.708 / 18.0	0.295 / 7.5	0.433 / 11.0	0.008 / 0.20	ERG4	F2049	4	25.00	1.378 / 35.0	0.866 / 22.0	F2050	2	35.00	Red	1.181 / 30.0	0.630 / 16.0	0.335 / 8.5	0.492 / 12.5	0.014 / 0.35	ERG4	F2051	2	35.00	1.260 / 32.0	0.708 / 18.0	F2052	2	35.00	Red	1.535 / 39.0	0.984 / 25.0	0.335 / 8.5	0.492 / 12.5	0.014 / 0.35	ERG4	F2053	1/0	50.00	1.417 / 36.0	0.787 / 20.0	F2054	1/0	50.00	Blue	1.614 / 41.0	0.984 / 25.0	0.413 / 10.5	0.591 / 15.0	0.014 / 0.35	ERG4																																													
F2022	20	0.50	Grey	0.610 / 15.5	0.394 / 10.0	0.051 / 1.3	0.110 / 2.8	0.010 / 0.25	T3, ERG4																																																																																																																																																																																																																																																																																																								
F2023	18	0.75		0.472 / 12.0	0.236 / 6.0						F2024	18	0.75	Grey	0.551 / 14.0	0.315 / 8.0	0.051 / 1.3	0.110 / 2.8	0.010 / 0.25	T3, ERG4	F2025	18	0.75	0.630 / 16.0	0.394 / 10.0	F2026	18	0.75	Red	0.709 / 18.0	0.472 / 12.0	0.059 / 1.5	0.118 / 3.0	0.006 / 0.15	T1, T3 & ERG4	F2027	18	1.00	0.492 / 12.5	0.236 / 6.0	F2028	18	1.00	Red	0.571 / 14.5	0.315 / 8.0	0.059 / 1.5	0.118 / 3.0	0.006 / 0.15	T1, T3 & ERG4	F2029	18	1.00	0.650 / 16.5	0.394 / 10.0	F2030	18	1.00	Black	0.728 / 18.5	0.472 / 12.0	0.071 / 1.8	0.134 / 3.4	0.006 / 0.15	T1, T3 & ERG4	F2031	16	1.50	0.571 / 14.5	0.315 / 8.0	F2032	16	1.50	Black	0.650 / 16.5	0.394 / 10.0	0.071 / 1.8	0.134 / 3.4	0.006 / 0.15	T1, T3 & ERG4	F2033	16	1.50	0.728 / 18.5	0.472 / 12.0	F2034	16	1.50	Blue	0.965 / 24.5	0.708 / 18.0	0.091 / 2.3	0.165 / 4.2	0.006 / 0.15	T1, T3 & ERG4	F2035	14	2.50	0.591 / 15.0	0.315 / 8.0	F2036	14	2.50	Blue	0.748 / 19.0	0.472 / 12.0	0.091 / 2.3	0.165 / 4.2	0.006 / 0.15	T1, T3 & ERG4	F2037	14	2.50	0.984 / 25.0	0.708 / 18.0	F2038	12	4.00	Grey	0.889 / 17.5	0.394 / 10.0	0.114 / 2.9	0.189 / 4.8	0.008 / 0.20	T3 & ERG4	F2039	12	4.00	0.787 / 20.0	0.472 / 12.0	F2040	12	4.00	Yellow	1.024 / 26.0	0.708 / 18.0	0.142 / 3.6	0.244 / 6.2	0.008 / 0.20	T3 & ERG4	F2041	10	6.00	0.787 / 20.0	0.472 / 12.0	F2042	10	6.00	Yellow	0.984 / 25.0	0.708 / 18.0	0.142 / 3.6	0.244 / 6.2	0.008 / 0.20	T3 & ERG4	F2043	8	10.00	0.827 / 21.0	0.472 / 12.0	F2044	8	10.00	Red	1.063 / 27.0	0.708 / 18.0	0.181 / 4.6	0.295 / 7.5	0.008 / 0.20	T3 & ERG4	F2045	6	16.00	0.906 / 23.0	0.472 / 12.0	F2046	6	16.00	Blue	1.142 / 29.0	0.708 / 18.0	0.236 / 6.0	0.346 / 8.8	0.008 / 0.20	T3 & ERG4	F2047	4	25.00	1.142 / 29.0	0.630 / 18.0	F2048	4	25.00	Yellow	1.220 / 31.0	0.708 / 18.0	0.295 / 7.5	0.433 / 11.0	0.008 / 0.20	ERG4	F2049	4	25.00	1.378 / 35.0	0.866 / 22.0	F2050	2	35.00	Red	1.181 / 30.0	0.630 / 16.0	0.335 / 8.5	0.492 / 12.5	0.014 / 0.35	ERG4	F2051	2	35.00	1.260 / 32.0	0.708 / 18.0	F2052	2	35.00	Red	1.535 / 39.0	0.984 / 25.0	0.335 / 8.5	0.492 / 12.5	0.014 / 0.35	ERG4	F2053	1/0	50.00	1.417 / 36.0	0.787 / 20.0	F2054	1/0	50.00	Blue	1.614 / 41.0	0.984 / 25.0	0.413 / 10.5	0.591 / 15.0	0.014 / 0.35	ERG4																																																												
F2024	18	0.75	Grey	0.551 / 14.0	0.315 / 8.0	0.051 / 1.3	0.110 / 2.8	0.010 / 0.25	T3, ERG4																																																																																																																																																																																																																																																																																																								
F2025	18	0.75		0.630 / 16.0	0.394 / 10.0						F2026	18	0.75	Red	0.709 / 18.0	0.472 / 12.0	0.059 / 1.5	0.118 / 3.0	0.006 / 0.15	T1, T3 & ERG4	F2027	18	1.00	0.492 / 12.5	0.236 / 6.0	F2028	18	1.00	Red	0.571 / 14.5	0.315 / 8.0	0.059 / 1.5	0.118 / 3.0	0.006 / 0.15	T1, T3 & ERG4	F2029	18	1.00	0.650 / 16.5	0.394 / 10.0	F2030	18	1.00	Black	0.728 / 18.5	0.472 / 12.0	0.071 / 1.8	0.134 / 3.4	0.006 / 0.15	T1, T3 & ERG4	F2031	16	1.50	0.571 / 14.5	0.315 / 8.0	F2032	16	1.50	Black	0.650 / 16.5	0.394 / 10.0	0.071 / 1.8	0.134 / 3.4	0.006 / 0.15	T1, T3 & ERG4	F2033	16	1.50	0.728 / 18.5	0.472 / 12.0	F2034	16	1.50	Blue	0.965 / 24.5	0.708 / 18.0	0.091 / 2.3	0.165 / 4.2	0.006 / 0.15	T1, T3 & ERG4	F2035	14	2.50	0.591 / 15.0	0.315 / 8.0	F2036	14	2.50	Blue	0.748 / 19.0	0.472 / 12.0	0.091 / 2.3	0.165 / 4.2	0.006 / 0.15	T1, T3 & ERG4	F2037	14	2.50	0.984 / 25.0	0.708 / 18.0	F2038	12	4.00	Grey	0.889 / 17.5	0.394 / 10.0	0.114 / 2.9	0.189 / 4.8	0.008 / 0.20	T3 & ERG4	F2039	12	4.00	0.787 / 20.0	0.472 / 12.0	F2040	12	4.00	Yellow	1.024 / 26.0	0.708 / 18.0	0.142 / 3.6	0.244 / 6.2	0.008 / 0.20	T3 & ERG4	F2041	10	6.00	0.787 / 20.0	0.472 / 12.0	F2042	10	6.00	Yellow	0.984 / 25.0	0.708 / 18.0	0.142 / 3.6	0.244 / 6.2	0.008 / 0.20	T3 & ERG4	F2043	8	10.00	0.827 / 21.0	0.472 / 12.0	F2044	8	10.00	Red	1.063 / 27.0	0.708 / 18.0	0.181 / 4.6	0.295 / 7.5	0.008 / 0.20	T3 & ERG4	F2045	6	16.00	0.906 / 23.0	0.472 / 12.0	F2046	6	16.00	Blue	1.142 / 29.0	0.708 / 18.0	0.236 / 6.0	0.346 / 8.8	0.008 / 0.20	T3 & ERG4	F2047	4	25.00	1.142 / 29.0	0.630 / 18.0	F2048	4	25.00	Yellow	1.220 / 31.0	0.708 / 18.0	0.295 / 7.5	0.433 / 11.0	0.008 / 0.20	ERG4	F2049	4	25.00	1.378 / 35.0	0.866 / 22.0	F2050	2	35.00	Red	1.181 / 30.0	0.630 / 16.0	0.335 / 8.5	0.492 / 12.5	0.014 / 0.35	ERG4	F2051	2	35.00	1.260 / 32.0	0.708 / 18.0	F2052	2	35.00	Red	1.535 / 39.0	0.984 / 25.0	0.335 / 8.5	0.492 / 12.5	0.014 / 0.35	ERG4	F2053	1/0	50.00	1.417 / 36.0	0.787 / 20.0	F2054	1/0	50.00	Blue	1.614 / 41.0	0.984 / 25.0	0.413 / 10.5	0.591 / 15.0	0.014 / 0.35	ERG4																																																																											
F2026	18	0.75	Red	0.709 / 18.0	0.472 / 12.0	0.059 / 1.5	0.118 / 3.0	0.006 / 0.15	T1, T3 & ERG4																																																																																																																																																																																																																																																																																																								
F2027	18	1.00		0.492 / 12.5	0.236 / 6.0						F2028	18	1.00	Red	0.571 / 14.5	0.315 / 8.0	0.059 / 1.5	0.118 / 3.0	0.006 / 0.15	T1, T3 & ERG4	F2029	18	1.00	0.650 / 16.5	0.394 / 10.0	F2030	18	1.00	Black	0.728 / 18.5	0.472 / 12.0	0.071 / 1.8	0.134 / 3.4	0.006 / 0.15	T1, T3 & ERG4	F2031	16	1.50	0.571 / 14.5	0.315 / 8.0	F2032	16	1.50	Black	0.650 / 16.5	0.394 / 10.0	0.071 / 1.8	0.134 / 3.4	0.006 / 0.15	T1, T3 & ERG4	F2033	16	1.50	0.728 / 18.5	0.472 / 12.0	F2034	16	1.50	Blue	0.965 / 24.5	0.708 / 18.0	0.091 / 2.3	0.165 / 4.2	0.006 / 0.15	T1, T3 & ERG4	F2035	14	2.50	0.591 / 15.0	0.315 / 8.0	F2036	14	2.50	Blue	0.748 / 19.0	0.472 / 12.0	0.091 / 2.3	0.165 / 4.2	0.006 / 0.15	T1, T3 & ERG4	F2037	14	2.50	0.984 / 25.0	0.708 / 18.0	F2038	12	4.00	Grey	0.889 / 17.5	0.394 / 10.0	0.114 / 2.9	0.189 / 4.8	0.008 / 0.20	T3 & ERG4	F2039	12	4.00	0.787 / 20.0	0.472 / 12.0	F2040	12	4.00	Yellow	1.024 / 26.0	0.708 / 18.0	0.142 / 3.6	0.244 / 6.2	0.008 / 0.20	T3 & ERG4	F2041	10	6.00	0.787 / 20.0	0.472 / 12.0	F2042	10	6.00	Yellow	0.984 / 25.0	0.708 / 18.0	0.142 / 3.6	0.244 / 6.2	0.008 / 0.20	T3 & ERG4	F2043	8	10.00	0.827 / 21.0	0.472 / 12.0	F2044	8	10.00	Red	1.063 / 27.0	0.708 / 18.0	0.181 / 4.6	0.295 / 7.5	0.008 / 0.20	T3 & ERG4	F2045	6	16.00	0.906 / 23.0	0.472 / 12.0	F2046	6	16.00	Blue	1.142 / 29.0	0.708 / 18.0	0.236 / 6.0	0.346 / 8.8	0.008 / 0.20	T3 & ERG4	F2047	4	25.00	1.142 / 29.0	0.630 / 18.0	F2048	4	25.00	Yellow	1.220 / 31.0	0.708 / 18.0	0.295 / 7.5	0.433 / 11.0	0.008 / 0.20	ERG4	F2049	4	25.00	1.378 / 35.0	0.866 / 22.0	F2050	2	35.00	Red	1.181 / 30.0	0.630 / 16.0	0.335 / 8.5	0.492 / 12.5	0.014 / 0.35	ERG4	F2051	2	35.00	1.260 / 32.0	0.708 / 18.0	F2052	2	35.00	Red	1.535 / 39.0	0.984 / 25.0	0.335 / 8.5	0.492 / 12.5	0.014 / 0.35	ERG4	F2053	1/0	50.00	1.417 / 36.0	0.787 / 20.0	F2054	1/0	50.00	Blue	1.614 / 41.0	0.984 / 25.0	0.413 / 10.5	0.591 / 15.0	0.014 / 0.35	ERG4																																																																																										
F2028	18	1.00	Red	0.571 / 14.5	0.315 / 8.0	0.059 / 1.5	0.118 / 3.0	0.006 / 0.15	T1, T3 & ERG4																																																																																																																																																																																																																																																																																																								
F2029	18	1.00		0.650 / 16.5	0.394 / 10.0						F2030	18	1.00	Black	0.728 / 18.5	0.472 / 12.0	0.071 / 1.8	0.134 / 3.4	0.006 / 0.15	T1, T3 & ERG4	F2031	16	1.50	0.571 / 14.5	0.315 / 8.0	F2032	16	1.50	Black	0.650 / 16.5	0.394 / 10.0	0.071 / 1.8	0.134 / 3.4	0.006 / 0.15	T1, T3 & ERG4	F2033	16	1.50	0.728 / 18.5	0.472 / 12.0	F2034	16	1.50	Blue	0.965 / 24.5	0.708 / 18.0	0.091 / 2.3	0.165 / 4.2	0.006 / 0.15	T1, T3 & ERG4	F2035	14	2.50	0.591 / 15.0	0.315 / 8.0	F2036	14	2.50	Blue	0.748 / 19.0	0.472 / 12.0	0.091 / 2.3	0.165 / 4.2	0.006 / 0.15	T1, T3 & ERG4	F2037	14	2.50	0.984 / 25.0	0.708 / 18.0	F2038	12	4.00	Grey	0.889 / 17.5	0.394 / 10.0	0.114 / 2.9	0.189 / 4.8	0.008 / 0.20	T3 & ERG4	F2039	12	4.00	0.787 / 20.0	0.472 / 12.0	F2040	12	4.00	Yellow	1.024 / 26.0	0.708 / 18.0	0.142 / 3.6	0.244 / 6.2	0.008 / 0.20	T3 & ERG4	F2041	10	6.00	0.787 / 20.0	0.472 / 12.0	F2042	10	6.00	Yellow	0.984 / 25.0	0.708 / 18.0	0.142 / 3.6	0.244 / 6.2	0.008 / 0.20	T3 & ERG4	F2043	8	10.00	0.827 / 21.0	0.472 / 12.0	F2044	8	10.00	Red	1.063 / 27.0	0.708 / 18.0	0.181 / 4.6	0.295 / 7.5	0.008 / 0.20	T3 & ERG4	F2045	6	16.00	0.906 / 23.0	0.472 / 12.0	F2046	6	16.00	Blue	1.142 / 29.0	0.708 / 18.0	0.236 / 6.0	0.346 / 8.8	0.008 / 0.20	T3 & ERG4	F2047	4	25.00	1.142 / 29.0	0.630 / 18.0	F2048	4	25.00	Yellow	1.220 / 31.0	0.708 / 18.0	0.295 / 7.5	0.433 / 11.0	0.008 / 0.20	ERG4	F2049	4	25.00	1.378 / 35.0	0.866 / 22.0	F2050	2	35.00	Red	1.181 / 30.0	0.630 / 16.0	0.335 / 8.5	0.492 / 12.5	0.014 / 0.35	ERG4	F2051	2	35.00	1.260 / 32.0	0.708 / 18.0	F2052	2	35.00	Red	1.535 / 39.0	0.984 / 25.0	0.335 / 8.5	0.492 / 12.5	0.014 / 0.35	ERG4	F2053	1/0	50.00	1.417 / 36.0	0.787 / 20.0	F2054	1/0	50.00	Blue	1.614 / 41.0	0.984 / 25.0	0.413 / 10.5	0.591 / 15.0	0.014 / 0.35	ERG4																																																																																																									
F2030	18	1.00	Black	0.728 / 18.5	0.472 / 12.0	0.071 / 1.8	0.134 / 3.4	0.006 / 0.15	T1, T3 & ERG4																																																																																																																																																																																																																																																																																																								
F2031	16	1.50		0.571 / 14.5	0.315 / 8.0						F2032	16	1.50	Black	0.650 / 16.5	0.394 / 10.0	0.071 / 1.8	0.134 / 3.4	0.006 / 0.15	T1, T3 & ERG4	F2033	16	1.50	0.728 / 18.5	0.472 / 12.0	F2034	16	1.50	Blue	0.965 / 24.5	0.708 / 18.0	0.091 / 2.3	0.165 / 4.2	0.006 / 0.15	T1, T3 & ERG4	F2035	14	2.50	0.591 / 15.0	0.315 / 8.0	F2036	14	2.50	Blue	0.748 / 19.0	0.472 / 12.0	0.091 / 2.3	0.165 / 4.2	0.006 / 0.15	T1, T3 & ERG4	F2037	14	2.50	0.984 / 25.0	0.708 / 18.0	F2038	12	4.00	Grey	0.889 / 17.5	0.394 / 10.0	0.114 / 2.9	0.189 / 4.8	0.008 / 0.20	T3 & ERG4	F2039	12	4.00	0.787 / 20.0	0.472 / 12.0	F2040	12	4.00	Yellow	1.024 / 26.0	0.708 / 18.0	0.142 / 3.6	0.244 / 6.2	0.008 / 0.20	T3 & ERG4	F2041	10	6.00	0.787 / 20.0	0.472 / 12.0	F2042	10	6.00	Yellow	0.984 / 25.0	0.708 / 18.0	0.142 / 3.6	0.244 / 6.2	0.008 / 0.20	T3 & ERG4	F2043	8	10.00	0.827 / 21.0	0.472 / 12.0	F2044	8	10.00	Red	1.063 / 27.0	0.708 / 18.0	0.181 / 4.6	0.295 / 7.5	0.008 / 0.20	T3 & ERG4	F2045	6	16.00	0.906 / 23.0	0.472 / 12.0	F2046	6	16.00	Blue	1.142 / 29.0	0.708 / 18.0	0.236 / 6.0	0.346 / 8.8	0.008 / 0.20	T3 & ERG4	F2047	4	25.00	1.142 / 29.0	0.630 / 18.0	F2048	4	25.00	Yellow	1.220 / 31.0	0.708 / 18.0	0.295 / 7.5	0.433 / 11.0	0.008 / 0.20	ERG4	F2049	4	25.00	1.378 / 35.0	0.866 / 22.0	F2050	2	35.00	Red	1.181 / 30.0	0.630 / 16.0	0.335 / 8.5	0.492 / 12.5	0.014 / 0.35	ERG4	F2051	2	35.00	1.260 / 32.0	0.708 / 18.0	F2052	2	35.00	Red	1.535 / 39.0	0.984 / 25.0	0.335 / 8.5	0.492 / 12.5	0.014 / 0.35	ERG4	F2053	1/0	50.00	1.417 / 36.0	0.787 / 20.0	F2054	1/0	50.00	Blue	1.614 / 41.0	0.984 / 25.0	0.413 / 10.5	0.591 / 15.0	0.014 / 0.35	ERG4																																																																																																																								
F2032	16	1.50	Black	0.650 / 16.5	0.394 / 10.0	0.071 / 1.8	0.134 / 3.4	0.006 / 0.15	T1, T3 & ERG4																																																																																																																																																																																																																																																																																																								
F2033	16	1.50		0.728 / 18.5	0.472 / 12.0						F2034	16	1.50	Blue	0.965 / 24.5	0.708 / 18.0	0.091 / 2.3	0.165 / 4.2	0.006 / 0.15	T1, T3 & ERG4	F2035	14	2.50	0.591 / 15.0	0.315 / 8.0	F2036	14	2.50	Blue	0.748 / 19.0	0.472 / 12.0	0.091 / 2.3	0.165 / 4.2	0.006 / 0.15	T1, T3 & ERG4	F2037	14	2.50	0.984 / 25.0	0.708 / 18.0	F2038	12	4.00	Grey	0.889 / 17.5	0.394 / 10.0	0.114 / 2.9	0.189 / 4.8	0.008 / 0.20	T3 & ERG4	F2039	12	4.00	0.787 / 20.0	0.472 / 12.0	F2040	12	4.00	Yellow	1.024 / 26.0	0.708 / 18.0	0.142 / 3.6	0.244 / 6.2	0.008 / 0.20	T3 & ERG4	F2041	10	6.00	0.787 / 20.0	0.472 / 12.0	F2042	10	6.00	Yellow	0.984 / 25.0	0.708 / 18.0	0.142 / 3.6	0.244 / 6.2	0.008 / 0.20	T3 & ERG4	F2043	8	10.00	0.827 / 21.0	0.472 / 12.0	F2044	8	10.00	Red	1.063 / 27.0	0.708 / 18.0	0.181 / 4.6	0.295 / 7.5	0.008 / 0.20	T3 & ERG4	F2045	6	16.00	0.906 / 23.0	0.472 / 12.0	F2046	6	16.00	Blue	1.142 / 29.0	0.708 / 18.0	0.236 / 6.0	0.346 / 8.8	0.008 / 0.20	T3 & ERG4	F2047	4	25.00	1.142 / 29.0	0.630 / 18.0	F2048	4	25.00	Yellow	1.220 / 31.0	0.708 / 18.0	0.295 / 7.5	0.433 / 11.0	0.008 / 0.20	ERG4	F2049	4	25.00	1.378 / 35.0	0.866 / 22.0	F2050	2	35.00	Red	1.181 / 30.0	0.630 / 16.0	0.335 / 8.5	0.492 / 12.5	0.014 / 0.35	ERG4	F2051	2	35.00	1.260 / 32.0	0.708 / 18.0	F2052	2	35.00	Red	1.535 / 39.0	0.984 / 25.0	0.335 / 8.5	0.492 / 12.5	0.014 / 0.35	ERG4	F2053	1/0	50.00	1.417 / 36.0	0.787 / 20.0	F2054	1/0	50.00	Blue	1.614 / 41.0	0.984 / 25.0	0.413 / 10.5	0.591 / 15.0	0.014 / 0.35	ERG4																																																																																																																																							
F2034	16	1.50	Blue	0.965 / 24.5	0.708 / 18.0	0.091 / 2.3	0.165 / 4.2	0.006 / 0.15	T1, T3 & ERG4																																																																																																																																																																																																																																																																																																								
F2035	14	2.50		0.591 / 15.0	0.315 / 8.0					F2036	14	2.50	Blue	0.748 / 19.0	0.472 / 12.0	0.091 / 2.3	0.165 / 4.2	0.006 / 0.15	T1, T3 & ERG4	F2037	14	2.50	0.984 / 25.0	0.708 / 18.0	F2038	12	4.00	Grey	0.889 / 17.5	0.394 / 10.0	0.114 / 2.9	0.189 / 4.8	0.008 / 0.20	T3 & ERG4	F2039	12	4.00	0.787 / 20.0	0.472 / 12.0	F2040	12	4.00	Yellow	1.024 / 26.0	0.708 / 18.0	0.142 / 3.6	0.244 / 6.2	0.008 / 0.20	T3 & ERG4	F2041	10	6.00	0.787 / 20.0	0.472 / 12.0	F2042	10	6.00	Yellow	0.984 / 25.0	0.708 / 18.0	0.142 / 3.6	0.244 / 6.2	0.008 / 0.20	T3 & ERG4	F2043	8	10.00	0.827 / 21.0	0.472 / 12.0	F2044	8	10.00	Red	1.063 / 27.0	0.708 / 18.0	0.181 / 4.6	0.295 / 7.5	0.008 / 0.20	T3 & ERG4	F2045	6	16.00	0.906 / 23.0	0.472 / 12.0	F2046	6	16.00	Blue	1.142 / 29.0	0.708 / 18.0	0.236 / 6.0	0.346 / 8.8	0.008 / 0.20	T3 & ERG4	F2047	4	25.00	1.142 / 29.0	0.630 / 18.0	F2048	4	25.00	Yellow	1.220 / 31.0	0.708 / 18.0	0.295 / 7.5	0.433 / 11.0	0.008 / 0.20	ERG4	F2049	4	25.00	1.378 / 35.0	0.866 / 22.0	F2050	2	35.00	Red	1.181 / 30.0	0.630 / 16.0	0.335 / 8.5	0.492 / 12.5	0.014 / 0.35	ERG4	F2051	2	35.00	1.260 / 32.0	0.708 / 18.0	F2052	2	35.00	Red	1.535 / 39.0	0.984 / 25.0	0.335 / 8.5	0.492 / 12.5	0.014 / 0.35	ERG4	F2053	1/0	50.00	1.417 / 36.0	0.787 / 20.0	F2054	1/0	50.00	Blue	1.614 / 41.0	0.984 / 25.0	0.413 / 10.5	0.591 / 15.0	0.014 / 0.35	ERG4																																																																																																																																																							
F2036	14	2.50	Blue	0.748 / 19.0	0.472 / 12.0	0.091 / 2.3	0.165 / 4.2	0.006 / 0.15	T1, T3 & ERG4																																																																																																																																																																																																																																																																																																								
F2037	14	2.50		0.984 / 25.0	0.708 / 18.0					F2038	12	4.00	Grey	0.889 / 17.5	0.394 / 10.0	0.114 / 2.9	0.189 / 4.8	0.008 / 0.20	T3 & ERG4	F2039	12	4.00	0.787 / 20.0	0.472 / 12.0	F2040	12	4.00	Yellow	1.024 / 26.0	0.708 / 18.0	0.142 / 3.6	0.244 / 6.2	0.008 / 0.20	T3 & ERG4	F2041	10	6.00	0.787 / 20.0	0.472 / 12.0	F2042	10	6.00	Yellow	0.984 / 25.0	0.708 / 18.0	0.142 / 3.6	0.244 / 6.2	0.008 / 0.20	T3 & ERG4	F2043	8	10.00	0.827 / 21.0	0.472 / 12.0	F2044	8	10.00	Red	1.063 / 27.0	0.708 / 18.0	0.181 / 4.6	0.295 / 7.5	0.008 / 0.20	T3 & ERG4	F2045	6	16.00	0.906 / 23.0	0.472 / 12.0	F2046	6	16.00	Blue	1.142 / 29.0	0.708 / 18.0	0.236 / 6.0	0.346 / 8.8	0.008 / 0.20	T3 & ERG4	F2047	4	25.00	1.142 / 29.0	0.630 / 18.0	F2048	4	25.00	Yellow	1.220 / 31.0	0.708 / 18.0	0.295 / 7.5	0.433 / 11.0	0.008 / 0.20	ERG4	F2049	4	25.00	1.378 / 35.0	0.866 / 22.0	F2050	2	35.00	Red	1.181 / 30.0	0.630 / 16.0	0.335 / 8.5	0.492 / 12.5	0.014 / 0.35	ERG4	F2051	2	35.00	1.260 / 32.0	0.708 / 18.0	F2052	2	35.00	Red	1.535 / 39.0	0.984 / 25.0	0.335 / 8.5	0.492 / 12.5	0.014 / 0.35	ERG4	F2053	1/0	50.00	1.417 / 36.0	0.787 / 20.0	F2054	1/0	50.00	Blue	1.614 / 41.0	0.984 / 25.0	0.413 / 10.5	0.591 / 15.0	0.014 / 0.35	ERG4																																																																																																																																																																						
F2038	12	4.00	Grey	0.889 / 17.5	0.394 / 10.0	0.114 / 2.9	0.189 / 4.8	0.008 / 0.20	T3 & ERG4																																																																																																																																																																																																																																																																																																								
F2039	12	4.00		0.787 / 20.0	0.472 / 12.0					F2040	12	4.00	Yellow	1.024 / 26.0	0.708 / 18.0	0.142 / 3.6	0.244 / 6.2	0.008 / 0.20	T3 & ERG4	F2041	10	6.00	0.787 / 20.0	0.472 / 12.0	F2042	10	6.00	Yellow	0.984 / 25.0	0.708 / 18.0	0.142 / 3.6	0.244 / 6.2	0.008 / 0.20	T3 & ERG4	F2043	8	10.00	0.827 / 21.0	0.472 / 12.0	F2044	8	10.00	Red	1.063 / 27.0	0.708 / 18.0	0.181 / 4.6	0.295 / 7.5	0.008 / 0.20	T3 & ERG4	F2045	6	16.00	0.906 / 23.0	0.472 / 12.0	F2046	6	16.00	Blue	1.142 / 29.0	0.708 / 18.0	0.236 / 6.0	0.346 / 8.8	0.008 / 0.20	T3 & ERG4	F2047	4	25.00	1.142 / 29.0	0.630 / 18.0	F2048	4	25.00	Yellow	1.220 / 31.0	0.708 / 18.0	0.295 / 7.5	0.433 / 11.0	0.008 / 0.20	ERG4	F2049	4	25.00	1.378 / 35.0	0.866 / 22.0	F2050	2	35.00	Red	1.181 / 30.0	0.630 / 16.0	0.335 / 8.5	0.492 / 12.5	0.014 / 0.35	ERG4	F2051	2	35.00	1.260 / 32.0	0.708 / 18.0	F2052	2	35.00	Red	1.535 / 39.0	0.984 / 25.0	0.335 / 8.5	0.492 / 12.5	0.014 / 0.35	ERG4	F2053	1/0	50.00	1.417 / 36.0	0.787 / 20.0	F2054	1/0	50.00	Blue	1.614 / 41.0	0.984 / 25.0	0.413 / 10.5	0.591 / 15.0	0.014 / 0.35	ERG4																																																																																																																																																																																					
F2040	12	4.00	Yellow	1.024 / 26.0	0.708 / 18.0	0.142 / 3.6	0.244 / 6.2	0.008 / 0.20	T3 & ERG4																																																																																																																																																																																																																																																																																																								
F2041	10	6.00		0.787 / 20.0	0.472 / 12.0					F2042	10	6.00	Yellow	0.984 / 25.0	0.708 / 18.0	0.142 / 3.6	0.244 / 6.2	0.008 / 0.20	T3 & ERG4	F2043	8	10.00	0.827 / 21.0	0.472 / 12.0	F2044	8	10.00	Red	1.063 / 27.0	0.708 / 18.0	0.181 / 4.6	0.295 / 7.5	0.008 / 0.20	T3 & ERG4	F2045	6	16.00	0.906 / 23.0	0.472 / 12.0	F2046	6	16.00	Blue	1.142 / 29.0	0.708 / 18.0	0.236 / 6.0	0.346 / 8.8	0.008 / 0.20	T3 & ERG4	F2047	4	25.00	1.142 / 29.0	0.630 / 18.0	F2048	4	25.00	Yellow	1.220 / 31.0	0.708 / 18.0	0.295 / 7.5	0.433 / 11.0	0.008 / 0.20	ERG4	F2049	4	25.00	1.378 / 35.0	0.866 / 22.0	F2050	2	35.00	Red	1.181 / 30.0	0.630 / 16.0	0.335 / 8.5	0.492 / 12.5	0.014 / 0.35	ERG4	F2051	2	35.00	1.260 / 32.0	0.708 / 18.0	F2052	2	35.00	Red	1.535 / 39.0	0.984 / 25.0	0.335 / 8.5	0.492 / 12.5	0.014 / 0.35	ERG4	F2053	1/0	50.00	1.417 / 36.0	0.787 / 20.0	F2054	1/0	50.00	Blue	1.614 / 41.0	0.984 / 25.0	0.413 / 10.5	0.591 / 15.0	0.014 / 0.35	ERG4																																																																																																																																																																																																				
F2042	10	6.00	Yellow	0.984 / 25.0	0.708 / 18.0	0.142 / 3.6	0.244 / 6.2	0.008 / 0.20	T3 & ERG4																																																																																																																																																																																																																																																																																																								
F2043	8	10.00		0.827 / 21.0	0.472 / 12.0					F2044	8	10.00	Red	1.063 / 27.0	0.708 / 18.0	0.181 / 4.6	0.295 / 7.5	0.008 / 0.20	T3 & ERG4	F2045	6	16.00	0.906 / 23.0	0.472 / 12.0	F2046	6	16.00	Blue	1.142 / 29.0	0.708 / 18.0	0.236 / 6.0	0.346 / 8.8	0.008 / 0.20	T3 & ERG4	F2047	4	25.00	1.142 / 29.0	0.630 / 18.0	F2048	4	25.00	Yellow	1.220 / 31.0	0.708 / 18.0	0.295 / 7.5	0.433 / 11.0	0.008 / 0.20	ERG4	F2049	4	25.00	1.378 / 35.0	0.866 / 22.0	F2050	2	35.00	Red	1.181 / 30.0	0.630 / 16.0	0.335 / 8.5	0.492 / 12.5	0.014 / 0.35	ERG4	F2051	2	35.00	1.260 / 32.0	0.708 / 18.0	F2052	2	35.00	Red	1.535 / 39.0	0.984 / 25.0	0.335 / 8.5	0.492 / 12.5	0.014 / 0.35	ERG4	F2053	1/0	50.00	1.417 / 36.0	0.787 / 20.0	F2054	1/0	50.00	Blue	1.614 / 41.0	0.984 / 25.0	0.413 / 10.5	0.591 / 15.0	0.014 / 0.35	ERG4																																																																																																																																																																																																																			
F2044	8	10.00	Red	1.063 / 27.0	0.708 / 18.0	0.181 / 4.6	0.295 / 7.5	0.008 / 0.20	T3 & ERG4																																																																																																																																																																																																																																																																																																								
F2045	6	16.00		0.906 / 23.0	0.472 / 12.0					F2046	6	16.00	Blue	1.142 / 29.0	0.708 / 18.0	0.236 / 6.0	0.346 / 8.8	0.008 / 0.20	T3 & ERG4	F2047	4	25.00	1.142 / 29.0	0.630 / 18.0	F2048	4	25.00	Yellow	1.220 / 31.0	0.708 / 18.0	0.295 / 7.5	0.433 / 11.0	0.008 / 0.20	ERG4	F2049	4	25.00	1.378 / 35.0	0.866 / 22.0	F2050	2	35.00	Red	1.181 / 30.0	0.630 / 16.0	0.335 / 8.5	0.492 / 12.5	0.014 / 0.35	ERG4	F2051	2	35.00	1.260 / 32.0	0.708 / 18.0	F2052	2	35.00	Red	1.535 / 39.0	0.984 / 25.0	0.335 / 8.5	0.492 / 12.5	0.014 / 0.35	ERG4	F2053	1/0	50.00	1.417 / 36.0	0.787 / 20.0	F2054	1/0	50.00	Blue	1.614 / 41.0	0.984 / 25.0	0.413 / 10.5	0.591 / 15.0	0.014 / 0.35	ERG4																																																																																																																																																																																																																																		
F2046	6	16.00	Blue	1.142 / 29.0	0.708 / 18.0	0.236 / 6.0	0.346 / 8.8	0.008 / 0.20	T3 & ERG4																																																																																																																																																																																																																																																																																																								
F2047	4	25.00		1.142 / 29.0	0.630 / 18.0					F2048	4	25.00	Yellow	1.220 / 31.0	0.708 / 18.0	0.295 / 7.5	0.433 / 11.0	0.008 / 0.20	ERG4	F2049	4	25.00	1.378 / 35.0	0.866 / 22.0	F2050	2	35.00	Red	1.181 / 30.0	0.630 / 16.0	0.335 / 8.5	0.492 / 12.5	0.014 / 0.35	ERG4	F2051	2	35.00	1.260 / 32.0	0.708 / 18.0	F2052	2	35.00	Red	1.535 / 39.0	0.984 / 25.0	0.335 / 8.5	0.492 / 12.5	0.014 / 0.35	ERG4	F2053	1/0	50.00	1.417 / 36.0	0.787 / 20.0	F2054	1/0	50.00	Blue	1.614 / 41.0	0.984 / 25.0	0.413 / 10.5	0.591 / 15.0	0.014 / 0.35	ERG4																																																																																																																																																																																																																																																	
F2048	4	25.00	Yellow	1.220 / 31.0	0.708 / 18.0	0.295 / 7.5	0.433 / 11.0	0.008 / 0.20	ERG4																																																																																																																																																																																																																																																																																																								
F2049	4	25.00		1.378 / 35.0	0.866 / 22.0					F2050	2	35.00	Red	1.181 / 30.0	0.630 / 16.0	0.335 / 8.5	0.492 / 12.5	0.014 / 0.35	ERG4	F2051	2	35.00	1.260 / 32.0	0.708 / 18.0	F2052	2	35.00	Red	1.535 / 39.0	0.984 / 25.0	0.335 / 8.5	0.492 / 12.5	0.014 / 0.35	ERG4	F2053	1/0	50.00	1.417 / 36.0	0.787 / 20.0	F2054	1/0	50.00	Blue	1.614 / 41.0	0.984 / 25.0	0.413 / 10.5	0.591 / 15.0	0.014 / 0.35	ERG4																																																																																																																																																																																																																																																																
F2050	2	35.00	Red	1.181 / 30.0	0.630 / 16.0	0.335 / 8.5	0.492 / 12.5	0.014 / 0.35	ERG4																																																																																																																																																																																																																																																																																																								
F2051	2	35.00		1.260 / 32.0	0.708 / 18.0					F2052	2	35.00	Red	1.535 / 39.0	0.984 / 25.0	0.335 / 8.5	0.492 / 12.5	0.014 / 0.35	ERG4	F2053	1/0	50.00	1.417 / 36.0	0.787 / 20.0	F2054	1/0	50.00	Blue	1.614 / 41.0	0.984 / 25.0	0.413 / 10.5	0.591 / 15.0	0.014 / 0.35	ERG4																																																																																																																																																																																																																																																																															
F2052	2	35.00	Red	1.535 / 39.0	0.984 / 25.0	0.335 / 8.5	0.492 / 12.5	0.014 / 0.35	ERG4																																																																																																																																																																																																																																																																																																								
F2053	1/0	50.00		1.417 / 36.0	0.787 / 20.0					F2054	1/0	50.00	Blue	1.614 / 41.0	0.984 / 25.0	0.413 / 10.5	0.591 / 15.0	0.014 / 0.35	ERG4																																																																																																																																																																																																																																																																																														
F2054	1/0	50.00	Blue	1.614 / 41.0	0.984 / 25.0	0.413 / 10.5	0.591 / 15.0	0.014 / 0.35	ERG4																																																																																																																																																																																																																																																																																																								

Ferrule dimensions conform to DIN 46228, Part 4

Insulated Ferrules

Strip Lengths



Cat. No.	Pin Length (in.)	Min. strip Length (in.)	Max. strip Length (in.)
F2020	0.236	0.3147	0.354
F2021	0.315	0.3937	0.433
F2022	0.394	0.4727	0.512
F2023	0.236	0.3147	0.354
F2024	0.315	0.3937	0.433
F2025	0.394	0.4727	0.512
F2026	0.472	0.5507	0.59
F2027	0.236	0.3147	0.354
F2028	0.315	0.3937	0.433
F2029	0.394	0.4727	0.512
F2030	0.472	0.5507	0.59
F2031	0.315	0.3937	0.433
F2032	0.394	0.4727	0.512
F2033	0.472	0.5507	0.59
F2034	0.708	0.7867	0.826
F2035	0.315	0.3937	0.433
F2036	0.472	0.5507	0.59
F2037	0.708	0.7867	0.826
F2038	0.394	0.4727	0.512
F2039	0.472	0.5507	0.59
F2040	0.708	0.7867	0.826
F2041	0.472	0.5507	0.59
F2042	0.708	0.7867	0.826
F2043	0.472	0.5507	0.59
F2044	0.708	0.7867	0.826
F2045	0.472	0.5507	0.59
F2046	0.708	0.7867	0.826
F2047	0.63	0.7087	0.748
F2048	0.708	0.7867	0.826
F2049	0.866	0.9447	0.984
F2050	0.53	0.6087	0.648
G2051	0.708	0.7867	0.826
G2052	0.984	1.0627	1.102
G2053	0.787	0.8657	0.905
F2054	0.984	1.0627	1.102

Cat. No.	Pin Length (in.)	Min. strip Length (in.)	Max. strip Length (in.)
F4000	0.315	0.3937	0.433
F4001			
F4002			
F4003			
F4004	0.236	0.3147	0.354
F4005	0.315	0.3937	0.433
F4006	0.236	0.3147	0.354
F4007	0.315	0.3937	0.433
F4008	0.236	0.3147	0.354
F4009	0.315	0.3937	0.433
F4020			
F4021			
F4022			
F4023			
F4024			
F4027			
F4028			

Note: The stripping length is based on the thickness of the insulation wire - more thickness, more stripping length.

Ferrules

Insulated Twin Ferrules

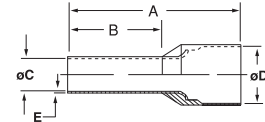

Cat. No.	Conductor Section		Colour	Dimensions in./mm				E	Installation Tooling	Pkg. Qty.
	AWG	mm ²		A	B	øC	øD			
F8000	2 x 20	2 x 0.50	White	0.591 / 15.0	0.315 / 8.0	0.059 / 1.5	0.177 / 4.5	0.010 / 0.25	T3	500
F8001	2 x 18	2 x 0.75	Grey	0.591 / 15.0	0.315 / 8.0	0.071 / 1.8	0.201 / 5.1			
F8002	2 x 18	2 x 0.75	Red	0.669 / 17.0	0.394 / 10.0	0.071 / 1.8	0.201 / 5.1			
F8003	2 x 17	2 x 1.00		0.591 / 15.0	0.315 / 8.0	0.081 / 2.05	0.201 / 5.1			
F8005	2 x 17	2 x 1.00	Black	0.669 / 17.0	0.394 / 10.0	0.081 / 2.05	0.201 / 5.1			
F8006	2 x 16	2 x 1.50		0.630 / 16.0	0.315 / 8.0	0.091 / 2.3	0.252 / 6.4			
F8007	2 x 16	2 x 1.50	Blue	0.787 / 20.0	0.472 / 12.0	0.091 / 2.3	0.252 / 6.4			
F8008	2 x 14	2 x 2.50		0.728 / 18.5	0.394 / 10.0	0.114 / 2.9	0.295 / 7.5			
F8009	2 x 14	2 x 2.50	Grey	0.846 / 21.5	0.512 / 13.0	0.114 / 2.9	0.295 / 7.5			
F8010	2 x 12	2 x 4.00		0.906 / 23.0	0.472 / 12.0	0.150 / 3.8	0.339 / 8.6			
F8011	2 x 10	2 x 6.00	Yellow	0.984 / 25.0	0.551 / 14.0	0.193 / 4.9	0.378 / 9.6	0.008 / 0.20	ERG4/6MM DIE	100
									ERG4/10MM DIE	100

Ferrule dimensions conform to DIN 46228, Part 4

Insulated Ferrules (Old DIN and French Standards)

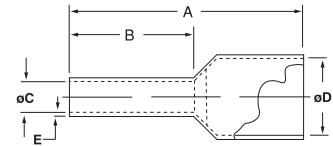

Cat. No.	Style	Conductor		Colour	Dimensions in./mm				E	Installation Tooling	Pkg. Qty.
		AWG	mm ²		A	B	øC	øD			
F4000	OLD DIN	20	0.50	Orange	0.571 / 14.5	0.315 / 8.0	0.043 / 1.1	0.102 / 2.6	0.006 / 0.15	T1, T3 & ERG4	500
F4001		18	0.75	White			0.051 / 1.3	0.110 / 2.8			
F4002		18-17	1.00	Yellow			0.059 / 1.5	0.118 / 3.0			
F4003		16	1.50	Red			0.071 / 1.8	0.134 / 3.4			
F4020		14	2.50	Blue			0.091 / 2.3	0.165 / 4.2			
F4021	FRENCH	20	0.50	White	0.571 / 14.5	0.315 / 8.0	0.043 / 1.1	0.102 / 2.6	0.006 / 0.15	T1, T3 & ERG4	500
F4023		18	0.75	Lt. Blue			0.051 / 1.3	0.110 / 2.8			
F4024		18-17	1.00	Red			0.059 / 1.5	0.118 / 3.0			
F4027		16	1.50	Black			0.071 / 1.8	0.134 / 3.4			
F4028		14	2.50	Grey			0.091 / 2.3	0.165 / 4.2			

Ferrule dimensions conform to DIN 46228, Part 4

Tooling for Sta-Kon® Insulated Ferrules

The crimping tools you need!

Cat. No.	Description	Pkg. Qty.
T1	Sta-Kon® Crimp Tool for wire ferrules #20-#14 AWG — insulated handle	1
T3	Sta-Kon® Crimp Tool for wire ferrules #26-#10 AWG — insulated handle	1
ERG4	Comfort Crimp™ Sta-Kon® Crimp Tool with Shure-Stake® mechanism, for installing wire ferrules #26-1/0 AWG. Four interchangeable die sets included. Insulated handle. Packaged in sturdy plastic carrying case	1



T1



ERG4



T3

Ferrules

Non-Insulated Ferrules

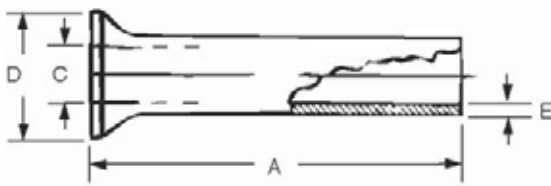

Cat. No.	Conductor Section		Dimensions in./mm			E	Installation Tooling	Pkg. Qty.
	AWG	mm ²	A	C	D			
F9000	24	0.25	0.196 / 5	0.030 / 0.75	0.067 / 1.7	0.006 / 0.15	T1, T3, ERG4	1,000
F9001	22	0.5	0.236 / 6	0.039 / 1.0	0.083 / 2.1			
F9002	22	0.5	0.394 / 10	0.039 / 1.0	0.083 / 2.1			
F9003	18	0.75	0.236 / 6	0.047 / 1.2	0.091 / 2.3			
F9004	18	0.75	0.394 / 10	0.047 / 1.2	0.091 / 2.3			
F9005	18	1	0.236 / 6	0.055 / 1.4	0.098 / 2.5			
F9006	18	1	0.394 / 10	0.055 / 1.4	0.098 / 2.5			
F9007	16	1.5	0.276 / 7	0.067 / 1.7	0.110 / 2.8			
F9008	16	1.5	0.394 / 10	0.067 / 1.7	0.110 / 2.8			
F9009	16	1.5	0.473 / 12	0.067 / 1.7	0.110 / 2.8			
F9010	16	1.5	0.709 / 18	0.067 / 1.7	0.110 / 2.8			
F9011	14	2.5	0.276 / 7	0.087 / 2.2	0.139 / 3.4			
F9012	14	2.5	0.394 / 10	0.087 / 2.2	0.139 / 3.4			
F9013	14	2.5	0.472 / 12	0.087 / 2.2	0.139 / 3.4			
F9014	14	2.5	0.709 / 18	0.087 / 2.2	0.139 / 3.4			
F9015	12	4	0.354 / 9	0.110 / 2.8	0.158 / 4			
F9016	12	4	0.472 / 12	0.110 / 2.8	0.158 / 4			
F9017	12	4	0.591 / 15	0.110 / 2.8	0.158 / 4			
F9018	12	4	0.709 / 18	0.110 / 2.8	0.158 / 4			
F9019	10	6	0.472 / 12	0.138 / 3.5	0.185 / 4.7			
F9020	10	6	0.591 / 15	0.138 / 3.5	0.185 / 4.7			
F9021	10	6	0.709 / 18	0.138 / 3.5	0.185 / 4.7			
F9022	8	10	0.472 / 12	0.177 / 4.5	0.228 / 5.8			
F9023	8	10	0.591 / 15	0.177 / 4.5	0.228 / 5.8			
F9024	8	10	0.709 / 18	0.177 / 4.5	0.228 / 5.8			
F9025	6	16	0.472 / 12	0.228 / 5.8	0.295 / 7.5			
F9026	6	16	0.591 / 15	0.228 / 5.8	0.295 / 7.5			
F9027	6	16	0.709 / 18	0.228 / 5.8	0.295 / 7.5			
F9028	6	16	0.984 / 25	0.228 / 5.8	0.295 / 7.5			
F9029	6	16	1.26 / 32	0.228 / 5.8	0.295 / 7.5			
F9030	4	25	0.591 / 15	0.287 / 7.3	0.374 / 9.5			
F9031	4	25	0.709 / 18	0.287 / 7.3	0.374 / 9.5			
F9032	4	25	0.984 / 25	0.287 / 7.3	0.374 / 9.5			
F9033	4	25	1.26 / 32	0.287 / 7.3	0.374 / 9.5			
F9034	2	35	0.709 / 18	0.327 / 8.3	0.433 / 11			
F9035	2	35	0.984 / 25	0.327 / 8.3	0.433 / 11			
F9036	2	35	1.26 / 32	0.327 / 8.3	0.433 / 11			
F9037	1/0	50	0.709 / 18	0.406 / 10.3	0.512 / 13			
F9038	1/0	50	0.984 / 25	0.406 / 10.3	0.512 / 13			
F9039	1/0	50	1.18 / 30	0.406 / 10.3	0.512 / 13			

Installing Kits

Sta-Kon® Mini-Pack Terminals

Convenient 20-count packaging!



- Wire ranges from #22 AWG to #10 AWG
- Vinyl insulated ring and forked-tongued terminals, female disconnects, butt-type splice connectors

Note: "CP" designates mini-pack quantities. Refer to other catalogue pages for description and dimensional information.

Cat. No.	Unit Qty.	Pkg. Qty.	Wire Range	Bolt Hole
18RA-6FCP	20	100	22-18	#6
18RA-8CP			22-18	#8
18RA-10CP			22-18	#10
14RB-6CP			16-14	#6
14RB-8CP			16-14	#8
14RB-10CP			16-14	#10
10RC-10CP			12-10	#10
10RC-14CP			12-10	1/4
18RA-8FCP			22-18	#8
18RA-10FCP			22-18	#10
14RB-6FCP			16-14	#6
14RB-8FCP			16-14	#8
14RB-10FCP			16-14	#10
10RC-8FCP			12-10	#8
10RC-10FCP			12-10	10
2RA18XCP			22-18	—
2RB14XCP			16-14	—
2RC10XCP			12-10	—
18RA-250FCP			22-18	—
14RB-250FCP			16-14	—
10RC-250FCP	12-10	—		

Installing Kits

Sta-Org™ Terminal and Splice Organizer Kit

Lightweight, durable, nylon construction!

- Ideal for contractors, OEMs or any other user of terminals and splices
- Slips in a tool box or sits on your bench — only 6.6 in. L x 3 in. dia.
- Bench-mountable (hardware included) Kit Contents
- (1) blue nylon organizer/carrier
- (6) see-through nylon canisters with lids
- (20) #12–#10 AWG vinyl ring terminals (Cat. No. 10RC-10)
- (25) #18–#14 AWG vinyl ring terminals (Cat. No. 14RB-10)
- (15) #12–#10 AWG vinyl butt splices (Cat. No. 2RC-10X)
- (25) #18–#14 AWG vinyl butt splices (Cat. No. 2RB-14X)
- (20) #12–#10 AWG vinyl fork terminals (Cat. No. 10RC-10F)
- (25) #18–#14 AWG vinyl fork terminals (Cat. No. 14RB-10F)

Cat. No.	Description	Pkg. Qty.
STA-ORG	Sta-Kon® Sta-Org™ Terminal and Splice Organizer Kit	1



Installing Kits



Terminal Kits

For residential or light commercial installations we recommend this proven assortment of popular Sta-Kon® vinyl terminals. This kit includes a WT112M crimping tool.

Kit contains

- 36 2RA18X butt splices for 22 - 16 AWG
- 36 18RA-8F fork terminals for 22 - 16 AWG
- 36 18RA-10F fork terminals for 22 - 16 AWG
- 36 18RA-8 ring terminals for 22 - 16 AWG
- 36 18RA-10 ring terminals for 22 - 16 AWG
- 36 RBB217-200 butt splices for 16 - 14 AWG
- 36 14RB-10F fork terminals for 18 - 14 AWG
- 36 18RA-250F disconnects for 22 - 18 AWG
- 36 14RB-8F fork terminals for 18 - 14 AWG
- 36 14RB-8 ring terminals for 18 - 14 AWG
- 36 14RB-10 ring terminals for 18 - 14 AWG
- 25 RCC217-250 butt splices for 12 - 10 AWG
- 25 10RC-8F fork terminals for 12 - 10 AWG
- 25 10RC-10 ring terminals for 12 - 10 AWG
- 20 RC6 wire joints
- 1 WT112M crimping tool
- 50 822D wire connectors XTP blue #22-#8 AWG

Cat. No.	Description	Pkg. Qty.
SK-CLASSIQUE	Terminal Kit	1

STAKIT Installing Kit

Perfect for residential or light commercial installations!

- Assortment of popular Sta-Kon® vinyl terminals
- Kit includes a WT112M crimping tool
- Includes cable ties and wire marker book



Kit contains

- 100 2RA18X butt splices for 22 - 18 AWG
- 100 2RB14X butt splices for 18 - 14 AWG
- 50 2RC10X butt splices for 12 - 10 AWG
- 50 10RC-10 ring terminals for 12 - 10 AWG
- 50 10RC-10FL locking fork terminals for 12 - 10 AWG
- 50 10RC-250F disconnects for 12 - 10 AWG
- 100 14RB-10 ring terminals for 18 - 14 AWG
- 100 14RB-8FL locking fork terminals for 18 - 14 AWG
- 100 14RB-250F disconnects for 18 - 14 AWG
- 100 18RA-8F fork terminals for 22 - 18 AWG
- 100 18RA-6FL locking fork terminals for 22 - 18 AWG
- 100 18RA-250F disconnects for 22 - 18 AWG
- 1 WM-0-THRU9 wire marker book
- 1 WT112M crimping tool
- 100 TY525M Ty-Rap® cable ties (approx. length 7-1/2)

Cat. No.	Description	Pkg. Qty.
STAKIT	Assortment of Sta-Kon® vinyl terminals, splices and disconnects. Includes crimp tool, cable ties and wire book marker	1

Note: All splices, terminals and disconnects are vinyl insulated.

Application Tools

Recommended Tools

The Shure-Stake® mechanism on mechanical ratchet tools and power tools prevents the dies from releasing the terminal until the proper compression has been completed. With this method, an operator achieves a reliable crimp every time. Thomas & Betts tooling techniques correctly match tools, wire size, and terminal to produce optimum mechanical and electrical performance.

Plier type if installations are fewer than 20 per day



WT112M

Ratchet type if installations are more than 20 per day



ERG4001

Power type if installations are more than 200 per day



12050



Plier-Type Tools

Used for installation of various Sta-Kon® terminal series



WT110M



WT111M



WT112M



WT161M



WT2000

Cat. No.	Description	Pkg. Qty.
WT110M	A, B, C non-insulated terminals and splices and A, B non-insulated terminals with insulation grip	1
WT111M	A, B, C, PT non-insulated terminals and splices; includes cutters	
WT112M	A, B, C non-insulated and RA, RB, RC insulated nylon and vinyl terminals and splices; includes cutters	
WT161M	A, B, C, PT non-insulated terminals and splices; includes plier grip and cutters	
WT2000	A, B, C, AB, PT, RA, RB, RC insulated and non-insulated terminals and splices; includes wire cutters, bolt cutters and wire stripper	

Application Tools

The proper installation procedure for the quality-assured connection!

The proper installation of terminals, splices and connectors is very important to the efficient performance of an electrical system. The properly installed connector will enable good conductivity through the termination. Certain basic requirements must be met to make a good termination.

- Strip the insulation carefully to avoid nicking or cutting conductor strands
- Strip the insulation to the proper length so the conductors can be inserted fully into the connector barrel; the wire/cable should be visible in the inspection hole of the lug

A poor termination results in a high-resistance connection.

A poor connector installation may cause damage or failure of an entire system.

Installation Procedure

1. Strip the insulation carefully to avoid nicking or cutting conductor strands.
2. Strip the insulation to the proper length so the conductors can be inserted fully into the connector barrel; the wire/cable should be visible in the inspection hole of the lug.
3. Train the wires to eliminate fanning of strands.
4. Open handles fully.
5. Insert terminal in proper die nest and locate it as shown on the right. When crimping a butt splice, position in proper die nest with window facing indenter.
6. Close handles slightly to secure terminal. Do not deform terminal.
7. Insert properly stripped wire into terminal.
8. Complete crimp by closing handles.

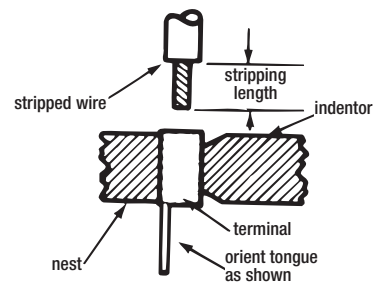

Shure-Stake® tools are matched to terminals



ERG4001

Safety Warning: Keep fingers and hands away from mechanism during crimp function.

Application Tools

Redesigned family of termination tools sets a new standard for manual crimping tools!

The most comfortable crimp available from a manual compression tool!

Sta-Kon® Comfort Crimp™ Compression Tools previously set the standard for manual crimp tools. Now, Thomas & Betts engineers have made a great line of tools even better with the newly redesigned Sta-Kon® Comfort Crimp™ Compression Tools. We kept all the performance features that made the tools industry leaders such as the Shure-Stake® mechanism and interchangeable dies with colour-coded die nests, and focused on creating the best possible user experience in terms of comfort and reduction of strain.

Ergonomic handles position the user's hands correctly to minimize the risk of strain, and soft, over-molded grips cushion fingers and palm for user comfort. A new Crimp-Assist™ foot stabilizes the tool when the user needs to place it on a work surface for leverage to crimp larger connectors. Best of all, the redesigned Comfort Crimp™ tools require 25% less handle force to complete the crimp cycle than the previous generation — and up to 75% less handle force than competing tools!

Requiring the lowest handle force of any tool in its class, the new Comfort Crimp™ family provides maximum comfort to installers, without sacrificing the durability or performance associated with Thomas & Betts tools.

Colour-coded die nests (left and right side) provided for proper crimping of insulated terminals

Shure-Stake® mechanism ensures a proper crimp every time

Crimp-Assist™ foot provides stability when work surface leverage is needed to crimp larger connectors



Ergonomically advanced, soft, over-molded handle grips reduce strain and enhance user comfort

Requires the lowest handle force of any tooling its class — 25% less than the previous generation of Comfort Crimp™ tools

- Perfect for OEM, MRO and field use
- UL Listed for use with Sta-Kon® connectors
- Shure-Stake® mechanism ensures a complete crimp cycle before release for a proper crimp every time
- Colour-coded die nests for easy matching with Sta-Kon® insulated terminals
- Creates integrity dots for quick verification of proper crimp
- Advanced manufacturing methods for improved durability and tool life
- Lanyard hole in handle for easy tethering to workstation
- Calibration service available through T&B Tool Services



Cat. No.	For use with STA-KON® Series	Pkg. Qty.
ERG4001	RA, RB, RC nylon & vinyl terminals, splices & disconnects	1
ERG4002	A, B, C non-insulated terminals, splices, disconnects	
ERG4004	A, B and C flag terminals	
ERG4005	B, C, D, E non-insulated terminals, splices, (D & E tubular only)	
ERG4006	RA, RB disconnects and RZ terminals	
ERG4007	RD & RE insulated terminals (tubular only)	
ERG4008	Non-insulated terminals #8–1/0 AWG (tubular only)	

Note: Contact Tool Services for gauging

Application Tools

WT1377 Ratchet Hand Tool

Correct compression every time — the Shure-Stake® mechanism principle prevents opening of the handles until full staking action is completed. Installs self-insulated and non-insulated Sta-Kon® terminal series in the #26–#10 AWG wire range.



Cat. No.	For use with STA-KON® Series	Pkg. Qty.
WT1377	NW ring terminals	1

WT2130A Ratchet Hand Tool



Cat. No.	For use with STA-KON® Series	Pkg. Qty.
WT2130A	RC, RBC and RD insulated terminals, RC6, RP7 wire joints	1

ERG4006 Hand Tool



Cat. No.	For use with STA-KON® Series	Pkg. Qty.
ERG4006	RZ terminals/splices RA, RB insulated disconnects	1

WT3185 Ratchet Hand Tool



Cat. No.	For use with STA-KON® Series	Pkg. Qty.
WT3185	For #8 AWG to 250 kcmil non-insulated Sta-Kon® Terminals	1

Note: For gauging information, contact Tool Services

ERG4255 Ratchet Hand Tool



Cat. No.	For use with STA-KON® Series	Pkg. Qty.
ERG4255	RA, RB, RC heat-shrinkable nylon-insulated terminals, butt splices, and disconnects	1

WT129 Flag Terminal Type Hand Tool



Cat. No.	For use with STA-KON® Series	Pkg. Qty.
WT129	D, E, F & G non-insulated flag terminals	1

Application Tools

Sta-Kon® ERG1-WS Wire Stripping/Cutting Tool

Integral wire cutter lets user cut and strip with the same tool!

- Interchangeable cassettes enable the user to strip a wide range of insulations without having to change tools
- Tool automatically strips wire to preset length



"V" Blade Cassette

Cat. No.	Description	Pkg. Qty.
ERG1-WS	Ergonomic Wire Stripping Tool	1
VBC-1	Replacement "V" Blade Cassette	

ERG1-WS Wire Stripping/Cutting Tool is shipped with one Straight Blade Cassette (SBC-1).
"V" Blade Cassettes sold separately.

WT115A Toggle-Type Hand Tool



Cat. No.	For use with STA-KON® Series	Pkg. Qty.
WT115A	D, E, F & G non-insulated terminals	1

TBM6 & TBM6S Toggle-Type Hand Tools



TBM6

Installing Dies for Non-Insulated Code and Aircraft Sta-Kon® Terminals

Cat. No.		Term. Size
Nest Stationary Die	Indenter Movable Die	
11803		D, E (Tubular)
11805		E (Brazeed), F (Tubular)
11806	11802	F (Brazeed), G
11807		H
11808		J
11809		K
11810		L
11811		M

Installing Dies for Nylon-Insulated Sta-Kon® Terminals TBM6 & TM6S Tools

Die Set Cat. No.	Term. Size
11821	RD (Tubular)
11822	RD (Brazeed Seam) RE (Tubular)
11823	RF
11824	RG
11825	RH
11826	RJ
11827	RK
11828	RL
11829	RM

Cat. No.	For use with STA-KON® Series	Pkg. Qty.
TBM6	D through M, RD through RM	1
TBM6S	D through M, RD through RM with Shure-Stake®	

Dies not included.

Note: These tools can also be used to crimp Blackburn® Lugs and Splices.

Application Tools

Shure-Stake® Auto-Feed Tool

Safe, fast, high-volume crimping machine!

- Shure-Stake® mechanism
- Fully guarded foot pedal
- Clear plastic safety guard over die area
- Dies colour-coded to terminals
- #26–#10 AWG wire range
- Installs insulated and non-insulated terminals and disconnects



INSTALLING DIES FOR 12050

Die Cat. No.	Sta-kon® Terminal Type	AWG Wire Size	Pkg. Qty.
12051	RA — Nylon	22–18	1
12054*	RA — Vinyl		
12061	RA — Disconnect	16–14	
12052	RB — Nylon		
12055*	RB — Vinyl	12–10	
12062	RB — Disconnect		
12056	RC — Nylon and Vinyl Insulated	22–18	
12057	A — Non-Insulated		
12058	B — Non-Insulated	16–14	
12059	C — Non-Insulated		
12060	C — Disconnect, Non-Insul.	12–10	

* Can also be used on nylon

Cat. No.	Description	Pkg. Qty.
12050	Compact, pneumatically operated unit for crimping tape-mounted Sta-Kon® terminals; equipped with a Shure-Stake® mechanism, which ensures a full compression each time	1

Space Requirement: 30 in. W x 20 in. H x 20 in. D

Weight: 55 lb.

Air Pressure: 90–125 psi input air supply

Application Tools

Battery-Powered Crimping Tool — BAT22-6

1-1/2 tons of grip that weighs less than three pounds!

T&B's newest battery-powered tool is fast and portable for making high-volume and difficult-to-reach terminal installations in a snap. The Sta-Kon® BAT22-6 delivers 1.5 tons of crimping force with an easy, pushbutton trigger. The lightweight, ergonomic design minimizes the risk of repetitive motion injuries that can occur with traditional hand crimping tools. And at less than three pounds, one-hand operation is easy while still packing enough power to crimp up to #6 AWG terminals in seconds.

- Interchangeable dies can be quickly changed to crimp non-insulated and insulated terminals up to #6 AWG
- Dies are the same as our hand tools — crimps will be exactly the same between Sta-Kon® hand tools such as our ERG4001 and the BAT22-6
- 360° rotating head gives the user the added flexibility when crimping hard-to-reach connections
- Short cycle time equates to crimping times of less than two seconds
- Quick, lightweight, and maneuverable
- NiCd battery operation provides long-lasting battery life to complete up to 150 crimps on a single charge
- Extra battery and charger are included with the tool, ensuring round-the-clock operation
- Battery charger provides full battery life in under an hour
- Linear crimping motion gives a symmetric, high-quality crimp every time



Easy to rotate with your wrist — delivers fast and effective crimping power



Uses the exact dies of the Comfort Crimp™ line of ergonomic tools for Sta-Kon® and Dragon Tooth™ terminals

Included Accessories

- Sturdy, plastic carrying case for portability
- Two 9.6V NiCd batteries and battery charger
- Sturdy tray for convenient storage of crimp dies

Cat. No.	Description	Pkg. Qty.
BAT22-6	Battery Crimping Tool, 1.5 Ton with 120-VAC Charger	1
Crimp Dies*		
DIE2001	Insulated #22–#10 AWG Sta-Kon® Terminals	1
DIE2002	Non-Insulated #22–#10 AWG Sta-Kon® Terminals	
DIE2005	Non-Insulated #16–#14/#12–#10/#8–#6 Sta-Kon® Terminals (Tubular Only)	
DIE2007	Insulated #8–#6 AWG Sta-Kon® Terminals (Tubular Only)	

*Dies sold separately.

Note: Battery-powered tools BPI42300CR, BPLT6BSCR and BPLT62BSCR can also be used to crimp non-insulated Sta-Kon® terminals.

PAIR22-6 Air Crimp Tool

Heavy-duty portable tool

- 1.25 tons output force at 100 psi
- Crimps #22–#6 AWG terminals
- Installs Sta-Kon® terminals as well as ferrules and Dragon Tooth™ connectors
- Interchangeable dies
- Open yoke enables easy access to insert and remove terminals for crimping



Cat. No.	Description	Pkg. Qty.
PAIR22-6	Open yoke, hand actuated	1
Crimp Dies*		
DIE2001	Insulated #22–#10 AWG Sta-Kon® Terminals	1
DIE2002	Non-Insulated #22–#10 AWG Sta-Kon® Terminals	
DIE2005	Non-Insulated #16–#10/#8–#6 Sta-Kon® Terminals (Tubular Only)	
DIE2007	Insulated #8–#6 AWG Sta-Kon® Terminals (Tubular Only)	

* Dies sold separately.

Note: The dies for the BAIR22-6, PAIR22-6 and BAT22-6 are interchangeable.

Note: Battery-powered tools BPI42300CR, BPLT6BSCR and BPLT62BSCR can also be used to crimp non-insulated Sta-Kon® terminals.

Application Tools

BAIR22-6 Bench-Mounted Air Tool

Crimps #22–#6 AWG terminals!

- 1.8 tons output force at 100 psi
- Bench-mounted heavy-duty air tool
- Short cycle time
- Shure-Stake® mechanism
- Foot actuated
- Accepts T&B standard hand tool dies
- Installs Sta-Kon® and Spec-Kon™ terminals as well as ferrules and Dragon Tooth™ connectors

Cat. No.	Description	Pkg. Qty.
BAIR22-6	Heavy-duty, high-speed production tool installs a wide range of Sta-Kon® terminals, from #26–#6 gauge; uses the DIE2000 Series dies for both non-insulated and insulated terminals; supplied complete with foot pedal, air hose/air lubricator	1
Crimp Dies*		
DIE2001	Insulated #22–#10 AWG Sta-Kon® Terminals	1
DIE2002	Non-Insulated #22–#10 AWG Sta-Kon® Terminals	
DIE2005	Non-Insulated #16–#10/#8–#6 Sta-Kon® Terminals (Tubular Only)	
DIE2007	Insulated #8–#6 AWG Sta-Kon® Terminals (Tubular Only)	

* Dies sold separately.

Note: The dies for the BAIR22-6, PAIR22-6 and BAT22-6 are interchangeable.

Note: Battery-powered tools BPI42300CR, BPLT6BSCR and BPLT62BSCR can also be used to crimp non-insulated Sta-Kon® terminals.



Air-Operated Bench-Mounted Tool

Crimps #8 AWG–250 kcmil!

Convenience and Economy

The tool accepts a full range of interchangeable dies, the same as used in the TBM6 or TBM6S tools. To install the dies, simply pull the spring-loaded pin and remove the indenter die. Then, flex the retaining spring and remove the die nest.

Shure-Stake® Mechanism Means Quality Connections

The Shure-Stake® mechanism senses inlet air pressure, and if insufficient, is designed to prevent the tool from cycling. Thus you avoid “undercrimping.” An 85–90-psi air pressure source is required.

Safety Features Increase Productivity, Reduce Downtime

Safety features include a guard over the die area, an air shutdown switch activated by a slight push with the finger and a foot pedal that’s enclosed to prevent accidental tool operation. In addition, the tool may be bench-mounted for stability and control. For convenience when crimping large size terminals on heavy wire, the head assembly may overhang the workbench.



Cat. No.	Description	Pkg. Qty.
25000	This compact heavy-duty air tool installs nylon insulated Sta-Kon® terminals on wire sizes from #8 AWG to 250 kcmil; non-insulated styles are also installed just as quickly and dependably; heavy-duty air tool installs non-insulated and insulated Sta-Kon® terminals from #8 AWG to 250 kcmil	1

Note: This tool uses the same dies as the TBM6 and TBM6S hand tools on page B45.

Application Tools

12-Ton Hydraulic Head

Installs insulated and non-insulated Sta-Kon® Terminals!



Cat. No.	Description	Pkg. Qty.
13400	12-ton crimping tool supplied with adapter TBM12D-AR is used for installing both insulated and non-insulated Sta-Kon® terminals #8 AWG to 250 kcmil (dies ordered separately)	1

12-Ton Crimping Tool (Military Spec. MS25441-1)

Military listed and 12 tons of crimping power!



Cat. No.	Description	Pkg. Qty.
13642M	Hydraulic-operated 12-ton tool installs #8 AWG through 250 kcmil Sta-Kon® terminals (dies ordered separately)	1

HEX DIES FOR NON-INSULATED STA-KON® TERMINALS TO FIT 13642M AND 13400

For Tubular Term	Cat. No.	For Braze Seam	Sta-Kon® Size	Wire Size	Hex Die Code
11732	—	11733	D	8	21
—	—	11733	D	8	24
11733	—	11734	E	6	24
—	—	11734	E	6	29
11734	—	11735	F	4	29
—	—	11735	F	4	33
11736	—	—	G	2-1	37
11737	—	—	H	1/0	42
11738	—	—	J	2/0	45
11739	—	—	K	3/0	50
11740	—	—	L	4/0	54
11771	—	—	M	250 kcmil	62

INDENT STYLE DIES FOR STA-KON® BRAZED SEAM NON-INSULATED TERMINALS TO FIT 13642M AND 13400

Nest Cat. No.	Indent. Cat. No.	Sta-Kon® Size	Wire Size	Pkg. Qty.
13643	13650	D	8	1
13644		E	6	
13645		F	4	

INDENT STYLE DIES FOR STA-KON® TUBULAR NON-INSULATED TERMINALS TO FIT 13642M AND 13400

Nest Cat. No.	Indent. Cat. No.	Sta-Kon® Size	Wire Size	Pkg. Qty.
13654	13650	G	2-1	1
13655		H	1/0	
13656		J	2/0	
13657		K	3/0	
13658		L	4/0	
13659		M	250 kcmil	

INSTALLING DIES FOR INSULATED STA-KON® TERMINALS TO FIT 13642M (MILITARY LISTED)

Die Cat. No.	Sta-Kon® Size	Wire Size	Pkg. Qty.
21707M	RD	8	1
21708M	RE	6	
21709M	RF	4	
21710M	RG	2-1	
21711M	RH	1/0	
21712M	RJ	2/0	
21713M	RK	3/0	
21714M	RL	4/0	
21715M	RM	250 kcmil	

HEX DIES FOR NON-INSULATED STA-KON® TERMINALS TO FIT 13642M (MILITARY LISTED)

Die Cat. No.	Sta-Kon® Size	Wire Size	Pkg. Qty.
11781M	D	8	1
11782M	E	6AN	
11783M	F	4AN	
11784M	G	2AN	
11785M	H	1AN	
11786M	J	1/0AN	
11787M	K	2/0AN	
11788M	L	3/0AN	
11789M	M	4/0AN	

INDENT STYLE DIES FOR FLAG TYPE STA-KON® TERMINALS — USE WITH 13642M AND 13400

Nest Cat. No.	Indent. Cat. No.	Sta-Kon® Size	Wire Size	Pkg. Qty.
21733	21731	D	8	1
21734		E	6	
21735		F	4	
21736	21732	G	2	
21737		H	1	
21738		J	1/0	
21739**		K	2/0	
21740**		L	3/0	
21741**		M	4/0	

** Cat. Nos. 21739, 21740 and 21741 dies must be left in 13642M head with 21732 indenter when gauging

Application Tools

13600 Electric Hydraulic Pump

- Designed for use with single-acting cylinders and tools rated for 10,000-psi operation
- Supplied with metal carrying case
- 13620 hand switch and 13619 hydraulic hose, both sold separately, required for operation

Specifications

- Motor: 1/2 hp, 115V 50–60 Hz, 10 amps
- Pumping Capacity:
 - 170 cu. in./min. at 100 psi
 - 32 cu. in./min. at 1,000 psi
 - 25 cu. in./min. at 5,000 psi
 - 18 cu. in./min. at 10,000 psi
- Reservoir Volume: 104 cu. in. (0.45 gal.)
- Basic Pump Dimension: 6 in. x 8 in. x 16 in.
- Weight: 25 lb.



Cat. No.	Description	Pkg. Qty.
13600	Electric Hydraulic Pump — hand or foot switch and nonmetallic hose (sold separately) required for operation	1

13610A Electric Hydraulic Pump with Shure-Stake® Control

- Shure-Stake® control mechanism requires 9,800-psi pump pressure before recycling to prevent under-crimping
- Designed for use with single-acting cylinders and tools rated for 10,000-psi operation
- Supplied with metal carrying case

Specifications

- Motor Rating: 1/2 hp, 115V, 50–60 Hz, 12.5 amps
- Pumping Capacity:
 - 170 cu. in./min. at 100 psi
 - 32 cu. in./min. at 1,000 psi
 - 25 cu. in./min. at 5,000 psi
 - 18 cu. in./min. at 10,000 psi

- Reservoir Volume: 104 cu. in. (0.45 gal.)
- Basic Pump Dimension: 8-1/2 in. x 10-1/2 in. x 16 in.
- Weight: 35 lb.



Cat. No.	Description	Pkg. Qty.
13610A	Electric Hydraulic Pump with Shure-Stake® control — hand or foot switch and nonmetallic hose (sold separately) required for operation	1

Application Tools

13810 Heavy-Duty Electric Hydraulic Pump with Shure-Stake® Control

- Designed for perfect crimps every time in heavy-duty OEM applications
- Heavy-duty OEM two-stage pump with high flow rate
- Shure-Stake® control mechanism requires 9,800-psi pump pressure before recycling to prevent under-crimping
- Requires hand or foot control (sold separately)

Specifications

- Motor Rating: 1-1/2 hp, 115V, 60 Hz, 23 amps
- Pumping Capacity: 235 cu.in./min. at 200 psi
6 cu.in./min. at 8,000 psi
- Reservoir Volume: 462 cu.in./2 gal.
- Dimensions (L x W x H): 10-3/4" x 15" x 20-3/4"
- Weight: 60 lb.



Cat. No.	Description	Pkg. Qty.
13810	Heavy-duty electric hydraulic pump with Shure-Stake® control — hand or foot switch and nonmetallic hose (sold separately) required for operation	1

Accessories for the pumps on these pages

Cat. No.	Description	Pkg. Qty.
You may also need...for 13600		
13620	Hand Switch	1
13589A	Foot Switch	
13619	10-ft. Nonmetallic Hose	
13618	20-ft. Nonmetallic Hose	
13600S	"Sled" type stand for 13600 pump	
You may also need...for 13610A & 13810		
13611	Hand Switch	1
13612	Foot Switch	
13619	10-ft. Nonmetallic Hose	

Die Selection Chart

Critical information for determining the products you need!

Terminal Type	Terminal Series	Pliers					Ergonomic Ratchet Hand Tools						Ratchet Hand Tools	
		WT110M	WT111M	WT112M	WT161M	WT2000	ERG4001	ERG4002	ERG4004	ERG4005	ERG4006	ERG4255	WT1377	WT145A
Nylon Terminals	RZ													
	RA, RAX			•		•	•				•			•
	RB			•		•	•							•
	RBC, RC			•		•	•							•
Nylon Butt Splices	RA			•		•	•							
	RB			•		•	•							
	RC			•		•	•							
Nylon Parallel Splices	RAA					•								
	RBB					•								
	RCC					•								
All Nylon Disconnects (except .110 size)	RA			•		•	•							
	RB			•		•	•							
	RC			•		•	•							
Heat-Shrinkable Terminals, Splices, Disconnects	RAS											•		
	RBS											•		
	RCS											•		
Vinyl Terminals and Splices	RA, RAA			•		•	•							
	RB, RBB			•		•	•							
	RC, RCC, RBC			•		•	•							
Bare Terminals and Splices	A, AA	•	•	•	•	•		•						
	B, BB	•	•	•	•	•		•		•				
	C, CC	•	•	•	•	•		•		•				
Wire Joints	RB			•		•	•							
	RC			•		•								
	RP			•		•								
	PT		•		•									
Hi-Temp Terminals and Splices	NW-Rings												•	
	NW-Splices												•	
Insulation Grip	A	•												
	B	•												
.110 Disconnects	A, B	•	•	•										
	RA, RB													
Flag Terminals	AB								•			•		
	C								•					
Tefzel® Terminals and Splices	RAT, RAAT			•		•								
	RBT, RBBT			•		•								
	RCT, RCCT			•		•								
Vinyl Disconnects	RA			•		•	•							
	RB			•		•	•							
	RC			•		•	•							
Bare Disconnects	A	•	•	•	•	•		•						
	B	•	•	•	•	•		•		•				
	C	•	•	•	•	•		•		•				

Tefzel® is a registered trademark of DuPont

Die Selection Chart

Critical information for determining the products you need!

Terminal Type	Terminal Series	Ratchet Hand Tools (cont.)		BAT22-6 BAIR22-6 PAIR22-6				12050 Mylar Tape Auto Tool								
		WT145C	WT2130A	DIE2001	DIE2002	DIE2005	DIE2009	12051	12052	12054	12055	12056	12057	12058	12059	12060
Nylon Terminals	RZ															
	RA, RAX	•		•				•		•						
	RB	•		•					•		•					
	RBC, RC	•	•	•							•					
Nylon Butt Splices	RA	•		•												
	RB	•		•												
	RC	•	•	•												
Nylon Parallel Splice	RAA															
	RBB															
	RCC															
All Nylon Disconnects (except .110 size)	RA	•		•				•		•						
	RB	•		•					•		•					
	RC	•	•	•								•				
Heat Shrinkable Terminals, Splices, Disconnects	RAS															
	RBS															
	RCS															
Vinyl Terminals and Splices	RA, RAA	•		•						•						
	RB, RBB	•		•							•					
	RC, RCC, RBC	•	•	•								•				
Bare Terminals and Splices	A, AA				•								•			
	B, BB				•	•								•		
	C, CC				•	•									•	
Wire Joints	RB			•				•								
	RC		•					•								
	RP		•					•								
	PT							•								
Hi-Temp Terminals and Splices	NW-Rings															
	NW-Splices															
Insulation Grip	A															
	B															
.110 Disconnects	A, B															
	RA, RB															
Flag Terminals	AB															
	C															
Tefzel® Terminals and Splices	RAT, RAAT	•														
	RBT, RBBT	•														
	RCT, RCCT	•														
Vinyl Disconnects	RA	•		•						•						
	RB	•		•							•					
	RC	•	•	•								•				
Bare Disconnects	A				•								•			
	B				•	•								•		
	C				•	•										•

Tefzel® is a registered trademark of DuPont

Die Selection Chart

Select the die numbers you need!

Description	Terminal		Hand Tool with dies	TBM6 Toggle Hand Tool TBM6S Toggle Hand Tool Die Cat. Nos.		BPI42300CR, BPLT6BSCR and BPLT62BSCR Crimp Tools		13642M (MS25441-1) and 13400 Hydraulic Tool		
	Series	Type		Nest (Stationary)	Indentor (Movable)	Hex Dies	Die Code	Hex Dies	Nest	Indentor
Non-Insulated Terminals and Splices	D	Tubular	ERG4005	11803	11802	—	—	11781M*	13651	13650**
	D	Tubular	ERG4008	11803	11802	—	—	11781M*	13651	13650**
	D	Tubular	WT3185/WT115A	11803	11802	TBM6221	21	11732	13651	13650**
	D	Brazed	WT3185/WT115A	11803	11802	TBM6224	24	11733	13643	13650**
	E	Tubular	ERG4005	11803	11802	—	—	11782M	13652	13650**
	E	Tubular	ERG4008	11803	11802	—	—	11782M	13652	13650**
	E	Tubular	WT3185/WT115A	11803	11802	TBM6224	24	11733*	13652	13650**
	E	Brazed	WT3185/WT115A	11804	11802	TBM6229	29	11734	13644	13650**
	F	Tubular	ERG4008	11805	11802	—	—	11783	13653	13650**
	F	Tubular	WT3185/WT115A	11805	11802	TBM6229	29	11734*	13653	13650**
	F	Brazed	WT3185/WT115A	11806	11802	TBM6233	33	11735	13645	13650**
	G	Tubular	ERG4008	11806	11802	—	—	11784M*	13654	13650**
	G	Tubular	WT3185/WT115A	11806	11802	TBM6237	37	11736	13654	13650**
	H	Tubular	ERG4008	11807	11802	—	—	11785M*	13655	13650**
	H	Tubular	WT3185	11807	11802	—	—	11785M*	13655	13650**
	H	Tubular	WT3185	11807	11802	TBM6242	42	11737	13655	13650**
	J	Tubular	WT3185	11808	11802	—	—	11786M*	13656	13650**
	J	Tubular	WT3185	11808	11802	TBM6245	45	11738	13656	13650**
K	Tubular	—	—	11809	11802	—	—	11787M*	13657	13650**
K	Tubular	—	—	11809	11802	TBM6250	50	11739	13657	13650**
L	Tubular	—	—	11810	11802	—	50	11788M*	13658	13650**
L	Tubular	—	—	11810	11802	TBM6254	54	11740	13658	13650**
M	Tubular	—	—	11811	11802	—	54	11789M*	13659	13650**
M	Tubular	—	—	11811	11802	TBM6262	62	11771	13659	13650**
Nylon Insulated Terminals and Splices	RD	Tubular	ERG4007	—	11821 (Set)	—	—	—	21707M* (Set)	—
	RD	Brazed & Tubular	—	—	11822 (Set)	—	—	—	21708M* (Set)	—
	RE	Tubular	ERG4007	—	—	11822 (Set)	—	—	21708M* (Set)	—
	RE	Brazed	—	—	—	11823 (Set)	—	—	21709M* (Set)	—
	RF	Tubular	—	—	—	11823 (Set)	—	—	21709M* (Set)	—
	RF	Brazed	—	—	—	11824 (Set)	—	—	21710M* (Set)	—
	RG	Tubular	—	—	—	11824 (Set)	—	—	21710M* (Set)	—
	RH	Tubular	—	—	—	11825 (Set)	—	—	21711M* (Set)	—
	RJ	Tubular	—	—	—	11826 (Set)	—	—	21712M* (Set)	—
	RK	Tubular	—	—	—	11827 (Set)	—	—	21713M* (Set)	—
RL	Tubular	—	—	—	11828 (Set)	—	—	21714M* (Set)	—	
RM	Tubular	—	—	—	11829 (Set)	—	—	21715M* (Set)	—	
Non-Insulated Flag Terminals	D	—	WT129	—	—	—	—	—	21733	21731
	E	—	WT129	—	—	—	—	—	21734	21731
	F	—	WT129	—	—	—	—	—	21735	21731
	G	—	WT129	—	—	—	—	—	21736	21732
	H	—	—	—	—	—	—	—	21737	21732
	J	—	—	—	—	—	—	—	21738	21732
	K	—	—	—	—	—	—	—	21739	21732
	L	—	—	—	—	—	—	—	21740	21732
M	—	—	—	—	—	—	—	21741	21732	

* Indicates military listed die.

** To order the military version, suffix the indentor catalogue number with an "M" (13650M). Nest catalog number does not change.

STUD SIZE AND CLEARANCE HOLE CHART

Stud Size	2	4	6	8	10	1/4	5/16	3/8	7/16	1/2	5/8	3/4
Min. hole diam. — in.	.92	.116	.143	.169	.196	.262	.323	.388	.453	.516	.650	.775
Min. hole diam. — mm	2.337	2.946	3.632	4.292	4.978	6.655	8.204	9.855	11.506	13.106	16.510	19.685

Wire Guide Table

Wire Strip Length Chart

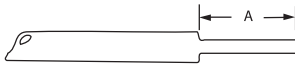

Wire Strip Length	Terminal Series	Recommend Wire Strip Length "A"
Non-Insulated	A	1/4
	B	1/4
	C, BC	5/16
Vinyl Insulated — Add 1/16" for Funnel Entry Type	RA	1/4
	RB	1/4
	RC, RBC	11/32
Nylon Insulated and Tefzel® Insulated	RA	7/32
	RB	7/32
	RC, RBC	5/16
Nylon Insulated and Tefzel® Insulated when using Aircraft and Code Wire	RD	17/32
	RE	17/32
	RF	9/16
	RG	11/16
	RH	11/16
	RJ	3/4
	RK	7/8
	RL	7/8
	RM	1
	Non-Insulated, when using Aircraft and Code Wire	D
E		15/32
F		1/2
G		41/64
H		43/64
J		47/64
K		55/64
L	55/64	
M	59/64	

Tefzel® is a registered trademark of DuPont

AWG or AN	Navy Shipboard†	Individual Strands		Whole Conductor		
		No.	Dia. (in.)	Cir. Mil. Area	Dia. (in.)	Dia. (mm)
22 Wire Size						
22	35 (1)	1	0.025	642	0.025	0.635
22	35 (7)	7	0.010	703	0.030	0.762
AN-22*		7	**	704	0.032	0.813
	1/2 (21)	21	0.005	525	0.028	0.711
20 Wire Size						
20	1 (1)	1	0.032	1,022	0.032	0.813
20		7	0.012	1,024	0.036	0.914
20		10	0.010	1,005	0.040	1.016
20		19	0.007	1,022	0.037	0.940
20		26	0.006	1,034	0.039	0.991
AN-20*		7	**	1,119	0.040	1.016
	1 (7)	7	0.013	1,119	0.038	0.965
	1 (10)	10	0.010	1,005	0.038	0.965
	1 (26)	26	0.006	1,034	0.042	1.067
18 Wire Size						
18	11/2 (1)	1	0.040	1,624	0.040	1.016
18	11/2 (7)	7	0.016	1,624	0.049	1.245
18	11/2 (16)	16	0.010	1,608	0.049	1.245
18		19	0.009	1,624	0.046	1.168
18	11/2 (41)	41	0.006	1,630	0.049	1.245
AN-18*	2 (7)	7	0.016	1,779	0.048	1.219
16 Wire Size						
16	2 1/2 (1)	1	0.051	2,583	0.051	1.295
16		7	0.019	2,583	0.058	1.473
16		19	0.012	2,601	0.058	1.473
16		26	0.010	2,613	0.059	1.499
16		65	0.006	2,580	0.058	1.473
AN-16*	2 1/2 (19)	19	0.011	2,407	0.061	1.549
	2 1/2 (26)	26	0.010	2,613	0.061	1.549
14 Wire Size						
14		1	0.064	4,107	0.064	1.626
14		7	0.024	4,107	0.073	1.854
14		19	0.015	4,107	0.074	1.880
14		37	0.011	4,107	0.074	1.880
14		14	0.009	4,157	0.083	2.108
14		104	0.006	4,128	0.074	1.880
AN-14*		19	**	3,830	0.076	1.930
	3 (7)	7	0.020	2,828	0.060	1.524
	3 (19)	19	0.013	3,036	0.063	1.600
	4 (1)	1	0.064	4,107	0.064	1.626
	4 (7)	7	0.025	4,497	0.076	1.930
	4 (19)	19	0.014	3,828	0.072	1.829
	4 (41)	41	0.010	4,121	0.077	1.956
12 Wire Size						
12		1	0.081	6,530	0.081	2.057
12		7	0.031	6,530	0.092	2.337
12		19	0.019	6,530	0.093	2.362
12		37	0.013	6,530	0.093	2.362
12		49	0.012	6,593	0.104	2.642
12		65	0.010	6,533	0.093	2.362
12		104	0.008	6,574	0.094	2.388
12		165	0.006	6,559	0.095	2.413
AN-12*	6 (19)	19	0.018	6,088	0.096	2.438
	6 (7)	7	0.031	6,512	0.092	2.337
	6 (65)	65	0.010	6,533	0.097	2.964
10 Wire Size						
10		1	0.102	10,380	0.102	2.591
10		7	0.039	10,380	0.116	2.946
10		19	0.023	10,380	0.117	2.972
10		37	0.017	10,443	0.117	2.972
10		49	0.015	10,445	0.131	3.327
10		104	0.010	10,452	0.116	2.946
AN-10*		37	**	10,380	0.117	2.972
	9 (7)	7	0.036	9,016	0.108	2.743
	9 (37)	37	0.016	9,402	0.109	2.769
	9 (90)	90	0.010	9,045	0.120	3.048

* MIL-W-5086. ** Strand diameter not specified. † MIL-E-16366 A.

Wire Guide Table

AWG or AN	Navy Shipboard†	Individual Strands		Whole Conductor		
		No.	Dia. (in.)	Cir. Mil. Area	Dia. (in.)	Dia. (mm)
9 Wire Size						
9		7	0.043	13,090	0.130	3.302
	14 (7)	7	0.045	14,340	0.136	3.454
8 Wire Size						
8		7	0.049	16,510	0.146	3.712
8		19	0.030	16,510	0.148	3.763
8		37	0.021	16,510	0.148	3.763
7 Wire Size						
7		1	0.144	20,820	0.144	3.662
	14 (7)	7	0.045	14,340	0.136	3.454
	14 (140)	140	0.010	14,070	0.145	3.787
6 Wire Size						
6		7	0.061	25,250	0.184	4.672
6		19	0.037	26,250	0.186	4.722
6		37	0.027	26,250	0.186	4.722
6		49	0.023	26,146	0.208	5.283
6		661	0.006	26,274	0.259	6.579
5 Wire Size						
5		1	0.181	33,100	0.181	4.595
	20 (49)	7x7	0.020	19,800	0.180	4.570
	23 (7)	7	0.057	22,800	0.171	4.345
	23 (228)	19x12	0.010	22,190	0.190	4.830
	26 (49)	7x7	0.023	26,250	0.210	5.330
4 Wire Size						
4		7	0.077	41,740	0.232	5.891
4		19	0.047	41,740	0.235	5.967
4		37	0.034	41,740	0.235	5.967
3 Wire Size						
3		1	0.229	52,630	0.229	5.819
	30 (304)	19x16	0.010	30,550	0.220	5.590
	33 (336)	7x48	0.010	33,370	0.235	5.967
	40 (19)	19	0.045	38,910	0.226	5.742
	42 (49)	7x7	0.029	41,740	0.260	6.600
	42 (209)	19x11	0.014	42,110	0.260	6.600
	50 (19)	19	0.051	49,080	0.254	6.452
2 Wire Size						
2		7	0.097	66,370	0.292	7.421
2		19	0.059	66,370	0.296	7.522
2		37	0.042	66,370	0.297	7.548
2		49	0.037	66,356	0.331	8.405
2		133	0.022	66,140	0.335	8.507
AN-2*		663	**	66,832	0.345	8.767
	53 (532)	19x28	0.010	53,470	0.304	7.772
	60 (37)	37	0.040	60,090	0.282	7.161
	60 (304)	19x16	0.014	61,260	0.310	7.870
	66 (133)	19x7	0.022	66,370	0.330	8.380
	75 (37)	37	0.045	75,780	0.317	8.048
1 Wire Size						
1		7	0.109	83,690	0.328	8.333
1		19	0.066	83,690	0.332	8.431
1		37	0.048	83,690	0.333	8.456
1		61	0.037	83,690	0.333	8.456
1		133	0.025	83,690	0.377	9.578
1		259	0.018	83,916	0.378	9.603
AN-1*		812	**	81,807	0.384	9.752
	83 (418)	19x22	0.014	84,230	0.380	9.650
	84 (2,107)	2107	**	83,690	0.410	10.41

* MIL-W-5086.

** Strand diameter not specified.

†MIL-E-16366 A

Wire Guide Table

AWG or AN	Navy Shipboard†	Individual Strands		Whole Conductor		
		No.	Dia. (in.)	Cir. Mil. Area	Dia. (in.)	Dia. (mm)
1/0 Wire Size						
1/0		7	0.123	105,500	0.368	9.343
1/0		19	0.075	105,500	0.373	9.476
1/0		37	0.053	105,500	0.374	9.502
1/0		61	0.042	105,500	0.374	9.502
1/0		133	0.028	105,761	0.423	10.721
1/0		259	0.020	105,672	0.424	10.772
AN-0*		1,033	**	104,118	0.432	10.971
	100 (61)	61	0.040	99,060	0.363	9.216
	105 (259)	37x7	**	105,500	0.410	10.410
2/0 Wire Size						
	105 (2,646)	2,646	**	105,500	0.460	11.680
2/0		7	0.138	133,100	0.414	10.512
2/0		19	0.084	133,100	0.419	10.639
2/0		37	0.060	133,100	0.420	10.670
2/0		61	0.047	133,100	0.420	10.670
2/0		133	0.032	132,800	0.474	12.042
2/0		259	0.023	133,462	0.477	12.118
AN-00*		1,327	**	133,665	0.490	12.450
	125 (61)	61	0.045	124,900	0.407	10.338
	133 (259)	37x7	**	133,100	0.460	11.680
	133 (684)	19x36	0.014	137,800	0.480	12.190
	133 (3,325)	3,325	**	133,100	0.520	13.210
	150 (61)	61	0.051	157,600	0.457	11.608
3/0 Wire Size						
3/0		7	0.155	167,800	0.464	11.782
3/0		19	0.094	167,800	0.470	11.940
3/0		37	0.067	167,800	0.471	11.965
3/0		61	0.052	167,800	0.472	11.991
3/0		133	0.036	167,607	0.533	13.536
3/0		259	0.026	167,402	0.536	13.612
3/0		4,227	0.006	168,023	0.610	15.490
	150 (760)	19x40	0.014	153,100	0.510	12.950
	168 (427)	61x7	**	167,800	0.520	13.210
4/0 Wire Size						
4/0		7	0.174	211,600	0.522	13.261
4/0		19	0.106	211,600	0.528	13.413
4/0		37	0.076	211,600	0.529	13.439
4/0		61	0.059	211,600	0.530	13.460
4/0		133	0.040	211,736	0.599	15.219
4/0		259	0.029	211,845	0.601	15.265
AN-000*		1,661	**	167,332	0.548	13.923
	200 (61)	61	0.057	198,700	0.514	13.652
	200 (988)	19x52	0.014	199,100	0.580	14.730
250 kcmil Wire Size						
250,000		19	0.115	250,000	0.574	14.582
250,000		37	2	250,000	0.575	14.607
250,000		61	0.064	250,000	0.576	14.632
250,000		91	0.052	250,000	0.576	14.632
AN-0000*		2,104	**	211,954	0.615	15.617
	220 (259)	37x7	0.029	220,700	0.610	15.490
	250 (61)	61	0.064	250,000	0.577	14.658

* MIL-W-5086.

** Strand diameter not specified.

†MIL-E-16366 A

Military Standard Cross Reference

MIL-T-7928 MS-25036	Cat. No. T&B Class 1 & 2
-101	RA333
-102	RA853
-103	RA873
-104	RA723
-105	RA733
-106	RB1333
-107	RB853
-108	RB873
-109	RB723
-110	RB733
-111	RC333
-112	RC363
-113	RC703
-114	RC733
-115	RD10361
-116	RD10711
-117	RD10721
-118	RD10731
-119	RE10261
-120	RE10711
-121	RE10721
-122	RE10731
-123	RF10711
-124	RF10721
-125	RF10731
-126	RG9711
-127	RG9731
-128	RG9751
-129	RH9711
-130	RH9731
-131	RH9751
-132	RJ9711
-133	RJ9731
-135	RK9721
-136	RK9731
-137	RK9751
-138	RL9731
-139	RL9751
-140	RM9731
-141	RM9751
-142	—
-143	—
-144	—
-145	—
-146	—
-147	—
-148	RA323
-149	RA863
-150	RA713
-151	RA753
-152	RB1323
-153	RB863
-154	RB713
-155	RB753
-156	RC863
-157	RC713
-158	RC753

MIL-T-7928 MS-20659	Cat. No. T&B
-101	A85G
-102	A87G
-103	B85G
-104	B87G
-105	C26
-106	C70
-107	D10361
-108	D10721
-109	E10711
-110	E10731
-111	F10711
-112	F10731
-113	G971
-114	G973
-115	H971
-116	H973
-117	J971
-118	J973
-119	K972
-120	K973
-121	L973
-122	L975
-123	M973
-124	M975
-128	C73
-129	D10731
-130	E10261
-131	E10721
-132	F10721
-133	G975
-134	H975
-135	J975
-136	K975
-140	D10161
-141	D10711
-144	F10261
-146	G926
-147	G972
-148	G974
-149	H972
-151	J972
-152	J974
-153	K971
-154	K974
-155	L972
-156	L974
-157	M972
-158	M974
-165	C33
-166	C75

MIL-T-22909 MS-90485	Cat. No. T&B
-8	11781M
-6	11782M
-4	11783M
-2	11784M
-1	11785M
-01	11786M
-02	11787M
-03	11788M
-04	11789M

MIL-T-7928 MS-17143	Cat. No. T&B
-1	RA480
-2	RB480
-3	RC480
-4	RA481
-5	RB481
-6	RC481
-7	RA482
-8	RB482
-9	RC482
-10	RA483
-11	RB483
-12	RC483
-13	RA484
-14	RB484
-15	RC484
-16	RA485
-17	RB485
-19	RA486
-20	RB486

MIL-T-7928 MS-21004	Cat. No. T&B
-1	A486
-2	A483
-3	A482
-4	A481
-5	A485
-6	A484
-7	A480
-8	B486
-9	B483
-10	B482
-11	B481
-12	B485
-13	B484
-14	B480
-15	C486
-16	C483
-17	C482
-18	C481
-19	C485
-20	C484
-21	C480

MIL-T-22909 MS-23002	Cat. No. T&B
-8	21707M
-6	21708M
-4	21709M
-2	21710M
-1	21711M
-01	21712M
-02	21713M
-03	21714M
-04	21715M

Cross Reference for Packaging

CAT. NO. T&B DISTRIBUTOR PACKAGE	CAT. NO. T&B BULK PACKAGE	CAT. NO. T&B DISTRIBUTOR PACKAGE	CAT. NO. T&B BULK PACKAGE	CAT. NO. T&B DISTRIBUTOR PACKAGE	CAT. NO. T&B BULK PACKAGE	CAT. NO. T&B DISTRIBUTOR PACKAGE	CAT. NO. T&B BULK PACKAGE
10RC-10	RC367	14RBC-516	RBC727	2RCC	RCC23	C10-10FL	C222-TB
10RC-10F	RC1157	14RBC-6	RBC857	2RD8	RDD27	C10-12	C75
10RC-10FL	RC2227	14RBC-8	RBC867	2RE6	REE28	C10-14	C71
10RC-10FLX	RC2227-250	14RBD-182	RBD1827	A18-10	A87	C10-14F	C116-TB
10RC-10FX	RC1157-250	14RBD-18277	RBD18277	A18-10F	A115-TB	C10-250A	C252G
10RC-10X	RC367-250	14RBD-183	RBD1837	A18-10FL	A225	C10-250F	C250
10RC-14	RC717	14RBD-18377	RBD18377	A18-110F	A10-TB	C10-38	C73
10RC-14F	RC1167	18RA-10	RA877	A18-111F	A11	C10-516	C70
10RC-14FL	RC2237	18RA-10F	RA1157	A18-12	A75	C10-6A	C51
10RC-14X	RC717-250	18RA-10FL	RA2257	A18-14	A71	C10-6F	C133
10RC-250F	RC257	18RA-10FLX	RA2257-170	A18-250	A250-TB	C10-6FL	C220-TB
10RC-250T	RC2517	18RA-14	RA717	A18-250A	A252G	C10-6-SK	C33
10RC-251T	RC25177	18RA-250F	RA257	A18-251T	A251	C10-8A	C52-TB
10RC-2577	RC2573	18RA-250T	RA2517	A18-38	A73	C10-8F	C114
10RC-38	RC737	18RA-251T	RA25177	A18-516	A72	C10-8FL	C221
10RC-38X	RC737-250	18RA-2577	RA2573	A18-6	A85	C10-8-SK	C77
10RC-516	RC707	18RA-38	RA737	A18-6F	A116	D8-10	D36
10RC-55PT	RC55PT	18RA-4	RA77	A18-6FL	A221	D8-12	D75
10RC-6	RC337	18RA-47PT	RA47PT	A18-8	A86	D8-14-SK	D71
10RC-6F	RC1337	18RA-516	RA727	A18-8F	A114	D8-38	D73
10RC-6FL	RC2207	18RA-516X	RA727-170	A18-8FL	A224	D8-516	D72
10RC-6FLX	RC2207-250	18RA-6	RA857	AB14-10A	AB53	E6-10	E26
10RC-6X	RC337-250	18RA-6F	RA1167	AB14-6A	AB51	E6-12	E75
10RC-8	RC777	18RA-6FL	RA2217	AB14-8A	AB52	E6-14	E71
10RC-8F	RC1147	18RA-6FLX	RA2217-170	AD18-182	AD182	E6-38	E73
10RC-8FL	RC2217	18RA-6FX	RA1167-170	AD18-183	AD183	E6-516	E72
10RC-8FLX	RC2217-250	18RA-6X	RA857-170	B14-10	B87	F250TA	FTA250
10RC-8X	RC777-250	18RA-8	RA867	B14-10F	B115	F4-10	F26
14RB-10	RB877	18RA-8F	RA1147	B14-10FL	B225	F4-12	F75
14RB-10F	RB1157	18RA-8FL	RA2247	B14-10G	B87G	F4-14	F71-TB
14RB-10FL	RB2257	18RA-8FX	RA1147-170	B14-110F	B10TB	F4-38	F73
14RB-10FLX	RB2257-200	18RA-8X	RA867-170	B14-111F	B11-TB	F4-516	F72
14RB-10FX	RB1157-200	18RAD-182	RAD1827	B14-12	B75TB	G2-12	G975
14RB-10X	RB877-200	18RAD-18277	RAD18277	B14-14	B71	G2-14	G971
14RB-14	RB717	18RAD-183	RAD1837	B14-250	B250	G2-38	G973
14RB-14X	RB717-200	18RAD-18377	RAD18377	B14-250A	B252G	G2-516	G972
14RB-250F	RB257	2A-18	AA2	B14-250F	B250G	H10-14	H971
14RB-250T	RB2517	2A20	RAA24	B14-250T	B251G	J20-38	J973
14RB-251T	RB25177	2A22-20	A1A	B14-251T	B251	K30-38	K973
14RB-2577	RB2573	2B-14	BB2	B14-38	B73	L40-38	L973
14RB-38	RB737	2B-16	RBB25	B14-4	B132	M250-38	M973
14RB-4	RB1327	2B18-16	B1B	B14-516	B72	NW14-10	NW83
14RB-47PT	RB47PT	2C-10	CC2-TB	B14-6	B133	NW14-12	NW84
14RB-516	RB727	2C-12	RCC26	B14-6F	B64	NW14-6	NW81
14RB-6	RB857	2C14-12	C1C	B14-6FL	B220	NW22-10	NW23
14RB-6F	RB647	2D10-9	D1D	B14-6FS	B19	RA18-10	RA873
14RB-6FL	RB2207	2D-8	DD102	B14-8	B86	RA18-10F	RA1153
14RB-6FLX	RB2207-200	2E-6	EE2	B14-8F	B65TB	RA18-10FL	RA2253
14RB-6FX	RB647-200	2E8-7	E1E	B14-8FL	B223	RA18-10FS	RA1253
14RB-6X	RB857-200	2F-4	FF2	B14-D	B23	RA18-110F	RA10SK
14RB-8	RB867	2F6-5	F1F	BC14-10	BC87	RA18-111F	RA11
14RB-8F	RB657	2G21	GG2	BC14-12	BC75	RA18-12	RA753
14RB-8FL	RB2237	2G4-2	G1G	BC14-14	BC71	RA18-14	RA713
14RB-8FLX	RB2237-200	2RA18	RAA21	BC14-38	BC79	RA18-14F	RA1163
14RB-8FX	RB657-200	2RA18X	RAA217-170	BC14-516	BC72	RA18-250A	RA2577F
14RB-8X	RB867-200	2RAA	RAA23	BC14-6	BC85	RA18-250F	RA250TB
14RBC-10	RBC877	2RB14	RBB21	BC14-8	BC86	RA18-250FP	RA250P
14RBC-12	RBC757	2RB14X	RBB217-200	BD14-183	BD183	RA18-38	RA733
14RBC-14	RBC717	2RBB	RBB23	C10-10	C26	RA18-4	RA323
14RBC-38	RBC797	2RC10	RCC21	C10-10A	C53	RA18-47PT	RA147PT
		2RC10X	RCC217-250	C10-10F	C115	RA18-516	RA723

Cross Reference for Packaging

CAT. NO. T&B DISTRIBUTOR PACKAGE	CAT. NO. T&B BULK PACKAGE	CAT. NO. T&B DISTRIBUTOR PACKAGE	CAT. NO. T&B BULK PACKAGE	CAT. NO. T&B BULK PACKAGE	CAT. NO. T&B DISTRIBUTOR PACKAGE	CAT. NO. T&B BULK PACKAGE	CAT. NO. T&B DISTRIBUTOR PACKAGE
RA18-6	RA853	RC10-516	RC703	A10-TB	A18-110F	C116-TB	C10-14F
RA18-6F	RA1103	RC10-55PT	RC155PT	A11	A18-111F	C133	C10-6F
RA18-6FL	RA2213	RC10-6	RC333	A114	A18-8F	C1C	2C14-12
RA18-6FS	RA1203	RC10-6F	RC1113	A115-TB	A18-10F	C220-TB	C10-6FL
RA18-8	RA863	RC10-6FL	RC2203	A116	A18-6F	C221	C10-8FL
RA18-8F	RA1123	RC10-8	RC863	A1A	2A22-20	C222-TB	C10-10FL
RA18-8FL	RA2243	RC10-8F	RC1123	A221	A18-6FL	C250	C10-250F
RA18-8FS	RA1223	RC10-8FL	RC2213	A224	A18-8FL	C252G	C10-250A
RA18D	RA23	RC10-8FS	RC1223	A225	A18-10FL	C26	C10-10
RAD18-182	RAD1823	RC10-8X	RC864	A250-TB	A18-250	C33	C10-6-SK
RAD18-183	RAD1833	RC55	RC6	A251	A18-251T	C51	C10-6A
RB14-10	RB873	RD8-10	RD367	A252G	A18-250A	C52-TB	C10-8A
RB14-10F	RB1153	RD8-12	RD757	A71	A18-14	C53	C10-10A
RB14-10FL	RB2253	RD8-14	RD717	A72	A18-516	C70	C10-516
RB14-10FS	RB1253	RD8-38	RD737	A73	A18-38	C71	C10-14
RB14-10X	RB874	RD8-516	RD727	A75	A18-12	C73	C10-38
RB14-110F	RB10-SK	RE6-10	RE267	A85	A18-6	C75	C10-12
RB14-111F	RB11-TB	RE6-12	RE757	A86	A18-8	C77	C10-8-SK
RB14-12	RB753	RE6-14	RE717	A87	A18-10	CC2-TB	2C-10
RB14-14	RB713	RE6-38	RE737	AA2	2A-18	D1D	D210-9
RB14-14F	RB1163	RE6-516	RE727	AB51	AB14-6A	D36	D8-10
RB14-14X	RB714	RF4-10	RF267	AB52	AB14-8A	D71	D8-14-SK
RB14-250	RBB250	RF4-12	RF757	AB53	AB14-10A	D72	D8-516
RB14-250A	RB2577F	RF4-14	RF717	AD182	AD18-182	D73	D8-38
RB14-250F	RB250	RF4-38	RF737	AD183	AD18-183	D75	D8-12
RB14-250FP	RB250P	RF4-516	RF727	B10TB	B14-110F	DD102	2D-8
RB14-38	RB733	RG2-10	RG267	B115	B14-10F	E1E	2E8-7
RB14-38X	RB734	RG2-12	RG757	B11-TB	B14-111F	E26	E6-10
RB14-4	RB1323	RG2-14	RG717	B132	B14-4	E71	E6-14
RB14-47PT	RB147PT	RG2-38	RG737	B133	B14-6	E72	E6-516
RB14-516	RB723	RG2-516	RG727	B19	B14-6FS	E73	E6-38
RB14-516X	RB724	RP12	RP7	B1B	2B18-16	E75	E6-12
RB14-6	RB853			B220	B14-6FL	EE2	2E-6
RB14-6F	RB1113			B223	B14-8FL	F1F	2F6-5
RB14-6FL	RB2213			B225	B14-10FL	F26	F4-10
RB14-6FS	RB1203			B23	B14-D	F71-TB	F4-14
RB14-6X	RB854			B250	B14-250	F72	F4-516
RB14-8	RB863			B250G	B14-250F	F73	F4-38
RB14-8F	RB1123			B251	B14-251T	F75	F4-12
RB14-8FL	RB2233			B251G	B14-250T	FF2	2F-4
RB14-8FS	RB1223			B252G	B14-250A	FTA250	F250TA
RB14-8X	RB864			B64	B14-6F	G1G	2G4-2
RB44	RB4-TB			B65TB	B14-8F	G971	G2-14
RBC14-14	RBC713			B71	B14-14	G972	G2-516
RBC14-516	RBC723			B72	B14-516	G973	G2-38
RBD14-182	RBD1823			B73	B14-38	G975	G2-12
RBD14-183	RBD1833			B75TB	B14-12	GG2	2G21
RC10-10	RC363			B86	B14-8	H971	H10-14
RC10-10F	RC1153			B87	B14-10	J973	J20-38
RC10-10FL	RC2223			B87G	B14-10G	K973	K30-38
RC10-10FS	RC1253			BB2	2B-14	L973	L40-38
RC10-10X	RC364			BC71	BC14-14	M973	M250-38
RC10-12	RC753			BC72	BC14-516	NW23	NW22-10
RC10-14	RC713			BC75	BC14-12	NW81	NW14-6
RC10-14F	RC1163			BC79	BC14-38	NW83	NW14-10
RC10-14FL	RC2233			BC85	BC14-6	NW84	NW14-12
RC10-14X	RC714			BC86	BC14-8	RA10SK	RA18-110F
RC10-250A	RC2577F			BC87	BC14-10	RA11	RA18-111F
RC10-250F	RC250			BD183	BD14-183	RA1103	RA18-6F
RC10-38	RC733			C114	C10-8F	RA1123	RA18-8F
RC10-38X	RC734			C115	C10-10F	RA1147	18RA-8F

Cross Reference for Packaging

CAT. NO. T&B BULK PACKAGE	CAT. NO. T&B DISTRIBUTOR PACKAGE	CAT. NO. T&B BULK PACKAGE	CAT. NO. T&B DISTRIBUTOR PACKAGE	CAT. NO. T&B BULK PACKAGE	CAT. NO. T&B DISTRIBUTOR PACKAGE	CAT. NO. T&B BULK PACKAGE	CAT. NO. T&B DISTRIBUTOR PACKAGE
RA1147-170	18RA-8FX	RB1163	RB14-14F	RBC727	14RBC-516	RC753	RC10-12
RA1153	RA18-10F	RB11-TB	RB14-111F	RBC757	14RBC-12	RC777	10RC-8
RA1157	18RA-10F	RB1203	RB14-6FS	RBC797	14RBC-38	RC777-250	10RC-8X
RA1163	RA18-14F	RB1223	RB14-8FS	RBC857	14RBC-6	RC863	RC10-8
RA1167	18RA-6F	RB1253	RB14-10FS	RBC867	14RBC-8	RC864	RC10-8X
RA1167-170	18RA-6FX	RB1323	RB14-4	RBC877	14RBC-10	RCC21	2RC10
RA1203	RA18-6FS	RB1327	14RB-4	RBD1823	RBD14-182	RCC217-250	2RC10X
RA1223	RA18-8FS	RB147PT	RB14-47PT	RBD1827	14RBD-182	RCC23	2RCC
RA1253	RA18-10FS	RB2207	14RB-6FL	RBD18277	14RBD-18277	RCC26	2C-12
RA147PT	RA18-47PT	RB2207-200	14RB-6FLX	RBD1833	RBD14-183	RD367	RD8-10
RA2213	RA18-6FL	RB2213	RB14-6FL	RBD1837	14RBD-183	RD717	RD8-14
RA2217	18RA-6FL	RB2233	RB14-8FL	RBD18377	14RBD-18377	RD727	RD8-19
RA2217-170	18RA-6FLX	RB2237	14RB-8FL	RC1113	RC10-6F	RD737	RD8-38
RA2243	RA18-8FL	RB2237-200	14RB-8FLX	RC1123	RC10-8F	RD757	RD8-12
RA2247	18RA-8FL	RB2253	RB14-10FL	RC1147	10RC-8F	RDD27	2RD8
RA2253	RA18-10FL	RB2257	14RB-10FL	RC1153	RC10-10F	RE267	RE6-10
RA2257	18RA-10FL	RB2257-200	14RB-10FLX	RC1157	10RC-10F	RE717	RE6-14
RA2257-170	18RA-10FLX	RB250	RB14-250F	RC1157-250	10RC-10FX	RE727	RE6-516
RA23	RA18D	RB250P	RB14-250FP	RC1163	RC10-14F	RE737	RE6-38
RA250P	RA18-250FP	RB2517	14RB-250T	RC1167	10RC-14F	RE757	RE6-12
RA250TB	RA18-250F	RB25177	14RB-251T	RC1223	RC10-8FS	REE28	2RE6
RA2517	18RA-250T	RB257	14RB-250F	RC1253	RC10-10FS	RF267	RF4-10
RA25177	18RA-251T	RB2573	14RB-2577	RC1337	10RC-6F	RF717	RF4-14
RA257	18RA-250F	RB2577F	RB14-250A	RC155PT	RC10-55PT	RF727	RF4-516
RA2573	18RA-2577	RB47PT	14RB-47PT	RC2203	RC10-6FL	RF737	RF4-38
RA2577F	RA18-250A	RB4-TB	RB44	RC2207	10RC-6FL	RF757	RF4-12
RA323	RA18-4	RB647	14RB-6F	RC2207-250	10RC-6FLX	RG267	RG2-10
RA47PT	18RA-47PT	RB647-200	14RB-6FX	RC2213	RC10-8FL	RG717	RG2-14
RA713	RA18-14	RB657	14RB-8F	RC2217	10RC-8FL	RG727	RG2-516
RA717	18RA-14	RB657-200	14RB-8FX	RC2217-250	10RC-8FLX	RG737	RG2-38
RA723	RA18-516	RB713	RB14-14	RC2223	RC10-10FL	RG757	RG2-12
RA727	18RA-516	RB714	RB14-14X	RC2227	10RC-10FL	RP7	RP12
RA727-170	18RA-516X	RB717	14RB-14	RC2227-250	10RC-10FLX		
RA733	RA18-38	RB717-200	14RB-14X	RC2233	RC10-14FL		
RA737	18RA-38	RB723	RB14-516	RC2237	10RC-14FL		
RA753	RA18-12	RB724	RB14-516X	RC250	RC10-250F		
RA77	18RA-4	RB727	14RB-516	RC2517	10RC-250T		
RA853	RA18-6	RB733	RB14-38	RC25177	10RC-251T		
RA857	18RA-6	RB734	RB14-38X	RC257	10RC-250F		
RA857-170	18RA-6X	RB737	14RB-38	RC2573	10RC-2577		
RA863	RA18-8	RB753	RB14-12	RC2577F	RC10-250A		
RA867	18RA-8	RB853	RB14-6	RC333	RC10-6		
RA867-170	18RA-8X	RB854	RB14-6X	RC337	10RC-6		
RA873	RA18-10	RB857	14RB-6	RC337-250	10RC-6X		
RA877	18RA-10	RB857-200	14RB-6X	RC363	RC10-10		
RAA21	2RA18	RB863	RB14-8	RC364	RC10-10X		
RAA217-170	2RA18X	RB864	RB14-8X	RC367	10RC-10		
RAA23	2RAA	RB867	14RB-8	RC367-250	10RC-10X		
RAA24	2A20	RB867-200	14RB-8X	RC55PT	10RC-55PT		
RAD1823	RAD18-182	RB873	RB14-10	RC6	RC55		
RAD1827	18RAD-182	RB874	RB14-10X	RC703	RC10-516		
RAD18277	18RAD-18277	RB877	14RB-10	RC707	10RC-516		
RAD1833	RAD18-183	RB877-200	14RB-10X	RC713	RC10-14		
RAD1837	18RAD-183	RBB21	2RB14	RC714	RC10-14X		
RAD18377	18RAD-18377	RBB217-200	2RB14X	RC717	10RC-14		
RB10-SK	RB14-110F	RB23	2RBB	RC717-250	10RC-14X		
RB1113	RB14-6F	RBB25	2B-16	RC733	RC10-38		
RB1123	RB14-8F	RBB250	RB14-250	RC734	RC10-38X		
RB1153	RB14-10F	RBC713	RBC14-14	RC737	10RC-38		
RB1157	14RB-10F	RBC717	14RBC-14	RC737-250	10RC-38X		
RB1157-200	14RB-10FX	RBC723	RBC14-516				

Catamount® Terminals

Catamount® Terminals – Now in Convenient, Spillproof, Re-Usable Packaging!

While poly bags keep their contents dry, they don't offer much other protection, and they aren't environmentally friendly. That's why Catamount® terminals now come in sturdy plastic containers that safeguard the connectors inside against crushing and can be re-used or recycled when empty. T&B is always adding value to its products. With the introduction of a durable plastic container, the value of T&B's Catamount® terminals has been significantly enhanced. No more lost or spilled terminals because of inadequate packaging.



UL LISTED

Cat. No.	Wire Range	Bolt Size	Pkg. Qty.
Vinyl Insulated Ring Terminals			
TV18-6R-XV	22-16	#6	15
TV18-8R-XV		#8	
TV18-10R-XV		#10	
TV14-6R-XV	16-14	#6	15
TV14-8R-XV		#8	
TV14-10R-XV		#10	
TV10-8R-XV	12-10	#8	15
TV10-10R-XV		#10	
TV10-14R-XV		1/4 in.	



UL LISTED

Cat. No.	Wire Range	Bolt Size	Pkg. Qty.
Vinyl Insulated Fork Terminals			
TV18-6F-XV	22-16	#6	15
TV18-8F-XV		#8	
TV18-10F-XV		#10	
TV14-6F-XV	16-14	#6	15
TV14-8F-XV		#8	
TV14-10F-XV		#10	
TV10-8F-XV	12-10	#8	15
TV10-10F-XV		#10	
TV10-14F-XV		1/4 in.	



SP UL LISTED

Cat. No.	Wire Range	Pkg. Qty.
Vinyl Insulated Butt Splices		
TV18-BS-XV	22-16	15
TV14-BS-XV	16-14	15
TV10-BS-XV	12-10	15



UL LISTED

Cat. No.	Wire Range	Pkg. Qty.
Nylon Insulated Wire Joints		
TN18-WJ-XV	22-18	15
TN14-WJ-XV	16-14	
TN10-WJ-XV	12-10	



UL LISTED

Cat. No.	Wire Range	Pkg. Qty.
Vinyl Insulated Double Crimp Locking Fork		
TV18-10LFD-XV	22-16	15
TV18-6LFD-XV		
TV18-8LFD-XV		
TV14-10LFD-XV	16-14	15
TV14-6LFD-XV		
TV14-8LFD-XV		
TV10-10LFD-XV	12-10	15
TV10-6LFD-XV		
TV10-8LFD-XV		



UL LISTED

Cat. No.	Wire Range	Pkg. Qty.
Vinyl Insulated Locking Fork Terminal		
TV18-10LF-XV	22-16	15
TV18-6LF-XV		
TV18-8LF-XV		
TV14-10LF-XV	16-14	15
TV14-6LF-XV		
TV14-8LF-XV		
TV10-10LF-XV	12-10	15
TV10-6LF-XV		
TV10-8LF-XV		



UL LISTED

Cat. No.	Wire Range	Qty	Pkg. Qty.
Vinyl Insulated Butt Splices Kit			
TV10-18-BS	22-18	5	15
	16-14		
	12-10		



UL LISTED

Cat. No.	Wire Range	Pkg. Qty.
Vinyl Insulated Male Disconnects – 250 Series		
TV18-250MD-XV	22-16	15
TV14-250MD-XV	16-14	15
TV10-250MD-XV	12-10	15



UL LISTED

Cat. No.	Wire Range	Pkg. Qty.
Non Insulated Ring Terminals		
T14-10R-XV	16-14	15
T14-8R-XV		
T10-10R-XV		
T10-14R-XV	12-10	15
T10-8R-XV		



UL LISTED

Cat. No.	Wire Range	Pkg. Qty.
Non Insulated Fork Terminals		
T18-10F-XV	22-18	15
T18-8F-XV		
T14-10F-XV		
T14-8F-XV	16-14	15
T10-10F-XV		
T10-14F-XV		
T10-8F-XV	12-10	15

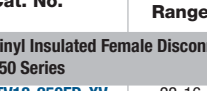

UL LISTED

Cat. No.	Wire Range	Pkg. Qty.
Vinyl Insulated Female Disconnects – 250 Series		
TV18-250FD-XV	22-16	15
TV14-250FD-XV	16-14	15
TV10-250FD-XV	12-10	15



UL LISTED

Cat. No.	Wire Range	Pkg. Qty.
Vinyl Insulated Pin Terminal		
TV18-12PT-XV	22-16	15
TV14-12PT-XV	16-14	15
TV10-14PT-XV	12-10	15



UL LISTED

Cat. No.	Wire Range	Pkg. Qty.
Vinyl Insulated Blade Terminal		
TV18-10BL-XV	22-16	15
TV14-10BL-XV	16-14	15
TV14-18BL-XV		
TV10-10BL-XV	12-10	15



Catamount® Terminals

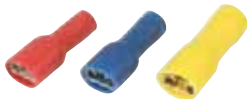

Cat. No.	Wire Range	Pkg. Qty.
Vinyl Fully Insulated Double Crimp Female Disconnect		
TVF18-250FDD-XV	22-16	15
TVF14-250FDD-XV	16-14	15
TVF10-250FDD-XV	12-10	15



Cat. No.	Wire Range	Pkg. Qty.
Vinyl Fully Insulated Female Disconnect		
TVF18-250FD-XV	22-16	15
TVF14-250FD-XV	16-14	15
TVF10-250FD-XV	12-10	15



Cat. No.	Wire Range	Pkg. Qty.
Vinyl Insulated Piggy Back Disconnect		
TV18-250PD-XV	22-16	15
TV14-250PD-XV	16-14	15
TV10-250PD-XV	12-10	15



Cat. No.	Wire Range	Pkg. Qty.
Vinyl Insulated Double Crimp Piggy Back Disconnect		
TV18-250PDD-XV	22-16	15
TV14-250PDD-XV	16-14	15
TV10-250PDD-XV	12-10	15



Cat. No.	Wire Range	Pkg. Qty.
Nylon Fully Insulated Female Disconnect		
TNF18-250FD-XV	22-16	15
TNF14-250FD-XV	16-14	15
TNF10-250FD-XV	12-10	15



Cat. No.	Wire Range	Pkg. Qty.
Nylon Fully Insulated Male Disconnect		
TNF18-250MD-XV	22-16	15
TNF14-250MD-XV	16-14	15
TNF10-250MD-XV	12-10	15



Cat. No.	Wire Range	Pkg. Qty.
Vinyl Insulated Double Crimp Female Disconnect		
TV18-250FDD-XV	22-16	15
TV14-250FDD-XV	16-14	15
TV10-250FDD-XV	12-10	15



Cat. No.	Wire Range	Pkg. Qty.
Vinyl Insulated Quick Splice		
TV18-00QS-V	22-18	15
TV14-00QS-V	18-14	15
TV10-00QS-V	12-10	15



Cat. No.	Wire Range	Pkg. Qty.
Nylon Fully Insulated Double Crimp Female Disconnects		
TNF18-250FDD-XV	22-16	15
TNF14-250FDD-XV	16-14	15
TNF10-250FDD-XV	12-10	15

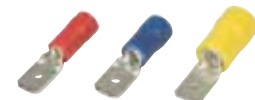

Cat. No.	Wire Range	Pkg. Qty.
Vinyl Insulated Double Crimp Male Disconnect		
TV18-250MDD-XV	22-16	15
TV14-250MDD-XV	16-14	15
TV10-250MDD-XV	12-10	15

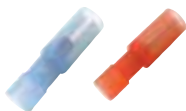

Cat. No.	Wire Range	Pkg. Qty.
Nylon Fully Insulated Female Bullet		
TNF18-4FB-XV	22-16	15
TNF14-4FB-XV	16-14	15



Cat. No.	Wire Range	Pkg. Qty.
Nylon Fully Insulated Male Bullet		
TNF18-4MB-XV	22-16	15
TNF14-4MB-XV	16-14	15



Cat. No.	Wire Range	Pkg. Qty.
Nylon Fully Insulated Double Crimp Male Disconnect		
TNF18-250MDD-XV	22-16	15
TNF14-250MDD-XV	16-14	15
TNF10-250MDD-XV	12-10	15

Catamount® Terminal Tools



WT111M



WT112M



ERG1-WS



CM2000A



TBM6S

Cat. No.	Description	Pkg. Qty.
WT111M	Pier tool with cutter for 22 - 10 AWG non-insulated terminals	1
WT112M	Pier tool with cutter for 22 - 10 AWG insulated and non-insulated terminals, splices and disconnects	
TBM6S	Toggle type hand tool with Shure-Stake® for 8 - 6 AWG, vinyl insulated terminals (dies sold separately)	
ERG1-WS	Ergonomic wire stripping tool	
CM2000A	10 in. ratchet crimping tool for insulated terminals (22 - 10 AWG)	

Polycarbonate Insulated Ring Terminals

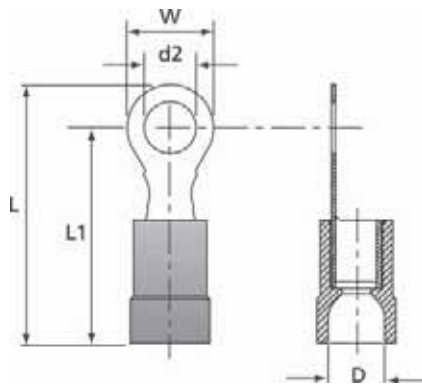

Technical Information

Material	Electrolytic copper
Plating	Tin-plated
Marking	Wire size and bolt size stamped on the tongue
Metal barrel	Brazed seam to prevent barrel separation
Insulation	PC = Polycarbonate
Temperature resistance	+115°C / +125°C
Colour coding of the insulation	According to the wire size
Cable insertion	Easy entry

Ordering Information											
Cat. No.	Wire Size Range (mm ²)	Colour	Stud Hole Size d2	Dimensions				Wt. (g/100)	Qty. (pieces)	Crimping Tool	
				W (mm)	L (mm)	D (mm)	L1 (mm)				
RZ3	0.25 - 0.75	Green	M3	5.5	18.0	3.2	15.0	36	100	ERG2510	
RZ4	0.25 - 0.75		M4	7.5	21.0	3.2	17.5	45			
RZ5	0.25 - 0.75		M5	9.0	22.0	3.2	17.5	51			
RA3RR	0.5 - 1.5	Red	M3	5.5	19.0	4.0	16.0	60		100	ERG2001A WT2124Y
RA4RR	0.5 - 1.5		M4	7.0	20.5	4.0	17.0	71			
RA5RR	0.5 - 1.5		M5	9.0	22.5	4.0	18.0	79			
RA6RR	0.5 - 1.5	M6	11.0	26.5	4.0	21.0	96				
RB3	1.5 - 2.5	Blue	M3	5.5	19.0	4.5	16.0	75			
RB4-EU	1.5 - 2.5		M4	7.0	20.5	4.5	17.0	92			
RB5	1.5 - 2.5		M5	9.0	22.5	4.5	18.0	96			
RB6	1.5 - 2.5	Blue	M6	11.0	26.5	4.5	21.0	117	100		ERG2001A WT2124Y
RB8	1.5 - 2.5		M8	14.0	27.5	4.5	21.0	141			
RC4	4.0 - 6.0		Yellow	M4	8.0	24.0	6.4	20.5			
RC5	4.0 - 6.0	M5		9.0	25.0	6.4	20.5	166			
RC6-EU	4.0 - 6.0	M6		11.0	28.5	6.4	23.0	179			
RC8	4.0 - 6.0	M8		14.0	31.0	6.4	24.0	220			
RC10E	4.0 - 6.0	Yellow	M10	17.0	34.0	6.4	25.5	245		100	ERG2001A WT2124Y

Polycarbonate Insulated Fork Terminals

Technical Information

Material	Electrolytic copper
Plating	Tin-plated
Marking	Wire size and bolt size stamped on the tongue
Metal barrel	Brazed seam to prevent barrel separation
Insulation	PC = Polycarbonate
Temperature resistance	+115°C / +125°C
Colour coding of the insulation	According to the wire size
Cable insertion	Easy entry

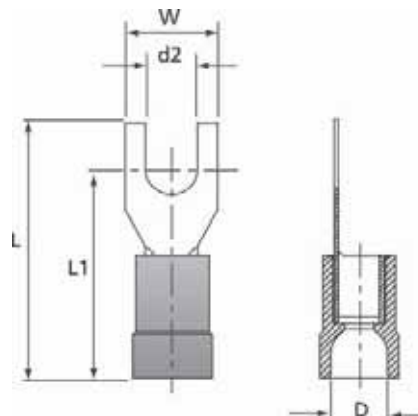

Ordering Information

Cat. No.	Wire Size Range (mm ²)	Colour	Stud Hole Size d2	Dimensions				Wt. (g/100)	Qty. (pieces)	Crimping Tool
				W (mm)	L (mm)	D (mm)	L1 (mm)			
RZ3F	0.25 - 0.75	Green	M3	5.5	18.0	3.2	15.0	41	100	ERG2510
RZ4F	0.25 - 0.75		M4	7.5	21.0	3.2	17.5	41		
RA35F	0.5 - 1.5	Red	M3.5	5.5	21.0	4.0	17.5	62		
RA4F	0.5 - 1.5		M4	7.0	20.5	4.0	17.0	64		
RA5F	0.5 - 1.5		M5	9.0	22.5	4.0	18.0	75		
RA6F	0.5 - 1.5	Blue	M6	11.0	26.5	4.0	21.0	90		
RB3F	1.5 - 2.5		M3	5.5	19.0	4.5	16.0	72		
RB4F	1.5 - 2.5		M4	7.0	20.5	4.5	17.0	84		
RB5F	1.5 - 2.5		M5	9.0	22.5	4.5	18.0	96		
RB6F	1.5 - 2.5	Yellow	M6	11.0	26.5	4.5	21.0	113		
RC4F	4.0 - 6.0		M4	8.0	24.0	6.4	20.5	159		
RC5F	4.0 - 6.0		M5	9.0	25.0	6.4	20.5	161		
RC6F	4.0 - 6.0		M6	11.0	28.5	6.4	23.0	174		
RC8F	4.0 - 6.0		M8	14.0	31.0	6.4	24.0	207		
RC10F	4.0 - 6.0		M10	18.0	36.0	6.4	27.0	280		

Vinyl Insulated Ring Terminals DIN 46237



Technical Information

Material	Copper
Plating	Tin-plated
Marking	Wire size and bolt size stamped on the tongue
Metal barrel	Brazed seam to prevent barrel separation
Insulation	PVC = Polyvinylchloride (Vinyl) Ideal for harsh environments, provides excellent chemical, impact and abrasion resistance
Max. electrical rating	+75°C 600 Volts max
Colour coding of the insulation	According to the wire size

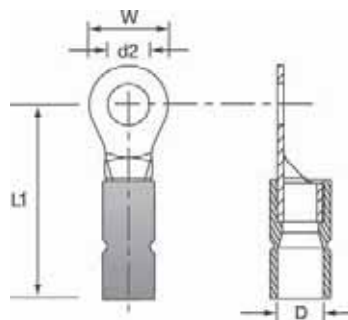

Ordering Information										
Cat. No.	Wire Size Range (mm ²)	Colour	Stud Hole Size d2	Dimensions			Wt. (g/100)	Qty. (pieces)	Crimping Tool	
				W (mm)	L1 (mm)	D (mm)				
VB-3RR	0.5 - 1.5	Red	M3	6.0	17.2	4.0	68	100	ERG2001A WT2124Y	
VB-35RR	0.5 - 1.5		M3.5	6.0	17.2	4.0	69			
VB-4RR	0.5 - 1.5		M4	8.0	18.2	4.0	73			
VB-5RR	0.5 - 1.5		M5	10.0	19.2	4.0	92			
VB-6RR	0.5 - 1.5		M6	10.0	19.2	4.0	87			
VB-8RR	0.5 - 1.5		M8	14.0	23.2	4.0	139			
VB-10RR	0.5 - 1.5		M10	14.0	23.2	4.0	100			
VB-3BR	1.5 - 2.5		Blue	M3	6.0	17.5	4.5			80
VB-35BR	1.5 - 2.5			M3.5	6.0	17.5	4.5			94
VB-4BR	1.5 - 2.5			M4	8.0	18.5	4.5			83
VB-5BR	1.5 - 2.5	M5		10.0	20.5	4.5	110			
VB-6BR	1.5 - 2.5	M6		11.0	22.5	4.5	122			
VB-8BR	1.5 - 2.5	M8		14.0	23.5	4.5	146			
VB-10BR	1.5 - 2.5	M10	15.0	23.5	4.5	204				
VB-4YR	4.0 - 6.0	Yellow	M4	8.0	22.1	6.3	167			
VB-5YR	4.0 - 6.0		M5	10.0	23.1	6.3	196			
VB-6YR	4.0 - 6.0		M6	11.0	24.1	6.3	195			
VB-8YR	4.0 - 6.0		M8	14.0	27.1	6.3	250			
VB-10YR	4.0 - 6.0		M10	18.0	29.1	6.3	305			

Nylon Insulated Ring Terminals DIN 46237

Technical Information

Material	Copper
Plating	Tin-plated
Marking	Wire size and bolt size stamped on the tongue
Metal barrel	Brazed seam to prevent barrel separation
Insulation	PA = Polyamide Ideal for harsh environments, provides excellent chemical, impact and abrasion resistance
Temperature resistance	+85°C / +105°C
Colour coding of the insulation	According to the wire size

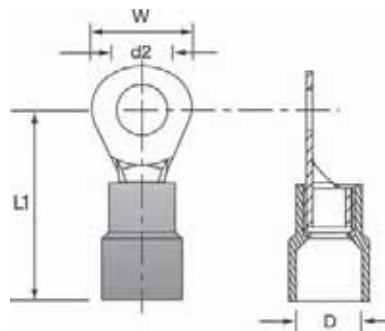

Ordering Information										
Cat. No.	Wire Size Range (mm ²)	Colour	Stud Hole Size d2	Dimensions			Wt. (g/100)	Qty. (pieces)	Crimping Tool	
				W (mm)	L1 (mm)	D (mm)				
TRA3	0.5 - 1.5	Red	M3	5.5	17.5	4.0	70	100	ERG2001A WT2124Y	
TRA35	0.5 - 1.5		M3.5	6.6	20.4	4.0	67			
TRA4	0.5 - 1.5		M4	8.0	21.8	4.0	76			
TRA5	0.5 - 1.5		M5	8.0	21.8	4.0	79			
TRA6	0.5 - 1.5		M6	11.6	27.5	4.0	108			
TRA8	0.5 - 1.5		M8	11.6	27.5	4.0	134			
TRB3	1.5 - 2.5		Blue	M3	6.0	20.6	4.5			79
TRB35	1.5 - 2.5			M3.5	8.5	23.0	4.5			76
TRB4	1.5 - 2.5	M4		8.5	23.0	4.5	79			
TRB5	1.5 - 2.5	M5		9.5	22.9	4.5	89			
TRB6	1.5 - 2.5	M6		12.0	28.0	4.5	117			
TRB8	1.5 - 2.5	M8		12.0	28.0	4.5	148			
TRB10	1.5 - 2.5	M10		13.6	31.7	4.5	204			
TRC4-EU	4.0 - 6.0	Yellow		M4	7.4	26.7	6.4			158
TRC5-EU	4.0 - 6.0		M5	9.5	26.7	6.4	175			
TRC6-EU	4.0 - 6.0		M6	12.0	32.7	6.4	187			
TRC8	4.0 - 6.0		M8	15.0	34.9	6.4	230			
TRC10	4.0 - 6.0		M10	15.0	34.9	6.4	296			

Nylon Insulated Fork Terminals DIN 46237

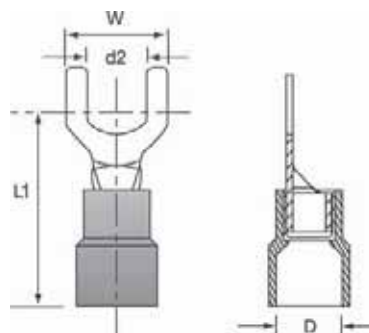

Technical Information

Material	Copper
Plating	Tin-plated
Marking	Wire size and bolt size stamped on the tongue
Metal barrel	Brazed seam to prevent barrel separation
Insulation	PA = Polyamide Ideal for harsh environments, provides excellent chemical, impact and abrasion resistance
Temperature resistance	+85°C / +105°C
Colour coding of the insulation	According to the wire size
Cable insertion	Easy entry

Ordering Information									
Cat. No.	Wire Size Range (mm ²)	Colour	Stud Hole Size d2	Dimensions			Wt. (g/100)	Qty. (pieces)	Crimping Tool
				W (mm)	L1 (mm)	D (mm)			
TRA3F	0.5 - 1.5	Red	M3	5.7	22.0	4.0	65	100	ERG2001A WT2124Y
TRA35F	0.5 - 1.5		M3.5	6.2	22.0	4.0	62		
TRA4F	0.5 - 1.5		M4	7.2	22.0	4.0	70		
TRA5F	0.5 - 1.5		M5	8.0	22.0	4.0	92		
TRA6F	0.5 - 1.5		M6	10.8	23.0	4.0	102		
TRB3F	1.5 - 2.5		Blue	M3	5.7	22.2	4.5		
TRB35F	1.5 - 2.5	M3.5		6.2	22.2	4.5	74		
TRB4F	1.5 - 2.5	M4		7.2	22.2	4.5	80		
TRB5F	1.5 - 2.5	M5		8.0	22.2	4.5	110		
TRB6F	1.5 - 2.5	M6		10.8	23.5	4.5	122		
TRC4F	4.0 - 6.0	Yellow		M4	8.2	26.7	6.4		
TRC5F	4.0 - 6.0		M5	9.0	26.7	6.4	182		
TRC6F	4.0 - 6.0		M6	12.0	30.3	6.4	190		

Vinyl Insulated Fork Terminals DIN 46237

Technical Information

Material	Copper
Plating	Tin-plated
Marking	Wire size and bolt size stamped on the tongue
Metal barrel	Brazed seam to prevent barrel separation
Insulation	PVC = Polyvinylchloride (Vinyl)
Max. electrical rating	+75°C 600 Volts
Colour coding of the insulation	According to the wire size
Cable insertion	Easy entry

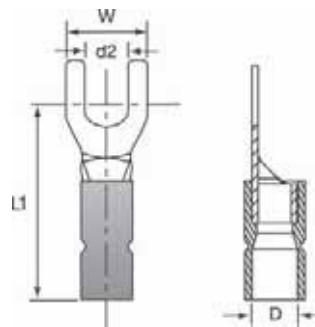

Ordering Information									
Cat. No.	Wire Size Range (mm ²)	Colour	Stud Hole Size d2	Dimensions			Wt. (g/100)	Qty. (pieces)	Crimping Tool
				W (mm)	L1 (mm)	D (mm)			
VB-4RF	0.5 - 1.5	Red	M4	6.8	18.2	4.0	73	100	ERG2001A
VB-5RF	0.5 - 1.5		M5	10.0	19.2	4.0	92		
VB-6RF	0.5 - 1.5		M6	11.0	21.2	4.0	103		
VB-3BF	1.5 - 2.5	Blue	M3	5.5	19.5	4.5	90		
VB-35BF	1.5 - 2.5		M3.5	6.0	17.5	4.5	97		
VB-4BF	1.5 - 2.5		M4	6.8	19.2	4.5	83		
VB-5BF	1.5 - 2.5	M5	10.0	20.5	4.5	110			
VB-6BF	1.5 - 2.5	M6	11.0	22.5	4.5	121			
VB-4YF	2.5 - 6.0	Yellow	M4	8.0	22.1	6.3	169		
VB-5YF	2.5 - 6.0		M5	10.0	23.1	6.3	189		
VB-6YF	2.5 - 6.0		M6	11.0	24.1	6.3	200		
VB-8YF	2.5 - 6.0		M8	14.0	27.1	6.3	235		
VB-10YF	2.5 - 6.0		M10	18.0	29.1	6.3	305		

Polycarbonate Insulated Pin Terminals



Technical Information

Material	Electrolytic copper
Plating	Tin-plated
Metal barrel	Brazed seam to prevent barrel separation
Insulation	PC = Polycarbonate
Temperature resistance	+115°C / +125°C
Colour coding of the insulation	According to the wire size
Cable insertion	Easy entry

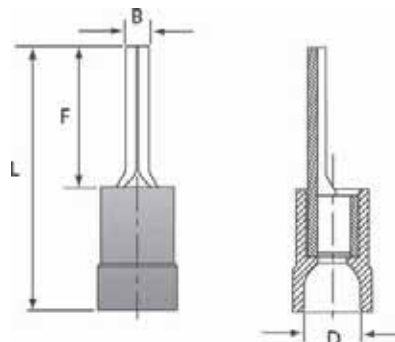

Ordering Information									
Cat. No.	Wire Size Range (mm ²)	Colour	Dimensions				Wt. (g/100)	Qty. (pieces)	Crimping Tool
			L (mm)	F (mm)	B (mm)	D (mm)			
RZP	0.25 - 0.75	Green	22.0	12.0	1.8	3.2	47	100	ERG2510
RAP	0.5 - 1.5	Red	22.0	12.0	1.9	4.0	67		ERG2001A
RBP	1.5 - 2.5	Blue	22.0	12.0	1.9	4.5	80		WT2124Y
RCP	4.0 - 6.0	Yellow	27.0	14.0	2.8	6.4	175		

Insulated Female Disconnects DIN 46245

Technical Information

Material	Brass
Plating	Tin-plated
Metal barrel	Brazed seam to prevent barrel separation
Insulation	PC = Polycarbonate
Temperature resistance	+115°C / +125°C (for PVC insulation +65°C / +75°C)
Colour coding of the insulation	According to the wire size (DIN)
Cable insertion	Easy entry

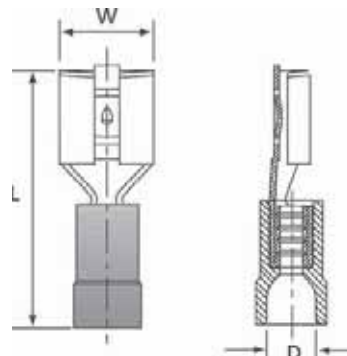

Ordering Information									
Cat. No.	Wire Size Range (mm ²)	Male Tab Size (mm)	Colour	Dimensions			Wt. (g/100)	Qty. (pieces)	Crimping Tool
				L (mm)	D (mm)	W (mm)			
RA28	0.5 - 1.5	2.8 x 0.8	Red	18.5	3.3	3.5	60	100	ERG2001A WT2124Y
RA29	0.5 - 1.5	2.8 x 0.5		18.5	3.3	3.5	60		
RA48**	0.5 - 1.5	4.8 x 0.8		19.0	3.7	5.7	82		
RA49**	0.5 - 1.5	4.8 x 0.5		19.0	3.7	5.7	83		
RA63	0.5 - 1.5	6.3 x 0.8		20.0	4.0	7.6	96		
RB48**	1.5 - 2.5	4.8 x 0.5	Blue	19.0	4.4	5.7	91		
RB49**	1.5 - 2.5	4.8 x 0.8		19.0	4.4	5.7	87		
RB63	1.5 - 2.5	6.3 x 0.8		20.0	4.5	7.6	106		
RC63	4.0 - 6.0	6.3 x 0.8	Yellow	24.0	6.4	7.6	183		
RC95**	4.0 - 6.0	9.5 x 1.2		31.0	6.2	11.0	233		

**Non-brazed, with support sleeve and PVC insulation, not easy entry

Insulated Male Disconnects DIN 46245



Technical Information

Material	Brass
Plating	Tin-plated
Metal barrel	Brazed seam to prevent barrel separation
Insulation	PC = Polycarbonate
Temperature resistance	+115°C / +125°C (for PVC insulation +65°C / +75°C)
Colour coding of the insulation	According to the wire size (DIN)
Cable insertion	Easy entry

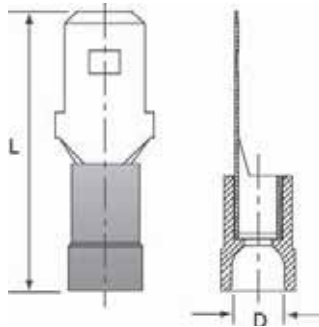

Ordering Information								
Cat. No.	Wire Size Range (mm ²)	Male Tab Size (mm)	Colour	Dimensions		Wt. (g/100)	Qty. (pieces)	Crimping Tool
				L (mm)	D (mm)			
RA63M	0.5 - 1.5	6.3 x 0.8	Red	22.0	4.0	107	100	ERG2001A WT2124Y
RB63M	1.5 - 2.5	6.3 x 0.8	Blue	22.0	4.5	107		
RC63M**	4.0 - 6.0	6.3 x 0.8	Yellow	25.0	6.3	155		

**PVC insulation. No easy entry and non-brazed, with brass support sleeve

Fully Insulated Female Disconnects

Technical Information

Material	Brass
Plating	Tin-plated
Metal barrel	Non-brazed, with brass support sleeve
Insulation	PA = Polyamide Ideal for harsh environments, provides excellent chemical, impact and abrasion resistance
Temperature resistance	+85°C / +105°C
Colour coding of the insulation	According to the wire size (DIN)

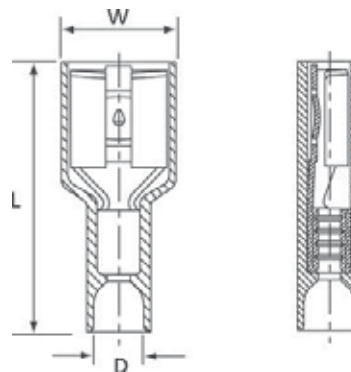

Ordering Information

Cat. No.	Wire Size Range (mm ²)	Male Tab Size (mm)	Colour	Dimensions			Wt. (g/100)	Qty. (pieces)	Crimping Tool
				W (mm)	L (mm)	D (mm)			
RA28V	0.5 - 1.5	2.8 x 0.8	Red	5.0	19.3	3.8	110	100	ERG2001A WT2124Y
RA29V	0.5 - 1.5	2.8 x 0.5		5.0	19.3	3.8	110		
RA48V	0.5 - 1.5	4.8 x 0.8		7.4	20.2	3.6	115		
RA49V	0.5 - 1.5	4.8 x 0.5		7.4	20.2	3.6	115		
RA63V**	0.5 - 1.5	6.3 x 0.8		8.8	21.0	4.0	123		
RB48V	1.5 - 2.5	4.8 x 0.8	Blue	7.1	19.5	3.9	120		
RB49V	1.5 - 2.5	4.8 x 0.5		7.1	19.5	3.9	120		
RB63V**	1.5 - 2.5	6.3 x 0.8		8.8	21.0	4.5	132		
RC63V	4.0 - 6.0	6.3 x 0.8		9.0	26.0	5.3	215		

**Easy entry and brazed barrel, polycarbonate insulator

Fully Insulated Butt Splices



Technical Information

Material	Electrolytic copper
Plating	Tin-plated
Metal barrel	Brazed seam to prevent barrel separation
Insulation	PC = Polycarbonate
Temperature resistance	+115°C / +125°C
Colour coding of the insulation	According to the wire size (DIN)
Cable insertion	Easy entry

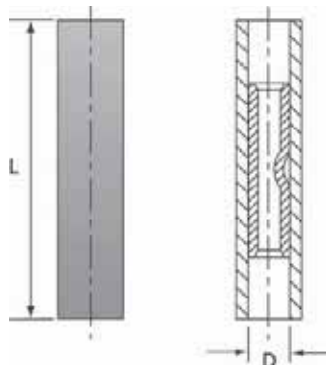

Ordering Information							
Cat. No.	Wire Size Range (mm ²)	Colour	Dimensions		Wt. (g/100)	Qty. (pieces)	Crimping Tool
			L (mm)	D (mm)			
RAA15	0.5 - 1.5	Red	24.0	3.4	97	100	ERG2001A WT2124Y
RBB25	1.5 - 2.5	Blue	26.0	4.3	150		
RCC6	4.0 - 6.0	Yellow	33.0	6.5	316		

Insulated Wire Joints

Technical Information

Material	Brass
Plating	Tin-plated
Metal barrel	Brazed seam to prevent barrel separation
Insulation	PA = Polyamide Ideal for harsh environments, provides excellent chemical, impact and abrasion resistance
Temperature resistance	+85°C / +105°C

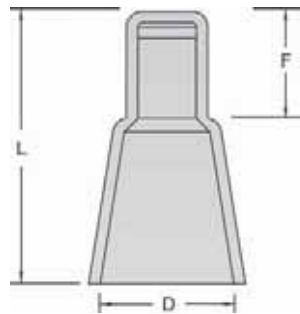

Ordering Information								
Cat. No.	Wire Size Range (mm ²)	Colour	Dimensions			Wt. (g/100)	Qty. (pieces)	Crimping Tool
			F (mm)	L (mm)	D (mm)			
RBJ	1.0 - 3.0	White	8.0	15.2	6.4	86	100	ERG2001A
RCJ	2.0 - 6.0		9.0	17.7	9.2	166		WT2124Y

Tools

- Ergonomic ratchet style hand tools used for installing insulated and non-insulated terminals
- Specially designed ergonomic handles distribute the crimping force more evenly across the user's hands. This helps to reduce the risk of Carpal Tunnel Syndrome, the cause of almost one in two industrial injuries
- Ratchet design greatly reduces handle forces over conventional hand tools and incorporates the Shure-Stake® mechanism which ensures a full crimp cycle every time
- Most dies incorporate wire range mark for easy inspection (insulated only)
- Colour-coded die nests (insulated only) make terminal and die nest selection easy
- The product design and engineering results in a long lasting precision tool
- Exists in 2 versions: with interchangeable dies or with fixed dies

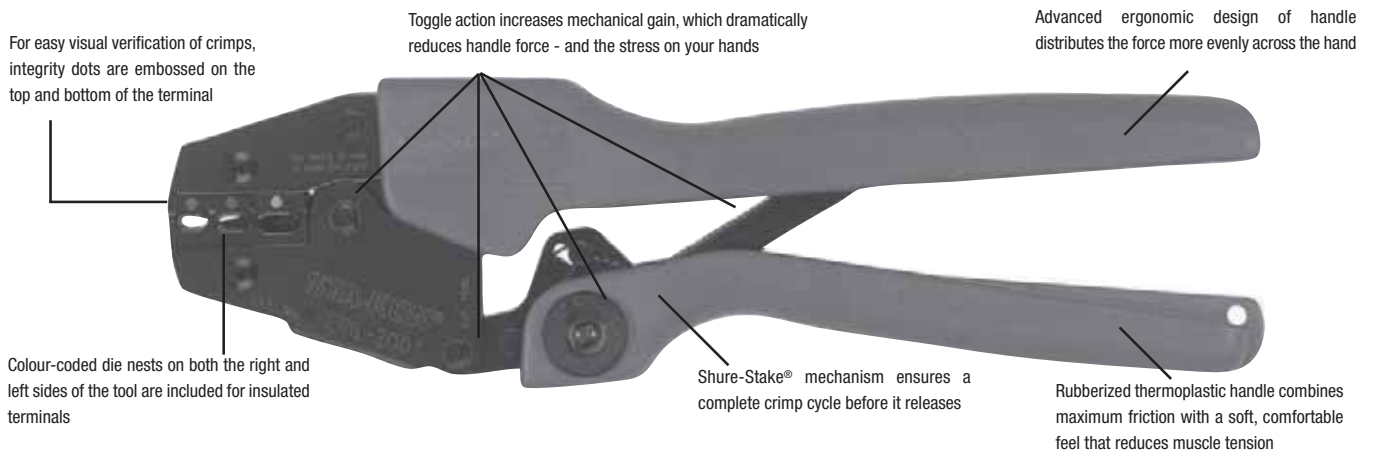

Ergonomic Hand Tools with Fixed Die

Product Ref.: ERG2001A

Ergonomic fixed die tool, with three colour-coded die nests for easy selection

For **insulated terminals** from:

- 0.5 to 1.5 mm² red
- 1.5 to 2.5 mm² blue
- 4.0 to 6.0 mm² yellow

Shure-Stake™ mechanism

Length: 255 mm

Weight: 560 g



Product Ref.: ERG2510

Ergonomic fixed die tool with 2 die nests

For **insulated terminals** and **insulated bootlace ferrules**

- from: 0.25 to 0.5 mm²
- 0.5 to 1.0 mm²

Shure-Stake™ mechanism

Length: 220 mm

Weight: 430 g



Tools

Metric Crimping Tools

An extensive range of tooling is available, suiting a variety of requirements, to crimp the following terminals:

- Insulated terminals and bootlace ferrules
- Non-insulated terminals
- Copper tube terminals

Different types of tooling are offered, depending on volume and application:

- Plier type hand tools for occasional applications (“Do-It-Yourself” users)
- Standard hand tooling for low to medium volume applications
- Ergonomic hand tooling for low to medium volume applications, where high, repeatable quality is essential
- Hydraulic tooling for heavy-duty applications
- Smart tools where no die change is necessary

Standard Crimping Tools

Product Ref.: WT52

Plier type tool

For **insulated** and **non-insulated** terminals from 0.5 to 6.0 mm²

Incorporates wire stripper and bolt cutters

Recommended for “Do-It-Yourself” applications only

Length: 225 mm

Weight: 200 g



Product Ref.: WT2124Y

Ratchet type hand tool, fixed die

For **insulated** and **non-insulated** terminals

from: 0.5 to 1.5 mm² red
1.5 to 2.5 mm² blue
4.0 to 6.0 mm² yellow

Built in **Shure-Stake®** mechanism to ensure a full compression every time

Length: 228 mm

Weight: 533 g

