

Practical Energy Efficient Solutions

MOBERN

L I G H T I N G

### Recessed Linear

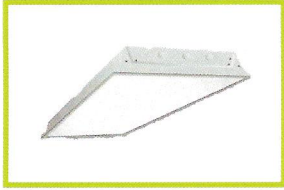

Troffer  
Series RG

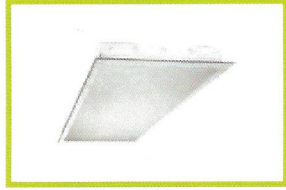

Troffer for Plaster Ceiling  
Series RF

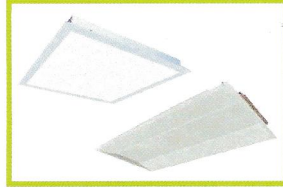

Flat Panel  
Series MFP

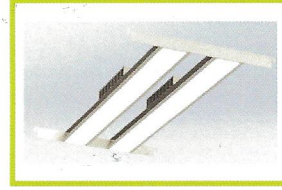

Linear Lines  
Series RL



Low Profile Center Basket  
Series RDIS



Low Profile Dual Basket Recessed  
Series RDISD



Dual Lens Concave  
Series RGLT



Dual Lens  
Series RGSB



Center Deco Lens  
Series SKY



Direct/Indirect Center Basket  
Series RDIW



Curve Direct/Indirect  
Series RGCVR



Parabolic Troffer  
Series RP

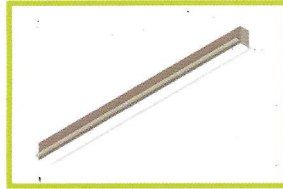

Linear 2" x 3"  
Series LI23

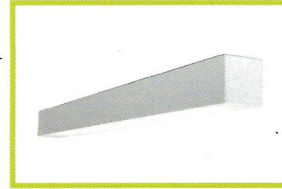

Linear 4" x 4"  
Series LI44

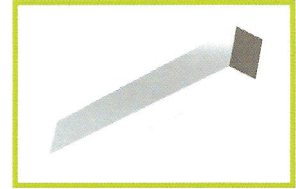

Linear 4" x 5" Direct/Indirect  
Series LI45

### Surface Linear



Linear 6" x 6"  
Series LI66



Elliptical Wall Wash  
Series RWW

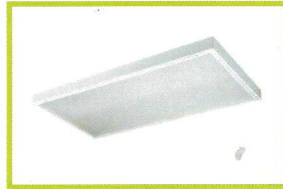

Troffer  
Series S



Center Basket Direct/Indirect  
Series SRDIS



Dual Basket Direct/Indirect  
Series SRDISD

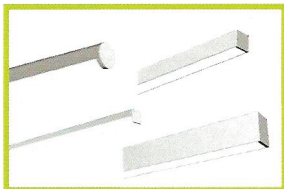

Linear Channels  
Series LLC



Linear 2" x 3"  
Series LI23

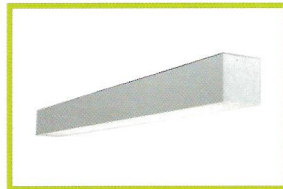

Linear 4" x 4"  
Series LI44



Linear 6" x 6"  
Series LI66

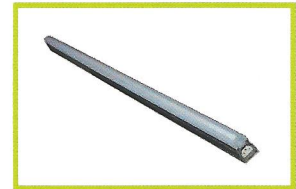

Linear Micro Profile  
Series MLPL

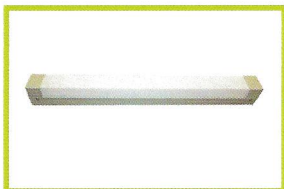

Low Profile Square  
Series 10T5S



Low Profile Round  
Series 10T5

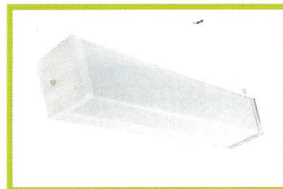

Ceiling 4" x 4" Lensed  
Series 155



Direct / Indirect Linear  
Series DIS



Louvered Industrial 6"  
Series DLV6

**Surface Decorative**



Louvered Industrial Series DLV

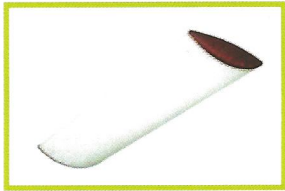

Eclipse Series MCH



Puff Cloud Series C

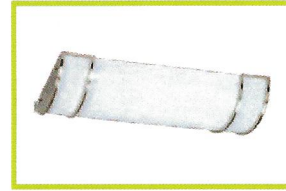

Spill Ring Series MDC

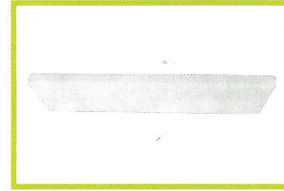

Linear Square Cloud Series MCE

**Wraparound**

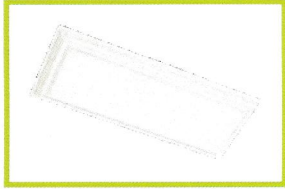

Crown Series CWN

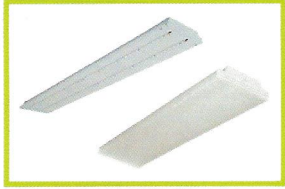

Spec Grade Wraparound Series 772



Wraparound 7" and 13" Series 769

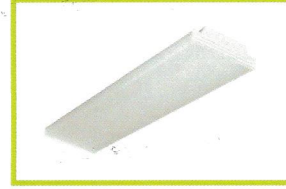

Wraparound 9" Series 770



Linear Wraparound Series 774



Narrow Wraparound Series 772N

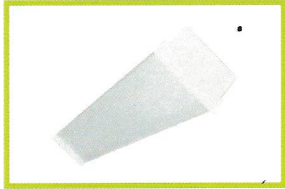

Premium 90 Degree Wraparound Series 779

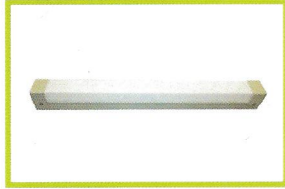

Low Profile Square Series 10T5S

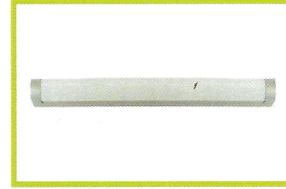

Low Profile Round Series 10T5

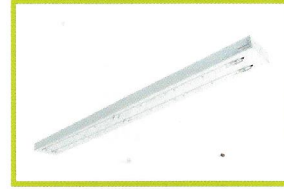

Medium Body Strip Series 44

**Strips**

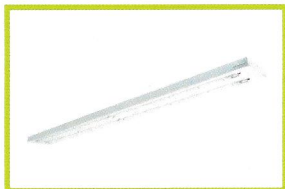

Narrow Body Strip Series 42

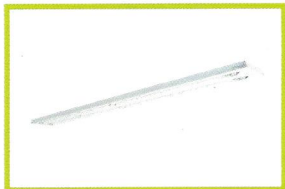

Mini Body Strip Series 41



Industrial Strip with Reflector Series I



Harsh Environment Enclosure DLC Series VWLB, VWPG



Harsh Environment Enclosure Series WV

**Enclosure**

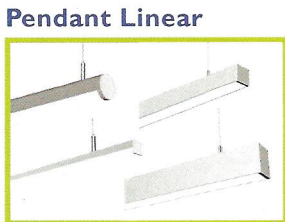

Linear Channels Series LLC



Low Profile Direct/Indirect Series LPLI



Linear Pendant Direct/Indirect Series LI, LIS, LIB



Linear Baffled Series FHBR



Linear 2" x 3" Series LI22

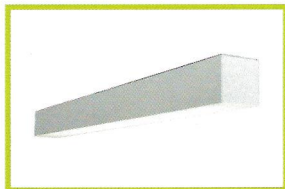

Linear 4" x 4" Series LI44

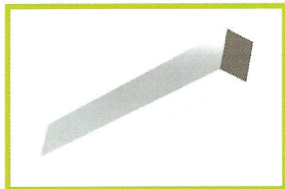

Linear 4" x 5" Series LI45



Linear 6" x 6" Series LI66



Louvered Industrial Series DLV6



Louvered Industrial Series DLV



Direct / Indirect Linear Series DIS

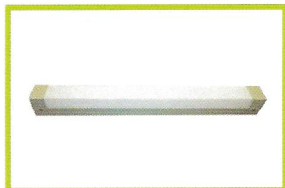

Low Profile Square Series 10T5S

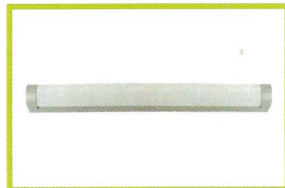

Low Profile Round Series 10T5



Full Body High Bay Series FHBC



Linear Baffled Series FHBR

**High Bays**

## Retrofit

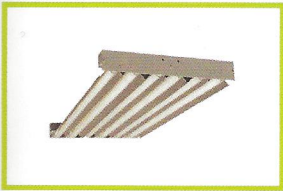

Industrial I Beam  
Series FHBI

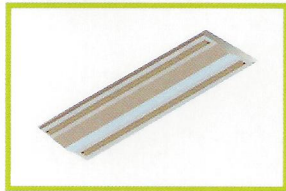

Troffer Retrofit Kit  
Series RKT



Retrofit Center Basket  
Series RKRDIW



Retrofit Center & Dual Basket  
Series RKDIC, RKDID

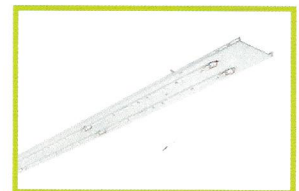

Strip Retrofit Kit 4 Ft  
Series RKBC4

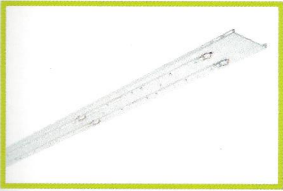

Strip Retrofit Kit 8 Ft  
Series RKBC8

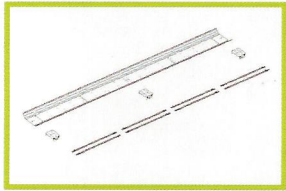

Universal Strip w/Reflector  
Series RKSR



Retrofit Harsh Enclosure  
Series RKVW



Retrofit C-T-C & Wall  
Series RKR



Linear 2" x 3"  
Series LI22

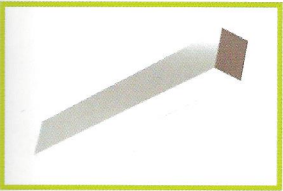

Linear 4" x 5" Direct/Indirect  
Series LI45



Linear 4" x 4"  
Series LI44

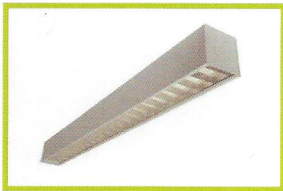

Linear 6" x 6"  
Series LI66



Low Profile Square  
Series 10T5S

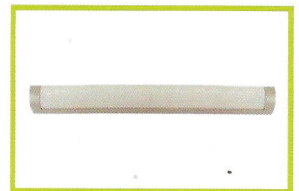

Low Profile Round  
Series 10T5

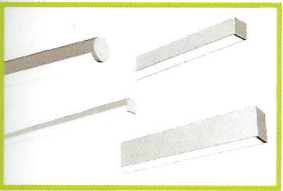

Linear Channels  
Series LLC

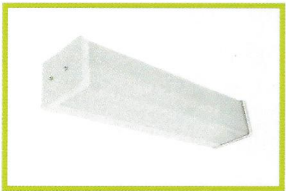

Up & Down 4" x 4"  
Series 158

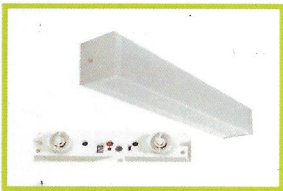

Smartsense Up & Down  
Series 1555W

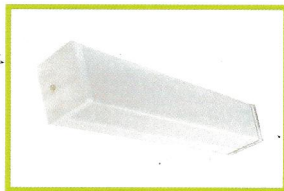

4" x 4" Lensed  
Series 155

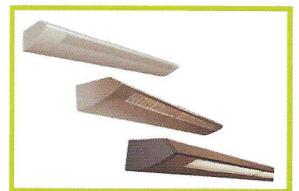

Direct/Indirect Linear  
Series LIW

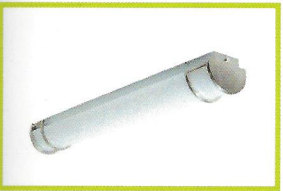

Spill Ring  
Series DECB



End Cap Bath Bars  
Series VB



Wall Mount - Classic Bath Styles  
Series 74, 741, 79, 791



Micro C-T-C Wet Location  
Series CTCM



Spill Ring  
Series DECCD



Deco Series  
Series DECCA



Melon C-T-C  
Series DECCM



Enclosed C-T-C  
Series DECC, DECCW



Mushroom C-T-C  
Series DECCE

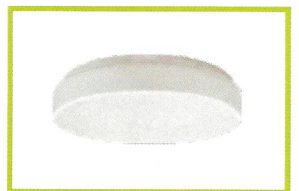

C-T-C Drum  
Series 69

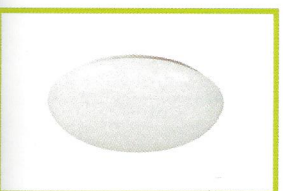

Mushroom  
Series 68



Décor Wall  
Series DECWD, DECWG, DECW



Dock Light & Arm  
Series DLL



Undercabinet  
Series MLEDDUCL



Linear Micro Profile  
Series MLPL

## Wall Linear

## C-T-C

## Undercabinet

## Outdoor Ceiling



Vandelier Wet  
Series MIMDCL



Wet Ceiling Light  
Series CLL



Wet C-T-C  
Series WRC, WSC



Micro C-T-C Wet Location  
Series CTCM

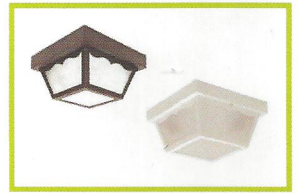

Wet Square  
Series MCBP, MBBP

## Outdoor Wall



Vapor Proof  
Series MVPW



Large Area Flood  
Series MPL



Flood  
Series MAFCO

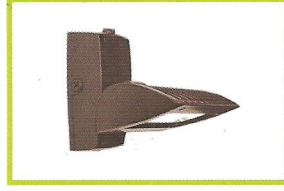

Wall Flood  
Series WLL



Wall Pack  
Series WPL



Full Cut-Off Wall Pack  
Series MIMDCOWPK, MILGCOWPK



Decorative Cut-Off Wall Pack  
Series MIRCOWPK



Medium Wall Pack  
Series MIMDWPK, MILGWPK



Mini Wall Pack  
Series MISMCOWPK



Mini Jelly Jar  
Series JJLED

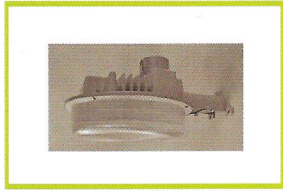

Dust-to-Dawn  
Series D2D



Vapor Proof  
Series MVPW



Nautical Oval / Round  
Series MCEO, MCER



Nautical  
Series MNOP, MNOB, MNOW



Amherst  
Series MAOP, MAOW, MAOL



Bradford  
Series MBRP, MBRW, MBRL



Colonial  
Series MCOP, MCOW, MCOL



Hexagon  
Series MHOP, MHOW, MHOL



Hatch  
Series MHTP, MHTW, MHTL



Kingston  
Series MKRP, MKRW, MKRL



Tudor Lantern and Post Top  
Series MTOL, MTOP



Premium Pocket Wall  
Series MBPW

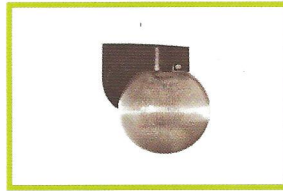

Classic Pocket Wall  
Series MBPW

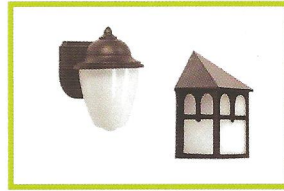

Economical Wall  
Series MAPW, MDH, MGBW



Philips InstaFit  
Series NOR433

## T8 LED Lamps



LED T8 Retrofit  
Series TLEDD



T8 Integral Driver  
Series TLED



4" Down  
Series MLEDRT4



6" Down  
Series MLEDRT6

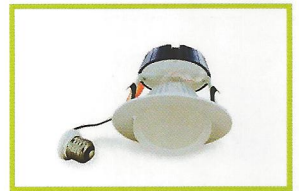

6" Gimbal  
Series MLEDR6-G

## Retrofit Downlights

# MOBERN

L I G H T I N G

## Buy America

The majority of Mobern Lighting Products are domestically produced in their BALTIMORE, MARYLAND facility that comply with the Buy American requirements. We can assist you in filling out all the necessary paperwork to certify Made in America.



## Rooted in Tradition

For over 60 years, Mobern has been providing the industry with quality lighting products. Mobern's success is rooted in the tradition of providing HIGH QUALITY, SPECIFICATION GRADE PRODUCTS with exceptional personalized service through long-standing partner-centric relationships with its clients. Maintaining this foundation has enabled Mobern to continually meet the changing industry dynamics.

## Energy Efficient Solutions

Over the last several years, Mobern has developed an expertise in ENERGY EFFICIENT SOLUTIONS. Working on major Public building retrofits, developing custom solutions for a major airport, or providing High Bay fluorescents and retrofit kits to Fortune 500 facilities has expanded Mobern's capabilities and made them a leader in working with ENERGY MANAGEMENT SPECIALISTS to provide the most cost effective solution. Mobern is uniquely qualified to provide the expertise, the right products, and the fastest payback for every retrofit project. In fact, Mobern is the preferred supplier on many utility rebate programs.



## Mass Customization

Mobern has addressed today's ever-expanding product options by re-engineering their manufacturing and assembly capabilities to provide an incredible amount of PRODUCT OPTIONS WITH OFF-THE-SHELF SERVICE and value. Whether it is a specific ballast, a specialized reflector, wire and mounting accessories factory installed to reduce installation time or simply a special finish, Mobern can react quickly to provide it your way.



See inside back cover for more information.

## Yes We Can

Mobern's "Yes We Can" mantra is a refreshing change from the all too common bureaucracy of the large lighting conglomerates. Mobern's personnel are lighting specialists who are equipped with the tools and expertise to try and meet all your specific requests. Whether you are trying to get something shipped quickly, a special product or just need a detailed lighting layout, Mobern's account focused team can MAKE IT HAPPEN.



# Table of Contents

4 | RECESSED FLUORESCENTS  
Indirect/Direct, Troffers, Parabolics



9 | LINEAR PENDANT LIGHTING  
Indirect/Direct, Geometric, Continuous Runs

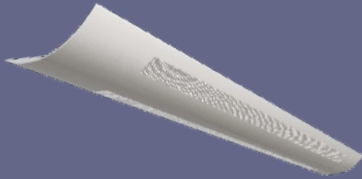

12 | SURFACE FLUORESCENTS  
Indirect/Direct, Troffers, Wraparounds,  
Enclosed All Weather, Decorative Fluorescents



20 | FLUORESCENT STRIPS  
T5, T8, Staggered, Industrials



26 | HIGH BAY FLUORESCENTS  
Industrial, Enclosed, Wet Location



32 | RETROFIT KITS  
Troffer, Strips, Custom

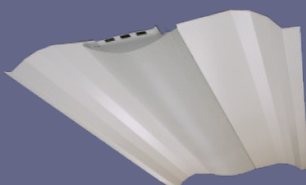

36 | WALL & CEILING FIXTURES  
Indirect/Direct, Linear, Bath, Utility, Decorative

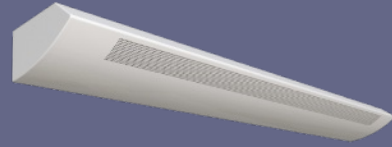

46 | OUTDOOR LIGHTING  
Architectural, Wall, Decorative, Wall Packs

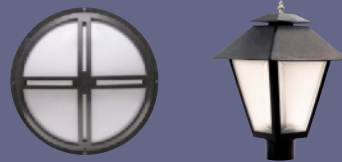

52 | HID LIGHTING  
Wall Packs, Floods, High Bays, Bollards, Poles



58 | ESSENTIALS  
Downlights, Exit and Emergency, Ballasts



66 | LED LIGHTING  
Tape, Strips, Cove and Lamps

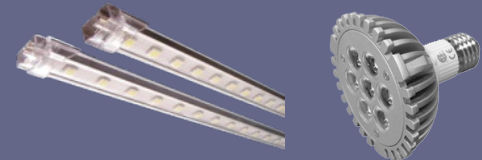

68 | PREMIUM PERFORMANCE OPTIONS  
Ballasts, Dimming, Sensors, Mounting,  
Wiring, Lamps





## Recessed Fluorescents

Mobern offers the latest in recessed fluorescents from the highly energy efficient Parabolics to today's most popular indirect/direct recessed fixtures. Most series now feature a shallow version to accommodate crowded plenum spaces. The indirect/direct recessed fixtures include choice of lampings, basket types and reflector options. Based on the lighting effect and amount of light desired, Mobern's assortment can be made to order to meet the exact specifications. Premium specification grade and budget focused models address your real world requirements.

### Universal Center Basket T5 & T8

This indirect/direct Center basket is available using T5 or T8 lamps in choice of one, two or three lamps. Perforated center shield comes with an inlay white diffuser and provides enhanced glare control. Ribbed linear diffuser provides more light and a fresh look. Shallow depth makes it the ideal solution for shallow plenum spaces.

Item Number	Dimensions (L x W x H)	Lamping
RDIS14 132PFMV	47.67" x 11.68" x 3.25"	1-F32T8
RDIS14 254PFMV	47.67" x 11.68" x 3.25"	2-F54T5HO
RDIS22 217PFMV	23.68" x 23.68" x 3.25"	2-F17T8
RDIS22 214PFMV	23.68" x 23.68" x 3.25"	2-F14T5
RDIS22 224PFMV	23.68" x 23.68" x 3.25"	2-F24T5HO
RDIS22 240BXPFMV	23.68" x 23.68" x 3.25"	2-F40BX
RDIS24 232PFMV	47.67" x 23.68" x 3.25"	2-F32T8
RDIS24 228PFMV	47.67" x 23.68" x 3.25"	2-F28T5
RDIS24 254PFMV	47.67" x 23.68" x 3.25"	2-F54T5HO

Choice of Center diffusers: PF for Perforated Basket or RL for Linear Ribbed Lens. Available in 1, 2 or 3 light lamping simply change the first number to the desired number of lamps.\*  
\*3 lamp available for 2x2 and 2x4 sizes only.

**NEW**

**Consult for  
LED Options**

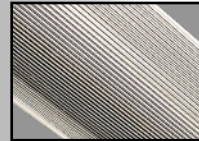

Choice of perforated basket (PF) or linear ribbed acrylic diffuser (RL) shown. **With linear ribbed diffuser, fixtures are over 80% efficient.**



#### Configure to Your Specs

Available with 1, 2 or 3 lamps in T5 or T8.  
For surface mount, see page 12.\*

### Universal Dual Basket T5 & T8

This indirect/direct Dual basket is available using T5 or T8 lamps in choice of two or four lamps. Perforated center shield comes with an inlay white diffuser and provides enhanced glare control. Ribbed linear diffuser provides more light and a fresh look. Shallow depth makes it the ideal solution for shallow plenum spaces.

Item Number	Dimensions (L x W x H)	Lamping
RDISD22 217PFMV	23.68" x 23.68" x 3.25"	2-F17T8
RDISD22 214PFMV	23.68" x 23.68" x 3.25"	2-F14T5
RDISD22 224PFMV	23.68" x 23.68" x 3.25"	2-F24T5HO
RDISD22 240BXPFMV	23.68" x 23.68" x 3.25"	2-F40BX
RDISD24 232PFMV	47.67" x 23.68" x 3.25"	2-F32T8
RDISD24 228PFMV	47.67" x 23.68" x 3.25"	2-F28T5
RDISD24 254PFMV	47.67" x 23.68" x 3.25"	2-F54T5HO

Choice of Dual diffusers: PF for Perforated Basket or RL for Linear Ribbed Lens. Available in 2 or 4 light lamping simply change the first number to the desired number of lamps.

**NEW**

**Compare to Lithonia's  
RT5 Series**

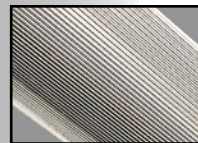

Choice of perforated basket (PF) or linear ribbed acrylic diffuser (RL) shown. **With linear ribbed diffuser, fixtures are over 80% efficient.**



#### Configure to Your Specs

Available with 2 or 4 lamps in T5 or T8.  
For surface mount, see page 12.



# RECESSED FLUORESCENTS

## Sky Recessed Direct/ Indirect

Reflected light from matte surfaces provide a softened “sky light” appearance for the modern office environment. Specification grade, direct/ indirect center diffuser luminaire provides smooth and uniform ambient lighting for all commercial and industrial buildings with recessed configurations. Unique dual curved lens with center perforated basket or linear ribbed acrylic diffuser provides a luminous housing with excellent visual comfort. Light reaches higher in the space to eliminate the “cave effect.”

**NEW**



Item Number	Dimensions (L x W x H)	Lamping
SKY22 217PFMV	24" x 24" x 4"	2-F17T8
SKY22 224PFMV	24" x 24" x 4"	2-F24T5HO
SKY22 317PFMV	24" x 24" x 4"	3-F17T8
SKY22 324PFMV	24" x 24" x 4"	3-F24T5HO
SKY24 232PFMV	48" x 24" x 4"	2-F32T8
SKY24 254PFMV	48" x 24" x 4"	2-F54T5HO
SKY24 332PFMV	48" x 24" x 4"	3-F32T8
SKY24 354PFMV	48" x 24" x 4"	3-F54T5HO

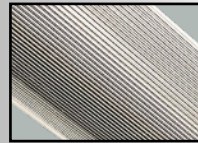

Choice of Center Diffusers: PF for Perforated Basket or RL for Linear Ribbed Lens. Three light T8 lamping requires external top of fixture ballast box.

Choice of perforated basket (PF) or linear ribbed acrylic diffuser (RL) shown.

### Configure to Your Specs

For surface mounts, see page 13. Consult for retrofit kit version.

## Center Basket Recessed Indirect

Specification grade indirect glare free lighting available in 1x4, 2x2 or 2x4 for T5 or T8 lamps. Snap-on white perforated metal basket.

Item Number	Dimensions (L x W x H)	Lamping
RDICB14 232MV	48" x 11.56" x 5.5"	2-F32T8
RDICB14 254MV	48" x 11.56" x 5.5"	2-F54T5HO
RDICB22 317MV	24" x 23.75" x 5.5"	3-F17T8
RDICB22 324MV	24" x 23.75" x 5.5"	3-F24T5HO
RDICB24 332MV	48" x 23.75" x 5.5"	3-F32T8
RDICB24 354MV	48" x 23.75" x 5.5"	3-F54T5HO



Indirect light is ideal to illuminate offices with computers.

Consult for Air Handling.



### Configure to Your Specs

Available with 1,2 or 3 lamps in T5 or T8. For surface mount, see page 12.

## Side Basket Direct/ Indirect

Direct/Indirect light from two perforated baskets at each side of the fixture provides a softened “sky light” appearance.

Item Number	Dimensions (L x W x H)	Lamping
RDISB22 217MV	24" x 23.75" x 5.5"	2-F17T8
RDISB22 417MV	24" x 23.75" x 5.5"	4-F17T8
RDISB22 224MV	24" x 23.75" x 5.5"	2-F24T5HO
RDISB22 424MV	24" x 23.75" x 5.5"	4-F24T5HO
RDISB24 232MV	48" x 23.75" x 5.5"	2-F32T8
RDISB24 432MV	48" x 23.75" x 5.5"	4-F32T8
RDISB24 254MV	48" x 23.75" x 5.5"	2-F54T5HO
RDISB24 454MV	48" x 23.75" x 5.5"	4-F54T5HO



### Configure to Your Specs

Available with 1 or 2 lamps in T5 or T8 per side basket.

## Dual Opal Recessed Indirect

Specification grade indirect glare free lighting available in 2x2 or 2x4 for T5 lamps. Opal polycarbonate diffusers provides a soft comfortable light.

**Best Value**

Item Number	Dimensions (L x W x H)	Lamping
RIOD22 214MV	23.8" x 23.8" x 2.6"	2-F14T5
RIOD22 224MV	23.8" x 23.8" x 2.6"	2-F24T5HO
RIOD24 228MV	47.8" x 23.8" x 2.6"	2-F28T5
RIOD24 254MV	47.8" x 23.8" x 2.6"	2-F54T5HO

SHALLOW DEPTH



# RECESSED FLUORESCENTS

## High Efficiency Parabolic

This high efficiency Parabolic uses a choice of 2" white or semi-specular louvers in a shallow body less than 4" deep. White louver version is over 80% efficient and more efficient than semi-specular versions. Available with optional reflector for enhanced efficiency and energy savings. Overlay lens available for softer output.

Item Number	Dimensions (L x W x H)	Lamping
RPHE22 2176SMV	24" x 23.75" x 3.7"	2-F17T8
RPHE22 2246SMV	24" x 23.75" x 3.7"	2-F24T5HO
RPHE24 23212SMV	48" x 23.75" x 3.7"	2-F32T8
RPHE24 25412SMV	48" x 23.75" x 3.7"	2-F54T5HO
RPHE24 33218SMV	48" x 23.75" x 3.7"	3-F32T8
RPHE24 35418SMV	48" x 23.75" x 3.7"	3-F54T5HO

S after cell configuration above is for semi-specular louver. Change to W for white louver. Add XS to end of item number for mirrored reflector to enhance light output. See cell configurations below for all options. For lamped fixtures add L plus color temperature to end of item number.



White louver provides broader light distribution and blends in better with most ceilings and can be over 80% efficient.

**GREAT FOR REBATE PROGRAMS**

### Configure to Your Specs

Choice of white or specular louver, T5 or T8 lamps, and number of lamps.

## Parabolics

Premium recessed 3" deep cell parabolic T-bar troffer designed for maximum efficiency and visual comfort. Post powder paint provides corrosion and scratch resistant and smooth edges for easy handling. Black reveal provides gap free floating louver. Standard with low iridescent semi-specular aluminum louver.

Item Number	Dimensions (L x W x H)	Lamping
RP14 2328MV	48" x 11.75" x 5.5"	2-F32T8
RP14 2548MV	48" x 11.75" x 5.5"	2-F54T5HO
RP14 3328MV	48" x 11.75" x 5.5"	3-F32T8
RP14 3548MV	48" x 11.75" x 5.5"	3-F54T5HO
RP22 2179MV	24" x 23.75" x 5.5"	2-F17T8
RP22 2249MV	24" x 23.75" x 5.5"	2-F24T5HO
RP22 2U32X9MV	24" x 23.75" x 5.5"	2-F32T8/U6
RP22 3179MV	24" x 23.75" x 5.5"	3-F17T8
RP22 3249MV	24" x 23.75" x 5.5"	3-F24T5HO
RP22 4179MV	24" x 23.75" x 5.5"	4-F17T8
RP22 4249MV	24" x 23.75" x 5.5"	4-F24T5HO
RP24 23218MV	48" x 23.75" x 5.5"	2-F32T8
RP24 25418MV	48" x 23.75" x 5.5"	2-F54T5HO
RP24 33218MV	48" x 23.75" x 5.5"	3-F32T8
RP24 35418MV	48" x 23.75" x 5.5"	3-F54T5HO
RP24 43232MV	48" x 23.75" x 5.5"	4-F32T8
RP24 45432MV	48" x 23.75" x 5.5"	4-F54T5HO

For U lamps add U after lamp quantity and designate U lamp spacing with X for 6" and Y for 1 5/8". For air return add A in between lamp wattage and cell count. For whip, add GR to end of item number. For lamped fixtures add L plus color temperature to end of item number.

Consult for LED version or less ballast to accommodate T8 LED Lamps.



### To Add Emergency Ballasts to Fixture

	T8	T5HO
500 Lumens	B1	B51
700 Lumens	B2	B52
1100-1400 Lumens	B3	B53
3000 Lumens	B4	B54

### Parabolic Cell Configurations

1x4	2x2	2x4
8 Cell: 1 Row of 8	6 Cell: 2 Rows of 3	12 Cell: 2 Rows of 6
	9 Cell: 3 Rows of 3	18 Cell: 3 Rows of 6
	16 Cell: 4 Rows of 4	24 Cell: 4 Rows of 6
		32 Cell: 4 Rows of 8

Standard Cells are Low Iridescent. Consult for Specular Finish. Consult for white louver and white reveal.

### Configure to Your Specs

Choose the size, number of lamps and lamp wattage and type T5 or T8, air handling or not, number of cells, ballast, and add options: emergency ballast, whips and lamps installed. For surface mount, see page 13.

# RECESSED FLUORESCENTS

## Lay-In

Premium quality low profile troffer with an almost limitless range of configurations to meet every application. Choice of door styles and gasketing, lamping options, air handling, lens options and a variety of optional adders including whips, lamps and emergency ballasts installed. Standard Lens is A12.100 prismatic lens.

Item Number	Dimensions (L x W x H)	Lamping
RG14 232MV	48" x 11.75" x 4.5"	2-F32T8
RG14 254MV	48" x 11.75" x 4.5"	2-F54T5HO
RG22 217MV	24" x 23.75" x 3.75"	2-F17T8
RG22 224MV	24" x 23.75" x 3.75"	2-F24T5HO
RG22 2U32XMV	24" x 23.75" x 3.75"	2-F32T8/U
RG22 240BXMV	24" x 23.75" x 3.75"	2-F40BX
RG22 317MV	24" x 23.75" x 3.75"	3-F17T8
RG22 324MV	24" x 23.75" x 3.75"	3-F24T5HO
RG24 232MV	48" x 23.75" x 3.75"	2-F32T8
RG24 254MV	48" x 23.75" x 3.75"	2-F54T5HO
RG24 332MV	48" x 23.75" x 3.75"	3-F32T8
RG24 354MV	48" x 23.75" x 3.75"	3-F54T5HO
RG24 432MV	48" x 23.75" x 3.75"	4-F32T8
RG24 454MV	48" x 23.75" x 3.75"	4-F54T5HO

For U lamps add U after lamp quantity and designate U lamp spacing with X for 6" and Y for 1 5/8". For air return add A in between lamp wattage and ballast.  
For whip, add GR to end of item number. For lamped fixtures add L plus color temperature code to end of item number.

## Lens Options (Add to end of Item Number)

CODE	DESCRIPTION
125	A12 .125 thick lens
156	A19 .156 thick lens
CL	Clear .100 thick lens
CL125	Clear .125 thick lens
SW	Smooth White .100 thick lens
S.5	Specular Parabolic Louver (1/2" x 1/2" x 3/8")
S7.5	Specular Parabolic Louver (3/4" x 3/4" x 3/8")
S1.5	Specular Parabolic Louver (1 1/2" x 1 1/2" x 1")
W.5	White Parabolic Louver (1/2" x 1/2" x 3/8")
DD	Drop Dish lens
A78	78 Cell (2x4) or 36 Cell (2x2)

## Recessed Fluorescent Frame-In-Kit

Allows standard Troffers, Recessed Indirect/Direct, or Parabolic to be mounted in plaster, or wood ceilings.

Item Number	Dimensions (L x W x H)
M596A	1 x 4 Plaster Recessed Kit - Ceiling Opening: 12.25" x 48.25"
M565A	2 x 2 Plaster Recessed Kit - Ceiling Opening: 24.25" x 24.25"
M566A	2 x 4 Plaster Recessed Kit - Ceiling Opening: 24.25" x 48.25"



Most Mobern Products Meet  
Buy American

## POST PAINTED

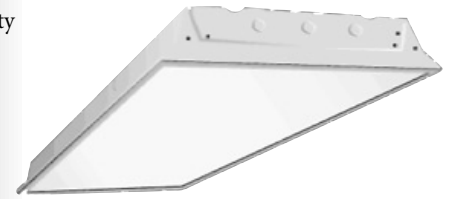

Flush steel door frame, white finish



Regressed door frame, aluminum, white, or black finish

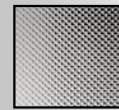

A12 Pattern.  
0.18" diamond prism  
Standard is 0.10 in. thick  
Also available in 0.125" thick

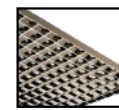

Specular parabolic grid,  
sizes: 1/2 sq x 3/8" deep,  
3/4 sq x 1/2" deep,  
and 1 1/2 sq x 1" deep

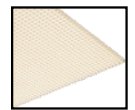

White cube grid, available  
in 1/2 sq x 3/8" deep.

Consult for LED.

Consult to add 1.4" Aluminum Parabolic Louver in 9 cell or 18 cell.

## Door & Gasketing Options

CODE	DESCRIPTION
Blank	Flush steel door
RA	Regressed AL door, white
RAB	Regressed AL door, black
G1	Single gasketed door - Single (lens to door frame)
G2	Double gasketed door - (lens/frame + frame to troffer)
G3	Triple gasketed (lens/frame + frame/troffer + troffer to T-bar grid)

## Configure to Your Specs

See above for regressed aluminum doors.



# RECESSED FLUORESCENTS

## Recessed Flanged Troffer

Premium quality flanged troffer suitable for drywall, plaster and Z-spline ceilings. Comes with four adjustable Uni-Lugs for easy installation.

Item Number	Dimensions (L x W x H)	Lamping
RF14 232MV	50.44" x 13.25" x 5.12"	2-F32T8
RF24 232MV	50.44" x 24.75" x 5.12"	2-F32T8
RF24 254MV	50.44" x 24.75" x 5.12"	2-F54T5HO
RF24 332MV	50.44" x 24.75" x 5.12"	3-F32T8
RF24 354MV	50.44" x 24.75" x 5.12"	3-F54T5HO
RF24 432MV	50.44" x 24.75" x 5.12"	4-F32T8
RF24 454MV	50.44" x 24.75" x 5.12"	4-F54T5HO

For additional options, see page 7 for similar RG series options. Consult for 2x2.



## Linear Wall Wash

Specification grade, recessed perimeter elliptical wall wash to highlight vertical surfaces. Provides uniform vertical surface lighting ideal for retail environments. Includes premium mirror reflector for enhanced performance. Special sized frame in kit for sheet rock or plaster ceilings available (consult factory).

Item Number	Dimensions (L x W x H)	Lamping
RWW 140BXMVXS	24" x 10.62" x 4.5"	1-F40BX
RWW 240BXMVXS	48" x 10.62" x 4.5"	2-F40BX

Consult factory for T5 and other lamping options.



## Linear Grid Wall Wash

Specification grade, recessed perimeter linear wall wash to highlight wall and shelf mounted goods in commercial and retail environments. Provides uniform vertical surface lighting.

Item Number	Dimensions (L x W x H)	Lamping
RGWW 132MVXS	48" x 11.75" x 4.5"	1-F32T8
RGWW 128MVXS	48" x 11.75" x 4.5"	1-F28T5
RGWW 154MVXS	48" x 11.75" x 4.5"	1-F54T5HO

**Best Value**

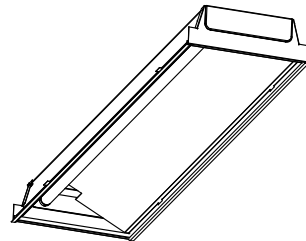

## Two Inch Parabolic T5

Three light T5 parabolic provides high efficient lighting in less than two inches of depth. With recessed or surface mounting, white steel blades and T5 lamps are ideal in shallow plenum applications.

Item Number	Dimensions (L x W x H)	Lamping
RPL22 314MV	23.75" x 23.75" x 1.78"	3-F14T5
RPL22 324MV	23.75" x 23.75" x 1.78"	3-F24T5HO
RPL24 328MV	47.75" x 23.75" x 1.78"	3-F28T5
RPL24 354MV	47.75" x 23.75" x 1.78"	3-F54T5HO

**Surface or Recessed Mounting**



LESS THAN 2" DEPTH



# Linear Pendant Lighting

Mobern's complete selection of linear pendant direct/indirect fixtures offer architecturally clean profiles that not only make a statement of elegance in offices, stores or residential applications but also provide energy efficient solutions to put lots of light where you need it. Each series is available for individual or continuous row mounting to enliven a space and provide visual impact. Mobern's Mass Customization Philosophy enables your choice of finishes and variations with off-the-shelf service and value.

## Linear Indirect Lighting

A shallow indirect linear fixture with perforated body provides the ultimate in comfortable lighting. Now available in four different housing configurations (lens, louver, solid or perforated) depending on look and up/downlight mix desired. Only 7" wide and 2" deep available in four and eight foot sections. It provides the right proportion for a variety of environments. Each section can be used individually or joined together. Each run is finished with die cast ends. Available in 2 light T8 or up to 3 light T5. Hangs with cable kit using only two cables per four or eight foot. Powder coated finish with choice of colors.

Item Number	Dimensions (L x W x H)	Lamping
LI 232WHMV	48" x 7" x 2"	2-F32T8
LI 254WHMV	48" x 7" x 2"	2-F54T5HO
LI 354WHMV	48" x 7" x 2"	3-F54T5HO
LI 232TANWWMV	96" x 7" x 2"	4-F32T8
LI 254TANWHMV	96" x 7" x 2"	4-F54T5HO
LI 354TANWHMV	96" x 7" x 2"	6-F54T5HO



Cable mounting kit included.

Perforated bottom provide 15% downlight.

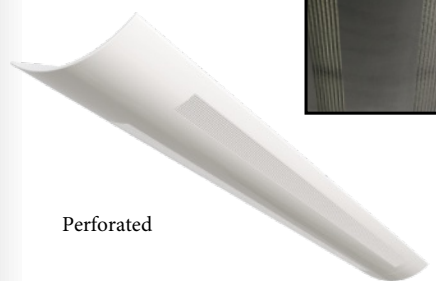
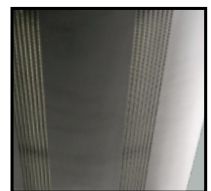

Perforated

## Louver (T5 Only)

Item Number	Dimensions (L x W x H)	Lamping
LIB 254WHMV	48" x 7" x 2"	2-F54T5HO
LIB 354WHMV	48" x 7" x 2"	3-F54T5HO
LIB 254TANWHMV	96" x 7" x 2"	4-F54T5HO
LIB 354TANWHMV	96" x 7" x 2"	6-F54T5HO

Available w/ either Spade or Bullnose ends.







Spade



Bullnose

### AVAILABLE FINISHES

-  Silver (SL)
-  Black (BK)
-  Iron (IN)
-  Red (RD)
-  Bronze (BZ)

40% downlight with dual rows of louvers for T5 only.

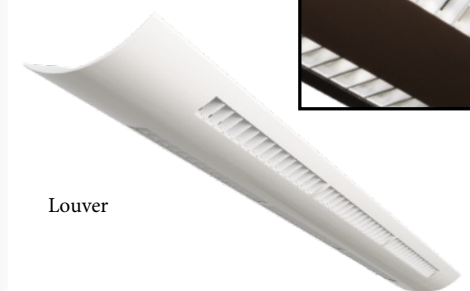
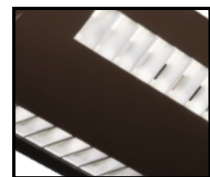

Louver

## Matte White Lens

Item Number	Dimensions (L x W x H)	Lamping
LIS 232WHMV	48" x 7" x 2"	2-F32T8
LIS 254WHMV	48" x 7" x 2"	2-F54T5HO
LIS 354WHMV	48" x 7" x 2"	3-F54T5HO
LIS 232TANWHMV	96" x 7" x 2"	4-F32T8
LIS 254TANWHMV	96" x 7" x 2"	4-F54T5HO
LIS 354TANWHMV	96" x 7" x 2"	6-F54T5HO

Standard kit with 4' cable and 4' power feed cable included. For 12' cable kit add C12 to end of catalog number. Add SL for Metallic Silver, RD for Red, and IN for Iron. Consult factory for custom finishes.

Matte White lens fascia provides softer lighting for the space ideal for circulation and living spaces.



Slotted

All versions are available with matching wall fixtures, see page 36.

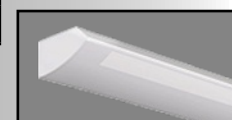

# LINEAR INDIRECT LIGHTING

**Ships in Days**

## Low Profile Linear Lighting

A sleek low profile, elegant statement that seems to float in any environment providing glare-free lighting with the semi specular aluminum parabolic louver. The 60% uplight and 40% downlight are ideal for residential and commercial applications demanding generous overall illumination with a controlled task light. Seamless steel ellipsoidal body is powder coated in choice of finishes. Can be mounted individually or in a continuous row and requires only two cable mounts every eight feet. Choice of 2 light T8 or up to 3 light T5 lamping.

Item Number	Dimensions (L x W x H)	Lamping
LPLI 232WHMV	48" x 10.8" x 3.5"	2-F32T8
LPLI 254WHMV	48" x 10.8" x 3.5"	2-F54T5
LPLI 354WHMV	48" x 10.8" x 3.5"	3-F54T5
LPLI 232TANWHMV	96" x 10.8" x 3.5"	4-F32T8
LPLI 254TANWHMV	96" x 10.8" x 3.5"	4-F54T5
LPLI 354TANWHMV	96" x 10.8" x 3.5"	6-F54T5

Standard with 4' cable and 4' power feed/cable included. For 12' cable kit add C12 to end of catalog number. Add "TR" for top reflector kit for more downlight. Add DFSW after LPLI for White Lens. Add SL for Metallic Silver, RD for Red and IN for Iron. Consult factory for other finishes. Add CF to Suffix for center power feed.

Joins easily for long runs.

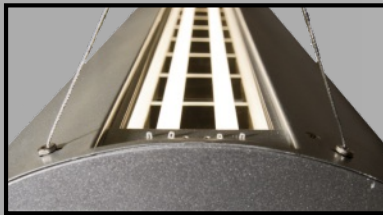
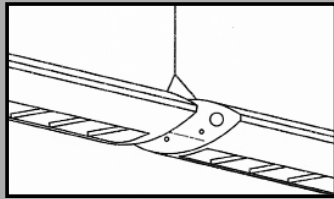

Cable kit included. Add top reflector (TR or TR10 - 10% uplight) to get more downlight.

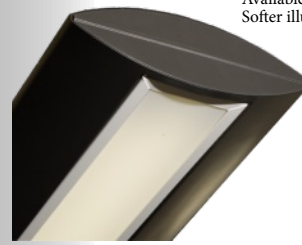

Available with Matte White Lens for Softer illumination. Add DFSW.



White canopy is standard. Change WH to BK for black canopy and cord.

## Perforated Linear Indirect Basket

A low-profile suspended direct/indirect fixture available in four foot sections that can be used individually or joined together.

Item Number	Dimensions (L x W x H)	Lamping
PBLI 332WHMV	48" x 10.75" x 4.125"	3-F32T8
PBLI 354WHMV	48" x 10.75" x 4.125"	3-F54T5HO
PBLI 332TANWHMV	96" x 10.75" x 4.125"	6-F32T8
PBLI 354TANWHMV	96" x 10.75" x 4.125"	6-F54T5HO

Standard with 4' cable and 4' power feed/cable included. For 12' cable kit add C12 to end of catalog number. Consult factory for custom finishes.

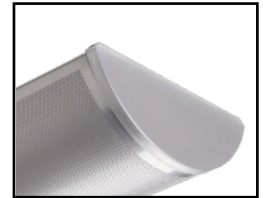

Available in Brushed Nickel (BN) or other custom finishes.

## Direct/ Indirect Linear Strip

**Great Value**

Make your own Direct/ Indirect linear strip at great value. Choice of reflector and basket materials provide a simple, beautiful and cost effective surface or pendant fixture. Use individually or as a continuous run.

Item Number	Dimensions (L x W x H)	Lamping
DIS 232XPPFMV	48" x 12.2" x 5.15"	2-F32T8
DIS 254XPPFMV	48" x 12.2" x 5.15"	2-F54T8
DIS 232TANXPPFMV	96" x 12.2" x 5.15"	4-F32T8
DIS 254TANXPPFMV	96" x 12.2" x 5.15"	4-F54T8

Reflector Options: XW - White Steel, XP - Perforated, XS - Full Specular. Basket Options: PF- Perforated, FF- Fine Fluted lens, SW- Smooth White Lens. Consult factory for Brushed Nickel and other finishes.

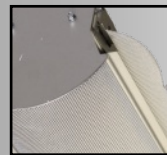

Perforated Reflector and Basket in Brushed Nickel. Consult for other finishes.



Solid white reflector (XW) with fine fluted lens (FF).



Perforated reflector (XP) with smooth white lens (SW).

# LINEAR INDIRECT LIGHTING

## Mini 2" Linear Pendant

This mini slimline linear pendant accommodate one T5 lamp per 4' shielded by a frosted acrylic lens. Cable mounted with choice of individual 4' or 8' length or row mounted for continuous run. Slots available in the top for 20% uplight. Matching surface or wall mount available. Consult for special finishes and two foot size.



Item Number	Dimensions (L x W x H)	Lamping
LI22 154MVWH	48" x 2" x 2"	1-F54T5HO
LI22 154TANMVWH	96" x 2" x 2"	2-F54T5HO

## 4x4 Direct or Indirect

Small is beautiful with this new sleeker 4x4 linear surface or pendant mounted fixture. Choice of direct or indirect lighting effect ideal for circulation spaces and open offices. Post painted in choice of finishes.



Item Number	Dimensions (L x W x H)	Lamping
LI44 DOSW232MVWH	48" x 4" x 4"	2-F32T8
LI44 DOSW254MVWH	48" x 4" x 4"	2-F54T5HO
LI44 DOSW232TANMVWH	96" x 4" x 4"	4-F32T8
LI44 DOSW254TANMVWH	96" x 4" x 4"	4-F54T5HO

Choice of lighting distribution: DO – Direct Only, IS – Indirect Only or DI - Direct/Indirect (slots). Choose diffuser options: S.5-Specular Parabolic Louver ½" x ½" x 3.8". SW – Matte White Lens. See pg 7 for lens choices. Consult for other finishes.

Consult for Recessed Version



Surface mount in a niche for great look and performance.

## 6x6 Direct or Indirect

A linear 6 x 6 surface or pendant mounted fixture provides a distinctive architectural aesthetic in corridors, lobbies and office areas. Fixtures can be used individually or joined together for a linear pattern. Choice of diffusers and mounting options.

Item Number	Dimensions (L x W x H)	Lamping
LI66 DOSW232MV	48" x 6" x 6"	2-F32T8
LI66 DOSW232TANMV	96" x 6" x 6"	4-F32T8
LI66 ISSW232MV	48" x 6" x 6"	2-F32T8
LI66 ISSW232TANMV	96" x 6" x 6"	4-F32T8
LI66 DISW232MV	48" x 6" x 6"	2-F32T8
LI66 DISW232TANMV	96" x 6" x 6"	4-F32T8

Choice of lighting distribution: DO – Direct Only, IS – Indirect Only or DI - Direct/Indirect (slots). Choose diffuser options: S.5-Specular Parabolic Louver ½" x ½" x 3.8". SW – Matte White Lens. Consult for other finishes.

Consult for Recessed Version



## Modern Louvered Industrial Strip

Change the look of any space with this modern suspended industrial fixture. It provides a blast of light that's glare-free with the semi specular parabolic louver. Suspended on cables, the hanging Powder Coat Finish fixtures look stylish in any setting. Illuminate any workspace. Consult factory for custom finishes.

Item Number	Dimensions (L x W x H)	Lamping
DLV 232MVWH	49" x 8" x 6.5"	2-F32T8
DLV 232TANMVWH	98" x 8" x 6.5"	4-F32T8

Standard with 4' cable and 4' power feed/cable included. For 12' cable kit add C12 to end of catalog number. Other finishes available. Change SL (silver) to BK (black), BZ (Bronze), or IR (Iron). Standard with painted body inside and outside, combined with semi specular reflector and louver blades.





## Surface Fluorescents

Mobern's selection of Direct/Indirect Surface Fluorescents are designed for surface-mount applications where comfort, aesthetics and energy savings are important. Each provides efficient and effective lighting for applications such as offices, schools, hospitals, retail and numerous other commercial applications. From specification grade to economy versions, Mobern has the most complete line of wraparounds including those manufactured in their Baltimore facility. The harsh weather fixtures meet the most rigorous specifications and offer a range of options.

### Low Profile Center Basket

Specially designed for T5 or T8 lamps and shallow surface applications, this fixture features specification grade optical design to distribute high quality direct/indirect light for uniformity and comfort throughout your work area. Perforated center shield comes with a diffuser, white translucent inlay for visual comfort. Ribbed linear diffuser provides more light and a fresh look.

Item Number	Dimensions (L x W x H)	Lamping
SRDIS22 214PFMV	23.68" x 23.68" x 3.25"	2-F14T5
SRDIS22 224PFMV	23.68" x 23.68" x 3.25"	2-F24T5HO
SRDIS22 240PFMV	23.68" x 23.68" x 3.25"	2-F40BX5
SRDIS24 228PFMV	47.67" x 23.68" x 3.25"	2-F28T5
SRDIS24 254PFMV	47.67" x 23.68" x 3.25"	2-F54T5HO

Choice of Center diffusers: PF for Perforated Basket or RL for Linear Ribbed Lens. Available in 1, 2 or 3 light lamping simply change the first number to the desired number of lamps.



Consult for LED options.

### Low Profile Dual Basket

Specially designed for T5 or T8 lamps and shallow surface applications, this fixture features specification grade optical design to distributes high quality direct/indirect light for uniformity and comfort throughout your work area. Perforated dual basket comes with a diffuser, white translucent inlay for visual comfort. Ribbed linear diffuser provides more light and a fresh look.

Item Number	Dimensions (L x W x H)	Lamping
SRDISD22 214PFMV	23.68" x 23.68" x 3.25"	2-F14T5
SRDISD22 224PFMV	23.68" x 23.68" x 3.25"	2-F24T5HO
SRDISD22 240PFMV	23.68" x 23.68" x 3.25"	2-F40BX
SRDISD24 228PFMV	47.67" x 23.68" x 3.25"	2-F28T5
SRDISD24 254PFMV	47.67" x 23.68" x 3.25"	2-F54T5HO

Choice of Dual diffusers: PF for Perforated Basket or RL for Linear Ribbed Lens. Available in 2 or 4 light lamping simply change the first number to the desired number of lamps.



### Surface Indirect/Direct

With a clean, fastener free shroud, most of our indirect/direct recessed fixtures can be made into a surface mount. Consult factory for other versions. This center basket indirect/direct provides glare free lighting ideal for premium commercial interiors.

Item Number	Dimensions (L x W x H)	Lamping
SRDI14 232MV	48" x 11.56" x 5.5"	2-F32T8
SRDI14 254MV	48" x 11.56" x 5.5"	2-F54T5HO
SRDI22 317MV	24" x 23.75" x 5.5"	3-F17T8
SRDI22 324MV	24" x 23.75" x 5.5"	3-F24T5HO
SRDI24 332MV	48" x 23.75" x 5.5"	3-F32T8
SRDI24 354MV	48" x 23.75" x 5.5"	3-F54T5HO

For Dual Basket Surface Fluorescent change SRDI to SRDISB.

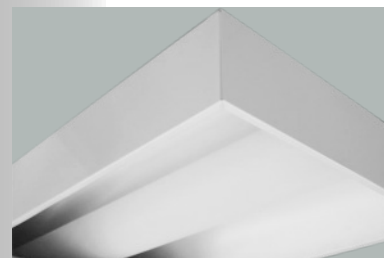



# SURFACE FLUORECENTS

## Narrow Direct/ Indirect

This graceful direct-indirect solution creates a bold luminaire, while providing a comfortable atmosphere. Wide winged reflectors effectively direct light, while adding a soft glow and presence to the fixture. A gentle up-lighting effect creates a distinctive look for task or general applications.



Item Number	Dimensions (L x W x H)	Lamping
SDI14 232PFMV	48" x 14.30" x 4.87"	2-F32T8
SDI14 254PFMV	48" x 14.30" x 4.87"	2-F54T5HO

Basket Options: PF- Perforated, SW- Smooth White Lens. Consult for different size and lamping options.

## SKY Direct/ Indirect Surface

SKY direct/ indirect center diffuser luminaire provides smooth and uniform ambient lighting for all commercial and industrial buildings from a surface mount. Reflected light from matte surfaces provide a softened "sky light" appearance to the modern office environment. Unique dual curved lens with center perforated basket or linear ribbed acrylic diffuser provides a luminous housing with excellent visual comfort. Light reaches higher in the space to eliminate the "cave effect."

Item Number	Dimensions (L x W x H)	Lamping
SSKY22 217PFMV	24" x 24" x 4"	2-F17T8
SSKY22 224PFMV	24" x 24" x 4"	2-F24T5HO
SSKY24 232PFMV	48" x 24" x 4"	2-F32T8
SSKY24 254PFMV	48" x 24" x 4"	2-F54T5HO

Choice of Center Diffusers: PF for Perforated Basket or RL for Linear Ribbed Lens.

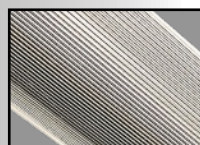

Choice of perforated basket (PF) or linear ribbed acrylic diffuser (RL) shown.



## Surface Mounted Parabolic

Specification grade surface mounted Parabolic using our standard recessed parabolic with a clean appearance shroud for a bold surface mount look.

Item Number	Dimensions (L x W x H)	Lamping
SPR14 2328MV	48" x 11.75" x 5"	2-F32T8
SPR22 2U32X9MV	24" x 23.75" x 5"	2-F32T8U
SPR22 3179MV	24" x 23.75" x 5"	3-F17T8
SPR24 23218MV	48" x 23.75" x 5"	2-F32T8
SPR24 33218MV	48" x 23.75" x 5"	3-F32T8
SPR24 43218MV	48" x 23.75" x 5"	4-F32T8

Consult factory for welded one piece construction Surface Parabolic as well as shallower High Performance RPHE series with shroud. See page 6 for options.

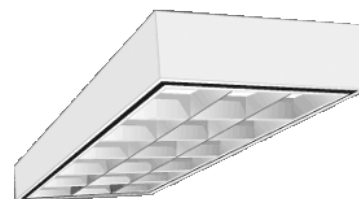

**Configure to Your Specs**  
Choice of white or specular louver, T5 or T8 lamps, and number of lamps.

## Surface Mounted Troffers

A framed recessed troffer offers improved photometrics and premium specification appearance. Offers full range of options available with RP series.

Item Number	Dimensions (L x W x H)	Lamping
SR14 232MV	48" x 11.75" x 4.5"	2-F32T8
SR22 2U32XMV	24" x 23.75" x 3.75"	2-F32T8U
SR24 232MV	48" x 23.75" x 3.75"	2-F32T8
SR24 332MV	48" x 23.75" x 3.75"	3-F32T8
SR24 432MV	48" x 23.75" x 3.75"	4-F32T8

Consult factory for welded one piece construction Surface Troffer. See options on page 7 for grid options.



# WRAPAROUNDS

## Premium 772 Series

Specification grade wraparound featuring a wider and lower profile silhouette, upright component on the edges and comfortable brightness. Available in two, four and eight foot lengths.

**MADE IN USA**

Item Number	Dimensions (L x W x H)	Lamping
772 217MV	24" x 11.25" x 3.4"	2-F17T8
772 417MV	24" x 15.8" x 3.4"	4-F17T8
772 232MV	48" x 11.25" x 3.4"	2-F32T8
772 332MV*	48" x 11.25" x 3.4"	3-F32T8
772 232TANMV	96" x 11.25" x 3.4"	4-F32T8
772 432MV	48" x 15.8" x 3.4"	4-F32T8
772 332TANMV*	96" x 15.8" x 3.4"	6-F32T8
772 432TANMV	96" x 15.8" x 3.4"	8-F32T8

Available for Residential or Multi-Family applications with specially designed Residential Electronic Ballast, change ballast from "MV" to "R120."

\*Lamps are off-centered. Add a "P" after lamp wattage for centered lamps.

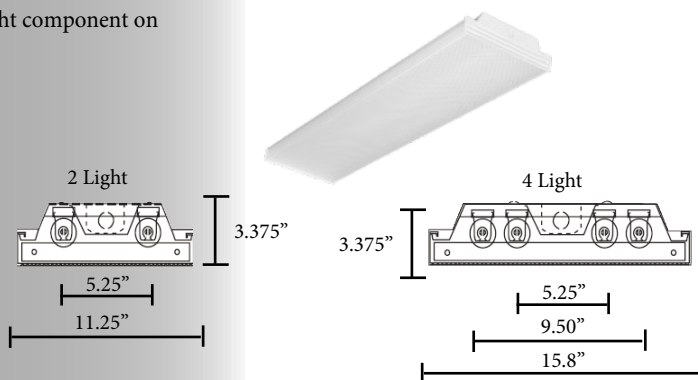

**Configure to Your Specs**

Available in full array of T5 and T8 lamps and ballasts.

## 9" Wraparound 770 Series

A shallow economical fixture with two lamps is slightly narrower than the specification grade fixture but with similar lighting performance. For economical version, see 769 Series below.

Item Number	Dimensions (L x W x H)	Lamping
770 217MV	24" x 9.2" x 3.1"	2-F17T8
770 232R120	48" x 9.2" x 3.1"	2-F32T8
770 232MV	48" x 9.2" x 3.1"	2-F32T8

Available for Residential or Multi-Family applications with specially designed Residential Electronic Ballast, change ballast from "MV" to "R120."

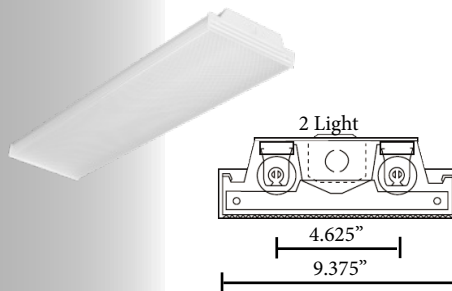

## Budget Wraparound 769 Series

Our most economical wraparound still provides excellent glare-control, comfortable light output, and the visual appeal of the specification grade wrap.

**Best Value**

Item Number	Dimensions (L x W x H)	Lamping
769 217R120	24" x 7.6" x 3"	2-F17T8
769 217MV	24" x 7.6" x 3"	2-F17T8
769 417R120	24" x 13" x 3"	4-F17T8
769 417MV	24" x 13" x 3"	4-F17T8
769 232R120	48" x 7.6" x 3"	2-F32T8
769 232MV	48" x 7.6" x 3"	2-F32T8
769 332R120	48" x 13" x 3"	3-F32T8
769 332MV	48" x 13" x 3"	3-F32T8
769 432R120	48" x 13" x 3"	4-F32T8
769 432MV	48" x 13" x 3"	4-F32T8
769 432TANMV	96" x 13" x 3"	8-F32T8

"R120" Ballast designates our economic, specially designed Residential Electronic Ballast.

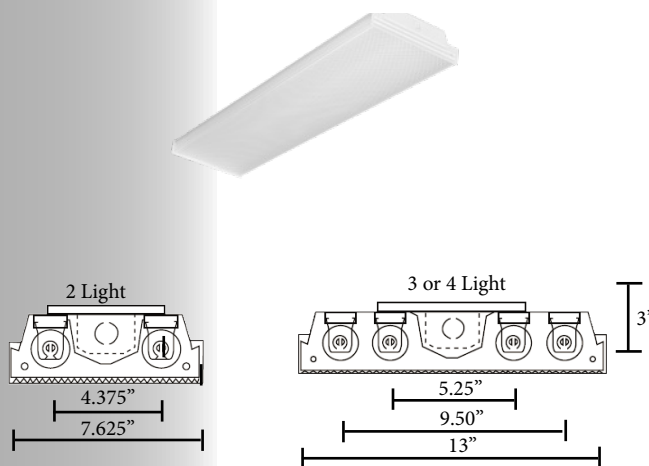

**Need over 1,000 fixtures this week?  
YES WE CAN!**

# WRAPAROUNDS

## Narrow Wraparound

Specially designed 1 or 2 light wraparound for surface or suspended mount. Lens is secured via left and shift. Add a reflector for enhanced performance.

Item Number	Dimensions (L x W x H)	Lamping
772N 132MV	48" x 5.6" x 3.2"	1-F32T8
772N 132TANMV	96" x 5.6" x 3.2"	2-F32T8
772N 232MV	48" x 5.6" x 3.2"	2-F32T8
772N 232TANMV	96" x 5.6" x 3.2"	4-F32T8

For Mirrored reflector add "XS" to the end of part number.



## Deep Wraparound

Specially designed for 3 lamp applications with exact spacing and more uniform light distribution. Ideal for corridors and stairwells and long run applications.

Item Number	Dimensions (L x W x H)	Lamping
774 132MV	48" x 8.75" x 4.4"	1-F32T8
774 232MV	48" x 8.75" x 4.4"	2-F32T8
774 332MV	48" x 8.75" x 4.4"	3-F32T8

Consult factory for Tandem 8'.



Consult for Wide Body Wrap to cover 12" Fixture.

## 779 Premium 90 Degree Wraparound

Premium grade surface mounted wraparound luminaire with low brightness linear sides. For use in indoor applications where high efficiency, high performance and ease of installation is required. 90 degree sides for easy side wiring with 7 3/4" nominal wrap with clear acrylic diffuser with prismatic bottom and ribbed linear sides.

Item Number	Dimensions (L x W x H)	Lamping
779 228MV	48" x 6.75" x 4.5"	2-F28T5
779 228TANMV	96" x 6.75" x 4.5"	4-F28T5
779 232MV	48" x 6.75" x 4.5"	2-F32T8
779 232TANMV	96" x 6.75" x 4.5"	4-F32T8
779 254MV	48" x 6.75" x 4.5"	2-F54T5HO
779 254TANMV	96" x 6.75" x 4.5"	4-F54T5HO
779 296T8MV	96" x 6.75" x 4.5"	2-F59(96)T8



## Corridor Light

Surface mounted corridor fixture with low brightness linear sides. Available in lengths from 18 to 96 inches (consult factory). For use in indoor applications, such as circulation spaces and stairwells. Standard in white finish.

Item Number	Dimensions (L x W x H)	Lamping
15 115MV	18" x 4.62" x 4.5"	1-F15T8
15 117MV	24" x 4.62" x 4.5"	1-F17T8
15 125MV	36" x 4.62" x 4.5"	1-F25T8
15 132MV	48" x 4.62" x 4.5"	1-F32T8
15 132TANMV	96" x 4.62" x 4.5"	2-F32T8



Consult for LED version.

### Configure to Your Specs

Available in painted finishes. Looks great in silver and bronze.

# ENCLOSED ALL WEATHER

## Harsh Environment Enclosures

More versatile than any other weatherproof enclosures. Mounting system provides dramatic savings on the installation labor. Tough diffusers, latches and gasket seals resist breakage and hold up to tough conditions. IP67 rated for water immersion, NSF certified for Splash Zone, and UL Listed for Wet location. Monopoint mounting, tamper resistant, and stainless steel latches are available options.

Item Number	Dimensions (L x W x H)	Lamping
VWN 117MV	24" x 4.6" x 4.1"	1-F17T8
VW 217MV	24" x 7.3" x 4.1"	2-F17T8
VW 317MV	24" x 7.3" x 4.1"	3-F17T8
VWN 124MV	24" x 4.6" x 4.1"	1-F24T5HO
VW 224MV	24" x 7.3" x 4.1"	2-F24T5HO
VW 324MV	24" x 7.3" x 4.1"	3-F24T5HO
VWN 132MV	48" x 4.6" x 4.1"	1-F32T8
VW 232MV	48" x 7.3" x 4.1"	2-F32T8
VW 332MV	48" x 7.3" x 4.1"	3-F32T8
VW 232TANMV	96" x 7.3" x 4.1"	4-F32T8
VW 332TANMV	96" x 7.3" x 4.1"	6-F32T8
VWN 154MV	48" x 4.6" x 4.1"	1-F54T5HO
VW 254MV	48" x 7.3" x 4.1"	2-F54T5HO
VW 254TANMV	96" x 7.3" x 4.1"	4-F54T5HO
VW 296T8MV	96" x 7.3" x 4.1"	2-F59(96)T8
VW 296T8HOMV	96" x 7.3" x 4.1"	2-F96T8HO
VW MB1L-B-2PK	Mounting Brackets w/ bail for 1 Light	
VW MB2L-B-2PK	Mounting Brackets w/ bail for 2 or 3 Light	
H21-I	Mounting 1/2" Hub Single Mount Installed	
H148-I	Mounting 3/4" Hub Single Mount Installed	
VW-LBRKT	Mounting VWL Bracket Wall Mount	

(VW 1, 2 or 3 Lamp)  
Standard Body Only



(VWN 1 Lamp only)

For one light in matching two light wider body add "WD"

### Configure to Your Specs

Enhance light output with this basic reflector by adding XS after ballast designation.

XS - Basic Reflector

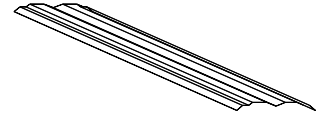

Add optional stainless steel latches (SL).

## MOUNTING OPTIONS

### Flush Mount



VW-MB2L-B-2PK Mounting Bracket

Stainless steel clips (sold separately) snaps onto housing at multiple places.

### Single Point Mount

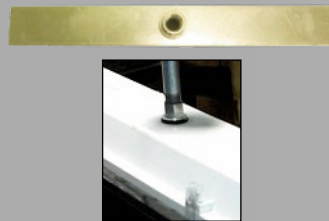

Add H21I (1/2" hub) or H148I (3/4") to provide single point mounting (pipe not supplied) which does void wet location.

### Wall Mount



Add flexible wall mount bracket (VW-LBRKT to end of catalog number) to mount neatly on the wall.

### Pendant Mount



Bail provides convenient means of suspending the fixture easily with a chain or cable. Standard w/ VW MB2L-B-2PK.

## Wide Distribution All Weather Enclosure

This specialized fixture utilizes a special mirror reflector with a deeper clear lens to provide a unique wider distribution light output. This specially designed reflector puts more light out the sides than straight down ideal for parking garages. Available in 4' and 8'.

Item Number	Dimensions (L x W x H)	Lamping
VWCL 232MV	48" x 7.3" x 4.1"	2-F32T8
VWCL 254MV	48" x 7.3" x 4.1"	2-F54T5HO
VWCL 232TANMV	96" x 7.3" x 4.1"	4-F32T8
VWCL 254TANMV	96" x 7.3" x 4.1"	4-F54T5HO

For wide distribution reflector add XSW to the end of catalog number.



This optically clear lens is injection molded for optical clarity and strength. This 3.5" impact modified acrylic is ideal for use with the wide distribution reflector.

### Configure to Your Specs

Add a Wet or Cold Location occupancy sensor for an additional 30% energy savings.



Wide Distribution Reflector Add XSW to end of catalog number.

# ENCLOSED ALL WEATHER

## Harsh Environment Enclosure

Corrosion proof fluorescents seal out bugs, vapor, moisture and dirt.

Item Number	Dimensions (L x W x H)	Lamping
VT 217MV	25.8" x 7" x 5.19"	2-F17T8
VT 224MV	25.8" x 7" x 5.19"	2-F24T5HO
VT 232MV	49.8" x 7" x 5.19"	2-F32T8
VT 232TANMV	97.8" x 7" x 5.19"	4-F32T8
VT 254MV	49.8" x 7" x 5.19"	2-F54T5HO
VT 254TANMV	97.8" x 7" x 5.19"	4-F54T5HO
VT 248T8HOMV	49.8" x 7" x 5.19"	2-F48T8HO
VT 248TANT8HOMV	97.8" x 7" x 5.19"	4-F48T8HO
VT 296T8MV	97.8" x 7" x 5.19"	2-F59(96)T8
VT 296T8HOMV	97.8" x 7" x 5.19"	2-F96T8HO
VT 296T12EL	97.8" x 7" x 5.19"	2-F96T12
VT 296T12ELHO	97.8" x 7" x 5.19"	2-F96T12HO



Add specular reflector to spread light on 3 lamp version. Consult factory for custom options.

## Vandal Resistant Enclosure

Ideal fixture for vandal resistant high abuse installation. Polycarbonate with an internal prismatic pattern is secured to backplate with tamper-resistant stainless steel screws.

Item Number	Dimensions (L x W x H)	Lamping
SVP 132MV	50.25" x 4.25" x 4.5"	1-F32T8
SVP 232MV	50.25" x 8.25" x 4.5"	2-F32T8
SVP 117MV	25" x 4.25" x 4.5"	1-F17T8
SVP 217MV	25" x 8.25" x 4.5"	2-F17T8

Consult factory for a Higher Gauged and sealed version to replicate a Kennal fixture.



See page 42 for matching compact fluorescent version.

## Sign Lighter

Integral ballast and T5 lamping provide great solutions for outdoor signage. Non-corrosive metal housing. Consult factory for high output T8 and T12 versions although, T5 HO versions are more efficient and economical.

Item Number	Dimensions (L x W x H)	Lamping
AOD 15MV	5.25" x 48" x 3.06"	1-F54T5HO
AOD 154TANMV	5.25" x 96" x 3.06"	2-F54T5HO
AOD 254MV	5.25" x 48" x 3.06"	2-F54T5HO
AOD 254TANMV	5.25" x 96" x 3.06"	4-F54T5HO

Dress up the AOD by custom painting. Standard white body with galvanized hardware.



UL Listed - Wet

## Architectural Linear Lighting

This new heavy duty die-cast aluminum linear all weather linear fixture is available in two and four foot with LED or T5 light sources. The slim and sweeping curve design is both aesthetically pleasing and engineered to provide an even, linear flood of light in most applications. A special BodyGuard powdercoat bronze finish provides excellent protection against the elements.

Item Number	Dimensions (L x W x H)	Lamping
AD 154MV	5.25" x 48" x 3.06"	1-F54T5HO
AD 154TANMV	5.25" x 96" x 3.06"	2-F54T5HO
AD 254MV	5.25" x 48" x 3.06"	2-F54T5HO
AD 254TANMV	5.25" x 96" x 3.06"	4-F54T5HO

UL Listed - Wet



Standard with 2 mounting brackets.

Consult for LED options.



Choice of LED or T5 Fluorescent. Both in bronze finish.

**NEW**

**LED Option**



## Decorative Fluorescents

Sleek, updated designs with shallower profiles for T8 lamps are combined with the Classics to provide a complete assortment of decorative surface fluorescents. Improved reliability and performance of the more economical residential electronic ballast combined with value engineered designs makes these products the choice for multi-family and volume home builders. The unique design of the Eclipse and the improved flush version of the Crown makes these series of choice for discriminating buyers.

### AVAILABLE IN 6 FINISHES

#### Eclipse & Eclipse Turbo

Designed especially for the T8 lamp, electronic ballast and today's interiors, this low profile softly rounded silhouette features a choice of decorative end caps to coordinate to popular interior finishes and countertops.

Item Number	Dimensions (L x W x H)	Lamping
MCH 217WHR120 (AL,BM,IM,SI, WM)	25.75" x 9.5" x 4.5"	2-F17T8
MCH 417WHR120 (AL,BM,IM,SI, WM)	25.75" x 16.5" x 5"	4-F17T8
MCH 232WHR120 (AL,BM,IM,SI, WM)	51.5" x 9.5" x 4.5"	2-F32T8
MCH 432WHR120 (AL,BM,IM,SI, WM)	51.5" x 16.5" x 5"	4-F32T8

RE - MicroProfile Diffuser. For commercial jobs, replace "R120" with "MV" for commercial electronic ballast.

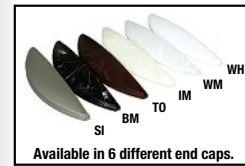

Available in 6 different end caps.



Eclipse Turbo

This specially designed diffuser offers enhanced high angle brightness while offering superior bulb obscurity through the use of specially designed mini-prisms. Add RE for this MicroProfile Diffuser after MCH.



#### Contemporary Cloud

This squared edge cloud has long been the more expensive version of the softly rounded cloud. The MCE series now provides this sleek design at the more affordable price.

Item Number	Dimensions (L x W x H)	Lamping
MCE 232R120	50" x 9.5" x 3.4"	2-F32T8
MCE 432R120	50" x 13.75" x 3.4"	4-F32T8

For commercial jobs, replace "R120" with "MV" for commercial electronic ballast.

### NEW Economical Version



#### Contemporary LUM

Premium grade, designer, shallow surface mount for the most discriminating modern look. Regressed housing provides a floating appearance.

Item Number	Dimensions (L x W x H)	Lamping
SC22-2U32XR120/ L1002	26.5" x 26.5" x 6"	2-F32UT8
SC14-232R120/ L1000	50.5" x 14.5" x 6"	2-F32T8
SC24-432R120/ L1003	50.5" x 26.5" x 6"	4-F32T8

Consult factory for other sizes, including 4 x 4.

For commercial jobs, replace "R120" with "MV" for commercial electronic ballast. Housing and lens packaged separately.



# DECORATIVE FLUORESCENTS

## Cloud Series/ InDestruct-A-Puff

A puff of light to illuminate the most discriminating office or home. A shallow contemporary opal acrylic diffuser softly and evenly distributes light at comfortable levels. All the Puff Series lens' are now made with a revolutionary high strength optical plastic, that prevents shipping damage and rigors of job installation.

Item Number	Dimensions (L x W x H)	Lamping
C9 232R120	50.5" x 11.75" x 6"	2-F32T8
C15 2U32XR120	26.5" x 26.5" x 6"	2-F32T8/U
C15 417R120	26.5" x 17" x 6"	4-F17T8
C15 432R120	50.5" x 17" x 6"	4-F32T8

For commercial jobs, replace "R120" with "MV" for commercial electronic ballast.



All cloud lens now have the indestructable formulation.

**Configure to Your Specs**  
Consult for T5 Lamping and three light versions.

## Spill Ring

Coordinated design in surface fluorescent, close-to-ceiling, wall and vanity, see pages 39, 41, & 45.

Item Number	Dimensions (L x W x H)	Lamping
MDC 332R120SN	48" x 11.75" x 4.5"	3-F32T8
MDC 332R120BZ	48" x 11.75" x 4.5"	3-F32T8

"SN" - Satin Nickel, "BZ" - Bronze. For other lamping or ballast options, consult factory. For commercial jobs, replace "R120" with "MV" for commercial electronic ballast.



Bronze



## Crown Series

Now constructed to be flush with the ceiling. Crown molding available in White, Golden Oak and Unfinished. Bracket and one screw frame design enables one person installation.

Item Number	Dimensions (L x W x H)	Lamping
CWN 2U32XWHR120	25" x 25" x 4.125"	2-F32T8/U
CWN 232WHR120	48.875" x 11.5" x 4.125"	2-F32T8
CWN 432WHR120	48.875" x 16.75" x 4.125"	4-F32T8

Consult factory for other sizes and finishes. For Golden Oak replace WH with GO, Unfinished with UF. Consult for Cherry Walnut version. For commercial jobs, replace "R120" with "MV" for commercial electronic ballast.



**MOBERN is the Leading Supplier to Multi-Family Projects and Production Homes. Call us for a quote today on your project.**



## Fluorescent Strips

Mobern Lighting offers a full range of fluorescents strips from subminiature to wide, carrying all common T5, T8 and T12 linear lamps in specification to residential grade. Available in all different sizes including tandem lengths and a multitude of configurations from side mount to staggered strips. Most strips can be enhanced with a variety of reflectors to put the light where you want it. Today's demand for green spaces is increasing the opportunities to use strips in a variety of applications that are both visible or hidden by coves, valences and recesses. Add dimming ballasts, reflectors, lens and more to meet your exacting requirements without breaking the budget.

**NEW**

### Seamless T5 Strip

Up to now, if you wanted continuous light you had to put up with dark zones and shadows between the luminaires – or “intended” overlaps. LUMILUX T5 HO SEAMLESS lamps from OSRAM overcome the limits of conventional fluorescent lamps. The new lamps enable “endless” strip lighting systems to be created without annoying shadows because they need a minimum end-to-end spacing. The new Seamless T5 strip utilizes these lamps and makes it easy to use in cove and lit ceiling applications. Choice of individual, starter or joiner modules allows these strips to install easily either individually or in a continuous run. Available with dimming ballasts.

Item Number	Dimensions (L x W x H)	Lamping
SEI124MV	23" x 1.75" x 1.96"	1-F24T5HOSLS
SEI139MV	34.8" x 1.75" x 1.96"	1-F39T5HOSLS
SEI154MV	46.6" x 1.75" x 1.96"	1-F54T5HOSLS



The Seamless T5 fluorescent lamp part of the OSRAM Lumilux series uses the entire luminaire for illumination and allows shadowless lighting by allowing a minimum distance between two lamps that is a mere 5 mm apart- in contrast with a standard T5 lamp which requires four times as much space between them.

### Configure to Your Specs

For individual run use fixture prefix SEI. To start a run use fixture starter SES and for joiners use SEJ. Each fixture comes with the necessary wiring harnesses to join together easily.



Wiring harness joins fixture easily and seamlessly.



### Low Profile T5 Surface Mount

Full body micro silhouette makes a bold statement with a minimal design in brushed nickel powder coated finish (consult factory for other finishes). Scaled to the T5 lamp the matte white diffuser surrounds the lamps for soft lighting. Brushed nickel fixture can be surface mounted on wall or ceiling or pendant mounted with specially engineering cable mounting kit.

Item Number	Dimensions (L x W x H)	Lamping
10T5 114MVBVN	24" x 2" x 2.5"	1 x F14T5
10T5 121MVBVN	36" x 2" x 2.5"	1 x F21T5
10T5 128MVBVN	48" x 2" x 2.5"	1 x F28T5
10T5 214MVBVN	24" x 3" x 3"	2 x F14T5
10T5 221MVBVN	36" x 3" x 3"	2 x F21T5
10T5 228MVBVN	48" x 3" x 3"	2 x F28T5
A-10T5C1BN	5' CABLE MOUNTING KIT	

**NEW**



Ideal for wall, bath or pendant mount.

Change wattage codes to high output wattage. Consult for other designer finishes. Change “MV” to “R120” for an economical residential electronic ballast for standard T5 lamps.



# FLUORESCENT STRIPS

## Linked Sub-Mini Strip

Sub-miniature strip with acrylic diffuser to illuminate tight spaces. Ideal for display and shelf lighting. Fixtures may be used individually, or linked, end to end without cords. Joiner cords are available to go around corners or impediments. Comes with cord and plug. Hardwire box accessory is an option.

Item Number	Dimensions (L x W x H)	Lamping
10M 108ELL1	13" x 0.9" x 1.7"	1-F8T5
10M 113ELL1	22.5" x 0.9" x 1.7"	1-F13T5
10M 114ELL1	23.7" x 0.9" x 1.7"	1-F14T5
10M 121ELL1	35.6" x 0.9" x 1.7"	1-F21T5
10M 128ELL1	47.4" x 0.9" x 1.7"	1-F28T5
10M 6JOIN	6" Cord	
10M 12JOIN	12" Cord	
10M 18JOIN	18" Cord	
10M 24JOIN	24" Cord	
10M JBOX	J Box for Hardware	

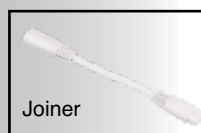

Joiner

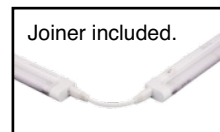

Joiner included.

Remove LI to include 6500K lamp.

## Mini Body Side Mount Strip

Small size, flexibility and lots of light distinguish this series which is ideal for display cases, coves and other tight spaces. Choose either 2 or 3 lamp configurations using all T5 lamps and sizes. Consult factory for configurations not listed.

Item Number	Dimensions (L x W x H)	Lamping
41SC 214MV	21.6" x 1.6" x 1.6"	2-F14T5
41SC 224MV	21.6" x 1.6" x 1.6"	2-F24T5HO
41SC 321MV	33.3" x 1.6" x 1.6"	3-F21T5
41SC 239MV	33.3" x 1.6" x 1.6"	2-F39T5HO
41SC 228MV	45.3" x 1.6" x 1.6"	2-F28T5
41SC 328MV	45.3" x 1.6" x 1.6"	3-F28T5
41SC 254MV	45.3" x 1.6" x 1.6"	2-F54T5HO
41SC 354MV	45.3" x 1.6" x 1.6"	3-F54T5HO



Lamp Count 1



Lamp Count 2



Lamp Count 2L

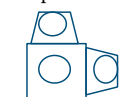

Lamp Count 3

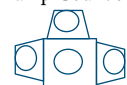

For lamp configurations shown on right, change the lamp count number after the "C," to the number shown.

Due to size constraints many fixture accept only dedicated voltage ballasts rather than multi-volt. Change "MV" to "E120" for 120 or "E277" for 277 volt fixtures.

Your cove has size constraints?

Contact us for the ideal solution for your applications.

## Side Mount Strips

Specification grade side mount fixtures for T8 lamps. For other configurations or lamping consult factory.

Item Number	Dimensions (L x W x H)	Lamping
42SC 115R120	18" x 2.75" x 1.8"	1-F15T8
42SC 117MV	24" x 2.75" x 1.8"	1-F17T8
42SC 125MV	36" x 2.75" x 1.8"	1-F25T8
42SC 132MV	48" x 2.75" x 1.8"	1-F32T8
42SC 217MV	24" x 2.75" x 1.8"	2-F17T8
42SC 225MV	36" x 2.75" x 1.8"	2-F25T8
42SC 232MV	48" x 2.75" x 1.8"	2-F32T8

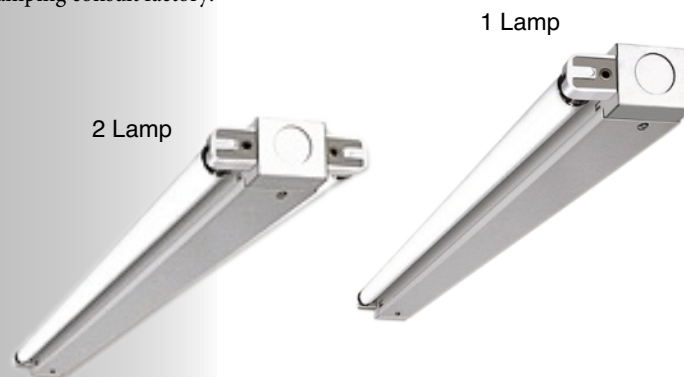

# FLUORESCENT STRIPS

## Mini Body T5 Strip - 1 and 2 Light

For size critical applications such as display cabinets, coves, and other indirect lighting applications, these specification grade T5 strips in 1 or 2 light provide lots of light. Choice of T5 and T5HO lamps and ballasts to provide up to 70% more light output. T5 lamps come in 46", 34", and 22" lengths to fit into standard size furniture. Available with a variety of reflectors.

Item Number	Dimensions (L x W x H)	Lamping
41 114MV	21.6" x 1.6" x 1.6"	1-F14T5
41 124MV	21.6" x 1.6" x 1.6"	1-F24T5HO
41 121MV	33.3" x 1.6" x 1.6"	1-F21T5
41 139MV	33.3" x 1.6" x 1.6"	1-F39T5HO
41 128MV	45.3" x 1.6" x 1.6"	1-F28T5
41 154MV	45.3" x 1.6" x 1.6"	1-F54T5HO
41 214MV	22.6" x 2" x 1.6"	2-F14T5
41 224MV	22.6" x 2" x 1.6"	2-F24T5HO
41 221MV	34.5" x 2" x 1.6"	2-F21T5
41 239MV	34.5" x 2" x 1.6"	2-F39T5HO
41 228MV	34.5" x 2" x 1.6"	2-F28T5
41 254MV	46.3" x 2" x 1.6"	2-F54T5HO

### Configure to Your Specs

Add dimming ballasts, reflectors and wiring harness to customize your cove lighting solutions.



Miniature T5 strips allow simple and inexpensive design of built-in modules. Add a matte white lens up to 100" for a lavish built-in look.



## Narrow - 1 and 2 Light Strip

Narrow body one lamp strip. Available for use with T8 or T5. Consult factory for lamp configurations and sizes not shown.

Item Number	Dimensions (L x W x H)	Lamping
42 115R120	18" x 2.75" x 1.8"	1-F15T8
42 117R120	24" x 2.75" x 1.8"	1-F17T8
42 117MV	24" x 2.75" x 1.8"	1-F17T8
42 125R120	36" x 2.75" x 1.8"	1-F25T8
42 125MV	36" x 2.75" x 1.8"	1-F25T8
42 125TANMV	72" x 2.75" x 1.8"	2-F25T8
42 132R120	48" x 2.75" x 1.8"	1-F32T8
42 132MV	48" x 2.75" x 1.8"	1-F32T8
42 132TANR120	96" x 2.75" x 1.8"	2-F32T8
42 132TANMV	96" x 2.75" x 1.8"	2-F32T8
42 215R120	18" x 2.75" x 1.8"	2-F15T8
42 217R120	24" x 2.75" x 1.8"	2-F17T8
42 217MV	24" x 2.75" x 1.8"	2-F17T8
42 225R120	36" x 2.75" x 1.8"	2-F25T8
42 225MV	36" x 2.75" x 1.8"	2-F25T8
42 232R120	48" x 2.75" x 1.8"	2-F32T8
42 232MV	48" x 2.75" x 1.8"	2-F32T8
42 224MV	24" x 2.75" x 1.8"	2-F24T5HO
42 239MV	36" x 2.75" x 1.8"	2-F39T5HO
42 254MV	48" x 2.75" x 1.8"	2-F54T5HO
A69*	48" Wire Guard	



### Configure to Your Specs

Mobern offers the widest assortment of strip fixtures to meet your exact application.



Made in USA

\*Order quantity of 2 for 8' tandem fixtures.

# FLUORESCENT STRIPS

## 1, 2, 3 or 4 Light Strip

Available for use with T8 or T5. Consult factory for lamp configurations and sizes not shown.

Item Number	Dimensions (L x W x H)	Lamping
44 217R120	24" x 4.25" x 1.93"	2-F17T8
44 217MV	24" x 4.25" x 1.93"	2-F17T8
44 225R120	36" x 4.25" x 1.93"	2-F25T8
44 225MV	36" x 4.25" x 1.93"	2-F25T8
44 225TANMV	72" x 4.25" x 1.93"	4-F25T8
44 232R120	48" x 4.25" x 1.93"	2-F32T8
44 232MV	48" x 4.25" x 1.93"	2-F32T8
44 232TANR120	96" x 4.25" x 1.93"	4-F32T8
44 232TANMV	96" x 4.25" x 1.93"	4-F32T8
44 254MV	48" x 4.25" x 1.93"	2-F54T5HO
44 254TANMV	96" x 4.25" x 1.93"	4-F54T5HO
44 354MV	48" x 8.75" x 1.93"	3-F54T5HO
44 354TANMV	96" x 8.75" x 1.93"	6-F54T5HO
44 454MV	48" x 8.75" x 1.93"	4-F54T5HO
44 454TANMV	96" x 8.75" x 1.93"	8-F54T5HO
A69*	48" Wire Guard (1 or 2 light)	
A70*	48" Wire Guard (3 or 4 light)	

\*Order quantity of 2 for 8' tandem fixtures.



Symmetrical Reflector

Asymmetrical Reflector



See page 71 for reflector options.

Wire Guard

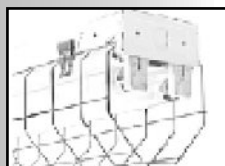

A69, A70

### Configure to Your Specs

Consult for complete assortment of mirrored or enhanced white reflectors.

## Slimline Strip

Heavy duty specification grade, deep body strip for warehouse and industrial applications. Great for Pendant mounting on chain or stems.

Item Number	Dimensions (L x W x H)	Lamping
80 296T8MV	96" x 4.25" x 1.93"	2-F59(96)T8
80 296T12EL	96" x 4.25" x 1.93"	2-F96T12
80 240T12EL	48" x 4.25" x 1.93"	2-F34T12
80 240 TANT12EL	96" x 4.25" x 1.93"	4-F34T12
81 248T8HOMV	48" x 4.25" x 2.75"	2-F48T8HO
81 296T8HOMV	96" x 4.25" x 2.75"	2-F96T8HO
81 296T12ELHO	96" x 4.25" x 2.75"	2-F96T12HO



Wire Guard

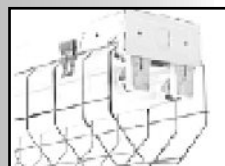

A69, A70

### Wire Guards for Strips

Item No.	Description
A69*	48" Wire Guard (1 or 2 light)
A70*	48" Wire Guard (3 or 4 light)

\*Order quantity of 2 for 8' tandem fixture.

## Wide Body Strip

Wider strip allows three or four lamps for higher illumination applications.

Item Number	Dimensions (L x W x H)	Lamping
81 496MV	96" x 8.75" x 2.75"	4-F59(96)T8
81 348T8HOMV	48" x 8.75" x 2.75"	3-F48T8HO
81 448T8HOMV	48" x 8.75" x 2.75"	4-F48T8HO
81 396T8HOMV	96" x 8.75" x 2.75"	3-F96T8HO
81 496T8HOMV	96" x 8.75" x 2.75"	4-F96T8HO
81 396T12EL	96" x 8.75" x 2.75"	3-F96T12
81 496T12EL	96" x 8.75" x 2.75"	4-F96T12
81 396T12ELHO	96" x 8.75" x 2.75"	3-F96T12HO
81 496T12ELHO	96" x 8.75" x 2.75"	4-F96T12HO



# FLUORESCENT STRIPS

## Staggered Strip - One Lamp T5

Specification grade, mini body single lamp (and Tandem) staggered strip for interior coves, valences and displays requiring smooth shadowless lighting even at the ends. Consult factory for other sizes and lamping including T8.

Item Number	Dimensions (L x W x H)	Lamping
44SS 114MV	21.6" x 3.1" x 1.4"	1-F14T5
44SS 124MV	21.6" x 3.1" x 1.4"	1-F24T5HO
44SS 121MV	33.3" x 3.1" x 1.4"	1-F21T5
44SS 139MV	33.3" x 3.1" x 1.4"	1-F39T5HO
44SS 128MV	46.3" x 3.1" x 1.4"	1-F28T5
44SS 154MV	46.3" x 3.1" x 1.4"	1-F54T5HO



## Staggered Strip - Two Lamp T5

Specification grade, mini body dual lamp (and Tandem) staggered strip for interior coves, valences and displays requiring smooth shadowless lighting even at the ends. Consult factory for other sizes and lamping including T8.

Item Number	Dimensions (L x W x H)	Lamping
44SS 214MV	26.5" x 3.1" x 1.4"	2-F14T5
44SS 224MV	26.5" x 3.1" x 1.4"	2-F24T5HO
44SS 221MV	38.25" x 3.1" x 1.4"	2-F21T5
44SS 239MV	38.25" x 3.1" x 1.4"	2-F39T5HO
44SS 228MV	50" x 3.1" x 1.4"	2-F28T5
44SS 254MV	50" x 3.1" x 1.4"	2-F54T5HO



## Staggered Strip One - Lamp T8

Specification grade, single lamp (and Tandem) strip for interior coves, valences and displays requiring smooth shadowless lighting even at the ends.

Item Number	Dimensions (L x W x H)	Lamping
44SS 117MV	24" x 4.25" x 2"	1-F17T8
44SS 125MV	36" x 4.25" x 2"	1-F25T8
44SS 132MV	48" x 4.25" x 2"	1-F32T8
44SS 132TANMV	96" x 4.25" x 2"	2-F32T8



## Staggered Strip - Two Lamp T8

Specification grade, dual lamp (and Tandem) staggered strip for interior coves, valences and displays requiring smooth shadowless lighting even at the ends.

Item Number	Dimensions (L x W x H)	Lamping
44SS 217MV	27" x 4.25" x 2"	2-F17T8
44SS 225MV	39" x 4.25" x 2"	2-F25T8
44SS 225TANMV	75" x 4.25" x 2"	4-F25T8
44SS 232MV	51" x 4.25" x 2"	2-F32T8
44SS 232TANMV	99" x 4.25" x 2"	4-F32T8



## Telescope Staggered Strip - Two Lamp T5

Fixture telescopes to maintain uniform distribution of light in end-of-row applications. Consult factory for other sizes and lamping including T8.

Item Number	Dimensions (L x W x H)	Lamping
44TSS 214TANMV	26.5" x 3.1" x 1.4"	2-F14T5
44TSS 224TANMV	26.5" x 3.1" x 1.4"	2-F24T5HO
44TSS 221TANMV	38.25" x 3.1" x 1.4"	2-F21T5
44TSS 239TANMV	38.25" x 3.1" x 1.4"	2-F39T5HO
44TSS 228TANMV	50" x 3.1" x 1.4"	2-F28T5
44TSS 254TANMV	50" x 3.1" x 1.4"	2-F54T5HO



### TELESCOPING DISTANCE

2 FT	Telescopes	10 inches
3 FT	Telescopes	20 inches
4 FT	Telescopes	26 inches

# FLUORESCENT STRIPS

Largest Assortment of Reflectors

## Industrial Strip w/ Reflectors

Medium body industrial strip with reflectors for interior warehouse, retail and utility areas requiring concentrated illumination in a commercial quality configuration. Choose from a variety of reflectors with one right for your application.

Item Number	Dimensions (L x W x H)	Lamping
1 232MV	48"x10.25"x4.2"	2-F32T8
1 232TANMV	96"x10.25"x4.2"	4-F32T8
1 254MV	48"x10.25"x4.2"	2-F54T5HO
1 254TANMV	96"x10.25"x4.2"	4-F54T5HO
1 354MV	48"x10.25"x4.2"	3-F54T5HO
1 354TANMV	96"x10.25"x4.2"	6-F54T5HO
1 296T8MV	96"x10.25"x4.2"	2-F59(96)T8
1 296T12EL	96"x10.25"x4.2"	2-F59(96)T8
1 296T8HOMV	96"x10.25"x4.2"	2-F96T8HO
1 296T12ELHO	96"x10.25"x4.2"	2-F96T12HO
A71	48" Wire Guard (1 or 2 light)	
A72	48" Wire Guard (3 or 4 light)	



### Configure to Your Specs

Consult factory for 3 or 4 light versions.  
See page 71 for reflector options.

All of the above are standard with a white reflector. Add XS at end of catalog number for mirrored reflector. For uplight options add UP after wattage. Order 2 wire guards for 8 ft fixture.

## Specification Industrial

Heavy duty, specification grade deep body industrial strip with embossed steel reflectors and rotating turret sockets for interior warehouse, retail and utility areas requiring extra rugged fixtures and illumination.

Item Number	Dimensions (L x W x H)	Lamping
9 232MV	48" x 13" x 5.25	2-F32T8
9 232TANMV	96" x 13" x 5.25	4-F32T8
9 332MV	48" x 13" x 6"	3-F32T8
9 432MV	48" x 13" x 6"	4-F32T8
9 296T8MV	96" x 13" x 5.25	2-F59(96)T8
9 296T12EL	96" x 13" x 5.25	2-F96T12
9 296T8HOMV	96" x 13" x 5.25	2-F96T8HO
9 296T12ELHO	96" x 13" x 5.25	2-F96T12HO
A71	48" Wire Guard (1 or 2 light)	
A72	48" Wire Guard (3 or 4 light)	



All of the above are standard with a white reflector. For uplight options add UP after wattage. Order 2 wire guards for 8 ft fixture.

## High Performance Industrial

Made completely at Mobern's Baltimore facility, this durable, heavily engineered industrial provide high light output for the most demanding applications including warehouses and retail spaces. Mirrored reflectors, surface, stem or chain mounting makes it ideal for higher ceiling applications.

Item Number	Dimensions (L x W x H)	Lamping
HPI 232MV	48" x 12.75" x 4.25"	2-F32T8
HPI 232TANMV	96" x 12.75" x 4.25"	4-F32T8
HPI 254MV	48" x 12.75" x 4.25"	2-F54T5HO
HPI 254TANMV	96" x 12.75" x 4.25"	4-F54T5HO
HPI 432MV	48" x 17.12" x 4.25"	4-F32T8
HPI 432TANMV	96" x 17.12" x 4.25"	8-F32T8
HPI 454MV	48" x 17.12" x 4.25"	4-F54T5HO
HPI 454TANMV	96" x 17.12" x 4.25"	8-F54T5HO



Buy American

Consult for wire guard option and for 3 lamp options.



## High Bay Fluorescents

Fluorescent High Bays are the highest efficiency (light for electricity) luminaire available in the market place today. They are the perfect choice for large area lighting applications including warehouses, gyms, ballrooms, and more. Mobern Lighting offers a complete selection of High Bay Fluorescents to meet the exacting needs of your specific application. Choose from a variety of unique High Bay Fluorescents series each offering a range of features and benefits. Within each series, you can choose all the options required - occupancy sensors, lens enclosures, T5 or T8 lamp, different hanging methods and more.

### The Advantages of the Fluorescent High Bays

The most popular and productive lighting upgrades today involve replacing older fluorescent or HID lighting systems for High Performance Fluorescent High Bays providing dramatic energy savings and superior performance.

#### Energy Savings

Dramatic energy saving opportunities over HID Lighting Systems and provide quick returns.

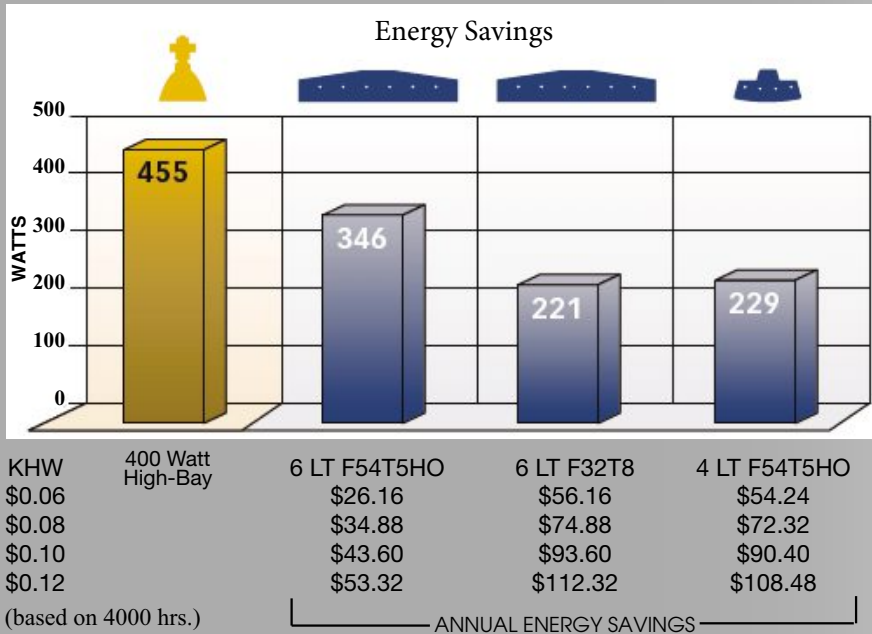

#### Uniformity

Fluorescent High Bays improve lighting uniformity compared to HID High Bays. While HID fixtures have a significantly greater initial lumens than fluorescent versions, their 66% light loss factor quickly equalizes the light output with either T8 or T5 options. With **Fluorescent High Bays your space will be lit evenly** from their first day of operation until relamping time.

#### Lamp Life and Lumen Maintenance

T5 and T8 fluorescent systems provide better maintained light levels over HID lighting systems with twice the lamp life. Mobern Lighting offers a variety of T5 and T8 lamp choices with **up to 75,000 hours of lamp life**.

#### Occupancy Sensors & Controls

Use Fluorescent High Bays with **occupancy sensors, daylight sensors, and multi-level controls can increase energy savings by up to 30%**. All Mobern Lighting High Bays are specially designed to accept a wide variety of options to enable the end user to maximize energy savings without compromising performance.



#### Lamp & Ballast Options

Mobern Lighting High Bays can be configured with the right lamp and ballast combination to ensure the right light for every application. **T8 lamps provide a more economical solution with mounting heights below 20 foot and maximize output at 78° F.**

Ballasts for T8 lamps are offered in multiple light output ranging typically from 66% to 118% of rated lamp life output allowing for more flexibility in application without changing lamp type. **T5HO are ideal for higher light levels, mounting heights over 20 feet** and come standard with program start ballasts for better performance with frequent on/off cycles normally associated with sensors. Most of our T5HO ballasts are pre-wired for dual switching, eliminating need for two ballasts. Consult factory.



# HIGH BAY FLUORESCENTS

## Enclosed Body High Bay

Die-formed heavy-gauge cold rolled steel is post painted with choice of reflectors, door frame and wire guard. Ballasts are accessible simply from below with reflector swinging down. Choice of chain, cable or stem pendant mounting as well as surface mount.

Item Number	Dimensions (L x W x H)	Lamping
FHB 432MV	48" x 14" x 3.9"	4-F32T8
FHB 632MV	48" x 19.875" x 3.9"	6-F32T8
FHB 454MV	48" x 14" x 3.9"	4-F54T5HO
FHB 654MV	48" x 19.875" x 3.9"	6-F54T5HO
FHB1 432MVCL100	48" x 15" x 4.5"	4-F32T8
FHB1 632MVCL125	48" x 21" x 4.5"	6-F32T8
FHB1 454MVCL125	48" x 15" x 4.5"	4-F54T5HO
FHB1 654MVCL125	48" x 21" x 4.5"	6-F54T5HO
FHB3 432MV	48" x 15" x 4.5"	4-F32T8
FHB3 632MV	48" x 21" x 4.5"	6-F32T8
FHB3 454MV	48" x 15" x 4.5"	4-F54T5HO
FHB3 654MV	48" x 21" x 4.5"	6-F54T5HO
FHB4 432MVCL100	48" x 15" x 4.5"	4-F32T8
FHB4 632MVCL125	48" x 21" x 4.5"	6-F32T8
FHB4 454MVCL125	48" x 15" x 4.5"	4-F54T5HO
FHB4 654MVCL125	48" x 21" x 4.5"	6-F54T5HO
A-FHBD	Single Point Mount w/ 3/4" HUB	

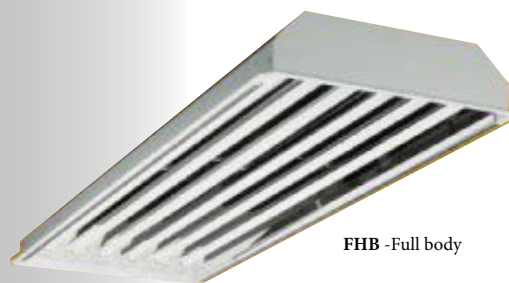

FHB - Full body



FHB1 - Full body w/ door frame and lens.



FHB3 - Full body w/ wire guard



FHB4 - Full body w/ door frame, lens and wire guard.

See page 7 for lens options.

Available in 8 light option. Consult for 8 FT Tandem.

## Full Body High Bay

Low profile, enclosed High Bay shown with optional wire guard has **rear ballast access**. Now available with door frame to hold lens and optional wire guard with lens.

Item Number	Dimensions (L x W x H)	Lamping
FHBA 332MV	48.5 x 13.38" x 4.25"	3-F32T8
FHBA 432MV	48.5" x 13.38" x 4.25"	4-F32T8
FHBA 532MV	48.5" x 18.5" x 4.25"	5-F32T8
FHBA 632MV	48.5" x 18.5" x 4.25"	6-F32T8
FHBA 354MV	48.5" x 13.38" x 4.25"	3-F54T5HO
FHBA 454MV	48.5" x 13.38" x 4.25"	4-F54T5HO
FHBA 554MV	48.5" x 18.5" x 4.25"	5-F54T5HO
FHBA 654MV	48.5" x 18.5" x 4.25"	6-F54T5HO
FHBA1 332MV	48.5" x 13.38" x 4.25"	3-F32T8
FHBA1 432MV	48.5" x 13.38" x 4.25"	4-F32T8
FHBA1 532MV	48.5" x 18.5" x 4.25"	5-F32T8
FHBA1 632MV	48.5" x 18.5" x 4.25"	6-F32T8
FHBA1 354MV	48.5" x 13.38" x 4.25"	3-F54T5HO
FHBA1 454MV	48.5" x 13.38" x 4.25"	4-F54T5HO
FHBA1 554MV	48.5" x 18.5" x 4.25"	5-F54T5HO
FHBA1 654MV	48.5" x 18.5" x 4.25"	6-F54T5HO
A-FHBA 4WG	Wire Guard for 3 or 4 LT for FHBA	
A-FHBA 6WG	Wire Guard for 5 or 6 LT for FHBA	
A-FHBA1 4WG	Wire Guard for 3 or 4 LT for FHBA1	
A-FHBA1 6WG	Wire Guard for 5 or 6 LT for FHBA1	

## 3 and 5 Light Options

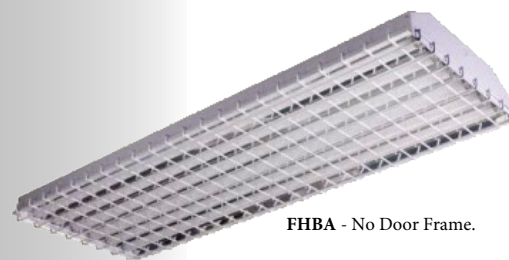

FHBA - No Door Frame.



FHBA1 - Door Frame Included.  
For Lens Options, see pg 7.

Door frame with lens options fits over housing and accepts integral wire guard.



Ballast is accessible from the back for easy maintenance.

Standard with mirror reflector add "W" after lamp wattage for white reflector.

# HIGH BAY FLUORESCENTS

## High Bay Workhorse and Tandem Workhorse

FHBF utilizes a shallow depth body to provide a sleek, low profile appearance. The Tandem FHBF utilizes a one piece eight foot shallow depth body to provide both a sleek low profile appearance and a highly durable and rigid construction. Choice of highly polished mirrored reflector or premium white reflector both have air vents in the ballast cover to enhance the ballast performance and life. The fixture's specially designed side rails enable superior fit and performance of added lens or wire guard options.

Item Number	Dimensions (L x W x H)	Lamping
FHBF 432MV	48" x 15.8" x 3.4"	4-F32T8
FHBF 432WMV	48" x 15.8" x 3.4"	4-F32T8
FHBF 454MV	48" x 15.8" x 3.4"	4-F54T5HO
FHBF 454WMV	48" x 15.8" x 3.4"	4-F54T5HO
FHBF 632MV	48" x 15.8" x 3.4"	6-F32T8
FHBF 632WMV	48" x 15.8" x 3.4"	6-F32T8
FHBF 654MV	48" x 15.8" x 3.4"	6-F54T5HO
FHBF 654WMV	48" x 15.8" x 3.4"	6-F54T5HO
FHBF 432TANMV	96" x 15.8" x 3.4"	8-F32T8
FHBF 632TANWMV	96" x 15.8" x 3.4"	12-F32T8
FHBF 654TANMV	96" x 15.8" x 3.4"	12-F54T5HO
FHBF 454TANMV	96" x 15.8" x 3.4"	8-F54T5HO

Add SS to end of part number for Integral Smart sensor.  
Add OS to end of part number for External OCC Sensor.



**1000W Metal Halide Replacement** - 12 Light Tandem high bay that can provide the output and the spread of light required to meet the most demanding high light output applications.



Clear Lens option. L-FHBFCLLEN

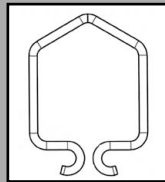

Chain kit comes with (4) eyelits to make mounting simple. A144-20SC

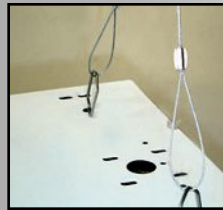

15' Aircraft cable kit. AC120-YHOOK



Sensor switch sensor mounts neatly in center of reflector for superior performance. Add SS to end of Item Number.



4' version



Tandem 8' version

### Integral Occupancy Sensor

### Options for FHBF

ACCESSORIES*	FHBF
Wired Guard Galv 4 FT	A-FHBF WG
Wired Guard White 4 FT	A-FHBF WGWH
Clear .100 Lens	L-FHBF CLLEN
Clear .125 Lens	L-FHBF CL125LEN
Acrylic .100 Lens	L-FHBF ALEN
Clear Polycarbonate Lens	L-FHBF PCLEN
15' AirCraft Cable Toggle Set Kit	AC120-YHOOK
Chain Kit w/ Eyelits	A144-20SC
Single Point Mount w/ 3/4" Hub	A-FHBF 7

For additional options see pages 70 and 71.  
\*Most accessories require 2 per for tandem version.

### Configure to Your Specs

Choose from an integral occupancy sensor mounted in the center of the fixture (SS) or an external occupancy sensor (OS). Add lens easily to side rails with choice of lens versions, see page 7.

### Configure to Your Specs

Choose the right ballast.





# HIGH BAY FLUORESCENTS

## Industrial Galvanized High Bay

More light, fully accessorized and rugged construction makes this the ideal choice in many applications. Premium, full specular reflectors with wide or narrow light distribution with a choice of 4, 6, 8, 10, or 12 lamps - T8 or T5HO - allows you to achieve the light levels you need. Galvanized code steel construction provides corrosion resistance in the most demanding applications. Access ballast without tools. Options include whips, cord sets, emergency battery, occupancy sensors and wire guards. Full choice of mounting methods including single or double stem mount, chain or cable mount or direct surface mount.

Item Number	Dimensions (L x W x H)	Lamping
FHBI 432MV	48" x 14.5" x 3.25"	4-F32T8
FHBI 632MV	48" x 21.5" x 3.25"	6-F32T8
FHBI 832MV	48" x 28.25" x 3.25"	8-F32T8
FHBI 1032MV	48" x 35.3" x 3.25"	10-F32T8
FHBI 1232MV	48" x 42.3" x 3.25"	12-F32T8
FHBI 454MV	48" x 14.5" x 3.25"	4-F54T5HO
FHBI 654MV	48" x 21.5" x 3.25"	6-F54T5HO
FHBI 854MV	48" x 28.25" x 3.25"	8-F54T5HO
FHBI 1054MV	48" x 35.3" x 3.25"	10-F54T5HO
FHBI 1254MV	48" x 42.3" x 3.25"	12-F54T5HO
A-FHBI 4WG	Wire Guard 4 LT	
A-FHBI 6WG	Wire Guard 6 LT	
A-FHBI 8WG	Wire Guard 8 LT	
A-FHBI 10WG	Wire Guard 10 LT	
A-FHBI 12WG	Wire Guard 12 LT	
A-7HBD	Single Point Mount w/ 34" Hub	

Mirrored wide distribution is the standard reflector. For mirrored narrow distribution, add XN to the end of catalog number or for enhanced white reflector, add W. For uplight add UP after lamp wattage.

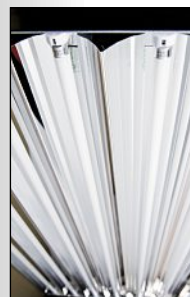
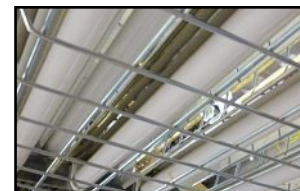

### Configure to Your Specs

Customize with a narrow mirrored, white or uplight reflector. Add a heavy duty wire guard that wraps around the back of the fixture. Add occupancy sensors or mounting hardware, see page 70.

## Baffled High Bay

The FHBR series is offered with baffles to cut glare and is dressed for applications requiring aesthetic appeal. Available with premium full specular mirrored reflectors for high efficiency lighting, white reflectors for wider distribution or standard without reflector for good economical performance. The FHBR series can also be configured to provide 10% uplight. Mounting options include direct surface, chain, or pendant cable. Custom painted finishes available. Ideal for retail applications.

### 4 FT or 8 FT Options

Item Number	Dimensions (L x W x H)	Lamping
FHBR 232MV	48" x 9.25" x 4.25"	2-F32T8
FHBR 232TANMV	96" x 9.25" x 4.25"	4-F32T8
FHBR 254MV	48" x 9.25" x 4.25"	2-F54T5HO
FHBR 254TANMV	96" x 9.25" x 4.25"	4-F54T5HO
FHBR 332MV	48" x 9.25" x 4.25"	3-F32T8
FHBR 332TANMV	96" x 9.25" x 4.25"	6-F32T8
FHBR 354MV	48" x 9.25" x 4.25"	3-F54T5HO
FHBR 354TANMV	96" x 9.25" x 4.25"	6-F54T5HO
FHBR 432MV	48" x 9.25" x 4.25"	4-F32T8
FHBR 432TANMV	96" x 9.25" x 4.25"	8-F32T8
FHBR 454MV	48" x 9.25" x 4.25"	4-F54T5HO
FHBR 454TANMV	96" x 9.25" x 4.25"	8-F54T5HO

Standard is without reflector. Add XS-Full Specular (Mirrored) or W for enhanced white reflector. For uplight add UP after lamp wattage. Change R to X to specify without baffle.



FHBX - Without the baffle.



FHBR

### Configure to Your Specs

Powder Coat in brushed nickel, bronze, black or your choice to dress up for retail and office applications. Use without the baffle by changing the part number to FHBX.

# HIGH BAY FLUORESCENTS

## Rough Service High Bay for Wet or Dusty Applications

CITADEL™ family of gasketed enclosures are designed to protect fluorescent lighting in harsh environments. These units seal out dust and moisture from the electrical components in a wide range of applications. CITADEL 4™ offers more versatility and benefits than any other weatherproof enclosure offered. Wide profile designed around T8 or T5 lamps for long term energy savings. Features include poured in place gasket and stainless steel latches to seal the enclosure; economical mounting options can provide dramatic savings on installation labor; very tough diffusers resist breakage and reduce replacement and maintenance costs; utilize off the shelf 1/2" fitting; and tamper resistance latches standard.

Item Number	Dimensions (L x W x H)	Lamping
VWFHB 432MV	51.91" x 14.61" x 5.95"	4-F32T8
VWFHB 632MV	51.91" x 14.61" x 5.95"	6-F32T8
VWFHB 454MV	51.91" x 14.61" x 5.95"	4-F54T5HO
VWFHB 654MV*	51.91" x 14.61" x 5.95"	6-F54T5HO

For 3 or 5 light simply change the number of lamps in the catalog number to 3 or 5.

\*Only recommended for cold storage environments.

Standard Geartray is white with 87% reflectivity.

Add XS to part number to achieve 94% reflectivity with mirror.



### Certifications



### MOUNTING OPTIONS

#### Mounting Hook



Mounting bracket allow V Hook or cable mounting without making any holes in the body (included) VWFHB-MBC.

#### Surface Mount



Surface Mount fixture 1.25" from ceiling (VWFHB-MBCM sold separately).

#### Pendant Mount

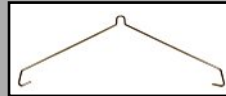

V Hook (H137) sold individually (need 2 per fixture).

#### Single Point Mount (For Damp Listing)

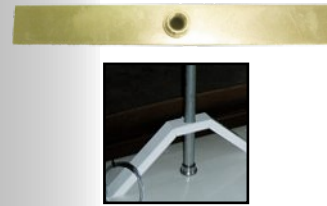

Add H21I (3/4") hub or H148I (A Frame 3/4" hub) with internal mounting plate to provide single point mounting (pipe not supplied).



## High Heat Version with Enhanced Mounting Options

**NEW**

## Ideal for Warmer Environments

Citadel 4 Plus builds on the engineering feats of the above Citadel 4 to expand the demanding applications that this new high bay enclosure will accommodate. A new heat management system for the ballasts allows 6 light T5HO lamps to operate much cooler than Citadel 4 and work in higher temperature environments, up to 30 degrees warmer than the VWFHB can operate. New plastic latch options to hold the lens provides improved maintenance and economy. New mounting options including a new mounting strap and rigid mounting beam enables enhanced mounting options including rigid ceiling mount and dual pendant mount.

Item Number	Dimensions (L x W x H)	Lamping
VWIFHB 432MV	51.91" x 14.61" x 5.95"	4-F32T8
VWIFHB 632MV	51.91" x 14.61" x 5.95"	6-F32T8
VWIFHB 454MV	51.91" x 14.61" x 5.95"	4-F54T5HO
VWIFHB 654MV	51.91" x 14.61" x 5.95"	6-F54T5HO

Standard Geartray is white with 87% reflectivity.

Add XS to part number to achieve 94% reflectivity with mirror reflector.



### Certifications



### Configure to Your Specs

New Mounting strap VWIFHB-MS-ZP (zinc) or VWIFHB-MS-SS (Stainless Steel) and mounting beam strap (VWIFHB-MB-ZP (zinc) or VWIFHB-MB-SS (Stainless Steel) available in zinc or stainless steel provides more mounting options with off-the-shelf components and faster installation time.

# HIGH BAY FLUORESCENTS

## Grid Mount Enclosed Body High Bay

Item Number	Dimensions (L x W x H)	Lamping
FHBG 454MVA125	47.75" x 23.75" x 6"	4-F54T5HO
FHBG 654MVA125	47.75" x 23.75" x 6"	6-F54T5HO
FHBG 632MVA125	47.75" x 23.75" x 6"	6-F32T8
A-FHBG WG	Wire Guard 4 or 6 LT	

Rugged steel body with hinged and latched door frame for lens options. Ballast housing above body provides cooler operation for longer life.

Standard with A.125 lens. See pg 7 for other lens options including Clear Acrylic.

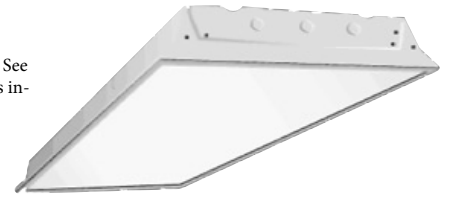

### Configure to Your Specs

Add a shroud to the High Bay for a high performance surface mount high bay.

## Occupancy Sensors

Our High Bay occupancy sensors are specifically designed for high mounted areas. The OS series installs directly to the high bay, and turns individual light fixtures on or off based on occupancy. Choose from three lenses for use in either a 360° high-bay or 360° low-bay general area or an aisle way, with reliable coverage up to 40 ft. mounting heights. Combination occupancy and daylight sensors will turn lights on/off based on occupancy, and will force lights off when sufficient daylight is available for additional energy savings.

CODE	DESCRIPTION
OS	On/Off, 1 Pole, Wide Field 120 - 277V
OSN	On/Off, 1 Pole, Narrow Field 120 - 277V
OS480	On/Off, 1 Pole, Wide Field 480V
OSW	On/Off, 1 Pole, Wide Field Wet
OSC	On/Off, 1 Pole, Wide Field Cold
OSPC (A412)	On/Off, Photocontrol, 1 pole, Wide Field 120 -277V
SS	On/Off, 1 Pole, Integral Sensor Switch

For 480 volt sensors add 480V to the end. For Wet Location add W to the end. For Cold Storage add C to the end. Conformal coated cold rated sensors are ideal for garage applications. See pg 70 for full selection of sensors. Consult factory for mounting bracket options.



Leviton OS



Wattstopper OSPC

## Mounting Kits

Item Number	Description
A411	Chain Kit, Incl. (6) S Hooks, 20Ft. Chain
A144-Footage	Tong Hangers, End Mount (Pair) with Footage of Chain
A144-Side	Tong Hangers, Side Mount (Pair)
A144-10	Tong Hangers, End Mount (Pair) with 10Ft. Chain Each
AC180-TOGGLE-2PK	15' 2 Pk Gripple Cable Hanger For Use with Holes In High Bay
A-5HBD	Single Point Hanger Adapter For FHBI Series 3/4" Hub
A-7HBD	Single Point Hanger Adapter For FHB Series 3/4" Hub
AC120-YHOOK	10' Cable Mounting Kit & 2 Spring Clips



A144

## Cord Sets

Item Number	Description
CS	8' Cordset 120V, 3-WIRE, NEMA 5-15P
CS8	8' 3/18 Cord, no plug
CS12	12' 3/18 Cord, no plug
CS8TL277	8' Cordset 277V, 3-WIRE, NEMA L7-15P
CS8TL480	480V 8' Cordset, L8-20P Twistlock
WP	6' Whip
WP12	12' Whip



### Configure to Your Specs

See page 71 for complete ordering guide for cord sets and whips.



## Retrofit Kits

Mobern has developed an assortment of retrofit kits to enable you to upgrade your existing lighting with improved performance and increased energy savings while reusing your existing fixtures. These kits not only eliminate any plenum entry requirements or wiring changes making change out simpler, cleaner and faster while enabling up to 70% energy savings and reducing future maintenance with longer lamp life. While our simplified Universal Retrofit kits are ideal for most fixtures and applications, we can provide custom kits for your specific fixture, application and performance.

### Universal Troffer/Parabolic Retrofit Kits

This kit is designed to convert most recessed fluorescent 2x2 and 2x4 troffers and parabolics from T12 or T8 to more efficient T8, T5 or led technology. These kits provide everything required to enhance the performance and energy savings of your recessed fixture while minimizing labor, clean up and expense. Choice of highly polished mirrored reflector or enhanced white reflector, both designed to maximize output and efficiency. Kits include centering socket bars with snap in tabs for reflectors, appropriate instant start / program start sockets and tek screws for easy assembly. To easily include a specific ballast please add the appropriate ballast code. Kit installs with simple hand tools in minutes.

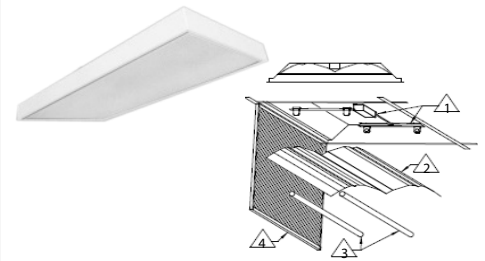
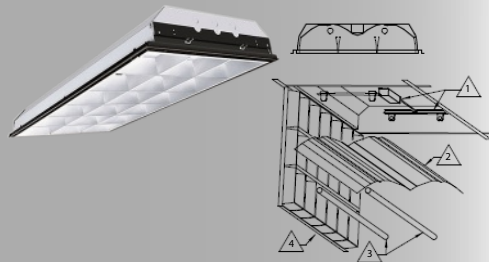

### Standard Kits

ITEM NO.	DESCRIPTION	LAMPING
RKT22 217MI	2 X 2 Troffer Retrofit 2 Lamp Mirrored Kit	2-F17T8
RKT22 217WI	2 X 2 Troffer Retrofit 2 Lamp White Kit	2-F17T8
RKT24 232MI	2 X 4 Troffer Retrofit 2 Lamp Mirrored Kit	2-F32T8
RKT24 232WI	2 X 4 Troffer Retrofit 2 Lamp White Kit	2-F32T8

I is for short, shunted snap fit lamp holders for Instant Start Ballasts. Change to P for short, unshunted, snap fit sockets for Rapid or Program Start ballasts. Ballasts sold separately on these kits.

### Customized Kits

SERIES	TROFFER SIZE	NUMBER OF LAMPS	LAMP TYPE	ALUMINUM REFLECTOR	SOCKET TYPE	BALLAST TYPE**	CONFIGURATION
RKT	14 - (1 X 4 troffer) 22 - (2 X 2 troffer) 24 - (2 X 4 troffer)	1 (1 Lamp) 2 (2 Lamp) 3* (3 Lamp) 4* (4 Lamp)	17 (T8) 14 (T5 STD) 24 (T5 HO) 32 (T8) 28 (T5 STD) 54 (T5 HO)	W - High Reflectivity White M - High Reflectivity Silver	I (For Instant Start Ballast) P (For Program Start Ballast)	Blank (No Ballast Included) MV (Mult Volt Ballast) PMV (Program Start Ballast)	Blank (Components Bulk Packed and Unassembled) W (Wire Ballasts and Sockets Together)

\* Only for 2x2 and 2x4 Kits

\*\*For Specific Brand and Ballast Factor See Page 68 for Ordering Codes.

### Retrofit Doorframe Kit

Sturdy Steel frame is installed onto a standard inverted tee system to replace missing, damaged or mismatched luminaire door frames.

Item Number	Dimensions (L x W x H)
FL RG 2X2 RETRO	23 3/4" X 23 3/4" Doors and Lens
FL RG 2X4 RETRO	23 3/4" X 47 3/4" Doors and Lens



Standard with A12 .10 Acrylic Lens "A". For other lens options see page 7.

# RETROFIT KITS

## Universal Strip Retrofit Kit

Designed to convert 4' or 8' T12 or T8 industrial and strip fixtures to more efficient T8, T5 or LED technology. Choose between retrofitting with a reflector for enhanced performance or simply a ballast cover. Both kits utilize a Universal Socket Bracket engineered to fit most fluorescent channels from 4" to 5.25" in width. The Reflector/Ballast Cover mount to socket brackets with two quarter-turn fasteners for easy maintenance after retrofit is complete. The Universal Socket Bracket ships flat and easily folds to fit channels and requires only simple hand tools.

For enhanced light output add either a mirrored specular reflector or an enhanced white reflector.

### Choice of Reflectors or Ballast Cover

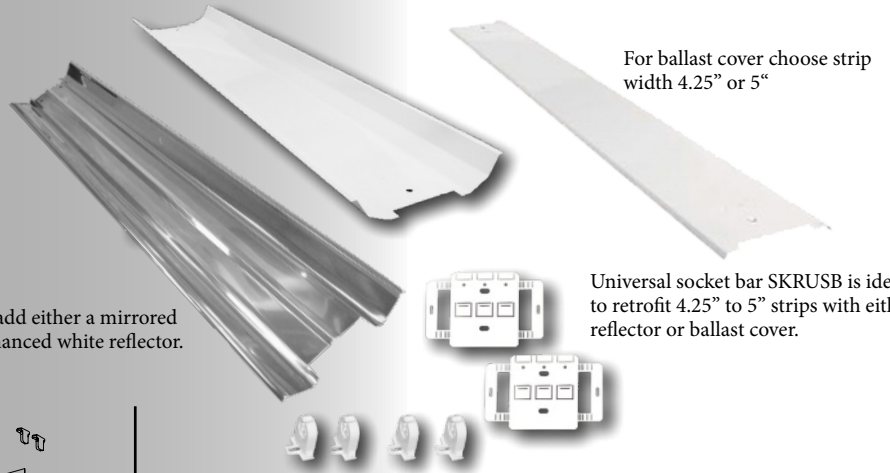

### How to Use

#### Installing Reflector Kit

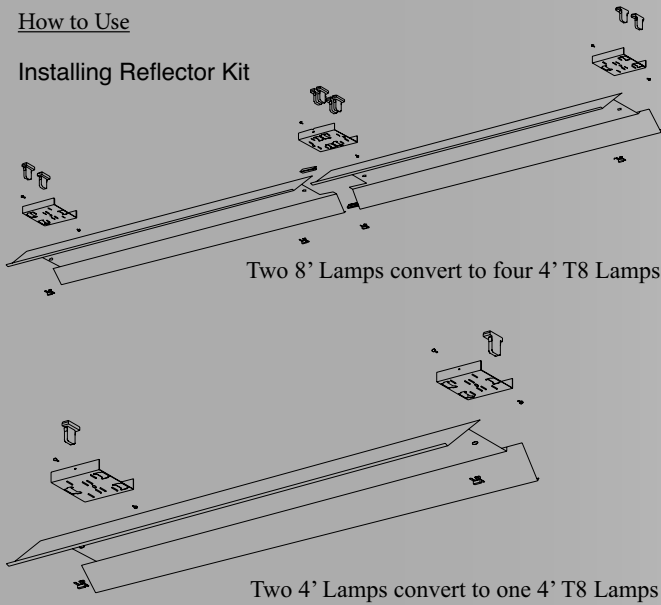

### How to Use

#### Installing Ballast Cover Kit

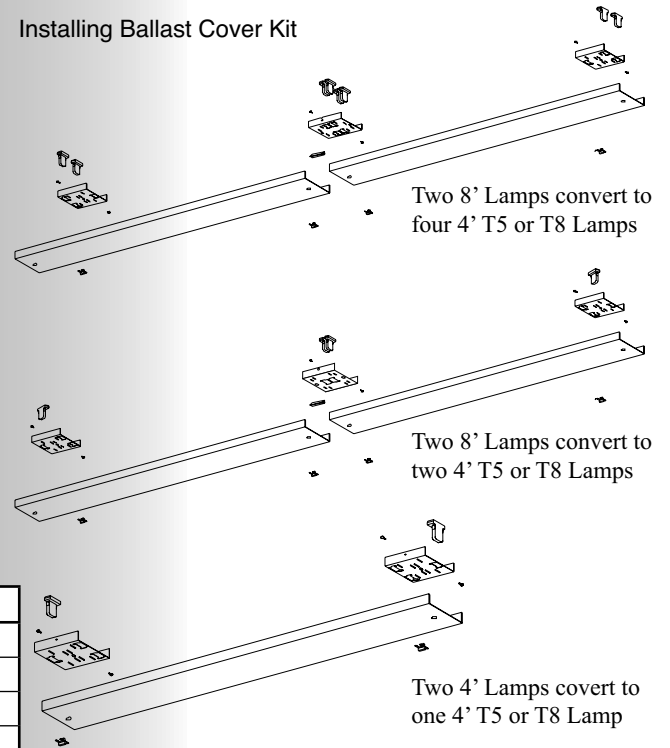

### Standard Kits

ITEM NO.	DESCRIPTION	LAMPING
RKSR-132W1	REFL KIT UNIV STRIP 1L T8 WHITE	1-F32T8
RKSR-232W1	REFL KIT UNIV STRIP 2L T8 WHITE	2-F32T8
RKSR-132TANW1	REFL KIT UNIV STRIP 2L T8 8' WHITE	2-F32T8
RKSR-232TANW1	REFL KIT UNIV STRIP 4L T8 8' WHITE	4-F32T8
RKSR-232M	REFL KIT UNIV STRIP 2L T8 MIRRORED	2-F32T8
RKSR-232TANM	REFL KIT UNIV STRIP 4L T8 8' MIRRORED	4-F32T8
RKSC-232BI	COVER KIT UNIV STRIP 2L T8 WHITE 4.25"	2-F32T8
RKSC-132TANBI	COVER KIT UNIV STRIP 2L T8 8' WHITE 4.25"	2-F32T8
RKSC-232TANBI	COVER KIT UNIV STRIP 4L T8 8' WHITE 4.25"	4-F32T8

### Custom Kits

SERIES	NUMBER OF LAMPS	STRIP TYPE	SOCKET TYPE	CONFIGURATION
RKS	1 2 3	Blank - 4' strip TAN - 8' Tandem strip	I (For Instant Start Ballast) P (For Program Start Ballast)	Blank (Components Bulk Packed and Unassembled) W (Wire Ballasts and Sockets Together)
TYPE	LAMP TYPE	REFLECTOR/ BALLAST COVER	BALLAST TYPE*	
R - Reflector C - Ballast Cover	32 (T8) 28 (T5) 54 (T5HO)	W - High Reflectivity White M - High Reflectivity Silver B - 4.25" Ballast Cover B5 - 5" Ballast Cover	Blank (No Ballast Included) MV (Multi Volt Ballast) PMV (Program Start Ballast)	

\*For Specific Brand and Ballast Factor See Page 68 for Ordering Codes.

# RETROFIT KITS

## Indirect / Direct Recessed Retrofit Kit - Center Diffuser

Now most recessed troffers and parabolics can be converted to more efficient Indirect/Direct Center diffuser recessed fixture with this unique kit. This kit offers a true Indirect/Direct solution that not only provides a more energy efficient solution but also the true comfortable performance of an Indirect/Direct fixture designed especially for workspaces with CRT's. Most other kits simulate the appearance while providing direct light only. This kit provides true reflected light off of the highly reflective white reflector for a true "sky light effect." This unique kit works with T5 lamps in 1, 2 or 3 lamps with either a perforated center basket or a highly efficient specially designed acrylic diffuser. With this kit, you will get the energy savings and performance of the latest technology without the fuss and mess of changing out fixtures completely.



Finished look after retrofitting.

### Configure to Your Specs

Available in 1, 2 or 3 lamps in T5.  
For new fixture, see page 4.

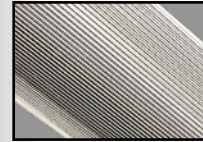

Choice of perforated basket (PF) or linear ribbed acrylic diffuser (RL) shown. With linear ribbed diffuser, fixtures are over 80% efficient.

### Standard Kits

ITEM NO.	DESCRIPTION	LAMPING
RKDIC22 214PFI	2X2 Perforated Center Basket Center T5	2-F14T5
RKDIC22 214RLI	2X2 Ribbed Lens Center KIT T5	2-F14T5
RKDIC24 228PFI	2X4 Perforated Center Basket Center T5	2-F28T5
RKDIC24 228RLI	2X4 Ribbed Lens Center KIT T5	2-F28T5

### Customized Kits

SERIES	TROFFER SIZE	NUMBER OF LAMPS	LAMP TYPE	ALUMINUM REFLECTOR	SOCKET TYPE	BALLAST TYPE*	CONFIGURATION
RKDIC	22 - (2 X 2 Indirect Kit) 24 - (2 X 4 Indirect Kit)	1 (1 Lamp) 2 (2 Lamp) 3 (3 Lamp)	14 (T5 STD) 24 (T5 HO) 28 (T5 STD) 54 (T5 HO)	PF - Perforated Basket w/White Inlay RL - Ribbed Linear Acrylic Diffuser	I (For Instant Start Ballast) P (For Program Start Ballast)	Blank (No Ballast Included) MV (Mult Volt Ballast) PMV (Program Start Ballast)	Blank (Components Bulk Packed and Unassembled) W (Wire Ballasts and Sockets Together)

\*For Specific Brand and Ballast Factor See Page 68 for Ordering Codes.

## Ballast Cover Retrofit Kit

The RKBC Assembled Strip Retrofit Kit is designed to convert 4' or 8' T12 fluorescent strip fixtures to more efficient T8 technology. The BC series can ship fully assembled and ready to install when ordered with ballast. The channel cover is designed to precisely fit 4" (42) or 5" (50) channels to provide a clean, factory installed appearance.



SERIES	CHANNEL WIDTH	LAMPS	LAMP TYPE	BALLAST/SOCKET TYPE	BALLAST MANUFACTURER	BALLAST TYPE*	BALLAST FACTOR	VOLTAGE
RKBC4 RKBC8	42 - 4.25"W 50 - 5.0"W	1 2	T8 T5	BL10 - Instant Start (standard for T8) BL11 - Programmed Start (optional for T8)	Blank (Generic) U (Universal) A (Advance) S (Sylvania) G (GE)	Blank (No Ballast Included) MV (Mult Volt Ballast) PMV (Program Start Ballast)	Blank (Normal .88) H (High 1.18) L (Low .77) NN (1.00) LL (Ultra Low .66)	MV (120v - 277v Normal BF T8 or T5) HMV (120v - 277v High BF T8) LMV (120v - 277v Low BF T8) ME480 (480v T8 or T5)

\*For Specific Brand and Ballast Factor See Page 68 for Ordering Codes.

## Indirect / Direct Recessed Retrofit Kit - Dual Diffuser

Now most recessed troffers and parabolics can be converted to more efficient Indirect/Direct Dual diffuser recessed fixture with this unique kit. This kit offers a true Indirect/Direct solution that not only provides a more energy efficient solution but also the true comfortable performance of an Indirect/Direct fixture designed especially for workspaces with CRT's. Most other kits simulate the appearance while providing direct light only. This kit provides true reflected light off of the highly reflective white reflector for a true "sky light effect." This unique kit works with T5 lamps in 2 or 4 lamps with either a perforated basket or a highly efficient specially designed acrylic diffuser. With this kit, you will get the energy savings and performance of the latest technology without the fuss and mess of changing out fixtures completely.



### Configure to Your Specs

Available in 2 or 4 lamps in T5.  
For new fixture, see page 4.

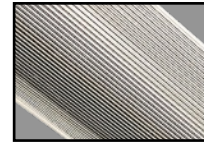

Choice of perforated basket (PF) or linear ribbed acrylic diffuser (RL) shown. With linear ribbed diffuser, fixtures are over 80% efficient.

### Standard Kits

ITEM NO.	DESCRIPTION	LAMPING
RKDID22 214PFI	2X2 Perforated Center Basket Center T5	2-F14T5
RKDID22 214RLI	2X2 Ribbed Lens Center KIT T5	2-F14T5
RKDID24 228PFI	2X4 Perforated Center Basket Center T5	2-F28T5
RKDID24 228RLI	2X4 Ribbed Lens Center KIT T5	2-F28T5

### Customized Kits

SERIES	TROFFER SIZE	NUMBER OF LAMPS	LAMP TYPE	ALUMINUM REFLECTOR	SOCKET TYPE	BALLAST TYPE**	CONFIGURATION
RKDID	22 - (2 X 2 Indirect Kit) 24 - (2 X 4 Indirect Kit)	2 (2 Lamp) 4 (4 Lamp)	14 (T5 STD) 24 (T5 HO) 28 (T5 STD) 54 (T5 HO)	PF - Perforated Basket w/White Inlay RL - Ribbed Linear Acrylic Diffuser	I (For Instant Start Ballast) P (For Program Start Ballast)	Blank (No Ballast Included) MV (Mult Volt Ballast) PMV (Program Start Ballast)	Blank (Components Bulk Packed and Unassembled) W (Wire Ballasts and Sockets Together)

\*Consult for T5 Only  
\*\*For Specific Brand and Ballast Factor See Page 68 for Ordering Codes.

### Custom Kits

Mobern also can supply custom retrofit kits to meet specific fixture requirements. Our design, engineering and fabrication departments can design, sample and produce custom retrofit kits in a matter of days. Kits for linear fluorescents, HID indoor and outdoor fixtures and older compact fluorescent fixtures can often save over 60% energy costs while providing better lighting performance. The right kit can not only provide the energy and performance objectives but make installation fast, trouble-free, and minimize disruption in the space.

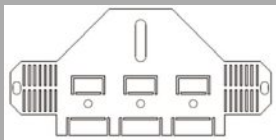

One product doesn't fit all in the retrofit business. Don't compromise. Contact us today to make the kit that works best for your next project.



Our expanded fabrication department with our Amada CNC allows a new design to be produced to exacting standards quickly, accurately and efficiently.



Retrofit parking garages from 175 watt HID to less than 100 watts of compact fluorescents. Add occupancy sensors, bi-level lighting, led modules for enhanced savings and performance.

# LINEAR WALL FIXTURES

## Direct/Indirect Wall

Specification grade, low profile direct/indirect wall mount with up and forward throw optics. Sleek design with T5 or T8 lamps is ideal for perimeter lighting of corridors and circulation spaces. Now available in four different housing configurations (lens, louver, solid or perforated) depending on look and up/downlight mix desired.

*Consult for  
2' and 3' sizes.*

### Perforated

Item Number	Dimensions (L x W x H)	Lamping
LIWMP 232WHMV	49.25" x 5.03" x 2.68"	2-F32T8
LIWMP 232TANWHMV	98" x 5.03" x 2.68"	4-F32T8
LIWMP 254WHMV	49.25" x 5.03" x 2.68"	2-F54T5HO
LIWMP 254TANWHMV	98" x 5.03" x 2.68"	4-F54T5HO

Add SL for Metallic Silver, RD for Red, IN for iron. Consult factory for other finishes.  
Add XS after lamping for specular mirrored reflector for enhanced uplight performance.



Perforated bottom provide 15% downlight.



Perforated

### Louver

Item Number	Dimensions (L x W x H)	Lamping
LIWMB 254WHMV	49.25" x 5.03" x 2.68"	2-F54T5HO
LIWMB 254TANWHMV	98" x 5.03" x 2.68"	4-F54T5HO

Add SL for Metallic Silver, RD for Red, IN for iron. Consult factory for other finishes.  
Add XS after lamping for specular mirrored reflector for enhanced uplight performance.



40% downlight with louvers.



Louvered

### Matte White Lens

Item Number	Dimensions (L x W x H)	Lamping
LIWMS 232WHMV	49.25" x 5.03" x 2.68"	2-F32T8
LIWMS 232TANWHMV	98" x 5.03" x 2.68"	4-F32T8
LIWMS 254WHMV	49.25" x 5.03" x 2.68"	2-F54T5HO
LIWMS 254TANWHMV	98" x 5.03" x 2.68"	4-F54T5HO

Add SL for Metallic Silver, RD for Red, IN for iron. Consult factory for other finishes.  
Add XS after lamping for specular mirrored reflector for enhanced uplight performance.



Matte White lens fascia provides softer lighting for the space ideal for circulation and living spaces.



Slotted

#### AVAILABLE FINISHES



All versions are available with matching pendants on page 9.

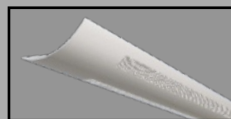

### Configure to Your Specs

Add SmartSense (SS) ultrasonic sensor to any of these Wall Linear fixtures to provide additional energy savings.



## Mini 2" Linear Wall Mount

This mini slimline linear wall mount accommodate one T5 lamp per 4' shielded by a frosted acrylic lens. Wall mounted with choice of individual 4' or 8' length or row mounted for continuous run. Slots available in the top for 20% uplight. Matching surface or pendant mount available. Consult for special finishes and two foot size.

Item Number	Dimensions (L x W x H)	Lamping
WM22 154MV	48" x 2" x 2"	1-F54T5HO
WM22 154TANMV	96" x 2" x 2"	2-F54T5HO





# LINEAR WALL FIXTURES

## SmartSense Series

Our popular 155 series versatile linear fluorescent fixtures are now available with integral ultrasonic occupancy sensor to sense motion within a space and automatically turn lights on even when the sensor has no direct line of sight to occupants. After the area is vacated and the time delay has elapsed, the sensors automatically turn the lights off.

Item Number	Dimensions (L x W x H)	Lamping
155SW 232PSMV	48.25" x 4.3" x 4.5"	2-F32T8
155SW 232PSMV-F13T5	48.25" x 4.3" x 4.5"	2-F32T8

For optional third light, add F13T5 to end of item number. F13T5 stays on all the time and the two F32T8 lights are on when occupied. Consult factory for 2 ft. version.

### Configure to Your Specs

Consult for step dim or dimming ballast option.



Reduce energy in stairwell by 70%.

## 155 Series

Available in white (consult for other finishes), this linear fixture is very versatile for ceiling or wall mount applications. Matte white acrylic diffuser surrounds lamps, for plentiful light. Ideal for stairwells, corridors, baths and displays.

Item Number	Dimensions (L x W x H)	Lamping
155 217MV	24.25" x 4.3" x 4.1"	2-F17T8
155 225MV	36.25" x 4.3" x 4.1"	2-F25T8
155 232MV	48.25" x 4.3" x 4.1"	2-F32T8

Standard with white ends. Add C for chrome ends after wattage.



## 4x4 Linear Wall Mount

Architectural, sleek styling in a 4 x 4 linear wall mounted fixture that can be used individually or joined together for longer runs. Powder coated in choice of finishes with several lens options and either direct or indirect lighting.

Item Number	Dimensions (L x W x H)	Lamping
WM44 IOSW232MVVWH	48" x 4" x 4"	2-F32T8
WM44 DOSW232TANMVVWH	96" x 4" x 4"	4-F32T8
WM44 IOSW232TANMVVWH	96" x 4" x 4"	4-F32T8

DO-Direct only, IO-Indirect only. SW-Smooth White lens is standard. Change to S.5 for Specular Paracube louver, W.5 for White Paracube louver, or 100 for Prismatic Acrylic .100. See page 7 for other lens options. Available in T5 lamping. Consult for baffled louver diffuser.



## 6x6 Linear Wall Mount

A linear 6 x 6 silhouette can be mounted individually or joined together for continuous rows of indirect/direct perimeter wall lighting. Available in multiple configurations of up and down light. Available standard in white or consult factory for other finishes.

Item Number	Dimensions (L x W x H)	Lamping
WM66 DOSW232MV	48" x 6" x 6"	2-F32T8
WM66 DISW232MV	48" x 6" x 6"	2-F32T8
WM66 IOSW232MV	48" x 6" x 6"	2-F32T8
WM66 DOSW232TANMV	96" x 6" x 6"	4-F32T8
WM66 DISW232TANMV	96" x 6" x 6"	4-F32T8
WM66 IOSW232TANMV	96" x 6" x 6"	4-F32T8

DO-Direct only, DI-Direct/Indirect, IO-Indirect only. SW-Smooth White lens is standard. Change to S.5 for Specular Paracube louver, W.5 for White Paracube louver, or 100 for Prismatic Acrylic .100. See page 7 for other lens options. Available in T5 lamping. Consult for baffled louver diffuser.

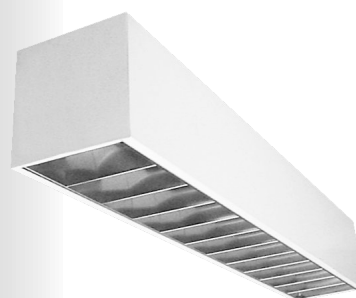

# LINEAR WALL FIXTURES

## Bed Light

Ideal for hospital/nursing homes and hospital bed lights. Internal lamp divider shield provides separate or combined up and down illumination. White metal front covers entire front of unit and directs illumination up or down. 3 circuit (for individual control of up, down and combined lighting) can be factory installed. Acrylic lens is standard. Consult factory for other configurations and lamping.

Item Number	Dimensions (L x W x H)	Lamping
158 1U1D17BAFMV	24.3" x 4.5" x 5.6"	2-F17T8
158 1U2D17BAFMV	24.3" x 4.5" x 5.6"	3-F17T8
158 2U2D17BAFMV	24.3" x 4.5" x 5.6"	4-F17T8
158 2U1D17BAFMV	24.3" x 4.5" x 5.6"	3-F17T8
158 1U1D25BAFMV	36.3" x 4.5" x 5.6"	2-F25T8
158 1U2D25BAFMV	36.3" x 4.5" x 5.6"	3-F25T8
158 2U2D25BAFMV	36.3" x 4.5" x 5.6"	4-F25T8
158 2U1D25BAFMV	36.3" x 4.5" x 5.6"	3-F25T8
158 1U1D32BAFMV	48.3" x 4.5" x 5.6"	2-F32T8
158 1U2D32BAFMV	48.3" x 4.5" x 5.6"	3-F32T8
158 2U2D32BAFMV	48.3" x 4.5" x 5.6"	4-F32T8
158 2U1D32BAFMV	48.3" x 4.5" x 5.6"	3-F32T8

U designated number of lamps for uplight and D designated number of lamps directing light downward. BAF - Designates front baffle. Dual ballast is standard.



Add SS SmartSense to any fixture for occupancy and daylight sensor. See pg 41 for more info.

## Angled 1 or 2 Light Wall

Angled one light and two light chrome fixtures provide softly angled light. Designed for bathrooms, kitchens, bulletin boards and above vanity mirrors.

Item Number	Dimensions (L x W x H)	Lamping
74 217MV	24.25" x 3.1" x 5.1"	2-F17T8
74 225MV	36.25" x 3.1" x 5.1"	2-F25T8
74 232MV	48.25" x 3.1" x 5.1"	2-F32T8
741 217MV	24.25" x 3.1" x 5.1"	2-F17T8
741 225MV	36.25" x 3.1" x 5.1"	2-F25T8
741 232MV	48.25" x 3.1" x 5.1"	2-F32T8

Standard comes in Chrome. Add W after wattage to change to white. For one light change 2 to 1.

74 SERIES



741 SERIES



## Classic 1 Light Wall

Decorative one light chrome fixtures are suitable for wall or ceiling mounting. Designed for bathrooms, kitchens, vanities, bulletin boards, recreation rooms and alongside mirrors.

Item Number	Dimensions (L x W x H)	Lamping
79 117MV	24.25" x 2.6" x 4.2"	1-F17T8
79 125MV	36.25" x 2.6" x 4.2"	1-F25T8
79 132MV	48.25" x 2.6" x 4.2"	1-F32T8
791 117MV	24.3" x 2.5" x 4.2"	1-F17T8
791 125MV	36.3" x 2.5" x 4.2"	1-F25T8
791 132MV	48.3" x 2.5" x 4.2"	1-F32T8

Standard comes in Chrome. Add W after wattage to change to white.

79 SERIES



791 SERIES



# LINEAR WALL FIXTURES

## Spill Ring Bath

Contemporary bath fixture with choice of brushed nickel "BN" or bronze ends "BZ". See matching close-to-ceiling, surface fluorescent or wall sconces on pages 19, 41 & 45.

Item Number	Dimensions (L x W x H)	Lamping
MFL 217R120BN	24.75" x 6" x 4.25"	2-F17T8
MFL 217R120BZ	24.75" x 6" x 4.25"	2-F17T8
MFL 225R120BN	36.75" x 6" x 4.25"	2-F25T8
MFL 225R120BZ	36.75" x 6" x 4.25"	2-F25T8
MFL 232R120BN	48.6" x 6" x 4.25"	2-F32T8
MFL 232R120BZ	48.6" x 6" x 4.25"	2-F32T8

For commercial applications, change R120 - residential ballast to MV - Multi-Volt Ballast.

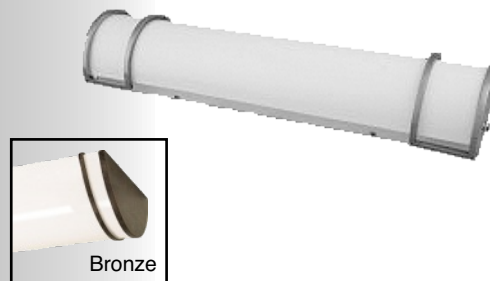

## End Cap Bath

Economical sleek bath fixtures with choice of end caps and diffusers. Choose from a variety of finishes for the end caps to match your décor and a variety of diffusers for different looks and lighting effects. Dress up the end caps with optional chrome or brass trim details.

Item Number	Dimensions (L x W x H)	Lamping
VB 217MVS	25.5" x 4.75" x 4"	2-F17T8
VB 225MVS	37.5" x 4.75" x 4"	2-F25T8
VB 232MVS	49.5" x 4.75" x 4"	2-F32T8

End Cap Finish Options - IV - Ivory Marble, BM - Black Marble, PM - Peach Marble, SW - Solid White (translucent), AL - Alabaster, TO - Tortoise, WM - White Marble, BW - Bone White, BG - Black Gravel.

Diffuser Options - Standard is White Smooth. Add after VB, WR for White Ribbed, CR - Clear Ribbed, FR - For Frosted Ribbed.



## Wall Puff

A shallow, fully luminous diffuser floats off the wall in front of a 2 light strip for clean, economical and energy efficient fixture.

Item Number	Dimensions (L x W x H)	Lamping
WP 217MV	27" x 6" x 2.75"	2-F17T8
WP 217R120	27" x 6" x 2.75"	2-F17T8
WP 225MV	39" x 6" x 2.75"	2-F25T8
WP 225R120	39" x 6" x 2.75"	2-F25T8
WP 232MV	51" x 6" x 2.75"	2-F32T8
WP 232R120	51" x 6" x 2.75"	2-F32T8

R120 for residential use only.



See page 45 for matching wall.

## Low Profile T5 Surface Mount

Full body micro silhouette makes a bold statement with a minimal design in brushed nickel powder coated finish (consult factory for other finishes). Scaled to the T5 lamp the matte white diffuser surrounds the lamps for soft lighting. Brushed nickel fixture can be surface mounted on wall or ceiling or pendant mounted with specially engineering cable mounting kit.

Item Number	Dimensions (L x W x H)	Lamping
10T5 114MVBN	24" x 2" x 2.5"	1 x F14T5
10T5 121MVBN	36" x 2" x 2.5"	1 x F21T5
10T5 128MVBN	48" x 2" x 2.5"	1 x F28T5
10T5 214MVBN	24" x 3" x 3"	2 x F14T5
10T5 221MVBN	36" x 3" x 3"	2 x F21T5
10T5 228MVBN	48" x 3" x 3"	2 x F28T5
A-10T5C1BN	5' CABLE MOUNTING KIT	

Change wattage codes to high output wattage. Consult for other designer finishes. Not available for continuous runs.



# UNDER CABINET WALL FIXTURES

## High Performance Undercabinet T5

Utilizing T5 lamp technology allows this shallow bright choice for undercabinet lighting. Opal acrylic wraparound diffuser evenly illuminates work areas.

Item Number	Dimensions (L x W x H)	Lamping
76T5 114R120	22.03" x 2.4" x 1.03"	1-F14T5
76T5 121R120	34.4" x 2.4" x 1.03"	1-F21T5
76T5 128R120	46.22" x 2.4" x 1.03"	1-F28T5

Dedicated voltage only. Change 120 to 277 for 277 Volt.



## Premium 1" T5

High performance fluorescent undercabinet lighting is only 1" depth using T5 lamps and electronic ballasts. Cool operation, energy saving and lots of light.

Item Number	Dimensions (L x W x H)	Lamping
77 108EL	12.25" x 5" x 1"	1-F8T5 (INCL)
77 113EL	21.25" x 5" x 1"	1-F13T5 (INCL)
77 208EL	24.25" x 5" x 1"	2-F8T5 (INCL)
77 813EL	33.25" x 5" x 1"	1-F8T5 & 1-F13T5 (INCL)
77 213EL	42.25" x 5" x 1"	2-F13T5 (INCL)
77 1083EL	12.25" x 3" x 1"	1-F8T5 (INCL)
77 1133EL	21.25" x 3" x 1"	1-F13T5 (INCL)
77 2083EL	24.25" x 3" x 1"	2-F8T5 (INCL)
77 8133EL	33.25" x 3" x 1"	1-F8T5 & 1-F13T5 (INCL)
77 2133EL	42.25" x 3" x 1"	2-F13T5 (INCL)



5" Width



3" Width

Rocker switch (120V only) included in parts bag.

## T8 Undercabinet

Economical fluorescent undercabinet light with wraparound diffuser.

Item Number	Dimensions (L x W x H)	Lamping
76 115R120	18" x 5" x 1.75"	1-F15T8
76 117R120	24" x 5" x 1.75"	1-F17T8
76 125R120	36" x 5" x 1.75"	1-F25T8
76 132R120	48" x 5" x 1.75"	1-F32T8

For multi-volt ballast change R120 to MV. For 2 light, change 1 to 2.



Rocker switch (120V only) included in parts bag.

## No Glare Undercabinet

Slim low profile contemporary undercabinet task luminaire, with solid front. Ideal for offices, furniture makers, bathrooms, hospitals, laboratories, utility areas, kitchen and display applications.

Item Number	Dimensions (L x W x H)	Lamping
78 115MV	18.1 x 5.1 x 1.75	1-F15T8
78 117MV	24.1 x 5.1 x 1.75	1-F17T8
78 125MV	36.1 x 5.1 x 1.75	1-F25T8
78 132MV	48.1 x 5.1 x 1.75	1-F32T8

Available in Residential Rated Ballast, change MV to R120.



## Xenon Line Wattage

A new economical version of the xenon undercabinet lighting in 120V. Provides similar light output to the low voltage with slightly higher wattage. Use individually or use knockouts to simply wire continuous runs. Consult factory for other finishes.

Item Number	Dimensions (L x W x H)	Lamping
77X 125WH	9" x 3.8" x 1.3"	1-25W 120V Wedge base Xenon (Incl)
77X 225WH	17.5" x 3.8" x 1.3"	2-25W 120V Wedge base Xenon (Incl)
77X 325WH	26" x 3.8" x 1.3"	3-25W 120V Wedge base Xenon (Incl)
77X 425WH	34.5" x 3.8" x 1.3"	4-25W 120V Wedge base Xenon (Incl)
77X G925120V		25W 120V Wedge Base Lamp

For bronze change WH to BZ. Consult for stainless steel (SS).



Choice of 3 finishes and easy to join together.

## FM-105 Super High Frequency Occupancy Sensor

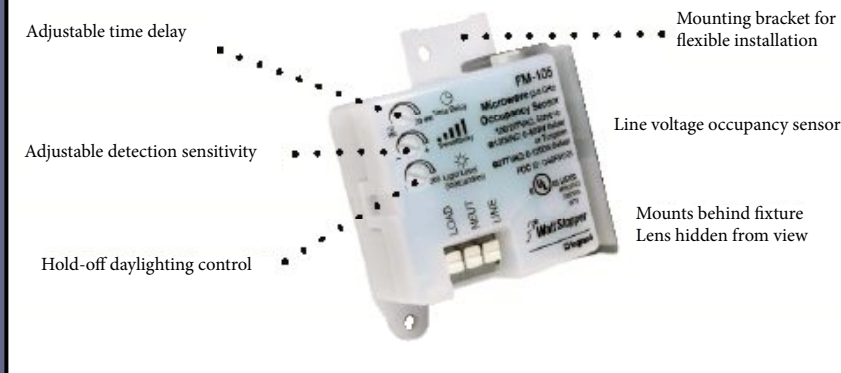

Popular Close-To-Ceiling fixtures with SmartSense.



## CLOSE-to-CEILING COMPACT FLUORESCENTS

### SmartSense CTC

Modern Lighting SmartSense offering of CTC fixtures uses a new Super High Frequency Occupancy Sensor that is line voltage and turns lights on and off based on occupancy, and can hold lights off when sufficient daylight is available. It detects motion via super high frequency (SHF) electromagnetic waves and the Doppler principle. It can detect motion through plastic or glass diffusers so it can be installed behind fixture lenses and hidden from view. The technology provides superior detection in hard surfaced areas such as stairwells and hallways. The sensor is also ideal for lensed fixtures in outdoor wall sconces and wall packs.

Add "SS" to the suffix of most ceiling and wall fixtures and start saving about 30 % of energy usage today.

## Spill Ring Series

Coordinated design in surface fluorescent, close-to-ceiling, wall, and vanity.

Item Number	Dimensions (L x W x H)	Lamping
DECCD 118RGUSN	10" x 10" x 4.25"	1-18W GU MAX
DECCD 218RGUSN	14" x 14" x 4.25"	2-18W GU MAX
DECCD 226RGUSN	17.75" x 17.75" x 4.25"	2-26W GU MAX
DECCDO 232RSN	32.3" x 18.1" x 4.25"	2-FC12T9 (32W CIRC)
DECSFD 218RGUSN*	14" x 14" x 11"	2-18W GU MAX
DECSFD 226RGUSN*	18" x 18" x 11"	2-26W GU MAX

Change SN (satin nickel) to BZ (bronze). \*Comes with 6" and 12" stem that can be used individually or together for overall height from 11", 17" or 23". Consult for ballasted versions or 277V versions with quad lamps.



Add emergency option to DECCD226 ballasted version, by adding B1 at the end of item number, for integral emergency ballast and test switch inside diffuser.

See matching linear ceiling, wall, and bath on pages 19, 39 and 45.



All fixtures available in Bronze. Change SN to BZ.

## Close-to-Ceiling

Modern offers a variety of Energy Smart solutions for corridors, living spaces, and storage areas. Consult for all available in design and lamping options.

Item Number	Dimensions (L x W x H)	Lamping
DECCB 213RSNGD	Gold with Silver Band 14"D x 8.25H	2-PL13 2 PIN
DECPLCA 213RSBN	Brushed Nickel 15.75"D x 5"H	2-PL13 2 PIN
DECBPC 109PCWH	White Finish/Opal Diffuser 6" D x 7.25" H	1-PL 9W 2 PIN
DECT9CA 122RSBN	Brushed Nickel Trim 13"D x 4"H	F22T9 CIRC
DECT9CA 2232RSBN	Brushed Nickel Trim 17"D x 4"H	FC8T9 (22W) & FC12T5 (32W)
DECT9CA 3240RSBN	Brushed Nickel Trim 21"D x 4"H	FC12T9 (32W) & FC16T5 (40W)
DECCJ 226SN	Satin Nickel w/Frosted Swirl Glass 16" D x 6.5"H	2-26W Quad 4 PIN

Consult for GU options.



# CLOSE-to-CEILING COMPACT FLUORESCENTS

## GU24 C-T-C

Choice of these styles for energy smart GU24 lamp(s). These fixtures not only look good but provide over 60 percent energy savings over the comparable incandescent version. Consult for other styles and finishes.

Item Number	Dimensions (W x H)	Lamping
DECCM 213GUSN	13.25" x 5.375"	(2) 13W GU24
DECCM 313GUSN	15.25" x 6"	(3) 13W GU24
DECCR 118GUSN	11.4" x 4.8"	1-18W GU24
DECCT 118GUSN	10.3" x 4.3"	1-18W GU24
DECCL 213GUSN	13" x 6.1"	2-13W GU24
DECCK 218GUSN	14" x 5.4"	2-18W GU24

Consult for white or bronze finish options, as well as different lamping options. Lamps sold separately.



## CTC Fluorescents

Full selection of drum, mushroom and square silhouettes in multiple sizes and lamping options. Consult for energy star versions.

Item Number	Dimensions (W x H)	Lamping
69 11122ELC	11" x 3"	FC8T9 (22W) (Incl)
69 142232ELC	14" x 3"	FC8 & FC12T9 (22&32W Circ) (Incl)
69 193240ELC	18" x 3"	FC12 & FC16T9 (32&40W Circ) (Incl)
69 11113GU	11" x 3"	(1) 13W GU24
69 11213GU	11" x 3"	(2) 13W GU24
69 14313GU	14" x 3"	(3) 13W GU24
68 1122ELCLP	11" x 3"	FC8T9 (22W Circ) (Incl)
68 142232ELCLP	14" x 3"	FC8 & FC12T9 (22&32W Circ) (Incl)
68 193240ELCLP	18" x 3"	FC12 & FC16T9 (32&40W Circ) (Incl)
68 11113GU	11" x 3"	(1) 13W GU24
68 11213GU	11" x 3"	(2) 13W GU24
68 14313GU	14" x 3"	(3) 13W GU24
MCS 122ELCL	11" x 3"	FC8T9 (22W Circ) (Incl)
MCS 2232ELCL	14" x 3"	FC8 & FC12T9 (22&32W Circ) (Incl)
MCS 3240ELCL	18" x 3"	FC12 & FC16T9 (32&40W Circ) (Incl)
MCS 113GU	11" x 3"	(1) 13W GU24
MCS 213GU	11" x 3"	(2) 13W GU24
MCS 313EGU	14" x 3"	(3) 13W GU24



Drum Fluorescent (69 SERIES)



Mushroom (68 SERIES)



Square (MCS)

Consult for other lamping options and 277 or multi-volt options.

## Compact Fluorescent Ceiling Utility

Energy smart PL lamp fixtures for wall or ceiling mount ideal for circulation spaces in commercial or multi-family applications. Consult factory for tamper proof options and other lens options.

Item Number	Dimensions (L x W x H)	Lamping
SVP 10PC109R120	10" x 10" x 4"	1-PL9
SVP 10PC113R120	10" x 10" x 4"	1-PL13
SVP 10PC209R120	10" x 10" x 4"	2-PL9
SVP 10PC213R120	10" x 10" x 4"	2-PL13
SVP 12PC213R120	12" x 12" x 4"	2-PL13
SVP 12PC218R120	12" x 12" x 4"	2-PL18
SVP 12PC313R120	12" x 12" x 4"	3-PL13

Consult for GU Lamps. See page 17 for matching linear version.



# CLOSE-to-CEILING COMPACT FLUORESCENTS

## Wet Location Close-to-Ceiling

This versatile all weather, wet location series is available standard with black polycarbonate base and white polycarbonate lens (options with white base and frosted prismatic diffuser). Choose from a variety of one or two light versions in 13W or 18W fluorescent configurations including GU24 lamps. Also available with photocell option.

Item Number	Dimensions (L x W x H)	Lamping
WSC 118GU	10" x 10" x 4.25"	1-18W GU MAX
WSC 218GU	10" x 10" x 4.25"	2-18W GU MAX
WRC 118GU	10" x 10" x 4.25"	1-18W GU MAX
WRC 218GU	10" x 10" x 4.25"	2-18W GU MAX

White Base – WH (Add after ballast type)  
 Frosted Lens – FR (Add after series designation)  
 Consult for ballasted versions and photocell option.

WSC



WRC



Photocell and Energy Star versions available.

Contemporary styled, rugged construction, vandal resistant ceiling or wall mount fixtures are suitable for both indoor and outdoor. Ideal for use in educational facilities, harsh environments such as coastal areas, hospitals, walkways, parking structures, office facilities, interiors, exteriors and common areas. Single or multi-unit family dwellings and any application where vandal resistant luminaires are required.

Item Number	Dimensions (W x H)	Lamping
HAL 12PC213GUB	12" x 12" x 4"	2-13W GU24
HAL 12PC218GUB	12" x 12" x 4"	2-18W GU24
HAL 12PC223GUB	12" x 12" x 4"	2-23W GU24
HAL 12PC313GUB	12" x 12" x 4"	3-13W GU24
HAL 12PC318GUB	12" x 12" x 4"	3-18W GU24

Standard lens is Clear Prismatic Polycarbonate. Lens options-change PC to PF for Frosted Prismatic Polycarbonate or PN for White Prismatic Polycarbonate. Housing color can be change from B for Black to W for White. Wattages available in 9, 13, 18 and 23 watts.



## Close-to-Ceiling Vandaliers

Item Number	Dimensions (L x W x H)	Lamping
MISMCL126ELPL	7.5" x 8" x 8"	(1) 26 Watt TTT 4-PIN
MISMCL142ELPL	7.5" x 8" x 8"	(1) 42 Watt TTT 4-PIN
MIMDCL242ELPL	8.75" x 12.375" x 12.375"	(2) 42 Watt TTT 4-PIN

Lamp sold separately.



## Compact Fluorescent Closet Fixture

Energy smart ceiling mount fixtures with polycarbonate body and clear acrylic lens. Add pull switch (PS). UL damp location.

Item Number	Dimensions (L x W x H)	Lamping
MF9595 109R120WH	9.25" x 9.25" x 2"	1-PL9
MF9595 209R120WH	9.25" x 9.25" x 2"	2-PL9
MF1212 113R120WH	12" x 12" x 2.25"	1-PL13
MF1212 213R120WH	12" x 12" x 2.25"	2-PL13

For Pull Switch add PS to item number suffix. Consult for black finish.



## Closet Light

Shallow and economical fluorescent light with pull chain meets National Electrical Codes for closet lighting. Simple installation to junction box or knockouts for conduit.

Item Number	Dimensions (L x W x H)	Lamping
76CL 115EL	18.25" x 9.5" x 1.25"	1-F15T8



# CLOSE-to-CEILING COMPACT FLUORESCENTS

## Compact Fluorescent Tapered Ceiling Globes

Economical, versatile PL ceiling fixtures in choice of acrylic globes or jar diffusers in white or clear. Polycarbonate ceiling canopies available in black or white. UL damp location.

Item Number	Dimensions (W x H)	Lamping
MBPC 109QCAGR120	6" x 7.25"	1-PL9 Quad
MBPC 109CPJR120	4.5" x 7.25"	1-PL9
MBPC 109QWAGR120	6" x 7.25"	1-PL9 Quad
MBPC 113CPJR120	4.5" x 8.5"	1-PL13
MBPC 113QWAGR120	6" x 7.25"	1-PL13Q
MWPC 109QCAGR120	6" x 7.25"	1-PL9 Quad
MWPC 109CPJR120	4.5" x 7.25"	1-PL9
MWPC 109QWAGR120	6" x 7.25"	1-PL9 Quad
MWPC 113CPJR120	4.5" x 8.5"	1-PL13
MWPC 113CPJR120	6" x 7.25"	1-PL13Q
MWPC 113CPJM120	6" x 7.25"	1-PL13Q
MWPC INCWAG	6" x 7.25"	1-A19 60 Watt

Available with GU24 13 Watt lamps, add GU after wattage and remove ballast designation R120 or M120.

### MIX and MATCH



MBPC  
w/WPJ



MWPC  
w/CPJ



MBPC  
w/CAG

#### Fitters:

"MBPC"  
Black Ceiling  
"MWPC"  
White Ceiling

#### Globes:

"WAG" White Acrylic Globe  
"CAG" Clear Acrylic Globe  
"WPJ" White Polycarbonate Jar  
"CPJ" Clear Polycarbonate Jar

For wall versions, see page 49.

## Compact Fluorescent Classic Ceiling Globes

Economical, versatile PL ceiling fixtures in choice of acrylic globes or jar diffusers in white or clear. Polycarbonate ceiling canopies available in black or white. UL damp.

Item Number	Dimensions (W x H)	Lamping
MBCC 109QCAGR120	6" x 7.25"	1-PL9 Quad
MBCC 109CPJR120	4.5" x 7.25"	1-PL9
MBCC 109QWAGR120	6" x 7.25"	1-PL9 Quad
MBCC 113CPJR120	4.5" x 8.5"	1-PL13
MBCC 113QWAGR120	6" x 7.25"	1-PL13Q
MWCC 109QCAGR120	6" x 7.25"	1-PL9 Quad
MWCC 109CPJR120	4.5" x 7.25"	1-PL9
MWCC 109QWAGR120	6" x 7.25"	1-PL9 Quad
MWCC 113CPJR120	4.5" x 8.5"	1-PL13
MWCC 113QWAGR120	6" x 7.25"	1-PL13Q
MWCC 113QWAGM120	6" x 7.25"	1-PL13Q

Available with GU24 13 Watt lamps, add GU after wattage and remove ballast designation R120 or M120.

### MIX and MATCH



MBCC  
w/WAG



MWCC  
w/WAG



MBCC  
w/CPJ



MWCC  
w/WPJ

#### Fitters:

"MBCC"  
Black Ceiling  
"MWCC"  
White Ceiling

#### Globes:

"WAG" White Acrylic Globe  
"CAG" Clear Acrylic Globe  
"WPJ" White Polycarbonate Jar  
"CPJ" Clear Polycarbonate Jar

For wall versions, see page 49.

## Metal CFL

Commercial grade 8.5" or 10.25" square PL fixtures, with galvanized steel base in white or black. Available with GU lamps or PL lamps with magnetic or electronic ballasts. Also available with photocell. UL damp location.

Item Number	Dimensions (L x W x H)	Lamping
MCBP 113ELBK	8.5" x 8.5" x 4.9"	1-13W QUAD 4 - Pin
MCBP 132ELBK	8.5" x 8.5" x 4.9"	1-32W TTT 4 - Pin
MBBP 213ELBK	10.25" x 10.25" x 8.4"	2-13W QUAD 4 - Pin
MBBP 226ELBK	10.25" x 10.25" x 8.4"	2-26W QUAD 4 - Pin
MBBP 113GUBK	10.25" x 10.25" x 8.4"	1-13W GU
MBBP 213GUBK	10.25" x 10.25" x 8.4"	2-13W GU
MBBP 213GUBK	10.25" x 10.25" x 8.4"	2-13W GU

For white base change BK to WH. Add PC for Photocell. Energy Star version requires photocell consult for economical plastic version.





# WALL FIXTURES - COMPACT FLUORESCENTS

## Spill Ring Brackets

Choice of two silhouettes of spill ring styles. Matches surface fluorescent page 19, close-to-ceiling page 41 or bath page 39. ADA Compliant.

Item Number	Dimensions (L x W x H)	Lamping
DECWD 213SNR120	9" x 4" x 10.5"	2-PL13 or 2-PL18
DECWH 126SNR120	16" x 4" x 8.5"	1-PL26

SN Satin Nickel. Change to BZ for Bronze. Consult for 18W versions and GU lamp versions.



DECWH



DECWD

## GU24 Wall Brackets

Choose from a variety of stylish wall brackets utilizing today's energy smart GU24 lamping. Consult factory for other styles.

Item Number	Dimensions (L x W x H)	Lamping
DECWF 213GUSN	11.5" x 10.3" x 4"	2-13W GU24
DECWV 126GUSN	10" x 7" x 4"	1-26W GU24
DECWW 118GUSN	7.8" x 11" x 3.5"	1-18W GU24

Consult for ballasted 277 Volt or Multi-Volt options.

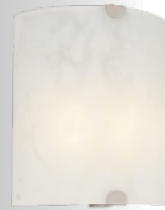

DECWF



DECWV



DECWW

## Cufflink Wall

Available with brushed nickel or bronze lens holders for a frosted glass diffuser.

Item Number	Dimensions (L x W x H)	Lamping
DECWG 213E120BN	15.75" x 10" x 2.9"	2-13W Quad 4 Pin
DECWG 226E120BN	15.75" x 10" x 2.9"	2-26W Quad 4 Pin

Change BN (Brushed Nickel) to BZ (Bronze) for Bronze finish. Consult for GU versions.

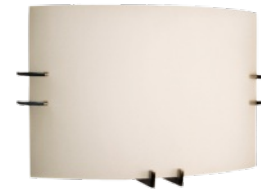

DECWG

## Utility Wall

Item Number	Dimensions (L x W x H)	Lamping
VBFR 213WHEL	4.5" x 9.75" x 3.83"	2-13W Quad 4-Pin
WP 113EL	6.5" x 14" x 3.75"	1-13W Quad 4-Pin
WP 213EL	6.5" x 14" x 3.75"	2-13W Quad 4-Pin
WP 217R120	27" x 6" x 2.75"	2-F17T8
WP 225R120	39" x 6" x 2.75"	2-F25T8
WP 232R120	51" x 6" x 2.75"	2-F32T8

\*Change FR (Frosted Ribbed) to WH for Smooth White lens on the VBFR series.



VBFR



WP



Don't see the style you want?  
Call us 800.444.WATT

### Modern Retrofit Fixtures



Convert an incandescent fixture into an energy-saving CFL fixture with all the features to qualify for Title 24 with these socket ballast. Now available in 277V. GU24 sockets available in a variety of configurations.

# OUTDOOR WALL FIXTURES

## Vandal Proof Architectural Lighting

Architecturally styled, ruggedly constructed, vandal resistant wall mount fixtures are suitable for indoor/outdoor. Quality die-cast aluminum backplates, injection-molded polycarbonate lens and guards, and tamper proof screws and gasketing provides spec-grade engineered quality but at more economical price points. Consult for LED versions.



VAPRC



VAPRE



VAPHOE



VAPOC



VAPOE

## Ordering Information

Example: VAPRCCL126QBKE120

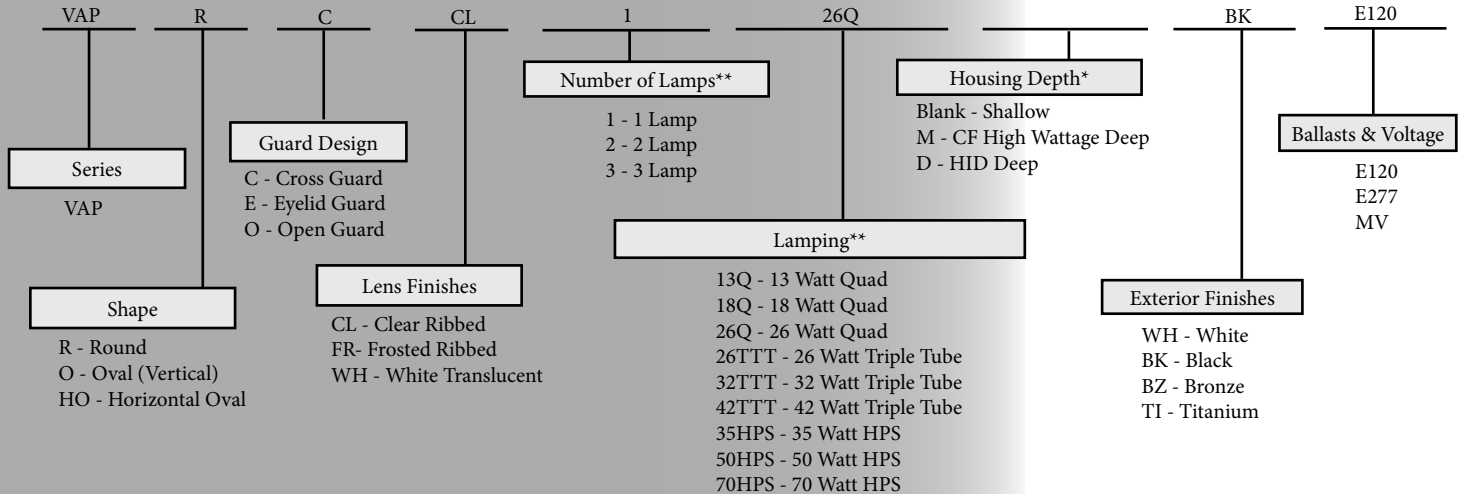

## FEATURES:

- Tamper Proof Fasteners
- Extruded Rubber Lens Gasket. Keeps moisture, dirt, and insects from penetrating the interior of the fixture.
- Lens Retaining Clips and Screws. Provides a single lens/outer guard unit which eases installations and relamping procedures.
- Weep Holes. Allow rain and liquids coming in contact with the face of the fixture to drain out from the front of the fixture, and reduce accumulation of dirt and moisture on the face of the installed fixture.
- Level Bar and "Top" Indicator. Ensures that the fixture housing is secured in a level position.
- Ribbed Injection Molded Lens. Internally ribbed injection molded polycarbonate lens and slightly textured exterior of lens reduces glare.

## Dimensions:

Round - 13.18" Diameter

Oval - 9.18" x 13.06"

## Housing Depth::



Shallow - 3.75" to 4.0"  
(Blank)



CF High Wattage - 6.21" to 6.46"  
(H)

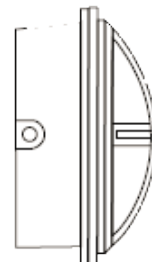

HID Deep - 7.56" to 7.89"  
(D)

\*Consult factory for Housing Depth required based on lamping.

\*\*Consult factory for available options. Not all lamping options available.

# OUTDOOR WALL FIXTURES

## Commercial Grade Nautical Oval

Aluminum back pan and choice of white or black molded plastic in a choice of styles and incandescent or fluorescent versions. UL listed for wet location. Photocell optional. Energy Star rated when used with electronic ballast or GU lamp and photocell.

Item Number	Dimensions (L x W x H)	Lamping
MCEO 113R120WH	10.6" x 5.9" x 3.7"	1-PL13
MCEO 213R120WH	10.6" x 5.9" x 3.7"	2-PL13
MCEO 113ELWH	10.6" x 5.9" x 3.7"	1-13W Quad 4-Pin
MCEO 213ELWH	10.6" x 5.9" x 3.7"	2-13W Quad 4-Pin
MCEO 132ELWH	10.6" x 5.9" x 3.7"	1-32W TTT 4-Pin
MCEO 113GUWH	10.6" x 5.9" x 3.7"	1-13W GU24
MCEO 118GUWH	10.6" x 5.9" x 3.7"	1-18W GU24



For different style replace MCEO with style code shown above. Change WH to BK for Black finish. \*For photocell add PC to electronic ballast or GU versions only.

## Commercial Grade Nautical Round

Aluminum back pan and choice of white or black molded plastic in a choice of styles and incandescent or fluorescent versions. UL listed for wet location. Photocell optional. Energy Star rated when used with electronic ballast and photocell.

Item Number	Dimensions (L x W x H)	Lamping
MCER 113R120WH	10.6" x 10.6" x 5.25"	1-PL13
MCER 213R120WH	10.6" x 10.6" x 5.25"	2-PL13
MCER 113ELWH	10.6" x 10.6" x 5.25"	1-13W Quad 4-Pin
MCER 213ELWH	10.6" x 10.6" x 5.25"	2-13W Quad 4-Pin
MCER 132ELWH	10.6" x 10.6" x 5.25"	1-32W TTT 4-Pin
MCER 232ELWH	10.6" x 10.6" x 5.25"	2-32W TTT 4-Pin
MCER 113GUWH	10.6" x 10.6" x 5.25"	1-13W GU24
MCER 213GUWH	10.6" x 10.6" x 5.25"	2-13W GU24
MCER 118GUWH	10.6" x 10.6" x 5.25"	1-18W GU24
MCER 218GUWH	10.6" x 10.6" x 5.25"	1-18W GU24



For different style replace MCER with style code shown above. Change WH to BK for Black finish. For photocell add PC to electronic ballast or GU versions only.

## Euro Oval

Energy smart architectural lighting at economical pricing. Molded plastic front and back pan in choice of white or black finishes with frosted lens. Available in choice of four styles with a variety of lamping. UL Listed for wet location.

Item Number	Dimensions (L x W x H)	Lamping
MEO 109R120WH	10" x 5" x 4"	1-PL9
MEO 113R120WH	10" x 5" x 4"	1-PL13
MEO 113GUWH	10" x 5" x 4"	1-18W GU MAX
MEO 118ELWHLP	10" x 5" x 4"	1-18W Quad 4-Pin

For different style replace MEO with style code shown right. Change WH to BK for Black finish.



## Euro Round

Energy smart architectural lighting at economical pricing. Molded plastic front and back pan in choice of white or black finishes with frosted lens. Available in choice of three styles with a variety of lamping. UL Listed for wet location.

Item Number	Dimensions (L x W x H)	Lamping
MER 113R120WH	10" x 10" x 5.25"	1-PL13
MER 209R120WH	10" x 10" x 5.25"	2-PL9
MER 118GUWH	10" x 10" x 5.25"	1-18W GU MAX
MER 118ELWH	10" x 10" x 5.25"	1-18W Quad 4-Pin

For different style replace MER with style code shown right. Change WH to BK for Black finish.



# ENERGY EFFICIENT DIE-CAST CFL's

This array of die-cast Compact Fluorescent fixtures provide energy efficient lighting with highly tooled and engineered luminaires. Ideal for enhanced energy savings and performance with photo-cells, multi-volt ballasts and emergency ballasts available.

Some fixtures allow integral emergency ballasts and some require remote ballasts.

## Mini Wall Pack

Item Number	Dimensions (L x W x H)	Lamping
MIMWPK142ELPL	6.95" x 11" x 5"	(1) 42 Watt TTT 4-PIN
MIMWPKRD242ELPL	8.7" x 12.3" x 5.8"	(2) 42 Watt TTT 4-PIN

Add "B1" for remote emergency ballast option. Works with 32W as well.

Photo Cell (Add "PC")  
Specify 120V or 277V



SQUARE UNIT - MIMWPK



ROUND UNIT - MIMWPKRD

## Wall Pack

**Now Available in 40 Watt LED**

Item Number	Dimensions (L x W x H)	Lamping
MIMDWPK242ELPL	14.25" x 9" x 7.25"	(2) 42 Watt TTT 4-PIN
MIMDWPK242ELPLB1*	14.25" x 9" x 7.25"	(2) 42 Watt TTT 4-PIN

\*Emergency ballast fits inside unit. Works with 32W as well.



## Large Deep Wall Pack

Item Number	Dimensions (L x W x H)	Lamping
MILGWPK257ELPL	18" x 9" x 12.75"	(2) 57 Watt Quad 4-PIN
MILGWPK257ELPLB1*	18" x 9" x 12.75"	(2) 57 Watt Quad 4-PIN

\*Emergency ballast fits inside unit.



## Medium Flood Lights

Item Number	Dimensions (L x W x H)	Lamping
MIMFLT242ELPL	9" x 10.25" x 7.25"	(2) 42 Watt TTT 4-PIN

Add "B1" for remote emergency ballast option.

Emergency Ballast  
(Add "B1")



Photo Cell  
(Add "PC")  
Specify 120V or 277V



## Cut Off Wall Packs

**Now Available in 40 Watt LED**

Item Number	Dimensions (L x W x H)	Lamping
MIRDCOWPK142ELPL	18" x 7.25" x 9"	(1) 42 Watt TTT 4-PIN
MIMDCOWPK242ELPL	14.25" x 9.125" x 11.375"	(2) 42 Watt TTT 4-PIN
MIMDCOWPK242ELPLB1*	14.25" x 9.125" x 11.375"	(2) 42 Watt TTT 4-PIN
MILGCOWPK257ELPL	18.25" x 9.125" x 17.125"	(2) 57 Watt Quad 4-PIN
MILGCOWPK257ELPLB1*	18.25" x 9.125" x 17.125"	(2) 57 Watt Quad 4-PIN

\*Emergency ballast fits inside unit.

MIRDCOWPK



MILGCOWPK

MIMDCOWPK



## Close-to-Ceiling Vandaliers

**Now Available in 40 Watt LED**

Item Number	Dimensions (L x W x H)	Lamping
MISMCL126ELPL	7.5" x 8" x 8"	(1) 26 Watt TTT 4-PIN
MISMCL142ELPL	7.5" x 8" x 8"	(1) 42 Watt TTT 4-PIN
MIMDCL242ELPL	8.75" x 12.375" x 12.375"	(2) 42 Watt TTT 4-PIN

Add "B1" for remote emergency ballast option.



# OUTDOOR WALL FIXTURES

## Compact Fluorescent Wall Packs

Energy smart PL lamp fixtures for wall mount are ideal for circulation spaces in commercial or multi-family applications. Consult factory for tamper proof options and other lens options. See page 42, for larger ceiling and wall versions.

Item Number	Dimensions (L x W x H)	Lamping
WSPC107M120	8" x 5" x 4"	1-PL7
WSPC109QM120	8" x 5" x 4"	1-PL9 watt Quad
WMPC109M120	10" x 6" x 4"	1-PL9
WMPC113M120	10" x 6" x 4"	1-PL13
WMPC209M120	10" x 6" x 4"	2-PL9
WMPC213M120	10" x 6" x 4"	2-PL13
WLPC1109M120	13" x 4" x 4"	1-PL9
WLPC1109M120CB	13" x 4" x 5"	1-PL9
WLPC1113M120	13" x 4" x 4"	1-PL13
WLPC1113M120CB	13" x 4" x 5"	1-PL13
WLPC1209M120	13" x 4" x 4"	2-PL9
WLPC1209M120CB	13" x 4" x 5"	2-PL9
WLPC1213M120	13" x 4" x 4"	2-PL13
WLPC1213M120CB	13" x 4" x 5"	2-PL13



Add "CB" for deeper backplate with knockouts for through wiring.

## Compact Fluorescent Flood Lights

Outdoor low light level lighting utilizes aluminum reflector, clear polycarbonate lens, swivel knuckle for directional lighting and neoprene lens gasket. Standard in bronze finish. Consult factory for ballast options.

Item Number	Dimensions (L x W x H)	Lamping
MIMDRBFLT113ELPL	8.25" x 4.5" x 4.5"	1-PL13



## Premium Pocket Outdoor Wall

Molded polycarbonate backplate is combined with a small (S) or full size white or clear elongated jar. UL Wet Location.

Item Number	Dimensions (L x W x H)	Lamping
MBPW118WSJEL	4.5" x 5.75" x 8"	1-18W Quad 4-Pin
MBPW113GUWSJ	4.5" x 5.75" x 8"	1-13W GU24
MBPW118GUWPJ	4.5" x 5.75" x 8"	1-18W GU24

### Fitters:

"MBPW" Black Wall  
"MWPW" White Wall

### Globes:

"WSJ" White Small Jar  
"CSJ" Clear Clear Small Jar  
"WPJ" White Polycarbonate Jar  
"CPJ" Clear Polycarbonate Jar

## MIX and MATCH



For ceiling versions, see page 44.

## Classic Pocket Outdoor Wall

Economical, versatile PL wall fixtures in choice of acrylic globes or jar diffusers in white or clear acrylic. Polycarbonate backplates are available in white or black. UL Wet Location.

Item Number	Dimensions (L x W x H)	Lamping
MBPW118WAGEL	6" x 6.5" x 8"	1-18W Quad 4-Pin
MBPW113GUWAG	6" x 6.5" x 8"	1-13W GU24
MBPW118GUWAG	6" x 6.5" x 8"	1-18W GU24

For photocell add PC to electronic ballast. For 60W Incandescent lamping change lamping to INC.

### Fitters:

"MBPW" Black Wall  
"MWPW" White Wall

### Globes:

"WAG" White Acrylic Globe  
"CAG" Clear Acrylic Globe  
"WPJ" White Polycarbonate Jar  
"CPJ" Clear Polycarbonate Jar

## MIX and MATCH



For ceiling versions, see page 44.

# OUTDOOR WALL FIXTURES

## Nautical Outdoor

High style Nautical style is made of durable plastic in choice of black or white. Available in matching post top and wall versions. White acrylic hides the fluorescent lamp and clear prismatic is ideal for incandescent version.

Item Number	Dimensions (L x W x H)	Lamping
MNOP213ELWH	23.4" x 10.1" x 13"	2-13W Quad 4-Pin
MNOP218ELWH	23.4" x 10.1" x 13"	2-18W Quad 4-Pin
MNOB113ELWH	10.1" x 10.1" x 10"	1-13W Quad 4-Pin
MNOB118ELWH	10.1" x 10.1" x 10"	1-18W Quad 4-Pin
MNOB132ELWH	10.1" x 10.1" x 10"	1-32W TTT 4-Pin
MNOW113ELWH	10.1" x 10.1" x 13"	1-13W Quad 4-Pin
MNOW118ELWH	10.1" x 10.1" x 13"	1-18W Quad 4-Pin

Change WH to BK for Black finish. For photocell add PC to electronic ballast and GU versions only. For 60W Incandescent lamping change lamping to INC.



AVAILABLE WITH GU LAMPS.

## Globe Outdoor

Classic globe style is made of durable plastic in choice of black or white fitters with white globes in a variety of sizes. Available in matching post top and wall versions. White acrylic diffuses and hides the light.

Item Number	Dimensions (L x W x H)	Lamping
MGP10113M120WH	10" x 10" x 12.75"	1-PL13
MGP12132ELWH	12" x 12" x 12"	1-32W TTT 4-Pin
MGP14132ELWH	14" x 14" x 14"	1-32W TTT 4-Pin
MGP16132ELWH	16" x 16" x 16"	1-32W TTT 4-Pin
MGOW113ELWH	8" x 8.5" x 15.5"	1-13W Quad 4-Pin

Change WH to BK for Black finish. For Incandescent lamping change lamping to INC (Consult for wattages up to 200W).



AVAILABLE WITH GU LAMPS.

## Bradford Outdoor

Wall mount in short tail and long tail and post top is available in a variety of lamp configurations. Molded plastic in white and black has white acrylic to hide the fluorescent lamp and clear prismatic ideal for incandescent options.

Item Number	Dimensions (L x W x H)	Lamping
MBRPINCWH	8" x 8" x 15"	1-A19 60W
MBRP113ELWH	8" x 8" x 15"	1-13W Quad 4-Pin
MBRW113ELWH	8" x 9" x 15"	1-13W Quad 4-Pin
MBRW118ELWH	8" x 9" x 15"	1-18W Quad 4-Pin
MBRL113ELWH	8" x 9" x 21"	1-13W Quad 4-Pin
MBRL118ELWH	8" x 9" x 21"	1-18W Quad 4-Pin

Change WH to BK for Black finish. For photocell add PC to electronic ballast. For 60W Incandescent change lamping to INC and diffuser will be Clear Bevel.



AVAILABLE WITH GU LAMPS.

## Colonial Outdoor

Classic series is available in matching post top and wall versions with style choice of short tail or long tail. Molded plastic in choice of white or black with clear flemished acrylic to hide the lamps source.

Item Number	Dimensions (L x W x H)	Lamping
MCOP113M120WH	8" x 8.5" x 8"	1-PL13
MCOW113M120WH	8" x 8.5" x 8"	1-PL13
MCOL113ELWH	8" x 8.5" x 8"	1-13W Quad 4-Pin
MCOL118ELWH	8" x 8.5" x 8"	1-18W Quad 4-Pin

Change WH to BK for Black finish. For photocell add PC to electronic ballast. For 60W Incandescent change lamping to INC and diffuser will be Clear Bevel.



AVAILABLE WITH GU LAMPS.

# OUTDOOR WALL FIXTURES

## Amherst Outdoor

High style series is available in matching post top and wall versions with style choice of short tail or long tail. Molded plastic in choice of white or black has white beveled plastic diffuser to hide the fluorescent lamp and clear beveled diffuser ideal for incandescent options.

Item Number	Dimensions (L x W x H)	Lamping
MAOP113M120WH	8" x 9" x 18"	1-PL13
MAOW113ELWH	8" x 9" x 20"	1-13W Quad 4-Pin
MAOW118ELWH	8" x 9" x 20"	1-18W Quad 4-Pin
MAOL113ELWH	8" x 9" x 25"	1-13W Quad 4-Pin
MAOL118ELWH	8" x 9" x 25"	1-18W Quad 4-Pin

Change WH to BK for Black finish. For photocell add PC to electronic ballast. For 60W Incandescent lamping change lamping to INC and diffuser will be Clear Bevel.



AVAILABLE WITH GU LAMPS.

## Hexagon Outdoor

Hexagon top series is available in matching post top and wall versions with style choice of short tail or long tail. Molded plastic in choice of white or black has white beveled diffuser to hide the fluorescent lamp and clear beveled diffuser for incandescent options.

Item Number	Dimensions (L x W x H)	Lamping
MHOP113M120WH	9" x 9" x 15.5"	1-PL13
MHOW113ELWH	9" x 9" x 16"	1-13W Quad 4-Pin
MHOL113ELWH	19" x 9" x 21.5"	1-13W Quad 4-Pin
MHOL118ELWH	9" x 9" x 21.5"	1-18W Quad 4-Pin

Change WH to BK for Black finish. Consult for photocell add PC to electronic ballast. For 60W Incandescent change lamping to INC and diffuser will be Clear Bevel.



AVAILABLE WITH GU LAMPS.

## Tudor Lanterns and Post Top

Molded plastic in choice of white or black has white plastic diffuser to hide the fluorescent lamp and clear diffuser for incandescent options.

Item Number	Dimensions (L x W x H)	Lamping
MTOP10113M120WH	10.5" x 10.5" x 18"	1-PL13
MTOP13113M120WH	13" x 13" x 18"	1-13W Quad 4-Pin
MTOL113ELWH	7.75" x 8" x 17"	1-13W Quad 4-Pin
MTOL118ELWH	7.75" x 8" x 17"	1-18W Quad 4-Pin
MTOLB113ELWH	7.75" x 8" x 17"	1-13W Quad 4-Pin
MTOLB118ELWH	7.75" x 8" x 17"	1-18W Quad 4-Pin

Change WH to BK for Black finish. Consult for photocell add PC to electronic ballast. For 60W Incandescent lamping change lamping to INC and diffuser will be Clear Bevel.

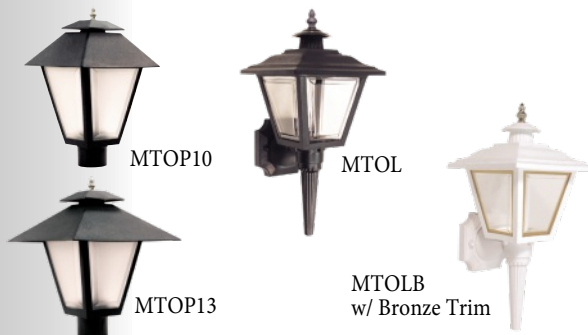

AVAILABLE WITH GU LAMPS.

## Economical Wall

These budget fixtures provide a finished look while providing energy smart lighting.

Item Number	Dimensions (L x W x H)	Lamping
MAPW118ELWHL1	6" x 7" x 9"	1-18W Quad 4-Pin (Incl)
MDH107BKM120L1	5" x 4.75" x 9.5"	1-PL7 (Incl)
MDH109BKM120L1	5" x 4.75" x 9.5"	1-PL9 (Incl)

Change WH to BK for Black finish on MAPWs series (MDH series only in black). For photocell add PC to electronic ballast. For 60W Incandescent lamping change lamping to INC.



AVAILABLE WITH GU LAMPS.

# HID Lighting

For safety, security and area lighting Mobern offers a complete offering of HID Wall Packs, Floods, Vandal Resistant Wall and Ceiling fixtures, and High Bays. HID Lamps, Ballasts, & Accessories are also available. Mobern has a full line of Dark Sky lighting fixtures designed specifically to limit and reduce "lighting pollution" while putting the light where you need it for safety and security. Mobern has an array of HID fixtures utilizing Pulse Start Technology. Pulse Start provides increased lumens per watt and higher lumen maintenance, greater color stability and faster starting time and re-start time.



## Mini Outdoor Lighting Wall Pack

- Heavy Duty Die Cast Aluminum Mounting Plate
- Optional photocell for easy field installation
- One Piece Anodized Aluminum
- One Medium base lamp included
- Bronze finish
- Polycarbonate Lens

Item Number	Dimensions (L x W x H)	Lamping
MIMWPK35HPS120	6.75" x 11.87" x 5"	35 Watt High Pressure Sodium
MIMWPK50HPS120	6.75" x 11.87" x 5"	50 Watt High Pressure Sodium
MIMWPK70HPS120	6.75" x 11.87" x 5"	70 Watt High Pressure Sodium
MIMWPK142ELPL	6.75" x 11.87" x 5"	42 Plug In Fluorescent



## Security Wall Pack

- High impact polycarbonate lens and housing
- UL listed for Wet Location
- Intelligence mounting template
- Semi specular finished reflector
- Rugged, heavy-duty, die-cast aluminum back plate
- One medium base lamp included

Item Number	Dimensions (L x W x H)	Lamping
MIMWPKRD70MH120	8.7" x 12.3" x 5.2"	70 Watt Metal Halide
MIMWPKRD70HPS120	8.7" x 12.3" x 5.2"	70 Watt High Pressure Sodium
MIMWPKRD100HPS120	8.7" x 12.3" x 5.2"	100 Watt High Pressure Sodium
MIMWPKRD242ELPL	8.7" x 12.3" x 5.2"	100 Watt High Pressure Sodium

- Optional photocell for easy field installation



## Small Outdoor Lighting Wall Pack

- Heavy Duty Die Cast Aluminum Mounting Plate
- Optional photocell for easy field installation
- One Piece Anodized Aluminum
- One Medium base lamp included
- Bronze finish
- Polycarbonate Lens

Item Number	Dimensions (L x W x H)	Lamping
MISMWPK35HPS120	8.5" x 9.375" x 7"	35 Watt High Pressure Sodium
MISMWPK50HPS120	8.5" x 9.375" x 7"	50 Watt High Pressure Sodium
MISMWPK70HPS120	8.5" x 9.375" x 7"	70 Watt High Pressure Sodium
MISMWPK100HPS120	8.5" x 9.375" x 7"	100 Watt High Pressure Sodium
MISMWPK50MHQV	8.5" x 9.375" x 7"	50 Watt Metal Halide
MISMWPK70MHQV	8.5" x 9.375" x 7"	70 Watt Metal Halide
MISMWPK100MHQV	8.5" x 9.375" x 7"	100 Watt Metal Halide



## Medium Outdoor Lighting Wall Pack

**Now Available in 40 Watt LED**

- Heavy Duty Die Cast Aluminum Mounting Plate
- Optional photocell for easy field installation
- One Piece Anodized Aluminum
- One Medium base lamp included
- Bronze finish
- Polycarbonate Lens

Item Number	Dimensions (L x W x H)	Lamping
MIMDWPK150MHQV	14.25" x 9" x 7.25"	150 Watt Metal Halide
MIMDWPK150HPSQV	14.25" x 9" x 7.25"	150 Watt High Pressure Sodium
MIMDWPK242ELPL	14.25" x 9" x 7.25"	(2) 42 Watt Plug In Fluorescent





# HID WALL PACKS

## Large Deep Outdoor Lighting Wall Pack

- Heavy Duty Die Cast Aluminum Housing
- Bronze Powder-coat finish
- Optional photocell for easy field installation
- Quad Tap Ballast

- One Piece Anodized Aluminum Reflector
- Glass Lens
- One Mogul base lamp included.
- Hinged Door

Item Number	Dimensions (L x W x H)	Lamping
MILGWPK250HPSQV	18" x 9" x 12.75"	250 Watt High Pressure Sodium
MILGWPK400HPSQV	18" x 9" x 12.75"	400 Watt High Pressure Sodium
MILGWPK320MHPSQV	18" x 9" x 12.75"	320 Watt Pulse Start Metal Halide
MILGWPK400MHPSQV	18" x 9" x 12.75"	400 Watt Pulse Start Metal Halide
MILGWPK257ELPL	18" x 9" x 12.75"	(2) 57 Watt Plug In Fluorescent



## Low Profile Wall Pack

- Heavy Duty Die Cast Aluminum Housing
- Bronze Powder-coat finish
- Optional photocell for easy field installation

- One Piece Anodized Aluminum Reflector
- Borosilicate glass lens with Hinged Door
- One Medium base lamp included

Item Number	Dimensions (L x W x H)	Lamping
MILFWPK250HPSQV	15.8" x 15.8" x 7.4"	250 Watt High Pressure Sodium
MILFWPK400HPSQV	15.8" x 15.8" x 7.4"	400 Watt High Pressure Sodium
MILFWPK320MHPSQV	15.8" x 15.8" x 7.4"	320 Watt Pulse Start Metal Halide
MILFWPK400MHPSQV	15.8" x 15.8" x 7.4"	400 Watt Pulse Start Metal Halide



## Decorative Cut-Off Wall Pack

**Now Available in 40 Watt LED**

- Heavy Duty Die Cast Aluminum Housing
- Bronze Powder-coat finish
- Downlight only

- One Piece Anodized Aluminum Reflector
- One Medium base lamp included.

Item Number	Dimensions (L x W x H)	Lamping
MIRDCOWPK150MHQV	18" x 7.25" x 9"	150 Watt Metal Halide
MIRDCOWPK142ELPL	18" x 7.25" x 9"	42 Watt Plug In Fluorescent
MIRDCOWPK150HPSQV	18" x 7.25" x 9"	150 Watt High Pressure Sodium



## Full Cut-Off Wall Pack

- Heavy Duty Die Cast Aluminum Housing
- Bronze Powder-coat finish

- One Piece Anodized Aluminum Reflector
- One Medium base lamp included.

Item Number	Dimensions (L x W x H)	Lamping
MIMDCOWPK150HPSQV	14.25" x 9.125" x 11.375"	150 Watt High Pressure Sodium
MIMDCOWPK242ELPL	14.25" x 9.125" x 11.375"	(2) 42 Watt Plug In Fluorescent
MILGCOWPK250HPSQV	18.25" x 9.125" x 13.75"	250 Watt High Pressure Sodium
MILGCOWPK250MHPSQV	18.25" x 9.125" x 17.125"	250 Watt Pulse Start Metal Halide
MILGCOWPK400HPSQV	18.25" x 9.125" x 17.125"	400 Watt High Pressure Sodium
MILGCOWPK320MHPSQV	18.25" x 9.125" x 17.125"	320 Watt Pulse Start Metal Halide
MILGCOWPK400MHPSQV	18.25" x 9.125" x 17.125"	400 Watt Pulse Start Metal Halide
MILGCOWPK257ELPL	18.25" x 9.125" x 17.125"	(2) 57 Watt Plug In Fluorescent



MILGCOWPK



### Additional Features:

- Tempered Clear Glass Lens
- Die Cast Hinged Front & Rear Housings, Gasket, Coin Plugs on Sides and Back.
- Built-In Template for Mounting to Electrical Box
- Chromate Conversion Coating
- Textured Bronze Finish
- Two Piece Hinged Aluminum Reflector
- Meets local "Dark Sky" Requirements
- Excellent for Use as an Uplight

### Accessories:

Photocell 120V	CAT. # PC	
Photocell 277V	CAT. # PC277	

**Now Available in 40 Watt LED**

**DARKSKY**

# HID FLOOD LIGHTS

## Small HID Flood Lights

- Heavy Duty Die Cast Aluminum Housing
- Glass Lens
- One Piece Anodized Aluminum Reflector
- 1/2" NPT Die Cast Slip Fitter Swivel
- Bronze Powder-coat finish
- One Medium base lamp included

Item Number	Dimensions (L x W x H)	Lamping
MIMDRFLT35HPSQV	6" x 9.375" x 7"	35 Watt High Pressure Sodium
MIMDRFLT50HPSQV	6" x 9.375" x 7"	50 Watt High Pressure Sodium
MIMDRFLT70HPSQV	6" x 9.375" x 7"	70 Watt High Pressure Sodium
MIMDRFLT100HPSQV	6" x 9.375" x 7"	100 Watt High Pressure Sodium
MIMDRFLT100HPSQV	6" x 9.375" x 7"	150 Watt High Pressure Sodium

Available in Compact Fluorescent - Change lamping to 213, 126, 132 or 142.



## Medium HID Flood Lights

- Heavy Duty Die Cast Aluminum Housing
- Glass Lens
- One Piece Anodized Aluminum Reflector
- 1/2" NPT Die Cast Slip Fitter Swivel
- Bronze Powder-coat finish
- Lamp included

Item Number	Dimensions (L x W x H)	Lamping
MIMFLT100HPSQV	9" x 10.25" x 7.25"	100 Watt High Pressure Sodium
MIMFLT150HPSQV	9" x 10.25" x 7.25"	150 Watt High Pressure Sodium
MIMFLT100MHQV	9" x 10.25" x 7.25"	100 Watt Metal Halide
MIMFLT150MHQV	9" x 10.25" x 7.25"	150 Watt Metal Halide
MIMFLT242ELPL	9" x 10.25" x 7.25"	(2) 42 Watt Plug-In Fluorescents



## Rounded Back HID Flood Lights

- Heavy Duty Die Cast Aluminum Housing
- Bronze Powder-coat finish
- 1/2" NPT Die Cast Slip Fitter Swivel
- One Piece Anodized Aluminum Reflector
- Glass Lens
- Lamp included

Item Number	Dimensions (L x W x H)	Lamping
MIRBFLT150HPSQV	11" x 8.5" x 8.6"	150 Watt High Pressure Sodium
MIRBFLT150MHPSQV	11" x 8.5" x 8.6"	150 Watt Metal Halide



## Large Horizontal HID Flood Light

- Heavy Duty Die Cast Aluminum Housing
- Glass Lens
- One Piece Anodized Aluminum Reflector
- One Medium base lamp included
- Bronze Powder-coat finish

Item Number	Dimensions (L x W x H)	Lamping
MILGRFLT250HPSQV	16.25" x 10.25" x 10.75"	250 Watt High Pressure Sodium
MILGRFLT400HPSQV	16.25" x 10.25" x 10.75"	400 Watt High Pressure Sodium
MILGRFLT250MHPSQV	16.25" x 10.25" x 10.75"	250 Watt Pulse Start Metal Halide
MILGRFLT320MHPSQV	16.25" x 10.25" x 10.75"	320 Watt Pulse Start Metal Halide
MILGRFLT400MHPSQV	16.25" x 10.25" x 10.75"	400 Watt Pulse Start Metal Halide

Use Accessories A on page 55



MIA41 (sold separately)

## Forward Throw HID Flood Light

- Heavy Duty Die Cast Aluminum Housing
- Glass Lens
- One Piece Anodized Aluminum Reflector
- Lamp included
- Bronze Powder-coat finish

Item Number	Dimensions (L x W x H)	Lamping
MIMDFTFLT250MHPSQV	16.25" x 17" x 7"	250 Watt Pulse Start Metal Halide
MIMDFTFLT320MHPSQV	16.25" x 17" x 7"	320 Watt Pulse Start Metal Halide
MIMDFTFLT400MHPSQV	16.25" x 17" x 7"	400 Watt Pulse Start Metal Halide

Use Accessories A on page 55



## Large HID Flood Lights

- Heavy Duty Die Cast Aluminum Housing
- Glass Lens
- One Piece Anodized Aluminum Reflector
- Lamp included
- Bronze Powder-coat finish

Item Number	Dimensions (L x W x H)	Lamping
MILGFLT250HPSQV	16.5" x 17" x 7"	250 Watt High Pressure Sodium
MILGFLT400HPSQV	16.5" x 17" x 7"	400 Watt High Pressure Sodium
MILGFLT250MHPSQV	16.5" x 17" x 7"	250 Watt Pulse Start Metal Halide
MILGFLT320MHPSQV	16.5" x 17" x 7"	320 Watt Pulse Start Metal Halide
MILGFLT400MHPSQV	16.5" x 17" x 7"	400 Watt Pulse Start Metal Halide

Use Accessories A on page 55



MIA41 (sold separately)

# HID FLOOD LIGHTS

## 1000 Watt HID Flood Light

- Heavy Duty Die Cast Aluminum Housing
- Bronze Powder-coat finish
- 1/2" NPT Die Cast Slip Fitter Swivel
- One Piece Anodized Aluminum Reflector
- Glass Lens
- One Mogul base lamp included

Item Number	Dimensions (L x W x H)	Lamping
MILGFLT1000MHQV	24" x 23.75" x 10.5"	1000 Watt Metal Halide

Use Accessories B on page 55



## Architectural Area Lighting

- Heavy duty steel housing with powder coating finish
- Heat and impact resistant flat clear tempered glass.
- UL listed for wet locations with weatherproof and durable silicone rubber gaskets.
- Two different optical distributions (Type 3 and Type 4)
- Using hydroformed anodized aluminum reflector and precision bent optics.
- Lamp Included

Item Number	Dimensions (L x W x H)	Lamping
MIMDPR250MHPSQV	15" x 6.1" x 22.4"	250W Pulse Start Metal Halide
MIMDPR320MHPSQV	15" x 6.1" x 22.4"	320W Pulse Start Metal Halide
MIMDPR400MHPSQV	15" x 6.1" x 22.4"	400W Pulse Start Metal Halide

For Type 4 distribution change T3 to T4.



Use Accessories A on page 55

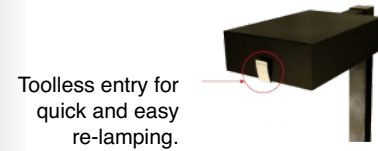

Toolless entry for quick and easy re-lamping.

## Accessories

1000w Adjustable  
2 Pieces U-Bracket

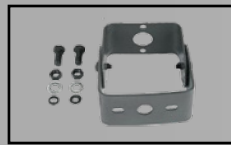

Accessories A  
Accessories B

MIA41  
PMIA41

Adjustable Slip Fitter

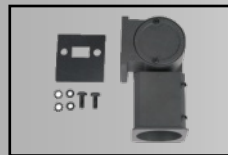

MI2AF  
PMI2AF

Mounting Arm 6"



MISSA-M  
PMISSA-M

Mounting Arm 10"



MISSA  
PMISSA

## Steel Poles

- Polycarbonate lexan spring loaded cover
- 12 top holes w/polycarbonate lexan brushings
- Reinforced hand hold cover
- Anchor Bolts and Template Included
- Easily Secured base cover
- Bronze polyester powder-coat finish
- Meets ASTM 500 standard
- Pole cap is included

Item Number	Dimensions (L x W x H)
MIPK164SQNT	16 ft. 4 x 4 Square 11 Gauge Pole
MIPK204SQNT	20 ft. 4 x 4 Square 11 Gauge Pole
MIPK254SQNT	25 ft. 4 x 4 Square 11 Gauge Pole
MIPK305SQNT-7G	30 ft. 5 x 5 Square 7 Gauge Pole
MIPK304SQNT	30 ft. 5 x 5 Square 11 Gauge Pole



Pole does not include tenon.  
Poles can be cut to any length.

## Direct Burial Poles

Round Aluminum Direct Burial Pole in 3 sizes with 3" Diameter.

Item Number	Dimensions (L x W x H)
MARP7BK	7 ft. H x 3 in. Dia.
MARP10BK	10 ft. H x 3 in. Dia.
MARP12BK	12 ft. H x 3 in. Dia.



# POLE FITTERS, ACORN LENSES, & BOLLARDS

## Bollards

- Die Cast Aluminum Top
- One piece extruded aluminum body
- Smooth Black Finish
- Round Top 41.375" H x 8" Dia.
- Flat Top 41" H x 8" Dia.
- Anchor Bolts & Templates Included

Item Number	Description
MBOLFA70MHM120	FLAT TOP 70MH (INCL), BALLAST MAGNETIC 120
MBOLRA70MHM120	ROUND TOP 70MH (INCL), BALLAST MAGNETIC 120
MBOLFA42PLMV	FLAT TOP 42WATT (INCL), ELECTRONIC BALLAST UNIV
MBOLRA42PLMV	ROUND TOP 42WATT (INCL), ELECTRONIC BALLAST UNIV
MBOLFALED14PLMV	FLAT TOP 14W LED (INCL), ELECTRONIC BALLAST UNIV
MBOLRALED14PLMV	ROUND TOP 14W LED (INCL), ELECTRONIC BALLAST UNIV

Add "B1" for remote emergency ballast option (Fluorescent Only). Change A (Anodized Louver) to P for Parabolic Cone.

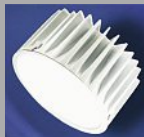

We have now added an LED option to our Bollards along with a parabolic cone diffuser option. The LED version utilizes a Sylvania LED module that uses 14 watts and provides 700 lumens. An LED bollard is an ideal and cost effective application for LED's benefits - long lamp life, energy savings, works well in cold temperatures and good color (83 CRI).



Flat Top (F)



Anodized Louver (A)

Round Top (R)



Parabolic Cone (P)

## Colonnade Pole Top Fitters

- Die Cast Housing
- Stamped Steel Plate
- Ballast, Capacitor, and Ignitor Brackets
- Set Screws, Porcelain Socket
- Smooth Black Finish
- Graceful Design Accommodates 3" Poles

Item Number	Dimensions (L x W x H)	Lamping
MARPCN8-50HPSBL	14.75" x 13.5" x 10.25"	50 Watt High Pressure Sodium
MARPCN8-70HPSBL	14.75" x 13.5" x 10.25"	70 Watt High Pressure Sodium
MARPCN8-100HPSBL	14.75" x 13.5" x 10.25"	100 Watt High Pressure Sodium
MARPCN8-150HPSBL	14.75" x 13.5" x 10.25"	150 Watt High Pressure Sodium
MARPCN9250HPSBL	14.75" x 13.5" x 10.25"	250 Watt High Pressure Sodium
MARPCN8-70MHBL	14.75" x 13.5" x 10.25"	70 Watt Metal Halide
MARPCN8-100MHBL	14.75" x 13.5" x 10.25"	100 Watt Metal Halide
MARPCN8-150MHBL	14.75" x 13.5" x 10.25"	150 Watt Metal Halide
MARPCN9-250MHPS-BL	14.75" x 13.5" x 10.25"	250 Watt Pulse Start Metal Halide



Size 8



Size 9



MARPL

One Piece Extrusion Blow Mold Construction

## Acorn Lens

Item Number	Dimensions (L x W x H)
MARPL-ER1188	16.375" x 24.8" - 8" Opening Acorn Large
MARPL-ER1189	16.375" x 26.375" - 9" Opening Acorn Large

## Globe Mount Fitters

Post Top Fitters are available in Incandescent or Compact Fluorescent. Order Globes Separately.

Item Number	Dimensions (L x W x H)	Lamping
MARPT-INCBK	6" x 5"	1-60 Watt
MARPT-113BK	6" x 5"	1-PL13 Watt
MARPT-213BK	6" x 5"	2-PL13 Watt

Available in Black and White. Change "BK" to "WH" for white.

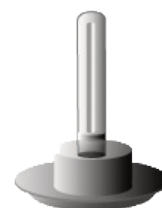
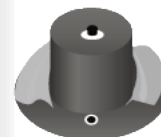

## Globes

Item Number	Description (Globe Size - Color - Fitter Size)
MARPL-AC010WHN	10" - White - 5.25" Neckless
MARPL-AC012WHN	12" - White - 5.25" Neckless
MARPL-AC014WHN	14" - White - 5.25" Neckless
MARPL-AC016WHN	16" - White - 5.25" Neckless
MARPL-AC018WHN	18" - White - 5.25" Neckless
MARPL-AC020WHN	20" - White - 5.75" Neckless
MARPL-AC022WHN	22" - White - 5.75" Neckless

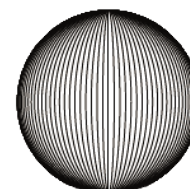
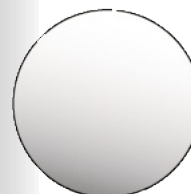

Consult factory for clear acrylic versions.

# HID HIGH BAYS & LOW BAYS

## HID High Bays

Mobern offer a complete selection of HID High Bays in a choice of two sizes and reflectors. Available now with Pulse Start lamps.



MIHB-16



MIHB-16-G



MIHB-16-C



MIHB-22



MIHBP-16-D

### Ordering Information

Example: MIHB400MHPS16QVG

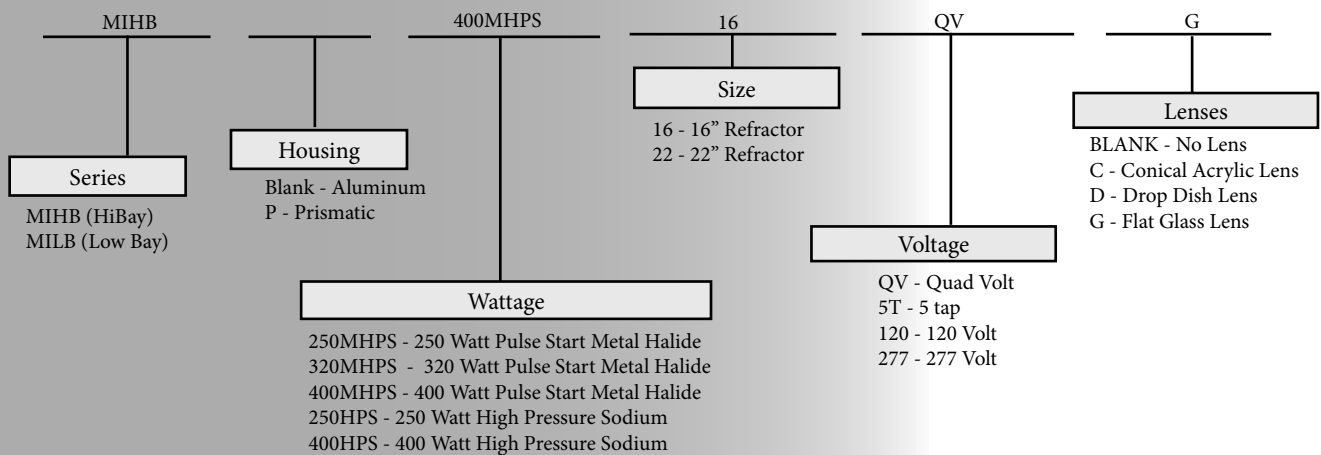

### Features

- Heavy Duty Die Cast Aluminum Housing
- White Powder-Coat Finish Housing
- Adjustable Lamp Position
- Rugged 4kv Porcelain Socket
- Wiring Compartment with Adjustable Leveling Feature
- 120/208/240/277V CWA Ballast HPF
- One Mogul Base lamp Included
- Vertically-seamed
- Die Cast Hook Included

### Options

- Drop Dish Lens
- Open Rated Socket & Lamp
- Quartz Restrike

Consult factory for Compact Fluorescent Options.

#### Accessories:

16" Galvanized Steel Wire Guard	CAT # A-WG16
22" Galvanized Steel Wire Guard	CAT # A-WG22

# RECESSED DOWNLIGHTS

Today's compact fluorescent lamps consume 70% less energy than comparable incandescent lamps and last up to 10 times longer. Mobern Lighting offers a range of energy saving compact fluorescent downlights and are constantly adding to the line. Consult factory for other options.

## COMMERCIAL GRADE

### 4" Vertical Fluorescent

Item Number	Description	Lamping
HOUSING		
MDFV4E26MV	4" Vertical New Construction, Multi-Volt Electronic Ballast	26W TTT 4-Pin
MDFV4E26MVEM	4" Vertical New Construction, Multi-Volt Electronic Ballast, Emergency Ballast	26W TTT 4-Pin
REFLECTORS		
MDFV438CC	4" Clear Reflector Trim	26W TTT 4-Pin



MDFV4E26MV



MDFV438CC

### 6" Vertical Fluorescent

Item Number	Description	Lamping
HOUSING		
MDF601AL2E26E120	6" Vertical IC Airtite New Construction, Resi Electronic Ballast 120V	26W TTT 4-Pin
MDF601AL21332MV	6" Vertical IC Airtite New Construction, Multi-Volt Electronic Ballast	26W or 32W TTT 4-Pin
MDF601AL2E42MV	6" Vertical New Construction, Multi-Volt Electronic Ballast	42W, 32W or 26W
REFLECTORS		
MDF638C	6" Clear Reflector Trim	26W or 32W TTT 4-Pin
MDFV625W	6" Frosted Lens w/Cone Reflector	26W or 32W TTT 4-Pin
MDFV637W	6" Wall Wash Trim w/Eyelid	26W or 32W TTT 4-Pin
MDFV638W	6" White Trim Airtite	26W or 32W TTT 4-Pin



MDF601AL2E26E120



MDF638C



MDFV638W

### 6" Horizontal Fluorescent

Item Number	Description	Lamping
HOUSING		
MDFH6226MV	6" Horizontal New Construction, Multi-Volt Electronic Ballast	(2) 26W TTT 4-PIN
REFLECTORS		
MDFH611C	6" Clear Reflector Trim	(2) 26W TTT 4-PIN



MDFH6226MV



MDFH611C

## SPECIFICATION GRADE

### 6" Vertical Fluorescent

Item Number	Description	Lamping
HOUSING - New Construction Non IC		HOUSING - Remodel Non IC
MDFH-VC6113MV	MDFH-VAR6113MV	13W OR 26W DTT 4-PIN
MDFH-VC6118MV	MDFH-VAR6118MV	18W OR 42W TTT 4-PIN
MDFH-VC6126MV	MDFH-VAR6126MV	26W OR 57W TTT 4-PIN
REFLECTORS		
MDFT-V64-CL	6" CLEAR OPEN REFLECTOR	--
MDFT-V614-CL-WH	6" WHITE BAFFLE TRIM W/CLEAR REFLECTOR	--
MDFT-V636CL-WH	6" Wall Wash w/ Kick Reflector White Flange	--

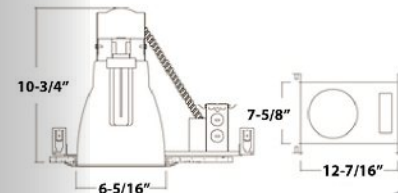

MDFH-VC6113MV



MDFH-VAR6126MV



MDFT-V614-CL-WH



MDFT-V64-CL



MDFT-V636CL-WH

Consult for Dimming or Emergency Ballast Options.  
Consult for other Reflector/Trim Options.

# RECESSED DOWNLIGHTS

## SPECIFICATION GRADE

### 6" Horizontal Fluorescent

Item Number		Lamping
HOUSING - New Construction Non IC	HOUSING - Remodel Non IC	
MDFH-HC6213MV	MDFH-HAR6213MV	(2) 13W DTT 4-PIN
MDFH-HC218MV	MDFH-HAR218MV	(2) 18W DTT 4-PIN
MDFH-HC6226MV	MDFH-HAR6226MV	(2) 26W DTT 4-PIN
REFLECTORS		
MDFT-H64-CL	6" CLEAR OPEN REFLECTOR	--
MDFT-H614-CL-WH	6" WHITE BAFFLE TRIM W/ CLEAR REFLECTOR	--
MDFT-H636CL-WH	6" Wall Wash w/ Kick Reflector White Flange	--

Consult for Dimming or Emergency Ballast Options.  
 Consult for 1 Light Triple Tube Housing Options.  
 Consult for other Reflector/Trim Options.



## COMMERCIAL GRADE

### 8" Vertical Fluorescent

Item Number	Description	Lamping
HOUSING*		
MDFV8E2642MV	8" Vertical Non-IC New Construction, Multi-Volt Electronic Ballast	26W to 42W TTT 4-Pin
REFLECTORS		
MDFV803CL	8" Clear Reflector Trim	26W to 42W TTT 4-Pin
MDFV837WW	8" Wall Washer w/Eyelid	26W to 42W TTT 4-Pin

\*Hanger Brackets sold separately.

### 8" Horizontal Fluorescent

Item Number	Description	Lamping
HOUSING*		
MDFH8E2642NV	8" Horizontal New Construction, Multi-Volt Electronic Ballast	(2) 26W Or 42W TTT 4-PIN
REFLECTORS		
MDFH811C	8" Clear Reflector Trim W/White Trim Ring	(2) 26W Or 42W TTT 4-PIN

\*Hanger Brackets sold separately.

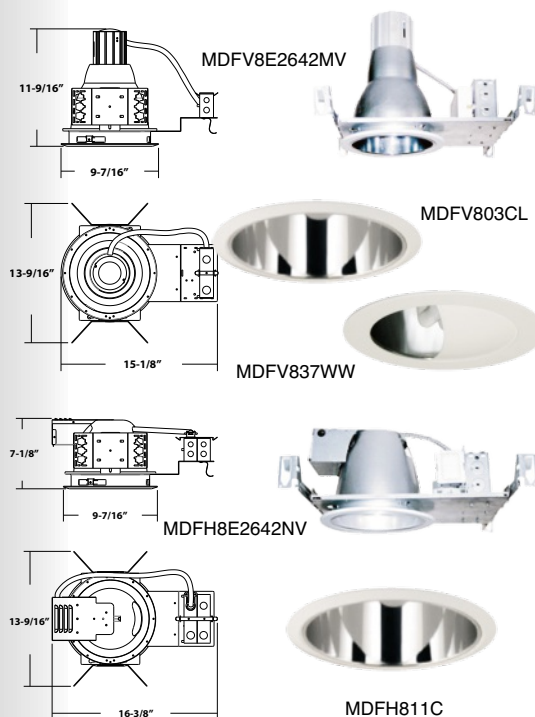

## SPECIFICATION GRADE

### 8" Vertical Fluorescent

Item Number		Lamping
HOUSING - New Construction Non IC	HOUSING - Remodel Non IC	
MDFH-VC8142MV	MDFH-VAR8142MV	42W TTT 4-PIN
MDFH-VC8157MV	MDFH-VAR8157MV	57W TTT 4-PIN
MDFH-VC8170MV	MDFH-VAR8170MV	70W TTT 4-PIN
REFLECTORS		
MDFT-V84-CL	8" CLEAR OPEN REFLECTOR	--
MDFT-V814-CL-WH	8" WHITE BAFFLE TRIM W/ CLEAR REFLECTOR	--
MDFT-V836CL-WH	8" Wall Wash w/ Kick Reflector White Flange	--

Consult for Dimming or Emergency Ballast Options.  
 Consult for other Reflector/Trim Options.



# RECESSED DOWNLIGHTS

## SPECIFICATION GRADE

### 8" Horizontal Fluorescent

Item Number		Lamping
HOUSING - New Construction Non IC	HOUSING - Remodel Non IC	
MDFH-HC8226MV	MDFH-HAR8226MV	(2) 26W TTT 4-PIN
MDFH-HC8232MV	MDFH-HAR8232MV	(2) 32W TTT 4-PIN
MDFH-HC8242MV	MDFH-HAR8242MV	(2) 42W TTT 4-PIN
REFLECTORS		
MDFT-H84-CL	8" CLEAR OPEN REFLECTOR	--
MDFT-H814-CL-WH	8" WHITE BAFFLE TRIM W/ CLEAR REFLECTOR	--
MDFT-H836CL-WH	8" Wall Wash w/ Kick Reflector White Flange	--



Consult for Dimming or Emergency Ballast Options.  
Consult for 1 Light Triple Tube Housing Options.  
Consult for other Reflector/Trim Options.

### 4" Low Voltage

Item Number	Description
F402AL	4" IC Airtight Low Voltage New Construction
F403AL	4" New Construction Low Voltage NON-IC
F404AL	4" Low Voltage Remodel
F426	4" Low Voltage Trim Black Baffle
F427W	4" Low Voltage Trim White Baffle
F431C	4" Low Voltage Clear Cone Reflector
F445W	4" Low Voltage Pull Down White
F446NW	4" Low Voltage Gimbal White



### 4" Line Voltage

Item Number	Description
F501AL	4" IC Airtight New Construction
F503	4" Line NON-IC Voltage New Construction
F504	4" Line NON-IC Voltage Remodel
F525W	4" Shower Wh/Frost R20
F526	4" Line Voltage Trim Black Baffle
F527W	4" Line Voltage Trim White Baffle
F527N	4" Baffle Nickel R20
F531C	4" Clear Reflector R20



### 6" Line Voltage

Item Number	Description
F601AL2	6" New IC Air Tight New Construction
F601-LV	6" Low Voltage New Construction Housing
F602	6" IC Remodel
F606AL	6" Shallow Air Tight New Construction
F613PW	6" Drop Opal Shower Trim
F614W	6" Fresnel Lens Shower Light
F615W	6" Eyeball Trim White
F625W	6" Shower Trim / Frost Glass
F626B	6" Black Baffle PAR38
F627W	6" White Baffle BR40
F628W	6" White Baffle R40 Trim
F629	6" Black Baffle R40 Trim
F638C	6" Clear Cone Reflector A19
F638W	6" White Cone Reflector





# RECESSED DOWNLIGHTS

**NEW & Coming Soon**

## LED Downlights

Our LED recessed downlights create high performing white light and is optimized for new construction and retrofit applications. Installation is done quickly and easily. Our LED selections includes 4" and 6" versions that fit into our 4" and 6" incandescent housings listed on page 60. Each version lasts 35,000 hours and reduces energy consumption by over 85%. If you are retrofitting the rest of your interior with our fluorescents products than make sure to address the downlights with our new LED Downlights. Consult the factory for our lumen packages and wattages.



Item Number	Description
MLEDRT430K	9 Watt LED Trim for 4" Housings, 3000K, 35,000 Hours, 82 CRI, Replaced 50 Watt Incandescent
MLEDRT630K	11 Watt LED Trim for 6" Housings, 3000K, 35,000 Hours, 82 CRI, Replaced 65 Watt Incandescent

Use Incandescent Housings on Page 60.

## New High Performance LED Downlights Coming Soon - Consult Factory



## Step Lights

Item Number	Description
MDSH-I8	Step Light Interior Housing Incandescent
MDSH-F8	Step Light Interior Housing Fluorescent
MDSH-LED8	Step Light Interior Housing Led
MDST-842	Step Light Interior Trim Louvered (Avail In White, Black, Or Silver)
MDST-843	Step Light Interior Trim Open Lens (Avail In White, Black, Or Silver)
MDSH-I8WP	Step Light Exterior Housing Incandescent
MDSH-F8WP	Step Light Exterior Housing Fluorescent
MDSH-LED8WP	Step Light Exterior Housing Led
MDST-844	Step Light Exterior Trim Louvered (Avail In White, Black, Or Silver)
MDST-845	Step Light Exterior Trim Open Lens (Avail In White, Black, Or Silver)
MDST-846	Step Light Exterior Trim Grilled (Avail In White, Black, Or Silver)



Available in LED

## Smoke Detectors

Choice of commercial grade Smoke Detectors and Fire Alarms and Carbon Monoxide Detectors. Features full dust and containment covers, battery pull tab to activate, super heavy duty battery included, test button, silencer feature and 5 year Limited Warranty.

Item Number	Description
MUSI1204	Smoke Alarm, 120 Volt AC Powered with Silencer and 9 Volt Battery Backup
MUSI7390	Carbon Monoxide Alarm, 120 Volt AC Powered CO with 9 Volt Battery Backup
MUSI7795	Smoke and Carbon Monoxide, 120 Volt Wired-In Applications with Battery Backup
MUSI2413	Smoke Alarm, 120 Volt AC Powered for Hearing Impaired
MF4518	Smoke Alarm, 120V AC smoke alarm with battery back-up



# EMERGENCY & EXIT LIGHTING

## LED Exit & Battery Backup

Slim and low-profile LED exit sign provides a crisp, clean look and excellent energy savings.



SERIES	LAMPS	LETTERS	FACE COLOR	OPERATION	FACES	OPTIONS
MEBX	L=LED	R=RED	W=WHITE	A=AC ONLY	U=UNIVERSAL	SD=SELF DIAGNOSTIC
		G=GREEN	B=BLACK	B=BATTERY BACKUP	1=SINGLE	RC=REMOTE CAPABILITY
					2=DOUBLE	

## Combo LED Exit/Emergency Light

Combination LED energy saving exit sign and emergency lighting unit in one compact, modern design. Now with choice of LED emergency light.



Available in Green/Black.

SERIES	LAMPS	LETTERS	FACE COLOR	OPERATION	FACES	OPTIONS
MEBCX	L=LED	R=RED	W=WHITE	B=BATTERY BACKUP	U=UNIVERSAL	SD=SELF DIAGNOSTIC
		G=GREEN	B=BLACK		1=SINGLE	RC=REMOTE CAPABILITY
					2=DOUBLE	LED=LED EMERGENCY SQUARE HEADS
						LED RD=LED EMERGENCY ROUND HEADS

## Edge-Lit LED Exit & Battery Backup

Surface mount edge-lit LED exits offer spec grade look with in-field installation flexibility.



Mounting Options



SERIES	HOUSING COLOR	LETTER COLOR	OPERATION	# OF FACES
MEBELX	W=WHITE	RC=RED ON CLEAR	A=AC ONLY	1=SINGLE
	B=BLACK	GC=GREEN ON CLEAR	B=BATTERY BACKUP	2=DOUBLE
	A=ALUMINUM			

## Edge-Lit LED Exit & Battery Backup with Recessed Mount

Recessed edge-lit offers precise engineering for architectural excellence.



Recessed Mounting

SERIES	HOUSING COLOR	LETTER COLOR	OPERATION	# OF FACES
MEBRELX	W=WHITE	RC=RED ON CLEAR	A=AC ONLY	1=SINGLE
	B=BLACK	GC=GREEN ON CLEAR	B=BATTERY BACKUP	2=DOUBLE
	A=ALUMINUM			

# EMERGENCY & EXIT LIGHTING

## Cast Aluminum LED Exit

LED cast aluminum series utilizes a unique illumination design in an architecturally pleasing housing with LED energy savings, curved face design, Built-in wiring channel, and 120V/277V dual voltage operation.



Available in Black.

SERIES	LED COLOR	HOUSING COLOR	FACE COLOR	OPERATION	# OF FACES
MEBDX	R=RED	W-WHITE	A=BRUSHED ALUMINUM	B=BATTERY BACKUP	1=SINGLE
	G=GREEN	B=BLACK	B=BLACK	A=AC ONLY	
		A=ALUMINUM	W=WHITE		

## Extra Face Plates

SERIES	LED COLOR	FACE COLOR
MEBDFP	R=RED or G=GREEN	A=BRUSHED ALUMINUM or B=BLACK or W=WHITE

## Wet Location LED Exit

### Single Face Battery Backup, LED w/Canopy 120/277v

- Completely self-contained
- Fully Automatic Operation
- LED Lamp life of 25 years
- UL Listed wet locations
- Universal mounting plate
- Push to test switch
- 120 or 277 VAC operation

Cat. # MEBXLRWBWBP

Change R to G for green face.

This exit sign features an enclosure that is resistant to corrosive atmospheres, non-hazardous dust environments, water spray and splashing water.



## Remote Lamp Heads

Requires Remote Capable Exit or Combo.

### Cat. # MEBRHLED2

- 2 Heads
- 3 Volt
- 1 Watt

### Cat. # MEBRHLED1

- 1 Head
- 5 Volt
- 1 Watt



MEBRHLED2



MEBRHLED1

### Cat. # MEBRH2WP\*

- 2 Heads
- 6 Volt
- 7.2 Watt

### Cat. # MEBRH1WP\*

- 1 Head
- 6 Volt
- 7.2 Watt

Use only with remote capable option.  
\*For LED version add LED to end of Cat. Number



MEBRH2WP\*



MEBRH1WP\*

WET LOCATION RATED

### Cat. # MEBRH2P65

- 2 Heads
- 6 Volt
- 5.4 Watt

### Cat. # MEBRH2P65

- 1 Head
- 6 Volt
- 5.4 Watt



MEBRH2P65



MEBRH2P65

\*Consult with factory for various watt and voltage versions.

## Lighting Accessories

### Wire Guards

For use with MEBX, MEBELX, MEBRELX, MEBDX, MEBEMS2, MEBEMMR162  
13.5" x 15" x 6"

Cat. # MEBWG-1



Order two wire guards to place side by side for Exit/  
Emergency combo unit (MEBCX).

# EMERGENCY & EXIT LIGHTING

## Decorative Emergency Light

### Decorative Emergency Light

- Low-profile, decorative die-cast, emergency fixture
- Standard bronze finish
- Integrated test switch/pilot light
- Polycarbonate lens and mirrored reflector for maximum illumination
- Two 6W Xenon lamps offer more light output than standard incandescent lamps
- Universal transformer for 120 or 277 VAC
- Automatic, low voltage disconnect (LVD)
- Designed for wall mount or conduit through the top
- Standard operating temperature 32°F to 122°F
- Self-diagnostic option available
- Remote version available
- Listed for Wet Location

Cat. # MEBDEMBZ\* (Bronze)

\*Change BZ to W for White, B for Black, or N for Nickel finish.

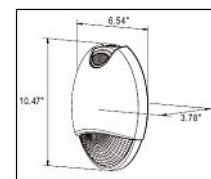

Dimensions

## 2 Head Emergency Fixture

### 2 Head Emergency Fixture - Battery Backup

- Completely self-contained
- Fully Automatic Operation
- 120 or 277 VAC operation
- Universal mounting plate
- Push to test switch

Cat. # MEBEMS2 / Cat. # MEBEMS2LED (LED)

Add B for Black.



MEBEMS2



MEBEMS2LED

### 2 Light Fixed Optics - Battery Backup

- Completely self-contained
- Fully Automatic Operation
- 120 or 277 VAC operation
- Universal mounting plate
- Push to test switch

Cat. # MEBELP2

Add B for Black.

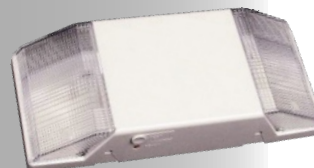

MEBELP2



MEBEMS2LEDRD

## 2 Head Emergency Fixture - MR16

### 2 Head Emergency Fixture - Battery Backup - MR16

- Ultra bright MR16 halogen lamps
- 6 Volt, sealed lead acid, rechargeable
- Fully Automatic Operation
- Completely self-contained
- Automatic, low-voltage disconnect (LVD)
- Push-to-test switch
- Dual Voltage, 120 or 277 VAC operation
- UL listed for damp location
- 2 x 5.4W Lamps

Cat. # MEBEMMR162

Add B for Black.



### 2 Head Emergency Fixture - Battery Backup - MR16

- Ultra bright MR16 halogen lamps
- 6 Volt, sealed lead acid, rechargeable
- Fully Automatic Operation
- Completely self-contained
- Automatic, low-voltage disconnect (LVD)
- Push-to-test switch
- Dual Voltage, 120 or 277 VAC operation
- UL listed for wet location
- 2 x 5.4W Lamps

Cat. # MEBEMMR162WP

Add B for Black.



## Wet Location Emergency Lighting

### 2 Head Emergency Fixture

- Ideal for wet locations, corrosive and dusty areas.
- ABS, corrosion-resistant enclosure
- Solid-state charging circuit
- Sealed momentary test switch
- UL listed for Wet Location
- Remote capable model offers 15W of remote capacity
- Short circuit overload protection on DC output circuit

Cat. # MEBEMWP2

Add RC for Remote Capable Model.



# EMERGENCY BALLAST

T5, T8 & T12 Battery Packs

The fluorescent emergency ballast allows the same fixture to be used for both normal and emergency operation. In the event of a power failure, the ballast switches to the emergency mode and operates one or two of the existing lamps for a minimum of 90 minutes. The unit contains a battery, charger and inverter circuit in a single package. The ballast can be mounted in the wireway or on top of the fixture. Damp location listed.



Item Number	Description
B11	450-500 Lumens - Works with: 17W - 40W, 4 FT. Max, T8, T10, T12, Slimline
B673-2	350-850 Lumens - Works with: Quad or Triple 2-Pin Fluorescents
B673	350-850 Lumens - Works with: 4-Pin Fluorescents
B48	700 Lumens - Works with: 17W - 215W, 8 FT. Max, T8, T10, T12, U-Lamp, Slimline
B223	1100-1400 Lumens - Works with: 17W - 215W, 8 FT. Max, T8, T10, T12, U-Lamp, Slimline
B510	3000 Lumens - Works with: 17W - 215W, 8 FT. Max, T8, T10, T12, BIAX, Slimline
B625	450-500 Lumens - Works with: 14W - 32W (2' - 4') T5 / T5HO
B585	800 Lumens - Works with: 14W - 54W (2' - 4') T5 / T5HO
B626	1300 Lumens - Works with: 17W - 40W, T8, T10, T12, (1) 8W - 54W T5 & T5HO lamp



## EMERGENCY BALLASTS

### LAMP COMPATIBILITY CHART

Mobern Item No	Lumen Output	LINEAR FLUORESCENT LAMPS							COMPACT FLUORESCENT LAMPS				
		T5 (W)		T5HO (W)	T8 (W)		U-Bend T8		4-Pin CFL (W)		4-Pin Long CFL (W)		2-Pin CFL (W)
1L: One lamp 2L: One or Two lamps	-	1L	2L	1L	1L	2L	1L	2L	1L	2L	1L	2L	1L
B673-2	650	-	-	-	-	-	-	-	-	-	-	-	13-26
B673	750	-	-	-	17-40	-	32,40	-	40-42	13-39	40-42	18-40	-
B11	500	-	-	-	17-40	-	32,40	-	13-39	-	13-39	-	-
B48	700	-	-	-	40-110	17-40	-	32,40	40-42	13-39	40-50	18-40	-
B223	1400	-	-	-	40-110	17-40	-	32,40	40-42	13-39	40-50	18-40	-
B510	3000	-	-	-	40-215	17-40	-	32,40	-	13-42	40-55	18-40	-
B625	500	14-28	8	-	17-32	-	-	-	-	13-26	-	-	-
B585	800	14-28	8	-	17-40	-	-	-	13-26	-	18-50	-	-
B626	1300	14-28	8	39, 54	17-40	-	32,40	-	26-42	13,18	36-50	18,24	-



## LED Lighting

While most agree that LED lighting is the future of lighting, there are just a few LED fixtures and lamps today that provide improved performance, value and energy savings over more traditional sources. Mobern has identified the LED fixtures and lamps that live up to the hype now. Smaller size, better color, more efficient, better output and energy savings are the benefits of our LED products. 3 year warranty and high performance LED's including Cree LEDs in some products distinguish Mobern offering. Check out [www.mobern.com](http://www.mobern.com) for more LED products coming all year long.

CONSULT FOR NEW LED INTRODUCTIONS

### LED Tape Light

LED Tapelight allows you to put light in the tightest space without tools, special wiring, or complicated installation. Simply peel 3M adhesive tape on back of each 18" tape and apply to the surface then plug in a driver and your done. Each LED is covered by epoxy to allow extra protection from the elements including water. You will have over 160 Luminous flux per 18 inches using less than 5 watts. Each 18" tapelight can be either joined to make a continuous run or joined with a 12" cable joiner to enable a single driver to power multiple strips.

The LED tapelight lasts up to 50,000 hours. If it is on 3 hours a day then it will highlight your space for the next 45 years. Choose from a selection of plug-in or hardwire drivers in different wattages to meet the needs of your specific application.

Item Number	Description
MLEDT18WW	4.5W - 18"L x .25"W - Warm White
MLEDT18CW	4.5W - 18"L x .25"W - Cool White
MLEDT10FTWW	27W - 120"L x .25"W - Warm White
MLEDT10FTCW	27W - 120"L x .25"W - Cool White
MLEDT18BL	4.5W - 18"L x .25"W - Blue
MLEDT18YLW	4.5W - 18"L x .25"W - Yellow
MLEDT18RGB	4.5W - 18"L x .25"W - Full Color
MLEDTD48WP	48 Watt capacity Plug-In Driver. Requires a MLEDTDCPI connector.
MLEDTD12WP	12 Watt capacity Plug-In Driver. Requires a MLEDTDCPI connector.
MLEDTD10WDW	10 Watt capacity Hardwire Driver. Requires a MLEDT6C connector.
MLEDTD25WDW	25 Watt capacity Hardwire Driver. Requires a MLEDT6C connector.
MLEDTDCPI	12" cable connects tape to plug driver.
MLEDTIC	Integral connector to join tape to tape or to connectors. (Each connection point requires one of these.)
MLEDTICELBOW	"L" connector to join two tapes 90 degree angle
MLEDTICCROSS	"X" connector to join four tapes.
MLEDTICTCONN	"T" connector to join three tapes.
MLEDT6C	Joins two LED tapes up to 12" apart. Requires two MLEDTIC.
MLEDRFDIMMER	RF Dimmer module adjust brightness infinitely, wireless control.
MLEDRGBCON	6-Key controller for RGB tape.



Installs easily with tape and adds drama to the scene. 10 ft tape available for runs.

Choice of colors.



LEDRGBCON

### Example of How to Layout and Order LED Tape

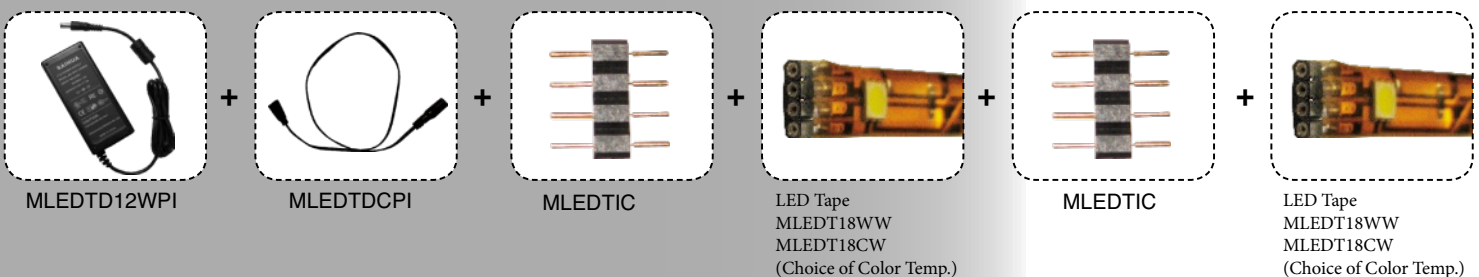

# LED LIGHTING

**LED Strip II** Ideal for cabinet lighting, cove lighting and other accent lighting applications. The aluminum housing can be used individually or joined together for longer runs and patterns. LED lamp provide a wide angle beam of light, 120 degree. Enjoy the benefits of LED with easy installation, long lamp life, and consistent color. Available in different lengths for use with 12V or 24V power supply.

Item Number	Description
MLEDRS6CW	6" Strip Warm White 1.8W, 140-160 Lumens
MLEDRS6WW	6" Strip Cool White 1.8W, 140-160 Lumens
MLEDRS12CW	12" Strip Warm White 3.5W, 270-320 Lumens
MLEDRS12WW	12" Strip Cool White 3.5W, 270-320 Lumens
MLEDRS24CW	24" Strip Warm White 7.2W, 550-650 Lumens
MLEDRS24WW	24" Strip Cool White 7.2W, 550-650 Lumens
MLEDRS48CW	48" Strip Warm White 14.4W, 900-1050 Lumens
MLEDRS48WW	48" Strip Cool White 14.4W, 900-1050 Lumens
MLEDRLINK	12" Joiner
MLEDRSSP5612	12" Cord between Strip and Driver
MLEDRSSP5648	48" Cord between Strip and Driver
MLEDTD48WPI	48W, Input 110V/220V, Output 12/24V
MLEDTD12WPI	12W, Input 110V/220V, Output 12/24V



\* See direct wire drivers in LED Tape on pg 60.

## LED Dimmable Undercabinet Task Lighting

This new LED undercabinet light provides the benefits of LED at a budget price. Utilizing less than a third the energy of fluorescent light and 75 percent less than xenon, this sleek LED undercabinet features Cree LED's engineered for wide spread comfortable task lighting. Choose from three sizes with integral LEDs and driver that can be used individually with a cord and plug and on/off switch provided or joined together with a mini coupler or 15" joiner cord also supplied with every fixture. An optional Hardwire Junction Box is available for hardwire applications. To dim use the hardwire junction box and one of the recommended dimmers.

Item Number	Description
MLEDDUCL12WH30	12 inch 5 watt w/3 Cree LEDs in 3000K
MLEDDUCL18WH30	18 inch 8 watt w/5 Cree LEDs in 3000K
MLEDDUCL24WH30	24 inch 11 watt w/7 Cree LEDs in 3000K
MLEDDUCLJBOXWH	LED Undercabinet hardwire Jbox white

For Bronze version change WH to BZ.



Mini Coupler (Expanded view)



Hardwire Junction Box mounts easily with two screws.

## LED MR16 and LED PAR

Item Number	Description
MLEDMR165FL30CW	MR16 5 Watt Cool White 5000-7000K 12V 30 Deg. Cree LEDs
MLEDMR165FL30WW	MR16 5 Watt Warm White 2500-3500K 12V 30 Deg. Cree LEDs
MLEDMR165RGB	RGB 5 Watt Color Changing MR16 (Requires Remote)
MLEDMR16RGBREM	Remote for RGB 5 Watt MR16 Color Changing
MLEDPAR3815CWDM	PAR 38 1.5Wx9 15.3W 1000 LUMEN, cool white (5500K)
MLEDPAR3815WWDM	PAR 38 1.5Wx9 15.3W 720 LUMEN, warm white (3500K)
MLEDPAR3011CWDM	PAR 30 1.5Wx7 10.5W 710 LUMEN, cool white (5500K)
MLEDPAR3011WWDM	PAR 30 1.5Wx7 10.5W 570 LUMEN, warm white (3500K)
MLEDPAR205CWDM	PAR 20 1.4Wx5 7W 450 LUMEN, cool white (6700K)
MLEDPAR205WWDM	PAR 20 1.4Wx5 7W 350 LUMEN, warm white (3150K)



MR16



MLEDPAR 38



MLEDPAR 20 - Dimmable



MLEDPAR 30



Remote for RGB

# Premium Performance Options

Mobern allows you to enhance each fixture with a variety of options to ensure that each fixture meets the exact requirements of the application. Some options improve the performance of the fixture in specific applications (ie: ballast choices, occupancy sensors, wire guards and lens), and some make installation easier and more user friendly. See all the options below. Consult factory to ensure that the options noted are available for the specific fixture you are specifying.

**Ballasts** Mobern strives to use the right ballast for every project with GE ballasts, the preferred brand. To meet your project's exact specifications, Mobern can use the brand and ballast of your choice.



**Fixture Equipped with a Quality GE Ballast**



- High Performance T8 Instant Start
- Multi-volt 120-277
- Nema Premium
- Consortium of Energy Efficiency (CEE) certified
- RoHs Compliant

To Order add G before voltage.



- Hi-Efficiency T8 Instant Start Ballast
- Multi-volt 120-277
- Nema Premium
- Consortium of Energy Efficiency (CEE) certified
- RoHs Compliant
- Anti-Striation Control
- UL CC Anti-Arc guard protection
- UL 55C Ambient temperature Rating
- -20 F Starting

To Order add GL,GH, GN before voltage.



- Program Start
- Hi-Efficiency T8 Instant Start Ballast
- For Frequent Starting --100K-250k starts
- Multi-volt 120-277
- Nema Premium
- Consortium of Energy Efficiency (CEE) certified
- RoHs Compliant
- Anti-Striation Control
- Starts in 700 millisecond (ms)

To Order add GPL, GPH, GPN before voltage.

**Ballast Options** Choose from a variety of ballast options. Add these ordering codes to the end of the specified item number to get the ballast shown.

### Brands

CODE NO.	DESCRIPTION
A	ADVANCE
G	GE BALLAST
L	LUTRON
S	SYLVANIA BALLAST
U	UNIVERSAL

### Performance Levels

Ballast			
Manufacturer	Standard ~ leave blank if no preference	High Efficiency Instant Start	High Efficiency Program Start
Advance (A)	Centium ICN (A)	Optanium (AL, AN, AH)	Optanium PS (APL, APN, APH)
GE (G)	Proline GE (G)	UltraMax (GL, GN, GH)	UltraStart (GPL, GPN, GPH)
Osram / Sylvania (S)	Quicktronic Pro QTP (S)	Quicktronic QHE (SL, SN, SH)	ProStart (SPL, SPN, SPH)
Universal (U)	ULT STD Electronic (U)	HP Electronic (UL, UN, UH)	AccuStart (UPL, UPN, UPH)

### Ballast Codes

CODE	DESCRIPTION
CMV	COLD START MULTI-VOLT
120V	ELECTRONIC 120V
277V	ELECTRONIC 277V
HMV	HIGH BALLAST FACTOR (1.14 TO 1.18)
NMV	NORMAL BALLAST FACTOR (1.0)
LMV	LOW BALLAST FACTOR (.75 TO .78) MULTI-VOLT
R120	RESIDENTIAL ELECTRONIC 120V.
480V	ELECTRONIC 480V
MV	ELECTRONIC 120 TO 277V
PMV	PROGRAM START MULTI-VOLT
NB	NO BALLAST

### Ballast Factor

Ballast Factor is the percentage of a lamp's rated lumen output when operated on a specific ballast. Changing the ballast factor will affect the lumen output and the energy consumed.

Example 1: F32T8 w/ 2800 design lumens X .87 ballast factor = 2436 lumens consuming 28 watts

Example 2: F32T8 w/ 2800 design lumens X 1.18 ballast factor = 3304 lumens consuming 38 watts

Ultra Low Ballast Factor (.66) : LL

Low Ballast Factor (.77) : L

Normal Ballast Factor (.88) : (N)

Medium Ballast Factor (1.0) : NN

High Ballast Factor (1.18) : H

### Multiple Ballast



Specify the number of ballasts required in the fixture based on how the fixture will be controlled. Add the following codes to the end of the ballast designation.

ITEM NO.	DESCRIPTION
11	Dual Ballasts 1 Lamp + 1 Lamp
21	Dual Ballasts 2 Lamp + 1 Lamp
22	Dual Ballasts 2 Lamp + 2 Lamp
31	Dual Ballasts 3 Lamp + 1 Lamp



# PREMIUM PERFORMANCE OPTIONS

## Dimming Ballasts

CODE	DESCRIPTION
AD120	120V MARK X DIMMING FOR LINE VOLTAGE FLUORESCENT DIMMERS. 2 ADD'L LEADS REQUIRED.
AD277	277V MARK X DIMMING FOR LINE VOLTAGE FLUORESCENT DIMMERS. 2 ADD'L LEADS REQUIRED.
ADMV	MULTIVOLT MARK VII 0-10V DIMMING FOR LOW VOLTAGE FLUORESCENT DIMMERS. 2 ADD'L LEADS REQUIRED.
SDMV	STEP DIMMING 100% OR 60%
DMV	SYLVANIA DIMMING 0-10V OR 2 WIRE PHASE CONTROL

Mobern can provide dimming ballasts from all major brands including Advance, Lutron, Sylvania and more. Choose either 0-10VDC system (4 input wires) or 2 wire system for T8 or T5 lamps. Mobern can also supply dimming options for compact fluorescent lamps. Sylvania's Quicktronic Powersense T8 and Quicktronic Helios T5 Dimming ballasts provide a range of features along with excellent value. Consult factory for the dimming ballast for your next project.

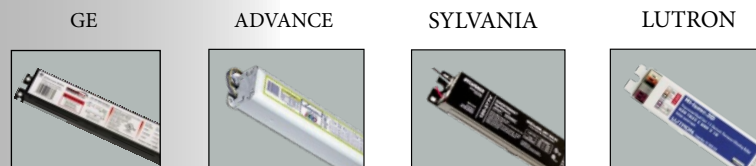

## T8 Dimming Matrix

BRAND NAME	Sylvania* (S)	GE (G)	GE UltraMax (G)		Philips/Advance (A)	Philips/Advance (A)	Lutron (L)	Lutron (L)
BALLAST NAME	T8 POWERSENSE	UltraStart N/H (3%)	Bi-Level	Var 60%	Mark 7	Mark 10	EcoSystem (10%*)	Hi-lume 3D (1%)
CONTROL TYPE	0-10V and/or 2-wire	4 wire 0-10v	2 hot leads	4 Wire 0-10V	4 wire	Two Wire Line Voltage	Digital or 3 wire	Digital or 3 wire
BALLAST NOMECLATURE	QTP#x32T8/UNV DIM	N-V03/H-VO3	Max90S60	Max90V60	RZT,VZT,IZT	REZ/VEZ	EC5, EC3...	H3D...
F17 T8	1, 2, 3, 4		1, 2, 3, 4, 5, (6)		1, 2, 3, 4	..	1, 2	1, 2, 3
F25 T8	1, 2, 3, 4		1, 2, 3, 4, 5		1, 2, 3, 4	1, 2, 3	1, 2	1, 2
F32 T8	1, 2, 3, 4	1, 2, 3, 4	1, 2, 3, 4, 5		1, 2, 3, 4	1, 2, 3	1, 2, 3	1, 2, 3

\*Quicktronic Powersense T8 Dimming Multi-Volt Operates (1 to 4) T8 Linear Lamps over a wide (100 - 5%) dimming range. Operates from standard low voltage (0-10VDC) fluorescent controllers or compatible 2-wire power line fluorescent dimmers, making them ideal for individual office lighting or automated building applications. Consult for other versions.

## T5 Dimming Matrix

BRAND NAME	Sylvania (S)	Sylvania (S)	Philips/Advance (A)	Philips/Advance (A)	Lutron (L)	Lutron (L)	Lutron (L)
BALLAST NAME	T5 POWERSENSE	T5HO Helios	Mark 7	Mark 10	EcoSystem (10%*)	Hi-lume 3D (1%)	Hi-lume (1%)
CONTROL TYPE	0-10V and/or 2-wire	0-10v	4 wire	Two Wire Line Voltage	Digital or 3 wire	Digital or 3 wire	3 wire
BALLAST NOMECLATURE	QTP2x28T8/UNV DIM	QT#x54/(volts)	RZT,VZT,IZT	REZ/VEZ	EC5, EC3...	H3D...	FDB...
F14 T5	2		..	..	1, 2	1, 2	
F21 T5	2		..	..	1, 2	1, 2	
F28 T5	2		..	..	1, 2	1, 2	
F35 T5	2		..	..	1		
F24 T5HO			..	2	1, 2	1, 2	1, 2
F39 T5HO			..	..	1, 2	1, 2	1, 2
F54 T5HO		1, 2	1, 2	1, 2	1, 2	1, 2	1, 2

Consult for other versions.

## Fluorescent Controls



LEVITON #	DESCRIPTION	RATING
For 2 Wire Ballasts		
A-IPX06-10	Preset Slider	600VA-120VAC
A-IPX10-10	Preset Slider	1000VA-120VAC
A-IPX06-70	Preset Slider	600VA-277VAC
A-IPX12-70	Preset Slider	1200VA-277VAC
For 0-10V Ballasts		
A-IPX710-DL	Preset Slider	1200VA @120/277 VAC

## HID Ballasts Kits



Update your HID fixtures with these ballast kits. Each kit contains lamp, core and coil ballast, pre-wired capacitor, ignitor (if applicable), mounting bracket and hardware.

CODE NO.	DESCRIPTION
MIBK35HPS	BALLAST KIT 35W HIGH PRESSURE SODIUM 120V
MIBK100HPSQV	BALLAST KIT 100W HIGH PRESSURE SODIUM QV
MIBK100MHQV	BALLAST KIT 100W METAL HALIDE QUAD VOLT
MIBK150HPSQV	BALLAST KIT 150W HIGH PRESSURE SODIUM QV
MIBK150MHQV	BALLAST KIT 150W METAL HALIDE QUAD VOLT
MIBK320MHPSQV	BALLAST KIT 320W METAL HALIDE PULSE START QV
MIBK1000MHPSQV	BALLAST KIT 1000W METAL HALIDE PULSE ST QV

# Occupancy Sensors

Adding occupancy sensors, daylight sensors or multi-level controls can increase energy savings by up to 30 percent. This comprehensive product line ensures that lights are turned off when spaces are unoccupied or light levels exceed a preset level. Sourcing top sensors from Leviton, Wattstopper and others, to ensure the right sensor for the application. The high bay occupancy sensors are designed to control lighting in high mount areas including warehouse aisle ways, open spaces and conveyor areas. The sensors turn lights on and off based on occupancy and install directly to T8 or T5 fixtures or to electrical junction boxes. Their specially designed lenses provide reliable coverage from a wide range of mounting heights.



SmartSense  
See pg 37 & 41  
for more details.



## High Bay Sensors



For wet location sensors  
order ASOW.

CODE	DESCRIPTION
OS	On/Off, 1 Pole, Wide Field 120 - 277V
OSN	On/Off, 1 Pole, Narrow Field 120 - 277V
OS480	On/Off, 1 pole, Wide Field 480V
OSW	On/Off, 1 pole, Wide Field Wet
OSC	On/Off, 1 pole, Wide Field Cold
OSPC (A412)	On/Off, Photocontrol, 1 pole, Wide Field 120 -277V
SS	On/Off, 1 pole, Integral Sensor Switch

### Operation

If no motion is detected for a field adjustable time delay, on/off sensors break power to the ballast(s). When multiple ballasts are specified, on/off sensors may control one or all ballasts.

## Wall Sensor



See pg 23 & 36  
for more details.



CODE	DESCRIPTION
0DS10IDW*	Decora White Wall Switch Occupancy Sensor, 120/277V rating. **

\*Consult for other wall and ceiling versions  
\*\* Load Rating: Fluorescent: 1200VA @ 120V 2700VA @ 277V;  
Incandescent: 800W @ 120V Motor: 1/4 HP @ 120V

## Mounting Kits



A411



AC120-  
TOGGLE



A-SCS



HC401

ITEM NO.	DESCRIPTION
<b>Linear Pendants</b>	
A-HC301WH	Cable kit with 4' Cable and Power Feed/Cable Included and White Canopy.
A-HC302WH	Cable kit with 12' Cable and Power Feed/Cable Included and White Canopy.
A-HC401WH	Cable kit with 4' Cable and Power Feed/Cable Included and White Canopy.
A-HC402WH	Cable kit with 12' Cable and Power Feed/Cable Included and White Canopy.
A-SCS24WH	One Stem kit with 24" Stem, Canopy and Mounting Hardware
A-2SCS24WH	Two stem kits with 24" Stem, Canopy and Mounting hardware for a 4' fixture.

ITEM NO.	DESCRIPTION
<b>High Bay Fluorescents</b>	
A411	Chain Kit, Incl. (6) S Hooks, 20Ft. Chain
A144-Footage	Tong Hangers, End Mount (Pair) with Footage of Chain
A144-SIDE	Tong Hangers, Side Mount (Pair)
A144-10	Tong Hangers, End Mount (Pair) With 10Ft. Chain Each
AC180-TOGGLE-2PK	15' 2 Pk Gripple Cable Hanger For Use With Holes In Hi-Bay
A-5HBD	Single Point Hanger Adapter For HBP Series 3/4" Hub
A-7HBD	Single Point Hanger Adapter For HBG Series 3/4" Hub
AC120-Y Hook	120" Cable Mounting Kit (2 assemblies)
AC120-Y Hook -VWFHB	120" Cable Mounting Kit (2 assemblies)
A142	Jack Chain (per foot)
A347	S hook (1)
A346	7.5" Y Hanger (1)

# PREMIUM PERFORMANCE OPTIONS

## Lamp Diffusers

Enhance your strip with Tube Guards or U shaped clip acrylic diffusers.



\*Please consult factory for additional options.

ITEM NO.	DESCRIPTION
LCLIP132	4' Matte White Diffuser W/ Clip for 4' one Light strip
LCLIP196	8' Matte White Diffuser W/ Clip for 8' one Light strip
LCLIP232	4' Matte White Diffuser W/ Clip for 4' two Light strip
LCLIP296	8' Matte White Diffuser W/ Clip for 8' two Light strip
A280	Amber Tube Guard for 4' T8
A132	Amber Tube Guard for 8' T12
A344	Blue Dark Tube Guard for 4' T8
A126	Blue Light Tube Guard for 4' T12
A151	Blue Tube Guard for 8' T12
A268	Clear Tube Guard for 2' T8
A214	Clear Tube Guard for 3' T12
A267	Clear Tube Guard for 3' T8
A262	Clear Tube Guard for 4' T12 (UV Rated)
A323	Clear Tube Guard for 4' T5 (28W)
A358	Clear Tube Guard for 4' T8 (UV Rated)
A81	Clear Tube Guard for 4' T12

ITEM NO.	DESCRIPTION
A107	Clear Tube Guard for 4' T12
A145	Clear Tube Guard for 4' T8
A82	Clear Tube Guard for 8' T12
A134	Clear Tube Guard for 8' T8
A121	Pink Tube Guard for 4' T12
A95	Red Tube Guard for 4' T12
A355	Red Tube Guard for 4' T12
A326	Red Tube Guard for 4' T5
A245	Red Tube Guard for 4' T8
A138	Red Tube Guard for 8' T12
A127	Yellow Tube Guard for 4' T12
A263	Yellow Tube Guard for 8' T12

Tube Guards not available for T5HO lamps.

## Reflector Options

Modern design, engineers and manufacturers its reflectors to put the light exactly where you want it. Choose from White Steel Reflector, Enhanced White Aluminum Reflector or Mirrored Reflectors in different configurations.

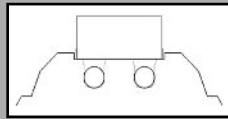

Style 1

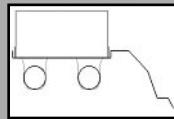

Style 2

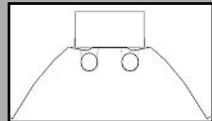

Style 3

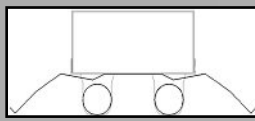

Style 4

ITEM NO.	DESCRIPTION	STYLE #
A-W30	White Steel Reflector	1
A-W14	Enhanced White Aluminum Reflector Standard Mount	1
A-M24	Mirrored Reflector Standard Mount	1
A-W30UP	White Steel Reflector Uplight	1
A-W35	White Steel Reflector Asymmetric	2
A-M25	Mirrored Reflector Asymmetric	2
A-M22	Mirrored Reflector Low Mount	4
A-W16	Enhanced White Aluminum Reflector High Mount	4
A-M26	Mirrored Reflector High Mount	4

## Fluorescent Wiring Options

Save time and money by having Mobern wire the fixture to make installation easier and faster. Add these codes to the item number to specify.



Whips: Flexible conduit, factory installed in access plate or EKO

SERIES	# OF WIRES	LENGTH	END FITTING	FINISH	VOLTAGE
WP - Whip	Blank (3 Wire)	Blank (Six Feet)	Blank (No Plug)	BK (Black)	Blank (120-277)
CS - Cordset	4 (4 Wire)	8 (Eight Feet)	P* (Standard Plug)	WH (White)	120 (120V)
	5 (5 Wire)	10 (10 Feet)	TL* (Twist Lock)		277 (277V)
		12 (12 Feet)	D** (Disconnect)		347 (347V)
		15 (15 Feet)	QC** (Quick Connect)		480 (480V)

\* Only for CS Required Voltage

\*\* Whip Only



Factory installed cord sets are available in black, white, various lengths, and plug styles.

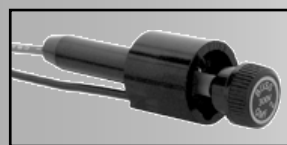

HLR/GLR/GMF

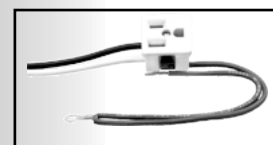

GCO



Disconnects may be added to any recessed fixture to meet National Electric Code (NEC) requirements.

# FLUORESCENT LAMPS

## Linear Fluorescents

### T8 - GE



Add GE Lamps to your fixtures. Add LN and the bold GE code to get the lamp installed in fixtures.

\*Lumens for 4100K Lumens

DESCRIPTION	LENGTH	CASE QTY.	RATED LIFE (12hr/Start)	INITIAL LUMENS*	**GE CODES by COLOR TEMPERATURE			
					3000	3500	4100	5000
<b>Standard (CRI 70+)</b>					3000	3500	4100	5000
F17T8/SP**/ECO	2'	24	24000	1325	45741	45743	45748	-
F25T8/SP**/ECO	3'	24	24000	2080	45750	45754	45756	-
F32T8/SP**/ECO	4'	36	36000	2800	26666	26667	26668	16090
<b>High CRI (CRI 80+)</b>								
F17T8/SPX**/ECO	2'	24	24000	1350	45742	45747	45749	-
F25T8/SPX**/ECO	3'	24	24000	2150	45753	45755	45757	-
F32T8/SPX**/ECO	4'	36	36000	2950	25611	25612	25613	42064
<b>Extra Life - High CRI (CRI 80+)</b>								
F17T8/XL/SPX**/ECO	2'	24	29000	1350	15481	15483	15484	10415
F25T8/XL/SPX**/ECO	3'	24	29000	2150	15486	15490	15491	10416
F32T8/XL/SPX**/ECO	4'	36	42000	2950	27619	27620	27621	16313
<b>High Lumen / Extra Life (CRI 80+)</b>								
F32T8/XL/SPX**/HL/ECO	4'	36	42000	3100	10327	10326	10322	42556
<b>Energy Saving 28 WATT (CRI 80+)</b>								
F28T8/XL/SPX**/ECO	4'	36	36000	2725	-	72864	72866	72867
<b>Super Energy Saving 25 WATT (CRI 80+)</b>								
F32T8/25W/SPX**/ECO	4'	36	40000	2400	-	72129	72130	72131

\*\* Your choice of Color Temp.

## Linear Fluorescents

### T5 - GE



Add GE Lamps to your fixtures. Add LN and the bold GE code to get the lamp installed in fixtures.

\*Lumens for 4100K Lumens

DESCRIPTION	LENGTH	CASE QTY.	RATED LIFE (12hr/Start)	INITIAL LUMENS*	**GE CODES by COLOR TEMPERATURE			
					3000	3500	4100	5000
<b>T5 Standard</b>					3000	3500	4100	5000
F14W/T5/8**/ECO	21.6	40	36000	1350	31590	46671	46673	46674
F21W/T5/8**/ECO	33.4	40	36000	2100	46677	46684	46687	46688
F28W/T5/8**/ECO	45.2	40	36000	2900	46704	46705	46706	46707
F35W/T5/8**/ECO	57.1	40	36000	3650	46724	46727	46735	46742
<b>T5HO High Output</b>								
F24W/T5/8**/ECO	21.6	40	36000	2000	46699	46700	46701	46702
F39W/T5/8**/ECO	33.4	40	36000	3500	46744	46745	46746	46747
F54W/T5/8**/ECO	45.2	40	36000	5000	46759	46760	47661	46762
F80W/T5/8**/ECO	57.1	40	36000	7000	46802	46803	46804	46805
<b>Ultra Energy Savings T5</b>								
F14W/T5/8**/WM/ECO	21.6	40	30000	1350	71632	71633	71634	71635
F21W/T5/8**/WM/ECO	33.4	40	30000	2100	71637	71638	71639	71640
F28W/T5/8**/WM/ECO	45.2	40	30000	2900	71642	71643	71644	71645
F35W/T5/8**/WM/ECO	57.1	40	30000	3650	71647	71648	71649	71650
<b>T5HO High Output Watt-Miser</b>								
F54W/T5/8**/WM/ECO	45.2	40	30000	5000	71627	71628	71629	71631
<b>T5 High Lumen</b>								
F28W/T5/8**/HL/ECO	45.2	40	24000	3050	71652	71653	71654	71655

\*\* Your choice of Color Temp.

# FLUORESCENT LAMPS

## Linear Fluorescents

### T8 - Sylvania



Add Sylvania Lamps to your fixtures. Add LN and the bold Sylvania code to get the lamp installed in fixtures.

DESCRIPTION	LENGTH	CASE QTY.	RATED LIFE (12hr/Start)	INITIAL LUMENS*	**SYLVANIA CODES by COLOR TEMPERATURE			
					3000	3500	4100	5000
Standard (CRI 70+)					3000	3500	4100	5000
FO17/7**/ECO	2'	30	30000	1300	21918	21769	21770	
FO25/7**/ECO	3'	30	30000	1950	21937	21941	21942	
FO32/7**/ECO	4'	30	30000	2900	21997	21998	21999	22141
High CRI (CRI 80+)								
FO17/8**/ECO	2'	30	36000	1350	22135	22136	22137	
FO17/8**/ECO	3'	30	36000	2150	22138	22139	22140	
FO32/8**/ECO	4'	30	36000	2950	21777	21779	21781	22143
Extra Life - High CRI (CRI 80+)								
FO17/8**/XP/ECO3	2'	30	42000	1375	21785	21778	21907	22193
FO25/8**/XP/ECO3	3'	30	42000	2175	21910	21776	21774	22194
FO32/8**/XP/ECO3	4'	30	42000	3000	21759	21763	21767	22026
High Lumen / Extra Life (CRI 80+)								
FO32/8**/XPS/ECO3	4'	30	42000	3100	21680	21697	21681	21660
Energy Saving 28 WATT (CRI 80+)								
FO28/830/XP/SS/ECO3	4'	30	42000	2725	22177	22178	22179	22184
Super Energy Saving 25 WATT (CRI 80+)								
FO32/25W/8**/XP/SS/ECO3	4'	30	42000	2500	22232	22233	22234	22235

\*\* Your choice of Color Temp.

## Linear Fluorescents

### T5 - Sylvania



Add Sylvania Lamps to your fixtures. Add LN and the bold Sylvania code to get the lamp installed in fixtures.

DESCRIPTION	LENGTH	CASE QTY.	RATED LIFE (12hr/Start)	INITIAL LUMENS*	**SYLVANIA CODES by COLOR TEMPERATURE			
					3000	3500	4100	5000
T5 Standard					3000	3500	4100	5000
FP14/8**/ECO	22.2	40	22000	1350	20907	20908	20914	
FP21/8**/ECO	34	40	22000	2100	20919	20921	20924	
FP28/8**/ECO	45.8	40	36000	2900	20868	20901	20902	22203
FP35/8**/ECO	57.6	40	24000	3650	20925	20926	20927	
T5HO High Output								
FP24/8**/HO/ECO	22.2	40	35000	2000	20928	20929	20931	
FP39/8**/HO/ECO	34	40	35000	3500	20932	20933	20934	
FP54/8**/HO/ECO	45.8	40	40000	5000	20903	20904	20906	20949
FP80/8**/HO/ECO	57.6	40	35000	7000	20935	20936	20937	
Ultra Energy Savings T5								
FP14/13W/8**/SSECO	22.2	40	30000	1350	21303	21304	21305	
FP21/19W/8**/SSECO	34	40	30000	2100	21306	21307	21308	
FP28/26W/8**/SSECO	45.8	40	30000	2900	21309	21310	21311	
T5HO High Output Watt-Miser								
FP54/51W/8**/HO/SS/ECO	45.8	40	40000	5000	21070	21071	20964	21072
T5HO High Output Super Saver								
FP54/47W/8**/HO/SS/ECO	45.8	40	40000	4575	20434	20435	20447	20448
T5 High Lumen								
FP28/8**/PM/ECO	45.8	40	36000	3050	20948	20943	20944	

\*\* Your choice of Color Temp.

# FLUORESCENT LAMPS

## Linear Fluorescents

### T8 - Philips

**PHILIPS**



Add Philips Lamps to your fixtures. Add LN and the bold Philips code to get the lamp installed in fixtures.

DESCRIPTION	LENGTH	CASE QTY.	RATED LIFE (12hr/Start)	INITIAL LUMENS*	**PHILIPS CODES by COLOR TEMPERATURE			
					3000	3500	4100	5000
Standard (CRI 70+)					3000	3500	4100	5000
F32T8/TL730 ALTO 25PK	48	25	30000	2700	272526	272492	272484	272682
High CRI (CRI 80+)								
F17T8/TL8**/ALTO 25PK	24	25	30000	1350		367912	367938	141234
F25T8/TL8**/ALTO 25PK	36	25	30000	2150		368142	368258	141242
F32T8/TL8**/ALTO 25PK	48	25	30000	2850	246678	246702	246710	272294
Extra Life - High CRI (CRI 80+)								
F17T8/TL8**/PLUS/ALTO 25	24	25	36000	1400	145524	145532	145540	145557
F25T8/TL8**/PLUS/ALTO 25	36	25	36000	2225	145565	145573	145581	145599
F32T8/TL8**/PLUS/ALTO 25	48	25	36000	2950	360008	360016	360024	360032
High Lumen / Extra Life (CRI 80+)								
F32T8/28W/ADV8**/XLL ALTO	48	25	40000	2675	234542	237263	169334	169383
Energy Saving 28 WATT (CRI 80+)								
F32T8/ADV8**/EW/ALTO 28W	48	25	36000	2725	147322	147330	147348	147355
Super Energy Saving 25 WATT (CRI 80+)								
F32T8/ADV8**/XEW/ALTO 25	48	25	36000	2500	137810	137828	137836	137844

\*\* Your choice of Color Temp.

## Linear Fluorescents

### T5 - Philips

**PHILIPS**



Add Philips Lamps to your fixtures. Add LN and the bold Philips code to get the lamp installed in fixtures.

DESCRIPTION	LENGTH	CASE QTY.	RATED LIFE (12hr/Start)	INITIAL LUMENS*	**PHILIPS CODES by COLOR TEMPERATURE			
					3000	3500	4100	5000
T5 Standard					3000	3500	4100	5000
F14T5/8**/ALTO 40PK	22	40	35000	1350	230771	230797	230805	412759
F21T5/8**/ALTO 40PK	34	40	35000	2100	230813	230821	230839	414342
F28T5/8**/ALTO 40PK	46	40	35000	2900	230847	230854	230862	412767
	58	40	35000	3650	230888	230912	230953	
T5HO High Output								
F24T5/8**/HO/ALTO 40PK	22	40	35000	2000	290197	290205	290213	46702
F39T5/8**/HO/ALTO 40PK	34	40	35000	3500	290221	290239	290254	46747
F54T5/8**/HO/ALTO 40PK	46	40	35000	5000	290262	290288	290833	46762
F80T5/8**/HO/ALTO 40PK	58	40	35000	7000	290841	147447	290882	46805
Ultra Energy Savings T5								
F28T5/25W/8**/HE EA	46	40	40000	2900	406306	406314	406322	414201
T5HO High Output Watt-Miser								
F54T5/8**/HO/EA/ALTO 49W	46	40	40000	5000	220491	220509	220525	406496

\*\* Your choice of Color Temp.

# FLUORESCENT LAMPS

## Name Brand 8 FT Fluorescent Lamps



TYPE	GE	PHILIPS	SYLVANIA	WATTAGE	LENGTH*	CASE QTY*	RATED LIFE* (12H/START)	INITIAL LUMENS*
T12, 8 FT	F96T12/CW/WM	F96T12/CW/EW/ALTO	F96T12/CW/SS	60	96"	15	12000	5500
T12HO, 8 FT	F96T12/CW/HO/CT	F96T12/CW/HO-O ALTO 15PK	F96T12/CW/HO/ COLD TEMP	95	96"	15	12000	8000
T8, 8 FT	F96T8/SP**/ECO	F96T8/TL735 PLUS ALTO 25	FO96/741/ECO	59	96"	24	20000	5800
T8HO, 8 FT	F96T8/SP**/HO	F96T8/TL8**/HO/ PLUS ALT		86	96"	24	18000	8000
T8, 8 FT LL	F96T8/XL/SP**/ECO	F96T8/TL735 PLUS ALTO 25		59	96"	24	29000	5800

\*Based on GE Lamp  
\*\* Your choice of Color Temp.

## Name Brand CFL Fluorescent Lamps



TT



QT



TTT



TT5

TYPE	GE	PHILIPS	SYLVANIA	WATTAGE	LENGTH*	CASE QTY*	RATED LIFE* (12H/START)	INITIAL LUMENS*
TT, 9W 2 PIN	F9BX/8**/ECO	PL-S 9W/8**/2P	CF9DS/**/ECO	9	6.6"	100	10000	600
TT, 13W 2 PIN	F13BX/8**/ECO	PL-S 13W/8**/2P	CF13DS/**/ECO	13	7"	100	10000	825
TT, 13W 4 PIN	F13BX/E/8**/ECO	PL-S 13W/8**/4P	CF13DS/E/8**	13	7"	100	10000	825

TYPE	GE	PHILIPS	SYLVANIA	WATTAGE	LENGTH*	CASE QTY*	RATED LIFE* (12H/START)	INITIAL LUMENS*
QT, 13W 2 PIN	F13DBX/8**/ECO	PL-C 13W/**/ALTO 10P	CF13DD/8**/ECO	13	5.3"	50	10000	900
QT, 13W 4 PIN	F13DBX/8**/ECO4P	PL-C 13W/**/4P/ALTO	CF13DD/E/8**/ECO	13	5"	50	20000	900
QT, 18W 4 PIN	F18DBX/8**/ECO4P	PL-C 18W/8**/ALTO	CF18DD/E/8**	18	5.8"	50	12000	1250

TYPE	GE	PHILIPS	SYLVANIA	WATTAGE	LENGTH*	CASE QTY*	RATED LIFE* (12H/START)	INITIAL LUMENS*
TTT, 26W 4 PIN	F26TBX/8**/A/ECO	PL-T 26W/8**/4P/ALTO	CF26DT/E/IN/8**/ECO	26	5.2"	10	12000	1710
TTT, 32W 4 PIN	F32TBX/8**/A/ECO	PL-T 32W/8**/4P/ALTO	CF32DT/E/IN/8**/ECO	32	5.5"	10	12000	2400
TTT, 42W 4 PIN	F42TBX/8**/A/ECO	PL-T 42W/8**/4P/ALTO	CF42DT/E/IN/8**/ECO	42	6.4"	10	12000	3200

TYPE	GE	PHILIPS	SYLVANIA	WATTAGE	LENGTH*	CASE QTY*	RATED LIFE* (12H/START)	INITIAL LUMENS*
TT5, 18W	F18BXSPX**/RS	PL-L 18W/8**/4P	FT18DL/8**/RS/ECO	18	10.5"	10	20000	1250
TT5, 27W	F27/BX/SPX**	PL-L 24W/8**/4P	FT24DL/8**/ECO	27	12.8"	10	12000	1800
TT5, 40W	F40/30BX/SPX**	PL-L 40W/8**/4P/RS/IS	FT40DL/**/ECO	40	22.5"	10	20000	3150
TT5, 50W	F50BX/SPX**/RS	PL -L50W/8**/4P/RS	FT50DL/8**/RS/ECO	50	22.5"	10	14000	4000
TT5, 55W	F55BX/8**	PL -L55W/8**/4P/RS	FT55DL/8**/ECO	55	20.7"	10	10000	4800

\*Based on GE Lamp  
\*\* Your choice of Color Temp.

# COMPACT FLUORESCENTS

## GU24 Base Compact Fluorescents



Lamp	Color Temp	Pack	Length	Dia	Initial Lumens	Rated Life
SL9WGU	27K, 30K, 41K, 50K	12	4.13"	2"	550	10000
SL13WGU	27K, 30K, 41K, 50K	12	4.27"	2.14"	900	10000
SL18WGU	27K, 30K, 41K, 50K	12	4.5"	2.5"	1200	10000
SL23WGU	27K, 30K, 41K, 50K	12	4.4"	2.4"	1600	10000
SL27WGU	27K, 30K, 41K, 50K	12	4.8"	2.4"	1850	10000
SL32WGU	27K, 30K, 41K, 50K	12	6.5"	3"	2200	10000
SL42WGU	27K, 30K, 41K, 50K	12	6.5"	3"	2800	10000



Lamp	Color Temp	Pack	Length	Dia	Initial Lumens	Rated Life
A9WGU	27K, 35K	12	4.75"	2.5"	450	10000
A14WGU	27K, 35K	12	5"	2.75"	800	8000
A19WGU	27K, 35K	12	5.75"	3"	900	8000



Lamp	Color Temp	Pack	Length	Dia	Initial Lumens	Rated Life
G2514GU	27K	6	4.6"	3.12"	800	8000



Lamp	Color Temp	Pack	Length	Dia	Initial Lumens	Rated Life
R3016WGU	27K	6	4.6"	3.7"	750	8000
R4016WGU	27K	6	5.3"	4.8"	750	10000
R4023WGU	27K	6	5.3"	4.8"	750	10000

Add Color Temperature Designation to Lamp Number.  
Product Data is representative. Exact Data is based on specific brand provided.

## Spiral Fluorescents



T2 Spiral



T3 Spiral

ITEM NO.	CASE QTY.	DESCRIPTION
<b>T2 Spiral**</b>		
FE-IISB-5W/27K E12	100	5 watt 2700K, 225 Lumens, 25W Incand Equiv
FE-IISB-9W/27K*	100	9 watt 2700K, 520 Lumens, 40W Incand Equiv
FE-IISB-11W/27K*	100	11 watt 2700K, 740 Lumens, 50W Incand Equiv
FE-IISB-14W/27K*	100	14 watt 2700K, 900 Lumens, 60W Incand Equiv
FE-IISB-19W/27K*	50	19 watt 2700K, 1200 Lumens, 75W Incand Equiv
FE-IISB-23W/27K*	50	23 watt 2700K, 1600 Lumens, 100W Incand Equiv
FE-IISB-26W/27K	50	26 watt 2700K, 1800 Lumens, 100W Incand Equiv
<b>T3 Spiral**</b>		
FE-IIS-30W/27K	50	30 watt 2700K, 2000 Lumens, 120W Incand Equiv
FE-IS-40W/27K	50	40 watt 2700K, 2650 Lumens, 150W Incand Equiv
*Energy Star		

\*\*Available in 4100K (41K), 5000K (50K), and 6500K (65K).



## COMPACT FLUORESCENTS

Reflector Flood Lights  
PAR30 & PAR38 Styles



ITEM NO.	CASE QTY.	DESCRIPTION
Indoor/Outdoor Flood		
SKR2009FLWW	48	9 Watt PAR20 Reflector Flood Light, 2700 Kelvin
SKR2009FLDL	48	9 Watt PAR20 Reflector Flood Light, 5000 Kelvin
SKR3015FLWW	12	15 Watt PAR30 Reflector Flood Light, 2700 Kelvin
SKR3820FLWW*	12	20 Watt PAR38 Reflector Flood Light, 2700 Kelvin
SKR3823FLWW*	12	23 Watt PAR38 Reflector Flood Light, 2700 Kelvin
SKR3823FLDL	12	23 Watt PAR38 Reflector Flood Light, 5000 Kelvin

\*Energy Star 

OzoneLite



An Amazing New Technology!

- TIO2 Technology used also by NASA.
- Removes airborne mold spores, viruses and bacteria.
- Eliminates odors from smoke, must and pets.
- Does not emit ozone.
- Energy Star approved.
- No filters to worry about.

ITEM NO.	CASE QTY.	DESCRIPTION
OZ2327*	24	23 Watt Spiral, 2700 Kelvin
OZ2355*	24	23 Watt Spiral, 5500 Kelvin - Full Spectrum
OZ4227*	24	42 Watt Spiral, 2700 Kelvin
OZ4255*	24	42 Watt Spiral, 5500 Kelvin - Full Spectrum

\*Energy Star 

## HID LAMPS

Metal Halide



ITEM NO.	CASE QTY.	DESCRIPTION
MH50/U/MED Import	24	50 Watt Clear Metal Halide Lamp
MH70/U/MED Import	24	70 Watt Clear Metal Halide Lamp
MH100/U/MED Import	24	100 Watt Clear Metal Halide Lamp
MH150/U/MED Import	24	150 Watt Clear Metal Halide Lamp
MH250/U/PS Import	24	250 Watt Mogul Base Pulse Start Metal Halide
MH300/U/PS Import	24	300 Watt Mogul Base Pulse Start Metal Halide
MH400/U/PS Import	24	400 Watt Mogul Base Pulse Start Metal Halide

High Pressure  
Sodium



ITEM NO.	CASE QTY.	DESCRIPTION
LU50/MED Import	24	50 Watt Clear High Pressure Sodium Lamp
LU70/MED Import	24	70 Watt Clear High Pressure Sodium Lamp
LU100/MED Import	24	100 Watt Clear High Pressure Sodium Lamp
LU150/MED Import	24	150 Watt Clear High Pressure Sodium Lamp
LU250/MED Import	24	250 Watt Mogul Base High Pressure Sodium
LU400/MED Import	24	400 Watt Mogul Base High Pressure Sodium

# INDEX (by series)

1.....25	DECCD.....41	MBPC.....44	MILGFLT.....54,55	SEI.....20
9.....25	DECCJ.....41	MBPW.....49	MILGRFLT.....54	SKY.....5
10M.....21	DECCK.....42	MBRL.....50	MILGWPK.....48,53	SPR.....13
10T5.....20,39	DECCL.....42	MBRP.....50	MIMDCL.....43,48	SR.....13
15.....15	DECCM.....42	MBRW.....50	MIMDCOWPK.....	SRDI.....12
41.....22	DECCR.....42	MCBP.....44	.....48,53	SRDIS.....12
41SC.....21	DECCT.....42	MCE.....18	MIMDFTFLT.....54	SRDISD.....12
42.....22	DECPLCA.....41	MCEO.....47	MIMDPR.....55	SS.....31,70
42SC.....21	DECSFD.....41	MCEOC.....47	MIMDRBFLT.....49	SSKY.....13
44.....23	DECT9CA.....41	MCEOG.....47	MIMDRFLT.....54	SVP.....17
44SS.....24	DECWD.....45	MCEOS.....47	MIMDWPK.....48,52	SVP.....42
44TSS.....24	DECWF.....45	MCER.....47	MIMFLT.....48,54	VAP.....46
68.....42	DECWG.....45	MCERC.....47	MIMWPK.....48,52	VB.....39
69.....42	DECWH.....45	MCERG.....47	MIMWPKRD.....	VBFR.....45
74.....38	DECWV.....45	MCH.....18	.....48,52	VT.....17
76.....40	DECWW.....45	MCOL.....50	MIPK.....55	VW.....16
76CL.....43	DIS.....10	MCOP.....50	MIRBFLT.....54	VWCL.....16
76T5.....40	DLV.....11	MCOW.....50	MIRDCOWPK.....	VWFHB.....30
77.....40	DMV.....69	MCS.....42	.....48,53	VWIFHB.....30
77X.....40	F4.....60	MDC.....19	MISMCL.....43, 48	VWN.....16
78.....40	F5.....60	MDF601.....58	MISMWPK.....52	WLPC.....49
79.....38	F6.....60	MDFH.....58,59,60	MISSA.....55	WM22.....36
80.....23	FHB.....27	MDFT.....58,59,60	MLEDDUCL.....67	WM44.....37
81.....23	FHB1.....27	MDFV.....58,59	MLEDMR.....67	WM66.....37
155.....37	FHB3.....27	MDH.....51	MLEDPAR.....67	WMPC.....49
155SW.....37	FHB4.....27	MDSH.....61	MLEDR.....66,67	WP.....31,71
158.....38	FHBA.....27	MDST.....61	MLEDRS.....67	WP.....39,45
741.....38	FHBA1.....27	MEBDEM.....64	MLEDRT.....61	WRC.....43
769.....14	FHBF.....28	MEBDPF.....63	MLEDT.....66,67	WSC.....43
770.....14	FHBG.....31	MEBDX.....63	MNOB.....50	WSPC.....49
772.....14	FHBI.....29	MEBEL.....64	MNOP.....50	
772N.....15	FHBR.....29	MEBELX.....62	MNOW.....50	
774.....15	FHBX.....29	MEBEMMR.....64	MTOL.....51	
779.....15	FLRG.....32	MEBEMS.....64	MTOLB.....51	
791.....15	H.....16	MEBEMW.....64	MTOP.....51	
A.....70,71	H137.....30	MEBREIX.....62	MUSI.....61	
A2SC.....70	H211.....30	MEBRH.....63	MWCC.....44	
A-5HBD.....31,70	HAL.....43	MEBWG.....63	MWPC.....44	
A-7HBD.....31,70	HPI.....25	MEBX.....62	OS.....31,70	
A-10T5.....20,39	L-FHBF.....28	MEMCX.....62	PBLI.....10	
A69,A70.....23	LAMPS.....72-77	MEMXLR.....63	PMI2AF.....55	
A71,A72.....25	LEN OPTIONS.....7	MEO.....47	PMIA41.....55	
A144.....28,31,70	LI.....9	MEOC.....47	PMISSA.....55	
A411.....31,70	LI22.....11	MEOG.....47	RDICB.....5	
AC120.....28,31,70	LI44.....11	MEOS.....47	RDIS.....4	
AD.....17,69	LI66.....11	MER.....47	RDISB.....5	
A-FHBA.....7	LIB.....9	MERC.....47	RDISD.....4	
A-FHBA1.....27	LIS.....9	MERG.....47	RF.....8	
A-FHBD.....27	LIWMB.....36	MF1212.....43	RG.....7	
A-FHBF.....28	LIWMP.....36	MF4518.....61	RGWW.....8	
A-FHBG.....31	LIWMS.....36	MF9595.....43	RIOD.....5	
A-FHBI.....29	LPLI.....10	MFL.....39	RKBC4.....34	
AHC.....70	M5.....7	MGOW.....50	RKBC8.....34	
A-IPX.....69	MAOL.....51	MGP.....50	RKDIC.....34	
A-M.....71	MAOP.....51	MHOL.....51	RKDID.....35	
AOD.....17	MAOW.....51	MHOP.....51	RKSC.....33	
A-W.....71	MAPW.....51	MHOW.....51	RKSR.....33	
A-WG.....57	MARP.....55	MI2AF.....55	RKT.....32	
B.....65	MARPCFN.....56	MIA41.....55	RP.....6	
C9.....19	MARPL.....56	MIBK.....69	RPHE.....6	
C15.....19	MARPT.....56	MIHB.....57	RPL.....8	
CS.....31,71	MBBP.....44	MILB.....57	RWW.....8	
CWN.....19	MBCC.....44	MILFWPK.....53	SC.....18	
DECBPC.....41	MBOLF.....56	MILGCOWPK.....	SDI.....13	
DECCB.....41	MBOLR.....56	.....48,53		

## Mobern Lighting

### THREE YEAR LIMITED WARRANTY

A. Mobern Lighting warrants that its products (other than ballasts) are free of defects in workmanship and materials. SUCH WARRANTY IS IN LIEU OF OTHER WARRANTIES INCLUDING WITHOUT LIMITATION, ANY IMPLIED WARRANTIES OF MERCHANTABILITY OR FITNESS FOR A PARTICULAR PUPOSE. Mobern Lighting, at its sole option, will repair or replace, F.O.B. our factory, freight prepaid, any Mobern Lighting products (other than ballasts) defective in workmanship or materials. Such repair or replacement is the sole and exclusive remedy against Mobern Lighting and is limited to three years from date of shipment. Mobern Lighting reserves the right to determine whether to repair or replace. No charge-back, or charge for labor or material, that does not have Mobern Lighting' prior written approval from its Corporate Offices in Maryland will be honored, accepted or paid by Mobern Lighting. Mobern Lighting will not be responsible for any consequential or incidental damages in connection with any breach of its aforementioned warranty.

B. Ballasts and emergency battery packs are covered by separate ballast manufacturers warranties. Mobern Lighting does not make any warranties whatsoever as to ballasts and will accept no responsibility or liability whatsoever therefore.

C. Mobern Lighting will not be responsible for any products subjected to inappropriate application or installed or modified in any way that is not in accordance with Mobern Lighting' instructions.

D. No agent, employee or representative of Mobern Lighting has any authority to bind Mobern Lighting to any affirmation, representation or warranty concerning goods sold by Mobern Lighting and unless an affirmation, representation or warranty made by an agent, employee or representative is specifically included herein, or in Mobern Lighting' acknowledgment or Buyer's purchase order, or in standard printed materials provided by Mobern Lighting, it does not form a part of the basis of any bargain between Mobern Lighting and Buyer and shall not in any way be enforceable by Buyer.



GSD Division - Government / ESCO Focus

- Mobern has a separate division to handle government and ESCO energy efficient work
- Custom fabrication capabilities to retrofit fixtures in field - critical to ROI / Performance driven contracts
- Custom prefabricated mounting products to reduce labor cost and speed installation of lighting products in field - critical to ROI / Performance driven contracts (picture available)
- In house staff to make product recommendations for special or "no retrofit available" applications
- Mobern is GSA approved and on the GSA schedule
- We have an experienced GSA in house representative to assist you in navigating GSA work
- Mobern is experienced in Government Requirements and can assist where needed in documentation
- Mobern can recommend set aside Distributors and Contractors (MBE, SDVOSB, etc.) to help meet set aside goals
- GSA representative opportunities available throughout the US - please contact us at 1.800.444.WATT

Note regarding Mobern Item Numbers:

With the explosion of part variations available today Mobern has simplified their base part numbering sequence to allow these additional options. The most obvious being the change from ELO DT to a straight MV. Since all the fluorescent ballast used by Mobern are electronic by nature we have done away with "ELO". And as ballast have moved from a dual tap to a Multi-volt / Multi-Hz design we have replaced DT with MV. Lamp size and type are now designated by the lamp wattage. If you have any questions please consult with factory for product verification.



Practical Energy Efficient Solutions

**MOBERN**

L I G H T I N G

FLUORESCENT | HID | LED

Mobern Lighting  
9731 Washington Blvd • Laurel, Maryland 20723  
1.800.444.WATT • Fax: 301.953.9310  
[www.mobern.com](http://www.mobern.com)