



Table of Contents



Pulling Grips



Support Grips



Cord Connectors



Product	Page	Product	Page
Products at a Glance	V-2	Strain Relief System Selection Chart	V-48
Quick Reference Selection Guide for Grip Applications	V-3	Deluxe Cord Grips	V-50
Kellems® Wire Mesh Grips Diagram	V-4	PG and Metric Threaded Deluxe Cord Grips	V-54
Pulling Grips		Dust-Tight Strain Relief Grips	V-55
Overhead DUA-PULL® and Multiple Strength	V-7	I-Grips	V-56
Underground K-Type and T-Type	V-8	Thread Adapters for Multi-Pin Connectors	V-57
Special Purpose	V-9	Strain Relief Grips for Liquidtight Conduit	V-58
Low Tension	V-13	Cord Connectors	
Wire Rope Splicing	V-14	Male Connectors	V-70
Cable Splicing	V-15	Female and Underground Feeder Connectors	V-73
Tools, Bands, and Swivels	V-16	Low Profile NPT, PG and Metric Thread Connectors	V-74
Support Grips		Accessories	V-75
Standard Duty	V-20	Hubbell Juniors® Miniature Cord Connectors	V-76
Special Purpose	V-24	PolyTuff® I and PolyTuff® II Non-Metallic Liquidtight	
Heavy Duty	V-24	Conduit Tubing	V-89
Service Drop	V-26	Non-Metallic Liquidtight Fittings	V-90
Bus Drop	V-28	Metallic Liquidtight Conduit Fittings	V-91
Conduit Riser	V-29		
Fiber Optic Cable Grips	V-38		
Hose Containment Grips	V-46		



Products at a Glance



Pulling Grips

- The galvanized steel mesh grip provides strength for secure pulling jobs
- Endless weave allows easy installation onto cable
- Flexible or rotating eyes will mate easily with line stringing swivels for attachment to pulling lines; they have great strength for trouble free pulling jobs
- Shoulder protectors contain the cable inside the grip



Support Grips

- Solid eye assemblies provide eye reinforcement at support hardware
- Four eye styles available: single, double, universal and offset
- Identification tag shows: catalog number, diameter range, agency approval and bar code
- Available in tin coated bronze, stainless steel and non-metallic aramid fiber



Fiber Optic Cable Grips

- Pulling Grips are used for outside plant cable; they are easy to install and remove, reusable and have a slim profile for small build up
- OPTISOK® Grip is a revolutionary tool to pull pre-terminated fiber optic cables. They will protect the connectors and guide the bundle through the pulling environment
- Will support the cable's weight as it hangs in vertical, sloping or horizontal position



Strain Relief Grips

- Stainless steel mesh is corrosion resistant. Can be used inside or outside
- Multiweave grip gives cable arc-of-bend control minimizing cable damage and extending cable life
- A liquidtight fitting is available with both cable and conduit fittings; prevents liquids from running through the fitting into the enclosure



Cord Connectors

- Machined threads provide a strong positive seal; the tapered interior dome easily drives the bushing into the connector bod
- Patented GOTCHA® ring incorporates a split hinge design to prevent friction and provide strain relief
- Lubricated neoprene bushing compresses easily for a liquidtight seal and added pull-out protection



PolyTuff® Non-Metallic Liquidtight Conduit and Fittings

- Nylon compression nut has a tapered dome to tighten ferrule onto conduit
- Tapered, machined threads fasten securely and provide additional liquidtight sealing
- Non-integral, reusable steel, ferrule is easily installed, to seal conduit
- PVC tubing handles twists, turns, bends, switchbacks and straightaways with ease
- UL listed/recognized and CSA certified



Quick Reference Selection Guide for Grip Applications

Pulling Grips

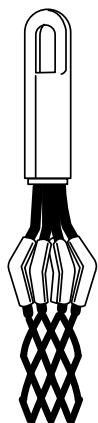

Heavy-Duty Rotating Eye

For underground wiring and overhead heavy-duty pulling of service lines and new construction cable. See pages V-8 and V-9.

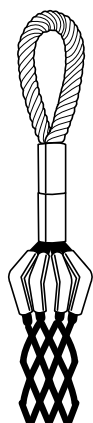

Heavy-Duty Flexible Eye

For overhead transmission and distribution line stringing. See pages V-7, V-8, and V-10.



Slack Grips

For removing underground cable and pulling slack in existing cable and new installations and when end of cable is not available. See pages V-11 and V-12.



Light-Duty Flexible Eye

For light industrial pulling of electrical cable and for underground and industrial plant wiring and re-wiring. See page V-13.

Support Grips

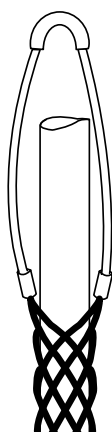

Single Eye

For single hook attachment of permanent indoor/outdoor cable. Available on heavy-duty, standard duty, and service drop grips. See pages V-20, V-24, and V-26.

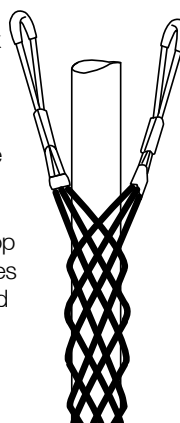

Double Eye

For double hook attachment of permanent indoor/outdoor cable. Available on heavy-duty and standard duty grips. See pages V-21 and V-25.

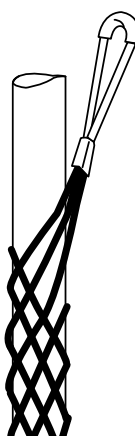

Single Offset Eye

For offset hook attachment of permanent indoor/outdoor cable. Available on standard duty and light-duty support grips. See page V-22.

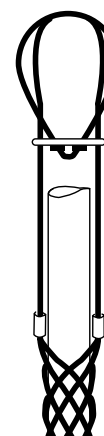

Universal Eye

Used to fasten around a structure or closed loop. Available on standard duty support and light or heavy duty service drop grips. See pages V-23 and V-27.

Support Grips

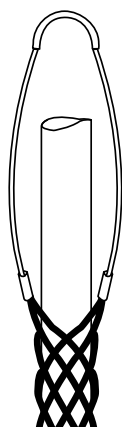

Wide Range Bus Drop

Used indoors for cable support where flexible cable connects electrical equipment to bus duct. Support air hose and water hose. See page V-28.



Dust-Tight Strain Relief

Indoor use only for wiring of electrical enclosures, machine tools, portable power tools, bus drop cable systems. See page V-55.

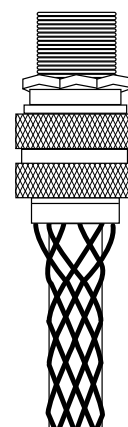

Deluxe Cord

Indoor or outdoor use where subject to moisture, splash, or washdown. Examples are enclosures, crane hoist and pendant drop stations, hand tools, pumps, and processing equipment. Available in straight, 90°, or 45° configurations. See pages V-50 to V-54.



Liquid-Tight, Flexible Metal Conduit

Wiring of machine tools, electrical enclosures, motors, and systems subjected to vibration, flexure, motion, or strain. Available in straight, 90°, or 45° configurations. See pages V-58 to V-60.

Other Specialty Grips

Splicing Grips

Used as temporary splice for cable and wire rope, or as reinforcement to protect cables and hoses. See pages V-14 and V-15.

Conduit Riser Grips

Ideal for supporting electrical wires inside rigid conduit via a supporting ring. See pages V-29 to V-31.

Hose Containment Grips

Used on flexible hose lines to prevent violent whipping of hose in the event of failure at the fitting. See pages V-46 and V-47.

Specifications are subject to change without notice.



Kellems® Wire Mesh Grips Diagram

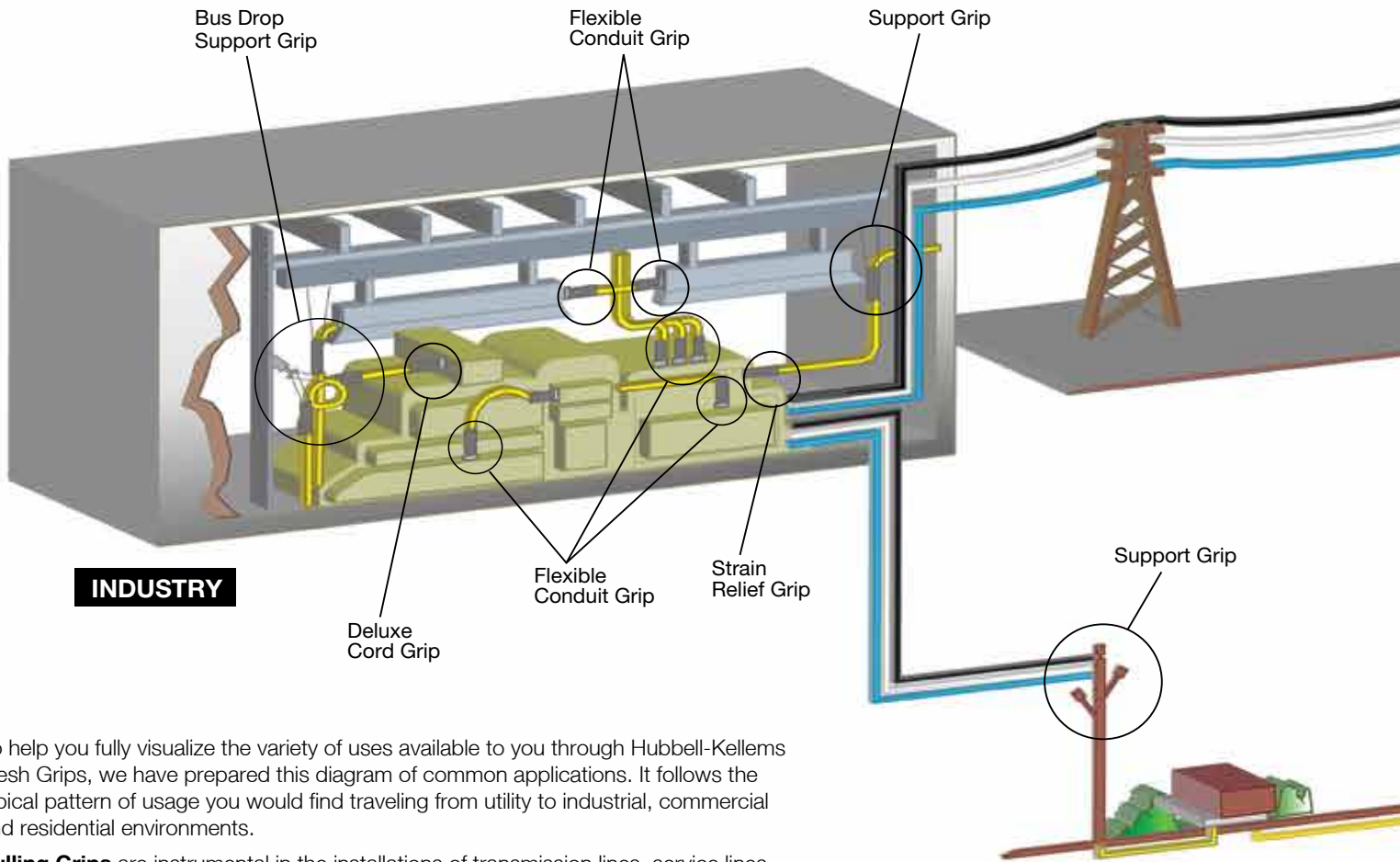

To help you fully visualize the variety of uses available to you through Hubbell-Kellems Mesh Grips, we have prepared this diagram of common applications. It follows the typical pattern of usage you would find traveling from utility to industrial, commercial and residential environments.

Pulling Grips are instrumental in the installations of transmission lines, service lines and cabling for construction and maintenance.

Support Grips provide holding management for indoor and outdoor permanent cable installations.

Strain Relief Grips are most often used to provide maximum reliability and minimum maintenance in areas where cords on machinery or equipment is impacted by motion or vibration or at risk of damage from cable pullout.

Beyond the electrical applications illustrated here, Hubbell-Kellems Mesh Grips can be used for wire management on radio and microwave communications towers, crane and hoist wire rope maintenance, elevator cable management and more.

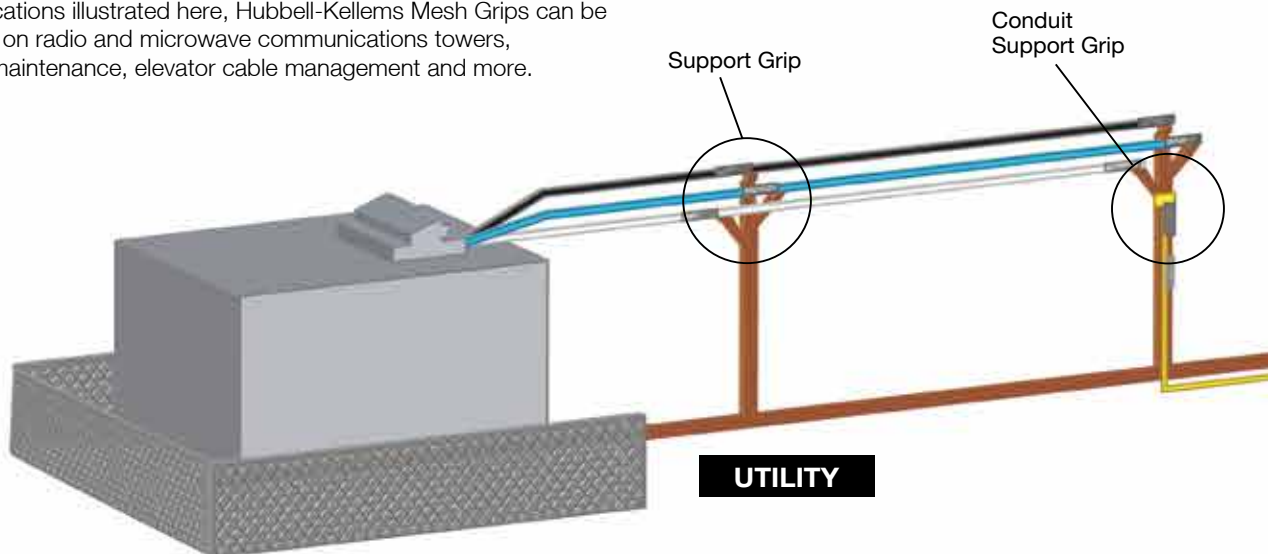

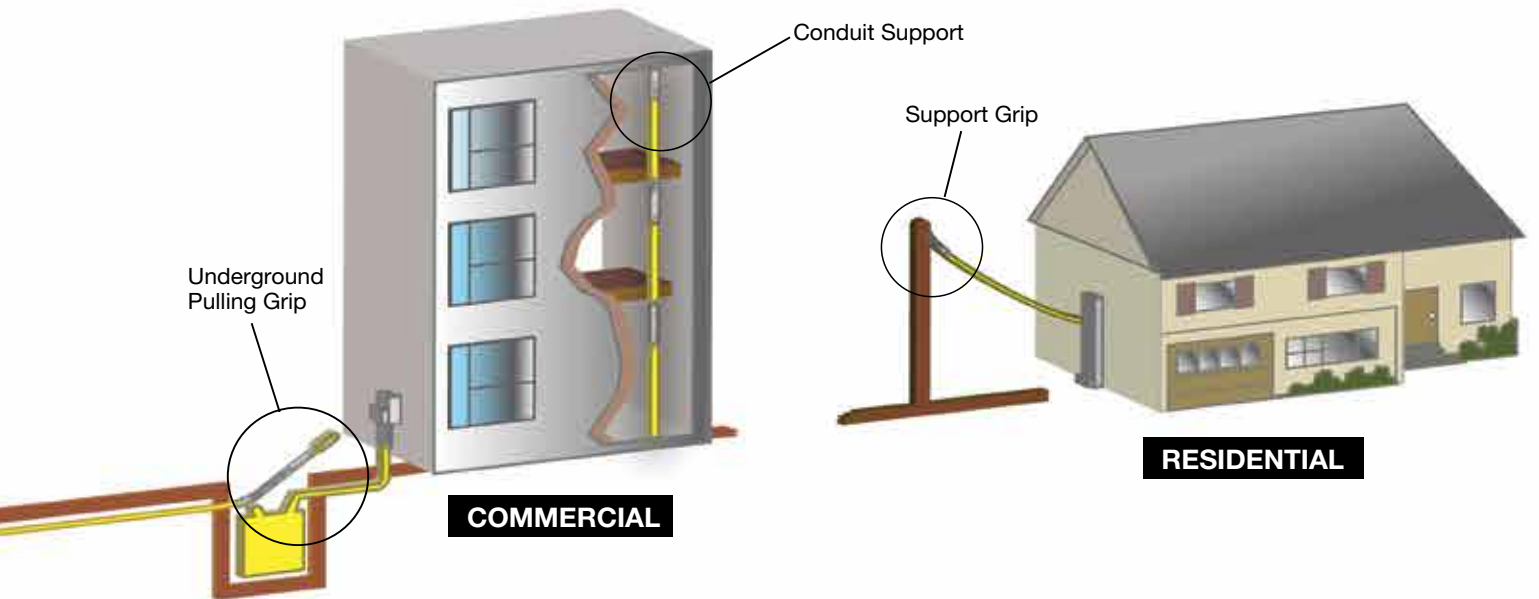
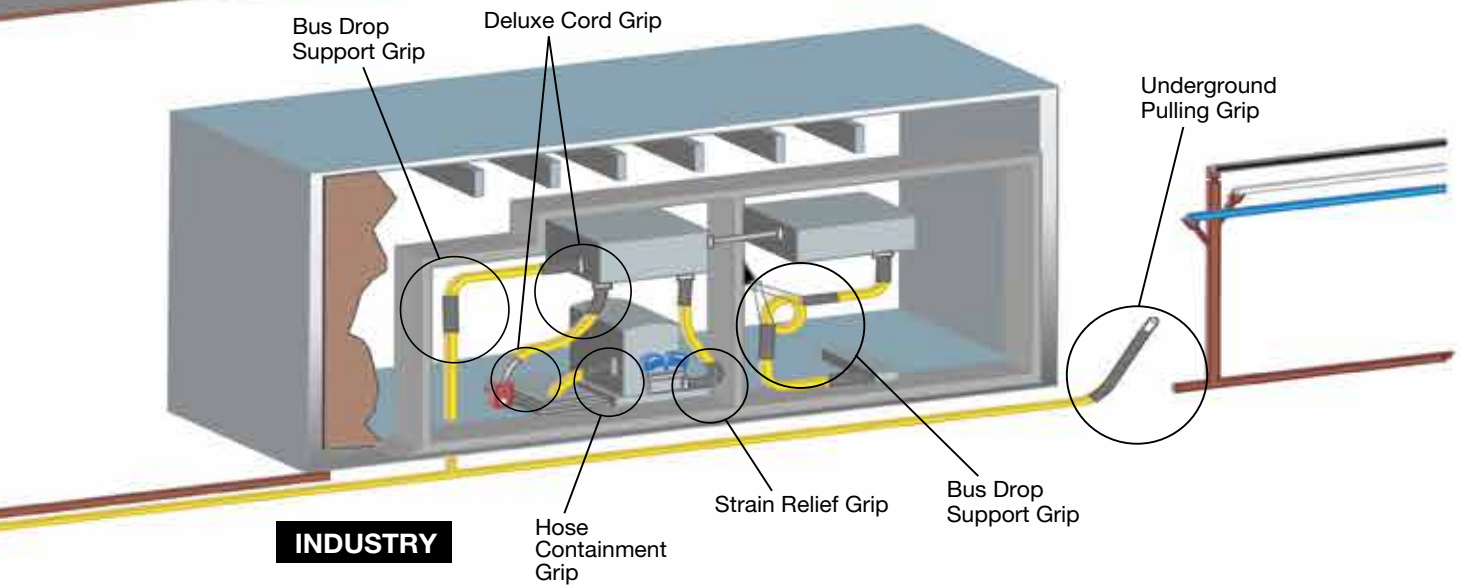
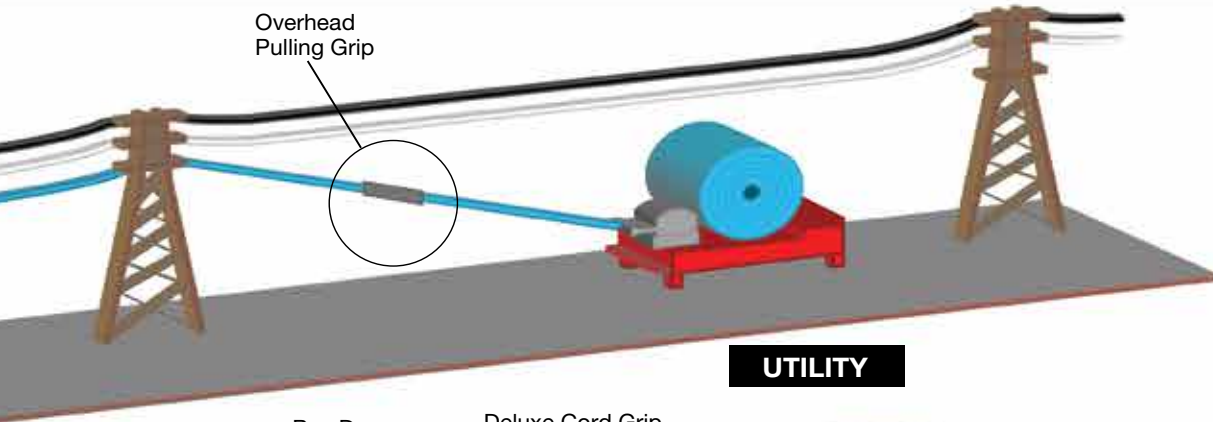



Features and Benefits

Kellems® Pulling Grips

Pulling grips are reusable tools for pulling electrical cable, bare conductor or rope. They are easy and fast to install, providing the user with a smooth, slim profile that allows for easy passage through ducts and conduit.

These grips are made of the highest quality galvanized steel strand which assures the user of a long lasting grip. There is a Kellems Pulling Grip for every pulling job.

- Made of high strength galvanized steel strand
- Mesh design offers the greatest holding power for all pulling applications
- Each grip size is color coded for fast and accurate identification and selection
- Will mate with swivels



03302016



Mesh Grip

- The galvanized steel mesh grip provides strength for secure pulling jobs and a slim profile with little build-up; it has flexibility to follow cable path
- The multiweave styles available add strength for big pulling jobs and provide positive gripping power



Eye Styles

- Heavy-duty rotating eye for underground wiring and overhead heavy-duty pulling of service lines and new construction cable
- Flexible or rotating eyes will mate easily with line stringing swivels for attachment to pulling lines; they have great strength for trouble free pulling jobs



Cable Protection

- Shoulder protectors contain the cable inside the grip and smooth the passage of the grip over line stringing blocks or conduit bends; they protect the leading edge of the grip from abrasion



Accessories

- Swivels are essential to the efficiency and safety of any high tension application
- Punch-Lok® Bands are applied over the tail of a grip to prevent the mesh from being tripped or pulled loose
- Banding tools



DUA-PULL® Grips, Flexible Eye, Double Weave Mesh

DUA-PULL Pulling Grips are the highest strength pulling grips manufactured for overhead transmission line stringing applications. They have a dual function of working with both bare and insulated conductors and synthetic rope, not provided by any other grip. Kellems' patented two-over, two-under weave design gives exceptional strength and gripping ability by putting more steel mesh in contact with the cable or rope surfaces. **THIS IS THE ONLY PULLING GRIP RECOMMENDED FOR USE ON SYNTHETIC ROPE.**

IMPORTANT:
Read all breaking strength, safety and technical data relating to this product.

Refer to pages V-17 and V-18.

Benefits

- Made of high strength galvanized steel strand
- Recommended for pulling bare or insulated conductor, wire rope and synthetic rope
- DUA-PULL mesh design offers the greatest holding power for all pulling applications
- Each grip size is color coded for fast and accurate identification and selection
- Will mate with swivels, see page V-16

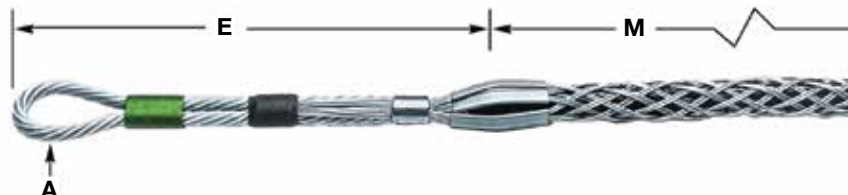

DUA-PULL® Grips

Diameter Range		Approx. Breaking Strength Lbs.	Working Load Lbs.	E Inches (cm)	M Inches (cm)	A Eye Dia. Inches (cm)	Over Cable and Grip** Inches (cm)	Color Code	Catalog Number
Conductor Inches (cm)	Rope* Inches (cm)								
.19"-.37" (48-.94)	.25"-.65" (.63-1.65)	6,500	1,300	10" (25.40)	24" (60.96)	.220" (.56)	.200" (.51)	Black	033271037
.38"-.62" (.97-1.57)	.50"-.90" (1.27-2.29)	14,000	2,800	12" (30.48)	36" (91.44)	.375" (.95)	.280" (.71)	Dk Green	033271038
.63"-.87" (1.60-2.21)	.75"-1.10" (1.90-2.79)	20,000	4,000	13" (33.02)	48" (121.92)	.437" (1.11)	.360" (.91)	Red	033271039
.88"-1.12" (2.24-2.84)	1.00"-1.50" (2.54-3.81)	30,600	6,120	15" (38.10)	60" (152.40)	.500" (1.27)	.500" (1.27)	Dk Blue	033271040
1.13"-1.37" (2.87-3.48)	1.25"-1.70" (3.17-4.32)	46,800	9,360	18" (45.72)	76" (193.04)	.625" (1.59)	.625" (1.59)	Yellow	033271041
1.38"-1.90" (3.51-4.38)	1.50"-2.10" (3.81-5.33)	66,500	13,300	24" (60.96)	89" (226.06)	.750" (1.90)	.750" (1.90)	Aluminum	033271042

Note: E = Eye length. M = Mesh length at nominal diameter.

*For rope, select smallest size grip which meets required work load.

**Add to cable or rope diameter.

Feed Tubes

The Kellems Feed Tube is used when assembling synthetic rope into the DUA-PULL Grip. It is required on the largest two sizes of DUA-PULL Grips. Feed Tubes are available for use on all size DUA-PULL Grips.

Benefits

- Saves time, allowing fast, easy assembly
- Can be reused if not damaged



DUA-PULL® Feed Tubes

For Use with DUA-PULL Grips	Rope Diameter Inches (cm)	Feed Tube Length Inches (cm)	Catalog Number
033271037	.25"-.65" (.63-1.65)	28" (71.12)	091061043
033271038	.50"-.90" (1.27-2.29)	40" (101.60)	091061044
033271039	.75"-1.10" (1.90-2.79)	52" (132.08)	091061045
033271040	1.00"-1.50" (2.54-3.81)	67" (170.18)	091061046
033271041	1.25"-1.70" (3.17-4.32)	83" (210.82)	091061047
033271042	1.50"-2.10" (3.81-5.33)	96" (243.84)	091061048

Note: 1. Do not run grips or swivels over bullwheels while under tension.

2. Two bands should be firmly attached approximately 1" and 2" (2.54cm and 5.08cm) from the grip's tail.

Banding is required to ensure maximum reliability and guard against accidental release, see page V-16.

3. Double braided rope, such as 2-in-1 type, should be back spliced for approximately 2/3 of the mesh length for best gripping results.

Grip size should be selected by diameter of back splice.



Dimensions in Inches (mm)



Multiple Strength Style Grips

Multiple Strength Pulling Grips are designed for pulling aluminum or copper bare conductor, ground wires, messenger strands, wire rope and insulated cables. They are made of high strength galvanized steel strand and feature a multi-weave mesh construction of single, double and triple weave for firm holding power.

IMPORTANT:

Read all breaking strength, safety and technical data relating to this product.

Refer to pages V-17 and V-18.

Rotating Eye Feature

Multiple Strength Grips are available with a forged steel rotating eye which can be attached to a swivel. The forged eye is durable, compact and streamlined and will thread through blocks and sheaves without binding. **The rotating eye is not a swivel and will not turn while under tension;** it can turn to relieve pulling torque when tension is relaxed. If constant swivel action is required, a swivel should be used. For swivel dimensions, see page V-16. For rotating eye dimensions, see page V-9.

Benefits

- Economical, high strength pulling tool
- Multi-weave construction provides greater strength and holding power
- Endless Weave Grip end lies flat on the cable and will not snag

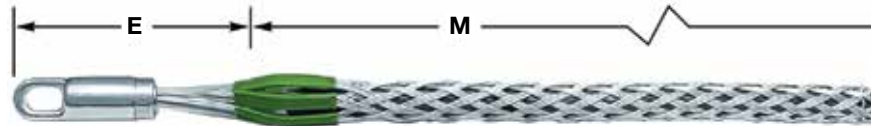

Multiple Strength Grip, Rotating Eye

Cable Diameter Range Inches (cm)	Approx. Breaking Strength Lbs.	Working Load Lbs.	E Inches (cm)	M Inches (cm)	Rotating Eye Dia. Inches (cm)	Color Code	Catalog Number
.25"--.49" (.63-1.24)	6,800	1,360	5" (12.70)	26" (66.04)	7/8" (2.22)	Dark Green	03302016
.50"--.74" (1.27-1.88)	10,000	2,000	6" (15.24)	32" (81.28)	1" (2.54)	Brown	03302018
.75"--.99" (1.90-2.51)	14,400	2,880	6" (15.24)	41" (104.14)	1" (2.54)	Light Blue	03302020
1.00"-1.24" (2.54-3.15)	24,600	4,920	8" (20.32)	52" (132.08)	1 1/8" (3.49)	Gold	03302022
1.25"-1.49" (3.17-3.78)	30,600	6,120	8" (20.32)	56" (142.24)	1 1/8" (4.13)	Black	03302024
1.50"-1.74" (3.81-4.42)	30,600	6,120	9" (22.86)	60" (152.40)	1 1/8" (4.76)	Red	03302026
1.75"-2.24" (4.44-5.69)	48,000	9,600	10" (25.40)	70" (177.80)	1 1/8" (4.76)	Dark Blue	03302028
2.00"-2.49" (5.08-6.32)	48,000	9,600	10" (25.40)	50" (127.00)	1 1/8" (4.76)	Yellow	03302066
2.50"-2.99" (6.35-7.59)	48,000	9,600	10" (25.40)	52" (132.08)	1 1/8" (4.76)	Orange	03302097
3.00"-3.49" (7.62-8.86)	48,000	9,600	10" (25.40)	50" (127.00)	1 1/8" (4.76)	Aluminum	033021030
3.50"-3.99" (8.89-10.13)	48,000	9,600	10" (25.40)	53" (134.62)	1 1/8" (4.76)	Light Green	033021031

Note: E- Eye length M-Mesh length at nominal diameter.

Flexible Eye Feature

Multiple Strength Grips are also available with a flexible, patented wire rope eye. This compact eye will mate with a swivel, and pass through blocks and sheaves without binding.



Multiple Strength Grip, Flexible Eye

Cable Diameter Range Inches (cm)	Approx. Breaking Strength Lbs.	Working Load Lbs.	E Inches (cm)	M Inches (cm)	A Eye Dia. Inches (cm)	Color Code	Catalog Number
.25"--.49" (.63-1.24)	6,800	1,360	9" (22.86)	26" (66.04)	1/4" (.63)	Dark Green	03302044
.50"--.74" (1.27-1.88)	10,000	2,000	9" (22.86)	32" (81.28)	5/16" (.79)	Brown	03302046
.75"--.99" (1.90-2.51)	14,400	2,880	11" (27.94)	41" (104.14)	3/8" (.95)	Light Blue	03302048
1.00"-1.24" (2.54-3.15)	24,600	4,920	12" (30.48)	52" (132.08)	1/2" (1.27)	Gold	03302050
1.25"-1.49" (3.17-3.78)	30,600	6,120	12" (30.48)	56" (142.24)	1/2" (1.27)	Black	03302052
1.50"-1.74" (3.81-4.42)	30,600	6,120	12" (30.48)	60" (152.40)	1/2" (1.27)	Red	03302054
1.75"-2.24" (4.44-5.69)	48,000	9,600	18" (45.72)	70" (177.80)	5/8" (1.59)	Dark Blue	03302056
2.00"-2.49" (5.08-6.32)	48,000	9,600	18" (45.72)	50" (127.00)	5/8" (1.59)	Yellow	033021078
2.50"-2.99" (6.35-7.59)	48,000	9,600	18" (45.72)	52" (132.08)	5/8" (1.59)	Orange	033021079
3.00"-3.49" (7.62-8.86)	48,000	9,600	18" (45.72)	50" (127.00)	5/8" (1.59)	Aluminum	033021080
3.50"-3.99" (8.89-10.13)	48,000	9,600	18" (45.72)	53" (134.62)	5/8" (1.59)	Light Green	033021081

Note: E- Eye length. M-Mesh length at nominal diameter.

1. Do not run grips or swivels over bullwheels while under tension.

2. Two bands should be firmly attached approximately 1" and 2" (2.54cm and 5.08cm) from the grip's tail.

Banding is required to ensure maximum reliability and guard against accidental release, see page V-16.

Dimensions in Inches (mm)

K-Type Grips

Kellems® Rotating Eye, K-Type Pulling Grips are made of high strength galvanized steel strand. All Grips feature double weave mesh for greater strength and added mesh contact on the table, to handle longer or heavier pulling jobs. The forged eye mates easily with a swivel or shackle.

IMPORTANT:
Read all breaking strength, safety and technical data relating to this product.

Refer to pages V-17 and V-18.

Rotating Eye Feature

K-Type Grips come equipped with a forged steel rotating eye which can be attached to a swivel. The forged eye is durable, compact and streamlined, and will thread through blocks and sheaves without binding. **The rotating eye is not a swivel and will not turn while under tension;** it can turn to relieve pulling torque when the tension is relaxed. If constant swivel action is required, a swivel should be used. For swivel dimensions, see page V-16. For rotating eye dimensions, see below.

Benefits

- An economical tool for pulling cable
- Safe, rugged and dependable
- Equipped with a rotating eye for spin out of pulling torque after load release
- Easily installed and removed



K-Type Grips

Cable Diameter Range Inches (cm)	Approx. Breaking Strength Lbs.	Working Load Lbs.	E Inches (cm)	M Inches (cm)	Rotating Eye Dia. Inches (cm)	Catalog Number
Short						
.50"-.62" (1.27-1.57)	5,600	1,120	5" (12.70)	11" (27.94)	7/8" (2.22)	03301001
.63"-.74" (1.60-1.88)	6,800	1,360	5" (12.70)	11" (27.94)	7/8" (2.22)	03301002
.75"-.99" (1.90-2.51)	6,800	1,360	6" (15.24)	20" (50.80)	1" (2.54)	03301013
1.00"-1.24" (2.54-3.15)	12,800	2,560	7" (17.78)	20" (50.80)	1 1/8" (3.49)	03301014
1.25"-1.49" (3.17-3.78)	12,800	2,560	7" (17.78)	21" (53.34)	1 1/8" (3.49)	03301016
1.50"-1.99" (3.81-5.05)	16,400	3,280	7" (17.78)	25" (63.50)	1 1/8" (3.49)	03301017
2.00"-2.49" (5.08-6.32)	27,200	5,440	8" (20.32)	26" (66.04)	1 1/8" (4.13)	03301018
2.50"-2.99" (6.35-7.59)	33,000	6,600	10" (25.40)	28" (71.12)	1 1/8" (4.76)	03301019
3.00"-3.49" (7.62-8.86)	41,000	8,200	10" (25.40)	30" (76.20)	1 1/8" (4.76)	03301020
3.50"-3.99" (8.89-10.13)	48,000	9,600	10" (25.40)	32" (81.28)	1 1/8" (4.76)	03301021
4.00"-4.49" (10.16-11.40)	48,000	9,600	10" (25.40)	33" (83.82)	1 1/8" (4.76)	033011017
Standard						
.50"-.62" (1.27-1.57)	5,600	1,120	5" (12.70)	16" (40.64)	7/8" (2.22)	03301011
.63"-.74" (1.60-1.88)	6,800	1,360	5" (12.70)	16" (40.64)	7/8" (2.22)	03301012
.75"-.99" (1.90-2.51)	9,600	1,920	6" (15.24)	32" (81.28)	1" (2.54)	03301024
1.00"-1.49" (2.54-3.78)	16,400	3,280	7" (17.78)	33" (83.82)	1 1/8" (3.49)	03301025
1.50"-1.99" (3.81-5.05)	16,400	3,280	7" (17.78)	34" (86.36)	1 1/8" (3.49)	03301026
2.00"-2.49" (5.08-6.32)	27,200	5,440	9" (22.86)	36" (91.44)	1 1/8" (4.13)	03301027
2.50"-2.99" (6.35-7.59)	33,000	6,600	10" (25.40)	38" (96.52)	1 1/8" (4.76)	03301028
3.00"-3.49" (7.62-8.86)	41,000	8,200	10" (25.40)	39" (99.06)	1 1/8" (4.76)	03301029
3.50"-3.99" (8.89-10.13)	48,000	9,600	10" (25.40)	41" (104.14)	1 1/8" (4.76)	03301030
4.00"-4.49" (10.16-11.40)	48,000	9,600	10" (25.40)	42" (106.68)	1 1/8" (4.76)	03301031
4.50"-4.99" (11.43-12.67)	48,000	9,600	10" (25.40)	58" (147.32)	1 1/8" (4.76)	03301039
5.00"-5.99" (12.70-15.21)	40,000	8,000	10" (25.40)	60" (152.40)	1 1/8" (4.76)	03301047
6.00"-6.99" (15.24-17.75)	48,000	9,600	10" (25.40)	66" (167.64)	1 1/8" (4.76)	03301045

Note: E- Eye length. M-Mesh length at nominal diameter.
See page V-18 for multiple cables in a single pulling grip.

Rotating Eye Dimensions

Rotating Eye Dimensions Inches (cm)	A	B	C	D	F
7/8" (2.22)	7/8" (2.22)	9/32" (.71)	1/2" (1.27)	7/8" (2.22)	2 5/8" (6.67)
1" (2.54)	1" (2.54)	1/2" (1.27)	9/16" (1.43)	1 3/16" (2.06)	3 1/2" (8.89)
1 1/8" (3.49)	1 1/8" (3.49)	1/2" (1.27)	1 1/16" (1.75)	1" (2.54)	4 1/2" (11.43)
1 1/8" (4.13)	1 1/8" (4.13)	9/16" (1.59)	7/8" (2.22)	1 3/16" (3.02)	5 5/16" (13.49)
1 1/8" (4.76)	1 1/8" (4.76)	2 1/32" (1.67)	1" (2.54)	1 1/8" (3.49)	6 1/8" (15.56)

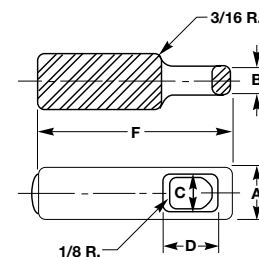

Dimensions in Inches (mm)



T-Type Grips

Kellems® Flexible T-Type Pulling Grips are made of high strength galvanized steel strand. They feature double weave mesh for positive holding power in medium to heavy pulling jobs. The grip eye will easily attach to a swivel.

IMPORTANT:

Read all breaking strength, safety and technical data relating to this product.

Refer to pages V-17 and V-18.

Application

T-Type Pulling Grips are used for the installation of underground power cables, communication lines and service lines into factories, construction projects and for general underground electrical construction. Available in two mesh lengths, short for medium pulls and standard for general purpose pulling.

Benefits

- Will pull a single cable or cable bundles
- Patented flexible eye design provides flexibility to follow line of pull
- A dependable, reusable pulling tool
- Easily installed and removed
- Mates easily with a swivel, see page V-16



T-Type Grips

Cable Diameter Range Inches (cm)	Approx. Breaking Strength Lbs.	Working Load Lbs.	E Inches (cm)	M Inches (cm)	Catalog Number
Short					
.50"-.62" (1.27-1.57)	4,500	900	8" (20.32)	21" (53.34)	033041082
.63"-.74" (1.60-1.88)	5,600	1,120	8" (20.32)	24" (60.96)	033041083
.75"-.99" (1.90-2.51)	6,800	1,360	9" (22.86)	24" (60.96)	033041084
1.00"-1.49" (2.54-3.78)	9,600	1,920	9" (22.86)	24" (60.96)	033041085
1.50"-1.99" (3.81-5.05)	16,400	3,280	11" (27.94)	24" (60.96)	033041086
2.00"-2.49" (5.08-6.32)	18,500	3,700	12" (30.48)	24" (60.96)	033041087
2.50"-2.99" (6.35-7.59)	24,500	4,900	12" (30.48)	24" (60.96)	033041088
3.00"-3.49" (7.62-8.86)	24,500	4,900	14" (35.56)	24" (60.96)	033041089
3.50"-3.99" (8.89-10.13)	31,000	6,200	14" (35.56)	26" (66.04)	033041090
Standard					
.75"-.99" (1.90-2.51)	6,800	1,360	9" (22.86)	36" (91.44)	033041091
1.00"-1.49" (2.54-3.78)	9,600	1,920	9" (22.86)	36" (91.44)	033041092
1.50"-1.99" (3.81-5.05)	16,400	3,280	11" (27.94)	36" (91.44)	033041093
2.00"-2.49" (5.08-6.32)	18,500	3,700	12" (30.48)	36" (91.44)	033041094
2.50"-2.99" (6.35-7.59)	24,500	4,900	12" (30.48)	36" (91.44)	033041095
3.00"-3.49" (7.62-8.86)	24,500	4,900	14" (35.56)	36" (91.44)	033041096
3.50"-3.99" (8.89-10.13)	31,000	6,200	14" (35.56)	40" (101.60)	033041097

Note: E- Eye length. M-Mesh length at nominal diameter.

See page V-18 for multiple cables in a single pulling grip.



Non-Conductive Grips

Kellems® Non-Conductive Pulling Grips, made of a high strength, non-conductive aramid fiber, are available for pulling single cable or cable bundles. Their braided double weave design adds strength and positive holding power.

IMPORTANT:
Read all breaking strength, safety and technical data relating to this product.

Refer to pages V-17 and V-18.

Benefits

- Color coded for fast on-site selection
- Extra flexibility for easy installation
- Non-metallic mesh provides for safe pulls over "hot" areas
- Pellethane jacketed aramid fiber mesh resists abrasion
- Grips are corrosion resistant

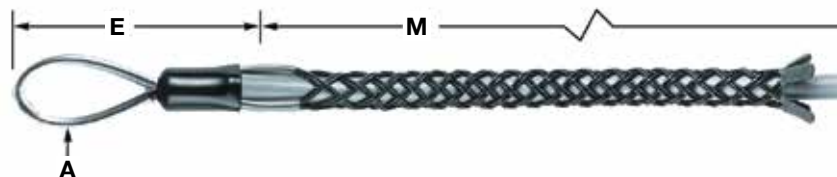

Non-Conductive Grips, Single Eye, Double Weave, Non-Metallic

Cable Diameter Range Inches (cm)	Approx. Breaking Strength Lbs.	Working Load Lbs.	E Inches (cm)	M Inches (cm)	A Inches (cm)	Color Code	Catalog Number
.50"--.62" (1.27-1.57)	1,000	200	5.5" (13.97)	24" (60.96)	.44" (1.12)	Green	03628001
.63"--.74" (1.60-1.88)	2,000	400	5.5" (13.97)	26" (66.04)	.44" (1.12)	Yellow	03628002
.75"--.99" (1.90-2.51)	2,000	400	6.0" (15.24)	31" (78.74)	.63" (1.60)	Red	03628003
1.00"-1.24" (2.54-3.15)	3,000	600	6.5" (16.51)	36" (91.44)	.63" (1.60)	Blue	03628004
1.25"-1.49" (3.17-3.78)	3,000	600	6.7" (17.02)	41.5" (105.41)	.63" (1.60)	White	03628005
1.50"-1.99" (3.81-5.05)	3,000	600	8.0" (20.32)	44.0" (121.76)	.63" (1.60)	Pink	03628006

Note: E- Eye length. M-Mesh length at nominal diameter.

Taping is required to guard against accidental release and to insure maximum reliability. Apply vinyl plastic electrical tape starting 2" to 3" (5.08cm to 7.62cm) from the tail of the grip onto 2" to 3" (5.08cm to 7.62cm) of cable.

Slack Pulling Grips

Slack Pulling Grips are offered in three styles made of galvanized steel. The closed type is used when the cable end is accessible. When not accessible, there are split lace and split rod closing styles. All grips feature a single offset eye for easy attachment to a pulling line.

Benefits

- Easy attachment to pulling lines
- Galvanized steel for strength



Slack Grip-Closed Mesh, Offset Eye, Double Weave, Galvanized Steel

Cable Diameter Range Inches (cm)	Approx. Breaking Strength Lbs.	Working Load Lbs.	E Inches (cm)	M Inches (cm)	Catalog Number
Standard					
.75"--.99" (1.90-2.51)	2,600	520	7" (17.78)	12" (30.48)	03308003
1.00"-1.24" (2.54-3.15)	4,000	800	8" (20.32)	15" (38.10)	03308004
1.25"-1.49" (3.17-3.78)	5,400	1,080	8" (20.32)	16" (40.64)	03308005
1.50"-1.74" (3.81-4.42)	6,600	1,320	8" (20.32)	20" (50.80)	03308006
1.75"-1.99" (4.44-5.05)	10,000	2,000	10" (25.40)	18" (45.72)	03308007
2.00"-2.49" (5.08-6.32)	11,000	2,200	10" (25.40)	19" (48.26)	03308008
2.50"-2.99" (6.35-7.59)	11,000	2,200	10" (25.40)	20" (50.80)	03308009
3.00"-3.49" (7.62-8.86)	14,500	2,900	12" (30.48)	21" (53.34)	03308010
3.50"-3.99" (8.89-10.13)	14,500	2,900	12" (30.48)	22" (55.88)	03308011

Note: E- Eye length. M-Mesh length at nominal diameter.

See page V-18 for multiple cables in a single pulling grip.

Dimensions in Inches (mm)



Slack Pulling Grips

Slack Pulling Grips are offered in three styles made of galvanized steel. The closed type is used when the cable end is accessible. When not accessible, there are split lace and split rod closing styles. All grips feature a single offset eye for easy attachment to a pulling line.

IMPORTANT:

Read all breaking strength, safety and technical data relating to this product.

Refer to pages V-17 and V-18.

Benefits

- Easy attachment to pulling lines
- Reusable rawhide lace for lace closure
- Galvanized steel for strength

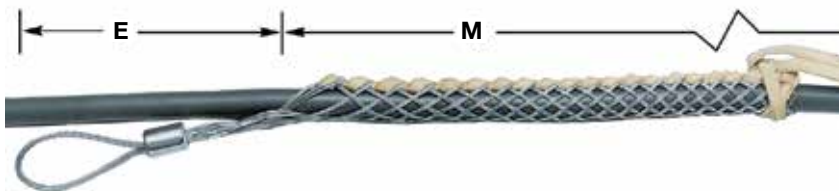

Slack Grip-Split Mesh, Rawhide Lace Closing, Offset Eye, Double Weave, Galvanized Steel

Cable Diameter Range Inches (cm)	Approx. Breaking Strength Lbs.	Working Load Lbs.	E Inches (cm)	M Inches (cm)	Catalog Number
Standard					
.75"-1.99" (1.90-2.51)	2,500	500	7" (17.78)	12" (30.48)	03309003
1.00"-1.24" (2.54-3.15)	3,500	700	8" (20.32)	15" (38.10)	03309004
1.25"-1.49" (3.17-3.78)	4,000	800	8" (20.32)	16" (40.64)	03309005
1.50"-1.74" (3.81-4.42)	4,000	800	9" (22.86)	17" (43.18)	03309006
1.75"-1.99" (4.44-5.05)	4,000	800	10" (25.40)	18" (45.72)	03309007
2.00"-2.49" (5.08-6.32)	4,000	800	10" (25.40)	19" (48.26)	03309008
2.50"-2.99" (6.35-7.59)	4,000	800	10" (25.40)	20" (50.80)	03309009
Long					
1.50"-1.99" (3.81-5.05)	4,000	800	9" (22.86)	25" (63.50)	03309015
2.00"-2.49" (5.08-6.32)	4,000	800	10" (25.40)	26" (66.04)	03309016
2.50"-2.99" (6.35-7.59)	4,000	800	10" (25.40)	29" (73.66)	03309017
3.00"-3.49" (7.62-8.86)	4,000	800	12" (30.48)	32" (81.28)	03309018
3.50"-3.99" (8.89-10.13)	4,000	800	12" (30.48)	35" (88.90)	03309019

Benefits

- Easy attachment to pulling lines
- Galvanized steel for strength

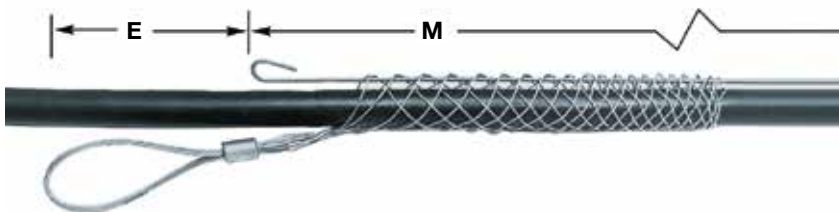

Slack Grip-Split Mesh, Rod Closing, Offset Eye, Single Weave, Galvanized Steel

Cable Diameter Range Inches (cm)	Approx. Breaking Strength Lbs.	Working Load Lbs.	E Inches (cm)	M Inches (cm)	Catalog Number
.50"-1.61" (1.27-1.55)	1,500	300	7" (17.78)	6" (15.24)	03310001
.62"-1.74" (1.57-1.88)	1,800	360	7" (17.78)	8" (20.32)	03310002
.75"-1.99" (1.90-2.51)	2,200	440	7" (17.78)	10" (25.40)	03310003
1.00"-1.24" (2.54-3.15)	3,400	680	8" (20.32)	12" (30.48)	03310004
1.25"-1.49" (3.17-3.78)	4,500	900	8" (20.32)	14" (35.56)	03310005
1.50"-1.74" (3.81-4.42)	5,800	1,160	9" (22.86)	15" (38.10)	03310006
1.75"-1.99" (4.44-5.05)	7,600	1,520	10" (25.40)	16" (40.64)	03310007
2.00"-2.49" (5.08-6.32)	9,000	1,800	10" (25.40)	19" (48.26)	03310008
2.50"-2.99" (6.35-7.59)	11,000	2,200	10" (25.40)	20" (50.80)	03310009
3.00"-3.49" (7.62-8.86)	12,000	2,400	12" (30.48)	21" (53.34)	03310010
3.50"-3.99" (8.89-10.13)	12,000	2,400	12" (30.48)	24" (60.96)	03310011

Note: E- Eye length. M-Mesh length at nominal diameter.

1. Replacement rawhide lace. Catalog number 20920002.
 2. See page V-35 for lace and rod closing instructions.
- See page V-18 for multiple cables in a single pulling grip.

Dimensions in Inches (mm)

Light Duty Grips

Light Duty Grips are made of galvanized steel in a single weave construction. They feature a flexible eye for easy attachment to a pulling line.

IMPORTANT:
Read all breaking strength, safety and technical data relating to this product.

Refer to pages V-17 and V-18.

Benefits

- Perfect tools for light pulling jobs
- Installs easily on cable
- Strong galvanized steel construction

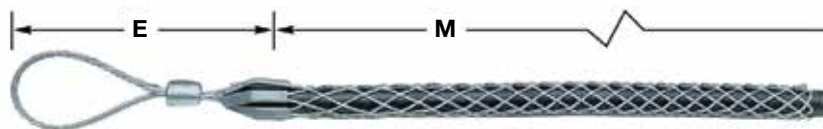

Light Duty Grips

Cable Diameter Range Inches (cm)	Approx. Breaking Strength Lbs.	Working Load Lbs.	E Inches (cm)	M Inches (cm)	Catalog Number
Short					
.50"--.62" (1.27-1.57)	2,800	560	5" (12.70)	11" (27.94)	03303001
.63"-.74" (1.60-1.88)	2,800	560	5" (12.70)	11" (27.94)	03303002
.75"-.99" (1.90-2.51)	4,000	800	6" (15.24)	12" (30.48)	03303003
1.00"-1.24" (2.54-3.15)	5,300	1,060	7" (17.78)	13" (33.02)	03303004
1.25"-1.49" (3.17-3.78)	5,300	1,060	7" (17.78)	14" (35.56)	03303005
1.50"-1.74" (3.81-4.42)	6,800	1,360	8" (20.32)	15" (38.10)	03303006
1.75"-1.99" (4.44-5.05)	8,500	1,700	9" (22.86)	17" (43.18)	03303007
2.00"-2.49" (5.08-6.32)	8,500	1,700	9" (22.86)	18" (45.72)	03303008
Standard					
.50"-.62" (1.27-1.57)	2,800	560	5" (12.70)	16" (40.64)	03303010
.63"-.74" (1.60-1.88)	2,800	560	5" (12.70)	16" (40.64)	03303011
.75"-.99" (1.90-2.51)	4,000	800	6" (15.24)	20" (50.80)	03303012
1.00"-1.24" (2.54-3.15)	6,800	1,360	7" (17.78)	20" (50.80)	03303013
1.25"-1.49" (3.17-3.78)	6,800	1,360	7" (17.78)	21" (53.34)	03303015
1.50"-1.99" (3.81-5.05)	6,800	1,360	8" (20.32)	23" (58.42)	03303016
2.00"-2.49" (5.08-6.32)	8,500	1,700	9" (22.86)	25" (63.50)	03303017
2.50"-2.99" (6.35-7.59)	10,600	2,120	9" (22.86)	27" (68.58)	03303018
3.00"-3.49" (7.62-8.86)	14,700	2,940	10" (25.40)	30" (76.20)	03303019
3.50"-3.99" (8.89-10.13)	14,700	2,940	10" (25.40)	32" (81.28)	03303029

Junior Pulling Grips

Junior Pulling Grips feature a strong galvanized steel, single weave mesh. A flexible eye easily attaches to a pulling line, snake or fish tape.

Benefits

- Installs easily over building wire
- Strong secure grip
- Reusable
- Pulls single cable or cable bundles

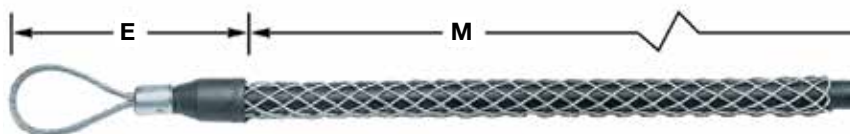

Junior Pulling Grips

Cable Diameter Range Inches (cm)	Approx. Breaking Strength Lbs.	Working Load Lbs.	E Inches (cm)	M Inches (cm)	Model	Catalog Number
.19"--.24" (.48-.61)	400	80	3¼" (8.25)	4¼" (10.79)	J19	03305011*
.25"-.37" (.63-.94)	450	90	3¼" (8.25)	4¼" (10.79)	J25	03305001
.38"-.49" (.97-1.24)	900	180	3¾" (9.52)	7" (17.78)	J37	03305002
.50"-.62" (1.27-1.57)	1,300	260	4¼" (10.79)	8½" (21.59)	J50	03305003
.63"-.74" (1.60-1.88)	1,950	390	5" (12.70)	10" (25.40)	J62	03305004
.75"-.99" (1.90-2.51)	2,800	560	5¾" (14.60)	10" (25.40)	J75	03305005
1.00"-1.24" (2.54-3.15)	3,900	780	6½" (16.51)	11½" (29.21)	J100	03305006
Junior Grip Kit contains 6 grips, one of each size above, except 03305011.						033051114

Note: E- Eye length. M-Mesh length at nominal diameter.

*Not included in Junior Grip Kit, 033051114.

See page V-18 for multiple cables in a single pulling grip.

Dimensions in Inches (mm)



Wire Rope Grips

Wire Rope Grips are made of high strength galvanized steel strand in a construction of triple, double and single weave for superior gripping ability. They are available with or without a rotating barrel which will help eliminate twist in the old rope from being transferred to the new rope.

IMPORTANT:

Read all breaking strength, safety and technical data relating to this product.

Refer to pages V-17 and V-18.

Benefits

- High strength for secure pulling
- Easy installation
- Flexible to pass through sheaves and blocks

Application

Wire Rope Grips are used for changing wire rope on oil derricks, large cranes, overhead cranes and drag lines. It provides a quick, safe, inexpensive temporary splice. By installing the used wire rope in one end and the new rope in the other, the new wire rope can be pulled in as the old one is pulled out.



Regular Wire Rope Grips

Cable Diameter Range Inches (cm)	Approx. Breaking Strength Lbs.	Working Load Lbs.	Approx. Strength of Grip Feet (m)	Catalog Number
9/16" - 5/8" (1.43-1.59)	7,500	1,500	5.75 (1.75)	03316001
3/4" - 7/8" (1.90-2.22)	12,500	2,500	6.75 (1.90)	03316002
1" - 1 1/8" (2.54-2.86)	16,000	3,200	7.00 (2.13)	03316003
1 1/4" - 1 3/8" (3.17-3.49)	20,000	4,000	8.00 (2.44)	03316004
1 3/8" - 1 1/2" (3.49-3.81)	20,000	4,000	8.00 (2.44)	03316006



Rotating Wire Rope Grips

Cable Diameter Range Inches (cm)	Approx. Breaking Strength Lbs.	Working Load Lbs.	Approx. Strength of Grip Feet (m)	Barrel Dimensions Length. x O.D. In. (cm)	Catalog Number
7/16" - 1/2" (1.11-1.27)	5,000	1,000	5.33 (1.63)	3.00" (7.62) x .87" (2.21)	03317001
9/16" - 5/8" (1.43-1.59)	7,500	1,500	5.83 (1.78)	4.25" (10.79) x 1.00" (2.54)	03317002
3/4" - 7/8" (1.90-2.22)	12,500	2,500	6.50 (1.98)	4.25" (10.79) x 1.00" (2.54)	03317003
1" - 1 1/8" (2.54-2.86)	16,000	3,200	8.67 (2.64)	5.50" (13.97) x 1.37" (3.48)	03317004
1 1/4" - 1 3/8" (3.17-3.49)	20,000	4,000	9.00 (2.74)	5.50" (13.97) x 1.37" (3.48)	03317005
1 1/2" - 1 3/4" (3.81-4.44)	20,000	4,000	11.00 (3.35)	5.50" (13.97) x 1.37" (3.48)	03317006

Note: 1. During installation each end of the grip should be banded and taped down securely over the rope to insure smooth passage through sheaves and to guard against accidental release. See page V-16 for end bands.
2. The rotating barrel is not a swivel and will not turn while under tension. It can turn to relieve pulling torque when tension is relaxed.

Cable Splicing Grips

Splicing Grips are made of galvanized steel in double weave mesh construction. They are available in various lengths and sizes to suit most applications.

IMPORTANT:

Read all breaking strength, safety and technical data relating to this product.

Refer to pages V-17 and V-18.

Benefits

- Easily installed or removed
- Galvanized steel construction for strength
- Flexible to follow cable path

Application

Splicing Grips are used as a temporary splice for rope, cable or wire rope. They can also be used as cable reinforcement and can act as a shield to protect cables and hoses from abrasion.



Double Weave Splicing Grips

Cable Diameter Range Inches (cm)	.37"-.49" (.94-1.24)	.50"-.61" (1.27-1.55)	.62"-.74" (1.57-1.88)	.75"-.99" (1.90-2.51)	1.00"-1.49" (2.54-3.78)
Approx. Breaking Strength Lbs.	3,500	3,500	4,400	7,500	10,000
Mesh Length Inches (cm)	Catalog Number				
18" (45.72)	013041330	01304064	01304009	—	—
24" (60.96)	—	01304011	01304013	01304010	01304015
36" (91.44)	—	—	013041234	01304054	01304055
48" (121.92)	—	—	—	01304017	01304029
72" (182.88)	—	—	—	01304037	013041333

Junior Splicing Grips, Single Weave

Junior Splicing Grips are made of galvanized steel and are designed for use in very light duty and small splicing jobs.

Benefits

- Easily installed or removed
- Galvanized steel construction for strength
- Flexible to follow cable path



Junior Tube

Cable Diameter Range Inches (cm)	Approx. Breaking Strength Lbs.	Working Load Lbs.	Length @ Nom Diameter Inches (cm)	Catalog Number
.18"-.24" (.46-.61)	400	80	7" (17.78)	01301008
.25"-.36" (.63-.91)	400	80	8" (20.32)	01301013

Note: 1. During installation each end of the grip should be banded and taped down securely over the rope to insure smooth passage through sheaves and to guard against accidental release. See page V-16 for end bands.

Dimensions in Inches (mm)



Punch-Lok® Bands

Punch-Lok Bands are applied over the tail of a grip to prevent the mesh from being tripped or pulled loose. Also, they assure full gripping action by locking the mesh of the tail in tight contact with the cable or rope.



When the tail of a grip is the leading end, the bands are particularly important to prevent accidental release caused by tripping on obstructions. A conductor-to-conductor (double-socking) pulling operation is a good example: where two grips connect two conductors to form a temporary splice. In all cases two Punch-Lok® Bands should be double wrapped approximately one inch to two inches (2.54cm to 5.08cm) from the grip's tail. Banding is required to ensure maximum reliability and guard against accidental release. It is also common practice to tape over the banded tail area to assure smooth passage through the sheaves. The conductor should be installed in the grip up to the elbows of the aluminum shoulders in order to assure full and complete gripping action as illustrated above.



Punch-Lok® Bands

Grip Banding Range Inches (cm)	Band Width Inches (cm)	Band Inside Diameter Inches (cm)	Model	Catalog Number
¼"-1½" (.63-2.86)	¾" (.95)	1¾" (3.49)	0-311	20320050
1½"-1¾" (2.86-4.13)	¾" (.95)	2" (5.08)	0-316	20320051
1½"-2¼" (4.13-5.71)	¾" (1.59)	2½" (6.35)	0-10	20320052
2¼"-3½" (5.71-8.89)	¾" (1.59)	4" (10.16)	0-16	20320053
3½"-5" (8.89-12.70)	¾" (1.59)	6" (15.24)	0-24	20320054

Accessories

Punch-Lok Tools	Catalog Number
P-1000 for use with ¾" width Banding tool.	20320048
P-38 for use with ¾" and ¾" width Banding tool for tight spaces.	20320047

Stainless Steel Swivels

Swivels are essential to the efficiency and safety of any high tension application. They are particularly important where continuous pulls develop higher and higher torque levels. Torque is intensified by the pull-resistance of the cable itself and the resistance of the high tension controlling equipment regulating line sag. Ball bearing swivels release torque and prevent it from reaching dangerous levels that can damage the cable and obstruct the lines.

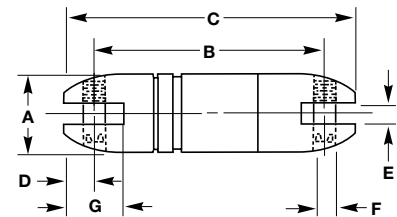

Stainless Steel Swivels

Maximum Safe Working Load Lbs. (N)	Dimensions in Inches (cm)							Model	Catalog Number
	A	B	C	D	E	F	G		
2,250 (10,000)	7/8" (2.22)	2½" (6.35)	3¾" (8.57)	7/16" (1.11)	3/8" (0.95)	5/16" (0.79)	3½" (2.46)	A-13L	20308001A
5,000 (22,240)	1¼" (3.17)	3¼" (9.37)	4¾" (12.06)	1¾" (1.35)	1¾" (1.35)	13/32" (1.03)	1¾" (3.25)	BB-13L	20308002A
9,000 (40,030)	1½" (3.81)	4¼" (10.79)	5¾" (14.29)	1¼" (1.75)	1¾" (1.51)	½" (1.27)	1¾" (3.97)	B-13L	20308003A
10,000 (44,480)	1¾" (4.13)	4½" (11.43)	6" (15.24)	¾" (1.90)	1¼" (1.75)	5/8" (1.59)	1¾" (4.36)	C-13L	20308004A
30,000 (133,440)	2¾" (6.03)	7¾" (19.37)	10" (25.40)	1¾" (3.02)	1¾" (2.62)	7/8" (2.22)	2¾" (7.06)	D-13L	20308005A

Punch-Lok® is a registered trademark of Punch-Lok Inc.



Kellems Pulling Grips are reusable tools for pulling electrical cable, bare conductor or rope. They are easy and fast to install, providing the user with a smooth, slim profile that allows for easy passage through ducts and conduit. Kellems Pulling Grips are made of the highest quality galvanized steel strand which assures the user of a long lasting grip. There is a Kellems Pulling Grip for every pulling job.

WARNING: It is very important to read and understand all safety information before proceeding. Failure to use as directed may result in property damage, personal injury or death.

Grips are to be installed and utilized by a qualified technician in accordance with all applicable national and local safety and electrical codes. Consult a licensed project safety professional, if necessary.

Ensure that the correct grip is selected for your specific needs. Grips should only be used for their intended purpose and not for other applications.

Banding the tail end of the grip is required to prevent unintended release of the grip's hold from the cable and to achieve maximum gripping strength

The strength of a Kellems grips is based on laboratory testing and does not evaluate variable conditions such as cable type, gripping surfaces, cable movement or impact loads. Suitability for the application must be determined by the user.

Thoroughly examine the condition of the grip prior to each use. Grips that are worn, bent, corroded, or show other signs of damage, such as frayed or broken wires, should never be used and must be replaced.

Do not modify the grip in any way.

Ensure that the recommended work load of the grip is suitable for the application. Never use a grip beyond its safe working load, which is the approximate breaking strength divided by the factor of safety. The recommended factor of safety is five (5) for pulling grips and ten (10) for support grips.

Pulling hardware should only be attached to the eye of the grip.

A swivel is recommended for attachment to the grip's eye in applications where torque release is necessary. Torque can build up in high tension pulling applications.

Do not run grips and swivels around sheaves or bull wheels while under tension. For synthetic rope, use Kellems Dua-Pull Grips only.

IMPORTANT:

Under normal conditions, Kellems' recommended factor of safety is five for catalog listed pulling grips, and ten for catalog listed support grips.

Select The Correct Pulling Grip

Each Kellems Grip is designed to work on a specific range of cable diameters.

Step 1 Refer to the chart below to determine the style of grip best suited for your application.

Step 2 Determine your cable outside diameter.

Step 3 Find the grip size that encompasses your cable diameter.

Step 4 Estimate the tension to be put on the grip, establish the working load you require and compare this to the listed approximate breaking strength of the grip to insure that the grip will be strong enough. Refer to page V-34 for safety and working load factors.

Pulling Grip Selection Chart

Grip Style	Application	Page Number
DUA-PULL®, flexible eye	Extra high strength overhead transmission line stringing for bare or insulated conductor and synthetic rope.	V-7
Multiple strength, flexible eye	Normal overhead transmission and distribution line stringing for bare or insulated conductor.	V-8
Multiple strength, rotating eye	Normal overhead transmission and distribution line stringing for bare or insulated conductor.	V-8
K-type grip, rotating eye	Underground power cables and communication lines. Service lines into factories.	V-9
T-type grip, flexible eye	Underground power cables and communication lines. Service lines into factories.	V-10
Non-conductive, flexible eye	Pull insulated distribution cable into place.	V-11
Slack pulling, closed mesh	Remove underground cable. For pulling slack in final placement of new cable when end of cable is available.	V-11
Slack pulling, split mesh,	Remove underground cable. For pulling slack in final placement of new cable rawhide lace closing when end of cable is not available.	V-12
Slack pulling, split mesh,	Remove underground cable. For pulling slack in final placement of new cable rod closing when end of cable is not available, with rod closing for quick installation.	V-12
Light duty, flexible eye	Light pulling, underground electrical construction. Industrial plant wiring and rewiring jobs.	V-13
Junior, flexible eye	Connect bundled insulated building wire to a pulling tape. Pull wire through conduit.	V-13
Regular and rotating wire rope	Restraining wire rope in cranes and oil rigs.	V-14
Splicing	Temporary splice for cable or wire rope.	V-15
Pulling Grip Accessories	Tools, bands, swivels.	V-16
Fiber Optic Cable Pulling Grips	Pull fiber optic cable into place overhead, underground or through duct and conduit.	V-39 to V-43



Multiple Cable Selection Charts for Cables and Wires of Unequal Diameters

How to choose the correct grip size:

1. Find the Grip Circumference Range by measuring the circumference of the bundle of different diameter cables to be gripped (see illustration).
2. Divide the bundle circumference by 3.14 to determine the diameter.
3. Choose a grip offering a range of cable diameters the same as the cable diameter.

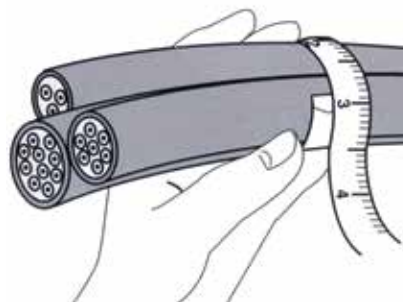

For Pulling Grips*

CAUTION: When a grip is used on multiple cables, the tail end of the grip should be banded after positioning on the cables.

For Cables of Equal Diameters

Under "Number of Cables in One Grip", find the diameter of your single cable in vertical column. Read the grip diameter range to the right.

If your diameter is the maximum of the range shown, go to the next larger size for Split Grips, stay with the same size for Closed Grips.

Example: Three cables, each with .89" (2.26cm) diameter, for a Closed Grip select the 1.50"-1.74" (3.81cm-4.42cm) range, for a Split Grip select the 1.75"-1.99" (4.44cm-5.05cm) range.

Number of Cables in One Grip

2	3	4	5	6 and 7	8	9	Grip Dia. Range Inches (cm)
.30-.38 (.76-.97)	.25-.31 (.63-.79)	.22-.27 (.56-.69)	.19-.24 (.48-.60)	.17-.22 (.43-.56)	.15-.19 (.38-.48)	.14-.18 (.36-.46)	.50-.61 (1.27-1.55)
.38-.44 (.97-1.12)	.31-.36 (.79-.91)	.27-.31 (.69-.79)	.24-.29 (.61-.74)	.22-.26 (.56-.66)	.19-.23 (.48-.58)	.18-.21 (.46-.53)	.62-.74 (1.57-1.88)
.44-.59 (1.12-1.50)	.36-.49 (.91-1.24)	.31-.42 (.79-1.07)	.29-.38 (.74-.97)	.26-.34 (.66-.86)	.23-.31 (.58-.79)	.21-.28 (.53-.71)	.75-.99 (1.90-2.51)
.59-.75 (1.50-1.90)	.49-.63 (1.24-1.60)	.42-.54 (1.07-1.37)	.38-.48 (.97-1.22)	.34-.43 (.86-1.09)	.31-.39 (.79-.99)	.28-.35 (.71-.89)	1.00-1.24 (2.54-3.15)
.75-.90 (1.90-2.29)	.63-.76 (1.60-1.93)	.54-.65 (1.37-1.65)	.48-.58 (1.22-1.47)	.43-.52 (1.09-1.32)	.39-.46 (.99-1.17)	.35-.42 (.89-1.07)	1.25-1.49 (3.17-3.78)
.90-1.07 (2.29-2.72)	.76-.89 (1.93-2.26)	.65-.77 (1.65-1.96)	.58-.67 (1.47-1.70)	.52-.60 (1.32-1.52)	.46-.54 (1.17-1.37)	.42-.49 (1.07-1.24)	1.50-1.74 (3.81-4.42)
1.07-1.22 (2.72-3.10)	.89-1.02 (2.26-2.59)	.77-.88 (1.96-2.24)	.67-.77 (1.70-1.96)	.60-.69 (1.52-1.75)	.54-.62 (1.37-1.57)	.49-.56 (1.24-1.42)	1.75-1.99 (4.44-5.05)
1.22-1.53 (3.10-3.89)	1.02-1.28 (2.59-3.25)	.88-1.10 (2.24-2.79)	.77-.96 (1.96-2.44)	.69-.86 (1.75-2.18)	.62-.77 (1.57-1.96)	.56-.71 (1.42-1.80)	2.00-2.49 (5.08-6.32)
1.53-1.83 (3.89-4.65)	1.28-1.53 (3.25-3.89)	1.10-1.32 (2.79-3.35)	.96-1.16 (2.44-2.95)	.86-1.03 (2.18-2.62)	.77-.93 (1.96-2.36)	.71-.85 (1.80-2.16)	2.50-2.99 (6.35-7.59)
1.83-2.14 (4.65-5.44)	1.53-1.79 (3.89-4.55)	1.32-1.54 (3.35-3.91)	1.16-1.35 (2.95-3.43)	1.03-1.20 (2.62-3.05)	.93-1.08 (2.36-2.74)	.85-.99 (2.16-2.51)	3.00-3.49 (7.62-8.86)
2.14-2.44 (5.44-6.20)	1.79-2.05 (4.55-5.21)	1.54-1.76 (3.91-4.47)	1.35-1.54 (3.43-3.91)	1.20-1.37 (3.05-3.48)	1.08-1.24 (2.74-3.15)	.99-1.13 (2.51-2.87)	3.50-3.99 (8.89-10.13)
2.44-2.75 (6.20-6.98)	2.05-2.30 (5.21-5.84)	1.76-1.98 (4.47-5.03)	1.54-1.74 (3.91-4.42)	1.37-1.55 (3.48-3.94)	1.24-1.39 (3.15-3.53)	1.13-1.27 (2.87-3.23)	4.00-4.49 (10.16-11.40)
2.75-3.06 (6.98-7.77)	2.30-2.56 (5.84-6.50)	1.98-2.20 (5.03-5.59)	1.74-1.93 (4.42-4.90)	1.55-1.72 (3.94-4.37)	1.39-1.55 (3.53-3.94)	1.27-1.41 (3.23-3.58)	4.50-4.99 (11.43-12.67)

Note: *This chart is not to be used for Conduit Riser Grips. Refer to the chart for Conduit Riser multiple cable section. It is always recommended that, when multiple cables are installed in a pulling grip, the tail end be banded and tightly taped after installation on the cable bundle. See page V-16 for end bands.



Features and Benefits

Kellems® Support Grips

They are used to hold the weight of electrical cable as it hangs in a vertical, sloping or horizontal position. Electrical cable must be supported, or its dead weight can cause excessive strain or pullout at the connections resulting in power failure. Support grips also absorb additional strain from flexure, vibration, expansion and contraction.

Kellems support grips listed in this catalog are made of high grade, non-magnetic tin-coated bronze strand. Stainless steel grips, made of alloy 302–304 series stainless are for severe service or unusual environmental conditions. For exceptional immunity to rust and corrosion with superior strength and flexibility for heavy duty support application in harsh environments available upon request; contact the factory.



02206010



Mesh Grip

- The positive action mesh grip is designed for light duty up to heavy duty; closed grips fit over the cable end, split grips wrap around the cable mid-span
- The endless weave provides easy installation onto cable and can be easily repositioned

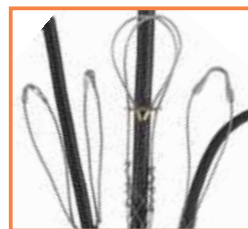

Eye Styles

- Four eye styles available: single (shown), double, universal and offset
- Solid eye assemblies provide eye reinforcement at support hardware
- Each Kellems grip is designed to work on a specific range of cable diameters



Cable Identification

- Identification tag shows: catalog number, diameter range, agency approval and bar code
- The strand equalizer positions wires for equal loading throughout the entire grip length

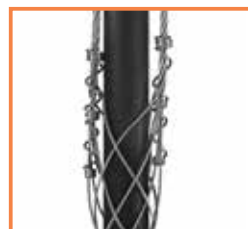

Strand Equalizer

- Positions wires for equal loading throughout the entire grip length



Standard Duty Support Grips

Single Eye, Single Weave, Tin-Coated Bronze and Stainless Steel.

IMPORTANT:

Read all breaking strength, safety and technical data relating to this product.

Refer to pages V-33 and V-34.

Single Eye, Closed Mesh

For permanent support when cable end is available to be installed through grip.

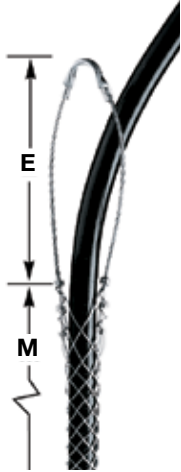

Cable Diameter Range Inches (cm)	Approx. Breaking Strength Lbs.		Working Load Lbs.		E Inches (cm)	M Inches (cm)	Tin-Coated Bronze	Stainless Steel
	Tin-Coated Bronze	Stainless Steel	Tin-Coated Bronze	Stainless Steel				
.50"--.62" (1.27-1.57)	530	1,370	53	137	7" (17.78)	10" (25.40)	02201013	02401013
.63"--.74" (1.60-1.88)	790	2,060	79	206	8" (20.32)	10" (25.40)	02201014	02401014
.75"--.99" (1.90-2.51)	1,020	2,060	102	206	8" (20.32)	13" (33.02)	02201015	02401015
1.00"-1.24" (2.54-3.15)	1,610	2,678	161	268	9" (22.86)	14" (35.56)	02201017	02401017
1.25"-1.49" (3.17-3.78)	1,610	4,490	161	449	10" (25.40)	15" (38.10)	02201018	02401018
1.50"-1.74" (3.81-4.42)	1,610	4,492	161	449	12" (30.48)	17" (43.18)	02201019	02401019
1.75"-1.99" (4.44-5.05)	2,150	5,000	215	500	14" (35.56)	19" (48.26)	02201020	02401020
2.00"-2.49" (5.08-6.32)	3,260	8,940	326	894	16" (40.64)	21" (53.34)	02201021	02401021
2.50"-2.99" (6.35-7.59)	3,260	8,947	326	895	18" (45.72)	23" (58.42)	02201022	02401022
3.00"-3.49" (7.62-8.86)	4,900	13,420	490	1,342	21" (53.34)	25" (63.50)	02201023	02401023
3.50"-3.99" (8.89-10.13)	4,900	—	490	—	24" (60.96)	27" (68.58)	02201024	—

Single Eye, Split Mesh, Lace Closing

For permanent support when cable end is not available.

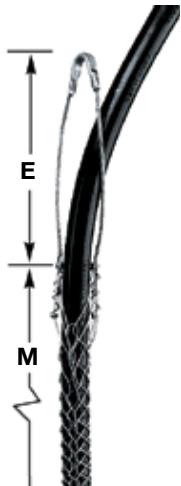

Cable Diameter Range Inches (cm)	Approx. Breaking Strength Lbs.		Working Load Lbs.		E Inches (cm)	M Inches (cm)	Tin-Coated Bronze	Stainless Steel
	Tin-Coated Bronze	Stainless Steel	Tin-Coated Bronze	Stainless Steel				
.50"--.62" (1.27-1.57)	530	1,370	53	137	7" (17.78)	10" (25.40)	02202013	02402013
.63"--.74" (1.60-1.88)	790	2,066	79	207	8" (20.32)	10" (25.40)	02202014	02402014
.75"--.99" (1.90-2.51)	1,020	2,060	102	206	8" (20.32)	13" (33.02)	02202015	02402015
1.00"-1.24" (2.54-3.15)	1,610	2,670	161	267	9" (22.86)	14" (35.56)	02202017	02402017
1.25"-1.49" (3.17-3.78)	1,610	4,490	161	449	10" (25.40)	15" (38.10)	02202018	02402018
1.50"-1.74" (3.81-4.42)	1,610	4,490	161	449	12" (30.48)	17" (43.18)	02202019	02402019
1.75"-1.99" (4.44-5.05)	2,150	4,375	215	437	14" (35.56)	19" (48.26)	02202020	02402020
2.00"-2.49" (5.08-6.32)	3,260	8,947	326	895	16" (40.64)	21" (53.34)	02202021	02402021
2.50"-2.99" (6.35-7.59)	3,260	8,940	326	894	18" (45.72)	23" (58.42)	02202022	02402022
3.00"-3.49" (7.62-8.86)	4,900	13,420	490	1,342	21" (53.34)	25" (63.50)	02202023	02402023
3.50"-3.99" (8.89-10.13)	4,900	13,420	490	1,342	24" (60.96)	27" (68.58)	02202024	02402024

Single Eye, Split Mesh, Rod Closing

For support when cable end is not available.

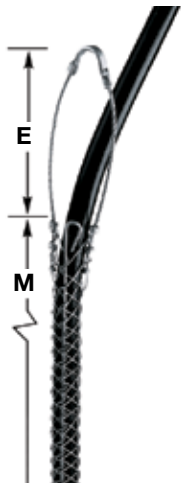

Cable Diameter Range Inches (cm)	Approx. Breaking Strength Lbs.		Working Load Lbs.		E Inches (cm)	M Inches (cm)	Tin-Coated Bronze	Stainless Steel
	Tin-Coated Bronze	Stainless Steel	Tin-Coated Bronze	Stainless Steel				
.50"--.62" (1.27-1.57)	790	1,050	79	105	7" (17.78)	8.5" (21.59)	02203013	02403013
.63"--.74" (1.60-1.88)	790	2,050	79	205	8" (20.32)	8.5" (21.59)	02203014	02403014
.75"--.99" (1.90-2.51)	1,020	2,050	102	205	8" (20.32)	10.5" (26.67)	02203015	02403015
1.00"-1.24" (2.54-3.15)	1,610	2,650	161	265	9" (22.86)	12.5" (31.75)	02203017	02403017
1.25"-1.49" (3.17-3.78)	1,610	4,500	161	450	10" (25.40)	14.5" (36.83)	02203018	02403018
1.50"-1.74" (3.81-4.42)	1,610	4,500	161	450	12" (30.48)	15.5" (39.37)	02203019	02403019
1.75"-1.99" (4.44-5.05)	2,150	6,000	215	600	14" (35.56)	16.5" (41.91)	02203020	02403020
2.00"-2.49" (5.08-6.32)	3,260	8,950	326	895	16" (40.64)	19.5" (49.53)	02203021	02403021
2.50"-2.99" (6.35-7.59)	3,260	7,750	326	775	18" (45.72)	21.5" (54.61)	02203022	02403022
3.00"-3.49" (7.62-8.86)	5,750	8,500	575	850	21" (53.34)	23.5" (59.69)	02203023	02403023
3.50"-3.99" (8.89-10.13)	5,750	—	575	—	24" (60.96)	25.5" (64.77)	02203024	—

Note: E-Eye length. M-Mesh length at nominal diameter.

Dimensions in Inches (mm)

Standard Duty Support Grips

Double Eye, Single Weave, Tin-Coated Bronze and Stainless Steel.

IMPORTANT:
Read all breaking strength, safety and technical data relating to this product.

Refer to pages V-33 and V-34.

Double Eye, Closed Mesh

For permanent support when cable end is available to be installed through grip.

Cable Diameter Range Inches (cm)	Approx. Breaking Strength Lbs.		Working Load Lbs.		E Inches (cm)	M Inches (cm)	Tin-Coated Bronze	Stainless Steel
	Tin-Coated Bronze	Stainless Steel	Tin-Coated Bronze	Stainless Steel				
.50"-.62" (1.27-1.57)	530	1,370	53	137	4" (10.16)	10" (25.40)	02201001	02401001
.63"-.74" (1.60-1.88)	790	2,060	79	206	4" (10.16)	10" (25.40)	02201002	02401002
.75"-.99" (1.90-2.51)	1,020	2,060	102	206	4" (10.16)	13" (33.02)	02201003	02401003
1.00"-1.24" (2.54-3.15)	1,610	2,670	161	267	5" (12.70)	14" (35.56)	02201005	02401005
1.25"-1.49" (3.17-3.78)	1,610	4,490	161	449	5" (12.70)	15" (38.10)	02201006	02401006
1.50"-1.74" (3.81-4.42)	1,610	4,490	161	449	5" (12.70)	17" (43.18)	02201007	02401007
1.75"-1.99" (4.44-5.05)	2,150	5,000	215	500	6" (15.24)	19" (48.26)	02201008	02401008
2.00"-2.49" (5.08-6.32)	3,260	8,940	326	894	6" (15.24)	21" (53.34)	02201009	02401009
2.50"-2.99" (6.35-7.59)	3,260	8,940	326	894	6" (15.24)	23" (58.42)	02201010	02401010
3.00"-3.49" (7.62-8.86)	4,900	12,000	490	1,200	8" (20.32)	25" (63.50)	02201011	02401011
3.50"-3.99" (8.89-10.13)	4,900	12,000	490	1,200	8" (20.32)	27" (68.58)	02201012	02401012

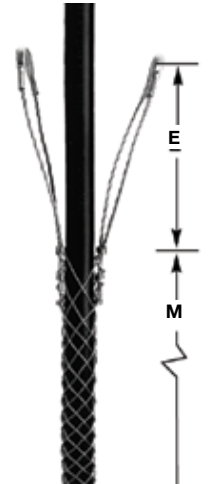

Double Eye, Split Mesh, Lace Closing

For permanent support when cable end is not available.

Cable Diameter Range Inches (cm)	Approx. Breaking Strength Lbs.		Working Load Lbs.		E Inches (cm)	M Inches (cm)	Tin-Coated Bronze	Stainless Steel
	Tin-Coated Bronze	Stainless Steel	Tin-Coated Bronze	Stainless Steel				
.50"-.62" (1.27-1.57)	530	—	53	—	4" (10.16)	10" (25.40)	02202001	—
.63"-.74" (1.60-1.88)	790	2,066	79	207	4" (10.16)	10" (25.40)	02202002	02402002
.75"-.99" (1.90-2.51)	1,020	2,060	102	206	4" (10.16)	13" (33.02)	02202003	02402003
1.00"-1.24" (2.54-3.15)	1,610	2,678	161	268	5" (12.70)	14" (35.56)	02202005	02402005
1.25"-1.49" (3.17-3.78)	1,610	4,490	161	449	5" (12.70)	15" (38.10)	02202006	02402006
1.50"-1.74" (3.81-4.42)	1,610	3,750	161	375	5" (12.70)	17" (43.18)	02202007	02402007
1.75"-1.99" (4.44-5.05)	2,150	5,000	215	500	6" (15.24)	19" (48.26)	02202008	02402008
2.00"-2.49" (5.08-6.32)	3,260	8,940	326	894	6" (15.24)	21" (53.34)	02202009	02402009
2.50"-2.99" (6.35-7.59)	3,260	—	326	—	6" (15.24)	23" (58.42)	02202010	—
3.00"-3.49" (7.62-8.86)	4,900	—	490	—	8" (20.32)	25" (63.50)	02202011	—
3.50"-3.99" (8.89-10.13)	4,900	—	490	—	8" (20.32)	27" (68.58)	02202012	—

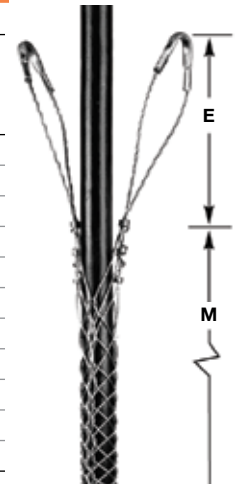

Double Eye, Split Mesh, Rod Closing

For support when cable end is not available.

Cable Diameter Range Inches (cm)	Approx. Breaking Strength Lbs.		Working Load Lbs.		E Inches (cm)	M Inches (cm)	Tin-Coated Bronze	Stainless Steel
	Tin-Coated Bronze	Stainless Steel	Tin-Coated Bronze	Stainless Steel				
.50"-.62" (1.27-1.57)	790	—	79	—	4" (10.16)	6.5"	02203001	—
.63"-.74" (1.60-1.88)	790	2,050	79	205	4" (10.16)	8.5" (21.59)	02203002	02403002
.75"-.99" (1.90-2.51)	1,020	2,050	102	205	4" (10.16)	10.5" (26.67)	02203003	02403003
1.00"-1.24" (2.54-3.15)	1,610	2,650	161	265	5" (12.70)	12.5" (31.75)	02203005	02403005
1.25"-1.49" (3.17-3.78)	1,610	3,750	161	375	5" (12.70)	14.5" (36.83)	02203006	02403006
1.50"-1.74" (3.81-4.42)	1,610	3,750	161	375	5" (12.70)	15.5" (39.37)	02203007	02403007
1.75"-1.99" (4.44-5.05)	2,150	5,000	215	215	6" (15.24)	16.5" (41.91)	02203008	02403008
2.00"-2.49" (5.08-6.32)	3,260	8,950	326	326	6" (15.24)	19.5" (49.53)	02203009	02403009
2.50"-2.99" (6.35-7.59)	3,260	8,950	326	326	6" (15.24)	21.5" (54.61)	02203010	02403010
3.00"-3.49" (7.62-8.86)	5,750	11,150	575	1,115	8" (20.32)	23.5" (59.69)	02203011	02403011
3.50"-3.99" (8.89-10.13)	5,750	—	575	—	8" (20.32)	25.5" (64.77)	02203012	—

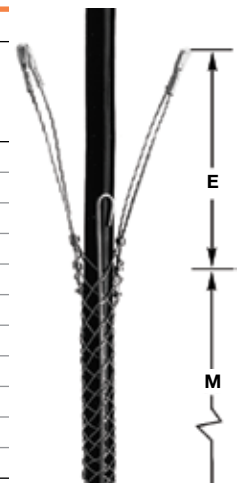

Note: E-Eye length. M-Mesh length at nominal diameter.

Dimensions in Inches (mm)



Standard Duty Support Grips

Offset Eye, Single Weave, Tin-Coated Bronze and Stainless Steel.

IMPORTANT:

Read all breaking strength, safety and technical data relating to this product.

Refer to pages V-33 and V-34.

Offset Eye, Closed Mesh

For permanent support when cable end is available to be installed through grip.

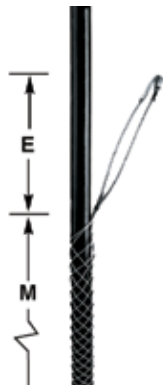

Cable Diameter Range Inches (cm)	Approx. Breaking Strength Lbs.		Working Load Lbs.		E Inches (cm)	M Inches (cm)	Tin-Coated Bronze	Stainless Steel
	Tin-Coated Bronze	Stainless Steel	Tin-Coated Bronze	Stainless Steel				
.50"- .62" (1.27-1.57)	530	1,370	53	137	4" (10.16)	10" (25.40)	02201037	02401037
.63"- .74" (1.60-1.88)	750	1,950	75	195	4" (10.16)	10" (25.40)	02201038	02401038
.75"- .99" (1.90-2.51)	950	2,060	95	206	4" (10.16)	13" (33.02)	02201039	02401039
1.00"-1.24" (2.54-3.15)	1,500	2,678	150	268	5" (12.70)	14" (35.56)	02201041	02401041
1.25"-1.49" (3.17-3.78)	1,500	4,490	150	449	5" (12.70)	15" (38.10)	02201042	02401042
1.50"-1.74" (3.81-4.42)	1,500	3,700	150	370	5" (12.70)	17" (43.18)	02201043	02401043
1.75"-1.99" (4.44-5.05)	2,000	4,375	200	437	6" (15.24)	19" (48.26)	02201044	02401044
2.00"-2.49" (5.08-6.32)	3,100	5,500	310	550	9" (22.86)	21" (53.34)	02201045	02401045
2.50"-2.99" (6.35-7.59)	3,100	—	310	—	9" (22.86)	23" (58.42)	02201046	—
3.00"-3.49" (7.62-8.86)	3,800	—	380	—	11" (27.94)	25" (63.50)	02201047	—
3.50"-3.99" (8.89-10.13)	3,250	—	325	—	11" (27.94)	27" (68.58)	02201048	—

Offset Eye, Split Mesh, Lace Closing

For permanent support when cable end is not available.

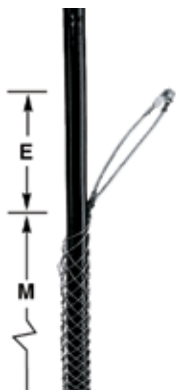

Cable Diameter Range Inches (cm)	Approx. Breaking Strength Lbs. (N)		Working Load Lbs.		E Inches (cm)	M Inches (cm)	Tin-Coated Bronze	Stainless Steel
	Tin-Coated Bronze	Stainless Steel	Tin-Coated Bronze	Stainless Steel				
.50"- .62" (1.27-1.57)	500	—	50	—	4" (10.16)	10" (25.40)	02202037	—
.63"- .74" (1.60-1.88)	750	1,952	75	195	4" (10.16)	10" (25.40)	02202038	02402038
.75"- .99" (1.90-2.51)	950	—	95	—	4" (10.16)	13" (33.02)	02202039	—
1.00"-1.24" (2.54-3.15)	1,500	—	150	—	5" (12.70)	14" (35.56)	02202041	—
1.25"-1.49" (3.17-3.78)	1,500	4,490	150	449	5" (12.70)	15" (38.10)	02202042	02402042
1.50"-1.74" (3.81-4.42)	1,500	—	150	—	5" (12.70)	17" (43.18)	02202043	—
1.75"-1.99" (4.44-5.05)	1,800	4,375	180	437	6" (15.24)	19" (48.26)	02202044	02402044
2.00"-2.49" (5.08-6.32)	2,150	5,500	215	550	9" (22.86)	21" (53.34)	02202045	02402045
2.50"-2.99" (6.35-7.59)	2,150	5,500	215	550	9" (22.86)	23" (58.42)	02202046	02402046
3.00"-3.49" (7.62-8.86)	3,250	10,190	325	1,019	11" (27.94)	25" (63.50)	02202047	02402047
3.50"-3.99" (8.89-10.13)	3,250	—	325	—	11" (27.94)	27" (68.58)	02202048	—

Offset Eye, Split Mesh, Rod Closing

For support when cable end is not available.

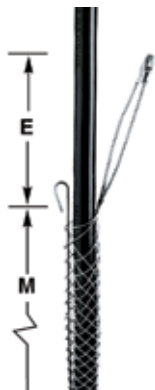

Cable Diameter Range Inches (cm)	Approx. Breaking Strength Lbs. (N)		Working Load Lbs.		E Inches (cm)	M Inches (cm)	Tin-Coated Bronze	Stainless Steel
	Tin-Coated Bronze	Stainless Steel	Tin-Coated Bronze	Stainless Steel				
.50"- .62" (1.27-1.57)	500	1,000	50	100	4" (10.16)	7" (17.78)	02203037	02403037
.63"- .74" (1.60-1.88)	750	1,950	75	195	4" (10.16)	9" (22.86)	02203038	02403038
.75"- .99" (1.90-2.51)	950	1,950	95	195	4" (10.16)	10" (25.40)	02203039	02403039
1.00"-1.24" (2.54-3.15)	1,500	2,500	150	250	5" (12.70)	12" (30.48)	02203041	02403041
1.25"-1.49" (3.17-3.78)	1,500	4,200	150	420	5" (12.70)	14" (35.56)	02203042	02403042
1.50"-1.74" (3.81-4.42)	1,500	4,500	150	450	5" (12.70)	15" (38.10)	02203043	02403043
1.75"-1.99" (4.44-5.05)	2,000	4,375	200	437	6" (15.24)	16" (40.64)	02203044	02403044
2.00"-2.49" (5.08-6.32)	3,100	8,350	310	835	9" (22.86)	19" (48.26)	02203045	02403045
2.50"-2.99" (6.35-7.59)	3,100	—	310	—	9" (22.86)	20" (50.80)	02203046	—
3.00"-3.49" (7.62-8.86)	4,300	8,400	430	840	11" (27.94)	21" (53.34)	02203047	02403047
3.50"-3.99" (8.89-10.13)	4,900	—	490	—	11" (27.94)	21" (53.34)	02203048	—

Note: E-Eye length. M-Mesh length at nominal diameter.

Dimensions in Inches (mm)

Standard Duty Support Grips

Universal Eye, Single Weave, Tin-Coated Bronze and Stainless Steel.

IMPORTANT:
Read all breaking strength, safety and technical data relating to this product.

Refer to pages V-33 and V-34.

Universal Eye, Closed Mesh

For permanent support when cable end is available to be installed through grip.

Cable Diameter Range Inches (cm)	Approx. Breaking Strength Lbs. (N)		Working Load Lbs.				Tin-Coated Bronze	Stainless Steel
	Tin-Coated Bronze	Stainless Steel	Tin-Coated Bronze	Stainless Steel	E Inches (cm)	M Inches (cm)		
.50"- .62" (1.27-1.57)	530	1,370	53	137	18" (45.72)	10" (25.40)	02201051	02401051
.63"- .74" (1.60-1.88)	790	2,060	79	206	18" (45.72)	10" (25.40)	02201052	02401052
.75"- .99" (1.90-2.51)	1,020	2,066	102	207	18" (45.72)	13" (33.02)	02201053	02401053
1.00"-1.24" (2.54-3.15)	1,610	—	161	—	18" (45.72)	14" (35.56)	02201050	—
1.25"-1.49" (3.17-3.78)	1,610	4,490	161	449	18" (45.72)	15" (38.10)	02201054	02401054
1.50"-1.74" (3.81-4.42)	1,610	4,490	161	449	18" (45.72)	17" (43.18)	02201055	02401055
1.75"-1.99" (4.44-5.05)	2,150	—	215	—	18" (45.72)	19" (48.26)	02201056	—
2.00"-2.49" (5.08-6.32)	3,260	—	326	—	18" (45.72)	21" (53.34)	02201057	—
2.50"-2.99" (6.35-7.59)	3,260	—	326	—	18" (45.72)	23" (58.42)	02201058	—



Universal Eye, Split Mesh, Lace Closing

For permanent support when cable end is not available.

Cable Diameter Range Inches (cm)	Approx. Breaking Strength Lbs. (N)		Working Load Lbs.				Tin-Coated Bronze	Stainless Steel
	Tin-Coated Bronze	Stainless Steel	Tin-Coated Bronze	Stainless Steel	E Inches (cm)	M Inches (cm)		
.50"- .62" (1.27-1.57)	530	—	53	—	18" (45.72)	10" (25.40)	02202050	—
.63"- .74" (1.60-1.88)	790	2,060	79	206	18" (45.72)	10" (25.40)	02202051	02402051
.75"- .99" (1.90-2.51)	1,020	—	102	—	18" (45.72)	13" (33.02)	02202052	—
1.00"-1.24" (2.54-3.15)	1,610	—	161	—	18" (45.72)	14" (35.56)	02202054	—
1.25"-1.49" (3.17-3.78)	1,610	—	161	—	18" (45.72)	15" (38.10)	02202055	—
1.50"-1.74" (3.81-4.42)	1,610	—	161	—	18" (45.72)	17" (43.18)	02202056	—
1.75"-1.99" (4.44-5.05)	2,150	—	215	—	18" (45.72)	19" (48.26)	02202057	—
2.00"-2.49" (5.08-6.32)	3,260	—	326	—	18" (45.72)	21" (53.34)	02202058	—
2.50"-2.99" (6.35-7.59)	3,260	—	326	—	18" (45.72)	23" (58.42)	02202059	—
3.50"-3.99" (8.89-10.13)	4,900	—	490	—	18" (45.72)	27" (68.58)	02202061	—



Universal Eye, Split Mesh, Rod Closing

For support when cable end is not available.

Cable Diameter Range Inches (cm)	Approx. Breaking Strength Lbs. (N)		Working Load Lbs.				Tin-Coated Bronze	Stainless Steel
	Tin-Coated Bronze	Stainless Steel	Tin-Coated Bronze	Stainless Steel	E Inches (cm)	M Inches (cm)		
.50"- .62" (1.27-1.57)	790	—	79	—	18" (45.72)	8.5" (21.59)	02203064	—
.63"- .74" (1.60-1.88)	790	2,050	79	205	18" (45.72)	8.5" (21.59)	02203065	02403065
.75"- .99" (1.90-2.51)	1,020	2,050	102	205	18" (45.72)	10.5" (26.67)	02203066	02403066
1.00"-1.24" (2.54-3.15)	1,610	2,650	161	265	18" (45.72)	12.5" (31.75)	02203068	02403068
1.25"-1.49" (3.17-3.78)	1,610	4,500	161	450	18" (45.72)	14.5" (36.83)	02203069	02403069
1.50"-1.74" (3.81-4.42)	1,610	4,500	161	450	18" (45.72)	15.5" (39.37)	02203070	02403070
1.75"-1.99" (4.44-5.05)	2,150	—	215	—	18" (45.72)	16.5" (41.91)	02203071	—
2.00"-2.49" (5.08-6.32)	3,260	—	326	—	18" (45.72)	19.5" (49.53)	02203072	—
2.50"-2.99" (6.35-7.59)	3,260	—	326	—	18" (45.72)	21.5" (54.61)	02203073	—
3.00"-3.49" (7.62-8.86)	5,750	—	575	—	18" (45.72)	23.5" (59.69)	02203074	—



Note: E-Eye length. M-Mesh length at nominal diameter.

Dimensions in Inches (mm)



Non-Metallic Support Grips

Single Eye, Double Weave, Non-Metallic Aramid Fiber.

IMPORTANT:

Read all breaking strength, safety and technical data relating to this product.

Refer to pages V-33 and V-34.



Kellems® Non-Metallic Support Grips

Kellems® Non-Metallic Support Grips, made of a high strength double weave aramid fiber, are available for supporting cable in corrosive environments.

Non-Metallic Support Grips, Single Eye, Closed Mesh

For permanent support when cable end is available to be installed through grip.

Cable Diameter Range Inches (cm)	Approx. Breaking Strength Lbs.	Working Load Lbs.	E Inches (cm)	M Inches (cm)	Color Code	Catalog Number
.50"--.62" (1.27-1.57)	1,000	100	6.0" (15.24)	22" (55.88)	Green	02601001
.63"--.74" (1.60-1.88)	2,000	200	6.0" (15.24)	24" (60.96)	Yellow	02601002
.75"--.99" (1.90-2.51)	2,000	200	6.0" (15.24)	28.5" (72.39)	Red	02601003
1.00"-1.24" (2.54-3.15)	3,000	300	6.0" (15.24)	31" (78.74)	Blue	02601004
1.25"-1.49" (3.17-3.78)	3,000	300	6.0" (15.24)	36.5" (92.71)	White	02601005
1.50"-1.99" (3.81-5.05)	3,000	300	6.0" (15.24)	40" (101.60)	Pink	02601006

Note: Specified for corrosive applications.

Heavy Duty Support Grips

Single Eye, Double Weave, Tin-Coated Bronze and Stainless Steel

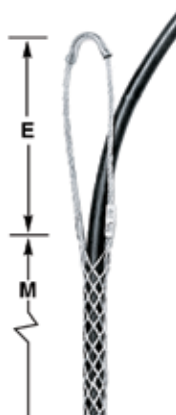

Heavy Duty, Single Eye, Closed Mesh

For heavy duty permanent support when cable end is available to be installed through grip.

Cable Diameter Range Inches (cm)	Approx. Breaking Strength Lbs.		Working Load Lbs.		E Inches (cm)	M Inches (cm)	Tin-Coated Bronze	Stainless Steel
	Tin-Coated Bronze	Stainless Steel	Tin-Coated Bronze	Stainless Steel				
.75"--.99" (1.90-2.51)	2,820	4,200	282	420	10" (25.40)	25" (63.50)	02206010	02406010
1.00"-1.24" (2.54-3.15)	4,280	7,300	428	730	12" (30.48)	28" (71.12)	02206011	02406011
1.25"-1.49" (3.17-3.78)	4,280	7,300	428	730	12" (30.48)	30" (76.20)	02206012	02406012
1.50"-1.99" (3.81-5.05)	4,280	11,150	428	1,115	12" (30.48)	34" (86.36)	02206013	02406013



Single Eye, Split Mesh, Lace Closing

For permanent support when cable end is not available to be installed through grip.

Cable Diameter Range Inches (cm)	Approx. Breaking Strength Lbs. (N)		Working Load Lbs.		E Inches (cm)	M Inches (cm)	Tin-Coated Bronze	Stainless Steel
	Tin-Coated Bronze	Stainless Steel	Tin-Coated Bronze	Stainless Steel				
.75"--.99" (1.90-2.51)	2,820	4,200	282	420	10" (25.40)	25" (63.50)	02207010	02407010
1.00"-1.24" (2.54-3.15)	4,280	7,300	428	730	12" (30.48)	28" (71.12)	02207011	02407011
1.25"-1.49" (3.17-3.78)	4,280	7,300	428	730	12" (30.48)	30" (76.20)	02207012	02407012
1.50"-1.99" (3.81-5.05)	4,280	11,150	428	1,115	12" (30.48)	34" (86.36)	02207013	02407013

Note: E-Eye length. M-Mesh length at nominal diameter.

Dimensions in Inches (mm)

Heavy Duty Support Grips

Double Eye, Double Weave, Tin-Coated Bronze and Stainless Steel.

IMPORTANT:
Read all breaking strength, safety and technical data relating to this product.

Refer to pages V-33 and V-34.

Double Eye, Closed Mesh

For permanent support when cable end is available to be installed through grip.

Cable Diameter Range Inches (cm)	Approx. Breaking Strength Lbs. (N)		Working Load Lbs.		E Inches (cm)	M Inches (cm)	Tin-Coated Bronze	Stainless Steel
	Tin-Coated Bronze	Stainless Steel	Tin-Coated Bronze	Stainless Steel				
.75"-1.99" (1.90-2.51)	2,820	4,250	282	425	10" (25.40)	25" (63.50)	02206001	02406001
1.00"-1.24" (2.54-3.15)	4,280	7,300	428	730	10" (25.40)	28" (71.12)	02206002	02406002
1.25"-1.49" (3.17-3.78)	4,280	7,300	428	730	10" (25.40)	30" (76.20)	02206003	02406003
1.50"-1.99" (3.81-5.05)	4,280	11,100	428	1,110	10" (25.40)	34" (86.36)	02206004	02406004
2.00"-2.49" (5.08-6.32)	8,050	20,100	805	2,010	12" (30.48)	36" (91.44)	02206005	02406005
2.50"-2.99" (6.35-7.59)	8,050	20,100	805	2,010	12" (30.48)	38" (96.52)	02206006	02406006
3.00"-3.49" (7.62-8.86)	10,060	25,200	1,006	2,520	12" (30.48)	40" (101.60)	02206007	02406007
3.50"-3.99" (8.89-10.13)	12,070	—	1,207	—	12" (30.48)	44" (111.76)	02206008	—
4.00"-4.49" (10.16-11.40)	12,070	—	1,207	—	12" (30.48)	46" (116.84)	02206009	—
4.50"-4.99" (11.43-12.67)	12,070	—	1,207	—	12" (30.48)	68" (172.72)	02208009	—

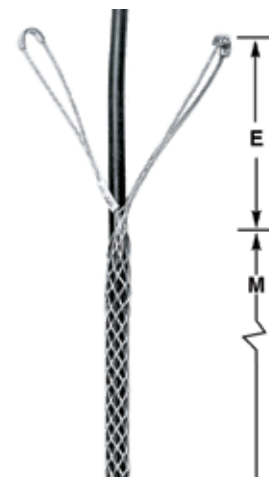

Double Eye, Split Mesh, Lace Closing

For support when cable end is not available.

Cable Diameter Range Inches (cm)	Approx. Breaking Strength Lbs. (N)		Working Load Lbs.		E Inches (cm)	M Inches (cm)	Tin-Coated Bronze	Stainless Steel
	Tin-Coated Bronze	Stainless Steel	Tin-Coated Bronze	Stainless Steel				
.75"-1.99" (1.90-2.51)	2,820	4,250	282	425	10" (25.40)	25" (63.50)	02207001	02407001
1.00"-1.24" (2.54-3.15)	4,280	7,300	428	730	10" (25.40)	28" (71.12)	02207002	02407002
1.25"-1.49" (3.17-3.78)	4,280	7,300	428	730	10" (25.40)	30" (76.20)	02207003	02407003
1.50"-1.99" (3.81-5.05)	4,280	11,150	428	1,110	10" (25.40)	34" (86.36)	02207004	02407004
2.00"-2.49" (5.08-6.32)	8,050	20,150	805	2,010	12" (30.48)	36" (91.44)	02207005	02407005
2.50"-2.99" (6.35-7.59)	8,050	20,150	805	2,010	12" (30.48)	38" (96.52)	02207006	02407006
3.00"-3.49" (7.62-8.86)	10,060	25,200	1,006	2,520	12" (30.48)	40" (101.60)	02207007	02407007
3.50"-3.99" (8.89-10.13)	12,070	30,200	1,207	3,020	12" (30.48)	44" (111.76)	02207008	02407008
4.00"-4.49" (10.16-11.40)	12,070	30,200	1,207	3,020	12" (30.48)	46" (116.84)	02207009	02407009
4.50"-4.99" (11.43-12.67)	12,070	—	1,207	—	12" (30.48)	68" (172.72)	02209009	—

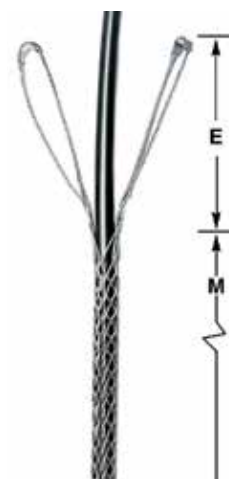

Note: E-Eye length. M-Mesh length at nominal diameter.

Dimensions in Inches (mm)



Service Drop Grips

Single Eye, Tin-Coated Bronze and Stainless Steel.

IMPORTANT:

Read all breaking strength, safety and technical data relating to this product.

Refer to pages V-33 and V-34.

Light Duty, Single Eye, Closed Mesh, Single Weave

For permanent support when cable end is available to be installed.

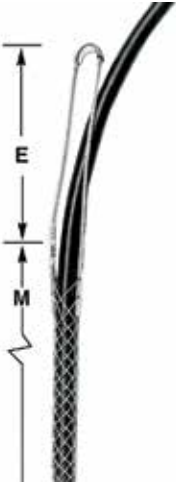

Cable Diameter Range Inches (cm)	Approx. Breaking Strength Lbs.		Working Load Lbs.		E Inches (cm)	M Inches (cm)	Tin-Coated Bronze	Stainless Steel
	Tin-Coated Bronze	Stainless Steel	Tin-Coated Bronze	Stainless Steel				
.23"-.31" (.58-.79)	290	700	29	70	3" (7.62)	3.75" (9.52)	02216001	02416001
.29"-.37" (.74-.94)	290	700	29	70	5" (12.70)	4.25" (10.79)	02216002	02416002
.35"-.44" (.89-1.12)	500	850	50	85	5.5" (13.97)	4.75" (12.06)	02216003	02416003
.41"-.50" (1.04-1.27)	500	850	50	85	5.5" (13.97)	5" (12.70)	02216004	02416004
.46"-.56" (1.17-1.42)	660	850	66	85	6" (15.24)	5.25" (13.33)	02216005	02416005
.52"-.62" (1.32-1.57)	790	1,050	79	105	7" (17.78)	6.25" (15.87)	02216006	02416006
.58"-.68" (1.47-1.73)	790	1,050	79	105	7" (17.78)	6" (15.24)	02216007	02416007
.64"-.75" (1.63-1.90)	790	1,050	79	105	7" (17.78)	6.75" (17.14)	02216008	02416008
.70"-.81" (1.78-2.06)	790	2,050	79	205	7" (17.78)	7.25" (18.41)	02216009	02416009
.75"-.87" (1.90-2.21)	1,020	2,050	102	205	8" (20.32)	8" (20.32)	02216010	02416010
.81"-.94" (2.06-2.39)	1,020	2,050	102	205	8" (20.32)	8.25" (20.95)	02216011	02416011
.87"-1.00" (2.21-2.54)	1,020	—	102	—	8" (20.32)	8.75" (22.22)	02216012	—
.94"-1.06" (2.39-2.69)	1,020	2,050	102	205	9" (22.86)	9" (22.86)	02216013	02416013
1.00"-1.18" (2.54-3.00)	1,020	2,050	102	205	9" (22.86)	9.5" (24.13)	02216014	02416014
1.06"-1.25" (2.69-3.17)	1,020	2,050	102	205	9" (22.86)	9.5" (24.13)	02216015	02416015

Heavy Duty, Single Eye, Closed Mesh, Multi-Weave

For permanent support when cable end is available to be installed.

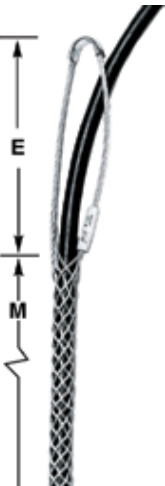

Cable Diameter Range Inches (cm)	Approx. Breaking Strength Lbs.		Working Load Lbs.		E Inches (cm)	M Inches (cm)	Tin-Coated Bronze	Stainless Steel
	Tin-Coated Bronze	Stainless Steel	Tin-Coated Bronze	Stainless Steel				
.23"-.31" (.58-.79)	500	1,400	50	140	5" (12.70)	4.5" (11.43)	02217001	02417001
.29"-.37" (.74-.94)	500	1,150	50	115	5" (12.70)	5.5" (13.97)	02217002	02417002
.35"-.44" (.89-1.12)	870	1,700	87	170	6" (15.24)	6.5" (16.51)	02217003	02417003
.41"-.50" (1.04-1.27)	870	1,700	87	170	6" (15.24)	7.5" (19.05)	02217004	02417004
.46"-.56" (1.17-1.42)	1,050	2,100	105	210	6" (15.24)	8" (20.32)	02217005	02417005
.52"-.62" (1.32-1.57)	1,050	2,100	105	210	7" (17.78)	8.5" (21.59)	02217006	02417006
.58"-.68" (1.47-1.73)	1,050	2,100	105	210	7" (17.78)	9.5" (24.13)	02217007	02417007
.64"-.75" (1.63-1.90)	1,390	4,161	139	416	7" (17.78)	9.5" (24.13)	02217008	02417008
.70"-.81" (1.78-2.06)	1,390	4,100	139	410	8" (20.32)	10.5" (26.67)	02217009	02417009
.75"-.87" (1.90-2.21)	1,390	—	139	—	8" (20.32)	10.5" (26.67)	02217010	—
.81"-.94" (2.06-2.39)	1,390	—	139	—	8" (20.32)	10.5" (26.67)	02217011	—
.87"-1.00" (2.21-2.54)	1,790	5,350	179	535	8" (20.32)	11.5" (29.21)	02217012	02417012
.94"-1.06" (2.39-2.69)	1,790	5,300	179	530	9" (22.86)	12.5" (31.75)	02217013	02417013
1.00"-1.18" (2.54-3.00)	1,790	5,300	179	530	9" (22.86)	13.5" (34.29)	02217014	02417014
1.06"-1.25" (2.69-3.17)	1,790	5,350	179	535	9" (22.86)	14.5" (36.83)	02217015	02417015

Note: E-Eye length. M-Mesh length at nominal diameter.

Screw Hook
Catalog Number **20303001**
Yield Strength 900 lbs (4003 N)

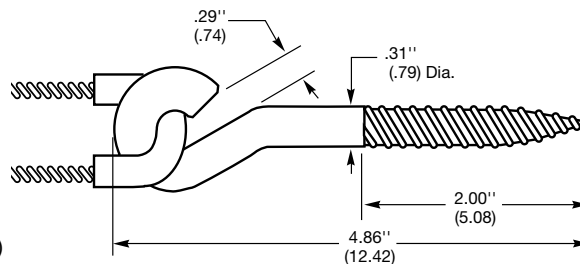

Dimensions in Inches (mm)



Service Drop Grips

Universal Eye, Tin-Coated Bronze.

IMPORTANT:
Read all breaking strength, safety and technical data relating to this product.

Refer to pages V-33 and V-34.

Light Duty, Universal Eye, Closed Mesh, Single Weave

For permanent support when cable end is available to be installed.

Cable Diameter Range Inches (cm)	Approx. Breaking Strength Lbs.	Working Load Lbs.	E Inches (cm)	M Inches (cm)	Catalog Number
.23"-.31" (.58-.79)	290	29	9" (22.86)	3.75" (9.52)	02216016
.29"-.37" (.74-.94)	290	29	10" (25.40)	4.25" (10.79)	02216017
.35"-.44" (.89-1.12)	500	50	10" (25.40)	4.75" (12.06)	02216018
.41"-.50" (1.04-1.27)	500	50	11" (27.94)	5" (12.70)	02216019
.46"-.56" (1.17-1.42)	660	66	12" (30.48)	5.25" (13.33)	02216020
.52"-.62" (1.32-1.57)	790	79	13" (33.02)	6.25" (15.87)	02216021
.58"-.68" (1.47-1.73)	790	79	13" (33.02)	6.5" (16.51)	02216022
.64"-.75" (1.63-1.90)	790	79	13" (33.02)	6.75" (17.14)	02216023
.70"-.81" (1.78-2.06)	790	79	13" (33.02)	7.25" (18.41)	02216024
.75"-.87" (1.90-2.21)	1,020	102	14" (35.56)	8" (20.32)	02216025
.81"-.94" (2.06-2.39)	1,020	102	14" (35.56)	8.25" (20.95)	02216026
.87"-1.00" (2.21-2.54)	1,020	102	14" (35.56)	8.75" (22.22)	02216027
.94"-1.06" (2.39-2.69)	1,020	102	15" (38.10)	9" (22.86)	02216028
1.00"-1.18" (2.54-3.00)	1,020	102	15" (38.10)	9.5" (24.13)	02216029
1.06"-1.25" (2.69-3.17)	1,020	102	15" (38.10)	9.5" (24.13)	02216030



Heavy Duty, Universal Eye, Closed Mesh, Multi-Weave

For permanent support when cable end is available to be installed.

Cable Diameter Range Inches (cm)	Approx. Breaking Strength Lbs.	Working Load Lbs.	E Inches (cm)	M Inches (cm)	Catalog Number
.23"-.31" (.58-.79)	500	50	11" (27.94)	4.5" (11.43)	02217016
.28"-.37" (.74-.94)	500	50	11" (27.94)	5.5" (13.97)	02217017
.35"-.44" (.89-1.12)	870	87	12" (30.48)	6.5" (16.51)	02217018
.41"-.50" (1.04-1.27)	870	87	12" (30.48)	7.5" (19.05)	02217019
.46"-.56" (1.17-1.42)	1,050	105	12" (30.48)	8" (20.32)	02217020
.52"-.62" (1.32-1.57)	1,050	105	13" (33.02)	8.5" (21.59)	02217021
.58"-.68" (1.47-1.73)	1,050	105	13" (33.02)	9.5" (24.13)	02217022
.64"-.75" (1.63-1.90)	1,390	139	13" (33.02)	9.5" (24.13)	02217023
.70"-.81" (1.78-2.06)	1,390	139	14" (35.56)	10.5" (26.67)	02217024
.75"-.87" (1.90-2.21)	1,390	139	14" (35.56)	10.5" (26.67)	02217025
.81"-.94" (2.06-2.39)	1,390	139	14" (35.56)	10.5" (26.67)	02217026
.87"-1.00" (2.21-2.54)	1,790	179	14" (35.56)	11.5" (29.21)	02217027
.94"-1.06" (2.39-2.69)	1,790	179	15" (38.10)	12.5" (31.75)	02217028
1.00"-1.18" (2.54-3.00)	1,790	179	15" (38.10)	13.5" (34.29)	02217029
1.06"-1.25" (2.69-3.17)	1,790	179	15" (38.10)	14.5" (36.83)	02217030

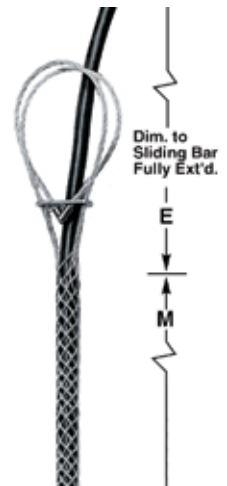

Note: E-Eye length. M-Mesh length at nominal diameter.

Dimensions in Inches (mm)



Bus Drop Support Grips

Single Eye, Universal Eye, Galvanized Steel.

IMPORTANT:
Read all breaking strength, safety and technical data relating to this product.

Refer to pages V-33 and V-34.



Safety Spring

Maximum Deflection Inches/Lbs (cm/N)	Approx. Breaking Strength Lbs.	Working Load Lbs.	Length* Inches (cm)	Diameter Inches (cm)	Model Lbs. (N)	Catalog Number
2¾" at 40 lbs. (6.98 at 178)	500	50	8.25" (20.95)	.75" (1.90)	40 lb. spring (178)	20302001
3½" at 80 lbs. (7.94 at 356)	850	85	8.25" (20.95)	1" (2.54)	80 lb. spring (356)	20302002

Note: Springs can be used with single eye grips by disassembling drawbar from coil, placing through eye and replacing drawbar.
*No load.



Single Eye, Wide Range

Cable Diameter Range Inches (cm)	Approx. Breaking Strength Lbs.	Working Load Lbs.	E Inches (cm)	M Inches (cm)	Catalog Number
.24"- .32" (.61-.81)	350	35	3" (7.62)	3.5" (8.89)	073041276**
.32"- .43" (.81-1.09)	450	45	4" (10.16)	4" (10.16)	073041277
.43"- .56" (1.09-1.42)	550	55	6" (15.24)	4.75" (12.06)	073041278
.56"- .73" (1.42-1.85)	1,000	100	7" (17.78)	6" (15.24)	073041279
.73"- .85" (1.85-2.16)	1,400	140	7" (17.78)	6.75" (17.14)	073041280
.85"-1.00" (2.16-2.54)	1,400	140	8" (20.32)	8" (20.32)	073041281
1.00"-1.25" (2.54-3.17)	1,500	150	9" (22.86)	9.5" (24.13)	073041282



Universal Eye, Wide Range

Cable Diameter Range Inches (cm)	Approx. Breaking Strength Lbs.	Working Load Lbs.	E Inches (cm)	M Inches (cm)	Catalog Number
.32"- .43" (.81-1.09)	450	45	10" (25.40)	4" (10.16)	073041284
.43"- .56" (1.09-1.42)	550	55	12" (30.48)	4.75" (12.06)	073041285
.56"- .73" (1.42-1.85)	1,000	100	13" (33.02)	6" (15.24)	073041286
.73"- .85" (1.85-2.16)	1,400	140	13" (33.02)	6.75" (17.14)	073041287
.85"-1.00" (2.16-2.54)	1,400	140	14" (35.56)	8" (20.32)	073041288
1.00"-1.25" (2.54-3.17)	1,500	150	15" (38.10)	9.5" (24.13)	073041289

Note: E-Eye length. M-Mesh length at nominal diameter.
**Item indicated is not UL listed.

Bus Drop Grips and Safety Springs

Kellems Bus Drop Grips are offered with either a single eye or universal bale attachment. The mesh is single weave galvanized steel with the patented wide range construction. They are suitable for indoor use only. Consult Technical Service for Stainless Steel Grips.

Application

Bus Drop Grips provide a safe, easy and economical method to support flexible cord or bus drop cable at bus duct and other industrial areas.

Benefits

- Easily installed
- Absorb tension, vibration and pull with no cable damage
- Patented mesh construction

Safety Spring

Springs can be used with single eye grips by disassembling drawbar from coil, placing through eye and replacing drawbar.

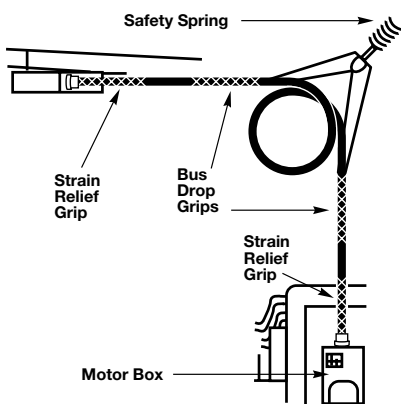

Dimensions in Inches (mm)



Conduit Riser Grips

Single Weave, Closed Mesh

Kellems® Conduit Riser Support Grips are available in closed mesh and in split mesh with lace or rod closures, to cover all applications including single cable or multiple wire support. Refer to page V-37 for grip selection assistance for cable bundles. The standard material is tin-coated bronze strand. The grip is permanently fastened to a support ring, resulting in a one piece unit which will allow air ventilation within the conduit. The ring will fit standard electrical rigid metal conduit and schedule 40 rigid PVC conduit only. See page V-32 for ring dimensions. For permanent support when cable end is available to be installed through the grip.

IMPORTANT:
Read all breaking strength, safety and technical data relating to this product.

Refer to pages V-33 and V-34.



IMPORTANT:
Recommended safety factor is ten for catalog listed support grips.

Suitable for Standard Electrical Rigid Metal Conduit and Schedule 40 Rigid PVC Conduit Only

Cable Sizes In. (cm)	.50"-.62" (1.27-1.57)	.63"-.74" (1.60-1.88)	.75"-.99" (1.90-2.51)	1.00"-1.24" (2.54-3.15)	1.25"-1.49" (3.17-3.78)	1.50"-1.74" (3.81-4.42)	1.75"-1.99" (4.44-5.05)	2.00"-2.49" (5.08-6.32)	2.50"-2.99" (6.35-7.59)	3.00"-3.49" (7.62-8.86)	3.50"-3.99" (8.89-10.13)
Model	R050	R062	R075	R100	R125	R150	R175	R200	R250	R300	R350
Length In. (cm)	8" (20.32)	9" (22.86)	11" (27.94)	12" (30.48)	12" (30.48)	14" (35.56)	15" (38.10)	17" (43.18)	18" (45.72)	20" (50.80)	21" (53.34)
Conduit Sizes											
Inches	Catalog Number Approx. Breaking Strength Lbs. (N)										
¾	02211106 530 (2,357)	-	-	-	-	-	-	-	-	-	-
1	02211100 490 (2,179)	02211101 790 (3,514)	-	-	-	-	-	-	-	-	-
1¼	02211001 450 (2,002)	02211002 740 (3,292)	02211003 1,030 (4,581)	-	-	-	-	-	-	-	-
1½	-	02211006 690 (3,069)	02211007 970 (4,315)	02211009 1,610 (7,161)	-	-	-	-	-	-	-
2	-	02211107 640 (2,847)	02211010 920 (4,092)	02211012 1,520 (6,761)	02211013 1,610 (7,161)	-	-	-	-	-	-
2½	-	-	-	-	02211017 1,510 (6,716)	02211018 1,610 (7,161)	02211019 2,150 (9,563)	-	-	-	-
3	-	-	-	02211022 1,340 (5,960)	02211023 1,400 (6,227)	02211024 1,490 (6,627)	02211025 1,990 (8,851)	02211026 3,260 (14,500)	-	-	-
3½	-	-	-	-	-	-	-	02211033 2,970 (13,211)	02211034 3,260 (14,500)	-	-
4	-	-	-	-	-	-	02211040 1,670 (7,248)	02211041 2,680 (11,921)	02211042 2,890 (12,855)	02211043 4,080 (18,148)	-
5	-	-	-	-	-	-	-	-	02211061 2,150 (9,563)	02211062 2,860 (12,721)	02211063 3,130 (13,922)
6	-	-	-	-	-	-	-	-	-	02211072 2,245 (9,986)	02211073 2,245 (9,986)

Note: See page V-37 for multiple cables in a single conduit riser grip.

Dimensions in Inches (mm)



Conduit Riser Grips

Double Weave, Split Mesh, Lace Closing

Kellems® Conduit Riser Support Grips will support cable runs in vertical or sloping standard rigid conduit. The grip is fastened to a support ring which seats on the rim of the conduit. The entire grip is supported by the conduit itself and no other hardware is required. See page V-32 for ring dimensions. The rings will fit schedule 40 rigid PVC conduit and standard electrical rigid metal conduit only. For permanent support when cable end is not available.

IMPORTANT:

Read all breaking strength, safety and technical data relating to this product.

Refer to pages V-33 and V-34.



IMPORTANT:

Recommended safety factor is ten for catalog listed support grips.

Suitable for Standard Electrical Rigid Metal Conduit and Schedule 40 Rigid PVC Conduit Only

Cable Sizes In. (cm)	.75"- .99" (1.90-2.51)	1.00"- 1.24" (2.54-3.15)	1.25"- 1.49" (3.17-3.78)	1.50"-1.74" (3.81-4.42)	1.75"- 1.99" (4.44-5.05)	2.00"- 2.49" (5.08-6.32)	2.50"- 2.99" (6.35-7.59)	3.00"- 3.49" (7.62-8.86)	3.50"- 3.99" (8.89-10.13)
----------------------	---------------------------	-----------------------------	-----------------------------	----------------------------	-----------------------------	-----------------------------	-----------------------------	-----------------------------	------------------------------

Model	RS075	RS100	RS125	RS150	RS175	RS200	RS250	RS300	RS350
Length In. (cm)	11" (27.94)	12" (30.48)	12" (30.48)	14" (35.56)	15" (38.10)	17" (43.18)	18" (45.72)	20" (50.80)	21" (53.34)

Conduit Sizes Inches	Catalog Number Approx. Breaking Strength Lbs. (N)								
1¼	02212003 1,580 (7,028)	—	—	—	—	—	—	—	—
1½	02212007 1,500 (6,672)	—	—	—	—	—	—	—	—
2	02212010 1,430 (6,361)	02212012 1,930 (8,585)	02212013 2,040 (9,074)	—	—	—	—	—	—
2½	—	—	02212017 1,910 (8,496)	02212018 2,040 (9,074)	—	—	—	—	—
3	—	—	02212023 1,780 (7,917)	02212024 1,890 (8,407)	02212025 2,520 (11,209)	02212026 4,300 (19,126)	—	—	—
3½	—	—	—	—	—	02212033 3,910 (17,392)	02212034 4,300 (19,126)	—	—
4	—	—	—	—	02212040 2,110 (9,385)	02212041 3,530 (15,701)	02212042 3,820 (16,991)	02212043 5,380 (23,930)	—
5	—	—	—	—	—	—	02212061 2,860 (12,721)	—	—
6	—	—	—	—	—	—	—	—	02212073 2,955 (13,144)

Note: See page V-37 for multiple cables in a single conduit riser grip.

Dimensions in Inches (mm)



Conduit Riser Grips

Single Weave, Split Mesh, Rod Closing

- Easy and fast to install
- Will not damage electrical cable
- Allows cable to expand or contract
- Ideal way to hold cable in vertical conduit
- Prevents cable creep in conduit
- Helps prevent cable pullouts
- The rings will fit schedule 40 rigid PVC conduit and standard electrical rigid metal conduit only
- For support when cable end is not available

IMPORTANT:
Read all breaking strength, safety and technical data relating to this product.

Refer to pages V-33 and V-34.



IMPORTANT:
Recommended safety factor is ten for catalog listed support grips.

Suitable for Standard Electrical Rigid Metal Conduit and Schedule 40 Rigid PVC Conduit Only

Cable Sizes In. (cm)	.75"-.99" (1.90-2.51)	1.00"-1.24" (2.54-3.15)	1.25"-1.49" (3.17-3.78)	1.50"-1.74" (3.81-4.42)	1.75"-1.99" (4.44-5.05)	2.00"-2.49" (5.08-6.32)	2.50"-2.99" (6.35-7.59)	3.00"-3.49" (7.62-8.86)	3.50"-3.99" (8.89-10.13)	
Model	RR075	RR100	RR125	RR150	RR175	RR200	RR250	RR300	RR350	
Length In. (cm)	11" (27.94)	12" (30.48)	12" (30.48)	14" (35.56)	15" (38.10)	17" (43.18)	18" (45.72)	20" (50.80)	21" (53.34)	
Conduit Sizes Inches	Catalog Number		Approx. Breaking Strength Lbs. (N)							
1¼	02213003 1,020 (4,537)	—	—	—	—	—	—	—	—	
1½	02213007 970 (4,315)	02213009 1,610 (7,161)	—	—	—	—	—	—	—	
2	—	02213012 1,520 (6,761)	02213013 1,610 (7,161)	—	—	—	—	—	—	
2½	—	—	02213017 1,510 (6,716)	02213018 1,610 (7,161)	—	—	—	—	—	
3	—	—	02213023 1,400 (6,227)	02213024 1,490 (6,627)	02213025 1,990 (8,851)	02213026 3,260 (14,500)	—	—	—	
3½	—	—	—	—	—	02213033 2,970 (13,211)	—	—	—	
4	—	—	—	—	—	02213041 2,670 (11,876)	02213042 2,890 (12,855)	—	—	

Note: See page V-37 for multiple cables in a single conduit riser grip.

Dimensions in Inches (mm)



Conduit Ring Dimensions

Ring dimensions are found in the chart below. The ring material is corrosion resistant. These rings will fit schedule 40 rigid PVC conduit and standard electrical rigid metal conduit only.

IMPORTANT:

Read all breaking strength, safety and technical data relating to this product.

Refer to pages V-33 and V-34.

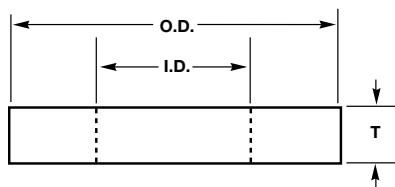

Conduit Size 3/4" and 1"

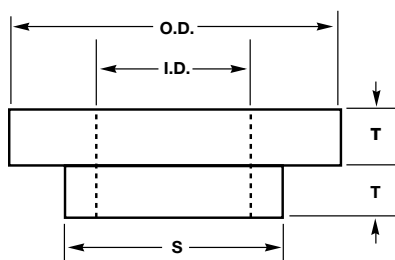

Conduit Size 1 1/4" to 6"

Conduit Size Inches	Ring Number	O.D. Inches (cm)	I.D. Inches (cm)	S Inches (cm)	T Inches (cm)
3/4	C-3/4	.94" (2.39)	.62" (1.57)	—	.19" (.48)
1	C-1	1.17" (2.97)	.80" (2.03)	—	.19" (.48)
1 1/4	C-1 1/4	1.50" (3.81)	1.03" (2.62)	1.31" (3.33)	.16" (.41)
1 1/2	C-1 1/2	1.76" (4.47)	1.23" (3.12)	1.52" (3.86)	.16" (.41)
2	C-2	2.23" (5.66)	1.55" (3.94)	1.97" (5.00)	.16" (.41)
2 1/2	C-2 1/2	2.67" (6.78)	2.05" (5.21)	2.40" (6.10)	.16" (.41)
3	C-3	3.20" (8.13)	2.55" (6.48)	2.97" (7.54)	.22" (.56)
3 1/2	C-3 1/2	3.80" (9.65)	3.05" (7.75)	3.47" (8.81)	.22" (.56)
4	C-4	4.30" (10.92)	3.55" (9.02)	3.94" (10.01)	.22" (.56)
4 1/2	C-4 1/2	4.80" (12.19)	4.03" (10.24)	4.45" (11.30)	.22" (.56)
5	C-5	5.30" (13.46)	4.46" (11.33)	4.96" (12.60)	.22" (.56)
6	C-6	6.30" (16.00)	5.36" (13.61)	5.96" (15.14)	.25" (.63)



Kellems® Support Grips

Kellems Support Grips are used to hold the weight of electrical cable as it hangs in a vertical, sloping or horizontal position. Electrical cable must be supported, or its dead weight can cause excessive strain or pullout at the connections resulting in power failure. Support grips also absorb additional strain from flexure, vibration, expansion and contraction. Kellems Support Grips listed in this catalog are made of high grade, non-magnetic tin-coated bronze strand. Stainless steel grips, made of alloy 302–304 SST for severe service or unusual environmental conditions, are available on request.

Select the Correct Support Grip

Each Kellems grip is designed to work on a specific range of cable diameters.

- Step 1** Refer to the Kellems chart below to determine the grip style best suited for your application.
- Step 2** Determine your cable outside diameter.
- Step 3** Find the grip size that encompasses your cable diameter.
- Step 4** Whenever possible, use a closed mesh that assembles over the cable end. If the cable end is not available, use a split mesh.
- Step 5** Where available, select an eye style that suits your needs.
- Step 6** Select the proper material—tinned bronze or stainless steel*.
- Step 7** Estimate the tension to be put on the grip, establish the working load you require and compare this to the listed approximate breaking strength of the grip to insure that the grip will be strong enough. Refer to page V-34 for safety and working load considerations.

WARNING: It is very important to read and understand all safety information before proceeding. Failure to use as directed may result in property damage, personal injury or death.

Grips are to be installed and utilized by a qualified technician in accordance with all applicable national and local safety and electrical codes. Consult a licensed project safety professional, if necessary.

Ensure that the correct grip is selected for your specific needs. Grips should only be used for their intended purpose and not for other applications.

Banding the tail end of the grip is required to prevent unintended release of the grip's hold from the cable and to achieve maximum gripping strength

The strength of a Kellems grips is based on laboratory testing and does not evaluate variable conditions such as cable type, gripping surfaces, cable movement or impact loads. Suitability for the application must be determined by the user.

Thoroughly examine the condition of the grip prior to each use. Grips that are worn, bent, corroded, or show other signs of damage, such as frayed or broken wires, should never be used and must be replaced.

Do not modify the grip in any way.

Ensure that the recommended work load of the grip is suitable for the application. Never use a grip beyond its safe working load, which is the approximate breaking strength divided by the factor of safety. The recommended factor of safety is five (5) for pulling grips and ten (10) for support grips.

Pulling hardware should only be attached to the eye of the grip.

A swivel is recommended for attachment to the grip's eye in applications where torque release is necessary. Torque can build up in high tension pulling applications.

Do not run grips and swivels around sheaves or bull wheels while under tension. For synthetic rope, use Kellems Dua-Pull Grips only.

Support Grip Selection Chart

Grip Styles	Application
Closed mesh	Standard, permanent support, cable end available.
Split lace closing	Standard, permanent support, cable end unavailable.
Split rod closing	Standard, temporary support, cable end unavailable. Tape or band tail end of wire mesh grip after positioning for permanent support.
Material*	Tin-coated bronze standard or stainless steel by special request.
Standard support grips	Support vertical runs to 99 ft. loads to 600 lbs.
Heavy duty grips	Support vertical runs over 100 ft. loads over 600 lbs.
Service drop	Light duty to support service entrance cable.
Bus drop	Light duty support, indoors only, on Bus drop cable.
Conduit riser	Support cable runs in rigid (Schedule 40) conduit.
Fiber optic cable support grips	Support fiber optic cable.

Note: *Most catalog listed support grips are made of tin-coated bronze strand. To order stainless steel support grips, change the first three catalog number digits from 022-0V-xxx to 024-0V-xxx. Consult Technical Service for details.

Eye Styles



Single



Double



Universal



Offset



Safety and Working Load Factors for Wire Mesh Grips

The broad application of Kellems grips on a wide variety of objects requires that adequate safety factors be used to establish working loads. The approximate breaking strength of a Kellems grip represents an average calculation based on data established from actual direct tension testing done in our engineering laboratories.

It is impossible to catalog or guarantee a safety factor suitable for all applications as operating conditions are never the same. The tension, diameter, movement, number of objects gripped, gripping surface, and the attachments used are just some of the factors which vary with each application. These factors, together with the effects of abrasion, corrosion, prior use or abuse and any other variables of a specific application, must be considered by the user and the grip replaced as appropriate. Where the

conditions of the application are not well defined or known, or where risk of injury to persons or property is involved, a greater safety factor should be utilized.

IMPORTANT:

Under normal conditions, Kellems' recommended factor of safety is five for catalog listed pulling grips, and ten for catalog listed support grips.

Any warranty as to quality, performance or fitness for use of grips is always premised on the condition that the published breaking strengths apply only to new, unused grips, and that such products are properly stored, handled, used, maintained, and inspected by the user at a frequency appropriate for the use and condition of the grip.

Examples

Grip Style	Approx. Breaking Strength Lbs. (N)	Safety Factor	Max. Recommended Load Lbs. (N)	Catalog Number
Pulling Grips	27,200 (120,986)	5	5,440 (24,197)	03301027
Support Grips	1,610 (7,161)	10	161 (716)	02202019

The maximum recommended working load is the tension to be exerted on the grip in application with a margin of safety to take care of unforeseen and unusual circumstances.

It is the end-user's decision to determine how much of a safety factor is acceptable for the application.

The metric unit of measure (force) for breaking strength and load is newtons (N). To convert from newtons to the metric unit of weight (kilograms) the conversion factor is 9.808 newtons/kilogram.

Support Grip Materials

Material	Features	Grip Type
Tin-coated bronze wire	<ul style="list-style-type: none"> • Corrosion resistant for normal outside areas • Non-magnetic • Moderate strength 	<ul style="list-style-type: none"> • Support grips • Service drop grips • Conduit riser grips
Stainless steel wire (302-304)	<ul style="list-style-type: none"> • High strength • Corrosion resistant 	<ul style="list-style-type: none"> • Support grips • Hose containment grips
Galvanized steel wire	<ul style="list-style-type: none"> • Slightly magnetic • Not subject to continuous outside environment 	<ul style="list-style-type: none"> • Bus drop grips
Non-metallic aramid fiber	<ul style="list-style-type: none"> • Corrosion resistant for highly corrosive gases 	<ul style="list-style-type: none"> • Support grips

Approvals

CSA Certifications are indicated on appropriate product catalog pages.

Note: It is always recommended that the tail end of the grip be banded after the installation on the cable to prevent accidental release of the mesh. See page V-16 for end bands.



Split Support Grip Lace Closing Instructions

Single Weave Grips should be laced with single strand lacing; double weave with double strand. Lacing strands should be the same material as the grip. Kellems supplies the appropriate lacing with each grip.

1. Start the lacing at the lead or anchoring end of the grip. Thread the lacings through the first two loops of the split and pull through until the lacings are centered at this point. Lace as you would your shoe, crossing the lacings before lacing the next two loops.
2. Don't pull lacing too tight. Leave a space between adjoining loops approximately equal to the width of one diamond of the mesh.
3. Twist the lacing strands tightly together at the tail end of the grip.
4. Wrap the ends of the lacings once or twice tightly around the tail of the grip, twisting the ends together securely. Excess lace can be cut off.



Split Support Grip Rod Closing Instructions

The stainless steel rod is a precise built-in feature which makes threading easy and fast. The strands of the mesh pass around the rod and match up with the strands from the opposite direction. The rod does not touch the cable at any point and therefore cannot cut the cable. Rod Closing Grips are reusable. They may be removed and reused as many times as desired.

1. Fast to install

Wrap the grip around the cable and thread the rod through the pre-formed loops with a corkscrew motion, using the curved end of the rod to engage the loops.

2. The action required is a steady push and twist simultaneously. The fingers of the left hand are used to bring the loops together just ahead of the hook on the end of the rod.
3. To remove, simply pull the rod out.





For Support Grips Only*

Multiple Cable Selection Charts for Cables and Wires of Unequal Diameters

How to choose the correct grip size:

1. Find the Grip Circumference Range by measuring the circumference of the bundle of different diameter cables to be gripped (see illustration).
2. Divide the bundle circumference by 3.14 to determine the diameter.
3. Choose a grip offering a range of cable diameters the same as the cable diameter.

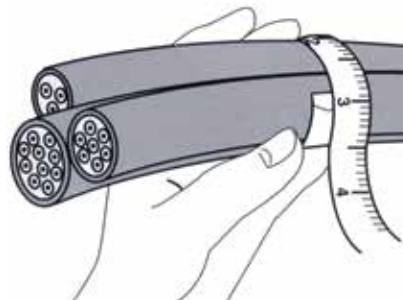

For Cables of Equal Diameters

Under "Number of Cables in One Grip", find the diameter of your single cable in vertical column. Read the grip diameter range to the right. If your diameter is the maximum of the range shown, go to the next larger size for Split Grips, stay with the same size for Closed Grips.

Example: 3 cables, each with .89" (2.26) diameter, for a Closed Grip select the 1.50"-1.74" (3.81-4.42) range, for a Split Grip select the 1.75"-1.99" (4.44-5.05) range.

Number of Cables in One Grip

2	3	4	5	6 and 7	8	9	Grip Dia. Range Inches (cm)
.30-.38 (.76-.97)	.25-.31 (.63-.79)	.22-.27 (.56-.69)	.19-.24 (.48-.61)	.17-.22 (.43-.56)	.15-.19 (.38-.48)	.14-.18 (.36-.46)	.50-.61 (1.27-1.55)
.38-.44 (.97-1.12)	.31-.36 (.79-.91)	.27-.31 (.69-.79)	.24-.29 (.61-.74)	.22-.26 (.56-.66)	.19-.23 (.48-.58)	.18-.21 (.46-.53)	.62-.74 (1.57-1.88)
.44-.59 (1.12-1.50)	.36-.49 (.91-1.24)	.31-.42 (.79-1.07)	.29-.38 (.74-.97)	.26-.34 (.66-.86)	.23-.31 (.58-.79)	.21-.28 (.53-.71)	.75-.99 (1.90-2.51)
.59-.75 (1.50-1.90)	.49-.63 (1.24-1.60)	.42-.54 (1.07-1.37)	.38-.48 (.97-1.22)	.34-.43 (.86-1.09)	.31-.39 (.79-.99)	.28-.35 (.71-.89)	1.00-1.24 (2.54-3.15)
.75-.90 (1.90-2.29)	.63-.76 (1.60-1.93)	.54-.65 (1.37-1.65)	.48-.58 (1.22-1.47)	.43-.52 (1.09-1.32)	.39-.46 (.99-1.17)	.35-.42 (.89-1.07)	1.25-1.49 (3.17-3.78)
.90-1.07 (2.29-2.72)	.76-.89 (1.93-2.26)	.65-.77 (1.65-1.96)	.58-.67 (1.47-1.70)	.52-.60 (1.32-1.52)	.46-.54 (1.17-1.37)	.42-.49 (1.07-1.24)	1.50-1.74 (3.81-4.42)
1.07-1.22 (2.72-3.10)	.89-1.02 (2.26-2.59)	.77-.88 (1.96-2.24)	.67-.77 (1.70-1.96)	.60-.69 (1.52-1.75)	.54-.62 (1.37-1.57)	.49-.56 (1.24-1.42)	1.75-1.99 (4.44-5.05)
1.22-1.53 (3.10-3.89)	1.02-1.28 (2.59-3.25)	.88-1.10 (2.24-2.79)	.77-.96 (1.96-2.44)	.69-.86 (1.75-2.18)	.62-.77 (1.57-1.96)	.56-.71 (1.42-1.80)	2.00-2.49 (5.08-6.32)
1.53-1.83 (3.89-4.65)	1.28-1.53 (3.25-3.89)	1.10-1.32 (2.79-3.35)	.96-1.16 (2.44-2.95)	.86-1.03 (2.18-2.62)	.77-.93 (1.96-2.36)	.71-.85 (1.80-2.16)	2.50-2.99 (6.35-7.59)
1.83-2.14 (4.65-5.44)	1.53-1.79 (3.89-4.55)	1.32-1.54 (3.35-3.91)	1.16-1.35 (2.95-3.43)	1.03-1.20 (2.62-3.05)	.93-1.08 (2.36-2.74)	.85-.99 (2.16-2.51)	3.00-3.49 (7.62-8.86)
2.14-2.44 (5.44-6.20)	1.79-2.05 (4.55-5.21)	1.54-1.76 (3.91-4.47)	1.35-1.54 (3.43-3.91)	1.20-1.37 (3.05-3.48)	1.08-1.24 (2.74-3.15)	.99-1.13 (2.51-2.87)	3.50-3.99 (8.89-10.13)
2.44-2.75 (6.20-6.98)	2.05-2.30 (5.21-5.84)	1.76-1.98 (4.47-5.03)	1.54-1.74 (3.91-4.42)	1.37-1.55 (3.48-3.94)	1.24-1.39 (3.15-3.53)	1.13-1.27 (2.87-3.23)	4.00-4.49 (10.16-11.40)
2.75-3.06 (6.98-7.77)	2.30-2.56 (5.84-6.50)	1.98-2.20 (5.03-5.59)	1.74-1.93 (4.42-4.90)	1.55-1.72 (3.94-4.37)	1.39-1.55 (3.53-3.94)	1.27-1.41 (3.23-3.58)	4.50-4.99 (11.43-12.67)

Note: *This chart is to be used for determining grip size when multiple cables are held in a single Support Grip. For Conduit Riser multiple cable selection, see page V-37. It is always recommended that, when multiple cables are installed in a Support Grip, the tail end of the grip be banded after installation on the cable bundle. See page Tech-23 for cable and wire charts.



For Conduit Riser Grips Only*

Multiple Cable Selection Charts for Cables and Wires of Unequal Diameters

How to choose the correct grip size:

1. Find the Grip Circumference Range by measuring the circumference of the bundle of different diameter cables to be gripped (see illustration).
2. Divide the bundle circumference by 3.14 to determine the diameter.
3. Choose a grip offering a range of cable diameters the same as the cable diameter.

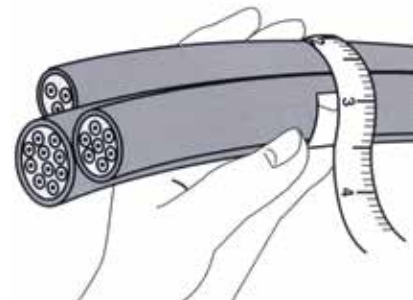

For Cables of Equal Diameters

Under "Number of Cables in One Grip", find the diameter of your single cable in vertical column. Read the grip diameter range to the right. If your diameter is the maximum of the range shown, go to the next larger size for Split Grips, stay with the same size for Closed Grips.

Example: 3 cables, each with .85" (2.16) diameter, for a Closed Grip select the 1.50"-1.74" (3.81-4.42) range, for a Split Grip select the 1.75"-1.99" (4.44-5.05) range.

Number of Equal Diameter Cables in One Grip

2	3	4	5	6 and 7	8	9	Grip Dia. Range Inches (cm)
.29-.36 (.74-.91)	.24-.30 (.61-.76)	.21-.25 (.53-.63)	.18-.22 (.46-.56)	.16-.20 (.41-.51)	.15-.18 (.38-.46)	.14-.17 (.36-.43)	.50-.62 (1.27-1.57)
.37-.43 (.94-1.09)	.31-.36 (.79-.91)	.26-.30 (.66-.76)	.23-.27 (.58-.69)	.21-.24 (.53-.61)	.19-.22 (.48-.56)	.18-.20 (.46-.51)	.63-.74 (1.60-1.88)
.44-.58 (1.12-1.47)	.37-.48 (.94-1.22)	.31-.41 (.79-1.04)	.28-.36 (.71-.91)	.25-.32 (.63-.81)	.23-.29 (.58-.74)	.21-.27 (.53-.69)	.75-.99 (1.90-2.51)
.59-.72 (1.50-1.83)	.49-.60 (1.24-1.52)	.42-.51 (1.07-1.30)	.37-.45 (.94-1.14)	.33-.40 (.84-1.02)	.30-.36 (.76-.91)	.28-.34 (.71-.86)	1.00-1.24 (2.54-3.15)
.73-.87 (1.85-2.21)	.61-.72 (1.55-1.83)	.52-.61 (1.32-1.55)	.46-.54 (1.17-1.37)	.41-.48 (1.04-1.22)	.37-.43 (.94-1.09)	.35-.40 (.89-1.02)	1.25-1.49 (3.17-3.78)
.88-1.01 (2.24-2.57)	.73-.85 (1.85-2.16)	.62-.71 (1.57-1.80)	.55-.63 (1.40-1.60)	.49-.56 (1.24-1.42)	.44-.51 (1.12-1.30)	.41-.47 (1.04-1.19)	1.50-1.74 (3.81-4.42)
1.02-1.16 (2.59-2.95)	.86-.96 (2.18-2.44)	.72-.81 (1.83-2.06)	.64-.72 (1.63-1.83)	.57-.64 (1.45-1.63)	.52-.58 (1.32-1.49)	.48-.54 (1.22-1.37)	1.75-1.99 (4.44-5.05)
1.17-1.44 (2.97-3.66)	.97-1.20 (2.46-3.05)	.82-1.02 (2.08-2.59)	.73-.90 (1.85-2.29)	.65-.80 (1.65-2.03)	.59-.72 (1.50-1.83)	.55-.67 (1.40-1.70)	2.00-2.49 (5.08-6.32)
1.45-1.73 (3.68-4.39)	1.21-1.45 (3.07-3.68)	1.03-1.22 (2.62-3.10)	.91-1.08 (2.31-2.74)	.81-.96 (2.06-2.44)	.73-.87 (1.85-2.21)	.68-.81 (1.73-2.06)	2.50-2.99 (6.35-7.59)
1.74-2.02 (4.42-5.13)	1.46-1.69 (3.71-4.29)	1.23-1.43 (3.12-3.63)	1.09-1.26 (2.77-3.20)	.97-1.11 (2.46-2.82)	.83-1.01 (2.11-2.57)	.82-.94 (2.08-2.39)	3.00-3.49 (7.62-8.86)
2.03-2.31 (5.16-5.87)	1.70-1.93 (4.32-4.90)	1.44-1.63 (3.66-4.14)	1.27-1.44 (3.23-3.66)	1.12-1.27 (2.84-3.23)	1.02-1.15 (2.59-2.92)	.95-1.08 (2.41-2.74)	3.50-3.99 (8.89-10.13)

Note: *This chart is to be used for determining grip size when multiple cables are held in a single Conduit Riser Grip. For Support Grip multiple cable selection, see page V-36. It is always recommended that, when multiple cables are installed in a Conduit Riser Grip, the tail end of the grip be banded after installation on the cable bundle. See page Tech-23 for cable and wire charts.



Features and Benefits

Fiber Optic Pulling Grips

Kellems has wide experience with grips for use with fiber optic cable. As the industry leader in producing wire mesh grips for the stringent requirements of fiber optic applications, Kellems has developed several series of grips for use with fiber optic communications cable.

These grips include pulling grips with built in swivels, grips with steel ends to protect fragile cable ends, grips with low profiles to pull cables in tight places and the OPTISOK® an effective tool to place pre-terminated cables. Also available are grips to support fiber optic cable.



CCPS2



PFOLT312



Non-Metallic

- OPTISOK® non-metallic fiber optic pulling tool for pre-terminated, inside plant fiber optic cables and bundles of twisted pair



Galvanized Steel

- Pulling grip for loose tube fiber optic cable
- These grips are used for outside plant cable; they are easy to install and remove, reusable and have a slim profile for small build up



Application

- Kellems flexible eye pulling grips for fiber optic cable are used for the installation of fiber optic communication lines either underground, overhead, through conduit or through enclosures
- They will fit single cables or cable bundles, are easily installed on the cable and are reusable



Comprehensive Offering

- Hubbell offers a full line of fiber optic pulling grips for all application needs
- OPTISOK® Grip is a revolutionary tool to pull pre-terminated fiber optic cables
- They will protect the connectors and guide the bundle through the pulling environment



OPTISOK® Non-Metallic Fiber Optic Pulling Tool for Pre-Terminated, Inside Plant Fiber Optic Cables and Bundles of Twisted Pair

Kellems offers a unique and simple to use tool for the installation of pre-connectorized fiber optic cables, jumpers and bundles of twisted pair communication cables - the OPTISOK®.

The OPTISOK® is a highly flexible and expandable non-metallic sleeve open on one end and with a pulling ring on the other. It will expand to enclose the larger group of fiber optic connectors and grab the cable below the connector bundle by wrapping and taping to provide a gripping tool that will grab the cable(s) below the connectors. The pulling ring can be attached to a pulling line or fish tape and the OPTISOK® will act as the pulling tool.

OPTISOK® will contain and protect the connector bundle and save time and labor by making the pulling job easier, protecting the connectors from possible damage during the pull and facilitating the passage of the connector bundle through cramped and tight spaces. The OPTISOK® can be used to pull cables through plenums, underfloor duct, office partitions, raised access floors and conduits. Three sizes are available for all applications.

IMPORTANT:
Read all breaking strength, safety and technical data relating to this product.

Refer to pages V-44 and V-45.



OPTISOK® Non-Metallic Fiber Optic Pulling Tool

Bundle/Size Range Inches (cm)	Maximum Work Load Lbs.	Approx. O/A Length Inches (cm)	Ring O.D. Inches (cm)	Ring Thickness Inches (cm)	Catalog Number
.125"-.562" (.318-1.427)	30	28" (71.12)	.71" (1.803)	.10" (.254)	CCPS1
.250"-.750" (.635-1.905)	40	31" (78.74)	.71" (1.803)	.10" (.254)	CCPS2
.750"-1.750" (1.905-4.445)	50	33" (83.82)	1.57" (3.988)	.16" (.406)	CCPS3

How to Select OPTISOK®

- Identify connector bundle diameter to be inserted into the OPTISOK®.
- Choose appropriate catalog number based on size range.

Installation Information

Step 1 Expand open end of OPTISOK® and gently work in fiber optic connector bundle.

Step 2 Still gently, work connector bundle up to the forward section of the OPTISOK®.

Step 3 Starting at approximately 6" (15.2cm) from tail end of OPTISOK®, tightly fold over the OPTISOK® around cables and tape wrapped section 3" (7.62cm) past tail end onto the bundle.

Step 4 Securely attach pulling line or tape to pulling ring.

Note: To remove OPTISOK® carefully unwrap tape and slide out cables and connectors or cut OPTISOK® away without damaging connectors or cables.

Step 1

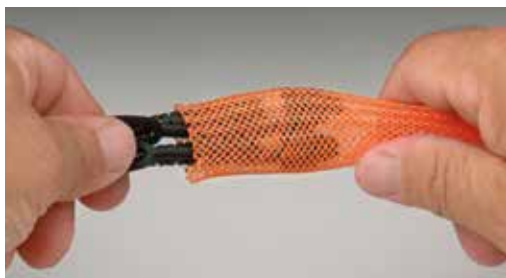

Step 2



Step 3



Step 4





Pulling Grip for Loose Tube Fiber Optic Cable, Galvanized Steel

Kellems offers a wire mesh specifically designed to pull loose tube fiber optic cable and meet the special pulling requirements recommended by fiber optic cable manufacturers.

Many fiber optic cable manufacturers require special cable preparation prior to pulling where a short section of the outer jacket is stripped off exposing the aramid strength member. This creates two cable diameters, one including the jacket and a second smaller diameter at the strength member. Kellems fiber grip with its special weave will accommodate and securely grab both diameters, at the outside jacket and the internal aramid strength member.

Additionally, this galvanized steel mesh grip has longer leads at the pulling eye to facilitate pulling the cable up through the top, a very low profile lug and eye to slip through tight areas, and short shoulders to protect the cable while maintaining the slim profile.

The grip can be used to pull cable overhead as well as underground through conduit and duct. It easily mates with a swivel and has the necessary strength to securely make pulls.

IMPORTANT:

Read all breaking strength, safety and technical data relating to this product.

Refer to pages V-44 and V-45.

Application Information

- Prior to pulling cable, follow cable manufacturers' cable preparation recommendations
- Never exceed cable manufacturers' pulling tension recommendations
- Never use grips to approximate breaking strength safety factor of 5 recommended

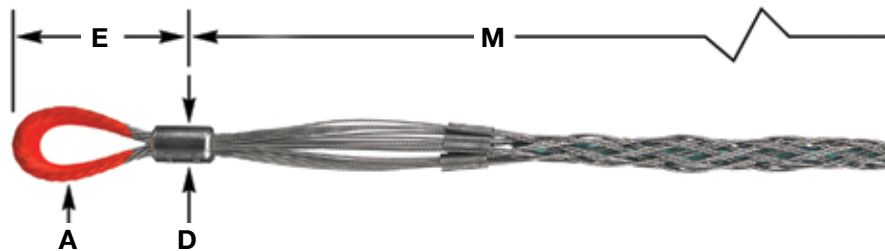

Pulling Grip For Loose Tube Fiber Optic Cable, Galvanized Steel

Diameter Range Inches (cm)	Maximum Breaking Strength Lbs.	Working Load Lbs.	E Eye Length Inches (cm)	M Mesh Length Inches (cm)	D Lug Diameter Inches (cm)	A Eye Diameter Inches (cm)	Catalog Number
.312"-.625" (.79-1.59)	3,000	600	6.3" (16.00)	22.5" (57.15)	.51" (1.30)	.20" (.51)	PFOLT312

Pulling Grips for Other Outside Plant Cables, Swivel Eye, Flexible Eye, Split Style, Low Profile

Kellems Pulling Grips for fiber optic cable are made of high strength galvanized steel strand. They feature a multiweave mesh, with one-half the mesh length double weave, and the second half single weave. This special weave provides positive holding power while allowing the grip to remain flexible with no damage to the cable jacket. Added features include a steel nose cone which protects the cable end and allows the grip to pass easily through conduit and enclosures. The eye connects easily to a swivel or a pulling line. Several grip sizes are available to accommodate all diameters of fiber optic cable.

IMPORTANT:
Read all breaking strength, safety and technical data relating to this product.

Refer to pages V-44 and V-45.

Application

Kellems Flexible Eye Pulling Grips for fiber optic cable are used for the installation of fiber optic communication lines either underground, overhead, through conduit or through enclosures. They will fit single cables or cable bundles, are easily installed on the cable and are reusable.

Benefits

- High strength multiweave mesh for positive holding power
- Highly flexible mesh to follow the pulling path of the cable
- Steel nose cone reduces snags and hang-ups and protects cable end
- Easily installed and removed
- A dependable, reusable pulling tool

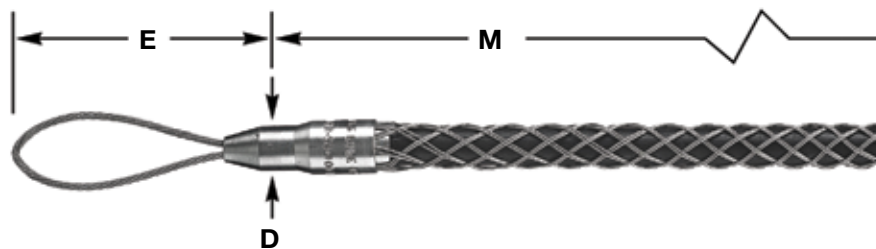

Fiber Optic Pulling Grip, Flexible Eye

Cable Diameter Range Inches (cm)	Approx. Breaking Strength Lbs.	Working Load Lbs.	E Approx. Inches (cm)	M Approx. Inches (cm)	D Approx. Inches (cm)	Catalog Number
.10"-.22" (.25-.56)	1,000	200	5.5" (14)	9" (23)	0.8" (2)	033291000
.21"-.35" (.53-.89)	1,500	300	5.5" (14)	14" (36)	0.8" (2)	033291001
.32"-.48" (.81-1.22)	2,200	440	6.0" (15)	18" (46)	0.9" (2.29)	033291002
.42"-.61" (1.07-1.55)	2,800	560	6.0" (15)	21" (53)	0.9" (2.29)	033291003
.53"-.74" (1.35-1.88)	3,300	660	6.5" (17)	24" (61)	1.3" (3.30)	033291004
.64"-.87" (1.63-2.21)	4,700	940	6.5" (17)	27" (69)	1.3" (3.30)	033291005

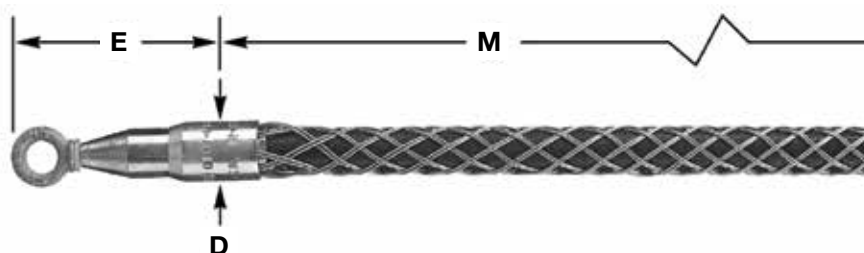

Fiber Optic Pulling Grip, Swivel Eye

Cable Diameter Range Inches (cm)	Approx. Breaking Strength Lbs.	Working Load Lbs.	E Approx. Inches (cm)	M Approx. Inches (cm)	D Approx. Inches (cm)	Catalog Number
.21"-.35" (.53-.89)	1,500	300	4.0" (10.16)	14" (35.56)	0.9" (2.29)	033291008
.32"-.48" (.81-1.22)	2,200	440	4.0" (10.16)	18" (45.72)	0.9" (2.29)	033291009
.42"-.61" (1.07-1.55)	2,800	560	4.0" (10.16)	21" (53.34)	0.9" (2.29)	033291010
.53"-.74" (1.35-1.88)	3,250	650	4.8" (12.19)	24" (60.96)	1.3" (3.30)	033291011
.64"-.87" (1.63-2.21)	4,700	940	4.8" (12.19)	27" (68.58)	1.3" (3.30)	033291012

Note: E-Eye length. M-Mesh length at nominal diameter.

Dimensions in Inches (mm)



Pulling Grips for Other Outside Plant Cables, Swivel Eye, Flexible Eye, Split Style, Low Profile

Kellems Pulling Grips for fiber optic cable are made of high strength galvanized steel strand. They feature a multiweave mesh, with one-half the mesh length double weave, and the second half single weave. This special weave provides positive holding power while allowing the grip to remain flexible with no damage to the cable jacket. Added features include a steel nose cone which protects the cable end and allows the grip to pass easily through conduit and enclosures. The eye connects easily to a swivel or a pulling line. Several grip sizes are available to accommodate all diameters of fiber optic cable.

IMPORTANT:

Read all breaking strength, safety and technical data relating to this product.

Refer to pages V-44 and V-45.

Application

Kellems Flexible Eye Pulling Grips for fiber optic cable are used for the installation of fiber optic communication lines either underground, overhead, through conduit or through enclosures. They will fit single cables or cable bundles, are easily installed on the cable and are reusable.

Benefits

- High strength multiweave mesh for positive holding power
- Highly flexible mesh to follow the pulling path of the cable
- Steel nose cone reduces snags and hang-ups and protects cable end
- Easily installed and removed
- A dependable, reusable pulling tool

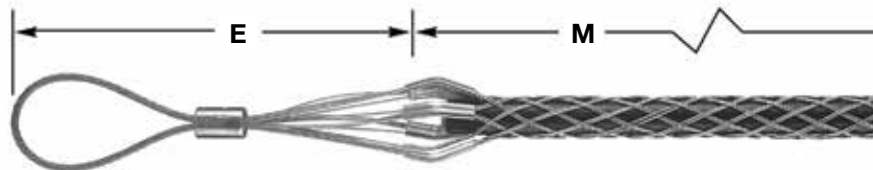

Fiber Optic Pulling Grip, Flexible Eye, Low Profile, Double/Single Weave Mesh

Cable Diameter Range Inches (cm)	Approx. Breaking Strength Lbs.	Working Load Lbs.	E Approx. Inches (cm)	M Approx. Inches (cm)	Catalog Number
.10"-.22 (.25-.56)	900	180	7.5" (19)	10" (25)	033291193
.21"-.35" (.53-.89)	1,400	280	7.5" (19)	14" (36)	033291194
.32"-.48" (.81-1.22)	2,000	400	8.5" (22)	19" (48)	033291195
.42"-.61" (1.07-1.55)	2,500	500	8.5" (22)	21" (53)	033291196
.53"-.74" (1.35-1.88)	3,000	600	8.5" (22)	23" (58)	033291197
.64"-.87" (1.63-2.21)	4,200	840	8.5" (22)	25" (64)	033291198
.75"-.1.00" (1.90-2.54)	4,200	840	8.5" (22)	28" (71)	033291199

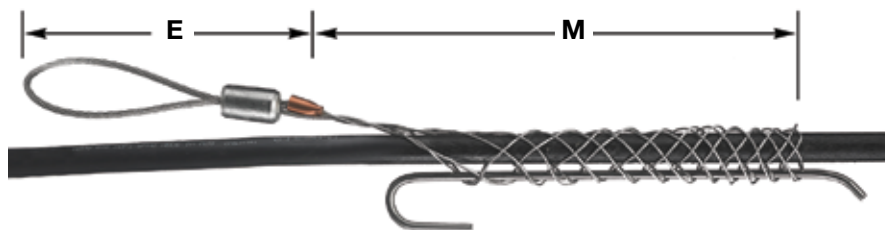

Fiber Optic Slack Pulling Grip, Split Mesh, Rod Closing, Single Weave

Cable Diameter Range Inches (cm)	Approx. Breaking Strength Lbs.	Working Load Lbs.	E Approx. Inches (cm)	M Approx. Inches (cm)	Catalog Number
.25"-.37" (.63-.94)	300	60	3" (7.6)	4.7" (12)	033291015
.38"-.49" (.97-1.24)	800	160	3" (7.6)	5" (13)	033291016
.50"-.61" (1.27-1.55)	800	160	3" (7.6)	7.5" (19)	033291017
.62"-.74" (1.57-1.88)	1,200	240	3" (7.6)	8" (20)	033291018

Note: E-Eye length. M-Mesh length at nominal diameter.

Dimensions in Inches (mm)



Fiber Optic Support Grips

Kellems Support Grips for fiber optic cable are specially designed to hold the cable weight as it hangs in a vertical or horizontal position. Fiber optic cable must be supported and Kellems Grips provide the support easily and economically.

These grips are made of high grade, non-magnetic tin-coated bronze strand. They are offered in universal bale or single eye configurations and are available in either closed mesh (for use where the cable end is available) or in split mesh, rod closing (for installation on existing cable runs or at specific locations).

IMPORTANT:
Read all breaking strength, safety and technical data relating to this product.

Refer to pages V-44 and V-45.

Fiber Optic Single Eye Cable Support Grip, Closed Mesh, Single Weave

For permanent support when cable end is available to be installed through grip.

Cable Diameter Range Inches (cm)	Approx. Breaking Strength Lbs.	Working Load Lbs.	E Approx. Inches (cm)	M Approx. Inches (cm)	Catalog Number
.18"-.25" (.46-.63)	300	30	3" (7.6)	1.7" (4.3)	022291000
.23"-.32" (.58-.81)	300	30	3" (7.6)	2.5" (6.4)	022291001
.30"-.39" (.76-.99)	300	30	4" (10)	2.5" (6.4)	022291002
.37"-.48" (.94-1.22)	300	30	5" (13)	4" (10)	022291003
.46"-.58" (1.17-1.47)	400	40	6" (15)	4" (10)	022291004
.56"-.71" (1.42-1.80)	600	60	7" (18)	5.5" (14)	022291005
.69"-.88" (1.75-2.24)	800	80	8" (20)	6" (15)	022291006



Fiber Optic Single Eye Cable Support Grip, Split Mesh, Rod Closing, Single Weave

For support when cable end not available.

Cable Diameter Range Inches (cm)	Approx. Breaking Strength Lbs.	Working Load Lbs.	E Approx. Inches (cm)	M Approx. Inches (cm)	Catalog Number
.18"-.25" (.46-.63)	300	30	3" (7.6)	2.5" (6.4)	022291016
.23"-.32" (.58-.81)	300	30	3" (7.6)	2.5" (6.4)	022291017
.30"-.39" (.76-.99)	300	30	4" (10)	2.5" (6.4)	022291018
.37"-.48" (.94-1.22)	300	30	5" (13)	4" (10)	022291019
.46"-.58" (1.17-1.47)	400	40	6" (15)	5" (13)	022291020
.56"-.71" (1.42-1.80)	600	60	7" (18)	5" (13)	022291021
.69"-.88" (1.75-2.24)	800	80	8" (20)	6" (15)	022291022



Note: E-Eye length. M-Mesh length at nominal diameter.

Dimensions in Inches (mm)



Support Grips for Fiber Optic Cable

Kellems Support Grips for fiber optic cable are specially designed to hold the cable weight as it hangs in a vertical or horizontal position. Fiber optic cable must be supported and Kellems Grips provide the support easily and economically.

These grips are made of high grade, non-magnetic tin-coated bronze strand. They are offered in universal bale or single eye configurations and are available in either closed mesh (for use where the cable end is available) or in split mesh, rod closing (for installation on existing cable runs or at specific locations).

Split Support Grip Rod Closing Instructions

The stainless steel rod is a precise built-in feature which makes threading easy and fast. The strands of the mesh pass around the rod and match up with the strands from the opposite direction. The rod does not touch the cable at any point and therefore cannot cut the cable. Rod Closing Grips are reusable. They may be removed and reused as many times as desired.

Fast to Install

- Step 1** Wrap the grip around the cable and thread the rod through the preformed loops with a corkscrew motion, using the curved end of the rod to engage the loops.
- Step 2** The action required is a steady push and twist simultaneously. The fingers of the left hand are used to bring the loops together just ahead of the hook on the end of the rod.
- Step 3** To remove, simply pull the rod out.





Kellems has wide experience with grips for use with fiber optic cable. As the industry leader in producing wire mesh grips for the stringent requirements of fiber optic applications, Kellems has developed several series of grips for use with fiber optic communications cable.

These grips include pulling grips with built in swivels, grips with steel ends to protect fragile cable ends, grips with low profiles to pull cables in tight places and the OPTISOK® an effective tool to place pre-terminated cables. Also available are grips to support fiber optic cable.

Select the Correct Fiber Optic Grip

Each Kellems grip is designed to work on a specific range of cable diameters.

- Step 1** Determine your cable outside diameter.
- Step 2** Find the grip size that encompasses your cable diameter.
- Step 3** Whenever possible, use a closed mesh that assembles over the cable end. If the cable end is not available, use a split mesh.
- Step 4** Where available, select an eye style that suits your needs.
- Step 5** Estimate the tension to be put on the grip, establish the working load you require and compare this to the listed approximate breaking strength of the grip to insure that the grip will be strong enough.

Safety And Working Load Factors For Wire Mesh Grips

The broad application of Kellems grips on a wide variety of objects requires that adequate safety factors be used to establish working loads. The approximate breaking strength of a Kellems grip represents an average calculation based on data established from actual direct tension testing done in our engineering laboratories.

It is impossible to catalog or guarantee a safety factor suitable for all applications as operating conditions are never the same. The tension, diameter, movement, number of objects gripped, gripping surface, and the attachments used are just some of the factors which vary with each application. These factors, together with the effects of abrasion, corrosion, prior use or abuse and any other variables of a specific application, must be considered by the user and the grip replaced as appropriate. Where the conditions of the application are not well defined or known

or where risk of injury to persons or property is involved, a greater safety factor should be utilized.

IMPORTANT:

Under normal conditions, Kellems' recommended factor of safety is five for catalog listed pulling grips, and ten for catalog listed support grips.

Any warranty as to quality, performance or fitness for use of grips is always premised on the condition that the published breaking strengths apply only to new, unused grips, and that such products are properly stored, handled, used, maintained and inspected by the user at a frequency appropriate for the use and condition of the grip.

For grip applications on materials other than those that the grips have been specifically designed for, consult the factory.

Examples

Grip Style	Approx. Breaking Strength Lbs. (N)	Safety Factor	Max. Recommended Load Lbs. (N)	Catalog Number
Pulling Grips	2,500 (11,120)	5	500 (2,224)	033291196
Support Grips	400 (1,779)	10	40 (178)	022291004

The maximum recommended working load is the tension to be exerted on the grip in application with a margin of safety to take care of unforeseen and unusual circumstances.

It is the end-user's decision to determine how much of a safety factor is acceptable to for the application.

Fiber Optic Grip Materials

Material	Features	Product Group
Galvanized steel wire	<ul style="list-style-type: none"> • High strength • Not subject to continuous outside environment 	<ul style="list-style-type: none"> • Pulling grips
Tin-coated bronze wire	<ul style="list-style-type: none"> • Corrosion resistant for normal outside areas • Non-magnetic • Moderate strength 	<ul style="list-style-type: none"> • Support grips
Non-metallic braid	<ul style="list-style-type: none"> • Superior flex life • Non-conductive • Corrosion resistant • Moderate strength 	<ul style="list-style-type: none"> • OPTISOK®

Approvals

CSA Certification is indicated on appropriate product catalog pages.



Hose Containment Grips

Kellems® Hose Containment Grips are used on high pressure, flexible hose lines to prevent the hose from whipping violently in the event of hose failure at the fitting. These grips will prevent serious injury to personnel and damage to equipment by holding the hose in place in the event of hose failure.

Kellems® patented Hose Containment Grips are made of stainless steel double weave mesh construction for high strength and come complete with hose clamps.

IMPORTANT:

Read all breaking strength, safety and technical data relating to this product.

Types of Attachment

The six attachment methods shown below provide unlimited flexibility of attachment to meet any condition.

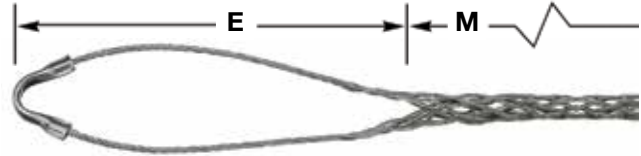

Type A

Single Eye, used where fastening is made with eyebolts or similar anchor terminations.

Cable Diameter Range Inches (cm)	Approx. Breaking Strength Lbs.	Working Load Lbs.	E Inches (cm)	M Inches (cm)	Catalog Number
.38"-.69" (.97-1.75)	2,900	290	10" (25)	24" (61)	014021285
.50"-.94" (1.27-2.39)	3,400	340	10" (25)	24" (61)	014021230
1.00"-1.56" (2.54-3.96)	9,400	940	10" (25)	36" (91)	014021453
1.25"-1.94" (3.18-4.93)	14,400	1,440	48" (122)	60" (152)	014021593
2.75"-3.44" (6.99-8.74)	12,500	1,250	10" (25)	48" (122)	014021524

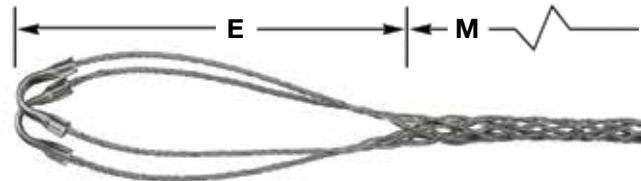

Type E

Double Eye Grip, used where fastening is made with eyebolts or similar anchor terminations.

Cable Diameter Range Inches (cm)	Approx. Breaking Strength Lbs.	Working Load Lbs.	E Inches (cm)	M Inches (cm)	Catalog Number
.50"-.94" (1.27-2.39)	4,250	425	8" (20)	24" (61)	014021224
.75"-1.25" (1.91-3.18)	6,000	600	8" (20)	24" (61)	014021223
1.00"-1.56" (2.54-3.96)	8,000	800	8" (20)	24" (61)	014021279

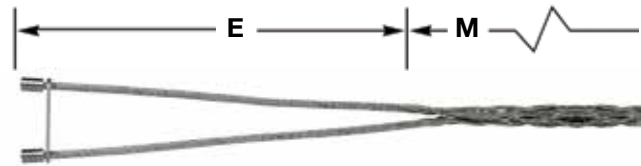

Type U

Universal Bale Grip, used to fasten around a structure or closed eye.

Cable Diameter Range Inches (cm)	Approx. Breaking Strength Lbs.	Working Load Lbs.	E Inches (cm)	M Inches (cm)	Catalog Number
.31"-.56" (.79-1.42)	2,100	210	12" (30)	24" (61)	014021304
.38"-.69" (.97-1.75)	2,600	260	12" (30)	24" (61)	014021308
.50"-.94" (1.27-2.39)	3,100	310	12" (30)	24" (61)	014021138
.50"-.94" (1.27-2.39)	3,100	310	24" (61)	24" (61)	014021139
.75"-1.25" (1.91-3.18)	4,500	450	12" (30)	24" (61)	014021140
1.00"-1.56" (2.54-3.96)	6,000	600	12" (30)	24" (61)	014021142
1.25"-1.94" (3.18-4.93)	6,000	600	12" (30)	36" (91)	014021527

Note: E- Eye length. M-Mesh length at nominal diameter.

It should be emphasized that Kellems® Hose Containment Grips are not to be used as a pressure reinforcing device for hose systems. These grips are custom made. Consult Technical Services for details.

Dimensions in Inches (mm)



Hose Containment Grips

Kellems Hose Containment Grips are supplied in diameters, length and attachments to meet individual requirements. Contact the Wiring Device-Kellems factory for specific information. These grips help meet OSHA Federal Register 1926-302 (b), 1926-603 (9), (10), JIC H-1-1973 (H13.11) and JIC P-1-1975 (P11.34) requirements.

IMPORTANT:

Read all breaking strength, safety and technical data relating to this product.

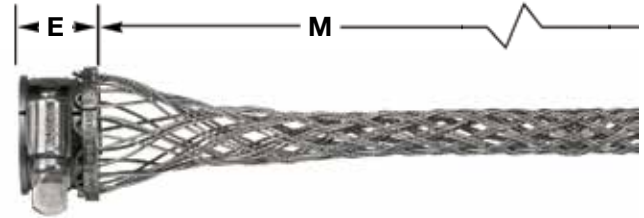

Type F

Split fitting to fit AN-818 nuts. Fitting is positioned over nut and located with internal flange. A hose clamp is furnished and required to hold the fitting in correct position.

Cable Diameter Range Inches (cm)	Approx. Breaking Strength Lbs.	Working Load Lbs.	E Inches (cm)	M Inches (cm)	Catalog Number
.38"-.69" (.97-1.75)	2,900	290	1" (2.54)	24" (61)	014021208
.50"-.94" (1.27-2.39)	3,400	340	1" (2.54)	24" (61)	014021156
.50"-.94" (1.27-2.39)	3,400	340	1" (2.54)	12" (30)	014021185
.50"-.94" (1.27-2.39)	3,400	340	1" (2.54)	12" (30)	014021186
.50"-.94" (1.27-2.39)	3,400	340	1" (2.54)	24" (61)	014021216
.75"-1.25" (1.91-3.18)	6,000	600	1" (2.54)	24" (61)	014021113
.75"-1.25" (1.91-3.18)	6,000	600	1" (2.54)	12" (30)	014021120
.75"-1.25" (1.91-3.18)	6,000	600	1" (2.54)	24" (61)	014021301
1.00"-1.56" (2.54-3.96)	6,000	600	1" (2.54)	24" (61)	014021157
1.00"-1.56" (2.54-3.96)	8,000	800	1.12" (2.84)	24" (61)	014021366
1.25"-1.94" (3.18-4.93)	8,000	800	1.12" (2.84)	36" (91)	014021314

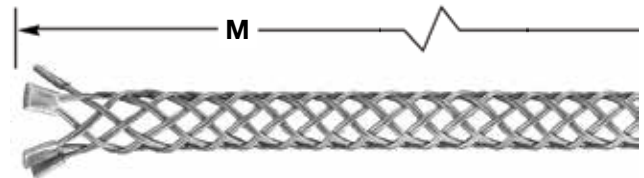

Type T

Tube Grips obtain complete grip coverage when hose is partially covered at either end with attachment grips. Type T-Grips fill in the exposed hose area between the two end grips. A telescoped assembly permits overlap to any degree desired beyond the 3" minimum.

Cable Diameter Range Inches (cm)	Approx. Breaking Strength Lbs.	Working Load Lbs.	E Inches (cm)	M Inches (cm)	Catalog Number
.50"-.94" (1.27-2.39)	3,400	340	—	24" (61)	014021152
.75"-1.25" (1.91-3.18)	6,000	600	—	24" (61)	014021085
1.44"-2.19" (3.66-5.56)	12,500	1,250	—	48" (122)	014021075

Note: E- Eye length. M-Mesh length at nominal diameter.



Type Y

Threaded bolt (5/16 – 18 x 1 1/2" long), used to fasten through drilled holes in a plate.

Note: Available upon request.

It should be emphasized that Kellems® Hose Containment Grips are not to be used as a pressure reinforcing device for hose systems. Kellems® Hose Containment Grips are supplied in diameters, length and attachments to meet individual requirements. Contact Technical services for specific information.

Dimensions in Inches (mm)









Kellems Strain Relief Grips are designed to prevent tension from being transmitted to joints and terminals on electrical cord, cable and conduit. In most applications, a Kellems grip for strain relief is stronger than the cable itself and gives much greater security than the use of a fitting alone. Kellems Grips for strain relief help make electrical systems safer, and save money by minimizing downtime from costly electrical failure due to cable pull-out. Kellems Grips also aid in compliance with the National Electric Code's terminal tension protection requirements.

Select the Correct Grip for Strain Relief

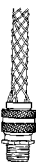
Kellems Grips for strain relief are designed to fit on electrical cord, cable or flexible conduit.

- Step 1** Refer to the chart below to determine the grip style best suited for your application.
- Step 2** Determine your cable outside diameter or conduit size.
- Step 3** Locate environment—indoors or outdoors.
- Step 4** Decide if a liquidtight seal is required.
- Step 5** Select NPT size and fitting style.

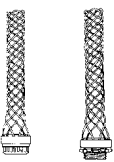
Strain Relief System Selection Chart

Grip Type	Application	Features	Cord or Conduit Range Inches (cm)	Type Fitting or Attachment	Page Number
Deluxe Cord Aluminum Fitting/ Stainless Steel Grip 	Outdoors or indoors where subjected to moisture or splash. Examples are crane and hoist pendant drop stations, hand tools, pumps and processing equipment.	Aluminum fittings, stainless steel mesh, neoprene oil-and-watertight bushing. Double-single weave.	.187"-3.250" (.47-8.25)	NPT, PG, and metric aluminum, male straight, 45° male, 90° male, female straight. Thread sizes 3/8"-3".	V-50, V-51, V-54
Deluxe Cord Nylon Fitting/ Stainless Steel Grip 	Outdoors or indoors where subjected to moisture or splash. Examples are marine and food processing equipment.	Nylon fitting, stainless steel mesh, double-single weave, neoprene oil-and-watertight bushing.	.187"-1.125" (.47-2.86)	NPT nylon, male straight, 90° male. Thread sizes 1/2"-1".	V-52
Deluxe Cord Nylon Fitting/ Non-metallic Grip 	Indoor or outdoors. Provides liquidtight seal, where exposed to moisture. Excellent for oil refining and chemical processing.	Non-metallic grip is corrosion resistant, nonconductive and provides superior gripping and flexing benefits. Neoprene liquidtight bushing. Nylon fitting.	.187"-1.000" (.47-2.54)	NPT nylon, straight male, thread sizes 3/8"-1" 90° male, thread sizes 1/2"-1".	V-53
Deluxe Cord Stainless Steel Fitting And Grip 	Indoor or outdoor use where exposed to moisture. Very strong for heavy abuse areas such as drilling platforms, steel mills and mines.	Stainless steel fitting and grip for strength. Neoprene liquidtight bushing. Double/single weave grip.	.187"-1.000" (.47-2.54)	Straight male Only with NPT Thread sizes 1/2"-1".	V-53
Dust-Tight Strain Relief 	Indoor use only for wiring of electrical enclosures, machine tools, portable power tools, bus drop cable systems.	Neoprene gasket—seals out chips, dirt, dust. One piece design with galvanized steel mesh. Insulating bushing available. Zinc-plated steel locknut.	.240"-2.450" (.61-6.22)	Straight male NPS or NPT	V-55
Liquidtight Flexible Conduit Grip (Metal and Non-Metallic) 	Wiring of machine tools, electrical enclosures, motors and systems where metallic liquidtight flexible conduit is subjected to vibration, flexure, motion or strain.	Stainless steel mesh, liquidtight fittings. Sealing "O" rings (optional). Choice of fittings.	.375"-4.000" trade sizes	NPT 1/2"-4", Hubbell fittings, Male straight, 45° male, 90° male, female straight.	V-58, V-59
Liquidtight Flexible Conduit Grip (UL Type A) 	Wiring or machine tools, electrical enclosures, motors and systems where conduit is subject to vibration and strain.	Stainless steel mesh, liquidtight fittings with "O" ring and locknut.	.375"-2.008" trade size male	NPT steel, Hubbell fittings, straight male, 90° Thread sizes 1/2"-2".	V-60



Features and Benefits

Deluxe Cord Grip

Deluxe cord grips help to alleviate pull tension on terminals, control cable arc-of-bend, prevent cord pull-out and provide a liquidtight seal. They are offered with either aluminum, stainless steel or nylon fittings in a variety of configurations and NPT thread sizes. Additionally, a completely non-metallic product is available.

Application

Specific uses are: wiring enclosures, pendant stations, hand tools, construction, processing and material handling equipment, pumps, motors and machine tools.

Benefits

- Helps to prevent cable pull-out
- Controls cable arc-of-bend
- Provides a liquidtight seal
- Corrosion resistant stainless steel mesh with aluminum collar



07401008



Mesh Grip

- Stainless steel mesh is corrosion resistant; can be used inside or outside
- Eliminates cable or flexible conduit pull out and reduces costly downtime
- Endless weave provides easy cable/flexible conduit installation



Deluxe Cord Grips

- An NPT and PG threaded body allows easy attachment to either threaded hub or knock-out in box
- A liquidtight fitting is available with both cable and conduit fittings; prevents liquids from running through the fitting into the enclosure



Cable Protection

- Multiweave grip gives cable arc-of-bend control minimizing cable damage and extending cable life
- It is the strongest strain relief device available; meets and exceeds all code requirements; prevents cable/conduit pull-out



Comprehensive Offering

- Hubbell offers a full line of deluxe cord grips with various material finishes
- Deluxe cord grips are used indoors or outdoors to help prevent cord pull-out and where cables are subjected to moisture, splash or submersion



Deluxe Cord Grips

Aluminum Fittings, Stainless Steel Mesh, Liquidtight for Insulated Cables.

IMPORTANT:

Read all safety and technical data relating to this product.

Refer to pages V-61 through V-68.

Straight Male Thread



NPT Thread Size Inches	Grip Diameter Range Inches (cm)		Form Size	Catalog Number
3/8	.250"-.312"	(.63-.79)	F1	07401001
	.312"-.375"	(.79-.95)		07401002
	.375"-.437"	(.95-1.11)		07401003
1/2	.187"-.250"	(.47-.63)	F2	07401004
	.250"-.375"	(.63-.95)		07401006
	.375"-.500"	(.95-1.27)		07401008
1/2	.500"-.625"	(1.27-1.59)	F3	07401010
	.625"-.750"	(1.59-1.90)		074011247*
	.750"-.875"	(1.90-2.22)		074011248*
3/4	.187"-.250"	(.47-.63)	F2	07401011
	.250"-.375"	(.63-.95)		07401013
	.375"-.500"	(.95-1.27)		07401015
3/4	.500"-.625"	(1.27-1.59)	F3	07401017
	.625"-.750"	(1.59-1.90)		07401018
	.750"-.875"	(1.90-2.22)		074011249*
1	.375"-.500"	(.95-1.27)	F4	074011195
	.500"-.625"	(1.27-1.59)		07401019
	.625"-.750"	(1.59-1.90)		07401021
1	.750"-.875"	(1.90-2.22)	F5	07401023
	.875"-.1.000"	(2.22-2.54)		07401025
	1.000"-.1.125"	(2.54-2.86)		074011250*
1	1.125"-.1.250"	(2.86-3.17)	F5	074011028*
	1.250"-.1.375"	(3.17-3.49)		074011029*
	.750"-.875"	(1.90-2.22)		074011251
1 1/4	.875"-.1.000"	(2.22-2.54)	F5	07401026
	1.000"-.1.125"	(2.54-2.86)		07401027
	1.125"-.1.250"	(2.86-3.17)		07401028
1 1/2	1.250"-.1.375"	(3.17-3.49)	F5	074011178*
	.750"-.875"	(1.90-2.22)		074011252
	.875"-.1.000"	(2.22-2.54)		07401029
1 1/2	1.000"-.1.125"	(2.54-2.86)	F5	07401030
	1.125"-.1.250"	(2.86-3.17)		07401031
	1.250"-.1.375"	(3.17-3.49)		07401032
1 1/2	1.312"-.1.437"	(3.33-3.65)	F6	074011253
	1.437"-.1.562"	(3.65-3.97)		074011254*
	1.562"-.1.687"	(3.97-4.28)		074011255*
1 1/2	1.687"-.1.812"	(4.28-4.60)	F6	074011256*
	1.750"-.1.875"	(4.44-4.76)		074011257*
	1.250"-.1.375"	(3.17-3.49)		074011258
2	1.312"-.1.437"	(3.33-3.65)	F6	074011259
	1.437"-.1.562"	(3.65-3.97)		07401033
	1.562"-.1.687"	(3.97-4.28)		07401034
2	1.687"-.1.812"	(4.28-4.60)	F7	07401035
	1.750"-.1.875"	(4.44-4.76)		074011260
	1.812"-.1.937"	(4.60-4.92)		074011261
2	1.937"-.2.062"	(4.92-5.24)	F7	074011262*
	2.062"-.2.187"	(5.24-5.55)		074011263*
	2.187"-.2.312"	(5.55-5.87)		074011264*
2 1/2	2.312"-.2.437"	(5.87-6.19)	F7	074011265*
	1.688"-.1.812"	(4.29-4.60)		074011030
	1.812"-.1.937"	(4.60-4.92)		074011031
2 1/2	1.937"-.2.062"	(4.92-5.24)	F7	074011032
	2.062"-.2.187"	(5.24-5.55)		074011033
	2.187"-.2.312"	(5.55-5.87)		074011034
3	2.312"-.2.437"	(5.87-6.19)	F7	074011266*
	1.937"-.2.062"	(4.92-5.24)		074011036
	2.062"-.2.187"	(5.24-5.55)		074011037
3	2.187"-.2.312"	(5.55-5.87)	F8	074011038
	2.312"-.2.437"	(5.87-6.19)		074011039
	2.437"-.2.625"	(6.19-6.67)		074011186
3	2.625"-.2.812"	(6.67-7.14)	F8	074011187
	2.812"-.3.000"	(7.14-7.62)		074011188
	3.000"-.3.250"	(7.62-8.25)		074011189*

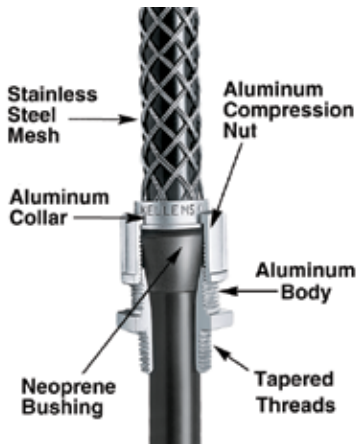

Note: Kellems® Deluxe Cord Grips are suitable for use in hazardous locations per Class I Div. 2, Class II Div. 1 & 2, Class III Div. 1 & 2 of the National Electric Code Sections 501.10(b)(2), 502.10(a)(2), 502.10(b)(2), 503.10(a)(2) and 503.10(b).
*Cable jacket may have to be stripped to pass through connector body.

Dimensions in Inches (mm)

Deluxe Cord Grips

Aluminum Fittings, Stainless Steel Mesh, Liquidtight for Insulated Cables.

IMPORTANT:
Read all safety and technical data relating to this product.

Refer to pages V-61 through V-68.

Straight Female Thread

NPT Thread Size Inches	Grip Diameter Range Inches (cm)		Form Size	Catalog Number
½	.375"-.500"	(.95-1.27)	F2	07401043
	.500"-.625"	(1.27-1.59)		07401045
¾	.500"-.625"	(1.27-1.59)	F2	07401052
¾	.625"-.750"	(1.59-1.90)	F4	07401053

90° Male Thread

NPT Thread Size Inches	Grip Diameter Range Inches (cm)		Form Size	Catalog Number
¾	.250"-.312"	(.63-.79)	F1	07401071
	.312"-.375"	(.79-.95)		07401072
	.375"-.437"	(.95-1.11)		07401073
½	.187"-.250"	(.47-.63)	F2	07401074
	.250"-.375"	(.63-.95)		07401076
	.375"-.500"	(.95-1.27)		07401078
¾	.500"-.625"	(1.27-1.59)	F3	07401080*
	.375"-.500"	(.95-1.27)		07401081
	.500"-.625"	(1.27-1.59)		07401083
1	.625"-.750"	(1.59-1.90)	F4	07401084*
	.750"-.875"	(1.90-2.22)		07401085
	.875"-.1.000"	(2.22-2.54)		07401087
1½	1.000"-.1.125"	(2.54-2.86)	F5	07401089
	1.125"-.1.250"	(2.86-3.17)		07401091*
	1.250"-.1.375"	(3.17-3.49)		07401092*
2	1.375"-.1.500"	(3.49-3.81)	F6	07401093*
	1.500"-.1.625"	(3.81-4.13)		07401094*
	1.625"-.1.750"	(4.13-4.45)		07401095*

45° Male Thread

NPT Thread Size Inches	Grip Diameter Range Inches (cm)		Form Size	Catalog Number
½	.250"-.375"	(.63-.95)	F2	074011236
	.375"-.500"	(.95-1.27)		074011021
	.500"-.625"	(1.27-1.59)		074011237*
¾	.500"-.625"	(1.27-1.59)	F3	074011049
	.625"-.750"	(1.59-1.90)		074011051*
	.750"-.875"	(1.90-2.22)		074011239*
1	.625"-.750"	(1.59-1.90)	F4	074011055
	.750"-.875"	(1.90-2.22)		074011057
	.875"-.1.000"	(2.22-2.54)		074011199*
1¼	1.000"-.1.125"	(2.54-2.86)	F5	074011059
	1.125"-.1.250"	(2.86-3.17)		074011060

Note: Kellems® Deluxe Cord Grips are suitable for use in hazardous locations per Class I Div. 2, Class II Div. 1 & 2, Class III Div. 1 & 2 of the National Electric Code Sections 501.10(b)(2), 502.10(a)(2), 502.10(b)(2), 503.10(a)(2) and 503.10(b).

*Cable jacket may have to be stripped to pass through connector body.



Dimensions in Inches (mm)



Deluxe Cord Grips

Nylon Fittings, Stainless Steel Mesh, Liquidtight for Insulated Cables.

IMPORTANT:

Read all safety and technical data relating to this product.

Refer to pages V-61 through V-68.



Straight Male Thread

NPT Thread Size Inches	Grip Diameter Range Inches (cm)	Form Size	Catalog Number
1/2	.187"-.250" (.47-.63)	F2	074011331
	.250"-.375" (.63-.95)		074011332
	.375"-.500" (.95-1.27)		074011333
	.500"-.625" (1.27-1.59)		074011334*
3/4	.375"-.500" (.95-1.27)	F3	074011335
	.500"-.625" (1.27-1.59)		074011336
	.625"-.750" (1.59-1.90)		074011337
1	.750"-.875" (1.90-2.22)	F4	074011338*
	.625"-.750" (1.59-1.90)		074011341
	.750"-.875" (1.90-2.22)		074011342
	.875"-1.000" (2.22-2.54)		074011343
	1.000"-1.125" (2.54-2.86)		074011344*



90° Male Thread

NPT Thread Size Inches	Grip Diameter Range Inches (cm)	Form Size	Catalog Number
1/2	.250"-.375" (.63-.95)	F2	074011346
	.375"-.500" (.95-1.27)		074011347
	.500"-.625" (1.27-1.59)		074011348*
3/4	.375"-.500" (.95-1.27)	F3	074011349
	.500"-.625" (1.27-1.59)		074011350
	.625"-.750" (1.59-1.90)		074011351*

Note: Kellems® Deluxe Cord Grips are suitable for use in hazardous locations per Class I Div. 2, Class II Div. 1 & 2, Class III Div. 1 & 2 of the National Electric Code Sections 501.10(b)(2), 502.10(a)(2), 502.10(b)(2), 503.10(a)(2) and 503.10(b).

*Cable jacket may have to be stripped to pass through connector body.

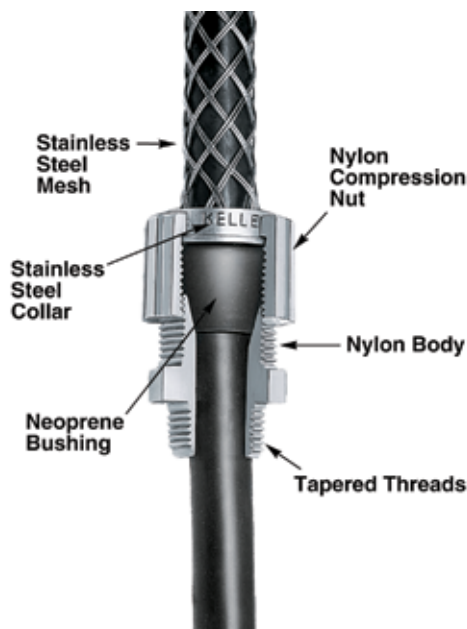

Dimensions in Inches (mm)

Deluxe Cord Grips

Nylon Fittings, Non-Metallic Mesh, and Stainless Steel Fittings, Stainless Steel Mesh, Liquidtight for Insulated Cables.

IMPORTANT:

Read all safety and technical data relating to this product.

Refer to pages V-61 through V-68.

Nylon Fittings Non-Metallic Mesh, Liquidtight for Insulated Cables Straight Male Thread

NPT Thread Size Inches	Grip Diameter Range Inches (cm)		Form Size	Catalog Number
3/8	.187"-.250"	(.47-.63)	F1	CG304NM CG305NM CG306NM
	.250"-.312"	(.63-.79)		
	.312"-.375"	(.79-.95)		
1/2	.187"-.250"	(.47-.63)	F2	CG404NM CG406NM CG408NM
	.250"-.375"	(.63-.95)		
	.375"-.500"	(.95-1.27)		
3/4	.375"-.500"	(.95-1.27)	F3	CG608NM CG610NM CG612NM
	.500"-.625"	(1.27-1.59)		
	.625"-.750"	(1.59-1.90)		
1	.500"-.625"	(1.27-1.59)	F4	CG810NM CG812NM CG814NM CG816NM
	.625"-.750"	(1.59-1.90)		
	.750"-.875"	(1.90-2.22)		
	.875"-.1.000"	(2.22-2.54)		



90° Male Thread

NPT Thread Size Inches	Grip Diameter Range Inches (cm)		Form Size	Catalog Number
1/2	.250"-.375"	(.63-.95)	F2	CG40690NM CG40890NM
	.375"-.500"	(.95-1.27)		
3/4	.375"-.500"	(.95-1.27)	F3	CG60890NM CG61090NM CG61290NM*
	.500"-.625"	(1.27-1.59)		
	.625"-.750"	(1.59-1.90)		
1	.625"-.750"	(1.59-1.90)	F4	CG81290NM CG81490NM
	.750"-.875"	(1.90-2.22)		



Stainless Steel Fittings, Stainless Steel Mesh, Liquidtight for Insulated Cables Straight Male Thread

NPT Thread Size Inches	Grip Diameter Range Inches (cm)		Form Size	Catalog Number
1/2	.187"-.250"	(.47-.63)	F2	CG404SST CG406SST CG408SST CG410SST
	.250"-.375"	(.63-.95)		
	.375"-.500"	(.95-1.27)		
	.500"-.625"	(1.27-1.59)		
3/4	.375"-.500"	(.95-1.27)	F2	CG608SST CG610SST
	.500"-.625"	(1.27-1.59)		
3/4	.625"-.750"	(1.59-1.90)	F3	CG612SST CG614SST
	.750"-.875"	(1.90-2.22)		
1	.500"-.625"	(1.27-1.59)	F4	CG810SST CG812SST CG814SST CG816SST
	.625"-.750"	(1.59-1.90)		
	.750"-.875"	(1.90-2.22)		
	.875"-.1.000"	(2.22-2.54)		



Note: Kellems® Deluxe Cord Grips are suitable for use in hazardous locations per Class I Div. 2, Class II Div. 1 & 2, Class III Div. 1 & 2 of the National Electric Code Sections 501.10(b)(2), 502.10(a)(2), 502.10(b)(2), 503.10(a)(2) and 503.10(b).
*Cable jacket may have to be stripped to pass through connector body.

Dimensions in Inches (mm)



PG and Metric Threaded Deluxe Cord Grips

Aluminum Fittings, Stainless Steel Mesh, Liquidtight for Insulated Cables.

IMPORTANT:

Read all safety and technical data relating to this product.

Refer to pages V-61 through V-68.



Straight PG* Male Thread

Hub Size	Cord Diameter Range Inches (cm)		Form Size	Catalog Number
PG16	.500"-.625"	(1.27-1.59)	F2	074PG16010
PG21	.500"-.625"	(1.27-1.59)	F2	074PG21010
PG21	.625"-.750"	(1.59-1.90)	F3	074PG211247
	.750"-.875"	(1.90-2.22)		074PG211248
PG29	.625"-.750"	(1.59-1.90)	F4	074PG29021
	.750"-.875"	(1.90-2.22)		074PG29023
	.875"-1.000"	(2.22-2.54)		074PG29025
PG29	1.125"-1.250"	(2.86-3.17)	F5	074PG291028*
PG36	1.125"-1.250"	(2.86-3.17)	F5	074PG36028*

Note: *Panzergewinde.



Straight Metric Male Thread

Hub Size	Cord Diameter Range Inches (cm)		Form Size	Catalog Number
M20	.500"-.625"	(1.27-1.59)	F2	074M20010
M25	.625"-.750"	(1.59-1.90)	F3	074M251247
	.750"-.875"	(1.90-2.22)		074M251248
M25	.500"-.625"	(1.27-1.59)	F2	074M25017
	.625"-.750"	(1.59-1.90)		074M32021
	.750"-.875"	(1.90-2.22)		074M32023
M32	.875"-1.000"	(2.24-2.54)	F4	074M32025
	1.000"-1.125"	(2.54-2.86)		074M321250
M32	1.125"-1.250"	(2.86-3.17)	F5	074M321028

Note: Kellems® Deluxe Cord Grips are suitable for use in hazardous locations per Class I Div. 2, Class II Div. 1 & 2, Class III Div. 1 & 2 of the National Electric Code Sections 501.10(b)(2), 502.10(a)(2), 502.10(b)(2), 503.10(a)(2) and 503.10(b).

*Cable jacket may have to be stripped to pass through connector body.

Specifications

Material	Temperature Range
Aluminum (Body)	-30°F to +240°F (-34°C to +115°C).
Stainless Steel (Mesh)	-30°F to +240°F (-34°C to +115°C).
Neoprene (Bushings)	-30°F to +240°F (-34°C to +115°C).
Hazardous Locations	Suitable for use in hazardous locations per Class I Div. 2, Class II Div. 1 & 2, Class III Div. 1 & 2 N.E.C. Reference 501.10(b)(2), 502.10(a)(2), 502.10(b)(2), 503.10(a)(2) and 503.10(b).
Approvals	
Deluxe Cord Grips	UL Listed in accordance with Standard 514B for indoor/outdoor use. UL Control numbers 898D and 899D.
Wet Locations	Suitable for use in wet locations when used with a listed sealing ring between box and fitting.

Dimensions in Inches (mm)

Dust-Tight Strain Relief Grips

Aluminum Fittings, Galvanized Steel Mesh for Insulated Cables.

IMPORTANT:

Read all safety and technical data relating to this product.

Refer to pages V-61 through V-68.

Non-Insulated, Wide Range Strain Relief

Thread Size	Cord Diameter Range Inches (cm)	Mesh Length @ Nom. Dia. Inches (cm)	Catalog Number
½ NPT	.24"-.32" (.61-.81)	3.25" (8.25)	073031200
	.32"-.43" (.81-1.09)	3.75" (9.52)	073031201
	.43"-.54" (1.09-1.37)	4.75" (12.06)	073031202
¾ NPT	.54"-.73" (1.37-1.85)	6.5" (16.51)	073031203A
1 NPT	.73"-.97" (1.85-2.46)	7" (17.78)	073031204
1¼ NPT	.97"-1.25" (2.46-3.17)	9" (22.86)	073031205
PG29*	.73"-.97" (1.85-2.46)	7" (17.78)	073PG291204

Note: *Panzergewinde.



Insulated, Wide Range Strain Relief with Insulating Bushing

Thread Size	Cord Diameter Range Inches (cm)	Mesh Length @ Nom. Dia. Inches (cm)	Dim. A Inches (cm)	Min. Space Between Grips Inches (cm)	Catalog Number
½ NPS	.24"-.32" (.61-.81)	3.25" (8.25)	1" (2.54)	1.25" (3.17)	073031206
	.32"-.43" (.81-1.09)	3.75" (9.52)	1" (2.54)	1.25" (3.17)	073031207
	.43"-.54" (1.09-1.37)	4.75" (12.06)	1" (2.54)	1.25" (3.17)	073031208
¾ NPS	.54"-.73" (1.37-1.85)	6.5" (16.51)	1" (2.54)	1.5" (3.81)	073031209A
1 NPS	.73"-.97" (1.85-2.46)	7" (17.78)	1.313" (3.02)	1.75" (4.44)	073031210
1¼ NPS	.97"-1.25" (2.46-3.17)	9" (22.86)	1.313" (3.02)	2.25" (5.71)	073031211
1½ NPT	1.25"-1.50" (3.17-3.81)	11.75" (29.84)	1.313" (3.02)	2.5" (6.35)	073031212
2 NPT	1.50"-1.70" (3.81-4.32)	13.25" (33.65)	1.375" (3.49)	3.25" (8.25)	073031213
2½ NPT	1.70"-2.00" (4.32-5.08)	13.5" (34.29)	1.5" (3.81)	3.625" (9.21)	073031214
	2.00"-2.45" (5.08-6.22)	13.75" (34.92)	1.5" (3.81)	3.625" (9.21)	073031215



Dimensions in Inches (mm)



I-Grips for Insulated Cables

Kellems® I-Grips are made of high strength, plastic coated galvanized steel strand. They are offered in six sizes to fit all cable diameters used with Hubbell Insulgrip®. Kellems I-Grips will control cable arc-of-bend and reduce high pull tensions from being transmitted to the wiring terminals.

IMPORTANT:

Read all safety and technical data relating to this product.

Refer to pages V-61 through V-68.



Application

Kellems® I-Grips will fit 2, 3, 4 and 5 wire Hubbell Insulgrip® plugs and connector bodies. The eye tabs fit under the nylon cord clamp and the screws slide through the eyelets, securing the grip in place.

I-Grips can be used on any Insulgrip cord set which requires cable, arc-of-bend control or heavy duty strain relief. Cord sets used at in-door construction sites or for plant maintenance jobs are examples.

These grips are for indoor use only.

Benefits

- Easily attached to Insulgrip plugs and connector bodies
- Controls cable arc-of-bend
- Provides heavy-duty strain relief
- Fits all sizes



I-Grips

Cable Diameter Range Inches (cm)	E Inches (cm)	M Inches (cm)	Catalog Number
.32"-.43" (.81-1.09)	1.25" (3.17)	4" (10.16)	07310001
.43"-.56" (1.09-1.42)	1.25" (3.17)	4.75" (12.06)	07310002
.56"-.73" (1.42-1.85)	1.50" (3.81)	6" (15.24)	07310003
.73"-.85" (1.85-2.16)	1.50" (3.81)	6.5" (16.51)	07310004
.85"-1.00" (2.16-2.54)	1.50" (3.81)	8" (20.32)	07310005
1.00"-1.25" (2.54-3.17)	1.50" (3.81)	10" (25.40)	07310006

Note: E-Eye length. M-Mesh length at nominal diameter.

Eyelet hole diameter .203" (.52cm).

I-Grips should not be used on Insulgrip devices when "Seal-Tite®" weatherproof covers are to be installed.

Thread Adapters for Multi-Pin Connectors

Kellems® Thread Adapters are devices formatting AN-MS connectors and other multi-pin connectors to Kellems grips with NPT threaded fittings. They are made of aluminum with internal threads and replace the connector cord clamp. These adapters permit the installation of Kellems Grips, to prevent cable or conduit pull-out and control arc-of-bend.

Applications

Thread adapters allow the installation of Kellems® Grips on multi-pin connectors at electrical consoles, mobile equipment, control switches, assembly equipment and testing machines.

Benefits

- Easy installation
- Allows the use of Kellems grips
- Extends connector and cable life



Thread Adapter
091041006

Thread Adapters for Multi-Pin Connectors

Thread Adapters					Deluxe Cord Grips		Strain Relief Grips		Liquidtight Conduit Grips (Insulated Throat)
AN-MS Connector Size**	AN-MS Cable Clamp Number***	Thread Size A Inch	NPT Thread Size B	Catalog Number	Cable Diameter Range Inches (cm)	Catalog Number	Cable Diameter Range Inches (cm)	Catalog Number	Catalog Number
8S, 10S	3057-3	1/2" x 28"		091041000	.250"-.312" (.63-.79)	07401001			
10SL, 12, 12S	3057-4	5/8" x 24"	3/8"	091041001	.312"-.375" (.79-.95)	07401002			
14, 14S	3057-6	3/4" x 20"		091041002	.375"-.437" (.95-1.11)	07401003			
14, 14S	3057-6	3/4" x 20"		091041003	.187"-.250" (.47-.63)	07401004	.24"-.32" (.61-.81)	073031200	
16, 16S	3057-8	7/8" x 20"	1/2"	091041004	.250"-.375" (.63-.95)	07401006	.32"-.43" (.81-1.09)	073031201	074093512
18	3057-10	1" x 20"		091041006	.375"-.500" (.95-1.27)	07401008	.43"-.54" (1.09-1.37)	073031202	
					.500"-.625" (1.27-1.59)	07401010*			
16, 16S	3057-8	7/8" x 20"		091041005	.187"-.250" (.47-.63)	07401011			
18	3057-10	1" x 20"	3/4"	091041007	.250"-.375" (.63-.95)	07401013			
20, 22	3057-12	1 1/16" x 18"		091041008	.375"-.500" (.95-1.27)	07401015	.54"-.74" (1.37-1.85)	073031203	074093513
					.500"-.625" (1.27-1.59)	07401017			
					.625"-.750" (1.59-1.90)	07401018			
20, 22	3057-12	1 1/16" x 18"		091041009	.375"-.500" (.95-1.27)	074011195			
24, 28	3057-16	1 1/16" x 18"		091041010	.500"-.625" (1.27-1.59)	07401019			
32	3057-20	1 3/4" x 18"	1	091041012	.625"-.750" (1.59-1.90)	07401021	.73"-.97" (1.85-2.46)	073031204	074093514
36	3057-24	2" x 18"		091041015	.750"-.875" (1.90-2.22)	07401023			
					.875"-.1.000" (2.22-2.54)	07401025			
24, 28	3057-16	1 1/16" x 18"		091041011	.750"-.875" (1.90-2.22)	074011251			
32	3057-20	1 3/4" x 18"	1 1/4"	091041013	.875"-.1.000" (2.22-2.54)	07401026	.97"-.1.25" (2.46-3.17)	073031205	074093515
36	3057-24	2" x 18"		091041016	1.000"-.1.125" (2.54-2.86)	07401027			
					1.125"-.1.375" (2.86-3.17)	07401028			
32	3057-20	1 3/4" x 18"		091041014	.875"-.1.000" (2.22-2.54)	07401029			
36	3057-24	2" x 18"	1 1/2"	091041017	1.000"-.1.125" (2.54-2.86)	07401030			074093516
40	3057-28	2 1/4" x 16"		091041019	1.125"-.1.250" (2.86-3.17)	07401031			
					1.250"-.1.375" (3.17-3.49)	07401032			

Note: *Cable jacket may have to be stripped to pass through connector body.

**Number stamped on connector shell.

***Number stamped on clamp shell.

Example

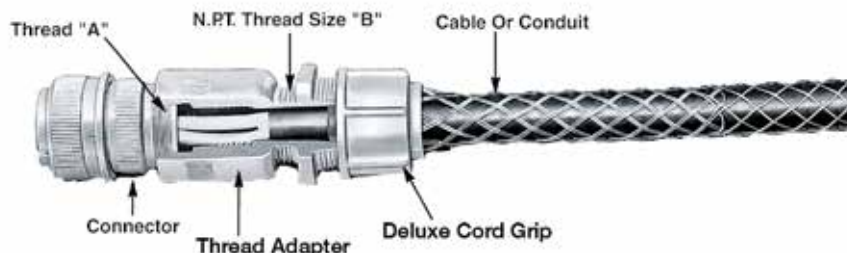

Dimensions in Inches (mm)



Strain Relief for Liquidtight Conduit

Steel Fitting, Stainless Steel Mesh for Liquidtight Metal Conduit and PolyTuff® I Non-Metallic Conduit.

IMPORTANT:

Read all safety and technical data relating to this product.

Refer to pages V-61 through V-68.

Benefits

- Helps prevent conduit pull-out and damage at the fitting
- Reduces equipment downtime

Straight With Male Fitting



Conduit Trade Size Inches	NPT Fitting Size Inches	Mesh Length Inches (cm)	Catalog Number (Insulated)	Catalog Number (Non-insulated)
3/8	1/2	3" (7.62)	074093511	074093401
1/2	1/2	3.5" (8.89)	074093512	074093402
3/4	3/4	4" (10.16)	074093513	074093403
1	1	5" (12.70)	074093514	074093404
1 1/4	1 1/4	6" (15.24)	074093515	074093405
1 1/2	1 1/2	6.75" (17.14)	074093516	074093406
2	2	8" (20.32)	074093518	074093408
2 1/2	2 1/2	9.75" (24.76)	074093520	074093410
3	3	11" (27.94)	074093522	074093412
4	4	14" (35.56)	074093526	—

90° Angle With Male Fitting



Conduit Trade Size Inches	NPT Fitting Size Inches	Mesh Length Inches (cm)	Catalog Number (Insulated)	Catalog Number (Non-insulated)
3/8	1/2	3" (7.62)	074093541	074093421
1/2	1/2	3.5" (8.89)	074093542	074093422
3/4	3/4	4" (10.16)	074093543	074093423
1	1	5" (12.70)	074093544	074093424
1 1/4	1 1/4	6" (15.24)	074093545	074093425
1 1/2	1 1/2	6.75" (17.14)	074093546	074093426
2	2	8" (20.32)	074093548	074093428
2 1/2	2 1/2	9.75" (24.76)	074093550	—
3	3	11" (27.94)	074093552	—

Note: For use with Liquidtight Metal conduit and PolyTuff® I Non-Metallic conduit.

Strain Relief for Liquidtight Conduit

Steel Fitting, Stainless Steel Mesh for Liquidtight Metal Conduit and PolyTuff® I Non-Metallic Conduit.

IMPORTANT:

Read all safety and technical data relating to this product.

Refer to pages V-61 through V-68.

Straight With Chase Fitting

Conduit Trade Size Inches	NPT Fitting Size Inches	Mesh Length Inches (cm)	Catalog Number
1/2	1/2	3.5" (8.89)	07406079
3/4	3/4	4" (10.16)	07406080
1	1	5" (12.70)	07406081
1 1/4	1 1/4	6" (15.24)	07406082
1 1/2	1 1/2	6.75" (17.14)	07406083



45° Angle With Male Fitting

Conduit Trade Size Inches	NPT Fitting Size Inches	Mesh Length Inches (cm)	Catalog Number (Insulated)	Catalog Number (Non-insulated)
3/8	1/2	3" (7.62)	074093561	074093441
1/2	1/2	3.5" (8.89)	074093562	074093442
3/4	3/4	4" (10.16)	074093563	074093443
1	1	5" (12.70)	074093564	074093444
1 1/4	1 1/4	6" (15.24)	074093565	074093445
1 1/2	1 1/2	6.75" (17.14)	074093566	074093446
2	2	8" (20.32)	074093568	074093448

Note: For use with Liquidtight Metal conduit and PolyTuff® I Non-Metallic conduit.



Dimensions in Inches (mm)



Strain Relief for Liquidtight Conduit

Steel Fitting, Stainless Steel Mesh for UL Type A Liquidtight Conduit.

IMPORTANT:

Read all safety and technical data relating to this product.

Refer to pages V-61 through V-68.



Straight Male Hubbell Fitting

Conduit Trade Size Inches	NPT Fitting Size Inches	Mesh Length Inches (cm)	Catalog Number
3/8	1/2	3.75" (9.52)	H038CNK
1/2	1/2	4.5" (11.43)	H050CNK
3/4	3/4	6.25" (15.87)	H075CNK
1	1	7.5" (19.05)	H100CNK
1 1/4	1 1/4	9" (22.86)	H125CNK
1 1/2	1 1/2	13.5" (34.29)	H150CNK
2	2	14.5" (36.83)	H200CNK



90° Male Hubbell Fitting

Conduit Trade Size Inches	NPT Fitting Size Inches	Mesh Length Inches (cm)	Catalog Number
3/8	1/2	3.75" (9.52)	H0389CNK
1/2	1/2	4.5" (11.43)	H0509CNK
3/4	3/4	6.25" (15.87)	H0759CNK
1	1	7.5" (19.05)	H1009CNK
1 1/4	1 1/4	9" (22.86)	H1259CNK
1 1/2	1 1/2	13.5" (34.29)	H1509CNK
2	2	14.5" (36.83)	H2009CNK

Dimensions in Inches (mm)



Wire Mesh Grip Materials

Material	Features	Product Group
Galvanized steel wire	<ul style="list-style-type: none"> • High strength • Not subject to continuous outside environment 	<ul style="list-style-type: none"> • Strain relief grips • I-Grips
Stainless steel wire (302/304)	<ul style="list-style-type: none"> • High strength • Corrosion resistant • Slightly magnetic 	<ul style="list-style-type: none"> • Deluxe cord grips • Liquidtight, flexible, metal conduit grips • UL type A conduit grips
Non-metallic strand	<ul style="list-style-type: none"> • Superior flex life • Non-conductive • Corrosion resistant • Moderate strength 	<ul style="list-style-type: none"> • Non-metallic deluxe cord grips

Operating Temperatures

Material	Temperature Range
Aluminum	-40°F to +300°F (-40°C to +149°C).
Aluminum Deluxe Cord Grips	-30°F to +240°F (-34°C to +115°C).
Non-Metallic Deluxe Cord Grips	-30°F to +225°F (-34°C to +107°C).
Nylon	-40°F to +225°F (-40°C to +107°C).
Nylon Fitting with Stainless Steel Mesh	-40°F to +225°F (-40°C to +107°C).
Stainless Steel	-60°F to +1000°F (-51°C to +537°C).
Stainless Steel Deluxe Cord Grips	-30°F to +240°F (-34°C to +115°C).
Neoprene (Bushings)	-30°F to +240°F (-34°C to +115°C).

Hazardous Locations

	Product Categories
The product categories listed to the right are suitable for use in hazardous locations per Class I Div. 2, Class II Div. 1 & 2, Class III Div. 1 & 2.	Deluxe cord grip, aluminum fitting; Deluxe cord grip, nylon fitting; Deluxe cord grip, non-metallic; Sealtite conduit grips; Dusttight strain relief grips.

Flammability

Non-metallic deluxe cord grips will not support combustion. Listed below are the ratings.

Component	Rating
Mesh grip	UL 94HB.
Fitting	UL 94V-2.

Approvals

UL Listing and CSA Certification are indicated on appropriate product catalog pages.

Agency	UL Control Number
Underwriters Laboratories Inc.	898D and 899D.
	UL Listed in accordance with Standard 514B for indoor/outdoor use.

Wet Locations

	Product Categories
The products noted to the right are suitable for use in wet locations when a listed sealing ring is used between box and fitting.	Deluxe cord grip, aluminum fitting; Deluxe sealing ring cord grip; Deluxe cord grip, non-metallic; Sealtite conduit grips; Hubbell non-metallic conduit grips; Cord connectors; Hubbell Juniors; PolyTuff® connectors; Hubbell sealtite conduit connectors.



Form Size Definition

The term "Form Size" refers to the physical mass or overall dimensions of a cord connector. Form 1 is the smallest size, Form 8 is the largest size.

Knockout Holes

NPT Hub Size Inches	Knockout Hole Recommended Min. to Max. Inches (cm)		
¼	.540"	to	.570" (1.37-1.45)
⅜	.671"	to	.701" (1.70-1.78)
½	.859"	to	.906" (2.18-2.30)
¾	1.094"	to	1.141" (2.78-2.90)
1	1.359"	to	1.406" (3.45-3.57)
1¼	1.719"	to	1.766" (4.37-4.49)
1½	1.969"	to	2.016" (5.00-5.12)
2	2.453"	to	2.500" (6.23-6.35)
2½	2.953"	to	3.000" (7.50-7.62)
3	3.578"	to	3.625" (9.09-9.21)

Product Data

Deluxe Cord Grips, Liquidtight for Insulated Cables

Deluxe Cord Grips helps to alleviate pull tension on terminals, control cable arc-of-bend, prevent cord pull-out, and provide a liquidtight seal. They are offered with either aluminum, stainless steel or nylon fittings in a variety of configurations and NPT thread sizes. Additionally, a completely non-metallic product is offered on page V-53.

Application

Deluxe Cord Grips are used indoors or outdoors to help prevent cord pull-out, and where cables are subjected to moisture, splash or submersion. Specific uses are: wiring enclosures, pendant stations, hand tools, construction, processing and material handling equipment, pumps, motors and machine tools.

Benefits

- Helps to prevent cable pull-out
- Controls cable arc-of-bend
- Provides a liquidtight seal
- Corrosion resistant stainless steel mesh with aluminum collar



Deluxe Cord Grips Fitting Dimensions

Straight Hubbell Connectors

F NPT Inches	Aluminum, Inches (cm)						Nylon, Inches (cm)					Stainless Steel, Inches (cm)								
	A	B	C	D Throat Dia.	E		A	B	C	D Throat Dia.	E		A	B	C	D Throat Dia.	E			
	Form Dia.	Ref.			A/C*	A/F*	Dia.	Ref.			A/C*	A/F*	A/C*	A/F*	Ref.		A/C*	A/F*		
3/8-18	1	.88" (2.24)	.90" (2.29)	.46" (1.17)	.44" (1.12)	.99" (2.51)	.88" (2.24)	1.00" (2.54)	1.10" (2.79)	.43" (1.09)	.45" (1.14)	1.00" (2.54)	.93" (2.36)	1.01" (2.57)	.88" (2.24)	.90" (2.29)	.46" (1.17)	.45" (1.14)	.87" (2.21)	.75" (1.90)
1/2-14	1	.88" (2.24)	.90" (2.29)	.46" (1.17)	.44" (1.12)	.99" (2.51)	.88" (2.24)	1.00" (2.54)	1.10" (2.79)	.43" (1.09)	.45" (1.14)	1.00" (2.54)	.93" (2.36)	—	—	—	—	—	—	—
1/2-14	2	1.13" (2.87)	1.10" (2.79)	.55" (1.40)	.64" (1.63)	1.11" (2.82)	1.00" (2.54)	1.32" (3.35)	1.50" (3.81)	.53" (1.35)	.58" (1.47)	1.25" (3.17)	1.12" (2.84)	1.30" (3.30)	1.13" (2.87)	1.10" (2.79)	.54" (1.37)	.63" (1.60)	1.16" (2.95)	1.00" (2.54)
1/2-14	3	1.38" (3.51)	1.50" (3.81)	.55" (1.40)	.64" (1.63)	1.40" (3.56)	1.25" (3.17)	—	—	—	—	—	—	—	—	—	—	—	—	—
3/4-14	2	1.13" (2.87)	1.10" (2.79)	.55" (1.40)	.64" (1.63)	1.29" (3.28)	1.13" (2.87)	—	—	—	—	—	—	—	—	—	—	—	—	—
3/4-14	3	1.38" (3.51)	1.50" (3.81)	.55" (1.40)	.82" (2.08)	1.40" (3.56)	1.25" (3.17)	1.56" (3.96)	1.60" (4.06)	.55" (1.40)	.77" (1.96)	1.44" (3.66)	1.31" (3.33)	1.59" (4.04)	1.38" (3.51)	1.30" (3.30)	.56" (1.42)	.81" (2.06)	1.44" (3.66)	1.25" (3.17)
1-11 1/2	3	—	—	—	—	—	—	—	—	—	—	—	—	—	—	—	—	—	—	—
1-11 1/2	4	1.75" (4.44)	1.60" (4.06)	.71" (1.80)	1.02" (2.59)	1.81" (4.60)	1.62" (4.11)	1.88" (4.78)	1.75" (4.44)	.70" (1.78)	1.01" (2.57)	1.84" (4.67)	1.63" (4.14)	2.02" (5.13)	1.75" (4.44)	1.40" (3.56)	.70" (1.78)	1.03" (2.62)	1.88" (4.78)	1.63" (4.14)
1-11 1/2	5	2.31" (5.87)	1.70" (4.32)	.66" (1.68)	1.01" (2.57)	2.28" (5.79)	2.00" (5.08)	—	—	—	—	—	—	—	—	—	—	—	—	—
1 1/4-11 1/2	5	2.31" (5.87)	1.70" (4.32)	.74" (1.88)	1.26" (3.20)	2.28" (5.79)	2.12" (5.38)	—	—	—	—	—	—	—	—	—	—	—	—	—
1 1/2-11	5	2.31" (5.87)	1.70" (4.32)	.74" (1.88)	1.38" (3.51)	2.28" (5.79)	2.12" (5.38)	—	—	—	—	—	—	—	—	—	—	—	—	—
1 1/2-11 1/2	6	3.00" (7.62)	2.20" (5.59)	.75" (1.90)	1.50" (3.81)	2.97" (7.54)	2.75" (6.98)	—	—	—	—	—	—	—	—	—	—	—	—	—
2-11 1/2	6	3.00" (7.62)	2.20" (5.59)	.80" (2.03)	1.92" (4.88)	3.24" (8.24)	3.00" (7.62)	—	—	—	—	—	—	—	—	—	—	—	—	—
2-11 1/2	7	3.85" (9.78)	2.70" (6.86)	.88" (2.24)	1.94" (4.93)	4.05" (10.29)	3.75" (9.52)	—	—	—	—	—	—	—	—	—	—	—	—	—
2 1/2-8	7	3.85" (9.78)	2.70" (6.86)	1.30" (3.30)	2.32" (5.89)	4.34" (11.02)	4.02" (10.21)	—	—	—	—	—	—	—	—	—	—	—	—	—
2 1/2-8	8	4.75" (12.06)	2.70" (6.86)	1.25" (3.17)	2.38" (6.05)	4.86" (12.34)	4.50" (11.43)	—	—	—	—	—	—	—	—	—	—	—	—	—
3-8	7	3.85" (9.78)	2.70" (6.86)	1.30" (3.30)	2.54" (6.45)	4.34" (11.02)	4.01" (10.21)	—	—	—	—	—	—	—	—	—	—	—	—	—
3-8	8	4.50" (11.43)	2.70" (6.86)	1.38" (3.51)	3.00" (7.62)	4.86" (12.34)	4.50" (11.43)	—	—	—	—	—	—	—	—	—	—	—	—	—

Note: *A/C— Across Corners; A/F—Across Flats.

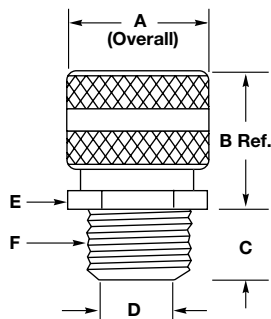

Dimensions shown are approximate and are subject to change without notice.



Deluxe Cord Grips Fitting Dimensions

45° Hubbell Connectors

Aluminum, Inches (cm)

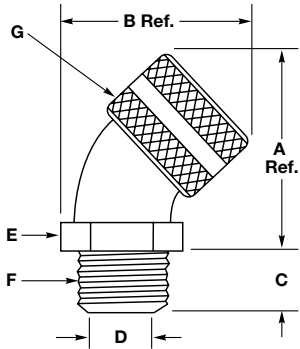

F NPT Inches	Form	A		C	D Throat Dia.	E		G Dia.
		Ref.	Ref.			Across Corners	Across Flats	
½-14	2	2.00" (5.08)	1.90" (4.83)	.550" (1.40)	.560" (1.42)	1.270" (3.23)	1.110" (2.79)	1.125" (2.86)
¾-14	3	2.30" (5.84)	2.50" (6.53)	.560" (1.42)	.750" (1.90)	1.480" (3.76)	1.281" (3.25)	1.375" (3.49)
1-11½	4	2.60" (6.60)	2.80" (7.11)	.700" (1.78)	1.000" (2.54)	1.690" (4.29)	1.500" (3.81)	1.750" (4.44)
1¼-11½	5	3.90" (9.91)	3.90" (9.91)	.740" (1.88)	1.250" (3.17)	2.45" (6.22)	2.125" (5.40)	2.310" (5.87)
1½-11½	5	3.90" (9.91)	3.90" (9.91)	.740" (1.88)	1.500" (3.81)	2.45" (6.22)	2.125" (5.40)	2.310" (5.87)

90° Hubbell Connectors

Aluminum, Inches (cm)

Nylon, Inches (cm)

F NPT Inches	Form	A	B	C	D Throat Dia.	E		G Dia.	A	B	C	D Throat Dia.	E		G Dia.
		Ref.	Ref.	A/C*		A/F*	A/C*						A/F*		
¾-18	1	1.27" (3.23)	2.00" (5.08)	.460" (1.17)	.440" (1.12)	1.15" (2.92)	1.10" (2.79)	.875" (2.22)	—	—	—	—	—	—	—
½-14	2	1.56" (3.96)	2.30" (5.84)	.500" (1.27)	.546" (1.39)	1.30" (3.30)	1.13" (2.87)	1.125" (2.86)	1.41" (3.58)	2.50" (6.35)	.550" (1.40)	.575" (1.46)	1.23" (3.12)	1.12" (2.82)	1.315" (3.34)
¾-14	3	1.79" (4.55)	2.80" (7.11)	.560" (1.42)	.765" (1.94)	1.49" (3.78)	1.31" (3.33)	1.375" (3.49)	1.65" (4.19)	2.81" (7.14)	.560" (1.42)	.765" (1.94)	1.42" (3.61)	1.29" (3.28)	1.560" (3.96)
1-11½	4	2.08" (5.28)	3.20" (8.13)	.700" (1.78)	1.000" (2.54)	1.70" (4.32)	1.50" (3.81)	1.750" (4.44)	1.99" (5.05)	3.30" (8.38)	.700" (1.78)	1.010" (2.57)	1.82" (4.62)	1.60" (4.06)	1.875" (4.76)
1¼-11½	5	3.18" (8.08)	4.30" (10.92)	.730" (1.85)	1.260" (3.20)	2.47" (6.27)	2.15" (5.46)	2.310" (5.87)	—	—	—	—	—	—	—
1½-11½	5	3.18" (8.08)	4.30" (10.92)	.750" (1.92)	1.500" (3.81)	2.47" (6.27)	2.15" (5.46)	2.310" (5.87)	—	—	—	—	—	—	—
2-11½	6	3.51" (8.92)	5.50" (13.97)	.800" (2.03)	1.920" (4.88)	2.98" (7.57)	2.78" (7.06)	3.000" (7.62)	—	—	—	—	—	—	—

Note: *A/C - Across Corners; A/F - Across Flats.

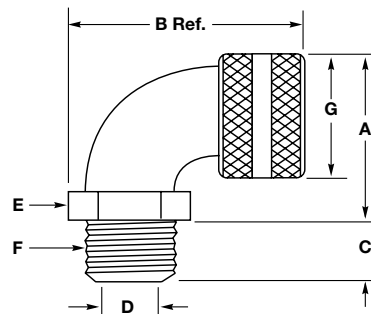

Dimensions shown are approximate and are subject to change without notice.



Deluxe Cord Grips Fitting Dimensions

Female Hubbell Connectors

Aluminum, Inches (cm)							
F NPT Inches	Form	A Dia.	B Ref.	C	D Throat Dia.	E	
						Across Comers	Across Flats
3/8-18	1	.88" (2.24)	1.40" (3.56)	.560" (1.42)	.44" (1.12)	.94" (2.39)	.81" (2.06)
1/2-14	2	1.13" (2.87)	1.80" (4.57)	.560" (1.42)	.63" (1.60)	1.15" (2.92)	1.00" (2.54)
3/4-14	2	1.13" (2.87)	2.10" (5.33)	.750" (1.90)	.63" (1.60)	1.44" (3.66)	1.25" (3.17)
1-11½	4	1.75" (4.44)	2.30" (5.84)	.880" (2.24)	1.10" (2.79)	1.88" (4.78)	1.63" (4.14)
1¼-11½	5	2.31" (5.87)	2.80" (7.11)	.950" (2.41)	1.43" (3.63)	2.64" (6.71)	2.29" (5.82)
1½-11½	5	2.31" (5.87)	2.80" (7.11)	.950" (2.41)	1.43" (3.63)	2.64" (6.71)	2.29" (5.82)

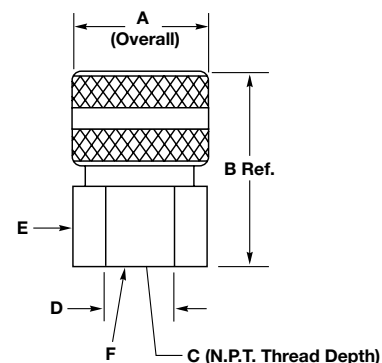

Product Data

Dust-Tight Strain Relief Grips for Insulated Cables

Kellems® Strain Relief Grips connect flexible cord or bus drop cable to electrical enclosures. For indoor use only, they are available with either insulated or non-insulated aluminum fittings, and feature single weave, galvanized steel mesh grips with patented wide range mesh construction. They come with a locknut and a neoprene gasket that provides a dust tight seal.

Application

Used to connect electrical cable to power boxes, cabinets, panel boards, power centers, machine tools and with bus drop systems.

Benefits

- Helps prevent cord or cable pull-out
- Provides a dust tight seal
- Easy installation
- Patented mesh construction
- One piece design

Dimensions shown are approximate and are subject to change without notice.



Strain Relief Grips for Liquidtight Flexible Metal and PolyTuff® I Non-Metallic Conduit

Kellems Liquidtight, Flexible Metal Conduit Grips are offered with high quality Hubbell plated steel fittings in a wide variety of NPT sizes and configurations, either insulated or non-insulated. The addition of a stainless steel mesh to these fittings makes them stronger than the conduit itself. Kellems Conduit Grips helps prevent conduit pull-out from the connecting fitting that is subject to stress, pull tension, vibration, motion or strain. They promote safe electrical systems and reduce equipment downtime.

Application

Kellems Conduit Grips are used in the wiring of machine tools, motors, molding equipment, transformers, weaving and paper machines, fans, lighting, bakeries, breweries, food processing, chemical plants, dairies, mines and any application that requires Liquidtight Conduit.

Benefits

- Helps prevent conduit pull-out and damage at the fitting
- Reduces equipment downtime
- Liquidtight fittings
- Easily installed
- Stainless steel grip resists corrosion

Kellems Conduit Grips are suitable for use in hazardous locations per Class I Div. 2, Class II Div. 1 & 2, Class III Div. 1 & 2 of the National Electric Code.

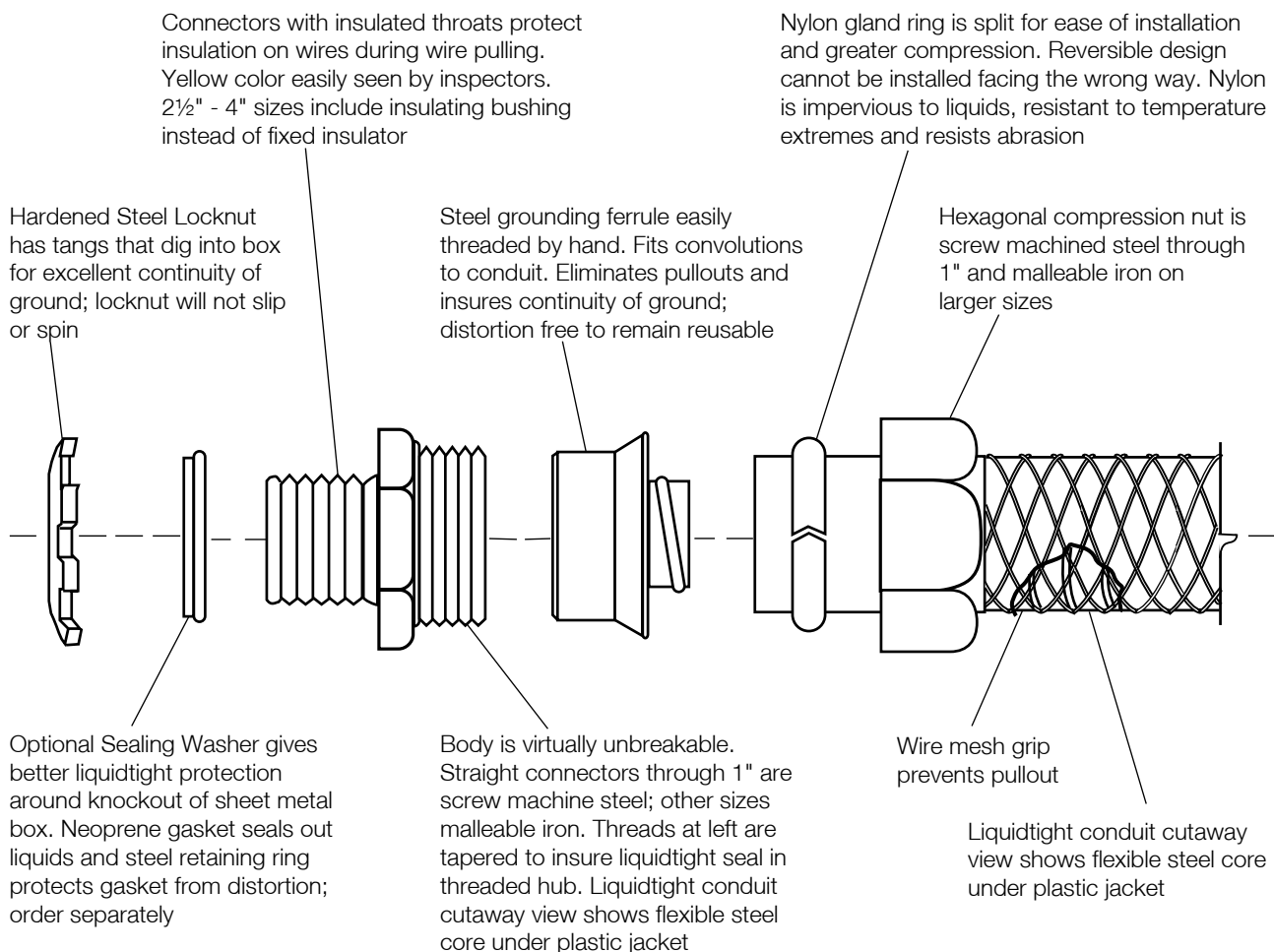



Liquidtight Conduit Grip Fitting Dimensions, Inches

Straight with Male Fitting

Dimensions, Inches								
Trade Size	A	B	C		D	E		Catalog Number
Inches	Ref.	Ref.	A/C*	A/F*	Throat Dia.	A/C*	A/F*	
3/8	1.43"	.59"	1.20"	1.06"	.61"	1.07"	.93"	074093401
1/2	1.43"	.59"	1.34"	1.19"	.61"	1.22"	1.06"	074093402
3/4	1.56"	.59"	1.55"	1.37"	.84"	1.43"	1.25"	074093403
1	1.68"	.66"	1.95"	1.69"	1.06"	1.73"	1.56"	074093404
1 1/4	2.03"	.63"	2.39"	2.06"	1.37"	2.36"	2.08"	074093405
1 1/2	2.21"	.63"	2.72"	2.38"	1.53"	2.79"	2.48"	074093406
2	2.28"	.69"	3.08"	2.87"	2.06"	3.32"	2.90"	074093408

Straight with Male Fitting with Insulated Throat

Dimensions, Inches								
Trade Size	A	B	C		D	E		Catalog Number
Inches	Ref.	Ref.	A/C*	A/F*	Throat Dia.	A/C*	A/F*	
3/8	1.50"	.66"	1.20"	1.06"	.57"	1.07"	.93"	074093511
1/2	1.50"	.66"	1.34"	1.19"	.57"	1.22"	1.06"	074093512
3/4	1.62"	.66"	1.55"	1.38"	.78"	1.43"	1.25"	074093513
1	1.75"	.72"	1.95"	1.69"	.98"	1.73"	1.56"	074093514
1 1/4	2.09"	.69"	2.39"	2.06"	1.29"	2.36"	2.08"	074093515
1 1/2	2.28"	.69"	2.72"	2.37"	1.53"	2.79"	2.48"	074093516
2	2.34"	.75"	3.08"	2.87"	1.95"	3.32"	2.90"	074093518
2 1/2	3.56"	1.06"	3.92"	3.62"	2.42"	3.85"	3.60"	074093520
3	3.81"	1.06"	4.70"	4.31"	3.01"	4.65"	4.33"	074093522
4	3.81"	1.06"	5.75"	5.31"	3.96"	5.75"	5.39"	074093526

45° Angle with Male Fitting

Dimensions, Inches									
Trade Size	H	J	K	L		M	N		Catalog Number
Inches	Ref.	Ref.	Ref.	A/C*	A/F*	Throat Dia.	A/C*	A/F*	
3/8	1.19"	1.28"	.59"	1.20"	1.06"	.60"	1.16"	1.02"	074093441
1/2	1.19"	1.28"	.59"	1.34"	1.19"	.61"	1.21"	1.06"	074093442
3/4	1.19"	1.43"	.59"	1.55"	1.45"	.84"	1.50"	1.32"	074093443
1	1.38"	1.53"	.66"	1.95"	1.69"	1.05"	1.82"	1.59"	074093444
1 1/4	1.42"	1.69"	.63"	2.39"	2.06"	1.37"	2.32"	2.03"	074093445
1 1/2	1.66"	2.00"	.66"	2.72"	2.38"	1.60"	2.62"	2.29"	074093446
2	1.69"	2.25"	.66"	3.08"	2.88"	2.05"	3.21"	2.80"	074093448

45° Angle with Male Fitting with Insulated Throat

Dimensions, Inches									
Trade Size	H	J	K	L		M	N		Catalog Number
Inches	Ref.	Ref.	Ref.	A/C*	A/F*	Throat Dia.	A/C*	A/F*	
3/8	1.25"	1.28"	.66"	1.20"	1.06"	.57"	1.16"	1.02"	074093561
1/2	1.25"	1.28"	.66"	1.34"	1.19"	.57"	1.21"	1.06"	074093562
3/4	1.25"	1.44"	.66"	1.55"	1.45"	.78"	1.50"	1.32"	074093563
1	1.44"	1.53"	.72"	1.95"	1.69"	.98"	1.82"	1.59"	074093564
1 1/4	1.48"	1.69"	.69"	2.39"	2.06"	1.29"	2.32"	2.03"	074093565
1 1/2	1.72"	2.00"	.72"	2.72"	2.38"	1.53"	2.62"	2.29"	074093566
2	1.75"	2.25"	.72"	3.08"	2.87"	1.95"	3.21"	2.80"	074093568

90° Angle with Male Fitting

Dimensions, Inches									
Trade Size	D	E	F		G	P		Catalog Number	
Inches	Ref.	Ref.	A/C*	A/F*	Ref.	Throat Dia.	A/C*		A/F*
3/8	1.31"	.59"	1.20"	1.06"	1.44"	.60"	1.13"	.99"	074093421
1/2	1.31"	.59"	1.34"	1.12"	1.44"	.61"	1.21"	1.00"	074093422
3/4	1.44"	.59"	1.55"	1.45"	1.63"	.83"	1.48"	1.29"	074093423
1	1.78"	.66"	1.95"	1.60"	2.19"	1.05"	1.80"	1.57"	074093424
1 1/4	1.97"	.63"	2.39"	2.06"	2.50"	1.37"	2.32"	2.02"	074093425
1 1/2	2.19"	.66"	2.72"	2.38"	2.69"	1.61"	2.58"	2.25"	074093426
2	2.53"	.66"	3.08"	2.87"	3.25"	2.05"	3.14"	2.75"	074093428

90° Angle with Male Fitting with Insulated Throat

Dimensions, Inches									
Trade Size	D	E	F		G	P		Catalog Number	
Inches	Ref.	Ref.	A/C*	A/F*	Ref.	Throat Dia.	A/C*		A/F*
3/8	1.38"	.66"	1.20"	1.06"	1.44"	.60"	1.13"	.99"	074093541
1/2	1.38"	.66"	1.34"	1.12"	1.44"	.57"	1.21"	1.00"	074093542
3/4	1.50"	.66"	1.55"	1.45"	1.63"	.78"	1.48"	1.29"	074093543
1	1.84"	.66"	1.95"	1.60"	2.19"	.98"	1.80"	1.57"	074093544
1 1/4	2.03"	.69"	2.39"	2.06"	2.50"	1.29"	2.32"	2.02"	074093545
1 1/2	2.25"	.69"	2.72"	2.38"	2.69"	1.53"	2.58"	2.20"	074093546
2	2.59"	.72"	3.08"	2.87"	3.25"	1.95"	3.14"	2.75"	074093548
2 1/2	3.44"	1.00"	3.92"	3.63"	4.25"	2.42"	3.78"	3.50"	074093550
3	3.75"	1.00"	4.70"	4.31"	4.87"	3.01"	4.64"	4.30"	074093552

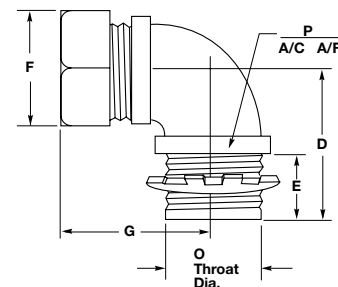
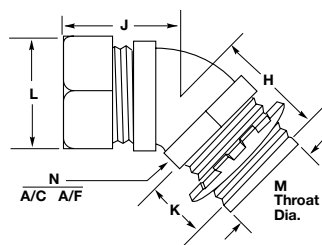
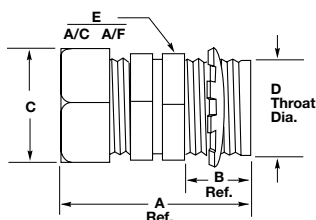

Note: *A/C - Across Corners; A/F - Across Flats.

Dimensions shown are approximate and are subject to change without notice.



Strain Relief for UL Type A, Flexible, Liquidtight Conduit

Kellems Grips for UL Type A, non-metallic, flexible, liquidtight conduit are available in straight and 90° male and feature a high quality Hubbell plated steel or malleable iron fitting, complete with a sealing O-ring, lock nut and stainless steel mesh. These grips increase the retention of the conduit in the fitting, control its arc-of-bend and provide a liquidtight seal.

Application

These grips are used on UL Type A non-metallic conduit connections at limit switches, motor boxes, panel boards, control stations and on all types of machinery and machine tools.

Steel Locknut has tangs that dig into box for excellent continuity of ground; locknut will not slip or spin

Benefits

- Provides a liquidtight seal
- Helps prevent conduit pull-out
- Reduces conduit cutting, kinking, fraying and splitting at the fitting
- Easily installed

Body is virtually unbreakable. Straight connectors through 1" are screw machine steel; other sizes are malleable iron. Threads are tapered to insure liquidtight seal when used in threaded hub; octagonal shape inside holds the ferrule to prevent conduit from twisting during installation

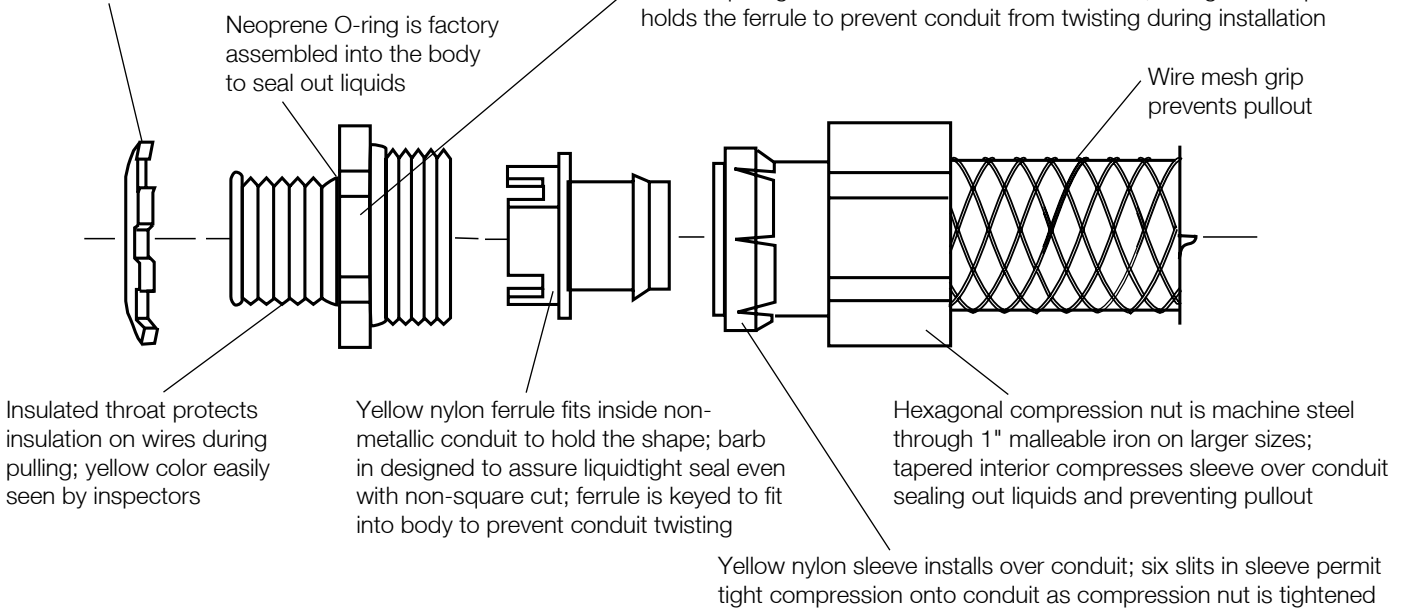

Dimensional Charts For UL Type A, Liquidtight Conduit Grip Fittings

Straight with Male Fitting with Insulated Throat

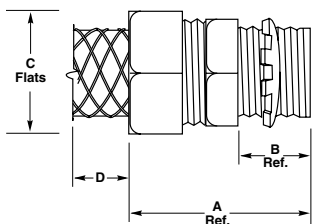

Dimensions Inches (cm)

Trade Size NPT Inches	A	B	C	D	Catalog Number
3/8	1.922" (4.88)	.594" (1.51)	1.156" (2.94)	3.75" (9.52)	H038CNK
1/2	1.922" (4.88)	.594" (1.51)	1.250" (3.17)	4.50" (11.43)	H050CNK
3/4	2.016" (5.12)	.594" (1.51)	1.500" (3.81)	6.25" (15.87)	H075CNK
1	2.157" (5.48)	.719" (1.83)	1.844" (4.68)	7.50" (19.05)	H100CNK
1 1/4	2.219" (5.64)	.750" (1.91)	2.312" (5.87)	9.00" (22.86)	H125CNK
1 1/2	2.344" (5.95)	.750" (1.91)	2.578" (6.55)	13.50" (34.29)	H150CNK
2	2.406" (6.11)	.750" (1.91)	3.187" (8.09)	14.50" (36.83)	H200CNK

90° Angle with Male Fitting with Insulated Throat

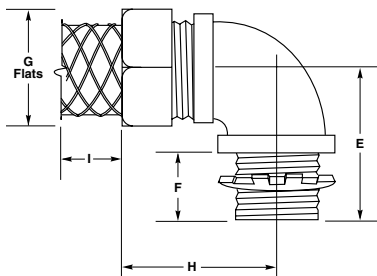

Dimensions Inches (cm)

Trade Size NPT Inches	E	F	G	H	I	Catalog Number
3/8	1.250" (3.18)	.594" (1.51)	1.156" (2.94)	1.453" (3.69)	3.75" (9.52)	H0389CNK
1/2	1.281" (3.25)	.594" (1.51)	1.250" (3.17)	1.453" (3.69)	4.50" (11.43)	H0509CNK
3/4	1.438" (3.65)	.594" (1.51)	1.500" (3.81)	1.000" (2.54)	6.25" (15.87)	H0759CNK
1	1.750" (4.44)	.719" (1.83)	1.844" (4.68)	2.125" (5.40)	7.50" (19.05)	H1009CNK
1 1/4	1.969" (5.00)	.750" (1.91)	2.312" (5.87)	2.344" (5.95)	9.00" (22.86)	H1259CNK
1 1/2	2.250" (5.71)	.750" (1.91)	2.578" (6.55)	2.500" (6.35)	13.50" (34.29)	H1509CNK
2	2.531" (6.43)	.750" (1.91)	3.187" (8.09)	2.781" (7.06)	14.50" (36.83)	H2009CNK



Features and Benefits

Cord Connectors

Hubbell has the broadest line and the widest choice of materials in the industry. NPT hub sizes from ¼" to 3" in straight male end, 90°, 45°, female and underground feed connectors. They are available in your choice of aluminum, plated steel, nylon and stainless steel.

The zinc-plated steel cord connectors offers the strength of steel and the corrosion resistance of zinc-plating. These heavy-duty connectors hold up to most manufacturing chemicals including acid solutions, solvents and other corrosive materials.

Their machined steel nut and body allows for tightening the compression nut and NPT hub without worrying about stripping the threads. For larger size cord, NPT hub sizes 1" to 2", Hubbell utilizes malleable iron connectors which provide excellent holding and liquidtight performance.

Hubbell's nylon cord connectors resist most common industrial corrosives and provide highly effective pullout protection in a lightweight design. They are ideal for any application where weight, conductivity or corrosion may be an issue. They're available in NPT hub sizes from ¼" to 1".

Stainless steel cord connectors provide superior strength and corrosion resistance for industrial and military applications. They are machined from 300 series stainless steel and come in ¼" to 1", NPT hub sizes.

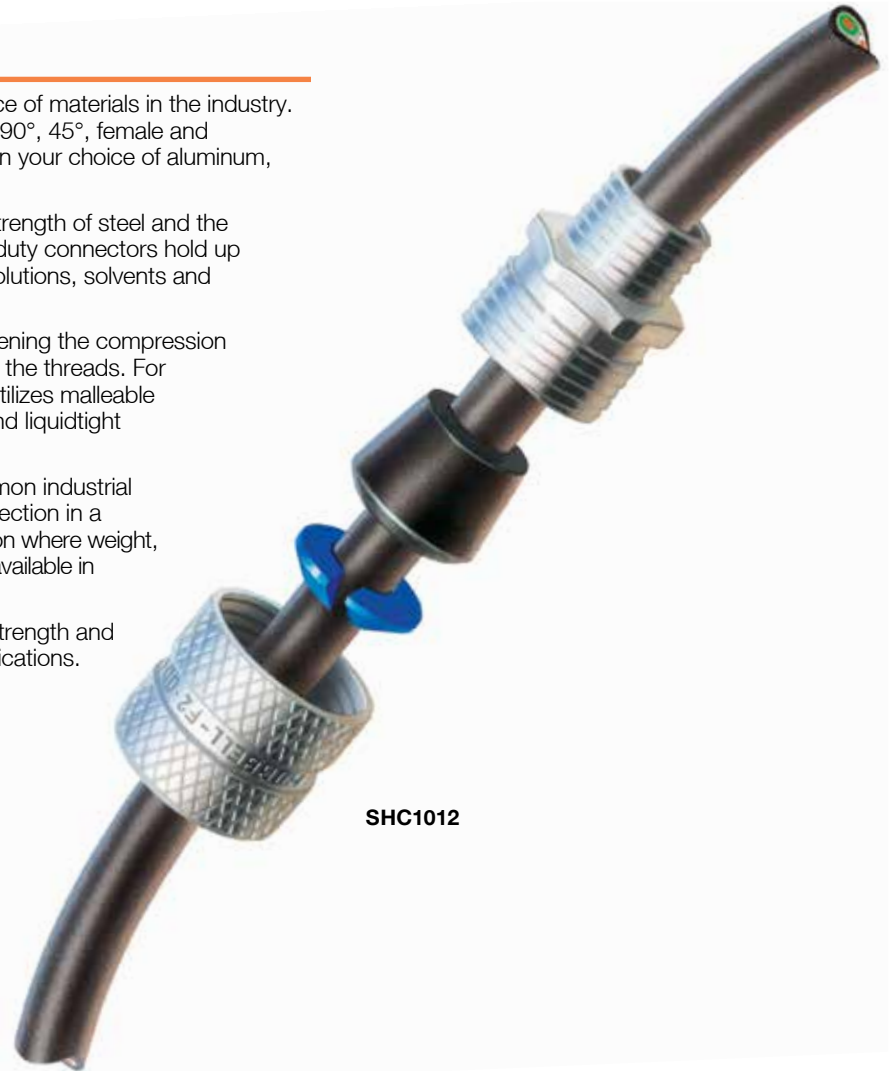

SHC1012



Liquidtight Seal

- Lubricated neoprene bushing compresses easily for a liquidtight seal and added pull-out protection
- The connector body is a one-piece design with machined threads; a tapered interior seats the bushing evenly for a liquidtight seal



Connector Body

- Machined threads provide a strong positive seal; the tapered interior dome easily drives the bushing into the connector body



Connector Identification

- The patented GOTCHA® ring incorporates a split hinge design to prevent friction and provide strain relief, also color-coded for sizing identification



Comprehensive Offering

- Hubbell offers a full line of machined aluminum cord connectors in NPT hub sizes ¼" through 1" and cast aluminum 1" to 3"
- They provide durable performance and a clean attractive look without adding unwanted weight; NPT hub sizes ¼" to 1" feature an attractive knurled finish which makes them easy to handle

Straight Male Cord Connectors

IP66*
SUITABILITY

Form Size 1-3



Straight Male

NPT Hub Size	Cord Dia. Inches (mm)	Form Size	Color Code	Machined Aluminum	Machined Zinc-Plated Steel	Stainless Steel	Nylon Gray	Nylon Black
¼	.06"-.13" (1.6-3.2)	F1	Green	—	—	—	SHC1001CR	—
	.13"-.19" (3.2-4.7)		Orange	SHC1002	—	—	SHC1002CR	—
	.19"-.25" (4.7-6.3)		Red	SHC1003	—	SHC1003SS	SHC1003CR	—
	.25"-.31" (6.3-7.9)		Black	SHC1004	—	SHC1004SS	SHC1004CR	—
	.31"-.38" (7.9-9.5)		White	SHC1005**	—	—	SHC1005CR	SHC2005CR
	.38"-.44" (9.5-11)		Blue	—	—	—	SHC1006CR	—
⅜	.06"-.13" (1.6-3.2)	F1	Green	SHC1007	—	—	—	—
	.13"-.19" (3.2-4.7)		Orange	SHC1008	SHC1008ZP	—	SHC1008CR	SHC2008CR
	.19"-.25" (4.7-6.3)		Red	SHC1009	—	SHC1009SS	SHC1009CR	—
	.25"-.31" (6.3-7.9)		Black	SHC1010	SHC1010ZP	—	SHC1010CR	SHC2010CR
	.31"-.38" (7.9-9.5)		White	SHC1011	—	SHC1011SS	SHC1011CR	SHC2011CR
	.38"-.44" (9.5-11.0)		Blue	SHC1012	SHC1012ZP	SHC1012SS	SHC1012CR	SHC2012CR
½	.19"-.25" (4.7-6.3)	F1	Red	SHC1015	—	—	—	—
	.25"-.31" (6.3-7.9)		Black	SHC1016	—	—	—	—
	.31"-.38" (7.9-9.5)		White	SHC1017	—	—	—	—
	.38"-.44" (9.5-11.0)		Blue	SHC1018	—	—	—	—
½	.06"-.13" (1.6-3.2)	F2	Green	SHC1019	—	—	SHC1019CR	—
	.13"-.19" (3.2-4.7)		Orange	SHC1020	SHC1020ZP	SHC1020SS	SHC1020CR	—
	.19"-.25" (4.7-6.3)		Red	SHC1021	SHC1021ZP	SHC1021SS	SHC1021CR	SHC2021CR
	.25"-.38" (6.3-9.7)		White	SHC1022	SHC1022ZP	SHC1022SS	SHC1022CR	SHC2022CR
	.38"-.50" (9.7-12.7)		Blue	SHC1023	SHC1023ZP	SHC1023SS	SHC1023CR	SHC2023CR
	.50"-.63" (12.7-15.9)		Brown	SHC1024	SHC1024ZP	SHC1024SS	SHC1024CR**	SHC2024CR**
½	.38"-.50" (9.7-12.7)	F3	Blue	SHC1025	—	—	—	—
	.50"-.63" (12.7-15.9)		Brown	SHC1026	—	—	—	—
	.63"-.75" (15.9-19.0)		Yellow	SHC1027**	SHC1027ZP**	—	—	—
	.75"-.88" (19.0-22.2)		Orchid	SHC1028**	SHC1028ZP**	—	—	—
¾	.06"-.13" (1.6-3.2)	F2	Green	SHC1029	—	—	—	—
	.13"-.19" (3.2-4.7)		Orange	SHC1030	SHC1030ZP	—	—	—
	.19"-.25" (4.7-6.3)		Red	SHC1031	SHC1031ZP	—	—	—
	.25"-.38" (6.3-9.7)		White	SHC1032	SHC1032ZP	—	—	—
	.38"-.50" (9.7-12.7)		Blue	SHC1033	SHC1033ZP	—	—	—
	.50"-.63" (12.7-15.9)		Brown	SHC1034	SHC1034ZP	—	—	—
¾	.38"-.50" (9.5-12.7)	F3	Blue	—	SHC1035ZP	SHC1035SS	SHC1035CR	SHC2035CR
	.50"-.63" (12.7-15.9)		Brown	SHC1036	—	SHC1036SS	SHC1036CR	SHC2036CR
	.63"-.75" (15.9-19.0)		Yellow	SHC1037	SHC1037ZP	SHC1037SS	SHC1037CR	SHC2037CR
	.75"-.88" (19.0-22.2)		Orchid	SHC1038**	SHC1038ZP**	SHC1038SS**	SHC1038CR**	SHC2038CR**
1	.50"-.63" (12.7-15.9)	F3	Brown	—	SHC1097ZP	—	—	—
	.63"-.75" (15.9-19.0)		Yellow	—	SHC1098ZP	—	—	—
	.75"-.88" (19.0-22.2)		Orchid	—	SHC1099ZP	—	—	—
1	.38"-.50" (9.7-12.7)	F4	Blue	SHC1039	—	SHC1039SS	SHC1039CR	—
	.50"-.63" (12.7-15.9)		Brown	SHC1040	—	—	SHC1040CR	SHC2040CR
	.63"-.75" (15.9-19.0)		Yellow	SHC1041	—	SHC1041SS	SHC1041CR	SHC2041CR
	.75"-.88" (19.0-22.2)		Orchid	SHC1042	—	SHC1042SS	SHC1042CR	SHC2042CR
	.88"-1.00" (22.2-25.4)		Gray	SHC1043	SHC1043ZP	SHC1043SS	SHC1043CR	SHC2043CR
	1.00"-1.13" (25.4-28.6)		Pink	SHC1044**	—	SHC1044SS**	SHC1044CR**	SHC2044CR**

Note: See pages V-78 to V-88 for technical information and dimensional drawings.

*IP66 Suitability when used with optional metal clad O-ring, see page V-75 for additional information.

**Cable jacket may have to be stripped to pass through connector body.

Form 4 aluminum and plated steel nuts are machined, bodies are cast aluminum.

Locknuts sold separately. See page V-75 for additional information.



Straight Male Cord Connectors

IP66*
SUITABILITY

Form Size 5-8



Straight Male

NPT Hub Size	Cord Diameter Inches (mm)	Form Size	Cast Aluminum	Malleable Iron
1	.88"-1.00" (22.2-25.4)	F5	SHC1046	—
	1.00"-1.13" (25.4-28.6)		SHC1047**	—
	1.13"-1.25" (28.6-31.7)		SHC1048**	—
	1.25"-1.38" (31.7-34.9)		SHC1049**	—
1¼	.75"-.88" (19.0-22.2)	F5	SHC1050	—
	.88"-1.00" (22.2-25.4)		SHC1051	—
	1.00"-1.13" (25.4-28.6)		SHC1052	SHC1052ZP
	1.13"-1.25" (28.6-31.7)		SHC1053	SHC1053ZP
1½	1.25"-1.38" (31.7-34.9)	F5	SHC1054**	SHC1054ZP
	.75"-.88" (19.0-22.2)		SHC1055	—
	.88"-1.00" (22.2-25.4)		SHC1056	—
	1.00"-1.13" (25.4-28.6)		SHC1057	SHC1057ZP
1½	1.13"-1.25" (28.6-31.7)	F5	SHC1058	SHC1058ZP
	1.25"-1.38" (31.7-34.9)		SHC1059	SHC1059ZP
	1.38"-1.50" (34.9-38.1)		SHC1061	—
	1.50"-1.63" (38.1-41.3)		SHC1062**	—
2	1.63"-1.75" (41.3-44.4)	F6	SHC1063**	—
	1.75"-1.88" (44.4-47.6)		SHC1064**	—
	1.25"-1.38" (31.7-34.9)		SHC1065	—
	1.38"-1.50" (34.9-38.1)		SHC1066	—
2	1.50"-1.63" (38.1-41.3)	F6	SHC1067	—
	1.63"-1.75" (41.3-44.4)		SHC1068	—
	1.75"-1.88" (44.4-47.6)		SHC1069	—
	1.69"-1.81" (42.9-46.0)		SHC1070	—
2	1.81"-1.94" (46.0-49.2)	F7	SHC1071	—
	1.94"-2.06" (49.2-52.4)		SHC1072**	—
	2.06"-2.19" (52.4-55.6)		SHC1073**	—
	2.19"-2.31" (55.6-58.7)		SHC1074**	—
2½	1.69"-1.81" (42.9-46.0)	F7	SHC1076	—
	1.81"-1.94" (46.0-49.2)		SHC1077	—
	1.94"-2.06" (49.2-52.4)		SHC1078	—
	2.06"-2.19" (52.4-55.6)		SHC1079	—
3	2.19"-2.31" (55.6-58.7)	F7	SHC1080	—
	2.31"-2.44" (58.7-61.9)		SHC1081**	—
	1.69"-1.81" (42.9-46.0)		SHC1086	—
	1.94"-2.06" (49.2-52.4)		SHC1088	—
3	2.06"-2.19" (52.4-55.6)	F7	SHC1089	—
	2.19"-2.31" (55.6-58.7)		SHC1090	—
	2.31"-2.44" (58.7-61.9)		SHC1091	—
	2.44"-2.63" (61.9-66.7)		SHC1092	—
3	2.63"-2.81" (66.7-71.4)	F8	SHC1093	—
	2.81"-3.00" (71.4-76.2)		SHC1094	—
	3.00"-3.25" (76.2-82.5)		SHC1095**	—

Note: See pages V-78 to V-88 for technical information and dimensional drawings.

*IP66 Suitability when used with optional metal clad O-ring, see page V-75 for additional information.

**Cable jacket may have to be stripped to pass through connector body.

Locknuts sold separately. See page V-75 for additional information.

45° and 90° Male Cord Connectors

IP66*
SUITABILITY

Form Size 1-6



90° Male

NPT Hub Size	Cord Diameter Inches (mm)	Form Size	Color Code	Machined Aluminum†	Machined Zinc-Plated SteelΔ	Cast Aluminum	Nylon Gray	Nylon Black
3/8	.25"-.31" (6.3-7.9)	F1	Black	NHC1010	—	—	—	—
	.31"-.38" (7.9-9.5)		White	NHC1011	—	—	—	
	.38"-.44" (9.5-11.0)		Blue	NHC1012	—	—	—	
1/2	.06"-.13" (1.6-3.2)	F2	Green	—	—	—	—	—
	.13"-.19" (3.2-4.7)		Orange	NHC1020	—	—	NHC1020CR	—
	.19"-.25" (4.7-6.3)		Red	NHC1021	NHC1021ZP	—	NHC1021CR	—
	.25"-.38" (6.3-9.7)		White	NHC1022	NHC1022ZP	—	NHC1022CR	NHC2022CR
	.38"-.50" (9.7-12.7)		Blue	NHC1023	NHC1023ZP	—	NHC1023CR	NHC2023CR
	.50"-.63" (12.7-15.9)		Brown	NHC1024**	NHC1024ZP**	—	NHC1024CR**	NHC2024CR**
3/4	.38"-.50" (9.7-12.7)	F3	Blue	NHC1035	NHC1035ZP	—	NHC1035CR	—
	.50"-.63" (12.7-15.9)		Brown	NHC1036	NHC1036ZP	—	NHC1036CR	—
	.63"-.75" (15.9-19.0)		Yellow	NHC1037	NHC1037ZP	—	NHC1037CR	—
	.75"-.88" (19.0-22.2)		Orchid	NHC1038	NHC1038ZP	—	NHC1038CR	—
1	.50"-.63" (12.7-15.9)	F4	Brown	NHC1040	—	—	—	—
	.63"-.75" (15.9-19.0)		Yellow	NHC1041	NHC1041ZP	—	NHC1041CR	NHC2041CR
	.75"-.88" (19.0-22.2)		Orchid	NHC1042	—	—	NHC1042CR	NHC2042CR**
	.88"-.1.00" (22.2-25.4)		Gray	NHC1043**	—	—	NHC1043CR	NHC2043CR**
	1.00"-.1.13" (25.4-28.7)		Pink	NHC1044**	—	—	—	—
1 1/4	.88"-.1.00" (22.2-25.4)	F5	—	—	—	NHC1051	—	—
	1.00"-.1.13" (25.4-28.6)		—	—	—	NHC1052	—	—
	1.13"-.1.25" (28.6-31.7)		—	—	—	NHC1053**	—	—
	1.25"-.1.38" (31.7-34.9)		—	—	—	NHC1054**	—	—
1 1/2	1.00"-.1.13" (25.4-28.6)	F5	—	—	—	NHC1057	—	—
	1.13"-.1.25" (28.6-31.7)		—	—	—	—	—	—
	1.25"-.1.38" (31.7-34.9)		—	—	—	NHC1059	—	—
2	1.38"-.1.50" (34.9-38.1)	F6	—	—	—	NHC1066	—	



45° Male

NPT Hub Size	Cord Diameter Inches (mm)	Form Size	Color Code	Machined Aluminum†	Machined Zinc-Plated SteelΔ	Cast Aluminum
1/2	.19"-.25" (4.7-6.3)	F2	Red	VHC1021	—	—
	.25"-.38" (6.3-9.7)		White	VHC1022	VHC1022ZP	—
	.38"-.50" (9.7-12.7)		Blue	VHC1023	VHC1023ZP	—
	.50"-.63" (12.7-15.9)		Brown	VHC1024**	VHC1024ZP**	—
3/4	.38"-.50" (9.7-12.7)	F3	Blue	VHC1035	—	—
	.50"-.63" (12.7-15.9)		Brown	VHC1036	—	—
	.63"-.75" (15.9-19.0)		Yellow	VHC1037**	—	—
1	.63"-.75" (15.9-19.0)	F4	Yellow	VHC1041	—	—
	.75"-.88" (19.0-22.2)		Orchid	VHC1042	—	—
1 1/4	1.00"-.1.13" (25.4-28.6)	F5	—	—	—	VHC1052
	1.13"-.1.25" (28.6-31.7)		—	—	—	VHC1053**

Note: See pages V-78 to V-88 for technical information and dimensional drawings.

*IP66 Suitability when used with optional metal clad O-ring, see page V-75 for additional information.

**Cable jacket may have to be stripped to pass through connector body.

†Nuts are machined aluminum and bodies are cast aluminum.

ΔCompression nuts are machined zinc-plated steel and bodies are zinc-plated malleable iron.

Locknuts sold separately. See page V-75 for additional information.



Straight Female, Underground Feeder and Metric Connectors

Form Size 1-4



Straight Female

NPT Hub Size	Cord Diameter Inches (mm)	Form Size	Color Code	Machined Aluminum
1/2	.25"-.38" (6.3-9.7)	F2	White	FHC1022
	.38"-.50" (9.7-12.7)		Blue	FHC1023
3/4	.38"-.50" (9.7-12.7)	F2	Blue	FHC1033
	.50"-.63" (12.7-15.9)		Brown	FHC1034
1	.75"-.88" (19.0-22.2)	F4	Orchid	FHC1042†
	.88"-.1.00" (22.2-25.4)		Gray	FHC1043†

Note: See pages V-78 to V-88 for technical information and dimensional drawings.

*Cable jacket may have to be stripped to pass through connector body.

†Nuts are machined aluminum and bodies are cast aluminum.



IP66*
SUITABILITY



Underground Feeder Connectors

NPT Hub Size	Cord Diameter Inches (mm)	Wire Size	UF** Machined Aluminum	Machined Zinc-Plated Steel	Nylon Gray	Nylon Black
1/2	.2"x.4" min (5.1 x 10.2)	2 # 14, 2 # 12, 2 # 10.	UFC0001	UFC0001ZP	UFC0001CR	UFC2001CR
	.25"-.55" max (6.3 x 14.0)					
3/4	.2"x.4" min (5.1x10.2)	2 # 14, 2 # 12, 2 # 10.	UFC0002	-	-	-
	.25"-.55" max (6.3x14.0)					
3/4	.2"x.6" min (5.1x15.2)	3 # 14, 3 # 12, 3 # 10.	UFC0003	-	UFC0003CR	UFC2003CR
	.26"x.78" max (6.6x19.8)					

Note: See pages V-78 to V-88 for technical information and dimensional drawings.

*IP66 Suitability when used with optional metal clad O-ring, see page V-75 for additional information.

**Wire sizes vary among manufacturers.

Locknuts sold separately, see page V-75 for additional information.



UL Listed to
Type 4, 4X, 12 and 13†

Metric Aluminum Cord Connectors



Metric Hub Size	Cord Diameter Inches (mm)	Form Size	Color Code	Catalog Number
M16	.31"-.38" (7.9-9.7)	F1	White	SHCM161011
M20	.31"-.38" (7.9-9.7)	F1	White	SHCM201017
	.25"-.38" (6.3-9.7)		White	SHCM201022
	.38"-.50" (9.7-12.7)		Blue	SHCM201023
M20	.50"-.62" (12.7-15.8)	F2	Brown	SHCM201024
	.38"-.50" (9.7-12.7)		Blue	SHCM251033
M25	.50"-.62" (12.7-15.8)	F2	Brown	SHCM251034
	.63"-.75" (15.9-19.0)		F3	Yellow

Note: †When used with metal clad O-ring, see page V-75 for additional information.

Non-metallic Locknuts sold separately, see page V-75 for additional information.



Low Profile NPT, PG and Metric Thread Connectors

Non-Metallic Cord Connectors.

IP66*
SUITABILITY



Low Profile NPT Cord Connectors

NPT Hub Size	Cord Diameter Inches (mm)	Black	Gray	Non-metallic Locknuts
3/8"	.18"-.31" (4.6-7.9)	SEC38BA*	SEC38GA*	31622002LPK50
1/2"	.17"-.45" (4.3-11.4)	SEC50BA	SEC50GA	31622003LPK50
3/4"	.25"-.48" (6.35-12.19)	—	SEC75RGA	31622007LPK50
1"	.45"-.71" (11.4-18.0)	SEC75BA	SEC75GA	31622007LPK50
1 1/2"	.59"-1.00" (15-25.4)	SEC100BA	SEC100GA	31622008LPK50

Note: See pages V-78 to V-88 for technical information and dimensional drawings.
Catalog numbers with "PK50" suffix are bulk packed 50 pieces.



Low Profile PG^Δ Cord Connectors

Hub Size	Cord Diameter Inches (mm)	Black	Gray	Non-metallic Locknuts
PG7	.11"-.25" (2.9-6.4)	SECP7BA*	SECP7GA*	LNP7BPK100
PG9	.18"-.31" (4.6-7.9)	SECP9BA*	SECP9GA*	LNP9BPK100
PG11	.23"-.40" (5.8-10.0)	SECP11BA*	SECP11GA*	LNP11BPK100
PG13.5	.17"-.47" (4.3-11.9)	SECP13BA	SECP13GA	LNP13BPK100
PG16	.23"-.53" (5.8-13.5)	SECP16BA	SECP16GA	LNP16BPK100
PG21	.45"-.71" (11.4-17.9)	SECP21BA	SECP21GA	LNP21BPK100
PG29	.59"-.99" (15-25.2)	SECP29BA	SECP29GA	LNP29BPK25
PG36	.88"-1.30" (22.2-32.0)	SECP36BA	SECP36GA	LNP36BPK25



Low Profile Metric Cord Connectors

Hub Size	Cord Diameter Inches (mm)	Black	Gray	Non-metallic Locknuts
M12	.12"-.25" (2.9-6.4)	SECM12B	SECM12G	LNM12BPK100
M16	.11"-.31" (2.7-7.9)	SECM16B	SECM16G	LNM16BPK100
M20	.17"-.45" (4.3-11.4)	SECM20B*	SECM20G*	LNM20BPK100
M25	.49"-.71" (12.3-18.0)	SECM25B*	SECM25G*	LNM25BPK100
M32	.59"-.100" (15.0-25.4)	SECM32B*	SECM32G*	LNM32BPK100
M40	.87"-1.30" (22.0-32.0)	SECM40B	SECM40G	LNM40BPK100

Note: See pages V-78 to V-88 for technical information and dimensional drawings.
Catalog numbers above with "PK100" suffix, i.e. LNP7BPK100, are bulk packed 100 per carton.
Catalog numbers above with "PK25" suffix, i.e. LNP29BPK25, are bulk packed 25 per carton.
*Items indicated are UL recognized components.
ΔPanzergerwinde.



Accessories



Multi-Hole Cord Grip Connectors

NPT Hub Size	Cord Diameter Inches (mm)	Color	Holes	Catalog Number
½	.205" (5.2mm)	Black	2	SEC50B252
¾	.205" (5.2mm)	Black	3	SEC75B352
¾	.205" (5.2mm)	Black	4	SEC75B452
½	.220" (5.6mm)	Black	3	SEC50B356
1	.215" (5.5mm)	Black	9*	SEC100BSMH9
1¼	.215" (5.5mm)	Black	13*	SEC125BSMH13

Note: *Skinned bushings, field configurable.



Cord Connector Parts

NPT Hub Size	Cord Diameter Inches (mm)	Form Size	Bushing Catalog Number	Color Code	GOTCHA® Ring Catalog Number
¼, ⅜, ½	.062"-.125" (1.58-3.17)	F1	31518101BPK100	Green	31648035GPK100
	.125"-.187" (3.17-4.76)		31518102BPK100	Orange	31648036GPK100
	.187"-.250" (4.76-6.35)		31518103BPK100	Red	31648037GPK100
	.250"-.312" (6.35-7.93)		31518104BPK100	Black	31648038GPK100
	.312"-.375" (7.93-9.50)		31518105BPK100	White	31605010GPK100
	.375"-.437" (9.50-11.1)		31518106BPK100	Blue	31648039GPK100
½, ¾	.187"-.250" (4.76-6.35)	F2	31518110BPK100	Red	31648042GPK100
	.250"-.375" (6.35-9.50)		31518111BPK100	White	31605015GPK100
	.375"-.500" (9.50-12.7)		31518112BPK100	Blue	31648043GPK100
	.500"-.625" (12.7-15.8)		31518113BPK100	Brown	31648044GPK100
½, ¾	.375"-.500" (9.50-12.7)	F3	31518116BPK100	Blue	31648045GPK100
	.500"-.625" (12.7-15.8)		31518117BPK100	Brown	31648046GPK100
	.625"-.750" (15.8-19.0)		31518118BPK100	Yellow	31648047GPK100
	.750"-.875" (19.0-22.2)		31518119BPK100	Orchid	31648048GPK100
1	.500"-.625" (12.7-15.8)	F4	31518123BPK100	Brown	31648050GPK100
	.625"-.750" (15.8-19.0)		31518124BPK100	Yellow	31648051GPK100
	.750"-.875" (19.0-22.2)		31518125BPK100	Orchid	31648052GPK100
	.875"-1.00" (22.2-25.4)		31518126BPK100	Gray	31648053GPK100
	1.00"-1.125" (25.4-28.5)		31518127BPK100	Pink	31648054GPK100

Note: Catalog numbers above with "PK100" suffix, i.e. 31518101BPK100, are bulk packed 100 per carton



Locknuts and Metal Clad Sealing O-Rings

NPT Hub Size	Zinc-Plated Steel Locknuts	Non-Metallic Locknuts	Metal Clad Sealing O-Rings*
¼	—	31622001LPK50	—
⅜	—	31622002LPK50	—
½	00322001LPK50	31622003LPK50	20509001
¾	00322002LPK50	31622007LPK50	20509002
1	00322003LPK50	31622008LPK50	20509003
1¼	00322004LPK50	—	20509004
1½	00322005LPK50	—	20509005
2	—	—	20509006
2½	—	—	20509007
3	—	—	20509008

Note: Catalog numbers above with "PK50" suffix, i.e. 00322001LPK50, are bulk packed 50 per carton.

See page V-87 for technical information and dimensional drawings.

*UL listed and CSA certified.



Features and Benefits

Hubbell Juniors® Miniature Nylon Cord Connectors

Hubbell Juniors are a miniature liquidtight version of the full-sized Hubbell cord connectors. They feature the same GOTCHA® ring technology and neoprene bushings.

They also come with or without a nylon spiral for arc-of-bend control and longer cord life. They are available in ¼", ⅜", and ½" NPT sizes in both gray and black.



HJ1040GPK25



Liquidtight Seal

- Lubricated neoprene bushing compresses evenly for a liquidtight seal and added pull-out protection
- Nylon connector body is a one-piece design with a tapered interior that seals the bushing evenly for a positive seal



Connector Body

- Nylon spiral provides arc-of-bend control for cord protection
- Threaded hexagon shaped nylon locknut secures tightly and is also corrosion resistant



Connector Protection

- Patented GOTCHA® ring incorporates a split hinge design to prevent friction and provide strain relief
- Nylon compression nut has a tapered interior dome to easily drive the bushing into the connector body



Comprehensive Offering

- Hubbell Juniors are a miniature liquidtight version of the full-sized Hubbell cord connectors and feature the same GOTCHA® ring technology and neoprene bushings

Hubbell Juniors® Miniature Nylon Cord Connectors

Miniature Nylon Cord Connector

NPT Hub Size	Cord Diameter Range Inches (mm)	Black	Gray
¼	.08"-.14" (1.9-3.4)	HJ1001BPK25	HJ1001GPK25
	.14"-.20" (3.4-5.1)	HJ1002BPK25	HJ1002GPK25
	.20"-.27" (5.1-6.7)	HJ1003BPK25	HJ1003GPK25
⅜	.15"-.21" (3.7-5.3)	HJ1004BPK25	HJ1004GPK25
	.21"-.28" (5.3-7.0)	HJ1005BPK25	HJ1005GPK25
	.28"-.34" (7.0-8.6)	HJ1006BPK25	HJ1006GPK25
½	.06"-.13" (1.6-3.2)	HJ1055BPK25	HJ1055GPK25
	.13"-.19" (3.2-4.7)	HJ1056BPK25	HJ1056GPK25
	.19"-.25" (4.7-6.3)	HJ1057BPK25	HJ1057GPK25
	.25"-.31" (6.3-7.9)	HJ1058BPK25	HJ1058GPK25
	.31"-.38" (7.9-9.5)	HJ1059BPK25	HJ1059GPK25
	.38"-.44" (9.5-11.1)	HJ1060BPK25	HJ1060GPK25



Black Cord Connector



Gray Cord Connector

Miniature Nylon Cord Connector with Spiral

NPT Hub Size	Cord Diameter Range Inches (mm)	Black	Gray
¼	.08"-.14" (1.9-3.4)	HJ1010BPK25	HJ1010GPK25
	.14"-.20" (3.4-5.1)	HJ1011BPK25	HJ1011GPK25
	.20"-.27" (5.1-6.7)	HJ1012BPK25	HJ1012GPK25
⅜	.15"-.21" (3.7-5.3)	HJ1013BPK25	HJ1013GPK25
	.21"-.28" (5.3-7.0)	HJ1014BPK25	HJ1014GPK25
	.28"-.34" (7.0-8.6)	HJ1015BPK25	HJ1015GPK25
½	.13"-.19" (3.2-4.7)	HJ1038BPK25	HJ1038GPK25
	.19"-.25" (4.7-6.3)	HJ1039BPK25	HJ1039GPK25
	.25"-.31" (6.3-7.9)	HJ1040BPK25	HJ1040GPK25
	.31"-.38" (7.9-9.5)	HJ1041BPK25	HJ1041GPK25
	.38"-.44" (9.5-11.1)	HJ1042BPK25	HJ1042GPK25
¾	.25"-.49" (6.4-12.3)	HJ1043BPK25*	HJ1043GPK25*
	.45"-.71" (11.4-18.0)	HJ1044BPK25*	HJ1044GPK25*



Black Cord Connector with Spiral



Gray Cord Connector with Spiral

Note: *Locknuts sold separately, see page V-75 for additional information.

Miniature Nylon Snap-In Cord Connector with Spiral

Cord Diameter Range Inches (mm)	For Chassis Thickness	Black	Gray
.22"-.27" (5.6-6.9)	.10" (2.5) Max	HS1001BPK25	HS1001GPK25
.28"-.32" (7.1-8.1)	.10" (2.5) Max	HS1002BPK25	HS1002GPK25
.30"-.36" (7.6-9.1)	.13" (3.2) Max	HS1003BPK25	HS1003GPK25
.32"-.43" (8.1-10.9)	.13" (3.2) Max	HS1004BPK25	HS1004GPK25

Note: Catalog numbers above with "PK25" suffix, i.e. HJ1001GPK25, are bulk packed 25 per carton. See page V-88 for technical information and dimensional drawings.



Black Snap-In Cord Connector



Gray Snap-In Cord Connector



Operating Temperatures

Material	Temperature Range	
Aluminum	-40°F to +300°F	(-40°C to +149°C)
Nylon (connectors and GOTCHA® rings)	-40°F to +225°F	(-40°C to +107°C)
Plated steel*	-60°F to +1000°F	(-51°C to +537°C)
Stainless steel*	-60°F to +1000°F	(-51°C to +537°C)
Neoprene (bushings)	-30°F to +240°F	(-34°C to +115°C)

Note: *Due to the limiting factors of nylon and neoprene, any complete cord connector with a GOTCHA ring, Form 1-5, will continuously perform in the range of -30°F to +225°F (-34°C to +107°C).

Cord connectors without GOTCHA rings, Form 6-8, will continuously operate in the range -30°F to +240°F (-34°C to +115°C) due to the limiting factor of neoprene.

Hazardous Locations

Hubbell cord connectors are suitable for use in hazardous locations per Class I Div. 2, Class II Div. 1 & 2, Class III Div. 1 & 2 in accordance with the NEC.

Flammability

Hubbell nylon cord connectors have a UL 94-V2 rating.

Approvals

Agency

UL Listed in accordance with Standard 514B for indoor/outdoor use.

CSA Certified.

United States Coast Guard Approved, Title 46-Part 111.

Form Size Definition

The term "Form Size" refers to the physical overall size of a cord connector.

Form 1 is the smallest size.

Form 8 is the largest size.

Knockout Holes

NPT Hub Size	Knockout Hole Recommended		PG Hub Size	Knockout Hole Recommended		Metric Hub Size	Knockout Hole Recommended	
	Min.	Max.		Inches	(mm)		Inches	(mm)
¼	.54"	.57"	PG7	.492"	(12.5)	M12	.472"	(12)
⅜	.67"	.70"	PG9	.599"	(15.2)	M16	.629"	(16)
½	.86"	.91"	PG11	.733"	(18.6)	M20	.787"	(20)
¾	1.04"	1.09"	PG13.5	.804"	(20.4)	M25	.984"	(25)
1	1.36"	1.41"	PG16	.888"	(22.5)	M32	1.25"	(32)
1¼	1.72"	1.77"	PG21	1.15"	(28.3)	M40	1.57"	(40)
1½	1.97"	2.02"	PG29	1.47"	(34.3)			
2	2.45"	2.50"	PG36	1.85"	(47.0)			
2½	2.95"	3.00"						
3	3.58"	3.63"						

NPT, PG and Metric Thread Low Profile Connectors

Specifications

Material	6/6 Nylon.
Gland	Buna N.
Temperature Range	-22°F to 225°F (-30°C to 107°C).
	Cord Connectors are Halogen and Silicon free.
Protection Class	IP66 Suitability.
Flammability	UL 94V-2.
Listings/Certifications	UL Listing File E-41567, UL Recognition File E-41567. CSA File LR27378C, VDE Marks Licence #136681.



SECP29G



Straight Hubbell Connectors

F NPT Inches	Aluminum Inches (mm)						Nylon Inches (mm)						
	Form	A Dia.	B Ref.	C	D Throat Dia.	E		A Dia.	B Ref.	C	D Throat Dia.	E	
						A/C*	A/F*					A/C*	A/F*
¼-18	1	.88" (22.4)	.90" (22.9)	.46" (11.7)	.32" (8.1)	.99" (25.1)	.88" (22.4)	1.00" (25.4)	1.10" (27.9)	.43" (10.9)	.33" (8.4)	1.00" (25.4)	.93" (23.6)
¾-18	1	.88" (22.4)	.90" (22.9)	.46" (11.7)	.44" (11.2)	.99" (25.1)	.88" (22.4)	1.00" (25.4)	1.10" (27.9)	.43" (10.9)	.45" (11.4)	1.00" (25.4)	.93" (23.6)
½-14	1	.88" (22.4)	.90" (22.9)	.46" (11.7)	.44" (11.2)	1.00" (25.4)	.88" (22.4)	1.00" (25.4)	1.10" (27.9)	.46" (11.7)	.45" (11.4)	1.00" (25.4)	.93" (23.6)
½-14	2	1.13" (28.7)	1.10" (27.9)	.55" (14.0)	.64" (16.3)	1.11" (28.2)	1.00" (25.4)	1.32" (33.5)	1.50" (38.1)	.53" (13.5)	.58" (14.7)	1.25" (31.7)	1.12" (28.4)
½-14	3	1.38" (35.1)	1.50" (38.1)	.55" (14.0)	.64" (16.3)	1.40" (35.6)	1.25" (31.7)	—	—	—	—	—	—
¾-14	2	1.13" (28.7)	1.10" (27.9)	.55" (14.0)	.64" (16.3)	1.29" (32.8)	1.13" (28.7)	—	—	—	—	—	—
¾-14	3	1.38" (35.1)	1.50" (38.1)	.55" (14.0)	.82" (20.8)	1.40" (35.6)	1.25" (31.7)	1.56" (39.6)	1.60" (40.6)	.55" (14.0)	.77" (19.6)	1.44" (36.6)	1.31" (33.3)
1-11½	4	1.75" (44.4)	1.60" (40.6)	.71" (18.0)	1.02" (25.9)	1.81" (46.0)	1.62" (41.1)	1.88" (47.8)	1.75" (44.4)	.70" (17.8)	1.01" (25.7)	1.84" (46.7)	1.63" (41.4)
1-11½	5	2.31" (58.7)	1.70" (43.2)	.66" (16.8)	1.01" (25.7)	2.28" (57.9)	2.00" (50.8)	—	—	—	—	—	—
1¼-11½	5	2.31" (58.7)	1.70" (43.2)	.74" (18.8)	1.26" (32.0)	2.28" (57.9)	2.12" (53.8)	—	—	—	—	—	—
1½-11½	5	2.31" (58.7)	1.70" (43.2)	.74" (18.8)	1.38" (35.1)	2.28" (57.9)	2.12" (53.8)	—	—	—	—	—	—
1½-11½	6	3.00" (76.2)	2.20" (55.9)	.75" (19.0)	1.50" (38.1)	2.97" (75.4)	2.75" (69.8)	—	—	—	—	—	—
2-11½	6	3.00" (76.2)	2.20" (55.9)	.80" (20.3)	1.92" (48.8)	3.24" (82.4)	3.00" (76.2)	—	—	—	—	—	—
2-11½	7	3.85" (97.8)	2.70" (68.6)	.88" (22.4)	1.94" (49.3)	4.05" (102.9)	3.75" (95.2)	—	—	—	—	—	—
2½-8	7	3.85" (97.8)	2.70" (68.6)	1.30" (33.0)	2.32" (58.9)	4.34" (110.2)	4.02" (102.1)	—	—	—	—	—	—
2½-8	8	4.75" (120.6)	2.70" (68.6)	1.25" (31.7)	2.38" (60.5)	4.86" (123.4)	4.50" (114.3)	—	—	—	—	—	—
3-8	7	3.85" (97.8)	2.70" (68.6)	1.30" (33.0)	2.54" (64.5)	4.34" (110.2)	4.02" (102.1)	—	—	—	—	—	—
3-8	8	4.50" (114.3)	2.70" (68.6)	1.38" (35.1)	3.00" (76.2)	4.86" (123.4)	4.50" (114.3)	—	—	—	—	—	—

Note: *A/C— Across Corners; A/F—Across Flats.

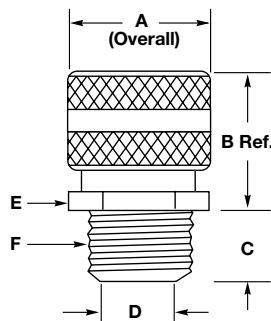

Dimensions shown are approximate and are subject to change without notice.



Straight Hubbell Connectors

F NPT Inches	Zinc-Plated Steel Inches (mm)								Stainless Steel Inches (mm)						
	Form	A		B	C	D Throat Dia.	E		A/C*	A/F*	Ref.	C	D Throat Dia.	E	
		A/C*	A/F*	Ref.	A/C*	A/F*	A/C*	A/F*							
¼-18	1	—	—	—	—	—	—	—	1.01" (25.7)	.88" (22.4)	.90" (22.9)	.46" (11.7)	.38" (9.7)	.87" (22.1)	.75" (19.0)
¾-18	1	.98" (24.9)	.88" (22.4)	.90" (22.9)	.42" (10.7)	.45" (11.4)	.99" (25.1)	.88" (22.4)	1.01" (25.7)	.88" (22.4)	.90" (22.9)	.46" (11.7)	.45" (11.4)	.87" (22.1)	.75" (19.0)
½-14	1	.98" (24.9)	.88" (22.4)	.90" (22.9)	.55" (14.0)	.45" (11.4)	1.00" (25.4)	.88" (22.4)	—	—	—	—	—	—	—
½-14	2	1.27" (32.3)	1.13" (28.7)	1.20" (30.5)	.55" (14.0)	.64" (16.3)	1.10" (28.2)	1.00" (25.4)	1.30" (33.0)	1.13" (28.7)	1.10" (27.9)	.54" (13.7)	.63" (16.0)	1.16" (29.5)	1.00" (25.4)
½-14	3	1.55" (39.4)	1.38" (35.1)	1.50" (38.1)	.55" (14.0)	.64" (16.3)	1.40" (35.6)	1.25" (31.7)	—	—	—	—	—	—	—
¾-14	2	1.27" (32.3)	1.13" (28.7)	1.20" (30.5)	.55" (14.0)	.64" (16.3)	1.29" (32.8)	1.13" (28.7)	—	—	—	—	—	—	—
¾-14	3	1.55" (39.4)	1.38" (35.1)	1.40" (35.6)	.55" (14.0)	.82" (20.8)	1.40" (35.6)	1.25" (31.7)	1.59" (40.4)	1.38" (35.1)	1.30" (33.0)	.56" (14.2)	.81" (20.6)	1.44" (36.6)	1.25" (31.7)
1-1½	3	1.55" (39.4)	1.38" (35.1)	1.40" (35.6)	.70" (17.8)	.89" (22.6)	1.54" (39.1)	1.38" (35.1)	—	—	—	—	—	—	—
1-1½	4	1.92" (48.8)	1.69" (42.9)	1.60" (40.6)	.70" (17.8)	1.02" (25.9)	1.95" (49.5)	1.69" (42.9)	2.02" (51.3)	1.75" (44.4)	1.40" (35.6)	.70" (17.8)	1.03" (26.2)	1.88" (47.8)	1.63" (41.4)
1-1½	5	2.40" (61.0)	—	1.70" (43.2)	.70" (17.8)	1.02" (25.9)	2.46" (62.5)	2.15" (54.6)	—	—	—	—	—	—	—
1¼-1½	5	2.40" (61.0)	—	1.70" (43.2)	.73" (18.5)	1.27" (32.3)	2.48" (63.0)	2.19" (55.6)	—	—	—	—	—	—	—
1½-1½	5	2.40" (61.0)	—	1.70" (43.2)	.74" (18.8)	1.39" (35.3)	2.48" (63.0)	2.19" (55.6)	—	—	—	—	—	—	—
1½-1½	6	3.06" (77.7)	—	2.20" (55.9)	.75" (19.0)	1.52" (38.6)	3.04" (77.2)	2.83" (71.9)	—	—	—	—	—	—	—
2-1½	6	3.06" (77.7)	—	2.20" (55.9)	.78" (19.8)	1.92" (48.8)	3.32" (84.3)	3.07" (78.0)	—	—	—	—	—	—	—
2-1½	7	3.95" (100.3)	—	2.70" (68.6)	.78" (19.8)	1.99" (50.5)	4.18" (106.2)	3.89" (98.8)	—	—	—	—	—	—	—

Note: *A/C— Across Corners; A/F—Across Flats.

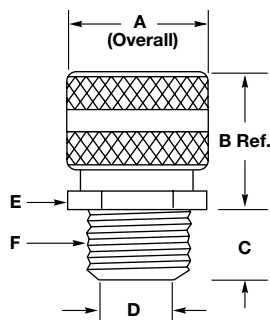

Dimensions shown are approximate and are subject to change without notice.



45° Hubbell Connectors

F NPT Inches	Aluminum Inches (mm)								Zinc Plated Steel Inches (mm)							
	Form	A Dia.	B Ref.	C	D Throat Dia.	E		G Dia.	A Dia.	B Ref.	C	D Throat Dia.	E		G	
						Across Corners	Across Flats						Across Corners	Across Flats		
1/2-14	2	2.00" (50.8)	1.90" (48.3)	.55" (14.0)	.56" (14.2)	1.27" (32.3)	1.10" (27.9)	1.13" (28.6)	1.97" (50.0)	1.90" (48.3)	.55" (14.0)	.57" (14.4)	1.24" (31.5)	1.06" (26.9)	1.27" (32.3)	1.13" (28.6)
3/4-14	3	2.30" (58.4)	2.50" (65.3)	.56" (14.2)	.75" (19.0)	1.48" (37.6)	1.28" (32.5)	1.38" (34.9)	—	—	—	—	—	—	—	—
1-11½	4	2.60" (66.0)	2.80" (71.1)	.70" (17.8)	1.00" (25.4)	1.69" (42.9)	1.50" (38.1)	1.75" (44.4)	—	—	—	—	—	—	—	—
1½-11½	5	3.90" (99.1)	3.90" (99.1)	.74" (18.8)	1.25" (31.7)	2.45" (62.2)	2.13" (54.0)	2.31" (58.7)	—	—	—	—	—	—	—	—
1½-11½	5	3.90" (99.1)	3.90" (99.1)	.74" (18.8)	1.50" (38.1)	2.45" (62.2)	2.13" (54.0)	2.31" (58.7)	—	—	—	—	—	—	—	—

90° Hubbell Connectors

F NPT Inches	Aluminum Inches (mm)								Zinc Plated Steel Inches (mm)							
	Form	A Dia.	B Ref.	C	D Throat Dia.	E		G Dia.	A Dia.	B Ref.	C	D Throat Dia.	E		G	
						Across Corners	Across Flats						Across Corners	Across Flats		
3/8-18	1	1.27" (32.3)	2.00" (50.8)	.46" (11.7)	.44" (11.2)	1.15" (29.2)	1.10" (27.9)	.88" (22.2)	—	—	—	—	—	—	—	—
1/2-14	2	1.56" (39.6)	2.30" (58.4)	.50" (12.7)	.55" (13.9)	1.30" (33.0)	1.13" (28.7)	1.13" (28.6)	1.65" (41.9)	2.38" (60.5)	.55" (14.0)	.55" (13.8)	1.29" (32.8)	1.13" (28.7)	1.27" (32.3)	1.13" (28.6)
3/4-14	3	1.79" (45.5)	2.80" (71.1)	.56" (14.2)	.77" (19.4)	1.49" (37.8)	1.31" (33.3)	1.38" (34.9)	1.88" (47.8)	2.90" (73.7)	.56" (14.2)	.77" (19.4)	1.52" (38.6)	1.33" (33.8)	1.55" (39.2)	1.38" (34.9)
1-11½	4	2.08" (52.8)	3.20" (81.3)	.70" (17.8)	1.00" (25.4)	1.70" (43.2)	1.50" (38.1)	1.75" (44.4)	2.16" (54.9)	3.20" (81.3)	.70" (17.8)	1.00" (25.4)	1.72" (43.7)	1.50" (38.1)	1.92" (48.8)	1.69" (42.8)
1¼-11½	5	3.18" (80.8)	4.30" (109.2)	.73" (18.5)	1.26" (32.0)	2.47" (62.7)	2.15" (54.6)	2.31" (58.7)	—	—	—	—	—	—	—	—
1½-11½	5	3.18" (80.8)	4.30" (109.2)	.75" (19.2)	1.50" (38.1)	2.47" (62.7)	2.15" (54.6)	2.31" (58.7)	—	—	—	—	—	—	—	—
2-11½	6	3.51" (89.2)	5.50" (139.7)	.80" (20.3)	1.92" (48.8)	2.98" (75.7)	2.78" (70.6)	3.00" (76.2)	—	—	—	—	—	—	—	—

90° Hubbell Connectors

F NPT Inches	Nylon Inches (mm)							
	Form	A Dia.	B Ref.	C	D Throat Dia.	E		G Dia.
						Across Corners	Across Flats	
3/8-18	1	—	—	—	—	—	—	—
1/2-14	2	1.41" (35.8)	2.50" (63.5)	.55" (14.0)	.58" (14.6)	1.23" (31.2)	1.12" (28.2)	1.32" (33.4)
3/4-14	3	1.65" (41.9)	2.81" (71.4)	.56" (14.2)	.77" (19.4)	1.42" (36.1)	1.29" (32.8)	1.56" (39.6)
1-11½	4	1.99" (50.5)	3.30" (83.8)	.70" (17.8)	1.01" (25.7)	1.82" (46.2)	1.60" (40.6)	1.88" (47.6)

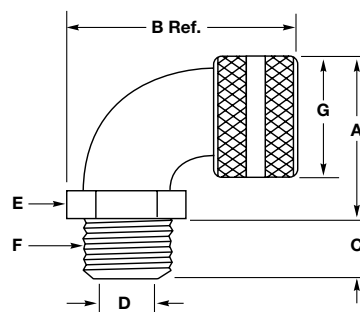
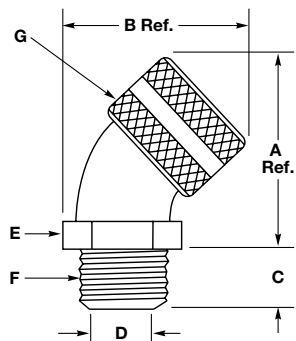

Dimensions shown are approximate and are subject to change without notice.



Female Hubbell Connectors

Aluminum Inches (mm)							
F NPT Inches	Form	A		C	D Throat Dia.	E	
		Dia.	Ref.			Across Corners	Across Flats
3/8-18	1	.88" (22.4)	1.40" (35.6)	.56" (14.2)	.44" (11.2)	.94" (23.9)	.81" (20.6)
1/2-14	2	1.13" (28.7)	1.80" (45.7)	.56" (14.2)	.63" (16.0)	1.15" (29.2)	1.00" (25.4)
3/4-14	2	1.13" (28.7)	2.10" (53.3)	.75" (19.0)	.63" (16.0)	1.44" (36.6)	1.25" (31.7)
1-11 1/2	4	1.75" (44.5)	2.30" (58.4)	.88" (22.4)	1.10" (27.9)	1.88" (47.8)	1.63" (41.4)
1 1/4-11 1/2	5	2.31" (58.7)	2.80" (71.1)	.95" (24.1)	1.43" (36.3)	2.64" (67.1)	2.29" (58.2)
1 1/2-11 1/2	5	2.31" (58.7)	2.80" (71.1)	.95" (24.1)	1.43" (36.3)	2.64" (67.1)	2.29" (58.2)

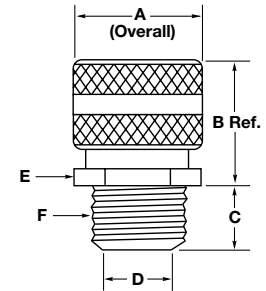
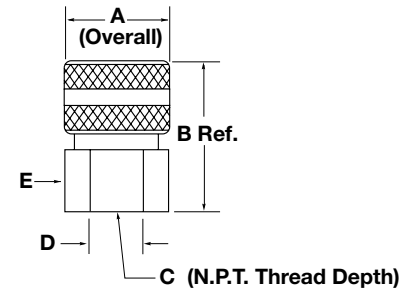

Underground Feeder Connectors

F NPT Inches	Form	Aluminum Inches (mm)						Zinc-Plated Steel Inches (mm)						Nylon Inches (mm)							
		A		C	D Throat Dia.	E		A		B	C	D Throat Dia.	E		A		B	C	D Throat Dia.	E	
		Dia.	Ref.			A/C*	A/F*	A/C*	A/F*				Ref.	A/C*	A/F*	Dia.				Ref.	A/C*
1/2-14	2	1.13" (28.7)	1.10" (27.9)	.55" (14.0)	.64" (16.3)	1.10" (27.9)	1.00" (25.4)	1.27" (32.3)	1.13" (28.7)	1.20" (30.5)	.55" (14.0)	.64" (16.3)	1.11" (28.2)	1.00" (25.4)	1.32" (33.5)	1.50" (38.1)	.55" (14.0)	.58" (14.7)	1.25" (31.7)	1.13" (28.7)	
3/4-14	2	1.13" (28.7)	1.10" (27.9)	.55" (14.0)	.64" (16.3)	1.29" (32.8)	1.13" (25.4)	1.27" (32.3)	1.13" (28.7)	1.20" (30.5)	.55" (14.0)	.64" (16.3)	1.29" (32.8)	1.13" (28.7)	—	—	—	—	—	—	
3/4-14	3	1.13" (28.7)	1.50" (38.1)	.55" (14.0)	.82" (20.8)	1.40" (35.6)	1.25" (31.7)	1.55" (39.4)	1.38" (35.1)	1.40" (35.6)	.56" (14.2)	.82" (20.8)	1.40" (35.6)	1.25" (31.7)	1.56" (39.6)	1.60" (40.6)	.56" (14.2)	.77" (19.6)	1.44" (36.6)	1.31" (33.3)	

Note: *A/C - Across Corners; A/F - Across Flats.

Low Profile Non-Metallic NPT, PG and Metric Thread Connectors

Hub Size	Nylon Inches (mm)					
	A	B	C	D	E	F
3/8 NPT	0.670" (17.0)	1.41" (35.8)	0.48" (12.4)	0.21" (5.3)	0.83" (21.0)	0.55" (14.0)
1/2 NPT	0.875" (22.2)	1.70" (43.2)	0.61" (15.5)	0.21" (5.3)	0.88" (24.8)	0.66" (16.8)
3/4 NPT	1.068" (27.1)	2.00" (50.8)	0.62" (15.7)	0.25" (6.3)	1.30" (33.0)	0.85" (21.6)
1 NPT	1.375" (35.0)	2.41" (61.2)	0.76" (19.3)	0.30" (7.6)	1.73" (43.9)	1.05" (26.7)
PG7	0.492" (12.5)	1.16" (29.5)	0.32" (8.1)	0.21" (5.3)	0.63" (16.0)	0.48" (12.4)
PG9	0.599" (15.2)	1.25" (31.8)	0.32" (8.1)	0.21" (5.3)	0.83" (21.0)	0.55" (14.0)
PG11	0.733" (18.6)	1.48" (37.6)	0.38" (9.7)	0.21" (5.3)	0.94" (23.9)	0.70" (17.8)
PG13.5	0.804" (20.4)	1.53" (38.9)	0.41" (10.4)	0.21" (5.3)	0.98" (24.9)	0.66" (16.8)
PG16	0.888" (22.5)	1.68" (42.7)	0.44" (11.2)	0.25" (6.4)	1.06" (27.0)	0.76" (19.3)
PG21	1.15" (28.3)	1.89" (48.0)	0.52" (13.2)	0.25" (6.4)	1.30" (33.0)	.085" (21.6)
PG29	1.47" (37.30)	2.23" (56.6)	0.58" (14.7)	0.30" (7.6)	1.73" (43.9)	1.05" (26.7)
PG36	1.85" (47.0)	2.39" (60.7)	0.47" (11.9)	0.31" (7.9)	2.05" (52.7)	1.19" (30.2)
M12	0.473" (12.0)	1.16" (29.5)	0.32" (8.1)	0.21" (5.3)	0.63" (16.0)	0.49" (12.4)
M16	0.630" (16.0)	1.25" (31.8)	0.32" (8.1)	0.21" (5.3)	0.83" (21.0)	0.55" (14.0)
M20	0.787" (20.0)	1.53" (38.9)	0.41" (10.4)	0.21" (5.3)	0.98" (24.9)	0.66" (16.8)
M25	0.985" (25.0)	1.89" (48.0)	0.52" (13.2)	0.25" (6.3)	1.30" (33.0)	0.85" (21.6)
M32	1.260" (32.0)	2.23" (56.6)	0.58" (14.7)	0.30" (7.6)	1.73" (43.9)	1.05" (26.7)
M40	1.575" (40.0)	2.39" (60.7)	0.48" (12.2)	0.30" (7.6)	2.05" (52.1)	1.19" (30.2)

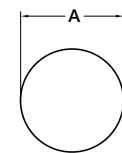
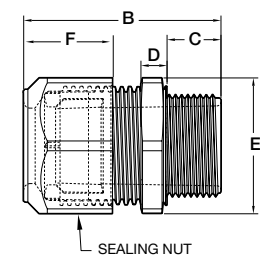

Recommended knockout size

Dimensions shown are approximate and are subject to change without notice.



2 Conductors

Cord Type	SVO, SV, SVT	SJ, SJO, SJT, SJTO				S, SO, ST, STO					
Cord Size	#18	#18	#16	#14	#18	#16	#14	#12	#10	#8	
Approx. Dia. Inches (mm)	.25" (6.2)	.31" (7.8)	.33" (8.4)	.37" (9.3)	.38" (9.7)	.40" (10.2)	.54" (13.7)	.62" (15.6)	.68" (17.1)	.81" (20.6)	
Color	Black	Black	White	White	Blue	Blue	Brown	Brown	Yellow	Orchid	
NPT	Form	Catalog Number*									
¼	1	HC1004	HC1004	HC1005	HC1005	HC1006	HC1006	—	—	—	—
⅜	1	HC1010	HC1010	HC1011	HC1011	HC1012	HC1012	—	—	—	—
½	1	HC1016	HC1016	HC1017	HC1017	HC1018	HC1018	—	—	—	—
½	2	HC1022	HC1022	HC1022	HC1022	HC1023	HC1023	HC1024	HC1024	—	—
½	3	—	—	—	—	HC1025	HC1025	HC1026	HC1026	HC1027	HC1028
¾	2	HC1032	HC1032	HC1032	HC1032	HC1033	HC1033	HC1034	HC1034	—	—
¾	3	—	—	—	—	HC1035	HC1035	HC1036	HC1036	HC1037	HC1038
1	4	—	—	—	—	HC1039	HC1039	HC1040	HC1040	HC1041	HC1042
1	5	—	—	—	—	—	—	—	—	—	HC1045
1¼	5	—	—	—	—	—	—	—	—	—	HC1050
1½	5	—	—	—	—	—	—	—	—	—	HC1055
1½	6	—	—	—	—	—	—	—	—	—	—
2	6	—	—	—	—	—	—	—	—	—	—
2	7	—	—	—	—	—	—	—	—	—	—
2½	7	—	—	—	—	—	—	—	—	—	—
3	7	—	—	—	—	—	—	—	—	—	—

Note: *Must add prefix, see Note 1; suffix, see Note 2, on page V-86.
 †F5 and larger will not be color coded.

3 Conductors

Cord Type	SVO, SV, SVT	SJ, SJO, SJT, SJTO				S, SO, ST, STO					
Cord Size	#18	#18	#16	#14	#18	#16	#14	#12	#10	#8	
Approx. Dia. Inches (mm)	.26" (6.5)	.33" (8.3)	.35" (8.9)	.39" (9.8)	.39" (9.9)	.42" (10.7)	.57" (14.4)	.65" (16.4)	.71" (18.0)	.85" (21.5)	
Color	Black	White	White	Blue	Blue	Blue	Brown	Yellow	Yellow	Orchid	
NPT	Form	Catalog Number*									
¼	1	HC1004	HC1005	HC1005	HC1006	HC1006	HC1006	—	—	—	—
⅜	1	HC1010	HC1011	HC1011	HC1012	HC1012	HC1012	—	—	—	—
½	1	HC1016	HC1017	HC1017	HC1018	HC1018	HC1018	—	—	—	—
½	2	HC1022	HC1022	HC1022	HC1023	HC1023	HC1023	HC1024	—	—	—
½	3	—	—	—	HC1025	HC1025	HC1025	HC1026	HC1027	HC1027	HC1028
¾	2	HC1032	HC1032	HC1032	HC1033	HC1033	HC1033	HC1034	—	—	—
¾	3	—	—	—	HC1035	HC1035	HC1035	HC1036	HC1037	HC1037	HC1038
1	4	—	—	—	HC1039	HC1039	HC1039	HC1040	HC1041	HC1041	HC1042
1	5	—	—	—	—	—	—	—	—	—	HC1045
1¼	5	—	—	—	—	—	—	—	—	—	HC1050
1½	5	—	—	—	—	—	—	—	—	—	HC1055
1½	6	—	—	—	—	—	—	—	—	—	—
2	6	—	—	—	—	—	—	—	—	—	—
2	7	—	—	—	—	—	—	—	—	—	—
2½	7	—	—	—	—	—	—	—	—	—	—
3	7	—	—	—	—	—	—	—	—	—	—

Note: *Must add prefix, see Note 1; suffix, see Note 2, on page V-95.
 †F5 and larger will not be color coded.



2 Conductors

Cord Type	SVO, SV, SVT			SJ, SJO, SJT, SJTO			S, SO, ST, STO				
Cord Size	#6	#4	#3	#2	#1	#1/0	#2/0	#3/0	#4/0	#250	
Approx. Dia. Inches (mm)	.94" (23.8)	1.08" (27.4)	1.17" (29.7)	1.27" (33.3)	1.44" (36.6)	1.52" (38.6)	1.65" (41.9)	1.77" (45.0)	1.92" (48.8)	2.16" (51.9)	
Color	Gray‡	Pink‡	‡	‡	‡	‡	‡	‡	‡	‡	
NPT	Form	Catalog Number*									
¼	1	—	—	—	—	—	—	—	—	—	
¾	1	—	—	—	—	—	—	—	—	—	
½	1	—	—	—	—	—	—	—	—	—	
½	2	—	—	—	—	—	—	—	—	—	
½	3	—	—	—	—	—	—	—	—	—	
¾	2	—	—	—	—	—	—	—	—	—	
¾	3	—	—	—	—	—	—	—	—	—	
1	4	HC1043	HC1044	—	—	—	—	—	—	—	
1	5	HC1046	HC1047	HC1048	HC1049	—	—	—	—	—	
1¼	5	HC1051	HC1052	HC1053	HC1054	—	—	—	—	—	
1½	5	HC1056	HC1057	HC1058	HC1059	—	—	—	—	—	
1½	6	—	—	—	HC1060	HC1061	HC1062	HC1063	HC1064	—	
2	6	—	—	—	HC1065	HC1066	HC1067	HC1068	HC1069	—	
2	7	—	—	—	—	—	—	—	HC1070	HC1071	HC1073
2½	7	—	—	—	—	—	—	—	HC1076	HC1077	HC1079
3	7	—	—	—	—	—	—	—	HC1086	HC1087	HC1089

Note: *Must add prefix, see Note 1; suffix, see Note 2, on page V-86.
 ‡F5 and larger will not be color coded.

3 Conductors

CordType	SVO, SV, SVT			SJ, SJO, SJT, SJTO			S, SO, ST, STO				
Cord Size	#6	#4	#3	#2	#1	#1/0	#2/0	#3/0	#4/0	#250	
Approx. Dia. Inches (mm)	1.00" (25.4)	1.17" (29.7)	1.24" (31.5)	1.34" (34.0)	1.51" (38.4)	1.65" (41.9)	1.75" (44.5)	1.80" (48.0)	2.07" (52.6)	2.39" (60.7)	
Color	Gray‡	‡	‡	‡	‡	‡	‡	‡	‡	‡	
NPT	Form	Catalog Number*									
¼	1	—	—	—	—	—	—	—	—	—	
¾	1	—	—	—	—	—	—	—	—	—	
½	1	—	—	—	—	—	—	—	—	—	
½	2	—	—	—	—	—	—	—	—	—	
½	3	—	—	—	—	—	—	—	—	—	
¾	2	—	—	—	—	—	—	—	—	—	
¾	3	—	—	—	—	—	—	—	—	—	
1	4	HC1044	—	—	—	—	—	—	—	—	
1	5	HC1047	HC1048	HC1048	HC1049	—	—	—	—	—	
1¼	5	HC1052	HC1053	HC1053	HC1054	—	—	—	—	—	
1½	5	HC1057	HC1058	HC1058	HC1059	—	—	—	—	—	
1½	6	—	—	—	HC1060	HC1062	HC1063	HC1064	—	—	
2	6	—	—	—	HC1065	HC1067	HC1068	HC1069	—	—	
2	7	—	—	—	—	—	—	HC1070	HC1071	HC1073	HC1075
2½	7	—	—	—	—	—	—	HC1076	HC1077	HC1079	HC1081
3	7	—	—	—	—	—	—	HC1086	HC1087	HC1089	HC1091

Note: *Must add prefix, see Note 1; suffix, see Note 2, on page V-86.
 ‡F5 and larger will not be color coded.



4 Conductors

Cord Type	SJ, SJO, SJT, SJTO			S, SO, ST, STO					
Cord Size	#18	#16	#14	#18	#16	#14	#12	#10	#8
Approx. Dia. Inches (mm)	.36" (9.0)	.39" (9.8)	.43" (10.8)	.42" (10.7)	.45" (11.4)	.61" (15.5)	.70" (17.8)	.77" (19.4)	.97" (24.6)
Color	White	Blue	Blue	Blue	Blue	Brown	Yellow	Orchid	Gray‡
NPT	Form	Catalog Number*							
¼	1	HC1005	HC1006	HC1006	HC1006	—	—	—	—
¾	1	HC1011	HC1012	HC1012	HC1012	—	—	—	—
½	1	HC1017	HC1018	HC1018	HC1018	—	—	—	—
½	2	HC1022	HC1023	HC1023	HC1023	HC1023	HC1024	—	—
½	3	—	HC1025	HC1025	HC1025	HC1025	HC1026	HC1027	HC1028
¾	2	—	HC1033	HC1033	HC1033	HC1033	HC1034	—	—
¾	3	—	HC1035	HC1035	HC1035	HC1035	HC1036	HC1037	HC1038
1	4	—	HC1039	HC1039	HC1039	HC1039	HC1040	HC1041	HC1042
1	5	—	—	—	—	—	—	—	HC1046
1¼	5	—	—	—	—	—	—	—	HC1051
1½	5	—	—	—	—	—	—	—	HC1056
1½	6	—	—	—	—	—	—	—	—
2	6	—	—	—	—	—	—	—	—
2	7	—	—	—	—	—	—	—	—
2½	7	—	—	—	—	—	—	—	—
3	7	—	—	—	—	—	—	—	—

Note: *Must add prefix, see Note 1; suffix, see Note 2, on page V-86.
‡F5 and larger will not be color coded.

5 Conductors

Cord Type	S, SO, ST, STO						
Cord Size	#18	#16	#14	#12	#10	#8	#6
Approx. Dia. Inches (mm)	.50" (12.7)	.54" (13.7)	.70" (17.7)	.76" (19.3)	.83" (21.1)	1.06" (26.9)	1.18" (30.0)
Color	Blue	Brown	Yellow	Orchid‡	Orchid‡	Pink‡	‡
NPT	Form	Catalog Number*					
½	2	HC1023	HC1024	—	—	—	—
½	3	HC1025	HC1026	HC1027	HC1028	HC1028	—
¾	2	HC1033	HC1034	—	—	—	—
¾	3	HC1035	HC1036	HC1037	HC1038	HC1038	—
1	4	HC1039	HC1040	HC1041	HC1042	HC1042	HC1044
1	5	—	—	—	HC1045	HC1045	HC1047
1¼	5	—	—	—	HC1050	HC1050	HC1052
1½	5	—	—	—	HC1055	HC1055	HC1057

Note: *Must add prefix, see Note 1; suffix, see Note 2, on page V-86.
‡F5 and larger will not be color coded.



4 Conductors

Cord Type	SJ, SJO, SJT, SJTO			S, SO, ST, STO						
Cord Size	#6	#4	#3	#2	#1	#1/0	#2/0	#3/0	#4/0	
Approx. Dia. Inches (mm)	.94" (23.8)	1.08" (27.4)	1.17" (29.7)	1.27" (33.3)	1.44" (36.6)	1.52" (38.6)	1.65" (41.9)	1.77" (45.0)	1.92" (48.8)	
Color	Pink‡	‡	‡	‡	‡	‡	‡	‡	‡	
NPT	Form	Catalog Number*								
¼	1	—	—	—	—	—	—	—	—	—
⅜	1	—	—	—	—	—	—	—	—	—
½	1	—	—	—	—	—	—	—	—	—
½	2	—	—	—	—	—	—	—	—	—
½	3	—	—	—	—	—	—	—	—	—
¾	2	—	—	—	—	—	—	—	—	—
¾	3	—	—	—	—	—	—	—	—	—
1	4	HC1044	—	—	—	—	—	—	—	—
1	5	HC1047	HC1049	HC1049	—	—	—	—	—	—
1¼	5	HC1052	HC1054	HC1054	—	—	—	—	—	—
1½	5	HC1057	HC1059	HC1059	—	—	—	—	—	—
1½	6	—	HC1060	HC1060	HC1061	HC1063	HC1064	—	—	—
2	6	—	HC1064	HC1065	HC1066	HC1068	HC1069	—	—	—
2	7	‡	—	—	—	—	HC1070	HC1071	HC1073	HC1074
2½	7	—	—	—	—	—	HC1076	HC1077	HC1079	HC1080
3	7	—	—	—	—	—	HC1086	HC1087	HC1089	HC1090

Note: *Must add prefix, see Note 1; suffix, see Note 2, below.
 ‡F5 and larger will not be color coded.

Note:

- Add the proper prefix to the HC number to identify the type of connector desired:
 SHC = Straight Hubbell Connector
 NHC = 90° Hubbell Connector
 FHC = Female Hubbell Connector
 VHC = 45° Hubbell Connector
- Add the proper suffix to identify material desired:
 Aluminum = No suffix
 Zinc-Plated Steel = ZP
 Corrosion Resistant Nylon = CR
 Stainless Steel = SS

- This chart is a general guide to assist in the selection of Hubbell Cord Connectors for various cord sizes. The Hubbell Cord Connector catalog numbers selected, have been inserted into spaces which in our judgment represent the best cord connector which will fit the listed cord size. The diameters of the cords are approximate and may vary depending on the manufacturer. It is suggested that the appropriate cord manufacturer's dimension chart be consulted for exact dimensions.
- Cable jacket may have to be stripped to allow conductors to pass through connector body.



NPT Thread Locknuts

Zinc-Plated Steel

NPT Hub Size	A Inside Diameter Inches	B Outside Dia. Inches (mm)	C Thickness Inches (mm)	Steel Catalog Number
½	½"-14	1.14" (29.0)	.09" (2.3)	00322001LPK50
¾	¾"-14	1.43" (36.3)	.11" (2.8)	00322002LPK50
1	1"-11½	1.77" (45.0)	.13" (3.3)	00322003LPK50
1¼	1¼"-11½	2.28" (57.9)	.13" (3.3)	00322004LPK50
1½	1½"-11½	2.60" (66.0)	.13" (3.3)	00322005LPK50

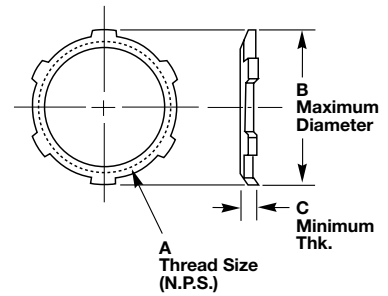

Metal Clad Sealing O-Rings – Sizes ½ - 4

Zinc-Plated Steel with Neoprene Ring

NPT Hub Size	A Inside Diameter Inches (mm)	B Outside Dia. Inches (mm)	C Thickness Inches (mm)	Catalog Number
½	.80" (20.3)	1.08" (27.4)	.16" (3.2)	20509001
¾	1.00" (25.4)	1.34" (34.0)	.16" (3.2)	20509002
1	1.25" (31.6)	1.63" (41.4)	.16" (3.2)	20509003
1¼	1.61" (40.9)	2.00" (50.8)	.16" (3.2)	20509004
1½	1.84" (46.7)	2.36" (59.9)	.16" (3.2)	20509005
2	2.31" (58.7)	2.83" (71.9)	.16" (3.2)	20509006

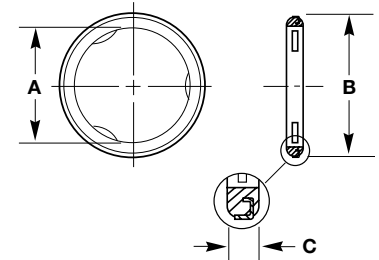

Chrome Plated Steel with Neoprene Ring

2½	2.91" (73.9)	3.44" (87.4)	.24" (6.1)	20509007
3	3.52" (89.4)	4.08" (103.6)	.24" (6.1)	20509008

Nylon PG Thread Locknuts

PG Thread Size	A Inches (mm)	B Inches (mm)	C Inches (mm)	Catalog Number
PG7	.75" (19.1)	.80" (20.3)	.22" (5.6)	LNP7BPK100
PG9	.86" (21.8)	.91" (23.2)	.22" (5.6)	LNP9BPK100
PG11	.94" (23.9)	1.03" (26.2)	.22" (5.6)	LNP11BPK100
PG13.5	1.06" (26.9)	1.14" (29.0)	.24" (6.1)	LNP13BPK100
PG16	1.18" (30.0)	1.30" (33.0)	.25" (6.1)	LNP16BPK100
PG21	1.41" (35.8)	1.54" (39.1)	.25" (6.1)	LNP21BPK100
PG29	1.81" (46.0)	2.00" (50.8)	.25" (6.1)	LNP29BPK25
PG36	2.24" (56.9)	2.50" (63.5)	.25" (6.1)	LNP36BPK25

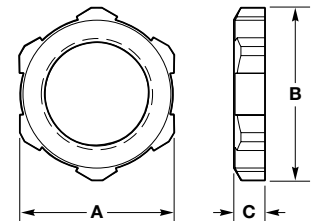

Nylon Metric Thread Locknuts

PG Thread Size	A Inches (mm)	B Inches (mm)	C Inches (mm)	Catalog Number
M12	.75" (19.1)	.82" (20.8)	.22" (5.6)	LNM12BPK100
M16	.87" (22.09)	.98" (25.0)	.22" (5.6)	LNM16BPK100
M20	1.06" (27.0)	1.18" (30.0)	.25" (6.4)	LNM20BPK100
M25	1.38" (35.1)	1.54" (39.1)	.28" (7.1)	LNM25BPK100
M32	1.61" (40.9)	1.80" (45.7)	.28" (7.1)	LNM32BPK100
M40	1.97" (50.0)	2.18" (55.4)	.28" (7.1)	LNM40BPK100

Dimensions shown are approximate and are subject to change without notice.



Hubbell Juniors®

Material	Operating Temperature Range
Nylon (connectors and GOTCHA® rings)	-40°F to +225°F (-40°C to +107°C)
Neoprene (bushings)	-30°F to +240°F (-34°C to +115°C)

Due to the limiting factors of nylon and neoprene, any complete liquidtight Hubbell Junior will continuously perform in the range of -30°F to +225°F (-34°C to +107°C).

Snap-In continuously performs -40°F to +225°F (-40°C to +107°C).

Flammability

Hubbell Juniors have a UL 94V-2 rating.

Certifications

Product	Agency
Liquidtight and Liquidtight with Spiral	UL Listed. CSA Certified.
Snap-In	UL Recognized. CSA Certified.

Knockout Holes

NPT Hub Size	Knockout Hole Recommended Min. to Max.	
	inches	(mm)
¼	.54"-.57"	(13.7-14.5)
⅜	.67"-.70"	(17.0-17.8)
½	.86"-.91"	(21.8-23.1)

Snap-In

Diameter Range Inches (mm)	For Chassis Thickness (Max.) Inches (mm)	Required Hole Size A Inches (mm)	B Inches (mm)	Dimensional Specifications					G Inches (mm)
				C Inches (mm)	D Inches (mm)	E Inches (mm)	F Inches (mm)		
.22"-.27" (5.6-6.9)	.10" (2.5)	.50" (12.7)	.45" (11.4)	.28" (7.1)	.28" (7.1)	.54" (13.7)	.12" (3.0)	1.84" (44.2)	
.28"-.32" (7.1-8.1)	.10" (2.5)	.50" (12.7)	.47" (11.9)	.28" (7.1)	.33" (8.4)	.59" (15.0)	.12" (3.0)	1.84" (44.2)	
.30"-.36" (7.6-9.1)	.13" (3.3)	.63" (16.0)	.55" (14.0)	.36" (9.1)	.37" (9.4)	.65" (16.5)	.14" (3.6)	2.18" (55.4)	
.32"-.43" (8.1-10.9)	.13" (3.3)	.75" (19.0)	.66" (16.8)	.45" (11.4)	.44" (11.2)	.75" (19.1)	.14" (3.6)	2.60" (66.0)	

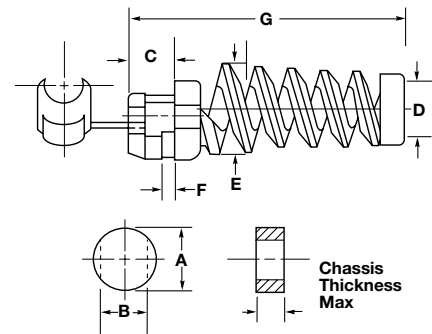

Liquidtight

F NPT Inches	A Dia. Inches (mm)	B Ref. Inches (mm)	C Inches (mm)	D Throat Dia. Inches (mm)	E	
					Across Corners Inches (mm)	Across Flats Inches (mm)
¼-18	.65" (16.5)	1.30" (33.0)	.40" (10.2)	.29" (7.4)	.65" (16.5)	.60" (15.2)
⅜-18	.81" (20.6)	1.44" (36.6)	.41" (10.4)	.36" (9.1)	.81" (20.6)	.75" (19.1)
½-14	1.00" (25.4)	1.56" (39.6)	.46" (11.7)	.45" (11.4)	.99" (25.1)	.92" (23.4)

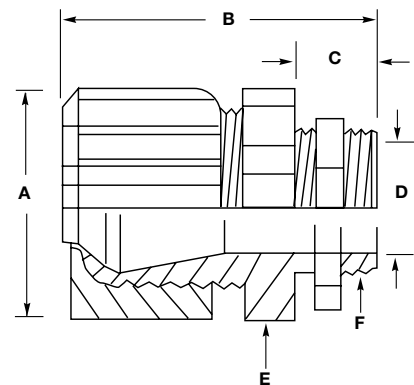

Liquidtight with Spiral

G NPT Inches	A Dia. Inches (mm)	B Ref. Inches (mm)	C Inches (mm)	D Throat Dia. Inches (mm)	E Inches (mm)	F	
						Across Corners Inches (mm)	Across Flats Inches (mm)
¼-18	.65" (16.5)	2.55" (64.8)	.40" (10.2)	.29" (7.4)	.27" (6.9)	.65" (16.5)	.60" (15.2)
⅜-18	.81" (20.6)	3.10" (78.7)	.41" (10.4)	.36" (9.1)	.35" (8.9)	.81" (20.6)	.75" (19.1)
½-14	1.00" (25.4)	3.72" (94.5)	.46" (11.7)	.45" (11.4)	.45" (11.4)	.99" (25.1)	.92" (23.4)

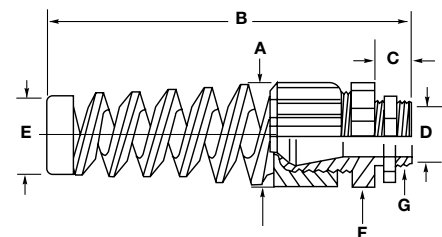

Dimensions shown are approximate and are subject to change without notice.



Features and Benefits

PolyTuff® I and PolyTuff® II Non-Metallic Liquidtight Conduit

All non-metallic construction ends fatigue and separation problems. They can be cut cleanly with a knife or PVC cutter so there are no jagged metal edges.



PolyTuff® I Conduit, Gray

- Rigid PVC core bonded to flexible PVC jacket
- Approved for outdoor use and direct burial
- UL Listed and CSA Certified



PolyTuff® II Tubing, Black

- PVC core with corrugated walls bonded to PVC jacket
- Handles twists, turns, bends, switchbacks and straightaways with ease
- UL Recognized and CSA Certified

PolyTuff® I Conduit

IP66
SUITABILITY



Trade Size (metric designator)	Feet (m)	Catalog Number
3/8 (12)	100 (30.5)	G1038
1/2 (16)	100 (30.5)	G1050
3/4 (21)	100 (30.5)	G1075
1 (27)	100 (30.5)	G1100
1 1/4 (35)	100 (30.5)	G1125
1 1/2 (41)	50 (15.2)	G1150
2 (53)	50 (15.2)	G1200

Note: See pages V-58 and V-59, V-90 and V-91 for approved fittings.
See pages V-92 and V-93 for technical information and dimensional drawings.



PolyTuff® II Tubing

IP66
SUITABILITY



Trade Size (metric designator)	Feet (m)	Catalog Number
1/4 (10)	100 (30.5)	B2025
3/8 (12)	100 (30.5)	B2038
1/2 (16)	100 (30.5)	B2050
3/4 (21)	100 (30.5)	B2075
1 (27)	100 (30.5)	B2100
1 1/4 (35)	100 (30.5)	B2125
1 1/2 (41)	50 (15.2)	B2150
2 (53)	50 (15.2)	B2200

Note: See page V-90 for approved fittings.
See pages V-92 and V-93 for technical information and dimensional drawings.



PolyTuff® Non-Metallic Liquidtight Fittings



P075NBKA



P075NGYA

Straight with Male Non-Metallic Liquidtight Fittings

Trade Size (metric designator)	Black Catalog Number	Gray Catalog Number
¼ (10)	F2025	—
⅜ (12)	P038NBKA	P038NGYA
½ (16)	P050NBKA	P050NGYA
¾ (21)	P075NBKA	P075NGYA
1 (27)	P100NBKA	P100NGYA
1¼ (35)	P125NBK	P125NGY
1½ (41)	P150NBK	P150NGY
2 (53)	P200NBK	P200NGY

Note: Fittings are to be used with PolyTuff I and PolyTuff II.
See pages V-94 and V-95 for technical information and dimensional drawings.
¾" Liquidtight conduit fitting have ½ NPT male threads.



PS0509NGY

SwivelLok® Multi-Position

SwivelLok® Multi-Position with Male Non-Metallic Liquidtight Fittings

Trade Size (metric designator)	Black Catalog Number	Gray Catalog Number
¾ (12)	PS0389NBK	PS0389NGY
½ (16)	PS0509NBK	PS0509NGY
¾ (21)	PS0759NBK	PS0759NGY
1 (27)	PS1009NBK	PS1009NGY

Note: Fittings are to be used with PolyTuff I and PolyTuff II.
See pages V-94 and V-95 for technical information and dimensional drawings.
¾" Liquidtight conduit fitting have ½ NPT male threads.



P0759NBK



P0759NGY

Fixed 90° Fittings for Non-Metallic Conduit

Trade Size (metric designator)	Black Catalog Number	Gray Catalog Number
¾ (12)	P0389NBK	P0389NGY
½ (16)	P0509NBK	P0509NGY
¾ (21)	P0759NBK	P0759NGY
1 (27)	P1009NBK	P1009NGY
1¼ (35)	P1259NBK	P1259NGY

Note: Fittings are to be used with PolyTuff I and PolyTuff II.
See pages V-94 and V-95 for technical information and dimensional drawings.
¾" Liquidtight conduit fitting have ½ NPT male threads.



PS05GYKIT

SwivelLok® Flexible Conduit Kit

Trade Size (metric designator)	Fitting and Conduit	Catalog Number
½ (16)	2 PS0509NGY, 6' G1050	PS05GYKIT
¾ (21)	2 PS0759NGY, 6' G1075	PS07GYKIT

Note: See pages V-94 and V-95 for technical information and dimensional drawings.

Metallic Liquidtight Conduit Fittings

Straight Conduit Fitting

Trade Size (metric designator)	Insulated	Non-Insulated
3/8 (12)	H0381	H038
1/2 (16)	H0501	H050
3/4 (21)	H0751	H075
1 (27)	H1001	H100
1 1/4 (35)	H1251	H125
1 1/2 (41)	H1501	H150
2 (53)	H2001	H200
2 1/2 (63)	H2501	H250
3 (78)	H3001	H300
3 1/2 (91)	H3501	H350
4 (103)	H4001	H400

Note: 3/8" Liquidtight conduit fitting have 1/2 NPT male threads.
For use with Liquidtight Metal conduit and PolyTuff I Non-Metallic conduit.
See page V-96 for technical information.



45° Conduit Fitting

Trade Size (metric designator)	Insulated	Non-Insulated
3/8 (12)	H03841	H0384
1/2 (16)	H05041	H0504
3/4 (21)	H07541	H0754
1 (27)	H10041	H1004
1 1/4 (35)	H12541	H1254
1 1/2 (41)	H15041	H1504
2 (53)	H20041	H2004

Note: 3/8" Liquidtight conduit fitting have 1/2 NPT male threads.
For use with Liquidtight Metal conduit and PolyTuff I Non-Metallic conduit.
See page V-96 for technical information.



90° Conduit Fitting

Trade Size (metric designator)	Insulated	Non-Insulated
3/8 (12)	H03891	H0389
1/2 (16)	H05091	H0509
3/4 (21)	H07591	H0759
1 (27)	H10091	H1009
1 1/4 (35)	H12591	H1259
1 1/2 (41)	H15091	H1509
2 (53)	H20091	H2009
2 1/2 (63)	H25091	H2509
3 (78)	H30091	H3009
4 (103)	H40091	H4009

Note: 3/8" Liquidtight conduit fitting have 1/2 NPT male threads.
For use with Liquidtight Metal conduit and PolyTuff I Non-Metallic conduit.
See page V-96 for technical information.





PolyTuff® I Conduit

Operating Temperature Range

Wet environment	0°F to +140°F (-18°C to +60°C).
Oil environment	0°F to +158°F (-18°C to +70°C).
Dry environment	0°F to +176°F (-18°C to +80°C).

Certifications

UL Listed CSA Certified	UL Standard 1660. Sunlight resistant approved for outdoor use, direct burial. Meets requirements of NEC.
----------------------------	---

Voltage Rating

Maximum	600V.
---------	-------

Material

Conduit	Co-extruded rigid and flexible PVC.
---------	-------------------------------------

PolyTuff® II Tubing

Operating Temperature Range

Operating environment	0°F to +140°F (-18°C to +60°C).
-----------------------	---------------------------------

Certifications

UL Recognized CSA Certified	
--------------------------------	--

Voltage Rating

Maximum	Same as wire insulation rating.
---------	---------------------------------

Material

Tubing	Co-extruded rigid and flexible PVC.
--------	-------------------------------------

PolyTuff® I Conduit

Trade Size (metric designator)	Conduit ID/OD		Bend Radius	
	Inches	(mm)	Inches	(mm)
¾ (12)	.49"/.70"	(12.6/17.8)	2.00"	(50.8)
½ (16)	.63"/.83"	(16.1/21.1)	3.00"	(76.2)
¾ (21)	.83"/1.04"	(21.1/26.4)	4.00"	(101.6)
1 (27)	1.05"/1.30"	(26.0/33.1)	5.00"	(127.0)
1¼ (35)	1.40"/1.65"	(35.4/41.8)	6.30"	(158.8)
1½ (41)	1.59"/1.88"	(40.3/47.8)	7.50"	(190.5)
2 (53)	2.03"/2.36"	(51.6/59.9)	10.00"	(254.0)

PolyTuff® II Tubing

Trade Size (metric designator)	Conduit ID/OD		Bend Radius	
	Inches	(mm)	Inches	(mm)
¼ (10)	.36"/.57"	(9.3/14.5)	1.50"	(38.1)
¾ (12)	.49"/.70"	(12.6/17.8)	2.00"	(50.8)
½ (16)	.63"/.83"	(16.1/21.1)	2.00"	(50.8)
¾ (21)	.83"/1.04"	(21.1/26.4)	3.00"	(76.2)
1 (27)	1.05"/1.30"	(26.0/33.1)	3.00"	(76.2)
1¼ (35)	1.40"/1.65"	(35.4/41.8)	5.00"	(127.0)
1½ (41)	1.59"/1.88"	(40.3/47.8)	5.00"	(127.0)
2 (53)	2.03"/2.36"	(51.6/59.9)	5.00"	(127.0)



PolyTuff® I and II Conduit/Tubing; PVC Chemical Resistance

Chemical	Conc.*	Temp.		Chemical	Conc.*	Temp.		Chemical	Conc.*	Temp.	
		70°F 21°C	150°F 66°C			70°F 21°C	150°F 66°C			70°F 21°C	150°F 66°C
Acetate Solvents		D	D	Coconut Oil		C	D	Lubricating Oils		A	A
Acetic Acid		B	C	Corn Oil		A	B	Magnesium Chloride		A	A
Acetic Acid (Glacial)		C	D	Cottonseed Oil		C	D	Magnesium Hydroxide		A	A
Acetone		D	D	Creosote		D	D	Magnesium Sulfate		A	A
Acrylonitrile		A	B	Cresol		C	D	Malathion 50 in Aromatics		D	D
Alcohols (Aliphatic)		C	C	Crysylic Acid		D	D	Malic Acid		A	A
Aluminum Chloride		A	A	Cyclohexane		B	C	Methyl Acetate		D	D
Aluminum Sulfate (Alums)		A	A	DDT Weed Killer		A	C	Methyl Alcohol		C	C
Ammonia (Anhydrous Liquids)		D	D	Dibutyl Phthalate		D	D	Methyl Bromide		D	D
Ammonia (Aqueous)		A	A	Diesel Oils		C	D	Methyl Ethyl Ketone		D	D
Ammoniated Latex		A	C	Diethylene Glycol		B	C	Methylene Chloride		D	D
Ammonium Chloride		A	A	Diethyl Ether		A	C	Mineral Oil			
Ammonium Hydroxide		A	A	Di-isodecyl Phthalate		D	D	Monochlorobenzene		A	A
Amyl Acetate		D	D	Diocetyl Phthalate		D	D	Muriatic Acid (see Hydrochloric Acid)			
Aniline Oils		D	D	Dow General Weed Killer (Phenol)		D	D	Naphtha		C	D
Aromatic Hydrocarbons		D	D	Dow General Weed Killer (H2O)		B	C	Naphthalene		D	D
Asphalt		D	D	Ethyl Alcohol		C	C	Nitric Acid	10%	A	B
ASTM Fuel A		C	C	Ethylene Dichloride		D	D	Nitric Acid	35%	A	C
ASTM Fuel B		D	D	Ethylene Glycol		B	C	Nitric Acid	70%	D	D
ASTM #1 Oil		B	C	Ferric Chloride		A	A	Oleic Acid		A	C
ASTM #3 Oil		C	D	Ferric Sulfate		A	A	Oleum		D	D
Barium Chloride		A	A	Ferrous Chloride		A	A	Oxalic Acid		A	A
Barium Sulfide		A	A	Ferrous Sulfate		A	A	Pentachlorophenol in Oil		B	C
Barium Hydroxide		A	A	Formaldehyde		D	D	Pentane		C	D
Benzene (Benzol)		D	D	Fuel Oil		B	C	Perchloroethylene		B	C
Benzine (Petroleum Ether)		C	C	Furfural		C	C	Petroleum Ether		C	C
Black Liquor		A	A	Gallic Acid		A	A	Phenol		A	A
Bordeaux Mixture		A	A	Gasoline (Hi Test)		C	D	Phosphoric Acid	10%	A	A
Boric Acid		A	A	Glycerine		A	A	Pitch	50%	A	B
Butyl Acetate		D	D	Grease		A	C	Potassium Hydroxide		C	D
Butyl Alcohol		B	C	Green Sulfate Liquor		A	A	Sodium Cyanide		A	A
Calcium Hydroxide		A	A	Heptachlor in Petroleum Solvents		A	C	Stoddard Solvent		D	D
Calcium Hypochlorite		A	A	Heptane		C	D	Styrene		D	D
Carbolic Acid (Phenol)		B	C	Hexane		C	D	Sulfur Dioxide (liquid)		D	D
Carbon Dioxide		A	A	Hydrobromic Acid		A	A	Sulfuric Acid	50%	A	B
Carbon Disulfide		D	D	Hydrochloric Acid	10%	A	A	Sulfuric Acid	98%	D	D
Carbon Tetrachloride		D	D	Hydrochloric Acid	40%	C	C	Sulfurous Acid		B	C
Carbonic Acid		A	A	Hydrofluoric Acid	70%	D	D	Tall Oil		D	D
Casein		A	C	Hydrofluorosilicic Acid		A	A	Tannic Acid		A	A
Caustic Soda		A	B	Hydrofluorosilicic Acid	10%	A	A	Toluene		D	D
Chlorine Gas (wet)		D	D	Hydrogen Peroxide		A	B	Trichlorethylene		D	D
Chlorine Gas (dry)		D	D	Iso-Octane		C	C	Triethanol Amine		C	D
Chlorine (water solution)		C	D	Isopropyl Acetate		D	D	Tricresyl Phosphate (Skydrol)		D	D
Chlorobenzene		D	D	Isopropyl Acid		B	C	Turpentine		C	D
Chlorinated Hydrocarbons		D	D	Jet Fuels (JP-3, and 5)		C	D	Vinegar		A	B
Chromic Acid		B	C	Kerosene		C	C	Vinyl Chloride		D	D
Citric Acid		A	A	Ketones		D	D	Water		A	A
Coal Tar		D	D	Linseed Oil		A	A	White Liquor		A	A
								Xylene		D	D
								Zinc Chloride		A	A
								Zinc Sulfate		A	A

Note: *Conc. = Concentration.

(All ratings apply to concentrated or saturated solutions unless otherwise specified.)

Chemical resistance ratings are based upon information supplied by the raw material manufacturers.

Use as a general guide only – samples should be tested by user under actual conditions.

Rating Code

A-Excellent service

No harmful effect to reduce service life. Suitable for continuous service.

B-Good service life.

Moderate to minor effect. Good for intermittent service. Generally suitable for continuous service.

C-Fair or limited service.

Depends on operating conditions. Generally suitable for intermittent service. Not recommended for continuous service.

D-Unsatisfactory service.

Not recommended.



PolyTuff® Fittings

Operating Temperature*

Nylon (Body, Nut, Gripping Ring and Locknut)	-40°F to +225°F (-40°C to +107°C).
Neoprene (Sealing Ring)	-30°F to +240°F (-34°C to +116°C).

Flammability

Fire Gas Toxicity Product Testing	Nylon PolyTuff Fittings have a UL 94V-2 rating.
-----------------------------------	---

Certifications

UL Listed	UL50 Type 4X, 12 and 13.
CSA Certified	PolyTuff I Fittings, PolyTuff II Fittings.

Liquidtight Fittings

Operating Temperature**

Steel/Malleable Iron (Nut, Body, Ferrule)	-60°F to +1000°F (-51°C to +538°C).
Nylon (Gland Ring)	-40°F to +225°F (-40°C to +107°C).

Hazardous Locations - NEC Reference

Class I, Div. 2 - 501-10(A)(3)B
Class II, Div. 1 - 502-10(A)(2)
Class II, Div. 2 - 502-10(A)(3)
Class III, Div. 1 - 503-10(A)(2)
Class III, Div. 2 - 503-10(B)

Certifications

UL Listed to UL 514B
CSA Certified

Note: *Due to the limiting factors of nylon and neoprene, PolyTuff Fittings will continuously perform in the range -30°F to +225°F (-34°C to +107°C).

**Due to the limiting factors of nylon, metallic liquidtight flexible conduit fittings will continuously perform in the range of -40°F to +225°F (-40°C to +107°C).



Straight with Male Non-Metallic Liquidtight Fittings

Trade Size (md**)	A	B	C	D Throat Dia.	E	
					Across Corners	Across Flats
¼ (10)	.93" (23.6)	1.45" (36.8)	.39" (9.9)	.32" (8.1)	.86" (Dia.) (21.8)	
⅜ (12)	1.14" (29.0)	1.63" (41.4)	.57" (14.5)	.42" (10.7)	1.41" (35.8)	1.30" (33.0)
½ (16)	1.30" (33.0)	2.14" (54.4)	.57" (14.5)	.55" (14.0)	1.41" (35.8)	1.30" (33.0)
¾ (21)	1.53" (38.9)	2.22" (56.4)	.58" (14.7)	.74" (18.8)	1.85" (47.0)	1.53" (38.9)
1 (27)	1.80" (45.7)	2.32" (58.9)	.72" (18.3)	.96" (24.4)	1.94" (49.3)	1.80" (45.7)
1¼ (35)	2.20" (55.9)	2.15" (54.6)	.74" (18.8)	1.30" (33.0)	2.38" (60.5)	2.18" (55.4)
1½ (41)	2.49" (63.2)	2.35" (59.7)	.76" (19.3)	1.46" (37.1)	2.63" (66.8)	2.43" (61.7)
2 (53)	3.05" (77.4)	2.51" (63.6)	.79" (20.1)	1.90" (48.3)	3.13" (79.5)	2.93" (74.4)

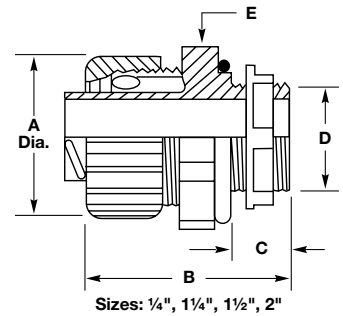

90° with Male Non-Metallic Liquidtight Fittings

Trade Size (md**)	A	B	C	D Throat Dia.	E	
					Across Corners	Across Flats
¼ (10)	.93" (23.6)	1.88" (47.8)	.39" (9.9)	.32" (8.1)	.86" (Dia.) (21.8)	
1¼ (35)	2.21" (56.1)	3.57" (90.7)	.74" (18.9)	1.30" (33.0)	2.38" (60.5)	2.18" (55.4)

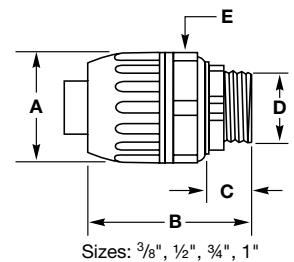

SwivelLok® Multi-Position Liquidtight Fittings

Trade Size (md**)	A	B	C	D	E	F	G	
							Across Corners	Across Flats
⅜ (12)	1.30" (33.0)	3.27" (83.1)	.57" (14.5)	.55" (14.0)	1.43" (36.3)	2.00" (50.8)	1.41" (35.8)	1.30" (33.0)
½ (16)	1.30" (33.0)	3.27" (83.1)	.57" (14.5)	.55" (14.0)	1.43" (36.3)	2.00" (50.8)	1.41" (35.8)	1.30" (33.0)
¾ (21)	1.53" (38.9)	3.66" (93.0)	.58" (15.7)	.74" (18.8)	1.59" (40.4)	2.23" (56.6)	1.65" (41.9)	1.53" (38.9)
1 (27)	1.80" (45.7)	4.00" (101.6)	.72" (18.3)	.96" (24.4)	1.84" (46.7)	2.30" (58.4)	1.94" (49.3)	1.80" (45.7)

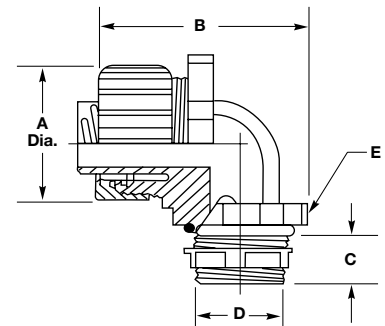

Note: *A/C = Across Corners, A/F = Across Flats.
 **md = metric designator.

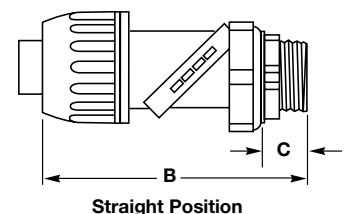
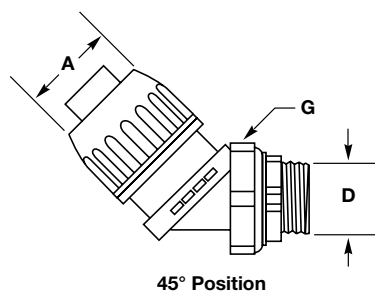
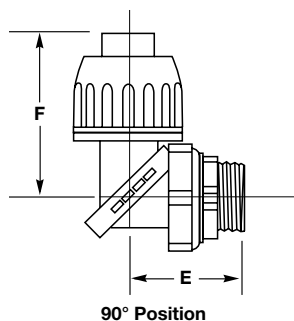



Straight with Male Metallic Metal Fitting

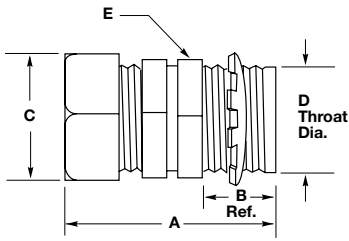

Trade Size (md**)	A Ref.	B	C		D Throat Dia.	E	
			A/C*	A/F*		A/C*	A/F*
3/8 (12)	1.43" (36.3)	.59" (15.0)	1.20" (30.0)	1.06" (26.9)	.61" (15.5)	1.07" (27.2)	.93" (23.6)
1/2 (16)	1.43" (36.3)	.59" (15.0)	1.34" (34.0)	1.19" (30.2)	.61" (15.5)	1.22" (31.0)	1.06" (26.9)
3/4 (21)	1.56" (39.6)	.59" (15.0)	1.55" (39.0)	1.37" (34.8)	.84" (21.3)	1.43" (36.3)	1.25" (31.8)
1 (27)	1.68" (42.7)	.66" (16.8)	1.95" (50.0)	1.69" (42.9)	1.06" (26.9)	1.73" (43.9)	1.56" (39.6)
1 1/4 (35)	2.03" (51.6)	.63" (16.8)	2.39" (61.0)	2.06" (52.3)	1.37" (34.8)	2.36" (59.9)	2.08" (52.8)
1 1/2 (41)	2.21" (56.1)	.63" (16.8)	2.72" (69.0)	2.38" (60.5)	1.53" (38.9)	2.79" (70.9)	2.48" (63.0)
2 (53)	2.28" (57.9)	.69" (17.5)	3.08" (78.0)	2.87" (72.9)	2.06" (52.3)	3.32" (84.3)	2.90" (73.7)
2 1/2 (63)	3.56" (90.4)	1.06" (26.9)	3.92" (100.0)	3.62" (91.9)	2.42" (61.5)	3.85" (97.8)	3.60" (91.4)
3 (78)	3.81" (96.8)	1.06" (26.9)	4.70" (119.0)	4.31" (109.5)	3.01" (76.5)	4.65" (118.1)	4.33" (110.0)
3 1/2 (91)	3.81" (96.8)	1.06" (26.9)	5.29" (134.0)	4.81" (122.2)	3.49" (88.6)	5.18" (131.6)	4.82" (122.4)
4 (103)	3.81" (96.8)	1.06" (26.9)	5.75" (146.0)	5.31" (134.9)	3.96" (100.6)	5.75" (146.1)	5.39" (136.9)

45° with Male Metallic Metal Fitting

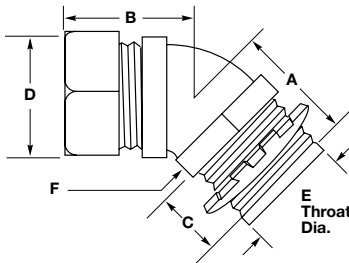

Trade Size (md**)	A	B	C	D		E Throat Dia.	F	
				A/C*	A/F*		A/C*	A/F*
3/8 (12)	1.19" (30.2)	1.28" (32.5)	.59" (15.0)	1.20" (30.5)	1.06" (26.9)	.60" (15.2)	1.16" (29.5)	1.02" (25.9)
1/2 (16)	1.19" (30.2)	1.28" (32.5)	.59" (15.0)	1.34" (34.0)	1.19" (30.2)	.61" (15.2)	1.21" (30.7)	1.06" (26.9)
3/4 (21)	1.19" (30.2)	1.43" (36.3)	.59" (15.0)	1.55" (39.4)	1.45" (36.8)	.84" (21.3)	1.50" (38.1)	1.32" (33.5)
1 (27)	1.38" (35.1)	1.53" (38.9)	.66" (16.8)	1.95" (49.5)	1.69" (42.9)	1.05" (26.7)	1.82" (46.2)	1.59" (40.4)
1 1/4 (35)	1.42" (36.1)	1.69" (42.9)	.63" (16.0)	2.39" (60.7)	2.06" (52.3)	1.37" (34.8)	2.32" (58.9)	2.03" (51.6)
1 1/2 (41)	1.66" (42.2)	2.00" (50.8)	.66" (16.8)	2.72" (69.1)	2.38" (60.5)	1.60" (40.6)	2.62" (66.5)	2.29" (58.2)
2 (53)	1.69" (42.9)	2.25" (57.2)	.66" (16.8)	3.08" (78.2)	2.88" (73.2)	2.05" (52.1)	3.21" (81.5)	2.80" (71.1)

90° with Male Metallic Metal Fitting

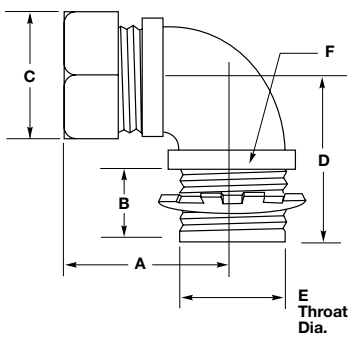

Trade Size (md**)	A	B	C		D Ref.	E Throat Dia.	F	
			A/C*	A/F*			A/C*	A/F*
3/8 (12)	1.31" (33.3)	.59" (15.0)	1.20" (30.5)	1.06" (26.9)	1.44" (36.6)	.60" (15.2)	1.13" (29.0)	.99" (25.1)
1/2 (16)	1.31" (33.3)	.59" (15.0)	1.34" (34.0)	1.12" (28.4)	1.44" (36.6)	.61" (15.5)	1.12" (28.0)	1.00" (25.4)
3/4 (21)	1.44" (36.6)	.59" (15.0)	1.55" (39.4)	1.45" (36.8)	1.63" (41.4)	.83" (21.1)	1.48" (38.0)	1.29" (32.8)
1 (27)	1.78" (45.2)	.59" (15.0)	1.95" (49.5)	1.60" (40.6)	2.19" (55.6)	1.05" (26.7)	1.80" (46.0)	1.57" (39.9)
1 1/4 (35)	1.97" (50.0)	.63" (16.0)	2.39" (60.7)	2.06" (52.3)	2.50" (63.5)	1.36" (34.5)	2.32" (59.0)	2.02" (51.3)
1 1/2 (41)	2.19" (55.6)	.63" (16.0)	2.72" (69.1)	2.38" (60.5)	2.69" (68.3)	1.61" (40.9)	2.58" (66.0)	2.25" (57.2)
2" (53)	2.53" (64.3)	.66" (16.8)	3.08" (78.2)	2.87" (72.9)	3.25" (82.6)	2.05" (52.1)	3.14" (80.0)	2.75" (69.9)
2 1/2 (63)	3.44" (87.4)	1.00" (25.4)	3.92" (99.6)	3.63" (92.2)	4.25" (108.0)	2.42" (61.5)	3.78" (96.0)	3.50" (88.9)
3 (78)	3.75" (95.3)	1.00" (25.4)	4.70" (119.4)	4.31" (109.5)	4.87" (123.7)	3.01" (76.5)	4.64" (118.0)	4.30" (109.2)
4 (103)	4.25" (108.0)	1.00" (25.4)	5.75" (146.1)	5.31" (134.9)	5.63" (143.0)	3.96" (100.6)	5.76" (146.0)	5.38" (136.7)

Note: *A/C = Across Corners, A/F = Across Flats.
**md = metric designator.