



In This Section...

Steel City® and Carlon®



Steel City® Fittings

Overview	F-2-F-3
Thinwall Conduit Fittings (EMT)	F-4-F-9
Rigid/Intermediate Grade Conduit Fittings	F-10-17
Flexible Cord and Power Cable Connectors	F-18
Liquidtight Flexible Metal Conduit and Connectors	F-19-F-23
Non-Metallic Sheathed Cable Fittings	F-24-F-25
Armored Cable/Flexible Metallic Conduit Fittings	F-26-F-31
Service Caps	F-31
Cable Caps, Protector, Straps and Clips; Threaded Rod and Coupling	F-32
Beam Clamps	F-33
Ground Clamps, Pipe Hangers	F-34

Carlon® Non-Metallic Rigid Conduit Fittings and Accessories

PVC Conduit Repair System	F-35-F-36
Schedule 40 & 80 Elbows	F-37-F-42
Schedule 40 & 80 Fittings & Accessories	F-43-F-46
Conduit Bodies & Accessories	F-47-F-48
Junction Boxes	F-49-F-50
Switch Boxes	F-51-F-53
Support Straps	F-54
Conduit Clamps	F-55-F-56
Schedule 40 & 80 Tech Specs	F-57
Utility Conduit	F-58-F-59
P&C Duct	F-60-F-68
Telephone Duct	F-69-F-71
Split Duct	F-72
Accessories	
PVC Cements and Sealers	F-73-F-77
PVC Conduit Cutters	F-78
EZ Bend™	F-79
Rope & Tape	F-80
Spacers	F-81-F-86
P&C Flex™	F-87-F-92

Steel City® Fittings & Carlon® Non-Metallic Rigid Conduit Fittings and Accessories

Thomas & Betts

Corporate Office
Tel: 901.252.8000
800.816.7809
Fax: 901.252.1354

Customer Service
Tel: 800.816.7809
Fax: 800.816.7810

Technical Services
Tel: 888.862.3289
Fax: 901.252.1321

Tool Services
Tel: 800.284.8665

Thomas & Betts

www.tnb.com

Steel City® Fittings

Steel City® Conduit Fittings provide long-lasting service in commercial, industrial and residential construction. Our fittings are manufactured within strict tolerances to maintain consistent performance. Installers can be assured that every fitting with the Steel City® name will work every time. So when you select Steel City® Conduit Fittings, that means fewer headaches and call-backs.

Steel City® products symbolize the highest quality standards in manufacturing and innovative design, with one of the most complete offerings available. Contact a T&B distributor nearest you to select the right Steel City® product for your requirements.



Advantages of Steel City® Commercial Conduit Fittings

Compression Fittings

Dependable Pipe Stop

- Strong, thick protrusion that does not exceed thickness of EMT. Keeps forcefully inserted conduit from breaking through the opposite side of the coupling, while not interfering with the pulling of conductors

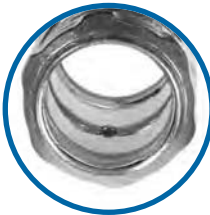

Heavy-Duty Thick Steel Body/Glands with Continuous Threading

- True hexagonal shape. The non-circular design has actual flats for gripping power using hand or tool force



Extra-Thick Electro-Plated Zinc Finish

- Ensures corrosion resistance while the clear chromate coating gives the fittings their quality shine and luster

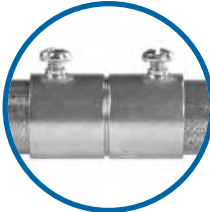

Couplings and Connectors

Superior Quality and Design

- Strict tolerances throughout fitting ensures a straight conduit run with no sagging over extreme lengths
- Chamfered entry provides lead-in for conduit insertion



Dependable Pipe Stop

- 360° groove traveling the circumference ensures that conduit forcefully inserted won't break through to the opposite side of the fitting. Also, it does not exceed thickness of EMT and prevents interference with pulling conductors



Extra-Large Head Tri-Drive Set Screw

- Accommodates Phillips, slotted and square drives

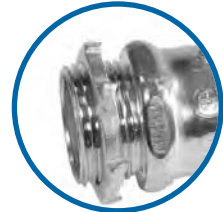

Enhanced Locknut Construction

- Heavy-duty turned sharp teeth, double-threaded



Here's How the Steel City® Part Number System Works

Easy-to-identify alphabetical prefixes:

- BG** – Bushings, Grounding
- BI** – Bushings, Insulated
- BL** – Blanks
- BR** – Rigid Spacer
- BS** – Box Spacer
- BT** – Thinwall Spacer
- BU** – Bushings
- CB** – Clamp Back
- CP** – Cable Protector
- EK** – 3-Piece Coupling
- FA** – Fire Alarm
- GA** – Ground Clamp (Armored Ground Wire)
- GC** – Ground Clamp
- H** – Hub
- HA** – Heavywall Adapter
- HC** – Heavywall Connector
- HK** – Heavywall Coupling
- HL** – Heavywall Elbow
- HO** – Heavywall Offset
- HS** – Heavywall Strap
- LG** – Locknut, Grounding
- LN** – Locknut
- LT** – Liquidtight
- NC** – Non-Metallic Sheathed Cable Connector
- NS** – Non-Metallic Sheathed Cable Strap
- RB** – Reducing Bushings
- RT** – Raintight

- SH** – Service Entrance Fitting
- SL** – Service Ells
- SR** – Sealing Rings
- SS** – Stainless Steel
- LS** – Locknut, Sealing
- TC** – Thinwall Connectors
- TK** – Thinwall Couplings
- TL** – Thinwall Elbow
- TO** – Thinwall Offset
- TS** – Thinwall Strap
- TX** – Thinwall to Flexible Metallic Conduit Fitting
- UC** – Utility Connector
- USA** – Made in USA
- WA** – Washer
- XC** – Armored Cable or Flexible Metallic Conduit Connector
- XK** – Armored Cable or Flexible Metallic Conduit Coupling

1st Digit — Material

- 1** = Steel
- 2** = Die Cast
- 3** = Combination Steel and Die Cast
- 4** = Malleable
- 5** = Plastic
- 6** = Aluminum
- 7** = Steel Insulated
- 8** = Die Cast Insulated
- 9** = Malleable Insulated

2nd Digit — Method

- 1** = Compression
- 2** = Set Screw
- 3** = Other

3rd/4th Digit — Size

- 0** = 3/8"
- 1** = 1/2"
- 2** = 3/4"
- 3** = 1"
- 4** = 1 1/4"
- 5** = 1 1/2"
- 6** = 2"
- 7** = 2 1/2"
- 8** = 3"
- 9** = 3 1/2"
- 10** = 4"
- 11** = 5"
- 12** = 6"

A few examples of the three-digit identification system for thinwall fittings are:

TK-111A: 1/2" steel, compression-type coupling

TC-714A: 1 1/4" steel insulated compression-type connector

TC-822SC: 3/4" die cast, insulated, set-screw type connector



Corporate Office
Tel: 901.252.8000
800.816.7809
Fax: 901.252.1354

Customer Service
Tel: 800.816.7809
Fax: 800.816.7810

Technical Services
Tel: 888.862.3289
Fax: 901.252.1321

Tool Services
Tel: 800.284.8665

Thomas & Betts

www.tnb.com

Set Screw Connectors — Steel

- Concrete tight when taped
- Zinc plated



Non-Insulated



"A" CAT NO.	CONDUIT SIZE (IN.)	INNER PACK	OUTER PACK
TC121A	½	50	500
TC122A	¾	50	250
TC123A	1	25	100
TC124A	1¼	—	25
TC125A	1½	—	25
TC126A	2	—	25
TC127A	2½	—	10
TC128A	3	—	5
TC129A	3½	—	5
TC1210A	4	—	5
TC121A-FA	½	50	500
TC122A-FA	¾	50	250
TC123A-FA	1	25	100

UL File No. E-16592.

FA — Fire Alarm.

Insulated



"A" CAT NO.	CONDUIT SIZE (IN.)	INNER PACK	OUTER PACK
TC-721A	½	50	500
TC722A	¾	50	250
TC-723A	1	25	100
TC724A	1¼	—	25
TC725A	1½	—	25
TC726A	2	—	25
TC727A	2½	—	10
TC728A	3	—	5
TC729A	3½	—	5
TC7210A	4	—	5
TC721A-FA	½	50	500
TC722A-FA	¾	50	250
TC723A-FA	1	25	100

UL File No. E-16592.

FA — Fire Alarm.

Set Screw Couplings — Steel

- Concrete tight when taped
- Zinc plated
- Fire Alarm (FA) painted red for fire alarm identification



"A" CAT NO.	CONDUIT SIZE (IN.)	INNER PACK	OUTER PACK
TK121A	½	50	500
TK122A	¾	50	250
TK123A	1	25	100
TK124A	1¼	—	25
TK125A	1½	—	25
TK126A	2	—	25
TK127A	2½	—	10

UL File No. E-16592.



"A" CAT NO.	CONDUIT SIZE (IN.)	INNER PACK	OUTER PACK
TK128A	3	—	5
TK129A	3½	—	5
TK1210A	4	—	5
TK121A-FA	½	50	500
TK122A-FA	¾	50	250
TK123A-FA	1	25	100

UL File No. E-16592.

Compression Connectors — Steel

- ½"–4" concrete tight
- Zinc plated
- RT — Raintight



Non-Insulated



"A" CAT NO.	CONDUIT SIZE (IN.)	INNER PACK	OUTER PACK
TC111A	½	50	500
TC112A	¾	50	250
TC113A	1	25	100
TC114A*	1¼	—	25
TC115A*	1½	—	25
TC116A*	2	—	25
TC117A	2½	—	10
TC118A	3	—	5
TC119A	3½	—	5
TC1110A	4	—	5
TC111A-RT	½	50	500
TC112A-RT	¾	50	250
TC113A-RT	1	25	100
TC114A-RT*	1¼	—	25
TC115A-RT*	1½	—	25
TC116A-RT*	2	—	25
TC117ART	2½	—	10
TC118ART	3	—	5
TC119ART	3½	—	5
TC1110ART	4	—	5

UL File No. E-16592.

*O-rings are supplied.

Insulated



"A" CAT NO.	CONDUIT SIZE (IN.)	INNER PACK	OUTER PACK
TC711A	½	50	500
TC712A	¾	50	250
TC713A	1	25	100
TC714A	1¼	—	25
TC715A	1½	—	25
TC716A	2	—	25
TC717A	2½	—	10
TC718A	3	—	5
TC719A	3½	—	5
TC7110A	4	—	5
TC711A-RT	½	50	500
TC712A-RT	¾	50	250
TC713A-RT	1	25	100
TC714A-RT*	1¼	—	25
TC715A-RT*	1½	—	25
TC716A-RT*	2	—	25
TC717ART	2½	—	10
TC718ART	3	—	5
TC719ART	3½	—	5
TC7110ART	4	—	5

UL File No. E-16592.

Steel City® Raintight EMT Compression Fittings feature a distinctive design and a vibrant gold gland nut, enabling inspectors to visually inspect conformance from a distance. There's no close-up inspection required!

NOTE: A sealing ring is required when fitting is used outside on the tops and side of enclosure.

Thinwall Conduit Fittings (EMT)



Compression Couplings — Steel

- ½"–4" concrete tight
- Zinc plated
- RT — Raintight



Steel City® Raintight EMT Compression Fittings feature a distinctive design and a vibrant gold gland nut, enabling inspectors to visually inspect conformance from a distance. There's no close-up inspection required!

"A" CAT NO.	CONDUIT SIZE (IN.)	INNER PACK	OUTER PACK
TK111A	½	50	250
TK112A	¾	50	250
TK113A	1	25	100
TK114A	1¼	—	25
TK115A	1½	—	25
TK116A	2	—	25
TK117A	2½	—	10
TK118A	3	—	5
TK119A	3½	—	5
TK1110A	4	—	5

UL File No. E-16592.

"A" CAT NO.	CONDUIT SIZE (IN.)	INNER PACK	OUTER PACK
TK111A-RT	½	50	250
TK112A-RT	¾	50	250
TK113A-RT	1	25	100
TK114A-RT	1¼	—	25
TK115A-RT	1½	—	25
TK116A-RT	2	—	25
TK117A-RT	2½	—	10
TK118A-RT	3	—	5
TK119A-RT	3½	—	5
TK1110A-RT	4	—	5

UL File No. E-16592.

Steel City® Fittings

Combination Compression Couplings — Heavywall to Liquidtight Flexible Metal Conduit — Steel

- Steel
- Raintight
- Zinc plated

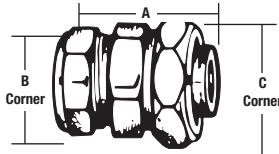

CAT. NO.	CONDUIT SIZE (IN.)	DIMENSIONS (IN.)			STD. CTN.
		A	B	C	
LTH 111	½ Rigid to ½ Liquidtight	1½	1⅞	1⅞	100

Combination Compression Couplings — Thinwall to Liquidtight Flexible Metal Conduit — Steel

- Steel
- Raintight
- Zinc plated

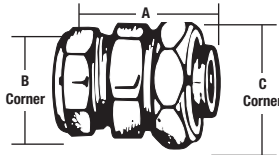

CAT. NO.	CONDUIT SIZE (IN.)	DIMENSIONS (IN.)			STD. CTN.
		A	B	C	
LTT 111	½ EMT to ½ Liquidtight	1¾	1⅞	1⅞	100
LTT-112	¾ EMT to ¾ Liquidtight	1¾	1⅞	1⅞	50
LTT-113	1 EMT to 1 Liquidtight	1⅞	1⅞	1¾	25

EMT LOK Conduit Connector — Steel

- Simple, one-piece installation with no locknuts
- Available in insulated or non-insulated throat
- Screw designed for exceptional pullout resistance
- Captive screw ensures that the screw is intact for installation and resists backing out after installation
- Corrosion-resistant, zinc-chromatic plating
- Positive grounding
- Vibration-resistant screw design
- UL listed and CSA certified

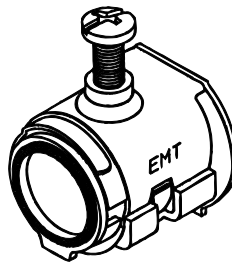

CAT. NO.	DESCRIPTION	STD. CTN.
TC101-SC	½" Uninsulated	500
TC102-SC	¾" Uninsulated	250
TC701-SC	½" Insulated	500
TC702-SC	¾" Insulated	250

UL Listing No. E16592, CSA Listing No. LR-12798.

Installation using either slotted or Phillips screwdriver head, 35-in-lb of torque onto the EMT.

NOTE: Excessive torque could damage EMT or housing.

Compression Connectors — Die Cast Zinc

- ½"-4" concrete tight

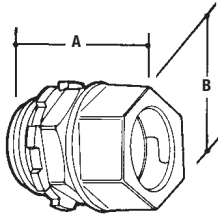

CAT NO.	CONDUIT SIZE (IN.)	DIMENSIONS (IN.)		STD. CTN.
		A	B	
Non-Insulated				
TC-211-SC	½	1¼	1	500
TC-212-SC	¾	1½ ¹ / ₃₂	1½ ¹ / ₃₂	250
TC-213-SC	1	1 ²⁹ / ₆₄	1½ ¹ / ₃₂	200
TC-214-SC	1¼	1¾ ¹ / ₁₆	1 ²⁷ / ₃₂	100
TC-215-SC	1½	1¾	2 ¹ / ₁₆	40
TC-216-SC	2	2 ⁵ / ₃₂	2 ¹⁷ / ₃₂	20
TC-217-SC	2½	2 ⁴⁵ / ₆₄	3¼	12
TC-218-SC	3	2¾	3½ ¹ / ₁₆	12
TC-219-SC	3½	2 ⁴⁷ / ₆₄	4¼ ¹ / ₁₆	10
TC-2110-SC	4	2¾ ¹ / ₁₆	4½ ¹ / ₁₆	6

UL File No. E-16592 — ½"-4".

CSA File No. LR-12798 — ½"-2".

CAT NO.	CONDUIT SIZE (IN.)	DIMENSIONS (IN.)		STD. CTN.
		A	B	
Insulated				
TC-811-SC	½	1 ²³ / ₆₄	6¾ ¹ / ₆₄	500
TC-812-SC	¾	1 ¹⁵ / ₃₂	1½ ¹ / ₁₆	250
TC-813-SC	1	1 ³⁵ / ₆₄	1½ ¹ / ₃₂	200
TC-814-SC	1¼	1 ²⁹ / ₃₂	1 ²⁷ / ₃₂	100
TC-815-SC	1½	1 ³¹ / ₃₂	2 ¹ / ₁₆	40
TC-816-SC	2	2¼	2 ¹⁷ / ₃₂	20
TC-817-SC	2½	2 ²⁵ / ₃₂	3¼	12
TC-818-SC	3	2 ³¹ / ₃₂	3½ ¹ / ₁₆	12
TC-819-SC	3½	2 ²⁷ / ₃₂	4¼ ¹ / ₁₆	10
TC-8110-SC	4	2 ²⁹ / ₃₂	4¾ ¹ / ₁₆	6



Offset Compression Connectors — Die Cast Zinc

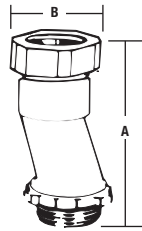

CAT NO.	OFFSET (IN.)	CONDUIT SIZE (IN.)	DIMENSIONS (IN.)		STD. CTN.
			A	B	
TO-211SC	¾	½	2 ¹³ / ₆₄	1	200

UL File No. E-16592.

Compression Couplings — Die Cast Zinc

- ½"-4" concrete tight

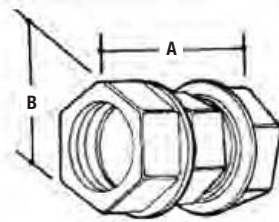

CAT NO.	CONDUIT SIZE (IN.)	DIMENSIONS (IN.)		STD. CTN.
		A	B	
TK-211-SC	½	1½	1½ ¹ / ₃₂	500
TK-212-SC	¾	1¾	1¾ ¹ / ₁₆	250
TK-213-SC	1	1¾	1 ⁴⁵ / ₆₄	200
TK-214-SC	1¼	1¾ ¹ / ₁₆	2 ³ / ₃₂	100
TK-215-SC	1½	2 ² / ₃₂	2 ² / ₆₄	40
TK-216-SC	2	2 ¹¹ / ₃₂	2 ²⁹ / ₃₂	20
TK-217-SC	2½	3 ¹ / ₆₄	3 ¹¹ / ₆₄	12
TK-218-SC	3	3 ³ / ₃₂	4½	12
TK-219-SC	3½	3 ³ / ₆₄	5 ¹ / ₁₆	10
TK-2110-SC	4	3 ¹ / ₁₆	5 ⁴ / ₆₄	6

UL File No. E-16592 — ½"-4".

CSA File No. LR-12798 — ½"-1¼", 2½"-4".

Capped Corner Couplings — Die Cast Zinc

- Concrete tight when taped

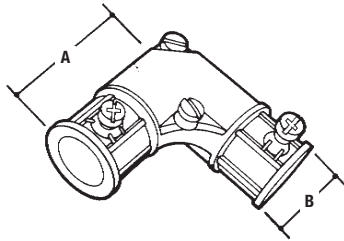

CAT NO.	CONDUIT SIZE (IN.)	DIMENSIONS (IN.)		STD. CTN.
		A	B	
TL-291	½	1.81	1.00	100
TL-292	¾	2.00	1.25	50

UL File No. E-16592.

CSA File No. LR-12798.



Set Screw Connectors — Die Cast Zinc

- Concrete tight when taped

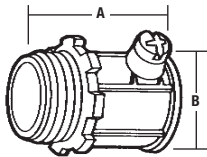

CAT. NO.	CONDUIT SIZE (IN.)	A (IN.)		B (IN.)	STD. CTN.
		TC-221 SERIES	TC-821 SERIES		
Non-Insulated					
TC-221-SC	1/2	1 1/32	1 1/64	1 5/16	500
TC-222-SC	3/4	1 13/32	1 3/64	1 1/2	250
TC-223-SC	1	1 1/16	1 27/32	1 27/64	200
TC-224-SC	1 1/4	1 15/16	2 1/32	1 13/16	100
TC-225-SC	1 1/2	2 9/32	2 3/8	2 3/64	40
TC-226-SC	2	2 33/64	2 39/64	2 17/32	20
TC-227-SC	2 1/2	3 1/16	3 9/32	3 19/64	12
TC-228-SC	3	3 25/64	3 31/64	4 1/16	12
TC-229-SC	3 1/2	3 31/64	3 19/32	4 17/32	10
TC-2210-SC	4	3 47/64	3 53/64	5 1/16	6

UL File No. E-16592 — 1/2"–2".

UL File No. E-23018 — 2 1/2"–4".

CSA File No. LR-12798 — 1/2"–1", 2 1/2"–4".

CAT. NO.	CONDUIT SIZE (IN.)	A (IN.)		B (IN.)	STD. CTN.
		TC-221 SERIES	TC-821 SERIES		
Insulated					
TC-821-SC	1/2	1 1/32	1 1/64	1 5/16	500
TC-822-SC	3/4	1 13/32	1 33/64	1 1/2	250
TC-823-SC	1	1 1/16	1 27/32	1 27/64	200
TC-824-SC	1 1/4	1 15/16	2 1/32	1 13/16	100
TC-825-SC	1 1/2	2 9/32	2 3/8	2 3/64	40
TC-826-SC	2	2 33/64	2 39/64	2 17/32	20
TC-827-SC	2 1/2	3 1/16	3 9/32	3 19/64	12
TC-828-SC	3	3 25/64	3 31/64	4 1/16	12
TC-829-SC	3 1/2	3 31/64	3 19/32	4 17/32	10
TC-8210-SC	4	3 47/64	3 53/64	5 1/16	6

UL File No. E-16592 — 1/2"–2".

UL File No. E-23018 — 2 1/2"–4".

CSA File No. LR 12798 — 1/2"–2".

Set Screw Connectors — Die Cast Zinc, Offset

- Concrete tight when taped

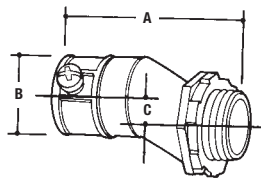

CAT. NO.	OFFSET (IN.)	CONDUIT SIZE (IN.)	DIMENSIONS (IN.)			STD. CTN.
			A	B	C	
TO 221	3/8	1/2	2.00	.90	.37	100
TO 222	3/4	3/4	2.98	1.16	.25	100
TO-223	3/4	1	3.15	1.42	.75	100

UL File No. E-16592.

CSA File No. LR-18130M57.

Set Screw Couplings — Die Cast Zinc

- Concrete tight when taped

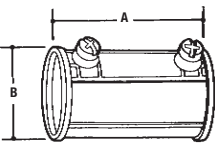

CAT. NO.	CONDUIT SIZE (IN.)	DIMENSIONS (IN.)		STD. CTN.
		A	B	
TK-221	1/2	1 33/64	59/64	500
TK-222	3/4	1 29/32	1 1/2	250
TK-223	1	2	1 1/16	200
TK-224	1 1/4	2 33/64	1 27/32	100
TK-225	1 1/2	2 27/32	2 1/16	40

UL File No. E-16592 — 1/2"–2".

UL File No. E-23018 — 2 1/2"–4".

CSA File No. LR-12798 — 1/2"–1 1/4", 2 1/2"–4".

CAT. NO.	CONDUIT SIZE (IN.)	DIMENSIONS (IN.)		STD. CTN.
		A	B	
TK-226A	2	3 13/32	2 1/2	20
TK-227	2 1/2	4 7/32	3 19/64	12
TK-228	3	4 11/16	4 3/64	12
TK-229	3 1/2	4 27/32	4 17/32	10
TK-2210	4	5 15/32	4 9/16	6

UL File No. E-16592 — 1/2"–2".

UL File No. E-23018 — 2 1/2"–4".

CSA File No. LR-12798 — 1/2"–1 1/4", 2 1/2"–4".

Combination Set Screw Couplings Thinwall to Heavywall — Die Cast Zinc

- Concrete tight when taped

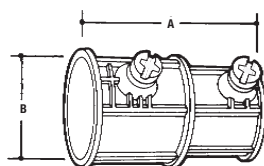

CAT. NO.	CONDUIT SIZE (IN.)	DIMENSIONS (IN.)		STD. CTN.
		A	B	
HT 221	1/2 EMT to 1/2 Rigid	1.67	1.07	500
HT-222	3/4 EMT to 3/4 Rigid	1.98	1.29	250
HT-223	1 EMT to 1 Rigid	2.15	1.58	100

UL File No. E-23018.

Combination Set Screw Couplings

- Concrete tight when taped

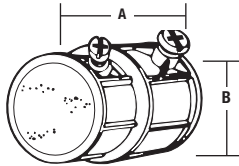

CAT. NO.	CONDUIT SIZE (IN.)	DIMENSIONS (IN.)		STD. CTN.
		A	B	
<i>Die Cast Zinc Flexible Metal Conduit to EMT</i>				
TX-220	¼ Flex to ½ EMT	1 ½	½	500
TX-221	½ Flex to ½ EMT	1 11/16	1 ½	250
TX-222	¾ Flex to ¾ EMT	1 31/32	1 11/32	150
TX-223	1 Flex to NMT	2 7/64	1 ½	150

UL File No. E-23018.

Combination Couplings

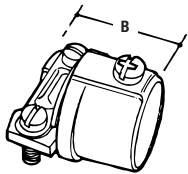

Fig. 1
½"–¾"

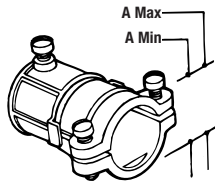
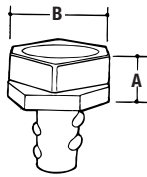

Fig. 2
½"–½" ¾"–¾"



CAT. NO.	TRADE FIG.	SIZE (IN.)	DIMENSIONS (IN.)			STD. CTN.
			A (MIN.)	A (MAX.)	B	
<i>EMT to Flex Set Screw Type — Die Cast Zinc</i>						
TX210	1	½–¾	0.15	0.61	1.16	250
TX211	2	½–½	0.60	1.00	1.71	250
TX-212	2	¾–¾	0.78	1.20	1.93	200

CAT. NO.	TRADE SIZE (IN.)	DIMENSIONS (IN.)		STD. CTN.
		A	B	
<i>EMT to Flex Compression to Screw-In Type — Die Cast Zinc</i>				
TX201	½	0.84	1.10	500
TX-202	¾	0.95	1.30	250

EMT to Box Set Screw Type — Die Cast Zinc

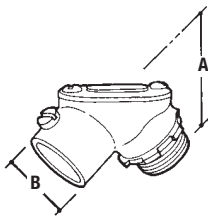

CAT. NO.	CONDUIT SIZE (IN.)	DIMENSIONS (IN.)		STD. CTN.
		A	B	
TL-211	½	1.31	.93	100
TL-212	¾	1.47	1.22	50

UL File No. E-23018.

EMT to EMT Set Screw Type — Die Cast Zinc

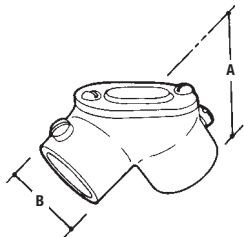

CAT. NO.	CONDUIT SIZE (IN.)	DIMENSIONS (IN.)		STD. CTN.
		A	B	
TL 201	½	1.31	1.10	100
TL-202-SC	¾	1.60	1.24	50
TL-203	1	1.94	1.59	25
TL-204	1 ¼	2.26	1.97	25

UL File No. E-23018.



EMT Connectors — Die Cast Zinc Two-Piece Type

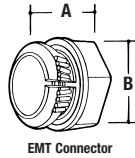

EMT Connector

CAT. NO.	TRADE SIZE (IN.)	DIMENSIONS (IN.)		STD. CTN.
		A	B	
TC-201-SC	1/2	0.68	1.05	1,000

UL File No. E16592.

90° Angle

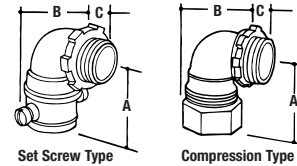

Set Screw Type

Compression Type

CAT. NO.	TRADE TYPE	SIZE (IN.)	DIMENSIONS (IN.)			STD. CTN.
			A	B	C	
TC921	Set Screw Type	1/2	1.27	1.15	.45	200
TC-911-SC	Compression Type	1/2	1.37	1.15	.45	200
TC-912-SC	Compression Type	3/4	1.86	.95	.52	200

One-Hole Snap Straps — Steel

- Steel
- Zinc plated

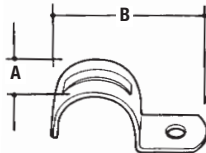

CAT. NO.	CONDUIT SIZE (IN.)	DIMENSIONS (IN.)		STAINLESS STEEL STD. CTN.	REGULAR STD. CTN.
		A	B		
TS 101	1/2	0.57	1.79	25	100
TS-102	3/4	0.62	1.96	25	50
TS-103	1	0.75	2.25	25	50
TS-104	1 1/4	0.88	2.85	10	25
TS-105	1 1/2	0.99	3.16	5	20
TS-106	2	1.10	3.93	5	10
HS-107	2 1/2	1.28	5.00	5	25
HS-108	3	1.28	5.55	5	25
HS-109	3 1/2	1.28	6.37	5	10
HS-110	4	1.28	6.87	5	10

*Add SS suffix to part number for Stainless Steel.

Two-Hole EMT Straps — Steel — Malleable Insulated

- Steel
- Zinc plated

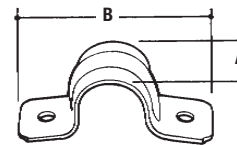

CAT. NO.	CONDUIT SIZE (IN.)	DIMENSIONS (IN.)		STAINLESS STEEL STD. CTN.	REGULAR STD. CTN.
		A	B		
TS-901	1/2	0.56	2.20	25	250
TS-902	3/4	0.62	2.67	25	200
TS-903	1	0.68	2.97	25	100
TS-904	1 1/4	0.75	3.67	10	50
TS-905	1 1/2	0.88	4.22	5	5
TS-906	2	1.00	4.91	5	25

*Add SS suffix to part number for Stainless Steel.

Space Caps — Plastic

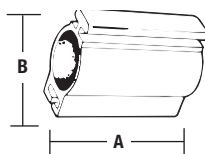

Space Cap

CAT. NO.	CONDUIT SIZE (IN.)	DIMENSIONS (IN.)		STD. CTN.
		A	B	
BT-501	1/2	2 ¹⁵ / ₃₂	1 ³³ / ₆₄	100
BT-502	3/4	2 ¹⁵ / ₃₂	1 ⁴¹ / ₆₄	100
BT-503	1	2 ¹⁵ / ₃₂	1 ³¹ / ₃₂	100
BT-504	1 1/4	2 ¹⁵ / ₃₂	2 ³¹ / ₆₄	100
BT-505	1 1/2	2 ¹⁵ / ₃₂	3 ¹ / ₃₂	100

Nail Straps — Steel

- Stamped steel
- Zinc plated

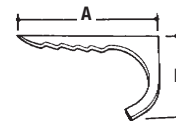

CAT. NO.	RIGID/MC SIZE (IN.)	EMT SIZE (IN.)	FLEX SIZE (IN.)	DIMENSIONS (IN.)		STD. CTN.
				A	B	
N-101-SC	—	1/2	3/8	1 ¹⁵ / ₁₆	1 ⁵ / ₆₄	1,000
N-102-SC	1/2	3/4	1/2	2 ³ / ₁₆	1 ¹⁷ / ₃₂	1,000
N-103-SC	3/4	1	—	2 ⁷ / ₈	1 ¹⁵ / ₃₂	1,000

Rigid/Intermediate Grade Conduit Fittings

Threadless Compression Connectors

- Malleable iron/zinc plated

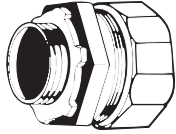

CAT. NO.	CONDUIT (IN.)	STD. CTN.
HC 401	½	300
HC-402	¾	150
HC-403	1	90
HC-404	1¼	60
HC-405	1½	30
HC-406	2	12
HC-407	2½	12
HC-408	3	6
HC-409	3½	6
HC-410	4	6

Suggested use — rigid conduit only.

UL File No. E-23018 ½"–1¼".

Threadless Compression Couplings

- Malleable iron/zinc plated

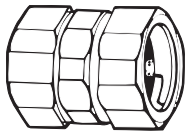

CAT. NO.	CONDUIT (IN.)	STD. CTN.
HK 401	½	300
HK 402	¾	150
HK 403	1	90
HK 404	1¼	60
HK 405	1½	30
HK 406	2	6
HK 407	2½	6
HK 408	3	4
HK 409	3½	4
HK 410	4	4

Suggested use — rigid conduit only.

UL File No. E-23018 ½"–1¼".

Set Screw Connectors

- Steel concrete tight when taped
- Zinc plated



CAT. NO.	CONDUIT SIZE (IN.)	DIMENSIONS (IN.)		STD. CTN.
		A	B	
HC 101	½	1½	1½	100
HC-102	¾	1¾	1½	50
HC-103	1	¾	1½	50
HC-104	1¼	2	2	25
HC-105	1½	2½	2¾	25
HC-106	2	2¾	2¾	20
HC-107	2½	3½	3½	10
HC-108	3	4½	3½	5
HC-109	3½	4¾	3½	5
HC-110	4	5½	4¾	5

One set screw or two. Two set screws starting at 2" trade size.

Suggested use — rigid conduit only.

UL File No. E-23018 ½"–1¼".

Set Screw Couplings

- Steel (concrete tight) when taped
- Zinc plated



CAT. NO.	CONDUIT SIZE (IN.)	DIMENSIONS (IN.)		STD. CTN.
		A	B	
HK-101	½	1½	2½	100
HK-102	¾	1¾	2½	50
HK-103	1	1¾	2½	25
HK-104	1¼	2	2½	25
HK-105	1½	2¼	3¼	25

Two set screws starting at 2".

UL File No. E-23018.

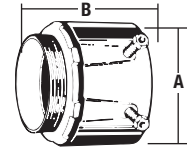

Insulated



CAT. NO.	CONDUIT SIZE (IN.)	DIMENSIONS (IN.)		STD. CTN.
		A	B	
HC 701	½	1½	1½	100
HC-702	¾	1¾	1½	50
HC-703	1	¾	1½	25
HC-704	1¼	2	2	25
HC-705	1½	2½	2¾	25
HC-706	2	2¾	2¾	20
HC-707	2½	3½	3½	10
HC-708	3	4½	3½	5
HC-709	3½	4¾	4¾	5
HC-710	4	4¾	4¾	5

One set screw or two. Two set screws starting at 2" trade size.

Suggested use — rigid conduit only.

UL File No. E-23018 ½"–1¼".

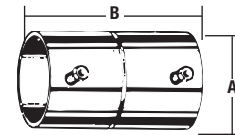

CAT. NO.	CONDUIT SIZE (IN.)	DIMENSIONS (IN.)		STD. CTN.
		A	B	
HK-106	2	2¾	3½	20
HK-107	2½	3½	3½	10
HK-108	3	4¾	4¾	5
HK-109	3½	4¾	4¾	5
HK-110	4	5½	5½	5

Two set screws starting at 2".

UL File No. E-23018.

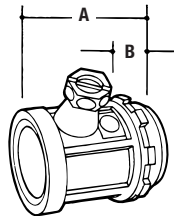

Rigid Connectors — Set Screw Type — Die Cast Zinc

CAT. NO.	TRADE SIZE (IN.)	DIMENSIONS (IN.)		STD. CTN.
		A	B	
HC-203	1	1.54	0.49	100
HC-802	¾	1.44	0.45	250
HC-803	1	1.54	0.49	100

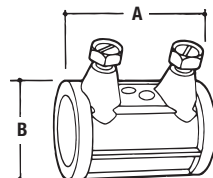

Rigid Couplings — Set Screw Type — Die Cast Zinc

CAT. NO.	TRADE SIZE (IN.)	DIMENSIONS (IN.)		STD. CTN.
		A	B	
HK 201	½	1.77	1.09	250
HK-203	1	2.29	1.61	100



Rigid/Intermediate Grade Conduit Fittings

90° Short Radius Elbows — Die Cast Zinc

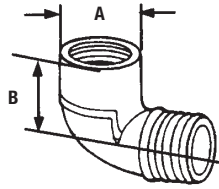

CAT. NO.	SIZE (IN.)	DIMENSIONS (IN.)		SHF. CTF./SHIP QTY.
		A	B	
HL-202-SC	¾	1.17	1.04	25/250

USE: To join rigid or IMC conduit at right angles where lack of room prevents using a standard sweep elbow, or to terminate a run of rigid or IMC conduit at a box.

UL Listing E37148.

Three-Piece Couplings

- ½"–2½" — Steel
- 2½"–6" — Malleable iron
- Zinc plated

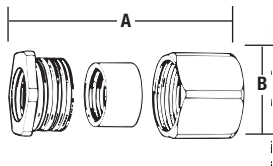

CAT. NO.	CONDUIT SIZE (IN.)	DIMENSIONS (IN.)		STD. CTN.
		A (ASSEMBLED)	B	
EK 401	½	1⅛	1⅞	100
EK 402	¾	1⅞	1⅞	50
EK 403	1	1⅞	1⅞	25
EK 404	1¼	1⅞	2⅞	25
EK 405	1½	1⅞	2⅞	25
EK 406	2	2	3⅞	20
EK 407	2½	2½	3⅞	10
EK 408	3	3⅞	4⅞	6
EK 409	3½	3⅞	5⅞	5
EK 410	4	3⅞	5⅞	5
EK 411	5	4⅞	7	1

UL File No. E-23018 ½"–4".

Rigid Couplings — Three Piece Type — Die Cast Zinc

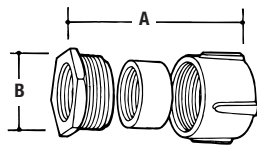

CAT. NO.	TRADE SIZE (IN.)	DIMENSIONS (IN.)		STD. CTN.
		A (ASSEMBLED)	B	
EK 201	½	1.39	1.31	100
EK-202	¾	1.53	1.58	50

The T&B Hub — Zinc Die Cast with Insulated Throat*



H050-SC Series Hub

- The T&B Hub with sealing ring that will not fall out
- Provides superior sealing for exceptional watertight performance
- Color blue is a registered trademark of Thomas & Betts Corporation

CAT. NO.	HUB SIZE (IN.)	STD. CTN.
H050-SC	½	100
H075-SC	¾	100
H100-SC	1	25
H125-SC	1¼	25
H150-SC	1½	10
H200-SC	2	5
H250-SC	2½	5
H300-SC	3	2
H350-SC	3½	2
H400-SC	4	1
H500-SC	5	1
H600-SC	6	1

*Available in nickel-chrome plating or with PVC coating.

Consult customer service for price and delivery.

UL File No. E-23018.

Pull Corner Elbows — Die Cast Zinc

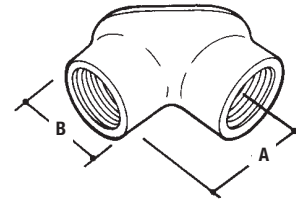

CAT. NO.	CONDUIT SIZE (IN.)	DIMENSIONS (IN.)		STD. CTN.
		A	B	
HL-601	½	1.31	1.10	100
HL-602	¾	1.60	1.24	50
HL-603	1	1.95	1.59	25
HL-604	1¼	2.26	1.97	30

UL File No. E-23018.

Rigid to Box with Gasket — Die Cast Zinc

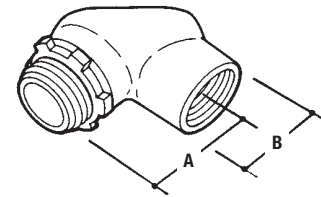

CAT. NO.	CONDUIT SIZE (IN.)	DIMENSIONS (IN.)		STD. CTN.
		A	B	
HL-611	½	1.31	1.09	100
HL-612	¾	1.47	1.29	50

UL File No. E-23018.

Rigid/Intermediate Grade Conduit Fittings

Conduit Nipples Iron/Zinc Plated

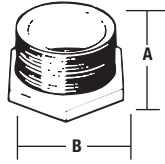

CAT. NO.	CONDUIT SIZE (IN.)	DIMENSIONS (IN.)		STD. CTN.
		A	B	
841-TB	3/8	9/16	1 1/16	500
HA-401	1/2	33/64	1 9/16	500
HA-402	3/4	43/64	1 3/8	200
HA-403	1	7/8	1 1/8	100
HA-404	1 1/4	1 1/8	1 3/4	100
HA-405	1 1/2	1 1/8	2 1/8	50
HA-406	2	1 1/8	2 3/8	50
HA-407	2 1/2	1 1/4	3	20
HA-408	3	1 1/2	3 3/8	10
HA-409	3 1/2	1 3/4	4 3/8	5
HA-410	4	—	—	5

UL File No. E-23018 3/8"-3 1/2".

Conduit Nipples Iron/Zinc Plated — Insulated

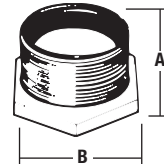

CAT. NO.	CONDUIT SIZE (IN.)	DIMENSIONS (IN.)		STD. CTN.
		A	B	
HA-901	1/2	43/64	1 1/8	500
HA-902	3/4	1 3/16	1 1/2	200
HA-903	1	7/8	1 1/8	100
HA-904	1 1/4	1 1/8	1 3/4	100
HA-905	1 1/2	1 1/8	2 1/8	50
HA-906	2	1 1/8	2 3/8	50

UL File No. E-23018 3/8"-3 1/2".

Offset Nipples Die Cast Zinc

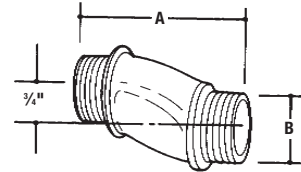

CAT. NO.	CONDUIT SIZE (IN.)	DIMENSIONS (IN.)		STD. CTN.
		A	B	
HO-221	1/2	2.60	1.00	100
HO-222	3/4	2.62	1.32	100
HO-223	1	2.68	1.51	100
HO-224	1 1/4	2.85	1.85	50
HO-225	1 1/2	2.88	2.08	50
HO-226	2	3.19	2.71	20

3/4" offset.

UL File No. E-23018.

Conduit Nipples Die Cast Zinc — 1" Long

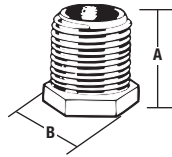

CAT. NO.	CONDUIT SIZE (IN.)	DIMENSIONS (IN.)		STD. CTN.
		A	B	
HA-211	1/2	1	1 1/16	1,000
HA-212	3/4	1	1 9/16	500
HA-213	1	1	1 1/8	250

UL File No. E-23018 1/2" & 3/4" only.

Conduit Nipples Die Cast Zinc — Insulated

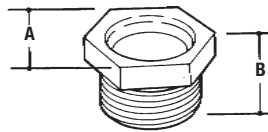

CAT. NO.	CONDUIT SIZE (IN.)	DIMENSIONS (IN.)		STD. CTN.
		A	B	
HA-801	1/2	0.98	0.59	1,000
HA-802	3/4	1.18	0.70	500
HA-803	1	1.50	0.80	250
HA-804	1 1/4	1.75	1.06	250
HA-805	1 1/2	2.11	1.01	100
HA-806	2	2.61	1.20	40
HA-807	2 1/2	3.13	1.49	25
HA-808	3	3.90	1.65	10
HA-809	3 1/2	4.20	1.68	10
HA-810	4	4.79	1.73	10

UL File No. E-23018 1/2" & 3/4" only.

Conduit Nipples Die Cast Zinc — Non-Insulated

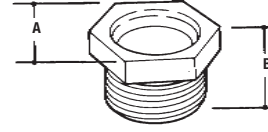

CAT. NO.	CONDUIT SIZE (IN.)	DIMENSIONS (IN.)		STD. CTN.
		A	B	
HA-201	1/2	0.98	0.59	1,000
HA-202	3/4	1.18	0.70	500
HA-203	1	1.50	0.80	250
HA-204	1 1/4	1.75	1.06	250
HA-205	1 1/2	2.11	1.01	100
HA-206	2	2.61	1.20	40
HA-207	2 1/2	3.13	1.49	40
HA-208	3	3.90	1.65	40
HA-209	3 1/2	4.20	1.68	40
HA-210	4	4.79	1.73	20

UL File No. E-23018 1/2"-2".

Rigid/Intermediate Grade Conduit Fittings



Locknuts Steel/Zinc Plated

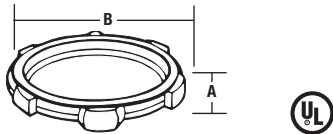

CAT. NO.	CONDUIT SIZE (IN.)	DIMENSIONS (IN.)		STD. CTN.
		A (MIN.)	B (MAX.)	
LN-100-SC	3/8	—	—	1,000
LN-101-SC	1/2	0.125	1.140	1,000
LN-102	3/4	0.140	1.420	1,000
LN-103	1	0.170	1.770	500
LN-104	1 1/4	0.170	2.281	200
LN-105	1 1/2	0.170	2.598	100
LN-106	2	0.187	3.175	50
LN-107	2 1/2	0.375	3.562	30
LN-108	3	0.375	4.250	25
LN-109	3 1/2	0.438	4.803	25
LN-110	4	0.438	5.402	25
LN-111	5	0.500	6.674	10
LN-112	6	0.561	7.934	10

UL File No. E-23018.

Sealing Locknuts Steel/Zinc Plated

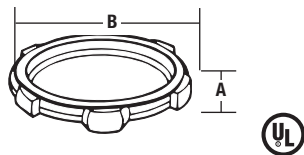

CAT. NO.	CONDUIT SIZE (IN.)	DIMENSIONS (IN.)		STD. CTN.
		A (MIN.)	B (MAX.)	
LS 101	1/2	0.26	1.12	1,000
LS-102	3/4	0.27	1.37	1,000
LS-103	1	0.28	1.75	500
LS-104	1 1/4	0.32	2.06	200
LS-105	1 1/2	0.32	2.37	100
LS-106	2	0.32	2.87	50
LS-107	2 1/2	0.32	3.43	50
LS-108	3	0.32	4.12	50
LS-109	3 1/2	0.32	4.62	50
LS-110	4	0.32	5.18	25

UL File No. E-23018.

Locknuts Non-Metallic

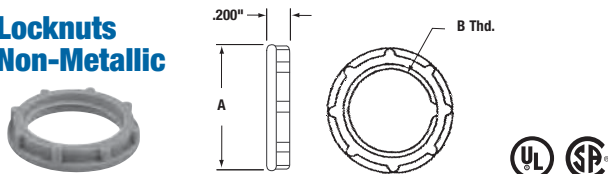

CAT. NO.	TRADE SIZE (IN.)	A DIA. (IN.)	B THD. (IN.)	STD. CTN.
LN-501	1/2	1.3	1/2-14	100
LN-502	3/4	1.4	3/4-14	100
LN-503	1	1.7	1-11 1/2	50

Material: Nylon 6/6.

Color: Gray.

Locknuts Die Cast Zinc

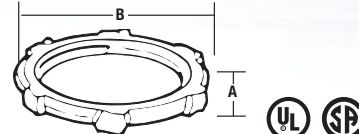

CAT. NO.	CONDUIT SIZE (IN.)	DIMENSIONS (IN.)		STD. CTN.
		A (MIN.)	B (MAX.)	
LN-201	1/2	0.125	1.140	2,000
LN-202	3/4	0.140	1.420	1,000
LN-203	1	0.170	1.770	1,000
LN-204	1 1/4	0.170	2.281	500
LN-205	1 1/2	0.170	2.598	500
LN-206	2	0.187	3.175	200
LN-207	2 1/2	0.375	3.562	100
LN-208	3	0.375	4.250	100
LN-209	3 1/2	0.438	4.803	40
LN-210	4	0.438	5.402	40

CSA File No. LR-12798.

UL File No. E-23018.

Grounding Locknuts Malleable — Iron/Zinc Plated

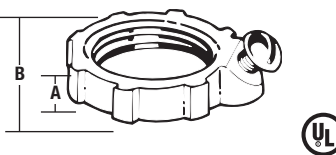

CAT. NO.	CONDUIT SIZE (IN.)	DIMENSIONS (IN.)		STD. CTN.
		A (MIN.)	B (MAX.)	
LG-401	1/2	0.125	1.140	100
LG-402	3/4	0.140	1.420	100
LG-403	1	0.170	1.770	50
LG-404	1 1/4	0.170	2.281	50
LG-405	1 1/2	0.170	2.598	50
LG-406	2	0.187	3.175	25
LG-407	2 1/2	0.375	3.562	10
LG-408	3	0.375	4.250	10
LG-409	3 1/2	0.438	4.803	50
LG 410	4	0.438	5.402	5

UL File No. E-23018.

Thin Construction Locknuts — Steel/Zinc Plated

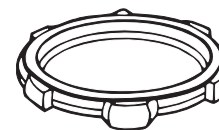

CAT. NO.	CONDUIT SIZE (IN.)	UNIT QTY.	STD. CTN.
SPLN-107	2 1/2	30	30
SPLN-108	3	25	25
SPLN-109	3 1/2	25	25
SPLN-110	4	25	25

Not UL Listed.

Rigid/Intermediate Grade Conduit Fittings

Conduit Bushings Die Cast Zinc — Insulated Metallic

- 105°C thermoplastic liners
- Heavy reinforced ribs

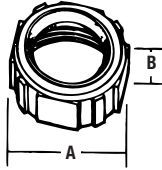

CAT. NO.	CONDUIT SIZE (IN.)	DIMENSIONS (IN.)		STD. CTN.
		A	B	
BU-801	½	1.06	0.43	1,000
BU-802	¾	1.31	0.43	1,000
BU-803	1	1.59	0.48	500
BU-804	1¼	1.96	0.56	250
BU-805	1½	2.18	0.60	250

UL File No. E-23018.

CAT. NO.	CONDUIT SIZE (IN.)	DIMENSIONS (IN.)		STD. CTN.
		A	B	
BU-806	2	2.68	0.56	250
BU-807	2½	3.25	0.90	50
BU-808	3	3.87	0.85	25
BU-809	3½	4.37	0.93	25
BU-810	4	5.00	0.93	10

UL File No. E-23018.

Conduit Bushings Die Cast Zinc — Heavy Reinforced Ribs

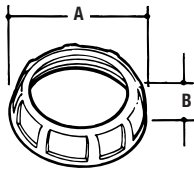

CAT. NO.	CONDUIT SIZE (IN.)	DIMENSIONS (IN.)		STD. CTN.
		A (MIN.)	B (MAX.)	
BU201	½	1.05	0.37	1,000
BU-202	¾	1.32	0.37	1,000
BU-203	1	1.58	0.47	500
BU-204	1¼	1.94	0.50	250
BU-205	1½	2.20	0.52	250

UL File No. E-23018.

CAT. NO.	CONDUIT SIZE (IN.)	DIMENSIONS (IN.)		STD. CTN.
		A (MIN.)	B (MAX.)	
BU-206	2	2.69	0.52	250
BU-207	2½	3.23	0.85	50
BU-208	3	3.84	0.85	25
BU-209	3½	4.35	0.85	25
BU-210	4	5.02	0.85	10

UL File No. E-23018.

Insulated Bushings — Thermoplastic

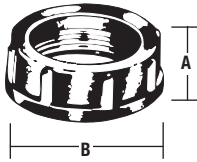

CAT. NO.	CONDUIT SIZE (IN.)	DIMENSIONS (IN.)		STD. CTN.
		A	B	
BU-501	½	1 ³ / ₃₂	1 ¹ / ₁₆	400
BU-502	¾	1 ¹ / ₃₂	1 ³ / ₁₆	400
BU-503	1	1 ⁹ / ₁₆	1 ¹ / ₁₆	200
BU-504	1¼	1 ⁹ / ₁₆	1 ² / ₃₂	100
BU-505	1½	1 ⁹ / ₁₆	2 ³ / ₁₆	100
BU-506	2	2 ⁷ / ₁₆	2 ¹ / ₁₆	60

UL File No. E-23018 ½"–4" only.
Rated 105° C.

CAT. NO.	CONDUIT SIZE (IN.)	DIMENSIONS (IN.)		STD. CTN.
		A	B	
BU-507	2½	2 ²³ / ₃₂	3 ³ / ₁₆	20
BU-508	3	3 ⁹ / ₁₆	3 ² / ₃₂	20
BU-509	3½	3 ³ / ₄	4 ²³ / ₆₄	5
BU-510	4	4 ²⁵ / ₃₂	4 ² / ₃₂	5
BU-511	5	1	6 ⁵ / ₁₆	5
BU-512	6	1	7 ¹ / ₁₆	5

UL File No. E-23018 ½"–4" only.
Rated 105° C.

Bushings — Iron/Zinc Plated

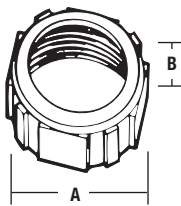

CAT. NO.	CONDUIT SIZE (IN.)	DIMENSIONS (IN.)		STD. CTN.
		A	B	
BU-401	½	1 ¹ / ₃₂	7 ¹ / ₁₆	1,000
BU-402	¾	1¼	7 ¹ / ₁₆	1,000
BU-403	1	1 ¹ / ₁₆	7 ¹ / ₂	500
BU-404	1¼	1 ¹ / ₁₆	1 ⁷ / ₃₂	200
BU-405	1½	2 ¹³ / ₆₄	9 ¹ / ₁₆	100
BU-406	2	2 ⁴ / ₆₄	9 ¹ / ₁₆	50

UL File No. E-23018.

CAT. NO.	CONDUIT SIZE (IN.)	DIMENSIONS (IN.)		STD. CTN.
		A	B	
BU-407	2½	3 ³ / ₁₆	1 ¹ / ₃₂	30
BU-408	3	3 ³ / ₁₆	2 ²⁵ / ₃₂	25
BU-409	3½	4 ¹ / ₁₆	2 ⁷ / ₃₂	25
BU-410	4	4 ² / ₃₂	1 ⁵ / ₁₆	25
BU-411	5	4 ² / ₃₂	1 ⁵ / ₁₆	10

UL File No. E-23018.

Grounding Bushings Die Cast Zinc — Insulated Metallic With Aluminum Lay-in Type Lug

- 105° C thermoplastic liners
- Heavy reinforced ribs

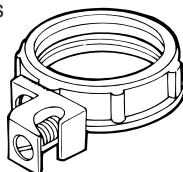

CAT. NO.	TRADE SIZE (IN.)	GROUNDING LUG WIRE SIZE		STD. CTN.
		MIN.	MAX.	
BG201	½	14	4	500
BG-202	¾	14	4	500
BG-203	1	14	4	250
BG-204A	1¼	14	4	200
BG-204	1¼	8	1/0	200
BG-205A	1½	11	4	100
BG-205	1½	8	1/0	50
BG-206A	1	14	4	100
BG-206	2	8	1/0	50

UL File No. E-3060.

CAT. NO.	TRADE SIZE (IN.)	GROUNDING LUG WIRE SIZE		STD. CTN.
		MIN.	MAX.	
BG-207	2½	8	1/0	50
BG-207A	2½	6	250 kcmil	50
BG-208	3	8	1/0	50
BG-208A	3	6	250 kcmil	50
BG-209	3½	8	1/0	10
BG-209A	3½	6	250 kcmil	10
BG-210	4	8	1/0	10
BG-210A	4	6	250 kcmil	10

UL File No. E-3060.

Rigid/Intermediate Grade Conduit Fittings



Insulated Bushings — Iron/Zinc Plated

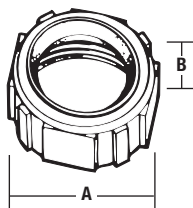

CAT. NO.	CONDUIT SIZE (IN.)	DIMENSIONS (IN.)		STD. CTN.
		A	B	
BI 901	½	1½ ₃₂	½	1,000
BI-902	¾	1¼	½	1,000
BI-903	1	1½ ₁₆	¾ ₁₆	500
BI-904	1¼	1½ ₁₆	1 ⁹ / ₃₂	200
BI-905	1½	2 ¹³ / ₆₄	¾	100

UL File No. E-23018.

CAT. NO.	CONDUIT SIZE (IN.)	DIMENSIONS (IN.)		STD. CTN.
		A	B	
BI-906	2	2 ⁴⁵ / ₆₄	¾	50
BI-907	2½	3 ⁷ / ₃₂	¾ ₁₆	30
BI-908	3	3 ²⁷ / ₃₂	¾ ₁₆	25
BI-909	3½	4 ⁷ / ₁₆	¾	25
BI910	4	4 ³¹ / ₃₂	2 ⁹ / ₃₂	25

UL File No. E-23018.

Insulated Grounding Bushings — Malleable Iron/Zinc Plated

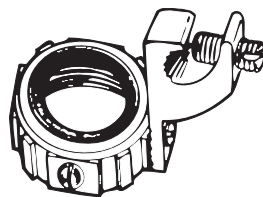

CAT. NO.	CONDUIT SIZE (IN.)	GROUNDING LUG WIRE CAPACITY	DIMENSIONS (IN.)		STD. CTN.
			A	B	
BG-801	½	—	1½ ₃₂	½	500
BG-802	¾	#14-#4 CU	1¼	½	500
BG-803	1	or	1½ ₁₆	¾ ₁₆	250
BG-804	1¼	#12-#4 AL	1½ ₁₆	1 ⁹ / ₃₂	150
BG-805	1½	—	2 ¹³ / ₆₄	¾	150

UL File No. E-3060.

½"-2" Iron, 2¼"-4" Die Cast Zinc.

CAT. NO.	CONDUIT SIZE (IN.)	GROUNDING LUG WIRE CAPACITY	DIMENSIONS (IN.)		STD. CTN.
			A	B	
BG-806	2	—	2 ⁴⁵ / ₆₄	¾	100
BG-807	2½	#14-1/0 CU	3 ⁷ / ₁₆	¾ ₁₆	60
BG-808	3	or #12-1/0 AL	3 ⁷ / ₁₆	¾ ₁₆	30
BG-809	3½	#6-250 kcmil	4 ⁷ / ₁₆	¾	30
BG-810	4	CU or AL	4 ²¹ / ₃₂	2 ⁹ / ₃₂	30

UL File No. E-3060.

½"-2" Iron, 2¼"-4" Die Cast Zinc.

Grounding Bushings Malleable Iron/Zinc Plated — Insulated With Aluminum Lug

- For copper or aluminum bare ground wire
- 105°C thermoplastic liners
- Heavy reinforced ribs

CAT. NO.	TRADE SIZE (IN.)	GROUNDING LUG WIRE SIZE		STD. CTN.
		MIN.	MAX.	
BG801A	½	14	6	500
BG-802A	¾	14	6	500
BG-803A	1	14	6	250
BG-804A	1¼	14	2	200
BG-805A	1½	14	2	100
BG-806A	2	14	2	100

UL File No. E-3060.

CAT. NO.	TRADE SIZE (IN.)	GROUNDING LUG WIRE SIZE		STD. CTN.
		MIN.	MAX.	
BG-807A	2½	14	2/0	50
BG-808A	3	14	2/0	50
BG-809A	3½	14	2/0	10
BG-810A	4	14	2/0	10
BG-810B	4	6	250 kcmil	10

UL File No. E-3060.

Reducing Bushings

- RB-121 thru RB-165 — Steel
- RB-175 thru RB-187 — Malleable iron (concrete tight), zinc plated

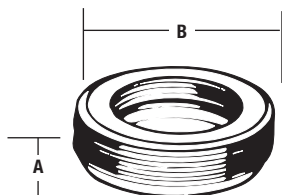

CAT. NO.	CONDUIT SIZE (IN.)	DIMENSIONS (IN.)		STD. CTN.
		A	B	
RB 121	¾-½	¾ ₁₆	¾	100
RB-131	1-½	¾	1½	50
RB-132	1-¾	¾	1½	50
RB-141	1¼-½	1 ¹ / ₁₆	1 ⁷ / ₁₆	50
RB 142	1¼-¾	1 ¹ / ₁₆	1 ⁷ / ₁₆	50
RB-143	1¼-1	1 ¹ / ₁₆	1 ⁷ / ₁₆	50
RB-151	1½-½	2 ⁹ / ₃₂	1 ¹¹ / ₁₆	50
RB-152	1½-¾	2 ⁹ / ₃₂	1 ¹¹ / ₁₆	50
RB-153	1½-1	2 ⁹ / ₃₂	1 ¹¹ / ₁₆	50
RB-154	1½-1¼	2 ⁹ / ₃₂	1 ¹¹ / ₁₆	50

UL File No. E-23018.

CAT. NO.	CONDUIT SIZE (IN.)	DIMENSIONS (IN.)		STD. CTN.
		A	B	
RB-161	2-½	2 ⁷ / ₃₂	2 ³ / ₃₂	25
RB-162	2-¾	2 ⁷ / ₃₂	2 ³ / ₃₂	25
RB-163	2-1	2 ⁷ / ₃₂	2 ³ / ₃₂	25
RB-164	2-1¼	2 ⁷ / ₃₂	2 ³ / ₃₂	25
RB-165	2-1½	2 ⁷ / ₃₂	2 ³ / ₃₂	25
RB-175	2½-1½	¾	2 ⁹ / ₁₆	25
RB-176	2½-2	¾	2 ⁹ / ₁₆	25
RB-186	3-2	2 ⁹ / ₃₂	2 ⁷ / ₁₆	25
RB-187	3-2½	2 ⁹ / ₃₂	2 ⁷ / ₁₆	25

UL File No. E-23018.

Corporate Office
Tel: 901.252.8000
800.816.7809
Fax: 901.252.1354

Customer Service
Tel: 800.816.7809
Fax: 800.816.7810

Technical Services
Tel: 888.862.3289
Fax: 901.252.1321

Tool Services
Tel: 800.284.8665

Thomas & Betts

www.tnb.com

Rigid/Intermediate Grade Conduit Fittings

Reducers — Malleable Iron/ Zinc Plated

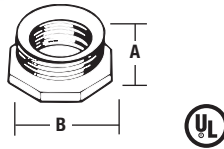

CAT. NO.	CONDUIT SIZE (IN.)	DIMENSIONS (IN.)		STD. CTN.
		A	B	
RB-421	3/4-1/2	5/8	1 1/16	100
RB-432	1/2-3/4	1	1 1/16	100
RB-443	1-3/4	1 1/16	1 1/16	50

UL File No. E-23018.

Reducing Washers — Steel/Zinc Plated

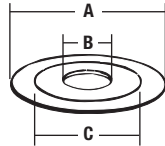

CAT. NO.	CONDUIT SIZE (IN.)	DIAMETER (IN.)			STD. CTN.
		A	B	C	
WA-110	1/2-3/8	1 1/16	1 1/16	2 1/32	500
WA-121	3/4-1/2	1 1/2	7/8	1 1/16	500
WA-131	1-1/2	1 3/4	7/8	1 5/16	500
WA-132	1-3/4	1 3/4	1 3/32	1 5/16	500
WA-141	1 1/4-1/2	2 3/16	7/8	1 11/16	200
WA-142	1 1/4-3/4	2 3/16	1 3/32	1 11/16	200
WA-143	1 1/4-1	2 3/16	1 23/64	1 11/16	200
WA-151	1 1/2-1/2	2 5/8	7/8	1 7/8	200
WA-152	1 1/2-3/4	2 5/8	1 3/32	1 7/8	200
WA-153	1 1/2-1	2 5/8	1 23/64	1 7/8	200
WA-154	1 1/2-1 1/4	2 5/8	1 23/32	1 7/8	200
WA-161	2-1/2	3 1/4	7/8	2 3/8	100
WA-162	2-3/4"	3 1/4	1 3/32	2 3/8	100
WA-163	2-1	3 1/4	1 23/64	2 3/8	100
WA-164	2-1 1/4	3 1/4	1 23/32	2 3/8	100
WA-165	2-1 1/2	3 1/4	1 23/32	2 3/8	100
WA-171	2 1/2-1/2	3 1/4	7/8	2 3/8	100
WA-172	2 1/2-3/4	3 1/4	1 3/32	2 3/8	100
WA-173	2 1/2-1	3 1/4	1 23/64	2 3/8	100
WA-174	2 1/2-1 1/4	3 1/4	1 23/32	2 3/8	100
WA-175	2 1/2-1 1/2	3 1/4	1 31/32	2 3/8	100
WA-176	2 1/2-2	3 1/4	2 1/16	2 3/8	100
WA-181	3-1/2	4 1/2	7/8	3 1/2	100
WA-182	3-3/4	4 1/2	1 23/32	3 1/2	100
WA-183	3-1	4 1/2	1 23/64	3 1/2	100
WA-184	3-1 1/4	4 1/2	1 23/32	3 1/2	100
WA-185	3-1 1/2	4 1/2	1 31/32	3 1/2	100
WA-186	3-2	4 1/2	2 1/16	3 1/2	100
WA-187	3-2 1/2	4 1/2	2 5/16	3 1/2	100

WA-121 thru WA-165 CSA Listed.

One-Hole Straps — Steel/Zinc Plated

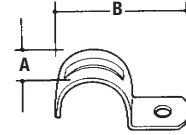

CAT. NO.	SCREW SIZE	CONDUIT SIZE (IN.)	DIMENSIONS (IN.)		STD. CTN.
			A	B	
HS-100-SC	10	3/8	3/4	1 47/64	1,000
HS-101	1/4	1/2	1	1 15/16	500
HS-102	1/4	3/4	1	2 5/64	500
HS-103	1/4	1	1	2 13/32	250
HS-104	3/16	1 1/4	1	3 3/32	100
HS-105	3/8	1 1/2	1 3/16	3 13/32	100
HS-106	3/8	2	1 3/16	3 27/32	100
HS-107	7/16	2 1/2	1 1/4	5 1/16	25
HS-108	1/2	3	1 3/8	5 7/8	25
HS-109	1/2	3 1/2	1 3/8	6 1/4	10
HS-110	1/2	4	1 3/8	6 7/8	10

Available in one-hole and two-hole in stainless steel.
Add SS suffix to part number for Stainless Steel.

Two-Hole Straps — Steel/Zinc Plated

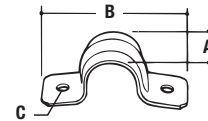

CAT. NO.	SCREW SIZE	CONDUIT SIZE (IN.)	DIMENSIONS (IN.)			STD. CTN.
			A	B	C	
HS-901	8	1/2	3/4	2 1/16	3/16	1,200
HS-902	10	3/4	3/4	2 11/16	3/16	900
HS-903	1/4	1	3/4	3 1/16	3/16	600
HS-904	1/4	1 1/4	3/4	3 27/32	3/16	450
HS-905	1/4	1 1/2	3/4	4 1/16	3/16	50
HS-906	1/4	2	3/4	4 1/16	3/16	150
HS-907	1/4	2 1/2	1	5 5/8	1/4	150
HS-908	1/2	3	1	6 3/16	1/4	60
HS-909	1/4	3 1/2	1	7 7/16	1/4	60
HS-910	1/4	4	1	8 11/16	1/4	60

CSA Certified.

Add SS suffix to part number for Stainless Steel.

Rigid/Intermediate Grade Conduit Fittings

Pipe Straps — Malleable Iron/ Zinc Plated

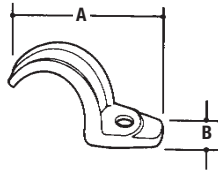

CAT. NO.	SCREW SIZE	CONDUIT SIZE (IN.)	DIMENSIONS (IN.)		STD. CTN.
			A	B	
HS-400	10	3/8	1 1/16	1/32	500
HS-401	1/4	1/2	2 3/4	3/8	500
HS-402	1/4	3/4	2 1/8	13/16	500
HS-403	1/4	1	2 1/8	15/16	100
HS-404-SC	5/16	1 1/4	3 5/8	1 1/32	100
HS-405	3/8	1 1/2	3 3/4	1 1/8	50
HS-406	1/2	2	4 13/32	1 1/16	25
HS-407	5/8	2 1/2	5 1/16	1 1/8	25
HS-408	5/8	3	6 1/8	1 1/8	25
HS-409	5/8	3 1/2	7 23/32	2 1/8	10
HS-410	5/8	4	8 1/8	2 3/8	10
HS-411	5/8	5	10 3/32	2 5/8	5

Available in one-hole and two-hole in Stainless Steel.

Add SS suffix to part number for Stainless Steel.

Nail Strap — Stamped Steel/ Zinc Plated

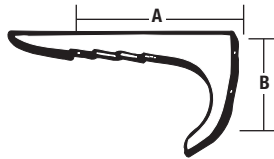

CAT. NO.	RIGID/MC SIZE (IN.)	EMT SIZE (IN.)	FLEX SIZE (IN.)	DIMENSIONS (IN.)		STD. CTN.
				A	B	
N-101-SC	—	1/2	3/8	2 5/32	1 5/64	1,000
N-102-SC	1/2	3/4	1/2	2 5/16	1 1/32	1,000
N-103-SC	3/4	1	—	2 5/8	1 15/32	1,000

Flange Plates — Malleable Iron/Zinc Plated

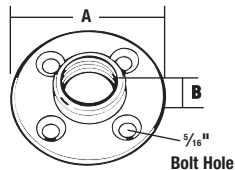

CAT. NO.	CONDUIT SIZE (IN.)	DIA. A (IN.)	DEPTH B (IN.)	STD. CTN.
FP 401	1/2	3	.625	50
FP-402	3/4	3 3/8	.656	50
FP-403	1	3 3/4	.765	50
FP-404	1 1/4	4	.875	25
FP-405	1 1/2	4 3/8	.937	25
FP-406	2	4 3/4	.843	25

Pipe Spacers for Rigid/Intermediate or Thinwall — Die Cast Zinc

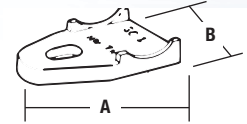

CAT. NO.	CONDUIT SIZE (IN.)	DIMENSIONS (IN.)		STD. CTN.
		A	B	
CB-201	1/2	2	1	1,000
CB-202	3/4	2 3/8	1 1/16	500
CB-203	1	2 3/4	1 1/16	500
CB-204	1 1/4	3 3/8	1 1/2	250
CB-205	1 1/2	3 13/16	1 5/8	100
CB-206	2	4 1/2	2	50

Rigid/Intermediate Space Caps — Plastic

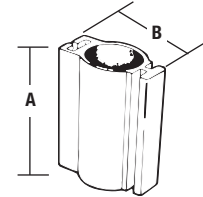

CAT. NO.	CONDUIT SIZE (IN.)	DIMENSIONS (IN.)		STD. CTN.
		A	B	
BR-501	1/2	2 15/32	1 21/32	100
BR-502	3/4	2 15/32	1 55/64	100
BR-503	1	2 15/32	2 1/8	100
BR-504	1 1/4	2 15/32	2 61/64	100
BR-505	1 1/2	2 15/32	3 3/64	100

Snap-in Blanks

- Steel
- Zinc plated



CAT. NO.	CONDUIT SIZE (IN.)	DIAMETER (IN.)	STD. CTN.
BL-111	1/2	1 1/4	1,000
BL-112	3/4	1 1/4	1,000
BL-113	1	1 1/2	1,000
BL-114	1 1/4	1 13/16	500
BL-115	1 1/2	2 1/32	500
BL-116	2	2 11/16	250

Box Spacer — Die Cast Zinc (1/4" Space)

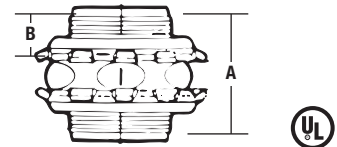

CAT. NO.	CONDUIT SIZE (IN.)	DIMENSIONS (IN.)		STD. CTN.
		A	B	
BS 201	1/2	1 1/8	1 3/32	500

UL File No. E-23018.

BLACK BEAUTY® Non-Metallic Liquidtight Strain Relief Connectors



- Installs on cord by hand
- Achieves maximum pullout strength without installation tools
- Each hub size takes a range of cord diameters
- Non-metallic construction provides corrosion resistance
- Weather-stabilized nylon rated at -34°C to 105°C

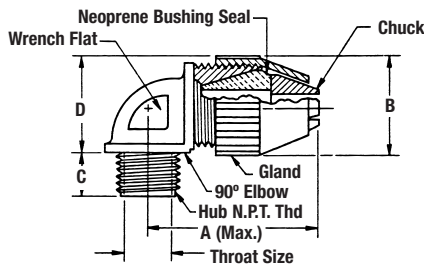
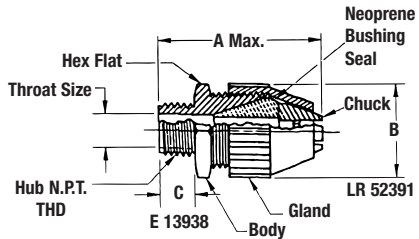

Straight



CAT. NO.	TRADE OR HUB SIZE (IN.)	CORD RANGE	THROAT SIZE ± .03	HEX FLAT ± .06	DIMENSIONS (IN.)			STD. CTN.
					A MAX.	B ± .06	C ± .06	
2671 †	3/8	.125-.275	0.33	.78	2.0	.90	.46	250
2690 †	1/2	.125-.275	0.33	1.00	2.3	.90	.60	100
2672	1/2	.250-.400	0.55	1.08	2.6	1.27	.60	100
2673*	1/2	.400-.560	0.55	1.08	2.6	1.27	.60	100
2691*	1/2	.560-.690	0.54	1.32	3.0	1.57	.60	100
2692*	1/2	.660-.780	0.54	1.32	3.0	1.57	.60	100
2693	3/4	.250-.400	0.55	1.22	2.7	1.27	.62	100
2694*	3/4	.400-.560	0.55	1.22	2.7	1.27	.62	100
2674	3/4	.560-.690	0.79	1.34	3.0	1.57	.62	100
2675	3/4	.660-.780	0.79	1.34	3.0	1.57	.62	100
2696*	3/4	.770-.895	0.76	1.64	3.2	1.89	.62	100
2676	1	.660-.780	0.98	1.60	3.3	1.89	.77	100
2677	1	.770-.895	0.98	1.60	3.3	1.89	.77	100
2678	1	.870-1.020	0.98	1.60	3.3	1.89	.77	50
2699	1	.890-1.090	0.98	2.25	4.2	2.58	.77	10
2702	1 1/4	.890-1.090	1.25	2.25	4.2	2.58	.80	10
2703*	1 1/4	1.080-1.280	1.25	2.25	4.0	2.58	.80	10
2704*	1 1/4	1.270-1.470	1.25	2.25	4.0	2.58	.80	10
2705-TB	1 1/4	.890-1.150	1.47	2.65	4.2	2.95	.82	10
2706	1 1/4	1.140-1.400	1.47	2.65	4.3	2.95	.82	10
2707*	1 1/4	1.390-1.650	1.47	2.65	4.3	2.95	.82	10
2708	2	1.190-1.530	1.89	3.13	5.1	3.50	.84	5
2709	2	1.520-1.860	1.89	3.13	4.9	3.50	.84	5
2710*	2	1.850-2.190	1.89	3.13	4.9	3.50	.84	5

*Remove sufficient outer covering of cable to permit conductors to pass through connector body.

†CSA certified for factory installation.

Material: Weather-stabilized nylon, rated at -34°C to 105°C.

For 90° style see AS-72555.

90° Angle



CAT. NO.	TRADE OR HUB SIZE (IN.)	CORD RANGE	THROAT SIZE	HEX FLAT	DIMENSIONS (IN.)				STD. CTN.
					A	B	C	D	
2680 †	3/8	.125-.275	.33	.62	1.8	.90	.46	1.00	100
2681	1/2	.250-.400	.55	.83	2.5	1.27	.60	1.35	50
2682*	1/2	.400-.560	.55	.83	2.5	1.27	.60	1.35	50
2683	3/4	.560-.690	.78	1.06	2.8	1.57	.62	1.60	50
2684	3/4	.660-.780	.78	1.06	2.8	1.57	.62	1.60	50
2688	1	.560-.690	1.00	1.280	3.0	1.89	.77	1.90	25
2685	1	.660-.780	1.00	1.280	3.0	1.89	.77	1.90	25
2686	1	.770-.895	1.00	1.280	3.0	1.89	.77	1.90	25
2687*	1	.870-1.020	1.00	1.280	3.0	1.89	.77	1.90	25

*Remove sufficient outer covering of cable to permit conductors to pass through connector body.

†CSA certified for factory installation.



Liquidtight Flexible Metal Conduit and Connectors

Steel City® Fittings



Liquidtight Flex for Type B Non-Metallic Conduit

Standard Material/Finish:

- Body/Gland — Nylon-Gray
- O-Ring — Nitrate (Black)
- Locknut — Nylon
- Temp. Rating — 80°C
- Material Flammability Rating: UL94-V2

Listed/Certified by:

- UL Listed (File # E23018)
- CSA Certified (File # LR52391)
- Conforms to watertight requirements for Type 4



Straight

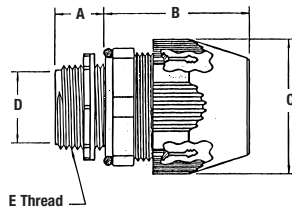

CAT. NO.	TRADE SIZE (IN.)	A5 .015 (0.40) IN. (MM)	B 5.35 (0.90) IN. (MM)	C 5.015 (0.40) ACROSS CORNERS IN. (MM)	MIN. THROAT DIA. D. IN. (MM)	E THREAD NPT.	F INCH (MM) APPROX.	STD. CTN.
LT-500	¾	.570	1.595 (40.51)	1.354	.417	½-14	1.880 (47.75)	100
LT-501	½	.570	1.636 (41.55)	1.448	.550	½-14	1.986 (50.44)	100
LT-502	¾	.582	1.757 (44.63)	1.740	.740	¾-14	2.212 (56.18)	50
LT-503	1	.726	1.923 (48.84)	2.068	.940	1½	2.508 (63.70)	50

90° Angle

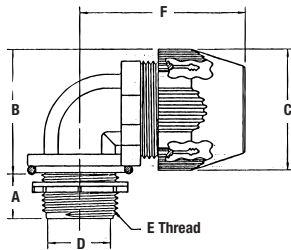

CAT. NO.	TRADE SIZE (IN.)	A5 .015 (0.40) IN. (MM)	B 5.35 (0.90) IN. (MM)	C 5.015 (0.40) ACROSS CORNERS IN. (MM)	MIN. THROAT DIA. D. IN. (MM)	E THREAD NPT.	F INCH (MM) APPROX.	STD. CTN.
LT-590	¾	(14.48)	1.380 (35.05)	(34.39)	(10.59)	½-14	1.880 (47.75)	50
LT-591	½	(14.48)	1.489 (37.82)	(36.78)	(13.97)	½-14	1.986 (50.44)	50
LT-592	¾	(14.78)	1.790 (45.47)	(44.20)	(18.80)	¾-14	2.212 (56.18)	50
LT-593	1	(18.44)	2.104 (53.44)	(52.53)	(23.88)	1½	2.508 (63.70)	25

45° Angle

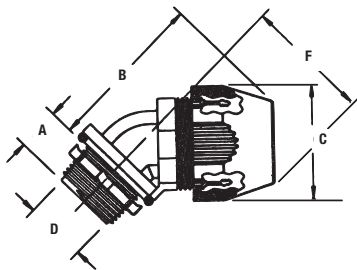

CAT. NO.	TRADE SIZE (IN.)	A5 .015 (0.40) IN. (MM)	B 5.35 (0.90) IN. (MM)	C 5.015 (0.40) ACROSS CORNERS IN. (MM)	MIN. THROAT DIA. D. IN. (MM)	E THREAD NPT.	F IN. (MM) APPROX.	STD. CTN.
LT-540	¾	(14.48)	2.012 (51.10)	(34.39)	(10.59)	½-14	1.534 (38.95)	50
LT-541	½	(14.48)	2.092 (53.14)	(36.78)	(13.97)	½-14	1.590 (40.39)	50
LT-542	¾	(14.78)	2.452 (62.28)	(44.20)	(18.80)	¾-14	1.821 (46.25)	50
LT-543	1	(18.44)	2.684 (68.17)	(52.53)	(23.88)	1½	2.034 (51.66)	25



Corporate Office
Tel: 901.252.8000
800.816.7809
Fax: 901.252.1354

Customer Service
Tel: 800.816.7809
Fax: 800.816.7810

Technical Services
Tel: 888.862.3289
Fax: 901.252.1321

Tool Services
Tel: 800.284.8665

Thomas & Betts

www.tnb.com

Outdoor XTRA FLEX® Raceway System (Type B)

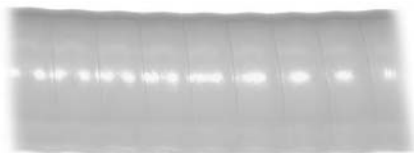

Specifications

- Color: Gray
- Length: 100 ft. for LTC038GY thru LTC125GY
50 ft. for LTC150GY and LTC200GY
- UL Temperature Rating:
80° C dry, 60° C wet
70° C oil. res. sunlight resistant,
outdoor, direct burial
- CSA Certified: File LR 80349-2
- CSA Temperature Rating: -18°C to 75°C
- Material: PVC Helix reinforcement surrounded
with flexible PVC
- Voltage Rating: 600V

CAT. NO. SERIES	TRADE SIZE (IN.)	I.D. (IN.)		O.D. (IN.)		STD. CTN.
		MIN.	MAX.	MIN.	MAX.	
LTC038GY	3/8	.484	.504	.690	.710	100
LTC050GY	1/2	.622	.642	.820	.840	100
LTC075GY	3/4	.820	.840	1.030	1.050	100
LTC100GY	1	1.041	1.066	1.290	1.315	100
LTC125GY	1 1/4	1.380	1.410	1.630	1.660	100
LTC150GY	1 1/2	1.575	1.600	1.865	1.900	50
LTC200GY	2	2.020	2.045	2.340	2.375	50

UL Listed: File E95745.

For use with Thomas & Betts LT38P, LT38M, LT500 series
and Liquidtight Flexible Metal Conduit Fittings.

Liquidtight Whip Assembly



CAT. NO.	CONDUIT SIZE (IN.)	LENGTH (FT.)	WIRE GAUGE	STD. CTN.
LTHWIP 12-6-10	1/2	6	#10	6
LTHWIP 12-4-10	1/2	4	#10	6
LTHWIP 34-6-8	3/4	6	#8	6
LTHWIP 34-4-8	3/4	4	#8	6

Whip with Metallic Fittings — One Straight, One 90°

LTWM 12-6-10	1/2	6	#10	6
LTWM 12-4-10	1/2	4	#10	6
LTWM 34-6-8	3/4	6	#8	6
LTWM 34-4-8	3/4	4	#8	6

Conduit Cutter



For Non-Metallic Flexible Conduit

CAT. NO.	DESCRIPTION
XF-CUT	For Cutting Non-Metallic Flexible Conduit up to 1"
XF-BLADE	Replacement Blade for XF-CUT

Liquidtight Flexible Metal Conduit and Connectors



Liquidtight Fittings

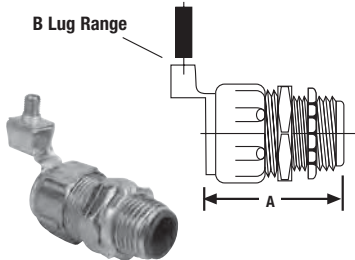

CAT. NO.	GROUNDING DEVICE (LUG ONLY)		TRADE SIZE (IN.)	A (IN.)	B	STD. CTN.
	CAT. NO.	TRADE SIZE (IN.)				
5331GR	38GR-TB	3/8	1 1/2	14-4	100	
5332GR	12GR-TB	1/2	1 1/8	14-4	100	
5333GR	34GR-TB	3/4	1 1/8	14-4	25	
5334GR	1GR-TB	1	2 1/8	14-4	50	
5231GR	38GR-TB	3/8	1 1/2	14-4	100	
5232GR	12GR-TB	1/2	1 1/8	14-4	100	

CAT. NO.	GROUNDING DEVICE (LUG ONLY)		TRADE SIZE (IN.)	A (IN.)	B	STD. CTN.
	CAT. NO.	TRADE SIZE (IN.)				
5233GR	34GR-TB	3/4	1 1/8	14-4	25	
5234GR	1GR-TB	1	2 1/8	14-4	50	
5231ALGR	38GR-TB	3/8	1 1/2	14-4	100	
5232ALGR	12GR-TB	1/2	1 1/8	14-4	100	
5233ALGR	13GR-TB	3/4	1 3/8	14-4	50	
5234ALGR	1GR-TB	1	2 1/8	14-4	50	

Liquidtight Fittings — 90° Type

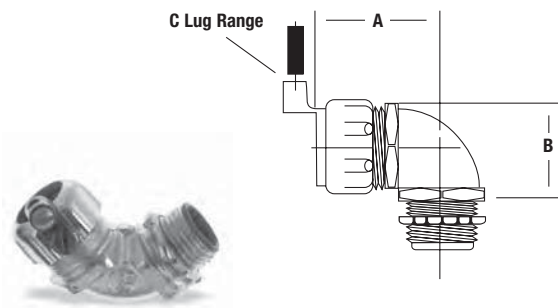

CAT. NO.	GROUNDING DEVICE (LUG ONLY)		TRADE SIZE (IN.)	A (IN.)	B (IN.)	C	STD. CTN.
	CAT. NO.	TRADE SIZE (IN.)					
5351GR	38GR-TB	3/8	1 1/8	1 1/4	14-4	50	
5352GR	12GR-TB	1/2	1 1/8	1 1/8	14-4	50	
5353GR	34GR-TB	3/4	1 3/4	1 3/8	14-4	50	
5354GR	1GR-TB	1	2 3/8	2 1/8	14-4	25	
5251GR	38GR-TB	3/8	1 1/8	1 1/4	14-4	50	
5252GR	12GR-TB	1/2	1 1/8	1 1/8	14-4	50	
5253GR	34GR-TB	3/4	1 3/4	1 13/16	14-4	50	
5254GR	1GR-TB	1	2 3/8	2 1/8	14-4	25	
5251ALGR	38GR-TB	3/8	1 1/8	1 1/4	14-4	50	
5252ALGR	12GR-TB	1/2	1 1/8	1 1/8	14-4	50	
5253ALGR	13GR-TB	3/4	1 3/4	1 13/16	14-4	50	
5254ALGR	1GR-TB	1	2 3/8	2 1/8	14-4	25	

Liquidtight Fittings — 45° Type

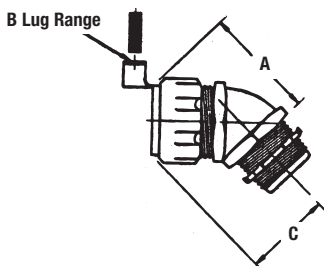

CAT. NO.	TRADE SIZE (IN.)	A (IN.)	B	C (IN.)	STD. CTN.
5342GR	1/2	1 1/8	14-4	1 3/8	50
5343GR	3/4	2 1/8	14-4	1 3/8	50
5344GR	1	2 1/4	14-4	1 3/4	25
5241GR	3/8	1 1/8	14-4	1 1/8	50
5242GR	1/2	1 1/8	14-4	1 3/8	50
5243GR	3/4	2 1/8	14-4	1 3/8	50
5244GR	1	2 1/4	14-4	1 3/4	25

Liquidtight to Rigid External Ground Adapter

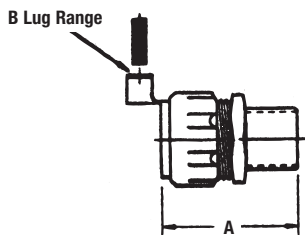

CAT. NO.	TRADE SIZE (IN.)	A (IN.)	B	STD. CTN.
5272GR	1/2	1 3/8	14-4	50
5273GR	3/4	1 11/32	14-4	50
5274GR	1	1 1/8	14-4	25

Fittings

Liquidtight Flexible Metal Conduit and Connectors

Straight Connectors

- 3/8"-1", steel
- 1 1/4"-4", malleable iron/zinc plated

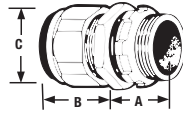

CAT. NO.	CONDUIT SIZE (IN.)	DIMENSIONS (IN.)			STD. CTN.
		A	B	C	
LT-100	3/8	1 1/16	1/2	1 13/16	100
LT-101	1/2	1 3/16	3/4	1 1/8	100
LT-102	3/4	1 7/16	9/16	2 1/32	50
LT-103	1	1 3/4	1	2 9/32	50
LT-104	1 1/4	2 1/16	1 1/16	2 19/32	25
LT-105	1 1/2	2 3/4	2 1/2	2 25/32	10
LT-106	2	3 1/32	2 5/32	3	5

CSA File No. LR-12798.

UL File No. E-23018 — 1/4"-4".

Straight Connectors (with Insulated Throat)

- 3/8"-1", steel
- 1 1/4"-4", malleable iron/zinc plated (with insulated throat)

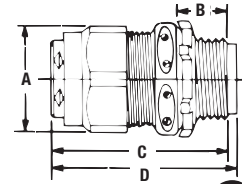

CAT. NO.	CONDUIT SIZE (IN.)	DIMENSIONS (IN.)			STD. CTN.
		A	B	C	
LT-700	3/8	1 1/16	1/2	1 29/32	100
LT-701	1/2	1 3/16	3/4	1 3/32	100
LT-702	3/4	1 7/16	9/16	2 1/8	50
LT-703	1	1 3/4	1	2 3/8	50
LT-704	1 1/4	2 1/16	1 1/16	2 11/16	25
LT-705	1 1/2	2 3/4	2 1/2	2 7/8	10
LT-706	2	3 1/32	2 5/32	3 1/8	5
LT-707	2 1/2	2 3/4	1	4	1
LT-708	3	2 1/2	1 1/2	4 3/16	1

CSA File No. LR-12798.

UL File No. E-23018 — 1/4"-4".

45° Connectors — Malleable Iron/Zinc Plated

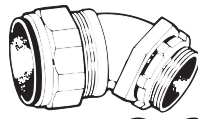

CAT. NO.	CONDUIT SIZE (IN.)	E	DIMENSIONS (IN.)			STD. CTN.
			F	G	H	
LT-450	3/8	1.140	.500	1.150	1.480	50
LT-451	1/2	1.250	.500	1.280	1.510	50
LT-452	3/4	1.280	.520	1.550	1.540	50
LT-453	1	1.430	.650	1.800	1.810	25
LT-454	1 1/4	1.500	.660	2.250	2.160	25
LT-455	1 1/2	1.610	.730	2.440	2.430	10
LT-456	2	1.760	.750	2.970	2.820	5
LT-459	3 1/2	2.610	1.180	5.250	5.930	1

CSA File No. LR-12798.

UL File No. E-23018.

45° Connectors — Malleable Iron/Zinc Plated (with Insulated Throat)

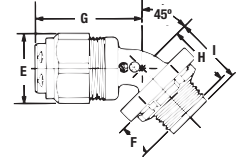

CAT. NO.	CONDUIT SIZE (IN.)	E	DIMENSIONS (IN.)			STD. CTN.
			F	G	I	
LT-950	3/8	1.140	.500	1.150	1.480	50
LT-951	1/2	1.250	.500	1.280	1.510	50
LT-952	3/4	1.280	.520	1.550	1.540	50
LT-953	1	1.430	.650	1.800	1.810	25
LT-954	1 1/4	1.500	.660	2.250	2.160	25
LT-955	1 1/2	1.610	.730	2.440	2.430	10
LT-956	2	1.760	.750	2.970	2.820	5
LT-959	3 1/2	2.610	1.180	5.250	5.930	1

90° Connectors — Malleable Iron/Zinc Plated

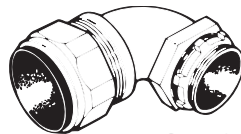

CAT. NO.	CONDUIT SIZE (IN.)	J	DIMENSIONS (IN.)			STD. CTN.
			K	L	M	
LT-490	3/8	1 1/16	1/2	1 1/8	1 3/8	50
LT-491	1/2	1 3/16	1/2	2	1 13/32	50
LT-492	3/4	1 7/16	9/16	2 3/16	1 21/32	50
LT-493	1	1 3/4	1	2 7/16	1 1/8	25

25CSA File No. LR-12798.

UL File No. E-23018.

90° Connectors — Malleable Iron/Zinc Plated (with Insulated Throat)

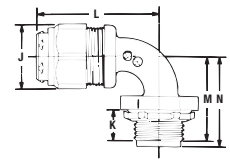

CAT. NO.	CONDUIT SIZE (IN.)	J	DIMENSIONS (IN.)			STD. CTN.
			K	L	N	
LT-990	3/8	1 1/16	1/2	1 1/8	1 13/32	50
LT-991	1/2	1 3/16	1/2	2	1 1/2	50
LT-992	3/4	1 7/16	9/16	2 3/16	1 3/4	50
LT-993	1	1 3/4	1	2 7/16	1 31/32	50



Liquidtight Flexible Metal Conduit and Connectors

Straight Connectors — Die Cast Zinc

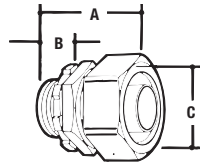

CAT. NO.	CONDUIT SIZE (IN.)	DIMENSIONS (IN.)			STD. CTN.
		A	B	C	
LT-200	3/8	1.81	0.50	1.06	100
LT-201	1/2	1.88	0.61	1.19	100
LT-202	3/4	2.03	0.56	1.44	100
LT-203	1	2.28	0.63	1.75	50
LT-204	1 1/4	2.59	0.69	2.44	40
LT-205	1 1/2	2.78	0.78	2.75	20
LT-206	2	3.22	0.78	3.53	20
LT-207	2 1/2	3.53	0.84	4.28	1
LT-208	3	3.91	0.88	4.72	1
LT-209	3 1/2	4.04	0.91	5.42	1
LT-210	4	4.16	0.94	5.91	1

UL File No. E-23018.

Straight Connectors — Die Cast Zinc (with Insulated Throat)

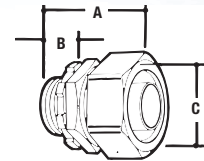

CAT. NO.	CONDUIT SIZE (IN.)	DIMENSIONS (IN.)			STD. CTN.
		A	B	C	
LT-800	3/8	1.81	0.50	1.06	100
LT-801	1/2	1.88	0.61	1.19	100
LT-802	3/4	2.03	0.56	1.44	100
LT-803	1	2.28	0.63	1.75	50
LT-804	1 1/4	2.59	0.69	2.44	40
LT-805	1 1/2	2.78	0.78	2.75	20
LT-806	2	3.22	0.78	3.53	20
LT-807	2 1/2	3.53	0.84	4.28	1
LT-808	3	3.91	0.88	4.72	1
LT-809	3 1/2	4.04	0.91	5.42	1
LT-810	4	4.16	0.94	5.91	1

CSA File No. LR-12798.

90° Connectors — Die Cast Zinc

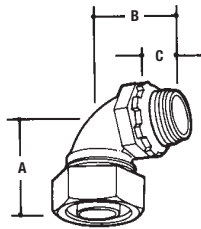

CAT. NO.	CONDUIT SIZE (IN.)	DIMENSIONS (IN.)			STD. CTN.
		A	B	C	
LT-290	3/8	1.88	1.38	0.50	100
LT-291	1/2	2.00	1.41	0.50	100
LT-292	3/4	2.19	1.66	0.56	100
LT-293	1	2.56	1.88	0.63	50
LT-294	1 1/4	3.00	2.00	0.69	40
LT-295	1 1/2	3.38	2.56	0.78	20
LT-296	2	4.06	3.00	0.78	10
LT-297	2 1/2	5.03	3.72	0.84	1
LT-298	3	5.63	4.66	0.88	1
LT-299	3 1/2	6.10	4.82	0.91	1
LT-2910	4	6.56	4.97	0.94	1

UL File No. E-23018.

90° Connectors — Die Cast Zinc (with Insulated Throat)

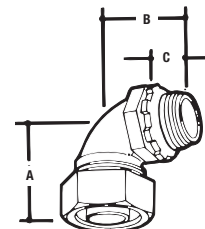

CAT. NO.	CONDUIT SIZE (IN.)	DIMENSIONS (IN.)			STD. CTN.
		A	B	C	
LT-890	3/8	1.88	1.38	0.50	100
LT-891	1/2	2.00	1.41	0.50	100
LT-892	3/4	2.19	1.66	0.56	100
LT-893	1	2.56	1.88	0.63	50
LT-894	1 1/4	3.00	2.00	0.69	20
LT-896	2	4.06	3.00	0.78	10
LT-897	2 1/2	5.03	3.72	0.84	1

Sealing O-Rings



CAT. NO.	CONDUIT SIZE (IN.)	STD. CTN.
SR 101	1/2	500
SR-102	3/4	500
SR-103	1	500
SR-104	1 1/4	250
SR-105	1 1/2	250
SR-106	2	250

Material: Neoprene

Fittings

Corporate Office
Tel: 901.252.8000
800.816.7809
Fax: 901.252.1354

Customer Service
Tel: 800.816.7809
Fax: 800.816.7810

Technical Services
Tel: 888.862.3289
Fax: 901.252.1321

Tool Services
Tel: 800.284.8665

Thomas & Betts

www.tnb.com

All Plastic Connector for NM Cable and Flexible Cord



Snap captive locking wedge into connector's cavity.



Press locking wedge into cavity that locks onto cable.



Cat. No. 3201 is ideal for multiple flexible cords and cable.

Steel City® Fittings

- High-impact thermoplastic: UL 94-V1
- Features push-in design
- Captive locking wedge secures cable with single squeeze of standard electrician's pliers
- Provides excellent insulation, strain-relief and high pull-out value

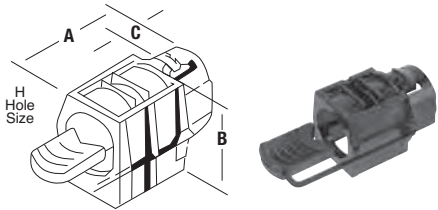

Fig. 1

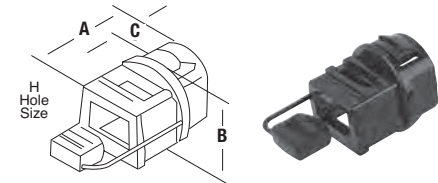

Fig. 2

Size Range

CAT. NO. DESCRIPTION

3300	For use with 10-2, 12-2 and 14-2 NM cables; 18-2 and 18-3 SJ and SJO cords and 18-2 SV, SVO, SJT and SJTO cords, single or multiple; cord capacity .125-.300" diameter
3201-TB	For use with 10-3, 12-3, 14-3, 10-2, 12-2, 4-2 NM cables; multiple (2) 12-2 and 14-2 NM cables; single and multiple flexible cords in wire range .300-.600"
3202	For use with 8-3 and 6-3 NM cables; (2) 14-3, 14-2, 12-2 and 10-2 NM cables; single and multiple flexible cords in wire range .500-.850"

Temperature Rating: 105° C.
CSA File Nos. 584 and 2884.
UL File No. E-17583.

CAT. NO.	KO SIZE (IN.)	FIG.	DIMENSIONS (IN.)					MAX THK. ENCLOSURE	H (IN.)	STD. CTN.
			A	B	C	D	E			
3300	1/2	2	1 1/32	1 1/16	3/8	.880	.795	.080	5/16 X 3/16	500
3201-TB	1/2	1	1 1/32	1	7/16	.880	.795	.080	2 1/32 dia.	500
3202	3/4	1	1 1/2	1 1/16	7/16	1.100	1.005	.090	7/8 dia.	250

Temperature Rating: 105° C.
CSA File Nos. 584 and 2884.
UL File No. E-17583.

Hit Lock® Connectors

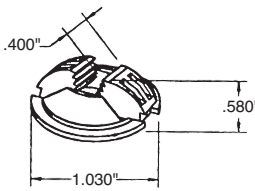

NC-501-SC

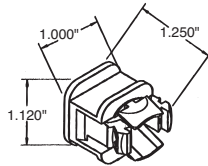

NC-501DBL-SC



NC-501-SC

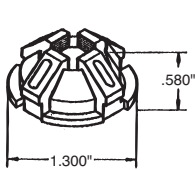

NC-502-SC

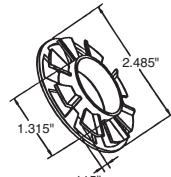

SB1216-SC

CAT. NO.	DESCRIPTION	STD. CTN.
NC-501SC	1/2" Hit Lock® Connector	500
NC-501DBL-SC	1/2" Double Hit Lock® Connector	500
NC-502SC	3/4" Hit Lock® Connector	100
SB1216-SC	Twist It Bushing For Metal Studs	50

UL File No. E-17583.

Non-Metallic Sheathed Cable Fittings

NM Clamp Type Connector — Die Cast Zinc

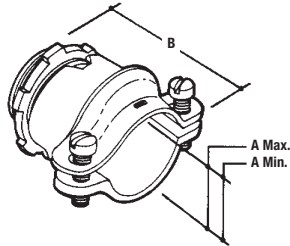

CAT. NO.	CONDUIT SIZE (IN.)	DIMENSIONS (IN.)			STD. CTN.
		A (MIN.)	A (MAX.)	B	
NC-201	½	0.40	0.95	1.87	250
NC-202	¾	0.50	1.10	1.84	200
NC-203	1	0.62	1.14	2.00	100
NC-204	1¼	0.50	1.38	2.28	100
NC-205	1¾	0.75	1.61	2.49	50
NC-206	2	0.90	2.04	3.35	50

CSA File No. LR-12798.

UL File No. E-17583.

Clamp Type Connector — Die Cast Zinc

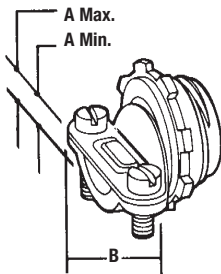

CAT. NO.	CONDUIT SIZE (IN.)	DIMENSIONS (IN.)			STD. CTN.
		A (MIN.)	A (MAX.)	B	
NC301	¾ (½ KO)	0.18	0.64	1.16	1,000
NC-302	¾	0.41	0.82	1.87	500
NC-303	1	0.34	0.94	2.01	250

CSA File No. LR-12798.

UL File No. E-17583.

Connectors Clamp Type Non-Watertight — Die Cast Zinc

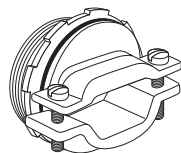

CAT. NO.	CONDUIT SIZE (IN.)	DIMENSIONS (IN.)			STD. CTN.
		A (MIN.)	A (MAX.)	B	
NC041	1¼	0.27	0.75	2.02	100
NC-051	1½	0.54	0.95	2.50	50
NC-061	2	0.75	1.12	3.41	40

UL File No. E-15170 — 1¼"–1½".

UL File No. E-17583 — 2".

Duplex Clamp Type Connector — Die Cast Zinc

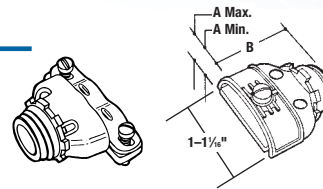

- For use with aluminum, smooth, extruded metal-clad cable. (min. dia. .410 — max. dia. .500).



CAT. NO.	CONDUIT SIZE (IN.)	DIMENSIONS (IN.)			STD. CTN.
		A (MIN.)	A (MAX.)	B	
XC-210	¾ (½ KO)	0.13	0.65	1.56	250
XC-211-SC	¾	0.24	0.63	1.59	200
XC-222-SC	¾	0.24	0.63	1.59	200

CONDUIT/CABLE	FMC (IN.)	AC	MCC	MCI
Max. Size	¾	10/2	.565	.565
Min. Size	¾	14/2	.425	.425

CSA File No. LR-12798.

UL File No. E1383.

NM Flex Connectors Saddle Type — Die Cast Zinc

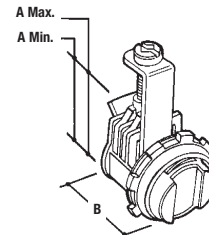

CAT. NO.	SIZE (IN.)	DIMENSIONS (IN.)			STD. CTN.
		A (MIN.)	A (MAX.)	B	
XC-2200-C	¾	0.12	0.63	0.98	500

Tilt-In Connector Metallic Steel — Electro-Galvanized

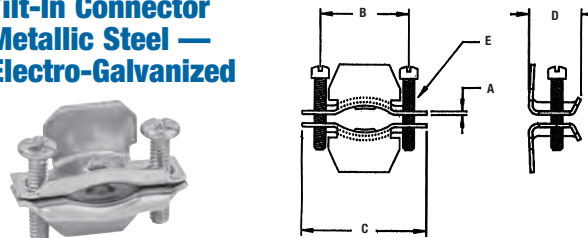

CAT. NO.	CONDUIT SIZE (IN.)	DIMENSIONS (IN.)					STD. CTN.
		A	B	C	D	E	
NC-850	½	.050	.950	1.312	.650	8–32 x ¾	1,000
NC-851	¾–1	.050	1.250	1.750	.760	8–32 x 1	500
NC-852	1–¾	.062	1.625	2.125	.760	10–32 x 1	250
NC-853	1–½	.062	1.970	2.500	.785	10–32 x 12	100

Armored Cable/Flexible Metallic Conduit Fittings

Straight Squeeze-Type Connectors — Malleable Iron or Stamped Steel/Zinc Plated



CAT. NO.	CONDUIT SIZE (IN.)	UNIT QTY.	STD. CTN.
XC-400	3/8 (1/2 KO)	50	100
XC-401	1/2	25	100
XC-402	3/4	25	100
XC-403	1	25	100
XC-404	1 1/4	5	10
XC-405	1 1/2	10	10
XC-406	2	10	10
XC-407	2 1/2	5	5
XC-408	3	5	5

UL File No. E-1383 1/2"-3/4".

UL File No. E-23018 1"-3".

3/8"-3/4" — Steel.

Straight Squeeze-Type Connectors — Insulated Malleable Iron or Stamped Steel/Zinc Plated



CAT. NO.	CONDUIT SIZE (IN.)	UNIT QTY.	STD. CTN.
XC-901	1/2	25	100
XC-902	3/4	25	100
XC-903	1	25	100
XC-904	1 1/4	5	10
XC-905	1 1/2	10	10
XC-906	2	10	10
XC-907	2 1/2	5	5
XC-908	3	5	5

1/2"-3/4" — Steel.

Clamp Straight Set, 90° and Duplex Connectors

90° Angle Squeeze-Type Connectors — Steel or Malleable Iron/Zinc Plated

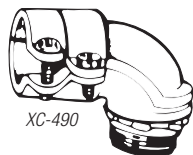

XC-490

NOTE: For die cast armored cable/flexible metallic conduit fittings and combination fittings, refer to the Steel City® Die Cast Conduit Fittings section.

CAT. NO.	CONDUIT SIZE (IN.)	UNIT QTY.	STD. CTN.
XC-490	3/8 (1/2 KO)	50	100
XC-491	1/2	25	100
XC-492	3/4	25	50
XC-493	1	25	25
XC-494	1 1/4	10	10
XC-495	1 1/2	10	10
XC-496	2	5	5
XC-497	2 1/2	1	1
XC-498	3	1	1

UL File No. E-1383 3/8" & 3/4".

UL File No. E-23018 1"-3".

3/8"-3/4" — Steel.

Straight Squeeze Type Connectors — Die Cast Zinc

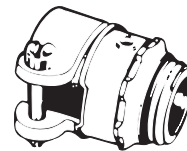

CAT. NO.	FIG.	SIZE (IN.)	DIMENSIONS (IN.)			STD. CTN.
			A (MIN.)	A (MAX.)	B	
XC-269	1	3/8 (1/2 KO)	0.45	0.60	0.96	500
XC-270	1	1/2	0.74	0.92	1.43	250
XC-272	1	3/4	0.88	1.10	1.59	250
XC-273	2	1	1.10	1.35	1.60	100
XC-274	2	1 1/4	1.48	1.65	1.91	100
XC-275	2	1 1/2	1.68	2.00	2.12	50
XC-276	3	2	2.12	2.47	2.54	40
XC-277	3	2 1/2	2.71	3.08	2.88	10
XC-278	3	3	3.15	3.60	3.88	5
XC-278A	3	3 1/2	3.20	4.03	5.04	1
XC-2710	3	4	3.15	4.25	5.04	

Armored Cable/Flexible Metallic Conduit Fittings

Straight Squeeze-Type Connectors — Insulated — Die Cast Zinc

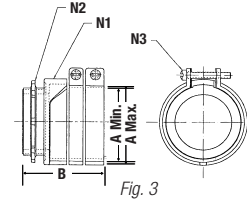
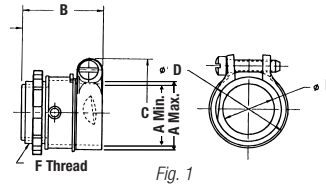
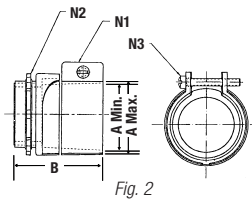

CAT. NO.	FIG.	SIZE (IN.)	DIMENSIONS (IN.)			STD. CTN.
			A (MIN.)	A (MAX.)	B	
XG-870	1	½	0.74	0.92	1.43	250
XG-872	1	¾	0.88	1.10	1.59	250
XG-873	2	1	1.10	1.35	1.60	100
XG-874	2	1¼	1.48	1.65	1.91	50
XG-875	2	1½	1.68	2.00	2.12	50
XG-876	3	2	2.12	2.47	2.54	10
XG-877	3	2½	2.71	3.08	2.88	10
XG-878	3	3	3.15	3.60	3.88	5
XG-879	3	3½	3.20	4.03	5.04	1
XG-8710	3	4	3.15	4.25	5.04	1

UL File No. E-17909 — ½"–¾".

UL File No. E-23018 — 1¼".

CSA File No. LR-12798.

Squeeze Type — BX Flex Connectors

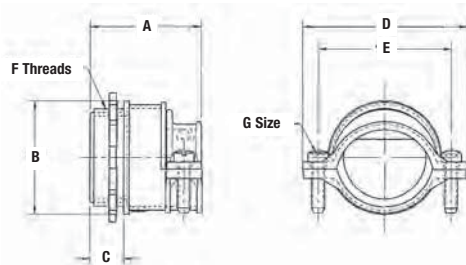

CAT. NO.	TRADE SIZE (IN.)	DIMENSIONS (IN.)					F THREADS	G SIZE	RANGE
		A	B	C	D	E			
XG-201	½	1 ²⁵ / ₆₄	1 ¹ / ₆₄	1 ³ / ₃₂	1 ⁵⁹ / ₆₄	1 ³ / ₈	½–14NPS	10–24 x 1 ¹ / ₈	.40–.95
XG-202	¾	1½	1¼	½	1 ⁵⁹ / ₆₄	1 ³ / ₈	¾–14NPS	10–24 x 1 ¹ / ₈	.50–1.10
XG-203	1	1¾	1 ²³ / ₃₂	9 ¹ / ₁₆	2 ⁹ / ₃₂	1 ¹ / ₈	1–11 1/2NPS	10–24 x 1 ¹ / ₈	.62–1.14
XG-204	1¼	1 ⁷ / ₈	1 ⁵⁷ / ₆₄	9 ¹ / ₁₆	2 ⁴⁷ / ₆₄	2 ¹ / ₃₂	1¼–11 1/2NPS	10–24 x 1 ¹ / ₈	.50–1.38

All dimensions are approximated to the nearest 1/64".



Steel City® Cable Lok®

- Simple, one-piece installation with no locknuts
- Screw designed for exceptional pullout resistance
- Captive screw ensures that the screw is intact for installation and resists backing out after installation
- Corrosion-resistant, zinc-chromatic plating
- Positive grounding
- Vibration-resistant screw design
- UL Listed and CSA Certified

Material: Body: Steel (spring steel);
Finish: Zinc;
Insulator: Nylon;
Temp.: 105°C

Listing: UL, CSA Listed



Simple, fast steps to install the Steel City® Cable Lok®.



1. Simply snap into place. No locknuts required!

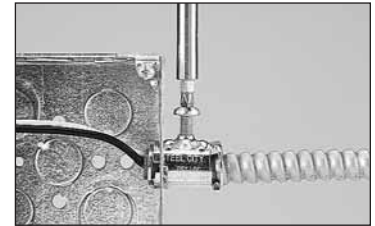

2. Insert cord and twist set screw. Connector tightens as screw is set.

- O.D. for over armor 0.400"–0.510"
- No set screws, locknuts or tools are required to attach MC cable to a box or enclosure
- One-piece spring-steel construction
- Accommodates the widest range of MC cable sizes in the industry — 14-2 to 10-3

- Compact, low-profile design saves space in the box or enclosure
- Fittings can be used in adjacent knockouts in the corner of the box
- Removable and reusable
- Ideal for commercial construction or prefabricated electrical wiring assemblies

Steel City® Cable Lok®



CAT. NO.	SIZE RANGE (IN.)	AC STEEL	AC ALUMINUM INTERLOCKED	MC (I) STEEL	MC (I) ALUMINUM	FLEX RW	STD. CTN.
XC-730	.450/.610 ½ KO	14/2 14/3 14/4	14/2 14/3 14/4	14/2 14/3 14/4	14/2 14/3 14/4	¾ Steel & AL	50
		12/2 12/3 12/4	12/2 12/3 12/4	12/2 12/3 12/4	12/2 12/3 12/4		
		10/2	10/2 10/3	½" KO	10/2 10/3		
XC-731	.450/.610 ½ KO	14/2 14/3 14/4	14/2 14/3 14/4	14/2 14/3 14/4	14/2 14/3 14/4	—	50
		12/2 12/3 12/4	12/2 12/3 12/4	12/2 12/3 12/4	12/2 12/3 12/4		
		10/2	10/2 10/3	½" KO	10/2 10/3		
XC-732	.610/.875 ¾ KO	10/3 10/4 10/5	—	10/4 10/5	—	¾ Steel & AL	25
		8/3 8/4	8/3 8/4	6/2	¾" KO		
		6/2	6/2	¾" KO	6/2		
XC-7300	.450/.610 ½ KO	14/2 14/3 14/4	14/2 14/3 14/4	14/2 14/3 14/4	14/2 14/3 14/4	—	25
		12/2 12/3 12/4	12/2 12/3 12/4	12/2 12/3 12/4	12/2 12/3 12/4		
		10/2	10/2 10/3	½" KO	10/2 10/3		

UL File No. E-1383.

CSA File No. LR-12798.



Snap-In Fitting for MC Cable — Steel



CAT. NO.	DESCRIPTION	STD. CTN.
XC-130	Steel Snap-In Fitting for MC cable (14-2+G to 10-3+G)	500

Armored Cable/Flexible Metallic Conduit Fittings



Steel City® Fittings

90° Clamp Type Connectors — Die Cast Zinc

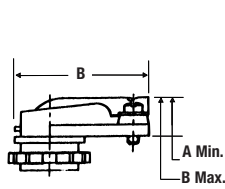

Fig. 1

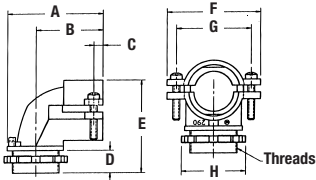
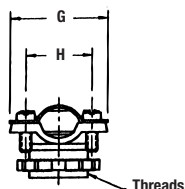

Fig. 2

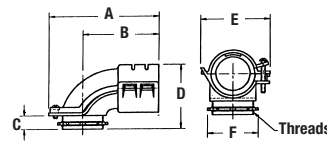

Fig. 3



XC-290

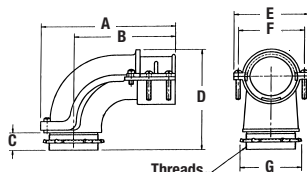

Fig. 4

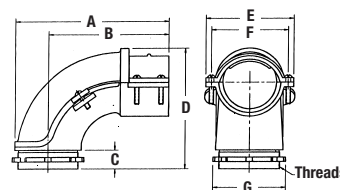

Fig. 5



Insulated Die Cast Zinc



CAT. NO.	FIG.	SIZE (IN.)	DIMENSIONS (IN.)			STD. CTN.
			A (MIN.)	A (MAX.)	B	
XC-290	1	¾ (½ KO)	0.40	0.63	1.80	500
XC-291	1	½	0.65	1.00	2.08	250
XC-292	1	¾	0.83	1.25	2.27	100
XC-293	2	1	1.27	1.50	2.60	50
XC-294	2	1¼	1.49	1.85	3.10	30
XC-295	3	1½	1.51	2.47	6.05	5
XC-296	3	2	1.51	2.47	6.05	5
XC-297	4	2½	2.45	3.50	7.75	2
XC-298	5	3	3.07	4.02	8.88	1
XC-299	4	3½	3.63	4.34	12.75	1
XC-2910	4	4	3.68	5.17	12.75	1

UL File No. E-1383.

CSA File No. LR-18130M57.

CAT. NO.	FIG.	SIZE (IN.)	DIMENSIONS (IN.)			STD. CTN.
			A (MIN.)	A (MAX.)	B	
XC-890	1	¾	0.40	0.63	1.81	500
XC-891	1	½	0.65	0.97	2.18	250
XC-892	1	¾	0.77	1.12	2.38	100
XC-893	2	1	1.06	1.40	2.87	50
XC-894	2	1¼	1.34	1.65	3.93	30
XC-895	3	1½	1.51	2.47	6.05	5
XC-896	3	2	1.51	2.47	6.05	5
XC-897	4	2½	2.45	3.50	7.75	2
XC-898	5	3	3.07	4.02	8.88	1
XC-899	4	3½	3.63	4.34	12.75	1
XC-8910	4	4	3.68	5.17	12.75	1

UL File No. E-1383.

CSA File No. LR-12798.

Clamp Type Connector — Die Cast Zinc

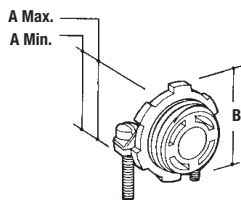

For use with Metal Clad Cable

CAT. NO.	CONDUIT SIZE (IN.)	DIMENSIONS (IN.)			STD. CTN.
		A (MIN.)	A (MAX.)	B	
XC-280	¾ (½ KO)	0.18	0.64	1.16	1,000

UL File No. E-1383.

CSA File No. LR-18130M57.

Duplex Clamp Type Connector — Die Cast Zinc



CAT. NO.	CONDUIT SIZE (IN.)	DIMENSIONS (IN.)			STD. CTN.
		A (MIN.)	A (MAX.)	B	
XC-210	¾ (½ KO)	0.13	0.65	1.56	250

CSA File No. LR-18130M57.

Corporate Office
Tel: 901.252.8000
800.816.7809
Fax: 901.252.1354

Customer Service
Tel: 800.816.7809
Fax: 800.816.7810

Technical Services
Tel: 888.862.3289
Fax: 901.252.1321

Tool Services
Tel: 800.284.8665

Thomas & Betts

www.tnb.com

Armored Cable/Flexible Metallic Conduit Fittings

Snap-In Connector for Flexible Metal Conduit — 105° C Rated

- No locknut required
- No special tools required
- High-impact thermoplastic with steel insert

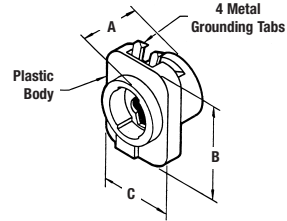

CAT. NO.	CONDUIT SIZE (IN.)	KO SIZE (IN.)	UNIT QTY.	STD. CTN.
100-TB	¾	½	50	500
100BP	¾	½	250	1,000

BX Flex Bushings — Anti-Short

- Packed in polybags
- Available bulk packed — 10,000 per carton
- Plastic



NOTE: For die cast armored cable/flexible metallic conduit fittings and combination fittings, refer to the Steel City® Die Cast Conduit Fittings section.

CAT. NO.	FITS STANDARD CABLE RANGE	SIZE	UNIT QTY.	STD. CTN.
IT 100 SC	14/2-14/3-12/2	0	100	100
IT-101	14/4-12/3-6/1-4/1	1	100	35
IT-102	12/4-10/2-10/3-2/1	2	50	50
IT-103	10/4-8/2-8/3-1/1	3	50	50
IT-104	8/4-6/2-6/3-4/2-4/3-6/4	4	50	50

Ordered by Bags.

Straight Set Screw Connectors Die Cast Zinc — Non-Insulated

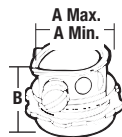

XC-220

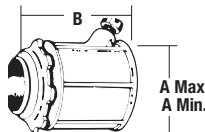

XC-221
XC-821



CAT. NO.	SIZE (IN.)	DIMENSIONS (IN.)			STD. CTN.
		A (MIN.)	A (MAX.)	B	
XC-220SC	¾ (½ KO)	0.38	0.63	0.84	1,000
XC-221	¾	0.74	0.94	1.46	250
XC-821	¾	0.74	0.94	1.46	250

XC-220 and XC-221: UL File No. E-1383 ¾".

UL File No. E-23018 ¾".

XC-821: UL File No. E-1275 ¾".

BX Flex Connectors Saddle Type — Die Cast Zinc

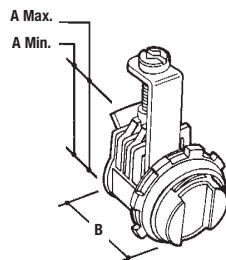

CAT. NO.	SIZE (IN.)	DIMENSIONS (IN.)			STD. CTN.
		A (MIN.)	A (MAX.)	B	
XC-2200-C	¾	0.12	0.63	0.98	500



Armored Cable/Flexible Metallic Conduit Fittings, Service Caps

Screw-In Connectors Die Cast Zinc — Non-Insulated

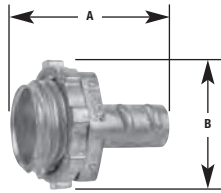

CAT. NO.	SIZE (IN.)	DIMENSIONS (IN.)		STD. CTN.
		A	B	
XG-240	3/8 (1/2 KO)	1.31	0.92	500
XG-241	1/2	1.38	0.92	500
XG-242	3/4	1.62	1.12	125
XG-243	1	1.94	1.37	125
XG-244	1 1/4	2.12	1.75	50
XG-245	1 1/2	2.31	2.13	50
XG-246	2	2.58	2.67	50

UL File No. E-23018.

CSA File No. LR-18130M57 3/8"-1 1/2".

Screw-In Connectors Die Cast Zinc — Insulated

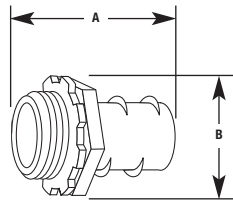

CAT. NO.	SIZE (IN.)	DIMENSIONS (IN.)		STD. CTN.
		A	B	
XG-840	3/8 (1/2 KO)	1.31	0.92	500
XG-841	1/2	1.38	0.92	500
XG-842	3/4	1.62	1.12	125
XG-843	1	1.94	1.37	125
XG-844	1 1/4	2.12	1.75	50
XG-845	1 1/2	2.31	2.13	50
XG-846	2	2.58	2.67	50

UL File No. E-23018.

CSA File No. LR-18130M57 3/8"-1 1/2".

Screw-In Couplings Die Cast Zinc

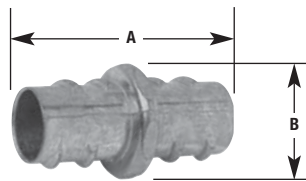

CAT. NO.	SIZE (IN.)	DIMENSIONS (IN.)		STD. CTN.
		A	B	
XK 241	1/2	1.81	0.92	250
XK-242	3/4	2.09	1.12	250
XK-243	1	2.41	1.37	125
XK-244	1 1/4	2.75	1.81	50
XK-245	1 1/2	3.05	2.12	50
XK-246	2	3.28	2.67	50

UL File No. E-23018.

Water-Tight Connectors

- For type SE, style U, flat;
2 insulating conductors, 1 bare

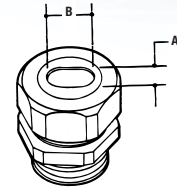

CAT. NO.	TRADE SIZE (IN.)	FITS CABLE	RUBBER GROMMET OPENING (IN.)		STD. CTN.
			A	B	
WT203A	1	3#8	.500	.750	100
WT-203B	1	3#6	.563	.844	100
WT-203C	1	3#4	.625	.938	100
WT-204A	1 1/4	3#3	.625	1.000	50
WT-204B	1 1/4	3#2	.580	.960	50
WT-204C	1 1/4	3#1	.660	1.090	50
WT-204D	1 1/4	3#1/0	.750	1.125	50
WT-205A	1 1/2	3#1/0 & 3#2/0	.735	1.240	20
WT-205B	1 1/2	3#2/0 & 3#3/0	.875	1.375	20
WT-205C	1 1/2	3#2/0 & 3#3/0	.938	1.438	20
WT-206A	2	3#1/0 & 3#2/0	.735	1.240	20
WT-206B	2	3#2/0 & 3#3/0	.875	1.375	20
WT-206C	2	3#2/0 & 3#3/0	.938	1.438	20
WT-206D	2	3#4/0	.890	1.550	20
WT-206E	2	3#4/0	1.063	1.688	20

For Underground Feeder Cable

UF201	1/2	2#14	.210	.440	250
UF-202	3/4	3#14	.220	.660	250

Aluminum Service Caps — Clamp Type for Rigid/Intermediate or Thinwall

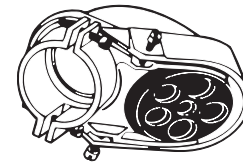

CAT. NO.	CONDUIT SIZE (IN.)	NO. HOLES	SIZE	STD. CTN.
SH-101	1/2	4	4 19/64"	50
SH-102	3/4	5	2 (3/8") 3 (19/32")	50
SH-103	1	5	2 (7/16") 3 (1/2")	10
SH-104	1 1/4	5	2 (19/32") 3 (5/8")	10
SH-105	1 1/2	6	2 (1/2") 1 (7/16") 3 (3/4")	5
SH-106	2	6	2 (3/4") 3 (1") 1 (1/2")	5
SH-107	2 1/2	7	3 (5/8") 1 (1") 3 (1 1/16")	1
SH-108	3	7	4 (1 1/8") 3 (1 1/4")	1
SH-109	3 1/2	4	4 (1 3/4") 2 (2")	1
SH-110	4	4	4 (1 3/4") 2 (1 1/4")	1

CSA File No. LR-12798.

UL File No. E-13938.

Corporate Office
Tel: 901.252.8000
800.816.7809
Fax: 901.252.1354

Customer Service
Tel: 800.816.7809
Fax: 800.816.7810

Technical Services
Tel: 888.862.3289
Fax: 901.252.1321

Tool Services
Tel: 800.284.8665

Thomas & Betts

www.tnb.com

Service Cable Caps — Oval

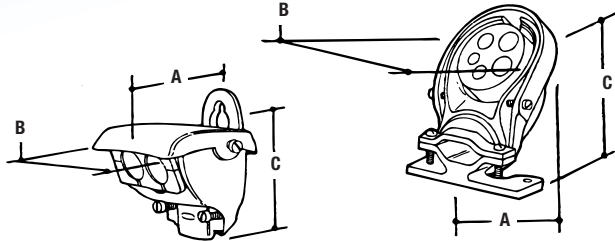

CAT. NO.	FITS CABLE	DIMENSIONS (IN.)			STD. CTN.
		A	B	C	
50130	To 2/0-3	5.00	3.31	4.75	10
50130A	To 4/0-3	6.75	4.62	6.00	5

With Split Insulator

SC1000	3#3-2	2.37	2.12	2.25	25
SC2001	3#3/0-4/0	4.93	3.12	3.75	10

Extra large body for additional wiring space.

Cable Protector

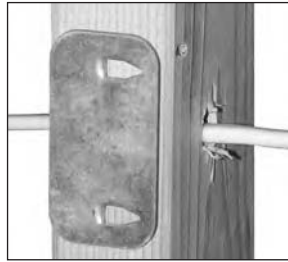
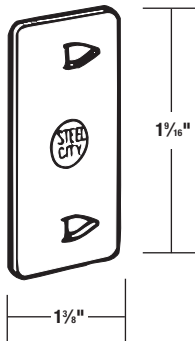

CAT. NO.	DESCRIPTION	STD. CTN.
CP-1	Steel	100

Cable Clip

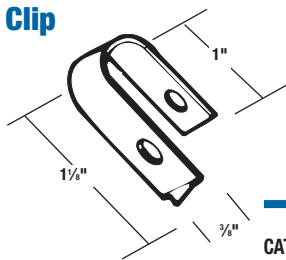

CAT. NO.	DESCRIPTION	STD. CTN.
NS 100	Steel	1,000

One-Hole Strap for 3/8" Armored Cable and Flexible Metal Conduit

CAT. NO.	STD. CTN.	WT./100 (LBS.)
FS100-SC	250	1.70

Service Cable Straps — One-Hole



CAT. NO.	FITS CABLE	SHELF CTN.	SHIP CASE	STD. CTN.
SE-100	3#8, 3#6, 3#4	100	1,000	1,000
SE101	3#3, 3#2	100	1,000	1,000
SE102	3#1, 3#0, 3#1/0, 3#2/0	25	250	250
SE103	3#3/0, 3#4/0	25	250	250

Service Cable Straps — Two-Hole



CAT. NO.	FITS CABLE	SHELF CTN.	SHIP CASE	STD. CTN.
SE-900	3#8, 3#6, 3#4	100	1,000	1,000
SE901	3#3, 3#2	100	1,000	1,000
SE902	3#1, 3#0, 3#1/0, 3#2/0	25	250	250
SE903	3#3/0, 3#4/0	25	250	250

H-195 Steel Rod Coupling

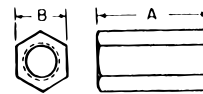

CAT. NO.	ROD SIZE (IN.)	DIMENSIONS (IN.)		STD. CTN.
		A	B	
H-195-1/4	1/4	3/4	3/8	1,000
H-195-3/8	3/8	1	1/2	500
H-195-1/2	1/2	1	5/8	500
H-195-5/8	5/8	1 1/2	3/4	50

R-Series Continuous Thread Rod — Galvanized



CAT. NO.	ROD SIZE (IN.)	ULTIMATE‡ LOAD IN LBS.	ROOT AREA THREAD	DATA FOR PRESSURE PIPING		STD. CTN.
				NOMINAL PIPE SIZE (IN.)	MAX. SAFE LOAD AT 450°	
R628-6 FT.	1/4-20	900	.027	—	—	300
R638-6 FT.	3/8-16	1,900	.068	3/4-2	610	150
R648-6 FT.	1/2-13	3,500	.126	2 1/2-3 1/2	1,130	60
R1028-10 FT.	1/4-20	900	.027	—	—	500
R1038-10 FT.	3/8-16	1,900	.068	3/4-2	610	250
R1048-10 FT.	1/2-13	3,500	.126	2 1/2-3 1/2	1,130	100

‡ Load Ratings based on safety factor of three.



Beam Clamps

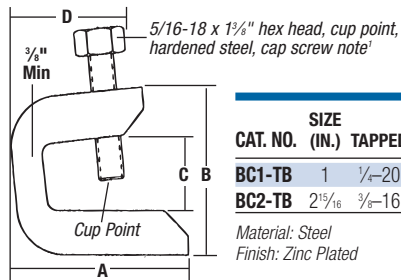

CAT. NO.	SIZE (IN.)	TAPPED	DIMENSIONS (IN.)				STD. CTN.
			A	B	C	D	
BC1-TB	1	1/4-20	1 1/16	1 1/8	5/8	1 3/16	250
BC2-TB	2 15/16	3/8-16	2 1/8	2 1/16	3/4	1 1/16	25

Material: Steel
Finish: Zinc Plated

Beam Clamps — Malleable Iron, Electroplated Finish

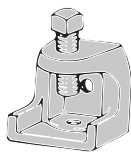

CAT. NO.	BASE SIZE (IN.)		JAW OPENING INCHES	TAPPING OF BASE AND BACK HOLES	LOAD RATING‡	STD. CTN.
	A	B				
510	2 7/32	1 1/8	5/8	1/4-20	400	100
511-SC	2 7/32	1 1/8	5/8	10-24	400	100
500-SC	1	1 1/4	15/16	1/4-20	450	50
509	1	1 1/4	15/16	10-24	375	100
501	1 1/2	1 5/8	7/8	5/16-18	800	50
502	2	2	1	3/8-16	1,300	50
503-SC	2 5/8	2 1/2	1	1/2-13	1,300	20
507	2 1/2	2 3/8	1 1/8	1/2-13	1,700	20
508	2 1/2	2 3/8	2 1/8	1/2-13	1,700	10

‡Safety Factor of 3.
Load Ratings based on bottom hole of Beam Clamp.
CSA File No. LR-52208.

Conduit/Pipe to Beam Clamps

EC Series

- For mounting pipe or conduit vertically across the beam
- Add a HDG suffix for hot-dip galvanized

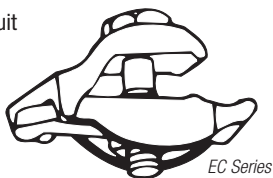

CAT. NO. & SIZE	O.D. OF CONDUIT OR PIPE	DIMENSIONS (IN.)		STD. CTN.
		NOM. CONDUIT OR PIPE SIZE	PIPE SIZE	
EC Clamp — Malleable Iron				
EC 1/2	.840	1/2	50	50
EC-3/4	1.050	3/4	50	50
EC-1	1.315	1	25	25
EC-1-1/4	1.660	1 1/4	25	25
EC-1-1/2	1.900	1 1/2	25	25
EC-2	2.375	2	25	25
EC-2-1/2	2.875	2 1/2	10	10

Conduit/Pipe to Beam Clamps

- For mounting pipe or conduit at right angles to the beam
- Add a SS316 suffix for stainless steel
- Add a HDG suffix for hot-dip galvanized

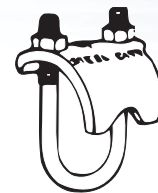

RCS Series

CAT. NO. & SIZE	O.D. OF CONDUIT OR PIPE	DIMENSIONS (IN.)		STD. CTN.
		NOM. CONDUIT OR PIPE SIZE	PIPE SIZE	
RCS Clamp — Steel				
RCS-1/2	.840	1/2	50	50
RCS-3/4	1.050	3/4	50	50
RCS-1	1.315	1	50	50
RCS-1-1/4	1.660	1 1/4	50	50
RCS-1-1/2	1.900	1 1/2	50	50
RCS-2	2.375	2	50	50

RC Clamp — Malleable Iron

RC-3/8	.675	3/8	50	50
RC-1/2	.840	1/2	50	50
RC-3/4	1.050	3/4	50	50
RC-1	1.315	1	50	50
RC-1-1/4	1.660	1 1/4	50	50
RC-1-1/2	1.900	1 1/2	50	50
RC-2-SC	2.375	2	50	50
RC-2-1/2	2.875	2 1/2	25	25
RC-3	3.500	3	25	25
RC-3-1/2	4.000	3 1/2	25	25
RC-4-SC	4.500	4	20	20

PC Series

- For mounting pipe or conduit parallel to the beam
- Add a HDG suffix for hot-dip galvanized

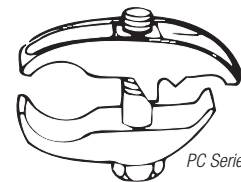

PC Series

CAT. NO. & SIZE	O.D. OF CONDUIT OR PIPE	DIMENSIONS (IN.)		STD. CTN.
		NOM. CONDUIT OR PIPE SIZE	PIPE SIZE	
PC Clamp — Malleable Iron				
PC-3/8	.675	3/8	50	50
PC 1/2	.840	1/2	50	50
PC-3/4	1.050	3/4	50	50
PC-1	1.315	1	50	50
PC-1-1/4	1.660	1 1/4	25	25
PC-1-1/2	1.900	1 1/2	25	25
PC-2	2.375	2	25	25
PC-2-1/2	2.875	2 1/2	25	25
PC-3	3.500	3	10	10
PC-3-1/2	4.000	3 1/2	10	10
PC-4	4.500	4	10	10

Ground Clamps — Die Cast Zinc, Brass Colored

- Two-screw ground connection for armored ground wire



CAT. NO.	CONDUIT SIZE (IN.)	STD. CTN.
GC-203-B	1/2, 1	200

6H Series Conduit and Pipe Hangers — Without Bolt

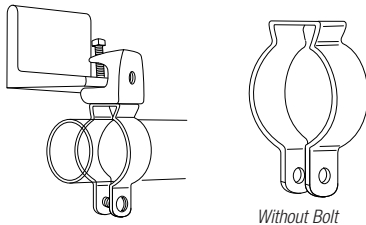

Without Bolt

All Steel City 6H Hanger Bolts include a combination Slot-Phillips Head.

For hanging conduit (rigid or EMT) and pipe.

The 6H series hangers are fast, easy and economical to use. May be fastened directly to a #500 beam clamp through a hole in the base of the hanger by means of a 1/4-20 stove bolt or suspended on 1/4" hanger rod.

CAT. NO.	RIGID CONDUIT OR PIPE SIZE (IN.)	EMT SIZE (IN.)	DIMENSIONS (IN.)				LOAD RATING	STD. CTN.
			A	B	C	D (DIA.)		
6H0	3/8-1/2	1/2	3/4	.045	1 ² / ₃₂	9/32	500	100
6H0 T	3/8-1/2	1/2	3/4	.045	1 ² / ₃₂	9/32	500	100
6H1	3/4	3/4	7/8	.045	1 ³ / ₃₂	9/32	500	100
6H1-T	3/4	3/4	7/8	.045	2 ³ / ₃₂	9/32	500	100
6H2	1	1	7/8	.045	2 ³ / ₈	9/32	500	100
6H2 1/2	—	1 ¹ / ₄	7/8	.045	2 ² / ₃₂	9/32	500	100
6H3-SC	1 ¹ / ₄	1 ¹ / ₂	7/8	.045	2 ⁷ / ₈	9/32	500	100
6H4	1 ¹ / ₂	—	1	.071	3 ³ / ₈	1 ¹ / ₃₂	500	100
6H5	2	2	1 ¹ / ₄	.071	3 ²⁹ / ₃₂	1 ¹ / ₃₂	500	50
6H6	2 ¹ / ₂	—	1 ¹ / ₄	.071	4 ³ / ₃₂	1 ¹ / ₃₂	500	50
6H7	3	—	1 ¹ / ₄	.071	5 ³ / ₁₆	1 ¹ / ₃₂	500	25
6H8	3 ¹ / ₂	—	1 ¹ / ₄	.071	5 ⁷ / ₁₆	1 ¹ / ₃₂	500	25
6H9	4	4	1 ¹ / ₄	.071	5 ⁷ / ₈	1 ¹ / ₃₂	500	10

UL File No. E-160899.

Add SS suffix to part number for Stainless Steel.

Load rating is 500 lbs. with a safety factor of 3. Available with or without closure bolt.

Standard finishes: Electro-Galvanized. (Add SS suffix for Type 302 Stainless Steel)

6H Series Conduit and Pipe Hangers — With Bolt

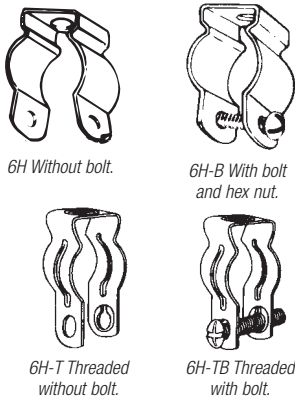

6H Without bolt.

6H-B With bolt and hex nut.

6H-T Threaded without bolt.

6H-TB Threaded with bolt.

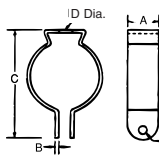

CAT. NO.	RIGID CONDUIT OR PIPE SIZE (IN.)	EMT SIZE (IN.)	DIMENSIONS (IN.)				LOAD RATING	STD. CTN.
			A	B	C	D (DIA.)		
6H0 B	3/8-1/2	1/2	3/4	.045	1 ² / ₃₂	9/32	500	100
6H0 TB	3/8-1/2	1/2	3/4	.045	1 ² / ₃₂	9/32	500	100
6H1-B	3/4	3/4	7/8	.045	1 ³ / ₃₂	9/32	500	100
6H1-TB	3/4	3/4	7/8	.045	2 ³ / ₃₂	9/32	500	100
6H2-B	1	1	7/8	.045	2 ³ / ₈	9/32	500	100
6H2-B	1	1 ¹ / ₄	7/8	.045	2 ²⁹ / ₃₂	9/32	500	100
6H3-B	1 ¹ / ₄	1 ¹ / ₂	7/8	.045	2 ⁷ / ₈	9/32	500	100
6H4-B	1 ¹ / ₂	—	1	.071	3 ³ / ₈	1 ¹ / ₃₂	500	100
6H5-B	2	2	1 ¹ / ₄	.071	3 ²⁹ / ₃₂	1 ¹ / ₃₂	500	50
6H6-B	2 ¹ / ₂	—	1 ¹ / ₄	.071	4 ³ / ₃₂	1 ¹ / ₃₂	500	50
6H7-B	3	—	1 ¹ / ₄	.071	5 ³ / ₁₆	1 ¹ / ₃₂	500	25
6H8-B	3 ¹ / ₂	—	1 ¹ / ₄	.071	5 ⁷ / ₁₆	1 ¹ / ₃₂	500	25
6H9-B	4	4	1 ¹ / ₄	.071	5 ⁷ / ₈	1 ¹ / ₃₂	500	10

UL File No. E-160899.

Add SS suffix to part number for Stainless Steel.

Load rating is 500 lbs. with a safety factor of 3.

Available with or without closure bolt.

Standard finishes: Electro-Galvanized. (Add SS suffix for Type 302 Stainless Steel)



A job that normally takes 20 minutes —
DONE in 2 minutes or less!

Carlton® PVC Conduit Repair System

The new, revolutionary Carlton® PVC Conduit Repair System significantly reduces the time and money associated with repairing broken PVC conduits, a.k.a. “stub-ups”, in concrete slabs.

The system includes a line of couplings, adapters, reamers and plugs designed to enable contractors to quickly and easily repair broken PVC conduits without having to chip away and repour concrete, while still maintaining the inside diameter of the conduit. Simply cut off the broken conduit, ream the I.D. of the conduit and insert a coupling or adapter. It's that easy. A job that normally takes 20 minutes can now be done in 2 minutes or less!



Features:

- cUL–US Listed
- PVC repair fittings are listed in accordance with the NEC® and Section 352.6
- Non-metallic couplings, adapters and plugs won't rust or corrode
- Available in sizes ½" through 2"

Benefits:

- Saves time and money
- Maintains inside diameter of conduit
- Metallic reamers for extra strength, durability and longer life
- Quickly and easily repair broken PVC conduits

Carlton® Non-Metallic Rigid Conduit, Fittings and Accessories

Reamers

CAT. NO.	TRADE SIZE (IN.)	STD. CTN.
E910REAMD	½	12
E910REAME	¾	12
E910REAMF	1	10
E910REAMG	1¼	10
E910REAMH	1½	10
E910REAMJ	2	10
E910REAMKIT	All sizes	5



Reamer



Reamer Kit

Couplings

CAT. NO.	TRADE SIZE (IN.)	STD. CTN.
E910D	½	25
E910E	¾	25
E910F	1	15
E910G	1¼	10
E910H	1½	10
E910J	2	10



Coupling

Male Threaded Adapters

CAT. NO.	TRADE SIZE (IN.)	STD. CTN.
E920D	½	25
E920E	¾	25
E920F	1	15
E920G	1¼	10
E920H	1½	10
E920J	2	10



Male Threaded Adapter

Schedule 40 Plugs

CAT. NO.	SIZE (IN.)	COLOR	CAT. NO.	SIZE (IN.)	COLOR	CAT. NO.	SIZE (IN.)	COLOR	STD. CTN.
HL-6XR	½	Red	HL-6XB	½	Blue	HL-6XY	½	Yellow	1 Bag of 50
HL-10R	¾	Red	HL-10B	¾	Blue	HL-10Y	¾	Yellow	1 Bag of 50
HL-13AR	1	Red	HL-13AB	1	Blue	HL-13AY	1	Yellow	1 Bag of 50
HL-16R	1¼	Red	HL-16B	1¼	Blue	HL-16Y	1¼	Yellow	1 Bag of 50
HL-18R	1½	Red	HL-18B	1½	Blue	HL-18Y	1½	Yellow	1 Bag of 50
HL-21R	2	Red	HL-21B	2	Blue	HL-21Y	2	Yellow	1 Bag of 50



Plug

PVC Conduit Repair Fittings



Broken conduit on jobsite



Coupling
E910_



Male Threaded Adapter
E920_

Instructions:

- 1** Cut broken conduit off flush.



- 2** Insert plug to keep conduit clean/dry through balance of rough-in. Once rough-in is complete, remove plug and **continue with Step 3.**

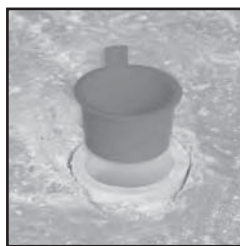

Alternative to Conduit Repairs:

Prior to concrete pour, measure and saw cut all conduit stub-ups to the thickness of the concrete pour. Insert plugs. Pour concrete flush to the conduit. When pour is complete, remove plugs and **proceed with Step 3.** This alternative method saves time/money by eliminating the need for transitions or use of metal elbows.

- 3** With reamer tool and standard 1/2" drill, ream I.D. of conduit. It is recommended to use a variable speed drill. Use slower speed to avoid overheating the conduit.



- 4** The guide will direct the cutter; the stop will touch when completed.



- 5** Insert the coupling and cement into place using the cement manufacturer's instructions.



Cementing Instructions:

- A. Clean socket I.D. and spigot O.D. of dirt and moisture.
- B. Apply a uniform coat of cement to spigot end and push onto socket bottom, rotating 1/4 turn.
- C. Allow time to set before disturbing. This will depend upon temperature.

Apply a uniform coat of cement.



Insert fitting.



Rotate 1/4 turn.



ETL Listed
to UL 651 in
compliance
to the NEC®



LISTED
E23018

Schedule 40 Elbows Standard Radius

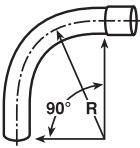
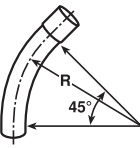
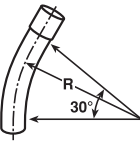
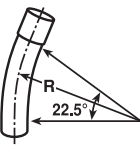
ITEM	PLAIN END CAT. NO.	BELLED END CAT. NO.	SIZE (IN.)	PLAIN END STD. CTN.	BELLED END STD. CTN.	
 90° ELBOW	UA9AD	UA9ADB	½	50	50	
	UA9ADR-CAR	UA9ADB	½	25	50	
	UA9AE	UA9AEB	¾	25	25	
	UA9AFR-CTN	UA9AFB-CTN	1	25	25	
	UA9AG	UA9AGB	1¼	20	20	
	UA9AH	UA9AHB	1½	25	25	
	UA9AJ	UA9AJB	2	20	20	
	UA9AK-CAR	UA9AKB-CAR	2½	10	10	
	UA9AL	UA9ALB	3	1	5	
	UA9AM	UA9AMB	3½	1	20	
	UA9AN	UA9ANB	4	1	1	
	UA9AP	UA9APB	5	1	1	
	UA9AR	UA9ARB	6	1	1	
	 45° ELBOW	UA7AD	UA7ADB	½	50	50
UA7AE		UA7AEB	¾	25	25	
UA7AF		UA7AFB	1	20	20	
UA7AF-CAR		UA7AFB	1	15	20	
UA7AG		UA7AGB	1¼	20	20	
UA7AH		UA7AHB	1½	20	20	
UA7AJ		UA7AJB	2	20	20	
UA7AJ-CAR		—	2	4	4	
UA7AK		UA7AKB	2½	20	20	
UA7AL		UA7ALB	3	5	25	
UA7AM		UA7AMB	3½	1	20	
UA7AN		UA7ANB	4	1	20	
UA7AP		UA7APB	5	1	1	
UA7AR		UA7ARB	6	1	1	
 30° ELBOW	UA6AD	UA6ADB	½	50	50	
	UA6AE	UA6AEB	¾	25	25	
	UA6AF	UA6AFB	1	25	1	
	UA6AG	UA6AGB	1¼	20	20	
	UA6AH	UA6AHB	1½	25	1	
	UA6AJ	UA6AJB	2	20	20	
	UA6AK	UA6AKB	2½	10	20	
	UA6AL	UA6ALB	3	1	1	
	UA6AM	UA6AMB	3½	1	1	
	UA6AN	UA6ANB	4	1	1	
	UA6AP	UA6APB	5	1	1	
	UA6AR	UA6ARB	6	1	1	
	 22½° ELBOW	UA5AD	—	½	1	—
		UA5AE	—	¾	1	—
UA5AF		—	1	1	—	
UA5AG		—	1¼	1	—	
UA5AH		—	1½	1	—	
UA5AJ		UA5AJB	2	25	1	
UA5AK		—	2½	20	—	
UA5AL		UA5ALB	3	5	1	
UA5AM		—	3½	1	—	
UA5AN		UA5ANB	4	1	1	
UA5AP		UA5APB	5	1	1	
UA5AR		UA5ARB	6	1	1	

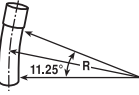
ITEM	PLAIN END CAT. NO.	BELLED END CAT. NO.	SIZE (IN.)	PLAIN END STD. CTN.	BELLED END STD. CTN.
 11½° ELBOW	UA3AD	—	½	1	—
	UA3AE	—	¾	1	—
	UA3AF	—	1	1	—
	UA3AG	—	1¼	1	—
	UA3AH	—	1½	1	—
	UA3AJ	—	2	1	—
	UA3AK	—	2½	1	—
	UA3AL	—	3	1	—
	UA3AM	—	3½	1	—
	UA3AN	UA3ANB	4	1	1
	UA3AP	—	5	1	—
	UA3AR	—	6	1	—

Available in plain and integral belled end for use with non-metallic solvent weld fittings.

Standard Radius Elbow Dimensions

SIZE (IN.)	A (IN.)	B MIN. (RADIUS) (IN.)	C MIN. (IN.)
½	.840	4	1½
¾	1.050	4½	1½
1	1.315	5½	1½
1¼	1.660	7¼	2
1½	1.900	8¼	2
2	2.375	9½	2
2½	2.875	10½	3
3	3.500	13	3½
3½	4.000	15	3½
4	4.500	16	3½
5	5.563	24	3½
6	6.625	30	3½

Integral Belled End Dimensions

TRADE SIZE (IN.)	A (IN.) AT ENTRANCE		B (IN.) AT BOTTOM		C (IN.) SOCKET DEPTH	
	MAX.	MIN.	MAX.	MIN.	MAX.	MIN.
½	.860	0.844	0.844	0.828	1.500	0.652
¾	1.074	1.054	1.056	1.036	1.500	0.719
1	1.340	1.320	1.320	1.300	1.875	0.875
1¼	1.689	1.665	1.667	1.643	2.000	0.938
1½	1.930	1.906	1.906	1.882	2.000	1.062
2	2.405	2.381	2.381	2.357	2.000	1.125
2½	2.905	2.875	2.883	2.853	3.000	1.469
3	3.530	3.500	3.507	3.477	3.125	1.594
3½	4.065	3.965	4.007	3.977	3.250	1.687
4	4.565	4.465	4.506	4.476	3.375	1.750
5	5.643	5.543	5.583	5.523	3.625	1.937
6	6.708	6.608	6.644	6.584	3.750	2.125

Carlton® Non-Metallic Rigid Conduit, Fittings and Accessories

Corporate Office
Tel: 901.252.8000
800.816.7809
Fax: 901.252.1354

Customer Service
Tel: 800.816.7809
Fax: 800.816.7810

Technical Services
Tel: 888.862.3289
Fax: 901.252.1321

Tool Services
Tel: 800.284.8665

Thomas & Betts

www.tnb.com

Schedule 40 Elbows

Special Radius

*Consult factory for additional sizes/configurations



ETL Listed
to UL 651 in
compliance
to the NEC®



LISTED
E23018

Carlton® Non-Metallic Rigid Conduit, Fittings and Accessories

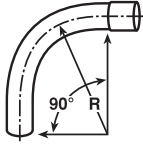
SEGMENT	PLAIN END CAT. NO.	BELLED END CAT. NO.	NOM. DIAM. (IN.)	RADIUS (IN.)	PLAIN END STD. CTN.	BELLED END STD. CTN.
90° ELBOW						
	UA9CF	UA9CFB	1	18	1	1
	UA9DF	UA9DFB	1	24	1	1
	UA9EF	UA9EFB	1	30	1	1
	UA9FF	—	1	36	1	—
	UA9HF	—	1	48	1	—
	UA9CG	UA9CGB	1½	18	1	1
	UA9DG	UA9DGB	1½	24	1	1
	UA9EG	UA9EGB	1½	30	1	1
	UA9FG	UA9FGB	1½	36	1	1
	UA9HG	—	1½	48	1	—
	UA9CH	UA9CHB	1½	18	1	1
	UA9DH	UA9DHB	1½	24	1	1
	UA9EH	UA9EHB	1½	30	1	1
	UA9FH	UA9FHB	1½	36	1	1
	UA9HH	—	1½	48	1	—
	UA9CJ	UA9CJB	2	18	1	1
	UA9DJ	UA9DJB-UPC	2	24	1	1
	UA9EJ	UA9EJB	2	30	1	1
	UA9FJ-UPC	UA9FJB	2	36	1	1
	UA9HJ	UA9HJB	2	48	1	1
	UA9JJ	—	2	72	1	—
	UA9CK	UA9CKB	2½	18	1	1
	UA9DK	UA9DKB-UPC	2½	24	1	1
	UA9EK	UA9EKB	2½	30	1	1
	UA9FK-UPC	UA9FKB	2½	36	1	1
	UA9HK	UA9HKB	2½	48	1	1
	UA9CL	UA9CLB	3	18	1	1
	UA9DL	UA9DLB-UPC	3	24	1	1
	UA9EL	UA9ELB	3	30	1	1
	UA9FL	UA9FLB	3	36	1	1
	UA9HL	UA9HLB	3	48	1	1
	UA9IL	—	3	60	1	—
	UA9DM	UA9DMB	3½	24	1	1
	UA9EM	UA9EMB	3½	30	1	1
	UA9FM	UA9FMB	3½	36	1	1
	UA9HM	UA9HMB	3½	48	1	1
	—	UA9CNB	4	18	—	1
	UA9DN	UA9DNB	4	24	1	1
	UA9EN	UA9ENB	4	30	1	1
	UA9FN	UA9FNB	4	36	1	1
	UA9HN	UA9HNB	4	48	1	1
	UA9IN	UA9INB	4	60	1	1
	UA9JN	—	4	72	1	1
	UA9EP	UA9EPB	5	30	1	1
	UA9FP	UA9FPB	5	36	1	1
	UA9HP	UA9HPB	5	48	1	1
	UA9IP	UA9IPB	5	60	1	1
	UA9FR	UA9FRB	6	36	1	1
	UA9HR	UA9HRB	6	48	1	1
	UA9IR	UA9IRB	6	60	1	1
	—	UA9TRB	6	180	—	1
	UA9HT	—	8	48	1	1

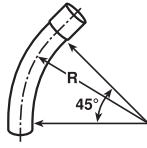
SEGMENT	PLAIN END CAT. NO.	BELLED END CAT. NO.	NOM. DIAM. (IN.)	RADIUS (IN.)	PLAIN END STD. CTN.	BELLED END STD. CTN.
45° ELBOW						
	UA7CF	—	1	18	1	—
	UA7DF	—	1	24	1	—
	UA7EF	—	1	30	1	—
	UA7FF	—	1	36	1	—
	UA7HF	—	1	48	1	—
	UA7CG	—	1½	18	1	—
	UA7DG	—	1½	24	1	—
	UA7EG	—	1½	30	1	—
	UA7FG	—	1½	36	1	—
	UA7HG	—	1½	48	1	—
	UA7CH	—	1½	18	1	—
	UA7DH	—	1½	24	1	—
	UA7EH	—	1½	30	1	—
	UA7FH	UA7FHB	1½	36	1	1
	UA7HH	—	1½	48	1	—
	—	UA7BJB	2	12	—	1
	UA7CJ	UA7CJB	2	18	1	1
	UA7DJ	UA7DJB	2	24	1	1
	UA7EJ	UA7EJB	2	30	1	1
	UA7FJ	UA7FJB	2	36	1	1
	UA7HJ	UA7HJB	2	48	1	1
	UA7SJ	—	2	150	1	—
	UA7CK	—	2½	18	1	—
	UA7DK	UA7DKB	2½	24	1	1
	UA7EK	—	2½	30	1	—
	UA7FK	UA7FKB	2½	36	1	1
	UA7HK	—	2½	48	1	—
	UA7CL	UA7CLB	3	18	1	1
	UA7DL	UA7DLB	3	24	1	1
	UA7EL	UA7ELB	3	30	1	1
	UA7FL	UA7FLB	3	36	1	1
	UA7HL	UA7HLB	3	48	1	1
	UA7DM	—	3½	24	1	—
	UA7EM	—	3½	30	1	—
	UA7FM	—	3½	36	1	—
	UA7DN	UA7DNB	4	24	1	1
	UA7EN	UA7ENB	4	30	1	1
	UA7FN	UA7FNB	4	36	1	1
	UA7HN	UA7HNB	4	48	1	1
	—	UA7NNB	4	120	—	1
	UA7SN	UA7SNB	4	150	1	—
	UA7EP	UA7EPB	5	30	1	1
	UA7FP	UA7FPB	5	36	1	1
	UA7HP	UA7HPB	5	48	1	1
	—	UA7IPB	5	60	—	1
	—	UA7NPB	5	120	—	1
	—	UA7SPB	5	150	—	1
	UA7FR	UA7FRB	6	36	1	1
	UA7HR	UA7HRB	6	48	1	1
	UA7FT	—	8	36	1	—
	UA7HT	—	8	48	1	—

NOTE: Elbows 72" and larger may be shipped in segments. Consult factory for specifics.



ETL Listed
to UL 651 in
compliance to
the NEC®



LISTED
E23018

Schedule 40 Elbows Special Radius

*Consult factory for additional sizes/configurations

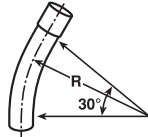
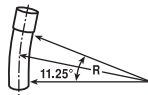
SEGMENT	PLAIN END CAT. NO.	BELLED END CAT. NO.	NOM. DIAM. (IN.)	RADIUS (IN.)	PLAIN END STD. CTN.	BELLED END STD. CTN.
30° ELBOW 	UA6CJ	—	2	18	1	—
	UA6DJ	UA6DJB	2	24	1	1
	UA6FJ	UA6FJB	2	36	1	1
	UA6HJ	UA6HJB	2	48	1	1
	UA6CK	—	2½	18	1	—
	UA6DK	—	2½	24	1	—
	UA6CL	—	3	18	1	—
	UA6DL	UA6DLB	3	24	1	1
	UA6FL	UA6FLB	3	36	1	1
	UA6HL	UA6HLB	3	48	1	1
	UA6DM	—	3½	24	1	—
	UA6FM	—	3½	36	1	—
	UA6HM	—	3½	48	1	—
	UA6DN	—	4	24	1	—
	UA6FN	UA6FNB	4	36	1	1
	UA6HN	UA6HNB	4	48	1	1
	UA6FP	UA6FPB	5	36	1	1
	UA6HP	UA6HPB	5	48	1	1
	UA6FR	UA6FRB	6	36	1	1
	UA6HR	UA6HRB	6	48	1	1
11¼° ELBOW 	UA3DJ	UA3DJB	2	24	1	25
	UA3FJ	UA3FJB	2	36	1	1
	UA3HJ	—	2	48	1	—
	UA3HK	—	2½	48	1	—
	UA3DL	UA3DLB	3	24	1	1
	UA3FL	UA3FLB	3	36	1	1
	UA3HL	—	3	48	1	—
	UA3DM	—	3½	24	1	—
	UA3HM	—	3½	48	1	—
	UA3DN	UA3DNB	4	24	1	1
	UA3FN	UA3FNB	4	36	1	1
	—	UA3SNB	4	150	—	1
	UA3HN	UA3HNB	4	48	1	1
	UA3FP	UA3FPB	5	36	1	1
	UA3HP	—	5	48	1	—
	—	UA3UPB	5	240	—	1
	UA3FR	UA3FRB	6	36	1	1
	UA3HR	—	6	48	1	—
	UA3FT	—	8	36	1	—

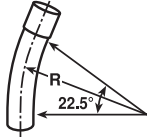
SEGMENT	PLAIN END CAT. NO.	BELLED END CAT. NO.	NOM. DIAM. (IN.)	RADIUS (IN.)	PLAIN END STD. CTN.	BELLED END STD. CTN.
22½° ELBOW 	UA5FF	—	1	36	1	—
	UA5FG	—	1¼	36	1	—
	UA5FH	UA5FHB	1½	36	1	1
	UA5CJ	UA5CJB	2	18	1	1
	UA5DJ	UA5DJB	2	24	1	25
	UA5EJ	UA5EJB	2	30	1	1
	UA5FJ	UA5FJB	2	36	1	1
	UA5HJ	—	2	48	1	—
	UA5VJ	—	2	300	1	—
	UA5CK	—	2½	18	1	—
	UA5DK	—	2½	24	1	—
	UA5EK	—	2½	30	1	—
	UA5FK	—	2½	36	1	—
	UA5HK	—	2½	48	1	—
	—	UA5CLB	3	18	1	1
	UA5DL	UA5DLB	3	24	1	1
	UA5EL	UA5ELB	3	30	1	1
	UA5FL	UA5FLB	3	36	1	1
	UA5HL	—	3	48	1	—
	UA5VL	—	3	300	1	—
	UA5DM	—	3½	24	1	—
	UA5EM	—	3½	30	1	—
	UA5FM	—	3½	36	1	—
	UA5HM	—	3½	48	1	—
	UA5DN	UA5DNB	4	24	1	1
	UA5EN	UA5ENB	4	30	1	1
	UA5FN	UA5FNB	4	36	1	1
	UA5HN	UA5HNB	4	48	1	—
	UA5IN	—	4	60	1	—
	UA5JN	—	4	72	1	—
	UA5SN	UA5SNB	4	150	1	—
	—	UA5UNB	4	240	—	1
	—	UA5VNB	4	300	—	1
	—	UA5DPB	5	24	1	1
	UA5EP	UA5EPB	5	30	1	1
	UA5FP	UA5FPB	5	36	1	1
UA5HP	UA5HPB	5	48	1	1	
UA5IP	—	5	60	1	—	
UA5SP	—	5	150	1	—	
—	UA5UPB	5	240	—	1	
—	UA5VPB	5	300	—	1	
UA5FR	UA5FRB	6	36	1	1	
UA5HR	UA5HRB	6	48	1	1	
UA5IR	—	6	60	1	—	
UA5RR	—	6	144	1	—	
UA5SR	—	6	150	1	—	
UA5VR	—	6	300	1	—	
UA5FT	—	8	36	1	—	
UA5HT	—	8	48	1	—	

NOTE: Elbows 72" and larger may be shipped in segments. Consult factory for specifics.

Carlton® Non-Metallic Rigid Conduit, Fittings and Accessories

Corporate Office
Tel: 901.252.8000
800.816.7809
Fax: 901.252.1354

Customer Service
Tel: 800.816.7809
Fax: 800.816.7810

Technical Services
Tel: 888.862.3289
Fax: 901.252.1321

Tool Services
Tel: 800.284.8665

Thomas & Betts

www.tnb.com



ETL Listed
to UL 651 in
compliance
to the NEC®



LISTED
E23018

Schedule 80 Elbows Standard Radius

For use with non-metallic solvent weld fittings.

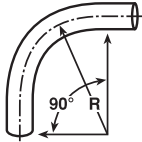
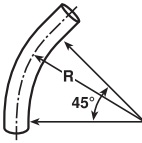
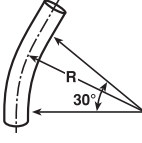
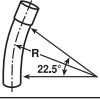
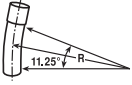
ITEM	PLAIN END CAT. NO.	BELLED END CAT. NO.	SIZE (IN.)	PLAIN END STD. CTN.	BELLED END STD. CTN.
 90° ELBOW	UB9AD	—	½	50	—
	UB9AE	—	¾	25	—
	UB9AF	—	1	25	—
	UB9AG	—	1¼	20	—
	UB9AH	—	1½	25	—
	UB9AJ	—	2	20	—
	UB9AK	—	2½	10	—
	UB9AL	—	3	5	—
	UB9AN	—	4	1	—
	UB9AP	UB9APB	5	1	1
	UB9AR	—	6	1	—
	 45° ELBOW	UB7AD	—	½	50
UB7AE-UPC		—	¾	25	—
UB7AF-UPC		—	1	20	—
UB7AG		—	1¼	20	—
UB7AH		—	1½	20	—
UB7AH-CAR		—	1½	5	—
UB7AJ-UPC		—	2	20	—
UB7AK		—	2½	20	—
UB7AL		—	3	1	—
UB7AN		—	4	1	—
 30° ELBOW	UB6AD	—	½	50	—
	UB6AE	—	¾	25	—
	UB6AF	—	1	25	—
	UB6AG	—	1¼	5	—
	UB6AH	—	1½	25	—
	UB6AJ	—	2	20	—
	UB6AK	—	2½	1	—
	UB6AL	—	3	1	—
	UB6AN	—	4	1	—
	UB6AP	—	5	1	—
 22½° ELBOW	UB5AL	—	3	5	—
	UB5AN	—	4	1	—
	UB5AP	UB5APB	5	1	1
	 11¼° ELBOW	UB3AL	—	3	1
UB3AR		—	6	1	—

Special Radius

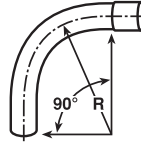
SEGMENT	PLAIN END CAT. NO.	BELLED END CAT. NO.	NOM. DIAM. (IN.)	RADIUS (IN.)	PLAIN END STD. CTN.	BELLED END STD. CTN.
 90° ELBOW	UB9CF	—	1	18	1	—
	UB9DF	—	1	24	1	—
	UB9FF	—	1	36	1	—
	UB9HF	—	1	48	1	—
	UB9CG	—	1¼	18	1	—
	UB9DG	—	1¼	24	1	—
	UB9FG	—	1¼	36	1	—
	UB9HG	—	1¼	48	1	—
	UB9CH	—	1½	18	1	—
	UB9DH-UPC	UB9DHB	1½	24	1	1
	UB9FH	—	1½	36	1	—
	UB9HH	—	1½	48	1	—
	UB9CJ	—	2	18	1	—
	UB9DJ-UPC	UB9DJB	2	24	1	1
	UB9FJ	UB9FJB	2	36	1	1
	UB9HJ	—	2	48	1	—
	UB9CK	—	2½	18	1	—
	UB9DK-UPC	UB9DKB	2½	24	1	1
	UB9FK	UB9FKB	2½	36	1	1
	UB9HK	—	2½	48	1	—
	UB9CL	—	3	18	1	—
	UB9DL	UB9DLB	3	24	1	1
	UB9FL	UB9FLB	3	36	1	1
	UB9HL	—	3	48	1	—
	UB9DN	UB9DNB	4	24	1	1
	UB9FN	UB9FNB	4	36	1	1
	UB9HN	UB9HNB	4	48	1	1
	UB9NN	—	4	120	1	—
UB9FP	—	5	36	1	—	
UB9HP	—	5	48	1	—	
UB9IP	—	5	60	1	—	
UB9FR	—	6	36	1	—	
UB9HR	—	6	48	1	—	
UB9IR	—	6	60	1	—	

NOTE: Elbows 72" and larger may be shipped in segments. Consult factory for specifics.

Continued on next page



Schedule 80 Elbows

Continued from previous page

Special Radius

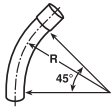
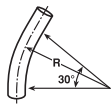
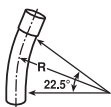
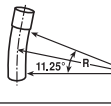
SEGMENT	PLAIN END CAT. NO.	BELLED END CAT. NO.	NOM. DIAM. (IN.)	RADIUS (IN.)	PLAIN END STD. CTN.	BELLED END STD. CTN.
45° ELBOW 	UB7CF	—	1	18	1	—
	UB7DF	—	1	24	1	—
	UB7FF	—	1	36	1	—
	UB7HF	—	1	48	1	—
	UB7DG	—	1 1/4	24	1	—
	UB7FG	—	1 1/4	36	1	—
	UB7HG	—	1 1/4	48	1	—
	UB7CH	—	1 1/2	18	1	—
	UB7DH	UB7DHB	1 1/2	24	1	1
	UB7FH	—	1 1/2	36	1	—
	UB7HH	—	1 1/2	48	1	—
	UB7CJ	—	2	18	1	—
	UB7DJ	UB7DJB	2	24	1	1
	UB7FJ	UB7FJB	2	36	1	1
	UB7HJ	—	2	48	1	—
	UB7DK	UB7DKB	2 1/2	24	1	1
	UB7FK	—	2 1/2	36	1	—
	UB7HK	—	2 1/2	48	1	—
	UB7CL	—	3	18	1	—
	UB7DL	UB7DLB	3	24	1	1
	UB7FL	UB7FLB	3	36	1	1
	UB7HL	—	3	48	1	—
	UB7DN	UB7DNB	4	24	1	1
	UB7FN	UB7FNB	4	36	1	1
	UB7HN	—	4	48	1	—
	UB7FP	—	5	36	1	—
	UB7HP	—	5	48	1	—
	UB7FR	—	6	36	1	—
UB7HR	—	6	48	1	—	
UB7IR	—	6	60	1	—	
30° ELBOW 	UB6FN	—	4	36	1	—
	UB6FR	—	6	36	1	—
22 1/2° ELBOW 	—	UB5DHB	1 1/2	24	—	20
	—	UB5DJB	2	24	—	20
	—	UB5FJB	2	36	—	25
	—	UB5DKB	2 1/2	24	—	15
	UB5DL	UB5DLB	3	24	1	10
	—	UB5FLB	3	36	—	1
	UB5DN	UB5DNB	4	24	1	5
	—	UB5FNB	4	36	—	1
11 1/2° ELBOW 	UB5FP	—	5	36	1	—
	UB3FP	—	5	36	1	—

NOTE: Elbows 72" and larger may be shipped in segments. Consult factory for specifics.

Flexible PVC Elbows

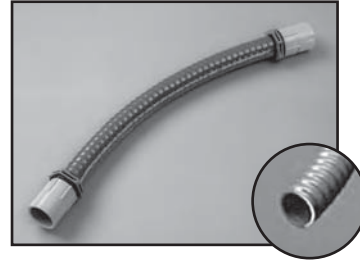

- UL Listed for exposed and direct burial applications in accordance with Article 356 of the NEC®
- 0°–90° bending and offset applications
- O-ring seal for moisture-tight connections
- Maintains round shape throughout bend
- Sunlight resistant
- Non-corrosive — all PVC and Neoprene material
- Fully assembled and ready to use

CAT. NO.	SIZE (IN.)	STD. CTN.	STD. WT. (LBS.)	LENGTH FULLY ASSEMBLED (IN.)
UAFAD	1/2	8	1.6	8.5
UFAFE	3/4	6	1.9	9.6
UFAFF	1	6	2.4	11.9



ETL Listed to UL 651 in compliance to the NEC®



LISTED E23018

Carlton® Non-Metallic Rigid Conduit, Fittings and Accessories



Canadian Schedule 40 Elbows Standard Radius

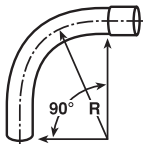
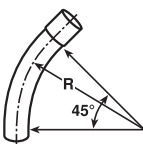
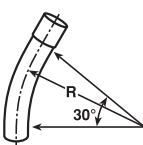

LR90813

ITEM	BELLED END CAT. NO.	BELLED END SIZE (IN.)	STD. CTN.
90° ELBOW 	UA9ADCB-CTN	½	40
	UA9AECB-CTN	¾	25
	UA9AFCB-CTN	1	25
	UA9AGCB-UPC	1¼	20
	UA9AHCB-UPC	1½	25
	UA9AJCB-UPC	2	20
	UA9AKCB-CTN	2½	10
	UA9ALCB-UPC	3	25
	UA9AMCB	3½	1
	UA9ANCB	4	1
	UA9APCB	5	1
	UA9ARCB	6	1
	45° ELBOW 	UA7AGCB	1¼
UA7AHCB		1½	20
UA7AJCB		2	20
UA7AKCB		2½	1
UA7ALCB		3	5
UA7AMCB		3½	1
UA7ANCB		4	1
30° ELBOW 	UA6AJCB	2	20
	UA6ANCB	4	1
	UA6ARCB	6	1

Standard Radius Elbow Dimensions

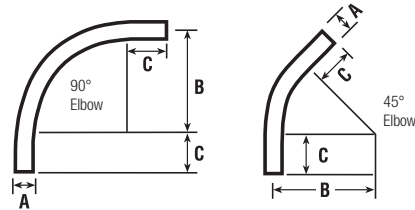

SIZE (IN.)	A (IN.)	B MIN. (RADIUS) (IN.)	C MIN. (IN.)
½	.840	4	1½
¾	1.050	4½	1½
1	1.315	5¼	1½
1¼	1.660	7¼	2
1½	1.900	8¼	2
2	2.375	9½	2
2½	2.875	10½	3
3	3.500	13	3½
3½	4.000	15	3½
4	4.500	16	3½
5	5.563	24	3½
6	6.625	30	3½

Available in plain and integral belled end for use with non-metallic solvent weld fittings.

Integral Belled End Dimensions

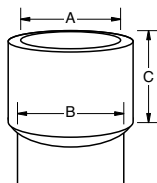

TRADE SIZE (IN.)	A AT ENTRANCE		B AT BOTTOM		C SOCKET DEPTH	
	MAX.	MIN.	MAX.	MIN.	MAX.	MIN.
½	.860	0.844	0.844	0.828	1.500	0.652
¾	1.074	1.054	1.056	1.036	1.500	0.719
1	1.340	1.320	1.320	1.300	1.875	0.875
1¼	1.689	1.665	1.667	1.643	2.000	0.938
1½	1.930	1.906	1.906	1.882	2.000	1.062
2	2.405	2.381	2.381	2.357	2.000	1.125
2½	2.905	2.875	2.883	2.853	3.000	1.469
3	3.530	3.500	3.507	3.477	3.125	1.594
3½	4.065	3.965	4.007	3.977	3.250	1.687
4	4.565	4.465	4.506	4.476	3.375	1.750
5	5.643	5.543	5.583	5.523	3.625	1.937
6	6.708	6.608	6.644	6.584	3.750	2.125

Rigid Non-Metallic Conduit Fittings (for use with Schedule 40 & 80 Conduit)



Expansion Fittings

E945 series expansion fittings are designed to compensate for length changes due to temperature variations in exposed conduit runs.

- Exclusive molded-in mid-point indicator on the piston
- Exclusive 2" expansion fitting with an 8" travel distance
- Two-piece molded design with lubricated seals for easier movement for the life of the product
- Ridges on the fitting for easier installation (sizes 2"-6" only)
- Male terminal adapter end design (½"-2" NPT Threads, and 2½"-6" NPSC threads)
- Two O-rings to prevent leakage
- Can be installed vertically or horizontally



COUPLING END CAT. NO.	MALE TERMINAL ADAPTER END CAT. NO.	SIZE (IN.)	STD. CTN.	TRAVEL LENGTH (IN.)
E945D	E945DX	½	20	4
E945E	E945EX	¾	15	4
E945F	E945FX	1	10	4
E945G	E945GX	1¼	5	4
E945H	E945HX	1½	5	4
E945J	E945JX	2	15	8
E945K	E945KX	2½	10	8
E945L	E945LX	3	10	8
E945M	E945MX	3½	5	8
E945N	E945NX	4	5	8
E945P	E945PX	5	1	8
E945R	E945RX	6	1	8

Short Expansion Couplings

Expand to a maximum of 2".

CAT. NO.	SIZE (IN.)	STD. CTN.
E955D	½	40
E955E	¾	40
E955F	1	25
E955G	1¼	15
E955H	1½	10
E955J	2	6



Couplings Standard Couplings

All socket fittings should be attached using Carlton® solvent cement.



Socket type for joining non-metallic conduit.

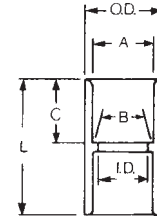

Except where noted by ▶

CAT. NO.	SIZE (IN.)	STD. CTN.	TYPICAL (IN.)		I.D. (IN.)	O.D. (IN.)	TYPICAL (IN.)	
			A	B			C	L
E940D	½	150	.852	.836	.728	1¼	1¼	1½
▶ CE940DR-CTN	½	75	.852	.836	.728	1¼	1¼	1½
E940E	¾	100	1.064	1.046	.840	1¾	¾	1¾
▶ CE940ER-CTN	¾	45	1.064	1.046	.840	1¾	¾	1¾
E940F	1	50	1.330	1.310	1.210	1¾	1½	2
▶ CE940F-UPC	1	50	1.330	1.310	1.210	1¾	1½	2
E940G	1¼	30	1.677	1.655	1.535	1¾	1	2½
E940H	1½	25	1.918	1.894	1.755	2¾	1¾	2¾
E940J	2	30	2.393	2.369	2.190	2¾	1¾	2½
E940K	2½	20	2.890	2.868	2.688	3¾	1¾	3¾
E940L	3	25	3.515	3.492	3.375	3¾	1¾	3¾
E940M	3½	20	4.015	3.992	3.780	4¾	1¾	3¾
E940N	4	15	4.515	4.491	4.265	5¾	1¾	3¾
E940P	5	8	5.593	5.553	5.097	6¾	1¾	4¾
E940R	6	5	6.658	6.614	6.115	7¾	2¾	4¾

▶ Canada only

Special Long Line Couplings



Long Line Couplings

CAT. NO.	SIZE (IN.)	STD. CTN.	STD. WT. (LBS.)	LENGTH (IN.)
E941H	1½	40	9	3.19
E941J	2	25	8	3.59
E941K	2½	15	8	4.29
E941L	3	15	14	6.44
E941N	4	10	15	6.96
E941PF	5	4	12	9.63
▶ E941RF	6	5	21	11.75

Fabricated Expansion Couplings



CAT. NO.	SIZE (IN.)	STD. CTN.	TRAVEL LENGTH (IN.)
E945KXL	2½	10	12

Non-Metallic Rigid Conduit, Fittings and Accessories

Rigid Non-Metallic Conduit Fittings (for use with Schedule 40 & 80 Conduit)

Couplings

Special Long Line Couplings —
Sleeve Couplings

Sleeve Coupling
(For Repair Work)
No Internal Stop



CAT. NO.	SIZE (IN.)	STD. CTN.	STD. WT. (LBS.)	LENGTH (IN.)
▶ E948H	1½	25	6	4
▶ E948J	2	25	5	3
▶ E948K	2½	25	16	6
▶ E948L	3	25	13	4
▶ E948N	4	10	8	6.5
▶ E948P	5	14	33	7
▶ E948R	6	6	16	6
▶ E948JR	2	15	8	6
▶ E948JS	2 (Sch. 40 Split Duct)	25	6	—
▶ E948KS7	2½ (Sch. 40 Split Duct)	25	19	7
▶ E948L12	3	1	1	12
▶ E948L6	3	15	15	6
▶ E948LS	3 (Sch. 40 Split Duct)	25	17	—
▶ E948N12	4	10	28	12
▶ E948N7	4	15	25	7
▶ E948NS	4 (Sch. 40 Split Duct)	10	15	—
▶ E948PS	5 (Sch. 40 Split Duct)	1	2	—
▶ E948R10	6	6	25	10
▶ E948R12	6	6	25	12
▶ E948RS	6 (Sch. 40 Split Duct)	1	2	—

Special Schedule 40 Swedge Couplings

CAT. NO.	SIZE (IN.)	STD. CTN.	STD. WT. (LBS.)
▶ E442K	2½	20	13
▶ E442R	6	6	27
▶ E442T	8	2	17

*Consult factory for additional sizes



Risers Schedule 40

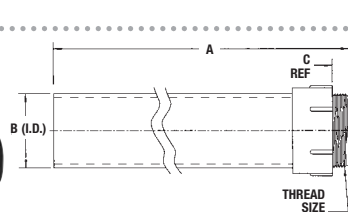

CAT. NO.	SIZE (IN.)	A (IN.) (LENGTH)	B (IN.)	C (IN.)	THREAD SIZE (IN.)	STD. CTN.	STD. WT. (LBS.)
▶ E954HX	1½	80.00	1.567	.950	1½ NPT	1	3.8
▶ E954J	2	60.00	2.024	.825	2 NPT	1	3.7
▶ E954JX	2	80.00	2.024	.825	2 NPT	1	5.0
▶ E954K	2½	60.00	2.418	.812	2½ NPSC	1	6.0
▶ E954KX	2½	80.00	2.418	.812	2½ NPSC	1	8.4
▶ E954L	3	60.00	3.012	.798	3 NPSC	1	8.7
▶ E954LX	3	80.00	3.012	.798	3 NPSC	1	11.0

Adapters

Female Adapters



Except where noted by ▶

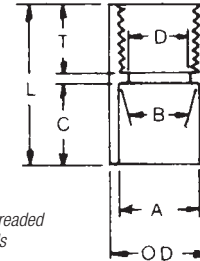

For adapting non-metallic conduits to threaded fittings, metallic systems. Female threads on one end, socket end on other.

CAT. NO.	SIZE (IN.)	STD. CTN.	TYPICAL (IN.)		MIN. D (IN.)	MAX. OD (IN.)	TYPICAL (IN.)		
			A	B			C	T	L
E942D	½	150	.852	.836	.620	1¼	1¼	¾	1¼
E942E	¾	100	1.064	1.046	.822	1½	1½	¾	1½
E942F	1	50	1.330	1.310	1.046	1¾	1¾	¾	1¾
E942G	1¼	30	1.677	1.655	1.377	2¼	1	¾	2
E942H	1½	25	1.918	1.894	1.607	2½	1½	¾	2½
E942J	2	30	2.393	2.369	2.064	2¾	1¾	1	2¾
E942K	2½	20	2.890	2.868	2.450	3½	1¾	1½	2¾
E942L	3	25	3.515	3.492	3.000	3¾	1¾	1½	3½
E942M	3½	20	4.015	3.992	3.500	4½	1¾	1½	3½
E942N	4	15	4.515	4.491	4.000	5¼	1¾	1½	3¾
▶ E942NX9*	4	15	(Call for information)						
E942P	5	8	5.593	5.553	5.047	6¼	1¾	1½	3¾
E942R	6	6	6.658	6.614	6.055	7¼	2½	1¾	3¾
▶ E942RX*	6	6	(Call for information)						

* Long Line Adapter

Male Terminal Adapters



For adapting non-metallic conduits to boxes, threaded fittings, metallic systems. Male threads on one end, socket end on other.

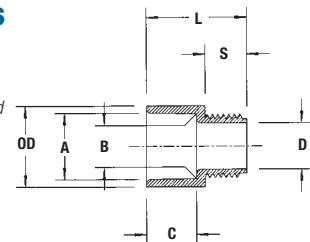

CAT. NO.	SIZE (IN.)	STD. CTN.	TYPICAL (IN.)		MIN. D (IN.)	MAX. OD (IN.)	TYPICAL (IN.)		
			A	B			C	S	L
E943D	½	150	.852	.836	.594	1.042	.652	.545	1.310
E943E	¾	125	1.064	1.046	.793	1.290	.809	.553	1.470
E943F	1	50	1.330	1.310	1.025	1.580	.965	.812	1.902
E943G	1¼	50	1.677	1.655	1.345	1.973	1.208	.816	1.986
E943H	1½	25	1.918	1.894	1.574	2.188	1.155	.802	2.105
E943J	2	50	2.393	2.369	1.998	2.713	1.145	.825	2.093
E943K	2½	25	2.890	2.868	2.400	3.290	1.490	.812	2.480
E943L	3	45	3.515	3.492	2.989	3.965	1.643	.797	2.660
E943M	3½	30	4.015	3.992	3.405	4.515	1.720	.802	2.740
E943N	4	20	4.515	4.491	3.895	5.065	1.788	.733	2.830
E943P	5	5	5.593	5.553	4.900	6.104	1.935	.990	3.200
E943R	6	10	6.658	6.614	5.900	7.288	2.128	.985	3.410

Rigid Non-Metallic Conduit Fittings (for use with Schedule 40 & 80 Conduit)



Adapters

Box Adapters for Enclosures



Adapts non-metallic conduit to all electrical enclosures by inserting adapter through knockout and cementing into Carlton couplings.

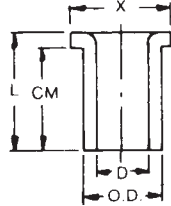

CAT. NO.	SIZE (IN.)	STD. CTN.	MIN D (IN.)	OD (IN.) TYPICAL	MAX X (IN.)	CM (IN.) TYPICAL	L (IN.) TYPICAL
E996D	1/2	100	.662	.840	1 1/4	2 1/2	2 1/2
E996E	3/4	100	.824	1.050	1 21/64	2 5/32	2 9/32
E996F	1	100	1.049	1.315	1 1/2	2 3/4	2 1/2
E996G	1 1/4	50	1.380	1.660	1 3/8	1 1/2	1 1/4
E996H	1 1/2	50	1.610	1.900	2 1/8	1 1/2	1 1/2
E996J	2	25	2.067	2.375	2 1/2	1 1/4	1 1/4
E996K	2 1/2	15	2.469	2.875	3 1/8	1 1/2	1 1/4
E996L	3	20	3.068	3.500	4 1/2	2	2 1/4
E996N	4	10	4.026	4.500	5 1/2	2 1/2	2 1/4

Threaded Adapters

CAT. NO.	SIZE (IN.)	STD. CTN.
E9842D ¹	1/2	25
E9842E ²	3/4	25

¹ Fits 3/4" sockets
² Fits 1" sockets



Reducers

Reducer Bushings



For connecting different sizes of conduit.
Bell x Spigot.

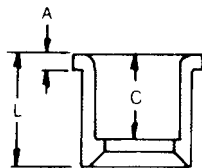

CAT. NO.	SIZE (IN.)	STD. CTN.	L (IN.) TYPICAL	A (IN.) TYPICAL	C (IN.) TYPICAL
E950ED	3/4 x 1/2	100	1 1/2	1 3/4	1 1/2
E950FD-CAR	1 x 1/2	25	1 1/2	3/4	5/8
E950FE	1 x 3/4	100	1 1/2	3/4	1 1/4
E950GE-CAR	1 1/4 x 3/4	10	1 1/2	3/4	1 1/4
E950GF	1 1/4 x 1	50	1 1/2	3/4	1 1/4
E950HF-CAR	1 1/2 x 1	10	1 1/2	3/4	1 1/4
E950HG-CAR	1 1/2 x 1 1/4	10	1 1/2	3/4	1 1/4
E950JG-CAR	2 x 1 1/4	10	1 1/2	7/8	1 1/4
E950JH-CAR	2 x 1 1/2	10	1 1/2	7/8	1 1/4
E950KJ-CAR	2 1/2 x 2	10	2 1/2	3/4	1 1/4
E950LJ-CAR	3 x 2	10	2 3/4	1/2	1 1/4
E950LK	3 x 2 1/2	25	2 3/4	1/2	1 1/4
E950NL	4 x 3	25	2 3/4	5/8	1 1/4

Plugs

Reducer Plugs

CAT. NO.	SIZE (IN.)	STD. CTN.	STD. WT. (LBS.)
E971C	3/4 x 1/2	100	2
E971D	1 x 3/4	100	3



Plugs (Polyethylene)

CAT. NO.	SIZE (IN.)	STD. CTN.	STD. WT. (LBS.)
P258H	1 1/2	50	2
P258K	2 1/2	25	1.5



Plugs with Pull Tabs (Polyethylene)

CAT. NO.	SIZE (IN.)	STD. CTN.	STD. WT. (LBS.)
P258JT	2	60	3
P258LT	3	30	3
P258NT	4	48	8
P258PT	5	30	6
P258RT	6	30	9



Fabricated Reducers



CAT. NO.	SIZE (IN.)	STD. CTN.	STD. WT. (LBS.)
Male x Male			
E952JH	1 1/2 x 2	48	20
E952KJ	2 1/2 x 2	48	26
E952LJ	3 x 2	36	21
E952LK	3 x 2 1/2	36	32
E952NL	4 x 3	15	21
E952NM	4 x 3 1/2	15	25
E952PN	5 x 4	12	27
E952RP	6 x 5	10	31
Male x Female			
E952NJF	4 x 2	15	16
E952RNF	6 x 4	10	28

SP® LR31146
UL LISTED E23018
Except where noted by ▶

Carlton® Non-Metallic Rigid Conduit, Fittings and Accessories

Carlton®

Rigid Non-Metallic Conduit Fittings (for use with Schedule 40 & 80 Conduit)

Caps Service Entrance Caps



UL US
LISTED
E13938

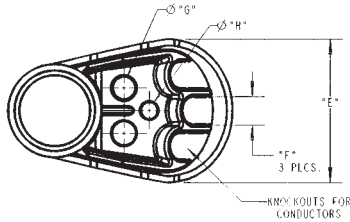

CAT. NO.	SIZE (IN.)	STD. CTN.	DIMENSIONS (IN.)			
			E	F	G	H
E998D	½	5	1.76	.45	.45	—
E998E	¾	20	1.76	.45	.45	—
E998E-CAR	¾	5	1.76	.45	.45	—
E998F	1	15	2.26	.59	.58	—
E998F-CAR	1	5	2.26	.59	.58	—
E998G-CAR	1¼	5	3.52	.74	.71	.50
E998H-CAR	1½	5	3.52	.74	.71	.50
E998J-CAR	2	5	4.26	.83	.78	.56
E998K-UPC	2½	2	7.47	1.70	1.31	1.00
E998L	3	2	7.47	1.70	1.31	1.00
E998N	4	2	10.45	2.25	1.88	1.31

End Caps

CAT. NO.	SIZE (IN.)	STD. CTN.	STD. WT. (LBS.)
▶ E958D	½	100	3
▶ E958E	¾	100	4
▶ E958F	1	75	5
▶ E958G	1¼	40	4
▶ E958H	1½	30	4
▶ E958J	2	25	5
▶ E958K	2½	10	4
▶ E958L	3	10	5
▶ E958N	4	5	17
▶ E958P	5	5	11
▶ E958R	6	5	13



PVC Riser Caps

CAT. NO.	SIZE (IN.)	STD. CTN.	STD. WT. (LBS.)
▶ E935J	2	25	3
▶ E935L	3	25	5
▶ E935N	4	25	7
▶ E935P	5	25	35
▶ E935R	6	10	7



Offsets Meter Offset

SP®
LR31146

UL LISTED
E23018
Except where noted by ▶

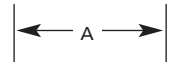

CAT. NO.	SIZE (IN.)	STD. CTN.	OFFSET (IN.)	A (IN.)
▶ E995G	1¼	15	0.758	4.230
▶ E995J	2	8	0.684	4.270

Offset

CAT. NO.	SIZE (IN.)	OFFSET (IN.)	STD. CTN.	STD. WT. (LBS.)
▶ E994D	½	.250	25	3
▶ E994E	¾	.250	25	3
▶ E994F	1	.500	50	12



End Bells End Bells

CAT. NO.	SIZE (IN.)	STD. CTN.	STD. WT. (LBS.)
E997F	1	50	2.6
E997G	1¼	35	2.5
E997H	1½	30	2.5
E997J	2	40	5.0
E997K	2½	30	2
E997L	3	50	10
E997M	3½	40	11
E997N	4	30	16
▶ E997P	5	15	8
▶ E997R	6	10	7
▶ E997T	8	3	15



Fabricated End Bells (Schedule 40)

CAT. NO.	SIZE (IN.)	STD. CTN.	STD. WT. (LBS.)
▶ E949J5	2 x 5	50	10
▶ E949J6	2 x 6	25	12
▶ E949JN	2 x 4	25	7
▶ E949JX	2 x 8	12	7
▶ E949LR	3 x 6	20	21
▶ E949N5	4 x 5	20	2
▶ E949NR	4 x 6	15	21
▶ E949R5	6 x 5	12	27
▶ E949RX	6 x 8	6	17



Carlton® Non-Metallic Rigid Conduit, Fittings and Accessories

Thomas & Betts

www.tnb.com

Corporate Office
Tel: 901.252.8000
800.816.7809
Fax: 901.252.1354

Customer Service
Tel: 800.816.7809
Fax: 800.816.7810

Technical Services
Tel: 888.862.3289
Fax: 901.252.1321

Tool Services
Tel: 800.284.8665



Rigid Non-Metallic Conduit Accessories, Conduit Bodies

Washers

Flat Sealing Washer

Where a waterproof termination is required into any enclosure (metallic or non-metallic), install the neoprene washer over the threads of a terminal adapter before inserting into the enclosure. Use a standard locknut or threaded bushing to secure the assembly.

CAT. NO.	SIZE (IN.)	STD. CTN.
▶ E943DW	½	125
▶ E943EW	¾	125
▶ E943FW	1	100
▶ E943GW	1¼	50
▶ E943HW	1½	50
▶ E943JW	2	25



Lock Nuts

PVC Lock Nut



CAT. NO.	SIZE (IN.)	STD. CTN.
▶ LT9LD	½	1200
▶ LT9LE	¾	700
▶ LT9LF	1	600



Pull Elbows

Access Pull Elbows

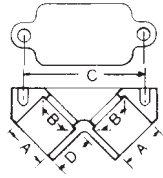

CAT. NO.	SIZE (IN.)	STD. CTN.	A (IN.) TYPICAL	B (IN.) TYPICAL	C (IN.) TYPICAL	D (IN.) TYPICAL
† E990D	½	75	.852	.836	2.187	.718
† E990E	¾	50	1.064	1.046	2.531	.781

Gasket included.

Sleeves

HOLFORM™ Concrete Sleeves

HOLFORM™ non-metallic concrete sleeve forms are the easy way to form holes in concrete. They install in seconds with nails, screws or staples and are easily removed. Concrete will not adhere to them. HOLFORMs are adjustable to any slab thickness.



LR31146
Except where noted by †



LISTED E23018
Except where noted by ▶

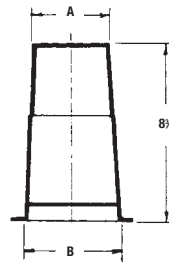

CAT. NO.	MIN. O.D. A (IN.)	B (IN.)	STD. CTN.	STD. WT. (LBS.)
† ▶ E92CSH	1½	1¼	20	3
† ▶ E92CSJ	2	2½	25	6
† ▶ E92CSL	3	3½	25	8
† ▶ E92CSN	4	4½	18	8
† ▶ E92CSP	5	5½	15	8
† ▶ E92CSR	6	6½	12	8

Conduit Bodies

Type X with Cover

Four knock-out type socket openings, 90° spacing. Available with ½" or ¾" socket outlets. Includes cover and gasket.

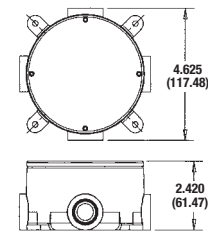
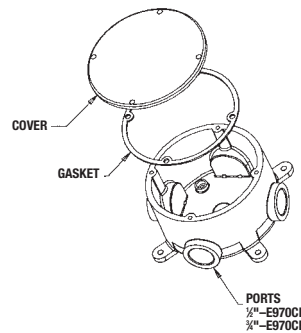

CAT. NO.	SIZE (IN.)	VOL. CU. IN.	STD. CTN.
▶ E970CD	½	15.16	15
E970CE	¾	15.16	15

Supplied with 4 stainless steel cover screws. Diameter ¼", Thickness ¼".
*Not designed for use with wiring devices or light fixtures.

Non-Metallic Rigid Conduit, Fittings and Accessories

Feature unthreaded hubs and textured lids with foam-in-place gaskets.

Conduit Bodies

Type LB

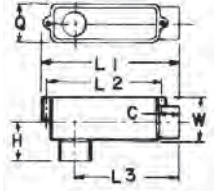

CAT. NO.	SIZE (IN.)	STD. CTN.	DIMENSIONS (IN.)							VOL. CU. IN.
			TYPICAL C	TYPICAL L1	TYPICAL L2	TYPICAL L3	MAX. H	MAX. Q	MAX. W	
E986D	1/2	25	1/16	4 5/16	3 1/2	3 1/16	1 1/16	1 1/2	1 1/2	4.0
E986E	3/4	15	2/32	6 1/2	5 1/2	4 29/32	1 1/2	1 1/4	2 1/2	12.0
E986F	1	10	29/32	6 3/2	5 1/2	4 29/32	1 1/2	1 1/4	2 1/2	12.0
E986G	1 1/4	10	1 1/2	7 3/2	6 1/2	6	2 1/2	2 1/2	2 3/4	32.0
E986H	1 1/2	10	1 1/2	7 3/2	6 1/2	6	2 1/2	2 1/2	2 3/4	32.0
E986J	2	10	1 1/2	9 3/2	8 1/2	7 1/4	2 1/2	3 1/2	3 1/2	63.0
▶ E986K	2 1/2	4	1 1/2	14 1/2	13 1/4	11 3/2	3 1/4	4 1/2	4 1/2	210.
▶ E986L	3	4	1 1/2	14 1/2	13 1/4	11 3/2	3 1/4	4 1/2	4 1/2	210.
▶ E986M	3 1/2	4	1 29/32	17 29/32	15 1/2	14 1/64	4 1/16	5 1/2	5 1/2	390.
▶ E986N	4	4	1 29/32	17 29/32	15 1/2	14 1/64	4 1/16	5 1/2	5 1/2	390.

Type E

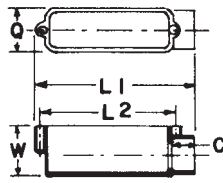

CAT. NO.	SIZE (IN.)	STD. CTN.	DIMENSIONS (IN.)				VOL. CU. IN.
			C	L1	L2	Q	
E988D	1/2	25	1/16	4 5/16	3 1/2	1 1/2	4.0
E988E	3/4	20	29/32	6 1/2	5 1/2	1 1/4	12.0
E988F	1	10	29/32	6 1/2	5 1/2	1 1/4	12.0
E988G	1 1/4	10	1 1/2	8	6 1/2	2 1/2	32.0
E988H	1 1/2	10	1 1/2	8	6 1/2	2 1/2	32.0
E988J	2	5	1 1/2	9 1/2	8 1/2	3 1/2	63.0

Type C

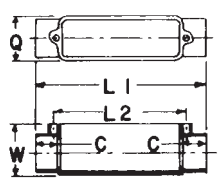
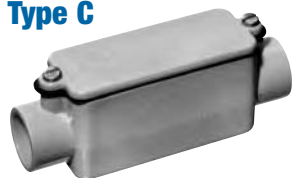

CAT. NO.	SIZE (IN.)	STD. CTN.	DIMENSIONS (IN.)					VOL. CU. IN.
			TYPICAL C	TYPICAL L1	TYPICAL L2	MAX. H	MAX. W	
E987D	1/2	25	1/16	4 1/16	3 1/2	1 1/2	4.0	
E987E-CAR	3/4	10	29/32	6 1/2	5 3/64	1 1/4	12.0	
E987F-CAR	1	10	29/32	6 1/2	5 1/2	1 1/4	12.0	
E987G	1 1/4	10	1 1/2	8 3/2	6 1/2	2 1/2	32.0	
E987H	1 1/2	10	1 1/2	8 3/2	6 1/2	2 1/2	32.0	
E987J	2	15	1 1/2	10 1/6	8 1/2	3 1/2	63.0	

Type LR

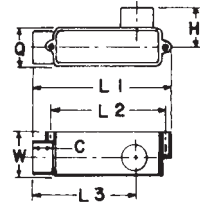

CAT. NO.	SIZE (IN.)	STD. CTN.	DIMENSIONS (IN.)							VOL. CU. IN.
			TYPICAL C	TYPICAL L1	TYPICAL L2	TYPICAL L3	MAX. H	MAX. Q	MAX. W	
E985D-CAR	1/2	10	1/16	4 5/16	3 1/2	3 1/16	1 1/16	1 1/2	1 1/2	4.0
E985E-CAR	3/4	10	29/32	6 1/2	5 1/2	4 29/32	1 1/2	1 1/4	2 1/2	12.0
E985F	1	10	29/32	6 1/2	5 1/2	4 29/32	1 1/2	1 1/4	2 1/2	12.0
E985G	1 1/4	10	1 1/2	7 3/2	6 1/2	6	2 1/2	2 1/2	2 3/4	32.0
E985H-CAR	1 1/2	5	1 1/2	7 3/2	6 1/2	6	2 1/2	2 1/2	2 3/4	32.0
E985J	2	10	1 1/2	9 1/2	8 1/2	7 1/4	2 1/2	3 1/2	3 1/2	63.0

Type T

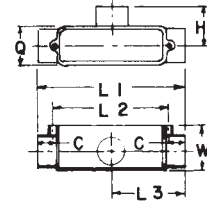

CAT. NO.	SIZE (IN.)	STD. CTN.	DIMENSIONS (IN.)							VOL. CU. IN.
			TYPICAL C	TYPICAL L1	TYPICAL L2	TYPICAL L3	MAX. H	MAX. Q	MAX. W	
E983D-CAR	1/2	10	1/16	4 1/16	3 1/2	2 1/2	1 1/16	1 1/2	1 1/2	4.0
E983E	3/4	15	29/32	6 1/2	5 1/2	4 1/16	1 1/2	1 1/4	2 1/2	12.0
E983F	1	20	29/32	6 1/2	5 1/2	3 1/16	1 1/2	1 1/4	2 1/2	12.0
E983G	1 1/4	10	1 1/2	8 3/2	6 1/2	4 3/64	2 1/2	2 1/2	2 3/4	32.0
E983H	1 1/2	10	1 1/2	8 3/2	6 1/2	4 3/64	2 1/2	2 1/2	2 3/4	32.0
E983J	2	10	1 1/2	10 1/6	8 1/2	5 1/2	2 1/2	3 1/2	3 1/2	63.0

Type LL

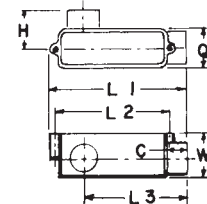

CAT. NO.	SIZE (IN.)	STD. CTN.	DIMENSIONS (IN.)							VOL. CU. IN.
			TYPICAL C	TYPICAL L1	TYPICAL L2	TYPICAL L3	MAX. H	MAX. Q	MAX. W	
E984D-CAR	1/2	10	1/16	4 5/16	3 1/2	3 1/16	1 1/16	1 1/2	1 1/2	4.0
E984E	3/4	20	29/32	6 1/2	5 1/2	4 29/32	1 1/2	1 1/4	2 1/2	12.0
E984F-CAR	1	10	29/32	6 1/2	5 1/2	4 29/32	1 1/2	1 1/4	2 1/2	12.0
E984G-CAR	1 1/4	5	1 1/2	7 3/2	6 1/2	6	2 1/2	2 1/2	2 3/4	32.0
E984H	1 1/2	10	1 1/2	7 3/2	6 1/2	6	2 1/2	2 1/2	2 3/4	32.0
E984J	2	10	1 1/2	9 1/2	8 1/2	7 1/4	2 1/2	3 1/2	3 1/2	63.0



LR31146



LISTED E11461

Except where noted by ▶



Molded Non-Metallic Junction Boxes — 6P Rated

Non-metallic junction boxes are UL Listed with a NEMA 6P rating per Section 314.29, Exception of the National Electrical Code® and CSA Certified per Section 12 of the Canadian Electrical Code. Manufactured from PVC or PPO thermoplastic molding compound and featuring foam-in-place gasketed lids attached with stainless steel screws, these rugged enclosures offer all the corrosion resistance and physical properties you need for direct burial applications.

Type 6P enclosures are intended for indoor or outdoor use, primarily to provide a degree of protection against contact with enclosed equipment, falling dirt, hose-directed water, entry of water during prolonged submersion at a limited depth and external ice formation.

- All Carlton® Junction Boxes are UL Listed/CSA Certified and maintain a minimum of a NEMA Type 4/4x Rating
- Part numbers with an asterisk (*) are UL Listed and maintain a NEMA Type 6P Rating and Type 4/4X Rating

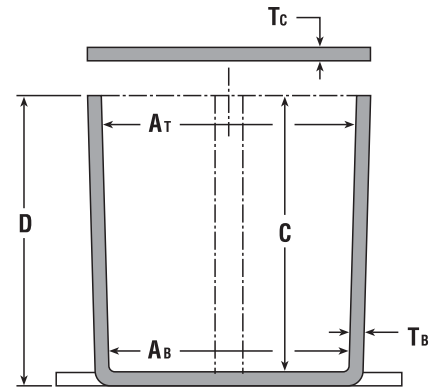
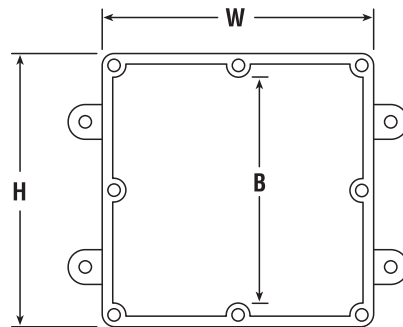
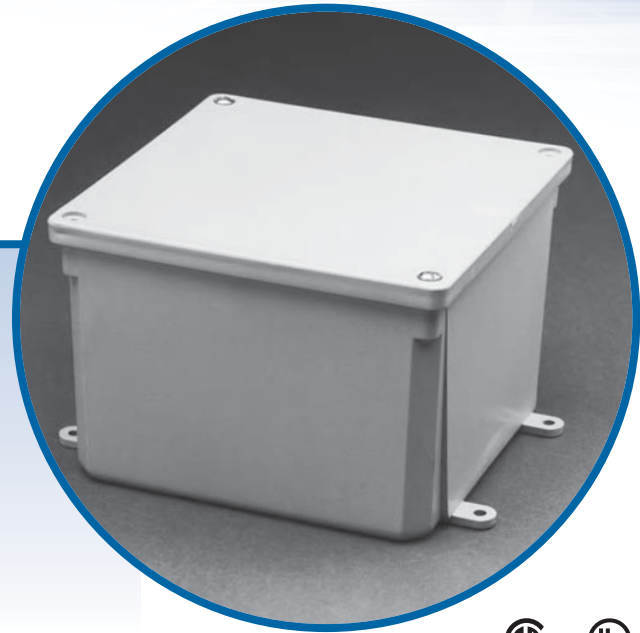

Carlton® Non-Metallic Rigid Conduit, Fittings and Accessories

CAT. NO.	SIZE (IN.) H X W X D	STD. CTN.	DIMENSIONS (IN.)						MATERIAL		STD. WT. (LBS.)
			MIN. Ar	MIN. As	MIN. B	MIN. C	Ts	Tc	PVC	THERMO-PLASTIC	
E989NNJ*	4 x 4 x 2	10	3 ¹ / ₁₆	3 ¹ / ₈	N/A	2	.160	.155	X		3
E987N*	4 x 4 x 4	10	3 ¹ / ₁₆	3 ¹ / ₂	N/A	4	.160	.155	X		4
† E989NNR*	4 x 4 x 6	10	3 ¹ / ₁₆	3 ¹ / ₈	N/A	6	.160	.200	X		5
E989PPJ*	5 x 5 x 2	10	4 ¹ / ₁₆	4 ¹ / ₂	N/A	2	.110	.150		X	3
E987R-CAR*	6 x 6 x 4	2	6	5 ¹ / ₈	N/A	4	.190	.190		X	3
E989RRR-UPC*	6 x 6 x 6	8	5 ¹ / ₈	5 ¹ / ₈	N/A	6	.160	.150		X	14
E989N-CAR	8 x 8 x 4	1	8	8	N/A	4	.185	.190		X	2
E989SSX-UPC	8 x 8 x 7	2	7 ¹ / ₃₂	7 ¹ / ₁₆	N/A	7	.160	.150		X	6
E989UUN	12 x 12 x 4	3	11 ¹ / ₁₆	11 ¹ / ₈	11 ¹ / ₈	4	.160	.150		X	12
E989R-UPC	12 x 12 x 6	2	11 ¹ / ₁₆	11 ¹ / ₈	11 ¹ / ₁₆	6	.265	.185		X	10

Corporate Office
Tel: 901.252.8000
800.816.7809
Fax: 901.252.1354

Customer Service
Tel: 800.816.7809
Fax: 800.816.7810

Technical Services
Tel: 888.862.3289
Fax: 901.252.1321

Tool Services
Tel: 800.284.8665

Thomas & Betts

www.tnb.com



Carlton®

Junction Boxes

Carlton® Non-Metallic Rigid Conduit, Fittings and Accessories

Large PVC Junction Boxes/ NEMA 4X

Large PVC Junction Boxes are fabricated from Type II PVC sheet. Reduce the use of steel boxes and keep your wiring connections clean, safe and dry using these high-quality, fully gasketed junction boxes.

Features and Benefits:

- PVC Type II material with “Uni-Body” construction and penetration welding providing a very strong, durable enclosure
- UL-94V-0 flame rating
- Suitable for exposure of up to 90°C
- PVC material enables the use of standard solvent cements for fitting attachment
- Junction boxes are available with or without mounting flanges
- Individual mounting feet are available and provided in kits of four
- Custom features such as windows or panel mounts are available
- Custom sizes are also available upon request
- Made in the USA

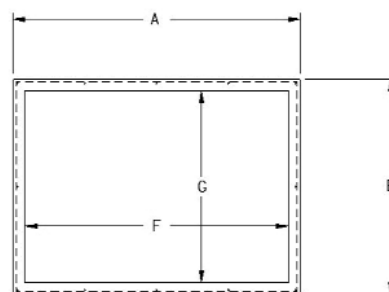
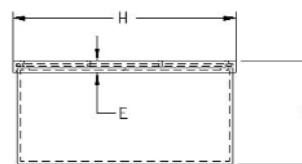
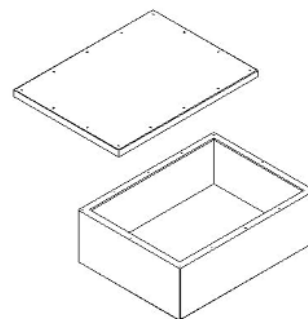
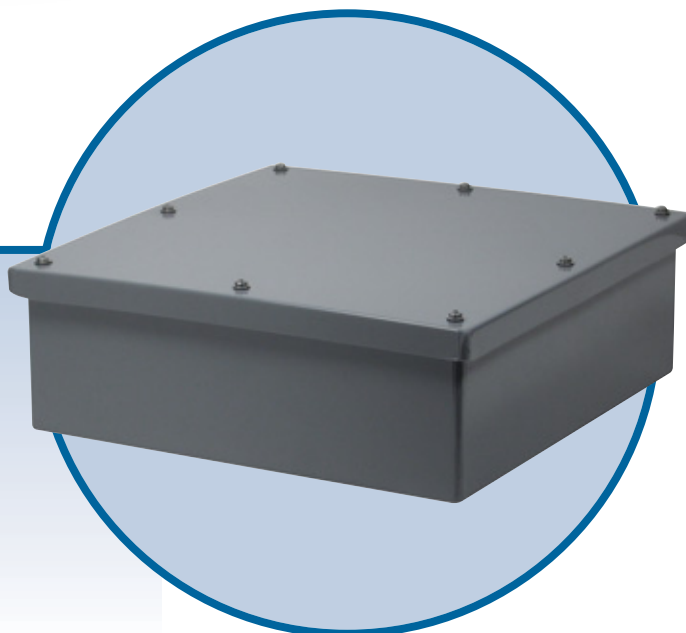

CAT. NO.	DIMENSIONS (IN.)								STD. WT. (LBS.)
	A	B	C	D	E	F	G	H	
EP12128	12	12	8	8.25	1.00	10.5	10.5	12.75	11
EP181812	18	18	12	12.25	1.00	16	16	18.75	21
EP201808	20	18	8	8.25	1.00	18	16	18.75	20
EP202008	20	20	8	8.25	1.00	18	18	20.75	22
EP241808	24	18	8	8.25	1.00	22	16	18.75	24
EP242008	24	20	8	8.25	1.00	21.5	17.5	20.75	25
EP242408	24	24	8	8.25	1.00	21.5	21.5	24.75	29
EP302408	30	24	8	8.25	1.00	27.5	21.5	24.75	34
EP362408	36	24	8	8.25	1.00	33.5	21.5	24.75	39

Accessories

CAT. NO.	DESCRIPTION	STD. WT. (LBS.)
ESMFK-1	“CleverMount” Mounting Feet (4 Feet and Fasteners)	5

Thomas & Betts

www.tnb.com

Corporate Office
Tel: 901.252.8000
800.816.7809
Fax: 901.252.1354

Customer Service
Tel: 800.816.7809
Fax: 800.816.7810

Technical Services
Tel: 888.862.3289
Fax: 901.252.1321

Tool Services
Tel: 800.284.8665



Single-Gang FS Boxes

Type FSE

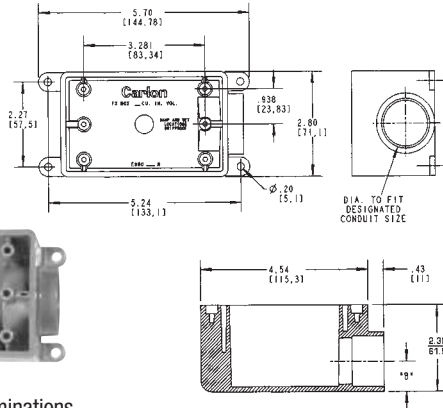

- For dead-end terminations
- All sizes take standard covers and accessories or devices
- Integral mounting feet provide easy mounting

CAT. NO.	SIZE (IN.)	VOL. CU. IN.	STD. CTN.
E980DFN	½	19	10
☛ C980DFN-CTN	½	18	12
E980EFN	¾	19	10
☛ C980EFN-CTN	¾	18	12
E980FFN	1	19	18
☛ C980FFN-CTN	1	18	8
E980FFN-CAR	1	19	10

☛ Canada Only

Type FSC

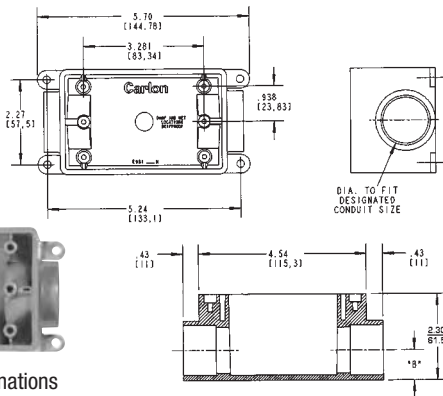

- For through terminations
- All sizes take standard covers and accessories or devices
- Detachable mounting feet provide easy mounting

CAT. NO.	SIZE (IN.)	VOL. CU. IN.	STD. CTN.
E981DFN	½	19	15
☛ C981DFN-CTN	½	18	12
E981EFN	¾	19	15
☛ C981EFN-CTN	¾	18	12
E981FFN	1	19	18
E981FFN-CAR	1	19	10
☛ C981FFN-CTN	1	18	8

☛ Canada Only

Type FSS

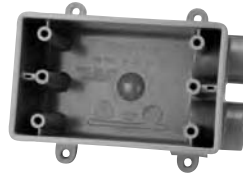
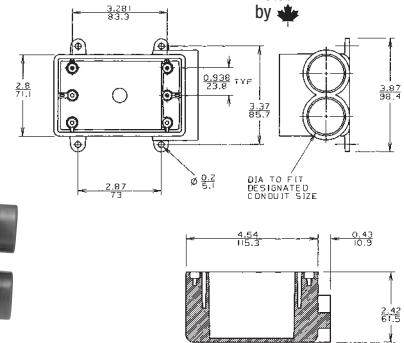

- For multiple dead-end circuit terminations or where additional support is required in stub-up applications
- All sizes take standard covers and accessories or devices
- Detachable mounting feet provide easy mounting

CAT. NO.	SIZE (IN.)	VOL. CU. IN.	STD. CTN.
E982DFN	½	19	10
☛ C982DFN-CTN	½	18	12
E982EFN	¾	19	10
☛ C982EFN-CTN	¾	18	12
E982FFN	1	19	10
☛ C982FFN-CTN	1	18	8

☛ Canada Only

Type FSCC

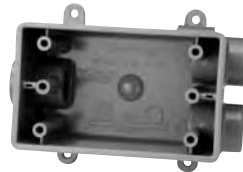
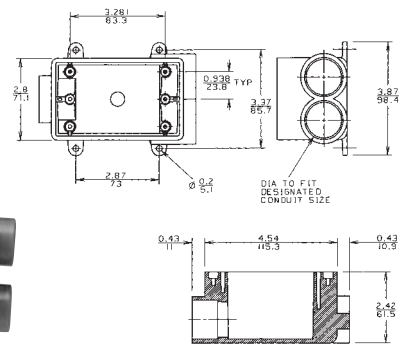

- For multiple through-circuit terminations or where additional support is required in stub-up applications
- All sizes take standard covers and accessories or devices
- Detachable mounting feet provide easy mounting

CAT. NO.	SIZE (IN.)	VOL. CU. IN.	STD. CTN.
E979DFN-CAR	½	19	10
☛ C979DFN	½	18	15
E979EFN-CAR	¾	19	10
☛ C979EFN	¾	18	15
E979FFN	1	19	15
☛ C979FFN	1	18	15

☛ Canada Only

Carlton® Non-Metallic Rigid Conduit, Fittings and Accessories

Single-Gang FD Deep Device Boxes



Type FD

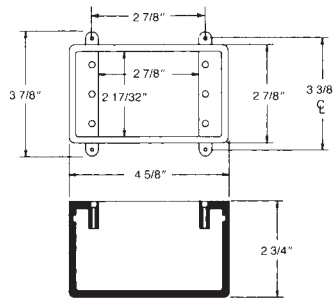
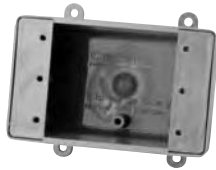

- For terminations where hub requirements vary according to application — hubs easily made with flared wood bit or hole saw
- All sizes take standard covers and accessories or devices
- Integral mounting feet provide easy mounting

CAT. NO.	SIZE (IN.)	VOL. CU. IN.	STD. CTN.
E9801	N/A	25	10
☛ CE9801-CTN	N/A	25	10
☛ C9801-347	N/A	25	10

☛ Canada Only

Type FDE

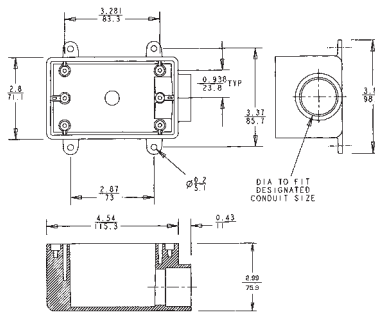

- For dead-end terminations where large devices or additional wiring capacity is required
- All sizes take standard covers and accessories or devices
- Integral mounting feet provide easy mounting

CAT. NO.	SIZE (IN.)	VOL. CU. IN.	STD. CTN.
E9801DN	1/2	25	10
☛ C9801DN	1/2	25	10
E9801EN	3/4	25	10
☛ C9801EN	3/4	25	10
E9801FN	1	25	10
☛ C9801FN	1	25	10

☛ Canada Only

Type FDC

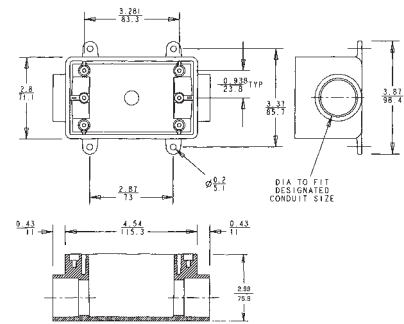
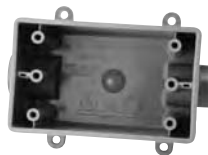

- For through terminations where large devices or additional wiring capacity is required
- All sizes take standard covers and accessories or devices
- Integral mounting feet provide easy mounting

CAT. NO.	SIZE (IN.)	VOL. CU. IN.	STD. CTN.
E9811DN	1/2	25	10
☛ C9811DN	1/2	25	10
E9811EN	3/4	25	10
☛ C9811EN	3/4	25	10
E9811FN	1	25	10
☛ C9811FN	1	25	10

☛ Canada Only



Two-Gang FS Boxes

Type 2FSC

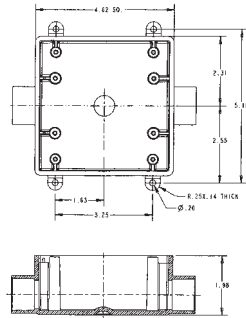

- For through terminations where two devices or additional wiring capacity is required
- All sizes take standard covers and accessories or devices
- Integral mounting feet provide easy mounting

CAT. NO.	SIZE (IN.)	VOL. CU. IN.	STD. CTN.
E9812D	½	32	10
☛ CE9812D-CTN	½	32	10
E9812E	¾	32	10
☛ CE9812E-CTN	¾	32	10
E9812F	1	32	10
☛ C9812F	1	32	10

☛ Canada Only

Type FS

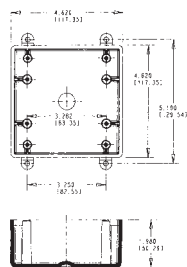

- For terminations where hub requirements vary according to application — hubs easily made with flared wood bit or hole saw
- All sizes take standard covers and accessories or devices
- Integral mounting feet provide easy mounting

CAT. NO.	SIZE (IN.)	VOL. CU. IN.	STD. CTN.
E9802	N/A	32	10
☛ CE9802	N/A	32	10

☛ Canada Only

Type 2FSE

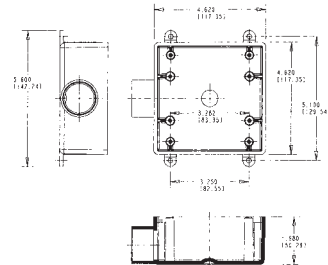

- For dead-end terminations where two devices or additional wiring capacity is required
- All sizes take standard covers and accessories or devices
- Integral mounting feet provide easy mounting

CAT. NO.	SIZE (IN.)	VOL. CU. IN.	STD. CTN.
E9802D	½	32	10
☛ CE9802D-CTN	½	32	10
E9802E	¾	32	10
☛ CE9802E-CTN	¾	32	10
E9802F	1	32	10
☛ C9802F	1	32	1

☛ Canada Only

Blank Covers

Single-Gang

- Fits Carlton® single-gang FS boxes
- Supplied with stainless steel mounting screws and gasket

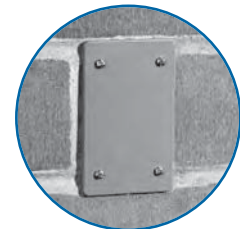

CAT. NO.	COLOR	STD. CTN.	STD. WT. (LBS.)
E980CN-CAR	Gray	12	1.60
E980CM-CAR	White	12	1.60

Two-Gang

- Fits Carlton® two-gang FS boxes, other non-metallic and metallic FS boxes
- Supplied with stainless steel mounting screws and gasket

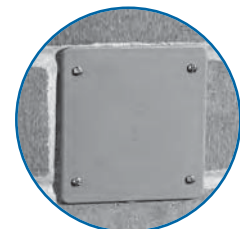

CAT. NO.	COLOR	STD. CTN.	STD. WT. (LBS.)
E9802CN-CAR	Gray	10	2.17

Carlton® Non-Metallic Rigid Conduit, Fittings and Accessories

Snap Strap™ Conduit Support Straps

Carlton's Snap Strap™ offers a unique support strap designed especially for the installation of PVC conduit. Also usable for installations of rigid steel. This high-strength, non-metallic clamp enables conduit to expand and contract freely, eliminating the bowing commonly seen from the expansion and contraction of conduit caused by varying temperature changes. Finished installations have a neat, attractive appearance on exposed applications.

To be used in accordance with conduit spacing requirements per the NEC®, Section 352.30 and 12-1114 of the CEC. This part is not supplied with screws.

- UV inhibited for use in direct sunlight

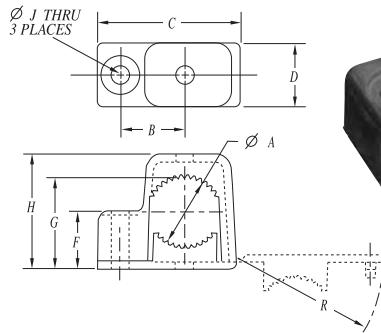
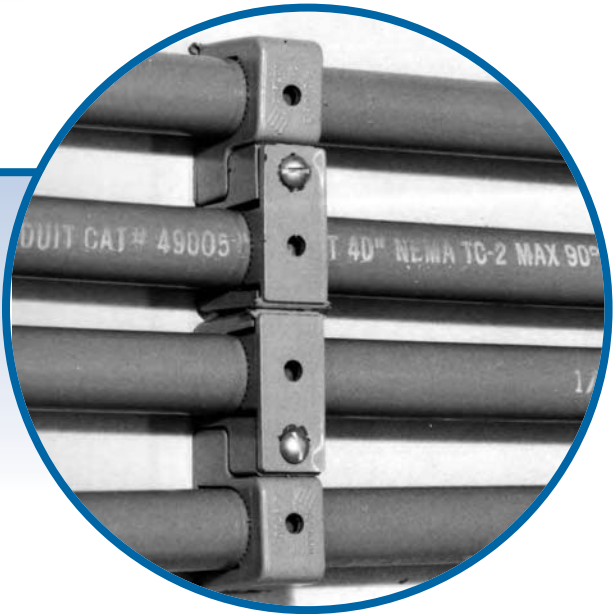

Single Mount

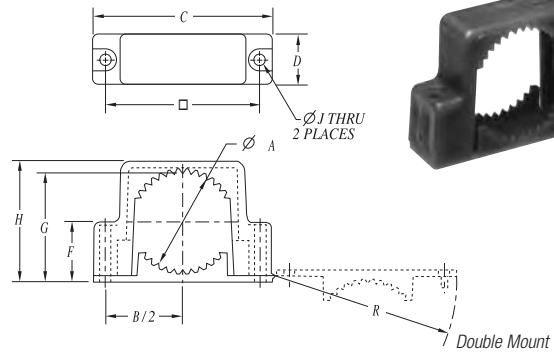

Double Mount

Single Mount

CAT. NO.	SIZE IN. (MM)	STD. CTN.	STD. WT. (LBS.)	DIMENSIONS IN. (MM)								
				A	B	C	D	F	G	H	J	R
E978DC-CAR	½ (16)	40	1	0.80 (20.3)	.75 (1.90)	1.63 (41.4)	0.75 (19.1)	.68 (14.9)	1.08 (25.1)	1.36 (34.5)	.21 (5.33)	1.67 (42.4)
E978EC-CAR	¾ (21)	40	3	1.00 (25.4)	.88 (22.4)	1.92 (48.7)	0.75 (19.1)	.79 (17.8)	1.29 (30.4)	1.58 (39.9)	.21 (5.33)	1.96 (49.8)
E978FC-CAR	1 (27)	30	4	1.20 (30.5)	1.02 (25.9)	2.17 (55.1)	0.75 (19.1)	.92 (21.1)	1.54 (36.3)	1.84 (46.7)	.21 (5.33)	2.22 (56.3)

Double Mount

CAT. NO.	SIZE IN. (MM)	STD. CTN.	STD. WT. (LBS.)	DIMENSIONS IN. (MM)								
				A	B	C	D	F	G	H	J	R
E978GC-CAR	1¼ (35)	15	4	1.66 (42.16)	2.75 (69.9)	3.23 (82.0)	1.00 (25.4)	1.07 (24.1)	1.90 (45.2)	2.15 (54.61)	.218 (5.54)	3.28 (83.3)
E978HC-CAR	1½ (41)	15	5	1.92 (48.77)	3.05 (77.5)	3.53 (89.7)	1.00 (25.4)	1.20 (27.4)	2.16 (51.8)	2.40 (60.96)	.218 (5.54)	3.58 (90.9)
E978JC-CAR	2 (53)	10	5	2.34 (59.44)	3.50 (88.9)	4.00 (101.6)	1.00 (25.4)	1.43 (33.3)	2.59 (63.0)	2.86 (72.64)	.218 (5.54)	4.06 (103.1)



Non-Metallic Clamps

Non-metallic clamps offer the same chemical resistance as Carlton® non-metallic conduits for a complete, corrosion-resistant system.

To be used in accordance with conduit spacing requirements per the NEC®, Section 352.30 and 12-1114 of the CEC.

- UV inhibited for use in direct sunlight

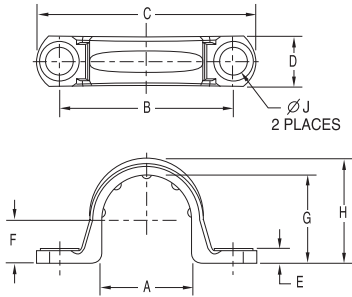

Conduit Clamp

Conduit Clamps

CAT. NO.	SIZE IN. (MM)	STD. CTN.	STD. WT. (LBS.)	DIMENSIONS IN. (MM)								
				A	B	C	D	E	F	G	H	J
E977DC	½ (16)	100	1.2	0.892 (22.6)	1.71 (43.4)	2.16 (54.8)	0.50 (12.7)	.14 (3.5)	.42 (10.6)	.866 (21.9)	1.04 (26.4)	.260 (6.6)
E977EC	¾ (21)	100	1.4	1.102 (27.9)	1.97 (50.0)	2.40 (60.9)	0.50 (12.7)	.14 (3.5)	.525 (13.3)	1.076 (27.3)	1.255 (31.8)	.260 (6.6)
E977FC	1 (27)	100	2	1.39 (35.3)	2.25 (57.1)	2.81 (71.3)	0.594 (15.0)	.14 (3.5)	.658 (16.7)	1.342 (34.0)	1.574 (39.9)	.260 (6.6)
E977GC	1¼ (35)	50	5	1.714 (43.5)	2.68 (68.0)	3.28 (83.3)	.64 (16.2)	.15 (3.8)	.83 (21.0)	1.687 (42.8)	1.89 (48.0)	.320 (8.1)
E977HC	1½ (41)	50	6	1.92 (48.7)	2.82 (71.6)	3.44 (87.3)	.70 (17.7)	.15 (3.8)	.97 (24.6)	1.93 (49.0)	2.12 (53.8)	.312 (7.9)
E977JC	2 (53)	25	4.5	2.54 (64.5)	3.54 (89.9)	4.18 (106.1)	.76 (19.3)	.16 (4.0)	1.05 (26.6)	2.29 (58.1)	2.49 (63.2)	.315 (8.0)
E977KC-CAR	2½ (63)	25	1.4	2.86 (72.6)	4.50 (114.3)	5.46 (138.7)	1.00 (25.4)	.20 (5.08)	1.43 (36.3)	2.86 (72.6)	3.12 (79.2)	.36 (9.14)
E977LC-CAR	3 (78)	20	1.4	3.47 (88.2)	5.00 (127.0)	6.00 (152.4)	1.00 (25.4)	.20 (5.08)	1.74 (44.3)	3.48 (88.4)	3.70 (94.0)	.36 (9.14)
E977NC-CAR	4 (103)	15	12.2	4.366 (110.9)	6.15 (156.2)	7.20 (182.9)	1.00 (25.4)	.20 (5.08)	2.32 (58.8)	4.50 (114.3)	4.70 (119.4)	.36 (9.14)

*NOTE: Some clamp applications require 2 screws, 2 nuts and 2 washers.

Non-Metallic Rigid Conduit, Fittings and Accessories

Carlton®

Clamps

Carlton® Masonry Pipe Clamps

Carlton® Masonry Pipe Clamps make installations faster and easier by eliminating the use of bolts and anchors. The one-piece design features an anchoring projection designed to push into a 5/16" drill hole.

The clamps are used to securely support pipe/conduit and electrical cables on concrete and masonry block, and unlike metallic clamps Carlton® Masonry Clamps won't rust or corrode.

Carlton® Masonry Pipe Clamps are available in sizes 1/2" and 3/4" and are ideal for commercial applications such as schools, hospitals, airports, condominiums, hotels, airports, office buildings and casinos.

Features

- One-piece design
- Material: Nylon PA6
- Color: Gray
- Flame resistance: V2
- Anchor length: 1.2" threaded
- Drill hole: 5/16"

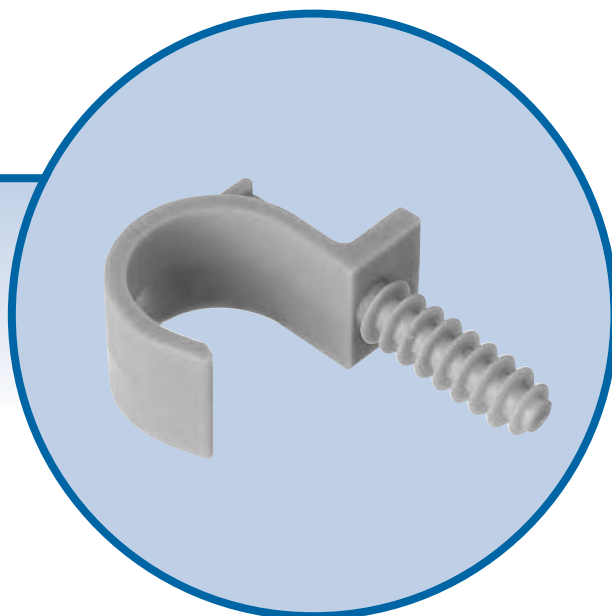

Installation:

1



Using a 5/16" masonry drill bit, drill a hole into the concrete.

2



Tap clamp with hammer until fully inserted.

3

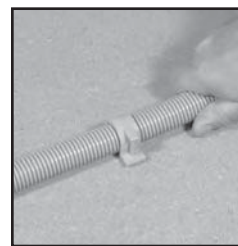

Hang desired conduit onto the clamp.

CAT. NO.	SIZE (IN.)	STD. CTN.	STD. WT. (LBS.)
E977NDC-CTN	1/2	12 (Equals 12 bags of 5 Clamps)	1.2
E977NEC-CTN	3/4	12 (Equals 12 bags of 5 Clamps)	1.3

Thomas & Betts

www.tnb.com

Corporate Office
Tel: 901.252.8000
800.816.7809
Fax: 901.252.1354

Customer Service
Tel: 800.816.7809
Fax: 800.816.7810

Technical Services
Tel: 888.862.3289
Fax: 901.252.1321

Tool Services
Tel: 800.284.8665

Corrosion Resistance of Carlton® Schedule 40 and Schedule 80 Fittings

Carlton Schedule 40 and Schedule 80 Fittings are generally acceptable for use in environments containing the chemicals **below**. These environmental-resistance ratings are based upon tests where the specimens were placed in complete submergence in the reagent listed. Schedule 40 and Schedule 80 Fittings can be used in many process areas where chemicals not on this list

are manufactured or used because worker safety requirements dictate that any air presence or splashing be at a very low level.

If there are any questions about specific suitability in a given environment, prototype samples should be tested under actual conditions.

CHEMICAL ENVIRONMENT					
Acetic Acid 0-20%	Bleach – 12.5% Active CL2	Cottonseed Oil	Hydrogen Phosphide	Palmitic Acid 10%	Sodium Cyanide
Acetic Acid 20-30%	Borax	Cresylic Acid 50%	Hydrogen Sulfide – Dry	Perchloric Acid 10%	Sodium Dichromate
Acetic Acid 30-60%	Boric Acid	Crude Oil – Sour	Hydrogen Sulfide – Aqueous Solution	Phenylhydrazine Hydrochloride	Sodium Ferricyanide
Acetic Acid 80%	Brine	Crude Oil – Sweet	Hydroquinone	Phosgene, Gas	Sodium Ferrocyanide
Acetic Acid – Glacial	Breeder Pellets – Dane. Fish	Deminerlized Water	Hydroxylamine Sulfate	Phosphoric Acid – 0-25%	Sodium Fluoride
Acetic Acid Vapors	Bromic Acid	Dextrin	Iodine	Phosphoric Acid – 25-50%	Sodium Hydroxide
Acetylene	Bromine – Water	Dextrose	Kerosene	Phosphoric Acid – 50-85%	Sodium Hypochlorite
Adipic Acid	Butane	Diglycolic Acid	Lactic Acid 28%	Photographic Chemicals	Sodium Nitrate
Alum	Butadiene	Disodium Phosphate	Lauric Acid	Plating Solutions	Sodium Nitrite
Aluminum Chloride	Butyl Alcohol	Ethyl Alcohol	Lauryl Chloride	Potassium Bicarbonate	Sodium Sulfate
Aluminum Fluoride	Butyl Phenol	Ethylene Glycol	Lauryl Sulfate	Potassium Bichromate	Sodium Sulfite
Aluminum Hydroxide	Butylene	Fatty Acids	Lead Acetate	Potassium Borate	Sodium Thiosulfate (Hypo)
Aluminum Oxychloride	Butyric Acid	Ferric Chloride	Lime Sulfur	Potassium Bromide	Stannic Chloride
Aluminum Nitrate	Calcium Bisulfite	Ferric Nitrate	Linoleic Acid	Potassium Carbonate	Stannous Chloride
Aluminum Sulfate	Calcium Carbonate	Ferric Sulfate	Linseed Oil	Potassium Chloride	Stearic Acid
Ammonia-Dry Gas	Calcium Chlorate	Ferrous Chloride	Lubricating Oils	Potassium Chromate	Sulfur
Ammonium Bifluoride	Calcium Chloride	Ferrous Sulfate	Magnesium Carbonate	Potassium Cyanide	Sulfur Dioxide – Gas Dry
Ammonium Carbonate	Calcium Hydroxide	Fluorine Gas – Wet	Magnesium Chloride	Potassium Dichromate	Sulfur Trioxide
Ammonium Chloride	Calcium Hypochlorite	Fluorine Gas – Dry	Magnesium Hydroxide	Potassium Ferricyanide	Sulfuric Acid – 0-10%
Ammonium Hydroxide 28%	Calcium Nitrate	Fluoroboric Acid	Magnesium Nitrate	Potassium Ferrocyanide	Sulfuric Acid – 10-75%
Ammonium Metaphosphate	Calcium Sulfate	Fluosilicic Acid	Magnesium Sulfate	Potassium Fluoride	Sulfuric Acid – 75-90%
Ammonium Nitrate	Carbonic Acid	Formaldehyde	Maleic Acid	Potassium Hydroxide	Sulfurous Acid
Ammonium Persulfate	Carbon Dioxide Gas – Wet	Formic Acid	Malic Acid	Potassium Nitrate	Tannic Acid
Ammonium Phosphate – Neutral	Carbon Dioxide – Aqueous Solution	Fructose	Mercuric Chloride	Potassium Perborate	Tanning Liquors
Ammonium Sulfate	Carbon Monoxide	Gallic Acid	Mercuric Cyanide	Potassium Perchlorate	Tartaric Acid
Ammonium Sulfide	Caustic Potash	Gas – Coke Oven	Mercurous Nitrate	Potassium Permanganate 10%	Titanium Tetrachloride
Ammonium Thiocyanate	Caustic Soda	Gas – Natural (Dry)	Mercury	Potassium Persulfate	Triethanolamine
Amyl Alcohol	Chloracetic Acid	Gas – Natural (Wet)	Methyl Sulfate	Potassium Sulfate	Trimethyl Propane
Antraquinone	Chloral Hydrate	Gasoline – Sour	Methylene Chloride	Propane	Trisodium Phosphate
Antraquinonesulfonic Acid	Chlorine Gas (Dry)	Gasoline – Refined	Mineral Oils	Propyl Alcohol	Turpentine
Antimony Trichloride	Chlorine Gas (Moist)	Glucose	Naphthalene	Silicic Acid	Urea
Aqua Regia	Chlorine Water	Glycerine (Glycerol)	Nickel Chloride	Silver Cyanide	Vinegar
Arsenic Acid 80%	Chlorosulfonic Acid	Glycol	Nickel Nitrate	Silver Nitrate	Whiskey
Arylsulfonic Acid	Chrome Alum	Glycolic Acid	Nitric Acid, Anhydrous	Silver Plating Solutions	White Liquor (Paper Industry)
Barium Carbonate	Chromic Acid 10%	Green Liquor (Paper Industry)	Nitric Acid 20%	Sodium Acetate	Wines
Barium Chloride	Chromic Acid 30%	Heptane	Nitric Acid 40%	Sodium Arsenite	Zinc Chloride
Barium Hydroxide	Chromic Acid 40%	Hexanol, Tertiary	Nitric Acid 60%	Sodium Benzoate	Zinc Chromate
Barium Sulfate	Chromic Acid 50%	Hydrobromic Acid 20%	Nitrobenzene	Sodium Bicarbonate	Zinc Cyanide
Barium Sulfide	Citric Acid	Hydrochloric Acid 0% - 25%	Nitrous Oxide	Sodium Bisulfate	Zinc Nitrate
Beet – Sugar Liquor	Copper Chloride	Hydrochloric Acid 25% - 40%	Oils and Fats	Sodium Bisulfite	Zinc Sulfate
Benzene Sulfonic Acid 10%	Copper Cyanide	Hydrocyanic Acid or Hydrogen Cyanide	Oils – Petroleum – (See Type)	Sodium Bromide	
Benzoic Acid	Copper Fluoride	Hydrofluoric Acid 10%	Oleic Acid	Sodium Chlorate	
Bismuth Carbonate	Copper Nitrate	Hydrofluorosilicic Acid	Oxalic Acid	Sodium Chloride	
Black Liquor (Paper Industry)	Copper Sulfate				

Deep-Socket Schedule 40 Utility Elbows with Integral Belled Ends

Non-UL Listed

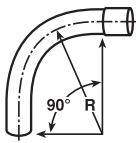
SEGMENT	CAT. NO.	NOM. DIA. (IN.)	RADIUS (IN.)	STD. CTN.	STD. WT. (LBS.)
90° SWEEP 	UC9BHB	1½	12	20	25.00
	UC9DHB	1½	24	1	2.13
	UC9FHB	1½	36	1	3.05
	UC9BJB	2	12	1	1.44
	UC9DJB	2	24	1	2.82
	UC9FJB	2	36	1	4.14
	UC9HJB	2	48	1	5.15
	UC9DKB	2½	24	1	5.00
	UC9FKB	2½	36	1	7.15
	UC9DLB	3	24	1	6.57
	UC9FLB	3	36	1	9.15
	UC9DNB	4	24	1	10.59
	UC9FNB	4	36	1	13.64
	UC9HNB	4	48	1	17.72
	UC9FRB	6	36	1	25.80
	UC9HRB	6	48	1	32.24

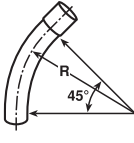
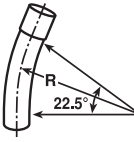
SEGMENT	CAT. NO.	NOM. DIA. (IN.)	RADIUS (IN.)	STD. CTN.	STD. WT. (LBS.)
45° ELBOW 	UC7FHB	1½	36	1	1.74
	UC7FJB	2	36	1	2.07
	UC7CKB	2½	18	1	2.27
	UC7FKB	2½	36	1	4.12
	UC7FLB	3	36	1	5.00
	UC7FNB	4	36	1	8.15
	UC7HNB	4	48	1	9.36
	UC7HRB	6	48	1	17.19
22½° ELBOW 	UC7ITB	8	60	1	33.00
	UC5CKB	2½	18	1	1.45
	UC5FKB	2½	36	1	2.49
	UC5FNB	4	36	1	5.18
	UC5FRB	6	36	1	11.82
	UC5HNB	4	48	1	5.57

Utility Elbow Bells (Dimensions in Inches)

TRADE SIZE	A AT ENTRANCE	B AT BOTTOM	C NOMINAL BELL
1½	1.921 ± .005	1.894 ± .006	2¾ ± ⅛
2	2.400 ± .005	2.369 ± .012	2¾ ± ⅛
2½	2.906 ± .005	2.868 ± .007	3 ± ⅛
3	3.538 ± .005	3.492 ± .008	3 ± ⅛
4	4.544 ± .005	4.491 ± .009	3¾ ± ⅛
5	5.614 ± .005	5.553 ± .010	4¾ ± ⅛
6	6.687 ± .005	6.614 ± .011	5¾ ± ⅛
8	8.687 ± .005	8.636 ± .005	6¾ ± ⅛

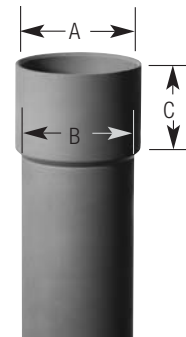



Rigid Non-Metallic Long Belled Utility Conduit

Non-UL Listed

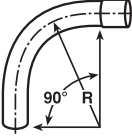
SEGMENT	CAT. NO.	NOM. DIA. (IN.)	RADIUS (IN.)	STD. CTN.	STD. WT. (LBS.)
90° ELBOW 	UC9CJBLB	2	18	1	1.3
	UC9DJBLB	2	24	1	1.4
	UC9DLBLB	3	24	1	5.0
	UC9DNBLB	4	24	1	5.8
	UC9DPBLB	5	24	1	8.5
	UC9FJBLB	2	36	1	2.2
	UC9FLBLB	3	36	1	5.2
	UC9FNBLB	4	36	1	7.8
	UC9FPBLB	5	36	1	11.1
	UC9FRBLB	6	36	1	9.6
	UC9HJBLB	2	48	1	2.8
	UC9HLBLB	3	48	1	12.0
	UC9HNBLB	4	48	1	9.7
	UC9HPBLB	5	48	1	13.7
	UC9HRBLB	6	48	1	18.1

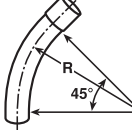
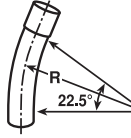
SEGMENT	CAT. NO.	NOM. DIA. (IN.)	RADIUS (IN.)	STD. CTN.	STD. WT. (LBS.)
45° ELBOW 	UC7CJBLB	2	18	1	1.3
	UC7DJBLB	2	24	1	1.4
	UC7DLBLB	3	24	1	5.0
	UC7DNBLB	4	24	1	5.8
	UC7DPBLB	5	24	1	8.5
	UC7FJBLB	2	36	1	2.2
	UC7FLBLB	3	36	1	5.2
	UC7FNBLB	4	36	1	7.8
	UC7FPBLB	5	36	1	11.1
	UC7FRBLB	6	36	1	9.6
	UC7HJBLB	2	48	1	2.8
	UC7HLBLB	3	48	1	6.6
UC7HNBLB	4	48	1	9.7	
UC7HPBLB	5	48	1	13.7	
UC7HRBLB	6	48	1	18.1	
22½° ELBOW 	UC5FRBLB	6	36	1	9.6

Long Belled Utility Elbow Bells (Dimensions in Inches)

TRADE SIZE	A AT ENTRANCE	B AT BOTTOM	C NOMINAL BELL
1½	1.918 ± .006	1.894 ± .006	2¼ ± ⅛
2	2.393 ± .006	2.369 ± .012	3¼ ± ⅛
2½	2.890 ± .007	2.868 ± .007	3¾ ± ⅛
3	3.515 ± .008	3.492 ± .008	4 ± ⅛
4	4.515 ± .009	4.491 ± .009	4¾ ± ⅛
5	5.593 ± .010	5.553 ± .010	5¾ ± ⅛
6	6.658 ± .011	6.614 ± .011	6¾ ± ⅛

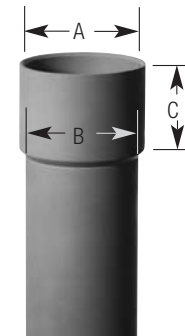

Carlton® Non-Metallic Rigid Conduit, Fittings and Accessories

Special California Type DB-100 Sweeps — Belled

**Consult your Thomas & Betts Sales Team for additional sizes*

	CAT. NO.	SIZE (IN.)	STD. CTN.
90° SWEEP — 48" RADIUS	PE9HN	4	1
	PE9HP	5	1

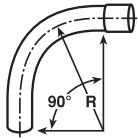

	CAT. NO.	SIZE (IN.)	STD. CTN.
11¼° SWEEP — 150" RADIUS	PE3SP	5	1
SEGMENTED SWEEPS			
	PE3SNS	4	1
	PE3SPS	5	1
	PE3SRS	6	1

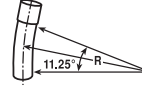

	CAT. NO.	SIZE (IN.)	STD. CTN.
45° SWEEP — 150" RADIUS	PE7SP	5	1

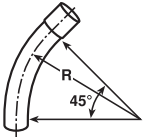



DB-60 Sweeps

**Consult your Thomas & Betts Sales Team for additional sizes*

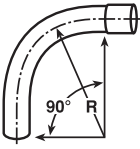
SEGMENT	CAT. NO.	SIZE (IN.)	RADIUS (IN.)	STD. CTN.
90° SWEEP 	PF9CH	1½	18	1
	PF9CJ	2	18	1
	PF9CL	3	18	1
	PF9CN	4	18	1
	PF9DF	1	24	1
	PF9DH	1½	24	1
	PF9DJ	2	24	1
	PF9DL	3	24	1
	PF9DN	4	24	1
	PF9DP	5	24	1
	PF9FF	1	36	1
	PF9FJ	2	36	1
	PF9FL	3	36	1
	PF9FN	4	36	1
	PF9FP	5	36	1
	PF9FR	6	36	1
	PF9HL	3	48	1
	PF9HN	4	48	1
	PF9HP	5	48	1
	PF9HR	6	48	1
	PF9IL	3	60	1
	PF9IN	4	60	1
	PF9IP	5	60	1
	PF9IR	6	60	1
	PF9SH	1½	150	1
	PF9SJ	2	150	1
	PF9SL	3	150	1
	PF9SR	6	150	1
	PF9VL	3	300	1
	PF9VN	4	300	1
PF9VP	5	300	1	

NOTE: Elbows 72" and larger may be shipped in segments. Consult factory for specifics.

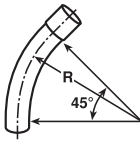
SEGMENT	CAT. NO.	SIZE (IN.)	RADIUS (IN.)	STD. CTN.
45° SWEEP 	PF7CF	1	18	1
	PF7CH	1½	18	1
	PF7CJ	2	18	1
	PF7CL	3	18	1
	PF7DF	1	24	1
	PF7DH	1½	24	1
	PF7DJ	2	24	1
	PF7DL	3	24	1
	PF7DN	4	24	1
	PF7FF	1	36	1
	PF7FH	1½	36	1
	PF7FJ	2	36	1
	PF7FL	3	36	1
	PF7FN	4	36	1
	PF7FP	5	36	1
	PF7FR	6	36	1
	PF7HJ	2	48	1
	PF7HL	3	48	1
	PF7HN	4	48	1
	PF7HP	5	48	1
	PF7HR	6	48	1
	PF7IL	3	60	1
	PF7IP	5	60	1
	PF7NN	4	120	1
PF7SH	1½	150	1	
PF7SJ	2	150	1	
PF7SL	3	150	1	
PF7SN	4	150	1	
PF7SP	5	150	1	
PF7SR	6	150	1	
PF7VN	4	300	1	
PF7VP	5	300	1	
PF7VR	6	300	1	

NOTE: Elbows 72" and larger may be shipped in segments. Consult factory for specifics.

DB-60 Sweeps

*Consult your Thomas & Betts Sales Team for additional sizes

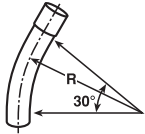
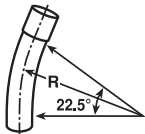
SEGMENT	CAT. NO.	SIZE (IN.)	RADIUS (IN.)	STD. CTN.
30° SWEEP 	PF6CJ	2	18	1
	PF6CL	3	18	1
	PF6DL	3	24	1
	PF6DN	4	24	1
	PF6DP	5	24	1
	PF6CH	1½	30	1
	PF6FJ	2	36	1
	PF6FL	3	36	1
	PF6FN	4	36	1
	PF6FR	6	36	1
	PF6HJ	2	48	1
	PF6HN	4	48	1
	PF6HP	5	48	1
	PF6HR	6	48	1
	PF6IN	4	60	1
	PF6IP	5	60	1
	PF6SJ	2	150	1
	PF6SN	4	150	1
	PF6SP	5	150	1
	PF6VJ	2	300	1
PF6VN	4	300	1	
PF6VR	6	300	1	
22½° SWEEP 	PH5DL	3	24	1
	PF5DN	4	24	1
	PF5DP	5	24	1
	PF5FF	1	36	1
	PF5FL	3	36	1
	PF5FN	4	36	1
	PF5FP	5	36	1
	PF5FR	6	36	1
	PF5HL	3	48	1
	PF5HN	4	48	1
	PF5HR	6	48	1
	PF5IJ	2	60	1
	PF5IL	3	60	1
	PF5IP	5	60	1
	PF5IR	6	60	1
	PF5SL	3	150	1
	PF5SN	4	150	1
	PF5SP	5	150	1
	PF5SR	6	150	1
	PF5VN	4	300	1
PF5VP	5	300	1	
PF5VR	6	300	1	

NOTE: Elbows 72" and larger may be shipped in segments. Consult factory for specifics.

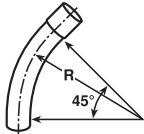
SEGMENT	CAT. NO.	SIZE (IN.)	RADIUS (IN.)	STD. CTN.
11½° SWEEP 	PF3CJ	2	18	1
	PF3CL	3	18	1
	PF3DF	1	24	1
	PF3DH	1½	24	1
	PF3DP	5	24	1
	PF3FJ	2	36	1
	PF3FL	3	36	1
	PF3FN	4	36	1
	PF3FP	5	36	1
	PF3FR	6	36	1
	PF3HL	3	48	1
	PF3HN	4	48	1
	PF3HP	5	48	1
	PF3HR	6	48	1
	PF3IJ	2	60	1
	PF3IR	6	60	1
	PF3SJ	2	150	1
	PF3SN	4	150	1
	PF3SP	5	150	1
	PF3SR	6	150	1
PF3VJ	2	300	1	
PF3VL	3	300	1	
PF3VN	4	300	1	
PF3VP	5	300	1	

NOTE: Elbows 72" and larger may be shipped in segments. Consult factory for specifics.



DB-120 Sweeps

**Consult your Thomas & Betts Sales Team for additional sizes*

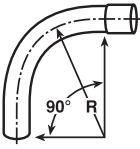
SEGMENT	CAT. NO.	SIZE (IN.)	RADIUS (IN.)	STD. CTN.
90° SWEEP 	PH9CJ	2	18	1
	PH9CL	3	18	1
	PH9CN	4	18	1
	PH9DJ	2	24	1
	PH9DL	3	24	1
	PH9DN	4	24	1
	PH9DP	5	24	1
	PH9FJ	2	36	1
	PH9FL	3	36	1
	PH9FN	4	36	1
	PH9FP	5	36	1
	PH9FR	6	36	1
	PH9HJ	2	48	1
	PH9HL	3	48	1
	PH9HN	4	48	1
	PH9HP	5	48	1
	PH9HR	6	48	1
	PH9IJ	2	60	1
	PH9IL	3	60	1
	PH9IN	4	60	1
	PH9IR	6	60	1
	PH9OJ	2	66	1
	PH9SJ	2	150	1
	PH9SL	3	150	1
	PH9SN	4	150	1
	PH9SP	5	150	1
	PH9SR	6	150	1
	PH9VN	4	300	1
	PH9VP	5	300	1
	PH9VR	6	300	1

NOTE: Elbows 72" and larger may be shipped in segments. Consult factory for specifics.

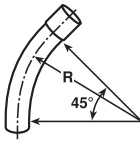
SEGMENT	CAT. NO.	SIZE (IN.)	RADIUS (IN.)	STD. CTN.
45° SWEEP 	PH7CJ	2	18	1
	PH7CL	3	18	1
	PH7CN	4	18	1
	PH7DJ	2	24	1
	PH7DL	3	24	1
	PH7DN	4	24	1
	PH7DP	5	24	1
	PH7FJ	2	36	1
	PH7FL	3	36	1
	PH7FN	4	36	1
	PH7FP	5	36	1
	PH7FR	6	36	1
	PH7HJ	2	48	1
	PH7HL	3	48	1
	PH7HN	4	48	1
	PH7HP	5	48	1
	PH7HR	6	48	1
	PH7IJ	2	60	1
	PH7IL	3	60	1
	PH7IP	5	60	1
PH7IR	6	60	1	
PH7SJ	2	150	1	
PH7SN	4	150	1	
PH7SP	5	150	1	
PH7SR	6	150	1	

NOTE: Elbows 72" and larger may be shipped in segments. Consult factory for specifics.

DB-120 Sweeps

*Consult your Thomas & Betts Sales Team for additional sizes

Carlton® Non-Metallic Rigid Conduit, Fittings and Accessories

SEGMENT	CAT. NO.	SIZE (IN.)	RADIUS (IN.)	STD. CTN.
30° SWEEP	PH6CJ	2	18	1
	PH6CL	3	18	1
	PH6CN	4	18	1
	PH6DJ	2	24	1
	PH6DN	4	24	1
	PH6DP	5	24	1
	PH6FJ	2	36	1
	PH6FL	3	36	1
	PH6FN	4	36	1
	PH6FP	5	36	1
	PH6FR	6	36	1
	PH6HN	4	48	1
	PH6HR	6	48	1
	PH6IN	4	60	1
	PH6SL	3	150	1
	22½° SWEEP	PH5CJ	2	18
PH5CL		3	18	1
PH5CN		4	18	1
PH5DJ		2	24	1
PH5DL		3	24	1
PH5DP		5	24	1
PH5FJ		2	36	1
PH5FL		3	36	1
PH5FN		4	36	1
PH5FP		5	36	1
PH5HL		3	48	1
PH5HN		4	48	1
PH5HP		5	48	1
PH5HR		6	48	1
PH5IJ		2	60	1
PH5IL		3	60	1
PH5IR		6	60	1
PH5SN		4	150	1
PH5SP	5	150	1	
PH5SR	6	150	1	
PH5VJ	2	300	1	
PH5VN	4	300	1	

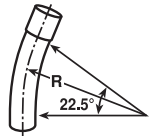
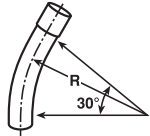

NOTE: For nominal diameter of 1", use 1" DB-60 Sweeps.
For nominal diameter of 1½", use 1½" DB-60 Sweeps.

NOTE: Elbows 72" and larger may be shipped in segments. Consult factory for specifics.

SEGMENT	CAT. NO.	SIZE (IN.)	RADIUS (IN.)	STD. CTN.
11¼° SWEEP	PH3CJ	2	18	1
	PH3CN	4	18	1
	PH3DJ	2	24	1
	PH3DN	4	24	1
	PH3DP	5	24	1
	PH3FJ	2	36	1
	PH3FL	3	36	1
	PH3FN	4	36	1
	PH3FP	5	36	1
	PH3FR	6	36	1
	PH3HN	4	48	1
	PH3IN	4	60	1
	PH3IP	5	60	1
	PH3IR	6	60	1
	PH3SJ	2	150	1
	PH3SL	3	150	1
	PH3SN	4	150	1
	PH3SP	5	150	1
PH3SR	6	150	1	
PH3VR	6	300	1	

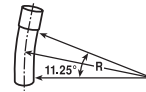

NOTE: For nominal diameter of 1", use 1" DB-60 Sweeps.
For nominal diameter of 1½", use 1½" DB-60 Sweeps.

NOTE: Elbows 72" and larger may be shipped in segments. Consult factory for specifics.



P&C Duct

(for use with all types of EB and DB Duct)

Couplings

Sleeve Coupling (for repair work)

CAT. NO.	SIZE (IN.)	STD. CTN.
E200J	2	30
E200L	3	25
E200M	3½	20
E200N	4	15
E200P	5	8
E200R	6	5



No internal stop

Coupling

CAT. NO.	SIZE (IN.)	STD. CTN.
E940F	1	50
E940H	1½	25
E940J	2	30
E940K	2½	20
E240L	3	30
E240N	4	15
E240P	5	20
E240RF	6	5



Long Line Coupling

CAT. NO.	SIZE (IN.)	STD. CTN.
E941H	1½	40
E941J	2	25
E941K	2½	15
E241L	3	15
E241N	4	10



5° Angle Coupling B x S (Bell x Spigot)

CAT. NO.	SIZE (IN.)	C (IN.)	STD. CTN.
E244J	2	2.13	15
E244L	3	3.25	5
E244NF	4	3.50	15
E244NF5 (SHORT)	4	1.87	25
E244PF	5	4.13	10
E244PF5 (SHORT)	5	2.00	20
E244RF	6	5.13	5
E244RF5 (SHORT)	6	2.25	10

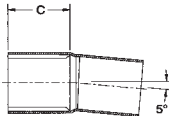

5° Angle Coupling BxB (Bell x Bell)

CAT. NO.	SIZE (IN.)	STD. CTN.
E2440NF	4	15
E2440PF	5	10
E2440RF	6	5



5° Angle Coupling B x B (Swedged)

CAT. NO.	SIZE (IN.)	STD. CTN.
E245J	2	20
E245N	4	10
E245P	5	10
E245R	6	5



Swedge Coupling

CAT. NO.	SIZE (IN.)	STD. CTN.
E242J	2	48

5° Angle Coupling S x S

CAT. NO.	SIZE (IN.)	STD. CTN.
E2440N5	4	15
E2440P5	5	20

Plugs

Plug

CAT. NO.	SIZE (IN.)	STD. CTN.
P258H	1½	50
P258K	2½	50



Plug with Pull Tab

CAT. NO.	SIZE (IN.)	STD. CTN.
P258JT	2	60
P258LT	3	30
P258NT	4	48
P258PT	5	30
P258RT	6	30



Adapters

Male Adapter

CAT. NO.	SIZE (IN.)	STD. CTN.
E943F	1	50
E943H	1½	25
E943J	2	50
E943L	3	50
E943N	4	20
E943P	5	5
E943R	6	10



Female Adapter

CAT. NO.	SIZE (IN.)	STD. CTN.
E942F	1	50
E942H	1½	25
E942J	2	30
E942L	3	25
E942N	4	15
E942P	5	8
E942R	6	6



Reducers

Swedge Reducer (Male x Male)

CAT. NO.	SIZE (IN.)	STD. CTN.
E252LJ	3 x 2	50
E252NJS	4 x 2	25
E252NL	4 x 3	25
E252PN	5 x 4	20
E252RNS	6 x 4	6
E252RP	6 x 5	10



Markers

Cable Marker

CAT. NO.	SIZE (IN.)	STD. CTN.
E299JM	2 x 42	1
E299JP	2 x 56	1
E299JR	2 x 78	1
E299LF	3 x 36	1
E299LR	3 x 60	1
E299NX7	4 x 84	1



End Bells

End Bell

CAT. NO.	SIZE (IN.)	STD. CTN.
E997F	1	50
E997H	1½	30
E997J	2	40
E997L	3	50
E997N	4	30
E997P	5	15
E997R	6	10



Molded End Bell

CAT. NO.	SIZE (IN.)	STD. CTN.
E297J	2	40
E297L	3	50
E297N	4	30
E297P	5	15



Fabricated End Bell

CAT. NO.	SIZE (IN.)	STD. CTN.
E297JN	2 x 4	25
E297LR	3 x 6	20
E297NT	4 x 10	15
E297PS	5 x 8	10
E297PT	5 x 10	10
E297RF	6 x 5	10
E297RT	6 x 10	6



Long-Length End Bell P&C Duct

CAT. NO.	SIZE (IN.)	STD. CTN.
E297RR	6 (6 long)	10





Canadian DB/2 Sweeps

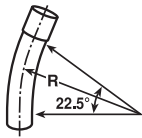
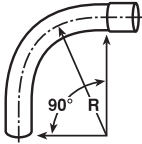

LR90813

SEGMENT	CAT. NO.	SIZE (IN.)	RADIUS (IN.)	STD. CTN.
90° SWEEP	CPF9DJ	2	24	1
	CPF9DL	3	24	1
	CPF9DM*	3½	24	1
	CPF9DN	4	24	1
	CPF9DP*	5	24	1
	CPF9FJ	2	36	1
	CPF9FL	3	36	1
	CPF9FM*	3½	36	1
	CPF9FN	4	36	1
	CPF9FP*	5	36	1
	CPF9FR*	6	36	1
	CPF9GJ*	2	42	1
	CPF9GL*	3	42	1
	CPF9GM*	3½	42	1
	CPF9GN*	4	42	1
	CPF9GP	5	42	1
	CPF9GR*	6	42	1
	CPF9IJ	2	60	1
	CPF9IL	3	60	1
	CPF9IM*	3½	60	1
CPF9IN	4	60	1	
CPF9IP	5	60	1	
CPF9IR	6	60	1	
22½° SWEEP	CPF5DJ*	2	24	1
	CPF5DL*	3	24	1
	CPF5DM*	3½	24	1
	CPF5DN*	4	24	1
	CPF5DP*	5	24	1
	CPF5FJ*	2	36	1
	CPF5FL*	3	36	1
	CPF5FM*	3½	36	1
	CPF5FN	4	36	1
	CPF5FP*	5	36	1
	CPF5GJ*	2	42	1
	CPF5GL*	3	42	1
	CPF5GM*	3½	42	1
	CPF5GN*	4	42	1
	CPF5GP	5	42	1
	CPF5IJ*	2	60	1
	CPF5IL*	3	60	1
	CPF5IM*	3½	60	1
	CPF5IN*	4	60	1
	CPF5IP*	5	60	1

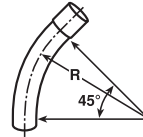

*Non-stock special radius sweeps are available on request — Quote only.
NOTE: Elbows 72" and larger may be shipped in segments. Consult factory for specifics.

SEGMENT	CAT. NO.	SIZE (IN.)	RADIUS (IN.)	STD. CTN.
45° SWEEP	CPF7DJ	2	24	1
	CPF7DL	3	24	1
	CPF7DM*	3½	24	1
	CPF7DN	4	24	1
	CPF7DP*	5	24	1
	CPF7FJ	2	36	1
	CPF7FL	3	36	1
	CPF7FM*	3½	36	1
	CPF7FN	4	36	1
	CPF7FP*	5	36	1
	CPF7FR*	6	36	1
	CPF7GJ*	2	42	1
	CPF7GL*	3	42	1
	CPF7GM*	3½	42	1
	CPF7GN*	4	42	1
	CPF7GP	5	42	1
	CPF7GR*	6	42	1
	CPF7IJ*	2	60	1
	CPF7IL*	3	60	1
	CPF7IM*	3½	60	1
CPF7IN	4	60	1	
CPF7IP*	5	60	1	
CPF7IR	6	60	1	



*Non-stock special radius sweeps are available on request — Quote only.
NOTE: Elbows 72" and larger may be shipped in segments. Consult factory for specifics.

Carlton® Non-Metallic Rigid Conduit, Fittings and Accessories



Canadian DB/2 Duct Fittings

PVC 5° Coupling B x B — Solvent Weld

CAT. NO.	SIZE (IN.)	STD. CTN.
CE245J	2	30
CE245L	3	15
CE245N	4	10
CE245P	5	20



PE 5° Coupling — Push Fit

CAT. NO.	SIZE (IN.)	STD. CTN.
CE2440L	3	100
CE2440N	4	90



PE Coupling — Push Fit

CAT. NO.	SIZE (IN.)	STD. CTN.
CE242J	2	213
CE242L	3	100
CE242N	4	100
CE242P	5	12



PVC Coupling — Solvent Weld

CAT. NO.	SIZE (IN.)	STD. CTN.
CE240J	2	30
CE240L	3	30
CE240N	4	15
CE240P	5	20
CE240R	6	1



Plugs

Plug with Pull Tab

CAT. NO.	SIZE (IN.)	STD. CTN.
P258JT	2	60
P258LT	3	30
P258NT	4	48
P258PT	5	30
P258RT	6	30



End Bells

End Bell (For use with DB/2 Duct only)

CAT. NO.	SIZE (IN.)	STD. CTN.
CE297J	2	40
CE297L	3	50
CE297N	4	30
CE297P	5	15



Adapters

PVC Female Adapter — I.P.S. Solvent Weld Duct

CAT. NO.	SIZE (IN.)	STD. CTN.
CE942DJ	2	25
CE942DL	3	30
CE942DN	4	50
CE942DP	5	15



PVC Conduit to DB/2 Duct Adapter

CAT. NO.	SIZE (IN.)	STD. CTN.
CE942RJ	2	24
CE942RL	3	1
CE942RN	4	1



Caps

Cap — Solvent Weld

CAT. NO.	SIZE (IN.)	STD. CTN.
CE935J	2	25
CE935L	3	25
CE935N	4	50
CE935P	5	25





RUS Accepted

Telephone Duct Sweeps Manufactured from Heavy Wall "C" Duct

- Size: 4"
- Each sweep is furnished with a belled end
- Straight-end length 3"

SEGMENT	CAT. NO.	BEND RADIUS	STD. CTN.	
90° SWEEP	GRAY			
	TP9CN	1'6"	1	
	TP9DN	2'	1	
	TP9FN	3'	1	
	TP9HN	4'	1	
	TP9IN	5'	1	
	TP9JN	6'	1	
	TP9MN	9'	1	
	TP9NN	10'	1	
	TP9SN	12'6"	1	
	TP9TN	15'	1	
	TP9UN	20'	1	
	WHITE			
	TW9DN	2'	1	
	TW9FN	3'	1	
	TW9HN	4'	1	
	TW9IN	5'	1	
	TW9JN	6'	1	
	TW9MN	9'	1	
	TW9NN	10'	1	
	TW9SN	12'6"	1	
	TW9TN	15'	1	
	45° SWEEP	GRAY		
		TP7DN	2'	1
		TP7FN	3'	1
		TP7HN	4'	1
		TP7ON	4'6"	1
TP7IN		5'	1	
TP7JN		6'	1	
TP7MN		9'	1	
TP7NN		10'	1	
TP7RN		12'	1	
TP7SN		12'6"	1	
TP7TN		15'	1	
TP7UN		20'	1	
WHITE				
TW7DN		2'	1	
TW7FN		3'	1	
TW7HN		4'	1	
TW7ON		4'6"	1	
TW7IN		5'	1	
TW7JN		6'	1	
TW7MN		9'	1	
TW7NN		10'	1	
TW7RN		12'	1	
TW7SN		12'6"	1	
TW7TN		15'	1	

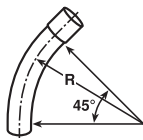
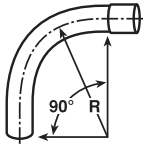

SEGMENT	CAT. NO.	BEND RADIUS	STD. CTN.	
30° SWEEP	GRAY			
	TP6FN	3'	1	
	TP6HN	4'	1	
	TP6JN	6'	1	
	TP6NN	10'	1	
	TP6RN	12'	1	
	TP6SN	12'6"	1	
	TP6TN	15'	1	
	WHITE			
	TW6FN	3'	1	
	TW6HN	4'	1	
	TW6JN	6'	1	
	TW6MN	9'	1	
	TW6NN	10'	1	
	TW6RN	12'	1	
	TW6SN	12'6"	1	
	TW6TN	15'	1	
	22½° SWEEP	GRAY		
		TP5DN	2'	1
		TP5FN	3'	1
TP5HN		4'	1	
TP5IN		5'	1	
TP5JN		6'	1	
TP5MN		9'	1	
TP5RN		12'	1	
TP5SN		12'6"	1	
TP5TN		15'	1	
TP5UN		20'	1	
TP5VN		25'	1	
WHITE				
TW5DN		2'	1	
TW5FN		3'	1	
TW5HN		4'	1	
TW5JN		6'	1	
TW5MN		9'	1	
TW5SN		12'6"	1	
TP3DN		2'	1	
11¼° SWEEP	GRAY			
	TP3FN	3'	1	
	TP3HN	4'	1	
	TP3IN	5'	1	
	TP3JN	6'	1	
	TP3SN	12'6"	1	
	WHITE			
	TW3DN	2'	1	
	TW3FN	3'	1	
	TW3HN	4'	1	

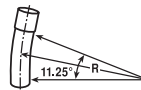
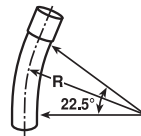
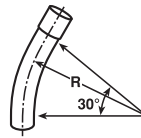

E-Bends — Riser Ells

SEGMENT	CAT. NO.	BEND RADIUS	STD. CTN.
90° SWEEP	TA9ENT (BELLED END)	2' 6"	1
	TA9FN (PLAIN END)	3'	1
	TA9FNT (BELLED END)	3'	1
	TA9FNTL (BELLED END-LONG)	3'	1

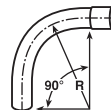

*Gray only

Carlton® Non-Metallic Rigid Conduit, Fittings and Accessories

Corporate Office
Tel: 901.252.8000
800.816.7809
Fax: 901.252.1354

Customer Service
Tel: 800.816.7809
Fax: 800.816.7810

Technical Services
Tel: 888.862.3289
Fax: 901.252.1321

Tool Services
Tel: 800.284.8665

Thomas & Betts

www.tnb.com

Couplings Sleeve Coupling

CAT. NO.	SIZE (IN.)	STD. CTN.
----------	------------	-----------

For Repair Work

E900N	4 x 6	25
E900NU	4 x 12	10
E900NW (WHITE)	4 x 6	25

Split Sleeve Couplings

E900NS	4	25
E900NS8 (WHITE)	4 x 8	15
E900NSW (WHITE)	4	25
E900PS	5	15

For Type D Duct Applications Only

E900DN (WHITE)	4	25
----------------	---	----



No internal stop

Molded Coupling

CAT. NO.	SIZE (IN.)	STD. CTN.
----------	------------	-----------

Internal Stop

E908N	4	25
-------	---	----



5° Angle Coupling

CAT. NO.	SIZE (IN.)	STD. CTN.
----------	------------	-----------

E914N	4	15
-------	---	----



Plugs

Plug with Pull Tab

CAT. NO.	SIZE (IN.)	STD. CTN..
----------	------------	------------

P258NTB	4	50
---------	---	----



End Bells Square to Round

CAT. NO.	SIZE (IN.)	STD. CTN.
----------	------------	-----------

E903N	4 (Sq.)	4
-------	---------	---



Molded End Bell

CAT. NO.	SIZE (IN.)	STD. CTN.
----------	------------	-----------

E971N	4	10
-------	---	----



Flare and Straight End Bell

CAT. NO.	SIZE (IN.)	STD. CTN.
----------	------------	-----------

E907N	4 (5 long, 5.5 flare)	10
E907NY	4 (9 long, 5.75 flare)	1



Split End Bell (PVC)

CAT. NO.	SIZE (IN.)	STD. CTN.
----------	------------	-----------

E9098NS	4	1
E9098PS	5	1





Adapters

Adapts Telephone Duct to Fiber Transite MCD

Internal Adapter

CAT. NO.	SIZE (IN.)	STD. CTN.
E901N	4	24
<i>Split</i>		
E901NS	4	24



Adapts Threaded Metal Pipe to Telephone Duct

Female Adapter

CAT. NO.	SIZE (IN.)	STD. CTN.
E902N	4	10



Square Clay Tile Adapter

CAT. NO.	SIZE (IN.)	STD. CTN.
<i>Adapts Clay to Telephone Duct</i>		
E904M	3¼-4 x 18	10
E904M12	3¼-4 x 12	10
E904M8	3¼-4 x 8½	12
E904MM	3½-3½ x 18	12
E904MX	3-4 x 18	10
E904N	3½-4 x 18	10
E904N12	3½-4 x 12	12
E904N24	3½-4 x 24	10
E904N8	3½-4 x 8	10



Split Square Adapter

E904MS	3¼ x 4	10
E904NS	3½-4 x 18	10

Adapts Telephone Duct to Cast Iron Bends

Cast Iron Adapter

CAT. NO.	SIZE (IN.)	STD. CTN.
E906N	4	1



Round Clay Tile Adapter

CAT. NO.	SIZE (IN.)	STD. CTN.
E923NM	4-3¼	10



Adapts Telephone Duct to P&C Duct and Rigid Non-Metallic Conduit

P&C Duct Adapter

CAT. NO.	SIZE (IN.)	STD. CTN.
E913N	4	15
E913NF	4	15



Reducers

Adapts Telephone Duct to P&C Duct and Rigid Non-Metallic Conduit

P&C Duct Adapter

CAT. NO.	SIZE (IN.)	STD. CTN.
E908NM	4-3¼	15



Expansion Fittings

Expansion Fitting — Type D

CAT. NO.	SIZE (IN.)	STD. CTN.
E905N	4	5
E905NL (LONG)	4	1



Wyes

For starting lateral runs

P&C Duct Adapter

CAT. NO.	SIZE (IN.)	STD. CTN.
E916N	4	1
E916NW (WHITE)	4	1



Split

E916NS	4	1
E916NSW (WHITE)	4	5

Split Sleeve Coupling

CAT. NO.	SIZE (IN.)	DESCRIPTION	LENGTH (IN.)	SPLIT	STD. CTN.	STD. WT. (LBS.)
Schedule 40 and 80						
E200JS6	2	Split Coupling	6	1	25	6.1
E200KS7	2½	Split Coupling	7	1	25	21
E200LS7	3	Split Coupling	7	1	25	15.5
*E200LSS	3	Split Coupling	6.5	1	25	10
E200MS8	3½	Split Coupling	8	1	25	41.2
E200NS8	4	Split Coupling	8	1	15	16
*E200NSS	4	Split Coupling	6	2	25	17
E200PS8	5	Split Coupling	8	1	15	25
E200PS9	5	Split Coupling	9	1	8	16.4
E200RS1	6	Split Coupling	10	1	6	24.2

C Duct

E900NS8 (WHITE)	4	C Duct Split Coupling	8	1	15	19
E900NSW (WHITE)	4	C Duct Split Coupling	6	1	25	22

*Two Piece Design



Split Sleeve Coupling
For joining Split Duct to existing duct.

Split Sleeve Sweeps

SEGMENT	CAT. NO.	NOM. SIZE (IN.)	RADIUS (IN.)	STD. CTN.	STD. WT. (LBS.)
45° SWEEP	UA7DJSD	2	24	1	1.4
	UA7FJSD	2	36	1	2.1
	UA7FLSD	3	36	1	4.7
	UA7HJSD	2	48	1	2.7
	UA7HLSD	3	48	1	6.1
	UA7IJSW	2	60	1	3.2
	UA7ILSD	3	60	1	7.2
	UA7INSW	4	60	1	10.2
	UA7INSD	4	60	1	6.1
22½° SWEEP	UA5INSW	4	60	1	6.1
11½° SWEEP	UA3IJSW	2	60	1	1
	UA3ILSD	3	60	1	3.6
	UA3INSD	4	60	1	5.1

Two 45° Elbows may be segmented for 90°.



Split Duct Sweeps



No waste • Sprays on in seconds • Fast setting Multi-Purpose Spray-On PVC Cement

- Equivalent to a medium-bodied low-VOC, quick-setting clear cement
- No more spills
- Reuse can until empty
- Installation: 50° to 80°F; Storage: 35° to 120°F
- Meets ASTM D-2564
- 3-year shelf life
- One 4 oz. can is equivalent to 4 oz. of non-aerosol PVC cement*

Applications:

- For use up to 4" diameter Schedule 40 or 80 PVC electrical conduit
- For use with PVC Raceways only. Not recommended for use on water, sewer, natural gas, compressed gas or air connections

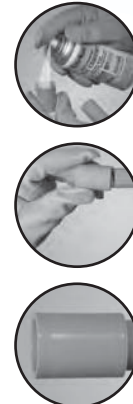

*Equivalence is subject to usage and will vary.

TEMPERATURE RANGE	RECOMMENDED SET TIME		
	PIPE SIZES ½" TO 1¼"	PIPE SIZES 1½" TO 2"	PIPE SIZES 2½" TO 4"
60°–100°F	2 min.	5 min.	30 min.
40°–60°F	5 min.	10 min.	2 hrs.
0°–40°F	10 min.	15 min.	12 hrs.

CAT. NO.	SIZE	DESCRIPTION	STD. CTN.	STD. WT. (LBS.)
VC9AC5	4 oz.	PVC Spray-On Medium Clear	12	5.6
VC9AC5C	4 oz.	PVC Spray-On Medium Clear	12	5.6
VC9AC16	11 oz.	PVC Spray-On Medium Clear	12	12.3
VC9AC16C	11 oz.	PVC Spray-On Medium Clear	12	12.3

Recommended set time may vary depending on humidity.

☼ Canada only

Low VOC — Gray

RECOMMENDED PIPE APPLICATION AND SIZES	SET-UP TIME (EVAPORATION RATE)	RECOMMENDED INSTALLATION TEMP.	LAP SHEAR @ 73°F	VISCOSITY AT 75° AS MANUFACTURED
Recommended for all grades and types of Carlton® wireway and fittings, except Flex-Plus® Blue™ ENT (Electrical Non-Metallic Tubing).	10°–30°F	Not recommended	40° to 100°F	2 hrs. 350 psi
	30°–50°F	5–6 minutes		16 hrs. 800 psi
	50°–70°F	3–4 minutes		72 hrs. 1,500 psi
	70°–90°F	1–2 minutes		

Up through 6" diameter.

VOC emission of 490 grams/liter per the Bay and South Coast test method.

CAT. NO.	SIZE	APPLICATOR	DESCRIPTION	STD. CTN.	STD. WT. (LBS.)
VC9LV4-24	½ Pint	Dauber	Low VOC Gray	24	15.5
VC9LV3	Pint	Dauber	Low VOC Gray	24	27.0
VC9LV2	Quart	Dauber	Low VOC Gray	12	26.0



Meets ASTM D-2564

Carlton® Non-Metallic Rigid Conduit, Fittings and Accessories

Corporate Office
Tel: 901.252.8000
800.816.7809
Fax: 901.252.1354

Customer Service
Tel: 800.816.7809
Fax: 800.816.7810

Technical Services
Tel: 888.862.3289
Fax: 901.252.1321

Tool Services
Tel: 800.284.8665

Thomas & Betts

www.tnb.com

RECOMMENDED PIPE APPLICATION AND SIZES	SET-UP TIME (EVAPORATION RATE)	RECOMMENDED INSTALLATION TEMP.	LAP SHEAR @ 73°F	VISCOSITY AT 75° AS MANUFACTURED
Recommended for all grades and types of Carlton® wireway and fittings, except Flex-Plus® Blue™ ENT (Electrical Non-Metallic Tubing). <i>Up through 6" diameter.</i>	10°–30°F	Not recommended	40° to 100°F	2 hrs. 350 psi
	30°–50°F	5–6 minutes		16 hrs. 800 psi
	50°–70°F	3–4 minutes		72 hrs. 1,500 psi
	70°–90°F	1–2 minutes		

Medium — Clear

CAT. NO.	SIZE	APPLICATOR	DESCRIPTION	STD. CTN.	STD. WT. (LBS.)
VC9963	Pint	Dauber	PVC Medium Clear	24	29.0
VC9962	Quart	Dauber	PVC Medium Clear	12	27.5
VC9961P	Gallon	—	PVC Medium Clear	6	53.5

Meets ASTM D-2564.



Medium — Gray

CAT. NO.	SIZE	APPLICATOR	DESCRIPTION	STD. CTN.	STD. WT. (LBS.)
VC9923	Pint	Dauber	PVC Medium Gray	24	29.0
VC9922	Quart	Dauber	PVC Medium Gray	12	27.5
VC9941P	Gallon	—	PVC Medium Gray	6	53.5

Meets ASTM D-2564.



Regular — Clear

CAT. NO.	SIZE	APPLICATOR	DESCRIPTION	STD. CTN.	STD. WT. (LBS.)
VC9964	½ Pint	Dauber	PVC Regular Clear	10	29.06.5

Meets ASTM D-2564.



Regular — Gray

CAT. NO.	SIZE	APPLICATOR	DESCRIPTION	STD. CTN.	STD. WT. (LBS.)
VC9924-24	½ Pint	Dauber	PVC Regular Gray	24	15.0

Meets ASTM D-2564.



Clear Primer

CAT. NO.	SIZE	APPLICATOR	STD. CTN.	STD. WT. (LBS.)
VC9903	Pint	Dauber	24	27.0
VC9902	Quart	Dauber	12	25.0

Meets ASTM F-686.



Purple Primer

CAT. NO.	SIZE	APPLICATOR	STD. CTN.	STD. WT. (LBS.)
VC9932	Quart	Dauber	12	25.0

Meets ASTM F-686.



RECOMMENDED PIPE APPLICATION AND SIZES	RECOMMENDED INSTALLATION TEMPERATURE
Recommended for use with Carlton® cement	5° to 100°F

RECOMMENDED PIPE APPLICATION AND SIZES	RECOMMENDED INSTALLATION TEMPERATURE
Recommended for use with Carlton® cement	5° to 100°F



All Weather — Clear

RECOMMENDED PIPE APPLICATION AND SIZES	SET-UP TIME (EVAPORATION RATE)	RECOMMENDED INSTALLATION TEMP.	LAP SHEAR @ 73°F	VISCOSITY AT 75° AS MANUFACTURED
Recommended for all grades and types of Carlton® wireway and fittings, except Flex-Plus® Blue™ ENT (Electrical Non-Metallic Tubing). <i>Up through 6" diameter.</i>	-5°-10°F	6-8 minutes	-5° to 100°F	2 hrs. 350 psi
	10°-30°F	4-5 minutes		16 hrs. 800 psi
	30°-50°F	3-4 minutes		72 hrs. 1,500 psi
	50°-70°F	1-2 minutes		
	70°-90°F	½-1½ minutes		

CAT. NO.	SIZE	APPLICATOR	DESCRIPTION	STD. CTN.	STD. WT. (LBS.)
VC9984	1/2 Pint	Dauber	All Weather "Quick-Set" Cement	10	7.0
VC9983	Pint	Dauber	All Weather "Quick-Set" Cement	24	30.0
VC9982	Quart	Dauber	All Weather "Quick-Set" Cement	12	29.0
VC9981P	Gallon	—	All Weather "Quick-Set" Cement	6	54.0

Meets ASTM D-2564.



All Weather — ENT Blue

RECOMMENDED PIPE APPLICATION AND SIZES	SET-UP TIME (EVAPORATION RATE)	RECOMMENDED INSTALLATION TEMP.	LAP SHEAR @ 73°F	VISCOSITY AT 75° AS MANUFACTURED
Required for use with Flex-Plus® Blue™ ENT (Electrical Non-Metallic Tubing), Riser-Gard®, P&C Flex™ and Carlton® PVC fittings. <i>Up through 6" diameter.</i>	-5°-10°F	6-8 minutes	-5° to 100°F	2 hrs. 350 psi
	10°-30°F	4-5 minutes		16 hrs. 800 psi
	30°-50°F	3-4 minutes		72 hrs. 1,500 psi
	50°-70°F	1-2 minutes		
	70°-90°F	½-1½ minutes		

CAT. NO.	SIZE	APPLICATOR	DESCRIPTION	STD. CTN.	STD. WT. (LBS.)
VC9992	Quart	Dauber	All Weather "Quick-Set" Blue	12	29.0

Meets ASTM D-2564.



Resi-Gard® — Clear

RECOMMENDED PIPE APPLICATION AND SIZES	SET-UP TIME (EVAPORATION RATE)	RECOMMENDED INSTALLATION TEMP.	LAP SHEAR @ 73°F	VISCOSITY AT 75° AS MANUFACTURED
For use with Resi-Gard®, Riser-Gard®, P&C Flex™ and Carlton® PVC fittings. <i>Up through 6" diameter.</i>	10°-30°F	4-5 minutes	40° to 100°F	2 hrs. 350 psi
	30°-50°F	3-4 minutes		16 hrs. 800 psi
	50°-70°F	1-2 minutes		72 hrs. 1,500 psi
	70°-90°F	½-1½ minutes		

CAT. NO.	SIZE	APPLICATOR	DESCRIPTION	STD. CTN.	STD. WT. (LBS.)
VC9963SC	Pint	Brush	Resi-Gard® Solvent Cement Clear	24	28.0

Meets ASTM D-2564.



Non-Metallic Rigid Conduit, Fittings and Accessories

Carlton®

Accessories — Sealers

No waste • Sprays on in seconds • Fast setting
Sealers

Multi-Purpose Weather Gard Spray-On Rubber Film

- Weatherproof
- Forms a protective weatherproof seal on electrical connections
- Dries in minutes to crystal clear rubber film
- Prevents corrosion on electrical connections
- Recommended installation temperatures: 50° to 80°F
- Can be used on wood and plastic
- 2-year shelf life

Applications:

- Electrical connections
- Outdoor lighting
- Panel boxes
- Pool motors and timers
- Water valves and connections
- Sprinkler connections and control box
- Marine applications



CAT. NO.	SIZE	DESCRIPTION	STD. CTN.	STD. WT. (LBS.)
VC9WG5	4 oz.	Multi-Purpose Weather-Gard Spray-On Rubber Film	12	5.6
✻ VC9WG5C	4 oz.	Multi-Purpose Weather-Gard Spray-On Rubber Film	12	5.6
VC9WG16	11 oz.	Multi-Purpose Weather-Gard Spray-On Rubber Film	12	12.3
✻ VC9WG16C	11 oz.	Multi-Purpose Weather-Gard Spray-On Rubber Film	12	12.3

✻ Canada only

Multi-Purpose Spray-On Rubber Thread Gasket

- Dries to rubber gasket to seal pipe threads
- Seals out leaks
- Protects against rust and corrosion
- UV resistant
- Weatherproof
- 2-year shelf life

Applications:

- PVC
- Copper
- Iron
- Brass

CAT. NO.	SIZE	DESCRIPTION	STD. CTN.	STD. WT. (LBS.)
VC9TS5	4 oz.	Multi-Purpose Rubber Thread Sealer	12	5.6
✻ VC9TS5C	4 oz.	Multi-Purpose Rubber Thread Sealer	12	5.6

✻ Canada only





Installation Instructions Cement Joints



Carlton® non-metallic products are joined by means of solvent cement joints. Sizes ½" through 1½" should be cut square (using a fine tooth handsaw) and deburred. For sizes 2" through 6", a miter box or similar saw guide should be utilized to keep the material steady. After cutting and deburring, wipe ends clean of dust, dirt and shavings.

Joining process as follows:

- Be sure that conduit end is clean and dry.
- Apply coat of Carlton® Solvent Cement (use dauber) to end of conduit for the length of the socket to be attached.
- Push conduit firmly into fitting while rotating conduit slightly, about one-quarter turn to spread cement evenly.
- Allow joint to set approximately 10 minutes.

Carlton® recommends the use of Carlton® cement for proper solvent cement joints. Because this cement is prepared particularly for our product compounds and tolerances, we cannot guarantee joints assembled with cement materials supplied by other manufacturers. Regular-grade gray solvent cement will accommodate most application situations being of a general-purpose nature. In situations requiring an extremely fast-setting joint (low temperature or difficult installation conditions), Carlton® All Weather Quick-Set Cement is recommended. Standard-grade clear cement is recommended for non-critical utility applications where gap filling and leak testing are not required.

Average Number of Joints per Can

TRADE SIZE (IN.)	½ PINT 8 OZ.	PINT 16 OZ.	QUART 32 OZ.	GALLON 128 OZ.	SPRAY 4 OZ.	SPRAY 16 OZ.
½	140	275	550	2,200	70	275
¾	90	180	360	1,440	45	180
1	70	140	280	1,120	35	140
1¼	50	100	200	800	25	100
1½	37	75	150	600	18.5	75
2	20	40	80	320	10	40
2½	17	35	70	280	8.5	35
3	15	30	60	240	7.5	30
3½	13	27	54	216	6.5	27
4	12	25	50	200	6	25
5	9	19	38	150	N/A	N/A
6	6	12	24	95	N/A	N/A

CAN: Average shelf-life of all Carlton® cement is 24 months (unopened cans stored below 80°F).

SPRAY: Average shelf-life of all Carlton® Spray PVC Cement is 3 years.

All Carlton® cements are specially formulated to be used with Carlton® PVC products, and do not require primers when parts are clean of dirt and moisture.

MSDS available at www.carlton.com.

Cementing PVC Conduit:

1. Make square saw cut with fine tooth saw.
2. Deburr and round inside edge of the cut end.
3. Clean socket I.D. and spigot O.D. of dirt and moisture.
4. Apply a uniform coat of cement to spigot end and push onto socket bottom, rotating 1/4 turn.
5. Allow time to set before disturbing. Setting time will depend upon temperature.



Cementing PVC Conduit for Submerged Areas Requiring Air or Water Tightness:

1. Follow the procedure **above** for cementing conduit.
2. Test workmanship by conducting a low-pressure air (3.0–5.0 psi) test after system is installed and cemented joints are set.
3. Plug and block ends to prevent movement prior to pressurization.
4. Check for leaks with soap solution.
5. Even low-pressure air can cause high-thrust loads and caution must be observed.



Cementing ENT for Concrete-Tight Applications:

1. Use Carlton® Socket tight fittings or couplings.
2. Do not use chemical primer or cleaner.
3. Apply a light uniform coat of cement labeled for use with ENT.
4. Use a brush to apply the cement.
5. Brush excess cement out of ENT grooves.
6. Promptly insert ENT into fitting while cement is wet until the fitting stop is reached and give 1/4 turn.
7. Do not disturb until the joint is set.



Carlton®

Accessories — Conduit Termination, Cutting and Joining

Fittings and Adapters for Terminating Non-Metallic Rigid Conduit

Terminating Non-Metallic Rigid Conduit is quick and easy utilizing either of the methods indicated **below**. Terminations may be made in any electrical box or enclosure using standard size knockouts or drilled holes.



Method 1. Permanent Termination

Apply solvent cement to shoulder and shank of box adapter and insert through knockout from inside the enclosure. Push coupling over the shank of the box adapter, tight against the enclosure wall. Rotate the coupling about one-half turn while installing, and hold in position for a few seconds to permit setting of solvent cement. The coupling is now ready for the conduit to be installed. Only the shoulder of the box adapter extends inside the enclosure.

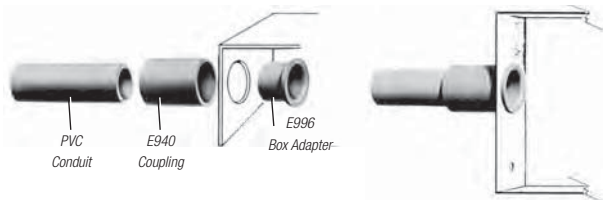

Method 2. Separable Termination

If a "wet location" as defined in Article 100 of the NEC® construction is required, place a flat washer or O-ring over the threads of the terminal adapter, securely against the shoulder. Insert the adapter threads through knockout and secure using either a standard locknut or threaded bushing. If watertight construction is not required, eliminate flat washer.

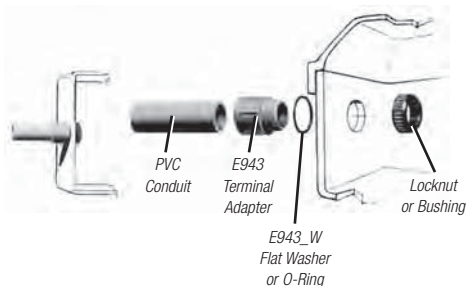

PVC Conduit Cutters

Small Cutter

For fast, smooth field cuts of ½" through 1" Non-Metallic Rigid Conduit, Flex-Plus® Blue™ ENT and Carflex® liquidtight flexible non-metallic conduit.



CAT. NO.	SIZE (IN.)	STD. CTN.
CC120B	8	10

Medium Cutter

Hand-held cutter makes fast, square, smooth field cuts on Non-Metallic Rigid Conduit from ½" through 1¼". Produces burr-free cut with no shavings. Fits into pocket or pouch.



CAT. NO.	SIZE (IN.)	STD. CTN.
CC125	9	12

Large Cutter

For clean cuts of conduit ½" through 2".



CAT. NO.	SIZE (IN.)	STD. CTN.
CC122	17½	1

Carlton® Non-Metallic Rigid Conduit, Fittings and Accessories

Thomas & Betts

www.tnb.com

Corporate Office
Tel: 901.252.8000
800.816.7809
Fax: 901.252.1354

Customer Service
Tel: 800.816.7809
Fax: 800.816.7810

Technical Services
Tel: 888.862.3289
Fax: 901.252.1321

Tool Services
Tel: 800.284.8665

Accessories — EZ BEND™ Conduit-Bending Equipment

EZ BEND™ Conduit-Bending Equipment

For field bending of small and large diameter non-metallic conduit, the easy answer is EZ BEND™ conduit-bending equipment.

- Lightweight
- Portable
- Fast, simple and safe
- Less expensive than factory bends
- Includes complete instructions and a convenient bending chart

EZ BEND™ Conduit-Bending Equipment is designed with the electrical contractor in mind. The completely portable and fully encased EZ BEND™ benders and plug kits can be transported from job to job without damage or harm to the equipment. Additionally, the heavy-duty construction and integrity of EZ BEND™ Conduit-Bending Equipment ensures that it will last for years to come.

EZ BEND™ Conduit Bender, Jr.

A practical, convenient portable conduit bender for ½" through 2" diameter non-metallic conduit enables bends up to 14" radius and to 90° elbows. The EZ BEND™ Conduit Bender, Jr. is a timesaving, easy-to-carry unit featuring a bracket to store the power cord, a carrying handle and a clasped cover. The unit operates on a standard 20 Amp, 120V circuit.

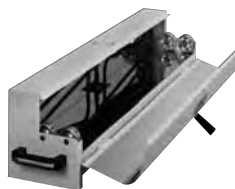

CAT NO.	STD. CTN.	STD. WT. (LBS.)
G280J	1	14

Dimensions: 7½" x 8½" x 31"
Operating Temperature: 180°–200°F



Non-Metallic Rigid Conduit, Fittings and Accessories

Field-Bending Rigid Non-Metallic Conduit



Minimum practice is required to master the three steps in bending non-metallic conduits and ducts.

1 Heating

Conduit section to be bent must be heated evenly over the entire length of the curve. Carlton® offers EZ BEND™ electric heaters designed specifically for this purpose, in sizes to accommodate all conduit diameters. These devices employ infrared heat energy, which is most quickly absorbed by the conduit. Small sizes are ready to bend after a few seconds, while larger diameters require two or three minutes or more, depending on conditions. The use of torches or other flame-type devices is not recommended. PVC conduit exposed to excessively high temperatures may take on a brownish color. Sections showing evidence of such scorching should be discarded.

2 Forming the Bend

½" thru 1½" Diameters — When properly heated, the conduit is very flexible and can be shaped to almost any configuration. The conduit is then cooled by sponging with water and the bend is ready to install.

2" and Larger Diameters — Larger sizes of conduit and ducts require internal support to prevent "crimping" or deforming during the bending process. Bending plugs are inserted in each end of the conduit section before heating. The plugs expand to provide an airtight seal.

NOTE: Carlton® does not offer bending plugs.

3 Cooling

As the conduit is heated, the retained air expands and the increased internal pressure enables the conduit to be bent without deforming. The conduit must be cooled before the plugs are removed. For an immediate cool and set, sponge with cold water.

Special Bends

For "blind" bends or for compound turns in a conduit run, the heated conduit may be solvent-cemented in place while still flexible.

Corporate Office
Tel: 901.252.8000
800.816.7809
Fax: 901.252.1354

Customer Service
Tel: 800.816.7809
Fax: 800.816.7810

Technical Services
Tel: 888.862.3289
Fax: 901.252.1321

Tool Services
Tel: 800.284.8665

Thomas & Betts

www.tnb.com

Rope (Conduit Pulling Lines for Conductors or Fiber Optics)

White Diamond Braid Rope

This rope is constructed of polyethylene over polyester, designed specifically for fiber optic pulling. The polyethylene jacket gives the “slippery” feel that gives less drag in pulling through conduit.

CAT. NO.	REEL LENGTHS (FT.)	DIAMETER (IN.)	RECOMMENDED WORKING LOAD (LBS.)	APPROXIMATE AVG. TENSILE (LBS.)	STD. WT. (LBS.)
SB14105	5,000	¼	260	1700	1000

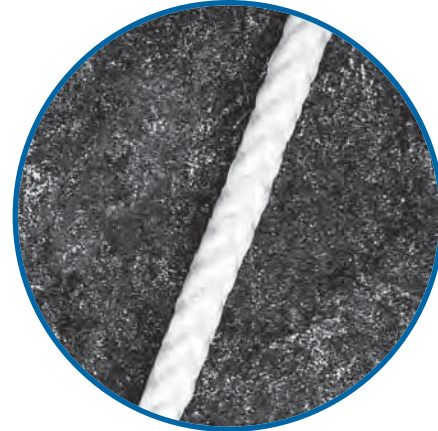

Tape

Pre-lubricated, woven polyester tape made from low-friction, high abrasion-resistant yarns, providing a low coefficient of friction. Tape is printed with sequential footage markings for accurate measurements.

CAT. NO.	SIZE (IN.)	TENSILE STRENGTH (LBS.)	REEL LENGTHS (FT.)
TL14203	½	1130	3,000
TL14505	½	1250	5,000
TL14510	½	1250	10,000
TL38203	¾	1800	3,000
TL38265	¾	1800	6,500
TL38210	¾	1800	10,000

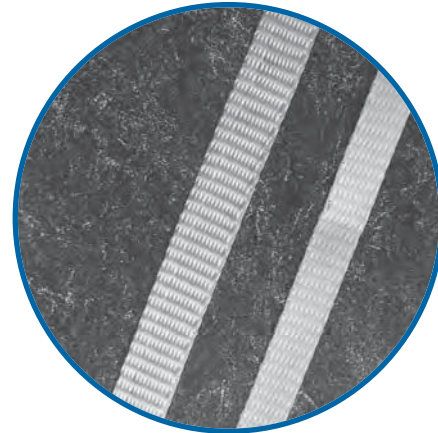



Carlton® Snap-Loc® Spacers

Carlton® Snap-Loc® Duct Spacers provide stability, consistent separation and relieve direct stress for duct materials encased in concrete and direct-bury applications.

Carlton® Snap-Loc® Spacers provide:

- A side dovetail rail-and-groove design enabling side-by-side interchangeability of conduit spacer sizes while maintaining horizontal stability
- Locking keyways incorporated into intermediate spacers eliminate the need for costly top spacers in each size. The locking keyways provide for the use of a beaded strap that secures the top section of conduit
- 1" and 2" Snap-Loc® Reducers enable fixturing of 1" or 2" conduit inside larger spacers
- The Snap-Loc® Rebar Holder provides stabilization on large banks of spacers



Non-metallic Snap-Loc® Spacers are designed specifically for use with non-metallic duct, with maximum O.D. dimensions as specified in NEMA TC-2, TC-6 & 8, and ASTM F512. The innovative vertical and horizontal interlocking Snap-Loc® design has tapered joining slots with maximum tolerances for easy jobsite assembly.

Important:

The use of duct spacers for direct burial may result in excessive point deflections unless proper design engineering is applied, such as the proper compaction of the appropriate backfill material.

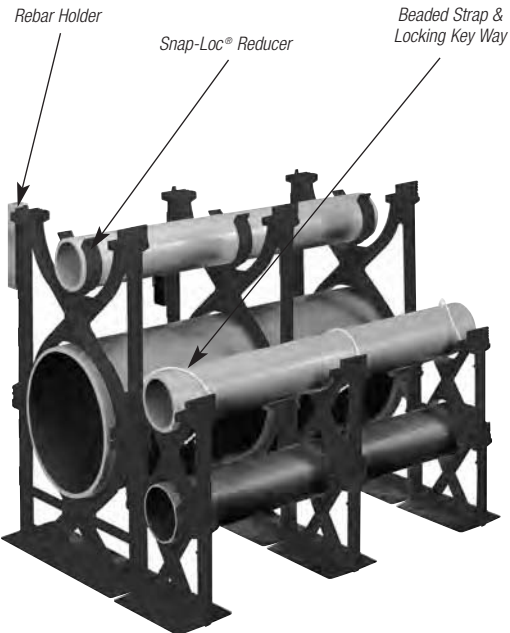

Carlton® Non-Metallic Rigid Conduit, Fittings and Accessories

Carlton® Snap-Loc® Spacers (continued) Dimensions — Base Spacers

CAT. NO.	SIZE (IN.)	A (IN.)	C (IN.)	D (DIA.) (IN.)	STD. CTN.
S288JHN	2 x 1½	4.25	4.12	2.50	100
S288JJN	2 x 2	4.25	4.62	2.50	100
S288JLN	2 x 3	4.25	5.62	2.50	100
S288LHN	3 x 1½	4.81	5.25	3.63	90
S288LJN	3 x 2	4.81	5.75	3.63	80
S288LLN	3 x 3	4.81	6.75	3.63	60
S288NFN	4 x 1	4.50	5.75	4.63	70
S288NHN	4 x 1½	5.31	6.25	4.63	50
S288NJN	4 x 2	5.31	6.75	4.63	50
S288NLN	4 x 3	5.31	7.75	4.63	60
S288PHN	5 x 1½	5.84	7.31	5.69	50
S288PJN	5 x 2	5.84	7.81	5.69	60
S288PLN	5 x 3	5.84	8.81	5.69	50
S288RHN	6 x 1½	6.38	8.38	6.75	50
S288RJN	6 x 2	6.38	8.88	6.75	50
S288RLN	6 x 3	6.38	9.88	6.75	40
S288SHN	8 x 1½	7.38	10.30	8.75	30
S288SJN	8 x 2	7.38	10.76	8.75	30

*First number indicates trade size of duct, second number indicates separation between conduits or ducts.

Dimensions — Intermediate Spacers

CAT. NO.	SIZE (IN.)	A (IN.)	C (IN.)	D (DIA.) (IN.)	STD. CTN.
S289JHN	2 x 1½	3.88	4.12	2.50	120
S289JJN	2 x 2	4.38	4.62	2.50	100
S289JLN	2 x 3	5.38	5.62	2.50	80
S289LHN	3 x 1½	5.01	5.25	3.63	100
S289LJN	3 x 2	5.51	5.75	3.63	80
S289LLN	3 x 3	6.51	6.75	3.63	60
S289NFN	4 x 1	5.51	5.73	4.63	70
S289NHN	4 x 1½	6.01	6.25	4.63	60
S289NJN	4 x 2	6.51	6.75	4.63	60
S289NLN	4 x 3	7.51	7.75	4.63	50
S289PHN	5 x 1½	7.07	7.31	5.69	50
S289PJN	5 x 2	7.57	7.81	5.69	50
S289PLN	5 x 3	8.57	8.81	5.69	30
S289RHN	6 x 1½	8.14	8.38	6.75	50
S289RJN	6 x 2	8.64	8.88	6.75	40
S289RLN	6 x 3	9.64	9.88	6.75	30
S289SHN	8 x 1½	10.14	10.30	8.75	30
S289SJN	8 x 2	10.64	10.76	8.75	30

Accessories

Snap-Loc® Reducer

CAT. NO.	SIZE (IN.)	STD. CTN.
S287F	1	100
S287J	2	100



Rebar Holder

CAT. NO.	STD. CTN.
S258RH	100

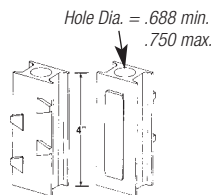

Beaded Strap

CAT. NO.	STD. CTN.
S28612	1 Bag of 250

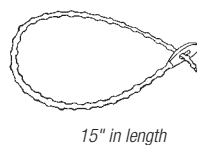

Specifications

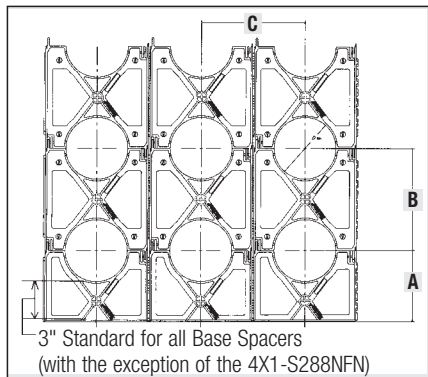

Suggested Specification:

(Duct) (Conduit) bank shall be encased in concrete with at least three inches of concrete at the top and bottom and two inches on each side. A horizontal and vertical separation between the ducts of ____* inches shall be maintained by installing Carlton® high-impact spacers with horizontal and vertical locking intervals of ____** feet.

*Standard Separations of 1", 1½", 2" and 3" are available.

**Preferred interval between spacer assemblies is 8 to 10 feet.

Installation Note

The Spacers and Rebar Holder are designed with a dovetail tongue-and-groove feature for easy installation.

If required to permanently fix the position of a group of Spacers and/or Rebar Holder, the following are recommended procedures:

1. Use Carlton® Quick-Set Cement glue during assembly or spot glue after assembly to secure.
2. During assembly, deform the edge of the tongue or groove portion of the dovetail slide with a pair of pliers or similar tool. This deformation will create an interference, restricting movement.
3. An assembled system may be wired together for additional support.

Important:

The use of duct spacers for direct burial may result in excessive point deflections unless proper design engineering is applied, such as the proper compaction of the appropriate backfill material.



Carlton® Snap-N-Stac™ Combo Spacers

Carlton® Snap-N-Stac™ Combo Duct Spacers are specifically designed to replace the two-piece base and intermediate spacer system, by combining the conventional base and intermediate spacer into a single unit!

Manufactured out of highly engineered thermoplastic material, Snap-N-Stac™ Spacers are strong, durable and able to withstand the rigors of concrete construction. They feature an innovative horizontal and EXCLUSIVE vertical locking system, and can be used as either a base or intermediate spacer.

Snap-N-Stac™ Spacers are available in one-way, two-way and three-way configurations (one-way and three-way only available in sizes 2" and 4"). They accept 2", 3", 4", 5" and 6" pipe and can be installed horizontally, vertically or turned upright for unique duct bank configurations.

This NEW one-piece design makes underground duct bank installations faster and easier than the conventional two-piece system — saving material and labor costs.

Carlton® Snap-N-Stac™ Combo Spacers...The IDEAL solution for underground duct bank installations.

Features:

- Conventional base and intermediate spacer in a single unit
- Less inventory required
- EXCLUSIVE vertical locking system
- Horizontal locking system
- Installs horizontally or turned upright
- Molded-in rebar holder on two-way and three-way
- One-, two- and three-way configurations (one-way and three-way only available in sizes 2" and 4")
- 5 sizes: 2", 3", 4", 5" and 6"
- Reducer to accommodate smaller duct sizes
- Can be used as either an intermediate or base spacer
- Spacers interlock horizontally regardless of size
- Non-metallic, non-corrosive, non-conductive
- Strong and durable
- Easy to handle
- Fast installation

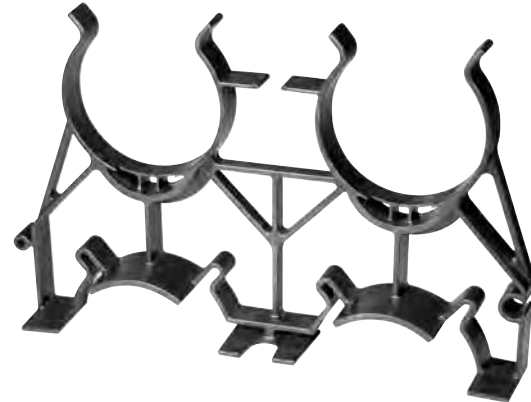

One-way



Three-way

Installations



Horizontal Locking

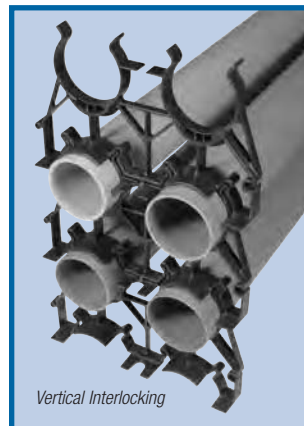

Vertical Interlocking

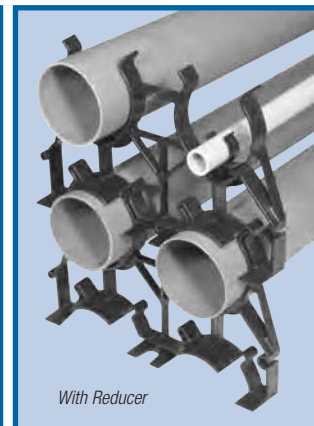

With Reducer

Carlton® Snap-N-Stack™ Combo Spacers (continued) Installation Instructions

IMPORTANT:

1. Snap-N-Stack™ Spacers are recommended for concrete-encased applications only.
2. The use of duct spacers for direct burial may result in excessive point deflections unless proper design engineering is applied, such as the proper compaction of the appropriate backfill material.

Vertical Interlocking Slide spacers together "Feet Facing Feet."

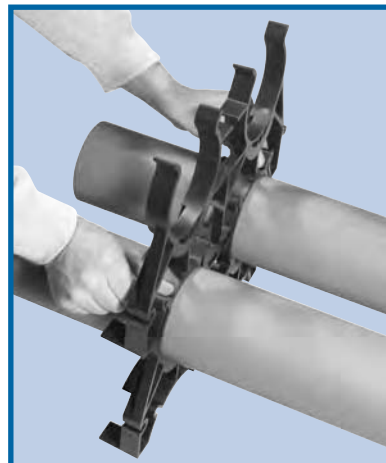
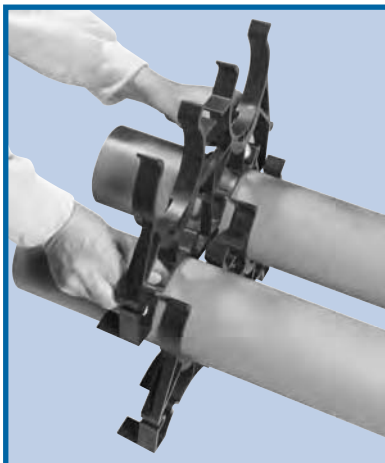
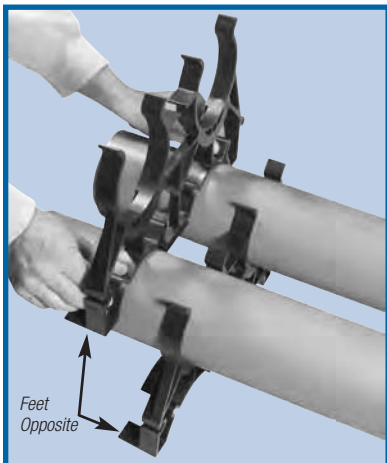
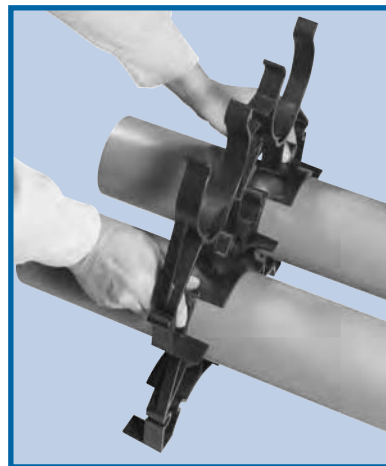
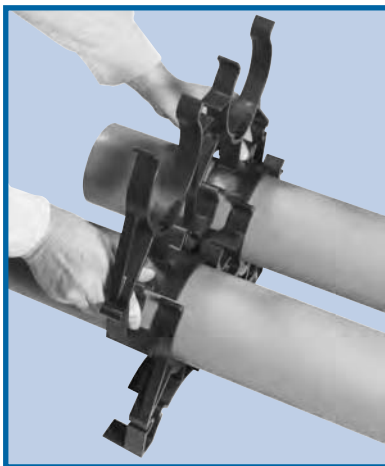
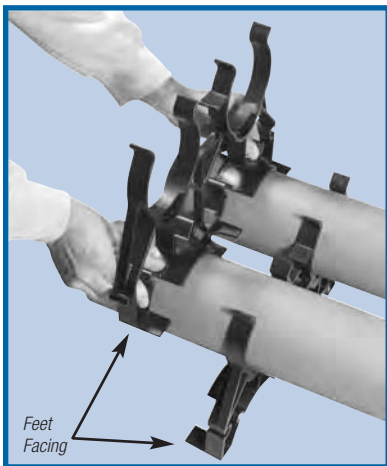

Molded-In Rebar Holder

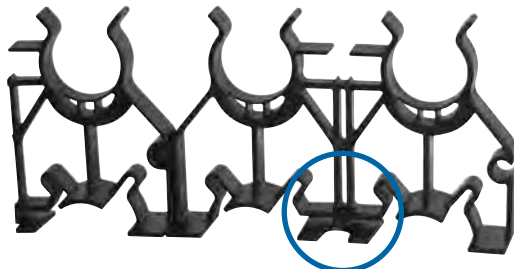
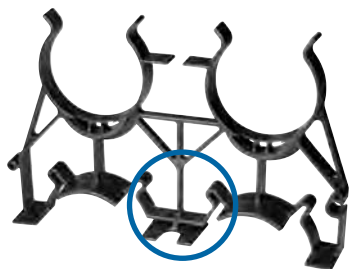



Carlton® Snap-N-Stack™ Combo Spacers (continued) Installation Instructions

Vertical Free Standing

If spacers are installed using free-standing method, it is recommended to install the spacer on the upper row mid-way between the two spacers on the bottom row.

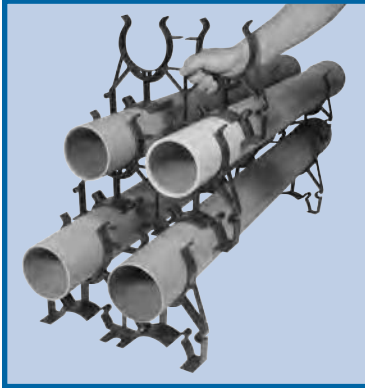

Reducer

1" and 2" Snap-Loc Reducers enable fixturing of 1" and 2" conduit inside of larger spacers.

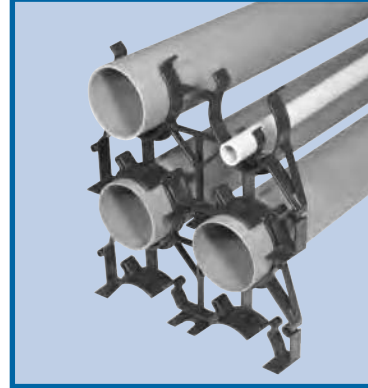

Transition to Various Duct Sizes

Install spacers side-by-side by inserting the male adapter into the female adapter.

NOTE: All Snap-N-Stack™ spacers are designed to interlock horizontally, regardless of size.

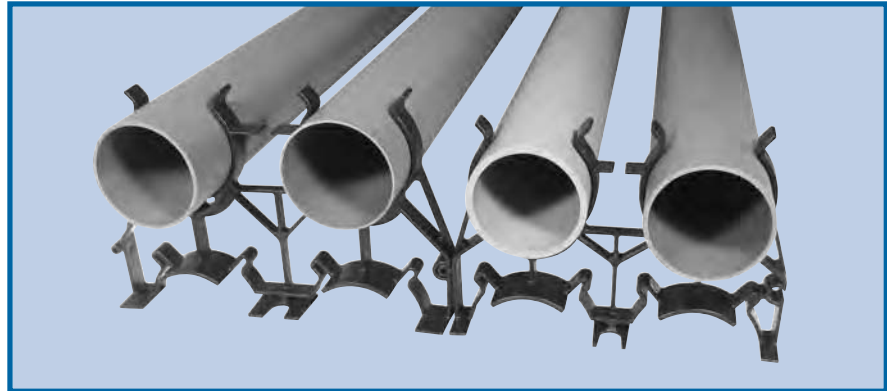
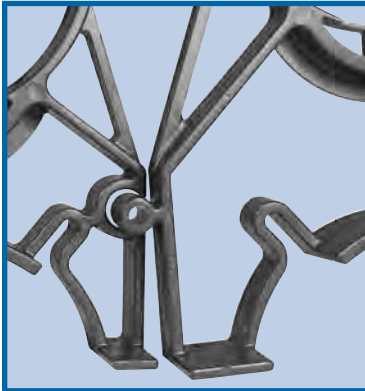

Odd Number of Ducts

Two-way spacers, size 2" and 4" only, can easily be cut apart to produce two one-way spacers. Create three-way and five-way spacers using the one-way spacer. Install spacers side-by-side by inserting the male adapter into the female adapter.

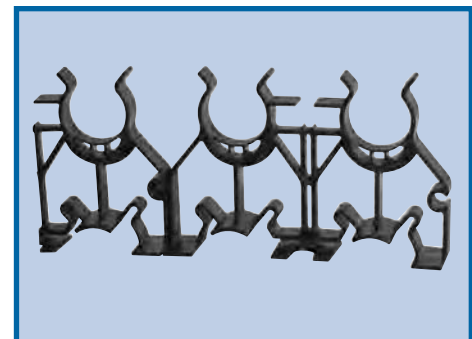
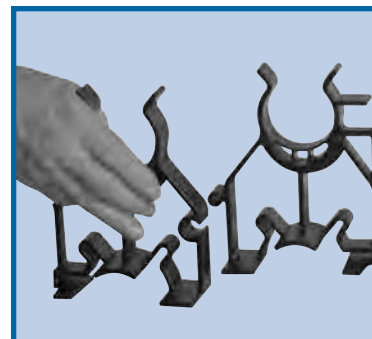

Carlton® Non-Metallic Rigid Conduit, Fittings and Accessories

Carlton® Snap-N-Stac™ Combo Spacers (continued)

CAT. NO.	DESCRIPTION	SIZE (IN.)	SEPARATION (IN.)	STD. CTN.	STD. WT. (LBS.)
SP2W20-1	1-Way Spacers	2	2	56	15.0
SP2W30-1		2	3	40	13.0
SP4W15-1		4	1½	26	9.6
SP4W20-1		4	2	20	10.0
SP4W30-1		4	3	20	9.4
SP2W20-2*	2-Way Spacers	2	2	56	28.5
SP2W30-2*		2	3	40	23.8
SP3W20-2		3	2	40	24.0
SP3W30-2		3	3	24	17.9
SP4W15-2*		4	1½	26	18.3
SP4W20-2*		4	2	24	18.8
SP4W30-2*		4	3	20	17.6
SP5W20-2	3-Way Spacers	5	2	20	17.2
SP5W30-2		5	3	14	15.5
SP6W20-2		6	2	12	12.8
SP6W30-2		6	3	12	14.1
SP2W20-3	3-Way Spacers	2	2	36	28.5
SP2W30-3		2	3	18	17.8
SP4W15-3		4	1½	18	19.4
SP4W20-3		4	2	16	19.3
SP4W30-3		4	3	14	19.1

*Can be cut apart to make (2) one-way spacers.

How to Interpret the Part Number:

POSITION 1 PRODUCT TYPE	POSITION 2 DUCT SIZE	POSITION 3 DUCT-TO-DUCT SPACING — HORIZONTAL AND VERTICAL	POSITION 4 HORIZONTAL DUCT POSITIONS
SP = Spacer	2W = 2" Width	15 = 1½"	-1 = One-Way
	3W = 3" Width	20 = 2"	-2 = Two-Way
	4W = 4" Width	30 = 3"	-3 = Three-Way
	5W = 5" Width		
	6W = 6" Width		

Accessories Snap-Loc® Reducer

CAT. NO.	SIZE (IN.)	STD. CTN.
S287F	1	100
S287J	2	100



Beaded Strap

CAT. NO.	STD. CTN.
S28612	100



15" in length

Technical Information

CAT. NO.	DUCT SIZE (IN.)	DUCT O.D.	HORIZONTAL DUCT POSITIONS	DUCT-TO-DUCT SPACING		CENTER-TO-CENTER SPACING		BOTTOM OF TRENCH TO BOTTOM OF DUCT	BOTTOM OF TRENCH TO CENTER OF BOTTOM OF DUCT	OVERALL LENGTH
				VERTICAL (IN.)	HORIZONTAL (IN.)	VERTICAL (IN.)	HORIZONTAL (IN.)			
SP2W20-1	2	2.375	1	2	2	2.19	2.19	3.13	4.25	4.38
SP2W30-1	2	2.375	1	3	3	2.69	2.69	4.13	5.25	5.38
SP4W15-1	4	4.500	1	1.5	1.5	3.00	3.00	3.38	5.56	6.00
SP4W20-1	4	4.500	1	2	2	3.25	3.25	3.88	6.06	6.50
SP4W30-1	4	4.500	1	3	3	3.75	3.75	4.88	7.06	7.50
SP2W20-2	2	2.375	2	2	2	4.38	4.38	3.13	4.25	8.75
SP2W30-2	2	2.375	2	3	3	5.38	5.38	4.13	5.25	10.75
SP3W20-2	3	3.500	2	2	2	5.50	5.50	3.63	5.38	11.00
SP3W30-2	3	3.500	2	3	3	6.50	6.50	4.63	6.38	13.00
SP4W15-2	4	4.500	2	1.5	1.5	6.00	6.00	3.38	5.56	12.00
SP4W20-2	4	4.500	2	2	2	6.50	6.50	3.88	6.06	13.00
SP4W30-2	4	4.500	2	3	3	7.50	7.50	4.88	7.06	15.00
SP5W20-2	5	5.500	2	2	2	7.56	7.56	4.38	7.25	15.12
SP5W30-2	5	5.500	2	3	3	8.56	8.56	5.38	8.25	17.14
SP6W20-2	6	6.625	2	2	2	8.62	8.62	4.13	7.38	17.25
SP6W30-2	6	6.625	2	3	3	9.62	9.62	5.13	8.38	19.25
SP2W20-3	2	2.375	3	2	2	4.38	4.38	3.13	4.25	13.13
SP2W30-3	2	2.375	3	3	3	5.38	5.38	4.13	5.25	16.13
SP4W15-3	4	4.500	3	1.5	1.5	6.00	6.00	3.38	5.56	18.00
SP4W20-3	4	4.500	3	2	2	6.50	6.50	3.88	6.06	19.50
SP4W30-3	4	4.500	3	3	3	7.50	7.50	4.88	7.06	22.50

Carlton® P&C Flex™ Corrugated Flexible Conduit

Carlton® P&C Flex™ Non-Metallic Corrugated Conduit makes power and communication installations faster and easier by providing maximum installation flexibility. The corrugated design is flexible enough to accommodate any degree of bend requirement. Unlike rigid conduit, it has a tight bend radius, making this product ideal for shallow trenches.

P&C Flex™ is manufactured to IPS dimensions and can be used with any existing conduit system using standard fittings. It is UV resistant and suitable for a variety of applications, including direct burial, under bridges, service entrance/FTTx terminations, manhole terminations, pedestal/enclosure terminations and running up utility poles or outside of buildings.

P&C Flex™ is available in sizes ¾" though 4", with or without pull tape (1" through 4" only) and comes in a variety of convenient standard put-ups.

Features:

- Accommodates any degree of bend — ideal for shallow trenches
 - For use with HDPE — Use ELA_ Series Fittings
 - For use with PVC — Use E940_ Series Fittings
- Easily handles offsets
- Manufactured to IPS dimensions — can be used with standard IPS coupling/fittings
- UV resistant
- Can be used as a flexible sweep or raceway — one SKU can do multiple bends
- Available in sizes ¾" though 4"
- Small put-ups for easy handling

NOTE: Not UL Listed.

Applications

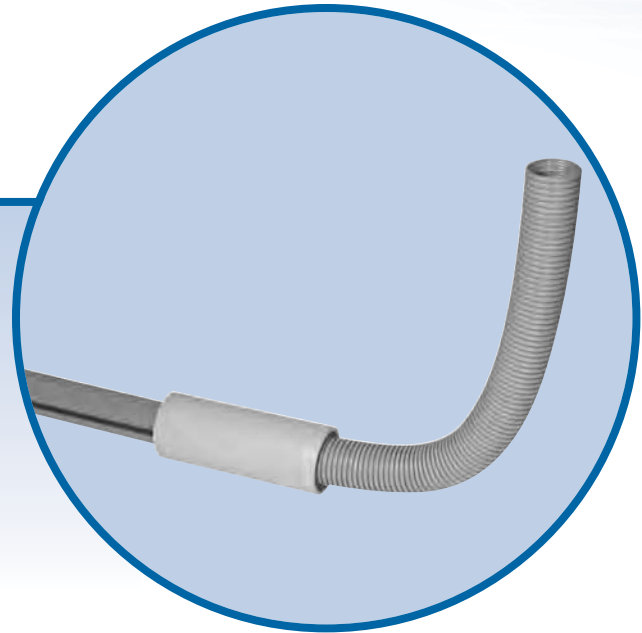
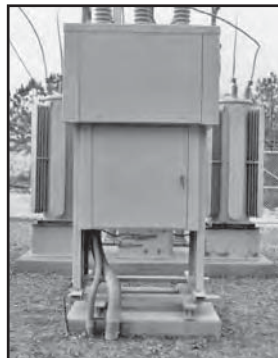

P&C Flex Conduit

CAT. NO.	SIZE (IN.)	I.D. (IN.)	O.D. (IN.)	PULL TAPE	REEL/ COIL	STD. CTN. (FT.)	STD. WT. (LBS.)
11807-350	¾	.83	1.040	Empty	Coil	350	39.9
1808-250C	1	1.000	1.315	Empty	Coil	250	36.3
11808-5200	1	1.000	1.315	Empty	Reel	5200	1019.0
11809-900	1¼	1.340	1.660	Empty	Reel	900	243.0
11809-4500	1¼	1.340	1.660	Empty	Reel	4500	972.0
11810-250	1½	1.570	1.900	Empty	Reel	250	75.8
11810-4500	1½	1.570	1.900	Empty	Reel	4500	1080.0
11810T-2300	1½	1.570	1.900	1250 lb.	Reel	2300	720.0
11810T-250	1½	1.570	1.900	1250 lb.	Reel	250	78.0
11811-1100	2	2.045	2.375	Empty	Reel	1100	521.4
11811-250	2	2.045	2.375	Empty	Reel	250	87.0
11811-2500	2	2.045	2.375	Empty	Reel	2500	815.0
11811-500	2	2.045	2.375	Empty	Reel	500	201.6
11811-700	2	2.045	2.375	Empty	Reel	700	269.0
11811T-250	2	2.045	2.375	1250 lb	Reel	250	89.0
11812-250	2½	2.469	2.875	Empty	Reel	250	121.0
11812AG-001	2½	2.469	2.875	Empty	Reel	1300	516.1
11813-1200	3	3.068	3.500	Empty	Reel	1200	850.8
11813-250	3	3.068	3.500	Empty	Reel	250	192.0
11813-500	3	3.068	3.500	Empty	Reel	500	523.0
11813-750	3	3.068	3.500	Empty	Reel	750	554.3
11815-250	4	4.026	4.500	Empty	Reel	250	324.0
11815-800	4	4.026	4.500	Empty	Reel	800	778.4

P&C Flex Fittings Couplings

CAT. NO.	SIZE (IN.)	STD. CTN.	STD. WT. (LBS.)
E940E	¾	100	4.6
E940F	1	50	3.5
E940G	1¼	30	3.2
E940H	1½	25	3.4
E940J	2	30	5.3
E940K	2½	20	7.5
E940L	3	25	14.7
E940N	4	15	12.5



Female Adapters

CAT. NO.	SIZE (IN.)	STD. CTN.	STD. WT. (LBS.)
E942E	¾	100	4.3
E942F	1	50	3.7
E942G	1¼	30	3.3
E942H	1½	25	3.3
E942J	2	30	5.4
E942K	2½	20	6.6
E942L	3	25	11.8
E942N	4	15	10.8



Terminal Adapters

CAT. NO.	SIZE (IN.)	STD. CTN.	STD. WT. (LBS.)
E943E	¾	125	4.2
E943F	1	50	3.0
E943G	1¼	25	4.1
E943H	1½	25	2.7
E943J	2	5	6.9
E943K	2½	20	6.3
E943L	3	45	16.6
E943N	4	15	11.7



Bell Ends (Schedule 40)

CAT. NO.	SIZE (IN.)	STD. CTN.	STD. WT. (LBS.)
E997F	1	50	2.6
E997G	1¼	35	2.5
E997H	1½	30	2.5
E997J	2	10	4.8
E997K	2½	10	2.0
E997L	3	10	10.0
E997N	4	30	16.0



Plugs

CAT. NO.	SIZE (IN.)	STD. CTN.	STD. WT. (LBS.)
P258H	1½	50	1.7
P258JT	2	60	3.1
P258K	2½	25	1.5
P258LT	3	30	3.4
P258NT	4	48	8.3





Technical Information

PERFORMANCE PROPERTIES	¾"	1"	1¼"	1½"	2"	2½"	3"	4"
Stiffness F/ y at 5% deflection	200	200	200	200	200	130	130	90
Impact Strength (ft./lbs.) 72°	35	40	40	50	50	70	120	140
Impact Strength (ft./lbs.) 32°	5	8	8	15	25	35	60	60
Minimum Bending Radius (inches)	6	6	6	7	8	12	15	18
Conduit Tensile Strength	200	300	400	500	700	1000	1500	2000

Storage: -4° to 158°F
 Handling: -4° to 104°F

Sweep and Elbow Conversion Chart

RADIUS (IN.) NOM. DIA.	SEGMENT	18" REQUIRED LENGTH OF P&C FLEX (IN.)	24" REQUIRED LENGTH OF P&C FLEX (IN.)	36" REQUIRED LENGTH OF P&C FLEX (IN.)	48" REQUIRED LENGTH OF P&C FLEX (IN.)	60" REQUIRED LENGTH OF P&C FLEX (IN.)
1½	90°	33	42	61	80	99
	45°	19	23	33	42	52
	30°	14	17	23	30	36
	22½°	12	14	19	23	28
2	90°	32	42	61	79	98
	45°	18	23	32	42	51
	30°	14	17	23	29	35
	22½°	11	12	18	23	28
2½	90°	34	44	63	81	100
	45°	20	25	33	44	53
	30°	16	19	24	31	37
	22½°	13	15	20	25	30
3	90°	35	44	63	82	101
	45°	20	25	34	44	53
	30°	16	19	24	32	38
	22½°	13	16	20	25	30
4	90°	37	46	65	84	103
	45°	22	27	37	46	55
	30°	18	21	27	34	40
	22½°	15	18	22	27	32

For other radius sweeps use this formula: $.0175 \times \text{Radius (inches)} \times \text{Angle}^\circ = \text{Required length of P\&C flex in inches}$

Carlton®

P&C Flex™

Technical Information

Carlton® Non-Metallic Rigid Conduit, Fittings and Accessories

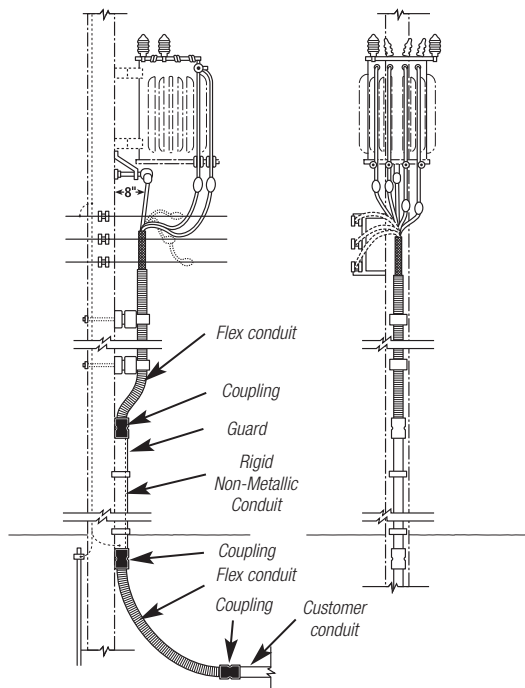

When soil conditions do not permit direct burial of cable, use Carlton® P&C Flex™ Non-Metallic Corrugated Conduit to protect the cable. A lower coefficient of friction provides easy wire pulls on location. Flexibility eliminates the need for elbows.

P&C Flex™ conduit is flexible. Carlton® P&C Flex™ Non-Metallic Corrugated Conduit is used to transition from Carlton® P&C Duct Type DB. Despite equipment being mounted away from the pole, P&C Flex™ conduit remains flush to the pole.

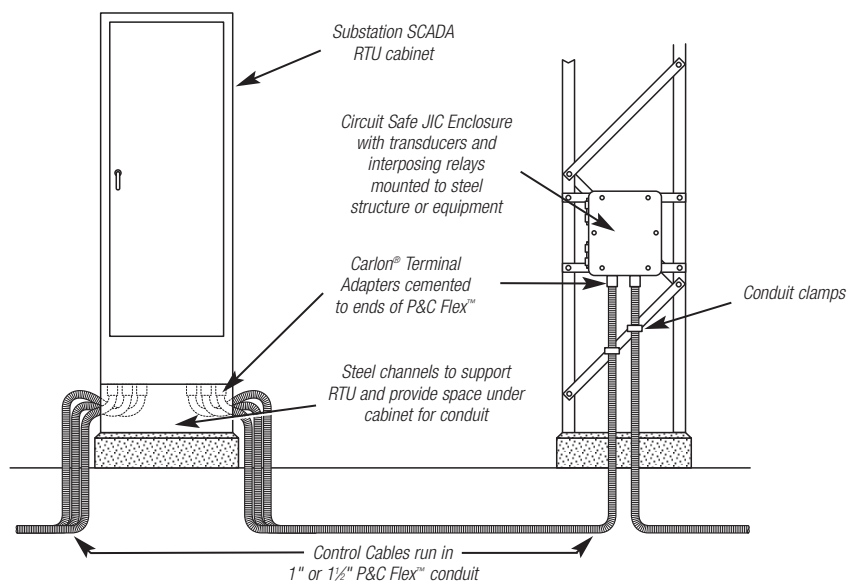

Carlton® P&C Flex™ Non-Metallic Corrugated Conduit protects control cables in supervisory control and data acquisition equipment (SCADA) in distribution substations. Flexibility provides maximum utilization of equipment.

Thomas & Betts

www.tnb.com

Corporate Office
Tel: 901.252.8000
800.816.7809
Fax: 901.252.1354

Customer Service
Tel: 800.816.7809
Fax: 800.816.7810

Technical Services
Tel: 888.862.3289
Fax: 901.252.1321

Tool Services
Tel: 800.284.8665



Suggested Applications

- Carlton® P&C Flex™ Non-Metallic Corrugated Conduit is the most versatile system available for power and communications applications
- P&C Flex™ combines high crush strength with flexibility. Longer coil lengths reduce installation time

Here are a few application ideas that illustrate how P&C Flex® can be effectively used:

In single-phase underground primary systems, lower the cost of direct buried and standard conduit systems by installing P&C Flex™ Non-Metallic Corrugated Conduit with a vibratory plow.

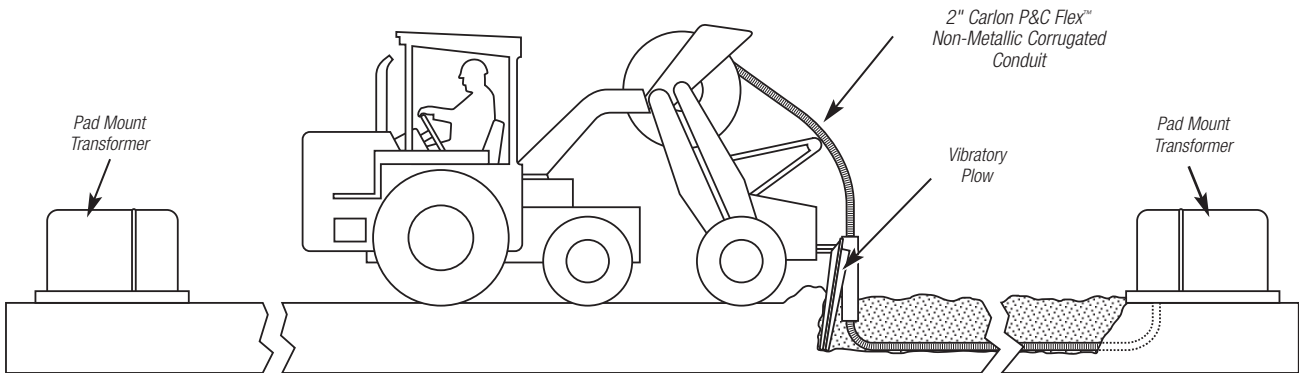

Digging up faulty cable in frozen ground can be expensive and time consuming. Use Carlton® P&C Flex™ from the customer service raceway to the temporary service pedestal to restore power on an interim basis. When the service length is more than 250 feet, use a splice box and an additional length of P&C Flex™ Non-Metallic Corrugated Conduit.

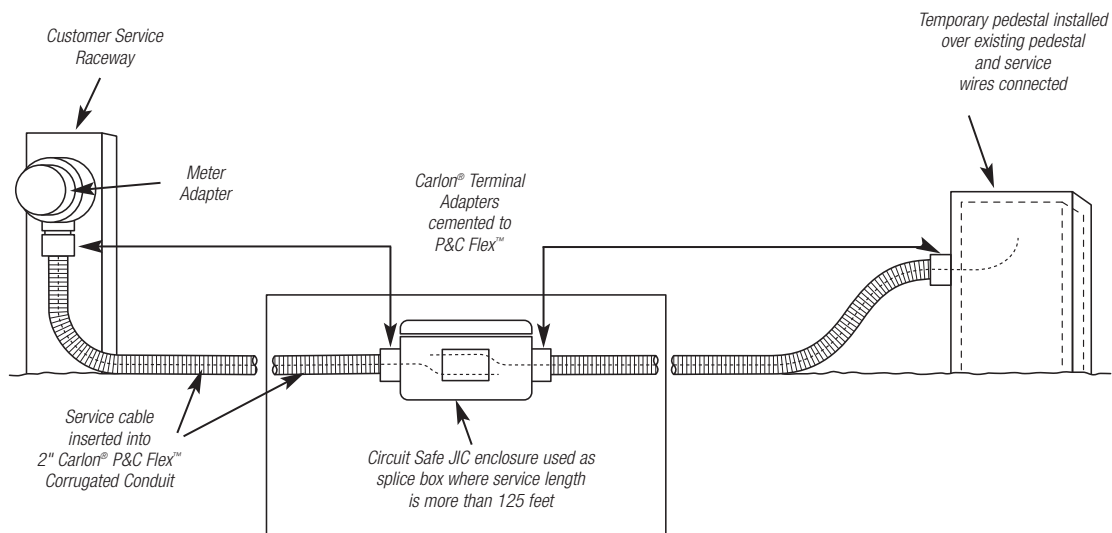

Carlton® Non-Metallic Rigid Conduit, Fittings and Accessories

Carlton®

P&C Flex™

Installation



Incorrect Method

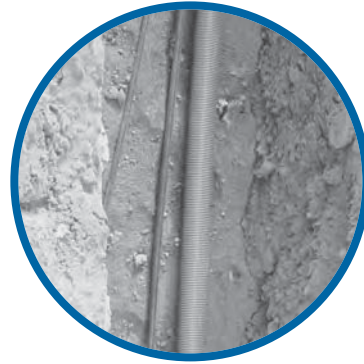

Correct Method

Lay conduit in the trench as straight as possible. Avoid undulations up and down and side to side.

Trenching

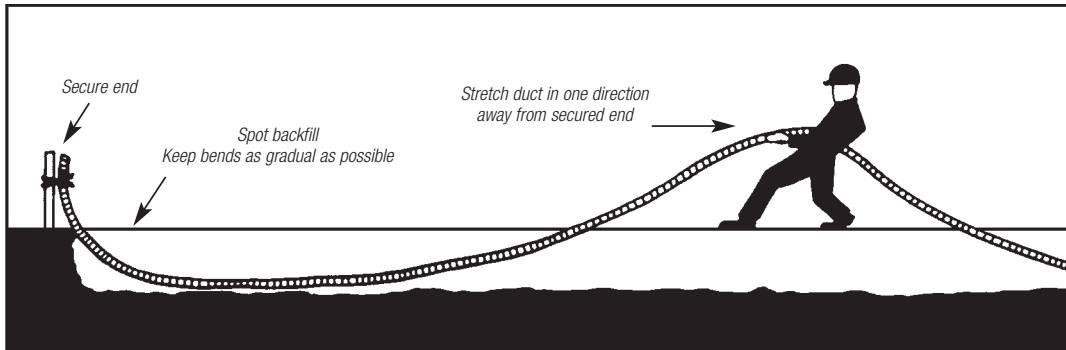

1 Trenching

Trench should be graded true and free from stones or soft spots. Backfill should also be free of stones and be firmly tamped around the sides of the conduit to develop maximum supporting strength. Tamping on top of the conduit is not recommended.

2 Backfill

In rocky soil where it is impossible to have an even trench bottom, a selected backfill should be put in before laying the conduit. Selected backfill (not tamped) at least 6" over the top of the conduit is recommended. After final backfill is placed, tamping may be used to finish the grade.

3 Duct Placement

Duct may be unreeled directly into trench or along side trench and subsequently placed in trench. After placing in trench, secure one end and stretch it by hand to take up the slack. Spot backfill to hold in position. Do not use mechanical stretching equipment.

4 Changes in Direction

Avoid unnecessary turns, dips or changes in direction. Keep bends as gradual as possible to ensure ease of cable pull-in after duct installation.

5 Pneumatic Rodding

All commonly used vacuum or pressure rodding equipment can be used to rod P&C Flex™. The line carrier (mouse, puck, rocket) should be soft, flexible material designed to fit snugly into duct without interference.

6 Mechanical Rodding

All commonly used mechanical rodding equipment can be used to rod P&C Flex™. The tip should have a ball-type arrangement to keep rod from catching in the convolutions on the inside of duct.



In This Section...

Carlon®

Carlon® Carflex® Liquidtight Flexible Tubing

Carflex®	P-2
Carflex® X-Flex™	P-3
Fittings	P-4-P-8
Technical Data	P-8
Pre-Wired Whips	P-9
Cord Grips.....	P-10

Carlon® Carflex® Liquidtight Flexible Tubing

Thomas & Betts

Corporate Office
 Tel: 901.252.8000
 800.816.7809
 Fax: 901.252.1354

Customer Service
 Tel: 800.816.7809
 Fax: 800.816.7810

Technical Services
 Tel: 888.862.3289
 Fax: 901.252.1321

Tool Services
 Tel: 800.284.8665

Thomas & Betts

www.tnb.com

Carlon®

Carflex®

Carflex® Liquidtight Flexible Non-Metallic Conduit

Liquidtight Flexible Non-Metallic Conduit provides superior wire protection in harsh, damp environments. Carflex® Conduit is non-conductive, non-corrosive and resistant to oil, acid, ozone and alkaline. Carflex® Conduit is strong and lightweight and, because it weighs 50% less than metallic systems, it's easy to handle, transport and install. Carflex® is ideal for industrial, air conditioning, heating and outdoor lighting applications.

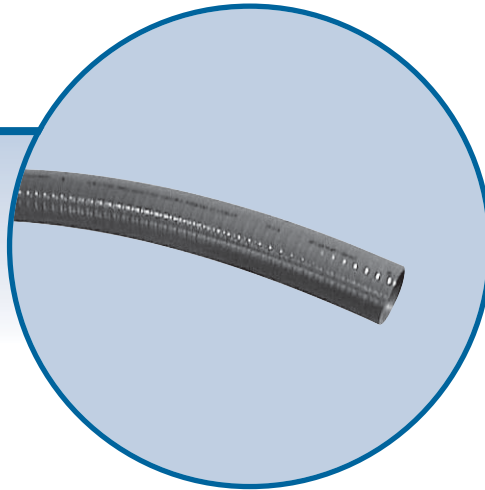

Features:

- Non-conductive and non-corrosive
- Lightweight for easy handling, transportation and installation
- Crush, abrasion and strain resistant
- Provides superior wire protection
- Smooth interior ideal for pulling cable
- No jagged edges
- Maintains internal I.D., even in tight-radius bends
- Type LFNC-B
- Resistant to oil, acid, ozone and alkaline
- UL Listed for use as indicated in Article 356.2 of the NEC®, and Section 12-1300 of the Canadian Electrical Code, Part 1
- UL Listed for outdoor use
- UL Listed for sunlight resistant
- Trade sizes ½", ¾" and 1" are UL Listed for direct burial and concrete encasement
- Sequentially marked footage
- Suitable for use at conduit temperatures of 80°C dry, 60°C wet and 60°C oil resistant as required by section 15-6 of ANSI/NFPA 79 and UL 1660

NOTE: Liquidtight flexible conduits, metallic and non-metallic, in contrast to rigid PVC conduit and electrical non-metallic tubing, does not have wire temperature limitations. Any temperature-rated wire (for example, 90° wire) can be used as long as the temperature conditions marked on the conduit are not exceeded. UL Listed conduits that are not marked are limited to a maximum temperature of 60°C wet or dry.

Applications:

- Control and motor
- Air conditioning and heating
- Computer power distribution
- Machine tools
- Console wiring
- Transformer connections
- Outdoor lighting

Custom Orders:

- Available in black and gray; consult your Thomas & Betts Sales Team for custom colors
- Custom-cut lengths available; consult your Thomas & Betts Sales Team for details



Coils

CAT NO.	NOM. SIZE (IN.)	AVG. O.D. (IN.)	AVG. I.D. (IN.)	STD. CTN. (FT.)	STD. WT. (LBS.)
15004-100	¾	0.700	.489	100	11.70
15005-50	½	0.830	.627	50	6.50
15005-100*	½	0.830	.627	100	13.00
15005BK-100*	½	0.830	.627	100	13.00
15007-100*	¾	1.040	.825	100	18.00
15008-100*	1	1.302	1.046	100	28.00
15009-100	1¼	1.645	1.385	100	37.60
15010-50	1½	1.882	1.580	50	22.55
15010-100	1½	1.882	1.580	100	47.80
15011-050	2	2.357	2.025	50	34.10

Standard color is gray.

*Joint listed UL/CSA Approved product available

Reels

CAT NO.	NOM. SIZE (IN.)	AVG. O.D. (IN.)	AVG. I.D. (IN.)	STD. CTN. (FT.)	STD. WT. (LBS.)
15004-001	¾	0.700	.489	1000	145.0
15005-001	½	0.830	.627	1000	157.0
15005BK-001	½	0.830	.627	1000	157.0
15007-001	¾	1.040	.825	1000	212.0
15008-500	1	1.302	1.046	500	155.0
15009-200	1¼	1.645	1.385	200	100.0
15010-150	1½	1.882	1.580	150	95.7
15011-100	2	2.357	2.025	100	94.6

Standard color is gray.

Carlon® Carflex® Liquidtight Flexible Tubing

Thomas & Betts

www.tnb.com

Corporate Office
Tel: 901.252.8000
800.816.7809
Fax: 901.252.1354

Customer Service
Tel: 800.816.7809
Fax: 800.816.7810

Technical Services
Tel: 888.862.3289
Fax: 901.252.1321

Tool Services
Tel: 800.284.8665



Carflex® X-Flex™ Non-Metallic Mechanical Protection Tubing

Extra-Flexible Non-Metallic Mechanical Protection Tubing is ideal for applications requiring extra strength and flexibility, such as robotics and repetitive-flexing arms. Carflex® X-Flex™ is non-conductive, non-corrosive and resistant to oil, acid, ozone and alkaline. It's designed for use with standard Carflex® fittings, providing a complete non-metallic system. Carflex® X-Flex™ is lightweight for easier handling, transportation and installation.



Features:

- Extra strong and flexible to withstand repetitive motions
- Non-conductive and non-corrosive
- Resistant to oil, acid, ozone and alkaline
- Lightweight for easy handling, transportation and installation
- Crush, abrasion and strain resistant
- Provides superior wire protection
- Smooth interior ideal for pulling cable
- No jagged edges
- Rated for continuous use at 60°C (140°F) ambient
- Type NMPT-B
- UL Recognized to UL Standard 1696

Applications:

- Repetitive flexing arms
- Robotics
- Machine tools
- Automatic/moving machinery
- Control and motor



E80040



LR88170

Where noted by ♦

Coils

CAT NO.	NOM. SIZE (IN.)	AVG. O.D. (IN.)	AVG. I.D. (IN.)	STD. CTN. (FT.)	STD. WT. (LBS.)
15104-100	3/8	0.700	0.489	100	9.09
15105-100	1/2	0.830	0.627	100	10.01
♦ 15107-100	3/4	1.040	0.825	100	13.91
♦ 15108-100	1	1.302	1.046	100	18.25
♦ 15109-100	1 1/4	1.645	1.385	100	27.65
15110-100	1 1/2	1.882	1.580	100	38.00
15111-050	2	2.357	2.025	50	24.22

Available in black only.

Carlton® Carflex® Liquidtight Flexible Tubing

Carlton®

Carflex® Fittings

For use with Carflex® conduit and Carflex® X-Flex™ conduit.

Carflex® Liquidtight Straight Fittings

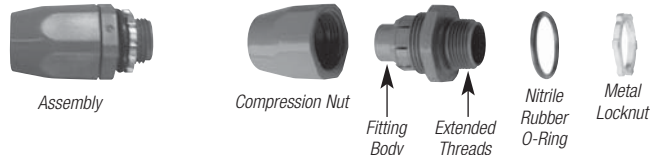

Features:

- Non-conductive and non-corrosive
- Resistant to oil, acid, ozone and alkaline
- Easy to install
- Approved for indoor and outdoor locations
- UL Listed for wet locations
- Nitrile rubber O-ring for a liquidtight termination
- Temperatures up to 225°F (107°C)
- Meets UL Standard 514B

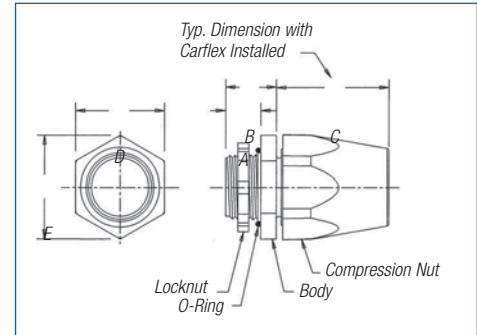

LT43C-CAR, LT43D-NEW, LT43E-NEW, LT43F

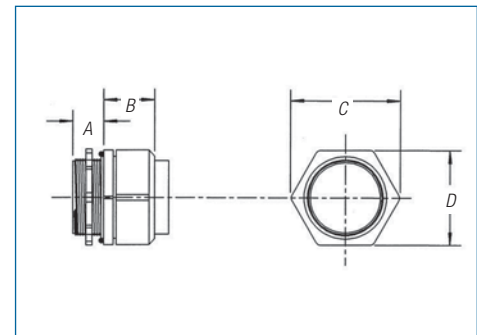

LT43G, LT43H

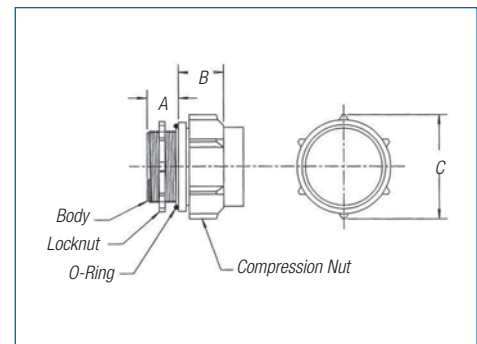

LT43J



CAT. NO.	SIZE (IN.)	STD. CTN.	STD. WT. (LBS.)	A (IN.)	B (IN.)	C (IN.)	D (IN.)	E (IN.)
LT43C	3/8	50	3.6	.55	.75	1.60	1.30	1.40
LT43C-CAR	3/8	15	1.4	.55	.75	1.60	1.30	1.40
LT43D-NEW	1/2	50	4.2	.56	.91	1.62	1.30	1.40
LT43E-NEW	3/4	50	6.6	.56	.91	1.88	1.61	1.71
LT43F	1	25	5.5	.70	1.00	2.20	1.90	2.04
LT43G	1 1/4	5	1.5	.71	1.16	2.50	2.17	
LT43H	1 1/2	5	2.0	.75	1.36	2.78	2.43	
LT43J	2	5	2.5	1.00	1.45	3.33		

Carlton® Carflex® Liquidtight Flexible Tubing

Thomas & Betts

www.tnb.com

Corporate Office
Tel: 901.252.8000
800.816.7809
Fax: 901.252.1354

Customer Service
Tel: 800.816.7809
Fax: 800.816.7810

Technical Services
Tel: 888.862.3289
Fax: 901.252.1321

Tool Services
Tel: 800.284.8665



For use with Carflex® conduit and Carflex® X-Flex™ conduit.

Carflex® Liquidtight 90° Fittings

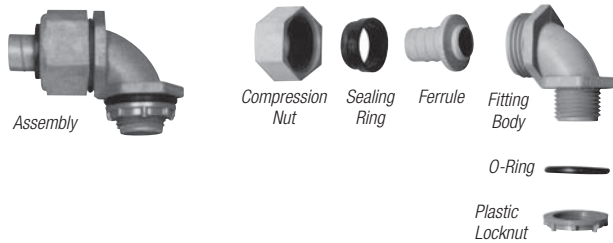

Features:

- Non-conductive and non-corrosive
- Resistant to oil, acid, ozone and alkaline
- Easy to install
- Approved for indoor and outdoor locations
- UL Listed for wet locations
- Nitrile rubber O-ring for a liquidtight termination
- Temperatures up to 225°F (107°C)
- Meets UL Standard 514B

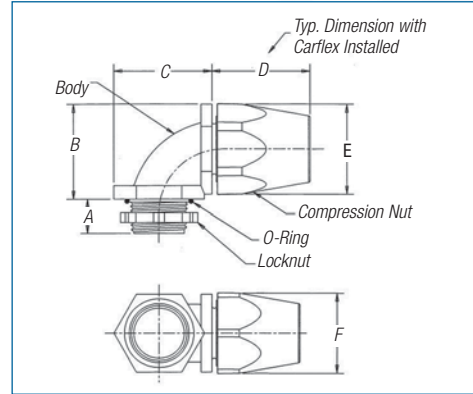

LT20C-CAR, LT20F-NEW

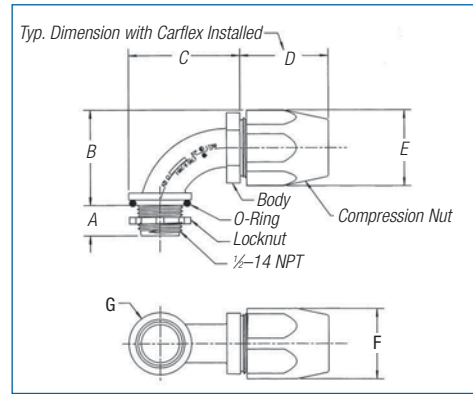

LT20D-NEW, LT20E-NEW

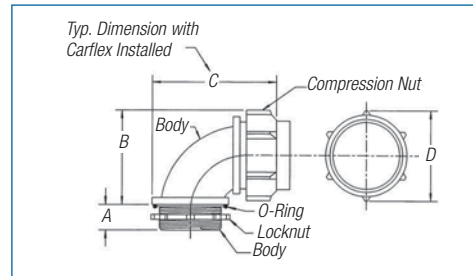

LT20G, LT20H, LT20J



CAT. NO.	SIZE (IN.)	STD. CTN.	STD. WT. (LBS.)	A (IN.)	B (IN.)	C (IN.)	D (IN.)	E (IN.)	F (IN.)	G (IN.)
LT20C	¾	50	4.9	.56	1.44	1.44	1.56	1.39	1.26	
LT20C-CAR	¾	15	1.8	.56	1.44	1.44	1.56	1.39	1.26	
LT20D-NEW	½	50	4.9	.56	1.76	2.05	1.62	1.40	1.30	1.15
LT20E-NEW	¾	50	8.0	.56	2.04	2.35	1.88	1.71	1.61	1.50
LT20F	1	25	6.9	.70	2.01	2.01	2.26	2.04	1.90	
LT20G	1¼	5	1.9	.75	2.50	3.55	2.48			
LT20H	1½	5	2.2	.75	2.80	3.98	2.77			
LT20J	2	5	3.4	.94	3.48	4.56	3.33			

Carflex® One-Piece Liquidtight Fittings

Unique Design

The simple, one-piece body design of the Carflex® One-Piece Liquidtight Non-Metallic Fitting requires no disassembly of components for installation. The system is so strong that there is no need for a compression nut.

PVC Construction

PVC construction of the fitting and locknut provides unparalleled protection from water, oil and dust. Totally non-metallic, the system is non-conductive and will not corrode or rust. Temperatures up to 140°F (60°C).

Features:

- Approved for indoor and outdoor locations
- UL Listed for wet locations



Straight Fittings

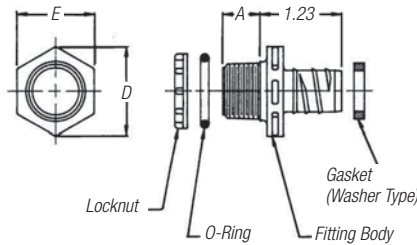
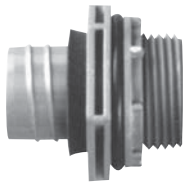

CAT. NO.	TRADE SIZE (IN.)	THREAD SIZE	STD. CTN.	STD. WT. (LBS.)	A (IN.)	D (IN.)	E (IN.)
LN43DA	½	½-14 NPT	100	2.8	0.56	1.34	1.19
LN43EA	¾	¾-14 NPT	50	2.2	0.56	1.63	1.44
LN43FA	1	1-11½ NPT	25	3	0.69	1.99	1.75
LN43FA-CAR	1	1-11½ NPT	15	1	0.69	1.99	1.75

90° Fittings

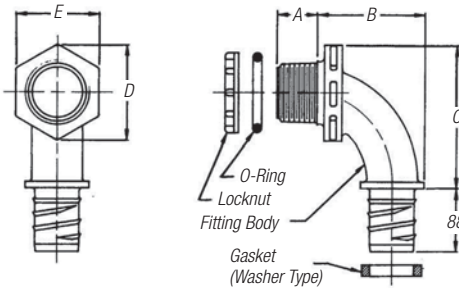

CAT. NO.	TRADE SIZE (IN.)	THREAD SIZE	STD. CTN.	STD. WT. (LBS.)	A (IN.)	B (IN.)	C (IN.)	D (IN.)	E (IN.)
LN20DA	½	½-14 NPT	100	4.3	0.56	1.50	1.99	1.34	1.19
LN20EA	¾	¾-14 NPT	50	3.1	0.56	1.73	2.25	1.63	1.44
LN20FA	1	1-11½ NPT	25	3.2	0.69	1.86	2.58	1.99	1.75
LN20FA-CAR	1	1-11½ NPT	10	1	0.69	1.86	2.58	1.99	1.75



Carflex® Omni Connectors Straight Fittings



Features:

- Available in sizes 3/8" through 1" conduit and tubing
- All-nylon construction resists saltwater, weak acids, gasoline, alcohol, oil, grease and common solvents

- No disassembly required
- No threading of the conduit or tubing required to install
- Complete conduit/connector system is reusable
- Suitable for indoor/outdoor use
- Lower installed cost
- Black connectors provided with nylon locknut
- Gray connectors provided with assembled O-ring and metal locknuts
- Protection class IP 68 per DIN 40050 up to 70 psi (5 bar) water pressure
- Molded of type 6/6 nylon. ASTM D-4066-PA 111; flammability classification 94V-2

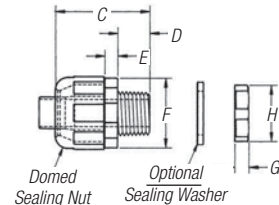

CAT. NO. BLACK	CAT. NO. GRAY*	SIZE (IN.)	DESCRIPTION	BODY & SEALING UNIT					LOCKING NUT		STD. CTN.
				CLEARANCE HOLE IN. (MM)	MAX O.A. LENGTH IN. (MM)	THREAD LENGTH IN. (MM)	WRENCHING NUT THICKNESS IN. (MM)	WRENCHING FLATS IN. (MM)	THICKNESS IN. (MM)	WRENCHING FLATS IN. (MM)	
LT38	LT38G	3/8	Straight L/T Fitting	.875 (22.2)	2.000 (50.8)	.625 (15.9)	.250 (6.3)	1.328 (33.7)	.266 (6.7)	1.062 (26.9)	50
LT50	LT50G	1/2	Straight L/T Fitting	.875 (22.2)	2.000 (50.8)	.625 (15.9)	.250 (6.3)	1.328 (33.7)	.266 (6.7)	1.062 (26.9)	50
LT75	LT75G	3/4	Straight L/T Fitting	1.109 (28.2)	2.031 (51.6)	.625 (15.9)	.250 (6.3)	1.562 (39.7)	.266 (6.7)	1.312 (33.3)	25
LT100	LT100G	1	Straight L/T Fitting	1.375 (34.9)	2.250 (57.1)	.781 (19.8)	.250 (6.3)	1.875 (47.6)	.266 (6.7)	1.625 (41.3)	20

*Gray connectors provided with assembled O-ring and metal locknuts. Black connectors provided with nylon locknuts only.

90° Fittings



Features:

- Available in sizes 3/8" through 1" conduit and tubing
- Smooth internal surfaces for easier wire installation around corner angles
- All-nylon construction resists saltwater, weak acids, gasoline, alcohol, oil, grease and common solvents
- No disassembly required

- No threading of the conduit or tubing required to install
- Complete conduit/connector system is reusable
- Use of a sealing washer may be required for wet locations
- Suitable for indoor/outdoor use
- Lower installed cost
- Black connectors provided with nylon locknut, packed separately
- Gray connectors provided with assembled O-ring and metal locknuts.
- Protection class IP 68 per DIN 40050 up to 70 psi (5 bar) water pressure
- Molded of type 6/6 nylon. ASTM D-4066-PA 111; flammability classification 94V-2

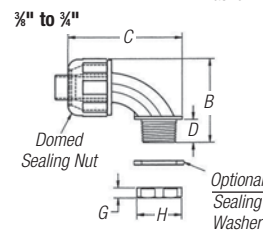
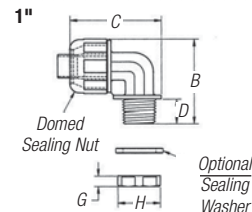

CAT. NO. BLACK	CAT. NO. GRAY	SIZE (IN.)	DESCRIPTION	BODY & SEALING UNIT				LOCKING NUT		STD. CTN.
				CLEARANCE HOLE IN. (MM)	MAX O.A. HEIGHT IN. (MM)	MAX O.A. LENGTH IN. (MM)	THREAD LENGTH IN. (MM)	THICKNESS IN. (MM)	WRENCHING FLATS IN. (MM)	
LT938	LT938G	3/8	90 Degree L/T Fitting	.875 (22.2)	1.98 (50.3)	2.91 (73.9)	.52 (13.2)	.27 (6.8)	1.06 (26.9)	25
LT950	LT950G	1/2	90 Degree L/T Fitting	.875 (22.2)	1.98 (50.3)	2.91 (73.9)	.52 (13.2)	.27 (6.8)	1.06 (26.9)	25
LT975	LT975G	3/4	90 Degree L/T Fitting	1.109 (28.2)	2.29 (58.2)	3.17 (80.5)	.52 (13.2)	.27 (6.8)	1.31 (33.3)	20
LT9100	LT9100G	1	90 Degree L/T Fitting	1.375 (34.9)	2.84 (72.1)	3.18 (80.8)	.78 (19.8)	.27 (6.8)	1.61 (40.9)	10

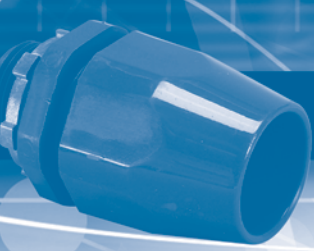

Carflex® Fittings Installation Instructions

LT43C-CAR, LT43F thru J, LT20C-CAR, LT20F thru J.

1. Cut the end of the Carflex® conduit or Carflex® X-Flex™ tubing square.
2. Install compression nut and sealing gland ring over the end of the conduit or tubing.
3. Insert the ferrule end of the fitting into the conduit using a clockwise twisting action.
4. Screw fitting body into compression nut.
5. When installation is completed, use a wrench to tighten compression nut one-quarter (1/4) turn past hand-tight. Do not overtighten fitting.

**To prevent damage to conductors, conduit and fittings, do not twist Carflex during installation.*

LT43D-New, LT43E-New, LT20D-New, LT20E-New.

1. Cut the end of the Carflex® conduit or Carflex® X-Flex™ tubing square.
2. Install compression nut over the end of the conduit or tubing.
3. Insert the ferrule end of the fitting into the conduit using a clockwise twisting action. (Be sure conduit is fully inserted to the bottom of the fitting shoulder).
4. Screw compression nut onto fitting body.
5. Use a wrench to tighten compression nut one (1) full turn past hand-tight. Do not overtighten fitting.

Carflex® Liquidtight Conduit Technical Information

1. There shall be no more than the equivalent of four (4) quarter (90°) bends (360° total) between pull points, conduit bodies and boxes.
2. The radius of the curve of the center of the conduit or tubing shall not be less than that shown in the table (right):

SIZE OF CONDUIT OR TUBING		RADIUS TO CENTER OF CONDUIT OR TUBING	
INCHES	(METRIC DESGR.)	INCHES	(MM)
3/8	(14)	4	(101.6)
1/2	(16)	4	(101.6)
3/4	(21)	4 1/2	(114.3)
1	(27)	5 1/2	(146.0)
1 1/4	(35)	7 1/4	(184.1)
1 1/2	(41)	8 1/4	(209.5)
2	(53)	9 1/2	(241.3)

UL Listed for Use as Indicated in Article 356 of the National Electrical Code®

- Cellular Metal Floor Raceways, Connections to Cabinets & Wall Outlets
- Class I, Div. 2, Hazardous Location
- Class II, Div. 1, Hazardous Location
- Class III, Div. 1, Hazardous Location
- Computer Room Raised Floor
- Concealed Locations
- Intrinsically Safe Systems
- Lighting Fixtures, Connection to Electric Discharge Fixture
- Non-Metallic Boxes
- RV Engine Generator
- Swimming Pool Pump Motors
- Tap Conductors (Fixture Whips)
- Underfloor Raceway, Connection to Cabinets and Wall Outlets
- Wireway, Extensions from Wireways, Wiring Methods
 - Agricultural Buildings, Flexible Connections
 - Electric Signs, 1000 Volts, Nominal, or Less
 - Electric Signs, Over 1000 Volts (per Section 600.32(A)(1))
 - Floating Buildings
 - Marinas and Boatyards
 - Service Entrance Conductors
- Wiring on Buildings, Outside Branch Circuits and Feeders
- Direct Burial Applications



Carflex® Liquidtight Whip

Carflex® Liquidtight Whip assemblies save the customer time and hassle of having to hunt for the needed components. Our moisture-tight non-metallic flexible conduit system is ideal for installing swimming pool motors, hot tubs, spas, air conditioners, pumps, outdoor lighting and more.

Unlike plastic-coated metal conduit, the Carlton® Carflex® system has no metal core to fatigue, rust or corrode. The Carflex® system has no sharp edges or burrs to cut into the wire insulation. Metal conduit is subject to fatigue and penetration of moisture.

The Carflex® Liquidtight Whip assembly is complete with Carflex® moisture-tight conduit, wire, one straight fitting and one 90° fitting.

All this enables quick and trouble-free installation.

Features:

- Designed for easy installation
- Will not rust or corrode
- Can be used for many commercial and residential applications
- Many applications such as swimming pool filters, hot tub spas, air conditioners, pumps, etc.
- Available in ½" and ¾" diameters
- Available in 4' and 6' lengths
- Each kit contains (1) straight and (1) 90° fitting
- Complete with (3) 8-, 10- or 12-gauge wires

Custom Orders:

Also available in special configurations including different fitting combinations, wire types and sizes and metal-fitting variations. Consult your Thomas & Betts Sales Team for details.

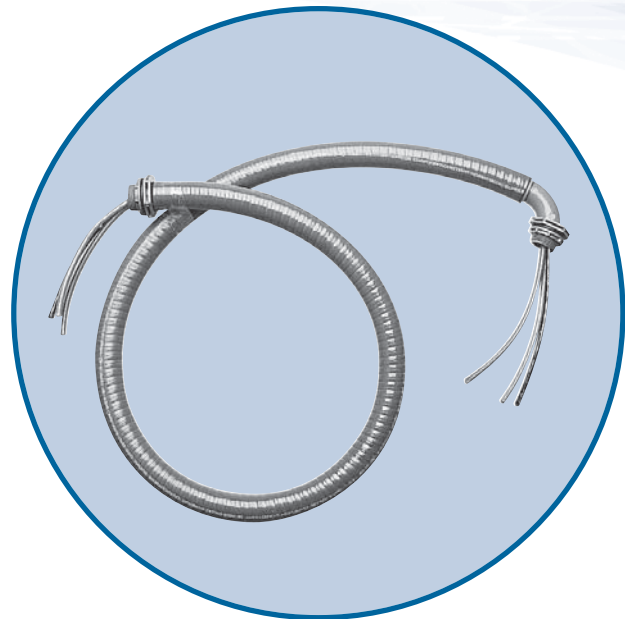

CAT. NO.	DESCRIPTION	WIRE SIZE (GAUGE)	STD. CTN.	STD. WT. (LBS.)
WCD4	½"	Carflex Whip — 4 foot 10	6 (poly bag)	10.6
WCD6	½"	Carflex Whip — 6 foot 10	6 (poly bag)	15.8
WCE4	¾"	Carflex Whip — 4 foot 8	6 (poly bag)	12.4
WCE6	¾"	Carflex Whip — 6 foot 8	6 (poly bag)	15.8
WCD3124	½"	Carflex Whip — 4 foot 12	20 (bulk pack)	32.4
WCD3126	½"	Carflex Whip — 6 foot 12	20 (bulk pack)	47.9
WCD3104	½"	Carflex Whip — 4 foot 10	20 (bulk pack)	35.2
WCD3106	½"	Carflex Whip — 6 foot 10	20 (bulk pack)	52.8
WCE3084	¾"	Carflex Whip — 4 foot 8	15 (bulk pack)	30.9
WCE3086	¾"	Carflex Whip — 6 foot 8	15 (bulk pack)	39.6

Carlton® Carflex® Liquidtight Flexible Tubing

Straight PG Hubs



Suggested Clearance Hole for Non-Threaded Mounting

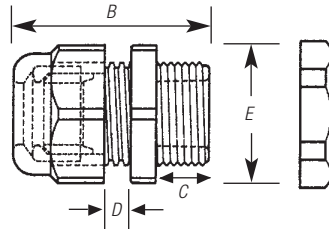

Features:

- New threads on body prevent skipping, speed installation
- PG hub threads are steel conduit per DIN 40430
- Six sizes for cable, tubing, etc.: PG07, PG09, PG11, PG13.5, PG16 and PG21
- All-nylon construction with TPE gland resists saltwater, weak acids, gasoline, alcohol, oil, grease and common solvents
- Suitable for NEMA Type 4 and 6 enclosures
- Locknuts are included
- Working temperatures: -22°F (-30°C) to 212°F (100°C). For short periods to 302°F (150°C)
- Protection Class IP68 per DIN 40050 up to 70 psi (5 bar) water pressure



STRAIGHT CAT. NO. BLACK	SIZE (PG)	STD. CTN.	STD. WT. (LBS.)	DIAMETER OF CABLE OR WIRE ACCOMMODATED IN. (MM)	A CLEARANCE HOLE IN. (MM)	B MAX O.A. LENGTH IN. (MM)	C THREAD LENGTH IN. (MM)	D WRENCHING NUT THICKNESS IN. (MM)	E WRENCHING FLATS IN. (MM)
LH07	PG07	100	1.3	.114-.250 (2.9-6.4)	.492 (12.5)	1.17 (29.7)	.33 (8.4)	.22 (5.6)	.59 (15.0)
LH09	PG09	100	2.0	.181-.312 (4.6-7.9)	.599 (15.2)	1.30 (33.0)	.34 (8.6)	.20 (5.1)	.75 (19.1)
LH11	PG11	100	2.6	.230-.395 (5.8-10.0)	.733 (18.6)	1.46 (37.1)	.39 (9.9)	.20 (5.1)	.86 (21.8)
LH13	PG13.5	100	3.1	.170-.470 (4.3-11.9)	.804 (20.4)	1.53 (38.9)	.41 (10.4)	.20 (5.1)	.95 (24.1)
LH16	PG16	50	2.1	.230-.546 (5.8-13.9)	.886 (22.5)	1.66 (42.2)	.45 (11.4)	.23 (5.8)	1.05 (26.7)
LH21	PG21	50	3.2	.450-.709 (11.4-18.0)	1.115 (28.3)	1.87 (47.5)	.52 (13.2)	.23 (5.8)	1.30 (33.0)

Carlton® recommends using the smallest maximum diameter fitting that will suit your application.

Straight NPT Hubs



Suggested Clearance Hole for Non-Threaded Mounting

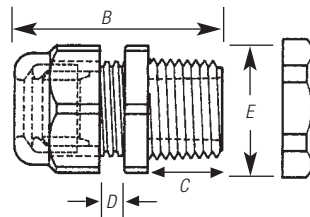

Features:

- New threads on body prevent skipping, speed installation
- Four sizes for cable, tubing, etc. with diameters of 3/8", 1/2", 3/4" and 1"
- All-nylon construction with TPE gland resists saltwater, weak acids, gasoline, alcohol, oil, grease and common solvents
- Suitable for NEMA Type 4 and 6 enclosures
- Locknuts are included
- Working temperatures: -22°F (-30°C) to 212°F (100°C). For short periods to 302°F (150°C)
- Protection Class IP68 per DIN 40050 up to 70 psi (5 bar) water pressure



STRAIGHT CAT. NO. BLACK	STRAIGHT CAT. NO. GRAY	SIZE (IN.) (NPT)	STD. CTN.	STD. WT. (LBS.)	DIAMETER OF CABLE OR WIRE ACCOMMODATED IN. (MM)	A CLEARANCE HOLE IN. (MM)	B MAX O.A. LENGTH IN. (MM)	C THREAD LENGTH IN. (MM)	D WRENCHING NUT THICKNESS IN. (MM)	E WRENCHING FLATS IN. (MM)
LH38	LH38G	3/8	100	1.9	.181-.312 (4.6-7.9)	.670 (17.0)	1.49 (37.8)	.53 (13.5)	.20 (5.1)	.75 (19.1)
LH50	LH50G	1/2	100	2.9	.170-.470 (4.3-11.9)	.875 (22.2)	1.72 (43.7)	.62 (15.7)	.20 (5.1)	.95 (24.1)
LH75	LH75G	3/4	50	2.7	.450-.709 (11.4-18.0)	1.068 (27.1)	1.97 (50.0)	.63 (16.0)	.23 (5.8)	1.30 (33.0)
LH100	LH100G	1	25	2.6	.590-1.000 (15.0-25.4)	1.375 (35.0)	2.42 (61.5)	.78 (19.8)	.28 (7.1)	1.66 (42.2)

Carlton® recommends using the smallest maximum diameter fitting that will suit your application.