

BUGLER SALES CORP.

2005



BUGLER SALES CORP.

Phone: 516 223-3868 • Fax: 516 868-6998 • E-Mail: info@buglersales.com
969 CHURCH STREET • BALDWIN, NY 11510

**LISTING BY MANUFACTURER**

- AEARO
PAGE 48
- ALL CRAFTS
PAGE 57
- ALLWAY TOOLS
PAGE 111
- AMERICAN SAW
PAGE 140-145
- AMERICAN STONE MIX
PAGES 44, 58, 60, 61
- AMES
PAGES 119
- ANSELL EDMONT
PAGES 57
- ARROW
PAGE 123
- **BACHARACH**
PAGES 66-69
- BAG SUPPLY INC.
PAGES 85-87
- BALTIMORE TOOL
PAGE 42,43
- **BAYCO**
PAGES 44-47
- BERKLEY TOOL
PAGES 15-17, 123, 139
- BERNZOMATIC
PAGE 131
- BETA
PAGES 66-68, 70+71, 78-85
- BLACKJACK
PAGE 39
- BLITZ
PAGE 55
- BONDHUS
PAGE 11
- BOSCH
PAGE 21
- **BUCKET BOSS**
PAGES 25
- BUGLER BRUSH
PAGES 26-30
- CALFONEX
PAGE 101
- CARBIDE
PAGE 43
- CELLO
PAGE 61
- CHANNELLOCK TOOLS
PAGE 119
- COLCO HVAC
FURNACE CEMENT
PAGE 77
- COLEMAN CABLE
DROPLIGHTS/
EXTENSIONS
PAGE 47
- CRESCENT
PAGES 39, 137
- DAP
PAGES 32/33/54/55/59/109
- DASCO
PAGES 14/40/42/44
- DIAMOND
PAGE 43
- DIXON
PAGES 45, 95
- DURACELL
PAGES 54, 55
- DURABOND
PAGE 59
- EKLIND
PAGE 11
- ENDERES
PAGE 119
- ENERGIZER
PAGES 55
- EVERHARD
PAGE 121
- FAST ORANGE
PAGE 61
- FIRE POWER
PAGE 131
- FLEXON GARDEN HOSE
PAGE 63
- FLUIDMASTER
PAGE 14
- GB
PAGES 47, 75
- GE
PAGE 33
- GT WATER PRODUCTS
PAGE 44
- GENERAL TOOLS
PAGE 133
- GENERAL WIRE
PAGEW 45, 133
- GILMOUR
PAGE 64
- GLOWMASTER
PAGE 133
- GOJO
PAGE 61
- GREAT NECK
PAGES 109/113/121/129
135-139
- HAGSTROM MAPS
PAGE 95
- HANSON
PAGE 47
- HEXCRAFT
PAGES 11, 13
- HK PORTER
PAGE 23
- HUOT
PAGE 19, 129
- ICE MELT INC.
PAGE 121
- IDEAL
PAGES 63, 65
- IRWIN
PAGES 17/19/21/23/38
43/135
- ITW BUILDEX
PAGE 119
- JAMERCO DRIVE PINS
PAGE 111
- JANITORIAL INC.
PAGES 85
- JOHNSON LEVEL
PAGES 91, 93
- K. MILLER
WIRE STRIPPING
PAGE 137
- KC PRO
PAGE 113

Manufacturers in bold, indicates a new addition



BUGLER SALES CORP.

Phone: 516 223-3868 • Fax: 516 868-6998
969 CHURCH STREET • BALDWIN, NY 11510

PAGE
3

LISTING BY MANUFACTURER

- KARNAK
PAGE 39
- KEEPER
PAGE 125
- KIDDE SAFETY
PAGE 51
- KIEL
PAGE 45
- KIMBERLY CLARK
PAGE 61
- KLENK
PAGE 121
- KRYLON
PAGE 101, 147-158
- LENOX
PAGE 140-145
- LUFKIN
PAGE 113
- 3M
PAGES 49/75/89/123-127
- **MAGLITE**
PAGES 52,53
- MAGNA
PAGE 131
- MALCO
PAGES 83, 99
- MANNIX
PAGES 46, 74
- MARTIN SENOUR
PAGE
- MASTER LOCK
PAGES 93, 95
- MCGUIRE NICHOLAS
PAGE 129
- MINWAX
PAGE 39
- NICHOLSON
PAGES 49
- NORTH SAFETY
PAGE 48
- **ODOR MAGNET**
PAGES 71
- OIL DRI
PAGE 41
- PAPER SUPPLY INC.
PAGE 89
- PERMATEX
PAGES
33/39/41/57/67/75
- PHENOSEAL
PAGES 34/35
- PLEWS
PAGE 58
- PLUMB
PAGE 59/61/109
- POLYKEN
PAGES 103/105
- POWERS FASTENING
PAGES 13/21/22/112
- PRIMARK
PAGE 127
- PROSNIP
PAGE 121
- QUICKRETE
PAGE 39
- RAYOVAC
PAGE 55
- RIPLEY
PAGE 33
- ROOSTER
PAGES 15, 91
- RUBBERSET
PAGE 30
- SAKRETE
PAGES 39
- SAND'S
PAGES 91/93
- **SANTRONICS**
PAGES 74,75
- SAVOGRAN
PAGE 59
- SEATEK
PAGE 33
- SECURITY CHAIN CO.
PAGE 39
- SEEKONK
PAGE 121
- SK HAND TOOLS
PAGE 99
- **SHEFFIELD**
PAGE 90,91
- **SIMPLE GREEN**
PAGE 87
- SKIL DRILL PUMP
PAGE 47
- SPEEDY PRODUCTS
PAGE 97
- SPRAYON
PAGE 152-156
- SPRAY NINE
PAGES 41/71
- STANLEY
PAGES 91
- STREAMLIGHT
PAGE 53
- TRI-FLOW
PAGE 155
- TURNER
PAGE 131
- TYCO ADHESIVES
PAGE 125, 127
- TYVEK
PAGE 131
- UNITED TAPE
PAGES 125, 127
- **US GYPSUM**
PAGE 77
- VISEGRIPS
PAGE 135
- WARPS BAGS
PAGE 86
- WD-40
PAGE 101
- WELLER
PAGE 123
- WHITE LIGHTNING
PAGES 23/29
- WHITE RODGERS
PAGES 75, 77, 79
- WHEELER REX
PAGES 49, 133
- WISS
PAGE 121
- WOODS
PAGE 47

IF YOU NEED IT... WE WILL TRY TO GET IT



Table Of Contents

E-mail: info@buglersales.com

A

AC DISCONNECTS.....67	RAY-O-VAC	SEE HVAC.....69
SEE HVAC	BEAM	CANS – TRASH
AC WHIPS.....67	SEE PIPE HANGERS	SEE JANITORIAL.....87
SEE HVAC	BELL	CAP SCREWS
ACID.....41	SEE PIPE HANGERS	SEE BOLTS.....23, 25
SEE CHEMICALS	BENDING TUBE SPRINGS.....15	CAPE
ACID BRUSHES.....27	BERKLEY TOOLS.....15-17	SEE CHISELS
ADAPTERS, ELECTRICAL.....47	BIBB SEAT REAMERS.....17	CARTS
ADAPTERS	BITS, AUGER.....17	SEE JANITORIAL
SEE DROPLIGHT.....47	BITS, DRILL & SETS.....17-23	CAULKING.....33
ADJUSTABLE	DRILL HIGH SPEED 17-19	DAP33
WRENCHES.....11, 137	EXTENSIONS	GE33
ALLEN TYPE KEYS.....11, 13	FEELER	FIRE STOP33
ALUMINUM TUBES	INSERT (P2 ETC.)	PERMATEX.....33
SEE HVAC	MASONRY	ROOF CAULKING
ANCHORING	PILOT	PHENOSEAL.....34, 35
SEE CEMENT	SDS	WHITE LIGHTNING33
ANCHORS.....13	SPADE	GOOP57
DOUBLE EXPANSION	SPLINE	CAULKING GUNS.....33
DROP-IN	SPEEDBOR	CAULKING IRONS.....43
LAG SHIELD	13 PC SET	CAUTION TAPE127
MUNGO	21 PC SET	SEE TAPE
NAIL	29 PC HOUT	CELLO61
POLY	TAP & DRILL	SEE HAND CLEANER
SELF DRILL	DIAL-A-DRILL	CEMENT.....39
SLEEVE	BLADES	ANCHORING
ZIP-ITS	CHOP43	KARNAC
ANTI FREEZE.....77	CIRCULAR43	ROOF
ANTI SIEZE.....67	LENOX140-145	SAKRETE
ANTISEPTIC	RECIPROCATING.....93	CHANNELLOCK.....36, 37
SEE HAND CLEANER	BLEACH41	CHAIN.....39
APRONS.....15	SEE CHEMICALS	COIL
ASH119	BOLT CUTTERS.....22	DOUBLE LOOP
SEE SHOVELS	BOLTS.....23, 25	CHAIN WRENCH.....39
ARBORS.....15	HEX, STOVE, & TOGGLE	CHALK LINES & CHALK.....39
AWLS.....15	BX CUTTERS.....33	CHANNELLOCK
B	BRUSHES.....26-31	SEE PLIERS
BACHARACH67,69	ACID	CHEESE SAWS59
BAGS	CHIP-BOILER	SEE SAWS
ALL TYPES AND SIZES.....85	DOPE	CHEMICALS.....39-41
BALLCOCKS.....15	FITTING	ACID
FLUIDMASTER	LONG HANDLE	BLEACH
BAND IRON.....15	WIRE	GREZ OFF
BARBEQUE LIGHT	BUCKETS & PAILS.....87	PADS
SEE STRIKERS	BUCKET BOSS25	PERMATEX
BARRIER TAPE127	SEE JANITORIAL.....85	RIGHT STUFF
SEE TAPE	BUTANE TORCH KIT131	SOCKS
BASIN WRENCHES.....15, 137	SEE TORCH KITS	SPEEDY-DRI
BATTERIES.....55	C	SPRAY NINE
DURACELL	CABLE TIES	(KNIGHTS)
EVEREADY	SEE NYLON	THINNER
	CANS – GAS & OIL	TUB & TILE



Table Of Contents

E-mail: info@buglersales.com

CHIP-BOILER BRUSHES.....26	CROWBARS.....45	DWV103
CHISELS.....41&43	NAIL CLAW BAR	SEE PIPE HANGERS
DASCO	CUPS87	E
CAPE	CUTTER WHEELS.....13	EAR PLUGS.....63
CAULKING IRON	D	EASY OUTS.....47
CHOP SAW BLADES.....43	DAP33	EXTRACTORS
CHUCK KEYS.....69	SEE CAULKING	ELECTRICAL & AC SUPPLIES
CIRCLE CUTTERS	DIAL-A-DRILL18	FITTINGS71
CIRCULAR	SEE BITS	HVAC.....71-75
SEE BLADES	DANGER TAPE127	SWITCHES75
CIRCULATOR101	SEE TAPE	TAPE.....127
SEE OIL	DASCO43	TESTERS.....47
CIRCULATOR FLANGES69	SEE CHISELS	WIRE71
CIRCULATOR KITS	DISPENSERS61	ELECTRIC DRILL PUMPS47
SEE HVAC.....71	SEE HAND CLEANER	ENVIRO TUBING
CLAMPS.....103-107	DIXON45	SEE HVAC.....75
SEE PIPE HANGERS	SEE CRAYONS AND	EPOXY-WELD STICK
C-CLAMPS	PENCILS	SEE GLUES.....57
TOP BEAM	ALSO SEE MARKERS	EXPANSION SHIELDS
IDEAL SS HOSE	DL61	SEE ANCHORS.....13
CLAMPS.....63, 65	SEE HAND CLEANER	EXTENSIONS
CLEANING PRODUCTS87	DOPE27	SEE DRILL BITS & SETS
SEE JANITORIAL	SEE BRUSHES	EXTENSION CORDS47
CLEVIS103	DOUBLE EXPANSION SHIELD.....13	EXTRACTORS47, 49
SEE PIPE HANGERS	DOUBLE LOOP	EXTRUCOAT TAPE125
CLOG CHASER45	SEE CHAIN	SEE TAPE
SEE DRAIN CLEANERS	DRAIN CLEANERS.....45	EYE WASH
CLOSE QUARTER59	CLOG CHASER	SEE FIRST AID.....51
SEE SAWS	CLOSET AUGER	F
CLOSET AUGER44	DRAIN KING	FACE MASKS.....49
CLOSET SPUD WRENCHES.....	DRILL HIGH SPEED17-19	FACE SHIELDS.....59
.....43, 137	SEE DRILL BITS & SETS	FALL PROTECTION.....49
CLOTH TAGS125	DRIVE PINS.....111	FAN AND LIMITS75
SEE TAGS	POWER ACTUATED	FAST ORANGE61
CO DETECTOR.....51	DRIVEWAY SEALER.....45	SEE HAND CLEANER
COIL39	DROP CLOTHS.....45	FAST SCREWS
SEE CHAIN	DROP-IN ANCHOR13	SEE SCREWS.....117
COLD PACKS.....51	DROP LIGHT BULBS.....45	FAST TACK ADHESIVES.....77
COMBINATION WRENCHES...	DROP LIGHTS.....47	FAUCET HANDLE PULLERS...49
.....43, 137	EXTENSION CORD	FAUCET NUT SPLITTERS...49
COMPASS SAWS & BLADES...43	ADAPTERS	FAUCET SEAT TOOLS.....49, 137
CONES.....87	DUSTER	FEELER19
CONTACTORS.....71	DRYWALL SCREWS	SEE DRILL BITS & SETS
CONTAINERS	SEE SCREWS.....116	FILES.....49
SEE JANITORIAL	DURACELL BATTERIES55	FIRE EXTINGUISHER.....51
CONSTRUCTION BARS.....45	DUCT CUTTER	FIREPOWER TORCHES.....131
CONSTRUCTION SHOVELS..121	SEE HVAC (TOOLS)	FIRESTOP33
COVERALLS	DUCT SEAL.....71	FIRST AID.....51
SEE TYVEK.....71, 133	DUCT TAPE125	FITTING27
CRAYONS AND PENCILS.....45	SEE TAPE	SEE BRUSHES
DIXON	DUSTER47	FLANGE107
KIEL	DUST MASKS.....43	SEE PIPE HANGERS

**BUGLER SALES CORP.**

Phone: 516 223-3868 • Fax: 516 868-6998

969 CHURCH STREET • BALDWIN, NY 11510

E-mail: info@buglersales.com

FLANGES SEE HVAC.....85	FAST ORANGE GOJO KIMBERLY CLARK (WIPES) TROUNCE	LEADER PIPE & STRAPS...77 LIQUID TIGHT OIL TANK MEASURING STX PIG TAILS.....77 PILOT LIGHTER.....79 RELAYS & ENCLOSURES..79 SWITCHES75 THERMOCOUPLES.....79 THERMOSTATS.....79 THERMOSTAT GUARDS....81 THHN WIRE.....81 TIME DELAYS.....83 TOOLS.....83
FLARES – ROAD.....51	HANGER BOLTS SEE GIMLET ROD.....55	DUCT CUTTER HEX KEY WRENCH TRANSFORMERS.....83
FLARING SETS.....51	HANGER FLANGES SEE PIPE HANGERS....85&87	BELL CONTROL DIGITAL WIRE CONNECTOR.....85 WIRE NUTS.....85
FLASHLIGHTS.....51, 53	HARD HATS & LINERS.....63	
GREATLITE MAGLITE RAY-O-VAC STREAMLIGHT	HARDWARE SEE HVAC.....77	
FLUIDMASTER SEE BALLCOCKS.....15	HEARING PROTECTION.....63	
FOAM SEALANT.....55	HEX BOLTS.....23, 25	
FUNNELS.....55	HEX KEY WRENCH SEE HVAC	
BLITZ	HEX NUTS.....99	
FURNACE CEMENT SEE HVAC.....77	HI-TEMP SILICONE.....33	
G	HOLE SAWS SEE LENOX SECTION	
GASKET SCRAPER71	HOOKS SEE PIPE HANGERS	
GAS VALVES77	HOSES.....63-67	I
GAUGE GLASS CUTTERS.....55	VINYL CLEAR.....65	ICECHOPPERS.....119 ICEMAKERKITS.....85 ICE MELT SEE SHOVELS.....121
GE33	WASHING MACH CLAMPS.....63-65	IDEAL SS HOSE CLAMPS INSERT BITS SEE BITS.....19 INSPECTION MIRRORS.....77
SEE CAULKING	IDEAL COUPLINGS65	
GIMLET RODS.....55	ADAPTERS.....55&57	
GLOVES.....57	NOZZLES, MENDERS & WASHERS.....57	
GLUE & EPOXY.....57	HVAC CONTROLS & ACCESSORIES.....67-85	
GOGGLES.....59	AC DISCONNECTS.....67	
GOJO SEE HAND CLEANER	AC WHIPS.....67	
GOOF OFF87	ALUMINUM TUBE.....67	
GOOP57	ANTI-SIEZE.....67	
GRAFITTI REMOVAL SEE JANITORIAL87	CANS & OILERS.....69	
GREAT NECK SEE PLIERS59	CIRCLE CUTTERS.....69	
GREASE & GREASE GUNS...59	CIRCULATOR KITS.....71	
GREZ OFF41	CLEANING & DEODORIZING CONTACTORS.....71	
SEE CHEMICALS	DUCT SEAL.....71	
GRIT & SAND CLOTH.....59	ELECTRICAL BX & COVERS ELECTRICAL TESTERS.....75	
GROUT & SPACKLE.....59	ENVIRO TUBING.....75	
H	FAST TACK ADHESIVES....75	
HACKSAWS & BLADES.....59	FLANGES.....69	
GREAT NECK NICHOLSON	FURNACE CEMENT.....77	
HACKSAW ROD SEE SAWS	GASKET SCRAPERS.....71	
HAMMERS.....59	GREENFIELD HARDWARE77	
HAMMER DRIVE PINS.....111	INSPECTION MIRRORS.....77	
HANDCLEANER.....61		
ANTISEPTIC CELLO DL DISPENSERS		



BUGLER SALES CORP.

Phone: 516 223-3868 • Fax: 516 868-6998
 969 CHURCH STREET • BALDWIN, NY 11510

E-mail: info@buglersales.com

URINAL BLOCK
 VEHICLE MAINTENANCE
 WASHER FLUID

K

KARNAK39
 SEE CEMENT
 KEY AIR VENTS111
 KEYS (B-TANK)
 SEE TORCH KITS
 KEYHOLE SAWS & BLADES.....91
 KEIL
 SEE CRAYONS.....45
 KIMBERLYCLARK(WIPES).....61
 SEE HAND CLEANER
 KNEE BRACKETS.....106
 KNEE PADS.....96
 KNIVES.....91
 ARDELL
 STANLEY (USA)
 SHEFFIELD
 KRYLON.....101
 ALSO SEE KRYLON SECTION

L

LAG DRIVERS.....91
 ACOUSTICAL
 LAG SCREWS
 SEE SCREWS
 LAG SHIELDS
 SEE ANCHORS.....13
 LAMPWICK.....91
 KWIK WICK
 LEAD SHIELDS
 SEE ANCHORS.....11
 LENOX
 SEE LENOX SECTION
 LEADERS/STRAPS
 ALSO SEE BLADES
 LEVELS.....91, 93
 LIGHTBULBS.....93
 LINERS
 SEE HARD HATS.....63
 LIQUID WAX91
 SEE JANITORIAL
 LOCKS.....93&95
 MASTERLOCK
 LONG HANDLE BRUSHES
 SEE BRUSHES
 LUBE OIL101
 SEE OIL
 LUFKIN
 RULERS.....113

M

MAGLITE
 SEE FLASH LIGHTS
 MANILA TAGS
 SEE TAGS
 MAPP GAS TORCH KIT
 SEE TORCH KITS.....107
 MAPS.....95
 HAGSTROM
 MARKERS.....95
 DIXON
 REDISHARP
 SHARPIES
 MASKING TAPE
 SEE TAPE.....127
 MASON LINE.....97
 MASONRY
 SEE BITS
 MASONRY AND LANDSCAPING
 TOOLS.....97
 MATCH HOLDER125
 SEE STRIKERS
 MEASURING TAPE113
 SEE TAPE
 MILWAUKEE SAWZALL KIT...97
 MIXER.....97
 FOR PAINT/ CEMENT
 MOPS89
 MUNGO
 SEE ANCHORS.....13
 MURIATIC ACID
 SEE CHEMICALS.....41

N

NAIL13
 SEE ANCHORS
 NAIL CLAW BAR
 SEE CROWBARS
 NATIC
 SEE PIPE HANGERS
 NIPPLE TRAYS.....97
 NO-HUB COUPLINGS65
 NO-HUB WRENCHES.....97, 139
 NUT DRIVERS.....97
 NUTS.....99
 HEX
 NUTSETTERS.....99
 NYLON TIES.....99

O

OAKUM33
 OIL.....101
 CIRCULATOR
 CUTTING

HYDRAULIC
 LUBE OIL
 OIL STICK
 PIPE BREAK
 WD-40
 OIL DRI PADS & SOCKS.....41
 OIL STICK
 SEE OIL
 O-RING PULLER.....101
 OSBOURNE BIBB SEAT
 REAMERS.....16

P

PACKING125
 SEE TAPE
 PADS41
 SEE CHEMICALS
 PAILS87
 SEE JANITORIAL
 PAINT.....101
 PAINT ALL
 KRYLON
 ALSO SEE KRYLON SECTION
 PAINT BRUSHES.....13
 PAINTERS TAPE127
 SEE TAPE
 PAPER TOWELS
 SEE JANITORIAL
 PEGBOARD HOOKS.....103
 PENCILS.....
 PERMATEX.....33/39/41/57/67/77
 SEE CHEMICALS.....39, 41
 PHENOSEAL.....30&31
 PICK-UP TOOL.....103
 PIG TAILS
 SEE HVAC.....77
 PILOT BITS.....21
 PINS & LOADS111
 PIPE BREAK.....101
 PIPE HANGERS.....103-107
 BEAM
 BELL
 CLEVIS
 DWV
 FLANGE
 J-HOOKS
 KNEE BRACKET.....107
 NATIC
 RISER
 ROD COUPLING.....107
 THREADED ROD.....107
 HOOKS.....107
 STRAPS.....109

**BUGLER SALES CORP.**

Phone: 516 223-3868 • Fax: 516 868-6998

969 CHURCH STREET • BALDWIN, NY 11510

E-mail: info@buglersales.com

WRENCHES.....109, 139
 PLASTER OF PARIS.....109
 PLASTIC SHEETING87
 PLIERS.....109
 GREAT NECK
 CHANNELLOCK
 PLUG WRENCHES.....109, 139
 PLUMB BOBS.....109
 PLUNGERS.....109
 POCKET THERMOMETER.....63
 POINTING TROWELS.....111
 POLY13
 SEE ANCHORS
 POWER ACTUATED & HAMMER
 DRIVE TOOLS.....111
 PROPANE TORCH KIT
 SEE TORCH KITS.....107
 PROSNIP
 SEE SNIPS
 PROTECTOR PLATES
 SEE STUD GUARDS.....101
 PUTTY KNIVES
 & SCRAPERS.....111
 PVC CUTTER.....111

R

RADIATOR KEYS
 & AIR VALVES.....111
 SPUD WRENCH.....111
 TOOL.....111
 RAGS.....111, 113
 SHOP WIPES
 PLUMBERS CLOTH
 RAIN SUITS.....113
 SLUSH BOOTS
 RAYOVAC
 SEE BATTERIES
 RECIPROCATING
 SAW BLADES.....113
 ALSO SEE LENOX
 REDI-SHARP MARKERS
 REINFORCING TAPE
 SEE TAPE
 RELAYS (BETA)
 SEE HVAC.....79
 RENEWAL FLINT
 SEE STRIKERS
 RESPIRATORS
 SEE FACE MASKS
 RESTROOM PRODUCTS89
 SEE JANITORIAL
 RIGHT STUFF
 SEE CHEMICALS

RISERS
 SEE PIPE HANGERS
 RIVET GUNS & PINS..... 91&93
 ROD COUPLING.....89
 ROD THREADED.....89
 ROLL TOWELS
 SEE JANITORIAL
 ROOF
 SEE CEMENT.....
 ROSIN PAPER.....44, 113
 RULES & TAPES.....112
 MONSTER TAPE
 SEE LUFKIN.....76&77

S

SAKRETE
 SEE CEMENT.....39
 SAMMY SUPER
 SEE SCREWS.....116
 SAND CLOTH
 SEE GRIT CLOTH.....59
 SAFETY EQUIPMENT...
 41,43,51,69
 SAWS.....49
 CHEESE
 CLOSE QUARTER
 COMPASS.....42
 HACKSAW
 ROD.....49
 ALSO SEE LENOX
 SCOTCH BRITE PADS.....
113
 SCREW & ANCHOR KITS....113
 BT 400 KITS
 SCREWDRIVERS.....119
 ENDERES
 CHANNELLOCK
 SCREW EXTRACTOR
 SEE EXTRACTOR.....41
 SCREWS.....116-117
 DRYWALL
 FAST/ SELF-TAP
 LAG
 SAMMY SUPER
 SHEET METAL
 SCRUBS61, 71
 SDS21
 SEE BITS
 SEALING/PACKING TAPE
 SEE TAPE.....127
 SEAT COVERS89
 SEE JANITORIAL
 SEATING TOOLS.....49

ANGLED
 STRAIGHT
 SELF DRILL13
 SEE ANCHORS
 SELF TAP SCREWS.....117
 SETTING TOOLS
 SEE ANCHORS.....11
 SHARPIES
 SEE MARKERS
 SHEET METAL SCREWS
 SEE SCREWS.....
 SHEETROCK.....119
 SHEFFIELD KNIVES.....
 SEE KNIVES
 SHOTS & PINS111
 SHOVELS.....119, 121
 ASH
 CONSTRUCTION
 SNOW
 TRENCHING
 SHOWER BODY
 SOCKET SETS.....121
 SHRINK WRAP.....121
 SILICONE
 SEE CAULK.....27
 SILLCOCK KEYS.....121, 139
 SIMPLE GREEN87
 SINK HOLE CUTTERS.....99
 SKWRENCHES.....121, 139
 SLAT HOOKS103
 SLEEVE13
 SEE ANCHORS
 SMOKEPIPE TOOLS.....120
 SMOKE DETECTOR.....51
 SNIPS.....121
 PROSNIP
 WISS
 SNOW SHOVELS121
 SOCKET SETS
 & RATCHETS.....121
 SOCKS
 SEE CHEMICALS
 SOLDERING GUNS.....123
 SPACKLE.....
 SPADE BITS.....21, 23
 SPEEDBORE21, 23
 SEE BITS
 SPEEDY DRI.....41
 SPLINE22
 SEE BITS
 SPONGES88
 SEE JANITORIAL



BUGLER SALES CORP.

Phone: 516 223-3868 • Fax: 516 868-6998
 969 CHURCH STREET • BALDWIN, NY 11510

PAGE

9

E-mail: info@buglersales.com

SPRAY BOTTLES.....123	SEE HVAC.....79	VESTS SAFETY135
SPRAY NINE (KNIGHTS) SEE CHEMICALS	THERMOMETER SEE HVAC.....79	WISE GRIPS.....135
SPRAY PAINT.....83 ALSO SEE KRYLON	THERMOSTATS.....79, 81 LOW VOLTAGE HIGH VOLTAGE DIGITAL	W
SQUARES.....123 COMBINATION RAFTER	THERMOSTAT GUARDS.....81	WALLBOARD SAWS135
SQUEEGEE.....91	THERMOSTAT WIRE.....81	WASHER FLUID SEE JANITORIAL
STAPLERS & STAPLES.....123	THHN WIRE SEE HVAC.....81-83	WASHERS.....135
STEEL WOOL.....123	THINNER SEE CHEMICALS	WASTE WRENCHES.....139
STOVE BOLTS.....25	THREADED ROD.....107	WATER HEATER WRENCH.....139
STOVE (BUTANE) SEE TORCH KIT.....131	13PCSET.....19 SEE BITS, DRILL	WD40 SEE OIL.....101
REFILLS	TIE WIRE.....129	WHIPS, AC67
STRAP WRENCHES.....123, 139	TIRE PUMP.....129	WHITE LIGHTNING33
STRAPS SEE PIPE STRAPS.....77	TOGGLE BOLTS & WINGS25	WICKING111
STREAMLIGHT..... SEE FLASH LIGHTS	TOILET TISSUE (ALL SIZES) SEE JANITORIAL	WINDSHIELD WASHER FLUID
STRETCHCORD.....123-125 CARGO/ VERSA	TOOLBOXES.....131	WIPES.....61,71,75,77
STRIKERS.....125 BARBEQUE LIGHT MATCH HOLDER RENEWAL FLINT	TOP BEAM SEE CLAMPS	WIRE BRUSHES
SRUCTOLITE77	TORCH KITS131 BUTANE MAPP GAS PROPANE	WIRE NUTS SEE WIRE CONNECTORS 85
STUD GUARDS.....124	TRANSFORMERS.....131	WIRE STRIPPERS.....113
SURGE PROTECTORS.....47	TRENCHING SHOVELS	WISS121 SEE SNIPS
SWEDGING TOOLS.....125	TROUBLE LIGHTS.....39	WOOD SCREWS SEESCREWS.....78&79
T	TROUNCE SEE HAND CLEANER	WRENCHES SEE PIPE HANGERS
TAGS.....125 MANILA CLOTH	TROWELS39	WRENCHES.....137-139 ADJUSTABLE15, 137
TAP & DRILL SEE BITS	TUB & TILE SEE CHEMICALS	BASIN15, 137
TAPE.....125, 127 BARRIER CAUTION DANGER DUCT ELECTRICAL EXTRUCOAT MASKING MEASURING PACKING PAINTERS REINFORCING SEALING	TUBING CUTTERS & WHEELS.....109&111	CHAIN39, 137
TAPS & TAP WRENCHES.....126	21 PC SET19 SEE BITS	CLOSET SPUD43, 137
TARPS.....129	29PC HOUT.....19 SEE BITS	COMBINATION43, 137
THERMOCOUPLES	TWINE & ROPE.....133	FAUCET SEAT49, 137
	TYVEK COVERALLS.....133	NO-HUB97, 139
	U	PIPE109, 139
	URINAL BLOCK89 SEE JANITORIAL	PLUG109, 139
	V	RADIATOR SPUD111, 139
	_VALVE TAGS132	SHOWER BODY121, 139
	VARI BITS SEE LENOX SECT.	SOCKET SETS
	VEHICLE MAINTENANCE89	SILLCOCK KEYS121, 139
		SK121, 139
		STRAP123, 139
		WASTE139
		WATER HEATER139
		Z
		ZIP-ITS13 SEE ANCHORS

Quantity Breaks are available on items marked with this symbol



order online at • WWW.BUGLERSALES.COM



BUGLER SALES CORP.

Phone: 516 223-3868 • Fax: 516 868-6998
969 CHURCH STREET • BALDWIN, NY 11510

E-mail: info@buglersales.com



ALLEN TYPE KEYS

- High torque industrial steel
- Color coded

- Inch - Yellow
- Metric - Red
- Torx - Green
- In/mm - Orange

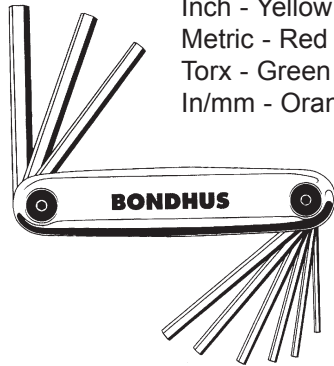

ADJUSTABLE WRENCHES



BN15532



BN12137



BN15232

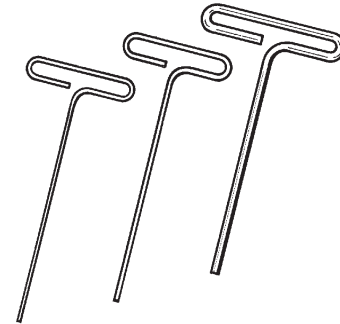

LOOP GRIP T-HANDLE
HEX KEYS
INCH & METRIC



ALL SIZES
AVAILABLE



HX56005

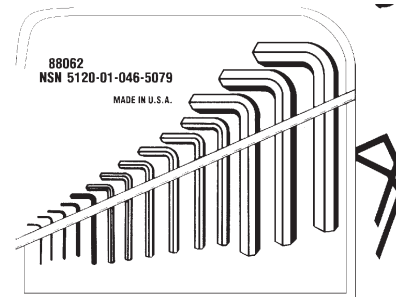

HX55023

METRIC / BALL / TORX / T-HANDLE / REGULAR



BUGLER SALES CORP.

Phone: 516 223-3868 • Fax: 516 868-6998
 969 CHURCH STREET • BALDWIN, NY 11510

E-mail: info@buglersales.com

NUMBER	DESCRIPTION	PK	RESALE	COST
ADJUSTABLE WRENCHES GREAT NECK				
GNAW4C	4" ADJUSTABLE WRENCH	6		
GNAW6C	6" ADJUSTABLE WRENCH	6		
GNAW8C BEST SELLER	8" ADJUSTABLE WRENCH	6		
GNAW10C BEST SELLER	10" ADJUSTABLE WRENCH	6		
GNAW12C	12" ADJUSTABLE WRENCH	6		
SEE CHANNELLOCK SECTION FOR MORE ADJUSTABLE WRENCHES				
ALLEN TYPE KEYS • HEXCRAFT • BONDHUS • EKLIND				
HX56005	3/32 SHORT ARM HEX KEY	25		
HX56006	1/8 SHORT ARM HEX KEY	25		
HX56009	5/32 SHORT ARM HEX KEY	25		
HX56013	5/16 SHORT ARM HEX KEY	25		
HX56014	3/8 SHORT ARM HEX KEY	25		
HX56015	7/16 SHORT ARM HEX KEY	2		
HX56016	1/2 SHORT ARM HEX KEY	2		
HX56018	5/8 SHORT ARM HEX KEY	20		
HX56019	3/4 SHORT ARM HEX KEY	5		
BN12137 BEST SELLER	13 PC. HEX KEY SET W/HOLDER LONG	5		
BN12237	13 PC. HEX KEY SET W/HOLDER SHORT	5		
BN12585 BEST SELLER	12585 5 PC. FOLDING HEX SET TO 3/8	6		
BN12589 BEST SELLER	12589 9 PC. FOLDING HEX SET 5/64-1/4	10		
BN12591	12591 8 PC. FOLDING HEX SET .05-3/16	12		
BN15207	1/8" x 6" VINYL GRIP T-HANDLE	10		
BN15209	5/32" x 6" VINYL GRIP T-HANDLE	10		
BN15210	3/16" x 6" VINYL GRIP T-HANDLE	10		
BN15307	1/8" x 9" COATED T-HANDLE	10		
BN15309	5/32" x 9" COATED T-HANDLE	10		
BN15310	3/16 x 9" COATED T-HANDLE	10		
BN15407 BEST SELLER	1/8 x 6" WIRE T-HANDLE HEX KEY	10		
BN15409 BEST SELLER	5/32x 6" WIRE T-HANDLE HEX KEY	10		
BN15410	3/16 x 6" WIRE T-HANDLE HEX KEY	10		
BN15507	1/8 x 9" WIRE T-HANDLE HEX KEY	10		
BN15509	5/32 x 9" WIRE T-HANDLE HEX KEY	10		
BN15510	3/16 x 9" WIRE T-HANDLE HEX KEY	10		
BN15232	8 PC. 6" T-HANDLE SET COATED 3/32-1/4	EA		
BN15532	8 PC. 9" T-HANDLE SET 3/32-1/4	EA		
HX55090	8 PC. 9" COATED T-HANDLES 3/32-1/4	6		
HX55000	55000 7 PC. HEX KEY SET SHORT	6		
HX55005 BEST SELLER	55005 9 PC. HEX KEY SET 6" LONG	6		
HX55023	55023 20 PC. HEX KEY SET .028-3/4	5		
METRIC, BALL END, TORX				
BN10937	1093713 PC. HEX KEY W/HOLDER BALL (.05-3/8)	5		
BN10999	10999 9 PC. HEX KEY SET W/HOLDER METRIC (1.5-10)	5		
BN12550	12550 12PC INCH/METRIC SET FOLDING	6		
BN12587	12587 7 PC. FOLDING METRIC SET (2mm-8mm)	6		
BN12592	12592 7 PC. FOLDING METRIC SET (1.5mm-6mm)	6		
BN12595	12595 6 PC. METRIC SET (3mm-10mm)	6		
BN12897	12897 5 PC. FOLDING METRIC BALL END SET (5mm-10mm)	6		
BN12632	12632 8 PC. FOLDING TORX (T6-T25)	6		



BUGLER SALES CORP.

Phone: 516 223-3868 • Fax: 516 868-6998
969 CHURCH STREET • BALDWIN, NY 11510

E-mail: info@buglersales.com

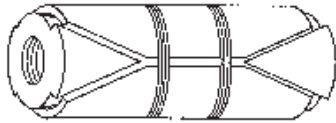

DOUBLE EXPANSION SHIELDS



DROP IN ANCHORS



SETTING TOOL



LAG SHIELD ANCHORS

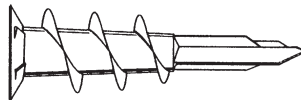

ZIP-ITS

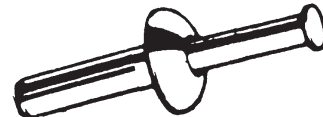

NAIL ANCHORS

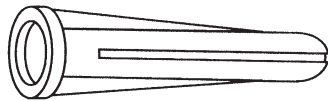

POLY SCREW ANCHORS

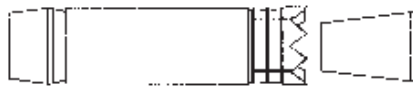

SELF DRILLING ANCHORS



SLEEVE ANCHORS



WEDGE ANCHOR



MUNGO PLUG WEDGE SET

DOUBLE EXPANSION ANCHOR / DRILL CHART

SIZE	BOX QUANTITY	DRILL SIZE	ANCHOR LENGTH	ULTIMATE PULLOUT LBS.	ULTIMATE SHEAR LBS.
1/4	100	1/2"	1-3/8"	1,850	2,650
3/8	50	3/4"	2"	4,010	4,340
1/2	50	7/8"	2-1/2"	4,600	8,790
5/8	25	1"	2-3/4"	5,950	13,000
3/4	10	1-1/4"	2-7/8"	9,350	16,200



BUGLER SALES CORP.

Phone: 516 223-3868 • Fax: 516 868-6998
 969 CHURCH STREET • BALDWIN, NY 11510

E-mail: info@buglersales.com

NUMBER		DESCRIPTION	PK	RESALE	COST
ALLEN TYPE KEYS • HEXCRAFT • BONDHUS <i>continued...</i>					
BN12634		12634 8 PC. FOLDING TORX (T9-T40)	6		
BN12894		12894 5 PC. BONDHUS BALL END SET (3/16 - 3/8)	6		
BN13354		13354 2.5mm COATED T-HANDLE	10		
BN13360		13360 4mm x 5.3 COATED T-HANDLE	10		
BN13364		13364 5mm x 5.9 COATED T-HANDLE	10		
EK15232	NEW	15232 1/2" X 8" LONGARM HEX KEY	5		
EK15308	NEW	15308 1/8" X 6" LONGARM HEX KEY	5		
EK15310	NEW	15310 5/32 X 6" LONGARM HEX KEY	5		
OTHER SIZES AND STYLES ALLEN WRENCHES & HEX KEYS ARE AVAILABLE					
ANCHORS, BUGLER					
A0200	BEST SELLER	1/4 DOUBLE EXPANSION SHIELD EA.	100		
A0201	BEST SELLER	3/8 DOUBLE EXPANSION SHIELD EA.	50		
A0202		1/2 DOUBLE EXPANSION SHIELD EA.	25		
A0203		5/8 DOUBLE EXPANSION SHIELD EA.	25		
A0204		3/4 DOUBLE EXPANSION SHIELD EA.	10		
A0170	BEST SELLER	1/4 DROP IN ANCHOR EA.	100		
A0171	BEST SELLER	3/8 DROP IN ANCHOR EA.	50		
A0172		1/2 DROP IN ANCHOR EA.	50		
A0173		5/8 DROP IN ANCHOR EA.	25		
A0174		3/4 DROP IN ANCHOR EA.	25		
A0180		ST 1/4 DROP IN SETTING TOOL	EA		
A0181		ST 3/8 DROP IN SETTING TOOL	EA		
A0182		ST 1/2 DROP IN SETTING TOOL	EA		
A0183		ST 5/8 DROP IN SETTING TOOL	EA		
A0184		ST 3/4 DROP IN SETTING TOOL	EA		
A0227		3/8 SHORT LAG SHIELD (EA)	50		
A0233		3/8 LONG LAG SHIELD (EA)	25		
A0307	NEW	1/4 X 1-3/8 MUNGO NYLON PLUGS (100)	EA		
A0308	NEW	5/16 X 1-1/2 MUNGO NYLON PLUGS (100)	EA		
PW2808		1/4 X 1 NAIL ANCHOR (EA)	100		
PW2814		1/4 X 1-1/4 NAIL ANCHOR (EA)	100		
PW2820		1/4 X 1-1/2 NAIL ANCHOR (EA)	100		
A0150		6-8 POLY SCREW ANCHOR (EA)	100		
A0151	BEST SELLER	10-12 POLY SCREW ANCHOR (EA)	100		
A0191	BEST SELLER	3/8 SELF DRILL ANCHOR (EA)	50		
AS38178		3/8 X 1-7/8 SLEEVE ANCHOR W/HEX NUT	100		
AS38300		3/8 X 3 SLEEVE ANCHOR W/HEX NUT	100		
AS38400	NEW	3/8 X 4 SLEEVE ANCHOR (EA) HEX	50		
AS12300		1/2 X 3 SLEEVE ANCHOR W/HEX NUT	100		
AS12400	NEW	1/2 X 4 SLEEVE ANCHOR (EA) HEX	25		
AST38300	NEW	3/8 X 3 SET ANCHOR (EA)	25		
AW12275	NEW	1/2 X 2-3/4 WEDGE ANCHOR (EA)	50		
AW12375	NEW	1/2 X 3-3/4 WEDGE ANCHOR (EA)	50		
AW38275	NEW	3/8 X 2-3/4 WEDGE ANCHOR (EA)	100		
AW38300	NEW	3/8 X 3 WEDGE ANCHOR (EA)	100		
AW38375	NEW	3/8 X 3-3/4 WEDGE ANCHOR W/NUTWSH	100		
PW2345		POWERS NYLON ZIP IT ANCHORS (100)	10		
PW2346		POWERS METAL ZIP IT ANCHORS (100)	10		
PW2367		POWERS ZIP IT JR KIT	10		



BUGLER SALES CORP.

Phone: 516 223-3868 • Fax: 516 868-6998
969 CHURCH STREET • BALDWIN, NY 11510

E-mail: info@buglersales.com

Great Neck



GNSC5C

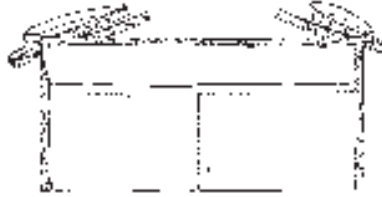

APRONS

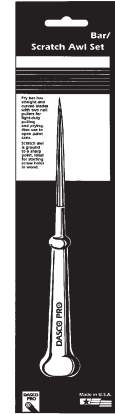

DA431-0

FLUIDMASTER, INC.

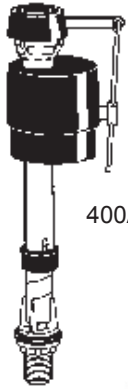

400A

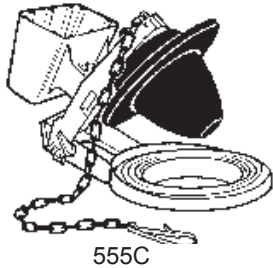

555C

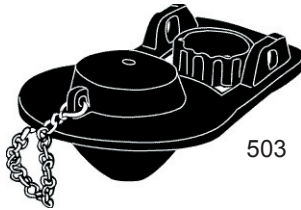

503

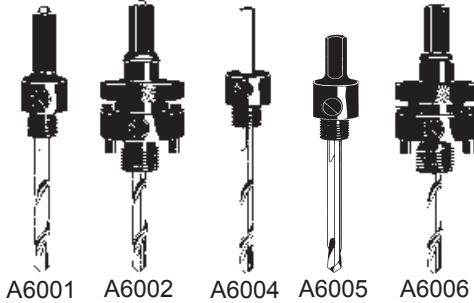

A6001

A6002

A6004

A6005

A6006

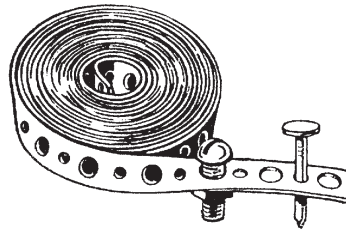

B0086
ALTERNATING HOLE SIZES

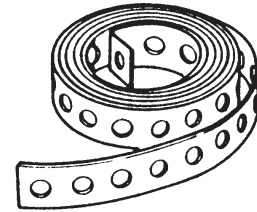

BAND IRON
COPPER CLAD □ STEEL
GALVANIZED □ PVC



COMPOUND
TUBING
BENDER



W4900
COMBO WRENCH



BENDING SPRINGS

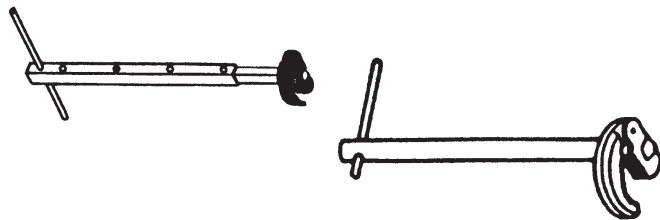

BASIN WRENCHES
REGULAR & HEAVY DUTY



PIPE & TUBING
CUTTING
WHEELS





BUGLER SALES CORP.

Phone: 516 223-3868 • Fax: 516 868-6998
 969 CHURCH STREET • BALDWIN, NY 11510

E-mail: info@buglersales.com

NUMBER		DESCRIPTION	PK	RESALE	COST
APRONS					
MCC17		2 POCKET CANVAS	10		
ARBORS (FOR HOLESAWS)					
A6001		#1 7/16" HEX ARBOR	EA		
A6002		#2 7/16" HEX ARBOR	EA		
A6004		#4 1/4" HEX ARBOR	EA		
A6005		#5 3/8" HEX ARBOR	EA		
A6006		#6 3/8" HEX ARBOR	EA		
B0290	BEST SELLER	1/4 PILOT BIT (FIT ALL)	10		
AWLS					
GNSC5C		SC5C GREAT NECK WOOD HDL. STEEL SHAFT	6		
DA4310	BEST SELLER	431-0 DASCO ALL STEEL AWL	5		
BALLCOCKS, FLUIDMASTER					
FM400A	BEST SELLER	ANTI-SYPHON	25		
FM503	NEW	503 FLUIDMASTER FLAPPER BLACK	20		
FM555C		FLUSHER FIX IT KIT	20		
FM242		REPLACEMENT SEAL	6		
BAND IRON TYPE HANGER STRAPPING - USA					
B0075	BEST SELLER	3/4 X 10' BAND IRON	50		
B0076		3/4 X 50' BAND IRON	10		
B0077	BEST SELLER	3/4 X 10' BAND IRON COPPER CLAD	50		
B0078		3/4 X 50' BAND IRON COPPER CLAD	10		
B0079		3/4 x 10' GALVANIZED BAND IRON	50		
B0082		3/4 X 100' BAND IRON	5		
B0083		3/4 X 10' BAND IRON HEAVY DUTY	50		
B0085		3/4 x 100' PLASTIC HANGER STRAPPING .05	10		
B0086		3/4 x 10' GALV. BAND IRON/ALT.HOLE	50		
ADDITIONAL SIZES AND GAUGES AVAILABLE					
BASIN WRENCHES					
W4981		11" BASIN WRENCH	EA		
W4982		15" BASIN WRENCH	EA		
W4980		ADJ. BASIN WRENCH 16-1/2"	EA		
W4985	BEST SELLER	ADJ. HEAVY DUTY BASIN WRENCH	6		
W4900	BEST SELLER	SLIP & LOCK NUT ADJ.	EA		
BENDING SPRINGS & TOOLS • GENERAL					
GE100-1/4		1/4" OD TUBE BENDING SPRING	6		
GE100-3/8	BEST SELLER	3/8" OD TUBE BENDING SPRING	6		
GE100-1/2		1/2" OD TUBE BENDING SPRING	6		
GE100-5/8		5/8" OD TUBE BENDING SPRING	6		
GE100-7/8		7/8" OD TUBE BENDING SPRING	6		
GE153		#153 COMPOUND TUBING BENDER 1/8-3/8	2		
GN25125		UP TO 1/2" OD TUBE BENDER	4		
BERKLEY PIPE CUTTER WHEELS					
RIDGID NO.					
BT-01000	BEST SELLER	33105 OR F-3 2" HEAVY DUTY	10		
BT-01100		33100 OR F-514 2" THIN	10		
BT-04000		33125 OR F-229 4" HEAVY DUTY	10		
BT-04100		33120 OR F-515 4" THIN"	10		



BUGLER SALES CORP.

Phone: 516 223-3868 • Fax: 516 868-6998
969 CHURCH STREET • BALDWIN, NY 11510

E-mail: info@buglersales.com



PIPE & TUBING
CUTTING
WHEELS



PIPE DIES

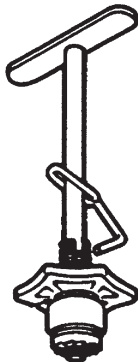

GOOD
B0126

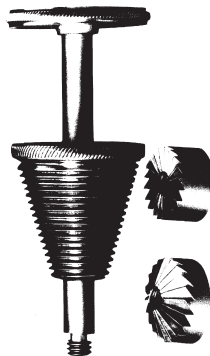

BETTER
B0125

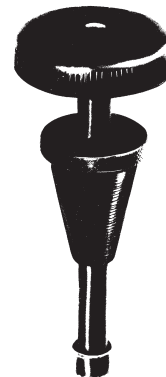

BEST
B0127



AUGER BITS

HIGH SPEED DRILL BITS





BUGLER SALES CORP.

Phone: 516 223-3868 • Fax: 516 868-6998
 969 CHURCH STREET • BALDWIN, NY 11510

E-mail: info@buglersales.com

NUMBER		DESCRIPTION	PK	RESALE	COST
BERKLEY TUBING CUTTER WHEELS					
RIDGID NO.					
BT-01500	BEST SELLER	33160 OR F158 THIN FITS #10,15,20	12		
BT-01210	BEST SELLER	33165 OR E1240 HVY DUTY #10,15,20	12		
BT-02500		33170 OR E2558 THIN	6		
BT-02110		33175 OR E2191 HEAVY DUTY	6		
BT-03400	BEST SELLER	33185 OR E3469 THIN FITS 103,104"	12		
BT-04500		33190 OR E4546 HEAVY DUTY	6		
BT-9015		IMPERIAL CUTTER WHEEL - FITS IMPERIAL 174-F 12			
BERKLEY PIPE DIES					
RIDGID NO.					
BT-00002		37820 3/8" NPT ALLOY PIPE DIES	EA		
BT-00003	BEST SELLER	37825 1/2" NPT ALLOY PIPE DIES	EA		
BT-00004	BEST SELLER	37830 3/4" NPT ALLOY PIPE DIES	EA		
BT-00005	BEST SELLER	37835 1" NPT ALLOY PIPE DIES	EA		
BT-00006		37840 1-1/4" NPT ALLOY PIPE DIES	EA		
BT-00007		37845 1-1/2" NPT ALLOY PIPE DIES	EA		
BT-00008		37850 2" NPT ALLOY PIPE DIES	EA		
BIBB SEAT REAMERS					
B0126		#1301 MELLARD FAUCET FIXER	6		
B0125	BEST SELLER	#500 BIBB SEAT REAMER STEEL CONE	EA		
B0127		#4170L BIBB SEAT REAMER BRONZE 8"	EA		
BITS, AUGER (ELECTRICIANS) • IRWIN					
IR49910		5/8" AUGER BIT	6		
IR49912	BEST SELLER	3/4" AUGER BIT	6		
IR49914	BEST SELLER	7/8" AUGER BIT	6		
IR49916	BEST SELLER	1" AUGER BIT	6		
IR49918		1-1/8" AUGER BIT	3		
IR49920		1-1/4" AUGER BIT	3		
IR49922		1-3/8" AUGER BIT	3		
IR49924		1-1/2" AUGER BIT	3		
BITS, DRILL					
B0200		1/16 HIGH SPEED DRILL BIT	12		
B0201		5/64 HIGH SPEED DRILL BIT	12		
B0202		3/32 HIGH SPEED DRILL BIT	12		
B0203		7/64 HIGH SPEED DRILL BIT	12		
B0204	BEST SELLER	1/8 HIGH SPEED DRILL BIT	12		
B0205		9/64 HIGH SPEED DRILL BIT	12		
B0206		5/32 HIGH SPEED DRILL BIT	12		
B0207		11/64 HIGH SPEED DRILL BIT	12		
B0208	BEST SELLER	3/16 HIGH SPEED DRILL BIT	12		
B0209		13/64 HIGH SPEED DRILL BIT	12		
B0210		7/32 HIGH SPEED DRILL BIT	12		
B0211		15/64 HIGH SPEED DRILL BIT	12		
B0212	BEST SELLER	1/4 HIGH SPEED DRILL BIT	12		
B0213		17/64 HIGH SPEED DRILL BIT	12		
B0214		9/32 HIGH SPEED DRILL BIT	12		
B0215		19/64 HIGH SPEED DRILL BIT	12		
B0216	BEST SELLER	5/16 HIGH SPEED DRILL BIT	6		



E-mail: info@buglersales.com

DIAL-A-DRILL

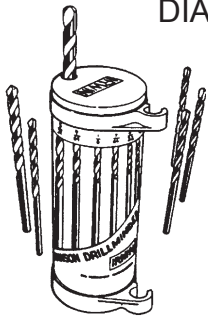

13pc.

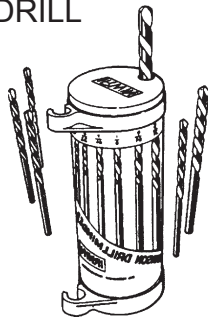

21pc.

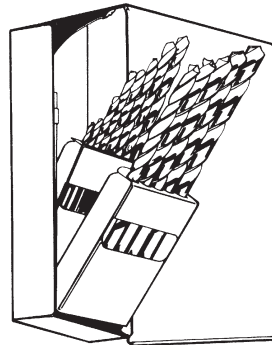

B0245



REDUCED SHANK DRILL BITS



WIRE SIZE DRILL BITS

IRWIN
Industrial Tools



FEELER BITS
1/4", 3/8", 1/2"



CARBIDE TIPPED
FEELER BITS



MA49438
LOCATER DRIVER



B0152



PHILLIPS INSERT
BITS



SLOTTED INSERT
BITS



MASONRY BITS
PERCUSSION INDUSTRIAL GRADE



BUGLER SALES CORP.

Phone: 516 223-3868 • Fax: 516 868-6998
 969 CHURCH STREET • BALDWIN, NY 11510

E-mail: info@buglersales.com

NUMBER		DESCRIPTION	PK	RESALE	COST
BITS, DRILL <i>continued...</i>					
B0217		21/64 HIGH SPEED DRILL BIT	6		
B0218	BEST SELLER	11/32 HIGH SPEED DRILL BIT	6		
B0219		23/64 HIGH SPEED DRILL BIT	6		
B0220	BEST SELLER	3/8 HIGH SPEED DRILL BIT	6		
B0221		25/64 HIGH SPEED DRILL BIT	6		
B0222		13/32 HIGH SPEED DRILL BIT	6		
B0223		27/64 HIGH SPEED DRILL BIT	6		
B0224	BEST SELLER	7/16 HIGH SPEED DRILL BIT	6		
B0225		29/64 HIGH SPEED DRILL BIT	6		
B0226		15/32 HIGH SPEED DRILL BIT	6		
B0227		31/64 HIGH SPEED DRILL BIT	6		
B0228	BEST SELLER	1/2 HIGH SPEED DRILL BIT	6		
B0240	BEST SELLER	13 PC. DIAL A DRILL SET 1/16-1/4	EA		
B0241		21 PC. DIAL A DRILL SET 1/16-3/8	EA		
B0245		29 PC. HUOT DRILL BIT SET 1/16-1/2	EA		
B1577	BEST SELLER	#7 H.S. DRILL BIT FOR 1/4-20 TAP	12		
B1591		#21 H.S. DRILL BIT FOR 10-32 TAP	12		
B1595		#25 H.S. DRILL BIT FOR 10-24 TAP	12		
B1599	BEST SELLER	#29 H.S. DRILL BIT FOR 8-32 TAP	12		
B1606		#36 H.S. DRILL BIT FOR 6-32TAP	12		
B1503		5/16 x 1/4 REDUCED SHANK HSS DRILL BIT	6		
B1507	BEST SELLER	3/8 x 1/4 REDUCED SHANK HSS DRILL BIT	6		
B1511		7/16 x 1/4 REDUCED SHANK HSS DRILL BIT	6		
B1515		1/2 x 1/4 REDUCED SHANK HSS DRILL BIT	6		
MA14613		5/8 X 1/2 REDUCED SHANK HSS DRILL BIT	1		
MA14625		3/4 X 1/2 REDUCED SHANK HSS DRILL BIT	1		
BITS, FEELER • IRWIN INDUSTRIAL TOOLS					
IR38904		1/4" x 12" FEELER BIT	6		
IR39104	BEST SELLER	1/4" x 18" FEELER BIT	6		
IR39504	BEST SELLER	1/4" x 24" FEELER BIT	6		
IR39106		3/8" x 18" FEELER BIT	6		
IR39506		3/8" x 24" FEELER BIT	6		
IR39108		1/2" x 18" FEELER BIT	1		
IR40004		1/4" x 18" CARBIDE TIPPED FEELER BIT	1		
IR40006		3/8" x 18" CARBIDE TIPPED FEELER BIT	1		
BITS, INSERT					
B0131		P1 PHILLIPS	25		
B0132	BEST SELLER	P2 PHILLIPS	25		
B0133		P3 PHILLIPS	25		
B0134		P1-2 PHILLIPS 2"	25		
B0135	BEST SELLER	P2-2 PHILLIPS 2"	25		
B0142		S-5 SLOTTED FOR SCREW SIZES #4 - #5	25		
B0143		S-6 SLOTTED FOR SCREW SIZES #6 - #8	25		
B0144		S-7 SLOTTED FOR SCREW SIZES #8 - #12	25		
B0152	BEST SELLER	1/4" X 3" MAGNETIC BIT HOLDER (DEPOT)	10		
B0155		7 PC. BIT & CHUCK KIT	EA		
BS49415	NEW	1/4 X 4 11/16 LOCATER DRIVER (BULK)	1		
MA49438		LOCATOR DRIVER W/2 BITS	6		



BUGLER SALES CORP.

Phone: 516 223-3868 • Fax: 516 868-6998
969 CHURCH STREET • BALDWIN, NY 11510

E-mail: info@buglersales.com



PILOT BIT
3 STEPS FITS ALL



MASONRY BITS
PERCUSSION INDUSTRIAL GRADE



SDS BITS
FOR HILTI, BOSCH, MILWAUKEE

IRWIN. SPEEDBOR.

SPEEDBOR2000
6" LONG - REGULAR
16" LONG - XL BITS



HS1914



HS1912



HS1909

BOSCH



HS1910



LOCK-N-LOAD
CONNECTION

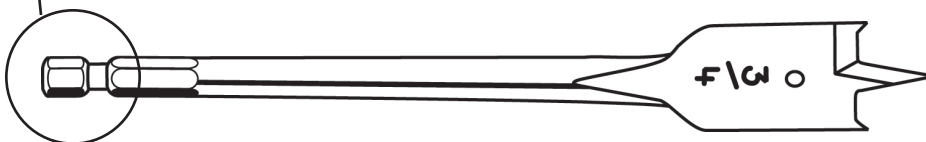



BUGLER SALES CORP.

Phone: 516 223-3868 • Fax: 516 868-6998
 969 CHURCH STREET • BALDWIN, NY 11510

E-mail: info@buglersales.com

NUMBER		DESCRIPTION	PK	RESALE	COST
BITS, MASONRY • POWERS • PERCUSSION • INDUSTRIAL GRADE					
PW0601		1/8 X 3 PERCUSSION DRILL BIT	10		
PW0604		3/16 X 4 PERCUSSION DRILL BIT	10		
PW0605		3/16 X 6 PERCUSSION DRILL BIT	10		
PW0612	BEST SELLER	1/4 X 4 PERCUSSION DRILL BIT	10		
PW0613		1/4 X 6 PERCUSSION DRILL BIT	10		
PW0614		1/4 X 12 PERCUSSION DRILL BIT	EA		
PW0615		1/4 X 18 PERCUSSION DRILL BIT	EA		
PW0618		5/16 X 4 PERCUSSION DRILL BIT	10		
PW0619		5/16 X 6 PERCUSSION DRILL BIT	10		
PW0620		5/16 X 12 PERCUSSION DRILL BIT	EA		
PW0621		3/8 X 4 PERCUSSION DRILL BIT	10		
PW0622		3/8 X 6 PERCUSSION DRILL BIT	10		
PW0623		3/8 X 12 PERCUSSION DRILL BIT	EA		
PW0625		3/8 X 24 PERCUSSION DRILL BIT	EA		
PW0631		1/2 X 6 PERCUSSION DRILL BIT	10		
PW0632		1/2 X 12 PERCUSSION DRILL BIT	EA		
PW0638		5/8 X 6 PERCUSSION DRILL BIT	EA		
PW0645		3/4 X 6 PERCUSSION DRILL BIT	EA		
PW0647		3/4 X 12 PERCUSSION DRILL BIT	EA		
PW8532		7/8 X 6 PERCUSSION DRILL BIT	EA		
PW8534		1 X 6 PERCUSSION DRILL BIT	EA		
BITS, PILOT					
B0290	BEST SELLER	1/4 PILOT BIT (FIT ALL)	10		
BITS, SDS - FITS BOSCH, HILTI & MILWAUKEE					
BSHS1909	NEW	HS1909 SDS-MAX BUSHING TOOL 16T	1		
BSHS1910	NEW	HS1910 SDS-MAX SCALING CHISEL	1		
BSHS1912	NEW	HS1912 SDS-MAX FLAT CHISEL	1		
BSHS1914	NEW	HS1914 SDS-MAX BULL PT CHISEL	1		
PW0306		3/16" X 6" SDS PLUS DRILL BIT	1		
PW0320		1/4" X 4" SDS PLUS DRILL BIT	1		
PW0321	BEST SELLER	1/4" X 6" SDS PLUS DRILL BIT	1		
PW0329		5/16" X 6" SDS PLUS DRILL BIT	1		
PW0333	BEST SELLER	3/8" X 6" SDS PLUS DRILL BIT	1		
PW0346	BEST SELLER	1/2" X 6" SDS PLUS DRILL BIT	1		
PW0359		5/8" X 8" SDS PLUS DRILL BIT	1		
PW0368		3/4" X 8" SDS PLUS DRILL BIT	1		
PW0375		7/8" X 8" SDS PLUS DRILL BIT	1		
BITS, SPADE • IRWIN SPEEDBOR					
IR88804		1/4" SPEEDBOR BIT 2000	6		
IR88805		5/16" SPEEDBOR BIT 2000	6		
IR88806		3/8" SPEEDBOR BIT 2000	6		
IR88807		7/16" SPEEDBOR BIT 2000	6		
IR88808		1/2" SPEEDBOR BIT 2000	6		
IR88809		9/16" SPEEDBOR BIT 2000	6		
IR88810		5/8" SPEEDBOR BIT 2000	6		
IR88811		11/16" SPEEDBOR BIT 2000	6		
IR88812	BEST SELLER	3/4" SPEEDBOR BIT 2000	6		
IR88813		13/16" SPEEDBOR BIT 2000	6		



BUGLER SALES CORP.

Phone: 516 223-3868 • Fax: 516 868-6998
969 CHURCH STREET • BALDWIN, NY 11510

E-mail: info@buglersales.com



LOCK-N-LOAD
CONNECTION

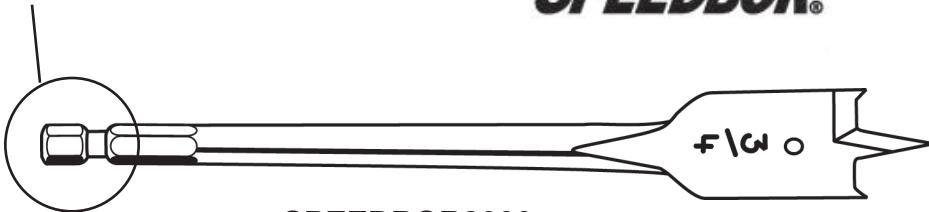

IRWIN. SPEEDBOR®

SPEEDBOR2000
6" LONG - REGULAR
16" LONG - XL BITS



IR88898

IRWIN®

Industrial Tools



STANDARD SPEEDBOR EXTENSION

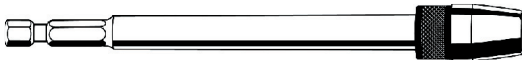

LOCK-N-LOAD EXTENSION
IR90112



SPLINE BITS

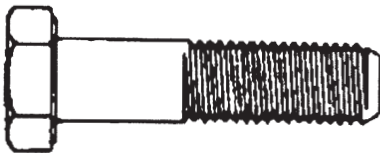

**AVAILABLE
KEG PRICING,
STAINLESS STEEL,
TAMPERPROOF &
SPECIAL PLATING**

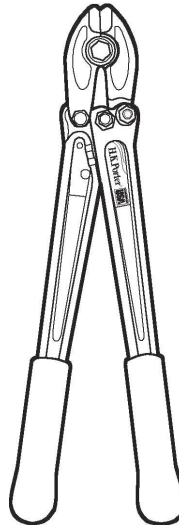

1490AC

H.K.Porter®

BOLT CUTTERS



BUGLER SALES CORP.

Phone: 516 223-3868 • Fax: 516 868-6998
 969 CHURCH STREET • BALDWIN, NY 11510

E-mail: info@buglersales.com

NUMBER		DESCRIPTION	PK	RESALE	COST
BITS, SPADE • IRWIN SPEEDBOR continued...					
IR88814	BEST SELLER	7/8" SPEEDBOR BIT 2000	6		
IR88815		15/16" SPEEDBOR BIT 2000	6		
IR88816	BEST SELLER	1" SPEEDBOR BIT 2000	6		
IR88818	BEST SELLER	1-1/8" SPEEDBOR BIT 2000	3		
IR88820	BEST SELLER	1-1/4" SPEEDBOR BIT 2000	3		
IR88822		1-3/8" SPEEDBOR BIT 2000	3		
IR88824		1-1/2" SPEEDBOR BIT 2000	3		
IR88706		3/8" XL SPEEDBOR BIT 16" LONG	6		
IR88708		1/2" XL SPEEDBOR BIT 16" LONG	6		
IR88710		5/8" XL SPEEDBOR BIT 16" LONG	6		
IR88712		3/4" XL SPEEDBOR BIT 16" LONG	6		
IR88714		7/8" XL SPEEDBOR BIT 16" LONG	6		
IR88716		1" XL SPEEDBOR BIT 16" LONG	6		
IR88898		6pc. SPEEDBOR SET 3/8-1" W/6" EXT.	6		
IR88601	BEST SELLER	1/4" x 12" EXTENSION (OLD STYLE)	6		
IR88702		1/4" x 6" EXTENSION (OLD STYLE)	6		
IR43805		5/16" x 18" EXTENSION	EA		
IR90102		2" QUICK EXTENSION	EA		
IR90106		6" QUICK EXTENSION	EA		
IR90112		12" QUICK EXTENSION	EA		
BITS, SPLINE • POWERS					
PW0952		1 X 12" FLAT CHISEL	EA		
BOLT CUTTERS / SHEARS • HK PORTER					
HK1490AC		14" GENERAL PURPOSE BOLT CUTTER	EA		
HK0090AC		18" GENERAL PURPOSE BOLT CUTTER	EA		
HK0190AC	BEST SELLER	24" GENERAL PURPOSE BOLT CUTTER	EA		
BOLTS, HEX					
B4362		1/4 x 1 HEX TAP BOLT (EA) FULL THREAD	100		
B4364		1/4 x 1-1/2 HEX TAP BOLT (EA) FT	100		
B4366		1/4 x 2 HEX TAP BOLT (EA) FT	100		
B4368		1/4 x 3 HEX TAP BOLT (EA) FT	100		
B4381		5/16 x 1-1/4 HEX TAP BOLT (EA) FT	100		
B4382		5/16 x 1-1/2 HEX TAP BOLT (EA) FT	100		
B4400		3/8 x 1 HEX TAP BOLT (EA) FT	100		
B4401		3/8 x 1-1/4 HEX TAP BOLT (EA) FT	100		
B4402		3/8 x 1-1/2 HEX TAP BOLT (EA) FT	100		
B4404	BEST SELLER	3/8 x 2 HEX TAP BOLT (EA) FT	50		
B4405		3/8 x 2-1/2 HEX TAP BOLT (EA) FT	50		
B4406		3/8 x 3 HEX TAP BOLT (EA) FT	50		
B4428	BEST SELLER	7/16 x 1-1/2 HEX TAP BOLT (EA) FT	50		
B4429		7/16 x 1-3/4 HEX TAP BOLT (EA) FT	50		
B4441		1/2 x 1 HEX TAP BOLT (EA) FT	50		
B4443		1/2 x 1-1/2 HEX TAP BOLT (EA) FT	50		
B4444	BEST SELLER	1/2 x 2 HEX TAP BOLT (EA) FT	50		
B4446		1/2 x 2-1/2 HEX TAP BOLT (EA) FT	50		
B4447		1/2 x 3 HEX TAP BOLT (EA) FT	50		
B4451		5/8 x 1-1/2 HEX TAP BOLT (EA) FT	50		
B4453		5/8 x 2 HEX TAP BOLT (EA) FT	50		



E-mail: info@buglersales.com

BOLTING DIMENSIONS FOR 150 LB. FLANGES

NOM PIPE SIZE	150 LB. STEEL FLANGES				
	DIAM OF JOINT CIRCLE	BEAM OF BOLTS	NO. OF BOLTS	LENGTH OF STUDS AT RAISED FACE	BOLT LENGTH
1/2	2 3/4	1 1/2	4	2 1/4	2 3/4
3/4	2 3/4	1 1/2	4	2 1/4	2
1	3 1/4	1 1/2	4	2 1/2	2
1 1/4	3 1/4	1 1/2	4	2 3/4	2 1/4
1 1/2	3 3/4	1 1/2	4	2 3/4	2 3/4
2	4 3/4	2 1/4	6	3	2 3/4
2 1/2	5 1/2	2 1/4	6	3 1/4	6
3	6	2 1/4	6	3 1/2	3
3 1/2	7	2 1/4	8	3 1/2	3
4	7 1/2	2 1/4	8	3 3/4	3
5	8 1/2	2 1/4	8	3 3/4	3 1/4
5	8 1/2	2 1/4	8	3 3/4	2 3/4
6	11 3/4	2 1/4	8	4	3 1/2
10	14 1/4	2 1/4	12	4 1/2	3 3/4
12	17	2 1/4	12	4 3/4	4
14	18 3/4	2 1/4	12	5	4 1/4
16	21 3/4	2 1/4	16	5 3/4	4 1/2
18	22 3/4	2 1/4	16	5 3/4	4 3/4
20	25	2 1/4	20	6	5 3/4
22	27 1/4	2 1/4	20	6 1/4	5 3/4
24	29 1/4	2 1/4	20	6 3/4	5 3/4
26	31 3/4	2 1/4	24	7	6
30	36	2 1/4	28	7 1/2	8 1/4
34	40 1/4	2 1/4	32	8	7
36	41 3/4	2 1/4	32	8 1/4	7
42	49 1/4	2 1/4	36	8 3/4	7 1/2

STOVE BOLTS
COMBO HEAD

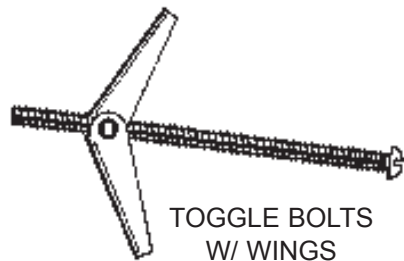
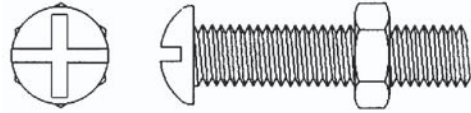

TOGGLE BOLTS
W/ WINGS
COMBO HEAD

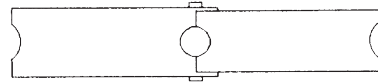

TOGGLE
WINGS

Stud lengths for lap joint flanges are equal to height shown plus the thickness of two laps of the stub ends.
Bolting arrangement for 125 lb. cast iron flanges are the same as shown for 150 lb. steel flanges.



BB08010



BB10010



BB40504



BUGLER SALES CORP.

Phone: 516 223-3868 • Fax: 516 868-6998
 969 CHURCH STREET • BALDWIN, NY 11510

E-mail: info@buglersales.com

NUMBER		DESCRIPTION	PK	RESALE	COST
BOLTS, HEX <i>continued...</i>					
B4454		5/8 x 2-1/4 HEX FLANGE BOLT (EA)	50		
B4455		5/8 x 2-1/2 HEX FLANGE BOLT (EA)	50		
B4456	BEST SELLER	5/8 x 2-3/4 HEX FLANGE BOLT (EA)	50		
B4457	BEST SELLER	5/8 x 3 HEX FLANGE BOLT (EA)	50		
B4458		5/8 x 3-1/4 HEX FLANGE BOLT (EA)	50		
B4459		5/8 x 3-1/2 HEX FLANGE BOLT (EA)	50		
B4460		5/8 x 4 HEX FLANGE BOLT (EA)	50		
B4467		3/4 x 3 HEX FLANGE BOLT (EA)	25		
B4468	BEST SELLER	3/4 x 3-1/4 HEX FLANGE BOLT (EA)	25		
B4469	BEST SELLER	3/4 x 3-1/2 HEX FLANGE BOLT (EA)	25		
B4471		3/4 x 4 HEX FLANGE BOLT (EA)	25		
B4491		7/8 x 4 HEX FLANGE BOLT (EA)	25		
B4492		7/8 x 4-1/2 HEX FLANGE BOLT (EA)	25		
BS4456		5/8 x 2-3/4 STAINLESS STEEL HEX BOLT	EA		
BS4457		5/8 x 3 STAINLESS STEEL HEX BOLT	EA		
BS4469		3/4 x 3-1/2 STAINLESS STEEL HEX BOLT	EA		
KEG PRICING AVAILABLE					
BOLTS, STOVE					
B4900		1/4 X 3/4 STOVE PLATED W/HEX NUTS	100		
B4901	BEST SELLER	1/4 X 1 STOVE PLATED W/HEX NUTS	100		
B4902		1/4 X 1-1/4 STOVE PLATED W/HEX NUTS	100		
B4903		1/4 X 1-1/2 STOVE PLATED W/HEX NUTS	100		
B4905		1/4 X 2 STOVE PLATED W/HEX NUTS	100		
BOLTS, TOGGLE					
B5000		1/8 X 2 TOGGLE BOLT W/WING (EA)	100		
B5001		1/8 X 3 TOGGLE BOLT W/WING (EA)	100		
B5002		1/8 X 4 TOGGLE BOLT W/WING (EA)	100		
B5005		3/16 X 3 TOGGLE BOLT W/WING (EA)	50		
B5006	BEST SELLER	3/16 X 4 TOGGLE BOLT W/WING (EA)	50		
B5008		3/16 X 6 TOGGLE BOLT W/WING (EA)	50		
B5010		1/4 X 3 TOGGLE BOLT W/WING (EA)	50		
B5011	BEST SELLER	1/4 X 4 TOGGLE BOLT W/WING (EA)	50		
B5013		1/4 X 6 TOGGLE BOLT W/WING (EA)	50		
B5020		3/8 X 3 TOGGLE BOLT W/WING (EA)	50		
B5021	BEST SELLER	3/8 X 4 TOGGLE BOLT W/WING (EA)	50		
B5023	BEST SELLER	3/8 X 6 TOGGLE BOLT W/WING (EA)	50		
B5034		1/2 X 4 TOGGLE BOLT W/WING (EA)	25		
B5036		1/2 X 6 TOGGLE BOLT W/WING (EA)	25		
TOGGLE WINGS					
B6001		1/8 TOGGLE WING ONLY (EA)	100		
B6002		3/16 TOGGLE WING ONLY (EA)	100		
B6003	BEST SELLER	1/4 TOGGLE WING ONLY (EA)	100		
B6005		3/8 TOGGLE WING ONLY (EA)	100		
B6007		1/2 TOGGLE WING ONLY (EA)	25		
BUCKET BOSS					
BB08010	NEW	08010 BUCKET GRIP	1/12		
BB10010	NEW	10010 BUCKET SEAT PRO	1/12		
BB40504	NEW	40504 BUCKET STACKER SYSTEM	EA		

SPECIALTY BRUSHES

REFRIGERATOR BRUSH TAPERED

Black, natural bristle,
twisted in wire with loop end.



ITEM NO.	SIZE	PACK	UPC #	RESALE	COST
BR00442	1"-2" X 42"	12	00442	\$	
BR00449	1/2"-1" X 30"	12	00449	\$	
BR00450	1/2"-1" X 36"	12	00450	\$	

WEIL MCLAIN BOILER BRUSH

1-1/2" x 1-1/8" x 4" oval shaped
brush with crimped carbon steel



or soft bristle. Long twisted wire handles w/ 1" ring end.

ITEM NO.	SIZE	PACK	UPC #	RESALE	COST
BR14466	30" Wire	6	14466	\$	
BR14467	30" Bristle	6	14467	\$	

NATURAL BRISTLE TUBE BRUSH**GAUGE GLASS BRUSH**

Natural bristles.



ITEM NO.	SIZE	PACK	UPC #	RESALE	COST
BR10220	3/8 X 3 X 9"	12	10220	\$	
BR10221	1/2 X 3 X 12"	12	10221	\$	
BR10223	1/2 X 3 X 24"	12	10223	\$	
BR10224	1/2 X 3 X 36"	12	10224	\$	

NYLON TUBE BRUSH

Gauge glass brush.

ITEM NO.	SIZE	PACK	UPC #	RESALE	COST
BR14512	3/8x2x15"	12	14512	\$	
BR14518	1/2x3x15"	12	14518	\$	
BR14520	1/2x3x30"	12	14520	\$	
BR14529	3/4x3x9"	12	14529	\$	
BR14533	3/4x3x30"	12	14533	\$	
BR14540	1x4x30"	12	14540	\$	
BR14567	1-1/2"x36"	12	14567	\$	

SLANT FIN RADIATOR BRUSH

Tapered tip nylon brush
with wood handle.



ITEM NO.	SIZE	PACK	UPC #	RESALE	COST
BR14596	2-1/4x4x20"	12	14596	\$	

LONG HANDLE POT/WHEEL BRUSH

Long handle brushes for many
applications. 20" x 3-1/8"



ITEM NO.	SIZE	PACK	UPC #	RESALE	COST
BR27740	Tampico	12	27740	\$	
BR27790	Poly	12	27790	\$	

SOOT SAW

ITEM NO.	SIZE	PACK	UPC #	RESALE	COST
BR20000		12	20000	\$	

TWISTED WIRE EXTENSION RODS

Semi-flexible, twisted



galvanized wire with one female end and 1" ring at the other end.

ITEM NO.	SIZE	PACK	UPC #	RESALE	COST
BR30438	4'	6	30438	\$	
BR30658	6'	6	30658	\$	
BR31438	4' M/FM	6	31438	\$	
BR31458	6' M/FM	6	31458	\$	

T-HANDLES FOR FIBERGLASS ROD & TWISTED WIRE RODS 1/4" MALE PT

ITEM NO.	SIZE	PACK	UPC #	RESALE	COST
BR30599	1/4" Male PT	6	30599	\$	

FIBERGLASS EXTENSION RODS & ACCESSORIES

Strong, extruded fiberglass rods in a variety of diameters provide the proper stiffness for most jobs. We recommend using these nonconducting fiberglass rods whenever possible.

ITEM NO.	SIZE	PACK	UPC #	RESALE	COST
BR30624	1/4"x4"	24	30664	\$	
BR30666	1/4"x6"	24	30666	\$	
BR36048	3/8"x4'	6	36048	\$	
BR36072	3/8x6'	6	36072	\$	
BR36350B	Pull ring -1/4"	12	36350	\$	
BR36352	1/4-3/8 red.	12	36352	\$	

FIBRE FLUE BRUSH

Heavily filled single spiral

natural tampico fibre brush part,

4-1/2" long with 1/4" male pipe threads w/ ring.

ITEM NO.	SIZE	PACK	UPC #	RESALE	COST
BR42933	1"	1	42933	\$	
BR42939	1-1/2"	1	42939	\$	
BR42945R	2"	1	42945	\$	
BR42950R	2-1/2"	1	42950	\$	
BR42956R	3"	1	42956	\$	
BR42960R	3-1/2"	1	42960	\$	
BR42964R	4"	1	42964	\$	
BR42974	5"	1	42974	\$	
BR42982	6"	1	42982	\$	
BR42988	7"	1	42988	\$	
BR42992	8"	1	42992	\$	

SPECIALTY BRUSHES

**TEMPERED WIRE BRUSH
SINGLE SPIRAL FLUE BRUSH** 

4-1/2" long tempered wire brush part, 1/4" male pipe thread.

ITEM NO.	SIZE	PACK	RESALE	COST
BR43206	3/4"	1	\$	
BR43208	1"	1	\$	
BR43212	1-1/4"	1	\$	
BR43214	1-1/2"	1	\$	
BR43216	1-3/4"	1	\$	
BR43218	2"	1	\$	
BR43222	2-1/4"	1	\$	
BR43224	2-1/2"	1	\$	
BR43226	2-3/4"	1	\$	
BR43228	3"	1	\$	
BR43232	3-1/4"	1	\$	
BR43234	3-1/2"	1	\$	
BR43236	3-3/4"	1	\$	
BR43238	4"	1	\$	
BR43294	5"	1	\$	
BR43298	6"	1	\$	

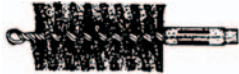
**TEMPERED WIRE BRUSH
DOUBLE SPIRAL FLUE BRUSH** 

4-1/2" long tempered wire brush part, 1/4" male pipe thread.

ITEM NO.	SIZE	PACK	RESALE	COST
BR43308	1"	1	\$	
BR43312	1-1/4"	1	\$	
BR43314	1-1/2"	1	\$	
BR43316	1-3/4"	1	\$	
BR43318	2"	1	\$	
BR43322	2-1/4"	1	\$	
BR43326	2-3/4"	1	\$	
BR43328	3"	1	\$	
BR43338	4"	1	\$	

**FLAT STYLE COLUMBIA
BOILER BRUSH** 

Bristles stick out to the 1" dimension as round brush is flattened after being made. 1/2 x 1 x 4-1/2

ITEM NO.	SIZE	PACK	RESALE	COST
BR46302	27" wire	6	\$	
BR46304	48" wire	6	\$	
BR46302FL	36" fibre	12	\$	

**WOODEN HANDLE
W/DIE CAST THREAD** 

Hardwood handle with an aluminum die cast thread.

ITEM NO.	SIZE	PACK	RESALE	COST
BR26900	5'	12	\$	
BR69026	6'	12	\$	
BR11091	BRACE	12	\$	

**COPPER FITTING BRUSH
"QUIK KLEEN"** 

Single spiral 2-ply carbon steel wire construction with oval wire handle

QUANTITY BREAKS AVAILABLE

ITEM NO.	SIZE	PACK	RESALE	COST
B7717	1/8"	12	\$	
B7718	1/4"	12	\$	
B7719	3/8"	12	\$	
B7720	1/2"	100	\$	
B7721	3/4"	100	\$	
B7722	1"	100	\$	
B7723	1-1/4"	50	\$	
B7724	1-1/2"	50	\$	
B7725	2"	50	\$	
B7727	2-1/2"	5	\$	
B7728	3"	1	\$	
B7729	4"	1	\$	

**COPPER FITTING BRUSH
W/ PLASTIC HANDLE** 

ITEM NO.	SIZE	PACK	RESALE	COST
BR00646	1/2"	12	\$	
BR00648	3/4"	12	\$	
BR00649	1"	12	\$	
BR00650	1-1/4"	6	\$	

TIN HANDLE ACID BRUSH 

Selected horsehair bristles are pressed securely in tin handles. Sold in gross packs only.

ITEM NO.	SIZE	PACK	RESALE	COST
B7714	3/8"	144	\$	
B7715	1/2"	144	\$	

**WOOD HANDLE
DOPE BRUSH** 

Select horsehair bristles secured tightly in a metal ferrule.

ITEM NO.	SIZE	PACK	RESALE	COST
B7745		36	\$	

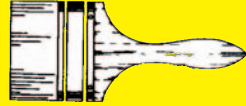
CHIP BRUSHES 

100% natural bristles.

ITEM NO.	SIZE	PACK	RESALE	COST
B7700	1/2"	36	\$	
B7701	1"	36	\$	
B7703	1-1/2"	36	\$	
B7704	2"	36	\$	
B7705	2-1/2"	12	\$	
B7706	3"	12	\$	
B7708	4"	12	\$	

PARTS CLEANING BRUSH 

Poly fill in strong plastic handles

ITEM NO.	SIZE	PACK	RESALE	COST
B7747	10-3/4"	12	\$	

SPECIALTY BRUSHES

LONG WOOD HANDLE DUSTING BRUSH W/FLARE



One row, curved handle. Horsehair.

ITEM NO.	SIZE	PACK	UPC #	RESALE	COST
BR76026	24"	12	76026	\$	

FIBRE BOILER BRUSH



Extra heavy fill, 6" long brush part with 42" twisted wire handle and large loop end.

ITEM NO.	SIZE	PACK	UPC #	RESALE	COST
BR76223	2-1/4" X 30"	12	76223	\$	
BR76235	2" wood hdl	12	76235	\$	
BR76236	3" wood hdl	6	76236	\$	
BR76237	2-1/2"	12	76237	\$	
BR76238	4"	12	76238	\$	

DUCT CLEANING BRUSH - 2-1/8 X 7" fibre.



ITEM NO.	SIZE	PACK	UPC #	RESALE	COST
BR76220	48"	6	76220	\$	

RADIATOR CLEANING BRUSH Bristle.



ITEM NO.	SIZE	PACK	UPC #	RESALE	COST
BR76221	2x7x27"	12	76221	\$	

STIFF WIRE BRUSH



Single spiral fine wire brush part 4" long, twisted in wire handle with loop end. 42" overall length.

ITEM NO.	SIZE	PACK	RESALE	COST
BR76252	1/2"	12	\$	
BR76253	3/4"	12	\$	
BR76254	1"	12	\$	
BR76256	2"	12	\$	
BR76257	2-1/2"	12	\$	
BR76258	3"	12	\$	

FIBRE/HAIR MIX BOILER BRUSH



Extra heavy fill, 6" long brush part with twisted 42" wire stem and wood handle.

ITEM NO.	SIZE	PACK	UPC #	RESALE	COST
BR76245	2"x42"	12	76245	\$	
BR76246	3"x42"	6	76246	\$	

BENCH DUSTER & PAN



ITEM NO.	SIZE	PACK	UPC #	RESALE	COST
BR62034	2x8 brush	12	62034	\$	
D9500	hvy duty pan	12		\$	
D9510	DUSTPAN, JUMBO DEBRIS PAN			\$	

BROOMS



ITEM NO.	SIZE	RESALE	COST
BR10160	#10 Hvy Dty Corn Broom	\$	
BR10703	24" Palmyra Broom Head	\$	
BR11091	Brace	\$	
BR20603	16" Afr. bass Broom Head	\$	
BR20672	24" blk tampico Broom Head	\$	
BR20674	36" blk tampico Broom Head	\$	
BR4043	Jumbo Angle Broom w/cushion grip	\$	
BR581924	24" Horsehair Broom Head	\$	
BR583124A	Asmbld Broom Red Med w. Bracket	\$	
BR587124A-1	24" Rough Surface Braced Broom	\$	
BRD18	Tool Holder f/ Broom Handle	\$	
BR69026	6' wd. handle	\$	

HAND SCRUB BRUSH

Comfortable Swiss style block is easy to hold and fits into tight places. Available in a variety of poly bristles, this brush works well for many different jobs. 2-1/2" wide, 6" long, 1-5/8" trim.



ITEM NO.	SIZE	PACK	UPC #	RESALE	COST
BR90464	soft	12	90464	\$	
BR90466	stiff	12	90466	\$	

TRUCK WASH BRUSH

Multipurpose wash brushes with round bumper. Soft X-nylon.



ITEM NO.	SIZE	PACK	RESALE	COST
BR90079	8" wide	1	\$	

SURE-SURFACE

WASH & SCRUB BRUSHES

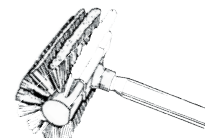

ITEM NO.	SIZE	PACK	UPC #	RESALE	COST
BR66318	8"	4	66318	\$	
BR66343	8" nylon	4	66343	\$	
BR69026	6' wd handle	12	69026	\$	

SPECIALTY BRUSHES

BOWL BRUSH 

ITEM NO.	SIZE	PACK	UPC #	RESALE	COST
BR66151	wd. hdl/tamp	12	66151	\$	

STOVE BRUSH 

Brass bristles.

ITEM NO.	SIZE	PACK	UPC #	RESALE	COST
BR25302	2x9	12	25302	\$	

WIRE SCRATCH BRUSHES 

ITEM NO.	SIZE	PACK	UPC #	RESALE	COST
BR27698	6x9 brass	12	27698	\$	
B7710	long hdl wire	12		\$	
BR81009	USA long hdl wire	12	81009	\$	
BR81461	stiff wire duster	12	81461	\$	

LOBBY BROOM & PAN 

ITEM NO.	PACK	RESALE	COST
BR06145	6	\$	

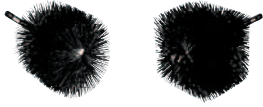
CHIMNEY BRUSHES 

1/4" Male pipe thread.
All brushes wire/round unless otherwise noted

ITEM NO.	SIZE	PACK	UPC #	RESALE	COST
BR35066	6" dbl spiral	1	35066	\$	
BR35076	7" dbl spiral	1	35076	\$	
BR35086	8" dbl spiral	1	35086	\$	
BR35096	9" dbl spiral	1	35096	\$	
BR35288	8x8 dbl sprl	1	35288	\$	
BR35412	8x12double sprl	1	35412	\$	
BR36406	6"	1	36406	\$	
BR36407	7"	1	36407	\$	
BR36408	8"	1	36408	\$	
BR36906	6" round poly	1	36906	\$	
BR36907	7" round poly	1	36907	\$	
BR36908	8" round poly	1	36908	\$	

DETAIL BRUSHES 

ITEM NO.	SIZE	PACK	UPC #	RESALE	COST
BR25405	brass	36	25405	\$	
BR25407	3 x 7 nylon	36	25407	\$	

DRYER VENT BRUSH 

ITEM NO.	SIZE	PACK	UPC #	RESALE	COST
BR37320	4" brush/20" hdl	1	37320	\$	

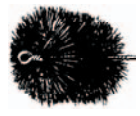
DUCT BRUSHES 

For improving indoor air quality.
Medium filament.
6" deep, 1/4 male pipe thread

ITEM NO.	SIZE	PACK	UPC #	RESALE	COST
BR404136	13"sq.x6"deep	1	404136	\$	
BR405126	8x12x6"deep	1	405126	\$	
BR408086	8"sq.x6"deep	1	408086	\$	

SOFT FILAMENT DUCT BRUSH 

All brushes have 1/4" male pipe threads that fasten to our flexible nylon rods or fiberglass rods.

ITEM NO.	SIZE	PACK	UPC #	RESALE	COST
BR400066	6" round	1	400066	\$	
BR400086	8" round	1	400086	\$	
BR400106	10" round	1	400106	\$	

OUTSIDE TUBE BRUSH 

Tough molded plastic holder with comfortable sure grip design and high carbon steel bristles.

ITEM NO.	SIZE	PACK	UPC #	RESALE	COST
B7733	1/2"	6	00966	\$	
B7735	3/4"	6	00968	\$	
B7737	1"	6	00970	\$	

LOW LINT WOVEN POLYESTER ROLLER COVERS - LATEX & OIL 

Custom weave for shed-free results. Best choice for gloss paints and all tacky coatings. Epoxy bonded to an oven baked, heavywall core.

ITEM NO.	SIZE	PACK	UPC #	RESALE	COST
P0625	9" - 1/4 NAP	4		\$	
P0638	9" - 3/8 NAP	4		\$	
P0650	9" - 1/2 NAP	4		\$	
P0654	9" - 3/4 NAP	4		\$	

VALUE LINE ROLLER COVERS 

Polyester fabric. Solvent based. Yields uniform coverage.

ITEM NO.	SIZE	PACK	UPC #	RESALE	COST
P0711	18" refill	10	91369	\$	
P0710	18" roller	6	91372	\$	

SPECIALTY BRUSHES

CUSTOM BRUSHES AVAILABLE

TRAYS

Each tray ramped is ribbed for even loading.



ITEM NO.	SIZE	PACK	UPC #	RESALE	COST
KR7643	9"	10	82030	\$	
KR7644	9" PLASTIC	50		\$	

PLASTIC TRAY LINER

Reusable, Recyclable.

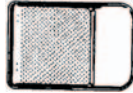

ITEM NO.	SIZE	PACK	UPC #	RESALE	COST
KR3556	9"	48	43558	\$	

ROLLER FRAMES

All cage frames thread accept extension poles.



ITEM NO.	SIZE	PACK	UPC #	RESALE	COST
KR7435	9" HVY DTY	12	44000	\$	
KR7650	9" HVY DTY			\$	
P0620	F&L Paint Roller Tray Set			\$	
P0660	5 in 1 Painters Tool Soft Grip			\$	

TACK CLOTH

Fine quality cheesecloth. Special resin lock onto dust.



ITEM NO.	SIZE	PACK	UPC #	RESALE	COST
RU115829000	18" X 36"	50	09567	\$	

PAINT BRUSHES

All purpose paint brushes. G/W.



ITEM NO.	SIZE	PACK	UPC #	RESALE	COST
BRP00751	1"	12		\$	
BRP00752	1-1/2"	12		\$	
BRP00753	2"	12		\$	
BRP00755	3"	12		\$	
BRP00757	4"	12		\$	
BRP00763	2" ANG	12		\$	

MASONRY BRUSHES

Tampico Masonry Brushes.



ITEM NO.	SIZE	PACK	UPC #	RESALE	COST
BR163	#163 Acid Brush	12		\$	
BR547	#547 Jumbo	6		\$	

SPECIALTY BRUSHES

MAINTENANCE BRUSH FILL MATERIALS

FILL MATERIAL	ATTRIBUTES	APPLICATIONS	PRODUCTS
Horsehair	Durable, Scratch Free, Water & Moisture Resistant	Fine Sweeping on Smooth Surfaces. Not for use on Oily or Wet Surfaces.	Push Brooms Counter Dusters Radiator Brushes
Nylon	Synthetic - Durable, resistant to most acids and alkalis. Can be used near high temperatures.	Long wear makes nylon best suited for scrubbing and cleaning applications. Will soften in water.	Pot Brushes Spotting Brushes Scrubbing Brushes
Polypropylene	Synthetic - Durable, long life and is resistant to acid and fungus.	Excellent in dry or wet applications. Will not soften in water.	Street Brooms Push Brooms Upright Brooms Scrub Brushes
Polystyrene	Synthetic - Extremely durable synthetic, oil & liquid resistant, but not for use with sweeping compounds.	Flagged synthetic is great on smooth surfaces. Flagged tips allow more fine dust retention.	Push Brooms Truck Wash Brooms Counter Dusters
Tampico	Natural - Durable plant fiber that is heat, alkali & acid resistant.	Durable for sweeping, scrubbing and washing applications.	Push Brooms Counter Dusters Radiator Brushes Scrub Brushes Roof Brushes Masonry Brushes
Palmyra	Natural - Durable water resistant natural plant fiber.	Used Wet or Dry on rough surfaces or for heavy debris.	Street Brooms Garage Brushes Deck Scrubs Scrub Brushes
Bassine	Natural - Coarse, durable water resistant fiber.	Used for heavy scrubbing and cleaning applications.	Street Brooms



BUGLER SALES CORP.

Phone: 516 223-3868 • Fax: 516 868-6998
969 CHURCH STREET • BALDWIN, NY 11510

E-mail: info@buglersales.com

Wiss®



CABLE/BX
CUTTERS

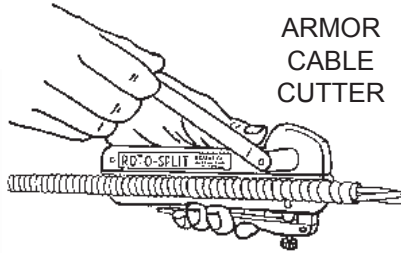

ARMOR
CABLE
CUTTER

FIRE STOP



GE
SILICONE



PE81409



PE81409



PE80647



PE81160



SILICONES
WL09010
WL09210



PL-200



PL-400



SMOOTH BORE
OR RATCHET
CAULKING GUN

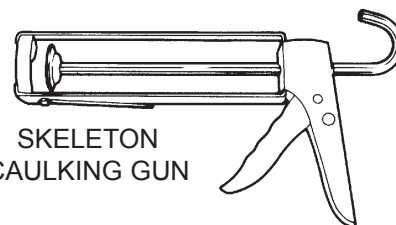

SKELETON
CAULKING GUN



BUGLER SALES CORP.

Phone: 516 223-3868 • Fax: 516 868-6998
 969 CHURCH STREET • BALDWIN, NY 11510

E-mail: info@buglersales.com

NUMBER		DESCRIPTION	PK	RESALE	COST
BX CUTTERS					
20901		ARMORED CABLE CUTTER 3/8		EA	
20903		REPLACEMENT BLADES (5)		1	
WSBXN		CABLE/BX CUTTERS WISS		6	
CAULKING DAP • GE • WHITE LIGHTNING • PERMATEX					
C0620	BEST SELLER	10 OZ. GE612 SILICONE BATH CLEAR		12	
C0621	BEST SELLER	10 OZ. GE712 SILICONE BATH WHITE		12	
C0622		2.8 OZ GE284 SILICONE CLEAR TUBE		12	
C0626		2.8 OZ. GE281 SILICONE WHITE TUBE		12	
C0634	NEW	10 OZ PL-200 CONSTRUCTION ADHESIV		EA	
C0636	NEW	10 OZ PL-400 CONSTRUCTION ADHESIV		EA	
C0638	NEW	10 OZ PL PREMIUM CARTRIDGE		12	
C0640	NEW	28 OZ PL PREMIUM CARTRIDGE		12	
C0652		1 GALLON FIRESTOP CAULKING PAIL		6	
GE5000	NEW	10 OZ 5000 GE SILICONE II CLEAR		12	
GE5070	NEW	10 OZ GE SILICONE II BATH WHITE		12	
DP17945	NEW	EASY SOLUTIONS DISPLAY 72 PC		EA	
DP18001	BEST SELLER	5.5 OZ. DAP QUIK SEAL WHITE TUBE		12	
DP18013		5.5 OZ. DAP QUIK SEAL ALMOND TUBE		12	
DP18130	NEW	10 OZ DAP ALEX PLUS W/SIL. ALMOND		12	
DP18152		10OZ DAP ALEX PLUS W/SILICONE WHITE		12	
DP18156		10OZ DAP ALEX PLUS W/SILICONE CLEAR		12	
DP18260		10 OZ. DAP RELY ON CAULK WHITE		12	
DP18539	NEW	5.5OZ KWIK SEAL BISQUE TUBE		12	
DP18670		10OZ DAP ALEX PAINTERS WHITE		12	
DP18806		10.3 OZ. FIRESTOP CAULK CARTRIDGE ASTM E-814		12	
DP18854		10 OZ. DAP HI-HEAT MORTAR ASTM E-136		12	
DP25082		10 OZ. DAP CONSTRUCTION ADHESIVE (PL200)		24	
DP25288	NEW	25288 TUB SURROUND INSTALL KIT		4	
DP27050	NEW	27050 10OZ CONSTRUCTION ADHESIVE		12	
PE80647		PERMATEX GEL SILICONE GASKET REMOVER		6	
PE81160		3 OZ HI-TEMP SILICONE "RED STUFF" 26BR		12	
PE81409	BEST SELLER	11 OZ HI-TEMP SILICONE "RED STUFF" 26C		12	
O2000		5LB OAKUM		EA	
PFEB1		EB1 ELECTRICAL BOX INSERT 4" X 4"		10	
PFEB2		EB2 ELECTRICAL BOX INSERT 2" X 4"		20	
PFEX1		3600EX 10 OZ TUBE FIRESTOP		12	
PFEX2		3600EX 29 OZ TUBE FIRESTOP		12	
PFEX4		3600EX 5 GAL PAIL FIRESTOP		EA	
PFEX9		3600EX 20 OZ SAUSAGE FIRESTOPPING		12	
PFWPP		MP1 PUTTY PAD		20	
WL09010		10 OZ. WHITE LIGHTNING 100% SILICONE CLEAR		12	
WL09210		10 OZ. WHITE LIGHTNING 100% SILICONE WHITE		12	
SEE PHENOSEAL SECTION FOR MORE CAULKING ON PAGES 34, 35					
CAULKING GUNS					
C0630		#1 CAULKING GUN SMOOTH BORE		24	
C0631	BEST SELLER	#2 CAULKING GUN RATCHET BORE		24	
C0632		#3 SKELETON CAULKING GUN HEAVY DUTY		12	
C0633		#4 QT SIZE CAULKING GUN RATCHET BORE		6	
WLPS600	NEW	#5 SAUSAGE PACK CAULKER FITS 10 OR 20 OZ		1	

PHENOSEAL does it all! VINYL ADHESIVE CAULKING

For interior and exterior caulking and sealing. Adheres to all common building materials. Paintable. Use where all high and adhesive caulk is needed...doors, window, concrete, tile, wood, plumbing, heating, and electrical.

BEST SELLERS

ITEM NO.	MFG. #	COLOR	UPC #	RESALE	COST
PH00006	102TR	TRANSLUCENT 10oz	00006-8	\$	◆
PH00005	102WH	WHITE 10oz	00005-1	\$	◆
PH02101	C101A	ALMOND 6oz	02101-8	\$	
PH01101	C101T	TRANSLUCENT 6oz	01101-9	\$	
PH00101	C101W	WHITE 6oz	00101-0	\$	

10oz. CARTRIDGE

PH02102	102AM	ALMOND	02102-5	\$
PH06102	102BL	BLACK	06102-1	\$
PH16102	102BO	BONE	16102-8	\$
PH09102	102BR	BROWN	09102-8	\$
PH04102	102MG	METAL GRAY	04102-3	\$
PH03102	102TA	TAN	03102-4	\$



10 OZ. TUBE

ALL PACKED 12

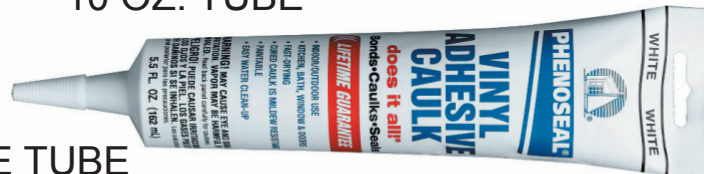

6 OZ. SQUEEZE TUBE



DP18806



DP18260



DP18854



DP18152



DP18670



DP27050



DP18001 /
DP18013



DP17945

PHENOSEAL

PHENOSEAL®

does it clear!

Styrene Acrylic Water-based Sealant

Acrylic Latex Adhesive Caulk is a water-based caulk ideal for use wherever an invisible seal is desired. It provides the durability, flexibility and adhesion properties of a silicone or solvent-based clear without the odor or messy clean-up. It can be used for a wide variety of interior and exterior applications. It provides a weatherproof seal by preventing air and moisture from passing through cracks and joints.

Does It Clear!™ won't crack or discolor with age and may be scrubbed with most household cleansers. It provides maximum protection from moisture damage and mildew growth when cured. And it cleans up easily with soap and water. Plus it comes with a lifetime guarantee.

Ideal for caulking and sealing around:

- Tub/shower surrounds
- Vanities, bath fixtures, tiles
- Window & Door perimeters
- Siding & Trim
- Vents, ducts, pipes
- Sinks, countertops, backsplashes
- Toilets
- Boat and marine upkeep (only above waterline)
- Baseboards & Molding
- Thresholds

Adheres to:

- Ceramic tile
- Glass
- Marble
- Vinyl
- Laminate
- Fiberglass
- Wood
- Wallboard
- Porcelain
- Metal
- Plastic
- Concrete & Masonry

PH00602 PK12 \$



Phenoseal®

Vinyl Adhesive Caulk

Phenoseal Vinyl Adhesive Caulk is a versatile all-purpose caulk that is perfect for almost any job. It truly does it all - BONDS, CAULKS & SEALS. You can use it as a caulk to seal gaps or as an adhesive to bond materials. It is a caulk and glue in one!

Phenoseal Vinyl Adhesive Caulk is easy to apply. It has a mild, pleasant odor and cleans up easily with soap and water. Cured caulk is mildew resistant. It is fast-drying and can be painted with latex and oil-based paint.

Phenoseal's unique Vinyl Adhesive Caulk formulation means increased durability and strength. It provides a waterproof seal and can be used indoors or out for wide variety of projects. And it comes with a lifetime guarantee.



SLIP JOINT PLIERS

With wire cutting shear.



ITEM NO.	MFG#	SIZE	PACK	UPC#	RESALE COST
CH526	526	6"	5	20037	\$
CH546	546	6" H.D.	5	20071	\$
CH548	548	8" H.D.	5	20091	\$
CH5410	5410	10" H.D.	5		\$

ADJUSTABLE WRENCHES



ITEM NO.	MFG#	SIZE	PACK	UPC#	RESALE COST
CH804	804	4"	5	70017	\$
CH806	806	6"	5	70037	\$
CH808	808	8"	5	70057	\$
CH810	810	10"	5	70077	\$
CH812	812	12"	5	70097	\$

WIRING TOOL

Strips wire with no damage to conductor. Crimps both insulated and non-insulated solderless connections and terminals.



ITEM NO.	MFG#	SIZE	PACK	UPC#	RESALE COST
CH908	908	WIRING TOOL	5	71131	\$
CH957	957	WIRING TOOL	5		

CRIMPER

For crimping and cutting of both insulated and non-insulated solderless connections and terminals.

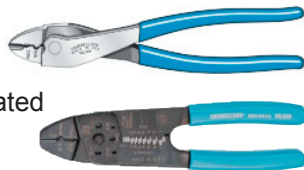

ITEM NO.	MFG#	SIZE	PACK	UPC#	RESALE COST
CH909	909	CRIMPER	5	71197	\$
CH959	959	8"	5		\$

CABLE CUTTER

241 mm



ITEM NO.	MFG#	SIZE	PACK	UPC#	RESALE COST
CH911	911	9-1/2"	5	40347	\$

CHEZK5 EZK-5 SPC SCREWDRIVER SET
CHPTD2 PTD PTD-2 CHANNELLOCK DISPLAY T&G

**IF YOU DON'T SEE WHAT
YOU NEED...
CALL & ASK**

WIRE STRIPPER

Strips insulation fast with no damage to wire. Cuts copper wire cleanly.



Blades are specially heat treated for long life.

ITEM NO.	MFG#	SIZE	PACK	UPC#	RESALE COST
CH958	958	WIRE STRIPPER	5	71141	\$

GRIPLOCK PLIERS

Special jaw design accommodates many shapes.



ITEM NO.	MFG#	SIZE	PACK	UPC#	RESALE COST
CHGL6	GL6	6"	5	50891	\$
CHGL10	GL10	9-1/2"	5	96017	\$
CHGL12	GL12	12"	5	96067	\$
CHGLS-1	GLS-1	GL10 & GL12	EA/10	99067	\$

GRIPLOCK PLIER SETS



ITEM NO.	MFG#	SIZE	PACK	RESALE COST
CHGS1	GS1	420 & 426	5	\$
CHGS3	GS3	420, 426 & 440	5	\$

SNAP RING PLIER



ITEM NO.	MFG#	SIZE	PACK	RESALE COST
CH907	907	7"	5	\$

INT/EXT RING PLIERS



ITEM NO.	MFG#	SIZE	PACK	RESALE COST
CH917	917	8"	5	\$

COAXIAL CABLE PLIER



ITEM NO.	MFG#	SIZE	PACK	RESALE COST
CH919	919	8-1/2"	5	\$

CHANNELLOCK

• INDICATES BEST SELLERS

OIL/WATER FILTER WRENCH

Works on closet spuds & PVC couplings.



ITEM NO.	MFG.#	SIZE	PACK	UPC#	RESALE COST
•CH212	212	2-3/8" - 4-1/4"	5	41571	\$

LONG NOSE PLIERS WITH SIDE CUTTER



ITEM NO.	MFG.#	SIZE	PACK	UPC#	RESALE COST
•CH317	317	7-1/2"	5	12197	\$
CH318	318	8"	5	12207	\$
CH318WS	318WS	8" w/stripper	5	12207	\$
CH326	326	6"	5	12237	\$

LAP JOINT PLIER



ITEM NO.	MFG.#	SIZE	PACK	UPC#	RESALE COST
•CH337	337	7"	5	13327	\$
CH338	338	8"	5	13361	\$

LINEMAN'S PLIER



ITEM NO.	MFG.#	SIZE	PACK	UPC#	RESALE COST
CH347	347	7"	5	14427	\$
CH348	348	8-1/2"	5	14487	\$
•CH349	349	9" BOX JOINT	5	14547	\$
CH351S	351S	9" w/l hdl	5	61331	\$
•CH369	369	9" HIGH LEVERAGE	5	14647	\$
CH369CR	369CR	9-1/2" w/ crimper	5	10221	\$

RING CLAMP PLIERS

Works on ring clamps for sprinkler installation.



ITEM NO.	MFG.#	SIZE	PACK	UPC#	RESALE COST
CH35220	35220	9"	5	99621	\$

END CUTTING PLIER



ITEM NO.	MFG.#	SIZE	PACK	UPC#	RESALE COST
CH357	357	7"	5	15607	\$
CH358	358	8"	5	15621	\$

BENT NOSE PLIER



ITEM NO.	MFG.#	SIZE	PACK	UPC#	RESALE COST
CH386	386	5-1/2"	5	12271	\$

NUTBUSTER

Double tongue and groove won't slip. Can be used like a pipe wrench.



ITEM NO.	MFG#	SIZE/CAPACITY	PACK	UPC#	RESALE COST
CH410	410	10"/1-1/8"	5	30027	\$
CH414	414	14"/2"	5	30227	\$

SMOOTH JAW PLIER

Tongue and groove plier.



ITEM NO.	MFG#	SIZE/CAPACITY	PACK	UPC#	RESALE COST
CH415	415	10"/2"	5	30047	\$

TONGUE AND GROOVE PLIERS



ITEM NO.	MFG#	SIZE/CAPACITY	PACK	UPC#	RESALE COST
•CH420	420	9"/1-1/2"	5	30067	\$
CH424	424	4"/1/2"	5	30107	\$
CH426	426	6"/7/8"	5	30127	\$
•CH430	430	10"/2"	5	30147	\$
•CH440	440	12"/2-1/4"	5	30167	\$
CH460	460	16"/4-1/4"	2	30197	\$
CH480	480	20"/5-1/2"	2	52014	\$

TONGUE AND GROOVE PLIERS CURVED JAW



ITEM NO.	MFG#	SIZE/CAPACITY	PACK	UPC#	RESALE COST
CH422	422	1-1/2"	5	30087	\$
CH442	442	2-1/4"	5	30187	\$
CH463	463	4-1/4"	2		\$

BOX JOINT CUTTING PLIER



ITEM NO.	MFG#	SIZE	PACK	UPC#	RESALE COST
CH436	436	6"	5	13747	\$

CURVED DIAGONAL CUTTING PLIER



ITEM NO.	MFG#	SIZE	PACK	UPC#	RESALE COST
•CH447	447	7-3/4"	5	13797	\$



BUGLER SALES CORP.

Phone: 516 223-3868 • Fax: 516 868-6998
969 CHURCH STREET • BALDWIN, NY 11510

E-mail: info@buglersales.com



10, 40, 60, 80 LB
PALLET PRICING
SAND
BLACKTOP



DP31090



C1100



ROOF CEMENT
& MEMBRANE



PROOF COIL
CHAIN
1/4", 3/8"

DOUBLE LOOP CHAIN

IRWIN® Industrial Tools



C1101



5LB
CHALK



8OZ
CHALK



Crescent®



CHAIN WRENCHES

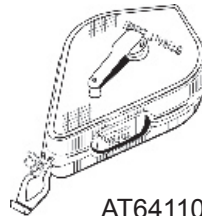

AT64110



PE25223



PE80010



14D
PE80633



51D
PE80045



BUGLER SALES CORP.

Phone: 516 223-3868 • Fax: 516 868-6998
 969 CHURCH STREET • BALDWIN, NY 11510

E-mail: info@buglersales.com

NUMBER		DESCRIPTION	PK	RESALE	COST
CEMENT & ACCESSORIES QUIKRETE • MINWAX • BLACKJACK • KARNAK					
B9020	NEW	26 X 20 X 6" PLASTIC MORTOR PAIL	6		
C1100	BEST SELLER	ONE GAL. AMSTONE ROOF CEMENT	6		
C1101		10 OZ. CARTRIDGE ROOF CEMENT	12		
C1103		5 LB. AQUA PLUG HYDRAULIC CEMENT	8		
C1104	NEW	10LB. AQUA PLUG HYDRAULIC CEMENT	4		
C1120		10 LB. QUIKRETE SAND MIX	6		
C1121	BEST SELLER	40 LB. QUIKRETE SAND MIX	EA/80		
C1122		60 LB. QUIKRETE SAND MIX	EA/56		
C1123	NEW	80LB. SAKRETE SAND MIX	EA/42		
C1138	NEW	60 LB. SAND	EA		
C1140	NEW	5" POINTED TROWEL WOOD HDL. 2205	12		
C1141	NEW	7" POINTED TROWEL WOOD HDL	12		
C1144	NEW	SQUARE TROWEL NO TEETH (PT2250)	12		
C1117		5 LB. ANCHORING CEMENT POR-ROK	8		
DP31090	NEW	GALLON READY MIXED CONCRETE PATCH	4		
C1180		60 LB. SAKRETE BLACKTOP PATCH	EA		
FC8045	NEW	50 LB. STRUCTOLITE	40		
KA195SG	BEST SELLER	KARNAK 5 GALLON CEMENT ROOF	EA		
KA5509		9" X 150' MEMBRANE	EA		
KA5536		36" X 150' MEMBRANE	EA		
KA9205		ASPHALT EMULSION 5 GALLON	EA		
KA975		FIBERED ALUMINUM ROOF COAT 5 GALLON	EA		
CHAIN					
C1210	BEST SELLER	2/0 INCO DOUBLE LOOP CHAIN FOOT	350'		
C1220		1/4" PROOF COIL CHAIN PAIL	141'		
C1222		3/8" PROOF COIL CHAIN PAIL	63'		
CHAIN WRENCHES CRESCENT					
CRCW12H		12" CHAIN WRENCH CRESCENT	EA		
CRCW15		15" CHAIN WRENCH CRESCENT	EA		
CRCW24		24" CHAIN WRENCH CRESCENT	EA		
W4916		12" CHAIN WRENCH SUPER EGO	6		
CHALK LINES & CHALK • IRWIN INDUSTRIAL					
IR64110	BEST SELLER	100' STRAIGHTLINE CHALK REEL	6		
IR64499		100' STRAIGHTLINE - REEL W/4oz CHALK	3		
IR64610		100' REPLACEMENT CHALK LINE	6		
IR64901		8OZ. BLUE CHALK REFILL	6/24		
IR64902		8OZ. RED CHALK REFILL	6/24		
IR64903		8OZ. YELLOW CHALK REFILL	6/24		
IR64904		8OZ. WHITE CHALK REFILL	6/24		
IR64905		8OZ. FL.ORANGE CHALK REFILL	6/24		
IR65101		5LB. BLUE CHALK REFILL	1/4		
IR65102		5LB. RED CHALK REFILL	1/4		
CHEMICALS PERMATEx • KNIGHTS					
PE80045	BEST SELLER	51D PIPE JOINT COMPOUND 1 PINT	12		
PE80632	NEW	14H 4OZ.TEFLON THRD. SEALENT	12		
PE80633	BEST SELLER	14D THREAD SEALANT W/TEFLON 1 PINT	12		
PE80022		6B RTV SILICON FORMAGASKET 3 OZ.	12		
PE80010		2B FORMAGASKET #2 SEALANT 3 OZ.	12		
PE25223		4 OZ. RIGHT STUFF GASKET MAKER	EA		
PE25224		7 OZ. RIGHT STUFF GASKET MAKER	6		



BUGLER SALES CORP.

Phone: 516 223-3868 • Fax: 516 868-6998
969 CHURCH STREET • BALDWIN, NY 11510

E-mail: info@buglersales.com



PE81409



C2380



C2306

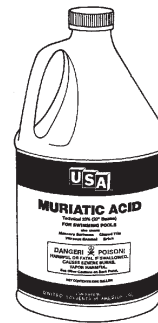

C2280ACID



C2271
PAINT THINNER

DASCO PRO



334-0



435-0



BULL POINT CHISEL - CONCRETE

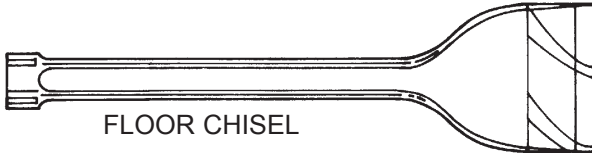

FLOOR CHISEL



LONG & SHORT COLD CHISELS

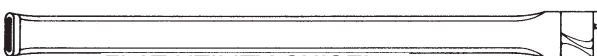

FLAT UTILITY CHISEL

OIL ONLY
ABSORBENT
SOCKS

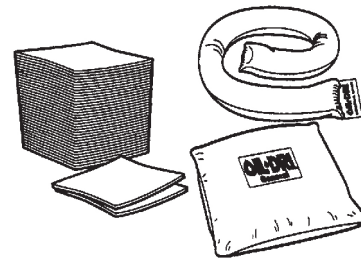

OIL SOAKER PADS

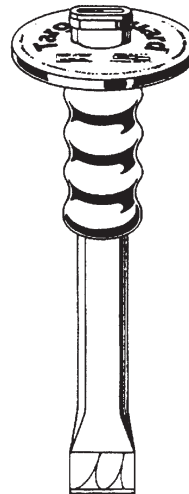

SPEEDY DRI



BUGLER SALES CORP.

Phone: 516 223-3868 • Fax: 516 868-6998
 969 CHURCH STREET • BALDWIN, NY 11510

E-mail: info@buglersales.com

NUMBER		DESCRIPTION	PK	RESALE	COST
CHEMICALS PERMATEx • KNIGHTS <i>continued...</i>					
PE81160		3 OZ HI-TEMP SILICONE "RED STUFF" 26BR	12		
PE81409	BEST SELLER	11 OZ HI-TEMP SILICONE "RED STUFF" 26C	12		
C2271		PAINT THINNER GALLON		EA	
C2280		MURIATIC ACID 1 GAL.		4	
C2306		A-1 BLEACH GALLON		6	
C2332		GAL SIMPLE GREEN		6	
C2380	NEW	PINT PVC CLEANER		12	
KN22732	BEST SELLER	32 OZ. GREZ-OFF		12	
KN22701		1 GAL. GREZ-OFF		6	
KN26832	BEST SELLER	32 OZ. SPRAY NINE		12	
KN26801		1 GAL. SPRAY NINE		6	
KN27532		32 OZ. TUB & TILE CLEANER		12	
CHEMICALS, SPILL CONTROL					
C2220	BEST SELLER	40 LB. SPEEDY DRY		EA	
C2221		50 LB. SPEEDY DRY		EA	
P0500		17x19 OIL SOAKER PADS (100) DBL WEIGHT		EA	
R0720		ALL WIPE 12 x 13 (50)		EA	
P0502	NEW	15 X 15 ORANGE POWER OIL PAD 85		EA	
P0505		4' OIL ONLY ABSORBENT SOCK 12-PACK		EA	
P0506		10' OIL ONLY ABSORBENT SOCK 6-PACK		EA	
P0550		UNIVERSAL DRUM TOP PADS (25)		EA	
CHISELS DASCO ALL STEEL PRODUCTS & CAULKING TOOLS					
DA4000	BEST SELLER	400-0 1/4" SHORT COLD CHISEL		5	
DA4010		401-0 5/16" SHORT COLD CHISEL		5	
DA4020		402-0 3/8" SHORT COLD CHISEL		5	
DA4050	BEST SELLER	405-0 1/2" SHORT COLD CHISEL		5	
DA4060		406-0 5/8" SHORT COLD CHISEL		5	
DA4080		408-0 3/4" SHORT COLD CHISEL		5	
DA4130		413-0 7/8" SHORT COLD CHISEL		5	
DA4170		417-0 1" SHORT COLD CHISEL		5	
DA4410	BEST SELLER	441-0 1/2x12" COLD CHISEL		5	
DA407		407 5/8x12" COLD CHISEL		5	
DA4100	BEST SELLER	410-0 3/4x12" COLD CHISEL		5	
DAG410		G410 3/4x12" SAFETY GRIP CHISEL		5	
DA4150		415-0 7/8x12" COLD CHISEL		5	
DA4190	BEST SELLER	419-0 1x12" COLD CHISEL		5	
DAG419		G419 1x12" SAFETY GRIP CHISEL		5	
DA3320	NEW	332-0 3/16" MASON'S CHISEL		5	
DA3330	NEW	333-0 1-3/4" MASON'S CHISEL		5	
DA3340	NEW	334-0 2-1/4" MASON'S CHISEL		5	
DA3350	NEW	335-0 2-3/4" MASON'S CHISEL		5	
DA4350	NEW	435-0 DASCO 3" BRICK SET		5	
DA3370		337-0 1-1/4x12" FLAT UTILITY CHISEL		5	
DA411		#411 3/4x18" COLD CHISEL		5	
DA420		#420 1x18" COLD CHISEL		5	
DA480		#480 3/4x12" CONCRETE CHISEL		5	
DAG480	BEST SELLER	G480 3/4x12" SAFETY GRIP CONCRETE		5	



BUGLER SALES CORP.

Phone: 516 223-3868 • Fax: 516 868-6998
969 CHURCH STREET • BALDWIN, NY 11510

E-mail: info@buglersales.com



LONG NOSE CAULKING IRON

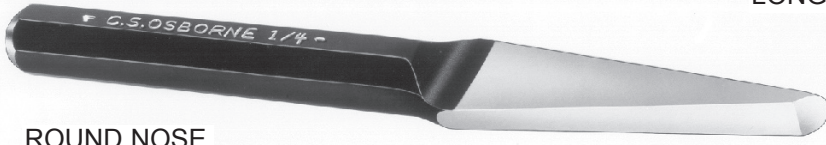

ROUND NOSE

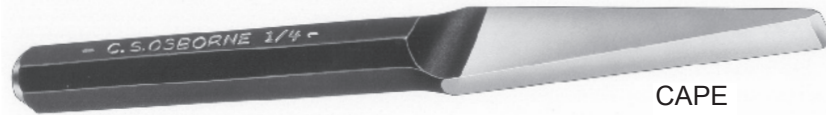

CAPE



CIRCULAR SAW BLADES



CHUCK KEYS



12" OR 14"
CHOP SAW BLADES



TYPE 27
GRINDING WHEELS



.045 WHEELS



STRAINER LOCK NUT WRENCH
W4962



4 IN 1 SPUD
W4901

Great Neck

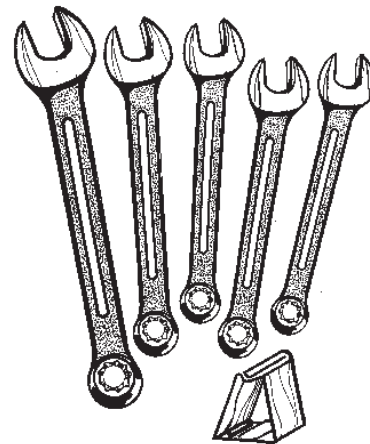

GNCOW5C

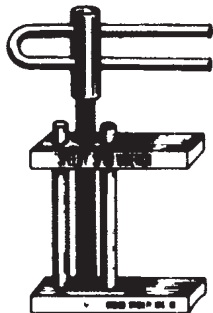

INTERNAL SPUD
W4945



GN25581

COMPASS SAW BLADES

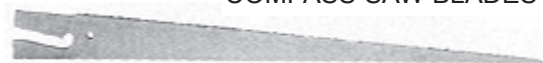



BUGLER SALES CORP.

Phone: 516 223-3868 • Fax: 516 868-6998
 969 CHURCH STREET • BALDWIN, NY 11510

E-mail: info@buglersales.com

NUMBER		DESCRIPTION	PK	RESALE	COST
CHISELS DASCO ALL STEEL PRODUCTS & CAULKING TOOLS <i>continued...</i>					
DA4730		473-0 3x11" FLOOR CHISEL	5		
C0695	BEST SELLER	#317 1/4" ROUND NOSE CHISEL	6		
C0696		#317 3/8" ROUND NOSE CHISEL	6		
C0698	BEST SELLER	#319 1/4" CAPE CHISEL	6		
C0700		#319 3/8" CAPE CHISEL	6		
BA1260		#1260 LG NOSE CAULKING IRON (IN)	6		
BA1270		#1270 LG NOSE CAULKING IRON (OUT)	6		
BA2400		#2400 5/8 X 12 PACKING TOOL	6		
CHOP, GRINDER & CIRCULAR SAW BLADES • IRWIN INDUSTRIAL • DIAMOND • CARBIDE					
IR14030		7-1/4" DIA. WOOD (FRAMING/RIPPING)	5		
S1504		7" METAL CUTTING (CIRCULAR SAW)	10		
S1505		12" METAL CUTTING	10		
S1506	BEST SELLER	14" METAL CUTTING	10		
S1513	NEW	12" X 1/8 X 20mm STEEL CHOP BLADE	10		
S1552		4-1/2" TYPE 27 GRINDING WHEEL METAL	25		
S1557		7" TYPE 27 GRINDING WHEEL METAL	25		
UN23099	NEW	4" .045 CUT-OFF WHEEL	50		
UN23101	NEW	4-1/2" X .045 X 7/8 METAL CUT WHEEL	50		
CHUCK KEY					
C1510		4 IN 1 CHUCK KEY	6		
CLOSET SPUD WRENCHES					
W4901		4 IN 1 SPUD	EA		
W4945		INTERNAL SPUD WRENCH	EA		
W4962		STRAINER LOCK NUT WRENCH	5		
COMBINATION WRENCHES					
GNCO25		1/4 COMBINATION WRENCH	6		
GNCO56		5/16 COMBINATION WRENCH	6		
GNCO1	BEST SELLER	3/8 COMBINATION WRENCH	6		
GNCO2	BEST SELLER	7/16 COMBINATION WRENCH	6		
GNCO3	BEST SELLER	1/2 COMBINATION WRENCH	6		
GNCO4	BEST SELLER	9/16 COMBINATION WRENCH	6		
GNCO5		5/8 COMBINATION WRENCH	6		
GNCO6		11/16 COMBINATION WRENCH	6		
GNCO7		3/4 COMBINATION WRENCH	6		
GNCO136		13/16 COMBINATION WRENCH	6		
GNCO78		7/8 COMBINATION WRENCH	6		
GNCO8		15/16 COMBINATION WRENCH	6		
GNCO10		1 COMBINATION WRENCH	6		
GNCO116		1-1/16 COMBINATION WRENCH	3		
GNCO118		1-1/8 COMBINATION WRENCH	3		
GNCO125		1-1/4 COMBINATION WRENCH	3		
GNCO5C		5 PC. COMBINATION WRENCH SET (3/8 - 5/8)	5		
GN25581		4 PC. COMBINATION W/RATCHET BOX	6		
GN51002		9 PC. COMBINATION WRENCH SET (1/4 - 3/4)	EA		
COMPASS SAWS & BLADES					
MA45565		4" COMPASS SAW BLADE	10		
MA45566	BEST SELLER	10" COMPASS SAW BLADE	10		
MA45568		12" COMPASS SAW BLADE	10		
MA45643		COMPASS SAW HANDLE, WOOD	10		



BUGLER SALES CORP.

Phone: 516 223-3868 • Fax: 516 868-6998
969 CHURCH STREET • BALDWIN, NY 11510

E-mail: info@buglersales.com

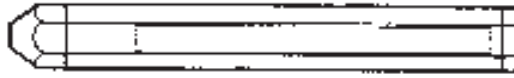

CARPENTER PENCILS

• YELLOW • RED • BLACK • BLUE • GREEN MARKING CRAYONS



HN00102
SHARPENER



AM1170500



STRIPPING BAR

AM1168800



AM1175300
MANHOLE COVER
LIFTER



POST HOLE DIGGING BAR
AM1160000



AM1175200



PINCH POINT BAR
AM1160100



DA152



WEDGE POINT BAR
AM1160200



CLOSET AUGER

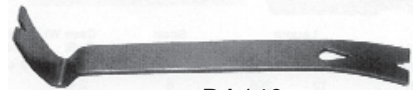

DA140

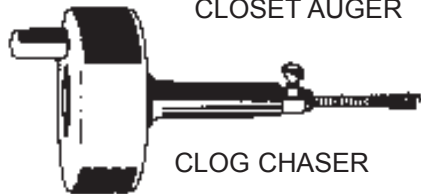

CLOG CHASER



DA130
NAIL CLAW



GT501



GT186



GTH34



GT750



C1189
DRIVEWAY
SEALER



BULBS
ROUGH SERVICE
BAYCO



Ultra Bright White





BUGLER SALES CORP.

Phone: 516 223-3868 • Fax: 516 868-6998
 969 CHURCH STREET • BALDWIN, NY 11510

E-mail: info@buglersales.com

NUMBER		DESCRIPTION	PK	RESALE	COST
CRAYONS AND PENCILS • KIEL • DIXON					
DI49600	BEST SELLER	YELLOW MARKING CRAYON	12		
DI52000		RED MARKING CRAYON	12		
DI52100		BLUE MARKING CRAYON	12		
DI49400		BLACK MARKING CRAYON	12		
DI00500		CRAYON HOLDER	6		
HN10316		7" FLAT WOOD CARPENTER'S PENCIL - MEDIUM	72		
HN00102		CARPENTER PENCIL SHARPENER	50		
CONSTRUCTION BARS, CROWBARS AMES • DASCO					
AM1170500		24" GOOSENECK WRECKING BAR	EA		
AM1171600		36" GOOSENECK WRECKING BAR	EA		
DA130		9" DASCO NAIL CLAW	10		
DA140		13-1/2" X 2" FLAT PRYBAR HI-VIZ - DASCO	EA		
AM1174800		60" X 1" SAN ANGELO BAR PENCIL POINT	EA		
AM1175200	BEST SELLER	72" X 1" SAN ANGELO BAR (DIGGING)	EA		
DA152		1-1/8 X 72" TELEGRAPH BAR	EA		
AM1175300		24" MANHOLE COVER LIFTER	EA		
AM1168800		1" X 48" STRIPPING BAR W/CLAW	EA		
AM1160000		69" POST HOLE DIGGING BAR	EA		
AM1160100		60" X 1-1/4" PINCH POINT CROWBAR	EA		
AM1160200		60" X 1-1/4" WEDGE POINT CROWBAR	EA		
DRAIN CLEANERS GENERAL WIRE					
GW15CL	BEST SELLER	15' CLOG CHASER	6		
GW25CL		25' CLOG CHASER	6		
GWC25CL	BEST SELLER	25' POWER CLOG CHASER	6		
GW3RB		CLOSET AUGER CARDED	12		
GT501		DRAIN KING - FOR 1" - 2" DRAINS	12		
GT186	BEST SELLER	DRAIN KING - FOR 1-1/2" - 3" DRAINS	12		
GTH34	BEST SELLER	DRAIN KING - FOR 3" - 4" DRAINS	6		
GT750		DRAIN KING - FOR 3" - 6" DRAINS	6		
GTVIP1		DRAIN KING VALUE PACK - W/ #501, #99, PE60	6		
DRIVEWAY SEALER AND ACCESSORIES					
C1189		5 GALLON FILLED DRIVEWAY SEALER	EA		
C1188		18" PALMYRA DRIVEWAY BRUSH	12		
DROP CLOTHS					
D1001	BEST SELLER	9 X 12 8 OZ.CANVAS	6		
D1002		4 X 12 12 OZ. CANVAS HALLWAY RUNNER	EA		
D1003		9 X 12 PLASTIC 1.0 MIL	36		
D1005	BEST SELLER	9 X 12 PLASTIC 2.0 MIL	24		
P1000		36" x 55yd ROSIN PAPER	EA		
D1008	NEW	31.5 X 72" SPUNPOLY DROPCLOTH	25		
DROP LIGHT BULBS					
L4175		#1 75 WATT ROUGH SERVICE BULB	6/120		
L4176	BEST SELLER	#2 100 WATT ROUGH SERVICE BULB	6/120		
L4177		#3 150 WATT ROUGH SERVICE BULB	6		
L4178		#4 TEFLON COATED BULB 100 WATT	6		
BYSL103	NEW	SL-103 13W FLUORESCENT BULB	12		
BYSL229	NEW	SL-229 18W FLUORESCENT BULB	12		



BUGLER SALES CORP.

Phone: 516 223-3868 • Fax: 516 868-6998
969 CHURCH STREET • BALDWIN, NY 11510

E-mail: info@buglersales.com

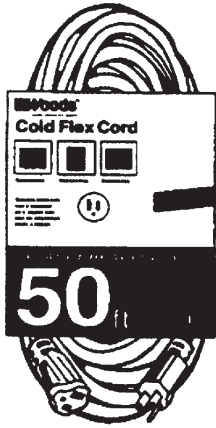

EXTENSION CORDS
ORANGE OR
BLUE/YELLOW COLDWEATHER



DROP LIGHTS
STEEL CAGE

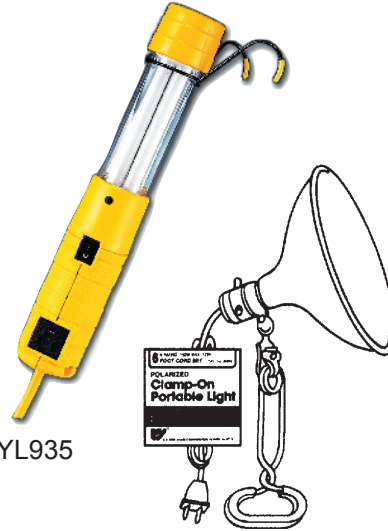

BSYL935



E9481

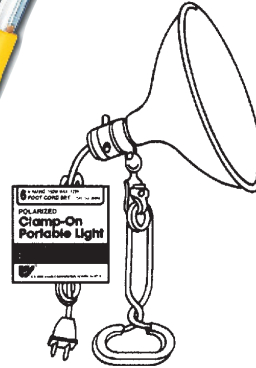

D1020 CLAMP ON



E9300



MXCT102



MXCT103



MXST400



MXCT500AV



MXMVS138



MXDMM830HS
W/ CONTINUITY



MXDMM51FSG



MXCT101



MXST600LED

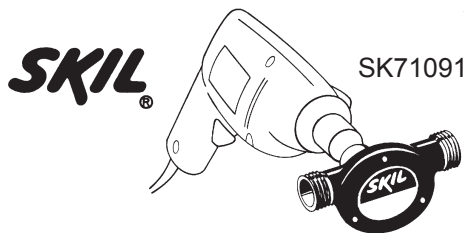
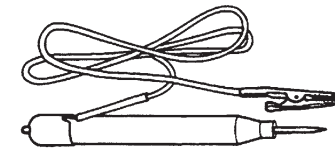

SK71091

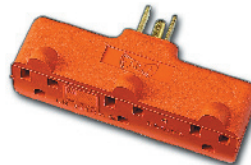

BSYL154



AIR
DUSTER



E1114-E1121



BUGLER SALES CORP.

Phone: 516 223-3868 • Fax: 516 868-6998
 969 CHURCH STREET • BALDWIN, NY 11510

E-mail: info@buglersales.com

NUMBER		DESCRIPTION	PK	RESALE	COST
DROP LIGHTS					
D1015	BEST SELLER	#691 25' 16/3 SJT ORANGE OSHA	12		
D1014		#692 50' 16/3 SJT ORANGE OSHA	6		
D1020		#149 15' 18/2 SJE CLAMP ON LAMP	12		
D1022		#2893 25' COLD WEATHER YELLOW	12		
D1016		TL825 BLUE 25' COLDWEATHER DROPLIGHT	12		
D1017		TL850 BLUE 50' COLDWEATHER DROPLIGHT	6		
BYSLR9000C2	NEW	7.2V CORDLESS 13W FLUORESCENT 90 MIN	2		
BYSL928	NEW	18W 25' 16/3 SJT YELLOW FLUORESCENT	6		
BYSL935	NEW	13W 25' 16/3 SJT YELLOW FLUORESCENT	6		
DUSTER					
AV134A		10OZ BLOW OFF NON FLAMMABLE - ORANGE	12		
AV152A	BEST SELLER	10OZ BLOW OFF DUSTER - GREEN	12		
ELECTRICAL TESTERS, G.B. , MANNIX					
E3610		GCT-304A CONTINUITY TESTER	10		
MXCT101		LINE VOLTAGE TESTER	10		
MXCT102	BEST SELLER	LOW VOLTAGE TESTER	10		
MXCT103		4-WAY TESTER	10		
MXCT500AV		AUD VIS LINE VOLTAGE TESTER	6		
MXDMM51FSG		DIGITAL MULTIMETER	EA		
MXDMM830HS	BEST SELLER	ECONOMY DIGITAL MULTIMETER	EA		
MXMVS138		STUD/METAL/VOLT FINDER	3		
MXST400	BEST SELLER	SCREWDRIVER TESTER 80/250V	10		
MXST600LED		LED SCREWDRIVER TESTER 70/250V	10		
ELECTRIC DRILL PUMP					
SK71091		DRILL PUMP FOR 5/8 HOSE	EA		
EXTENSION CORDS & ADAPTERS / SURGE PROTECTORS					
E9400		#625 25' 14/3 SJT ORANGE UL	12		
E9401	BEST SELLER	#626 50' 14/3 SJT ORANGE UL	6		
E9402		#627 100' 14/3 SJT ORANGE UL	3		
E9404		#529 50' 12/3 SJT ORANGE UL	4		
E9405	NEW	#530 100' 12/3 SJT ORANGE UL	3		
E9406		#842 2' 12/3 3-WAY TAP	12		
E9407		#268 50' 16/3 SJT ORANGE UL	12		
E9410		#82816 2' 3 OUTLET 12/3 IN LINE GFCI	6		
E9412		#2526 GFCI QUAD BOX 20 AMP 6' 12/3	4		
E9420	NEW	12/3 100' **HI-VIS** EXT. CORD	4		
E9300		3 TO 2 WIRE ADAPTER	25		
E9481		6' PREMIER SURGE PROTECTOR	2		
BYSL154	NEW	TRIPLE TAP ADAPTER	6		
EXTRACTORS					
E1114		#4 EASY OUT 1/8" PIPE	5		
E1115		#5 EASY OUT 1/4" PIPE	5		
E1116	BEST SELLER	#6 EASY OUT 3/8" PIPE	5		
E1117	BEST SELLER	#7 EASY OUT 1/2" PIPE	5		
E1118	BEST SELLER	#8 EASY OUT 3/4" PIPE	EA		
E1119		#9 EASY OUT 1" PIPE	EA		
E1120	NEW	#10 EASY OUT 1 1/4" PIPE	EA		
E1121	NEW	#11 EASY OUT 1-1/2" PIPE	EA		



E-mail: info@buglersales.com

OSHA SAFETY EQUIPMENT



3M8210



AE95050

PAINT, PESTICIDE &
ASBESTOS



AEARO 95090

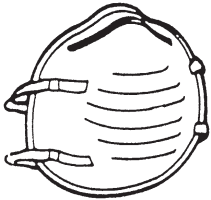

S1354 NIOSH
TWO STRAP

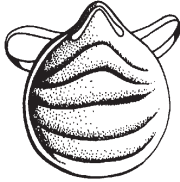

S1351
S1350

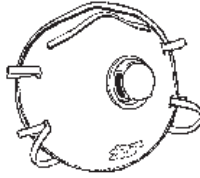

S1357 N95
MASK

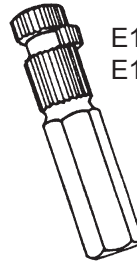

E1135
E1137



NRFP700XL
FALL PROTECTION

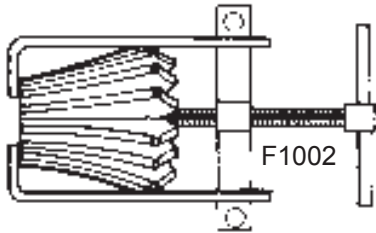

F1002

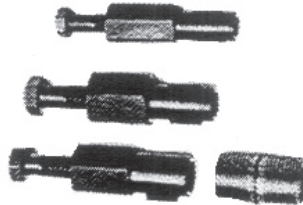

WH87050-WH87100

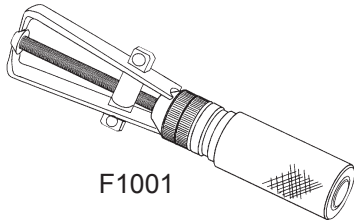

F1001

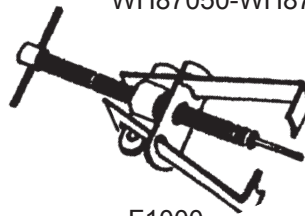

F1000

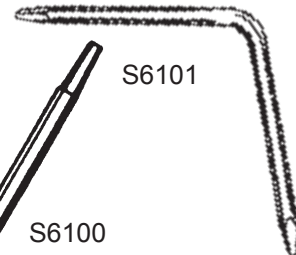

S6101

S6100

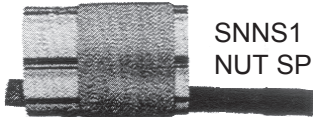

SNNS1
NUT SPLITTER



ASSORTED FILES

Great Neck Nicholson®

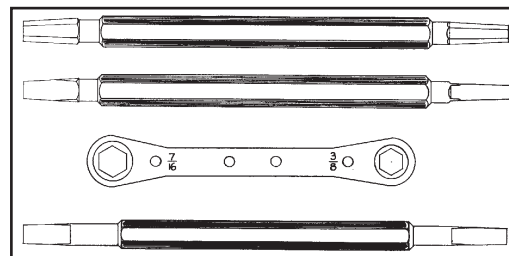

S6103 - 4 PIECE SET



BUGLER SALES CORP.

Phone: 516 223-3868 • Fax: 516 868-6998
 969 CHURCH STREET • BALDWIN, NY 11510

E-mail: info@buglersales.com

NUMBER		DESCRIPTION	PK	RESALE	COST
EXTRACTORS <i>continued...</i>					
WH87050		1/2" NIPPLE CHUCK (PROTO STYLE)	EA		
WH87075		3/4" NIPPLE CHUCK (PROTO STYLE)	EA		
WH87100		1" NIPPLE CHUCK (PROTO STYLE)	EA		
E1135	BEST SELLER	1/2" IPS NIPPLE EXT. (SAME AS RODDICK)	6		
E1137		3/4" IPS NIPPLE EXT. (SAME AS RODDICK)	6		
FACE MASKS • AEARO • NORTH SAFETY					
3M8000	NEW	8000 N95 RESPIRATOR - PK30 (NO NOSE PAD)			
3M8210	NEW	8210 PARTICULATE RESPIRATOR (20)	4		
S1351	BEST SELLER	2985 DUST MASKS BULK PACK - 50 PER BOX	12		
S1350	BEST SELLER	#805 DUST MASKS - FIVE PER PACK	12		
S1354	BEST SELLER	8610 N95 MASK 20 PER PACK 2-STRAP	12		
S1357		8611 N95 MASK W/ EXHALATION VALVE PK10	12		
AE95050		#95050 ASBESTOS PAINT/PEST. RESPIRATOR	EA		
AE95061		#95061 ASBESTOS REPLACEMENT CART.	EA		
AE95090	NEW	#95090 QUICKLATCH RESPIRATOR	EA		
AE95115		#95115 ECONOMY RESPIRATOR	EA		
AE95111		#95111 REPLACEMENT FILTERS FOR 95115	EA		
FALL PROTECTION					
NRFP700XL		FP700 NYLON FULL BODY HARNESS / XL	EA		
FAUCET HANDLE PULLERS					
F1000		FAUCET HANDLE PULLER	10		
F1001		DELUXE / IMPACT HANDLE PULLER	EA		
F1002	BEST SELLER	BIG YANK FAUCET HDL. PULLER	6		
FAUCET NUT SPLITTERS					
SNNS1		NS-1 FAUCET NUT SPLITTER	EA		
FAUCET SEAT TOOLS					
S6100	BEST SELLER	STRAIGHT FAUCET TOOL	12		
S6101	BEST SELLER	ANGLE FAUCET TOOL TAPERED	12		
S6103		FAUCET SEAT WRENCH KIT 4 PC.	6		
FILES • GREAT NECK • NICHOLSON					
GNHCMB8		#HCMB8 8" FLAT FILE W/HDL	6		
GNHCRF8		#HCRF8 8" ROUND FILE W/HDL.	6		
GNHHR8C	BEST SELLER	#HHR8C 8" HALF ROUND FILE W/HDL.	6		
GNMB10		10" MILL BASTARD FILE	10		
GNMB12		12" MILL BASTARD FILE	10		
GNSR8C		8" 4 IN 1 MULTICUT FILE	6		
NI21745	BEST SELLER	8" HALF ROUND CARDED NICHOLSON	6		
NI21858		10" HALF ROUND CARDED NICHOLSON	6		
NI05090		12" HALF ROUND CARDED NICHOLSON	6		
NI21687		6" FLAT MILL CARDED NICHOLSON	6		
NI21694	BEST SELLER	8" FLAT MILL CARDED NICHOLSON	6		
NI21701		10" FLAT MILL CARDED NICHOLSON	6		
NI21708		6" ROUND CARDED NICHOLSON	6		
NI21715		8" ROUND CARDED NICHOLSON	6		
NI21729		6" TAPER SLIM CARDED NICHOLSON	6		
NI21736		6" EXTRA TAPER SLIM CARDED NICHOLSON	6		
NI21860		8" 4-IN-ONE (FORM. SHOE RASP) NICHOLSON	6		



BUGLER SALES CORP.

Phone: 516 223-3868 • Fax: 516 868-6998
969 CHURCH STREET • BALDWIN, NY 11510

E-mail: info@buglersales.com

CARBON MONOXIDE



KI9000102
C/O SMOKE ALARM



KI9000113



KI466164



KI466225



KI0914E

FULL LINE OF OSHA PRODUCTS...



OSHA FIRST AID KITS
10 PERSON
25 PERSON
50 PERSON



S1348

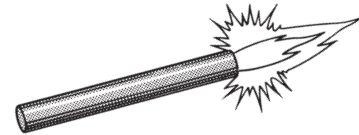

F6000 ROAD FLARES



COPPER TUBE FLARE PUNCHES

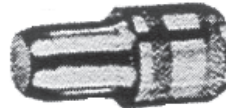

FLARING SETS



AA - TAKES MINI-MAGLITE BULBS



GN32051



RASPHLTLED

RAIN2

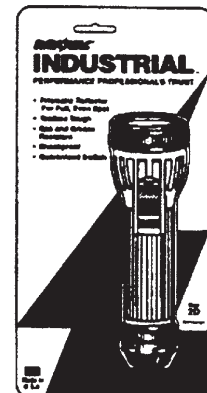

GN32055



BUGLER SALES CORP.

Phone: 516 223-3868 • Fax: 516 868-6998
 969 CHURCH STREET • BALDWIN, NY 11510

E-mail: info@buglersales.com

NUMBER		DESCRIPTION	PK	RESALE	COST
FIRE EXTINGUISHERS & CO DETECTORS KIDDE					
KI466164		XL5MP 2.5LB. ABC FIRE EXTINGUISHER	4		
KI466204K		PRO10MP 10LB. ABC W/ WALL BRACKET	1		
KI466225		XL2.5MP 2.5LB. ABC FIRE EXTINGUISHER	6		
KI9000107		AC BASIC CO ALARM	3		
KI9000113		CO/EXPLOSIVE GAS DC ALARM DIGITAL	2		
KI9000102		COMBO CO/SMOKE ALARM DC	3		
KI1235		AC HARDWIRE SMOKE DETECTOR	1		
KI0914E	NEW	914E KIDDE SMOKE DETECTOR BATTERY	12		
KI21005293	NEW	BASIC CO DETECTOR 3 AAA BATTERY	10		
KI21005296	NEW	CO/SMOKE COMBO UNIT BATTERY	10		
KI9000120	NEW	9000210 KIDDE DETECTOR HARDWRE	6		
FIRST AID KITS					
S1335	BEST SELLER	10-PERSON FIRST AID KIT OSHA PLASTIC	10		
S1336	BEST SELLER	25-PERSON FIRST AID KIT OSHA METAL	12		
S1337		25-PERSON FIRST AID KIT PLASTIC	12		
S1338		50-PERSON FIRST AID STATION PLASTIC	EA		
S1339		50-PERSON FIRST AID STATION OSHA METAL	EA		
S1347		8 OZ. ISOTONIC EYEWASH	12		
S1344		INSTANT COLD PACKS	12		
S1348		32OZ EYEWASH STATION M-745	4		
S1349		32OZ EYEWASH STATION **REFILL**	1		
FLARES, ROAD					
F6000		30 MINUTE FLARE W/WIRE HOLDER	36		
FLARING SETS					
GE155	BEST SELLER	#155 FLARING TOOL 3/16" TO 5/8" (GENERAL)	3		
GNFT3C		#FT3C FLARING TOOL (IMPORT)	6		
F6010		3/4" COPPER TUBE FLARER	EA		
F6011		1" COPPER TUBE FLARER	EA		
FLASHLIGHTS • RAYOVAC - GREAT NECK					
RAIN4	BEST SELLER	IN4 INDUSTRIAL AA CELL "YELLOW"	6		
RAIN2	BEST SELLER	IN2 INDUSTRIAL 2 D CELL "YELLOW"	6		
RAIN2KML		IN2KML INDUSTRIAL 2 D CELL W/MAGNET	6		
RAIN2CT		IN2-CT INDUSTRIAL 2 D CELL W/TESTER	6		
RAIN3		IN3 HEAVY DUTY 3D CELL FLASHLIGHT	6		
GNGLFB002	BEST SELLER	MINI MAGLITE BULBS (2 PK)	10		
RAK2-2		K2-2 KRYPTON BULB FOR 2 D CELL	10		
RAPR2-2	BEST SELLER	PR2-2 2-PACK REPLACEMENT BULB FOR IN2	10		
RAPR4-2	BEST SELLER	PR4-2 2-PACK REPLACEMENT BULB FOR IN4	10		
RASP3N1LED-B	NEW	SP3N1LED 3 IN 1 FLASHLIGHT WITH BATTERIES	4		
RASPHLTLED	NEW	SPHLTLED 3 IN 1 LED HEADLIGHT	4		
RASPLED3AAA	NEW	SPLED3AAA LED FLASHLIGHT WITH CLIP	4		
RAE2DCC		E2DCC ECONOMY FLASHLIGHT 2D CELL	12		
GN32021	BEST SELLER	AA CELL ALUMINUM GREATLIGHT W/ BATTERIES	10		
GN32023		2-D CELL ALUMINUM GREATLIGHT W/ BATTERIES	12		
GN32051	NEW	#32051 LED KEYCHAIN FLASHLIGHT	12		
GN32055	NEW	#32055 GREATLITE LED 3D FLASHLIGHT	12		



E-mail: info@buglersales.com

STREAMLIGHT



SL61100



SL45503



SL65018
BLACK, BLUE, RED
LED STYLUS

MAG-LITE®



Maglite® Solitaire® Flashlight Single Cell AAA



Mini Maglite® Flashlight 2-Cell AAA



Mini Maglite® Flashlight 2-Cell AA



Maglite® Flashlight 2 through 6 C-Cell



Maglite® Flashlight 2 through 6 D-Cell



Maglite® Rechargeable Flashlight System™

STREAMLIGHT



TWIN TASK

SL51003 - 3AAA
SL51002 - 3C



BUGLER SALES CORP.

Phone: 516 223-3868 • Fax: 516 868-6998
 969 CHURCH STREET • BALDWIN, NY 11510

E-mail: info@buglersales.com

NUMBER		DESCRIPTION	PK	RESALE	COST
FLASHLIGHTS BY MAGLITE					
MAGLITE AAA SINGLE CELL FLASHLIGHTS					
MGK3A016	NEW	AAA MAG SINGLE CELL	12		
MINI MAGLITE AAA FLASHLIGHTS					
MGM3A016	NEW	MINI MAGLITE AA BLACK	12		
MGM3A116	NEW	MINI-MAG 2-AAA CELL FLASHLIGHT W/ BATTERIES (BLUE)	12		
MINI MAGLITE AA FLASHLIGHTS					
MGM2A016	NEW	MINI MAGLITE AA HANG PACK BLACK	12		
MGM2A01C	NEW	MINI MAGLITE AA COMBO PACK BLACK	12		
MGM2A026	NEW	MINI MAG AA W/2 BATTERIES CAMO	12		
MGM2A036	NEW	MINI MAGLITE W/2 AA BATTERIES RED	12		
MGM2A106	NEW	MINI MAGLITE W/2 AA BATTERIES SILVER	12		
MGM2A116	NEW	MINI MAGLITE AA W/2 AA BATTERIES BLUE	12		
MGM2A986	NEW	MINI MAGLITE W/2 AA BATTERIES PURPLE	12		
MGM2A01H	NEW	MINI MAGLITE AA BLACK W/VINYL HOLSTER	12		
MGM2A03H	NEW	MINI MAGLITE HOLSTER COMBO PACK RED	12		
MGM2A11H	NEW	MINI MAGLITE HOLSTER COMBO PAK BLUE	12		
C CELL FLASHLIGHTS					
MGS2C016	NEW	2 CELL C MAGLITE	12		
MGS3C016	NEW	3 CELL C MAGLITE	12		
D CELL FLASHLIGHTS					
MGS2D016	NEW	2 CELL D MAGLITE	12		
MGS3D016	NEW	3 CELL D MAGLITE BLACK	12		
MGS4D016	NEW	4 CELL D MAGLITE	12		
MGS5D016	NEW	5 CELL D MAGLITE	12		
ACCESSORIES					
MGAM2A026	NEW	PLAIN LEATER HOLSTERFOR AA PMH11	12		
MGASXC046	NEW	BELT HOLDER PLAIN LEATER C CELL	12		
MGASXD036	NEW	BELT HOLDER PLAIN LEATHER D CELL	12		
MGLM2A001	NEW	MINI MAGLITE AA REPL LAMP 2/PKG	12		
MGLM3A001	NEW	MINI MAGLITE AAA REPL LAMP 2/PKG	12		
MGLMSA201	NEW	2 CELL MAGNUM STAR C OR D REPL BULB 1/PKG	12		
MGLMSA301	NEW	3 CELL MAGNUM STAR C OR D REPL BULB 1/PKG	12		
MGLMSA401	NEW	4 CELL MAGNUM STAR C OR D REPL BULB 1/PKG	12		
MGLMSA501	NEW	5 CELL MAGNUM STAR C OR D REPL BULB 1/PKG	12		
FLASHLIGHTS BY STREAMLIGHT					
SL22311		LITEBOX AC CHARGE CORD	EA		
SL45503		LITEBOX ONLY ORANGE	EA		
SL45070		LITEBOX CHARGER / HOLDING RACK	EA		
SL51002	NEW	51002 TWIN TASK 3C LED BLACK	3		
SL51003	NEW	51003 TWIN TASK 3AAA LED BLACK	3		
SL61100	NEW	61100 CLIPMATE YELLOW W/BATERIES	12		
SL65018	NEW	65018 BLACK STYLUS LED WHITE	12		
SL65035	NEW	65035 RED STYLUS LED WHITE	12		
SL65050	NEW	65050 BLUE STYLUS LED WHITE	12		



BUGLER SALES CORP.

Phone: 516 223-3868 • Fax: 516 868-6998
969 CHURCH STREET • BALDWIN, NY 11510

E-mail: info@buglersales.com

PACKAGED OR BULK



DURACELL®

CARDED OR BULK



Energizer®

brand Battery

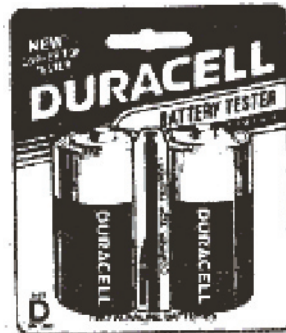

BLITZ®



BL05064

BL05090

BL11881



BL06064



DURACELL®



DP18230

FIRE RETARDANT



DP18826



DP18836



G5575



WH69012



C3020



GIMLET RODS



BUGLER SALES CORP.

Phone: 516 223-3868 • Fax: 516 868-6998
 969 CHURCH STREET • BALDWIN, NY 11510

E-mail: info@buglersales.com

NUMBER		DESCRIPTION	PK	RESALE	COST
BATTERIES ENERGIZER • RAYOVAC • DURACELL					
B0100		AA ALKALINE INDUSTRIAL ENERGIZER	24		
B0101		AAA ALKALINE INDUSTRIAL ENERGIZER	24		
B0102		C ALKALINE INDUSTRIAL ENERGIZER	12		
B0103		D ALKALINE INDUSTRIAL ENERGIZER	12		
B0105		9V ALKALINE INDUSTRIAL ENERGIZER	12		
B0092	NEW	#123 LITHIUM BATTERY DURACELL 3V	12		
B0096		AA ALKALINE INDUSTRIAL DURACELL	24		
B0095		AAA ALKALINE INDUSTRIAL DURACELL	16		
B0097		C ALKALINE INDUSTRIAL DURACELL	12		
B0098		D ALKALINE INDUSTRIAL DURACELL	12		
B0099		9V ALKALINE INDUSTRIAL DURACELL	12		
RAHD-D	BEST SELLER	HD-D DCELL H. D. INDUSTRIAL	6/72		
RAAL-AA	BEST SELLER	AL-AA ALKALINE INDUSTRIAL RAYOVAC	8/96		
RAAL-AAA		AL-AAA ALKALINE INDUSTRIAL RAYOVAC	8/96		
RAAL-C		AL-C ALKALINE INDUSTRIAL RAYOVAC	6/72		
RAAL-D	BEST SELLER	AL-D ALKALINE INDUSTRIAL RAYOVAC	6/72		
RAAL-9V		AL-9V ALKALINE INDUSTRIAL RAYOVAC	6/72		
DU9V2PK		9V DURACELL - 2 PACK	EA		
DUAA4PK		AA DURACELL - 4 PACK	EA		
DUAAA2PK		AAA DURACELL - 2 PACK	EA		
DUC2PK		C DURACELL - 2 PACK	EA		
DUD2PK		D DURACELL - 2 PACK	EA		
FOAM SEALANT • DAP					
DP18230	BEST SELLER	12 OZ. FOAM SEALANT FLAME RETARDANT	12		
DP18826		12 OZ. DAPTEX LATEX FOAM SEALANT	12		
DP18836	NEW	12 OZ. DAPTEX PLUS FOAM SEALANT	12		
FUNNELS • BLITZ					
BL05064		2 QUART FUNNEL	12		
BL05090		LONG SPOUT FUNNEL	12		
BL06064	NEW	06064 TRANSMISSION FUNNEL	12		
BL11881	NEW	11881 FLEXI FUNNEL	12		
GAUGE GLASS CUTTERS					
G5575	BEST SELLER	GAUGE GLASS CUTTER BEAM TYPE	EA		
G5574		REPLACEMENT WHEEL & PIN FOR G5575	6		
WH69012		GAUGE GLASS CUTTER CHAIN TYPE	EA		
GIMLET RODS / HANGER BOLTS					
C3019		1/4" GIMLET ROD DRIVER	5		
C3020	BEST SELLER	3/8" GIMLET ROD DRIVER	10		
G5500	BEST SELLER	1/4 X 3 GIMLET ROD PLATED	100		
G5502		3/8 X 3 GIMLET ROD PLATED	50		
G5503		3/8 X 3-1/2 GIMLET ROD PLATED	50		
G5504	BEST SELLER	3/8 X 4 GIMLET ROD PLATED	50		
G5506	BEST SELLER	3/8 X 6 GIMLET ROD PLATED	50		
G5508		3/8 X 8 GIMLET ROD PLATED	50		
G5510		3/8 X 10 GIMLET ROD PLATED	25		
G5512		3/8 X 12 GIMLET ROD	25		
G5514		1/2 X 4 GIMLET ROD	50		
G5516		1/2 x 6 GIMLET ROD	50		



BUGLER SALES CORP.

Phone: 516 223-3868 • Fax: 516 868-6998
969 CHURCH STREET • BALDWIN, NY 11510

E-mail: info@buglersales.com



G5601



G5602



G5603

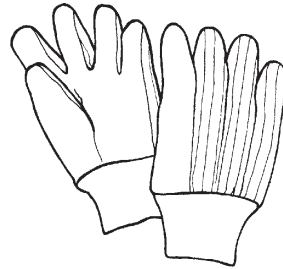

G5604



G5606

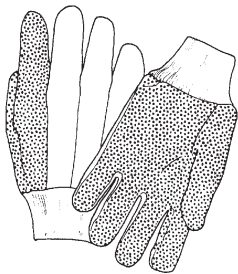

G5701

**BUGLER SALES
HAS 117
STYLES
OF GLOVES
IN MANY
DIFFERENT
SIZES TO
SUIT YOUR NEEDS**



G5702



G5974 RED PALM
G5975 BLUE PALM



MC17001



MC17002



G5625



Ansell

Protective Products

DISPOSABLE GLOVES
NITRILE / VINYL / LATEX
POWDERED
POWDER-FREE
13 MIL DE-CON

**ALL CRAFTS
PROFESSIONAL EPOXY**



PE84101



PE80065

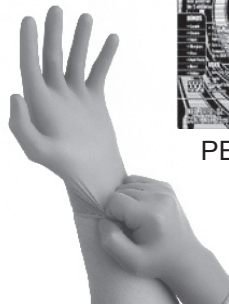

TNT / NITRILE / LATEX / VINYL



G6010



66000



BUGLER SALES CORP.

Phone: 516 223-3868 • Fax: 516 868-6998
 969 CHURCH STREET • BALDWIN, NY 11510

E-mail: info@buglersales.com

NUMBER		DESCRIPTION	PK	RESALE	COST
GLOVES, MANY STYLES, SIZES - CASE PRICING AVAILABLE					
G5601	BEST SELLER	#1 BROWN JERSEY PAIR 9 OZ.	12/300		
G5602		#2 RED LINED BROWN JERSEY	12/144		
G5603	BEST SELLER	#3 LEATHER PALM W/SAFETY CUFF	12/120		
G5604		#4 LEATHER PALM KNIT WRIST	12		
G5605		#5 LINED LEATHER PALM WORK GLOVE	6		
G5606		#6 LEATHER DRIVERS	12		
G5607		#7 LEATHER DRIVERS LINED	12		
G5608		#8 DRIVERS "THINSULATE" LINED	6		
G5625	NEW	GLOVE / HANDWARMERS 2 PACK	40		
G5626	NEW	LARGE FOOT WARMERS	36		
G5701		#P1 PVC DOT JERSEY	12		
G5702		#P2 PVC COATED	12		
G5707	NEW	VINYL MEDIUM CLEAR	100	10	
G5708		VINYL LG CLEAR	100	10	
G5709	NEW	VINYL X-LG CLEAR	100	10	
G5765		#P3 LATEX MEDIUM	100	10	
G5766	BEST SELLER	#P3 LATEX LARGE	100	10	
G5767	BEST SELLER	#P3 LATEX XLG.	100	10	
G5772	NEW	LATEX POWDER FREE 100 MD GRPR	10		
G5773		LATEX POWDER FREE 100 LG GRPR	10		
G5774	NEW	LATEX POWDER FREE 100 XL GRPR	10		
AN92500M		TNT NITRILE MEDIUM (92-500)	100	10	
AN92500L	BEST SELLER	TNT NITRILE LARGE (92-500)	100	10	
AN92500XL	BEST SELLER	TNT NITRILE XL (92-500)	100	10	
AN92600M		POWDER FREE NITRILE MEDIUM TNT (92-600)	100	10	
AN92600L		POWDER FREE NITRILE LARGE TNT (92-600)	100	10	
AN92600XL		POWDER FREE NITRILE XL TNT (92-600)	100	10	
AN34650L		#P22L BLUE VINYL (LG) 100 (34-650)	10		
AN34650XL		#P22X BLUE VINYL (XL) 100 (34-650)	10		
G5726		#P26 PVC W/CUFF LINED ORANGE	12		
G5745		FLOCK LINED LATEX DISHWASHER GLOVE	12		
G5763		PROTECTIVE RUBBER GLOVE 16"	6		
G5776	NEW	12" 13ML LATEX GLOVES (50) GHRL MED	10		
G5777	NEW	12" 13ML LATEX GLOVES (50) GHRL LG	10		
G5778	NEW	12" 13ML LATEX GLOVES (50) GHRL XL	10		
G5917	NEW	18" CUFF PVC COATED GLOVE PAIR	12		
G5975		BLUE PALM STRING KNIT GLOVES PAIR	12/300		
G5974	BEST SELLER	RED PALM STRING KNIT GLOVES PAIR	10/300		
AN34100LG		34-100 GREEN VINYL 6.5 MIL LARGE	4		
AN34100XL		34-100 GREEN VINYL 6.5 MIL XL	4		
MC17001	NEW	17001-L POWER TOOL GLOVES - PAIR	6		
MC17002	NEW	17002-L VIBRATION KILLER GLOVE - PAIR	6		
OTHER TYPES AVAILABLE					
GLUES AND EPOXY					
E5600		ET-12 DURO CRAFT EPOXY (ALL CRAFTS)	20		
G6000	BEST SELLER	KRAZY GLUE CARDED	12		
G6010		PLUMBERS GOOP 3.7 FLUID OZ.	12		
PE84101		PERMATEX PERMA POXY	12		
PE80065		9OZ. HIGH TACK PERMATEX SEALANT	12		
PE84309		20OZ 4 MIN MULTI METAL EPOXY STICK	12		



BUGLER SALES CORP.

Phone: 516 223-3868 • Fax: 516 868-6998
969 CHURCH STREET • BALDWIN, NY 11510

E-mail: info@buglersales.com

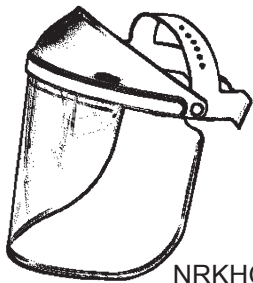

NRKHG5001
NRA815040



AE90791

AE90959

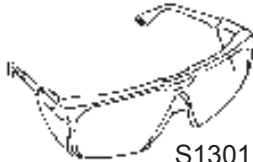

S1301



GOGGLES



S1322
UV SAFETY
TINTED



SAND CLOTH

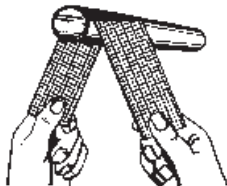

GRIT CLOTH



PL30132



PL30139



GE858



S1520 ROD SAW



GN50

Great Neck



GN35C
CHEESE
SAW

PL30445



GN125



GNHF10



GN245



DP10731
GROUT



SPACKLE



ANTI-VIBRATION

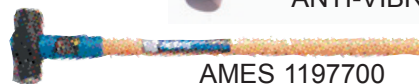

AMES 1197700



BUGLER SALES CORP.

Phone: 516 223-3868 • Fax: 516 868-6998
 969 CHURCH STREET • BALDWIN, NY 11510

E-mail: info@buglersales.com

NUMBER		DESCRIPTION	PK	RESALE	COST
GOGGLES					
AE90791	NEW	90791 CLEAR SAFETY GLASSES (LANDSCAPER)	10		
AE90959	NEW	90959 YELLOW LENS SAFETY GLASSES	10		
S1300	BEST SELLER	SAFETY GOGGLES	12		
S1301	BEST SELLER	SAFETY SPECTACLES CLEAR	12		
S1322		TINTED SPECTACLES "TERMINATOR TYPE" UV	12		
NRKHG5001		HEAD PIECE FOR FACE SHIELD	10		
NRA815040		CLEAR FACE SHIELD (OSHA/ANSI)	10		
GREASE GUNS & ACCESSORIES • PLEWS					
PL11300		4PK MULTI-PURPOSE LITHIUM GREASE MINI	5		
PL30132		MIDGET GREASE GUN KIT	1		
PL11354		14 oz. MULTI-PURPOSE LITHIUM GREASE	10		
PL30445		LEVER GREASE GUN (PAINTED)	1		
GRIT & SAND CLOTH • BUGLER					
G8095	BEST SELLER	5 YD. 180 GRIT SIL. CARB (WATERPROOF)	25		
G8096	BEST SELLER	10 YD. 180 GRIT SIL. CARB (WATERPROOF)	25		
G8097		25 YD. 180 GRIT SIL. CARB (WATERPROOF)	EA		
G8098	BEST SELLER	5 YD. SAND ALUM. OXIDE (WATER RESIST)	25		
G8099	BEST SELLER	10 YD. SAND ALUM. OXIDE (WATER RESIST)	25		
G8100		25 YD. SAND ALUM. OXIDE (WATER RESIST)	EA		
GROUT & SPACKLE DAP • SAVOGRAN • DURABOND					
G9003		5 LB. TILE GROUT WHITE (EA)	6		
DP10731		4 FL OZ. ARCTIC WHITE TILE GROUT REPAIR	12		
G9010	BEST SELLER	ONE PT. READY MIX GROUT WHITE (EA)	12		
G9011		ONE QT. READY MIX GROUT WHITE (EA)	6		
DP12142		ONE QT. DAP ALL PURPOSE SPACKLE	6		
DP12336	NEW	DRYDEX 2 OZ. SQUEEZE TUBE	12		
DP12341	NEW	DRYDEX WALL REPAIR PATCH KIT	12		
HACKSAWS & BLADES GREAT NECK					
GN35C	BEST SELLER	CHEESE SAW #35C MINI HACKSAW FRAME	12		
GN615C	BEST SELLER	CHEESE SAW BLADES 5 PER PACK	10		
GN50	BEST SELLER	#50 HACKSAW FRAME	6		
GN125		#125 HACKSAW FRAME	1		
GN245	BEST SELLER	#245 PRO HACKSAW (LENOX TYPE)	6		
GNHF10		HF10 CLOSE QUARTER HACKSAW FRAME	6		
S1520		12" CARBIDE GRIT RODSAW CARDED	10		
S1527		12" 32T CARBON HACKSAW BLADE	100		
GE858	NEW	858 GENERAL PVC PIPE CABLE SAW	3		
SEE LENOX SECTION FOR MORE HACKSAWS					
HAMMERS AMES • GREAT NECK • PLUMB					
AM1197700	NEW	8 LB SLEDGE HAMMER 36" HICK HDL	3		
AM1199100	NEW	10 LB. SLEDGE HAMMER 36 "HICK HDL	2		
AM1199400	NEW	12 LB SLEDGE HAMMER 36" HICK HDL	2		
AM1199700	NEW	16 LB SLEDGE HAMMER 36" HICK HDL	2		
AM1199900	NEW	20 LB SLEDGE HAMMER 36" HICK HDL	2		
H1303		16 OZ. BALL PEIN	4		
H1304		24 OZ. BALL PEIN	4		
H1305		32 OZ. BALL PEIN	4		
PBSS16R		16 OZ. HI-VIZ ANTI-VIBRATION PLUMB	4		
PBSS20R		20 OZ. HI-VIZ ANTI-VIBRATION PLUMB	4		
PBSS22R		22 OZ. HI-VIZ ANTI-VIBRATION PLUMB	4		



BUGLER SALES CORP.

Phone: 516 223-3868 • Fax: 516 868-6998
969 CHURCH STREET • BALDWIN, NY 11510

E-mail: info@buglersales.com



PE01013



PE03013



PE25218
GALLON

AMES TRUE TEMPER.
Lawn & Garden Tools—Since 1774



LUMP HAMMER
FIBERGLASS or
WOOD HANDLES



CE01545
ANTISEPTIC



KC91371
75 CT



SCRUBS
72 CT



60 CT
TOOL BOX PACK



130 CT
BUCKET



GJ9034

Great Neck



BALL PEIN HAMMERS



GJ0955
GALLON W/ PUMP



GJ0957



GJ0915



GJ9172



GNHG16S



H1357

DISPENSERS AVAILABLE FOR ALL APPLICABLE ITEMS



BUGLER SALES CORP.

Phone: 516 223-3868 • Fax: 516 868-6998
 969 CHURCH STREET • BALDWIN, NY 11510

E-mail: info@buglersales.com

NUMBER		DESCRIPTION	PK	RESALE	COST
HAMMERS AMES • GREAT NECK • PLUMB <i>continued...</i>					
PB11419		16 OZ. PREMIUM RIPPING CLAW PLUMB	4		
PB11418	BEST SELLER	20 OZ. PREMIUM RIPPING CLAW PLUMB	4		
PB11414		22 OZ. PREMIUM RIPPING CLAW PLUMB	4		
GNHG16S		16 OZ. FIBERGLASS HDL. RIP - GREAT NECK	6		
GNHG20S		20 OZ. FIBERGLASS HDL. RIP - GREAT NECK	4		
KC96705		20 OZ. BLUE FIBERGLASS HDL. RIP - SMOOTH	4		
H1357		32 OZ RUBBER Mallet	6		
AM1196100		2 LB. LUMP (DOMESTIC)	2		
AM1101300	BEST SELLER	3 LB. LUMP (DOMESTIC)	2		
AM1101800		4 LB. LUMP (DOMESTIC)	2		
AM1101400		3 LB. FIBERGLASS HANDLE LUMP	2		
HAND CLEANER DL • TROUNCE • FAST ORANGE • CELLO • KIMBERLY CLARK					
GJ0912		LEMON W/PUMICE 18oz CARTRIDGE	12		
GJ0915		GOJO 4.5lb. LEMON W/ PUMICE	6		
GJ0955	BEST SELLER	GOJO NATURAL ORANGE W/PUMP PUMICE	4		
GJ0957	BEST SELLER	14fl oz GOJO ORANGE W/BRUSH PUMICE	12		
GJ0958		GOJO NATURAL ORANGE 1/2 GALLON W/PUMP	6		
GJ0971		14OZ TUB GOJO ORANGE W/ PUMICE	12		
GJ1115		4.5lb ORIGINAL FORMULA CRÈME	6		
GJ1135		4lb GOJO PUMICE CRÈME	6		
GJ1204		DISPENSER FOR 4.5 lb GOJO	1		
GJ6285	BEST SELLER	60ct GOJO FAST WIPES TOOL BOX PACK	6		
GJ6298		130ct GOJO FAST WIPES BUCKET	4		
GJ7200		DISPENSER FOR 2000ml BLACK	1		
GJ7250		GOJO NATURAL 2000ml ORANGE	4		
GJ7265		GOJO MULTI GREEN MEDIUM	4		
GJ8142		2fl oz GOJO HAND MEDIC	12		
GJ8145		8fl oz GOJO HAND MEDIC	6		
GJ9034		DISPENSER 800ml WHITE for BAG-IN-BOX	1		
GJ9112	BEST SELLER	DERMAPRO 800ml LOTION BAG-IN-BOX	12		
GJ9172		DERMAPRO 800ml LIME BAG-IN-BOX	12		
SCRUBS	NEW	72 CT HAND WIPES BUCKET SCRUBS	6		
KC91371	NEW	75 CT WYP-ALL HAND WIPES BUCKET	6		
PE01013	BEST SELLER	DL BLUE 14 OZ. WATERLESS	12		
PE01406		DL BLUE 4.5 LB. WATERLESS	6		
PE03013		TROUNCE 14 OZ. CAN WATERLESS GRIT	12		
PE21218	NEW	TROUNCE GALLON WITH PUMP	4		
PE23113		FAST OR 15 OZ. SQUEEZE SMOOTH (NAIL BR)	12		
PE23217	NEW	FAST OR 1/2 GALLON SMOOTH W/ PUMP	6		
PE23218	NEW	FAST OR GALLON SMOOTH W/ PUMP	4		
PE25108		7.5OZ FAST ORANGE W/PUMICE	12		
PE25113		FAST OR 15 OZ. SQUEEZE W/PUMICE (NAIL BR)	12		
PE25217		FAST ORANGE 1/2 GAL. W/PUMICE & PUMP	6		
PE25218		FAST ORANGE GALLON W/PUMICE & PUMP	4		
PE33013		14OZ TUB FAST ORANGE SMOOTH	12		
CE01545		ANTISEPTIC HAND SOAP GALLON	4		



E-mail: info@buglersales.com

OSHA HARD HATS & WINTER LINERS



NREM3144



NR284200
EAR PLUGS

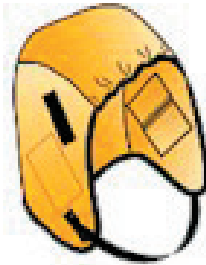

NRWL3



NRWL4

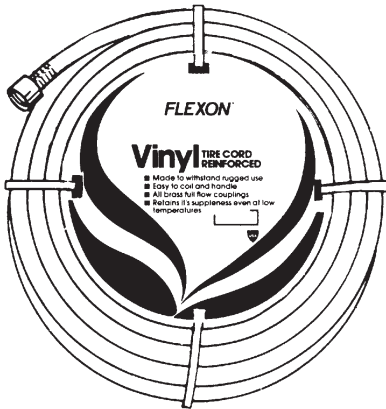

GOOD

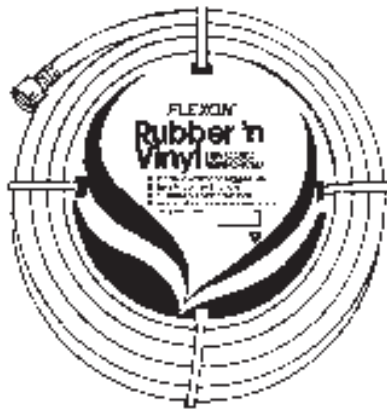

BETTER

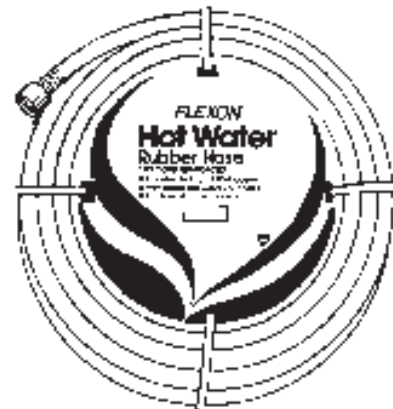

BEST

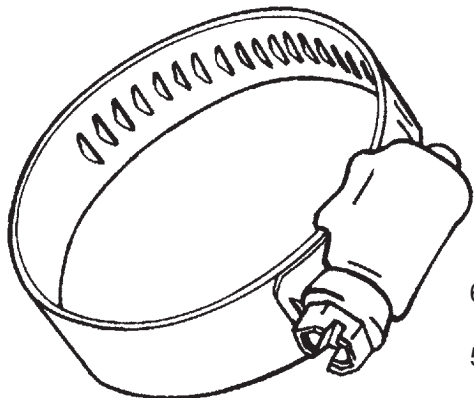

HOSE CLAMPS

68 SERIES = ALL STAINLESS

OR

57 SERIES = STAINLESS W/
PLATED SCREW



BUGLER SALES CORP.

Phone: 516 223-3868 • Fax: 516 868-6998
 969 CHURCH STREET • BALDWIN, NY 11510

E-mail: info@buglersales.com

NUMBER		DESCRIPTION	PK	RESALE	COST
HARD HATS & LINERS					
NRA79R01		HARD HAT W/ RATCHET SUSPENSION WHITE	20		
NRA59S1		REPLACEMENT SUSPENSION FOR HARDHAT	6		
NRA5904		HARD HAT OSHA GREEN	20		
NRA5901		HARD HAT OSHA WHITE	20		
NRA5902	BEST SELLER	HARD HAT OSHA YELLOW	20		
NRA5907		HARD HAT OSHA BLUE	20		
NRA5903		HARD HAT OSHA ORANGE	20		
NRWL3		WINTER LINER COTTON	12		
NRWL4	BEST SELLER	HARD HAT DELUXE WINTER LINER	20		
HEARING PROTECTION					
NR284200		DECI 4200 TAPERED EARPLUG - PAIR	200		
NREM3144		EM3144 HEARING PROTECTOR	EA		
NR280005	BEST SELLER	DISPOSABLE EAR PLUG-PAIR	200		
HOSE					
H5944		5/8" x 25' RUBBER HOT WATER HOSE 5-PLY	5		
H5945	BEST SELLER	5/8" x 50' RUBBER HOT WATER HOSE 5-PLY	5		
H5950	BEST SELLER	5/8" x 50' RUBBER VINYL HOSE 3-PLY	5		
H5949		5/8" x 75' RUBBER VINYL HOSE 3-PLY	4		
H5951		5/8" x 25' VINYL HOSE 3-PLY	10		
H5952	BEST SELLER	5/8" x 50' VINYL HOSE 3-PLY	5		
H5954		5/8" x100' VINYL HOSE 3-PLY	3		
HOSE CLAMPS IDEAL [STAINLESS=68 SERIES - PLATED=57 SERIES]					
ID62602	#4	1/4 TO 5/8"	ALL STAINLESS	BX10	
ID62606	#6	5/16 TO 7/8"	ALL STAINLESS	BX10	
ID6808	BEST SELLER #8	1/2 TO 1"	ALL STAINLESS	BX10	
ID6810	BEST SELLER #10	9/16 TO 1-1/6"	ALL STAINLESS	BX10	
ID6812	BEST SELLER #12	11/16 TO 1-1/4"	ALL STAINLESS	BX10	
ID6816	BEST SELLER #16	5/8 TO 1-1/2"	ALL STAINLESS	BX10	
ID6820	BEST SELLER #20	11/16 TO 1-3/4"	ALL STAINLESS	BX10	
ID6824	#24	1-1/16 TO 2"	ALL STAINLESS	BX10	
ID6828	#28	1-5/16 TO 2-1/4"	ALL STAINLESS	BX10	
ID6832	#32	1-9/16 TO 2-1/2"	ALL STAINLESS	BX10	
ID6836	#36	1-1/2" TO 2-3/4"	ALL STAINLESS	BX10	
ID6840	#40	2 TO 3"	ALL STAINLESS	BX10	
ID6856	#56	2-1/8 TO 4"	ALL STAINLESS	BX10	
ID6864	#64	2-3/4 TO 4-1/2"	ALL STAINLESS	BX10	
ID6872	BEST SELLER #72	3-1/8 TO 5"	ALL STAINLESS	BX10	
ID6880	#80	3-5/8 TO 5-1/2"	ALL STAINLESS	BX10	
ID6896	#96	4-3/4 TO 6-1/2"	ALL STAINLESS	BX10	
ID63128	#63128	8-1/2" MAX	ALL STAINLESS	BX10	
ID5706	#6	3/8 TO 7/8"	S.S. W/PLT SCREW	BX10	
ID5708	#8	7/16 TO 1"	S.S. W/PLT SCREW	BX10	
ID5710	#10	1/2 TO 1-1/16"	S.S. W/PLT SCREW	BX10	
ID5712	#12	1/2 TO 1-1/4"	S.S. W/PLT SCREW	BX10	
ID5716	#16	3/4 TO 1-1/2"	S.S. W/PLT SCREW	BX10	
ID5720	#20	3/4 TO 1-3/4"	S.S. W/PLT SCREW	BX10	
ID5724	#24	1 TO 2"	S.S. W/PLT SCREW	BX10	
ID5728	#28	1-5/16 TO 2-1/4"	S.S. W/PLT SCREW	BX10	
ID5732	#32	1-9/16 TO 2-1/2"	S.S. W/PLT SCREW	BX10	
ID5736	#36	7/8 TO 2-3/4"	S.S. W/PLT SCREW	BX10	



E-mail: info@buglersales.com

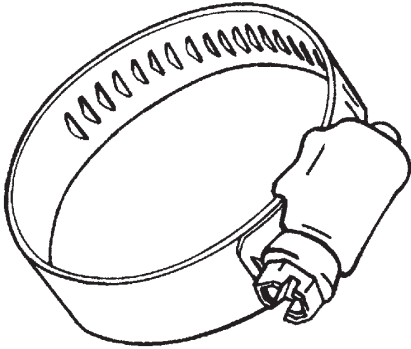

HOSE CLAMPS

68 SERIES = ALL STAINLESS
OR
57 SERIES = STAINLESS W/
PLATED SCREW

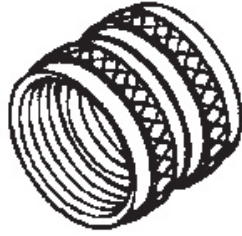

H5006

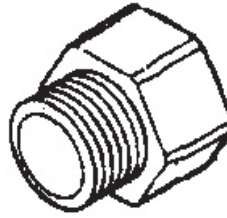

H5008

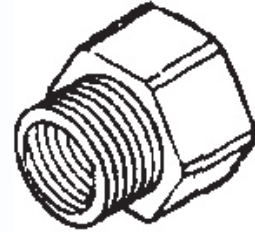

H500



H5004



H5000



H5016



GI15



H5963
BRASS

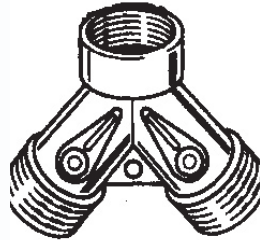

H5964
PLASTIC

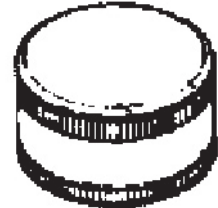

H5978
BRASS



GI17



H5962



H5961

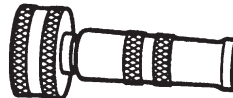

H5958

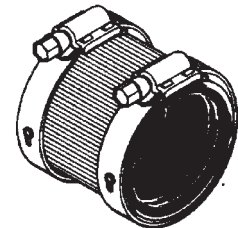

NO-HUB COUPLINGS

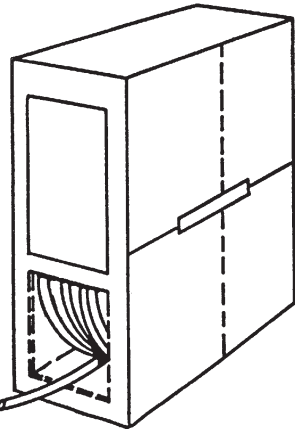

CLEAR VINYL TUBING



H5975 HOSE WASHER



GI571



GI573



GI593



BUGLER SALES CORP.

Phone: 516 223-3868 • Fax: 516 868-6998
 969 CHURCH STREET • BALDWIN, NY 11510

E-mail: info@buglersales.com

NUMBER		DESCRIPTION	PK	RESALE	COST
HOSE CLAMPS IDEAL [STAINLESS=68 SERIES-PLATED=57 SERIES] continued...					
ID5740	#40	1-1/8 TO 3"	S.S. W/PLT SCREW	BX10	
ID5752	#52	1-7/8 TO 3-3/4"	S.S. W/PLT SCREW	BX10	
ID5772	#72	3-1/8 TO 5"	S.S. W/PLT SCREW	BX10	
ID5788	#88	4-1/4 TO 6"	S.S. W/PLT SCREW	BX10	
ID57104	#104	5 TO 7"	S.S. W/PLT SCREW	BX10	
ID57116	#116	5-3/4 TO 7-3/4"	S.S. W/PLT SCREW	BULK	
HOSE COUPLINGS • NO-HUB					
G115	NEW	#15 ZINC "Y" SHUT-OFF CONNECTOR		12	
G117	NEW	#17 POLY "Y" SHUT-OFF CONNECTOR		12	
H5000		3/4 FM HOSE TO 3/4 FM PIPE (SWIVEL)		10	
H5002		3/4 FM HOSE TO 1/2 FM PIPS (SWIVEL)		10	
H5004		3/4 FM HOSE TO 1/2 M PIPE (SWIVEL)		10	
H5006		3/4 FM HOSE TO 3/4 FM HOSE (SWIVEL)		10	
H5007		3/4 M HOSE X 1/2 MIP X 1/2 SWT		10	
H5008		3/4 M HOSE TO 3/4 FM PIPE		10	
H5010		3/4 FM HOSE TO 3/4 M IPS OR 1/2 F IPS		10	
H5014		3/4 FM HOSE X DOUBLE 3/4 M HOSE (ZINC)		10	
H5016		MALE HOSE X 3/4 M PIPE OR 1/2 FM PIPE		10	
H5018		MALE HOSE X 1/2 M PIPE ADAPTER		10	
H5020		MALE HOSE X MALE HOSE ADAPTER		10	
H5023	NEW	MALE HOSE/SHAMPOO HT X AERATOR		10	
H5963		BRASS SIAMESE HOSE Y CONNECTOR		10	
H5964		SIAMESE Y W/SHUT OFF - 3/4" PLASTIC		10	
H5978		BRASS HOSE END CAP		20	
NO-HUB COUPLINGS					
H5031		1-1/2 NO-HUB COUPLING		50	
H5032		2 NO-HUB COUPLING		50	
H5033		3 NO-HUB COUPLING		50	
H5034		4 NO-HUB COUPLING		50	
HOSE VINYL CLEAR - F.D.A. APPROVED ID X OD X WALL (100')					
H6041		1/8 X 3/16 X 1/32		EA	
H6044		1/4 X 3/8 X 1/16		EA	
H6046	NEW	5/16 X 7/16 X 1/16		EA	
H6047		5/16 X 1/2 X 3/32		EA	
H6048	BEST SELLER	3/8 X 1/2 X 1/16		EA	
H6051		1/2 X 5/8 X 1/16		EA	
H6053		5/8 X 3/4 X 1/16		EA	
HOSE VINYL CLEAR - ID X OD (50')					
H6055	NEW	3/4 X 1		EA	
H6057	NEW	1 X 1-1/4		EA	
HOSE NOZZLES, MENDERS, & WASHERS GILMOUR					
G1571	BEST SELLER	#571 HOSEMASTER HUSKY PISTOL NOZZLE		12	
G1573		#573 HOSEMASTER CLASSIC PISTOL NOZZLE		12	
G1593		#593 PISTOL GRIP NOZZLE W/THREADS		12	
G1529		#529 BRASS HOSE NOZZLE TWIST		12	
GI01HM		#01HM HOSE MENDER 5/8 & 3/4		12	
GI01M		#01HM MALE HOSE END CONNECTOR		12	
GI01F		#01F FEMALE HOSE END CONNECTOR		12	
H5975	BEST SELLER	RED RUBBER HOSE WASHERS BULK PACK (EA)		100	



BUGLER SALES CORP.

Phone: 516 223-3868 • Fax: 516 868-6998
969 CHURCH STREET • BALDWIN, NY 11510

E-mail: info@buglersales.com



WASHING MACHINE HOSE

STAINLESS STEEL FULL FLOW!

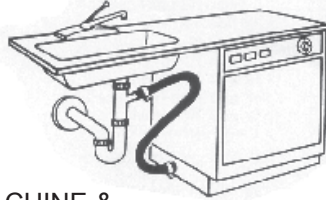
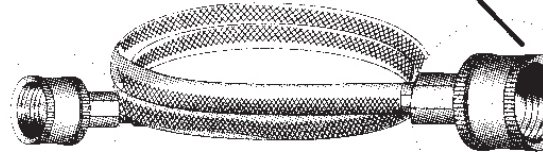

DRAIN HOSE
FOR WASHING MACHINE &
DISHWASHER



H6021

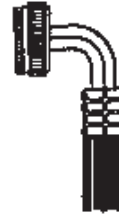

ANGLED WASHING
MACHINE HOSE



Y MIXER

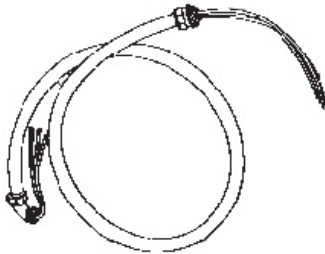

AC WHIPS



A/C DISCONNECT
BOX



13-300



17-7002



MXALT78
ALUMINUM TUBING



PE81343



KS62008
ANTI-SIEZE

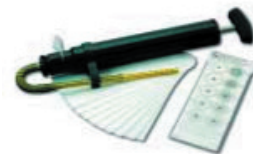

21-9006



BUGLER SALES CORP.

Phone: 516 223-3868 • Fax: 516 868-6998
 969 CHURCH STREET • BALDWIN, NY 11510

E-mail: info@buglersales.com

NUMBER		DESCRIPTION	PK	RESALE	COST
HOSE, WASHING MACHINE BAGGED 3/8 & 1/2"					
H6004		4' WASHING MACHINE HOSE	12		
H6005		5' WASHING MACHINE HOSE	12		
H6006	BEST SELLER	6' WASHING MACHINE HOSE	12		
H6008	BEST SELLER	8' WASHING MACHINE HOSE	12		
H6010		10' WASHING MACHINE HOSE	12		
H6012		12' WASHING MACHINE HOSE	12		
H6015		"Y" HOSE MIXER	12		
H6025		5' ANGLED WASHING MACHINE HOSE	12		
H6026		6' ANGLED WASHING MACHINE HOSE	12		
H6022	BEST SELLER	5/8" x 50' REINFORCED DRAIN HOSE BOXED	EA		
H6023		1" x 50' REINFORCED DRAIN HOSE BOXED	EA		
H6021		1 X 11" ALUMINUM DISCHARGE HOOK	10		
H6035		5' (1/2") HVY DUTY WASHING MACHINE HOSE	12		
H6036		6' (1/2") HVY DUTY WASHING MACHINE HOSE	12		
H6040		10' (1/2") HVY DUTY WASHING MACHINE HOSE	12		
H6064		4' STAINLESS STEEL BRAIDED WASH MACH	5		
H6065		5' STAINLESS STEEL BRAIDED WASH MACH	5		
H6066		6' STAINLESS STEEL BRAIDED WASH MACH	5		
H6070		10' STAINLESS STEEL BRAIDED WASH MACH	5		
HVAC CONTROLS & ACCESSORIES					
AC WHIPS & ACCESSORIES					
EBN6000NF		N6000NF A/C DISCONNECT 60AMP N/FS	8		
W1204		4' X 1/2 NON-METALLIC WHIP	12		
W1206		6' X 1/2 NON-METALLIC WHIP	12		
W1214		4' X 3/4 NON-METALLIC WHIP	12		
W1216		6' X 3/4 NON-METALLIC WHIP	12		
W1226		6' X 1/2 METALLIC WHIP	12		
W1236		6' X 3/4 METALLIC WHIP	12		
ALUMINUM TUBING					
MXALT78		ALUM. TUBING FOR PILOT GAS LINES 7/8x1/4	12		
ANTI-SEIZE					
KS62008	NEW	8 OZ ANTI-SIEZE COMPOUND BRUSHTOP	12		
KS62016	NEW	16 OZ ANTI-SEIZE COMPOUND BRUSHTOP	12		
PE81343	NEW	1 OZ 81343 PERMATEX ANTI-SEIZE	12		
BACHARACH TESTING AND MEASURING					
BH10-0100	NEW	CARRY CASE LARGE BACH	EA		
BH10-5000	NEW	CO2 INDICATOR KIT BACH	EA		
BH10-5002	NEW	OIL SERVICE KIT BACH	EA		
BH10-5014	NEW	UTILITY OIL KIT BACH	EA		
BH10-5022	NEW	OIL KIT BACH	EA		
BH10-5030	NEW	GAS SAVER KIT BACH	EA		
BH10-5036	NEW	OIL KIT BACH	EA		
BH10-5057	NEW	20-60% CO2 FLD (3) BTLS BACH	EA		
BH10-5060	NEW	20-60% O2 FLD (3) BTLS BACH	EA		
BH10-5064	NEW	FIRE EFFY FINDER BACH	EA		
BH10-8000	NEW	BOILER TEST KIT	EA		
BH11-7029	NEW	SAMPLING ASSY BACH	EA		
BH11-7032	NEW	CO2 FYRITE 20% BACH	EA		
BH11-7036	NEW	21% O2 FYRITE BACH	EA		
BH11-7052	NEW	CO2 REPAIR PKG BACH	EA		



BUGLER SALES CORP.

Phone: 516 223-3868 • Fax: 516 868-6998
969 CHURCH STREET • BALDWIN, NY 11510

E-mail: info@buglersales.com



21-7006

13-3000

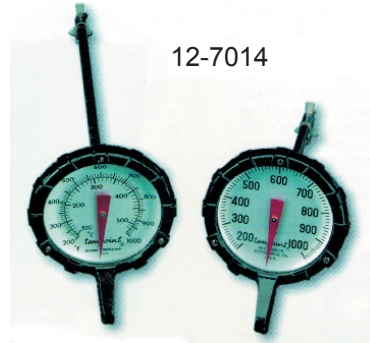

12-7014



13-7019



BL12020



PL50514 OILER



BL11010 GAS CAN
(NJ, CT)



BL31710 GAS CAN
(NY)



BL21605



12 QUART FIRE PAILS
FLAT OR ROUND
BOTTOM

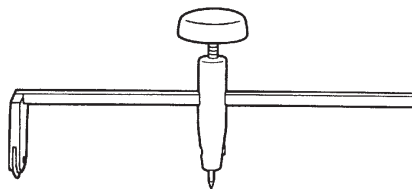

CIRCLE CUTTER



CIRCULATOR
FLANGES



BUGLER SALES CORP.

Phone: 516 223-3868 • Fax: 516 868-6998
 969 CHURCH STREET • BALDWIN, NY 11510

E-mail: info@buglersales.com

NUMBER		DESCRIPTION	PK	RESALE	COST
HVAC CONTROLS & ACCESSORIES <i>continued...</i>					
BACHARACH TESTING AND MEASURING <i>continued...</i>					
BH11-7054	NEW	O2 REPAIR PKG BACH			
BH12-0011	NEW	WICH REPL KIT (4) BACH			
BH12-0266	NEW	REFILL THERM (RED SPIRIT) BACH			
BH12-0267	NEW	REFILL THERM (MERCURY) BACH			
BH12-7011	NEW	SLING PSYCHROMETER (MERC) BACH			
BH12-7012	NEW	SLING PSYCHROMETER (RED SPRT) BACH			
BH12-7014	NEW	TEMPOINT 1000F 6 IN BACH			
BH12-7018	NEW	TEMPOINT 1000F 12 IN BACH			
BH13-3000	NEW	DRAFTRITE 0.14 BACH			
BH13-3001	NEW	DRAFTRITE 0.25" BACH			
BH13-5010	NEW	DRAFTRITE REPL TUBE SET BACH			
BH13-7019	NEW	DRAFT GAUGE 0.25 BACH			
BH16-7001	NEW	FLORITE MRF 1000 FPM BACH			
BH16-7002	NEW	FLORITE MRF 3000 FPM BACH			
BH16-7009	NEW	FLORET 1000 FPM BACH			
BH17-0025	NEW	MANOMETER REPL FLUID (1) BTL BACH			
BH17-7002	NEW	MANOMETER 15/8.5OZ BACH			
BH19-5002	NEW	MONOXOR CO TUBES (12) BACH			
BH19-5010	NEW	CO INDICATOR TUBES 2000PPM BACH			
BH19-5015	NEW	CO INDICATOR TUBES 5000PPM BACH			
BH19-7021	NEW	CO DETECTOR KIT BACH			
BH21-0018	NEW	SMOKE SCALE			
BH21-0019	NEW	FILTER PAPER BACH			
BH21-0020	NEW	SCALE / PAPER PKG BACH			
BH21-7006	NEW	TRUE SPOT SMOKE DETECTOR BACH			
CANS & OILERS / PAILS					
BL11010		G.I. STYLE 5 GALLON METAL GAS CAN (NJ, CT)	1/5		
BL11910		JERRY CAN GASKET	6		
BL11915		JERRY CAN CAP	EA		
BL12020		1-1/4 JERRY CAN SPOUT - SCREW ON	EA		
BL11805		1 PLUS GALLON GAS CAN PLASTIC/SELFVENT	12		
BL21510	NEW	21510 2+SPILLPROOF CARB GAS CAN	6		
BL21605	NEW	21605 1+SPILLPROOF CARB GAS CAN	8		
BL31710	NEW	GI STYLE 5 GAL METAL GAS W/ SPOUT (NY)	1/5		
BL31733	NEW	31733 5 GAL SPILLPRF CARB GAS CAN	4		
BL50810		2 PLUS GALLON GAS CAN PLASTIC/SELFVENT	6		
BL50833		5 PLUS GALLON GAS CAN PLASTIC/SELFVENT	4		
PL50514		50514 6OZ. FLEXIBLE SPOUT OILER	6		
P0100		FIRE PAIL (RED) - FLAT BOTTOM 12 QT.	12		
P0101		FIRE PAIL (RED) - ROUND BOTTOM 12 QT.	12		
P0102		FIRE PAIL HOOK	12		
CIRCLE CUTTERS					
C3500		DRYWALL CIRCLE CUTTER	3		
CIRCULATOR FLANGES					
C3708		3/4" CIRCULATOR FLANGE	EA		
C3709		1" CIRCULATOR FLANGE	EA		
C3710		1-1/4" CIRCULATOR FLANGE	EA		
C3711		1-1/2" CIRCULATOR FLANGE	EA		



BUGLER SALES CORP.

Phone: 516 223-3868 • Fax: 516 868-6998
969 CHURCH STREET • BALDWIN, NY 11510

E-mail: info@buglersales.com

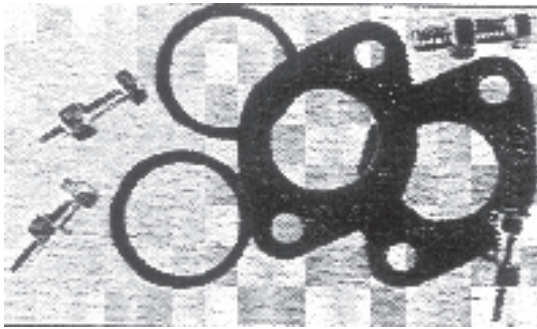

CIRCULATOR KITS



HM8909

BA48501



TYVEK COVERALLS
& SHOE COVERS



R0680



KC91371



SCRUBS
72 CT



QUARTS
GALLONS

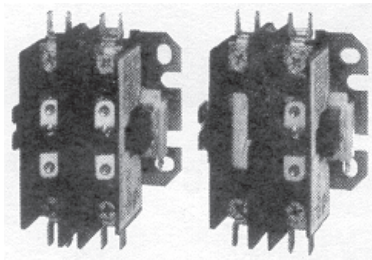

TWO-POLE
CONTACTORS

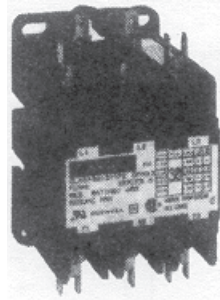

THREE-POLE
CONTACTORS

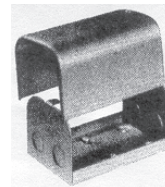

CONTACTOR
ENCLOSURES

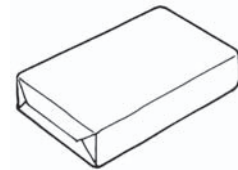

DUCT SEAL
D9000



BESC790



BECA876

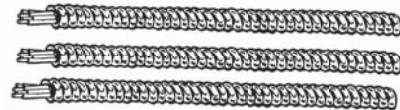

BX WIRE
GREENFIELD



BUGLER SALES CORP.

Phone: 516 223-3868 • Fax: 516 868-6998
 969 CHURCH STREET • BALDWIN, NY 11510

E-mail: info@buglersales.com

NUMBER		DESCRIPTION	PK	RESALE	COST
HVAC CONTROLS & ACCESSORIES <i>continued...</i>					
CIRCULATOR KITS AND GASKET SCRAPERS					
C3701	BEST SELLER	BG#1 CIRCULATOR KIT - FLAT GASKET	25		
C3702		BG#27 CIRCULATOR KIT - ROUND GASKET	25		
C3703		CB#4 CIRCULATOR BOLTS (4)	50		
C3704	BEST SELLER	CG#1 CIRCULATOR GASKETS (2) FLT GASKET	50		
C3705		CG#27 CIRCULATOR GASKETS (2) RD GASKET	50		
C3706		BG#1XL CIRCULATOR KIT (1-3/4" BOLTS)	25		
BA48501		8" STEEL GASKET SCRAPER W/ HDL	3		
CLEANING & DEODORIZING					
SCRUBS	NEW	72CT HAND WIPES BUCKET SCRUBS	6		
KC91371	NEW	75CT WYP-ALL HAND WIPES BUCKET	6		
KN22732		32 OZ. GREZ-OFF	12		
KN22701		1 GAL. GREZ-OFF	6		
KN26832		32 OZ. SPRAY NINE	12		
KN26801		1 GAL. SPRAY NINE	6		
R1095	BEST SELLER	TYVEK COVERALL W/HOOD XL	25		
R0680		ALLWIPE 220 SHOP TOWELS BOX	9		
R0720		ALLWIPE 12 X 13 WHITE OIL ABSORBENT	50		
HM8909	NEW	8 OZ ODOR AIR MAGNET	12		
CONTACTORS					
BEDP30224		2 POLE, SMALL FRAME-30 FL AMPS / 24 COIL VAC	10		
BEDP302120		2 POLE, SMALL FRAME-30 FL AMPS / 120 COIL VAC	10		
BEDP302240		2 POLE, SMALL FRAME-30 FL AMPS / 240 COIL VAC	10		
BEDP40224		2 POLE, SMALL FRAME-40 FL AMPS / 24 COIL VAC	10		
BEDP402120		2 POLE, SMALL FRAME-40 FL AMPS / 120 COIL VAC	10		
BEDP402240		2 POLE, SMALL FRAME-40 FL AMPS / 240 COIL VAC	10		
BEDP30324		3 POLE, LARGE FRAME-30 FL AMPS / 24 COIL VAC	10		
BEDP303120		3 POLE, LARGE FRAME-30 FL AMPS / 120 COIL VAC	10		
BEDP303240		3 POLE, LARGE FRAME-30 FL AMPS / 240 COIL VAC	10		
BEDP50324		3 POLE, LARGE FRAME-50 FL AMPS / 24 COIL VAC	10		
BEDP503120		3 POLE, LARGE FRAME-50 FL AMPS / 120 COIL VAC	10		
BEDP503240		3 POLE, LARGE FRAME-50 FL AMPS / 240 COIL VAC	10		
BEAHK425A		30 & 40 AMP CONTACTOR ENCLOSURE	12		
COUPLER ASSEMBLY					
BESC790	NEW	SPRING COUPLER BRASS BODY	25		
BECA858	NEW	HVY DUTY SPRINGS CAST IRON	25		
BECA876	NEW	CIRCULATOR COUPLING CAST IRON	25		
DUCT SEAL					
D9000		DUCT SEAL - 1 POUND	EA		
ELECTRICAL BOXES/COVERS/FITTING/WIRE/PIPE					
E9201		BX 14/2 25' STEEL BX WIRE	EA		
E9202		BX 14/2 50' STEEL BX WIRE	EA		
E9203		BX 14/3 50' STEEL BX WIRE	EA		
E9204		BX 14/4 50' STEEL BX WIRE	EA		
E9212		BX 14/2 100' STEEL BX WIRE	EA		
E9222		BX 14/2 250' STEEL BX WIRE	EA		
E9223		BX 14/3 250' STEEL BX WIRE	EA		
E9224	NEW	BX 14/4 250' STEEL BX WIRE	EA		
E9230		3/8 GREENFIELD 250' COIL	EA		
E9232		3/8 GREENFIELD 50' COIL	5		



BUGLER SALES CORP.

Phone: 516 223-3868 • Fax: 516 868-6998
969 CHURCH STREET • BALDWIN, NY 11510

E-mail: info@buglersales.com

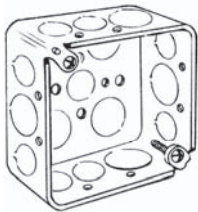

EBHR00192

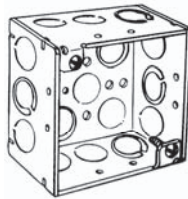

EBHR00232

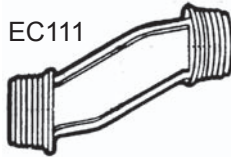

EC111

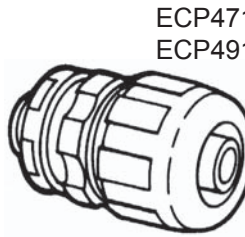

ECP471
ECP491

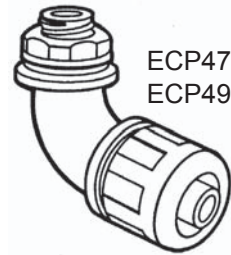

ECP472
ECP492



EBHR00410

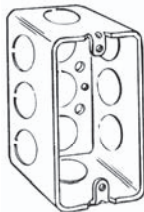

EBHR00660

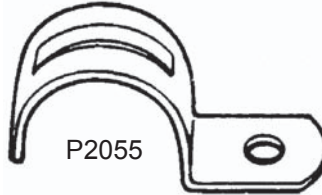

P2055

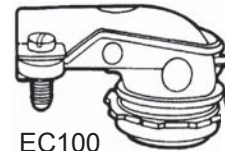

EC100
EC101

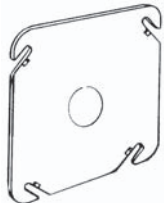

EBHR00753



EBHR00860



EC281

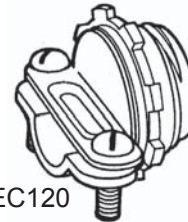

EC120

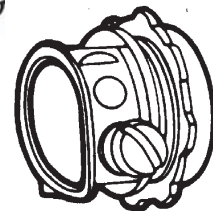

EC130

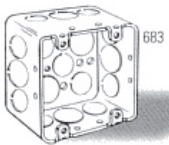

EBHR00683

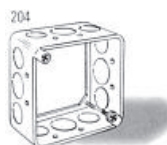

EBHR00204

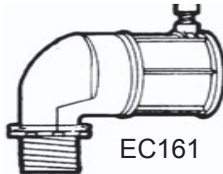

EC161



EC631

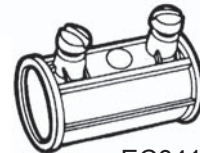

EC641

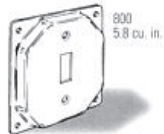

EBHR00800



EBHR08670



EC180

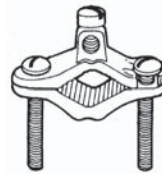

EC626A



EBACD50



LIQUID-TIGHT



EC350

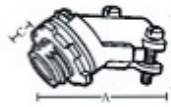

EC390

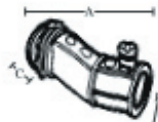

EC771

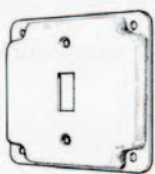

EB11401

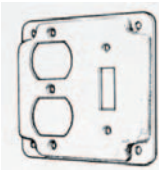

EB11413



EB10001

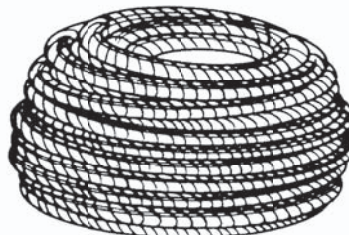

GREENFIELD

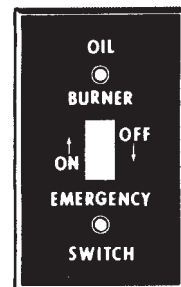



BUGLER SALES CORP.

Phone: 516 223-3868 • Fax: 516 868-6998
 969 CHURCH STREET • BALDWIN, NY 11510

E-mail: info@buglersales.com

NUMBER		DESCRIPTION	PK	RESALE	COST
HVAC CONTROLS & ACCESSORIES <i>continued...</i>					
ELECTRICAL BOXES/COVERS/FITTING/WIRE/PIPE <i>continued...</i>					
E9233		3/8 GREENFIELD 25' COIL	10		
E9275		1/2" LIQUID TIGHT 100' ROLL	EA		
E9276		3/4" LIQUID TIGHT 100' ROLL	EA		
EB10001	NEW	BLANK HANDY BOX PLATE	25		
EB11201		BLANK STEEL 1900 COVER	50		
EB11401	NEW	PLAIN SINGLE SWITCH PLATE	50		
EB11413	NEW	11413 RAISED COVER SWITCH AND OUTLET	50		
EB41001		RED OIL COVER STANDARD	25		
EB41004		RED OIL COVER FLUSH MOUNT GEM	10		
EB41005		RED OIL COVER HANDY BOX	25		
EB41006		RED OIL COVER 1900 BX RAISED	50		
EB41009		RED OIL 2 POLE COVER 1900	50		
EB41020		RED GAS COVER STANDARD	25		
EB41023		RED GAS COVER FLUSH MOUNT GEM	10		
EB41024		RED GAS COVER HANDY BOX	25		
EB41025		RED GAS COVER 1900 BX RAISED	50		
EB41026		RED GAS 2 POLE COVER 1900BX	50		
EBACD50	NEW	30 AMP FUSED DISCONNECT BOX	6		
EBHR00192		RACO 1-1/2" D SQUARE BOX 1900	50		
EBHR00204	NEW	#204 RACO 1900 BX *EXTENDER*	50		
EBHR00232		#8232 SQUARE BOX 2-1/8" DEEP	25		
EBHR00410		RACO 410 1-1/2"D BOX W/CLAMPS 950	50		
EBHR00660		HANDY BOX STEEL 1-7/8" DEEP 1/2KO	50		
EBHR00683	NEW	#683 1900 BOX 2-1/8 DEEP RED CRNER	25		
EBHR00753		#753 SQUARE COVER FLAT W/1/2" KO	25		
EBHR00800	NEW	#800 4" COVER F/TOGGLE SWITCH	25		
EBHR00860		HR00860 HANDY BOX COVER METAL	25		
EBHR08670	NEW	8670 RACO 2-1/8 DEEP HANDY BOX	50		
EC350	NEW	#350 DUPLEX BX CONNECTOR 3/8	25		
EC390	NEW	45 DEGREE 3/8 BX CONNECTOR	50		
EC771	NEW	OFFSET MALE BY CONDUIT 1/2" EACH	10		
ECP471		1/2 STRAIGHT LIQUID TIGHT CONNECTOR	25		
ECP472		1/2 ANGLED LIQUID TIGHT CONNECTOR	10		
ECP491		3/4 STRAIGHT LIQUID TIGHT CONNECTOR	10		
ECP492		3/4 ANGLED LIQUID TIGHT CONNECTOR	10		
P2055		1/2" EMT CLAMP	100		
EC100		#100 3/8" 90° ANGLED BX CONNECTOR	100		
EC101		#101 1/2" 90° ANGLED BX CONNECTOR	25		
EC111		1/2" RIGID OFFSET NIPPLE	10		
EC120		#120 ROMEX CONNECTOR	100		
EC130		HR02511 3/8" BX CONNECTOR	100		
EC161		EMT 90DEGREE CONNECTOR TO MT	25		
EC180		BX TO EMT CONNECTOR	50		
EC281		1/2" LOCK NUT	100		
EC626A		1/2 TO 1" BRASS GROUNDING CLAMP	10		
EC631		#631 1/2" EMT CONNECTOR	100		
EC641		#641 1/2" EMT COUPLING	100		



BUGLER SALES CORP.

Phone: 516 223-3868 • Fax: 516 868-6998
969 CHURCH STREET • BALDWIN, NY 11510

E-mail: info@buglersales.com



EPEB1



MXDMM51FSG



MXDMM830HS



MXCT101



MXMVS138



MXCT500AV

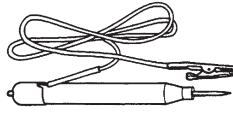

E3610



MXST600LED



MXST400



PE80065



KS03102



MXCT102



MXCT103

White Rodgers



COPPER TUBING COATED FOR
OIL OR PROPANE

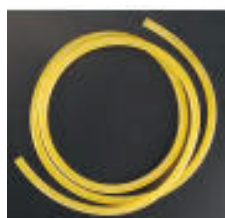

COATED OIL & LP GAS LINES





BUGLER SALES CORP.

Phone: 516 223-3868 • Fax: 516 868-6998
 969 CHURCH STREET • BALDWIN, NY 11510

E-mail: info@buglersales.com

NUMBER		DESCRIPTION	PK	RESALE	COST
HVAC CONTROLS & ACCESSORIES <i>continued...</i>					
ELECTRICAL BOXES/COVERS/FITTING/WIRE/PIPE <i>continued...</i>					
EP1210		1/2 X 10' EMT PIPE	10		
EPEB1		EB1 1/2" EMT BENDER	10		
ER15840		BROWN DUPLEX RECEPTACLE	10		
ES18610		EAGLE BROWN SWITCH 1 POLE W/GRND	10		
ES40460		40460 SWITCH GUARD	15		
ELECTRICAL TESTERS, G.B. • MANNIX					
SAAC3000	NEW	AUDIBLE & VISUAL VOLTAGE DETECTOR 50-600V AC	12		
SAAC3115	NEW	VISUAL VOLTAGE DETECTOR 110-600V AC	12		
SALAC3215	NEW	VISUAL LOW AC LOCATOR 24-90V AC	12		
SADC3315	NEW	VISUAL DC DETECTOR 6-50V DC	12		
E3610		GCT-304A CONTINUITY TESTER	10		
MXCT101		LINE VOLTAGE TESTER	10		
MXCT102	BEST SELLER	LOW VOLTAGE TESTER	10		
MXCT103		4-WAY TESTER	10		
MXCT500AV		CT500AV AUD VIS LINE VOLTAGE TESTER	6		
MXDMM830HS		ECONOMY DIGITAL MULTIMETER	3		
MXDMM51FSG		DIGITAL MULTIMETER	EA		
MXDPM40	NEW	DPM40 DIGITAL PANEL METER-40TO122	5		
MXMVS138		STUD/METAL/VOLT FINDER	3		
MXST400	BEST SELLER	SCREWDRIVER TESTER 80/250V	10		
MXST600LED		LED SCREWDRIVER TESTER 70/250V	10		
FAN AND LIMITS (WHITE RODGERS)					
WR5D51-35	NEW	FAN LIMIT CONTROL 5" ELEMENT	20		
WR5D51-78	NEW	FAN LIMIT CONTROL 11" ELEMENT	20		
WR5D51-90	NEW	FAN LIMIT CONTROL 8" ELEMENT	20		
ENVIRO TUBING					
CTCG1260	NEW	1/2 X 60' LP GAS LINE YELLOW	4		
CTCG12100	NEW	1/2 X 100 LP GAS LINE YELLOW	2		
CTCG38100	NEW	3/8 X 100' LP GAS LINE YELLOW CTD	2		
CTCG3860	NEW	3/8 X 60' LP GAS LINE YELLOW CTD	5		
CTCO1250	NEW	1/2 X 50' COATED OIL LINE ORANGE	4		
CTCO12100	NEW	1/2 X 100' COATED OIL LINE ORANGE	2		
CTCO12250	NEW	1/2 X 250' COATED OIL LINE ORANGE	1		
CTCO3850	NEW	3/8 X 50' COATED OIL LINE ORANGE	5		
CTCO38100	NEW	3/8 X100' COATED OIL LINE ORANGE	3		
CTCO38250	NEW	3/8 X 250' COATED OIL LINE ORANGE	1		
FAST TACK ADHESIVES					
KS03102		16OZ FAST TACK ADHESIVE	12		
PE80065		9OZ PERMATEX HIGH TACK ADHESIVE	12		
3M77	NEW	#77 16.5 OZ SPRAY ADHESIVE	6		
3M90	NEW	#90 HI- STRENGTH ADHESIVE AEROSOL	12		



BUGLER SALES CORP.

Phone: 516 223-3868 • Fax: 516 868-6998
969 CHURCH STREET • BALDWIN, NY 11510

E-mail: info@buglersales.com



WR36C03-300



WR36C03U433



WR36C03-400

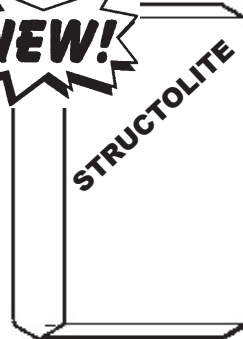

STRUCTOLITE

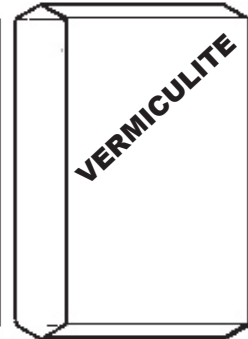

VERMICULITE

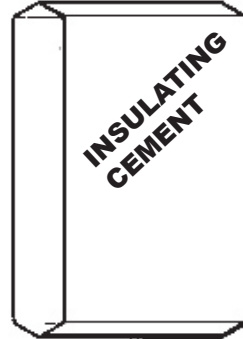

INSULATING
CEMENT

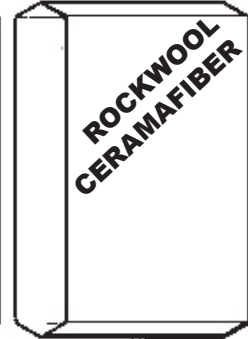

ROCKWOOL
CERAMAFIBER

White Rodgers



-100
ANTIFREEZE

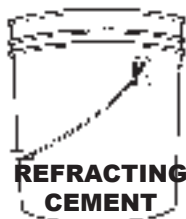

REFRACTING
CEMENT

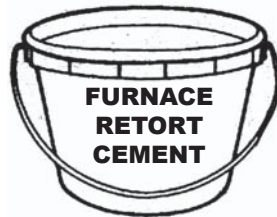

FURNACE
RETORT
CEMENT



ASPHALT
PAINT



WATERGLASS



MXHG15



BE38400



H5210

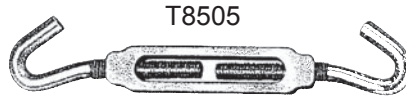

T8505



MXM555



LEADER PIPE & STRAPS



OIL TANK STICKS
FOUR SIZES



ANGLED
PIGTAIL



STRAIGHT
PIGTAIL

BRASS & STEEL
DOMESTIC



BUGLER SALES CORP.

Phone: 516 223-3868 • Fax: 516 868-6998
 969 CHURCH STREET • BALDWIN, NY 11510

E-mail: info@buglersales.com

NUMBER		DESCRIPTION	PK	RESALE	COST
HVAC CONTROLS & ACCESSORIES <i>continued...</i>					
FURNACE CEMENTS / INSULATORS / ANTI-FREEZE					
FC4100		1 GAL FURNACE / RETORT CEMENT	4		
FC4115		15LB PAIL REFRACTORY CEMENT	4		
FC4150		1/2 GAL FURNACE / RETORT CEMENT	6		
FC4200		ONE GALLON PAIL ASPHALT PAINT	4		
FC4210		ONE QUART WATERGLASS	12		
FC4500		5 GAL NON-TOXIC ANTIFREEZE - 100	EA		
FC8000		35 LB ROCKWOOL / CERAMAFIBER	EA		
FC8050	NEW	50 LB STRUCTOLITE	1/40		
FC8100		4 CUBIC FOOT BAG VERMICULITE	EA		
GAS VALVES (WHITE RODGERS)					
WR36C03-300	NEW	1/2 X 3/4 24V, W/RED BUSH L/P KIT	10		
WR36C03-400	NEW	3/4 X 3/4 24V, W/RED BUSH L/P KIT	10		
WR36C03U433	NEW	3/4 X 3/4 MILLIVOLT RED BUSHING, LP KIT	10		
WR37C63U114	NEW	GAS WATER HTR CONTROL	10		
HARDWARE					
BE38400		3/8 X 4 EYEBOLT W/ NUT	20		
BE516400	NEW	5/16 X 4 EYEBOLT REG. 10841	EA		
H5210		2-1/8" MEDIUM OPEN STYLE S-HOOK	20		
T8505		5/16 HOOK & HOOK TURNBUCKLE	10		
INSPECTION MIRRORS					
MXM555		1-1/4" ROUND INSPECTION MIRROR - M555	12		
MXM557		2-1/4" ROUND INSPECTION MIRROR - M557	12		
MXM560		3-1/2" x 2" RECT. INSPECTION MIRROR - M560	12		
LEADER PIPE & STRAPS (ALUMINUM)					
L0610		LEADER PIPE 2" X 3" X 10' WHITE	10		
L0611		LEADER •STRAP BANDS• WHITE	25		
L0612		LEADER PIPE 2" X 3" X 10' BROWN	10		
L0613		LEADER •STRAP BANDS• BROWN	25		
MANOMETERS					
MXDM8215	NEW	DM8215 DIGITAL MANOMETER 36"	1		
MXHG15	NEW	HG15 HYDROGAUGE MANOMETER 15"	5		
OIL TANK MEASURING STICKS					
BKFGS3		9' 3 SECTION OIL TANK MEASURING STICK	1		
BKFGS4	BEST SELLER	12" 4-FOLD OIL TANK MEASURING STICK	1		
BKGP8		8FT 1pc OIL GAUGE STICK	1		
PIG TAILS					
P1800	BEST SELLER	1/4" BLACK STRAIGHT PIG TAIL	10		
P1801		1/4" BRASS STRAIGHT PIG TAIL	5		
P1802		1/4" BRASS STRAIGHT PIG TAIL (5-5/8")	5		
P1805		1/4" BLACK ANGLED PIG TAIL	10		
P1806		1/4" BRASS ANGLED PIG TAIL	5		
P1810	NEW	MALE BY FEM BRASS PIGTAIL ANGLED	5		
P1812	NEW	MALE BY FEM BRASS PIGTAIL STR.	5		



E-mail: info@buglersales.com



THERMOSTATS
(LOW & LINE VOLTAGE)

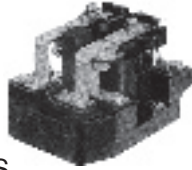

RELAYS



MXIRT4

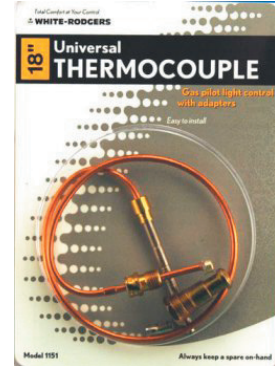

WRTC24P

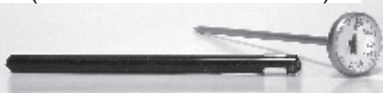

MXPT220P



MXBTL11M MATCH HOLDER



MXHDT303K



MXIRT203L



MXDTH03A



BUGLER SALES CORP.

Phone: 516 223-3868 • Fax: 516 868-6998
 969 CHURCH STREET • BALDWIN, NY 11510

E-mail: info@buglersales.com

NUMBER		DESCRIPTION	PK	RESALE	COST
HVAC CONTROLS & ACCESSORIES <i>continued...</i>					
PILOT LIGHTER					
MXBTL11M		TELESCOPIC ALLIGATOR CLIP	6		
S8114	NEW	LONG BUTANE FLEX LIGHTER	16		
RELAYS & ENCLOSURES • WEIL MCLAIN FAN CENTER					
BEBCR4011-024		GEN. PURPOSE SPST 30A, 24V	24		
BEBCR4011-120		GEN. PURPOSE SPST 30A, 120V	24		
BEBCR4011-240		GEN. PURPOSE SPST 30A, 240V	24		
BEBCR4012-024		GEN. PURPOSE SPST 30A, 24V	24		
BEBCR4012-120		GEN. PURPOSE SPST 30A, 120V	24		
BEBCR4012-240		GEN. PURPOSE SPST 30A, 240V	24		
BEBCR4021-024		GEN. PURPOSE DPST 30A, 24V	24		
BEBCR4021-120		GEN. PURPOSE DPST 30A, 120V	24		
BEBCR4021-240		GEN. PURPOSE DPST 30A, 240V	24		
BEBCR4022-024		GEN. PURPOSE DPDT 30A, 24V	24		
BEBCR4022-120		GEN. PURPOSE DPDT 30A, 120V	24		
BEBCR4022-240		GEN. PURPOSE DPDT 30A, 240V	24		
BEEC4031R		RELAY ENCLOSURE	24		
BEWM18FC	S84A-85	WM18FC FAN CENTER RELAY W/RELAY	12		
BE90340	NEW	REPLACEMENT PLUG IN RELAY FOR WM18FC20	20		
ROLL OUT SWITCHES					
BE4D4258A1	NEW	258o FUSIBLE LINK W/INSULATOR	10		
BE4D4300A1	NEW	300o FUSIBLE LINK W/INSULATOR	10		
BE4D4333A1	NEW	333o FUSIBLE LINK W/INSULATOR	10		
THERMOCOUPLES - WHITE RODGERS					
WRTC18P		18" THERMOCOUPLE TC18P	10		
WRTC24P		24" THERMOCOUPLE TC24P	10		
WRTC30P	NEW	30" THERMOCOUPLE TC30P	10		
WRTC36P	NEW	36" THERMOCOUPLE TC36P	10		
WRTC48P		48" THERMOCOUPLE TC48P	10		
WRTC72P	NEW	72" THERMOCOUPLE TC72P	10		
THERMOMETER					
MXIRT4		GUN STYLE INFARED THERMOMETER	EA		
MXPT160		POCKET THERMOMETER -40-160°F	6		
MXHDT303K	NEW	HDT303K DIGITAL POKKER THERMOMETER	3		
MXPT220P	BEST SELLER	POCKET THERMOMETER 0-220°F	6		
MXDPT300E	NEW	DPT300E 1"RD DIGITAL THERMOMETER	3		
MXDPT392FC	NEW	DPT392FC DIGITAL THERMOMETER 14-392-F	3		
MXDTH03A	NEW	DTH03A TEMP. & HUMIDITY MONITOR	3		
MXIRT203L	NEW	IRT203L INFARED THERMOMETER	1		
THERMOSTATS (LOW VOLTAGE)					
BEVH200	NEW	24 V HEAT ONLY THERMOSTAT REED SWITCH VERT	25		
BEHH200	NEW	24 V HEAT ONLY THERMOSTAT REED SWITCH HOR	25		
BEVH200M	NEW	24 V HEAT ONLY THERMOSTAT MERCURY SW VERT	25		
BEHH200M	NEW	24 V HEAT ONLY THERMOSTAT MECURY SW HOR	25		
THERMOSTATS (LINE VOLTAGE)					
BELV100H		ALMOND VERTICAL LINE VOLTAGE	25		
BELV100HW		WHITE VERTICAL LINE VOLTAGE	25		
BELV100HN	NEW	LINE VOLTAGE THERMOSTAT SPST/ NO THERM VERT	25		
BELV100DPT	NEW	LINE VOLTAGE THERMOSTAT DP / W THERMOMETER	25		
BELV100DPNT	NEW	LINE VOLTAGE THERMOSTAT DP /NO THERMOMETER	25		



E-mail: info@buglersales.com

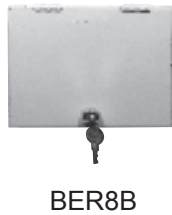
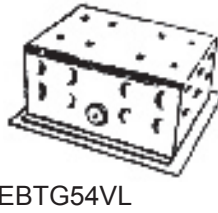
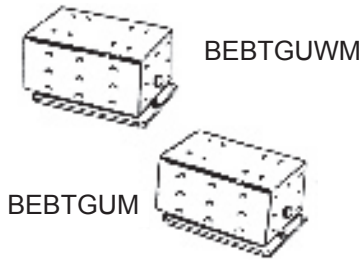

THERMOSTAT GUARDS DIMENSIONS CHART

BUGLER #	WHITE RODGERS #	TYPE	BASE	HEIGHT	WIDTH	DEPTH
BEBTGUWM	F29-0222	METAL	RING	6-3/4"	4-1/4"	3-9/16"
BEBTGUM	F29-0220	METAL	SOLID	7-1/4"	5-3/8"	3-1/2"
BEBTG54VLW	F29-0193	METAL	RING	6"	3-1/16"	3-1/8"
BEBTG54VL	F29-0192	METAL	SOLID	6"	3-13/16"	3-1/8"
BEBTGEM	F29-0233	METAL	SOLID	3-7/8"	3-1/2"	2-1/2"
BEBTGKWM	F29-0235	METAL	RING	5-1/4"	4-5/8"	3-1/4"
BEBTGRWM	F29-0237	METAL	RING	6-3/8"	3-1/2"	3-1/4"
BEBTGEK	F29-0225	PLASTIC	SOLID	3-7/8"	3-1/2"	2-1/2"
BEBTGK	F29-0227	PLASTIC	DUAL	5-1/4"	4-5/8"	3"
BEBTGRK	F29-0143	PLASTIC	DUAL	6-3/8"	3-1/2"	3"
BEBTGDK	F29-0231	PLASTIC	DUAL	4-1/4"	7-5/8"	2-1/4"
BEBTGUK2	F290198	PLASTIC	DUAL	8-1/4"	5-3/8"	3-1/4"
BER8B	70253	METAL	SOLID	7-1/8"	5-1/8"	2-3/4"
BER8C	70252	METAL	SOLID	7-1/8"	5-1/8"	2-3/4"
BETG87FR	70250	METAL	RING	ROUND	3-1/2" DIA.	
BETG87FS	70251	METAL	RING	3-1/4"	3-1/4"	1-1/2"

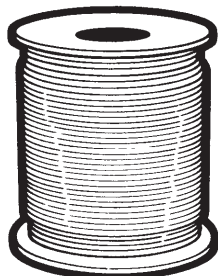

THERMOSTAT
WIRE

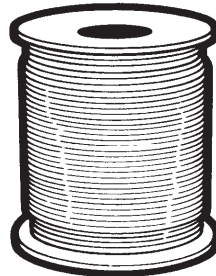

THHN WIRE
SOLID



BUGLER SALES CORP.

Phone: 516 223-3868 • Fax: 516 868-6998
 969 CHURCH STREET • BALDWIN, NY 11510

E-mail: info@buglersales.com

NUMBER		DESCRIPTION	PK	RESALE	COST
HVAC CONTROLS & ACCESSORIES <i>continued...</i>					
DIGITAL THERMOSTATS (LOW VOLTAGE)					
BEP3000	NEW	DIG PROG THERMOSTAT 1HT 1CL 24 VOLTS	25		
THERMOSTAT GUARDS					
BEBTGUWM		UNIVERSAL METAL RING BASE	12		
BEBTGUM		UNIVERSAL SOLID BASE	12		
BEBTG54VLW		HINGED METAL RING BASE	12		
BEBTG54VL		HINGED METAL SOLID BASE	12		
BEBTGEM	NEW	METAL SMALL SOLID BASE	12		
BEBTGKWM	NEW	METAL MEDIUM W/RING BASE	12		
BEBTGRWM	NEW	METAL W/RING BASE	12		
BEBTGEK		CLEAR PLASTIC SMALL (ELITE)	12		
BEBTGK		CLEAR PLASTIC DUAL BASE (CLASSIC)	12		
BEBTGRK		CLEAR PLASTIC MEDIUM (REGAL)	12		
BEBTGDK		CLEAR PLASTIC DUAL BASE (DESIGNER)	12		
BEBTGUK2		CLEAR PLASTIC LARGE (UNIVERSAL)	12		
BEF310	NEW	REPLACEMENT LOCK & KEY (BTG SERIES)	25		
BEF336		UNIVERSAL T-STAT GUARD KEY FOR BTG GUARDS	25		
THERMOLOCK THERMOSTAT GUARDS					
BER8B		METAL SOLID GUARD	12		
BER8C		METAL GUARD WITH WINDOW	12		
BETG87FR		TG87FR ROUND METAL T-STAT GUARD	12		
BETG87FS		METAL SQUARE GUARD WITH WINDOW	12		
BETKEY	NEW	REPLACEMENT KEY THERMOLOCK	25		
BETLKY		LOCK & KEY SET (TWO KEYS, ONE LOCK)	25		
THERMOSTAT WIRE					
E9560	BEST SELLER	2 CONDUCTOR 20 AWG U.L. 500'	8		
E9561		3 CONDUCTOR 20 AWG U.L. 500'	4		
E9562		4 CONDUCTOR 20 AWG U.L. 250'	8		
E9563		5 CONDUCTOR 20 AWG U.L. 250'	8		
E9564		6 CONDUCTOR 20 AWG U.L. 250'	4		
E9566		8 CONDUCTOR 20 AWG U.L. 250'	4		
E9610		2 CONDUCTOR 18 AWG U.L. 500'	4		
E9611		3 CONDUCTOR 18 AWG U.L. 500'	4		
E9612	BEST SELLER	4 CONDUCTOR 18 AWG U.L. 250'	4		
E9613		5 CONDUCTOR 18 AWG U.L. 250'	4		
E9614		6 CONDUCTOR 18 AWG U.L. 250'	4		
E9616		8 CONDUCTOR 18 AWG U.L. 250'	4		
E9620		50' THERMOSTAT WIRE 2/20 BAGGED	10		
E9615		25' THERMOSTAT WIRE 5/18 BAGGED	10		
THHN WIRE (SOLID)					
E9087	NEW	#12 THHN WIRE SOLID WIRE 500' WHITE	1/4		
E9088	NEW	#12 THHN WIRE SOLID WIRE 500' YELLOW	1/4		
E9081	NEW	#12 THHN WIRE SOLID WIRE 500' BLACK	1/4		
E9082	NEW	#12 THHN WIRE SOLID WIRE 500' BLUE	1/4		
E9084	NEW	#12 THHN WIRE SOLID WIRE 500' ORANGE	1/4		
E9086	NEW	#12 THHN WIRE SOLID WIRE 500' RED	1/4		



E-mail: info@buglersales.com

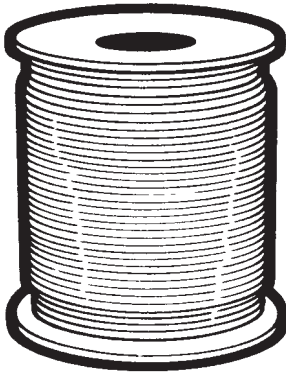

THHN WIRE
SOLID &
STRANDED

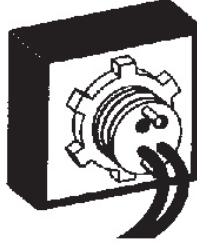

TIME DELAYS



MCSL1

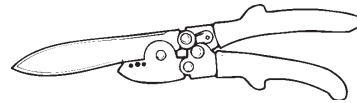
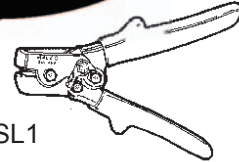

MCFDC1

**LOW VOLTAGE TRANSFORMERS
CONVERSION CHART**

BUGLER #	HONEYWELL #	EDWARDS #	MARS #
MXT10E	AT140A1000	599	50213
MXT10P	AT140A, AT72B		50204
MXT12			50203
MXT12MV			50215
MXT42			50211
MXT43	AT140AA1000	599	50210
MXT45			
MXT50	AT150A1007		50216
MXT75C/B			50231
MXT100C/B			50232
BE590		590	
BE591		591	
BE592		592	
BE598		593	

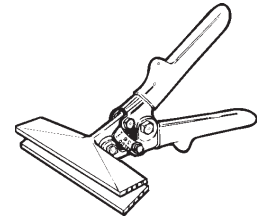

MCS6



MCRRW316

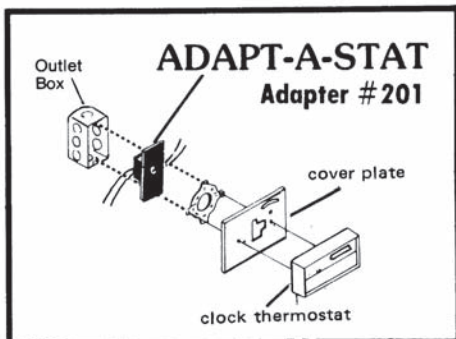

Manufactured in U.S.A.

Patent Pending



ES891R

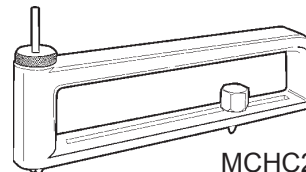

MCHC2



BUGLER SALES CORP.

Phone: 516 223-3868 • Fax: 516 868-6998
 969 CHURCH STREET • BALDWIN, NY 11510

E-mail: info@buglersales.com

NUMBER		DESCRIPTION	PK	RESALE	COST
HVAC CONTROLS & ACCESSORIES <i>continued...</i>					
THHN WIRE (SOLID) <i>continued...</i>					
E9100		#14 THHN SOLID WIRE 500' BLACK	1/4		
E9101		#14 THHN SOLID WIRE 500' BLUE	1/4		
E9103		#14 THHN SOLID WIRE 500' ORANGE	1/4		
E9105		#14 THHN SOLID WIRE 500' RED	1/4		
E9106		#14 THHN SOLID WIRE 500' WHITE	1/4		
E9107		#14 THHN SOLID WIRE 500' YELLOW	1/4		
THHN WIRE (STRANDED)					
E9090	NEW	#12 THHN STRANDED WIRE 500' BLACK	4		
E9091	NEW	#12 THHN STRANDED WIRE 500' BLUE	4		
E9093	NEW	#12 THHN STRANDED WIRE 500' ORANGE	4		
E9095	NEW	#12 THHN STRANDED WIRE 500' RED	4		
E9096	NEW	#12 THHN STRANDED WIRE 500' WHITE	4		
E9097	NEW	#12 THHN STRANDED WIRE 500' YELLOW	4		
E9110	NEW	#14 THHN STRANDED WIRE 500' BLACK	4		
E9111	NEW	#14 THHN STRANDED WIRE 500' BLUE	4		
E9113	NEW	#14 THHN STRANDED WIRE 500' ORANGE	4		
E9115	NEW	#14 THHN STRANDED WIRE 500' RED	4		
E9116	NEW	#14 THHN STRANDED WIRE 500' WHITE	4		
E9117	NEW	#14 THHN STRANDED WIRE 500' YELLOW	4		
TIME DELAYS					
BETDCAR-4		4 SECOND TIME DELAY	EA		
BETDMA		TDMA M32391 TIME DELAY 6 SEC - 8 MIN MAKE	25		
BETDBA		TDMA M32392 TIME DELAY 6 SEC - 8 MIN BREAK	25		
TOOLS					
ES891R	NEW	SNAKE 50 FT W/REEL	3		
MCFDC1		MALCO FDC1 FLEX DUCT CUTTER	EA		
MCHC2		MALCO HC2 2-20 INCH HOLE CUTTER	EA		
MCRRW316		MALCO RRW3/16 3/16" HEX KEY WRENCH	EA		
MCRRW516		MALCO RRW5/16 5/16" HEX KEY WRENCH	EA		
MCS6		MALCO 6" HAND SEAMER	EA		
MCSL1		MALCO SL1 SNAP LOCK PUNCH	EA		
CONTROL TRANSFORMERS					
AOS		ADAPT-A-STAT MED 201	EA		
MXT10E	BEST SELLER	120V P, 24V S, 3 WAY MOUNT, 40VA	18		
MXT10P		120V P, 24 V S, PL. MOUNT, 40VA	18		
MXT12	NEW	120,208,240V PRI,24V SEC FT MNT, 40V SEC	30		
MXT12MV		120/208/240V P, 24V S, 3 WAY MOUNT, 40VA	18		
MXT42	NEW	120,208,240V PRI,24,12,2.5V SEC MULTI MNT,48VA	18		
MXT43		120V P, 24V S, 3 WAY MOUNT, 40VA	18		
MXT45		120/208/240V P24/16/12/8/2.5V S, 3 WAY MOUNT, 48VA	18		
MXT50		120/208/240V P, 24V S, 3 WAY MOUNT, 50VA	18		
MXT75C/B		120/208/240/480 , 24V S, FT MOUNT, 75VA W/CB	12		
MXT100C/B		120/208/240/480 P, 24V S, FT. MOUNT, 100VA W/CB	12		



BUGLER SALES CORP.

Phone: 516 223-3868 • Fax: 516 868-6998
969 CHURCH STREET • BALDWIN, NY 11510

E-mail: info@buglersales.com

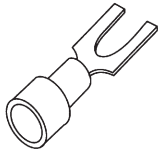

W20150

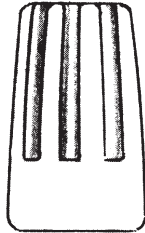

WIRE CONNECTORS

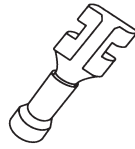

W20180



BELL TRANSFORMER



SCREW IN ELEMENT



FLAT FLANGE ELEMENT



UNIVERSAL ELEMENT



COPPER / PLASTIC

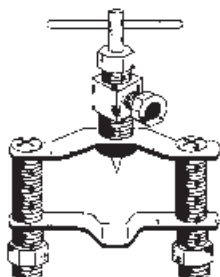

SADDLE VALVE
IMPORT
DOMESTIC

CLEAR SUPPLY HOUSE BAGS

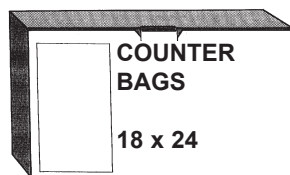

COUNTER
BAGS

18 x 24

B0024

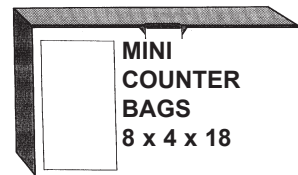

MINI
COUNTER
BAGS

8 x 4 x 18

B0023



BUGLER SALES CORP.

Phone: 516 223-3868 • Fax: 516 868-6998
 969 CHURCH STREET • BALDWIN, NY 11510

E-mail: info@buglersales.com

NUMBER		DESCRIPTION	PK	RESALE	COST
HVAC CONTROLS & ACCESSORIES <i>continued...</i>					
BELL TRANSFORMERS					
BETR590		BELL TRANSFORMER AC10V / 5VA	30		
BETR591		BELL TRANSFORMER AC16V ./ 10VA	30		
BETR592		BELL TRANSFORMER AC8-24V / 10-20VA	30		
BETR598		BELL TRANSFORMER AC8 @ 20VA - 16-24@30VA	30		
WIRE CONNECTORS WE CARRY A FULL LINE OF INSULATED CONNECTORS					
W20150		16-14 VINYL INS SPADES #10 STUD (100)	1		
W20180		16-14 VINYL INS QUICK CONNECTORS FEM (100)	1		
W20501		GRAY WIRE NUTS (100) 22-16 AWG	EA		
W20502		BLUE WIRE NUTS (100) 22-16 AWG	EA		
W20503	BEST SELLER	ORANGE WIRE NUTS (100) 22-14 AWG	EA		
W20504	BEST SELLER	YELLOW WIRE NUTS (100) 18-10 AWG	EA		
W20506		RED WIRE NUTS (100) 18-10 AWG	EA		
W4510		175 PIECE TERMINAL KIT	EA		
W4512		120 PIECE WIRE NUT KIT	EA		
VALVES, WONDER					
WV4	NEW	ANGLE RADIATORS IN ROOM W/THERMOSTAT	12		
WV5	NEW	ANGLE RADIATORS NEAR BOILER/ IN WARM ROOMS	12		
WV6	NEW	ANGLE RADIATORS FARTHER FROM BOILER	12		
WVC	NEW	ANGLE RADIATORS FARTHEST/HARD/TO/HEAT/ROOMS	12		
WVD	NEW	ANGLE WHERE LARGE AMT OF AIR MUST BE VENTED	12		
WATER HTR ELEMENTS					
CA02103	NEW	1000W 120V SCREW IN ELEMENT HWD	6		
CA02143	NEW	1500W 120V SCREW IN ELEMENT HWD	6		
CA02203	NEW	2000W 120V SCREW IN ELEMENT HWD	12		
CA2223	NEW	2000W 240V SCREW IN ELEMENT WHD	12		
CA02263	NEW	3000W 240V SCREW IN ELEMENT HWD	12		
CA02303	NEW	4000W 240V SCREW IN ELEMENT HWD	12		
CA02343	NEW	4500W 240V SCREW IN ELEMENT HWD	12		
CA03743	NEW	1500 120V SCREW IN ELEMENT	12		
CA03943	NEW	4500W 240V FLAT FLANGE ELEMENT HWD	12		
CA04363	NEW	1500W 120V FLAT FLANGE ELEMENT HWD	12		
CA04443	NEW	2000W 120V UNIVERSAL ELEMENT HWD	12		
CA04503	NEW	3000W 240V UNIVERSAL ELEMENT HWD	12		
CA04603	NEW	4500W 240V UNIVERSAL ELEMENT HWD	6		
CA07223	NEW	UNIVERSAL ADAPTER KIT	12		
ICE MAKER KITS					
I2000	BEST SELLER	ICEMAKER KIT BAGGED 25' POLY	10		
I2005		ICEMAKER KIT BAGGED 25' COPPER	12		
V0500		SADDLE VALVE SELF PIERCING IMPORT	6		
V0501		SADDLE VALVE SELF PIERCING DOMESTIC	10		
JANITORIAL SUPPLIES					
BAGS & PLASTIC SHEETING					
B0008	NEW	3 X 4 2 MIL WHT ZIP LOCK BAGS 1000	EA		
B0010	NEW	4 X 6 4 MIL WHT ZIP LOCK BAGS 1000	EA		
B0011	NEW	4 X 6 2 MIL WHT ZIP LOCK BAGS 1000	EA		
B0015	NEW	6 X 9 2 MIL WHT ZIP LOCK BAGS 1000	EA		
BZL8367	NEW	4 X 5 4 MIL WHT PTCH ZIP LOCK BAGS 1000	EA		
B0023		8x4x18 MINI COUNTER BAG - CLEAR 1000	EA		
B0024	BEST SELLER	18 x 24 COUNTER BAG - CLEAR	250		



E-mail: info@buglersales.com

TRASH BAGS

ON A ROLL OR BOXED

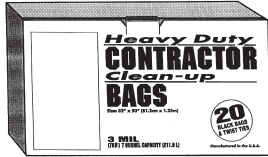

3 MIL 20 & 50 PACK

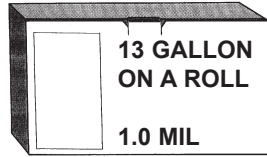

B0040

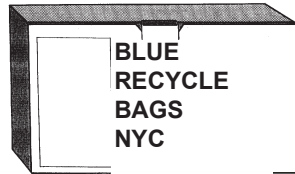

B0064,63

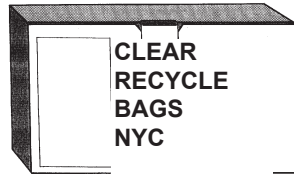

B0061

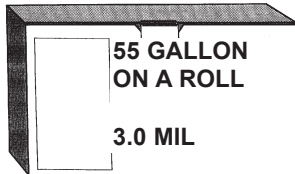

B0038

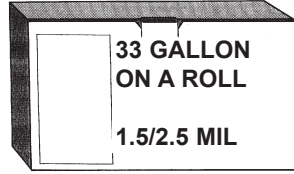

B0039/B0036



KC91371



SCRUBS

BUCKETS
10 QUART
5 GALLON
LIDS



44/55 GALLON
HUSKEE CAN
INDUSTRIAL



TWIST-ON DOLLY



PLASTIC &
STYROFOAM
CUPS

9 STYLES & SIZES

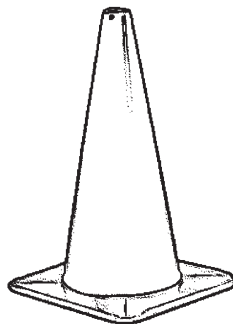

SAFETY CONES



BUGLER SALES CORP.

Phone: 516 223-3868 • Fax: 516 868-6998
 969 CHURCH STREET • BALDWIN, NY 11510

E-mail: info@buglersales.com

NUMBER		DESCRIPTION	PK	RESALE	COST
JANITORIAL SUPPLIES <i>continued...</i>					
BAGS & PLASTIC SHEETING <i>continued...</i>					
B0028		10' x 100' POLY SHEETING - 4MIL CLEAR	EA		
B0031	NEW	10' X 200' 2 MIL CLEAR POLY SHEETING	EA		
B0036		33 GAL H.D. TRASH LINER PK 60 2.5 MIL/ROLL	EA		
B0038		55 GAL H.D. TRASH LINER PK 30 3.0 MIL/ROLL	EA		
B0039	BEST SELLER	33 GAL H.D. TRASH LINER PK 100 1.5 MIL/ROLL	EA		
B0040	BEST SELLER	13 GAL H.D. TRASH BAGS PK 150 1.0 MIL/ROLL	EA		
B0043	BEST SELLER	CONTRACTOR CLEAN UP BAGS 3 MIL. (20)/ROLL	EA		
B0050		CONTRACTOR CLEAN UP BAGS 3 MIL. (50)/ROLL	EA		
B0044		13 GALLON SUPER HEXENE PK 500 (FOLDED)	EA		
B0045	BEST SELLER	33 GALLON - 2.3 MIL DISP. BOX (FOLDED) 100	EA		
B0047	BEST SELLER	45 GALLON - 2.3 MIL DISP. BOX (FOLDED) 100	EA		
B0049		55 GALLON - 2 MIL DISP. BOX (FOLDED) 100	EA		
B0051		55 GALLON - 2.3 MIL - (22 x 14 x 58) 100	EA		
B0058		22x16x58 BLACK *ED* BAG 3MIL 100	EA		
B0061		16x14x36 CLEAR NYC RECYCLE BAG 100 - 1.5 mil	EA		
B0063		23x17x46 BLUE NYC RECYCLE BAG 100 45GAL 1.2 MIL	EA		
B0067		13 GAL WHITE BAG W/DRAW STRING 200	EA		
CLEANING PRODUCTS					
KC07209	NEW	LEMON FURNITURE POLISH	12		
KC07218	NEW	CARPET CLEANER	12		
KC07225	NEW	BATHROOM CLEANER	12		
KC07233	NEW	GLASS CLEANER	12		
KC07766	NEW	FOAMING TIRE PROTECTANT	12		
KC07770	NEW	UPHOLSTERY CLEANER	12		
KC91371	NEW	75CT WYPE-ALL HAND WIPES BUCKET	6		
C2304		LEMON PLEDGE - CASE OF 12	EA		
C2332	NEW	SIMPLE GREEN GALLON	6		
C2348	NEW	18 OZ LYSOL CASE OF 12	EA		
C2330	NEW	16 OZ SIMPLE GREEN TRIGGER CONTCRT	12		
C2337	NEW	20 OZ CASCADE POWDER 24 TO CASE	EA		
SCRUBS	NEW	72CT HAND WIPES BUCKET SCRUBS	6		
CONES					
S1365		18" SAFETY CONE	12		
CONTAINERS - BUCKETS, CANS, PAILS					
B9000		10 QT. BUCKET	12		
B9002		5 GAL BUCKET	10		
B9003		5 GAL LID	10		
B9006		44 GAL GRAY HUSKEE CAN	1/2		
B9007		TWIST ON DOLLY FOR HUSKEE CAN	EA		
B9018	NEW	55GAL GRAY HUSKEE CAN	1/3		
CUPS					
C9005	NEW	5 OZ FABRICAL CUPS TRANS. (PACK 2500)	EA		
C9012		12 OZ CLEAR CUP (PACK 1000)	EA		
C9030		10 OZ FOAM CUPS (PACK 1000)	EA		
C9031	NEW	12 OZ FOAM CUP (PACK 1000)	EA		
C9032	NEW	12 OZ HOT CUP (PACK 1000)	EA		
C9033	NEW	12 OZ LIDS FOR CUPS (PACK 1000)	EA		
GRAFITTI REMOVAL					
GF416		16 OZ GOOF OFF GRAFITTI REMOVER	12		



BUGLER SALES CORP.

Phone: 516 223-3868 • Fax: 516 868-6998
969 CHURCH STREET • BALDWIN, NY 11510

E-mail: info@buglersales.com

JANITORIAL SUPPLIES



R0788

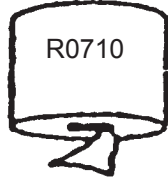

R0710

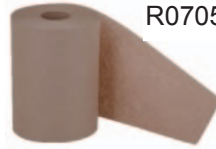

R0705



R0780

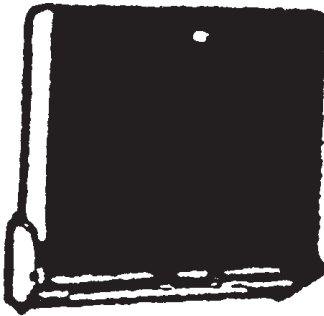

C-FOLD &
MULTI-FOLD
R0790

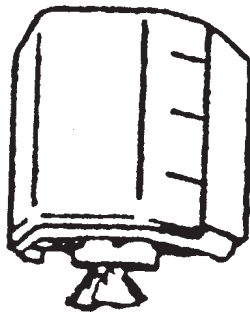

CENTER PULL
R0712

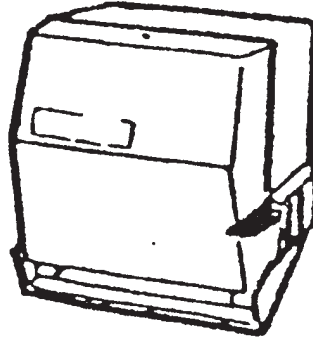

ROLL TOWELS
R0704

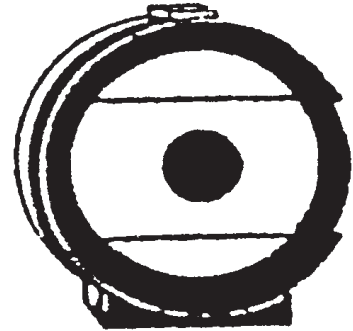

JUMBO TOILET TISSUE
R0781



2-PLY
TOILET PAPER
(HOUSEHOLD)
R0775



ARMOR ALL

URINAL BLOCK
R0800



C2215
WINDSHIELD
WASHER
FLUID



**WE CARRY DISPENSERS FOR ALL OF OUR PRODUCTS
PAPER FOR PROPRIETARY DISPENSERS TOO!**



BUGLER SALES CORP.

Phone: 516 223-3868 • Fax: 516 868-6998
 969 CHURCH STREET • BALDWIN, NY 11510

E-mail: info@buglersales.com

NUMBER		DESCRIPTION	PK	RESALE	COST
JANITORIAL SUPPLIES <i>continued...</i>					
RESTROOM PRODUCTS					
CE01648		NO-FUME DRAIN OPENER - QUART	12		
CE0164932		BIO BLAST ODOR CONTROL - QUART	4		
R0704		DISPENSER FOR ROLLED TOWELS F/R0705	1		
R0705		350' ROLL TOWELS CASE - BROWN - PK12	1		
R0708	NEW	8 X800' WHITE ROLL TOWEL PACK	1		
R0710		1-PLY 8" X 1000' CENTER PULL TOWEL - PK6	1		
R0712		DISPENSER MEDIUM - CENTER PULL F/R0710	1		
R0715	BEST SELLER	KITCHEN ROLL TOWELS - CASE OF 30	1		
R0716		203 BAYWEST ROLL TOWEL 8" x 425' PK 12	1		
R0775		2-PLY 500 SHEET TOILET PAPER - CASE OF 96	1		
R0779	BEST SELLER	2-PLY 9" JUMBO JUNIOR BATHROOM TISSUE	12		
R0780		2-PLY 12" JUMBO BATHROOM TISSUE - PK6	1		
R0781		JUMBO TOILET TISSUE DISPENSER 12"	1		
R0782		JUMBO JR. TOILET TISSUE DISPENSER 9"	1		
R0786		MULTIFOLD TOWEL WHITE 16/250	3		
R0788		C-FOLD TOWELS - WHITE - 2400	1		
JS56650	NEW	C-FOLD DISPENSER SMOKE PLASTIC	1		
R0795		SCA SINGLE FOLD TOWELS PK 15	1		
R0800	BEST SELLER	URINAL BLOCK	12		
R0809		6.5OZ TIME MIST DISPENSER WHITE	1		
R0811		6.5OZ METERED SPRAY CINNAMON / CASE 12EA			
R0902	NEW	ANGELSOFT 100CT FACIAL TISSUE PK30	1		
M7000		26QT. GALVANIZED MOP BUCKET	EA		
M7002		MOP RINGER GALVANIZED	EA		
M7005		JAW TYPE MOP HANDLE	EA		
M7006		#16 MOP HEAD	6		
M7008		QUICKIE AUTO SPONGE MOP	6		
M7009		#24 CUT COTTON MOP HEAD	12		
M7010		#32 MOPHEAD - CASE OF 12	12		
M7012		72" FIBERGLASS SCREWTYPE MOP HDL	EA		
R0692	NEW	24" X 24" DUSTCLOTH - PK 200	2		
R0805		UNDERSEAT TOILET DEODORIZER	24		
R0807		TOILET SEAT COVERS - CASE OF 5000	EA		
3M510017		17" RED BUFFER PAD PK 5	EA		
SEE HAND CLEANER SECTION FOR SOAPS & DISPENSERS					
SPONGES					
S6880	NEW	OVAL GROUT SPONGE	12		
3M420		SCOTCHBRITE SCRUB SPONGE	24		
VEHICLE MAINTENANCE SUPPLIES					
3M7456T		C41 XL CAR & BOAT SPONGE	24		
C2215		WINDSHIELD WASHER FLUID WINTER MIX	6		
C2288	NEW	20 OZ ORG ARMORALL CLEANER PK 12	EA		
C2292		ARMORALL 10 OZ PROTECTANT - PK 12	EA		
C2294		ARMORALL 20 OZ MULTI-PURPOSE CLNR - 12	EA		
C2296		NO 7 CHROME CLEANER - CASE OF 12	EA		
C2325		GLIPTONE WASH & GLO - 64OZ - CASE OF 6	EA		



BUGLER SALES CORP.

Phone: 516 223-3868 • Fax: 516 868-6998
969 CHURCH STREET • BALDWIN, NY 11510

E-mail: info@buglersales.com

"GOOD"
KNEE



"BETTER"
PRO KNEE



"BEST"

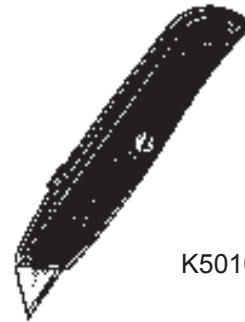

K5010



K5030
ERGONOMIC
UTILITY KNIFE
W/HOLSTER

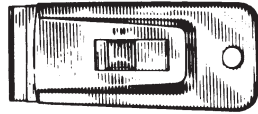

K5014



ALHSN



10-049

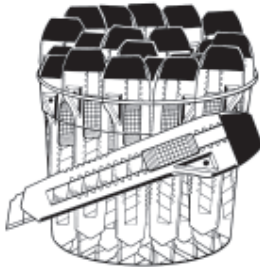

K7-25

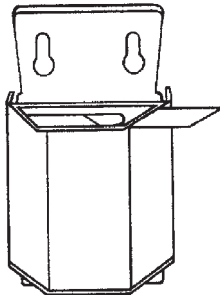

AL07109



GN12008



KWIK WICK

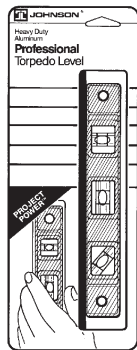

L0958
PLASTIC

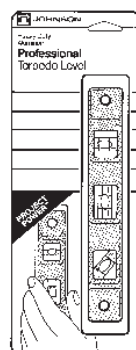

L0959
METAL



GN12113



GN12109

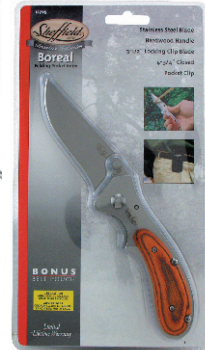

GN12705



LAMPWICK



C3020 LAG DRIVER

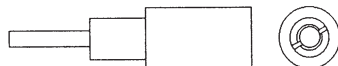

C3010 ACOUSTICAL
LAG DRIVER



BUGLER SALES CORP.

Phone: 516 223-3868 • Fax: 516 868-6998
 969 CHURCH STREET • BALDWIN, NY 11510

E-mail: info@buglersales.com

NUMBER		DESCRIPTION	PK	RESALE	COST
JANITORIAL SUPPLIES <i>continued...</i>					
VEHICLE MAINTENANCE SUPPLIES					
JS18080	NEW	18080 2PLY 604 SHEET TT PK 80		EA	
JSCRYSTAL	NEW	1 GAL CRYSTAL GLASS CLEANER GALLON		4	
KN21101		KNIGHTS GLOSS CAR WASH - GALLON		6	
S6900		36" PRO SQUEEGEE W/ BRACED HANDLE		EA	
MW05701		MOTHERS GOLD LIQUID WAX - PK 6		EA	
PL54400	NEW	32 OZ CAPT CHOMP ALL PURPOSE CLEANER		6	
PL54500	NEW	32 OZ CAPT CHOMP BILGE CLEANER		6	
PL54600	NEW	32 OZ CAPT CHOMP MILDEW CLEANER		6	
PL54700	NEW	32 OZ CAPT CHOMP HULL CLEANER		6	
KEYHOLE SAWS & BLADES • ALLWAY					
ALHSN	BEST SELLER	HSN HANDY SAW NEST		10	
ALHB24T	BEST SELLER	HB24T METAL BLADE		10	
KNEE PADS					
MC319		50040 PROFESSIONAL KNEE PADS		6	
MC22373		MONSTER KNEE PADS		EA	
MC313	BEST SELLER	50010 HANDYMAN RUBBER KNEE PADS		6	
KNIVES ARDELL • STANLEY (USA) • SHEFFIELD					
K5010	BEST SELLER	099 UTILITY KNIFE		10	
K5015	BEST SELLER	02-043 UTILITY BLADES 5 PK (FOR 099)		10	
K5014	BEST SELLER	SCRAPER W/5 BLADES		10	
K5018		SEB10 SINGLE EDGE BLADES2-5 PACKS		10	
HN03009	NEW	03009 SPEED ROCKER KNIFE		12	
K5030		ERGONOMIC UTILITY KNIFE W/HOLSTER		6	
GN12008	NEW	12008 SHEFFIELD MULTI TOOL 19-IN-1		12	
GN12109	NEW	12109 FOLDING HAWKBILL BLADE KNIFE		10	
GN12113	NEW	12113 SHEFFIELD UTILITY KNIFE		12	
GN12119	NEW	12119 UTILITY KNIFE W/ BLADE STORAGE		12	
GN12705	NEW	12705 BOREAL FOLDING POCKET KNIFE		12	
GNWSRC	NEW	WSRC UTILITY BLADE SCRAPER		12	
HN03020	NEW	03020 INSULATION KNIFE		12	
A0143	BEST SELLER	K7-25 25 H.D. SNAP KNIVES		EA	
A0144	BEST SELLER	K13-50 50 SNAP KNIVES		EA	
AL07109		DSP100 100 PACK UTILITY BLADE DISPENSER		EA	
ST10-049	BEST SELLER	STANLEY POCKET KNIFE		6	
ST11-040		STANLEY REPLACEMENT BLADE FOR 10-049		10	
LAG DRIVERS					
C3010		ACOUSTICAL LAG EYE DRIVER		10	
C3019		GIMLET ROD DRIVER (1/4)		5	
C3020	BEST SELLER	GIMLET ROD DRIVER (3/8)		10	
LAMPWICK					
W1500		2 OZ. BALL FINE LAMPWICK		12	
W1501	BEST SELLER	SPOOL KWIK WICK FINE		50	
LEVELS • JOHNSON • SANDS					
L0959		#4500M 9" METAL MAG TORPEDO		10	
L0958		#7500M 9" PLASTIC MAG TORPEDO		10	
L0950		PL318 18" 3 VIAL ALUMINUM		EA	
L0951	BEST SELLER	PL324 24" 3 VIAL ALUMINUM		EA	



BUGLER SALES CORP.

Phone: 516 223-3868 • Fax: 516 868-6998
969 CHURCH STREET • BALDWIN, NY 11510

E-mail: info@buglersales.com



18", 24", 36", 48" REGULAR



TORPEDO / MAGNETIC / REGULAR



L0961

LIGHT BULBS

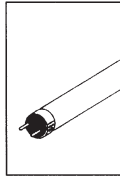

48" & 96"

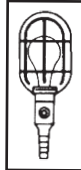

Ultra Bright White

40W / 50W / 75W
REGULAR BULBS
AVAILABLE

Master Lock®



1D, 3D, 5D, 7D,
15D, KEYED ALIKE

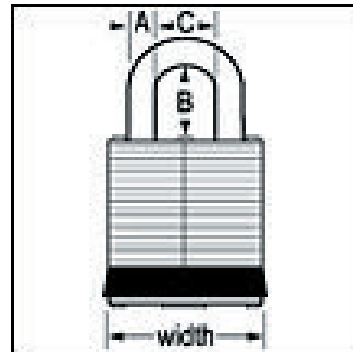

SHACKLE DIMENSIONS

	A	B	C
1D	5/16	15/16	3/4
3D	9/32	3/4	5/8
5D	3/8	1	15/16
7D	3/16	9/16	1/2
15D	7/16	1-1/4	1-3/16



BUGLER SALES CORP.

Phone: 516 223-3868 • Fax: 516 868-6998
 969 CHURCH STREET • BALDWIN, NY 11510

E-mail: info@buglersales.com

NUMBER		DESCRIPTION	PK	RESALE	COST
LEVELS • JOHNSON • SANDS <i>continued...</i>					
L0954		TR24 24" 3 VIAL HVY. DUTY ALUMINUM	EA		
L0953		PML18 18" PROFESSIONAL MAG. ALUMINUM	EA		
L0955	BEST SELLER	PML24 24" PROFESSIONAL MAG. ALUMINUM	EA		
L0970		PML48 48" PROFESSIONAL MAG. ALUMINUM	EA		
L0956		SC-55 HVY. DUTY LINE & SURFACE	10		
L0961		#556 5" POCKET LEVEL W/CLIP	12		
LIGHT BULBS - SPECIAL STYLES, BASES & WATTAGE AVAILABLE - CASE PRICING					
L4175		#1 75 WATT ROUGH SERVICE BULB	6/120		
L4176	BEST SELLER	#2 100 WATT ROUGH SERVICE BULB	6/120		
L4177		#3 150 WATT ROUGH SERVICE BULB	6/120		
L4192		200 WATT REGULAR SERVICE BULB	60		
L4178		#4 100 WATT TEFLON COATED BULB	6/24		
L4179		#5 50 WATT TRUCK BULB 12VOLT	120		
L4184		48" 34 WATT BI-PIN FLOUR (EN. SAV.)	30		
L4188		96" 60 WATT SINGLE PIN FLOUR (EN.SAV.)	15		
L4189		96" 75 WATT BI-PIN FLOUR (HIGH OUTPUT)	15		
L4240		20 WATT SOFT WHITE COMPACT FLOUR.	10		
BYSL103	NEW	13W FLUORESCENT BULB	12		
BYSL229	NEW	9W FLUORESCENT BULB	12		
EXIT LIGHTS & REPLACEMENT BULBS AVAILABLE					
LOCKS • MASTER					
ML1KA2359		#1KA 1-3/4" KEYED ALIKE **2359 KEYWAY**	6/48		
ML1KA2730		#1KA 1-3/4" KEYED ALIKE **2730 KEYWAY**	6		
ML3DLF		#3DLF 1-1/2" SHACKLE MASTERLOCK	4		
ML3KA0356		#3KA MASTERLOCK **0365 KEYWAY**	6		
ML3UP		#3UP UNIVERSAL PIN MASTERLOCK	6		
ML475KA2206		#475KA MASTERLOCK **2206 KEYWAY**	36		
ML5KAA101		#5KA 2" LOCKED KEYED ALIKE A101	6/36		
ML5KAA102		#5KA 2" LOCKED KEYED ALIKE A102	6/36		
ML5KAA103		#5KA 2" LOCKED KEYED ALIKE A103	6/36		
ML5KAA104		#5KA 2" LOCKED KEYED ALIKE A104	6/36		
ML5KAA105		#5KA 2" LOCKED KEYED ALIKE A105	6/36		
ML5KAA108		#5KA 2" LOCKED KEYED ALIKE A108	6/36		
ML5KAA112	BEST SELLER	#5KA 2" LOCKED KEYED ALIKE A112	6/36		
ML5KAA178		#5KA 2" LOCKED KEYED ALIKE A178	6/36		
ML5KAA383	BEST SELLER	#5KA 2" LOCKED KEYED ALIKE A383	6/36		
ML5KAA389	BEST SELLER	#5KA 2" LOCKED KEYED ALIKE A389	6/36		
ML5KAA473		#5KA 2" LOCKED KEYED ALIKE A473	6/36		
ML5KAA500	NEW	5KA MASTER LOCK **A500 KEYWAY**	6/36		
ML5KAA699	BEST SELLER	#5KA 2" LOCKED KEYED ALIKE A699	6/36		
ML5KAA999		#5KA 2" LOCKED KEYED ALIKE A999	6/36		
ML5KA2126		#5KA 2" LOCKED KEYED ALIKE 2126	6/36		
ML5KALJ		#5KALJ 2-1/2" SHACKLE	6/36		
ML1D		#1D MASTER LOCK 1-3/4"	4		
ML3D		#3D MASTER LOCK 1-1/2"	4		
ML5D		#5D MASTER LOCK 2"	4		
ML7D		#7D MASTER LOCK 1-1/8"	4		
ML15D		#15D MASTER LOCK 2-1/2"	6		



BUGLER SALES CORP.

Phone: 516 223-3868 • Fax: 516 868-6998
969 CHURCH STREET • BALDWIN, NY 11510

E-mail: info@buglersales.com

Master Lock®



6840KA



6270KA
VAN LOCK



ML8413XDPF

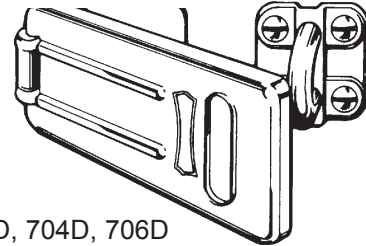

703D, 704D, 706D

MASTERLOCK CAN MATCH ALL
AMERICAN LOCK KEYWAYS



ML22D

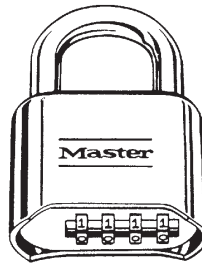

175D
RESETTABLE



6121KA
WEATHER TOUGH



#230KA
STOREFRONT



#420

LOCKOUT
TAGOUT



ML176D

DIXON®
DIXON TICONDEROGA COMPANY

"Since 1795"

"SHARPIES"

Hagstrom



METAL OR PLASTIC BARREL
REDISHARP SHARPIES



BUGLER SALES CORP.

Phone: 516 223-3868 • Fax: 516 868-6998
 969 CHURCH STREET • BALDWIN, NY 11510

E-mail: info@buglersales.com

NUMBER		DESCRIPTION	PK	RESALE	COST
LOCKS • MASTER <i>continued...</i>					
ML22D		#22D MASTER LOCK 1-1/2"	12		
ML105KA075		#105KA MASTER LOCK **075 KEYWAY**	12		
ML175D	BEST SELLER	#175D K436 SESAMEE KEYLESS LOCK	4		
ML175DLH		#175DLH MASTERLOCK 2-1/4" SHACKLE	6		
ML176D	NEW	#176 MASTERLOCK P150 KEYWAY	6/36		
ML230KA	BEST SELLER	#230KA ROUND HEAVY DUTY KEYED ALIKE	5		
ML230KALH		#230LAKH STEEL PADLOCK MASTERLOCK	5		
ML376		HAND HELD KEYING TOOL	1		
ML410		SAFETY LOCKOUT PADLOCK	6		
ML411		SAFETY LOCKOUT PADLOCK 3" BODY	6		
ML420		1" SAFETY LOCKOUT	12		
ML421	BEST SELLER	1-1/2" SAFETY LOCKOUT	12		
ML703D		3-1/2" SAFETY HASP	4		
ML704D	BEST SELLER	4-1/2" SAFETY HASP	4		
ML706D	BEST SELLER	6" SAFETY HASP	4		
ML770		HASP FOR 6270 VAN MASTERLOCK	1		
ML1500D		COMBINATION MASTERLOCK	6		
ML6121KA		WEATHER TOUGH **16G526 KEY**	6		
ML6270KA		#6270KA MASTER VAN LOCK (HOCKEY PUCK)	6		
ML6840KA		#6840KA MASTER LOCK 1-3/4"	6		
ML8413XDPF		6' CINCHABLE CABLE LOCK	6		
MLP150	NEW	P150 KEY FOR 176D MASTER LOCK	6		
MAPS • HAGSTROM					
HA1001	BEST SELLER	NASSAU ATLAS	EA		
HA1002	BEST SELLER	SUFFOLK ATLAS	EA		
HA1003	BEST SELLER	FIVE BORO ATLAS	EA		
HA1008		WESTCHESTER ATLAS	EA		
HA1013		BERGEN PASSAIC ROCKLAND ATLAS	EA		
HA1014		DUTCHESS PUTNAM ATLAS	EA		
HA1016		FAIRFIELD ATLAS	EA		
HA1017		NEW HAVEN ATLAS	EA		
HA1018		ORANGE COUNTY ATLAS	EA		
HA1020		UNION HUDSON ESSEX ATLAS	EA		
HA1021		MIDDLESEX ATLAS	EA		
HA1022		MORRIS SUMMERSET	EA		
HA1201		LAMINATED NASSAU ATLAS	EA		
HA1202		LAMINATED SUFFOLK ATLAS	EA		
HA1203		LAMINATED FIVE BORO ATLAS	EA		
HA1208		LAMINATED WESTCHESTER ATLAS	EA		
OTHERS AVAILABLE					
MARKERS • DIXON INDUSTRIAL GRADE - SHARPIE STYLE					
DX95001		#95001 CHISEL TIP MARKER RED	12		
DX95007	BEST SELLER	#95007 CHISEL TIP MARKER BLACK	12		
DX95008		#95008 CHISEL TIP MARKER BLUE	12		
DX87180		#8718 6" CHISEL TIP MARKER METAL BLUE	12		
DX87170	BEST SELLER	#8717 6" CHISEL TIP MARKER METAL BLACK	12		
DX87110		#8711 6" CHISEL TIP MARKER METAL RED	12		
DX47025		#47021 YELLOW HIGHLIGHTER CHISEL TIP	12		



BUGLER SALES CORP.

Phone: 516 223-3868 • Fax: 516 868-6998
969 CHURCH STREET • BALDWIN, NY 11510

E-mail: info@buglersales.com

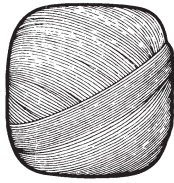

MASON LINE

HN25001



ANAHEIM / HUSKEY / MG
CLAMP-ALL
MISSION

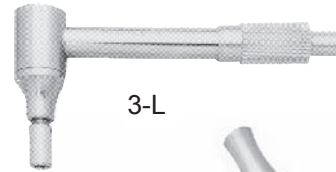
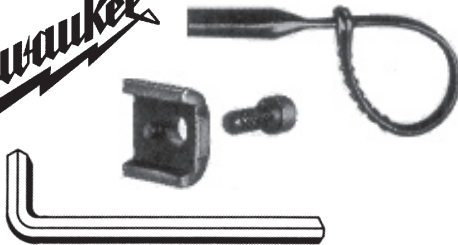

3-L

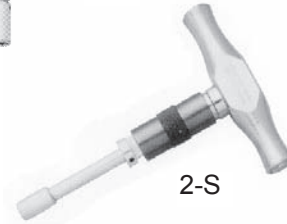

2-S

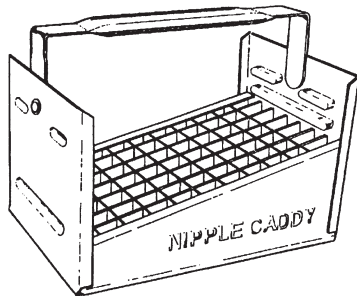

NIPPLE CADDY

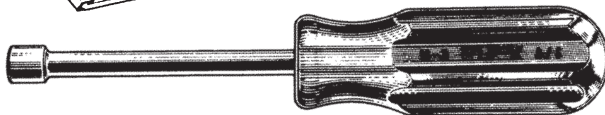

NUT DRIVERS



EW2050P



AM1962600



AM1133400



AM1904600



AM1706100



AM1939600



AM1646200



AM2316930



BUGLER SALES CORP.

Phone: 516 223-3868 • Fax: 516 868-6998
 969 CHURCH STREET • BALDWIN, NY 11510

E-mail: info@buglersales.com

NUMBER		DESCRIPTION	PK	RESALE	COST
MARKERS • DIXON INDUSTRIAL GRADE - SHARPIE STYLE <i>continued...</i>					
DI97207	BEST SELLER	#97207 REDISHARP BLACK MARKER BULLET TIP	12		
DI80223	NEW	#80223 PAINT MARKER YELLOW DIXON	12		
MASON LINE					
M2001		1/2 LB. MASON LINE	12		
HN35462	NEW	500' ROLL FL. PINK MASON LINE BRAIDED	12		
HN35401	NEW	500' ROLL GOLD MASON LINE TWISTED	12		
HN25001		100' MASONRY LINE W/REEL	12		
HN35001		100' TWISTED GOLD MASON LINE	24		
MASONRY & LANDSCAPING TOOLS					
AM1133400	NEW	8 X 8 TAMPER 42' ASH HANDLE	2		
AM1646200	NEW	7 X 5 SIDEWALK SCRAPER 48" HDL	6		
AM1706100	NEW	HVY DUTY POST HOLE DIGGER KODIAK	2		
AM1939600	NEW	CONCRETE MOVER W/HOOK 60" HDL	2		
AM1962600	NEW	MORTAR MIXER HOE 52" HANDLE	6		
AM1904600	NEW	CLOG FREE POLY LAWN RAKE	12		
AM2316930	NEW	FRESH CUT REPLACEABLE BLADE PRUNR	12		
EW2050P	NEW	2050 ESTATE SPREADER ASSEMBLED	EA		
EW2170PRO	NEW	COMMERCIAL 100LB BROADCAST SPRDR	EA		
C1140	NEW	5" POINTED TROWEL WOOD HDL. 2205	12		
C1141	NEW	7" POINTED TROWEL WOOD HDL	12		
C1144	NEW	SQUARE TROWELL NO TEETH (PT2250)	12		
MILWAUKEE SAWZALL KIT					
M3750	BEST SELLER	MILWAUKEE SAWZALL KIT	12		
M3751	BEST SELLER	MILWAUKEE SUPER SAWZALL KIT	6		
M2750		BLADE CLAMP FOR SAWZALL	10		
HX56009		WRENCH FOR SAWZALL	25		
M2752		SET SCREW FOR SAWZALL	25		
NIPPLE TRAYS					
N2500		1/2" NIPPLE TRAY	4		
N2501		3/4" NIPPLE TRAY	4		
N2502		1" NIPPLE TRAY	4		
N2510		TOTE TRAY/ORGANIZER	10		
NO-HUB WRENCHES • SEEKONK					
W4970		NO HUB TORQUE WRENCH IMPORT	12		
SN1L		1-L 5/16" SOCKET, 5" SHAFT, 60"LBS.	EA		
SN2S	BEST SELLER	2-S 5/16" SOCKET, 2-3/4" SHAFT, 60"LBS	EA		
SN2SC	NEW	2-SC 1/4" SOCKET CLAMP-ALL 80"LBS	EA		
SN2SM	NEW	2SM 5/16 80"LB MISSION	EA		
SN3L	BEST SELLER	3-L 5/16"SOCKET ANGLED 60"LBS.	EA		
SN8A		8-A 3/8" SOCKET ANAHEIM 80"LBS.	EA		
NUT DRIVERS (HOLLOW SHAFT)					
N8104		1/4 NUT DRIVER	6		
N8106	BEST SELLER	5/16 NUT DRIVER	6		
N8107		11/32 NUT DRIVER	6		
N8108		3/8 NUT DRIVER	6		
N8109		7/16 NUT DRIVER	6		
N8110		1/2 NUT DRIVER	6		
KC97297		7 PC. NUT DRIVER SET 3/16",1/4",5/16",11/32",3/8",7/16",1/2"	EA		



BUGLER SALES CORP.

Phone: 516 223-3868 • Fax: 516 868-6998
969 CHURCH STREET • BALDWIN, NY 11510

E-mail: info@buglersales.com

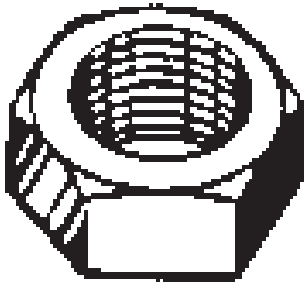

PLAIN, ZINC, GALV.
STAINLES STEEL,
REGULAR
HEAVY

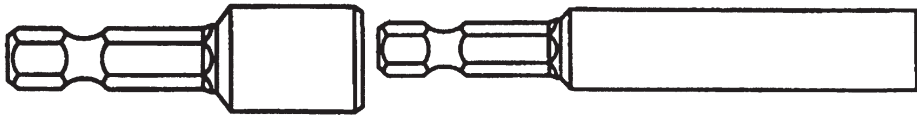
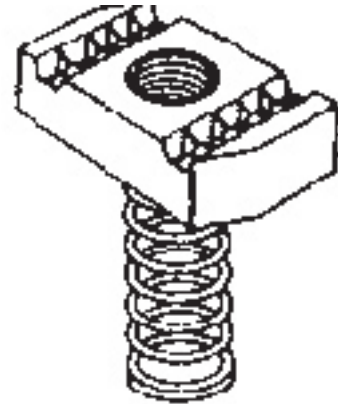

1/4", 5/16", 3/8"

1-3/4" TO 6" LONG



NYLON TIES (4"-48")



MCTY4G



BUGLER SALES CORP.

Phone: 516 223-3868 • Fax: 516 868-6998
 969 CHURCH STREET • BALDWIN, NY 11510

E-mail: info@buglersales.com

NUMBER		DESCRIPTION	PK	RESALE	COST
NUTS					
N8547		6-32 HEX NUT ZINC (EA)	100		
N8548		8-32 HEX NUT ZINC (EA)	100		
N8549		3/16 HEX NUT ZINC (EA)	100		
N8510	BEST SELLER	1/4 HEX NUT ZINC (EA)	100		
N8552		5/16 HEX NUT ZINC (EA)	100		
N8512	BEST SELLER	3/8 HEX NUT (EA)	100		
N8513		7/16 HEX NUT ZINC (EA)	100		
N8514		1/2 HEX NUT (EA)	100		
N8520		3/8 HEAVY HEX NUT (EA)	100		
N8521		1/2 HEAVY HEX NUT (EA)	100		
N8522	BEST SELLER	5/8 HEAVY HEX NUT (EA)	100		
N8523	BEST SELLER	3/4 HEAVY HEX NUT (EA)	100		
N8524		7/8 HEAVY HEX NUT (EA)	100		
N8644		3/8 PLATED SPRING NUT	100		
N8645		1/2 PLATED SPRING NUT	100		
N8646		5/8 PLATED SPRING NUT	50		
NG8512		3/8 GALVANIZED HEX NUT	100		
NG8514		1/2 GALVANIZED HEX NUT	100		
NG8516		5/8 GALVANIZED HEX NUT	100		
NG8517		3/4 GALVANIZED HEX NUT	100		
NS8522		5/8 STAINLESS STEEL HVY HEX NUT	10		
NS8523		3/4 STAINLESS STEEL HVY HEX NUT	10		
NUTSETTERS - MAGNETIC CHUCK					
C3000	BEST SELLER	1/4" X 1-3/4"	10		
C3008		1/4" X 2-9/16"	10		
C3001		1/4" X 4"	10		
C3002		1/4" X 6"	10		
C3003	BEST SELLER	5/16" X 1-3/4"	10		
C3006		5/16" X 4"	10		
C3004		5/16" X 6"	10		
C3005		3/8" X 2-9/16"	10		
C3009		5/16" X 2-9/16"	10		
B0155		7 PIECE BIT & CHUCK KIT	1		
NYLON TIES					
N9504	BEST SELLER	4" LONG, 18 LB. TEST (100/BAG)	10		
N9505		5" LONG, 30 LB. TEST (100/BAG)	10		
N9507	BEST SELLER	7" LONG, 50 LB. TEST (100/BAG)	20		
N9508		8" LONG, 40 LB. TEST (100/BAG)	20		
N9511	BEST SELLER	11" LONG, 50 LB. TEST (100/BAG)	20		
MCTY4G	NEW	TY4G MALCO TIE TOOL STD GRIP	EA		
N9514		14" LONG, 50 LB. TEST (100/BAG)	10		
N9524		24" LONG, 175 LB. TEST (50/BAG)	10		
N9532		32" LONG, 120 LB. TEST (50/BAG)	10		
N9536		36" LONG, 175 LB. TEST (50/BAG)	10		
N9548		48" LONG, 175 LB. TEST (50/BAG)	10		

BULK & UV BLACK TIES AVAILABLE



BUGLER SALES CORP.

Phone: 516 223-3868 • Fax: 516 868-6998
969 CHURCH STREET • BALDWIN, NY 11510

E-mail: info@buglersales.com



3-IN-ONE®



WD10335



WD10045



W1005
PIPE BREAK

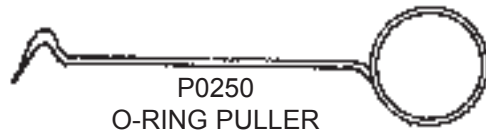

P0250
O-RING PULLER



KA



KR

13 MOST
POPULAR
COLORS



BUGLER SALES CORP.

Phone: 516 223-3868 • Fax: 516 868-6998
 969 CHURCH STREET • BALDWIN, NY 11510

E-mail: info@buglersales.com

NUMBER		DESCRIPTION	PK	RESALE	COST
OIL • WD-40 • CALFONEX • 3-IN-1 CIRCULATOR					
C2370		1 GAL DARK CUTTING OIL	4		
C2374		1 GAL CLEAR CUTTING OIL	4		
C2377		4 OZ RAPID TAP	24		
C2378		1 PINT RAPID TAP	12		
C2379		1 GAL RAPID TAP	4		
WD10108	BEST SELLER	8 OZ. WD-40 SPRAY LUBE	12		
WD10111		11 OZ. WD-40 SPRAY LUBE	12		
WD10110		GALLON WD-40 SPRAY LUBE	4		
WD10145		3 IN 1 BURNER OIL 3 OZ.	12		
WD10335		3 IN 1 MULTI-PURPOSE 3 OZ.	12		
WD40003	NEW	2 OZ. WD-40	24		
O4005	NEW	4 OZ ZOOM SPOUT MOTOR OIL	12		
O4030	NEW	1 GAL HYDRAULIC OIL	6		
O4032	NEW	QUART HYDRAULIC OIL	12		
PL11532	NEW	11532 CHAIN SAW OIL - QUART	12		
W1005		9 OZ. PIPE BREAK	12		

SEE KRYLON SECTION FOR MORE LUBRICANTS

O-RING PULLER

P0250		O-RING PULLER	6		
-------	--	---------------	---	--	--

PAINT, SPRAY -



PK 6

•BEST SELLERS

KR1501 •GLOSSY WHITE	KR1608 SMOKE GRAY	KR1813 SAFETY YELLOW OSHA
KR1502 FLAT WHITE	KR1613 SEMI-FLAT BLACK	KR1929 SAFETY PURPLE OSHA
KR1504 IVORY	KR1806 SUN YELLOW	KR2410 SAFETY ORANGE OSHA
KR1506 ALMOND	KR1901 REGAL BLUE	KR1401 BRIGHT SILVER METALLIC
KR1508 SEMI-GLOSS WHITE	KR1910 TRUE BLUE (OSHA)	KR1403 DULL ALUMINUM METALLIC
KR1601 •GLOSSY BLACK	KR2001 HUNTER GREEN	KR1404 •CHROME ALUMINUM METALLIC
KR1602 •ULTRA FLAT BLACK	KR2101 • CHERRY RED	KR1406 SILVER METALLIC
KR1604 •SHADOW GRAY	KR2108 BANNER RED	KR1701 BRIGHT GOLD METALLIC
KR1605 DOVE GRAY	KR2501 LEATHER BROWN	KR1706 GOLD METALLIC

SEE KRYLON SECTION FOR MORE AEROSOL PRODUCTS

PAINT, SPRAY 16 OZ. • PAINT ALL / ADJUSTABLE VALVE **PK 12**

• BEST SELLERS

KA04102 BLACK, FLAT	KA04115 GRAY	KA04116 RED CHERRY
KA04114 BLACK, GLOSS	KA04121 GRAY PRIMER	KA04101 WHITE FLAT
KA04105 BLUE	KA04106 GREEN	KA04113 WHITE GLOSS
KA04108 BROWN	KA04107 ORANGE	KA04104 YELLOW
KA04110 CHROME AL		



BUGLER SALES CORP.

Phone: 516 223-3868 • Fax: 516 868-6998
969 CHURCH STREET • BALDWIN, NY 11510

E-mail: info@buglersales.com



PICK UP TOOL
GNMPU24

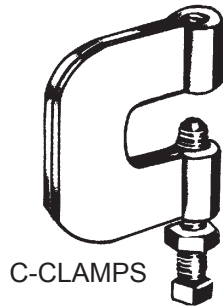

C-CLAMPS



TOP BEAM CLAMP



PEG HOOKS

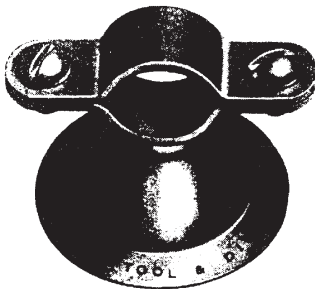

BELL HANGER

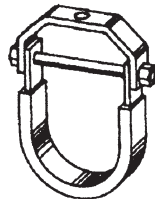

CLEVIS HANGER



SLAT HOOK

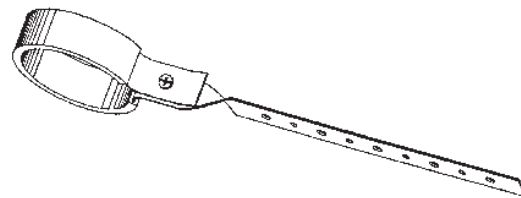

DWV HANGER



J-HOOKS



UG92134
NIFTY NABBER



BUGLER SALES CORP.

Phone: 516 223-3868 • Fax: 516 868-6998
 969 CHURCH STREET • BALDWIN, NY 11510

E-mail: info@buglersales.com

NUMBER		DESCRIPTION	PK	RESALE	COST
PEGBOARD HOOKS					
P1323		1/4" X 3" PEG HOOK (EA)	20		
P1325		1/4" X 5" PEG HOOK (EA)	20		
P1328		1/4" X 8" PEG HOOK (EA)	10		
P1329		1/4" X 11" PEG HOOK (EA)	10		
P1346		6" HEAVY DUTY SLAT BOARD HOOK	100		
OTHER TYPES AVAILABLE					
PICK UP TOOL					
GNMPU24		CLAW PICK UP TOOL 24"	12		
MXMG383		MG383 TELESCOPING MAGNET - 25"	12		
UG92134	NEW	36" NIFTY NABBER	EA		
PIPE HANGERS BEAM • BELL • CLEVIS • DWV • FLANGE • NATICK • RISER					
C4740	BEST SELLER	3/8 STEEL C-CLAMP (EA)	100		
C4741		1/2 STEEL C-CLAMP (EA)	100		
C4742	BEST SELLER	3/8 TOP BEAM CLAMP 3/4" OPENING (EA)	25		
C4743		1/2 TOP BEAM CLAMP 3/4" OPENING (EA)	25		
H1401		1/2" COPPERCLAD BELL HANGER	25		
H1402		3/4" COPPERCLAD BELL HANGER	25		
H1403		1" COPPLERCLAD BELL HANGER	25		
H1485		1/2" COPPERCLAD CLEVIS HANGER	100		
H1486		3/4" COPPERCLAD CLEVIS HANGER	100		
H1487		1" COPPERCLAD CLEVIS HANGER	100		
H1488		1-1/4" COPPERCLAD CLEVIS HANGER	100		
H1489		1-1/2" COPPERCLAD CLEVIS HANGER	100		
H1490		2" COPPERCLAD CLEVIS HANGER	50		
H1500		1/2" HEAVY CLEVIS HANGER	25		
H1501		3/4" HEAVY CLEVIS HANGER	25		
H1502		1" HEAVY CLEVIS HANGER	25		
H1503		1-1/4" HEAVY CLEVIS HANGER	25		
H1504		1-1/2" HEAVY CLEVIS HANGER	25		
H1505		2" HEAVY CLEVIS HANGER	25		
H1506		2-1/2" HEAVY CLEVIS HANGER	25		
H1507		3" HEAVY CLEVIS HANGER	25		
H1508		4" HEAVY CLEVIS HANGER	25		
H1509		5" HEAVY CLEVIS HANGER	25		
H2000		1-1/2" DWV PLASTIC COATED	50		
H2001		2" DWV PLASTIC COATED	50		
H2002	BEST SELLER	3" DWV PLASTIC COATED	50		
H2003		4" DWV PLASTIC COATED	50		
H2005		DWV GALVANIZED EXTENSION BAR 3'	25		
H2011		1-1/2" X 7" DWV PLASTIC J HOOKS	25		
H2012		2" X 7" DWV PLASTIC J HOOKS	25		
H2013		3" X 7" DWV PLASTIC J HOOKS	25		
H2014		4" X 7" DWV PLASTIC J HOOKS	25		



E-mail: info@buglersales.com

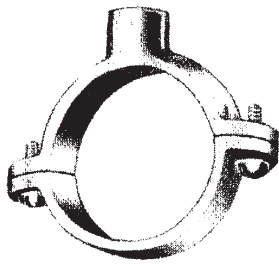

SPLIT RING HANGER
GALVANIZED &
COPPERCLAD



TUBE TALLON

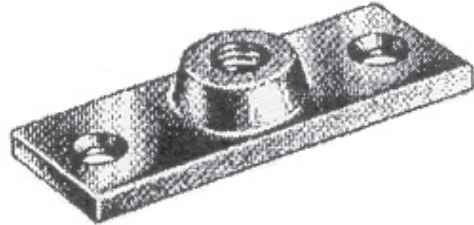

HANGER FLANGE



NATICK TYPE
HANGER



RISER CLAMP

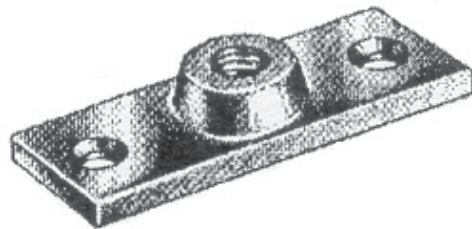

HANGER FLANGE

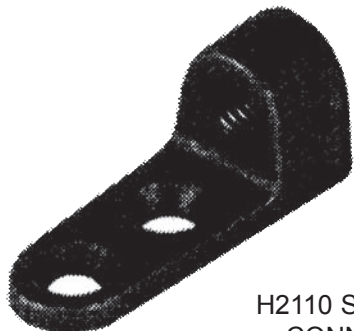

H2110 SIDE BEAM
CONNECTOR



SWIVEL (SPRINKLER)
HANGER



BUGLER SALES CORP.

Phone: 516 223-3868 • Fax: 516 868-6998
 969 CHURCH STREET • BALDWIN, NY 11510

E-mail: info@buglersales.com

NUMBER	DESCRIPTION	PK	RESALE	COST
PIPE HANGERS DWV • FLANGE • NATICK <i>continued...</i>				
H3040	1/2 RISER CLAMP CARBON STEEL	25		
H3041	3/4 RISER CLAMP CARBON STEEL	25		
H3042	1 RISER CLAMP CARBON STEEL	25		
H3043	1-1/4 RISER CLAMP CARBON STEEL	25		
H3044	1-1/2 RISER CLAMP CARBON STEEL	25		
H3045	2 RISER CLAMP CARBON STEEL	25		
H3046	2-1/2 RISER CLAMP CARBON STEEL	25		
H3047	3 RISER CLAMP CARBON STEEL	25		
H3048	3-1/2 RISER CLAMP CARBON STEEL	25		
H3049	4 RISER CLAMP CARBON STEEL	25		
H3050	5 RISER CLAMP CARBON STEEL	25		
H3051	6 RISER CLAMP CARBON STEEL	25		
H2100	BEST SELLER 3/8 BT FLANGE BLACK (EA)	25		
H2101	3/8 BT FLANGE GALVANIZED (EA)	25		
H2103	NEW 1/2 BT HANGER FLANGE **GALV**	25		
H2107	3/8 BT FLANGE COPPERCLAD (EA)	25		
H2110	3/8" BLACK SIDE BEAM CONNECTOR	25		
H3010	1/2 X 12" NATICK TYPE (EA)	25		
H3011	3/4 X 12" NATICK TYPE (EA)	25		
H3012	1 X 12" NATICK TYPE (EA)	25		
H3013	1-1/4 X 12" NATICK TYPE (EA)	25		
H3014	1-1/2 X 12" NATICK TYPE (EA)	25		
H3015	2 X 12" NATICK TYPE (EA)	25		
H3090	3/4" SPLIT RING HANGER GALVANIZED	25		
H3091	1" SPLIT RING HANGER GALVANIZED	25		
H3092	1-1/4" SPLIT RING HANGER GALVANIZED	25		
H3093	1-1/2" SPLIT RING HANGER GALVANIZED	25		
H3096	2" SPLIT RING HANGER GALVANIZED	25		
H3103	3/4" SPLIT RING COPPERCLAD	25		
H3104	1" SPLIT RING COPPERCLAD	25		
H3105	1-1/4" SPLIT RING COPPERCLAD	25		
H3106	1-1/2" SPLIT RING COPPERCLAD	25		
H3107	2" SPLIT RING COPPERCLAD	25		
H3200	1/2 SWIVEL HANGERS GALVANIZED	25		
H3201	3/4 SWIVEL HANGERS GALVANIZED	25		
H3202	1 SWIVEL HANGERS GALVANIZED	25		
H3203	1-1/4 SWIVEL HANGERS GALVANIZED	25		
H3204	1-1/2 SWIVEL HANGERS GALVANIZED	25		
H3205	2 SWIVEL HANGERS GALVANIZED	25		
H3206	2-1/2 SWIVEL HANGERS GALVANIZED	25		
H3207	3 SWIVEL HANGERS GALVANIZED	25		
H3208	3-1/2 SWIVEL HANGERS GALVANIZED	25		
H3209	4 SWIVEL HANGERS GALVANIZED	25		
H3210	5 SWIVEL HANGERS GALVANIZED	25		
H3211	6 SWIVEL HANGERS GALVANIZED	25		
H3220	1/2 SWIVEL HANGERS COPPER PLATE	25		
H3221	3/4 SWIVEL HANGERS COPPER PLATE	25		
H3222	1 SWIVEL HANGERS COPPER PLATE	25		
H3223	1-1/4 SWIVEL HANGERS COPPER PLATE	25		
H3224	1-1/2 SWIVEL HANGERS COPPER PLATE	25		



E-mail: info@buglersales.com

SINGLE SHOT

HANGER

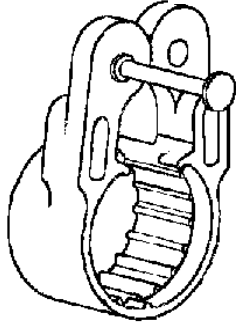

QUICK INSTALLATION

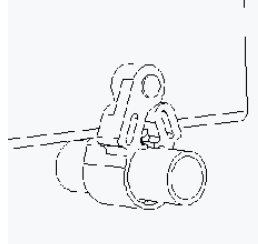

HANGING FROM A JOIST

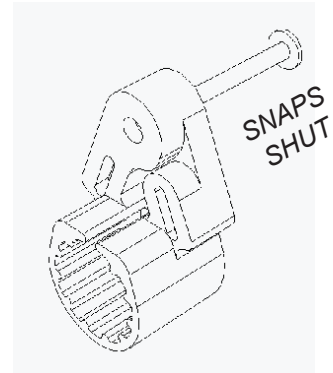

ON A METAL STUD

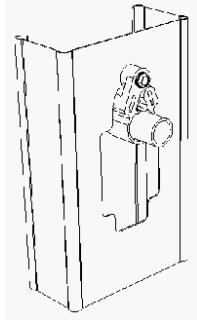

KNEE BRACKET

- ◎ ONE HAND INSTALLATION
- ◎ PRE-LOADED NAIL
- ◎ 40 LBS. WORKING LOAD
200 POUND PROOF LOAD
- ◎ RIBBED FOR LOW NOISE
- ◎ COPPER SAFE - COPOLYMER
- 50/BAG, 1000/CTN**

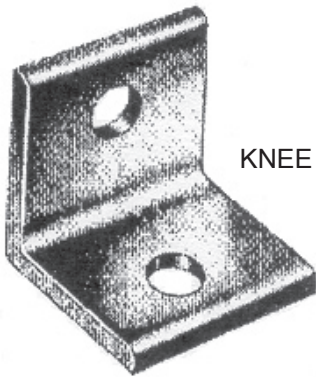

STUD GUARDS

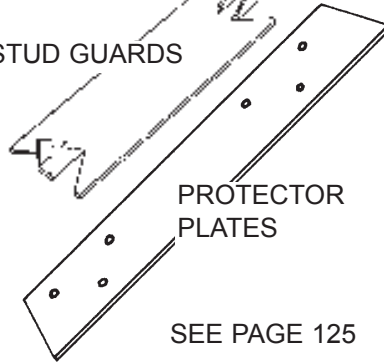

PROTECTOR PLATES

SEE PAGE 125



ROD COUPLING 1/4" - 1"

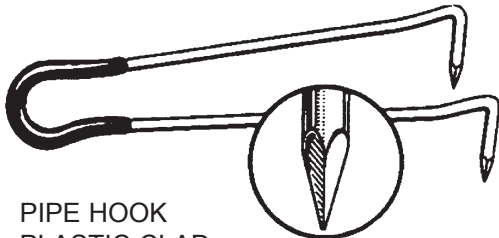

PIPE HOOK
PLASTIC CLAD



PIPE HOOK
COPPER CLAD

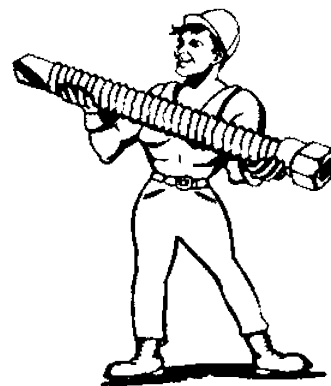

SAMMY SUPER SCREWS

SEE OUR FULL LINE ON
PAGE 116



THREADED ROD - PLAIN OR PLATED



BUGLER SALES CORP.

Phone: 516 223-3868 • Fax: 516 868-6998
 969 CHURCH STREET • BALDWIN, NY 11510

E-mail: info@buglersales.com

NUMBER		DESCRIPTION	PK	RESALE	COST
PIPE HANGERS DWV • FLANGE • NATICK <i>continued...</i>					
H3225		2 SWIVEL HANGERS COPPER PLATE	25		
P2100		1/2" PLASTIC CLAMP TUBE TALLON	25		
P2101		3/4" PLASTIC CLAMP TUBE TALLON	25		
P2102		1" PLASTIC CLAMP TUBE TALLON	25		
P2110		1/2" PLASTIC SINGLE SHOT HANGER	50		
P2111		3/4" PLASTIC SINGLE SHOT HANGER	50		
P2120		1/2" SINGLE SHOT HANGER FOR METAL STUDS	50		
P2121		3/4" SINGLE SHOT HANGER FOR METAL STUDS	50		
ROD COUPLING FULL LENGTH					
R7601	BEST SELLER	1/4 ROD COUPLING (EACH) PLATED	100		
R7603	BEST SELLER	3/8 ROD COUPLING (EACH) PLATED	50		
R7605		1/2 ROD COUPLING (EACH) PLATED	25		
R7606		5/8 ROD COUPLING (EACH) PLATED	25		
R7607		3/4 ROD COUPLING (EACH) PLATED	25		
R7612		1/2-3/8 REDUCING ROD COUPLING (EA)	50		
R7614		3/8-1/4 REDUCING ROD COUPLING (EA)	100		
ROD, THREADED					
R7620	BEST SELLER	1/4 x 6' THREADED ROD (EA)	50		
R7622	BEST SELLER	3/8 x 6' THREADED ROD (EA)	25		
R7624		1/2 x 6' THREADED ROD (EA)	12		
R7625		5/8 x 6' THREADED ROD (EA)	8		
R7626		3/4 x 6' THREADED ROD (EA)	5		
R7630	BEST SELLER	1/4 x 6' THREADED ROD PLATED (EA)	50		
R7632	BEST SELLER	3/8 x 6' THREADED ROD PLATED (EA)	25		
R7634		1/2 x 6' THREADED ROD PLATED (EA)	12		
R7635		5/8 x 6' THREADED ROD PLATED (EA)	8		
R7636		3/4 x 6' THREADED ROD PLATED (EA)	5		
KNEE BRACKETS					
K1638		3/8" KNEE BRACKET (EA)	100		
K1650		1/2" KNEE BRACKET (EA)	50		
PIPE HOOKS					
P2006	BEST SELLER	1/2 X 6 PIPE HOOK COPPER CLAD	50		
P2008		1/2 X 8 PIPE HOOK COPPER CLAD	50		
P2016	BEST SELLER	3/4 X 6 PIPE HOOK COPPER CLAD	50		
P2018		3/4 X 8 PIPE HOOK COPPER CLAD	50		
P2020		3/4 X 10 PIPE HOOK COPPER CLAD	50		
P2023	NEW	2 X 12 PIPE HOOK COPPER CLAD	50		
P2026		1 X 6 PIPE HOOK COPPER CLAD	50		
P2028		1 X 8 PIPE HOOK COPPER CLAD	50		
P2032		1-1/4 X 6 PIPE HOOK COPPER CLAD	50		
P2034		1-1/4 X 8 PIPE HOOK COPPER CLAD	50		
P2035	NEW	1-1/4 X 12 PIPE HOOK COPPER CLAD	50		
P2036	BEST SELLER	3/4 X 6 PIPE HOOK PLASTIC CLAD	50		
P2037		3/4 X 8 PIPE HOOK PLASTIC CLAD	50		
P2038		1 X 6 PIPE HOOK PLASTIC CLAD	50		
P2039		1 X 8 PIPE HOOK PLASTIC CLAD	50		



E-mail: info@buglersales.com

Great Neck



GALVANIZED
COPPERCLAD



GNSJ8C

PW24
PIPE
WRENCH



4 WAY P.O. PLUG
W4960



4 LB
8 LB
25 LB



GN85009



GE159



GN12008
19 IN 1 w/case

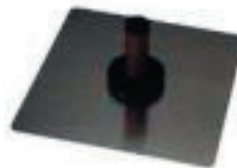

H3500
HAWK

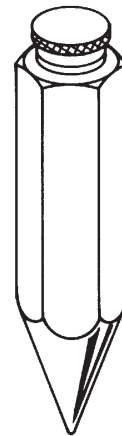

PLUMB
BOB

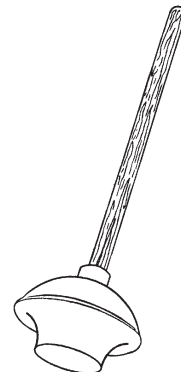

PLUNGER



BUGLER SALES CORP.

Phone: 516 223-3868 • Fax: 516 868-6998
 969 CHURCH STREET • BALDWIN, NY 11510

E-mail: info@buglersales.com

NUMBER		DESCRIPTION	PK	RESALE	COST
PIPE STRAPS					
P2041		1/2" GALVANIZED 2 HOLE	100		
P2042		3/4" GALVANIZED 2 HOLE	100		
P2043	BEST SELLER	1" GALVANIZED 2 HOLE	100		
P2044		1-1/4" GALVANIZED 2 HOLE	50		
P2045		1-1/2" GALVANIZED 2 HOLE	50		
P2046	BEST SELLER	2" GALVANIZED 2 HOLE	50		
P2047		2-1/2" GALVANIZED 2 HOLE	25		
P2048		3" GALVANIZED 2 HOLE	25		
P2049		4" GALVANIZED 2 HOLE	25		
P2051		6" GALVANIZED 2 HOLE	25		
P2055		1/2" EMT	100		
P2064		1/4" COPPERIZED 2 HOLE	100		
P2065		3/8" COPPERIZED 2 HOLE	100		
P2066	BEST SELLER	1/2" COPPERIZED 2 HOLE	100		
P2067	BEST SELLER	3/4" COPPERIZED 2 HOLE	100		
P2068		1" COPPERIZED 2 HOLE	100		
P2069		1-1/4" COPPERIZED 2 HOLE	100		
P2070		1-1/2" COPPERIZED 2 HOLE	100		
P2071		2" COPPERIZED 2 HOLE	100		
PIPE WRENCHES					
GNAPW14		14" HEAVY DUTY PIPE WRENCH ALUM HDL	6		
GNAPW18		18" HEAVY DUTY PIPE WRENCH ALUM HDL	5		
GNAPW24		24" HEAVY DUTY PIPE WRENCH ALUM HDL	2		
GNAPW36		36" HEAVY DUTY PIPE WRENCH ALUM HDL	1		
GNPW8		8" HEAVY DUTY PIPE WRENCH	6		
GNPW10	BEST SELLER	10" HEAVY DUTY PIPE WRENCH	6		
GNPW14	BEST SELLER	14" HEAVY DUTY PIPE WRENCH	6		
GNPW18		18" HEAVY DUTY PIPE WRENCH	2		
GNPW24		24" HEAVY DUTY PIPE WRENCH	2		
PLASTER OF PARIS, DAP (PLASTIC TUBS)					
DP10308	BEST SELLER	4 LB. PLASTER OF PARIS	6		
DP10310		8 LB. PLASTER OF PARIS	4		
DP10312		25 LB. PLASTER OF PARIS (BAG)	EA		
H3500	NEW	13 X 13 ALUM. PLASTERING HAWK	4		
PLIERS • GREAT NECK					
GE159	NEW	159 GENERAL SOFT JAW PLIER	2		
GN12008	NEW	19 IN 1 SHEFFIELD MULTI-TOOL	12		
GN85009	NEW	85009 5PC. HOLSTER TOOL SET	6		
GNSJ8C	BEST SELLER	8" SLIP JOINT PLIERS W/PLASTIC GRIPS	6		
SEE CHANNELLOCK SECTION FOR MORE PLIERS					
PLUG WRENCHES					
W4920		DRUM TRAP PLUG WRENCH	1		
W4960	BEST SELLER	4-WAY P.O. PLUG WRENCH	5		
PLUMB BOBS					
GN8PB		8 OZ. STEEL PLUMB BOB	6		
PLUNGERS					
P2801		FORCE CUP 6" BLACK PROFESSIONAL	12		



BUGLER SALES CORP.

Phone: 516 223-3868 • Fax: 516 868-6998
969 CHURCH STREET • BALDWIN, NY 11510

E-mail: info@buglersales.com



POWER DRIVEN

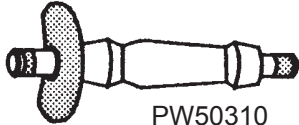

PW50310
HAND HAMMER
DRIVER



HAMMER DRIVE

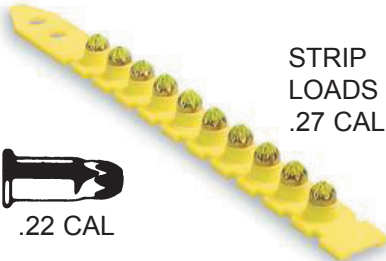

STRIP
LOADS
.27 CAL



.22 CAL

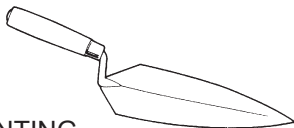

POINTING
TROWEL
FORGED

C1140 5"
C1141 7"



MARGIN
TROWELS

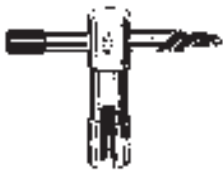

R0405
3 IN 1
RADIATOR
TOOL



PUTTY KNIVES & SCRAPERS



RADIATOR KEYS



R0410

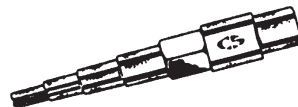

W4990
RADIATOR SPUD
WRENCH

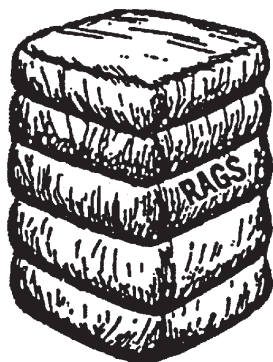



BUGLER SALES CORP.

Phone: 516 223-3868 • Fax: 516 868-6998
 969 CHURCH STREET • BALDWIN, NY 11510

E-mail: info@buglersales.com

NUMBER		DESCRIPTION	PK	RESALE	COST
POINTING TROWELS					
C1140	BEST SELLER	5" POINTING TROWEL FORGED WD. HDL.	12		
C1141		7" POINTING TROWEL FORGED WD. HDL.	12		
C1143	NEW	11 X 4-1/2" PLASTERERS TROWEL	6		
C1146	NEW	14 X 4" CEMENT FINISHING TROWEL	6		
C1148	NEW	7" GAUGING TROWEL	12		
C1152	NEW	5 X 2" MARGIN TROWEL	12		
POWER ACTUATED AND HAMMER DRIVE TOOLS & ACCESSORIES					
P7007		SP-75 3/4" POWER NAILS (100)	EA		
P7010	BEST SELLER	SP-100 1" POWER NAILS (100)	EA		
P7012	BEST SELLER	SP-125 1-1/4" POWER NAILS (100)	EA		
P7015		SP-150 1-1/2" POWER NAILS (100)	EA		
P7020		SP-200 2" POWER NAILS (100)	EA		
P7025		SP-250 2-1/2" POWER NAILS (100)	EA		
P7030		SP-300 3" POWER NAILS (100)	EA		
SHOTS/LOADS					
P7035		LV-1 GRAY (100) .22 CAL. A CRIMP	EA		
P7036		LV-2 BROWN (100) .22 CAL. A CRIMP	EA		
P7037	BEST SELLER	LV-3 GREEN (100) .22 CAL. A CRIMP	EA		
P7038	BEST SELLER	LV-4 YELLOW (100) .22 CAL. A CRIMP	EA		
P7044	NEW	GREEN (100) .27 CAL STRIP LOADS	EA		
P7045	NEW	YELLOW (100) .27 CAL STRIP LOADS	EA		
P7046	NEW	RED (100) .27 CAL STRIP LOADS	EA		
PW50310		RAWL HAND HAMMER DRIVE	EA		
P7052	BEST SELLER	1" HAMMER DRIVE PINS (100)	10		
P7053		1-1/4" HAMMER DRIVE PINS (100)	5		
P7054		1-1/2" HAMMER DRIVE PINS (100)	5		
PUTTY KNIVES & SCRAPERS • ALLWAY					
ALT15F	BEST SELLER	T15F 1-1/2" FLEXIBLE PUTTY KNIFE	10		
ALT30F	BEST SELLER	T30F 3" FLEXIBLE PUTTY KNIFE	10		
A0145		2" PLASTIC PUTTY KNIFE (DISPOSABLE)	36		
A0146		3" PLASTIC PUTTY KNIFE (DISPOSABLE)	36		
ALT45		T45 4-1/2" TAPE KNIFE	10		
ALT60		T60 6" TAPE KNIFE	10		
ALT100		T100 10" TAPE KNIFE	10		
RADIATOR KEYS & AIR VALVES					
R0400		7/32 SQUARE HOLE RADIATOR KEY	25		
R0410		RADIATOR AIR VALVE	25		
RADIATOR SPUD WRENCH					
W4990	BEST SELLER	RADIATOR SPUD WRENCH 1/2 TO 2"	EA		
RADIATOR TOOLS					
R0405		3 IN 1 RADIATOR TOOL	6		
RAGS & WIPERS					
BU60227	NEW	200 PACK TERRY TOWELS 14 X 17	EA		
BU62051	NEW	14 X 14 NATURAL SHOP TOWEL 25PK	10		
R0500		TERRY RAGS 1 POUND (BAGGED)	EA		
R0600	BEST SELLER	TERRY RAGS 5 POUNDS	EA		
R0602		TERRY RAGS 50 POUNDS	EA		
R0605		COTTON, WHITE (FOR WAXING) 10 LBS.	EA		
R0607		PLUMBERS WIPING CLOTH (LEAD)	12		



BUGLER SALES CORP.

Phone: 516 223-3868 • Fax: 516 868-6998
969 CHURCH STREET • BALDWIN, NY 11510

E-mail: info@buglersales.com

RAGS

ALL TYPES
BOXED
1#, 5#, 10#, 50#
PLUMBER'S CLOTH



R0720
ALLWIPE



R0680

YELLOW SLUSH BOOTS



RAINSUITS

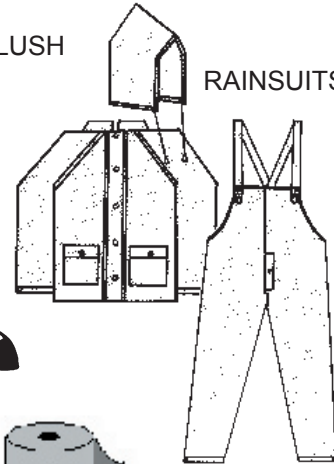

RECIPROCATING BLADES
WOOD/METAL

RED ROSIN PAPER (RUNNER)

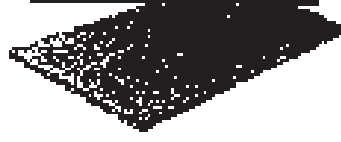
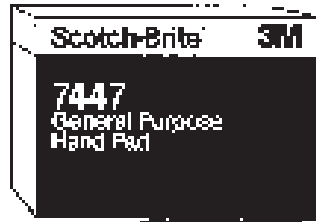
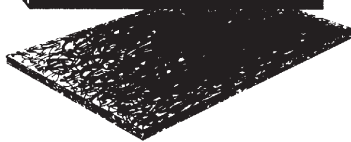

MONSTER TAPE

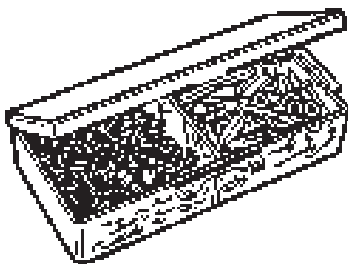

SCREW & ANCHOR KITS
ALSO AVAILABLE IN
CUSTOM KITS
AND PRIVATE LABELS

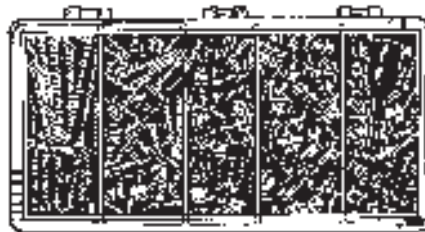

S3518
288 KIT

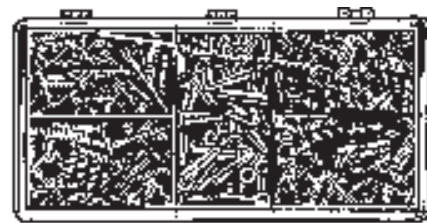

S3519
317 KIT

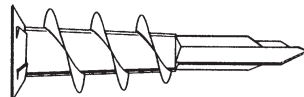

ZIP IT JR KIT - RA2367

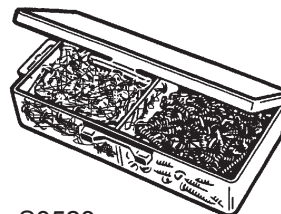

S3523
BT400 KIT

order online at • WWW.BUGLERSALES.COM



BUGLER SALES CORP.

Phone: 516 223-3868 • Fax: 516 868-6998
 969 CHURCH STREET • BALDWIN, NY 11510

E-mail: info@buglersales.com

NUMBER		DESCRIPTION	PK	RESALE	COST
RAGS & WIPERS <i>continued...</i>					
R0680		ALLWIPE 225 SHOP TOWELS BOX	EA		
R0720		ALLWIPE 12 X 13 WHITE OIL ABSORBENT	50		
R0737		SUPER RAGS 13" X 16" - PK 250	EA		
R0730		NUCLOTH BLUE LOW LINT	500		
RAINSUITS & BOOTS					
R1030		PVC/POLY 3 PIECE SUIT MED.	EA		
R1031	BEST SELLER	PVC/POLY 3 PIECE SUIT LG.	EA		
R1032	BEST SELLER	PVC/POLY 3 PIECE SUIT XLG.	EA		
R1033		PVC/POLY 3 PIECE SUIT XXLG.	EA		
R1034		PVC/POLY 3 PIECE SUIT XXXLG	EA		
R1035	NEW	PVC/POLY 3 PIECE SUIT XXXXLG	EA		
R1036	NEW	PVC/POLY 3 PIECE SUIT XXXXXLG	EA		
R1037	NEW	PVC/POLY 3 PIECE SUIT XXXXXXLG	EA		
B6296		SIZE 12 YELLOW SLUSH BOOT PAIR	6		
B6297		SIZE 13 YELLOW SLUSH BOOT PAIR	6		
B6298		SIZE 14 YELLOW SLUSH BOOT PAIR	6		
RECIPROCATING SAW BLADES					
R3614		BULK 6" 14T RECIPROCATING BLADE	50		
R3618		BULK 6" 18T RECIPROCATING BLADE	50		
R3656	NEW	BULK 6" WOOD BLADE	50		
R3818		BULK 8" 18T RECIPROCATING BLADE	50		
SEE AMERICAN SAW SECTION FOR LENOX BLADES - IN BACK OF CATALOG					
ROSIN PAPER					
P1000		36" X 55 YD RED ROSIN PAPER	EA		
RULES & TAPES • GREAT NECK • KC					
GNHM2P		1" X 25' TAPE MEASURE W/UTILITY KNIFE	18		
KM7025	BEST SELLER	1" X 25' TAPE MEASURE MAGNETIC TIP	6		
KC10211		1/2" X 12' TAPE MEASURE	12		
KC90115		1" X 16' MONSTER TAPE MEASURE	6		
KC90133		1" x 33' MONSTER TAPE MEASURE	6		
SEE PAGES 114, 115 FOR LUFKIN					
SCOTCHBRITE PADS - USA					
3M7447		3M SCOTCHBRITE PADS	60		
S7525	BEST SELLER	SCOTCHBRITE TYPE PADS	20/60		
3M96		#96 GENERAL PURPOSE PAD - GREEN	20/60		
SCREW & ANCHOR KITS (PRIVATE LABELING AVAILABLE)					
S3471		#1 S & A KIT 100/100 (3/16 DRILL)	12		
S3472	BEST SELLER	#2 S & A KIT 100/100 (1/4 DRILL)	12		
S3473	BEST SELLER	#3 S & A KIT 50/50 (5/16 DRILL)	12		
S3475	NEW	#5 S & A KIT RIBBED ANCHOR (1/4 DRILL)	12		
S3476		#6 S & A KIT 100/100 (1/4 DRILL VINYL)	12		
S3482		#2XL S & A KIT W/10 X 1-1/2 COMBO	12		
S3484	NEW	#2 HEX S & A KIT W/10X 1 REDS	12		
S3517	BEST SELLER	#BT288 KIT-HEX TEK SCREWS W/DRIVER	8		
S3518	BEST SELLER	#288 KIT-HEX SCREWS W/DRIVER	8		
S3519		#317 KIT W/DRIVER, DRILL	8		
S3523		BT400 (200 BT 8 X 1/2 & 3/4 W/CHUCK)	8		
S3530		DRYWALL KIT METAL E-Z ANCHORS & SCREWS 50/50	6		
PW2367		POWERS ZIP-IT JR. KIT (PLASTIC)	10		

SEE PAGES 116, 117 FOR MORE SCREWS



TAPES

- ⊙ Lightweight, high strength case.
- ⊙ Fits easily into most tape holsters.
- ⊙ Toggle lock is positioned for convenient operation.
- ⊙ Virtually unbreakable Quad Hook; four rivets for extra strength (1" only)
- ⊙ Cushioned blade return.

ITEM NO.	MFG.#	SIZE	PACK	UPC#	RESALE COST
LU1312	1312	3/4" X 12'	6	01314	\$
LU1316	1316	3/4" X 16'	6	01317	\$
LUHV1425	HV1425	1" X 25'	6	03954	\$



LUSV125	SV125	1" X 25'	6		\$
---------	-------	----------	---	--	----



QUICK READ

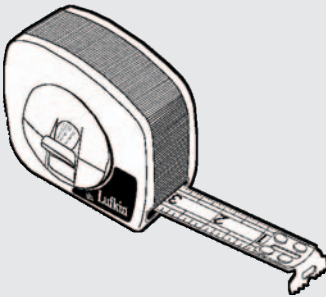

Unique blade graphics simplify layout work.

7 1/2" stand-out, just like a power tape.
Durable ABS case in Hi-Viz yellow.
Ribbed insert makes tape easy to hold on to.

ITEM NO.	MFG.#	SIZE	PACK	UPC#	RESALE COST
LUEL50	EL50	1" X 50"	6	13510	\$

HI-VIZ LINEAR

Durable 1/2"/13mm wide fiberglass tape is encapsulated in flexible plastic.
Non-conductive material.
Lightweight high impact ABS winding drum provides smooth tape recovery.
Blaze orange case.



ITEM NO.	MFG.#	SIZE	PACK	UPC#	RESALE COST
LU706D	706D	1/2" X 100'	1	45358	\$

Lufkin

COOPER Tools



HI-VIZ LINEAR REEL

Lightweight open reel is easy to handle and rewind; line does not collect dirt in case.
Hi-Viz orange case.

ITEM NO.	MFG.#	SIZE	PACK	UPC#	RESALE COST
LUHY1750CME	HY1750CME	1/2" X 164'	1	45827	\$



RED END EXTENSION

Graduated slide rule extends up to 6".
Slide rule runs under friction in T-slot.

© **BEST SELLERS**

ITEM NO.	MFG.#	SIZE	PACK	UPC#	RESALE COST
© LUX46	X46	5/8" X 6"	6	45062	\$
LUX48	X48	5/8" X 8"	6	45066	\$



RED END

Marked both sides, both edges.
Graduated to 1/16ths both edges; 16" stud centers marked in red.

ITEM NO.	MFG.#	SIZE	PACK	UPC#	RESALE COST
LU066	066	5/8" X 6"	6	45084	\$



RED END PLUMBER'S

Used for working with 45° elbows to eliminate figuring.
Graduated one side, in black, inches to 1/16ths upper edges.
Other side in red, 45° scale inches to 1/16ths upper edge only.
Turning rule from black to red gives the corresponding 45° elbow measurement.

Example: Sketch at right shows 10" 45° offset; by turning rule at 10" graduation on standard inch side red graduation directly opposite indicates center-to-center fittings to be 14 1/8". Actual pipe length varies as allowances must be made for type of pipe and fitting used. All other size offsets are calculated in same manner. Where offset is longer than length of rule, add 45° scale measurement of extra distance to last scale on rule (101-13/16).

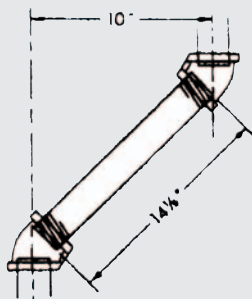

ITEM NO.	MFG.#	SIZE	PACK	UPC#	RESALE COST
LU626	626L	5/8" X 6"	6	45343	\$

SCREWS

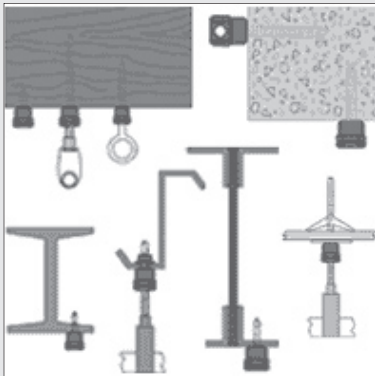
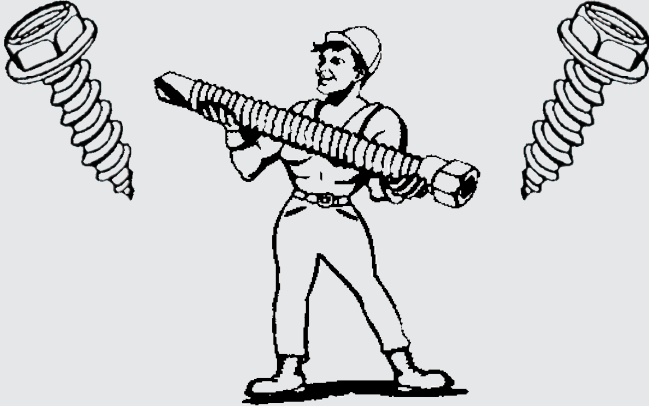

SCREWS

SAMMY SUPER SCREWS (FOR CONCRETE)

125 per box.
 (five inner boxes containing 25 pcs each)
 For 3/8" rod • vertical mount
 Self drilling and tapping in concrete.



ITEM NO.	SIZE	RESALE	COST
SPCST20	3/8 X 2		

SAMMY SUPER SCREWS

125 per box.
 (five inner boxes containing 25 pcs each)
 For 3/8" rod • vertical mount
 Self drilling and tapping in wood



ITEM NO.	SIZE	RESALE	COST
SP14	* DRIVER		
SPGST10	3/8 X 1		
SPGST20 BEST SELLER	3/8 X 2		
SPGST25-380	3/8 X 2-1/2		
SPGST30	3/8 X 3		
SPSHGST20	2 SWIVEL		

WOOD/CONCRETE/STEEL SIDEWINDERS

For 3/8" rod.
 Side mount (horizontal)



ITEM NO.	SIZE	RESALE	COST
SP14SW	* DRIVER		
SPSWG20 BEST SELLER	1/4 X 2		
SPSWC20	5/16 X 1-1/2		
SPSWG25380	3/8 X 2-1/2		
SPSWDRI	1/4 X 1		
SPSWDR516	5/16 X 1-1/4		

SHEET METAL SCREWS (TAMPERPROOF AVAILABLE)

Pan head combo. Zinc plated. Pk. 100.

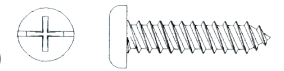

ITEM NO.	SIZE	PACK	RESALE	COST
SS8050	8 X 1/2	10		
SS8075	8 X 3/4	10		
SS8100	8 X 1	10		
SS8125	8 x 1-1/4	10		
SS8150	8 X 1-1/2	10		
SS8200	8 x 2	10		
SS10075	10 X 3/4	10		
SS10100	10 X 1	10		
SS10125	10 X 1-1/4	10		
SS10150	10 X 1-1/2	10		
SS10200	10 X 2	10		
SS10250	10 X 2-1/2	10		
SS10300	10 X 3	10		
SS12100	12 x 1	10		
SS12125	12 x 1-1/4	10		
SS12150	12 X 1-1/2	10		
SS12200	12 X 2	10		
SS12250	12 x 2-1/2	10		
SS12300	12 X 3	10		

SAMMY SUPER SCREWS (FOR METAL)

125 per box.
 (five inner boxes containing 25 pcs each)
 Self drilling and tapping in steel.
 For 3/8" rod • vertical mount



ITEM NO.	SIZE	RESALE	COST
SPDSTR	1/4 X 1		
SPDSTR516	5/16 X 1-1/4		
SPTEK50	12-24 X 1-1/2		
SPDST10 BEST SELLER	1/4 X 1		
SPDST15	1/4 X 1-1/2		
SP14	* DRIVER		

SCREWS

HEX HEAD SLOTTED SCREWS (FAST SCREWS RED LABEL)

For H.V.A.C. or other thin gauge metal fastener. Screws have a needle point for self piercing of sheet metal in a range of .0209 to .0359, and for other general purpose fastening. 100 per box.

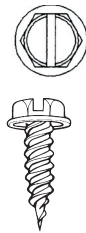

© INDICATES BEST SELLERS

ITEM NO.	SIZE	PACK	RESALE COST
S4700	6 X 3/8	20	
S4702	7 X 1/2	20	
©S4705	8 X 1/2	20	
S4750	8 X 1/2 (500)	EA	
S4790	8 X 1/2 (1000)	EA	
©S4706	8 X 3/4	12	
S4752	8 X 3/4 (500)	EA	
S4792	8 X 3/4 (1000)	EA	
©S4707	8 X 1	12	
S4753	8 X 1 (500)	EA	
S4708	8 X 1-1/4	12	
S4754	8 X 1-1/4 (500)	EA	
S4709	8 X 1-1/2	10	
S4755	8 X 1-1/2 (250)	EA	
S4710	8 X 2	10	
S4756	8 X 2 (250)	EA	
S4720	10 X 1/2	12	
S4760	10 X 1/2 (1000)	EA	
S4721	10 X 3/4	12	
S4762	10 X 3/4 (500)	EA	
S4722	10 X 1	12	
S4723	10 X 1-1/4	10	
S4724	10 X 1-1/2	10	

PAINTED HEAD (WHITE)

S4890	8 X 2 HEX	250
MCP08X2ZW NEW	8 X 2 TRUSS	250

PAINTED HEAD (BEIGE)

S4892	8 X 2 HEX	250
-------	-----------	-----

DRYWALL SCREWS

Black phosphate, coarse. 100 per box.



ITEM NO.	SIZE	PACK	RESALE COST
S4601	6 X 1"	10	
S4602	6 X 1-1/4"	10	
S4603	6 X 1-5/8"	10	
S4604	6 X 2"	10	
S4605	8 X 2-1/2"	10	
S4606	8 X 3"	10	
S4607	8 X 4"	10	
S4620	6 X 1-5/8" ZINC	10	
S4623	8 X 3" ZINC	10	

HEX HEAD SCREWS SELF TAPPING/DRILLING (BT TECH SCREWS BLUE LABEL)

Metal to metal fastening used in light sheet metal and light gauge steel framing. Very common in H.V.A.C. ductwork assembly. 100 per box.

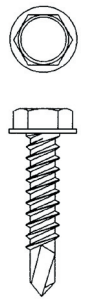

© INDICATES BEST SELLERS

ITEM NO.	SIZE	PACK	RESALE COST
©S4730	BT8 X 1/2	20	
S4770	BT8 X 1/2 (500)	EA	
S4810	BT8 X 1/2 (1000)	EA	
©S4732	BT8 X 3/4	12	
S4772	BT8 X 3/4 (500)	EA	
S4811	BT8 X 3/4 (1000)	EA	
©S4733	BT8 X 1	12	
S4734	BT8 X 1-1/4	12	
S4735	BT8 X 1-1/2	10	
S4737	BT8 X 2	10	
S4739	BT10 X 1/2	12	
S4778	BT10 X 1/2 (500)	EA	
S4741	BT10 X 3/4	12	
S4780	BT10 X 3/4 (500)	EA	
S4821	BT10 X 3/4 (1000)	EA	
S4742	BT10 X 1	12	
S4822	BT10 X 1(1000)	EA	
S4743	BT10 X 1-1/4	10	
S4744	BT10 X 1-1/2	10	
S4745	BT10 X 2	10	

SCREWS, LAG

Hex head unless specified otherwise. See pack for box quantity.



ITEM NO.	SIZE	PACK	RESALE COST
S5100	ACUS. 1/4 X 3	100	
C3010	ACUS. DRIVER 1/4"	EA	
S5108	1/4 x 1	100	
S5110	1/4 X 1-1/2	100	
S5112	1/4 X 2	100	
S5113	1/4 x 2-1/2	100	
S5115	1/4 x 3	100	
S5123	3/8 x 1	100	
S5125	3/8 X 1-1/2	100	
S5127	3/8 X 2	50	
S5128	3/8 X 2-1/2	50	
S5129	3/8 X 3	50	
S5131	3/8 X 4	50	
S5135	3/8 X 6	50	



BUGLER SALES CORP.

Phone: 516 223-3868 • Fax: 516 868-6998
969 CHURCH STREET • BALDWIN, NY 11510

E-mail: info@buglersales.com

CHANNEL LOCK

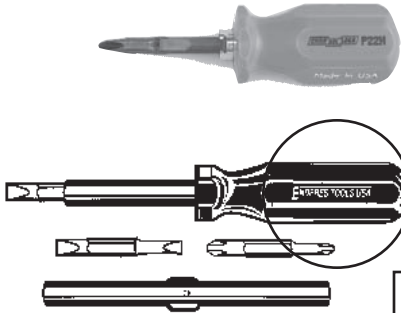

PUT YOUR NAME HERE
CUSTOM IMPRINTING AVAILABLE

FIREPROOF SHEETROCK

4' X 4'

AMES TRUE TEMPER

Lawn & Garden Tools - Since 1774



ROUND POINTED SHOVEL

AM1504700 WOOD
AM1345300 FIBERGLASS

CALCIUM CHLORIDE

ICE
MELT



SQUARE POINTED SHOVEL

AM1504900 WOOD
AM1345100 FIBERGLASS

S6120
ASH
SHOVEL



AM1638600
ALUMINUM



AM1625500
STEEL



AM1640900
STEEL



AM1632400
STEEL



AM1647800



AM1346100



AM1627000



BUGLER SALES CORP.

Phone: 516 223-3868 • Fax: 516 868-6998
 969 CHURCH STREET • BALDWIN, NY 11510

E-mail: info@buglersales.com

NUMBER	DESCRIPTION	PK	RESALE	COST
SCREWDRIVERS ENDERES • CHANNELLOCK				
CH52	5/32 X 4 STANDARD - FLATHEAD	10		
CH54	5.32 X 7.25 STANDARD - FLATHEAD	10		
CH56	5/32 X 9.625 STANDARD - FLATHEAD	10		
CH58	5/32 X 11.625 STANDARD - FLATHEAD	10		
CH72	7/32 X 4.25 STANDARD - FLATHEAD	10		
CH74	7/32 X 8 STANDARD - FLATHEAD	10		
CH77	7/32 X 11 STANDARD - FLATHEAD	10		
CH106	5/16 X 10 STANDARD - FLATHEAD	10		
CH108	3/8 X 12.75 STANDARD - FLATHEAD	10		
CH110	3/8 X 14.75 STANDARD - FLATHEAD	10		
CHP14	#1 X 7.25 STANDARD - PHILLIPS	10		
CHP24	#2 X 8 STANDARD - PHILLIPS	10		
CHP36	#3 X 10 STANDARD - PHILLIPS	10		
CH53C	5/32 X 6.75 CUSHION GRIP - FLATHEAD	10		
CH71C	7/32 X 3 CUSHION GRIP - FLATHEAD	10		
CH74C	7/32 X 8.25 CUSHION GRIP - FLATHEAD	10		
CH106C	7/32 X 10 CUSHION GRIP - FLATHEAD	10		
CH108C	3/8 X 12.875 CUSHION GRIP - FLATHEAD	10		
CHP14C	#1 X 7.75 CUSHION GRIP - PHILLIPS	10		
CHP24C	#2 X 7.75 CUSHION GRIP - PHILLIPS	10		
CHP36C	#3 X 9.75 CUSHION GRIP - PHILLIPS	10		
CH53CC	5/32 X 6.75 CUSHION GRIP - CABINET TIP	10		
CH54CC	5/32 X 7.75 CUSHION GRIP - CABINET TIP	10		
CH56CC	5/32 X 9.75 CUSHION GRIP - CABINET TIP	10		
CHAD52	5/32 X 4.625 POCKET SCREWDRIVER - FLATHEAD	10		
CHADP12	5/32 X 4.625 POCKET SCREWDRIVER - PHILLIPS	10		
S3761	4 IN 1 SCREWDRIVER ENDERES USA	12		
S3768	4 IN 1 EXTENSION	6		
S3762	2 IN 1 SCREWDRIVER (STUBBY)	12		
S3770	BEST SELLER 6 IN 1 SCREWDRIVER ENDERES USA	12		
S3776	NEW 6 IN 1 CUSTOM **IMPRINT** 28 CHARACTERS	72		
GE744	NEW 4 IN 1 POCKET MINI SCREWDRIVER	10		
SHEETROCK				
S5970	5/8" X 4' X 4' FIREPROOF SHEETROCK	EA		
SHOVELS & ICE CHOPPERS • AMES				
S6120	BEST SELLER 19" ASH SHOVEL	12		
AM1309300	13-093 KODIAK D-HANDLE SQUARE POINT SHOVEL	6		
AM1345100	13-451 STINGER SQ. PT. LG FIBERGLASS/HDL	6		
AM1345300	13-453 STINGER RD. PT. LG FIBERGLASS/HDL	6		
AM1346100	BEST SELLER 13-461 STINGER 4" DITCHMASTER LG HANDLE	6		
AM1504400	BEST SELLER SQUARE PT. D-HDL SHOVEL WOOD HDL	6		
AM1504500	BEST SELLER RD. POINT D-HANDLE SHOVEL WOOD	6		
AM1504700	BEST SELLER 15-047 LONG HANDLE ROUND POINT	6		
AM1504900	15-049 LONG HANDLE SQUARE POINT	6		
AM1625500	16-355 18" STEEL PUSHER SNOW	6		
AM1627000	BEST SELLER 16-270 POLY BACKSAVER W/ STRIP SNOW	6		
AM1632400	16-324 14" STEEL SNOW LG/HDL.	6		

order online at • WWW.BUGLERSALES.COM



BUGLER SALES CORP.

Phone: 516 223-3868 • Fax: 516 868-6998
969 CHURCH STREET • BALDWIN, NY 11510

E-mail: info@buglersales.com

SK®

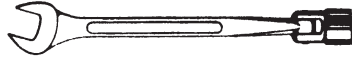

88814



RB1214

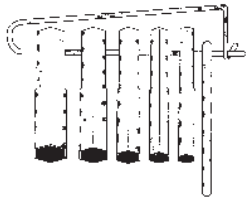

SHOWER BODY
SOCKET SET

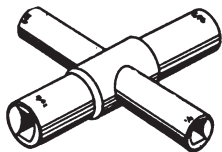

4-WAY SILCOCK KEY

**CALCIUM
CHLORIDE**

**ICE
MELT**



BL10020

KLENKS

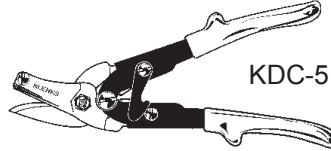

KDC-5

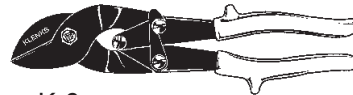

K-6
71250



SOCKET SETS
40 PC. OR 52 PC.

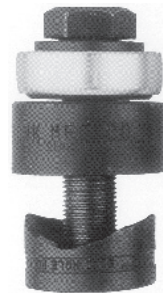

SNSHC
SINK HOLE
CUTTER

Wiss®



M1R



M2R



M3R



M300



HC5



M41R
CENTER CUT



A-9



MPX

IRWIN® Industrial Tools



IR20SL
OFFSET

order online at • WWW.BUGLERSALES.COM



BUGLER SALES CORP.

Phone: 516 223-3868 • Fax: 516 868-6998
 969 CHURCH STREET • BALDWIN, NY 11510

E-mail: info@buglersales.com

NUMBER		DESCRIPTION	PK	RESALE	COST
AM1638600	BEST SELLER	16-386 ALUMINUM SQ D-HDL. SNOW	EA		
AM1640900		16-409 18" D-HDL. STEEL SNOW	6		
AM1647800		16-478 ICE CHOPPER 5" X 7"	6		
AM1671900	NEW	16-719 FIBERGLASS D-HDL SCOOP ALUMINUM	3		
BL10020	NEW	10020 EXPANDABLE SNOW SHOVEL	4		
KC4000		HEAVY DUTY CHOPPER - WOOD HANDLE	12		
C2225	BEST SELLER	50 LB CALCIUM CHLORIDE PELLETS ICE MELT PAIL	EA		
C2228		50 LB CALCIUM CHLORIDE PELLETS ICE MELT BAG	EA		
SHOWER BODY SOCKET SETS					
S6150	BEST SELLER	SHOWER BODY SOCKET SET	6		
SILLCOCK KEYS					
S6175	BEST SELLER	FOUR WAY SILLCOCK KEY	25		
SINK HOLE CUTTERS SEEKONK					
SNSHC		1-1/2" SINK HOLE CUTTER	EA		
SK WRENCHES					
SKRB1214		3/8 X 7/16 RATCHET BOX END WRENCH	EA		
SKRB1618		1/2 X 9/16 RATCHET BOX END WRENCH	EA		
SKRB2024		5/8 X 3/4 RATCHET BOX END WRENCH	EA		
SKRB810		1/4 X 5/16 RATCHET BOX END WRENCH	EA		
SK88812		3/8 COMBINATION FLEX WRENCH	EA		
SK88814		7/16 COMBINATION FLEX WRENCH	EA		
SK88816		1/2 COMBINATION FLEX WRENCH	EA		
SK88818		9/16 COMBINATION FLEX WRENCH	EA		
SK88820		5/8 COMBINATION FLEX WRENCH	EA		
SK88822		11/16 COMBINATION FLEX WRENCH	EA		
SK88824		3/4 COMBINATION FLEX WRENCH	EA		
SMOKEPIPE TOOLS • KLENK • WISS					
WSM41R	BEST SELLER	M41R WISS SMOKEPIPE CUTTER	6		
WSHC5		HC5 WISS SMOKEPIPE CRIMPER	3		
KLKDC5		KDC-5 DOUBLE CUT KLENK SNIPS	6		
KLK6	BEST SELLER	K-6 KLENK SMOKEPIPE CRIMPERS	6		
SNIPS • WISS • PROSNIP					
WSM1R		M1R WISS SNIPS REDS (LEFT)	6		
WSM2R		M2R WISS SNIPS GREENS (RIGHT)	6		
WSM3R	BEST SELLER	M3R WISS SNIPS YELLOWS (STRAIGHT)	6		
WSA9		12 - 1/2" TINNER'S SNIPS (STRAIGHT) A-9	6		
WSA11		10" TINNER'S SNIPS (STRAIGHT) A-11	6		
WSMPX	NEW	MPX WISS ALL PURPOSE CUTTER	6		
WSM300		M300 WISS LONG SNIP ORANGE	6		
IR20SL		20SL PROSNIP OFFSET SNIPS RED	5		
IR20SR		20SR PROSNIP OFFSET SNIPS GREEN	5		
SOCKET SETS & RATCHETS • GREAT NECK					
GNPS040	BEST SELLER	40 PC. SOCKET SET 1/4" & 3/8"	EA		
GNSCS52		52 PC. SOCKET SET METAL CASE	EA		
GNRA38		3/8" DRIVE 8" RATCHET	EA		
GNRA12		1/2" DRIVE 10" RATCHET	EA		



BUGLER SALES CORP.

Phone: 516 223-3868 • Fax: 516 868-6998
969 CHURCH STREET • BALDWIN, NY 11510

E-mail: info@buglersales.com

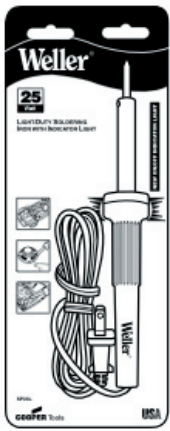

WESP23K



WE8200PK

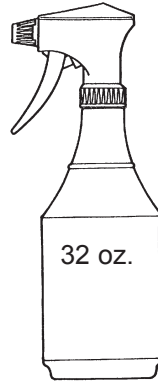

S6000



L0965

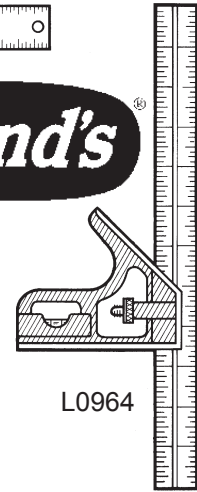

L0964

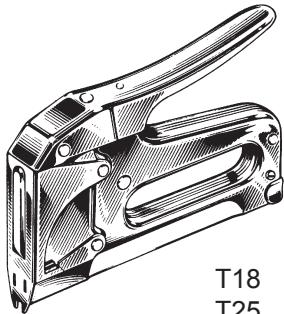

T18
T25
T37

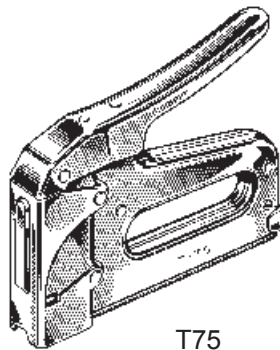

T75

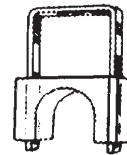

5911 INSULATED
STAPLES - FOR
USE WITH RG59
& RG6 CABLE

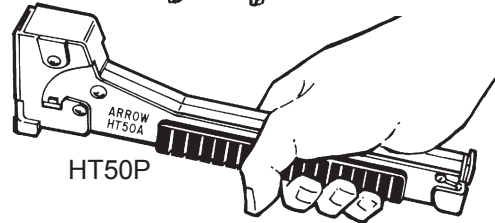

HT50P

STRAP WRENCH



BUNGEE CORDS



ML3043DAT

STRETCH
CORDS

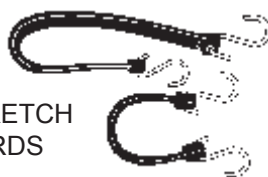

S7801

VERSA
STRAP

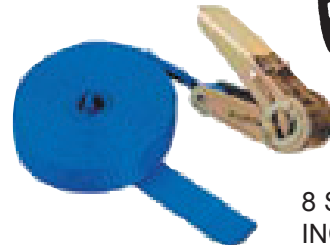

8 STYLES AVAILABLE
INCLUDING E-TRACK

KEEPER®





BUGLER SALES CORP.

Phone: 516 223-3868 • Fax: 516 868-6998
 969 CHURCH STREET • BALDWIN, NY 11510

E-mail: info@buglersales.com

NUMBER		DESCRIPTION	PK	RESALE	COST
SOLDERING GUNS • WELLER					
WED550PK		D550 SOLDERING GUN KIT W/ PLASTIC CASE	1		
WE7250		REPLACEMENT TIP FOR D550 (2 EACH)	6		
WE8200PK		8200 SOLDERING GUN KIT W/ PLASTIC CASE	1		
WE7135		REPLACEMENT TIP FOR 8200 (2 EACH)	6		
WESP23K BEST SELLER		SP23 SOLDERING IRON KIT	1		
SPRAY BOTTLES					
S6000		32 OZ. PROFESSIONAL SPRAYER	12		
SQUARES • SANDS					
L0965	BEST SELLER	SCIP 16" x 24" STEEL RAFTER SQUARE	10		
L0964		CS-0 12" COMBINATION SQUARE	12		
STAPLERS / STAPLES • ARROW - MADE IN THE USA					
ART18		T18 STAPLE GUN LOW VOLTAGE WIRE 3/16"	EA		
ART25	BEST SELLER	T25M STAPLE GUN LOW VOLTAGE WIRE 1/4"	EA		
ART37		T37 STAPLE GUN WIRE & CABLE 5/16"	EA		
ART50		T50M HEAVY DUTY STAPLE GUN	EA		
ART50OC		T50OC OUTWARD CLINCH STAPLE GUN	EA		
ARHT50P		HT50P HEAVY DUTY HAMMER TACKER	EA		
ART59		T59 WIRING TACKER FOR UL INS. STAPLES	EA		
ART75		T75 STAPLE GUN WIRE & CABLE 1/2"	EA		
AR186		T18 3/8 STAPLES (5M)	EA		
AR187		T18 7/16 STAPLES (5M)	EA		
AR256		T25 3/8 STAPLES (5M)	EA		
AR257		T25 7/16 STAPLES (5M)	EA		
AR259		T25 9/16 STAPLES (5M)	EA		
AR376		T37 3/8 STAPLES (5M)	EA		
AR378		T37 1/2 STAPLES (5M)	EA		
AR379		T37 9/16 STAPLES (5M)	EA		
AR504		T50 1/4 STAPLES (5M)	EA		
AR505		T50 5/16 STAPLES (5M)	EA		
AR506		T50 3/8 STAPLES (5M)	EA		
AR508		T50 1/2 STAPLES (5M)	EA		
AR509		T50 9/16 STAPLES (5M)	EA		
AR591188		T59 1/4 ROMEX STAPLES (300) CLEAR	EA		
AR591189BL		T59 5/16 ROMEX STAPLES (300) BLACK	EA		
AR7510S		T75 5/8 SUPER POWER UL STAPLES (1M)	EA		
AR7514S		T75 7/8 SUPER POWER UL STAPLES (1M)	EA		
STEEL WOOL					
S7501	BEST SELLER	O BLEND INDUSTRIAL PADS FINE	12		
STRAP WRENCHES					
W4964		7" STRAP WRENCH	6		
GN54000	NEW	54000 6" DIAMETER STRAP WRENCH	6		
GN54001	NEW	54001 4" DIAMETER STRAP WRENCH	6		
BT78012		12" STRAP WRENCH "BERKLEY"	1		
STRETCH CORDS & STRAPS					
ML3043DAT	NEW	3043DAT STEELCOR STRETCH CORDS	4		
S7801	NEW	1" X 15' UTLY LASHING STRAP CC1415	1/10		
S7812		14" STRETCH CORD HVY. DUTY (USA)	10		
S7814		19" STRETCH CORD HVY. DUTY (USA)	10		
S7820	BEST SELLER	24" STRETCH CORD HVY. DUTY (USA)	10		
S7833	BEST SELLER	35" STRETCH CORD HVY. DUTY (USA)	10		



BUGLER SALES CORP.

Phone: 516 223-3868 • Fax: 516 868-6998
969 CHURCH STREET • BALDWIN, NY 11510

E-mail: info@buglersales.com

9' CARGO BARS



S7806

E-TRACK RATCHET

STRAP
S7803
S7804

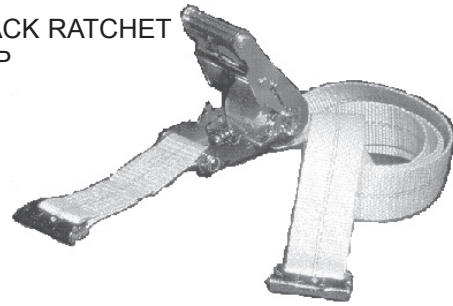

ROPE
WRANGLER

S7850

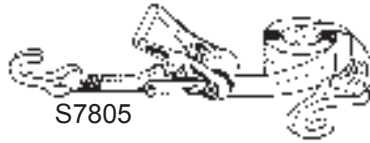

S7805

S7800



S7808
RATCHET

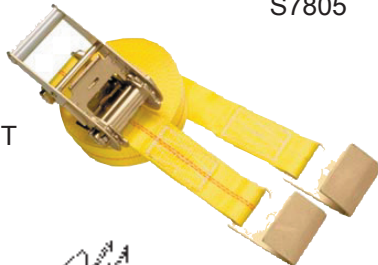

SQUARE
HEAD
STRIKER

S8101



STUD GUARDS

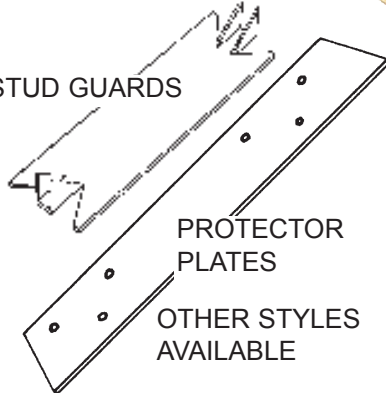

PROTECTOR
PLATES

OTHER STYLES
AVAILABLE



STUD GUARD BOCA
S9020

S8110 BARBEQUE LIGHTER



GE1543

tyco
ADHESIVES

3M

POLYKEN®

CARTON
SEALING TAPE



DUCT TAPE

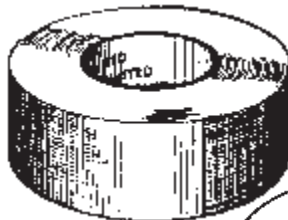

EXTRUCOAT / FOIL / FSK
MASKING TAPE
DOUBLE SIDED
ASJ

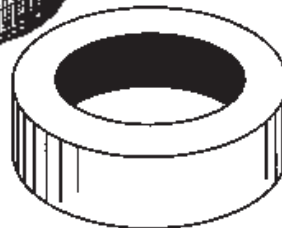

TEFLON TAPE
T1731
T1732

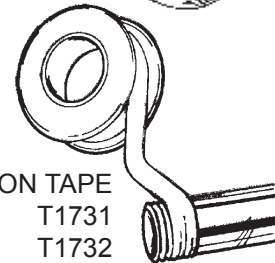

MANILA &
CLOTH TAGS

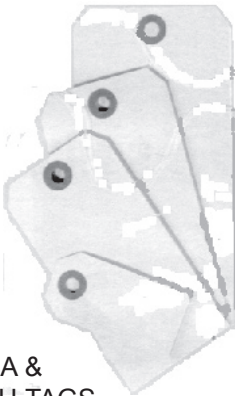



BUGLER SALES CORP.

Phone: 516 223-3868 • Fax: 516 868-6998
 969 CHURCH STREET • BALDWIN, NY 11510

E-mail: info@buglersales.com

NUMBER		DESCRIPTION	PK	RESALE	COST
STRETCH CORDS & STRAPS <i>continued...</i>					
S7840		41" STRETCH CORD HVY. DUTY (USA)	10		
S7800		10' UNIVERSAL TIE DOWN, 1,200 LB.	4		
S7803	BEST SELLER	12' RATCHET STRAP F/E TRACK	4		
S7804		16' RATCHET STRAP F/E TRACK	8		
S7805		2" X 27' RATCHET, 10,000 LB. WIRE HOOKS	EA		
S7806	NEW	1" X 15' RATCHET TIE DOWNS W/HOOKS	1/10		
S7808		2" X 30' RATCHET, 10,000 LB. FLAT HOOKS	EA		
S7810		1/4" X 8' ROPE WRANGLER (150 LBS.)	EA		
S7824	BEST SELLER	24" VERSA-STRAP	EA		
S7834		34" VERSA-STRAP	EA		
S7850	NEW	CARGO BAR 48" TO 108"	EA		
S7860	NEW	4" X 27' FLAT HOOK WEB STRAP CC4027	8		
STRIKERS					
S8101	BEST SELLER	2001 STRIKER (EA)	10		
S8105		2001X RENEWAL FLINT (5 PER PACK) F/S8101	40		
S8102		5011 3 FLINT STRIKER (EA)	1		
S8106		5003X RENEWAL FLINT (1 PER PACK) F/S8102	1		
S8110	BEST SELLER	BARBEQUE LIGHTER REFILLABLE	12		
S8112	NEW	MAGNUM 14" MATCH REFILLABLE	20		
S8114	NEW	FLEXIBLE BARBEQUE LIGHTER	16		
STUD GUARDS & PROTECTOR PLATES					
S9000	BEST SELLER	6" X 1-1/2" STUD GUARDS (EA)	100		
S9001		3" X 1-1/2" STUD GUARDS (EA)	100		
S9010		3" x 1-1/2" PROTECTOR PLATE 18 GA (EA)	250		
S9011		6" x 1-1/2" PROTECTOR PLATE 18 GA (EA)	100		
S9020	NEW	5 X 8 #957 BOCA STUD GUARD	12		
STUD GUARDS AVAILABLE TO COMPLY WITH INTERNATIONAL PLUMBING CODE					
SWEDGING TOOLS					
GE1543		SWEDGE TOOL 1/2, 5/8, 7/8, 1-1/8 O.D. TUBING	EA		
TAGS					
T1000		#5 MANILA SHIPPING TAG	1000		
T1001	NEW	#5 MANILA SHIPPING TAG WITH STRING	1000		
T1005		#1 CLOTH 1-3/8x2-3/4 SHIPPING TAG	1000		
TAPE					
3M3710		48mm X 50M PACKING TAPE CLEAR - 3M	36		
T1711	BEST SELLER	DUCT TAPE 2 X 60 YDS INDUSTRIAL GRADE	24		
T1712		DUCT TAPE 2 X 60 YDS #203	24		
T1790		DUCT TAPE 2 X 60 YDS #212	24		
T1713		DUCT TAPE 2 x 60 YDS BLACK IND. GRADE	24		
T1710		DUCT TAPE 2 X 10 YDS INDUSTRIAL GRADE	24		
T1750	BEST SELLER	A/C FOIL TAPE 2" x 50 YD.	24		
T1753		3" X 50 YD FOIL SCRIM KRAFT TAPE	16		
T1731	BEST SELLER	TEFLON TAPE 1/2 X 520 INCHES	120		
T1732		TEFLON TAPE 3/4 X 520 INCHES	120		
T1745	BEST SELLER	2" x 100' YELLOW PIPE TAPE EXTRUCOAT	24		
T1746		4" x 100' YELLOW PIPE TAPE EXTRUCOAT	12		
T1747		PIPE TAPE PRIMER ONE QUART EXTRUCOAT	12		
T1709	BEST SELLER	PACKING TAPE 2 X 55 YD. CLEAR	36		
T1774	NEW	2 X 110YD CLEAR PACKING TAPE	36		



BUGLER SALES CORP.

Phone: 516 223-3868 • Fax: 516 868-6998
969 CHURCH STREET • BALDWIN, NY 11510

E-mail: info@buglersales.com



T1742



9 COLORS

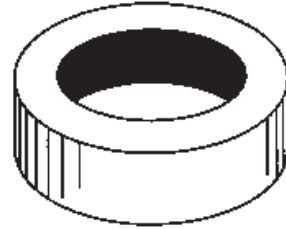

BLUE & GREEN
PAINTERS MASKING
TAPE

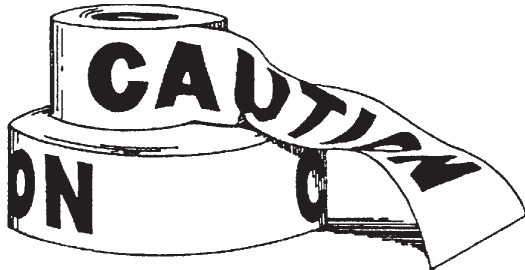

BARRIER TAPE

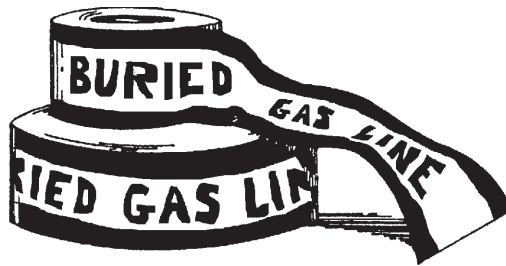

DETECTABLE GAS TAPE



MA95904

IRWIN[®]
Industrial Tools



IR80187



PIPE TAPS



TAP-PLUG BOLT



BUGLER SALES CORP.

Phone: 516 223-3868 • Fax: 516 868-6998
 969 CHURCH STREET • BALDWIN, NY 11510

E-mail: info@buglersales.com

NUMBER		DESCRIPTION	PK	RESALE	COST
TAPE <i>continued...</i>					
T1775		PACKING TAPE 2 X 55 YD. TAN	36		
T1776	NEW	2 X 110YD TAN PACKING TAPE	36		
3MHB903		PACKING TAPE DISPENSER	EA		
T1704		3" X 375' GUMMED SEALING TAPE	8		
T1740	NEW	3/4" X 60YDS STRAPPING TAPE	24		
T1741	BEST SELLER	18" X 1500' SHRINKWRAP	4		
T1742		SHRINKWRAP DISPENSER	EA		
T1706	BEST SELLER	ELECTRICAL 3/4 X 60' BLACK UL	10		
T1757		ELECTRICAL 3/4 X 66' BLUE UL	12		
T1758		ELECTRICAL 3/4 X 66' BROWN UL	12		
T1759		ELECTRICAL 3/4 X 66' GREY UL	12		
T1760		ELECTRICAL 3/4 X 66' GREEN UL	12		
T1761		ELECTRICAL 3/4 X 66' ORANGE UL	12		
T1762		ELECTRICAL 3/4 X 66' RED UL	12		
T1763		ELECTRICAL 3/4 X 66' WHITE UL	12		
T1764		ELECTRICAL 3/4 X 66' YELLOW UL	12		
T1718		2 x 60 YD. GREEN PAINTERS TAPE	24		
T1721		2 x 60 YD. MASKING TAPE	24		
T1722		1 x 60 YD. MASKING TAPE	36		
T1727		2 x 60 YD. BLUE PAINTERS MASKING	24		
3M2090		2 x 60 YD. BLUE MASKING TAPE	12		
T1752	NEW	3 x 50 YD. ASJ WHITE SKRIM TAPE	16		
T1700		BARRIER TAPE 300' "CAUTION"	12		
T1705	BEST SELLER	BARRIER TAPE 1000' "CAUTION"	12		
T1702		BARRIER TAPE "FIRE LINE" 1000'	6		
T1703		3" X 1000' DETECTABLE GAS TAPE	EA		
T1780		3" X 1000' NON-DETECTABLE RED	8		
		"CAUTION: BURIED ELECTRIC LINE BELOW"			
T1782		3" X 1000' NON-DETECTABLE GAS TAPE YELLOW	EA		
3M11008		3-1/4" x4-1/2" MASTIC PAD	10		
3M21296		4-1/2" x6-1/2" MASTIC PAD	10		
OTHER COLORS, GRADES & WIDTHS AVAILABLE					
TAPS & TAP WRENCHES					
MA95397		4-40 NC PLUG BOLT TAP	5		
MA95406		6-32 NC PLUG BOLT TAP	5		
MA95409		8-32 NC PLUG BOLT TAP	5		
MA95415		10-32 NF PLUG BOLT TAP	5		
MA95412		10-24 NC PLUG BOLT TAP	5		
MA95418		12-24 NC PLUG BOLT TAP	5		
MA95432	BEST SELLER	1/4-20 NC PLUG BOLT TAP	5		
MA95438		5/16-18 NC PLUG BOLT TAP	5		
MA95444	BEST SELLER	3/8-16 NC PLUG BOLT TAP	5		
MA95904		T-HANDLE TAP WRENCH (0-1/4)	5		
IR80187	BEST SELLER	13 PC. TAP & DRILL SET W/WRENCH	EA		
TAPS, PIPE - NPT					
T2100	BEST SELLER	1/8" HIGH CARBON STEEL PIPE TAP	5		
T2101	BEST SELLER	1/4" HIGH CARBON STEEL PIPE TAP	5		
T2102	BEST SELLER	3/8" HIGH CARBON STEEL PIPE TAP	5		
T2103	BEST SELLER	1/2" HIGH CARBON STEEL PIPE TAP	EA		
T2104	BEST SELLER	3/4" HIGH CARBON STEEL PIPE TAP	EA		



E-mail: info@buglersales.com

IRWIN
Industrial Tools



B0261
HUOT TAP &
DRILL SET



IR80187

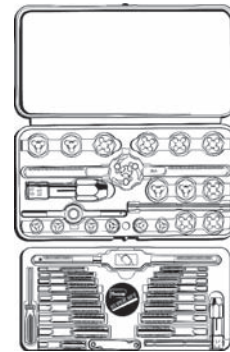

IR24606

THERMOSTAT GUARDS
DIMENSIONS CHART

BUGLER #	WHITE RODGERS #	TYPE	BASE	HEIGHT	WIDTH	DEPTH
BEBTGUWM	F29-0222	METAL	RING	6-3/4"	4-1/4"	3-9/16"
BEBTGUM	F29-0220	METAL	SOLID	7-1/4"	5-3/8"	3-1/2"
BEBTG54VLW	F29-0193	METAL	RING	6"	3-1/16"	3-1/8"
BEBTG54VL	F29-0192	METAL	SOLID	6"	3-13/16"	3-1/8"
BEBTGEM	F29-0233	METAL	SOLID	3-7/8"	3-1/2"	2-1/2"
BEBTGKWM	F29-0235	METAL	RING	5-1/4"	4-5/8"	3-1/4"
BEBTGRWM	F29-0237	METAL	RING	6-3/8"	3-1/2"	3-1/4"
BEBTGEK	F29-0225	PLASTIC	SOLID	3-7/8"	3-1/2"	2-1/2"
BEBTGK	F29-0227	PLASTIC	DUAL	5-1/4"	4-5/8"	3"
BEBTGRK	F29-0143	PLASTIC	DUAL	6-3/8"	3-1/2"	3"
BEBTGDK	F29-0231	PLASTIC	DUAL	4-1/4"	7-5/8"	2-1/4"
BEBTGUK2	F290198	PLASTIC	DUAL	8-1/4"	5-3/8"	3-1/4"
BER8B	70253	METAL	SOLID	7-1/8"	5-1/8"	2-3/4"
BER8C	70252	METAL	SOLID	7-1/8"	5-1/8"	2-3/4"
BETG87FR	70250	METAL	RING	ROUND	3-1/2" DIA.	
BETG87FS	70251	METAL	RING	3-1/4"	3-1/4"	1-1/2"

TARPAULINS
AND COVERS
FROM
5' X 7'
TO
50' X 100'

CUSTOM FABRICS
AND SIZES
AVAILABLE

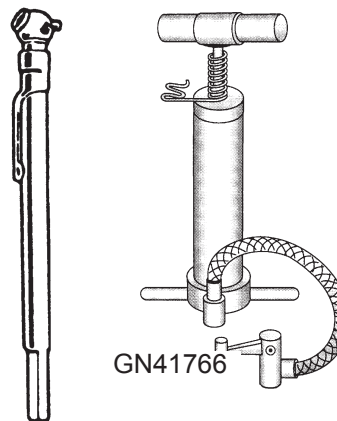

TIRE GAUGE

TIE WIRE
1# OR 5#
16 OR 18 GAUGE





BUGLER SALES CORP.

Phone: 516 223-3868 • Fax: 516 868-6998
 969 CHURCH STREET • BALDWIN, NY 11510

E-mail: info@buglersales.com

NUMBER	DESCRIPTION	PK	RESALE	COST
TAPS, PIPE - NPT <i>continued...</i>				
T2105	1" HIGH CARBON STEEL PIPE TAP	EA		
T2106	1-1/4" HIGH CARBON STEEL PIPE TAP	EA		
T2107	1-1/2" HIGH CARBON STEEL PIPE TAP	EA		
T2108	2" HIGH CARBON STEEL PIPE TAP	EA		
IR24606	TAPS&HEX DIES TAPS:1/4~1/2 DIES:4-40~12-24	EA		
IR80187	TAP&DRILL SET - 13 PIECE	5		
B0261	#99 HUOT TAP & DRILL SET	EA		
TARPS (TRUCK & STOCK) - BLUE				
T2350	8' X 10' POLY TARPAULIN	EA		
T2352	10' X 12' POLY TARPAULIN	EA		
T2354	12' x 14' POLY TARPAULIN	EA		
T2355	12' X 20' POLY TARPAULIN	EA		
T2356	20' x 20' POLY TARPAULIN	EA		
T2357	20' X 30' POLY TARPAULIN	EA		
T2361	15' X 20' POLY TARPAULIN	EA		
T2362	15' X 30' POLY TARPAULIN	EA		
CUSTOM SIZES AND MATERIALS ARE AVAILABLE				
THERMOSTAT GUARDS				
BEBTGUWM	UNIVERSAL METAL T-STAT GUARD, RING BASE	12		
BEBTGUM	UNIVERSAL T-STAT GUARD, SOLID BASE	12		
BEBTG54VLW	HINGED METAL T-STAT GUARD, RING BASE	12		
BEBTG54VL	HINGED METAL T-STAT GUARD, SOLID BASE	12		
BEBTGEM	NEW METAL SMALL SOLID BASE	12		
BEBTGKWM	NEW METAL MEDIUM W/RING BASE	12		
BEBTGRWM	NEW METAL W/RING BASE	12		
BEBTGEK	CLEAR PLASTIC T-STAT GUARD SMALL (ELITE)	12		
BEBTGK	CLEAR PLASTIC T-STAT GUARD, DUAL BASE (CLASSIC)	12		
BEBTGRK	CLEAR PLASTIC T-STAT GUARD MEDIUM (REGAL)	12		
BEBTGDK	CLEAR PLASTIC T-STAT GUARD, DUAL BASE (DESIGNER)	12		
BEBTGUK2	CLEAR PLASTIC T-STAT GUARD LARGE (UNIVERSAL)	12		
BEF310	NEW REPLACEMENT LOCK & KEY (BTG SERIES)	25		
BEF336	UNIVERSAL T-STAT GUARD KEY FOR BTG GUARDS	25		
THERMOLOCK THERMOSTAT GUARDS				
BER8B	METAL SOLID GUARD	12		
BER8C	METAL GUARD WITH WINDOW	12		
BETG87FR	ROUND METAL GUARD W/ WINDOW	12		
BETG87FS	METAL SQUARE GUARD WITH WINDOW	12		
BETKEY	NEW REPLACEMENT KEY THERMOLOCK	25		
BETLKY	LOCK & KEY SET (TWO KEYS, ONE LOCK)	25		
TIE WIRE				
T5370	TIE WIRE 16 GAUGE 1 LB.	12		
T5372	BEST SELLER TIE WIRE 18 GAUGE 1 LB.	12		
T5373	TIE WIRE 18 GAUGE 5 LB. / ON SPOOL	12		
T5375	NEW MASONS TIE WIRE 3.5 LB	20		
TIRE PUMP & ACCESSORIES				
G5580	TIRE GAUGE W/ POCKET CLIP	10		
GN41766	TIRE PUMP	6		



BUGLER SALES CORP.

Phone: 516 223-3868 • Fax: 516 868-6998
969 CHURCH STREET • BALDWIN, NY 11510

E-mail: info@buglersales.com



MC505



MC22178

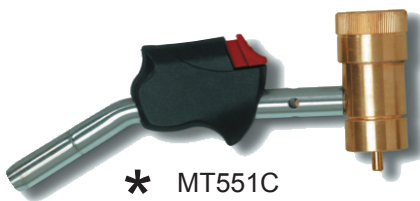

* MT551C

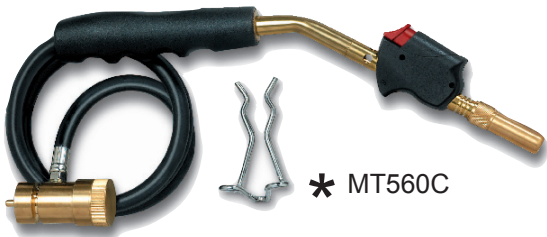

* MT560C



WELDER'S
SOAP
STONE



B-TANK KEY

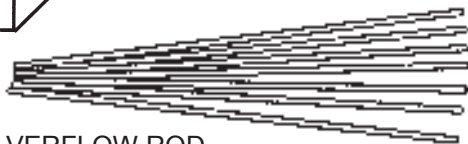

SILVERFLOW ROD

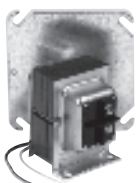

T10E

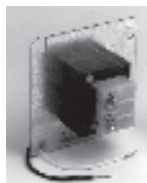

T10P



TR43

TRANSFORMERS
CONVERSION CHART ON PAGE 128



* BZTS4000T



* BZTS7000T



*
FP410
SMP-41
TL-44



PROPANE
MAPP



T7410
TU100K



STOVE
FUEL

* USES MAPP GAS

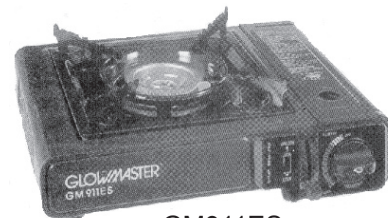

GM911ES
BUTANE STOVE



21010



21011



21012



21013

order online at • WWW.BUGLERSALES.COM



BUGLER SALES CORP.

Phone: 516 223-3868 • Fax: 516 868-6998
 969 CHURCH STREET • BALDWIN, NY 11510

E-mail: info@buglersales.com

NUMBER		DESCRIPTION	PK	RESALE	COST
TOOL BOXES & BAGS • GREAT NECK • MCGUIRE NICHOLAS					
GN71000		14" HARD BOTTOM TOOL BAG	EA		
GN71001	BEST SELLER	17" HARD BOTTOM TOOL BAG	EA		
GN71002		20" HARD BOTTOM TOOL BAG	EA		
MC22128	NEW	22128 ELECTRICIAN'S TOTE BAG	EA		
MC439	NEW	#439 STEEL LOOP HAMMER HOLDER	EA		
MC464	NEW	#464 SADDLE TAPE MEASURE HOLDER	EA		
MC505	NEW	#505 POLY WEB BELT	EA		
TORCH KITS & ACCESSORIES • TURNER • BERNZOMATIC • FIREPOWER					
FP400		MP-90 FIREPOWER HAND TORCH - SWIVEL	6		
FP410	BEST SELLER	SMP-41 SELF LIGHTING TORCH - MAPP	1		
FP427		FHA-12 3/16" X 12' ACETYLENE HOSE	1		
FP463		SMP-31 SELF LIGHTING TORCH HEAD	1		
MT200C	BEST SELLER	MT-200 PROPANE TORCH HEAD ONLY	12		
BZT54000T		TS4000T PRO TORCH HEAD	6		
BZT57000T		TS7000T PRO TORCH HEAD (T655)	6		
MT560C	NEW	MT560C SELF IGNITING TORCH W/4' HOSE®	6		
MT551C	NEW	MT-551C SELF IGNITING TORCH HEAD MAPP	6		
T7410	BEST SELLER	2 pc. TORCH KIT PROPANE (HEAD & TANK)	6		
T7411	BEST SELLER	PROPANE REFILL	12		
T7412	BEST SELLER	MAPP GAS REFILL	12		
T7420		9 X 12 TORCH GUARD HEAT SHIELD	6		
GM911ES		BUTANE STOVE	EA		
GMF2		8OZ. BUTANE STOVE FUEL	4		
WELDING ACCESSORIES					
FP025	BEST SELLER	SF-1FS SILVERFLOW ROD 1/2LB	1		
K1000		B-TANK KEY (CARDED AVAILABLE)	12		
HN10377		1/4" SQUARE 5" WELDERS SOAPSTONE PK 144	EA		
TRANSFORMERS					
BETR590		BELL TRANSFORMER 120V PRI 10V SEC, FT MNT, 5VA	30		
BETR591		BELL TRANSFORMER 120V PRI 16V SEC, FT MNT, 10VA	30		
BETR592		BELL TRANSFORMER 120V PRI 8-24V SEC, FT MNT, 10-20VA	30		
BETR598		BELL TRANSFORMER 120V 8@20VA - 16-24@30VA	30		
MXT10E	BEST SELLER	120V P, 24V S, 3 WAY MOUNT, 40VA TERM SEC	18		
MXT10P		120V P, 24 V S, PL. MOUNT, 40VA TERM SEC	18		
MXT12	NEW	120,208,240V PRI,24V SEC FT MNT, 40VA SEC	30		
MXT12MV		120/208/240V P, 24V S, 3 WAY MOUNT, 40VA	18		
MXT42	NEW	120,208,240V PRI,24,12,2.5V SEC MULTI MNT,48VA	18		
MXTR43		120V P, 24V S, 3 WAY MOUNT, 40VA	18		
MXT45		120/208/240V P24/16/12/8/2.5V S, 3 WAY MOUNT, 50VA	18		
MXT50		120/208/240V P, 24V S, FRONT MOUNT, 40VA	18		
MXT75C/B		120/208/240/480 VP, 24V S, FT MOUNT, 75VA W/CB	12		
MXT100C/B		120/208/240/480 VP, 24V S, FT. MOUNT, 100VA W/CB	12		
TUBING & PIPE CUTTERS					
21010	NEW	TC11/8 TUBING CUTTER 1-1/8" LENOX	1		
21011	NEW	TC13/8 TUBING CUTTER 1-3/8" LENOX	1		
21012	NEW	TC134 TUBING CUTTER 1/8" TO 1-3/4" LENOX	1		
21013	NEW	TC258 TUBING CUTTER 1/4" TO 2-5/8" LENOX	1		
21015	NEW	21015 COPPER / ALUMINUM BRASS WHEEL	6		
21016	NEW	21016 PLASTIC / PVC WHEEL	6		



BUGLER SALES CORP.

Phone: 516 223-3868 • Fax: 516 868-6998
969 CHURCH STREET • BALDWIN, NY 11510

E-mail: info@buglersales.com



GE133



TUBING &
PIPE
CUTTERS



INSIDE PLASTIC
PIPE CUTTER
T8020

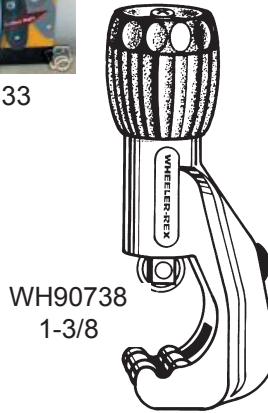

WH90738
1-3/8

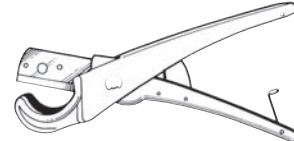

WH5190

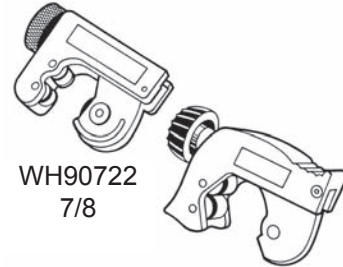

WH90722
7/8



WH90728
1-1/8



PVC CUTTER
T8030



AUTO
TUBING
CUTTER
GWATC12

TYVEK
COVERALLS



SISAL, ROPE
PULL ROPE



LAMP WICK



KWIK WIK

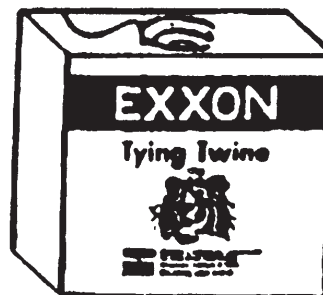

T9005
TYING TWINE

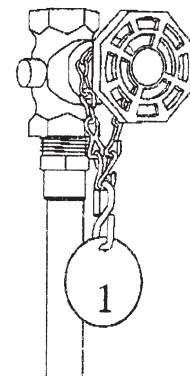

VALVE TAGS
BEADED CHAIN
SASH CHAIN

order online at • WWW.BUGLERSALES.COM



BUGLER SALES CORP.

Phone: 516 223-3868 • Fax: 516 868-6998
 969 CHURCH STREET • BALDWIN, NY 11510

E-mail: info@buglersales.com

NUMBER		DESCRIPTION	PK	RESALE	COST
TUBING & PIPE CUTTERS <i>continued...</i>					
21017	NEW	21017 COPPER / ALUMINUM CUTTER WHEEL	6		
21018	NEW	SCWS FOR TC-1 1/8 LENOX CUTTER	6		
21022	NEW	SCWS FOR TC- 1 3/8 LENOX CUTTER	EA		
21026	NEW	21026 SCREWS AND PIN FOR 21013	EA		
21191	NEW	CUTTER WHEELS FOR PLASTIC 2-PACK	2		
GE120	BEST SELLER	#120 TUBING CUTTER 1/8" TO 1-1/8" O.D.	5		
GER121/2		#121/2 REPLACEMENT WHEEL PK 2	10		
GE125	BEST SELLER	#125 TUBING CUTTER 1/4" TO 1-1/2" O.D.	3		
GE129X	BEST SELLER	#129X TUBING CUTTER 1/8" TO 7/8"	5		
GE133	NEW	133 GENERAL RATCHET TUBING CUTTER	2		
T8020		INSIDE PLASTIC PIPE CUTTER	1		
T8021		REPLACEMENT WHEEL FOR PVC CUTTER 3PK	EA		
S1535		1 X 1/16 HUMMER WHEEL 1/4 ARBOR	25		
S1536		1-1/4 X 1/16 HUMMER WHEEL 1/4 ARBOR	25		
S1537		1-1/2 X 1/16 HUMMER WHEEL 1/4 ARBOR	25		
S1538		2 X 1/16 HUMMER WHEEL 1/4 ARBOR	25		
WH90735	BEST SELLER	90735 TELESCOPIC TUBING CUTTER 1/4to1-3/8EA			
WH90728		90728 MINI TUBING CUTTER 1-1/8 OD	EA		
WH8071		REPLACEMENT WHEEL FOR T8000 & T8005	6		
WH80711		DEBURRING BLADE FOR T8000	EA		
WH90722		90722 MINI TUBING CUTTER 1/4-7/8	EA		
WH8070		8070 REPLACEMENT WHEEL FOR T8012	6		
WH5190		5190 PLASTIC PIPE CUTTER 1/8-1-1/4	EA		
GWATC12		ATC-12 1/2" AUTO TUBING CUTTER GENERAL WIRE	1/12		
GWATC34		ATC-34 3/4" AUTO TUBING CUTTER GENERAL WIRE	1/12		
GWATCW		ATCW CUTTER WHEEL F/ T8015,T8016	12		
GWATC100	NEW	ATC100H 1" AUTOCUT TUBING CUTTER	1/12		
T8030		PVC PIPE CUTTER 1-5/8" CAPACITY	EA		
TWINE/ROPE & ACCESSORIES					
R8002		3/8 MANILLA ROPE 600'	EA		
R8033	NEW	1/4 X 1200' YELLOW PULL ROPE	EA		
T9000		50 LB. SISAL REEL	EA		
T9005	BEST SELLER	SYNTHETIC TYING TWINE 10 LB.	4		
W1500		LAMPWICK FINE (2OZ) BALL (EA)	40		
W1501	BEST SELLER	KWIK WIK FINE	25		
TYVEK COVERALLS					
R1094	NEW	TYVEK COVERALL W/HOOD LARGE	25		
R1095	BEST SELLER	TYVEK COVERALL W/HOOD XL	25		
R1096	NEW	TYVEK COVERALL W/HOOD XXL	25		
R1097		POLY PRO SHOE COVER W/ ELASTIC BLUE	300		
R1100		ADVANTAGE PRO COVERALL XL CLEAN SUIT	25		
VALVE TAGS					
V1000		#1-25 BRASS VALVE TAGS 1-1/2" RD.	SET		
V1001		#26-50 BRASS VALVE TAGS 1-1/2" RD.	SET		
V1002		#51-75 BRASS VALVE TAGS 1-1/2" RD.	SET		
V1003		#76-100 BRASS VALVE TAGS 1-1/2" RD.	SET		
V1004		#101-125 BRASS VALVE TAGS 1-1/2" RD.	SET		



BUGLER SALES CORP.

Phone: 516 223-3868 • Fax: 516 868-6998
969 CHURCH STREET • BALDWIN, NY 11510

E-mail: info@buglersales.com

WISE-GRIP®



CURVED JAW

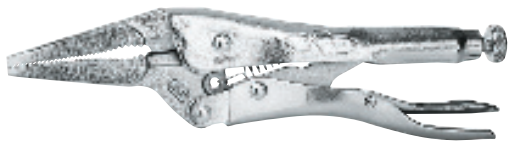

LONG NOSE



SAFETY VESTS

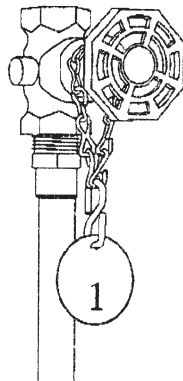

BEADED CHAIN
SASH CHAIN
S-HOOKS

IRWIN®

Industrial Tools



STRAIGHT JAW

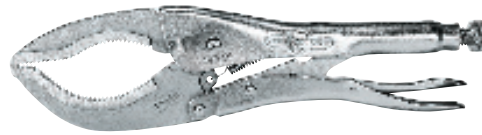

PIPE JAW



LOCKING WRENCH

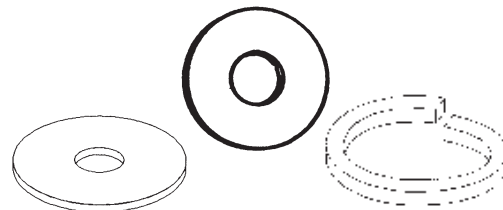

WASHERS - ALL TYPES

- FLAT • FENDER • LOCK •
- ZINC - GALVANIZED
- STAINLESS STEEL



GN4932
WALLBOARD SAW

Great Neck

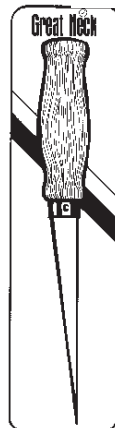

GNWL6C
WALLBOARD SAW

order online at • WWW.BUGLERSALES.COM



BUGLER SALES CORP.

Phone: 516 223-3868 • Fax: 516 868-6998
 969 CHURCH STREET • BALDWIN, NY 11510

E-mail: info@buglersales.com

NUMBER		DESCRIPTION	PK	RESALE	COST
VALVE TAGS <i>continued...</i>					
V1005		#126-150 BRASS VALVE TAGS 1-1/2" RD.	SET		
V1025		BLANK BRASS VALVE TAGS 1-1/2" RD. (25)	SET		
V1050		#10 SOLID BRASS S-HOOK	100		
V1060	NEW	4-1/2" BRASS BEADED CHAIN 100 PCS	EA		
V1100		#1-25 BRASS VALVE TAGS 1-1/2" COLD WAT	SET		
V1101		#26-50 BRASS VALVE TAGS 1-1/2" COLD WAT	SET		
V1150	NEW	#1-25 BRASS VALVE TAGS 1-1/2" GAS	SET		
V1200		#1-25 BRASS VALVE TAGS 1-1/2" HOT WAT	SET		
V1201		#26-50 BRASS VALVE TAGS 1-1/2" HOT WAT	SET		
C1229	NEW	#8 FLAT SASH CHAIN 40 FT.	EA		
VESTS					
S1295		#133 ORANGE/WHITE SAFETY VEST	EA		
WISE-GRIPS-IRWIN					
IR10R		10" STRAIGHT JAW	5		
IR7R		7" STRAIGHT JAW	5		
IR10WR	BEST SELLER	10" CURVED JAW W/ CUTTER	5		
IR7WR	BEST SELLER	7" CURVED JAW W/ CUTTER	5		
IR5WR	BEST SELLER	5" CURVED JAW W/ CUTTER	5		
IR9LN		9" LONG NOSE W/ CUTTER	5		
IR6LN		6" LONG NOSE W/ CUTTER	5		
IR4LN		4" LONG NOSE W/ CUTTER	5		
IR7LW		7" LOCKING WRENCH W/ CUTTER	5		
IR12LC		12" HEAVY DUTY 3-1/8" JAW OPENING	5		
WALLBOARD SAWS • GREAT NECK					
GNWL6C		WALLBOARD SAW (SHEET ROCK) WL6C	6/48		
GN4932	NEW	WALLBOARD SAW DOUBLE EDGED	6/48		
WASHERS					
WF316100		3/16 x 1 FENDER WASHER (EA)	100		
WF316125		3/16 x 1-1/4 FENDER WASHER (EA)	100		
WF14100		1/4 x 1 FENDER WASHER (EA)	100		
WF14125	BEST SELLER	1/4 x 1-1/4 FENDER WASHER (EA)	100		
WF14150		1/4 x 1-1/2 FENDER WASHER (EA)	100		
WF38125		3/8 x 1-1/4 FENDER WASHER (EA)	100		
WF38150	BEST SELLER	3/8 x 1-1/2 FENDER WASHER (EA)	100		
WF12200		1/2 x 2 FENDER WASHER (EA)	100		
W0649		3/16 USS FLAT WASHER (EA)	100		
W0650	BEST SELLER	1/4 USS FLAT WASHER (EA)	100		
W0651		5/16 USS FLAT WASHER (EA)	100		
W0652	BEST SELLER	3/8 USS FLAT WASHER (EA)	100		
W0653		7/16 USS FLAT WASHER (EA)	100		
W0654	BEST SELLER	1/2 USS FLAT WASHER (EA)	100		
W0656		5/8 USS FLAT WASHER (EA)	100		
W0658		3/4 USS FLAT WASHER (EA)	100		
W0660		7/8 USS FLAT WASHER (EA)	100		
W0662		1" USS FLAT WASHER (EA)"	100		
W0674		1/4 REGULAR SPLIT LOCK WASHER (EA)	100		
W0676		3/8 REGULAR SPLIT LOCK WASHER (EA)	100		
W0678		1/2 REGULAR SPLIT LOCK WASHER (EA)	100		
WG0652		3/8" USS FLAT WASHERS GALVANIZED	100		
WG0654		1/2" USS FLAT WASHERS GALVANIZED	100		



E-mail: info@buglersales.com

Great Neck



GN25581

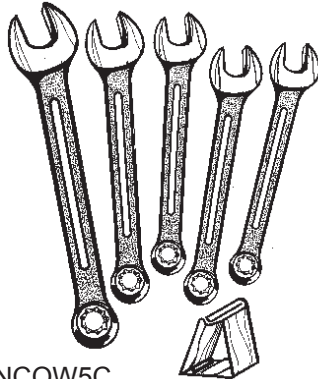

GNCOW5C



W4654

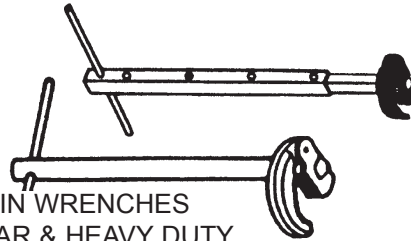

BASIN WRENCHES
REGULAR & HEAVY DUTY



W4650

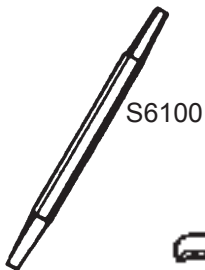

S6100

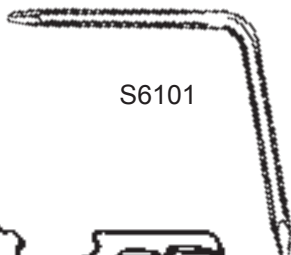

S6101



W4652



4 IN 1 SPUD
W4901

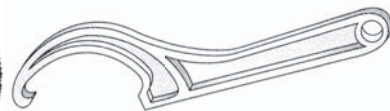

STRAINER LOCK NUT WRENCH
W4962

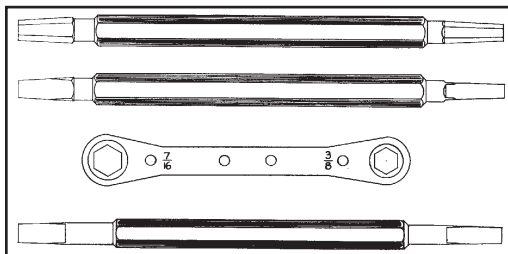

S6103 - 4 PIECE SET

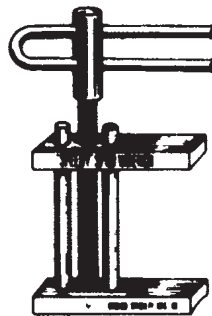

INTERNAL SPUD
W4945



W4900
COMBO WRENCH



BUGLER SALES CORP.

Phone: 516 223-3868 • Fax: 516 868-6998
 969 CHURCH STREET • BALDWIN, NY 11510

E-mail: info@buglersales.com

NUMBER		DESCRIPTION	PK	RESALE	COST
WIRE STRIPPERS					
W4650	BEST SELLER	#100 MILLER WIRE STRIPPERS	12		
W4652		#100-S MILLER WIRE STRIPPERS W/SPRING	12		
W4654		#95 MILLER CABLE STRIPPERS	12		
WRENCHES					
ADJUSTABLE WRENCHES GREAT NECK					
GNAW4C		4" ADJUSTABLE WRENCH	6		
GNAW6C		6" ADJUSTABLE WRENCH	6		
GNAW8C	BEST SELLER	8" ADJUSTABLE WRENCH	6		
GNAW10C	BEST SELLER	10" ADJUSTABLE WRENCH	6		
GNAW12C		12" ADJUSTABLE WRENCH	6		
SEE CHANNELLOCK SECTION ON PAGE 28 FOR MORE ADJUSTABLE WRENCHES					
BASIN WRENCHES					
W4981		11" BASIN WRENCH	EA		
W4982		15" BASIN WRENCH	EA		
W4980		ADJ. BASIN WRENCH 16-1/2"	EA		
W4985	BEST SELLER	ADJ. HEAVY DUTY BASIN WRENCH	6		
W4900	BEST SELLER	SLIP & LOCK NUT ADJ.	EA		
CHAIN WRENCHES					
CRCW12H		12" CHAIN WRENCH CRESCENT	EA		
CRCW15		15" CHAIN WRENCH CRESCENT	EA		
CRCW24		24" CHAIN WRENCH CRESCENT	EA		
CLOSET SPUD WRENCHES					
W4901		4 IN 1 SPUD	EA		
W4945		INTERNAL SPUD WRENCH	EA		
W4962		STRAINER LOCK NUT WRENCH	5		
COMBINATION WRENCHES					
GNCO25		1/4 COMBINATION WRENCH	6		
GNCO56		5/16 COMBINATION WRENCH	6		
GNCO1	BEST SELLER	3/8 COMBINATION WRENCH	6		
GNCO2	BEST SELLER	7/16 COMBINATION WRENCH	6		
GNCO3	BEST SELLER	1/2 COMBINATION WRENCH	6		
GNCO4	BEST SELLER	9/16 COMBINATION WRENCH	6		
GNCO5		5/8 COMBINATION WRENCH	6		
GNCO6		11/16 COMBINATION WRENCH	6		
GNCO7		3/4 COMBINATION WRENCH	6		
GNCO136		13/16 COMBINATION WRENCH	6		
GNCO78		7/8 COMBINATION WRENCH	6		
GNCO8		15/16 COMBINATION WRENCH	6		
GNCO10		1 COMBINATION WRENCH	6		
GNCO116		1-1/16 COMBINATION WRENCH	3		
GNCO118		1-1/8 COMBINATION WRENCH	3		
GNCO125		1-1/4 COMBINATION WRENCH	3		
GNCOW5C		5 PC. COMBINATION WRENCH SET (3/8 - 5/8)	5		
GN25581		4 PC. COMBINATION W/RATCHET BOX	6		
GN51002		9 PC. COMBINATION WRENCH SET (1/4 - 3/4)	EA		
FAUCET SEAT TOOLS					
S6100	BEST SELLER	STRAIGHT FAUCET TOOL	12		
S6101	BEST SELLER	ANGLE FAUCET TOOL TAPERED	12		
S6103		FAUCET SEAT WRENCH KIT 4 PC.	6		

order online at • WWW.BUGLERSALES.COM



E-mail: info@buglersales.com

**WE CARRY SEEKONK TORQUE WRENCHES
FOR ANAHEIM, CLAMP-ALL, HUSKY, MISSION &
MG TOO.**



ANAHEIM
CLAMP ALL
HUSKY
MG
MISSION

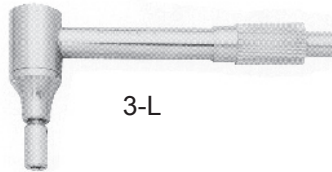

3-L



2-S



PIPE
WRENCH

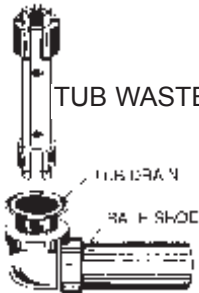

TUB WASTE WRENCH

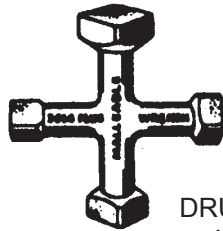

DRUM TRAP
W4920



4 WAY P.O. PLUG
W4960

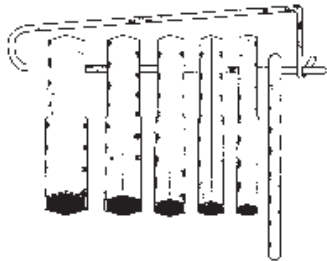

SHOWER BODY
SOCKET SET



W4990
RADIATOR SPUD
WRENCH

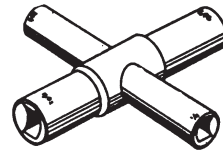

4-WAY SILCOCK KEY

STRAP WRENCH



GN54000

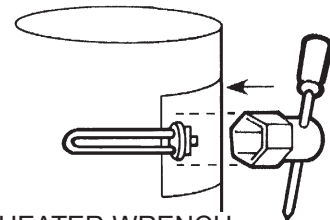

WATER HEATER WRENCH

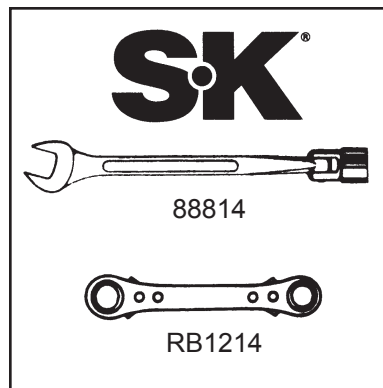

88814

RB1214



BUGLER SALES CORP.

Phone: 516 223-3868 • Fax: 516 868-6998
 969 CHURCH STREET • BALDWIN, NY 11510

E-mail: info@buglersales.com

NUMBER		DESCRIPTION	PK	RESALE	COST
WRENCHES <i>continued...</i>					
NO-HUB WRENCHES					
W4970		NO HUB TORQUE WRENCH IMPORT	12		
SN1L		1-L 5/16" SOCKET, 5" SHAFT, 60"LBS.	EA		
SN2S	BEST SELLER	2-S 5/16" SOCKET, 2-3/4" SHAFT, 60"LBS	EA		
SN2SC	NEW	2-SC 1/4" SOCKET CLAMP-ALL 80"LBS	EA		
SN3L	BEST SELLER	3-L 5/16"SOCKET ANGLED 60"LBS.	EA		
SN2SM	NEW	2SM 5/16 80"LB	EA		
SN8A		8-A 3/8" SOCKET ANAHEIM 80"LBS.	EA		
PIPE WRENCHES					
GNAPW14		14" HEAVY DUTY PIPE WRENCH ALUM HDL	6		
GNAPW18		18" HEAVY DUTY PIPE WRENCH ALUM HDL	5		
GNAPW24		24" HEAVY DUTY PIPE WRENCH ALUM HDL	2		
GNAPW36		36" HEAVY DUTY PIPE WRENCH ALUM HDL	1		
GNPW8		8" HEAVY DUTY PIPE WRENCH	6		
GNPW10	BEST SELLER	10" HEAVY DUTY PIPE WRENCH	6		
GNPW14	BEST SELLER	14" HEAVY DUTY PIPE WRENCH	6		
GNPW18		18" HEAVY DUTY PIPE WRENCH	2		
GNPW24		24" HEAVY DUTY PIPE WRENCH	2		
FOR LENOX PIPE WRENCHES, SEE PAGE 146					
PLUG WRENCHES					
W4920		DRUM TRAP PLUG WRENCH	1		
W4960	BEST SELLER	4-WAY P.O. PLUG WRENCH	5		
RADIATOR SPUD WRENCH					
W4990	BEST SELLER	RADIATOR SPUD WRENCH 1/2 TO 2"	EA		
SHOWER BODY SOCKET SETS					
S6150	BEST SELLER	SHOWER BODY SOCKET SET	6		
SILLCOCK KEYS					
S6175	BEST SELLER	FOUR WAY SILLCOCK KEY	25		
SK WRENCHES					
SKRB1214		3/8 X 7/16 RATCHET BOX END WRENCH	EA		
SKRB1618		1/2 X 9/16 RATCHET BOX END WRENCH	EA		
SKRB2024		5/8 X 3/4 RATCHET BOX END WRENCH	EA		
SKRB810		1/4 X 5/16 RATCHET BOX END WRENCH	EA		
SK88812		3/8 COMBINATION FLEX WRENCH	EA		
SK88814		7/16 COMBINATION FLEX WRENCH	EA		
SK88816		1/2 COMBINATION FLEX WRENCH	EA		
SK88818		9/16 COMBINATION FLEX WRENCH	EA		
SK88820		5/8 COMBINATION FLEX WRENCH	EA		
SK88822		11/16 COMBINATION FLEX WRENCH	EA		
SK88824		3/4 COMBINATION FLEX WRENCH	EA		
STRAP WRENCHES					
W4964		7" STRAP WRENCH	6		
GN54000	NEW	54000 6" DIAMETER STRAP WRENCH	6		
GN54001	NEW	54001 4" DIAMETER STRAP WRENCH	6		
BT78012		12" STRAP WRENCH "BERKLEY"	1		
WASTE WRENCHES					
W4968	BEST SELLER	TUB WASTE WRENCH (SMART DUMBELL)	1		
W4940		GARBAGE DISPOSAL WRENCH	6		
WATER HEATER WRENCH					
W4930		WATER HEATER ELEMENT WRENCH	6		

LENOX®





LENOX SAW BLADES & ACCESSORIES

METAL RECIPROCATING BLADES

Shatter and shock resistant, wear and heat resistant bi-metal blades.



They cut stronger, faster and longer than any other blade.

ITEM NO	MFG.#	SIZE	PACK	RESALE	-43%	-46%
20550	414R	4" - 14T	5	\$		
20552	418R	4" - 18T	5	\$		
20554	424R	4" - 24T	5	\$		
20564	614R	6" - 14T	5	\$		
20566	618R	6" - 18T	5	\$		
20568	624R	6" - 24T	5	\$		
20578	818R	8" - 18T	5	\$		
20580	810R	8" - 10T	5	\$		
20583	110R	12" - 10/14T	5	\$		
21510	118R	12" - 18T	5	\$		

METAL CONTOUR RECIPROCATING BLADES

Shatter and shock resistant, wear and heat resistant bi-metal blades.



ITEM NO	MFG.#	SIZE	PACK	RESALE	-43%	-46%
20520	314RC	3" - 14T	5	\$		
20521	318RC	3" - 18T	5	\$		

WOOD CONTOUR RECIPROCATING BLADES

Cuts nail embedded wood.



ITEM NO	MFG.#	SIZE	PACK	RESALE	-43%	-46%
20556	676RC	6" - 6T	5	\$		

WOOD RECIPROCATING BLADES

Shatter and shock resistant, wear and heat resistant bi-metal blades.

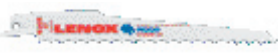

Cuts nail embedded wood.

ITEM NO	MFG.#	SIZE	PACK	RESALE	-43%	-46%
20575	634R	6" - 4T	5	\$		
20560	606R	6" - 6T	5	\$		
20562	610R	6" - 10T	5	\$		
20572	656R	6" - 6T	5	\$		
20582	956R	9" - 6T	5	\$		
20585	156R	12" - 6T	5	\$		

PLASTER RECIPROCATING BLADES

Shatter and shock resistant, wear and heat resistant bi-metal blades.



ITEM NO	MFG.#	SIZE	PACK	RESALE	-43%	-46%
20449	456RP	4" - 6T	5	\$		
20570	636RP	6" - 6T	5	\$		

DEMOLITION RECIPROCATING BLADES

Stays rigid, does not vibrate from side to side. Blade is durable in wood or metal



for fast and easy cutting. 966,6066 for wood, 960,106 for metal

ITEM NO	MFG.#	SIZE	PACK	RESALE	-43%	-46%
20512	6066R	6" - 6T	2	\$		
20598	966R	9" - 6T	2	\$		
20597	960R	9" - 10T	2	\$		
20500	106R	12" - 6T	2	\$		

RECIPROCATING BLADES BULK PACKED (25 PER PLASTIC CONTAINER)



ITEM NO	MFG.#	SIZE	PACK	RESALE	-43%	-46%
20488	B414R	4" - 14T	25	\$		
20489	B418R	4" - 18T	25	\$		
20490	B424R	4" - 24T	25	\$		
20492	B606R	6" - 6T	25	\$		
20493	B610R	6" - 10T	25	\$		
20494	B614R	6" - 14T	25	\$		
20529	B618R	6" - 18T	25	\$		
20496	B624R	6" - 24T	25	\$		
20497	B636RP	6" - 6T	25	\$		
20515	B650R	6" - 10/14T	25	\$		
20525	B9514R	9" - 14T	25	\$		
20530	B656R	6" - 6T	25	\$		
20487	B818R	8" - 18T	25	\$		
20590	B810R	8" - 10T	25	\$		
20558	B956R	9" - 6T	25	\$		
20495	B156R	12" - 6T	25	\$		
20491	B110R	12"-10/14T	25	\$		
21511	B118R	12" - 18T	25	\$		

CARBIDE GRIT RECIPROCATING BLADES

High abrasion resistance. Cuts materials more effectively than bi-metal blades.



Medium carbide grit. Good for fiberglass, ceramic tile, and cast iron pipe.

ITEM NO	MFG.#	SIZE	PACK	RESALE	-43%	-46%
20505	600RG	6"	2	\$		
20576	800RG	8"	2	\$		
20506	100RG	10"	2	\$		

HEAVY DUTY RECIPROCATING BLADES

Stays rigid, does not vibrate from side to side. Blade is durable in wood or metal



for fast and easy cutting. Recommended for fire/rescue.

ITEM NO	MFG.#	SIZE	PACK	RESALE	-43%	-46%
20592	650R	6"-10/14T	2	\$		
20511	9514R	9" - 14T	2	\$		

HAND HACKSAW BLADES

Bi-metal construction. Shatter and shock resistant,



virtually unbreakable. A smoother cut for faster cutting.

ITEM NO	MFG.#	SIZE	PACK	RESALE	-43%	-46%
20110	018HE	10" - 18T	100	\$		
20111	024HE	10" - 24T	100	\$		
20112	032HE	10" - 32T	100	\$		
20116	218HE	12" - 18T	100	\$		
20117	224HE	12" - 24T	100	\$		
20118	232HE	12" - 32T	100	\$		
20140	V018HE	10" - 18T	10	\$		
20141	V024HE	10" - 24T	10	\$		
20142	V032HE	10" - 32T	10	\$		
20143	V214HE	12" - 14T	10	\$		
20144	V218HE	12" - 18T	10	\$		
20145	V224HE	12" - 24T	10	\$		
20146	V232HE	12" - 32T	10	\$		

LENOX SAW BLADES & ACCESSORIES

HACKSAW FRAME

Heavy-duty aluminum handle hacksaw frame with bi-metal 12" blade. Large throat for deep cutting. BOXED.



ITEM NO	MFG.#	SIZE	PACK	RESALE	-43%	-46%
20919	2012	HackFrame	5	\$		

HACKSAW FRAME

High tension (up to 30,000 psi) hacksaw frame with heavy-duty aluminum handle and rectangular steel crossbar. Can be used as a compass saw. Stores spare blades inside crossbar. Blade can also be mounted at a 45 degree angle for flush cuts. BOXED.



ITEM NO	MFG.#	SIZE	PACK	RESALE	-43%	-46%
20918	4012	HackFrame	5	\$		

HACKSAW FRAME

Frame has 4" pipe clearance combined with sloped front for access in tight work spaces.



ITEM NO	MFG.#	SIZE	PACK	RESALE	-43%	-46%
20920	5012	HackFrame	5	\$		

MINI HACKSAW

Rugged heavy-duty aluminum, design for hard to get at spots. Includes 10" bi-metal blade. BOXED.



ITEM NO	MFG.#	SIZE	PACK	RESALE	-43%	-46%
20975	975	Hacksaw	5	\$		

TRI-FOLD SAWS

Heavy-duty aluminum, complete with 6" reciprocating blade. Comfortable hand grip with hand hole. Blade locks in 3 positions. Perfect for those hard to get at spots.

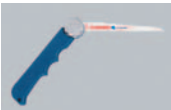

ITEM NO	MFG.#	SIZE	PACK	RESALE	-43%	-46%
20992	3636		5	\$		
20993	3618		5	\$		
20995	TFHS W/HOLSTER		5	\$		

PVC/ABS PLASTIC PIPE HAND SAWS

Sturdy and durable. Comfortable and long lasting. Cuts plastic, wood, and drywall.



ITEM NO	SIZE	PACK	RESALE	-43%	-46%
20985	12" saw	5	\$		
20980	18" saw	5	\$		
20982	12" replacement	5	\$		
20981	18" replacement	5	\$		
20987	Flush cut adapter	5	\$		

CLOSE QUARTER SAW

Rigid steel construction, hardened carbon steel blade (holed) with increased blade tension. Cuts where other frames can't, BOXED.



ITEM NO	SIZE	PACK	RESALE	-43%	-46%
20908	Hand saw	5	\$		
20906	6x1/4x.014 - 32T	10	\$		

HOLE SAWS

Bi-metal construction. Faster, smoother, quieter cuts. Cuts through 2"x 4".



ITEM NO	MFG.#	SIZE	PACK	RESALE	-43%	-46%
30009	9L	9/16	1/BOX	\$		
30010	10L	5/8	1/BOX	\$		
30011	11L	11/16	1/BOX	\$		
30012	12L	3/4	1/BOX	\$		
30013	13L	13/16	1/BOX	\$		
30014	14L	7/8	1/BOX	\$		
30015	15L	15/16	1/BOX	\$		
30016	16L	1	1/BOX	\$		
30017	17L	1-1/16	1/BOX	\$		
30018	18L	1-1/8	1/BOX	\$		
30019	19L	1-3/16	1/BOX	\$		
30020	20L	1-1/4	1/BOX	\$		
30021	21L	1-5/16	1/BOX	\$		
30022	22L	1-3/8	1/BOX	\$		
30023	23L	1-7/16	1/BOX	\$		
30024	24L	1-1/2	1/BOX	\$		
30025	25L	1-9/16	1/BOX	\$		
30026	26L	1-5/8	1/BOX	\$		
30027	27L	1-11/16	1/BOX	\$		
30028	28L	1-3/4	1/BOX	\$		
30029	29L	1-13/16	1/BOX	\$		
30030	30L	1-7/8	1/BOX	\$		
30032	32L	2	1/BOX	\$		
30033	33L	2-1/16	1/BOX	\$		
30034	34L	2-1/8	1/BOX	\$		
30036	36L	2-1/4	1/BOX	\$		
30037	37L		1/BOX	\$		
30038	38L	2-3/8	1/BOX	\$		
30040	40L	2-1/2	1/BOX	\$		
30041	41L	2-9/16	1/BOX	\$		
30042	42L	2-5/8	1/BOX	\$		
30044	44L	2-3/4	1/BOX	\$		
30046	46L	2-7/8	1/BOX	\$		
30048	48L	3	1/BOX	\$		
30050	50L	3-1/8	1/BOX	\$		
30052	52L	3-1/4	1/BOX	\$		
30054	54L	3-3/8	1/BOX	\$		
30056	56L	3-1/2	1/BOX	\$		
30058	58L	3-5/8	1/BOX	\$		
30060	60L	3-3/4	1/BOX	\$		
30062	62L	3-7/8	1/BOX	\$		
30064	64L	4	1/BOX	\$		
30066	66L	4-1/8	1/BOX	\$		
30068	68L	4-1/4	1/BOX	\$		
30072	72L	4-1/2	1/BOX	\$		
30074	74L	4-5/8	1/BOX	\$		
30076	76L	4-3/4	1/BOX	\$		
30080	80L	5	1/BOX	\$		
30088	88L	5-1/2	1/BOX	\$		
30096	96L	6	1/BOX	\$		



LENOX SAW BLADES & ACCESSORIES

HOLE SAW KITS



7/8", 1-1/8", 1-3/8", 1-3/4", 2", 2-1/2", 2L, 5L arbors, arbor adaptor, one 4321

3/4", 7/8", 1-1/8", 1-3/8", 1-3/4", 2", 2-1/2", 2-11/16", 3", 3-5/8", 4-1/8", 4-3/4", 2L, 5L arbors, (2) 4321, (1) 56PD



3/4", 7/8", 1", 1-1/8", 1-3/8", 1-1/2", 1-3/4", 2", 2-1/8", 2-1/4", 2-1/2", 2-11/16", 3", 3-1/4", 3-3/8", 3-5/8", 3-3/4", 4-1/8", 4-1/2", 4-3/4", 1L, 2L, 5L arbors, (2) 4321, (1) 56PD



5/8", 3/4", 7/8", 1", 1-1/8", 1-1/4", 1-3/8", 1-1/2", 1-3/4", 2", 2-1/2", 3", 1L, 2L arbors, (3) 4321



3/4", 7/8", 1-1/8", 1-1/2", 1-3/4", 2-1/4", 2L, 5L arbors (1) 4321, (1) arbor adaptor

ITEM NO	MFG.#		RESALE	-43%	-46%
30800	600L	Electrician	\$		
30802	1200L	Electrician	\$		
30804	2000G	Big Daddy	\$		
30808	600P	Plumber	\$		
30820	1200G	Gen.Purpose	\$		

ARBORS

Shank diameter
1L, 2L -1/2"hex, 4L-1/4" round, 5L, 6L-3/8"hex, 1SL, 2SL - SDS. BOXED.

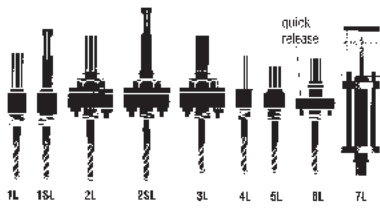

ITEM NO	MFG.#	PACK	RESALE	-43%	-46%
30001	1L	1/BOX	\$		
30101	1SL	1/BOX	\$		
30002	2L	1/BOX	\$		
30102	2SL	1/BOX	\$		
30003	3L	1/BOX	\$		
30004	4L	1/BOX	\$		
30005	5L	1/BOX	\$		
30006	6L	1/BOX	\$		
30007	7L	1/BOX	\$		

HOLE SAW PILOT DRILL BITS

POUCHED. 1 PER POUCH. 1/4"



ITEM NO	MFG.#	FITS	PACK	RESALE	-43%	-46%
30850	4321	1L,2L,4L	1/CLAM	\$		
30851	56PD	5L,6L	1/CLAM	\$		

ARBOR ADAPTOR

Fits 1L,4L,5L arbors.
For use with hole saws requiring 2L or 6L arbor. 1 par hang up pouch.



ITEM NO	MFG.#	FITS	PACK	RESALE	-43%	-46%
30857	AA1	1L,4L,5L	1/CLAM	\$		

WOOD BIT & HOLE SAW EXTENSIONS

Hex shank with single set screw.
10X has 3/8" shank. Others have 1/2" shank and can be used with wood boring bits. POUCHED - 1 PER POUCH.



ITEM NO	FITS	SIZE	PACK	RESALE	-43%	-46%
30848	1L,2L	18"	1/CLAM	\$		
30847	1L,2L	12"	1/CLAM	\$		
30843	5L,6L	10"	1/CLAM	\$		
30846	1L,2L	5-1/2"	1/CLAM	\$		

CARBIDE TIPPED HOLESAWS

Carbie tooth tips for smoother, concentric cuts. Effectively cuts materials standard bi-metal hole saws will not. Great for ceramic tile.



ITEM NO	MFG.#	SIZE	PACK	RESALE	-43%	-46%
30211	11CT	11/16	1/BOX	\$		
30212	12CT	3/4	1/BOX	\$		
30214	14CT	7/8	1/BOX	\$		
30216	16CT	1	1/BOX	\$		
30218	18CT	1-1/8	1/BOX	\$		
30220	20CT	1-1/4	1/BOX	\$		
30222	22CT	1-3/8	1/BOX	\$		
30224	24CT	1-1/2	1/BOX	\$		
30226	26CT	1-5/8	1/BOX	\$		
30228	28CT	1-3/4	1/BOX	\$		
30232	32CT	2	1/BOX	\$		
30234	34CT	2-1/8	1/BOX	\$		
30236	36CT	2-1/4	1/BOX	\$		
30238	38CT	2-3/8	1/BOX	\$		
30240	40CT	2-1/2	1/BOX	\$		
30242	42CT	2-5/8	1/BOX	\$		
30248	48CT	3	1/BOX	\$		
30252	52CT	3-1/4	1/BOX	\$		
30254	54CT	3-3/8	1/BOX	\$		
30256	56CT	3-1/2	1/BOX	\$		
30258	58CT	3-5/8	1/BOX	\$		
30260	60CT	3-3/4	1/BOX	\$		
30264	64CT	4	1/BOX	\$		
30266	66CT	4-1/8	1/BOX	\$		
30268	68CT	4-1/4	1/BOX	\$		
30272	72CT	4-1/2	1/BOX	\$		
30276	76CT	4-3/4	1/BOX	\$		
30280	80CT	5	1/BOX	\$		
30288	88CT	5-1/2	1/BOX	\$		
30296	96CT	6	1/BOX	\$		
30297	123CT	PILOT	1/BOX	\$		



LENOX SAW BLADES & ACCESSORIES

MASTER GRIT RECESSED LIGHTING HOLESAWS

Feature a hard tungsten carbide grit cutting edge that will cut tough abrasive materials. Lasts up to 10 times longer on thin abrasive materials!



ITEM NO	MFG.#	SIZE	PACK	RESALE	-43%	-46%
30861	438RL	4-3/8	1/BOX	\$		
30862	638RL	6-3/8	1/BOX	\$		
30863	658RL	6-5/8	1/BOX	\$		
30864	678RL	6-7/8	1/BOX	\$		

VARI-BIT

High speed steel construction for faster, cleaner holes. Drills various types of materials including stainless steel, mild steel, cast iron, plastic and wood.



ITEM NO	MFG.#	SIZE	RESALE	-43%	-46%
30881	VB1	1/8" - 1/2"	\$		
30882	VB2	1/2" - 1"	\$		
30883	VB3	1/4" - 3/4"	\$		
30884	VB4	3/16" - 1/2"	\$		
30886	VB6	3/8" - 1/2"	\$		
30887	VB7	7/8"	\$		
30908	VB8	3/16" - 7/8"	\$		
30888	VB11	7/8" - 1-1/8"	\$		
30912	VB12	7/8" - 1-3/8"	\$		

LENOX LEADER

AUTOMATIC FEED WOOD BITS

Self-feeding, produces a very clean hole. Cuts through tough wet wood and hardwoods. Can be resharpened. Cuts through 4x4.



ITEM NO	MFG.#	SIZE	PACK	RESALE	-43%	-46%
33100	LL100	1	1/CLAM	\$		
33112	LL112	1-1/8	1/CLAM	\$		
33125	LL125	1-1/4	1/CLAM	\$		
33137	LL137	1-3/8	1/CLAM	\$		
33150	LL150	1-1/2	1/CLAM	\$		
33175	LL175	1-3/4	1/CLAM	\$		
33200	LL200	2	1/CLAM	\$		
33212	LL212	2-1/8	1/CLAM	\$		
33225	LL225	2-1/4	1/CLAM	\$		
33256	LL256	2-9/16	1/CLAM	\$		
33300	LL300	3	1/CLAM	\$		
33362	LL362	3-5/8	1/CLAM	\$		
33462	LL462	4-5/8	1/CLAM	\$		
33900	12LS	PILOT	5 PACK	\$		

DISCOUNT LEVELS

All items receive (list -43%).
Net orders totalling \$650 or more receive (list -46%).

WOOD BORING BITS

One piece construction, self-feeding bit. Bit can be sharpened on the job.



ITEM NO	MFG.#	SIZE	PACK	RESALE	-43%	-46%
32100	WB100	1	1/CLAM	\$		
32112	WB112	1-1/8	1/CLAM	\$		
32125	WB125	1-1/4	1/CLAM	\$		
32137	WB137	1-3/8	1/CLAM	\$		
32150	WB150	1-1/2	1/CLAM	\$		
32175	WB175	1-3/4	1/CLAM	\$		
32200	WB200	2	1/CLAM	\$		
32212	WB212	2-1/8	1/CLAM	\$		
32225	WB225	2-1/4	1/CLAM	\$		
32256	WB256	2-9/16	1/CLAM	\$		
32900	WBPS	PILOT	5 PACK	\$		

UNIVERSAL STYLE JIG SAW BLADES

Bi-metal construction.



ITEM NO	MFG.#	SIZE	PACK	RESALE	-43%	-46%
20332	318JC	3" - 18T	2	\$		
20333	320JC	3" - 20T	2	\$		
20320	300JG	3"	2	\$		
20321	314J	3" - 14T	2	\$		
20322	318J	3" - 18T	2	\$		
20323	324J	3" - 24T	2	\$		
20325	350JC	3-1/2" - 10T	2	\$		
20324	340JV	3-1/2" - 10/14	2	\$		
20326	356JF	3-1/2" - 6/10	2	\$		
20334	416JC	4" - 6T	2	\$		
20335	450J	4" - 10T	2	\$		
20336	450JR	4" - 10T	2	\$		
20327	424J	4" - 24T	2	\$		
20337	456J	4-1/2" - 6T	2	\$		
20329	486J	4-1/2" - 6T	2	\$		
20328	480J	4-1/2" 10T	2	\$		
20330	518J	5-1/4" - 18T	2	\$		
20331	686J	6" - 6T	2	\$		

LAZER BLADE

Wider blade for straighter cuts.



ITEM NO	MFG.#	SIZE	PACK	RESALE	-43%	-46%
20170	6110R	6 x 1 - 10T	5	\$		
20172	6114R	6 x 1 - 14T	5	\$		
20174	6118R	6 x 1 - 18T	5	\$		
20176	9110R	9 x 1 - 10T	5	\$		
20178	9114R	9 x 1 - 14T	5	\$		
20180	9118R	9 x 1 - 18T	5	\$		
20182	12110R	12 x 1 - 10T	5	\$		
20184	12114R	12 x 1 - 14T	5	\$		
20190	12118R	12 x 1 - 18T	5	\$		

YOU CAN NOW ORDER ONLINE AT
WWW.BUGLERSALES.COM



LENOX SAW BLADES & ACCESSORIES

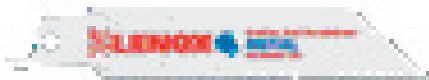

BULK 50 PACK

ITEM NO	MFG.#	SIZE	PACK	RESALE	-43%	-46%
22750	B656R		50	\$		
22751	B618R		50	\$		
22752	B956R		50	\$		
22753	B810R		50	\$		
22754	B818R		50	\$		
22755	B156R		50	\$		
22756	B614R		50	\$		
22757	B624R		50	\$		
22758	B110R		50	\$		
22759	B418R		50	\$		
22760	B414R		50	\$		
22761	B610R		50	\$		
21511	B118R		50	\$		

CARBIDE HOLE CUTTERS

If you're using a knock-out punch, you're wasting your time.



Do the job in seconds, not minutes - and save time with every accurate, burr-free hole. A built-in over-drill stopper means our Hole Cutter never crashes into work or damages the work piece. With a split-point pilot drill bit, you get fast penetration without walking - even in tough materials like stainless steel. No wrench required.

ITEM NO	MFG. #	SIZE	PACK	RESALE	-43%	-46%
20092	12CHC	3/4	1	\$		
20093	14CHC	7/8	1	\$		
20094	16CHC	1	1	\$		
20095	17CHC	1-1/16	1	\$		
20096	18CHC	1-1/8	1	\$		
20097	19.5CHC	1-7/32	1	\$		
20098	20CHC	1-1/4	1	\$		
20099	21CHC	1-5/16	1	\$		
20100	22CHC	1-3/8	1	\$		
20101	23CHC	1-7/16	1	\$		
20102	24CHC	1-1/2	1	\$		
20103	28CHC	1-3/4	1	\$		
20104	32CHC	2	1	\$		
20105	34CHC	2-1/8	1	\$		
20106	36CHC	2-1/4	1	\$		
20107	38CHC	2-3/8	1	\$		
20108	40CHC	2-1/2	1	\$		
20109	42CHC	2-5/8	1	\$		
20113	44CHC	2-3/4	1	\$		
20114	48CHC	3	1	\$		

CARBIDE HOLE CUTTER ACCESSORIES



ITEM NO	MFG. #	SIZE	PACK	RESALE	-43%	-46%
30879	35PD	1/4	3	\$		
30880	3CHC		3	\$		

ONE TOOTH® ROUGH WOOD HOLE CUTTER



ITEM NO	MFG. #	SIZE	PACK	RESALE	-43%	-46%
25434	34HC	2/1/8	1	\$		
25436	36HC	2-1/4	1	\$		
25441	41HC	2-9/16	1	\$		
25442	42HC	68MM	1	\$		
25444	44HC	2-3/4	1	\$		
25451	51HC	80MM	1	\$		
25454	54HC	3-3/8	1	\$		
25456	56HC	3-5/8	1	\$		
25464	64HC	4	1	\$		
25469	69HC	4-5/16	1	\$		
25474	74HC	4-5/8	1	\$		
25480	80HC	5	1	\$		
25487	87HC	5-1/2	1	\$		
25500	00HC	6-1/4	1	\$		

ONE TOOTH ROUGH WOOD HOLE CUTTER KITS



ITEM NO	MFG. #	SIZE	PACK	RESALE	-43%	-46%
25476	301G		1	\$		
25477	701G		1	\$		

ONE TOOTH ROUGH WOOD HOLE CUTTER ACCESSORIES



ITEM NO	MFG. #	SIZE	PACK	RESALE	-43%	-46%
25312	DIAF1		1	\$		
25310		3/8"	1	\$		

LENOX SAW BLADES & ACCESSORIES

TUBING CUTTERS



ITEM NO	MFG. #	SIZE	PACK	RESALE	-43%	-46%
21010	TC11/8	1/8 - 1-1/8"	1	\$		
21011	TC13/8	1/8 - 1-3/8"	1	\$		
21012	TC13/4	1/8 - 1-3/4"	1	\$		
21013	TC25/8	1/4 - 2-5/8"	1	\$		
21015	21015	COPPER	6	\$		
21016	21016	PVC	6	\$		
21017	21017	COPPER	6	\$		
21022	SCREW & PIN FOR 21011-12			\$		
21026	SCREW & PIN FOR 21013			\$		
21192	TCW158C2 - 2PK	EA	\$			

LENOX HAND TORCHES

Self igniting with adjustable flame.



ITEM NO	MFG. #	SIZE	PACK	RESALE	-43%	-46%
21176	21176	LT91	1	\$		

LENOX TORPEDO LEVEL

Super strong magnets. Spec

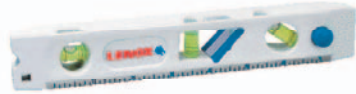

ITEM NO	MFG. #	SIZE	PACK	RESALE	-43%	-46%
21190	21190	LU9T	1	\$		

LENOX PIPE WRENCHES

Tool size - Wrench size/Pipe Capacity



ITEM NO	MFG. #	SIZE	PACK	RESALE	-43%	-46%
CAST IRON PIPE WRENCHES						
23812	23812	8"/1"	1	\$		
23813	23813	10"/1-1/2"	1	\$		
23814	23814	12"/2"	1	\$		
23815	23815	14"/2"	1	\$		
23816	23816	18"/2-1/2"	1	\$		
23817	23817	24"/3"	1	\$		
23818	23818	36"/5"	1	\$		
23819	23819	48"/6"	1	\$		

ALUMINUM PIPE WRENCHES

23820	23820	10"/1-1/2"	1	\$		
23821	23821	12"/2"	1	\$		
23822	23822	14"/2"	1	\$		
23823	23823	18"/2-1/2"	1	\$		
23824	23824	24"/3"	1	\$		
23825	23825	36"/5"	1	\$		
23826	23826	48"/6"	1	\$		

LENOX GOLD BLADES

BI-METAL, TITANIUM EDGE
LONGEST LASTING EVER.

LENOX GOLD™ WOOD CUTTING 5 PACK



ITEM NO	MFG. #	SIZE	PACK	RESALE	-43%	-46%
21060	656G	6 X 3/4 X .050	5	\$		
21061	156G	12 X 3/4 X .050	5	\$		
21062	956G	9 X 3/4 X .050	5	\$		
21063	676GC	6 X 3/4 X .050	5	\$		

LENOX GOLD™ WOOD CUTTING 25 PACK



ITEM NO	MFG. #	SIZE	PACK	RESALE	-43%	-46%
21074	656G	6 X 3/4 X .050	25	\$		
21075	156G	12 X 3/4 X .050	25	\$		
21076	956G	9 X 3/4 X .050	25	\$		
21077	676GC	6 X 3/4 X .050	25	\$		

LENOX GOLD™ METAL CUTTING 5 PACK



ITEM NO	MFG. #	SIZE	PACK	RESALE	-43%	-46%
21064	610G	6 X 3/4 X .050	5	\$		
21065	810G	8 X 3/4 X .050	5	\$		
21066	414G	4 X 3/4 X .050	5	\$		
21067	614G	6 X 3/4 X .050	5	\$		
21068	418G	4 X 3/4 X .050	5	\$		
21069	618G	6 X 3/4 X .050	5	\$		
21070	818G	8 X 3/4 X .050	5	\$		
21071	424G	4 X 3/4 X .050	5	\$		
21072	624G	6 X 3/4 X .050	5	\$		
21073	824G	8 X 3/4 X .050	5	\$		

LENOX GOLD™ METAL CUTTING 25 PACK



ITEM NO	MFG. #	SIZE	PACK	RESALE	-43%	-46%
21078	610G	6 X 3/4 X .050	25	\$		
21079	810G	8 X 3/4 X .050	25	\$		
21080	414G	4 X 3/4 X .050	25	\$		
21081	614G	6 X 3/4 X .050	25	\$		
21082	418G	4 X 3/4 X .050	25	\$		
21083	618G	6 X 3/4 X .050	25	\$		
21084	818G	8 X 3/4 X .050	25	\$		
21085	424G	4 X 3/4 X .050	25	\$		
21086	624G	6 X 3/4 X .050	25	\$		
21087	824G	8 X 3/4 X .050	25	\$		



Full Krylon Industrial Line of:

- ◆ 5-Ball Paints
- ◆ Upside-Down Marking & Striping Paints
- ◆ Electrical Cleaners
- ◆ Lubricants
- ◆ Maintenance Cleaners



INDUSTRIAL

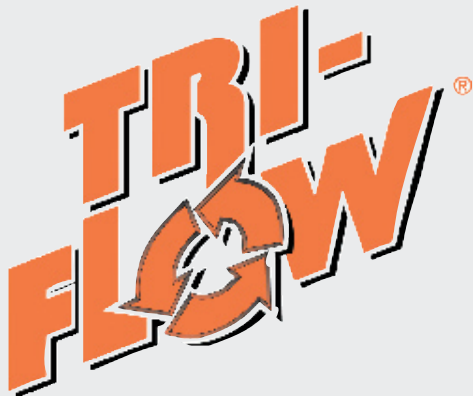

Spray & Bulk Paints



INDUSTRIAL MAINTENANCE PAINTS

FLOURESCENT PAINTS
 FUSION FOR PLASTIC
 HIGH HEAT INDUSTRIAL PAINTS
 INDUSTRIAL PRIMERS
 MARTIN SENOUR
 FLOOR, PORCH & TRIM ENAMEL
 METALLIC PAINTS
 NO-PREP RUST CONVERTOR
 OSHA APPROVED PAINTS
 REFLECT-A-LITE
 RUST TOUGH
 TOUGH COAT

UPSIDE DOWN MARKING PAINTS

- ◆ SOLVENT BASED
- ◆ WATER BASED

ATHLETIC FIELD STENCILSSOLVENT
 BASED STRIPING PAINTS
 PARKING LOT STENCILS
 STRIPING MACHINES

- ◆ PAVEMENT
- ◆ ATHLETIC FIELDS

 STRIPING WANDS

Electronic Cleaners & Specialty Items



BLAST'EM WASP & HORNET KILLER
 CONTACT CLEANER
 CONTACT & TUNER CLEANER
 ELECTRIC MOTOR
 DEGREASER/SOLVENT
 ELECTRONIC CLEANER & LUBE
 SPRAYELECTRONIC DUSTER
**ENVIRONMENTAL CLEANER/
 DEGREASER**

FAST TACK ADHESIVE
 GREEN EPOXY INSULATING VARNISH
 HIT SQUADRED INSULATING VARNISH
 INSECT REPELLENT
 SAFETY CLEANER/DEGREASER
ZINC RICH GALVANIZING COMPOUND

Lubricants



ALL PURPOSE SILICONE
**ANTI-SEIZE & LUBRICATING
 COMPOUND**
 BELT DRESSING
 CUTTING OIL

PREMIUM SILICONE LUBE
 RUSTBREAKER PENETRANT
 THE PROTECTOR #711
TRI-FLOW

Maintenance Cleaners



AIR RESHENER/POTPOURRI
ANTISEPTIC HAND SOAP
 ENZYME DRAIN/ODOR KILLER
 DRAIN OPENER
 GENERAL PURPOSE CLEANER
 LEMON DISINFECTANT
NEUTRA GREEN

ODOR KILLER
**POWER WASHER CLEANER/
 DEGREASER**
 RTU WINDOW CLEANER
 SCRATCHLESS METAL
 VELVET HAND SOAP

Spray Paints *Industrial Maintenance Paints, Metallic, OSHA Approved, Rust Tough Aerosols*



Interior/Exterior Industrial Maintenance Paints

The most asked for spray paint in the industrial marketplace. Dries fast, in just 4-6 minutes to the touch. "No runs, no drips, no errors" formula. Packed 6

KR1501	Glossy White	KR2206	Dark Anodized Bronze
KR1502	Flat White	KR2501	Leather Brown
KR1503	Antique White	OSHA PAINTS	
KR1504	Ivory	KR1813	Safety Yellow
KR1506	Almond	KR1929	Safety Purple
KR1508	Semi-Gloss White	KR2012	Safety Green
KR1601	Glossy Black	KR2116	Safety Red
KR1602	Ultra-Flat Black	KR2410	Safety Orange
KR1604	Shadow Gray	KR2416	Safety Blue
KR1605	Dove Gray	KR2417	Safety White
KR1608	Smoke Gray	KR2418	Safety Black
KR1613	Semi-Flat Black	PRIMERS	
KR1806	Sun Yellow	KR1357	All-Purpose Ruddy Brown
KR1901	Regal Blue	KR1358	All-Purpose Gray
KR1909	Ford Blue	METALLIC PAINTS	
KR1910	True Blue (OSHA Safety Blue)	KR1000	18KT Gold Plate
KR1928	Chrysler Blue	KR1010	Original Chrome
KR2001	Hunter Green	KR1401	Bright Silver
KR2013	G.M. Alpine Green	KR1403	Dull Aluminum
KR2101	Cherry Red	KR1404	Chrome Aluminum
KR2108	Banner Red	KR1701	Bright Gold
		KR1706	Gold Metallic



Most Popular Spray Paint



RESALE	COST
\$	\$



RESALE	COST
\$	\$

Rust Tough Aerosols

Complete coverage with one coat. Dries to touch in 25 minutes; dries to handle in 1 hour. For both indoor and outdoor use. Acrylic enamels and primers are equipped with EZ Touch Fanspray Nozzle. 15 oz. cans. Packed 6

KRRT0159	Aluminum	KRRT0569	Equipment Orange
KRRT0239	Light Blue	KRRT0649	Bright Red
KRRT0249	Safety Blue	KRRT0719	Tan
KRRT0339	Safety Green	KRRT0759	Chestnut Brown
KRRT0439	Safety Yellow	KRRT0769	Hi-Temp Black
KRRT0559	Safety Orange	KRRT0779	Semi-Gloss Black
KRRT0639	Safety Red	KRRT0789	Flat Black
KRRT0259	Deep Blue	KRRT0799	Gloss Black
KRRT0349	Bright Green	KRRT0839	Lt. Gray (ASA-61)
KRRT0379	Dark Green	KRRT0879	Dk. Gray (ASA-49)
KRRT0449	Federal Yellow (Safety Railing)	KRRT0909	Flat White
KRRT0459	School Bus Yellow	KRRT0919	Semi-Gloss White
KRRT0479	Industrial Yellow	KRRT0929	Gloss White
KRRT0489	Equipment Yellow	KRRT0699	Red Oxide
		KRRT0829	Gray

Spray Paints *Tough Coat Enamels, Flourescent Paints, High-Heat Paints, Fusion™ & Reflect-A-Lite™*



Tough Coat Acrylic Alkyd Enamels

Ideal for light to heavy-duty painting projects, both indoor and outdoors. Excellent hiding characteristics. Fast drying. 16 oz. cans. Packed 12.

- KT0325 Dark Gray (ASA-49)
- KT0326 Light Gray (ASA-61)
- KT0329 Blue Gray (ASA-24)
- KT1000 Clear Gloss Topcoat (TTL-50)
- KT1003 International Harvester Red
- KT1005 Bright Red
- KT1006 Allis Chalmers Orange
- KT1008 Ford Blue
- KT1009 Federal Highway Yellow
- KT1101 Cherry Red
- KT1110 OSHA Red
- KT1210 OSHA Orange (#60 Equip. Orange)
- KT1285 Cordova Brown
- KT1310 OSHA Yellow
- KT1318 New Caterpillar Yellow
- KT1470 OSHA Safety Green
- KT1485 Ivy Green (John Deere & case)
- KT1510 OSHA Blue
- KT1515 Dark Blue
- KT1540 Light Blue

- KT1580 OSHA Purple
- KT1615 Medium Gray
- KT1620 Machinery Gray
- KT1625 Blue/Gray
- KT1630 Industrial Gray
- KT1645 Light Gray
- KT1760 Aluminum
- KT1765 Gold
- KT1770 OSHA Black
- KT1800 OSHA White
- KT3720 Flat White
- KT3725 Semi-Flat Black
- KT3727 Max-Flat Black
- KS00341 Light Gray - sandable
- KS00344 Green Rust Inhibitor
- KT1811 Orange
- KT1812 Red
- KT1815 Electric Green
- KT0324** High-Heat Aluminum
- KT0332** High-Heat Black



RESALE	COST
\$	\$

Flourescent Paints Industrial Maintenance

16 oz cans Packed 6

- KR3101 Red Orange
- KR3102 Yellow Orange
- KR3104 Lemon Yellow
- KR3105 Cerise
- KR3106 Green

RESALE	COST
\$	\$



High-Heat Paints Industrial Maintenance

Withstand temperatures up to 1200° F. 16 oz cans Packed 6

- KR1402 Aluminum
- KR1505 White
- KR1614 Black
- KRDH1608 Red

RESALE	COST	RESALE	COST
\$	\$	\$	\$



NEW! Fusion For Plastic™



16 oz cans Packed 6

- KRF2320 GLOSS WHITE
- KRF2321 GLOSS BLACK
- KRF2322 DOVER WHITE
- KRF2323 RIVER ROCK
- KRF2324 HUNTER GREEN
- KRF2325 BURGUNDY
- KRF2326 NAVY
- KRF2327 SPRING GRASS
- KRF2328 RED PEPPER
- KRF2339 PATRIOTIC BLUE
- KRF2330 SUNBEAM
- KRF2331 FAIRYTALE PINK
- KRF2332 SUN DRIED TOMATO
- KRF2333 BLUE HYACINTH
- KRF2334 BUTTERCREAM
- KRF2335 HONEYDUE
- KRF2337 PUMPKIN (SAFETY) ORANGE
- KRF2340 ESPRESSO

RESALE	COST
\$	\$

NEW! Reflect-A-Lite™



Reflect-A-Lite™

16 oz cans (12 oz Net Wt.) Pack 12

Clear coating directly reflects flashlight or headlights, making items extraordinarily visible in the dark of under emergency lighting conditions.

KR9955

RESALE	COST
\$	\$

Spray Paints

*Upside-Down Marking Paints, Line-Up
Striping Paints, Striping Machines/Wands*



UPSIDE-DOWN, SOLVENT BASED MARKING PAINTS

Fast drying.
VOC compliant and lead-free.
20oz cans. Packed 12

RESALE **COST**
\$ \$

SAFETY		FLOURESCENT	
KS03611	APWA Red	KS03613	Safety Red
KS03621	APWA Blue	KS03614	Neon Green
KS03631	APWA Green	KS03615	Purple
KS03731	APWA Bright Orange	KS03622	Hot Pink
KS03823	APWA Safety Yellow	KS03701	Red/Orange
KS03550	Asphalt Black	KS03702	Orange
KS03600	Clear	KS03722	Blue
KS03821	High Vis Yellow		
KS03900	Utility White		

Line-Up STRIPING PAINTS

Solvent-based, fast drying.
long-lasting durability on outdoor pavement and indoor surfaces
Non-clogging spray tip
VOC compliant, free-of-lead hazards
20oz cans. Pack 12

RESALE **COST**
\$ \$

- KR8300 Highway White
- KR8301 Highway Yellow
- KR8302 Handicap Blue
- KR8303 Firelane Red
- KR8304 Cover-Up Black
- KR8340 Striping Machine



STRIPING MACHINE

KR8340 Striping Machine

RESALE **COST**
\$ \$



MARKING WANDS

Comfortable pistol grip for easy handling and marking.
Apply a uniform, 1" to 1-1/2" width of paint.
For Quick-Mark Paint

KR7095 Spotter Hand-Held Wand 12"

RESALE **COST**
\$ \$

KR7096 Wheeler Hand-Held Wand 34"

RESALE **COST**
\$ \$



Electronic Cleaners & Specialty Items



ENVIRONMENTAL CLEANER/DEGREASER

- ◆Designed for fast, effective removal of dirt, oil, grease, wax and tar on electrical equipment.
- ◆Leaves no residue, fast evaporating
- ◆20oz cans, Pack 12

KS00749

RESALE COST
\$ \$

ELECTRIC MOTOR DEGREASER

- ◆A chlorinated solvent that penetrates quickly to easily lift dirt, grease and tars.
- ◆Non-flammable, non-corrosive and non-staining.
- ◆20oz cans, Pack 12

KS00703

RESALE COST
\$ \$



ELECTRICAL CLEANER & LUBRICATING SPRAY

- ◆Removes contaminants such as grease, dirt, dust and oxidation residue; eliminates related humming noise.
- ◆Dielectric strength: 36,700v
- ◆16oz cans, Pack 12

KS02001

RESALE COST
\$ \$



DUSTER

- ◆Ultra-pure, non-CFC gas that removes microscopic particles of lint, dust, ferrous oxide and other contaminants.
- ◆Useful on delicate components and instruments where residual entrapment could be a problem.
- ◆12oz cans, Pack 12

KS02008

RESALE COST
\$ \$



ENVIRONMENTAL CONTACT CLEANER

- ◆Heavy-duty degreaser and quick drying cleaner.
- ◆Fast-evaporating.
- ◆Safe on most plastics.
- ◆Leaves no residue.
- ◆For use on non-energized equipment.
- ◆16oz cans, Pack 12

KS02302

RESALE COST
\$ \$

CONTACT & TUNER CLEANER

- ◆Non-conductive and non-flammable so equipment can be cleaned while operating.
- ◆Will not react with most plastics or elastomers.
- ◆16oz cans, Pack 12

KS02202

RESALE COST



Electronic Cleaners & Specialty Items



FAST TACK ADHESIVE
 ♦White Lightening Premium Adhesive Spray
 ♦24oz cans, Pack 12

KS03102
 RESALE COST
 \$ \$

SAFETY CLEANER & DEGREASER

♦Penetrates instantly to remove dirt, oil, grease and wax.
 ♦16oz cans, Pack 12

KS00748
 RESALE COST
 \$ \$



KS00856

INSECT REPELLENT II

♦Effectively repels mosquitos, chiggers, ticks, deer flies, black flies, gnats and fleas; also protects against Lyme disease
 • Personal Protection - Similar to

“OFF”
 ♦8oz cans, Pack 12

RESALE COST
 \$ \$

KS00859

HIT SQUAD INDUSTRIAL INSECTICIDE

♦Works on houseflies, mosquitos, gnats, wasps, small moths, ants, roaches, waterbugs, silverfish, centipedes, spiders, crickets, sowbus, beetles(carpet, flour, and rice), grain mites, lice, bedbugs, and fleas.

RESALE COST
 ♦20oz cans, Pack 12 \$ \$

KS00857

BLAST'EM WASP & HORNET KILLER

♦Kills wasps, hornets, yellow jackets, flies, mosquitos and flying moths.

RESALE COST
 ♦16oz cans, Pack 12 \$ \$



RED INSULATING VARNISH

♦High arc resistance and non-tracking properties.
 ♦Resists oil, water acids and alkalis.
 ♦Oil resistant per ASTMD-115-55
 ♦20oz cans, Pack 12

KS00601
 RESALE COST
 \$ \$

ZINC-RICH COLD GALVANIZING COMPOUND

♦Fuses zinc to the metal substrate to protect against corrosion; equal to or better than hot-dipped galvanizing.
 ♦May be topcoated with conventional primers or finish coats.
 ♦16oz cans, Pack 12

KS00740
 RESALE COST
 \$ \$



Lubricants

Tri-Flow, Silicone Lube, Cutting Oil,
The Protector #711



ANTI-SEIZE & LUBRICATING COMPOUND

◆ Designed to lubricate and protect metal parts under the most demanding condition or heat, cold, pressure, steam and salt water exposure.

◆ Provides protection from -297°F to +2200°F.

◆ Won't react to most gases, including propane, butane, natural gas, helium and nitrogen.

BUGLER #	DESCRIPTION	RESALE	COST
KS00620	12oz AEROSOL	\$	\$
KS62008	8oz CONTAINER	\$	\$
KS62016	16oz CONTAINER	\$	\$



PREMIUM SILICONE LUBE

- ◆ 6.6% silicone formula
- ◆ Stops squeaks and sticking, eliminates friction, repels water and prevents freezing.
- ◆ 16oz cans, Pack 12

KS01324	RESALE	COST
	\$	\$

ALL PURPOSE SILICONE LUBE

- ◆ Effective from -50° to +375°F
- ◆ Equipped with spray in any position valve and extension tube.
- ◆ 16oz cans, Pack 12

KS00206	RESALE	COST
	\$	\$



RUST BREAKER PENETRANT

- ◆ Quickly loosens rust while penetrating grease and dirt.
- ◆ Jet stream sprays up to two feet for safe, accurate application.
- ◆ Will not harm painted surfaces.
- ◆ 16oz cans, Pack 12

KS00103	RESALE	COST
	\$	\$



CUTTING OIL

- ◆ Recommended for all metals, including stainless steel.
- ◆ Jet spray allows precision applications.
- ◆ 16oz cans, Pack 12

KS00208	RESALE	COST
	\$	\$

Lubricants

Tri-Flow, Silicone Lube, Cutting Oil,
The Protector #711



TRI-FLOW

- ◆Penetrates inaccessible areas to displace contaminants.
- ◆Lubricates with oils, additives and Teflon to reduce friction and increase part life.
- ◆Protects against moisture and corrosion damage, displaces moisture to prevent icing, inhibits rust formation and corrosive build-up.
- ◆Pack 12. 18oz. Pack 6.



BUGLER #	DESCRIPTION	RESALE	COST
KRTF20025	AEROSOL - 6oz.	\$	\$
KR20027	AEROSOL - 12oz.	\$	\$
KR21010TF	NON-AEROSOL - 2oz.	\$	\$
KR29200TF	PUMP - 18oz.	\$	\$

THE PROTECTOR #711

- ◆Formulated to ensure maximum moisture displacement.
- ◆Rust-preventative film inhibits corrosion and penetrates surface irregularities to release frozen or corroded parts.
- ◆Sprays in upright or inverted position.
- ◆16oz cans, Pack 12



KS00711

RESALE	COST
\$	\$

CITRUS CLEANER/DEGREASER

- ◆20oz aerosol.Pack 12
- Biodegradable
- Heavy Duty. Removes grimy dirt, grease & oil.

KS00757

RESALE	COST
\$	\$



BELT DRESSING

- ◆Conditions belts while increasing pulling power up to 50%.
- ◆Will not glaze or collect dirt and dust; reduces squeaky noise.
- ◆16oz cans, Pack 12

KS00607

RESALE	COST
\$	\$



Maintenance Cleaners



GENERAL PURPOSE CLEANER

- ◆All-purpose formula that cuts through dirt with ease.
- ◆Authorized by the USDA.
- ◆20oz cans, Pack 12

KS00880

RESALE COST
\$ \$



LEMON DISINFECTANT CLEANER

- ◆Powerful, neutral pH, broad-spectrum disinfectant with virucide and fungicide properties.
- ◆Effective against the HIV-1 virus., Herpes Simplex Types I&II, canine and feline parvovirus.
- ◆EPA reg. No. 47371-131-64695
- ◆5 gallon pail

CE00532

RESALE COST
\$ \$



STAINLESS STEEL CLEANER

- ◆Powerful...
- ◆Effective ...
- ◆Pack 12.

KS00885

RESALE COST
\$ \$



GLASS CLEANER

- ◆Powerful...
- ◆Effective...
- ◆20 oz can. Pack 12

KS00888

RESALE COST
\$ \$



NEUTRA GREEN CONCENTRATE

- ◆Neutral pH cleaner/degreaser penetrates and suspends tough soils, grease, oil, wax, gum and light carbon deposits
- ◆An environmentally responsible product.

BUGLER #	SIZE	PACK	RESALE	COST
CE01201	1 GALLON	4	\$ \$	
CE1201T	33oz.	12	\$	\$

Maintenance Cleaners



ANTISEPTIC HAND SOAP

◆Combines outstanding cleansing capability with special anti-bacterial and anti-microbial properties.

◆For use in food processing areas, health care facilities, restaurant and public rest-rooms.

◆1 gallon

CE01545

RESALE COST
\$ \$



RTU WINDOW CLEANER

◆Ready-to-use, ammoniated cleaner for windows and other glass.

BUGLER #	SIZE	RESALE	COST
CE01100	1 GALLON	\$	\$
CE1104N	32oz SPRAY	\$	\$



AIR FRESHENERS

◆Contains the exclusive "HS-25" malodor counteractant.

◆Freshens air without wet, messy fallout.

◆11oz Aerosol

BUGLER #	SIZE	RESALE	COST
CE05403	SPEARMINT	\$	\$
CE05404	GREEN APPLE	\$	\$



MARTIN SENOUR INDUSTRIAL ALKYLD ENAMELS - 53 SERIES

◆For use over prepared substrates in industrial environments

- Interior/Exterior all-purpose maintenance enamel
- Safety and pipe marking enamel.
- Economical machinery and equipment finish.
- Interior wall and ceiling enamel.
- Gallon. Pack 4.

PRICING VARIES BY COLOR.
SEE SALESPERSON FOR COLOR CHART AND PRICING.



FLOOR, PORCH & TRIM ENAMEL PAINT

◆Gallon. Pack 4.

BUGLER #	SIZE	RESALE	COST
MS368076	PATIO GRAY	\$	\$

Maintenance Cleaners



NO-FUME DRAIN OPENER

Alkaline based drain opener.

- ◆ Won't harm pipes, disposals or porcelain.
- ◆ Contains no phosphates.
- ◆ 1 quart

Pack 12

CE01648

RESALE	COST
\$	\$



BIO BLAST BACTERIAL DIGESTANT

- ◆ For drain line maintenance and odor control.
- ◆ Use with automatic dispensing systems, septic systems, porta toilets, urinals and as an additive to cleaning solutions.

CE01649 - Quart (pack 12)

RESALE	COST
\$	\$

CE01649 - Gallon (pack 4)

RESALE	COST
\$	\$



Special Offer

**Buy 96
cans of Krylon
5-Ball
Spray Paint and
get
10% off
and a
free rack!
(dim. 60" x 24" x 19")**



INDUSTRIAL





BUGLER SALES CORP.

Phone: 516 223-3868 • Fax: 516 868-6998
969 CHURCH STREET • BALDWIN, NY 11510

E-mail: info@buglersales.com

TERMS

ALL PRICES ARE SUBJECT TO CHANGE WITHOUT NOTICE. ALL SHORTAGE CLAIMS MUST BE MADE WITHIN FIVE (5) DAYS. NO material shall be returned without prior authorization. A 20% handling charge will be made to cover inspection, repacking, etc.

Terms are net 30 days. Past due accounts are subject to 1.5% per month late charge. Free freight will be allowed on orders totalling \$750 except where noted with (*) are F.O.B. Baldwin, New York. Minimum order is \$50. Shipments will be made only on the basis of price sheet prevailing at time of shipments.

WARRANTY AND LIMITATIONS

BUGLER SALES WARRANTS TO BUYER THAT THE PRODUCT SOLD SHALL BE FREE OF DEFECTS IN MATERIAL AND WORKMANSHIP AT TIME OF SHIPMENT.

Buyer's sole and exclusive remedy under this warranty is limited to repair and/or replacement, at our option, or any part or parts thereof, which have been returned to us within one year of date of purchase.

We disclaim any liability for incidental or consequential damages which may be incurred either by the buyer or user of Bugler Sales Products. Bugler Sales neither assumes nor authorizes any person to assume for it any obligation in connection with the sale of the product in excess of the above mentioned warranty and remedy.

DISCLAIMER

NO OTHER WARRANTIES OF ANY KIND ARE EXPRESSED OR IMPLIED, AND BUGLER SALES CORP. EXPRESSLY EXCLUDES THE IMPLIED WARRANTIES OF MERCHANTABILITY AND FITNESS FOR A PARTICULAR PURPOSE FROM ANY AND ALL SALES OF ITS PRODUCTS.