



Spec-Setter^{*} Safety Switches



General Electric's Spec Setter safety switches are available for all your disconnect needs, no matter what the application.

GE offers a wide variety of general duty switches for residential and light commercial purposes, while our extensive line of heavy duty switches is best suited for commercial and industrial applications. For the toughest industrial environments – like cement foundries, steel mills and processing plants – mill duty and stainless steel switches are available. We also offer a variety of double throw switches for emergency generators.

No matter what the application, we've got you covered with a rugged, reliable and easy-to-install Spec Setter safety switch. When it comes to getting the job done right, you can count on GE!

GE has a variety of safety switches to fit many applications



General Duty (Type TG)
Pages 4–5



Heavy Duty (Type TH)
Pages 6–9



Stainless Steel (Type TH)
Pages 10-11



Mill Duty (Type TH)
Pages 12-13



Double Throw (Types TC, TDT)
Pages 14-16



Emergency Power
Transfer (Type TC)
Page 17



Accessories Pages 18-24
Dimensions Pages 25-33
Knock Outs Page 34

Spec Setter Safety Switches Product Number Structure

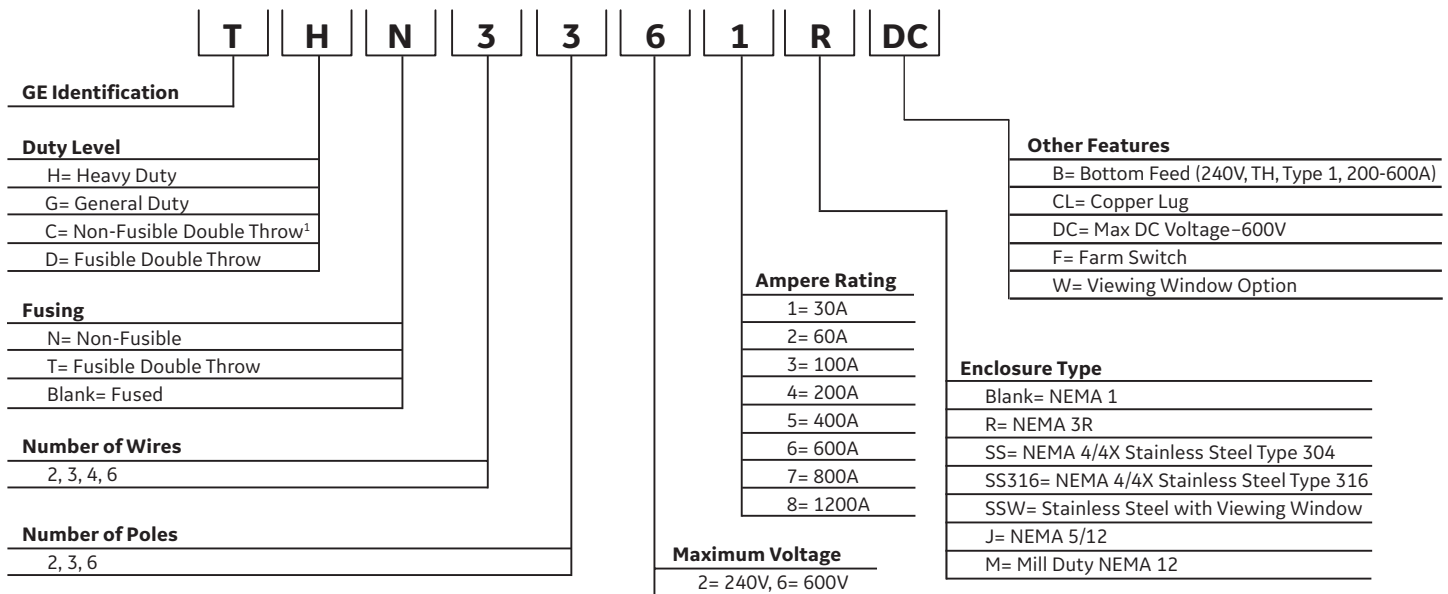

¹800A and 1200A non-double throw safety switches also use the C nomenclature

Note: This information is provided for interpreting numbers. It should not be used to build product numbers.

Applications of Enclosures for Non-Hazardous Locations

Provides a Degree of Protection Against the Following Environmental Conditions	Type of Enclosure					
	1 ²	3R ²	4	4X	5	12
Incidental contact with the enclosed equipment	X	X	X	X	X	X
Falling dirt	X	-	X	X	X	X
Falling liquids and light splashing	-	-	X	X	X	X
Windblown/circulating dust, lint, fibers and flyings ³	-	-	X	X	-	X
Settling airborne dust, lint, fibers and flyings ³	-	-	X	X	X	X
Rain, snow and sleet ⁴	-	X	X	X	-	-
Hosedown and splashing water	-	-	X	X	-	-
Oil and coolant seepage	-	-	-	-	-	X
Corrosive agents	-	-	-	X	-	-

²These enclosures may be ventilated.

³These fibers and flyings are nonhazardous materials and are not considered Class III type ignitable fibers or combustible flyings. For Class III type ignitable fibers or combustible flyings see the National Electrical Code, Article 500.

⁴External operating mechanisms are not required to be operable when the enclosure is ice covered.

General Duty Safety Switches

GE's general duty safety switches are available in 30-600 amps, 240 Vac, 250 Vdc maximum in both fusible and non-fusible units, and in NEMA Type 1 (indoor) and Type 3R (outdoor) enclosures. The UL Listed short-circuit rating is 10,000 rms symmetrical amps as standard. When Class R fuses and fuse kits are installed, 30-200 amp switches have a UL Listed short circuit rating of 100,000 rms symmetrical amps. GE's general duty safety switches are UL Listed as service entrance equipment when installed in accordance with the National Electrical Code.

All GE General Duty safety switches carry the following certifications:

- UL Listed and cUL Listed (UL98 Enclosed Switches/CSA-C22.2 No. 4-04)
- Federal Specification WS-865C
- NEMA Enclosed Safety Switch Standard KS1-2013
- Seismic Certified

Features



60A/Fusible/3 Pole/240V/N1
TG4322

- ✓ 1 Highly visible ON/OFF label
- ✓ 2 Highly visible, easy to grip red handle and accepts 1 padlock in the OFF position
- ✓ 3 Direct-drive, quick-make, quick-break mechanism "snaps" contacts open and closed providing positive ON/OFF indication
- 🔧 4 Unobstructed gutter
- 🔧 5 Self-leveling, three-point mounting system
- ✓ 6 Integral cover interlock
- ✓ 7 Visible confirmation of plated blade contact positions
- ✓ 8 Spring reinforced fuse clips assure reliable contact for cool operation. Suitable for Class H, K, J or R fuses, where applicable





Safety



Ease of Installation
and Maintenance



General Duty Safety Switches

	Amperage Rating	Product Number		Horsepower Rating				DC Hp
		NEMA Type 1 Indoor	NEMA Type 3 Outdoor	Single-Phase 240 Vac		Three-Phase 240 Vac		250 Vdc
				Standard Fuse	Time Delay	Standard Fuse	Time Delay	Standard Fuse
Fusible / 2 Pole / 3 Wire / 240V / 50/60 Hz								
	30	TG3221	TG3221R	1.5	3			5
	60	TG3222	TG3222R	3	10			10
	100	TG3223	TG3223R	7.5	15			20
	200	TG3224 ¹	TG3224R	15	15			
	400	TG3225 ^{1,2}	TG3225R ²					
	600	TG3226 ^{1,2}	TG3226R ²					
Fusible / 3 Pole / 4 Wire / 240V / 50/60 Hz								
	30	TG4321	TG4321R	1.5	3	3	7.5	5
	60	TG4322	TG4322R	3	10	7.5	15	10
	100	TG4323	TG4323R	7.5	15	15	30	20
	200	TG4324 ¹	TG4324R	15	15	25	50	
	400	TG4325 ^{1,2}	⁴			50	100	
	600	TG4326 ^{1,2}	⁴			75	100	

	Amperage Rating	Product Number		Horsepower Rating		DC Hp
		NEMA Type 1 Indoor	NEMA Type 3 Outdoor	Single-Phase	Three-Phase	250 Vdc
				240 Vac Standard		Standard
Non-Fusible / 3 Pole / 3 Wire / 240V / 50 / 60 Hz						
	30	TGN3321	TGN3321R	3	7.5	5
	60	TGN3322 ³	TGN3322R ³	10	15	10
	100	TGN3323 ³	TGN3323R ³	15	30	20
	200	TGN3324 ¹	TGN3324R	15	50	
	400	TGN3325 ^{1,2}	⁴		100	
	600	TGN3326 ^{1,2}	⁴		100	

For Type 3R Enclosure: 30-200 amp devices have removable closing cap. Order hubs for these devices separately on page 23.

Larger amp devices require field cut openings and customer-supplied hub.

General Duty safety switches are not suitable for use as service equipment in Canada. Use Heavy Duty safety switches.

¹Add "B" suffix for factory reversed bottom feed. (e.g., TG3224B.) UL Listed.

²Single make- single break mechanism

³Not suitable for use as service equipment. Solid neutral not available.

⁴NEMA Type 3R Fusible or Non-Fusible versions, 400-600 ampere rating, available in heavy duty, type TH models. See page 7.

General Duty Safety Switch Short Circuit Ratings

Maximum System Voltage	Ampere Rating	UL Listed Fusing		Enclosure Type
		Class	Withstand Rating (rms Sym Amps)	
Fusible				
240 Vac 250 Vdc	30-600	K	10,000	N1 N3R
		H	10,000	
		R ⁵	100,000	
Non-Fusible: Fuse withstand ratings apply to non-fused switches when protected by an upstream fuse as listed				
240 Vac 250 Vdc	30-600	No upstream protection	10,000	N1 N3R
		K upstream	10,000	
		H upstream	10,000	
		R upstream	100,000	

⁵Class R fuse is not available for 400A or 600A General Duty switches.



Lug Wire Sizes Line and Load Terminals

Ampere Rating	Wire Range AWG/kcmil Copper	Wire Range AWG/kcmil Aluminum
30A (250V)	14-8	12-8
30A (600V)	12-2	12-2
60A	12-2	12-2
100A	10-1/0	10-1/0
200A	2-250	2-250
400A	(1) 2-800 or (2) 1/0-250	(1) 2-800 or (2) 1/0-250
600A	(2) 4-500	(2) 4-500

Heavy Duty Safety Switches

GE's Type TH heavy duty safety switches are designed for commercial and industrial applications where safety, high performance and continuity of service are essential. Heavy duty switches are available in 30-1200 amps, 600 Vac, 600 Vdc maximum, fusible and non-fusible units, and in NEMA Type 1 (indoor), Type 3R (outdoor), Type 4/4X (water and dust-tight, corrosion resistant), and Type 5/12 (drip and dust-tight) enclosures. When used with Class R or J fuses, 30-600 amp switches have a UL Listed short-circuit rating of 200,000 rms symmetrical amps. Switches rated 800-1200 amps use Class L fuses and have a UL Listed short circuit rating of 100,000 rms symmetrical amps. GE's heavy duty safety switches are UL Listed as service entrance equipment when installed in accordance with the National Electrical Code.

All GE Heavy Duty safety switches carry the following certifications:

- UL Listed and cUL Listed (UL98 Enclosed Switches/CSA-C22.2 No. 4-04)
- Federal Specification WS-865C
- NEMA Enclosed Safety Switch Standard KS1-2013
- Seismic Certified

Features

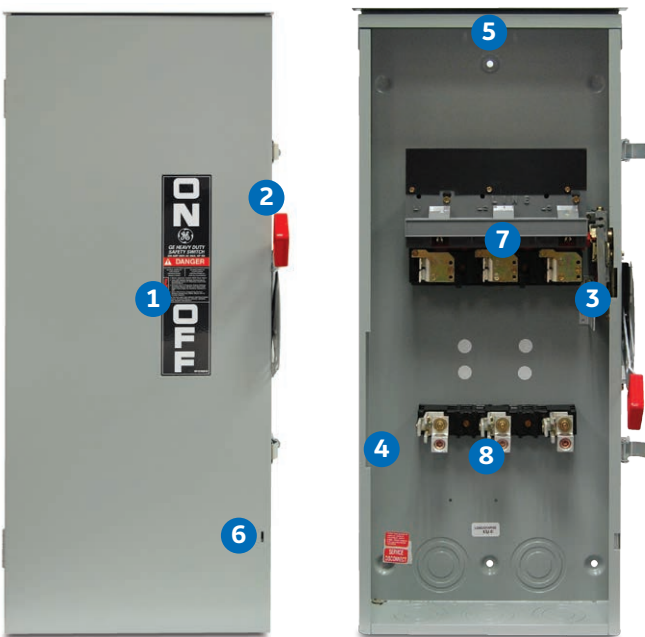

200A/Fusible/3 Pole/600V/N3R
TH3364R

- ✓ 1 Highly visible ON/OFF label
 - ✓ 2 Donut handle ideal for hook stick operation and accepts 3 padlocks in the OFF position
 - ✓ 3 Direct-drive, quick-make, quick-break mechanism "snaps" contacts open and closed providing positive ON/OFF indication
 - ✓ 4 Wide, unobstructed gutter
 - 🔧 5 Self-leveling, three-point mounting system
 - 🔧 6 Coin-proof, defeatable interlock
 - ✓ 7 Visible confirmation of plated blade contact positions
 - ✓ 8 Spring reinforced fuse clips assure reliable contact for cool operation. Suitable for Class H, K, J or R fuses, where applicable
- ✓ Safety 🔧 Ease of Installation and Maintenance



Heavy Duty Safety Switches

Fusible

	Amperage Rating	Product Number			Horsepower Rating				DC Hp
		NEMA Type 1 Indoor	NEMA Type 3R Outdoor	NEMA Type 5, 12	Single-Phase 240 Vac		Three-Phase 240 Vac		250 Vdc
					Standard Fuse	Time Delay	Standard Fuse	Time Delay	Standard Fuse
Fusible / 2 Pole / 3 Wire / 240V / 50/60 Hz									
	30	TH3221	TH3221R	TH3221J ⁴	1.5	3			5
	60	TH3222	TH3222R	TH3222J ⁴	3	10			10
	100	TH3223	TH3223R	TH3223J ⁴	7.5	15			20
	200	TH3224 ^{1,2}	TH3224R ²	TH3224J ⁴	15				40
	400	TH3225 ^{1,2}	TH3225R ²	TH3225J					50
	600	TH3226 ^{1,2}	TH3226R ²	TH3226J					50
	800	3	3						
1200	3	3							

	Amperage Rating	Product Number			Horsepower Rating				DC Hp
		NEMA Type 1 Indoor	NEMA Type 3R Outdoor	NEMA Type 5, 12	Single-Phase 240 Vac		Three-Phase 240 Vac		250 Vdc
					Standard Fuse	Time Delay	Standard Fuse	Time Delay	Standard Fuse
Fusible / 3 Pole / 3 Wire / 240V / 50/60 Hz									
	30			TH3321J ⁴	1.5	3	3	7.5	5
	60			TH3322J ⁴	3	10	7.5	15	10
	400	TH3325 ¹	TH3325R				50	125	50
	600	TH3326 ¹	TH3326R				75	200	50

	Amperage Rating	Product Number			Horsepower Rating				DC Hp
		NEMA Type 1 Indoor	NEMA Type 3R Outdoor	NEMA Type 5, 12	Single-Phase 240 Vac		Three-Phase 240 Vac		250 Vdc
					Standard Fuse	Time Delay	Standard Fuse	Time Delay	Standard Fuse
Fusible / 3 Pole / 4 Wire / 240V / 50/60 Hz									
	30	TH4321	TH4321R	TH4321J ⁴	1.5	3	3	7.5	5
	60	TH4322	TH4322R	TH4322J ⁴	3	10	7.5	15	10
	100	TH4323	TH4323R	TH4323J ⁴	7.5	15	15	30	20
	200	TH4324 ^{1,2}	TH4324R ²	TH4324J ⁴	15		25	60	40
	400	TH4325 ^{1,2}	⁵	TH4325J			50	125	50
	600	TH4326 ^{1,2}	⁵	TH4326J			75	200	50

	Amperage Rating	Product Number		Horsepower Rating				DC Hp
		NEMA Type 1, 3R, 5, 12 Indoor/Outdoor		Single-Phase 240 Vac		Three-Phase 240 Vac		250 Vdc
				Standard Fuse	Time Delay	Standard Fuse	Time Delay	Standard Fuse
Fusible / 6 Pole / 6 Wire / 240V / 50/60 Hz								
	30	TH6621		1.5	3	3	7.5	5
	60	TH6622		3	10	7.5	15	10
	100	TH6623		7.5	15	15	30	20
	200	TH6624		15		25	60	40

¹Type 1 Enclosure: 200-600 Amp devices available factory reversed for bottom feed. Add "B" suffix.

²For switches CSA Certified for service entrance, add "C" suffix.

³For switches suitable for service entrance applications in Canada, order TH3267C, TH3267RC, TH3268C and TH3268RC.

⁴Available with Viewing Window. Add "W" suffix.

⁵For switches suitable for service entrance applications in Canada, order TH4325RC and TH4326RC.

Note: Many Heavy Duty Switches are available with a Stainless Steel enclosure. See page 11.



60A/Fusible/
3 Pole/240V/ N1
TH4322



200A/Fusible/
3 Pole/600V/ N3R
TH3364R



30A/Fusible/
3 Pole/600V/ N3R
TH3361R

Heavy Duty Safety Switches (continued)

Fusible

	Amperage Rating	Product Number		Horsepower Rating										DC Hp	
		NEMA Type 1 Indoor	NEMA Type 3R Outdoor	Three-Phase 240 Vac		Single-Phase 480 Vac		Three-Phase 480 Vac		Single-Phase 600 Vac		Three-Phase 600 Vac		125 Vdc	250 Vdc
				Standard Fuse	Time Delay	Standard Fuse	Time Delay	Standard Fuse	Time Delay	Standard Fuse	Time Delay	Standard Fuse	Time Delay	Standard Fuse	

Fusible / 2 Pole / 2 Wire¹ / 600V / 50/60 Hz

	800	TC72267 ^{2,3}	TC72267R ^{2,3}													
	1200	TC72268 ^{2,3}	TC72268R ^{2,3}													

Fusible / 3 Pole / 3 Wire / 600V / 50/60 Hz

	30	TH3361	TH3361R		7.5	3	7.5	5	15	3	10	7.5	20		5
			TH3361RF ⁶												
			TH3361RF2 ⁶												
	60	TH3362	TH3362R		5	20	15	30	10	25	15	50	5	10	
			TH3362RF ⁶												
	100	TH3363	TH3363R		10	30	25	60	15	40	30	75		20	
	200	TH3364 ⁴	TH3364R ⁷		25	50	50	125	30	50	60	150		40	
	400	TH3365 ⁴	TH3365R	50	125			100	250			125	350		50
600	TH3366 ⁴	TH3366R	75	200			150	400			200	500		50	
800	TC72367 ^{2,3,5}	TC72367R ^{3,5}													
1200	TC72368 ^{2,3,5}	TC72368R ^{3,5}													

Fusible / 3 Pole / 4 Wire / 600V / 50/60 Hz CSA Certified for service entrance

	200	TH4364C	TH4364RC			25	50	50	125	30	50	60	150		40
	400	TH4365C	TH4365RC	50	125			100	250			125	350		50
	600	TH4366C	TH4366RC	75	200			150	400			200	500		50
	800	TH4367C	TH4367RC												
	1200	TH4368C	TH4368RC												

	Amperage Rating	Product Number		Horsepower Rating										DC Hp	
		NEMA Type 5, 12 Indoor	NEMA Type 3R, 5, 12 Outdoor	Three-Phase 240 Vac		Single-Phase 480 Vac		Three-Phase 480 Vac		Single-Phase 600 Vac		Three-Phase 600 Vac		125 Vdc	250 Vdc
				Standard Fuse	Time Delay	Standard Fuse	Time Delay	Standard Fuse	Time Delay	Standard Fuse	Time Delay	Standard Fuse	Time Delay	Standard Fuse	

Fusible / 3 Pole / 3 Wire / 600V / 50/60 Hz

	30	TH3361J ⁷	TH3361JR		7.5	3	7.5	5	15	3	10	7.5	20		5
	60	TH3362J ⁷	TH3362JR			5	20	15	30	10	25	15	50	5	10
	100	TH3363J ⁷	TH3363JR			10	30	25	60	15	40	30	75		20
	200	TH3364J ⁷	TH3364JR			25	50	50	125	30	50	60	150		40
	400	TH3365J	TH3365JR	50	125			100	250			125	350		50
	600	TH3366J	TH3366JR	75	200			150	400			200	500		50

	Amperage Rating	Product Number		Horsepower Rating								DC Hp	
		NEMA Type 1, 3R, 5, 12 Indoor/Outdoor		Single-Phase 480 Vac		Three-Phase 480 Vac		Single-Phase 600 Vac		Three-Phase 600 Vac		250 Vdc	
				Standard Fuse	Time Delay	Standard Fuse	Time Delay	Standard Fuse	Time Delay	Standard Fuse	Time Delay	Standard Fuse	

Fusible / 6 Pole / 6 Wire / 600V / 50/60 Hz

	30	TH6661		3	7.5	5	15	3	10	7.5	20		5
	60	TH6662		5	20	15	30	10	25	15	50		10
	100	TH6663		10	30	25	60	15	40	30	75		20
	200	TH6664		25	50	50	125	30	50	60	150		40

	Amperage Rating	Product Number		Receptacle Manufacturer	Mating Receptacle	Horsepower Rating
		NEMA Type 5, 12 Indoor				

Fusible / 3 Pole / 3 Wire / 600V / 50/60 Hz

60		TH3362JCH		Crouse Hinds	Arktite #APJ6485	For horsepower ratings, see switch without "CH" suffix.
----	--	-----------	--	--------------	------------------	---------------------------------------------------------

Non-Fusible / 3 Pole / 3 Wire / 600V / 50/60 Hz

60		THN3362JCH		Crouse Hinds	Arktite #APJ6485	For horsepower ratings, see switch without "CH" suffix.
----	--	------------	--	--------------	------------------	---------------------------------------------------------

¹3 wire with neutral kit. For 800A use TNI67; for 1200A use TNI68A.

²Rated 600 Vac only. Accepts Class L fuses only. Type HD electrical performance does not apply.

³Order switch and neutral separately.

⁴Type 1 Enclosure: 200-600 Amp devices available, factory reversed for bottom feed. Add "B" suffix.



⁵4 wire with neutral kit. For 800A use TNI67; for 1200A use TNI68A.

⁶Farm Switch with oversize Type 3R enclosure with vertical hinge. See page 27 for dimensions.

⁷Available with Viewing Window. Add "W" suffix.

Heavy Duty Safety Switches (continued)

Non-Fusible

	Amperage Rating	Product Number			Horsepower Rating						DC Hp
		NEMA Type 1 Indoor	NEMA Type 3R Outdoor	NEMA Type 5, 12	Single-Phase	Three-Phase	Single-Phase	Three-Phase	Single-Phase	Three-Phase	250 Vdc
					240 Vac Standard		480 Vac Standard		600 Vac Standard		Standard
Non-Fusible / 3 Pole / 3 Wire / 240V / 50/60 Hz											
	30	THN3321			3	10					5
Non-Fusible / 3 Pole / 3 Wire / 600V / 50/60 Hz											
	30	THN3361 ²	THN3361R	THN3361J ^{2,3}	3	10	7.5	20	10	30	5
			TH3361RF ⁴								
	60	THN3362 ²	THN3362R	THN3362J ^{2,3}	10	20	20	50	25	60	103
			THN3362RF ⁴								
	100	THN3363 ²	THN3363R	THN3363J ^{2,3}	20	40	30	75	40	100	20
	200	THN3364 ^{1,2}	THN3364R	THN3364J ³	30	60	50	125	50	150	40
	400	THN3365 ¹	THN3365R	THN3365J		125		250		350	50
	600	THN3366 ¹	THN3366R	THN3366J		200		400		500	50
800	TC36367										
1200	TC36368										
Non-Fusible / 6 Pole / 6 Wire / 600V / 50/60 Hz											
	30		THN6661		3	7.5		15	10	20	5
	60		THN6662		10	20		30	25	50	10
	100		THN6663		15	30		60	40	75	20
	200		THN6664		15	50		125	50	150	40



¹Type 1 Enclosure: 200-600 Amp devices available factory reversed for bottom feed. Add "B" suffix.

²Available with Copper Lug. Add "CL" suffix

³Available with Viewing Window. Add "W" suffix.

⁴Farm switch with oversize Type 3R enclosure and vertical hinge. See page 27 for dimensions.

DC Rated Heavy Duty Safety Switches

	Amperage Rating	Product Number			DC Horsepower Ratings				
		NEMA Type 1 Indoor	NEMA Type 3R Outdoor	NEMA Type 5, 12	125 Vdc		250 Vdc	600 Vdc	
					Standard Fuse	Time Delay	Standard Fuse	Standard Fuse	Time Delay
Fusible / 2 Pole / 2 Wire / 600Vdc / 50/60 Hz									
	30	TH2261DC	TH2261RDC	TH2261JDC	2	3	5	10	15
	60	TH2262DC	TH2262RDC	TH2262JDC	5		10	25	
	100	TH2263DC	TH2263RDC	TH2263JDC			20	25	
Non-Fusible / 2 Pole / 2 Wire / 600Vdc / 50/60 Hz									
	30	THN2261DC	THN2261RDC	THN2261JDC	3		5	15	
	60	THN2262DC	THN2262RDC	THN2262JDC	5		10	25	
	100	THN2263DC	THN2263RDC	THN2263JDC			20	25	

Heavy Duty Safety Switch Short Circuit Ratings

Maximum System Voltage	Ampere Rating	UL Listed Fusing		Enclosure Type
		Class	Withstand Rating (rms Sym Amps)	
Fusible				
600 Vac 600 Vdc	30-1200	H	10,000	N1
		R	200,000 ⁶	N3R
		J	200,000 ⁶	N4/4X
		L ⁵	100,000	N5 N12
Non-Fusible: Fuse withstand ratings apply to non-fused switches when protected by an upstream fuse as listed				
600 Vac 600 Vdc	30-1200	No upstream protection	10,000	N1
		H upstream	10,000	N3R
		R upstream	200,000	N4/4X
		J upstream	200,000	N5
		L upstream	100,000	N12

⁵Class L fuses are only applicable when used with 800 and 1200A Type TC safety switches.

⁶Unless otherwise noted on the enclosure

Lug Wire Sizes Line and Load Terminals

Ampere Rating	Wire Range AWG/kcmil Copper	Wire Range AWG/kcmil Aluminum
30A (250V)	14-8	12-8
30A (600V)	12-2	12-2
60A	12-2	12-2
100A	10-1/0	10-1/0
200A	2-250	2-250
400A	(1) 2-600 or (2) 1/0-250	(1) 2-600 or (2) 1/0-250
600A	(2) 4-500	(2) 4-500
800A	(3) 2-600 or (6) 1/0-250	(3) 2-600 or (6) 1/0-250
1200A	(4) 3/0-800	(4) 3/0-800



Heavy Duty Stainless Steel Safety Switches

GE's Stainless Steel safety switches are designed for commercial and industrial applications in corrosive environments where safety, high performance and continuity of service are essential. They are suitable for use as service equipment. The conductor rating is 60/75°C. Horsepower ratings are to UL Listed maximums. Short circuit ratings are UL Listed to 200,000 rms symmetrical amps when Class J or R fuses are installed.

We offer two types of NEMA 4X enclosures:









- Grade 304 stainless steel (order product numbers with SS suffix)
- Grade 316 stainless steel (order product numbers with SS316 suffix)

All GE Heavy Duty stainless steel safety switches carry the following certifications:

- UL Listed and cUL Listed (UL98 Enclosed Switches/CSA-C22.2 No. 4-04)
- Federal Specification WS-865C
- NEMA Enclosed Safety Switch Standard KS1-2013
- Seismic Certified

Features





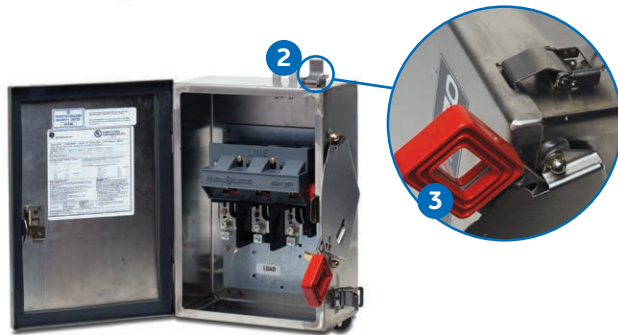



-  **1** Highly visible ON/OFF label
 -  **2** Over-center latching system
 -  **3** Donut handle ideal for hook stick operation and accepts 3 padlocks in the OFF position
 -  **4** Three or four welded mounting brackets
 -  **5** Wide, unobstructed side wiring gutter
 -  **6** Easily removable cover
 -  **7** Spring reinforced fuse clips assure reliable contact for cool operation. Suitable for Class H, K, J or R fuses (not displayed)
-  Safety  Ease of Installation and Maintenance





Heavy Duty Stainless Steel Safety Switches

NEMA Type 4X Enclosure Grade 304 Stainless Steel (see footnote below for 316 Stainless Steel offering)

	Amperage	Product Number	Horsepower Ratings				DC Horsepower Ratings	
			Single-Phase 240 Vac		Three-Phase 240 Vac		250 Vdc	
			Standard Fuse	Time Delay	Standard Fuse	Time Delay	Standard Fuse	
Fusible / 2 Pole / 3 Wire / 240V / 50/60 Hz								
	30	TH2221SS ^{1,2}	1.5	3				5
	60	TH2222SS ^{1,2}	3	10				10
Fusible / 2 Pole / 3 Wire / 240V / 50/60 Hz								
	30	TH3221SS ^{1,2}	1.5	3				5
	60	TH3222SS ^{1,2}	3	10				10
	100	TH3223SS ^{1,2}	7.5	15				20
	200	TH3224SS ^{1,2}	15					40
	400	TH3225SS						50
	600	TH3226SS						50
Fusible / 3 Pole / 3 Wire / 240V / 50/60 Hz								
	30	TH3321SS ^{1,2}	1.5	3	3	7.5		5
	60	TH3322SS ^{1,2}	3	10	7.5	15		10
Fusible / 3 Pole / 4 Wire / 240V / 50/60 Hz								
	30	TH4321SS ^{1,2}	1.5	3	3	7.5		5
	60	TH4322SS ^{1,2}	3	10	7.5	15		10
	100	TH4323SS ^{1,2}	7.5	15	15	30		20
	200	TH4324SS ^{1,2}	15		25	60		40
	400	TH4325SS			50	125		50
	600	TH4326SS			75	200		50

	Amperage	Product Number	Horsepower Ratings										DC Horsepower Ratings		
			Three-Phase 240 Vac		Single-Phase 480 Vac		Three-Phase 480 Vac		Single-Phase 600 Vac		Three-Phase 600 Vac		125 Vdc		250 Vdc
			Std Fuse	Time Delay	Std Fuse	Time Delay	Std Fuse	Time Delay	Std Fuse	Time Delay	Std Fuse	Time Delay	Std Fuse	Time Delay	Std Fuse
Fusible / 3 Pole / 3 Wire / 600V / 50/60 Hz															
	30	TH3361SS ^{1,2,4}		7.5	3	7.5	5	15	3	10	7.5	20	2	3	5
	60	TH3362SS ^{1,2,4}			5	20	15	30	10	25	15	50	5		10
	100	TH3363SS ^{1,2,4}			10	30	25	60	15	40	30	75			20
	200	TH3364SS ^{1,2,4}			25	50	50	125	30	50	60	150			40
	400	TH3365SS ⁴	50	125			100	250			125	350			50
	600	TH3366SS ⁴	75	200			150	400			200	500			50
Non-Fusible / 3 Pole / 3 Wire / 600V / 50/60 Hz															
	30	THN3361SS ^{1,2,3,4}	10		7.5		20		10		30		3		5
	60	THN3362SS ^{1,2,3,4}	20		20		50		25		60		5		10
	100	THN3363SS ^{1,2,4}	40		30		75		40		100				20
	200	THN3364SS ^{1,2,3,4}	60		50		125		50		150				40
	400	THN3365SS ⁴	125				250				350				50
	600	THN3366SS ⁴	200				400				500				50

DC Rated Heavy Duty Stainless Steel Safety Switches

	Amperage	Product Number	DC Horsepower Ratings					
			125 Vdc		250 Vdc		600 Vdc	
			Standard Fuse	Time Delay	Standard Fuse	Time Delay	Standard Fuse	Time Delay
Fusible / 2 Pole / 2 Wire / 600Vdc / 50/60 Hz								
	30	TH2261SSDC	2	3	5		10	15
	60	TH2262SSDC	5		10		25	
	100	TH2263SSDC			20		25	
Non-Fusible / 2 Pole / 2 Wire / 600Vdc / 50/60 Hz								
	30	THN2261SSDC	3		5		15	
	60	THN2262SSDC	5		10		25	
	100	THN2263SSDC			20		25	

¹For switches manufactured in the USA, add BA suffix.

²Available with Viewing Window - add W suffix

³Available with Copper Lugs - add CL suffix

⁴Available in NEMA Type 4X Enclosure Grade 316 Stainless Steel - add "316" suffix.

Selected Double Throw safety switches available in stainless steel. Refer to pages 14-16.

Note: See page 9 for Short Circuit Ratings and Lug Wire Sizes Line and Load Terminals.

Mill Duty Safety Switches

GE's Mill Duty safety switches are designed for mill, foundry and industrial applications where safety, high performance and continuity of service are required. A standard NEMA 12 enclosure protects the interior from dust, lint, fibers, coolants, metal filings and other non-corrosive contaminants. The stainless steel NEMA 4/4X enclosure additionally shields the interior from hose directed water, splashing and falling liquids. Interlocks on all enclosure covers assure gasket compression before the switch can be turned ON. These switches are suitable for use as service entrance equipment when installed in accordance with the National Electric Code.









Mill Duty switches are available in 30-600 amps, 600 Vac, 600 Vdc maximum, fusible and non-fusible units, and in NEMA Type 4/4X (water and dust-tight, corrosion resistant) and Type 12 (drip and dust-tight) enclosures. Horsepower ratings are to UL Listed maximums. Short circuit ratings are UL Listed to 200,000 rms symmetrical amps when Class J or R fuses are installed.

All GE Mill Duty safety switches carry the following certifications:

- UL Listed and cUL Listed (UL98 Enclosed Switches/CSA-C22.2 No. 4-04)
- Federal Specification WS-865C
- NEMA Enclosed Safety Switch Standard KS1-2013
- Seismic Certified

Features



-  **1** Highly visible ON/OFF label
-  **2** Donut handle ideal for hook stick operation and accepts 3 padlocks in the OFF position
-  **3** Manual interlock defeat knob permits contact inspection when switch is OFF
-  **4** Three or four point mounting brackets
-  **5** Unobstructed side wiring gutter
-  **6** Easily removable cover
-  **7** Spring reinforced fuse clips assure reliable contact for cool operation. Suitable for Class H, K, J or R fuses
-  **8** Equipment ground lugs provided. Lugs approved for both copper and aluminum wire; 60/75° C rated tang lugs are field convertible to compression (crimp) connectors



Safety



Ease of Installation and Maintenance



Mill Duty Safety Switches

Amperage Rating	Product Number ²		Horsepower Rating				DC Horsepower Rating	
	NEMA Type 12	NEMA Type 4X Grade 304 Stainless Steel	Single-Phase 240 Vac		Three-Phase 240 Vac		250 Vdc	
			Standard Fuse	Time Delay	Standard Fuse	Time Delay	Standard Fuse	
Fusible / 2 Pole / 240V / 50/60 Hz								
30	TH2221M	TH2221MSS	1.5	3				5
60	TH2222M	TH2222MSS	3	10				10
100	TH2223M	TH2223MSS	7.5	15				10
200	TH2224M	TH2224MSS	15					40
Fusible / 3 Pole / 240V / 50/60 Hz								
30	TH3321M	TH3321MSS	1.5	3	3	7.5		5
60	TH3322M ¹	TH3322MSS	3	10	7.5	15		10
100	TH3323M	TH3323MSS	7.5	15	15	30		20
200	TH3324M	TH3324MSS	15		25	60		40
400	TH3325M	TH3325MSS			50	125		50
600	TH3326M	TH3326MSS			75	200		50

Amperage Rating	Product Number ²		Horsepower Rating										DC Horsepower Rating		
	NEMA Type 12	NEMA Type 4X Grade 304 Stainless Steel	Three-Phase 240 Vac		Single-Phase 480 Vac		Three-Phase 480 Vac		Single-Phase 600 Vac		Three-Phase 600 Vac		125 Vdc		250 Vdc
			Standard Fuse	Time Delay	Standard Fuse	Time Delay	Standard Fuse	Time Delay	Standard Fuse	Time Delay	Standard Fuse	Time Delay	Standard Fuse	Time Delay	Standard Fuse
Fusible / 3 Pole / 600V / 50/60 Hz															
30	TH3361M ¹	TH3361MSS		7.5	5	7.5	5	15	3	10	7.5	20	2	3	5
60	TH3362M	TH3362MSS ¹			5	20	15	30	10	25	15	50	5		10
100	TH3363M	TH3363MSS			10	30	25	60	15	40	30	75			20
200	TH3364M	TH3364MSS			25	50	50	125	30	50	60	150			40
400	TH3365M	TH3365MSS	50	125			100	250			125	350			50
600	TH3366M	TH3366MSS	75	200			150	400			200	500			50
Non-Fusible / 3 Pole / 600V / 50/60 Hz															
30	THN3361M	THN3361MSS ¹	10		7.5		20		10		30				5
60	THN3362M ¹	THN3362MSS	20		20		50		25		60				10
100	THN3363M	THN3363MSS	40		30		75		40		100				20
200	THN3364M	THN3364MSS	60		50		125		50		150				40
400	THN3365M	THN3365MSS	125				250				350				50
600	THN3366M	THN3366MSS	200				400				500				50

DC Rated Mill Duty Safety Switches

Amperage Rating	Product Number ²		Horsepower Rating					
	NEMA Type 12		125 Vdc		250 Vdc		600 Vdc	
			Standard Fuse	Time Delay	Standard Fuse	Time Delay	Standard Fuse	Time Delay
Fusible / 2 Pole / 600Vdc / 50/60 Hz								
30	TH2261MDC		2	3	5		10	15
60	TH2262MDC		5		10		25	
100	TH2263MDC				20		25	
Non-Fusible / 2 Pole / 600Vdc / 50/60 Hz								
30	THN2261MDC		3		5		15	
60	THN2262MDC		5		10		25	
100	THN2263MDC				20		25	

¹Available with Viewing Window - add W suffix.

²All Mill Duty switches accept neutral and auxiliary contact kits. Order from page 20.

Type TH Interrupting and Withstand Ratings

Ampere Rating	Interrupting Rating Amps ³ Symmetrical 600 volts AC, 3-phase	Fuse Clearing ⁴ (I ² t x 10 ³)
30A	360	50
60A	1200	200
100A	1200	500
200A	3,400	2,000
400A	10,000	6,000
600A	10,000	12,000

³Maximum current at rated voltage that switch will interrupt three times without assistance from an external device.

⁴Peak let-through energy for withstandability and circuit closing tests.

Lug Wire Sizes Line and Load Terminals

Ampere Rating	Wire Range AWG/kcmil Copper	Wire Range AWG/kcmil Aluminum
30A (240V)	14-8	12-8
30A (600V)	14-6	14-6
60A	14-2	14-2
100A	14-1/0	12-1/0
200A	2-250	-
400A	(1) 2-600 or (2) 1/0-250	-
600A	(2) 4-600	-

Double Throw Safety Switches

GE's Double Throw safety switches are designed for applications where safety, high performance and continuity of service are required. Double Throw Safety Switches are used for switching one load between two different power sources. Applications include commercial buildings, healthcare facilities, manufacturing/mining and more.

Our Double Throw safety switches meet the following standards:

- UL Listed and cUL Listed (UL98 Enclosed Switches/CSA-C22.2 No. 4-04)
- Federal Specification W-S-865C
- NEMA Enclosed Switch Standard KS1 – 2013
- Seismic Certified

Features

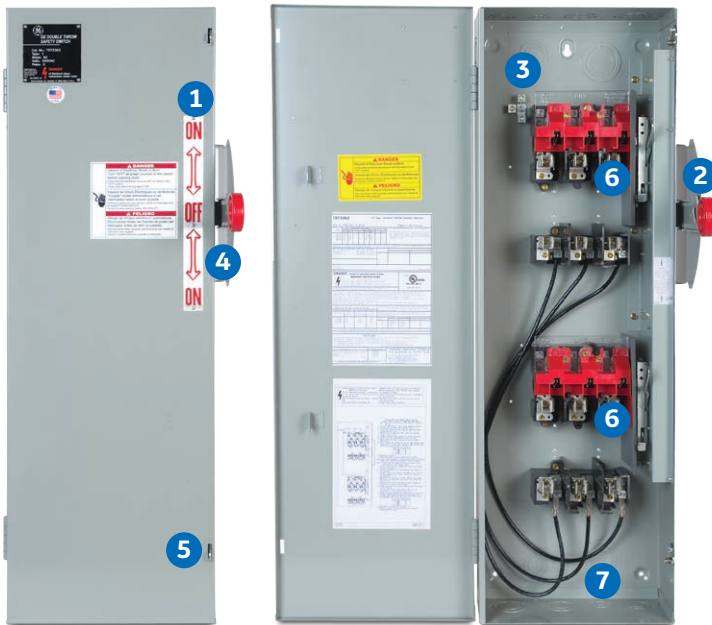

- 1 Highly visible ON/OFF label
- 2 Bright red handle
- 3 Self-leveling three point mounting pattern
- 4 Lockable three position (ON-OFF-ON) handle
- 5 Lockable cover latch
- 6 Quick-make, quick-break mechanisms 30-1200 amps
- 7 Ample wire bending space
- 8 Use of common fuses in stacked design; fewer fuses required and reduced enclosure size: 600-1200A (not displayed)



Safety



Ease of Installation and Maintenance

60A/Fusible/3 Pole/600V/N1
TDT3362

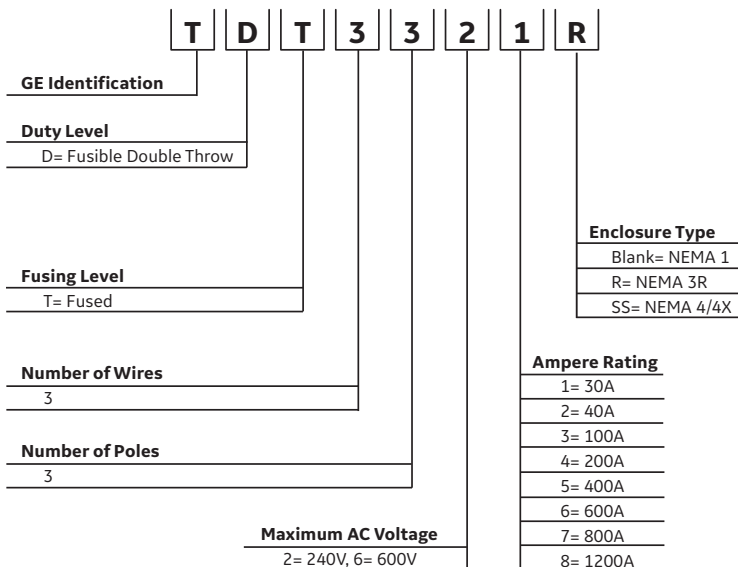

Double Throw Safety Switches

Fusible

Amperage Rating	Product Number		Horsepower Rating												DC Horsepower Rating						
	NEMA Type 1 Indoor	NEMA Type 3R Outdoor	Single-Phase				Three-Phase								125 Vdc		250 Vdc				
			120 Vac		240 Vac		120 Vac		240 Vac		480 Vac		600 Vac		Std Fuse	Time Delay	Std Fuse	Time Delay			
			Std Fuse	Time Delay	Std Fuse	Time Delay	Std Fuse	Time Delay	Std Fuse	Time Delay	Std Fuse	Time Delay	Std Fuse	Time Delay							
Fusible / 3 Pole / 3 Wire / 240V																					
30	TDT3321	TDT3321R	0.5	2	1.5	3	1.5	3	3	7.5								2	3	5	5
60	TDT3322	TDT3322R	1.5	3	3	10	3	7.5	7.5	15								5		10	10
100	TDT3323 ¹	TDT3323R ¹			7.5	15			15	30										20	
200	TDT3324 ¹	TDT3324R ¹			15	15			25	60										40	40
400	TDT3325 ¹	TDT3325R ¹							50	125										50	
600	TDT3326 ^{3,4}	TDT3326R ^{3,4}							50	125	100	250	125	350						50	50
800	TDT3327 ^{3,4}	TDT3327R ^{3,4}							100	125											
1200	TDT3328 ⁴	TDT3328R ⁴																			

Amperage Rating	Product Number			Horsepower Rating												DC Horsepower Rating								
	NEMA Type 1 Indoor	NEMA Type 3R Outdoor	NEMA Type 4X Stainless Steel	Single-Phase				Three-Phase								125 Vdc		250 Vdc						
				120 Vac		240 Vac		480 Vac		600 Vac		120 Vac		240 Vac		480 Vac		600 Vac		Time Delay	Std Fuse	Time Delay	Std Fuse	Time Delay
				Std Fuse	Time Delay	Std Fuse	Time Delay	Std Fuse	Time Delay	Std Fuse	Time Delay	Std Fuse	Time Delay	Std Fuse	Time Delay	Std Fuse	Time Delay	Std Fuse	Time Delay					
Fusible / 3 Pole / 3 Wire / 600V																								
30	TDT3361	TDT3361R	TDT3361SS	0.5	2			3	7.5	3	10	1.5	3	3	7.5	5	15	7.5	20	3		5		
60	TDT3362 ¹	TDT3362R ¹	TDT3362SS ¹	1.5	3	3	10	5	20	10	25	3	7.5	7.5	15	15	30	15	50	5		10		
100	TDT3363 ¹	TDT3363R ¹	TDT3363SS ¹			7.5	15	10	30	15	40			15	30	25	60	30	75			20		
200	TDT3364 ¹	TDT3364R ¹	TDT3364SS ¹			15	15	25	50	30	50			25	25	50	125	60	150			40		
400	TDT3365 ²	TDT3365R ²	TDT3365SS ²											50	125	100	250	125	350			50		
600	TDT3366 ^{3,4}	TDT3366R ^{3,4}												50	125	100	250	125	350			50		
800	TDT3367 ^{3,4}	TDT3367R ^{3,4}												100	125	200	250	250	350					
1200	TDT3368 ⁴	TDT3368R ⁴																						

¹Class J fuse option available when load base is moved.

²400 Amp at 600V switches available with Class T fuse provision only.

³Field convertible to Class T.

⁴Stacked design requiring only one set of fuses (Class L).

Double Throw Safety Switch Short Circuit Ratings

Maximum System Voltage	Ampere Rating	UL Listed Fusing		Enclosure Type
		Class	Withstand Rating (rms Sym Amps)	
Fusible				
600 Vac	30-1200	R	100,000	N1 N3R N4X
		J	100,000	
		T	100,000	
		L	100,000	
Non-Fusible: Fuse withstand ratings apply to non-fused switches when protected by an upstream fuse as listed				
600 Vac	30-1200	No upstream protection	10,000	N1 N3R N4X
		R upstream	100,000	
		J upstream	100,000	
		T upstream	100,000	
		L upstream	100,000	

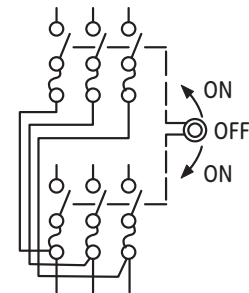

Fusible / 3 Pole / 3 Wire / 240 V

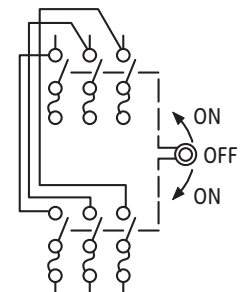

Fusible / 3 Pole / 3 Wire / 600 V

Lug Wire Sizes Line and Load Terminals

Ampere Rating	Wire Range AWG/kcmil Cu/Al
30	14-2
60	14-1/0
100	14-1/0
200	6-250
400	(2) 1/0-(2) 300 or (1) 1/0-(1) 750 ⁵
600	(1) 2-(1) 600 or (1) 1/0-(1) 750 ⁶
800	(3) 250-(3) 500
1200	(4) 1/0-(4) 750

⁵Single barrel lug that accepts one or two cables per phase as detailed above.

⁶Double barrel lug that accepts two cables per phase as detailed above.

Double Throw Safety Switches (continued)

Non-Fusible

Amperage Rating	Product Number			Horsepower Rating			DC Horsepower Rating		Lug Wire Sizes Line and Load Terminals
	NEMA Type 1 Indoor	NEMA Type 3R Outdoor	NEMA Type 4X Stainless Steel	Three-Phase			125 Vdc	250 Vdc	AWG/kcmil
				240 Vac	480 Vac	600 Vac			
Non-Fusible / 3 Pole / 3 Wire / 240V / 50/60 Hz									
30	TC35321	TC35321R		2					14-8 (Cu)
60	TC35322	TC35322R		3					14-4 (Cu)
100	TC35323	TC35323R		7.5					14-1/0 (Cu)
200	TC35324	TC35324R		15					6-250 (Cu)
400	TC35325	TC35325R		30					(2) 1/0-250 (Cu) or 2-600 (Cu)
600	TC35326 ²			50					(2) 3/0-350 (Cu) or 2-600 (Cu)
		TC35326R		125	250	350		50	(2) 250 - (2) 500 (Cu/Al)
800	TC35327 ⁴	TC35327R ⁴		125					(3) 250 - (3) 500 (Cu/Al)
1200	TC35328	TC35328R							(4) 1/0 - (4) 750 (Cu/Al)
Non-Fusible / 3 Pole / 3 Wire / 600V / 50/60 Hz									
30	TC35361	TC35361R	TC35361SS	10	20	30	3	5	14-2 (Cu/Al)
60	TC35362	TC35362R		10	10	10			14-4 (Cu)
			TC35362SS	20	50	60	5	10	14-2 (Cu/Al)
100	TC35363	TC35363R		15	15	15			14-1/0 (Cu)
			TC35363SS	40	75	100		20	14-1/0 (Cu/Al)
200	TC35364	TC35364R		30	30	30			6-250 (Cu)
			TC35364SS	60	125	150		40	6-250 (Cu/Al)
400	TC35365 ^{1,2,3}								(2) 1/0-250 (Cu) or 2-600 (Cu)
		TC35365R	TC35365SS	125	250	350		50	(2) 1/0 - (2) 300 (Cu/Al) or ⁵ (1) 1/0 - 750 (Cu/Al)
600	TC35366 ^{1,2}								(2) 3/0-350 (Cu) or 2-600 (Cu)
		TC35366R	TC35366SS	125	250	350			(2) 250 - (2) 500 (Cu/Al)
800	TC35367 ⁴	TC35367R ⁴	TC35367SS	125	250	350			(3) 250 - (3) 500 (Cu/Al)
1200	TC35368	TC35368R							(4) 1/0 - (4) 750 (Cu/Al)

¹Not UL Listed.

²Not suitable for use as service equipment per NEC Article 702

³No provision for auxiliary contact kit

⁴Available with factory installed neutral. Add N suffix. For example: TC35327N.

⁵Single barrel lug that accepts one or two cables per phase.

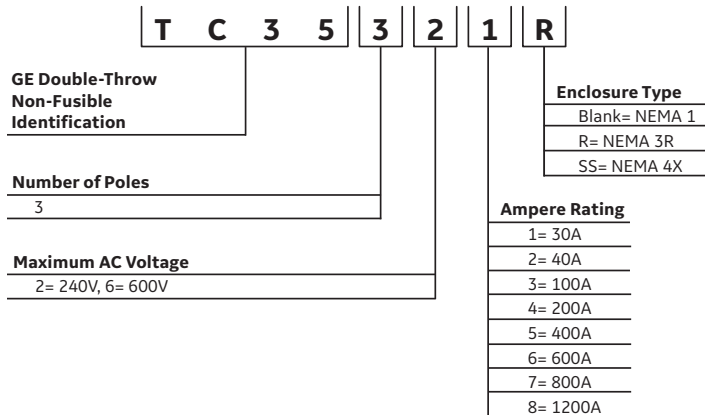

30A/Non-Fusible/3 Pole/240V/N1
TC35321

Emergency Power Transfer Switches

GE's Type TC Emergency Power Transfer switches are specifically designed to permit the connection of power from a standby generator or other emergency source of electricity and are ideally suited for outdoor applications in rural dwellings and farm buildings. They are suitable for use as service entrance equipment when installed in accordance with the National Electrical Code.

Emergency Power Transfer switches are non-fusible and are available in 100-200 amps for 120/240V three-wire systems and in 200 amps for 240V four-wire systems and in NEMA Type 3R (outdoor) enclosures. The side operated handle can be locked in either the ON or OFF position.

All GE Emergency Power Transfer switches carry the following certifications:

- UL Listed and cUL Listed (UL98 Enclosed Switches/CSA-C22.2 No. 4-04)
- Federal Specification WS-865C
- NEMA Enclosed Safety Switch Standard KS1-2013
- Seismic Certified

Features

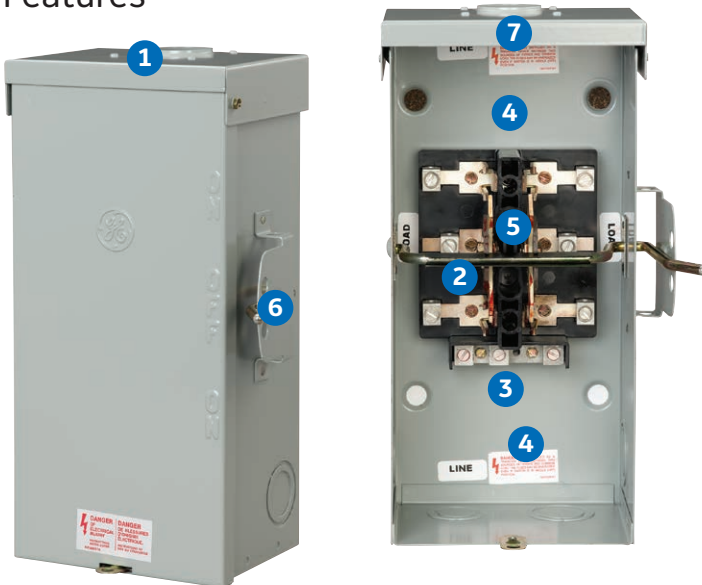

100A/Non-Fusible/2 Pole/120/240V/N3R
TC10323R

-  **1** Wide range of interchangeable rain-tight conduit hubs available
 -  **2** Plated copper current-carrying parts increase longevity and performance
 -  **3** Bonding strap can be used to ground factory installed neutral for service entrance applications
 -  **4** Ample wiring space
 -  **5** Positive make and break is provided by fiber loop straps between knife blade contacts and one-piece operating yoke
 -  **6** Lockable three-position (ON-OFF-ON) handle
 -  **7** Galvanized steel enclosure with drip shield
-  Safety  Ease of Installation and Maintenance

Lug Wire Sizes Line and Load Terminals

	Amperage Rating	Product Number NEMA Type 3 Outdoor
Non-Fusible / 2 Pole / 3 Wire / 120/240V / 50/60Hz		
	100	TC10323R
	200	TC10324R
Non-Fusible / 3 Pole / 4 Wire / 240V / 50/60Hz		
	200	TC10424R

Amperage Rating	Wire Range AWG/kcmil Cu/Al
100	12-1
200	6-250



Safety Switch Accessories

NEMA Type 1 and 3R Enclosures

30-600 Amperes: TG and TH

800-1200 Amperes: TC (Single Throw Fusible Only)

Equipment Ground Kits

Ampere Rating	Product Number	Wire Range AWG/kcmil Copper	Wire Range AWG/kcmil Aluminum	Std. Pkg
30A	TGL1	(4) 14-8, (3) 14-4	(4) 12-8, (3) 6-4	20
60A				
100A	TNG3	(3) 10-1/0	(3) 10-1/0	1
200A				
400A	TGL6	(3) 2-250	(3) 2-250	1
600A				



Equipment Ground Kit
TNG3

Neutral Kit Insulated, Groundable and Bondable

Ampere Rating	Product Number	System Voltage	Fusible/ Non-Fusible	Wire Range AWG/kcmil Copper	Wire Range AWG/kcmil Aluminum
30A	TNI21	240Vac	Either	14-8	12-8
30A	TNI62 ¹	600Vac	Either	12-2	12-2
30A	TNI62 ¹	600Vac	Non-Fusible	12-2	12-2
60A	TNIA62	600Vac	Fusible	12-2	12-2
100A	TNI63 ¹	600Vac	Non-Fusible	10-1/0	10-1/0
100A	TNIA63	600Vac	Fusible	10-1/0	10-1/0
200A	TNIA64	600Vac	Either	2-250	2-250
400A	TNI65	240Vac or 600Vac	Either	(1) 2-600 or (2) 1/0-250	(1) 2-600 or (2) 1/0-250
400A	TNI65A		Either	(1) 350-800	(1) 350-800
600A	TNI66		Either	(2) 4-500	(2) 4-500
800A	TNI67 ²		Either	(3) 2-600 or (6) 1/0-250	(3) 2-600 or (6) 1/0-250
1200A	TNI68A ²		Either	(4) 3/0-800	(4) 3/0-800
			Either	(4) 3/0-800	(4) 3/0-800



Neutral Kit Insulated,
Groundable and Bondable
TNIA64

Switching Neutral: Order standard switch of required number of poles and use dummy fuse in neutral pole.

¹ Not suitable for type TG switches.

² Not suitable for type TC Double Throw or TC Single Throw Non-Fusible.

Note: All accessories are available in standard package of 1 unless otherwise noted.

Safety Switch Accessories

NEMA Type 1 and 3R Enclosures

Heavy Duty Switches

30-600 Amperes: TH

Auxiliary Contact Kits

Auxiliary contacts designed to open before switch blades. UL Listed for field installation.

Product number listed is for field installed kit.

Ampere Rating	No. of Poles	Contacts	Contact Ratings	Product Number
30A	2 3	DPDT	10A, 125/250Vac 0.30A, 125Vdc 0.15A, 250Vdc	THAUX21D
30A	2 3	SPDT	15A, 600Vac 0.50A, 125Vdc 0.25A, 250Vdc	THAUX61S
60A 100A 200A	2 3	DPDT	15A, 600Vac 0.50A, 125Vdc 0.25A, 250Vdc	THAUX64D
400A 600A	2 3	DPDT	15A, 600Vac 0.50A, 125Vdc 0.25A, 250Vdc	THAUX66D
30A 60A 100A	6	DPDT	15A, 600Vac 0.50A, 125Vdc 0.25A, 250Vdc	THAUX66D
200A	6	DPDT	15A, 600Vac 0.50A, 125Vdc 0.25A, 250Vdc	THAUX66D2

Contact Pilot Duty Ratings - 600 Volt Kits

Inrush Current			AC	DC (Resistive)	
Volts	N.C	N.O.	Break Normal Current	Volts	Break Normal Current
115	30	15	15	125	0.5
230	30	15	25	0.25	-
460	30	15	15	-	-
575	15	15	2	-	-

Semidust-tight Door Gasket Kits

Types TH Indoor, TG and TH Outdoor Switches.

Product Number listed is for field mounted kit.

Ampere Rating	Product Number
30A 60A 100A	THG106
200A	THG107
400A 600A	THG108

Safety Switch Accessories

NEMA Type 4/4X, 12 and Mill Duty Enclosures

Heavy Duty Switches

30-600 Amperes: TH

Lug Wire Sizes

Line and Load Terminals

Ampere Rating	Factory Installed		Field Installed Crimp Lugs (see table on page 21)	
	Wire Range AWG/kcmil Copper	Wire Range AWG/kcmil Aluminum	Wire Range AWG/kcmil Copper	Wire Range AWG/kcmil Aluminum
30A (250V)	14-8	12-8	-	-
30A (600V)	14-6	14-6	14-8	-
60A	14-2	14-2	8-4	-
100A	14-1/0	12-1/0	6-1/0	6-2/0
200A	6-250	-	1/0-250	-
400A	(1) 2-600 or (2) 1/0-250	-	(2) 300-600 or (1) 750	(2) 250-600 or (1) 750
600A	(2) 4-600	-	(2) 300-600 or (1) 750	(2) 250-600 or (1) 750

Equipment Ground Terminals—Two lugs supplied per switch, provision for one additional lug.

Switch Ampere Rating	Factory Installed		Field Installed Crimp Lugs (See table on page 21)	
	Copper	Aluminum	Copper	Aluminum
30A	14-6	14-6	14-8	-
60A	14-6	14-6	14-8	-
100A	14-4	14-4	8	6
200A	14-4	14-4	6	4
400A	14-1/0	14-1/0	3-2	1
600A	14-2/0	14-2/0	1	2/0

Auxiliary Contact Kits

Auxiliary contacts designed to open before switch blades. UL Listed for field installation. Product number listed is for field installed kit.

For Auxiliary Contact Kits, see page 19.

Optional Copper Lug Neutrals

Ampere Rating	Fusible	Lug Wire Size, AWG/kcmil, Cu Only	Product Number
30A-60A	No	14-2	TNIJA62CL

Neutral Kit Insulated, Groundable and Bondable

Ampere Rating	Product Number	System Voltage	Fusible/ Non-fusible	Lug Wire Size AWG/kcmil Factory Installed Aluminum	Lug Wire Size AWG/kcmil Factory Installed Copper	Lug Wire Size AWG/kcmil Field Installed Crimp Lugs Copper	Lug Wire Size AWG/kcmil Field Installed Crimp Lugs Aluminum
30A	TNI21	240Vac	Fusible	12-8	14-8	-	-
30A	TNIJ61	600Vac ¹	Either	14-6	14-6	14-8	-
60A	TNIJ62	600Vac ²	Fusible	14-2	14-2	8-4	-
60A	TNIJ62	240Vac ²	Fusible	14-2	14-2	8-4	-
60A	TNIJ62	600Vac	Fusible	14-2	14-2	8-4	-
60A	TNIJA62	600Vac ²	Non-fusible	14-2	14-2	8-4	-
60A	TNIJA62	600Vac	Non-fusible	14-2	14-2	8-4	-
100A	TNIJ63	240Vac or 600Vac	Either	12-1/0	14-1/0	6-1/0	6-2/0
200A	TNIJ64		Either	6-250	6-250	1/0-250	1/0-250
400-600A	TNIJ66		Either	(2) 4-600	(2) 4-600	(2) 300-600 or (1) 750	(2) 250-600 or (1) 750

¹Type 4, 4X, 12

²Mill duty type

Safety Switch Accessories

NEMA Type 4/4X, 12 and Mill Duty Enclosures

Heavy Duty Switches

30-600 Amperes: TH

Crimp-type Connectors - Field Replaceable¹

Line and Load Terminals

Switch Ampere Rating	Lug Wire Size AWG/kcmil	Thomas and Betts Product Number		Burndy Product Number	
		Copper	Aluminum	Copper	Aluminum
30A	14-12	-	-	YAV12 G2	-
30A	12-10	-	-	YAV10	-
30A	8	54104	-	YAV8C-L	-
60A	8	54130	-	YAV8C-L1	-
60A	6	54105	-	YAV6C-L	-
60A	4	54106	-	YAV4CLY1	-
100A	6	54105	60107	-	-
100A	4	54106	60112	-	-
100A	2	54017	60116	-	-
100A	1	54108	60122	-	-
100A	1/0	-	-	YA25-L	YA25A1
200A	1/0	54153	60129	-	-
200A	1/0	54109	60130	-	-
200A	2/0	54158	60135	-	-
200A	2/0	54110	60136	-	-
200A	3/0	54163	60141	-	-
200A	3/0	54111	60142	-	-
200A	4/0	54168	60147	-	-
200A	4/0	54112	60148	-	-
200A	250	54173	60153	-	-
200A	250	54174	60154	-	-
400A and 600A	250	-	60156	-	-
400A and 600A	300	54114	60162	-	-
400A and 600A	350	54115	60165	-	-
400A and 600A	400	54116	-	-	-
400A and 600A	500	54118	60171	-	-
400A and 600A	600	54120	60174	-	-
400A and 600A	750	54123	60178	-	-

Equipment Ground Terminals (provision for three per switch)

Switch Ampere Rating	Lug Wire Size AWG/kcmil	Thomas and Betts Product Number		Burndy Product Number	
		Copper	Aluminum	Copper	Aluminum
30A	10	-	-	-	-
30A	8	54104	-	YAV8C-L	-
60A	8	54104	-	YAV8C-L	-
100A	8	54105	-	-	-
100A	6	-	60106	-	-
200A	6	54105	-	-	-
200A	4	-	60112	-	-
400A	3-2	54107	-	-	-
400A	1	-	60122	-	-
600A	1	54108	-	-	-
600A	2/0	-	60134	-	-

¹Not furnished with switches.

Safety Switch Accessories

General Duty: TG

Heavy Duty: TH

Class R Fusing Kit Field Installable, General Duty, Type TG, UL Listed

When specifications permit only Class R fuses to be used, these kits may be installed in the safety switch to deter fuses other than Class R from being installed.

- 30–60A = Fuse Clips
- 100–200A = Rejection Pins
- One kit required per two pole or three pole switch

Series Prefix	Ampere Rating	Enclosure Type	Product Number
TG	30A	NEMA Type 1, 3R	TGRK12
	60A	NEMA Type 1, 3R	TGRK22
	100A	NEMA Type 1, 3R	TGRK42
	200A	NEMA Type 1, 3R	TGRK42



TGRK22 Class R Rejection Kit

Class J Fuse Field Conversion Kit, Heavy Duty, Type TH, UL Listed

TH switches, 30-400 amperes, 600 volt and 100-400 amperes, 240 volt, may be adapted to accept Class J fuses without a kit by moving the load-block toward the switch base and remounting. One kit required per two-pole or three-pole switch.

Series Prefix	Ampere Rating	System Voltage	Product Number
TH	600A	240Vac 600Vac	THJ6

Class R Fusing Kit Field Installable, Heavy Duty, Type TH, UL Listed

When specifications permit only Class R fuses to be used, these kits may be installed in the safety switch to deter fuses other than Class R from being installed.

- 30–60A = Fuse Clips
- 100–600A = Rejection Pins
- One kit required per two pole or three pole switch

Series Prefix	Ampere Rating	System Voltage	Enclosure Type	Product Number
TH	30A	240Vac	NEMA Type 1, 3R, 4/4X, 12	TRK12B
	30A	600Vac	NEMA Type 1, 3R	TRK16B
	30A	600Vac	NEMA Type 4/4X, 12	TRK16SA
	60A	240Vac	NEMA Type 1, 3R, 4/4X, 12	TRK22A
	60A	600Vac	NEMA Type 1, 3R, 4/4X, 12	TRK26A
	100A	240Vac 600Vac	NEMA Type 1, 3R	TRK46A
	100A	240Vac 600Vac	NEMA Type 4/4X, 12	TPBRK36A
	200A	240Vac 600Vac	NEMA Type 1, 3R, 4/4X, 12	TRK46A
	400A	240Vac 600Vac	NEMA Type 1, 3R, 4/4X, 12	TRK56A
	600A	240Vac 600Vac	NEMA Type 1, 3R, 4/4X, 12	TRK66A



TRK46A Class R Rejection Kit

Safety Switch Accessories

Universal Raintight Aluminum Hubs

For outdoor enclosures that have removable closing caps.

Nominal Conduit Diameter (in.)	Product Number
3/4	TC75
1	TC100
1 1/4	TC125
1 1/2	TC150
2	TC200
2 1/2	TC250



TC200 Universal Raintight Hub

Closing Cap for Universal Raintight Aluminum Hub

Product Number
TCCP

Replacement Red Handle Grip for HD Switches

Product Number
THGRIP

Safety Switch Accessories

NEMA Type 1, 3R and 4X (Grade 304 Stainless Steel)

Double Throw Switches

30–1200 Amperes: TC, TDT

Type TC Accessories

Amperage Rating	Product Number			Neutral Kit	Ground Kit	Aux Contact		Control Pole
	NEMA Type 1 Indoor	NEMA Type 3R Outdoor	NEMA Type 4X Grade 304 Stainless Steel			1 Normally Open 1 Normally Closed	2 Normally Open 2 Normally Closed	
Non-Fusible / 3 Pole / 3 Wire / 240V								
30	TC35321	TC35321R		TNK100	TGL1	THAUXDT		
60	TC35322	TC35322R						
100	TC35323	TC35323R						
200	TC35324	TC35324R						
400	TC35325	TC35325R		TNK400	TGL6			
600	TC35326				TGL6			
		TC35326R		DT600NK	DS468GK	DS200EK1	DS200EK2	DS16CP
800	TC35327	TC35327R ¹		DT800NK				DS16CP
1200	TC35328	TC35328R		DT1200NK				
Non-Fusible / 3 Pole / 3 Wire / 600V								
30	TC35361	TC35361R	TC35361SS	DT100NK	DS100GK	DS200EK1	DS200EK2	DS16CP
60	TC35362	TC35362R		TNK100	TGL1	THAUXDT		
			TC35362SS	DT100NK	DS100GK	DS200EK1	DS200EK2	DS16CP
100	TC35363	TC35363R		TNK100	TNG3	THAUXDT		
			TC35363SS	DT100NK	DS100GK	DS200EK1	DS200EK2	DS16CP
200	TC35364	TC35364R		TNK200	TNG3	THAUXDT		
			TC35364SS	DT200NK	DS200GK	DS200EK1	DS200EK2	DS16CP
400	TC35365			TNK400	TGL6	THAUXDT		
		TC35365R	TC35365SS	DT400NK	DS468GK	DS200EK1	DS200EK2	DS16CP
600	TC35366				TGL6			
		TC35366R	TC35366SS	DT600NK	DS468GK	DS200EK1	DS200EK2	DS16CP
800	TC35367	TC35367R ¹	TC35367SS	DT800NK				DS16CP
1200	TC35368	TC35368R		DT1200NK				

¹Order same accessories for the "N" version.

Type TDT Accessories

Voltage	Product Number				Neutral Kit	Ground Kit	Standard Fuse Class	"R" Fuse Adapter Kit	"T" Fuse Adapter Kit	"J" Fuse Adapter Kit	Aux Contact		Control Pole
	Amps	NEMA Type 1 Indoor	NEMA Type 3R Outdoor	NEMA Type 4X Stainless Steel							1 Normally Open 1 Normally Closed	2 Normally Open 2 Normally Closed	
240V	30	TDT3321	TDT3321R		DT100NK	DS100GK	H	DS12FK			DS200EK1	DS200EK2	DS16CP
	60	TDT3322	TDT3322R										
	100	TDT3323	TDT3323R										
	200	TDT3324	TDT3324R		DT200NK	DS200GK	H	DS46FK					
	400	TDT3325	TDT3325R		DT400NK	DS468GK	H	DS56FK	DS526TK ²				
	600	TDT3326	TDT3326R		DT600NK		J		DT626TK ²				
	800	TDT3327	TDT3327R		DT800NK	DS468GK	L		DT726TK ²				
	1200	TDT3328	TDT3328R		DT1200NK		L		move up				
600V	30	TDT3361	TDT3361R	TDT3361SS	DT100NK	DS100GK	H	DS16FK			DS200EK1	DS200EK2	DS16CP
	60	TDT3362	TDT3362R	TDT3361SS									
	100	TDT3363	TDT3363R	TDT3361SS									
	200	TDT3364	TDT3364R	TDT3361SS	DT200NK	DS200GK	H	DS46FK		move up			
	400	TDT3365	TDT3365R	TDT3361SS	DT400NK	DS468GK	T			DT400JK ³			
	600	TDT3366	TDT3366R		DT600NK		J		DS666TK ²				
	800	TDT3367	TDT3367R		DT800NK	DS468GK	L		DS766TK ²				
	1200	TDT3368	TDT3368R		DT1200NK		L		move up				

²Kits come with 1 pole - must order 3 for 3-pole switch

³Kits come with 6 poles

Safety Switch Enclosure Dimensions

General Duty, NEMA Type 1 Approximate Dimensions in inches

Product Number	Dimension H	Dimension W (Box)	Dimension W ₂ (W/ Handle)	Dimension D (Box)	Dimension D ₂ (W/ Handle)	Weight (lbs)	Drawing #	KO Figure Number
TG3221	10.3	6.4	6.9	3.3	6.3	5	10103091SH104	1
TG3222	13.8	8.4	8.9	4.0	7.9	10	10103091SH104	15
TG3223	21.3	9.4	10.6	4.9	9.9	16	10103091SH108	3
TG3224	29.1	13.4	14.6	5.2	9.3	30	10103091SH108	4
TG3224B	29.1	13.4	14.6	5.2	9.3	30	10103091SH108	4
TG3225	49.4	21.6	22.8	8.7	14.6	102	10103091SH116	5
TG3225B	49.4	21.6	22.8	8.7	14.6	102	10103091SH116	5
TG3226	49.9	22.9	24.1	9.0	14.8	107	10103091SH116	6
TG3325	49.4	21.6	22.8	8.7	14.6	107	10103091SH116	7
TG3325B	49.4	21.6	22.8	8.7	14.6	107	10103091SH116	7
TG3326	49.9	22.9	24.1	9.0	14.8	124	10103091SH116	6
TG3326B	49.9	22.9	24.1	9.0	14.8	124	10103091SH116	6
TG4321	10.3	6.4	6.9	3.3	6.3	5	10103091SH104	1
TG4322	13.8	8.4	8.9	4.0	7.9	10	10103091SH104	15
TG4323	21.3	9.4	10.6	4.9	9.9	17	10103091SH108	3
TG4324	29.1	13.4	14.6	5.2	9.3	32	10103091SH108	4
TG4324B	29.1	13.4	14.6	5.2	9.3	32	10103091SH108	4
TG4325	49.4	21.6	22.8	8.7	14.6	111	10103091SH116	7
TG4325B	49.4	21.6	22.8	8.7	14.6	111	10103091SH116	7
TG4326	49.9	22.9	24.1	9.0	14.8	126	10103091SH116	6
TG4326B	49.9	22.9	24.1	9.0	14.8	126	10103091SH116	6
TGN3321	10.3	6.4	6.9	3.3	6.3	5	10103091SH104	1
TGN3322	13.8	8.4	8.9	4.0	7.9	10	10103091SH104	15
TGN3323	21.3	9.4	10.6	4.9	9.9	16	10103091SH108	3
TGN3324	29.1	13.4	14.6	5.2	9.3	30	10103091SH108	4
TGN3324B	29.1	13.4	14.6	5.2	9.3	30	10103091SH108	4
TGN3325	49.4	21.6	22.8	8.7	14.6	118	10103091SH116	7
TGN3325B	49.4	21.6	22.8	8.7	14.6	118	10103091SH116	7
TGN3326	49.9	22.9	24.1	9.0	14.8	120	10103091SH116	6
TGN3326B	49.9	22.9	24.1	9.0	14.8	120	10103091SH116	6

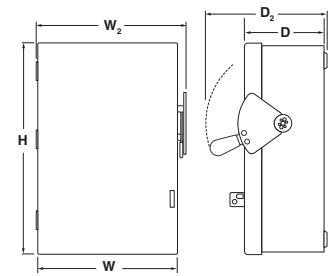

General Duty
NEMA Type 1

Heavy Duty, NEMA Type 1 Approximate Dimensions in inches

Product Number	Dimension H	Dimension W (Box)	Dimension W ₂ (W/ Handle)	Dimension D (Box)	Dimension D ₂ (W/ Handle)	Weight (lbs)	Drawing #	KO Figure Number
TH2261DC	12.6	8.3	9.5	4.0	7.6	11	10103091SH102	15
TH2262DC	21.3	9.1	9.4	5.0	8.6	18	10103091SH102	3
TH2263DC	22.3	9.3	10.1	4.8	9.8	19	10103091SH105	14
TH3221	10.3	6.3	7.1	3.3	6.1	6	10103091SH102	1
TH3222	17.6	9.4	10.1	5.0	9.0	15	10103091SH102	3
TH3223	21.3	9.3	10.1	4.8	9.8	17	10103091SH105	3
TH3224	31.5	13.3	14.1	5.1	10.5	33	10103091SH105	4
TH3224B	31.5	13.3	14.1	5.1	10.5	33	10103091SH105	4
TH3224C	31.5	13.3	14.1	5.1	10.5	33	10103091SH105	4
TH3225	50.9	22.9	23.6	8.3	14.4	120	10103091SH112	6
TH3225B	50.9	22.9	23.6	8.3	14.4	120	10103091SH112	6
TH3225C	50.9	22.9	23.6	8.3	14.4	135	10103091SH112	6
TH3226	50.9	22.9	23.6	8.3	14.4	134	10103091SH112	6
TH3226B	50.9	22.9	23.6	8.3	14.4	134	10103091SH112	6
TH3226C	50.9	22.9	23.6	8.3	14.4	134	10103091SH112	6
TH3267C	61.5	40.8	44.0	11.9	18.5	500	10103091SH112	6
TH3268C	76.6	46.6	45.8	12.9	18.9	480	10103091SH112	6
TH3325	50.9	22.9	23.6	8.3	14.4	126	10103091SH112	6
TH3325B	50.9	22.9	23.6	8.3	14.4	126	10103091SH112	6
TH3326	50.9	22.9	23.6	8.3	14.4	138	10103091SH112	6
TH3326B	50.9	22.9	23.6	8.3	14.4	138	10103091SH112	6
TH3361	12.6	8.3	9.5	4.0	7.6	11	10103091SH102	15
TH3362	21.3	9.1	9.4	5.0	8.6	18	10103091SH102	3
TH3363	22.3	9.3	10.1	4.8	9.8	18	10103091SH105	14
TH3364	31.5	13.3	14.1	5.1	10.5	33	10103091SH105	4
TH3364B	31.5	13.3	14.1	5.1	10.5	34	10103091SH105	4
TH3365	53.9	22.9	23.6	8.3	14.4	126	10103091SH112	6
TH3365B	53.9	22.9	23.6	8.3	14.4	122	10103091SH112	6
TH3366	53.9	22.9	23.6	8.3	14.4	139	10103091SH112	6
TH3366B	53.9	22.9	23.6	8.3	14.4	139	10103091SH112	6
TH4321	10.3	6.3	7.1	3.3	6.1	6	10103091SH102	1

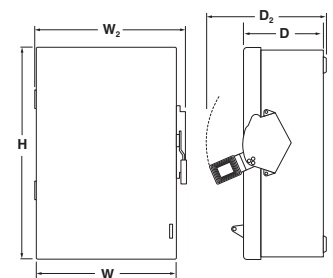

Heavy Duty
NEMA Type 1

(table continued on next page)

Safety Switch Enclosure Dimensions

Heavy Duty, NEMA Type 1 (cont.) Approximate Dimensions in inches

Product Number	Dimension H	Dimension W (Box)	Dimension W ₂ (W/ Handle)	Dimension D (Box)	Dimension D ₂ (W/ Handle)	Weight (lbs)	Drawing #	KO Figure Number
TH4322	17.6	9.4	10.1	5.0	9.0	16	10103091SH102	3
TH4323	21.3	9.3	10.1	4.8	9.8	17	10103091SH105	3
TH4324	31.5	13.3	14.1	5.1	10.5	33	10103091SH105	4
TH4324B	31.5	13.3	14.1	5.1	10.5	32	10103091SH105	4
TH4324C	31.5	13.3	14.1	5.1	10.5	32	10103091SH105	4
TH4325	50.9	22.9	23.6	8.3	14.4	128	10103091SH112	6
TH4325B	50.9	22.9	23.6	8.3	14.4	128	10103091SH112	6
TH4325C	50.9	22.9	23.6	8.3	14.4	128	10103091SH112	6
TH4326	50.9	22.9	23.6	8.3	14.4	139	10103091SH112	6
TH4326B	50.9	22.9	23.6	8.3	14.4	139	10103091SH112	6
TH4326C	50.9	22.9	23.6	8.3	14.4	80	10103091SH112	6
TH4364C	31.5	13.3	14.1	5.1	10.5	32	10103091SH105	4
TH4365C	53.9	22.9	23.6	8.3	14.4	132	10103091SH112	6
TH4366C	53.9	22.9	23.6	8.3	14.4	132	10103091SH112	6
TH4367C	61.5	40.8	44.0	11.9	18.5	331	10103091SH118	No KO
TH4368C	76.6	46.6	45.8	12.9	18.9	377	10103091SH118	No KO
TH6621	14.4	18.7	19.9	5.9	12.3	33	10103091SH121	20
TH6622	23.9	18.7	19.9	5.9	12.7	40	10103091SH121	20
TH6623	23.9	18.7	19.8	5.8	10.9	45	10103091SH127	20
TH6624	35.1	26.0	26.8	5.7	10.4	45	10103091SH127	20
TH6661	14.4	18.7	19.9	5.9	12.3	33	10103091SH121	20
TH6662	23.9	18.7	19.9	5.9	12.7	46	10103091SH121	20
TH6663	23.9	18.7	19.8	5.8	10.9	46	10103091SH127	20
TH6664	35.1	26.0	26.8	5.7	10.4	45	10103091SH127	20
THN2261DC	10.3	8.3	9.3	4.0	7.7	9	10103091SH102	15
THN2262DC	23.4	13.4	15.3	5.0	10.1	15	10103091SH102	3
THN2263DC	17.6	9.3	10.1	4.8	9.8	23	10103091-SH105	3
THN3321	10.3	6.3	7.1	3.3	6.1	6	10103091SH102	1
THN3361	10.3	8.3	9.3	4.0	7.7	9	10103091SH102	15
THN3361CL	10.3	8.3	9.3	4.0	7.7	9	10103091SH102	15
THN3362	17.6	9.4	10.1	5.0	9.0	15	10103091SH102	3
THN3362CL	17.6	9.4	10.1	5.0	9.0	15	10103091SH102	3
THN3363	17.6	9.3	10.1	4.8	9.8	15	10103091SH105	3
THN3363CL	17.6	9.3	10.1	4.8	9.8	15	10103091SH105	3
THN3364	31.5	13.3	14.1	5.1	10.5	32	10103091SH105	4
THN3364B	31.5	13.3	14.1	5.1	10.5	32	10103091SH105	4
THN3364CL	31.5	13.3	14.1	5.1	10.5	33	10103091SH105	4
THN3365	42.6	22.9	23.6	8.3	14.4	108	10103091SH112	6
THN3365B	42.6	22.9	23.6	8.3	14.4	108	10103091SH112	6
THN3366	42.6	22.9	23.6	8.3	14.4	109	10103091SH112	6
THN3366B	42.6	22.9	23.6	8.3	14.4	109	10103091SH112	6
THN3366CL	42.6	22.9	23.6	8.3	14.4	109	10103091SH112	6
THN6661	14.4	18.7	19.9	5.9	12.3	33	10103091SH121	20
THN6662	23.9	18.7	19.9	5.9	12.7	46	10103091SH121	20
THN6663	23.9	18.7	19.8	5.8	10.9	46	10103091SH127	20
THN6664	35.1	26.0	26.8	5.7	10.4	47	10103091SH127	20

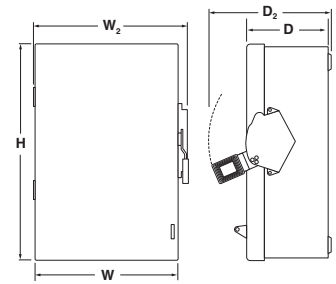

Heavy Duty
NEMA Type 1

Safety Switch Enclosure Dimensions

General Duty, NEMA Type 3R Approximate Dimensions in inches

Product Number	Dimension H	Dimension W (Box)	Dimension W ₂ (W/ Handle)	Dimension D (Box)	Dimension D ₂ (W/ Handle)	Weight (lbs)	Drawing #	KO Figure Number
TG3221R	9.8	6.4	6.8	3.3	6.3	6	10103091SH103	8
TG3222R	13.7	8.4	8.8	3.9	7.9	11	10103091SH103	19
TG3223R	21.1	9.3	10.3	5.0	9.1	17	10103091SH107	10
TG3224R	29.3	13.4	13.7	5.4	9.9	31	10103091SH183	11
TG3225R	49.7	21.7	22.4	8.9	14.7	110	10103091SH141	12
TG3226R	50.1	23.0	23.8	9.4	15.1	119	10103091SH141	13
TG3325R	49.7	21.7	22.4	8.9	14.7	109	10103091SH141	12
TG3326R	50.1	23.0	23.8	9.4	15.1	124	10103091SH141	13
TG4321R	9.8	6.4	6.8	3.3	6.3	6	10103091SH103	8
TG4322R	13.7	8.4	8.8	3.9	7.9	11	10103091SH103	19
TG4323R	21.1	9.3	10.3	5.0	9.1	17	10103091SH107	10
TG4324R	29.3	13.4	13.7	5.4	9.9	32	10103091SH183	11
TGN3321R	9.8	6.4	6.8	3.3	6.3	6	10103091SH103	8
TGN3322R	13.7	8.4	8.8	3.9	7.9	10	10103091SH103	19
TGN3323R	15.6	9.3	10.3	5.0	9.1	13	10103091SH107	10
TGN3324R	29.3	13.4	13.7	5.4	9.9	31	10103091SH183	11

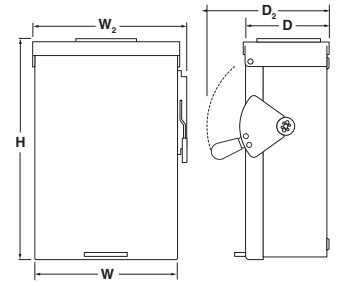

General Duty
NEMA Type 3R

Heavy Duty, NEMA Type 3R Approximate Dimensions in inches

Product Number	Dimension H	Dimension W (Box)	Dimension W ₂ (W/ Handle)	Dimension D (Box)	Dimension D ₂ (W/ Handle)	Weight (lbs)	Drawing #	KO Figure Number
TH2261RDC	13.1	8.2	8.9	4.0	7.9	11	10103091SH101	19
TH2262RDC	22.0	9.2	9.7	4.8	7.9	19	10103091SH101	10
TH2263RDC	22.1	9.3	10.2	4.9	9.8	20	10103091SH106	10
TH3221R	10.5	6.2	6.6	3.1	7.7	7	10103091SH101	8
TH3222R	17.2	9.2	9.7	4.8	7.9	16	10103091SH101	10
TH3223R	22.1	9.3	10.2	4.9	9.8	18	10103091SH106	10
TH3224R	31.7	13.4	14.3	5.4	9.5	34	10103091SH182	11
TH3224RC	31.7	13.4	14.3	5.4	9.5	34	10103091SH182	11
TH3225R	49.5	23.0	24.1	8.5	13.9	128	10103091SH140	18
TH3225RC	49.5	23.0	24.1	8.5	13.9	128	10103091SH140	18
TH3226R	53.5	23.0	24.1	8.5	13.9	134	10103091SH140	18
TH3226RC	53.5	23.0	24.1	8.5	13.9	134	10103091SH140	18
TH3267RC	61.5	40.8	44.0	11.9	18.5	500	10103091SH118	No KO
TH3268RC	76.6	46.6	45.8	12.9	18.9	490	10103091SH118	No KO
TH3325R	49.5	23.0	24.1	8.5	13.9	127	10103091SH140	18
TH3326R	53.5	23.0	24.1	8.5	13.9	139	10103091SH140	18
TH3361R	13.1	8.2	8.9	4.0	7.9	11	10103091SH101	19
TH3361RF	14.9	10.3	10.9	3.9	8.0	11	10103091SH133	No KO
TH3361RF2	22.4	13.3	14.0	4.8	9.9	23	10103091SH134	No KO
TH3362R	22.0	9.2	9.7	4.8	7.9	18	10103091SH101	10
TH3362RF	22.4	13.3	14.0	4.8	9.9	18	10103091SH134	No KO
TH3363R	22.1	9.3	10.2	4.9	9.8	19	10103091SH106	10
TH3364R	31.7	13.4	14.3	5.4	9.5	33	10103091SH182	11
TH3365R	53.5	23.0	24.1	8.5	13.9	132	10103091SH140	18
TH3366R	53.5	23.0	24.1	8.5	13.9	136	10103091SH140	18
TH4321R	10.5	6.2	6.6	3.1	7.7	7	10103091SH101	8
TH4322R	17.2	9.2	9.7	4.8	7.9	16	10103091SH101	10
TH4323R	22.1	9.3	10.2	4.9	9.8	18	10103091SH106	10
TH4324R	31.7	13.4	14.3	5.4	9.5	34	10103091SH182	11
TH4324RC	31.7	13.4	14.3	5.4	9.5	34	10103091SH182	11
TH4325RC	49.5	23.0	24.1	8.5	13.9	125	10103091SH140	No KO
TH4326RC	53.5	23.0	24.1	8.5	13.9	130	10103091SH140	No KO
TH4364RC	31.7	13.4	14.3	5.4	9.5	32	10103091SH182	No KO
TH4365RC	49.5	23.0	24.1	8.5	13.9	130	10103091SH140	No KO
TH4366RC	53.5	23.0	24.1	8.5	13.9	132	10103091SH140	No KO
TH4367RC	61.5	40.8	44.0	11.9	18.5	510	10103091SH118	No KO
TH4368RC	76.6	46.6	45.8	12.9	18.9	750	10103091SH118	No KO
THN2261RDC	13.1	8.2	8.9	4.0	7.9	11	10103091SH101	19
THN2262RDC	17.2	9.2	9.7	4.8	7.9	16	10103091SH101	10
THN2263RDC	17.3	9.3	10.2	4.9	9.8	16	10103091SH106	10
THN3361R	13.1	8.2	8.9	4.0	7.9	11	10103091SH101	19
THN3361RF	14.9	10.3	10.9	3.9	8.0	13	10103091SH133	19
THN3361RF2	22.4	13.3	14.0	4.8	9.9	22	10103091SH134	17
THN3362R	17.2	9.2	9.7	4.8	7.9	15	10103091SH101	10
THN3362RF	22.4	13.3	14.0	4.8	9.9	22	10103091SH134	17
THN3363R	17.3	9.3	10.2	4.9	9.8	15	10103091SH106	10
THN3364R	31.7	13.4	14.3	5.4	9.5	33	10103091SH182	11
THN3365R	49.5	23.0	24.1	8.5	13.9	122	10103091SH140	18
THN3366R	53.5	23.0	24.1	8.5	13.9	130	10103091SH140	18

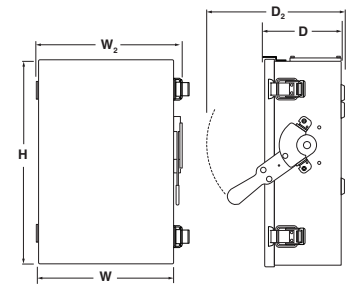

General Duty
NEMA Type 3R
200-600A Side Swing

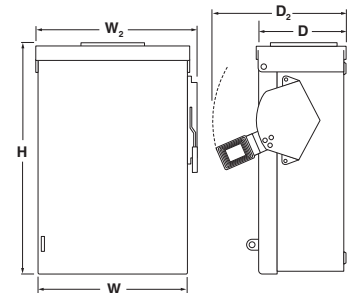

Heavy Duty
NEMA Type 3R

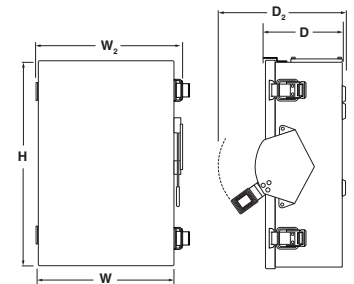

Heavy Duty
NEMA Type 3R
200-600A Side Swing

Safety Switch Enclosure Dimensions

800–1200A NEMA Type 1 and 3R Approximate Dimensions in inches

Product Number	Dimension H	Dimension W (Box)	Dimension W ₂ (W/ Handle)	Dimension D (Box)	Dimension D ₂ (W/ Handle)	Weight (lbs)	Drawing #	KO Figure Number
TC36367	52.0	31.3	34.5	10.5	18.5	317	10103091SH118	No KO
TC36368	65.0	36.5	39.7	11.8	18.9	331	10103091SH118	
TC72267	61.5	40.8	44.0	11.9	18.5	377	10103091SH118	
TC72267R	61.5	40.8	44.0	11.9	18.5	480	10103091SH118	
TC72268	76.6	46.6	45.8	12.9	18.9	391	10103091SH118	
TC72268R	76.6	46.6	45.8	12.9	18.9	575	10103091SH118	
TC72367	61.5	40.8	44.0	11.9	18.5	377	10103091SH118	
TC72367R	61.5	40.8	44.0	11.9	18.5	480	10103091SH118	
TC72368	76.6	46.6	45.8	12.9	18.9	480	10103091SH118	
TC72368R	76.6	46.6	45.8	12.9	18.9	490	10103091SH118	

Heavy Duty, NEMA Type 4/4X (316 Stainless) Approximate Dimensions in inches

Product Number	Dimension H	Dimension W (Box)	Dimension W ₂ (W/ Handle)	Dimension D (Box)	Dimension D ₂ (W/ Handle)	Weight (lbs)	Drawing #	KO Figure Number
TH3361SS316	13.3	9.4	10.1	4.9	9.4	18	10103091SH109	No KO
TH3361SS316-BA	13.3	9.4	10.1	4.9	9.4	18	10103091SH109	
TH3362SS316	19.3	9.4	10.1	5.2	9.6	23	10103091SH109	
TH3362SS316-BA	19.3	9.4	10.1	5.2	9.6	23	10103091SH109	
TH3363SS316	25.4	13.4	14.3	5.2	9.6	36	10103091SH113	
TH3363SS316-BA	25.4	13.4	14.3	5.2	9.6	36	10103091SH113	
TH3364SS316	35.1	14.5	15.5	5.2	9.6	49	10103091SH113	
TH3364SS316-BA	35.1	14.5	15.5	5.2	9.6	49	10103091SH113	
THN3361SS316	11.3	9.4	10.1	4.9	9.4	16	10103091SH109	
THN3361SS316-BA	11.3	9.4	10.1	4.9	9.4	9	10103091SH109	
THN3362SS316	13.3	9.4	10.1	5.2	9.6	22	10103091SH109	
THN3362SS316-BA	13.3	9.4	10.1	5.2	9.6	22	10103091SH109	
THN3363SS316	25.4	13.4	14.3	5.2	9.6	36	10103091SH113	
THN3363SS316-BA	25.4	13.4	14.3	5.2	9.6	36	10103091SH113	
THN3364SS316	35.1	14.5	15.5	5.2	9.6	50	10103091SH113	
THN3364SS316-BA	35.1	14.5	15.5	5.2	9.6	50	10103091SH113	
THN3365SS316	59.5	24.6	25.6	8.4	13.8	239	10103091SH119	
THN3366SS316	59.5	24.6	25.6	8.4	13.8	239	10103091SH119	

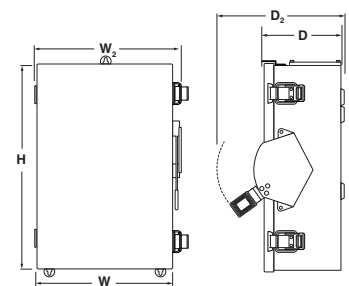

Heavy Duty
NEMA Type 4/4X

Heavy Duty, NEMA Type 4/4X Water/Dust-tight Approximate Dimensions in inches

Product Number	Dimension H	Dimension W (Box)	Dimension W ₂ (W/ Handle)	Dimension D (Box)	Dimension D ₂ (W/ Handle)	Weight (lbs)	Drawing #	KO Figure Number
TH2221MSS	11.2	7.4	8.1	4.7	9.8	14	10103091SH123	No KO
TH2221SS	11.3	7.4	8.1	5.4	10.0	12	10103091SH110	
TH2221SS-BA	11.3	7.4	8.1	4.9	9.4	12	10103091SH109	
TH2221SSW	11.3	7.4	8.1	5.4	10.0	12	10103091SH110	
TH2222MSS	19.3	9.4	14.1	5.0	10.1	20	10103091SH123	
TH2222SS	19.3	9.4	10.1	5.2	9.6	21	10103091SH109	
TH2222SS-BA	19.3	9.4	10.1	5.2	9.6	21	10103091SH109	
TH2222SSW	19.3	9.4	10.1	5.2	9.6	21	10103091SH109	
TH2223MSS	25.4	13.4	15.3	5.0	10.4	24	10103091SH128	
TH2224MSS	35.1	14.4	16.3	5.0	10.4	25	10103091SH128	
TH2261SSDC	13.3	9.4	10.1	4.9	9.4	18	10103091SH109	
TH2262SSDC	19.3	9.4	10.1	5.2	9.6	19	10103091SH109	
TH2263SSDC	25.4	13.4	14.3	5.2	9.6	30	10103091SH113	
TH3221SS	11.3	7.4	8.1	4.9	9.4	12	10103091SH109	
TH3221SS-BA	11.3	7.4	8.1	4.9	9.4	12	10103091SH109	
TH3221SSW	11.3	7.4	8.1	4.9	9.4	12	10103091SH109	
TH3222SS	19.3	9.4	10.1	5.2	9.6	15	10103091SH109	
TH3222SS-BA	19.3	9.4	10.1	5.2	9.6	15	10103091SH109	
TH3223SS	25.4	13.4	14.3	5.2	9.6	30	10103091SH113	
TH3223SS-BA	25.4	13.4	14.3	5.2	9.6	30	10103091SH113	
TH3223SSW	25.4	13.5	14.2	5.2	9.6	30	10103091SH113	
TH3224SS	35.1	14.5	15.5	5.2	9.6	33	10103091SH113	
TH3224SS-BA	35.1	14.5	15.5	5.2	9.6	33	10103091SH113	
TH3224SSW	35.2	14.5	15.5	5.2	9.6	33	10103091SH113	
TH3225SS	59.5	24.6	25.6	8.4	13.8	128	10103091SH119	
TH3226SS	59.5	24.6	25.6	8.4	13.8	140	10103091SH119	
TH3321MSS	11.2	7.4	8.1	4.7	9.8	14	10103091SH123	
TH3321SS	11.3	7.4	8.1	4.9	9.4	12	10103091SH109	
TH3321SS-BA	11.3	7.4	8.1	4.9	9.4	12	10103091SH109	
TH3322MSS	19.3	9.4	14.1	5.0	10.1	23	10103091SH123	

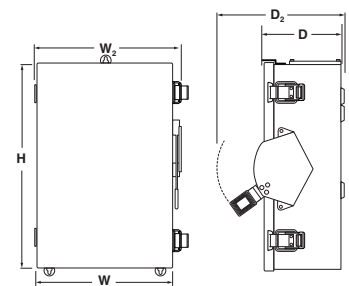

Heavy Duty
NEMA Type 4/4X

(table continued on next page)

Safety Switch Enclosure Dimensions

Heavy Duty, NEMA Type 4/4X Water/Dust-tight (cont.) Approximate Dimensions in inches

Product Number	Dimension H	Dimension W (Box)	Dimension W ₂ (W/ Handle)	Dimension D (Box)	Dimension D ₂ (W/ Handle)	Weight (lbs)	Drawing #	KO Figure Number
TH3322SS	19.3	9.4	10.1	5.2	9.6	22	10103091SH109	KO
TH3322SS-BA	19.3	9.4	10.1	5.2	9.6	22	10103091SH109	
TH3322SSW	19.3	9.4	10.1	5.2	9.6	22	10103091SH109	
TH3323MSS	25.4	13.4	15.3	5.0	10.4	23	10103091SH128	
TH3324MSS	35.1	14.4	16.3	5.0	10.4	27	10103091SH128	
TH3325MSS	59.4	24.5	25.6	7.9	14.4	193	10103091SH130	
TH3326MSS	59.4	24.5	25.6	7.9	14.4	200	10103091SH130	
TH3361MSS	19.3	9.4	14.1	5.0	10.1	21	10103091SH123	
TH3361SS	13.3	9.4	10.1	4.9	9.4	17	10103091SH109	
TH3361SS-BA	13.3	9.4	10.1	4.9	9.4	17	10103091SH109	
TH3361SSW	13.3	9.4	10.1	4.9	9.4	18	10103091SH109	
TH3362MSS	19.3	9.4	14.1	5.0	10.1	23	10103091SH123	
TH3362MSSW	19.3	9.4	14.1	5.0	10.1	23	10103091SH123	
TH3362SS	19.3	9.4	10.1	5.2	9.6	23	10103091SH109	
TH3362SS-BA	19.3	9.4	10.1	5.2	9.6	23	10103091SH109	
TH3362SSW	19.3	9.4	10.1	5.2	9.6	22	10103091SH109	
TH3363MSS	25.4	13.4	15.3	5.0	10.4	23	10103091SH128	
TH3363SS	25.4	13.4	14.3	5.2	9.6	36	10103091SH113	
TH3363SS-BA	25.4	13.4	14.3	5.2	9.6	36	10103091SH113	
TH3363SSW	25.4	13.5	14.2	5.2	9.6	35	10103091SH113	
TH3364MSS	35.1	14.4	16.3	5.0	10.4	45	10103091SH128	
TH3364SS	35.1	14.5	15.5	5.2	9.6	49	10103091SH113	
TH3364SS-BA	35.1	14.5	15.5	5.2	9.6	49	10103091SH113	
TH3364SSW	35.2	14.5	15.5	5.2	9.6	33	10103091SH113	
TH3365MSS	59.4	24.5	25.6	7.9	14.4	206	10103091SH130	
TH3365SS	59.5	24.6	25.6	8.4	13.8	131	10103091SH119	
TH3366MSS	59.4	24.5	25.6	7.9	14.4	211	10103091SH130	
TH3366SS	59.5	24.6	25.6	8.4	13.8	139	10103091SH119	
TH4321SS	11.3	7.4	8.1	4.9	9.4	12	10103091SH109	
TH4321SS-BA	11.3	7.4	8.1	4.9	9.4	12	10103091SH109	
TH4321SSW	11.3	7.4	8.1	4.9	9.4	12	10103091SH109	
TH4322SS	19.3	9.4	10.1	5.2	9.6	23	10103091SH109	
TH4322SS-BA	19.3	9.4	10.1	5.2	9.6	23	10103091SH109	
TH4322SSW	19.3	9.4	10.1	5.2	9.6	23	10103091SH109	
TH4323SS	25.4	13.4	14.3	5.2	9.6	36	10103091SH113	
TH4323SS-BA	25.4	13.4	14.3	5.2	9.6	36	10103091SH113	
TH4323SSW	25.4	13.5	14.2	5.2	9.6	36	10103091SH113	
TH4324SS	35.1	14.5	15.5	5.2	9.6	47	10103091SH113	
TH4324SS-BA	35.1	14.5	15.5	5.2	9.6	47	10103091SH113	
TH4324SSW	35.2	14.5	15.5	5.2	9.6	47	10103091SH113	
TH4325SS	59.5	24.6	25.6	8.4	13.8	135	10103091SH119	
TH4326SS	59.5	24.6	25.6	8.4	13.8	139	10103091SH119	
THN2261SSDC	13.3	9.4	10.1	5.4	10.0	16	10103091SH110	
THN2262SSDC	19.3	9.4	10.1	5.7	10.2	16	10103091SH110	
THN2263SSDC	25.4	13.4	14.3	5.2	9.6	30	10103091SH113	
THN3361MSS	19.3	9.4	14.1	5.0	10.1	22	10103091SH123	
THN3361MSSW	19.3	9.4	14.1	5.0	10.1	22	10103091SH123	
THN3361SS	11.3	9.4	10.1	4.9	9.4	16	10103091SH109	
THN3361SS-BA	11.3	9.4	10.1	4.9	9.4	16	10103091SH109	
THN3361SSCL	13.3	9.4	10.1	5.2	9.6	9	10103091SH109	
THN3361SSW	11.3	9.4	10.1	4.9	9.4	19	10103091SH109	
THN3362MSS	19.3	9.4	14.1	5.0	10.1	15	10103091SH123	
THN3362SS	13.3	9.4	10.1	5.2	9.6	21	10103091SH109	
THN3362SS-BA	13.3	9.4	10.1	5.2	9.6	21	10103091SH109	
THN3362SSCL	13.3	9.4	10.1	5.2	9.6	21	10103091SH109	
THN3362SSW	13.3	9.4	10.1	5.2	9.6	22	10103091SH109	
THN3363MSS	25.4	13.4	15.3	5.0	10.4	20	10103091SH128	
THN3363SS	25.4	13.4	14.3	5.2	9.6	36	10103091SH113	
THN3363SS-BA	25.4	13.4	14.3	5.2	9.6	36	10103091SH113	
THN3363SSW	25.4	13.5	14.2	5.2	9.6	36	10103091SH113	
THN3364MSS	35.1	14.4	16.3	5.0	10.4	32	10103091SH128	
THN3364SS	35.1	14.5	15.5	5.2	9.6	50	10103091SH113	
THN3364SS-BA	35.1	14.5	15.5	5.2	9.6	50	10103091SH113	
THN3364SSCL	35.1	14.5	15.5	5.2	9.6	32	10103091SH113	
THN3364SSW	35.2	14.5	15.5	5.2	9.6	32	10103091SH113	
THN3365MSS	47.9	24.5	25.6	7.9	14.4	110	10103091SH130	
THN3365SS	48.0	24.6	25.6	8.4	13.7	239	10103091SH119	
THN3366MSS	47.9	24.5	25.6	7.9	14.4	110	10103091SH130	
THN3366SS	48.0	24.6	25.6	8.4	13.7	139	10103091SH119	

No KO

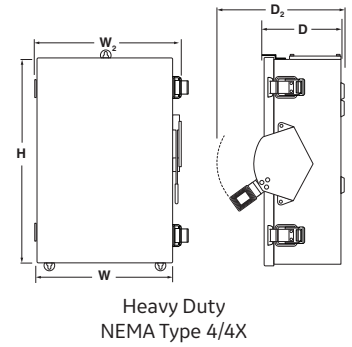

Safety Switch Enclosure Dimensions

Heavy Duty, NEMA Type 5, 12 Drip/Dust-tight Approximate Dimensions in inches

Product Number	Dimension H	Dimension W (Box)	Dimension W ₂ (W/ Handle)	Dimension D (Box)	Dimension D ₂ (W/ Handle)	Weight (lbs)	Drawing #	KO Figure Number
TH2221J	11.3	7.4	8.1	5.4	10.0	12	10103091SH110	No KO
TH2221JW	11.3	7.4	8.1	5.4	10.0	12	10103091SH110	
TH2222J	19.3	9.4	10.1	5.7	10.2	21	10103091SH110	
TH2222JW	19.3	9.4	10.1	5.7	10.2	21	10103091SH110	
TH2261JDC	13.3	9.4	10.1	5.4	10.0	16	10103091SH109	
TH2262JDC	19.3	9.4	10.1	5.7	10.2	22	10103091SH109	
TH2263JDC	25.4	13.4	14.0	5.0	10.1	35	10103091SH113	
TH3221J	11.3	7.4	8.1	5.4	10.0	12	10103091SH110	
TH3221JW	11.3	7.4	8.1	5.4	10.0	12	10103091SH110	
TH3222J	19.3	9.4	10.1	5.7	10.2	15	10103091SH110	
TH3222JW	19.3	9.4	10.1	5.7	10.2	15	10103091SH110	
TH3223J	25.4	13.4	14.0	5.0	10.1	37	10103091SH120	
TH3223JW	25.4	13.4	14.0	5.0	10.1	37	10103091SH120	
TH3224J	35.1	14.5	15.1	5.0	10.1	33	10103091SH120	
TH3224JW	35.1	14.5	15.1	5.0	10.1	33	10103091SH120	
TH3225J	59.5	24.5	25.6	7.9	14.5	120	10103091SH124	
TH3226J	59.5	24.5	25.6	7.9	14.5	134	10103091SH124	
TH3321J	11.3	7.4	8.1	5.4	10.0	12	10103091SH110	
TH3321JW	11.3	7.4	8.1	5.4	10.0	12	10103091SH110	
TH3322J	19.3	9.4	10.1	5.7	10.2	21	10103091SH110	
TH3322JCH	19.3	9.4	9.8	5.7	10.3	28	10103091SH132	
TH3322JW	19.3	9.4	10.1	5.7	10.2	21	10103091SH110	
TH3361J	13.3	9.4	10.1	5.4	10.0	16	10103091SH110	
TH3361JW	13.3	9.4	10.1	5.4	10.0	16	10103091SH110	
TH3362J	19.3	9.4	10.1	5.7	10.2	22	10103091SH110	
TH3362JCH	19.3	9.4	9.8	5.7	10.3	31	10103091SH132	
TH3362JCHSS	19.3	9.4	9.8	5.7	10.3	32	10103091SH132	
TH3362JW	19.3	9.4	10.1	5.7	10.2	22	10103091SH110	
TH3363J	25.4	13.4	14.0	5.0	10.1	36	10103091SH120	
TH3363JW	25.4	13.4	14.0	5.0	10.1	35	10103091SH120	
TH3364J	35.1	14.5	15.1	5.0	10.1	49	10103091SH120	
TH3364JW	35.1	14.5	15.1	5.0	10.1	33	10103091SH120	
TH3365J	59.5	24.5	25.6	7.9	14.5	206	10103091SH124	
TH3366J	59.5	24.5	25.6	7.9	14.5	215	10103091SH124	
TH4321J	11.3	7.4	8.1	5.4	10.0	12	10103091SH110	
TH4321JW	11.3	7.4	8.1	5.4	10.0	12	10103091SH110	
TH4322J	19.3	9.4	10.1	5.7	10.2	22	10103091SH110	
TH4322JW	19.3	9.4	10.1	5.7	10.2	22	10103091SH110	
TH4323J	25.4	13.4	14.0	5.0	10.1	36	10103091SH120	
TH4323JW	25.4	13.4	14.0	5.0	10.1	36	10103091SH120	
TH4324J	35.1	14.5	15.1	5.0	10.1	52	10103091SH120	
TH4324JW	35.1	14.5	15.1	5.0	10.1	52	10103091SH120	
TH4325J	59.5	24.5	25.6	7.9	14.5	128	10103091SH124	
TH4326J	59.5	24.5	25.6	7.9	14.5	139	10103091SH124	
THN2261JDC	13.3	9.4	10.1	5.4	10.0	16	10103091SH110	
THN2262JDC	19.3	9.4	10.1	5.7	10.2	15	10103091SH110	
THN2263JDC	25.4	13.4	14.0	5.0	10.1	34	10103091SH120	
THN3361J	13.3	9.4	10.1	5.4	10.0	16	10103091SH110	
THN3361JCL	13.3	9.4	10.1	5.4	10.0	22	10103091SH110	
THN3361JW	13.3	9.4	10.1	5.4	10.0	16	10103091SH110	
THN3362J	19.3	9.4	10.1	5.7	10.2	21	10103091SH110	
THN3362JCH	19.3	9.4	9.8	5.7	10.3	21	10103091SH132	
THN3362JW	19.3	9.4	10.1	5.7	10.2	21	10103091SH110	
THN3363J	25.4	13.4	14.0	5.0	10.1	34	10103091SH120	
THN3363JCL	25.4	13.4	14.0	5.0	10.1	33	10103091SH120	
THN3363JW	25.4	13.4	14.0	5.0	10.1	33	10103091SH120	
THN3364J	35.1	14.5	15.1	5.0	10.1	47	10103091SH120	
THN3364JW	35.1	14.5	15.1	5.0	10.1	47	10103091SH120	
THN3365J	48.0	24.5	25.6	7.9	14.5	164	10103091SH124	
THN3366J	48.0	24.5	25.6	7.9	14.5	109	10103091SH124	

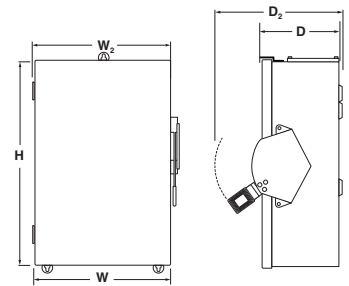

Heavy Duty
NEMA Type 5/12

Safety Switch Enclosure Dimensions

Heavy Duty, NEMA Type 3R, 5, 12 Approximate Dimensions in inches

Product Number	Dimension H	Dimension W (Box)	Dimension W ₂ (W/ Handle)	Dimension D (Box)	Dimension D ₂ (W/ Handle)	Weight (lbs)	Drawing #	KO Figure Number
TH3361JR	13.3	9.4	10.1	5.4	10.0	17	10103091SH110	20
TH3362JR	19.3	9.4	10.1	5.7	10.2	23	10103091SH132	
TH3363JR	25.4	13.4	14.0	5.0	10.1	38	10103091SH120	
TH3364JR	35.1	14.5	15.1	5.0	10.1	49	10103091SH120	
TH3365JR	59.5	24.5	25.6	7.9	14.5	197	10103091SH124	
TH3366JR	59.5	24.5	25.6	7.9	14.5	212	10103091SH124	

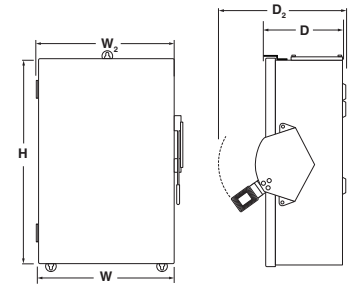

Heavy Duty
NEMA Type 3R/5/12

Heavy Duty, NEMA Type 12 Drip/Dust-tight Approximate Dimensions in inches

Product Number	Dimension H	Dimension W (Box)	Dimension W ₂ (W/ Handle)	Dimension D (Box)	Dimension D ₂ (W/ Handle)	Weight (lbs)	Drawing #	KO Figure Number
TH2221M	11.3	7.4	8.1	4.7	9.9	13	10103091SH123	No KO
TH2222M	19.3	9.4	14.1	5.0	10.1	23	10103091SH123	
TH2223M	23.4	13.4	15.3	5.0	10.1	24	10103091SH128	
TH2224M	35.1	14.4	16.3	5.0	10.1	25	10103091SH128	
TH2261MDC	19.3	9.4	14.1	5.0	10.1	20	10103091SH123	
TH2262MDC	19.3	9.4	14.1	5.0	10.1	22	10103091SH123	
TH2263MDC	23.4	13.4	15.3	5.0	10.1	35	10103091SH128	
TH3321M	11.3	7.4	8.1	4.7	9.9	13	10103091SH123	
TH3322M	19.3	9.4	14.1	5.0	10.1	21	10103091SH123	
TH3322MW	19.3	9.4	14.1	5.0	10.1	21	10103091SH123	
TH3323M	23.4	13.4	15.3	5.0	10.1	24	10103091SH128	
TH3324M	35.1	14.4	16.3	5.0	10.1	30	10103091SH128	
TH3325M	59.4	24.5	25.6	7.9	14.4	193	10103091SH130	
TH3326M	59.4	24.5	25.6	7.9	14.4	200	10103091SH130	
TH3361M	19.3	9.4	14.1	5.0	10.1	22	10103091SH123	
TH3361MW	19.3	9.4	14.1	5.0	10.1	22	10103091SH123	
TH3362M	19.3	9.4	14.1	5.0	10.1	22	10103091SH123	
TH3363M	23.4	13.4	15.3	5.0	10.1	35	10103091SH128	
TH3364M	35.1	14.4	16.3	5.0	10.1	45	10103091SH128	
TH3365M	59.4	24.5	25.6	7.9	14.4	206	10103091SH130	
TH3366M	59.4	24.5	25.6	7.9	14.4	211	10103091SH130	
THN2261MDC	19.3	9.4	14.1	5.0	10.1	20	10103091SH123	
THN2262MDC	19.3	9.4	14.1	5.0	10.1	20	10103091SH123	
THN2263MDC	23.4	13.4	15.3	5.0	10.1	35	10103091SH128	
THN3361M	19.3	9.4	14.1	5.0	10.1	21	10103091SH123	
THN3362M	19.3	9.4	14.1	5.0	10.1	15	10103091SH123	
THN3362MW	19.3	9.4	14.1	5.0	10.1	15	10103091SH123	
THN3363M	23.4	13.4	15.3	5.0	10.1	20	10103091SH128	
THN3364M	35.1	14.4	16.3	5.0	10.1	35	10103091SH128	
THN3365M	47.9	24.5	25.6	7.9	14.4	110	10103091SH130	
THN3366M	47.9	24.5	25.6	7.9	14.4	110	10103091SH130	

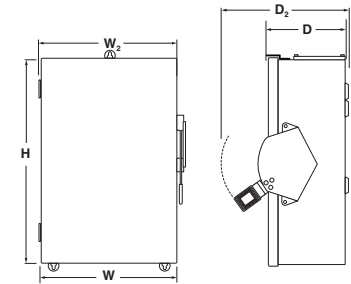

Heavy Duty
NEMA Type 5/12

Safety Switch Enclosure Dimensions

Double Throw, NEMA Type 1 TC Approximate Dimensions in inches

Product Number	Dimension H	Dimension W (Box)	Dimension W ₂ (W/ Handle)	Dimension D (Box)	Dimension D ₂ (W/ Handle)	Weight (lbs)	Drawing #	KO Figure Number
TC35321	15.8	10.4	12.0	5.2	8.7	14	10103091SH115	7
TC35322	18.8	11.4	13.0	6.3	9.3	19	10103091SH115	7
TC35323	22.4	14.5	16.0	7.9	14.5	34	10103091SH117	9
TC35324	30.2	17.9	19.5	8.9	11.9	54	10103091SH117	10
TC35325	34.3	24.5	26.7	10.3	17.1	83	10103091SH122	10
TC35326	44.4	23.5	25.6	11.3	17.5	140	10103091SH122	12
TC35327	63.8	27.0	27.8	8.9	14.1	175	10103091SH143	No KO
TC35327N	63.8	27.0	27.8	8.9	14.1	175	10103091SH143	
TC35328	78.1	42.6	43.8	20.5	29.6	471	10103091SH145	
TC35361	25.0	12.0	12.8	6.0	11.2	44	10103091SH185	7
TC35362	18.8	11.4	13.0	6.3	9.3	21	10103091SH115	
TC35363	22.4	14.5	16.0	7.9	14.5	38	10103091SH117	
TC35364	30.2	17.9	19.5	8.9	11.9	62	10103091SH117	10
TC35365	34.3	20.4	22.6	10.3	17.1	89	10103091SH122	10
TC35366	44.4	23.5	25.6	11.3	17.5	140	10103091SH122	12
TC35367	63.8	27.0	27.8	8.9	14.1	175	10103091SH143	No KO
TC35367N	63.8	27.0	27.8	8.9	14.1	175	10103091SH143	
TC35368	78.1	42.6	43.8	20.5	29.6	471	10103091SH145	

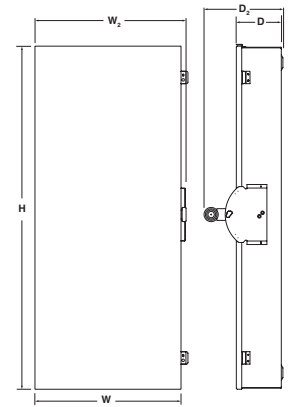

Double Throw
NEMA Type 1

Double Throw, NEMA Type 3R TC Approximate Dimensions in inches

Product Number	Dimension H	Dimension W (Box)	Dimension W ₂ (W/ Handle)	Dimension D (Box)	Dimension D ₂ (W/ Handle)	Weight (lbs)	Drawing #	KO Figure Number
TC10323R	15.1	7.2	8.2	5.2	8.5	10	10103091SH131	15
TC10324R	30.2	13.3	16.8	8.5	12.1	38	10103091SH131	13
TC10424R	30.2	13.3	16.8	8.5	12.1	38	10103091SH131	13
TC35321R	19.8	10.4	12.3	5.2	10.3	14	10103091SH126	No KO
TC35322R	20.8	11.4	13.3	6.3	11.4	19	10103091SH126	
TC35323R	22.9	14.4	16.6	7.9	14.5	35	10103091SH125	
TC35324R	30.6	17.9	19.6	8.9	11.9	54	10103091SH125	No KO
TC35325R	34.8	24.4	27.3	10.3	17.3	98	10103091SH143	
TC35326R	63.8	23.7	24.5	8.9	14.1	175	10103091SH143	
TC35327R	63.8	27.0	27.8	8.9	14.1	175	10103091SH143	No KO
TC35327RN	63.8	27.0	27.8	8.9	14.1	175	10103091SH143	
TC35328R	78.1	42.6	43.8	20.5	29.6	473	10103091SH145	
TC35361R	25.0	12.0	12.8	6.0	11.2	44	10103091SH185	No KO
TC35362R	20.8	11.4	13.3	6.3	11.4	21	10103091SH126	
TC35363R	22.9	14.4	16.6	7.9	14.5	39	10103091SH125	
TC35364R	30.6	17.9	19.6	8.9	11.9	62	10103091SH125	No KO
TC35365R	54.3	22.7	23.5	7.3	12.5	140	10103091SH143	
TC35366R	63.8	23.7	24.5	8.9	14.1	175	10103091SH143	
TC35367R	63.8	27.0	27.8	8.9	14.1	175	10103091SH143	No KO
TC35367RN	63.8	27.0	27.8	8.9	14.1	175	10103091SH143	
TC35368R	78.1	42.6	43.8	20.5	29.6	473	10103091SH145	

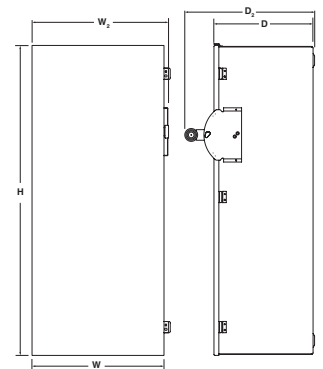

Double Throw
NEMA Type 3R

Safety Switch Enclosure Dimensions

Double Throw, NEMA Type 1 TDT Approximate Dimensions in inches

Product Number	Dimension H	Dimension W (Box)	Dimension W ₂ (W/ Handle)	Dimension D (Box)	Dimension D ₂ (W/ Handle)	Weight (lbs)	Drawing #	KO Figure Number
TDT3321	37.0	12.0	12.8	8.3	11.2	47	10103091SH137	No KO
TDT3322	37.0	12.0	12.8	8.3	11.2	43	10103091SH137	
TDT3323	37.0	12.0	12.8	8.3	11.2	48	10103091SH137	
TDT3324	51.4	19.2	19.9	6.1	11.3	159	10103091SH138	
TDT3325	74.7	25.3	26.2	8.9	14.1	163	10103091SH139	
TDT3326	86.1	27.4	28.3	8.9	14.1	341	10103091SH139	
TDT3327	58.9	28.1	29.3	20.5	25.6	275	10103091SH147	
TDT3328	78.1	42.6	43.8	20.5	29.6	501	10103091SH146	
TDT3361	37.0	12.0	12.8	8.3	11.2	42	10103091SH137	
TDT3362	37.0	12.0	12.8	8.3	11.2	43	10103091SH137	
TDT3363	37.0	12.0	12.8	8.3	11.2	62	10103091SH137	
TDT3364	51.4	27.6	28.6	8.8	16.2	102	10103091SH138	
TDT3365	74.7	25.3	26.2	8.9	14.1	274	10103091SH139	
TDT3366	58.9	28.1	29.3	20.5	25.6	278	10103091SH144	
TDT3367	58.9	28.1	29.3	20.5	25.6	278	10103091SH145	
TDT3368	78.1	42.6	43.8	20.5	29.6	501	10103091SH146	

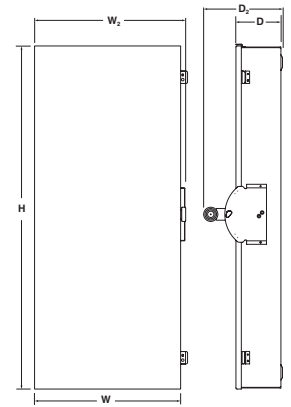

Double Throw
NEMA Type 1

Double Throw, NEMA Type 3R TDT Approximate Dimensions in inches

Product Number	Dimension H	Dimension W (Box)	Dimension W ₂ (W/ Handle)	Dimension D (Box)	Dimension D ₂ (W/ Handle)	Weight (lbs)	Drawing #	KO Figure Number
TDT3321R	37.0	12.0	12.8	8.3	11.2	47	10103091SH137	No KO
TDT3322R	37.0	12.0	12.8	8.3	11.2	47	10103091SH137	
TDT3323R	37.0	12.0	12.8	8.3	11.2	62	10103091SH137	
TDT3324R	51.4	27.6	28.6	8.8	16.2	159	10103091SH138	
TDT3325R	74.8	26.3	24.5	8.8	14.1	230	10103091SH143	
TDT3326R	58.9	28.1	29.3	20.5	25.6	320	10103091SH144	
TDT3327R	58.9	28.1	29.3	20.5	25.6	276	10103091SH147	
TDT3328R	78.1	42.6	43.8	20.5	29.6	503	10103091SH146	
TDT3361R	37.0	12.0	12.8	6.0	11.9	44	10103091SH185	
TDT3362R	37.0	12.0	12.8	6.0	11.9	44	10103091SH185	
TDT3363R	37.0	12.0	12.8	8.3	11.2	49	10103091SH137	
TDT3364R	51.4	27.6	28.6	8.8	16.2	160	10103091SH138	
TDT3365R	74.8	26.3	24.5	8.8	14.1	230	10103091SH143	
TDT3366R	58.9	28.1	29.3	20.5	25.6	278	10103091SH144	
TDT3367R	58.9	28.1	29.3	20.5	25.6	278	10103091SH147	
TDT3368R	78.1	42.6	43.8	20.5	29.6	503	10103091SH146	

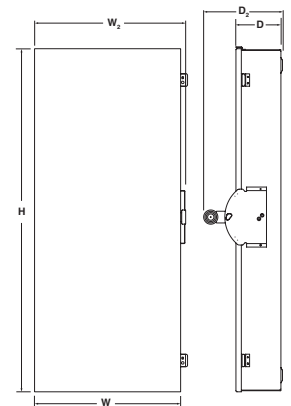

Double Throw
NEMA Type 3R

Double Throw, NEMA Type 4X (304 Stainless) TC Approximate Dimensions in inches

Product Number	Dimension H	Dimension W (Box)	Dimension W ₂ (W/ Handle)	Dimension D (Box)	Dimension D ₂ (W/ Handle)	Weight (lbs)	Drawing #	KO Figure Number
TC35361SS	25.7	11.9	12.7	5.5	11.4	60	10103091SH150	No KO
TC35362SS	25.7	11.9	12.7	5.5	11.4	60	10103091SH150	
TC35363SS	25.7	11.9	12.7	5.5	11.4	60	10103091SH150	
TC35364SS	39.8	19.6	20.3	6.5	11.7	105	10103091SH186	
TC35365SS	37.9	19.6	20.3	6.5	14.1	185	10103091SH149	
TC35366SS	67.0	24.1	25.3	9.0	14.0	195	10103091SH188	
TC35367SS	63.3	27.4	28.4	8.9	14.1	230	10103091SH187	

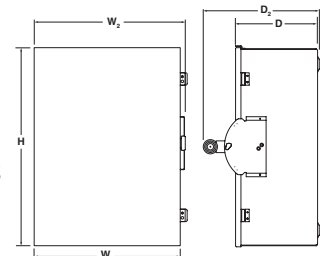

Double Throw
NEMA Type 4X

Double Throw, NEMA Type 4X (304 Stainless) TDT Approximate Dimensions in inches

Product Number	Dimension H	Dimension W (Box)	Dimension W ₂ (W/ Handle)	Dimension D (Box)	Dimension D ₂ (W/ Handle)	Weight (lbs)	Drawing #	KO Figure Number
TDT3361SS	38.8	12.0	12.8	5.5	11.4	45	10103091SH148	No KO
TDT3362SS	38.8	12.0	12.8	5.5	11.4	45	10103091SH148	
TDT3363SS	38.8	12.0	12.8	5.5	11.4	45	10103091SH148	
TDT3364SS	53.3	19.6	20.3	6.5	11.6	100	10103091SH142	
TDT3365SS	37.9	19.6	20.3	6.5	14.1	260	10103091SH149	

Safety Switch Knockouts

Dimensions—Knockouts

Symbol	A	B	C	D	E	F	G	H	J	K	L	M	N
Conduit Size (Inches)	9/32	½	½	½	½	½	¾	¾	1	1	2	2	2 ½
	-	-	¾	¾	¾	¾	1	1	1 ¼	1 ½	2 ½	2 ½	3
	-	-	-	1	1	1	-	1 ¾	1 ½	2	3	3	-
	-	-	-	-	1 ¼	1 ½	-	1 ½	2	2 ½	-	3 ½	-

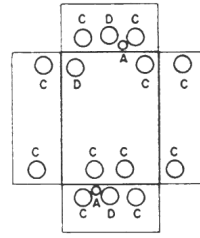

Figure 1

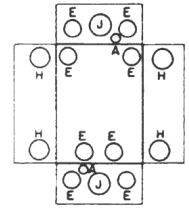

Figure 2

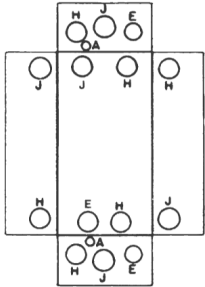

Figure 3

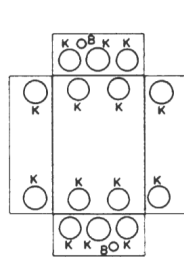

Figure 4

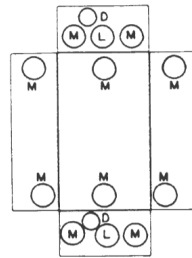

Figure 5

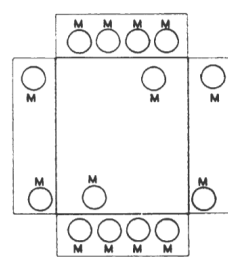

Figure 6

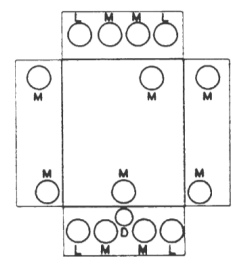

Figure 7

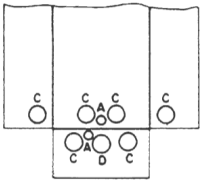

Figure 8

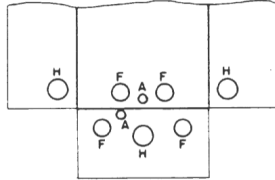

Figure 9

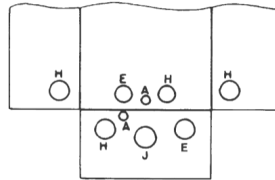

Figure 10

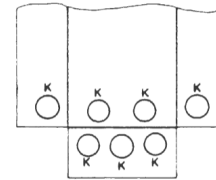

Figure 11

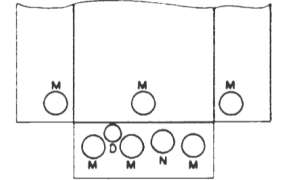

Figure 12

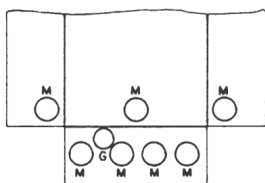

Figure 13

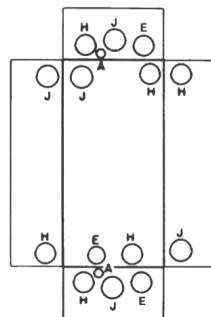

Figure 14

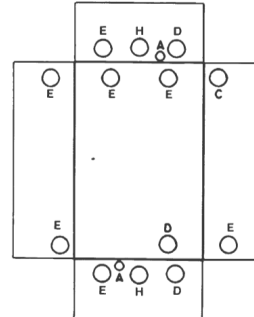

Figure 15

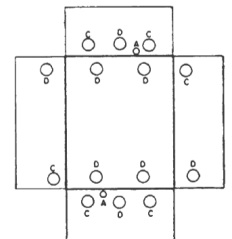

Figure 16

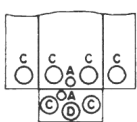

Figure 17

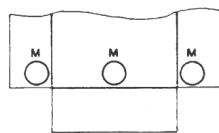

Figure 18

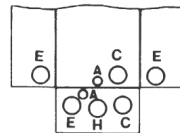

Figure 19

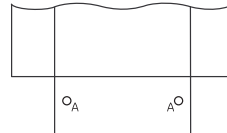

Figure 20

For additional information on GE safety switches, please visit the Publication Library at www.geindustrial.com to view and download the following resources:

Pub. Number	Title
GEA-12144	Spec Setter Safety Switches
DET-842	Stainless Steel Safety Switches Sealed Tight – Latch It!
DEE-576	General Duty Safety Switches
DEQ-219	GE's Side-Swing Safety Switches
DET-843	GE Residential Products and Solutions
DEA-464	Small Projects Same Day Flyer
DET-651	Small Projects Selection Guide



GE Energy Connections
41 Woodford Avenue
Plainville, CT 06062
1-800-431-7867
www.geindustrial.com

*Indicates a trademark of the General Electric Company and/or its affiliates.
Information provided is subject to change without notice. Please verify all details with GE. All values are design or typical values when measured under laboratory conditions, and GE makes no warranty or guarantee, express or implied, that such performance will be obtained under end-use conditions.
©2017, General Electric Company and/or its affiliates. All rights reserved.

7.17 DET-845A