

## Energi TriPak® Basic Packages

The Energi TriPak® Basic Package incorporates Maestro® load controls and wireless sensors which provides a system that delivers energy savings, convenience, and ease of installation.

Maestro Wireless® switches use Lutron® patented Clear Connect® RF Technology, which enables wireless communication with Radio Powr Savr™ sensors for light control.

### Features

- The Energi TriPak® Basic package provides switching and occupancy/vacancy sensing of multiple load types.
- Lutron® patented Clear Connect® RF Technology works through walls and floors.
- Controls include Front Accessible Service Switch (FASS™) for safe lamp replacement.
- Two-wire installation for any retrofit application.
- Power failure memory: If power is interrupted, the control will return to its previously set level prior to interruption.

### Model Numbers

- |               |  |
|---------------|--|
| MRF2-1S8A-10C | (1) 8 A Switch<br>(1) Radio Powr Savr™ ceiling sensor            |
| MRF2-1S8A-10H | (1) 8 A Switch<br>(1) Radio Powr Savr™ hallway sensor            |
| MRF2-1S8A-10K | (1) 8 A Switch<br>(1) Radio Powr Savr™ corner sensor             |
| MRF2-1S8A-10W | (1) 8 A Switch<br>(1) Radio Powr Savr™ wall sensor               |
| MRF2-1S8A-1VC | (1) 8 A Switch<br>(1) Radio Powr Savr™ ceiling<br>vacancy sensor |
| MRF2-2S8A-10W | (2) 8 A Switches<br>(1) Radio Powr Savr™ wall sensor             |

### Receiving Devices

Maestro Wireless® Control

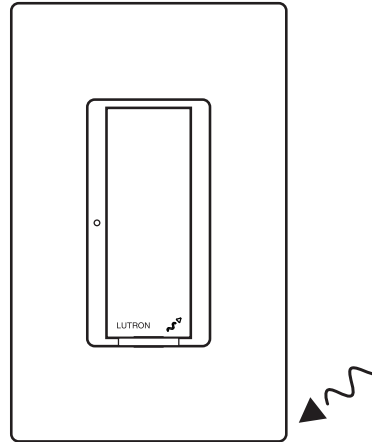

RF Switch

### Transmitting Devices

Radio Powr Savr™ Sensors

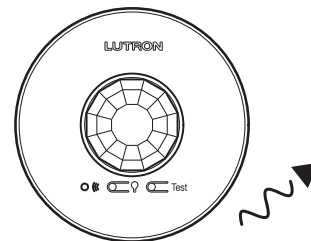

Ceiling-Mounted Occupancy and Vacancy Sensor

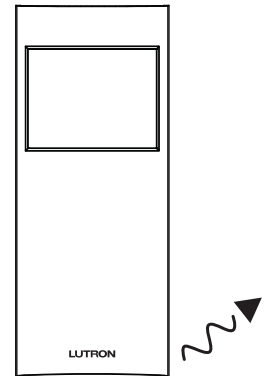

Wall, Corner, or Hall Mounted Occupancy and Vacancy Sensor

<b>Job Name:</b>	<b>Model Numbers:</b>
<b>Job Number:</b>	

## Maestro Wireless® Switch

### Model Number

#### Switch

Lighting and motor loads

MRF2-8S-DV-XX 8 A Lighting, 3 A Fan (1/10 HP motor, 120 V~ only), Spec Grade Electronic Switch 120–277 V~, NO NEUTRAL WIRE REQUIRED

### Companion Controls

#### Claro® Gloss Finishes

MA-AS-XX Companion Switch 120 V~  
 MA-AS-277-XX Companion Switch 277 V~

#### Satin Colors® Satin Finishes

MSC-AS-XX Companion Switch 120 V~  
 MSC-AS-277-XX Companion Switch 277 V~

“XX” in the model number represents color/finish code.

Switch



MRF2-8S-DV-XX

Companion Switch



MA-AS-XX

## Switch Load Type and Capacity

### No Neutral Required

Control	Voltage	Load Type	Minimum Load	Maximum Load		
				Not Ganged	End of Gang	Middle of Gang
MRF2-8S-DV <sup>1,2</sup>	120–277 V~	Incandescent/ Halogen	25 W	8 A	8 A/7 A <sup>3</sup>	7 A
	120–277 V~	Fluorescent/ LED/CFL	40 W (LUT-MLC) <sup>4</sup>	8 A	8 A/7 A <sup>3</sup>	7 A
	120 V~	Fan Motor	0.4 A	1/10 HP 3 A	1/10 HP 3 A	1/10 HP 3 A

<sup>1</sup> Switch Load Type: MRF2-8S-DV is designed for use with permanently installed lighting loads and with fan motor loads up to 1/10 HP (3 A, 120 V~ only).

<sup>2</sup> Switch Load Type: MRF2-8S-DV are designed for use with permanently installed lighting loads.

<sup>3</sup> Maximum load for double gang application is 8 A. Triple gang application derates maximum load to 7 A.

<sup>4</sup> The LUT-MLC (included) ensures proper function with certain fluorescent, CFL, and LED load types.

<b>Job Name:</b>	<b>Model Numbers:</b>
<b>Job Number:</b>	

## Specifications

### Regulatory Approvals

- UL® Listed.
- CSA Certified.
- FCC Approved. Complies with the limits for a Class B digital device, pursuant to Part 15 of the FCC Rules.
- Industry Canada Certified.

### Power

Operating voltage:  
120 – 277 V~ 50/60 Hz

## Key Design Features

### Switch

- On a single-tap, lights turn ON or OFF.

### All RF Local Controls

- Tested to withstand electrostatic discharge without damage or memory loss, in accordance with IEC 61000-4-2.
- Tested to withstand surge voltages without damage or loss of operation, in accordance with IEEE C62.41-1991 Recommended Practice on Surge Voltages in Low-Voltage AC Power Circuits.
- Controls always operate locally and do not require system control.
- Power failure memory: should power be interrupted, the control will return to its previously set level prior to the interruption when power is restored.
- Uses conventional Single-pole, 3-way and 4-way wiring.
- Multiple location control from Switch and up to 9 Companion Switches.
- Use Lutron® Designer (Claro® and Satin Colors®) wallplates or designer-style wallplates from other manufacturers. Wallplates are sold separately.
- Lutron Claro® and Satin Colors® wallplates snap on with no visible means of attachment.
- Requires a 1-gang U.S. wallbox. 3½ in (89 mm) deep recommended, 2¼ in (57 mm) deep minimum.
- Green indicator light.

### System Communications and Capacity

- Maestro Wireless® controls communicate with the Pico® wireless controls and Radio Power Savr™ sensors through radio frequency (RF).
- Maestro Wireless® local controls must be located within 60 ft (18 m) line of sight or 30 ft (9 m) through walls, of Radio Power Savr™ sensors.
- Maestro Wireless® local controls must be located within 60 ft (18 m) line of sight or 30 ft (9 m) through walls, of a Pico® wireless control.
- Up to 10 sensors or Pico® wireless controls can be assigned to each switch.
- Sensors can be assigned to multiple switches.

### Environment

- Ambient operating temperature: 32 °F to 104 °F (0 °C to 40 °C), 0%-90% humidity, non-condensing. Indoor use only.

<p><b>Job Name:</b></p>  <p><b>Job Number:</b></p>	<p><b>Model Numbers:</b></p>
--	------------------------------

### Operation

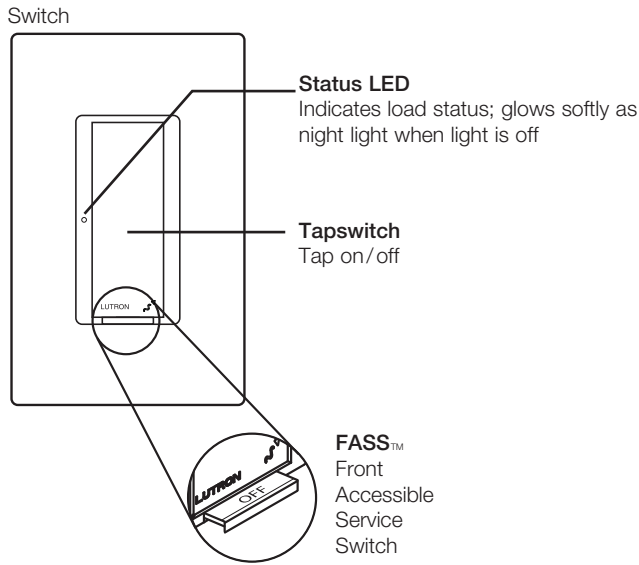

### Mounting

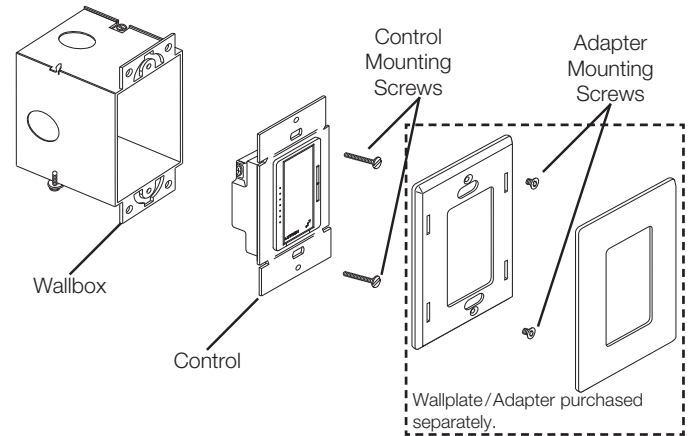

**IMPORTANT NOTICE:**  
**FASS™** - Front Accessible Service Switch - to service load, remove power by pulling the FASS™ switch out completely on either the Switch or Companion Switch. After servicing load, push the FASS™ switch back in fully to restore power to the control.

### Dimensions

Front View

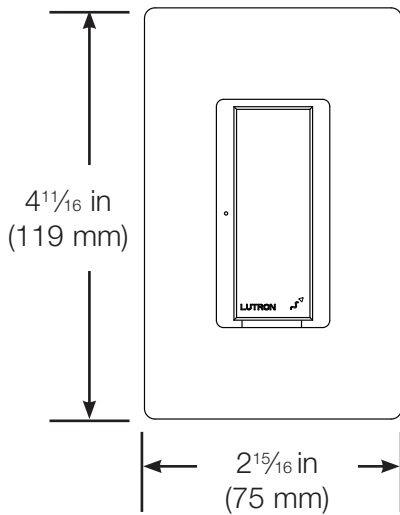

Side View

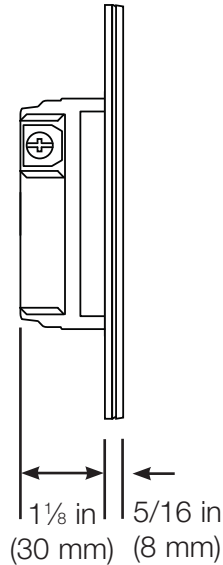

Job Name:	Model Numbers:
Job Number:	

# Wiring Diagrams

## Single Location Installation

MRF2-8S-DV

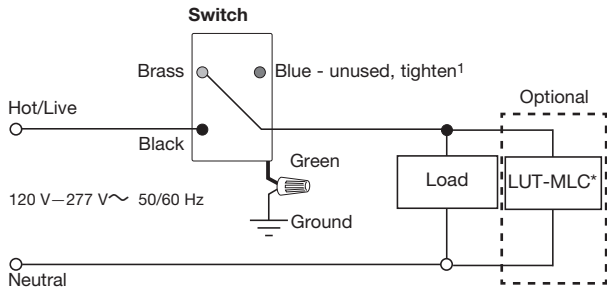

\* A LUT-MLC ensures proper function when fluorescent, CFL, or LED loads are used. Install the LUT-MLC inside a load fixture or in a separate J-box of the circuit.

## Multi-Location Installation²

MRF2-8S-DV³ with MA-AS/MA-AS-277 or MSC-AS/MS-AS-277

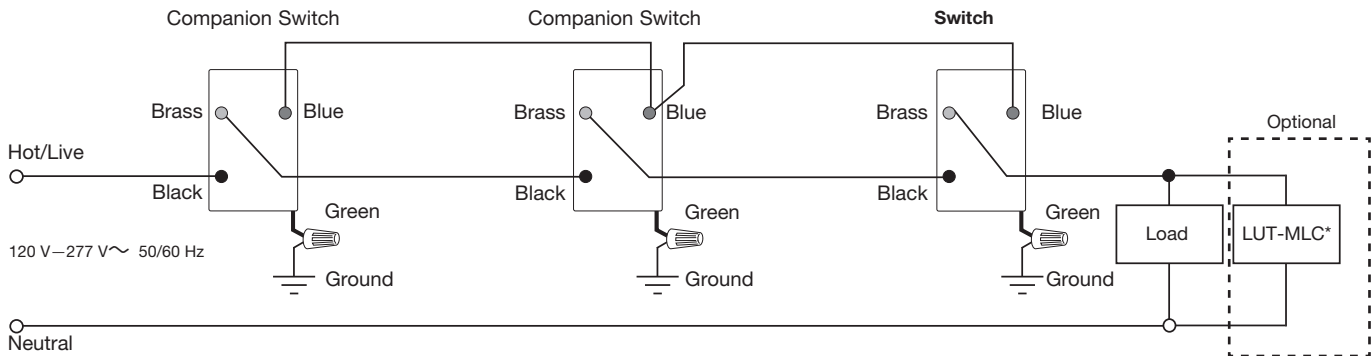

¹ When using controls in single location installations, tighten the blue terminal without any wires attached. **DO NOT** connect the blue terminal to any other wiring or to ground.

² Up to 9 Maestro® Companion Switches may be connected to the Maestro Wireless® Switch. Total blue terminal wire length may be up to 250 ft (76 m).

³ Requires MA-AS/MS-AS for 120 V~ applications, and MA-AS-277/MS-AS-277 for 277 V~ applications.

Job Name:	Model Numbers:
Job Number:	

## Colors and Finishes

### Gloss Finishes

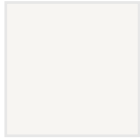

White  
WH



Ivory  
IV

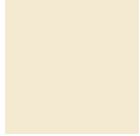

Almond  
AL

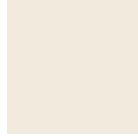

Light  
Almond  
LA



Gray  
GR



Brown  
BR



Black  
BL

### Satin Finishes



Hot  
HT



Merlot  
MR



Plum  
PL



Turquoise  
TQ



Taupe  
TP



Eggshell  
ES



Biscuit  
BI



Snow  
SW



Palladium  
PD



Midnight  
MN



Sienna  
SI



Terracotta  
TC



Greenbriar  
GB

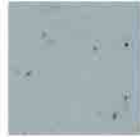

Bluestone  
BG



Mocha  
Stone  
MS



Goldstone  
GS

Due to printing limitations, colors and finishes shown cannot be guaranteed to perfectly match actual product colors.



Desert Stone  
DS



Stone  
ST



Limestone  
LS

### Metal Finish (wallplate only)



Stainless Steel  
SS

When using Stainless Steel wallplates, it is recommended to order the controls in Black (BL) or Midnight (MN).

<p>Job Name:</p>  <p>Job Number:</p>	<p>Model Numbers:</p>
--	-----------------------

## Radio Powr Savr™ Wireless Occupancy/Vacancy Ceiling Sensor

Lutron® Radio Powr Savr™ occupancy/vacancy sensors are wireless, battery-powered passive infrared (PIR) sensors that automatically control lights via RF communication to compatible dimming and switching devices. These sensors detect the heat from people moving within an area to determine when the space is occupied. The sensors then wirelessly transmit the appropriate commands to the associated dimming and switching devices to turn the lights on or off automatically. They combine both convenience and exceptional energy savings potential along with ease of installation.

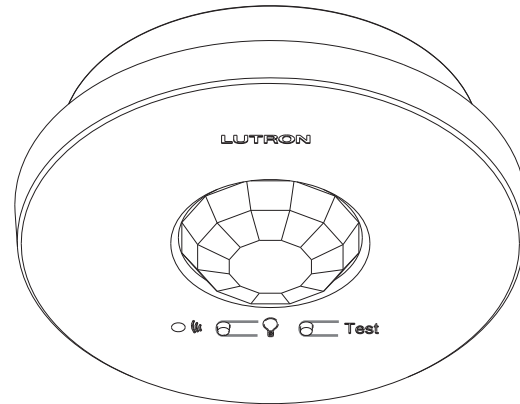

### Features

- Wireless occupancy sensor has 3 settings available: Auto-On/Auto-Off, Auto-On Low-Light/Auto-Off, and Manual-On/Auto-Off
- Auto-On Low-Light feature will only turn lights on automatically if there is less than approximately 10 Lux (1 fc) of ambient light
- Vacancy only model available to meet California (U.S.A.) Title 24 requirements
- Uses Clear Connect® technology
- Passive infrared motion detection with exclusive Lutron® XCT™ Technology for fine motion detection
- 360° coverage ranges from 324 ft² (30.2 m²) to 676 ft² (62.4 m²), depending on mounting height. See range diagrams for more details.
- Simple and intuitive adjustments available for Timeout, Auto-On, and Activity settings
- Supports advanced occupancy features, such as dependent occupancy groups and customizable occupied/unoccupied presets in some systems
- Multiple sensors can be added for extended coverage—refer to product specification submittal of receiving device to determine system limits
- Lens illuminates during test mode to verify ideal locations
- Multiple ceiling-mount methods available for different ceiling materials
- Front accessible test buttons make programming easy
- 10-year battery life design
- RoHS compliant

Job Name:	Model Numbers:
Job Number:	

## Specifications

### Regulatory

- Lutron® Quality Systems Registered to ISO 9001:2008

### Standards Approved

- FCC certified
- IC certified
- Meets CA (U.S.A.) Energy Commission Title 24 requirements
- COFETEL
- ANATEL
- SUTEL

### Power/Performance

- Operating voltage: 3 V<sub>DC</sub>
- Operating current: 14 µA nominal
- Requires one CR 123 lithium battery
- 10-year battery life
- Non-volatile memory (saved changes are stored during power loss)

### Environment

- Temperature: 32 °F to 104 °F (0 °C to 40 °C)
- For indoor use only

### Range

Local load controls must be located within 60 ft (18 m) line of sight, or 30 ft (9 m), through walls, of a sensor.

### Sensor Coverage Test

- Front accessible test button
- Lens illuminates orange in response to motion during test mode and is visible from 60 ft (18 m)

### Wireless Communication Test

- Front accessible test button
- Turn associated loads on and off

### Timeout Options

- 1 minute \*
- 5 minutes
- 15 minutes – default setting
- 30 minutes

### Auto-On Options (Occupancy Versions Only)

- “Enabled” – Sensor turns lights ON and OFF automatically – default setting.
- “Low Light” – Sensor turns lights ON automatically only in low ambient light conditions. Sensor turns lights OFF automatically.
- “Disabled” \*\* – Lights must be turned ON manually from dimming or switching device. Sensor turns lights OFF automatically.

### Activity Options

- Low Activity (Ⓐ) – default setting
- Medium Activity (Ⓑ)
- High Activity (Ⓒ)

\* Intended for use in high-activity, briefly occupied areas only

\*\* There is a 15-second grace period that begins when the lights are automatically turned off, during which the lights will automatically turn back on in response to motion. This grace period is provided as a safety and convenience feature in the event the lights turn off while the room is still occupied, so that the user does not need to manually turn the lights back on. After 15 seconds, the grace period expires and the lights must be manually turned on.

Job Name:	Model Numbers:
Job Number:	



## Installation Overview

### Sensor Setup

- Sensor setup is available as a service by Lutron. For more information see the **Sensor Layout and Tuning** service document (Lutron® P/N 3601235).

### Sensor Placement

- The ability of the sensor to detect motion requires line of sight of room occupants. The sensor must have an unobstructed view of the room. **DO NOT** mount behind or near tall cabinets, shelves, hanging fixtures, ceiling fans, etc. The sensor cannot see through glass objects such as patio or shower doors.
- Hot objects and moving air currents can affect the performance of the sensor. To ensure proper operation, the sensor should be mounted at least 4 ft (1.2 m) away from HVAC vents and light bulbs that are below the ceiling line.
- The performance of the sensor depends on a temperature differential between the ambient room temperature and that of room occupants. Warmer rooms may reduce the ability of the sensor to detect occupants.

### Mounting

Temporary mounting is optional to test sensor coverage and wireless communication before permanently installing the sensor.

#### Drop Ceiling (Compressed Fiber Ceiling Tile)

The mounting wire is provided for both temporary and permanent mounting of the sensor to ceiling tiles. It is designed to allow temporary mounting, testing, and repositioning (if necessary) of the sensor without damaging a ceiling tile. Once the final position of the sensor has been chosen, the mounting wire should be twisted together to permanently secure the sensor in place.

#### Solid Ceiling (Drywall, Plaster, Concrete, or Wood)

- Temporary mounting: Ten (10) temporary mounting strips can be purchased in the kit L-CMDPIRKIT for temporarily mounting and testing the sensor.
- Permanent mounting: Screws and anchors (for drywall or plaster) provided to mount the sensor.

#### Recess Mount

- Do not recess mount sensor in a metal surface.
- Recess mounting ring requires an opening of 3 in (76 mm) in diameter.
- Recess mounting ring secures internally to ceiling. Sensor twists into the recess mounting ring and sits flush with ceiling (see image to right).
- Recess mounting ring purchased as a separate kit: L-CRMK-WH.

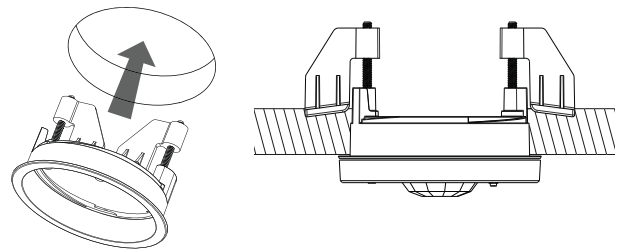

<p>Job Name:</p>  <p>Job Number:</p>	<p>Model Numbers:</p>
--	-----------------------

Dimensions

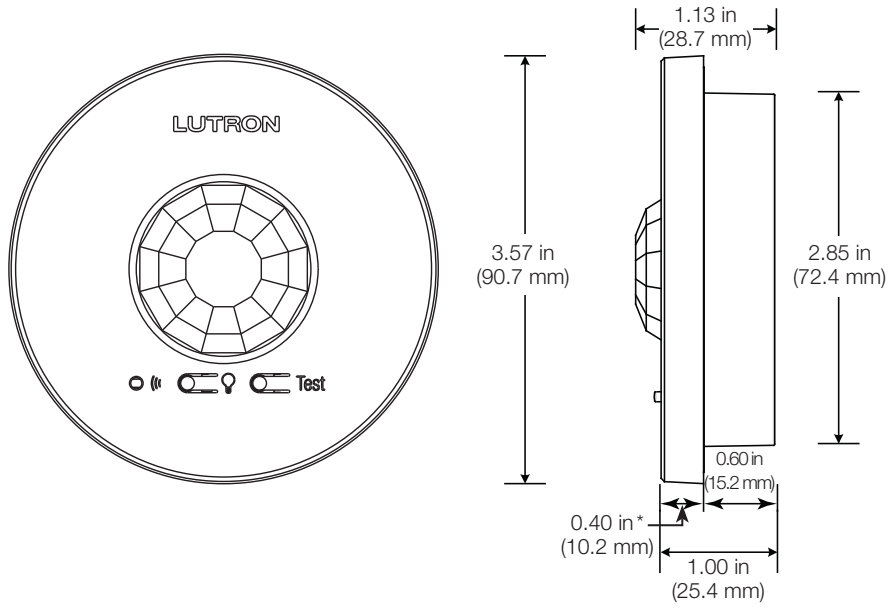

\* With the recess mounting kit 0.46 (11.7 mm) is below the plane of the ceiling.

Job Name:	Model Numbers:
Job Number:	

## Range Diagrams

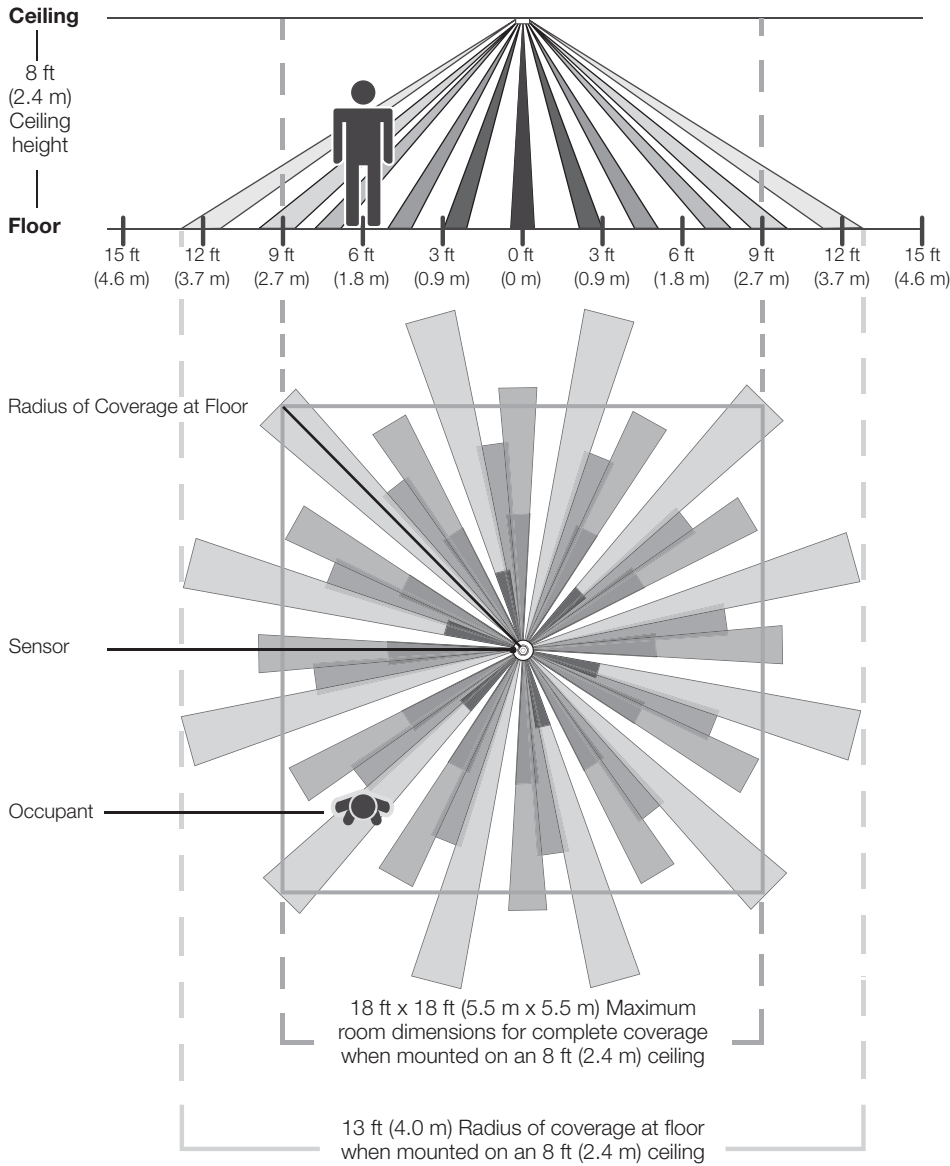

### Sensor Coverage Chart (for sensor mounted in center of room)

Ceiling Height	Maximum Room Dimensions for Complete Floor Coverage*	
8 ft (2.4 m)	18 ft x 18 ft (5.5 m x 5.5 m)	324 ft <sup>2</sup> (30.2 m <sup>2</sup> )
9 ft (2.7 m)	20 ft x 20 ft (6.1 m x 6.1 m)	400 ft <sup>2</sup> (37.2 m <sup>2</sup> )
10 ft (3.0 m)	22 ft x 22 ft (6.7 m x 6.7 m)	484 ft <sup>2</sup> (44.9 m <sup>2</sup> )
12 ft (3.7 m)	26 ft x 26 ft (7.9 m x 7.9 m)	676 ft <sup>2</sup> (62.4 m <sup>2</sup> )

\* 12 ft (3.7 m) is the recommended maximum mounting height

<b>Job Name:</b>	<b>Model Numbers:</b>
<b>Job Number:</b>	

## Lens Masking

Whenever possible, the sensor should be installed in a location where it cannot view areas outside the intended space, such as hallways or adjacent rooms. If this situation cannot be avoided, portions of the lens may be masked to block the view of the sensor into undesired areas. Ten (10) PIR Lens Masks can be purchased in the kit L-CMDPIRKIT.

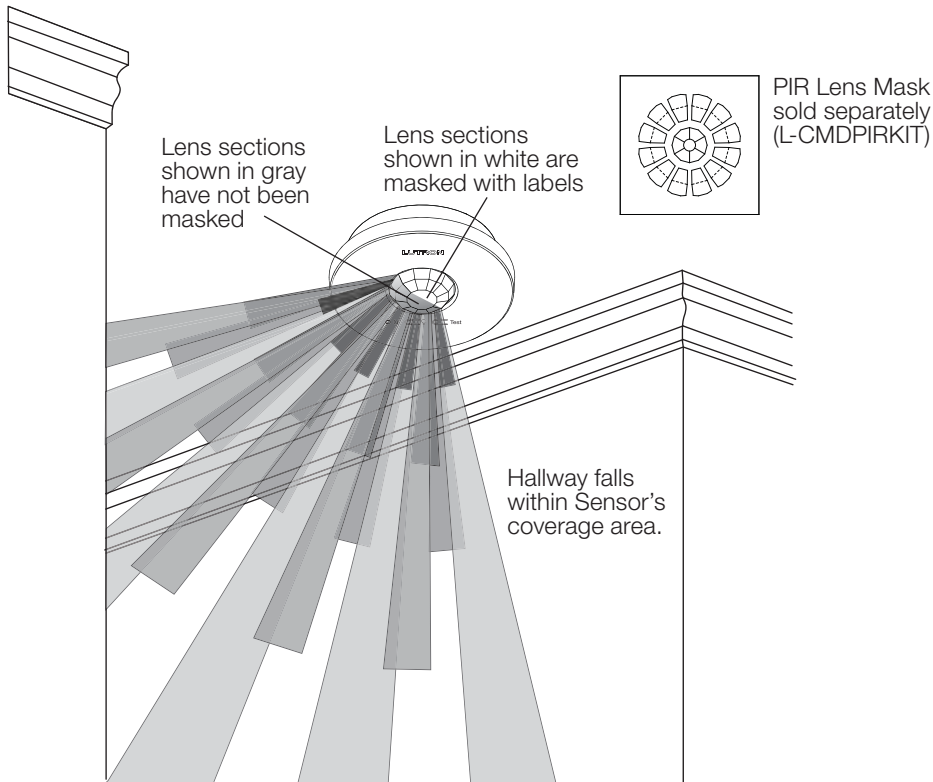

Job Name:	Model Numbers:
Job Number:	

## Wireless Wall-Mount Sensor

Lutron® wall-mounted occupancy and vacancy sensors are wireless battery-powered passive infrared (PIR) sensors that automatically control lights via RF communication to compatible dimming or switching devices. These sensors detect the heat from people moving within an area to determine when the space is occupied. The sensors then wirelessly transmit the appropriate commands to the associated dimming or switching devices to turn the lights on or off automatically. They combine both convenience and exceptional energy savings along with ease of installation.

### Features

- Wireless occupancy/vacancy sensor has 2 settings available: Auto-On/Auto-Off, and Manual-On/Auto-Off
- Vacancy model meets California Title 24 requirements
- Passive infrared motion detection with exclusive Lutron® XCT™ Technology for fine motion detection
- 180° field of view model:
  - Minor motion = 1500 ft<sup>2</sup> (139.4 m<sup>2</sup>)
  - Major motion = 3000 ft<sup>2</sup> (278.7 m<sup>2</sup>)
- 90° field of view model:
  - Minor motion = 1225 ft<sup>2</sup> (113.8 m<sup>2</sup>)
  - Major motion = 2500 ft<sup>2</sup> (232.3 m<sup>2</sup>)
- Hallway model with long, narrow field of view:
  - Major motion = coverage of up to 150 ft (45.7 m)
- Simple and intuitive adjustments available for Timeout, Activity, and Auto-On settings
- Accessible test buttons make setup easy
- Lens illuminates during test mode to verify ideal locations
- Multiple sensors can be added for extended coverage—refer to product specification submittal of receiving device to determine system limits
- 10-year battery life design
- RoHS compliant



### Compatible RF Devices

- For use with Lutron® products only
- Communicates to various wireless Lutron® Clear Connect® systems\*

\* Contact Lutron Customer Service at [www.lutron.com](http://www.lutron.com) for frequency/channel code compatibility with your particular geographic region, and for integrating with other Lutron® lighting and shading products.

<b>Job Name:</b>	<b>Model Numbers:</b>
<b>Job Number:</b>	

## Specifications

### Regulatory

- Lutron Quality Systems Registered to ISO 9001:2008

### Regulatory Approvals

- cULus Listed
- FCC certified
- IC certified
- COFETEL certified
- ANATEL certified
- SUTEL certified
- Meets CA (U.S.A.) Energy Commission Title 24 requirements

### Power/Performance

- Operating voltage: 3 V<sub>DC</sub>
- Operating current: 14 µA nominal
- Requires one CR 123 lithium battery
- 10-year battery life design
- Non-volatile memory (saved changes are stored during power loss)

### Environment

- Temperature: 32 °F to 104 °F (0 °C to 40 °C)
- For indoor use only

### RF Range

Distance between local load controls and sensor should not exceed 60 ft (18 m) line of sight or 30 ft (9 m) through walls.

### Sensor Coverage Test

- Dedicated test button
- Lens illuminates orange in response to motion during test mode

### Wireless Communication Test

- Dedicated test button
- Turn associated loads on and off

### Timeout Options

- 1 minute \*
- 5 minutes
- 15 minutes – default setting
- 30 minutes

### Auto-On Options (Occupancy Versions Only)

- “Enabled” – Sensor turns lights ON and OFF automatically – default setting.
- “Disabled” \*\* – Lights must be turned ON manually from dimming or switching device. Sensor turns lights OFF automatically.

### Sensitivity Options

- Low Activity (Ⓕ) – default setting
- Medium Activity (Ⓖ)
- High Activity (Ⓗ)

\* Intended for use in high-activity, briefly occupied areas only

\*\* There is a 15-second grace period that begins when the lights are automatically turned off, during which the lights will automatically turn back on in response to motion. This grace period is provided as a safety and convenience feature in the event the lights turn off while the room is still occupied, so that the user does not need to manually turn the lights back on. After 15 seconds, the grace period expires and the lights must be manually turned on.

<b>Job Name:</b>	<b>Model Numbers:</b>
<b>Job Number:</b>	

### Dimensions

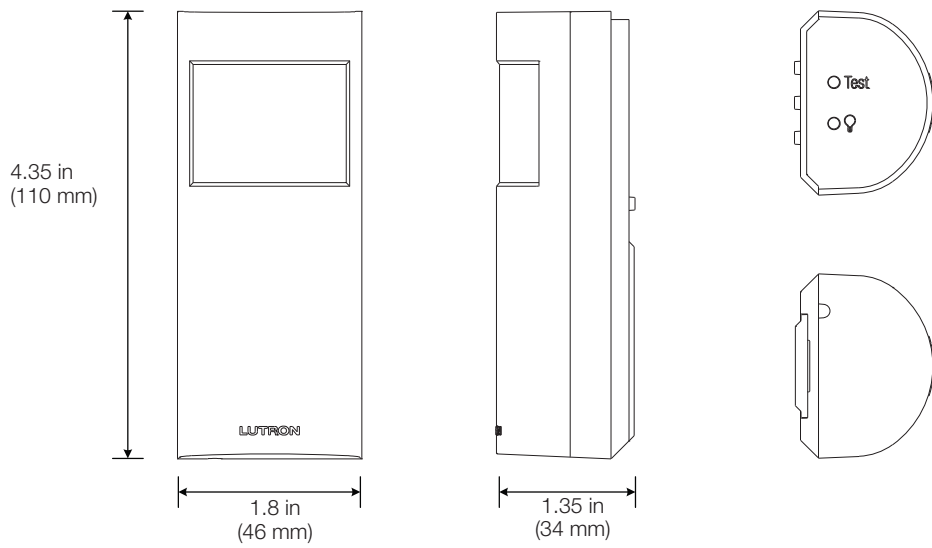

Job Name:  Job Number:	Model Numbers:
------------------------------	----------------

## Coverage Diagrams

### 180° Wall-Mount Sensors

(Models: LRFX-OWLB-P-WH and LRFX-VWLB-P-WH)

#### Horizontal Beam Diagram

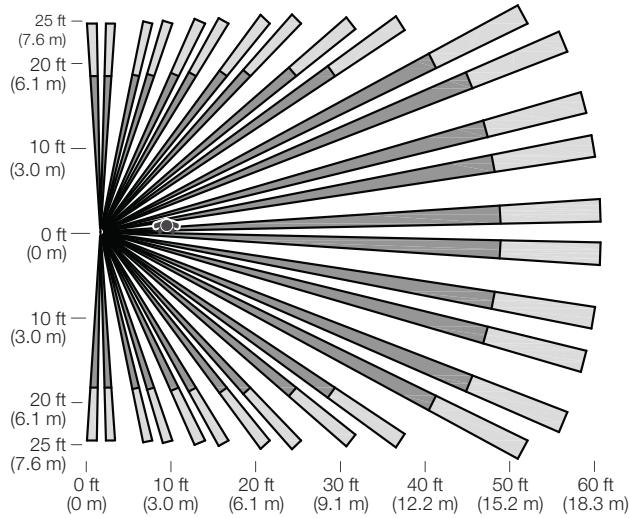

#### Vertical Beam Diagram \*

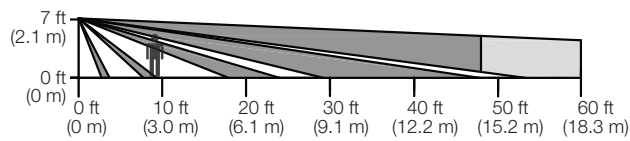

#### Tested Coverage Area

- Major Motion 3000 ft<sup>2</sup> (278.7 m<sup>2</sup>) coverage
- Minor Motion 1500 ft<sup>2</sup> (139.4 m<sup>2</sup>) coverage

Compliant to NEMA WD7 test grid shown below

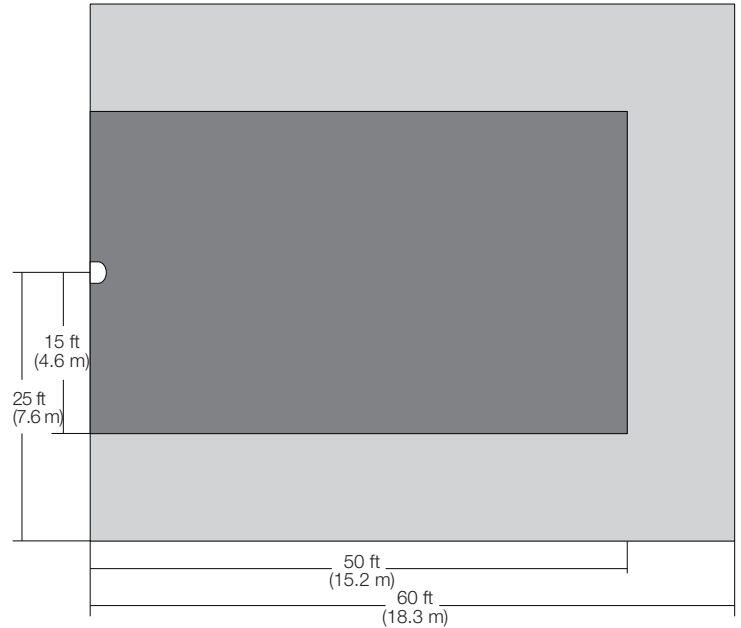

\* Sensor mounting shown at 7 ft (2.1 m). Mounting height should be between 6 ft and 8 ft (1.6 m and 2.4 m).

<b>Job Name:</b>	<b>Model Numbers:</b>
<b>Job Number:</b>	



## Coverage Diagrams

### 90° Corner-Mount Sensors

(Models: LRFX-OKLB-P-WH and LRFX-VKLB-P-WH)

#### Horizontal Beam Diagram

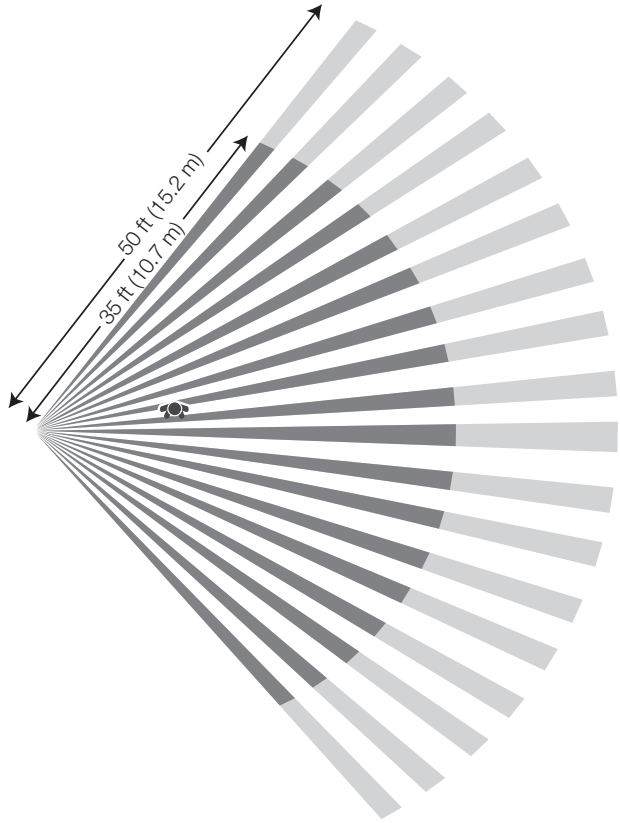

#### Vertical Beam Diagram \*

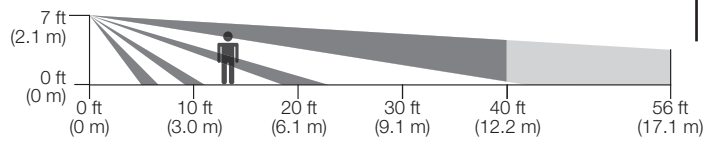

#### Tested Coverage Area

- Major Motion 2500 ft<sup>2</sup> (232.3 m<sup>2</sup>) coverage
- Minor Motion 1225 ft<sup>2</sup> (113.8 m<sup>2</sup>) coverage

Compliant to NEMA WD7 test grid shown below

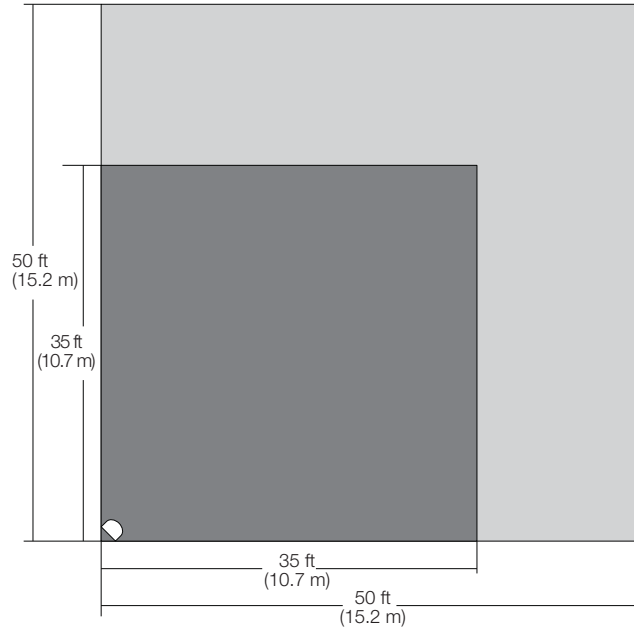

\* Sensor mounting shown at 7 ft (2.1 m). Mounting height should be between 6 ft and 8 ft (1.6 m and 2.4 m).

<b>Job Name:</b>  <b>Job Number:</b>	<b>Model Numbers:</b>
--	-----------------------

## Coverage Diagrams

### Hallway Sensors

(Models: LRFX-OHLB-P-WH and LRFX-VHLB-P-WH)

#### Maximum Recommended Hallway Length

Width of Hall	Length of Hall
6 ft (1.8 m) or less	50 ft (15.2 m)
8 ft (2.4 m)	100 ft (30.5 m)
10 ft (3.0 m) or more	150 ft (45.7 m)

#### Top View

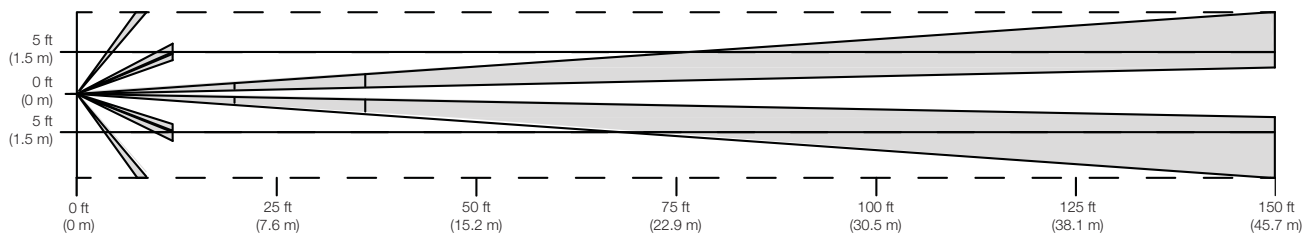

#### Side View

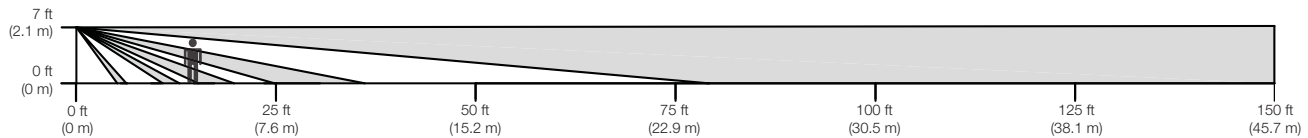

\* Sensor mounting shown at 7 ft (2.1 m). Mounting height should be between 6 ft and 8 ft (1.8 m and 2.4 m) and centered within hallway.

- Designed to mount at the end of a hallway with a clear view down the length of a hall.
- Detection at longer distances is best when motion occurs at right angles to the sensor.
- Multiple sensors can be used to extend coverage.

Job Name:	Model Numbers:
Job Number:	

## Installation Overview

### Sensor Placement

- The mounting height of the sensor should be between 6 ft and 8 ft (1.6 m and 2.4 m)
- For smaller rooms less than 12 ft x 12 ft (3.7 m x 3.7 m), detection may be improved by mounting the sensor at 6 ft (1.8 m) from the floor.
- The ability to detect motion requires that the sensor have line-of-sight of all room occupants. The sensor must have an unobstructed view of the room. **DO NOT** mount behind or near tall cabinets, shelves, hanging fixtures, etc. The sensor cannot detect occupants through glass objects such as patio or shower doors.
- Hot objects and moving air currents can affect the performance of the sensor. To ensure proper operation, the sensor should be mounted at least 4 ft (1.2 m) away from light bulbs and HVAC vents.
- The performance of the sensor depends on a temperature differential between the ambient room temperature and that of room occupants. Warmer rooms may reduce the sensor's ability to detect occupants.
- Distance between local load controls and sensor should not exceed 60 ft (18 m) line of sight or 30 ft (9 m) through walls.

Job Name:	Model Numbers:
Job Number:	

## Mounting

- 180° and hallway sensors mount directly to wall with mounting bracket (included). See figure below.
- 90° sensors mount directly in corner or on wall offset away from corner with mounting bracket (included). See figure below.
- Temporary mounting is recommended to test sensor coverage and wireless communication before permanently installing the sensor.
  - Temporary mounting: A 3M™ Command™ adhesive strip is provided for temporarily mounting and testing the sensor. This strip is designed for easy, damage-free removal and is not reusable.
  - Permanent mounting: Mounting bracket, screws and anchors are provided to mount sensor.
  - Flexible Armature Mounting Kit - P/N LRF2-MTG-KIT-CPN5991 (sold separately): A flexible sensor mounting bracket which allows sensor to be mounted at right angles and at greater heights to increase coverage area.

### 180° Wall-Mount Sensor & Hallway Sensor

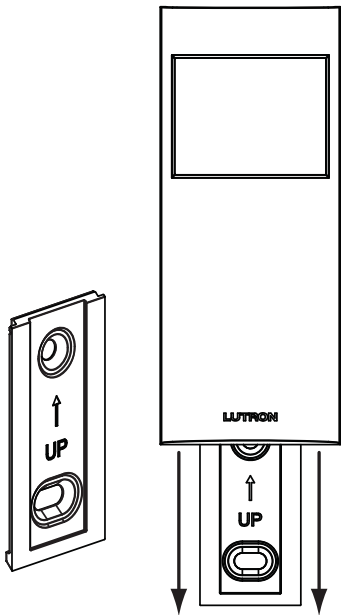

### 90° Corner-Mount Sensor

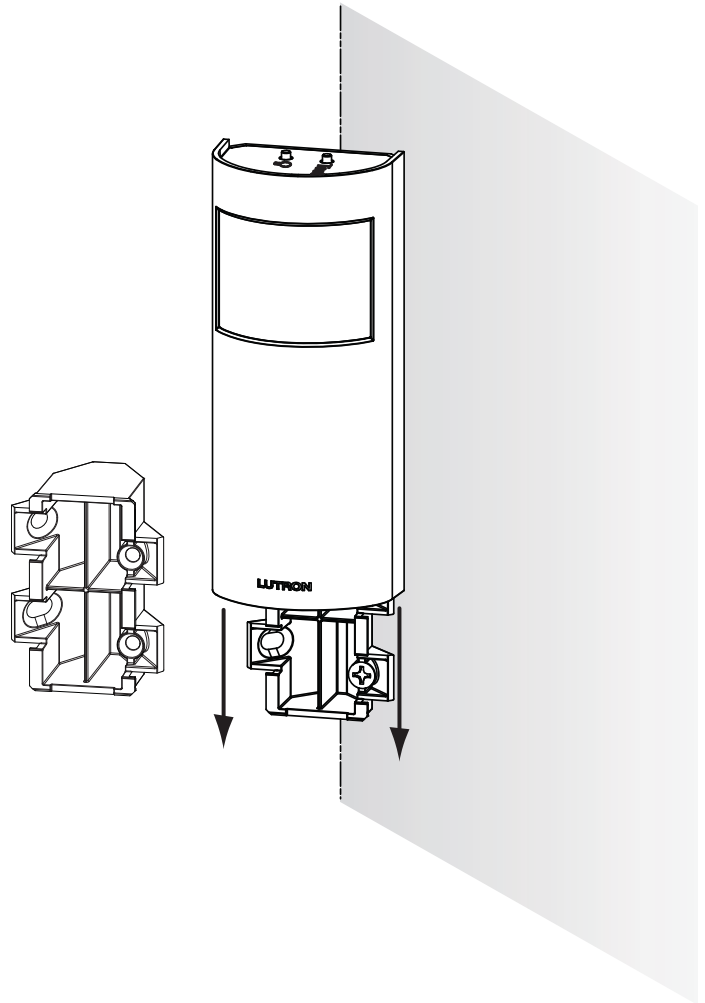

3M and Command are trademarks of 3M Company.

Job Name:	Model Numbers:
Job Number:	