

WAC LIGHTING

Responsible Lighting®

sample

Table of Contents

LED Recessed	1 - 12
LED Task	13 - 19
LED Track	20 - 25
LED Exterior	26 - 39
LED Decorative	40 - 42
DweLED	43 - 59

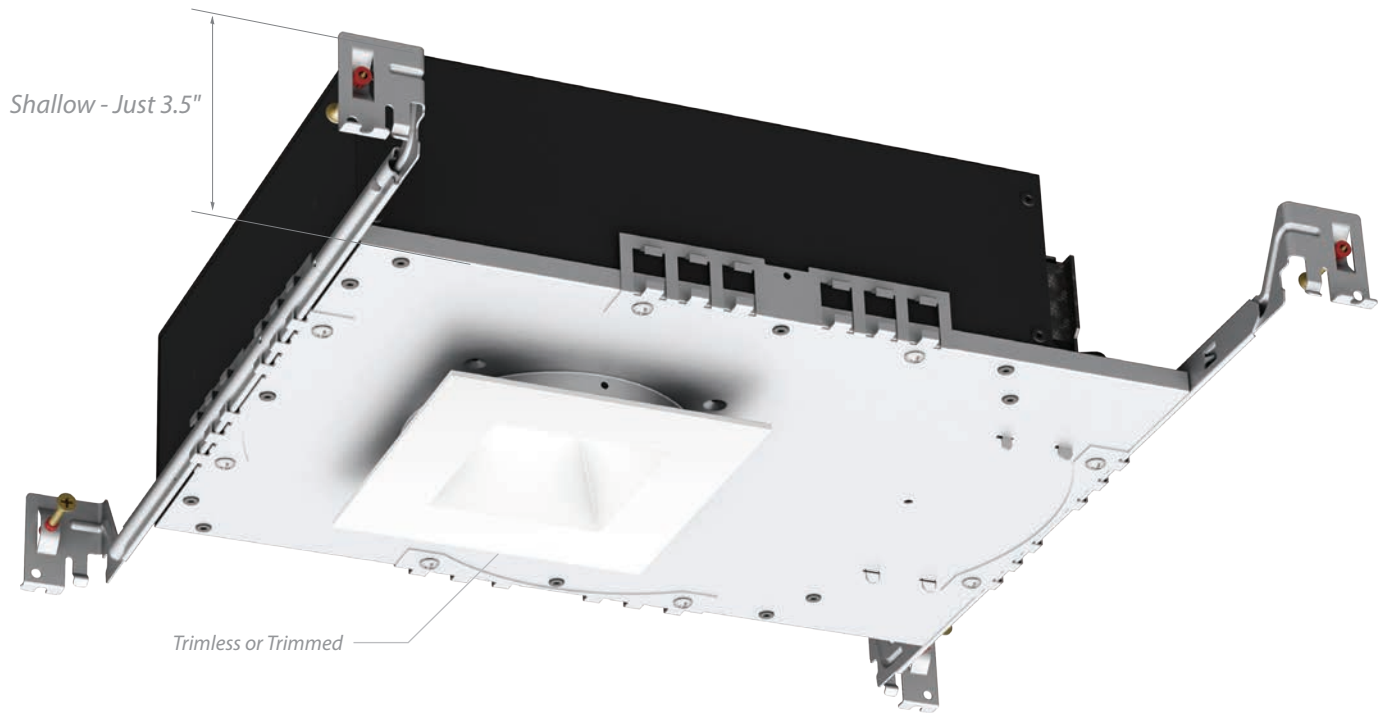







Aether™ 3.5" LED Shallow Housing

Power:	22.5W
Delivered Lumens:	Up to 1375
Comparable to:	75W MR16
ELV Dimming:	100%-15% (120V Only)
0-10V Dimming:	100%-10%
Rated Life:	70,000 hours

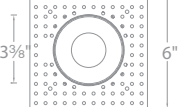

Designed to fit in tight plenum

- Narrow IC Housing
- Energy Star® rated
- Wet location listed
- 3.5" trim aperture, 3.5" housing height
- 35° cut-off angle
- Universal input voltage (120V-220V-277V)
- Ceiling thickness: ½" - 1½"

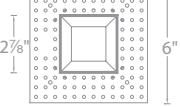
Trims (Order Housing Separately)

		HR-3LED-T120-WT Round
		HR-3LED-T720-WT Square
		HR-3LED-TL220-WT Round Trimless
		HR-3LED-TL820-WT Square Trimless

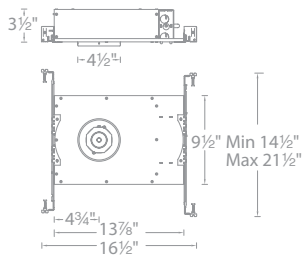
Housings

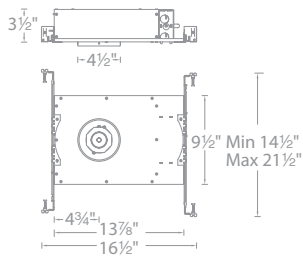
	Beam	Max CBCP	Max Lumen	Color Temp	CRI
 	HR-3LED-H20A New Construction Non-IC, Airtight				
	N 25°	4480	1375	927 2700K	90
 	HR-3LED-H20AC New Construction Non-IC, Airtight Chicago Plenum				
	F 40°	2555	1315	27 2700K	85
				930 3000K	90
				30 3000K	85
			35 3500K	85	
			40 4000K	85	

Example: **HR-3LED-H20A-F-930**

Tesla Pro 2" LED















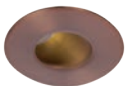

Delivered Lumens: Up to 1090
Comparable to: 50W MR16
Power: 14.5W
ELV Dimming: 100%-15% (120V Only)
0-10V Dimming: 100%-10%
Rated Life: 50,000 hours

High Output LED

- 2" aperture
- Energy Star® rated
- CEC Title 24 Compliant (see website for list of models)
- Damp and wet location listed
- 30° visual cutoff angle for glare control
- Adjustable fixtures are ideal for sloped ceiling applications
- Universal input voltage (120V-220V-277V)

Trims (Order Housing Separately)

Trims (Order Housing Separately)		Beam	Color Temp	CRI	Finish
		HR2LD-ET109P High Brightness Wet Location Listed Energy Star® 9° visual cutoff	N 30° F 55°		
		HR2LEDT109P Open Reflector Energy Star®	N 27° F 40°		
		HR2LEDT309P 0°- 30° Adjustable Energy Star®	N 27° F 40°		
		HR2LEDT409P 30°- 45° Adjustable Energy Star®	N 27° F 40°	827 2700K 85 927 2700K 90 830 3000K 85 930 3000K 90 835 3500K 85 840 4000K 85	BN Brushed Nickel CB Copper Bronze WT White
		HR2LEDT209P Shower Light Wet Location Listed Energy Star®	N 27°		
		HR2LEDT709P Open Reflector Energy Star®	N 30° F 45°		
		HR2LEDT509P 0°- 30° Adjustable Energy Star®	N 30° F 45°		

Example: **HR2LEDT109PF835BN**

Replacement Modules

Reflectors with different beam spreads and LED modules with different color temperature may be ordered separately

Reflectors

Narrow Flood **SL-REF-BL10-1-N**
 Flood **SL-REF-BL10-1-F**

LED

2700K 85 CRI **BXRC-27E1000-B-03**
 2700K 90 CRI **BXRC-27G1000-B-03**
 3000K 85 CRI **BXRC-30E1000-B-03**
 3000K 90 CRI **BXRC-30G1000-B-03**
 3500K 85 CRI **BXRC-35E1000-B-03**
 4000K 85 CRI **BXRC-40E1000-B-03**

Chicago Plenum

Chicago Plenum housings add extra building safety features that confine airflow in and out of the housing with elastomer gasket

Tesla Pro 2" Housing

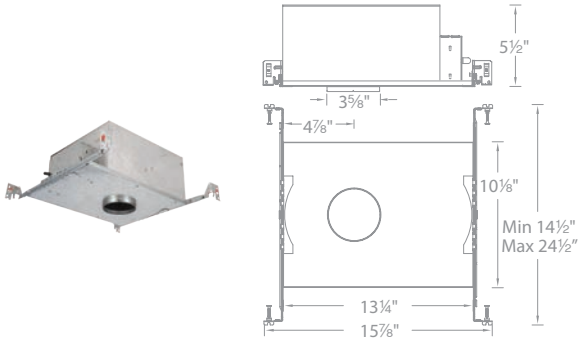
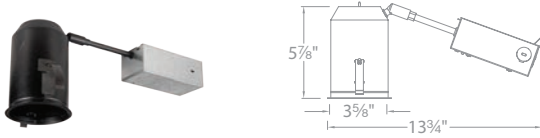
Housings (Required)	Model	Input	Notes
	HR-2LED-H09D-ICA <i>New Construction</i> <i>IC-Rated, Airtight</i>	120V-277V	Ceiling thickness: 1/2"–3/4"
	HR-2LED-H09D-ICAC <i>New Construction</i> <i>IC-Rated, Airtight</i> <i>Chicago Plenum</i>		
	HR-2LED-R09D-A <i>Remodel</i> <i>Non-IC, Airtight</i>	120V-277V	<i>Does not accommodate adjustments for T309P, T409P, T509P</i> <i>Requires 3" of clearance from insulation on all sides</i> <i>Ceiling thickness: 1/2"–1"</i>















Tesla 2" LED

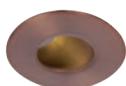

Delivered Lumens: Up to 730
Comparable to: 50W MR16
Power: 14.5W
ELV Dimming: 100%-15% (120V Only)
0-10V Dimming: 100%-10%
Rated Life: 90,000 hours

- 2" aperture
- Damp and wet location listed
- 30° visual cutoff angle for glare control
- Adjustable fixtures are ideal for sloped ceiling applications
- Universal input voltage (120V-220V-277V)

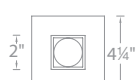
Trims (Order Housing Separately)

Trims (Order Housing Separately)		Beam	Color Temp	CRI	Finish
		HR-2LD-ET109 <i>Wet Location Listed</i> <i>Energy Star®</i> <i>9° visual cutoff</i>	S 16.5° N 30° F 53°		
		HR-2LED-T109 <i>Open Reflector</i>			
		HR-2LED-T309 <i>0°-30° Adjustable</i>	S 15° N 26° F 45°		
		HR-2LED-T409 <i>30°-45° Adjustable</i>	27 2700K 85 9W 3000K 90 W 3000K 85 35 3500K 85 C 4000K 85		BN Brushed Nickel CB Copper Bronze WT White
		HR-2LED-T209 <i>Shower Light</i> <i>Wet Location Listed</i>	N 26°		
		HR-2LED-T709 <i>Open Reflector</i>	S 15° N 26° F 45°		
		HR-2LED-T509 <i>0°-30° Adjustable</i>			

Example: **HR-2LD-ET109F-9W-BN**

Replacement Modules

Reflectors with different beam spreads and LED modules with different color temperature may be ordered separately

Reflectors

Spot	SL-REF-LUX10-S
Narrow Flood	SL-REF-LUX10-N
Flood	SL-REF-LUX10-F

LED

2700K	85 CRI	LXS8-PW27
3000K	90 CRI	LXS9-PW30
3000K	85 CRI	LXS8-PW30
3500K	85 CRI	LXS8-PW35
4000K	85 CRI	LXS8-PW40

Chicago Plenum

Chicago Plenum housings add extra building safety features that confine airflow in and out of the housing with elastomer gasket

Tesla 2" Housing

Housings (Required)

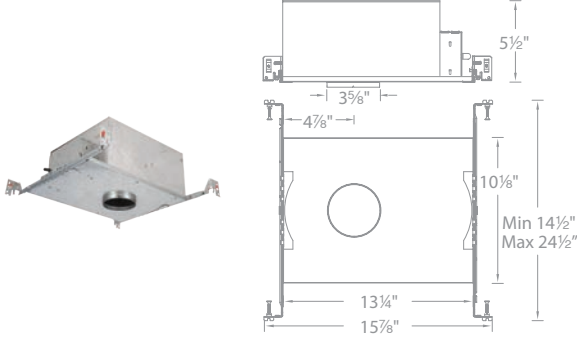
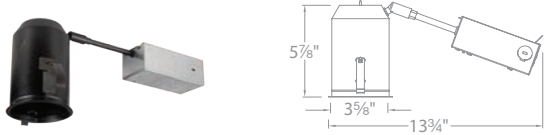
Housings (Required)	Model	Input
	<p>HR-2LED-H09D-ICA New Construction IC-Rated, Airtight</p> <p>HR-2LED-H09D-ICAC New Construction IC-Rated, Airtight Chicago Plenum</p>	<p>120V-277V</p> <p>Ceiling thickness: 1/2" - 3/4"</p>
	<p>HR-2LED-R09D-A Remodel Non-IC, Airtight</p>	<p>120V-277V</p> <p>Does not accommodate adjustments for T309, T409, T509</p> <p>Requires 3" of clearance from insulation on all sides</p> <p>Ceiling thickness: 1/2" - 1"</p>

sample



Tesla Pro 3.5" LED













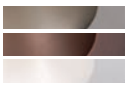

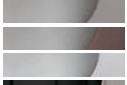



Power: 22W
Delivered Lumens: Up to 1460
Comparable to: 75W MR16
ELV Dimming: 100%-15% (120V Only)
0-10V Dimming: 100%-10%
Rated Life: 50,000 hours

High Output LED

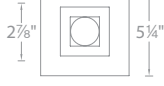
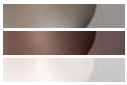
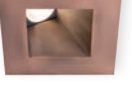
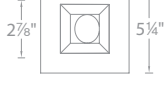

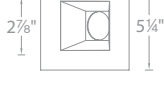

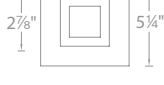

- 3.5" aperture
- Energy Star® rated
- Damp and wet location listed
- 30° visual cutoff angle for glare control
- Adjustable fixtures are ideal for sloped ceiling applications
- Universal input voltage (120V-220V-277V)

Trims (Order Housing Separately)

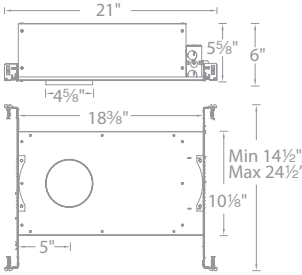
	Beam	Color Temp	CRI	Finish	Reflector/Trim	
  <p>HR3LD-ET118P High Brightness Wet Location Listed Energy Star® 9° visual cutoff</p>	F 48°	827 2700K 85 927 2700K 90 830 3000K 85 930 3000K 90 835 3500K 85 840 4000K 85	BN Brushed Nickel CB Copper Bronze WT White			
  <p>HR3LEDT118P Downlight Energy Star®</p>	N 30° F 55°	827 2700K 85 927 2700K 90 830 3000K 85 930 3000K 90 835 3500K 85 840 4000K 85	HBN Haze/Brushed Nickel HCB Haze/Copper Bronze HWT Haze/White BBN Specular Black/Brushed Nickel BCB Specular Black/Copper Bronze BWT Specular Black/White BN Brushed Nickel CB Copper Bronze WT White			
  <p>HR3LEDT318P 0°-30° Adjustable Energy Star®</p>	N 30° F 55°					
  <p>HR3LEDT418P 30°-45° Adjustable Energy Star®</p>	N 26° F 38°					
  <p>HR3LEDT218P Shower Light Wet Location Listed Energy Star®</p>	N 30°					
  <p>HR3LEDT718P Open Reflector Energy Star®</p>	N 30° F 52°	827 2700K 85 927 2700K 90 830 3000K 85 930 3000K 90 835 3500K 85 840 4000K 85	BN Brushed Nickel CB Copper Bronze WT White			
  <p>HR3LEDT518P 0°-30° Adjustable Energy Star®</p>	N 30° F 52°					
  <p>HR3LEDT918P 30°-45° Adjustable Energy Star®</p>	N 26° F 38°					
  <p>HR3LEDT818P Shower Light Wet Location Listed Energy Star®</p>	N 30°					

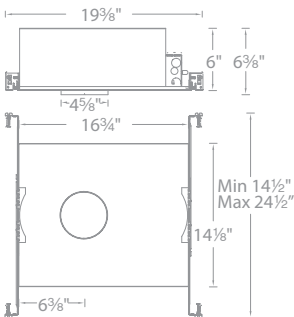
Example: **HR3LD-ET118PF930BN**

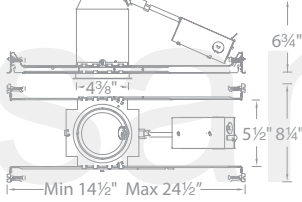
Tesla Pro 3.5" Housing

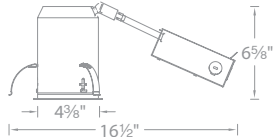
Housings (Required)	Model	Input	Notes
 	HR-3LED-H18D1-ICA New Construction IC-Rated, Airtight	120V -277V	Allows adjustment in one direction when used with adjustable trims Ceiling thickness: ½"–¾"
	HR-3LED-H18D1-ICAC New Construction IC-Rated, Airtight Chicago Plenum		
 	HR-3LED-H18D-ICA New Construction IC-Rated, Airtight	120V -277V	Allows adjustment in any direction when used with adjustable trims Ceiling thickness: ½"–¾"
	HR-3LED-H18D-ICAC New Construction IC-Rated, Airtight Chicago Plenum		
	HR-3LED-H18D-EMICA New Construction IC-Rated, Airtight Emergency Backup Battery		
 	HR-3LED-H18D-A New Construction Non-IC, Airtight	120V -277V	Does not accommodate adjustments for T318P, T418P, T518P, T918P Requires 3" of clearance from insulation on all sides Ceiling thickness: ½"–1"
 	HR-3LED-R18D-A Remodel Non-IC, Airtight	120V -277V	Does not accommodate adjustments for T318P, T418P, T518P, T918P Requires 3" of clearance from insulation on all sides Ceiling thickness: ½"–1"

Replacement Modules

Reflectors with different beam spreads and LED modules with different color temperature may be ordered separately

Reflectors

Narrow Flood	SL-REF-BL10-1-N
Flood	SL-REF-BL10-1-F

LED

2700K	85 CRI	BXRC-27E1000-B-03
2700K	90 CRI	BXRC-27G1000-B-03
3000K	85 CRI	BXRC-30E1000-B-03
3000K	90 CRI	BXRC-30G1000-B-03
3500K	85 CRI	BXRC-35E1000-B-03
4000K	85 CRI	BXRC-40E1000-B-03

Chicago Plenum

Chicago Plenum housings add extra building safety features that confine airflow in and out of the housing with elastomer gasket





Tesla 3.5" LED



Power: 21.5W
Delivered Lumens: Up to 1070
Comparable to: 75W MR16
ELV Dimming: 100%-15% (120V Only)
0-10V Dimming: 100%-10%
Rated Life: 50,000 hours

- Damp location listed (Shower Light is wet location listed)
- 30° visual cutoff angle for glare control
- Adjustable fixtures are ideal for sloped ceiling applications
- Universal driver (120V-220V-277V)

Trims (Order Housing Separately)

	Beam	Color Temp	CRI	Finish	Reflector/Trim	
  <p>HR-3LED-ET118 Round Downlight Energy Star® 9° visual cutoff</p>	F 40°	27 2700K 85 9W 3000K 90 W 3000K 85 35 3500K 85 C 4000K 85		BN CB WT	Brushed Nickel/Brushed Nickel Copper Bronze/Copper Bronze White/White	
  <p>HR-3LED-T118 Round Downlight</p>	S 15° N 28° F 50°	27 2700K 85 9W 3000K 90 W 3000K 85 35 3500K 85 C 4000K 85		HZ/BN HZ/CB HZ/WT SB/BN SB/CB SB/WT BN CB WT	Haze/Brushed Nickel Haze/Copper Bronze Haze/White Specular Black/Brushed Nickel Specular Black/Copper Bronze Specular Black/White Brushed Nickel/Brushed Nickel Copper Bronze/Copper Bronze White/White	
  <p>HR-3LED-T318 Round 0°- 30° Adjustable</p>						
  <p>HR-3LED-T618 Round Pin Hole, 0°- 30° Adjustable</p>	S 15°					
  <p>HR-3LED-T418 Round 30°- 45° Adjustable</p>	S 15° N 28° F 41°					
  <p>HR-3LED-T218 Round Shower Light Wet Location Listed</p>	N 28°					
  <p>HR-3LED-T718 Square Downlight</p>	S 15° N 28° F 50°	27 2700K 85 9W 3000K 90 W 3000K 85 35 3500K 85 C 4000K 85		BN CB WT	Brushed Nickel/Brushed Nickel Copper Bronze/Copper Bronze White/White	
  <p>HR-3LED-T818 Square Shower Light Wet Location Listed</p>	N 28°					
  <p>HR-3LED-T518 Square 0°- 30° Adjustable</p>	S 15° N 28° F 50°					
  <p>HR-3LED-T918 Square 30°- 45° Adjustable</p>						

Example: **HR-3LED-T918F-W-CB**

Tesla 3.5" Housing

Housings (Required)	Model	Input
<p>Technical drawing showing dimensions: 21" width, 6" height, 5 5/8" depth, 18 3/8" width, 10 1/8" height, 5" width, 4 5/8" depth, Min 14 1/2" Max 24 1/2" length.</p>	HR-3LED-H18D1-ICA <i>New Construction</i> <i>IC-Rated, Airtight</i>	120V -277V <i>Allows adjustment in one direction when used with adjustable trims</i> <i>Ceiling thickness: 1/2"–3/4"</i>
	HR-3LED-H18D1-ICAC <i>New Construction</i> <i>IC-Rated, Airtight</i> <i>Chicago Plenum</i>	
<p>Technical drawing showing dimensions: 19 3/8" width, 6 3/8" height, 4 5/8" depth, 16 3/4" width, 14 1/8" height, 6 3/8" depth, Min 14 1/2" Max 24 1/2" length.</p>	HR-3LED-H18D-ICA <i>New Construction</i> <i>IC-Rated, Airtight</i>	120V -277V <i>Allows adjustment in any direction when used with adjustable trims</i> <i>Ceiling thickness: 1/2"–3/4"</i>
	HR-3LED-H18D-ICAC <i>New Construction</i> <i>IC-Rated, Airtight</i> <i>Chicago Plenum</i>	
	HR-3LED-H18D-EMICA <i>New Construction</i> <i>IC-Rated, Airtight</i> <i>Emergency Backup Battery</i>	
<p>Technical drawing showing dimensions: 6 9/8" height, 4 3/8" depth, 5 1/2" height, 8 1/4" height, Min 14 1/2" Max 24 1/2" length.</p>	HR-3LED-H18D-A <i>New Construction</i> <i>Non-IC, Airtight</i>	120V -277V <i>Does not accommodate adjustments for T318, T418, T518, T618, T918</i> <i>Requires 3" of clearance from insulation on all sides</i> <i>Ceiling thickness: 1/2"–1"</i>
<p>Technical drawing showing dimensions: 6 9/8" height, 4 3/8" depth, 16 1/2" length.</p>	HR-3LED-R18D-A <i>Remodel</i> <i>Non-IC, Airtight</i>	120V -277V <i>Does not accommodate adjustments for T318, T418, T518, T618, T918</i> <i>Requires 3" of clearance from insulation on all sides</i> <i>Ceiling thickness: 1/2"–1"</i>

Replacement Modules

Reflectors with different beam spreads and LED modules with different color temperature may be ordered separately

Reflectors

Spot	SL-REF-LUX10-S
Narrow Flood	SL-REF-LUX10-N
Flood	SL-REF-LUX10-F

LED

2700K	85 CRI	LXS8-PW27
3000K	90 CRI	LXS9-PW30
3000K	85 CRI	LXS8-PW30
3500K	85 CRI	LXS8-PW35
4000K	85 CRI	LXS8-PW40

Chicago Plenum

Chicago Plenum housings add extra building safety features that confine airflow in and out of the housing with elastomer gasket

Precision Multiples 4" LED with ELV and 0-10V dimming options



Black trim shown



Comparable to: 75W MR16
 Rated Life: 50,000 hours

Retractable Spot Lights

- ELV and 0-10V dimming options
- Black, white, or Invisible Trim™
- Energy Star® rated
- CEC Title 24 Compliant
- Fully retractable from housing
- 365° horizontal rotation and 180° vertical aiming
- Accepts 1 replacement lens

1 Light

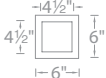
Trims

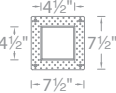
		MT-4LD116T Trim	WT White BK Black
		MT-4LD116TL-WT Invisible Trim™	

Example: **MT-4LD117T-WT**

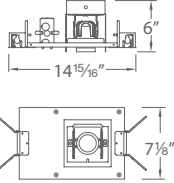

Housings

	Power	Max Lumens		Max CBCP		Beam	Color Temp	CRI	Interior
		20°	40°	20°	40°				
	MT-4LD116N 0-10V dimming Non-IC, 120V-277V input	16.5W	1100	1080	5370	2390	S 20° F 40°	27 2700K 85	BK Black
	MT4LD116NE ELV dimming Non-IC, 120V input	16.5W	1005	990	4700	2115		927 2700K 90	
	MT4LD111NE ELV dimming IC-Rated, 120V input	11.5W	890	885	3925	1820		30 3000K 85	
						35 3500K 85			
						40 4000K 85			

Example: **MT4LD111NE-F930-BK**

2 Lights

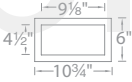
Trims

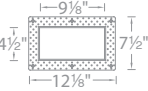
		MT-4LD216T Trim	WT White BK Black
		MT-4LD216TL-WT Invisible Trim™	

Example: **MT-4LD216T-WT**

Housings

	Power	Max Lumens		Max CBCP		Beam	Color Temp	CRI	Interior
		20°	40°	20°	40°				
	MT-4LD216N 0-10V dimming Non-IC, 120V-277V input	33W	2200	2160	5370x2	2390x2	S 20° F 40°	27 2700K 85	BK Black
	MT4LD216NE ELV dimming Non-IC, 120V input	33W	2010	1980	4700x2	2115x2		927 2700K 90	
	MT4LD211NE ELV dimming IC-Rated, 120V input	23W	1785	1765	3925x2	1820x2		30 3000K 85	
						35 3500K 85			
						40 4000K 85			

Example: **MT-4LD216N-S927-BK**



Replacement Lens

Amber	LENS-16-AMB	
Blue	LENS-16-BLU	
Green	LENS-16-GRN	
Red	LENS-16-RED	
Yellow	LENS-16-YEL	

UV Filter	LENS-16-UVF	
Frosted	LENS-16-FR	
Spread	LENS-16-SPR	
Beam Elongator	LENS-16-BEL	

3 Lights

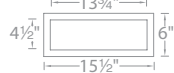
Trims

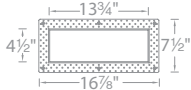
		MT-4LD316T Trim	WT White BK Black
		MT-4LD316TL-WT Invisible Trim™	

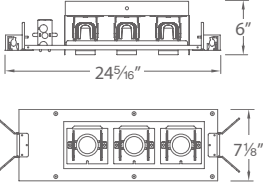

Example: MT-4LD316T-WT

Housings	Power	Max Lumens		Max CBCP		Beam	Color Temp	CRI	Interior
		20°	40°	20°	40°				
	MT-4LD316N 0-10V dimming Non-IC, 120V-277V input	49.5W	3300	3240	5370x3	2390x3	S 20° F 40°	27 2700K 85 927 2700K 90 30 3000K 85 930 3000K 90 35 3500K 85 40 4000K 85	BK Black
	MT4LD316NE ELV dimming Non-IC, 120V input	49.5W	3015	2970	4700x3	2115x3			
	MT4LD311NE ELV dimming IC-Rated, 120V input	34.5W	2680	2650	3925x3	1820x3			

Example: MT4LD311NE-S30-BK

4 Lights

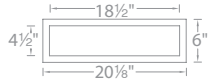
Trims

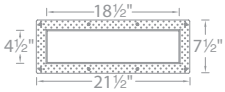
		MT-4LD416T Trim	WT White BK Black
		MT-4LD416TL-WT Invisible Trim™	

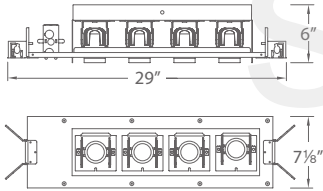

Example: MT-4LD416T-WT

Housings	Power	Max Lumens		Max CBCP		Beam	Color Temp	CRI	Interior
		20°	40°	20°	40°				
	MT-4LD416N 0-10V dimming Non-IC, 120V-277V input	66W	4400	4320	5370x4	2390x4	S 20° F 40°	27 2700K 85 927 2700K 90 30 3000K 85 930 3000K 90 35 3500K 85 40 4000K 85	BK Black
	MT4LD416NE ELV dimming Non-IC, 120V input	66W	4020	3960	4700x4	2115x4			
	MT4LD411NE ELV dimming IC-Rated, 120V input	46W	3570	3535	3925x4	1820x4			

Example: MT-4LD416N-S927-BK

4 Lights (2x2)

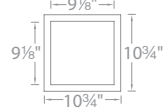
Trims

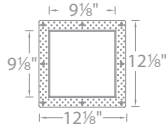
		MT-4LD226T Trim	WT White BK Black
		MT-4LD226TL-WT Invisible Trim™	

Example: MT-4LD226T-WT

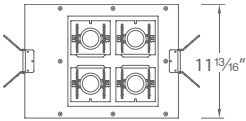
Housings	Power	Max Lumens		Max CBCP		Beam	Color Temp	CRI	Interior
		20°	40°	20°	40°				
	MT-4LD226N 0-10V dimming Non-IC, 120V-277V input	66W	4400	4320	5370x4	2390x4	S 20° F 40°	27 2700K 85 927 2700K 90 30 3000K 85 930 3000K 90 35 3500K 85 40 4000K 85	BK Black
	MT4LD226NE ELV dimming Non-IC, 120V input	66W	4020	3960	4700x4	2115x4			
	MT4LD221NE ELV dimming IC-Rated, 120V input	46W	3570	3535	3925x4	1820x4			

Example: MT4LD226NE-S930-BK

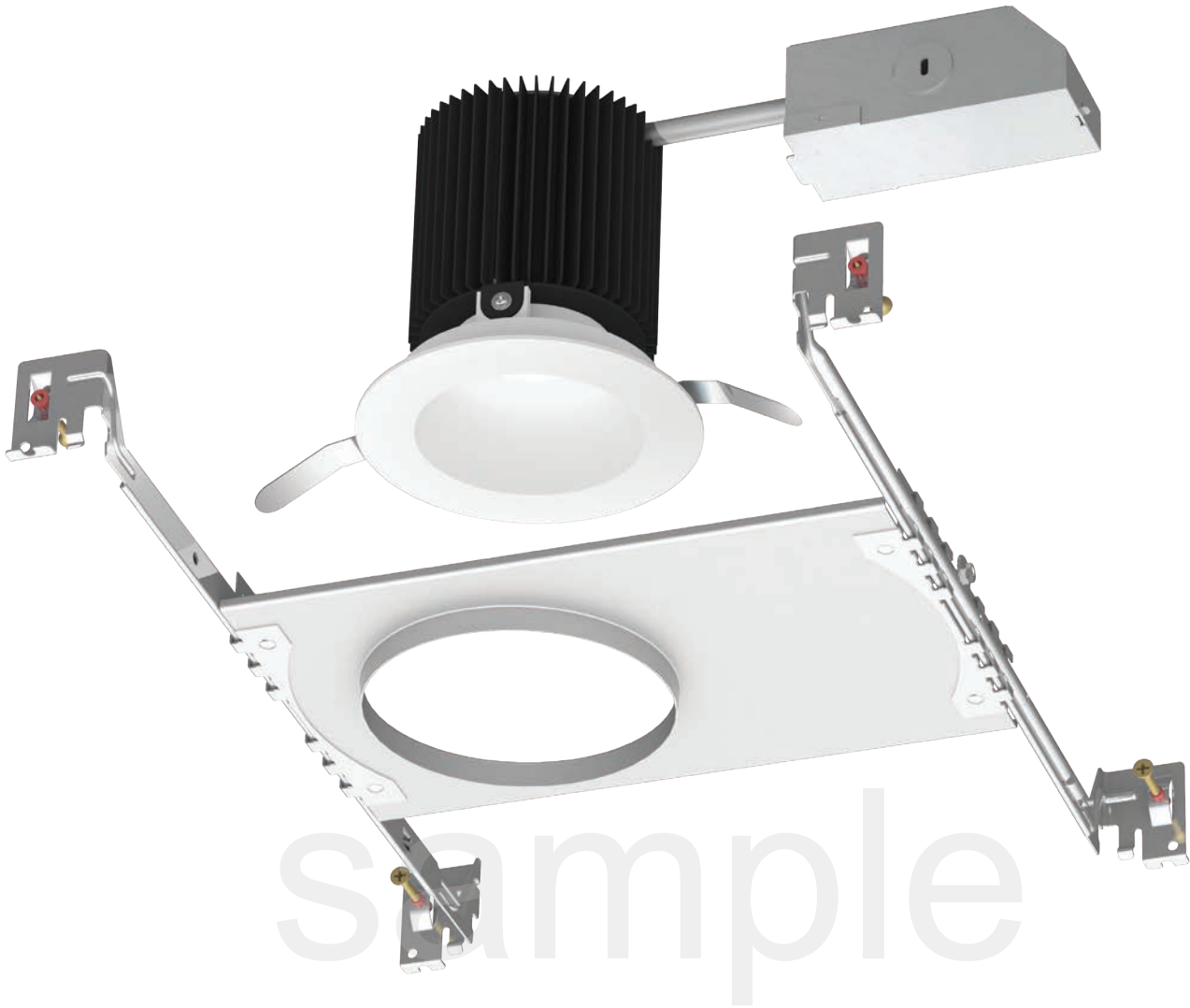

sample

Summit™ 3.5" LED

Power: 17W
 Delivered Lumens: 880
 Comparable to: 50W MR16
 ELV Dimming: 100%-10%
 Input: 120V
 Rated Life: 70,000 hours

Simple one size fits most

- ACLED non-IC downlight
- Configurable for both new construction and remodel
- Integral housing and trim
- Energy Star® rated
- Wet location listed
- 30° Visual cutoff angle for glare control
- Single proprietary lens for optimal light distribution
- Frosted lens for glare control
- 120VAC - no driver needed
- Ceiling thickness: 1/2" - 3/4"

Trims and Housing

		Beam	Color Temp	CRI
	<p>HR-3LED-17R-F30-WT <i>New Construction and Remodel Non-IC, Airtight</i></p>	50°	3000K	85

LED-T-CH1 mounted onto LED-T-CL2

LED-T-CH1

LED-T-CH

LED-T-CH2

Aluminum Channels for InvisiLED® Series

	2 pcs	LED-T-CL2-PT	2 Adjustable Clips	Used to mount any aluminum channel Adjusts 50° from center either way Includes 2 pieces, 4 screws
	5 feet	LED-T-CH1	Deep Aluminum Channel	Includes a diffuser, two end caps, and five screws
	5 feet	LED-T-CH	Aluminum Channel	Includes a diffuser, two end caps, and five screws
	5 feet	LED-T-CH2	45° Angled Aluminum Channel	Includes a diffuser, two end caps, and five screws

Compatible InvisiLED® Indoor Products

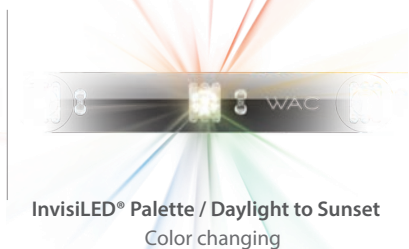



Surface mounted

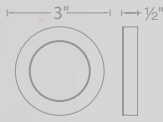

Recessed

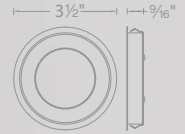

LED90 Edge Lit Button Light

Power: 24V, 5W
CRI: 90
ELV Dimming: 100% – 5%
Rated Life: 100,000 hours
Cutout: 3¼" for recessed applications

- Energy Star® rated
- CEC Title24 Compliant
- Can be surface mounted or recessed
- Super thin profile at ½"
- Edge-lit LEDs reduce glare and assure even light distribution
- Anti-microbial white paint



Model	Color Temp	Lumens	Finish
HR-LED90	27 2700K	200	BN Brushed Nickel
	30 3000K	200	BK Black
			WT White

Example: **HR-LED90-30-BN**

Includes 6 foot lead wire

Power consumption may vary depending on the efficiency of the power supply being used

Class 2 enclosed electronic transformers (Required)

Model	Input	Output	Min Load	Max Fixture Run	L	W	H		
	EN-2460-RB2	120V	24V, 60W	1W	7	6½"	1⅝"	1¼"	Fits through small openings
	EN-24100-RB2	120V	24V, 96W	1W	10	6½"	1⅝"	1¼"	
	EN-2460-P-AR	120V	24V, 60W	1W	7	2¾"	1⅝"	1¾"	Plug-in power supply with on/off switch and 6' detachable cord

- Secondary wiring for Class 2 transformers does not require conduit sheathed cable or clamp wiring techniques
- Intrinsically safe, Class 2 transformers permit no greater than a 5 amp current to be drawn
- Non-metallic sheathed cable may be used for secondary wiring in walls and ceilings
- Drop down to a smaller gauge wire if space in fixture does not permit secure connection directly with the non-metallic sheathed cable

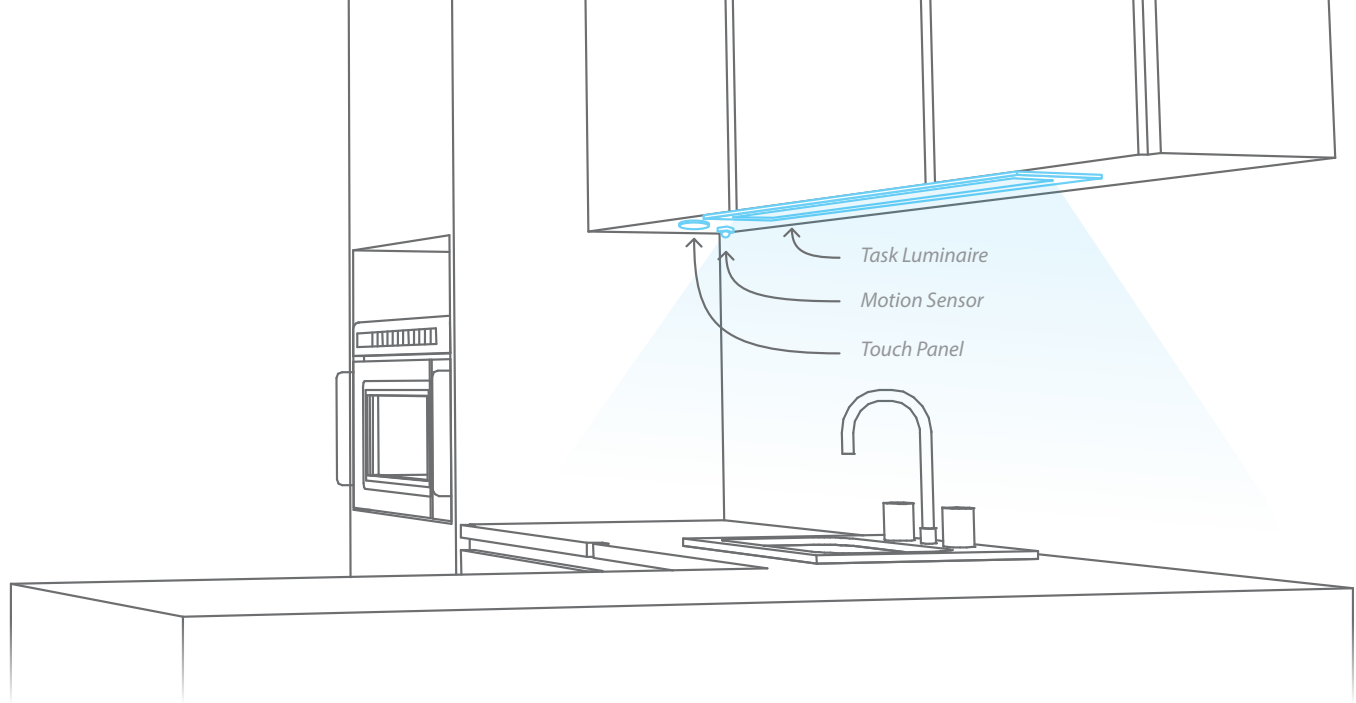

Touch On/Off and Occupancy Sensor

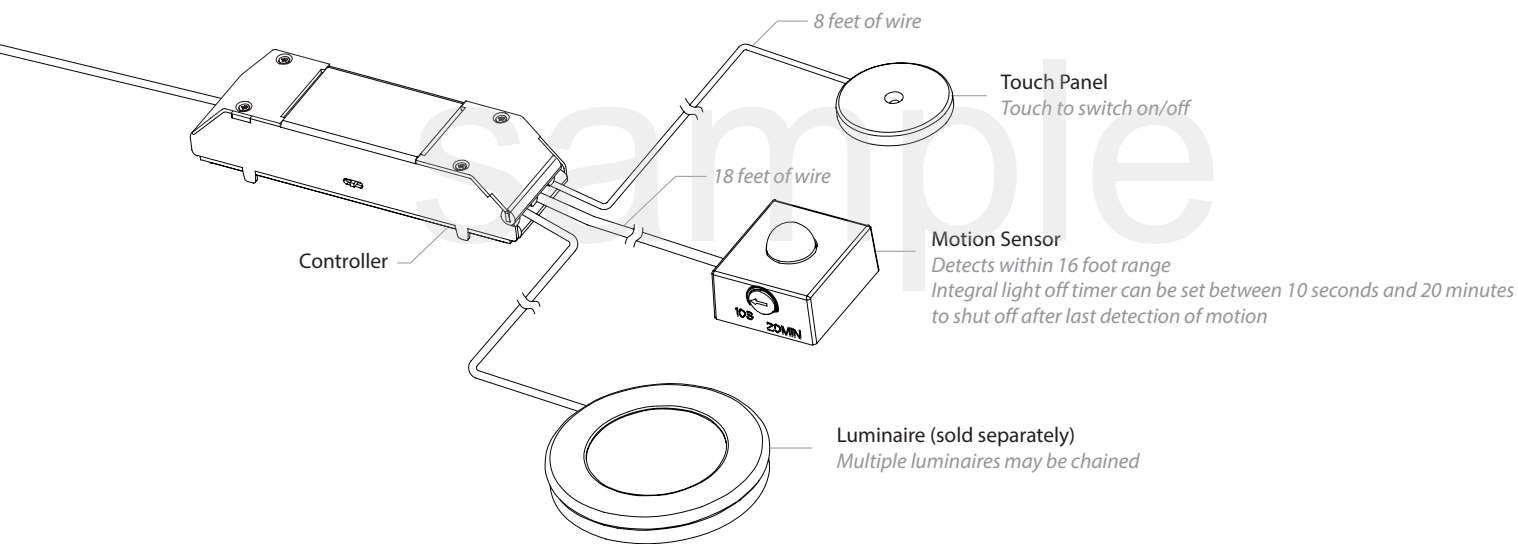

CT-6A-R2

Includes a Touch Panel, an Occupancy Sensor, and a Controller
AC/DC input at 12V(60W Max) or 24V(96W Max)
Connect on secondary side of driver/transformer

Three custom settings of lighting control

Touch and Sensor: Touch panel turns the luminaire on/off manually while the motion sensor turns it off when the space is vacant

Touch: Touch panel turns the luminaire on/off manually

Sensor: Motion sensor turns the luminaire on/off autonomously



LINE™ 2.0 LED Undercabinet

Fixed Light Panel

- Energy Star® rated
- Diffused light source reduces glare, eliminates hard shadows
- Asymmetrical forward throw for optimal light distribution
- Anti-microbial paint (white only)
- Connections made at the center of each fixture

CRI: 90+
ELV Dimming: 100% – 10% (120V only)
Rated Life: 100,000 hours

	Length	Watt	Max Lumens	Max Fixture Run		Color Temp	Finish
				60 W	96 W		
	LN-LED06P	6.5W	265	6	11	27 2700K 30 3000K	AL Brushed Aluminum WT White
	LN-LED12P	10.5W	515	3	6		
	LN-LED18P	16W	875	2	4		
	LN-LED24P	20W	1160	2	3		
	LN-LED30P	23.5W	1345	1	2		

Example: **LN-LED18P-30-WT**



LINE™ LED Undercabinet

Magnetized light panel detaches for maintenance

- Energy Star® rated
- Diffused light source reduces glare, eliminates hard shadows
- Asymmetrical forward throw for optimal light distribution



CRI: 90+
ELV Dimming: 100% – 10% (120V only)
 100% / 50% high/low settings on board
Rated Life: 80,000 hours

	Length	Watt	Max Lumens	Max Fixture Run		Color Temp	Finish
				60 W	96 W		
	LN-LED06	7.0W	275	8	13	27 2700K 30 3000K	AL Brushed Aluminum
	LN-LED12	12.5W	600	4	7		
	LN-LED18	19.0W	955	3	5		
	LN-LED24	23.0W	1245	2	4		
	LN-LED30	26.0W	1345	2	3		

Example: **LN-LED18-27-AL**

"I" connector included with each luminaire





Class 2 Power Supply for LINE™ and LINE™ 2.0 (Required)

Type		Model	Output	Input	Dim	Dimensions
Remote		EN-2460-RB2-S EN-24100-RB2-S	60W (24V) 96W (24V)	120V	Yes	6½" × 1⅝" × 1¼"
Plug-In		EN-2460-P-AR-S EN-24100-P-AR-S	60W (24V) 96W (24V)	120V	Yes	2¾" × 1⅝" × 1¾" 4⅝" × 2" × 1⅝"





Control Accessory

Touch Panel and Motion Sensor		CT-6A-R2	Includes a Touch Panel, an Occupancy Sensor, and a Controller AC/DC input at 12V(60W Max) or 24V(96W Max) Connect on secondary side of driver/transformer
-------------------------------	---	-----------------	---

Power Supply Accessories

Wiring Box with On/Off Switch option		TB-S	6¼" × 1⅝" × 1¼"	Use when spanning a large gap in a system layout without leaving exposed wiring (i.e. lighting kitchen cabinets on either side of a sink or window).
Multiple Terminal Block		MTB-08	8 outputs 4⅞" × 1⅝" × ¾"	Easily wire multiple output connections for a neat installation without the use of open splices. One power supply input and 8 outputs. 5A capacity. Three mounting screws included.
12' Extension Cable		SL-EXT-144	Wire: 144" Connector: 1⅝"	Use to extend the distance between power supply or wiring box (TB-S) to a LINE™ section.
Wire Clip (10 Pack)		SL-WC-1	½" × ⅜"	Use to tack power cords or joiner cables neatly to a surface.

Connection Accessories

Joiner Cables		SL-IC-06 SL-IC-12 SL-IC-24 SL-IC-36	6" 12" 24" 36"	Connects two sections of LINE™.
Custom Cable Extenders		SL-IF	Ø3/8" × 3⅝"	Two female ends. Connects two joiner cables to create custom lengths.
4-way "X" Connector		SL-X	Wires: 4" each Connectors: 1⅝" each	"X" connector has four male connectors and can be used to easily customize your design layout.
3-way "Y" Connector		SL-Y	Wires: 4" each Connectors: 1⅝" each	"Y" connector has three male connectors and can be used to easily customize your design layout.
"I" Connector		SL-I	Ø¼" × ⅞"	For end-to-end connection of LINE™ sections.



New Brushed Aluminum Finish

Minimal space between chained diffusers

Shown:
Two **BA-ACLED12-AL** connected

sample

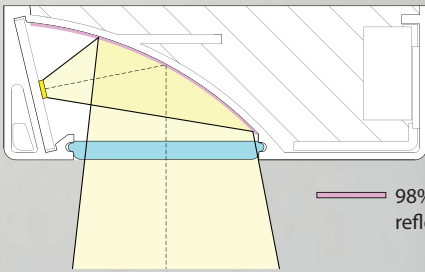

98% efficient reflector

Uniform light

Using a 98% efficient reflector, light from the LED sources inside the housing diffuse inside the mixing chamber in order to create evenly distributed illumination. Energy Star® compliant.

- May be hard-wired with 120V power or used with a plug-in power cord
- Subsequent fixtures may be powered with an "I" Connector or Interconnect Cable carrying 120V
- May be individually switched and/or wired to a wall box switch/dimmer

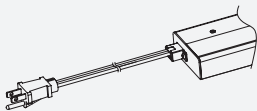

Power Cord

Model	WT	Length
BA-PC6	WT	White 6'
	BK	Black

Supplies power in any application.

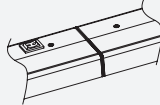

"I" Connector

Model	Max Fixture Run
BA-I-WT	6

Interconnection for seamless end to end transitions. Each light bar includes one.

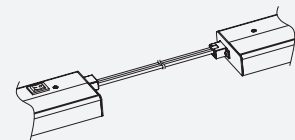

Interconnect Cable

Model	Length	Max Fixture Run	WT	BK
BA-IC12	12"	4	WT	White
BA-IC24	24"	4	BK	Black
BA-IC36	36"	3		

Example: **BA-IC12-WT**

Links two light bars using a single power connection.



Light Bars LEDme® Pro

Color Temp: 2700K, 3000K
CRI: 90+
Dimming: 100% – 10% smooth and continuous ELV dimming
Rated Life: 90,000 hours

- Uniform Light
- Energy Star® Rated
- CEC Title24 Compliant
- 120VAC - no driver needed
- Diffused light source reduces glare
- 1 inch Profile
- Extruded aluminum construction for optimal thermal management
- Multiple knock outs for ease of wiring

	Model	Length	Watt	Lumens	Color Temp	Finish
	BA-ACLED8	8"	5.5W	255	927 2700K 930 3000K	BZ Bronze AL Brushed Aluminum WT White
	BA-ACLED12	12"	8.0W	365		
	BA-ACLED18	18"	10.0W	450		
	BA-ACLED24	24"	15.0W	705		
	BA-ACLED30	30"	17.0W	785		

Example: **BA-ACLED12-927-WT**

sample

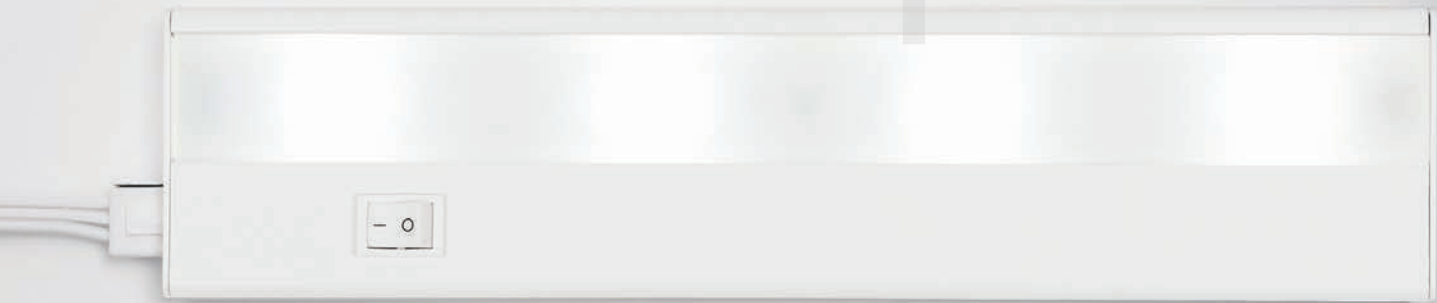

Light Bars LEDme®

Color Temp: 2700K, 3000K
CRI: 85
Dimming: 100% – 10% smooth and continuous ELV dimming
Rated Life: 70,000 hours

- Integral drivers
- 1 inch Profile
- Extruded aluminum construction for optimal thermal management
- Multiple knock outs for ease of wiring

	Model	Length	Watt	Lumens	Color Temp	Finish
	BA-LED2	8"	3.5W	150	27 2700K 3000K	BB Bronze SN Satin Nickel WT White
	BA-LED4	12"	6W	285		
	BA-LED6	18"	8.6W	465		
	BA-LED8	24"	10.9W	585		
	BA-LED10	30"	13.4W	695		

Example: **BA-LED4-27-BB** for 2700K
BA-LED4-BB for 3000K

Driver hidden inside
W track

Twist to adjust beam angle



Use with a track cover for a seamless installation



8 foot W track cover: **W8-COV-WT**
Can be field-cut and painted

Paloma Adjustable Beam LED

Power: 24W
Delivered Lumens: Up to 1350
CBCP: Up to 8555
Comparable to: 20W HID
Rated Life: 50,000 hours

Museum-quality LED luminaire with adjustable beam angle

- Adjustable beam angle between 15° - 60°
- Die-cast aluminum construction
- 365° horizontal rotation and 180° vertical aiming
- Smooth and continuous ELV dimming for 120V

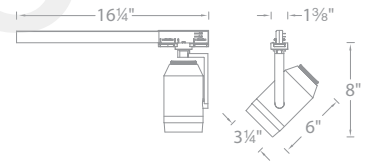

Track		Model	Color Temp		CRI	Max Lumens	Max CBCP	Finish	
W Track	WTK WHK	120V 277V	LED523	27	2700K	85	1340	6840	BK Black PT Platinum WT White
				927	2700K	90	1260	6515	
				30	3000K	85	1500	7595	
				930	3000K	90	1350	6635	
				35	3500K	85	1495	7280	
				40	4000K	85	1600	7650	

Example: **WTK-LED523-927-WT**

Adjustable Beam Angle

Adjustable between 15° - 60°

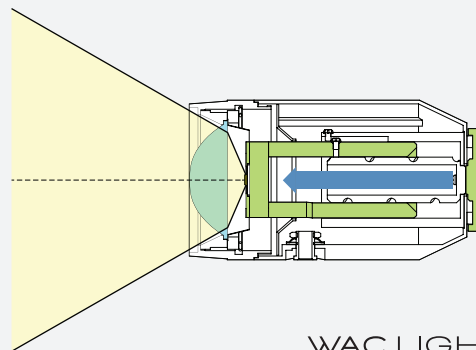
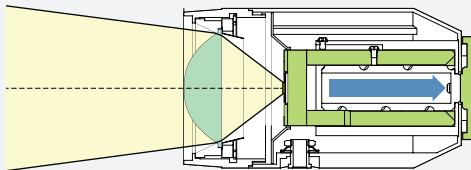



Precision LED H/L/JTrack

Power: 14.5W
Delivered Lumens: Up to 975
CBCP: Up to 4500
Comparable to: 65W MR16
ELV Dimming: 100%-10%
Rated Life: 70,000 hours

Compact single diode LED

- CEC Title24 Compliant
- Die-cast aluminum construction
- 365° horizontal rotation and 180° vertical aiming

Track	Model	Beam	Color Temp	CRI	Finish
H H TRACK L L TRACK J J/J2 TRACK	 LED160	S 20° F 40°	927 2700K	90	BK Black WT White
			27 2700K	85	
			930 3000K	90	
			30 3000K	85	
			35 3500K	85	
			40 4000K	85	

Example: **H-LED160S-927-BK**

Replacement Lenses

Amber	LENS-16-AMB	
Blue	LENS-16-BLU	
Green	LENS-16-GRN	
Red	LENS-16-RED	
Yellow	LENS-16-YEL	

UV Filter	LENS-16-UVF	
Frosted	LENS-16-FR	
Spread	LENS-16-SPR	
Beam Elongator	LENS-16-BEL	

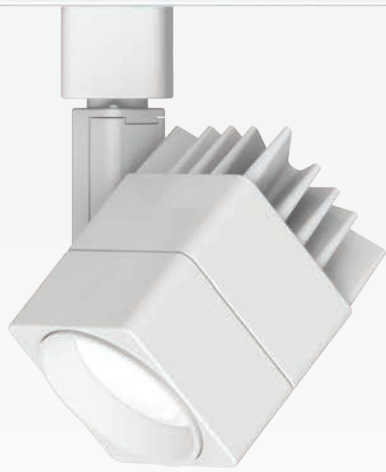

LED207



LED201

Summit LED H/L/J Track

Power: 15W
Comparable: 50W MR16
CRI: 85
ELV Dimming: 100% - 10%
Input: 120V
Rated Life: 50,000 hours

Compact LED track luminaire

- Energy Star® rated
- 120VAC - no driver needed
- Beamshift™ enables in-field change of beam angle (patent pending)
- Die-cast aluminum construction

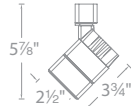
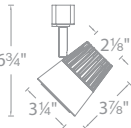
Track	Model	Color Temp	Beam*	Lumens	CBCP	Finish
H H TRACK L L TRACK J J/J2 TRACK	 LED207-30	3000K	25° 40°	540 660	1275 1030	BK Black WT White
	 LED201-30	3000K	25° 40°	540 660	1275 1030	BK Black WT White

Example: **H-LED207-30-WT**

*All Summit LED track luminaires come with Flood (40°) beam setting by default, which may be reconfigured to Narrow(25°) in field.

BeamShift™

All Summit series track luminaires come with BeamShift™, allowing in-field change of beam angle simply by changing the location of the lens

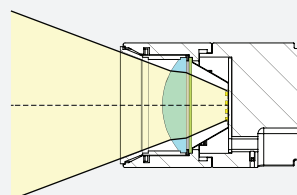

Flood Configuration
 Lens located at the back

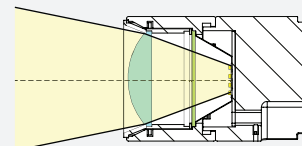

Spot Configuration
 Lens located in the front



LED202



LED208

Summit LED H/L/J Track

Power: 15W
 Comparable: 50W MR16
 CRI: 85
 ELV Dimming: 100% - 10%
 Input: 120V
 Rated Life: 50,000 hours

Compact LED track luminaire

- Energy Star® rated
- 120VAC - no driver needed
- Beamshift™ enables in-field change of beam angle (patent pending)
- Die-cast aluminum construction

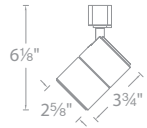
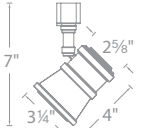
Track	Model	Color Temp	Beam*	Lumens	CBCP	Finish
H L J H TRACK L TRACK J/J2 TRACK	 LED202-30	3000K	25° 40°	540 660	1275 1030	BK Black WT White
	 LED208-30	3000K	25° 40°	540 660	1275 1030	AB Antique Bronze

Example: **H-LED202-30-BK**

* All Summit LED track luminaires come with Flood (40°) beam setting by default, which may be reconfigured to Narrow(25°) in field.

Replace the Halogen MR16

Summit series are the perfect replacement for the halogen MR16 as we offer

- Lower wattage with superior lumen output
- Over 10 times the rated life
- Less maintenance
- No projected heat
- Beamshift™ In-field changeable beam angle

Luminous Efficacy At flood (40°) Beam angle

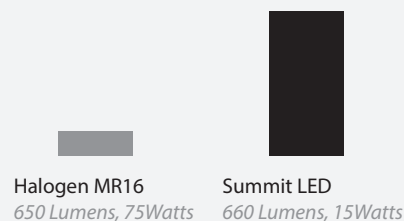

Rated Life

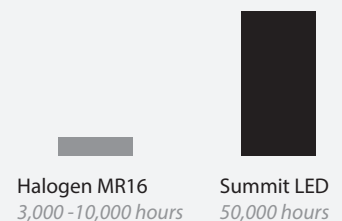



LED202



LED208

Summit LED Flexrail1™ Track

Power: 15W
Comparable: 50W MR16
CRI: 85
ELV Dimming: 100% - 10%
Input: 120V
Rated Life: 50,000 hours

Compact LED track luminaire

- Energy Star® rated
- 120VAC - no driver needed
- Beamshift™ enables in-field change of beam angle (patent pending)
- Die-cast aluminum construction

Track	Model	Color Temp	Beam*	Lumens	CBCP	Finish	
HM1 FLEXRAIL1™		LED202-30	3000K	25° 40°	540 660	1275 1030	PT Platinum

Example: HM1-LED202-30-PT

* All Summit LED track luminaires come with Flood (40°) beam setting by default, which may be reconfigured to Narrow(25°) in field.

BeamShift™

All Summit series track luminaires come with BeamShift™, allowing in-field change of beam angle simply by changing the location of the lens

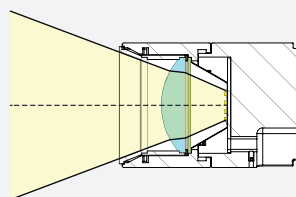

Flood Configuration
Lens located at the back

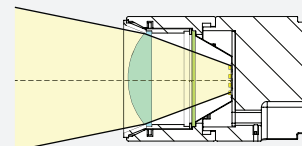









Spot Configuration
Lens located in the front







LED Track Luminaires MR16 Replacement - Now with 1W-60W Transformer

Power: 8W
Lumens: 450
CBCP: 850
Color Temp: 3000K
CRI: 85
ELV Dimming: 100% - 10%
Input: 120V
Rated Life: 25,000 hours

- 1 W to 60 W load transformer
- Fixtures specifically designed to ensure proper lamp fit
- LED lamp included

System	Model	Finish
 HHT LHT JHT	164LED	BK WT <i>Black White</i>
 HHT LHT JHT	886LED	AB <i>Antique Bronze</i>
 HHT LHT JHT	874LED	AB <i>Antique Bronze</i>
 HHT LHT JHT	856LED	AB BK BN WT <i>Antique Bronze Black Brushed Nickel White</i>
 HHT LHT JHT	817LED	BK PT/BK PT/WT WT <i>Black Platinum/Black Platinum/White White</i>
 HHT LHT JHT	826LED	BK BN WT <i>Black Brushed Nickel White</i>
 HHT LHT JHT	816LED	BK BN WT <i>Black Brushed Nickel White</i>
 HHT LHT JHT	808LED	BK DB WT <i>Black Dark Bronze White</i>

Example: HHT-808LED-DB

System	Model	Finish
 HHT LHT JHT	160LED	BK WT <i>Black White</i>
 HHT LHT JHT	180LED	BK BN WT <i>Black Brushed Nickel White</i>
 HHT LHT JHT	809LED	BK BN WT <i>Black Brushed Nickel White</i>
 HHT LHT JHT	802LED	BK BN WT <i>Black Brushed Nickel White</i>
 HHT LHT JHT	204LED	BK BN WT <i>Black Brushed Nickel White</i>
 HHT LHT JHT	801LED	BK WT <i>Black White</i>
 HHT LHT JHT	007LED	BK BN WT <i>Black Brushed Nickel White</i>

Example: HHT-801LED-WT

Endurance™

WAC LIGHTING

LED technology offers superior alternatives to conventional Halogen and HID sources. With factory sealed die-cast aluminum housings. Endurance™ provides lasting performance for years.

Patent pending design for a water and dust proof, IP66 rated luminaire. Thermal engineering for up to 100,000 hours of rated life, eliminating the need for maintenance once installed. Thoughtful details include a built-in level and factory sealed light engine.



Energy Star® Rated



Factory-Sealed Fixture Housing
Protects LEDs From
Environmental Factors



Dark Sky Friendly



IP66, WET

IP 66 Rated
Dust Tight, Waterproof



Motion and Photosensor Ready



LED Performs Efficiently
In Cold Weather With Added Lifespan



ETL & cETL Listed



Aluminum

Durable Die-Cast Aluminum



5 Year
Warranty

5 Year WAC Product Warranty

sample

Flood	Fin		Hawk		
35W	19W	27W	35W	19W	27W
100W HID Equivalent 1945lm (3000K) 2070lm (5000K)	39W HID Equivalent 1390lm (3000K) 1460lm (5000K)	70W HID Equivalent 2075lm (3000K) 2135lm (5000K)	100W HID Equivalent 2750lm (3000K) 2825lm (5000K)	39W HID Equivalent 1345lm (3000K) 1435lm (5000K)	70W HID Equivalent 2050lm (3000K) 2095lm (5000K)
Architectural Bronze, White	Architectural Bronze, Graphite, White		Architectural Bronze, Graphite, White		

Sensors for Endurance™ Series



Motion Sensor
(120V)

MS-120-BZ Bronze
MS-120-GY Gray
MS-120-WT White



Photosensor
(120V)

PC-120-BZ Bronze
PC-120-GY Gray
PC-120-WT White

Endurance™ Flood





360° Horizontal Rotation
90° Vertical Aiming

CRI: 85
Rated Life: 60,000 hours

- Energy Star® rated
- Factory-Sealed LED Light Engine
- IP66 and ETL & cETL Wet Location Listed
- Die-Cast Aluminum Construction
- 120V Direct Wire - No Driver Needed
- Photo/Motion Sensor Sold Separately
- Smooth and Continuous ELV Dimming

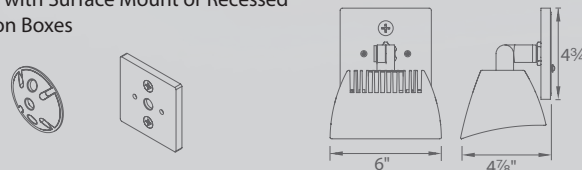
1/2" Threaded Heavy Duty Mounting Arm
 Also Includes Two Canopy Accessories
 for use with Surface Mount or Recessed
 Junction Boxes

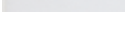

		Power	Comparable	Max Delivered Lumens	Color Temp	Finish	
	WP-LED335	35W	100W HID	2070	30 3000K 50 5000K	aBZ Architectural Bronze	
						aWT Architectural White	

Example: **WP-LED335-30-aBZ**



Endurance™ Fin



3 Outputs
2 Color Temperatures
1 Size

Tempered Prismatic Glass
Reduces glare while optimizing light distribution

CRI: 85
Rated Life: 100,000 hours

- Energy Star® and DLC rated
- Factory-Sealed LED Light Engine
- IP66 and ETL & cETL Wet Location Listed
- Die-Cast Aluminum Construction
- 20° Forward Throw Illumination
- Built-in Level For Easy Adjustment
- Photo/Motion Sensor Sold Separately
- Universal Voltage Input (120V - 277V)
- Multi-Function Dimming: ELV (120V) or 0-10V

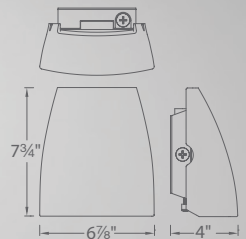

	Power	Comparable	Max Delivered Lumens	Color Temp	Finish
	WP-LED119	19W	39W HID	1460	aBZ Architectural Bronze aGH Architectural Graphite aWT Architectural White
	WP-LED127	27W	70W HID	2135	
	WP-LED135	35W	100W HID	2825	

Example: **WP-LED119-30-aWT**



sample

Endurance™ Hawk



Box Sleeve Attached to Mount on Surface Mount Junction Box



Tempered Prismatic Glass
Reduces glare while optimizing light distribution

Mounts In Any Orientation

For Direct and Indirect Illumination

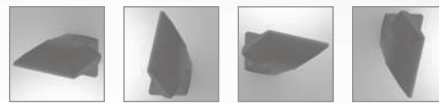

CRI: 85
Rated Life: 100,000 hours

- Energy Star® and DLC rated
- Factory-Sealed LED Light Engine
- IP66 and ETL & cETL Wet Location Listed
- Die-Cast Aluminum Construction
- 20° Forward Throw Illumination
- Photo/Motion Sensor Sold Separately
- Built-in Level For Easy Adjustment
- Universal Voltage Input (120V - 277V)
- Dimming: ELV (120V) or 0-10V

Also Includes a Box Sleeve when used with existing Surface Mount Junction Boxes

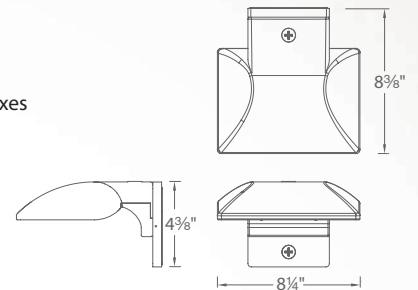

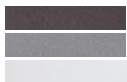
		Power	Comparable	Max Delivered Lumens	Color Temp	Finish	
	WP-LED219	19W	39W HID	1435	30 3000K	aBZ Architectural Bronze	
	WP-LED227	27W	70W HID	2095	50 5000K	aGH Architectural Graphite	
						aWT Architectural White	

Example: **WP-LED219-30-aBZ**



Tube Wall Mount

Color Temp: 3000K
CRI: 90
Rated Life: 70,000 hours

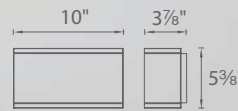

- Energy Star® rated
- CEC Title 24 Compliant
- IP65 Rated, ETL & cETL Wet Location Listed
- Mounts up or down
- Die-Cast Aluminum Construction
- Universal Voltage Input (120V - 277V)
- Dimming: ELV (120V) or 0-10V
- ADA Compliant

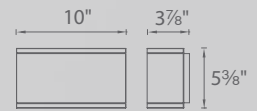

WS-W2609



WS-W2610

Distribution	Beam	Voltage	Watt	Lumens	Finish
 Single Light	WS-W2609 Dark Sky Friendly Energy Star®	70°	120V - 277V	16W	825
 Double Light	WS-W2610	70°	120V - 277V	30W	1525
					AL Brushed Aluminum BK Black BZ Bronze GH Graphite WT White



Example: **WS-W2609-WT**



sample

Tube Wall Mount

Color Temp: 3000K
CRI: 90
Rated Life: 70,000 hours

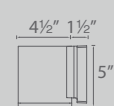

- Energy Star® rated
- CEC Title 24 Compliant
- IP65 Rated, ETL & cETL Wet Location Listed
- Mounts up or down
- Die-Cast Aluminum Construction
- Universal Voltage Input (120V - 277V)
- Dimming: ELV (120V) or 0-10V
- ADA Compliant

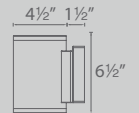

WS-W2605



WS-W2604

Distribution	Beam	Voltage	Watt	Lumens	Finish
 Single Light WS-W2605 <i>Dark Sky Friendly</i> <i>Energy Star®</i>	33°	120V	16W	800	AL Brushed Aluminum BK Black BZ Bronze GH Graphite WT White 
 Double Light WS-W2604	33°	120V - 277V	30W	1750	

Example: **WS-W2604-BZ**



sample

Tube Ceiling Mount

Color Temp: 3000K
CRI: 90
Rated Life: 70,000 hours

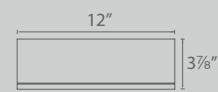

- Energy Star® rated
- CEC Title 24 Compliant
- Wall or Ceiling Mount
- IP65 Rated, ETL & cETL wet Location Listed
- Die-Cast Aluminum Construction
- Universal Voltage Input (120V - 277V)
- Dimming: ELV (120V) or 0-10V

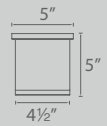

FM-W2612



FM-W2605

	Distribution		Beam	Voltage	Watt	Lumens	Finish
	Down	FM-W2612 Energy Star®	91°	120V - 277V	30W	1740	AL Brushed Aluminum BK Black BZ Bronze GH Graphite WT White
	Down	FM-W2605 Energy Star®	33°	120V	16W	800	

Example: **FM-W2612-GH**



Tube Pendant Mount

Color Temp: 3000K
CRI: 90
Rated Life: 70,000 hours

- Energy Star® rated
- CEC Title 24 Compliant
- IP65 Rated, ETL & cETL Wet Location Listed
- Die-Cast Aluminum Construction
- Dimming: ELV (120V) or 0-10V
- Hang Straight Swivel
- Three 12" and one 6" down rods included

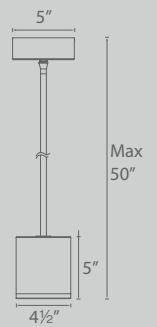

PD-W2605

Distribution	Beam	Voltage	Watt	Lumens	Finish	
 Down	PD-W2605 Energy Star®	33°	120V	16W	800	AL Brushed Aluminum
						BK Black
						BZ Bronze
						GH Graphite
						WT White

Example: **PD-W2605-BK**

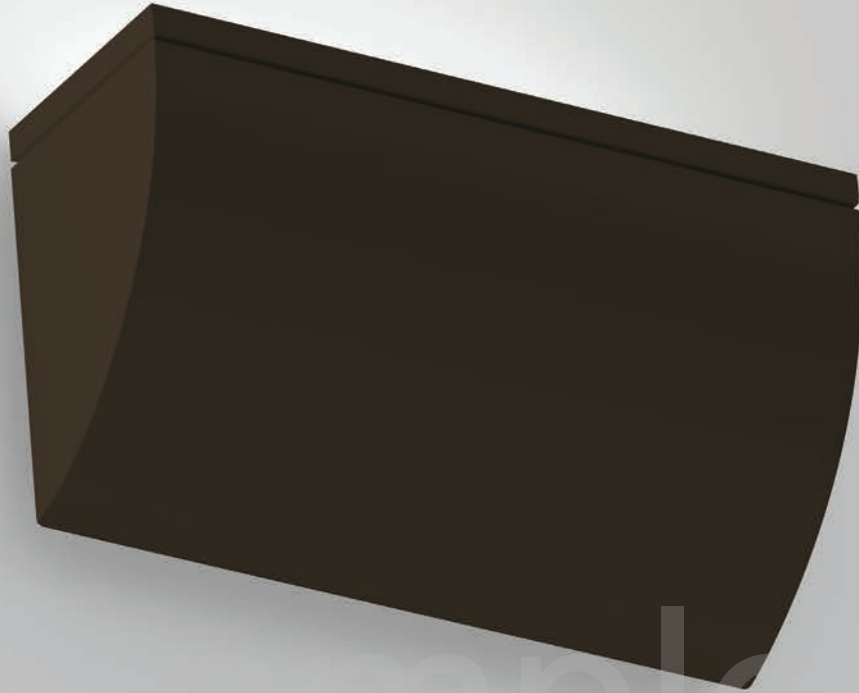

Scoop Wall Mount

Color Temp: 3000K
 CRI: 90
 Rated Life: 70,000 hours

- Energy Star® rated
- CEC Title 24 Compliant
- Mounts Up or Down
- IP65 Rated, ETL & cETL Wet Location Listed
- Die-Cast Aluminum Construction
- Universal Voltage Input (120V - 277V)
- Dimming: ELV (120V) or 0-10V
- ADA Compliant

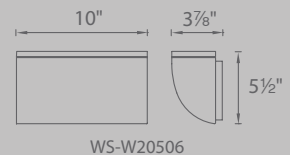

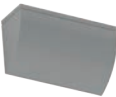
Distribution	Beam	Voltage	Watt	Lumens	Finish	
 Single Light	WS-W20506 Energy Star®	86°	120V - 277V	16W	805	AL Brushed Aluminum
						BK Black
						BZ Bronze
						GH Graphite
						WT White

Example: **WS-W20506-BZ**

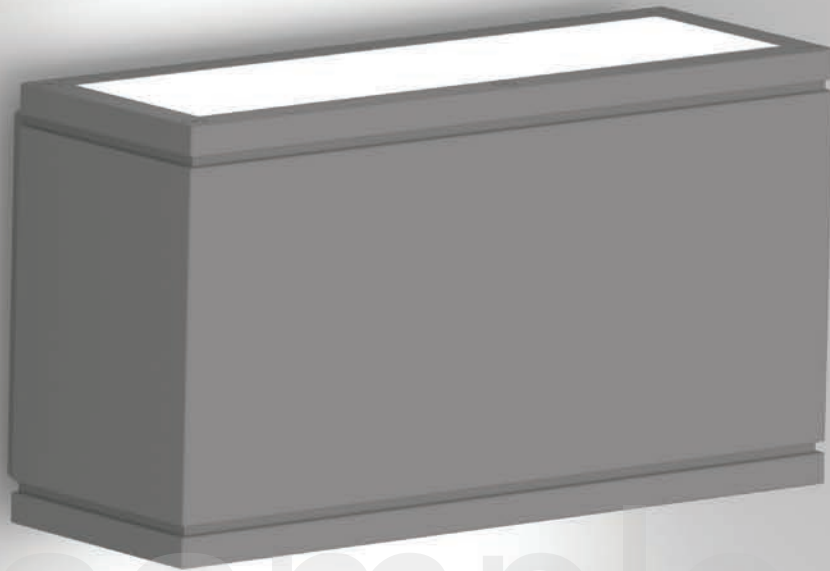

Rubix Wall Mount

Color Temp: 3000K
CRI: 90
Rated Life: 70,000 hours

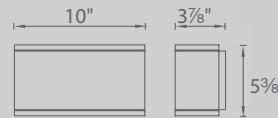

- Energy Star® rated
- CEC Title 24 Compliant
- Mounts Up or Down
- IP65 Rated, ETL & cETL Wet Location Listed
- Die-Cast Aluminum Construction
- Universal Voltage Input (120V - 277V)
- Dimming: ELV (120V) or 0-10V
- ADA Compliant

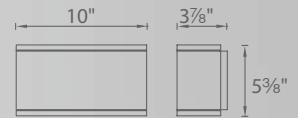

WS-W2509



WS-W2510

Distribution	Beam	Voltage	Watt	Lumens	Finish
 Single Light	WS-W2509 Dark Sky Friendly Energy Star®	86°	120V - 277V	16W	805
 Double Light	WS-W2510	86°	120V - 277V	30W	1385
					AL Brushed Aluminum BK Black BZ Bronze GH Graphite WT White



Example: **WS-W2510-GH**





sample

Rubix Wall Mount

Color Temp: 3000K
CRI: 90
Rated Life: 70,000 hours

- Energy Star® rated
- CEC Title 24 Compliant
- Mounts up or down
- IP65 Rated, ETL & cETL Wet Location Listed
- Die-Cast Aluminum Construction
- Universal Voltage Input (120V - 277V)
- Dimming: ELV (120V) or 0-10V



Distribution		Beam	Voltage	Watt	Lumens	Finish
 Single Light	WS-W2504 Dark Sky Friendly Energy Star®	86°	120V - 277V	16W	750	AL Brushed Aluminum BK Black BZ Bronze GH Graphite WT White
 Double Light	WS-W2505	86°	120V - 277V	30W	1400	

Example: **WS-W2504-GH**







sample

Rubix Ceiling Mount

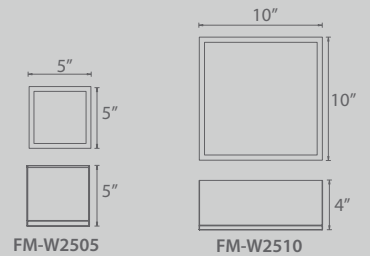
Color Temp: 3000K
CRI: 90
Rated Life: 70,000 hours

- Energy Star® rated
- CEC Title 24 Compliant
- Wall or Ceiling Mount
- IP65 Rated, ETL & cETL Wet Location Listed
- Die-Cast Aluminum Construction
- Universal Voltage Input (120V - 277V)
- Dimming: ELV (120V) or 0-10V

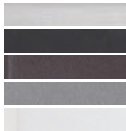

	Distribution		Beam	Voltage	Watt	Lumens	Finish	
	Down	FM-W2505 Energy Star®	86°	120V - 277V	16W	750	AL Brushed Aluminum BK Black BZ Bronze GH Graphite WT White	
	Down	FM-W2510 Energy Star®	95°	120V - 277V	30W	1875		

Example: **FM-W2510-WT**





sample

Monterrey Fixed Rail

Color Temp: 3000K
CRI: 90
Rated Life: 60,000 hours

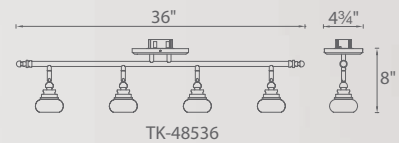
- Individually Adjustable Heads
- CEC Title 24 Compliant
- ETL & cETL Damp Location Listed
- Wall or Ceiling Mount
- Universal Voltage Input (120V - 277V)
- Driver located in J box with minimum inside dimension of 3½" x 3½" x 1½"
- Dimming: ELV (120V) or 0-10V



		Watt	LED Lumens	Delivered Lumens	Finish
	TK-48536	33W	1972	1905	AB <i>Antique Bronze</i> AN <i>Antique Nickel</i> BB <i>Burnished Brass</i> PN <i>Polished Nickel</i>

Example: **TK-48536-AB**



sample



Vector Fixed Rail

Color Temp: 3000K
CRI: 90
Rated Life: 60,000 hours

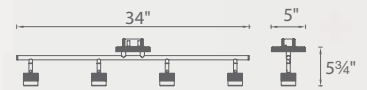
- Energy Star® rated
- Individually Adjustable Heads
- ETL & cETL Damp Location Listed
- Wall or Ceiling Mount
- Aluminum Construction
- Universal Voltage Input (120V - 277V)
- Driver located in J box with minimum inside dimension of 3½" x 3½" x 1½"
- Dimming: ELV (120V) or 0-10V



TK-49534

		Watt	LED Lumens	Delivered Lumens	Finish
	TK-49534	33W	1500	1465	BN <i>Brushed Nickel</i> BR <i>Brushed Brass</i> CH <i>Chrome</i> 

Example: **TK-49534-CH**









sample

GLO LED Ceiling and Wall

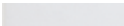
CRI: 85
Dimming: 100% - 10%
Rated Life: 50,000 hours

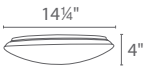
- Energy Star® rated
- ADA compliant for FM-211 and FM-214
- Wall or Ceiling Mount
- Opaque acrylic diffuser
- Multiple LED array for uniform illumination
- 120VAC - no driver needed
- Smooth and continuous ELV dimming

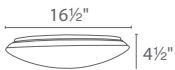
			Watt	Color Temp	LED Lumens	Delivered Lumens	Finish
		FM-211	15W	27 2700K 35 3500K	1355 1465	1015 1100	WT White 
		FM-214	24W	27 2700K 35 3500K	1915 2175	1435 1630	
		FM-216	33.5W	27 2700K 35 3500K	2815 3015	2110 2260	

Example: **FM-214-35-WT**

dweLED

by WAC Lighting

[dweL-E-D]

LED Ceiling and Wall	44 - 45
LED Vanities and Sconces	46 - 55
LED Outdoor	56 - 57
LED Floor	58
LED Task	59

sample

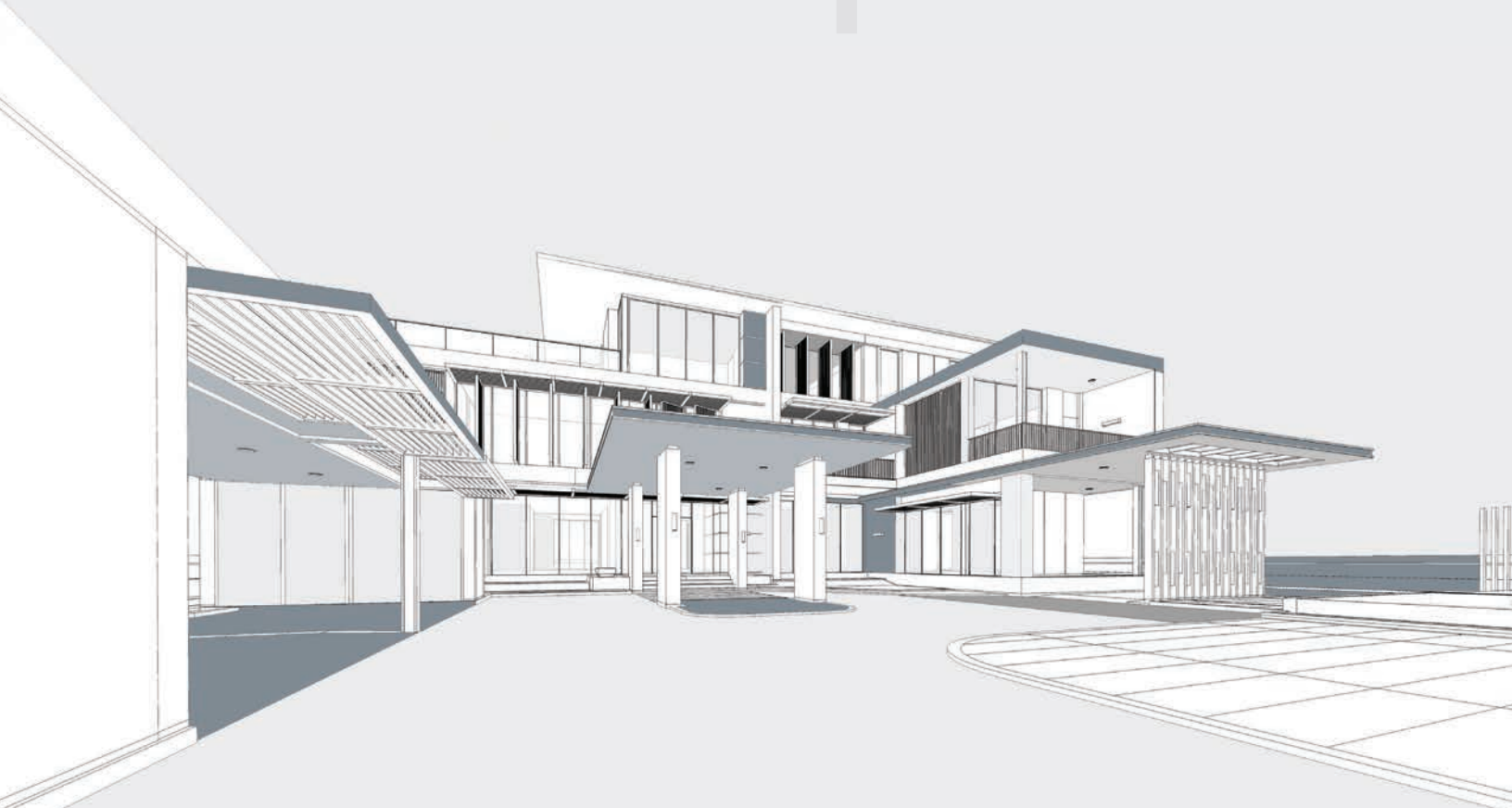

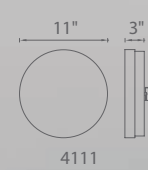
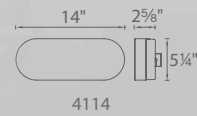











Slice LED Ceiling and Wall

CRI: 90
Dimming: 100% - 10%
Rated Life: 50,000 hours

- Etched 3/4" thick pressed glass diffuser with interior ceramic glaze
- Mount as a ceiling fixture or wall sconce
- ADA compliant when mounted on wall
- ETL & cETL damp location listed

- Smooth and continuous ELV dimming
- Also rated for installation in closets
- Transformer located in J box
- 277V available (special order)

		Color Temp	Watt	LED Lumens	Delivered Lumens	Finish
	FM-4114-27	2700K	31W	1323	595	BN <i>Brushed Nickel</i> 
	FM-4114-30	3000K	31W	1356	670	
	FM-4109-27	2700K	27W	1356	750	BN <i>Brushed Nickel</i>  BZ <i>Bronze</i>  CH <i>Chrome</i> 
	FM-4109-30	3000K	27W	1392	770	
	FM-4111-27	2700K	31W	1593	915	BN <i>Brushed Nickel</i>  BZ <i>Bronze</i>  CH <i>Chrome</i> 
	FM-4111-30	3000K	31W	1635	940	

Example: **FM-4114-27-BN**

For 277V, add an "F" before the color temperature: **FM-4114F-27-BN**





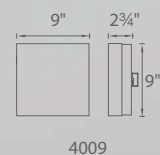
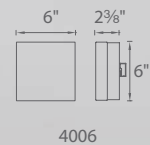
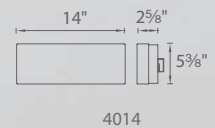



sample



Dice LED Ceiling and Wall

CRI: 90
Dimming: 100% - 10%
Rated Life: 50,000 hours

- Etched 3/4" thick pressed glass diffuser with interior ceramic glaze
- Mount as a ceiling fixture or wall sconce
- ADA compliant when mounted on wall
- ETL & cETL damp location listed
- Smooth and continuous ELV dimming
- Also rated for installation in closets
- Transformer located in J box
- 277V available (special order)

		Color Temp	Watt	LED Lumens	Delivered Lumens	Finish
	FM-4014-27	2700K	31W	1323	610	BN <i>Brushed Nickel</i> 
	FM-4014-30	3000K	31W	1356	640	
	FM-4006-27	2700K	17.5W	779	355	BN <i>Brushed Nickel</i>  BZ <i>Bronze</i>  CH <i>Chrome</i> 
	FM-4006-30	3000K	17.5W	800	365	
	FM-4009-27	2700K	27W	1341	885	
	FM-4009-30	3000K	27W	1376	910	

Example: **FM-4014-30-BN**

For 277V special order, add an "F" before the color temperature: **FM-4014F-30-BN**

sample

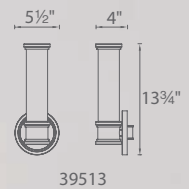

Ashton LED Vanities & Sconces

Color Temp: 2700K
CRI: 90
Dimming: 100% - 10%
Rated Life: 50,000 hours

- Etched opal glass
- Vertical or horizontal mount
- ETL & cETL Wet Location listed
- ADA compliant
- Smooth and continuous ELV dimming
- Transformer located in J box
- WS-39513 emits downlight as well as ambient light
- 277V available (special order)

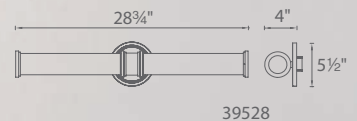

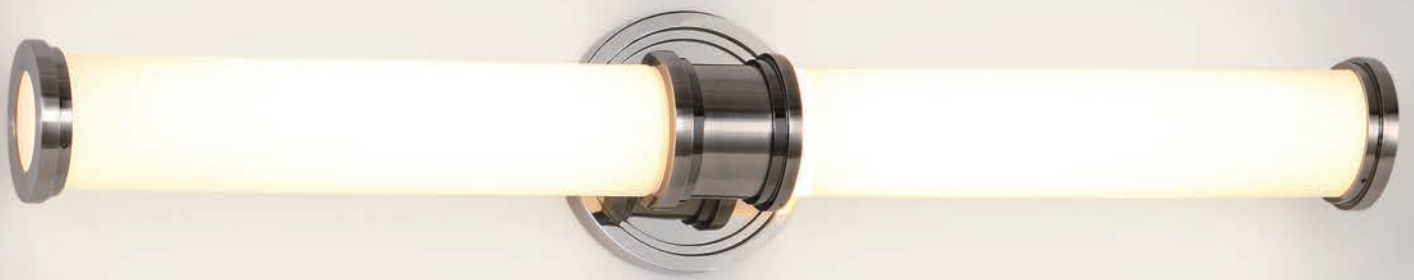

sample

			Watt	LED Lumens	Delivered Lumens	Finish
	13"	WS-39513	25.5W	1093	770	
	22"	WS-39522	30W	1373	990	
	28"	WS-39528	41W	1512	1320	
						AB <i>Antique Bronze</i> AN <i>Antique Nickel</i> BB <i>Burnished Brass</i> PN <i>Polished Nickel</i> 

Example: **WS-39513-BB**

For 277V special order, add an "F" before the finish: **WS-39513F-BB**
 For alternate color temperature, special order adding 30 or 35: **WS-39513-35-BB**



sample

Dunhill LED Vanities & Sconces

Color Temp: 2700K
CRI: 90
Dimming: 100% - 10%
Rated Life: 50,000 hours

- Etched opal glass
- Vertical or horizontal mount
- ETL & cETL damp location listed
- ADA compliant
- Conversion plate included
- Smooth and continuous ELV dimming
- Transformer located in J box
- 277V available (special order)

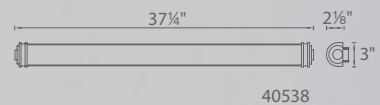
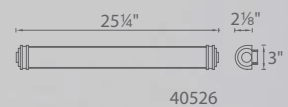



sample

			Watt	LED Lumens	Delivered Lumens	Finish
	20"	WS-40520	27W	1125	770	AB <i>Antique Bronze</i> AN <i>Antique Nickel</i> BB <i>Burnished Brass</i> PN <i>Polished Nickel</i> 
	26"	WS-40526	33.5W	1551	935	
	38"	WS-40538	50W	2437	1330	

Example: **WS-40520-PN**

For 277V special order, add an "F" before the finish: **WS-40520F-PN**
 For alternate color temperature, special order adding 30 or 35: **WS-40520-30-PN**



sample

Soho LED Vanities & Sconces



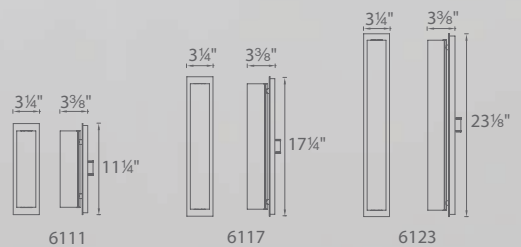

Color Temp: 2700K
CRI: 90
Dimming: 100% - 10%
Rated Life: 50,000 hours

- Etched opal glass
- Vertical or horizontal mount
- ETL & cETL damp location listed
- ADA compliant
- Smooth and continuous ELV dimming
- Conversion plate for 4 inch Jbox included
- Transformer located in J box
- 277V available (special order)





sample

			Watt	LED Lumens	Delivered Lumens	Finish
	11"	WS-6111	16W	700	520	
	17"	WS-6117	25W	1170	860	BN <i>Brushed Nickel</i> CH <i>Chrome</i> GL <i>Gold Plated</i> 
	23"	WS-6123	33.5W	1597	1245	

Example: **WS-6117-GL**

For 277V special order, add an "F" before the finish: **WS-6117F-GL**
 For alternate color temperature, special order adding 30 or 35: **WS-6117-30-GL**



Sample

Kube LED Vanities & Sconces

Color Temp: 2700K
CRI: 90
Dimming: 100% - 10%
Rated Life: 60,000 hours

- Each light also contains a powerful downlight
- ETL & cETL damp location listed
- ADA compliant for WS-44505
- Smooth and continuous ELV dimming
- Driver located in J box
with minimum inside dimension of 3½" x 3½" x 1½"
- 277V available for WS-44505 and WS-44512 (special order)
- WS-44522 has Universal Voltage Input (120V-277V)

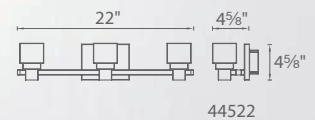



sample

		Watt	LED Lumens	Delivered Lumens	Finish
	1 Light WS-44505	18W	675	605	
	2 Lights WS-44512	32W	1554	1355	CH Chrome 
	3 Lights WS-44522 (120V-277V Input)	47.5W	2346	2210	

Example: **WS-44505-CH**

For 277V special order, add an "F" before the finish: **WS-44505F-CH**

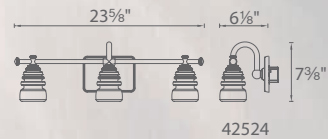
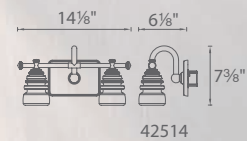
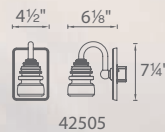





Rondelle LED Vanities & Sconces

Color Temp: 3000K
CRI: 90
Dimming: 100% - 10%
Rated Life: 60,000 hours

- ETL & cETL damp location listed
- Smooth and continuous ELV dimming
- Driver located in J box
- 277V available (special order)



sample

			Watt	LED Lumens	Delivered Lumens	Finish
	1 Light	WS-42505	8.5W	230	220	
	2 Lights	WS-42514	16W	518	490	PN Polished Nickel 
	3 Lights	WS-42524	24.5W	865	805	

Example: **WS-42524-PN**

For 277V special order, add an "F" before the finish: **WS-42524F-PN**



sample

Steampunk LED Outdoor

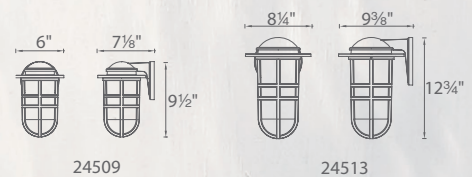

Color Temp: 3000K
CRI: 90
Dimming: 100% - 10%
Rated Life: 80,000 hours

- Clear hammered seeded mouth blown glass
- ETL & cETL wet location listed, IP65 rated
- Die-cast Aluminum Construction
- Smooth and continuous ELV dimming





sample

			Watt	LED Lumens	Delivered Lumens	Finish
	9"	WS-W24509	10W	624	365	BZ <i>Bronze</i>
	13"	WS-W24513	10W	657	440	GH <i>Graphite</i>



Example: **WS-W24513-BZ**



sample

Arch LED Outdoor

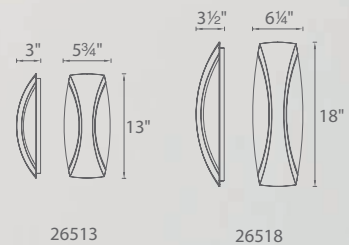

Color Temp: 3000K
CRI: 90
Dimming: 100% - 10%
Rated Life: 80,000 hours

- Mounts vertical or horizontal
- ADA compliant
- Die-cast aluminum construction
- ETL & cETL wet location listed, IP65 rated
- Smooth and continuous ELV dimming



sample

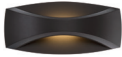

			Watt	LED Lumens	Delivered Lumens	Finish
	13"	WS-W26513	5W	154	120	BZ Bronze GH Graphite 
	18"	WS-W26518	9.5W	398	225	

Example: **WS-W26518-BZ**



sample

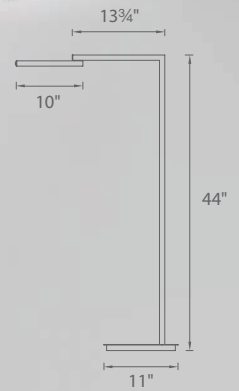

Flip LED Floor

Color Temp: 3000K

CRI: 85

Dimming: 100% - 10% (Integral dimmer)

Rated Life: 70,000 hours

- Fingertip touch dimmer
- Smooth arm swivel
- ETL & cETL damp location listed
- Driver located at the plug

	Watt	LED Lumens	Delivered Lumens	Finish
FL-1350	8W	490	430	BZ Bronze TT Titanium

Example: **FL-1350-BZ**



sample

Flip LED Task

Color Temp: 3000K
CRI: 85
Dimming: 100% - 10% (Integral dimmer)
Rated Life: 70,000 hours

- Fingertip touch dimmer
- Smooth arm swivel
- ETL & cETL damp location listed
- Driver located at the plug

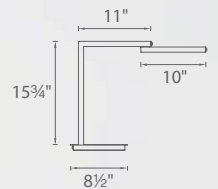

	Watt	LED Lumens	Delivered Lumens	Finish
TL-1310	8W	490	430	BZ Bronze TT Titanium

Example: **TL-1310-BZ**

sample

WAC LIGHTING
Responsible Lighting®